

# 2014 FORMULA ONE TECHNICAL REGULATIONS

## CONTENTS SUMMARY

	<b>Pages</b>
<b>ARTICLE 1 : DEFINITIONS</b>	<b>6-8</b>
1.1 Formula One Car	
1.2 Automobile	
1.3 Land Vehicle	
1.4 Bodywork	
1.5 Wheel	
1.6 Complete wheel	
1.7 Automobile Make	
1.8 Event	
1.9 Weight	
1.10 Cubic capacity	
1.11 Pressure charging	
1.12 Cockpit	
1.13 Sprung suspension	
1.14 Survival cell	
1.15 Camera	
1.16 Camera housing	
1.17 Cockpit padding	
1.18 Brake caliper	
1.19 Electronically controlled	
1.20 Open and closed sections	
1.21 Power train	
1.22 Power unit	
1.23 Engine	
1.24 Energy Recovery System (ERS)	
1.25 Motor Generator Unit - Kinetic (MGU-K)	
1.26 Motor Generator Unit - Heat (MGU-H)	
1.27 Energy Store (ES)	
1.28 Compressor inlet	
1.29 Compressor outlet	
<b>ARTICLE 2 : GENERAL PRINCIPLES</b>	<b>9</b>
2.1 Role of the FIA	
2.2 Amendments to the regulations	
2.3 Dangerous construction	
2.4 Compliance with the regulations	
2.5 New systems or technologies	
2.6 Measurements	
2.7 Duty of competitor	

**ARTICLE 3 : BODYWORK AND DIMENSIONS**

10-19

- 3.1 Wheel centre line
- 3.2 Height measurements
- 3.3 Overall width
- 3.4 Width ahead of the rear wheel centre line
- 3.5 Width behind the rear wheel centre line
- 3.6 Overall height
- 3.7 Front bodywork
- 3.8 Bodywork in front of the rear wheels
- 3.9 Bodywork between the rear wheels
- 3.10 Bodywork behind the rear wheel centre line
- 3.11 Bodywork around the front wheels
- 3.12 Bodywork facing the ground
- 3.13 Skid block
- 3.14 Overhangs
- 3.15 Aerodynamic influence
- 3.16 Upper bodywork
- 3.17 Bodywork flexibility
- 3.18 Driver adjustable bodywork

**ARTICLE 4 : WEIGHT**

20

- 4.1 Minimum weight
- 4.2 Weight distribution
- 4.3 Weight of tyres
- 4.4 Ballast
- 4.5 Adding during the race

**ARTICLE 5 : POWER UNIT**

21-29

- 5.1 Engine specification
- 5.2 Other means of propulsion and energy recovery
- 5.3 Power unit dimensions
- 5.4 Weight and centre of gravity
- 5.5 Power unit torque control
- 5.6 Engine control
- 5.7 Engine high rev limits
- 5.8 Exhaust systems
- 5.9 Variable geometry systems
- 5.10 Fuel systems
- 5.11 Ignition systems
- 5.12 Energy Recovery System (ERS)
- 5.13 Engine ancillaries
- 5.14 Engine intake air
- 5.15 Materials and construction - Definitions
- 5.16 Materials and construction – General
- 5.17 Materials and construction – Components
- 5.18 Materials and construction – Pressure charging and exhaust systems
- 5.19 Materials and construction – Energy recovery, storage systems and electronic systems
- 5.20 Starting the engine
- 5.21 Stall prevention systems
- 5.22 Replacing power unit parts

<b>ARTICLE 6 : FUEL SYSTEM</b>	30-31
6.1 Fuel tanks	
6.2 Fittings and piping	
6.3 Crushable structure	
6.4 Fuel tank fillers	
6.5 Refuelling	
6.6 Fuel draining and sampling	
<b>ARTICLE 7 : OIL AND COOLANT SYSTEMS AND CHARGE AIR COOLING</b>	32
7.1 Location of oil tanks	
7.2 Longitudinal location of oil system	
7.3 Catch tank	
7.4 Transversal location of oil system	
7.5 Coolant header tank	
7.6 Cooling systems	
7.7 Oil and coolant lines	
<b>ARTICLE 8 : ELECTRICAL SYSTEMS</b>	33-36
8.1 Software and electronics inspection	
8.2 Control electronics	
8.3 Start systems	
8.4 Data acquisition	
8.5 Telemetry	
8.6 Driver controls and displays	
8.7 Driver radio	
8.8 Accident data recorders (ADR)	
8.9 Track signal information display	
8.10 Medical warning system	
8.11 Installation of electrical systems or components	
<b>ARTICLE 9 : TRANSMISSION SYSTEM</b>	37-40
9.1 Transmission types	
9.2 Clutch control	
9.3 Traction control	
9.4 Clutch disengagement	
9.5 Gearboxes	
9.6 Gear ratios	
9.7 Reverse gear	
9.8 Gear changing	
9.9 Torque transfer systems	
<b>ARTICLE 10 : SUSPENSION AND STEERING SYSTEMS</b>	41-42
10.1 Sprung suspension	
10.2 Suspension geometry	
10.3 Suspension members	
10.4 Steering	
10.5 Suspension uprights	
<b>ARTICLE 11 : BRAKE SYSTEM</b>	43-44
11.1 Brake circuits and pressure distribution	
11.2 Brake calipers	
11.3 Brake discs and pads	
11.4 Air ducts	
11.5 Brake pressure modulation	
11.6 Liquid cooling	
11.7 <a href="#">Rear brake control system</a>	

<b>ARTICLE 12 : WHEELS AND TYRES</b>	45-47
12.1 Location	
12.2 Number of wheels	
12.3 Wheel material	
12.4 Wheel dimensions	
12.5 Supply of tyres	
12.6 Specification of tyres	
12.7 Treatment of tyres	
12.8 Wheel assembly	
<b>ARTICLE 13 : COCKPIT</b>	48
13.1 Cockpit opening	
13.2 Steering wheel	
13.3 Internal cross section	
13.4 Position of the driver's feet	
<b>ARTICLE 14 : SAFETY EQUIPMENT</b>	49-52
14.1 Fire extinguishers	
14.2 Master switch	
14.3 Rear view mirrors	
14.4 Safety belts	
14.5 Rear light	
14.6 Cockpit padding	
14.7 Wheel retention	
14.8 Seat fixing and removal	
14.9 Head and neck supports	
<b>ARTICLE 15 : CAR CONSTRUCTION</b>	54-60
15.1 Permitted materials	
15.2 Roll structures	
15.3 Structure behind the driver	
15.4 Survival cell specifications	
15.5 Survival cell safety requirements	
<b>ARTICLE 16 : IMPACT TESTING</b>	60-62
16.1 Conditions applicable to all impact tests	
16.2 Frontal test 1	
16.3 Frontal test 2	
<a href="#">16.4</a> Rear test	
<a href="#">16.5</a> Steering column test	
<b>ARTICLE 17 : ROLL STRUCTURE TESTING</b>	63
17.1 Conditions applicable to both roll structure tests	
17.2 Principal roll structure test	
17.3 Second roll structure test	
<b>ARTICLE 18 : STATIC LOAD TESTING</b>	64-67
18.1 Conditions applicable to all static load tests	
18.2 Survival cell side tests	
18.3 Fuel tank floor test	
18.4 Cockpit floor test	
18.5 Cockpit rim tests	
18.6 Nose push off test	
18.7 Side intrusion test	
18.8 Rear impact structure push off test	
18.9 Side impact structure push off tests	
<a href="#">18.10</a> Side impact structure squeeze tests	

<b>ARTICLE 19 : FUEL</b>	68-70
19.1 Purpose of Article 19	
19.2 Definitions	
19.3 Properties	
19.4 Composition of the fuel	
19.5 Air	
19.6 Safety	
19.7 Fuel approval	
19.8 Sampling and testing at an Event	
<b>ARTICLE 20 : TELEVISION CAMERAS AND TIMING TRANSPONDERS</b>	71
20.1 Presence of cameras and camera housings	
20.2 Location of camera housings	
20.3 Location and fitting of camera and equipment	
20.4 Transponders	
20.5 Installation	
<b>ARTICLE 21 : FINAL TEXT</b>	72
<b><u>ARTICLE 22 : CHANGES FOR 2015</u></b>	<u>73-74</u>
<u>22.1 Changes to Article 3.15</u>	
<u>22.2 Changes to Article 4.1</u>	
<u>22.3 Changes to Article 4.2</u>	
<u>22.4 Changes to Article 4.3</u>	
<u>22.5 Changes to Article 12.7</u>	
<u>22.6 Changes to Article 15.4.4</u>	
<b>APPENDIX 1 : DRAWINGS</b>	<u>75-82</u>
<b>APPENDIX 2 : POWER UNIT SYSTEMS, FUNCTIONS AND COMPONENTS</b>	<u>83-85</u>
<b>APPENDIX 3 : POWER UNIT ENERGY FLOW</b>	<u>86-87</u>
<b><u>APPENDIX 4 : ANNUAL F1 POWER UNIT HOMOLOGATION</u></b>	<u>88-89</u>

## **ARTICLE 1: DEFINITIONS**

### **1.1 Formula One Car :**

An automobile designed solely for speed races on circuits or closed courses.

### **1.2 Automobile :**

A land vehicle running on at least four non-aligned complete wheels, of which at least two are used for steering and at least two for propulsion.

### **1.3 Land vehicle :**

A locomotive device propelled by its own means, moving by constantly taking real support on the earth's surface, of which the propulsion and steering are under the control of a driver aboard the vehicle.

### **1.4 Bodywork :**

All entirely sprung parts of the car in contact with the external air stream, except cameras, camera housings and the parts definitely associated with the mechanical functioning of the engine, transmission and running gear. Airboxes, radiators and engine exhausts are considered to be part of the bodywork.

### **1.5 Wheel :**

Flange and rim.

### **1.6 Complete wheel :**

Wheel and inflated tyre. The complete wheel is considered part of the suspension system.

### **1.7 Automobile Make :**

In the case of Formula racing cars, an automobile make is a complete car. When the car manufacturer fits an engine which it does not manufacture, the car shall be considered a hybrid and the name of the engine manufacturer shall be associated with that of the car manufacturer. The name of the car manufacturer must always precede that of the engine manufacturer. Should a hybrid car win a Championship Title, Cup or Trophy, this will be awarded to the manufacturer of the car.

### **1.8 Event :**

Any event entered into the FIA F1 Championship Calendar for any year commencing at the scheduled time for scrutineering and sporting checks and including all practice and the race itself and ending at the later of the time for the lodging of a protest under the terms of the Sporting Code and the time when a technical or sporting verification has been carried out under the terms of that Code.

### **1.9 Weight :**

Is the weight of the car with the driver, wearing his complete racing apparel, at all times during the Event.

### **1.10 Engine cubic capacity :**

The volume swept in the cylinders of the engine by the movement of the pistons. This volume shall be expressed in cubic centimetres. In calculating engine cubic capacity, the number Pi shall be 3.1416.

### **1.11 Pressure charging :**

Increasing the weight of the charge of the fuel/air mixture in the combustion chamber (over the weight induced by normal atmospheric pressure, ram effect and dynamic effects in the intake and/or exhaust system) by any means whatsoever. The injection of fuel under pressure is not considered to be pressure charging.

**1.12 Cockpit :**

The volume which accommodates the driver.

**1.13 Sprung suspension :**

The means whereby all complete wheels are suspended from the body/chassis unit by a spring medium.

**1.14 Survival cell :**

A continuous closed structure containing the fuel tank and the cockpit.

**1.15 Camera :**

Television cameras the dimensions of which are defined in Drawing 6.

**1.16 Camera housing :**

A device which is identical in shape and weight to a camera and which is supplied by the relevant competitor for fitting to his car in lieu of a camera.

**1.17 Cockpit padding :**

Non-structural parts placed within the cockpit for the sole purpose of improving driver comfort and safety. All such material must be quickly removable without the use of tools.

**1.18 Brake caliper :**

All parts of the braking system outside the survival cell, other than brake discs, brake pads, caliper pistons, brake hoses and fittings, which are stressed when subjected to the braking pressure. Bolts or studs which are used for attachment are not considered to be part of the braking system.

**1.19 Electronically controlled :**

Any command system or process that utilises semi-conductor or thermionic technology.

**1.20 Open and closed sections :**

A section will be considered closed if it is fully complete within the dimensioned boundary to which it is referenced, if it is not it will be considered open.

**1.21 Power train :**

The power unit and associated torque transmission systems, up to but not including the drive shafts.

**1.22 Power unit :**

The internal combustion engine, complete with its ancillaries, any energy recovery system and all actuation systems necessary to make them function at all times.

**1.23 Engine**

The internal combustion engine including ancillaries and actuator systems necessary for its proper function.

**1.24 Energy Recovery System (ERS) :**

A system that is designed to recover energy from the car, store that energy and make it available to propel the car and, optionally, to drive any ancillaries and actuation systems necessary for its proper function.

**1.25 Motor Generator Unit - Kinetic (MGU-K) :**

The Kinetic Motor Generator Unit is the electrical machine mechanically linked to the drive train as part of the ERS.

**1.26 Motor Generator Unit - Heat (MGU-H) :**

The Heat Motor Generator Unit is the electrical machine linked to the exhaust turbine of a pressure charging system as part of the ERS.

**1.27 Energy Store (ES) :**

The part of ERS that stores energy, including its safety control electronics and a minimal housing.

**1.28 Compressor Inlet :**

A component containing a duct of closed cross section through which all combustion air enters any compressor; the duct must extend upstream of any part of any variable geometry device permitted by Article 5.9.

**1.29 Compressor Outlet :**

A component containing a duct of closed cross section through which all combustion air exits any compressor.



## **ARTICLE 2 : GENERAL PRINCIPLES**

### **2.1 Role of the FIA :**

The following technical regulations for Formula One cars are issued by the FIA.

### **2.2 Amendments to the regulations :**

Changes to these regulations may only be made in accordance with the provisions of the Code.

### **2.3 Dangerous construction :**

The stewards of the meeting may exclude a vehicle whose construction is deemed to be dangerous.

### **2.4 Compliance with the regulations :**

Automobiles must comply with these regulations in their entirety at all times during an Event.

Should a competitor introduce a new design or system or feel that any aspect of these regulations is unclear, clarification may be sought from the FIA Formula One Technical Department. If clarification relates to any new design or system, correspondence must include:

- a) A full description of the design or system.
- b) Drawings or schematics where appropriate.
- c) The competitor's opinion concerning the immediate implications on other parts of the car of any proposed new design.
- d) The competitor's opinion concerning any possible long term consequences or new developments which may come from using any such new designs or systems.
- e) The precise way or ways in which the competitor feels the new design or system will enhance the performance of the car.

### **2.5 New systems or technologies :**

Any new system, procedure or technology not specifically covered by these regulations, but which is deemed permissible by the FIA Formula One Technical Department, will only be admitted until the end of the Championship during which it is introduced. Following this the Formula One Commission will be asked to review the technology concerned and, if they feel it adds no value to Formula One in general, it will be specifically prohibited.

Any team whose technology is prohibited in this way will then be required to publish full technical details of the relevant system or procedure.

### **2.6 Measurements :**

All measurements must be made while the car is stationary on a flat horizontal surface.

### **2.7 Duty of Competitor :**

It is the duty of each competitor to satisfy the FIA technical delegate and the stewards of the meeting that his automobile complies with these regulations in their entirety at all times during an Event.

The design of the car, its components and systems shall, with the exception of safety features, demonstrate their compliance with these regulations by means of physical inspection of hardware or materials. No mechanical design may rely upon software inspection as a means of ensuring its compliance.

## **ARTICLE 3 : BODYWORK AND DIMENSIONS**

One of the purposes of the regulations under Article 3 below is to minimize the detrimental effect that the wake of a car may have on a following car.

Furthermore, infinite precision can be assumed on certain dimensions provided it is clear that such an assumption is not being made in order to circumvent or subvert the intention of the relevant regulation.

For illustrations refer to drawings 1A-17A in the Appendix to the Technical Regulations.

### **3.1 Wheel centre line :**

The centre line of any wheel shall be deemed to be half way between two straight edges, perpendicular to the surface on which the car is standing, placed against opposite sides of the complete wheel at the centre of the tyre tread.

### **3.2 Height measurements :**

All height measurements will be taken normal to and from the reference plane.

### **3.3 Overall width :**

The overall width of the car, excluding tyres, must not exceed 1800mm with the steered wheels in the straight ahead position.

### **3.4 Width ahead of the rear wheel centre line :**

**3.4.1** Bodywork width between the front and the rear wheel centre lines must not exceed 1400mm.

Bodywork width ahead of the front wheel centre line must not exceed 1650mm.

**3.4.2** In order to prevent tyre damage to other cars, any bodywork outboard of the most inboard part of the bodywork used to define the area required by Article 3.7.5, and which is more than 450mm ahead of the front wheel centre line, must be at least 10mm thick (being the minimum distance when measured normal to the surface in any direction) with a 5mm radius applied to all extremities.

**3.4.3** In order to avoid the spread of debris on the track following an accident, the outer skins of the front wing endplates and any turning vanes in the vicinity of the front wheels (and any similarly vulnerable bodywork parts in this area), must be made predominantly from materials which are included for the specific purpose of containing debris.

The FIA must be satisfied that all such parts are constructed in order to achieve the stated objective.

### **3.5 Width behind the rear wheel centre line :**

**3.5.1** The width of bodywork behind the rear wheel centre line and less than 150mm above the reference plane must not exceed 1000mm.

**3.5.2** The width of bodywork behind the rear wheel centre line and more than 150mm above the reference plane must not exceed 750mm.

### **3.6 Overall height :**

No part of the bodywork may be more than 950mm above the reference plane.

### **3.7 Front bodywork :**

**3.7.1** All bodywork situated forward of a point lying 330mm behind the front wheel centre line, and more than 250mm from the car centre line, must be no less than 75mm and no more than 275mm above the reference plane.

- 3.7.2** Any horizontal section taken through bodywork located forward of a point lying 450mm forward of the front wheel centre line, less than 250mm from the car centre line, and between 125mm and 135mm above the reference plane, may only contain two closed symmetrical sections with a maximum total area of 5000mm<sup>2</sup>. The thickness of each section may not exceed 25mm when measured perpendicular to the car centre line.

Once fully defined, the sections at 125mm above the reference plane must be projected vertically to join the profile required by Article 3.7.3. A radius no greater than 10mm may be used where these sections join.

- 3.7.3** Forward of a point lying 450mm ahead of the front wheel centre line and less than 250mm from the car centre line and less than 125mm above the reference plane, only one single section may be contained within any longitudinal vertical cross section parallel to the car centre line.

Furthermore, with the exception of local changes of section where the bodywork defined in Article 3.7.2 attaches to this section, the profile, incidence and position of this section must conform to drawing 7. This section may not contain any closed channel the effect of which is to duct air directly or indirectly to or from the external air stream for any purpose other than data acquisition.

- 3.7.4** In the area bounded by lines between 450mm and 1000mm ahead of the front wheel centre line, 250mm and 400mm from the car centre line and between 75mm and 275mm above the reference plane, the projected area of all bodywork onto the longitudinal centre plane of the car must be no more than 20,000mm<sup>2</sup>.
- 3.7.5** Ahead of the front wheel centre line and between 685mm and 775mm from the car centre line there must be bodywork with a projected area of no less than 95,000mm<sup>2</sup> in side view.
- 3.7.6** Ahead of the front wheel centre line and between 775mm and 825mm from the car centre line there must be bodywork with a projected area of no less than 23,000mm<sup>2</sup> in plan view. Furthermore, when viewed from underneath, the bodywork in this area must form one continuous surface which may not be more than 100mm above the reference plane.
- 3.7.7** Any longitudinal vertical cross section taken through bodywork ahead of the front wheel centre line and between 775mm and 825mm from the car centre line must contain an area no greater than 15,000mm<sup>2</sup>.
- 3.7.8** Only a single section, which must be open, may be contained within any longitudinal vertical cross section taken parallel to the car centre line forward of a point 150mm ahead of the front wheel centre line, less than 250mm from the car centre line and more than 125mm above the reference plane.

Any cameras or camera housings approved by the FIA in addition to a single inlet aperture for the purpose of driver cooling (such aperture having a maximum projected surface area of 1500mm<sup>2</sup> and being situated forward of the section referred to in Article 15.4.3) will be exempt from the above.

- 3.7.9** No bodywork situated forward of the line A-A referred to Drawing 5 may extend above a diagonal line from a point on A-A and 625mm above the reference plane to a point 50mm rearward of the forward-most point of the impact absorbing structure defined in Article 15.4.3 and 300mm above the reference plane. No bodywork situated forward of the forward-most point of this diagonal line may be more than 300mm above the reference plane.

With the exception of a transparent windscreen, antenna or pitot tubes, no bodywork situated between the line A-A referred to in Drawing 5 and the secondary roll structure may lie more than 625mm above the reference plane.

Any bodywork situated above the impact absorbing structure defined by Article 15.4.3 or above the survival cell, and forward of the line B-B, must be of prescribed laminate, details of this laminate may be found in the Appendix to the Technical Regulations.

### **3.8 Bodywork in front of the rear wheels :**

- 3.8.1** Other than the rear view mirrors (including their mountings), each with a maximum area of 12000mm<sup>2</sup> and 14000 mm<sup>2</sup> when viewed from directly above or directly from the side respectively, no bodywork situated more than 330mm behind the front wheel centre line and more than 330mm forward of the rear wheel centre line, which is more than 600mm above the reference plane, may be more than 300mm from the car centre line.
- 3.8.2** No bodywork between the rear wheel centre line and a line 800mm forward of the rear wheel centre line, which is more than 375mm from the car centre line, may be more than 500mm above the reference plane.
- 3.8.3** No bodywork between the rear wheel centre line and a line 400mm forward of the rear wheel centre line, which is more than 375mm from the car centre line, may be more than 300mm above the reference plane.
- 3.8.4** Any vertical cross section of bodywork normal to the car centre line situated in the volumes defined below must form one tangent continuous curve on its external surface. This tangent continuous curve may not contain any radius less than 75mm :
- a) The volume between 50mm forward of the rear wheel centre line and 300mm rearward of the rear face of the cockpit entry template, which is more than 25mm from the car centre line and more than 100mm above the reference plane.
  - b) The volume between 300mm rearward of the rear face of the cockpit entry template and the rear face of the cockpit entry template, which is more than 125mm from the car centre line and more than 100mm above the reference plane.
  - c) The volume between the rear face of the cockpit entry template and 450mm forward of the rear face of the cockpit entry template, which is more than 350mm from the car centre line and more than 100mm above the reference plane.
  - d) The volume between the rear face of the cockpit entry template and 450mm forward of the rear face of the cockpit entry template, which is more than 125mm from the car centre line and more than 675mm above the reference plane.

The surfaces lying within these volumes, which are situated more than 55mm forward of the rear wheel centre line, must not contain any apertures (other than those permitted by Article 3.8.5) or contain any vertical surfaces which lie normal to the car centre line.

- 3.8.5** Once the relevant bodywork surfaces are defined in accordance with Article 3.8.4, apertures, any of which may adjoin or overlap each other, may be added for the purpose of allowing suspension members and driveshafts to protrude through the bodywork. Only one aperture may be added for each suspension member and no such aperture may have an area greater than 12,000 mm<sup>2</sup> when projected onto the surface itself. No point on an aperture may be more than 200mm from any other point on the aperture.
- 3.8.6** The impact absorbing structures defined by Article 15.5.2 must be fully enclosed by bodywork, such that no part of the impact structure is in contact with the external air flow. When cut by a longitudinal vertical plane, the bodywork enclosing these impact structures must not form closed sections in the region between 450mm and 875mm forward of the rear edge of the cockpit template.

### **3.9 Bodywork between the rear wheels :**

- 3.9.1** No bodywork situated between 50mm and 330mm forward of the rear wheel centre line may be more than 730mm above the reference plane.

**3.9.2** There must be no bodywork behind a line 30mm forward of the rear wheel centre line which lies between 100mm and 355mm from the car centre line and between 150mm and 750mm above the reference plane.

**3.9.3** No bodywork situated between 50mm and 30mm forward of the rear wheel centre line, and which is between 100mm and 355mm from the car centre line, may be located between 550mm and 750mm above the reference plane.

### **3.10 Bodywork behind the rear wheel centre line :**

**3.10.1** Other than the bodywork defined in [Article 3.10.8](#), any bodywork behind a point lying 50mm forward of the rear wheel centre line which is more than 750mm above the reference plane, and less than 355mm from the car centre line, must lie in an area when viewed from the side of the car that is situated between the rear wheel centre line and a point 350mm behind it.

With the exception of minimal parts solely associated with adjustment of the section in accordance with Article 3.18 :

- a) When viewed from the side of the car, no longitudinal vertical cross section may have more than two sections in this area, each of which must be closed.
- b) No part of these longitudinal vertical cross sections in contact with the external air stream may have a local concave radius of curvature smaller than 100mm.

Once the rearmost and uppermost section is defined, 'gurney' type trim tabs may be fitted to the trailing edge. When measured in any longitudinal vertical cross section no dimension of any such trim tab may exceed 20mm.

The chord of the rearmost and uppermost closed section must always be smaller than the chord of the lowermost section at the same lateral station.

Furthermore, the distance between adjacent sections at any longitudinal vertical plane must lie between 10mm and 15mm at their closest position, except, in accordance with Article 3.18, when this distance must lie between 10mm and 65mm.

**3.10.2** In order to ensure that the individual profiles and the relationship between these two sections can only change whilst the car is in motion in accordance with Article 3.18, they must be bridged by means of pairs of rigid impervious supports arranged such that no part of the trailing edge of the forward section may be more than 200mm laterally from a pair of supports. These pairs of supports must :

- a) Be located no more than 355mm from the car centre line.
- b) Fully enclose each complete section such that their inner profiles match that of each section. With the exception of minimal local changes where the two sections are adjacent to each other, their outer profiles must be offset from the inner profiles by between 8mm and 30mm and may not incorporate any radius smaller than 10mm ('gurney' type trim tabs may however be fitted between the supports).
- c) Be aligned as a pair so as to provide a bearing across their full thickness and along a profile length of at least 10mm when the distance between the two sections is at its closest position.
- d) Not be recessed into the wing profiles (where a recess is defined as a reduction in section at a rate greater than 45° with respect to a lateral axis).
- e) Be arranged so that any curvature occurs only in a horizontal plane (other than when this bodywork is adjusted in accordance with Article 3.18).
- f) Be between 2mm and 5mm thick.
- g) Be rigidly fixed to their respective sections.
- h) Be constructed from a material with modulus greater than 50GPa.

These supports will be ignored when assessing whether the car is in compliance with Articles 3.6, 3.9.2, 3.10.1, [3.10.3](#) and [3.10.5](#).

- [3.10.3](#) No part of the car between 75mm and 355mm from the car centre line may be more than 350mm behind the rear wheel centre line.
- [3.10.4](#) Any parts of the car less than 75mm from the car centre line and more than 500mm behind the rear wheel centre line must be situated between 200mm and 400mm above the reference plane.
- [3.10.5](#) No part of the car less than 75mm from the car centre line and more than 350mm behind the rear wheel centre line may be more than 400mm above the reference plane.
- [3.10.6](#) No part of the car more than 375mm from the car centre line may be more than 350mm behind the rear wheel centre line.
- [3.10.7](#) In side view, the projected area of any bodywork lying between 300mm and 950mm above the reference plane and between the rear wheel centre line and a point 600mm behind it and more than 355mm from the car centre line must be greater than 330000mm<sup>2</sup>.
- [3.10.8](#) Any horizontal section between 600mm and 750mm above the reference plane, taken through bodywork located rearward of a point lying 50mm forward of the rear wheel centre line and less than 75mm from the car centre line, may contain no more than two closed symmetrical sections with a maximum total area of 5000mm<sup>2</sup>. The thickness of each section may not exceed 25mm when measured perpendicular to the car centre line.

Once fully defined, the section at 745mm above the reference plane may be extruded upwards to join the sections defined in [Article 3.10.1](#). A fillet radius no greater than 10mm may be used where these sections join.

### **3.11 Bodywork around the front wheels :**

**3.11.1** With the exception of the air ducts described in Article 11.4 and the mirrors described in Article 3.8.1, in plan view, there must be no bodywork in the area formed by the intersection of the following lines :

- a) A longitudinal line parallel to and 900mm from the car centre line.
- b) A transverse line 450mm forward of the front wheel centre line.
- c) A diagonal line from 450mm forward of the front wheel centre line and 400mm from the car centre line to 750mm forward of the front wheel centre line and 250mm from the car centre line.
- d) A transverse line 750mm forward of the front wheel centre line.
- e) A longitudinal line parallel to and 165mm from the car centre line.
- f) A diagonal line running forwards and inwards, from a point 875mm forward of the rear face of the cockpit entry template and 240mm from the car centre line, at an angle of 4.5° to the car centre line.
- g) A diagonal line from 875mm forward of the rear face of the cockpit entry template and 240mm from the car centre line to 625mm forward of the rear face of the cockpit entry template and 415mm from the car centre line.
- h) A transverse line 625mm forward of the rear face of the cockpit entry template.

For reference this area is shown in Drawing 17A in the Appendix to the Technical Regulations.

**3.11.2** With the exception of the air ducts described in Article 11.4, in side view, there must be no bodywork in the area formed by two vertical lines, one 325mm behind the front wheel centre line, one 450mm ahead of the front wheel centre line, one diagonal line intersecting the vertical lines at 100mm and [135mm](#) above the reference plane respectively, and one horizontal line on the reference plane.

### 3.12 Bodywork facing the ground :

**3.12.1** With the skid block referred to in Article 3.13 removed all sprung parts of the car situated from 330mm behind the front wheel centre line to the rear wheel centre line, and which are visible from underneath, must form surfaces which lie on one of two parallel planes, the reference plane or the step plane. This does not apply to any parts of rear view mirrors which are visible, provided each of these areas does not exceed 12000mm<sup>2</sup> when projected to a horizontal plane above the car, or to any parts of the panels referred to in Article 15.4.7 and 15.4.8.

The step plane must be 50mm above the reference plane.

**3.12.2** Additionally, the surface formed by all parts lying on the reference plane must :

- a) Cover the area which is bounded by two transversal lines, one 330mm behind the front wheel centre line and the other on the rear wheel centre line, and two longitudinal lines 150mm either side of the car centre line.
- b) Have a maximum width of 500mm.
- c) Be symmetrical about the car centre line.
- d) Have a 50mm radius (+/-2mm) on each front corner when viewed from directly beneath the car, this being applied after the surface has been defined.

**3.12.3** The surface lying on the reference plane must be joined around its periphery to the surfaces lying on the step plane by a vertical transition. If there is no surface visible on the step plane vertically above any point around the periphery of the reference plane, this transition is not necessary.

**3.12.4** The boundaries of the surface lying on the reference plane and the point at which the vertical transitions meet the surfaces on the step plane may incorporate a radius no greater than 25mm.

A radius in this context will be considered as an arc of constant curvature applied perpendicular to the boundary and tangential to both surfaces.

The boundaries of the surfaces lying on the step plane which do not meet one of the vertical transitions may be curved upwards with a radius no greater than 50mm which must be of constant curvature.

The surface lying on the reference plane, the surfaces lying on the step plane, the vertical transitions between them and any surfaces rearward of the surfaces lying on the reference or step planes, must first be fully defined before any radius can be applied or the skid block fitted. Any radius applied is still considered part of the relevant surface.

**3.12.5** All parts lying on the reference and step planes, in addition to the transition between the two planes, must produce uniform, solid, hard, continuous (no fully enclosed holes), rigid (no degree of freedom in relation to the body/chassis unit), impervious surfaces under all circumstances.

Fully enclosed holes are only permitted in the surfaces lying on the reference and step planes forward of a line 450mm forward of the rear face of the cockpit entry template, provided no part of the car is visible through them when viewed from directly below. This does not apply to any parts of rear view mirrors which are visible, provided each of these areas does not exceed 12000mm<sup>2</sup> when projected to a horizontal plane above the car, or to any parts of the panels referred to in Article 15.4.7 and 15.4.8.

**3.12.6** To help overcome any possible manufacturing problems, and not to permit any design which may contravene any part of these regulations, dimensional tolerances are permitted on bodywork situated between a point lying 330mm behind the front wheel centre line and the rear wheel centre line. A vertical tolerance of +/- 3mm is permissible across the surfaces lying on the reference and step planes and a horizontal tolerance of 3mm is permitted when assessing whether a surface is visible from beneath the car.

**3.12.7** No bodywork which is visible from beneath the car and which lies between the rear wheel centre line and a point 350mm rearward of it may be more than 125mm above the reference plane. Any intersection of the surfaces in this area with a lateral or longitudinal vertical plane should form one continuous line which is visible from beneath the car.

Additionally, any bodywork in this area must produce uniform, solid, hard, continuous (**no fully enclosed holes**), rigid (no degree of freedom in relation to the body/chassis unit), impervious surfaces under all circumstances).

**3.12.8** All sprung parts of the car situated behind the rear wheel centre line, which are visible from underneath and are more than 250mm from the car centre line, must be at least 50mm above the reference plane.

**3.12.9** In an area lying 450mm or less from the car centre line, and from 450mm forward of the rear face of the cockpit entry template to 350mm rearward of the rear wheel centre line, any intersection of any bodywork visible from beneath the car with a lateral or longitudinal vertical plane should form one continuous line which is visible from beneath the car.

**3.12.10** In an area lying 650mm or less from the car centre line, and from 450mm forward of the rear face of the cockpit entry template to 350mm forward of the rear wheel centre line, any intersection of any bodywork visible from beneath the car with a lateral or longitudinal vertical plane should form one continuous line which is visible from beneath the car.

**3.12.11** Compliance with Article 3.12 must be demonstrated with the panels referred to in Articles 15.4.7 and 15.4.8 and all unsprung parts of the car removed.

### **3.13 Skid block :**

**3.13.1** Beneath the surface formed by all parts lying on the reference plane, a rectangular skid block, with a 50mm radius (+/-2mm) on each front corner, must be fitted. This skid block may comprise no more than three pieces, the forward one of which may not be any less than 1000mm in length, but must :

- a) Extend longitudinally from a point lying 330mm behind the front wheel centre line to the rear wheel centre line.
- b) Be made from an homogeneous material with a specific gravity between 1.3 and 1.45.
- c) Have a width of 300mm with a tolerance of +/- 2mm.
- d) Have a thickness of 10mm with a tolerance of +/- 1mm.
- e) Have a uniform thickness when new.
- f) Have no holes or cut outs other than those necessary to fit the fasteners permitted by 3.13.2 or those holes specifically mentioned in g) below.
- g) Have seven precisely placed holes the positions of which are detailed in Drawing 1. In order to establish the conformity of the skid block after use, its thickness will only be measured in the four 50mm diameter holes and the two forward 80mm diameter holes.  
Four further 10mm diameter holes are permitted provided their sole purpose is to allow access to the bolts which secure the Accident Data Recorder to the survival cell.
- h) Be fixed symmetrically about the car centre line in such a way that no air may pass between it and the surface formed by the parts lying on the reference plane.

**3.13.2** Fasteners used to attach the skid block to the car must :

- a) Have a total area no greater than 40000mm<sup>2</sup> when viewed from directly beneath the car.
- b) Be no greater than 2000mm<sup>2</sup> in area individually when viewed from directly beneath the car.



- c) Be fitted in order that their entire lower surfaces are visible from directly beneath the car.

When the skid block is new, ten of the fasteners may be flush with its lower surface but the remainder may be no more than 8mm below the reference plane.

- 3.13.3 The lower edge of the periphery of the skid block may be chamfered at an angle of 30° to a depth of 8mm, the trailing edge however may be chamfered over a distance of 200mm to a depth of 8mm.

### 3.14 Overhangs :

- 3.14.1 No part of the car may be more than 600mm behind the rear wheel centre line or more than 1200mm in front of the front wheel centre line.

- 3.14.2 No part of the bodywork more than 200mm from the car centre line may be more than 1000mm in front of the front wheel centre line.

- 3.14.3 All overhang measurements will be taken parallel to the reference plane.

### 3.15 Aerodynamic influence :

With the exception of the driver adjustable bodywork described in Article 3.18 (in addition to minimal parts solely associated with its actuation) and the ducts described in Article 11.4, any specific part of the car influencing its aerodynamic performance :

- a) Must comply with the rules relating to bodywork.
- b) Must be rigidly secured to the entirely sprung part of the car (rigidly secured means not having any degree of freedom).
- c) Must remain immobile in relation to the sprung part of the car.

Any device or construction that is designed to bridge the gap between the sprung part of the car and the ground is prohibited under all circumstances.

No part having an aerodynamic influence and no part of the bodywork, with the exception of the skid block in 3.13 above, may under any circumstances be located below the reference plane.

With the exception of the parts necessary for the adjustment described in Article 3.18, any car system, device or procedure which uses driver movement as a means of altering the aerodynamic characteristics of the car is prohibited.

### 3.16 Upper bodywork :

- 3.16.1 With the exception of the opening described in Article 3.16.3, when viewed from the side, the car must have bodywork in the area bounded by four lines. One vertical 1330mm forward of the rear wheel centre line, one horizontal 550mm above the reference plane, one horizontal 925mm above the reference plane and one diagonal which intersects the 925mm horizontal at a point 1000mm forward of the rear wheel centre line and the 550mm horizontal at a point lying 50mm forward of the rear wheel centre line.

Bodywork within this area must be arranged symmetrically about the car centre line and, when measured 200mm vertically below the diagonal boundary line, must have minimum widths of 150mm and 50mm respectively at points lying 1000mm and 50mm forward of the rear wheel centre line. This bodywork must lie on or outside the boundary defined by a linear taper between these minimum widths.

- 3.16.2 Bodywork lying vertically above the upper boundary as defined in 3.16.1 may be no wider than 125mm and must be arranged symmetrically about the car centre line.

- 3.16.3 In order that a car may be lifted quickly in the event of it stopping on the circuit, the principal rollover structure must incorporate a clearly visible unobstructed opening designed to permit a strap, whose section measures 60mm x 30mm, to pass through it.

### 3.17 Bodywork flexibility :

**3.17.1** Bodywork may deflect no more than 10mm vertically when a 1000N load is applied vertically to it at points 675mm and 975mm forward of the front wheel centre line and 720mm from the car centre line. The load will be applied in a downward direction using a 50mm diameter ram on a rectangular adapter measuring 400mm x 150mm. This adapter must be supplied by the team and :

- a) Have a flat top surface without recesses.
- b) Be fitted to the car so as to apply the full load to the bodywork at the test point and not to increase the rigidity of the parts being tested.
- c) Be placed with the inner 400mm edge parallel to the car centre line and displaced from it by 645mm.
- d) Be placed with its forward edge 1025mm forward of the front wheel centre line.

The deflection will be measured along the loading axis at the bottom of the bodywork at this point and relative to the reference plane.

**3.17.2** Bodywork may deflect no more than 10mm vertically when a 500N load is applied vertically to it 450mm forward of the rear wheel centre line and 650mm from the car centre line. The load will be applied in a downward direction using a 50mm diameter ram and an adapter of the same size. Teams must supply the latter when such a test is deemed necessary.

**3.17.3** Bodywork may deflect by no more than one degree horizontally when a load of 1000N is applied simultaneously to its extremities in a rearward direction 925mm above the reference plane and 20mm forward of the forward edge of the rear wing endplate.

**3.17.4** Bodywork may deflect no more than 2mm vertically when a 500N load is applied simultaneously to each side of it 200mm behind the rear wheel centre line, 325mm from the car centre line and 970mm above the reference plane. The deflection will be measured at the outer extremities of the bodywork at a point 345mm behind the rear wheel centre line.

The load will be applied in a downward direction through pads measuring 200mm x 100mm which conform to the shape of the bodywork beneath them, and with their uppermost horizontal surface 970mm above the reference plane. The load will be applied to the centre of area of the pads. Teams must supply the latter when such a test is deemed necessary.

**3.17.5** Bodywork may deflect no more than 5mm vertically when a 2000N load is applied vertically to it at three different points which lie on the car centre line and 100mm either side of it. Each of these loads will be applied in an upward direction at a point 380mm rearward of the front wheel centre line using a 50mm diameter ram in the two outer locations and a 70mm diameter ram on the car centre line.

Stays or structures between the front of the bodywork lying on the reference plane and the survival cell may be present for this test, provided they are completely rigid and have no system or mechanism which allows non-linear deflection during any part of the test.

Furthermore, the bodywork being tested in this area may not include any component which is capable of allowing more than the permitted amount of deflection under the test load (including any linear deflection above the test load), such components could include, but are not limited to :

- a) Joints, bearings pivots or any other form of articulation.
- b) Dampers, hydraulics or any form of time dependent component or structure.
- c) Buckling members or any component or design which may have any non-linear characteristics.
- d) Any parts which may systematically or routinely exhibit permanent deformation.

**3.17.6** The uppermost aerofoil element lying behind the rear wheel centre line may deflect no more than 5mm horizontally when a 500N load is applied horizontally. The load will be applied 950mm above the reference plane at three separate points which lie on the car centre line and 190mm either side of it. The loads will be applied in a rearward direction using a suitable 25mm wide adapter which must be supplied by the relevant team.

**3.17.7** The forward-most aerofoil element lying behind the rear wheel centre line and which lies more than 730mm above the reference plane may deflect no more than 2mm vertically when a 200N load is applied vertically. The load will be applied in line with the trailing edge of the element at any point across its width. The loads will be applied using a suitable adapter, supplied by the relevant team, which :

- a) May be no more than 50mm wide.
- b) Which extends no more than 10mm forward of the trailing edge.
- c) Incorporates an 8mm female thread in the underside.

**3.17.8** In order to ensure that the requirements of Article 3.15 are respected, the FIA reserves the right to introduce further load/deflection tests on any part of the bodywork which appears to be (or is suspected of), moving whilst the car is in motion.

### **3.18 Driver adjustable bodywork :**

**3.18.1** The incidence of the rearmost and uppermost closed section described in Article 3.10.2 may be varied whilst the car is in motion provided :

- a) It comprises only one component that must be symmetrically arranged about the car centre line with a minimum width of 708mm.
- b) With the exception of minimal parts solely associated with adjustment of the section, no parts of the section in contact with the external airstream may be located any more than 355mm from the car centre line.
- c) With the exception of any minimal parts solely associated with adjustment of the rearmost and uppermost section, two closed sections are used in the area described in [Article 3.10.1](#).
- d) Any such variation of incidence maintains compliance with all of the bodywork regulations.
- e) It cannot be used to change the geometry of any duct, either directly or indirectly, other than the change to the distance between adjacent sections permitted by [Article 3.10.1](#).
- f) When viewed from the side of the car at any longitudinal vertical cross section, the physical point of rotation of the rearmost and uppermost closed section must be fixed and located no more than 20mm below the upper extremity and no more than 20mm forward of the rear extremity of the area described in [Article 3.10.1](#) at all times.
- g) The design is such that failure of the system will result in the uppermost closed section returning to the normal high incidence position.
- h) Any alteration of the incidence of the uppermost closed section may only be commanded by direct driver input and controlled using the control electronics specified in Article 8.2.

## **ARTICLE 4 : WEIGHT**

### **4.1 Minimum weight :**

The weight of the car, without fuel, must not be less than **691kg** at all times during the Event.

If, when required for checking, a car is not already fitted with dry-weather tyres, it will be weighed on a set of dry-weather tyres selected by the FIA technical delegate.

### **4.2 Weight distribution :**

For 2014 only, the weight applied on the front and rear wheels must not be less than **314kg and 370kg** respectively at all times during the qualifying practice session.

If, when required for checking, a car is not already fitted with dry-weather tyres, it will be weighed on a set of dry-weather tyres selected by the FIA technical delegate.

### **4.3 Weight of tyres :**

The weight limits specified in Articles 4.1 and 4.2 will be adjusted up or down according to any differences (rounded up to the nearest 1kg) between the total set and individual axle set weights respectively of the 2013 and 2014 dry-weather tyres.

### **4.4 Ballast :**

Ballast can be used provided it is secured in such a way that tools are required for its removal. It must be possible to fix seals if deemed necessary by the FIA technical delegate.

### **4.5 Adding during the race :**

With the exception of compressed gases, no substance may be added to the car during the race. If it becomes necessary to replace any part of the car during the race, the new part must not weigh any more than the original part.

## ARTICLE 5 : POWER UNIT

### 5.1 Engine specification :

- 5.1.1 Only 4-stroke engines with reciprocating pistons are permitted.
- 5.1.2 Engine cubic capacity must be 1600cc (+0/-10cc).
- 5.1.3 Crankshaft rotational speed must not exceed 15000rpm.
- 5.1.4 Fuel mass flow must not exceed 100kg/h.
- 5.1.5 Below 10500rpm the fuel mass flow must not exceed  $Q \text{ (kg/h)} = 0.009 N(\text{rpm}) + 5.5$ .
- 5.1.6 Pressure charging may only be effected by the use of a sole single stage compressor linked to a sole single stage exhaust turbine by a shaft assembly parallel to the engine crankshaft and within 25mm of the car centre line. The shaft must be designed so as to ensure that the shaft assembly, the compressor and the turbine always rotate about a common axis and at the same angular velocity, an electrical motor generator (MGU-H) may be directly coupled to it.
- 5.1.7 All engines must have six cylinders arranged in a 90° “V” configuration and the normal section of each cylinder must be circular.

All six cylinders must be of equal capacity.

- 5.1.8 Engines must have two inlet and two exhaust valves per cylinder.  
Only reciprocating poppet valves with axial displacement are permitted.  
The sealing interface between the moving valve component and the stationary engine component must be circular.
- 5.1.9 Engine exhaust gases may only exit the cylinder head through outlets outboard of the cylinder bore centre line and not from within the “V” centre.
- 5.1.10 The crankshaft may only have three connecting rod bearing journals.

### 5.2 Other means of propulsion and energy recovery :

- 5.2.1 The use of any device, other than the engine described in 5.1 above, and one MGU-K, to propel the car, is not permitted.
- 5.2.2 Energy flows, power and ES state of charge limits are defined in the energy flow diagram shown in Appendix 3 of these regulations.

When the car is on the track a lap will be measured on each successive crossing of the timing line, however, when entering the pits the lap will end, and the next one will begin, at the start of the pit lane (as defined in the F1 Sporting Regulations).

Electrical DC measurements will be used to verify that the energy and power requirements are being respected.

A fixed efficiency correction of 0.95 will be used to monitor the maximum MGU-K power.

- 5.2.3 The MGU-K must be solely and permanently mechanically linked to the powertrain before the main clutch. This mechanical link must be of fixed speed ratio to the engine crankshaft.

The rotational speed of the MGU-K may not exceed 50,000rpm.

The maximum torque of the MGU-K may not exceed 200Nm. The torque will be referenced to the crankshaft speed and the fixed efficiency correction defined in Article 5.2.2 will be used to monitor the maximum MGU-K torque.

The laminate thickness of the MGU-K may not be less than 0.05mm.

- 5.2.4 The MGU-H must be solely mechanically linked to the exhaust turbine of a pressure charging system. This mechanical link must be of fixed speed ratio to the exhaust turbine and may be clutched.

The rotational speed of the MGU-H may not exceed 125,000rpm.

- 5.2.5 Cars must be fitted with homologated sensors which provide all necessary signals to the FIA data logger in order to verify the requirements above are being respected.

### 5.3 Power unit dimensions :

- 5.3.1 Cylinder bore diameter must be 80mm (+/- 0.1mm).
- 5.3.2 The crankshaft centre line must lie on the car centre line and 90mm (+/-0.5mm) above the reference plane. The power unit may only transmit torque to the gearbox by means of a single output shaft that must be co-axial with the crankshaft. The output shaft must rotate clockwise when viewed from the front of the car.
- 5.3.3 Valve stem diameter must not be less than 4.95mm.
- 5.3.4 All elements of the power unit specified in the relevant column of the table in Appendix 2 of these regulations must be installed in the union of the volumes that exist between two vertical planes normal to the car centre line separated by 700mm and in a box 150mm long, 250mm wide and 800mm high which lies symmetrically about the car centre line immediately ahead of the front vertical plane.
- 5.3.5 Power unit mountings may only comprise six M12 studs for connection to the survival cell and six M12 studs for connection to the transmission. All studs must be used and may be fitted on the survival cell, power unit or transmission. The installed end of the studs must be M12 and the free end may be a different diameter.

The mounting faces of the studs for connection to the survival cell must lie on the forward of the two planes described in Article 5.3.4 and be located at Y215/Z15(2), Y340/Z260(2) and Y175/Z420(2).

The mounting faces of the studs for connection to the transmission must lie on one vertical plane normal to the car centre line and be located at Y100/Z15(2), Y150/Z140(2) and Y255/Z345(2).

A tolerance of +/- 0.2mm will be permitted on all of the above dimensions, all dimensions refer to the centre of the studs.

The distance between the two planes is fixed at 480mm (+/-0.2mm).

Any part which provides an additional load path from the survival cell to the gearbox, with a connection to the power unit, may only do so if this is incidental to its principal purpose.

- 5.3.6 The ES must be installed wholly within the survival cell.

### 5.4 Weight and centre of gravity :

- 5.4.1 The overall weight of the power unit must be a minimum of 145kg.
- 5.4.2 The centre of gravity of the power unit may not lie less than 200mm above the reference plane.
- 5.4.3 The total weight of the part of the ES that stores energy, i.e. the cells (including any clamping plates) and electrical connections between cells, must be no less than 20kg and must not exceed 25kg.
- 5.4.4 When establishing conformity with Articles 5.4.1, 5.4.2 and Appendix 4 of the F1 Sporting Regulations, the homologated power unit perimeter will be defined in accordance with the table shown in Appendix 2 of these regulations.

### 5.5 Power unit torque control :

- 5.5.1 The only means by which the driver may control acceleration torque to the driven wheels is via a single chassis mounted foot (accelerator) pedal.

5.5.2 Designs which allow specific points along the accelerator pedal travel range to be identified by the driver or assist him to hold a position are not permitted.

5.5.3 The accelerator pedal shaping map in the ECU may only be linked to the type of the tyres fitted to the car : one map for use with dry-weather tyres and one map for use with intermediate or wet-weather tyres.

5.5.4 At any given engine speed the driver torque demand map must be monotonically increasing for an increase in accelerator pedal position.

5.5.5 At any given accelerator pedal position and above 4,000rpm, the driver torque demand map must not have a gradient of less than – (minus) 0.045Nm/rpm.

5.5.6 The power unit shall achieve the torque demanded by the FIA standard software within a period of [TBD]ms.

5.5.7 Homologated sensors must be fitted which measure the torque generated at the power unit output shaft and the torques supplied to each driveshaft. These signals must be provided to the ECU.

## 5.6 Engine control :

5.6.1 The maximum delay allowed, computed from the respective signals as recorded by the ADR or ECU, between the accelerator pedal position input signal and the corresponding output demand being achieved is 50ms.

5.6.2 Teams may be required to demonstrate the accuracy of the engine configurations used by the ECU.

5.6.3 Engine control must not be influenced by clutch position, movement or operation.

5.6.4 The idle speed control target may not exceed 4,000rpm.

5.6.5 A number of engine protections are available in the ECU.

A minimum of nine seconds hold time should be configured for the power unit protections enabled during qualifying and race. The configuration of the air tray fire detection and throttle failsafe are exceptionally unrestricted in order to allow each team to achieve the best level of safety.

## 5.7 Engine high rev limits :

Engine high rev limits may vary for differing conditions provided all are contained within a band of 750rpm. However, a lower rev limit may be used when :

- a) The gearbox is in neutral.
- b) Stall prevention is active.
- c) The driver clutch request is greater than 95% of the total available travel of the driver clutch actuation device, used only to protect the engine following a driver error.
- d) An engine protection is active.
- e) The bite point finder strategy is active.
- f) The safety car is deployed or during the formation lap.

Except for the above conditions, power unit actuators may not be used to artificially control the power unit speed or alter the power unit response in a rev range more than 750rpm below the final rev limit.

## 5.8 Exhaust systems :

5.8.1 With the exception of incidental leakage through joints (either into or out of the system), all (and only) the fluids entering the compressor inlet must exit from the engine exhaust system.

- 5.8.2 Engine exhaust systems **must have only a single tailpipe exit** which must be rearward facing **and** through which all exhaust gases must pass.
- 5.8.3 The cross-sectional area of the exhaust exit at the rearmost point of the tailpipe must lie between 7500mm<sup>2</sup> and 14000mm<sup>2</sup>.
- 5.8.4 The last 150mm of any tailpipe must in its entirety :
- Form a thin-walled unobstructed right circular cylinder with its axis +/- 5° to the car centre line when viewed from above the car and between 0° and 5° (tail up) to the reference plane when viewed from the side of the car. The entire circumference of the exit should lie on a single plane normal to the tailpipe axis and be located at the rearmost extremity of the last 150mm of the tailpipe.
  - Be located between 350mm and 550mm above the reference plane.
  - Be located no more than **100mm** from the car centre line.
  - Be positioned in order that the entire circumference of the exit of the tailpipe lies between two vertical planes normal to the car centre line and which lie between **170mm and 185mm rearward** of the rear wheel centre line.
- 5.8.5 There must be no bodywork lying within a right circular cylinder which :
- Shares a common axis with that of the last 150mm of **the** tailpipe.
  - Has a diameter **30mm** greater than **the** tailpipe.
  - Starts at the exit of the tailpipe and extends rearwards as far as a point 600mm behind the rear wheel centre line.

## 5.9 Variable geometry systems :

- 5.9.1 With the exception of devices needed for control of pressure charging systems, variable geometry exhaust systems are not permitted. No form of variable geometry turbine (VGT) or variable nozzle turbine (VNT) or any device to adjust the gas throat section at the inlet to the turbine wheel is permitted.
- 5.9.2 Variable valve timing and variable valve lift profile systems are not permitted.
- 5.9.3 Variable length intake trumpets are forbidden in 2014 only.

## 5.10 Fuel systems :

- 5.10.1 The pressure of the fuel supplied to the injectors may not exceed 500bar. **Only approved parts may be used and the list of parts approved by the FIA, and the approval procedure, may be found in the Appendix to the Technical Regulations.**
- 5.10.2 There may only be one direct injector per cylinder and no injectors are permitted upstream of the intake valves or downstream of the exhaust valves. **Only approved parts may be used and the list of parts approved by the FIA, and the approval procedure, may be found in the Appendix to the Technical Regulations.**
- 5.10.3 Homologated sensors must be fitted which directly measure the pressure, the temperature and the flow of the fuel supplied to the injectors, these signals must be supplied to the FIA data logger.
- 5.10.4** Only one homologated FIA fuel flow sensor may be fitted to the car which must be placed wholly within the fuel tank.
- 5.10.5** Any device, system or procedure the purpose and/or effect of which is to increase the flow rate after the measurement point is prohibited.



## 5.11 Ignition systems :

5.11.1 Ignition is only permitted by means of a single ignition coil and single spark plug per cylinder. No more than five sparks per cylinder per engine cycle are permitted.

The use of plasma, laser or other high frequency ignition techniques is forbidden.

Only approved ignition coils may be used and the list of parts approved by the FIA, and the approval procedure, may be found in the Appendix to the Technical Regulations.

5.11.2 Only conventional spark plugs that function by high tension electrical discharge across an exposed gap are permitted.

Spark plugs are not subject to the materials restrictions described in Articles 5.16 and 5.17.

## 5.12 Energy Recovery System (ERS) :

5.12.1 The system will be considered shut down when no high voltage can be present on any external or accessible part of the ERS.

The shutdown process must take no longer than two seconds from activation.

It must be possible to shut down the ERS via the following means :

- a) The switch required by Article 14.2.1.
- b) The switches required by Article 14.2.2.
- c) The switch or button required by Article 9.4.

5.12.2 The ERS must shut down when the ECU required by Article 8.2 initiates an anti-stall engine shut off.

5.12.3 All cars must be fitted with an ERS status light which :

- a) Has been supplied by an FIA designated manufacturer and fitted to the car in accordance with the instructions in the Appendix to these regulations.
- b) Is in working order throughout the Event even if the main hydraulic, pneumatic or electrical systems on the car have failed.
- c) Remains powered for at least 15 minutes if the car comes to rest with its engine stopped.
- d) Is marked with a "HIGH VOLTAGE" symbol according to ISO3864 of at least 30mm along the triangle side and no more than 50mm away from the lights.

5.12.4 All cars must provide signals regarding the car operating and insulation states to the ADR in order to facilitate control of the ERS status light.

5.12.5 The maximum peak voltage on the car must never exceed 1000V.

## 5.13 Engine ancillaries :

All coolant pumps, oil pumps, scavenge pumps, oil/air separators, hydraulic pumps and fuel pumps delivering more than 10bar must be mechanically driven directly from the engine and/or MGU-K with a fixed speed ratio.

## 5.14 Engine intake air :

5.14.1 With the exception of incidental leakage through joints or cooling ducts in the inlet system (either into or out of the system), all air entering the engine must enter the bodywork through a maximum of two inlets which are located :

- a) Between the front of the cockpit entry template and a point 500mm forward of the rear wheel centre line longitudinally.
- b) No less than 200mm above the reference plane vertically.
- c) On vertical cross-sections normal to the car centre line.

Furthermore, any such inlets must be visible in their entirety when viewed from the front of the car and without the driver seated in the car.

5.14.2 Other than engine sump breather gases, exhaust gas recirculation, and fuel for the normal purpose of combustion in the engine, the spraying of any substance into the engine intake air is forbidden.

#### 5.15 Materials and Construction – Definitions :

5.15.1 X Based Alloy (e.g. Ni based alloy) – X must be the most abundant element in the alloy on a %w/w basis. The minimum possible weight percent of the element X must always be greater than the maximum possible of each of the other individual elements present in the alloy.

5.15.2 X-Y Based Alloy (e.g. Al-Cu based alloy) – X must be the most abundant element as in Article 5.15.1 above. In addition element Y must be the second highest constituent (%w/w), after X in the alloy. The mean content of Y and all other alloying elements must be used to determine the second highest alloying element (Y).

5.15.3 Intermetallic Materials (e.g. TiAl, NiAl, FeAl, Cu<sub>3</sub>Au, NiCo) – These are materials where the material is based upon intermetallic phases, i.e. the matrix of the material consists of greater than 50%v/v intermetallic phase(s). An intermetallic phase is a solid solution between two or more metals exhibiting either partly ionic or covalent, or metallic bonding with a long range order, in a narrow range of composition around the stoichiometric proportion.

5.15.4 Composite Materials – These are materials where a matrix material is reinforced by either a continuous or discontinuous phase. The matrix can be metallic, ceramic, polymeric or glass based. The reinforcement can be present as long fibres (fibre length greater than 10mm) or short fibres, whiskers and particles (discontinuous reinforcement). Nanoscale reinforced materials are to be considered as composites. (a reinforcement is considered to be nanoscale if any dimension of the reinforcement is less than 100nm.)

5.15.5 Metal Matrix Composites (MMC's) – These are composite materials with a metallic matrix containing a phase of greater than 2%v/v which is not soluble in the liquid phase of the metallic matrix.

5.15.6 Ceramic Materials (e.g. Al<sub>2</sub>O<sub>3</sub>, SiC, B<sub>4</sub>C, Ti<sub>5</sub>Si<sub>3</sub>, SiO<sub>2</sub>, Si<sub>3</sub>N<sub>4</sub>) – These are inorganic, non-metallic solids.

#### 5.16 Materials and construction – General :

5.16.1 Unless explicitly permitted for a specific application, the following materials may not be used anywhere on the power unit :

- a) Magnesium based alloys.
- b) Metal Matrix Composites (MMC's).
- c) Intermetallic materials.
- d) Alloys containing more than 5% by weight of Iridium or Rhenium.
- e) Copper based alloys containing more than 2.75% Beryllium.
- f) Any other alloy class containing more than 0.25% Beryllium.
- g) Tungsten base alloys.
- h) Ceramics and ceramic matrix composites.

5.16.2 The restrictions in Article 5.16.1 do not apply to coatings provided the total coating thickness does not exceed 25% of the section thickness of the underlying base material in all axes. In all cases, other than under Article 5.16.3(b), the relevant coating must not exceed 0.8mm.

5.16.3 The restrictions in Article 5.16.1(h) do not apply to the following applications :

- a) Any component whose primary purpose is for electrical or thermal insulation.

- b) Any coating whose primary purpose is for thermal insulation of the outside of the exhaust system.

**5.16.4** Magnesium based alloys, where permitted, must be available on a non-exclusive basis and under normal commercial terms to all competitors. Only those alloys covered by ISO16220 and approved by the FIA may be used.

**5.17 Materials and construction – Components :**

**5.17.1** Pistons must respect Article 5.16. Titanium alloys are not permitted.

**5.17.2** Piston pins must be manufactured from an iron based alloy and must be machined from a single piece of material.

**5.17.3** Connecting rods must be manufactured from iron or titanium based alloys and must be machined from a single piece of material with no welded or joined assemblies (other than a bolted big end cap or an interfered small end bush).

**5.17.4** Crankshafts must be manufactured from an iron based alloy.

No welding is permitted between the front and rear main bearing journals.

No material with a density exceeding 18,400 kg/m<sup>3</sup> may be assembled to the crankshaft.

These parts assembled to the crankshaft may be manufactured in a Tungsten based material.

**5.17.5** Camshafts must be manufactured from an iron based alloy.

Each camshaft and lobes must be machined from a single piece of material.

No welding is allowed between the front and rear bearing journals.

**5.17.6** Valves must be manufactured from intermetallic materials or from alloys based on Aluminium, Iron, Nickel, Cobalt or Titanium. However, hollow structures cooled by sodium, lithium or similar are also permitted.

In addition, the restrictions detailed in Articles 5.16.2 and 15.1.2 do not apply to valves.

**5.17.7** Reciprocating and rotating components :

- a) Reciprocating and rotating components must not be manufactured from graphitic matrix, metal matrix composites or ceramic materials, this restriction does not apply to the clutch and any seals.
- b) Rolling elements of rolling element bearings must be manufactured from an iron based alloy or from a ceramic material.
- c) All timing gears between the crankshaft and camshafts (including hubs) must be manufactured from an iron based alloy.
- d) High pressure fuel pumps elements may be manufactured from a ceramic material.
- e) Torsional damper elements may be manufactured in a Tungsten based material.

**5.17.8** Static components :

- a) Other than inserts within them, engine crankcases including sump and cylinder heads must be manufactured from cast or wrought aluminium or iron alloys.  
No composite materials or metal matrix composites are permitted either for the whole component or locally.
- b) Other than parts listed in a) above, magnesium based alloys are permitted for static parts which may not be changed without incurring a penalty under Article [5.22](#).
- c) Any metallic structure whose primary or secondary function is to retain lubricant or coolant within the engine must be manufactured from an iron based alloy, an aluminium alloy or a magnesium based alloy if permitted by Article 5.17.8(b).

- d) All threaded fasteners, other than the two exceptions below, must be manufactured from an alloy based on Cobalt, Iron or Nickel. The exceptions are :
  - i) Fasteners whose primary function requires them to be an electrical insulator may be manufactured from ceramic or polymeric materials.
  - ii) Fasteners that are used in electronic control units may be manufactured from aluminium alloys.Composite materials are not permitted.
- e) Valve seat inserts, valve guides and any other bearing component may be manufactured from metallic infiltrated pre-forms with other phases which are not used for reinforcement.
- f) Ballast may be manufactured in a Tungsten based material.

#### **5.18 Materials and construction – Pressure charging and exhaust systems :**

- 5.18.1** All components of the power unit exhaust system, (from the engine exhaust flange up to and including turbine housing or waste-gate exit housing) that are in contact with the main exhaust gas flow must be manufactured from a Cobalt, Iron or Nickel based alloy. Any gaskets or seals are excluded from this restriction.
- 5.18.2** Any rotating and reciprocating component in the compressor (from compressor inlet to compressor outlet) must be manufactured from an aluminium, titanium or iron based alloy.
- 5.18.3** Static components that are neither in the exhaust system nor in the compressor line must be manufactured from iron based alloys, aluminium alloys or titanium alloys.
- 5.18.4** The compressor housing (from compressor inlet to compressor outlet) must be manufactured from aluminium or magnesium based alloys.

**5.18.5** Measures must be taken to ensure that in the event of failure of the turbine wheel any resulting significant debris is contained within the car.

#### **5.19 Materials and construction – Energy recovery, storage systems and electronic systems :**

- 5.19.1** All metallic casings for the energy recovery and storage systems must be manufactured in iron, aluminium or titanium based alloys and must comply with all aspects of Article 5.16 except for power electronic cooling base plate where metal matrix composite may be used.
- 5.19.2** All metallic casings for electronic systems, with the exception of metallic casings for the energy recovery and storage systems, must be manufactured in iron, aluminium, titanium or magnesium based alloys.
- 5.19.3** Energy storage devices are not subject to Articles 5.16.1a), b), c) and h) nor to 5.16.2.
- 5.19.4** Permanent magnets in electrical machines are not subject to Articles 5.16.1 a), b), c) or h) nor to Article 5.16.2.
- 5.19.5** Electronic components contained inside electronic units are not subject to any material restriction.

#### **5.20 Starting the engine :**

A supplementary device temporarily connected to the car may be used to start the engine both on the grid and in the pits.

#### **5.21 Stall prevention systems :**

If a car is equipped with a stall prevention system, and in order to avoid the possibility of a car involved in an accident being left with the engine running, all such systems must be configured to stop the engine no more than ten seconds after activation.

The sole purpose of such systems is to prevent the engine stalling when a driver loses control of the car. If the car is in second gear or above when the system is activated multiple gear changes may be made to either first gear or neutral, under all other circumstances the clutch alone may be activated.

Each time such a system is activated the clutch must be fully disengaged and must remain so until the driver de-activates the system by manually operating the clutch with a request greater than 95% of the total available travel of the drivers clutch actuation device.

## **5.22 Replacing power unit parts :**

Refer to the table in Appendix 2 of these regulations.

The parts listed as "EXC" in the table referred to above may be changed without incurring a penalty under Article 28.4 of the F1 Sporting Regulations. If changing any of these parts involves breaking a seal this may be done but must be carried out under FIA supervision. Any parts changed may only be replaced by parts homologated in accordance with Appendix 4 of the F1 Sporting Regulations.

## ARTICLE 6 : FUEL SYSTEM

### 6.1 Fuel tanks :

6.1.1 The fuel tank must be a single rubber bladder conforming to or exceeding the specifications of FIA/FT5-1999, the fitting of foam within the tank however is not mandatory. A list of approved materials may be found in the Appendix to the Technical Regulations.

6.1.2 When viewed in lateral projection, all the fuel stored on board the car must be situated between the forward-most of the two vertical planes referred to in [Article 5.3.4](#) and the line a-b-c in Drawing 2.

Furthermore, no fuel can be stored more than 300mm forward of point c) in Drawing 2. However, a maximum of 2 litres of fuel may be kept outside the survival cell, but only that which is necessary for the normal running of the engine.

6.1.3 Fuel must not be stored more than 400mm from the longitudinal axis of the car.

6.1.4 All rubber bladders must be made by manufacturers recognised by the FIA. In order to obtain the agreement of the FIA, the manufacturer must prove the compliance of his product with the specifications approved by the FIA. These manufacturers must undertake to deliver to their customers exclusively tanks complying to the approved standards.

A list of approved manufacturers may be found in the Appendix to the Technical Regulations.

6.1.5 All rubber bladders shall be printed with the name of the manufacturer, the specifications to which the tank has been manufactured and the date of manufacture.

6.1.6 No rubber bladders shall be used more than 5 years after the date of manufacture.

### 6.2 Fittings and piping :

6.2.1 All apertures in the fuel tank must be closed by hatches or fittings which are secured to metallic or composite bolt rings bonded to the inside of the bladder. The total area of any such hatches or fittings which are in contact with the fuel may not exceed 30000mm<sup>2</sup>.

Bolt hole edges must be no less than 5mm from the edge of the bolt ring, hatch or fitting.

6.2.2 All fuel lines between the fuel tank and the engine must have a self sealing breakaway valve. This valve must separate at less than 50% of the load required to break the fuel line fitting or to pull it out of the fuel tank.

6.2.3 No lines containing fuel may pass through the cockpit.

6.2.4 All lines must be fitted in such a way that any leakage cannot result in the accumulation of fuel in the cockpit.

6.2.5 All components containing fuel at a pressure greater than 10bar must be located outside the fuel tank.

### 6.3 Crushable structure :

The fuel tank must be completely surrounded by a crushable structure, which is an integral part of the survival cell and must be able to withstand the loads required by the tests in Articles 18.2.1 and 18.3.

### 6.4 Fuel tank fillers :

Fuel tank fillers must not protrude beyond the bodywork. Any breather pipe connecting the fuel tank to the atmosphere must be designed to avoid liquid leakage when the car is running and its outlet must not be less than 250mm from the cockpit opening.

All fuel tank fillers and breathers must be designed to ensure an efficient locking action which reduces the risk of an accidental opening following a crash impact or incomplete locking after refuelling.

## **6.5 Refuelling :**

- 6.5.1** A cover must be fitted over any refuelling connector at all times when the car is running on the track. The cover and its attachments must be sufficiently strong to avoid accidental opening in the event of an accident.
- 6.5.2** No fuel intended for immediate use in a car may be more than ten degrees centigrade below ambient temperature. When assessing compliance, the ambient temperature will be that recorded by the FIA appointed weather service provider one hour before any practice session or two hours before the race. This information will also be displayed on the timing monitors.
- The temperature of fuel intended for use in a car must be measured via an FIA approved and sealed sensor.
- 6.5.3** The use of any device on board the car to decrease the temperature of the fuel is forbidden.

## **6.6 Fuel draining and sampling :**

- 6.6.1** Competitors must provide a means of removing all fuel from the car.
- 6.6.2** Competitors must ensure that a **1.0** litre sample of fuel may be taken from the car at any time during the Event.
- After a practice session, if a car has not been driven back to the pits under its own power, it will be required to supply the above mentioned sample plus the amount of fuel that would have been consumed to drive back to the pits. The additional amount of fuel will be determined by the FIA.
- 6.6.3** All cars must be fitted with a –2 'Symetrics' male fitting in order to facilitate fuel sampling. If an electric pump on board the car cannot be used to remove the fuel an externally connected one may be used provided it is evident that a representative fuel sample is being taken. If an external pump is used it must be possible to connect the FIA sampling hose to it and any hose between the car and pump must be -3 in diameter and not exceed 2m in length. Details of the fuel sampling hose may be found in the Appendix to the Technical Regulations.
- 6.6.4** The sampling procedure must not necessitate starting the engine or the removal of bodywork (other than the nosebox assembly and the cover over any refuelling connector).

## ARTICLE 7 : OIL AND COOLANT SYSTEMS AND CHARGE AIR COOLING

### 7.1 Location of oil tanks :

All oil storage tanks must be situated between the front wheel axis and the rearmost gearbox casing longitudinally, and must be no further than the lateral extremities of the survival cell are from the longitudinal axis of the car.

### 7.2 Longitudinal location of oil system :

No other part of the car containing oil may be situated behind the complete rear wheels.

### 7.3 Catch tank :

In order to avoid the possibility of oil being deposited on the track, the engine sump breather must vent into the main engine air intake system.

### 7.4 Transversal location of oil system :

No part of the car containing oil may be more than 700mm from the car centre line.

### 7.5 Coolant header tanks :

[Any](#) header tank [used](#) on the car [with a water based coolant](#) must be fitted with an FIA approved pressure relief valve which is set to a maximum of 3.75 bar gauge pressure, details of the relief valve may be found in the Appendix to [the Technical Regulations](#). If the car is not fitted with a header tank, an alternative position must be approved by the FIA.

### 7.6 Cooling systems :

The cooling systems of the power unit, including that of the charge air, must not intentionally make use of the latent heat of vaporisation of any fluid with the exception of fuel for the normal purpose of combustion in the engine as described in Article 5.14.

### 7.7 Oil and coolant lines :

7.7.1 No lines containing coolant or lubricating oil may pass through the cockpit.

7.7.2 All lines must be fitted in such a way that any leakage cannot result in the accumulation of fluid in the cockpit.

7.7.3 No hydraulic fluid lines may have removable connectors inside the cockpit.



## **ARTICLE 8 : ELECTRICAL SYSTEMS**

### **8.1 Software and electronics inspection :**

**8.1.1** Prior to the start of each season the complete electrical system on the car must be examined and all on board and communications software must be inspected by the FIA Technical Department.

The FIA must be notified of any changes prior to the Event at which such changes are intended to be implemented.

**8.1.2** All re-programmable microprocessors must have a mechanism that allows the FIA to accurately identify the software version loaded.

Acceptable solutions to verify the programmed software may be found in the Appendix to the Technical Regulations.

**8.1.3** All electronic units containing a programmable device, and which are intended for use at an Event, must be presented to the FIA before each Event in order that they can be identified.

**8.1.4** All on-car software versions must be registered with the FIA before use.

**8.1.5** The FIA must be able to test the operation of any compulsory electronic safety systems at any time during an Event.

### **8.2 Control electronics :**

**8.2.1** All components of the power unit, gearbox, clutch and differential, in addition to all associated actuators, must be controlled by an Electronic Control Unit (ECU) which has been manufactured by an FIA designated supplier to a specification determined by the FIA.

The ECU may only be used with FIA approved software and may only be connected to the control system wiring loom, sensors and actuators in a manner specified by the FIA.

Additional information regarding the ECU software versions and setup may be found in the Appendix to the Technical Regulations.

**8.2.2** All control sensors, actuators and FIA monitoring sensors will be specified and homologated by the FIA. Details of the homologation process may be found in the Appendix to the Technical Regulations.

Each and every component of the control system will be sealed and uniquely identified and their identities tracked through their life cycle.

These components and units may not be disassembled or modified in any way and seals and identifiers must remain intact and legible.

**8.2.3** The control system wiring loom connectivity must be approved by the FIA.

All wiring looms must be built to ensure that each control sensor and each control actuator connected to the ECU is electrically isolated from logging-only sensors connected to either the ECU or a team data acquisition unit.

In general, there must be no active or passive electronic component in the control loom. Exceptions (e.g. termination resistors) must be approved by the FIA before use.

Additional wiring guidelines may be found in the Appendix to the Technical Regulations.

**8.2.4** If sensor faults or errors are detected by the driver or by the on-board software, back-up sensors may be used and different settings may be manually or automatically selected. However, any back-up sensor or new setting chosen in this way must not enhance the performance of the car. Any driver default turned on during the start lockout period may not be turned off before the end of that period.

**8.2.5** Pneumatic valve pressure may only be controlled via a passive mechanical regulator or from the ECU and its operation will be monitored by the ECU.

### **8.3 Start systems :**

**8.3.1** Any system, the purpose and/or effect of which is to detect when a race start signal is given, is not permitted.

**8.3.2** The ECU will implement a “lockout” period after each race start or pit stop during which a number of power unit and clutch related functions will be frozen or disabled. Details of the strategy may be found in the Appendix to the Technical Regulations.

### **8.4 Data acquisition :**

**8.4.1** To assist scrutineering, the FIA requires unlimited access to the following ECU information before, during and after any track session :

- a) Application parameter configurations.
- b) Logged data and events.
- c) Real-time telemetry data and events.

Throughout the Event, the logging memory and events buffer may only be cleared by an FIA engineer.

The FIA must have the ability to connect to the ECU via a jump battery using an FIA laptop. The teams should make a jump battery available at all times during the Event.

The teams should transfer the real-time telemetry data and events on the FIA network as requested by, and in the format defined by, the FIA.

Prior to the race, the ECU data logger must be configured in such a way that allows logging of data for at least two hours and fifteen minutes without exceeding the size of the logger memory.

**8.4.2** Any data acquisition system, telemetry system or associated sensors additional to those provided by the ECU and ADR must be physically separate and electrically isolated from any control electronics with the exception of :

- a) The primary regulated voltage supply.
- b) The car system ground.
- c) Communication links to the ECU, telemetry unit and ADR.
- d) Power supplies, provided they are not used to power any control electronics, control sensors or actuators.
- e) Time synchronisation lines.
- f) Power unit synchronisation lines.
- g) An umbilical loom whose connector will remain disconnected when the car is moving.

No junction box or break-out box may be shared between the ECU system and a team data acquisition system.

### **8.5 Telemetry :**

**8.5.1** Telemetry systems must operate at frequencies which have been approved by the FIA.

**8.5.2** Pit to car telemetry is prohibited.

### **8.6 Driver controls and displays :**

**8.6.1** Any electronic modules used for driver information displays and switch inputs must be supplied by an FIA designated supplier to a specification determined by the FIA and be suitably housed by each team.

**8.6.2** Any single control device, including but not limited to switch, button, paddle or pedal, used by the driver must be connected to a single analogue or digital input of the ECU.

Exceptions will be considered to handle the following :

- a) A spare clutch paddle sensor.
- b) A spare accelerator pedal sensor.
- c) A separate "kick-down" sensor which indicates that the accelerator pedal has been deliberately depressed past full travel.
- d) Multiplexed shift signals.
- e) A spare brake pressure and pedal sensor.

Any interface between such driver operated devices and the ECU must be approved by the FIA.

**8.6.3** Any alteration of the driver's controls may only be commanded by direct, deliberate and primary driver actions.

The logged raw signals from the ECU inputs must provide a true representation of the driver's actions.

## **8.7 Driver radio :**

Other than authorised connections to the FIA ECU, any voice radio communication system between car and pits must be stand-alone and must not transmit or receive other data. All such communications must be open and accessible to both the FIA and broadcasters.

## **8.8 Accident data recorders (ADR) :**

**8.8.1** The recorder must be fitted and operated :

- a) In accordance with the instructions of the FIA.
- b) Symmetrically about the car centre line and with its top facing upwards.
- c) With each of its 12 edges parallel to an axis of the car.
- d) Less than 200mm above the reference plane.
- e) In a position within the cockpit which is readily accessible at all times from within the cockpit without the need to remove skid block or floor.
- f) In order that the entire unit lies between 30% and 50% of the wheelbase of the car.
- g) Via anti-vibration mountings giving a clearance of 5mm to all other objects.
- h) With its connectors facing forwards.
- i) In order that its status light is visible when the driver is seated normally.
- j) In order that the download connector is easily accessible when the driver is seated normally and without the need to remove bodywork.

**8.8.2** The recorder must be connected to two external 500g accelerometers which are solidly bolted to the survival cell, on the car centre line, using four 4mm bolts. One must be as close to the nominal car centre of gravity as practical and the other as far forward as possible inside the survival cell. The forward accelerometer may be mounted to the underside of the top surface provided it is solidly bolted to a structural part of the survival cell.

**8.8.3** The recorder must be powered from a nominally 12V supply such that its internal battery can be recharged at all times when the car's electronic systems are powered and when the car systems are switched off, but a jump battery or umbilical is connected.

**8.8.4** An ADR and two accelerometers must be fitted to every car at all times during an Event and at all tests attended by more than one team.

**8.8.5** Details of the connections to the ADR may be found in the Appendix to the Technical Regulations.

**8.9 Track signal information display :**

All cars must be fitted with red, blue and yellow cockpit lights the purpose of which are to give drivers information concerning track signals or conditions. The lights must be LEDs each with a minimum diameter of 5mm and fitted directly in the driver's normal line of sight.

Details of the light control system, which must be fitted to every car, may be found in the Appendix to the Technical Regulations.

**8.10 Medical warning system :**

In order to give rescue crews an immediate indication of accident severity each car must be fitted with a warning light which is connected to the FIA data logger.

The light must face upwards and be recessed into the top of the survival cell no more than 150mm from the car centre line and the front of the cockpit opening and as near to the clutch disengagement system, as described in Article 9.4, as is practical.

Details of the light and its control system may be found in the Appendix to the Technical Regulations.

**8.11 Installation of electrical systems or components :**

**8.11.1** Exceptionally, each car may be equipped with a maximum of five test sensor installations, which do not comply with the Technical Regulations, during P1 and P2, provided :

- a) They could not materially affect the outcome any of the impact tests described in Articles 16.2, 16.3 and [16.4](#).
- b) They comply with Articles 3.3, 3.4.1, 3.6, 3.14.1 and 3.14.2.
- c) They do not reduce or affect driver visibility.
- d) They do not obstruct on-board camera views.

Any such test sensor installations do not need to be homologated.

The FIA technical delegate must be notified of any intended test sensor installations prior to the Event at which they are first used.

**8.11.2** Competitors must be notified of any changes to the installation instructions for any FIA specified systems or components before 30 June of the previous season.

## **ARTICLE 9 : TRANSMISSION SYSTEM**

### **9.1 Transmission types :**

No transmission system may permit more than two wheels to be driven.

### **9.2 Clutch control :**

The following applies only to the main drivetrain clutch or clutches, any clutch used exclusively as part of an ERS is exempt.

- 9.2.1 If multiple clutch operating devices are used, they must all have the same mechanical travel characteristics and be mapped identically.
- 9.2.2 Designs which allow specific points along the travel range of the clutch operating device to be identified by the driver or assist him to hold a position are not permitted.
- 9.2.3 The minimum and maximum travel positions of the clutch operating device must correspond to the clutch fully engaged normal rest position and fully disengaged (incapable of transmitting any useable torque) positions respectively.
- 9.2.4 Designs or systems which in addition to typical inherent hydraulic and mechanical properties are designed to, or have the effect of, adjusting or otherwise influencing the amount, or rate, of engagement being demanded by the FIA ECU, are not permitted.
- 9.2.5 The amount by which the clutch is engaged must be controlled solely and directly by the driver with the exception of :
  - a) Stall prevention.
  - b) Gearshifts.
  - c) Bite point finder where brake pressure, wheel speed and driver clutch demand safeguards are used.
  - d) De-clutch protections.
  - e) Drivetrain protection on the track outside of any start lockout period or immediately following stall prevention activation only.
  - f) Test signals enabled only when the car is connected to the garage system.

The relationship between the clutch operating device in the cockpit and the amount of clutch engagement may be non-linear but must remain fixed.

- 9.2.6 When the clutch operating device is released from its maximum travel position it must return to its resting position within 50ms.

The maximum delay allowed, computed from the respective positions as recorded by the ADR or ECU, between the clutch driver control input signal and the corresponding output demand being achieved is 50ms.

- 9.2.7 Any device or system which notifies the driver of the amount of clutch slip or engagement is not permitted.

### **9.3 Traction control :**

No car may be equipped with a system or device which is capable of preventing the driven wheels from spinning under power or of compensating for excessive torque demand by the driver.

Any device or system which notifies the driver of the onset of wheel spin is not permitted.

#### **9.4 Clutch disengagement :**

All cars must be fitted with a means of disengaging the clutch for a minimum of fifteen minutes in the event of the car coming to rest with the engine stopped. This system must be in working order throughout the Event even if the main hydraulic, pneumatic or electrical systems on the car have failed. This system must also disconnect any ERS system fitted to the car.

In order that the driver or a marshal may activate the system in less than five seconds, the switch or button which operates it must :

- a) Face upwards and be recessed into the top of the survival cell no more than 150mm from the car centre line.
- b) Be designed in order that a marshal is unable to accidentally re-engage the clutch.
- c) Be less than 150mm from the front of the cockpit opening.
- d) Be marked with a letter "N" in red at least 40mm tall, with a line thickness of at least 4mm, inside a white circle of at least 50mm diameter with a red edge with a line thickness of at least 2mm.

#### **9.5 Gearboxes :**

**9.5.1** A gearbox is defined as all the parts in the drive line which transfer torque from the power unit output shaft, as described in Article 5.3.2, to the drive shafts (the drive shafts being defined as those components which transfer drive torque from the sprung mass to the un-sprung mass). It includes all components whose primary purpose is for the transmission of power or mechanical selection of gears, bearings associated with these components and the casing in which they are housed.

**9.5.2** In this context the following parts are not considered part of the gearbox and may be changed without incurring a penalty under the F1 Sporting Regulations. If changing any of these parts involves breaking an FIA applied seal this may be done but must be carried out under FIA supervision :

- a) The clutch assembly and the power unit output shaft, provided this is located prior to any mechanical speed reduction from the engine.
- b) The clutch actuator and clutch release bearing(s).
- c) Inboard driveshaft joints and seals but not their housing if that housing is integral with the gearbox output shaft and therefore part of the sprung mass.
- d) The hydraulic system prior to the point at which it produces direct mechanical movement of the gear selection mechanism by means of hydraulic actuator(s).
- e) Oil, oil pumps, oil filters, oil seals, oil coolers and any associated hoses or pipes.
- f) Electrical sensors, actuators, servo valves and wiring.
- g) Any parts associated with the suspension or functioning of the sprung suspension that are attached to the gearbox casing.
- h) The rear impact structure provided it can be separated from any gearbox casing.
- i) Any other component mounted to the casing whose primary purpose is unconnected with the transmission of power or selection of gears.

#### **9.6 Gear ratios :**

**9.6.1** The number of forward gear ratios must be 8.

**9.6.2** Each competitor must nominate the forward gear ratios (calculated from engine crankshaft to drive shafts) to be employed within their gearbox. These nominations must be declared to the FIA technical delegate at or before the first Event of the Championship. For 2014 only a competitor may re-nominate these ratios once within the Championship season, in which case the original nomination becomes immediately void. Ratio re-nominations must be declared as a set.

**9.6.3** No forward gear ratio pair may be :

- a) Less than 12mm wide when measured across the gear tooth at the root diameter or any point 1mm above or below the root diameter. Above this area each side of the gear teeth may be chamfered by a maximum of 10°. In addition, a chamfer or radius not exceeding 2.0mm may be applied to the sides and the tip of the teeth.
- b) Less than 85mm between centres.
- c) Less than 600g in weight (excluding any integral shaft or collar). If an integral shaft or collar is to be excluded the mass of this may be shown by calculation assuming the gear to be 12mm wide and the shaft geometry to be the same as that where slide on gears are used.

**9.6.4** Gear ratios must be made from steel.

**9.6.5** Continuously variable transmission systems are not permitted to transmit the power of the power unit defined in Article 5.1.

## **9.7 Reverse gear :**

All cars must be able to be driven in reverse by the driver at any time during the Event.

## **9.8 Gear changing :**

**9.8.1** Automatic gear changes are considered a driver aid and are therefore not permitted.

For the purposes of gear changing, the clutch and power unit torque need not be under the control of the driver.

**9.8.2** Gear changing is restricted during the following periods :

One gear change is permitted after the race has started and before the car speed has reached 80km/h, provided every gear fitted to the car is capable of achieving at least 80km/h at 15,000rpm.

**9.8.3** The minimum possible gear the driver is able to select must remain fixed whilst the car is moving.

Each individual gear change must be separately initiated by the driver and, within the mechanical constraints of the gearbox; the requested gear must be engaged immediately unless over-rev protection is used to reject the gear shift request. Once a gear change request has been accepted no further requests may be accepted until the first gear change has been completed.

Multiple gear changes may only be made under Article 5.22 or when a shift to gearbox neutral is made following a request from the driver.

If an over-rev protection strategy is used this may only prevent engagement of the target gear, it must not induce a delay greater than 50ms. If a gear change is refused in this way, engagement may only follow a new and separate request made by the driver.

Any de-bounce time used to condition driver gear change requests must be fixed.

**9.8.4** The maximum permitted duration for down changes and up changes is 300ms and 200ms respectively. The maximum permitted delay for the latter is 80ms from the time of the driver request to the original gear being disengaged.

The duration of a gear change is defined as the time from the request being made to the point at which all gear change processes are terminated. If for any reason the gear change cannot be completed in that time the car must be left in neutral or the original gear.

**9.8.5** Distance channel or track position is not considered an acceptable input to gearbox control.

**9.9 Torque transfer systems :**

**9.9.1** Any system or device the design of which is capable of transferring or diverting torque from a slower to a faster rotating wheel is not permitted.

**9.9.2** Any device which is capable of transferring torque between the principal axes of rotation of the two front wheels is prohibited.



## ARTICLE 10 : SUSPENSION AND STEERING SYSTEMS

### 10.1 Sprung suspension :

10.1.1 Cars must be fitted with sprung suspension.

10.1.2 The suspension system must be so arranged that its response results only from changes in load applied to the wheels.

### 10.2 Suspension geometry :

10.2.1 With the steering wheel fixed, the position of each wheel centre and the orientation of its rotation axis must be completely and uniquely defined by a function of its principally vertical suspension travel, save only for the effects of reasonable compliance which does not intentionally provide further degrees of freedom.

10.2.2 Any powered device which is capable of altering the configuration or affecting the performance of any part of the suspension system is forbidden.

10.2.3 No adjustment may be made to the suspension system while the car is in motion.

### 10.3 Suspension members :

10.3.1 With the exception of minimal local changes of section for the passage of hydraulic brake lines, electrical wiring and wheel tethers or the attachment of flexures, rod ends and spherical bearings, the cross-sections of each member of every suspension component, when taken normal to a straight line between the inner and outer attachment points, must :

- a) Intersect the straight line between the inner and outer attachment points.
- b) Have a major axis no greater than 100mm.
- c) Have an aspect ratio no greater than 3.5:1.
- d) [Have no dimension which exceeds 100mm.](#)

The major axis will be defined as the largest [axis of symmetry](#) of any such cross-section. [The length of the intersection of this axis with the cross-section must not be less than 95% of the maximum dimension of the section.](#)

10.3.2 Suspension members having shared attachment points will be considered by a virtual dissection into discrete members.

10.3.3 No major axis of a cross section of a suspension member, when assessed in accordance with Article 10.3.1, may subtend an angle greater than 5° to the reference plane when projected onto, and normal to, a vertical plane on the car centre line with the car set to the nominal design ride height.

10.3.4 Non-structural parts of suspension members are considered bodywork.

10.3.5 There may be no more than six suspension members connecting each suspension upright to the fully sprung part of the car.

Redundant suspension members are not permitted.

10.3.6 In order to help prevent a wheel becoming separated in the event of all suspension members connecting it to the car failing, flexible tethers each with a cross sectional area greater than 110mm<sup>2</sup> must be fitted. The sole purpose of the tethers is to prevent a wheel becoming separated from the car, they should perform no other function.

The tethers and their attachments must also be designed in order to help prevent a wheel making contact with the driver's head during an accident.

Each wheel must be fitted with two tethers each of which [comply with FIA standard 8864-2013.](#)

Each tether must have its own separate attachments at both ends which :

- a) Are able to withstand a tensile force of 70kN in any direction within a cone of 45° (included angle) measured from the load line of the relevant suspension member.
- b) On the survival cell or gearbox are separated by at least 100mm measured between the centres of the two attachment points.
- c) On each wheel/upright assembly are separated by at least 90° radially with respect to the axis of the wheel and 100mm measured between the centres of the two attachment points.
- d) Are able to accommodate tether end fittings with a minimum inside diameter of 15mm.

Furthermore, no suspension member may contain more than one tether.

Each tether must exceed 450mm in length and must utilise end fittings which result in a tether bend radius greater than 7.5mm.

#### **10.4 Steering :**

- 10.4.1** Any steering system which permits the re-alignment of more than two wheels is not permitted.
- 10.4.2** Power assisted steering systems may not be electronically controlled or electrically powered. No such system may carry out any function other than reduce the physical effort required to steer the car.
- 10.4.3** No part of the steering wheel or column, nor any part fitted to them, may be closer to the driver than a plane formed by the entire rear edge of the steering wheel rim. All parts fixed to the steering wheel must be fitted in such a way as to minimise the risk of injury in the event of a driver's head making contact with any part of the wheel assembly.
- 10.4.4** The steering wheel, steering column and steering rack assembly must pass an impact test, details of the test procedure may be found in [Article 16.5](#).

#### **10.5 Suspension Uprights :**

- 10.5.1** The suspension uprights may only be made from UNS A92014, UNS A92618, UNS A97075 or EN/AA 7022 aluminium alloys.
- 10.5.2** The loads from the suspension members and wheel bearings must individually and entirely be carried by the suspension upright. Exceptionally up to three suspension members may be connected together by titanium, aluminium alloy or steel components before their load is passed into the upright.
- 10.5.3** Suspension uprights may not protrude beyond :
  - a) A vertical plane parallel to the inner face of the wheel rim and displaced from it by 120mm toward the car centre line.
  - b) A radius of 180mm from the centre of the wheel when viewed from the side.

The above measurements will be made with the wheel held in a vertical position.

## ARTICLE 11 : BRAKE SYSTEM

### 11.1 Brake circuits and pressure distribution :

11.1.1 With the exception of a power unit, all cars must be equipped with only one brake system. This system must comprise solely of two separate hydraulic circuits operated by one pedal, one circuit operating on the two front wheels and the other on the two rear wheels. This system must be designed so that if a failure occurs in one circuit the pedal will still operate the brakes in the other.

The diameters of the master cylinders acting on the two rear wheels and the two front wheels must be within 2mm of each other and have the same available travel. The same principle must be applied in multi-stage master cylinder designs.

11.1.2 The brake system must be designed in order that the force exerted on the brake pads within each circuit are the same at all times.

11.1.3 Any powered device, other than the system referred to in Article 11.7, which is capable of altering the configuration or affecting the performance of any part of the brake system is forbidden.

11.1.4 Any change to, or modulation of, the brake system whilst the car is moving must be made by the driver's direct physical input or by the system referred to in Article 11.7, and may not be pre-set.

### 11.2 Brake calipers :

11.2.1 All brake calipers must be made from aluminium materials with a modulus of elasticity no greater than 80Gpa.

11.2.2 No more than two attachments may be used to secure each brake caliper to the car.

11.2.3 No more than one caliper, with a maximum of six pistons, is permitted on each wheel.

11.2.4 The section of each caliper piston must be circular.

### 11.3 Brake discs and pads :

11.3.1 No more than one brake disc is permitted on each wheel.

11.3.2 All discs must have a maximum thickness of 28mm and a maximum outside diameter of 278mm.

11.3.3 No more than two brake pads are permitted on each wheel.

### 11.4 Air ducts :

Air ducts around the front and rear brakes will be considered part of the braking system and shall not protrude beyond :

- a) A plane parallel to the ground situated at a distance of 160mm above the horizontal centre line of the wheel.
- b) A plane parallel to the ground situated at a distance of 160mm below the horizontal centre line of the wheel.
- c) A vertical plane parallel to the inner face of the wheel rim and displaced from it by 120mm toward the car centre line.

Furthermore :

- d) When viewed from the side the ducts must not protrude forwards beyond a radius of 330mm from the centre of the wheel or backwards beyond a radius of 180mm from the centre of the wheel.
- e) The ducts may not rotate with the wheels nor may they, or any of their mountings, protrude axially beyond the outer face of the wheel fastener.

- f) No part of the car, other than those specifically defined in Articles 12.8.1 and 12.8.2, may obscure any part of the wheel when viewed from the outside of the car towards the car centre line along the axis of the wheel.

All measurements will be made with the wheel held in a vertical position.

#### **11.5 Brake pressure modulation :**

**11.5.1** No braking system may be designed to prevent wheels from locking when the driver applies pressure to the brake pedal.

**11.5.2** No braking system may be designed to increase the pressure in the brake calipers above that achievable by the driver applying pressure to the pedal under all conditions.

#### **11.6 Liquid cooling :**

Liquid cooling of the brakes is forbidden.

#### **11.7 Rear brake control system :**

The pressure in the rear braking circuit may be provided by a powered control system provided that :

- a) The driver brake pedal is connected to a hydraulic master cylinder that generates a pressure source that can be applied to the rear braking circuit if the powered system is disabled.
- b) The powered system is controlled by the control electronics described in Article 8.2.

## **ARTICLE 12 : WHEELS AND TYRES**

### **12.1 Location :**

Wheels must be external to the bodywork in plan view, with the rear aerodynamic device removed.

### **12.2 Number of wheels :**

The number of wheels is fixed at four.

### **12.3 Wheel material :**

Wheels must be made from AZ70 or AZ80 magnesium alloys.

### **12.4 Wheel dimensions :**

**12.4.1** Complete wheel width must lie between 305mm and 355mm when fitted to the front of the car and between 365mm and 380mm when fitted to the rear.

**12.4.2** Complete wheel diameter must not exceed 660mm when fitted with dry-weather tyres or 670mm when fitted with wet weather tyres.

**12.4.3** Complete wheel width and diameter will be measured horizontally at axle height, with the wheel held in a vertical position and when fitted with new tyres inflated to 1.4 bar.

**12.4.4** Wheel dimensions and geometry must comply with the following specifications :

- a) The minimum wheel thickness is 3.0mm.
- b) The minimum bead thickness is 4.0mm (measured from hump to outer edge of the lip).
- c) The ETRTO standard bead profile is prescribed.
- d) The tyre mounting widths are 12" (304.8mm +/-0.5mm) front; 13.7" (348.0mm +/-0.5mm) rear.
- e) The wheel lip thickness is 9mm (+/-1mm).
- f) The outer lip diameter is 358mm (+/-1mm).
- g) A lip recess of maximum 1.0mm depth between a radius of 165mm and a radius of 173mm from wheel axis is permitted (for wheel branding, logo, part number, etc.).
- h) With the exception of the wheel lip, only a single turned profile with a maximum thickness of 8mm is allowed radially outboard of the exclusion zones specified in Article 12.4.5.
- i) The design of the wheel must meet the general requirements of the tyre supplier for the mounting and dismounting of tyres including allowance for sensors and valves.
- j) The wheel design cannot be handed between left and right designs.

**12.4.5** No wheel material is permitted in the following exclusion zones :

- a) A concentric cylinder of diameter 305mm and length 115mm positioned with its inner face lying in the same plane as the inboard face of the front wheel.
- b) A concentric cylinder of diameter 305mm and length 25mm positioned with its outer face lying in the same plane as the outboard face of the front wheel.
- c) A concentric cylinder of diameter 305mm and length 100mm positioned with its inner face lying in the same plane as the inboard face of the rear wheel.
- d) A concentric cylinder of diameter 305mm and length 30mm positioned with its outer face lying in the same plane as the outboard face of the rear wheel.

**12.4.6** When viewed perpendicular to the plane formed by the outer face of the wheel and between the diameters of 120mm and 270mm the wheel may have an area of no greater than 24,000mm<sup>2</sup>.

## **12.5 Supply of tyres :**

**12.5.1** All tyres must be used as supplied by the manufacturer, any modification or treatment such as cutting, grooving, the application of solvents or softeners is prohibited. This applies to dry, intermediate and wet-weather tyres.

**12.5.2** If, in the opinion of the appointed tyre supplier and FIA technical delegate, the nominated tyre specification proves to be technically unsuitable, the stewards may authorise the use of additional tyres to a different specification.

**12.5.3** If, in the interests of maintaining current levels of circuit safety, the FIA deems it necessary to reduce tyre grip, it shall introduce such rules as the tyre supplier may advise or, in the absence of advice which achieves the FIA's objectives, specify the maximum permissible contact areas for front and rear tyres.

## **12.6 Specification of tyres :**

**12.6.1** An intermediate tyre is one which has been designed for use on a wet or damp track.

All intermediate tyres must, when new, have a contact area which does not exceed 280cm<sup>2</sup> when fitted to the front of the car and 440cm<sup>2</sup> when fitted to the rear. Contact areas will be measured over any square section of the tyre which is normal to and symmetrical about the tyre centre line and which measures 200mm x 200mm when fitted to the front of the car and 250mm x 250mm when fitted to the rear. For the purposes of establishing conformity, void areas which are less than 2.5mm in depth will be deemed to be contact areas.

**12.6.2** A wet-weather tyre is one which has been designed for use on a wet track.

All wet-weather tyres must, when new, have a contact area which does not exceed 240cm<sup>2</sup> when fitted to the front of the car and 375cm<sup>2</sup> when fitted to the rear. Contact areas will be measured over any square section of the tyre which is normal to and symmetrical about the tyre centre line and which measures 200mm x 200mm when fitted to the front of the car and 250mm x 250mm when fitted to the rear. For the purposes of establishing conformity, void areas which are less than 5.0mm in depth will be deemed to be contact areas.

**12.6.3** Tyre specifications will be determined by the FIA no later than 1 September of the previous season. Once determined in this way, the specification of the tyres will not be changed during the Championship season without the agreement of at least 70% of the competing teams.

Notwithstanding the above, the FIA may decide to change the specification during the Championship season for safety reasons without notice or delay.

## **12.7 Treatment of tyres :**

**12.7.1** Tyres may only be inflated with air or nitrogen.

**12.7.2** Any process the intent of which is to reduce the amount of moisture in the tyre and/or in its inflation gas is forbidden.

**12.7.3** The only permitted type of tyre heating devices are blankets which use resistive heating elements. The heating elements may only act upon the outer tyre surface.

## **12.8 Wheel assembly :**

**12.8.1** The only parts which may be physically attached to the wheel in addition to the tyre are surface treatments for appearance and protection, valves for filling and discharging the tyre, wheel fasteners, balance weights, drive pegs, tyre pressure and temperature monitoring devices and spacers on the inboard mounting face of identical specification on all wheels for the same axle.

- 12.8.2** The wheel must be attached to the car with a single fastener. The outer diameter of the fastener must not exceed 105mm and the axial length must not exceed 75mm. The wheel fastener may not attach or mount any part to the car except the wheel assembly described in Article 12.8.1.
- 12.8.3** A complete wheel must contain a single fixed internal gas volume. No valves, bleeds or permeable membranes are permitted other than to inflate or deflate the tyre whilst the car is stationary.
- 12.8.4** Devices which are used to fit or remove wheel fasteners may only be powered by compressed air or nitrogen.
- Any sensor systems may only act passively.

## **ARTICLE 13 : COCKPIT**

### **13.1 Cockpit opening :**

**13.1.1** In order to ensure that the opening giving access to the cockpit is of adequate size, the template shown in Drawing 2 will be inserted into the survival cell and bodywork.

During this test the steering wheel, steering column, seat and all padding required by Articles 14.6.1-6 (including fixings), may be removed and :

- a) The template must be held horizontal and lowered vertically from above the car until its lower edge is 525mm above the reference plane.
- b) Referring to Drawing 2, the edge of the template which lies on the line d-e must be no less than 1800mm behind the line A-A shown in Drawing 5.

Any measurements made from the cockpit entry template (when referred to in Articles 13.1.3, 14.3.3, 15.2.2, 15.4.5, 15.4.6, 15.5.4, 16.3 and 18.5), must also be made whilst the template is held in this position.

**13.1.2** The forward extremity of the cockpit opening, even if structural and part of the survival cell, must be at least 50mm in front of the steering wheel.

**13.1.3** The driver must be able to enter and get out of the cockpit without it being necessary to open a door or remove any part of the car other than the steering wheel. When seated normally, the driver must be facing forwards and the rearmost part of his crash helmet may be no more than 125mm forward of the rear edge of the cockpit entry template.

**13.1.4** From his normal seating position, with all seat belts fastened and whilst wearing his usual driving equipment, the driver must be able to remove the steering wheel and get out of the car within 5 seconds and then replace the steering wheel in a total of 10 seconds.

For this test, the position of the steered wheels will be determined by the FIA technical delegate and after the steering wheel has been replaced steering control must be maintained.

### **13.2 Steering wheel :**

The steering wheel must be fitted with a quick release mechanism operated by pulling a concentric flange installed on the steering column behind the wheel.

### **13.3 Internal cross section :**

**13.3.1** A free vertical cross section, which allows the outer template shown in Drawing 3 to be passed vertically through the cockpit to a point 100mm behind the face of the rearmost pedal when in the inoperative position, must be maintained over its entire length.

The only things which may encroach on this area are the steering wheel and any padding that is required by Article 14.6.7.

**13.3.2** A free vertical cross section, which allows the inner template shown in Drawing 3 to be passed vertically through the cockpit to a point 100mm behind the face of rearmost pedal when in the inoperative position, must be maintained over its entire length.

The only thing which may encroach on this area is the steering wheel.

**13.3.3** The driver, seated normally with his seat belts fastened and with the steering wheel removed must be able to raise both legs together so that his knees are past the plane of the steering wheel in the rearward direction. This action must not be prevented by any part of the car.

### **13.4 Position of the driver's feet :**

**13.4.1** The survival cell must extend from behind the fuel tank in a forward direction to a point at least 300mm in front of the driver's feet, with his feet resting on the pedals and the pedals in the inoperative position.

**13.4.2** When he is seated normally, the soles of the driver's feet, resting on the pedals in the inoperative position, must not be situated forward of the front wheel centre line.



## ARTICLE 14 : SAFETY EQUIPMENT

### 14.1 Fire extinguishers :

- 14.1.1** All cars must be fitted with a fire extinguishing system which will discharge into the cockpit and into the engine compartment.
- 14.1.2** Any extinguishant listed in the Appendix to the Technical Regulations is permitted.
- 14.1.3** The quantity of extinguishant may vary according to the type of extinguishant used, a list of quantities may be found in the Appendix to the Technical Regulations.
- 14.1.4** When operated, the fire extinguishing system must discharge 95% of its contents at a constant pressure in no less than 10 seconds and no more than 30 seconds.  
If more than one container with extinguishant is fitted, they must be released simultaneously.
- 14.1.5** Each pressure vessel must be equipped with a means of checking its pressure which may vary according to the type of extinguishant used. A list of pressures may be found in the Appendix to the Technical Regulations.
- 14.1.6** The following information must be visible on each container with extinguishant :
- Type of extinguishant ;
  - Weight or volume of the extinguishant ;
  - Date the container must be checked which must be no more than two years after the date of filling.
- 14.1.7** All parts of the extinguishing system must be situated within the survival cell and all extinguishing equipment must withstand fire.
- 14.1.8** Any triggering system having its own source of energy is permitted, provided it is possible to operate all extinguishers should the main electrical circuits of the car fail.  
The driver must be able to trigger the extinguishing system manually when seated normally with his safety belts fastened and the steering wheel in place.  
Furthermore, a means of triggering from the outside must be combined with the circuit breaker switches described in [Article 14.2.1](#). They must be marked with a letter "E" in red at least 80mm tall, with a line thickness of at least 8mm, inside a white circle of at least 100mm diameter with a red edge with a line thickness of at least 4mm.
- 14.1.9** The system must work in any position, even when the car is inverted.
- 14.1.10** All extinguisher nozzles must be suitable for the extinguishant and be installed in such a way that they are not directly pointed at the driver.

### 14.2 Master switch :

- 14.2.1** The driver, when seated normally with the safety belts fastened and the steering wheel in place, must be able to cut off the electrical circuits to the ignition, all fuel pumps and the rear light by means of a spark proof circuit breaker switch.  
This switch must be located on the dashboard and must be clearly marked by a symbol showing a red spark in a white edged blue triangle.
- 14.2.2** There must also be two exterior horizontal handles which are capable of being operated from a distance by a hook. These handles must be situated at the base of the main roll over structure on both sides of the car and have the same function as the switch described in Article 14.2.1.

### 14.3 Rear view mirrors :

- 14.3.1** All cars must have two mirrors mounted so that the driver has visibility to the rear and both sides of the car.

**14.3.2** The reflective surface of each mirror must be at least 150mm wide, this being maintained over a height of at least 50mm. Additionally, each corner may have a radius no greater than 10mm.

**14.3.3** All parts of the rear view mirrors, including their housings and mountings, must be situated between 250mm and 500mm from the car centre line and between 550mm and 750mm from the rear edge of the cockpit entry template.

**14.3.4** The FIA technical delegate must be satisfied by a practical demonstration that the driver, when seated normally, can clearly define following vehicles.

For this purpose, the driver shall be required to identify any letter or number, 150mm high and 100mm wide, placed anywhere on boards behind the car, the positions of which are detailed below :

Height : From 400mm to 1000mm from the ground.

Width : 4000mm either side of the car centre line.

Position : 10m behind the rear wheel centre line.

#### **14.4 Safety belts :**

It is mandatory to wear two shoulder straps, one abdominal strap and two straps between the legs. These straps must be securely fixed to the car and must comply with FIA standard 8853/98.

#### **14.5 Rear light :**

All cars must have a red light in working order throughout the Event which :

- a) Has been supplied by an FIA designated manufacturer.
- b) Faces rearwards at 90° to the car centre line and the reference plane.
- c) Is clearly visible from the rear.
- d) Is mounted nominally on the car centre line.
- e) Is mounted 300mm (+/-5mm) above the reference plane.
- f) Is no less than 595mm behind the rear wheel centre line measured parallel to the reference plane.
- g) Can be switched on by the driver when seated normally in the car.

The two measurements above will be taken to the centre of the rear face of the light unit.

#### **14.6 Cockpit padding :**

**14.6.1** All cars must be equipped with three areas of padding for the driver's head which :

- a) Are so arranged that they can be removed from the car as one part.
- b) Are located by two horizontal pegs behind the driver's head and two fixings, which are clearly indicated and easily removable without tools, at the front corners.
- c) Are made from a material which is suitable for the relevant ambient air temperature, details of approved materials and the temperature bands in which they should be used may be found in the Appendix to the Technical Regulations.
- d) Are covered, in all areas where the driver's head is likely to make contact, with two plies of Aramid fibre/epoxy resin composite pre-preg material in plain weave 60gsm fabric with a cured resin content of 50% (+/-5%) by weight.
- e) Are positioned so as to be the first point of contact for the driver's helmet in the event of an impact projecting his head towards them during an accident.

**14.6.2** The first area of padding for the driver's head must be positioned behind him and be between 75mm and 90mm thick over an area of at least 40000mm<sup>2</sup>. If necessary, and only for driver comfort, an additional piece of padding no greater than 10mm thick may be attached to this headrest provided it is made from a similar material which incorporates a low friction surface.

**14.6.3** Whilst he is seated normally the two further areas of padding for the driver's head must be positioned in an area bounded by two vertical lines and one horizontal line through the front, rear and lower extremities of the driver's helmet (on the car centre line), and the upper surface of the survival cell.

Each of these must cover an area greater than 33000mm<sup>2</sup> when viewed from the side of the car and be no less than 95mm thick, this minimum thickness being maintained to the upper edges of the survival cell and over their entire length. The minimum thickness will be assessed perpendicular to the car centre line but a radius no greater than 10mm may be applied along their upper inboard edges.

If necessary, and only for driver comfort, an additional piece of padding no greater than 10mm thick may be attached to these headrests provided they are made from a similar material which incorporates a low friction surface.

**14.6.4** Forward of the side areas of padding further cockpit padding must be provided on each side of the cockpit rim. The purpose of the additional padding is to afford protection to the driver's head in the event of an oblique frontal impact and must therefore be made from the same material as the other three areas of padding.

These extensions must :

- a) Be symmetrically positioned about the car centre line and a continuation of the side areas of padding.
- b) Be positioned with their upper surfaces at least as high as the survival cell over their entire length.
- c) Have a radius on their upper inboard edge no greater than 10mm.
- d) Be positioned in order that the distance between the two is no less than 320mm.
- e) Be as high as practicable within the constraints of driver comfort.

**14.6.5** All of the padding described above must be so installed that if movement of the driver's head, in any expected trajectory during an accident, were to compress the foam fully at any point, his helmet would not make contact with any structural part of the car.

Furthermore, for the benefit of rescue crews all of the padding described above must be installed using the system described in the Appendix to the Technical Regulations. The method of removal must also be clearly indicated.

**14.6.6** No part of the padding described above may obscure sight of any part of the driver's helmet when he is seated normally and viewed from directly above the car.

**14.6.7** In order to minimise the risk of leg injury during an accident, additional areas of padding must be fitted each side of, and above, the driver's legs.

These areas of padding must :

- a) Be made from a material described in the Appendix to the Technical Regulations.
- b) Be no less than 25mm thick over their entire area.
- c) Cover the area situated between points lying 50mm behind the centre of the point at which the second roll structure test is carried out and 100mm behind the face of the rearmost pedal when in the inoperative position, as shown in Drawing 4.
- d) Cover the area above the line A-A shown in Drawing 3.

#### **14.7 Wheel retention :**

All cars, whilst under their own power, must be fitted with devices which will retain the wheel fastener in the event of it coming loose.

#### **14.8 Seat fixing and removal :**

**14.8.1** In order that an injured driver may be removed from the car in his seat following an accident, all cars must be fitted with a seat which, if it is secured, must be done so with no more than two bolts. If bolts are used they must be :

- a) Clearly indicated and easily accessible to rescue crews.
- b) Fitted vertically.
- c) Removable with the same tool for all teams and which is issued to all rescue crews.

**14.8.2** The seat must be equipped with receptacles which permit the fitting of belts to secure the driver and one which will permit the fitting of a head stabilisation device.

**14.8.3** The seat must be removable without the need to cut or remove any of the seat belts.

**14.8.4** Details of the tool referred to above, the belt receptacles and the head stabilisation device may be found in the Appendix to the Technical Regulations.

#### **14.9 Head and neck supports :**

No head and neck support worn by the driver may be less than 25mm from any structural part of the car when he is seated in his normal driving position.

## ARTICLE 15 : CAR CONSTRUCTION

### 15.1 Permitted materials :

15.1.1 The following is the list of permitted materials. These are the only materials permitted to be used in the construction of the Formula One Car provided only that in all cases the material is available on a non-exclusive basis and under normal commercial terms to all competitors.

#### Permitted materials :

- 1) Aluminium alloys.
- 2) Silicon carbide particulate reinforced aluminium alloy matrix composites.
- 3) Steel alloys.
- 4) Cobalt alloys.
- 5) Copper alloys containing  $\leq 2.5\%$  by weight of Beryllium.
- 6) Titanium alloys (but not for use in fasteners with  $<15\text{mm}$  diameter male thread).
- 7) Magnesium alloys.
- 8) Nickel based alloys containing  $50\% < \text{Ni} < 69\%$ .
- 9) Tungsten alloy.
- 10) Thermoplastics : monolithic, particulate filled, short fibre reinforced.
- 11) Thermosets : monolithic, particulate filled, short fibre reinforced.
- 12) Carbon fibres manufactured from polyacrylonitrile (PAN) precursor. (\*)
- 13) Carbon fibres manufactured from polyacrylonitrile (PAN) precursor which have :
  - A tensile modulus  $\leq 550\text{GPa}$ .
  - A density  $\leq 1.92 \text{g/cm}^3$ .
  - Unidirectional or planar reinforcement within their pre-impregnated form, not including three dimensional weaves or stitched fabrics (but three dimensional preforms and fibre reinforcement using Z-pinning technology are permitted).
  - No carbon nanotubes incorporated within the fibre or its matrix.
  - A permitted matrix, not including a carbon matrix.
- 14) Aramid fibres.
- 15) Poly(p-phenylene benzobisoxazole) fibres (e.g. "Zylon").
- 16) Polyethylene fibres.
- 17) Polypropylene fibres.
- 18) E and S Glass fibres.
- 19) Sandwich panel cores: Aluminium, Nomex, polymer foams, syntactic foams, balsa wood, carbon foam.
- 20) The matrix system utilised in all pre-impregnated materials must be epoxy, cyanate ester, phenolic, bismaleimide, polyurethane, polyester or polyimide based. (\*)

- 21) The matrix system utilised in all pre-impregnated materials must be epoxy, cyanate ester or bismaleimide based.
- 22) Monolithic ceramics.

[Materials marked (\*) are permitted only for parts classified as either front, rear or side impact structures, side intrusion panels or suspension members as regulated by Articles 15.4.3, 15.5.3, 15.4.6, 15.4.7 and 10.3 of the Technical Regulations respectively.]

**Exceptions :**

- 1) All electrical components (e.g. control boxes, wiring looms, sensors).
- 2) All seals & rubbers (e.g. rubber boots, o-rings, gaskets, any fluid seals, bump rubbers).
- 3) Fluids (e.g. water, oils).
- 4) Tyres.
- 5) Coatings and platings (e.g. DLC, nitriding, chroming).
- 6) Paint.
- 7) Adhesives.
- 8) Thermal insulation (e.g. felts, gold tape, heat shields).
- 9) All currently regulated materials (e.g. fuel bladder, headrest, extinguishant, padding, skid block).
- 10) Brake and clutch friction materials.
- 11) All parts of power units homologated according to Appendix 4 of the Sporting Regulations.

**15.1.2** No parts of the car may be made from metallic materials which have a specific modulus of elasticity greater than  $40\text{GPa} / (\text{g}/\text{cm}^3)$ . Tests to establish conformity will be carried out in accordance with FIA Test Procedure 03/02, a copy of which may be found in the Appendix to the Technical Regulations.

**15.2 Roll structures :**

**15.2.1** All cars must have two roll structures which are designed to help prevent injury to the driver in the event of the car becoming inverted.

The principal structure must be at least 940mm above the reference plane at a point 30mm behind the rear face of the cockpit entry template. The secondary structure must be in front of the steering wheel and its highest point may be no more than 1050mm forward of the rear face of the cockpit entry template.

The two roll structures must be of sufficient height to ensure the driver's helmet and his steering wheel are at least 70mm and 50mm respectively below a line drawn between their highest points at all times. The measurements will be taken normal to the line between the highest points of the two structures.

**15.2.2** The principal structure must pass a static load test details of which may be found in Article 17.2. Furthermore, each team must supply detailed calculations which clearly show that it is capable of withstanding the same load when the longitudinal component is applied in a forward direction.

**15.2.3** The secondary structure must pass a static load test details of which may be found in Article 17.3. The highest point of the secondary structure may not be more than 670mm above the reference plane.

15.2.4 The principal roll structure must have a minimum enclosed structural cross section of 10000mm<sup>2</sup>, in vertical projection, across a horizontal plane 50mm below its highest point. The area thus established must not exceed 200mm in length or width and may not be less than 10000mm<sup>2</sup> below this point.

15.2.5 The secondary roll structure must have a minimum enclosed structural cross section of 10000mm<sup>2</sup>, in vertical projection, across a horizontal plane 50mm below its highest point.

### 15.3 Structure behind the driver :

The parts of the survival cell immediately behind the driver which separate the cockpit from the car's fuel tank, and which lie less than 150mm from the car centre line, may be situated no further forward than the line a-b-c-d-e shown in Drawing 2.

In order to validate the integrity of this structure the survival cell must pass an impact test against a solid vertical barrier placed at right angles to the car centre line. Details of the test procedure may be found in Article 16.3.

### 15.4 Survival cell specifications :

15.4.1 Every survival cell must incorporate three FIA supplied transponders for identification purposes. These transponders must be a permanent part of the survival cell, be positioned in accordance with Drawing 6 and must be accessible for verification at any time.

15.4.2 The survival cell must have an opening for the driver, the minimum dimensions of which are given in Article 13.1. Any other ducts or openings in the survival cell must either :

a) Be of the minimum size, and for the sole purpose of, allowing access to mechanical components.

b) Be for the sole purpose of cooling the driver or mechanical or electrical components, the area of any such duct or opening may not exceed 3000mm<sup>2</sup>.

15.4.3 An impact absorbing structure must be fitted in front of the survival cell. This structure need not be an integral part of the survival cell but must be solidly attached to it.

No part of this structure may lie more than 525mm above the reference plane.

It must have a single external cross section, in horizontal projection, of more than 9000mm<sup>2</sup> at a point 50mm behind its forward-most point. Furthermore :

a) No part of this cross-section may lie more than 250mm or less than 135mm above the reference plane.

b) The centre of area of this section must be no more than 185mm above the reference plane and no less than 750mm forward of the front wheel centre line.

15.4.4 Referring to Drawing 5 :

The external width of the survival cell between the lines B-B and C-C must be no less than 450mm and must be at least 60mm per side wider than the cockpit opening when measured normal to the inside of the cockpit aperture. These minimum dimensions must be maintained over a height of at least 350mm.

The width of the survival cell may taper forward of the line B-B but, if this is the case, the outer surface must not lie closer to the car centre line than a plane which has a linear taper to a minimum width of 300mm at the line A-A.

The minimum width must be arranged symmetrically about the car centre line, must be maintained over a height of at least 400mm at the line B-B and 275mm at the line A-A. The height at any point between A-A and B-B must not be less than the height defined by a linear taper between these two sections. When assessing the minimum external cross-sections of the survival cell, radii of 50mm at the line B-B, and reducing at a linear rate to 25mm at the line A-A, will be permitted.

Following the application of the permitted radii, the external cross-sections of the survival cell between the lines A-A and B-B must, over their respective minimum widths, have a minimum height of 300mm at the line B-B reducing at a linear rate to a minimum height of 225mm at the line A-A. Furthermore, no part of any external cross section of the survival cell in this area which lies more than 250mm above the reference plane may contain any concave radius of curvature.

The minimum height of the survival cell between the lines A-A and B-B need not be arranged symmetrically about the horizontal centre line of the relevant section but must be maintained over its entire width.

The maximum height of the survival cell between the lines A-A and B-B is 625mm above the reference plane.

No part of sections taken at the lines A-A and B-B may lie more than 525mm and 625mm respectively above the reference plane.

The minimum height of the survival cell between the lines B-B and C-C is 550mm.

- 15.4.5** When the test referred to in Article 13.1.1 is carried out and the template is in position with its lower edge 525mm above the reference plane, the shape of the survival cell must be such that no part of it is visible when viewed from either side of the car. The parts of the survival cell which are situated each side of the driver's head must be no more than 550mm apart.

In order to ensure that the driver's head is not unduly exposed and for him to maintain good lateral visibility he must, when seated normally and looking straight ahead with his head as far back as possible, have his eye visible when viewed from the side. The centre of gravity of his head must lie below the top of the survival cell at this position. When viewed from the side of the car, the centre of gravity of the driver's head will be deemed to be the intersection of a vertical line passing through the centre of his ear and a horizontal line passing through the centre of his eye.

- 15.4.6** In order to give additional protection to the driver in the event of a side impact a flat test panel of uniform construction, which is designed and constructed in order to represent a section of the survival cell sides, must pass a strength test. Details of the test procedure may be found in Article 18.7.

Referring to Drawing 5, with the exception of local re-enforcement and/or inserts, all parts of the survival cell which are as wide or wider than the minimum widths stipulated in Article 15.4.4, including any radii applied, must be manufactured to the same specification as a single panel which satisfies the requirements of Article 18.7. Furthermore, parts to this tested specification must cover an area which :

- a) Begins no less than 250mm high at the line A-A tapering at a linear rate to a minimum of 450mm high at the line B-B.
- b) Lies between two horizontal lines 100mm and 550mm above the reference plane between the line B-B and the rear of the survival cell.

- 15.4.7** Once the requirements of Articles 15.4.4, 15.4.6, 15.5.1, 15.5.2, 15.5.4, 15.5.5, 16.1, 16.2, 16.3, 17.1, 17.2, 17.3, 18.1, 18.2, 18.3, 18.4, 18.5, 18.6, 18.7 and 18.9 have been met, panels no less than 6.2mm thick must then be permanently attached to the survival cell sides. These panels must :

- a) In a longitudinal sense, cover the area lying between the line B-B and a vertical plane 50mm to the rear of the rear edge of the cockpit entry template. A 50mm horizontal linear taper may be included at both ends.
- b) In a vertical sense, cover the area lying between two horizontal planes 100mm and 550mm above the reference plane.



- c) Be constructed from 16 plies of Zylon and two plies of carbon, precise lay-up details must be followed and may be found in the Appendix to the Technical Regulations.
- d) Be permanently attached to the survival cell with an appropriate adhesive which has been applied over their entire surface.

Cut-outs in these panels totalling 35000mm<sup>2</sup> per side will be permitted for fitting around side impact structures, wiring loom holes and essential fixings.

**15.4.8** Once the requirements of Articles 15.4.4, 15.4.6, 15.5.1, 15.5.2, 15.5.4, 15.5.5, 16.1, 16.2, 16.3, 17.1, 17.2, 17.3, 18.1, 18.2, 18.3, 18.4, 18.5, 18.6, 18.7 and 18.9 have been met one further panel, which may be made in a maximum of three parts but which is no less than 3.0mm thick, must then be permanently attached to the survival cell. This panel must :

- a) In a longitudinal sense, cover the area lying between a vertical plane 300mm to the rear of the line A-A and a vertical plane 650mm forward of the rear edge of the cockpit entry template. A 25mm horizontal linear taper may be included at both ends.
- b) In a vertical sense, cover every part of the outer skin of the survival cell in the area lying between two horizontal planes 60mm and 550mm above the reference plane. This will not apply at the top of this panel where any radius permitted by Article 15.4.4 falls inside the minimum permitted chassis width nor for the area fitted with the panel defined by Article 15.4.7.
- c) If made in more than one part, have all adjacent parts overlapping by a minimum of 25mm. These overlaps may include linear tapers in the thickness of both parts.
- d) Overlap the panel defined by Article 15.4.7 along all joining edges by a minimum of 25mm. These overlaps may include linear tapers in the thickness of both parts.
- e) Be constructed from seven plies of Zylon and two plies of carbon, precise lay-up details must be followed and may be found in the Appendix to the Technical Regulations.
- f) Be permanently attached to the survival cell with an appropriate adhesive which has been applied over its entire surface including all overlapping joints.

Cut-outs in this panel totalling 15000mm<sup>2</sup> per side will be permitted for fitting around wiring loom holes and essential fixings.

## **15.5 Survival cell safety requirements :**

**15.5.1** The survival cell and frontal absorbing structure must pass an impact test against a solid vertical barrier placed at right angles to the car centre line. Details of the test procedure may be found in Article 16.2.

**15.5.2** Between the principal and secondary roll structures, two impact absorbing structures must be fitted on each side of the survival cell and must be solidly attached to it. The purpose of these structures is to protect the driver in the event of a lateral impact and, in order to ensure this is the case, strength tests of the mountings must be carried out successfully. Details of the test procedure may be found in Articles 18.9 and 18.10.

The impact absorbing structures must be manufactured and mounted to the survival cell in accordance with the following specifications :

- a) The construction and geometry of the structures may be found in the Appendix to the Technical Regulations.
- b) The structures must be mounted with the principal axes of their prismatic mounting sections perpendicular to the longitudinal and vertical centre plane of the car, and with the centres of area of their outermost longitudinal vertical cross sections positioned :
  - i) Longitudinally : 500mm (+/-25mm) forward of the rear face of the cockpit entry template and within 1mm of each other.

ii) Vertically : Between 400mm and 520mm above the reference plane and between 70mm and 190mm above the reference plane for the upper and lower structures respectively.

iii) Laterally : Within 1mm of each other.

Refer to the drawings which may be found in the Appendix to the Technical Regulations.

c) Mountings must be permanently bonded to the structures to enable them to be attached to the survival cell, each of them must :

i) Incorporate a closed end and internal abutment to the impact structure that must be capable of withstanding the lateral load described in Article 18.10 without a structural contribution from the bonded interface.

ii) Lie entirely inboard of a plane which lies 292mm inboard of the outermost longitudinal vertical cross section of the impact structure.

iii) Be arranged in order that the outermost surface created by an interface between the mounting and structure lies on a vertical surface that is located within the zone indicated in the Appendix to the Technical Regulations.

iv) Be arranged in order that the innermost extent of the bonded interface between the mounting and structure is offset inboard by a minimum of 44mm from the vertical surface defined in (iii) above.

v) Be arranged in order that the bonded interface covers the entire external area of the structure between the innermost and outermost extents defined in iii) and iv) above.

d) To allow for debris compaction, the internal volume of the :

i) Upper structure must be empty outboard of a vertical plane intersecting the structure leading edge at 367mm and trailing edge at 342mm measured from the outermost longitudinal vertical cross section of the impact structure as indicated in the Appendix to the Technical Regulations.

ii) Lower structure must be empty outboard of a vertical plane intersecting the structure leading edge at 382mm and trailing edge at 357mm measured from the outermost longitudinal vertical cross section of the impact structure as indicated in the Appendix to the Technical Regulations.

No parts which, in the opinion of the FIA technical delegate, would prevent proper function of the impact structures in the event of a lateral impact may be present in the volume lying between 300mm and 700mm forward of the rear face of the cockpit entry template, and between 50mm and 600mm above the reference plane, and outboard of a plane 280mm inboard of the outermost longitudinal vertical cross section of the impact structures.

**15.5.3** An impact absorbing structure must be fitted behind the gearbox symmetrically about the car centre line with the centre of area of its rearmost face 300mm (+/-5mm) above the reference plane and no less than 575mm behind the rear wheel centre line.

The rearmost face of the impact structure must be a rectangular section no less than 100mm wide, this minimum width must be maintained over a height of at least 130mm and each corner may incorporate a radius no greater than 10mm.

Furthermore, when viewed from the side, the lowest and highest points of the impact absorbing structure between its rear face and 50mm aft of the rear wheel centre line may not be separated vertically by more than 275 mm.

Between the rear face and the rear wheel centre line no dimension of the area thus defined may diminish nor may any part of the structure or gearbox which is visible from below, other than the permitted radii, be higher than the lower edge of the rear face. Pockets of minimum size within the structure are permitted for the sole purpose of attaching suspension members.

This structure must pass an impact test and must be constructed from materials which will not be substantially affected by the temperatures it is likely to be subjected to during use. Details of the test procedure may be found in [Article 16.4](#).

In order to minimise the likelihood of the structure penetrating a survival cell, it must be designed so that the majority of its material lies evenly around its perimeter. Therefore, the perimeter of every vertical cross section between points 50mm forward of its rear face and 200mm forward of its rear face must be of a uniform construction and, with the exception of minimal local changes for attachments, have a minimum thickness of 1.75mm. Material with a specific gravity of less than 1 will not be considered when calculating these thicknesses and, furthermore, any internal structure must not be thicker than any part of the perimeter at that section.

Only those parts of the structure which genuinely contribute to its performance during the impact test, and which are designed and fitted for that sole purpose, will be considered when assessing compliance with any of the above.

**15.5.4** The survival cell must also be subjected to [five](#) separate static load tests :

- 1) On a vertical plane passing through the centre of the fuel tank.
- 2) On a vertical plane passing through the rearmost point at which the outer end of the forward-most front wheel tether would make contact with the survival cell when swung about the inner attachment.
- [3\)](#) From beneath the fuel tank.
- [4\)](#) On each side of the cockpit opening.
- [5\)](#) From beneath the cockpit floor.

Details of the test procedures may be found in Article 18.2, [18.3](#), [18.4](#) and [18.5](#).

**15.5.5** To test the attachments of the frontal, side and rear impact absorbing structures static side load tests must be carried out. Details of these test procedures may be found in Articles 18.6, 18.8 and 18.9.2.

## **ARTICLE 16 : IMPACT TESTING**

### **16.1 Conditions applicable to all impact tests :**

- 16.1.1** All tests must be carried out in accordance with FIA Test Procedure 01/00, in the presence of an FIA technical delegate and by using measuring equipment which has been calibrated to the satisfaction of the FIA technical delegate. A copy of the test procedure may be found in the Appendix to the Technical Regulations.
- 16.1.2** Any significant modification introduced into any of the structures tested shall require that part to pass a further test.

### **16.2 Frontal test 1:**

All parts which could materially affect the outcome of the test must be fitted to the test structure which must be solidly fixed to the trolley through its engine mounting points but not in such a way as to increase its impact resistance.

The fuel tank must be fitted and may contain water.

A dummy weighing at least 75kg must be fitted with safety belts described in Article 14.4 fastened. However, with the safety belts unfastened, the dummy must be able to move forwards freely in the cockpit.

The extinguishers, as described in Article 14.1 must also be fitted.

For the purposes of this test, the total weight of the trolley and test structure shall be 780kg (+1%/-0) and the velocity of impact not less than 15 metres/second.

The resistance of the test structure must be such that during the impact either :

- a) The peak deceleration over the first 150mm of deformation does not exceed 10g.
- b) The peak deceleration over the first 60kJ energy absorption does not exceed 20g.
- c) The average deceleration of the trolley does not exceed 40g.
- d) The peak deceleration in the chest of the dummy does not exceed 60g for more than a cumulative 3ms, this being the resultant of data from three axes.

Or :

- a) The peak force over the first 150mm of deformation does not exceed 75kN.
- b) The peak force over the first 60kJ energy absorption does not exceed 150kN.
- c) The average deceleration of the trolley does not exceed 40g.
- d) The peak deceleration in the chest of the dummy does not exceed 60g for more than a cumulative 3ms, this being the resultant of data from three axes.

Furthermore, there must be no damage to the survival cell or to the mountings of the safety belts or fire extinguishers.

This test may be carried out on any survival cell provided it has been successfully subjected to the tests described in Articles 17.2, 17.3 and 18.2-5. The test must however be carried out on the survival cell and frontal impact absorbing structure which was subjected to the test described in Article 18.6.

### **16.3 Frontal test 2 :**

A 50mm (+/-1mm) thick aluminium plate should be attached to the front bulkhead of the survival cell through the mounting points of the frontal impact absorbing structure. The plate should :

- a) Measure 375mm (+/-1mm) wide x 375mm (+/-1mm) high.
- b) Be fitted symmetrically about the car centre line.

- c) Be fitted in a vertical sense in order to ensure force distribution is similar to that measured during the first frontal test.
- d) Have four M10 x 30mm holes in the outer face arranged in a 125mm square pattern about its geometric centre. The test laboratory will then fit a 5mm thick 300mm x 275mm steel plate to these holes using a 5mm washer stack.

All parts which could materially affect the outcome of the test must be fitted to the test structure which must be solidly fixed to the trolley through its engine mounting points but not in such a way as to increase its impact resistance.

The fuel tank must be fitted and must be full of water.

A dummy weighing at least 75kg must be fitted with safety belts described in Article 14.4 fastened. However, with the safety belts unfastened, the dummy must be able to move forwards freely in the cockpit.

For the purposes of this test, the total weight of the trolley and test structure shall be 900kg (+1%/-0) and the velocity of impact not less than 15 metres/second.

The impact wall must be fitted with six 60kN crush tubes which develop a combined 360kN as follows :

- a) 2 x 60kN from T-zero to T-end, directed into the two lower M10 attachment points.
- b) 2 x 60kN from T-100mm to T-end, directed into the two upper M10 attachment points.
- c) 2 x 60kN from T-200mm to T-end, directed into the sled.

The resistance of the test structure must be such that following the impact there is no damage to the survival cell or to the mountings of the safety belts.

This test may be carried out on any survival cell provided it has been successfully subjected to the tests described in Articles 17.2, 17.3 and 18.2-5.

Specifications of the crush tubes and test arrangement may be found in the Appendix to the Technical Regulations.

#### **16.4 Rear test :**

All parts which will be fitted behind the rear face of the engine and which could materially affect the outcome of the test must be fitted to the test structure. If suspension members are to be mounted on the structure they must be fitted for the test. The structure and the gearbox must be solidly fixed to the ground and a solid object, having a mass of 780kg (+1%/-0) and travelling at a velocity of not less than 11 metres/second, will be projected into it.

The object used for this test must be flat, measure 450mm (+/-3mm) wide by 550mm (+/-3mm) high and may have a 10mm radius on all edges. Its lower edge must be at the same level as the car reference plane (+/-3mm) and must be so arranged to strike the structure vertically and at 90° to the car centre line.

During the test, the striking object may not pivot in any axis and the crash structure may be supported in any way provided this does not increase the impact resistance of the parts being tested.

The resistance of the test structure must be such that during the impact :

- a) The peak deceleration over the first 225mm of deformation does not exceed 20g.
- b) The maximum deceleration does not exceed 20g for more than a cumulative 15ms, this being measured only in the direction of impact.

Furthermore, all structural damage must be contained within the area behind the rear wheel centre line.

This test must be carried out on the rear impact absorbing structure which was subjected to the test described in Article 18.8.

#### **16.5 Steering column test :**

The parts referred to in Article 10.4.4 must be fitted to a representative test structure; any other parts which could materially affect the outcome of the test must also be fitted. The test structure must be solidly fixed to the ground and a solid object, having a mass of 8kg (+1%/-0) and travelling at a velocity of not less than 7metres/second, will be projected into it.

The object used for this test must be hemispherical with a diameter of 165mm (+/-1mm).

For the test, the centre of the hemisphere must strike the structure at the centre of the steering wheel along the same axis as the main part of the steering column.

During the test the striking object may not pivot in any axis and the test structure may be supported in any way provided this does not increase the impact resistance of the parts being tested.

The resistance of the test structure must be such that during the impact the peak deceleration of the object does not exceed 80g for more than a cumulative 3ms, this being measured only in the direction of impact.

After the test, all substantial deformation must be within the steering column and the steering wheel quick release mechanism must still function normally.

## **ARTICLE 17 : ROLL STRUCTURE TESTING**

### **17.1 Conditions applicable to both roll structure tests :**

- 17.1.1 Rubber 3mm thick may be used between the load pads and the roll structure.
- 17.1.2 Both peak loads must be applied in less than three minutes and be maintained for 10 seconds.
- 17.1.3 Under the load, deformation must be less than 25mm in the case of the principal roll structure and 50mm in the case of the **secondary** roll structure, measured along the loading axis and any structural failure limited to 100mm below the top of the rollover structure when measured vertically.
- 17.1.4 Any significant modification introduced into any of the structures tested shall require that part to pass a further test.

### **17.2 Principal roll structure test :**

A load equivalent to 50kN laterally, 60kN longitudinally in a rearward direction and 90kN vertically, must be applied to the top of the structure through a rigid flat pad which is 200mm in diameter and perpendicular to the loading axis.

During the test, the roll structure must be attached to the survival cell which is supported on its underside on a flat plate, fixed to it through its engine mounting points and wedged laterally by any of the static load test pads described in Article 18.2.

### **17.3 Secondary roll structure test :**

A vertical load of 75kN must be applied to the top of the structure through a rigid flat pad which is 100mm in diameter and perpendicular to the loading axis. The loading axis must be aligned with the highest point of the structure.

During the test, the rollover structure must be attached to the survival cell which is fixed to a flat horizontal plate.

## ARTICLE 18 : STATIC LOAD TESTING

### 18.1 Conditions applicable to all static load tests :

- 18.1.1 The tests described in Articles 18.2, 18.3, 18.4 and 18.5 must be carried out on every survival cell intended for use. During these tests (on deflections greater than 3.0mm), the deflection across the inner surfaces must not exceed 120% of the deflection obtained on the chassis used for the tests described in Articles 17.2 and 17.3.
- 18.1.2 Deflections and deformations will be measured at the centre of area of circular load pads and at the top of rectangular pads.
- 18.1.3 All peak loads must be applied in less than three minutes, through a ball jointed junction at the centre of area of the pad, and maintained for 30 seconds.
- 18.1.4 Following the tests described in 18.2, 18.3, 18.4 and 18.5, permanent deformation must be less than 1.0mm (0.5mm in 18.3 and 18.4) after the load has been released for 1 minute.
- 18.1.5 All tests must be carried out by using measuring equipment which has been calibrated to the satisfaction of the FIA technical delegate.
- 18.1.6 A radius of 3mm is permissible on the edges of all load pads and rubber 3mm thick may be placed between them and the test structure.
- 18.1.7 For the tests described in 18.2, 18.3, 18.4 and 18.5, the survival cells must always be produced in an identical condition in order that their weights may be compared. If the weight differs by more than 5% from the one subjected to the impact tests described in Articles 16.2 and 16.3 further frontal and side impact tests and roll structure tests must be carried out.
- 18.1.8 Any significant modification introduced into any of the structures tested shall require that part to pass a further test.

### 18.2 Survival cell side tests :

- 18.2.1 For test 1), referred to in Article 15.5.4, pads 100mm long and 300mm high, which conform to the shape of the survival cell, must be placed against the outermost sides of the survival cell with the lower edge of the pad at the lowest part of the survival cell at that section.

A constant transverse horizontal load of 25.0kN will be applied and, under the load, there must be no structural failure of the inner or outer surfaces of the survival cell.

- 18.2.2 For test 2), referred to in Article 15.5.4, pads 200mm in diameter which conform to the shape of the survival cell, must be placed against the outermost sides of the survival cell.

The centre of the pads must pass through the plane mentioned above and the mid point of the height of the structure at that section.

A constant transverse horizontal load of 30.0kN will be applied to the pads and, under the load, there must be no structural failure of the inner or outer surfaces of the survival cell and the total deflection must not exceed 15mm.

### 18.3 Fuel tank floor test :

A pad of 200mm diameter must be placed in the centre of area of the fuel tank floor and a vertical upwards load of 12.5kN applied.

Under the load, there must be no structural failure of the inner or outer surfaces of the survival cell.

### 18.4 Cockpit floor test :

A pad of 200mm diameter must be placed beneath the survival cell, on the car centre line and with its centre 600mm forward of the rear edge of the cockpit entry template, and a vertical upwards load of 15kN applied.

Under the load, there must be no structural failure of the inner or outer surfaces of the survival cell.



### 18.5 Cockpit rim tests :

Two pads, each of which is 50mm in diameter, must be placed on both sides of the cockpit rim with their upper edges at the same height as the top of the cockpit side with their centres at a point 250mm forward of the rear edge of the cockpit opening template longitudinally.

A constant transverse horizontal load of 15.0kN will then be applied at 90° to the car centre line and, under the load, there must be no structural failure of the inner or outer surfaces of the survival cell and the total deflection must not exceed [5mm](#).

This test must be repeated at positions 50mm and 150mm forward of the rear edge of the cockpit opening template longitudinally.

### 18.6 Nose push off test :

During the test the survival cell must be resting on a flat plate and secured to it solidly but not in a way that could increase the strength of the attachments being tested.

A constant transversal horizontal load of 40.0kN must then be applied to one side of the impact absorbing structure, using a pad identical to the ones used in the lateral tests in Article 18.2.1, at a point 550mm from the front wheel axis.

The centre of area of the pad must pass through the plane mentioned above and the mid point of the height of the structure at the relevant section. After 30 seconds of application, there must be no failure of the structure or of any attachment between the structure and the survival cell.

### 18.7 Side intrusion test :

18.7.1 The test must be carried out in accordance with FIA Test Procedure 02/05, in the presence of an FIA technical delegate and by using measuring equipment which has been calibrated to the satisfaction of the FIA technical delegate. A copy of the test procedure may be found in the Appendix to the Technical Regulations.

18.7.2 The test panel must be 500mm x 500mm and will be tested by forcing a rigid truncated cone through the centre of the panel at a rate of 2mm (+/-1mm) per second until the displacement exceeds 150mm.

During the first 100mm of displacement the load must exceed 250kN and the energy absorption must exceed 6000J. There must be no systematic damage to the border or damage to the fixture before these requirements have been met.

### 18.8 Rear impact structure push off test :

During the test the gearbox and the structure must be solidly fixed to the ground but not in a way that could increase the strength of the attachments being tested.

A constant transversal horizontal load of 40kN must then be applied to one side of the impact absorbing structure, using a pad identical to the ones used in the lateral tests in Article 18.2.1, at a point 400mm behind the rear wheel axis.

The centre of area of the pad must pass through the plane mentioned above and the mid point of the height of the structure at the relevant section. After 30 seconds of application, there must be no failure of the structure or of any attachment between the structure and the gearbox.

### 18.9 Side impact structure push off tests :

18.9.1 Each team must supply detailed calculations which clearly show that [the mountings of the upper and lower side impact](#) structures are capable of withstanding :

- a) Horizontal loads of [40kN and 60kN](#) applied [simultaneously to the upper and lower structures respectively](#) in a rearward direction [through](#) ball-jointed pads, which may conform to the shape of the structures, measuring [100mm](#) high x 100mm wide and whose centre of area lies [100mm inboard of the centre of the outermost longitudinal vertical cross-section of the impact structure](#).

- b) Horizontal loads of 40kN and 60kN applied simultaneously to the upper and lower structures respectively in a forward direction through ball-jointed pads, which may conform to the shape of the structures, measuring 100mm high x 100mm wide and whose centre of area lies 100mm inboard of the centre of the outermost longitudinal vertical cross-section of the impact structure.
- c) A vertical load of 35kN applied in an upward direction to the lower impact structure through a ball-jointed pad, which may conform to the shape of the structure, measuring 200mm long x 100mm wide whose centre of area lies 100mm inboard of the centre of the outermost longitudinal vertical cross section of the impact structure.
- d) A vertical load of 27kN applied in a downward direction to the upper impact structure through a ball-jointed pad, which may conform to the shape of the structure, measuring 200mm long x 100mm wide whose centre of area lies 100mm inboard of the centre of the outermost longitudinal vertical cross section of the impact structure.

In all cases the calculations should show that there will be no structural failure of the parts. It should be assumed that ball-jointed pads are used, the joint lying at the centre of area of the pad.

**18.9.2** These tests may be carried out on any survival cell provided it has been successfully subjected to the tests described in Articles 17.2, 17.3 and 18.2-5. The tests may be performed on either side of the survival cell.

During the push off tests the survival cell must be resting on a flat plate and secured to it solidly but not in a way that could increase the strength of the attachments being tested.

Temporary spacers representing part sections of the panels described in Article 15.4.7 may be incorporated within the assembly of the impact structures to the survival cell. These spacers may not in any way increase the strength of the survival cell being tested.

Dummy test parts may be used in place of the impact structure provided the test part incorporates identical mounting details to those described in Article 15.5.2(c) and does not in any way increase the strength of the attachments being tested.

During the first test rearward horizontal loads of 40kN and 60kN applied simultaneously to the upper and lower structures respectively through ball joints or ball-jointed pads whose centre of area lies 100mm inboard of the centre of the outermost cross-section of the dummy impact structures.

During the second test an upward vertical load of 35kN must then be applied to the lower impact absorbing structure using a ball joint or a ball-jointed pad whose centre of area lies 100mm inboard of the centre of the outermost cross section of the dummy lower impact structure.

After five seconds of application there must be no failure of any structures or of any attachment between the structure and the survival cell.

#### **18.10 Side impact structure squeeze tests :**

This test may be carried out on any survival cell which has been subjected to the tests described in Articles 17.2, 17.3 and 18.2-5. The test may be performed on either side of the survival cell.

During the test, the survival cell may be supported in any way provided this does not increase the strength of the attachments being tested.

Temporary spacers representing part sections of the panels described in Article 15.4.7 may be incorporated within the assembly of the impact structures to the survival cell. These spacers can not in any way increase the strength of the survival cell being tested.

Dummy test parts may be used in place of the impact structure provided the test parts incorporate identical mounting details to those described in Article 15.5.2(c) and do not in any way increase the strength of the attachments being tested.

Loads of 100kN and 150kN must be applied simultaneously to the dummy upper and lower structures respectively in a lateral direction using a hemispherical pad or ball joint, loading through the centre cross section, 292mm from the outermost longitudinal vertical cross-section of both impact structures.

After five seconds of application there must be no failure of the survival cell or the attachments between the structures and the survival cell.

Each team must supply detailed calculations which clearly show that the mountings of the upper and lower side impact structures satisfy the requirement of 15.5.2(c)(i).

## ARTICLE 19 : FUEL

### 19.1 Purpose of Article 19 :

- 19.1.1 The purpose of this Article is to ensure that the fuel used in Formula One is petrol as this term is generally understood.
- 19.1.2 The detailed requirements of this Article are intended to ensure the use of fuels that are composed of compounds normally found in commercial fuels and to prohibit the use of specific power-boosting chemical compounds. Acceptable compounds and compound classes are defined in 19.2 and 19.4.3. In addition, to cover the presence of low level impurities, the sum of components lying outside the 19.2 and 19.4.3 definitions are limited to 1% max m/m of the total fuel.
- 19.1.3 Any petrol, which appears to have been formulated in order to subvert the purpose of this regulation, will be deemed to be outside it.

### 19.2 Definitions :

- Paraffins - Straight chain and branched alkanes.
- Olefins - Straight chain and branched mono-olefins and di-olefins.  
- Monocyclic mono-olefins (with five or more carbon atoms in the ring) with or without paraffinic side chains.
- Di-olefins - Straight chain or branched or monocyclic hydrocarbons (with five or more carbon atoms in any ring) with or without paraffinic side chains, containing two double bonds per molecule.
- Naphthenes - Monocyclic alkanes (with five or more carbon atoms in the ring) with or without paraffinic side chains.
- Aromatics - Monocyclic and bicyclic aromatic rings with or without paraffinic or olefinic side chains. Only one double bond may be present outside the aromatic ring.
- Oxygenates - Organic compounds containing oxygen.
- Biocomponents - Paraffins, olefins, di-olefins, naphthenes, aromatics and oxygenates, as defined above, derived in whole or part from biological origins. For the purposes of quantification, the biocomponent contribution of a given molecule is defined as the carbon, hydrogen and oxygen atoms from biological origin as a percent of the total molecule, on a mass/mass basis. The biocomponent contribution of a co-produced stream is determined as the bio feedstock percentage on a mass/mass basis.

### 19.3 Properties :

The only fuel permitted is petrol having the following characteristics :

Property	Units	Min	Max	Test Method
(RON+MON)/2		87.0		ASTM D 2699/D 2700
Oxygen	wt%		3.7	Elemental Analysis
Nitrogen	mg/kg		500	ASTM D 5762
Benzene	wt%		1.0	GC-MS
DVPE	kPa	45	60 <sup>(1)</sup>	EN13016-1
Lead	mg/l		5	ASTM D 3237
Oxidation Stability	minutes	360		ASTM D 525
Sulphur	mg/kg		10	EN ISO 20846

Electrical conductivity	pS/m	200	ASTM D 2624
Final Boiling Point	°C	210	ISO 3405
Distillation Residue	%v/v	2.0	ISO 3405

- (1) The maximum DVPE may rise to 68kPa if a minimum of 2% bio-methanol and/or bio-ethanol are included in the fuel.

The fuel will be accepted or rejected according to ASTM D 3244 with a confidence limit of 95%.

#### 19.4 Composition of the fuel :

19.4.1 The composition of the petrol must comply with the specifications detailed below :

Component	Units	Min	Max	Test Method
Aromatics	wt%		40*	GCMS
Olefins	wt%		17*	GCMS
Total di-olefins	wt%		1.0	GCMS
Total styrene and alkyl derivatives	wt%		1.0	GCMS

\* Values corrected for fuel oxygen content.

In addition, the fuel must contain no substance which is capable of exothermic reaction in the absence of external oxygen.

- 19.4.2 The total of individual hydrocarbon components present at concentrations of less than 5% m/m of the total fuel must be at least 30% m/m of the hydrocarbon component of the fuel.
- 19.4.3 The only oxygenates permitted are paraffinic mono-alcohols and paraffinic mono-ethers with a final boiling point below 210°C.
- 19.4.4 A minimum of 5.75% (m/m) of the fuel must comprise bio-components.
- 19.4.5 Initially the bio-components are restricted to oxygenates. However, hydrocarbons (as defined in 19.2) and oxygenates (lying outside the 19.4.3 definition) or mixtures thereof, which have been produced from biomass, may be included in Formula One fuel as part of the 5.75% biocomponents quota, provided that a suitable analytical procedure is available for their quantification and to verify their biological origin. Their use in F1 fuel will be dependent on evidence indicating that the supplier is genuinely developing these compounds for use in commercial fuels.
- 19.4.6 Manganese based additives are not permitted.

#### 19.5 Air :

Only ambient air may be mixed with the fuel as an oxidant.

#### 19.6 Safety :

- 19.6.1 All competitors must be in possession of a Material Safety Data Sheet for each type of petrol used. This sheet must be made out in accordance with EC Directive 93/112/EEC and all information contained therein strictly adhered to.

#### 19.7 Fuel approval :

- 19.7.1 Before any fuel may be used in an Event, two separate five litre samples, in suitable containers, must be submitted to the FIA for analysis and approval.
- 19.7.2 No fuel may be used in an Event without prior written approval of the FIA.

#### 19.8 Sampling and testing at an Event:

- 19.8.1 All samples will be taken in accordance with the FIA Formula One fuel sampling procedure, a copy of which may be found in the Appendix to the Technical Regulations.

19.8.2 Fuel density will also be checked and must be within 0.25% of the figure noted during pre-approval analysis.

**19.8.3** Fuel samples taken during an Event will be checked for conformity by using a gas chromatographic technique, which will compare the sample taken with an approved fuel. Samples which differ from the approved fuel in a manner consistent with evaporative loss, will be considered to conform. However, the FIA retains the right to subject the fuel sample to further testing at an FIA approved laboratory.

**19.8.4** GC peak areas of the sample will be compared with those obtained from the reference fuel. Increases in any given peak area (relative to its adjacent peak areas) which are greater than 12%, or an absolute amount greater than **0.10%** for compounds present at concentrations below 0.8%, will be deemed not to comply.

If a peak is detected in a fuel sample that was absent in the corresponding reference fuel, and its peak area represents more than 0.10% of the summed peak areas of the fuel, the fuel will be deemed not to comply.

If the deviations observed (above) by GC indicate that they are due to mixing with another Formula One fuel, which has been approved by the FIA for use by the team, the fuel sample will be deemed to comply, provided that the adulterant fuel is present at no more than 10% in the sample.

## ARTICLE 20 : TELEVISION CAMERAS AND TIMING TRANSPONDERS

### 20.1 Presence of cameras and camera housings :

All cars must be fitted with at least five cameras or camera housings at all times throughout the Event.

### 20.2 Location of camera housings :

Camera housings, when used, must be fitted in the same location as cameras. Details concerning the size and weight of all camera housings may be found in the Appendix to the Technical Regulations.

### 20.3 Location and fitting of camera equipment :

20.3.1 All cars must be equipped with five positions in which cameras or camera housings can be fitted. Referring to Drawing 6, all cars must carry (i) a camera in position 4 and (ii) a camera or camera housing in positions 2 (both sides), 3 and either 1 or 5.

Any decision as to whether a camera or camera housing is fitted in those positions will be by agreement between the relevant Competitor and the Commercial Rights Holder.

20.3.2 Any part provided by the Competitor for the purpose of aligning a camera or camera housing in positions 2 or 3 correctly will be considered part of the camera or housing provided it is being fitted for that sole purpose.

20.3.3 Any camera or camera housing fitted in positions 2, 3 or 4 shown in Drawing 6 must be mounted in order that its major axis does not subtend an angle greater than 1° to the reference plane.

20.3.4 When viewed from the side of the car, the entire camera (or dummy camera) in position 2 shown in Drawing 6 must lie within a box formed by two vertical lines 150mm and 450mm forward of the front wheel centre line and two horizontal lines 325mm and 525mm above the reference plane.

Any camera or camera housing fitted in the left hand position 2 shown in Drawing 6 must be mounted in order that its major axis where passing through the centre of the camera lens (or corresponding position for a camera housing) does not intersect any part of the car lying forward of the camera or camera housing.

20.3.5 The camera fitted in position 4 shown in Drawing 6 must be mounted in order that its forward-most point is no more than 80mm rearward of the rear face of the cockpit entry template.

### 20.4 Transponders :

All cars must be fitted with two timing transponders supplied by the officially appointed timekeepers. These transponders must be fitted in strict accordance with the instructions detailed in the Appendix to the Technical Regulations. Teams must use their best endeavours to ensure that the transponders are in working order at all times.

### 20.5 Installation :

Competitors must be notified of any changes to the camera or transponder installation instructions before 30 June of the previous season.

**ARTICLE 21 : FINAL TEXT**

The final text for these regulations shall be the English version should any dispute arise over their interpretation.



## ARTICLE 22 : CHANGES FOR 2015

### 22.1 Changes to Article 3.15 :

#### 3.15 Aerodynamic influence :

With the exception of ~~the driver adjustable bodywork described in Article 3.18 (in addition to minimal parts solely associated with its actuation) and the ducts described in Article 11.4,~~ any specific part of the car influencing its aerodynamic performance :

- a) Must comply with the rules relating to bodywork.
- b) Must be rigidly secured to the entirely sprung part of the car (rigidly secured means not having any degree of freedom).

With the exception of the driver adjustable bodywork described in Article 3.18 (in addition to minimal parts solely associated with its actuation) and the ducts described in Article 11.4, any specific part of the car influencing its aerodynamic performance must remain immobile in relation to the sprung part of the car.

Any device or construction that is designed to bridge the gap between the sprung part of the car and the ground is prohibited under all circumstances.

No part having an aerodynamic influence and no part of the bodywork, with the exception of the skid block in 3.13 above, may under any circumstances be located below the reference plane.

With the exception of the parts necessary for the adjustment described in Article 3.18, any car system, device or procedure which uses driver movement as a means of altering the aerodynamic characteristics of the car is prohibited.

### 22.2 Changes to Article 4.1 :

#### 4.1 Minimum weight :

The weight of the car, without fuel, must not be less than ~~691kg~~ 701kg at all times during the Event.

If, when required for checking, a car is not already fitted with dry-weather tyres, it will be weighed on a set of dry-weather tyres selected by the FIA technical delegate.

### 22.3 Changes to Article 4.2 :

#### 4.2 Weight distribution :

~~For 2014 only, The weight applied on the front and rear wheels must not be less than 314kg and 370kg~~ 319kg and 375kg respectively at all times during the qualifying practice session.

If, when required for checking, a car is not already fitted with dry-weather tyres, it will be weighed on a set of dry-weather tyres selected by the FIA technical delegate.

### 22.4 Changes to Article 4.3 :

#### 4.3 Weight of tyres :

The weight limits specified in Articles 4.1 and 4.2 will be adjusted up or down according to any differences (rounded up to the nearest 1kg) between the total set and individual axle set weights respectively of the ~~2013 and 2014~~ 2014 and 2015 dry-weather tyres.

### 22.5 Changes to Article 12.7 :

#### 12.7 Treatment of tyres :

12.7.1 Tyres may only be inflated with air or nitrogen.

12.7.2 Any process the intent of which is to reduce the amount of moisture in the tyre and/or in its inflation gas is forbidden.

**12.7.3** Any device, system or procedure the purpose and/or intention of which is to heat a wheel or tyre, or retain heat within a wheel or tyre, is prohibited. This applies to both dry and wet-weather tyres.

~~The only permitted type of tyre heating devices are blankets which use resistive heating elements. The heating elements may only act upon the outer tyre surface.~~

**22.6 Changes to Article 15.4.4 :**

**15.4.4** Referring to Drawing 5 :

The external width of the survival cell between the lines B-B and C-C must be no less than 450mm and must be at least 60mm per side wider than the cockpit opening when measured normal to the inside of the cockpit aperture. These minimum dimensions must be maintained over a height of at least 350mm.

The width of the survival cell may taper forward of the line B-B but, if this is the case, the outer surface must not lie closer to the car centre line than a plane which has a linear taper to a minimum width of 300mm at the line A-A.

The minimum width must be arranged symmetrically about the car centre line, must be maintained over a height of at least 400mm at the line B-B and 275mm at the line A-A. The height at any point between A-A and B-B must not be less than the height defined by a linear taper between these two sections. When assessing the minimum external cross-sections of the survival cell, radii of 50mm at the line B-B, and reducing at a linear rate to 25mm at the line A-A, will be permitted.

Following the application of the permitted radii, the external cross-sections of the survival cell between the lines A-A and B-B must, over their respective minimum widths, have a minimum height of 300mm at the line B-B reducing at a linear rate to a minimum height of 225mm at the line A-A. Furthermore, no part of any external cross section of the survival cell in this area which lies more than 250mm above the reference plane may contain any concave radius of curvature.

The minimum height of the survival cell between the lines A-A and B-B need not be arranged symmetrically about the horizontal centre line of the relevant section but must be maintained over its entire width.

The maximum height of the survival cell between the lines A-A and B-B is 625mm above the reference plane.

No part of the survival cell, nor any part rigidly attached to it (with the exception of the panel of prescribed laminate referred to in Article 3.7.9), may lie above a diagonal line starting 525mm above the reference plane at A-A and rising to 625mm above the reference plane at a point 375mm behind A-A.

No part of sections taken at the lines A-A and B-B may lie more than 525mm and 625mm respectively above the reference plane.

The minimum height of the survival cell between the lines B-B and C-C is 550mm.

# **APPENDIX 1**

## **DRAWINGS**

**Drawing 1**



**Skid Block Dimensions**

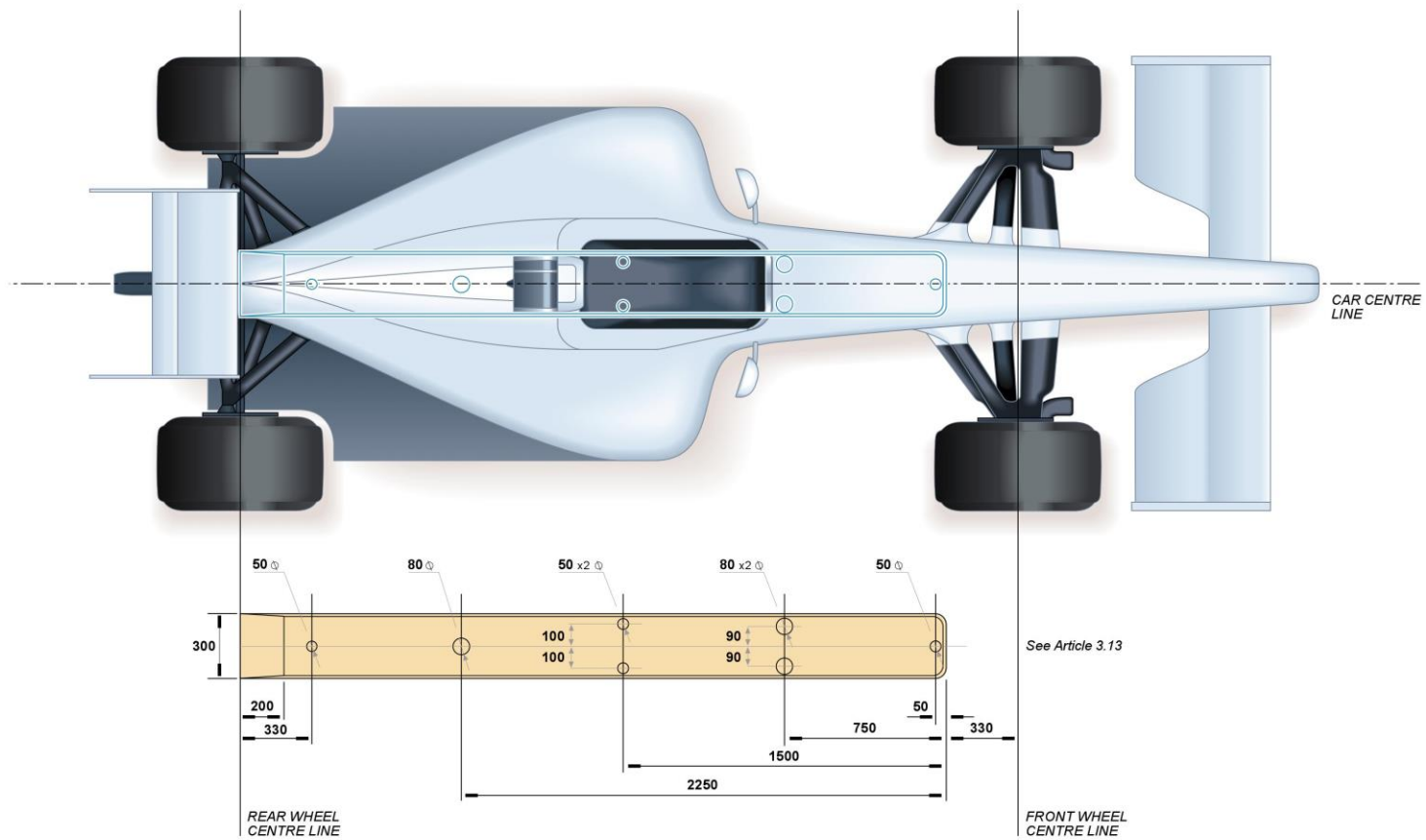



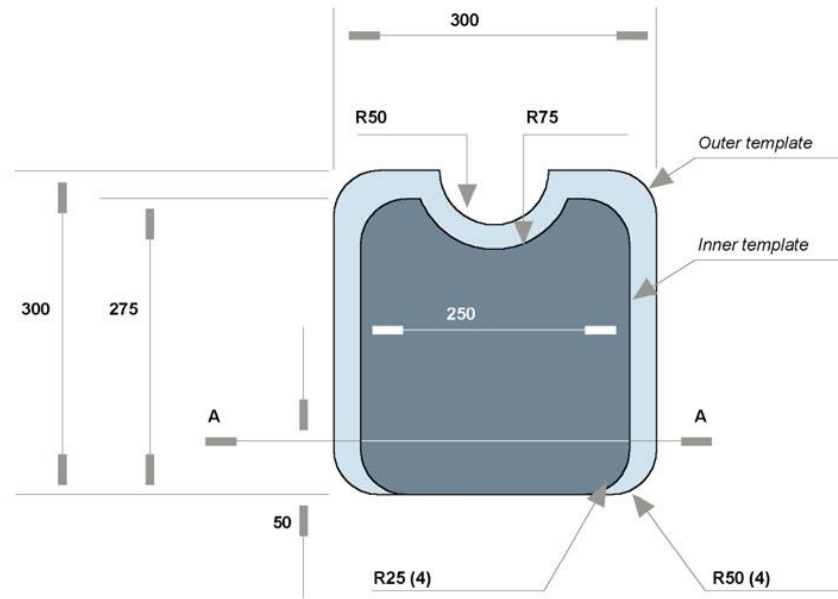

See Article 13.3.1 & Article 14.6.7

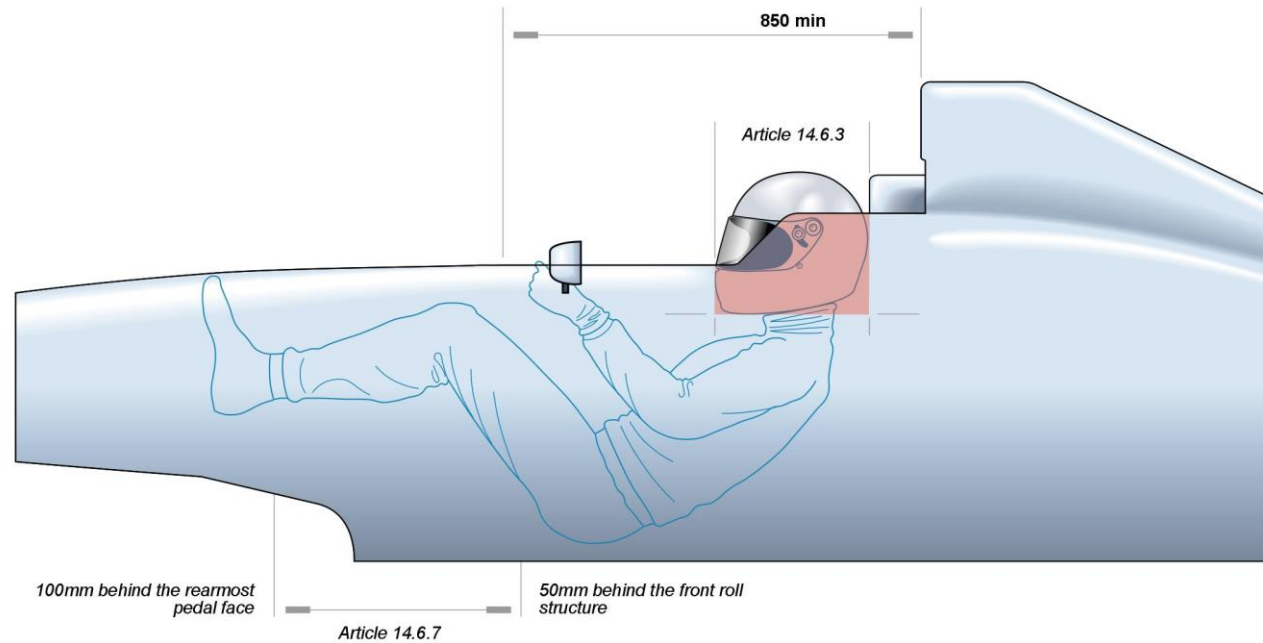



See Article 13.1.1, Article 15.4.4, Article 15.4.6

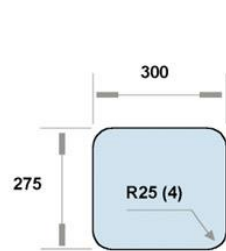
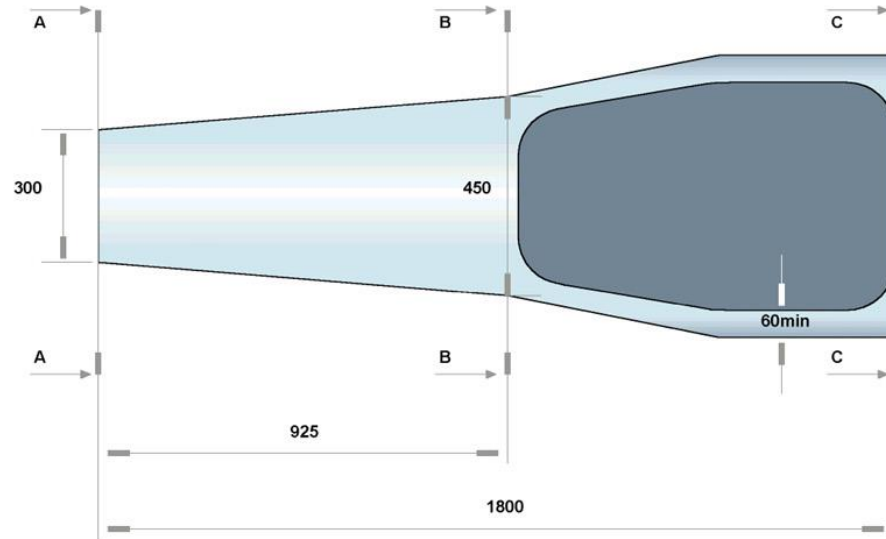

Minimum external dimensions at the section A-A

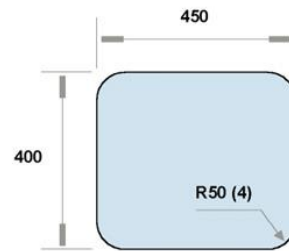

Minimum external dimensions at the section B-B



# Drawing 6



## Cameras and Transponders

- Camera locations
- Transponder locations

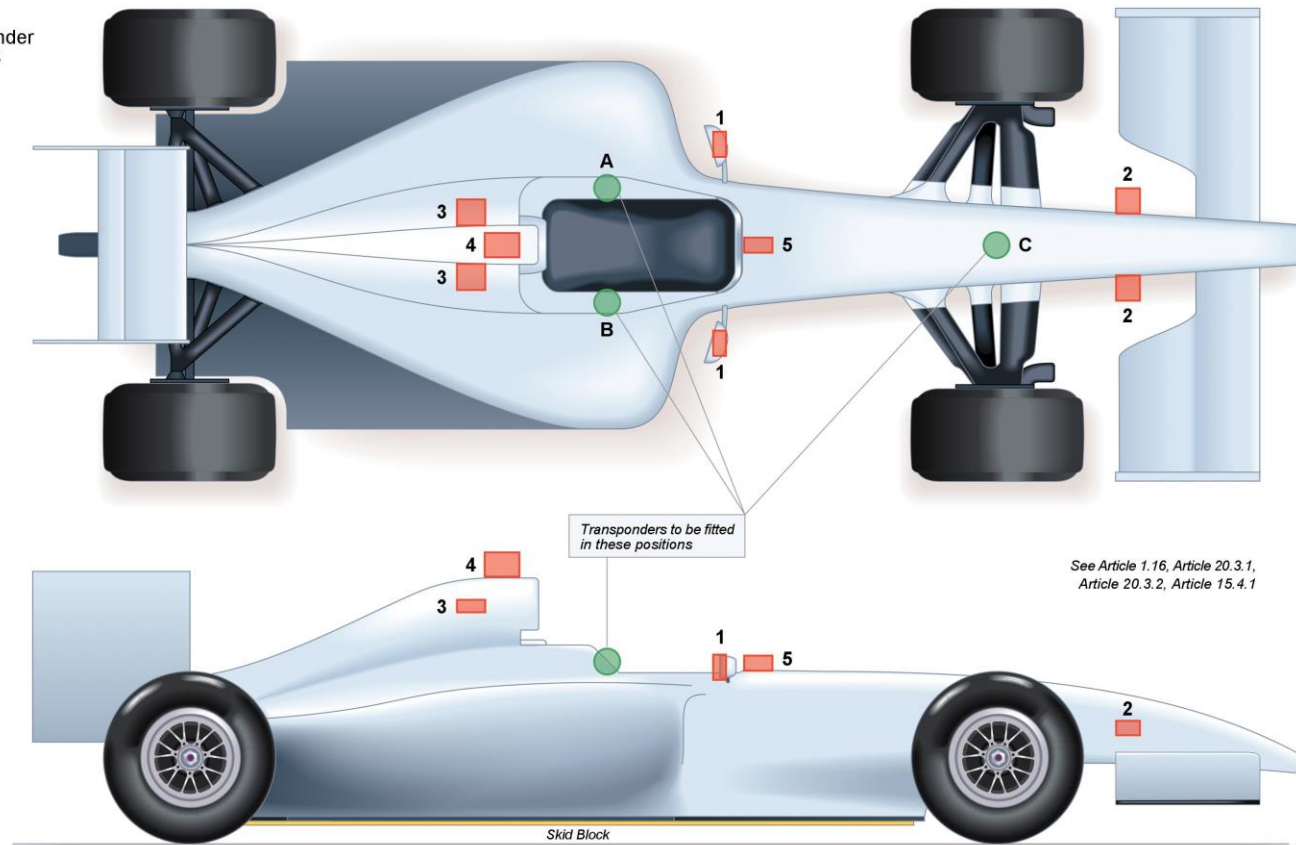

# Drawing 7



## Front Wing Section - Side & Front View

### Front Wing Co-ordinates

TE upper		Highest		LE		Lowest	
x	y	x	y	x	y	x	y
-760.506	88.605	-933.867	120.391	-999.999	103.784	-875.371	75.000
-760.957	88.749	-936.245	120.389	-999.956	103.015	-872.484	75.007
-761.778	89.003	-938.592	120.369	-999.835	102.418	-869.587	75.033
-762.825	89.332	-940.904	120.338	-999.664	101.808	-866.680	75.078
-764.061	89.716	-943.189	120.289	-999.424	101.222	-863.769	75.143
-765.447	90.149	-945.435	120.230	-999.128	100.584	-860.848	75.224
-766.969	90.621	-947.649	120.156	-998.766	99.969	-857.926	75.324
-768.606	91.124	-949.824	120.072	-998.348	99.354	-855.003	75.441
-770.353	91.663	-951.965	119.969	-997.869	98.743	-852.074	75.577
-772.194	92.229	-954.070	119.855	-997.330	98.140	-849.144	75.733
-774.125	92.821	-956.136	119.727	-996.735	97.537	-846.217	75.905
-776.136	93.431	-958.162	119.588	-996.079	96.938	-843.293	76.093
-778.221	94.062	-960.150	119.430	-995.366	96.347	-840.375	76.298
-780.373	94.710	-962.099	119.262	-994.598	95.756	-837.461	76.520
-782.592	95.374	-964.004	119.082	-993.776	95.163	-834.553	76.757
-784.866	96.054	-965.870	118.884	-992.894	94.568	-831.657	77.008
-787.200	96.743	-967.693	118.675	-991.960	94.024	-828.771	77.275
-789.581	97.439	-969.477	118.455	-990.969	93.457	-825.897	77.551
-792.009	98.146	-971.214	118.219	-989.926	92.895	-823.037	77.845
-794.486	98.860	-972.907	117.969	-988.826	92.341	-820.193	78.147
-797.002	99.577	-974.554	117.703	-987.677	91.791	-817.369	78.459
-799.554	100.297	-976.157	117.426	-986.476	91.246	-814.567	78.784
-802.146	101.020	-977.713	117.138	-985.223	90.709	-811.785	79.115
-804.770	101.745	-979.222	116.835	-983.917	90.177	-809.031	79.452
-807.422	102.467	-980.684	116.516	-982.562	89.653	-806.304	79.798
-810.102	103.184	-982.098	116.186	-981.159	89.134	-803.605	80.151
-812.811	103.899	-983.466	115.840	-979.707	88.624	-800.938	80.506
-815.540	104.611	-984.782	115.483	-978.206	88.122	-798.310	80.863
-818.294	105.313	-986.047	115.110	-976.657	87.624	-795.719	81.223
-821.068	106.008	-987.261	114.726	-975.064	87.132	-793.167	81.586
-823.859	106.696	-988.427	114.331	-973.421	86.648	-790.664	81.948
-826.666	107.370	-989.538	113.919	-971.734	86.174	-788.209	82.306
-829.487	108.036	-990.598	113.496	-969.999	85.707	-785.802	82.663
-832.320	108.687	-991.604	113.057	-968.223	85.246	-783.456	83.020
-835.167	109.327	-992.557	112.610	-966.402	84.790	-781.166	83.369
-838.022	109.952	-993.451	112.148	-964.540	84.347	-778.945	83.711
-840.882	110.561	-994.285	111.669	-962.634	83.909	-776.792	84.046
-843.752	111.155	-995.083	111.183	-960.688	83.476	-774.716	84.370
-846.627	111.733	-995.816	110.681	-958.700	83.057	-772.721	84.687
-849.507	112.295	-996.489	110.167	-956.672	82.642	-770.819	84.992
-852.388	112.837	-997.107	109.645	-954.603	82.237	-769.015	85.282
-855.266	113.359	-997.666	109.106	-952.498	81.837	-767.324	85.553
-858.146	113.865	-998.165	108.556	-950.356	81.451	-765.750	85.808
-861.027	114.352	-998.610	107.997	-948.173	81.070	-764.318	86.045
-863.901	114.821	-998.992	107.407	-945.958	80.698	-763.041	86.252
-866.773	115.271	-999.311	106.860	-943.702	80.332	-761.957	86.433
-869.638	115.700	-999.579	106.281	-941.417	79.980	-761.110	86.570
-872.497	116.108	-999.768	105.705	-939.095	79.633		
-875.348	116.496	-999.917	104.949	-936.741	79.300		
-878.189	116.867	-999.990	104.369	-934.354	78.972		
-881.020	117.217			-931.934	78.655		
-883.840	117.547			-929.485	78.347		
-886.649	117.859			-927.004	78.049		
-889.440	118.147			-924.494	77.766		
-892.219	118.421			-921.959	77.492		
-894.985	118.671			-919.395	77.225		
-897.731	118.907			-916.802	76.975		
-900.459	119.118			-914.185	76.732		
-903.168	119.315			-911.546	76.507		
-905.858	119.491			-908.879	76.293		
-908.529	119.650			-906.190	76.093		
-911.174	119.795			-903.480	75.911		
-913.799	119.918			-900.749	75.740		
-916.402	120.032			-897.997	75.592		
-918.978	120.124			-895.224	75.454		
-921.526	120.206			-892.433	75.339		
-924.051	120.274			-889.629	75.236		
-926.550	120.325			-886.804	75.154		
-929.018	120.361			-883.966	75.088		
-931.458	120.383			-881.114	75.041		
				-878.249	75.013		

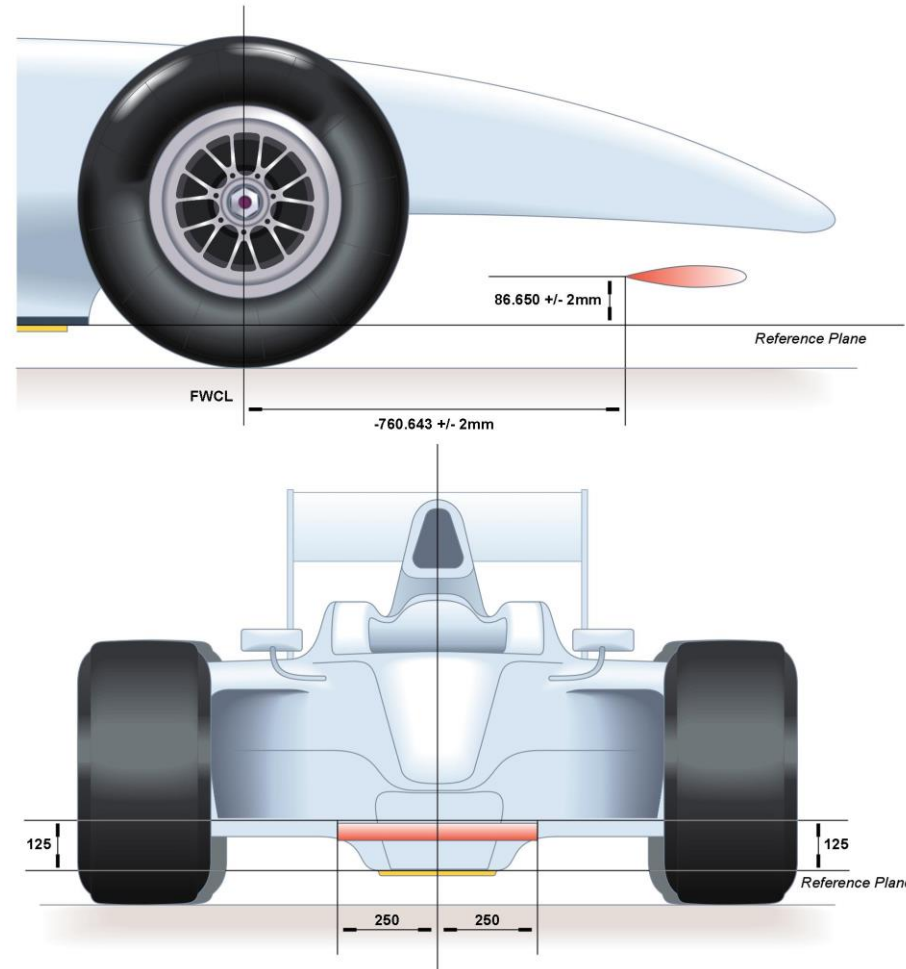

## **APPENDIX 2**

### **POWER UNIT SYSTEMS, FUNCTIONS AND COMPONENTS**

Item No	List of PU functions/systems/components	Article 1.22 Definition	Article 5.3.4 Legality Box	Article 5.4.1 Weight	Article 5.4.2 Cen.Gravity	Article 5.22 Seal. Perim.	App. 4 Sporting Regs.
1	All Engine sub-assemblies sealed according to Article 28 of the F1 Sporting Regulations (e.g. engine components within cam-covers, cylinder heads, crankcase, any gear case)	INC	INC	INC	INC	INC	INC
2	PU pressure charging components (e.g. compressor from inlet to outlet including wheel; turbine from inlet to outlet including wheel; shaft, bearings and housings)	INC	INC	INC	INC	INC	INC
3	Wastegate, Pop-off valve or similar	INC	INC	INC	INC	EXC	INC
4	PU Engine air inlet system from plenum entry to cylinder head (e.g. plenum, trumpets, throttles)	INC	INC	INC	INC	EXC	INC
5	PU exhaust system from the engine exhaust flange up to but not including the turbine or wastegate exit tail-pipe	INC	INC	INC	EXC	EXC	INC
6	PU mounted fuel system components: (e.g. High Pressure fuel hose, fuel rail, fuel injectors, accumulators)	INC	INC	INC	INC	EXC	INC
7	PU mounted electrical components (e.g. wiring loom within legality volume, sensors, actuators, ignition coils, alternator, spark plugs)	INC	INC	INC	INC	EXC	INC
8	All PU coolant pumps, oil pumps, scavenge pumps, oil air separators and fuel high pressure pumps (delivering more than 10bar) including any <a href="#">of the following associated components</a> : motors, actuators, filters, brackets, supports, screws, nuts, dowels, washers, cables, oil or air seals. <a href="#">All tubes or hoses between components of the PU that are not described by line 26.</a> Excludes hydraulic pumps and ERS parts described in line 9.	INC	INC	INC	INC	EXC	INC
9	Cooling pumps (and associated motors, actuators, associated filters, brackets, support, screws, nuts, dowels, washers, cables, tubes, hoses, oil or air seals) for ERS components not mandatorily included in the PU legality volume.	INC	EXC	INC	EXC	EXC	INC
10	<a href="#">Main</a> PU oil tank, catch tanks, and any breather system PU connected to them and associated filters, brackets, support, screws, nuts, dowels, washers, cables, tubes, hoses, oil or air seals	INC	INC	INC	INC	EXC	INC
11	MGU-K excluding mechanical power transmission components and mounting accessories	INC	INC	INC	INC	INC	INC
12	MGU-K mechanical power transmission components and mounting accessories	INC	INC	INC	INC	EXC	INC
13	MGU-H excluding mechanical power transmission components and mounting accessories.	INC	INC	INC	INC	INC	INC
14	MGU-H mechanical power transmission components and mounting accessories	INC	INC	INC	INC	EXC	INC
15	ES parts defined in Article 5.4.3	INC	EXC	EXC	EXC	INC	INC
16	ES excluding parts defined in Article 5.4.3	INC	EXC	EXC	EXC	EXC	INC
17	Wiring between any ECU and phases of MGU-K	INC	EXC	INC	EXC	EXC	INC
18	Wiring between any ECU and phases of MGU-H	INC	EXC	INC	EXC	EXC	INC
19	Wiring between ECU and ES	INC	EXC	INC	EXC	EXC	INC

20	Any ECU or associated device containing programmable semiconductors or containing high power switching devices. <u>This includes, but is not limited to, MGU-K control unit, MGU-H control unit, injector control unit, ignition control unit, voltage regulator, intelligent sensors and actuators containing complex electronics.</u>  <u>This excludes</u> associated brackets, supports, screws, nuts, dowels, washers or cables.  Excludes Standard ECU <u>and FIA sensors.</u>	INC	EXC	INC	EXC	INC	INC
21	<u>Brackets, supports, screws, nuts, dowels, washers or cables associated to the parts listed in line 20.</u>	INC	EXC	INC	EXC	EXC	INC
22	Standard ECU.	INC	EXC	EXC	EXC	EXC	INC
23	Any actuators needed to make the PU function at all times. (except specific exclusions)	INC	INC	INC	INC	EXC	INC
24	Intake upstream of compressor inlet up to and including the air filter.	EXC	EXC	EXC	EXC	EXC	EXC
25	Heat Shields and associated mounting hardware.	EXC	EXC	EXC	EXC	EXC	EXC
26	Water system accumulators	EXC	EXC	EXC	EXC	EXC	EXC
27	Heat exchangers and their associated accessories. (included but not limited to tubes, hoses, supports, brackets and fasteners)	EXC	EXC	EXC	EXC	EXC	EXC
28	Hydraulic system (e.g. pumps, accumulators, manifolds, servo-valves, solenoids, actuators) other than servo valve(s) and actuator(s) for PU control.	EXC	EXC	EXC	EXC	EXC	EXC
29	Hydraulic system servo valve(s) and actuator(s) for PU control.	INC	INC	INC	INC	EXC	INC
30	Fuel feed pumps delivering less than 10 bars and their associated accessories (included but not limited to tubes, hoses, supports, brackets and fasteners).	EXC	EXC	EXC	EXC	EXC	EXC
31	Any ancillary equipment associated with the PU air valve system such as regulators or compressors.	INC	EXC	EXC	EXC	EXC	INC
32	Exhaust beyond turbine exit and WG exit and associated brackets, support, screws, nuts, dowels, washers or cables.	INC	EXC	EXC	EXC	EXC	EXC
33	Studs used to mount PU to chassis or gearbox.	EXC	EXC	EXC	EXC	EXC	EXC
34	Flywheel, clutch and clutch actuation system between the PU and the gearbox.	EXC	EXC	EXC	EXC	EXC	EXC
35	Liquids.	EXC	EXC	EXC	EXC	EXC	EXC
36	Ballast mounted on the PU up to 2kg. This is permitted (subject to Article 4.4) but any in excess of 2kg will be removed before measuring PU weight.	EXC	INC	INC	INC	EXC	EXC
37	Ballast mounted on the PU in excess of 2kg.	EXC	EXC	EXC	EXC	EXC	EXC
38	Wiring harnesses which are not ordinarily part of a power unit.	EXC	EXC	EXC	EXC	EXC	EXC

## **APPENDIX 3**

### **POWER UNIT ENERGY FLOW**

**POWER UNIT ENERGY FLOW**  
**Legend: Engine - ERS - Other**

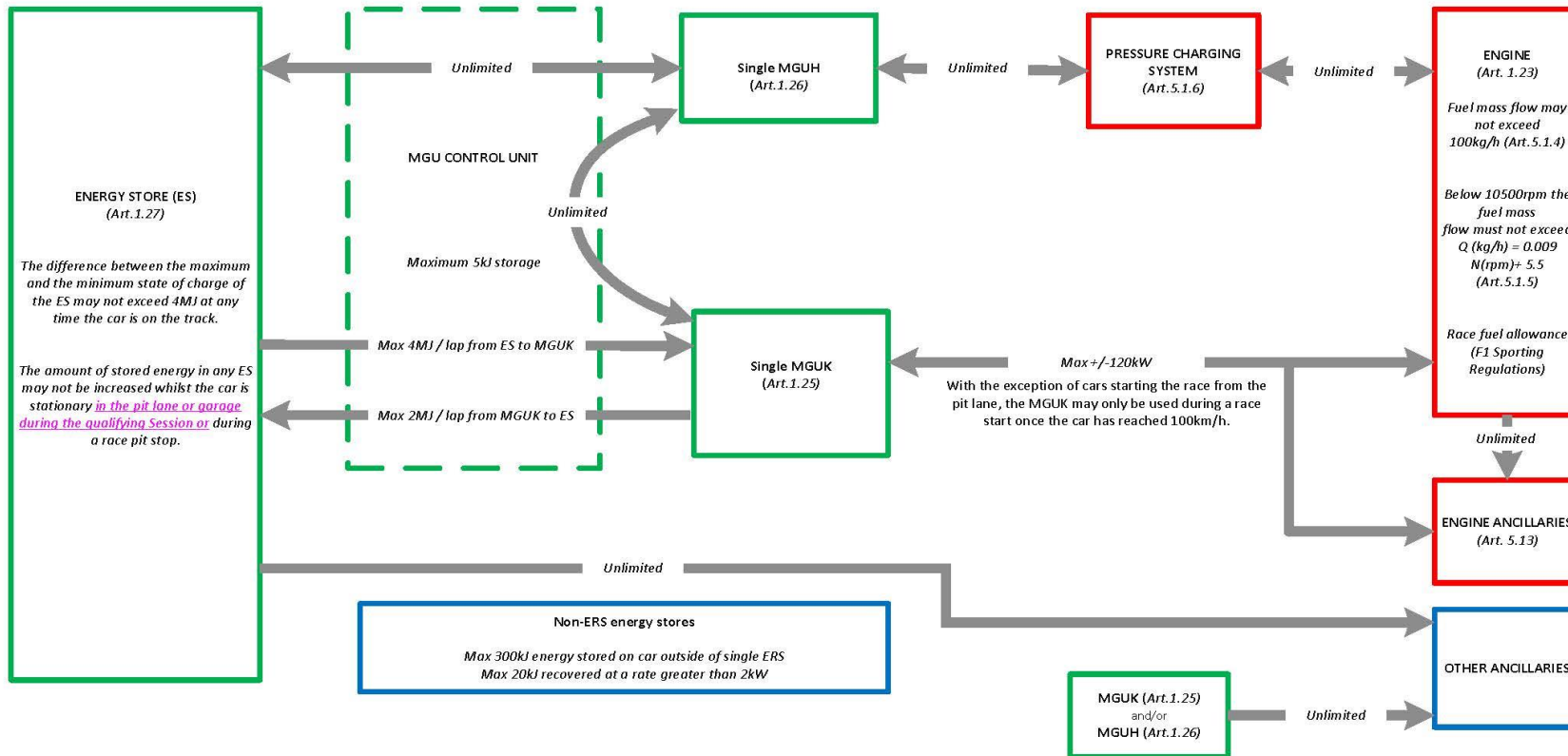

**Control of Energy Management:**  
 -One sensor is connected to measure all electrical energy into and out of the Energy Store.  
 -One Sensor is connected to measure all electrical energy into and out of the MGU-K.  
 -The DC-DC convertor may only consume energy. This will be verified by inspection.

Issue 8 - 30/04/2013

## APPENDIX 4

# ANNUAL F1 POWER UNIT HOMOLOGATION



Function	Function details	Weight	For 2015	For 2016	For 2017	For 2018	For 2019 + 2020
Upper/lower crankcase	Cylinder bore spacing, deck height, bank stagger.	2					
Upper/lower crankcase	All dimensions including Cylinder bore position relative to legality volume, water core.	3					
Cylinder Head	Except modifications linked to subsequent modifications.	2					
Combustion	All parts of parts defining combustion. Included: Ports, Piston crown, Combustion chamber, Valves geometry, timing, lift, injector nozzle, coils, spark plug Excluded: Valves position.	3					
Valves axis position	Includes angle but excludes axial displacement	2					
Valves drive	From valve to camshaft lobe. Position and Geometry. Exhaust and Inlet. Including valve return function inside the head.	2					
Valve drive - Camshafts	From camshaft lobe to gear train. Geometry except lift profile. Includes damping systems linked to camshaft. Exhaust and Inlet.	1					
Valve drive	Gear train down to crankshaft gear included. Position and Geometry. Includes dampers	2					
Covers	Covers closing the areas in contact with engine oil Cam covers, Cam-timing covers...	1					
Crankshaft	Crank throw, main bearing journal diameter, rod bearing journal diameter.	2					
Crankshaft	Except Crank throw, main bearing journal diameter, rod bearing journal diameter. Includes Crankshaft bearings.	2					
Con rods	Including small and big end bearings.	2					
Pistons	Including bearings and pin. Excluding crown.	2					
Air valve system	Including compressor, air pressure regulation devices.	1					
Ancillaries drive	From ancillary to power source. Includes position of the ancillaries as far as drive is concerned.	3					
Oil pressure pumps	Including filter. Excluding internal if no impact on body.	1					
Oil scavenge systems	Any scavenging system	1					
Oil recuperation	Oil/air separator, Oil tank, catch tank.	1					
Engine Water pumps	Include power unit mounted water pipes.	1					
Injection system	PU mounted fuel system components: (e.g. High Pressure fuel hose, fuel rail, fuel injectors, accumulators). Excluding injector nozzle.	2					
Inlet system	Plenum and associated actuators. Excluding pressure charging, trumpets and throttle associated parts and actuators.	1					
Inlet system	Trumpets and associated parts and actuators.	1					
Inlet system	Throttles and associated parts and actuators.	1					
Pressure charging	From compressor inlet to compressor outlet.	2					
Pressure charging	From turbine inlet to turbine outlet.	2					
Pressure charging	From Engine exhaust flanges to turbine inlet.	1					
Pressure charging	External actuators linked to Pressure charging.	1					
Electrical system	Engine mounted electrical components (e.g. wiring loom within legality volume, sensors, alternator). Excluding actuators, ignition coils and spark plugs.	1					
Ignition system	Ignition coils, driver box.	1					
Lubrication	All parts in which circulates oil under pressure (Oil pump gears, channels, piping, jets) and not mentioned elsewhere in the table.	1					
Friction coatings		1					
Sliding or rotating seals		1					
MGU-H	Complete. All internals including bearings, casing...	2					
MGU-H	Position, Transmission.	2					
MGU-H	Power electronics.	1					
MGU-K	Complete. All internals including bearings, casing...	2					
MGU-K	Position, Transmission.	2					
MGU-K	Power electronics.	1					
ERS	Wiring loom	1					
ES	Cells (Article 5.4.3).	2					
ES	BMS.	2					
ERS - Cooling/lubrication	Cooling/Lubrication systems (Including ES jackets, pipes, pumps, actuators).	1					

	For 2015	For 2016	For 2017	For 2018	For 2019	For 2020
Total of weighted items	66	66	66	66	66	66
Total of weighted modifiable items	61	51	51	43	3	3
Quota of total weighted items allowed for modifications	32	25	20	15	3	3
% of modifications allowed vs. complete weighted PU	48	38	30	23	5	5
Total of frozen items	5	15	15	23	63	63
% PU being frozen	8	23	23	35	95	95