

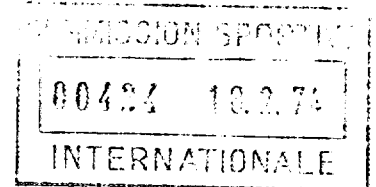

F.I.A. Recognition No. 5566

Group 1



ROYAL AUTOMOBILE CLUB
31 Belgrave Square, London, SW1X 8QH

Form of recognition in accordance with appendix J to the International Sporting Code of the
FEDERATION INTERNATIONALE DE L'AUTOMOBILE

	<u>Cylinder-capacity</u> 1993 cm. ³ 121.6 in. ³
Manufacturer FORD	Model ESCORT RS 2000
Serial No. of chassis/body BATN	Manufacturer FORD
Serial No. of engine -	Manufacturer FORD
Recognition is valid from 1.4.74	List
The manufacturing of the model described in this recognition form started on MARCH 1973	
and the minimum production of 5000 identical cars, in accordance with the specifications of this form was reached on NOVEMBER 1973	

Photograph A. 1/4 view of car from front



F.I.A. Stamp



5566

B



C

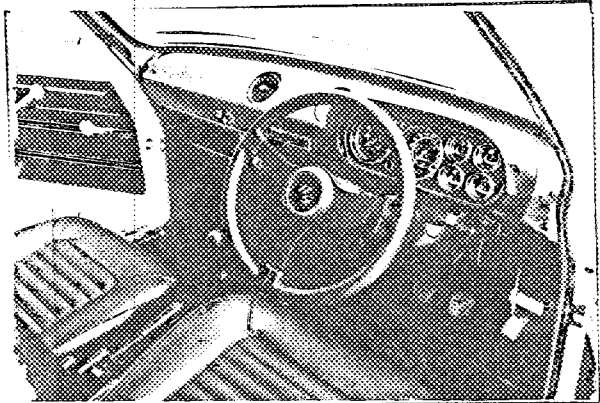

D

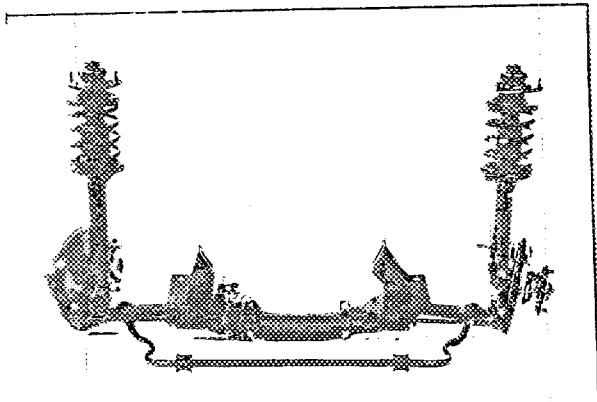

E

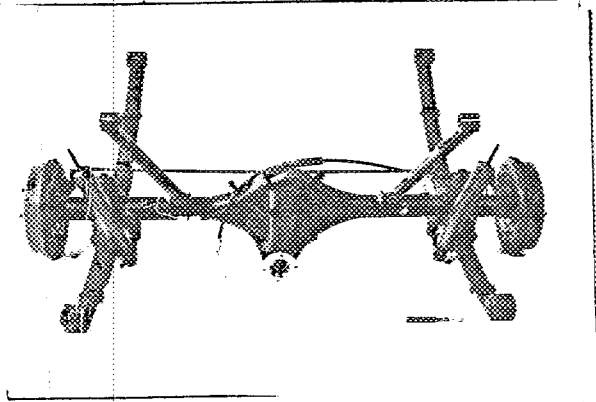

F

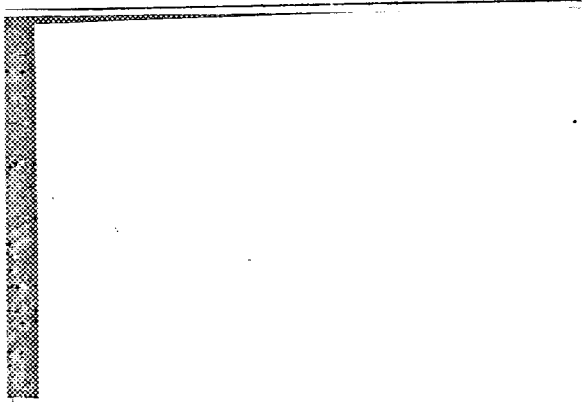

G

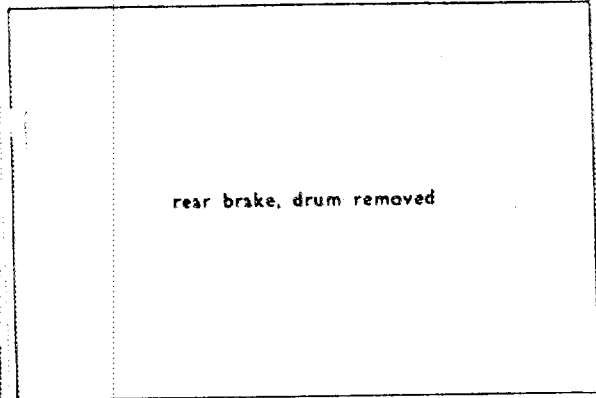

H

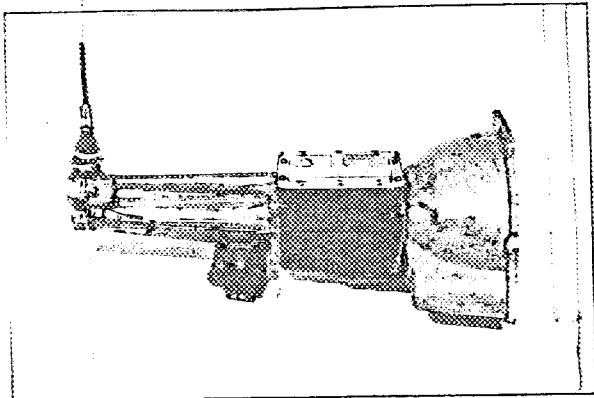

I



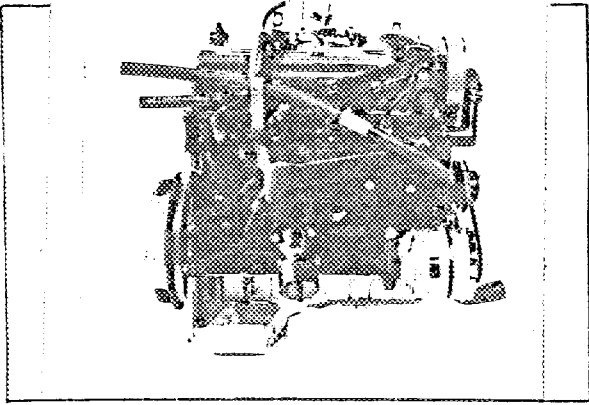

J

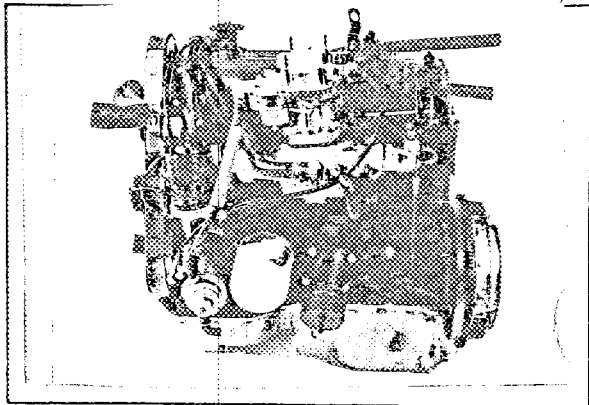

K

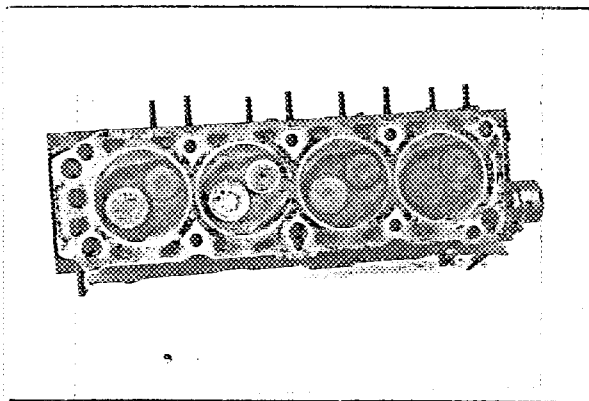

L

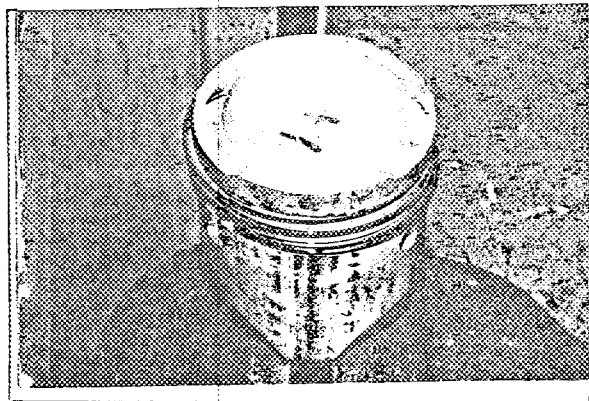

M

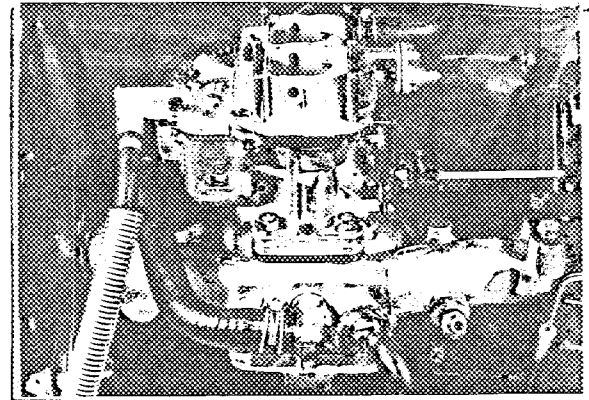

N

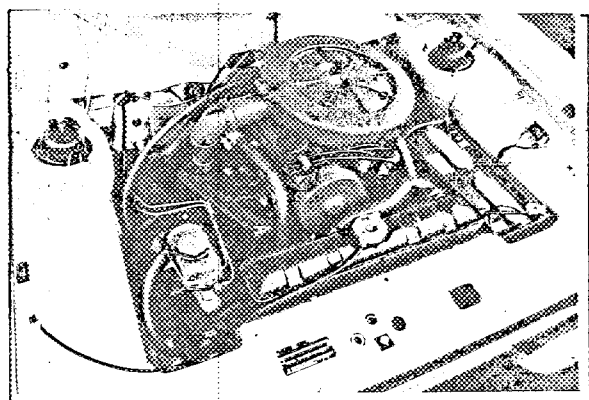

O

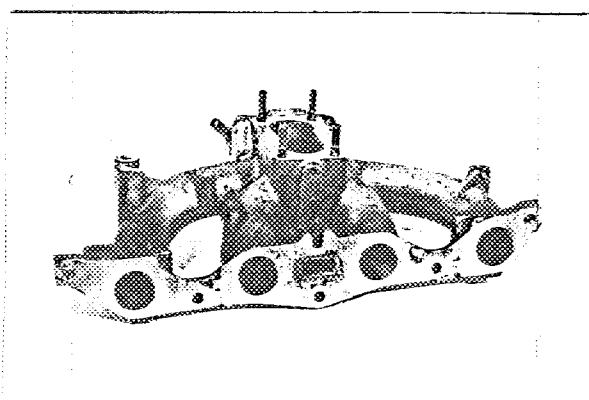

P

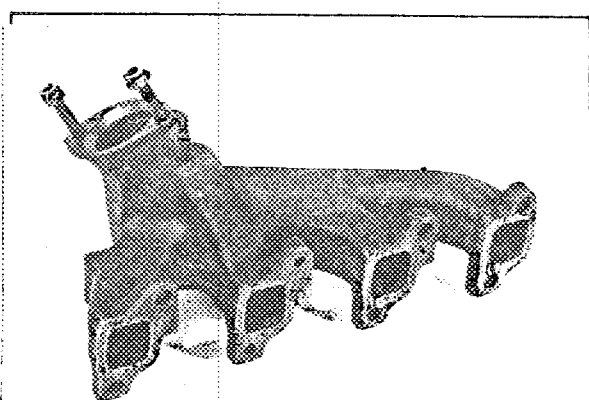

Q

Make

FORD

Model

ESCORT RS 2000

F.I.A. Rec. No.

5566

Insert Tolerances

Drawing inlet manifold ports, side of cylinderhead. Indicate scale or dimensions and manufacturing tolerance.

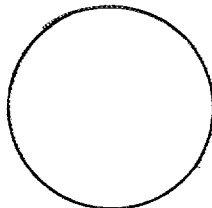

1.380 ins 35.05 mm

Drawing of entrance to inlet port of cylinderhead. Indicate scale or dimensions and manufacturing tolerance.

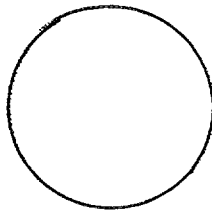

1.550 ins 39.37 mm

Drawing of exhaust manifold ports, side of cylinderhead. Indicate scale or dimensions and manufacturing tolerance.

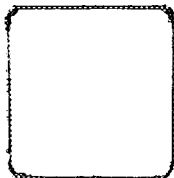

1.470 ins 37.33 mm

1.295 ins 32.89 mm

Drawing of exit to exhaust port of cylinderhead. Indicate scale or dimensions and manufacturing tolerance.

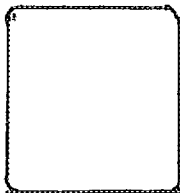

1.350 ins
34.29 mm

0.975 ins
24.76 mm

All dimensions ± 0.030 ins 0.7620 mm

Make FORD Model ESCORT RS 2000 F.I.A. Rec. No. 5566

NOTE 1.

All dimensions must be given in two measuring systems, see Note 3.

CAPACITIES AND DIMENSIONS

- | | | | | |
|----------------|------|-----|------|--------|
| 1. Wheelbase | 2400 | mm. | 94.5 | inches |
| 2. Front track | 1293 | mm. | 50.9 | inches |
| 3. Rear track | 1313 | mm. | 51.6 | inches |

Ground Clearance rocker panel to road	
Front	Rear
9.25 ins	9.25 ins
234.9 mm	234.9 mm
See Note 2	

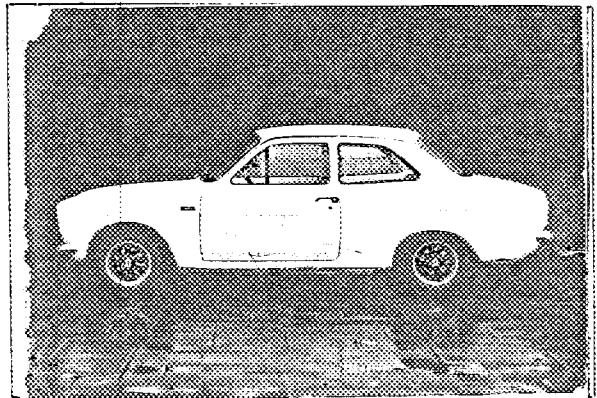

- | | | | | | | | | |
|--|-------------|-------|--------|------------|------------|------------|------|---------|
| 4. Overall length of the car | 398.4 | cm. | 156.8 | inches | | | | |
| 5. Overall width of the car | 160.8 | cm. | 63 | inches | | | | |
| 6. Overall height of the car | 139.1 | cm. | 54.7 | inches | | | | |
| 7. Capacity of fuel tank (reserve included) | 40.9 | ltrs. | 10.8 | gall. U.S. | 9 | gall. Imp. | | |
| 8. Seating Capacity. | 4 | | | | | | | |
| 9. Weight. Total weight of the car with normal equipment, water, oil, and spare wheel but without fuel or repair tools : | 865 | kg. | 1903.0 | lbs. | 16.99 | cwts. | | |
| 10. Width of the car measured at the axles | Front 155.0 | cm. | 61.0 | inches | Rear 157.2 | cm. | 61.8 | inches. |

NOTE 2.

Differences in track caused by the use of other wheels with different rim widths must be stated when recognition is requested for the wheels concerned. Specify ground clearance in relation to the track and give drawing of two easily recognisable points at front and rear at which measurements are taken. These ground clearance dimensions are only for information when checking the track and can in no way affect the eligibility of the car.

NOTE 3.

CONVERSION TABLE

1 inch/pouce	—	2.54	cm.	1 quart US	—	0.9464	ltrs.
1 foot/pied	—	30.4794	cm.	1 pint (pt)	—	0.568	ltrs.
1 sq. inch/pouce carre	—	6.452	cm. ²	1 gallon Imp.	—	4.546	ltrs.
1 cubic inch/pouce cube	—	16.387	cm. ³	1 gallon US	—	3.785	ltrs.
1 pound/livre (lb)	—	453.593	gr.	1 hundred weight (cwt.)	—	50.802	kg.

Make FORD

Model ESCORT RS 2000

F.I.A. Rec. No. 5566

CHASSIS AND COACHWORK (Photographs A, B and C)

- 20. Chassis/body construction: ~~separate~~/unitary construction
- 21. Unitary construction, material(s) Steel
- 22. Separate construction, Material(s) of chassis -
- 23. Material(s) of coachwork Steel
- 24. Number of doors 2 Material(s) Steel
- 25. Material(s) of bonnet Steel
- 26. Material(s) of boot lid Steel
- 27. Material(s) of rear-window Toughened glass
- 28. Material(s) of windscreen Laminated ~~Available~~ glass
- 29. Material(s) of front-door windows toughened glass
- 30. Material(s) of rear-door windows toughened glass
- 31. Sliding system of door windows toughened glass
- 32. Material(s) of rear-quarter light toughened glass

ACCESSORIES AND UPHOLSTERY

- 38. Interior heating : yes — ~~no~~
- 39. Air conditioning : yes — no
- 40. Ventilation : yes — ~~no~~
- 41. Front seats, type of seat and upholstery Adjustable bucket pvc or cloth
- 42. Weight of front seat(s), complete with supports and rails, out of the car :

8.1	kg.	18	lbs.
-----	-----	----	------
- 43. Rear seats, type of seat and upholstery Bench, pvc or cloth
- 44. Front bumper, material(s) Steel Weight 0.59 kg. each 1.3 lbs. each
- 45. Rear bumper, material(s) Steel Weight 2.5 kg. 5.5 lbs.

WHEELS

- 50. Type Pressed steel disc
- 51. Weight (per wheel, without tyre) 5.94 kg. 13 lbs. 2 ozs
- 52. Method of attachment 4 taper nut
- 53. Rim diameter 330 mm. 13.0 ins. 54. Rim width 139.7 mm. 5.5 ins.

STEERING

- 60. Type Rack and pinion
- 61. Servo-assistance : yes — no
- 62. Number of turns of steering wheel from lock to lock 3.5
- 63. In case of servo-assistance N/A

Make FORD Model ESCORT RS 2000 F.I.A. Rec. No. 5566

SUSPENSION

- 70. Front suspension (photograph D), type Independent MacPherson strut
- 71. Type of spring Coil
- 72. Stabiliser (if fitted) Integral with lower arms
- 73. Number of shock absorbers 2
- 74. Type Integral suspension leg
Telescopic double acting
- 78. Rear suspension (photograph E), type Live axle
- 79. Type of spring Semi-elliptic leaf
- 80. Stabiliser (if fitted) Trailing links
- 81. Number of shock absorbers 2
- 82. Type Telescopic double acting

BRAKES (photographs F and G)

- 90. Method of operation Hydraulic
- 91. Servo-assistance (if fitted), type Hydraulic vacuum
- 92. Number of hydraulic master cylinders One with twin pistons and dual line braking

93. Number of cylinders per wheel	2	FRONT		REAR	
94. Bore of wheel cylinder(s)	54.0	mm.	2.126 inches	19.05	mm. 0.75 inches

Drum Brakes

95. Inside diameter		mm.	inches	203.2	mm. 8.0	inches
96. Length of brake linings		mm.	inches	159.0	mm. 6.25	inches
97. Width of brake linings		mm.	inches	38.10	mm. 1.5	inches
98. Number of shoes per brake					2	
99. Total area per brake		mm. ²	sq. in.	12160	mm. ² 18.58	sq. in.

Disc Brakes

100. Outside diameter	244.0	mm.	9.6	inches	mm.	inches
101. Thickness of disc	12.7	mm.	0.5	inches	mm.	inches
102. Length of brake linings	76.6	mm.	3.00	inches	mm.	inches
103. Width of brake linings	50.8	mm.	2.00	inches	mm.	inches
104. Number of pads per brake			2			
105. Total area per brake	6671	mm. ²	10.34	sq. in.	mm. ²	sq. in.

Make **FORD** Model **ESCORT RS 2000** F.I.A. Rec. No. **5566**
ENGINE (photographs J and K)

- | | | | |
|---|---|--|---------------------------------------|
| 130. Cycle | Four | 131. Number of cylinders | Four |
| 132. Cylinder Arrangement | In line | | |
| 133. Bore | 90.82 mm. 3.57 in. | 134. Stroke | 76.95 mm. 3.02 in. |
| 135. Capacity per cylinder | 498.25 | | cm. ³ 30.40 cu. in. |
| 136. Total cylinder capacity | | 1993 | cm. ³ 121.6 cu. in. |
| 137. Material(s) of cylinder block | cast iron | 138. Material(s) of sleeves (if fitted) | cast iron |
| 139. Cylinder head, material(s) | cast iron | Number fitted | One |
| 140. Number of inlet ports | 4 | 141. Number of exhaust ports | 4 |
| 142. Compression ratio | 9.4 ± 0.5 | | |
| 143. Volume of one combustion chamber | | 56.1 - 63.2 cm. ³ | 3.423 - 3.856 cu. in. |
| 144. Piston, material | Aluminium alloy | 145. Number of rings | 3 |
| 146. Distance from gudgeon pin centre line to highest point of piston crown | | 41.5 - 41.6 mm. | 1.633 - 1.637 in. |
| 147. Crankshaft: moulded/ stamped | | 148. Type of crankshaft: integral/ cast with balance weight | |
| 149. Number of crankshaft main bearings | Five | | |
| 150. Material of bearing cap | cast iron | | |
| 151. System of lubrication: dry sump /oil in sump | | | |
| 152. Capacity, lubricant | 3.52 ltrs. 6.2 pts. | 3.33 | quarts U.S. |
| 153. Oil cooler: yes /no optional | | 154. Method of engine cooling water and electric fan | |
| 155. Capacity of cooling system | 6.9 ltrs. 12.2 pts. | 6.5 | quarts U.S. |
| 156. Cooling fan (if fitted) dia. | | 30.5 cm. | 12.0 in. |
| 157. Number of blades of cooling fan | 10 | | |
| <u>Bearings</u> (insert tolerances) | | | |
| 158. Crankshaft main, type | steel backed aluminium/
tin or lead/bronze | dia. 57.004 - 57.038 | m.m. 1.4478 - 1.4485 in. |
| 159. Connecting rod big end, type | steel backed
aluminium/tin or lead/bronze | dia. 52.004 - 52.038 | m.m. 1.3209 - 1.3217 in. |
| <u>Weights</u> (insert tolerances) | | | |
| 160. Flywheel (clean) | | 7.62 kg. | 16.7 lbs. |
| 161. Flywheel with clutch (all turning parts) | | 13.52 kg. | 29.7 lbs. |
| 162. Crankshaft | 13.85 kg. 30.47 lbs. | 163. Connecting rod | 0.506 kg. 1.11 lbs. |
| 164. Piston with rings and pin | | 0.612 kg. | 1.34 lbs. |
| 254. Reboring dimensions | 90.95255 mm 3.58 ins | Total resultant cylinder capacity | 1999.4 cm. ³ 122.0 cu. in. |
| 256. Volume of the combustion chamber in the head | | 48.0 - 53.0 cm. ³ | 2.929 - 3.234 cu. in. |
| 257. Thickness of the head gasket after tightening | 0.116 mm. 0.046 in. | 258. Piston Dimension | 90.88 mm. 3.577 in. |

Make FORD

Model ESCORT RS 2000

F.I.A. Rec. No. 5566

FOUR STROKE ENGINES

170. Number of camshafts One 171. Location In cylinder head
172. Type of camshaft drive Toothed belt
173. Type of valve operation o.h.c and fingers

INLET (see page 4)*

180. Material(s) of inlet manifold Aluminium alloy
181. Diameter of valves 42.0 \pm 0.2 mm. 1.654 \pm 0.008 ins.
182. Max. valve lift 10.39 mm. 0.4093 in. 183. Number of valve springs One or two
184. Type of spring Coil 185. Number of valves per cylinder One
186. Tappet clearance for checking timing (cold/warm) 0.05 mm. 0.002 ins.
187. Valves open at (with tolerance for tappet clearance indicated) 58° B T D C
188. Valves close at (with tolerance for tappet clearance indicated) 136° A B D C
189. Air filter, type Paper element

EXHAUST (see page 4)*

195. Material(s) of exhaust manifold cast iron
196. Diameter of valves 36.0 \pm 0.2 mm. 1.42 \pm 0.008 ins.
197. Max. valve lift 10.39 mm. 0.4093 in. 198. Number of valve springs One or two
199. Type of spring Coil 200. Number of valves per cylinder One
201. Tappet clearance for checking timing (cold/warm) 0.05 mm. 0.002 ins.
202. Valves open at (with tolerance for tappet clearance indicated) 105° B B D C
203. Valves close at (with tolerance for tappet clearance indicated) 88° A T D C
204. Diameter outlet orifice exhaust manifold 47 mm. 1.845 ins.

CARBURETION (photograph N)

210. Number of carburettors fitted One 211. Type Downdraught
212. Make Weber 213. Model DGAV 32/36
214. Number of mixture passages per carburettor Two
215. Flange hole diameter of exit port(s) of carburettor 36/32 mm. 1.42/1.26 ins.
216. Minimum diameter of venturi/minimum diam., with piston at maximum height (example : SU)
Primary 26 mm 1.02 ins
Secondary 27 mm 1.06 ins

INJECTION (if fitted)

220. Make of pump N/A 221. Number of plungers N/A
222. Model or type of pump N/A 223. Total number of injectors N/A
224. Location of injectors N/A
225. Minimum diameter of inlet pipe N/A mm. ins.

* For additional information concerning two-stroke engines and super-charged engines, see page 13.

Make FORD Model ESCORT RS 2000 F.I.A. Rec. No. 5566

ENGINE ACCESSORIES

230. Fuel pump: mechanical ~~and/or electrical~~
231. No. fitted One
232. Type of ignition system Coil
233. No. of distributors One
234. No. of ignition coils One
235. No. of spark plugs per cylinder One
236. Generator, type: ~~dynamo~~/alternator—number fitted One
237. Method of drive 'V' belt
238. Voltage of generator 12 volts
239. Battery, number One
240. Location Engine Compartment
241. Voltage of battery 12 volts

ENGINE AND CAR PERFORMANCES (as declared by manufacturer in catalogue)

250. Max. engine output 100 (type of horsepower: DIN PS) at 5750 r.p.m.
251. Max. r.p.m. 6000 output at that figure 97
252. Max. torque 14.9 M/kp at 3750 r.p.m.
253. Max. speed of the car 175 km./hour 109 miles/hour

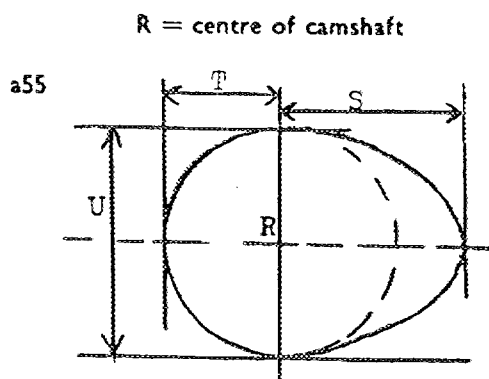

Inlet cam

S =	36.532	mm.	1.438	inches
T =	15.1	mm.	0.594	inches
U =	30.37	mm.	1.195	inches

Exhaust cam

S =	36.532	mm.	1.438	inches
T =	15.1	mm.	0.594	inches
U =	30.35	mm.	1.194	inches

Make FORD Model ESCORT RS. 2000 F.I.A. Rec. No. _____

DRIVE TRAIN

CLUTCH

260. Type of clutch Diaphragm 261. No. of plates One
 262. Dia. of clutch plates 21.6 cm. 8.5 ins.
 263. Dia. of linings, inside 15.3 cm. 6.02 ins.
 outside 21.6 cm. 8.5 ins.
 264. Method of operating clutch cable

GEAR BOX (photograph H)

270. Manual type, make Ford Method of operation Manual
 271. No. of gear-box ratios forward 4 272. Synchronized forward ratios 4
 273. Location of gear-shift Remote central floor control
 274. Automatic, make N/A type N/A
 275. No. of forward ratios N/A 276. Location of gear shift N/A

277.	Manual		Automatic		Alternative manual/automatic			
	Ratio	No. teeth	Ratio	No. teeth	Ratio	No. teeth	Ratio	No. teeth
1	3.65	$\frac{34}{18} \times \frac{29}{15}$			2.54	$\frac{20}{32} \times \frac{27}{17}$		
2	1.97	$\frac{34}{18} \times \frac{25}{24}$			1.66	$\frac{20}{32} \times \frac{25}{28}$		
3	1.37	$\frac{34}{18} \times \frac{21}{29}$			1.255	$\frac{20}{32} \times \frac{22}{28}$		
4	1.00	Direct			1.00	Direct		
5								
6								
reverse	3.66	$\frac{34}{18} \times \frac{31}{16}$			3.66	$\frac{20}{32} \times \frac{31}{16}$		

278. Overdrive, type N/A
 279. Forward gears on which overdrive can be selected N/A
 280. Overdrive ratio N/A

FINAL DRIVE

290. Type of final drive Semi-floating hypoid 291. Type of differential Two pinion
 292. Type of limited slip differential (if fitted in series-production) Salisbury four pinion
 293. Final drive ratio 3.54 or 4.1 Number of teeth 11 x 39 or 9 x 37

5566

IMPORTANT:

The vehicle described in this form has been subject to the following amendments :

on.....	19	rec. no.....	List.....	on.....	19	rec. no.....	List.....
on.....	19	rec. no.....	List.....	on.....	19	rec. no.....	List.....
on.....	19	rec. no.....	List.....	on.....	19	rec. no.....	List.....
on.....	19	rec. no.....	List.....	on.....	19	rec. no.....	List.....
on.....	19	rec. no.....	List.....	on.....	19	rec. no.....	List.....

Optional equipment affecting preceding information. This to be stated together with reference number.

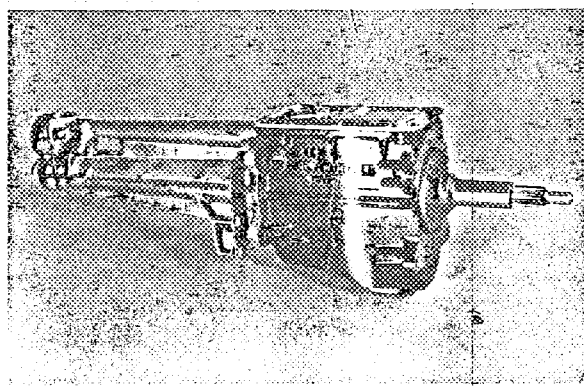

Alternative Gear box listed under item 277.

Boite de Vitesses optionnelle decrite au § 277.



MOTOR SPORT DIVISION
The Royal Automobile Club
 31 Belgrave Square, London SW1X 8QH

Manufacturer FORD
 Model ESCORT RS 2000
 F.I.A. Recognition No. 5566
 Amendment No. 1/IV

Amendment to Form of Recognition

FEDERATION INTERNATIONALE DE L'AUTOMOBILE

No.	Reference No.
	Production Variant
	RS 2000 GT
	Different inlet manifold Photo No. 1
	Part No. FC 0533
	Twin Solex carburettors Photo No. 2
210	Two
211	Downdraught
212	Weber
213	40 CCI "valable en Groupe 2 uniquement"
214	Two "valid for Group 2 only"
215	40 mm 1.574 ins
216	32 mm 1.259 ins
	Different exhaust manifold Photo No. 3 Part No. FC 0534
	Production variant for German manufacture
195	Cast iron
204	35 mm 1.373 ins
	Different exhaust system Photo No. 4 Part No. FC 0535
	Production variant for German manufacture

Ford

Date amendment is valid from 1.4.76

[Signature]
 Stamp of F.I.A./R.A.C.



MOTOR SPORT DIVISION
The Royal Automobile Club
 31 Belgrave Square, London SW1X 8QH

Manufacturer FORD
 Model ESCORT RS 2000
 F.I.A. Recognition No. 5566
 Amendment No. 1/IV

Amendment to Form of Recognition

FEDERATION INTERNATIONALE DE L'AUTOMOBILE

612

No.	Reference No.
	Production variant for German manufacture
	Carburettor Photo No. 5
210	One
211	Downdraught
212	Solex
213	35 EEIT
214	Two
215	35 mm 1.377 ins
216	28 mm 1.1024 ins

Inlet manifold for Solex carburettor
 Photo No. 6 Part No. FC 0536

"valable en Groupe 2 uniquement"
 "valid for Group 2 only"

Date amendment is valid from.....

Stamp of F.I.A./R.A.C.



MOTOR SPORT DIVISION
The Royal Automobile Club
 31 Belgrave Square, London SW1X 8QH

Manufacturer **FORD**

Model **ESCORT RS 2000**

F.I.A. Recognition No. **5566**

Amendment No. **1/IV**

"valable en Groupe 2 uniquement"
valid for Group 2 only

Amendment to Form of Recognition
FEDERATION INTERNATIONALE DE L'AUTOMOBILE

Photographs must be 3" x 2" and a matt finish

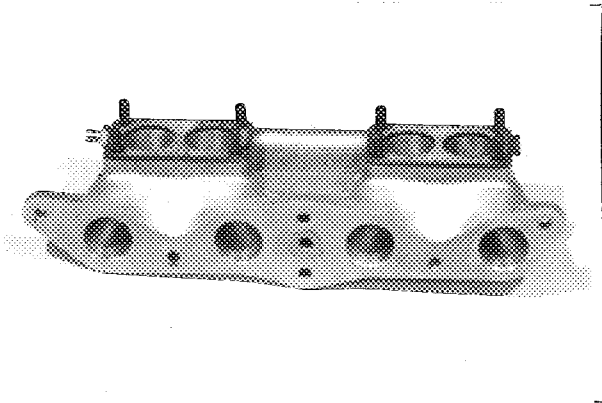

Photo No. 1

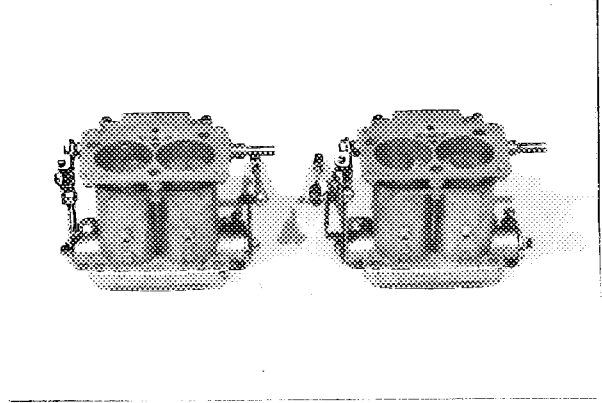

Photo No. 2

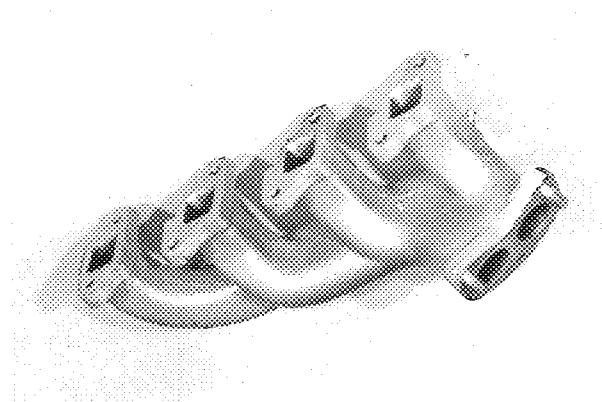

Photo No. 3

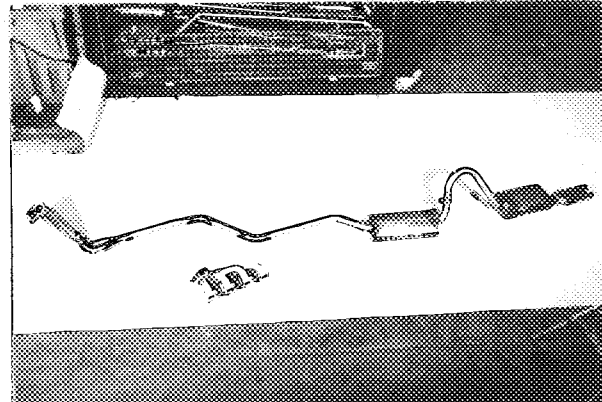

Photo No. 4

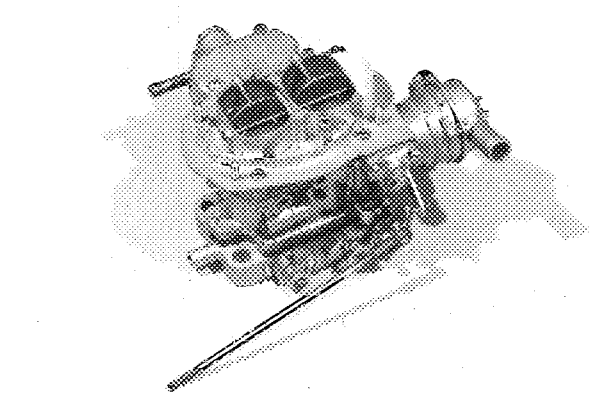

Photo No. 5

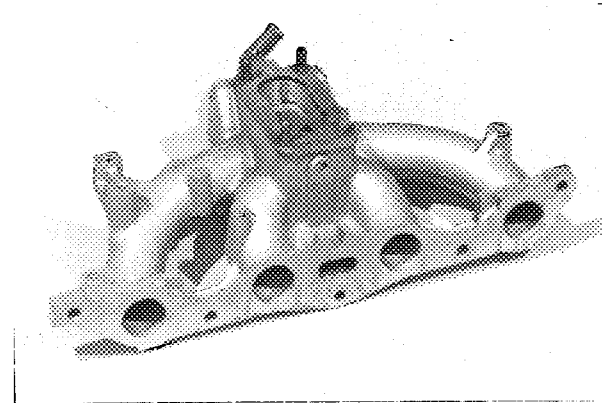

Photo No. 6

Date amendment is valid from..... *"valable en Groupe 2 uniquement"*
valid for Group 2 only

Stamp of F.I.A./R.A.C.



MOTOR SPORT DIVISION
The Royal Automobile Club
 31 Belgrave Square, London SW1X 8QH

Manufacturer FORD

Model ESCORT RS 2000

F.I.A. Recognition No. 5566

Amendment No. 2/2V

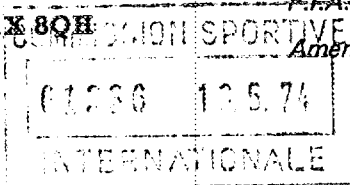

Amendment to Form of Recognition

FEDERATION INTERNATIONALE DE L'AUTOMOBILE

VALID IN GROUP

No.	Reference No.
	Production Variant for German manufacture
	Carburettor
210	One
211	Downdraught
212	Solex
213	35 EELT
214	Two
215	35 mm 1.377 ins
216	32 mm 1.259 ins
	Photograph No 5
	Inlet manifold for above
	Part No. FC 0536
	Photograph No 6

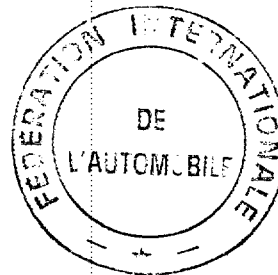

Date amendment is valid from.....

Stamp of F.I.A./R.A.C.



MOTOR SPORT DIVISION
 The Royal Automobile Club
 31 Belgrave Square, London SW1X 8QH

Manufacturer FORD
 Model ESCORT RS 2000
 F.I.A. Recognition No. 5566
 Amendment No. 2/W

COMMISSION SPORTIVE
 01833 13.5.74
 INTERNATIONALE

Amendment to Form of Recognition

FEDERATION INTERNATIONALE DE L'AUTOMOBILE

Photographs must be 3" x 2" and a matt finish

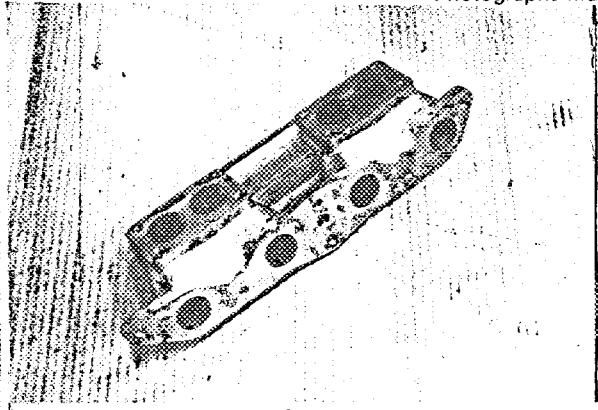

Photograph No 1

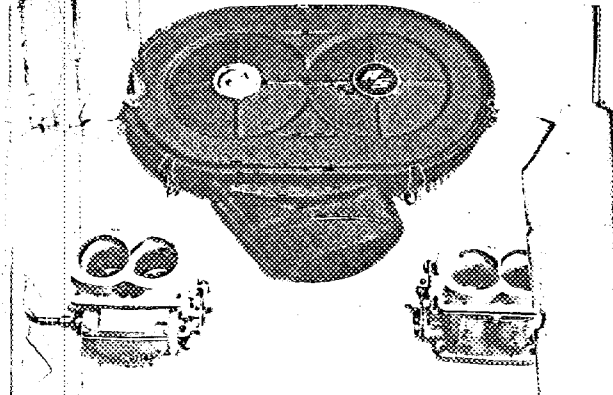

Photograph No 2

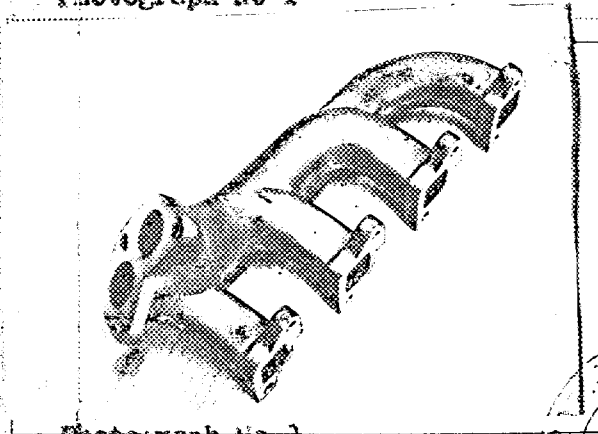

Photograph No 3

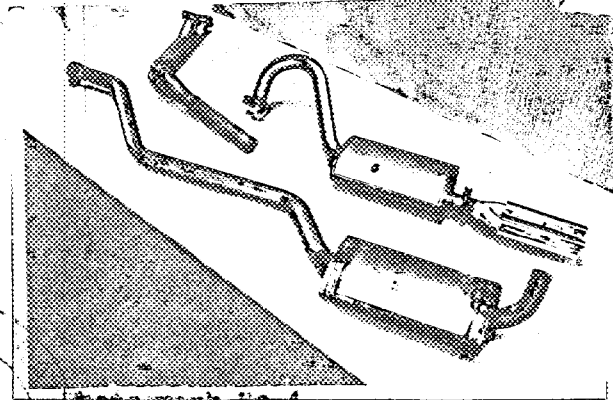

Photograph No 4

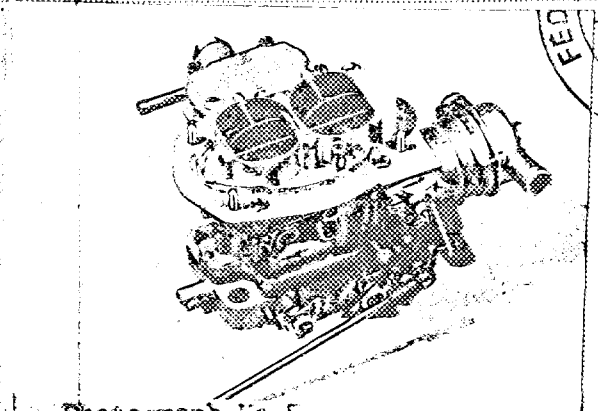

Photograph No 5

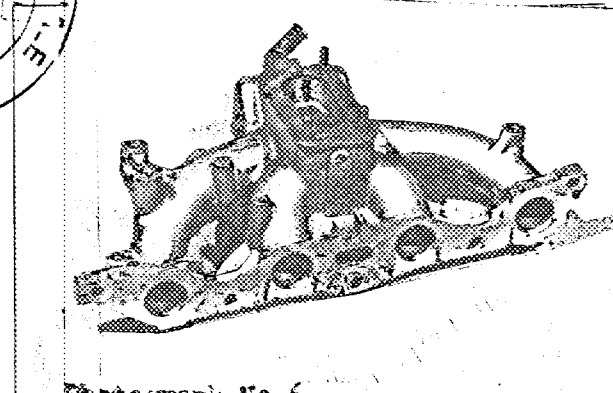

Photograph No 6

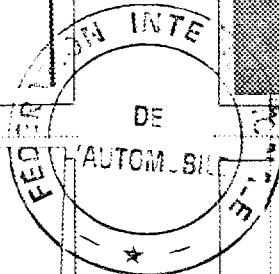

Date amendment is valid from.....

Stamp of F.I.A./R.A.C.



MOTOR SPORT DIVISION

The Royal Automobile Club

31 Belgrave Square, London

COMMISSION SPORTIVE

SWIX 8QH

13.5.74
INTERNATIONALE

Manufacturer FORD

Model ESCORT RS 2000

F.I.A. Recognition No. 5566

Amendment No. 2/21

Amendment to Form of Recognition

FEDERATION INTERNATIONALE DE L'AUTOMOBILE

No.

Reference No.

PRODUCTION VARIANT

RS 2000 GT

Different inlet manifold for twin Solex carburettors

Part No. FC 0533

Photograph No 1

Twin Solex carburettors

Two

Downdraught

Solex

40CC1

Two

40 mm 1.574 ins

32 mm 1.259 ins

Photograph No 2

Production Variant for German manufacture

Different exhaust manifold

Part No. FC 0534

Cast Iron

35 mm 1.373 ins

Photograph No 3

Different exhaust system

Production variant for German manufacture

Part No. FC 0535

Photograph No 4

210
211
212
213
214
215
216

195
204

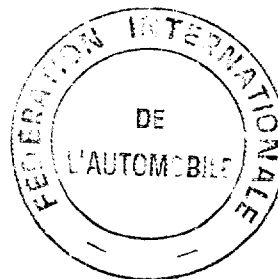

Date amendment is valid from 1.7.74

Stamp of F.I.A./R.A.C.



MOTOR SPORT DIVISION

The Royal Automobile Club

31 Belgrave Square, London SW1X 8QB

Manufacturer FORD

Model ESCORT RS 2000

F.I.A. Recognition No. 5566

Amendment No. 3/3v

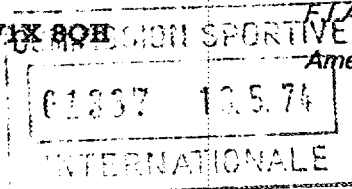

Amendment to Form of Recognition

FEDERATION INTERNATIONALE DE L'AUTOMOBILE

VALID IN GROUP.....

No.	Reference No.
	Production Variant on Emission Control Cars
181	44.5 mm 1.75 ins
182	11.95 mm 0.471 ins
196	38.2 mm 1.50 ins
197	11.95 mm 0.471 ins
a55	Inlet S = 21.4 mm
	& exhaust T = 14.0 mm
	U = 28.17 mm

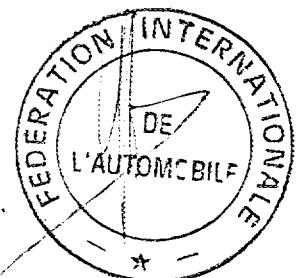

Stamp of F.I.A./R.A.C.

Date amendment is valid from 17.76



MOTOR SPORT DIVISION
The Royal Automobile Club
 31 Belgrave Square, London SW1X 8QH 5.74

COMMISSION SPORTIVE
 INTERNATIONALE

Manufacturer FORD
 Model RS 2000
 F.I.A. Recognition No. 5566
 Amendment No. h/hv

Amendment to Form of Recognition

FEDERATION INTERNATIONALE DE L'AUTOMOBILE

VALID IN GROUP

No.

Reference No.

41

Alternative Manufacturers supply seats to same specification, but different external pleating. Photo: C.1. and C.2.

Weight 38 lbs 15kg

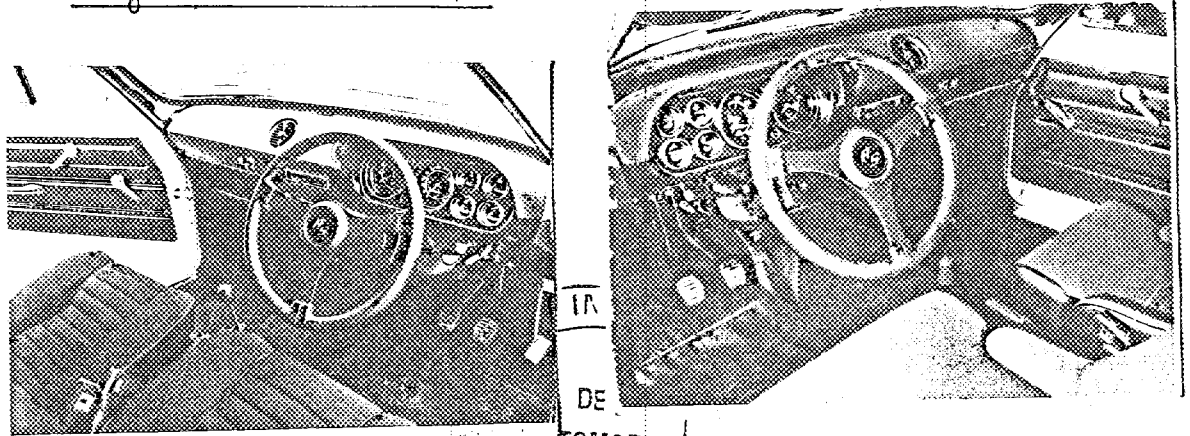
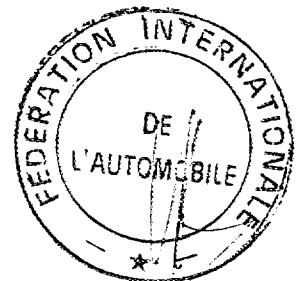
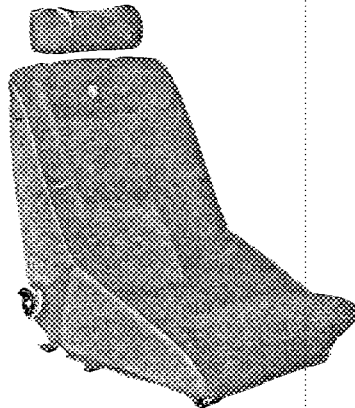
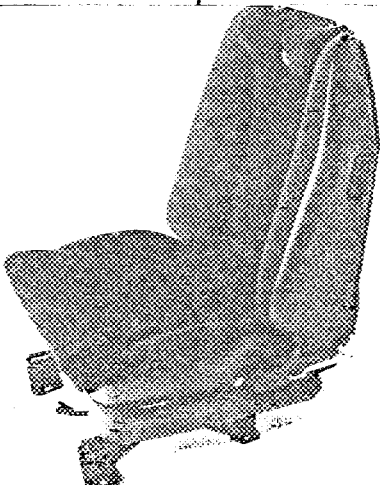

Photo C.1.

Photo C.2



Date amendment is valid from 1.9.74

Stamp of F.I.A.



MOTOR SPORT DIVISION
The Royal Automobile Club
 31 Belgrave Square, London SW1X 8QH

Manufacturer FORD

Model ESCORT RS 2000

F.I.A. Recognition No. 5566

Amendment No. 5/5V

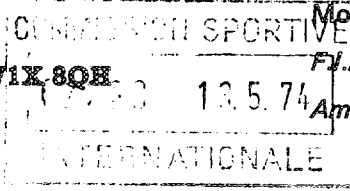

Amendment to Form of Recognition

FEDERATION INTERNATIONALE DE L'AUTOMOBILE

No. | Reference No.

Variant for Group 2

Alternative gearbox
 ZF 5-speed Part No. CD 70/4
 Photo A

Alternative bellhousing in light alloy to suit above
 Part No. H69AB 7505 CA
 Photo B

Different prop-shaft for above
 Part No. H71AB 4602 AA

"valable en Groupe 2 uniquement"
"valid for Group 2 only"

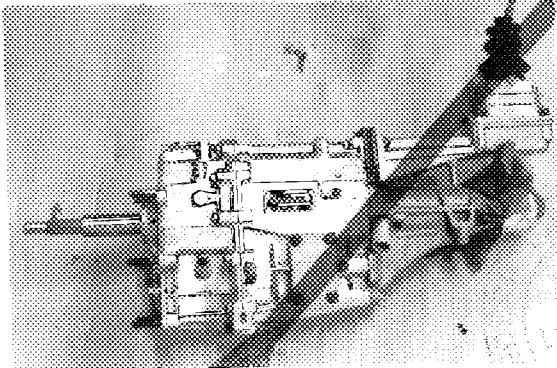

Photo A

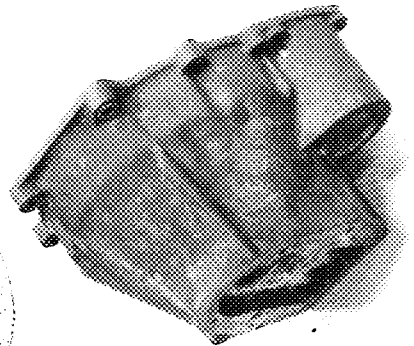
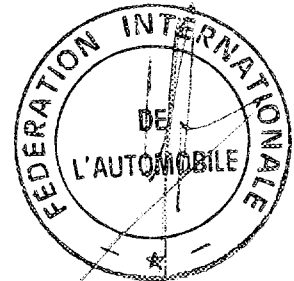
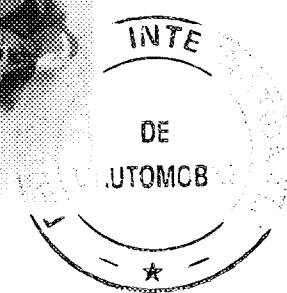

Photo B



Date amendment is valid from 1.9.74

Stamp of F.I.A./R.A.C.



MOTOR SPORT DIVISION
The Royal Automobile Club
31 Belgrave Square, London SW1X 8QH

Manufacturer FORD.....
 Model ESCORT RS 2000.....
 F.I.A. Recognition No. 5566.....
 Amendment No. 5/5V

COMMISSION SPORTIVE
 01337 13.5.74
 INTERNATIONALE

Amendment to Form of Recognition

FEDERATION INTERNATIONALE DE L'AUTOMOBILE

VALID IN GROUP.....

No.

Reference No.

Variant for Group 2

"valable en Groupe 2 uniquement"
"c.s. valid for Group 2 only"

CORRECTION

~~heavy duty rear axle assembly~~
 Part No. CD 1033/205
 Photo C

Brakes of different dimensions

94	22.8 mm	0.9 ins
95	228 mm	9.0 ins
96	182.8 mm	7.2 ins
97	55.8 mm	2.2 ins
98	2	
99	2042 mm ²	31.68 ins ²

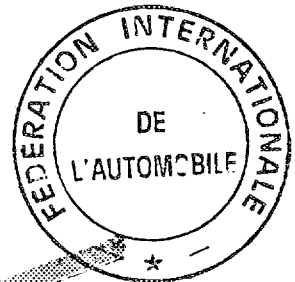

~~heavy duty axle shafts and bearings~~
 Part No. CD 1000/206
 Photo D

Equipment for disc rear brake conversion
 includes caliper mounting bracket, disc and mounting collar

104

2 (+ 2 for handbrake)

Photo E

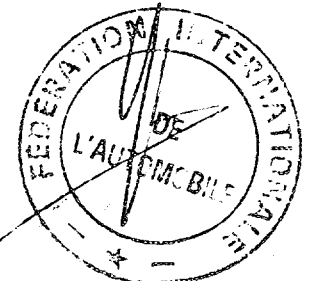
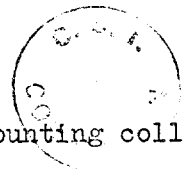

Date amendment is valid from 1.9.76

Stamp of F.I.A./R.A.C.



MOTOR SPORT DIVISION
The Royal Automobile Club
 31 Belgrave Square, London SW1X 8QH

Manufacturer FORD.....

Model ESCORT RS 2000.....

COMMISSION SPORTIVE
 F.I.A. Recognition No. 5566
 Amendment No. 515 V
 INTERNATIONALE

Amendment to Form of Recognition

FEDERATION INTERNATIONALE DE L'AUTOMOBILE

No. | Reference No.

"valable en Groupe 2 uniquement"
"valid for Group 2 only"

Variant for Group 2

Alternative crossmember for use with heavy duty engine mounts
 Part No. CD 1000/151
 Photo F

Wheel arch extension kit (increases overall width by 5 cms each side)
 Part No. CD 111 F
 Photos G & H

Sump shield in light alloy with mounting bar
 Part No. H69AB 631 BA
 Photo J

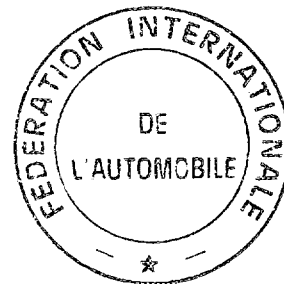

Date amendment is valid from 1 9 76

Stamp of F.I.A./R.A.C



MOTOR SPORT DIVISION
The Royal Automobile Club
31 Belgrave Square, London SW1X 8QH

Manufacturer FORD

Model ESCORT RS 2000

F.I.A. Recognition No. 5566

Amendment No. 5/5V

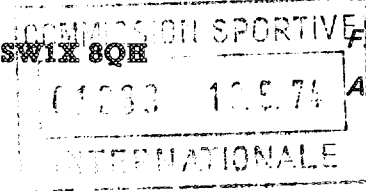

Amendment to Form of Recognition

FEDERATION INTERNATIONALE DE L'AUTOMOBILE

"valable en Groupe 2 uniquement"
"valid for Group 2 only"

No.	Reference No.
	Variant for Group 2
	Alternative cylinder head
139	Aluminium alloy
170	Two
171	In cylinder head
172	Toothed belt
173	o.h.c. and bucket tappet
185	Two
200	Two
	Photo K
	Alternative connecting rod Part No. 5067
	Alternative crankshaft (steel)
163	0.613 kg 1 lb 5 oz
	Photo L
	Alternative oil pump Part No. 5084
	Photo M
	Fuel injection equipment
	Photo N
	Different bearing cap
	Photo O

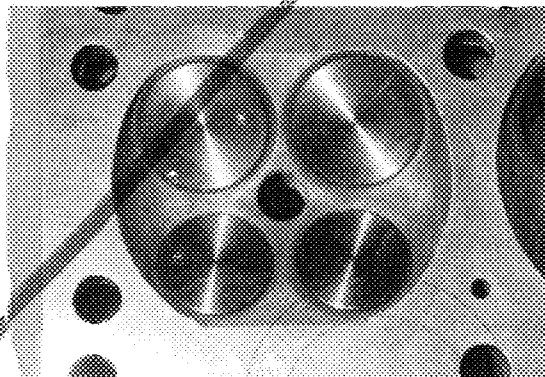

Date amendment is valid from 1.9.74

Stamp of F.I.A./R.A.C.



MOTOR SPORT DIVISION
The Royal Automobile Club
 31 Belgrave Square, London SW1X 8QH

Manufacturer FORD.....
 Model ESCORT RS 2000.....
 F.I.A. Recognition No. 5566.....
 Amendment No. 5/5V.....

Amendment to Form of Recognition

FEDERATION INTERNATIONALE DE L'AUTOMOBILE

"valable en Groupe 2 uniquement"
 "valid for Group 2 only"

hs must be 3" x 2" and ... finish

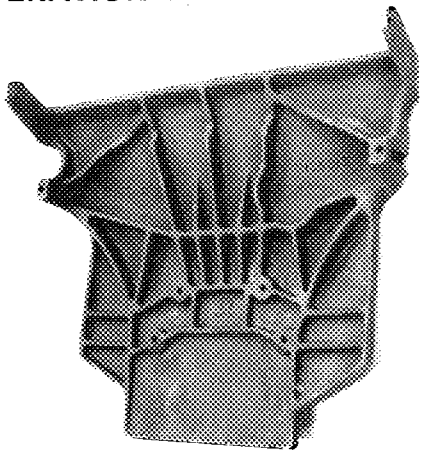

Photograph J

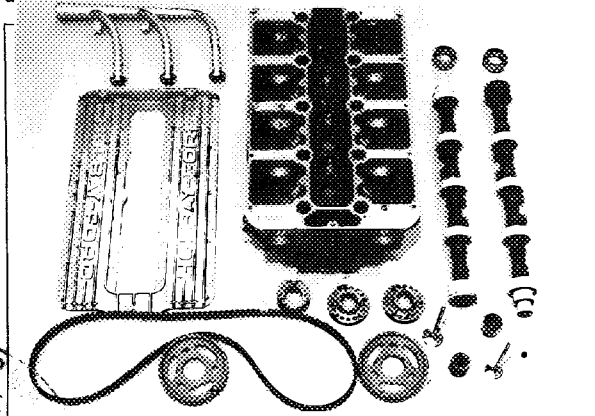

Photograph K

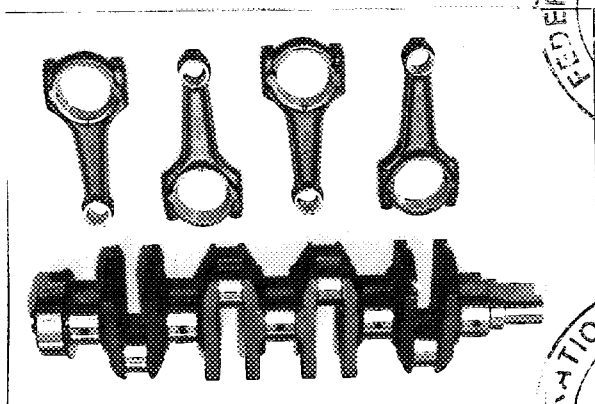

Photograph L

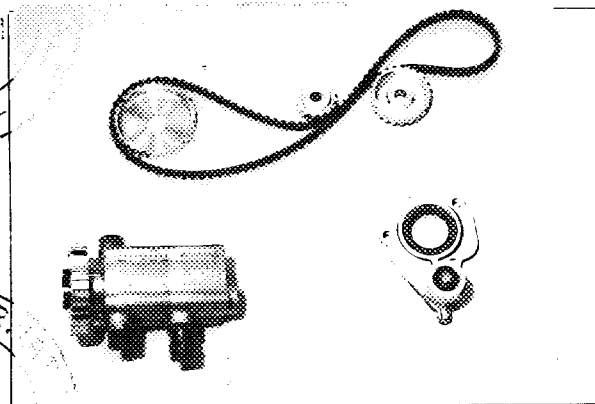

Photograph M

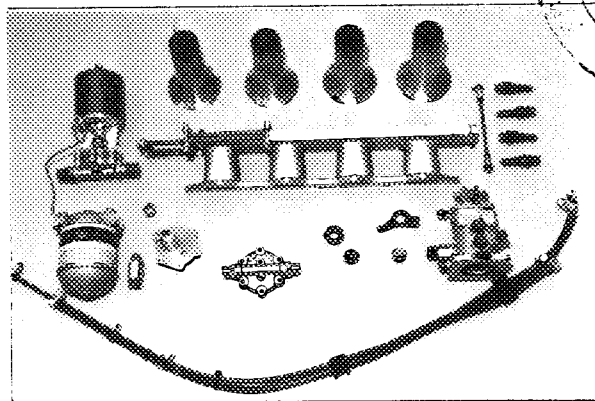

Photograph N

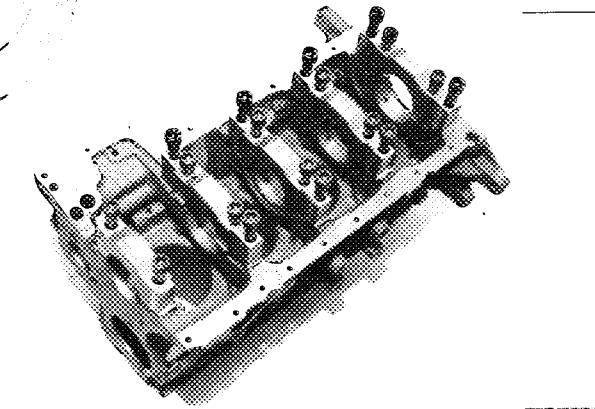

Photograph O

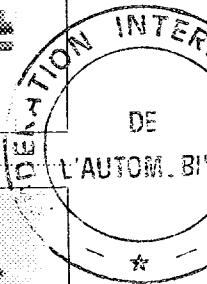
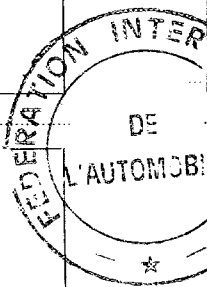

Date amendment is valid from... 1 9 7 6

Stamp of F.I.A./R.A.C.



MOTOR SPORT DIVISION

The Royal Automobile Club

31 Belgrave Square, London SW1X 8QH

Manufacturer FORD

Model ESCORT RS 2000

F.I.A. Recognition No. 5566

Amendment No. 5/5V

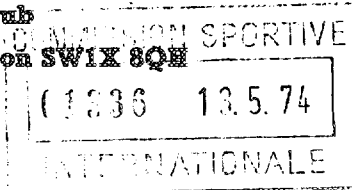

Amendment to Form of Recognition

FEDERATION INTERNATIONALE DE L'AUTOMOBILE

"valable en Groupe uniquement"
"valid for Group 2 only"

No.	Reference No.
	Variant for Group 2
160	Alternative Flywheel Part No. FC 0539 4.1 kg 9 lb Photo P
260	Alternative clutch Part No. CP 2289
261	Diaphragm multi-plate
262	2 or 3
263	194.0 mm 7.625 ins Inside diameter 132.0 mm 5.18 ins Outside diameter 184.0 mm 7.25 ins
264	Hydraulic or cable Photo Q
260	Alternative clutch Part No. GP 2246/7
261	Single dry plate
262	One Inside diameter 146.0 mm 5.75 ins Outside diameter 215.9 mm 8.5 ins
160	Alternative flywheel Part No. FC 0540 5.5 kgs 12 lb Photo S

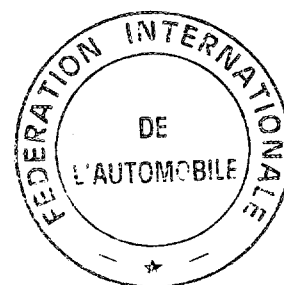

Date amendment is valid from 1.9.76

Stamp of F.I.A./R.A.C.



MOTOR SPORT DIVISION
The Royal Automobile Club
31 Belgrave Square, London SW1X 8QH

Manufacturer FORD
 Model ESCORT RS 2000
 F.I.A. Recognition No. 5566
 Amendment No. 5/SV

Amendment to Form of Recognition

FEDERATION INTERNATIONALE DE L'AUTOMOBILE

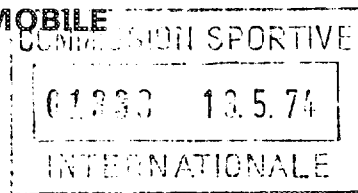

No.	Reference No.
	Variant for Group 2
	Brakes of different type and dimensions including larger hubs and spindles
100	266 mm 10.5 ins
101	20 mm 0.75 ins
102	115 mm 4.55 ins
103	518 mm 2.1 ins
104	2
105	34.7 cm ² 5.42 ins ²
	Photo T

"valable en Groupe 2 uniquement"
"valid for Group 2 only"

~~Alternative front hub
 Part No. H69AB 1104 AA
 Photo U~~

~~Auxiliary chassis member
 Part No. CD 70/9
 Photo V~~

~~Rear axle differential protection shield
 Part No. FC 008
 Photo W~~

~~Alternative heavy duty axle shafts and bearing
 Photo U~~

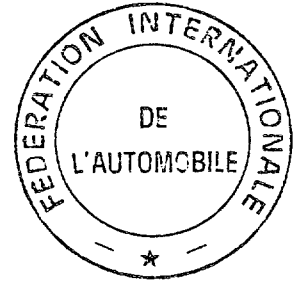
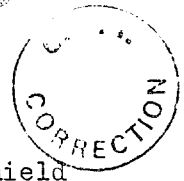

Date amendment is valid from 1.9.74

Stamp of F.I.A./R.A.C.



MOTOR SPORT DIVISION
The Royal Automobile Club
 31 Belgrave Square, London SW1X 8QH

Manufacturer FORD

Model ESCORT RS 2000

F.I.A. Recognition No. 5566

Amendment No. 5/5V

"valable en Groupe 2 uniquement"
"valid for Group 2 only"

Amendment to Form of Recognition

FEDERATION INTERNATIONALE DE L'AUTOMOBILE

Photographs must be 3" x 2" and a matt finish

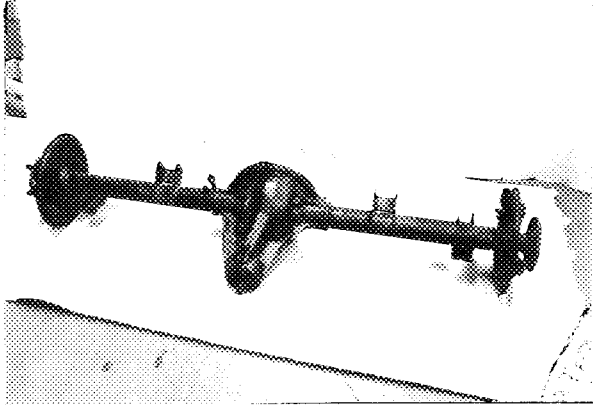

Photograph C

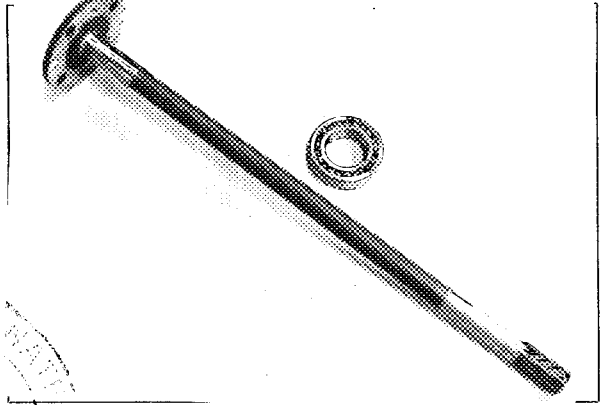

Photograph D

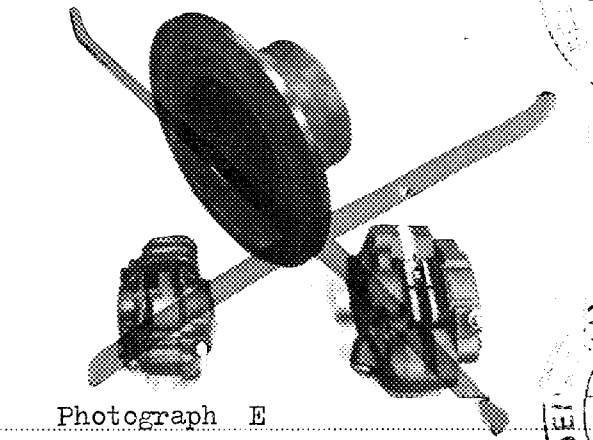

Photograph E

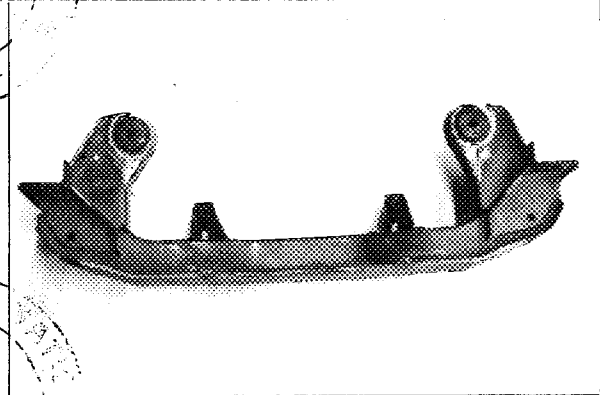

Photograph F

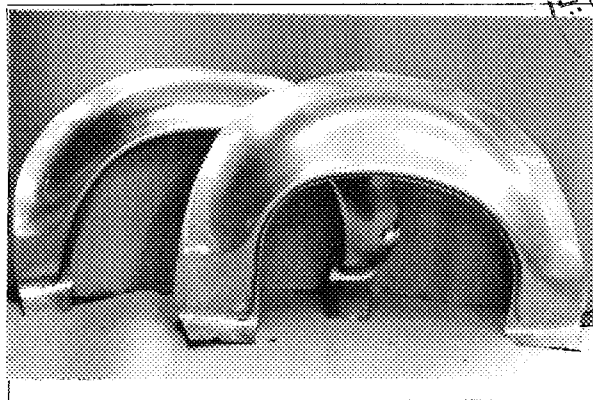

Photograph G

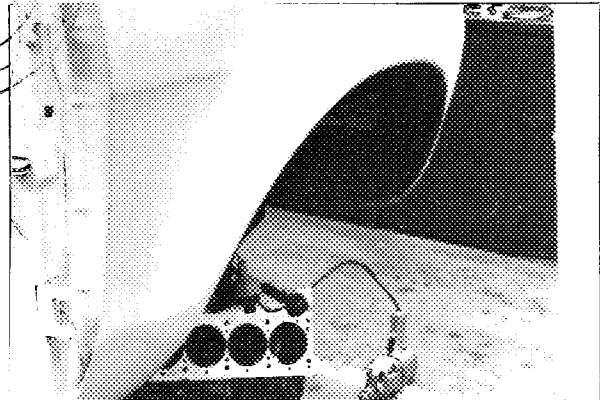

Photograph H

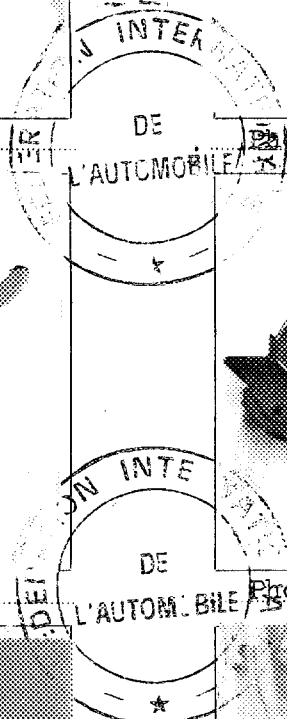

Date amendment is valid from 1.9.86

Stamp of F.I.A./R.A.C



MOTOR SPORT DIVISION
The Royal Automobile Club
31 Belgrave Square, London SW1X 8QH

Manufacturer FORD

Model ESCORT RS 2000

F.I.A. Recognition No. 5566

Amendment No. 5/5V

Amendment to Form of Recognition

"valable en Groupe 2 uniquement"

FEDERATION INTERNATIONALE DE L'AUTOMOBILE

"valid for Group 2 only"

Photographs must be 3" x 2" and a matt finish

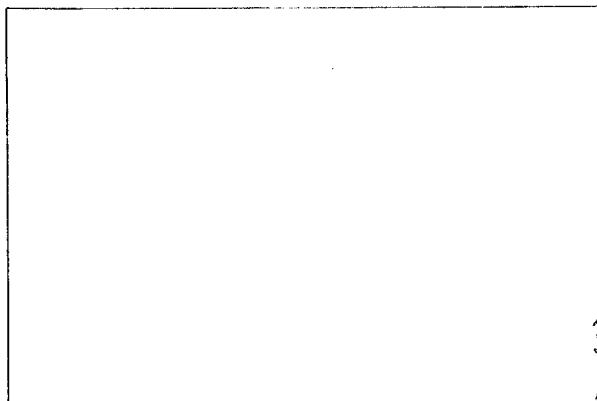

Photograph P

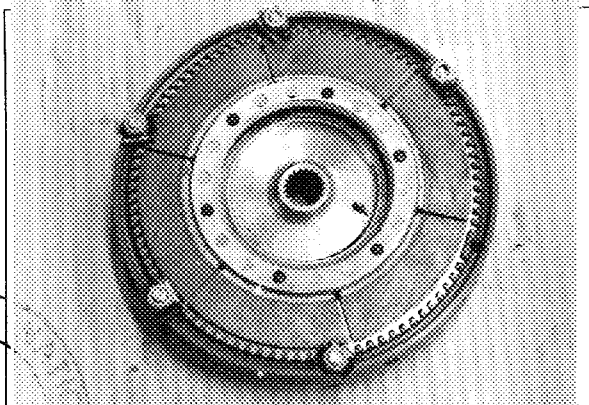

Photograph Q

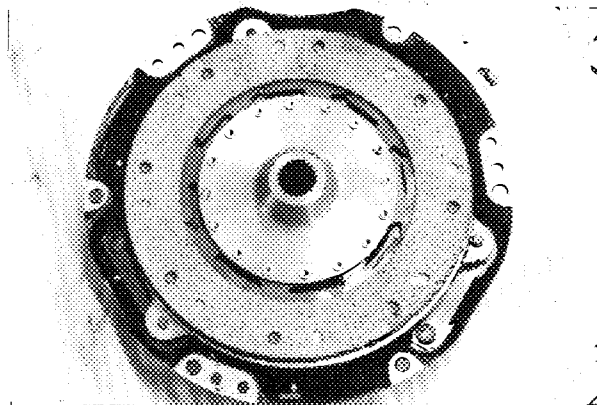

Photograph R

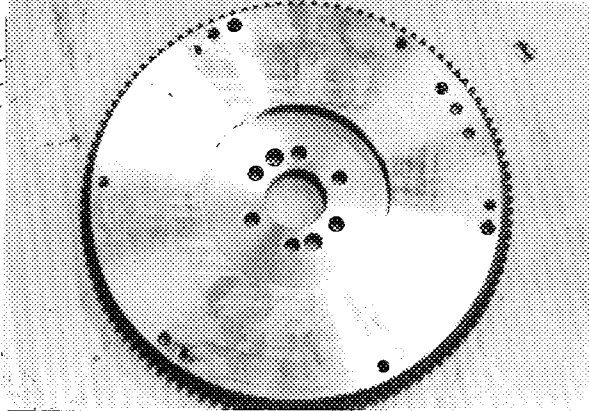

Photograph S

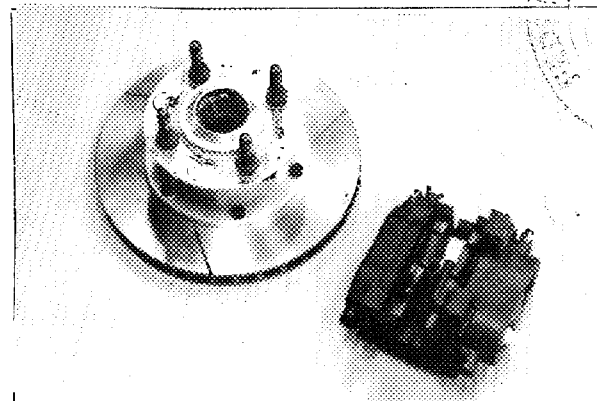

Photograph T

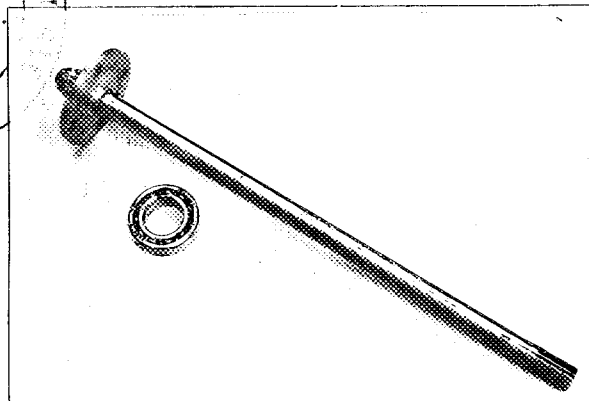

Photograph U

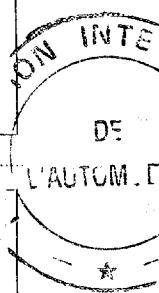

Date amendment is valid from 1 9 76

Stamp of F.I.A./R.A.C.



MOTOR SPORT DIVISION
The Royal Automobile Club
 31 Belgrave Square, London SW1X 8QH

Manufacturer FORD.....

Model ESCORT RS 2000.....

COMMISSION SPÉCIALE F.I.A.R. Recognition No. 5566.....

01833 13.5.74 Amendment No. 5/5V

INTERNATIONALE en Groupe 2 uniquement
 "valid for Group 2 only"

Amendment to Form of Recognition

FEDERATION INTERNATIONALE DE L'AUTOMOBILE

must be 3" x 2" and a matt finish



Photograph V

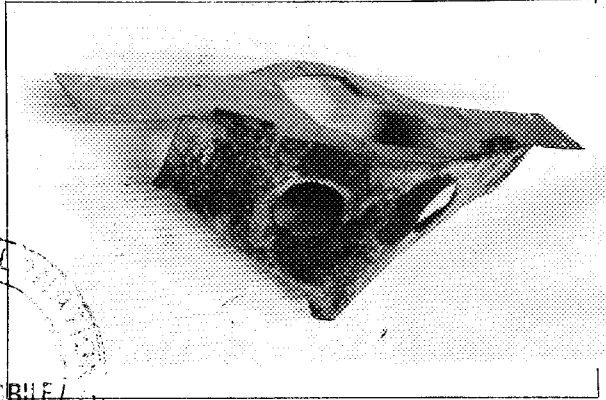

Photograph W

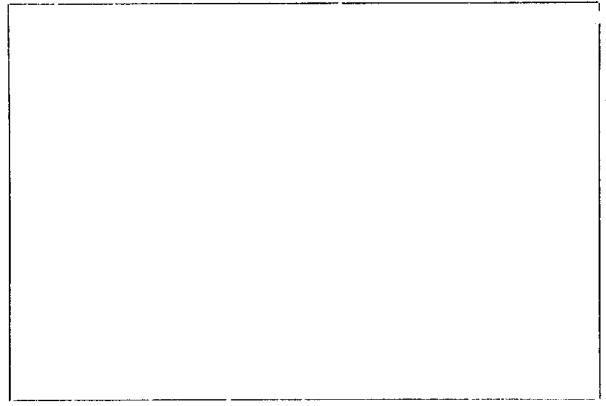
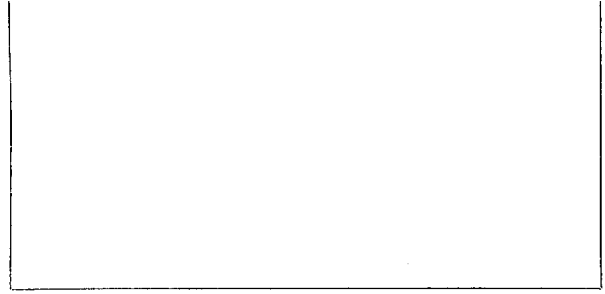
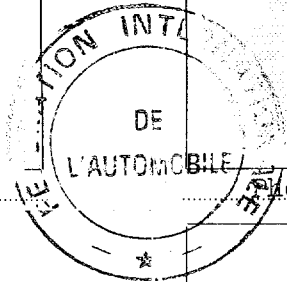

Date amendment is valid from..... 1.9.74

Stamp of F.I.A./R.A.C.



MOTOR SPORT DIVISION
The Royal Automobile Club
 31 Belgrave Square, London SW1X 8QH

Manufacturer FORD
 Model ESCORT RS 2000
 F.I.A. Recognition No. 5566
 Amendment No. 6/6U

Amendment to Form of Recognition

FEDERATION INTERNATIONALE DE L'AUTOMOBILE

VALID IN GROUP A

No.

Reference No.

Page 2/2V

Alternative supplier of rear silencer box (muffler)

Photograph 4

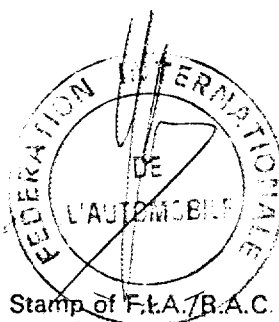
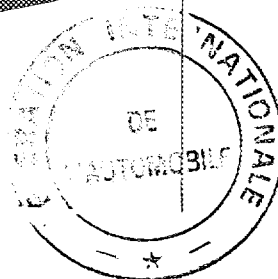
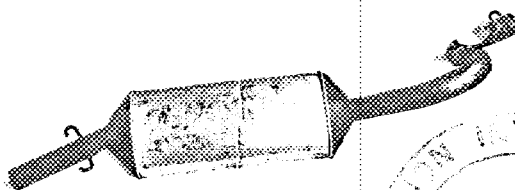

Date amendment is valid from 1.10.74

Stamp of F.I.A./B.A.C.



MOTOR SPORT DIVISION
The Royal Automobile Club
 31 Belgrave Square, London SW1X 8QH

Manufacturer FORD

Model ESCORT RS 2000

F.I.A. Recognition No. 5566

Amendment No. 7/3

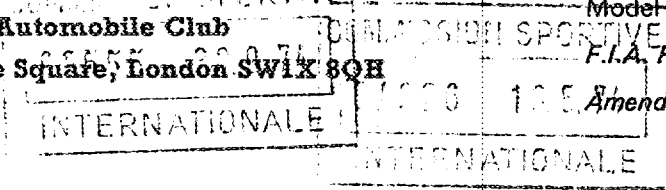

Amendment to Form of Recognition

FEDERATION INTERNATIONALE DE L'AUTOMOBILE

No.	Reference No.
	Production Variant
	Different road wheel
50	Light metal construction
51	4.2 kg 9.26 lb
52	4 mm nut
53	330 mm 13.0 ins
54	152.5 mm 6.0 ins
	Photograph X

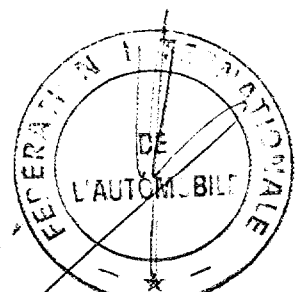
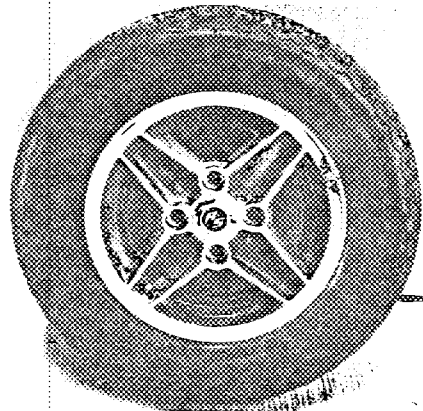

Date amendment is valid from 1.10.76

Stamp of F.I.A./R.A.C.



MOTOR SPORT DIVISION
The Royal Automobile Club
 31 Belgrave Square, London SW1X 8QH

Manufacturer FORD

Model ESCORT RS 2000

F.I.A. Recognition No. 5566

Amendment No. 8/1E

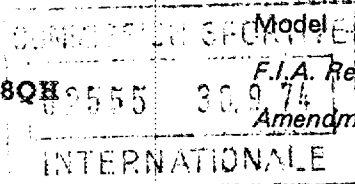

Amendment to Form of Recognition

FEDERATION INTERNATIONALE DE L'AUTOMOBILE

VALID IN GROUP.....

No.	Reference No.	<u>ERRATA</u>
-----	---------------	---------------

Page 8	Item 158	57.004 mm Dia = 2.244" DIA
	Item 159	52.004 mm Dia = 2.047" DIA



Page 11	Item 293	Tooth combination for 4.125 Differential = 8.33
---------	----------	---

Page 3	Photo M	Production 2 litre piston
--------	---------	---------------------------

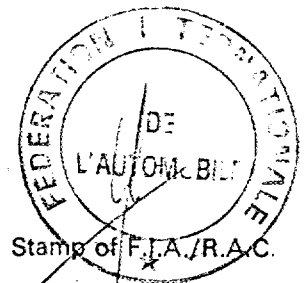
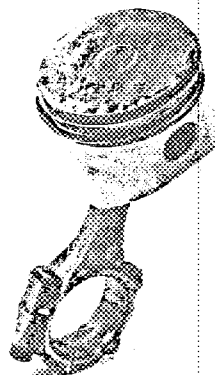

Date amendment is valid from 1 10 74



MOTOR SPORT DIVISION
The Royal Automobile Club
 31 Belgrave Square, London SW1X 8QH

Manufacturer FORD
 Model ESCORT RS2000
 F.I.A. Recognition No. 5566
 Amendment No. 9/7E

Amendment to Form of Recognition

FEDERATION INTERNATIONALE DE L'AUTOMOBILE

VALID IN GROUP.....I.....

No.	Reference No.
	Erratum
160	7.12 Kg 15.7 lbs
277	Rev. gear alternative box = 3.1

	Amendment 5/5V
	Heavy duty axle - track increased by 38 mm (1.5 in)

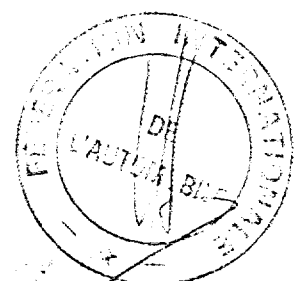

Date amendment is valid from 1.1.75

Stamp of F.I.A./R.A.C.



MOTOR SPORT DIVISION
The Royal Automobile Club
31 Belgrave Square, London SW1X 8QH

Manufacturer FORD
 Model ESCORT RS2000
 F.I.A. Recognition No. 5566
 Amendment No. 10/8V

Amendment to Form of Recognition

FEDERATION INTERNATIONALE DE L'AUTOMOBILE

VALID IN GROUP I

No.	Reference No.
293	Production Variant. Group I 3.77 9/34 Alternative crown wheel and pinion fitted in production.

Date amendment is valid from... 1 2 75

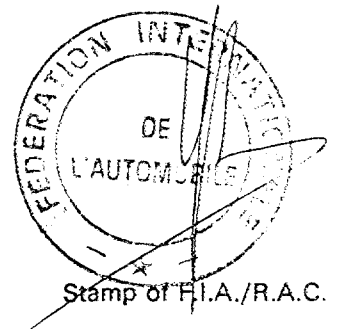

Stamp of F.I.A./R.A.C.



MOTOR SPORT DIVISION
The Royal Automobile Club
 31 Belgrave Square, London SW1X 8QH

Manufacturer FORD
 Model ESCORT RS 2000
 F.I.A. Recognition No. 5566
 Amendment No. 11/3E

Amendment to Form of Recognition

FEDERATION INTERNATIONALE DE L'AUTOMOBILE

VALID IN GROUP 1

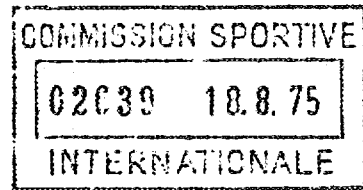

No.

Reference No.

Reference Amendment 2/2V

Clean air intake duct to air cleaner

Reference Amendment 7/7V

Alternative photograph of same wheel

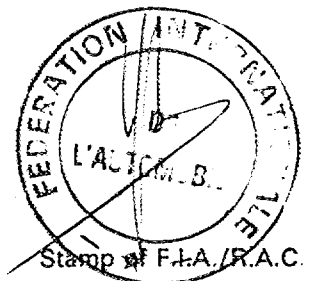
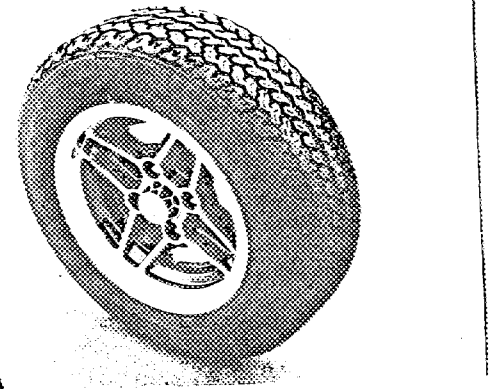
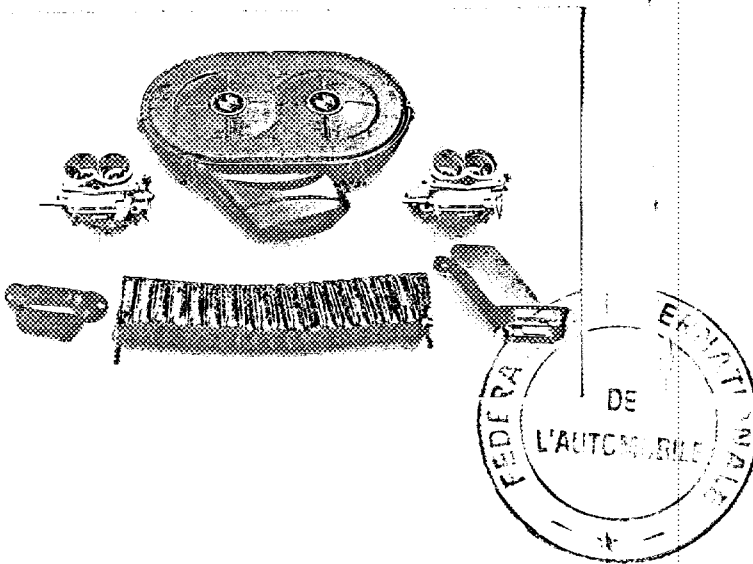

Date amendment is valid from 1.10.75

Stamp of F.I.A./R.A.C.



MOTOR SPORT DIVISION
The Royal Automobile Club
 31 Belgrave Square, London SW1X 8QH

Manufacturer FORD
 Model ESCORT RS 2000
 F.I.A. Recognition No. 5566
 Amendment No. 12/4E

Amendment to Form of Recognition

FEDERATION INTERNATIONALE DE L'AUTOMOBILE

VALID IN GROUP.....1.....

No.	Reference No.		
		Evolution in Production	
162		Weight of Crankshaft	12.8Kg 28.2 lbs
163		Connecting rod (without bearings)	0.66Kg 1.45 lbs

Date amendment is valid from 1.1.76

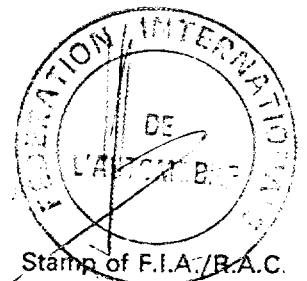



MOTOR SPORT DIVISION
The Royal Automobile Club
31 Belgrave Square, London SW1X 8QH

Manufacturer FORD
Model ESCORT RS 2000
F.I.A. Recognition No. 5566
Amendment No. 13/av

Amendment to Form of Recognition

FEDERATION INTERNATIONALE DE L'AUTOMOBILE

No.	Reference No.
	Alternative supplier of induction for emission kit.
212	Weber
213	44 I D F
215	44mm 1.732 in
216	34mm 1.338 in
	Alternative kit supplied under Part No: 9053032 - see photos E & F
	Dia of inlet port at cylinder head face = 37mm 1.45 in

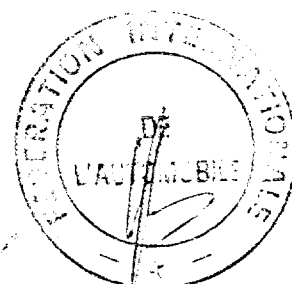

Date amendment is valid from 1.1.76

Stamp of F.I.A./R.A.C.



MOTOR SPORT DIVISION
The Royal Automobile Club
 31 Belgrave Square, London SW1X 8QH

Manufacturer FORD
 Model ESCORT RS2000
 F.I.A. Recognition No. 5566
 Amendment No. 14/SE

Amendment to Form of Recognition

FEDERATION INTERNATIONALE DE L'AUTOMOBILE

VALID IN GROUP 1

No.	Reference No.			
	Evolution in Production.			
162	Weight of crankshaft	12.8 Kg	28.2 lbs	
163	connecting rod (without bearings)	0.66 Kg	1.45 lbs	
	Alternative supplier of induction for emission kit.			
212	Weber			
213	44 I D F			
215	44 mm	1.732 in		
216	34 mm	1.338 in		
	Alternative kit supplied under Part No: 9053032 - see photos E & F.			
	Dia of inlet port ^{at} cylinder head face =	37 mm	1.45 in.	
	(Inlet manifold dimension)			

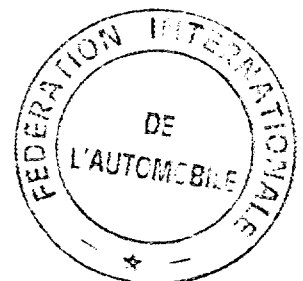

Date amendment is valid from.....

Stamp of F.I.A./R.A.C.



MOTOR SPORT DIVISION
The Royal Automobile Club
31 Belgrave Square, London SW1X 8QH

Manufacturer FORD
 Model ESCORT RS2000
 F.I.A. Recognition No. 5566
 Amendment No. 14/5E

Amendment to Form of Recognition

FEDERATION INTERNATIONALE DE L'AUTOMOBILE

VALID IN GROUP 1

No.	Reference No.
	Evolution in Production.
	Revised body shell - Escort II - see photographs A, B and C.
	Also revised instrument panel see photograph D.
1	2407 mm 94.75 in
2	1290 mm 50.75 in
3	1315 mm 51.77 in
4	4150 mm 163.4 in
5	1607 mm 63.2 in
6	1384 mm 54.5 in
10	Front 1565 mm 61.6 in
	Rear 1600 mm 63.0 in

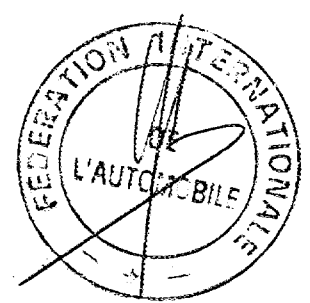

Date amendment is valid from 1.1.76

Stamp of F.I.A./R.A.C.



MOTOR SPORT DIVISION
The Royal Automobile Club
31 Belgrave Square, London SW1X 8QH

Manufacturer FORD
 Model ESCORT RS2000
 F.I.A. Recognition No. 5566
 Amendment No. 14/5E

Amendment to Form of Recognition

FEDERATION INTERNATIONALE DE L'AUTOMOBILE

Photographs must be 3" x 2" and a matt finish



A



B

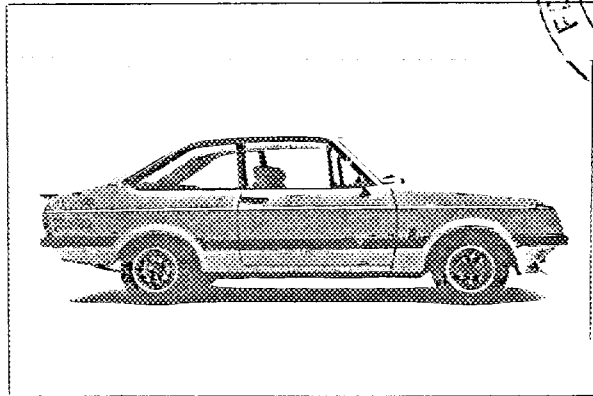
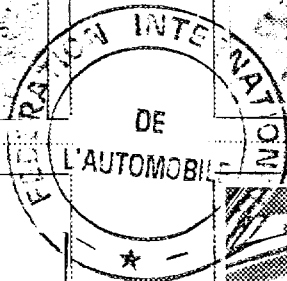

C

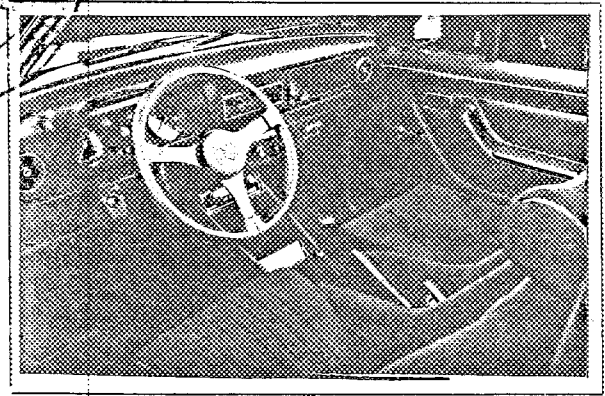

D

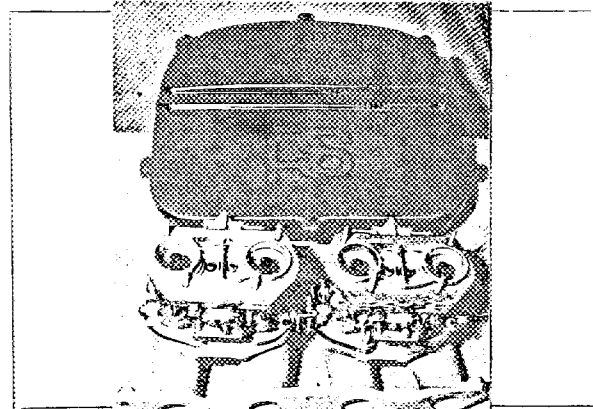

E

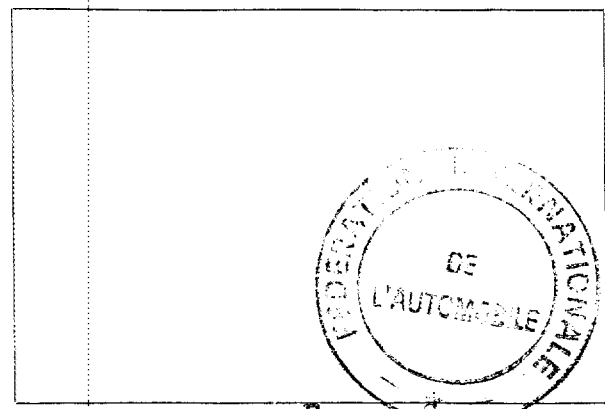

F

Date amendment is valid from

Stamp of F.I.A./R.A.C.



MOTOR SPORT DIVISION
The Royal Automobile Club
31 Belgrave Square, London SW1X 8QH

Manufacturer Ford
 Model Escort RS 2000
 F.I.A. Recognition No. 5566
 Amendment No. 15/10V

Amendment to Form of Recognition

FEDERATION INTERNATIONALE DE L'AUTOMOBILE

VALID IN GROUP.....1.....

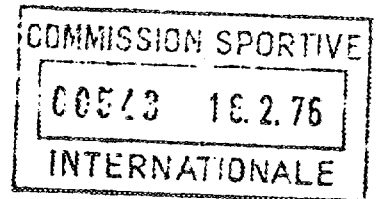

No.

Reference No.

Optional Equipment (Variants)

62. Steering ratio, lock to lock 2,7
 Pt.-No 9052 872 LHD and 9052 871 RHD

Reinforced suspension mounting point for specified
 export territories. Pt.-No. 9052 989

see photo D 76

Ventilated front disc and associated calipers

Kit Part No T 9051 676

- 94. 54 mm
- 100. 244 mm
- 101. 20 mm
- 102. 76.6 mm
- 103. 50.8 mm
- 104. 2
- 105. 65660 sq mm

see photo F 76

Touring fuel tank 60 litres Pt.-No 9053 179

Cooling Fan. Method of Drive: Vee belt

- 156. 314 mm dia
- 157. 7

Protection shields for specified export territories

Part Nos. 9052 889
 69026853

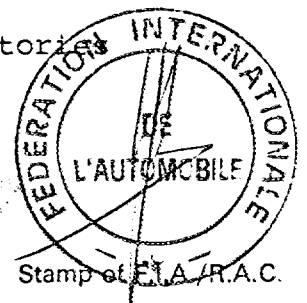

Date amendment is valid from 1.6.76

Stamp of F.I.A./R.A.C.



MOTOR SPORT DIVISION
The Royal Automobile Club
 31 Belgrave Square, London SW1X 8QH

Manufacturer Ford
 Model Escort RS 2000
 F.I.A. Recognition No. 5566
 Amendment No. 15/10V

Amendment to Form of Recognition

FEDERATION INTERNATIONALE DE L'AUTOMOBILE

Photographs must be 3" x 2" and a matt finish

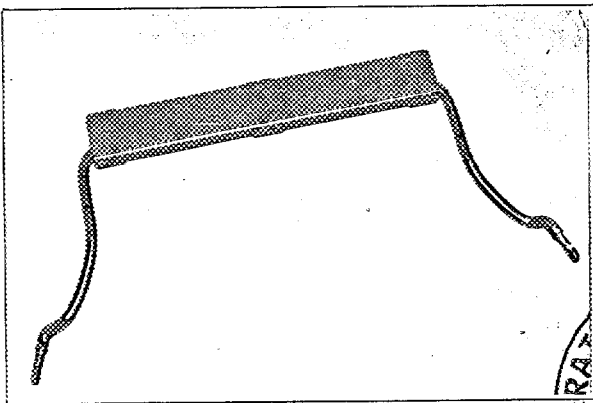

D 76

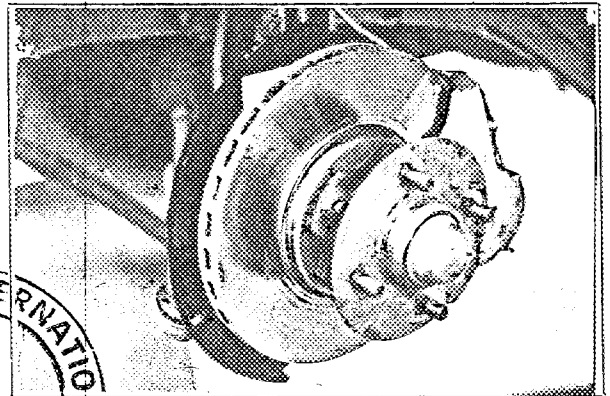

F 76

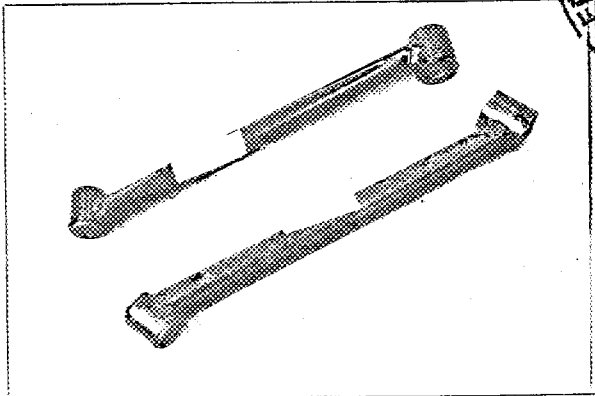
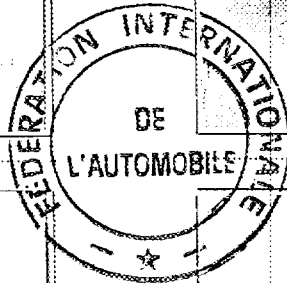

E 76/1

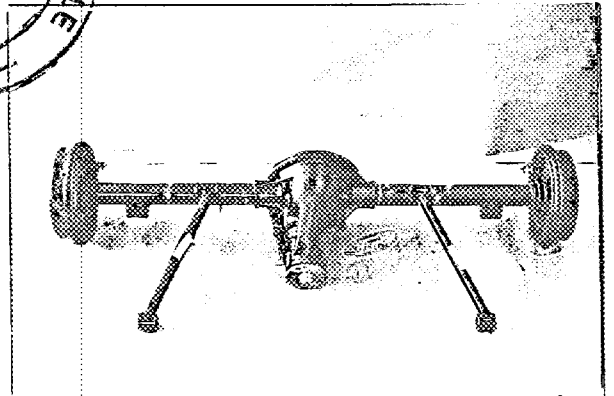

E 76/2

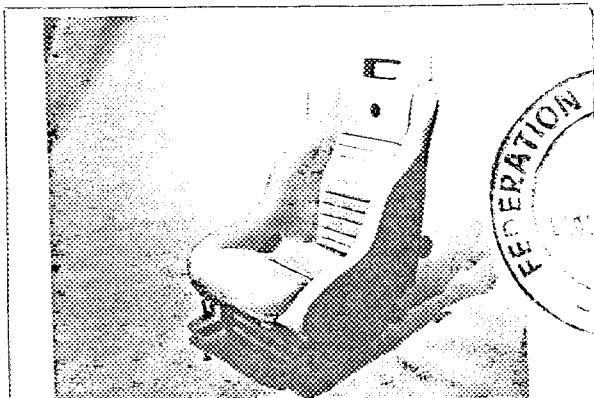

C 76

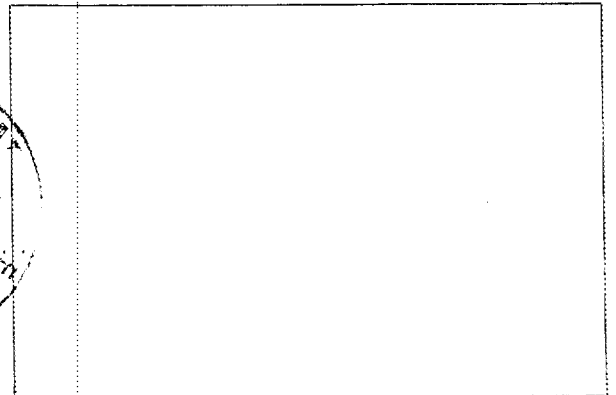
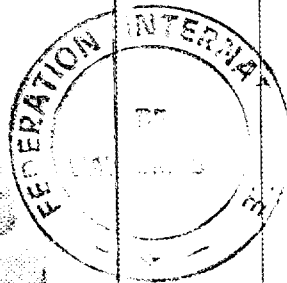

Date amendment is valid from.....

Stamp of F.I.A./R.A.C.



MOTOR SPORT DIVISION
The Royal Automobile Club
 31 Belgrave Square, London SW1X 8QH

Manufacturer Ford
 Model Escort RS 2000
 F.I.A. Recognition No. 5566
 Amendment No. 16/6E

Amendment to Form of Recognition

FEDERATION INTERNATIONALE DE L'AUTOMOBILE

VALID IN GROUP ¹.....

No.

Reference No.

Evolution in Production

Car exhaust System

Drawing of exhaust manifold ports, side of cylinder head

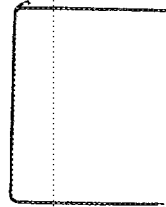

35,5 mm

31,0mm

204. Diameter outlet exhaust 35 mm two times
 All dimensions \pm 2 mm

see photo I 76 and Q 76

Interchangeable in all respects with previous emission exhaust system.

Rear Drum Brakes

94 17.78 mm
 95 228.6 mm
 96 180 mm
 97 42,65 mm
 98 2
 99 30885 sq mm

see photo G 76

Aircleaner Assembly see photo O 76

Road Wheel

50 Cast light alloy
 51 4,65 kg min
 52 4 nut
 53 330 mm
 54 152 mm (6")

(Minor casting changes from previous wheel) Pt/-Nos. 1565 557
 9053 134

see photo V 76

Date amendment is valid from 1.4.76

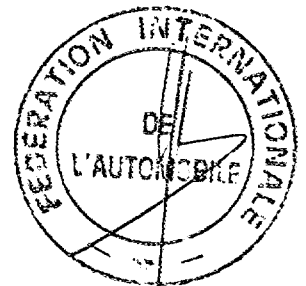

Stamp of F.I.A./R.A.C.



MOTOR SPORT DIVISION
The Royal Automobile Club
 31 Belgrave Square, London SW1X 8QH

Manufacturer Ford
 Model Escort RS 2000
 F.I.A. Recognition No. 5566
 Amendment No. 16/6E

Amendment to Form of Recognition

FEDERATION INTERNATIONALE DE L'AUTOMOBILE

Photographs must be 3" x 2" and a matt finish

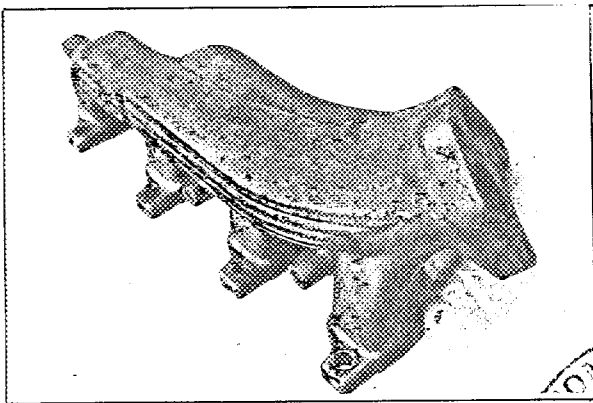

I 76

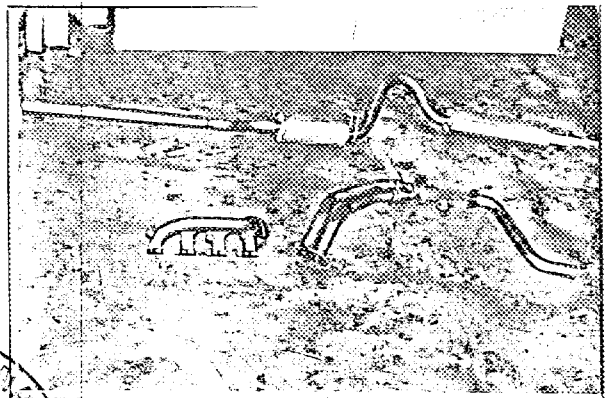

Q 76

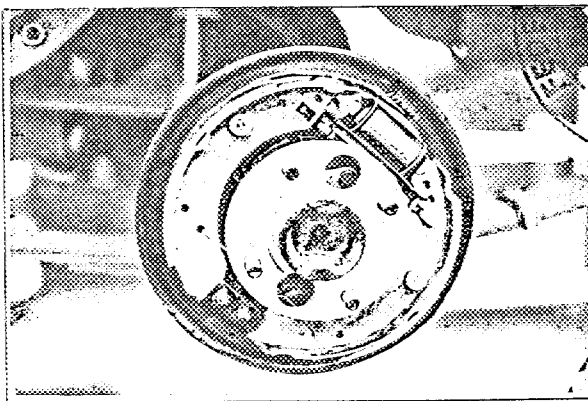

G 76

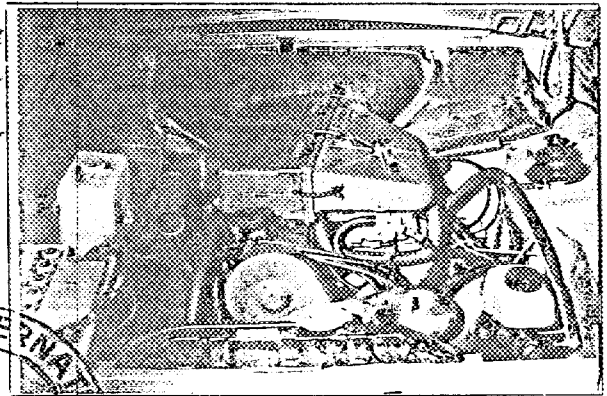

Q 76

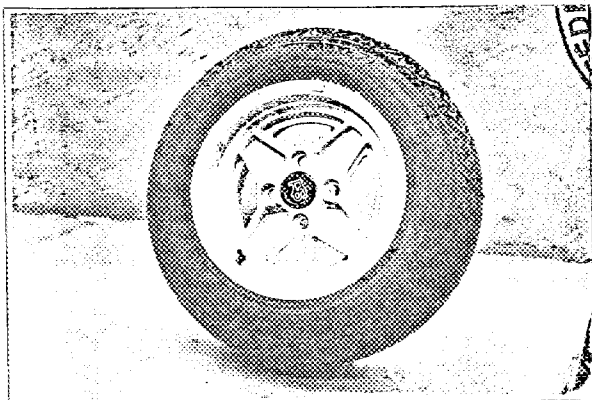

V 76

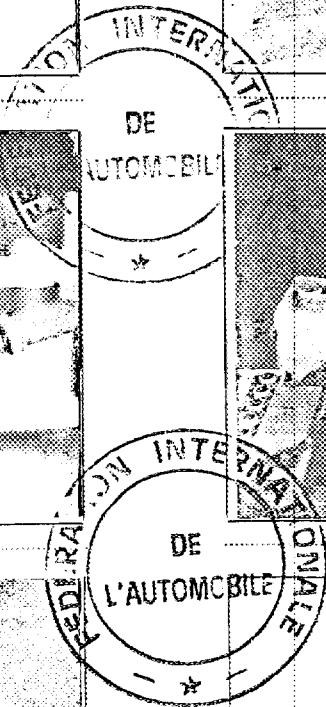

Date amendment is valid from

Stamp of F.I.A./R.A.C.



MOTOR SPORT DIVISION
The Royal Automobile Club
 31 Belgrave Square, London SW1X 8QH

Manufacturer FORD
 Model ESCORT RS 2000
 F.I.A. Recognition No. 5566
 Amendment No. 17/7E

Amendment to Form of Recognition

FEDERATION INTERNATIONALE DE L'AUTOMOBILE

VALID IN GROUP 1.....

No.	Reference No.
	ERRATA
	Ref. Amendment No 15/10 V
	Part No must read 9052 879 not 9052 889

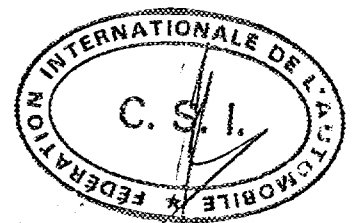

-1.OCT.19/6
 Date amendment is valid from.....

Stamp of F.I.A./R.A.C.



MOTOR SPORT DIVISION
The Royal Automobile Club
31 Belgrave Square, London SW1X 8QH

Manufacturer FORD
 Model ESCORT RS 2000
 F.I.A. Recognition No. 5566
 Amendment No. 18/8E

Amendment to Form of Recognition

FEDERATION INTERNATIONALE DE L'AUTOMOBILE
VALID IN GROUP.....1.....

No.	Reference No.	
		Optional Equipment (Variant)
		Alternative crown wheel and pinion
293	4,63 - 8/37	German supplier
	4,7 - 7/33	British supplier

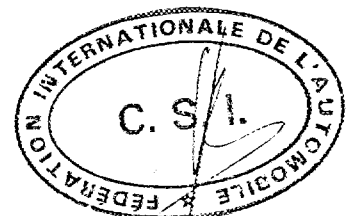

Date amendment is valid from 1.11.76

Stamp of F.I.A./R.A.C.



MOTOR SPORT DIVISION
The Royal Automobile Club
 31 Belgrave Square, London SW1X 8QH

Manufacturer FORD
 Model ESCORT RS2000
 F.I.A. Recognition No. 5506
 Amendment No. 19/11V

Amendment to Form of Recognition

FEDERATION INTERNATIONALE DE L'AUTOMOBILE

VALID IN GROUP 1.....

No.	Reference No.	Variant
		Heavy duty front and rear spring package
		Front Spring Part No. 9052707
		Rear Spring Part No. 9053261
		Heavy duty suspension top mount
		Part No. 9053007
		Suspension leg to suit top mount
		Part No. 9053062 R.H.
		9053063 L.H.
		Heavy duty anti-roll bar
		Part No. 8016163
		Rear wheel cylinder
		Item 94 Bore = 19.05 mm (0.75 in)
		Dual braking system - pedal box
		Part No. 9052599 - Hydraulic clutch
		9053064 - Cable clutch

photos unchanged

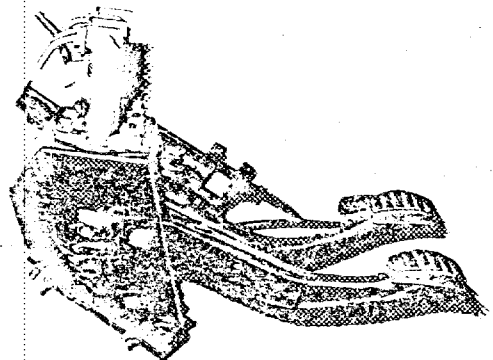

~~Optional Fuel Tank in accordance with F.I.A. regulations~~

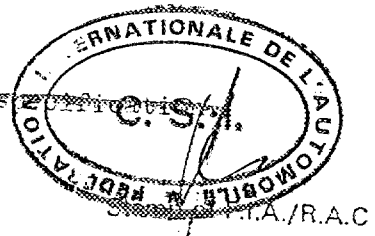

Date amendment is valid from 10/11/76



MOTOR SPORT DIVISION
The Royal Automobile Club
 31 Belgrave Square, London SW1X 8QH

Manufacturer FORD
 Model ESCORT RS2000
 F.I.A. Recognition No.5.5.6.6.....
 Amendment No.

26/9E

Amendment to Form of Recognition

FEDERATION INTERNATIONALE DE L'AUTOMOBILE

Valid in Group 1

No.

Reference No.

Evolution

All inlet and exhaust tracts may be reclaimed by fettling.

-1. JAN. 1977

Date amendment is valid from.....

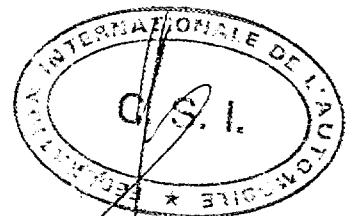

Stamp of F.I.A./R.A.C



MOTOR SPORT DIVISION
The Royal Automobile Club
 31 Belgrave Square, London SW1X 8QH

Manufacturer FORD
 Model ESCORT RS 2000
 F.I.A. Recognition No. 5566
 Amendment No. 21/12V

Amendment to Form of Recognition

FEDERATION INTERNATIONALE DE L'AUTOMOBILE
VALID IN GROUP.....¹.....

No.	Reference No.
154	Heavy duty radiator (Alteration in fin pattern only)
156	Cooling fan dia 254 mm
157	Number of blades 6
41	Sports seat "ASS-Scheel 302"
42	Weight 10,5 kg



Date amendment is valid from -1. JAN. 1977

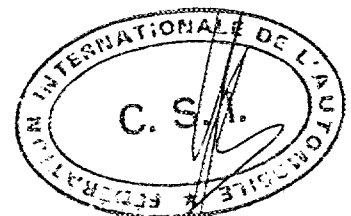

Stamp of F.I.A./R.A.C.



MOTOR SPORT DIVISION
The Royal Automobile Club
 31 Belgrave Square, London SW1X 8QH

Manufacturer FORD
 Model ESCORT RS 2000
 F.I.A. Recognition No. 5566
 Amendment No. 22/10E

Amendment to Form of Recognition

FEDERATION INTERNATIONALE DE L'AUTOMOBILE

VALID IN GROUP.....1.....

No.

Reference No.

Evolution in Production

164. Piston weight complete with rings and pin
 .730 kg. \pm .03

277. Modification to gear teeth in alternative gearbox -
 ratio unchanged.
 3rd gear $\frac{32}{20} \times \frac{25}{24}$

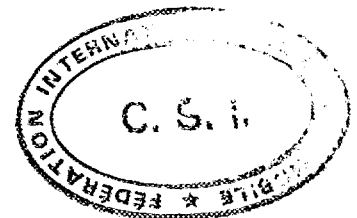

Date amendment is valid from.....1.7.77.....

Stamp of F.I.A./R.A.C.



MOTOR SPORT DIVISION
The Royal Automobile Club
 31 Belgrave Square, London SW1X 8QH

Manufacturer FORD
 Model ESCORT RS 2000
 F.I.A. Recognition No. 5566
 Amendment No. 23/13V

Amendment to Form of Recognition

FEDERATION INTERNATIONALE DE L'AUTOMOBILE

VALID IN GROUP 1

No.

Reference No.

Heavy duty cross member with associated engine mounts.

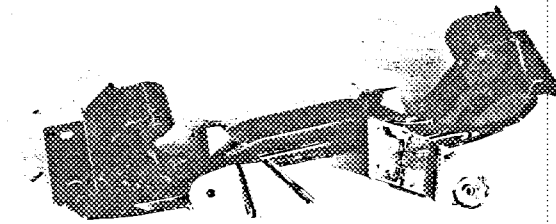

Differential skid and support plate.

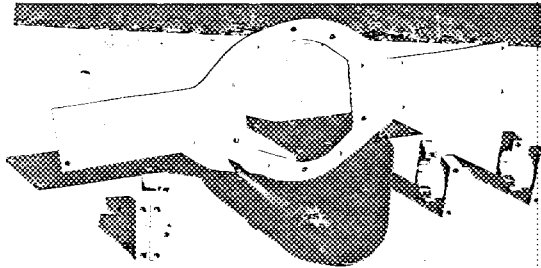

Date amendment is valid from 1.10.77

Stamp of F.I.A./R.A.C



MOTOR SPORT DIVISION
The Royal Automobile Club
 31 Belgrave Square, London SW1X 8QH

Manufacturer **FORD**
 Model **ESCORT RS 2000**
 F.I.A. Recognition No. **5566**
 Amendment No. **24/14V**

Amendment to Form of Recognition

FEDERATION INTERNATIONALE DE L'AUTOMOBILE

VALID IN GROUP.....1.....

No.

Reference No.

Production Variant

Australian assembled car - Minor styling and mechanical changes - see photo's A77.1; B77.1; C77.1; All parts and options completely interchangeable between different assembly plants.

Revised Front & Rear spring rates and damper settings.

Rear Anti roll bar/radius arm.

Alternative Final drive ratio.‡



{ 9:31 = 3.44
 9:40 = 4.44

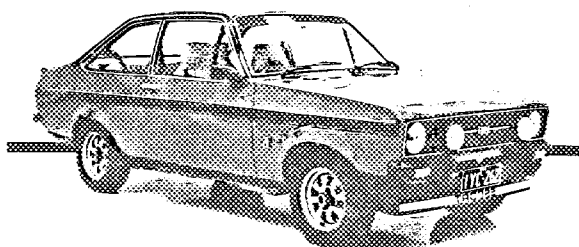

A77.1

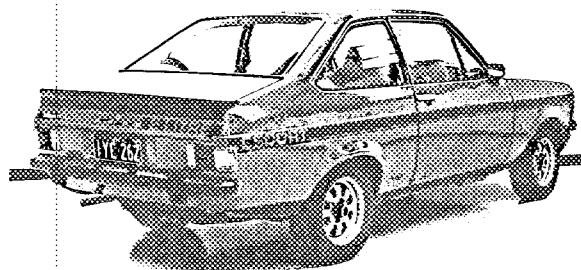

B77.1

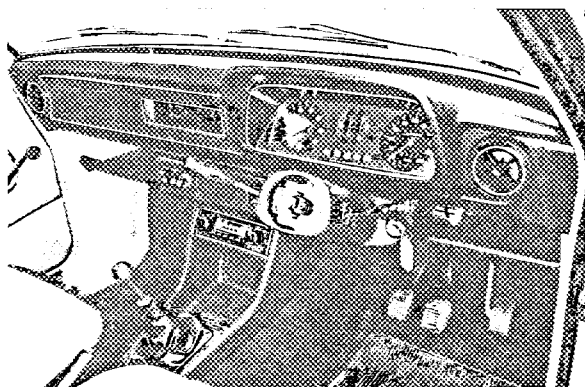

C77.1

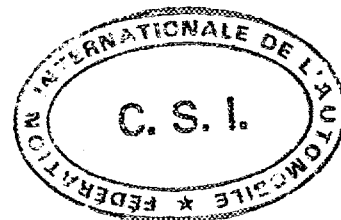

Date amendment is valid from.....-1.FEV.1978.....

Stamp of F.I.A./R.A.C.

5566

F.I.A. - Homologation N° 24/14V

FÉDÉRATION INTERNATIONALE DE L'AUTOMOBILE

FICHE D'EXTENSION D'HOMOLOGATION
CONFORME A L'ANNEXE J DU CODE SPORTIF INTERNATIONAL

Marque Modèle

Numéros de série inaugurant les modifications décrites :
Châssis/Carrosserie

Date de sortie des premiers véhicules construits avec les modifications : 19.....
Moteur

Dénomination commerciale après application des modifications :

Cette extension d'homologation doit être considérée comme : variante - évolution normale du type.

L'homologation est valable du 19..... Liste

Descriptions des modifications :

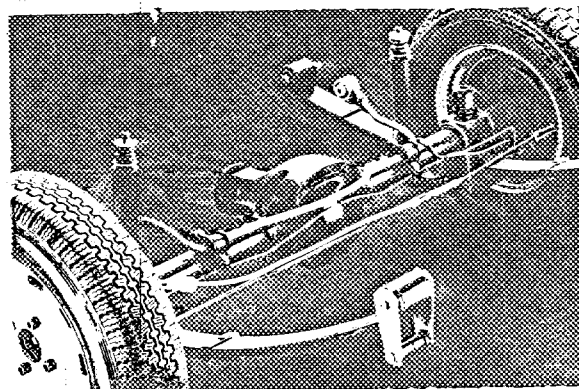
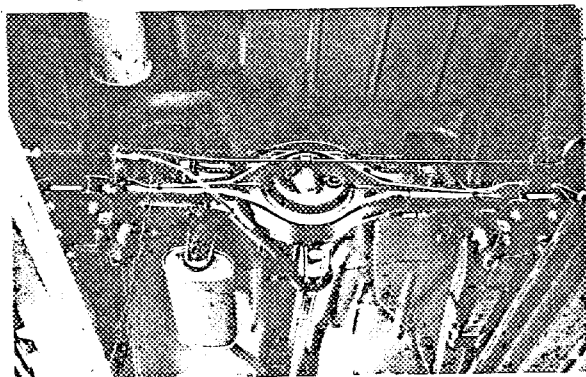

Signature et cachet
de l'Autorite Sportive Nationale :

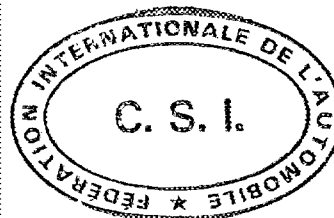

Signature et cachet de la F.I.A. :



MOTOR SPORT DIVISION
The Royal Automobile Club
 31 Belgrave Square, London SW1X 8QH

Manufacturer **FORD**
 Model **ESCORT RS 2000**
 F.I.A. Recognition No. **5566**
 Amendment No. **25/15 V**

Amendment to Form of Recognition

FEDERATION INTERNATIONALE DE L'AUTOMOBILE

VALID IN GROUP.....1.....

No.

Reference No.

Long range fuel tank - modification in design material and construction increases capacity to 69 litres.
 Part number MS77 9002 A

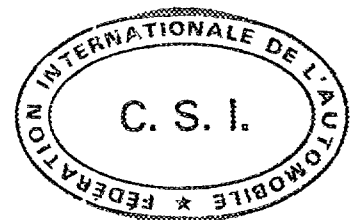
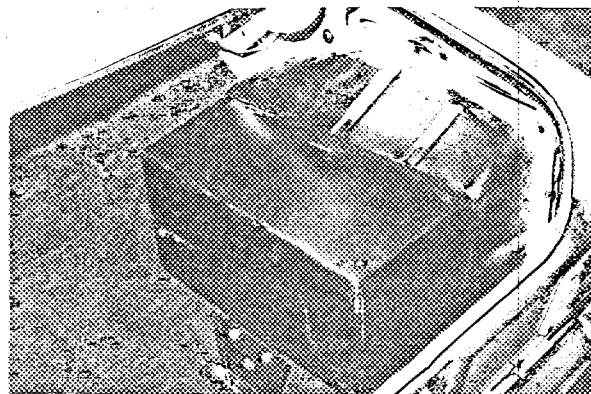
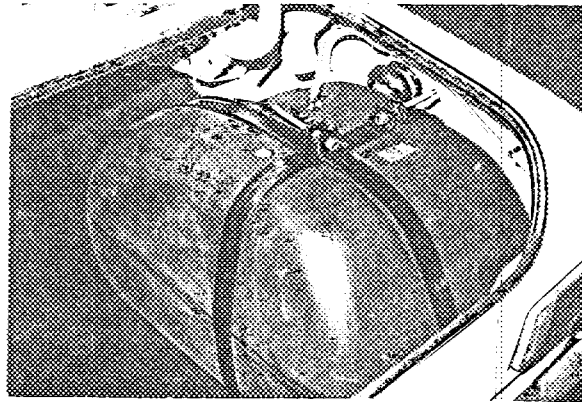

Date amendment is valid from.....**-1.FEV.1978**

Stamp of F.I.A./R.A.C.



MOTOR SPORT DIVISION
The Royal Automobile Club
 31 Belgrave Square, London SW1X 8QH

Manufacturer FORD
 Model ESCORT RS 2000
 F.I.A. Recognition No. 5566
 Amendment No. _____

26 / 16 V

Amendment to Form of Recognition

FEDERATION INTERNATIONALE DE L'AUTOMOBILE

VALID IN GROUP.....1.....

No.

Reference No.

Sports seats. Type - Bucket
 Supplied with or without head restraint
 Manufacture: Ford
 Weight: 9 kg.
 Mounting: Slide runners

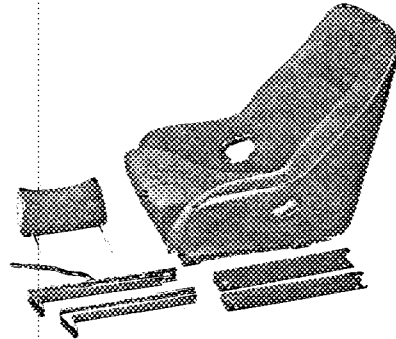

Sports seats. Type - recliner
 Supplied with or without head restraint
 Recliner mechanism can be fitted either side of seat to
 suit left hand, or right hand drive cars.
 Manufacture: Ford
 Weight: 12 kg.
 Mounting: Slide runners

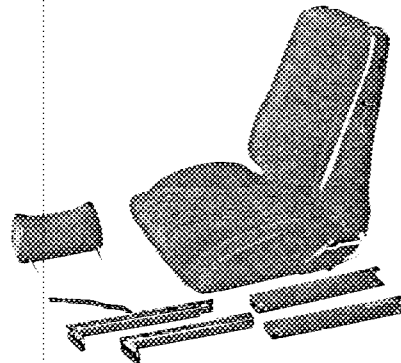

-1.AVR.1978





MOTOR SPORT DIVISION
 The Royal Automobile Club
 31 Belgrave Square, London SW1X 8QH

Manufacturer FORD
 Model ESCORT RS 2000
 F.I.A. Recognition No. 5566
 Amendment No. 27/111E

Amendment to Form of Recognition

FEDERATION INTERNATIONALE DE L'AUTOMOBILE

VALID IN GROUP.....1.....

-1 MAI 1978

No.

Reference No.



Evolution in Production

cylinder head:

Tolerance on all ports to be increased to ± 2 mm. Allows for core mismatch, but does not change 'averaged' port cross sectional area.



28 / 12 E

F.I.A. - Homologation No 5566

FÉDÉRATION INTERNATIONALE DE L'AUTOMOBILE

FICHE D'EXTENSION D'HOMOLOGATION
CONFORME A L'ANNEXE J DU CODE SPORTIF INTERNATIONAL

Marque FORD U.K. Modèle Escort RS 2000
Chassis/Carrosserie _____
Moteur _____
Numéros de série inaugurant les modifications décrites : _____
Date de sortie des premiers véhicules construits avec les modifications : _____ 19____
Dénomination commerciale après application des modifications : _____
Cette extension d'homologation doit être considérée comme : ~~_____~~ - évolution normale du type.
L'homologation est valable du -1.AVR.1978 19____ Liste _____

Descriptions des modifications :

ERRATA

on 3/3V, the camshaft timing is as follows:

INLET

- 186. Tappet clearance : 1 mm
- 187. Valves open at : 48° BTDC
- 188. Valves close at : 139° ABDC

EXHAUST

- 201. Tappet clearance: 1 mm
- 202. Valves open at : 132° BBDC
- 203. Valves close at : 76° ATDC

Signature et cachet
de l'Autorité Sportive Nationale :

Signature et cachet de la F.I.A. :



FÉDÉRATION INTERNATIONALE DE L'AUTOMOBILE

FICHE D'EXTENSION D'HOMOLOGATION
CONFORME A L'ANNEXE J DU CODE SPORTIF INTERNATIONAL

Marque FORD U.K. Modèle Escort RS 2000
 Numéros de série inaugurant les modifications décrites : _____
 Châssis/Carrosserie _____
 Moteur _____
 Date de sortie des premiers véhicules construits avec les modifications : _____ 19____
 Dénomination commerciale après application des modifications : _____
 Cette extension d'homologation doit être considérée comme : ~~_____~~ évolution normale du type.
 L'homologation est valable du -1. MAI 1978 19____ Liste _____

Descriptions des modifications :

ERRATA

As from January 1976, the camshaft timing described by 3/3V and 28/12E was changed to:

INLET

- 186. Tappet clearance : 1 mm
- 187. Valves open at : 70° BTDC
- 188. Valves close at : 104° ABDC

EXHAUST

- 201. Tappet clearance : 1 mm
- 202. Valves open at : 104° BBDC
- 203. Valves close at : 68° ATDC

Signature et cachet de l'Autorité Sportive Nationale :

Signature et cachet de la F.I.A. :

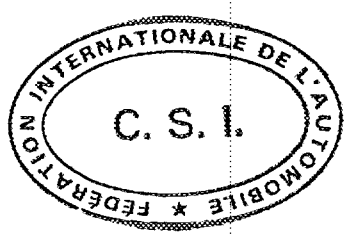

A handwritten signature in black ink.



MOTOR SPORT DIVISION
The Royal Automobile Club
 31 Belgrave Square, London SW1X 8QH

Manufacturer FORD

Model ESCORT RS 2000

F.I.A. Recognition No. 5566

Amendment No. 30/171

-1 JUL 1978

Amendment to Form of Recognition

FEDERATION INTERNATIONALE DE L'AUTOMOBILE

VALID IN GROUP.....1.....

No.

Reference No.

Product Variant

Cost and weight saving, plus multi sourcing, have resulted in the following weight changes

160 Flywheel 7.1 kg 15.6 lb

161 Flywheel and clutch (weights clean, without bolts, washers, etc...) due to alternative clutch suppliers:

a) Clutch pressure plate assembly:

Fichtel and Sachs : 3.9 kg

Laycock : 5.1 kg or 4.4 kg

b) Clutch driven plate:

Laycock : 1.1 kg

Borg and Beck: 1.45 kg



Alternative supply axle not quoted by C.S.I. on 24/14V for 4.44 axle = 8-35 for 4.375

Various export territories require rear brake system to incorporate pressure limiting valve.





MOTOR SPORT DIVISION
 The Royal Automobile Club
 31 Belgrave Square, London SW1X 8QH

Manufacturer FORD

Model ESCORT RS2000

F.I.A. Recognition No. 5566

Amendment No. 317/187
 -1 JAN 1979

Amendment to Form of Recognition

FEDERATION INTERNATIONALE DE L'AUTOMOBILE

VALID IN GROUP.....1.....

No.

Reference No.

Product Variant

Local supply content for Australian cars.
 Heavy duty axle - interchangeable with standard unit
 photo E79-1

Automatic transmission
 Type Ford C3
 1st gear 2.47-1
 2nd gear 1.47-1
 3rd gear 1-1
 Reverse gear 2.11-1

Heavy duty rear springs
 2 leaf

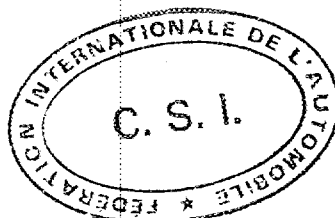
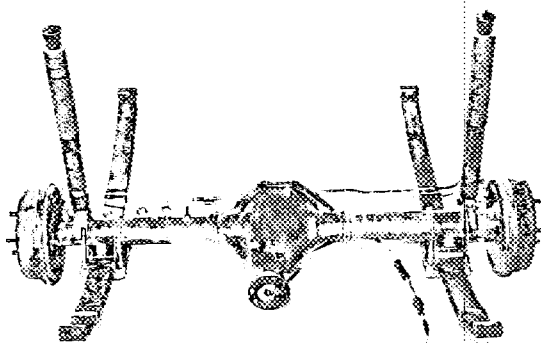

Date amendment is valid from.....

Stamp of F.I.A./R.A.C.



MOTOR SPORT DIVISION
The Royal Automobile Club
 31 Belgrave Square, London SW1X 8QH

Manufacturer FORD
 Model ESCORT RS2000
 F.I.A. Recognition No. 5566
 Amendment No. 32/14E

-1 JAN 1979

Amendment to Form of Recognition

FEDERATION INTERNATIONALE DE L'AUTOMOBILE

VALID IN GROUP.....1.....

No.

Reference No.

Errata

Tappet clearance for measuring cam angles is 0.1mm and not
 1mm as quoted on forms 28/12E and 29/13E



Date amendment is valid from.....

Stamp of F.I.A./R.A.C.



MOTOR SPORT DIVISION
The Royal Automobile Club
 31 Belgrave Square, London SW1X 8QH

Manufacturer FORD
 Model ESCORT RS2000
 F.I.A. Recognition No. 5566
 Amendment No. ~~33/19~~V

Amendment to Form of Recognition

FEDERATION INTERNATIONALE DE L'AUTOMOBILE

VALID IN GROUP.....¹.....

No.

Reference No.

Variant

Variant

Deletion of centre consol and modified internal trim on base level car - see photo C79.1

Slots between louvers deleted on plastic front end - see photo C79.2

Propshaft (driveshaft - gearbox to axle) may be either single or piece dependant on territory.

293

Final drive ratio 3.89; 35.9

Dual circuit braking (see also sheet 19/11V)

Type A - no servo assistance

Type B - with servo units fitted remote from pedal box in hydraulic line.

Actuating force by vacuum - as Art. 258i 1979.

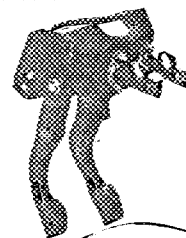

[Handwritten signature]



MOTOR SPORT DIVISION
The Royal Automobile Club
31 Belgrave Square, London SW1X 8QH

Manufacturer FORD
 Model ESCORT RS2000
 F.I.A. Recognition No. 5566
 Amendment No. **33/191**

Amendment to Form of Recognition

FEDERATION INTERNATIONALE DE L'AUTOMOBILE

Valid in Group 1

Photographs must be 3" x 2" and a matt finish

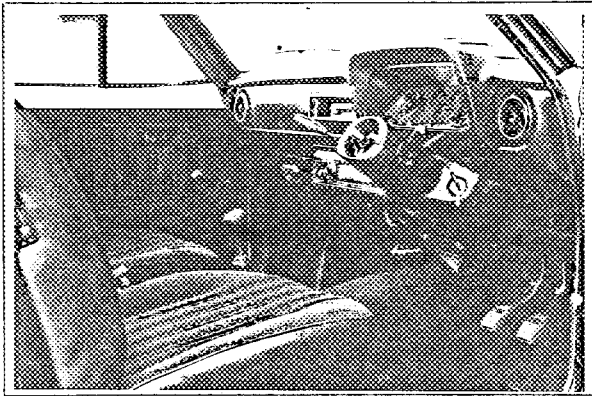

C79-1

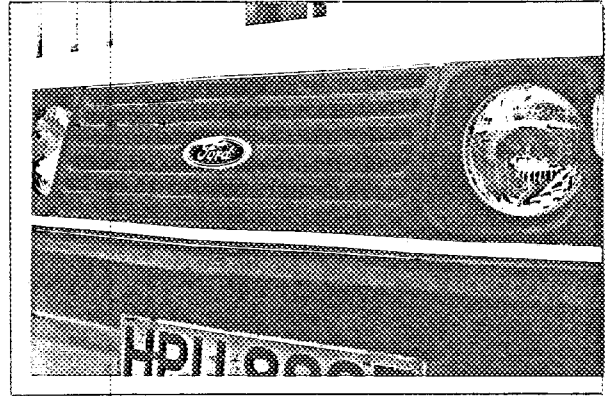

C79-2

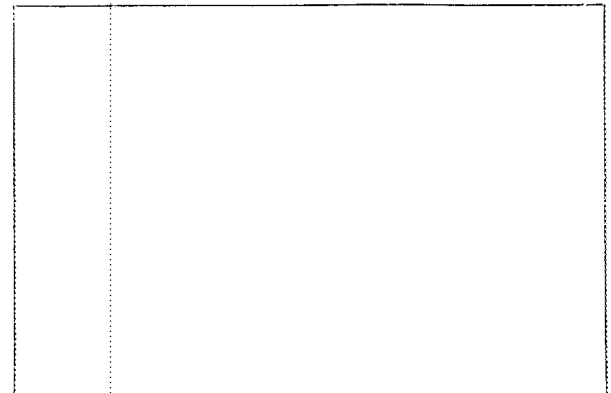
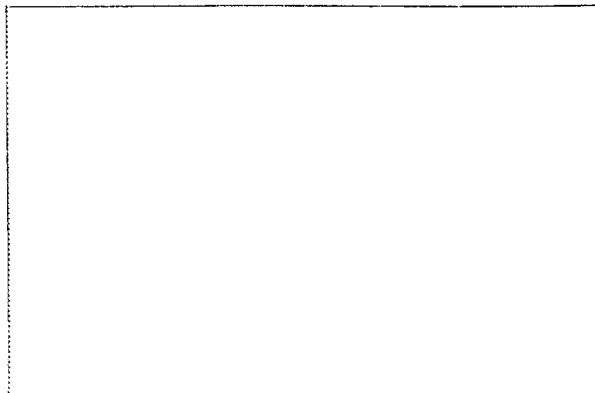
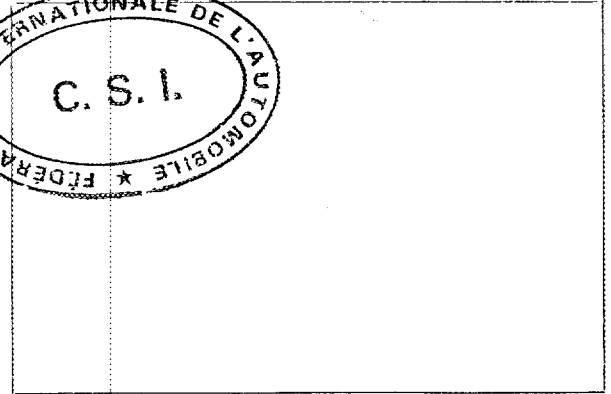
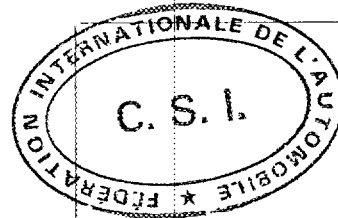
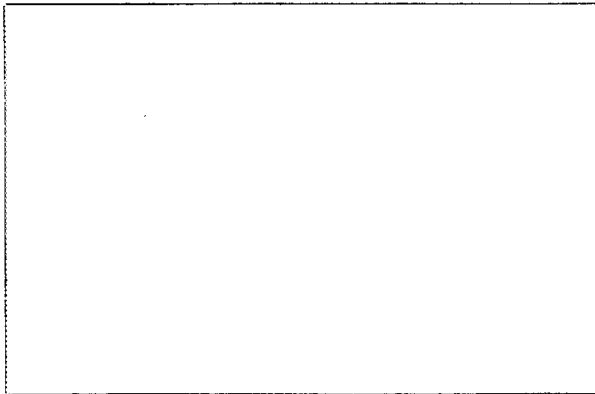

Date amendment is valid from.....

Stamp of F.I.A./R.A.C.

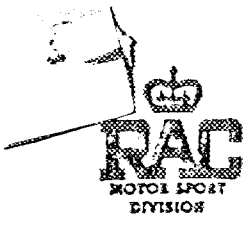

MOTOR SPORT DIVISION
The Royal Automobile Club
31 Belgrave Square, London SW1X 8QH

Manufacturer FORD
 Model ESCORT RS 2000
 F.I.A. Recognition No. 5566
 Amendment No. ~~34720~~V

Amendment to Form of Recognition
FEDERATION INTERNATIONALE DE L'AUTOMOBILE
 VALID IN GROUP.....1.....

No. Reference No.

With Heavy duty brake kit, a rear brake circuit pressure limiting valve can be fitted

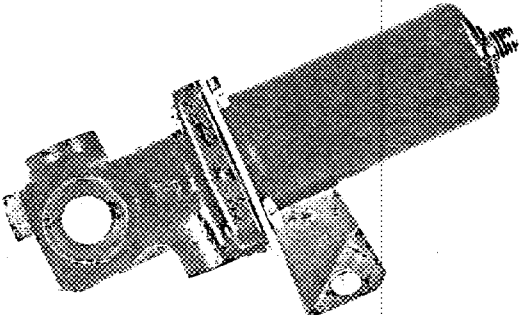

Part No: H71WB2493AA (9051551)

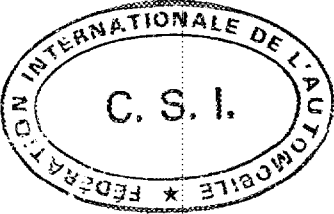



FEDERATION INTERNATIONALE DE L'AUTOMOBILE

FORD - ESCORT RS 2000

MARQUE ET MODELE

4/76 - 12/81

VALIDITE HOMOLOGATION

5566

FICHE NR.

1 / 2000

GROUPE / CLASSE

EXTENSIONS	DEBUT VALIDITE	DESCRIPTION	NOTES
1/1V	4/76	MODELE RS 2000 GT	
2/2V		MODELE POUR ALLEMAGNE -	
3/3V	7/74	MOTEUR - ARBRE A CAMES	
4/4V	9/74	SIEGE	
5/5V	9/74	BOITE A VITESSES - RAPE AR -	
		TRANSMISSION - FREIN -	
		CHASSIS - ELARGISSEUR D'AILES -	
		PROTECTION INFERIEURE -	
		BOULASSE - BIELLE - VILLEBEQUIN	
		POMPE A HUILE - INJECTION -	
		CHAPEAUX DE PALIER -	
		VOLANT MOTEUR - EMBRAYAGE -	
6/6V	10/74	ECHEAPPPEMENT -	
7/7V	10/74	JANTE -	
8/8E	10/74	PALIER - COUPLE FINAL - PISTON	
9/9E	1/75	VOLANT MOTEUR - RAPPORT-VOLE	
10/10V	2/75	COUPLE FINAL	
11/11E	10/75	FILTRE A AIR - JANTE	
Autres homologations du modèle		5566 TRANSFERT A - B 214	
		A 5035	

Vérifiée le 24/10/95 par  visée ce jour le _____ par _____



FORD - ESCORT RS 2000

MARQUE ET MODELE

4/76 - 12/81

VALIDITE HOMOLOGATION

5566

FICHE NR.

1 / 2000

GROUPE / CLASSE

EXTENSIONS	DEBUT VALIDITE	DESCRIPTION	NOTES
12/4E	1/76	VILLEBREVIN - BIELLE -	
13/9V	1/76	CARBURATEUR - COLLECTEUR ADM.	
14/5E		VILLEBREVIN - BIELLE -	
		CARBURATEUR - COLLECTEUR ADM.	
15/10V	4/76	CARROSSERIE - TABLEAU DE BORD	
		DIRECTION - SUSPENSION -	
		FREIN - RESERVOIR - VENTILATEUR -	
		PROTECTION INF. - SUSPENSION -	
		COUPLE FINAL - DIFFERENTIEL	
		AUTOBLOQUANT - GLACES -	
		SIEGE -	
16/6E	4/76	COLLECTEUR D'ECHAPPEMENT -	
		CONDUIT D'ECHAPPEMENT - FREIN	
		FILTRE AIR - JAMBE -	
17/7E	10/76	-	
18/8E	11/76	COUPLE FINAL	
19/11V	11/76	SUSPENSION - FREIN -	
20/3E	1/77	CONDUITS	
21/12V	1/77	RADIATEUR - VENTILATEUR - SIEGE	
Autres homologations du modèle			

Vérifiée le 24/10/85 par DUT visée ce jour le _____ par _____



FEDERATION INTERNATIONALE DE L'AUTOMOBILE

FORD - ESCORT RS 2000

MARQUE ET MODELE

4/76 - 12/81

VALIDITE HOMOLOGATION

5565

FICHE NR.

1 / 2000

GRUPE / CLASSE

EXTENSIONS	DEBUT VALIDITE	DESCRIPTION	NOTES
22/10E	7/77	PISTON - RAPPORT	
23/13V	10/77	8000 CHASSIS - AXE AR -	
24/14V	2/78	MODELE AUSTRALIA	
25/14V	2/78	RESERVOIR -	
26/15V	4/78	SIEGE -	
27/11E	5/78	CULASSE -	
28/12E	4/78	ARBRE A CAMES -	
29/13E	5/78	ARBRE A CAMES -	
30/17V	7/78	VOLANT MOTEUR - EMBRAYAGE	
		COUPLE FINAL - FREIN -	
31/18	1/79	AXE AR - BOITE AUTOMATIQUE	
		SUSPENSION -	
32/14E	1/79	DISTRIBUTION -	
33/19V		CARROSSERIE - TRANSMISSION -	
		COUPLE FINAL - FREIN -	
34/20V	4/80	FREIN	

Autres homologations du modèle

Vérifiée le 31/10/95 par  visée ce jour le _____ par _____