

SOUTHERN ARCHITECT

MAY 1958

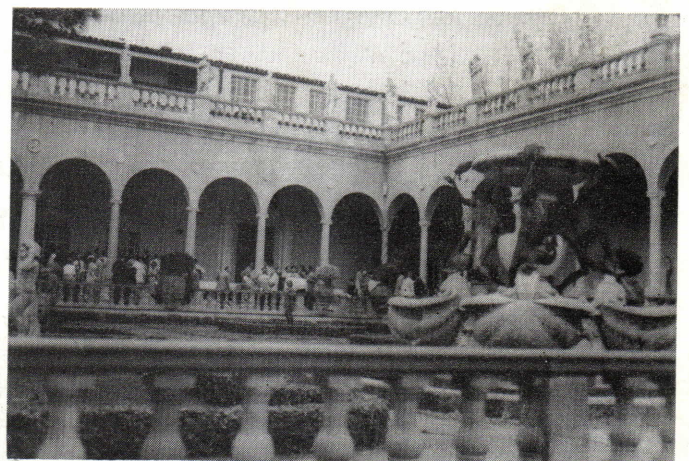

Official Publication
North Carolina Chapter

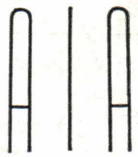

American Institute
of Architects

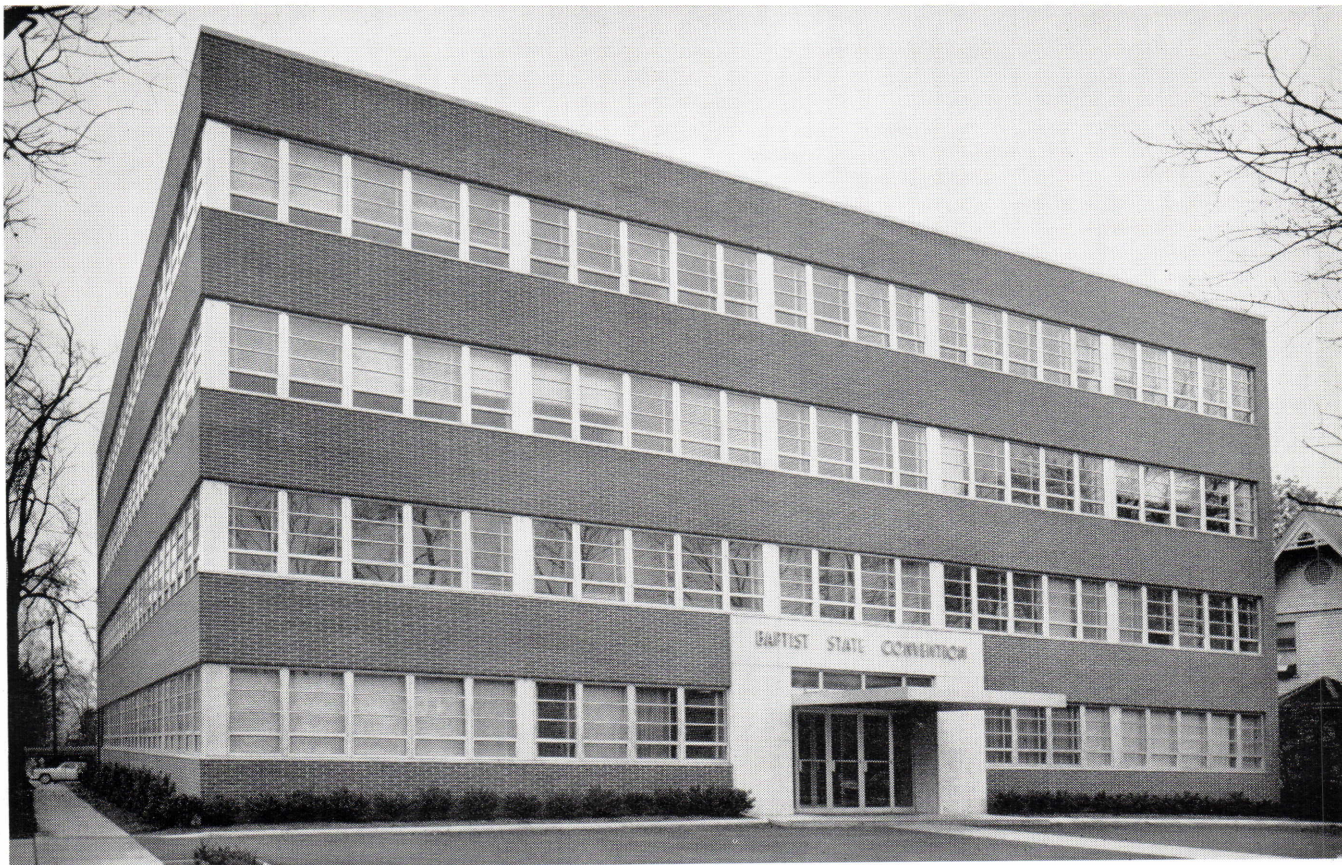

The Baptist State Convention Building in Raleigh, N. C. • Haskins & Rice, Architects
 J. M. Thompson, Contractor • Gardner and Mier, Structural Engineers

MULTIPLE SAVINGS

with **SOLITE**®

SOLITE lightweight structural concrete for the Baptist State Convention building in Raleigh, N. C., was used in 2½" slabs on bar joists . . . was also used to encase the vertical steel columns of the building.

SOLITE'S light weight made it possible to cut down on structural steel framing. It saved over 720 tons of deadweight . . . saved on material costs . . . labor costs . . . and gained more usable floor space. SOLITE reduced materials shipping costs, cut construction time. SOLITE-sheathed columns added the invaluable bonus of fireproofing.

This is just one more example of modern building with a modern product . . . SOLITE lightweight structural concrete. A product that means multiple savings . . . better, more beautiful buildings.

So Light . . . So Safe . . .

Plants:	Offices:
Aquadale, N. C.	Box 9138, Richmond, Va.
Bremo Bluff, Va.	Box 1843, Charlotte, N. C.
Leaksville Junction, Va.	Box 235, Gaithersburg, Md.

SOLITE®

FOR BETTER BUILDING - - Consult your architect or engineer. No matter what your construction needs, professional advice can save your time and money.

a **NEW** giant is born

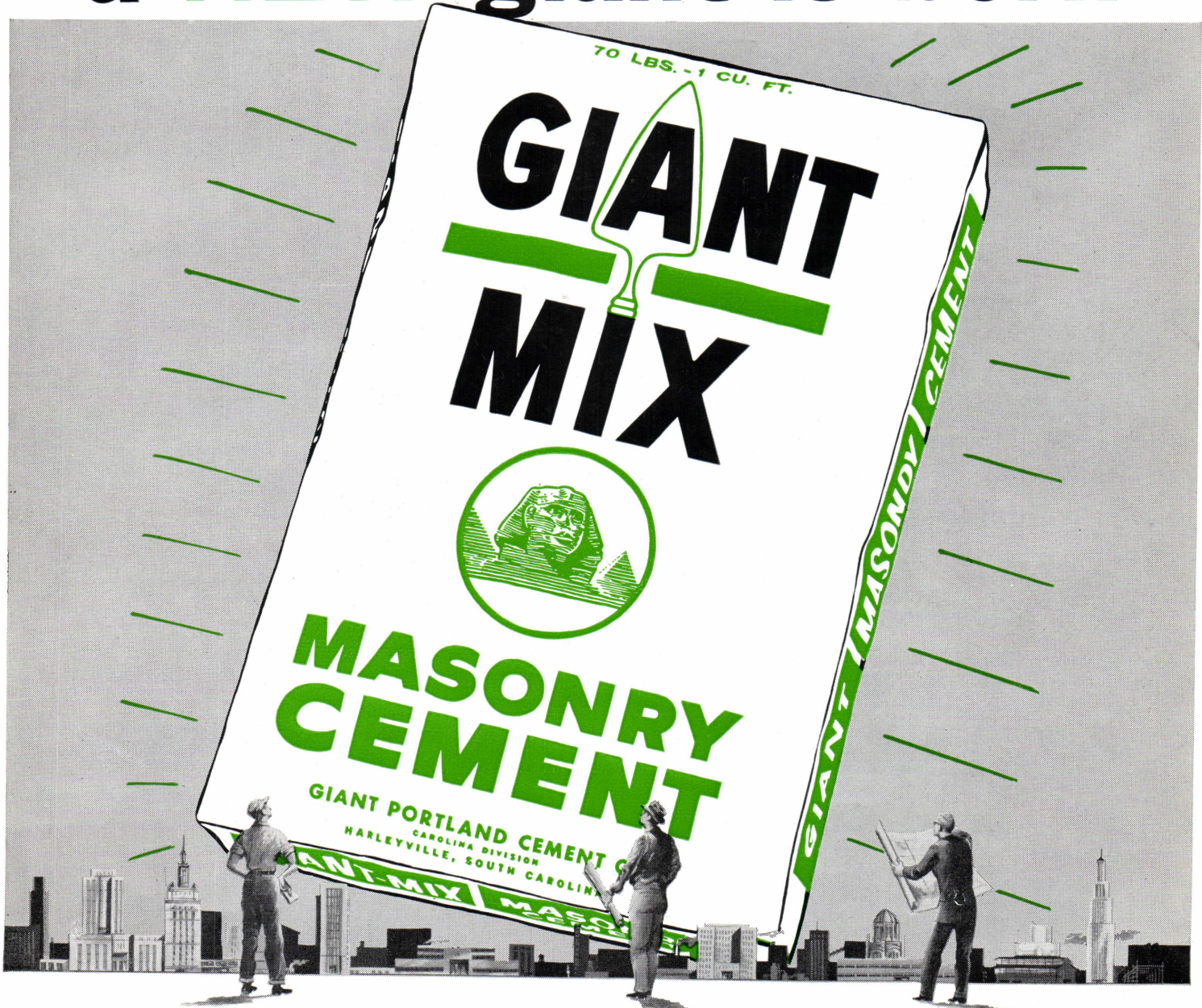

Made for the mason who wants smooth workability.

Designed for the contractor who demands unfailling uniformity, excellent yield and labor saving workability.

Developed for the architect who wants a light color masonry cement of fine uniformity and texture.

The mason, contractor, architect and the dealer — each had his separate demands for a masonry cement — GIANT-MIX was developed with these demands in mind.

So you have the workability, the cling-quality. You have the productive yield

qualities and the lightness of color in Giant Mix Masonry Cement.

For the best in job after job quality and production — look to GIANT-MIX — your 1958 design in Masonry Cement.

GIANT PORTLAND CEMENT COMPANY
Carolina Giant Division • SALES OFFICE, COLUMBIA, S. C.



Spanning a half century of
service to Carolinians

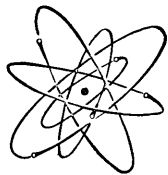

The progress made during our first fifty years of service is a matter of much pride to all of us here at CP&L. We intend to maintain this tradition of service and we dedicate ourselves anew to an even Finer Carolina in the years that lie ahead.

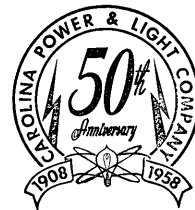

CAROLINA POWER & LIGHT COMPANY

Coal *has always been dependable* now it can be automatic

Will - Burt Hopper and Bin Feed Model Stokers — capacities, 150 through 750 lbs. per hr.



WILL-BURT
STOKERS
ORRVILLE, OHIO

A Will-Burt coal heat installation will bring coal from bin to stoker . . . feed the necessary coal at any of three adjustable rates . . . and automatically adjust air supply minute by minute, to fuel bed needs. Panel controls by Will-Burt will automatically cycle one stoker, or several.

What could be more practical — especially when you consider the known economy and safety of coal fired heat?

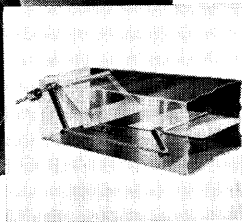

W-B Automatic Air Control — sensitively controls air supply — prevents excessive soot or smoke.

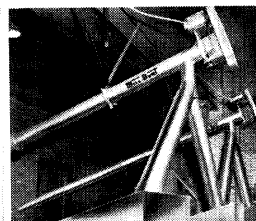

W-B Coal Conveyor — practical for any installation — operates at any angle — single, dual, or cross feed tandem.

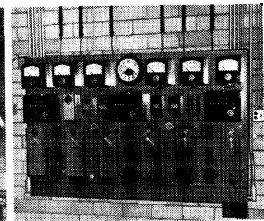

W-B Panel Controls — make scheduled heating a simplified, supervisory operation — tailored to the job.

Southern Architect

Volume 5

May 1958

Number 5

COMMITTEE ON PUBLICATIONS

Richard L. Rice, AIA, Chm.	Raleigh
Sam T. Snoddy, Jr., AIA	Laurinburg
James L. Brandt	Raleigh
James C. Hemphill, Jr., AIA	Charlotte
Edward E. Aldrich, AIA	Asheville
A. Lewis Polier, AIA	Raleigh
Conrad B. Wessell, Jr., AIA	Goldsboro
Turner G. Williams, AIA	Raleigh
David B. Oden	High Point

PUBLIC RELATIONS COMMITTEE

Robert F. Arey, AIA, Chm.	Winston-Salem
Louise Hall, AIA	Durham
Nils F. Larson, AIA	Winston-Salem
Allen J. Bolick, AIA	Hickory
Anthony Lord, FAIA	Asheville
J. Norman Pease, Jr., AIA	Charlotte
Edward Loewenstein, AIA	Greensboro
Cecil D. Elliott, AIA	Raleigh

Southern Architect is the official publication of the North Carolina Chapter of the American Institute of Architects and is published monthly by H. J. Stockard, Jr., 122 W. Hargett St., Raleigh, North Carolina, Telephone TEmple 4-4384.

Address all communications to Southern Architect, Post Office Box 408, Raleigh, North Carolina. Advertising rates on request.

Opinions expressed by contributors are not necessarily those of the North Carolina Chapter of the American Institute of Architects or the Publisher. Reproduction of any articles, pictures, or any other material appearing in Southern Architect is forbidden without the specific approval of the Publisher.

Subscription price: One year \$3.00; Two years \$5.00. Single copies 25 cents. Full name and address shall accompany all subscriptions. Kindly notify Southern Architect in the event of change of address.

CONTENTS

● President's Message	7
● Letters	7
● NCAIA Summer Meeting Plans	8-9
● Residence Addition — Lumberton	10-11
● Parish House Addition — Chapel Hill	12-13
● NC Personality of the Month	14
● Regional Meet Highlights	15-17
● Legal Lines	18
● North Carolina's Capitol	19-22
● Architects and Builders in the News	25
● AIA News	26
● Advertisers Index	30
● Architectural Calendar	30

COVER

Ringling Museum inspection during AIA Regional Meeting in Sarasota (see page 15)

NORTH CAROLINA CHAPTER • THE AMERICAN INSTITUTE OF ARCHITECTS

William R. James, Jr., AIA 865 W. 4½ Street, Winston-Salem	President	Leslie N. Boney, Jr., AIA 120 S. Fifth Street, Wilmington	Director
Robert L. Clemmer, AIA 226 Second Street, N.W., Hickory	Vice-President	F. Carter Williams, AIA 133 Fayetteville Street, Raleigh	Director
Arthur C. Jenkins, Jr., AIA Box 1003, Fayetteville	Treasurer	Charles H. Wheatley, AIA P. O. Box 4043, Charlotte	Director
Kenneth M. Scott, AIA 3126 Eton Road, Raleigh	Secretary	Louise Hall, AIA Box 6636, College Station, Durham	Archivist
H. J. Stockard, Jr. 122 W. Hargett Street, Raleigh	Executive Secretary	R. Mayne Albright 824 Insurance Building, Raleigh	Attorney

YOU GET KNOWN

Quality

when you buy
CONCRETE BLOCKS
from a member of the
NCCMA!

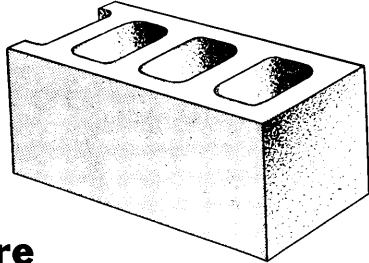

They're
Quality Controlled

for DENSITY • AGGREGATE
• STRENGTH

TESTED by recognized independent laboratories

**NORTH CAROLINA CONCRETE
MASONRY ASSOCIATION**
715 W. Johnson St., Raleigh, N. C.

Make every plan complete...

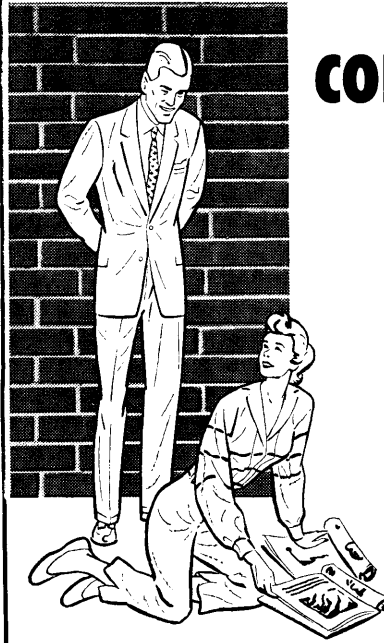

include
distinctive

PINE HALL BRICK

OVER 60 VARIETIES
TO CHOOSE FROM

OFFICE AND
SALES YARD
1045 NORTHWEST BLVD.
WINSTON-SALEM, N. C.
PHONE PA 4-8331

PINE HALL

BRICK AND PIPE CO.

EXPANDED-CLAY AND SHALE AGGREGATE

USE



it makes **BETTER LIGHTWEIGHT BLOCKS
AND LIGHTWEIGHT CONCRETE**

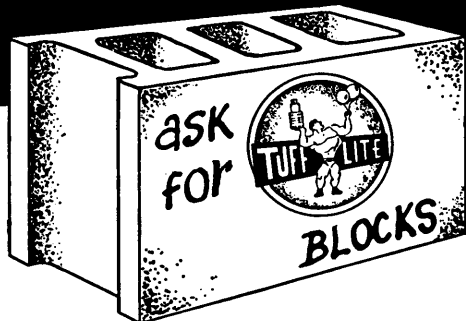

For Better Building

CAROLINA **TUFF-LITE** CORPORATION
P. O. BOX 1037 PHONE 188
SALISBURY, N. C.

DEWEY BROS., INC.

- Structural Steel
- Ornamental Iron
- Bar & Longspan Joists
- Miscellaneous Iron
- Metal Windows, Doors
- Building Specialties



DEWEY BROS., INC.

Goldsboro, N. C.

Grey Iron Construction Castings
Since 1885

PRESIDENT'S MESSAGE

We all look forward to an interesting and stimulating meeting at Morehead this summer and I urge all of you to make plans to attend. Accommodations and facilities at the renovated Morehead Biltmore are excellent from all reports. The hotel has been done over from stem to stern with the idea of accommodating conventions such as ours. Facilities include swimming pool, putting green, fishing pier and just about everything for which we could ask. Our program will be interesting and productive and every effort will be made to keep afternoons and evenings free for shore activities.

I have just returned from the Regional Conference at Sarasota where we were represented by about seven of our members. This was one of the most interesting and best planned conferences the Region has ever had and the host chapter, Florida Central, deserves appreciation and congratulations from all of us. The program was built around Seminars conducted by Paul Rudolph, Richard Neutra, Rex Anderson and John Taylor Egan,



JAMES

which were very educational and interesting. The manufacturer's products exhibit, very extensive and informative, was well attended. The social activities and entertainment could never be surpassed and the hospitality shown by our hosts was warm and truly "Southern". An excellent affair! One item of business in which you will be interested was the resolution that Florida be made into a Separate Region. This resolution was unanimously passed because of the belief that Florida with its strong central organization composed of ten chapters is ready for this important step. Texas has been made into a separate Region and several other large, well organized states have requested this Status. The original resolution offered to the council included a paragraph recommending Regional Status for all States which are well organized, and implied that the eventual goal of the Institute should be an organization divided into units on the basis of individual status. This part of the resolution was defeated much to the sorrow of the several of us who believe that the profession could be best served by a Professional Society so organized.

See you all at Morehead.

W. R. JAMES, President
President, NCAIA

LETTERS

State of North Carolina
DEPARTMENT OF LABOR
Raleigh

April 14, 1958

Mr. H. J. Stockard, Jr., Exec. Secy.
North Carolina Chapter
The American Institute of Architects
122 West Hargett Street
Raleigh, North Carolina

Dear Jerry:

I want to thank you and the members of the North Carolina Chapter of the American Institute of Architects for including our Construction Rules and Regulations in the March Issue of the Southern Architect. This is a real service to your North Carolina Department of Labor, and also to the various organizations with which the NCAIA works. Your article has enabled us to get these Rules and Regulations before the people to whom they apply.

Our limited staff has hampered us in getting our Regulations into the hands of the proper persons, and I feel sure that your article has alleviated this situation to a great extent.

I want to thank you and the NCAIA for making it possible for us to distribute this information, and I also want to express my personal appreciation to you for your cooperation and consideration.

With my best regards and personal well wishes, I am

Sincerely yours,
Frank Crane,
Commissioner.

State of North Carolina
INSURANCE DEPARTMENT
Raleigh

May 6, 1958

Mr. H. J. Stockard, Jr.
122 W. Hargett Street
Raleigh, North Carolina

Dear Jerry;

The Interdepartmental Building Regulation Committee in regular session on April 28, 1958, asked me to write the "Southern Architect" and prevail on its Editors to forward the following message to all Architectural and Engineering firms in North Carolina:

"The Interdepartmental Building Regulation Committee has recently published Rules and Regulations regarding processing of plans and specifications for approval, copy of which has been mailed to all Architectural and Engineering firms and reprinted in the 'Southern Architect'.

Under the provisions of Section 2b of these Rules, the Architect or Engineer has the option of submitting his plans and specifications direct to the various State Agencies having jurisdiction or submitting the correct number of sets to the control agency who will then distribute them for the applicant.

The Committee would greatly appreciate it if all Architectural and Engineering firms would notify the control agency when plans and specifications are submitted direct to the other agencies having jurisdiction as required in Section 2b of these Rules."

Yours very truly,

Kern E. Church, Secretary
Interdepartmental Building
Regulation Committee



NCAIA SUMMER MEETING AT MOREHEAD JUNE 19-21

Room reservations are coming in at a rapid pace at the Morehead Biltmore Hotel in Morehead City, headquarters for the Summer Meeting of the N. C. Chapter The American Institute of Architects. Final touches have been just about completed on the convention program, with some excellent speakers and plenty of recreational activities, night and day, in and around the hotel, which is managed by Michael L. "Bill" Taft, formerly manager of Asheville's Battery Park and Manor Hotels.

Here are a few facts about the hotel: It is the old Morehead Villa, which has been redecorated, refinished and re-equipped, at a cost in the neighborhood of \$600,000, and made into North Carolina's finest coastal hotel. It has 100 air conditioned rooms and 100 baths. It features a new 55-foot swimming pool on the grounds and a new 570-foot pier out into Bogue Sound. An 18-hole golf course is only a couple of minutes away, tennis courts and riding stables the same distance, and Atlantic Beach is only a few minutes drive away. The parking area has been enlarged to more than take care of the vehicles of all at the convention.

The entire atmosphere of the hotel might be described as informally elegant, and at the NCAIA convention, sport shirts and comfortable dresses and slacks will be the uniform of the day (the exception will be at the banquet on Friday night, when coats will be suitable

for the men and semi-formal dress for the ladies will be optional), with bathing suits a "must" for everybody attending the convention who enjoys a good swim, fresh or saltwater, or sun-bathing.

The long pier jutting out into the Inland Waterway from the rear of the hotel isn't there just for looks. Docking facilities are available and Bogue Sound offers some good fishing. For those who do not bring their own tackle, some will be available, at a very nominal rental, from the hotel.

Registration will open in the lobby at 1:30 P.M. on Thursday. The NCAIA officers and Directors will meet in the Governor's Suite at the hotel at 2:00 P.M. on Thursday, June 19, and the first convention business session will open on Friday, June 20, at 9:30 A.M.

The Program Committee, under Chairman Archie Royal Davis, AIA of Durham, has left every afternoon free for relaxing. Several suppliers have indicated that they plan special entertainment features. The banquet Friday night will be preceded by a social hour, with the traditional dance following.

The Chapters Summer Meeting will take over almost the entire hotel, if not every room, and members are urged to get reservations in immediately. Rates are single \$6 to \$8, double \$9 to \$10 and twin \$11 to \$14.

Shown right is the main dining room-ballroom at the Morehead Biltmore Hotel, just off the main lobby. It is here that the general sessions of the NCAA Convention will be held, as will the banquet on Friday night, June 20. Another ballroom-dining room is located off the lobby which will offer simultaneous facilities for meeting and dining. Also off the lobby is a coffee shop to accommodate diners only.

Below is the lobby of the Hotel, looking toward the registration desk. The front doors are at the right of the picture, and the French doors to the left open out on a lovely patio and the dining room-ballroom. Rooms open off either end of the mezzanine balcony shown in the photo, and all furnishings in the hotel are new.

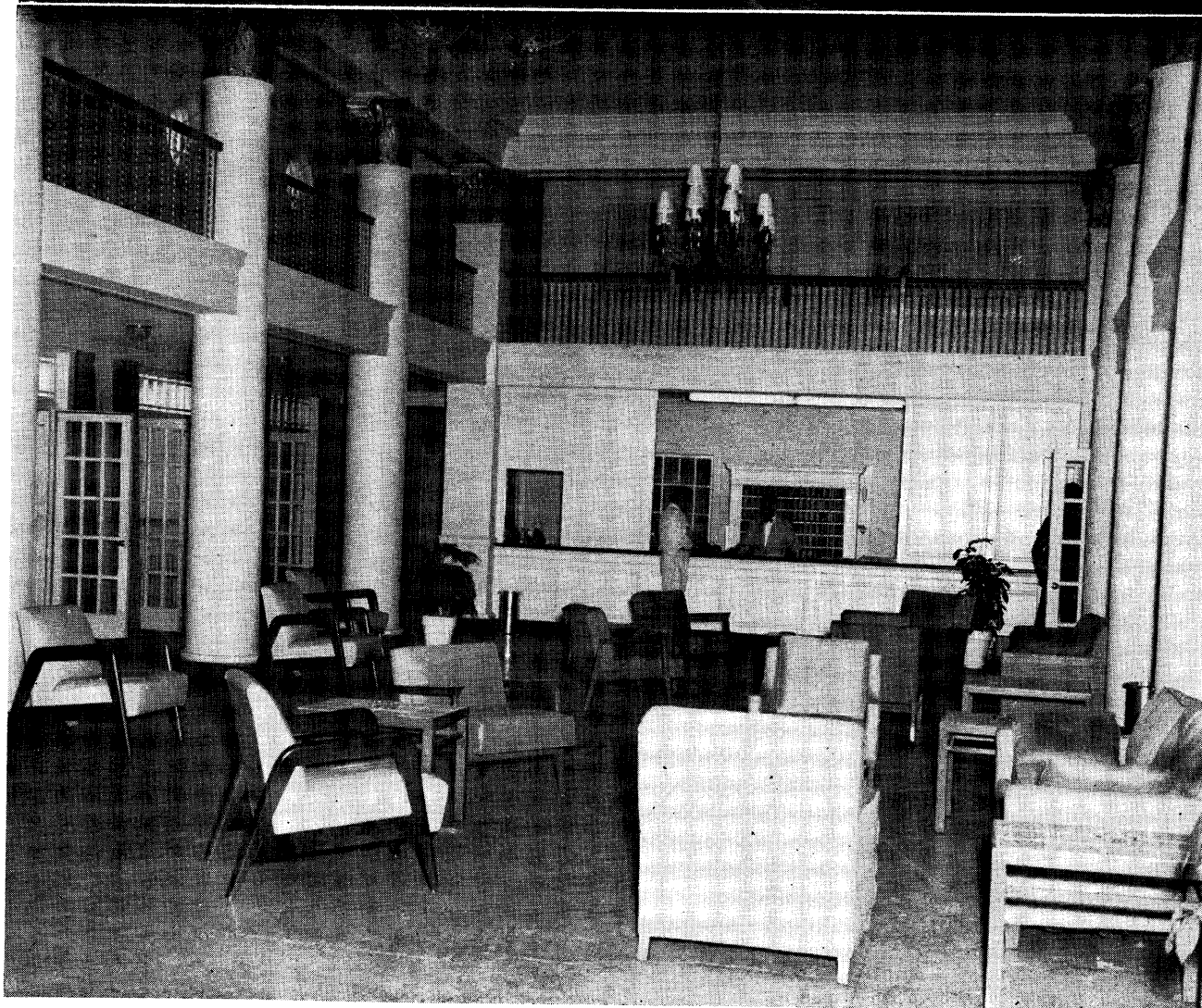



RESIDENCE ADDITION

LUMBERTON, N. C.

Elizabeth B. Lee, AIA

Lumberton, N. C.

Horace Smith - General Contractor

Lumberton, N. C.

This 850-square foot family room is for Dr. and Mrs. F. P. Ward, who have four children ranging from pre-school to high school age. It incorporates television, hi-fi, movie screen, desk, card table storage, coat closet, efficiency kitchen, book-cases and many other items for relaxed living by the family. The Lumber River is to the East and South, and the walls on those sides are sliding glass doors. The North and West walls are cyprus. The floor is pompeiiian vinyl tile in 12 x 12 inch blocks. The floor next to the original house is brick on a slab in order not to undermine the existing foundation and to provide some transition, the other part is on wood joist. The ceiling is sand finished plaster and cyprus. It is heated with a separate heat pump located under the East end. Architect Lee is the Chapters only practicing member of the dis-taff side.

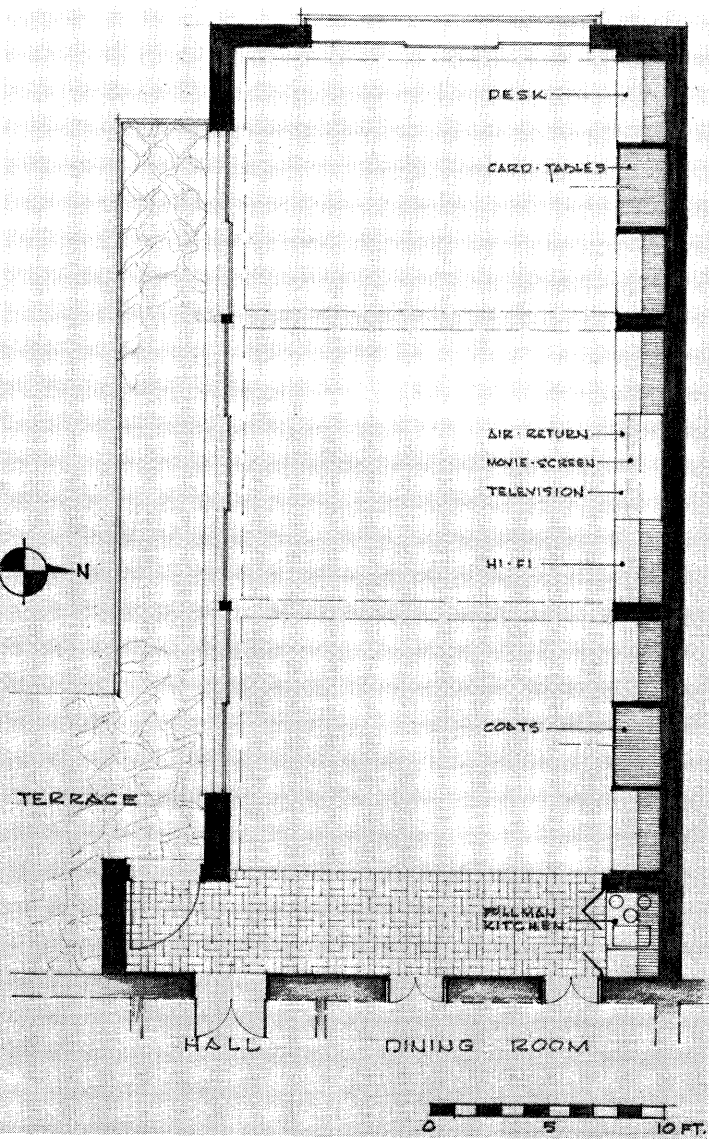
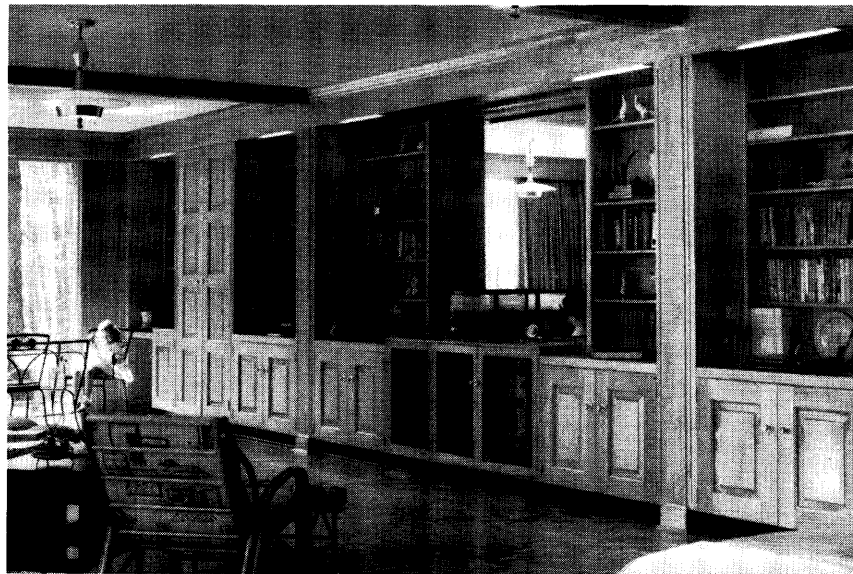



PARISH HOUSE ADDITION

CHAPEL HILL, N. C.

S. Porter Graves and Walter D. Toy, Jr. AIA

Charlotte, N. C.

George W. Kane, General Contractor

Roxboro, N. C.

The Chapel of the Cross has served its communicants for one hundred fifteen years. Six years after the parish was established the original church was built in 1848. The present church and parish house were erected in 1924. The original church, now the chapel, was restored in 1952.

Construction on the addition will be completed by fall. Deed restrictions with the University dictated the exterior appearance and the style of roof.

The church works with the more than 700 Episcopal students at the University. With increasing University enrollment a certainty, there was urgent need for an accessible and adequate student chaplain's office, a student lounge, and a library and conference room.

Other new facilities needed by the Church were for youth work, school work, scouts, adequate space for the choirs and womens groups, and increased kitchen and dining room.

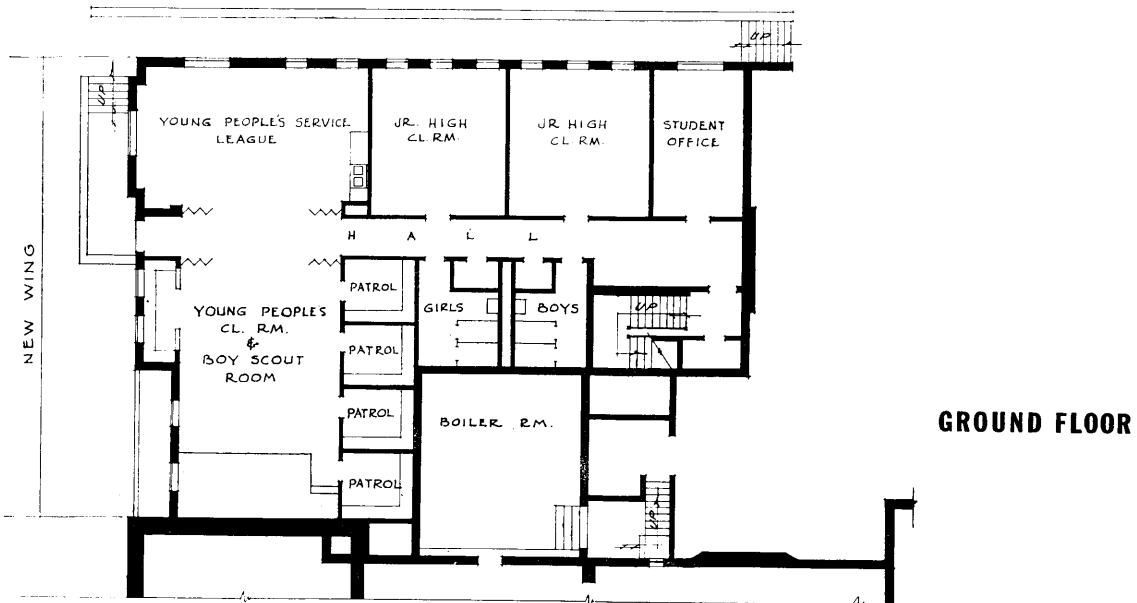
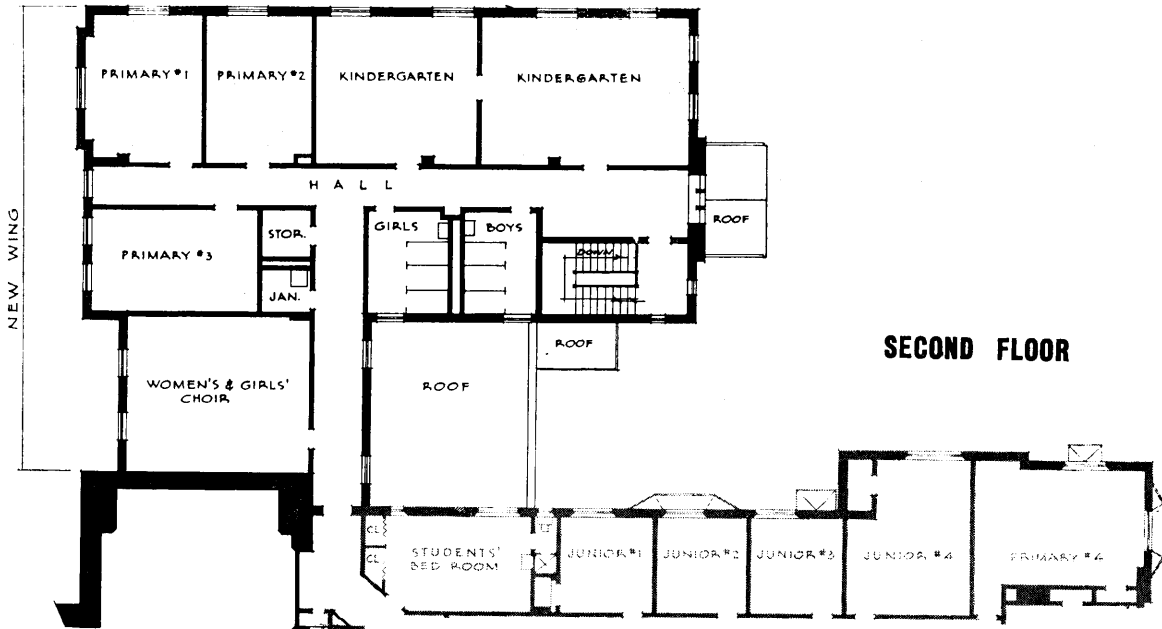
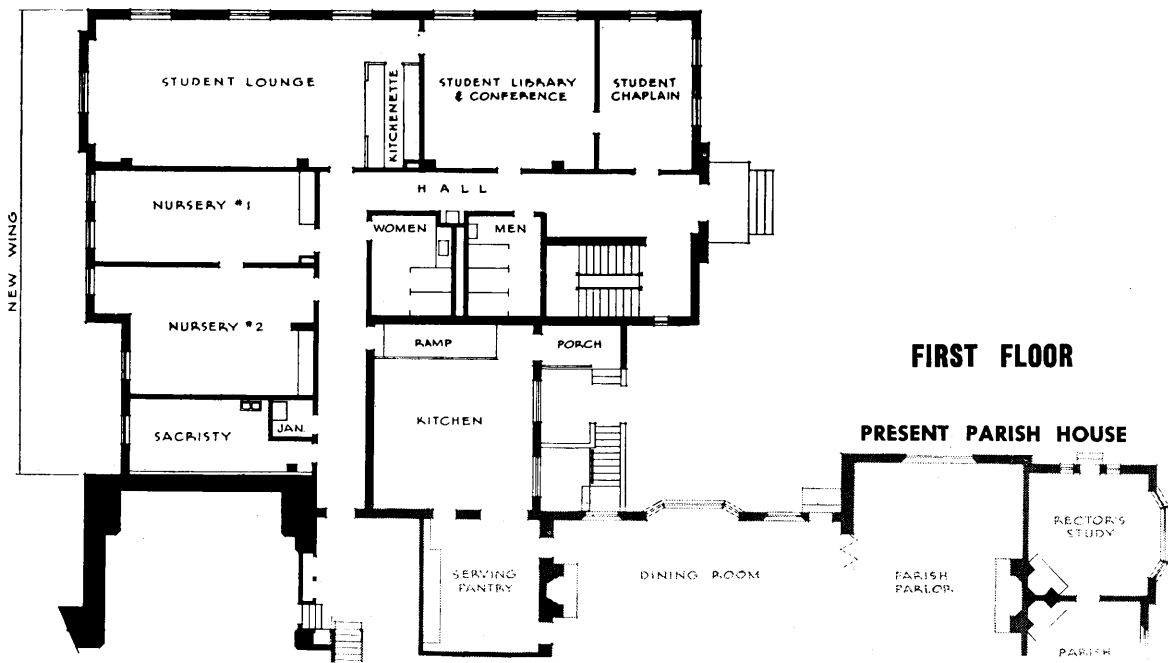



NORTH CAROLINA PERSONALITY OF THE MONTH

PAUL A. JOHNSTON

This is another of a series of articles giving a sketch of the leaders of various organizations and fields of business with which members of NCAIA are connected.

Paul Johnston was named last June 17 by Governor Hodges as the first Director of the Department of Administration, created by the last General Assembly to bring the State's fiscal agencies under one head. Thus it is his responsibility to supervise and coordinate the many activities of the Budget, Purchase and Contract, and Property Control Division, the latter of which includes an Architecture and Engineering Branch.

Mr. Johnston was born in Smithfield on May 17, 1916 and graduated from high school there. Among his first interests was music, and he played saxophone with nationally known bands throughout the country. After two years in the army he entered the University of North Carolina and at the age of 35 received his A.B. and LL.B. degrees with honors in the School of Law. His senior year he was Editor-in-Chief of the North Carolina Law Review. He also teamed with Robert E. Giles, currently Administrative Assistant to Governor Hodges, and entered the National Moot Court Competition in New York. They had outstanding success and were among the final four teams. While in New York he was offered and accepted a position with the firm of Satterlee, Warfield and Stevens. However, love of the home state was strong and he returned to Chapel Hill as Assistant Professor of Public Law and Government with the University and as Assistant Director of the Institute of Government as Assistant Director in charge of Studies in State Government. It was his work in this field that brought him to the attention of Governor Hodges, whom he served as Administrative Assistant from January 1955 until the appointment to his present position.

Paul is married to the former Margaret Gainey McGirt of Chapel Hill and they have one 15 year old son Paul, Jr. Paul is a Methodist, member of the N. C. State Bar, the N. C. Bar Association, and the Bar of the District Court of the U. S. for the Eastern District of North Carolina. He is also a member of Phi Delta Phi legal fraternity and the Order of the Coif.

A man with so many responsibilities and duties has little time for a hobby, but he lists among his loves golf and fishing and professes no competence in either. He is to be among the speakers at the Chapter's Summer Meeting, and it is hoped that he will have a little time to enjoy them.

1958 A.I.A. REGIONAL CONFERENCE SUMMARY

A resounding challenge to the architectural profession to help guide the growth of the South Atlantic area and the nation was sounded at the Regional Conference of the South Atlantic district of the American Institute of Architects April 17-19 in Sarasota, Florida.

Awards for architectural excellence were presented by Leon Chatelain, Jr., president of the American Institute of Architects, at the dinner meeting at which Sanford W. Goin, regional director, presided. Awards of merit, highest honor, were given Victor A. Lundy of Sarasota for his tourist center at Florida Silver Springs; Edward J. Seibert of Sarasota for the Thyne and Swain House, and Mark Hampton of Tampa for Galloway furniture showrooms. Honorable mentions were awarded to James Norman Pease, Jr., of Charlotte, N. C., for a Home Finance Company structure; and to Alfred Browning Parker of Miami for the M. R. Kitchens residence. Mentions were awarded to F. Carter Williams, M. S. Smith and T. G. Williams of Raleigh, N. C., for a First National Bank drive-in; to Edwin T. Reeder Associates of Miami for the Dade Federal Savings and Loan Bank; to Harry Burns and George Fisher of Jacksonville for the Normandy School; to Ralph Twitchell and Jack West of Sarasota, associated architects, for the Dennis House in Glasgow, Ky.; to Stefan Zacher of Miami for a TV studio, and to Morris Lapidus of Miami for the Americana Hotel.

Architects, planners, educators and editors all threw the gauntlet squarely at the assembled delegates and their colleagues during the three-day meeting at this Gulf coast resort city. The Conference was geared to a grass-roots exchange of ideas on the theme "The Architect's New Responsibilities in the Dynamic South".

The architect was singled out as the man who can work in his own community on planning boards, zoning boards and in public office. Douglas Haskell, editor of Architectural Forum, served as keynoter. Richard Neutra of Los Angeles moderated the roundtable on "The Architect's Role in Revitalizing Existing Communities". Paul Rudolph, chairman of the Department of Architecture at Yale University, led a discussion on "Ways and Means of Creating New Communities". A fiery discussion was held on planning for beauty and utility in the national highway program. John Taylor Egan of Washington, D. C., former U. S. Commissioner of Housing, led a discussion on "The Architect's Role in Working with Government Agencies".

Architects from Florida, Georgia, South Carolina, and North Carolina were told that their experience and background was urgently needed in the planning of community long range improvements. "This is where the architect should come in as he is the only one with the background to visualize things in three-dimensional form," Haskell said. He said that in the coming years the architect will have to deal with the total physical environment. He encouraged the architects with the comment "It is astonishing to what degree the country is with you. Not since Burnham's days in 1905 has there been the same concern." He said the need has arisen out of despair. He stated American people want to have a beautiful way of living but the only people who are telling them how right now are the automobile advertisers and the soap salesmen. He challenged, "They need leadership."

Immediately after the keynote talk, Richard Neutra, community planning consultant, led a discussion on "Revitalizing Existing Communities". One of the most hard hitting comments in the spirited discussions was delivered by Cecil Alexander of Atlanta who said "The architect must and can get into this picture in the beginning. I think that you ought to be out there in the forefront fighting for redevelopment legislation. You'll find yourself tied up in the biggest political pullings and haulings you ever got into," he said. "Let's get out of the ivory tower, let's get off the drawing boards, and see that what is left for us to design isn't just a dirty hole at the end of a narrow winding street choked by automobiles."

Paul Rudolph urged architects even in the design of individual buildings to consider them in terms of community surroundings. "We think in terms of buildings isolated in space unrelated to each other, unrelated to the older buildings." He urged a reuse of the great principles of architecture . . . of relating on buildings to another, giving certain types of buildings real emphases by their silhouette and size and the amount of space given to them in the front for viewing them.

On the second day of the Conference came an explosion which rocked the meeting and the community which hosted the parley. Keynote speaker Haskell arose during the question period which followed regional highway engineer Rex Anderson's talk on the federal highway program. He delivered a slashing attack on the lack of aesthetics and community welfare considerations and used a local highway project as a case in point. Speaking of the Sarasota Bayfront Drive now under construction he exclaimed: "Gorillas and jackasses could not have done a more stupid job of planning." This launched a discussion geared to the need for having community participation in the planning and embellishment of these projects.

The following day John Taylor Egan focused attention on the new challenge to the architect, that of "Concerning himself with large scale planning whether it be for large commercial centers, housing developments or a combination of both which create new neighborhoods within the municipal limits. He urged architects to work closely with government. "You must be prepared to offer intelligent constructive advice; establish confidence in your ability to serve and guide your elected officials into accomplishment." He cited the life of Charles Hollen McKim as a classic example of the architect whose advice and guidance was often asked by presidents and committees of Congress.

At the conclusion of the three day discussion program Philip Hiss, Sarasota county school board chairman, summarized the program by saying, "The architect should take his rightful place in the community. He must demonstrate over the years that he is capable of designing sound buildings that are beautiful to look at and reasonable in cost. They must be planned as part of the community."

Architects attending from North Carolina were Leslie N. Boney, Jr., Frank Horton, Hollis L. Ivey, William R. James, Jr., Henry L. Kamphoefner, David M. Mackintosh, Jr., J. Norman Pease, Jr., and C. M. Sappenfield.

PHOTOGRAPHIC SUMMARY OF THE REGIONAL AIA MEETING



1

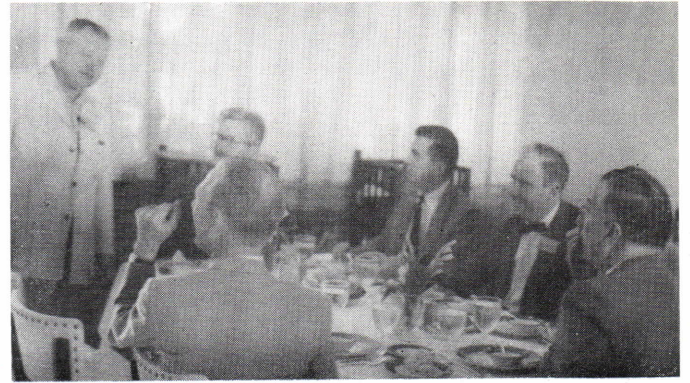

5



2



6



3

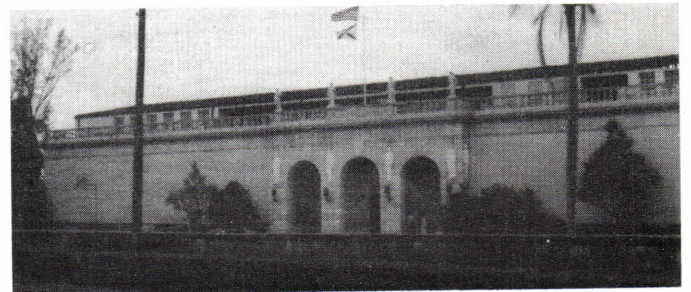

7



4

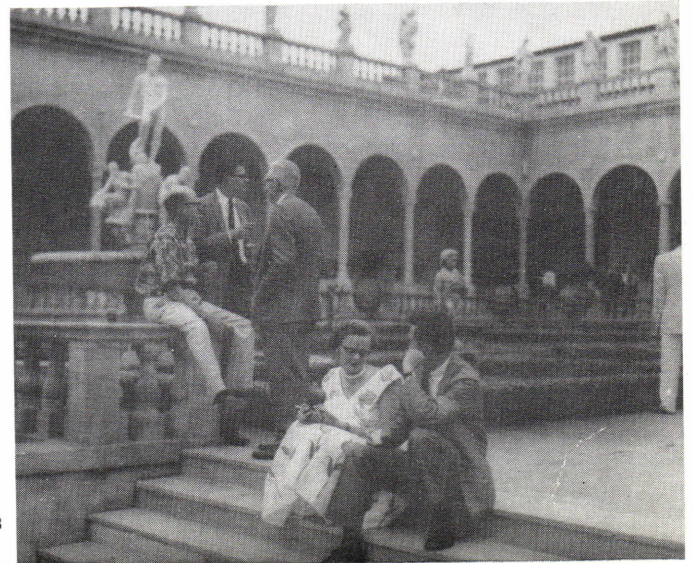

8

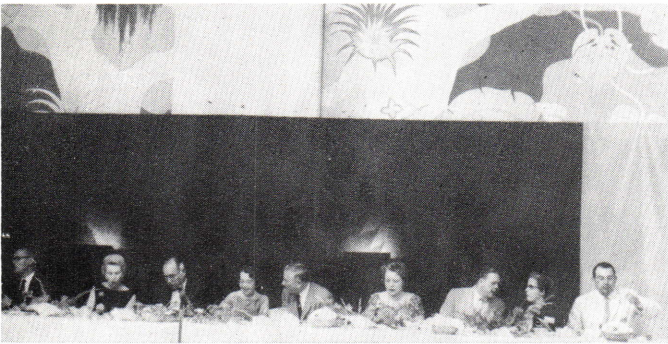

9



10

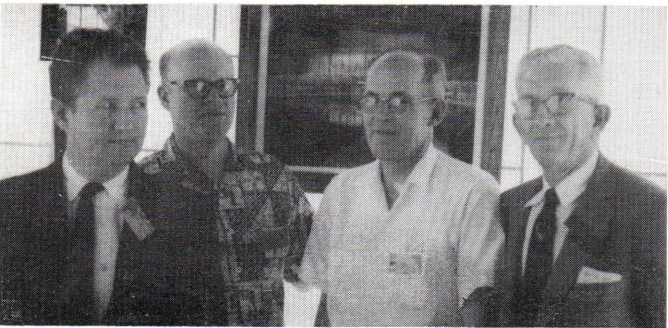

11



12



13



14

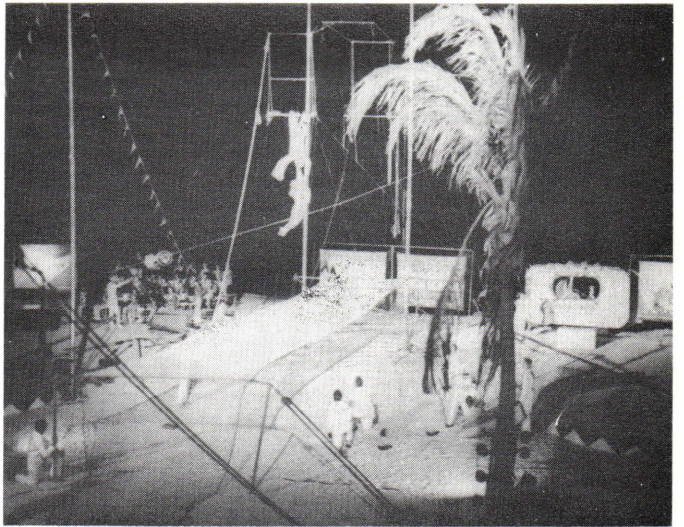

15

We are grateful to Leslie Boney, Jr. for the following photographs taken April 17-19 during the South Atlantic AIA Regional Meeting in Sarasota, Florida:

- (1) Mr. & Mrs. David Mackintosh, Jr., AIA of Charlotte, shown at registration desk in the Orange Blossom Hotel.
- (2) Municipal Auditorium, where general meetings and building materials exhibits were held.
- (3) View of audience at Friday session.
- (4) W. R. James, Jr., AIA of Winston Salem, President of the N. C. Chapter, Walter Chatelain, Jr., FAIA of Washington, D. C., President of the Institute and Leslie N. Boney, Jr., AIA of Wilmington.
- (5) Shown at Lido Biltmore luncheon: J. H. Bell, Jr., Greensboro; Verner Johnson, Miami, Fla.; Henry L. Kamphoefner, FAIA of Raleigh; J. Norman Pease, Jr., AIA of Charlotte; John Ross, Miami, Fla.; Leon Chatelain, Jr.
- (6) The Friday morning session panel on "Building New Communities" W. E. Freeman, Arthur Lee Campbell, Paul Rudolph, Sydney Wilkinson, Robert Hall, Hollis Ivey, W. R. James, Jr. Note: Students exhibits on stage which were a feature of the meeting.
- (7) Exterior of the John Ringling Museum, scene of Friday afternoon gathering.
- (8) Interior court of the Museum, W. R. James, Jr., Charles Sappenfield, Asheville; Frank Horton, Mrs. Ross, J. N. Pease, Jr.
- (9) Speakers table at Friday nights banquet at Lido Casino.
- (10) Part of attendees from N. C. at Casino: J. H. Bell, Greensboro; Mr. and Mrs. Mackintosh; Mrs. W. R. James, Jr.; Frank Horton, AIA of Hickory; Mr. and Mrs. J. Norman Pease, Jr.; Mrs. J. H. Bell; W. R. James, Jr.; Mr. and Mrs. John Ross, Greensboro.
- (11) Viewing the exhibits with photo of U. S. Pavillion at Brussels Fair on wall in rear are Francis Walton, Daytona Beach, Fla.; W. R. James, Jr.; Sanford W. Goin, Regional Director AIA of Gainesville, Fla.; Frank Horton.
- (12) Discussing events at the hotel are Charles Laws, Charlotte; Henry L. Kamphoefner; J. H. Bell; John Ross; Joe Lavery, Columbia, S. C.; George N. Foxworth, AIA of Burlington.
- (13) Institute President Chatelain, next to right, with award winners Hampton Lundy, Seiber tand Pease.
- (14) On the Italian Theatre stage examing costumes are Mrs. Douglas Haskell; Leslie N. Boney, Jr.; David Mackintosh, Jr.; Mrs. W. R. James, Jr.; Doug Haskell, Keynote Speaker.
- (15) A trapeze act at Sailor's Circus

LEGAL LINES



ALBRIGHT

This is the first in a series of articles by NCAIA Attorney R. Mayne Albright prepared in cooperation with the Chapter's Legal Affairs Committee, Albert L. Haskins, Jr., Chairman.

Liability of Architect and School Superintendent for improper issuance of certificate.

Query: Are the architect and County School Superintendent liable to a construction contractor's surety who has been compelled to pay outstanding laborers' and materialmen's bills when the architect has issued his final certificate approving release of retainage funds without exercising proper diligence to ascertain whether the bill had been paid, and the County Superintendent has approved the release without proper authority to do so?

Answer: The act of the superintendent concurred with that of the architect in releasing the retainage funds and both became liable to the surety for the latter's loss in the amount of the retainage funds released.

In the case of the superintendent, it was argued that he incurred no personal liability since he acted in good faith and in the honest belief that he was authorized to issue the certificate. However the Appellate Court held that his action was not lawfully authorized since only the trustees had authority to issue the certificate, and therefore his act constituted a failure to well and faithfully perform the duties of his office, good faith being no defense.

In the case of the architect, the court held that where an architect by terms of his contract with the owner, was to require of the contractor evidence that payroll and material bills had been paid before issuing the certificate of substantial compliance, he is liable to the contractor's surety for negligence in issuing the certificate without requiring such evidence. *State vs. Malvaney* (Mississippi—1954) 72 So. 2d. 424. 43 ALR 2d 1227.

Construction contracts commonly provide that the architect shall supervise the construction and that payments to the contractor shall be made only on the architect's certification that the work is satisfactory.

In the *Malvaney* case, the construction contract provided for progress payments of 85% and retainage of 15%, and for submission by the contractor to the architect of satisfactory evidence of payment of all payrolls

and material bills before issuance by the architect of the final certificate.

Attorneys for the architect argued that the architect owed no duty to the surety and therefore no cause of action could arise either under the contract or otherwise there being no privity of contract between the architect and the surety. Also that where the contract provides for the doing of a thing to the satisfaction or approval of the architect, he is thereby constituted the sole arbitrator as between the parties, and in the absence of fraud, he is not bound thereby, as arbitrators and umpires enjoy immunity from private actions for damages against them for acts done in arriving at their award. It was also argued that the surety was barred by its contributory negligence.

On the other hand the attorneys for the surety company argued that the retained percentages were for the protection of the owner and the surety, and where the surety has suffered a loss, its rights to the retained percentage are protected under the doctrine of equitable subrogation.

The court held that the retainage was for the mutual benefit of the owner and the contractor's surety, who had a right to subrogation against the same, commencing from the date of the execution of the bond; and that the architect was under a duty to the surety on the contractor's bond not to issue the certificate in the absence of satisfactory evidence of payment of laborer's and materialmen's bills.

The court held "the architect, therefore, undertook the performance of an act which, it was apparent, if negligently done would result in loss to the surety, and the law imposed upon him the duty to exercise due care to avoid such loss."

"Accordingly, the law imposes upon every person who undertakes the performance of an act which, it is apparent, if not done carefully, will be dangerous to other persons or the property of other persons, the duty to exercise his senses and intelligence to avoid injury, and he may be held accountable at law for an injury or to property which is directly attributable to a breach of such duty." 38 Am. Jur. 656-657.

THE NORTH CAROLINA STATE CAPITOL

by Cecil D. Elliot, AIA
with the assistance of Ross Shumaker, AIA

This is the first in a series of three articles about our State Capitol written by a member of the Chapter. The next two sections will follow in the June and July issues.

Section I—How It Was Built

It was very difficult for the State of North Carolina to choose a place to build its capitol. From the first meeting of the General Assembly in Perquimans County in 1715, the legislative sessions had been held in the more densely populated and more prosperous eastern edge of the State, until the Revolutionary period when they were moved inland to the central area. In 1787 the General Assembly decided that it should fix upon a permanent location for its meetings and for the management of governmental affairs. The convention called to act upon approval of the federal constitution, in addition to that matter, decided that the permanent capitol of the state should be within ten miles of the plantation in Wake County that was the residence of Isaac Hunter.⁽¹⁾ This location was a geographical compromise. Near the center of the state, it might serve as common ground to both the landed aristocracy of the eastern counties which dominated the state politics and the aggressively democratic spirit of the western counties. Apparently the legislature of 1790 was unwilling to accept this compromise. In the lower house, the bill for establishing the capital produced a tie vote and the speaker voted in its favor. In the Senate, however, another tie resulted and the Speaker decided against the bill. The following year the bill was passed with its provision that a group of ten people be appointed to locate and lay out a city within ten miles of Isaac Hunter's farm and that a group of five people should be charged to see that there "... be built and erected a State-house sufficiently large to accommodate with convenience both houses of the General Assembly, at an expense not to exceed ten thousand pounds."⁽²⁾

In 1792, the exact location of the city was chosen and William Christmas, a State Senator from Franklin County, laid out the streets and lots. Time has obscured the reasons for their choice of the plan that centered about a central square with four other squares, but evidently it was borrowed from the city plan of Philadelphia or one of the many similar American city patterns. To raise funds for the construction of the State House, lots were sold by a commission, and work progressed with sufficient speed that in the spring of 1793, it was noted "... the public buildings at the seat of government of this state are prosecuting with vigor—that the foundation of the state-house is raised above the surface of the earth—that large quantities of bricks and other articles are provided, so that no delay is apprehended from the want thereof."⁽³⁾ That year the legislature met in Fayetteville in spite of rumors of an epidemic in that city, but the following year the State House was sufficiently enclosed to serve as its meeting place. The building seems to have been a simple rectangular mass with some form of entrance portico on the East side.

With the years Raleigh grew and became more prosperous. Churches, taverns, and commercial buildings were added to the city and in 1802 it was large enough that its citizens purchased a fire engine. During the many months that the Legislature was not using the State House, it was frequently used by the people of the city. There they held their social functions such as "subscription assemblies", and there the dancing masters taught social graces to the children of the town. In fact, the Legislators of 1810 found it necessary to order that the doorkeepers "remove from the conference hall any rope or wires or other apparatus there found for the purpose of rope or wire dancing."

In 1818, 24 years after the completion of the State House, a committee reported its condition to the State Legislature.

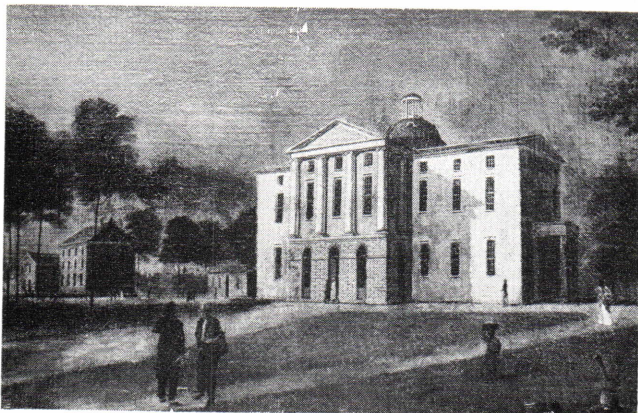

THE MAY 1958 SOUTHERN ARCHITECT

"... In Company with Mr. Nichols the Superintendent of the Public Buildings, they examined the Governor's House and the State House, and found each in a State of Dilapidation and requiring the immediate Attention of the Legislature. . . . They think that Another Story Should be added, for the Purpose of making Suitable Committee rooms, and that there should be Projections on the North & South sides, for Offices, the two Halls should be enlarged by Running the Partitions which Separate them from the rooms now occupied by the Clerks: and decent Galleries Should be constructed—The Cupola should be converted into a simple Dome and the present Bell be recast or Another One procured. Arrangements are also necessary for placing the Statue of General Washington in an eligible Situation within the Building."⁽⁴⁾

Nichol's subsequent remodeling work included stuccoing the brick structure in imitation of cut stone and adding major porticoes on the East and West. These were actually wings of the building with the lower story in rusticated stone having three arched openings and above that ionic columns, set half into the wall, supporting a simplified classical pediment. Thus additional space and a degree of architectural pomp were obtained at the same time. In the center of the building a shallow dome, its form derived from that of the Roman Pantheon, was topped by a circular temple form as its cupola. At the North and South ends simple columned porches extended over the doors.

The new rotunda was certainly a fitting setting for the statue of George Washington which the Legislature of 1815 had commissioned the Italian sculptor, Antonio Canova, to carve for them. It was completed in 1821 and from Boston a federal gunboat brought it to Wilmington; another boat brought it up river to Fayetteville, and a wagon hauled it into Raleigh. There was some surprise among the local people when they first saw the classical form of the statue, the Virginia squire rigged out in the costume of a Roman Emperor and posed languidly on a sort of marble park bench. But Canova was the greatest sculptor of this period for neo-classical monumentality and patriotic eulogies, and the people of Raleigh, though perhaps somewhat startled by the ways of a more sophisticated work, ushered the sculpture into their capitol with affection that reached its peak in 1825 when the Marquis de Lafayette toured the United States and stood before the statue in moist-eyed meditation.

The State House caught fire in 1830, but the blaze was halted before public records were lost. When the General Assembly convened that fall, it ordered that "... the chimney corners should be made safe, that sheet iron should be laid in under the fireplaces, a trap door made to the roof, and a zinc roof should be placed on the building."⁽⁵⁾ But fire again struck the building on June 21, 1831.

"It is our painful and melancholy duty again to announce to the public another appalling instance of loss by fire which will be deeply felt and lamented by every individual in our State. It is nothing less than the total destruction of the Capitol of the State, located in this city. Of that noble edifice, with its splendid decorations, nothing now remains but the blackened walls and smouldering ruins. The State Library is also entirely consumed, and the statue of Washington, that proud monument of national gratitude, which was our pride and glory, is so mutilated and defaced that none can behold it without mournful feelings. . . . The alarm was given about 7 o'clock on Tuesday morning, and it was presently evident that all attempts to extinguish the fire would prove perfectly fruitless. The efforts of the bystanders were then directed toward the protection of the public offices on the square and the adjacent private buildings and to the preservation of the official archives. We are happy to add that none of the former were injured, and that the latter, including the legislative records, were all saved. The beautiful grove of oaks, of which the Capitol was the center ornament, did more towards staying the progress of the flames than any human effort. Seldom has the eye witnessed so awful a spectacle of that vast building in one concentrated blaze, streaming from every window, and the vast column from the roof, forming together a scene not adequately to be described. The origin of the fire is not certainly known, but we believe the general impression is that it was a result of most culpable carelessness on the part of a man who had been employed to assist in soldering the new zinc roof, as he was seen carrying up a coal of fire between two shingles, considerably ignited, a spark from which, in all probability, fell among some combustible matter between the roof and ceiling, which took fire while the hands were at break-fast."⁽⁶⁾

The following November, in his address to the legislature, the Governor of North Carolina pointed out that the fire had probably done them a service in destroying the building which had become, forty years after it was built, so unsound that it might well have fallen on the

(continued next page)

The North Carolina State Capitol (continued)

members of the legislature as they met.⁽⁷⁾ A bill was introduced to authorize the reconstruction of a Capitol building, but it met with long and bitter argument, for this was an extremely melancholy period of North Carolina's history. "From 1815 to 1835, North Carolina made so little economic and social progress that it was called the Rip Van Winkle of the States and the Ireland of America. The chief cause of this backwardness was inaccessibility to markets.⁽⁸⁾ The depressed economic condition of the State had led a large part of its population to move west where opportunity and adventure lay. Although over half of the State's population was west of Raleigh, the State's government was firmly controlled by the squires of eastern plantations and every new county formed in the West was balanced by the formation of another in the East. Caught in this bitter struggle for power, the members of the legislature of 1831 could neither agree to rebuild their capitol in Raleigh nor to change its location. The following year the assembly passed by a rather narrow margin a bill directing the appointment of commissioners to supervise the rebuilding of the Capitol and making an appropriation for that purpose. Although it was opposed by a resolution proposing that the Capitol site be moved from Raleigh and a bill to call a convention which would locate a new seat of government, the bill for rebuilding passed both houses of the Legislature.

The two thousand citizens of Raleigh breathed a sigh of relief, and their newspaper happily warbled, ". . . now is the gloomy winter of our discontent made glorious summer. It is with feelings of heartfelt satisfaction, that we announce the final passage of the bill appropriating \$50,000 for rebuilding the Capitol in this city. This decision will go far to dissipate the cloud which, for more than a year, has hung over the prospects of our community. . . . With a view to the public expression of this feeling and ENTERTAINMENT complimentary to the Members of the Legislature to be given this evening (Friday) at the City Hotel."⁽⁹⁾ During the year there may have been some hopeful thought on the design of the new building, for at this entertainment the ". . . assemblage of ladies was brilliant, the Music good and the Supper splendid" . . . and among the decorations was a transparency over six feet square displaying a ". . . view of the proposed new Capitol, over which floated a majestic Eagle, bearing this inscription in his bill—'The Legislature of 1832.'"⁽¹⁰⁾

The first Board of Commissioners appointed was composed of: Mr. William Boylan, President of the State Bank; Judge Duncan Cameron, who later was on the committee to build Christ Episcopal Church; Judge Henry Seawell of the Superior Court and formerly Attorney General; Judge Romulus M. Saunders, Attorney General at that time and later Superior Court Judge; and William S. Mhoon, State Treasurer.

The commissioners met very soon and decided ". . . that the capitol be immediately rebuilt, entirely of Stone; and that Mr. William S. Drummond (a builder from Washington City, who come highly recommended) be appointed Superintendent of the Building. . . ."⁽¹¹⁾ And they advertised for bidders to submit unit prices for executing the masonry work and for supplying the lumber for the building. A source of sound granite was found southeast of Raleigh and quarrying was commenced.

At the same time that the bill to rebuild the capitol had been considered by the General Assembly, Henry Seawell had introduced a bill to incorporate the Experimental Railroad Company of Raleigh. Perhaps it is only a romantic story, but this corporation is said to have been inspired by Sarah Hawkins Polk, the wife of General William Polk, who had been an officer in the Revolutionary War. Her stepson was in Boston on a holiday from his studies at West Point, where he supposedly saw the railway used to haul stones for the construction of Bunker Hill monument. He wrote her describing this new device and included diagrams of its operation. This railroad, which ran four miles from a shaft to the building site, was the first railway in the United States and was built by Gridley Bryant in 1826 in imitation and elaboration of the British railways of George Stephenson.

The Experimental Railroad of Raleigh ran horse-drawn wagons on wooden rails which were covered with flat straps of metal. (It was a mile and a quarter in length and its construction cost only \$2760.) Before the end of the year 1832, the corporation advertised, "The Railroad Company of this city expects to have their road completed by New Year's Day, (if not prevented by inclement weather) and a handsome car upon it, for the accommodation of such ladies and gentlemen who desire to take the exercise of a railroad airing", but it was actually completed ten days later. The quarry and the Experimental Railroad also made possible a new surge of permanent building in the business district of the city. A part of the quarry was reserved for use in building the capitol and the remainder was left for the use of Raleigh citizens. By autumn it was observed that, "The ranges of brick stores on Fayetteville street, with heavy granite fronts, are now so nearly completed, as to give the spectator some definite idea of what the appearance of our City will be when all its improvements are consummated."⁽¹²⁾ The railroad was not only financially successful, realizing about 300 percent on original investments,⁽¹³⁾ but it also suggested the possibility of its extension to "south-Washington and New-Hanover County."⁽¹⁴⁾

By April 1833, the Board of Commissioners for Rebuilding the Capitol had decided upon the increases of dimension that would be necessary over those of the previous building and the ruins of the old State House had been removed from Union Square to make way for construction. By the first of June the entire foundation was substantially completed and an area had been left where, on the fourth day of July, 1833, Governor David L. Swain lead the building's cornerstone with the full quota of oratory and ceremony. Enclosed in the cornerstone, a lead box within it, and a coating of wax were the following objects: a printed copy of the journal of the proceedings of the North Carolina Provincial Congress, Halifax, 1776; a copy of the Declaration of Independence and the Declaration of Independence of Mecklenburg citizens; United States and North Carolina Constitutions and the Rules of Order for both houses of the North Carolina Legislature; a Bible; a variety of coins; one copy of each newspaper published in the state; and a silver plate engraved in English on one side and in Latin on the other side with the names of the Board of Commissioners, the State Officers, etc.

When the Legislature met in 1833, the walls of the Capitol were not far above ground and, according to the treasurer's report to the Legislature \$32,030 had been spent on the building. The original appropriation of \$50,000 had been a naive estimate even at that time for a building of substantial quality, but in addition the decisions of the Board of Commissioners had been toward a quality of construction far more costly than had probably been envisaged by the Legislators. The bill appropriating an additional \$75,000 for continuing the work passed the Senate, ayes—50, noes—5. It is doubtful that this enthusiastic vote indicates any change in sectional sentiment. It seems more likely that it only expresses the representatives' fear of being held responsible for a costly miscarriage of the work; and the legislators were told that this sum would be sufficient to complete a major part of the work and that it would . . . enable the Commissioners to have the building finished in a style of durability and splendor, that will vie with the proudest specimens of European architecture."⁽¹⁵⁾

When the Legislature met again at the end of 1834, the Board of Commissioners for the Capitol project faced severe criticism. They were requested by the Legislature to submit a full and complete report of the affairs under their charge and a joint select committee was appointed to recommend action on their report. In the first place the work had not been carried very far, the walls of the building being only about thirty-nine feet high with twenty-four feet more to be built; and, above all, if the building were to be completed the Commissioners needed still another appropriation. The joint committee recommended an appropriation of \$75,000, bringing the total to \$200,000, and for the third time the Legislature dug deep in the State's coffers. Besides this there had been some criticism based on a rumor that the members of the Board had diverted workmen to their private use to the use of the Experimental Railroad Company. These charges were denied and, with the perplexed resignation that must occasionally be felt by even the most patient and public-spirited men, the whole Board of Commissioners resigned, explaining that they had been "under the conviction that they could not contract for the whole building"⁽¹⁶⁾ without hazard to price and the adequacy of workmanship. And in defense of their actions, it must be recognized that the joint committee found no fault with the Board's decisions and stated that as planned the building would stand unparalleled and ". . . as a specimen of architectural taste, it will be an ornament to the State."⁽¹⁷⁾

The State Senate in considering a bill for an additional appropriation referred it to a committee which was instructed to estimate the total cost of the project and to determine if the plan might be altered to lessen its cost. A parallel investigation went into the reasons for the discharge of William S. Drummond, who had been superintendent of the building construction and such a local favorite that he had been one of the speakers at the cornerstone ceremony. The local temper can be judged by editorial reaction in reporting that the committee's opinion that ". . . from the character and complexion of the whole matter, they refrain from a positive expression of opinion . . . at the same time the Committee express their decided opinion that Mr. D. still deserves the public confidence. The plain meaning of which is, that Mr. Drummond was unjustly removed, but as the Commissioners . . . were discharging a public duty without remuneration, it would not look well to censure them. The citizens of Raleigh have thus been virtually sustained by the Legislature . . ."⁽¹⁸⁾ In spite of all this turmoil and several ineffectual efforts to attach amendments stipulating requirements for the project, a bill was passed by the General Assembly appropriating \$75,000 to further the construction.

A completely new Board of Commissioners was made up of Samuel F. Patterson, State Treasurer; General Beverly Daniel, Adjutant General of the State who was Chairman of the Board; Charles Manly, Clerk of the House of Commons and later Governor; Alfred Jones; and Charles L. Hunter. It was almost certainly the challenge of economy that led this new Board to refuse the plea of their architect for increased compensation.⁽¹⁹⁾ When the next legislature met the report of the Commission-

(continued next page)

The North Carolina State Capitol (continued)

ers began somewhat apologetically by stating, "The magnitude of the work, the nature of the materials . . . , and the order of Architecture designed for its plan, must, under any circumstances, in its execution be tedious and slow in its progress."⁽²⁰⁾ It also observed that masons had been attracted by high wages to the north and that few had been available in this area, that the weather had halted construction for a period of almost four weeks, and that having arrived at the top of the walls they had discovered that larger stones were needed which necessitated reopening the quarry and hiring more laborers to move the stones. However, the commissioners pointed out that of the \$200,000 that had been appropriated \$22,970 was yet on hand and that an additional appropriation of \$100,000 would probably be sufficient for completion which they expected within two years. The effectiveness of this statement was perhaps lessened by a personal footnote which State Treasurer Patterson added stating that he believed this estimate of cost to be too low. The Legislature of 1835 appropriated another \$75,000 for the project.

General Daniel came before the Legislature of 1836 requesting an additional appropriation and some provision in case the legislature should decide not to meet the following year. Daniel had given the project his close personal attention using his not inconsiderable influence to manage the affairs more positively than had been done before. When the demand for "rock cutters" in the New York area produced a shortage in Raleigh, he sent his superintending architect there and offered the workmen their traveling expenses for the trip South as well as a competitive wage; he arranged to lease the Experimental Railroad for a fixed sum, which gave the opportunity to shift laborers from the railroad to the building as they might be needed in either place, and which also promised a saving of at least \$1,000 per year in hauling charges in addition to this increased efficiency in the use of manpower. He pointed out to the legislators the savings that had been made by the use of the State's own quarry and by the use of the Experimental Railroad, declaring that the building when completed would "be one among the cheapest of its character in the United States. . . ."⁽²¹⁾ Because he had diligently consulted some of the most famous architects in the United States on points of architectural principles, he was able to say: "The Board have (acted) . . . with the strictest regard to the principles of Architecture and rules of Architectural taste . . . they have been guided by the highest professional skill, not even adapting the design upon the recommendation of Mr. Paton, our superintendent alone (who has dispayed unexampled skill in carrying this work through nearly all of its most difficult and intricate parts of execution, with extraordinary accuracy and precision,) but in accordance with his wishes, it has been submitted to Architects of the first character, in the United States, who have examined and given their approval and strongly recommended its adoption."⁽²²⁾ One might judge the effectiveness of General Daniel's report by the fact that the original bill once more appropriating \$75,000 for the project was amended to bring the sum to \$120,000, which was to include the furnishings required for its completion.

Construction of the building had been going on for about three years now and the workmen had become part of the city scene. The location and symbolic importance of the work gave their humble skills unusual importance in the small city. They were regularly included as a part of the marching order for the procession in Fourth of July celebrations and in 1837 came after the officials of the City of Raleigh and just before a body identified as "citizens and strangers". Of the twenty-three toasts that year, (having been scheduled, and ten volunteered in patriotic enthusiasm) the 12th was: "The State Capitol.—For architectural beauty and durability, it stands unrivalled. It will remain to future generations a monument of liberality and taste of the Legislature of North Carolina."⁽²³⁾ The building must have been near completion for that same holiday" . . . the Star Spangled Banner waved proudly over the top of the lofty dome of the Capitol."⁽²⁴⁾

There were still delays and the next year, when the Governor's Council met in lieu of a General Assembly, the condition of the capitol project was considered and the Council decided that it was not within their power to appropriate more money to the work than had been granted by the last Legislature, which by this time had been almost entirely spent. Believing it unwise to call a special session of the Legislators, who were already somewhat disgruntled at the slow progress of the work, the Governor's Council concurred with the Commissioners suggestion that money be borrowed, assuming that the good will of the next legislature would prompt it to include the amount of the debt in future appropriations. The State Bank and the Bank of Cape Fear loaned \$30,300 in order that the work might proceed without delay.

When the Legislature of 1838 met it was ruefully recognized that, "The Capitol not being in a state of sufficient forwardness for the accommodation of the Legislature, the very spacious building, just erected at the corner of Fayetteville and Market Streets, by Benjamin B. Smith, Esq. has been fitted up for that purpose."⁽²⁵⁾ General Daniel, presenting his case before the Legislature and proudly insisting upon the excellence of its architecture, estimated that an additional appropriation of \$70,000 would cover the remaining expenses although the Board expressed reluctance to estimate, "having been taught by exper-

ience how difficult and uncertain" such forecasts might be. A bill was introduced in the Legislature to appropriate \$75,000 for the project, perhaps the fact that it exceeds the request of the Board of Commissioners may indicate a more realistic point of view and some resignation on the part of the Legislators. The bill was vigorously opposed by some members of the body and one even suggested that it might be wise for the State to purchase a less expensive building and sell their incomplete structure to private ownership. Nevertheless, \$75,000 was appropriated by that session of the Legislature, perhaps because they agreed with the Board, saying, "In the construction of an Edifice designed to last for ages, any petty attempts at economy in labor or materials could but defeat the true intent of the work, or display a ludicrous contrast of meanness and magnificence."⁽²⁶⁾

So much of the controversy on the building of the capitol had centered about finances that it is interesting to note a criticism of its architecture from another point of view. A reader of the Elizabeth City Phoenix wrote that newspaper, "When the State House shall be finished, the view must be imposing to an observer, and here, by the bye, let me mention, that fault has been found with this noble structure, and although I profess not to be an architect, yet I must confess, some of the complaints I deem entirely just. The outward style of the Capitol is in the pure Doric order, the inside work is a mixture of Corinthian and Gothic. So far, I find no fault; but the appearance of the interior is too heavy and massive; the Porticos extend out rather farther than necessary if true taste and strict propriety had been consulted to make it accord with the main body of the building."⁽²⁷⁾

At the beginning of 1839, most of the work having been completed, General Daniel resigned from the Board of Commissioners. The character of the Board had greatly changed. A year before Daniel's resignation the other members had been the Rev. Dr. William McPheeters; Dr. John Beckwith whose anti-dyspeptic pills had been so popular by 1835 that 20 employees were kept busy producing daily 40,000 pills which merited testimonials by the State Treasurer, a Bishop, a Federal Judge and a former Governor; D. W. Courts, State Treasurer; and W. F. Collins. Courts resigned and was replaced by Charles L. Hinton, who succeeded as State Treasurer and soon afterwards Collins resigned and was replaced by W. R. Gales, editor of the Raleigh Register. When General Daniel resigned, E. B. Freeman was appointed to the Board and Dr. Beckwith was made chairman. In the period shortly before the completion of the building, both Freeman and Hinton resigned and were not replaced so that at the time of the completion of the building, the last of the many men who had diligently worked in its behalf were Dr. Beckwith, the Rev. Dr. McPheeters, and Mr. Gales.

The Board's report to the Legislature of 1840 itemizes the appropriations that had been made:

Appropriated Session of	1832	\$50,000
	1833	75,000
	1834	75,000
	1835	75,000
	1836	120,000
	1838	75,000
Appropriated for Bank Loans		
	1838	30,300
	Total	\$500,300
1840		
Proposed Appropriation		2,000
Amount Due State Bank		20,000
Interest		300
Amount of Accounts Unpaid	\$	9,374.46
Due Major West		59.47
	Total since Session 1838	\$ 31,733.93
	Less amount held by Birdsall	1,349.78
		\$ 30,384.15
Making total amount:		\$530,684.15

As noted above the Board had once more been forced to borrow between the biennial meetings of the Legislature. They had requested \$2,000 more, which the State Bank had refused to loan them. This amount of goods they had already bought on credit in order to meet the emergency of housing the legislature's meeting, and even then it had been necessary to leave the Supreme Court Room, the Library, and two rooms on the first floor unfurnished.

The Board recommended that a fence matching the building be put around the square to protect the building itself and the trees that grew there; and later a high fence of iron on a granite base was put around the square, where it remained until it was removed to the old city cemetery. The Board also recommended that the other buildings on the square soon be removed, for on the southwest corner there was a red brick building in which were kept the rifles of the State Guard and on the northwest corner was a wooden building which contained the wood

(continued next page)

The North Carolina State Capitol (continued)

pile and the bell that called the legislators into session (this building burned). The Board's report gives a lengthy explanation of their difficulties with regard to the work, stressing their lack of time for full control of the work, their lack of experience, the complexity of so large a project, and the limited experience in building so large a building that they had encountered in this area. Looking back over the whole history of the project, they believed that "... experience proves that a salary to the commissioners would have been the best economy, ..." and furthermore, that "... it must be admitted that in the plan of the building, and particularly in the Legislative Halls, much of convenience and comfort have been sacrificed; and though it may be urged, that the costliness of the building, is incompatible with the true principles of republican simplicity ... they cannot believe but that the worth of the building has surmounted all controversy and expense."⁽²⁸⁾

"We understand that Wednesday, the 10th of June, has been fixed on as the day for celebrating the completion of the Raleigh and Gaston Railroad into our State Capital."⁽²⁹⁾ The railroad had really been finished much earlier for on March 24, the locomotive Tornado had roared and hissed its way into town for the first time. However, it was particularly fitting that the completion of the capitol building and the railroad should be celebrated together. At the time of the bitter controversy between the East and West parts of the State over the continuation of Raleigh as capital, there had been demands by the westerners that a program of internal improvements including railroads and riverways be instituted and the Easterners had stubbornly opposed the idea. "From 1831 to 1835, North Carolina appeared to be on the verge of a revolution."⁽³⁰⁾ Since there were to be a great many men of importance attending the laying of the cornerstone for the new capitol building on July 4, 1833, proponents of the internal improvement program called those citizens who wished to discuss the matter to meet in convention at this time. Delegates came from twenty counties and "... two points with regard to this convention may be noted. First, practically all of the discussion was concerned with railroads. Second, there was considerable sectional feeling. Representatives of counties bordering on the sea favored roads from East to West ... Delegates from the Roanoke Region wanted a railroad from Raleigh to the Roanoke."⁽³¹⁾ The meeting ended with the appointment of county committees and setting a date for a later meeting.

On the second day of 1836, the people of the surrounding area met in Raleigh to discuss the Raleigh and Gaston Railroad which had just been chartered by the Legislature and at this meeting they were addressed by Judge Duncan Cameron who had been a member of the first ill-fated Board of Commissioners for Rebuilding the Capitol. Into the construction of railroads, the people of North Carolina put their hopes for a new vitality in the economy of the state and a new and brighter future. But at first the noisy locomotive and the iron clad rails were but an exciting novelty and it was announced, "... a train of cars will leave the depot this day at 11:00 precisely and will carry passengers to Wake Forest and back for \$1.00 each,"⁽³²⁾ which must have been far more exciting than the horse-drawn trip to the rock quarry that had been advertised by the Experimental Railroad over seven years before. After all, the schedule between Raleigh and Gaston averaged more than seven miles per hour.

The celebration was begun on the morning of June 10 by the roar of cannons, and business was abandoned for the day. Early in the afternoon the procession formed in front of the court house under the supervision of the parade marshal, General Beverly Daniel, and marched to the music of a band from Richmond toward the railroad freight depot where over five hundred people sat at five long tables for the dinner which opened the festivities. In the parade the commissioners for rebuilding the state capitol were the eighth group in line, coming after the clergy and before the President and Directors of the railroad; and the artisans who had been employed on the capitol joined with those of the railroad company and walked in the thirteenth position after the railroad stockholders and before the invited guests. The fifth toast at the dinner was to the Capitol and the accompanying music was the Star-Spangled Banner; the sixth was to the Raleigh and Gaston Rail-

road ("Its structure will accelerate with the velocity of a tornado, the trend of public opinion in its favor"⁽³³⁾) and the appropriate music was named Hope Wally. The twelfth toast was to railroads in general and it came just before the one to women.

"On Wednesday evening the Union Square upon which the Capitol is situated, was rendered in a high degree engaging by the brilliant illumination. ... On Thursday evening a most magnificent Ball was given in the Senate Chamber, a Ball which has been rarely surpassed ... We should not omit to mention, too, that whilst a portion of the Assembly were entertained by the spirit stirring evolutions of the dance, those of a graver case of character were refreshed in the Commons Hall by Monsieur and Madame Canderbeck, two accomplished performers in music. There was a Ball in the Senate Chamber on Friday evening also which was not so numerously attended as that of the previous evening. ... From distant counties men, women, and children came to see the new wonders—the State-House, the railroad and locomotive. At night the trees of Capitol Square were illuminated with colored lamps, as well also as was Fayetteville Street. Gorgeous transparencies could be everywhere seen. One was a representation of locomotive, another of the State-House."⁽³⁴⁾

Thirteen years later a traveler from the North, Frederic Law Olmsted, the famous landscape architect of New York's Central Park, visited Raleigh on a journey through the South and wrote,

"The City of Raleigh (old Sir Walter), the capital of North Carolina, is a pleasing town—the streets wide and lined with trees, and many white wooden mansions all having little court-yards of flowers and shrubbery around them. The State-House is in every way, a noble building constructed of brownish-grey granite in Grecian style. It stands on an elevated position near the center of the city, in a square field which is shaded by some tall old oaks, and could easily be made into an appropriate and beautiful little park; but which with singular negligence, or more singularly economy (while \$500,000 has been spent upon the simple edifice), remains in a rude state of undressed nature, and is used as hog-pasture. A trifle of the expense employed with doubtful advantage, to give a smooth exterior face of the blocks of stone, if laid out in grading, smoothing and dressing its ground base, would have added indescribably to the edifice."⁽³⁵⁾

Several decades later, the firm of landscape architects, Olmsted Brothers, designed the pathways and the planting which at present surround the building and have greatly changed its setting, enhancing the original interior.

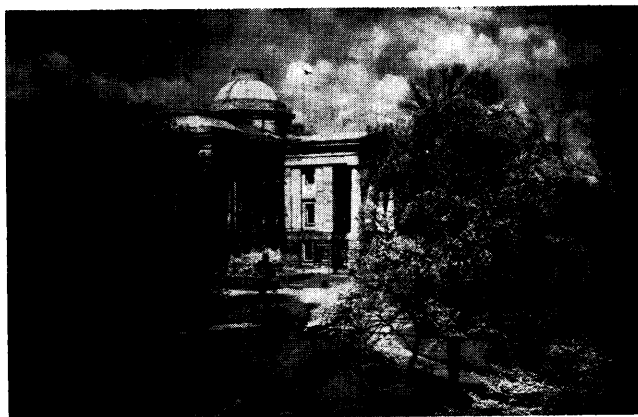

"In spite of proposals to add wings to the building or raise the dome, it remains much as it was built, "A monument to the liberality and taste of the Legislature of North Carolina."⁽³⁶⁾

(Section 2 of this 3 installment article, titled "The Capitol Architects," will appear next month. The footnotes will be carried in one of the later installments.)

ETOWAH BRICK

IN

- ◆ Red Face
- ◆ Buff Face
- ◆ Colonial Sand Finish Red
- ◆ Colonial Sand Finish Peach Blossom

THE MOLAND-DRYSDALE CORP.

HENDERSONVILLE, N. C.

TEL. 6561

McDevitt & Street Company

GENERAL CONTRACTORS

505 Builders Building
Charlotte, North Carolina



*Over 35 Years Continuous Experience in
General Construction in the Southeast.*

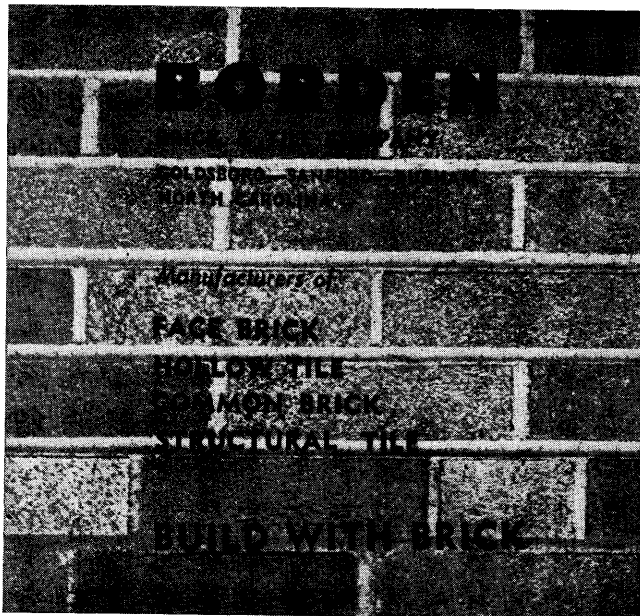

Law Engineering Testing Co.

(formerly Law-Barrow-Agee Laboratories, Inc.)

SOIL MECHANICS ENGINEERING

TEST BORINGS SOIL TESTING

COMPACTION CONTROL

MATERIAL TESTING

— There is no substitute for experience —

1216 E. 7th St.
CHARLOTTE, N. C.
EDison 4-0866

136 Forrest Ave., N.E.
ATLANTA, GA.
TRinity 5-6601

SAVANNAH — ALBANY — WILMINGTON — TAMPA — BIRMINGHAM

in **BRICK**
and **TILE**



means

ISENHOUR QUALITY

Complete lines buff, red
brick and tile products.

ISENHOUR Salisbury, N.C.
Subsidiary, **TAYLOR Clay Products**

F. N. THOMPSON Inc.

GENERAL CONTRACTORS



Charlotte, N. C.

Raleigh, N. C.

Tel. JA 3-0515

Tel. TE 2-2687

SNOW LUMBER COMPANY

Quality
MILLWORK

Since 1880

HIGH POINT, NORTH CAROLINA

Salisbury Lumber & Supply Company

MILLWORK



BUILDING MATERIALS

S. Main St. at City Limits
Salisbury, N. C.

Phone 2280

Ezra Meir & Associates

713 W. Johnson St. Raleigh, N. C.
Phone TE 4-4041

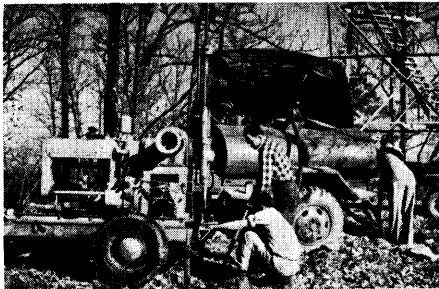

- Soil Borings
- Rock Drilling
- Laboratory Analysis
- Field Testing
- Reports

Specify

BIRD ROOFING
CURTIS WOODWORK

H & S LUMBER CO.
CHARLOTTE, N. C.

*Manufacturers Of Quality
Special Millwork*

Only Way To Protect Investment Is Tested Modern Materials

Newest floors, walls and acoustical
sanitary ornamental ceilings.

New vinyl floors, easiest cleaning.

New vinyl wall coverings eliminate
painting and papering.

Folding Doors and Partitions.

Standard and Synthetic Carpets.

Come see 4 types of steel or wood
kitchens to make modern decisions.

BOST BUILDING EQUIPMENT CO.

FLOOR AND ACOUSTICAL CONTRACTORS

912 E. 4th St., Charlotte, N. C. Phone ED 3-0321

**MONARCH
ELEVATORS**

*Serving
the South*

Monarch strives to provide the finest in elevator engineering, manufacturing, installation, and service. Call for full information on electric and oil-hydraulic freight and passenger elevators, dumbwaiters, and residence elevators. We invite you to visit our plant.

Greensboro, N. C., Ph. BR 2-4563 (Main office and plant)
Augusta, Ph. 6-5397 Greenville, S. C., Ph. 5-4016
Roanoke, Ph. DI 4-4700 Raleigh, Ph. TE 2-6612
Charlotte, Ph. ED 4-5971

Largest Elevator Manufacturer in the South

DUNCAN PRINTMAKERS, INCORPORATED

Reproduction in All Its Phases

Complete Engineering Microfilming

DISTRIBUTOR FOR OZALID

Machines — Sensitized Materials

313 E. 7th St. Charlotte, N. C.

Expanded at Our New Location to Better Serve You



Mo-Sai
ARCHITECTURAL STONE

THE MABIE-BELL COMPANY
P. O. Box 2909 - Phone BR 4-7674 - Greensboro, N. C.

ARCHITECTS AND BUILDERS IN THE NEWS

FIVE SHARE TWO AWARDS

Five juniors in architecture in the N. C. State College School of Design shared in two awards for design work on libraries. Receiving the Brick & Tile Service Award were Arthur J. Hamill, Jr. of Gastonia, George B. Hobson, Jr. of Charlotte and John S. MacRae, III of Hamilton. Receiving the Tile Council of America Award were Wilborne E. Hammer of Newport News, Virginia and Martha D. Sanders of Sanford. The

jury was composed of Albert B. Cameron, AIA of Charlotte, Thomas T. Hayes, AIA of Southern Pines, and three members of the faculty: Horacio Caminos, Joseph H. Cox and Fred M. Taylor.

TWO FROM N. C. AT MEET

Archie Royal Davis, AIA of Durham, and Leslie N. Boney, Jr., AIA of Wilmington, attended the American Association of School Administrators Convention in Cleveland, Ohio March 29-April 1.

SCHOLARSHIP WINNER

James R. Washburn, Jr., member of the Raleigh Council of Architects, and a native of Lake Lure, is one of seven winners in the Edward Langley Scholarships presented by the AIA. He will use the \$1,200 award to study at Harvard University's Graduate School of Design, from which he expects to receive his Masters Degree in June 1959. He is a 1957 graduate of the School of Design at N. C. State College, and this year has served on the faculty.



WASHBURN

NEW PARTNERSHIP

Four Chapter members have formed a new partnership in Charlotte. They are new Director Charles H. Wheatley, Mangum W. Sloan, James H. Benton and David M. Mackintosh, Jr. The firm will be known as Sloan-Mackintosh-Wheatley-Benton, Inc. and will have offices at 1617 East Boulevard.

ARTICLE SALUTES FIRM

The March 1958 issue of Building Construction Illustrated had under its "Architectural Profiles" an article on the firm McMinn, Norfleet and Wicker of Greensboro.

APPRENTICE CONTEST

Forty-two state champion brick layer apprentices from all parts of the United States competed for the title Champion Bricklayer Apprentice in Cincinnati April 25-30 in the 10th Annual Bricklayer Competition, sponsored by the Bricklayers, Masons, and Plasterers International Union (AFL-CIO). \$1,200 in prizes are being offered. According to Union President Harry C. Bates their sponsored apprentice programs have resulted in the training of more than 50,000 journeymen since the end of World War II, with approximately 14,000 men presently in training, and the average age of bricklayers now being 41 compared to 58 at the end of the war.

RALEIGHITE ELECTED

James B. Godwin of Raleigh has been named Secretary-Treasurer of the Southeastern Chapter of the American Society of Landscape Architects. Godwin is an associate member of the Raleigh Council of Architects.

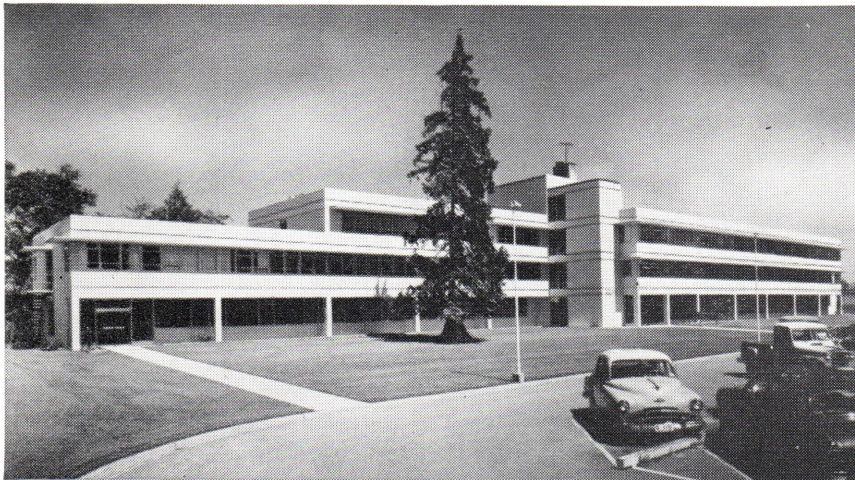

Better, More Economical Hospitals Are Built with **CONCRETE**

More and more designers and builders are turning to concrete construction for hospitals. That's because concrete offers greater durability, safety and economy.

Concrete meets every structural requirement—great strength and unexcelled resistance to destructive forces. Properly designed concrete hospitals protect patients, staff and equipment against storms, quakes, explosions and fire.

Concrete's neat, clean appearance, both inside and out, symbolizes the cleanliness associated with

hospitals. And its enduring beauty makes concrete hospitals a source of community pride.

Concrete is versatile. It can be used in single or multi-story hospitals to meet the needs of any community. Hospital administrators like concrete's moderate first cost, low maintenance and long life. Result: true *low annual cost*.

PORTLAND CEMENT ASSOCIATION

1401 State Planters Bank Bldg., Richmond 19, Va.

A national organization to improve and extend the uses of portland cement and concrete . . . through scientific research and engineering field work



Many hospitals use concrete masonry for interior walls and partitions as shown above. Concrete masonry walls have greater economy, durability and beauty. They can be painted in any of a wide variety of distinctive, modern colors with long-lasting portland cement paint.

AIA NEWS

N. C. CONVENTION PRAISED

The May issue of the AIA Journal contained the last of a series of articles on Public Relations by Robert R. Denny titled "Capitalize On Your Conventions". It was based on the January 1958 Winter Meeting of this Chapter in Winston Salem under Chairman Robert F. Arey. The interesting article praised the meeting and pointed out the opportunity that such occasions afford Chapters for good public relations and publicity. The picture to the right was made during the meeting by Leslie N. Boney, Jr., AIA of Wilmington, and received too late to be included with those summarizing the meeting in our February issue. It shows the three Presidents: W. R. James, Jr. of Winston Salem of the N. C. Chapter, Leon Chatelain, Jr., of Washington, D. C. of AIA, Mrs. Chatelain, and Fred W. Butner, Jr. of the Winston Salem Council.

MAY WINNER

The AIA Document-of-the-Month for May is Southern California Chapter's "Seminar Day—December 7, 1957" which was particularly recognized by the AIA Chapters Affairs Committee in its "Operation Reread" work with the AIA Department of Education and Research.

NEW FILE-INDEX

AIA has a revised 1958 edition of the Standard Filing System and Alphabetical Index. The new and amplified edition is document E-301, replacing former document 172, and copies may be obtained from the Institute's headquarters at a cost of \$2.00.

OREGON DOCUMENT WINNER

The AIA Document-of-the-Month for April 1958 is "Architecture, Portland, Oregon". The interesting folder shows 32 selected works in the area with a city map indicating their location, and photographs of the structures and the name of architect and AIA honors won in state and national awards. It is the third Chapter Affairs Committee document so selected. Others were by Cleveland in March 1954 and San Diego in December 1956.

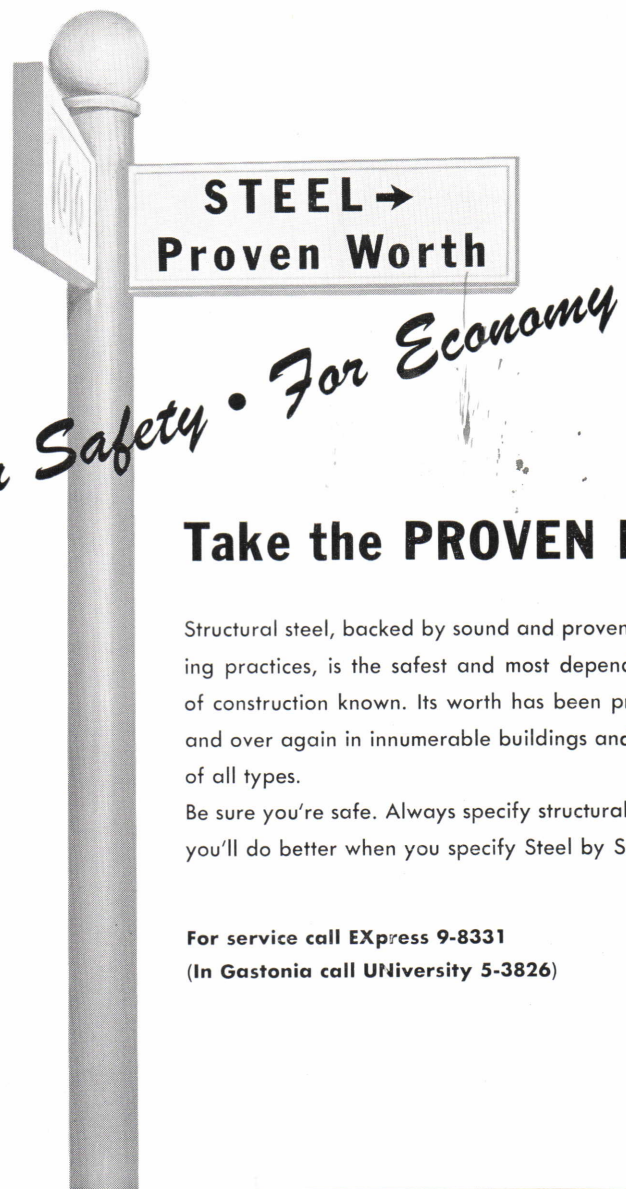
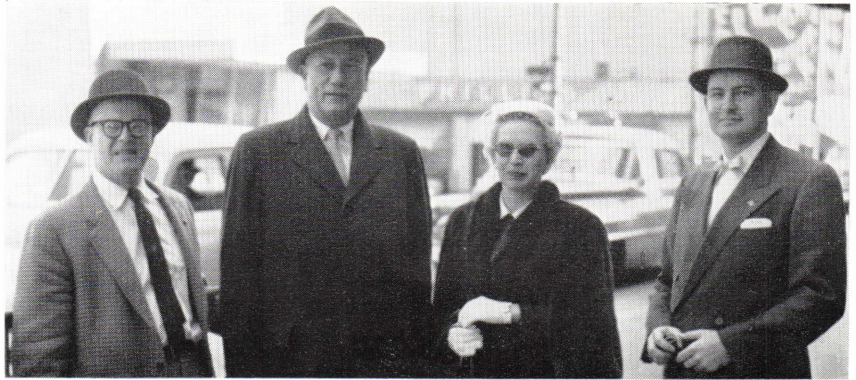

**STEEL →
Proven Worth**

For Safety • For Economy



Take the PROVEN Road

Structural steel, backed by sound and proven engineering practices, is the safest and most dependable type of construction known. Its worth has been proven over and over again in innumerable buildings and structures of all types.

Be sure you're safe. Always specify structural steel, and you'll do better when you specify Steel by Southern.

For service call **EXpress 9-8331**
(In Gastonia call **UNiversity 5-3826**)

SOUTHERN ENGINEERING COMPANY
"Little Pittsburgh"
P.O. Box 10588 Charlotte 1, N.C.



IN BUILDING CONSTRUCTION

Ability to produce the best job, at the lowest cost, in the shortest possible time, are the primary factors in satisfying clients.

For twenty-three years H. L. Coble Construction Company has worked throughout the Southeast with Architects and Owners producing these results.

H. L. COBLE CONSTRUCTION CO.

GREENSBORO, N. C.



FIRST CHOICE—LAST COST

It's real clay

Suntile

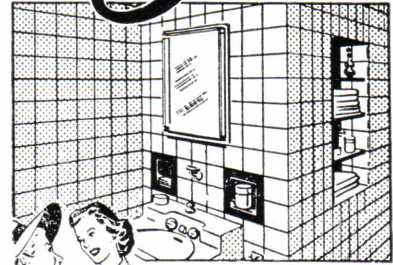

When you choose Suntile for your home you put an end to costly upkeep and maintenance—practically forever. This durable, real clay tile resists marring, chipping or cracking—is so easy to clean—never needs any painting or redecorating. Year after year it will reduce your household expense.

Suntile's Color-Balanced beauty and exclusive quality are built-in. Let us help you select the right colors for your bathroom, laundry or kitchen.

Let us show you why it's long term economy to select real clay Suntile.

Renfrow Distributing Co., Inc.

1820 Sunnyside Avenue

Telephone ED 4-6811

CHARLOTTE, N. C.

Central LUMBER CO.

ARCHITECTURAL WOODWORK
TO DETAIL IN SOFTWOODS
AND HARDWOODS

H. H. BAXTER - J. T. LAND - C. L. KISER

Tel. ED 3-1194

300 South Brevard Street

Charlotte, N. C.

CHAS. A. TORRENCE

ESTABLISHED 1916

BLUE PRINTS
BLUE LINE PRINTS
PHOTO COPIES

TEL. ED 3-5702

214 LATTA ARCADE

CHARLOTTE, N. C.

ARNOLD STONE CO.

GREENSBORO, N. C.

PHONE BR 2-1194

Pioneers in the Manufacture
OF

STRUCTURAL PRECAST CONCRETE PRODUCTS

- LITH-I-BAR JOIST
- CHANNELCRETE SLABS
- PRESTRESSED JOIST
- TECTUM ROOF PLANK AND TILE
- F & A FLOOR AND ROOF SYSTEMS
- TONGUE & GROOVE NAILABLE PLANKS

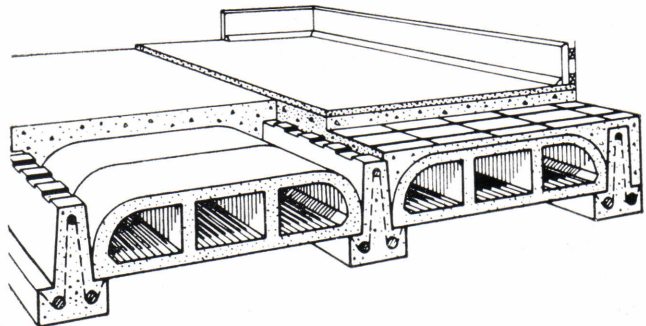

Typical F & A Filler Block Installation

A REALLY CLEAN JOB

Hertro-Clean is a product of chemical research designed to eliminate the usual objections to cleaning masonry with muriatic acid. It makes brick-work stand out in its natural colors.

Hertro-Clean is from 500 to 700 per cent less corrosive to metals than muriatic acid and may be used to clean ceramic and quarry tile without damage to adjacent chrome or aluminum work.

Plaster may be safely and quickly removed from metal door bucks or aluminum windows with **Hertro-Clean**.

It is packed in crystal form in convenient sized polyethylene bags to be dissolved in water on the job. It is economical to use. It is easy to work. It does a good job.

For guide specifications and samples, write to:

CHEMICAL *HERTRON* COMPANY
SALES DIVISION INC., CHARLOTTE, N. C.
P. O. BOX 3090

- Industrial
- Institutional
- Commercial



DICKERSON, INC.

General Contractors

AT 3-3111
Monroe, N. C.

MORE AND MORE ARCHITECTS NOW SPECIFY . . .

- High Insulation Efficiency
- Positive Vapor Barrier
- Odorless and Clean



FIRST IN REFLECTIVE INSULATION



BOX 1050, DURHAM, NORTH CAROLINA

Better Construction is assured when you Specify

50% LESS
SHRINKAGE



HIGH PRESSURE
STEAM CURED
MASONRY UNITS

SMITH CONCRETE PRODUCTS

KINSTON, N. C.
TEL. 3412

We Build To a STANDARD — Not To a Price

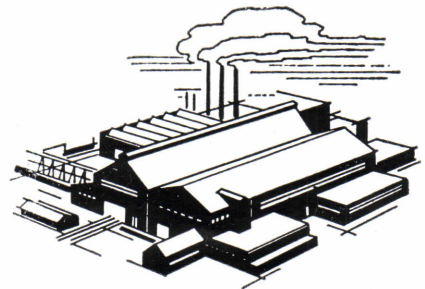

•
STRUCTURAL STEEL

•
STEEL STAIRS

SOULE STEEL & IRON CO.

901 North Church Street
Tel. ED 2-4580
CHARLOTTE, N. C.

—TYPE—

B O R E N

CLAY PRODUCTS COMPANY

Manufacturers of

B R I C K

for Color and Texture

Phone Greensboro BR 4-6353

Offices

PLEASANT GARDEN, N. C.

—SIZES—

Standard
Modular
Oversize
Roman
Norman
Jumbo

Colonial
Antique
Handmade
Tapestry
Common
Special Shapes

INSTRUCTIONS FOR SUBMITTING MATERIAL FOR PUBLICATION IN SOUTHERN ARCHITECT

Architects are invited and urged to submit their projects for publication in *Southern Architect*. All material should be addressed to *Southern Architect*, P. O. Box 408, Raleigh, North Carolina.

In submitting projects, all material should be in the publication office by the 25th day of the month prior to publication. Ink renderings or glossy prints may be submitted and all such work will be returned to the architect after publication.

In preparing material for publication, it is suggested that the material include exterior renderings or photographs, elevations, floor plans, plot plans, interior photographs if the building has been completed, and name and address of general contractor if the job has been let.

It is essential that the following information be furnished:

Name and address of architect.

Title of structure.

Name and address of owner.

Location of project.

It is very desirable that additional information be provided, including an analysis of the problems faced by the architect in preparing his design and his solution of those problems.

Below is a sample form which may be followed in submitting material for publication.

Name of architect	John H. Jones, AIA
Address of architect	Charlotte, N. C.
Title of structure	John Smith Elementary School
Name of owner	Charlotte City School Board
Address of owner	Charlotte, N. C.
Location of project	100 Street, Charlotte
Name of Contractor	Day Construction Co.
Address of Contractor	Charlotte, N. C.
Renderings, date or photographs submitted:	
Special foundations	
Floor plans	
Elevations	
Roof	
Plot plan	
Interior photographs	
Wall finishes	
Exterior photographs	
Landscaping	
Problems	(State problems faced in preparation of design briefly, but completely.)
Comments	(State solution to problems briefly, but completely.)

Yes, you can subscribe or give a gift subscription to
Southern Architect

Just fill out and mail form below. Your subscription will start immediately.

Southern Architect P. O. Box 408
Raleigh, North Carolina

Please enter my subscription to *Southern Architect* as checked below.

\$3.00 for one year. **\$5.00 for two years.**

Name _____

Firm Name _____

Address _____

City _____ State _____

Index of Advertisers

	page
Arnold Stone Company	27
Borden Brick & Tile Company	23
Boren Clay Products Company	28
Bost Building Equipment Company	24
Brick & Tile Service, Inc.	Back
Carolina Power & Light Company	4
Carolina Solite Corp.	2
Carolina Tuff-Lite Corp.	6
Central Lumber Company	27
H. L. Coble Construction Company	27
Dewey Brothers, Inc.	6
Dickerson, Inc.	28
Duke Power Company	31
Duncan Printmakers, Inc.	24
Giant Portland Cement Company	3
H & S Lumber Company	24
Hertron Chemical Company	28
Isenhour Brick & Tile Co., Inc.	23
Kendrick Brick & Tile Company	31
Law Engineering Testing Company	23
The Mabie Bell Company	24
Ezra Meir & Associates	24
McDevitt & Street Company	23
The Moland-Drysdale Corp.	23
Monarch Elevator Company	24
N. C. Concrete Masonry Association	6
Pine Hall Brick & Pipe Company	6
Portland Cement Association	25
Renfrow Distributing Company	27
Salisbury Lumber & Supply Company	24
Smith Concrete Products	28
Snow Lumber Company	24
Soule Steel & Iron Company	28
Southern Engineering Company	26
Southernair Company	28
F. N. Thompson, Inc.	23
Chas. A. Torrence	27
The Will-Burt Company	4

The N. C. Chapter American Institute of Architects is appreciative of the support of our advertisers and invites your consideration of their products and their representatives.

ARCHITECTURAL CALENDAR

MAY 1, 15: Raleigh Council of Architects, S. & W. Cafeteria, Raleigh.

MAY 7: Charlotte Council of Architects. Chez Montet, Charlotte.

MAY 7, 14, 21, 28: Architects Guild of High Point, High Point.

MAY 20: Winston-Salem Council of Architects. Y.W.C.A., Winston-Salem.

JUNE 1: N. C. State College School of Design Commencement, College Union Building, Raleigh.

JUNE 1: Deadline for items for this publication's next issue.

JUNE 2-3: Society of Naval Architects and Marine Engineers Annual Meeting, Chamberlin Hotel, Norfolk, Va.

JUNE 19: NCAIA Executive Committee Meeting, Morehead City.

JUNE 19-21: N. C. Chapter American Institute of Architects Summer Meeting, Morehead-Biltmore Hotel, Morehead City.

JUNE 26-29: N. C. Board of Architecture. Gardenia Terrace Motel, Myrtle Beach, S. C.

JUNE 27: Eastern Council of Architects. Southern Pines.

JULY 7-11: American Institute of Architects Annual Convention, Hotel Cleveland, Cleveland, O.

Make Reservations Early

Summer Meeting

**NORTH CAROLINA CHAPTER
AMERICAN INSTITUTE
OF ARCHITECTS**

JUNE 19-21, 1958

Morehead-Biltmore Hotel Morehead City, N. C.

FAMOUS "Kendrick"

BRICK

**Made in North Carolina of
North Carolina Raw Material!**

At Kendrick Brick and Tile Co. we pride ourselves on the beauty and quality of our Brick. For over 40 years we have supplied our products to customers in the building of homes, schools, churches and commercial buildings.

At Kendrick Brick we have kept our plants and equipment abreast of time and demand, we are proud of our four plants — they are modern in every capacity.

Samples, specifications and engineering data furnished on request.

Producers of Common . . . Select Common . . . Sand Face . . . Rug Face . . . Scored and Fine Texture Face . . . Norman . . . Roman . . . Jumbo . . . SCR . . . Colonial Antique . . . Jack Arch and Special Shape Brick . . . a full range of colors and textures.



**K
E
N
D
R
I
C
K**



BRICK & TILE

**C COMPANY,
INC.**

K

3235 So. Boulevard
Phone JA 3-6716

Plant No. 1 — Mt. Holly, N. C. . . . Plant No. 2-3-4 — Monroe, N. C. . . . Sales Office — 3235 S. Boulevard, Charlotte, N. C.

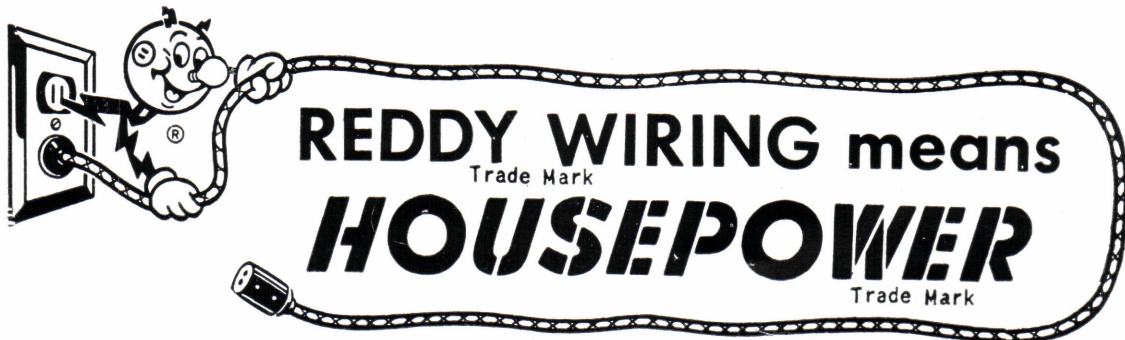

You'll be proud of the home you design if it is wired for full HOUSE-POWER, to meet future needs and provide for today's comforts . . . For convenience, for beauty, and for safety — be sure your plans include REDDY WIRING so your clients can live better . . . electrically!

For free copies of "Residential Wiring Handbook" write:
Lighting Dept., Duke Power Company, Charlotte, North Carolina

DUKE POWER COMPANY
Serving the Piedmont Carolinas

LIVE BETTER ELECTRICALLY!



Iredell County Health Center
Statesville, North Carolina

Architect: Thomas H. Hutchins,
Statesville

Contractor: P. S. West Construction Co.,
Statesville

Beauty

INSIDE AND OUT

J. AUBREY KIRBY, AIA
454 Archer Road
Winston-Salem, NC 27106-5406

The warmth of brick interiors combine with the economy of load-bearing brick construction to provide a real bargain here in the Brick Capital of the Nation.

BRICK & TILE SERVICE, INC.

A Service of North Carolina's Clay Products Manufacturers
Greensboro, North Carolina