

SECRETARIES OF DEFENSE HISTORICAL SERIES

# HAROLD BROWN

Offsetting the Soviet Military Challenge

—— 1977–1981 ——

## SECRETARIES OF DEFENSE HISTORICAL SERIES

ERIN R. MAHAN, GENERAL EDITOR

Volume I, *The Formative Years, 1947–1950*, by Steven L. Rearden (1984)

Volume II, *The Test of War, 1950–1953*, by Doris M. Condit (1988)

Volume III, *Strategy, Money, and the New Look, 1953–1956*, by Richard M. Leighton (2001)

Volume IV, *Into the Missile Age, 1956–1960*, by Robert J. Watson (1997)

Volume V, *The McNamara Ascendancy, 1961–1965*, by Lawrence S. Kaplan, Ronald D. Landa, and Edward J. Drea (2006)

Volume VI, *McNamara, Clifford, and the Burdens of Vietnam, 1965–1969*, by Edward J. Drea (2011)

Volume VII, *Melvin Laird and the Foundation of the Post-Vietnam Military, 1969–1973* by Richard A. Hunt (2015)

SECRETARIES OF DEFENSE HISTORICAL SERIES

Volume IX

HAROLD BROWN  
Offsetting the Soviet Military Challenge  
—— 1977–1981 ——

Edward C. Keefer



Historical Office  
Office of the Secretary of Defense  
Washington, DC • 2017



### Use of ISBN

This is the official U.S. Government edition of this publication and is herein identified to certify its authenticity. Use of 978-0-16-093755-2 is for the U.S. Government Publishing Office editions only. The Superintendent of Documents of the U.S. Government Publishing Office requests that any reprinted edition clearly be labeled a copy of the authentic work with a new ISBN.

### Library of Congress Cataloging-in-Publication Data

Names: Keefer, Edward C. (Edward Coltrin), 1945– author.

Title: Harold Brown : offsetting the Soviet military challenge 1977–1981 / Edward C. Keefer.

Other titles: Offsetting the Soviet military challenge 1977–1981

Description: Washington, DC : Historical Office, Office of the Secretary of Defense, 2017. |

Series: Secretaries of Defense historical series ; volume 9 | Includes bibliographical references and index.

Identifiers: LCCN 2017011702 | ISBN 9780160937552 (alk. paper)

Subjects: LCSH: Brown, Harold, 1927– | Cabinet officers—United States—Biography. | United States. Department of Defense—Officials and employees—Biography. | United States. Department of Defense—History—20th century. | United States—Military policy—History—20th century. | National security—United States—History—20th century. | Arms control—United States—History—20th century. | United States—Politics and government—1977–1981. | World politics—20th century.

Classification: LCC U53.B745 K44 2017 | DDC 355.6092 [B] —dc23

LC record available at Caution-<https://lcn.loc.gov/2017011702>

∞ The paper used in this publication meets the requirements for permanence established by the American National Standard for Information Sciences “Permanence of Paper for Printed Library Materials” (ANSI Z39.48-1984).

---

For sale by the Superintendent of Documents, U.S. Government Publishing Office  
Internet: [bookstore.gpo.gov](http://bookstore.gpo.gov) Phone: toll free (866) 512-1800; DC area (202) 512-1800  
Fax: (202) 512-2104 Mail: Stop IDCC, Washington, DC 20402-0001

ISBN 978-0-16-093755-2

———— CONTENTS ————

Foreword . . . . .	xi
Preface . . . . .	xiii
Acknowledgments . . . . .	xvii
CHAPTER 1 <b>The Carter Administration Takes Charge . . . . .</b>	<b>1</b>
Different Paths: Jimmy Carter and Harold Brown . . . . .	2
Carter's and Brown's World Views . . . . .	8
Selections and Confirmations . . . . .	11
Brown's Previous Service . . . . .	14
Brown's Initial Team . . . . .	18
Carter's National Security Team and Process . . . . .	21
CHAPTER 2 <b>The FY 1978 Defense Budget and the B-1</b>	
<b>Bomber Decision . . . . .</b>	<b>27</b>
The Ford-Rumsfeld FY 1978 Budget . . . . .	29
Carter's Modification to the FY 1978 Budget . . . . .	33
Rescissions to the FY 1977 Budget . . . . .	37
Hearings on the FY 1978 Revisions . . . . .	38
Passage of the FY 1978 Defense Authorization Act . . . . .	42
Passage of the FY 1978 Defense Appropriations Bill . . . . .	46
B-1: The Once and Future Penetration Bomber . . . . .	48
Carter's Decision on the B-1 . . . . .	50
Congressional Approval of the B-1 Decision . . . . .	58
CHAPTER 3 <b>Latin America . . . . .</b>	<b>61</b>
The Panama Canal Treaty Negotiations . . . . .	63
Ratification of the Treaties . . . . .	69
Implementing the Treaty . . . . .	72
A New Direction toward Latin America . . . . .	75
Argentina, Brazil, and Chile . . . . .	77
Cuba and the Soviets . . . . .	82

	Cuban Refugee Crisis . . . . .	88
	Central America: Nicaragua and El Salvador . . . . .	91
CHAPTER 4	<b>Reorganization and Reassessment of the Department of Defense.</b> . . . . .	101
	Intelligence Reorganization . . . . .	106
	Presidential Government Reorganization Project at Defense . . . . .	110
CHAPTER 5	<b>Defining National Security Policy</b> . . . . .	117
	Presidential Review Memorandum 10 . . . . .	120
	The National Security Council Considers PRM 10. . . . .	127
	Andrew Marshall and the Office of Net Assessment . . . . .	133
	Presidential Directive 18 . . . . .	135
	Rethinking Nuclear War . . . . .	137
	Presidential Directive 59 . . . . .	142
CHAPTER 6	<b>SALT II and the MX Missile Decision.</b> . . . . .	147
	SALT II Negotiations Prior to Carter . . . . .	148
	The Comprehensive/Deep Cuts Proposal. . . . .	149
	Negotiations Resume . . . . .	153
	Another Year without SALT II . . . . .	159
	Success and Frustration . . . . .	164
	The MX Decision . . . . .	169
CHAPTER 7	<b>Arms Control and Global Issues</b> . . . . .	183
	Comprehensive Nuclear Test Ban . . . . .	184
	Antisatellite Negotiations and Space . . . . .	188
	Banning Chemical Warfare . . . . .	193
	Nuclear Nonproliferation . . . . .	196
	Foreign Military Sales . . . . .	198
	Military Assistance Program . . . . .	203
	Energy, Terrorism, and Use of the Sea . . . . .	204
CHAPTER 8	<b>The FY 1979 Budget and the Future of the Navy</b> . . . . .	215
	Budget Priorities and the FY 1979 Budget . . . . .	217
	President Carter and the DoD Budget . . . . .	226
	The Navy at Center Stage. . . . .	231
	Carter's Veto and the Supplemental Bill . . . . .	239

CHAPTER 9	<b>The Middle East Peace Process</b> . . . . .	247
	Sadat and Egypt . . . . .	248
	Arms for Israel . . . . .	251
	Middle East Aircraft Package . . . . .	258
	Camp David Accords and the Sinai Airfields . . . . .	261
	Military Assistance to Israel, Egypt, and Saudi Arabia . . . . .	265
	Post-Peace Security Assistance and Arms Sales . . . . .	270
	Saudi Arabia . . . . .	274
CHAPTER 10	<b>Iran and the Hostage Crisis</b> . . . . .	285
	Arms Sales to Iran . . . . .	286
	The Huyser Mission . . . . .	291
	Military Options . . . . .	298
	The Hostage Rescue Attempt . . . . .	302
	Postmortem . . . . .	316
CHAPTER 11	<b>Southwest Asia and the Framework for Persian Gulf Security</b> . . . . .	321
	Afghanistan . . . . .	322
	Pakistan . . . . .	327
	Security in the Persian Gulf . . . . .	332
	Rapid Deployment Joint Task Force . . . . .	342
CHAPTER 12	<b>The FY 1980 Budget and the Conversion of Harold Brown</b> . . . . .	351
	The Long View: FYs 1980–1984 . . . . .	352
	Meetings with Carter . . . . .	356
	Program Objective Memoranda from the Services . . . . .	359
	Carter’s Budget Decisions . . . . .	362
	Congress Takes Up the Budget . . . . .	365
CHAPTER 13	<b>Readjustment in East Asia</b> . . . . .	377
	Korea: Decision to Withdraw . . . . .	378
	Retreat from Withdrawal . . . . .	385
	Political Unrest in South Korea . . . . .	390
	People’s Republic of China . . . . .	395
	Arms Sales and Withdrawal from Taiwan . . . . .	402
	Japanese Defense . . . . .	406
	Philippine Base Negotiations . . . . .	411

CHAPTER 14	<b>NATO Conventional Forces</b> . . . . .	417
	The Carter Administration's Review of NATO . . . . .	422
	DoD and NATO's Long-Term Defense Plan . . . . .	424
	The Washington NATO Summit . . . . .	429
	Tank Guns and the Two-Way Street . . . . .	431
	NATO's Airborne Warning and Control System . . . . .	434
	Rapid Reinforcement and Armaments Cooperation . . . . .	438
	Mutual and Balanced Force Reductions . . . . .	443
	NATO's Southern Flank . . . . .	448
CHAPTER 15	<b>NATO and the Theater Nuclear Forces</b> . . . . .	455
	The Neutron Bomb . . . . .	458
	Modernization of Long-Range Theater Nuclear Forces . . . . .	466
	The Modernization Program . . . . .	471
	Discussions with the Soviets on TNF Reductions . . . . .	473
CHAPTER 16	<b>Conflict and Confrontation in Africa</b> . . . . .	477
	First Challenges: Zaire and the Horn of Africa . . . . .	479
	Shaba II and the Ethiopian Offensive in the Ogaden . . . . .	484
	Soviets and Cubans in Africa . . . . .	489
	Somalia, Kenya, and the Middle East . . . . .	491
	The Pariahs: South Africa and Rhodesia . . . . .	494
	Morocco and Western Sahara . . . . .	498
CHAPTER 17	<b>The All-Volunteer Force and the Legacy of Vietnam</b> . . . . .	503
	Assessing the All-Volunteer Force . . . . .	505
	Recruitment and Retention . . . . .	508
	Women in the All-Volunteer Force . . . . .	512
	African Americans in the All-Volunteer Force . . . . .	519
	Draft Registration . . . . .	522
	Pay Compensation and Retirement Reform . . . . .	526
	Pardons and Upgrades . . . . .	531
	Missing in Action and Reclassification . . . . .	534
	The Code of Conduct . . . . .	536
CHAPTER 18	<b>Making the Case: Defense Budgets for Fiscal Years 1981 and 1982</b> . . . . .	541
	Reassessing the Soviet Threat . . . . .	543
	Formulation of the FY 1981 Budget in DoD . . . . .	547



	Negotiations with the White House . . . . .	553
	Congress and the FY 1981 Budget . . . . .	558
	The FY 1982 Defense Budget. . . . .	565
<b>CHAPTER 19</b>	<b>A Revolution in Military Warfare: The Offset Strategy . . . .</b>	<b>575</b>
	Stealth Technology . . . . .	576
	Assault Breaker . . . . .	586
	Cruise Missile Development. . . . .	590
	Defense Legacy . . . . .	594
<b>CHAPTER 20</b>	<b>The 1980 Election and Transition. . . . .</b>	<b>601</b>
	Brown Joins the Political Fight. . . . .	602
	The Announcements: PD 59 and Stealth . . . . .	604
	Transition. . . . .	608
<b>CHAPTER 21</b>	<b>In Retrospect. . . . .</b>	<b>615</b>
	Relations with the President, the White House, and State . . .	617
	The Joint Chiefs, Office of the Secretary of Defense, and the Armed Forces . . . . .	620
	Brown as Diplomat . . . . .	624
	Relations with Congress . . . . .	626
	Abbreviations. . . . .	629
	Notes . . . . .	637
	Note on Sources and Selected Bibliography . . . . .	773
	Index . . . . .	797
 <b>Maps, Charts, and Diagrams</b>		
	Panama Canal as Defined by the 1978 Treaties. . . . .	68
	Combat Radius of Cuban MiG-23s. . . . .	83
	Cuba. . . . .	89
	Nicaragua . . . . .	92
	Department of Defense, June 1978. . . . .	103
	Five-Year Costs, FYs 1978-1983 . . . . .	129
	Sizes and Profiles of U.S. and Soviet ICBMs. . . . .	171
	Minuteman III and MX Missile Comparisons . . . . .	172
	Detail of Proposed MX Missile Mobile Road System. . . . .	177
	Proposed MX Multiple Protective System . . . . .	178

Combat Aircraft in the Middle East, 1977 .....	261
Israel, 1982 .....	265
Aircraft Routes on 24 April 1980 .....	306
Planned Hostage Extraction Routes for 25 April 1980.....	307
Collision at Desert One, 24 April 1980 .....	313
Soviet Invasion of Afghanistan, 1979 .....	325
Egypt .....	337
Proposed Persian Gulf Unified Command .....	346
Range of Soviet SS-20 Mobile Missiles .....	459
The Horn of Africa .....	481
Zaire.....	485
Minorities as a Percent of Active-Duty Forces (Enlisted Only) at the End of Fiscal Years .....	519
DoD Budget Trends, FYs 1964-1982 .....	573
Assault Breaker Concept Against Stand-Off Armored Forces.....	587
Heavy/Light Mix of U.S. Divisions .....	595

**Tables**

1. Carter Modifications to the Ford Defense Budget, FY 1978 .....	36
2. Major Weapons Authorizations, FY 1978.....	45
3. Alternative Integrated Military Strategies (AIMS) .....	123
4. Major Weapons Authorizations, FY 1979.....	236
5. Defense Appropriations, FY 1979.....	243
6. Major Weapons Authorizations, FY 1980 .....	367
7. Defense Authorization Bill, FY 1980 .....	369
8. Defense Appropriations, FY 1980 .....	373
9. Military Balance in Europe, NATO and Warsaw Pact.....	419
10. Projected Population Estimates, FYs 1976-2000.....	507
11. Second Term Retention Rates (%), FYs 1975-1979 .....	509
12. Number of Women on Active Duty, FYs 1976-1982 .....	515
13. Defense Weapons Authorizations, FY 1981 .....	560
14. DoD Fiscal Guidance, FYs 1981-1986.....	568
15. DoD Budget Totals, FYs 1980-1982.....	573

## — FOREWORD —

THE NINTH VOLUME IN THE Secretaries of Defense Historical Series focuses on President Jimmy Carter's defense secretary, Harold Brown, who brought stability to an office that had seen three different secretaries in the last four years under the Nixon-Ford administrations. When Brown began his tenure in January 1977, he and his staff confronted an array of national security and international policy concerns, especially the Warsaw Pact's conventional and nuclear theater forces superiority over NATO and the Soviet threat to U.S. land-based missiles. Within the context of the national security and foreign policy challenges of Carter's administration, this volume describes the role of the Pentagon chief, the advice he gave the president, and his interactions with other senior political and military leaders. It is also a history of the management of the Defense Department, including the continual development of the All-Volunteer Force and the organizational changes that saw improved policy formulation and acquisition decisions.

One of the book's major themes is inherent in the title. Secretary Brown and his staff responded to a daunting challenge: to offset the Soviet Union's quantitative strategic and conventional military advantages by the judicious use of America's ability to innovate and apply its lead in technology. The book also reveals that more continuity than contrast existed between the later years of Carter's term and the start of the Reagan administration's first term, due in good part to the offset strategy and the insistence of Brown, the Joint Chiefs of Staff, and defense supporters in Congress that the president allocate increased funding for the Pentagon. At the very least, Brown and Carter prepared the foundation for President Ronald Reagan's and Secretary of Defense Caspar Weinberger's military buildup and revolution in defense.

This volume and the series as a whole have a value above and beyond their contribution to historical scholarship about the Defense Department under the Carter administration. The Pentagon is the largest department with the largest discretionary budget in the United States government. An organization of this size requires an institutional memory. Even before this volume was published, its

analyses and discoveries provided answers to questions from the deputy secretary and secretary of defense. The series continues to serve as a reference and framework for policymakers seeking to draw insights from the past as they meet the challenges of the present and future. There is another intrinsic value to this body of work: in a democracy such as the United States, the public has the right to know what its leaders did in its name. Transparency is the bedrock of democratic accountability. The titles in the Secretaries of Defense Historical Series examine the decisions and motivations of the Pentagon leadership some three decades after a secretary has left office. This time lag allows for the release of previously classified information. It also permits the reader to assess a book's conclusions in conjunction with similarly timed releases of documents by the relevant presidential library and by the Department of State's *Foreign Relations of the United States* series.

This is an authorized history, but not an official one. There is a distinction. The OSD Historical Office has contracted with an experienced historian to write an account of Harold Brown and the office he led. Dr. Edward Keefer has succeeded in producing an eminently readable and revealing narrative of a secretary of defense whose accomplishments and legacy heretofore have not been fully appreciated. While this book has been peer reviewed—by an outside panel, staff historians, and myself—and cleared for publication by Department of Defense declassification review officials and their counterparts in other interested agencies, it remains the author's own assessment of Brown's tenure. Although the text has been declassified, some of the official sources in the volume may remain classified. The opinions and assessments are the author's and do not necessarily represent those of the Department of Defense.

Erin R. Mahan  
Chief Historian  
Office of the Secretary of Defense

## — P R E F A C E —

HAROLD BROWN, PRESIDENT JIMMY CARTER'S secretary of defense, was among the most low-profile defense chiefs to hold the post, and among the most misunderstood. When he is remembered, his image suffers from a common misconception about the administration of Jimmy Carter: that it was throughout its four years antidefense, favoring arms control and disarmament to the point of jeopardizing the nation's security. For those who hold this interpretation, Brown is considered at best a capable secretary swimming against the riptide of Carter's incompetence, often undercut by the president's misguided thinking.

Such characterizations of Carter and especially Brown are simply false. The story is much more complicated. Secretary Brown was a leader among a group of top likeminded policy advisers, including National Security Adviser Zbigniew Brzezinski, the Joint Chiefs of Staff, and key members of Congress such as Senator Samuel A. Nunn (D-GA), who advised a reluctant President Carter to challenge the Soviet Union's military resurgence. The impact that Brown and his staff in the Office of the Secretary of Defense (OSD) had in persuading Carter to reverse the decline in defense spending since 1974 and upgrade America's defenses is central to the theme of this book. Carter proved a reluctant convert, but nonetheless changed his mind in the middle of his term. As a result, beginning in his last two years, he and Brown increased defense spending and brought into production new weapons, including stealth aircraft, precision bombs, and modern digital technology. Their actions paved the way for a new, more accurate and powerful missile, the MX (later called Peacemaker), to counter Soviet advances in missile technology that threatened to make the U.S. Minuteman missile force vulnerable to a devastating first strike. Brown championed the low-flying cruise missile, which could be fired from aircraft well off the borders of the Soviet Union, offsetting advantages enjoyed by the Soviet air defense system. The Carter administration obtained West European approval for the deployment of Pershing II missiles and cruise missiles on European NATO (North Atlantic Treaty Organization) members' soil to match the Soviet Union's

mobile SS-20 missiles that gave Moscow a clear superiority on the continent. Brown and OSD spearheaded a campaign to upgrade NATO's conventional forces, created a new security framework in the Persian Gulf backstopped by an incipient rapid deployment force, and supported Afghan resistance to the Soviet invasion. These initiatives provided a head start for the much-acclaimed Ronald Reagan defense revolution. Although Reagan and his surrogates in 1980 emphasized the difference between their defense policy and Carter's, there was much more continuity than contrast between the two. The defense revolution began with Carter.

This book highlights Brown's policymaking efforts and his influence on the president's response to international events. The major foreign policy issues covered—the Middle East peace process, the Iran revolution and hostage crisis, negotiations with the Soviet Union and the Strategic Arms Limitations Talks (SALT II), the strengthening of NATO, readjustment in East Asia, the Soviet invasion of Afghanistan, and a new command structure in the Persian Gulf—emphasize the role of the secretary of defense and his immediate staff. Other topics cover the role of Brown and OSD in shaping Carter's policies on Latin America, Africa, lesser-known arms control initiatives, and global issues such as terrorism.

This volume also provides a history of the Pentagon during the Carter years. It recounts how Brown took control of the government's largest executive agency, and how he and his staff worked with the White House and then Congress to pass Defense budgets, the lifeblood of national security. It documents Brown's and OSD's attempts to rethink both conventional and nuclear warfare and to ensure the continued success of the All-Volunteer Force. The major weapons procurement issues of the Carter years—the decisions to scrap the B-1 bomber and the neutron bomb and to move ahead with the MX missile—are discussed within the context of budgets or SALT II negotiations. The campaign to use defense technology to offset the Soviet Union's military advantages, spearheaded by Brown and Under Secretary of Defense for Research and Engineering William J. Perry, supplied the United States with a crucial advantage during the Cold War competition with Moscow.

Harold Brown, an intellectually gifted nuclear physicist with outstanding administrative abilities, by his own admission often gave the impression of being aloof and introverted. Yet he dominated the Pentagon and put it under his central control, much like his mentor, Robert McNamara. He worked well with the Joint Chiefs, who were often at odds with presidential decisions. When Brown had to

deliver the support of the Chiefs, he usually did. After working with people over time Brown found his comfort zone. Those who earned his trust and worked closely with him found him to be loyal, generous, fair, and considerate. They especially appreciated his willingness to delegate responsibility without looking over their shoulders.

One critic of Brown, General Alexander M. Haig Jr., who served as Supreme Allied Commander in Europe during the Carter years, recalled that Brown was unwilling to confront the president when he disagreed with him. The charge misses the point of the relationship between Carter and his Pentagon chief. Brown was and has remained loyal to Carter. A team player, Brown realized that he would not always see eye-to-eye with his commander in chief. Ultimately, the president was the final arbiter. Dramatic confrontation was not the secretary's style. A great friend and fellow physicist, Eugene G. Fubini, described Brown in a newspaper interview as "extremely sensitive." Brown had difficulty opening up and praise made him uncomfortable. By his own accounting, if the secretary had a major difference of principle with the president, he would have resigned. That point never came, but Brown certainly had differences with Carter. He did not shy away from making recommendations that would not be well received by the president, yet he did so with rational arguments and persistence, not dramatic confrontations or resignation threats. Brown prepossessed a remarkable ability to see both sides of an issue and to appreciate the value of an opposing argument, tendencies that made him a natural compromiser in the best sense of the word.

Brown assembled an impressive staff. His first deputy secretary of defense, businessman Charles W. Duncan Jr., successfully administered the Pentagon. Duncan's talents so impressed Carter that he chose him to succeed James R. Schlesinger as secretary of energy. Businessman and Washington, DC, lawyer W. Graham Claytor Jr. fit the traditional model of a strong, assertive secretary of the Navy. He then replaced Duncan as deputy secretary. Carter had wanted to name Claytor secretary of transportation, but Brown successfully argued that he was too valuable a Pentagon leader to lose. Under Secretary for Research and Engineering William J. Perry became Brown's crucial collaborator in applying technology to the Pentagon's weapon systems as part of the offset strategy to negate the Soviet Union's advances in conventional forces and ballistic missiles. Robert W. Komer provided bureaucratic energy, first as a NATO point man and then as under secretary of defense for policy. Komer's exuberance and unorthodox approach to problem solving were his

trademarks. Brown also received support from a strong team of under secretaries, assistant secretaries, and directors of the Office of the Secretary of Defense.

Brown's prodigious work ethic and intellectual abilities allowed him to digest large amounts of information and to put his own imprimatur on the policy memoranda that went out under his name. He made at least a few significant revisions to most documents he reviewed, and routinely caught typos or mistakes in graphs and budget figures.

Unlike previous secretaries of defense, Brown faced the Soviet Union at the apex of its Cold War military might. Flush from new discoveries of oil and natural gas in an era of high energy prices, the Soviet Union of the Carter years came closer to matching the United States in strategic power than it had in any other period. By most reckonings, the Kremlin held advantages over the West in conventional weapons and forces in central Europe. Brown and his staff worked diligently and creatively to offset the formidable Soviet military challenge. Yet the achievements Brown amassed as secretary have been overshadowed by one horrendous failure, the Iran hostage rescue mission. As a result, history has paid scant attention to his successes. Similarly, it has ignored the foundation that the Carter administration built for the Reagan revolution in defense. This volume aims to remedy the oversight.



## ———— ACKNOWLEDGMENTS ————

HISTORIANS USUALLY WORK ALONE, but historical publications are rarely the product of one person. I would like to acknowledge the many people who helped me. First I would like to remember the late Stuart I. Rochester, who hired me to write this study of Secretary of Defense Harold Brown and oversaw its beginning. Stuart's brave fight against a terminal disease provided inspiration to me as he worked to almost his final days as chief historian of the Office of the Secretary of Defense (OSD). His example and his own historical work on prisoners of war in Vietnam set a high standard that I strove to meet as best I could. Alfred Goldberg, a fixture as chief historian at OSD for over four decades and a vast reservoir of knowledge about the Department of Defense, provided an initial review of many chapters of the book. John Glennon, a longtime friend and former general editor of the Department of State's series, *Foreign Relations of the United States*, also provided an invaluable initial review and his unvarnished opinion. The book was better for it. Erin Mahan, the current OSD chief historian, took over the historical office after Rochester's early death and infused the office with a new spirit and direction. I hope that this book contributes to the tradition of excellence that she has continued at the OSD Historical Office.

A panel of historians reviewed this book. They included chief historian Erin Mahan and deputy chief historian Glen Asner, whose expertise of science and technology proved invaluable. He corrected my mistakes, showed me better ways to explain technology, and offered an excellent overall review of the book. Outside reviewers Stephen Randolph, the historian of the Department of State, and Ronald Granieri, director of research at the Lauder Institute, Wharton School of Business, University of Pennsylvania, provided additional valuable insights and comments. All of these reviews gave me helpful suggestions and constructive criticism. These reviews were much appreciated and useful. Any errors that remain are my responsibility alone.

I also want to acknowledge Secretary Brown's tremendous assistance to me. He was always cooperative in providing interviews and answering inquiries, no small

advantage to an author because of his prodigious ability to recall events. He read the final manuscript, caught errors, and provided observations and comments, but never asked to have any of my judgements or conclusions changed, noting that my account was “accurate and eminently fair.” He also allowed us to use family photographs that add an extra dimension to this study. A longtime friend to the OSD Historical Office, Secretary Brown has offered commentary on our books covering Secretary McNamara and weapons acquisition in the 1960s. As the only secretary of defense to visit the Historical Office during his tenure, he showed a direct interest in what then Chief Historian Alfred Goldberg and his staff produced.

I would like to thank Joyce Winslow, who helped Brown to write his latest book, *Star Spangled Security: Applying Lessons Learned Over Six Decades of Safeguarding America*. She generously loaned me 700 hours of tapes of her interviews with Brown. More than that, she was someone to talk to and trade ideas about our mutual subject, someone who had come to know and admire Brown and his family.

I benefited greatly from the extensive collection of oral history interviews done by Dr. Goldberg and former members of the Historical Office staff. They are listed in my notes on sources and bibliography. I would like to thank Robert Storer, the former chief of the Records and Declassification Division, Washington Headquarters Service, and his staff for their assistance in my research in the official records of Secretary of Defense Brown and his principal deputies and assistants. Luz Ortiz, the current chief of the Records and Declassification Division, oversaw the declassification of documents for the volume and Mark Langerman, the chief of the Policy Branch, Office of Prepublication and Security Review, cleared the volume for publication. I owe Ernest Emrich of the Library of Congress, Manuscript Division, a great deal of thanks for expediting my access to the yet unprocessed Brown papers. He is one of those librarian-archivists who make things happen. At the Carter Presidential Library in Atlanta, James Yancey was my crucial contact, providing entry to the still-classified Carter national security records. Other members of the Carter Library were also helpful in my research there. Official historians place a large burden on presidential library archivists. I am grateful for their assistance.

I would like to thank Philip Shiman, a former contract historian at the OSD Historical Office and an expert author on Department of Defense’s acquisition of weapons. He shared his vast knowledge and research on the 1970s, which proved especially useful for my chapter on the revolution of military affairs under Brown’s

tenure. For help in collecting many of the photographs in this volume, which I hope add to the readers enjoyment and understanding, I thank Ryan Carpenter, Joel Christenson, and David Hadley. Their research and technical expertise made up for my lack of skill. I also thank Allen Mikaelian for carefully reviewing and assisting in the editing of the manuscript. Special thanks go to James Helicke, who prepared the index and assisted with editing, and to Elliott V. Converse III. Last but hardly least, I would like to thank Senior Editor Sandra Doyle who ably oversaw the editing of the manuscript and the production of the book.

In putting this book together, I owe a debt of gratitude to Jamie Harvey of GPO's Creative Services for design and layout of the book; to Amy Bunting of OSD Graphics for the attractive tables, charts, and diagrams she prepared; and to cartographer Lance Fraker of GIS Cartography and Publishing for map production.

As a postscript, I note that the body of scholarly research on the Carter presidency has been growing as the Carter Library declassifies its holdings on national security and foreign policy. I appreciate the scholarly work that has already been done, from which I have benefited. Most presidents receive a bump in their ratings from the release of their records, as historians look more closely at primary documentation on their policy deliberations. In the past President Jimmy Carter has received his share of criticism, some of it warranted, some of it not. I hope that this volume adds to the more nuanced view of the Carter years and particularly the role that Secretary Brown and his Pentagon staff played in formulating and directing national security and defense policy.



SECRETARIES OF DEFENSE HISTORICAL SERIES

# HAROLD BROWN

Offsetting the Soviet Military Challenge

—— 1977–1981 ——



## The Carter Administration Takes Charge

ON THE FOURTH OF JULY, 1976, the United States celebrated its bicentennial. Two hundred years after declaring independence, this former British colony had become the most prosperous and powerful nation in the world, the uncontested leader of the noncommunist West with all of the responsibilities that such a position entailed. Americans enjoyed the day off work, attending parades, cookouts, and fireworks displays. In New York harbor, a magnificent naval review of tall ships, their canvas billowing against the blue sky, sailed under the Verrazano Bridge and past the Statue of Liberty. On the National Mall, Americans celebrated two centuries of U.S. independence and prosperity, watching the spectacular fireworks display over the Washington Monument.

The festivities, however, masked a sense of unease. The recently concluded and highly divisive Vietnam War had split the country uneasily between hawks and doves, with the majority of the population increasingly weary of military involvement in foreign lands. The ignominious end of the long and costly conflict, and the scenes of Americans and a handful of Vietnamese fleeing Saigon by helicopter in April 1975 as North Vietnamese troops captured the capital, shook many American's sense of invincibility. With the exception of the almost 600 prisoners of war who returned to America from North Vietnam in Operation Homecoming, most Vietnam veterans came home not to heroes' welcomes, but to a populace that seemed suspicious of or uninterested in their sacrifices. The proud tradition of American military service was at one of its lowest ebbs.

Vietnam was only part of the problem. The U.S. political system had suffered its own trauma. Americans had watched the Watergate scandal unravel and then climax with the resignation of President Richard M. Nixon on 8 August 1974. Whether they were pro- or anti-Nixon, most people believed that the nation's

political leaders had failed. To Nixon's supporters, a vengeful and out-of-control Congress had unnecessarily limited his powers as commander in chief by legislative fiat and then had driven him from office for minor offenses. To Nixon's opponents, an imperial executive had covered up a political scandal, flouted the rule of law, and forfeited the right to govern the nation. President Gerald R. Ford, generally regarded as a well-meaning and decent man, had tried to heal the nation's wounds, but they still festered. As most polls indicated, Americans were not happy with Washington, believing that the federal government had become overly bureaucratic, too expensive, too intrusive, and largely ineffective when it came to their everyday problems. In Gallup's first annual public poll of American perception of ethics and honesty in the workforce in 1976, politicians came in dead last, with a 10 percent approval rating.<sup>1</sup>

After the bicentennial, the Democratic Party held its national convention in New York City and selected a southern governor, James Earl Carter Jr., or Jimmy Carter as he preferred to be known, as its candidate for president. Carter narrowly defeated President Ford in the election. A populist with little foreign policy and national security experience had become the nation's commander in chief. Recognizing his own lack of expertise, Carter drew heavily from the administrations of John F. Kennedy and Lyndon B. Johnson for his national security team, and selected Harold Brown, a nuclear scientist whose career had been dedicated to defending the nation, to serve as secretary of defense.

### **Different Paths: Jimmy Carter and Harold Brown**

Jimmy Carter grew up in a small town in rural Georgia; Harold Brown, on a residential street on the Upper West Side of Manhattan. Carter's childhood revolved around the rhythms, routines, and rituals of Plains, a small agricultural community on the rich flatlands of southwest Georgia.<sup>2</sup> Carter identified strongly with his southern roots, family, land, and Baptist religion.

Brown was born in Brooklyn, and his childhood homes were apartments in middle-class Jewish neighborhoods between 100th and 108th streets on Broadway and West End Avenue. The Browns were secular Jews with a steadfast political allegiance to Franklin D. Roosevelt and the Democrats. Harold's mother, Gertrude, gave up her job as a diamond merchant's bookkeeper, which she had held since graduating from high school, to become a mother and wife. His athletic father,



Abraham, was a small-business lawyer who had been known to his soldier comrades as Sergeant “Buster” Brown while serving as an artilleryman in France during World War I. He rarely talked about the war, although he did tell his son he had seen a friend die in combat. Gertrude remained proud of her ability in arithmetic and was delighted to discover her son had mathematical aptitude. The Browns soon realized that their son was a prodigy, displaying amazing intelligence at an early age and later excelling academically. As a high school student he often retreated to his room after supper to read weighty classics, but his mother encouraged him to take up sports as well. As an adult he regularly played tennis and swam most days.<sup>3</sup>

Both Carter and Brown grew up in the midst of the Great Depression, attended college during World War II, and finished their undergraduate degrees in accelerated wartime programs. Carter attended one year of junior college and one year at Georgia Tech before his congressional representative nominated him in 1943 for the Naval Academy, his college of choice. Brown graduated at age 15 from Bronx High School of Science,



Young Harold with his mother, Gertrude.  
(Courtesy Harold Brown Family)



Abraham “Buster” Brown in uniform,  
U.S. Army, World War I. (Courtesy Harold  
Brown Family)



Harold Brown as he graduated from the Bronx High School of Science at age 15. (Courtesy Harold Brown Family)

one of the foremost public science high schools in America, with a 99.5 grade average and most of the school's honors. In 1943 he entered Columbia University, where he received an A.B. at 17 years of age in 1945 and won the Green Memorial Prize for the best academic record. He continued as a graduate student at Columbia, earning a Ph.D. in physics in 1949 when he was still 21. Jimmy Carter and Harold Brown were smart, hardworking, and dedicated, but Brown, by any measure, was absolutely brilliant.<sup>4</sup> He started his working career in nuclear physics

less than two years before the United States detonated the first hydrogen bomb in November 1952—marking the dawn of the thermonuclear age.

Among top physicists, who were in high demand during the early years of the Cold War, Brown was one of the best. After postdoctoral work and a teaching stint, Brown joined the University of California Radiation Laboratory at Berkeley as a research scientist in 1950. He moved in 1952 to the newly established E. O. Lawrence Radiation Laboratory at Livermore, California, an institution led by Herbert F. York, who would become Brown's good friend and would precede him as the first director of defense research and engineering (DDR&E) in the Office of the Secretary of Defense (OSD). At Livermore, Brown led a team of six other physicists (all slightly older than he was) who used some of the first computers, along with mathematics and engineering, to reduce the size of thermonuclear warheads for strategic military use. A thousand times more powerful than the one dropped on Hiroshima, the first hydrogen bomb weighed many tons and filled a small building. Brown and his team helped make Livermore's reputation by designing nuclear warheads small and light enough to be placed on the Navy's nuclear-powered ballistic missile submarines (SSBNs).<sup>5</sup>

In addition to weapons work, Brown proved an excellent manager and conscientious administrator. The administration of President Dwight D. Eisenhower

tapped him to serve on official scientific committees, boards, and delegations. In 1960 he succeeded Edward Teller, “father of the H-Bomb,” as director of Lawrence Livermore Lab. As a 33-year-old head of one of the nation’s premier nuclear laboratories, Brown continued his service as adviser and consultant to the U.S. government. When, in May 1961, Secretary of Defense Robert S. McNamara asked outgoing DDR&E Herbert York who should succeed him, York recommended Brown. After a face-to-face interview, McNamara offered Brown the job. Brown dithered momentarily, thinking that he was probably too young for the job, but McNamara warned that opportunities like DDR&E did not come twice. After some encouragement from York, Brown accepted the next day.<sup>6</sup> One of McNamara’s “whiz kids,” Brown served as DDR&E until September 1965 and then as secretary of the Air Force until the end of President Johnson’s second term. He became president of the California Institute of Technology (Caltech) in Pasadena in 1969, and also served as a part-time delegate to the Strategic Arms Limitation Talks (SALT) in Helsinki, Vienna, and Geneva.<sup>7</sup> At 42 years old, Harold Brown was chief executive of a major science-based university and a former government official with eight years of Department of Defense (DoD) service.



Left to right: Sidney Fernbach, Harold Brown, and Edward Teller with the Livermore Advanced Research Computer, which improved the ability to simulate nuclear explosions, 1960. (Lawrence Livermore National Laboratory)



President John F. Kennedy visits the Lawrence Livermore Laboratory in March 1962. Left to right: Norris Bradbury, director of Los Alamos Scientific Laboratory; John Foster, director of Lawrence Livermore Laboratory; Edwin Miller, director of Lawrence Radiation Laboratory; Glen Seaborg, chairman of the Atomic Energy Commission; President Kennedy; Edward Teller, associate director, Lawrence Radiation Laboratory; Robert McNamara, Secretary of Defense; and Harold Brown, director of Defense Research and Engineering. (RG 434, NARA II)



Secretary of Defense Robert McNamara swears in Harold Brown as secretary of the Air Force, 28 October 1965. (RG 434, NARA II)

Jimmy Carter took a circuitous route to the presidency. Upon graduation from Annapolis in 1946, Carter married Rosalynn Smith, also from Plains, and began his career as a naval officer on experimental electronics and gunnery ships, known somewhat derogatorily as “Chesapeake raiders” because their operations were limited primarily to the bay. After assignments in the Pacific and New London, Connecticut (where he qualified to command a submarine), he applied to join Captain (later Admiral) Hyman G. Rickover’s program to develop nuclear-powered submarines. Carter remembers his interview with Rickover as a defining moment in his life. Rickover asked him if he had tried his best at Annapolis, and Carter admitted he had not. Rickover then asked, “Why not?” Thereafter Carter promised himself always to give his best effort. After six months at the Atomic Energy Commission in Washington, DC, he and his family moved to Schenectady, New York, where he trained with crew members to operate the USS *Seawolf*, one of the Navy’s two newly constructed nuclear submarines.<sup>8</sup>

Carter’s career as a naval officer ended when his father died in October 1953. Resigning his commission, he returned to Plains to take over the family agricultural business. Carter had been a conscientious and ambitious naval officer but not one whom the Navy earmarked for quick promotion or leadership. Plains, civilian life, and his family drew him away from the kind of full commitment to the service required for rapid advancement. His wife tried to convince him to stay in the Navy, but, as he later recalled, “I decided to resign from the Navy and come home to Plains—to a tiny town, a church, a farm, an uncertain income. I had only one life to live, and I wanted to live it as a civilian, with a potentially further opportunity for varied public service.”<sup>9</sup>

For most of the next decade Carter concentrated on the peanut business, becoming a leading citizen of Plains. In 1962 he ran for the Georgia state legislature, serving two terms as a moderate, progressive “good government” legislator. Carter decided to make a run for governor of Georgia in 1966, but he lost the Democratic primary.<sup>10</sup> Determined to win the governorship, Carter ran a 1970 campaign that appealed to white segregationists by opposing school busing and visiting a segregated private school. Elected governor in 1970, Carter soon ditched the segregationists and promoted racial moderation in Georgia, opening up a wider variety of state jobs for African Americans. A progressive and a fiscal reformer, Carter launched a major reorganization of the Georgia state government.

Most prominently, he instituted “zero-based budgeting,” a practice that required government officials to start each budget from scratch and defend their program anew each budget cycle.”<sup>11</sup>

In 1972 Carter began to consider a run for the White House, an audacious idea for a one-term governor from the Deep South. Realizing that the road to the presidency ran through the primaries where momentum could build, Carter entered all primary contests. He and his advisers also knew that Americans had been traumatized by the Vietnam War and the Watergate scandal. Although not a natural born campaigner, Carter was tenacious and single-minded, outlasting all challengers and benefiting from Senator Edward M. Kennedy’s decision to not run. In July 1976 he became the Democratic candidate for president. His Republican opponent, President Gerald Ford, was tainted by his pardon of President Nixon and was also not a strong campaigner. Although Ford closed the gap during the last few weeks of October, on 2 November 1976 Carter won the presidency by a slim margin.<sup>12</sup>

### **Carter’s and Brown’s World Views**

President Carter and his secretary of defense held different world views. Carter was a Washington outsider with distaste for intrigues along the Potomac. The imperial presidency that his predecessors, Lyndon Johnson and Richard Nixon, had constructed deeply troubled him, and he had campaigned against such pretensions. Carter promised the voters a breath of fresh air that would sweep away the miasma of mendacity, cynicism, and corruption that he believed had come to characterize Washington and the White House. He offered a downsized and down-home presidency. Most important, Carter did not underplay that he was a born-again Christian, sprung from the progressive wing of the evangelical movement that had become influential during the latter half of the 19th century. In international affairs, Carter’s progressive evangelicalism translated into championing human rights and democracy abroad, support for international disarmament and arms control, antipathy to nuclear weapons, opposition to racism as practiced by minority governments, and a concern for the developing world and the plight of their poor. Although a graduate of Annapolis and a former career naval officer, Carter developed a healthy skepticism of the military. Only his Johnny-come-lately opposition to the Vietnam War in 1975 marred an otherwise near-perfect profile of an international progressive.<sup>13</sup>

Although Carter was internationally minded, he had limited experience with foreign affairs and national security policy. Realizing this shortfall would handicap him in the election, Carter took an informal cram course provided by the privately funded Trilateral Commission, a small group of influential business people, academics, journalists, and government and political figures. Commission members believed that the triangle of America, Japan, and Europe held the future to world economic prosperity and political stability. They organized meetings and made contacts with similar elites in Japan and Europe. At the suggestion of *Time* magazine editor Hedley Donovan, Zbigniew Brzezinski, the commission's director, recruited Carter while he was still an up-and-coming southern governor in order to broaden the commission's regional base. Under Brzezinski's tutelage, during the next three years Carter attended the exclusive Trilateral Commission meetings, participated in discussions, read papers and reports, and generally networked among foreign policy and national security experts, including Harold Brown, a member of the commission's executive committee and regular attendee at Trilateral meetings.<sup>14</sup> In May 1975 Carter traveled to Kyoto, Japan, for a commission meeting; Brown was also a participant. Peter G. Bourne, a Carter campaign official, remembered that he and Carter spent several days talking with the "incredibly brilliant" Brown.<sup>15</sup> Carter looked back nostalgically on his experience: "Those Trilateral Commission meetings for me were like classes in foreign policy—reading papers produced on every conceivable subject, hearing experienced leaders debate internal issues and problems, and meeting the big names like Cy Vance and Harold Brown and Zbig."<sup>16</sup>

Brown had a point of reference very different from Carter's. Early in his career Brown saw the world from a physics laboratory, and was focused on atomic particles and chain reactions. He then ran a major U.S. government-supported research facility before Secretary of Defense McNamara plucked him from the relative obscurity of Lawrence Livermore Laboratory and brought him into the Pentagon.

Although initially on the periphery of JFK's "Camelot," Brown soon became a technical adviser to the president. In the summer of 1961 the Soviet Union upgraded its nuclear arsenal by testing small devices in the atmosphere, in violation of a moratorium on above-ground testing that had been observed by Moscow and Washington since 1958. Brown briefed the president, his Cabinet, and the National Security Council (NSC) on these and related developments. When the

Soviets exploded a 50-megaton thermonuclear bomb, the largest nuclear bomb to date, Brown again provided advice to the president and his advisers. In October 1961, Kennedy asked Brown to come to his summer retreat in Hyannis Port, Massachusetts, to brief him on the Nike Zeus antiballistic missile defense system. As a science adviser, he also accompanied Kennedy to Palm Beach and to Bermuda, where the president met with British Prime Minister Harold Macmillan. Although Brown never established a similar rapport with President Johnson, by 1969 he was well known and widely respected throughout the Washington political establishment.<sup>17</sup>

Brown considered himself a liberal internationalist, but he lacked Carter's fervor. While Brown acknowledged the value of human rights, he did not believe it should trump U.S. international interests. He understood the president's unwillingness to sell arms to dictatorships, but noted that the Europeans and the Russians quickly filled the void. As a result the United States lost sales and influence. As he later told Congress, he was in favor of arms control as long as it was verifiable and did not harm U.S. national security. As a nuclear scientist and a witness to multiple atomic tests, Brown had no philosophical aversion to nuclear weapons. He saw them as a necessary deterrent to the possibility of a nuclear war and a retardant to conventional conflict between the two superpowers.<sup>18</sup>

As for their views on the Soviet Union, the two men had both differences and similarities. Brown had spent most of his working career either designing or overseeing the development of weapons for potential use against the Soviets or leading Air Force efforts to match weapons and forces with strategic threats. He had few illusions about the Soviet threat, but he trusted that what he called an "essential equivalence" between the two superpowers would provide essential security. The theory held that if both Moscow and Washington realized they faced assured vulnerability, they would be less likely to use nuclear weapons. If either the Soviet Union or the United States attacked first with strategic weapons, each faced assured retaliation. Carter also campaigned as a cold warrior proponent of mutual assured destruction, but as a former submariner he thought that Polaris missiles on submarines formed the ultimate deterrence. The president-elect also hoped for a serious dialogue with the Kremlin leadership to control the U.S.-Soviet strategic arms race.<sup>19</sup> Carter had another concern: the dismal Soviet human rights record, especially its treatment of dissidents. When he became president, Carter got off on



the wrong foot with the Kremlin, tweaking them on their human rights record and establishing a dialogue with Andrei Sakharov, a leading Soviet dissident. Moscow viewed this as interference with its domestic affairs.<sup>20</sup>

### **Selections and Confirmations**

Although Brown and the president-elect had different views, Carter and his principle foreign policy adviser Zbigniew Brzezinski tapped Brown to be one of a number of advisers on strategic and military affairs during the 1976 presidential campaign. In July 1976 Brown and a half-dozen other defense experts traveled to Plains by bus from Atlanta to brief Carter. They ate cold fried chicken as the bus wound through country roads. During the ride Brown and Paul H. Nitze, former SALT II negotiator and hardline cold warrior, argued about U.S. vulnerability to the Soviet threat. In the coming months of the Carter campaign, Brown provided occasional advice to Carter.<sup>21</sup>

After the election, Brown met with Carter in Atlanta on 8 December 1976 for a one-on-one meeting, followed by a discussion with Vice President-elect Walter F. Mondale, Carter's lawyer-adviser Charles H. Kirbo, and his political adviser Hamilton W. Jordan.<sup>22</sup> After these meetings Carter phoned Brown to offer him the job of secretary of defense, provided Brown accepted Charles W. Duncan Jr. as his deputy. If Brown was unwilling, Carter would give the job to his friend Duncan, the former president of Coca-Cola Company. Convinced he could work with Duncan after visiting with him in Houston for a day, Brown traveled to Atlanta to meet again with the president-elect. On 21 December Carter announced Brown as his pick. As his first order of business, Brown telephoned all the former secretaries of defense to ask for advice. He then met with outgoing Defense Secretary Donald H. Rumsfeld, who provided him with a Pentagon office.<sup>23</sup>

From 26 to 29 December 1976 Carter's Cabinet designees gathered at a St. Simon Island resort off the coast of Georgia. Brown found himself in an awkward position when he suggested to a reporter during the meetings that he doubted that an "absolute reduction" of \$5 billion to \$7 billion in defense spending, a Carter campaign promise, could be achieved. On 29 December, Brown and Duncan visited the powerful chairman of the Senate Committee on Armed Services (SCAS), John C. Stennis (D), at his home in DeKalb, Mississippi, to obtain his blessing and discuss budget cuts. In conversation with reporters after the meeting, Brown

called the proposed cuts “savings.” Stennis assured the press that there would be no “cutting at the bone and muscle of the military program.”<sup>24</sup>

Carter later explained that he chose Brown and Duncan out of determination “to eliminate as much waste in defense spending as possible,” to rationalize the acquisition process for highly technical weapon systems, and “to institute efficient management procedures in the Pentagon.” Carter continued, “The Pentagon needed some discipline, and I wanted both a scientist with a thorough knowledge of the most advanced technology and a competent business manager, strong willed enough to prevail in the internecine struggles among the different military services.” Duncan recalls that Carter stressed to him the need for “corporate business experience” in the Pentagon when offering him the deputy job.<sup>25</sup>

Carter’s selection of Brown proved noncontroversial and was applauded by most of the mainstream media. However, some conservative media figures and key officials in labor’s AFL-CIO favored James R. Schlesinger, former secretary of defense under Presidents Nixon and Ford. They orchestrated a low-level campaign to convince the president-elect to pick Schlesinger, but Carter asked him to take charge of the soon-to-be established Energy Department.<sup>26</sup> The *Wall Street Journal* editorialized, “Our contacts in the national security community are absolutely terrified” of Brown’s appointment.<sup>27</sup> The composite conservative position against Brown was that he was too closely identified with arms limitation, had been too ready to cut Air Force programs during the Johnson administration, and was too willing to second Carter’s campaign promises to cut defense spending.<sup>28</sup>

Brown and Duncan’s joint confirmation hearings took place on 11 January 1977 before the Senate Armed Services Committee. Familiarizing himself with the Ford defense budget, Brown fell back on his old technique of being the smartest and most knowledgeable person in the room. He also feared that some of the older members of the committee, who had been critical of his former boss, Robert McNamara, might transfer their animosity to him. Brown wrote advice to himself on a piece of paper: “Say less; stop; keep cool,” and placed it on the hearing table in front of him. Democratic Senator Lloyd M. Bentsen Jr. of Texas happened to see the slip and read it aloud to the committee, setting the tone for nonconfrontational hearings. Brown defined his responsibilities as he saw them: preserve national security, help formulate national security policy, understand vital foreign policy commitments and interests, determine the most appropriate

force structure at the lowest cost, and represent the department to the rest of the government and the world.<sup>29</sup>

Republican Senator John G. Tower from Texas asked Brown if the Soviet Union was seeking nuclear superiority and even a first-strike capability. Admitting the issue needed more study, Brown judged that “the Soviet Union could not attack the United States without our being able to deliver a devastating retaliatory blow which would destroy the Soviet Union as a modern functioning society.” When pressed by Senator Henry M. “Scoop” Jackson (D-WA) about Soviet military intentions, Brown stated that while the Soviets were clearly increasing their conventional and strategic military capabilities, America would “have to live with ambiguity” about their intentions and the threat they posed. Later in the hearings, Republican Barry M. Goldwater from Arizona, Brown’s most skeptical questioner, asked the secretary-designate if he was “a strong arms control advocate.” Brown replied he had been associated with arms control for 20 years, but only endorsed agreements that enhanced U.S. security. “If we can achieve it and it is verifiable,” Brown continued, he was in favor of it, so long as it “would leave us in a position of essential equivalence.”<sup>30</sup>

The committee also queried Brown on specific issues: cruise missiles, SALT II, women in combat, the All-Volunteer Force, withdrawal of U.S. troops from South Korea, and Carter’s proposal to cut \$5 billion to \$7 billion in defense spending. Brown answered when he could and remained vague on other issues where he was not up to speed or which were politically loaded. For example, he suggested that \$5 billion to \$7 billion “could be squeezed out” of the defense budget, but not in the upcoming year.<sup>31</sup> He promised to study the question of the B-1 bomber as a replacement for the B-52. Admitting that the Soviet threat to the U.S. intercontinental ballistic missile (ICBM) force was increasing, he conceded that the Soviets could probably knock out a substantial portion of the U.S. Minuteman missiles before they were launched. When asked if the new Soviet Backfire bomber was a tactical or strategic weapon, a question that bedeviled the Ford administration’s SALT negotiations, Brown suggested it was a strategic weapon and should be limited.<sup>32</sup>

Duncan received a free pass during the confirmation hearings because of his lack of knowledge about defense issues. He worked out a deal with the committee that allowed him to keep his \$13 million in Coca-Cola shares, since DoD purchases of Coke products represented only 0.5 percent of the company’s annual \$3 billion

in soft drink sales.<sup>33</sup> Brown and Duncan had easy confirmations, especially after Brown went out of his way to be solicitous of senatorial advice. Both received the unanimous recommendation of the committee, and on 21 January 1977 the Senate confirmed them by voice vote.

### **Brown's Previous Service**

Brown's confirmation went well because the Armed Services Committee and the whole Senate, like the president-elect, were confident of his abilities. During his previous tenure at the Department of Defense, Brown had been involved in some controversial decisions that provided fodder to his few critics. He supported McNamara's unsuccessful attempt to persuade the Air Force and the Navy to accept a joint multiservice aircraft, the tactical fighter experimental (TFX), and he agreed with McNamara's decision to kill the nuclear plane program and the XB-70 bomber as a replacement for the B-52. This decision was unpopular among the uniformed Air Force. General Curtis E. LeMay groused about how "that son of a bitch [director of Defense Research and Engineering Brown]," who tried to convince him to accept the decision to kill the XB-70 bomber, "was in junior high school when I was out bombing Japan." Although sometimes criticized as "Dr. No," while secretary of the Air Force, Brown supported the Minuteman II missile and the laser-guided bomb programs.<sup>34</sup>

Brown's service at Defense during the 1960s proved difficult to characterize. He was a reformer, budget cutter, arms controller, hawk, and then dove. Brown considered himself a centralizer, believing that OSD should control the management of the Pentagon.<sup>35</sup> Most of all, he was a pragmatist with an undying faith in U.S. technology. As he recalled in 2004, "My argument . . . was that we are not going to be able to afford the manpower to create a lot of low tech things and we believe that our comparative advantage is technology, that is we're better at technology than we are at mass, large mass." Brown continued, "It's not just that we have so much more than everybody else. We have it better than everyone else. We're able to use electronics, sensors, sub-systems, systems, and systems of systems in a way that no other military organization can, and we train to do so."<sup>36</sup>

As for his decision-making process, Brown explained: "I myself tend to weigh the rational and analytical matters first, and try to come to some kind of conclusion on that basis. Then I put in my own view of what the political problems [are]—and I

define political rather broadly here—the things that can't be quantified, the things that can't be approached so rationally—and see whether they affect the conclusion. And my decision is then made on that basis.” On a number of occasions Brown expressed his fear that that he could get “bogged down, run by my in-basket, not asking what single problem is likely to produce a disaster, or alternatively . . . what single thing can I really accomplish that . . . will last after I'm gone.”<sup>37</sup>

Brown was the first to admit that he was not the most gregarious person and found small talk a chore: “Various styles can be successful, but you can't be something you're not and get away with it. I have never pretended to be terribly gregarious or politic, and I guess it's too late for me to start now.” As one of his aides remembered: “He had, and has, no small talk. . . . I don't mean he was rude. . . . But he didn't talk about baseball.” A private man, Brown preferred written communications to face-to-face meetings. Colin L. Powell, then a military aide to Duncan, recalled, “I always had the impression that Brown would be just as happy if we slipped his paperwork under the door and left him alone to pore over it or to work out theorems.” A speed reader, with almost photographic retention, the secretary would read and annotate in his tiny handwriting long memoranda as well as their multiple tabs or attachments. As Brown's Special Assistant John G. Kester recalled, “Probably, the assistant secretary who sent it hadn't read all of the attachments. Harold was a phenomenal person.”<sup>38</sup>

Colene D. McDowell, whom Brown married in October 1953, provided crucial help in meeting the social responsibilities heaped upon a college president and top government official. “Her easy warmth at social functions compensated for my social reticence,” Brown recalled. A swimmer and competitive tennis player like her husband, she laid out Brown's clothes for the next day and took major responsibility for raising their two daughters.<sup>39</sup> Earlier, in his thirties, as a director of defense research and engineering, Brown had displayed occasional impatience with people, particularly those in uniform who did not have his depth of scientific and technical knowledge. Over his career, he worked hard to dispel that impression. He recalled, “Since I have always regarded my own personality as being introverted and likely to come across as cold, I made some extra efforts. They probably mitigated but certainly did not eliminate that problem.” He made a point of eating and conversing with the enlisted men and junior officers when he visited a base as secretary of the Air Force, although his often awkward remarks could never be confused



Harold and Colene Brown photographed by Jill Krementz, 19 July 1978.

with easy banter. Believing an Air Force secretary should know how to fly, he took flying lessons. When he was appointed by Carter, journalists could not resist the temptation to paint him as child prodigy turned wunderkind bureaucrat. It did not help that his proud mother told reporters that when he was four he took the back off the refrigerator to see how it worked.<sup>40</sup> It was hard to overcome the image of the no-small-talk, all-business nuclear physicist.

In his early years Brown looked the part of the stereotypical young scientist, but as he aged his physical appearance gained distinction and bearing. Tall at 6 feet 1 inch, trim, and athletic, Brown was an exercise swimmer. On one of his daily swims in the Pentagon pool in 1979, Brown was kicked in the face by an Air Force colonel racing past him in the lane. Brown's staff noticed his swollen nose when he returned to the office and insisted he go to the health clinic, where the doctor confirmed his nose was broken. No one ever told the colonel.<sup>41</sup>

A prodigious worker, Brown kept long weekday hours and worked Saturday mornings into the early afternoon, standard for a conscientious cabinet officer. Sometimes Colene would bring supper to the office and dine with him while he continued to read and annotate memoranda between bites. When he did take a



Secretary of Defense Harold Brown and broadcast journalist Martin Agronsky in Brown's Pentagon Office. (OSD Historical Office)

whole weekend off, he would devour mystery novels, often up to half a dozen. John Kester remembered that Saturdays at the office were relatively relaxed, a time to catch up. By midafternoon, Brown would occasionally turn on the television and watch reruns of *Mission Impossible*, causing Kester to wonder what the public would think if they knew that their Pentagon chief was sitting in his office watching a popular 1970s covert operations show.<sup>42</sup>

Secretaries of defense had their choice of the department's historical artifacts for furnishing their offices. Brown followed tradition by retaining General John "Black Jack" Pershing's 9-foot-long desk, and the official portrait of the first secretary of defense, James V. Forrestal, on the wall across from it. Brown mused that his predecessors, if they stayed for any length of time, usually left with their reputation damaged. As he told interviewers in 1981, his job was "the graveyard of national reputations." Perhaps the portrait of Forrestal, who worked himself into a nervous breakdown and suicide, hung there to remind Brown to keep things in perspective. Brown loved classical music and it played softly in his office, not only by choice but by necessity. The secretary's office on the third floor of the Pentagon in the Eisenhower Corridor originally had white noise piped in as a security measure to

prevent electronic eavesdropping. Brown's predecessor, Donald Rumsfeld, replaced the noise with country and western music. Brown asked his special assistant to change the track to Mozart, but Kester could only procure Bach's six Brandenburg concertos, which played over and over again in Brown's office on an endless loop for the next two years.<sup>43</sup>

### **Brown's Initial Team**

With the exception of Duncan, Carter allowed Brown to choose his team. Brown tapped William J. Perry in early March 1977 to be director for defense research and engineering. A mathematician with a Ph.D. from Pennsylvania State University and a founder, director, and president of Electromagnetic Systems Laboratory (ESL) of Palo Alto, California, Perry developed one of the first digital image processing capabilities for aerial photography and devised systems to process coherent signals from a high electronic noise environment. He was reluctant to leave his thriving business, but Brown convinced him to join the Pentagon team. Faced with nuclear weapons parity with Moscow and a 3 to 1 Soviet lead in conventional weapons systems, Brown asked Perry to use ESL digital technology to offset these advantages. Brown told the president, "He [Perry] is a technologist who knows development, production, and business." Perry proved to be a key appointment for the development of new weapon systems. Longtime national security official Robert W. Komer characterized Perry in 1981 as "the only guy I've met in this Defense Department who I would say unhesitatingly is SecDef material himself, an amazingly broad gauge guy, immensely articulate, as outgoing as Harold is indrawn, and brilliant."<sup>44</sup> Since ESL did business with the Pentagon, Perry hoped to place his company stock in a nonprofit trust, but Senator Stennis objected on the grounds that the DoD job was too sensitive to allow even a blind trust connection to ESL. Perry sold his stock in ESL, which some months later TRW Corporation bought at a much higher price.<sup>45</sup>

Brown chose a colleague from the McNamara years, David E. McGiffert, who had been active in briefing the Carter transition team, to be assistant secretary of defense for international security affairs (ISA), effectively heading the Pentagon's "mini state department."<sup>46</sup> An ambitious bureaucratic player, McGiffert guarded ISA's turf like a bulldog. To serve as press spokesman and public affairs adviser—with the official title of assistant secretary of defense for public affairs—Brown tapped Thomas B. Ross, the Washington bureau chief of the *Chicago Sun-Times*



and author of well-respected books on the intelligence community. Ross had helped Brown prepare for his Senate confirmation hearings. His job was to keep Brown on the right side of the press, since the secretary's public relations instincts were not among his strong points. For example, when Brown insisted on responding to an unfair *Washington Post* editorial, Ross responded, "Not on this one. . . . [It will] keep the story alive. Harold, when you wrestle with a pig, the pig has fun and you just get dirty."<sup>47</sup> Career government lawyer, Jack L. Stempler, who had served as assistant secretary of defense (legislative affairs) to three secretaries of defense, became Brown's congressional affairs assistant. Stempler advised Brown to visit Senator Stennis before his confirmation and had helped prepare the secretary-designate for his meeting with the Armed Services Committee. Colin Powell recalled that Stempler had a "degree in practical politics from the back streets of Baltimore." His job was to ensure that Brown cultivated congressional support, no matter what the secretary thought of influential congressmen. Stempler did not mince words; he was about the only person who would talk frankly to Brown.<sup>48</sup>

Brown also chose people with scientific backgrounds. Another colleague from the McNamara days, Russell Murray II, became assistant secretary of defense for program analysis and evaluation (PA&E). An aeronautical engineer from the Massachusetts Institute of Technology (MIT), Murray would serve as "devil's advocate" when evaluating costly programs. A persuasive writer, he could always be counted to oppose the services' pet projects. "Although I only supported him against the service proposals perhaps 10 percent of the time, that forced the services to be much more sensible the other 90 percent," Brown remembered.<sup>49</sup> Gerald P. Dinneen, the director of MIT Lincoln Laboratories in Lexington, Massachusetts, and a University of Wisconsin–Madison mathematics Ph.D., became the assistant secretary of defense for command, control, communications, and intelligence (C3I).<sup>50</sup>

When it came to service secretaries, Brown had a free hand, although he received a strong suggestion from the White House. According to Brown, "the world is full of people who want to be Secretary of the Navy," including some of Carter's campaign supporters. The president urged Brown to hire the head of his Pennsylvania presidential campaign, but Brown told Carter that this candidate "was not a good person for the job," and Carter accepted Brown's judgment. Instead, Brown picked W. Graham Claytor Jr., a longtime Washington, DC lawyer and the president and chairman of the board of Southern Railway Company. According to Brown, Carter

was suspicious of lawyers, industrialists, and doctors, but the secretary convinced the president to hire Claytor even with two strikes against him. It helped that Claytor had seen active duty with the Navy, commanding three ships during World War II. Claytor would prove to be one of Brown's best appointments, so good, in fact, that in 1979 Carter tried, in Brown's words, "to steal him" for secretary of transportation.<sup>51</sup>

For secretary of the Army, Brown and the White House agreed on Clifford L. Alexander Jr., whose appointment made him one of the highest ranking African Americans in the government at the time. Alexander, a Washington, DC lawyer, served in the Johnson administration and was chairman of the Equal Employment Opportunity Commission from 1967 to 1969.<sup>52</sup> For secretary of the Air Force, a job near to his heart, Brown chose John C. Stetson, a former aircraft designer with extensive business experience. Unfortunately, Stetson and Brown were like "oil and water." Stetson served only two years and was replaced by Hans M. Mark, his under secretary, an MIT physicist who had overlapped at Lawrence Livermore Laboratory with Brown. Mark had also worked at the Ames Laboratory of the National Aeronautics and Space Administration (NASA).<sup>53</sup>

An official who would become a longtime fixture at the Pentagon, Andrew W. Marshall, the director of the Office of Net Assessment (ONA) at the Pentagon, forged a close intellectual and working relationship with Brown. Marshall attended public schools in Detroit and then earned a master's in economics at the University of Chicago. After 21 years at the RAND Corporation, President Nixon and Assistant to the President for National Security Affairs Henry A. Kissinger tapped Marshall to help revitalize the intelligence products reaching the president. In October 1973 Secretary of Defense James Schlesinger, a former colleague of Marshall's at RAND, chose him to head ONA, created, in part, by Secretary Melvin R. Laird to prevent Kissinger's NSC from dominating comparative military assessments of the United States and the Soviet Union. Under Schlesinger, Marshall gained the reputation of an analyst who thought "outside the box." Marshall's considerable influence continued under Brown, who consumed more ONA studies than any Pentagon defense chief including Schlesinger. Marshall and ONA greatly reinforced Brown's strategic thinking.<sup>54</sup>

Two people at the deputy assistant secretary level in ISA, Walter B. Slocombe and Lynn E. Davis, worked closely with Brown. A former Rhodes Scholar and lawyer, Slocombe had served during 1969–1970 on the Nixon NSC staff, specializing in strategic, military, and intelligence issues. As Brown's point man on SALT II

negotiations, Slocombe fulfilled a key job requiring an ongoing relationship with the secretary. Davis, a former assistant professor of political science at Columbia University, had worked on the Senate Select Committee to Study Governmental Operations with Respect to Intelligence Activities (the “Church Committee”) from 1975 to 1976 and met Brown during those years. After his service at Defense, Brown collaborated with Davis on articles and scholarly papers on national security. Finally, Brown’s special assistant, John Kester, had served in the Army’s Judge Advocate General’s Corps as assistant to the general counsel of the Army until 1968, and deputy assistant secretary of defense (manpower and reserves) under the first Nixon administration. Colin Powell portrayed Kester as a consummate “player” who controlled the flow of bureaucratic paper to his bosses and considered himself *de facto* chief of staff to Brown and Duncan. “I stood in awe of three-star and four-star generals,” Powell recalled, “John Kester did not.” If an assistant secretary wanted action on a pet memorandum to the secretary, he would have to return a favor to Kester and then the memo would find its way to Brown’s desk. “That was the Kester style,” Powell remembered, “punishment and reward, one for you and one for him (and sometimes two for him.)”<sup>55</sup>

### **Carter’s National Security Team and Process**

Carter’s three principal national security officials, the secretary of defense, secretary of state, and assistant to the president for national security affairs, were all members of the Trilateral Commission who had briefed candidate Carter on national security issues during his election campaign. Cyrus R. Vance, whom Carter chose for State, and Brown were close friends who had served together at the Pentagon under Presidents Kennedy and Johnson and whose wives, Colene and Gay, also socialized. Tall and lean, with a patrician bearing, Vance was the very model of the Washington establishment figure. Ten years older than Brown, Vance was born in Clarksburg, West Virginia, to a prominent family—his uncle John W. Davis was the unsuccessful Democratic candidate for president in 1924. Vance’s obituary in the *New York Times* described him as “Mr. Integrity” with the “open face of a prep school boy,” and remarked that he moved “seamlessly from the prep schools of New England and Ivy League colleges of the East to the law firms of Wall Street, with time out for service in government.” Vance served in various jobs in the Kennedy and Johnson administrations, rising to deputy secretary of defense in January 1964.

In 1968 Johnson chose him to be a delegate to the Paris Peace Talks, the public peace negotiations to end the Vietnam War, where he acted as second to the chief of the delegation, W. Averell Harriman, a longtime presidential adviser, confidant, and troubleshooter. Vance's tour in Paris confirmed his liberal internationalist leanings and his belief in the efficacy of negotiation with adversaries. Increasingly, Vance assumed the aging Harriman's mantle, taking on ad hoc peacekeeping and negotiating roles in Cyprus and later in Korea during the 1968 *Pueblo* crisis. Carter recalled that he chose Vance to be secretary of state because he "was cool under pressure" and "very knowledgeable in both military and foreign matters."<sup>56</sup>

Carter's third major national security appointment, Zbigniew Brzezinski, assistant for national security affairs, was not born to the East Coast establishment, but he leveraged his admission. Son of a Polish diplomat, Brzezinski left Europe in 1938, when he was 10 years old, for his father's next post in Canada. In 1939 Germany and the Soviet Union divided Poland, marooning the Brzezinski family in North America. Brzezinski remembers listening to the radio and reading the papers for war news, especially about the Soviet invasion of Poland and the capitulation of Warsaw. After earning a B.A. and an M.A. from McGill University in Montreal, Brzezinski crossed the border to attend Harvard, where he earned a Ph.D. in Russian history and joined the faculty. Denied tenure, Brzezinski moved to Columbia University and in 1958 became a U.S. citizen.<sup>57</sup>

A reporter and sometime counselor to President Kennedy and an adviser to Democratic presidential candidate Hubert H. Humphrey Jr. in 1968, Brzezinski came to national prominence as Carter's principal adviser for national security and foreign affairs during the presidential campaign. Brzezinski greatly wanted the job of national security adviser, although he went through the motions of recommending others, including Brown (unless Carter wanted him for Defense). Carter recalls that he chose Brzezinski for his alternative views, despite knowing full well that he was ambitious, outspoken, provocative, and not always deferential. Furthermore, Carter believed that Brzezinski would operate best within the small NSC staff, while Vance would be the better person to head the State Department's bureaucracy.<sup>58</sup>

While Vance and Brown were old friends, Brown and Brzezinski were newer acquaintances who never became friends. The main mechanism for their working relationship were the so-called VBB (Vance, Brown, Brzezinski) Wednesday lunches, where the three hashed out issues and policies that, if required, would then be taken

up with the president in his weekly Friday breakfast meetings with Brzezinski and Vance (in late 1977 Brown and Hamilton Jordan also attended the breakfast meetings at the urging of Vice President Mondale). In his excellent and frank memoirs, Brzezinski admitted that when the administration took office, he fully expected that Vance would be the soft-liner, the person less willing to use force; Brown would be the hard-liner; and he, Brzezinski, would be the “man in the middle” who sided with one or the other. Brzezinski claimed that during the first two years Brown preempted his expected role, sometimes siding with Vance, sometimes with Brzezinski, and sometimes, according to Brzezinski, Brown used “his agile mind” to side effectively with both colleagues. Brzezinski recalled that in the administration’s last two years he and Brown increasingly found themselves on the same side—pro-defense spending, pro-use of force, pro-China, and less willing to make concessions to the Soviets, especially when it came to SALT, where Brown was even tougher than Brzezinski. While he generally sang Brown’s praises, Brzezinski also revealed some problems he had with Brown’s style, for example, a tendency to interrupt and debate a matter in front of the president when Brzezinski believed Brown had agreed with him beforehand. “On one-to-one he was very easy to deal with,” Brzezinski elaborated, but “in larger settings he was very prickly and always wanted to prove something and have the last word. But I found him easy to get along with.” Brzezinski also detected what he considered a deeper flaw: “There was in him ambivalence and a lack of interest in broader strategy, which reduced the impact of what we had to say to the President. I wondered sometimes why this was so, and I suspect that the reason was deeply rooted partly in his intellectual brilliance, which often is an enemy of clear cut action, and partly in the fact that broader strategy was not his central concern. This occasionally created a Hamlet-like impression.”<sup>59</sup>

For his part, Brown admired Brzezinski for what he characterized as his “child-like attributes: spontaneous, imaginative, very expressive,” basically the polar opposite of Brown himself. As for presenting the full range of the bureaucracy’s recommendations, “so far as I could tell,” Brown recalled, “he didn’t keep other people’s views from the president. . . . His paper always went on the top, but . . . that didn’t mean much because Carter always read everything.” After more than three decades, Brown’s memory of Brzezinski had not mellowed. In a 2012 book, Brown recalled how he knew him as “brash, ingenuous, and a newcomer to senior government rather than as the elder statesman he is 35 years later. He saw himself,

however, as a global thinker and mastermind, who could run the State Department and the Defense Department better than any two people could.” Comparing Vance and Brzezinski, Brown described Vance as “not the same intellectual force, but enormous integrity, negotiating skills, and openness to listening.”<sup>60</sup>

Brown, Vance, and Brzezinski served as principal actors in the national security debates, but there was also a formal NSC system that structured policy decisions. During the presidential campaign, at the urging of former Under Secretary of State George W. Ball, Carter criticized Nixon and Ford’s national security system on the grounds it concentrated too much decision-making power in the hands of Henry Kissinger. Carter vowed that there would be no “Lone Ranger” (a.k.a. Kissinger) in his administration. At the meeting on St. Simon Island in late December 1976, Carter insisted on a less complicated NSC system with fewer NSC subgroups than Nixon’s. With Carter’s input, Brzezinski prepared a simple plan with only two policy bodies: the Policy Review Committee (PRC) and the Special Coordination Committee (SCC). The chairmanship of the PRC would rotate among the secretaries of state, defense, and occasionally treasury or the director of central intelligence (DCI), depending on the topic’s subject matter. The PRC’s portfolio centered upon regional and topical foreign policy issues, defense policy, and international economic matters. Brzezinski convinced Carter that the SCC, theoretically the lower subgroup, did not need a department head in the chair and that he, Brzezinski, should run it. While the PRC dealt with the more general issues, the SCC’s responsibilities for intelligence activities and covert operations, arms control policy—most importantly SALT—and crisis management in such spots as Iran made it in many instances the place where the action was, placing Brzezinski at the center of it all. According to Brzezinski, on the last day of the St. Simon meetings, the president-elect announced to the rest of the Cabinet that he and Brzezinski had come up with this plan. Given that introduction, the Cabinet members nodded their heads in agreement.<sup>61</sup>

Under the Carter NSC system, the president would request a presidential review memorandum (PRM) providing options and/or unanimous recommendations on a specific national security or foreign policy issue. The request would go to the PRC or SCC depending on which bailiwick the topic fell into. If it went to the PRC, the secretary chairing the meeting would also be responsible for having his staff prepare the paper. If it fell to the SCC, Brzezinski and the NSC staff would take the

lead in drafting the response. For issues that did not require full NSC-level attention, a mini-PRC chaired by the relevant under secretary or a mini-SCC, headed by Brzezinski's deputy, David L. Aaron, would lead the discussion and coordinate the preparation of the PRMs. Whether they were generated by the PRC, SCC, or a mini, PRMs would go either to the full NSC if they had options or directly to the president if they had unanimous recommendations for decision. Brzezinski would draft the covering memorandum of the decisions or recommendations for the president. If neither a consensus nor options could be agreed on, Brzezinski would send a descriptive account of the deadlocked meeting to Carter. Once the president had made his decision, a presidential directive (PD) drafted by Brzezinski or the NSC staff would be signed by Carter and sent to the relevant departments and agencies. For less important issues, Brzezinski would sign a decision memorandum on behalf of the president and send it to the pertinent agency heads. PD 1 and PD 2, issued on Inauguration Day, codified this arrangement.<sup>62</sup>

In retrospect, Vance believed he had made a mistake in allowing Brzezinski and the NSC staff to interpret the thrust of the SCC or PRC discussions for the president in their minutes or summaries of discussion, and even more so in the PDs or action memoranda. He complained that PDs, memoranda of action, or reports to the president were too terse and even incorrect. He bitterly regretted not being more adamant on control of the final papers for Carter. Brown apparently was not as concerned, trusting as he did that Carter would read everything. However, late in the Carter administration, when Brzezinski suggested that he would summarize the consensus of less than crucial SCC meetings for a busy president and leave it up to any dissenters to appeal to the president, Brown remarked, "Well, I hope this isn't like Lincoln's Cabinet, with you feeling that you have all of the votes even if you are in the minority."<sup>63</sup>

How well did Carter and Brown take charge? Compared with previous administrations, the fleshing out of Carter's national security team had been slow. After the Carter administration, however, tardy appointments and confirmations would be the norm. Carter's effort would look much better with hindsight. At the Defense Department, Brown got an especially late start because he did not have his entire team in place until mid-1977. In choosing his key subordinates, Brown tapped former colleagues, scientists, businessmen, lawyers, and academics. Almost none

were his close friends; he met many of them for the first time at the formal interview stage. The NSC system as devised by Carter and Brzezinski theoretically accorded Brown as large a role as Vance's, but not Brzezinski's. Unlike Brzezinski, Brown was not on close terms with the president. Nor would he become a close associate, like Vance, whom Carter eventually considered a friend, in part because of their numerous diplomatic trips together. With the exception of those North Atlantic Treaty Organization (NATO) meetings Carter attended, Brown rarely traveled with the president. Still, Brown had Carter's respect and admiration for his intelligence and abilities. Their working relations would not always be smooth, but Brown proved to be a loyal and conscientious Cabinet officer and a trusted adviser on defense policy.



## The FY 1978 Defense Budget and the B-1 Bomber Decision

AS AN EARLY ORDER OF BUSINESS, the Carter administration reviewed the FY 1978 Defense budget that it inherited from President Gerald Ford and Secretary of Defense Donald Rumsfeld. During the 1976 presidential campaign, candidate Jimmy Carter had promised to cut \$5 billion to \$7 billion of “waste” from defense spending. Although Secretary of Defense-designate Harold Brown had tried to dampen expectations of immediate savings of that magnitude, White House domestic advisers pressed for reductions. During their first week in office, Secretary of Defense Brown, Office of Management and Budget (OMB) Director Thomas B. “Bert” Lance, and their staffs deliberated and agreed to cut almost \$3 billion from the Defense budget. Brown outlined to the president the reductions, mostly cosmetic or derived from postponements (“stretchouts” in budget lingo) in production of weapon systems, but warned that more reductions would have to wait for later budgets.<sup>1</sup>

On Monday, 31 January 1977, Carter met with his advisers to review the cuts that Brown and Lance had recommended. Staffs at the Office of the Secretary of Defense and OMB had labored all of Friday and Saturday to prepare briefing books and transparencies for the meeting. They expected the president to look only at the five summary graphs on major issues. The meeting began at 4:33 p.m. in the Cabinet Room of the White House, with the president flanked on his right by Secretary of State Cyrus Vance and Zbigniew Brzezinski, the special assistant to the president for national security affairs (better known as the national security adviser), and on his left by Brown and Deputy Secretary of Defense Charles W. Duncan Jr. Across the table sat Lance with other OMB and OSD officials. Carter scrutinized the first summary chart on strategic forces and then asked for more details. For the next six

hours and nine minutes the president looked at all 45 of the detailed transparencies and the remaining four summary ones, peppering presenters with questions but never giving any indication of whether he agreed or disagreed with their answers. After the last viewgraph and the president's final question, the participants staggered out of the meeting at 10:42 p.m. Past presidents had generally left the details of the Defense budget review to the OMB staff; in fact, one OMB veteran was taken aback at Carter's attention to detail at this first meeting.<sup>2</sup>

More surprising, the president eventually accepted every Brown-Lance recommendation. Why had Carter subjected the national security leadership to such a marathon meeting? At the earlier 27 January meeting of the National Security Council, Carter announced that no defense program or line item was "sacrosanct," including personnel levels. He declared his intention to make decisions on major new weapon systems, involve himself early in the budget process, and understand the process fully, including decisions on items resolved without him. In effect, Carter used the 31 January budget meeting to put the Defense bureaucracy on notice that he would scrutinize their submissions.<sup>3</sup>



National Security Adviser Zbigniew Brzezinski, Budget Director Bert Lance, and Defense Secretary Harold Brown review the FY 1978 DoD budget, February 1977. (Carter Presidential Library)

Carter considered the Defense budget important for good reason. The planning, presentation, debate, analysis, and passage of the budget represented one of the most significant annual actions of the federal government, and was certainly one of its most complicated and exhaustive processes. Formulation of the budget within the Department of Defense usually took about 18 months, followed by brief but intense negotiations with the White House and OMB. Finally, the secretary of defense and other DoD officials spent a cumulative total of weeks testifying before congressional committees.<sup>4</sup> Over a period of months Congress listened to testimony, deliberated in public sessions, made deals behind closed doors, authorized weapon systems, and appropriated funding. Crucial to national security, the Defense budget was second only to Social Security and other income security nondiscretionary programs of the Department of Health, Education, and Welfare as the largest expenditure by the U.S. government. DoD's FY 1978 budget represented 56 percent of all discretionary U.S. annual spending for that year. The question of "how much is enough" perennially sparked defense spending debates. Too little could lead to a national security disaster; too much could have serious domestic social and economic consequences. Furthermore, a good part of the DoD budget went for development and acquisition of weapon systems that would not be in service for years and would remain in the arsenal for decades. Budget decisions on weapons had long-term consequences.<sup>5</sup>

### **The Ford-Rumsfeld FY 1978 Budget**

In its last year the Ford administration engaged in a spirited internal dialogue about the size of the Defense budget and the nature of the Soviet military threat. Ford's new director of central intelligence, George H. W. Bush, agreed in 1976 to issue security clearances to outside "experts" so they could prepare a "competitive analysis" of the Soviet military threat based on the same information that CIA analysts possessed. Team A, the regular CIA Soviet strategic analysts, prepared their annual National Intelligence Estimate (NIE) on the net assessment of the U.S. and Soviet military balance. Using the same data, Team B, the outside consultants, among them Professor Richard E. Pipes of Harvard University, former Deputy Defense Secretary Paul Nitze, and retired Army Lt. Gen. Daniel O. Graham, prepared their assessment. Team B held a generally more alarmist view of the Soviet military threat and the recent improvements to the Soviet Union's conventional and strategic forces. Not surprisingly, its members concluded that the Soviet Union's

military strength represented a serious and dangerous threat to the United States. They maintained that the CIA's current and previous assessments of rough military parity between the two superpowers were wrong; rather, the Soviets had gained or were about to gain military superiority and would use the advantage to achieve their global objectives.<sup>6</sup>

The debate went public. Former California governor Ronald Reagan sounded the alarm on speaking tours and with public statements on the inadequacy of U.S. defense and the dangers of *détente*. Senator Scoop Jackson intensified his campaign against ongoing SALT II negotiations and *détente*. Several former Nixon-Ford officials and distinguished bipartisan former cold warriors joined the chorus. They organized themselves into a committee, which after the election in November announced itself as the reconstituted Committee on the Present Danger. The committee contended that *détente* and strategic arms limitation talks were leading the United States down the path of military inferiority to the Soviet Union. The Ford administration bent to these pressures for more defense spending and less trust in Moscow. *Détente* virtually disappeared from the administration's public vocabulary, Henry Kissinger's star diminished, and SALT II negotiations were suspended until after the election.<sup>7</sup>

Faced with candidate Carter's charges that he relied too heavily on *détente* with the Soviets and at the same time was wasting too much money on defense, Ford tried to walk a fine line, seeking a DoD budget lean enough to counter criticisms of waste while designing a five-year defense program robust enough to calm the anti-*détente* and too-little-defense critics from both parties. For FY 1978, Ford proposed an increase of \$12.9 billion (about 4 percent in nominal terms) in Total Obligational Authority (TOA) over FY 1977 (which saw a modest rise over the FY 1976 budget) and a five-year budget plan that would include substantial across-the-board additional spending. In his final annual budget message to Congress in January 1977, Ford noted that "after several years of decline" the last two years had seen "real spending [increases] for national security purposes." The outgoing president hoped for continued increases in defense spending, adding that his FY 1978 budget and the five-year plan recognized that "we must plan for defense systems we will need 10 years from now."<sup>8</sup>

The president sets the tone for the Defense budget, but the secretary of defense explains and defends it. Secretary Rumsfeld, at 43 the youngest person to hold the

job, was ready for the challenge.<sup>9</sup> He laid out the rationale for increasing spending on 17 January 1977 in an annual report to Congress that read as if it had been prepared by the Committee on the Present Danger. Immediately below a chart indicating that 1976 Soviet military outlays were \$150 billion in constant U.S. dollars as opposed to the \$104.5 billion spent by the United States in FY 1977, the executive summary stated: “The Soviet Union, whatever its purposes, is without question engaged in a serious, steady, and sustained effort which, in the absence of a U.S. response, could make it the dominant military power in the world.”<sup>10</sup> Obviously the secretary did not write the annual report, although as Rumsfeld told the news media, “It is the product of a great many hours by a good many people. I have personally spent many, many hours and days on it.”<sup>11</sup>

The Ford administration planned the FY 1978 budget to be the start of a sustained effort to raise DoD spending between 4 percent and 5 percent annually in constant dollars through FY 1982. To critics this “Christmas tree” budget and five-year wish list relied on highly optimistic and unrealistic assumptions, such as small deficits each year leading to a balanced federal budget in 1980, a decrease in inflation, high economic growth, and new efficiencies in operations, many of which would supposedly be attained through politically unlikely military base closings.<sup>12</sup>

In all fairness, the Ford FY 1978 budget and its related five-year plan addressed some serious deficiencies and problems in the military establishment. U.S. weapon systems needed updating because diversion of funds to operations during the Vietnam War had starved research and development (R&D) as well as weapons acquisition. Immediately after the war, however, it was hard to convince Congress or the public that money should be spent on a new generation of weapons. The All-Volunteer Force necessitated additional personnel costs—decent pay and housing, enlistment and reenlistment bonuses—that were not needed with the draft. The military services lined up their key requests for new weapons: replacement of World II ships and more ballistic missile submarines for the Navy; more tactical fighters, a new penetrating bomber, and a new missile to replace the Minuteman missile systems for the Air Force; for the Army, new tanks, personnel carriers, and attack helicopters. Many of the services’ current weapons were reaching the end of their life cycles. How many new systems could the United States afford and how soon?<sup>13</sup>

The Ford-Rumsfeld FY 1978 budget also sought to attract a new generation of soldiers, sailors, marines, and airmen to maintain and employ these new systems by allocating a 4.5 percent increase (total \$25.6 billion) in pay and benefits over the FY 1977 budget for 2,090,000 active-duty personnel. Retirement pay for the 1.1 million military retirees would rise from \$8.2 billion in FY 1977 to \$9.1 billion for FY 1978 with projected costs by 1982 of \$12.1 billion. Outlays for 1,031,000 civilian workers would go from \$17.6 billion to \$18.6 billion for the same period. Although DoD had fewer military personnel (40 percent less) and civilians (25.9 percent less) on its payrolls than in 1968, it was paying them and military retirees more in constant dollars. Military personnel (along with other federal workers) received pay based on compatibility with their counterparts in the private sector after 1967, increasing their annual salaries beyond the inflation rate to catch up with nongovernment workers. The military retirement system also provided adjustments for inflation for the large bulge of World War II and Korean War-era military retirees who had or would soon reach retirement age.<sup>14</sup>

Development and procurement of new weapon systems represented a large budget item, amounting to \$35.1 billion (25.8 percent over the previous fiscal year) for FY 1978. New weapon systems or upgrades accounted for \$23 billion, or 65 percent of the procurement budget, including conversion of one naval ship; the purchase of 25 new vessels, 697 aircraft, 45,830 missiles, and 3,148 tanks and other tracked combat vehicles; and continued development of new weapons.<sup>15</sup> The five-year plan placed special emphasis on shipbuilding, proposing to add a total of 157 ships to the Navy by 1982. Ships were expensive, especially the nuclear Trident-equipped SSBN, the new cornerstone of the U.S. submarine-launched strategic missile deterrent, which at \$1.646 billion apiece was five times more costly than a Polaris-carrying submarine. The Ford administration proposed constructing two *Ohio*-class submarines in FY 1978 and six more during FYs 1979–1982. It also proposed launching two nuclear-powered *Los Angeles*-class antisubmarine warfare (ASW) submarines at \$280.5 million apiece in FY 1978 and six more through FYs 1979–1982, plus 11 conventionally powered guided missile frigates of the *Oliver Hazard Perry* class (FFG-7) at \$185.1 million each in FY 1978 and another 45 through FY 1982. The Navy would also receive two new nuclear-powered strike cruisers (CSGNs) armed with the Aegis advanced antiaircraft and antimissile system, the long-range tactical Tomahawk surface-to-surface missiles, the Harpoon missile for shorter ranges, and several vertical takeoff and landing (VTOL) aircraft.<sup>16</sup>

Under the five-year plan the Air Force would undergo a major upgrade. The B-1 bomber program, costing \$93.4 million per unit, 12 times more expensive than the B-52 Stratofortress strategic bomber, had four aircraft prototypes in testing, but Ford's five-year plan called for another eight in FY 1978 and a total of 244 by the end of FY 1982. To upgrade U.S. tactical aircraft, the budget and plan proposed an almost \$70 billion program for 2,000 aircraft, bringing the total number in the U.S. inventory to 5,300 by the end of FY 1982. This included the Navy's F-14A Tomcat and F/A-18 Hornet strike fighters at \$24.5 and \$16 million per unit respectively; the Air Force's F-15 Eagle all-weather tactical fighter and F-16 Fighting Falcon at \$16.8 million and \$9.9 million each; and the Air Force's A-10 Thunderbolt close combat support aircraft costing \$6.1 million per unit. The most expensive missile program in the budget, the MX system, was still in research and development but promised to be a highly accurate ICBM with a warhead that held multiple independently targetable reentry vehicles (MIRVs). The system would be deployed on a mobile basing mode. The 300 planned MX missiles were expected to cost about \$35 billion. The Army's major weapons upgrade, the XM1 tank (later known as the Abrams), at \$1.5 million apiece, would replace the Army's M60 tank at 2.5 times the cost per unit.<sup>17</sup>

The budget included an increase in spending for research, development, and test and evaluation (RDT&E) to offset the dearth of funding for such purposes during and after the Vietnam War. The budget proposed a \$12.044 billion in TOA for RDT&E, a 41 percent increase over the FY 1975 level. The U.S. technology base, which included funding for the Defense Advanced Research Projects Agency (DARPA), would receive \$1.88 billion of RDT&E's total money on the grounds that it was key to maintaining technological advantage over the Soviet Union. Ford's electoral loss left his budget to the Carter team, but it created a benchmark against which Carter's defense spending would be judged.<sup>18</sup>

### **Carter's Modification to the FY 1978 Budget**

Before Inauguration Day, Pentagon officials prepared briefing papers for the president-elect. Bristling with facts, figures, intelligence findings, charts, and graphs, the papers acknowledged the rough U.S.-USSR equivalence in strategic nuclear forces but saw the scale beginning to tip toward the Soviets. The Air Force warned that U.S. Minuteman missiles were increasingly vulnerable to the newer Soviet ICBMs, and that the Soviets were hardening their military and industrial targets.

The Navy cautioned that American superiority at sea faced a challenge from the Red Navy because of the decline in the number of U.S. ships since 1968. The Army stated that Soviet tanks, artillery, and other conventional weapons placed U.S. and NATO troops at a disadvantage in a nonnuclear war in Europe. Director for Defense Research and Engineering Malcolm R. Currie reported that the Soviets had outspent America on military research and development over the previous six years. According to Currie, the only reason the United States still enjoyed a lead in technology derived from the longstanding partnership between private industry and government. The problems of the All-Volunteer Force were highlighted for Carter. After successful recruiting in 1973–1975, the services were having trouble meeting their quotas and were down to 19,000 below planned strength. The Navy predicted a 4,500 personnel shortfall for FY 1978. The Army worried about the falling quality of its recruits, of which only 56 percent were high school graduates, and the sensitive issue of a future Army potentially composed of mostly undereducated recruits from low socioeconomic levels loomed.<sup>19</sup>

The Joint Chiefs of Staff (JCS) scheduled a face-to-face briefing with Carter to highlight these deficiencies, but the president-elect cancelled the session. Instead, Brown sent Carter copies of the JCS briefing slides, informing him that “although I agree with much of the presentation, parts of it (especially the comparison with the USSR) are presented in a way that can be misleading.” If Brown was wary, Carter and most of his White House team were thoroughly skeptical, and remained eager to slash what they considered to be a bloated defense establishment.<sup>20</sup>

Time was not on their side. Under tight deadlines to submit a budget to Congress, the administration had a short window to modify the Ford FY 1978 budget.<sup>21</sup> Carter instructed Brown to “eliminate those programs that contribute marginally to our security” and defer others if their value was questionable. Lance, Brown, and their OMB and OSD teams quickly finalized proposed cuts.<sup>22</sup> To meet congressional deadlines, the Carter administration submitted the Ford FY 1978 budget to Congress on 25 January 1977, but promised revisions. Aware of the broad scope of Brown’s tentative reductions through their informal contacts, most senators asked specific questions about weapon systems. Brown previewed expected changes, indicating an increased emphasis on combat readiness, procurement, and research and development coupled with reductions from stretching out planned production of aircraft and ships—the big ticket items in



the Ford-Rumsfeld budget. Brown would return in late February with revisions to the budget.<sup>23</sup>

Review of Brown's proposed revisions following the 25 January budget submission fell to service secretaries, the assistant secretaries, the military chiefs of staff, selected uniformed operations staff and financial staff, and, in most cases, JCS Chairman General George S. Brown. After making a preliminary decision, Secretary Brown gave the services less than a week to submit their reclaims. He then made decisions based on their appeals and held another smaller meeting with the relevant service secretary, the military chiefs of staff, and two or three staff members from OSD to refine the final recommendations for reductions to the president. Given the short preparation and appeal time, and the Carter administration's pressure for cuts, the major outlines of the budget reductions basically remained the same.<sup>24</sup>

On 26 January, Brown informed the president of proposed budget revisions in four areas: stretchouts in development or production of strategic weapons programs (B-1 bomber, MX missile program, and cruise missiles), in tactical fighter aircraft, in the Navy's shipbuilding program, and in increased funding for NATO readiness and mobility programs. Looking beyond the immediate FY 1978 Defense budget, Carter envisioned a "long-term assessment of defense expenditures, and particularly of the trade-offs between new weapons and the possible consequences on the strategic as well as conventional US/Soviet [military] equation."<sup>25</sup> On 18 February, Brown sent the president his recommendations for immediate reductions of \$3.357 billion in some areas and increases of \$605 million in others for a total reduction of \$2.752 billion in budget outlays for FY 1978. Four days later Carter approved the revisions, expressing through Brzezinski his unqualified support for them.<sup>26</sup>

The 31 modifications (26 reductions plus 5 increases) represented only a 2.3 percent reduction in TOA (money for FY 1978 and money authorized but unspent from previous fiscal years). The \$400 million cut in outlays represented only 0.4 percent of FY 1978 proposed expenditures.<sup>27</sup> Furthermore, 80 percent of the reductions came from tactical or conventional weapons, only \$493 million from strategic weapons. Four programs were slated for elimination or cancellation: the nuclear-powered strike cruiser, the Navy's final six A-7E Corsair tactical close air support aircraft, the Army's 360 nonnuclear Lance missiles, and the Uniformed Services University

**Table 1. Carter Modifications to the Ford Defense Budget, FY 1978 (\$ millions)**

Program	Modification	Savings/Increases
<b>Reductions</b>		
<b>Strategic</b>		
MX missile	Defer development	160
B-1 bomber	Reduce procurement (8 to 5)	280
Follow-On Interceptor	Defer procurement	26
Ballistic missile submarine	Defer overhaul	27
Subtotal		493
<b>General Purpose</b>		
F-15 fighter	Reduce procurement (108 to 78)	334
CH-53E helicopter	Defer procurement	62
ATCA tanker/cargo aircraft	Defer procurement	277
AAH antitank helicopter	Slow development	100
Lance missile	Terminate program	78
A-7E attack aircraft	Terminate program	24
AWAC S aircraft	Reduce procurement (6 to 3)	150
Hawk missile system	Defer procurement	35
CSGN strike cruiser	Cancel	187
PHM hydrofoil	Cancel LST conversion	43
Missile frigate	Reduce procurement (11 to 9)	282
Attack submarine	Reduce procurement (2 to 1)	230
Service Equipment	Adjust delivery schedules	893
Subtotal		2,695
<b>Management &amp; Operational Efficiencies</b>		
Retirement	Defer reform	25
University of the Health Sciences	Close	14
Naval Reserve	Paid drill reductions	50
Flight operations	Improve efficiency	55
Intelligence activities	Improve efficiency	25
Subtotal		169
Total, savings through reductions in programs		3,357
<b>Additions</b>		
Aircraft survivability	Additional facilities	60
Maintenance of equipment in Europe	Additional facilities	50
Civil Reserve Air Fleet	Increase modifications (4 to 8)	15
Maintenance of weapon systems	Reduce backlog	280
Domestic bases	Increase construction	200
Total, increases through additions to programs		605

Source: DoD Press Release 72-77, 22 February 1977, *Public Statements of Harold Brown, Secretary of Defense, 1977*, 3:1036-1060, OSD Historical Office.

of the Health Sciences, about to enroll its first class of students. Brown also cut \$70 million in naval ship conversions and overhauls.<sup>28</sup>

The stretchout of weapons programs provided the bulk of the savings. Delaying the MX missile program by a year saved \$160 million. Reducing the number of planes and ships brought further savings in FY 1978: 5 instead of 8 B-1 bombers (\$280 million cut); 78 instead of 108 F-15s (\$334 million cut); 3 instead of 6 Airborne Warning and Control System (AWACS) aircraft (\$150 million cut); 9 instead of 11 frigates (\$282 million cut); and one *Los Angeles*-class submarine instead of two (\$230 million cut). Increases of \$605 million included \$280 million to reduce the backlog of deferred maintenance for all services and \$200 million for formerly deferred domestic military construction projects.<sup>29</sup> See table 1, page 36.

### Rescissions to the FY 1977 Budget

Not only did Brown inherit the Ford budget, he also assumed responsibility for the Ford administration's rescissions and deferrals (which had yet to be approved by Congress) to the FY 1977 budget. The major rescissions occurred in shipbuilding: \$350 million for long lead time components for the Navy's new *Nimitz*-class nuclear-powered aircraft carrier and \$371 million for an Aegis conversion of the USS *Long Beach*, the first nuclear-powered guided missile cruiser launched in 1959. The other two rescissions involved \$143.6 million in pay for retired military personnel and \$14.4 million of the Air Force's terminated Advanced Logistics System. In addition, the Ford administration planned to defer \$387.7 million in military construction. When Brown testified before the House Committee on Appropriations (HCA) on 17 February 1977, he announced that the administration would reprogram \$268.4 million of the \$350 million rescission, using the money for spare parts for the nuclear carriers (CVNs) USS *Enterprise* and USS *Nimitz*, already in service, as well as the USS *Eisenhower*, scheduled for delivery in October 1977. That decision would keep the production line open whether or not a fourth nuclear carrier (the third of the *Nimitz* class) followed. The other Ford rescissions and deferrals remained.<sup>30</sup>

Brown's testimony before the HCA, a hotbed of supporters of large nuclear-powered carriers, revived a debate from the previous year on the future of aircraft carriers. The Ford administration had recommended building two medium-size (40,000 to 50,000 tons) conventionally powered aircraft carriers (CVVs), with planes

that could take off and land on a short deck, instead of adding another 90,000-ton *Nimitz*-class carrier. Committee proponents of nuclear supercarriers queried Brown, Duncan, and Chief of Naval Operations Admiral James L. Holloway III on whether that decision would jeopardize U.S. security. Brown answered no; he considered the two smaller nonnuclear carriers a better option. Duncan echoed his boss' view, as did Holloway, who added that he had recommended the fourth CVN to President Ford but now had changed his mind. Later in his testimony, Brown suggested that the age of the aircraft carrier was passing. In 20 years, he believed, many of their jobs would be done by cruise missiles, advanced tracking, detection, and identification of targets by satellites and radio transmissions. Brown opposed conversion of the nuclear-powered *Long Beach* to the Aegis system, suggesting that conventionally powered guided missile destroyers of the new DDG-47 class offered a faster way to get this advanced combat system into the fleet. Brown recommended placing Aegis on a nuclear ship later.<sup>31</sup>

In March 1977 Congress moved on the FY 1977 defense rescissions in earnest. Secretary Brown and General George Brown gave extensive testimony before the House Committee on Armed Services (HCAS) on 2 and 3 March. The future of the nuclear carrier program was very much on members' minds. Admiral Hyman Rickover, the president's one-time boss and idol, had broken with Carter over postponement of the fourth *Nimitz*-class carrier and the decision to drop the *Long Beach* conversion. After the House Appropriations Committee voted 24 to 23 to rescind funding for these projects from the FY 1977 budget, the full House on 3 March soundly defeated amendments to restore funds for the carrier and *Long Beach* conversion. It then voted by voice to pass H.R. 3839, which accepted the rescissions as outlined by the Carter administration. This vote stymied the proponents of large carriers and other nuclear ships, but only for the FY 1977 budget. The Senate passed H.R. 3938 (P.L. 95-15) by voice vote without amendments, rescinding a total of \$664 million from the FY 1977 budget, including \$81.6 million for the CVN and \$371 million for the *Long Beach* conversion.<sup>32</sup>

### Hearings on the FY 1978 Revisions

Brown reported to Carter that his 22-23 February 1977 testimony on the FY 1978 budget before the House Appropriations Committee "focused on rationale for our amendments to the Ford budget, particularly the B-1, MX, A-7E, and Minuteman

III, and the slowdown in procurement of certain aircraft. Congressman [Elford A.] Cederberg [R-MI], speaking for the minority, characterized the Defense budget reductions as 'political budgeteering,' adding that the slow-down in procurement will only add to our costs in the long run." Brown assured the president that "overall, however, the sessions were amicable, and the Members, I believe, understand the reasoning behind the revisions."<sup>33</sup> Brown and General Brown then testified before the Senate Committee on Armed Services (SCAS) on 24 February. Senator Howard W. Cannon (D-NV), a former World War II bomber pilot and major general in the Air Force Reserve, bore in on the F-15 deferrals. The secretary explained that while the F-15 was a high-quality aircraft, some of its armament systems had problems. Given cost overruns in the program, a mix of F-15s and less costly fighters would be a better alternative. Cannon suggested that the F-15, AWACS, improved Hawk missile system, the shoulder-held Stinger missile, and the advanced attack helicopter (AAH) were "first line major weapons systems that had achieved good measure of production stability." Cannon suggested that the Carter administration was disrupting their production based on either superficial analysis or to redeem campaign promises of budget cuts.<sup>34</sup>

Another senatorial expert on the Air Force, Barry Goldwater, told Brown, "I am very disturbed by what seems to be the attitude of this administration to new weapons." While Goldwater accepted the proposed production slowdown from eight to five B-1 bombers, he tried to pin Brown down on a total purchase figure. Brown reminded Goldwater that the cut was only an interim measure and the ultimate fate of the B-1 program remained undecided.<sup>35</sup>

Senator Dewey F. Bartlett (R-OK) questioned the termination of the Army's Lance missile on the grounds that it would lessen NATO's firepower in the face of new, longer-range Soviet artillery. Brown conceded that the Lance was a solution, but not the best one. With a less lethal radius warhead than its nuclear version, the conventional Lance had to be stationed closer to the edge of battle where it was more vulnerable. Brown considered the nonnuclear Lance a "makeshift solution" and favored the new General Support Rocket System as a potentially better alternative. Senator Edwin J. "Jake" Garn (R-UT) mounted a defense of the Minuteman III missile program. The Ford administration had planned to procure five additional missiles, but the Carter administration proposed ceasing production and applying the money saved to the purchase of components for existing missiles. Besides an

admittedly “parochial interest” of the 3,700 people in Utah who would assemble the Minuteman IIIs, Garn suggested it was a mistake to end this program when the Minuteman II was aging. Brown responded that while no Minutemen IIIs would be built, the capability of the existing Minutemen would be upgraded.<sup>36</sup>

Toward the end of the hearing, Cannon questioned slowing down the development of the Army’s advanced attack helicopter. Brown responded that he was not convinced that the AAH had the “survivability” to fulfill the role intended for it in a European battle given the weakness of its airframe to infrared surface-to-air missiles. Cannon tried to enlist General George Brown’s support for the AAH, but the JCS chairman stated that “the potential future of ground launched missiles really leaves the question a nagging worry.”<sup>37</sup>

Asked by Cannon if the Joint Chiefs individually supported the Carter modified budget, General Brown responded that they did, “even though they did not win on some items. They would have had it a different way, but they support the budget.”<sup>38</sup> These two hearings only began the process. As Brown informed the president, he was scheduled to testify five more times in the next eight days, complaining that “the burden of almost daily testimony greatly diminishes the time available for department matters, a particularly serious problem in the absence of assistant secretaries of defense on board to share the load.”<sup>39</sup>

Such time-consuming congressional testimony requirements followed the process outlined by the 1974 Congressional Control and Impoundment Act (P.L. 93-344). Under this law, six committees—Budget, Armed Services, and Appropriations of the House and Senate—acted on the Defense budget. First, the budget committees of the House and Senate determined federal revenues and spending levels to serve as guidance for authorizations and appropriations, and then passed concurrent resolutions that set nonbinding targets for spending. The first resolutions were due by 15 April. The House and Senate would then vote on them by 15 May. Next, Congress would approve authorization bills for weapon systems by early June; the appropriation committees would complete appropriation bills by mid-June; Congress would approve the appropriations by Labor Day; the budget committees would complete a second set of concurrent resolutions by 15 September that the House and Senate would approve; and finally Congress would approve the budget by 25 September.<sup>40</sup>

In theory, that was how the process was supposed to work, but it almost came apart at the start. In early April 1977 the House Committee on the Budget reported

its nonbinding total budget figures amounting to \$2.3 billion less in outlays and \$4.15 billion less in TOA than the \$111.9 billion in outlays and \$120.1 billion in TOA that the Carter administration had requested for defense. In a session that began on 27 April and extended into the morning hours of the next day, the full House voted down the budget committee's recommendations, the first time they had been rejected since the Budget and Impoundment Act had been instituted in 1975. An amendment by Omar Burleson (D-TX) sought to restore the budget, but House liberals revolted on the grounds that the equilibrium between social programs and defense had been compromised. They joined forces with fiscal conservatives, who believed the federal deficit was too high, to defeat the amended resolution by a vote of 320 to 84.<sup>41</sup>

In the aftermath, House congressional leaders did not mince words about who was to blame for the defeat. Speaker Thomas P. "Tip" O'Neill (D-MA) complained that Brown had pulled an "end around play" by working with Burleson to restore the defense cuts. Chairman of the Budget Committee Robert N. Giaimo (D-CT) stated: "This is the United States Congress. . . . Not the Georgia Legislature. . . . You don't just call from downtown and send word from the secretary of defense to the Armed Services Committee members and others and just say, 'write a resolution.'" In fact, Brown and Duncan had done just that. As Duncan told the president before the vote, "Both Harold and I have been contacting members of the [House Budget] committee to solicit support of full funding of our request. However, we expect the vote to be close." After the House's rejection of the concurrent budget resolution, Brown told Carter, "Although I did not 'sponsor' the Burleson amendment, I did provide, at his request, a letter stating that I continued to support your budget request. Moreover, I orally suggested to him, as a tactical matter, a \$2 billion restoration of budget authority on the Floor, followed by a compromise in conference with the Senate Committee on the Budget to restore another \$1 billion, would be a reasonable compromise."<sup>42</sup>

The flap over Brown's "interference" was intense but short-lived. Senate and House Budget Committees prepared new compromise budget resolutions that passed the full Senate and House on 4 and 5 May respectively. In conference, participants agreed upon a compromise of \$118.5 billion in TOA and \$111 billion in defense outlays (essentially splitting the differences between Senate- and House-approved levels). On 13 May the Senate approved the nonbinding conference levels for the total budget including the defense compromise. The House

followed suit on 17 May by a vote of 221 to 117, with 29 Republicans joining 192 Democrats in favor and 10 Democratic liberals joining 107 Republicans opposing the final version. Four months later, the House and Senate passed the binding FY 1978 budget levels, resulting in a projected \$61.25 billion federal deficit.<sup>43</sup>

### Passage of the FY 1978 Defense Authorization Act

With a target for a total budget including defense spending established, Congress could get down to passing the DoD budget. The House and Senate Armed Services Committees had to recommend how much to spend on development and procurement of aircraft, weapons, and naval vessels; research, and civil defense before the total Defense budget could be appropriated. On 7 April the HCAS reported H.R. 5970 (House Report 95-194) authorizing \$35.9 billion (about 30 percent of the entire Defense budget) for procurement of weapons, military research, and civilian defense. Funding almost \$61 million more than Carter had requested, the bill included earmarks, deadlines, and requirements that in effect micromanaged the development and procurement process. While accepting the deferrals and terminations that the Carter administration recommended (the B-1, the MX missile, and an end to Minuteman missile production), the committee considered the administration's shipbuilding program "grossly inadequate." It approved lowering the number of *Perry*-class frigates from 11 to 9 and the construction of a conventionally powered Aegis destroyer. It authorized FY 1978 funds for a nuclear reactor for an Aegis strike cruiser to be ordered in FY 1979, restored the number of nuclear attack submarines from one to two, but authorized construction of three more reactors for yet-to-be funded submarines. To offset some of these increases, the committee cut delivery of noncombat ships.<sup>44</sup>

The committee restored funding for the Army's nonnuclear Lance missile and the attack helicopter. It cut funds to modernize any more M60 tanks and insisted that the Army replace all M60 tanks in Europe with XM1 tanks by 1987 on the grounds that M60s could not stand up to superior Russian tanks. The Air Force received more airlift capability, including six new advanced tanker/cargo aircraft and 16 more C-130 transports that neither the Ford nor the Carter administrations had requested.<sup>45</sup>

Some of the HCAS's lesser revisions would become contentious. It eliminated outright, on the grounds it was superfluous to the Navy's needs, a plan to lay 2,400



miles of underground cable in Michigan's Upper Peninsula for the Seafarer submarine communications system. The plan, which would have created environmental problems, was strongly opposed by politicians in Michigan and Carter as a presidential candidate. The HCAS cut \$38 million from the \$362 million request for the Air Force and Navy cruise missile development programs, suggesting that some of the funding could be recouped by consolidating the two programs. Citing the large Soviet expenditures for protecting its civilian population from nuclear war, conservatives on the committee increased funding for civil defense by 50 percent to create a regional emergency headquarters. The HCAS rejected the administration's plans to cut the Naval Reserve from 93,600 to 52,000. H.R. 5970 passed the House with no additional substantial amendments by a vote of 347 to 43, with House liberals supporting it.<sup>46</sup>

The Senate Armed Services Committee report on the authorization bill H.R. 5970 (Senate Report 95-129) added almost one billion dollars to the Carter ship-building budget and left open the option of whether to build a CVN or CVVs. The committee also required a general review, especially of the value of aircraft carriers, before the FY 1979 Defense budget submission. It restored funds for developing the fifth CVN to preserve options and approved funds to design a new CVV as well as a smaller carrier with vertical/short takeoff and landing (V/STOL) aircraft. It reduced the *Perry*-class frigates from nine to eight, but added \$619 million for two large *Spruance*-class destroyers modified to carry antisubmarine helicopters or aircraft. The committee demanded that the Navy continue development of a large experimental antisubmarine surface ship that would ride on a cushion of air and achieve speeds of 100 miles per hour. Nonnuclear attack submarines might be a better alternative, the committee suggested, to expensive nuclear ones.<sup>47</sup>

The Senate committee was not as generous to the Air Force and the Army. It accepted the administration's B-1, F-15, and AWACS deferrals and the MX missile slowdown, deferral of decision on a tanker/cargo air transport, and refusal to fund modifications to civilian aircraft to make them ready for emergency transport. It cut \$10 million of the \$25 million for a new medium-range transport based on the Hercules C-130 cargo transport plane. The Army's purchase of transport helicopters (the Utility Tactical Transport Aircraft System, or UTTAS) was reduced from 56 to 24 and M60 tanks from 859 to 664, but the Lance missile was restored and the XM1 tank's development kept on track. Unlike its House counterpart, the Senate committee recommended only a \$5.25 million increase to the \$90 million request

for civil defense, kept Seafarer on life support with \$20 million, and reduced the administration's requested active-duty personnel ceiling by 17,100 and the Naval Reserve from 96,500 to 76,400. In its shortest debate on a defense authorization bill since 1967, the full Senate passed H.R. 5970 by a vote of 90 to 3.<sup>48</sup>

There had been significant political changes in the House and, to a lesser extent, the Senate that related to defense issues. The former chairman of the House Armed Services Committee, F. Edward Hébert (D-LA), a staunch ally of the Pentagon, retired in 1976 and was replaced by C. Melvin Price (D-IL), still a friend to DoD, but less willing to dominate his committee on its behalf. The House committee contained Democratic liberals, such as Lucien N. Nedzi (D-MI), Charles H. Wilson (D-CA), Robert L. Leggat (D-CA), Leslie "Les" Aspin (D-WI), Patricia S. Schroeder (D-CO), Milton R. "Bob" Carr (D-MI), and Thomas J. Downey (D-NY), who proved increasingly willing to challenge DoD. As Brown told the president, "I think that all concerned have learned something about the evolving budget process—including the realization that none of the principal actors, the House leadership among them, wields as much power to direct the course of events as he might like." While the SCAS remained friendly under Stennis' leadership, Chairman of the Senate Budget Committee Edmund S. Muskie (D-ME) proved less supportive on defense issues.<sup>49</sup>

After reconciliation, the conference report on H.R. 5970 of 21 June 1977 approved the administration's request of \$35.9 billion for procurement, research and development, and civil defense but rearranged some priorities. The conferees accepted administration production schedules for the B-1, MX missile, and the Trident-equipped *Ohio*-class submarine but insisted that \$81.6 million be spent as a down payment on the fifth CVN and \$35 million be expended for the design of a CVV. The administration's decision on 23 May to request a fifth guided missile cruiser of the *Virginia* class, modified to carry Aegis, defused the differences between the two congressional bodies over a nuclear-powered Aegis cruiser. The conferees authorized \$180 million for a nuclear power plant for the supercruiser expected to cost \$1 billion. The ship lacked other weapon systems and armor that the House's \$1.5 billion version of this nuclear strike cruiser would have had. The conferees accepted the Senate's plan for one nuclear attack submarine, eight *Perry*-class frigates, and the \$619 million for the two *Spruance*-class destroyers with antisubmarine aircraft. The conferees reversed the Carter administration's decision to stop production of the Navy's A-7E Corsair light attack aircraft, insisting that the Navy buy 36 more (12 in FY 1978)—a victory

**Table 2. Major Weapons Authorizations, FY 1978 (\$ millions)**

	Carter Request		House Passed		Senate Passed		Final Action	
	No.	Amount	No.	Amount	No.	Amount	No.	Amount
<b>Strategic Warfare</b>								
B-1 Bomber	5	1,173	5	1,173	5	1,173	5	1,173
Ballistic missile submarine	2	1,703	2	1,703	2	1,703	2	1,703
Trident missile	96	1,133	96	1,133	96	1,133	96	1,133
MX missile	-	134	-	134	-	134	-	134
Cruise missiles	-	362	-	325	-	362	-	349
Missile sub comm	-	24	-	7	-	20	-	25
Civil defense	-	90	-	135	-	95	-	95
<b>Ground Warfare</b>								
XM1 tank	-	295	-	295	-	295	-	295
M60 tanks	859	542	859	542	649	360	800	505
(New rangefinders)	-	36	-	-	-	6	-	6
AAH antitank helicopter	-	100	-	155	-	175	-	165
UTTAS troop helicopter	56	236	56	236	24	115	56	236
Nonnuclear Lance missile	-	-	360	78	360	78	360	78
<b>Airlift</b>								
ATCA tanker/cargo	-	-	6	277	-	-	-	-
C-130 transport	-	-	16	124	-	-	8	62
AMST transport	-	25	-	5	-	10	-	10
<b>Naval Warfare</b>								
Nuclear-powered carrier	-	-	-	-	-	82	-	82
Small carrier design	-	7	-	7	-	35	-	35
V/STOL research	-	41	-	4	-	41	-	23
Aegis cruiser	-	-	-	187	-	663	-	180
Aegis destroyer	1	930	1	930	1	930	1	930
Helicopter destroyer	-	-	-	-	2	614	2	614
Missile frigate	9	1,319	9	1,319	8	1,205	8	1,205
Attack submarine	1	279	2	701	1	279	1	279
<b>Tactical Airpower</b>								
F-15 fighter	78	1,363	108	1,697	78	1,363	108	1,697
F-16 fighter	105	1,503	105	1,441	105	1,503	105	1,503
F-14 fighter	44	907	44	907	36	708	40	756
F-18 fighter	-	627	-	627	-	627	-	627
A-7E attack aircraft	-	-	6	45	12	108	12	108

(Some amounts include funds for spare parts and for advance payments on additional items to be purchased in FY 1979.)

Source: *Congressional Quarterly Almanac, 1977*, vol. 33 (Washington, DC: Congressional Quarterly, 1977), 3.

for the Texas congressional delegations in whose state the plane was built. The conferees authorized \$22.5 million for development of the new VTOL aircraft, half the administration's request but five times what the House was prepared to spend.<sup>50</sup>

For the Air Force, the conferees authorized purchase of 108 F-15 Eagles. They also provided \$15 million for modification of civilian aircraft as transport, but no money for the House's plan to purchase commercial aircraft as military transports. The conferees authorized development of the XM1 tank as requested by the Army and the purchase of 800 A3 models of the M60 tank. The conferees cleared an obstacle to the experimental fighting vehicle (later to become the Bradley fighting vehicle) by requiring, as the Senate had insisted, that it be modified to carry antitank missiles to match Soviet tank superiority. The Army received full production of 56 Sikorsky troop carrying helicopters. Both Houses voted to restore the nonnuclear Lance missile. The conferees funded civil defense at \$95.3 million (\$5.3 million more than the administration requested, but less than the \$134.8 million the House passed) and compromised on 87,000 naval reservists. The House on 13 July passed the conference report by a 350 to 40 margin and the Senate passed it on 14 July by a voice vote. The president signed the Department of Defense Appropriation Authorization Act (P.L. 95-79) on 30 July 1977.<sup>51</sup> See table 2, page 45.

### **Passage of the FY 1978 Defense Appropriations Bill**

While Defense authorization bills generally precede appropriations bills, in this case the two processes overlapped. On 21 June the HCA reported H.R. 7933 (House Report 95-451), providing \$110.1 billion in outlays for Pentagon programs with the exception of military construction (a separate bill), almost \$3.8 billion less than the administration had requested. Since the HCA finished much of its work on H.R. 7933 before the House and Senate conferees reported on the weapons authorization bill, HCA recommendations for weapons and research funding differed from the authorization agreements worked out for H.R. 5970. To further complicate matters, on 30 June 1977 Carter terminated the B-1 bomber program and later successfully convinced the Senate and House to delete \$1.4 billion for the five bombers slated for production in FY 1978. The House debated H.R. 7933 on 24, 28, and 30 June 1977. Attempts by perennial defense critic Representative Joseph P. Addabbo (D-NY) to remove funding for the nonnuclear Lance missile failed. On 30 June the House passed H.R. 7933 by a vote of 333 to 54. A week before the vote Brown correctly

assured the president that he did not “anticipate adoption of any amendments which would seriously affect weapons program.”<sup>52</sup>

In both the Senate Committee on Appropriations (SCA) markup and the Senate debate on H.R. 7933—with the exception of the B-1 bomber battle—personnel issues proved the most contentious. The Senate had the advantage of having passed H.R. 5970, the weapons procurement bill, and did not need to refight weapons battles. The full Senate easily overturned an SCA recommendation of a three-year phase out of subsidies for military commissaries (PXs). Opponents of PXs unsuccessfully argued that military pay was now the equal of civilians in the federal workforce and the perk was unnecessary. The Senate also overturned a ban on double dipping by retired service personnel with pensions over \$6,000 and a freeze of DoD blue collar civilian wages. The Senate approved limiting payments to hospitals and physicians under the military health care system to 75 percent of local customary charges, thus bringing them in line with Medicare and Medicaid, and approved a stipulation that required recipients to pay the first \$60 for hospitalization. The Senate passed H.R. 7933 by a vote of 91 to 2 on 19 July.<sup>53</sup>

The conferees of the two houses agreed to accept the higher House figure of \$213.5 million as opposed to the Senate’s \$39.6 million for development of a faster, second generation air-launched cruise missile (ALCM). The Seafarer project was cut to only \$15 million after Carter assured Congress that the downsized version only required work in Wisconsin and not Michigan. The conferees agreed to fund 780 A3 model M60 tanks at a cost of \$461.6 million but added \$6.3 million to adapt the XM1 tank’s aiming system to the A3 model tank. The Senate had passed almost \$8 million for the 400-mile range, nonnuclear Pershing missiles potentially to attack Warsaw Pact airfields and the new armored personnel carrier, neither of which the House had funded. The conferees appropriated half of the Senate’s funding. Ground-launched cruise missiles (GLCMs) to attack Eastern European targets received \$18.7 million, much closer to the House’s figure than the Senate’s.<sup>54</sup>

The conferees rejected the authorization of \$81.6 million for the nuclear reactor for the fifth CVN, another temporary setback to proponents of large nuclear carriers, but a victory for the administration. The Navy took a second blow when only one of the two authorized destroyers carrying submarine hunting helicopters was funded at \$310 million. The dream of an antisubmarine destroyer traveling at 100 mph on a cushion of air was kept alive when the conferees approved the Senate’s full amount of

\$43.9 million for continued development work. The conferees provided all but \$250 million of DoD's request for \$1.24 billion to cover the cost of inflation in maintenance and operating expenses, but they required that the inflation cushion be used only on tanks, aircraft, and ships. In an experiment the administration had not requested, the conferees appropriated \$100 million for Brown to use at his discretion to enhance combat readiness. Administration hopes for a reduction of military benefits and personnel costs went mostly unrealized. In the end, the conferees allowed a 75 percent payment to physicians for customary local charges for military health care projects. On 21 September 1977 Carter signed the Department of Defense Appropriation Act of 1978 (H.R. 7933, P.L. 95-111), which funded DoD at \$109.75 billion for FY 1978.<sup>55</sup>

The Carter administration's first budget experience had been a mixed success. It obtained from Congress most of the funds it requested. On most of the big issues, naval shipbuilding stretchouts, slowdown of MX missile development, and more money for maintenance and combat readiness, it did reasonably well. It fought off, at least for the time being, attempts by proponents of \$2 billion *Nimitz*-class nuclear aircraft carriers to commit to building another. However, it was unable to kill the non-nuclear Lance missile or the A-7E aircraft, or even the Uniformed Services University of the Health Sciences. The Brown team underestimated the power of individual congressional delegations to preserve weapon system production lines operating in their home states; it was hardly the first time a defense secretary had done so. Even firebrand antidefense legislators usually found religion when the DoD threatened to shut down a weapon system that employed workers in their district. The Carter administration had one huge win during the budget process: the termination of the B-1 bomber, the touchstone for a national debate on defense spending. How Jimmy Carter came to that decision and how he convinced Congress to accept it merits close examination.

### **B-1: The Once and Future Penetration Bomber**

Since 1961 the Air Force had been studying development of a low-altitude, manned strategic bomber to replace existing B-52s and the faltering B-70 bomber program, the latter so plagued by research and development problems and cost overruns that the Eisenhower administration had virtually cancelled it. When President Kennedy's secretary of defense, Robert McNamara, killed the B-70 outright, the Air Force renewed its search for a new manned bomber capable of penetrating Soviet air defenses and delivering a large nuclear payload.<sup>56</sup> After eight years of study, the Air

Force refined the required capabilities of the new bomber: supersonic with swing wings enabling it to fly at subsonic speeds at treetop level to evade Soviet radar air defenses; speed of Mach 1.6 (Mach 2.2 with variable engine inlets installed); offensive avionics and defense avionics—new electronic equipment to find its targets and to foil enemy attacks; a range of 6,000 miles; and the ability to carry a heavy payload of 75,000 pounds of nuclear bombs or 24 nuclear short-range attack missiles (SRAMs). Extended swing wings made it possible to take off from short runways and thus deploy to more airfields worldwide. In June 1969 the Air Force chose Rockwell International Corporation over Boeing and General Dynamics to build the new supersonic B-1 bomber, with General Electric producing the aircraft's four powerful engines, Boeing manufacturing the offensive avionics, and Cutler-Hammer the defensive electronics. After \$1.89 billion in development support from Congress, the first B-1 flew in December 1974. By 1976, with another \$1.25 billion in funding, three prototypes were constructed and tested, and a fourth, with defensive avionics, received funding. Later in 1976 Congress appropriated \$1.03 billion to produce three B-1s and begin long lead-time engineering and purchase of materials for an additional eight aircraft as well as an additional \$500 million for continued research and development on the fourth prototype. But in August 1976 opponents in Congress limited the actual funding of production of the B-1 bombers to \$87 million a month with the stipulation that the next president, whether Ford or Carter, would review and decide the fate of the extremely expensive bomber in February 1977.<sup>57</sup>

The B-1 bomber became an issue in the 1976 presidential election. Since October 1973, a coalition of peace advocates and former anti-Vietnam war protesters led and funded by the American Friends Service Committee, a Quaker peace group, had been running a shoestring, grassroots campaign against the B-1. They confronted Democratic candidates for president about their positions on the B-1, hoping to convince them to oppose it. At a small gathering in Waterloo, Iowa, in August 1975, Robert Brammer of Cedar Rapids, an employee of the American Friends Service Committee, asked Jimmy Carter if, as president, he would build the B-1. Carter gave a politician's answer: he abhorred Pentagon waste, the B-1 was exorbitantly expensive, and he would give the program very careful scrutiny if he were president. While the campaign against the bomber by no means dominated the Democratic primary campaign, peace workers and volunteers kept the issue in the spotlight.<sup>58</sup>

At the urging of his young campaign adviser, Stuart E. Eizenstat, Carter signed off on a white paper for the Democratic Platform Committee in July 1976 that concluded, "Exotic weapons which serve no real function do not contribute to the defense of this country. The B-1 is an example of a system which should not be funded and is a waste of taxpayers' dollars." During the campaign, Ford posed for photos in the cockpit of a prototype, having embraced the B-1 not only as an integral part of the strategic nuclear triad (ICBMs and submarine-launched ballistic missiles [SLBMs] were the other components) but also as a source of new jobs. With Ford closing the gap in the polls, Carter backed away from his earlier opposition to the B-1, stressing that he was open minded and would give the bomber a fair hearing. As a former defense official, Brown was also drawn into the B-1 debate. In April 1976, when president of Caltech, he declined to sign a Federation of American Scientists petition against it, yet he would not go so far as to publicly endorse it. Brown also privately wrote to Senators William Proxmire (D-WI) and John C. Culver (D-IA), leading opponents of the B-1, noting that he had read an Air Force analysis of DoD's 1974 Joint Strategic Bomber Study (highly favorable to the B-1) and the Brookings Institute study on the B-1, directed by two retired Air Force colonels, Alton Quanbeck and Archie Wood, that considered modernized B-52s a better alternative to the B-1s. Brown told Proxmire and Culver that the Air Force analysis "has the better of the argument" than the Brookings study and that the B-1 was "most cost effective."<sup>59</sup>

### **Carter's Decision on the B-1**

Two days after the election, anti-B-1 campaign forces focused their attention on Carter, staging a peace vigil at his house in Plains that coincided with demonstrations against the bomber in 145 cities, including Washington, DC. Carter hinted to the protesters that he was with them. To many B-1 opponents, weapons were evil and the arms race was a colossal waste of money that did not deter war but made it more probable. To Brown, the White House staff, the president, and Congress, these ideological arguments held little sway. The issue centered on whether the B-1 was the best weapon for the job at the best price.<sup>60</sup>

What concerned officials and most lawmakers was whether the aircraft was too expensive, could meet its prescribed requirements, needed to be supersonic, and, most important, whether upgraded versions of the B-52 could do the job



of a penetrating bomber as well as the B-1 at a much lower cost. Opponents maintained that B-52s, armed with long-range cruise missiles, were capable of attacking Soviet targets from 1,000 to 1,500 miles away, thus doing the job more effectively and much more inexpensively than the almost \$100-million-per-unit B-1 (based on anticipated inflation through 1983–1984 and including amortization of R&D and production costs). As Proxmire put it, “Think of the B-1 as a flying Rayburn Office Building in terms of cost”; or as Senator George S. McGovern (D-SD) suggested, “The B-1 is to practical bomber roles what the Rolls Royce is to the basic transportation.” Proponents of the B-1 countered that cruise missiles were untested and slow (thus easy targets for Soviet air defenses); upgrading the aging B-52s and purchasing enough cruise missiles to swamp Soviet air defenses would be as expensive as producing the B-1, if not more. The B-1 was the most thoroughly tested aircraft in history. Its short-range attack missile was faster and less visible to Soviet radar than the B-52’s, and so less likely to be shot down by Soviet surface-to-air missiles (SAMs). As Senator Goldwater asserted, “Critics of the B-1 have been numerous, vociferous, and wrong.”<sup>61</sup>



The fourth B-1 bomber prototype on a test mission from Edwards Air Force Base, California, January 1980. (RG 330, NARA II)

After Carter's inauguration, Rockwell lobbyists met with Air Force congressional affairs officers in early February 1977, expecting to work on a joint campaign to push the bomber through Congress. They were stunned to hear that on "orders from the top" (Air Force Chief of Staff General David C. Jones), the Air Force would not be lobbying for the B-1. Jones recalled in 1987 that "I was asked by some members of Congress to help end-run the president, and I said I wouldn't do it. He [Carter] was recently elected president, I was not elected, who was I to undermine the president?"<sup>62</sup> Rockwell International was on its own.

In late January, Brown chose director for Planning and Evaluation Edward C. "Pete" Aldridge Jr., a Ford appointee holdover, to chair a study on the modernization of the Strategic Bomber Force to assess the ability of B-52s armed with cruise missiles to defeat Soviet air defenses as they improved, and to compare this ability to that of the B-1. The Aldridge group studied three options: a force of only B-1s, a mixed force of B-1s and B-52s with cruise missiles, and B-52s only, some as penetrating bombers and some as standoff platforms with cruise missiles.<sup>63</sup>

Completed in draft in April 1977 and in final form on 16 May, the Aldridge study made no specific conclusions but clearly implied that the choice of aircraft over the next ten years was a close call—although the B-1 had much better capabilities. Both planes could penetrate Soviet air defenses for the next decade. The supersonic B-1 had to fly low over Soviet terrain at subsonic speed. After ten years, the B-52s could become problematic given increasing Soviet improvements in air defense. Against this possibility, the study noted that cruise missile technology showed great promise, suggesting strongly that the best choice would be a mixed force of 120 to 150 B-1s supplemented by modernized B-52s with cruise missiles.<sup>64</sup>

Even before the study's completion, B-1 partisans slipped Rockwell officials the report's preliminary findings. Gary Hillary, who headed Rockwell's aircraft division in Washington, called Aldridge to complain that the report was too neutral. "Jesus Christ, Pete," Hillary reportedly said, "why did you have to make it like this?" Aldridge replied that they had "bent over backwards" to make it look like they were not favoring the B-1. Hillary reportedly telephoned General Jones to complain about the report but Jones did not find it neutral and told Hillary that there was a "60-40 chance that Carter will go for the B-1." Later, Rockwell President Robert Anderson met Jones who reportedly asked him: "What do you think of 50 B-1's?" Anderson responded it would be too expensive to build so few aircraft. Jones then asked, "What do you think of zero B-1s?"<sup>65</sup>



A B-52 Stratofortress bomber launches a Tomahawk cruise missile, July 1979.  
(OSD Historical Office)

It did not take a high-paid Washington lobbyist to figure out that Air Force and DoD support for the B-1 was beginning to dissolve. Anderson, who had known Brown from his Caltech days, thought he had an ally in the secretary; now he was not so sure. Critics of the Aldridge study pointed out that basing cost comparisons on a ten-year span, as the study did, was unfair and flawed; it favored the older B-52s. Had the time span been 20 years, the B-1 would have been the clear choice.<sup>66</sup> Brown received some key advice from old friends and colleagues, such as Ivan Selin, a former deputy assistant secretary of defense for systems analysis when Brown was secretary of the Air Force, and Herbert York, Brown's boss at Livermore Laboratory and predecessor as DDR&E. Both highly regarded, Selin and York had served as senior consultants to the Aldridge study. Selin told Brown that the study's text favored the B-1, but the "tables and cost streams tell a different story" and arguments for the B-1 "now come out as quite weak." He recommended deferring production of the B-1 for two years, telling Brown the important thing was to develop the cruise missile and its offensive and defensive technology. York saw in the study a clear case for a mixed force of B-1 penetrating bombers and standoff B-52s with ALCMs. He thought current production of two B-1s per month (rather than the anticipated four) would maintain parity with the Soviet Union.<sup>67</sup>

The cruise missile option on the B-52 would prove a hard pill to swallow. The Air Force had gagged for years on the long-range cruise missile, fearing it could doom any new penetrating bomber. There was nothing sexy or romantic about the cruise missile, a slow, inexpensive, unmanned air-breathing flying cylinder with stubby wings. Several unrelated technological developments—small, efficient turbofan engines, small-yield warheads, radar-evading airframes, accurate data mapping, and contour matching guidance systems—gave the cruise missile great potential in the late 1970s.<sup>68</sup> Nevertheless, the Air Force clearly preferred the sleek, highly powered B-1, looking more like a fighter than a clunky bomber. Supporters on Capitol Hill, like former military pilots Senator Goldwater and Representative William V. Chappell Jr. (D-FL), both of whom the Air Force had let fly the B-1 prototypes, extolled its virtues. “It is the finest strategic weapon ever developed by any country,” Goldwater exclaimed.<sup>69</sup>

Goldwater and Chappell were right, the B-1 seemed a wonderful machine, but was it worth the cost and would it provide the nation adequate security? On 31 May 1977 Assistant Secretary of Defense (ISA) David McGiffert sent Brown an analysis of the Aldridge study, drafted by Lynn Davis, director for national security policy at ISA. McGiffert and Davis thought the study and its observations were “a reasonable sound piece of analysis.” While they found B-1s economically competitive with B-52s as penetrators and as cruise missile platforms, they suggested that a ten-year span “was an inadequate basis for procurement decisions which will not reach full operational capacity until then” and would be operational for the next 30 years. Accepting the “not unreasonable hypothesis” that Soviet air defenses would improve, there was no estimate of how much longer the B-1 would prove more effective than the B-52. Clearly the B-1 could respond to the threat more effectively. McGiffert and Davis opposed cancellation of the aircraft as “imprudent” and suggested slowing production. As for the number of B-1s needed, they continued, “In no case does it appear that we would need more than 100–150 B-1s by 1988 since a force of 140 B-1s will cover the entire target complex . . . assuming 60% alert rate, 85% reliability, and 30% attrition.” Ford’s target of 244 B-1s was excessive. Standoff cruise missiles in an attack mode “have high potential,” they continued, but because they were untested it was “imprudent” to count on them as a total replacement for the B-52s. A mixed force of B-1s and B-52s would best confound Soviet air defenses, they concluded.<sup>70</sup>

Brown sent the Aldridge study to the NSC staff, where Brzezinski’s deputy, David Aaron, routed it to the resident physicist on the staff, Victor A. Utgoff, who

prepared a standard impartial assessment reflecting the pro-B-1 tone of the original study and its case for a mixed force of B-1s and B-52s with air-launched cruise missiles. Aaron reportedly sent it back to Utgoff as unacceptable. Utgoff got the message and made a strong case for B-52s with cruise missiles, which would provide adequate security at a better price than the B-1s, and for a delay in production of the B-1. On reviewing the revised analysis, Aaron reportedly pronounced, "This is useful."<sup>71</sup> There seems little doubt that Carter was leaning toward the B-52 option. As he wrote in his memoirs, "If I had absolute power, the answer would have been a simple: do not build it [the B-1], because it is a waste of money. My problem was I would have to win the argument not merely in the Office, but also in the public arena—indirectly with the American people and directly with Congress."<sup>72</sup>

In early June 1977 Carter met briefly with the pro-B-1 congressional delegation led by Goldwater and including George H. Mahon (D-TX), Stennis, Senator Ernest F. "Fritz" Hollings (D-SC), and Senator Alan M. Cranston (D-CA), a critic of big defense budgets, who made an exception for the B-1, which was built in his home state. By this time the pro-bomber forces realized that the B-1 would not prevail, so they grasped at the life ring of Aldridge's mixed force solution. Goldwater argued that cruise missiles were untested; bombers could be launched and kept in the air for 28 hours with refueling. "Don't make the red button the only alternative," the Arizonan pleaded. The president admitted that the B-1 was a better bomber, but B-52s with cruise missiles could do the job as effectively at half the cost. On 10 June, Carter met for less than a half-hour with the "antis," including Senators McGovern, Kennedy, Clifford P. Case (R-NJ), Jacob K. Javits (R-NY), and Culver. A leading anti-B-1 senator, Culver made the case that the B-1 was marginal and would gobble up defense dollars needed for more important programs such as combat readiness and reviving NATO. Polls showed that Americans opposed the B-1, Culver pointed out, and he asked Carter to remember his campaign promises to use some of the saved money for social programs.<sup>73</sup>

Four days later the president met with Brown for a half-hour, and then called him on the phone later that afternoon and on the morning of the next day to discuss the aircraft. Brown recommended "keeping the B-1 bomber open" by stretching out its production. There was little chance that the B-52 would lose its ability to penetrate Soviet air defenses before "a follow on bomber" could go into production.<sup>74</sup> As Brown recalled in late 1981, he recommended to Carter "some production

tooling without committing to any specific amount of aircraft until we saw how the cruise missile came along.” Carter told Brown, “I can’t go along with you on your recommendation,” but Brown recalled that the president misunderstood his advice. In 2004 Brown characterized his advice: “I had recommended to the President that instead [of cancelling the B-1], we go with a low production rate, not necessarily because I thought that the B-1 was the right way to go but because I believed that if we didn’t proceed with the B-1 the pressure to do another missile [the MX] would be enormously greater and I would like to defer that a little bit.”<sup>75</sup>

On the weekend of 18–19 June at Camp David, the Maryland mountain presidential retreat, Carter pondered the Air Force request for 244 B-1s. His briefing package contained Brown’s account of the Aldridge study, the Utgoff analysis, assorted articles and editorials, and a *New Republic* article by Stephen Chapman entitled “This Bomber Is a Bummer: Dump the B-1,” included by domestic adviser Stu Eizenstat. Carter also possessed top secret research that suggested new stealth technology could make cruise missiles and aircraft virtually invisible to radar. Brzezinski laid out the options for the president, but he clearly stacked the deck against Brown’s arguments: “We and the Soviets have long since run out of worthwhile targets. Should we spend vast sums of money to ‘make the rubble bounce’? . . . The B-1 requires an argument that the force we have is becoming unsatisfactory and that the B-1 is the right answer. . . . There is no argument forcing your hand. . . . I believe a delay in production deserves the most careful consideration.” Carter listed 47 pros and cons of the issue and then weighed them with 5 points for a strong argument and 2 points for a modest one. The B-1 lost.<sup>76</sup>

After Carter returned from Camp David, he received recommendations from Lance, who looked at the decision primarily through a political lens. Congress could overturn the president’s decision and weaken his prestige and standing. Like Brown, Lance worried that cancelling the B-1 would make the MX inevitable, so he recommended building three more prototypes and a two-year delay in production. The only downside Lance saw was a possible charge that the administration had been wasteful and indecisive should it eventually decide to go with the B-1 after the two-year delay. The president then had lunch with Vice President Mondale on 20 June and met with him again on 21 June. Mondale told Carter, “If we are going to kill this plane, let’s do it now. The closer we get to the 1980 election the more difficult it will become.” If there was any doubt that Carter would change his mind, Mondale

probably eliminated it for him. Immediately after meeting with Mondale, the president and Brown went over the pros and cons of the two aircraft for a final time.<sup>77</sup>

Following a Cabinet meeting on 27 June, the president called Brown, Mondale, Brzezinski, and Eizenstat into the Oval Office. Looking at Brown, he said that aside from the military, strategic, and cost issues they had discussed over the past days, he had decided to kill the B-1 to keep his campaign promise. Brown reiterated that he would support his decision fully.<sup>78</sup> As Carter recalled, “Harold spent an enormous amount of time analyzing the pros and cons of the B-1 bomber. He knew we had, coming along, air-launched cruise missiles that could be launched a thousand miles off the shores of the Soviet Union. . . . Later, we were beginning to get a glimpse of the potential of the stealth concept, at first primarily for air launched cruise missiles, almost totally undetectable. After the pros and cons were considered, Harold and I made the decision that we not build the B-1—which I think was a very wise decision.” This recollection and an extract from the president’s diary of 24 June reproduced in his memoirs—“Harold Brown has made a very courageous decision to recommend that the B-1 not be built”—indicate that Carter misapprehended the secretary’s position. Brown did not recommend cancelling production, just slowing it down. But presidents often hear what they want to hear. Carter mistook Brown’s loyal support for confirmation of his own decision.<sup>79</sup>

When Carter publicly announced cancellation on 30 June, with the observation that Brown “agrees this is a preferable decision,” the president indicated he would reprogram much of the money into research, development, and production of cruise missiles, but he also recommended \$460 million to continue research and development of the B-1, “in the unlikely event that the most cost-effective system [B-52s] should run into difficulty.”<sup>80</sup> Reactions to Carter’s decision were predictable: whoops and rebel yells of joy in the West Wing; gloom and doom in Rockwell offices and among B-1 congressional supporters. McGovern called the decision Carter’s “finest hour.” Representative Robert K. “Bob” Doran (R-CA) suggested that “they are breaking open the vodka in the Kremlin.” Chappell called General Jones to complain that the Air Force had caved. Jones responded that the president had decided; the Air Force would support him. A week later Brown assured Carter that the “uniformed Air Force leadership is reacting professionally and with intellectual honesty to your decisions. . . . This kind of professional response is encouraging.”<sup>81</sup>

## Congressional Approval of the B-1 Decision

As Carter anticipated, the real problem remained how to convince Congress to support his decision to terminate the B-1 program. Brown optimistically told the president: "Because the cruise missile, on the B-52 or perhaps a Cruise Missile Carrier, is the better choice than the B-1, I think we have (and can) make our case well." Brown warned that "we need to continue showing we are not unilateral disarmers."<sup>82</sup> To make sure Congress voted the right way, Robert G. Beckel of the White House Congressional Liaison Office headed an aggressive campaign to win support for the B-1 cancellation, contacting key representatives, promising reversals of base closings or hinting that businesses in their districts might receive contracts to build parts for a new aircraft that would eventually carry the cruise missile. For their part, Rockwell lobbyists and pro-B-1 forces fought back, primarily stressing to target senators and representatives the number of jobs that would be lost in their districts if the bomber was not funded. On 19 July 1977 the Senate voted 69 to 39 to delete funds for B-1 production for FY 1978, with Stennis and eight other pro-bomber Southern senators voting aye.<sup>83</sup>

The real battle for the B-1 was in the House. On 8 September, as representatives readied to vote on striking FY 1978 funds for the bomber, Carter held a working breakfast with Democratic House leaders, including Speaker Tip O'Neill, Majority Leader James C. "Jim" Wright Jr. (D-TX), and Majority Whip S. John Brademas (D-IN), to plan strategy and count heads. As the House began to vote on an Abbaddo amendment to delete funds for the B-1, the Democratic House leadership was still twisting arms for support. Addabbo's amendment squeaked through by 202 to 199, with 27 Democrats and 8 Republicans changing their votes in favor of it. The next day the Senate adopted a conference report with no funds for the B-1.<sup>84</sup>

The administration had won a victory by eliminating the B-1 from the FY 1978 appropriation, but \$463 million remained in the FY 1977 budget for funding for B-1 numbers five and six. Prototypes one, two, and three were already built, and four was under construction. Brown stated that while the law required funds be obligated, he saw no need to spend the money immediately. Pro-B-1 proponents accused him of stalling.<sup>85</sup> On 6 December 1977 the House voted against an amendment to rescind the money for these planes. The clear subtext indicated that the two additional planes would keep the B-1 production line going and allow the program to be revived. Brown's talk of modifying the interdictor and tactical attack F-111 as a penetrating



bomber caused B-1 supporter Representative John J. Flynt Jr. (D-GA) to ask, "Why not the best." Why not the B-1? For seven months the two sides sparred sporadically over the issue. Finally, on 22 February 1978, the House voted 234 to 182 to eliminate the FY 1977 funding for B-1s five and six as the Senate had done earlier.<sup>86</sup>

The Carter administration thought it had finally killed the B-1, but that was not the case. Development money still remained in the budget. With the support of new Secretary of the Air Force Hans Mark, the bomber lived on in a shadow existence of "research and development" moving the aircraft closer to production so it would be ready if revived. As Brown recalled, while his old friend Hans was a good Air Force under secretary, "he became perhaps too much an advocate for some programs, both for continuing the B-1—he did continue R&D—and for the space shuttle." According to Brown, "the mistake was not destroying the B-1 tooling because we had a better bomber, which became the B-2. . . . In retrospect, the right decision would have been not only to cancel the B-1 but to have started early on the stealth bomber." Deputy Secretary Claytor was even blunter: "Clearly we ought not to develop a penetrating bomber until we could do one with stealth technology. It would be a hell of a waste of money."<sup>87</sup>

At the time of the B-1 decision, stealth technology was so top secret and so experimental that the Carter administration was unwilling to bring it into the public debate for national security reasons, arguing instead against the B-1 bomber mostly on cost effectiveness grounds and on the promise of the cruise missile. However, Brown recalled that at least HCA Chairman George Mahon received a secret briefing on stealth technology.<sup>88</sup> For those who fought against the B-1, the clear heroes of the battle were Democratic senators and representatives, such as Stennis and Mahon, initial proponents of the bomber and longtime supporters of Air Force programs, who changed their votes at the president's request. Without their support, the B-1 would have begun production in 1978. The other heroes to B-1 opponents were General Jones and the Air Force who chose not to lobby Congress behind the president's back for the bomber they so dearly wanted. Some in DoD muttered that Jones had sold out (a suspicion that they believed was confirmed when Carter named Jones chairman of the Joint Chiefs of Staff). Brown himself walked a fine line. He thought the B-1 was not the right aircraft, but he also knew that the Air Force and others in the Defense Department expected him to defend it. He did so, arguing for the mixed force, but he also extolled cruise missiles. At the same

time, Brown assured the president that whatever the decision, he would support it. As Brzezinski observed, Carter first was exasperated with Brown's "protective attitude regarding his [Brown's] positioning in DOD," but after the B-1 decision he began to appreciate Brown's dilemma. Carter realized what Brown already knew: as secretary of defense he had to advocate for his department if he wanted to lead it effectively.<sup>89</sup>

Was the decision the right one? The Reagan administration and Congress answered with a definitive no by reviving the B-1 and eventually producing 100 bombers, but as a slower and heavier model than the B-1 prototype. Given the development of the B-2 stealth bomber, the success of cruise missiles, the unexpected end of the Cold War, and the limited conflicts of the post-Cold War era, the decision to terminate the B-1 proved a wise one. As expected, sophisticated Soviet air defenses increased in effectiveness in the decade after 1977, requiring electronic countermeasures that worked equally well with the B-1 or the old reliable B-52. An aircraft costing \$100 million per unit in 1977 (\$283 million in 1998), the B-1 disregarded the rule that capability must be weighed against cost effectiveness. In hindsight the B-1 of the 1970s, the once and future penetrating bomber, may have seemed a marvelous aircraft, but it proved to be the wrong plane for its time.

## Latin America

THE UNITED STATES AND LATIN AMERICA, both born of revolt against European colonialism, have endured a complicated and often adversarial relationship. In 1823 President James Monroe staked out a sphere of influence for Washington and warned European nations to desist from further colonization of the Americas. Yet the United States did not attain the military and economic power to enforce Monroe's doctrine until the end of the 19th century. The 1898 war with Spain that eliminated Spanish colonialism from the Western Hemisphere attested to this new strength. In 1904 President Theodore Roosevelt added a corollary to the Monroe Doctrine: the right to intervene in Latin American and Caribbean countries if they could not keep their financial and political houses in order. Hardly a year went by during the first third of the 20th century when U.S. military forces were not involved in intervening or occupying at least one Central American or Caribbean country. Such "big-stick" actions did not endear Washington to those residing south of its border. President Franklin D. Roosevelt's "good neighbor policy" in the 1930s tried to heal the damage.

World War II changed U.S.-Latin American dynamics temporarily. During the war a network of military relations between the two regions emerged, including the Inter-American Defense Board and lend-lease to Latin allies in the war against the Axis (although only Brazil sent troops to fight in Europe). These wartime institutions continued in different forms into the Cold War. The post-war Organization of American States (OAS) held yearly political and military consultations. U.S. military assistance and advisory programs expanded and strengthened the World War II ties that connected the United States to military leaders of the Americas. The military services and the Department of Defense

established close relationships with their South and Central American and Caribbean military officers, many of them trained in the United States or in the Panama Canal Zone. Most Latin American armed forces' weapons and equipment came from the United States. Finally, U.S. defense attachés often enjoyed intimate and longstanding relations with the military of the countries to which they were accredited.

The establishment of communism and Soviet influence in Fidel Castro's Cuba in 1959 shattered the security and supremacy that the United States had enjoyed in the Western Hemisphere. Henceforth, the specter of Cuban and Soviet-sponsored insurgency haunted Washington policymakers and dominated U.S.-Latin American relations during the administrations of Presidents John Kennedy, Lyndon Johnson, and Richard Nixon. Their common mantra was "no more Cubas." The Kennedy and Johnson versions of FDR's good neighbor policy, the Alliance for Progress, designed to counter the appeal of Castro's Marxism, began with high hopes but lost its way. Nixon's Latin American policy focused mainly on preventing by overt and covert means Marxist President Salvador Allende from consolidating power in Chile. By the end of the second Ford administration, in January 1977, the overwhelming majority of Latin American countries existed under some form of institutionalized military regime, and a handful of others retained the one-man *caudillo* model. Only Costa Rica, Mexico, Venezuela, and Colombia enjoyed democratic or representative rule. In the Caribbean, where the British tradition of parliamentary rule survived, democracy fared better.<sup>1</sup>

President Jimmy Carter envisioned a different Latin America—not through more security and better relations with Latin American military regimes and dictators— but through promoting human rights and improving economic conditions. In Carter's view, if the United States lifted up the poor and middle classes and promoted democracy instead of propping up the military juntas, dictators, elites, and oligarchies, Castro would lose his appeal. The president even harbored hopes that he could orchestrate a rapprochement with Havana and wean Castro from Moscow. Carter's Latin Americanists looked askance at DoD's longstanding and close relations with military establishments in the hemisphere. Latin American policy became an important concern of the U.S. government because the president himself conceived initiatives and insisted that they be implemented.

## The Panama Canal Treaty Negotiations

The lynchpin of Carter's new policy for Latin America centered on the Panama Canal and the U.S. Canal Zone, America's physical control of the vital shipping link between the Atlantic and Pacific Oceans. Carter believed that return of the canal and the zone offered a litmus test for better relations with Latin America. Yet the fate of the canal ignited U.S. popular interest that political operatives in Washington were quick to channel. The issue energized the so-called New Right, which mounted an effective grassroots political campaign that galvanized U.S. public opinion against the canal's return to Panamanian control. The successful negotiation of the Panama Canal Treaties of 1977 and their ratification overcame strenuous political opposition only after multiple deals and compromises between a wide range of interests and political actors. The central mover, President Carter, expended tremendous political capital to overcome public and congressional opposition. Brown and DoD played key roles in Carter's first international negotiation and in his showdown with Congress.

Part of the problem in relinquishing the canal was that it had been so long a part of the United States. In 1903 the provisional government of newly independent Panama deeded the Canal Zone and a prospective canal (built from 1904 to 1914) to U.S. jurisdiction forever by the terms of the Hay-Bunau-Varilla Treaty. Pressure from Panama to revise the treaty began to bear fruit in 1964, when President Johnson promised to renegotiate the agreement. But U.S. and Panamanian negotiators failed to produce a new treaty acceptable to both sides. In 1974 Secretary of State Henry Kissinger and Panama's Foreign Minister Juan Antonio Tack signed a joint statement agreeing on principles for renegotiation: the United States would relinquish the Canal Zone in stages while retaining rights to operate and defend the canal during the term of the new treaty. In the interim, Panama would receive increased revenues. Nevertheless, at the end of 1976 talks remained deadlocked. Panama insisted on a 25-year termination date; the United States, at JCS and OSD insistence, held out for 40 years with residual rights for unilateral U.S. intervention to maintain the security of the canal. Panama insisted on return of 90 percent of the land and water under U.S. control, but the United States offered only 35 percent.<sup>2</sup>

Carter regarded a new treaty as a break from the old paternalistic U.S. approach to Latin America. He saw no need for self-conscious "Good Neighbors"

or “Alliance for Progress” slogans. Carter would treat Latin Americans as equals and, by an act of magnanimity, win their respect and gratitude. While the Republican right, especially former governor of California Ronald Reagan, had strenuously opposed “giving back the Canal” during the Nixon-Ford administrations’ negotiations, Carter regarded the return of the Canal Zone as a bipartisan foreign policy and national security issue. As his first national security policy act, the president issued Presidential Review Memorandum 1 of 21 January 1977, which called for a comprehensive review of previous negotiations, an analysis of possible new treaties, an assessment of the regime of President Omar Torrijos Herrera and the situation in Panama, a defense study of the military implications of various treaty possibilities, an appraisal of a new treaty’s impact on Latin America, and a strategy to sell the treaty to Congress and the American public. At the Policy Review Committee meeting to plan a strategy, State, OSD, and JCS agreed to a coordinated effort to win congressional support for the treaties.<sup>3</sup>

Even before inauguration, State and the Carter transition team began drafting a Panama study, as later authorized by PRM 1, completing it by 26 January 1977. The study maintained that basic U.S. national interest did not reside in ownership of the canal but in a waterway that was efficient, secure, neutral, and continuously open to world shipping. The economic value of the canal had declined as had its military significance, according to the study. While the canal had proved its worth during World War II and the Korean and Vietnam Wars, the Navy’s 13 supercarriers could not passage it, nor could super oil tankers.<sup>4</sup> In August 1977 Brown amplified for the president the military assessment of the PRM study. The canal had two broad strategic functions: transport of warships and their auxiliaries, and movement of supplies and equipment for forces in the Pacific and Europe. Of course, large attack carriers and their escorts could not use the canal; they had to sail around Africa or South America, adding 15 to 21 days to transit times. In a potential NATO conflict, cruisers, destroyers, and a large part of the Marine amphibious lift ships would use the canal, as would military cargo ships. For a conflict in the Pacific, the canal would prove valuable for supply of critical cargo because West Coast port capacities were limited. Brown concluded: “In sum, assured ability to transit the canal remains of military importance, though rather less than in the past.”<sup>5</sup>

Since the intelligence community estimated that delay in renegotiation would invite popular Panamanian violence against the canal and zone, endangering the



Chairman of the Joint Chiefs of Staff General George Brown, June 1976.  
(Ford Presidential Library)

Torrijos government, the study concluded that both sides had incentive to settle. While domestic opposition in Panama and the United States were wild cards, the study suggested that the successful conclusion of a new treaty not only would remove a source of tensions and potential bloodshed, but “would strengthen the reputation of the United States as a force for creative world leadership.”<sup>6</sup>

To sell the treaty to Congress and the public, Carter needed the support of the Joint Chiefs. Secretary Brown’s task was to deliver them. In preparing their response to PRM 1, State drafters included a paper of 15 January 1977 indicating that “Defense’s support for the treaty is imperative. Institutional support has gradually increased; individual reactions remain more problematic.”<sup>7</sup> At a 26 January 1977 meeting, Brown suggested to JCS Chairman General George Brown a broadly worded neutrality agreement that would continue beyond U.S. operation of the canal, allowing either the United States or Panama to protect and defend the waterway as they deemed fit. General Brown thought such a guarantee expedient

because it dodged two sensitive issues that had plagued previous treaty negotiations: Panama's sovereignty over the canal after its return and the right of unilateral U.S. intervention. General Brown polled the other chiefs, who, although not enthusiastic, nevertheless endorsed the idea. This concept known as the "Brown and Brown formula" proved one of the keys to breaking the negotiating deadlock. At the PRC meeting the next day, General Brown told the participants that while the JCS would have preferred "strong residual defense/neutrality guarantees," they would accept the Brown and Brown formula, to the effect that "both the United States and Panama agree that neutrality of the Canal will continue beyond the termination of US operations and each country commits itself to guaranteeing the neutrality of the Canal after the termination of US operations." While ambiguous, and open to different interpretations, the formula, according to General Brown, "would achieve our objective."<sup>8</sup>

Lawyers at State and Defense reworked the language of the formula but not its basic intent. On 20 May 1977 the JCS formally notified Brown that they could support the treaty if the United States maintained primary responsibility for the operation and defense of the canal through 1999, and if, after 2000, Panama and the United States guaranteed a canal open to all with reasonable tolls and efficient operation. Most important, the Chiefs required that both countries commit to protecting and defending the canal. The JCS considered that after the year 2000, legal and political arguments could support unilateral intervention should any nation, including Panama, threaten the neutrality or security of the canal.<sup>9</sup> Earlier, in March 1977, U.S. negotiators had suggested to their Panamanian counterparts a concept that also proved instrumental in achieving a successful conclusion of the negotiations: instead of one treaty, there would be two, one to cover the period until the termination of U.S. operations of the canal, and the other to ensure the canal's neutrality afterwards. The Panamanians accepted the two-treaty concept in principle.<sup>10</sup>

Questions of political, military, and social significance bedeviled negotiations. How much of the Canal Zone should the United States return before 2000? Would the U.S. Southern Command (SOUTHCOM), headquartered in the Canal Zone, be able to operate effectively within a smaller area—a major consideration for DoD?<sup>11</sup> Furthermore, the zone retained a special place in the hearts of those who had served there. With neat lawns, suburban-style houses, movie theaters, golf courses, and



commissaries, the zone was a part of Central America that many military and civilian personnel considered should be forever American.

The main opposition in DoD to relinquishing the Canal Zone resided in the U.S. Army, which had been dragging its feet in negotiations over land and water issues. The secretary of the Army, by law the “stockholder” of the canal enterprise, served as a direct representative of the president (he was not under the authority of the secretary of defense for this function). Frustrated with the Army’s resistance, Sol Linowitz, one of the U.S. canal negotiators, intervened directly with Army Secretary Clifford Alexander to gain greater concessions. Within a day, Alexander presented Linowitz and the other negotiator, Ellsworth Bunker (a former U.S. ambassador to Vietnam, to the Organization of American States, and to Argentina), with a package that all but eliminated land and water problems. When the new treaty would enter into force, the facilities of the Pacific port of Balboa and the Atlantic port of Cristobal would pass to Panama, with a joint port authority allocating shore activities to Panama. Waterway traffic would be jointly controlled. The U.S. trans-isthmus railroad would pass to Panama without conditions. Civilian housing occupied by non-U.S. citizens would go to Panama at the treaties’ onset; the rest would be jointly managed and turned over to Panama at five-year intervals. Ancon Hill, overlooking Panama City and a dominating symbol of U.S. control resented by many Panamanians, would pass entirely to Panama (not just the top of the Hill as previously offered), with only Ancon’s U.S. hospitals, schools, and other key installations remaining under American control. The Albrook airstrip next to downtown Panama City, minus a few military installations, also reverted to Panama, as did the entire city of Cristobal. In all, the offer returned more than 40 percent of the zone to Panama. It was not so much the amount of land that made the offer attractive, but rather its economic and symbolic value. According to one observer, the offer proved a game changer, although wrangling over adjustments continued and the United States conceded even more land to Panama (about 55 percent of the zone) in the final treaty.<sup>12</sup>

Throughout the summer of 1977 the negotiators ironed out remaining details. Issues surrounding payment for Panamanian-claimed “injustices”—historically low transit tolls, Zonians paying no taxes to Panama, and limitations on Panamanian entrepreneurship in the zone—required some form of settlement. President Torrijos asked for a billion dollars up front, followed by \$300 million annually until 2000.





President Jimmy Carter and President Omar Torrijos of Panama sign the Panama Canal Treaties, 7 September 1977. (Carter Presidential Library)

president invited Latin American leaders to Washington to witness the historic signing. The celebration, mutual congratulations, and bonhomie were genuine, but a major question remained: would the Senate ratify the treaties or would Carter's accomplishment go the way of Woodrow Wilson's League of Nations?<sup>14</sup>

### **Ratification of the Treaties**

The Pentagon played a pivotal role in the battle for Senate ratification and in the passage of follow-on legislation from the House of Representatives. Ratification proved an epic political and legislative donnybrook. Carter recalled it as "the most difficult political battle I had ever faced, including my long campaign for President."<sup>15</sup> The national security policy agencies of the Carter administration contributed the time and effort of many of their top officials to an orchestrated public relations/legislative campaign to convince a reluctant Congress and the public to accept the treaties. Deputy Secretary of State Warren M. Christopher and Presidential Assistant Hamilton Jordan performed the heavy lifting. State officials gave more than 1,500 speeches on Panama to the American public and Christopher and his associates managed the legislative campaign. Pentagon officials, including Brown, also gave hundreds of speeches to public groups. More important, they helped convince the Senate that the

treaties adequately protected U.S. security, and conversely, if the treaties were rejected, that the canal's infrastructure would be vulnerable to attacks from within Panama.<sup>16</sup>

Brown testified before a number of congressional committees, but his testimony before the Senate Committee on Foreign Relations (SCFR) on 27 September 1977 was perhaps his most persuasive. He told the committee: "Use of the canal is more important than ownership. Efficient operation of the canal in the years ahead is more important than nostalgia for a simpler past. . . . I believe personally . . . that these treaties fully serve and greatly promote our national security interests." As for defense of the canal, Brown maintained that the United States would be able to defend the Atlantic and Pacific approaches with overwhelming force. For the duration of the new treaty (until the end of 1999), U.S. forces in the zone and all key bases and training areas would remain under U.S. control and could be reinforced as needed. The real danger to the canal, according to Brown, would come not from an external conventional attack, but from terrorism and guerrilla attacks on vulnerable locks or other facilities by dissident Panamanians and other Latin American opponents of the United States. The new treaties would minimize the threat. General George Brown; Admiral Robert L. J. Long, vice chief of naval operations; and Lt. Gen. Dennis P. "Phil" McAuliffe, the SOUTHCOM commander, all followed Brown with similar support for the treaties.<sup>17</sup>

Carter knew he needed favorable testimony of the secretary of defense and "uniforms," but the opposition also had its military supporters. The former chief of naval operations (CNO) and former JCS chairman, Admiral Thomas H. Moorer, told the House International Relations Committee that the reversion of the canal under threat of riots or sabotage was "surrender," and that there was a "Torrijos-Castro-Moscow axis" that could easily turn the Canal Zone into a "satellite base." He ridiculed the 1976 DoD estimate that it would require 100,000 troops to defend the canal without a treaty. Three former CNOs, Admirals Robert B. Carney, George W. Anderson Jr., and Arleigh A. Burke, joined Moorer, albeit in less hyperbolic language, in opposing the treaties.<sup>18</sup> Still, the Carter administration had good success in forging a bipartisan coalition of support. Former President Ford and Henry Kissinger signed on early; conservative columnist William F. Buckley Jr. had a change of heart and supported the treaties; former CNO Admiral Elmo R. Zumwalt Jr. and two former JCS chairmen, Generals Lyman L. Lemnitzer and Maxwell D. Taylor, joined the pro-treaty ranks. Hardliner and SALT critic Paul Nitze provided qualified support.

A slew of prominent businessmen and the conservative movie icon John “Duke” Wayne supported the president.<sup>19</sup> The problem was that the American public and probably more than one-third of the Senate did not want to return the canal. The required two-thirds Senate majority for ratification seemed problematic.<sup>20</sup>

The Carter administration pulled out all the stops, making promises to senators, accepting amendments, and inviting those senators uncommitted or leaning toward rejection to visit Panama to see for themselves. At the White House’s request, Brown asked CNO Admiral James Holloway to meet with wavering Senator Herman E. Talmadge (D–GA) and then asked General Brown to contact him. Such pressure apparently helped; at the last minute Talmadge supported the treaties. The major hurdles were the fence-straddling senators who wanted an explicit recognition of the U.S. right to intervene in Panama to protect the canal’s security after 2000. To Torrijos and the Panamanians, this was a red flag, an insult to Panama’s sovereignty. Panamanian government public statements, albeit mostly for domestic consumption, about its view of sovereignty and the canal’s neutrality hindered the Carter cause in the Senate.<sup>21</sup>

As an advocate of human rights, Carter was at a disadvantage in his promotion of a deal with Omar Torrijos Herrera, a left-leaning military dictator who could claim only the thinnest veneer of democracy. The antithesis of Carter, Torrijos drank, womanized, and affected a macho strongman image. Opponents of the treaty pointedly asked why give the canal to such a man, hinting that he dealt drugs and sympathized with Castro’s Cuba. Carter refuted the drug charge, but later events indicated that Torrijos’ second in command, General Manuel Noriega, might not have passed a drug-dealing test.<sup>22</sup> What most officials in the government and the public did not know was that in 1955 then-Captain Torrijos had joined the U.S. Army payroll as an intelligence source at \$25 a month. As he moved up in the National Guard (Panama’s sole armed force), his payments increased to \$300 per month until 1969, when they stopped at his request after he assumed power in Panama following a coup. Torrijos was not a particularly productive intelligence source; his handlers assumed he was taking the money to pay for drinks and women. The charge that Torrijos was a nascent Castro was wrong; he was a nationalist, and basically pro-American, so it was not surprising that Carter succeeded in convincing him to accept amendments and statements to modify the Neutrality Treaty. Torrijos had no options but to acquiesce. Panama was not a wealthy country; its only asset was the canal, and sabotage

or terrorism against it would hurt Panama more than the United States. Popular demonstrations had set the renegotiation process in motion in 1964, but Torrijos was unlikely to encourage them because they could easily turn against his regime.<sup>23</sup>

After the Senate concluded deliberations in early spring 1978, the Carter administration endured nail-biting votes. On 16 March the Senate passed by a vote of 75 to 23 an amendment by Senator Dennis W. DeConcini (D-AZ), stating that the United States could intervene in Panama against any action that impeded canal operations. The Senate then ratified the Neutrality Treaty by 68 to 32. On 18 April the treaty on U.S. operation of the canal until the end of 1999 passed by the same 68 to 32 margin, in both cases with one vote to spare over the required two-thirds majority.<sup>24</sup>

### **Implementing the Treaty**

Ratification in the Senate represented a major victory, but it did not end the legislative battle. The House of Representatives and Senate still needed to fund implementation of the treaties. House opponents vowed to carry on the fight. Before Congress voted, the administration had to decide how to run the canal and the zone until the end of 1999. The new treaty—to come into force on 1 October 1978—abolished the two major civilian agencies formerly operating in the zone, the Panama Canal Company and the Canal Zone Government, replacing them with a new agency, the Panama Canal Commission (PCC). Under the supervision of a board of governors (five Americans and four Panamanians), the PCC would manage, operate, and maintain the canal. The question was which U.S. government agency would have oversight of the U.S. members of the commission?

The Pentagon presented itself as the best choice, given that the secretary of the Army had performed a similar function for more than 25 years. The Department of Transportation (DoT) pushed for oversight responsibility because the canal was about transportation. Most of Carter's interagency canal team agreed with Defense, in some part because a transfer to DoT would upset the Senate Armed Services Committee by removing its jurisdiction over the canal. The committee had to pass legislation authorizing funding for implementation of the treaty. Carter opted for Defense as the lead agency, but required a civilian canal administrator, rather than a military officer, to oversee treaty implementation. As for the U.S. board members, the president decided that membership would comprise representatives from the

five agencies with major interests in the canal—Defense, Transportation, State, Commerce, and Treasury—rather than a random selection of qualified individuals as the Army and OMB recommended. Most agencies thought the five U.S. board members should serve as an interagency coordination group for overall canal policy, but DoD argued that it and State were best able to solve most problems. Carter opted for the former arrangement. A related issue had to do with whether the U.S. ambassador to Panama would have any responsibility for direction, coordination, and supervision of the commission given the general U.S. policy of making the ambassador responsible for all U.S. operations in the country to which he was accredited. Both State and Defense agreed that there should be an exemption from this policy, with the PCC administrator independent of the U.S. chief of mission. Carter approved.<sup>25</sup>

Such was the Carter administration's vision of how the canal should be run. Unfortunately, Congress held a different view—both the Senate and House would have to pass and fund implementing legislation by 1 October 1979. Most opposition came from the House, where some members thought they should have had a vote on ratification of the operations treaty because it involved the disposition of U.S. property. The battle to win implementation legislation for the turnover of the canal took longer than ratification of the treaties and was almost as bitter. Carter described it as “horrible.”<sup>26</sup> Instead of dealing with 100 senators, the administration had to face 435 representatives elected every two years and highly susceptible to public opinion. Many House opponents hoped to forge a majority to defeat funding, thus torpedoing the treaty. In trying to win over reluctant House members, Carter relied heavily on his experts, including Secretary Brown and Lieutenant General McAuliffe, to explain in seemingly endless briefing sessions with 30 or 40 House members at a time the intricacies of the legislation to implement the treaties. Opposition coalesced around Representative John M. “Jack” Murphy (D-NY), who introduced a bill to replace the government corporation with an agency funded by Congress. Murphy's bill overrode the self-executing provision of the new Canal Treaty by requiring congressional consent for property transfers; placing the canal under a military officer in time of war; giving the secretary of defense direct control over the PCC and the binational board of governors; requiring Senate confirmation of key U.S. and Panamanian officials; increasing the membership and role of the five-agency oversight committee; and increasing annual canal toll payments to the U.S. Treasury.<sup>27</sup>

In addition to these larger issues, a raft of smaller concerns imperiled the implementation legislation: a new justice system for the zone, job protection for U.S. canal employees, protection for their retirement provisions, Social Security adjustments for Panamanians who paid into the U.S. system and who would transfer to Panama's system, reemployment rights, cost of relocating military facilities, transfer of schools and hospitals to DoD, basis for collecting tolls, and other accounting procedures.<sup>28</sup>

As expected, the Senate passed implementing legislation on 26 July 1979 by a vote of 64 to 30, basically meeting the administration's requirements.<sup>29</sup> The House was another matter. After passing legislation as outlined by Murphy on 20 September 1979 (10 days before the treaty was to take effect), the House rejected legislation that emerged from conference with the Senate, even though the conference committee had accepted many of the House's (and some of Murphy's) provisions. The House action represented a statement of discontent and pique rather than real policy differences, because five days later the House passed a bill very similar to the conference version it had rejected, funding the transfer at \$665.7 million.<sup>30</sup>

The canal transfer had been a long and arduous process, requiring much of the administration's attention and expending virtually all of its political capital with Congress. Had it been worth it? Some have suggested it was a pyrrhic victory that soured relations with Congress and doomed ratification of the second Strategic Arms Limitation Treaty by calling in all of its support on Capitol Hill, leaving little for SALT. No doubt the return of the canal would improve U.S. relations with Central and South America, but it came at a price. The American public never approved of the policy. In 1980 the Senate shifted to the right as 17 pro-treaties senators (and potential SALT supporters) failed to be reelected in 1978.<sup>31</sup>

For the Department of Defense, the new treaties increased its immediate responsibilities but did not, as feared by many opponents of returning the canal, limit U.S. freedom of action. Eight years after Torrijos' death in a plane crash in 1981, U.S. forces stormed into Panama in Operation Just Cause in 1989 and captured and arrested Torrijos' successor, Manuel Noriega, who was later found guilty of drug dealing and incarcerated in the United States. One of the justifications for the action was that a narco-regime such as Noriega's endangered the canal. In the longer view, the peaceful transfer of the canal to Panama in 2000 and its successful operation by Panamanians validated Carter's policy.<sup>32</sup> The passions about "giving back our canal" eventually dissipated and the Panama



Canal operated as a nondiscriminatory international waterway, as Carter and DoD had intended.

### **A New Direction toward Latin America**

While return of the Panama Canal issue constituted a key part of the president's new approach, Carter also launched the comprehensive "Review of U.S. Policy Toward Latin America" (PRM 17) on 26 January 1977. The memorandum called for six areas of analysis: definition of and changes in U.S. interests, economic issues, human rights, special country problems, the Caribbean, and institutional issues. The last item included an examination of U.S. relations with military regimes and arms sales to Latin America. An important and controversial part of the Carter dialogue on Latin America, it became a main concern of OSD.<sup>33</sup>

Brown's staff held that the nation needed to preserve the military-to-military relations between Latin America and the United States, forged over decades. Until Latin Americans felt secure, they would balk at diverting scarce resources to economic and social betterment. Furthermore, with Latin American militaries remaining the dominant political force in most countries for the foreseeable future, it was essential to harness their efforts in directions consonant with U.S. objectives. The Office of International Security Affairs maintained that the response to PRM 17 required more emphasis on military security and on encouraging Latin American militaries to embrace economic and social reform and democracy. Furthermore, PRM 17 failed to identify the basic U.S. security interests in Latin America and the Caribbean: preventing the introduction of hostile forces, protecting lines of communication, cooperating in defense matters, and maintaining U.S. defense installations. Finally, the president needed flexibility in arms sales to influence Latin American governments in a positive way and to defuse regional tensions.<sup>34</sup>

These policy recommendations ran against the grain of congressional restrictions on U.S. military advisers, military assistance, and U.S. arms sales to Latin America enacted over the previous decade. The culmination of this campaign was the 1976 Arms Export and Control Act (P.L. 94-329) eliminating security grant assistance unless Congress specifically approved it; restricting International Military Education and Training (IMET) programs; and reducing Military Advisory Group (MILAG) programs. An increasingly liberal Congress held that U.S. military involvement in Latin America encouraged military juntas and slowed the democratic

process. In 1976 Congress eliminated the MILAGs in Costa Rica (which had no armed forces), Paraguay, and Uruguay, and scaled back the 17 remaining programs. Many of Carter's Latin American specialists looked forward to the total elimination of MILAG programs in Latin America.<sup>35</sup>

On 24 March 1977 at a PRC meeting, Deputy Secretary of Defense Charles Duncan and JCS Chairman General Brown argued the case for special military relationships, which they maintained were eroding and would be missed when they were gone. Military training provided an opportunity to influence young military leaders from the Americas on human rights, democracy, and other issues. The PRC recommended that the United States encourage "warm relations with civilian and democratic governments, normal relations with nonrepressive military regimes, and cool, but correct relations with repressive governments." Both Duncan and General Brown agreed with the view of Brzezinski and Deputy Secretary of State Christopher that not all military governments were repressive. On the topic of arms sales, General Brown recalled what the Kennedy administration discovered when it discouraged Latin American countries from purchasing U.S. arms, in the hopes of encouraging a shift in resources from defense spending to nation-building: they turned to other sources to buy arms. "As long as they are going to buy," General Brown stated, "he preferred that they buy from us rather than the Russians."<sup>36</sup>

Although there was general agreement on U.S. policy toward Latin America, especially on military issues, the results of the review were incomplete and no presidential directive emerged. Carter did give a major speech to the Organization of American States on 14 April 1977, outlining many recommendations made by the PRC, but deemphasizing military/security issues.<sup>37</sup> In the next two years, the JCS expressed unease about what they perceived as a lack of concern for U.S. security interests in Latin America, coupled with an overemphasis on political and social concerns, especially human rights. They recommended to Secretary Brown a balance between security and political/social issues, making the case for retaining the military advisory group system and granting reasonable requests for arms from the region.<sup>38</sup> In late 1977, and again in mid-1978, the JCS tried to get OSD to kick-start another interagency review of Latin America policy, but by 1980 it became clear that the issues the chiefs envisioned with South America and the Caribbean were overtaken by more pressing problems in Central America.<sup>39</sup> In many respects the U.S. policy of dealing with Latin America as a region was flawed. As Robert A. Pastor, the NSC staffer in

charge of Latin America, told Brzezinski, “The idea of ‘Latin America’ as a *region* is a myth. It is composed of extremely diverse economies and politics, which can manage to form a collective negotiating position only when there is a symbolic need to confront the U.S.”<sup>40</sup> Nonetheless, Argentina, Brazil, and Chile formed a distinct group, with military regimes governing by various degrees of repression—Argentina the worst, Chile not much better, and Brazil the least repressive. Large states with economic potential, they suffered from bad economic policies and worse governance.

### **Argentina, Brazil, and Chile**

Of the three, Brazil had the largest population and the greatest economic prospects. Although ruled by a military government, it “was not so repressive as is commonly thought,” according to Brzezinski.<sup>41</sup> With its growing economic strength and self-assurance, Brazil had the potential to become a major regional power with global projection. But the Brazilian military government did not respond well to Carter’s human rights policy. During 1977 Brazil denounced five bilateral military agreements with the United States: mutual defense, aerial mapping, maintenance of Joint Defense Commissions, the Naval Mission, and disposition of military equipment and material. Brazil refused all security assistance that depended on the submission of a human rights report to the U.S. Congress. Later, in September 1978, Brazil’s eligibility for foreign military sales (FMS) and IMET would terminate. ISA recommended and Brown agreed to ask Carter to use the occasion of the president’s trip to Brazil to reverse “the serious erosion of our security ties with Brazil . . . our firmest ally in South America.” What Brown and ISA hoped Carter could do was open a dialogue with the Brazilian president. Without some initiative from the United States, OSD feared losing the military relationship with Brazil, and with it U.S. ability to pursue such key objectives as human rights, conventional arms restraint, and nuclear non-proliferation.<sup>42</sup> OSD found an ally in Brzezinski, who supported improving relations with Brazil—“of great importance to us as a potentially new regional stabilizer”—and pointed out that the State Department used human rights policy to punish rightist Latin American regimes regardless of the severity of the violations.<sup>43</sup>

Carter followed OSD’s advice, raising the issue of continued defense cooperation, but Brazilian President Ernesto Geisel insisted that the agreements eliminate the human rights report requirement. At ISA’s recommendation, Brown asked State and the new U.S. ambassador to Brazil, Robert M. Sayre, to follow up on the

two presidents' discussion with military exchanges, visits, joint activities, high-level security consultations, and perhaps an eventual move toward a bilateral defense board—such as the one with Canada—where political, diplomatic, and military officials from both countries met periodically to discuss common security problems. “As an opening move” Brown suggested U.S. approval of commercial exports to Brazil on the Munitions List (weapons and equipment requiring State Department approval before export).<sup>44</sup> Secretary Vance agreed with the Munitions List suggestion, but State remained wary of formal agreements and suggested informal ties for the time being.<sup>45</sup> While the informal strategy met with some success, the military and security relationship with Brazil remained shaky during Carter's administration. In late November 1980 Deputy Secretary of Defense Graham Claytor approved Under Secretary (Policy) Robert Komer's suggestion to prepare a “game plan” for better military relations with Brazil, but it had to await the Reagan administration.<sup>46</sup>

If Brazil had a relatively benign military government, the same could not be said for Argentina, which had the worst human rights record in the hemisphere. In its “Dirty War” against Marxists rebels, the Argentine junta seized thousands of political opponents, dissidents, and potential insurgents who just disappeared, often never to be seen again, detained without trial in secret prisons with no notice to their families. Interrogators often used torture. This appalling record led the U.S. Congress to prohibit all forms of security assistance and arms sales to Argentina in August 1977.<sup>47</sup> In March 1978, again at ISA's recommendation, Brown wrote Vance suggesting that the current arms sales prohibition to Argentina was not contributing to better human rights there, but having the opposite effect. Brown suggested that a “carrot” might be more effective than a “stick” approach, starting with some training and spare parts for U.S.-originated equipment, and the dispatch of a U.S. senior military official to Argentina to make “crystal clear” that only meaningful improvement in human rights would convince Congress to modify the arms embargo legislation.<sup>48</sup> Vance agreed, but he preferred a senior level State-Defense team. Brown readily accepted, naming two senior officers, Maj. Gen. Lee E. Surut and Rear Adm. Gordon J. Schuller, who joined Under Secretary of State for Political Affairs David Newsom in a late May mission to Buenos Aires. Unfortunately, the Argentine government refused to give firm commitments on accounting for missing persons or releasing detainees, so State recommended minimal U.S. aid.<sup>49</sup>

The team effort might not have been in vain. The Carter administration detected some signs that the Argentina junta had lessened repression later in the summer. Arrests and detentions continued, but some prisoners were released. Reports of torture, disappearances, and summary executions were still “relatively frequent.”<sup>50</sup> Nevertheless, Assistant Secretary (ISA) David McGiffert believed “we did gain some ground through the State/DoD mission . . . although it has been a daily battle to follow through for tangible results.” One of the more moderate junta members, Air Force Commander General Orlando Ramon Agousti, sent a personal letter to the new JCS chairman, General David Jones, which McGiffert described as “baring his soul” in a plea for more dialogue.<sup>51</sup> Brown suggested inviting Agousti to Washington. Vance countered that the human rights situation in Argentina “still remains bad”; his visit would be inappropriate without evidence of further progress.<sup>52</sup>

Not to be deterred, Brown recommended that the U.S. approve all pending Argentine requests for spare parts and allow Argentina to purchase U.S. military training courses. The secretary noted that since the decision to deny spare parts and training had not been made public, its reversal would not be seen as vacillation on human rights steadfastness.<sup>53</sup> State, NSC, and OSD officials met in September 1978, agreeing to release \$17 million for spare parts and training.<sup>54</sup>

The human rights issue festered. It was difficult to determine if U.S.-Argentine relations improved with these limited U.S. concessions, but then a new international issue arose. After Soviet forces invaded Afghanistan, the United States embargoed grain sales to the Soviet Union. Moscow looked to Argentina, the world’s fourth largest producer, for its grain needs. The junta refused to participate in the embargo—a domestically popular stance—although they privately assured Washington that they would limit sales. U.S. officials were doubtful that Argentina would restrict its exports of grain to Moscow. Generally, Buenos Aires and Moscow were developing closer trade relations. The junta’s rejection of offers of Soviet military assistance provided the only hopeful sign.<sup>55</sup>

By mid-1980 Argentina’s human rights violations trended downward.<sup>56</sup> Motivated by both the improvements in human rights and closer Argentine-Soviet relations, in May 1980 the PRC recommended to the president that the United States seek improvements in relations with Argentina. DoD representative Claytor and Deputy Secretary of Commerce Luther H. Hodges Jr. favored rapid improvements,

lest the United States drive Argentina into the embrace of the Russian bear. The president's reaction: "I'm inclined to move faster."<sup>57</sup>

In response to Carter's instruction, the Interagency Group for Latin America recommended a strategy, which Carter approved. Before the plan could be implemented, the military leaders in Buenos Aires helped stage a military coup in Bolivia and refused to agree to continue limiting grain sales to Moscow. Following the lead of Secretary of State Edmund Muskie in October, the group recommended delaying most of the plan, including high-level military visits.<sup>58</sup> Claytor strongly opposed the delay, writing Carter that it would be a mistake since "the best chance" for talking sense to Argentina was through "military to military channels."<sup>59</sup> The issue was resolved at a Muskie, Brown, and Brzezinski lunch at which Brzezinski promised to revive the military rapprochement to Argentina in 1981, after General Roberto E. Viola, the junta's newly selected president, made his scheduled private visit to Washington in late 1980 for discussions with Carter. After Carter's loss in the November 1980 election, however, Viola delayed his visit. Better relations with Argentina became the responsibility of the Reagan administration.<sup>60</sup>

If Argentina had the worst human rights record, Chile under President Augusto Pinochet ran a close second. In September 1976 Pinochet government agents murdered a political opponent, former President Salvador Allende's ambassador to the United States, Orlando Letelier, using a car bomb in Sheridan Circle in Washington, DC, that also killed Letelier's U.S. assistant, Ronni Moffitt, and injured her husband. The assassination was an in-your-face provocation; military juntas did not dare to murder opponents in the streets of Washington. In October 1979, the Chilean Supreme Court denied the U.S. request for extradition of those Chilean intelligence officers indicted for planning and directing the murders. While Brown considered the denial of extradition a "lamentable and most unfortunate turn of events," he disagreed with Vance's proposal to sever military ties with Chile in retaliation. Brown argued that Chile's geographical location made it strategically important, and to sever ties would set back U.S.-Chilean relations for years. A ban on U.S.-Chile military relations would result in a long-term U.S. loss of influence within the government and an abandonment of control levers that Washington could use over Chilean armed forces; the denial of spare parts would drive Chile to acquire new, more sophisticated weapons elsewhere. Brown

warned that vacuums of U.S. influence in the Western Hemisphere provided opportunities for the Soviets or Cubans to fill. As the secretary told the president, “I strongly recommend that military-related actions not be included in any short-term retaliation directed toward Chile,” and he specifically opposed terminating the FMS pipeline, phasing out the U.S. Military Group (MILGP), and denying validated licenses for commercial exports of equipment to Chilean armed forces.<sup>61</sup>

Carter completely disregarded Brown’s advice, terminating the arms sales pipeline in 1980 and reducing the MILGP to two people (with a later judgment by State on whether the two should subsequently leave after the termination of the pipeline). He instructed State and Commerce to continue holding up current licenses for export of commercial items for use by the Chilean military (new requests would be carefully reviewed).<sup>62</sup> For many at the NSC, the White House, and State (especially the Bureau of Human Rights and Humanitarian Affairs), who harbored strong objections, if not aversions, to Pinochet, this was the right course.<sup>63</sup>

The anti-Pinochet sentiment continued to work against DoD recommendations. After the JCS convinced Brown that the Chilean navy should be allowed to take part in the 1980 annual *Unitas* exercises, which the U.S. Navy held with its South American counterparts, he tried to convince Vance and Brzezinski to agree, but Vance refused, saying the time was not right. Brzezinski reportedly stated that the president was too politically vulnerable on the Letelier extradition case to permit Chilean participation.<sup>64</sup> Pastor of the NSC staff said it most explicitly: “You can be absolutely certain that the decision to put the ‘Letelier phase’ behind us and proceed with *Unitas* will be noticed. Kennedy [Senator Edward Kennedy, who was challenging Carter for the Democratic presidential nomination] is hungry for issues.” Pastor suggested that the JCS and OSD arguments about loss of influence in Chile were overstated: “We are hardly in danger of losing Chile to anyone but the militarists.” Brzezinski denied Chile’s participation in *Unitas*.<sup>65</sup>

A clear pattern emerged. DoD argued for concessions to Chile while the human rights advocates in State and the White House opposed them. Commenting on an OSD proposal to send Secretary of the Navy Edward Hidalgo to Chile and Argentina in mid-1980, Pastor characterized the request as “symptomatic of their [DoD’s] continued efforts to undermine the President’s human rights and security objective in Latin America.” Pastor recommended instead that Hidalgo focus on strengthening military ties in democratic countries in the Caribbean.<sup>66</sup> After the 1980 presidential

election, Muskie, Brown, and Brzezinski agreed to leave a credible human rights Chilean policy behind for the next administration by publically announcing the president's decision to terminate the FMS pipeline and the MILGP. Carter also took nonmilitary action such as reducing the size of the embassy mission in Santiago, suspending Export-Import financing, and prohibiting the Overseas Private Investment Corporation (OPIC) from approving guarantees or underwriting for new economic activities in Chile. No doubt, Carter officials knew the Reagan administration would reverse these measures, but they had left their mark.<sup>67</sup>

In all three countries DoD efforts to protect or reestablish military relations failed. While the Carter administration eventually agreed to improve military relations with Argentina and Brazil, it did so slowly and so tentatively that it was forced to leave the major implementation to the Reagan administration. On Chile, the president's rejection of DoD advice in part reflected his own passion for human rights reinforced by advocates in his administration—not to mention political considerations—but also his anger at the audacity of the Letelier assassination and Pinochet's failure to extradite the men behind the crime. Brown did not fully share Carter's passion for human rights. He later recalled that "idealism frequently lost out to our strategic interests, as in my opinion it generally should when they compete, but it paid off handsomely in the long run."<sup>68</sup> At the time, the secretary did not enjoy this long view. In Latin America he argued that a military relationship and reward for better behavior could promote the kind of reforms the Carter administration hoped to achieve. Simply terminating military programs was, in his mind, counterproductive.

### **Cuba and the Soviets**

Cuba had been a thorn in the side of the United States through five U.S. presidential administrations ever since Fidel Castro and his band of revolutionaries defeated the forces of Cuban dictator Fulgencio Batista in 1959 and took power. A Communist state just 90 miles from the U.S. mainland, relying almost exclusively on Soviet economic and military assistance and actively promoting revolution in the Western Hemisphere, Cuba demanded Washington's attention. To some U.S. presidents, the thorn proved an annoyance or an irritation; to others, such as Kennedy, it became an obsession. Yet no U.S. president could ignore Cuba. Carter was no exception, but he had a plan to normalize relations with Cuba and wean Castro away from the Soviet Union.



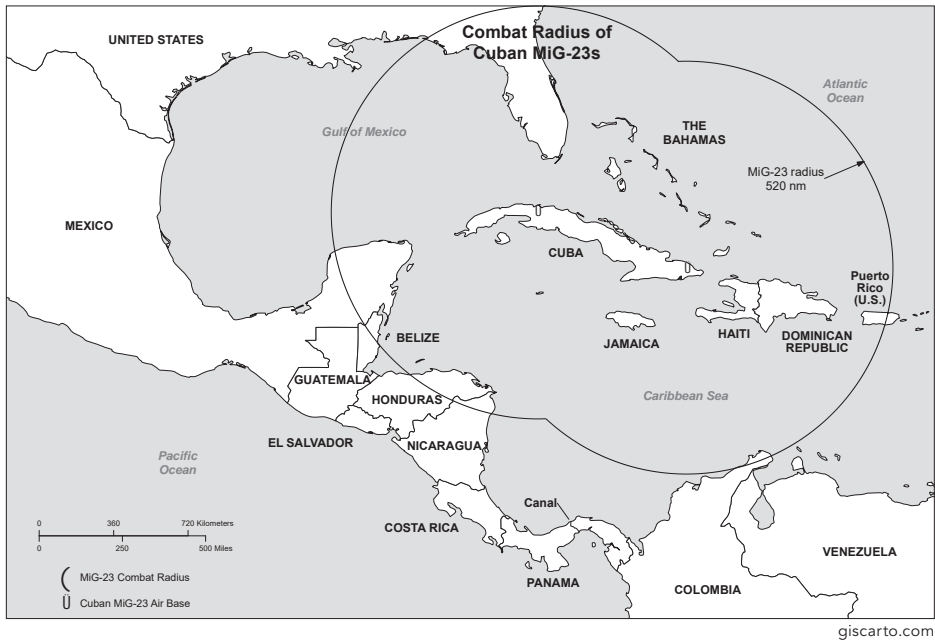

Early in his term, Carter directed the State Department to review Cuban policy and explore renewing regular relations. After a positive response, Carter instructed the diplomats to begin direct and confidential talks with Cuban officials, using a step-by-step approach, hoping the talks would blossom into full diplomatic relations, relaxation of the trade embargo on Cuba, and less promotion of Marxist revolutions in Latin America by the Cubans.<sup>69</sup> Defense played the role of bystander as State undertook these negotiations. Suffice to say these overtures did not achieve Carter's objectives of rapprochement with Castro. If anything, relations between Havana and Washington deteriorated during the last three years of the Carter presidency.<sup>70</sup>

Much of the deterioration derived from U.S. concern about the Soviet Union's modernization of Cuban armed forces. In summer 1978, U.S. intelligence confirmed that the Soviets had provided 12 to 24 MiG-23 aircraft to Castro. Were these MiGs the D model, a ground attack aircraft capable of carrying nuclear weapons, or the defensive interceptor/air-to-air attack F model, which required modifications to make it nuclear capable? In either case, the MiGs could penetrate up to Jacksonville, Florida, threatening U.S. military installations in the state. At DoD's urging, and over State Department opposition as "too politically sensitive," the president ordered

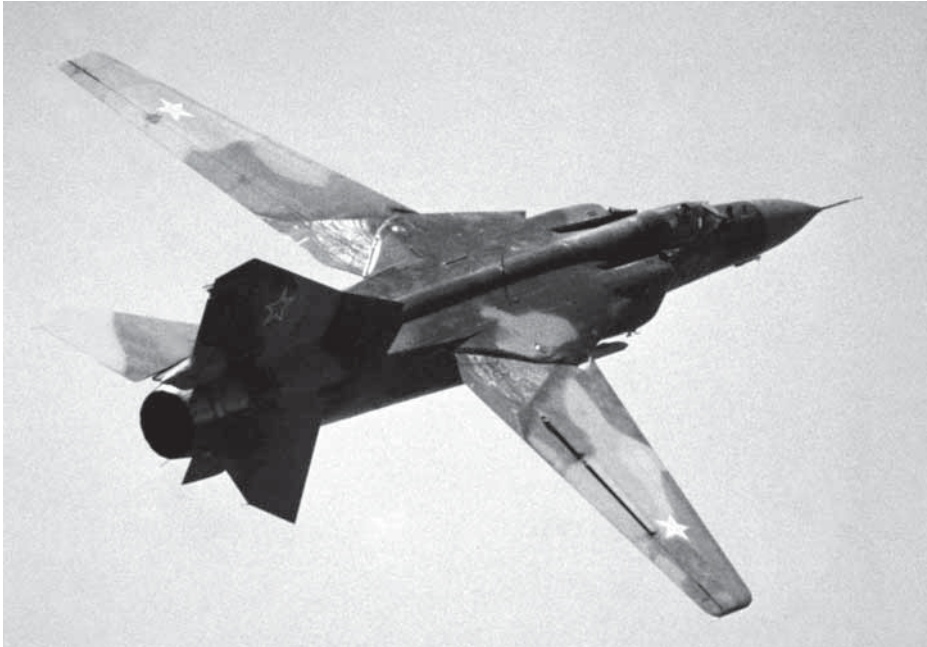

Soviet MiG-23 Flogger aircraft similar to the ones stationed in Cuba. (RG 330, NARA II)

SR-71 Blackbird reconnaissance planes, grounded since early 1977 as a gesture to encourage U.S.-Cuban bilateral negotiations, to overfly the island again. U.S. intelligence analysts poured over the raw intelligence gathered by these flights, eventually concluding there was no evidence indicating the Soviets were reintroducing nuclear weapons into Cuba; the MiGs were the F model. Although a reconfigured F model could carry nuclear weapons, intelligence analysts thought the MiG-23s in Cuba were more an example of “technology creep.”<sup>71</sup>

The general consensus in DoD was that the MiG-23s would not significantly alter the balance of power in the Caribbean, but their presence, if unchallenged, could lead to more dangerous Soviet improvements in Cuban forces. Based on this advice and the intelligence findings, in late October 1978 the secretary alerted the president, stressing that while the aircraft were not that militarily significant, their presence could have serious domestic political considerations. Brown’s memorandum harbored the unspoken assumption that the MiGs could complicate the Senate’s ratification of the SALT II agreements, negotiations of which were thought to be nearing completion. Brown’s memorandum leaked to the press, causing a two-week media circus.<sup>72</sup>

Brzezinski later recalled that in talking with Vance in November, he and Brown had a prior agreement that Brown would take the lead and Brzezinski would support him in opposing Vance, who did not want the MiG-23 issue to complicate U.S.-Soviet relations. Brzezinski remembered Brown as “not very forceful” and Vance as extremely adamant.<sup>73</sup> Was it a matter of Brown’s friendship with Vance or his realization that the MiGs were not a real threat? Whatever the reason, the spiraling publicity from the leak backed Vance into a corner. In late November 1978, he met with Soviet Ambassador Anatoly Dobrynin to discuss the MiGs. In addition, the U.S. ambassador in Moscow, Malcolm Toon, held multiple talks with Soviet Foreign Minister Andrei Gromyko. Both Soviet officials assured the Americans that the MiGs were not nuclear capable, Cuba would receive no additional MiGs, and nuclear weapons would not be sent to Cuba. The Soviets insisted, however, that this assurance did not preclude their right to upgrade Cuba’s air force with conventional weapons such as the MiG-23. Carter went public with these promises.<sup>74</sup>

Brzezinski sent the NSC staff delving into the historical files at NSC, State, and the Kennedy Presidential Library to determine whether or not the MiGs represented a violation of the nebulous 1962 U.S.-Soviet Cuban missile understanding on offensive weapons. The records they uncovered indicated that the Soviets maintained at the time that the 1962 prohibition applied only to the medium-range ballistic missile (MRBM) and the reintroduction of nuclear weapons, not even IL-28 bombers (although Moscow had agreed later in 1962 to withdraw them and not to reintroduce them). As the United States failed to protest when the Soviets introduced MiG-21s, Brzezinski and the NSC staff concluded that the introduction of MiG-23s could hardly be interpreted as a violation of the understanding.<sup>75</sup>

In May 1979 Brown became increasingly concerned over the Soviet buildup in Cuba and Moscow’s upgrading of Cuban offensive capabilities. The Soviets were clearly upgrading Cuban conventional forces. The secretary asked Brzezinski to call a Special Coordination Committee meeting to discuss the problem.<sup>76</sup> Before the meeting, Brown circulated to fellow NSC members an ISA background paper on U.S.-Cuba relations, suggesting that Cuban arms modernization—the MiG-23s, naval base construction at Cienfuegos, and acquisition of diesel-electric Soviet Foxtrot and older Whiskey-class submarines, together with Cuban activities in the Caribbean and Africa—posed serious security problems. ISA suggested that within two years or less Cuba could threaten U.S. oil supply lines from Nigeria, Venezuela,

and potentially Mexico, as well as the bauxite supply from Jamaica, Surinam, and Guyana, and even endanger the Panama Canal. Neither the commander in chief, Atlantic Command (CINCLANT) nor the JCS believed that CINCLANT had forces adequate to neutralize the Cuba threat and still meet NATO obligations. ISA noted that “Cuba’s revolutionary small country mystique” gave it special cache and provided “a cheap proxy to carry out Soviet policy with little direct Soviet Commitment.”<sup>77</sup> Often critical of DoD, Brig. Gen. William E. Odom, Brzezinski’s military assistant, deemed it a “surprisingly excellent paper.”<sup>78</sup>

Always alert to Soviet adventurism, Brzezinski reinforced Brown’s new concern in one of his weekly reports to the president, noting that since 1960 the Soviet Union had given Cuba \$13 billion in economic aid and supplied the country with all of its military equipment. In return, Soviet intelligence ran many operations out of Cuba and stationed 2,000 military personnel on the island (including pilots flying tactical missions in Cuban aircraft).<sup>79</sup> Notwithstanding this confluence of concern, the SCC meeting proved anticlimactic. The committee reached no major conclusions, although it agreed to upgrade intelligence coverage and sharing on Cuba and instructed DoD, JCS, State, and NSC to prepare detailed recommendations on how to increase U.S. military presence in the Caribbean, thus sending a “message of caution” to Castro. During August and September 1979 DoD, State, and NSC traded memos on how best to upgrade U.S. military forces and influence in the Caribbean and on which strategy to recommend to the president to counter Cuba there and elsewhere.<sup>80</sup> The issue assumed a new urgency at the end of August, when U.S. intelligence concluded that the Soviet Union had stationed in Cuba a Soviet Red Army brigade of 2,600 to 3,000 men, including a brigade headquarters, three motorized rifle battalions, one tank battalion, and service and support units.<sup>81</sup> What the intelligence community did not know exactly was how long the troops had been there and what their purpose was.<sup>82</sup> On 30 August, Senate Foreign Relations Committee Chairman Frank F. Church (D-ID) went public with information he had from a briefing about the brigade (he apparently did so to improve his reelection chances in conservative Idaho), creating a media firestorm that coincided with the Senate’s consideration of the SALT II Treaty. Vance and Carter made a series of public statements that did nothing to dampen the fire, rather they stoked it.<sup>83</sup>

The brigade was not a training center as the Soviets feebly claimed, but it was not a new development as U.S. intelligence had initially believed. Furthermore, it

did not contradict the 1962 U.S.-Soviet understanding on offensive weapons in Cuba. There was no deal in 1962 about Soviet combat troops in Cuba. The U.S. intelligence community thought that combat troops accompanying the Soviet MRBMs and IL-28 bombers had left in 1963-1964, but they had not. Without assault capability—no airlift or sealift capability—and given its small size, the Soviet brigade represented no real threat to the United States.<sup>84</sup> While the issue petered out as the MiG-23 flap had almost a year earlier, with vague Soviet assurances and a Carter public statement, this had been a self-inflicted wound by the intelligence community, State, and the White House.<sup>85</sup>

More important than Soviet combat soldiers in Cuba, growing Cuban influence in the Caribbean and Central America caused Brown, Vance, and Brzezinski at the end of September to come up with an anti-Cuban strategy and present it to the president in 1979. The strategy aimed to reduce and eventually remove Cuban military forces abroad, deny Cuba leadership within the third world, restrain Cuba from inciting Puerto Rican independence, and inhibit the Soviet buildup of Cuba's armed forces. The three presidential advisers recommended a "six prong strategy" that began with an increase of U.S. military presence in the region through U.S. Navy port calls, training of friendly countries armed forces, and greater economic and military assistance to countries that respected human rights and democratic values. Carter approved the strategy as Presidential Directive 52.<sup>86</sup>

At the end of October 1979, Brown reported to Brzezinski on specific DoD initiatives in conjunction with PD 52. They included establishment of a permanent Caribbean joint force at Key West, Florida, responsible for planning, exercising, and operating U.S. forces in the Caribbean; Defense Intelligence Agency participation in an intelligence community-wide surveillance of Cuba; a reinforcement exercise for Guantanamo; increased Caribbean port calls by U.S. naval ships; use of U.S. military personnel (both active and reserve) in Caribbean natural disasters; and improved readiness of the Army Reserve and National Guard in Puerto Rico and the Virgin Islands.<sup>87</sup>

Brown and Director of Central Intelligence (DCI) Stansfield M. Turner discussed possible responses to the Cuban threat, but ISA thought that the CIA and the NSC staff had failed to follow up the initiative. At ISA's suggestion, Brown advocated a covert program to complement the overt one approved in PD 52 to disrupt Cuban-Soviet arm supplies and lines of communication to insurgent groups; identify,

infiltrate and expose Cuban-Soviet covert operations; covertly keep Caribbean and Latin America friendly countries apprised of these operations; and use clandestine broadcasting to expose the repressive measures of the Castro regime and the economic hardships caused by its mismanagement of the economy.<sup>88</sup> Brzezinski and the NSC, unimpressed with the proposal, claimed that DoD had not properly staffed its proposals with it or CIA or State. Furthermore the United States was already engaged in such action. DoD disagreed. The current program focused only on El Salvador; DoD's recommendations covered the region.<sup>89</sup>

Later in the month Brown made his pitch to the president. The solution to countering Soviet military aid to Cuba foundered on the nebulous meaning of the 1962 understanding and Soviet unwillingness to interpret it as restrictive in any way beyond prohibiting medium-range missiles, nuclear weapons, and, by inference, nuclear-capable bombers in Cuba. The idea of destroying Soviet equipment in Cuba, tentatively raised by Vance, seemed to Brown far too risky. Furthermore, Moscow could always ship replacements. The only reasonable response was to "not allow Soviets and/or Cubans to use combat forces in Latin America." Instead of more FMS, military aid, or training teams—a poor response to the insurgent threat—the secretary recommended police assistance programs, better monitoring of Cuban-Soviet support of insurgents, and the covert action program as described earlier to Brzezinski, in conjunction with an adequately financed diplomatic strategy.<sup>90</sup> Whether Carter would have implemented Brown's recommendations remains unclear. Such regional developments as the Sandinista victory in Nicaragua, the insurgency in El Salvador, and the Cuban refugee crisis—not to mention Afghanistan and the Iran hostage problem—prevented the Carter administration from focusing on the specific remedies proposed by Brown.

### **Cuban Refugee Crisis**

Castro confronted a significant problem in the spring of 1980. Many Cubans wanted to leave for Miami and South Florida. Carter estimated, apparently based on reliable intelligence, that the disaffected Cuban population amounted to 10 percent. Cuban-Americans paid for clandestine boat escapes for their relatives in Cuba while others found a way to join the exodus, some by stealing or hijacking Cuban vessels. Initially the U.S. government welcomed the Cubans as political refugees, but the stream turned into a torrent. In mid-April Castro made the best of a bad



situation. He allowed those who wanted to leave to do so; he also opened his prisons and mental hospitals, adding those inmates to the others departing from the port of Mariel. South Florida was overwhelmed with refugees.<sup>91</sup>

Only the Department of Defense had the resources to deal with the crisis. Four Navy minesweepers assisted the Coast Guard in search and rescue of refugee boats in distress at sea. The Navy set up reception and processing areas for refugees at the Key West Naval Air Station, where 900 marines provided security. As the influx increased, the president directed the Federal Emergency Management Agency (FEMA) to coordinate the effort; in turn, FEMA directed DoD to provide a reception area at Eglin Air Force Base in Florida. Within 11 days DoD had established a tent city and food service facilities for 10,000 refugees. In late May DoD established additional reception areas at Fort Chaffee, Arkansas; Fort Indiantown Gap, Pennsylvania; and Fort McCoy, Wisconsin.<sup>92</sup> In early June the president approved a memorandum of understanding between DoD, the Department of Justice, and FEMA that delineated the responsibilities for law enforcement and peacekeeping for refugee detainees at military installations. Military police performed perimeter patrols at the detainee camps and were prepared to respond in force if riots or disturbances broke out.<sup>93</sup>

While the desperate exodus provided Castro with a propaganda black eye, it overwhelmed U.S. resources. The president needed a way to stop the refugees before they arrived in Florida. Carter directed Brown to position three or four U.S. naval ships 12 miles from Mariel harbor “as a quiet demonstration that we are prepared to turn back vessels illegally bringing Cubans to the United States.” Carter also

ordered DoD and the Coast Guard to prepare a range of options to stop illegal vessels and return them and their passengers to Cuba.<sup>94</sup> At Brown's request, the Joint Chiefs provided two possibilities: naval quarantine of the port of Mariel or all of Cuba. Brown did not recommend either option. Quarantine contained significant risk of U.S.-Cuba confrontation that could squelch the interest the Cubans seemed to be showing in restoring an orderly departure program, the official mechanism for Cubans to leave for the United States.<sup>95</sup>

In addition, the president required Brown to prepare a plan with the Coast Guard to surreptitiously deposit Cuban criminal refugees back in Cuba.<sup>96</sup> Neither Brown nor the JCS thought this a good idea. They did provide four military options (gradations of secret sealifts or airlifts) and one nonmilitary overt option (the Coast Guard plan to steam an unarmed vessel carrying the criminals into a Cuban port). None of these schemes offered a good prospect of success, and the military ones risked the use of military force.<sup>97</sup>

Still determined to stop the Cuban assault, the president asked that 90 percent of northbound ships and boats from Cuba be interdicted. Claytor told Carter that interdicting northbound vessels meant the possible use of force to stop or disable an overcrowded and unseaworthy craft, which would endanger lives and might cause desperate refugees to jump into the sea rather than be returned to Cuba. Under international law, the United States was obligated to rescue refugees in life or death situations and bring them to the United States. Thus, the easier and safer method was to interdict the empty vessels as they returned southbound to Cuba to pick up more passengers. Defense estimated a potential success rate for the southbound option at 70 percent to 75 percent interdiction.<sup>98</sup>

At two Special Coordination Committee meetings in late August 1980, Carter's advisers discussed the interdiction options and potential clandestine military plans to return the criminals, the latter deemed too risky. Although pessimistic, NSC officials recommended exploring with the Castro regime its willingness to negotiate an end to the crisis.<sup>99</sup> The president opted for the southbound interdiction, in which four Navy minesweepers, five patrol boats, and P-3 Orion and S-3 Viking surveillance aircraft would assist the Coast Guard in stopping vessels and issuing a warning that U.S. authorities were prepared to confiscate any boat with illegal refugees arriving at a U.S. port.<sup>100</sup> When, in September 1980, U.S. diplomats informed Castro that closure of Mariel as a refugee departure point from Cuba was



a prerequisite for a resumed dialogue with Washington, Castro agreed. The refugee flood ceased and the president directed withdrawal of the Navy forces carrying out the interdiction campaign. The Coast Guard posture in South Florida remained unchanged to deal with illegal Haitian immigrants.<sup>101</sup> DoD's role in the refugee crisis proved substantial, opening five reception facilities for 20,000 refugees. Four thousand soldiers, airmen, marines, and sailors took part in the DoD effort that received, processed, and resettled 110,000 Cuban refugees.<sup>102</sup>

### **Central America: Nicaragua and El Salvador**

Although hardly beacons of democracy (only Costa Rica practiced representative government), the military and caudillo regimes of the isthmus dividing North and South America kept a low profile. With the exception of Panama, Carter human rights advocates, mostly located in the NSC's Global Issues Cluster and the State Department's Bureau of Human Rights and Humanitarian Affairs, concentrated on the big offenders—Argentina, Chile, and Brazil. Central America did not appear on their radar. Ruled by the Somoza family since 1936, Nicaragua proved a case in point. The United States had trained and armed the country's national guard, which kept the Somozas firmly in power. The current president, Anastasio Somoza, a graduate of the U.S. Military Academy at West Point, carefully cultivated U.S. members of Congress, especially influential Representative Charlie Wilson (D-TX), and enjoyed close relations with many U.S. flag officers. Corrupt and unconcerned about the well-being of ordinary Nicaraguans, the Somozas used Nicaragua as their personal piggy bank. Toward the leftist opposition they employed the iron fist. Their moderate opponents received slightly more lenient treatment. In 1977 it seemed as if the Somoza family would rule for years. The unraveling of the Somoza regime at the hands of the leftist Sandinista guerrillas in 1978–1979 is a long and convoluted story. Of concern here is the role DoD—Brown and his staff, the JCS, and SOUTHCOM—played in political change in Nicaragua that had far-reaching consequences beyond 1981.<sup>103</sup>

In 1978 Sandinista guerrillas orchestrated a series of brazen challenges to the Somoza regime and the National Guard: occupation of the city of León, attacks on National Guard posts, temporary seizure of the Presidential Palace in Managua, freeing political prisoners and orchestrating their escape to Panama and then Cuba (many Nicaraguans cheered the prisoners as they left the airport), and a nationwide strike. To make matters worse, the moderate political opposition to Somoza refused

to negotiate with him.<sup>104</sup> Faced in September 1978 with a well-financed Sandinista insurgency, Somoza unleashed the National Guard, generating more hostility among Nicaraguans caught in the crossfire and raising the hackles of human rights advocates in Washington. In a series of Special Coordination Committee meetings in September 1978, the participants, including Under Secretary of Defense for Policy Stanley R. Resor, called the situation “bleak and . . . deteriorating” and concluded Somoza had to go. The participants agreed the best way to encourage his exit was to create a mediation group of Latin American nations supported by the United States that would ease Somoza out and encourage the moderate opposition groups to coalesce so they could win the scheduled 1981 elections.<sup>105</sup>



As the pace of deterioration and polarization in Nicaragua quickened, State prodded the Pentagon to ask retired U.S. military officers who had worked with Somoza to influence him to resign. SOUTHCOM Lt. Gen. Phil McAuliffe, a close friend of Somoza, could have a heart-to-heart talk with him, but McAuliffe considered it inappropriate for an active-duty soldier to pass a political message. Still, ISA thought, if worse came to worst, McAuliffe might be the man to deliver it.<sup>106</sup> The general expressed great concern to Brown about the insurgency and its implications for the rest of Central America.<sup>107</sup>

Throughout autumn 1978 the NSC's Policy Review Committee—with either Duncan or McGiffert attending for DoD—followed events in Nicaragua. State officials insisted mediation had reached a critical point. The non-Sandinista political opposition demanded as nonnegotiable Somoza's resignation and an orderly process from interim constitutional successor to a new constitution and elections. McGiffert put the choice to Brown: the intelligence community's assessment reasoned Somoza could survive in the short run, but not in the long run, because support for the Sandinistas was growing and Somoza had lost support of the middle class. The United States faced “a choice between the devil we know and the devil we don't. . . . [The] consensus (not unanimity) [was] that choosing the devil we don't know is a better way to avoid an eventual Castro type regime.”<sup>108</sup>

In December 1978 the administration decided to send a delegation including McAuliffe to Managua. The general did not mince words in informing Somoza, as the Nicaraguan president heard it, that his time was up, or as McAuliffe later described it, that it was time to accept a plebiscite on his future and abide by it. Both McAuliffe and Ambassador William G. Bowdler, the U.S. Nicaragua mediator and Assistant Secretary of State for Inter-American Affairs, recommended presenting Somoza with an ultimatum. If he refused to come to terms with the non-Marxist opposition on a plebiscite, the two officials urged the United States to withdraw the U.S. military advisory group, the U.S. Agency for International Development (USAID) mission, the Peace Corps, the U.S. Information Agency (USIA) mission, and the U.S. ambassador.<sup>109</sup>

At the 26 January 1979 Policy Review Committee meeting—the first one on Nicaragua attended by Brown, who had been consumed by budget issues, SALT II negotiations, and the Iranian crisis—the participants recommended and the president approved an even more serious signal to Somoza than that of Bowdler and

McAuliffe. In addition to withdrawing the USAID mission, the Peace Corps, and the Military Advisory Group (but not USIA), the United States would terminate all military assistance to Nicaragua, withdraw all nonessential embassy personnel from Managua, censure Somoza's human rights record in an OAS report, suspend two USAID loans, and encourage other governments to withhold arms sales to Somoza or not provide arms to the Sandinistas. These actions would be made public.<sup>110</sup>

The Carter administration essentially let the chips fall where they might. State stopped its mediation effort. As long as the National Guard supported him Somoza could survive, but for how long? The administration took advantage of an interlude in its Nicaraguan policy to undertake a review of general U.S. policy toward Central America (PRM 46 of 4 May 1979), producing a response in June 1979. Prepared by State, it mirrored the Carter administration thinking: most Central American governments lacked political legitimacy. The best course was to encourage dialogue among moderates in Central America so as to promote democracy, free elections, and social and economic reform. While this was all to the good, McGiffert in ISA commented that the response to the PRM "understates the fact that the U.S. is part of the problem. Where our policy efforts sought to support and strengthen the political moderates in Central America, they may well have served only to weaken the current regimes and strengthen the leftists/radical movements." An even more basic flaw, according to McGiffert, political liberalization could not succeed without the reversal of violence and polarization. Defense had the ability to help protect security in Central America, but "we have allowed our leverage to atrophy." McGiffert cited as examples of this lessened influence: lower FMS credits to the region, less international military education and training, withdrawal of the MILGP, and termination of military assistance to Nicaragua. DoD had to sensitize the administration to the need for these tools.<sup>111</sup>

At a PRC meeting in early June 1979 to discuss the response to PRM 46, Deputy Secretary Duncan insisted that the reduction of violence and instability in the region be given the highest priority, not political liberalization. "Only after there is a stable foundation," Duncan continued, "can we begin to talk about moving 'toward more open political systems.'" On Nicaragua, Duncan suggested that the Sandinistas prevented Somoza from maintaining law and order. They succeeded "because of the support they are getting from Cuba, Panama, and Costa Rica, which permits the Sandinistas refuge." Lean on Somoza, but also "lean on these countries"

as well to calm the violence. Deputy Secretary of State Warren Christopher and others disagreed; Duncan was odd man out.<sup>112</sup>

Events in Nicaragua quickly limited U.S. policy options. In May 1979 the Sandinistas began a final offensive supported by arms, technical military advice, money, and military advisers from Cuba and other Latin American revolutionaries trained in Cuba. Until this final push, the Cubans had been circumspect in their support of the Sandinistas, only coordinating such support through Panama and Costa Rica. Sensing the kill, the Cubans now joined the battle in earnest.<sup>113</sup> The National Guard found itself short of everything—rockets, hand grenades, mortar rounds, and recoilless rifle and heavy machine gun ammunition. Its former suppliers, Israel and Argentina, had apparently succumbed to U.S. pressure for an arms embargo. Somoza turned to his air force, a blunt weapon that killed civilians and guerrillas indiscriminately.<sup>114</sup>

On 22 June, Carter met with Brown, Vance, Mondale, and Hamilton Jordan to discuss the situation in Nicaragua. Brzezinski made the case for U.S. intervention in the form of a peacekeeping force, citing dire and dark international consequences if the United States allowed another Latin American country to go Communist with Cuban help. Neither Brown nor Vance agreed. Carter emphatically opposed U.S. unilateral intervention. The president hoped for an internationally supervised referendum to determine the new government.<sup>115</sup>

Deliberations continued at the 25 June SCC meeting, with DCI Stansfield Turner suggesting that Somoza was likely to last only one to three weeks. Discussions centered on a possible coalition of moderates and Sandinistas that could form the basis for a transition government, but Brown stated “it will still look as if it is a political defeat for us.” Duncan suggested that if the Sandinistas won the military battle, it would make little difference if the United States walked away or tried to frame a political solution. The Sandinistas would be in control. Brown stated that it was time to resupply the National Guard; whether it could be done in 90 days or 6 months, it would not affect the current military campaign, but might affect future ones. Both Brown and JCS Chairman General Jones stated that without resupply from the United States the guard could not stand up to the Sandinistas. At the end of the meeting, Brzezinski recommended a scenario that brought all parties together, allowing for a peaceful Somoza exit. Brown insisted that Carter be told this strategy was a long shot and might well complicate relations with the Sandinistas if and when they took power.<sup>116</sup>

Under no illusion about the eventual outcome in Nicaragua, Brown outlined in a private memorandum to Carter (prepared in ISA) a strategy to save the rest of Central America from Marxist insurgencies. The Sandinista victory would encourage leftist oppositions in El Salvador, Guatemala, and Honduras; Nicaragua would no doubt support them. In Guatemala, where the leftists were weak and the military and ruling elite were strong and brutal—they systematically killed moderate opponents—Brown did not suggest going beyond what was already recommended, a \$6 million rural development loan and a helicopter for the Guatemalan president's use. The United States should cultivate moderate Guatemalan military leaders and protect them from government attack in the hope they could eventually push the government toward moderation. For Honduras, where the leftist threat was minimal, Brown recommended using incentives like increased economic aid, more FMS, and expanded IMET to ensure that the military held the promised elections. In El Salvador the current military-appointed president, Carlos Humberto Romero, seemed responsive to U.S. pressure for political liberalization, but he faced a significant leftist opposition that would almost certainly be emboldened by the Sandinista victory. To Brown, Washington could not do better than Romero and suggested the administration encourage him with nonmilitary assistance and limit the actions that “would squeeze him because of human rights violations.”<sup>117</sup> As most expected, Somoza rule in Nicaragua soon ended. He lasted until 17 July 1979, when he, his family, and the leaders of the National Guard fled Managua. Two days later the Sandinistas formed a government, the first successful one established through a Marxist-Leninist armed revolution in Latin America since Cuba.<sup>118</sup>

Was El Salvador next? State Department officials described the rulers of El Salvador as “a weak and frightened government, representing and resting upon a controlling alliance of military and economic oligarchy which refuses to yield power, [and which] faces a radicalized opposition with a terrorist nucleus against a backdrop of serious socio-economic inequities and human rights violations and class hatreds.” DoD's ISA chief said it succinctly: “El Salvador is one of the sickest societies in the world.”<sup>119</sup>

Brown had hopes for the Romero regime, but the intelligence community considered it only a matter of time before military officers, impatient and frustrated by his inability to prevent kidnappings, bombings, and shootings of government

officials and business community members, overthrew him.<sup>120</sup> In early August 1979 the PRC, with Brown in attendance, recommended providing El Salvador with economic and military aid (including nonlethal tear gas and other crowd control equipment, commercial purchase of military equipment, and new engines for C-47 Skytrain transport aircraft) and ending the pressure on other countries not to sell arms to El Salvador. Both changes could come about—but only at the price of better human rights and political reform by the Romero government.<sup>121</sup>

Before the deal could be finalized with Romero, “reformist” military officers overthrew him on 15 October. The Carter administration faced a decision: to stay aloof or engage the five-man (three military and two civilian) Revolutionary Government Junta, or the JRG, in the hopes of leading it toward an effective national unity government of moderate military and civilians. Carter agreed to provide the JRG with limited nonlethal military assistance, reprogram \$3.5 million of FMS financing for the most pressing security needs, and notify Congress of intent to reprogram \$300,000 IMET funds immediately for needed training.<sup>122</sup> Unsure that a U.S. military assistance program would be a good idea, the new junta worried that it would provide the leftist opposition with a propaganda bonus. It favored a more multilateral approach.<sup>123</sup>

Still, the Pentagon stood ready to begin security assistance and programmed three mobile training teams (MTTs) totaling 36 men and \$4.5 million of foreign military sales, mostly for ground transportation (10 large 2½-ton trucks) and communications equipment. In addition, Defense recommended granting the government in San Salvador \$7.5 million to purchase six UH-1H Iroquois helicopters. This assistance would bolster the military’s ability to deal with internal subversion and insurgency but would not address the infiltration of arms from outside El Salvador to both the left and right factions.<sup>124</sup> The campaign to obtain military assistance from other countries proved difficult. Carter had second thoughts about sending mobile training teams, insisting that they have some “multilateral cover” before they went. Venezuela agreed to provide thin cover. One of the main voices for reform in El Salvador, Catholic Archbishop Oscar Romero (assassinated in March 1980), asked Carter to make reforms a precondition for dispatching the teams. The president agreed.<sup>125</sup>

Pastor told Brzezinski and Aaron in March 1980: “DoD and JCS are confused and uncertain why the MTTs are being held up. . . . If we do not get a firm and

favorable decision on the MTTs, we face a mutiny from across the river.” The U.S. Military Group in San Salvador reported that the promise of the training teams constituted its best tool to prevent a right wing coup against the JRG coalition.<sup>126</sup> Still, State delayed the dispatch of the teams, hoping to substitute lower-profile technical survey teams. Frustration, not mutiny, reigned at the Pentagon as the president sided with those who counseled that, until the JRG enacted meaningful reforms, high-profile military assistance must be delayed.<sup>127</sup>

In October 1980 Brown informed the president that the United States was not providing enough military assistance support to save El Salvador. The secretary considered inadequate the approved downsized package of nonlethal military equipment to improve communications, mobility, and medical capabilities of armed forces, as well as small technical teams to improve logistics, vehicle maintenance, communications, medical services, and public relations. After nine months of delay, it was time to send the MTTs for two- to three-month tours and provide the helicopters that had been on hold since February. Brown recommended specialized U.S. training in border control, intelligence operations, special operations for interdiction of arms, counterinsurgency training, and civic action teams to counter the influence of the guerrillas in the countryside. He also suggested replacing ordnance and equipment lost in hostile action and expanding the existing covert operations program. Turner agreed with Brown’s suggestions, adding that a training program for Salvadorian security forces was already underway.<sup>128</sup>

The military in El Salvador did not help Brown’s case. Right-wing security forces murdered four American women, three of whom were Catholic nuns.<sup>129</sup> Carter suspended all economic and military assistance in early December 1980 and sent the current and a former assistant secretary of state for Latin America (Bowdler and William D. Rogers) to investigate the murders and encourage the Revolutionary Government Junta to get the right-wing death squads under control. Bowdler and Rogers concluded that the JRG would launch a serious investigation of the American deaths. Pastor suggested that their report gave sufficient reason to restore economic aid, but FY 1981 security assistance, helicopters, and the dispatch of MTTs should be held up until the JRG reined in security forces and made real reforms. Carter agreed with Pastor, approving only nonlethal military aid in the FY 1980 pipeline and training of Salvadoran military officers in code of conduct and other courses in the United States and Panama.<sup>130</sup>



Brown told Carter that these measures did not suffice. El Salvador's security forces (12,000 military, 2,000 National Guard, 2,000 security police, and 500 Treasury police) were in dire straits. Soldiers lacked boots, and the entire force had only three small operational helicopters. They faced 5,000 guerrillas, many of them trained by Cubans, Sandinistas, and the Palestine Liberation Organization. The insurgents received arms from Cuba, Nicaragua, Ethiopia, Vietnam, and the Eastern Bloc. While not strong enough to defeat El Salvador's armed forces, the guerrillas could mount major operations of 100–200 men. Brown disagreed with the U.S. ambassador's policy of withholding military assistance until the most culpable right-wing military officers were removed from office, arguing that it only exacerbated an already precarious situation and invited a right wing coup against the JRG.<sup>131</sup>

Brown's advice set against new military setbacks—insurgents blew up one of the three helicopters and the government reported its ammunition supplies were down to a week's worth—convinced Carter's advisers that something had to be done. On 12 January 1981, just eight days before the end of his term and during frenetic Iran hostage negotiations, Carter approved sending helicopters, dispatching the first two from stocks in Panama, along with associated training teams as recommended by all agency representatives at a SCC meeting that morning. By 1 February 1981 four additional helicopters were to arrive with a 12-man maintenance MTT. None of the training personnel would take part in combat or operational missions against insurgents. The president waived the Arms Export Control Act, authorizing \$5 million in defense articles and services to El Salvador.<sup>132</sup> The decision finally ended the impasse between those on the NSC staff and at State, who wanted to withhold military aid to encourage reform, and those in DoD and CIA, who thought the coalition JRG coalition would not survive without military assistance.

In both El Salvador and Nicaragua Carter had ignored the advice of Brown and DoD until the final hours. The Sandinistas' triumph and the precarious state of El Salvador convinced many that Carter's human rights policy had been counterproductive in Central America. In Argentina and Brazil the case could be made that a better military relationship with the United States may have ameliorated human rights violations. For Chile, any improvements that occurred did

not come from an improved relationship, just from the prospect of one. Overall, Carter's Latin American policy suffered more setbacks than successes. After the substantial achievement of a successful renegotiation and ratification of the Panama Canal Treaties, the administration failed to prevent the growth of Cuban influence in the hemisphere despite DoD's program of increased military presence in the region. Brown and his OSD staff usually found themselves on the losing side of policy debates for the Western Hemisphere. Their pleas to use the U.S. military assistance and training to influence events in Central America usually fell on deaf ears until the situation became dire. The rest of the Carter team did little to stop insurgencies in Central America, and could point to only marginal improvements in human rights in South America's major states. It was hardly the outcome expected in January 1977.

## Reorganization and Reassessment of the Department of Defense

AS A PRESIDENTIAL CANDIDATE, Jimmy Carter promised to reorganize the government, make it much more efficient, and eliminate unnecessary spending, as he believed he had done with the Georgia state government. Cabinet officers had their subordinates dutifully prepare reorganization plans. Brown had definite ideas about reform of his unwieldy office. Foremost was his conviction that 36 people reporting directly to the secretary of defense were too many. Twenty was the maximum number; more than that and you had people reporting to no one, in Brown's view, a definite "span of control" problem. Brown worried that while the Defense agencies theoretically reported to him, he had no time to supervise them. As he told the president, his scheme would reduce executive positions and save "personnel spaces and dollars."<sup>1</sup> Under his draft plan most Defense agencies would report to either under secretaries or assistant secretaries. Furthermore, Brown wanted to raise the profile of the director for defense research and engineering to the under secretary level and give the director even more responsibility for weapons development and acquisition. Another goal was to create an under secretary for policy. According to Kester, who claimed inspiration for the title, one function of the under secretary was "to snoop on what the JCS was doing in the Joint Staff." The innocuous name, Kester maintained, ought not "to set off alarm bells anywhere." Brown confirmed that the job was "deliberately intended to be Under Secretary for Plans and Operations, but I didn't use that name, because the military would have found it intrusive."<sup>2</sup>

As an initial solution to these problems, Brown and his staff devised an organization of three clusters of assistant secretaries and directors reporting to an under secretary for resources, an under secretary for policy, and an under secretary for evaluation. Some of the assistant secretaries and directors were logical fits; others

were square pegs in round holes. As an interim step in the plan, Brown reduced by administrative action the number of people reporting to him by consolidating four positions into two super ones: an assistant secretary for command, control, communications, and intelligence and another for manpower, reserve affairs, and logistics.<sup>3</sup>

In early February, Brown and Duncan discussed the plan with congressional leaders in the House and Senate and their staffs. Brown reported their reaction as “encouraging to enthusiastic.” On 22 February, Brown, Duncan, and JCS Chairman General George Brown had a breakfast meeting with the entire House Armed Services Committee. The secretary’s explanation of the reform plan “was generally well received, although some questions were raised about span of control versus extra layers of authority.”<sup>4</sup>

On 7 April 1977 Brown sent forward a legislative proposal to replace one (the vacant position) of the two existing deputy secretaries with two, not three, under secretaries: one for policy and one for research and engineering. The three under secretaries plan had become a two cluster concept, with other offices reporting directly to Brown or other assistant secretaries. DDR&E Perry would be raised to undersecretary of defense for research and engineering (USD/R&E) and his former position disestablished. The recently established assistant secretary for command, control, communications, and intelligence would be designated as the principal assistant secretary to the USD/R&E. The assistant secretary for international security affairs would serve the same role for the under secretary for policy (USD/P).<sup>5</sup>

At open hearings before the Investigations Subcommittee of the House Committee on Armed Services, Deputy Secretary Duncan explained the proposal, emphasizing that it would strengthen management of the department by streamlining the organization, lessening the span of control, and reducing staffing levels. Chairman Samuel S. Stratton (D-NY) pointed out the changes seemed minimal and would only reduce the number of offices reporting to Brown and Duncan from 36 to 32. Duncan responded that the bill represented the initial stage of a larger reorganization. The House approved amendments to the bill on 19 September, and the Senate concurred on 6 October. On 21 October 1977 the president signed the bill into law.<sup>6</sup>

Having passed this hurdle, Brown organized the Defense agencies so that they reported to either of the two under secretaries, the assistant secretary for manpower, reserves, and logistics, the comptroller, or the general counsel. By mid-1978 Brown had improved his span of control to the point where 13 OSD offices, the JCS, and the eight specific commands, plus the three secretaries of the military departments, reported to him.





Stanley Resor is sworn in as under secretary of defense for policy, 14 August 1978.  
(OSD Historical Office)

Perry took office immediately, but nine more months elapsed before Brown selected an under secretary for policy. On 18 July the president nominated former Secretary of the Army Stanley R. Resor, who was then serving as head of the U.S. delegation to the Mutual Balanced Force Reductions (MBFR) negotiations in Vienna. Brown recalled that he hoped to induce “someone with high-level experience outside the defense establishment to provide a different perspective,” but of those he wanted, none was willing to serve. Brown settled on Resor, who became the third ranking civilian in the Department of Defense. Resor never strongly took to the job of supervising and faced already entrenched officials, such as David McGiffert, assistant secretary of defense for international security affairs, who reportedly wanted his job and was willing to go around him. The director of the Office of Net Assessment (ONA), Andrew Marshall, also had a direct line of access to Brown, providing the secretary with predictions and planning options. Resor maintained that Brown did not provide him with the personnel or the moral support to do his job. He resigned in March 1979 and was replaced by Robert Komer, who had held numerous jobs under Kennedy and Johnson, and had been working since 1978 as Brown’s adviser on North Atlantic Treaty Organization Affairs. Looking back on the episode, Brown recalled that Resor told him he lacked the drive to overcome the resistance of McGiffert and the ISA bureaucracy in order to carve out a new defense policy position. In Brown’s opinion, Komer,

known as “Blowtorch Bob” for his less than subtle approach, overrode bureaucratic opposition and made the USD/P job work as intended.<sup>7</sup>

The decision to create two under secretaries took time to bear fruit. Perry slipped seamlessly into his new position and prospered; Resor fared less well; and Komer defined his new job. Brown’s other major reform of 1977 called for a 22 percent staff reduction in the Office of the Secretary of Defense by November 1978—448 positions out of 2,065 in OSD itself and 334 out of the agency’s 1,539 positions in field offices (Defense Security Assistance Agency, Defense Advanced Research Projects Agency, Defense Audit Service, American Forces Information Service, Civilian Health and Medical Programs of the Uniformed Services, Tri-Service Medical Information System and the administrative portion of the Defense Dependents School System). Early retirement and attrition were supposed to help make the cuts, with reductions in force (RIF) contemplated as a last resort. To provide consolidated administrative and operating support to OSD and other DoD activities in the National Capital Region, the



Under Secretary of Defense for Policy, Robert Komer succeeded Stanley Resor on 24 October 1979. (OSD Historical Office)



Assistant Secretary of Defense for International Security Affairs David McGiffert, who served from 4 April 1977 to 20 January 1981. (OSD Historical Office)

Washington Headquarters Services (WHS) was established in October 1977. Under the directorship of Deputy Assistant Secretary of Defense for Administration David O. “Doc” Cooke, WHS received an initial allotment of 260 administrative personnel from OSD and was slated for more. When asked by reporters if WHS was just a way to reshuffle jobs rather than make cuts, Cooke said, “Fair enough,” but pointed out that functional transfers of 260 administration people out of OSD made obvious sense since they



Andrew Marshall, director of DoD’s Office of Net Assessment from 16 November 1973 to 5 January 2015. (RG 330, NARA II)

were “not in the business of policy formulation.” One year later federal government watchdog columnist Norman M. “Mike” Causey of the *Washington Post* cited a General Accounting Office (GAO) report indicating that of the 2,900 positions abolished in the offices of the secretary of defense and secretaries of the Army and Navy, 2,838 were transferred to the field. GAO stated that only 62 persons left the DoD payroll by retirement, resignation, or involuntary separation.<sup>8</sup> Reducing actual personnel in the federal workforce, an incredibly difficult and time consuming process, caused great disruption; attrition and early retirements were normally preferred to RIFs. Obviously functional transfers represented the easiest solution. While the establishment of WHS might have seemed a sleight of hand to some GAO investigators, consolidation of administrative services made good sense. WHS survived subsequent Defense reorganizations. Nonetheless, the touted reductions resulted mostly from functional transfers.

### **Intelligence Reorganization**

Soon after he became secretary, Brown found himself in a “turf” battle with DCI Turner over control of the Defense Intelligence Agency (DIA), the National Security Agency (NSA), the National Reconnaissance Office (NRO), and the military services intelligence operations. The NRO and NSA fell under DoD’s organizational



jurisdiction but reported to both the director of central intelligence and the secretary of defense. DIA reported through the Joint Chiefs to the secretary of defense. Since its creation in 1961, DIA had assumed many of the functions and personnel of the service intelligence organizations. Still, the Army, Navy, and Air Force zealously guarded their own intelligence units. When Carter offered Turner the job as DCI, the secretary of defense controlled 80 percent of the intelligence budget, and analysts in DIA, NSA, and the services' intelligence organization far outnumbered similar personnel in the Central Intelligence Agency (CIA). Turner accepted the position of DCI, he recalled, with the explicit assurance from the president that he would be director of all intelligence—as his title implied—not just the person who ran the CIA. Turner asked Carter to make good on his promise that the DCI would be intelligence czar.<sup>9</sup>

In late February 1977 Carter ordered the Special Coordination Committee of the NSC to undertake a “comprehensive review of major foreign intelligence activities and the organization and structure of the intelligence community.” Much of the impetus for this review, called for by Presidential Review Memorandum 11, came from recent exposés of past intelligence transgressions and failures. Exhaustive and contentious—as bureaucratic turf battles invariably are—the review lasted a year before the president issued a new executive order (EO) reorganizing the intelligence community.<sup>10</sup>

Briefing the president on the fiscal year 1978 Defense budget in early 1977, Brown also planned to discuss intelligence reorganization. His main point concerned organizational diversity, a system that produced intelligence to top policymakers but also provided tactical commanders in the field with the intelligence they required. To OSD, the DCI already had the authority to task collection assets and set priorities. More management responsibilities would only impair the DCI's ability to provide sound intelligence judgments to senior policymakers. Brown's brief suggested that the organizational structure was already sound and did not need major reorganization.<sup>11</sup>

In mid-June 1977 the Special Coordination Committee met, with both Brown and Deputy Secretary Duncan attending, to discuss a draft of PRM 11, especially its executive summary. DoD opposed changes to the summary that the CIA made after the SCC drafting committee did its work. To DoD, the summary “did not represent a balanced presentation of the main text.” The response failed to address the “need for adequate integration and interoperability of intelligence with military command

and control.” Giving the DCI authority to task and manage collection assets outside of the CIA would degrade DoD’s ability to respond to its own collection and production needs. Defense was even more opposed to the recommendation advocating DCI bureaucratic authority over all collections entities. While Turner believed he had too much responsibility and not enough authority, Brown countered that centralization of DoD’s intelligence functions under DCI authority would prevent Defense from meeting its intelligence needs in peace, crisis, and war.<sup>12</sup>

With the battle lines drawn, each side continued to make its case. Turner contended that the flow of information between DoD intelligence units and the CIA had been inadequate. The system did not encourage the sharing of intelligence, with the NRO as the worst offender. When Attorney General Griffen B. Bell asked why not amalgamate CIA and NRO, Brown responded that such centralization would cripple intelligence responsiveness to the needs of local military commanders. Furthermore, NSA and NRO produced large savings because of the high percentage of military personnel in their organizations. The SCC agreed to refine and then present the president with options on how to reorganize the intelligence structure.<sup>13</sup>

When the SCC met again in late June, Brown summarized DoD’s position favoring the present structure, but with two organizational changes: providing DCI access to the details of all intelligence organizations’ budgets; and creating a tasking committee comprising intelligence users, with the DCI as chairman, to establish collection and production requirements and to set priorities. Brown reiterated it would be a mistake to give the DCI line authority over NSA or NRO. To Turner, Brown’s solution was merely a “restatement” of access. He contended that “more words won’t work. DCI needs clout” in the form of both access and line authority.<sup>14</sup> On 7 July Brown sent Carter a personal handwritten letter stating his “strong personal conviction” that combat readiness and military capability “depend crucially on the ability of the military to have adequate tactical as well as strategic warning, and on having continuous information on opposing force capabilities, equipment, and disposition—in peace and war.” His recommendation would meet such requirements, but the secretary did not see how the organization proposed by the DCI could meet this test. Brown noted that the Joint Chiefs agreed with him. If Carter opted for Turner’s solution, Brown would insist on a face-to-face meeting with the president.<sup>15</sup>

Carter chose Brown’s alternative but eased the blow to Turner by making the authority as director of central intelligence less ambiguous. Presidential Directive

17 of 4 August 1977 retained the NSC as the highest entity providing guidance and direction to intelligence activities, but named the DCI as chairman of the Policy Review Committee–Intelligence (PRC–I), comprising also the secretaries of defense, state, treasury, and the national security adviser. This committee had responsibility for prioritizing intelligence requirements and evaluating performance. The DCI would translate PRC–I guidance into specific collection requirements and targets. To assist him in this task, the directive created a National Intelligence Tasking Center, manned jointly by civilians and military personnel. In time of crisis or war, the president could transfer direction of this center to the secretary of defense. PD 17 granted the DCI full and exclusive authority over intelligence budget presentations to the president and Congress (including access to budget data from all intelligence organizations), with department heads having the right to reclaim his presentations. Specifically named as “primary adviser” to the NSC and the president, the DCI did not have authority to hire or fire intelligence personnel in other agencies or direct their day-to-day operations. Personnel administration, management and support activities, operational implementation of DCI taskings, and audit/inspector general functions would remain with the departments.<sup>16</sup>

These issues did not end there because the PD needed to be turned into an executive order. Physicist Eugene G. Fubini, a sometime-Pentagon consultant, unofficial adviser, and close friend to Brown, alerted the secretary to rumors that Turner would use an executive order “to extend his control beyond the literal interpretation of the Presidential decision.” Brown agreed with Fubini’s advice to check carefully the EO’s wording.<sup>17</sup> The intelligence community drafters of the new order had a hard time wording it. They submitted three drafts to the president only to have Carter reject each one on the grounds they were too long and “not written in plain English.” By the third rejection Carter was steaming mad. The NSC staff provided a shorter fourth draft devoid of intelligence jargon. Before it went to the president, Duncan vetted it to remove any problems for DoD. The deputy secretary’s main concern proved to be Turner’s attempt to designate the DoD’s General Defense Intelligence Program (GDIP), which had responsibility for providing tactical intelligence to OSD, JCS, the services, and the unified and specified commands, as part of the National Foreign Intelligence Program. If this language stood, Duncan believed Turner could claim the GDIP was subject to his budget control. Duncan wrote to Brzezinski and convinced the national security adviser

to veto the language.<sup>18</sup> Carter finally signed Executive Order 12036, replacing the intelligence EO of the Ford administration. The new EO retained DoD intelligence organizations and the GDIP under the authority of the secretary of defense. In implementing the order to Pentagon intelligence organization, Duncan stressed DoD's control of its intelligence agencies and designated the under secretary of defense for policy as responsible for resolution of problems with the DCI. This battle over control of the intelligence function lasted over a year. Turner received encouraging words and some additional management authority, especially over access to budget data and overall direction of intelligence priorities, but he did not obtain control of the National Reconnaissance Office, the National Security Agency, the Defense Intelligence Agency, or the service intelligence operations.<sup>19</sup>

### **Presidential Government Reorganization Project at Defense**

Intelligence reorganization was just a small part of an ambitious plan by the Carter administration to reorganize the entire federal government as Carter had done to the Georgia state government when he was governor and as promised during his presidential campaign. As a result, all departments and agencies had to reassess their structures, functions, and processes. In September 1977 the White House officials in charge of the President's Government Reorganization Project pressed Brown to initiate management and organization studies to streamline the Defense Department. The president wanted "a searching organizational review" producing "an unconstrained examination of alternative reforms in organization, management, and decision processes in the Department of Defense." White House staff provided a preliminary OMB-drafted issues summary on how to improve DoD's resource management, management structure, and military command structure. While conceding that many of OMB's ideas had merit, Brown commented that "some of the suggestions are naïve; we need to provide the leadership." Rather than concede the initiative to OMB and the White House, DoD took charge of the process. Nevertheless, the resultant studies, led mostly by former "insiders," presented judgments and recommendations overwhelmingly critical of DoD's organization and management.<sup>20</sup>

On 17 November 1977 Brown announced that former defense official Paul R. Ignatius, then president of the Air Transport Association, would direct a study—later known as the *Departmental Headquarters Study*—of the defense management structure, primarily reviewing the interrelationships of OSD, the service secretariats,

and the service chiefs. Richard C. Steadman, also a former DoD official and member of the Carter transition team, would lead a study on improving efficiency in the national military command structure by examining how the structure responded to the needs of the president, secretary of defense, and Congress. The study would also assess the respective roles of the secretary of defense, the JCS chairman, the Joint Chiefs, and unified commanders in the decision-making process. Donald B. Rice, president of the RAND Corporation, a former deputy assistant secretary of defense for resource analysis, and former assistant director of OMB, would head a study of defense resources, examining the DoD's resource management system, including the Planning, Programming, and Budgeting System (PPBS) along with the systems acquisition process and DoD logistics, health, and personnel functions. These studies were the most important of a series of reports that became known collectively as the Carter administration's Defense Organization Study. A reorganization study headed by a White House official successfully recommended the creation of the Federal Management Preparedness Agency. The new agency comprised disaster or preparedness units from departments and agencies throughout the federal government, including the Pentagon's Civil Defense Preparedness Agency.<sup>21</sup>

The headquarters study under Ignatius addressed the basic question of how to assert strong leadership at the OSD level while delegating enough authority to the military departments to allow for efficient implementation of policy and operations. Expressing a preference for evolutionary improvement, the study concluded that the department was too large to be centrally managed by OSD without assistance from its subordinate units. Thus, the study recommended not organizational realignment but a change in emphasis, giving the service secretaries more responsibilities and a bigger say in management. Ideally, the secretary of defense and his office would concentrate on broad policy while the military departments focused on resource management and policy implementation.

On 1 June 1978 Ignatius presented to Brown 13 recommendations drawn from his study. He proposed reviving the Armed Forces Policy Council (AFPC), holding its membership to the original eight-person statutory number, and reducing the 32 staff and observers who were also currently attending. The AFPC was created in 1947 to advise the secretary on broad military matters, but its mission had atrophied. The Ignatius study suggested creating a specific planning office headed by the under secretary for policy and linking it to the JCS chairman. Ignatius also



Left to right: Paul Ignatius, Richard Steadman, and Under Secretary of Defense Charles Duncan at a news conference releasing DoD reorganization studies, 12 July 1978. (OSD Historical Office)

recommended changes to improve analysis of requirements for weapon systems, elimination of redundant budget reviews, and reexamination of Brown's decision to place manpower, reserves, installations, and logistics under a single assistant secretary since that the job was too much for one official. To upgrade the service secretaries' function, the study recommended that they undertake occasional multiservice assignments and their under secretaries have a formal liaison role to OSD. The study endorsed continued reduction of Washington headquarters personnel and greater reliance on subordinate commands, particularly in the materiel area, and rotation of civil service executives in and out of the Department of Defense. These recommendations did not convince Brown.<sup>22</sup>

The most controversial study, Steadman's *Report to the Secretary of Defense on the National Military Command Structure*, tackled the perennial problem of the Joint Chiefs' dual responsibilities as heads of their respective services and as advisers to the president, NSC, secretary of defense, and Congress. The study highlighted the basic contradiction that had bedeviled the command structure for decades: the need for unified command of the armed forces and military advice that rose above individual service interests while preserving the services' historic autonomy. The

most serious result of this contradiction, according to the study, was JCS inability to allocate resources effectively. The Chiefs failed to find consensus on budget levels, force structure, and procurement of weapon systems, except “to agree that they should be increased without consideration of resource constraints”<sup>23</sup>

Serious flaws existed in the JCS staff procedures and paper systems, so the Joint Staff found it difficult to transcend service positions and reach joint decisions. The remedy, according to the Steadman report, was to make the Joint Staff alone responsible for JCS papers, allow for the presentation of alternative views, assure that the papers were based on better initial guidance, and encourage the assignment of the highest quality officers to the Joint Staff. The report recommended that the secretary make the chairman responsible for national military advice on program and budget issues. If he could not or would not perform this function, the Steadman group proposed a radical alternative: replace the JCS with a National Military Advisers (NMA) group, made up of senior service officers and the JCS chairman. Having no service assignments, the NMA’s joint planning, operations, and budget and other advice would be less influenced by their services.<sup>24</sup>

When the Steadman report came out in July 1978, the JCS was undergoing an almost complete turnover of personnel (a new chairman and two other new members). Restructuring the JCS gained little traction in DoD. The new chairman, General David Jones, privately told Brown that, while he could foresee minor improvements in the structure, “the fundamental organizational structure is sound,” and the Chiefs felt that change would have to be “evolutionary in nature.”<sup>25</sup> This evolution was not to occur during the Carter administration, although Carter did sign a law, on 20 October 1978, officially making the commandant of the Marine Corps a member of the Joint Chiefs. This was the product of a long campaign by the Marines to formalize an already de facto practice. The decision was not part of the President’s Reorganization Project.<sup>26</sup>

The *Defense Resource Management Study* under Donald Rice differed from those of Ignatius and Steadman in its concentration on process. It followed a case study approach to five specific issues: the resource allocation process, weapons acquisition process, logistical support of combat missions, military health care system, and career mix of enlisted personnel. The study suggested that the budget process suffered from micromanagement, especially in overly detailed and voluminous OSD guidance documents that focused on specifics of service programs rather

than broad strategies and objectives. Furthermore, the number of budget reviews under the PPBS was excessive, usually 5 or 6, but sometimes as many as 12. Instead of allowing OSD to oversee the process, these reviews drew OSD into the details of the budget and diminished its ability to provide needed strategy assessments of political, economic, and technological trends on defense issues.<sup>27</sup> The acquisition portion of the study highlighted the adverse effects of the tendency of the services to acquire new weapon systems as rapidly as possible without proper consideration of reliability, operability, costs, or alternatives. The institutional imperative for defense program managers was to satisfy milestone goals on time and within budget. While not illogical, these goals precluded consideration of possible alternatives, especially those based on technological breakthroughs. The solution was for OSD to ensure sufficient testing and consideration of alternatives before moving into production.<sup>28</sup> As for the health care system, OSD was not properly managing military health care, causing widespread dissatisfaction by service members and their families.<sup>29</sup> The Rice study recommended consolidation of logistical functions at the theater commander level in any future battlefield conditions, relieving combat units of that responsibility and making them more nimble. As for the career mix of enlisted personnel, OSD ought to assume responsibility for increasing the average experience level of enlisted personnel as a way to increase productivity.<sup>30</sup>



Under Secretary Charles Duncan and Donald Rice, author of the *Defense Resource Management Study*, part of the Defense Reorganization Project, 28 February 1979. (OSD Historical Office)



Before the release of the Steadman and Ignatius studies in early July 1978 (the Rice study followed in early 1979), Brown promised the president that he and Duncan would carefully review their recommendations for appropriate implementation and keep Carter informed. There is little evidence that Brown kept this promise. By mid-1978 the steam had left the Carter reorganization project. The White House staffer responsible for monitoring DoD reorganization concluded that he was pushing “the DoD reorganization boulder straight uphill” without much success.<sup>31</sup> With the exception of the Defense Resources Board as the secretary’s high-level focal point in programming and budgeting, as recommended in the Rice study, neither Brown nor Carter acted on any of the other recommendations of the three studies. It was not that the studies had not accurately identified problems, or suggested reasonable solutions; it was that most of the issues they tackled were perennial problems that had defied resolution for decades. As it turned out, in the mid-1980s a serious reform movement, initiated by Congress and culminating in the 1986 Goldwater-Nichols Department of Defense Reorganization Act, succeeded in enacting many of the reforms that Carter’s defense reorganization studies, especially the Steadman report, had first recommended.<sup>32</sup>

In response to White House pressure to reform and reorganize the Department of Defense, Brown made the changes that he believed were important and then let the bureaucracy and the nongovernment study groups write their reports and make their recommendations. The bureaucracy moved jobs around to create the impression that it reduced the number of positions. The study groups prepared their extensive analyses and recommendations, which in the main were ignored by Brown and the Carter administration. Change came slowly to an organization as large and complex as the Pentagon. Carter’s determination to revamp the U.S. government, as he believed he had done with the Georgia state government, fell victim to the overwhelming problems and crises that any presidential administration invariably encountered. Day-to-day priorities overwhelmed long-term reorganization and restructuring plans. Furthermore, bureaucracies resist change, as the Carter reorganization project’s fate at the Pentagon confirmed. There were some successes: the creation of the Defense Resources Board, the transfer of DoD’s Civil Defense Preparedness Agency to the Federal Emergency Management Agency, and the establishment of Washington Headquarters Services, which increasingly

assumed responsibility for the administration of and operational support to DoD activities in the Washington National Capital Area. Still, the Pentagon at the end of Carter's term was little changed from the one that the president had inherited in 1977. Few in the Pentagon lamented the modest impact of the Carter reorganization effort.

## Defining National Security Policy

JIMMY CARTER, LIKE ALL COLD WAR PRESIDENTS, relied on extensive interagency reviews, deliberations, and net assessments of the relative military strengths of the Soviet Union and United States to define national security and foreign policy objectives and offer potential strategies. At the end of this process, he approved one or more strategic approach, providing guidance for DoD budgets, conventional and strategic force levels, weapons procurement, and decisions on military aid and sales to allies and friends. President Harry S. Truman undertook such a review, National Security Council Report 68 of 1950, which called for a massive U.S. military buildup to contain the Soviet Union. At the beginning of his term in 1953, President Dwight Eisenhower ordered a broad review of Soviet capabilities and options for countering them—Project Solarium. He then launched a major national security review that resulted in the “New Look” strategy of massive nuclear retaliation in response to Soviet aggression against the United States or its allies. In its first year, 1961, the Kennedy administration tried but failed to agree on a basic national security policy. Instead, it articulated a general policy of “flexible response,” an initial conventional response, then an escalation to theater nuclear war, and finally strategic nuclear hostilities as a last resort. Overwhelmed by Vietnam, President Lyndon Johnson relied on flexible response. President Richard Nixon during his first administration adopted a policy of ensuring strategic capability sufficient for a second strike to deter an all-out surprise Soviet nuclear attack. In 1974, the Nixon administration developed contingency plans for “limited nuclear deployment options,” a counterforce strategy to attack only selective military and other targets, avoiding population centers as much as possible and leaving open the possibility of mutual de-escalation. This approach provided an alternative to

all-out nuclear war that was expected to last 6 to 10 hours—30 minutes' flight time for intercontinental and submarine-launched missiles and the remaining time for strategic bombers to reach their targets. The Ford administration continued to observe the basics of Nixon's national security planning guidelines. Throughout the process in each administration, DoD and the secretary of defense contributed to the formulation of national security strategy.<sup>1</sup>

Such reviews assumed added significance for the newly elected president who lacked extensive national security experience. Carter's views, articulated by degrees during the presidential campaign, added up to a less than fully formed strategic outlook. He steadfastly maintained that he could provide national security more cheaply and effectively than his predecessors. For his part, Harold Brown had extensive experience in national security related positions—director of defense research and engineering, secretary of the Air Force, and delegate to the SALT I negotiations. He was not a national security or defense intellectual in the image of former academics Henry Kissinger and Zbigniew Brzezinski. Yet Brown had a perspective that no one else in the Carter administration could claim. As a nuclear physicist who helped develop small but powerful thermonuclear weapons that revolutionized the nuclear arms race, he witnessed more than a dozen atmospheric nuclear tests in the 1950s. His interest then was mainly “scientific and professional,” but he felt the shock waves, saw the fireballs and mushroom clouds. “I was gratified when designs I'd overseen worked and disappointed if they fizzled,” Brown recalled. By the sixth atmospheric nuclear test, he had “no poetic or religious or inspirational sort of reaction,” but a firm belief that nuclear deterrence required such weapons. He was equally determined to make sure they would never be used.<sup>2</sup>

In a major public statement on national security, Brown, then president of Caltech, gave a speech in Moscow at the Soviet Academy of Sciences in March 1975. He postulated that of the three potential uses of strategic nuclear weapons—deterrence, coercion, and war-winning—only the deterrence of assured destruction of nuclear attack was practical. Coercion could work only if one superpower considered itself superior in strategic nuclear capabilities. Yet it really came down to “a weakness of will rather than a weakness of weapons,” for no matter the disparity, even a small thermonuclear exchange would yield unacceptable costs to both sides. As for war-winning, even a nuclear exchange that concentrated on military targets

and communications hubs (mostly located in populated industrial centers) would result in tens of millions dead, casualties of 100-plus million on each side, and the bulk of productive capacity of the United States and Soviet Union destroyed. Calling this “winning” struck Brown “as a strange assessment.”<sup>3</sup>

Brown did not preclude the possibility of a tactical nuclear response to a large conventional attack (basic NATO doctrine for the defense of Western Europe), but doubted a conflict could be contained once tactical nuclear weapons were fired. As for the Nixon-Ford concept of limited nuclear war strategy, Brown suggested that as long as “no one is deceived into thinking that the existence of forces, options and plans for a strategic counter military exchange makes survival of either the United States or the U.S.S.R. in a nuclear war at all likely, or into forgetting that the fatal and almost certain outcome is explosion on the cities of both countries of nuclear weapons, the existence of such plans and the development of such forces is an acceptable idea.” However, Brown added that this strategy, to the extent it eroded deterrence, increased “the likelihood of catastrophe.” To Brown, such plans ought to be “severely limited” because “the limitations on their effectiveness are not matched by limitations on their cost.”<sup>4</sup>

Brown’s Moscow address demonstrated his support for the standard concept of deterrence based on mutual assured destruction, the basic tenet of strategic thinking that dominated the Cold War after Eisenhower. Brown suggested that only when the two superpowers achieved “a strategic force situation . . . that is both stable and essentially equivalent,” would they be free to tackle new economic and political problems. An escalating race in strategic weapons was in vain, in Brown’s view, since it only exacerbated tensions and “wastes time and resources.”<sup>5</sup>

Like Brown, Carter supported deterrence through fear of mutual destruction. As a former nuclear submarine officer, Carter placed most of his trust in submarine-launched ballistic missiles. While he never said so explicitly during the presidential campaign, he believed that SLBMs provided sufficient deterrence. Nuclear-powered submarines had proven almost impossible to detect, making both U.S. and Soviet antisubmarine warfare largely ineffective. While SLBMs were less accurate and had lower yields than the Air Force’s intercontinental ballistic missiles, they could hit Soviet cities and industrial centers, thus providing the required level of deterrence in Carter’s view. The president shared Brown’s mistrust of the limited nuclear war strategy, believing that it would inevitably lead to a full-blown

nuclear exchange. While Brown suggested that the end game for arms limitation agreements was a stable and finite combination of nuclear weapon systems that resulted in “essential equivalence,” Carter saw the ultimate end as elimination of all nuclear weapons. To Brown, nuclear weapons in controlled numbers acted as a stabilizing force; to Carter, they were evil and immoral.<sup>6</sup>

During the presidential campaign Carter promised a thorough and comprehensive review of national security, no doubt at the urging of his future national security adviser, Zbigniew Brzezinski. Not as idealistic as Carter or as scientific as Brown, Brzezinski was a realist who maintained that the Soviet Union respected only power. He and Carter believed that since Eisenhower’s first term, national security policy had not received the serious review it required.<sup>7</sup> In one of his first presidential actions, Carter instructed his national security bureaucracy to undertake a study that included a comprehensive net assessment of the relative military, political, economic, and technological strengths of the United States and its allies versus the Soviet Union and other potential adversaries. Carter also required a more specific contingency assessment of how well U.S. forces might do in representative scenarios against opponents, as well as a military strategy and force posture review with multiple alternative military strategies and the costs for each alternative. The president assigned the net assessment and the contingency studies to Brzezinski and the military strategy posture review to Brown.<sup>8</sup>

### **Presidential Review Memorandum 10**

Before the formal request for PRM 10 was issued on 18 February 1977, the OSD and NSC staffs discussed how to frame the study and which agency should direct it. Brzezinski insisted that the NSC manage the net assessment and contingency study; he had hoped to take control of Brown’s portion of the study too. Brown successfully retained the military strategy and posture review for OSD, entrusting Lynn Davis, a Columbia Ph.D. and former assistant professor of political science, with responsibility for managing the process and drafting the final study. A protégé of Brown and a newcomer to DoD, who had served on the NSC staff during the Ford administration, Davis was deputy assistant secretary for international security affairs in charge of its policy portfolio. At 32 years of age and not well known in the Pentagon, she was keen to manage the project, but knew she needed Brown’s support at the interagency level.<sup>9</sup>

OSD had the task of producing a broad study that would “define a wide range of alternative military strategies and construct alternative military force postures and programs to support each of these military strategies.” The other main PRM requirement, the “dynamic net assessment”—the NSC staff job under the direction of Harvard professor and friend of Brzezinski, Samuel P. Huntington—called for “review and comparison of the overall trends in the political, diplomatic, economic, technological, and military capacities of the United States, its allies, and potential adversaries,” with an evaluation of objectives and national strategies of principal adversaries and appropriate U.S. responses.<sup>10</sup>

The terms of reference for the OSD study specified the assessment of military contingencies that covered a spectrum of conflicts from a major U.S.-Soviet nuclear exchange to intervention by the Soviet Union in remote areas (such as Southern Africa) to conflict with third countries such as North Korea. For each contingency, PRM 10 required cost and key force structure assessments.<sup>11</sup> In hindsight, PRM 10 asked too much. Not surprisingly, the OSD study exploded into a massive interagency task force operation with several working groups churning out long and detailed papers. Lynn Davis labored to bring the findings all together into a manageable document.

Initially, Carter seemed interested in OSD’s military force and strategy study. Brown provided him a status report on the project in early April 1977. A month later Davis pulled together a draft presidential memorandum that outlined major contingencies. As required by PRM 10, for each of the five potential conflicts the Davis team eventually submitted seven Alternative Integrated Military Strategies (AIMS). For contingency 1, a NATO conventional defense of Central Europe, the study provided three “soft” options (a less aggressive conventional defense of NATO) and four hard options (a rigorous counterattack). The three soft options provided for a conventional defense of Western Europe sustainable for 30 days against a Warsaw Pact attack by 86 to 92 divisions, halting the Warsaw Pact at the Weser-Lech River line, thus yielding about a third of West Germany. The hard options for this conventional defense were more ambitious: they would reclaim lost territory in Central Europe without resorting to nuclear weapons, and they contemplated a direct defense of Central Europe against 130 Warsaw Pact divisions lasting from at least 90 days to indefinitely. The more robust conventional defense raised the NATO nuclear threshold (the point at which NATO would decide to use nuclear

weapons). With these augmented conventional forces, NATO would counterattack the Warsaw Pact to regain any territory lost in the initial attack. By conducting a sustained forward defense and restoring the alliance's territorial boundaries, however long it took, NATO's conventional forces would greatly decrease the possibility of having to go nuclear. Finally, the hardest option, a conventional counterattack strategy for Europe, required clear U.S. conventional and nuclear superiority. NATO forces would engage in a strenuous conventional defense of Europe against 130 or more divisions, taking the offensive against the Warsaw Pact, initiating offensive action at sea, and attacking in a region of relative pact weakness to secure a better likelihood for the end of the conflict. To Western European NATO allies, the soft AIMS were likely more acceptable, because they were more affordable, but they were not militarily effective, nor were they apt to produce victory or restore lost territory in a conventional war with the Warsaw Pact.<sup>12</sup>

Each AIMS contained an integrated strategy for the remaining four contingencies, following the basic soft-versus-hard pattern. The soft alternatives for contingency 2, non-European operations against the Soviet Union, would keep the Atlantic open and initiate limited offensive operations against non-European Soviet targets where practical. The hard options contemplated significant U.S. and NATO air and naval attacks on the non-European Soviet Union. For contingency 3, U.S. military presence in East Asia, the softest option reduced a U.S. military presence; the slightly harder ones maintained the current U.S. force levels; and the hardest recommended increased U.S. military presence in the region. The reasoning behind the harder options was that such deployments would support China as a potential opponent of the Soviet Union and encourage more Soviet redeployments to Asia, this reducing Soviet military power in Europe. As for contingency 4, peacekeeping and local wars, the soft options envisioned limited action to light unilateral U.S. action. The hard options called for significant unilateral U.S. war and peacekeeping capabilities, up to providing considerable additional land, tactical air, and naval power. Contingency 5, a homelands nuclear exchange, had several options, including maintaining the overall strategic force balance while retaining the U.S. advantage with assured retaliatory capability, against either soft or hard targets, with minimal counter capability (the ability to destroy Soviet economic and leadership resources). The hardest option contemplated clear strategic superiority over the Soviet Union in nuclear capabilities and force balance.<sup>13</sup>



**Table 3. Alternative Integrated Military Strategies (AIMS)**

AIMS	NATO/WP Conflict in Europe	Operations Outside Europe in U.S.-USSR War	East Asia	Peacekeeping and Potential Local Wars	U.S.-USSR Nuclear Conflict
E	Limit Loss: Hold 86-92 division threat at Weser-Lech w/30-day sustainability	Limited Action	Reduced Presence	Limited Action	Maintain overall Force Balance
F		Limited Action	Current Presence	Light Intervention	Retain U.S. Force advantages
G		Initiatives	Current Presence	Heavy Intervention	Maintain overall Force Balance
F (Variant)	Limit Loss: Hold 130 division threat at Weser-Lech w/90-day sustainability	Limited Action	Current Presence	Light Intervention	Retain U.S. Force advantages
H	Direct Defense: Restore prewar line against 130 division threat w/90-day sustainability	Limited Action	Reduced Presence	Limited Action	Maintain overall Force Balance
I		Limited Action	Current Presence	Light Intervention	Retain U.S. Force Advantages
J	Direct Defense: w/indefinite sustainability	Initiatives	Current Presence	Heavy Intervention	Assured Retaliation only
M	Offsetting Attacks: Flank attack on Pact while holding in central region against 130+ division threat w/indefinite sustainability	Initiatives	Increased Presence	Heavy Intervention	Clear Superiority

Source: PRM 10, Strategy and Force Posture Review, Final Report, 6 July 1977, 2, CK31000056945, Declassified Documents Reference System (DDRS).

Brown circulated the May draft presidential memorandum summarizing the study and included the AIMS for interagency comment. Realizing that the West Europeans preferred a strong NATO nuclear force to deter any conventional

Warsaw Pact attack rather than a prolonged conventional war in their backyards, acting Secretary of State Warren Christopher agreed the memorandum should go forward, but emphasized the “vital political-psychological” consequences among NATO allies of improving the alliance’s conventional capacities. State officials feared that emphasis on conventional war might signal a “downgrading of the U.S. nuclear commitment” to the defense of NATO. State also insisted that the individual AIMS should be presented as “representative” and not distinct options, with the president not expected to answer the key questions at the first meeting.<sup>14</sup>

The JCS commented that the draft study lacked clear focus, especially since the rationale for selecting the AIMS was not evident. They thought that the AIMS “leave to conjecture many assumptions necessary for force posturing and subsequent broad costing,” observing that AIMS “are more than simple summations of substrategies; integration of the substrategies must be accomplished to provide a single coherent military strategy.” The Chiefs viewed deterrence globally across the spectrum of forces, and for them, the AIMS had to consider continued conventional operations after an escalation to nuclear conflict.<sup>15</sup>

With these comments in hand, Brown prepared to brief the president. Before the meeting with Brown, Brzezinski informed Carter that NATO strategy remained the key issue: “The NATO mission is the major factor driving the size of our general purpose forces which currently account for 70–80% of our defense spending.”<sup>16</sup>

At a meeting of the national security team with the president on 19 May 1977 on the Military Strategy and Force Posture study, Carter warned that U.S. strategy choices were “financially restrained.” Most of the discussion focused on NATO’s defense of Europe. Carter suggested that the Soviets realized an attack on NATO would probably lead to a nuclear exchange and regional conflicts beyond Central Europe. Nuclear weapons should be a last resort, the goal was “a stalwart conventional defense and a minimum loss of territory,” and therefore the analysis of the DoD study should assume nonuse of nuclear weapons or a standoff if they were used. To Carter, the fight would have to be more than 30 days. He instructed that NATO allies be told the goal was 90 days, with a reminder of how short they were of that goal. The president agreed that the counteroffensive strategy (AIMS M) for a NATO defense was “probably not worth pursuing further.” The group spent less time on the non-NATO options of the DoD study. Outside of Europe the president favored “initiatives” over “limited action.” He saw parity as the current strategic

policy, which he defined as the United States ahead in some areas and behind the Soviets in others—Brown’s “essential equivalence.”<sup>17</sup>

Brown informed the members of the Presidential Review Committee on 25 May that the remaining AIMS were “representational and illustrative, rather than definitive.” The secretary suggested the next tasks were to estimate a reasonable range of force postures, prepare a phased program and appropriate funding estimates for each AIMS, assess the adequacy of the AIMS and associated force postures to achieve national objectives, and estimate domestic, economic, foreign policy, and arms control implications, as well as reactions of allies, third countries, and the Soviet Union. Beyond these steps, Brown expected to reduce the number of AIMS to “the two or three most advantageous.”<sup>18</sup>

For the next month, Davis labored to revise the study only to encounter at its completion a torrent of opposition by the JCS, military services, and other senior leaders in DoD. Davis, whose youthful exuberance and gender did not sit well with some in the Pentagon, did not help her cause, as one participant in the exercise recalled, by allegedly opening meetings with an “OK campers” greeting.<sup>19</sup> Discerning only a modest role for aircraft carriers under most AIMS, the Navy considered the study “a dangerous vehicle on which to base decisions concerning the national defense.”<sup>20</sup> Assistant Secretary of Defense for Program Analysis and Evaluation Russell Murray characterized it as wrong in tone: treating national security “like choices in a Chinese restaurant—one from Column A, one from Column B . . . an orgy of option generation.” Murray could not endorse it, believing a single comprehensive study of national security policy was impossible given the complexity of the issues. “It must be an iterative process,” Murray maintained.<sup>21</sup> Assistant Secretary of Defense for Manpower, Reserve Affairs, and Logistics John White stated that the study had “critical and fundamental deficiencies that must be corrected before it is submitted to the White House.”<sup>22</sup> Assistant to the Secretary for Atomic Energy Donald Cotter and DDR&E William Perry recommended that it be “abandoned.”<sup>23</sup> Brown’s Special Assistant for NATO, Robert Komer, thought it too unilateral (not cooperative enough with NATO allies), and a serious underestimation of the role that China and Japan could play in threatening the Soviet rear.<sup>24</sup> Andrew Marshall, director of the OSD Net Assessment Office, suggested that while “there has been an historical lack of strategic planning in the DoD processes,” if the PRM 10 study “was meant to be an ambitious effort . . . to do the job . . . then it has not succeeded.”<sup>25</sup>

The Joint Chiefs remained persistent critics, stressing the study's "inadequacies and shortcomings":

- No precise statement of national interest and objectives
- No clear definition of enemy capabilities
- Underestimation of the extent of mutual reliance between the United States, NATO, and other allies
- Ignorance of the practicality and cost of various strategic options
- No examination of the U.S. industrial base's ability to support the strategies
- No realization of the need for access to raw materials
- No analysis of U.S. manpower needs for each strategy
- Insufficient attention to the role of theater nuclear forces in both warfighting and deterrence

In short, the JCS recommended against submitting the study to the president.<sup>26</sup> Davis defended the study against these criticisms of poor methodology, conceptual problems, lack of adequate costing estimates, vague force estimates, and serious omissions, but she was virtually alone in DoD in doing so.<sup>27</sup>

What was it about the study that produced near total DoD opposition? The exercise offered an object lesson in how not to generate consensus on national security policy within the Pentagon, let alone the larger national security establishment. Davis set out to be provocative and ask "hard" questions. Since she had written a paper examining the possibilities for a limited nuclear war, some in Washington feared she was using the study to reduce military options or to promote arms control options.<sup>28</sup> Worse still, some Pentagon officials and defense hawks feared her study was meant as a justification for the defense spending cuts that Carter had promised during the 1976 presidential campaign.<sup>29</sup> Additionally, Davis and her team were viewed as outsiders, Carter administration appointees from academia and think tanks, who were so bold as to instruct the Pentagon on how to plan for national security. Although meticulous in providing drafts of the study for comment to relevant OSD components and other agencies, Davis failed to ensure that these entities had a stake in the product. They could only criticize, and they did so with gusto.

Brown also bore responsibility for the study spinning out of control. Entrusting the job to someone with limited experience carried significant hazards. Davis was not a longtime member of the national security intellectual establishment; nor was

she a Pentagon old hand. No doubt some in the Pentagon bridled that a woman had been entrusted with such a monumental task. Brown's focus on the study was sporadic. It appeared that the secretary essentially threw Davis into the policy pool, letting her sink or swim.<sup>30</sup>

Carter lost interest in PRM 10, and Brzezinski focused on the net assessment, which, while not without its controversies, ran a much smoother course. At the urging of Deputy Secretary Charles Duncan and Marshall, Brown decided in late June 1977 to resuscitate the Davis study. The NSC staff suggested that there was no way even a detail-oriented president like Carter could digest such a massive document of 400-plus pages. Brown created an ad hoc group chaired by Assistant Secretary of Defense (ISA) David McGiffert (Davis' immediate boss) and including Lt. Gen. William Smith, the assistant to JCS Chairman General George Brown; Murray; Marshall; and Perry to narrow the range of alternatives to realistic options and discern which issues would benefit from presidential guidance.<sup>31</sup>

While Brown's redrafting team did a fair job of highlighting the conclusions of the study, the secretary told other NSC members that he had decided to wait for further presidential guidance before recommending overall military strategy to Carter. Brown noted that, while the study had served a "useful purpose" by elaborating important issues and problems, it was not sufficient to provide a base for actual decisions on force structure or military planning: "None of the notional AIMS is completely satisfactory." Instead, Brown suggested that one of the two NSC sub-groups, the Presidential Review Committee, look at the issue from the standpoint of conventional forces and strategic capabilities and coordinate its findings with the NSC's net assessment (which PRM 10 did not require). Brown hoped to obtain from Carter approval of a broad military strategy on which to base not only force levels and weapons acquisition decisions but also foreign policy, arms control, and intelligence activities.<sup>32</sup> To gain JCS support, Brown assured the Chiefs that the revisions of the redrafting team "should remove much of the concern that had been expressed about the PRM-10, at least the concern within this building [the Pentagon]."<sup>33</sup>

### **The National Security Council Considers PRM 10**

The PRC, with Brown as chairman, agreed to meet twice in July 1977 to discuss the military strategy and force posture study of PRM 10, concentrating first on conventional strategy and then on strategic nuclear policy. As an agenda, Brown

reprise the key questions of the report, which had undergone considerable revision during the drafting process. First, how should the United States balance nuclear and conventional forces to confront Soviet aggression in Europe? Related questions asked whether merely to blunt a Warsaw Pact conventional attack or seek to restore any ground lost to a Soviet invasion. Did NATO need a greater military sustaining capability than that of the Warsaw Pact? If deterrence failed, what conventional military capacity was required, and should the United States rely on early first use of nuclear weapons? Second, did it make sense to plan military operations in excess of capabilities of NATO allies? Another set of questions centered on operations outside of Europe. To what extent should the United States acquire military capabilities above those required for the European theater? Should it go on the offensive or defensive in a worldwide U.S.-USSR war, and what should strategy toward China entail? The questions pertaining to crisis management and local wars focused on the scale of military resources that should go into planning for these contingencies. To what extent should these resources be available without drawing on those required for a major U.S.-Soviet war; what were the most likely flash points to plan for—probably the Middle East and Korea—and should the use of U.S. land forces be considered? For East Asia strategy, should the current military presence in South Korea and the Philippines be maintained or adjusted?<sup>34</sup>

Anticipating the first PRC meeting on 8 July 1977, James Thompson and Victor Utgoff of the NSC urged Brzezinski to place more emphasis on NATO's conventional deterrent, with a goal of minimal territorial loss and the ability to outlast the pact; to forgo plans to take war to Soviet non-European territory; to maintain only a minimal capacity to intervene in local wars; and, after the U.S. Army 2nd Infantry Division withdrew from Korea, to maintain current force levels in East Asia. While admitting the unsuitability of some AIMS for presidential decision, they noted: "There is strong pressure within DOD to abandon the AIMS analysis totally and to carry on an academic discussion of the key questions, hoping to lead only to the broadest (and vaguest) Presidential guidance on military strategy." Thompson and Utgoff elaborated: The campaign against the AIMS was "mainly bureaucratically motivated." Most in DoD resented the AIMS because they were "not invented here [i.e., not by the JCS and services but by an academic in OSD]." The services, especially the Navy, bridled at the discussion on allocation of roles and missions by service. Finally, the two NSC staffers suggested that DoD's aversion to

detailed guidance came from its dislike of anything that constrained its freedom of action. They advised Brzezinski to resist any attempt to jettison the AIMS, thus giving support to the beleaguered Lynn Davis.<sup>35</sup>

Thompson and Utgoff noted that the high end of the range of costs for the AIMS had come from the military services, especially the Navy, and the low end from OSD. These high-cost AIMS were “patently absurd,” but Brzezinski could safely use the low-end figures offered by Brown and his staff. Thompson and Utgoff highlighted the basic NATO dilemma: to defend and restore Central Europe with conventional forces would cost more than the NATO allies were willing to pay. The strategies they could afford required them to accept territorial loss (politically unacceptable) or threaten first use of nuclear weapons. NATO had lived with this problem for years, the NSC staffers maintained. Moreover DoD’s cost estimate for restoring territory was probably overrated. A glaring intelligence omission in the study, according to the staffers, was an estimate of just how long the Warsaw Pact could sustain the conflict. Given all these imponderables, they recommended to Brzezinski a combination of two hard, direct defense options for conventional defense of Europe.<sup>36</sup>

As for military operations outside Europe—either the limited-action AIMS or the proactive strategies—Utgoff and Thompson were “not convinced that planning to take initiatives against the USSR in a NATO–Warsaw Pact War has any strategic merit worthy of the costs,” a view that Brown also held. It was in the U.S. interest to confine the fighting to Europe and prevent it from spreading worldwide, so the limited-action AIMS appealed to

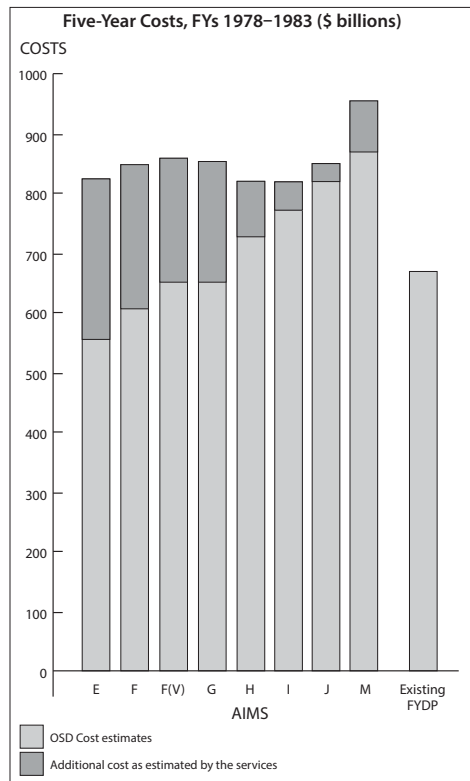

Source: PRM 10, Strategy and Force Posture Review, Final Report, 6 July 1977, 7, CK31000056945, DDRS.

them. In crisis management and local war scenarios, the NSC staffers thought it most likely that the United States would fight in the Middle East. The options for local war and peacekeeping in the study included limited action, light intervention, and heavy intervention. The staffers suggested some troops designated for Europe could be used in these operations, although capabilities required for forcible entry—airborne or amphibious units—were not readily available from U.S. forces intended for European operations. They favored a strategy between limited action and light intervention.<sup>37</sup>

In discussing East Asia, the staffers told Brzezinski that “it almost disappeared from the key question list numerous times,” but Brown always resuscitated it in a maneuver to argue against further reductions of U.S. troops in the Western Pacific and Korea. Although attracted to proposals for continuing small reductions of U.S. forces in East Asia, and some carefully managed Japanese rearmament, the staffers believed that given proposed U.S. withdrawals from Korea, it was not the time for further withdrawals from the rest of Asia. Decisions could wait until the dust settled on Korean pullouts.<sup>38</sup>

At the PRC meeting on 8 July 1977, Brzezinski took the lead, suggesting that given current U.S. and European political climates, it was impossible to afford enough conventional forces to maintain NATO’s territorial integrity if deterrence failed. Most participants agreed, except JCS Chairman General Brown, who suggested that with a 3 percent rise in real spending every year, NATO would be able to mount a strong conventional defense. Brzezinski proposed a “stalemate” strategy whereby NATO would fall back and blunt the Warsaw Pact attack, leaving the Soviet Union to face the political and international consequences of its aggression, including U.S. mobilization. All agreed that NATO strategy must continue to rely on strategic nuclear, theater nuclear, and conventional forces for deterrence. There was also general agreement that the distinction between declaratory policy (that NATO would prevent loss of West German territory) and the Alliance’s actual limited capability to accomplish such a policy had to be blurred, at least publicly, for political reasons, because the United States could not openly acknowledge a strategy that contemplated loss of West German soil.<sup>39</sup>

Most participants agreed that taking the war to non-European Soviet territories could have useful results. Secretary Brown took exception, stating he did not see any real opportunities to hurt the Soviets outside Europe. Deputy National Security



Adviser David Aaron suggested it was more important to defend access to the Persian Gulf than to take initiatives against non-European Soviet territory. As for crisis management and local wars, all participants generally agreed that forces for this purpose should be added to those required for a NATO–Warsaw Pact war. If the United States planned for operations in Korea, the Middle East, and the Persian Gulf, these forces would also cover any other local contingencies. All accepted that beyond the planned pullouts from Korea, there should be no changes in the Far East. Brzezinski raised the need for a highly responsive global strike force, suggesting that the 2nd Infantry Division, after it withdrew from Korea, might be a good candidate. There was agreement that cost estimates for the AIMs needed refinement.<sup>40</sup>

At the next PRC meeting, on 13 July, Brown dominated the discussion, first briefing participants on the objectives of U.S. nuclear strategic policy as outlined in the DoD study: deterring a nuclear attack on the United States or its allies, controlling escalation and limiting damage if deterrence failed, and avoiding the perception of imbalance in strategic forces to inhibit coercion of the United States and its allies. How to satisfy these objectives raised many questions in Brown’s mind, which he enumerated at the PRC meeting. What was needed to deter Soviet conventional and nuclear aggression? What actions would avoid the perception of U.S.-Soviet asymmetry? Should the United States seek hard-target kill capability, and would it endanger stability? How much defensive strategic capability was needed to limit damage? Was a strategic reserve force even necessary? What should U.S. declaratory policy be toward strategic forces? What was the relationship between strategic and general purpose forces? Brown then asked the other participants for their views.<sup>41</sup>

Most of the group felt comfortable with overall strategic equivalence and could tolerate asymmetries. The decision to go for hard-target capability caused more disagreement, but the participants generally agreed that some limited hard-target kill capability was needed. The discussion moved to the strategy of National Security Decision Memorandum (NSDM) 242, with the group accepting the basic principle outlined in NSDM 242 of 17 January 1974: “to conduct selective nuclear operations . . . to control escalation” while withholding “some vital enemy target hostage” to later attacks. If escalation could not be controlled, U.S. nuclear attacks should seek “destruction of the political, economic, and military resources critical to the enemy’s postwar power.”<sup>42</sup>

The CIA representative raised the related issue of whether the Soviets were seeking to fight and win a nuclear war. The magnitude of their ICBM and civil defense programs seemed to suggest so. Some intelligence analysts believed that the Soviets would be emboldened to take more risks unless the United States matched their nuclear warfighting efforts. Brown recommended that the group look at basic defense strategies, but this discussion soon narrowed down to whether a mobile MX was needed—all participants thought it made sense but required more study, except Spurgeon M. Keeny Jr., deputy director of the Arms Control and Disarmament Agency (ACDA), who favored augmenting Minuteman missiles. Finally, Brown and Duncan extolled cruise missiles as a long-term viable strategic option. As Brown had candidly told the Soviets, nuclear-armed cruise missiles had the potential to negate extensive Soviet antiballistic missile and air defense advantages.<sup>43</sup> The meeting determined nothing definitive (in fact, the summary of conclusions was just a shorter version of the minutes). What emerged, however, was the realization that the old strategic equations required rethinking.<sup>44</sup>

After the PRC meeting, Brown submitted the DoD Strategy and Force Posture study to Carter, stressing that it was still very much a work in progress. For the first time, Brown commented officially on the NSC's net assessment, finding it overly optimistic on the current military balance in Europe, but adding that U.S.-NATO initiatives could improve the situation over the next few years. He agreed with the net assessment's conclusion that the Soviet Union was competitive only in "the military dimension" and that the United States should exploit its advantages, especially technological, in both conventional and strategic forces. In recommending the DoD study to the president, Brown indicated that it raised multiple issues confronting NATO for the next 10 years: the role of allies and the need for an alliance strategy in Europe; a consensus on how long to fight in Europe; and a possible divergence between the United States and its allies on the latter. As for strategic nuclear deterrence, "the cornerstone of US and Allied military security," Brown highlighted the attendant choices of political sufficiency (the requirement that Soviet leaders perceive that the U.S. nuclear arsenal was a sufficient deterrent, and that the U.S. leadership had the will to use it), hard-kill retaliatory capability in the face of Soviet offensive and defense posture, and a strategic reserve force. Brown quickly recounted the study's limitations: no coordination with the NSC's net assessment; no single recommendation for a national strategy or formulation of national objectives; only rough cost estimates; no in-depth

examination of NATO warning time, reinforcement, and readiness requirements; and no estimate of Soviet buildup rates, warning indicators, or lag time. Moreover, the study did not address theater nuclear forces, strategic defensive and mobility forces, U.S.-USSR industrial capacity, or access to raw materials and energy.<sup>45</sup>

With these limitations, it was no wonder the DoD study failed to capture Carter's attention. Even before the president received the study, Davis admitted to Brown that "the PRM Study is over. We have learned what we can. . . . At this point, the critical question is not whether the study was good or bad or whether you support it or disavow it." Rather, should Brown provide the president with general (as most in DoD wanted) or "fairly specific guidance?" The secretary considered the study too unfocused to provide anything but generalities.<sup>46</sup>

### **Andrew Marshall and the Office of Net Assessment**

In evaluating the NSC staff assessment of the U.S.-Soviet defense balance as requested under PRM 10, Brown had an asset at the Pentagon, Andrew Marshall, the director of the Office of Net Assessment. At Brown's direction, Marshall worked with Huntington of the NSC staff on the comprehensive net assessment portion of PRM 10. Marshall provided the Huntington team copies of ONA studies on the comparative balances between the United States and Soviet Union in strategic nuclear forces, antisubmarine warfare, maritime projection, and the conventional forces of NATO and the Warsaw Pact. ONA had initially prepared the strategic balance study in August 1976 for Secretary of Defense Donald Rumsfeld. Looking at the next decade and a half, Marshall—the principal drafter—concluded that while current net assessment methodologies were imperfect, they nonetheless suggested three conclusions. First, the Soviet Union seemed to be seeking the ability to prevent a nuclear U.S. counterstrike after a Soviet first strike. Second, new technologies would only improve ICBM accuracy and warheads yields for both sides. Third, the United States had to come to terms with strategic nuclear parity. The erosion of U.S. superiority in nuclear weaponry vis-à-vis the Soviet Union caused by Soviet advances in ICBM throw weight and its new SLBMs, combined with its emphasis on civil defense, suggested to ONA that Soviet leaders might be tempted to consider a first strike. To deter that possibility, Marshall recommended devising a strategy that played on Soviet weaknesses and forced them to make difficult choices.<sup>47</sup>

Another ONA study prepared for Rumsfeld fleshed out this strategy. Brown read the paper when he took over the Pentagon. ONA reiterated that rather than solely matching Soviet strategic strengths with larger budgets and more and better strategic weapons, the United States should also take advantage of Soviet weaknesses and U.S. strengths, thus shifting the initiative from Moscow to Washington. The best example of this was the rationale Marshall provided to Rumsfeld, but also read by Brown, on the B-1 penetrating bomber. Ever since Operation Barbarossa in 1941, when the Luftwaffe destroyed most of the Soviet air forces, the Soviet military placed inordinate resources in creating by 1976 the world's premier and most extensive territorial air defense system (along borders extending 11 time zones). But this massive defense came at the expense of other military programs, including nuclear technology. For its part, by 1976 the United States had virtually given up on its air defense. ONA and Marshall argued that the B-1 bomber, although not inexpensive, would prove such a threat to Soviet air defenses that it would force them to spend even more money to counter it, thus limiting resources for other military programs. Carter was not convinced about the B-1, considering that cruise missiles on B-52s could perform the same function less expensively to the same effect. Brown, who recommended a mix of B-1s and B-52s with cruise missiles (see chapter 2) saw in Marshall's ONA the kind of analysis he needed. The two men thought along similar lines.<sup>48</sup>

Beyond similarities on defense strategies, Brown and Marshall had a long professional relationship. They had worked together when Marshall was at RAND and Brown at Livermore Laboratory. As director of defense, research and engineering, Brown tried unsuccessfully to convince Marshall to join the organization. When he became secretary of defense, Brown could utilize Marshall as he saw fit. In the reorganization of his office (see chapter 4), the secretary removed ONA from his direct authority, placing ONA under the new under secretary of defense for policy, Stanley Resor. Importantly, however, Brown allowed Marshall to send his assessments directly to him without the laborious coordination and clearances. Under this relationship Marshall avoided interference from military services and OSD bureaucracies (including Resor's office), each with their own agendas and priorities. As Brown recalled, he relied upon Marshall for long-term issues, knowing that in-box issues could crowd out such thinking.<sup>49</sup>

Brown used ONA more than any secretary of defense, requesting 11 major studies during his tenure. Marshall recounted that the studies usually comprised

150 pages, with a 4-page covering memorandum. Expecting Brown to focus on the covering memorandum, ONA received, within two or three days, an annotated comeback copy with Brown's marginalia on almost every page. The secretary provided directions for new studies, follow-up actions, observations, and other related instructions. "It was absolutely amazing," Marshall remembered. As ONA's most receptive customer, Brown profited from the Marshall team, and the office expanded accordingly. Brown found value in ONA's main message: compete with the Soviet Union on U.S. terms; stress those programs that the United States was best at; and exploit the Soviets where they were at a disadvantage.<sup>50</sup> This message also resonated within Brzezinski's NSC and found its way into Carter's PD 18 on national security.

### **Presidential Directive 18**

Drafted by Aaron, Brzezinski, and Huntington, and approved by Carter on 24 August, PD 18, "U.S. National Strategy" was the administration's first attempt at national security guidance. It was a mishmash of everyone's pet concepts that plumbed the depths of generalities. Brzezinski showed the final draft to the president, who thought it "excessively defensive," emphasizing neither U.S. advantages nor Soviet problems.<sup>51</sup> Such a concern was in line with the advice that ONA was providing Brown. To rectify this criticism, PD 18 echoed the net assessment, seeing competition and potential conflict as well as cooperation and stabilization in U.S.-Soviet relations. Apart from the Soviet Union's rough military equivalence with the United States, Washington enjoyed technological, economic, and political advantages as well as international support. The Soviet Union had few committed allies and faced economic and national (ethnic) difficulties. The United States could employ its assets to counterbalance Soviet military power and influence in Europe, the Middle East, and East Asia. The PD called for emphasizing the American commitment to human rights (Carter's special interest) and freedom from Soviet domination (a Brzezinski hobbyhorse) in the geopolitical competition with the Soviet Union, while seeking cooperation in defusing regional conflicts and tension with the Soviets where possible. The United States would continue verifiable arms control and disarmament agreements and engage Moscow constructively through economic and social developments and nonstrategic trade. An overall military balance with the Soviets, "at least as favorable as that now exists," remained an absolute

prerequisite for the JCS and military. The United States specifically committed itself to fulfilling its pledge to increase defense spending by 3 percent real growth each year along with the NATO allies, a last-minute addition for Komer and Brown.<sup>52</sup>

The PD outlined guidance for nuclear strategy. U.S. strategic forces had to be designed to deter any nuclear attack on America or its allies. If deterrence failed, U.S. forces had to be able to inflict “an appropriate retaliatory response on the Soviet Union” and “to enhance deterrence of non-nuclear aggression against NATO and our Asian allies.” The strategic posture of “essential equivalence” for the United States required offsetting Soviet advantages with U.S. advantages in strategic forces while never accepting inferiority. The PD eschewed a disarming first strike. While promoting nuclear stability in a crisis, the United States should have the capacity to inflict “an appropriate retaliatory response on the Soviet Union” and “to enhance deterrence of non-nuclear aggression against NATO and our Asian allies.” U.S. targeting plans should provide “limited strategic employment options.” PD 18 left one set of key issues unresolved for strategic weapons deployment doctrine: what targets to hit, when to hit them, and to what effect.<sup>53</sup>

As for conventional forces, the PD directed planning for conflicts in Europe and outside the European theater. While confirming a NATO defense based on conventional, theater nuclear, and strategic nuclear forces, the PD pushed for strengthening NATO’s conventional forces in order to repel a Warsaw Pact advance with a minimum loss of territory, ultimately win the lost territory back, and protect lines of communication and access to raw materials vital to the U.S. and NATO. The directive remained silent on how to accomplish the above. The PD’s guidance included Brzezinski’s idea of a global “force of light divisions with strategic mobility independent of overseas bases and logistical support,” a force that could move rapidly into trouble spots with its initial logistical support equally mobile. It also acknowledged the use of moderate naval and tactical air and limited land combat forces in the Middle East, Persian Gulf, and Korea. In Asia, with the exception of the planned withdrawal of the 2nd Infantry Division from Korea, U.S. forces would remain on duty.<sup>54</sup>

Portions of the OSD study, the net assessment, and PD 18 leaked to the press. Hardline columnists Rowland Evans and Robert Novak decried a strategy that “concedes one-third of West Germany to a Soviet invasion rather than seek increased defense spending.” The major conclusions of the OSD study on Military Strategies

and Force Structures appeared in the *Washington Post*. There was so much selective quoting from OSD's response to PRM 10 by so many columnists and journalists that Brown gave a speech before the National Security Industrial Association on 15 September 1977 to explain the study.<sup>55</sup> In fact, the result of DoD's and NSC's responses to PRM 10, Presidential Directive 18, proved more a road map than a blueprint because it left multiple questions unanswered. PD 18 was not the break from the national security policy of the Nixon-Ford administrations that many had initially feared. It provided none of the details required to implement its guidance, and it was mute on cost considerations. As one OMB analyst suggested, it "was long on abstractions and short on specifics."<sup>56</sup> To Brzezinski, in retrospect, it confirmed his "own predisposition in favor of an activist, assertive, and historically optimistic policy of détente. . . . Based on adequate military power . . . its concomitant had to be a deliberated decision to reverse military trends of the preceding decade." Brzezinski rather too starkly cast PD 18 as a triumph over those officials in the State Department, including Secretary Vance, and in its sister agency, the ACDA, who wished to limit strategic forces to an assured destruction level, reduce forces in Korea and Europe, and address the Indian Ocean and Persian Gulf in light of arms control efforts with the Russians. While Brzezinski viewed PD 18 through his particular prism, Brown, Davis, and OSD staff knew they had fumbled the military strategy and posture study by failing to provide the specific guidance and viable alternatives that PRM 10 had sought. While the president ultimately determined national security policy, DoD can and should have a major role. The failure of the PRM 10 study forced OSD to fall back on generalities, ceding to Brzezinski and his staff the opportunity to define national security policy, which they did less successfully.<sup>57</sup>

### Rethinking Nuclear War

When the Special Coordination Committee members (the other NSC subgroup chaired by the national security adviser) met to work out assignments to flesh out PD 18, Brzezinski and Brown locked horns. Brzezinski insisted that PD 18 required multiple further studies, but Brown objected on the grounds that they all concerned military topics and "his Department was choking already on work." At least prioritize them, Brown recommended. Brzezinski countered that the NSC needed this information and "may want to guide the studies." Eventually Brown and Brzezinski whittled the number of studies down to five.<sup>58</sup> Of these, the study to review nuclear

targeting policy and recommend new criteria for consideration by the president and NSC generated the most interest. The study would consider political and strategic advantages of several targeting options; assess the specific amount of future hard-target kill capability needed and for what purposes; and examine acquisition capabilities required for a secure reserve strategic force.<sup>59</sup>

The targeting study request did not come out of the blue. It was a direct result of a policy instituted by the Nixon administration in January 1974 and embodied in NSDM 242, which refined nuclear targeting policy. For years defense intellectuals and planners had argued over whether mutual assured destruction represented the best approach, given that its only options were all-out nuclear exchange or backing down. Why not have plans to fight, or even win, a limited nuclear war employing both nuclear and conventional forces? The policy guidelines of NSDM 242 opened the possibility for limited targeting options in a nuclear war to avoid a resort to mutually assured destruction. Simply put, the United States would attack specific targets, such as certain industries and high-profile military, political, or economic targets, offering the possibility that the Soviets would display similar restraint. The key was flexibility and the possibility of de-escalation after the war began, thus avoiding nuclear Armageddon.<sup>60</sup>

A technological-intelligence breakthrough offered the possibility of changing targets, including mobile military forces, in real time during a potential nuclear conflict. Previously reconnaissance photographs captured on silver nitrate film had to be recovered from satellites, developed, and then printed. The time lag created by this process precluded a major change in targeting once hostilities began, seriously handicapping strategic planners. In the words of Brig. Gen. William Odom, Brzezinski's military adviser, "The SIOP [Single Integrated Operational Plan] and its executive plan . . . was a war plan that did not allow for choosing specific war aims at the time and in the context of the outbreak of hostilities. It was just a huge mechanical war plan aimed at creating maximum damage without regard to political context." Technological advances in electro-optical imagery, however, allowed digital data to be transmitted live from the satellite and printed immediately, opening up opportunities to select new targets once the conflict commenced.<sup>61</sup>

As noted earlier, neither Carter nor Brown initially felt comfortable with NSDM 242. Initially a proponent of mutual assured destruction, Brown's views changed as the Soviets built ICBMs that exceeded those of the U.S. in explosive power, increased



the number of warheads that their missiles could carry, and expanded their civil defense program. Accepting the concept of limited targeting options of NSDM 242, he still believed there was no consensus on targeting criteria. Brigadier General Odom, a vocal opponent of mutual assured destruction, promoted more flexible nuclear targeting, especially striking mobile military targets.<sup>62</sup> Brzezinski's doubts about NSDM 242, however, compelled him at the end of March 1977 to ask OSD to study the whole targeting issue.<sup>63</sup> Brown took no chances with inexperienced leaders, naming trusted advisers Andrew Marshall and Walter Slocombe, principal deputy assistant secretary of defense (ISA) and Brown's point man on SALT II, to coordinate the study. Brown tapped Leon Sloss, a former deputy director of the Bureau of Political and Military Affairs at State and an ACDA assistant director under Nixon and Ford, as director of the study. An old hand at national security and arms control, Sloss consulted with the Joint Chiefs and his friend General Richard H. Ellis, commander in chief of the Strategic Air Command and director of strategic target planning, aiming for good relations with the military leadership.<sup>64</sup>

As Sloss was preparing his final report, the Defense Intelligence Agency concluded that the Soviet leadership had ordered construction of extensive harden facilities that would allow them, and presumably their families, to survive a nuclear exchange. Marshall encouraged Sloss to use his targeting study to convince Soviet leaders that they themselves could not survive a nuclear war. These shelters would be targets. In the words of Marshall's biographers, Brown "directly and personally cleared [for release] certain articles and discussions to drive this point home to the Kremlin."<sup>65</sup>

In November 1978 Sloss officially submitted his report to Brown. He opened with the generally held assumption in the U.S. intelligence community that the Soviets were considering fighting and winning a nuclear war that would leave them with the last military forces standing and dominance in a postwar world. All of their planning for nuclear war, especially with an emphasis on civil defense and emergency preparedness, seemed to confirm this objective. While not seeking nuclear conflict, if it came, the Soviet leadership had plans to survive and emerge victorious. In response to this Soviet strategy, the new U.S. policy outlined by Sloss advocated a targeting policy that could "respond approximately and effectively to any level of Soviet aggression, over the continuum of nuclear weapons systems . . . to employing all elements of our nuclear forces in attacks on a broad spectrum of enemy targets." DoD's study continued: "The ability to respond with selectivity

to less than an all-out Soviet attack in keeping with the needs of the situation is required . . . to provide suitable alternatives, strengthen deterrence, and enhance the prospects of limiting escalation of the conflict. In addition to preplanned options we need the ability to design employment plans on short notice in response to the latest and changing circumstances.”<sup>66</sup>

The Sloss report recommended flexibility to hit targets of high value to the Kremlin leaders, such as Soviet strategic and general purpose military forces; command, control, and communications facilities; and military support. The United States was expected to hit these targets if they were dispersed, or with hard-kill capability if they were hardened.<sup>67</sup>

In addition, the report concluded that the United States should be prepared for an extended, albeit limited in scale, nuclear exchange over a period of weeks or even months, requiring more emphasis on civil defense; improved command, control, communications, and intelligence; and creation of a robust strategic reserve force able to survive and endure initial attacks. The report raised the option of launching under enemy attack the U.S. ICBM Minuteman force against Soviet targets, with predetermined objectives. Built on Nixon’s NSDM 242, this new policy stressed flexibility and envisioned an extended and limited nuclear war.<sup>68</sup>

The Sloss report was as definitive and directed as the PRM 10 Military Strategy and Force Posture study was diverse and inconclusive. Sloss provided clear, unequivocal guidelines and posed a thought-provoking challenge to nuclear war planners. JCS Chairman General David Jones considered it “an excellent framework for shaping a revised national nuclear employment policy.”<sup>69</sup> Among the NSC’s national security experts the report occasioned a spirited debate. NSC Planning Director Samuel Huntington considered the document “an excellent description and critique of existing targeting policies and appropriately sets forth the major issues deserving of top-level consideration and decision.” To Huntington, its two main themes pointed up flexibility of target selection and a new priority on targeting Soviet warfighting rather than war-recovery capabilities.<sup>70</sup> To Victor Utgoff, head of NSC’s Defense Coordination, however, the study represented essentially an advocacy piece in favor of targeting Soviet warfighting. Utgoff preferred that the president be provided with all options, not advocacy.<sup>71</sup> Odom agreed with Huntington, citing “the study’s virtues” as survivable C3I to guide attacks and assess results; flexible planning that supported a wide range of political and campaign realities,

most of which could not be anticipated; and the need for a secure reserve force for a long-term conflict. Nonetheless, Huntington worried that the new strategy required knowing “ex ante” what the Soviets would do. As Odom saw it, “We never can know that. The Politburo probably does not know and could not tell us if it were willing!”<sup>72</sup>

At the end of December 1978, Sloss left government service “with a mixture of satisfaction about the work we have accomplished [and] apprehension about its future course.” He warned

Brown that the implementation of the report’s recommendations would have to be “evolutionary” because improvements in some capabilities would take years.<sup>73</sup>

The difference of views within the NSC staff and the concerns Sloss expressed proved all too prescient as the targeting report languished at the NSC and then under interagency review. Its findings could not be kept secret. When it leaked, journalists claimed that it represented a revolutionary change in policy, abandoning mutual deterrence in favor of a nuclear warfighting strategy.<sup>74</sup> Such talk spooked policymakers, especially those at State and the Arms Control and Disarmament Agency, who considered the new policy too provocative. In April 1979 the SCC discussed the targeting study at three meetings without making formal decisions. Brown stressed that the Sloss report “does not propose that we move from deterrence to [nuclear] warfighting” or “shift from targeting the Soviet urban industrial base to . . . military forces,” since most “SIOP weapons have always been targeted on Soviet military forces.” The SCC group agreed with Brown that “flexibility” in targeting was desirable. The president waited until July 1980 to approve the new targeting policy, letting the NSC participants fully discuss it and work out their differences.<sup>75</sup>



Army Maj. Gen. William Odom was the military assistant to National Security Adviser Zbigniew Brzezinski from January 1977 to January 1981. (RG 330, NARA II)

While the targeting recommendations of the Sloss report stalled in the approval process, Brzezinski moved quickly on its other recommendations. He obtained Carter's approval for Presidential Directive 41 of 29 September 1978, which revived the civil defense program, all but moribund for a decade and a half. To strengthen national telecommunications to withstand and continue to operate after a nuclear attack, the president issued PD 53 on 15 November 1979. Finally, PD 58 of 30 June 1980 ordered preparations for improved continuity of government during a protracted nuclear attack.<sup>76</sup> Taken together, these three initiatives plus the Sloss report signaled the administration's intention to prepare better for a nuclear conflict. When Carter officially approved (and leaked) the new nuclear targeting strategy in July 1980, planners in the Kremlin could only conclude that U.S. national security policy had undergone a profound shift.

### **Presidential Directive 59**

The new nuclear targeting strategy grew directly from the Sloss findings and recommendations. From the fourth quarter of 1979 into 1980, a team of defense specialists at NSC worked with OSD and Brown to formulate a presidential directive (PD 59 issued on 25 July 1980). As Brzezinski made clear, "There should be a PD to bless implementation at the presidential level."<sup>77</sup> In fact, Brown had already asked the JCS in January 1979 to apply the recommendations of Sloss' Nuclear Targeting Policy Review (NTPR) to their revision of nuclear weapons employment policy (NUWEP) to build more flexibility into the SIOP. The Chiefs began the process in October 1979 and promised more revisions to that effect by October 1980. In the FY 1981 *Annual Report to the Secretary of Defense* released in January 1980, Brown publically described the concept of countervailing strategy.<sup>78</sup>

Following discussions between NSC and OSD staff members, in late March 1980 Brzezinski sent Brown a draft of the PD. After discussing it with the Chiefs, Brown told Brzezinski that the PD "is sound in approach and consistent with the NTRP," but he suggested making clear that "our objective remains deterrence and that we have no illusions about either side being able to count on fighting and winning a nuclear war." According to Brown, a statement to this effect in the PD would insulate the administration from the distortion that Carter had accepted "a war-fighting policy—which would be attacked from the left as immoral and dangerous, from the right as a move of desperation, and from the center as infeasible." Brown thought that using

the word “priorities” when describing targets would cause confusion; he preferred to call them “categories.” He recommended including the option of launch under attack to convince the Soviets that it had not been ruled out.<sup>79</sup>

Formulating PD 59 had been a joint effort by OSD and NSC principals without much input from other National Security Council members and their staffs. Brzezinski, in the words of Odom, “dragged Brown along on this PD.”<sup>80</sup> Neither Brzezinski nor Brown saw any need to send drafts (or the approved version) of PD 59 to the new secretary of state, Edmund Muskie. Brown briefed Muskie on changes to the SIOP, but he did not go into details of PD 59 because one of the State Department people present was not cleared to know about it. A relative neophyte to national security issues, with an unfortunate tendency to fall asleep in meetings, Muskie did not understand the full significance of Brown’s opaque briefing. When the president signed PD 59 it evoked newspaper reports based on leaks. Muskie went through the roof, asking why he had not be involved or at least informed. Brown found himself soothing ruffled feathers reminding the State principals that Vance had been aware of the planning. Brown briefed and showed Muskie the PD after the fact, hardly good interagency coordination.<sup>81</sup>

Carter signed PD 59, “Nuclear Weapons Employment Policy,” on 25 July 1980, which embodied Sloss’ NTPR and the changes Brown and OSD suggested. It stated that nuclear deterrence remained the United States’ fundamental objective. Countervailing strategy required improvements in U.S. strategic forces, their C3I, and their employment plans and planning apparatus to achieve high flexibility, enduring survivability, and adequate performance in the face of enemy actions. PD 59 also required the flexibility to design nuclear employment plans on short notice in response to changing circumstances, and the ability to integrate strategic forces with theater nuclear and general purpose forces.<sup>82</sup>

PD 59 called for withholding a robust reserve strategic force of the most survivable and enduring systems for possible subsequent use. The acquisition of new nuclear weapons and their supporting C3I systems would be evaluated in terms of how they could support countervailing strategy. This would be tested by at least two exercises involving the National Command Authority. The PD required continued study and evaluation, with annual reports to the president.<sup>83</sup>

Inevitably some reports about PD 59 that leaked to the media misrepresented it as a new departure in nuclear strategy. Since the 1980 presidential campaign

was underway, some speculated that the leak of PD 59 was a ploy to demonstrate that the Carter administration was tough on defense, thus offsetting Republican candidate Ronald Reagan's charges to the contrary. To liberal arms control advocates, such as the Federation of American Scientists, PD 59 seemed warlike and dangerous.<sup>84</sup> Brown spent considerable time trying to convince the public that PD 59 was not a radical shift from a past policy of mutual assured destruction, but rather a continuation of the Nixon-Ford doctrine espoused in NSDM 242. Some attributed to the White House ulterior motives. Under Secretary of Defense for Policy Robert Komer expressed it most frankly: "For my money you [Brown] got mousetrapped on PD-59, an NSC product we didn't even want (we were happier with NUWEP [Nuclear Weapons Employment Policy 80 finalized in October 1980, which implemented countervailing strategy] and one blown out of proportion by ZB's [Brzezinski's] ham-handed leaking as a bold 'new' strategy. . . . DoD didn't draft the PD. DoD didn't leak it."<sup>85</sup>

Taken together, the two national security directives of the Carter administration, PD 18 and PD 59, were about as different in their conception and formulation as they could be. The Carter administration's initial attempt at reformulating national security policy (the response by both OSD and the NSC to PRM 10) generated mountains of paper, countless interagency committees, and heartburn in DoD. Those working on the response to PRM 10 labored for months, but Presidential Directive 18 proved to be only a general statement that had only minimal relationship to the OSD's Military Strategy and Force Posture study. On the other hand, PD 59's determinations were firmly based on the decisive Sloss report. After two NSC staffers wrote PD 59, and Brown and OSD revised it, the president approved it with almost no interagency coordination.<sup>86</sup>

Nuclear strategy planning traditionally has been a complex undertaking. In a time of nuclear parity between the two superpowers, military planners anticipated the worst and planned for all contingencies. The Carter administration took a hard new look at nuclear war, not only with countervailing strategy, but also with its emphasis on better C3I, civil defense, and continuity of government during and after a nuclear war. Brzezinski has argued that these directives amounted to a better "*doctrine of deterrence*, designed in keeping with both the capabilities and the doctrines of our potential opponent and thus more likely to deter him effectively."<sup>87</sup>

Brzezinski and Brown and their respective staffs had created a much more coherent, comprehensive strategy for the possibility of nuclear war. The Carter administration's definition of national security policy had undergone a major conversion that carried the concept of flexible nuclear response to Soviet aggression, introduced by Secretary of Defense Robert McNamara in the Kennedy administration and refined by the Nixon-Ford administration, to its logical conclusion.





## SALT II and the MX Missile Decision

A FEW DAYS PRIOR TO HIS INAUGURATION on 20 January 1977, President-elect Jimmy Carter sat down with Secretary of Defense-designate Harold Brown for a briefing by the Joint Chiefs of Staff on the U.S. military posture and the strategic balance with the Soviet Union. Over the years the Chiefs had honed these sessions to a fine art, projecting on a screen highly classified materials, including graphs, charts, slides, and maps, to demonstrate unequivocally how desperately the United States had fallen behind the Soviet Union in the strategic arms competition. Carter watched with his tight, toothy smile that signified anything but happiness. If the Joint Chiefs hoped to “educate” the new president, they met with disappointment. After the lights came on, Carter said all the niceties, thanking the Chiefs, promising to study the materials, and reiterating his commitment to harmonious military-civilian relations and national security. He asked a few specific questions, suggesting that he was not all that convinced the Soviets were gaining the military edge. Then the president-elect dropped his own bomb: how long would it take to reduce drastically the number of U.S. nuclear weapons? Neither Secretary-designate Brown nor JCS Chairman General George Brown quite understood what Carter was asking. Was he talking about strategic arms limitation talks reductions? The president-elect clarified by asking how long it would take to reduce the U.S. strategic arsenal to 200 intercontinental ballistic missiles.

One Joint Staff aide reportedly recalled that Carter’s question so quieted the room that one could have heard a pin drop. Deliberately shocking the JCS—vintage Carter style—the president-elect placed them on notice for deep strategic arms cuts.<sup>1</sup> After the inauguration, it fell to Harold Brown to explain to his new boss how such cuts were unrealistic and counterproductive in achieving a SALT II agreement. A

limit of only 200 ICBMs would result in a U.S. strategy almost totally reliant on retaliatory nuclear attacks on the Soviet population and industry. In the extremely unlikely circumstance that the Soviets agreed to make similar reductions, such mutual reductions would encourage them to cheat by covertly deploying antiballistic missile (ABM) defenses, or by upgrading air defense missiles. It would spur them to enhance civil defense and concentrate on the 200 U.S. offensive strategic launchers. Moscow would be more likely to contemplate a possible first strike. While Carter probably never intended to reduce the number of ICBMs to 200, he clearly anticipated drastically changing the SALT II negotiation dynamics with a bold and dramatic gesture.<sup>2</sup>

### **SALT II Negotiations Prior to Carter**

Carter inherited SALT from previous administrations. President Richard Nixon's team had successfully concluded both the 1972 SALT I agreement, which had frozen the number of strategic ICBMs and SLBMs (submarine-launched ballistic missiles) for five years, and the 1972 Anti-Ballistic Missile Treaty, which constrained development, testing, and deployment of strategic antimissile systems. Brown had been part of the SALT I negotiations, providing both technical expertise and bipartisanship. During the Nixon-Ford second term, National Security Adviser and Secretary of State Henry Kissinger sought to build upon SALT I with a more permanent SALT II treaty. Kissinger and President Gerald Ford almost succeeded at the November 1974 summit in Vladivostok. Under the formula worked out, each side would be limited to 2,400 strategic nuclear delivery vehicles (SNDVs), a category that included ICBMs, SLBMs, and heavy bombers. The agreement recognized the asymmetries of the respective nuclear arsenals. The larger, more powerful Soviet ICBMs but less robust SLBM and bomber forces would be balanced and offset with the stronger SLBM and bomber forces of the United States and the smaller but more accurate ICBM force made up of Minuteman missiles.

Technological advances, in addition to differences in strategic forces, complicated the SALT II negotiations. The United States had placed multiple independently targeted reentry vehicles on ICBMs beginning in 1970, thus transforming one missile into the equivalent of as many independently targeted warheads as could be placed on the missile. The Soviets soon developed their own MIRVs, flight testing and deploying them in the mid-1970s on some of their heavy SS-18 and SS-19 ICBMs.<sup>3</sup>

The Vladivostok formula permitted each side to have MIRV capabilities on 1,320 of their 2,400 launchers. Moscow had almost 2,520 strategic launchers (mostly ICBMs) but just over 500 carried MIRVs. Washington possessed 2,287 launchers (counting nonoperational B-52s) and about 1,050 carried MIRVs. While MIRV numbers were settled in principle, the Vladivostok agreement foundered on how to account for fast-developing U.S. cruise missile (CM) technology and on whether the new Soviet Tu-22M bomber, known in the West as the Backfire, should also be counted as a strategic weapon. In January 1976 Kissinger attempted to nail down an agreement before the presidential election, but the Backfire and cruise missile issues defied resolution. Ford suspended negotiations until after November 1976. With Ford's loss at the polls it fell to Jimmy Carter to carry forward the SALT II negotiations.<sup>4</sup>

### **The Comprehensive/Deep Cuts Proposal**

Carter stood ready and willing to negotiate SALT II and its expected follow-on SALT III treaty, recognizing these negotiations as the best chance for meaningful strategic arms reductions. At last Carter could fulfill his dream, at least in part, of ending the tyranny of ever greater and more powerful nuclear weapons on more dangerous launchers. The tide would turn in SALT II and then be rolled back in SALT III. While Secretary of State Cyrus Vance was the chief SALT negotiator with the Soviet leadership and Paul C. Warnke, director of the Arms Control and Disarmament Agency, headed the U.S. SALT II delegation, Brown worked on formulating SALT negotiating policy inside Washington. His experience as a former part-time member of the SALT delegation, his nuclear weapons background, and his scientific and technological expertise allowed him to grasp the intricacies of SALT's many technical issues. If Brown supported a specific SALT initiative, Carter and the White House—although not necessarily the critics of SALT—could feel reasonably confident it was feasible and would not harm U.S. national security. Furthermore, any hope of gaining Senate ratification for the SALT II treaty required the Joint Chiefs of Staff to state that the final deal would not leave the United States vulnerable. Brown provided the principal conduit between the Joint Chiefs and the White House.<sup>5</sup>

On 24 January, Carter issued Presidential Review Memorandum 2, calling for review of the SALT negotiations.<sup>6</sup> To that end, National Security Adviser Brzezinski chaired a Special Coordination Committee meeting in early February. The president

attended this SCC session, opening the discussion with a declaration of his “most cherished hope” that SALT would eventually banish nuclear weapons forever, perhaps not in their lifetimes, but “without leadership it would never be done.” It became clear that Carter preferred substantial reductions in SALT II—allowing only 1,000 missiles with single warheads for each side—although he asked his advisers for other options. He expressed confidence the Backfire and cruise missile issues could be resolved. Brown focused on cruise missiles, an old technology gaining new life in the 1970s, suggesting that limiting their range (a key Soviet position during SALT II) would stymie further U.S. development of a valuable weapon and allow time for the Soviet military to develop better cruise missiles. As Soviet military technology moved toward miniaturization, Moscow could expand the range of its cruise missiles. The U.S. lead would disappear and the Soviets would have caught up. Brzezinski tasked the SCC to prepare options for SALT II that Vance could present in late March 1977 in Moscow.<sup>7</sup>

During February and March the SCC principals deliberated, often with Vice President Mondale present, but without the president.<sup>8</sup> On 12 March, Brown, Brzezinski, Vance, Warnke, and Brzezinski’s deputy, David Aaron, attended a principals-only meeting. Three basic strategies seemed possible. All could be combined with settling or deferring the contentious issues of the Backfire and cruise missiles as well as the NSC staff idea, supported by Brown, of freezing future ICBM development and production. One option proposed modest cuts in strategic nuclear delivery vehicles to 2,000, of which 1,200 could be converted into MIRVs, the option Brown and his staff favored. A second possibility basically reaffirmed the Vladivostok levels of 2,300 launchers, with 1,320 MIRVed ICBMs. The final option, later known as the “comprehensive” or “deep cuts” proposal, envisioned major reductions which would reduce total SNDVs to 1,500 and the MIRVed launchers to 1,000. The deep cuts proposal was dear to Carter’s heart. While Brown, Vance, and Brzezinski remained wary of it, as Vance recalled, they were willing to give it a try.<sup>9</sup>

Cruise missiles and the Backfire proved contentious among Washington policymakers. Vance and Warnke leaned toward accommodating the Soviets by agreeing that the Backfire was not a strategic launcher and accepting limits of 1,500 kilometers (km) on the range of air-launched cruise missiles and 600 kilometers on ground- and sea-launched ones. At the 12 March SCC meeting, both Vance and Warnke agreed to defer the cruise missile and Backfire issues. Brown recommended



Soviet Backfire (Tupolev Tu-22M) bomber escorted by a U.S. F-14A Tomcat. (RG 330, NARA II)

that the range for ALCMs and GLCMs remain no less than 2,500 kilometers, thus allowing maximum flexibility for their potential use as both strategic and conventional weapons. As for the Backfire, the JCS maintained that the aircraft should count as a strategic launcher. Not as adamant as the Chiefs on Backfire, because he believed U.S. air defenses could handle it for the time being, Brown remained rock solid on the ALCM range limit because he thought the Soviet Union was more vulnerable to cruise missiles than the United States was to Backfires.<sup>10</sup>

The principals and Carter met on 19 March and again on 22 March in a formal National Security Council meeting. On 19 March the president insisted that the comprehensive/deep cuts proposal be the first alternative presented to the Soviets, although he made the cuts not as drastic as originally conceived: strategic nuclear delivery vehicles limited to 1,800–2,000 for each side, of which 1,100–1,200 would be MIRVed, with a sub-ceiling of 550 for MIRVed ICBMs. In conjunction with this proposal, both sides would freeze deployment of existing ICBMs, ban modifications to them, and limit ICBM and SLBM test flights to six per year. Brown recommended these limits on modification and testing of ICBMs in an attempt to slow down Soviet improvements to their ICBM force and to postpone the time when the U.S. Minuteman land-based ICBMs would become vulnerable to Soviet

missiles. The Carter proposal would freeze Minuteman III deployment at 550 missiles and require the Soviets to freeze the total number of their MIRVed SS-17, SS-18, and SS-19 ICBMs to the same number. Soviet SS-9 and SS-18 modern large ballistic missiles (MLBMs), the largest Soviet ICBMs in terms of launch and throw-weight, would be limited to a total of 150. Both sides would abandon any further development of ICBMs. All cruise missiles (either conventional or nuclear-armed) would be limited to a 2,500km range. If the Soviets agreed to this package, the United States would accept the Soviet assertion that Backfire would not be deployed as a strategic weapon and would consider favorably a comprehensive freeze on all strategic weapons, including B-1 bombers, Tridents, and Backfires.<sup>11</sup>

As a fallback alternative to this comprehensive proposal, the United States would propose deferring the Backfire and cruise missiles to SALT III and agreeing to a limit of 2,300 strategic launchers (as opposed to 2,400 in the Vladivostok agreement), but with mobile ICBMs included in the total. The final alternative, the one Carter least preferred, envisioned a cut in SNDVs to between 2,200 and 2,400, a Soviet agreement (in a separate document) to a ceiling on the number of Backfires produced through 1985, and a limit of 2,500 kilometers for both tactical and strategic cruise missiles. Cruise missiles beyond that range would be banned pending a possible reconsideration in SALT III. Mobile ICBMs would be permitted and counted against overall launcher levels.<sup>12</sup>

Brown had succeeded in protecting the cruise missile range up to 2,500 kilometers, but the JCS had recommended no constraints on it at all. If limits had to be included, the Chiefs recommended applying 3,000 kilometers only to nuclear-armed cruise missiles. They also considered all Backfires strategic launchers but would accept counting all but 100 Backfires as SNDVs in the aggregate limit, with a serious quid pro quo, such as dismantling all 150 MLBMs. Brown commented: "This is quite a position. Would JCS prefer USSR [to] have 200 Backfires or 308 SS-18s[?]" In Brown's mind the Soviets would hardly concede their SS-18s, which posed a far greater threat than Backfires. Prepared to count mobile ICBMs as part of the aggregate limit, the JCS feared that a deployment ban in SALT II would constrict U.S. options, such as the MX missile then under development.<sup>13</sup>

Virtually all key SALT advisers, including Brown, worried at one time or another during the policy deliberations that the Soviets would react negatively to Carter's deep cuts proposal, given the Kremlin's insistence that the parties had

already reached a basic deal at Vladivostok in November 1974, and knowing that Soviet leaders hated surprises. Carter naively believed that his proposal would somehow jolt the Kremlin into cooperative negotiations and an early SALT II agreement. To make matters worse, Carter talked publicly about his bold initiative and then mused that if it failed, “we’ll try to modify our stance.” The president’s negotiating tactics proved clumsy, if not faulty. He agreed that Vance could present the comprehensive/deep cuts proposal and second alternative proposal together, but with the clear indication that Carter preferred the former. Vance could not go to the final fallback position until the Soviets showed some good faith in the negotiations.<sup>14</sup>

The Soviets expected Vance to move to the final fallback closest to the 1974 Vladivostok understanding. To Moscow’s surprise and chagrin, Vance submitted the comprehensive/deep cuts and the first alternative deferral proposals simultaneously. Soviet leader General Secretary Leonid I. Brezhnev rejected both and released publicly the proposal to show how different it was from Vladivostok. Although Vance asked, Carter did not allow him to present the final fallback option. The secretary of state returned from Moscow frustrated and embarrassed.<sup>15</sup> Some SALT experts at State, ACDA, and on the NSC staff (mostly those left out of the policy deliberations on the comprehensive/deepcuts proposal) pointed to Brown as the father of this disaster for supporting Carter’s scheme for deep cuts and insisting that CMs have a 2,500km range. In the minds of the SALT “technocrats,” the secretary and the president did not realize that the two proposals would be viewed in the Kremlin as much more advantageous to Washington and a crude ploy to gain a strategic edge. Critics of Brown reportedly hoped to keep him and the JCS from derailing further progress.<sup>16</sup>

### **Negotiations Resume**

Unprepared to abandon his comprehensive approach to SALT, the president involved himself in day-to-day strategy planning, relying heavily on Vance and Warnke. Carter met his advisers on Saturdays for long strategy sessions and consulted with Soviet Ambassador Anatoly Dobrynin, a fixture in Washington since the Kennedy presidency. Now Vance carried the baton within Carter’s inner circle. The influence of Brown and OSD diminished.<sup>17</sup> After the failure of the comprehensive proposal for deep cuts, the SCC recommended a public strategy emphasizing that SALT was “a long-term process” requiring “patient efforts” that did not underplay “potential difficulties” and avoided “over-optimistic assessments.” When

engaged in private discussions with the Soviets, the SCC continued, “We should emphasize our preference for the comprehensive approach. We should try to obtain a more specific Soviet critique of our proposals and Soviet counterproposals.”<sup>18</sup>

On 23 April 1977 Carter, Mondale, Vance, Brown, Warnke, and Brzezinski agreed to a plan that combined the comprehensive proposal with the deferral option on the Backfire and cruise missiles. A three-tiered package would include a two-year SALT II agreement from October 1977 through October 1979 (later changed to three years), another SALT II agreement lasting until 1985, and a statement of principles for a more comprehensive SALT III agreement. Under the two treaties the SNDVs aggregate would number between 2,200 and 2,400 and MIRVed missiles between 1,200 and 1,320. The United States would limit itself to 250 ALCM-equipped bombers and cruise missiles with a 2,500km range, while the Soviets would limit production and deployment of Backfires to 250 in number. Long-range ALCMs could be deployed only on heavy bombers, and those not on heavy bombers would be limited to a 600km range. The Soviets would limit MIRVed modern large ballistic missiles to 190 and provide high-level assurances that the Backfire would not be deployed as a strategic system.<sup>19</sup> Both Brown and Brzezinski argued for stiffer conditions on the Soviets, fearing that State’s and ACDA’s rush to reach an agreement would lead to too many U.S. concessions.<sup>20</sup>

The day before the 23 April meeting, Brown had recommended—unsuccessfully as it turned out—that the president reject the 600km limit for ALCMs on all but heavy bombers. The 2,500km range, the secretary contended, was simpler and neater, and in any event the limits should apply only to *nuclear*-armed CMs. If applied to all armed cruise missiles the 600km limit would bar the Navy’s Tomahawks from their conventional antiship and land-target roles at ranges greater than 600 kilometers. The 600km limit would destroy the ability to use ground-launched cruise missiles and sea-launched cruise missiles as NATO theater nuclear forces (causing concern among the alliance allies), and eliminate a good option without a strong reason. “In short,” Brown concluded, “the case for the 600km provision seems weak, it poses some substantive military and Alliance problems, and it could create difficulties both for negotiation and for ratification.”<sup>21</sup>

Brown remained unsatisfied with the SALT II guidance. He suggested to Carter that limits imposed for two years would likely prove permanent. Furthermore, MIRV limits would impact Washington earlier than Moscow because of the U.S. lead in



MIRV deployment. Brown thought that a permanent mobile ICBM ban could hurt the United States more, to which Carter commented, "Assuming we plan to deploy the MX." Brown suggested that the U.S. proposals already favored the Soviets even if not altered during negotiations. The Soviets were masters at waiting until "improved" U.S. positions matched their own goals. The president sprinkled Brown's memorandum with "agree" and "true" comments, but how much of the secretary's advice he would heed remained to be seen.<sup>22</sup>

During spring 1977 Vance and Warnke met with Dobrynin for "talking aloud" sessions, and Vance formally resumed negotiations with Foreign Minister Andrei A. Gromyko in Moscow, where he obtained what he described as "an adequate framework for negotiations."<sup>23</sup> Gromyko accepted the concept of the three-tiered package, but he insisted that cruise missiles and Backfires be covered in a three-year protocol to the SALT II treaty, thus not subject to Senate confirmation. As the Carter administration defined and clarified its SALT II positions during summer 1977, Brown found himself opposing Warnke's attempts to make concessions to the Soviets. Often Vance and Brzezinski took a middle position, which inevitably led to more concessions than Brown and OSD thought prudent.<sup>24</sup> Walter Slocombe, the principal deputy assistant secretary of defense for international security affairs, or ISA, in charge of SALT II within OSD, complained about his staff being left out of key SALT working-level deliberations. He took issue with Warnke's contention that the Soviets had been forthcoming in the negotiations, even more so than the United States.<sup>25</sup>

In anticipation of Vance meeting again with Gromyko in New York at the United Nations General Assembly session and in Washington in September 1977, the president approved additional SALT II guidelines. Both sides would agree to accept continuation of SALT I beyond its October 1977 expiration date, a noncontroversial proposal readily accepted by the Soviets. More controversial were the 120 silos at Derazhnyia and Pervomaisk (known as "D and P" to Americans who had trouble pronouncing the names) in the Ukraine that housed SS-11 missiles, older third-generation single warhead ICBMs more powerful but less accurate than U.S. Minuteman missiles. The Soviets were constructing 60 additional silos at Derzahnnya and Pervomaisk to hold SS-19s, ICBMs with the range of 5,000 nautical miles that had already been flight tested with MIRVs. The original 120 SS-11 silos at D and P could also hold MIRVed SS-19s, making it impossible to verify which

missiles were in which silos.<sup>26</sup> In June 1977 Brown had warned Brzezinski that it would be a mistake to exclude Derazhnya and Pervomaisk silos from the interim SALT II agreement's ceiling on MIRVed ICBMs. "It [the concession] should be held for use to win a significant Soviet step," Brown argued. Even raising the issue would imply a willingness to agree to their exclusion.<sup>27</sup>

The U.S. guidance as agreed upon in September offered to exempt the 120 Derazhnya and Pervomaisk sites from categorization as MIRV launchers provided their disposition was negotiated in SALT III, they were not converted to SS-19 for three years, the Soviets accepted that if a launcher could be MIRVed it would be counted as MIRVed (the so-called type rule), and Moscow agreed to the 1,200 level for MIRVed ICBMs starting in October 1979. The guidance offered to exempt heavy Soviet Bison and Bear bomber variants, such as those deployed for antisubmarine warfare and reconnaissance, and as tankers, from the aggregate limit on strategic nuclear delivery vehicles provided the Soviets did not convert them to heavy bombers. An additional condition required the Soviets to accept the reduced total of 2,160 strategic launchers. Brown strongly recommended two points: the U.S. side would continue to press for a test ban on new ICBMs in the protocol, and for "maximum system operational range" as the definition of cruise missile 600km and 2,500km limits; and only nuclear-armed cruise missiles would be covered under SALT II, not conventional missiles. As for the Backfire, the United States would require assurances on the limits of upgrading, training, and refueling the aircraft as well as a maximum production of 250 during the SALT II protocol's three years.<sup>28</sup>

As the SCC forged its internal consensus, which NSC members blessed, Vance presented Gromyko with an approved U.S. position in September 1977. Brown and the JCS felt that the administration was rushing toward compromise without weighing the consequences, especially in its willingness to omit Soviet bomber variants in counting the aggregate strategic launcher vehicles limit. To Brown, these proposals paid the Soviets for reductions that were supposed to be beneficial to both sides. Furthermore, concessions on bombers within the counting rules were ill-advised because at lower levels of strategic launchers, marginal forces (such as the Soviet bomber variants) could prove significant. The secretary suggested eventually trading the bomber variant concessions for something the U.S. side wanted; the Chiefs agreed.<sup>29</sup>

While Brown agreed with the JCS on the need to keep open the option of developing mobile ICBMs during the three-year protocol, he did not believe they

needed to be flight tested because the MX would not be ready for such tests within the next three years. In a major departure from the JCS's views, the secretary considered the Backfire a "gray area" system . . . difficult to unambiguously classify as a central strategic system, but which definitely has certain capabilities in common with central strategic systems." To the Chiefs this was heresy. The Backfire could reach a significant portion of the United States when operating from the Arctic and landing in third countries (like Cuba). Soviet technology could improve its range by 20 percent without U.S. knowledge. Brown suggested leaving the Backfire and other gray area systems, such as the Soviet SS-X-20, a mobile intermediate-range MIRVed missile, or long-range ground-launched and sea-launched cruise missiles, for SALT III. Unlike the JCS, Brown did not believe Backfires needed to be counted in the strategic nuclear delivery vehicle aggregate during the interim protocol.<sup>30</sup>

As for the range of ALCMs on heavy bombers, Brown preferred the JCS-recommended limit of 3,000 kilometers or even 3,500 kilometers, but he considered the 2,500km level acceptable during the three-year protocol. To make sure a 2,500km range did not become a precedent, as the JCS feared, Brown recommended clear language that future range limits would not be restricted to 2,500 kilometers. He shared the JCS objection to counting heavy bombers with ALCMs in the MIRVed sub-ceiling limit but could accept counting some number of them within the 1,320 limit. If some ALCM platforms were counted in a reduced MIRV sub-ceiling, Brown argued that the Soviets should have to match this important concession. Like the JCS, the secretary recommended that only nuclear-armed cruise missiles be limited by SALT II, but he was willing to defer the issue as long as that remained the U.S. position and the range was defined as "system operational range." Unlike the JCS, Brown reluctantly accepted the 600km limits of GLCMs and SLCMs provided their longer range (up to 5,000 kilometers) was addressed in SALT III.<sup>31</sup>

During their discussions in Washington in late September 1977, Vance, Carter, and Gromyko moved closer to an agreement. They closed the gap on an overall aggregate for delivery vehicles. Vance proposed 2,160 and Gromyko 2,250. They agreed on a MIRVed missile ceiling at 1,320, with a sub-ceiling of 820 MIRVed ICBMs and with heavy bombers carrying ALCMs also counted in the 1,320 ceiling. On the separate question of a ceiling for launchers of MIRVed missiles, they closed the gap to between 1,200 (U.S. preference) to 1,250 (Soviet preference). Issues still remained—the Backfire, cruise missile range, introduction of new ICBMs including

mobiles, and whether improvements could be made to existing missiles—but both sides had moved closer to agreement. The resolution of outstanding issues seemed possible. After the talks, Vance recalled that he was “heartened and optimistic.”<sup>32</sup> In early October, Brown assured the president that progress in the recent SALT II negotiations had accommodated JCS concerns, “although not always by the precise mechanisms and provisions suggested by the JCS.”<sup>33</sup>

The JCS took exception to the secretary’s characterization. Because a great portion of the U.S. missile stock was already MIRVed, they warned that the United States lacked a new non-MIRV or non-ALCM system to achieve a 2,160 limit on strategic nuclear delivery vehicles without departing from current scheduled weapon programs. Brown suggested retaining older forces (Titan II and Polaris missiles) but noted that their retention would be at considerable cost and to marginal benefit. The secretary remained open to the JCS suggestion to study the need for a new, non-MIRV, ICBM system. The JCS still worried that the 2,500km range for ALCMs on heavy bombers in the protocol would create a precedent. Brown agreed. The chiefs did not consider the 820 sub-ceiling on MIRVed ICBMs an adequate counterbalance to the limits on heavy bombers with ALCMs. Brown commented on this assertion: “We continue to disagree. Perhaps I am wrong, or perhaps for the first time in history the Chiefs are wrong.” Brown echoed the JCS concern that the protocol should not limit SLCMs and GLCMs as theater nuclear defenses of NATO, but he thought that the Soviet position, which allowed testing, “gives us the options we need.” The JCS and Brown worried about the precedent for the protocol’s ban on mobile ICBMs. Ideally, Brown admitted, he would have included Backfires in the delivery vehicle limit, but he was prepared to accept Soviet assurances and considered that a firm production limit offered an acceptable solution. Brown’s position on Backfire had hardened. He no longer relegated it to SALT III.<sup>34</sup>

Brown noted that the Chiefs did acknowledge that the September agreements provided “the basis for concluding a workable SALT II agreement” as long as the U.S. position on the many outstanding issues did not erode. These issues were (1) U.S. insistence that heavy bombers not be defined by the “type rule” (i.e., if some B-52 carried ALCMs, all B-52s were counted as ALCM carriers), but on an aircraft-by-aircraft basis; (2) the Soviet proposal to ban development of cruise missiles beyond the 2,500km range; (3) Soviet insistence that it be allowed to deploy SS-NX-17, SS-NX-18 and the untested Typhoon (all three SLBMs) in exchange for

the U.S. right to deploy the Trident I SLBM; (4) Soviet attempts to ban U.S. transport aircraft as potential ALCM carriers; and (5) the inconsistency in Soviet willingness to count all launchers at Derazhnya and Pervomaisk as MIRVed while opposing the U.S. MIRV launcher rule (i.e., if national technical means, that is, satellite photo reconnaissance and electronic monitoring, failed to establish an ICBM as not MIRVed, it would be counted as MIRVed). Soviet intransigence on bomber variant rules and insistence that limits on armed ALCMs would last for the full period of the treaty, until 1985, not just the protocol period, were the final outstanding issues. Brown agreed that these should not be traded away.<sup>35</sup>

### **Another Year without SALT II**

The year 1978 was not a good one for SALT II negotiations. Outstanding issues that negotiators had expected to resolve dragged on, and new secondary issues came to the fore to complicate the process. U.S.-Soviet relations deteriorated, especially in the Horn of Africa where Soviet proxies enjoyed military success. Brzezinski lobbied hard to delay SALT II until the Kremlin behaved in a more “acceptable” way.<sup>36</sup> All the while, critics of SALT II outside the administration kept up an increasing drumbeat of opposition. In late December 1977 Vance and Warnke had optimistically informed the president that “the number of serious issues remaining is quite small,” and a treaty could be signed in spring 1978.<sup>37</sup> Early in January 1978, Brown told Carter that while signature of a SALT II treaty in spring 1978 was a “good window, it is not a vital one,” and certainly not worthy of undue concessions to achieve it. Brown predicted that SALT II would be a much harder sell to the Senate than SALT I. He estimated the outstanding issues to be far from inconsequential, contrary to the assurances of Vance and Warnke. The United States must retain the right to decide which aircraft could carry ALCMs and must rebut the Soviet contention that cruise missile carriers should count as more than one SNDV in the MIRV or total strategic nuclear delivery vehicle aggregates. Deciding which Soviet bomber variants should be counted as heavy bombers could prove a difficult technical problem. The Soviets absolutely opposed the U.S. position that the treaty, unlike the protocol, should apply only to nuclear-armed cruise missiles. Their contention that these missiles and ICBMs were analogous was “simply false,” in Brown’s view. No nation would develop ICBMs with nonnuclear warheads, but conventionally armed cruise missiles had great conventional military potential and SALT was not

“a proper forum for limiting conventional weapons.” The secretary also warned that the Backfire issue was far from resolved. Confusion and imprecision surrounded the “type rule.” The Soviets now accepted that if a missile was tested with a MIRV, all missiles of the type were considered MIRVed, and if a launcher was MIRVed, all similar ones would be counted as MIRVed (the missile and launcher type rules). However, their concession that all 180 silos at Derazhnya and Pervomaisk could be counted as MIRVed—even though they maintained that 120 were non-MIRVed and only 60 were MIRVed—muddled the verification of the launcher type rule by disregarding it.<sup>38</sup>

During spring 1978 the Carter team held almost weekly SCC meetings seeking to resolve the remaining SALT negotiating positions. As Brzezinski recalled, these gatherings in the windowless Situation Room in the White House basement often proved lively. Brown and Warnke dominated the discussions—debating, arguing, and sometimes shouting at each other over myriad SALT details.<sup>39</sup> Tempers sometimes flared. On 6 March, Vance and Spurgeon Keeny, heading the ACDA team for an absent Warnke, clashed with Brown and JCS Chairman General David Jones. State and ACDA wanted to concede to the Soviets that the ban on ALCMs with a range over 600 kilometers, other than those on heavy bombers, would apply to conventionally armed cruise missiles in the treaty as well as the protocol. Brown and Jones vigorously opposed the idea. After the meeting, Brown explained his reasoning to the president: “Long-range, conventionally-armed, air-launched cruise missiles could well be cost-effective future means for conducting all-weather strikes against heavily defended targets to reduce aircraft attrition.” Carter agreed with Brown.<sup>40</sup> One need only look at the role of the cruise missiles in later wars involving the United States in the Gulf, Iraq, and Afghanistan to realize how prescient Brown’s advice had been. The Soviets responded, with some justification, that it was impossible to verify whether a cruise missile was conventionally or nuclear-armed. It also proved very difficult to verify their ranges.<sup>41</sup>

In late March 1978 Vance and Warnke provided Carter with a strategy for completing the negotiations and signing an agreement at the forthcoming summit meeting with Soviet General Secretary Brezhnev. Commenting on the strategy, Brown identified issues that he considered “vital militarily”: heavy bomber definition; treatment of bomber variants (making sure they did not have a combat role); ALCM-equipped B-52s and other cruise missile carriers (not overcounting B-52s

and flexibility to use other carriers); cruise missile range of 2,500 kilometers for ALCMs and 600 kilometers for GLCMs and SLCMs during the protocol; and the exception for the initial 120 ALCM-carrying heavy bombers not to be counted as MIRVed. Next, Brown identified issues key for allies: the U.S. position on noncircumvention, and not including conventional cruise missiles on non-heavy bombers in the treaty after the protocol expired. Finally, Brown's list of the issues comprised the "symbols of who 'wins' the negotiations": Soviet Backfire assurances, verification of single reentry vehicles (RVs) versus MIRVs, assurances against telemetry encryption, and verifiable standards on what modernizations of ballistic missiles were banned. Success on resolving these issues to U.S. satisfaction would allow the administration to sell SALT II as verifiable.<sup>42</sup>

Negotiations dragged on, with Vance and Gromyko meeting in April 1978 in Moscow and again in May in Washington. During the latter visit the Soviet foreign minister met also with Carter. Vance and Gromyko talked again in Geneva in July. Progress was slow, but at last a compromise emerged on the strategic nuclear delivery vehicle aggregate at 2,250 (the Soviet offer) and the new U.S. proposal that the MIRVed ICBM sub-ceiling be 1,200 within the total 1,320 limit on MIRVed ICBMs and ALCM carriers. Each side agreed in principle to deploy no more than one new type ICBM (MIRVed or not) during the duration of the treaty. The two sides resolved the prohibition against transferring systems and technology to allies, either NATO or Warsaw Pact members, by a general clause opposing circumvention of the treaty through other states (the U.S. preference) rather than an outright ban (the Soviet's).<sup>43</sup>

The Carter administration not only had to negotiate a SALT II agreement with Moscow, it had to convince the Senate to ratify it. Recent tests of Soviet SS-18 and SS-19 missiles demonstrated much greater accuracy, suggesting that with or without a SALT II treaty, the stationary U.S. Minuteman missile force would be vulnerable to virtual elimination by a Soviet first strike sometime between 1983 and 1985. The only solution was the old pea in the shell game: make ICBMs mobile by moving them randomly and periodically so that the attacker could not be sure where they were located, a system called multiple aim point (MAP). To destroy all or most of a mobile ICBM force with thousands of aim points would require more ICBMs and warheads than the Soviets could deploy under SALT II. Brown assured the president that the expected vulnerability of Minuteman was "not synonymous with the vulnerability of the United States nor with the loss of our capability for

deterrence of general nuclear war,” but it presented a problem “in military terms and even more so in perception of the military balance.” Without safe, land-based ICBMs, Congress and the public would never accept SALT II. The issue, according to Brown, was to assure that the treaty did not preclude the U.S. ability to deploy multiple aim points with the existing Minuteman or the new MX missiles.<sup>44</sup>

Initially Carter seemed skeptical, commenting that MAPs violated the no-concealment aspects of SALT I. Brown suggested that nuclear submarines armed with ballistic missiles were essentially mobile, but not banned by SALT I. A way would have to be found to allow mobile ICBMs to be counted without revealing their specific locations. Carter commented that this seemed to be “the crucial issue.”<sup>45</sup> The SCC recommended, and Carter agreed, to provide a marker to the Soviets that mobile ICBMs could have MAPs. A statement to that effect went to Soviet leaders who “explicitly and unequivocally rejected” it. Brown informed the president that the United States could not accept this interpretation or consider itself bound by it. If the Soviets were unwilling to withdraw their objection (the likely scenario), the United States would have to declare unilaterally its view that MAP was permissible under SALT II and the system would be verifiable, making clear its position by public statements and repetition in the negotiations. Brown began the campaign with a speech to the American Legion Convention in August 1978.<sup>46</sup>

Other issues required resolution. How many MIRVs, the use of which was known as fractionation, would be allowed on ICBMs? Here the United States had some room to maneuver because of its lead in MIRV technology, but as Brown warned Director of Central Intelligence Stansfield Turner, the U.S. lead could dissipate quickly.<sup>47</sup> Both sides had tentatively agreed to freeze fractionation on existing ICBMs, specifying the number of reentry vehicles for Minuteman (3), SS-17 (4), and SS-18 and SS-19 (10 on each). Differences persisted between the two sides on the RVs for the MX and SLCMs. Although the Soviets accepted 14 RVs on SLBMs, they balked at the limit of 10 on the MX and would only go beyond 6 if they were allowed to have 10 on existing ICBMs. Related issues addressed how many ALCMs could be deployed on a cruise missile carrier and whether ALCMs could have multiple warheads. The U.S. side initially proposed 35 ALCMs on a carrier, the Soviets countered with 25, and the U.S. counter-proposed 30. As for multiple warheads on ALCMs, the Soviets initially wanted a ban but then agreed to them so long as each warhead counted as one in the 1,320 MIRV launcher limit. Washington opposed such a counting procedure.



The two sides did agree tentatively to exchange letters assuring the nonstrategic nature of the Backfire bomber. When the United States demanded a limit on production of Backfires, the Soviets refused. A final issue proved most exasperating. Both sides agreed in principle not to engage in deliberate concealment when the other side verified test flight information by national technical means. But the Soviets maintained that encrypting telemetric information about a flight did not constitute deliberate concealment. Since telemetry (electronic data that profiles a missile performance during flight testing) was such a key source of information about missile capabilities, the Kremlin viewed the U.S. ban on encryption as fishing for an intelligence bonus in the name of verification.<sup>48</sup>

At the end of September 1978 Gromyko and Vance met twice, and Carter consulted with the Soviet foreign minister once. SALT negotiators at State and ACDA suggested that an agreement could be signed by the end of the year.<sup>49</sup> The Soviets had made a tantalizing proposal offering to drop the 2,500km range limit for ALCMs on heavy bombers in exchange for tight (no wiggle factor) limits on the range of GLCMs and SLCMs at the 600km range for both nuclear or conventionally armed cruise missiles during both the protocol period and the treaty. Vance and Keeny of ACDA proposed accepting the offer. On the grounds that the limit would inhibit development of GLCMs and SLCMs and weaken NATO, and since SALT was a strategic, not a conventional, arms limitation agreement, Brown, Jones, and Brzezinski opposed the deal. Nonetheless, Carter opted to accept the Soviet offer.<sup>50</sup>

As for numbers of ALCMs on heavy bombers, the United States was prepared to accept 30 as the average number, but would assent to a limit of 20 on existing heavy bombers (B-52s, Soviet Bears and Bisons). The United States would agree not to exercise its right to deploy independently targeted warheads on ALCMs prior to the expiration of the treaty in 1985. It would accept a statement that Backfire production would be limited to 30 per year and that the Soviets would not significantly increase the bomber's range and payload capability. The U.S. proposal for the telemetry issue would be resolved by stating that both sides were obligated not to engage in deliberate denial of telemetric information, whenever such denial impeded verification. Vance proceeded to Moscow to present the U.S. offer to the Soviet leadership in late October 1978, but the "talks produced little movement." While in Geneva for a meeting with Gromyko in December, Vance appealed to the president for more flexible language on telemetry, but Carter opted for the restrictive version.<sup>51</sup>

Assessing the results of the Vance mission to Geneva, Slocombe characterized it as “a reluctant success, in that on all of the major issues, we were able to go a long way towards achieving the results we . . . needed.” Gromkyo accepted the telemetry approach in language that combined the U.S. prohibitory with the Soviet permissive tone, but cautioned that he would have to obtain approval from the Soviet Politburo. The Soviets agreed to split the armed definition of cruise missiles into two parts, one for GLCMs and SLCMs in the protocol and one for ALCMs in the treaty, but refused to make any distinction between nuclear and nonnuclear (to which Carter had already agreed) missiles. Gromyko confirmed the 30 Backfire per year rate and held out hope that Brezhnev would agree. The two sides inched closer to 30 ALCMs per heavy bomber, but Slocombe suggested that the “de facto” limit of 20 per carrier during the treaty could present problems. This limit applied only to deployment, not the development and testing of more than 20 ALCMs on air carriers. Fractionation was already settled and merely dependent on resolution of the ALCM issue. New issues that emerged at the Vance-Gromyko meeting were unarmed pilotless vehicles, the predecessors of today’s unmanned aircraft (now popularly known as drones) and multiple warheads on cruise missiles. Slocombe recommended and Brown agreed that it would be a mistake to try to negotiate these issues. It was better to stick to current U.S. positions that the type rule was sufficient for unmanned aerial vehicles and that limits on multiple warheads would apply only to ALCMs after the protocol expired. A final issue “to be cleaned up” was the environment shelters covering Minuteman silos, which President Ford had promised to remove in 1974.<sup>52</sup>

At least to negotiators at State and ACDA, SALT II seemed ready for signatures. The White House began planning for a SALT summit in Washington in mid-January 1979. When the plans leaked, Kremlin leaders no doubt interpreted it as pressure play by a presidential administration they had come to distrust. Provoked by the announcement of normalization of relations with China and the January visit of Chinese Premier Deng Xiaoping to Washington, Moscow refused to finalize the deal. SALT negotiations still had a few months to go and some still contentious issues to settle before Carter and Brezhnev signed the treaty, protocol, and related documents.<sup>53</sup>

### **Success and Frustration**

During winter 1979, with Brown and Deputy Defense Secretary Charles Duncan usually in attendance, the SCC worked out the remaining, mostly technical, SALT

issues. Vance continued his dialogue with Dobrynin. Carter wrote directly to Brezhnev, who publicly predicted that SALT II agreements would be signed at a forthcoming summit meeting.<sup>54</sup> In late April, Brown advised the president to take two actions before signing the agreements. First, whether or not Carter approved deploying a mobile MX missile, Brown recommended that the president maintain the principle that mobile ICBMs would be permissible after the protocol expired, and state this publicly in a post-SALT signing speech. Second, the secretary predicted that verification via telemetry would become a major issue in the Senate ratification because the exchange of letters on the issue between Carter and Brezhnev, in which the Soviet leader refused to be pinned down, would not convince skeptical senators or other critics of SALT II verifiability. Brown suggested a joint statement at the end of the summit indicating that telemetry relevant to verification and compliance could not be denied. The kind of encryption that the Soviets used to during tests of the SS-18 on 29 July and 21 December 1978 would not be permitted under SALT II. Brown recommended passing the word through Dobrynin that the president would raise the telemetry issue at the summit.<sup>55</sup>

As the SALT II negotiations inched toward conclusion, visible JCS support for the treaty became crucial. Without it, Senate ratification was a forlorn hope. It fell to Brown to bridge the differences between the Chiefs and the Carter administration and obtain JCS approval of the agreements. In mid-March the secretary summarized the Chiefs' thinking for the president. They were tepidly in favor of SALT II as "a modest but useful framework which gives the United States flexibility to regain ultimate strategic parity, but it is by no means a risk-free panacea nor a substitute for modernization programs." The JCS preferred a larger reduction of strategic weapons than offered by SALT and inclusion of the Backfire in the strategic nuclear delivery vehicle aggregate. While Brown did not accept the JCS view that the United States faced the immediate prospect of strategic inferiority, he agreed that SALT II gave no cause for complacency or a reason not to buildup U.S. strategic forces. Still, Brown saw benefits. SALT II prevented a greater Soviet build up in delivery vehicle numbers and types, limited MIRVs, and made the U.S. ICBM force less vulnerable, at least for the immediate future.<sup>56</sup>

The secretary hoped to persuade Carter to meet with the JCS before leaving for Vienna to sign SALT II. The president responded, "I don't have the time," and instructed Brown and Jones to "have a send-off meeting with the other Chiefs." By

appearing to snub them, Carter teetered on the verge of making another tactical blunder. The JCS were anything but united. As Brown told the president, Marine Corps Commandant General Louis H. Wilson disagreed with the notion that SALT “was modest and useful,” but he supported it on political, not military grounds. Army Chief of Staff General Bernard W. Rogers agreed that SALT II advanced broader national interests, but he thought it contributed “only marginally to our military interests.” Specifically, the Chiefs wanted a clear unequivocal statement that verification and monitoring would not be impeded, especially by encryption of telemetry; Brown agreed. The JCS still feared the protocol would establish unwanted precedents. While Brown believed that the Soviets knew the United States did not want the protocol to be claimed as a precedent for future SALT agreements, he still favored a presidential statement to that effect. As for cruise missiles, both Brown and the JCS believed that that current U.S. acceptance of range limits on ALCMs for the treaty and GLCMs and SLCMs for the protocol should not predetermine cruise missile range limits under SALT III.<sup>57</sup>

To emphasize his general concern, Brown sent a handwritten, eyes-only letter to the president commenting more informally on the JCS advice. As the secretary summarized it, “Overall this is about as supportive as I thought we could get the Chiefs to be in writing. Several will be more so in testimony. None of them says SALT II is not in the national interest—if their assumed conditions are met.”<sup>58</sup> Brown again asked the president to meet with the Chiefs before Vienna, suggesting a face-to-face discussion would be beneficial. Heeding his secretary’s counsel, Carter met with them the next day for a half-hour.<sup>59</sup>

Brown and Chairman Jones joined the president along with Vance and Brzezinski at the Vienna Summit in mid-June. Although Brown met with Soviet Defense Minister Dimitri F. Ustinov and other Soviet defense officials, this was really a Carter-Brezhnev performance, with Gromyko providing key support on SALT details to the seriously ailing Soviet general secretary. Brown was shocked at the deterioration of Brezhnev’s health. He remembered him as “pretty well gone. I sat next to him at dinner one night and he could hardly keep from drooling into his food.” Still the Soviet general secretary seemed at least to the public in charge at the summit. Not confined to SALT II, the meeting covered the broad spectrum of U.S.-Soviet relations, but the signing of SALT II on 18 June 1979 marked its most tangible achievement. Carter received from Brezhnev’s own lips a promise



President Jimmy Carter and Soviet Union leader Leonid Brezhnev shake hands after the signing of the SALT II agreements in Vienna, Austria, 18 June 1979. (Carter Presidential Library)

that the Soviet Union would produce only 30 Backfires a year and would not increase the range to allow the aircraft to reach U.S. mainland targets. The United States attached a written version of these promises to the SALT II agreements, with the understanding statement that Carter considered their implementation “essential to the obligations assumed under the Treaty.”<sup>60</sup>

The SALT II Treaty, Protocol, Agreed Statements and Common Understandings, and Memorandum of Understanding on a Data Base on the Numbers of Strategic Offensive Arms constituted a set of related agreements that only arms control or national security specialists could love. Long and complex, these documents were full of definitions, technical data, commentary, and a plethora of weapon systems with their accompanying acronyms.<sup>61</sup> Just how well did Brown achieve his goals in the SALT II agreements? Foremost, Brown sought to protect the U.S. lead in and potential for future development of both nuclear and conventionally armed cruise missiles. While the secretary failed to convince Carter to demand that the conventional cruise missiles not be limited to 600km range

in the protocol, the range of ALCMs carried by heavy bombers in the treaty was conceded as unlimited by the Soviets. Since the protocol expired at the end of 1981, the 600km limit on GLCMs and SLCMs would have no impact on possible plans to upgrade NATO's long-range theater nuclear force, slated to begin after that date. Brown and the JCS opposed a ban on mobile ICBM systems; the treaty allowed each side to build one, thus the U.S. retained the right to deploy the MX. While the treaty limited existing heavy bombers to carrying 20 ALCMs each, it compromised on an average of 28 ALCMs on new heavy bombers, a prime objective of Brown and the JCS, who still had designs on a new cruise missile carrier other than the cancelled B-1 bomber. Initially not worried about the Backfire, the secretary came around to insisting on production limits, which the attached statement to the treaty confirmed. He saw limits on fractionation as a plus, partly mitigating the concession to the Soviets of the right to 308 heavy ICBMs under the treaty. On telemetry, Brown remained uneasy, but Carter took his advice by stressing in his post-SALT II speech that the U.S. considered the use of encryption to nullify verification a violation of the spirit, if not the letter, of the treaty.<sup>62</sup>

Brown had often reminded Carter that selling the treaty to the Senate would not be easy. The secretary had the JCS on board, and they performed as Carter and Brown had hoped during congressional hearings. Brown remained cautiously optimistic. Brown and his staff lobbied hard for ratification. As he informed the president in August 1979, "We have won the debate on SALT II in the Senate hearings and with the media (and probably the public). But we have not yet won the Senate vote." The secretary's prescription for winning a two-thirds majority in the Senate was to increase defense spending and thus win over Senator Samuel Augustus "Sam" Nunn Jr. (D-GA) and his group of influential hawks in the upper chamber. Brown's insistent recommendations for more real defense spending increases—"a genuine after-inflation annual budget growth rate of three percent" through 1985—to grease the way for SALT irritated Carter, but it was sound advice if the president hoped for Senate approval of the treaty.<sup>63</sup>

As the Senate debated SALT II ratification during autumn and early winter 1979, a series of events helped doom the treaty. The Senate's failure to ratify the SALT II Treaty had many causes, some beyond the control of the administration. Brzezinski primarily blamed the Soviet Union's military buildup in postwar Vietnam, its support of Cuban proxies in Africa, its growing involvement in Afghanistan,

and the existence of a Soviet brigade in Cuba, all of which caused critics of SALT to question the Soviet leadership's good faith. Then the late December 1979 Soviet invasion of Afghanistan blew any chance for SALT ratification. Assessing the failure, Carter stressed the Soviet brigade's role in undermining Senate support but placed special blame on liberal Senator Frank Church, who stirred up the issue to shore up his support for reelection in conservative Idaho. While Vance did not excuse Soviet actions and their linkage to SALT, he noted, "The driving force behind much of the opposition to SALT II came from the ideological Right, which supported reflexively almost any argument against the treaty, however unsound." Brown had his own views. Consultations with Nunn suggested that maybe 3 percent real growth [Nunn wanted 5] in defense spending might have saved SALT II. Still Brown placed much of the blame on bad timing and Soviet actions: "If [the ratification vote for] SALT II hadn't been delayed by the Cuban brigade [Soviets in Cuba] affair, it might have been approved by the Senate before the Afghan invasion. . . . It [the invasion] killed the SALT ratification."<sup>64</sup>

If one accepts that delays in SALT II negotiations meant the agreements came up for ratification at an inopportune time, then those who held out for more restrictive conditions on the Soviet Union—the hardliners such as Brown, the JCS, and Brzezinski—could be held responsible for the delay that allowed the confluence of events in Cuba and Afghanistan to doom the treaty. Would a treaty signed sooner because it was based on more concessions to Moscow have passed the Senate before the Soviets invaded Afghanistan? Given the strong conservative opposition to SALT II, a treaty without the assurances and qualifications that the administration hardliners insisted upon would have been considered even more flawed by its opponents. It would have been less likely to receive the two-thirds majority needed to pass it.<sup>65</sup> Soviet leaders deserve a share of the blame, notwithstanding the concessions that they made in the SALT II agreements.<sup>66</sup> They haggled too long and hard on issues, such as encryption, and refused to concede on Backfire until the very end. The Soviets themselves, of course, had no problems with ratification, but they failed to understand the difficulty the Carter administration faced in the Senate.<sup>67</sup>

### **The MX Decision**

The decision to deploy the MX, the most destructive U.S. missile yet designed (although not a heavy ICBM by Soviet standards), was inextricably bound up with

the SALT II agreements. The conventional wisdom that the decision to build the MX was the JCS price for support of SALT II has much truth to it, but the decision to build and deploy a mobile MX missile has a history all its own. Carter confided to his diary that he found the MX “nauseating,” and a “gross waste of money,” but he would eventually come around to accepting it. Also wary of the MX, Brown considered developing a lighter missile that would be easier to deploy in a mobile basing mode, but he eventually concluded that national security required the MX. The multitude of basing modes studied (30), with their advantages and disadvantages, provided the intellectual and technical challenges that Brown enjoyed. The Air Force did not deploy the MX during the Carter presidency. When it became operational during the Reagan years it was not in mobile mode, defeating its original *raison d'être*.

The MX, or Peacemaker as it was later called, proved a fiasco in terms of cost versus national security benefit. Like most major weapon systems, the MX was the product of multiple administrations. Conceived in the Nixon administration, developed during the Nixon and Ford administrations, the MX was further developed and then approved for deployment during the Carter administration.<sup>68</sup> The missile was the Air Force’s answer to the perceived growing disparity between Soviet and U.S. ICBM land-based systems. An Air Force study in late 1976 typically argued the worst-case scenario. The Soviet Union’s upgrading of its strategic nuclear forces was “massive in scope. Three, possibly four, new ICBMs are being deployed . . . [with] improvements of 2–3 times in accuracy, up to four to five times in throw-weight, and up to 10 times as many warheads as the systems they are replacing.” The new Soviet ICBMs were the huge Soviet SS–18, with 8–10 MIRV warheads and a 7,000-nautical-mile range; the SS–19, a 5,500-nautical-mile missile, with 6 warheads; the SS–17, a SLBM tested for MIRVs; and possibly the mobile SS–X–16, a three-stage solid propellant missile with a single warhead. Placed in “super hard silo launchers,” new Soviet land-based ICBMs would deploy in the early 1980s. If the MX entered full-scale development in fiscal year 1978, it was expected to deploy in 1983. If the administration delayed, Minuteman missiles would be sitting ducks after 1983, according the Air Force report.<sup>69</sup>

Neither Brown nor Under Secretary for Research and Engineering William Perry, to whom the secretary entrusted the day-to-day decisions on the MX, shared the Air Force’s sense of urgency. Both Perry and Brown leaned toward studying MX issues, especially those concerning its basing mode, before deciding how to deploy





the missile. Obvious questions remained. Was the extensive trench system (missiles moving along covered trenches to multiple underground sites) the best basing mode; where would they locate the system; and how would it be verified under SALT II? The president’s science adviser, Frank Press, headed an important study on these questions. A geologist who combined advanced research with the ability to explain science to the lay person, Brooklyn-born Press received his Ph.D. from Columbia at the same time as Brown. Press proved to be a successful scientist-politician who worked well with Carter. The Air Force officers disdained Press as a “minimum deferrer,” much like they regarded the president himself. Press doubted the veracity of the Air Force analysis, believing it employed flawed estimates and scare tactics to push the MX into deployment. Not surprisingly, the science adviser found the threat to the Minuteman force was not so great that the MX needed to be put into full-scale development in FY 1979 (let alone FY 1978). Minuteman would remain survivable through the 1980s unless the Soviets increased the accuracy of their warheads. Press also concluded that the covered trench system was a mistake—it facilitated propagation of damage by providing paths for the shockwaves of nuclear

explosions to travel. He suggested that the Minuteman could probably be made more survivable at much less cost than the MX. In good part on this advice, Carter turned down full-scale development of the MX in the Defense budget for FY 1979, saving \$100 million.<sup>70</sup>

Unfortunately, the Soviets soon tested new guidance systems on the SS-18 and SS-19, suggesting that they could reduce their circular error probability to a dangerous 200 to 250 meters. Should the Soviets successfully retrofit this guidance system on their ICBMs, they would be able, by 1983, to launch 308 SS-18s and SS-19s and destroy all

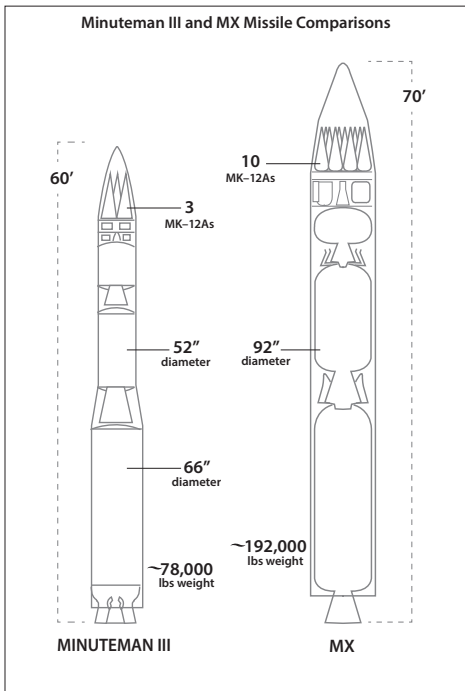

OSD Graphics

but 100 of the 900-Minuteman missile force. To Perry, such a state of affairs would be an invitation to the Soviets to attack and an incentive to the United States to launch on warning. Such a “hair trigger” would render Minuteman a “destabilizing” force. “After much thought,” Perry told Brown, “there is a need for a new missile” with “enough throw-weight to carry 8 to 10 MK12As [warheads].” Perry suggested two novel ideas, the latter of which would cause heartburn to the Air Force and Navy: either add a third stage to the Trident II missile and use it as a land-based ICBM or create a new common missile for the two services.<sup>71</sup> At the end of March 1978, Brown passed the bad news to the president: “I judge that there is a 50% chance that the number of Minuteman survivors in 1980 would be below 300 and, by 1985, at least an even chance that this number would be reduced below 100.” Brown assured Carter that “we face no immediate crisis”: a modernized bomber force with cruise missiles and an SLBM force with Trident I missiles (and later upgraded missiles) would still make the triad viable. Now was the time to study the options.<sup>72</sup>

Alternatives abounded. The Air Force favored placing 200 MX missiles, with 11 warheads each, between 4,500 multiple aim point shelters located in the Southwest. The Defense Systems Acquisition Review Council (DSARC) judged the system to be feasible, credible, and survivable, but hard to verify (for SALT II purposes) and with a heavy environmental impact. Brown still thought an air-mobile system, rejected by DSARC, had “considerable promise” and ordered the Air Force to study it. The air mobile system that appealed to Brown would place 100 ICBMs (about Trident II size) and their launchers on aircraft based in remote areas deep in the United States ready to take off on a warning of attack. A variant air mobile system placed a new big missile or MX plus a heavy ground transporter on a modified 747 jumbo aircraft or C-5A transport. Another idea consisted of placing light missiles on semitrailer trucks and cruising them about on interstate highways (the 190,000-pound MX and launcher were too heavy for interstates) to be launched on warning of a Soviet attack. Small missile-carrying submarines were considered but found to be too vulnerable and expensive to build from scratch. Defense planners even suggested submerged launcher platforms creeping along the ocean floor, but this technology would require much study and probably prove very costly.<sup>73</sup>

After laying out the issues to the president and receiving his approval, Brzezinski asked Brown for “a side-by-side comparison” of the following five options: air-mobile ICBMs; the 200 MXs deployed in the U.S. Southwest in multiple shelters; an off-road

mobile system; minor improvements to the current Minuteman silo-based ICBM force if none of the above proved acceptable; and new efforts to improve bomber and SLBM forces. In early April 1979 Carter added to the mix the idea of ICBMs mounted on trucks poised in dispersed bases, ready to take to the highways on warning of an attack.<sup>74</sup>

The comparison process culminated at three PRC meetings chaired by Brown in May 1979. The Policy Review Committee was one of two principal NSC committees responsible for recommendations for policy decisions to the president. The PRC took its lead from a report prepared by Seymour L. Zeiberg, deputy under secretary of defense for strategic and space systems, research and evaluation. Zeiberg's report assessed Brzezinski's five options. He concluded that a minimum modernization program, which included the deployment of ALCMs on B-52s—and ultimately on new cruise missile carriers (CMCs)—and the continuation of the Trident missile programs, without upgrading of the U.S. ICBM force, did not provide an essential equivalence with the Soviet Union. Thus, the study identified two cost-effective upgrades to the modernization program: add 200 MX missiles in multiple protective shelters; or add 100 new CMCs and deploy Trident II missiles on all *Ohio*-class submarines and in 400 existing Minuteman III silos (with the Minuteman III phased out). At the 4 May PRC meeting, the JCS expressed a strong preference for the MX missile option, on the grounds that it solved Minuteman vulnerability, endangered Soviet ICBMs, and thus held out an incentive for Soviet cooperation in SALT III. Brown supported this view. The least cost-effective upgrade, according to Zeiberg, comprised 70 airmobile MXs and 100 MXs in silos; it floundered because of the high cost of developing new aircraft and launching platforms. And most DoD specialists considered the road mobile system of 232 missiles smaller than the MX impractical because the American public would not stand for the idea of nuclear missiles on interstate highways.<sup>75</sup> Brown and Perry came into the PRC meetings at least receptive to the common missile. In the face of opposition by the JCS and Brzezinski, they moved toward the MX in a transporter in an open trench or track.<sup>76</sup>

At the last PRC meeting in May 1979, the participants decided on two alternatives. The MX alternative (A) would put 200 MX missiles in a track mobile base moving between 8,800 hardened shelters, while maintaining 300 Minuteman IIIs in present silos, continuing to deploy the Trident I in older ballistic missile submarines, building 12 more SSBNs armed initially with Trident I missiles by 1990, and

retiring the 30-year-old SSBNs. In addition, alternative A would develop hardened CMCs to deliver 3,000 cruise missiles, retiring B-52s as the new CMCs came on line. The B-52H model would remain as a penetrating bomber. The cost of this alternative, which included some improvements to existing strategic forces, totaled \$78 billion over 10 years.

Alternative B, the common missile option, would develop a common missile for deployment in *Ohio*-class submarines and in the 300 stationary Minuteman silos (the Minuteman IIIs would be retired). Of the fully funded 20-submarine force with common missiles, 16 would be in service by 1990. In addition, alternative B upped the number of cruise missiles to 5,000 in new CMCs, retiring the B-52s as the new carriers became operational, with the B-52Hs remaining as penetrating bombers. With the extras to existing systems, alternative B would cost \$73 billion.<sup>77</sup>

For the common missile to work it would have to be designed to fit through the Trident firing ports on the submarines. The MX missile's diameter was a few inches too big. The Air Force along with the JCS adamantly opposed the idea of downsizing to the smaller common missile, which had less throw weight and could carry fewer warheads than the MX (SALT II put the MX limit at 10). The Air Force feared that if the biggest missile that the U.S. built could be fired from submarines, why deploy it on land? Furthermore, bad precedents existed. Previous attempts at common weapon systems had not been successful, such as the 1960s experience of the F-111 common fighter aircraft. The Navy opposed the idea of developing a new common missile because it would probably slow its Trident II program.<sup>78</sup>

Help for the Air Force and the Navy came from OMB Director James T. McIntyre, who thought more important factors prevailed than the \$2 billion savings from the common missile. Besides, the savings were far from assured given technical difficulties and interservice rivalries; commonality could reduce some of the stability of the triad; developing a new common missile could slow development of a new ICBM by a year; and the common missile surrendered the opportunity to deploy the largest missile, all of which led into the area of political considerations. Brown commented: "A very good memo."<sup>79</sup>

Carter's major national security advisers agreed to meet on 4 June 1979 to discuss the MX in the broader context of strategic arms policy and U.S. Soviet relations. The president was not happy, having received the relevant papers from the Defense Department only the Friday before the Monday meeting, requiring

him to do his homework at Camp David that weekend. He groused that Brzezinski was “jamming a decision down his throat.” When the NSC meeting of 4 June began, Carter had done his homework. Virtually all of Carter’s advisers, including Brown, favored the MX in varying degrees. Only DCI Stansfield Turner thought the MX was a bad idea, suggesting that the Soviets, who already had a head start with their larger number of ICBMs, could add warheads to their missiles faster than the United States could build MX shelters. Furthermore, the MX would encourage the Soviets to MIRV. Brown disagreed, stating the United States could build shelters at half the price of Soviet missiles and more quickly than the Soviets could MIRV their launchers. The president grudgingly but definitely accepted the need for the MX. Concerned about its environmental impact, he postponed a decision on its basing mode. On 5 June the NSC met to resolve that question but punted again. Brzezinski summarized all that was agreed on at this second NSC meeting: The MX, the largest missile allowed the United States under SALT II, and the preferred missile, would be land-based and verifiable (one of Carter’s main concerns), moving from shelter to shelter. The exact basing mode would be decided on after the signing of the SALT II Treaty. While the decision on where to base the MX was not final, the obvious choices were DoD and Bureau of Land Management areas in Utah, Nevada, Arizona, and New Mexico.<sup>80</sup>

After the PRC meeting in August and the NSC meeting in September, the president chose a road-mobile horizontal shelter system as the preferred mode, noting “without the M-X the Soviets will whip [us]—something the U.S. has been slow to realize.”<sup>81</sup> The system required 200 horizontal missiles in 4,600 shelters, with each missile carried on a transporter erector launcher within a closed loop (a racetrack) of 23 shelters spaced 7,000 feet apart on a road 10–15 miles long. The number of loops in each complex ranged from 3 to 8, with a total of 40 MX complexes in southern Utah and Nevada.<sup>82</sup> The plan required about 10,000 miles of road, encompassing 5,000–6,000 miles for the racetracks over which the MX would dash. In addition there would be at least 4,000 miles of security, service, and construction roads. OMB was not convinced that the system would cost only the publicly announced figure of \$33 billion. Given the cost overruns of similar large projects, such as the Alaska Pipeline and the Washington, DC metro subway system, OMB thought \$35 billion to \$41 billion was closer to the mark.<sup>83</sup> To get the system up and running on time, Congress would have to pass a number of exemptions to

## Detail of Proposed MX Missile Mobile Road System

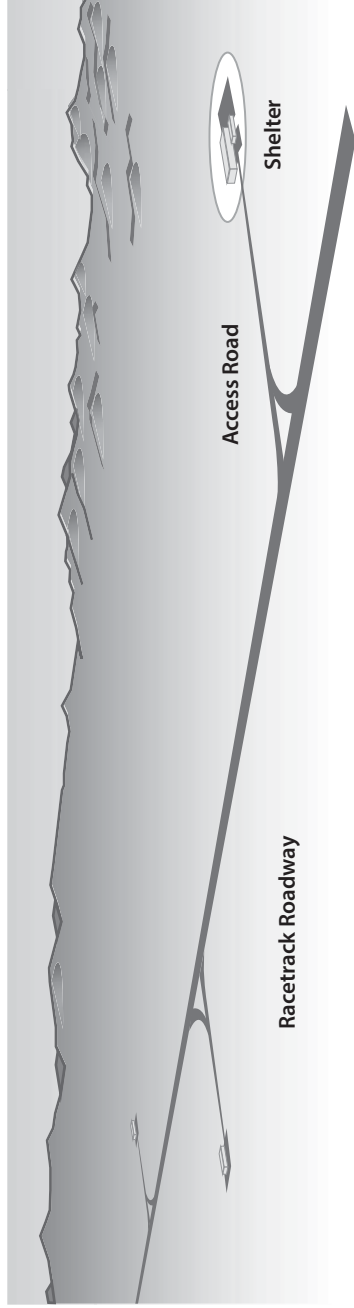
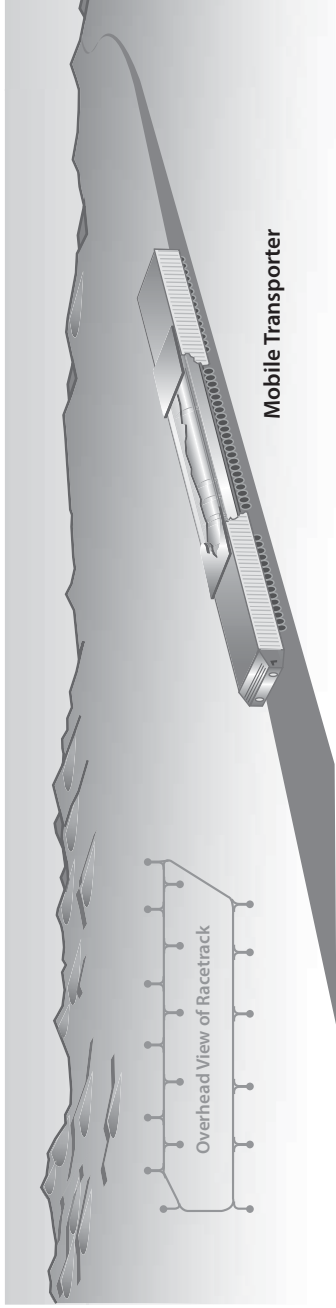

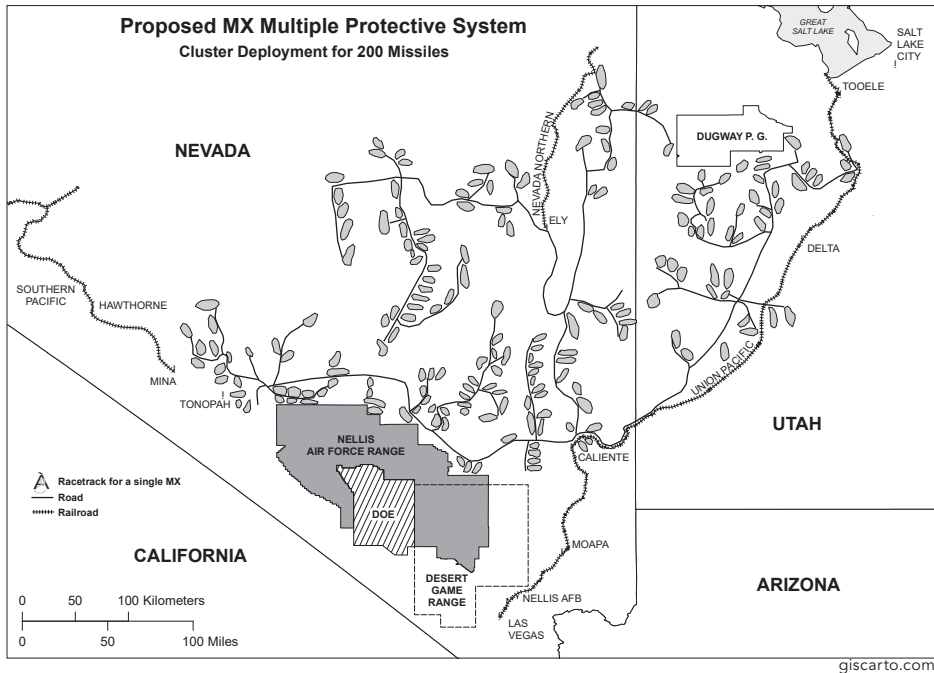

According to the proposed plan, an MX Multiple Protective Shelter would house 200 missiles, each on a mobile launcher, which would move among 23 shelters. Under attack, the missile could launch on the roadway or move to a nontargeted shelter.

environmental, pollution, land withdrawal, endangered species, and water rights legislation—a formidable legislative task.<sup>84</sup>

Although Brown initially felt optimistic that the citizens of Utah and Nevada were prepared to accept the MX, environmentalists, governors, senators and congressmen from the two states, local Nimbys (not-in-my-backyarders), and strange bedfellows—opponents of nuclear weapons and pro-defense critics of SALT who favored different basing modes for the MX—coalesced to oppose any extensive basing scheme in Nevada and Utah. In late February 1980 Brown informed the president that “the MX system faces serious obstacles in Congress and also in Nevada and Utah.” Only with strong support from Carter could the MX basing system survive.<sup>85</sup> The White House, equally pessimistic, noted that the governors of Nevada and Utah, who were both facing reelection, were distancing themselves from the MX basing scheme in the face of strong popular opposition.<sup>86</sup> Normally optimistic and upbeat, even Brown became concerned. After Perry’s appearance in Salt Lake City, Utah, on a nationally televised forum on the MX basing met with mixed results, the secretary conceded “we have a great deal





Antonia H. "Toni" Chayes, under secretary of the Air Force, explains the environmental impact of the proposed MX missile multiple protective shelter, 17 December 1980. (OSD Photo)

more work to do." Brzezinski described Brown's view on the ability to win support for the MX as "guardedly optimistic," but requiring "a long and arduous campaign."<sup>87</sup>

The basing scheme was so difficult to undertake and opposition so strong that it never happened. The decision to choose a mobile basing mode for the large MX before laying the groundwork for where it would be located proved a major mistake. Politicians and citizens in Utah and Nevada seemed initially supportive of the MX until they learned how much it would fence in their wide open spaces. Was an opportunity missed when the Carter administration opted for the MX rather than the common missile, which would have been lighter and easier to disperse in an air, sea, and/or land mobile basing system? In retrospect the answer is yes, but it would have come at the price of a year's delay in rectifying the vulnerability of the ICBM land-based force. Furthermore, the Chiefs would probably not have supported SALT II without the MX, as their chairman made clear publicly in July 1978.<sup>88</sup> It would have taken a lot of convincing for the JCS to accept smaller common missiles, not to mention overcoming the opposition of the Navy and Air Force. To sell the common missile to the opponents of SALT II would have been an equally difficult task.

As standard bearers for the common missile, Brown and Perry wavered in the face of this opposition and uncertainties. Subsequent problems with MX basing—the Reagan administration rejected the Carter plan but could not figure out how to make the MX mobile—resulted in the deployment of only 50 MXs in super hardened Minuteman silos in 1980s. Brown and Perry were on the right track with the common missile, but other considerations and other voices prevailed to shunt the common missile aside.

Was the United States actually as vulnerable in the mid-1980s as feared by Brown, the military services, and the defense hawks outside of DoD? The land-based Minuteman ICBMs constituted only one component of a formidable triad. Survival of the Minuteman ICBM during its period of vulnerability had much to do with the intentions of the Soviet leadership. The Soviet Union in the 1980s was a far different from place than it was in the 1970s. In the late 1960s the Soviets discovered oil and natural gas in Siberia. By the mid-1970s the Soviets vaulted to the top of all oil-producing countries, reaping a bonanza in 1979, when the price of a barrel of crude oil skyrocketed. Flush from oil and gas revenues, the Soviet Union committed more resources to challenging the United States militarily while making small steps to improve the condition of Soviet civilian society. During the 1980s crude dropped quickly until, in 1986, it was down to just over \$21.50 a barrel.<sup>89</sup> Moscow's guns-and-butter policy faltered in the face of rising demand for consumer goods and reduced revenues. With the country spurred on by access to Western European television and culture and facing the formidable U.S. lead in high-technology weapon systems, Mikhail Gorbachev set out to change Soviet society by enacting economic and political reforms. At the same time, the Defense Department under President Ronald Reagan built on Carter's late-term Defense budgets and applications of new defense technology to ramp up the U.S. military posture. The U.S. ICBM force's vulnerability, which looked so dangerous in the late 1970s, diminished in the 1980s.

SALT II did not work out as planned. Even with the MX decision the Senate did not ratify the SALT II Treaty. After the Soviet invasion of Afghanistan, Carter pulled the treaty back from the Senate with the full knowledge that it would never obtain a two-thirds majority. During the negotiations for the SALT II agreements, the participants, including Brown, believed themselves engaged in a monumentally

important endeavor. Next to the DoD budgets, SALT probably took as much of Brown's attention as any other single issue. To what did all those papers, meetings, deliberations, negotiations, and internal administration negotiations on SALT II amount? Even though never ratified, both sides basically agreed to the terms of the treaty. SALT II did not cap the nuclear arms race as Carter and arms control advocates had hoped. Rather, it created general ground rules under which both sides spent enormous sums within those established guidelines. SALT II metamorphosed into strategic arms reductions talks, or START, under Reagan and continued its momentum into the 21st century, outliving the Cold War itself.



## Arms Control and Global Issues

PRESIDENT JIMMY CARTER WAS a born-again Christian, the nation's first evangelical president. His personal religious faith drew inspiration from the progressive wing of evangelicalism, especially pre-Civil War northern abolitionists opposed to slavery and evangelicals who championed racial equality, rights for women, public education, and other social reforms. Progressive evangelicals took seriously their creed's obligation to help the needy, care for the poor, and battle injustice. Piety was not enough. Evangelicals not only had to be good, they had to "do good." In international relations, Carter's religious activism resulted in applying morality to the interaction between nation-states. Many of Carter's more idealistic supporters who came to Washington to work in his administration advocated human rights, arms control, and environmental preservation. While international human rights ranked first, nuclear and conventional arms control greatly mattered to the president. Although dominated by SALT II, the follow-on to the SALT I agreement with the Soviet Union, the new administration's arms control initiatives did not focus exclusively on strategic arms limitation talks. Carter championed nuclear nonproliferation and limitations on the transfer of conventional arms, especially advanced weaponry that might destabilize regions by encouraging regional arms races or increasing the lethality of local conflicts. A host of separate arms control and global issues—a comprehensive nuclear test ban, banning the use of chemical weapons, prohibiting antisatellite weapons in space, demilitarizing the Indian Ocean, opening up the resources of the seas to all nations, reducing dependence on fossil fuels, and fighting terrorism—completed his agenda.<sup>1</sup>

Almost every issue engaged the Department of Defense and its chief, Harold Brown. Although Brown was not part of Carter's inner circle of idealists, he was

committed to arms control, having served as a member of the SALT delegation under the Nixon-Ford Republican administration. Brown supported arms reductions as long as they were verifiable and did not endanger U.S. national security. In that respect he did not differ from many in the Pentagon, even the Joint Chiefs of Staff. Between the secretary and the Chiefs it was a matter of degree. For their part, the JCS remained suspicious of Carter's arms control initiatives, fearing that the president and his advisers would give away crucial U.S. military advantages in exchange for unequal arms control treaties and agreements with Moscow. The secretary, the JCS, and the defense bureaucracy acted as a brake on the president's plans for a new international system whenever they believed initiatives clashed with U.S. national security interests.

### **Comprehensive Nuclear Test Ban**

An earth free of nuclear weapons and their dangerous radioactive fallout was one of the defining visions of Carter's world. Early in the 1976 presidential campaign, Carter promised that if elected he would work for a nuclear comprehensive test ban (CTB) treaty, a total ban of unlimited duration. Support for prohibiting nuclear testing was not a new idea but rather one that emerged in the 1950s when it became clear that radioactive fallout in the atmosphere constituted a health danger. Antinuclear proponents also adopted a test ban as a first step to slowing the growth of larger and more powerful nuclear arsenals. In 1963 the United States and the Soviet Union signed a limited test ban treaty that prohibited tests in the atmosphere, underwater, and in space, thus relegating testing to underground. Then, in 1974, Moscow and Washington agreed on a Threshold Test Ban Treaty, limiting underground tests to 150 kilotons. Yet neither the Soviet Union nor the United States ratified the agreement, although both announced their willingness to hold to the 150-kiloton limit. In 1976 the United States, Soviet Union, and United Kingdom began negotiations for a total test ban, continuing with the informal arrangement of the 150-kiloton limit pending agreement on a comprehensive ban.<sup>2</sup>

The Defense Department and the JCS had serious doubts about negotiations for a CTB treaty. Thinking in the Pentagon held that a moratorium on testing would adversely affect strategic capabilities, undermining the reliability of nuclear systems. Many in DoD also remained skeptical about enforcing a related total ban on all peaceful nuclear explosions (PNEs). Both the United States and the

Soviet Union had experimented with nuclear explosions for large construction and other civilian projects, but the Soviet program was more extensive. Since the technologies of testing a nuclear weapon and exploding a peaceful nuclear device, for example, in a large construction project, were indistinguishable, PNEs could mask nuclear weapons testing. The JCS argued for adequate verification, including on-site inspection and unmanned seismic stations and for negotiating the CTB and PNE treaties together.<sup>3</sup>

The Carter administration undertook an early review of the issues related to the two treaties, as directed in Presidential Review Memorandum 16, "Nuclear Testing," in late January 1977. In March, the PRM study recommended resuming negotiations with the Soviets and British for a comprehensive test ban treaty and for a ban on peaceful nuclear explosions, with the expectation that other nuclear states would sign the treaties later. While the State Department and the Arms Control and Disarmament Agency favored an immediate CTB initiative possibly coupled with an interim moratorium on testing, OSD, JCS, and the Energy Research and Development Administration (successor to the Atomic Energy Commission) favored deferral of CTB. The National Security Council discerned no convincing arguments against seeking a comprehensive ban. They noted good reasons for doing so, such as the boost the treaty would give to Carter's nuclear nonproliferation efforts.<sup>4</sup>

Looking forward to the resumption of tripartite exploratory talks in Geneva in July, the president met with Brown, Deputy Secretary of Defense Charles Duncan, and the Joint Chiefs on 23 March. While no record of the discussion at this meeting has been found, Carter no doubt impressed on the Chiefs his belief that a CTB treaty was possible, verifiable, and could include a moratorium. As for peaceful explosions, the realistic solution was a total ban, although the NSC staff considered as an alternative an exchange of nuclear explosive design data so that weapons-related benefits were shared equally between Moscow and Washington when a peaceful explosion occurred.<sup>5</sup> Secretary of State Cyrus Vance explored the idea of a limited number of peaceful explosions for specific projects for the Soviets as part of the treaty. Brown felt very strongly that "such explosions, even in limited numbers . . . would allow stockpile confidence testing . . . which I consider important and which the US would lack." Failing an outright PNE ban, the Pentagon chief suggested a five-year prohibition, reopening the issue only by amendment to the PNE treaty, as an "acceptable fallback" and a "face saving arrangement" for Moscow.<sup>6</sup>

While Brown worried about PNEs, the Joint Chiefs adamantly opposed a comprehensive test ban, asserting that continued testing was essential to maintain a viable U.S. nuclear deterrent. They could not support a ban that did not provide specifically for testing necessary to maintain confidence in stockpile reliability or that could lead to undesirable asymmetries, given the U.S. inability to verify Soviet compliance. Brown passed the JCS concerns to the president without comment.<sup>7</sup> The uncertainty of the U.S. nuclear stockpile, the Chiefs argued, resulted from the fact that most U.S. strategic nuclear weapons were highly tuned designs that required periodic testing to avoid degrading over time.<sup>8</sup>

In May 1978 the president issued PD 38, "Comprehensive Test Ban," authorizing the Geneva delegation to propose a CTB treaty with a five-year duration that in the last year allowed the signatories to decide whether to negotiate a replacement treaty. When Carter sent the treaty to the Senate for ratification, he would announce that after the five years the United States would resume testing only for safety and reliability. Prepared to accept the Soviet insistence on a fixed duration for the treaty and on only voluntary—not mandatory—on-site verifications, Washington expected Moscow to accept U.S. positions on remaining verification issues.<sup>9</sup>

The arms control advocates in the White House, ACDA and State Department clearly had the president's ear. None of the concerns of JCS and DoD found their way into the presidential directive for the negotiations. At the Chiefs' request, Brown sent a second JCS recommendation to the president. While Brown believed the Chiefs' argument "accurately identifies the technical and military factors involved," he agreed, "with some, but not everyone, of their evaluations." Brown admitted that a CTB involved some military risk, but he thought it was acceptable if the ban lasted three years (less so for five years). He also worried that once a limited term ban took effect, it would be difficult to resume required testing as pressure would build to renew the treaty. Like the Chiefs, the secretary noted that the heavier, more simply designed Soviet warheads, which were less susceptible to malfunction than the smaller, highly tuned U.S. warheads, did not require frequent testing. As a former nuclear physicist and former Livermore Laboratory director, Brown agreed with the JCS that a long or indefinite ban would dissipate U.S. nuclear scientific and technological talent. Limiting explosions up to a maximum of 100 pounds and accepting a five-year ban would threaten the operations of U.S. nuclear laboratories. Unlike the Chiefs, Brown accepted the value of the



CTB for nonproliferation purposes, but he believed the State Department and ACDA had to make a more convincing case.<sup>10</sup>

In summer 1978 the CTB negotiations started to unravel. Carter still hoped for an eventual indefinite ban on testing, a view not held by most in his administration, who considered a five-year duration reasonable. Secretary of Energy James Schlesinger arranged a briefing for Carter by the heads of the Los Alamos and Lawrence Livermore Laboratories in mid-June 1978. The nuclear scientists convinced the president that tests of nuclear weapons and experiments were needed, especially because it was impossible to identify very small tests that the Soviets would undoubtedly conduct. In the face of opposition from Brzezinski, Schlesinger, the Joint Chiefs, and to a lesser extent Brown, Carter agreed to forgo a total ban on testing.<sup>11</sup>

After a recess in the CTB talks in mid-September 1978, Carter's advisers agreed that they needed a presidential decision on three points: the duration of the treaty, the number of seismic stations required for verification, and the level of experiments permissible. After tabling a proposal for a five-year duration, the U.S. delegation also told its Soviet counterpart it was now proposing a three-year term. Another issue requiring resolution concerned what would trigger a request for a voluntary onsite inspection. The delegation suggested that either seismic or other physical evidence could trigger a request; the Soviets would require both. Its proposal for direct data transfers via satellite instead of the Soviet proposal for monthly exchanges of data tapes differed in that the United States wanted to use only U.S.-manufactured seismographs, while the Soviets insisted on any design that met agreed technical requirements.<sup>12</sup> Brown, who feared that these CTB proposals could adversely impact SALT II (see chapter 6), reported that both the JCS and "at least working levels of DOE [Department of Energy]" would testify before Congress that the CTB would not be "in the best interests of national security." The resulting congressional reaction would "make serious trouble for CTB but also for SALT ratification."<sup>13</sup>

Brown's fears became moot. Displeased with the revised U.S. positions, the Soviets considered them a definite step back. Those in favor of a comprehensive ban had gained the president's support, but not Moscow's agreement. The Joint Chiefs, Brown, and Schlesinger had insisted upon enough qualifications on U.S. proposals to slow down the negotiations. For his part, Brzezinski later claimed to have only gone through the motions out of respect for Carter's deeply held belief in reducing nuclear weapons and tests. Brzezinski thought the CTB would only

complicate SALT II ratification, the administration's chief arms control priority. When the Soviets invaded Afghanistan, Carter cancelled Senate consideration of the SALT II treaty and suspended CTB talks, another casualty of the freeze in U.S.-Soviet relations.<sup>14</sup>

Initially ignored in CTB negotiations, the Joint Chiefs and Brown convinced the president to accommodate their two major concerns—acceptance of a three-year duration and small experiments to test the reliability of the stockpile. They also asked for desirable secondary requirements such as beefing up voluntary on-site inspection with real-time data retrieval from satellites and the use of U.S.-manufactured seismographs. The initial enthusiasm of the Carter administration gave way to the realities of a viable nuclear stockpile and the need for a verifiable test ban agreement. Attainment of a treaty has proved elusive. In 1996 the United Nations adopted a Comprehensive Test Ban Treaty, which the United States signed, but to date it has not come into force because eight specified nations, including the United States, have not ratified it.

### **Antisatellite Negotiations and Space**

By the late 1970s, orbiting satellites were essential to U.S. national security not only for overhead intelligence reconnaissance but also for communications, navigation, warning of missile launches, and meteorological support. Two days before he left office on January 1977, President Gerald Ford directed DoD to develop an operational nonnuclear antisatellite (ASAT) system in response to renewed testing by the Soviet Union of a low-orbit satellite interceptor, a multiton shrapnel warhead lofted into space by a modified SS-9 intercontinental missile. The Soviet system was co-orbital, that is, it launched into the same orbit as its target. Once close enough, the killer satellite fired an explosive charge that destroyed the target with shrapnel. The Ford directive also included a provision to study arms control options for ASAT. In March 1977 Carter raised with Soviet leader Leonid Brezhnev the possibility of prohibiting antisatellite systems, but the president found himself ahead of the rest of the government, which had not yet devised a coherent space policy.<sup>15</sup>

Since the United States did not yet have the ability to shoot down low-orbit satellites, the JCS strongly recommended the development of an antisatellite capability, with no ban on research, development, testing, and deployment. The United

States was developing a direct ascent system, which would hone in on a target from near space without co-orbiting its target. The would-be developers promised a more effective system than the Soviets'. The Chiefs argued that any ban would kill the U.S. project, ensuring that the technological lead held by the Soviets would be permanent.<sup>16</sup> The U.S. dependence on space was greater than that of the Soviets. Brown believed that limits on ASAT served the national interest, but effectively verifying such limits would be difficult. NSC, State, and ACDA recommended a comprehensive ban, even though the Soviets already had an ASAT capability.<sup>17</sup>

In March 1977 the president directed DoD to prepare a study on a coherent space policy that included goals for civil, military, and intelligence programs in space. Given the diverse issues and the mix of military, intelligence, and civilian agencies involved, the process moved slowly.<sup>18</sup> Pursuant to the president's suggestion to Brezhnev about ASAT talks, Brzezinski urged DoD to complete the study, including nonnuclear antisatellite systems, for presidential review.<sup>19</sup> In September 1977, after receiving DoD recommendations, Carter chose the option that banned all ASAT capabilities except electronic warfare, testing in space or against objects in space, and deployment and use of any system for physical attacks on satellites. The Soviets would have to dismantle their existing orbital interceptor. In the negotiations the United States would insist on strict compliance with the ban and vigorous verification. At the same time, the president directed the Pentagon to continue development of an ASAT capability—short of operational space-based testing—to ensure carrying to production those elements not prohibited in the treaty. Some research and development would continue even after a treaty was signed to counter any Soviet breakout in ASAT capability. Finally, Carter believed that acknowledging the U.S. program publicly would enhance the likelihood that the Soviets would accept U.S. proposals.<sup>20</sup>

After deliberations in early 1978, the Carter administration formed its strategy for ASAT talks with the Soviets that would secure a comprehensive limitation on antisatellite weapons, with the exception of electronic countermeasures. The delegation to the Helsinki ASAT negotiations would explore informally their Soviet counterparts' willingness to consider attacks on satellites "a hostile act"; to pledge not to conduct such acts; to agree to a six-month moratorium on low-level ASAT systems; and to explore the possibility of an indefinite suspension of high-level tests.<sup>21</sup>

During deliberations leading up to the negotiations in Helsinki, Brown and the Pentagon experts had second thoughts. To achieve an ASAT interceptor capability, they believed DoD had to be able to test against targets in space. Therefore any restrictive clause limiting tests to demonstration purposes and/or prohibiting development of flight tests was a bad idea. Furthermore, the secretary suggested that testing could help convince the Soviets to accept U.S. proposals by demonstrating the U.S. intent to develop an ASAT capability if negotiations failed. This latter recommendation was included in the negotiating instructions. If the Soviets did not respond positively to U.S. proposals, the United States would seek an ASAT capability. It would not accept asymmetry.<sup>22</sup>

Negotiations began in May 1978 in Helsinki with Brown's old Livermore Laboratory mentor, Herbert York, serving as his personal representative on the delegation.<sup>23</sup> The Soviets immediately brought up the U.S. space shuttle (scheduled to launch in 1980), which they claimed was capable of carrying antisatellite systems and therefore should be part of the negotiation. The U.S. delegation followed explicit orders to reject the definition of the shuttle as an antisatellite system. The delegations also explored the definition of hostile acts against a satellite, with the Soviets favoring a broad one.<sup>24</sup> During the second session in Bern, January and February 1979, and a third one in Vienna, April to June 1979, the U.S. delegation raised informally the issue of a one-year moratorium on testing at all altitudes.<sup>25</sup>

By mid-1979 the State Department and ACDA believed sufficient progress had been made at the ASAT talks to warrant signing the interim agreement prohibiting certain actions against satellites and prescribing a temporary test suspension on ASAT technology. U.S. and Soviet negotiators, however, failed to agree on such steps.<sup>26</sup> As the administration prepared for a fourth session in June 1980, DoD remained concerned that expanding the testing moratorium beyond ASAT interceptors to all means of destroying satellites, including lasers, was a mistake. The JCS worried that the uncertain start date for the moratorium would restrict or delay the U.S. laser testing program, scheduled to begin in 1981. Representatives of JCS and OSD also failed to see how to verify a laser test suspension.<sup>27</sup> These concerns proved moot when the Soviets occupied Afghanistan in December 1979. Carter suspended ASAT talks scheduled for June 1980. Another arms control initiative was doomed by the end of *détente* in late 1979.

Were the ASAT negotiations a lost opportunity? The Soviet Union's interest in the issue, apparently genuine, was based on the hopes of limiting the U.S. program. Nevertheless, Moscow had suspended ASAT testing during the negotiations. During the Reagan administration, the Soviets announced a second moratorium on their own testing and submitted a draft treaty to the United Nations banning space weapons. With his strategic defense initiative in mind, Reagan rejected the Soviet proposals but ran into opposition from the U.S. Congress, which inserted legislation enacting a unilateral moratorium in Reagan's first Defense budget. Eventually the United States and other space powers tested ASAT systems by taking down their own obsolete or malfunctioning satellites, but a consensus emerged that satellites were so crucial that a hostile shootdown, at least in peacetime, was unthinkable.<sup>28</sup>

In addition to antisatellite weapons, the Pentagon focused on determining how best to transport satellites and other systems into space. President Nixon approved the National Aeronautics and Space Administration's Space Transportation System (STS), more commonly called the space shuttle, in January 1972. From the beginning the shuttle program was a NASA and Air Force partnership. The Air Force required that the shuttle have the capacity to launch large reconnaissance satellite and land up to 1,000 nautical miles from the point at which it entered the earth's atmosphere, thus allowing for polar orbits. At the onset of the Carter administration, Vice President Mondale, OMB officials, science adviser Frank Press, and some in Congress suggested, for budgetary savings, reducing the shuttle program from the planned five shuttles and two launch sites (the one at the Kennedy Space Center in Florida and a yet-to-be-built site in California) to three orbiters and one launch site—the Kennedy Space Center.<sup>29</sup>

In September 1977 Carter asked Brown to provide information on the cost-effectiveness of the space shuttle versus expendable rocket launchers for DoD's national security and intelligence missions in space.<sup>30</sup> OSD informed the president that the shuttle "could support the launch of all projected DoD space systems in the foreseeable future," delivering twice the payload weight and three times the payload volume into orbit as previous rocket launchers at a projected 99.5 percent reliability—as opposed to 88 percent to 98 percent for current expendable boosters. The shuttle would be much more flexible than earlier systems, permitting return of defective payloads or retrieval of older payloads from orbit and allowing for reuse,

updating, and repair of existing systems in space. Defense and NASA maintained that five space orbiters operating out of the Kennedy Space Center and DoD's Vandenberg Air Force Base in California would be optimal, clashing with OMB's budget-saving plan for three shuttles and one launch site.<sup>31</sup>

In November and December 1977 Brown, DCI Stansfield Turner, and acting OMB Director James McIntyre met to decide the size of the shuttle program. Brown argued that OMB's cutback option was incompatible with national security interests. The United States planned on a minimum of four shuttles, but the recently completed *Enterprise* and the next two in the pipeline, *Columbia* and *Challenger*, were incapable of carrying the largest and heaviest Defense Department reconnaissance satellites. According to Brown, the program required two lighter shuttles with greater payload capacity, *Discovery* and *Atlantis*, given the importance of launching reconnaissance satellites and especially to verify arms control agreements such as SALT II. To the secretary, a single, higher payload shuttle risked leaving the U.S. national security vulnerable if it were destroyed by accident. The Pentagon chief strongly endorsed a second launch site so that the shuttle could conduct polar orbiting flights required for national security missions. Turner supported Brown. The president decided on four orbiters with the eastern and western launch sites.<sup>32</sup>

Part of the shuttle's attraction for DoD was its ability to place people in space—most early astronauts were military officers—applying human judgment to missions like reconnaissance (allowing for flight crew on-site optimization of target selection and data simplification), satellite inspection, repair and service of military payloads, and military research and development programs in space. If the ASAT negotiations failed, the shuttle could carry ASAT weapons into space (as the Soviets feared), deploy large structures in space intended for military purposes, and support space-based nonnuclear weapons.<sup>33</sup>

In 1979 and 1980 the space shuttle program ran into funding difficulties and technical delays, causing Brown's expert, Hans Mark, the new secretary of the Air Force and a former NASA deputy administrator, to assume the role of chief explainer and defender of the program inside the Pentagon. The Air Force was also responsible for building the second launch complex at Vandenberg Air Force Base at an estimated cost of \$200 million. Mark assured Brown that NASA's problems, although serious, were not insurmountable—"there are no major technical problems that could cause really long delays." The program was vital to national security since "it will give us

capabilities to operate in space that we do not now possess.”<sup>34</sup> Mark’s confidence was confirmed in April 1981 when the first shuttle *Columbia* launched from the Kennedy Space Center. The program, although not without its tragedies and critics, qualified as one of America’s most successful multipurpose space programs.

### **Banning Chemical Warfare**

The Carter administration’s arms control strategy included a ban on the production and stockpiling of chemical weapons (CWs). Ever since the deployment of mustard gas in World War I, the international community had sought to prevent the future use of horrendous and indiscriminate chemical weapons. In 1925 most nations, including the United States, signed and eventually ratified the Geneva Protocol outlawing the use of chemical and biological weapons in warfare but not preventing their production as a deterrent. Some nations continued to use these weapons. Italy employed chemical weapons in its 1930s conquest of Ethiopia. The Nazis used them in their “final solution” against Jews and other peoples in concentration camps. The Allied and Axis Powers in World War II refrained from employing chemical or biological weapons against each other’s military combatants. In 1972 President Richard Nixon unilaterally ended U.S. production of offensive biological and toxin weapons when he signed the Biological and Toxin Weapons Convention, which Congress ratified in 1975. Unlike the Geneva Convention, the biological and toxin agreement outlawed the development, production, and stockpiling of such weapons, and ordered the destruction of existing stocks.<sup>35</sup>

The Biological and Toxin Weapons Convention provided the model for a chemical weapons prohibition sought by the Carter administration. In May 1977 the president directed the Special Coordination Committee to review the U.S. chemical weapons posture with a view to developing arms limitations options. Brown commented on the directive: “Since our military are so concerned about the [Soviet] CW threat, we should look carefully at the possibility of reducing the threat by CW arms limitations.”<sup>36</sup> The resulting study concluded that the Soviets possessed a substantial and growing CW capability while the U.S. chemical weapons arsenal was marginal and likely to decline. The first of two main issues for decision asked what military posture was required to deter a chemical attack (or how to retaliate if such deterrence failed) until an acceptable arms control agreement was achieved or proved impossible. The second asked, what arms control approach would work best for U.S. security interests?

Brown commented, “My bias is towards trying for a comprehensive agreement given reasonable verifications agreements, which may be very hard. Failure to reach it would give us a better chance than we have now to improve our own deterrent capability.”<sup>37</sup>

General support for a comprehensive limitation on CW deployment and production and for banning stockpiling resided within the Pentagon. Opinions therein differed over what to do with chemical weapons until such an agreement was reached. The Joint Chiefs favored modernizing the U.S. chemical retaliatory stockpile. DDR&E William Perry and Donald Cotter, assistant to the secretary of defense for atomic energy, favored establishing a facility for producing binary chemical weapons (a binary reaction occurs when two harmless chemicals are combined) but deferring production pending progress on negotiating a ban. Assistant Secretary of Defense (ISA) David McGiffert and Assistant Secretary of Defense (PA&E) Russell Murray supported retaining the current stockpile during negotiations.<sup>38</sup>

At the SCC meeting in early June 1978, Deputy Secretary Duncan told participants: “Compared to the Soviets we have virtually no offensive capability and our defensive capability is inferior to theirs.” Duncan also outlined the internal splits within DoD. He and Brown supported retaining the current stockpile during the negotiations on a chemical weapons ban. State and the ACDA agreed.<sup>39</sup>

In mid-June 1977 Brzezinski briefed the president on the SCC meeting, informing him that the Soviets possessed CW capabilities superior to those of the United States, yet they were the ones—not the United States—“pushing for a CW ban.” While the Soviets spent considerably more funds on CW than the United States, Brzezinski noted that much of it was for “defensive facilities producing decontamination kits, washdown vehicles, air purification systems, etc.” Brzezinski suggested that the Soviets’ defensive effort and their eagerness for a treaty were in part a response to the huge casualties that Russia suffered in World War I from chemical weapons. Carter directed a delegation to work out with the Soviet Union a detailed joint U.S.-Soviet proposal to the United Nations’ Conference on Disarmament for a comprehensive multilateral treaty to ban chemical weapons. He instructed in the meantime that the current chemical weapons arsenal be maintained without improvement. The president agreed to review his decision when the FY 1980 budget cycle began.<sup>40</sup>

Brown provided guidance for the president’s sparse instructions on the future of DoD’s chemical weapons programs, directing that efforts to upgrade and develop



the U.S. protective posture against CW (training, doctrinal developments, chemical defense manpower improvements, and other additions) should continue. Other instructions included maintaining the stockpile for retaliatory readiness, continuing research and development on improved chemical agents and munitions, and initiating Army planning for a binary facility so the service would be ready to start building one if approved in the FY 1980 budget.<sup>41</sup> In October 1977 Vance and State took exception to this guidance as contrary to the president's decision and likely to derail talks with Moscow. In order to gain congressional support for the program, Brown agreed with Vance that "we must make a real try at a verifiable CW ban." He assured Vance that DoD was not asking for funds for production or preproduction of binary CWs, just for a limited R&D program.<sup>42</sup>

Moscow and Washington talked about a ban on chemical weapons development and production, but without reaching agreement. In part because of Vance's concerns that developing a binary plant could adversely impact negotiations, the planned review of the issue was delayed for two years until 1979. In autumn 1979 both Brown and JCS Chairman General David Jones told Brzezinski that the United States had been in talks with Moscow on a CW ban without any apparent success since 1976. Now was the time to build a binary plant and send Moscow a clear signal.<sup>43</sup> Brown and OSD favored asking Congress to fund a binary production facility, notwithstanding problems it could cause. On the downside, such a public funding decision could suggest to Moscow a lack of U.S. commitment to a UN ban; could worry the NATO allies who would eventually have to deploy binary CWs on their soil; and could become entangled in presidential election politics. On the positive side, if the negotiations for a ban failed, it would be less expensive to build a binary facility than to reopen existing facilities to add new weapons to an aging stock, a good part of which was so obsolete as to be unusable. Brown suggested going "ahead with [a] pilot plant without deciding on more right now."<sup>44</sup>

During 1980 the CW issue continued to divide the Carter administration. Reports indicated that the Soviets were expanding their already extensive CW capability and had used the lethal weapons in Afghanistan. Brown thought this unlikely, but believed it was somewhat more likely that the Vietnamese had used CW against the Hmong (the international community later concluded that the Vietnamese did not use them in Laos).<sup>45</sup> Part of the problem was that DoD did not have good intelligence on the Soviet-Warsaw Pact program, so Brown asked for a

comprehensive review of the Soviet chemical weapons program. As the presidential election of 1980 loomed, the administration had not resolved the issue.<sup>46</sup>

In early December 1980 Brown and Under Secretary of Defense for Policy Robert Komer recommended going ahead with binary production, a move Congress was pressing them to do. They suggested deferring the question of deployment of binary CWs in Europe until there was an adequate stock available in the United States. All present at the Policy Review Committee meeting agreed with Brown that they should accept the congressional decision to add funds to the FY 1981 Defense budget for a binary plant. DoD would begin plant construction and purchase of equipment but announce that no further decisions had been undertaken.<sup>47</sup> The Carter administration left for President Reagan the next steps in the process. Brown advocated improving capacity to protect U.S. forces if attacked with CWs and enabling them to operate with better protective clothing. While admitting current U.S. stocks were aging and could be unsafe, he still considered them effective. As for safer binary weapons, he suggested that they could “create more problems domestically and with the NATO allies than this advantage is worth.” Neither the populace in NATO countries nor the American public favored the idea of spending money on chemical weapons. As secretary of defense, Brown displayed similar ambivalence about CWs, but apparently overrode his doubts to support his department’s position.<sup>48</sup>

While the Reagan administration had little interest in a CW ban, its successors, Presidents George H. W. Bush and William J. Clinton, took up the campaign. The United Nations Conference on Disarmament, which had long been negotiating a CW ban, finally agreed on the Chemical Weapons Convention in 1993 that outlawed possession of chemical weapons and required verification of their destruction. Over 180 nations (including the United States and Russia) eventually signed and ratified the convention, which entered into force in 1997.<sup>49</sup>

### **Nuclear Nonproliferation**

Nuclear nonproliferation, a special concern of the president, found support in DoD for the obvious reason that fewer nuclear states ostensibly made the world safer and made it easier for the United States to defend itself and its allies. The administration pursued a diplomatic campaign to encourage states to sign the 1968 Nuclear Nonproliferation Treaty (NPT), which allowed nations that foreswore the development

of nuclear weapons to receive peaceful nuclear technology from the three nuclear signatories to the NPT—the United States, Great Britain, and the Soviet Union (France, India, and China did not sign the treaty, although France followed its provisions on the nontransfer of nuclear technology). The idea was simple; the details complex: provide nuclear power and technology without providing the necessary materials to make nuclear weapons. The rub was that a legitimate peaceful nuclear power program could produce enriched uranium and plutonium that nations could divert to make nuclear weapons. The signatories of the NPT, therefore, agreed to limit export of materials or equipment that could facilitate that process. Certain U.S. allies—Japan, West Germany, and the other democratic European countries committed to nonproduction of nuclear weapons—believed that these restrictions should not apply to them. They wanted the ability to reprocess spent U.S. fuel and use the resulting plutonium in breeder and advanced reactor programs. These allies also opposed restrictions on their export of nuclear fuel and technology to other responsible states. The State Department suggested easing these restrictions to allow dependable allies to reprocess while saving the tough restrictions for problem countries such as Pakistan, India, and South Africa. Furthermore, the United States needed the cooperation of Japan and the West Europeans, especially West Germany, in preventing the export of sensitive technology and fissionable material. Deputy Secretary of Defense Graham Claytor agreed wholeheartedly with this initiative, noting that the current policy “is bankrupt and not accomplishing our objectives.”<sup>50</sup>

At a regular Friday breakfast gathering in early June 1980, Brown, Muskie (who replaced Vance as secretary of state) and Brzezinski obtained the president’s approval of the State Department plan: offering longer-term licensing of low-level enriched fuel exports to countries with good nonproliferation credentials and “predictable ground rules” for reprocessing. In return, the recipients would support nonproliferation efforts by accepting safeguards; restraining transfers of sensitive technology, facilities, and use of plutonium; limiting stockpiles; supporting international oversight; and applying controls over their exports. These measures would require negotiations and formal agreements with allies, so accomplishment of the program was not expected until well into a second Carter term.<sup>51</sup>

The progress that the Carter administration made on nonproliferation, while helping to ensure that U.S. allies did not allow other states to develop nuclear weapons, did not stem the tide of all nuclear proliferation. Pakistan, South Africa,

and eventually North Korea successfully established their own nuclear weapons programs, although South Africa stopped its secret program with the end of the white minority government. Iraq under Sadaam Hussein sought to develop nuclear weapons. Concern about the threat of nuclear proliferation remains as crucial today as it was during Carter's presidency.

### **Foreign Military Sales**

As in the case of nuclear nonproliferation, many of Carter's arms control initiatives sought to reduce or prohibit weapons of mass destruction, nuclear or chemical. The president also felt strongly that the sale of conventional weapons through the U.S. foreign military sales, or FMS, program exacerbated tensions and regional conflicts. Between the U.S. defense industry and the Departments of State and Defense, Carter discerned a political and diplomatic nexus that served inexorably to increase such sales every year until the developing world bristled with arms. The president maintained that lesser developed countries with limited resources could ill afford the luxury of sophisticated weapons. Critics of arms sales blamed the Pentagon, but contrary to popular perception, DoD did not have primary responsibility for foreign military sales policy (or military assistance policy). The State Department did. In reality, Defense and State worked together on proposing policy and the president made the final decision. As the sole implementer of these policies, DoD inexorably became an active promoter military sales and security assistance. Since Congress had to approve foreign military sales and appropriate money for credits as well military assistance grants, legislators on Capitol Hill also had a stake in the FMS process.

In late January 1977 the administration undertook an interagency review of arms transfers under the chairmanship of Vance. Presidential Review Memorandum 12 called for a study of arms transfers in the conduct of foreign policy, identifying benefits and disadvantages, and examining how they related to U.S. political, economic, and military interests. The crux of the exercise lay in determining the feasibility of restricting these transfers on a national, regional, and global basis.<sup>52</sup> In framing the review, DoD suggested—and State agreed—to focus on controlling those arms transfers (approximately 40 percent of the total sales) that would demonstrably increase a recipient's military capability, not just maintain its armed forces.<sup>53</sup> The study in response to PRM 12 exposed a diversity of opinion

among the drafters. Some focused on the problem at the macro level, seeing arms transfers as unproductive consumption of scarce resources; others saw the regional problems it could engender, such as encouraging conflict and diminishing the chances for peaceful resolution of conflicts. OSD and State maintained that their examination of transfers on a case by case basis responded to legitimate security needs and provided a deterrent to local wars. Staff members of the NSC's global issues section and the leadership of the Arms Control and Disarmament Agency held the opposite view—the volume and superior quality of U.S. weapons only created larger appetites for such arms.<sup>54</sup>

As the NSC, State, and OSD refined policy decisions for the president, Brown warned Brzezinski that the restrictions must not prevent the transfer of advanced weapons to NATO members and other allies such as Japan, Australia, and New Zealand. Brown also recommended clarifying the provisions that prohibited the transfer of weapons to other countries before those weapons had entered the U.S. inventory, suggesting a presidential waiver as a possibility.<sup>55</sup>

Reflecting Carter's preference, the policy guidance, Presidential Directive 13 of 13 May 1977, was restrictive: "Arms transfers are an exceptional foreign policy implement, to be used only in instances where it can be clearly demonstrated that the transfers contribute to our national security interests." U.S. restraint alone could not be effective without cooperation from other arms-supplying nations. The United States would use security assistance programs as a reward to promote human rights and would weigh the economic impact of arms sales on countries receiving U.S. economic assistance. In keeping with DoD's concerns, NATO allies, Japan, Australia, and New Zealand were exempt from the restrictions of PD 13 and the United States would "honor its historic responsibilities regarding Israel's security." The directive included the presidential waiver provision, but only in "extraordinary circumstances" when a U.S. "friend" had to "depend on advanced weaponry to offset quantitative and other disadvantages in order to maintain a regional balance." The president directed that new commitments of military sales and military assistance for FY 1978 amount to less in total constant dollars than in FY 1977 and continue to fall in each subsequent year. Finally, the United States would hold back introducing into a region advanced weapons that created a higher combat capacity for the recipient; it would not commit to sell or coproduce weapons until operationally deployed with U.S. forces; coproduction of significant

weapons, equipment, or major components and fabrication of high turnover spare parts would be prohibited; and weapons could not be retransferred from recipients to others.<sup>56</sup>

As part of PD 13, the president instructed DoD to determine which government procedures promoted the sale of arms and how to reduce them. In September 1977, DoD sent the president a study highlighting 13 changes that could inhibit arms sales. Most of the proposed changes were technical, such as tighter control over the release of U.S. government-owned military equipment to defense contractors for sales promotion. Others were more basic, such as improved review procedures, closer U.S. control of government contractors' promotional efforts for sales of combat equipment, and a "standard of conduct" for U.S. personnel involved with arms sales and industry.<sup>57</sup> Brown put his finger on the underlying problem when reviewing a draft of the report: "The whole thrust of this paper is to inhibit incentives for the Defense bureaucracy & contractors to push FMS. That's all to the good. But the real *push* comes from genuine foreign policy motives—and a search for (double-edged unfortunately) tools to advance them."<sup>58</sup> Deputy Assistant to the President for National Security David Aaron gave DoD the go-ahead to implement or coordinate implementation with other agencies for all but one of the 13 recommendations.<sup>59</sup>

PD 13 represented the high-water mark of influence of those in the administration who sought to limit conventional weapons sales and transfers. OSD supported this initiative constructively while it assured flexibility to provide FMS and military assistance to friends and allies. The president's injunction that future ceilings for arms transfers be lower in constant dollars than each previous year created complications. To gain a handle on the magnitude of these problems, Brzezinski required State and DoD to create a management system to track and prioritize arms sales. In January 1978 the NSC's Policy Review Committee discussed on two occasions how to reduce the FY 1978 ceiling (including both cash sales and credits) to below the FY 1977's \$11.5 billion—\$0.3 billion in military assistance programs and \$11.2 billion in FMS. The baseline figure of \$9.3 billion for FY 1978 resulted from deducting transfers to exempt countries and non-weapon items (mostly construction) and then adding the inflation factor.<sup>60</sup> At the first PRC meeting three options were raised: a reduction of 5 percent in FY 1978, 7.5 percent (later adjusted to 8 percent) in FY 1978, or 10 percent for FYs 1978–1979, with at least 5 percent in the first year.

State and ACDA favored the 7.5 percent figure on the grounds that it would show the public and press that the administration's arms transfer restraints were credible. DoD opted for 10 percent over two years, the most flexible option.<sup>61</sup>

At the second PRC meeting at the end of January, the members agreed to present the three reduction options for FMS to the president. They recommended a flexible approach to managing the ceiling—a necessity because Iran was planning to purchase airborne warning and control system aircraft and a large Middle East aircraft package for Israel, Egypt, and Saudi Arabia was in the works. Carter approved the recommendations and directed a reduction of 8 percent in sales in FY 1978.<sup>62</sup>

During spring 1978 Carter approved numerous arms transfer requests within the agreed ceiling. On one such request of early May for the Republic of China (Taiwan), Kuwait, and Spain, the president wrote the following note: "To Cy, Harold, Zbig. Do *not* fail to meet my commitment to cut back at least 8% on arms sales. I don't want a last minute or ex post facto embarrassment. Check projected total sales carefully." In November 1978 State reported that there existed inter-agency agreement on the FY 1979 arms transfer plan that would reduce arms sales by 8 percent over the previous year. The resulting ceiling would be \$8.4 billion. Brown and his staff agreed with these figures, but the Joint Chiefs considered the cuts too deep given that both the Soviet Union and Western Europe had not displayed similar restraint. The Chiefs recommended a more modest 2 percent to 5 percent cut. Carter approved the 8 percent reduction. He warned: "Be very careful. Don't come close to our limit" and commented that the 8 percent "is not much of a restraint."<sup>63</sup>

In September 1979 Brown and Vance reported to the president on the results of arms transfer policy as directed in PD 13. They agreed that the policy had worked without denying the United States the ability to meet foreign policy requirements and the defense needs of allies and friends. But among the recipients, the policy was not popular since it often denied them access to advanced U.S. military equipment. U.S. defense industries complained that PD 13 restrictions put them at a competitive disadvantage against other arms exporters. Some members of Congress remained skeptical, considering PD 13 an exercise in "creative bookkeeping" or the loss of an effective instrument of foreign policy. On the plus side, Brown and Vance concluded that the policy had created a multiyear planning system of priorities and a means of accounting for "a wide range of factors—political, security, arms

control, economic, and human rights” in deciding on major arms transfer cases. Most significantly, the directive’s requirements provided measurable restraint of U.S. arms transfers.<sup>64</sup>

Still, there were problems and issues that required attention, such as the need for an intermediate fighter plane solely for export to replace the aging F-5E aircraft and prohibitions on coproduction that were hamstringing some U.S. programs. The new revolutionary Islamic Iranian Government cancellation of its FY 1979 FMS package reduced that year’s FMS significantly, meaning that the FY 1980 program money ceiling would be even lower at just the time that the United States wanted to increase arms sales to Israel, Egypt, and Saudi Arabia to fill the gap left by Iran. None of the other major arms-dealing countries, however, showed similar restraint. The Soviets talked endlessly about reducing arms sales in ongoing bilateral conventional arms transfer negotiations, but continued to sell more and more arms abroad. The European allies made their actions contingent on the Soviet sales behavior and kept their arms export pipeline pumping. The United States was the only country exercising true restraint. Nevertheless, the president told Brzezinski “I won’t be eager to change the policy.”<sup>65</sup>

Brown found Carter more flexible than he expected when he asked him to increase the FY 1981 credits program for financing FMS by an additional \$700 million to \$2.055 billion. Double digit inflation meant the program had been decreasing in real dollars for years. Since all FMS credit programs other than Israel required only 10 percent budget authority, an outlay of \$70 million would produce the additional \$700 million in sales. Brown noted that more than half of the \$2.055 billion would go to Israel (\$1 billion) and for treaty obligations to Spain, Portugal, Panama, and the Philippines (\$191 million), leaving \$864 million for 25 other countries of which Korea, Greece, and Turkey would receive the bulk (\$525 million). DoD priorities for any additional credit sales were Egypt, then Turkey, the Sudan, the rest of the world (some friendly countries in Africa would get no FMS credits unless the ceiling was raised), and finally Jordan.<sup>66</sup> The president agreed. The administration requested a FY 1981 ceiling for FMS credits of \$2.8 billion. As happened in FY 1980, Congress failed to pass a foreign assistance bill and authorization for funding for the military sales credit programs actually rose to slightly from the FY 1980 figure under a continuing resolution, but not to the requested \$2.8 billion.<sup>67</sup>



## Military Assistance Program

Although dwarfed by U.S. foreign military sales, the Military Assistance Program (MAP), part of a broader security assistance, continued to offer a useful means to provide military equipment, training, and in-country assistance to U.S. allies and friends on a grant basis. In existence for over three decades, MAP had enjoyed a heyday in the 1950s and 1960s. The Carter administration initially planned to phase out MAP by FY 1981, but in late November 1978 it started to have second thoughts. Brzezinski asked Brown and Vance if the program was worth continuing on a limited basis. The secretaries responded that it was “an efficient instrument” for U.S. national security and foreign policy interests, contributing to the NATO readiness of Portugal, the acquisition of bases in Spain and the Philippines, and the support for U.S. political interests in Jordan. Termination would not be without cost. Substitute programs could cost as much or more, or if not developed, could expose U.S. security interests to risk and strain ties with allies and friends. Congress had been supporting the program on a case-by-case basis. Both men recommended delaying the decision. If Congress was informed that the MAP was to be terminated, it might prove unwilling to finance it until its termination.<sup>68</sup> The president agreed to keep open the possibility of MAP support for some countries.<sup>69</sup>

MAP was only one part of a security assistance program that included credits for foreign military sales and the International Military Education and Training program, whereby officers from allied and friendly countries received training in the United States. Military Assistance Advisory Groups (MAAGs), defense attachés stationed abroad, and emergency security funding (ESF) were also a part of the overall program. In late 1979, in an effort to reduce U.S. personnel abroad, the Office of Management and Budget ordered cuts in the number of overseas personnel managing MAPs that totaled more than a hundred people, thereby reducing their number to a ceiling of 636, and consolidation of the defense attaché offices in up to 20 countries. Brown asked the president to reconsider letting DoD manage its own program. He also asked Carter to raise the FMS credit program by \$2.72 billion for FY 1981, allowing Egypt to purchase F-16s, in addition to M60 tanks already approved; providing enough FMS to the Sudan to keep it in the United States–Egypt orbit; and granting adequate credits in Southeast Asia, the Middle East, and Latin America. The secretary made a strong plea for restoring cuts and then increasing the \$33 million IMET program: “Per dollar spent, we

probably receive more return in terms of our national security and foreign policy goals from IMET than any other assistance program.” Clearly, foreign friends in high military positions were valuable assets in the secretary’s view.<sup>70</sup> As with the FMS credits, the effort proved moot because Congress failed to pass a Foreign Assistance Bill (in which security assistance was included): funding would be on as continuing resolution.<sup>71</sup>

By 1980, faced with worsening situations in the Persian Gulf (Iran), Southwest Asia (Afghanistan and the threat to Pakistan), and Central America (Nicaragua and El Salvador), Brown concluded that the FY 1982 security assistance program must rise in conjunction with the increase in the overall Defense budget. Rather than phasing out MAP, Brown recommended increasing its funding by \$100 million over FY 1981 levels, upping FMS credits from \$2.8 billion to \$4 billion (to reflect inflation and to include \$1 billion in loans at low interest rates for poorer countries), and doubling IMET funding from the FY 1980 level.<sup>72</sup> He received support from the NSC staff; the State Department eventually came on board, but OMB remained opposed.<sup>73</sup>

In early December 1980 Brown presented his case to the president: “In sum, this is not a routine reclama. With all that is at stake in the defense of the Persian Gulf, it is essential that we supplement our military preparations with adequate military assistance programs.” Furthermore, both Brown and Muskie strongly believed in the need for an additional \$2 billion in FMS credits and security grants in the Persian Gulf and Indian Ocean to implement Persian Gulf policy and support the Carter Doctrine warning the Soviets against meddling there.<sup>74</sup> Carter’s defeat in the 1980 presidential election meant that a new administration would take over the programs. President Reagan’s team requested a revised FY 1982 Military Assistance Program that closely followed Brown’s recommendations. While Congress whittled down the Reagan request somewhat, it passed a bill (the first time in two years) that significantly increased the overall Security Assistance Program to a total of \$4.369 billion.<sup>75</sup>

### **Energy, Terrorism, and Use of the Sea**

Arms control was one part of Carter’s vision for a better world. Tackling global issues that adversely impacted the planet was another. Given the second great oil price increase in the late 1970s, Carter engaged in a campaign to reduce U.S. dependency on fossil-based fuels. In April 1977 the president declared the energy crisis the

“moral equivalent of war.”<sup>76</sup> At first glance, DoD might not seem to be a candidate for fighting this “war,” but its energy use in 1976 amounted to 78 percent of federal government’s energy consumption, and its operating forces consumed 89 percent of the government’s petroleum. While DoD energy consumption was only 1.7 percent of total U.S. energy use, its efforts to use less energy were more than symbolic.<sup>77</sup> The Pentagon made adjustments by installing more efficient energy systems and energy-saving technologies and procedures, but the armed forces’ emphasis on readiness (more flying time, at-sea training, and reserve unit training) and mechanization (two new mechanized brigades in Europe) guaranteed an increase in petroleum usage. OSD began to study the possibility of producing “synthetic fuel” from shale oil as an alternative to crude-based oil, but the prospects for such a change were long term—the time frame considered feasible stretched from 1985 to 2010. In effect, DoD had a mixed record, saving energy where possible and increasing its use where required. To make matters worse, the cost of energy, especially petroleum, rose sharply with inflation and the related rise in the price of crude oil in the late 1970s. As Duncan informed OMB Director McIntyre in late 1979, DoD’s fuel purchases then represented 90 percent of all the U.S. government’s energy acquisitions and 7 percent of the department’s total purchases. With oil prices continuing to rise after the 1979 oil shock (the second of the decade), the future looked bleak despite energy-saving programs like the Army’s, which reduced energy consumption by 9.5 percent in FY 1979 compared with FY 1975.<sup>78</sup>

These developments made the friendly oil producers in the lower Persian Gulf (Saudi Arabia especially, but also the United Arab Emirates and Kuwait) keys to Western security—hence the U.S. program of closer military ties with the Saudis. A more specific problem concerned what to do if a hostile power or an insurgency destroyed Middle East oilfields. As one of his final acts, Brown appointed the secretary of the Army as the DoD executive agent for oilfield repair and restoration, with responsibilities for preparing a plan to use the Army Corp of Engineers for such a purpose.<sup>79</sup>

The energy crisis, a real threat to the national security and economy of the United States, brought economic pain and inconvenience to average Americans. The specter of terrorism, which also received front-page headlines and television news coverage, caused real fear at home and abroad. After the massacre of Israeli athletes at the Munich Olympics in 1972, the United States had established a Cabinet committee to coordinate U.S. terrorism policy. Under State Department

direction, its working group met but never engaged policymakers in terrorism policy, nor did it exercise crisis management authority. Each agency on the committee exercised its own judgment about how to respond to terrorism.<sup>80</sup> The JCS developed a plan to deploy a Ranger battalion, operating under the U.S. Readiness Command (REDCOM), for small rescue and recovery operations outside of the United States.<sup>81</sup> In mid-1977 the president ordered a review of policy and procedures for dealing with terrorist incidents. As part of this review, the SCC concluded that U.S. military capabilities for countering terrorism at home and abroad were “generally adequate,” but use of military forces in the United States raised legal problems.<sup>82</sup>

Successful action by West German commandos in freeing hostages in a hijacked Lufthansa aircraft in Somalia in October 1977 piqued Carter’s interest in establishing a dedicated U.S. counterterrorism capability like that of the West Germans and Israelis.<sup>83</sup> In October 1977 the JCS informed Brown that the United States possessed such a force built around two Ranger battalions, one always on alert status. Although not exclusively a counterterrorism force, these battalions could count on Air Force Special Operations and other units to support all-weather, low-level operations and night landings. For over a year, REDCOM had conducted counterterrorist exercises approximately every two months but still did not have a fully formed counterterrorism team. The Army therefore developed Special Forces Operational Detachment Delta (more commonly known as Delta Force), a small force of 172 soldiers with wartime special operations experience to undertake counterterrorism missions.<sup>84</sup> Speaking for DoD, Deputy Secretary Duncan remained wary of using U.S. military counterterrorism forces within the United States, suggesting that the Federal Bureau of Investigation might be the best candidate for the purpose. Secondly, Duncan recommended that “an on-the-scene presidential representative could in some cases enhance the chance of a successful conclusion to a terrorist event.”<sup>85</sup> The Carter administration explored the issue of command and control of antiterrorist operations without coming to a clear decision. In an overseas operation who would be in charge? Where did operational command of a military unit such as the Delta Force reside? Who would be in direct command of the force? Whose responsibility was it to respond to a terrorist incident within the United States?<sup>86</sup>

These issues were not fully resolved when the Carter administration ordered the rescue of the Iranian hostages. The failure of this ill-fated mission called into

question U.S. counterterrorism capabilities (see chapter 10). The main positive change resulting from the failed rescue operation was the creation of a permanent joint task force to conduct counterterrorism operations, commanded by an Army general officer with headquarters at Fort Bragg, North Carolina, and manned by members of the four services to perform joint administrative, intelligence, operations, training, logistics, planning, and communications functions. The Delta Force, elements of the Navy SEAL Command, and the Air Force's fixed- and rotary-wing aircraft, with pilots and crews, were the operating units of the force, whose primary peacetime mission was to remain ready to conduct counterterrorism operations. Brown approved the setup. Although terrorism during the Carter years—with the exception of the Iran hostages—did not pose a major threat to Americans, the organization of a counterterrorism structure that took place under Carter's and Brown's tenures created a foundation that would be refined and built upon by successive administrations.<sup>87</sup>

If terrorism and energy conservation provided new global issues for the Carter administration, the long-standing global concern about the use of the oceans caused serious disagreement among the JCS, OSD, State Department, and National Security Council. Some in the Carter White House saw the issue, as played out in the UN Law of the Sea (LOS) negotiations, as a way to implement the president's policy of bettering North-South relations (the administration's terminology for relations between industrialized nations and developing countries) by accepting an economic zone stretching 200 miles from national coastlines in addition to the traditional territorial 3-mile limit. A controversial provision in the negotiations would open international sea beds to all states for economic purposes—deep-sea mining was thought to be a potential economic bonanza for both developed and developing nations alike.<sup>88</sup>

The Defense Department, especially the Joint Chiefs, held that the 200-mile limit placed unacceptable restrictions on the freedom of the seas. Following JCS advice, Duncan sent Vance a request that the U.S. delegation to the LOS conference “retain the ‘high seas’ status of the Exclusive Economic Zone [the 200-mile limit] in explicit, unambiguous language,” otherwise DoD would have to recommend against signing and ratifying the treaty.<sup>89</sup> The State Department responded that it had made clear that, within the economic zones, the high seas freedom and reasonable military uses must be preserved, but it suggested that the treaty should not be

judged on one provision alone.<sup>90</sup> By August 1977 OSD and State came to a meeting of the minds. Law of the Sea chief negotiator, Ambassador at Large and former Secretary of Defense Elliot Richardson, agreed on the need for a formal interpretive statement that preserved traditional freedom of the seas within the 200-mile limit.<sup>91</sup> Although conceding that the draft treaty that emerged from the 1977 LOS session could permit an interpretation consistent with U.S. security needs, the Joint Chiefs also noted that coastal and archipelago states could interpret it the opposite way. Therefore, they recommended stronger, more direct language preserving freedom of the seas. They also requested interagency agreement that scientific research and sound surveillance systems (SOSUS) for submarine detection be allowed in the 200-mile zone, although the latter requirement would not be publicized.<sup>92</sup>

In mid-February 1978, at JCS urging, OSD informed State that the draft text of the treaty was still too ambiguous—it contained no specific grant of authority to conduct military exercises or operations in the economic zones or in archipelago sea lanes, no language stating that submarines could transit them while submerged, no provision for SOSUS and other military devices on continental shelves, and no military research exemption from restrictions on marine scientific research in the zones. OSD and JCS suggested an expanded interpretive statement beyond the Richardson one endorsed by the major maritime powers that specifically included these endeavors as permissible in the treaty. Richardson and the LOS staff expressed agreement but made no promises.<sup>93</sup>

DoD and LOS officials met in early July 1978 to discuss their differences, especially the need for clarifications pertaining to SOSUS, scientific and military research, and the right of aircraft to overfly the zones. Preferring unilateral statements to that effect, some in DoD became increasingly concerned that LOS advocates in the Carter administration were favoring the developing world. Still, Brown told the president that the current draft of the LOS treaty “adequately” accommodated DoD concerns.<sup>94</sup>

In late 1979 DoD submitted a schedule of extensive worldwide actions (exercises, transits, and overflights) to assert navigational rights and U.S. security interests against coastal states making claims that were clearly illegal.<sup>95</sup> Deputy Secretary Claytor explained to Brzezinski that even if an LOS treaty included these guarantees, it would not come into effect for three or four years: “In the meantime, a new body of customary international law claims could become so widespread and forceful as to

clearly be incompatible with basic U.S. security interests.” For that reason, DoD would exercise its right of innocent passage and free navigation, but State had not embarked on a corresponding diplomatic campaign to protest these coastal state self-declared restrictions. Brzezinski agreed that the State Department was foot-dragging and reiterated his support for the DoD program.<sup>96</sup>

Throughout 1980 the Carter administration approved an aggressive campaign to challenge illegal claims, but rejected as too risky using naval maneuvers off the Korean Peninsula in spring 1980 to contest North Korea’s claim of an exclusive military zone 50 miles from its coasts. Officials in the JCS and DoD suspected that State and the White House did not want to seem too belligerent against Pyongyang for fear of undermining the LOS treaty nearing completion. As it turned out, an LOS treaty was not completed until 1982, and the Reagan administration refused to sign it based on DoD concerns, the seabed mining provisions, and Carter’s support for it. Although the United States eventually abided by all provisions of the 1982 treaty, except seabed mining, it has not ratified the treaty as of 2016.<sup>97</sup>

The Law of the Sea dealt with all oceans. The Carter administration also focused upon the Indian Ocean as a potential candidate for U.S.-Soviet arms reductions. In his initial correspondence with Brezhnev, Carter suggested exploring arms control in the Indian Ocean. Since neither the United States nor the Soviet Union had large naval forces in the region, this idea seemed possible.<sup>98</sup> The Soviets generally deployed 19 ships (eight or nine were combat vessels including one or two submarines). The United States had a flagship and two destroyers based in Bahrain and deployed task groups from the Pacific Fleet into the Indian Ocean periodically during each year. The Soviet Union had a naval base at Berbera, Somalia; the United States had a naval facility at Diego Garcia, an island in the Indian Ocean. The Soviet Navy had more ships; the U.S. Navy had more firepower whenever a carrier task force from the Seventh Fleet made its annual visit to the Indian Ocean.<sup>99</sup>

The president initiated a study of arms control in the Indian Ocean that presented options for objectives and a negotiating strategy with the Soviets. The objectives ran from “demilitarization” (Carter used the term to DoD’s dismay) to a limited military balance below current levels to a freeze or cap near current levels. As for negotiating strategy, the options included an exchange of views; an exchange, plus a U.S. proposal for confidence-building measures and notifications of naval transits and deployments; general principles to guide future negotiations;

and formal negotiations with a U.S. draft outline of a bilateral agreement. The JCS supported the first option; OSD supported either the first or second.<sup>100</sup>

When the SCC met in early June 1977 prior to the U.S. delegation's departure for Moscow, there was general agreement that the talks should be exploratory, with State and DoD favoring inclusion of confidence-building measures. But what was to be explored? Most U.S. agencies remained wary of limiting the introduction of strike aircraft or ground forces—actions most likely to upset the current military balance already favorable to the United States—because it would raise the issue of Seventh Fleet carrier operations and land-based facilities of the French and British. Most SCC participants agreed that giving up Diego Garcia for Berbera was a poor trade. SCC members puzzled over what Carter meant by demilitarization, agreeing that it should be the end product of the negotiations, whereby the two superpowers would undertake gradually to reduce their military presence in the Indian Ocean.<sup>101</sup>

After the first negotiating session in Moscow, ACDA Director Paul Warnke reported that the Soviets were serious about the talks and were in them for the long haul.<sup>102</sup> The JCS expressed concern that the U.S. European allies' dependence on access to Middle East oil required an ability to deploy forces to protect the sea lanes in the Indian Ocean and Persian Gulf, and respond to terrorist attacks and potential harassment by littoral states. Any agreement with Moscow had to retain the ability to protect access to oil; it could not be negotiated away. The goal of the exchanges should be to prevent future increases in naval, air, and ground forces in the region, not to reduce them. Brown took a different view, suggesting that the United States could return to lower deployments of the recent past as long as any potential agreement allowed the United States to do what was required if it became engaged in hostilities in the Persian Gulf.<sup>103</sup> As the chart below suggests, the secretary contemplated a return to the pre-1973 and the 1976 levels, when U.S. ship-days per year were between 1,200 and 1,500 rather than the 2,000 plus of 1973–1975.

As recommended at SCC meetings in August and September 1977 and approved by the president, the stated U.S. objective of the talks was to stabilize the existing level of the U.S. and Soviet military for the next five years and then consider further reductions. Both State and ACDA preferred reductions from existing levels.<sup>104</sup> DoD strongly opposed banning submarine-launched ballistic



missiles, a precedent that could possibly limit a key U.S. strategic advantage. The issue came to a head at the September 1977 SCC meeting. The Joint Chiefs favored stabilizing the situation and avoiding assurances about future deployments of strategic systems to preserve maximum flexibility. Brown, supported by Vance, favored mutual restraint plus assurances that major strategic systems would not be deployed, but both secretaries were reluctantly prepared to go to some form of numerical limits on combatants, including submarines, and restraints on military facilities and land-based aircraft, if necessary. ACDA favored a numerical limit on combatants, a ban on submarines, restraint on facilities and land-based aircraft as the “only option that was truly negotiable.”<sup>105</sup>

Carter approved the Brown-Vance option: a mutual declaration of restraint that stabilized the military situation by not increasing current deployments for five years, with assurances that deployments of submarines would not increase and that no deployment of B-52s would take place during the five years. Moreover, both sides would agree not to construct facilities beyond those currently programmed (possibly affecting Diego Garcia).<sup>106</sup> The second round of talks in Washington in late September 1977, and the third in Bern in early December 1977, went well, with both sides tabling drafts.<sup>107</sup> It looked as if the Carter administration might sign a major arms restraint agreement. Then, from the Washington perspective, events deteriorated in the Indian Ocean littoral and the Persian Gulf.

Soviet support of the Marxist government in Ethiopia in its war against Somalia in early 1978 convinced the JCS that the Indian Ocean talks were a bad idea. On the recommendation of the Joint Chiefs, Brown suggested using the next meeting with the Soviets in Bern in February 1978 to indicate U.S. displeasure at Soviet activities in the Horn of Africa, which, if continued, would jeopardize the negotiations. The president agreed to a strong private warning to the Soviet negotiator.<sup>108</sup> The Soviet response at the second Bern talks was to stonewall. Warnke argued unsuccessfully in Washington to proceed without delay to the next round.<sup>109</sup> Once the Iranian Islamic revolutionary government came to power in late 1979 and later refused to return the U.S. hostages it held, any hope of an Indian Ocean agreement vanished. Carter increased U.S. presence in the Indian Ocean significantly as a signal to Tehran of U.S. resolve. Another arms control initiative slipped away.

The failure to negotiate with Moscow the demilitarization of the Indian Ocean added to Carter's string of misfortunes. The U.S.-Soviet arms control negotiations initiated with Brezhnev in March 1977 called for not only Indian Ocean demilitarization but also a nuclear test ban, a chemical weapons ban, and ASAT limitations. None of these initiatives succeeded. And in the UN Law of the Sea negotiations, which had aspects of arms control, the president also failed to achieve an agreement. It was not because the Joint Chiefs or the Defense Department actively opposed these arms control initiatives. The Chiefs, always concerned and cautious, usually came around to supporting them as long as their concerns about national security were accepted. Brown and OSD demonstrated even more willingness to negotiate with certain modifications. The failure was partially self-inflicted. The Carter administration undertook too many arms control negotiations, especially since the higher priority SALT II negotiations went on until mid-1979. Furthermore, the administration's negotiating strategy proved inconsistent, if not maladroit. The comprehensive test ban negotiations constituted the most obvious case in point, with the United States having to renege on some of its own proposals. Carter's initial loose talk of demilitarization of the Indian Ocean proved a poor negotiating tactic. These failings finally dawned on the administration in August 1979, when it attempted to establish guidelines for its ongoing multiple and future arms control negotiations. The resulting Brzezinski-inspired Presidential Directive 50, "Arms Control Decision Process," required that new proposals or significant modifications of positions in current arms control negotiations be weighed against four criteria. Did they contribute to U.S. defense and posture goals; deter or restrain adversaries; support allies; and promise to limit arms competition and reduce the likelihood of conflict? If new proposals did not meet these tests, they were not to be undertaken.<sup>110</sup>

In addition to juggling too many arms control negotiations, the Carter administration expected too much from the Soviets. Moscow was more than ready to negotiate but less willing to give real concessions without serious hard bargaining. Both superpowers quickly downplayed arms control when events changed or opportunities to gain advantage arose. For example, with the Iranian revolution and the potential Soviet threat to the Persian Gulf, Washington lost interest in Indian Ocean disarmament. Critics of the president still claimed he was naïve, too willing to negotiate away advantages. Admittedly the president set great store in

arms control, but when the Soviets invaded Afghanistan, he believed he had learned a bitter lesson from the realities of Cold War confrontation—the Soviets could not be trusted. Arms control negotiations with Moscow ceased.

What part did Brown and OSD play in this saga of unrealistic hopes and dashed expectations? Although not as committed as the president and his arms control advisers, Brown considered himself a member of the arms control chorus. Nevertheless, he took seriously his responsibility to transmit DoD (especially JCS) concerns about arms control weakening U.S. national security. As a result, arms control initiatives followed a pattern: initial optimism, some ill-advised strategies and proposals, and then a series of qualifications and modifications insisted upon by Defense, which for the most part the president accepted. The result often required backtracking at the negotiating table.

The balance sheet for the Carter administration's response to global issues was somewhat better. While Carter initial move to limit arms sales to developing countries with a demonstrated need had some success, eventually the pressure for sales, credits, and military assistance as a tool for foreign and national security policy overcame the president's effort. The global problems Carter faced defied easy solution. The energy crisis eased in the 1980s, but dependence on fossil fuels and its implications for the climate remain a problem. Terrorism would prove a long-standing and persistent threat to the United States. Conflict over control of the seas remains an ongoing issue, especially in East Asia.

Still, the administration enjoyed limited successes. It created a counterterrorism force structure, sounded the alarm in energy conservation, and raised the need for alternative sources. The Law of the Sea Convention defined how to protect U.S. navigation rights and security but failed to obtain resolution of the deep-sea mining issue to U.S. satisfaction. Congress refused to ratify the treaty. Carter's instincts for a world less threatened by military weapons, energy crises, or terrorism were admirable. Unfortunately circumstances—domestic pressure, national security considerations, Soviet hardball negotiating, and international crises—thwarted his administration's efforts to attain its arms control goals and a make greater progress on global issues. It was an all too familiar pattern of high expectations and good intentions giving way to the hard realities of Cold War confrontation.



## The FY 1979 Budget and the Future of the Navy

THE FISCAL YEAR 1979 Department of Defense budget provided the first real opportunity for Secretary of Defense Harold Brown and President Jimmy Carter to transform their public positions on defense spending into significant action. During the FY 1978 process, Brown and Carter could only tweak the Ford-Rumsfeld FY 1978 budget, because congressionally mandated deadlines required their revisions to the Ford submission just weeks after they assumed office. In FY 1979 they controlled the budget process from start to finish. Carter and his Office of Management and Budget staff were determined to take an early role in the DoD process. Brown and the OSD staff tried to retain their influence by working closely with the president and the OMB team. Still there were disagreements, the most basic one centering on Carter's campaign promise to cut defense spending by \$5 billion to \$7 billion and his promise to NATO allies, made at Brown's urging, to request that all alliance members pledge to allot 3 percent real growth (after inflation) of their overall budgets for defense spending, earmarking programs and weapons that strengthened the alliance. Reconciling competing promises of budget cuts and 3 percent real defense increases provided a stern challenge.

Brown shared most of the president's budget priorities but differed on some points. The secretary wished to upgrade NATO's conventional forces, including U.S. forces in Europe, which in 1977 were in deplorable condition (see chapter 7). Carter had campaigned on improving NATO forces, but when it came to paying for it he and OMB were less enthusiastic. Brown stressed the importance of maintaining the readiness of U.S. forces, a perennial loser in past budget decisions. Both men agreed that the Navy's shipbuilding plan, with the exception of Trident-equipped submarines and upgrades to older submarines with Trident missiles, would have to be limited.

The Air Force pressed hard for a new penetrating bomber capable of avoiding Soviet air defenses. Their hopes were dashed when Carter killed the B-1 bomber in June 1977 (see chapter 2). Brown strongly advocated cruise missiles on B-52 bombers. The Air Force also needed more tactical aircraft, an expensive proposition. Paying higher salaries and benefits to the All-Volunteer Force nibbled away at the overall Defense budget. Brown and Carter hoped to limit the trend. In Asia, Carter saw an opportunity to make at least a token saving by withdrawing U.S. combat troops from the peninsula. Brown and the Joint Chiefs thought it a bad idea that sent the wrong signal to North Korea, China, and the Soviet Union (see chapter 13).

In keeping with his NATO goals, Brown's budget proposed upgrading NATO's ability to withstand a Warsaw Pact conventional attack in Central Europe. This required increasing combat readiness, improving U.S. armor and antitank weapons, prepositioning supplies and equipment in Europe, and ensuring enough military airlift so that U.S.-based forces could join the battle before the Warsaw Pact overran Europe or NATO launched nuclear weapons. Such emphasis caused observers to dub the FY 1979 submission the "NATO budget" with a "Europe only strategy." Navy supporters grumbled that the budget was too focused on NATO, neglecting the formidable Soviet global naval threat.<sup>1</sup>

The Navy had good reason to feel anxious. If it ever believed that Annapolis graduate Carter would give preferential treatment to his former service, the Navy now viewed his emphasis on conventional war in Central Europe as favoring the Army. Carter's record thus far had not been encouraging. He had struck a serious blow at Ford's promise of an accelerated five-year shipbuilding program in the FY 1978 budget, concluding that the Navy's existing construction program was in chaos, plagued by delays, cost overruns, and lawsuits with private contract shipbuilders. The Navy lost the fight to build another *Nimitz*-class nuclear-powered carrier in the last days of Ford's presidency and witnessed Carter and Brown successfully blocking congressional demands for another in 1977 (see chapter 2). Advocates of large nuclear carriers viewed the FY 1979 budget as the last chance to obtain one during the Carter term.

The battle was not limited to seagoing vessels. Development of more advanced vertical/short takeoff and landing aircraft, able to operate from midsize and small aircraft carriers or other surface combatant ships, also figured in the debate. The Navy wanted V/STOLs as insurance for continuation of the carrier program; the

Marines wanted an updated version of their V/STOL, the British-designed AV-8A Harriers, already in service, for flexibility in close-air support. OSD preferred the less expensive, more flexible F-18 Hornet for the Marines and as carrier aircraft, but the Navy preferred the already-in-service F-14 Tomcat. Its greater capacity made it ideally suited for power projection against Soviet land targets. OSD's support for the F-18 implied a less dramatic role for the Navy—a return to the traditional role of control of convoys and sea lanes.<sup>2</sup>

The Navy enjoyed powerful allies in Congress who supported naval aviation and advocated nuclear carriers for power projection. In summer 1978, Congress successfully passed the FY 1979 weapons authorization bill that included construction of another \$2 billion *Nimitz*-class CVN, a direct challenge to Carter and Brown. With Brown's encouragement and support, the president took the unprecedented step of vetoing the Defense authorization bill. The House of Representatives sustained his veto. The FY 1979 budget process involved a choice between opposing visions of the Navy: a large naval force capable of countering the growing Soviet naval challenge, attacking Soviet flanks in a war in Europe, and projecting power worldwide; or a smaller, lighter naval force designed to defend NATO's sea-lanes. The FY 1979 budget battle proved to be a virtual referendum on the Navy's future.<sup>3</sup>

### **Budget Priorities and the FY 1979 Budget**

The formulation of the Defense budget typically involved a long and complex effort of about 20 months, with approximately half the time spent on intra-DoD planning, deliberations and negotiations among the JCS, the military services, Defense agencies, and OSD. There were short but intense periods of negotiation with the president and OMB. Finally, the secretary and his team shepherded the budget through the legislative process usually lasting about nine months. At any given time the secretary and OSD dealt with three budgets simultaneously. When Brown began considering the FY 1979 budget, Congress was still debating the FY 1978 as well as rescissions to the FY 1977 budget. Brown and his staff had to juggle these three budgets and master thousands of details about hundreds of defense programs.

The secretary had some advantages. As a veteran of Secretary Robert McNamara's Pentagon in the 1960s—as director of defense research and engineering and then as secretary of the Air Force—Brown had firsthand experience

with the Pentagon budget process, the Planning, Programming, and Budgeting System that McNamara introduced in 1962.<sup>4</sup> Brown had a tremendous talent for details relating to technical and budget issues. His extensive notes and comments on budget memoranda, issue papers, and studies indicate that the secretary was in one of his natural elements.

The PPBS required not only an FY 1979 budget, but a Five-Year Defense Program (FYDP) covering FYs 1979–1983. In 1976 the Joint Chiefs had kicked off the process by formally drafting their Joint Strategic Objectives Plan (JSOP), an assessment of the global military requirements and policies to meet national security over the next seven years. Between the Ford JSOP and the Carter administration's objectives there appeared an obvious disconnection, but the differences hardly mattered. By the mid-1970s those in the White House, OMB, and OSD for whom the JSOPs were ostensibly written considered them “irrelevant . . . wish lists” lacking fiscal constraints. Even the Joint Chiefs themselves acknowledged that these planning documents had lost their usefulness.<sup>5</sup>

The first budget planning document that Brown's OSD produced—prepared by Assistant Secretary of Defense (PA&E) Russell Murray—was the Planning and Program Guidance Memorandum (PPGM) for FYs 1979–1983, issued in March 1977. Perhaps more important was its accompanying fiscal guidance that set tentative dollar limits for the military departments, making deep cuts in the Ford 1978–1982 FYDP. Much of the guidance was noncontroversial. The Soviet Union remained the main threat; the People's Republic of China was not a major potential enemy. In descending order, U.S. security priorities ranged from the United States (and by extension the Western Hemisphere), Western Europe, Japan and Korea, the Middle East, the rest of the Pacific, Africa, and South Asia. To deter a conflict, U.S. armed forces required a clear and evident capability and resolve to win at any level with a flexible force structure able to respond to a wide range of nuclear and nonnuclear threats.<sup>6</sup> The PPGM left the basic conventional force structure as it was in late 1976: 16 active Army divisions, 8 reserve divisions; 26 active USAF wings, 10 reserve wings; 3 active Marine amphibious forces, 1 reserve force; for the Navy, 12 aircraft carriers (plus one for training), 80 attack submarines, and 203 surface combatants, of which 175 were active and 28 were reserve.<sup>7</sup>

The PPGM also provided specific guidance that caused some concern to the services and JCS because it narrowed their fields of responsibilities. The Army and



the Air Force would have as first priorities repelling a conventional Warsaw Pact attack in Central Europe, with a minimum loss of territory. The Navy's first priority would be to defend convoys in the North Atlantic. The PPGM's emphasis on NATO mobilization, deployment, combined operations, and an immediate combat capability required stockpiling of arms and equipment in Europe. Otherwise, on the assumption that NATO did not enjoy the luxury of supply capabilities over an extended period during a conventional war, it anticipated the Pact would overrun Western Europe before such reinforcements could arrive.<sup>8</sup>

As for strategic forces, the guidance recommended that current force levels remain stable, constrained by the informal 1976 Vladivostok understanding in the SALT II negotiations. Full-scale development work on the cruise missile and improvements in the Trident II submarine-launched ballistic missile received continued endorsement, but the fate of the B-1 bomber and MX missile remained undecided, awaiting Carter's decision on whether or not to produce them. After reading a summary by the Office of Program Analysis and Evaluation and glancing at the book-size PPGM, Brown approved issuance of the guidance, subject to revision after the Carter administration finished its review of national security policy later in the year (see chapter 5).<sup>9</sup>

The JCS responded in May 1977 in their Joint Force Memorandum (JFM) that the PPGM's programmed conventional forces would not be sufficient to fight two wars simultaneously, such as a major conflict in Central Europe and a lesser one in Korea. The only option would be to use nuclear weapons in one of the conflicts. The Joint Chiefs were less critical of the program for strategic forces. JCS concerns about conventional forces fell on deaf ears at OSD and the White House, indicative of the JCS's decreasing influence in the administration's defense planning.<sup>10</sup>

As the next step in the PPBS, each military department and Defense agency prepared its Program Objective Memorandum (POM)—their specific cases for force and manpower levels, procurement, support programs, and costs within the fiscal guidance. Brown instructed PA&E to assume responsibility for screening the POMs, coordinating issue papers, and resolving minor points. Brown and Deputy Secretary Charles Duncan reviewed the major POM submissions during summer 1977 and issued a Program Decision Memorandum that approved or disapproved the recommendations of the POMs. In mid-August Brown held meetings with the services and agencies to hear their reclaims of his decisions. Then, in September,

Brown issued an Amended Program Decision Memorandum (APDM), which conveyed the approved DoD program for each service and agency.<sup>11</sup>

For the Army, the process went relatively smoothly because the Carter-Brown emphasis on the buildup of conventional capabilities in Europe coincided with the main focus of the Army's POM: "mechanized warfare in Central Europe while providing for contingency options elsewhere in the world." Still, the Army expressed concern that it lacked sufficient combat and support manpower to fight a sustained war in Central Europe. OSD suggested the Army reallocate its priorities by focusing on prepositioning equipment, weapons, and supplies for units arriving in Europe from the United States via aircraft. The required 95,000 troops (five divisions) would pick up their already stored equipment and quickly engage the enemy in what was dubbed "a come as you are" war. OSD instructed the Army to deemphasize late deployment of combat and support troops and program prepositioning within its already allocated resources. The Army responded that it had not been allocated sufficient funds in the FYDP to do everything required of it in Europe, and that prepositioning equipment sets for five divisions over the next five years was impractical and needed a one-year deferral. It also claimed that the plan to reduce the number of military personnel by 33,100 (civilians were to replace about one-third of them) was a critical cut "antithetical to NATO interests." In response, Brown reduced the transfer of 12,000 soldiers to civilian slots to 1,500 conversions, as the Army had recommended in its POM, but he insisted on no delay in the prepositioning schedule.<sup>12</sup>

The Air Force enjoyed a noncontroversial experience, with the exception of funding for production of the B-1 bomber, which the president canceled in June 1977. Carter's B-1 decision forced the Air Force to revise its initial POM. In its amended version, the Air Force seconded Brown's recommendation that Carter emphasize development of air-launched cruise missiles and choose the B-52 D and G bombers as the "logical cruise missile carriers in the near term." The Air Force also proposed developing the FB-111, based on the F-111 fighter, as a possible penetrating bomber to supplement the B-52. Secretary of the Air Force John Stetson recommended modernizing the Minuteman II ICBM force and redeveloping the engine for the KC-135 Stratotanker (the Air Force's first jet aerial refueling tanker).<sup>13</sup> The Air Force opposed the OSD decisions to reduce the KC-135 force by 70 aircraft and not to re-engine existing tankers, arguing that both were "premature" measures,

given possible NATO needs. It also opposed the OSD decision to deactivate two tactical RF-4C Phantom II reconnaissance squadrons and convert F-111Ds (the Air Force's only all-weather tactical fighter) to reconnaissance aircraft at the cost of \$1 billion. The Air Force reiterated its desire to procure 145 F-16 fighters and opposed transfer of 26,000 positions from military to civilian status during 1979-1983, citing damage to its combat readiness, mobilization potential, wartime capacity, and rotation base. Responding to the reclama, Brown stood firm on his decision to reject the modernization of the Minuteman II force; opposed purchasing new engines for KC-135 tankers; cut the tanker force by 70 aircraft; allowed for procurement of 145 F-16s; restored one squadron of RF-4C Phantoms; and delayed other reconnaissance decisions until further study. The secretary restored all of the Air Force's 26,000 positions slated for civilian conversion.<sup>14</sup>

The Navy's experience during this process was a far cry from that of the Army or the Air Force. Both the White House and OSD set their sights on reducing the Navy's expensive five-year shipbuilding program, by now seriously behind on already-funded ship construction and mired in lawsuits with contractors.<sup>15</sup> Furthermore some critics, especially in OMB, strongly believed that the Navy needed to change its role from power projection based on large aircraft carriers, their escorts, and high-performance naval aviation to a leaner force designed to secure the sea-lanes to Europe or elsewhere in the event of a war. This sea control mission for the Navy's future hardly appealed to the admirals or strong-willed Secretary of the Navy Graham Claytor.<sup>16</sup>

Nonetheless, the Navy had to operate within predetermined tight fiscal guidelines. When submitting its POM for the Five-Year Defense Program at the end of May 1977, it deferred full funding of the midsize conventionally powered carrier (CVV) until FY 1980, but it included long lead money for it in FY 1979 to minimize delay in delivery. Claytor proposed a second CVV in FY 1982 and the construction of four derivative *Virginia*-class nuclear Aegis cruisers during FYs 1979-1983. Although less expensive than strike cruisers, Aegis cruisers were still able to defend aircraft carriers against massed Soviet cruise missile raids or act independently in combat. The "build and charter method" whereby the Navy chartered auxiliary vessels built at private expense, thus bypassing the DoD procurement process, seemed to Claytor a way to reduce initial funding and allow for earlier starts in construction of auxiliaries. As for aircraft, Claytor expressed concern about the F-18's suitability. The Navy proposed to develop both a supersonic and subsonic V/STOL aircraft,

replace the Marines' light attack force of AV-8A Harriers with AV-8Bs (a higher performance version of the vertical takeoff airplane), and in the interim upgrade the existing AV-8As. As for strategic forces, the Navy recommended delaying Trident II missile development by a year and accelerating the retirement of Polaris submarines during FYs 1979–1983.<sup>17</sup>

Brown's PDM slowed down development of V/STOL aircraft "until it has been shown that CTOL [conventional takeoff and landing] is no longer the more cost-effective way of accomplishing the Navy's primary sea-base aircraft missions" and rejected the Marines conversion to V/STOL AV-8B Harriers. It also prescribed for auxiliary and support ships regular funding, not "build and charter." Aegis nuclear cruisers designed to protect carriers were to be acquired at the rate of one every other year, beginning in FY 1979, and procurement of mine countermeasure (MCM) ships was put on hold until new MCM technology had been evaluated and Soviet deep-water mining countered. The secretary also lowered the amphibious lift objective to 115 percent from its previous 133 percent level of one Marine Amphibious Force and cancelled the LSD-41 dock landing ship program. He relegated Polaris-carrying submarines to caretaker status instead of retirement, thus keeping them in the force structure.<sup>18</sup>

In its reclama, the Navy objected strongly to the slowdown of V/STOL development, cancellation of AV-8Bs for the Marines, and reduction of amphibious lift capabilities, asking for full restoration of all three. The Navy also recommended restoration of the MCM force and full retirement of Polaris missile submarines, arguing that a caretaker status for submarines was inefficient. In response, Brown restored V/STOL development in FYs 1979 and 1980, but reduced its FYs 1981–1983 funding; allowed procurement of five MCM ships during FY 1980–1983; and deferred revision of the reduced amphibious lift objective until an evaluation of the AV-8B versus the F-18 was completed. Brown made no changes in plans to place Polaris submarines in caretaker status.<sup>19</sup>

Brown and PA&E also differed sharply with the Navy on which fighter aircraft to procure for carriers. The Navy wanted more high-performance Grumman-built F-14 Tomcats, a supersonic, twin-engine, two-seat, variable swing-wing aircraft, which it used as its primary air superiority fighter and fleet interceptor (the F-14 was reputed to be the only U.S. aircraft capable of shooting down a Soviet MiG-25 at very high altitudes). Brown and PA&E preferred the cheaper McDonnell Douglas-built F-18

Hornet, an all-weather, multipurpose fighter with less range and payload than the F-14. The versatile F-18 could be a fighter, fleet interceptor, or land-based attack bomber.<sup>20</sup>

In June 1977 PA&E sent Brown an issue paper maintaining that the Navy had been so wedded to the F-14 (costing \$19.2 million per unit) that it had skimped on its other aviation needs, resulting in excessive and eventual decline in force levels of its fighter aircraft. Since 1970, instead of buying 180 light fighters per year to fill the fleet's needs, the PA&E paper charged that the Navy procured only 60 per year, having invested so much of its money on F-14s.<sup>21</sup> Not surprisingly, Brown had little sympathy for acting Secretary of the Navy R. James Woolsey Jr.'s recommendation to cancel development of the F-18 as a cost-saving measure and to rely on additional re-engined F-14s and subsonic Vietnam-era A-7E Corsairs. The Navy justified the F-14 as the only aircraft capable of countering the major maritime threat of the 1980s, the Soviet Backfire bomber whose range extended from the Soviet Far East mainland to Pearl Harbor in the Pacific and from its European mainland to the Azores in the Atlantic. The F-18 was not "a lower cost complement to the F-14. It is, rather, a lower capability substitute," Woolsey maintained. Behind this debate lurked the larger issue of the future of the Navy. Longer-range F-14s on carriers allowed the Navy to engage the Soviet Union at greater distance from its shores; the F-18 relegated the Navy to either a more dangerous role closer to the enemy's mainland or more likely, as some Navy officials told the press, to "brush fire" wars far from the main U.S.-Soviet conflict.<sup>22</sup>



An F-18 Hornet fighter readies for a flight demonstration, September 1981. (RG 330, NARA II)



An F-14 Tomcat fighter lands onboard the *USS Independence*, June 1979. (RG 330, NARA II)

An equally intense debate swirled around the future of Marine aviation. Brown refused to develop a newer version of the British-designed AV-8B Harrier until he determined how it matched up with the F-18. In early November 1977, Claytor forwarded to Brown the Navy's study of the cost effectiveness of the two aircraft. It concluded that the costs were equal, but that the AV-8B would be more effective in close-air support and would provide the dominant mobility and flexibility required by the Marine Corps. A PA&E evaluation came to an opposite conclusion. For the same money on the basis of proper discounted costs, OSD could procure 25 percent more F-18s than AV-8Bs. PA&E believed the Navy's analysis of method of operations in the study were skewed to make the AV-8B look better. Most important, in PA&E's view, the F-18 offered outstanding flexibility, providing a local commander more than twice the air-to-air capability of the Harrier, as well as better interdiction capability. To PA&E, the F-18 "dominated the AV-8B." Claytor strongly disagreed, suggesting that the Navy study was "surprisingly, almost artlessly objective" and the prime role of the AV-8B was close-air support. As it had in past operations, the Marines would rely on other carrier aircraft to provide initial air superiority and deep interdiction. Only if air superiority and interdiction were the main criteria—and the Navy believed not—could the F-18 be considered the better airplane.<sup>23</sup>



A Marine AV-8B Harrier II takes off from an amphibious assault ship, October 1979. (RG 330, NARA II)

Brown's marginal comments on the Navy and PA&E issue papers reflected his skepticism about the AV-8B. The British-built Harrier had proved a difficult aircraft to fly, having crashed 26 times since it was acquired in 1971, resulting in the deaths of 10 pilots. Claytor assured Brown that 18 or 19 of the accidents were due to pilot error, not design deficiencies. In any case, Claytor commented, to make the Harrier more stable in vertical flight the Navy had developed a design modification, which would be included in the AV-8B model and retrofitted into AV-8As. Further complicating the problem, Brown had to contend with strong congressional support for the F-18 from Speaker of the House Tip O'Neill and Senators Edward Kennedy and Edward W. Brooke (R-MA), in whose state F-18 engines were made.<sup>24</sup> Facing competing pressures from Congress, the Navy, and an OMB that strongly preferred the cheaper F-18, Brown compromised by procuring five of the aircraft (the minimum production without contract renegotiation) and continuing reduced research and development on the AV-8B. As for F-14s, Brown cut the FY 1979 procurement of these aircraft from 36 to 24.<sup>25</sup>

In this budget process the secretary and his OSD staff, especially the assistant secretary (PA&E), fulfilled the role of counterweight to the military services' demands for newer and more expensive weapons. This is not to say that Brown

was opposed to defense spending. Rather he was committed to obtaining the best defense at the best price. Brown took seriously the technical analysis his staff provided and did his best to balance competing interests and priorities, seeking the best weapon systems for the long-term capabilities of the services.

### **President Carter and the DoD Budget**

Brown and OSD contended not only with the needs of the competing services but with a president and an OMB staff with strong views about their role in Defense budgeting. At a meeting with the secretary on 31 January 1977, Carter insisted on early and periodic White House involvement to avoid *fait accompli* at the end of the budget consideration. Carter planned to meet with Brown and DoD budget officials in May, August, and December.<sup>26</sup> In addition, Carter instituted zero-based budgeting (ZBB), a system that theoretically required budget planners to justify their entire budget each year from scratch, not just add or subtract from the previous year's budget. Employing ZBB as governor of Georgia, Carter highlighted it during the presidential campaign as a reform that he would institute government-wide. Many in OSD noticed that the PPBS had "many inherent features which are similar to ZBB." Deputy Assistant Secretary for Administration Doc Cooke recalled that PPBS did all that ZBB required and that ZBB requirements were just "extra work." Brown was also dubious about the system: "You can't keep pulling up the plants to look at the roots every year," but for the White House ZBB was nonnegotiable. Dutifully charging DoD in late April 1977 with implementing it, Brown assured the president that Defense could handle ZBB and that "our proposals must meet your commitment to assure all spending programs meet a clear test of need."<sup>27</sup>

In addition to ZBB, OMB officials tried to interject themselves directly into the PPBS system. Assistant Secretary (PA&E) Murray recommended providing OMB relevant issue papers for comment, just as OSD did with the services, but he opposed OMB attendance at budget meetings with the secretary: "This would keep OMB rather more at arm's length, while you are coming to your own positions." Brown approved but also decided to meet privately with OMB's chief defense analyst Edward R. "Randy" Jayne, Murray, and Assistant Secretary of Defense (Comptroller) Fred P. Wacker periodically.<sup>28</sup>

In early June 1977, during a somewhat delayed "spring budget review," Carter met with Brown, Wacker, and other OSD and OMB budget officials for just under



three hours to discuss the DoD budget. OMB prepared 26 key budget issues, with possible alternative decisions and their associated costs, anticipating that the president would make preliminary decisions on each. The NSC staff analyzed them and provided comments and questions for Carter. In briefing the president, National Security Adviser Zbigniew Brzezinski warned him “to emphasize the preliminary nature of your preferences on individual issues,” lest he limit his ability to revise the budget. Issue number one in the OMB paper was the size of the DoD budget, with OMB recommending a FY 1979 total obligational authority of \$127 billion, which resulted in less than 2 percent real growth as opposed to Ford’s projected 3 percent. For his part, Brzezinski argued it was unnecessary to define the budget so carefully, recommending a range from \$125 billion (“OMB’s ‘lower’ budget level”) to the \$135 billion preliminary target Brown had suggested in March.<sup>29</sup> Signaling its view of the future of the Navy, OMB recommended reducing the carrier force from 12 to 8 carriers by 1982, with Air Force or Navy land-based aircraft replacing the four carriers in sea control and power projection missions. OMB also envisioned a total fleet size of 470 vessels in 1995. The NSC staff, however, favored 12 carriers and a future fleet of 550 ships. The president, Brown, and budget advisers discussed these issues in a preliminary way, but the meeting did not bode well for the DoD budget and boded ill for the Navy.<sup>30</sup>

In July 1977, citing the president’s decision to balance the budget in 1981, Lance provided Brown with presidential fiscal guidance for the FY 1979 budget of just under \$125.7 billion TOA and just over \$117 billion in outlays. Brown queried, “Is it customary for SecDef to get a bogey [a numerical standard of performance to be aimed at]?” Wacker replied it was, although “the depth of the President’s involvement this year is unique, however.” To Brown’s question of whether the figures would allow “real growth” over FY 1978, Wacker responded affirmatively—about 3 percent real growth (although Wacker was referring only to outlays).<sup>31</sup>

The president next became involved in the fall budget review, which began in September and culminated in a mid-January transmittal of the budget to Congress. In mid-December 1977 Brown told Carter that he and Duncan had been through the 300 decision packages containing about 2,000 decisions. After Brown and Duncan went through the budget twice, ranking the elements (the second time with relevant under secretaries and assistant secretaries of defense), they met with the military departments (secretary and military chief) to hash out figures. The

programs were ranked in five priority bands (in keeping with ZBB). In Brown's view, the program levels through priority bands one to three (totaling \$130 billion TOA) were the right ones for FY 1979, because they signaled the administration's resolve and determination to maintain a military balance with the USSR.<sup>32</sup>

OMB officials found the \$130 billion too much. They hoped to keep TOA to \$125 billion. OSD countered that the president had promised real growth of 3 percent to the NATO allies, a policy confirmed in Presidential Directive 18, "U.S. National Strategy," issued on 24 August 1977 (see chapter 5). As a fallback position, OMB floated the idea of funding only NATO-related programs at 3 percent increase in real growth and the rest of the budget at 1 percent. On the advice of Special Assistant for NATO Robert Komer, Murray, and Assistant Secretary of Defense (ISA) David McGiffert, Brown argued that the allies hardly could be asked to increase their total defense budgets by 3 percent while the United States increased only NATO-related funding by that figure. The total budget was the litmus test by which allies and adversaries measured U.S. defense. Brown reminded Carter that Congress had cut the last 10 budgets substantially. It was nearly impossible to separate NATO and non-NATO items, and it would be a mistake. As the secretary put it, "Playing with allocations is too easy a game—and all can play at it. . . . In the end we would find that everyone had decreased his real efforts while pretending to increase them."<sup>33</sup>

After a 16 December 1977 meeting with Brown, OMB, and DoD officials, Carter decided on a Defense budget of \$126 billion TOA and \$115.2 billion in outlays, much closer to OMB's figure than Brown's. Outlays of \$115.2 billion represented 3.1 percent real growth (counting 1977 inflation at over 6 percent) over FY 1978 outlays of \$105.3 billion, but total TOA real growth of \$126 billion was only—allowing for inflation—1.9 percent over FY 1978's \$116.8 billion. Brown's effort with the president killed OMB's ill-advised 3 percent NATO-items-only scheme, added \$1 billion additional funding to the president's figure, but just barely fulfilled the NATO pledge of a 3 percent rise in defense spending after inflation by meeting the benchmark only in outlays. More important to Carter, his budget came in at over \$8 billion less than Ford's projected TOA and \$5 billion less in outlays, more than fulfilling his campaign promise of \$5 billion to \$7 billion in savings.<sup>34</sup> After more than a year of work, intra-DoD debate, and negotiation with the president and OMB, Brown had the FY 1979 budget ready for submission to Congress, where the debate would be renewed, especially over force levels and funding for the Navy.



The nuclear-powered aircraft carrier USS *Nimitz* en route to its homeport of Norfolk, Virginia, May 1981. (RG 330, NARA II)

OMB did not envision its role solely as holding down the DoD budget. It ventured into force planning with a paper issued in early November 1977, titled “Navy Roles, Missions, and Related Combatant Ship Requirements,” which struck at the heart of the Navy’s traditional reliance on the aircraft carrier. OMB wanted to reexamine the concept of the carrier as the backbone of the Navy, given the extreme expense of carriers and their escort protection as well as their vulnerability to mass cruise missile attack and other Soviet high-technology, anticarrier efforts. The availability of alternatives, OMB maintained, such as advances in cruise missiles, guidance, sensors, communications, command and control, mining, and aircraft technology created less expensive options for some of the missions now performed by carriers, thus saving money without impacting adversely the security of the United States or its allies. Brown insisted that the Navy be given the opportunity to comment on the paper.<sup>35</sup>

Claytor did not mince words: “The analysis is neither accurate nor adequate. The options are not appropriate, and the President should be afforded the opportunity to review the findings of the Naval Force Planning Study.” The secretary of the Navy was not opposed to discussing carriers with the president but recommended doing it in March 1978, when the results of the related DoD studies would be available. Claytor raised another concern: cutting back or killing V/STOL and the AV-8B programs would force him to reconsider his support for delaying a CVV until FY 1980. Without V/STOL, the Navy would need to procure more CVVs with conventional aircraft. The cost-effectiveness of such midsize carriers in greater numbers had yet to be demonstrated to Congress. Without the transition to V/STOL, Claytor warned, “There may well be no political choice available other than a [single] NIMITZ [CVN] in FY 1979.”<sup>36</sup>

According to Murray, one of the main motivations of the OMB paper was to dissuade Congress from insisting on another *Nimitz*-class CVN when it debated the FY 1979 budget. Carriers were indispensable to the Navy’s five-year shipbuilding program since over half of the Navy’s active ships were numerically derived from the planned number of carriers. Brown commented that it would “take a lot of arguing to keep Congress from preemption” in favor of another CVN. Murray echoed these sentiments, noting that “we will need very convincing rationale and a sustained effort to get Congress to go along with deferral of carrier procurement for another year.”<sup>37</sup>

Brown accepted Claytor’s advice and recommended to Carter on 1 December not to rush into restructuring the Navy, as OMB implied, but rather to wait for the two soon-to-be-released studies on the Navy. The secretary raised other reasons to delay: the foreign policy implications (ignored by OMB) of reduction to eight carriers and the need to wait at least two years to see if V/STOL would provide viable alternatives to conventional carrier-launched aircraft. To Brown, the OMB paper lacked sufficient information. While some options had merit, they were premature. To prevent Congress from overriding the administration by insisting on funding a CVN in FY 1979, Brown urged using the fact that aircraft carriers were under active study to ask Congress to delay tackling the issue until the FY 1980 budget debate. While Carter no doubt sympathized with OMB’s small-Navy advocates, he accepted Brown’s recommendations.<sup>38</sup>

## The Navy at Center Stage

On 23 January 1978 Brown described the FY 1979 budget as “austere but adequate.” Carter had characterized it as “prudent and tight” when he submitted it to Congress three days earlier.<sup>39</sup> The budget focused on three main goals: maintaining essential equivalence with the Soviet Union in strategic weapons; enhancing combat capacity of U.S. NATO and other NATO member forces; and improving readiness of U.S. forces worldwide. Most observers described it as the “NATO budget.”<sup>40</sup> It included funds for increased helicopter production, increased purchases of A-10 antitank aircraft, and production of 110-unit XM1 tanks. It provided for continued production of 508 M60 tanks, purchase of artillery and ammunition, and repositioning—all enhancing NATO capabilities against potential Warsaw Pact blitzkrieg-type armored thrusts spearheaded by a combined heavy tank and air support assault. For tactical aircraft, the budget requested additional A-4 Skyhawks and F-16 Fighting Falcons and initial production of F-18 Hornets for the Navy as well as production funding for an advanced tanker/cargo aircraft for the Air Force. To upgrade potential nuclear counterattack of Warsaw Pact targets at different ranges, the budget also called for purchases of additional theater nuclear weapons, including the 70-mile-range Lance, 400-mile Pershing, and the 2,000-mile ground-launched cruise missile, now ready for production. As for standardization and interoperability of NATO weapon systems, the budget requested purchase of the French-German-designed Roland surface-to-air missile and Belgian and British small arms, in addition to maximizing commonality between the XM1 and German Leopard II tanks, arming both with German 120mm smoothbore guns.<sup>41</sup>

While supportive of NATO, the budget dramatically cut Navy programs. It slashed shipbuilding for FY 1979 from Ford’s 29 vessels to 15 and reduced funding by \$1.1 billion from the FY 1978 budget—half of it the result of procurement of only one Trident-equipped *Ohio*-class submarine in FY 1979 (in keeping with the pattern of three new submarines every two years, with FY 1979 being the one submarine year) and decreased combatant vessels from 11 to 9. The CVV and an Aegis cruiser were delayed for a year. Research and development of V/STOL and procurement of two prototype AV-8Bs also represented stopgap measures, basically awaiting the results of the Navy studies expected in February and March 1978.<sup>42</sup> The construction of a frigate-size surface-effect ship, capable of speeds of 80 to 100 nautical miles per hour on a cushion of air, was cancelled.<sup>43</sup> The budget gave the

Navy little to celebrate in the face of what it considered a growing Soviet maritime threat. To the Navy, the Soviets were fast approaching a serious challenge to U.S. blue-water maritime dominance.<sup>44</sup>

Strategic missile force levels remained constant: 450 Minuteman II missiles, 550 Minuteman III, 54 Titan II missiles, 10 submarines with Polaris missiles, 31 submarines with Poseidon missiles, and 24 squadrons of B-52 and FB-111 bombers. Plans to upgrade the FB-111 as a more sophisticated penetrating bomber were cancelled. Accelerated development of air-launched cruise missiles and upgrading of B-52s as ACLM carriers and penetrating bombers continued. MX missile development remained on hold until its basing requirements were settled and its vulnerability to Soviet attack determined. Its funding for R&D and prototypes was held at a modest \$158.2 million, much less than the \$1 billion the Air Force had wanted. At the other end of the spectrum from strategic weapons of mass destruction, the budget scheduled cuts in the active-duty military (20,000 personnel) and in the reserves (14,000 personnel). The cuts in the reserves hit the Navy the hardest since the Army Reserve and National Guard were actually increased. The budget also cut DoD civilian manpower by 13,000.<sup>45</sup>

In parts of DoD and the services there were rumblings that Brown had conceded too much control of the details in the budget process. Less charitable interpretations held that a “wishy-washy” Brown had caved to presidential and OMB pressure for cuts. One anonymous “close aide” to the secretary told a reporter, “Harold really thinks of himself as an agent of the White House rather than a defender of the military.” Compared with recent secretaries, such as Melvin Laird who fought against Henry Kissinger and Richard Nixon over the DoD budget, or James Schlesinger who brashly protected defense spending against Ford and Kissinger, Brown accommodated the president’s insistence on having the final say. That was part of the deal in becoming secretary of defense, as the president made clear from the start. Most agreed, however, that Brown had successfully centralized the budget process in OSD to the point where his control matched that of Brown’s old boss, Robert McNamara.<sup>46</sup>

The reaction from the pundits was predictable. To conservative defense hawks, Carter was “markedly closer to George McGovern than Scoop Jackson”; to liberals, the “prudent defense budget” was “refreshing and reassuring.”<sup>47</sup> While media and public opinion counted, the fate of the budget rested squarely in Congress, where many senators, representatives, and their staffs believed that the Navy was being

shortchanged. The epicenter of unwavering support of all things naval, but especially large nuclear carriers, the House Armed Services Subcommittee on Seapower, under the chairmanship of Representative Charles E. Bennett (D-FL), set the tone for House legislation on the Navy.<sup>48</sup> In the previous year's budget debate, Navy officers had refrained from criticizing the FY 1978 budget with this subcommittee, other committees, individual members of Congress, and congressional staff. FY 1979 was a different matter. Behind the scenes Navy officials lobbied Congress to the point where an exasperated Brown stated, "I'm not about to gag anybody. It's not appropriate or feasible. But I think the services recognize that although private approaches to individuals [senators or representatives] or staff members in Congress can have an effect, it can also have a negative effect on me." Brown suggested that if naval officers disagreed with the administration, they had the option of resigning and taking their case public.<sup>49</sup> For his part, Claytor walked a fine line in his congressional testimony, supporting midsize carriers, reduced ship construction, and slowdowns in development and procurement in naval aviation, but he reportedly was starting to crack.<sup>50</sup>

At the annual forum at the Navy War College in Newport, Rhode Island, in March 1978, attended by Claytor, NSC and OMB staffers, contractors and businessmen, and current and retired naval officers, the cracks appeared for all to see. What the Carter White House had been thinking privately for months, OMB's Randy Jayne articulated publicly at the Newport forum. He maintained that Soviet antiship cruise missiles precluded the Navy from attacking the Soviet Union on its flanks, as naval doctrine assumed. As Jayne told it, the Navy would probably require most of its resources "simply to stay afloat" in a conflict in the Mediterranean or Barents Sea against Soviet forces. Additional ship construction, Jayne maintained, was not possible with multimillion dollar cost overruns, two-year delays, and lawsuits with contractors; it was time for "bailing out the bilge," not "damn the torpedoes, full-speed ahead." To get additional ships, the Navy had to reform its ways.<sup>51</sup>

Such straight talk clashed with the two recently completed Navy studies. Prepared in response to the Carter administration's national security review, the Navy's Force Study, "Sea Plan 2000," argued that with 30-year-life-span ships, the Navy should be designed for the long haul rather than retrofitted to current circumstances. Looking to the late 1980s, U.S. naval forces could use breakthroughs in cruise missile defense to protect a fleet as it tied down Soviet forces on NATO's flanks with direct strikes on Soviet land bases. The study also suggested that fewer

than 12 conventional or nuclear carriers (14 preferred) would require removal of one carrier from forward deployment in the Mediterranean or Pacific, “with attendant high political costs,” especially in prestige and power projection. The plan concluded that a 535-ship Navy in 2000 would just be adequate. A lesser option of 439 ships was a “high risk option with a low degree of flexibility” that provided only “minimal capability.” The optimum, 585 ships, provided “a high degree of versatility.” The “Assessment of the Sea-Based Air Platform Project Report,” a study mandated by the FY 1978 budget, endorsed all carriers: *Nimitz*-class CVNs (approximately 91,000 tons) were more effective than a slightly larger force of midsize-CVVs (approximately 60,000 tons), but the two were “generally comparable.” Even smaller carriers (20,000–30,000 tons) with V/STOL aircraft, if procured in sufficient numbers, had some real advantages.<sup>52</sup> Claytor declared at the Newport symposium that if Congress funded another *Nimitz*, he would build it.<sup>53</sup>

As the public debate over the future of the Navy heated up, Brown testified on Capitol Hill on the FY 1979 budget. Although not the only issues (personnel and total size of the Navy were others), carriers and aircraft dominated the dialogue. In early March 1978, Brown wrote the president that he had completed testifying before the Senate and House Armed Services, Appropriations, and Budget Committees. The House Armed Services Committee was recommending \$2.6 billion more than the administration’s request, including provision for an Aegis destroyer, a nuclear-powered carrier, and additional aircraft. Brown informed Carter that the committee also recommended an additional 10,500 active-duty military personnel, 14,000 civilians, and 35,600 naval reservists. Carter commented: “Try to hold to our budget.” On 24 March, after meeting with Senate Armed Services Committee Chairman John Stennis, House Appropriations Committee Chairman George Mahon, and Seapower Subcommittee Chairman Bennett, Brown informed the president that “increases above our budget request, to include at least a nuclear carrier and additional fighter aircraft, are very likely to be authorized, and probably appropriated.” Brown vowed to resist these “very strong pressures for defense increases.”<sup>54</sup>

Navy proponents were riding a wave of support in Congress. During Seapower Subcommittee hearings, soon-to-retire Chief of Naval Operations Admiral James Holloway and Claytor provided tepid support for the Carter-Brown five-year ship-building plans for a fleet of 400–450 ships. They suggested that the cutback should only be temporary. Holloway stated that a fleet of 535 ships would give him reasonable



confidence, but 585 would provide “a substantial degree of confidence” of U.S. naval superiority.<sup>55</sup> Against growing criticism, Brown suggested to Carter and Brzezinski that the president use his speech at Wake Forest University in mid-March to send a powerful message that the United States would “not allow the Soviets to gain a military or political advantage by outstripping us.” The secretary warned that the Republicans planned to make defense a major campaign issue in the 1978 congressional elections: “We need to get out ahead of them on this issue.” Brown envisioned the president’s speech as “a firm and unapologetic commitment to an adequate defense.”<sup>56</sup> Carter’s speech at Wake Forest articulated a good justification of defense spending, but its effect on a public concerned with the state of America’s defense was less clear.<sup>57</sup>

During April and May 1978 the House and Senate Armed Services Committees worked on the Defense weapons authorization bill for FY 1979. Brown informed the president in late April of the committee’s markup, which included \$2.4 billion more than the administration’s request—altogether \$2.1 billion toward a nuclear carrier, \$1.1 billion for a nuclear cruiser, procurement of an additional 12 F-14s, 4 F-18s, 16 C-130s, 40 A-7s, and long-lead money for additional aircraft. Offsetting some of the increase, the committee recommended a cutoff of all but long-lead procurement funds for the Trident missile submarine for FY 1979 and cuts in research and development for the B-1 and cruise missile carriers. This last action, Brown suggested, would cheer hearts in the Kremlin, since the Soviets had been desperately trying to prohibit such new carriers at the SALT negotiations. Brown mentioned a few “sad example[s] of Congressional irresponsibility”: \$8.1 million for a luxury Gulf Stream II for the Marine Corps top brass and \$19.65 million in similar spending for the Army.<sup>58</sup>

From the administration’s viewpoint, the Senate Armed Services Committee markup of the authorization bill in early May offered only a minor improvement. The committee added a nuclear carrier, but not a nuclear cruiser, and the Senate’s most vociferous supporter of V/STOL and small carriers, Gary W. Hart (D-CO), successfully pushed the committee to add \$700 million for an amphibious assault ship, \$45 million to convert an amphibious helicopter assault ship to carry Harriers, more funding for Harriers, and more design money for another small carrier. Even with postponement of the FY 1979 Trident-equipped submarine, the additional funding for shipbuilding added \$2 billion to the administration’s request. While the SCAS authorized cruise missile carrier funds, it cut procurement of M60 tanks drastically. Assuring the president that Stennis was working to prevent more add-ons,

Brown warned it would be an uphill fight. The secretary then raised the possibility of a deal with Stennis and Representative Les Aspin: move up the midsize CVV to FY 1979 to avoid building a CVN. The senator from Mississippi was not optimistic given the strong preference in the committee for a nuclear carrier. Aspin thought it would take the active support of House Majority Leader Jim Wright and House Appropriations Committee Chairman George Mahon, as well as that of Brown and Carter, to pull it off.<sup>59</sup>

**Table 4. Major Weapons Authorizations, FY 1979 (\$ millions)**

	Carter Request		House Passed		Senate Passed		Final Action	
	No.	Amount	No.	Amount	No.	Amount	No.	Amount
<b>Strategic Warfare</b>								
Ballistic missile submarine	1	1,186.7	—	274.8	—	55.0	—	274.8
Trident missiles	86	814.3	86	814.3	86	814.3	86	814.3
MX missile	—	158.2	—	158.2	—	158.2	—	158.2
Widebody cruise missile carrier	—	41.2	—	—	—	41.2	—	20.6
Civil defense	—	96.5	—	137.0	—	96.5	—	96.5
<b>Ground Warfare</b>								
XM1 tank	110	403.1	110	368.5	110	368.5	110	368.5
M60 tank	480	383.8	480	383.8	240	191.8	410	345.0
M60 modernization	220	98.4	500	147.6	460	162.1	380	132.4
Infantry fighting vehicle	—	—	—	34.6	—	39.0	—	39.0
M113 troop carrier	910	74.2	910	74.2	550	44.5	550	44.5
<b>Naval Warfare</b>								
Nuclear aircraft carrier	—	—	1	2,129.6	1	1,930.0	1	1,930.0
Aegis cruiser	—	—	1	1,096.0	—	—	—	369.0
Missile frigate	8	1,533.1	8	1,533.1	8	1,533.1	8	1,533.1
Attack submarine	1	433.0	1	433.0	1	433.0	1	433.0
Surface effect ship	—	—	—	93.0	—	30.0	—	80.0
<b>Tactical Airpower</b>								
F-15 fighter	78	1,328.7	78	1,328.7	78	1,328.7	78	1,328.7
F-16 fighter	145	1,375.1	145	1,375.1	145	1,375.1	145	1,375.1
F-14 fighter	24	632.2	36	834.4	28	729.3	36	834.4
F-18 fighter	5	350.5	9	488.5	9	484.5	9	484.5
A-4M light bomber	18	113.0	—	—	—	—	—	—
<b>V/STOL-Related</b>								
Harrier V/STOL light bomber	—	—	15	90.0	—	—	—	—
Advanced Harrier	—	85.6	—	85.6	—	173.0	—	173.0
Other V/STOL research	—	72.4	—	15.5	—	55.5	—	35.5

*(Some amounts include funds for spare parts and for advance payments on additional items to be purchased in FY 1980.)*

Source: *Congressional Quarterly Almanac*, 1978, vol. 34 (Washington, DC: Congressional Quarterly, 1979), 322.

The secretary met privately with Mahon, who was “receptive” to helping with the CVN-CVV deal, and with Wright, who offered to assist but declined to take a leading role.<sup>60</sup> Neither congressional leader’s support made much difference. The House voted to increase the Defense Authorization Bill (H.R. 10929) for weapons procurement from Carter’s \$35.5 billion request to \$37.9 billion, the primary additions being a \$2 billion CVN, a \$1 billion nuclear cruiser, and \$41 million for an experimental cruise missile carrier using commercial wide-body jet airliners, as requested by Carter but denied by the House Armed Services Committee. Liberal Democrat Bob Carr sought to replace the committee figures with Carter’s original request, but his effort failed. Aspin’s amendment to replace the CVN with a CVV also failed.<sup>61</sup> See table 4 for the bill’s major authorizations.

Brown offered the president four reasons why attempts to derail the CVN failed: Congress and the public supported a stronger defense force; the Carr amendment challenged the whole committee system and seemed a slap in the face to popular House Armed Services Committee Chairman Melvin Price; Aspin was still identified—unfairly in Brown’s mind—as antidefense; and the 1977 vote to rescind the CVN (252 to 161) had been unrealistically high, a honeymoon expression of support for the new administration. Absent from Brown’s explanation was a fifth reason: DoD’s failure to conduct any self-examination. As the president pointed out in his notes on the report, “DoD has been relatively ineffective. . . . Have you polled the committee? . . . Asked me or Fritz [Mondale] to help? . . . Mounted [a] PR campaign to show consequences of CVNs vs other defense needs, etc.”<sup>62</sup> Furthermore, the deal to substitute a conventional midsize carrier for the nuclear one could well have hurt the cause, convincing congressional opponents that the administration was on the run. Also Brown and OSD were loath to support Carr over Price, with whom they would have to work in future funding requests.<sup>63</sup> The next battleground for the CVN would be the Senate’s floor discussion of the authorization bill, where Brown judged the administration’s chances as “poor—we will be bucking John Stennis.” Furthermore, the House Appropriations Committee seemed likely to fund the CVN unless Brown could “swing six or seven votes in the committee.” The secretary advised Carter: “While I am not aware that a Defense authorization bill ever has been vetoed, a veto nevertheless remains an option if the nuclear carrier stays in the bill.” It must be “considered carefully and cautiously,” he added.<sup>64</sup>

Brown still hoped to stem congressional momentum toward another CVN. He talked to Mahon about eliminating its funding in the House Appropriations Committee. In an address to the Chicago Council on Foreign Relations on 6 June, the secretary stressed the “wastefulness” of another nuclear carrier given the Navy’s “unrivaled” power. To those who charged that the administration was “allergic to defense in general and to the United States Navy in particular,” Brown responded, “That is nonsense. . . . On the basic issues, the President and I are strong supporters of the Navy,” and he pointed out that the Navy received the largest share of the proposed budget dollars.<sup>65</sup>

On 11 July 1978 the Senate voted 87 to 2 in favor of the \$36.1 billion Defense Authorization Bill (H.R. 10929), granting \$615.7 million more in procurement for weapons than Carter requested, but \$1.8 billion less than the House version passed on 24 May. The bill included \$1.93 billion for a CVN, but omitted the \$1 billion for a nuclear cruiser that the House had approved. Hart fought with only minimal success to proceed with V/STOL development and to kill the F-18. Claiming that choosing the agile F-18 dogfighter “plays directly into Soviet hands,” Hart maintained that the F-14 was the only aircraft able to stop waves of Soviet cruise missiles and warned, “The F-18s are going to be up there . . . playing Red Baron, while the carrier is sinking.” Opponents of large carriers, both nuclear and conventional, could take some solace when the Senate passed by voice vote an amendment by Senator John Culver requiring that future carriers be “substantially smaller and less costly,” unless the president determined a large carrier was in the national interest. Brown told Carter that the nuclear cruiser would probably drop out in conference, but the only way to defeat the CVN (other than veto it) was to drop it from the appropriations bill.<sup>66</sup>

The CVN’s authorization sailed through the House and Senate conference committee as expected, along with authority to design a new small carrier and convert a helicopter carrier as an interim conventional aircraft carrier, plus \$70 million toward the expected \$700 million cost of a larger helicopter carrier. As Brown anticipated, the nuclear cruiser dropped out of FY 1979 funding, but the conferees authorized \$369 million for an Aegis anti-aircraft system for it as long as the components could also be used on the less expensive nonnuclear cruisers. The conferees also earmarked \$20.6 million (half of the Senate’s figure) for the development of aircraft to carry cruise missiles, but insisted that the B-1 and military

transports be included as possible carriers. The B-1 remained on life support with \$55 million for R&D (half the administration's request), and advanced cruise missile research continued with authorization of \$48.5 million. Just under \$200 million was earmarked for modernizing the Trident I missile, but only \$5 million for the Trident II, a program the House claimed was "too vague."<sup>67</sup>

Authorization for NATO-related systems fared relatively well. Pershing missiles and development of an even longer-range nuclear missile for Europe received additional modest funding. The conferees did not authorize as many of the new version M60 tanks with improved gun-aiming equipment as the administration requested (410 instead of 480), and they limited new gun-aiming equipment on older M60s to 380 tanks. Still, the authorization represented a major overhaul of U.S. armor with 110 XM1 tanks authorized for production. The new infantry fighting vehicle was also funded for production while the older, less armed and armored version continued rolling off the production lines. The conferees rejected the House's "Buy American" provision, thus authorizing money to adapt the German 120mm gun to the XM1 tank and to purchase the French-German Roland short-range anti-aircraft missile for the Army; both considered steps toward NATO interoperability and standardization. As for airlift and tanker capabilities, the conference bill authorized funds to modify existing commercial airliners so they could be rapidly converted to military cargo aircraft, to procure two DC-10 air tankers, and to re-engine KC-135s. V/STOL research received just \$5 million, surviving the administration's recommendation to kill it, and a modest \$3 million went to designing an improved AV-8B Harrier for sea duty. In the end, after voice-vote adoption by both Houses on 4 August, H.R. 10929 authorized just under \$37 billion for weapons procurement, military research, and civil defense—\$1.5 billion more than Carter had requested.<sup>68</sup>

### **Carter's Veto and the Supplemental Bill**

Brown had warned Carter that he might have to veto the authorization bill. After both Houses passed H.R. 10929 as reported out of conference, the time for decision had arrived. The president had 10 working days to act, or the bill became law (the pocket veto was not an option since the current session of Congress would not end within 10 working days). In a personal and confidential memorandum, Brown presented the case for the veto. To stay within congressionally approved budget limits and pay for the CVN, Congress had displaced funds for investments proposed for

readiness, sustainability, and R&D, thus weakening the U.S. defense posture. Brown also noted that the bill continued the trend toward larger and more expensive Navy ships, which meant fewer ships in the long run. Although a gamble, the secretary believed “a veto is in order.”<sup>69</sup>

On 16 August 1978 Carter, Mondale, Brown, Brzezinski, OMB Director James McIntyre and various White House aides met. Their consensus recommendation was to veto the bill. Carter agreed. The next morning, Brown and Carter briefed congressional leaders on their decision, explaining that \$2 billion for a CVN weakened U.S. national security. To pay for the nuclear carrier, Carter maintained, the bill forced reductions in other more crucial areas such as R&D, combat readiness, and purchase of existing weapon systems. As a “top defense official” (Brown “on background”) told reporters, the “glamorous” carrier would be built at the expense of funds needed to maintain the fighting fitness of ships, aircraft, and other military equipment already in use.<sup>70</sup>

Carter designated Mondale to head a task force to sustain his veto. It focused on the House rather than the Senate. On 17 August, Mondale, Brown, Brzezinski, and other White House aides divvied up and contacted 165 House members they believed would likely support the president. Hardcore carrier advocates numbered 161, so the force worked on 109 members who were potential supporters of the veto. The task force initiated a full-blown media campaign that briefed influential private individuals, groups, television and radio outlets, Democratic congressional candidates, and other political leaders. Brown taped segments for national television, while Duncan worked on labor leaders as well as the regional television stations. Brown sent a letter to every House member rebutting arguments against the veto and telephoned Stennis, Price, and Mahon requesting their support.<sup>71</sup>

Opponents of the veto claimed, with some justification, that the president had vetoed the wrong bill; he should have waited for the appropriations bill. The nuclear carrier could not have been built until the money was actually appropriated, not merely authorized. Vetoing an appropriations bill, which was usually passed at the end of the fiscal year, however, would have required a continuing resolution to avoid a DoD shutdown. Additionally, as Price pointed out on 31 August, many dollar figures cited by the administration for “reductions” in combat readiness, R&D, and existing weapons were either not in the authorization bill (they were in the still-pending appropriations bill) or were much less than what Carter claimed.

Price refused to accept that Congress' role was to rubber stamp the president's Defense budget. In a handwritten letter, Carter tried to soothe Price by stating that he was aware "of the positive and constructive Constitutional role of Congress in providing our nation's defense" and appreciative of Price's leadership. He added, "My veto . . . was predicated on . . . the entire authorization and appropriations prospects resulting from approval of another CVN in the 1979 fiscal year."<sup>72</sup> For his part, Brown informed House Speaker O'Neill of four points he considered essential: the veto was to prevent the elimination during the ongoing appropriations process of \$2 billion in high-priority items in order to pay for a CVN; the next year's CVV would cost only \$1 billion; all Carter requested was that the authorization for the CVN be deleted and the money for procurement, readiness, and R&D be restored; and finally "we must stop the trend of the past ten years toward a Navy of fewer and fewer, more-and-more expensive ships."<sup>73</sup>

To sustain the veto, the task force focused on a basic premise: "The Administration's message . . . must be *simple* and *consistent*. In the time we have to sell this veto we must repeat as often and as forcefully as possible a simple argument that *makes sense* and *can be easily remembered*."<sup>74</sup> The public relations team at the White House realized that few Americans understood the intricacies of the Defense budget, so the details need not encumber their argument. When the House voted on 7 September not even a majority of representatives opposed the president. The vote to override the veto lost 191 to 206 to sustain, a far cry from the two-thirds required.<sup>75</sup>

Once the veto was sustained, few in Congress wished to rewrite the authorization bill, especially with congressional elections looming in November and members adjourning to campaign in their home districts. Furthermore, if the new authorization bill failed to pass by 1 October, DoD procurement would have to operate under a continuing resolution, delaying new programs passed included in the vetoed bill, such as the production of the XM1 tank. The two Armed Services Committees agreed to drop the \$2 billion for the CVN from the bill, but they were unreceptive to Brown's position in favor of spreading the money among the 126 programs that the authorization bill had cut or that were being cut in the appropriations bill. The secretary attributed their reluctance to "an unwillingness to admit they were wrong to remove those items" and a belief, which he conceded was probably correct, that if they added items, they would "open the door to an

interminable wrangle over what else to add.” Instead, the two committees agreed to eliminate funding for the CVN, to pass the bill as agreed on in conference committee (that is, minus the \$2 billion but with an added \$209 million to settle shipbuilding claims), and then to pass a supplemental bill after they returned from adjournment. Obviously Brown and DoD needed the supplemental to fill out their already pared-down FY 1979 appropriation. As Brown warned the president, if the DoD budget dropped below \$126 billion in TOA, the move would send the wrong signal to allies and potential enemies.<sup>76</sup>

Debate and markup of the Defense appropriations bill, the second part of the legislative process, followed the authorization bill. In July 1978 the House Appropriations Committee fought off amendments by pro-Carter legislators to remove the CVN or replace it with a CVV. The committee provided more funds for V/STOL development and procurement of AV-8B Harriers as well as 15 AV-8A older version Harriers; supported the administration’s XM1 tank request, but increased by 50 percent (to \$147.6 million) funding for modernization of M60 tanks; eliminated the program to modify commercial wide-body passenger planes for potential conversion to military transports; supported the Air Force’s requests for more combat planes, and increased by \$170 million the administration’s request for \$6 billion for general overhaul of aircraft, engines, tanks, and ships to get them back in service. Although the Appropriations Committee retained a CVN and increased funding for additional programs, it adhered to the same dollar amount requested by the president, just not the programs and priorities he desired. On 9 August 1978 the House approved the appropriations bill (H.R. 13635) basically as recommended by the committee, with total outlays of \$119 billion.<sup>77</sup>

On 2 October 1978, two days into FY 1980, the Senate Appropriations Committee reported H.R. 13635 (Senate Report 95-1264) at just over \$116.3 billion, considerably less than the House, in part because it did not fund a CVN given the House’s vote to sustain the Carter veto. Like the House, the Senate gave up on building a Trident missile-launching submarine in FY 1979 because of construction delays at Electric Boat shipyard. It allocated only \$55 million, almost five times less than the House had appropriated, for long-lead funding of nuclear power plants for future nuclear submarines and surface combatants, made moderate reductions in the number of combat aircraft approved by the House,



added development funds for a small aircraft carrier to carry V/STOL aircraft, and restored funding for three submarine hunting ships (deleted earlier by the House). The Senate Appropriations Committee agreed to cut the Naval Reserve to 76,400 (25,000 more than the administration's request, but 12,400 fewer than the House funded).<sup>78</sup>

In a race to pass a bill before the first payroll checks of the fiscal year for DoD personnel came due in mid-October, the Senate passed the Senate Appropriations Committee version with little change on 5 October. Now it was the turn of the conference committee to iron out the differences before DoD employees missed a paycheck (no continuing resolution was considered). The respective appropriations committees' staffs worked around the clock to resolve the differences between the House and Senate versions of the bill. The conferees dropped the V/STOL package, which included modification of a helicopter carrier to serve as a light aircraft carrier and a new amphibious attack ship for the Marines. The House adopted the conference report by voice vote and the Senate did so by a vote of 77 to 3 on 12 October. The outlays funded for FY 1979 totaled \$117.3 billion compared with the \$115.3 billion in the administration's submission. On the next day the president signed the appropriations bill into law (P.L. 95-457).<sup>79</sup>

**Table 5. Defense Appropriations, FY 1979 (\$ thousands)**

Program	Administration Request	Final Appropriation
Military Personnel	27,211,200	27,213,328
Military Pensions	10,148,938	10,139,838
Operations Maintenance	37,376,200	37,336,915
Procurement	31,927,600	30,238,716
(Transfers from prior appropriations)	(0)	(107,000)
Research and Development	12,468,000	12,156,262
(Transfers from prior appropriations)	(0)	(15,000)
Spec Foreign Currency Prog	14,362	14,362
Working Capital Funds	100,800	100,800
(Transfer authority)	(750,000)	(-)
Related Agencies	53,183	55,500
Total, New Budget Authority	119,300,283	117,255,721
Total transfers from prior appropriations	0	(122,000)
Total funding made available	119,300,283	117,377,721

Source: *Congressional Quarterly Almanac*, 1978, vol. 34 (Washington, DC: Congressional Quarterly, 1979), 133.

Only by counting the additional bills that funded military construction, atomic weapons research, and annual pay raises for DoD personnel, did congressional DoD appropriations for FY 1979 approach the \$126 billion TOA the president requested for Defense. DoD still required passage of a supplemental bill of \$2.2 billion to reach the administration's real target of \$126 billion TOA. Brown included in that supplemental \$675 million for shipbuilding and \$430 million for strategic weapons. The remaining \$1.1 billion went for readiness, NATO-related items, and some offsets for overseas dollar adjustment (the German mark was rising while the dollar was sinking).<sup>80</sup>

In early 1979 Brown testified before three committees on the supplemental. While the defense oversight committees supported the supplemental, both Brown and OMB Director McIntyre saw difficulties in "translating that into timely action."<sup>81</sup> A concerned Brown told the president in March that since Congress was working at a "disturbingly slow pace" on the FY 1979 supplemental, emergency interim funding might be required to avoid terminating crucial defense programs. In early April the two Armed Services Committees finally finished their markups of the supplemental. The Senate Committee funded all four *Spruance*-class destroyers for the U.S. Navy, which Iran had previously ordered but cancelled after the fall of the Shah of Iran in early 1979, and dropped the funding for 55 F-16s originally destined for Iran (they were earmarked for sale to Israel after the Camp David settlement between Israel and Egypt in September 1978).

The MX missile program proved to be the most controversial issue in the supplemental. The administration was considering placing MX missiles on cargo planes able to take off on short runways, making them easily verifiable under a potential strategic arms limitation agreement. Defense hardliners in Congress thought the plan left the missiles too vulnerable to Soviet attack. The Senate Armed Services Committee approved \$190 million to test the MX and an additional \$75 million to develop an airborne system to deliver it with the requirement that Brown report on which system—land-based or airborne—he considered better before the FY 1980 budget deliberations began.<sup>82</sup>

The House Armed Services Committee also approved \$265 million for MX development, but with language requiring Brown to consider land-based mobile deployment and certify that any air-based deployment was "militarily or technologically superior" or more cost effective. The issue became moot when, in June, the

administration opted for the land-based system. The House committee funded only two of the four destroyers, originally intended for Iran, in FY1979 and two in the next fiscal year. It agreed to the administration's request for 18 airborne warning and control system aircraft for NATO and money for Pershing missiles, as well as development of more powerful antitank TOW (tube-launched, optically tracked, wire-guided) missiles to counter Soviet tank improvements. In early May the Senate passed its version of the supplemental. In late May the House followed suit. In conference the MX basing again came to the fore with a debate over shuttling the MX vertically (as the Air Force favored) or horizontally (more costly but it allowed the missiles to be moved more quickly and also to be more easily verified by Soviet reconnaissance satellites). The conferees required an additional justification if the horizontal system was chosen. They reported a supplemental bill of just over \$2 billion (about \$140 million less than Carter had requested). After passage by both houses, the president signed the act into law (P.L. 96-29).<sup>83</sup> Brown reported to Carter: "Overall I think we came out fairly well," citing approval of the Navy's procurement of four Iranian destroyers (which he characterized as a "political issue"), the MX prototype development and testing, and the NATO AWACS.<sup>84</sup>

Brown's first effort to mold a DoD budget from scratch had been a struggle, with the president and OMB keeping a close watch and revising budget ceilings downward. The Navy and Congress balked at cuts in ship construction and resisted the administration's lack of enthusiasm for carriers. Given the problems of inflation running at over 6 percent, the growing—at least by 1978 standards—federal deficit, and the president's commitment to restraining defense spending, Brown expended considerable effort just to obtain 3 percent growth in outlays. The future of the Navy remained, of course, one of the fundamental questions raised during the budget process. Should the Navy be reduced to primarily protecting supply lines or should it be a large, carrier-based force capable of carrying the fight to the flanks of the Soviet Union? Could the United States protect its wartime control of the seas with only 400–450 ships against a growing Soviet naval threat, or were 550–600 ships the ideal numbers for end of the 20th century? Did the Navy need more CVNs? Could the United States afford such a Navy? Carter's unprecedented veto—at the suggestion of Brown—and the White House campaign to sustain it, indicated unequivocally where the two men stood. With their emphasis on combat

preparedness and NATO in the FY 1979 budget, Carter and Brown—with constant encouragement from Robert Komer, Brown's NATO special assistant—had fulfilled a goal that the president outlined before coming to office.

Budgets tell a story about a nation's security priorities. Like any good narrative, the history of the FY 1979 Defense budget was not as simplistic as later critics of Brown and Carter have charged. The FY 1979 budget did not indicate neglect by an administration complacent on threats to national security. Instead it proved a successful effort to redress some of the inadequacies in America's conventional defense of NATO and Europe, but it was certainly less successful in its controversial effort to redefine the role of the Navy. The FY 1979 budget emerged as a result of give-and-take by competing institutions and personalities, their differing visions of the Soviet threat, and their opposing views of how to counter it. Like virtually all Defense budgets, it was a compromise.

## The Middle East Peace Process

WHEN ISRAELI PRIME MINISTER Menachem Begin and Egyptian President Anwar Sadat signed the Camp David Peace Accords on 17 September 1978, and then followed with the Egyptian-Israeli Peace Treaty on 26 March 1979, Jimmy Carter enjoyed the finest moments of his presidency. Finally, these major combatants of previous Arab-Israeli wars were officially at peace. While this accomplishment owed much to Henry Kissinger's step-by-step, incremental negotiations to disengage the combatants after the 1973 Arab-Israeli War, Carter's approach differed from the drawn-out shuttle diplomacy practiced by Kissinger. During two weeks of September 1978, Carter lived side by side with Israeli and Egyptian leaders. He met with them on a daily, sometimes hourly basis, at Camp David, the presidential retreat in Maryland. After intense negotiations, the two sides agreed to the Camp David Peace Accords, which outlined the general framework for an Egyptian-Israeli peace treaty, initiated Israeli withdrawal from the Sinai, and created a blueprint for an overall settlement in the Middle East. It was an audacious gamble and a stunning success. Carter believed he had begun the process of a comprehensive settlement in the Middle East that would finally end the three-decades-old state of war between Arabs and Israelis and settle their long-held dispute over Palestine.<sup>1</sup>

During these negotiations in the lush green Catoctin Mountains, so different from Israel or Egypt, Carter appealed to the better natures of the two delegations and their leaders, but he also had another lever for bringing the two sides together—the promise of military sales, credits, grants, and other security assistance. Credit for the success of the Camp David Accords belongs to Carter, his White House staff, and Secretary of State Cyrus Vance. The Defense Department and Harold Brown played a secondary and supportive role in the actual negotiations at Camp David,

but the accords and the peace treaty could not have succeeded without a massive infusion of weapons and materiel to the key combatant states—Israel and Egypt. In this process Brown and his staff played a crucial part.

### Sadat and Egypt

There was no question in Carter's mind that Egyptian President Sadat represented a game changer in the Middle East. Carter described him as "a shining light burst on the Middle East scene" and "a man who would change history and whom I would come to admire more than any other leader." When Sadat and Carter met in Washington in early April 1977, they got along famously. Pleasant and charming, Sadat did not sweat the details, leaving them to his aides and ministers. But when they raised inevitable problems, he often overruled their concerns. To Carter's mind, the Egyptian president was bold, open-minded, and impatient of timidity or over-cautiousness. Sadat was the key to Carter's plan for peace. In reality, Sadat's flexibility and responsiveness to Carter's appeals indicated a leader desperate for U.S. weapons and modernization of his armed forces. Having ousted the Soviets in 1972, he cast his lot with the United States after the 1973 war with Israel. He had yet to reap the benefits of this bold move. Sadat would make peace with Israel, but at the price of substantial U.S. arms sales and military assistance.<sup>2</sup>

Brown also met with Sadat in April 1977, but he had a difficult assignment: to discourage Sadat from expecting too much in military sales and assistance from the United States until he invested more in the peace process. Sadat felt especially vulnerable, he told Brown, since the Soviets had cut off all arms and spare parts to Egypt. The United States continued to supply Israel with weapons and equipment, and the Soviets poured arms into Syria, one of Egypt's rivals for leadership of the Arab world. Sadat requested as a first priority F-5E Tiger II fighter aircraft, C-130 Hercules transport aircraft, M113 armored personnel carriers (APCs), and pilotless reconnaissance drones. Brown responded noncommittally, offering far less than Sadat had hoped for: a hydrographic survey of the Suez Canal approaches, training for Egyptian military officers in the United States under the International Military Education and Training, or IMET, program, reconnaissance drones and related photographic equipment, T-37 jet trainers, help in maintaining Egypt's Soviet equipment, and possibly a few C-130s. According to Brown, F-5s and M113s "would create political problems for us in the near term"; a favorable response would

be dependent on peace negotiation prospects. Sadat was particularly disappointed with the response on the F-5, which he described as a “10th rate plane compared to what Israel has.” As he told Brown, “Israel is armed to the teeth with the most sophisticated aircraft. . . . I want the F-5 only for defensive purposes.”<sup>3</sup>



Secretary Harold Brown and Egyptian President Anwar Sadat discuss Egypt’s military needs in the secretary’s office, March 1979. (Courtesy U.S. Naval Institute)



An F-5E Tiger II fighter carrying AIM-9 Sidewinder missiles, November 1981. (RG 330, NARA II)

Carter approved Brown's initial offer to Sadat, authorizing 14 C-130s, 12 reconnaissance drones, 6 long-range reconnaissance photography pods and supporting equipment, the hydrographic survey, and IMET.<sup>4</sup> As Carter met with recalcitrant Israeli leaders in his search for regional peace, Sadat looked better and better. When the Egyptian president announced in November 1977 that he was prepared to go to Jerusalem to meet with his Israeli counterpart and members of the Knesset to discuss peace, he moved the process along sufficiently for the Carter administration to consider some of the requests that had been too politically sensitive in April 1977. In December 1977 Brown suggested that, subject to congressional review, Egypt should receive 60 F-5s (48 F-5E and 12 more modern F-5Fs) starting in 1980 as part of an overall military package.<sup>5</sup> National Security Adviser Zbigniew Brzezinski and the White House wanted an earlier delivery, suggesting that Iran transfer some of its F-5s to Egypt. Both Secretary of State Vance and Brown considered the Iran transfer scheme full of problems. It would weaken the political impact of a direct U.S. sale to Egypt and would encourage the shah's insatiable demand for high-performance aircraft (F-14s and F-16s). Also, Congress might see it as an end run since the legislators ultimately had to fund U.S. military sales on credit. Additionally, Sadat would probably be satisfied politically with a commitment now and delivery later.<sup>6</sup>

When Sadat returned to Washington in February 1978, he wanted more than just commitments; he needed F-5s and soon. The Sadat-Brown meeting at Blair House lasted almost 60 minutes, twice its scheduled time. The Egyptian president told Brown he wanted to make the F-5s "the backbone of the Egyptian Air Force." Brown suggested that given political sensibilities, especially in Congress, Sadat could not get the 120 F-5s that he requested, but the administration was considering providing him with 30 as part of an aircraft package that included Israel and Saudi Arabia. Sadat also made a strong argument for more and earlier delivery of C-130 cargo planes. The secretary suggested the dispatch of a DoD survey team to assess Egypt's military need for F-5s, C-130s, and armored personnel carriers (APCs), Sadat's three big requests. Brown also suggested further discussion with Egyptian Minister of War General Mohammed Abdel Ghani al-Gamasy in Washington later that spring. Sadat readily agreed.<sup>7</sup>

When Gamasy and Brown met four months later, the Egyptian defense minister kept the pressure on for F-5s and earlier delivery. Also, Gamasy was keen



to get U.S. Ranger training for Egyptian Rangers. Brown replied it could be done under IMET. He suggested, and Gamasy agreed to, the establishment of a small Defense Cooperation Office in Cairo to expedite transfer of C-130s. The secretary informed the defense minister that the APCs would have to wait until next year since the Carter administration had “used up our political credibility this year with our Congress.”<sup>8</sup> In fact, the United States and Egypt were beginning to establish a budding military relationship (which concerned Israel’s supporters in Congress), but the F-5 aircraft remained Egypt’s highest profile request and the litmus test of U.S. support for Sadat’s peace effort. As always, the Carter administration had to weigh its military assistance to Arab states such as Egypt against its overriding and traditional commitment of military aid to Israel.

### **Arms for Israel**

Although the United States had been a key supporter of Israel since its creation in 1948—with the exception of the Eisenhower administration’s outright opposition to the British, French, and Israeli attack on Egypt during the Suez crisis in 1956—U.S. security assistance for Israel did not begin until the early 1960s with the sale of Hawk antiaircraft missile systems, M48 and M60 main battle tanks, and A-4 Skyhawk attack aircraft. Before the early 1960s, Israel’s armed forces relied mostly on Europe for weapons and equipment that Israel could not produce itself. The refusal of Western European suppliers, especially France, to provide additional aircraft and other weapons after the 1967 Arab-Israeli War forced Israel to look to the United States for military upgrades, including F-4 Phantom attack aircraft, high-technology items such as electronic countermeasures (ECM), and highly sophisticated munitions. The next turning point in the U.S.-Israel arms relationship proved to be the 1973 October war, when Israel suffered serious losses in aircraft and significant degradation of its ground equipment. From October 1973 to the beginning of 1977, Israel placed \$4 billion in foreign military sales orders with the United States to replace equipment lost in the war. By comparison, in the 21 years from July 1952 to October 1973 the United States provided Israel with only \$2 billion in FMS.<sup>9</sup>

The Ford administration approved large portions of the Israeli government’s requests. In June 1974 Israel presented the United States with a 10-year plan for a military buildup, called by Israel MATMON B. During 1976, Ford approved sale of over \$2 billion in weapon systems, equipment, and materiel including high

technology items such as F-15s, laser-guided bomb systems, E-2C Hawkeye aircraft, electronic warfare systems, ECM, communications equipment, 126 tanks, 94 self-propelled 155mm howitzers, 250 CBU-72 fuel-air explosive systems (cluster bombs), and scanners and infrared systems for aircraft. The Israelis proposed expanded research and development cooperation with the United States, coproduction of most of the 250 F-16 aircraft they requested (Ford had approved sales in principle but not the specific numbers), and U.S. financing for the Israeli-built Merkava tanks that used U.S.-made diesel engines, transmissions, and other major components and assemblies. Ford created the Middle East Arms Transfer Panel chaired by DoD, with interagency representation to provide an analysis of Israel's military requirements and the threat it faced.<sup>10</sup>

The panel concluded in October 1976 that Israel had military superiority over all of its Arab foes (based more on qualitative factors than amounts of weapons) and that the U.S. military equipment already in the pipeline was sufficient for Israel's defense needs. Realizing the political ramifications of such an assessment, especially during a presidential election, Secretary of Defense Donald Rumsfeld, who did not agree with its conclusions, delayed the release of the report through the end of his tenure. It came as no surprise to Brown and the new Carter appointees in DoD that Israeli military requirements could prove a political hot potato. Israel had broad support in the influential Jewish-American community and enjoyed powerful supporters in Congress. With the Carter administration poised to take office, Ford and Rumsfeld left to their successors how to respond to Israel's requests.<sup>11</sup>

Brown's holdover assistant secretary of defense (ISA), Eugene McAuliffe, raised questions: Should the Carter administration provide substantial new quantities of materiel to Israel as planned by its predecessor? How much of it should be credit assistance? Should the United States support Israel's efforts to develop its own munitions industry? Should it provide Israel with advanced technology and manufacturing techniques? And what political actions could and should it expect from Israel in return?<sup>12</sup>

In one of his first acts as president, Carter ordered a review of Middle East policy, Presidential Review Memorandum 3, on 21 January 1977, to consider, among other issues, how much additional security assistance and how many FMS credits should be granted to Israel as part of an overall policy looking toward an Arab-Israeli peace, and what portion of the total Middle East aid package should go to Israel.<sup>13</sup> The State Department's study in response to PRM 3 provided four

options ranging from \$1.5 billion (\$1 billion in FMS and \$500 million in supporting assistance, the Ford decision) to \$2.285 billion (\$1.5 billion in FMS and \$785 million in supporting assistance, the Israeli request). Defense recommended the Ford figures.<sup>14</sup> But the participants at a National Security Council meeting in late February, attended by Brown, opted for \$1 billion in FMS, half of which would be forgiven, and \$785 million in supporting assistance for Israel, with just over \$1 billion in security assistance for friendly Arab states.<sup>15</sup>

The NSC participants did not recommend specific weapon systems to be provided, realizing that in light of upcoming visits by Israeli Prime Minister Yitzak Rabin, Egyptian President Anwar Sadat, and other Middle East leaders, the president would not wish to be tied down in his peace effort. Brown's military assistant forwarded six specific military topics for the president's discussion with Rabin: How many of the requested 52 F-16 aircraft should Israel be allowed to purchase and should they be allowed to coproduce 200? Should Israel be provided \$106 million in FMS credits to produce 178 Merkava tanks or should it buy a similar number of U.S. M60A1 tanks? Should the United States support Israel's expanding arms sales program to third countries? What should be the U.S. response to the new December 1976 Israeli list of high priority items? Should Israel have access to U.S. R&D through coproduction of weapons? And what should be the amount of FMS credits for FY 1978? Given that most of these questions were still under study, DoD recommended that Rabin not receive specific answers.<sup>16</sup> This advice proved useful as the prime minister's visit turned out to be a failure from Carter's perspective. Rabin did not respond to the president's overtures for peace, and Carter did not bring up security assistance.<sup>17</sup> In separate discussions with Rabin during the visit, Brown covered some of the ground that DoD had suggested to the president.<sup>18</sup>

Defense believed that Israel needed some carrots to accompany the sticks. Brown suggested to Vance that Israel be allowed to purchase 50 F-16s for delivery in 1981 and 1982, a number that would help bolster Israel's security, but would not inhibit the pursuit of peace by sending the wrong signal to the Arabs. He nonetheless believed that the current Israeli Air Force of 550 combat aircraft could maintain air superiority through 1982 and probably 1986.<sup>19</sup> The secretary also suggested that a total of 125-150 F-16s delivered to Israel by the end of 1986 might be justified militarily.<sup>20</sup> At DoD's recommendation, Carter denied Israel (or any other foreign nation) the CBU-72/B cluster bomb. The president considered it a "terror" weapon.<sup>21</sup>

In mid-June the Policy Review Committee, with Brown attending the meeting, recommended to the president dividing Israeli arms requests into three categories: items for immediate approval; items to be agreed on during the visit of Prime Minister Begin (the Likud Party and its leader Begin had replaced Rabin and the Labor Party after elections in May); and those which should be given only after discernible progress in peace negotiations. Carter approved.<sup>22</sup>

The Pentagon prepared detailed lists. The noncontroversial items for immediate referral to Congress prior to shipment included 700 M113 APCs, 200 heavy antitank TOW missiles, 18 AH-1S Cobra attack helicopters, and 15 M728 combat engineer vehicles (tank dozers). All had been sold previously to Israel; none were sophisticated weapons or equipment; and some had been released to Arab states (tank dozers and AH-1S helicopters). In the second group, Defense included 400–500 more APCs, 18 hydrofoil patrol boats, and 5,000 CBU-71 cluster bombs, an earlier incendiary bomblet version already provided to Israel. While recommending CBU-71 bombs, the department realized the White House might oppose them, given its denial of fuel-air explosive CBU-72 bombs. Finally, the third group, the incentives for progress toward peace, included 250 F-16 aircraft (50 purchased and 200 coproduced in Israel), 3 KC-135 tanker aircraft, and 1,350 AIM-9Js (heat-seeking, short-range) Sidewinder air-to-air missiles. DoD excluded a number of other requested items on the grounds that they were not critical to Israel's needs or they were based on advanced and sensitive technology.<sup>23</sup> Carter approved the first tranche, except for the 18 AH-1Ss, on 25 June 1977.<sup>24</sup>

Begin visited Washington in mid-July 1977. On the morning of the 19th, Carter and the Israeli prime minister met for the first time. Although Carter had reservations about Begin, he was pleasantly surprised. They discovered common interests—both were students of the Old Testament and deeply religious. Carter decided Begin had come to Washington with an open mind but not, as it turned out, to the point of making concessions acceptable to the Arabs.<sup>25</sup> On the afternoon of the 19th, Brown and Begin met for a long discussion. The Israeli prime minister outlined military intelligence from captured Soviet equipment that Israel had provided the United States, stating that he “was astonished at how much Israel has contributed” to the security of the United States.” Brown noted that the intelligence helped Israel too. Begin then launched into a monologue on Israeli military vulnerability and its need for tanks and F-16s. Begin asked when the

United States was going to implement the F-16 coproduction agreement. Brown corrected him, noting that there was no coproduction agreement and rebuffed Begin's request for co-development and coproduction of weapons. The secretary stated that there could be no "blank check," rather the issues would be decided on a case-by-case basis. The discussion covered most of the major Israeli weapon requests. Brown promised to look into them, knowing full well that the Carter administration had already decided what to provide.<sup>26</sup> After Begin departed the president approved \$107 million in FMS credits to finance Merkava tanks, 18 AH-1s, 2 hydrofoil patrol boats, and \$59 million in miscellaneous ammunition (but not the CBU-71s).<sup>27</sup>

Brown had met with two Israeli prime ministers. Reserved, proper, and polite, Brown was not effusive or extravagantly witty in the Kissinger mode. It was not in his nature or in his talents. The secretary was direct, never hesitant to correct a misapprehension or an inflated claim. Like most U.S. intelligence analysts, he believed that Israel was more than able to defend itself against its Arab opponents in either an all-out war or a war of attrition. He was prepared to give Israel only what it needed to defend itself, but he fully accepted that security assistance must be part of the president's Middle East peace policy.<sup>28</sup>

In October 1977 Israeli defense officials briefed Pentagon officials on a new Israeli request for security assistance, MATMON C, which asked for an annual FMS credit assistance level of \$1.5 billion (in 1977 dollars) through 1983 and provided a 10-year Israeli force structure plan. FMS credits allowed the United States to deliver weapons to friendly countries repayable 10 years after delivery. Based on a worst-case scenario, MATMON C envisioned Israel being attacked by virtually every Arab country including Iraq, the Persian Gulf states, and Islamic countries in North Africa, and even East Africa. Such an all-out attack seemed unlikely, especially given the Egyptian peace overtures (in November 1977, Sadat announced he would go to Jerusalem for peace talks with Begin). MATMON C comprised an eight-page, single-spaced list of weapons, including 400 tanks; 3,105 APCs; 25 F-15s and 150 F-16s; 60 helicopters; 12 hydrofoils; 100 newly developed all-weather, over-the-horizon, antiship Harpoon missiles; equipment including \$200 million for communications; and large amounts of ammunitions and air ordnance—all in no order of priority.<sup>29</sup> To the Joint Chiefs of Staff, it was "not a good planning document."<sup>30</sup>

Prior to Begin's return to Washington in mid-December 1977, he and Sadat had met in Jerusalem and discussed a joint initiative for peace. Peace prospects seemed good; Begin seemed prepared to make concessions.<sup>31</sup> Israeli sources hinted that Begin would raise F-16s, increased FMS credits, and MATMON C during his hastily arranged December 1977 visit to Washington. The Carter administration was in no hurry to respond to MATMON C, since it provided a major lever to keep Israel on the path to peace.<sup>32</sup>

During January and February 1978 DoD studied MATMON C. Assistant Secretary of Defense (ISA) McGiffert informed Brown that it was "not a rational planning document"; it overestimated the threat to Israel and called for a force structure that was not supportable. Whether to approve or disapprove MATMON C items was a political decision, given that Israel had sufficient forces to protect itself through 1983. ISA maintained that replacement of obsolete weapons with modern ones and a time-phased release of selected technology to enhance the effectiveness of existing weapon systems was all that could be justified. On the other hand, Israeli Defense Minister Ezer Weizman was coming to Washington to see Brown in March 1978 fully expecting to return home with substantial U.S. approvals from the MATMON C request list.<sup>33</sup>

At a PRC meeting in late February chaired by Brown, the interagency participants agreed that the United States could not commit to the flawed request and force plan, since it lacked a clear strategy, a rational force structure, and real priorities. When and if Israel provided that information, the United States would be prepared to make decisions on a case-by-case basis. Also they agreed that FMS credits for FY 1979 would be pegged at \$1 billion—not the \$1.5 billion Israel requested. All the members of the PRC opposed coproduction, although Brown did not rule out a very limited program. All agreed that approval of MATMON C requests must further Middle East peace.<sup>34</sup>

These decisions did not augur well for the Weizman-Brown meeting on 8 March 1978. After arriving on a frigid, snowy day, Weizman received an equally cold reception at Brown's office. The Israeli defense minister considered Sadat's peace initiative to be motivated by Israeli military strength. Only when Israel was even stronger would Egypt and the other Arab states make peace. Brown asked Weizman to be flexible in his requests for military sales and grants, suggesting that Israel should take some short-term risks for long-term gains. As to MATMON C,

Brown dismissed it as “a long shopping list” with “a lot of margin in it” and later as “a wish list.” He fended off requests for closer R&D cooperation. Weizman made a “strong pitch” for \$1.5 billion annual FMS, but Brown reiterated the U.S. offer of \$1 billion (plus \$784 million in security support assistance). A disappointed defense minister left Washington surprised at what he later described as Brown’s “very reserved” and unforthcoming attitude. The meeting with Brown convinced the Israeli defense minister that Carter and Begin would have to settle the issues raised by MATMON C later in March during the prime minister’s visit.<sup>35</sup> So that Weizman would not go home totally empty handed, Carter approved sales to Israel of \$20.7 million in imaging technology, but only after U.S. forces and allies deployed it; 30 MD-500 TOW missile attack helicopters in lieu of the 18 AH-1Ss; and \$100 million in munitions.<sup>36</sup>



Defense Secretary Harold Brown welcomes Israeli Defense Minister Ezer Weizman to the Pentagon to discuss Israel’s military needs, 8 March 1978. (RG 330, NARA II)

Israeli defense needs came to the fore during a later March 1978 Begin visit to Washington. In a private meeting Begin handed Carter a list of his top priority items from MATMON C, including 200 M60A3 tanks, 960 APCs, 25 F-15s, 90 F-16s by 1983, and 60 more by 1986; almost 1,300 air-to-air and 600 air-to-ground missiles; 6 hydrofoils; R&D cooperation; and a few new twists, such as \$105 million for in-country manufacture in Israel of Kfir aircraft and \$150 million for similar production of Merkava tanks.<sup>37</sup> Carter passed this list to DoD. Deputy Secretary of Defense Charles Duncan advised the White House to “hold off until after the aircraft package has cleared the Congress.” His advice made sense to Carter and the NSC staff.<sup>38</sup>

### **Middle East Aircraft Package**

As important as MATMON C was to Israel, the Carter administration had far more interest in designing an aircraft sales package for all the major players in the Middle East peace process. After Sadat and Carter hit it off in their first meeting in April 1977 and Sadat made his trip to Israel in November of that year, Carter felt indebted to the Egyptian president.<sup>39</sup> Furthermore, supplying advanced aircraft to Egypt and Saudi Arabia would make them more forthcoming by investing Egypt in the peace process and tempering conservative Saudi leaders’ hostility to a peace between Israel and Egypt. The Carter administration looked for some politically expedient means of providing F-5E and F-15 aircraft, respectively, to the two countries. Congress would allow such sales only as part of a larger package including Israel.<sup>40</sup> Yet the president had concerns about the size of the aircraft sales package—it totaled more than \$8 billion—and how it fit into the entire arms sales program. Given that Carter had instituted a policy of restraining U.S. arms sales, he initially remained skeptical that the program was commensurate with whatever encouragement it would provide toward peace in the Middle East.<sup>41</sup>

The solution was to offer Israel, Egypt, and Saudi Arabia more sales and sales credits, but lower sales to most of the rest of the world. Brown told the president that the Middle East aircraft packages to Egypt and Saudi Arabia should roughly equal those for Israel, in line with public and congressional expectations. Most important, the packages had to be linked. “If we are to be successful with the Saudi and Egyptian sales, we need from the outset to tie the elements of the package together and maintain the political will to keep them tied,” Brown advised Carter. The package as conceived in DoD provided 125 F-16s and 25 more sophisticated F-15s to Israel (25 F-15s had





U.S. Air Force F-15D Eagles, high-performance strike fighters sold to Israel and Saudi Arabia. (RG 330, NARA II)

in 1980, and 10 in 1981. Saudi Arabia's timetable for its 60 aircraft began with 10 F-15s in 1982 and extended through 1983. Israel would receive 10 of its F-15s by 1981, the rest during 1982 to 1983.<sup>43</sup>

Since Congress had to approve the sales, the Carter administration braced for a bruising fight, knowingly full well that the Israelis were disappointed with their allotment and the size and nature of aircraft for the Egyptians and Saudis. Israel's friends in Congress as well as the Jewish-American community would attempt to obtain more aircraft for Israel and fewer for the Saudis and Egyptians. Carter cited the American Israel Public Affairs Committee (AIPAC) as his main opponent in the legislative fight. Brzezinski later admitted that the aircraft package—requiring lobbying with members of Congress, assuaging the Jewish-American community, and assuring Israeli leaders—proved a “costly diversion” from the main objective of peace in the Middle East, but maintained that it was necessary to gain the trust of Arab moderates and convince them to buy into the process.<sup>44</sup>

already been delivered), 60 F-5s for Egypt, and 60 F-15s to Saudi Arabia. Carter had promised to sell the Saudis F-15s as replacements for the aging Lightning fighters—British-designed-and-built jets of the late 1950s, advanced for their time but obsolete by 1977—during his January 1978 visit to the kingdom.<sup>42</sup> The figures announced by the White House in mid-February 1978 for Egypt and Saudi Arabia were almost the same as those recommended by DoD, except aircraft numbers for Israel were less than DoD recommended—75 F-16s and an additional 15 F-15s. The proposed timetable delivered to Egypt its F-5s (reduced to 50) the most quickly—10 in 1978, 20 in 1979, 10



The U.S. Air Force F-16 Falcon, a multipurpose fighter-bomber sold to Egypt. (RG 330, NARA II)

The Senate became the battlefield. The U.S. intelligence community had concluded that the original package would not reduce Israel's military superiority over its potential Arab opponents even though Israel's opponents had far more total combat aircraft. The Israelis had better training, pilots, maintenance, and already many serviceable aircraft. Israel had the ability to take full advantage of its F-15s and F-16s. Egypt's and Saudi Arabia's ability to use their F-5s and F-15s effectively was constrained by their deficient logistics and maintenance systems and a shortage of skilled personnel. If anything, the sales would increase Israeli air superiority.<sup>45</sup> These assessments had little effect on Capitol Hill. To obtain congressional approval, the Carter administration offered to raise the Israel sales of F-15s to 60 (25 already delivered and 35 more), making them equal to Saudi Arabia's. In addition, the administration agreed that the Saudis' F-15s would be sold with restrictions on air-to-ground capability, making them less effective. The Senate Foreign Relations Committee did not comment on the sale when presenting it to the full Senate, where it passed narrowly in mid-May 1978 with both Republican and Democratic support. Less than two months later Brown

and Duncan met with prominent Jewish-American leaders. While most of the group saw an erosion of the Carter administration's commitment to Israel's security, the secretary reported that the tone of the meeting was "friendly rather than rancorous," with "no inclination on their [the leaders'] part to rehash the Mid-East arms package sale."<sup>46</sup>

### Camp David Accords and the Sinai Airfields

Carter regarded the aircraft package as a prerequisite for the Camp David meetings' success. To the president a defeat of the package meant a win for the Israeli lobby. Carter recalled "I was determined not to lose" since a congressional disapproval of the package would have reinforced Begin's intransigence and deflated Sadat and the Saudis.<sup>47</sup> After the successful Senate vote on the sales, the president returned to the peace process to see if he could break the latest logjam. On 31 July 1978 he met with Vice President Mondale, Vance, Brzezinski, Brown, and White House Chief of Staff Hamilton Jordan at a breakfast meeting at Camp David to review the process. All agreed that Carter should invite Begin and Sadat to Camp David for an uninterrupted negotiating session. Brzezinski stressed that it was a gamble; the president felt more confident that both leaders wanted peace, but he still accepted that the chances of success were slim. Brown offered no dissenting views.<sup>48</sup>

On 8 August, White House Press Secretary Jody Powell announced that Begin and Sadat had agreed to a September Camp David summit.<sup>49</sup> On 1 September at an NSC meeting to discuss all aspects of an Egyptian-Israeli peace, including security ramifications, Brown took the lead. As at most NSC meetings, the dialogue tended toward the pro forma since the basic positions had been worked

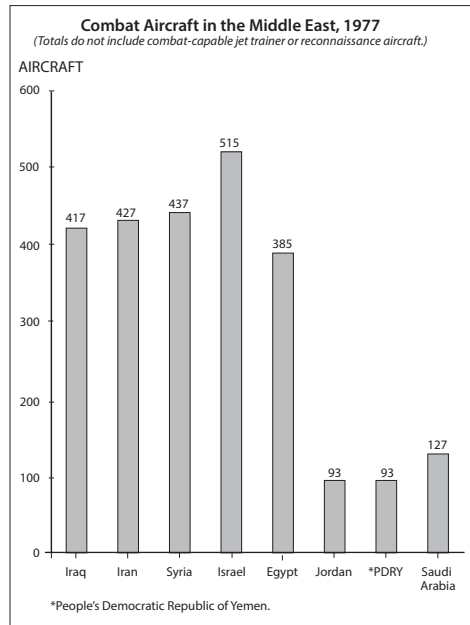

Source: Folder Middle East 452, 1978, box 61, SecDef Files, RG 330-81-0202, Washington National Records Center (WNRC).

out in less formal talks. Yet at this meeting the primary issues centered on how Israel's security could be maintained if it eventually withdrew from the Sinai, the Golan Heights, and the West Bank, and whether the United States should sign a formal defense treaty with Israel if this occurred. Lukewarm to the idea of a treaty, Brown preferred to rely on monitoring demilitarized zones, increased military assistance, and other measures to safeguard Israel. Carter agreed with Brown that a U.S. security guarantee was not an attractive military option. The discussion verged on the purely theoretical, since Israel was unlikely to withdraw from all the territory it had won in the 1967 war.<sup>50</sup> The real objective of Camp David was an Egyptian-Israeli peace agreement whereby Israel gave back the Sinai and Egypt promised non-belligerency. Then all sides could move on to an overall settlement of Arab differences with Israel as agreed in principle at Camp David.

Brown and OSD played little part in the intense 13-day negotiations at the Catoctin Mountain retreat. The secretary spent only one day there, 15 September, to discuss Defense budget issues with the president and to have lunch with Israeli Defense Minister Weizman. As it turned out, it was a momentous day, because in the first hour of Carter's meeting with Brown, Vance burst into the room at Aspen Lodge exclaiming, "Sadat is leaving." The Egyptians had packed their bags and Sadat had requested a helicopter to take him to Washington. Carter broke off the meeting with Brown, changed into a suit and tie, and hurried over to Sadat's cabin. The breaking point, Sadat told the president, was Israeli Foreign Minister Moshe Dayan's unwillingness to sign any agreement with the United States and Egypt that limited Israeli settlements in the Sinai. Sadat feared that if only Egypt signed an agreement, the Israelis would have great flexibility and leverage in future negotiations, using the U.S.-Egyptian agreement as a negotiation starting point. Carter assured Sadat that would not happen; if Israel rejected any part of the Camp David agreements, the whole deal was off. With this assurance, Sadat agreed to stay. Carter returned to Aspen Lodge to brief Mondale, Vance, Brzezinski, Brown, and Rosalynn Carter on his meeting.<sup>51</sup> Brown later joined Brzezinski for lunch with Weizman, during which the defense minister made an important concession. Begin had refused to give up Israeli air bases in the Sinai, but at the lunch Weizman suggested that if the United States would build Israel replacement bases in the Negev, the Sinai bases could be returned after the completion of the new ones. Brown's single day at the negotiations proved to be an eventful one.<sup>52</sup>



Harold Brown, Cyrus Vance, and Anwar Sadat at Dogwood Cabin, Camp David, Maryland, discussing the Camp David Peace process, 15 September 1978. (Carter Presidential Library)

Once the accords were signed at Camp David on 17 September 1978, OSD and Brown took up the task of replacing the Israeli air bases at Eitam in the northern part of the peninsula and Eztion in the south with new bases in the Negev. The Sinai bases provided Israel with the ability to patrol the peninsula and the Straits of Tiran leading to their port of Eilat on the Gulf of Aqaba. The new ones in the Negev could perform the same role. At the end of September 1978, Brown suggested to Weizman that the two governments consult on building the Negev air bases.<sup>53</sup> On 20 October, Weizman met in Washington with Brown and learned that the United States had not committed itself to any post-Egyptian-Israeli peace treaty financial aid beyond paying for the construction of the air bases in the Negev. Brown warned Weizman: “My marching orders were to make those [bases] no more capable or luxurious than those in the Sinai that they are to replace.” Weizman made a plea for help for additional infrastructure—barracks, roads, training areas, firing ranges, arms storage depot, road and water systems—but the secretary refused to make any commitments. On seeing the report of the meeting, Carter commented: “Hold firm on this. Make no commitments.”<sup>54</sup>

At the end of October, Brown presented the president with a preliminary \$1.22 billion estimate for replacing the two Sinai airfields, noting that Israeli and Pentagon officials had mentioned considerably higher costs, but he was committed only to replication of the current operational capabilities and support facilities of Eitam and Etzion, adding in a handwritten post-script: “We will continue to be both very tight-fisted on these costs and very non-committal toward Israeli requests.”<sup>55</sup> McGiffert, who drafted Brown’s memorandum to the president, noted that the Israelis claimed Eitam cost \$1.2 billion and Etzion \$1.4 billion to build. McGiffert’s comment: “I think this is baloney.”<sup>56</sup>

A DoD survey team composed of U.S. Air Force engineering and operational personnel and members of the Army Corps of Engineers visited Eitam and Etzion, and the proposed sites in the Negev. Their report concluded that if the bases were to be operational within three years as agreed on at Camp David, they could not be built by Israel contractors, who lacked the necessary management experience and capability for accelerated construction of the bases. Only the U.S. Army Corp of Engineers and a U.S. contractor could provide the essential ingredients—management, equipment, manpower, and materiel—most of which would be imported from the United States. When Brown presented the report to the president, he noted that Eitam and Etzion currently accommodated four squadrons (120 planes), but the Israelis requested an expansion of the capabilities for three new Negev (not two) bases for five squadrons (later to be expanded to 8) at a cost of \$1.5 billion. Brown recommended only two bases for four squadrons at a cost of \$988 million, plus \$57 million for housing and recreational and other non-mission essential facilities, for a total of \$1.045 billion. Excluded would be off-base infrastructure such as roads, maintenance facilities, and port and terminal expenses.<sup>57</sup> Brown’s hard bargain reflected Carter’s lack of enthusiasm for the ever-increasing demands of the Israeli government for more money coupled with its stubborn refusal to make concessions on the West Bank. As Carter told Brzezinski in November, he did not want “Harold Brown wandering around the desert trying to figure out where to put the airfield for the Israelis, with us having to foot the bill.”<sup>58</sup> Such presidential pessimism related more to the lack of progress on the Camp David framework for peace than to DoD’s performance. Carter knew with confidence that the air bases were a firm commitment. The Corps of Engineers acted as the construction agent, OSD provided a project manager, and the Israeli Ministry of Defense had a program manager; all three at times considered themselves

the “real” project manager, causing friction and delay. Still, the bases at Ovda and Ramon in the Negev were built on time and close to budget.<sup>59</sup>

### Military Assistance to Israel, Egypt, and Saudi Arabia

The Negev air bases constituted just one part of a much larger program whereby the United States provided assistance and weapons—to Israel to compensate it for withdrawal from the Sinai, to Egypt for modernization of its armed forces, and to Saudi Arabia in the form of sales of high-end weapons to encourage its support of a Middle East peace. These actions represented the levers that led to the Egyptian-Israeli Peace Treaty and what little progress it signified toward a comprehensive peace settlement. Was Carter buying an Egyptian-Israeli peace or did peace in the Middle East require moderate Arab states like Egypt, Saudi Arabia, and Jordan to receive large infusions of U.S. weapons and equipment to remain confident in their security?

Brown’s February 1979 trip to Israel, Egypt, Jordan, and Saudi Arabia, the first by a secretary of defense to any of these nations, suggested some answers. After consultation with the president, Brown received his official instructions. His main task as relayed was to “restore and reinforce confidence in the United States” among the states he visited, emphasizing the need for a rapid Egyptian-Israeli peace treaty as a first step to an Arab-Israeli accommodation. For Israel, Egypt, and Saudi Arabia, Carter provided Brown with specific instructions.<sup>60</sup>



The relocation of Israel’s Sinai airfields to the Negev was part of the Egyptian-Israeli Peace Treaty.

Brown sent the president a general account at the end of his trip, which Carter called a "Good report." As instructed by Carter, when in Egypt Brown offered a DoD survey team to gauge Egypt's air defense requirements and 800 armored personnel carriers "in the context of progress" toward a peace treaty. The secretary feared that "time is probably running against success" for an Egyptian-Israeli peace accord. To make Sadat's peace with Israel "digestible to the other moderate Arabs," the United States had to go beyond portrayal of it as part of a comprehensive political peace. More was required: regional economic development, arms sales (although not blank checks), and a U.S. military presence (not a base) in the Middle East. Secondly, Brown concluded that the real threat to moderate Arabs lay in internal violence supported from across borders or resulting from their own economic, political, or social instability. Military hardware was not a cure-all for these internal threats.<sup>61</sup>

If the Saudis wanted a "special' relationship" with the United States, the president told the secretary to stress the importance of Middle East peace and keeping oil flowing at reasonable prices. Brown could not offer the Saudis specifics about arms sales and training, Carter would do so after he met with Crown Prince Fahd. As for King Hussein and Jordan, Brown offered the promise of additional security assistance and military modernization as Jordan became more actively involved in the peace process.<sup>62</sup>

In Israel, Brown agreed "in principle to provide equipment and technical assistance in overcoming the loss of intelligence and early warning stemming from the Sinai withdrawal." As instructed, he avoided going beyond the already decided FY 1980 package of \$1 billion FMS and \$785 million security support assistance. The secretary informed the Israelis that the administration would sell them 960 APCs and 200 howitzers, again stressing that the sales were "in the context of progress on the Israeli-Egyptian peace treaty."<sup>63</sup>

As for the peace process, Brown stated that Egypt and Israel were wedded to it; Jordanians and the Saudis feared it carried more risk than reward, hoping it would fade away. The secretary reported that joint military planning and intelligence sharing were not enough: "No one was satisfied. Everyone had his list." The Saudis renewed requests for advanced weapons, such as XM1 tanks. Jordan presented a plan for \$2 billion for filling shortfalls and force modernization, including F-16s and Roland short-range, surface-to-air missiles. Israel took the hint and scrapped



MATMON C, substituting a new eight-year plan that was supposedly 20–25 percent cheaper but front-loaded most of the advanced items of MATMON C. Egypt went for it all, listing weapons and equipment worth \$15 billion to \$20 billion to “Americanize” its armed forces. Brown did not respond to these requests. Rather, he recommended approving military hardware items “at a somewhat faster rate (without increasing dollar levels where credit is involved)” for all three Arab states. The exception was Egypt, which Brown believed required a sharp infusion of arms and FMS credits given its need for more robust self-defense, its former reliance on Soviet equipment, no prospect for Soviet supplied spare parts, and the expectation that Sadat would assume the former shah’s role as regional security leader. Nevertheless, Brown considered the Egyptian \$15 billion to \$20 billion request unrealistic.<sup>64</sup>

Carter had asked Brown to look into a possible U.S. military presence in the area. Brown reported that Israel would welcome a U.S. base on its soil but would happily settle for U.S. troops anywhere in the Middle East. Neither Egypt nor Saudi Arabia wanted a U.S. base on its territory. The secretary suggested that the answer might be a greater U.S. military presence—periodic aircraft deployments, joint exercises, use of facilities in crises, prepositioning of critical items, and more U.S. naval activity. He described these as having the “military advantages of a base with fewer political burdens.” Brown also provided admittedly “sketchy” military appraisals. He found Israel’s armed forces “very capable, very tough, and very ready”; they would have no trouble defeating the combined forces of Egypt and Jordan and probably Syria and Iraq too, but given Israel’s small population it was sensitive to casualties. Egypt’s forces had good morale but were not battle ready. For all their spit and polish, Jordan’s armed forces were small and modestly equipped. The Saudis, although moving toward a professional air force, seemed to Brown “a military zero at this time.”<sup>65</sup>

Carter rated Brown’s trip to the Middle East allies as “successful in assuring them of our staunchness.” The president also noted the secretary’s views that the moderate Arabs were not as keen on close relationships as was the United States, opposed a “major defensive role” in the Middle East for Israel, and did not want U.S. military bases. However, what they did want, Carter concluded, was “excessive American military sales and/or financial aid.”<sup>66</sup> Fritz W. Ermarth, who had been detailed to the NSC staff from CIA, accompanied Brown on the trip. He noted that the secretary and his team did a good job, but he suggested that “their approach is

mechanical rather than political.” Ermarth continued: “Future steps will require more pressuring and negotiating. Moreover, we’re dealing with people who have a keen sense of political theater. Personal style is important to Arabs and Israelis.” Ermarth recommended that Brown and OSD/ISA should not be allowed to use arms supply issues to run the Middle East policy show. Brzezinski noted in the margins of Ermath’s report that he found it “interesting [he no doubt agreed with its premise].”<sup>67</sup> This trip represented Brown’s first major venture into diplomacy abroad. More such missions would follow.

From 8 to 14 March 1979 Carter undertook a peace mission to Egypt and Israel to nail down a treaty. Brown provided the president with specific recommendations on the military supply aspects of the Egyptian-Israeli negotiations as well as some general advice. The Israeli estimate of \$4 billion for the cost of the three-year Sinai withdrawal was “clearly overstated.” Brown suggested \$1 billion in FMS credits and \$1 billion to \$1.5 billion in straight loans to cover it. Egypt wanted to replace all of its Soviet equipment; Brown recommended \$1.5 billion over the next three years, 40 percent in FMS credits and the rest in cash sales. The 40 percent amounted to \$200 million per year, all that the secretary thought Congress would allocate.<sup>68</sup>

Israel’s arms and equipment requests, although reduced from the now-jettisoned MATMON C, amounted to a still substantial \$15 billion over 10 years and comprised a conglomeration of specific weapons and equipment sales, technology transfers, and coproduction. While Brown and the JCS did not consider the package justified by the threat (even adding Iraq and Syria to Israel’s potential opponents), it was “important . . . in psychological terms” to Israel. For that reason Brown suggested speeding up already programmed deliveries of F-16s, M60A3 tanks, APCs, and M109 armored self-propelled howitzers. If Israel got its aircraft sooner, so should Egypt. Although F-5 aircraft were not Egypt’s highest priority (they now wanted F-15s and F-16s), Brown suggested selling more F-5s as well as Hawk missiles and C-130 cargo planes. Tanks for Egypt represented too hot a political issue, especially in Congress. Brown recommended that the French and British should sell them the 1,000 Chieftain tanks that the Shah had ordered, now cancelled by the new Iranian government.<sup>69</sup>

Brown also presented Carter with a specific checklist of military items for his discussions with Begin and Sadat.<sup>70</sup> During the trip (Brown, Vance, and

Brzezinski accompanied Carter) Brown offered Carter some advice just before a hastily arranged final 13 March meeting when chances for a peace treaty looked darkest: “I sense Mr. Begin considers that concluding a peace treaty is more urgent for you than for him. If so, we need to convince him that time has run out for him. . . . [And] make a final attempt to blast him into the orbit of statesman and peacemaker.” If Begin refused to cooperate, Brown advised telling him negotiations were ended.<sup>71</sup> While the president did not follow Brown’s advice *per se*, Carter and his aides conveyed to the Israelis that it was showdown time. Finally, Begin agreed to the terms for a peace treaty with Egypt. When Carter returned to Egypt, Sadat accepted the treaty provisions.<sup>72</sup>

In Egypt, Brown met with Egyptian Defense Minister Kamal Hassan Ali and afterward officially informed him that once Egypt signed the peace treaty, it could expect \$1.5 billion over the next three years—half in cash sales and half in FMS credits. Weapons and equipment available to Egypt included one cruiser, 4 Gearing-class destroyers, 800 APCs, 12 I-Hawk missile batteries, 50 additional F-5s, 20 C-130s, 40 CH-47 Chinook helicopters, and retrofitting of existing Egyptian Soviet-built tanks. Items to be considered included 35 F-4s and one or two diesel submarines, but F-15s, F-16s, attack helicopters, and M60 tanks were off the table. Since the available items would cost more than \$1.5 billion, the Egyptians would have to prioritize and forego some weapons.<sup>73</sup>

The offer to the Egyptians included sale of F-4E Phantom II jets, the early 1960s aircraft that the Israelis had deployed so effectively in the 1973 war. While the F-5, with a top speed of Mach 1.6, was cheaper and easier to fly and to maintain than the F-4 (with a top speed of Mach 2), the political symbolism of having aircraft as capable as those of the Israelis became an important factor for Cairo. Since the Saudis had suspended their offer to finance the \$525 million for purchase of the 60 F-5s, the Egyptian government insisted that \$600 million of the \$1.5 billion FMS credits given over the next three years be used to purchase 35 F-4s. In October the first 18 F-4s, all from active U.S. Air Force units, officially arrived in Cairo at a ceremony attended by Sadat. The F-4s became, in effect, the holding plane for Egypt until the early 1980s when it received its first F-16s. The long, drawn-out Egyptian negotiations over the F-5E and the consultations, and the vote in Congress, were overtaken by the decision to substitute the F-4s for F-5s. The change received *pro forma* congressional approval, and little problem from Israel.<sup>74</sup>



A U.S. Air Force F-4 Phantom II, the 1960s aircraft flown by the Israeli Air Force during the 1973 Arab-Israeli War. (RG 330, NARA II)

Israel would get up to \$2.5 billion in total military aid, with \$1 billion in grant assistance for air base construction and \$1.5 billion FMS credits (half of which would be forgiven) over next three years. Israel could expect accelerated delivery of 55 of the total 75 F-16s, 600 precision-guided bombs, 600 air-to-air missiles, 200 M60A3 tanks, 800 APCs, 200 M109 howitzers, 14 Phalanx close-in weapons for defense of ships against missiles, 4 encapsulated Harpoon missile fire-control systems, and intelligence and early warning equipment. Under consideration would be 55 additional F-16s, bringing the total to 130.<sup>75</sup> All this required congressional approval. Brown recommended a single supplemental package funded entirely in FY1979. Such was the price of peace. On 26 March 1979 Carter, Sadat, and Begin signed the treaty in Washington.<sup>76</sup>

### **Post-Peace Security Assistance and Arms Sales**

Carter planned to cap the success of the peace treaty with a general Middle East settlement including the Palestinians, an impasse that had evaded all previous efforts. Carter planned to use the prestige of the Egyptian-Israeli Peace Treaty,

presidential diplomacy, and the Department of State to negotiate a comprehensive settlement and, he hoped, lasting peace in the Middle East. The grease for moving the disputants toward peace was the same combination of arms sales and military assistance that had worked for the Camp David Accords and the treaty. This effort resulted in an expanded security relationship with Egypt and the Saudi kingdom as well as additional support of security assistance and military sales to Israel, but no overall settlement.

Egypt's armed forces were the most in need of help. Egypt lost its chief financial backer when the Saudis cut off their considerable funds for Egyptian military modernization in retaliation for peace with Israel, which the kingdom's leaders vehemently opposed. In July 1979 Carter asked Brown and Vance to look into enhanced military assistance to Egypt. The two secretaries informed the president that during Egyptian Vice President Hosni Mubarak's visit to Washington during the previous month, DoD and State had discussed a five-year military assistance plan, including a further \$500 million in FMS per year beginning in FY 1982. The plan had potential political problems. The Egyptian-Israeli Peace Treaty package, approved by Congress, granted Egypt \$500 million per year through FY 1982, meaning that in FY 1982 Egypt would get a total of \$1 billion in FMS, approaching parity with Israel. As for weapons and equipment, Egypt's priorities—modern tanks, antitank helicopters, and advanced fighter aircraft—would appear to Israel and its allies on Capitol Hill as changing the regional military balance in the Middle East. The secretaries cautioned the president that “we need to begin conditioning both Congress and the public to the fact that Egypt has legitimate defense requirements . . . that serve U.S. national interests.”<sup>77</sup>

Such advice raised a host of questions: When should the expanded support for Egypt start? How should it be financed? How much was Congress willing to appropriate? How would Israel react? Would the Egyptians be satisfied? What military equipment should Egypt get?<sup>78</sup> A State-chaired PRC meeting, attended by Brown, took up these issues. Brown opened discussion with a strong case for Egypt's “very substantial legitimate security needs.” Given that “Sadat has in effect burned his bridges by turning to us,” the secretary saw no alternative to providing major support of \$800 million per year from FY 1982 to FY 1986 and adding \$350 million to the \$500 million earmarked for FY 1981. The representatives of JCS, State, CIA, and NSC supported him, but the OMB representative expressed doubts and

asked to comment separately to the president. Nevertheless, the PRC recommended \$350 million in additional FMS credits to Egypt for FY 1981; cash flow financing whereby Egypt, like Israel and Jordan, could borrow from future years' obligated unspent funds to make down payments on new orders (on the assumption that Congress would appropriate more money in the future and the cash stream would continue to flow); \$800 million in FMS credits for FY 1982 to FY 1986; and approval in principle to sell high-performance F-16 aircraft (but not F-15s) and M60A3 tanks. The NSC committee noted that the other items Egypt required, APCs, air defense systems, and ships presented no problems for arms transfer policy.<sup>79</sup>

Carter insisted on a decision paper examining the implications of such long-term military assistance to Egypt, adding ominously that the drafters "be cautious about excessive U.S. commitments, noting that budget constraints will be very severe."<sup>80</sup> Brzezinski sent the October 1979 joint DoD-State paper to the president, adding his own recommendation that "Sadat has nowhere else to turn for military assistance" and failure to support Egypt "militarily at this critical juncture could have disastrous effect on our overall peace effort."<sup>81</sup> But OMB reported to the president that the Egyptian FMS program was well above planning ceilings for FY 1981. Neither State nor Defense ranked the alternative Egyptian FMS levels according to zero-based budgeting despite a specific request by OMB; the cash flow method increased unfunded future liabilities; and such a program would only encourage Israel to ask for more assistance.<sup>82</sup> Carter accepted OMB's advice, stating: "State and DOD must assess Egypt/Israel military needs as part of the ZBB approach to '81 budget—compared to worldwide nation-by-nation priorities."<sup>83</sup>

The decision to rework the Egyptian military program carried into 1980. Vance and Brown proposed increasing FMS credits for accelerated delivery of F-16s and M60 tanks by borrowing against the \$1.5 billion approved and then paying it back from future obligations, the cash flow funding option that OMB had opposed. Given that the administration already had unlimited cash flow financing for Israel, DoD considered a similar scheme appropriate since Carter had committed to a long-term program for Egypt. Furthermore, cash flow funding was an accounting sleight of hand that did not show up as a program cost.<sup>84</sup> The new program was substantial. The \$800 million figure was second only in size to Israel's \$1 billion, and it represented almost one-third of all FMS credits for the year—four times the amount granted any country other than Israel.<sup>85</sup>

The main purpose of this proposed financial ledgerdemain was to allow Sadat the advanced weapons that Egypt needed to rebuild its military and maintain a force capable of fighting regional foes. Cairo set its sights on the F-16 Falcon, the same advanced fighter that Israel was already receiving. Egyptian Vice President Hosni Mubarak visited Washington in January 1980 and passed on a request from Sadat for 40 F-15s, 120 F-16s, and 900 M60A3 tanks, with delivery dates beginning in 1980 and 1981. The Sadat request would cost almost \$7 billion, about \$2 billion more in new money per year.<sup>86</sup> Carter promised Mubarak accelerated delivery of F-16 aircraft and M60A3 tanks but without specific numbers or delivery dates.<sup>87</sup> Brown informed Mubarak that his full request could not be met. DoD representatives presented an Egyptian military delegation accompanying Mubarak with a more modest range of weapons and longer delivery schedules.<sup>88</sup>

At the end of January 1980, Brown sent the president illustrative options for accelerating deliveries to Egypt based on different FMS credit levels. Carter approved adding \$200 million to the \$350 million for FY 1981, thus enabling Egypt to buy 700 tanks and still have \$70 million a year for new programs in FY 1980 and FY 1981, along with expedited delivery of 80 F-16s in December 1982. The president did not approve an increase in the ceiling for cash flow funding from \$1.5 billion to \$2.7 billion. It was now up to DoD to work out an agreement with Egypt.<sup>89</sup>

Brown chose McGiffert to negotiate the deal. The assistant secretary took the message to Cairo that the funding and the package were the best that the United States could do. As Brown reported to the president, the Egyptian senior military took a “practical and professional approach . . . in deciding to build an effective fighting force with F-16s rather than seeking ‘prestige’ with F-15s.” The negotiations resulted in Egypt obtaining expedited delivery of 40 F-16s, 244 M60A3 tanks, 130 M48 tanks (later changed to M60A3s), 550 APCs, tank-wrecker and recovery vehicles, and \$332 million in miscellaneous equipment. Although the five-year program’s details underwent almost constant adjustment due to availability, production schedules, and other factors, it resulted in a military modernization program based on U.S. equipment that helped place Sadat and his successor Mubarak firmly in the U.S. camp, allowing Egypt to assume the role of a key U.S. ally in the Middle East.<sup>90</sup>

The Israelis could be counted on to increase their requests for greater FMS in light of the U.S.-Egyptian negotiations. Carter had promised Weizman a small but “more than . . . symbolic” concession as part of the peace package.<sup>91</sup> Weizman

visited Washington in April 1980, asking for \$3.45 billion in FMS credits and assistance for FY 1981. Israel was facing a cash flow problem because of its weakened economy, the shrinking value of the U.S. dollar, and the rising costs of imports, especially crude oil. The \$3.45 billion the Israelis requested, McGiffert noted, equaled what Israel planned to spend on settlements in the occupied territories. If short on cash, the Begin government should build fewer settlements or dip into the unreserved part of the \$2.2 billion from the peace package. Others in DoD proposed a less draconian solution whereby Israel's cash flow problem could be worked out by judicious planning to stretch out deliveries and payments.<sup>92</sup> The Israelis also wanted approval to procure 10 F-15s, 25 to 75 F-16s, and 50 F-18s. DoD could support the eventual procurement of 85 U.S. aircraft (10 F-15s, 25 F-16s, and 50 F-18s). Israel's most dramatic overture proposed replacing the low end of Israel's fighter aircraft force (A-4s, Kfir, and Mirages) with an indigenous Israeli-designed fighter, the Lavi, which would have an advanced U.S. engine.<sup>93</sup> After Weizman's visit, the United States granted an exemption from arms transfer restrictions and permitted Israeli coproduction of a GE F404 or similar engine for the Lavi.<sup>94</sup>

### **Saudi Arabia**

The Saudis also needed an upgrade to their air force. Unlike the Israelis, they had neither the ability to produce their own planes nor the support in Congress or from the American public for the purchase of advanced U.S. aircraft. Saudi Arabia had won no friends among Americans because of its 1973 oil embargo in support of the Arab combatants in the October war. Friends of Israel feared Saudi Arabia might use advanced weapons against Israel. What the Saudis possessed was oil and U.S. dollars. Some of these billions of petrodollars could be recycled back to the United States through arms, equipment, and training purchases. As an added benefit, U.S. arms sales to the desert kingdom could tie the Saudis into the peace process and provide an indication of U.S. support for their territorial integrity. The Carter administration was not the first to realize this. At Ford and Kissinger's instruction, Deputy Secretary of Defense William P. Clements Jr., a former oilman and close friend of the Saudi royal family, had offered the Saudis an "advanced aircraft" of their choosing in 1976. The Saudis opted for the top-of-the-line F-15.<sup>95</sup>

The Joint Chiefs of Staff concluded in July 1977 that the F-15s fulfilled "a valid military requirement" and that delivery by 1981 would allow time to train Saudi pilots and



technicians. Brown agreed, but advised being “vague on how many and when.”<sup>96</sup> The Middle East aircraft package provided the mechanism whereby the Saudis obtained their F-15s, but congressional opponents of the sale insisted that none of the aircraft be fitted with conformal fuel tanks that would extend their range, or with multiple ejector racks (MERs) for a larger bomb payload. That was the price that Carter and Brzezinski claimed the Israeli lobby extracted for sale of F-15s to Saudi Arabia.<sup>97</sup>

The U.S. relationship with Saudi Arabia consisted of more than F-15s or even other military sales. Nevertheless, by 1980 U.S. arms sales to the kingdom were the largest such program in the world, and the Saudi military services obtained virtually all of their equipment and training from the United States. During the 1970s, the Saudis also provided a convenient means of supplying other countries with U.S. equipment from Saudi stocks or military assistance where direct U.S. sales or assistance was politically difficult (Morocco, Somalia, and North Yemen). More than willing to oblige the United States in these third-party transfers, the Saudis nonetheless expected something in return.<sup>98</sup>

When North Yemen, officially the Yemen Arab Republic, was threatened militarily by the Soviet-backed Communist People’s Democratic Republic of Yemen, better known as South Yemen, the Saudis requested U.S. help for North Yemen. On the strong recommendation of the U.S. ambassador to the kingdom, John C. West, DoD dispatched in March 1979 two AWACS aircraft and crews to Saudi Arabia to monitor the North-South Yemen situation and authorized two SR-71 Blackbird reconnaissance flights over the North-South Yemen border. In addition, the Defense Department airlifted 7,000 light antitank weapons and an air defense mobile training team to North Yemen. The 15-member team under the command of Army Maj. Gen. Richard D. Lawrence deployed to Saudi Arabia to assist in planning for the defense of the kingdom and North Yemen. Also at Saudi request, the United States provided North Yemen with 12 F-5E aircraft, 64 M60A1 tanks, and 50 M113 armored personnel carriers, plus support, spares, training, and munitions for the three weapon systems.<sup>99</sup>

Notwithstanding this rapid response to events in North Yemen, all was not well between Riyadh and Washington. When the Policy Review Committee met in early May 1979, with Deputy Secretary Duncan in attendance, the participants concluded that “the U.S. relationship with Saudi Arabia is undergoing a period of severe strain and will require special attention in the months ahead.”<sup>100</sup> The U.S. intelligence community confirmed this view, suggesting at the end of 1979 that “the US ‘special

relationship' with Saudi Arabia—based on an implicit trade-off of oil for security—is in transition.” It was not just the Sadat-Begin peace treaty that gnawed at the royal family. Saudi society was dispirited, corrupt, and most of all, vulnerable, as dramatically demonstrated when fundamentalist terrorists captured and held temporarily the Grand Mosque of Mecca, the holiest shrine of Islam. Too weak militarily and with too few citizens, Saudi Arabia could not protect its oil wealth. Forced to rely on the United States, Saudi royal princes believed that they were not receiving the U.S. support they needed.<sup>101</sup> To counter such discontent, Ambassador West had suggested a “new U.S. military relationship with Saudi Arabia.” Brown supported the idea, but only if Washington made it “clear to the Saudis that they and we need a more efficient and capable organization, not merely a symbolic change.” As Brown told the president, it was time to shelve the “Sears and Roebuck’ approach of equipment deliveries and small unit training” in favor of more “central planning and operations assistance.”<sup>102</sup>

No matter how important the U.S.-Saudi strategic and operational planning, the Saudis and most U.S. officials saw the relationship in terms of arms sales. This was especially true during 1980, when Saudi Arabia pushed for U.S. action on the so-called Big Five of military sales to the kingdom: bomb racks, extended fuel tanks, and AIM-9 Sidewinder air-to-air missiles for the F-15s; boom tanker aircraft for aerial refueling of F-15s; and sale of AWACS. All of these systems would enhance the Saudi ability to defend its large and sparsely populated kingdom, but they would also dramatically upgrade the Royal Saudi Air Force by extending its range and firepower. Given that 1980 was an election year, these requests were sure to be politically controversial as a potential threat to Israel. Ambassador West kept the pressure on Washington, suggesting that Saudi security requests (including but not limited to the Big Five) were a “litmus test” of the special bilateral relationship between the two countries. West stated that U.S. responsiveness was “no longer an option, it has become an imperative.”<sup>103</sup> He continued “the negativism of our past hesitancy about Saudi defense procurement is inadmissible,” a criticism aimed directly at the Pentagon and not appreciated. Brzezinski agreed with West, suggesting acceleration of responses to the Saudis on an urgent basis and accommodating them as much as possible.<sup>104</sup> Brown commented: “I think this is a terrible idea. It would feed the Saudis’ delusion that they can defend themselves from external & internal threats with sophisticated weapons they can’t use.”<sup>105</sup> Brown found himself isolated; even the president asked, “What can we do to expedite delivery of committed weapons to Saudi Arabia?”<sup>106</sup>



External fuel tanks on an F-15, a key enhancement demand of Saudi Arabia for the fighters it planned to purchase from the United States. (RG 330, NARA II)



A KC-135R Stratotanker, on Saudi Arabia's request list, refuels an F-15. (RG 330, NARA II)

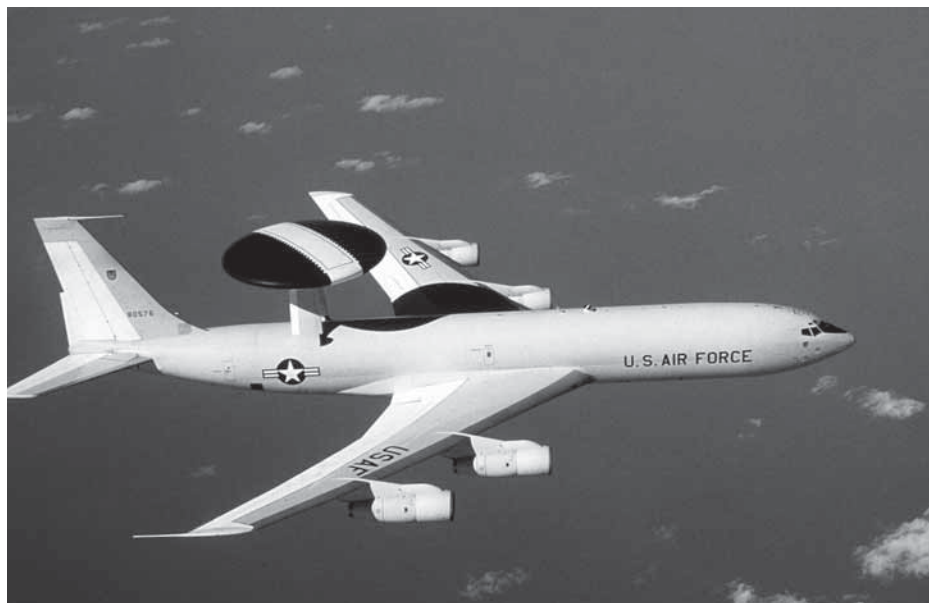

An E-3A Sentry AWACS aircraft, also requested by Saudi Arabia. (RG 330, NARA II)

At DoD's recommendation, Carter's advisers agreed to delay a response to the Saudi request until Brown met with Saudi Defense and Aviation Minister Prince Sultan bin Abdulaziz al-Saud in Geneva in late June 1980.<sup>107</sup> This meeting, not solely about arms sales, took on a crucial importance. Brown was inundated with advice and recommendations. At a meeting between Brown, Brzezinski and Secretary of State Edmund Muskie, the three agreed that Brown could tell the Saudis that they would get AIM-9L Sidewinder air-to-air missiles. The administration would approach Congress in 1981 to reconsider conformal fuel tanks and aerial tankers but would not raise the topic of bomb racks. Brown consulted Senate Majority Leader Robert C. Byrd (D-WV), who saw no problem as long as the Saudis realized the offers were dependent on congressional approval (hardly a sure thing).<sup>108</sup> West thought a favorable response on additional F-15 equipment both important and helpful in convincing the Saudis that Washington appreciated their oil pricing and production, proof that the administration did not consider Israeli interests paramount. He also suggested that the real impetus for the requests came from Saudi senior princes, who wanted to keep the military happy to prevent them from causing trouble. McGiffert and Brown considered interservice rivalry (a Saudi senior prince headed each military service) the more

likely explanation.<sup>109</sup> Muskie advised that Brown should tell Prince Sultan that the administration had approved in principle the sale of AIM-9L sidewinders and would consult with Congress about conformal fuel pods, but would not agree to consult with Congress on KC-130 boom tankers, as they spelled deep trouble on Capitol Hill. The State Department also thought Brown should avoid the facilities access issue, which the Saudis would resent in light of lack of progress on an overall Middle East peace. Brown disagreed.<sup>110</sup>

The secretary knew that he should not allow the meeting to concentrate solely on arms sales. He hoped to restore Saudi confidence in the United States, reconnect a U.S.-Saudi security dialogue, agree on prepositioning of U.S. military equipment in the Persian Gulf and Indian Ocean littoral, and discuss how to deal with Afghanistan, Iran, and the Soviet threat. Still, in his heart Brown realized that the meeting would rise or fall on decisions on the Big Five. For that reason he wanted to inform Prince Sultan that the United States would consider boom refueling—a capability denied Israel—but the Saudis must realize that it would encourage Israel and Soviet clients in the area to demand the same capability. Furthermore, it was not a certainty with Congress, even given changed circumstances after the Iranian revolution and the Soviet invasion of Afghanistan. The AIM-9L had a good chance of passing muster with Congress, but bomb racks for F-15s did not and should be delayed. In addition, Brown suggested offering the Saudis the Patriot missile air defense system as a sweetener for the only tentative decisions.<sup>111</sup>

While Brown would make no commitments, given that Congress needed to approve the sales, he believed that assurances from the administration to obtain congressional approval on conformal fuel pods, aerial refueling, and the AIM-9L would satisfy the Saudis for the time being. He did not agree with Muskie, who opposed consultation with Congress on aerial refueling as a sale too far: “I believe that were we to reject *both* the refueling and MERs requests there would be a very substantial adverse effect on our relations with Saudi Arabia.”<sup>112</sup>

The meeting with Prince Sultan on 26 June lasted seven hours: a four-hour private discussion between Brown and Sultan with only an interpreter present during the morning, followed by a three-hour lunch meeting with a larger group of officials and aides from both sides. Brown sent Carter an eyes-only telegram noting that the meeting was “cordial in tone and useful in substance. . . . I believe we have defused the F-15 issue, gained Saudi acceptance of a security consultative

mechanism which may over time let us deal more effectively with mutual security problems and laid down a marker for possible future discussions of prepositioning and other actions to permit surge of US forces to positions north of the oil fields.” Brown admitted that Sultan expressed disappointment about the inability to commit to the enhancements for the F-15 but realized the need for consultation with Congress. Brown claimed to have “finessed the F-15 issues for the time being, but Sultan made clear that failure to seek approval of at least some F-15 items after the election would have a very serious effect on our relations and weaken Saudi resistance to radical Arab criticism of its close US ties.”<sup>113</sup>

Brown was putting the best light on the Saudi reaction. In the lunch meeting, the Saudi Air Force chief of operations, Col. Fahad bin Abdullah, went through the list of Saudi requested equipment, including howitzers, the Roland surface-to-air missile, the new Bradley fighting vehicle, and the Lance mobile field tactical surface-to-surface missile, but not the XM1 tank. Brown reiterated U.S. decisions, suggesting that there might be good substitutes for the Lance. Sultan stated that it was his understanding that the United States was prepared to lend Saudi Arabia AWACS aircraft. Brown replied no, the United States would deploy them to the kingdom for joint training and a joint study on their applicability. Sultan asked for how long. Brown admitted he had not thought about that question. Fahd interrupted to say why not just sell the Saudis the AWACS, but Brown suggested that such a move was premature without study of ground-based systems, command-and-control analysis, and interoperability.<sup>114</sup>

Turning to other than military hardware discussions, Sultan urged Brown to support Afghan rebels fighting the Soviet invasion and provide the Pakistanis (“nationalists and also strong Muslims”) with more military assistance. The secretary told Sultan that if the Persian Gulf was threatened by Soviet aggression only the United States had the military strength to combat it, depending on the preparations it could make to do so, including gaining access to facilities in Oman, Kenya, Somalia, and Egypt; prepositioning tanks and equipment on ships in the Indian Ocean; and obtaining fast transport ships and large transport aircraft. Brown admitted that U.S. bases in Saudi Arabia would not be wise politically, even though militarily they would be useful. Sultan asked Brown whether he was talking in the abstract or asking for bases. The secretary replied he was not asking for bases, but he raised the idea of potential use of Saudi facilities in the event of a

Soviet attack in the Middle East. An obviously relieved Sultan rose from his chair and shook the secretary's hand in appreciation. The desert kingdom was not ready for American GIs on its soil.<sup>115</sup>

NSC staffer Gary Sick told Brzezinski that "from all accounts to date, Brown did a superb job of delivering the F-15 news to Sultan while making the key points about our strategic view of the regional situation and our need for assistance from the Saudis . . . to meet our security responsibilities." Still, Sick suggested asking Brown some follow-up questions.<sup>116</sup> Brown responded to these queries, noting that the Saudis would come back with renewed requests for the F-15 accessories late in 1980 or early 1981, insisting in the long run on approval of all the items, including the bomb racks, even though Brown had been "particularly reticent with respect to MERs." Sultan dodged the secretary's "probe" about U.S. use of Saudi facilities, but Brown saw hope for future discussion, provided the United States steered clear of the idea of U.S. "bases." Brown believed he could get the joint U.S.-Saudi military consultative mechanism going before the end of the year. He also believed the Saudis "will press hard to buy AWACS," but he thought he could hold them off with a long-term integrated air defense study.<sup>117</sup>

At the end of September 1980, Iraq invaded Iran and serious fighting erupted between the leading secular Arab state under Saddam Hussein and the militant Shiite Islamic Republic of Iran. The Saudis were seriously in need of some assurance, which Brown and DoD sought to provide. At Saudi request, DoD rushed four AWACS with supporting equipment (including secure communications) and personnel and two additional mobile land-based radar (TPS-43) to the kingdom. DoD dispatched a U.S. team to Saudi Arabia to assess the Saudis' request for enhancement of their command, control, and communications capabilities and another team to discuss multinational naval patrols of the Persian Gulf. The Saudis also agreed to raise oil production by one-half million barrels a day or more and encourage other Gulf states to follow suit to make up for the loss of oil from the Iran-Iraq War.<sup>118</sup>

In fall 1980, with the presidential election in full swing and facing strong opposition from Republican candidate Ronald Reagan, Carter had little time for consideration of issues like Saudi Arabia and the Iran-Iraq War. But the election had an impact on arms sales policy. When news of OSD's intention to study the F-15's offensive accessories for the Saudis leaked to the press, Carter reaffirmed that there

would be “absolutely no change” in Saudi arms sales as given to Congress by Brown in 1978 (no F-15 enhancements) and that “we will not agree to provide offensive capabilities for the planes that might be used against Israel, and that obviously includes bomb racks.”<sup>119</sup> Carter’s statement was one of those convenient half-truths a presidential candidate utters in an election campaign. Yes, there was no change, but Brown and Carter fully anticipated that there would be. The tanker refueling equipment, conformal fuel pods, Sidewinders, and even the MERS could be considered defensive, but they would give the Saudis a much longer range and better air force. Displeased with both the president’s and candidate Ronald Reagan’s remarks about Saudi Arabia, the Saudis cancelled talks on military contingency planning, naval cooperation, and prepositioning of equipment for the Rapid Deployment Force.<sup>120</sup>

JCS Chairman General David Jones stopped over in Saudi Arabia in mid-November, promising Sultan early delivery of six F-15s and early review of the Big Five. Not satisfied, Sultan subjected Jones to an hour-long protest about the U.S. arms policy, suggesting F-15s were valueless without the enhancement items. He also vented his anger that both Reagan and Carter tried to outdo each other in Saudi-bashing during the just-completed presidential campaign. Sultan gave Jones two weeks to come up with action on the sale of AWACS and the F-15 enhancements, with the exception of MERs, which he realized had special problems. He backed up the ultimatum with an implicit threat to cancel the F-15 sale and even the “special relationship.” Brown also became a target for Saudi wrath. An angry Prince Sultan terminated Saudi coordination with the U.S. military training mission, reportedly in response to Brown’s public comments that they had agreed at Geneva “that the equipment issue would lie dormant until after the U.S. elections.”<sup>121</sup>

The president, Brown, Muskie, and Brzezinski decided on 24 November 1980 to provide the Saudis continued U.S. AWACS patrols, AIM-9L missiles, and fuel tanks, but not refueling and bomb racks. Carter would have agreed to refueling, but he wanted President-elect Reagan’s concurrence.<sup>122</sup> On 26 November (two weeks after the Saudi ultimatum), Brown sent Sultan a letter promising an “early and positive decision” on fuel tanks and Sidewinders for F-15s and on the sale of AWACS. Until the AWACS could be delivered in 1985, the United States would be prepared to station AWACS in the kingdom from time to time as required by the regional situation. Brown stated that he recognized the need for aerial refueling



and ground attack capability of the F-15s (the bomb racks). Since Carter had lost the election, Brown informed Sultan that he and the president were in contact with the Reagan transition team about these issues.<sup>123</sup>

Reagan refused to be tied down on Saudi arms sales, so on 12 January 1981 Brown sent Sultan a letter informing him that after consultations with Secretary of State-designate Alexander M. “Al” Haig Jr. and Secretary of Defense-designate Caspar W. Weinberger, he found the two men “sympathetic” to Saudi requests. It was the new administration’s preference, however, to complete the congressional procedures for the transfers. Immersed in final hostage release negotiations with Iran and looking toward his departure from Washington, Carter had no time for the Saudis.<sup>124</sup>

Carter’s Middle East policy succeeded in forging peace between Egypt and Israel and facilitating Israeli withdrawal from the Sinai, both major accomplishments in the long and tragic saga of the post-World War II Middle East. Harold Brown and the Department of Defense played an important although smaller role, the grittier end of the stick. They had to rein in often-inflated Israeli requests for arms and equipment, inform Sadat that Egypt was not going to get all the military modernization that he hoped for in the peace process, keep the costs of the transfer of the air bases in the Sinai to the Negev at a minimum, limit financial support for Israel’s overall withdrawal from the Sinai, and string the increasingly impatient Saudis along on enhancements for the F-15s. Relations with Saudi Arabia dipped at the end of 1980, when it became clear that the Carter administration could not provide all the enhancements to the F-15 the Saudis desired. Still, Brown and DoD could take satisfaction that during their four-year tenure U.S. relations with Egypt and for the most part with Saudi Arabia, the major Arab moderate states, had undergone a dramatic transformation. When the administration concluded that if the Soviet Union’s threat to the Middle East required a new framework for security and a rapid deployment capability (see chapter 11), the United States and its allies had attained a better position to create such a system.



## Iran and the Hostage Crisis

IRAN WAS THE ROCK on which the Carter presidency foundered. The collapse of the government of longtime U.S. ally Shah Mohammad Reza Pahlavi in early 1979 ended U.S. reliance on Iran as the policeman of the Persian Gulf. The subsequent hostage crisis, during which militant Iranians held U.S. embassy officials—including DoD personnel—prisoner in Tehran, sapped the life out of the Carter administration. The hostages' ordeal created a national obsession with their release as reinforced by journalist Ted Koppel's television report, *The Iran Crisis—America Held Hostage*, each night indicating the number of days that Iranian militants had held American embassy personnel hostage. The failed Iran hostage rescue mission was Carter's darkest day, and a most discouraging one for America. Defense Secretary Harold Brown and his staff engaged fully in all administration decisions on Iran—the one exception being the hostage release negotiations, which both predated and postdated the rescue attempt.<sup>1</sup>

Ever since the United States helped the shah to retain his throne in 1953 by secretly financing popular street support against Prime Minister Mohammad Mossadegh, the fortunes of the United States and Iran had been intertwined. Although some presidents such as John F. Kennedy pushed the shah to reform his one-man government, all presidents from Eisenhower to Ford saw Iran as a model of a modernizing state in the Middle East and as a powerful surrogate for American interests there. While the shah demanded top dollar for his oil, he kept it flowing and included Israel among his customers. For the Nixon and Ford administrations, Iran was one of the “twin pillars” of the Middle East. The far less militarily significant Saudi Arabia, relying on its oil-fueled economic power, was the other pillar. What the shah wanted, the shah usually got; the United States

provided sophisticated military weapons, equipment, and training in return for his petrodollars.<sup>2</sup>

### Arms Sales to Iran

Unlike the Nixon and Ford administrations, from the onset Carter had serious doubts about selling advanced weapons worldwide, including to Iran, a major U.S. customer. In May 1977 Carter signed Presidential Directive 13, setting limits on conventional arms transfers and restricting sale of advanced weapons. Equally troublesome to Carter, the shah's human rights record was much lacking, but the president understood Iran's significance to U.S. Middle East strategy.<sup>3</sup> The shah had a long list of requirements for his Imperial Iranian Armed Forces, of which the air force was closest to his heart. With personnel strength of 110,000, it was a modern, jet-equipped tactical force equal to or better than any other in the Middle East with the exception of Israel. It possessed 407 fighters and fighter-bombers (primarily early 1960s F-4 Phantoms and F-5 Freedom Fighters, and more advanced early 1970s F-14 Tomcats), 87 transports, 40 helicopters, 37 trainer/utility aircraft and 36 special-purpose aircraft. But as the Defense Intelligence Agency concluded, Iran's air force lacked adequately trained technical personnel and suffered from poor logistics, which meant it could sustain full-scale operations on its own for only a week.<sup>4</sup>

To the shah these DIA concerns were minor details. He wanted more advanced aircraft. After discussions with the Northrop Corporation in September 1976, Iran formally requested 250 F-18L aircraft (a land-based derivative of the U.S. Navy's F/A-18 Hornet) to replace its F-4 Phantom force, offering to pay Northrop \$8 million to jump-start a for-export-only program for the F-18L. In addition, he requested an additional 140 F-16 Falcons (160 had already been requested and approved) and 7 E-3 Sentry AWACS aircraft. Secretary of Defense Donald Rumsfeld placed the F-18L request under study; after the election of November 1976 it became Carter's decision.<sup>5</sup>

In May 1977 DoD completed the study of the F-18L request. At the suggestion of Assistant Secretary of Defense for International Security Affairs David McGiffert, Brown informed Secretary of State Cyrus Vance that since even Iran's oldest F-4s (the F-4Ds) were good until the mid-1980s, the F-18Ls were "premature." Such a conclusion eliminated two problems raised by PD 13: the first required that

no aircraft could be sold to a foreign nation until it entered the U.S. inventory (the Navy would not get its first F-18As until 1982 at the earliest); the second stipulated that exports not reflect a major modification of U.S. planes without the president making a formal exception to PD 13. Brown considered the F-18L a major modification. The secretary recommended denying the Iranian request with a promise to reexamine it in 1979–1980. Seeing the writing on the wall, the shah dropped his demand for F-18Ls.<sup>6</sup>

While opponents of increased arms sales to Iran no doubt took heart from the denial of F-18Ls to Iran, they were still concerned about the request for Boeing E-3 Sentry AWACS aircraft. Originally the shah had contemplated an elaborate system of 32 to 41 ground radars, known as Seek Sentry, which could see through the thick Persian Gulf weather inversion. But ground radar facilities would be expensive—\$10 billion to \$15 billion at 1976 dollars over the next 10 years. Combining seven to nine AWACS with only 20 or so ground radars would provide Iran with a credible air defense system and reduce the cost to between \$1.9 billion and \$2.8 billion. Such a system could be up and running in six to eight years. Too sweet a deal for him to pass up, the shah canceled Seek Sentry and asked for nine AWACS to be combined with 20 ground radars (some of which Iran already had). Both Brown and the Joint Chiefs of Staff supported Iran's request as a "practical solution" that would upgrade Iran's air defense system more cheaply and quickly.<sup>7</sup>

Carter saw the logic of the argument, but he was prepared to sell only seven E-3 AWACS to Iran despite the JCS making a case for nine.<sup>8</sup> Carter's own concerns about advanced weapons proliferation and human rights coalesced. Congressional critics of arms sales to Iran, especially Senator John Culver of Iowa, took a similar stance, opposing the sale on the grounds that the shah was a dictator, the sale would require stationing U.S. personnel in Iran, and it would undermine Carter's policies of arms sales restraint. But Culver and his group lacked the votes.<sup>9</sup> However, DCI Stansfield Turner presented an additional hurdle by informing the General Accounting Office (Congress' investigation arm) that the sale posed sensitive technological and espionage risks should an E-3 Sentry plane or an Iranian crew fall into Soviet hands. Written without consultation with DoD, the DCI's assessment failed to understand that the United States would not sell sensitive AWACS communications security equipment to Iran, but rather less sensitive commercial applications. The Iranians would be getting 1960s' AWACS technology (they already

possessed a form of more advanced look-down radar in their F-14s). The chance of defection of a 17-man crew of the seven AWACS was no more and probably less than defection of a two-man crew from one of Iran's 80 F-14s. Even if the Soviets obtained an AWACS aircraft, reverse engineering would prove difficult.<sup>10</sup>

Providing Congress with these assurances, Brown assumed he was making headway with Congress. But on 28 July the House International Affairs Committee voted to disapprove the sale, suggesting the probability of full congressional rejection. The president delayed the process for 30 days, complaining that DoD and State had not done their job on Capitol Hill.<sup>11</sup> The administration convinced an irate shah to agree to six assurances to safeguard the technology of the AWACS—Vance admitted they were largely cosmetic.<sup>12</sup> Brown and his staff redoubled their efforts to persuade the skeptics in Congress. On 23 September the secretary informed the president, "I believe we have won this debate." The 7 October deadline for full congressional disapproval passed; the first AWACS aircraft were scheduled to deploy to Iran in 1981.<sup>13</sup>

The shah arrived for a state visit in Washington in mid-November 1977. Junior U.S. Embassy officials in Iran had reported for years that all was not right with his imperial government, but their superiors in Washington disregarded the warnings.<sup>14</sup> When Carter greeted the shah at the White House, pro- and anti-shah demonstrators (mostly Iranian students studying in the United States) battled on the Ellipse. The police responded with tear gas that drifted to the White House lawn where Carter, the shah, and other dignitaries had to use handkerchiefs to wipe the tear gas from their eyes. Carter wrote in his diary: "It was *really* rough. I think I took it perhaps better than anyone else because I didn't want to admit that it was hurting me so bad."<sup>15</sup> Although no one at the time saw this as an omen, it surely was.

Once the shah was safely in U.S. government buildings, his meetings went smoothly. Forewarned by ISA that Mohammad Reza Pahlavi was a man who did not take no for an answer, Brown displayed extreme caution when meeting him at the Pentagon on the first afternoon of his visit. The shah did most of the talking, expounding on the new weapons he required to defend Iran, hinting that if he could not get them from the United States he would have to consider starting his own weapons industry. Brown demurred. When the shah expressed interest in Wild Weasel—a system used during the Vietnam War to allow U.S. aircraft equipped with radar-seeking missiles to destroy SAM sites and high-speed antiradiation missiles (HARMs) that homed in on electronic SAM radar systems—Brown cautioned that



President Jimmy Carter and Rosalyn Carter welcome Mohammad Reza Pahlavi, Shah of Iran, and Farah Diba, Shahbanu of Iran, to the White House during the shah's state visit, 15 November 1977. (Carter Presidential Library)

the United States had not yet decided on introducing HARMs. The secretary added that the HARM, still in early development, was only good for fixed targets, so it “raises the question of offensive capability. . . . These two represent a whole different category of weaponry than have been discussed so far,” Brown observed.<sup>16</sup>

In providing a report of his hour-long meeting with the Iranian monarch, Brown noted that the shah agreed that “the F-4 aircraft have useful lives until the 1990s,” and rather than replacing all F-5s, he wanted to procure 70 more F-14 Tomcats with new engines. The secretary suggested that the president raise the aircraft issue with the shah later in the visit. The shah and the secretary also discussed other weapons—helicopters, destroyers, American engines for Chieftain tanks, and more self-propelled 155mm guns. With his characteristic reserve, Brown stated: “I made no commitment nor offer of encouragement beyond stating a willingness to analyze the shah's ideas within the framework of our strong bilateral relationship and your arms transfer policy.” Looking back at the meeting from the perspective of 35 years, Brown recalled the Iran monarch as a “control freak” determined to exercise sole authority over Iran's military.<sup>17</sup>

When the shah visited the White House to discuss arms transfers, the president noted that Iran accounted for almost half of the previous year's total of \$11.5 billion in U.S. arms sales. When the shah raised future aircraft requests, especially the 140 additional F-16s, Carter informed him that "he had had to 'go to the mat' with Congress to get the AWACS sale approved." Like Brown, Carter strove to dampen the shah's grandiose plans, falling back on standard arguments, such as the need to consult with congressional leaders, more studies, and a more orderly and predictable arms sales program for Iran.<sup>18</sup>

After the shah's visit, the administration faced a plethora of requests and inquiries from Iran about weapon systems. In June 1978 the Policy Review Committee agreed to consider the sale of specific military items to Iran based on an equipment list Carter had asked the shah to produce during the November meetings. From the long list, ISA recommended that Brown and Deputy Defense Secretary Charles Duncan approve the sale of some F-4E aircraft as attrition replacements and substantial numbers of howitzers and cargo carriers to replace older systems, as well as other equipment to "heavy-up" Iran's ground forces. ISA suggested delaying for the time being the sale of 70 U.S. built F-14s and combat systems for frigates being built for Iran by the Dutch and Germans.<sup>19</sup> At a PRC meeting in early July, with Duncan attending, the participants realized that Iran needed to be able to project its power in the Persian Gulf. Given Soviet and Cuban military presence in Ethiopia and growing Soviet influence in Afghanistan, the committee agreed that Iran's weapon requests should not be turned down just because they could be construed as offensive. Subject to Carter's approval, the PRC recommended that the State Department inform the shah that the United States would sell him 298 self-propelled howitzers, 100 M-548 cargo carriers, and 31 F-4Es, with 1,000 Shrike antiradiation missiles with wiring that would allow eventual upgrading of the antiradiation equipment. As for U.S. combat systems for Iran's Dutch/German-built frigates, the PRC members recommended approval in principle and raised the possibility of U.S. shipbuilders providing Iran frigates in the future. The PRC group recommended sending a team to Iran to survey the U.S.-Iran politico-military relationship. It also directed that a strategy be developed for consulting with Congress about the sales.<sup>20</sup>

After the meeting, Vance and National Security Adviser Zbigniew Brzezinski had second thoughts about the F-4Es with the so-called Group A wiring that would allow



later upgrading to Wild Weasel.<sup>21</sup> When the shah was offered the F-4Es without the Group A wiring, he rejected them. Brown recommended to Carter that the shah get the wiring after all. Vance again opposed it on the grounds that Iran did not need it to defend itself against Iraq. Congress would regard it as tantamount to a commitment to sell Wild Weasel, and it would require another exception to arms restraint policy. The secretary of state did not want the administration to give in to pressure from the shah. Carter followed Vance's advice, but as usual he did not rule out the possibility of eventual sale of such advanced electronic technology. Notwithstanding U.S. good intentions to restrict arms sales, the extensive program with Iran continued under the Carter presidency. The shah continued to amass a large arsenal of advanced U.S. weapons (some still in the pipeline), with promises of more to come.<sup>22</sup>

### **The Huyser Mission**

Arms sales to Iran quickly became less desirable in the latter part of 1978 as it appeared that the shah and his White Revolution of modernization and social transformation faced serious domestic trouble. The inability to foresee—or, more accurately, to acknowledge the conclusions of the Iran experts—that the shah's policies had unleashed opposition from both Islamic fundamentalists and the ranks of militant young Iranians was one of the great intelligence failures of the second half of the 20th century. All of the leaders of the intelligence community, including those in DoD, failed to alert their superiors to the vulnerability of the shah's government until it was undeniable. As DCI Turner recalled, the intelligence community had not understood "how shaky the shah's political foundation was; did not know that the shah was terminally ill;" did not understand Khomeini; and had no idea who the hostage-takers were or what their objectives were.<sup>23</sup>

Duncan's two trips to Iran in late 1978 proved a loud wake-up call. During his October visit, the shah could not focus on arms sales. Ongoing strikes at Iran's oil refineries in Ahwaz and Abadan, riots in Hamadan, unrest among university students, and constant street demonstrations by secondary school students commanded all of the monarch's attention. Should he install a military or a coalition government? The shah had no confidence in either option.<sup>24</sup> Duncan's second trip with his wife in early December proved even more revealing. The deputy secretary heard continuous gunfire all night in Tehran; when he traveled to Isfahan another gunfight erupted. On the way back from a function in Isfahan, an Iranian soldier stopped Duncan's wife

and his military assistant, Colin Powell, traveling in a second car, holding them at gunpoint until the Iranians accompanying Mrs. Duncan talked the soldier into letting them proceed. During the visit, the Empress of Iran told Mrs. Duncan that “it [the shah’s rule] was all over”; the shah inferred the same to Duncan. The deputy secretary reported this information to Brown on the one secure telephone line between Tehran and Washington (soon changed to two secure lines). Duncan was understandably upset with the prior intelligence he had received on the situation in Iran.<sup>25</sup>

Duncan’s trips coincided with DoD finally concluding that the shah faced the most challenging crisis since he had almost lost his throne to Mossadegh and his supporters in 1953.<sup>26</sup> During the first week of November 1978, the Special Coordination Committee (the other major NSC subcommittee chaired by Brzezinski) and the PRC discussed Iran. The president held informal policy sessions with his major advisers, including Brown, exploring the possibility of urging a coalition or military government. Deputy Secretary of State Warren Christopher and DCI Turner argued for a civilian coalition. Brown suggested that a military government need not be a step back, but rather could be seen as a first step toward elections.<sup>27</sup> The participants asked for more information on the loyalty and reliability of the Iranian military at the top, middle, and conscript levels. DoD agreed to look into the sale of sensitive security equipment—for fear it might fall into the hands of a hostile successor government—as well as the possibility of providing Iran with Commando V-150 armored cars for crowd control. Vance opposed the idea, but the sale was overtaken by events as the shah’s regime unraveled. OSD and JCS assumed responsibility for contingency planning for the evacuation of U.S. dependents from Iran, a powerful signal that the United States had lost faith in the shah’s ability to govern.<sup>28</sup> The administration began to allow the military and DoD civilian dependents to return to the United States or safe havens at U.S. government expense.<sup>29</sup>

During November and into December 1978, Brown and the OSD staff grew increasingly pessimistic about the shah’s future without more visible signs of U.S. support. Brown joined Brzezinski on a number of occasions to argue for greater measures to encourage the shah: a stronger response to Soviet warning against U.S. intervention in Iran; U.S. encouragement in resisting a coalition government that included radical clerics and/or Communists; support for a moderate civilian government that did not threaten to undermine the military; support for a military government if the Iranian military was threatened; and contingency planning,

including U.S. occupation of southern Iran to protect the oilfields if worse came to worst.<sup>30</sup> At the end of December Iranian opponents of the shah shut down the oil refineries and oilfields. McGiffert told Brown that “the time has come to begin disassociating ourselves from the shah’s rule. . . . Supporting a politically weak government, propped up by military forces, is not a likely formula for success.” Brown’s comment went to the heart of the matter: “The shah’s absolute power is over in any event. The question is what the new distribution of power will be and (to us) whether those who exercise it will be pro-American.”<sup>31</sup>

At SCC meetings in late December, participants considered moving a carrier battle group to Singapore and then, if necessary, to the Indian Ocean, but they worried that it might send a signal that the United States was prepared to support the shah militarily and worsen the situation.<sup>32</sup> In early January 1979 the “moment of truth” arrived, according to U.S. Ambassador William H. Sullivan in Tehran. He recommended that Carter tell the shah that it was time to go and to warn him that if he stayed the military would probably overthrow him. On 4 January the president authorized Sullivan to reinforce the shah’s decision to create a civilian government and to assure him of a welcome in the United States should he leave. During this meeting, Duncan suggested dispatching Air Force General Robert E. Huyser, the deputy commander of the U.S. European Command, to Tehran to consult with the Iranian military.<sup>33</sup>

The Huyser mission became the principal point of contact in Iran for OSD in the unfolding crisis leading to the fall of the shah. One of Huyser’s objectives was to assure the Iranian generals that they still enjoyed the support and confidence of the U.S. government,



Air Force General Robert Huyser, the presidential representative to Iran from December 1978 to January 1979. (RG 330, NARA II)

which expected them to provide order and stability. Brzezinski envisioned another role for Huyser: to seek out the military and encourage them to overthrow the new civilian government of Shapour Bakhtiar, a leader of the opposition National Front, or any more radical government that might replace it, if these governments threatened the stability and integrity of the Iranian armed forces. While Brown certainly agreed with Huyser's first mission, he was also fully aware of and supported the second one.<sup>34</sup>

Carter jumped at the first goal of the Huyser mission because he had decided the only hope was to "retain our relationships with the shah and the military—our only two ties to future sound relationships with Iran." Carter welcomed the advice of "Dutch" Huyser, whom he described as a combat hero trusted by Brown and a skillful diplomat who enjoyed good rapport with top Iranian military officers. Equally important, the president had lost confidence in an "insubordinate" Ambassador Sullivan whose reports he considered "biased and erroneous." Huyser's reporting seemed to Carter "quite accurate," and most importantly "he followed orders." Carter set up a dual system of reportage, one from Sullivan and the embassy to Vance, and another from Huyser to Brown, Duncan, and Jones, which Brown later admitted was not the best way to coordinate a policy. Huyser reported to DoD by cable; he usually telephoned Brown or Jones daily from Tehran. OSD summarized these secure calls in detail for the president and Brzezinski, the only two who read the summaries. Huyser became the focal point for information and communication with the Iranian military and the principal source for presidential decisions on Iran. Unhappy about Huyser's presence in Tehran, Sullivan insisted they coordinate at the end of the day—not difficult since Huyser stayed at Sullivan's residence—but coordination or not, State and the ambassador had lost the confidence of the president. Carter became so disillusioned with Sullivan that he asked Vance to fire him. Vance refused on the grounds it would be a mistake at such a crucial time. Henceforth, Carter recalls, "I relied primarily on General Huyser, who remained cool and competent" and "sent back balanced views."<sup>35</sup>

Huyser's mission could not have begun at a more crucial time. Suffering from terminal cancer (not known at the time), the shah dithered about leaving Iran. The Ayatollah Ruhollah Khomeini, the spiritual leader of the Iranian Shiites, was poised to return to Tehran from exile in France. Confused and dejected, the Iranian generals vacillated between considering a military takeover, supporting the government of

Prime Minister Shapour Bakhtiar, or cutting a deal with Khomeini. After slipping into Tehran on 4 January 1979, under the thin cover of “consultations” with Iran’s military, Huyser set about talking with Iranian top military officers to gauge their collective state of mind. In his first important report on 10 January, Huyser told Brown—who relayed the conversation to the president—that the Iranian military would not undercut the Bakhtiar government, and that they seemed united and loyal to the nation rather than to the shah. Huyser thought he could build on this unity; Carter’s comment: “I hope he’s right.”<sup>36</sup>

On 13 January, Huyser reported that he saw five possible outcomes: a successful Bakhtiar government; another civilian government, more acceptable to Khomeini and the religious factions, lasting for some months, but eventually replaced by a civilian government acceptable to Khomeini; a military coup; a Khomeini government; or a Communist (Tudeh Party) government. These alternatives became shorthand for policy alternatives within the administration.<sup>37</sup>

One of Huyser’s instructions was to assure that the Iranian military would remain cohesive and supportive of the transition to civilian government, an ideal solution, but if not possible, Huyser was to assess and, if necessary, prepare for a coup by the Iranian generals to prevent a Khomeini or Tudeh (Communist) Party government and, at Brzezinski’s and Brown’s urging, a civilian government acceptable to Khomeini. In his 13 January conversation with Huyser, Brown made this perfectly clear: “I [Brown] then said to General Huyser that it remained very important that we not imply to the military that there would never be a basis for strong military action, or that any civilian government, whatever its composition would be better than a military coup.” Brown repeated that Huyser needed “to walk a narrow line” to prevent a coup against Bakhtiar, but he must not allow the Iranian military “to stand idly by if the situation deteriorated continuously.” Huyser said he understood those to be his instructions.<sup>38</sup>

On 16 January an embattled and ailing shah left Iran. Two days earlier Carter had called French President Valéry Giscard d’Estaing to ask him to delay Khomeini’s return.<sup>39</sup> The Ayatollah’s return raised urgent questions. Would he support Bakhtiar and be willing to run his Islamic revolution from the mosques? Would he plunge into politics and form his own government? Could he control the other mullahs or would the Islamic fundamentalists engage in infighting? Brzezinski and Brown agreed that if Khomeini threatened Bakhtiar’s control, the Iranian generals

had to be ready to act. Brown probed Huyser about what circumstances would require a coup, the so-called option C. Was there a window for action beyond which the chance to act would be lost; how much lead time would be needed for option C; was the military “ready psychologically, physically, and in terms of planning” for a coup, and if not, then when? Huyser responded that an imminent return of Khomeini made option C more feasible, the military was ready—but would be much readier in a week—and was “psychologically prepared to act.” Brown asked if a coup would involve many casualties. The general answered yes.<sup>40</sup>

By the fourth week of January, Khomeini’s return to Iran seemed imminent. Huyser worried about a “disaster” caused by clashes among the Ayatollah’s followers, other religious factions, the Communists, and possibly other groups. By now there was no preventing the Ayatollah’s return. If Bakhtiar proved able to retain control with Khomeini in Iran, Huyser recommended that the administration support the Iranian prime minister; if not, it should proceed to option C.<sup>41</sup> At the end of January Huyser reported that Sullivan disagreed with him. While Huyser preferred a military government to one led by Khomeini, even if it eventually led to a coalition, Sullivan favored a Khomeini government and consideration of a coup only later.<sup>42</sup> On 31 January, Eric von Marbod, the deputy director of the Defense Security Assistance Agency, visited Iran to work out an arrangement for terminating the military assistance program. He reported intelligence that the generals could not undertake a coup as they could not count on the support of their troops.<sup>43</sup>

Huyser felt himself increasingly vulnerable. He reported: “The situation . . . has become very hot for me. . . . I am the number one target of certain opposition forces.” Posters on walls began to appear with the slogan: “Death to Huyser.” Sullivan felt very strongly that Huyser’s presence in Tehran was endangering Americans still in Iran. Huyser himself trusted that Maj. Gen. Philip C. Gast, the chief of the Military Assistance Advisory Group in Tehran, who had accompanied him on his consultations, could fulfill his role with less notoriety.<sup>44</sup> Sullivan reported to Vance that Huyser was not accomplishing anything, reduced to waiting all day at Iran’s military headquarters for a half-hour briefing of the generals at the end of the day. “This is not a proper role for a four-star General,” the ambassador stated.<sup>45</sup> Brzezinski, Jones, Vance, and Christopher agreed on 3 February that Huyser should return to Washington.<sup>46</sup>

Back in Washington on 5 February, Huyser briefed the president and his senior advisers. He still maintained that a coup was a viable option, discounting reports that the generals were nervous and contemplating following the shah into exile. In Huyser's view, the army was still able to operate, and the rank and file would follow orders. DCI Turner stated that was not the intelligence he was receiving—Brown agreed. Even in retrospect, Brown admitted that a coup “was an attractive idea. The trouble was that he [Huyser] was pushing on the wet end of a string.”<sup>47</sup>

Less than a week later it became obvious that Huyser had been too optimistic. After Khomeini's return at the beginning of February, the Iranian high command soon disintegrated, and Bakhtiar was replaced as prime minister by Mehdi Bazargan, with the support of Khomeini, who was now the real power in Iran.<sup>48</sup> Was a coup ever a real option? Encouraging a coup from Washington was bound to be a slippery and murky business. Officials had to be assured that enough top military commanders would support or at least not oppose the coup for it to succeed; that the rank and file troops would follow orders; and that the coup plotters would know that they had assurances of U.S. support. Once the “green light” was given, events often took a course not anticipated. The Carter administration spent many hours deliberating the coup option (it was discussed in all the telephone calls between Brown and Huyser). Yet the administration seemed unable to pull the trigger, always asking for more assurances and more information. In retrospect, Carter and Brown initially relied too much on Huyser, whose close relationship with Iran's military leaders colored his assessment that they were ready and able to move once called upon. It became eventually clear that Huyser was overly optimistic.

A basic question remained: Even if the rank and file of the Iranian armed forces followed their generals' orders to take control of the government and the oilfields, could any coup have overcome serious popular opposition once Khomeini had returned? U.S. understanding of the revolution taking place in Iran was flawed. Huyser himself epitomized the defect. He hoped that religious feelings and the mullahs' influence in Iran ran shallow; he feared that a Khomeini government would eventually lead to a Communist takeover in Iran. He was wrong on both judgments. An enduring Islamic radical fundamentalist movement nourished the Iranian Revolution's deep roots, sweeping away the Communist Tudeh Party and encouraging similar movements beyond Iran that challenged and changed the Islamic world.<sup>49</sup>

## Military Options

With the shah gone and Bazargan ostensibly in control (although Khomeini was the real controlling force behind the scenes), the U.S.-Iranian military relationship began to unravel. Iran cancelled the advanced weapons the shah had ordered, such as frigates, F-16s, and Phoenix and Harpoon missiles.<sup>50</sup> Sensitive equipment and facilities already in Iran—the F-14, with its sophisticated radar, and intelligence listening posts, for example—were now vulnerable. From a strategic point of view, a much-reduced and weakened Iran no longer stood as a positive deterrent to the Soviet Union expansion in the Middle East. In mid-March, Gast reported: “Today there is no effective government, the armed forces are in complete disarray, and the former social and political structure is virtually destroyed.” Both Gast and the Pentagon’s Office of International Security Affairs anticipated that the future U.S. military relationship with Iran would be much reduced, but that it was still desirable and possible.<sup>51</sup>

These illusions vanished on 4 November 1979 when radical Iranian students stormed the U.S. Embassy, taking 63 hostages. An additional three embassy personnel were at the Iranian Foreign Ministry at the time and six escaped during the takeover and made their way to the Canadian embassy residence. The shah’s stay in the United States for medical treatment in late October 1979 proved the catalyst for the embassy takeover. Of the 66 hostages, 28 were military or DoD personnel. For the remainder of Carter’s presidency, the Iran hostage crisis dominated foreign and national security policy, engaging Carter’s top advisers, including Brown and his OSD staff, in seemingly endless meetings, informal deliberations, and staff papers and strategies on how to free the hostages.<sup>52</sup>

The president expected his principal advisers to attend all policy meetings of Brzezinski’s Special Coordination Committee and full NSC meetings. During the 14 months of the crisis, 97 of the 133 SCC meetings, which Brzezinski considered the focus of policy deliberations for the hostage crisis, discussed Iran. Of the 17 NSC meetings, 15 concerned Iran. These meetings were just the formal gatherings. Brown met informally with the president and other advisers as well. Brzezinski created a small, highly secret group, composed of himself, Brown, Turner, and General Jones, to develop possible military options against Iran. It is almost impossible to overstate the extent to which the Iran hostage crisis consumed the time and energy of Carter’s major advisers, including the secretary and the deputy secretary of defense.<sup>53</sup>



As for military options, Brown and Brzezinski recommended that Carter take no immediate military response to the hostage situation and that any preliminary military moves not be made public. Brzezinski believed the situation highly fluid; past experience suggested that hostage takers were most trigger-happy in the early stages of a hostage situation. Both men agreed with the State Department's plan to use intermediaries to encourage the Iranian government to assume control of the embassy and free the hostages. Carter reluctantly agreed.<sup>54</sup>

Initially the president assumed a bellicose stance, suggesting in a meeting on 9 November with Brown, Vice President Mondale, Jones, and Brzezinski that once the hostages were released—the expectation then was that the crisis would be resolved shortly—he wanted to punish Iran militarily. Jones spread out a map of Iran, and the four men examined military options. As discussed then and over the next weeks, four major options emerged: using a small amphibious force to capture Kharg Island (Iran's main oil terminal), bombing the oil refinery at Abadan, taking out Iran's F-14s at their bases, or mining Iran's harbors.<sup>55</sup> To undertake any military action the United States had to have assets within striking distance of Iran. Two weeks after the embassy takeover, fearing that it “may be a long crisis,” Brown suggested to the president that U.S. military capabilities in the area be upgraded. He recommended sending the carrier USS *Kitty Hawk* from Subic Bay to the Arabian Sea, thus bringing its large helicopters closer to the scene. As a next step, he envisioned deploying B-52Hs to Guam, able to reach the Arabian Sea with fewer refuelings (unfortunately the runway on the Indian Ocean U.S. base on Diego Garcia island was too short for them); deploying to Egypt USAF F-111 Aardvark fighter-bombers, a Marine amphibious unit of battalion size, and AWACS; and moving KC-135 Stratotanker aircraft (to refuel the B-52s) and AC-130 aircraft gunships from Guam to Diego Garcia. On 20 November Carter approved most of these preliminary actions. Three days later, the president discussed with Mondale, Brown, Vance, Brzezinski, Jones, Turner, Chief of Staff Hamilton Jordan, and Press Secretary Jody Powell—the president's most trusted advisers—what to do if the hostages were put on trial, physically punished, or executed. Carter and the group again explored punitive military actions.<sup>56</sup>

Brown sent a memorandum to Carter on 1 December in which he agreed that the diplomatic option and focusing world opinion on Iran represented the best response for the immediate future. European allies would probably go along with economic



Defense Secretary Harold Brown and National Security Adviser Zbigniew Brzezinski return from Camp David after meetings with the president during the Iran hostage crisis, November 1979. (OSD Historical Office)

sanctions against Iran, but such measures would take a long time to work. Brown foresaw a deterioration of the U.S. case over time as U.S. friends and allies pressed Washington “to confess our sins of espionage” and to promise amnesty to Iran. Even currently strong U.S. domestic support would begin to diminish. Rather than waiting to react if Iran tried, harmed, or executed the hostages, Brown suggested preemptive action that would hit Khomeini and Iran where it would hurt. Although the idea of blockading Iran’s harbors had been suggested, Brown considered mining Iran’s harbors less risky and less escalatory. A blockade required stopping ships and that could degenerate into a firefight. Although an act of war, to Brown mining was a “bloodless act of war, like invading an embassy and taking hostages.” There was a downside. Mining could upset the not very productive negotiation process, “such as it is,” as Brown observed. Mining could also worry friends and allies, but it would send a message to Iran and hurt its economy. Brown noted that a mining would be dangerous to hostages, although potentially less fatal for U.S. troops than a rescue attempt. Carter responded positively: “Zbig-Harold, I agree completely.”<sup>57</sup>

Nevertheless, the president wanted to try economic sanctions, including asking allies and friends to freeze Iranian assets in their banks (as the United States had

done) and to voluntarily implement a trade embargo against Iran. The administration also hoped to persuade the United Nations to impose nonmilitary economic sanctions against Iran. Furthermore, Vance and Hamilton Jordan were still engaged in negotiations with official and unofficial third party intermediaries for release of the hostages, but with only slight prospect of success.<sup>58</sup>

Some bright spots occurred. In January 1980 the CIA, working closely with the Canadian Foreign Ministry, successfully exfiltrated the six hostages who had taken refuge at the Canadian ambassador's residence. Using a clever deception operation, the hostages escaped Iran as Canadians working on a fictitious science fiction movie to be filmed by a Canadian company that was scoping out Iran as a possible filming location. In addition, in November 1979 Iran released 13 female and African-American hostages (it had earlier freed one suffering from a debilitating illness in July 1979). Still, 52 Americans remained as hostages under adverse and difficult conditions. The crisis was by no means over.<sup>59</sup>

If military action had been a possibility in forcing Iran to release the remaining hostages, it began to slip away during the initial months of 1980, even after an attempt by Brzezinski and Turner to resurrect it in March 1980. At the presidential retreat at Camp David in late March 1980, an exasperated Carter asked what could be done. Turner recalled that Brown presented only marginal military actions, such as dropping aluminum down the intakes of Iranian power plants to disable them or overflying Tehran to intimidate. Changing his mind, Brown now joined Jones in opposing mining Iran's harbors, noting that the Soviets were capable of sweeping the mines. Furthermore, to close the Iranian port of Khorramshahr by mining meant cutting off Iraq's principal oil port of Basra (Iraqi president Saddam Hussein al-Tikriti was considered a potential friend). Such possible actions raised the issue of retaliation against the hostages and an adverse reaction within the Islamic world.<sup>60</sup>

On 7 April 1980 a frustrated Carter held a restricted NSC meeting where he leaned toward mining of Iran's ports over the idea of a rescue. All present, including Brown, argued for the rescue. At the same time the ongoing negotiations for release of the hostages collapsed. Desperate for some action, Carter broke diplomatic relations, expelled Iranian diplomats, declared an embargo on U.S. exports to Iran, except and food and medicine, and began the process of allowing claims to be made against frozen Iranian assets in the United States.<sup>61</sup> Jordan recalled a conversation with Brown on 10 April in which he told the secretary "we're in a box, Harold. We've

broken relations with Iran and imposed sanctions, but we still have no leverage on Khomeini.” Brown replied: “Neither the naval blockade or mining the harbors will bring the hostages home.” Jordan interjected, “except in boxes.” Brown then worried that if the Iranian militants started killing hostages, “we’ll have to take punitive measures—and God only knows where that will lead.” Jordan concluded that the rescue was “the best of a lousy set of options.”<sup>62</sup>

Beyond those cited by Brown and Jones, other good reasons existed for the military option slippage. With the Soviet invasion of Afghanistan in December 1979, the United States needed the Islamic world to join in condemning and countering this aggression. U.S. military action against Iran, such as mining its harbors, would blunt that policy. Attacking Iran could ignite a firestorm among Islamic fundamentalists and endanger the lives of the hostages. The best “lousy option,” to use Jordan’s characterization, seemed the only option. The administration’s Iranian policy and its fate would succeed or fail on the rescue plan.

### **The Hostage Rescue Attempt**

From the very beginning, the Carter national security team had considered rescuing the hostages with as little violence and loss of life as possible to both hostages and Iranians. Initially, Carter and his advisers envisioned the rescue as a response to plans to put the hostages on trial and then execute them, or a decision by militants to begin killing hostages. At the NSC meeting on 6 November 1979, the day after the storming of the embassy and taking of the hostages, the participants first broached the rescue. Brown pointed out that it would be difficult, if not impossible. The secretary warned that this would be no Entebbe raid, where in 1976 Israeli commandos saved almost all of their hostages from hijackers at Uganda’s small airport. The U.S. hostages were in the center of Tehran, a city of over four million people, with the nearest airport nine miles away. U.S. intelligence would have to discover exactly where the hostages were being held in the embassy compound and how well they were guarded. The president stated he was not inclined toward rescue, but he needed a plan as a “last resort.” Later that day he authorized contingency planning for a rescue.<sup>63</sup>

On 8 November at the White House, and then at the Pentagon on 11 November, Joint Staff officers briefed Brzezinski, Jones, and Brown on possible rescue strategies and the problems they faced. Initial plans proved so dangerous as to be untenable, such as parachuting troops into Tehran, hijacking trucks, driving

to the embassy, loading the hostages on the trucks, and dashing to the Turkish border—probably under fire. Other options considered helicopters flown in from Turkey or from a deserted site to pick up the hostages.<sup>64</sup> For the next five months a small, very secret group in DoD examined plans and scenarios for a rescue. Jones established an independent Joint Task Force (JTF) under Maj. Gen. James E. Vaught, the Army's top unconventional warfare general officer, with Major General Gast, the former MAAG chief in Iran, acting as an adviser to the force. The task force reported only to JCS Chairman General Jones and Secretary Brown, who purposely kept the group small to assure strict operational security since surprise was essential for the success of any potential mission. The secretary, the chairman, and often the national security adviser crammed into a secure, windowless, cigarette smoke-filled room (smoking was permitted in government buildings then) in the Pentagon to hear periodic briefings on the rescue plan.<sup>65</sup>

Who should undertake the hostage rescue and who should lead it? Having witnessed and been impressed by an exercise of the Army's counterterrorism Ranger Delta Force, NSC military adviser Col. William Odom promoted the force and its commander, Col. Charles "Charging Charlie" Beckwith as the best candidate for the job.<sup>66</sup> Carter later met Beckwith to discover that the colonel was from Schley County, next door to Carter's home county of Sumter, and had played football for the University of Georgia. "You're my neighbor," the president exclaimed, "Who are your folks?" Brown slipped Jordan a note: "You've got to hand it to the Pentagon for finding a good ol' boy to head up the mission." Beckwith and the Delta Force would do the extracting, while General Vaught would command the operation with Gast, who eventually became second in command.<sup>67</sup>

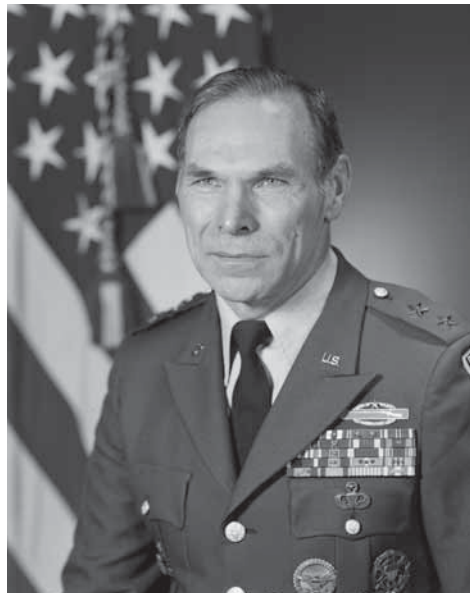

Air Force Maj. Gen. James Vaught, head of the Joint Task Force for the Iran hostage rescue mission. (RG 330, NARA II)



Air Force Lt. Gen. Philip Gast served as adviser to the Joint Task Force and then as second-in-command of the force. (RG 330, NARA II)

In March 1980 the task force produced a tentative plan that Brown considered plausible. On 22 March, Brown, Mondale, Turner, Jones, Brzezinski, and David Aaron of the NSC staff traveled by helicopter to Camp David for a meeting with Carter and Vance, who were already there. For most of the day they examined the plan and made some changes. Original planning called for the seizure of an Iranian air base as the extraction area, but the Camp David group considered that too risky because it was likely to tip off the Iranians. They chose the less conspicuous airstrip at



Army Col. Charles "Charlie" Beckwith, commander of the Delta Force of the Iran hostage rescue team. (Courtesy World Wide Photos)

Manzariyeh, some 30 miles from Tehran. Gradually, the rescue attempt took its final shape: Helicopters from an aircraft carrier in the Gulf of Oman would fly 600 miles to a deserted site in the Iranian desert (Desert One) to rendezvous with six C-130 tankers from Egypt carrying the rescue team and more fuel for the helicopters. The C-130s would fly to an island off Oman and from there over 600 miles to Desert One (see map on page 306). After refueling the helicopters and unloading the rescue team, the C-130s would return to Oman, and the helicopters would take the rescue team to a hide site (Desert Two) near Tehran. The helicopters would then fly to a hideout in the hills north of Desert Two to spend daylight hours under camouflage nets. The Delta Force would travel to Tehran from Desert Two in trucks rented by U.S. personnel already infiltrated into Tehran, blast their way into the embassy compound, and overpower the guards. Another Ranger team would rescue the three State officials, including Chargé D'Affairs Lowell Bruce Laingen (Sullivan had retired before the embassy seizure), under house arrest in the Iranian Foreign Ministry. The helicopters would then pick up all the freed hostages, now collected in the embassy compound, and the Delta Force would fly them to an abandoned airstrip near the city. There they would rendezvous with C-141 Starlifter aircraft flown from Dhahran, Saudi Arabia, which would whisk them to freedom. C-130 transports flown from Wadi Kena, Egypt, carrying 100 Rangers would provide support (see map on page 307).<sup>68</sup>

As a preliminary step to a potential mission, Carter authorized sending a short take-off and landing plane to reconnoiter the remote site, Desert One. After flying low over the area and landing to determine the suitability of the desert floor for C-130s, it returned without incident. The pilot and crew attested to the site's suitability: flat and firm for easy landing, isolated with only a seldom-traveled country road nearby. The reconnoitering mission also tested Iranian air defenses, few and far between in that area, and allowed one crew member to bury battery-operated landing lights that could be turned on when the rescue planes came to land.<sup>69</sup>

Carter called a full NSC meeting for 11 April to discuss Iran. The day before the meeting, Brzezinski sent him a memorandum recommending either increasing the pressure on Iran by graduated military actions to convince Khomeini and his fundamentalist supporters that there was a price for hostage taking, or going the rescue route. "From a political point of view, this course of action [rescue] has tremendous appeal," Brzezinski argued. "It is quick and almost totally under our control." There

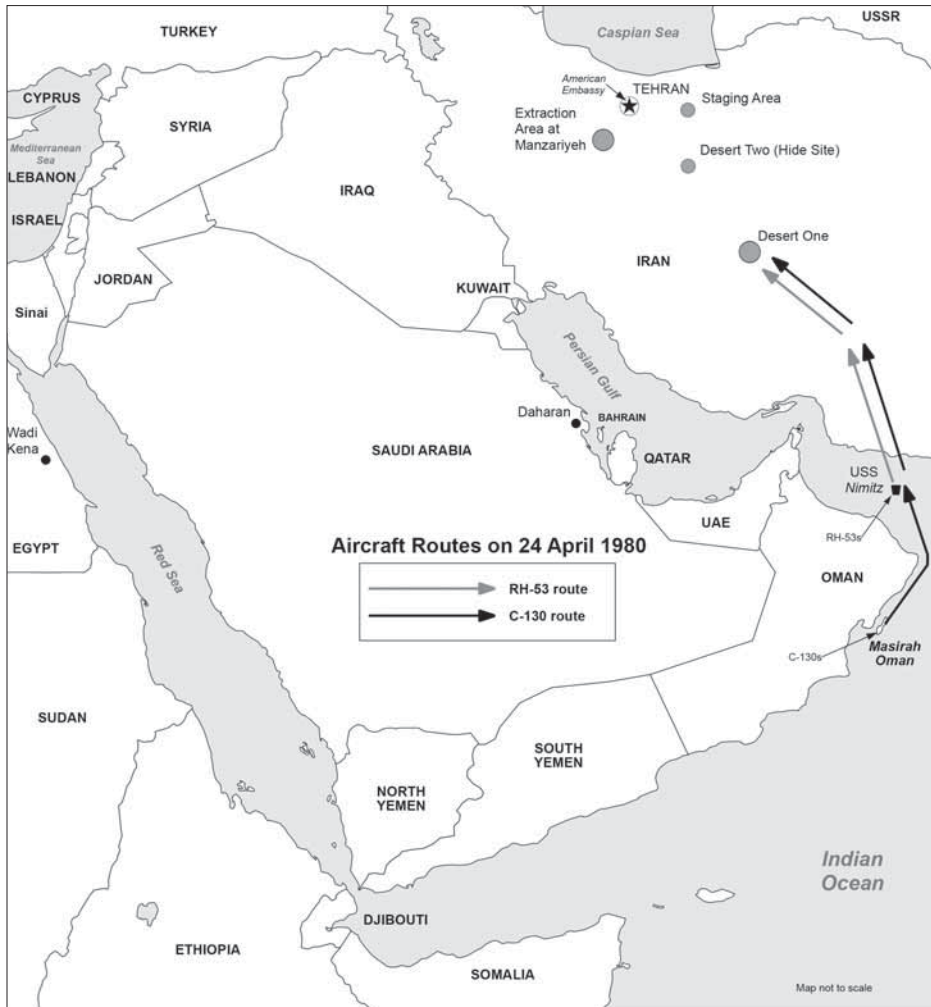

giscarto.com

were obvious risks in such a complex plan: Could the U.S. forces get in and out before the Iranians reacted, and how many hostages and rescuers would be killed? Brzezinski noted that the NSC staffer for Iran, Gary Sick, was strongly in favor of the rescue. Farsi-speaking Foreign Service officers had also recommended the option to Vance. According to Brzezinski, there would never be a better time to rescue the hostages. Security at the embassy had become routine; Iranians did not expect the attempt. “A carefully planned and boldly executed rescue operation represents the only realistic prospect that the hostages—any of them—will be freed in the foreseeable future,” Brzezinski advised.<sup>70</sup>



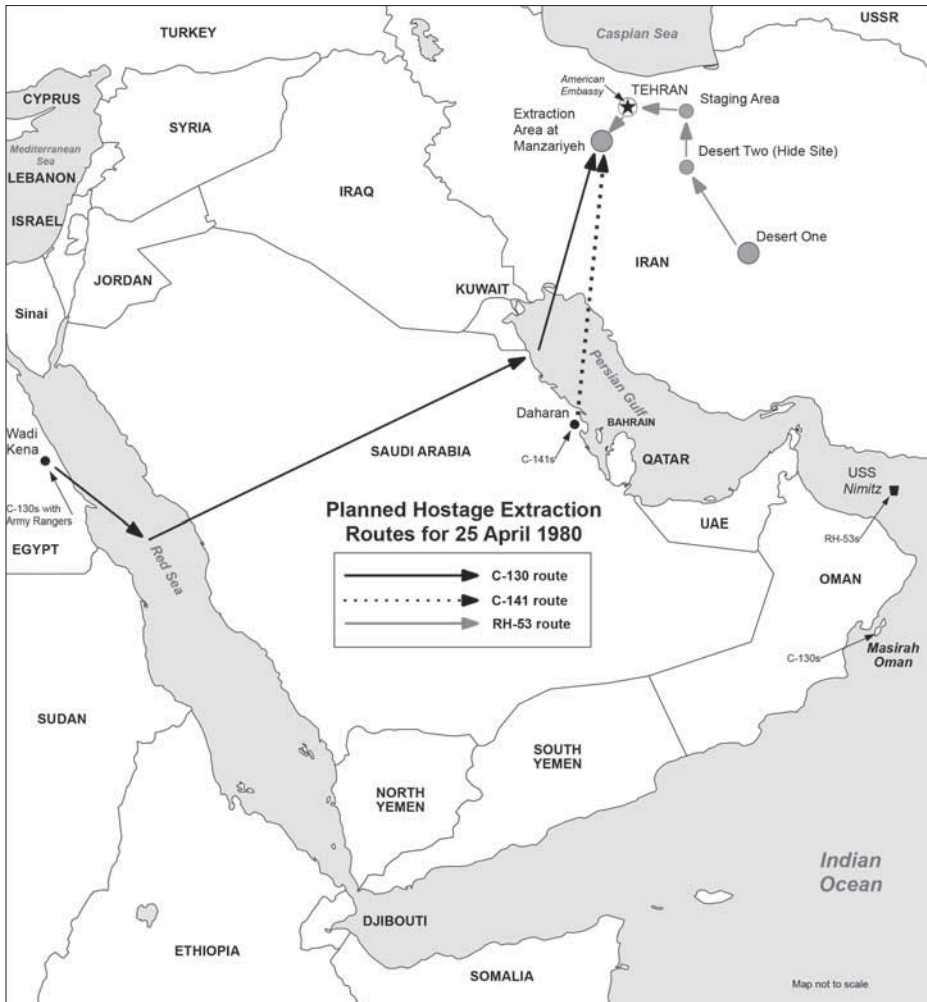

giscarto.com

The NSC meeting lasted almost two hours. Christopher, attending in place of Vance who was on vacation, in keeping with State’s consistently more cautious approach recommended additional nonmilitary options—more UN sanctions, blacklisting Iranian shipping and aircraft from using U.S. and allies’ ports, and a telecommunications embargo. Brown countered that these actions would hardly impress the mullahs. He warned that the punitive measures, especially a blockade, would only throw the Iranians into the Soviet Union’s embrace. While he favored rescue, he suggested waiting two or three weeks to make the final decision. Brzezinski stated his preference for rescue as soon as possible. Mondale strongly supported immediate

rescue. Jones then outlined the training of the rescue team and answered queries about the operational plan from the president and others. Turner explained the considerable operational role of his agency in support of the effort from within Tehran, including its presence there and its last-minute discovery of a source who knew the location of the hostages, the identity of the guards, and the hostages' daily schedules.<sup>71</sup>

CIA agents were not the only Americans on the ground in the Iranian capital planning for the rescue and providing first-hand intelligence. Richard J. "Dick" Meadows, a former major in the Green Berets, who had a legendary reputation for special operations as well as for telling his superiors the unvarnished truth as he saw it, led a defense team that infiltrated Tehran under false identities. Meadows' team provided another set of eyes, checked the plans and routes, reconnoitered the embassy for any last minute changes, and prepared to work communications equipment once the raid on the embassy and foreign ministry commenced. Meadows traveled to Washington to brief the rescue planners and then returned to Tehran before the rescue mission.<sup>72</sup>

Given this on-site intelligence and the hard information that a CIA source was able to provide on the whereabouts of the hostages, Carter decided to go forward, ascertaining from Jones that 24 April was the earliest possible date.<sup>73</sup> Returning from his vacation in Florida, Vance was appalled to discover the rescue was on. He met with Brzezinski and Carter and then formally made his case at the 15 April NSC meeting. The secretary of state argued that sanctions were working. Now that Khomeini had given authority over the hostages to the newly formed Majlis (parliament), an organization with which the United States could negotiate, the hostages were in no physical danger and in good health. A rescue raid would undoubtedly cause casualties and deaths of hostages and guards. Even if successful, what was to stop the Iranians from taking more hostages—probably U.S. news media personnel? Fearing a Western-Islamic confrontation as a consequence, Vance also raised the danger that the Iranians would respond by moving closer to the Russians. Opposing Vance, Brown argued: "When do you expect the hostages to be released in that case?" Vance offered no answer. Brown hoped the rescue might "shock" the Iranians, "perhaps into sanity." Brown was not sure Iran would take more hostages if the rescue proved successful, as Vance suggested. He maintained it was one thing to take advantage of a militant takeover of the embassy, another thing entirely to round up Americans to replace freed hostages. He later admitted

his reasoning was “somewhat cynical” based on the fact that the news people went into Iran voluntarily, so he did not worry about them.<sup>74</sup>

This NSC meeting was Vance’s last stand, his chance to put his objections on the record. He stood alone in his opposition and had decided to resign after the operation. Brzezinski raised the possibility of the rescue team taking Iranian guards prisoners—a tit-for-tat move: you take our diplomats, we take your guards. Jones, Deputy Defense Secretary Graham Claytor, and Brown supported him. The national security adviser revived his idea of a simultaneous military response against Iran that could compensate for a potential failure of the rescue mission. Brown and Turner supported him, with Vance strongly opposed to the idea. The president allowed the mission commander to make the call on prisoners and delayed any final decision on a concurrent retaliatory military strike.<sup>75</sup>

Brown harbored a nagging suspicion that Carter remained uncomfortable with the details of the rescue mission, so he arranged a meeting of the commanders of the team—Vaught, Gast, and Beckwith—with the president and his inner circle in the White House Situation Room on the evening of 16 April. The briefing lasted for two and a half hours, with Carter taking notes and asking numerous questions, such as “what is the most difficult part of the mission?” “Getting in undetected,” Vaught replied. The president followed up with a query as to what were the other critical elements that worried the general. “The helicopters,” Vaught responded, noting that they were not made for long distance flights with heavy loads at low altitudes. “We could lose a helicopter,” hence the additional two for “a wide margin of safety.” Beckwith then briefed the group on the Delta Force’s assault and extraction. Carter queried Beckwith and Vaught about prospective hostage and Iranian casualties, one of Carter’s fears. Vaught hazarded an estimate of casualties: four hostages and eight rescuers. Beckwith assured the president the Delta Force was not going in to shoot Iranians, but rescue the hostages. A reassured Carter told him, “Keep your mission simple.”<sup>76</sup>

In the week prior to the scheduled 24 April date for the rescue, Carter talked with Brzezinski, Brown, Jones, and Turner on an almost daily basis to reconfirm details of the plan and to deal with a number of issues, such as whether and when to inform congressional leaders of the raid and whether to throw the Iranians off guard by sending signals that Washington wanted to resume negotiations. Throughout these meetings, the president insisted that potential casualties be kept to a minimum. Carter telephoned Brown frequently with queries, perhaps to reassure himself that all

the details were in place during the tense days leading up to Operation Eagle Claw, as the rescue mission was codenamed.<sup>77</sup>

On 23 April, Carter decided against any concurrent military attacks on other Iranian targets. Command and control was in place—Jones would report to Brown from the National Military Command Center, to which the commanders of the mission would submit their reports. From the Pentagon, the secretary would report the progress of the mission to Brzezinski at the White House. The national security adviser would discreetly notify the president, who over the two planned days of the operation would maintain the fiction of business as usual.<sup>78</sup>

Carter described the day of the failed mission as “one of the worst of my life.” Brzezinski characterized it as “the longest day of my four White House years.”<sup>79</sup> The story of the failed mission has been told by participants and analyzed by a special official group and subsequent writers.<sup>80</sup> At 7:05 p.m. local time, 24 April, eight RH–53D Sea Stallion helicopters took off from the carrier *Nimitz* in the Arabian Sea and headed for Desert One. Over an hour earlier, at 5:50 p.m., the first of six C–130 aircraft took off from the island of Masirah off Oman to transport the rescue force to its rendezvous with the helicopters. The six C–130s carried fuel for the helicopters and the rescue team of 120 men, of whom 106 were Rangers (the remainder included two Iranian interpreters and drivers for the trucks). The C–130s arrived at Desert One on time.<sup>81</sup>



The helicopter crew onboard carrier *Nimitz* prepares RH–53 Sea Stallions for the Iran hostage rescue mission. (RG 330, NARA II)



Six Sea Stallions en route to Desert One. (RG 330, NARA II)

The Sea Stallion helicopters had a much harder time. Two hours into their flight, the pilots of helicopter no. 6 received cockpit indications of an impending rotor blade failure. They landed in the Iranian desert and verified the malfunction, an automatic abort situation for the stricken chopper. Another helicopter picked up the crew and together they resumed their flight. Approximately one hour later, the seven helicopters encountered a dust storm, managed to break out of it, but an hour later entered a larger and denser dust storm, which severely degraded their visibility. While navigating this storm, helicopter no. 5 experienced a failure of several critical navigation and flight instruments, causing the pilot (who commanded the helicopter detachment) to return to the *Nimitz*. Another helicopter, no. 3, experienced a partial hydraulic failure, but the crew pressed on to Desert One, trusting that they could make the repairs there. The remaining six helicopters—the predetermined minimum number required—arrived at Desert One between 50 and 85 minutes later than scheduled.<sup>82</sup>

All had not gone as planned at Desert One. The seldom-used road had traffic on it. The road watch unit of the Delta Force team interdicted a Mercedes bus with 44 Iranians, mostly elderly and children. If the mission had gone ahead as planned, these Iranians would have been airlifted out on C-130s to Egypt for security reasons and later returned to the abandoned airfield outside of Tehran. There were

also two trucks traveling the road, a gasoline tanker and a pickup. The road watch team destroyed the tanker, causing it to burn all night, but the driver of the truck escaped in the pickup. Beckwith did not consider the two escapees—thought to be smugglers—a threat, believing that they had not seen the aircraft and that they probably thought the watch team was an Iranian security force.<sup>83</sup>

Back in Washington, everyone including Brown was on pins and needles while trying to carry out a normal day. The inner group of Carter, Mondale, Brown, Brzezinski, Vance, Jordan, and Powell met for lunch where they learned that two of the eight helicopters would not make it to Desert One. No one thought to tell this group that the crew of the downed helicopter had been picked up by another helicopter, so they worried about its fate. Still there would be six helicopters at Desert One, the minimum for the mission. The lunch, which lasted from noon to 1 p.m., finished with the helicopters and C-130s still in the air (Iran is nine and a half hours ahead of Washington). At 3:15 p.m. Washington time, Brown learned that the crew of the downed helicopter had probably been picked up. Soon after he received reports that the C-130s landed at Desert One to find the road more traveled than anticipated. Brown and Brzezinski agreed that the mission should continue even after the bus and truck incidents, but it took some convincing to obtain Carter's reluctant approval.<sup>84</sup>

Back at Desert One a new problem arose. The crew of helicopter no. 2, the one that had experienced a partial hydraulic failure during its flight, discovered that one of its pumps had leaked so much hydraulic fuel that it had frozen; there was no spare to replace it. The crew and the helicopter flight leader, Lt. Col. Edward R. Seiffert, USMC, determined that the problem could not be repaired and the helicopter was unsafe to continue the mission.<sup>85</sup> Beckwith and commander of the C-130, Col. James H. Kyle, USAF, called Commander Vaught in Egypt to report the situation and recommended calling off the mission. At 4:45 p.m. Washington time, Brown informed Brzezinski of the need to abort because of the hydraulic problem. The secretary required an answer from the president as soon as possible to prevent the rescue team from spending any more time than necessary at Desert One. Brzezinski called Carter out of a meeting with campaign advisers and gave him the bad news, stating that Jones and Brown recommended aborting. Carter specifically asked for Beckwith's recommendation. Vaught then asked if Beckwith could proceed with five helicopters—much to the colonel's annoyance since all had

agreed previously that six was the minimum number. Beckwith insisted the mission had to be aborted. Carter agreed at 4:57 p.m.<sup>86</sup> Brown and Vance joined the deflated president in his private study. Carter took some comfort: “At least there were no American casualties and no innocent Iranians were hurt.”<sup>87</sup>

Carter was soon to be disappointed. At Desert One the six helicopters were parked behind the three C-130s tankers, which if brought up to power to turn, would have buried the choppers in sand. Helo no. 6, the first to arrive, needed to refuel; C-130 no. 4, with its fuel bladders spent, needed to take off. Kyle ordered helo no. 3 to ground taxi, or failing that, to air taxi out of the way so that the C-130 could turn around and take off. When helo no. 4 then made the same move as helo no. 3, the two repositioned helicopters could be refueled from C-130 no. 6. The pilot of helo no. 3 could not ground taxi, so in a huge cloud of dust he lifted to about 25 feet off the ground and then drifted, hitting C-130 no. 4 containing two empty

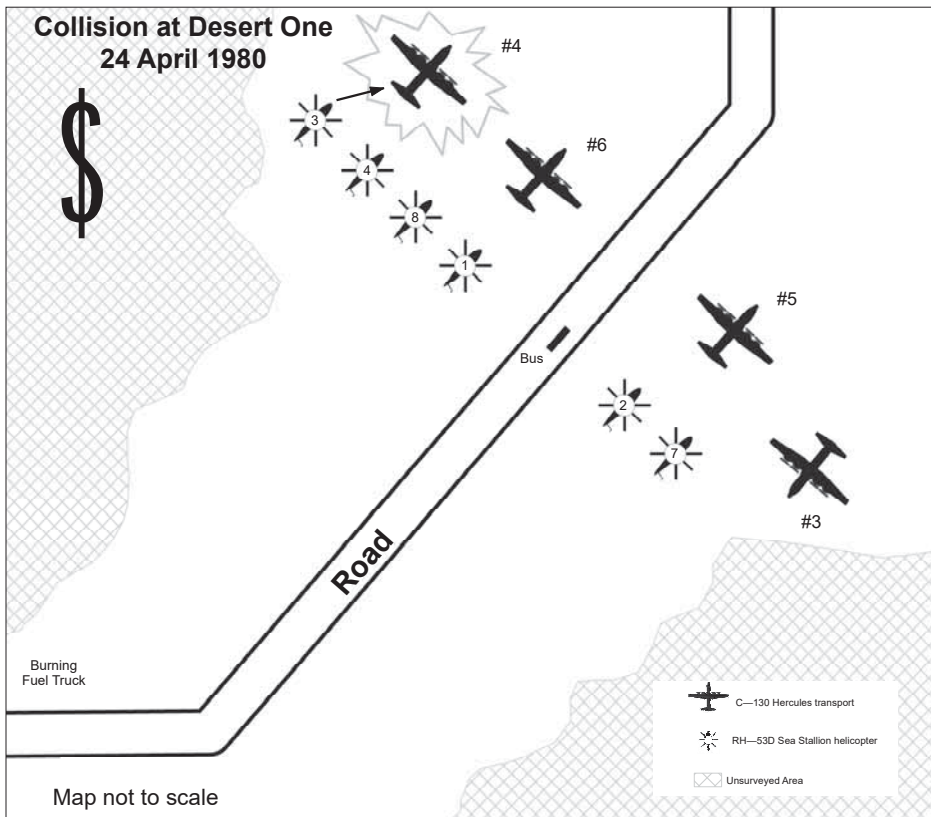

fuel bladders, weapons and munitions, 14 crew members, and some of the Delta Force. The crash caused an explosion that set both the helicopter and the C-130 ablaze. Everyone in the Delta Force evacuated safely, but eight U.S. servicemen died: five crew members of the Air Force C-130 and three Marines from helio no. 3. Five others from the assault team were injured. With the remaining helicopters punctuated by exploding munitions and perilously close to the blaze, the entire rescue team boarded the remaining five C-130s and took off leaving the five helicopters intact and one burning in the desert.<sup>88</sup>

At just before 6 p.m. Washington time, Jones learned of the catastrophe. Soon after 8 p.m. Carter joined the inner group in the Cabinet Room, where they had been discussing a number of issues for decision: how long to wait before making a public announcement of the mission's failure so as to give CIA and Delta Force personnel agents in Tehran time to leave the country or protect themselves as best they could; when to inform Congress; and how and when to notify nations whose territory the United States had used in the mission without their permission. Brown gave the president and the inner group a fuller briefing on the situation at Desert One just after 11 p.m. After calling key congressional leaders, the president agreed to go public at 1 a.m. on 25 April. Carter asked Brown about the procedure to notify the families of the men killed at Desert One: Brown answered it would be in the normal way, by their service secretaries. Carter interrupted, stating he would like to make the calls himself. It had been a long day and Brown apparently was in no mood for presidential condolences: "Mr. President, these were military professionals who volunteered for a dangerous mission and were killed in the line of duty. I appreciate your willingness to make the calls, but it is something that has always been done by the service secretaries. Because of the unusual nature of this mission, I'll make some calls myself." Faced with Brown's insistence that the military take care of its own, Carter backed off, asking that the secretaries tell the families that he considered their deceased loved ones heroes. During the rest of night, Brown attempted to get some sleep in the small bedroom attached to his office, but it would not come.<sup>89</sup>

Brown arrived at the White House at dawn and sat at the president's desk to use the secure telephone line to call Admiral Bobby R. Inman, director of the National Security Agency, to ascertain if the Soviet Union had picked up intelligence on the failed mission and made any moves in response. They had not. Brown then scheduled a press conference for noon to elaborate on the president's earlier





Secretary Brown briefs the press on the failed Iran hostage rescue mission. (OSD Historical Office)

statement. At the conference, the secretary gave a concise briefing and answered press questions about the rescue mission, leaving out the role of the CIA and countries (Egypt, Oman, Saudi Arabia) from which the various elements had launched their rescue mission. Brown replied to a question about who was responsible: “I’ll take responsibility within the Defense Department. . . . I’m not looking for [scape] goats.” The secretary later learned that that a cheer went up from the members of the Joint Staff watching the conference on the Pentagon internal television channel after his reply.<sup>90</sup>

On 20 May the president, his advisers (including Brown), the top military leaders, and surviving members of the rescue team held a memorial service at Arlington Cemetery for the eight American service members killed at Desert One. Next to Carter sat the families of the dead—young wives, children, and parents. After the ceremony on the way to their cars, Jordan saw Brown wiping tears from his eyes with his handkerchief, a bit embarrassed to be showing his emotions. Jordan remarked, “Harold, it was a beautiful ceremony.” “It was and I’ll always feel that we did the right thing,” the secretary replied as he walked briskly to his car.<sup>91</sup>

## Postmortem

Did the Carter administration make the right decision in attempting such a dangerous and complex rescue? Could it have succeeded? After the failure, investigative newspaper reporters descended on the Pentagon and the military services to discover what went wrong. They churned out articles, columns, and special reports, often based on erroneous information.<sup>92</sup> Congress demanded accountability.<sup>93</sup>

At the end of April, Brown ordered a reluctant Beckwith to answer questions from the news media. Before the briefing, General Jones told Beckwith to talk only about the military operation, not anything beyond that. Beckwith offered “to lie about any CIA or other intelligence participation in the mission.” Brown, to use Beckwith’s characterization, “really bit into my ass,” stating, “We don’t lie about anything up here. If you get a question you believe is sensitive . . . all you will say is, ‘I can’t answer that question and I suggest you ask my superiors about it.’” Perhaps initially fearing that he was being set up as the scapegoat, Beckwith felt a wave of relief; he “was dealing with honest brokers.”<sup>94</sup>

Brown and Carter took the blame for the failed mission, fully supporting the actions and decisions of men on the ground, with no second-guessing, no evading responsibility, and no finger-pointing. As Jones later made clear, the rescuers appreciated the president’s acceptance of responsibility. “President Carter got a bum rap, that somehow he interfered with things,” Jones stated. “He handled it better than any president I had seen. . . .” Jones praised Carter for his unwillingness to interfere with the operation and his acceptance of the recommendations of the commanders in the field and on the ground.<sup>95</sup>

The JCS instituted its own formal review of the disaster, creating the Special Operations Review Group, composed of five senior active and retired officers, under the chairmanship of Admiral James Holloway, the former chief of naval operations, to investigate and draw lessons from the failure.<sup>96</sup> Brown later drew his own conclusion, no doubt based on his careful reading of the Holloway report. Brown recalled that the “forces were assembled in great secrecy.” He saw “two large mistakes.” The first, “we were so eager to keep it secret that we didn’t rehearse it. There should have been a full-scale rehearsal conducted in the United States in equivalent circumstances.” Second, “mixing Marines and Air Force people on the air side was a mistake. We probably should have had Air Force helicopters [and pilots] do the whole thing, because they are used to working with Air Force C-130s.” Brown later

considered that a related “major mistake” was “that too many elements of the rescue team were chosen so that all the services would be represented although they had never worked together before.”<sup>97</sup>

Brown’s concern about excessive secrecy was one of the two major conclusions of the Holloway report, which stated that the obsession with operational security precluded improvements in the mission’s planning. JCS staffers or CIA and NSA specialists, all with proven track records for security, could have helped to improve the complex plan or even simplified it. Second, the Holloway group concluded that the whole operation was too ad hoc, forcing the rescue task force to reinvent the wheel when the existing Joint Force Staff organization (albeit reduced to a few key members) could have been a great help in giving the planning team a running start.<sup>98</sup>

Some months after he left office, Brown told Jordan that “six or seven times out of ten” the rescue would have worked. “We just had some bad luck.” Holloway insisted that the bad luck sentiment be included in the report: the mission was a “high risk” gamble with “little margin to compensate for mistakes or plain bad luck.” In retrospect, the mission should not have been undertaken if good luck was a requirement. There is an old sports cliché that good teams make their own luck, bad ones blame bad luck. Good planning would have foreseen the possibility of sandstorms, the need for additional helicopters, and the added risk of Marine and Air Force working together without joint training.<sup>99</sup>

The Holloway report concluded that the CH-53D Sea Stallion helicopters, normally used for minesweeping operations, were the only feasible candidates for the mission. The failure of five of eight of them points to one obvious conclusion. Why not a larger margin for error? Would 10 Sea Stallions have done the trick?<sup>100</sup> The rescue planners initially thought four helicopters adequate but raised the number eventually to eight as the number of rescuers and adjuncts rose. Perhaps more eyes on the plans might have increased the number of helicopters. The rendezvous at Desert One represented the most difficult part of the plan for the helicopters, given the long distance traveled and weather conditions, but would more helicopters have been lost in the subsequent operations?<sup>101</sup> Other nagging questions: Could one of the C-130s with its superior navigation equipment have flown ahead of the helicopters, which had no navigators and less sophisticated navigation systems, to scout out the dust storms; and could the mission have been delayed until the storms passed? The crash of one helicopter into a C-130 after

the mission had been aborted was a deadly postscript to an ill-fated operation. There were scores of other tantalizing “might have beens” raised and analyzed in the Holloway report.<sup>102</sup>

From the wreckage in the Iranian desert came some potential positive developments. The JCS and Brown approved the creation of a Counter Terrorism Joint Task Force with assigned personnel and dedicated forces and a Special Operations Advisory Panel of officers with particular operational experience to advise in future operations.<sup>103</sup> Two days after the disaster, Carter, his top advisers, and the commanders of the mission had a raucous discussion about how to undertake another Iran hostage rescue operation, this time based on the injection of a large force shooting its way into Tehran and taking a nearby air base as a launching and leaving pad. Carter and Brown authorized Brig. Gen. Richard V. Secord, USAF, who had a strong record of unconventional warfare experience in Laos, to plan another rescue. Some consideration was given to using Turkish smugglers to prepare the ground for this second effort. In the end, the planners never asked for the go signal because the hostages had been dispersed around Iran. An intelligence report that they were back in the embassy compound in October 1980 proved too unreliable to base a rescue decision upon. As it turned out, the hostages were back in Tehran, not in the embassy compound, but rather in Komiteh prison on the city’s outskirts. Sick believed that Carter would never have given the green light unless the hostages’ lives were in danger; the president was now committed to the negotiating track. The second elaborate rescue mission never got beyond the planning and training stage.<sup>104</sup>

As Secretary of Defense, Brown rightly took heat for the failed hostage mission. Initially Brown warned of the complexity and dangers of the rescue. Perhaps the momentum of the planning and Carter’s increasing desire to do something before the upcoming presidential election wore down the secretary’s initial skepticism—“this would be no Entebbe”—and his innate caution. Certainly, by 11 April, Brown believed that the rescue formed the best of a series of poor options. If he had it to do over, he likely would have insisted on more fail-safes and more redundancies in the plan.

With the failure of the rescue and the ongoing hostage crisis, any chance that the Carter team members could put Iran behind them before the November 1980

presidential election evaporated. While the economy and Ronald Reagan's ability to connect with voters proved powerful factors in the 1980 presidential election, the failure in Iran probably doomed Carter's chances. Conversely, a successful rescue mission might have saved his presidency. Under criticism from Republican candidates that he had skimmed on defense spending, Carter became all the more vulnerable to such public perception because of the Iran hostage rescue disaster.

When asked later if he had drawn conclusions or lessons from the whole Iran experience, Brown gave powerful advice in hindsight: "Don't get into this kind of situation in the first place; don't become so preoccupied with American hostages that it distorts your foreign policy and damages your administration."<sup>105</sup> Unfortunately, Carter and Brown would not be the last president and secretary of defense forced to deal with Islamic fundamentalism in Iran.

From Washington's point of view the Islamic Revolution in Iran that toppled the shah and brought an anti-American government to power constituted a serious tear in the U.S. security fabric in the Middle East and Southwest Asia. Having come to office concerned about the balance of power in Europe, Carter and Brown had to cope with a security void in the Persian Gulf and Southwest Asia where, as the hostage rescue mission proved, the United States had great difficulty projecting its power. The other great rent in the fabric of security, the Soviet invasion of Afghanistan, placed Soviet troops closer to an unstable and much less militarily powerful Iran, threatening the rest of the oil-rich Middle East. The Carter administration and the Defense Department had to seek viable adjustments to major strategic changes in the Persian Gulf, Southwest Asia, and the Indian Ocean to meet these challenges.



## Southwest Asia and the Framework for Persian Gulf Security

THE FALL OF THE SHAH and the Islamic fundamentalist revolution that overturned Iran's old regime represented only the most dramatic in a series of events in the Middle East, Southwest Asia, and the Persian Gulf that shook the underpinnings of U.S. policy across that region. In April 1978 Marxist-Leninist Afghan politicians and leftist military officers overthrew the government of Mohammad Daoud Khan in Afghanistan, altering the neutralist orientation of that traditional buffer state between Pakistan and the Soviet Union. Although not recognized as particularly significant at the time, this event had great implications for the Cold War. Afghanistan did not loom large in the planning of the National Security Council, Department of Defense, and Joint Chiefs of Staff until late December 1979, when the Soviets invaded—ostensibly to aid and sustain the Communist revolution there. Then alarm bells rang in the Pentagon and the White House. With Iran under a hostile theocracy and Afghanistan's government and major cities increasingly under Soviet domination, uncertainty and instability pervaded Southwest Asia. Pakistan became the most likely U.S. ally in the area, but it was hardly an ideal candidate. Pursuit of an "Islamic atomic bomb" to match the 1974 "peaceful atomic explosion" of its archenemy India made Pakistan a pariah among nuclear nonproliferation proponents in the Carter administration, including the president. While DoD and the JCS argued that Pakistan's antiquated armed forces required upgrading, the White House and State Department took no notice until the twin shocks of Iran and the Soviet invasion of Afghanistan. Shelving its concerns about nuclear proliferation, the administration offered Pakistan military assistance, but it proved too little. The United States and Pakistan never fully established a meaningful overt military relationship, although they cooperated secretly in supporting the local rebellion

against the Soviets and their allies in Afghanistan. Finally, the Iranian revolution and the Soviet invasion of Afghanistan drove home the importance of expanding the ability of the United States to project its power in the Middle East and the Persian Gulf, and persuaded the administration to issue the Carter Doctrine, which drew a line against further Soviet intervention in the area. To back up the doctrine, the administration constructed a framework for security in the Persian Gulf and created the Rapid Deployment Joint Task Force. The new emphasis on the Gulf and Southwest Asia, coupled with creating a means of deploying U.S. military power to the area, represented a major shift in the strategic outlook of the United States.

### **Afghanistan**

One of the least developed and most geographically rugged places in the world, Afghanistan had long been a point of conflict, the site of the storied “Great Game” between the British and Russian empires during the 19th and early 20th centuries. The British fought three wars in Afghanistan, determined that pro-Russian Afghans should not gain a foothold in the country between its empire in India and Czarist Central Asia. As long as Afghanistan remained fiercely independent, it provided a crucial buffer zone. The United States picked up the British mantle, courting Afghanistan from 1946 to 1955 with economic and military assistance. In the late 1950s and 1960s Afghanistan followed a policy of nonalignment, accepting both Soviet and U.S. aid, but with a definite tilt toward Moscow. The United States remained content to let events take their course as long as the Soviets did not attain undue influence over the government in Kabul. When the former neutralist prime minister, Mohammad Daoud Khan, seized power in a 1974 coup d’état against his first cousin, King Mohammad Zahir Shah, relations with the Soviets remained friendly. In the mid-1970s Afghanistan accepted aid from Iran, Kuwait, and Saudi Arabia—close U.S. friends. Daoud planned to visit Washington in 1978, but in April, Afghan Communists (a small group of elite and left-leaning Army officers) overthrew his government and murdered him. Although the new regime declared itself nonaligned and played down its Marxist leanings, it proved Communist in all but name. As it consolidated power, the regime drew closer to Moscow.<sup>1</sup>

Many Afghans, especially the more traditional elements in the countryside and many of the tribal and ethnic groups that made up the country, rejected the new government. Rebellions among the religiously faithful rural villagers spread



to almost all of Afghanistan's 28 provinces.<sup>2</sup> The Soviets supplied equipment and military advisers to the beleaguered Afghan army under attack from insurgents, a reverse of the U.S. experience in supporting South Vietnam against Communist guerrillas. The revolt of the Islamic fundamentalists in Afghanistan provided the United States an opportunity to blunt Communist and Soviet influence and make Moscow pay for its intervention. Although Carter was not an enthusiast of covert action, the United States began a cautious and modest program of secret operations to support the Afghan insurgents, the mujahideen (holy war fighters). In March 1979 the intelligence community submitted for approval a lengthy plan, including propaganda and other support for the insurgency and a possible coup d'état against the Communist government dominated by the leftist elite in Kabul. The NSC's Special Coordination Committee-Intelligence (SCC-I)—the mechanism for assessing and recommending such operations (DoD provided a member)—approved only propaganda efforts, asking for more definition and details of other aspects of the program. A fact-finding mission traveled to Pakistan to assess requirements for aid to the Afghan resistance. In late June 1979 the mission reported to the SCC-I that to undermine the regime of then-President Nur Muhammad Taraki, the United States should undertake psychological warfare in support of the Afghan rebels and provide them with humanitarian aid and military supplies. The SCC-I approved modest funding for the propaganda effort, psychological operations, and humanitarian assistance to victims of the war but withheld lethal aid, including antitank weapons and communications gear. Carter signed the presidential directive to this effect in July 1979, six months before the Soviet invasion.<sup>3</sup>

Those responsible for intelligence at Defense viewed the Carter administration's policy in Afghanistan as hesitant and reactive; unenthusiastically supported by senior officials; lacking clear policy guidance, effective staffing, and follow-up; and concentrating too much on propaganda—"sound and fury" but no measureable results." Pentagon officials suggested ways to fund the mujahideen's purchase of arms and ammunition, but the administration was not prepared to go that far. In October 1979 the SCC-I again took up the question of Afghanistan, agreeing to continue nonlethal aid, but this time providing tactical communications gear and advice on how to procure ammunition. Pentagon officials concluded that after eight months of paperwork and meetings, the United States had provided the Afghan resistance only limited support to little effect. While the resistance had

achieved much success on its own against the Afghan army, the tide now seemed to be turning against the mujahideen as Soviet troops increased their advisory role and provided supplies and support to the Afghan army. Brown agreed to discuss more military aid to the Afghan resistance with Secretary of State Cyrus Vance and National Security Adviser Zbigniew Brzezinski, which he apparently did at a regular meeting of the three men in early December 1979. The administration was gearing up to extend more assistance to the Afghan resisters.<sup>4</sup>

In mid-December, Under Secretary of Defense for Policy Robert Komer, the DoD official charged with responsibility for intelligence operations, and Director of Central Intelligence Stansfield Turner discussed Afghanistan, no doubt as a result of the Brown initiative with Vance and Brzezinski. U.S. lethal aid remained off the table—a view confirmed at an SCC meeting of 18 December 1979—but the mujahideen needed military hardware and command and control equipment. Saudi Arabia appeared an obvious choice for financial support for arms purchases. The Pakistani Army could provide the rebels instruction in how to use radios and communications gear that the United States had already agreed to provide. Prepared to offer DoD's support in negotiations with the Saudis and Pakistanis, Komer suggested that, in light of increasing Soviet intervention, support to the mujahideen should be increased about threefold.<sup>5</sup>

On Christmas Eve 1979 the Soviets airlifted troops and equipment into Afghanistan. Three days later the Soviet Union sent motorized divisions overland. The Soviets installed their own president to replace the one killed during a Soviet-inspired coup that coincided with the incursion. The invasion shocked Carter, who had never experienced firsthand the iron fist of Soviet power.<sup>6</sup> For the next few days Carter and his senior advisers, including Brown, discussed in NSC and other meetings how to respond to this aggression. They decided on a series of diplomatic, social, cultural, and economic steps. They included a protest message to Soviet General Secretary Leonid Brezhnev via the hotline, a UN condemnation, recall of the U.S. ambassador from Moscow, suspension or delay of bilateral arms control talks, limitations on official and social contacts between U.S. Embassy and State Department personnel and Soviet officials, cancellation or delay of trade fairs and cultural exchanges, and denial of Soviet requests for U.S. export licenses. Carter initially ruled out withdrawing the SALT II agreements from the Senate but within days changed his mind. In March 1980 he reversed his

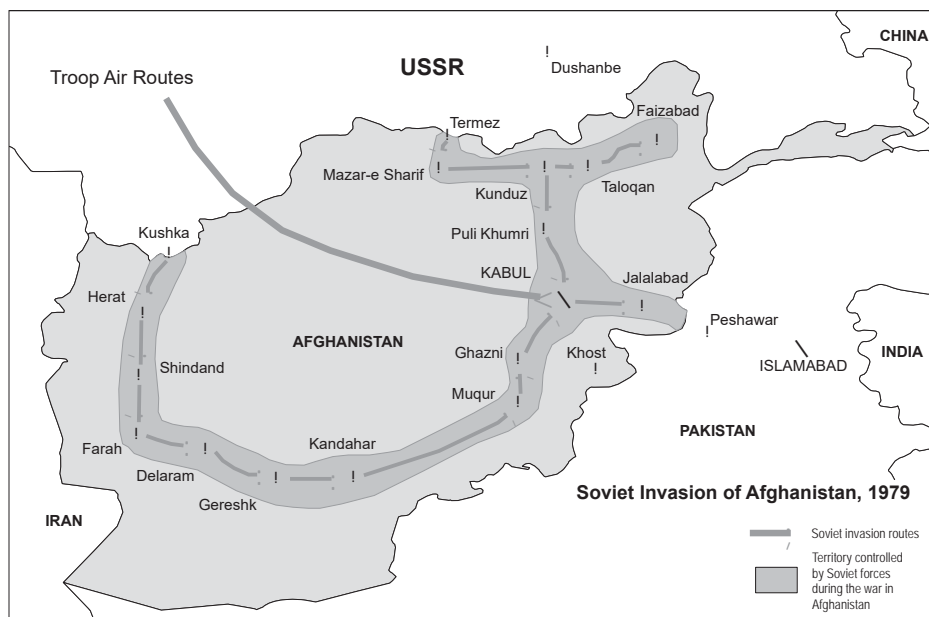

decision to allow U.S. athletes to participate in the Moscow Olympics, boycotting them instead. The main economic sanctions included curtailing Soviet fishing privileges in U.S. waters, a cutoff of high technology sales, and an embargo on U.S. grain sales to the Soviet Union.<sup>7</sup> Brown suggested extending action against Soviet clients by restricting Cuba's worldwide sugar exports or by increasing covert pressure on North Yemen, but neither idea was implemented. Carter avidly accepted Brown's other suggestion that China should be included as part of the "Contact Group" in opposing the Soviets in Afghanistan.<sup>8</sup>

Brown's proposal to engage China was more than just an off-the-cuff idea. He was about to become the first U.S. secretary of defense to visit the People's Republic of China (see chapter 13). Given the Soviet invasion of Afghanistan, his trip took on added significance. The secretary asked the president what he could say to Chinese leaders about tangible U.S. support for the Afghan resistance. Could he inform them of arrangements with the Saudis and Pakistanis for arms and supplies? Such an admission might induce the Chinese to join the effort, or at least be more forthcoming about their plans.<sup>9</sup> In meeting Chinese leader Deng Xiaoping in Beijing, Brown informed him of U.S. support for the Afghan resistance. Deng countered that it would make a difference only if the support was "more than symbolic."

Appreciating the opportunity to bog the Soviet Union down in a guerrilla war, Deng promised China would cooperate, but only if the United States was serious.<sup>10</sup>

Clearly the Chinese would judge the seriousness of the U.S. response by the military assistance provided the mujahideen. In mid-1980 the Carter administration agreed secretly to fund and pass arms to the Afghan resistance in equal partnership with another interested regional power with deep pockets.<sup>11</sup> But the arms pipeline proved slow and unwieldy. A case in point was procurement of SA-7 missiles, the NATO name for a Soviet-produced, shoulder fired, low altitude surface-to-air missile with a passive infrared homing device. Effective against helicopters and prop aircraft—but not against jets—this simple, low maintenance weapon became the SAM of choice of the mujahideen, but the Soviets and their Warsaw Pact allies clamped down on the sale of these weapons to arms dealers to prevent them from ending up in Afghan resistance hands. Nations such as Egypt that had supplies of SA-7s would not swap them for the more complicated and less reliable U.S. Redeye missile, even at a two- or three-to-one basis. The only option DoD could see would be to produce the SA-7 on a reverse engineering basis, but that would take time.<sup>12</sup>

By autumn 1980 the situation in Afghanistan assumed the classic stalemate of guerrilla war. Soviet forces controlled the cities, the air, and lines of communication; they could move around the country in convoy or by air, but the mujahideen controlled the countryside. Suffering from defections and low morale, the Afghan army was a shell of a force, requiring 40,000 Soviet troops for support and to assume more of the fighting. A young RAND Corporation analyst, Francis Fukuyama, who undertook a trip to Pakistan to investigate, predicted that this stalemate would probably continue for the immediate future. Soviet strategy sought to minimize casualties; the mujahideen were poorly organized and rife with tribal rivalries. Fukuyama also concluded that as of June 1980 (the time he was in Pakistan), few outside arms had actually reached the Afghan resistance. Beyond the weapons captured from the Soviets or the Afghan army, the resistance relied on locally produced and plentiful single-bolt rifles rather than on automatic weapons or grenades.<sup>13</sup> What was surprising was how well the mujahideen fought with such little firepower and support. To Komer, this state of affairs offered possibilities: “Shouldn’t we be working on plans to keep the Afghan resistance going on a long term basis—for years if necessary—to maintain a steady drain on Soviet resources?”<sup>14</sup>

With Carter's loss in the November 1980 presidential election, the answer to Komer's question fell to President Ronald Reagan, Director of Central Intelligence William J. Casey, and key supporters in Congress, who carried on and then augmented the initial program established by Carter to the point where the mujahideen wore down and eventually defeated Soviet forces. The war in Afghanistan was a total failure from the Kremlin's perspective; furthermore, it helped to undermine the Communist Party's control of the Soviet Union and ultimately contributed to the fall of the Soviet empire.<sup>15</sup> Not foreseen at the time, the alliance between the Afghan successor regime, the Taliban, and a small anti-Western terrorist group, al-Qaeda, would have appalling consequences for the United States in September 2001.

## **Pakistan**

Events in Afghanistan inevitably affected Pakistan, a longtime ally of the United States that had joined both the Southeast Asia Treaty Organization in 1954 and the Central Treaty Organization in 1955, thus providing a linchpin between two Asian anticommunist alliances. U.S. relations with Pakistan remained stable through the 1950s and 1960s, exemplified by generous American economic and military assistance. After the loss of East Pakistan in 1971 (thereafter an independent Bangladesh), Pakistan looked to the Muslim nonaligned world and China rather than the United States. By January 1977 relations between Washington and Islamabad had deteriorated.<sup>16</sup> For its part, the Carter administration tried to institute evenhanded military sales to Pakistan and India, a policy hardly appreciated in Islamabad.<sup>17</sup> Intelligence analysts estimated that Pakistan's nuclear weapons program would produce an atomic bomb within five years to match that of its rival India. This ran against the president's deep commitment to nuclear nonproliferation. Within DoD support for Pakistan remained strong despite its quest for an atomic bomb, with the exception of Komer, who maintained a definite preference for India over Pakistan. Komer considered himself an expert on the Indian subcontinent from his days on the NSC staff, when South Asia was part of his portfolio. As he told Brown and Claytor: "The US military's romantic attachment to the stalwart Pakistani remains unshakable, despite the fact that they always used us more than we used them. . . . [A] cool calculation of our strategic interest in the subcontinent shows that a billion Indians are far more important to our overall interest than 150 million Paks."<sup>18</sup>

In November 1978, after the leftist coup in Afghanistan and with the shah's failing regime in Iran, Carter's advisers reviewed U.S. policy toward Pakistan. With a projected Pakistani nuclear explosion thought to be four or five years away, there seemed to be an interlude during which the United States could provide economic assistance and military aid to Islamabad before Congress restricted such aid. At some point the administration would have to declare that Pakistan was seeking a nuclear weapon and congressional restrictions would then kick in. There might still be time to dissuade Pakistan from producing a nuclear bomb. As a first step Pakistan had to feel more secure. The National Security Council's Policy Review Committee recommended a cash sale of 76 F-5E fighter aircraft to Pakistan to replace its obsolete Korean-era F-86 Sabre jets on a one-for-one basis, thus bringing Islamabad closer to parity with New Delhi, which had agreed to purchase 150-170 Anglo-French-built Jaguar fighter-bomber aircraft. To meet Pakistan's concern about Indian and Afghan-Soviet tank forces, the PRC members recommended selling the Pakistanis TOW antitank systems for helicopters. In addition, the United States would also consider approving third-country transfer of U.S. tanks to Pakistan and would be prepared to ask the Saudis or United Arab Emirates to pay for them.<sup>19</sup>

In addition, Assistant Secretary of Defense for International Security Affairs David McGiffert drew up a long list of military items that DoD could send to Pakistan. The extent and nature of the weapons and supplies depended on what the United States expected Pakistan to do. The minimalist list would help Pakistan protect its borders in the north and southwest, allowing it to "respond to Soviet/Afghan counter-insurgency operations." The next more extensive list would allow Pakistan to support the insurgency in Afghanistan. The final most extensive list would upgrade Pakistan's military to "represent a credible deterrent to Soviet aggression mounted from Afghanistan."<sup>20</sup>

Carter was not ready to go as far as the PRC and DoD recommended, in part because of Pakistan's nuclear weapons program but also because of its dismal human rights and democracy record. The deposed Pakistani president Bhutto was under a death sentence (executed in 1979) from the military junta that overthrew him. The administration cobbled together a \$400 million aid package that included \$100 million in foreign military sales credits and \$100 million in economic support funding. As for military sales, the president ruled out F-16 Falcon aircraft—the

plane Pakistan really wanted—but agreed to most of the PRC’s other recommendations with the proviso that the weapons must be those capable of defending Pakistan only, not those that would pose a real threat to India. When the administration made the \$400 million offer, Pakistani President Muhammad Zia-ul-Haq publicly rejected it as “peanuts.”<sup>21</sup>

U.S. policy toward Pakistan remained divided between two camps: Brzezinski, his military advisers on the NSC staff, and DoD (with the exception of Komer) favoring a more pro-Pakistan approach, and in the opposite camp, the Department of State and the Arms Control and Disarmament Agency. In early February 1980 McGiffert headed a DoD team that accompanied Deputy Secretary of State Warren Christopher and Brzezinski on their trip to Pakistan. Brzezinski visited a Pakistani military post in the Khyber Pass and held an AK-47 (he wisely declined to fire it into Afghanistan). The press accompanying him correctly interpreted this action as evidence of his pro-Pakistan leanings. Komer opposed supporting Pakistan, arguing that the “key to our deterrent position in South Asia is not Pakistan but India.”<sup>22</sup> McGiffert’s team consulted with Pakistani military commanders on equipment needs, visited installations, and surveyed the lay of the land on the western border with Afghanistan. For years Pakistan had focused on India, but now it faced a threat from Soviet-Afghan forces that had already engaged in hot pursuit of mujahideen into Pakistan. A limited invasion and/or occupation or a major attack to cut off sanctuaries in Pakistan and disrupt supply routes remained real threats. McGiffert recommended preparing an equipment list that focused on weapons for defense of the western border with Afghanistan, financed half by the United States with European allies and the Saudis assuming the other half. McGiffert concluded that a reconstituted, modernized Soviet-supported Afghan army was probably two to three years away, so the more military modernization for Pakistan now, the better.<sup>23</sup>

There was a hidden dimension to the U.S.-Pakistan relationship: the Pakistani role as a conduit for arms and other assistance to the Afghan resistance. If the public relations between Islamabad and Washington sometimes seemed strained, U.S.-Pakistani mutuality of interest in opposing the Soviets in Afghanistan remained stalwart. While willing to perform this function—President Zia described it as a “calling”—Pakistan sought a way to defend against potential Soviet-Afghan raids against its western border (the Northwest Territories and Baluchistan) that provided key sanctuaries for the mujahideen, their families, and other Afghan refugees.

Pakistan most wanted Soviet-built, SA-7 SAMs and equally simple and efficient Soviet-built, shoulder-launched, rocket-propelled grenades (RPG-7s) that were effective against tanks. The Soviet bloc again cut off access to sale of these weapons, making rapid delivery to Pakistan problematic.<sup>24</sup>

In spring 1980 most PRC members agreed that Pakistan needed an overt military-to-military relationship with the United States that would “have some independence of political vicissitudes.” Using input from the McGiffert team’s visit, DoD prepared a list of U.S. military equipment for Pakistan that included the sale of 100 to 200 M60 tanks. While State vigorously opposed the idea, Komer supported it, noting that India already had ordered 70 Soviet T-72 tanks and could hardly object to Pakistan obtaining M60s to be delivered in 1982–1983. The president agreed in principle to negotiations with Islamabad on the assistance program.<sup>25</sup>

During summer 1980 DoD pushed for fiscal year 1982 foreign military sales credits for Pakistan in the \$400 million range, believing Pakistan was now a frontline state against Soviet aggression and still smarting from Zia’s “peanuts” belittlement.<sup>26</sup> Then, in late September, Brown, who had not been much involved in the Pakistan debate because of Iran and other more pressing issues, made an appeal to Carter for better security ties with Pakistan, especially in light of the Iran-Iraq War. Brown reported agreement with Islamabad on the sale of military equipment, including cash purchase of M60 tanks, and noted that two old Gearing-class destroyers had been transferred to the Pakistani navy. Since DoD could not convince Congress to lift restrictions on granting security aid or FMS credits, “even if we renewed our earlier decision to turn a blind eye to their nuclear weapons program,” cash military sales would be virtually all that was left on which to build a military relationship with Pakistan. If DoD could offer to sell F-16s and deliver them by 1984 or 1985, it “would be taken by Pakistan as very positive evidence of our continued concern for Pak security” and “would have great symbolic value.” Brown noted that in addition to its purchases of Jaguar aircraft, India reportedly planned to acquire advanced Soviet MiG-23 and MiG-25 aircraft. Pakistan’s air force, no match for India’s, was “practically unable to maintain sovereignty over its own air space.” Brown asked the president to offer Zia F-16s during the Pakistani president’s upcoming visit to Washington.<sup>27</sup>

Carter responded: “I do not approve. Defensive air and ground to deal with Afghan-Soviet threat—not to threaten India.”<sup>28</sup> Brown immediately came back to



Carter with a reclamation, reiterating his arguments and asking him to reconsider, noting that the United States could also offer to sell F-16s to India, but as the secretary assured the president, New Delhi would probably not be interested. Furthermore, U.S. reluctance to sell advanced weapons to Pakistan had not induced India to oppose Soviet aggression in Southwest Asia; continuing that policy was not likely to influence the Indians in the future.<sup>29</sup> When Carter met Zia two days later, the president wrote: "I met with Zia and liked him. He's calm, I think very courageous, intelligent. He's willing to accommodate refugees coming into Pakistan from Afghanistan and needs to have his debts rescheduled. We'll sell them F-16s in the future." Brown no doubt believed that his arguments carried the day, but the Carter-Zia personal connection (shades of the president's relations with Egyptian President Sadat) probably played at least an equal part.<sup>30</sup>



President Jimmy Carter meets with General Muhammad Zia-ul-Haq, president of Pakistan, 3 October 1980. (Carter Presidential Library)

U.S.-Pakistani relations proved complicated. The threat of India, Pakistan's quest for the nuclear bomb, the war in Afghanistan, secret aid to the mujahideen, congressional restrictions on FMS credits and security grants, opposition by State and ACDA combined to make it difficult for Washington and Islamabad to forge a meaningful military relationship. Encouraged by DoD, the Carter administration began the process but accomplished little beyond its cooperation against the Soviets in Afghanistan. The successor Reagan administration saw the issue in starker terms, enjoyed the support of Congress, and harbored no compunctions about selling Pakistan advanced weapons, including F-16s.

### **Security in the Persian Gulf**

After the Arab oil-producing states embargoed their petroleum in response to the October 1973 war between Israel and its Arab neighbors, the United States realized how vulnerable it and its allies had become to a shutoff of Mideast oil. While the United States did look to the region for its energy needs, Europe and Japan were almost totally dependent on Middle East oil. When the Arab oil-producing states denied their oil to the West the result was long lines at the gas pumps and "no gas today" signs in the United States. The international oil market was interdependent and interconnected. Shortages in Europe and Asia meant shortages in the United States. Even after the embargo ended, the Organization of Petroleum Exporting Countries (OPEC), a worldwide oil cartel, kept a firm rein on production and thus the price of crude, retaining a powerful economic lever over the world's economies. As a primary goal for his presidency, Carter sought to break OPEC's stranglehold on Western economies by energy conservation, development of alternative domestic sources, establishment of an oil stockpile in storage to offset future embargos, and creation of an oil consumer organization to counterbalance OPEC.<sup>31</sup>

A corollary of this energy policy required that the United States and its allies protect their sources of oil in the Middle East from either an outside threat—the Soviet Union—or an internal upheaval, such as occurred in Iran. The United States had severely limited access to staging grounds or bases in the area, which circumscribed U.S. ability to project power there. From the beginning of the Cold War, Europe and then Asia provided the focal points of U.S. interest. The Middle East represented a distant third priority, originally left to the British whose influence

waned as diminished resources caused them to withdraw their forces east of Suez. In the Middle East and Persian Gulf, the United States had no bases; its closest was the tiny atoll of Diego Garcia in the Indian Ocean, rented from Great Britain.<sup>32</sup> The U.S. Middle East Force (MIDEASTFOR), consisting only of a flagship and two surface combatants, operated in the Arabian Sea and Persian Gulf; a task force of four surface combatants (sometimes including an aircraft carrier) and logistical ships from the U.S. Pacific Command (PACOM) augmented it by periodic deployments for about 50 days to the Indian Ocean.<sup>33</sup>

For Carter's first two years the Soviet threat to Europe and NATO, the Egyptian-Israeli negotiations leading to an Israeli Sinai withdrawal and peace treaty, the search for a larger peace between Arabs and Israelis, the second-round strategic arms limitation talks, and the Soviet challenge to the U.S. intercontinental ballistic missile force formed the primary national security considerations. Everyone agreed that the Middle East, with the exception of Egypt and Israel, needed more attention. Presidential Review Memorandum 10 cited the Middle East as a principal potential source of conflict and the subsequent Presidential Directive 18 called for a force able to respond rapidly to emergencies, most likely in the Middle East. But the bureaucracy was slow to respond; not much actually happened.<sup>34</sup>

Then a series of crises in the Persian Gulf and adjacent areas drove home the lesson of just how limited U.S. military assets were in the area. The Soviet-Cuban support for Ethiopia in its war with Somalia, Soviet support for South Yemen against Saudi-supported North Yemen, and the collapse of the shah's government in Iran were the flash points. In each instance, the U.S. response to the crisis was severely hampered by the limited assets that Washington could bring to the area. In his memoirs, Brzezinski claimed much of the credit for alerting the administration to the need for a larger military presence and better power projection. While he was a prime mover, he had within DoD considerable support from the JCS, Deputy Secretary Charles Duncan and his successor Graham Claytor, and Under Secretary of Defense for Policy Robert Komer.<sup>35</sup>

In September 1978 the JCS completed a full review of U.S. strategy in the Middle East and Persian Gulf, highlighting as major U.S. interests access to oil, survival of Israel, and the prevention of a hostile power from achieving hegemony. Resolution of the Arab-Israeli dispute would go a long way toward assuring these interests, but it would not solve the threat of the hostile power—the Soviet

Union—that the Chiefs maintained was actively working against U.S. interests, seeking to control the flow of oil and to neutralize Turkey and Iran. The JCS recommended reviving the Central Treaty Organization. The Chiefs also urged a firm and public commitment to Iran and Saudi Arabia—more military sales, development of their military base infrastructure, a limited military presence in the Persian Gulf region and eventually U.S. bases there. Brown considered the paper “good background” for the NSC, although “not very imaginative.”<sup>36</sup>

At least the JCS provided a start. After a late 1978 visit to the Middle East and East Africa, Deputy Secretary Duncan reported that in every country he visited each respective leader “saw himself and his country on the front lines of opposition to Soviet encroachment and domination.” Duncan warned that “the area of the Persian Gulf–Arabian Peninsula is a fragile and potentially explosive one, as events in Iran suggest. The risks of instability are significant and Russian opportunities for meddling are substantial.” With a small military investment—U.S. naval visits, joint military exercises, and modest security and financial assistance for the poorer countries—the United States could make a difference. Duncan suggested an inter-agency review of the area and Carter agreed.<sup>37</sup>

The interagency review took place in early 1979 at PRC and SCC meetings, the latter chaired by Brzezinski and attended by Duncan (and later Claytor) or sometimes Komer. As noted, these DoD officials formed a loose alliance with Brzezinski’s NSC staff, especially his military adviser, William Odom, to press for greater military action in the Persian Gulf, East Africa, and Southwest Asia. With the fall of the shah in January 1979, this review took on greater urgency.<sup>38</sup>

As part of this review, OSD prepared multiple contingency papers, including one on the Persian Gulf. Paul D. Wolfowitz, deputy assistant secretary of defense for international security affairs, directed the study that examined Iraq as a potential threat to the Persian Gulf States, especially Kuwait and Saudi Arabia. The study recommended putting Iraq on notice that the United States was prepared to defend Kuwait and Saudi Arabia and warning that without forward troop deployments, the U.S. response would have to rely on tactical air support. The study read like a preview for the 1991 Persian Gulf War. Brown was unimpressed with the study, suggesting that Islamic revolutionary Iran, not Iraq, was the potential regional disrupter in the Persian Gulf. Furthermore, most of DoD’s planning envisioned the Soviet Union as the real threat to the region. When Iran and Iraq went to war

in September 1980 and fought a costly, gruesome conflict for the next eight years, it was clear that Iraq had its hands full. Brown was not alone in discounting Iraq. The Reagan and George H. W. Bush administrations (the latter almost to the point of the Iraqi invasion of Kuwait) shared this view.<sup>39</sup>

In early spring 1979 Brown visited the Middle East to promote a peace treaty between Egypt and Israel, assure the Saudis of U.S. willingness to defend them, and scout out ways to enhance the U.S. military presence there. He outlined the possibilities in the area for the president. Neither Egypt nor Saudi Arabia nor many of the other U.S. friends in the area would permit U.S. bases on their soil for a variety of reasons, including the issues of state sovereignty and Islamic religious traditions. Oman might agree to refuel P-3 aircraft maritime patrols from Diego Garcia on its island of Masirah (to replace Bandar Abbas in Iran). The most likely outcome the United States could hope for from most Middle East friends was the use of their military facilities in a crisis—the so-called contingent operating bases (COBs). To pave the way for COBs, Brown cited as first steps actions such as the dispatch of 16 unarmed F-15 Eagle fighters plus 300 support personnel to Saudi Arabia for a week as a show of force and a preview of the planes the Saudis had purchased. He recommended prepositioning logistical material, unilateral and joint training exercises, and increasing the U.S. naval presence in the Persian Gulf, Arabian Sea, and Indian Ocean.<sup>40</sup>

Three months later Brown reported to Carter on the SCC and PRC deliberations, recommending that the United States “strengthen its defense ties with the moderate Persian Gulf States, continue to assist them in improving their self-defense capabilities, improve U.S. military surge capabilities, and moderately increase peacetime U.S. military presence in the region.” Specifically, the secretary recommended regular bilateral security consultations with selected Gulf States, responsiveness to their requests for arms and equipment, and participation in joint exercises to improve the readiness of their local forces. He advocated increasing MIDEASTFOR by two to three surface ships; increasing routine PACOM naval deployments to the Indian Ocean and Persian Gulf from three to four per year, including deploying two carrier groups and one or two Marine air-ground task forces; and dispatching, if politically feasible, a tactical air squadron to participate with local states in training and combined exercises each year. In the longer run, Brown foresaw a near-continuous naval presence in the Indian Ocean. He

recommended obtaining access clearances from states for military overflights en route to the Persian Gulf in the event of an emergency, including access to airfields and ports; upgrading local facilities in the Persian Gulf and adjacent areas; prepositioning of supplies and equipment there; and expanding Diego Garcia. These actions required a low-key approach, with leaders of Congress briefed on them confidentially, and allies, such as NATO members, supporting them where possible. Carter approved implementation in principle.<sup>41</sup>

While most agreed on the basic outline for the U.S. presence in the Persian Gulf and Indian Ocean, neither Brown nor the Joint Chiefs were as anxious to move as quickly as Brzezinski and outgoing Secretary of Energy James Schlesinger, who argued for not just a larger U.S. military presence in those areas, but enough troops to counterbalance Soviet forces there.<sup>42</sup> Like Brown, the JCS worried that an immediate shift to the Middle East would detract from the U.S. military posture in Europe and Asia. According to Brzezinski, Brown was “ambivalent” and only came around to supporting the idea (unlike Claytor and Komer) in late 1979. In retrospect, it seems that Brown’s caution stemmed more from the difficulties he saw in upgrading the U.S. presence than from any basic opposition to the idea.<sup>43</sup>

After more PRC and SCC meetings in fall and early winter 1979, the president approved preparations and negotiations to establish an air base in Oman and a naval base in Berbera, Somalia, or Mombasa, Kenya. Carter also instructed DoD, State, and the NSC to “expedite” additional planning efforts for increased U.S. security presence in the Middle East and Persian Gulf.<sup>44</sup> Brown reported to Carter on his low-key success with Egypt in obtaining limited operational access to Wadi Qena Air Base for two E-3A Sentry AWACS aircraft. During these negotiations, Vice President Hosni Mubarak reiterated President Anwar Sadat’s offer of allowing a U.S. upgrade of the Red Sea port and airfield complex at Ras Banas (Berenice), located on a peninsula jutting out into the Red Sea, which U.S. forces could use in an emergency. While this remote southern Egyptian base provided an attractive operational potential, Brown warned that the base’s austere conditions would require considerable funds to meet U.S. standards.<sup>45</sup> As to U.S. aircraft overflights of European countries for military deployments to the Persian Gulf, Brown reported that the current access remained “highly uncertain” given Europe’s need for oil and its unwillingness to offend oil producers.<sup>46</sup>

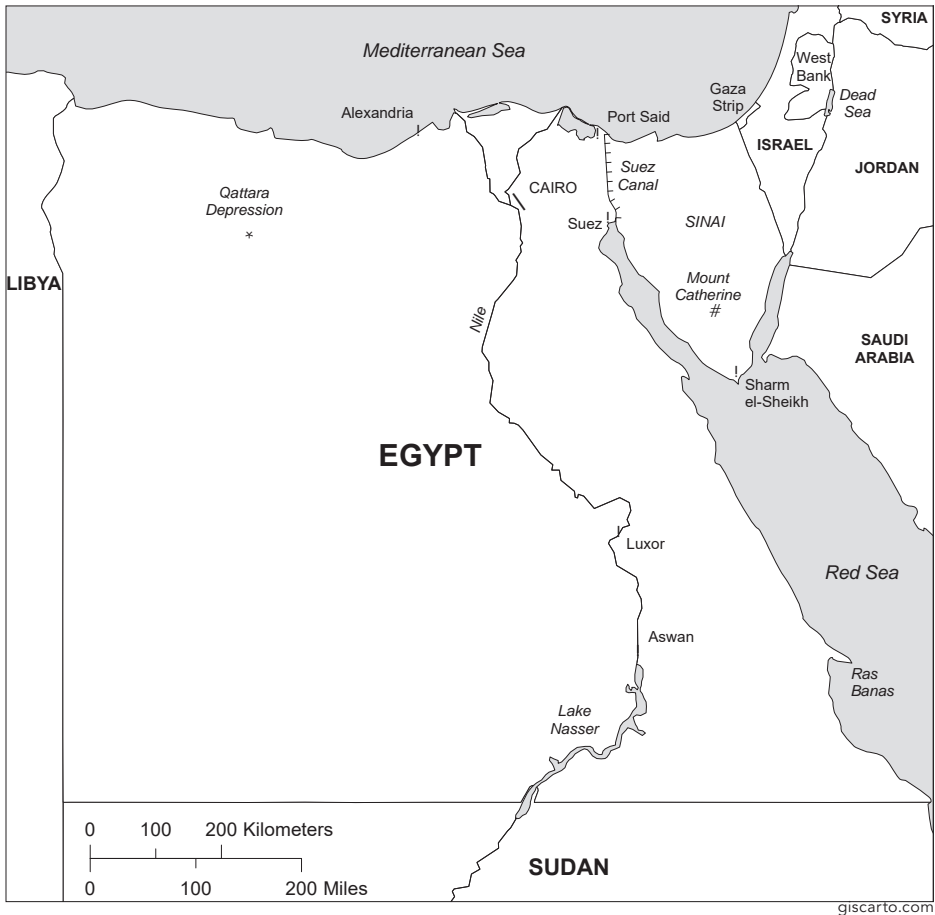

In late January 1980 Brzezinski sent Brown a think piece entitled “Consultative Security Framework for the Middle East,” apparently prepared by the NSC staff about 11 months earlier and well before the hostage crisis. It advocated a loose arrangement for cooperation among a core group of regional states comprising Egypt, Israel, and Turkey, with Jordan, Iran, Morocco, and Sudan as associated members. Because of its great wealth, matched by great military weakness, Saudi Arabia required special U.S. attention. Brzezinski’s NSC paper envisioned the United States assuming heavy military, economic, and political burdens; providing security guarantees; augmenting its military presence; and increasing its military and economic assistance, especially to Turkey and Egypt. Brzezinski foresaw agreements on landing rights and prepositioning of onshore facilities in Egypt, Saudi

Arabia, and Oman; upgrading military facilities and naval presence including expanding Diego Garcia; adding several ships to MIDEASTFOR; sending a nuclear combatant ship through the Suez Canal; conducting relevant military exercises in the United States and the Persian Gulf; and eventually obtaining U.S. access to military bases in Egypt and Saudi Arabia.<sup>47</sup>

Brown commented extensively on Brzezinski's paper. Whereas the national security adviser thought in broad, sweeping geopolitical terms, the secretary of defense focused on the specifics. Brown saw little benefit from increasing economic and military assistance, even to Turkey, since past efforts had produced little. He recalled that during his trip to the Middle East in February 1979, he could not persuade the Saudis to permit access and landing rights, but he thought Oman, Egypt, and Somalia would eventually agree. As for pressing the Soviets to stop destabilization efforts in Iran and reduce the number of Soviet-Cuban advisers in Libya, South Yemen, and Ethiopia, Brown saw no progress—"nothing." The Egyptians had not followed through on granting permission for a U.S. nuclear warship to pass through the Suez Canal despite Sadat's verbal agreement in principle to him. Base access in Saudi Arabia was "stalled politically."<sup>48</sup>

Also in January 1980 Brzezinski persuaded the president to make a public pronouncement on U.S. interests in the Persian Gulf. Carter used the occasion of his State of the Union speech to Congress on 23 January to enunciate the Carter Doctrine, putting the Soviet Union on notice that "an attempt by any outside force to gain control of the Persian Gulf region will be regarded as an assault on the vital interests of the United States of America, and such an assault will be repelled by any means necessary, including military force." Later in the speech, Carter specifically mentioned shaping "a cooperative security framework" for the region—Brzezinski and Press Secretary Jody Powell reinserted the phrase at the last minute after the State Department had eliminated it. To back up his doctrine, Carter ordered another naval battle group led by the carrier *Coral Sea* to join in February 1980 the *Nimitz* carrier group deployed in the Indian Ocean since mid-January. For the remainder of the Carter presidency two carrier battle groups always operated in the Indian Ocean.<sup>49</sup>

Was the threat that Carter sought to prevent real? The Joint Chiefs certainly thought so. As Chairman General Jones made clear at a mid-January 1980 SCC meeting, the Soviet military presence in Afghanistan greatly improved the Kremlin's ability to threaten the Persian Gulf. He outlined a scenario of potential Soviet





Aircraft carrier USS *Coral Sea* on duty in the Indian Ocean, February 1980. (RG 330, NARA II)



Bow view of nuclear-powered carrier USS *Nimitz* in the Indian Ocean, June 1980. (RG 330, NARA II)

moves (some appear far-fetched and unrealistic in light of subsequent Soviet performance).<sup>50</sup> Second, could the Carter administration back up its doctrine? The framework for security proved extremely nebulous. As Brzezinski described it at an SCC meeting, “We cannot duplicate NATO in this region; a more eclectic mix of bilateral, multilateral, and informal arrangements must suffice.”<sup>51</sup> It fell to DoD and State to create this eclectic framework. From the Pentagon’s perspective, the



Runway on Diego Garcia, the U.S. base leased from the British in the Indian Ocean, February 1980. (RG 330, NARA II)

task required study, planning, consultation, and money. Technical teams traveled to Oman, Somalia, and Kenya to assess options for base access to be followed by political teams to negotiate the deals. Diego Garcia—not the best base in the Indian Ocean, but the only one available—required upgrading, and the landlord, the British government, had to be consulted.<sup>52</sup>

Komer threw himself into the task of providing a blueprint of an action program (one of his favorite terms) for the security framework. The under secretary understood that whatever bases or COBs the United States obtained, the bulk of the U.S. presence in the Persian Gulf and Indian Ocean would be naval and therefore expensive. He also foresaw the need to project existing U.S. ground forces into the region: two to three divisions plus tactical air within two weeks, and five to seven divisions within a month to six weeks to stop, for example, a Soviet invasion at Iran's southern border. The problem was not the U.S. force structure but the ability to deploy troops and equipment quickly enough. Komer prescribed better access and transit rights, more rapid air and sealift, and prepositioning of equipment in the area. The Saudis would have to face up to the prospect of prepositioning U.S. supplies, assuming a larger share of the funding for the buildup of the forces and

military infrastructure in the region, and overbuilding their air bases for potential U.S. use in the event of an emergency that required U.S. forces to deploy to the desert kingdom. Komer also argued for a rear base in Egypt (such as Great Britain provided NATO). His plan was well received; many of his proposed actions were already underway, according to the NSC staff.<sup>53</sup>

The idea of a base in Egypt became one of the principal goals for DoD and the Carter administration. When Carter asked the cost, the secretary provided a rough estimate of \$250 million; the president approved in principle.<sup>54</sup> In late July 1980 Brown provided Secretary of State Edmund Muskie with a formal rationale for the Egyptian base: a staging area for large numbers of troops and prepositioned stocks that provided a safe complex to support combat operations in the Gulf; a regional training venue; and a base for B-52 interdiction operations. Ras Banas fit the bill. Beyond the radius of hostile tactical aircraft, it was only 800 nautical miles from Iran's Abadan oil refinery and within the C-130 cargo aircraft's Gulf flight radius range. Closer to the Gulf than Diego Garcia (800 instead of 2,700 nautical miles), its area was much larger and therefore better suited to B-52 operations.<sup>55</sup> When Carter gave the go-ahead, DoD and State began negotiations with the Egyptians, who initially favored the idea.<sup>56</sup> Needless to say, the project's costs rose. Brown estimated the cost in May 1980 at \$250 million; by September, the JCS Joint Staff pegged a two-phase concept for development of the base at just under \$350 million. Congress would have to appropriate military construction funds for the project; prospects were not good. As Brown told Mubarak, DoD would need a written agreement that he could present to Congress.<sup>57</sup>

As the Carter administration prepared to leave office, the framework for security in the Persian Gulf and Indian Ocean remained unfinished. In part, the work was not complete because the administration only seriously began work on the concept in late 1979 and 1980. It was an ambitious program requiring numerous negotiations with potential friends and allies. The presidential directive that was supposed to outline Carter's decision, PD 63, consisted merely of a list of actions assigned to various departments and agencies, a stark admission that the framework was still a work in progress.<sup>58</sup> Although the administration had signed agreements with Oman, Kenya, and Somalia to access military facilities, negotiations with Egypt were ongoing, and arrangements with Saudi Arabia on overbuilding its facilities and prepositioning U.S. equipment on its soil still lay over the horizon. Nevertheless, the administration had

made some decisions unilaterally, such as expanding MIDEASTFOR from three to five ships, maintaining two carrier-led battle groups in the Indian Ocean, deploying a Marine amphibious unit in the area for 70 percent of the time, undertaking frequent tactical air deployments to the Gulf, engaging in U.S.-based and joint military exercises (especially with Egypt), and sharing intelligence with Saudi Arabia. The Navy increased its sealift capacities by prepositioning seven ships—two chartered *Maine*-class roll on/roll off (RO/RO) ships, three break-bulk ships (on which goods were loaded individually, not in containers or in bulk, like grain), and two tankers—at Diego Garcia and agreeing to purchase eight high-speed container ships capable of rapid sealift from the United States.<sup>59</sup> However, perhaps the most visible accomplishment of the Carter administration in increasing its presence in the Gulf took the form of an administrative action: creation of the Rapid Deployment Joint Task Force (RDJTF), which in January 1983 became U.S. Central Command.

### **Rapid Deployment Joint Task Force**

In 1977 Brzezinski and the NSC staff first broached the idea of a military force capable of responding quickly to threats anywhere in the world. In the DoD study in response to Presidential Review Memorandum 10 (issued 18 February 1977 and calling for a review of the military force structure), defense planners added an additional strategy that contemplated fighting local wars, including one in the Middle East–Persian Gulf. Following the review, the president issued PD 18 in August 1977, into which Brzezinski and his staff inserted the related idea of a global force of light divisions with its own logistical support able to go anywhere to fight local wars without relying on overseas bases. A multidivision force stationed in the United States, supported by air and naval forces and able to operate on its own without dependence on NATO stocks or reinforcements, proved a pipe dream. With many more pressing obligations (conventional force upgrades in Europe, countering the Soviet threat to the Minuteman missile force, Pershing II missiles for Europe, and escalating naval costs) and other compelling fiscal constraints, DoD failed to focus on a “surge force” or a “unilateral corps” as it was initially dubbed. After the fall of the shah and the dissolution of his armed forces, the prospect of a potential Soviet invasion of Iran, the actual Soviet invasion of Afghanistan, and the general instability in the region provided a new urgency to prepare for fighting a limited war in the Middle East and Persian Gulf.<sup>60</sup>

Twice in July 1979 Brzezinski formally asked Brown for a report on DoD's efforts of the past two years for a "quick reaction force" as envisioned in PD 18.<sup>61</sup> Brown responded defensively, outlining the steps that DoD would undertake. Carter commented, "I don't see that any progress has actually been made." Brzezinski came back to Brown with a request for another report "on what specifically, if anything, has been done since August 1977 to enhance our: Airlift and sealift capabilities; Support assets for contingency areas; [and] Basic force structure permitting us to deploy without risking capabilities to back up NATO."<sup>62</sup>

As Assistant Secretary (ISA) David McGiffert confessed, DoD's achievements were "modest indeed." McGiffert saw the problem arising from the lack of a military commander—let alone a military command—to develop contingency plans, train troops, or sponsor, monitor, and oversee peacetime readiness for a potential Middle East–Persian Gulf conflict. Also, the U.S. European Command (EUCOM), responsible for the region since 1972, treated it as a stepchild. There was little training of troops for fighting Middle East conflicts, insufficient sealift or airlift to move troops and equipment quickly, and little political and military cooperation with regional friends.<sup>63</sup> Brown's response to Brzezinski amounted to a *mea culpa*: "In summary, we have made some progress in the last two years; but the programs we have instituted since August 1977 are just now beginning to take effect, and most of our work is before us. Major changes in defense posture take five or more years—all the more reason for us to get on with it."<sup>64</sup>

Reporting the bad news to Carter, Brzezinski reiterated that "very few of our earmarked contingency forces can be brought to bear quickly in the Mideast; our capability to move anything beyond our lightest forces will be severely constrained by our airlift deficiencies; and, logistics support for our contingency forces will be a bottleneck." Brown and Brzezinski agreed to define goals for establishing a viable contingency force, both realizing that it would cost more than the tight Defense budget levels for the next fiscal year and beyond would allow.<sup>65</sup>

One thing DoD could accomplish quickly was to create a more rational command structure for the Persian Gulf and Indian Ocean area. Under the then-current structure, the land areas of Africa and the Middle East (including the Arabian Peninsula and Iran) were the responsibility of EUCOM while the adjacent waters, the Arabian Sea and Indian Ocean, fell to U.S. Pacific Command, with the Persian Gulf ostensibly a dual responsibility, but in fact generally ignored

by both.<sup>66</sup> In June 1979 Brown asked the JCS for a review of Middle East–Persian Gulf Command relations, setting off interservice rivalries, which eventually came down to a turf fight between the Army (supported by the Air Force) and the Marines (supported by the Navy). The JCS chairman, Army chief of staff, and Air Force chief of staff favored assigning the Middle East and Sub-Saharan Africa to the U.S. Readiness Command in the United States (a traditional Army command), with EUCOM (another Army command) responsible for security assistance and operations (such as disaster relief or peacekeeping support) short of major contingencies. EUCOM would also retain all responsibility for North Africa (Morocco, Tunisia, Libya, and Egypt). The chief of naval operations and the commandant of the Marine Corps dissented. They proposed instead an independent U.S. continental (CONUS)-based joint task force under REDCOM (thus increasing the influence of the Navy and Marine Corps and diluting that of the Army) that would be responsible for planning, military exercises, and deployments to the region. Once in the field during hostilities, the joint task force would operate under a unified commander. For Middle East operations, it would report to and be under the commander in chief, Europe (CINCEUR).<sup>67</sup>

In October 1979 Brown chose the Navy–Marine Corps option, establishing a CONUS-based joint task force to plan, train, exercise, and prepare to deploy a rapid deployment force. The secretary directed that a commander be nominated by December 1979 and that the RDJTF be up and running by March 1980. Brown specifically informed the JCS that he was thinking of a “capacity for a very rapid deployment of small, highly effective force elements,” and suggested that the Marines have a large role in the planning for it.<sup>68</sup>

The JCS identified a tentative force composition for the RDJTF, built using units already earmarked for wartime use by other commands, especially EUCOM, as reinforcements. This quick-planning solution created a problem in that the forces slated for the RDJTF would be unavailable in the event of a NATO–Warsaw Pact war. To solve the problem, the Chiefs suggested considering programs and budget decisions for 1982–1986 based on the assumption of a dedicated task force, without the added task of defending NATO from a Warsaw Pact attack. The RDJTF would be able to fight whether or not there was a simultaneous NATO theater war. It would have increased strategic lift to deploy to non-NATO areas simultaneously with any rapid reinforcement in Europe. While Brown acknowledged that DoD had

started on these goals, their success was by no means assured, nor was their funding. As for command arrangements, the Chiefs recommended the establishment of a task force headquarters at MacDill Air Force Base in Tampa, Florida, comprising 253 personnel, with a small liaison staff of 15 to 20 personnel at the Pentagon. The JCS envisioned a force capable of deployment under a unified command; Brown wanted to keep open the possibility of command not through a unified commander (CINC). The secretary appointed Maj. Gen. Paul X. Kelley, USMC, as commander of the RDJTF, promoting him to lieutenant general.<sup>69</sup>



Marine Corps Lt. Gen. Paul X. Kelley, commander of the Rapid Deployment Joint Task Force, February 1980. (RG 330, NARA II)

In early January 1980 Odom briefed Brzezinski on the force's progress, explaining that units had been designated for task force training sized at 6,000 personnel for small contingencies to 100,000 for a large-scale operation. The president would have to issue a reserve call-up and a mobilization order for the larger force. Odom warned that while the RDJTF now existed, its ability to intervene effectively was still "soft." He maintained that "formation of [a] Persian Gulf Command is becoming critical"; there was no organization to maintain a U.S. military presence in the Gulf and to support local military forces.<sup>70</sup>

Later in the month Brown reported to the president on progress in establishing the force, noting that in peacetime its headquarters would be subordinate to REDCOM, but during contingencies it would transfer to the appropriate CINC or operate directly under National Command Authorities. The RDJTF would plan for joint exercises and potential combat operations in the Middle East. Carter was unconvinced: "Harold—This still does not seem to me adequate to insure clear command responsibility for crisis planning. Ultimately is it Europe, Pacific, JCS or RDJTF>REDCOM[?]"<sup>71</sup>

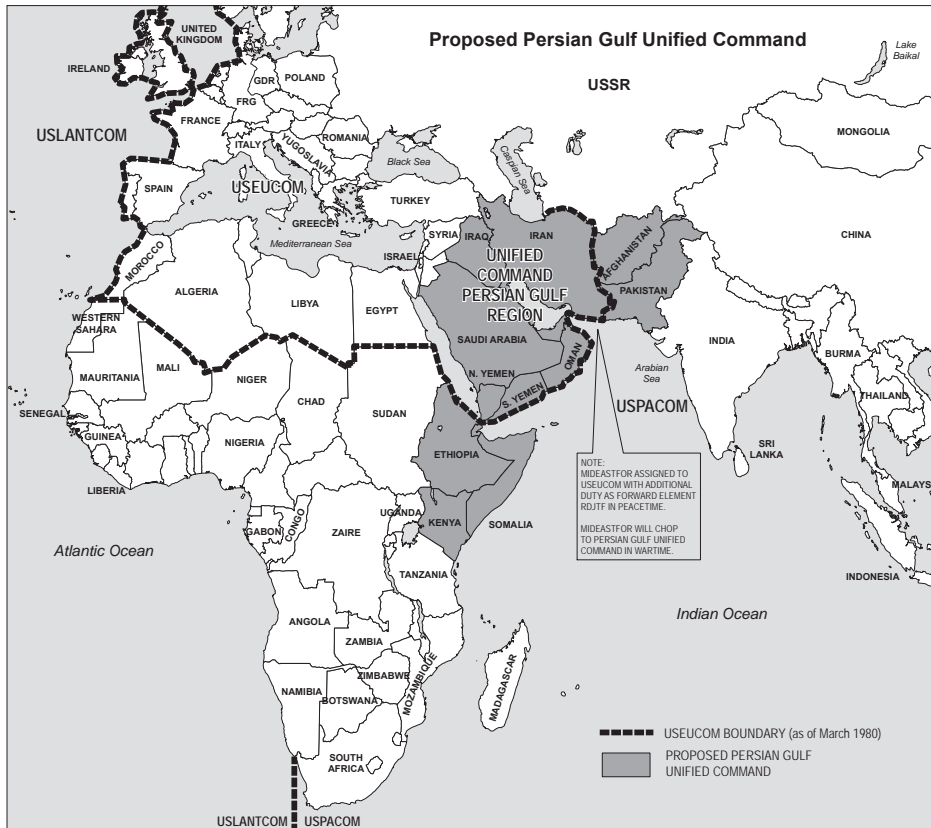

Brown and the JCS again reviewed the command arrangements, confirming that on a daily basis CINCEUR would continue to have responsibility for the Persian Gulf, Southwest Asia, the Horn of Africa, and Kenya (the eastern line of separation of the new proposed command was the Iranian border with Afghanistan and Pakistan). Afghanistan and Pakistan would remain under the responsibility of the commander in chief, Pacific (CINCPAC). However, the RDJTF would have the primary role in peace and war for operational planning in the Persian Gulf area (defined as Iran, Pakistan, all countries of the Arabian Peninsula, Ethiopia, Djibouti, Somalia, the Red Sea, Persian Gulf, and adjacent waters). In wartime in the Persian Gulf area, the RDJTF commander would be a virtual unified commander, in effect, creating a new unified command.<sup>72</sup>

Carter remained unsatisfied, sending Brown a handwritten note: “Harold—re Persian Gulf Command. The latest proposal is obviously an improvement, but I have



a couple of questions: a) How quickly could the RDJTF Command take over in time of crisis? How soon could we have such an exercise? b) Is it logical to exclude Israel & Egypt etc. from the Persian Gulf Region Unified Command? I think not.”<sup>73</sup> Brown responded that since Israel and Egypt were accessible to the Sixth Fleet, they were better left under EUCOM. Adding those two countries to task force responsibilities would, in the secretary’s view, ensure that an Arab-Israeli conflict would soon overwhelm anything the RDJTF was trying to accomplish in the Persian Gulf. The same held to a lesser extent for Sudan, Jordan, and Syria, which Brown thought should remain under EUCOM as well. In a month the RDJTF would deploy for a training exercise in North Carolina, although not the Persian Gulf. Brown estimated that in a major near-term contingency, the force could deploy advance elements within hours, just as rapidly as EUCOM or PACOM.<sup>74</sup>

In March 1980 the RDJTF under Lieutenant General Kelley officially opened its doors at MacDill Air Force Base. At White House urging, Brown and the JCS continued to tinker with the task force. On JCS advice, the secretary narrowed its mission to only the Persian Gulf and Southwest Asia (eliminating its worldwide responsibilities) and transferred to the joint task force all contingency planning for the area. The force would remain under REDCOM rather than report directly to the secretary of defense and the president, as the Marine Corps commandant had recommended and Brown had previously approved as a possibility. In the future, a separate command could be located somewhere in the region. As no locale existed, Brown thought a separate command without a Middle East headquarters would draw too much attention to the political problems of basing U.S. forces in the Middle East. Furthermore, most of the units earmarked for the RDJTF were located in CONUS. Carter remained dubious, commenting: “Harold—OK if you and the JCS insist. I still have the belief that in a real crisis we would have to initiate a different and simpler command structure.”<sup>75</sup>

The Rapid Deployment Joint Task Force took on new significance in late summer 1980 as U.S. intelligence began to pick up reports that Soviet military units in Afghanistan were massed on the Iranian border in anticipation of a possible Soviet invasion of Iran. In addition, skirmishes between Iran and Iraq escalated into a full-scale war. With these two developments it seemed likely that the RDJTF might have to meet a serious contingency in Southwest Asia. At an SCC meeting in fall 1980 to discuss the U.S. response to a possible Soviet invasion of Iran, Secretary

of State Muskie engaged Brown and Brzezinski in discussions that Brzezinski remembered as quite heated. The two sides differed on whether to put the Soviets on direct notice that the Carter Doctrine applied to Iran. State advocated a soft approach, while Brzezinski and Brown recommended a firm statement to Moscow that under the Carter Doctrine the United States would react to any such Soviet move. The president favored a direct statement to the Soviets; he sent the warning.<sup>76</sup>

As planning continued, Brown concluded that it ought to include the possibility of deploying not just  $3\frac{1}{3}$  divisions but  $6\frac{1}{3}$  divisions in response to a potential Soviet invasion of Iran or some other major Soviet aggression in the area.<sup>77</sup> But what could the RDJTF actually do at that time? Naval tactical air units in the Indian Ocean could be in the Gulf in a matter of hours. Tactical air units based in the United States would take up to 75 hours to close in on the Persian Gulf, assuming airlift, overflight clearances, and prior alerts for units to deploy, but the problem of shore basing and logistical support would remain. A light infantry battalion from CONUS could be in the region within 48 hours assuming clearances and prior notification; the combat elements of a light infantry division would take 14 days to close by air with minimal tactical air support. While the seven near-term repositioning ships (NTPS) in the Indian Ocean at Diego Garcia had sufficient equipment, POL (petroleum, oil, and lubricants), and water for a force of 12,000, these cargo ships required port facilities for off-loading and distribution to actual forces. The off-loading operation would be challenging. The NTPS could support over 500 aircraft and 3,240 sorties but could also experience logistical problems getting the POL and weapons to the aircraft.<sup>78</sup>

While the RDJTF was no superforce, it had a command structure responsible for planning. It also had the support of limited prepositioned weapons and equipment as well as an increased naval presence in the Indian Ocean, Persian Gulf, and adjacent waters. Military exercises began on a small scale—a single U.S. Army battalion in the mountains of Idaho simulating a defense of Pakistan against Soviet forces—but by November 1980 it had progressed to 6,500 U.S. troops spending 20 days in the Egyptian desert (Operation Bright Star). The RDJTF could bring a limited force to the region on short notice, but it was hardly ready for a major contingency. Former NSC Middle East staffer Gary Sick considered the force “more symbol than reality.” Carter’s former Secretary of Energy Schlesinger went further, claiming it was neither “rapid” nor “deployable” nor a “force.” Still, both Sick and

Schlesinger admitted that creating the RDJTF at least allowed the deficiencies in responding to emergencies in the area to be addressed.<sup>79</sup> Taken with the new access to bases on the western littoral of the Indian Ocean, improvements in sealift from Diego Garcia, and a closer military relationship with Saudi Arabia, the RDJTF represented part of an overall plan to strengthen security in the Persian Gulf and Southwest Asia. Brzezinski's claim that it "was a strategic revolution in America's global position" oversold the achievement, but his contention that by 1980 the U.S. security vision now comprised not just Europe and Asia but also the Middle East certainly rang true.<sup>80</sup>

The Carter administration and DoD recognized the growing significance of threats to the Persian Gulf and Southwest Asia. Previous administrations had focused on Europe and East Asia, but with the oil embargo of 1973, the rise of Islamic fundamentalism in Iran, and the Soviet invasion of Afghanistan, the Persian Gulf and Southwest Asia loomed larger on the Pentagon's radar screen. Most of Carter's military advisers still saw the most likely threat to the region as Soviet intervention in the Persian Gulf or Southwest Asia, but they also envisioned countering local conflicts or upheavals that threatened U.S. interests. They began the process of establishing a security framework with friendly nations in the area. The Rapid Deployment Joint Task Force, prepositioned equipment, upgrades to Diego Garcia, and rapid-response shipping allowed the United States to respond more effectively when an actual crisis erupted in the Gulf—the Iraqi invasion of Kuwait in 1990. Few in 1980 envisioned the Iraqi invasion and the resulting Gulf War of 1991. After 1980 the Persian Gulf, and later Southwest Asia, became a major preoccupation of the United States. The Carter administration laid the foundation for the initial U.S. military response to these new challenges in the region. It was a legacy not always acknowledged—the Reagan administration often received all the credit—but it was a major achievement.



## The FY 1980 Budget and the Conversion of Harold Brown

DURING THE FORMULATION and passage of the Defense Department budgets for fiscal years 1978 and 1979, Harold Brown had generally followed the administration line. A conscientious team player, he argued for adequate Defense budgets and force structures, but he did not rock the boat either in deliberations with President Carter or with the Office of Management and Budget. When challenged by critics in Congress, the secretary loyally supported Carter's efforts to restrain defense spending. The Joint Chiefs of Staff and the military services often found themselves at odds with the secretary and his immediate staff over how much defense was needed in the face of a militarily resurgent Soviet Union. Many in the Pentagon outside the secretary's inner circle considered Brown too willing to compromise with a president whose priorities lay with strengthening domestic social programs, fighting inflation, and lowering the federal deficit. Carter remained determined to limit defense spending, believing that a reduced budget and force structure could adequately safeguard the nation. Brown accepted his appointment as secretary respecting Carter's viewpoint.

As Brown prepared the FY 1980 DoD budget, he increasingly concluded that the Soviet Union was outstripping the United States in defense spending and gaining some major advantages in weapon systems. These shifts came more rapidly than the secretary had anticipated. In earlier budget submissions to OMB and the president, Brown accepted that the United States and the Soviet Union were roughly equal in strategic nuclear forces, but there was a danger that the Soviets might convince themselves that a nuclear victory was a possibility in a crisis. During the FY 1980 budget preparations, his worst fears were confirmed. While Brown was not ready to concede Soviet military superiority, he believed that if current trends continued it

would be a matter of time before the Soviet Union surpassed U.S. strength. The secretary used the FY 1980 budget process to bombard the president with memoranda, charts, and figures to present a coherent case for more spending. At first he met with only marginal success. A stubborn Carter dug in, but after an eventually sustained effort by Brown, the president allowed the Pentagon more money than what OMB recommended, but less than what Brown had asked for.<sup>1</sup>

### **The Long View: FYs 1980–1984**

As usual, at the beginning of a budget cycle, the JCS prepared and submitted their Joint Strategic Objectives Plan as part of the planning for the FY 1980 budget. This time the Chiefs insisted they were serious about the inadequacy of planned force levels, but skeptical OSD civilians still believed the JSOP was nothing more than the usual wish list and a “sky-is-falling” assessment.<sup>2</sup> The planning document that received the most scrutiny both in DoD and from the Carter administration, however, was Brown’s new initiative, the Consolidated Guidance (CG), which combined three documents—the Defense Guidance, the Planning and Programming Guidance, and the Fiscal Guidance—into one, providing a single rationale for programing and budgeting for both the FY 1980 budget and the accompanying Five-Year Defense Program. The Consolidated Guidance would permit the president to view comprehensively the defense program at the beginning of the budget process, thus allowing him to provide direction early enough in the cycle for OSD to accommodate it. According to Brown, the old system had forced the secretary and the president “into [becoming] judges rather than leaders.” Brown suggested that the guidance for 1980–1984 would “improve our ability to shape and balance the Defense program as a whole while still encouraging the initiative and ingenuity of the military departments in proposing and managing that program; integrate better the guidance to the military departments on policy, military strategy, planning, programming, and fiscal limitations; and facilitate analysis of program alterations.” What Brown did not say was that he hoped the CG would prevent Carter and OMB from swooping in with last-minute reductions and changes just before the budget went to Congress, thereby causing major and hurried budget scrubs.<sup>3</sup>

Brown entrusted Assistant Secretary of Defense for Program Analysis and Evaluation Russell Murray with the task of drafting the massive CG. Given Murray’s reputation as an anti-spending iconoclast, skeptical of the military services’ budget

requests, it was not surprising that the JCS and military departments were wary of his initial drafts.<sup>4</sup> In what Brown considered a “very good and generally fair summary,” Murray laid out their main concerns. Military critics considered the total fiscal guidance figure inadequate to guarantee the requirement of Presidential Directive 18 for a basic national security strategy (see chapter 5) that would maintain an overall military balance with the Soviet Union “at least as favorable as now exists.” They also thought the draft CG concentrated too much on defending NATO’s central region and not enough on the alliance’s flanks and other areas of the world; pushed too aggressively on expanding prepositioning of equipment in Europe; appeared too vague on which forces would be earmarked for non-NATO contingencies; and presented misleading calculations for nuclear war—for example, assuming a high penetration probability of U.S. air-launched cruise missiles without targeting Soviet air defenses. The Army’s most basic criticism held that the CG required actions costing roughly \$3 billion to \$5 billion for FY 1980 beyond funding that the CG allocated for that year. The Army and JCS also believed that additional combat troops for potential early deployment to Europe or the Persian Gulf had to be accompanied by support troops not provided for in the CG. The Navy complained about the lack of growth potential in the guidance since the current programs—ballistic missile submarine construction and maintenance of current ships, aircraft, weapons, and forces—would leave no room for any increase in its capabilities. It feared that the CG’s discussion of a 10-carrier Navy implied a change from “selective sea control worldwide to the defense of a sea lane from Norfolk to the English Channel . . . the naval equivalent of the Maginot line.” The Air Force worried that the CG’s fiscal guidance ensured only the status quo, especially when 10 percent (and sure to grow in the Air Force’s view) of its budget consisted of intelligence funding that the director of central intelligence controlled.<sup>5</sup> JCS Chairman General George Brown phrased it bluntly to the secretary: “I would be less than candid were I not to report to you . . . [that] I view the paper as do the Services and the CINCs as the expression of one view of the world by well-intended but militarily inexperienced analysts.”<sup>6</sup>

Brown took these criticisms in good stride, instructing Murray and the senior military leaders to work out their differences. Murray was not so tolerant. After two meetings with the military leaders, he reported to Brown: “What a wasted opportunity. . . . We gave them a golden opportunity [to formulate policy, strategy, and objectives], and they chose to use it to argue for programmatic changes, for relief even

from your limited amount of mandatory guidance, and to urge some gobbledygook section justifying all conceivable requests and the resulting edged-in-black estimates of the military 'risk.'" Murray asked: "Where are the distinguished military scholars in uniform? Are we reduced to professional military advice via the JSOP?"<sup>7</sup>

Tempers cooled, feelings subsided, and drafting continued. In early March 1978 Brown sent the final CG to the president. Even detail-oriented Carter could not be expected to plow through the 300-page document, so Brown sent him a 10-page summary, reserving the guidance itself for the defense policy specialists at OMB and the National Security Council staff. Brown noted that his subordinates held only one unanimous view: given the pro-defense views then predominant on Capitol Hill, Congress would probably be willing to pass a Defense budget with a real growth rate of 5 percent (not the initially programmed 3 percent). The secretary suggested that many in DoD perceived 5 percent annual real growth funding as the solution to "their most severe problems" and the key to a low-risk defense capability. Brown added, "They may even be right on both scores. You (and I) may take a different view from that one. But that imposes on us . . . an obligation carefully to consider the alternatives proposed by the Military Departments and the Joint Chiefs of Staff."<sup>8</sup>

Although content for the time being to let the rest of DoD make the case for more defense spending, Brown vigorously presented much of their case to the president. The CG summary laid out some of the difficult choices demanded by Carter's tight fiscal guidance. Recalling that cuts to the Ford budget had been taken "in a rather pro forma manner in February of 1977," the secretary observed that they had resulted in real pain to the military services, especially the Navy, whose unit cost of naval hardware was rising faster than its share of the budget. The choices appeared to be either stick with current funding, resulting in a much smaller and less capable Navy by 1988, or cut other services by \$3 billion and apply the money saved to naval shipbuilding, but at the cost of weakening efforts to shore up NATO's central front. In Brown's view, the Navy had to make do.<sup>9</sup>

Turning to strategic forces, Brown questioned whether the Soviet leaders actually perceived the U.S. ability to absorb a nuclear attack and retaliate with "catastrophic and intolerable" damage as a viable deterrence to a nuclear first strike. What little evidence existed suggested they did not. Thus the requirement of the CG—as well as national security PD 18—for maintaining "essential equivalence" needed an extra punch to maintain the balance, convince the Soviets of the folly of a nuclear first



strike, and disabuse them of the idea that they could win a nuclear conflict. Brown recommended acquisition of cruise missile carriers with advanced cruise missiles, more submarine-launched ballistic missiles, and a less vulnerable intercontinental ballistic force for the 1980s. By FY 1987 DoD expected to deploy 100 carriers with 6,000 cruise missiles, a relatively cheap way to counter future increases in Soviet strategic forces. Poseidon- and Trident-equipped submarines faced a far different future. Production of the super costly *Ohio*-class submarines was experiencing delays and cost overruns, so the Navy would launch one per year, requiring the service to keep the older Poseidon-fitted submarines beyond their 25-year retirement dates. The increasing number and accuracy of Soviet intercontinental missiles exposed the vulnerability of the Minuteman missile force and presented a major problem for the Air Force's ICBM program. By FY 1984 Brown expected a 70 percent to 85 percent attrition rate of the ICBM force if the United States decided to ride out a first attack. It would take at least 10 years for a mobile land-based system (the MX) to restore ICBM retaliatory capability. Placing MX missiles in Minutemen silos could short-circuit the process, but that would require a launch-under-attack policy to assure ICBM retaliatory capability. Brown also noted the inequality between Soviet and U.S. civil defense programs. Recent studies suggested that with a week's warning of an attack, a relatively modest program relying on evacuation of targeted areas and some fallout protection would increase the survival rate of the U.S. population from 20 percent to 50 percent, but at a cost of more than the then-recommended \$100 million per year. It would start with an additional \$50 million for FY 1980 and rise to an additional \$200 million by FY 1984.<sup>10</sup>

The Soviet ability to attack Central Europe within a matter of days presented perhaps the greatest threat to NATO. U.S. planning based on a 30-day Warsaw Pact mobilization was inherently flawed. Prepositioning equipment for all active U.S. combat divisions planned for Europe—except for the two light divisions (the 82nd Airborne Division and the 101st Air Assault) and the 2nd Division after its planned withdrawal from Korea—and commandeering the U.S. commercial airlines fleet to move troops quickly to Europe provided the only solutions to confront a Warsaw Pact attack. Brown told Carter that he planned to divert funds from the Air Force and Navy to pay for Army prepositioning. Similarly, he reallocated to the Army funding to add heavy (armored and mechanized) battalions during FYs 1980–1982 for use in Europe, the Middle East, or the Persian Gulf area.<sup>11</sup>

Early U.S. combat capability in NATO planning would allow the alliance to survive the first few weeks of a conventional attack, but only if the NATO European allies also upgraded their initial capabilities. The West Europeans had a poor track record on upgrading their conventional forces. Sustainability of the fight, based on convoys to Europe, would be irrelevant if the battle was lost before they arrived. While NATO needed to be concerned with its northern and southern flanks, Brown believed the central front presented the greatest threat and potentially the most telling defeat.<sup>12</sup>

The Consolidated Guidance raised choices for other geographical areas. Should the United States defend the Far East, the Middle East and the Persian Gulf or just concentrate on Europe? Brown's answer was to do it all. With the U.S. withdrawal from Southeast Asia and plans to withdraw 2nd Division troops from South Korea, the CG recommended no additional pullouts of U.S. forces from the Western Pacific beyond those planned for the Korean Peninsula. As for the Middle East, should another Arab-Israeli war lead to a U.S.-Soviet naval confrontation in the Mediterranean, the United States would require doubling the normal two-carrier force there. If U.S. and Soviet forces joined the Arab-Israeli conflict, the CG directed the United States to maintain the capability to counter Soviet intervention. As to the Persian Gulf, crucial to NATO (it provided Western Europe with oil), the guidance could not draw any conclusions with confidence without further study. Fighting a half war in the Far East (Korea), Middle East, or Persian Gulf simultaneously with a full NATO war in Europe required earmarking a Marine division/wing team, two Army divisions (one light and one mechanized) with appropriate support, three Air Force tactical wings, and three Navy carriers with accompanying support to these potential non-European battle areas. These forces also could be deployed to Europe.<sup>13</sup>

### Meetings with Carter

Brown had hoped to engage the president in answering the questions raised by the CG, thus allowing time to pass on presidential guidance to the services before they submitted their program objective memoranda for FYs 1980–1984. POMs were the compilation of weapon systems, force structures, and funding that the services believed they needed to meet the requirements of the CG. The secretary and his staff assessed the POMs and then amended them to meet the overall fiscal guidance for defense spending for that year. Carter insisted on discussing the CG in early May 1978, when he focused on the entire federal budget just two weeks

before the services' POMs were due. By delaying presidential review until this time, he eliminated any chance that Brown could give the services presidential direction before they finalized their POMs.<sup>14</sup>

Working to his schedule, Carter arranged a lunch meeting with Brown and the JCS to be followed by an NSC meeting on the Consolidated Guidance, both on 10 May 1978. The secretary warned the president: "The Chiefs, I think, may be more outspoken than at previous meetings." They were still smarting, according to Brown, from experiences of earlier meetings at which the president had disregarded their advice and decided on a budget that they considered unfavorable to national defense. Pessimistic about recent Soviet political-military actions in the Horn of Africa and Afghanistan, the Chiefs would press for a 5 percent increase in the budget.<sup>15</sup>

On the advice of National Security Adviser Zbigniew Brzezinski, Carter steered clear of specifics and concentrated on underlying policy assumptions at the meeting with the Joint Chiefs. They thought that the Five-Year Defense Program for FYs 1980–1984 failed to meet the criteria of PD 18 to remain at least militarily even with the Soviets.<sup>16</sup> Noncommittal as always, Carter warned them not to expect significant spending increases, but he promised no major cuts. Any new program, such as the MX missile, would require funding by budget tradeoffs, not increases. The Chiefs no doubt left the meeting disappointed.<sup>17</sup>

At the NSC meeting, with Chairman-designate General David Jones joining the regular council members, the discussion on the CG concentrated on shipbuilding costs, NATO center versus flanks, prepositioning, and non-NATO contingencies, especially the Persian Gulf. With strong support from Secretary of State Cyrus Vance, Brown convinced the president that OMB plans for a 10-carrier force were a mistake. Carter conceded that it was "reasonable" to stay with 12 carriers "for the time being." The participants agreed to reexamine the Navy's mission and emphasize the rebuilding of NATO's capabilities as a continuing priority.<sup>18</sup>

While the NSC meeting had touched on some broad themes of the guidance, it did not deal with it in any detail. Such brief and superficial discussion convinced Brown that the president needed better guidance for the upcoming budget process. The next day he sent Carter a series of questions with answers crafted by Murray and his senior staff, inviting the president's reactions. The most basic question asked: Would the fiscal guidance in the CG fulfill the requirements of PD 18 to maintain the military balance? The answer that Brown passed to the president stated "probably

not quite.” In the strategic nuclear balance there would be “a net degradation.” With NATO modernization, the alliance would maintain its overall edge, but only with a real effort by NATO allies who had never been enthusiastic about preparing for conventional war. Brown suggested that “NATO will probably degrade somewhat.” While the United States held a vast lead in power projection, the Soviet Union had made rapid improvements to narrow the gap. In defense expenditures, the Soviets were averaging between 3 percent and 4 percent real growth in U.S. dollar terms, while the basic annual growth level of the U.S. FYDP averaged only 2.8 percent. Brown meant these figures to be red flags, but he couched his warnings in such qualified language that he diminished their impact.<sup>19</sup>

Brown also suggested that perception of equality might well be more important than actual balance of military power. The secretary contended that the current FYDP as recommended by DoD provided a good start toward altering the perceived view that the military balance was swinging to the Soviet side. Carter wrote in the margin, “I agree,” but the president was not prepared to accept an increased five-year plan as a perception changer. Instead, Carter looked for short cuts and fixes: “Harold. A key point is that, within almost inevitable budget limits, we must do at least as good a job as the Soviets in assessing the priority and allocation of expenditures. . . . Honoring ‘service’ demands or political factors robs us of defense capability.” The president recommended a “good & accurate PR [public relations] effort,” including “a good NATO conference. . . . [and] frequent SecDef reports on technological advances, positive analyses of defense budget items, emphasis on CM’s,” and presidential visits to troops. Again the president seemed to not comprehend Brown’s message.<sup>20</sup>

The question on the size and role of the Navy also struck a responsive chord with the president. He agreed with the proposition that “a larger share of the Defense budget” for “a bigger Navy would not be wise” and that “the trend toward even more expensive hardware [i.e., nuclear-powered carriers, combat ships, and *Ohio*-class submarines; large destroyers; and complex carrier aircraft] should at least be restrained, if not reversed.” Here Brown and Carter were in agreement.<sup>21</sup>

The secretary had not convinced Carter to increase defense spending. Brown was still too restrained and deferential in pushing his program. Carter responded most positively to suggestions for limitations on funding, especially on the Navy. When Brown suggested adding funds or new weapon systems, Carter lectured him on his failure to set priorities or restrain the services. Carter saw the solution

as better public relations rather than more defense spending. Brown's qualified and nuanced efforts to suggest that a strong undercurrent of opinion in DoD and Congress favored more defense spending failed to register with the president. The secretary would have to be more blunt with Carter, but first he and Deputy Secretary Charles Duncan had to deal with the service programs requests for the FY 1980 budget, one of their most time-consuming annual obligations.

### **Program Objective Memoranda from the Services**

On 23 May 1978, two weeks after Brown met with the president, the services submitted their POMs, providing exhaustive recommendations for funding FY 1980–1984 programs at three levels—basic (just under 3 percent real growth over FY 1979 plus 6 percent for inflation); enhanced (4 percent real growth plus inflation over the basic in FY 1980 growing to 6 percent in FY 1984); and decremented (4 percent decrease from the basic in FY 1980 dropping to 6 percent decrease by FY 1984).<sup>22</sup> Army Secretary Clifford Alexander's overview of his service's POM retained as a first priority defense of NATO against conventional attack but expressed concern about maintaining combat capabilities 30 days after the onset of hostilities. He noted that combat support and combat service support would be marginal and that programmed force levels were appreciably below those approved in JCS planning levels for Central Europe. As a second priority, Alexander called for a stronger training capability, especially the establishment of a National Training Center at Fort Irwin in the Mojave Desert in California. A third emphasis centered on support for soldiers, especially those living with their families in Europe, since an all-volunteer Army required better housing, recreation, child care, travel entitlements, and financial counseling. The Army also emphasized improved manpower management by better use of the reserve component and more funding for recruitment. As for weapon systems, the Army recommended continuing development of the Pershing II (740km range) missile toward an FY 1984 initial operational capability (IOC), but no funding for the extended Pershing II (1,500km range) or the proposed new single-stage Pershing II (740km range), a new design that would in the view of the NSC staff decrease operational costs. The Army pegged XM1 tank production at 90 per year at the basic level, 120 at the enhanced.<sup>23</sup>

Air Force Secretary John Stetson stated in his overview that the fiscal guidance's basic level forced choices that would not allow "essential equivalence" with

the Soviet Union into the mid to late 1980s. Addressing the obvious danger, ICBM survivability, required enhanced strategic deterrence with additional hard-kill capability. To meet this challenge, the Air Force POM called for four essential steps: cruise missiles on B-52G aircraft; development of a second generation air-launched cruise missile; a survivable ICBM in a multiple aim point basing system; and an austere prototype program for a follow-on penetration bomber. The Air Force believed that even at the enhanced level it could not procure enough cruise missile carriers to keep even with the Soviet strategic threat. While the MX missile was the number one strategic priority, Stetson stated that given the uncertainty around its deployment, the focus should be on MAP basing and the actual MX deployment should be delayed. The Air Force slipped the ground-launched cruise missile's initial operational capability from FY 1982 to FY 1985 and did not include research and development funding for a 2,000km-range (medium range) ballistic missile or a theater-based ALCM carrier. As for tactical needs, the Air Force required more F-15s and six AWACS aircraft to defend North America from the Soviet Backfire bombers, more tactical aircraft to defend Central Europe and the Persian Gulf at the same time, and more airlift capability. Funding at the enhanced level provided the only solution for strategic and tactical needs.<sup>24</sup>

Navy Secretary Graham Claytor expressed concern in his POM overview that the Navy would not be able to enlist enough sailors in FY 1980, so it reduced proposed manpower from 478,000 to 465,000. Like the Army, the Navy POM stressed quality of life programs (bachelor housing, a shorter work week, and better travel benefits for junior enlisted personnel). Claytor addressed the Naval Reserve issue—each year the Carter administration attempted to reduce its numbers only to have Congress restore the cuts—and suggested working out a figure acceptable to Congress. In weapon systems, the Navy wanted to start procuring a land-attack cruise missile capability (564 CMs on 90 submarines and 52 cruisers). Carter's austere shipbuilding program was Claytor's "biggest concern" by far. Only a program at the enhanced level would move a more capable Navy toward its future goal of Sea Plan 2000 (see chapter 8). Otherwise, Claytor maintained that the Navy "we pass to our successors will be smaller and less capable. This is a legacy I do not want to leave, and, at some point we dare not leave it."<sup>25</sup>

On 25 July 1978 Deputy Secretary Duncan sent out the tentative program decision memoranda to the services, which in turn submitted their reclaims in

early August. In the third week of August, Brown sent the services his amended program decisions, the final ones in the planning and budget process within the Pentagon. The secretary instructed the Army to include at all three budget levels the Pershing II missile with a 1,500km range. To “heavy up” divisions for Europe, OSD moved monthly production of 90 XM1 tanks forward by over a year to June 1983. On appeal, Brown added more recruiters and reenlistment personnel and more funding for training; he also restored funds for Blackhawk helicopters.<sup>26</sup> As for the Air Force, Brown required a 1982 IOC for the ground-launched cruise missile. Unable to win approval for all of the F-15 aircraft it wanted, the Air Force received full support for the development of ALCMs, delayed approval for the MX (to FY 1986), and the go-ahead for a multiple aim point system.<sup>27</sup>

As with previous budgets, the Navy found itself the least-satisfied service. In their amended POM decisions, Brown and Duncan slowed the construction rate of ballistic missile submarines to one per year and moved up the IOC date for the Trident II missile at the basic level from FY 1990 to FY 1988. Lack of funding for nuclear cruisers disappointed the Navy’s nuclear proponents; cancellation of some and delay of other LSD-41 transport ships at the decremented/basic/enhanced levels forced the Marines to rely more on prepositioning and less-costly transport. At all three fiscal levels, OSD limited construction of surface ships to less than the Navy had recommended. Brown denied funding for the Marines AV-8B aircraft (a new generation vertical takeoff Harrier), ordering continued testing and evaluation of the AV-8B versus the F/A-18 aircraft.<sup>28</sup> David Aaron, deputy assistant for national security affairs, alerted the president to the problem of “goldwatching” in the service POMs, especially the Air Force POM. As Aaron explained, “goldwatching” was “a long-standing Service device of protecting or beefing up their budgets by structuring them in such a way that programs of special importance for the civilian authorities require net additions to the budget.” The trick was to place these civilian high priorities either at only the enhanced level or not in the budget at all. Aaron cited as examples the MX missile, Trident II missile, air-launched cruise missiles and their carriers, the strategic mobility programs, and ground-launched cruise missiles. As a result, Brown and OSD had to insert them into the basic level, thus adding about \$3 billion more to fund these goldwatching programs that would have to be offset by cuts in other programs. Aaron predicted “tough infighting that is likely to spill out into public view.”<sup>29</sup>

### Carter's Budget Decisions

Even before the services submitted their POMs, Brown entertained serious second thoughts about Carter's tight fiscal guidance for FY 1980. In early May 1978 he told Carter that public and congressional attitudes were becoming more pro-defense and suggested that the administration could face a Republican political campaign that branded the administration as weak on national security.<sup>30</sup> Three months later JCS Chairman General Jones sent Brown his view of the implications of the FYs 1980–1984 budgets. While Jones conceded that “in absolute terms” the United States was not militarily inferior to the Soviet Union, “the balance has shifted” and the margin of U.S. superiority “is narrower today than it has ever been. . . . There is no escaping the fact that the Soviets have for years continued to out-man, out-gun, out-develop, out-build, and out-deploy us in most meaningful military categories.” According to Jones, the United States enjoyed “essential equivalence” in strategic nuclear forces and enjoyed a lead in power projection, but the Soviets had the momentum and were poised to break out in both categories. The United States had already lost its tactical nuclear advantage over the Soviets, and the numbers of Soviet general purpose forces trumped U.S. qualitative advantages. The United States enjoyed a more diverse, efficient, and technologically sophisticated production base than the Soviet Union did, but the Soviets had a greater capacity to produce military hardware. Jones did not blame this state of affairs solely on the Carter administration, suggesting that for the last decade the “slips and reductions in U.S. defense programs [were] unmatched by Soviet restraint.” He offered as a solution sustained and substantial growth in U.S. defense programs.<sup>31</sup>

A few days later Brown sent Carter an eyes-only memorandum—with graphs and charts on U.S. and Soviet defense investment outlays, defense totals, and budget trends—essentially presenting the case that Jones had made to him. Brown also passed Jones' memorandum to the president at Camp David during negotiations for the Egyptian and Israeli peace accords. In mid-September 1978 the secretary sent another eyes-only memorandum—also containing graphs and charts—stating that he would be remiss in his obligation to defend the United States if he did not alert the president to the dangers of the Soviet military buildup, which within six to eight years would tip fully in favor of the Soviets. Admitting that the Soviets had regional problems, especially the threat posed by China's rising military power, he believed that those problems did not offset the Soviet's growing advantage. “You should



know me well enough to know that I am not by nature an alarmist,” Brown concluded, but “I believe I owe it to you to make you aware of my very deep concern.”<sup>32</sup>

The Joint Chiefs added their collective voice by submitting a memorandum of their own. Brown considered their advice “very good”: “It tracks well with our views, perhaps [it] somewhat underestimates Soviet military difficulties/vulnerabilities.” Brown instructed his staff to incorporate the memo into material for his next meeting with Carter.<sup>33</sup> When the secretary met with Carter on 29 September, his advice fell on deaf presidential ears. Carter consistently favored OMB efforts to hold down military spending. Brown failed to convince the president that he and DoD—along with Brzezinski—were not overestimating Soviet military power.<sup>34</sup> In late November 1978 Brown told Carter that while he understood the importance of domestic programs and holding the overall deficit to \$30 billion, the military budget had to have at least 3 percent real growth. While it would not reverse the unfavorable trends vis-à-vis the Soviets, anything less would destroy NATO’s commitment to the 3 percent pledge as well as alliance programs for standardization, rationalization, and interoperability. Domestically, failure to increase the Defense budget would adversely affect, perhaps even doom, SALT II ratification in the Senate. Vance and Brzezinski added their support.<sup>35</sup>

In early December 1978, in anticipation of a weekend meeting on the entire budget, a persistent Brown sent Carter an exhaustive program and budget analysis that pulled together most of the arguments that OSD and JCS had been making for months. It also included a submission prepared by Jones of what defense was possible under the basic, enhanced, and decremented levels.<sup>36</sup> On 6 December, Brown received a handwritten note from Carter that must have given him pause: “The DOD FY 80 budget approach has not been satisfactory in helping me make my final decisions, although you have done a good job of presenting your case.” The president wanted a budget submission along zero-based budgeting lines: “Arrange individual budget items (or increments of those items) in an order of priority. O&M [operations and maintenance], MilCon [military construction], R&D, & procurement levels should be ranked along with major programs such as MX, CM, XM1, heavying up divisions, etc. This is the way I think and work.” Carter promised decisions made in harmony with “no turf protection” and vowed “not to be penurious.”<sup>37</sup>

Brown sent Carter a priority list showing what the budget bands (DoD’s version of ZBB) from one (\$134.5 billion) through seven (\$141.4 billion) would buy. On 18 December, Brown briefed the president by telephone on DoD budget and program

recommendations. The next day Carter, Brown, and OMB Director James McIntyre and their aides met for more than two hours. Issues between OMB and DoD had narrowed. OSD recommended \$137.7 billion in total obligational authority and \$123.2 billion in outlays for FY 1980, providing 3 percent real growth in TOA and outlays based on its calculations. The OMB figures were \$133.1 billion in TOA and \$122.3 billion in outlays (by OMB reckoning a decrease of 0.7 percent real growth in TOA over the previous year's budget and an increase of 2.1 percent in outlays over FY 1979).<sup>38</sup>

As for specifics, OSD proposed \$750 million (with \$463 million more in bands 6 and 7) for ballistic missiles (MX and Trident II), while OMB allotted \$500 million. OMB's civil defense price tag was \$100 million, OSD's \$139 million. For general purpose forces OSD wanted to add nine heavy Army battalions by 1980. OMB opposed further "heavying up." OSD wanted to continue funding EF-111 tactical jamming aircraft; OMB opposed it. For the Navy, Brown and his team had proposed real growth of 4 percent over FY 1979, including a large conventional aircraft carrier; OMB recommended 2 percent with a medium conventional carrier. Funding for research, development, and test and evaluation was only \$200 million apart (\$13.5 billion versus \$13.3 billion), but \$900 million separated OSD's and OMB's figures for operations and maintenance. Brown's team proposed a large increase in military construction (20 percent) while OMB recommended a 25 percent decrease.<sup>39</sup>

Eager to leave for Christmas in Plains, Georgia, an indisposed Carter studied the Defense budget. Vance, Brzezinski, and White House Chief of Staff Hamilton Jordan and White House Communications Director Gerald M. Rafshoon supported OSD. The president's other top advisers fell into the camp headed by Vice President Walter Mondale, domestic affairs adviser Stuart Eizenstat, and McIntyre who opposed 3 percent real growth. By dropping real growth to 2 percent, \$2 billion could be freed up for domestic social spending.<sup>40</sup> The president essentially split the difference, approving a budget submission at essentially the band two level—\$135.5 billion in TOA and \$122.7 billion in outlays for FY 1980, providing DoD \$2.4 billion more in TOA and \$500 million more in outlays than OMB had recommended at the 19 December meeting. This figure included military construction, civil defense, family housing, and military assistance, for which Congress would pass separate bills. The resulting real growth came to 3.1 percent in outlays and 1.7 percent in TOA over the FY 1979 budget. In his budget message, Carter stated: "In total, the 1980 budget provides for growth in outlays in real terms of

3% above the current year's spending," but he failed to mention TOA at about half that figure, leaving it to Brown to discuss at his news briefing in January 1979.<sup>41</sup>

At the briefing the secretary noted that the overall federal budget reduced the deficit to \$30 billion, a 50 percent decrease from the \$60 billion 1976 deficit. The Defense budget represented 23.1 percent of all federal spending and only 4.9 percent of U.S. GNP, the lowest slice since FY 1950. Brown admitted that the budget provided resources for only "a very austere, but sufficient[ly] balanced, defense program," yet allocated a priority "to high peacetime readiness and to technological superiority as counters to Soviet numerical and deployment advantages in Europe." In strategic programs, Brown highlighted \$670 million allocated for full-scale development of the MX; additional funds for its alternative basing modes; and \$41 million for the long-range, hard target-busting Trident II missile. For the Air Force, Brown noted improvements in Minuteman missiles and full-scale production of ALCMs. As for Navy shipbuilding, Brown cited the new ballistic missile submarine and the new conventional midsize aircraft carrier.<sup>42</sup>

### **Congress Takes Up the Budget**

Brown's assertion that Congress would view the FY 1980 Defense budget more favorably than previous budgets proved to be true, but that did not prevent legislators from finding "waste" to cut (a virtual political necessity on Capitol Hill) or programs and weapon systems to replace, augment, or reduce based on the members' views of defense priorities and their desire to protect their constituents' jobs. During the first three months of 1979 Brown, Duncan, and Jones made the rounds on Capitol Hill, testifying before the Senate and House Armed Services, Budget, and Appropriations Committees. Emerging issues covered the spectrum of current defense matters: the strategic balance, the 3 percent real growth in defense spending pledge, SALT II, U.S. troop withdrawals from Korea, the All-Volunteer Force, the need for Selective Service registration, possible savings from reinstating the draft, costs of military retirement, Navy carriers, shipbuilding, and the AV-8B. Before the House Armed Services Committee, Brown caused some excitement when he suggested that if there was future draft registration "women should probably be included."<sup>43</sup>

In May 1979 Brown reported problems on Capitol Hill for the president's attention. Although neither the House nor the Senate Armed Services Committees had completed markups of the authorization bill, the House was sure to substitute

a nuclear carrier for the midsize carrier requested by the administration and add funds for the Marines AV-8B Harrier and for other Navy and reserve aircraft. The Senate would also add funds for Harriers and Navy aircraft. Brown thought a large conventional (90,000 tons) carrier (CV) might convince Congress to forgo a nuclear-powered one, but the smaller midi carrier (60,000 tons) would not satisfy the legislators. The secretary predicted “a heated floor debate.”<sup>44</sup>

As expected, the House Armed Services Committee authorized a *Nimitz*-class nuclear carrier (at a \$2.1 billion cost) instead of a conventional midi (costing \$1.6 billion). The committee also authorized additional aircraft for the Navy and Air Force. It eliminated funds for the NATO-built Roland air defense missile—a potential blow to OSD’s “buy European campaign”—but Brown hoped the Senate Armed Services Committee, although skeptical of Roland, might just accept it. When the committee included a *Kennedy*-class CV (\$1.76 billion cost) instead of a nuclear carrier, Brown predicted that the House would yield to the Senate rather than continue to push for a CVN.<sup>45</sup> The full House proved the secretary wrong when it refused to substitute a CV for a CVN. Brown characterized the vote to the president as “severely disappointing” but suggested that “congressmen are reluctant to vote against issues seen as pro-defense. I do not think it means overwhelming support for a nuclear carrier.”<sup>46</sup>

After the House and Senate passed their versions of the Defense Department’s authorization bills for weapon systems, they went into conference to resolve their differences. The House authorized \$41.5 billion while the Senate’s figure was \$40.9 billion.<sup>47</sup> The bill that emerged from conference committee authorized total funding of \$41.4 billion, \$1.3 billion more than the administration requested, including \$2.1 billion for a *Nimitz*-class carrier. Otherwise, the administration received much of what it asked for. Strategic warfare authorizations included \$670 million for initial development of a movable, hard-target MX missile, \$1.12 billion for a ballistic missile submarine, \$763 million for Trident II missiles, almost \$422 million for modification of B-52s to carry cruise missiles, and only \$2 million less for civil defense (\$106.8 million) than the administration requested. As for general purpose forces, the bill provided all the XM1 tanks and XM2 troop carriers asked for but replaced most of the administration’s requests for new M60 tanks with modifications of existing ones. The conferees also funded the Roland missile.<sup>48</sup>

The Navy fared better with Congress than it did with OSD and the White House, especially for carrier aircraft. The conference committee authorized 30 instead of 26

F-14s, 25 instead of 15 F-18s, 6 A-6E Intruders instead of none (thus saving jobs at the Grumman Aerospace Corporation plant in Bethpage, New York), and \$180 million in funding for development of an advanced Harrier bomber. As requested, the Navy gained authorization for one Aegis combat control destroyer and six missile frigates, but Congress doubled the number of nuclear-powered attack submarines from one to two. The Air Force received exactly the additional tactical airpower the administration requested: 60 F-15s, 175 F-16s, 144 A-10 tank hunters, and 4 KC-10 tankers (see table 6).<sup>49</sup>

**Table 6. Major Weapons Authorizations, FY 1980 (\$ millions)**

	Carter Request		House Passed		Senate Passed		Final Action	
	No.	Amount	No.	Amount	No.	Amount	No.	Amount
<b>Strategic Warfare</b>								
Ballistic missile submarine	1	1,121.1	1	1,121.1	1	1,121.1	1	1,121.1
Trident missile	82	763.0	82	763.0	82	763.0	82	763.0
MX missile	-	670.0	-	670.0	-	670.0	-	670.0
Civil defense	-	108.8	-	106.8	-	138.0	-	106.8
B-52 modification	-	421.9	-	421.9	-	421.9	-	421.9
<b>Ground Warfare</b>								
XM1 tank	352	647.6	352	633.4	352	647.6	352	647.6
M60 tank	251	216.8	0	0	251	216.8	64	55.0
M60 modernization	500	117.4	751	177.4	500	117.4	687	162.0
XM2 troop carrier	208	170.4	208	225.4	208	227.4	208	226.4
Roland antiaircraft missile	410	296.9	410	296.9	0	0	410	296.9
<b>Carrier-related</b>								
Aircraft carrier	1	1,617.1	1	1,760.0	1	2,094.0	1	2,094.0
F-14 fighter	24	580.4	24	580.4	36	815.5	30	763.0
F-18 fighter	15	666.1	25	1,017.6	30	1,151.9	25	1,116.9
A-6E bomber	0	56.7	6	145.6	0	56.7	6	145.6
Advanced Harrier V/STOL bomber	-	0	-	180.0	-	180.0	-	180.0
<b>Other Naval Warfare</b>								
Aegis destroyer	1	820.0	1	820.0	1	820.0	1	820.0
Missile frigate	6	1,204.2	6	1,204.2	6	1,204.2	6	1,204.2
Attack submarine	1	461.5	1	429.6	2	831.5	2	809.6
Surface effect ship	-	0	-	(-44.0)*	-	100.0	-	60.0
<b>Tactical Airpower</b>								
F-15 fighter	60	965.5	60	965.5	60	965.5	60	965.5
F-16 fighter	175	1,562.6	175	1,562.6	175	1,562.6	175	1,562.6
A-10 fighter	144	855.3	144	855.3	144	855.3	144	855.3
KC-10 tanker	4	178.5	4	178.5	4	178.5	4	178.5

(Some amounts include funds for spare parts and for advance payments on additional items to be purchased in FY 1981.)

Source: *Congressional Quarterly Almanac*, 1979, vol. 35 (Washington, DC: Congressional Quarterly, 1980), 453.

No one in the executive branch had any inclination to recommend that the president veto the defense procurement bill, as in the 1978 authorization over the nuclear carrier issue. The mood of Congress and the people had changed. At first glance, the nuclear carrier cost only \$300 million more than a large conventional one based on funding figures of the House and Senate bills. OSD argued that the real cost would be \$600 million to \$700 million because Congress incorrectly assumed already funded spare reactor components costing \$340 million could be used on the new CVN. The Navy agreed that the spares could not be used for a new CVN, citing the need to maintain existing ones. Arguments made in 1978 that funding a nuclear carrier would hurt other NATO-related weapon programs and structural improvements would not hold water this time, since NATO requirements were adequately funded. Furthermore, as Brown informed Carter, SCAS Chairman John Stennis opposed a veto.<sup>50</sup> The Senate adopted the Conference Report on 24 October 1979 by voice vote and the House voted (300–26) to do the same on 26 October. On 9 November 1979 Carter signed the Defense Procurement Act (P.L. 96-106) providing \$41.4 billion for weapons procurement; research, development, and test and evaluation; and civil defense (see table 7). The authorization for naval vessels included \$2.09 billion for a nuclear carrier.<sup>51</sup>

Before the president signed the bill, Congress had considered its budget resolutions that set targets and spending limits for FY 1980 defense appropriations and beyond. Defense spending became an issue in mid-September 1979 when the Senate began to debate its Budget Committee's second and binding resolution for FYs 1980–1984. The committee recommended that the Pentagon's budget should rise substantially in the next few years. The full Senate recommended even greater increases, 5.6 percent for FY 1980, 13 percent for FY 1981, and 23.9 percent for the following year. During floor debate, leading defense hawks Fritz Hollings, Barry Goldwater, and San Nunn all supported increases. Brown and McIntyre, along with Vance, Brzezinski, and presidential adviser Lloyd N. Cutler, urged Carter to respond to this pressure. They noted that congressional critics of SALT II hoped to use the defense spending issue to defeat the treaty ratification by arguing that without a strong DoD budget, SALT II was too great a risk. Brown and McIntyre suggested that Carter make clear his support for a 3 percent rise in FY 1980 but not be pinned down to 5 percent or more for the next two years, especially since the Budget Committee's figures for years beyond FY 1980 were not binding. In a letter to Hollings, Carter

**Table 7. Defense Authorization Bill, FY 1980 (\$ millions)**

	Administration Request	Final Authorization
<b>Procurement</b>		
<b>Aircraft</b>		
Army	946.4	1,002.6
Navy and Marine Corps	3,967.9	4,534.9
Air Force	7,931.2	8,085.4
<b>Missiles</b>		
Army	1,250.5	1,202.9
Navy	1,548.3	1,575.1
Marine Corps	20.5	20.5
Air Force	2,288.6	2,263.8
<b>Naval Vessels</b>	6,173.8	6,706.8
<b>Tracked Combat Vehicles</b>		
Army	1,692.2	1,679.0
Marine Corps	13.0	13.0
<b>Torpedoes</b>	267.2	336.8
<b>Other Weapons</b>		
Army	196.4	170.5
Navy	158.0	153.0
Marine Corps	18.7	25.2
Subtotal	26,473.0	27,769.5
<b>Research and Development</b>		
Army	2,927	2,866.5
Navy	4,489.3	4,543.0
Air Force	5,005.1	4,994.0
Defense Agencies	1,120.0	1,110.6
Subtotal	13,541.4	13,514.1
<b>Civil Defense</b>	108.8	106.8
Total	40,123.2	41,390.5

Source: *CQ Almanac* 1979, 35:442–443.

stated that he believed 3 percent real growth would be adequate given economies and improved coordination with allies for the next three years. Should that not be the case, he would request more money in future years. When the second budget resolution emerged from conference at the end of October the projected defense levels for FY 1980 (\$141.2 billion in TOA and \$129.9 billion in outlays) were well above Carter's requests. This resolution did not require Congress to appropriate these figures; they were target levels above which Congress could not go.<sup>52</sup>

Congress could not take final action on a defense appropriation bill that funded DoD for FY 1980 until the budget resolution passed. Nevertheless, work began on

the legislation well before then. In early August, Brown told Carter that he expected the House Subcommittee on Defense Appropriations to allocate \$2.2 billion less than the administration had requested and that the Senate subcommittee would not do its markup until the authorization bill's conference report. As the end of the fiscal year loomed with no authorization, Brown worried how he was going to pay the troops and civilians.<sup>53</sup>

The House Committee on Appropriations reported out its bill (House Report 96-450) on 20 September 1979, cutting \$2.3 billion from the administration's overall request of \$132.3 billion in TOA. The biggest recommended reduction of \$1.7 billion fell on operations and maintenance, of which \$900 million came at the expense of Pentagon civilians (cuts in overtime pay, use of sick leave for retirement, travel, and the institution of a blue-collar pay cap) and contractors providing studies and analyses. As usual, the committee added more money for the reserve components and the National Guard and blocked the administration's third attempt to reduce the Naval Reserve from 87,000 to 50,000 personnel. The committee rejected OSD's assertion that 20 older destroyers (partly crewed by reservists) were useless and should be decommissioned, recommending relatively inexpensive modifications for 15 that would allow their use in an antisubmarine defense role. On 28 September the House passed the bill (H. 5359) at a TOA of \$129.9 billion.<sup>54</sup>

After cutting O&M costs by \$674 million less than the administration requested, the Senate Committee on Appropriations pegged funding for DoD at \$132.1 billion in TOA—\$2.2 billion more than the House's approved figure. The committee restored about half the money that the House had cut from DoD civilians and added back the \$300 million for contract studies and analyses. While staunchly supporting the number of naval reservists at 87,000, the SCA eliminated the \$98 million that the House had earmarked for overhauling 15 older destroyers. Otherwise, the SCA proved more pro-Navy than the House by doubling the number of nuclear attack submarines to two, restoring House cuts for three of the five Navy ships to tow long-range listening devices to detect submarines, and retaining funds for development of a destroyer-size submarine chaser that could skim over the water at 100 mph on air bubbles. The Senate committee approved \$2.1 billion for the CVN, and also funded conversion of helicopter carriers to vertical takeoff aircraft carriers and equipping Harrier bombers to operate from them.<sup>55</sup>



As for the Army, the Senate committee restored \$62.3 million for an artillery rocket cut by its House equivalent, and \$55 million to build more M60 tanks (unlike the House which mostly wanted to upgrade existing ones). It also provided more money than the House (\$144.8 million versus \$116 million) for Pershing II missiles with a range of 1,000 miles. The SCA provided funding to convert one Air Force F-111 fighter into a plane able to jam enemy radar (as opposed to the House's five), but it eliminated the program to reimburse commercial airlines to modify their wide body jets to permit them to carry military cargo in the event of a NATO conflict. For strategic weapons, the SCA eliminated \$75 million of \$228.5 million requested for antiballistic missile defense on the grounds that more than enough money had been spent with no discernable results.<sup>56</sup>

The full Senate debated the SCA markup in early November, more than a month after the fiscal year had begun. On 12 October, Congress passed a continuing resolution that allowed DoD to meet its payrolls, but with some paychecks delayed. During Senate floor debate of the appropriations bill, Senator Mark O. Hatfield (R-OR) led a charge against funding the MX on the grounds that Minuteman missile modernization was far cheaper and would not threaten the Soviet Union with a first-strike capability that might "endanger the strategic balance and force the Soviets into decisions which could put a hair-trigger on nuclear war." Most senators disagreed with Hatfield and voted to fund the MX at \$670 million. On the grounds that the vertical mode was less vulnerable, conservative hard-liners preferred vertical basing of the MX rather than a horizontal racetrack mode that Carter had chosen. The Senate solved the problem by stipulating that none of the money could be used to commit the MX to any specific kind of basing mode.<sup>57</sup>

Government waste watchdog Senator William Proxmire led a ritual fight against the CVN on the grounds that it was too expensive. Counting equipment, carrier aircraft, escort ships, and operating expenses, Proxmire estimated the cost of the CVN over its life span at \$42 billion. Given that Soviet antiship cruise missiles made CVNs vulnerable, he thought it better to spend money on a larger number of cheaper ships. Proxmire's amendment failed, garnering only 20 votes. A scheme granting military personnel a 10.4 percent cost of living increase (the rest of the government received 7 percent) failed with opponents citing its \$1 billion price tag and the inevitability of political pressure to extend the higher figure to civilians.<sup>58</sup>

In conference session, members reconciled the Senate and House appropriations bills. The \$2.1 billion for a CVN met with approval in conference, but conferees turned down the Senate's attempt to increase the number of small carriers by requiring conversion of helicopter carriers to bear Harrier vertical/short takeoff and landing bombers. The conferees did earmark \$10 million to design one small V/STOL carrier to be ready by FY 1982. They agreed on \$180 million to develop an advanced Marine Harrier bomber flown from land and added \$5 million to develop a Harrier B to fly from small carriers. As for conventional carrier fighter aircraft, the conferees funded the 6 additional F-14s and 10 more F-18s. They added two nuclear attack submarines, cut the number of Navy ships towing listening devices to a single ship, dumped the air-cushioned submarine chaser program, and ordered the Navy to continue to operate 12 of the 20 older destroyers.<sup>59</sup>

The conference participants approved full development funding for Pershing II missiles with a 1,600km range able to strike Soviet territory from Western Europe as requested by the administration. They also sided with the House view that it was cheaper to modernize M60 tanks than build new ones. The conferees approved \$576.9 million to procure 352 XM1 tanks but insisted that \$14.2 million be spent to develop a diesel engine as a possible backup to their troubled gas turbine engines. The conferees appropriated \$38.6 million to modify civilian aircraft for quick conversion to military cargo craft. Both the House and Senate versions of the bill had tried to limit the number of dependents accompanying military personnel overseas, but DoD arguments that they were essential to morale convinced the conferees to eliminate these restrictions. As for the MX, the conference report approved requested funding but added the Senate prohibition on spending any money on specific basing modes. Conferees appropriated \$241.6 million for research and development of ABM defenses.<sup>60</sup>

While generally cutting O&M costs, the conferees added \$75.4 million for engine parts to allow the many grounded F-15s to fly again. The conference report approved the Senate figure of \$470 million (as opposed to the House's \$370 million) to offset overseas cost increases caused by the declining dollar. Following the House lead, the conferees reduced funding for satellite systems by \$104.2 million and cut funding for intelligence activities by \$58.8 million.<sup>61</sup>

On 13 December the House and Senate passed the Defense Appropriation Bill (H.R. 5359) providing \$131.3 billion in total obligational authority (this figure

**Table 8. Defense Appropriations, FY 1980 (\$ millions)**

Program	Administration Request	Final Appropriation
Military Personnel	29,096.4	28,768.9
Military Pensions	11,451.5	11,451.5
Operations and Maintenance	42,710.6	41,713.5
Procurement	35,420.2	35,528.1
Proceeds from foreign sales	(-)	106.0
Transfers from prior appropriations	(1.00)	202.8
Research and Development	13,571.0	13,449.5
Transfers from prior appropriations	(20.1)	(61.9)
Special Foreign Currency Program	6.7	6.7
Related Agencies	64.2	63.1
Total, new budget authority	132,320.6	130,981.3
Total funding made available	132,340.7	131,351.9

Source: *CQ Almanac* 1979, 35:249.

did not count the administration's requests for military construction, civil defense, military family housing, or military assistance, which Congress voted as separate bills). The figure was approximately \$1 billion less than requested by the president, who signed the act into law on 21 December (P.L. 96-154).<sup>62</sup> This, in fact, was the smallest reduction Congress had made to a Defense budget in a decade and \$10 billion more than in the previous year's appropriation. The small reduction indicated that defense hawks in Congress had begun to gain the upper hand against those opposed to more defense spending.<sup>63</sup> See table 8 for program funding.

In presenting the FY 1980 Defense budget, Brown and the JCS made a strong case that the Soviet Union presented a serious military threat to U.S. security that would reach the danger point in the mid to late 1980s unless the United States took appropriate measures. Differing perceptions by Moscow and Washington of their strategic relationship proved to be one of the defining issues of the Cold War. Did the Soviet Union in reality represent the kind of threat that Brown and his colleagues in DoD perceived? One defense critic has noted that the buildup of Soviet ICBMs, especially the SS-18 ICBM force, still threatened only a limited portion of U.S. strategic power, especially in the late 1970s. Even if Soviet missiles destroyed 90 percent of U.S. ICBMs, that destruction represented only 18 percent of all U.S. strategic forces. The Soviets lagged well behind the United States in multiple reentry vehicles on ICBMs and even further behind in MIRVs on SLBMs. In submarine-launched missiles and bombers,

the United States enjoyed a clear lead. In 1977 the United States had more than twice as many warheads as the Soviets (8,500 to 4,000), and in 1980 the U.S. still had over one and one-half times more (9,200 to 6,000). To leaders in Moscow, U.S. professions of acceptance of parity or “essential equivalence” could be perceived as a disguise for achieving superiority by the development of the Pershing II missile, the MX, air-launched cruise missiles, ground-launched cruise missiles, another nuclear aircraft carrier, and U.S. and NATO improvements in conventional forces. To make it worse in Soviet eyes, U.S. defense hawks used the Soviet buildup to justify their U.S. increases.<sup>64</sup>

Brown entertained no illusions that the Soviet Union was an aggrieved peace-loving nation forced to spend billions of rubles on defense because of the U.S. threat. The Soviet military, unlike its U.S. counterpart, was telling its civilian leaders in 1979 that a nuclear war might be winnable and represented a genuine threat. The secretary’s recommendations to the president were neither duplicitous nor self-serving; nor did he exaggerate the Soviet threat. Brown was careful to point out Soviet weaknesses and corresponding U.S. strengths. He took the long view on the need to keep America safe. Given Soviet advances in ICBMs in the 1970s, it seemed both prudent and wise to assume that the Soviet Union would continue to make technological strides in strategic forces. If he erred on the side of caution, it was hardly surprising.

Many in Congress reached similar conclusions about Soviet strategic improvements, some sooner than the secretary. Congress passed an FY 1980 Defense appropriations bill that resulted in the smallest congressional cuts in over a decade. The administration received only about \$1 billion less than its request for \$132.3 billion in total obligational authority. Congress also made significant reallocations of monies, funding more weapons or different ones than requested. Congressional proponents of building another nuclear aircraft carrier finally broke the Carter administration’s previous block on appropriations for nuclear-powered carriers by successfully voting to reprogram funding for a conventional midsize carrier into a nuclear-powered one. Congress added a second nuclear attack submarine, additional carrier aircraft, and more planes for the Air National Guard, offsetting these increases mostly with reductions in funds for operations and maintenance. Pro-defense legislators passed a budget resolution setting targets for FYs 1980–1984 and beyond well above the Carter requests. Such pressure from Congress helped Brown in his campaign to begin persuading the president to accept more defense spending.

The budget process for FY 1980 had been far easier and less contentious than in previous years, in good part because Carter bowed at least partially to hawkish congressional and public pressure for more money for the Pentagon, a sentiment strongly encouraged by Brown. While the president proved only a halfhearted convert, who still harbored doubts about defense spending, the same could not be said for Brown, who underwent a full conversion to the need for considerably more money to protect U.S. national security. The FY 1980 budget process marked Brown's new awareness. It remained for him to convince the president.



## Readjustment in East Asia

IN THE YEARS AFTER WORLD WAR II the United States maintained a strong military presence in Japan, South Korea, the Philippines, and Taiwan. Committed by its 1947 constitution and by postwar political tradition to a modest self-defense force, Japan relied on the security alliance with the United States and U.S. military forces in Japan for protection against potential enemies such as the Soviet Union and the People's Republic of China (PRC). After the Korean War the United States signed a mutual security treaty with the Republic of Korea (ROK) and retained over 60,000 forces there. After granting the Philippines independence in 1946, the United States continued to occupy important military bases in the island nation. The victory of the Communists in China relegated the defeated Nationalists to the island of Taiwan. Long-term U.S. military aid to Taiwan and the presence of U.S. troops on the island during the 1950s and 1960s deepened the enmity between the United States and the PRC until the early 1970s, when the Nixon administration and the Beijing leadership reconciled, based in large part on a common adversarial stance against the Soviet Union. The U.S. military presence in East Asia posed a problem for each ally in the region. The South Koreans and Taiwanese both wanted U.S. troops to stay; the Philippines wanted more financial support for the use of U.S. bases on the islands; and Japan, content to rely on the U.S. military for its defense, resisted increasing their own defense spending and responsibilities.

President Carter came to office in January 1977 determined to reduce the U.S. military presence in East Asia by withdrawing all combat troops from South Korea and decreasing the U.S. military presence at bases in the Philippines. His goal of establishing full diplomatic relations with the People's Republic of China required termination of the 1954 Mutual Security Treaty with Taiwan and withdrawal of

all U.S. military personnel and war materiel from the island. The president also endorsed a campaign, spearheaded by Defense Secretary Harold Brown, to make Japan less dependent on the United States for its security. The impulse for these policy adjustments lay mostly outside East Asia. Resurgent Soviet and Warsaw Pact military power required a shift of resources to Europe to shore up a neglected NATO alliance. The fall of the pro-American Shah of Iran and the Soviet invasion of Afghanistan in 1979 necessitated additional military presence in the Persian Gulf and Southwest Asia. In East Asia itself, Carter discounted the chance of another war on the Korean Peninsula and pushed to withdraw U.S. troops from South Korea. Brown found himself caught between Carter's desire to redefine East Asian security and the concerns of the military and many in Congress that the president's withdrawal plans were too precipitous to adequately protect U.S. interests in the area.

### **Korea: Decision to Withdraw**

During the post-1953 armistice years the U.S. security commitment to the Republic of Korea remained constant until 1971, when the Nixon administration withdrew the U.S. Army's 7th Infantry Division (approximately 20,000 of 60,000 U.S. troops in Korea) and, as compensation, established a long-term program to modernize ROK armed forces. In January 1977 approximately 39,000 U.S. troops were stationed in Korea, with an infantry company always on duty at the Demilitarized Zone (DMZ). Carter accepted that Korea was crucial to U.S. security, but he believed he had a better way to protect it: withdraw all U.S. troops and defend the ROK with air and sea power. He announced his intention to withdraw U.S. troops and selected tactical weapons from Korea in his 1976 presidential campaign. President Ford highlighted his differences with Carter on Korea by promising not to "retreat from the front lines of freedom," but the issue did not excite voters and had little impact on the presidential race.<sup>1</sup>

Among defense analysts and the military strategists the reaction proved different. They opposed a unilateral pullout from South Korea without some quid pro quo from North Korea and its major ally China. Unilateral withdrawal would send the wrong signal to Pyongyang, the Soviet Union, and China. For his part Brown felt conflicted. As he recalled, he "had defended the Carter position during the campaign," but "did not think it [withdrawal] was a very good idea." Brown found himself in the uncomfortable position of supporting a policy in public about which he had private doubts. Brown recalled, "I thought a tolerable argument could



be made for it.” He noted that in January 1977 the peninsula was quiet, the North posed no immediate threat, and “the South Koreans had clearly gotten stronger, and economically they were pulling away from the North even then.” What the ROK lacked in artillery, tanks, and air and sea power could be provided by U.S. air and naval forces outside the peninsula. Still, to the secretary, “the timing was wrong.”<sup>2</sup>

Within a week after inauguration, Carter issued Presidential Review Memorandum 13, ordering a broad reassessment of policy toward Korea. Reduction of U.S. forces on the peninsula and the military balance between North and South were the two main Korean issues for the Office of the Secretary of Defense.<sup>3</sup> Clearly, the North Korean threat dictated the scale of withdrawal. In early 1975 a junior intelligence analyst, John Armstrong of the Army’s Special Research Detachment at the National Security Agency, challenged the intelligence community’s acceptance of rough parity between the two Koreas. Concluding that the North had 80 percent more tanks than previously estimated, Armstrong convinced the Army to create a team of six analysts to study the balance. The team’s preliminary results, available in January 1977, estimated that the artillery imbalance was as bad as the disparity in tanks, and that a major part of the North’s armor and artillery was near the DMZ.<sup>4</sup>

The White House staff soon became aware of this intelligence. As staffer Michael H. Armacost told National Security Adviser Zbigniew Brzezinski, “We confront a potential problem. . . . A consensus has emerged within CIA and DIA during the past six months that North Korea enjoys a substantial military advantage against South Korea alone (i.e., if one leaves the U.S. forces out of the equation). . . .” The North would retain “a substantial advantage in armor, firepower, and mobility of ground forces, in the numbers of its aircraft and naval forces, and in defense capabilities” through 1982. Conversely, the South’s dependence on U.S. air, naval, and logistics support left “serious gaps in their capabilities.” Moreover, Seoul’s proximity to the DMZ restricted an ROK defense of “depth and maneuver.” Finally, the South’s advantage in overall ground troops was decreasing. Armacost himself did not accept this assessment, believing the ROK deficiencies in command and control, tactical intelligence, air support, and logistics capabilities (all provided by the United States) could be overcome because a U.S. withdrawal would force the ROK to assume these responsibilities. To Armacost, “the DIA/CIA analysis too often relied on ‘bean counts,’” ignoring the large disparities between the economies of the two Koreas. Brzezinski agreed that a more balanced intelligence assessment to accompany PRM 13 was in order.<sup>5</sup>

While the White House staff discounted the new intelligence, the U.S. military embraced it. The Joint Chiefs of Staff and Far East commanders had reacted with shock to Carter's campaign statements. They suspected that the PRM 13 exercise was wired to recommend withdrawal. The commander of U.S. Forces in Korea (COMUSKOREA), General John W. Vessey Jr., became so alarmed that he asked for a meeting with Brown in mid-February 1977. The secretary heard the senior officer out and then arranged for him to brief the president. In the midst of a conversation that covered the full range of U.S.-ROK relations, Carter asked about withdrawal. Vessey said it would weaken the ROK militarily, and the turnover of the 2nd Division's equipment after the division's withdrawal would be of only "marginal" benefit. Carter promised to consult the commander before the final decision.<sup>6</sup>

As a prelude to the president's decision, the Policy Review Committee and the National Security Council discussed the response to PRM 13 in April 1977. Director of Central Intelligence Stansfield Turner stated that "the North enjoyed a substantial advantage in the static military balance between the forces of North and South Korea alone." Only with substantial U.S. assistance to the ROK Army to improve its firepower and other deficiencies, as well as U.S. air, naval, and logistics support for the foreseeable future, could U.S. troops be withdrawn. According to a summary of the discussion, "several participants" at the meeting argued that the risks of any immediate pullout outweighed the benefits.<sup>7</sup>

At the NSC meeting on 27 April, with the president attending, all agreed "that the withdrawal of ground forces over four or five years could be managed without upsetting the military balance on the peninsula." Brzezinski, Brown, and Secretary of State Cyrus Vance argued for flexibility in the withdrawal schedule. Carter countered that he did not want to allow ROK President Park Chung Hee to manipulate tensions to delay withdrawals. Brown told Carter that the pullout would require additional firepower and equipment for South Korea, noting that the U.S. 2nd Division slated for withdrawal possessed more antitank weapons than the entire ROK Army. JCS Chairman General George Brown warned that withdrawal of combat troops would mean loss of U.S. operational control of South Korean troops defending against the North, eliminating a valuable tool for coordination with, intelligence about, and control of the ROK Army. Turner worried that withdrawal would send the wrong signals no matter how it was managed.<sup>8</sup>

The NSC participants considered withdrawal options. Vance favored a five-year plan with three withdrawal stages (a combat brigade in 1978, a second in FYs 1979 or 1980 conditions permitting, and the third in 1981 or 1982). Brown and OSD preferred to “back load” the process: one brigade in 1978 and the second and third in 1982. Brzezinski recommended withdrawing two brigades by 1979 or 1980 and leaving intentions about the third vague. Brown warned the president that funding the equipment transfer from the 2nd Division to the ROK would require a major battle with Congress. In addition to a poor human rights record, the 1976 Koreagate scandal, which revealed South Korean bribery and influence-buying of U.S. congressional members, made the ROK government obnoxious in the eyes of Capitol Hill legislators. Brown suggested that military assistance should not be tied to human rights in Korea, but Carter countered that inevitably assistance would depend on Park’s record. The president asked Brown to provide a detailed plan for withdrawals and requirements for military offsets to the ROK to implement the Brzezinski option.<sup>9</sup>

Brown instructed the JCS to prepare plans to withdraw either 4,300 or 10,000 troops (one or two brigades) of the 2nd Division by the end of 1978, with all remaining U.S. troops by June 1980, June 1981, or June 1982. The Chiefs would also assess what military assistance the ROK needed to complement the withdrawals. Asked for advice by the JCS, both the commander in chief, Pacific and COMUSKOREA opposed the 1978 pullout as “not a viable option”; it would create gaping holes in ROK defense capabilities too costly and difficult to plug even by 1982. The commanders stated total withdrawal by December 1980 ran a “significant risk to peace on [the] Korean peninsula.” According to CINCPAC, “What might appear now as an acceptable U.S. troop reduction will be extremely costly, exceed the short-term ROK capability to absorb equipment and training, and possibly increase the risk of North-South hostilities.”<sup>10</sup>

Carter was unconvinced. Brown remained conflicted, suspecting that the president was rushing the pace of the pullout. But, as he later recalled, his difference was one not “of principle” but of “degree and timing,” so he refused to allow “any daylight between the president and myself.” Carter signed Presidential Directive 12 on 5 May 1977, directing withdrawal of one brigade and its supporting elements (no less than 6,000 troops) by the end of 1978, and a second brigade (no less than 9,000 troops) by the end of June 1980. Additional pullouts would be decided later. OSD and JCS were instructed to finalize options for these reductions and propose options for increasing military assistance. Given their initial advice against significant withdrawals, totally

discounted by Carter and Brzezinski and reluctantly agreed to by the NSC staff and Brown, it was not surprising that the Chief's plan was rife with qualifications.<sup>11</sup>

The JCS informed Brown that, while they accepted PD 12, it “cannot be executed without risk” and high costs. Doubting the ROK's ability to absorb U.S. military equipment and the required training by 1982, they recommended that no additional withdrawals above the 15,000 figure take place until 1982, after which a residual force of 6,000 U.S. troops should remain to support and liaise with the ROK. The Chiefs endorsed a plan for gradual improvement of materiel and training and an ongoing security assistance program. They recommended periodic reassessments of PD 12 to ensure it conformed to conditions on the peninsula.<sup>12</sup>

While the JCS reluctantly accepted PD 12, General Vessey and his chief of staff, Maj. Gen. John K. Singlaub, did not acquiesce in silence. Vessey raised the risk of war on the peninsula in an off-the-record interview with a United Press International reporter before the president issued PD 12. Apparently without defining rules for attribution, Singlaub spoke along similar lines to a *Washington Post* reporter after the president signed the PD. Within hours after the *Post* released the article,



Army General John Vessey (second from right), commander in chief of the United Nations Command and commander of U.S. Forces in Korea, greets members of the 18th Tactical Fighter Wing, March 1979. (RG 330, NARA II)

Singlaub was recalled to Washington for a tense meeting with Carter, who personally reassigned him. To congressional and other opponents of the withdrawal, Singlaub became a martyr.<sup>13</sup>

When Deputy Defense Secretary Charles Duncan presented the OSD-JCS plan to Carter, he cautioned him that it was tentative, subject to change based on new evaluations or consultations with the ROK. Duncan also noted that the plan sought to “preserve and maximize the combat power of the remaining ground forces” so that the U.S. combat brigade would be “capable of defending itself.” Duncan again raised doubts whether the ROK could absorb the 2nd Division’s equipment in the compressed timeframe or provide the trained manpower to use it. Duncan foresaw as a “rock bottom” level \$500 million to \$600 million over the next five years to provide new weapons, and an additional \$200 million over the same time span to improve existing ROK artillery, air/ground tactical mobility, and ground air defense.<sup>14</sup>

While Carter had accepted that Korea was crucial to U.S. security, he still believed in his way of protecting it: withdraw all U.S. troops and defend the ROK with air and sea power.<sup>15</sup> As noted before, he announced this strategy during the 1976 presidential race and throughout the campaign reiterated his intention to withdraw from South Korea all U.S. troops and selected tactical weapons. True to his public presidential campaign promise, once in office Carter insisted on a plan to remove troops and weapons. On 27 January 1977 Brzezinski relayed to Brown the following presidential instruction: “Without public notice . . . submit plan to me.” Brown’s reaction was not recorded, but he was concerned. He and Brzezinski discussed possible alternatives.<sup>16</sup>

Beyond his campaign pronouncements, Carter had not provided a reason for this instruction, but the Brzezinski-Brown reaction provides a clue. In 1975 ROK and U.S. forces had discovered tunnels under the DMZ, which allowed North Korean infiltrators in ROK uniforms to roam South Korea almost at-will. North Korea could revive this threat. Brown and Brzezinski convinced the president at the NSC meeting of 27 April 1977 to fold the plan into the PRM 13 exercise and consult South Korea.<sup>17</sup>

At the suggestion of Brown and Vance, General Brown and Under Secretary of State for Political Affairs Philip C. Habib traveled to Seoul and Tokyo to explain the withdrawal decision. Carter instructed that “these are genuine consultations” but insisted they “be quite firm in delineating the general timeframe” for the pullout while “retaining flexibility” on the phasing.<sup>18</sup> On their return, General Brown and

Habib reported that Park understood and accepted the Carter plan, but he insisted on extensive compensation—the cost-free transfer of the 2nd Division’s equipment, additional U.S. military equipment, and support for ROK coproduction of much of its military requirements. Most of all, Park wanted a modification of the plan: the headquarters and two under-strength combat brigades of the 2nd Division would remain in South Korea until the final pullout of the third combat brigade sometime after June 1980.<sup>19</sup> Reviewing their report, Carter thought that his emissaries had “over-obligated” him on compensatory actions and complained that the second withdrawal of 9,000 troops by June 1980 was too slow (PD 12 stated “no later than June 1980”). In reality, Carter and his advisers were too optimistic about their selling job in Tokyo and Seoul and insufficiently aware of the opposition to withdrawal in South Korea, Japan, Congress, and the Pentagon.<sup>20</sup>

When, in June 1977, the Subcommittee on Investigation of the House Armed Services Committee asked for information on the military implications of withdrawal, the staff of the assistant secretary of defense for congressional relations turned over JCS, CINCPAC, and COMUSKOREA cables opposing or revising the policy. NSC staffer Armacost complained: “It is an outrageous procedure. Openness is one thing. Providing the Congress the internal recommendations of the JCS even before the final decisions are in is quite another.” It was an open invitation to Congress to use the military’s arguments against the administration. This “unprecedented hemorrhage of internal documents,” Brzezinski told the president, would only complicate Korea policy. Brzezinski complained to Brown who took responsibility for OSD’s action, but with the damage already done, there was little Brown could do.<sup>21</sup>

Before he visited Seoul for the annual Security Consultative Meeting (SCM) in July 1977, Brown asked Carter for authorization to agree to Park’s proposal to retain under-strength combat units of the 2nd Division until 1982. While not changing the scheduled withdrawals of 6,000 and 9,000 (they could be filled by support troops), the revision would allow 7,000 combat troops to remain until the final pullout. Then, as Park had indicated, the U.S. commander could retain operational control over Korean troops. Without this compromise, Brown believed Park would not accept U.S. control in the revised form of a Combined Forces Command (CFC)—with an American officer as commander and an ROK officer as his deputy. Brown also recommended that the U.S. Air Force increase its tactical fighters in Korea from 60 to 72 (not the 120 proposed by the ROK); that three

AWACS aircraft in Okinawa be available for emergency duty in Korea; that joint military exercises be upgraded and publicized; and that the U.S. agree to coproduction of weapons. In tandem with Vance, Brown recommended a security package of \$800 million consisting of \$400 million to fund transfer of the 2nd Division's equipment and \$400 million in foreign military sales credits. Carter approved all of Brown's requests except for the announcement of the \$800 million package; he wished Brown to explore congressional receptivity before offering a dollar figure.<sup>22</sup>

Brown's SCM discussions "went rather smoothly," although ROK "anxieties about our troop withdrawals remain deep and pervasive," according to Armacost. Park and Defense Minister Suh accepted Brown's offers, especially the retention of 2nd Infantry Division combat units, but they pressed for better equipment, including M60 tanks and helicopters, and a larger compensatory package. The two sides agreed to consult on the package before OSD produced a comprehensive list of South Korea's military needs. They also agreed to establish the CFC in October 1978. Brown promised support for the production of an indigenous ROK tank, although he believed it uneconomical. He dangled prospects of later sales of advanced weapons, including the F-16 fighter.<sup>23</sup>

### **Retreat from Withdrawal**

Before leaving for Seoul, Brown told Carter that while Congress was skeptical about withdrawal, it could still be won over.<sup>24</sup> When Brown informally briefed congressional leaders at the White House, he received what Brzezinski described as a "very chilly" reception: "Not one Senator or Congressman spoke up in support of the troop withdrawal. Many expressed outright opposition or noted significant misgivings. It is clear we face an uphill battle on the issue with Congress." Brzezinski advised the president: "We need not fall back now," but he warned that the administration faced "tough choices." Brown suggested to Carter that congressional funding for the transfer of equipment and military assistance would require some adjustments.<sup>25</sup> What Brzezinski and Brown considered an uphill battle proved an insurmountable obstacle. In September, Brzezinski successfully recommended postponing any push in Congress on the equipment transfer and security assistance legislation: "The calendar is crowded. The mood on the Hill is sour," and given the Koreagate scandal and already stated congressional opposition, most representatives were unwilling to touch the legislation "with a ten foot pole."<sup>26</sup>

During fall 1977 and winter 1978 Congress delayed acting on Korean legislation. On 4 April 1978 an ad hoc NSC East Asian working group comprising Assistant Secretary of State for East Asian and Pacific Affairs Richard C. Holbrooke, Armacost, NSC China staffer Michel Oksenberg, and Deputy Assistant Secretary of Defense Morton I. Abramowitz recommended to Brzezinski that it was time to postpone the 1978 withdrawals until Congress acted. If the administration did not delay withdrawal for six months to a year, legislation on Korea was dead, and its failure would adversely impact overall Asian policy, especially normalization with China.<sup>27</sup> Brown, Vance, and Brzezinski discussed this proposal on 11 April. Brown and Vance supported the delay, but Brzezinski suggested withdrawing only one battalion and pulling out two additional battalions three months later.<sup>28</sup> On 18 April Brzezinski alerted the president to these discussions. On the next day Duncan, Deputy Secretary of State Warren Christopher, Brzezinski, Turner, the newly nominated JCS Chairman General David Jones, and Special Assistant to the President Hamilton Jordan concluded that if the withdrawal remained on schedule, Congress would never pass an \$800 million Korea package resulting in “excessive foreign policy and political costs.” Two days later Brown and Brzezinski met with Carter and convinced him to accept the inevitable: withdraw only one combat battalion (700 troops) of the 2nd Division along with 2,600 support troops by 31 December 1978.<sup>29</sup> On 21 April the president publicly announced that decision, stating that congressional failure to act was the primary reason.<sup>30</sup>

In September 1978 Congress finally passed the International Security Assistance Act (P.L. 95-384) authorizing the transfer of the 2nd Infantry Division equipment but requiring prior reports on any future withdrawals in 1979. In November 1978 Brown visited Hawaii, Japan, and Korea, hoping to be able to tell the Koreans that the United States was prepared to sell F-16s to them. In his pitch to Carter, Brown noted that he had already informed the South Korean government that the sale was approved at the interagency level. Brzezinski supported Brown on the grounds the sale would ease Korean acceptance of future combat withdrawals, give the South an edge in the air until the 1990s, and not impel the Soviet Union to send MiG-23s to North Korea in response. The president, however, rejected the sale, siding with his human rights and arms control advisers—among them NSC staffer Jessica Tuchman Mathews—who opposed introduction of such advanced weapons to the South.<sup>31</sup>



Brown's trip to Seoul lost its luster. In a private meeting with Park, Brown gently chided the Korean president for the Koreagate scandal and human rights violations, and recommended that South Korea emphasize its economic miracle as a human rights success. Park remained defensive, claiming that South Korea's image was unfairly tarnished in the United States.<sup>32</sup> Brown still held out hope for the F-16 sale (saying it was on track in principle) and raised the possibility, not promise, of coproduction of a less advanced fighter like the A-10. Post-trip assessments were positive, but all was not well in either Seoul or Washington.<sup>33</sup>

In the nation's capital storm clouds loomed over the ongoing intelligence reassessment. Since June 1978 a new team of 35 Army analysts under Armstrong had been examining the North Korean order of battle, especially infantry divisions. In September, OSD's Director of Net Assessment Andrew Marshall alerted Brown that North Korean forces "may turn out to have been substantially underestimated," and that the North was spending more of its GNP on defense even though its economy was probably weaker than previously thought.<sup>34</sup> Skeptical of the Armstrong findings, Turner and DIA Director Lt. Gen. Eugene M. I. Tighe ordered their Army analysts to recheck the data. A worried Turner consulted with Brown about the Army's intelligence methodology.<sup>35</sup> In early January 1979 the controversy went public when the *Army Times* and major newspapers published accounts of these new intelligence findings.<sup>36</sup>

The leaked document, a DIA interim report, acknowledged that instead of 23 active divisions, North Korea had between 27 (CIA's estimate) and 33 (Army's estimate). The report accepted Armstrong's findings on the North's tank and artillery superiority, concluding that it enjoyed significant advantages in every measure of combat power, except possibly air, and that the advances overshadowed any improvements by the South. Perhaps most damaging, the report stated: "Should North Korea—as a consequence of any perceived changes in the political/military posture of the United States vis-à-vis South Korea—come to regard the US security commitment to Seoul as diluted, it would consider the chances for reunification by military means as having improved." In plain language, Carter's withdrawal invited a North Korean attack.<sup>37</sup>

In mid-January 1979 Vance and Brzezinski decided it was time for Brown to make the case to the president that a new PRM review on the withdrawal from South Korea was needed.<sup>38</sup> Brown received help from Democratic Senators Sam

Nunn, John H. Glenn (OH), and Gary Hart, as well as liberal Republican Senator William S. Cohen of Maine, who told the president that the withdrawal should be postponed. It would cost \$2 billion to \$2.5 billion and would not strengthen NATO any time soon, since it would take years for the 2nd Infantry to be reequipped, retrained, and reestablished in Europe. Even if another division went in its place, the United States lacked the air capacity to support it. Nunn bluntly stated: "I see nothing but minuses . . . and no plusses. . . . Mr. President, your credibility is involved here and will be improved if you halt troop withdrawals pending the assessment."<sup>39</sup> The resulting new reassessment, PRM 45, would address directly the question that PRM 12/PD 13 had avoided: Could the ROK repel an invasion from the North without U.S. combat troops, relying only on timely U.S. logistics support, and air and naval power? Carter agreed to the reassessment.<sup>40</sup>

The NSC response to PRM 45 concluded that "both now and in 1982, it is doubtful that the ROK, even with timely U.S. air, naval, and logistical support, could halt a major North Korean surprise attack north of Seoul." The paper presented four alternatives: (1) withdraw on current schedule; (2) slow down and stretch out the current schedule; (3) make completion of the withdrawal contingent on a reduction of tensions and improvement in the military balance; and (4) suspend withdrawal. At the Policy Review Committee meeting on 8 June 1979, Brzezinski argued that with a strong affirmation of U.S. support for ROK security option 1 was still viable, but no one else agreed. Head of the Arms Control and Disarmament Agency Paul Warnke favored option 2; Brown, Vance, and U.S. Ambassador to South Korea William H. Gleysteen favored option 3; and the JCS, option 4. The sense of the meeting was to delay a final decision until after Carter's discussions with Park in Seoul the next month.<sup>41</sup>

The president's visit to Korea proved to be a fiasco. On the morning of 20 June, Carter, Brown, Vance, and Brzezinski met with Park, who launched into a long monologue criticizing the U.S. pullout and emphasizing the dangers from the North. A furious Carter reportedly passed Brown a note: "If he goes on like this much longer I am going to pull every troop out of the country." Carter told Park that he was only contemplating withdrawing 3,000 troops, one half of one percent of the U.S. forces.<sup>42</sup> When Carter and Park adjourned for a private meeting, they continued to rub each other the wrong way. Given the supposed threat from the North, Carter asked Park why South Korea was spending only 5 percent of its GNP

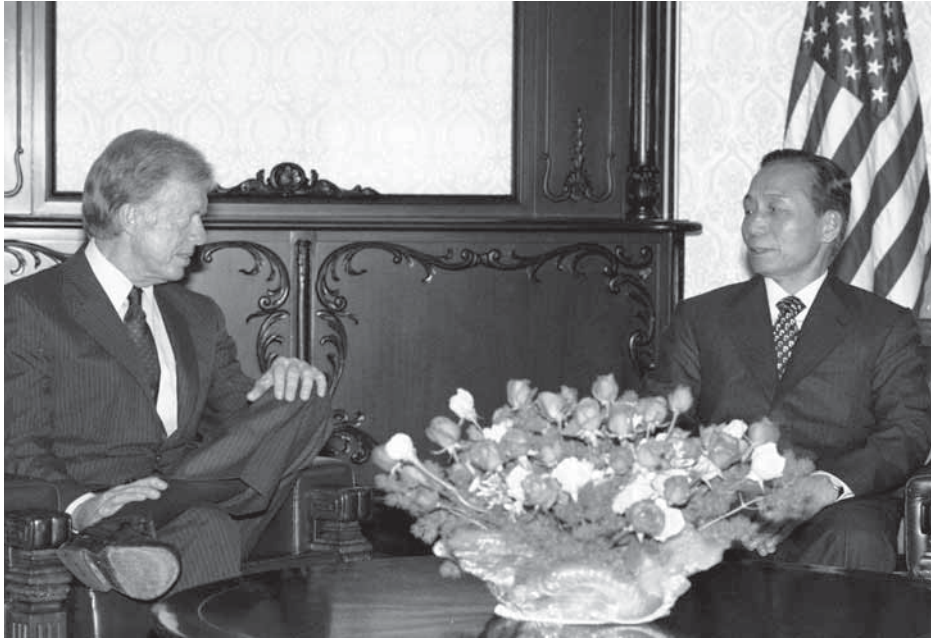

President Jimmy Carter meets with Republic of Korea President Park Chung Hee during Carter's June 1979 trip to Korea. (Carter Presidential Library)

on defense while the U.S. was spending 6 percent and North Korea 20 percent. Park promised increased military spending. Carter then asked him to rescind Emergency Measure 9, a martial law measure allowing imprisonment without trial of political opponents. Park bristled, claiming the law was necessary. His opponents were trying to overthrow his government. It would be rescinded when the threat passed.<sup>43</sup>

When the stormy meeting ended, Carter, Brown, Vance, Brzezinski, and Gleysteen piled into the presidential limousine for the short ride to the ambassador's residence. Carter berated Gleysteen for South Korean opposition to withdrawal, its level of defense spending, and human rights abuses. As they pulled up to the residence, the heated discussion continued for half an hour in the limo. Gleysteen recounts that he laid it on the line to Carter: Park had been expecting a freeze in withdrawals; South Korea as a developing country was spending plenty on defense, and, the ambassador continued, more would just encourage already dangerous authoritarian tendencies. After what seemed like an eternity to Gleysteen, Brown and Vance came to his defense, but Brzezinski remained silent. Gleysteen asked the president what he wanted from Park. Carter responded: 6 percent of GNP on

defense and better human rights. That afternoon the message was passed to Korean officials, who indicated that they were amenable.<sup>44</sup>

After Carter returned to Washington, Brzezinski put slightly modified options of the PRM study to him, admitting that given the need for Nunn's and Glenn's support for SALT and in light of the discussions in Seoul, he now preferred option 2 or option 3. He added that the latter (completion of the withdrawals contingent on reduced tension and an improved military balance), still favored by Brown and Vance, had been revised slightly to suspend all further combat withdrawals but allow for one I-Hawk missile battalion and 1,500 support troops to pull out by the end of 1980 to be followed by a 1981 review of the resumption of withdrawals. Carter chose option 3, instructing Brown and Vance to consult with Congress and ordering Brzezinski to make the public announcement. The president no longer bothered with policies regarding South Korea. Without any major withdrawal of the 2nd Infantry, there was no need for congressional funding to transfer its equipment.<sup>45</sup>

Carter's push for withdrawal was a serious miscalculation, calling into question the U.S. commitment to Korea while removing only a token number of troops and some outdated weapons. The president believed that he was adhering to his principles and keeping at least one of his campaign promises, but in this case he was just being stubborn. The military, Congress, the South Koreans, the Japanese, the U.S. intelligence community, key DoD officials (including Brown), eventually the NSC staff, and finally Brzezinski all opposed the withdrawal decision. Even given his reluctance to challenge Carter publicly, Brown had played an insider role in inching the president away from his initial plan, but he was merely one voice in a large chorus whose opposition overwhelmed Carter.

### **Political Unrest in South Korea**

The long, drawn-out decision to suspend withdrawals did not end the Carter administration's troubles in Korea. Four interrelated events in 1979 and 1980 seriously disrupted the already bruised relationship: the assassination of Park; the rise of a new military strongman, Chun Doo Hwan; a student-worker uprising in Kwangju Province; and the Chun government's planned execution of a major political opponent, Kim Dae Jung. These problems engaged Carter's national security leaders including Brown and other officials, but not the president; faced with the fate of the shah and the subsequent Iran hostage crisis, Carter found little time for Korea.

During a mid-October 1979 U.S.-ROK Security Consultative Meeting in Seoul, Brown offered Park coproduction of 68 additional F-5 aircraft (an older fighter already in the ROK inventory) as an exception to U.S. arms transfer policy. Brown also raised human rights concerns, especially the imprisonment of Kim Yong Sam, a leading Park political opponent. Park told Brown that he could accept private U.S. advice on South Korea's domestic matters, but not public criticism of the ROK's human rights record. When informed of these remarks, Carter responded, "We will decide how to react." As for defense spending, Brown received from Park a promise of between 6 percent and 7 percent of GNP.<sup>46</sup> Less than a week after Brown returned from his East Asia trip (he also went to Japan), Kim Jae Kyu, the director of the Korean Central Intelligence Agency, assassinated Park during a private dinner at the Blue House. The 26 October assassination caught Washington off guard. U.S. intelligence later concluded it was the result of rivalry between Kim and rising star Cha Ji Chul, chief of Presidential Security. Fueled by alcohol and jealousy, Kim killed his rival and Park.<sup>47</sup>

Many assumed that the North might have been involved (it was not) or would try to exploit it (it did not). Just before the news arrived in Washington, Carter left the White House for a long recreational weekend at Camp David. Brown, Brzezinski, Vance, and other advisers met and placed U.S. and ROK forces in South Korea on alert posture DEFCON 3 (a higher possibility of war than the previous DEFCON 4), positioned a carrier task force in the vicinity of Cheju Island, and sent two AWACS aircraft to Osan Air Base in South Korea, authorizing their use for surveillance. Carter apparently approved Brown's actions by phone. On the next day the CFC accepted the withdrawal from its command of two regiments from the ROK 20th Division for internal security duty. The State Department sent public and private messages to China and the Soviet Union warning against North Korea taking advantage of the confused situation.<sup>48</sup>

The assassination left a political vacuum quickly filled by General Chun Doo Hwan, the chief of Defense Security and leader of a group of ambitious young generals, the so-called "Taegu (the city from which they came) Stars," who graduated from the 11th class of the Korean Military Academy. On 12 December 1979 Chun and his allies took over the country in all but name. The group "12/12," as it came to be called, was no less than the beginning of a gradual military coup.<sup>49</sup> It caused the already shaky government to unravel and allowed Chun and his allies to grab

incrementally the reins of power. While Korean domestic politics fell primarily to the State Department and the U.S. ambassador, Brown and OSD had considerable influence because COMUSKOREA General John A. Wickham, by the nature of his job, had close contact with all the ROK military. Initially Wickham was more anti-Chun than Gleysteen. While supporting Wickham, Brown suggested that “little purpose would be served by challenging the sincerity of their [the Chun group’s] disavowals of wider political ambition.” Rather, “take them at their word while making clear we will judge them by their deeds with respect to their support for political liberalization and CFC command arrangements.”<sup>50</sup>

Chun’s deeds soon made it clear that he was not going to liberalize the government, respect the CFC chain of command, or in any way curb his ambition. He increased his de facto control of the government and reduced interim president Choi Kyu-ha to a figurehead. Chun cracked down on political opponents, including students and workers demonstrating against the government. Seeking a way to express



U.S. officers view an F-16 flyby in Korea, December 1981. Left to right: Navy Admiral Robert Long, commander in chief of the U.S. Pacific Command; Air Force Col. Donald Snyder, commander of the 8th Fighter Tactical Wing; and Army General John Wickham, commander in chief of the United Nations Command and commander of U.S. Forces in Korea. (RG 330, NARA)

U.S. concern, Brown settled on the postponement of the 1980 SCM—against the advice of both Gleysteen and Wickham.<sup>51</sup> Beyond that action options were limited. Although Wickham hinted that the troop withdrawal question could be revived if things did not improve in Korea, Washington had no real intention to revisit that failed policy. When a South Korean general contacted Wickham and Gleysteen about a countercoup against Chun, they recommended against becoming involved. Washington agreed it would be a bad idea and the potential coup, if it was ever a serious possibility, fizzled.<sup>52</sup>

The situation went from bad to worse during 1980. South Korean workers, suffering from the first downturn since the economic miracle of the early 1970s, and students, perennial opponents of ROK authoritarianism, took to the streets in Seoul and the southern city of Kwangju, home of opposition leader Kim Dae Jung. Chun was able to keep the lid on in Seoul and to a lesser extent in Kwangju. As NSC staffer Donald Gregg told Brzezinski: “Korea lies sullen, bewildered and largely quiet under the heavy hand of martial law. In the southern city of Kwangju . . . bayonet wielding troops put down riots on May 19. No major disturbances have taken place elsewhere in the country.”<sup>53</sup> Gregg was soon proven wrong. Kwangju students and workers raided armories, took to the streets and building tops, and drove the 7th and 11th brigades of the ROK Special Warfare Command out of the city. Kwangju was under the demonstrators’ control.<sup>54</sup>

Participants at a PRC meeting, including Brown, decided that the ROK had to resume authority in Kwangju before the U.S. government could revive its pressure for reform and political liberalization. During a standoff, demonstrators and South Korean officials negotiated informally for a week, but to no end. On 27 May 1980 Chun sent in special forces and the elements of the 20th Division, released by the Combined Forces Command in October 1979, to restore order by force. Ignoring all U.S. advice to minimize violence, Chun orchestrated a campaign to make it appear that the United States had approved his action. Demonstrators were killed; the number remains disputed. The official ROK total was 30 (soon raised to at least 152); Gleysteen estimated between 200 and 1,000; and protesters claimed many thousands.<sup>55</sup>

The Kwangju Uprising became a cause célèbre in South Korean democratic circles. The false impression that the United States approved and encouraged the repression rankled for years. The Chun regime had outmaneuvered the U.S. administration, which found itself in a difficult situation. Carter’s emphasis on human

rights and democracy gave hope to ROK demonstrators that the U.S. government would support them, but security considerations trumped human rights. As Carter told CNN on 31 May 1980, while he was all for democracy “we can’t sever our relationships with our allies and friends and trading partners and turn them all over to Soviet influence, and perhaps even subversion, simply because they don’t measure up to our standard of human rights.”<sup>56</sup>

After Kwangju relations were strained. Only slowly did the Carter administration resume official contacts with Chun. Brown, among those officials less willing to forgive and forget, wrote in July: “I believe we should continue to defer SCM and should not put 2nd Div under CFC opcon. Deferring these does not interfere with substance of security, and it shows we’re not about to do them any favors that help legitimize the new crowd. They’ll have to take forthcoming (to the Korean people and the US) actions themselves to legitimize their present and future position of power.”<sup>57</sup> In August 1980, without prior authorization, Wickham told a reporter on background that if Chun was elected legitimately, demonstrated a broad political base, and did not jeopardize the U.S.-ROK security relationship, the United States would support him. His remarks did not remain on background for long, becoming widely reported in the U.S. and Korean press. Later that month Chun resigned from the ROK Army, stood for president, and was elected under the Yushin Constitution by 2,500 government-picked members of a quasi-electoral college. Not a democratic election, but South Korea was hardly a democracy.<sup>58</sup>

During the last months of the Carter term, the fate of Kim Dae Jung, sentenced to death for his supposed role in fomenting the Kwangju Uprising, dominated U.S.-Korean policy. Kim was so obviously innocent that Carter’s human rights advocates mounted a campaign to convince the Chun government to stay the execution and commute his sentence. Brown took the lead in formulating options that DoD could undertake to show how strongly the United States opposed Kim’s death sentence, but the president’s other advisers convinced Carter that Brown’s actions were too drastic and Ambassador Gleysteen should be the channel for such measures.<sup>59</sup> On 13 December 1980 Brown traveled to Seoul to meet with Chun—the Korean president’s first meeting with a high-level U.S. official—and plead Kim’s case.<sup>60</sup> Relying on persuasion alone, Brown was unsuccessful. At the Carter administration’s request, the incoming national security adviser-designate of the Reagan administration, Richard Allen, acting on President-elect Ronald Reagan’s





Republic of Korea President Chun Doo Hwan and his wife, Lee Soon Ja, prepare to depart after their visit to Washington, February 1981. (RG 330, NARA II)

expressed authority, negotiated Kim's deliverance by promising Chun a January 1981 meeting with Reagan, but not a state visit.<sup>61</sup>

After the assassination of Park, the Carter administration merely reacted to events in Korea, reeling from crisis to crisis. Brown had been one of the most persistent critics of Chun, but the president's inability to focus on Korea and Reagan's electoral victory rendered the administration's Korea policy ineffective. Nevertheless, through it all the U.S.-ROK security relationship survived, proving its durability.

### People's Republic of China

Normalizing relations with the PRC became one of Carter's major foreign policy accomplishments, but it came at a price: jettisoning the Republic of China on Taiwan, a longtime ally. Normalization's main proponent, Brzezinski, sought to reestablish the triangular diplomacy of the Nixon-Kissinger years and play the so-called China card against the Soviet Union.<sup>62</sup> Vance argued for caution, believing a quick veer toward the PRC would upset SALT II negotiations and generally disrupt relations with Moscow. Brown and ISA strongly supported closer security

relations with Beijing on the assumption that the stronger the Chinese military establishment the more military resources the Soviet Union would have to divert to counter it and the better off NATO and the United States would be.

This was essentially the advice Brown gave the president and Brzezinski in early February 1977: “The most important factor for the next decade is that the US-PRC relationship will be a major influence on US-Soviet relations. . . . This Administration must foster a relationship with Peking which gives greater global balance to our national security position.” As he told the Joint Chiefs, “the objective was to find some way to normalize relations without abandoning Taiwan,” warning them that “it will be a long slow process.” Brown also made it clear that DoD would no longer accept being cut out of the China policy process. This was just what ISA, smarting from DoD’s exclusion from China policy since 1969, wanted to hear.<sup>63</sup> Nevertheless, Brown remained hesitant to take the lead, as he later recalled, but he did put forward ideas. He endorsed a JCS proposal to establish U.S.-PRC military contacts as a complement to proposed military contacts with the Soviet Union. “The potential is not as great,” Brown wrote the president, “but there are steps we can take. Moreover, we do need to remain aware in our efforts toward such exchanges with the Soviets of the possible adverse effects on our relations with the PRC. Parallel approaches to the PRC could mitigate that problem.”<sup>64</sup>

These proposed exchanges with the PRC were low-key: contacts between defense attachés in third countries, reciprocal visits by defense liaison officers or military historians, observation by PRC officers of U.S. exercises in the Pacific, and exchanges of military students to study at respective defense institutions. The president found it interesting enough to fold the idea into interagency policy planning on relations with China, as requested by PRM 24 of 5 April 1977.<sup>65</sup> Later, in October 1977, Brown suggested a “modest proposal” for briefing the Chinese on NATO initiatives and exercises and possibly for PRC officials to visit NATO headquarters or observe some of the alliance’s military exercises. Brzezinski’s deputy, David Aaron, noted that Brown’s proposal “will not be a ‘low key’ event. It will be big news and will leak almost as soon as we propose it.” Brzezinski agreed to postpone the idea.<sup>66</sup>

The policy examination of normalizing relations with China ordered under PRM 24 continued under State’s chairmanship. Brown’s reaction to the final study was that “the paper undervalues the military value to US of USSR/PRC adversary relationship. 20% of USSR military assets face PRC.” On 27 June 1977 the Policy

Review Committee recommended to the president negotiations for normalization in the “near term” but without jeopardizing Taiwan’s security against potential PRC invasion, unofficial economic and cultural U.S.-Taiwan relations, or U.S. arms sales to Taipei. Vance, who recalled that both Brzezinski and Brown wanted to play the China card, worried that an augmented U.S.-PRC security relationship would spook the Soviet Union, already paranoid about China. Nevertheless, in August 1977, Carter sent Vance to Beijing. Apparently unwilling to make a decision until they sorted out their internal leadership situation, the Chinese refused to compromise, insisting on total acceptance of their three conditions for normalization: termination of the U.S.-Taiwan mutual security treaty, recognition of Beijing as the sole legitimate government of China, and withdrawal of all U.S. forces from Taiwan. At Vice President Walter Mondale’s urging, Carter postponed normalization until after ratification of the Panama Canal treaty (see chapter 3) to prevent the two issues from overwhelming the Senate.<sup>67</sup>



President Carter receives a China briefing on 28 August 1977. Left to right: National Security Adviser Zbigniew Brzezinski, Secretary of State Cyrus Vance, President Carter, Secretary of Defense Harold Brown, and Vice President Walter Mondale. (Carter Presidential Library)

In April 1978, just days before the Senate ratified the canal treaty, Brown, Brzezinski, Vance, and their deputies discussed the pros and cons of normalization timing. Brown favored early resolution: "If the President does not normalize by early 1979, then we may not be able to normalize until the second term, with all the attendant risks entailed." When asked what was gained by normalization, Brown replied, "If we sign SALT and there is not movement on China, then our posture toward the two will be out of kilter." Holbrooke suggested that defending normalization publicly as anti-Soviet would be a diplomatic mistake. Brown answered, "That would be implicit. We have to demonstrate where we have parallel interests with the Chinese, and we have to demonstrate that there is substance to these parallel interests."<sup>68</sup>

Brzezinski presented the meeting's consensus options to the president: seek normalization either before the congressional elections in November 1978, soon after, or wait until 1981. Brzezinski added his own idea that the sale of dual-use technology to Beijing should not set a precedent for sale to Moscow. Unconvinced, Carter wrote at the bottom of the page: "I'm concerned about transferring advanced electronics & other technology to PRC if it can later be used for military purposes. Also [concerned about] a policy of favoring PRC over S. Union."<sup>69</sup> Carter hesitated, but Brzezinski persevered. After fighting a bureaucratic battle with Vance, Brzezinski, with strong support from Brown and Mondale, convinced the president that he, Brzezinski, was the best person to go to Beijing to recharge the normalization negotiations before the congressional elections. With Carter's authorization to accept the three Chinese conditions for normalization, Brzezinski traveled to China in May 1978. As his memoirs make clear, this trip proved to be one of the professional high points of his career; his meeting with the acknowledged successor to Mao, Vice Premier Deng Xiaoping, was the culmination of the trip. Brzezinski and Deng agreed to move forward on normalization negotiations based on the three Chinese conditions. Brzezinski reported that he had obtained a promise from Deng that the Chinese would not contradict the U.S. statement that the solution of the Taiwan issue would be settled peacefully. The price was no U.S. arms sales to Taiwan.<sup>70</sup>

Brown realized that a prohibition of arms sales to Taiwan would make the JCS, others in the military, and many in Congress uneasy. His new deputy assistant secretary of defense (ISA), former NSC staffer Michael Armacost, alerted him to signs that some senior military commanders were questioning and even undermining the policy of gradual reduction of U.S. contacts with Taiwan, a policy designed to

condition Taipei to life after normalization. Armacost recommended getting the Joint Chiefs on board. To that end Brown asked them for their advice in September 1978. They responded that they favored normalization so long as it did not endanger Taiwan's security, noting that the treatment of Taiwan would be viewed as a litmus test of the United States as an ally and as evidence of American resolve in East Asia. If Beijing gave assurances of respect for Taiwan's security and allowed the United States to continue economic and cultural ties, as well as to provide security assistance in the post-normalization period, then the JCS would certify that the Mutual Security Treaty could be terminated.<sup>71</sup> Brown saw their advice as a glass half full, informing the president that "their attitudes toward normalization can be helpful, provided we concentrate on their basic conclusion that they favor normalization and keep their concerns in mind." Brown promised the JCS that he would heed their advice, but he warned them that "the PRC leaders have always rejected public and explicit commitments" on Taiwan, "a matter they consider a question of sovereignty."<sup>72</sup>

With negotiations in Beijing virtually concluded, Carter invited Deng to visit Washington, only to have the visit hit a snag over arms sales to Taiwan. The PRC insisted on a permanent cessation, while the United States offered a one-year suspension. Knowing that the JCS and Taiwan supporters in Congress viewed arms sales to Taiwan as crucial, Carter and Brzezinski worked out a solution with Deng: no mention of the one-year suspension in the communiqué and an assurance that if asked about future arms sales U.S. officials would answer that after one year there would be "restrained sale of selective defense arms . . . in a way that will not endanger the prospects for peace in the region." Furthermore, Carter would say—if asked—that while the Chinese did not "endorse" this U.S. position, they would not let it prevent normalization.<sup>73</sup>

On 15 December 1978 Beijing and Washington issued a joint communiqué establishing relations on 1 January 1979, acknowledging the PRC as the sole legal government of China, and stating that "within this context, the people of the United States would maintain cultural, commercial, and other unofficial relations with the people of Taiwan." A corresponding statement announced termination of the U.S.-Taiwan Mutual Security Treaty, departure of all U.S. troops from the island within four months, and the expectation that the Taiwan issue would be resolved peacefully "by the Chinese themselves." Deng's visit to Washington later in January 1979 was a great success.<sup>74</sup>



Deng Xiaoping, vice premier of the People's Republic of China, and his wife, Madame Zhuo Lin, at their White House arrival ceremony, with President Jimmy Carter and First Lady Rosalyn Carter, 29 January 1979. (Carter Presidential Library)

In August 1979 Mondale visited Beijing and suggested—with Carter's approval—that Brown next visit the PRC. Deng immediately agreed. In Beijing, Mondale announced publicly that the United States did not contemplate a substantial military relationship with the PRC.<sup>75</sup> Nevertheless, in mid-September, Brown told the president: "The time has come to develop a strategic dialogue and military contacts with China to parallel arrangements we have with the USSR." While broadening the bilateral relationship with China, Brown noted the trip could send a message to the Soviet Union.<sup>76</sup> Believing that a Brown trip so soon after Mondale's seemed too obvious a tilt toward China, Vance argued it was the wrong time to begin a military/security relationship that once started would take on a life of its own. Vance also opposed Brown's offering to sell dual-use technology clearly destined for the PRC military or the Chinese underground nuclear testing program. Brown acknowledged Vance's call for caution in fashioning security cooperation with China, but argued "our objective should be to reinforce the impression to

the Soviets that however little or modest [initiatives] we have undertaken with the Chinese to which they could object or honestly fear, *we could* do much more.” Given State’s concerns, the Brown trip was delayed until January 1980.<sup>77</sup>

Initially Carter prohibited discussion of arms sales and a military relationship and playing of the China card during Brown’s trip, reflecting Vance’s warnings. After the Soviets invaded Afghanistan in December 1979, the president reshuffled the deck, authorizing Brown to offer nonlethal military equipment and some high technology transfers. He then gave the secretary last-minute instructions to propose follow-up U.S.-PRC consultations on Afghanistan; to explore U.S.-PRC coordination of support for Pakistan, including Chinese permission for U.S. overflights of China to deliver military equipment to the Karachi government; and to inform the Chinese that the United States would differentiate in Western export controls between them and the Soviets. Specifically, Brown was authorized to offer China a ground receiving station allowing access to a photoreconnaissance satellite, Landsat D (noting it was denied to the Soviet Union) and the sale of a geophysical data processing computer system. If the PRC asked for arms sales, Brown could offer a survey on a no-commitment basis and suggest that the invitation of the PRC defense minister to visit Washington could become a regular event.<sup>78</sup>

The Carter administration had undertaken a major shift in U.S. China policy. The reason was clear: Moscow’s invasion of Afghanistan, which rattled the president and also elevated the China card to one of the best ways for the United States to respond to Soviet aggression. Brown remembers his trip fondly; in 1980 Beijing was still a very exotic place and the Chinese entertained the first U.S. secretary of defense to visit China lavishly. An added attraction was that Brown’s wife, Colene, and daughter Deborah were among the large DoD delegation. Brown met with Vice Premier Geng Biao, secretary general of the party’s military affairs commission, Premier Hua Guofeng, and Deng Xiaoping. Assistant Secretaries Gerald Dinneen (C3I) and David McGiffert (ISA) met with their Chinese equivalents to discuss the transfer of dual-use equipment, the Chinese noting frankly that much of the equipment had military applications.<sup>79</sup>

The Brown-Deng meeting was the pivotal point of the visit. When Brown told Deng that the administration was supporting Afghan refugees in Pakistan, Deng quickly countered that the “only correct approach” was “aid to the resistance forces” with support that was “more than symbolic,” suggesting U.S.-PRC cooperation. “We

must turn Afghanistan into a quagmire in which the Soviet Union is bogged down for a long time, engaged in guerrilla warfare,” Deng added prophetically. Brown responded that “our actions will have that effect, but we must keep our intentions confidential.” Deng saw no problem with Brown’s suggestion of U.S. overflights of China to supply Pakistan. Brown and the Chinese reviewed intelligence collaboration, including the use of sites in China to monitor Soviet missile development and space activities.<sup>80</sup>

The trip to the PRC was stronger on symbolism than apparent results, but it marked an important step in balancing Beijing against Moscow. Expecting a public announcement of a joint strategy to counter the Soviet invasion of Afghanistan or a budding military alliance, many contemporary observers underestimated the impact of Brown’s visit, but he laid the foundation of a Sino-American security relationship. In May 1980 Geng Biao visited Washington for discussions with DoD, which eventually resulted in U.S. approval of 29 licenses for sale of dual-use items and 9 applications for military equipment, thus further solidifying the U.S.-PRC military relationship.<sup>81</sup>

### **Arms Sales and Withdrawal from Taiwan**

Normalization with the PRC required termination of the security treaty and official relations with the Republic of China (ROC) on Taiwan. Ever since 1949, when Chinese Nationalists fled to Taiwan in the wake of the Communist victory on the mainland, the United States had steadfastly recognized the ROC as the legitimate government of China. In the early 1950s Republicans accused the Democrats under Harry Truman of “losing China.” Taiwan established close relations with parts of the U.S. conservative establishment, especially in Congress.<sup>82</sup> Nixon’s 1972 opening to China shocked both U.S. Asian allies and much of the U.S. Republican Party. The Carter administration establishment of full relations with Beijing and abrogation of the Mutual Security Treaty with Taipei reopened these wounds. Taiwan’s supporters claimed Carter was discarding a loyal U.S. ally. While there was certainly truth to the charge, Carter was following Nixon’s lead. Under Nixon and Ford, the drawdown of U.S. troops and personnel on Taiwan began. In January 1977 there were only about 1,800 U.S. troops on the island, whereas five years earlier there had been 9,000—but Carter applied the coup de grace to Taiwan. Brown assumed responsibility for implementing the final withdrawal and reduced U.S. arms sales



to Taiwan, a difficult politico-military decision further complicated by Carter's general policy of restraining sales of advanced weapons.<sup>83</sup>

Before normalization, Taiwan hoped to shore up its defenses with U.S. advanced weaponry. With support of Brig. Gen. L. R. Forney Jr., chief of the U.S. Military Assistance Advisory Group, Taiwan's chief of general staff, Admiral Soong Chang-chih, pressed Washington for the sale of F-16s, Harpoon antiship missiles, improved Chaparral surface-to-air missiles, and other systems "essential" for Taiwan's defense. Such demands convinced the administration of the need for guidelines for arms sales to Taipei. In March 1978 the NSC approved defensive weapons that conformed with Carter's arms transfer policy, would not jeopardize normalization with the PRC, would not change the strategic balance in the Taiwan Straits, and would not provide support for long- or intermediate-range missiles or chemical weapons. In practice this meant that Taiwan received basic weapons and equipment, such as howitzers, low-flying aircraft detection systems, mobile radars, and unserviceable M48 tanks to "cannibalize" for spare parts for existing tanks, but none of the advanced weapons that Taiwan had specifically requested.<sup>84</sup>

Which all-weather inceptor aircraft to sell to the ROC became the focus of policy toward Taiwan for the rest of 1978. Taiwan had 29 serviceable F-104G Starfighters with all-weather capacity that would reach the end of their normal service life by 1980-1981. The JCS wanted to sell Taipei 60 F-4s (armed with eight air-to-air missiles but without air-to-ground capability), which in their opinion would provide a real deterrent to the PRC.<sup>85</sup> The F-4, because of its greater range and larger bomb payload, required a presidential exception to arms transfer policy outlined in PD 13, "Conventional Arms Transfer Policy," approved in May 1977. Worried that Beijing would view the F-4 sale as a "hostile diplomatic signal," the State Department favored sales of F-5Es modified for all-weather capability. DoD preferred the F-4, noting it would take Northrop four years to develop the all-weather F-5E (designated F-5G). Nevertheless, DoD could accept the F-5G.<sup>86</sup> Not satisfied with State's recommendation, the NSC staff checked back with DoD to discover that the all-weather F-5G required a larger engine (that of the F-18), which would make the aircraft superior to the F-5E, would cost more than the F-4, and would not be available until mid-1982 at earliest, more probably in 1984. In effect, the administration would be encouraging the development of a Northrop advanced F-5G fighter solely for export. Brzezinski delayed the decision.<sup>87</sup>

After an interagency meeting in August 1978, Brown, Brzezinski, and Vance recommended to the president the sale of the F-5G with F-16 radar in its nose, avionics changes allowing it to fire the AIM-7 Sparrow radar missile, and a bigger engine with improved performance, but with a range similar to the F-5E. The JCS accepted the F-5G but worried it might not be available as soon as promised. The Arms Control and Disarmament Agency opposed the sale as a violation of arms transfer policy, as did OMB, which added that the U.S. taxpayer could be left subsidizing Northrop's F-5G production since the aircraft would likely tempt few foreign buyers beyond Taiwan.

Carter wrote his decision on the action memorandum: "I agree with OMB and ACDA. My preference would be to offer additional F-5Es with the Israeli option."<sup>88</sup> The Israeli option allowed Taiwan to buy Israeli-built KFIR fighter-interceptors (built with U.S.-made engines), which Taiwan had previously rejected. Anticipating Taipei's disappointment, State recommended that the president sweeten the deal by agreeing to Taiwan's request to buy 500 laser-guided bombs and 400 Maverick air-to-surface missiles, making an offer of coproduction of more than the 48 F-5E aircraft requested by Taipei, and announcing that the United States was keeping open the possibility of "a follow-on aircraft to the F-5E." The president approved the package. No matter how the United States sugarcoated the offer, Taiwan declined, leaving its air force without a weapons upgrade.<sup>89</sup>

In anticipation of normalization of relations with the PRC, Brown submitted to Brzezinski plans to remove from Taiwan two key regional facilities: the USAF Contract Maintenance Center and War Reserves Munitions Stockpile, which included one-third of USAF aviation fuel for the Western Pacific. Brzezinski approved the plans for the president.<sup>90</sup> Brown also outlined additional decisions on Taiwan to be made after normalization: continued delivery of and follow-on support for weapon systems sold or agreed to before 1 January 1979; dispatch of up to 100 additional DoD temporary-duty personnel to supervise and manage the withdrawal; and permission for the 140 ROC military receiving training in the United States to finish their courses. As for equipment provided to Taiwan under the Military Assistance Program, DoD would retain residual rights and probably have the American Institute in Taiwan, an unofficial embassy staffed by "retired" Foreign Service officers (who would be rehired after their Taiwan duty) and military personnel on contract, monitor its utilization and disposition.<sup>91</sup> Brown promised to settle remaining issues: whether U.S. Navy ships should visit Taiwan, whether

Taiwan's military personnel should continue to receive U.S. military training, whether DoD workers could go to Taiwan on temporary duty to troubleshoot, and whether a host of other political-military agreements, such as search and rescue or Taiwan Strait Patrol, should continue.<sup>92</sup> The U.S.-Taiwan relationship had been essentially severed. The Carter administration, including Brown, had cast its lot with Beijing. As the secretary recalled, they worried about abandoning Taiwan, but the value of China as a potential counterweight to the Soviet Union and the necessity of full relations with the emerging power in Asia necessitated the break.<sup>93</sup>

The really big post-normalization issue centered on arms sales to Taiwan after the one-year arms embargo. Congressional hearings on the Taiwan Relations Act, establishing the unofficial American Institute on Taiwan, brought this issue to the fore in spring 1979. Brown and JCS Chairman General Jones assured Congress that Taiwan was safe and secure, that it would receive adequate military equipment, and that invasion from the mainland was extremely unlikely. These assurances did not work. Congress added language in the act so that Taiwan would receive "defense articles and defense services" sufficient to protect itself.<sup>94</sup> In August 1980 Taipei submitted a new list of 15 (later 17) major weapon systems, including all-weather aircraft and air and sea defense weapons. State opposed granting the request, fearing its adverse impact on relations with Beijing. When the administration announced \$287 million in arms sales to Taiwan in January 1980, just before Brown's visit to Beijing, it was for only 6 of the 17 requests, almost all older weapons Taiwan already possessed. Under pressure from Congress, DoD allowed U.S. contractors to discuss purchase of modified all-weather fighter aircraft with Taiwanese officials, but by January 1981 nothing definitive had come of the discussions. With the Reagan administration, Taiwan would enjoy better days.<sup>95</sup>

For many in the Carter administration, normalization with the PRC and termination of relations with Taiwan was a difficult, but necessary readjustment in China policy, in which Brown and OSD played an important role. Brown's trip to Beijing in January 1980 began a security relationship, albeit a modest one, with the PRC that helped rebalance triangular diplomacy among Washington, Moscow, and Beijing. It also sent Moscow a signal of U.S. disapproval of its invasion of Afghanistan. The withdrawal from Taiwan, so disliked by conservatives in Congress and beyond as well as many in the U.S. military, was undertaken carefully and smoothly, with consultation with the government of Taiwan, but it was a gut-wrenching experience for Taipei.

## Japanese Defense

Unlike the pullout from Korea, normalization with the PRC, or withdrawal from Taiwan, there was little controversy about U.S. policy toward Japan. Former Tri-lateral Commission members Carter, Brown, and Vance were equally dedicated to Japan's security.<sup>96</sup> The principal issues had to do with how far and how quickly Japan should be pressed to assume more responsibility for its own and the region's defense, how deeply the Japanese should engage in joint strategic planning with the U.S. military, and how these objectives could be accomplished without undermining the Japanese belief in the steadfastness of the U.S. security commitment.

The American-written Japanese constitution of 1947 permitted the Japan Self-Defense Forces (JSDF) to engage in conflict only in the country's defense. By tradition, Japanese governments limited defense spending to less than 1 percent of gross national product. The highly motivated JSDF could maintain internal security and defend the homeland, its contiguous waters, and airspace against a small conventional attack, but it could not repel a major attack or conduct protracted defensive operations.<sup>97</sup> Japan relied for security against potential adversaries, the Soviet Union and China, on the American nuclear umbrella and U.S. forces in Japan and the Pacific. With growing Japanese prosperity based on its competitive export economy, it seemed natural to ask Japan to pay more to defend itself. In late 1976 the Japanese agreed to adopt a five-year plan to improve JSDF logistics, air defense, and antisubmarine warfare capabilities.<sup>98</sup>

Carter's determination to reduce the U.S. military presence in East Asia made a larger defense role for Japan a logical goal. When Japanese Prime Minister Takeo Fukuda visited Washington in early March 1977, Brown urged the president to encourage the prime minister to increase Japan's defensive capabilities, pay more of the cost of stationing U.S. troops in his country, and cooperate more fully with the U.S. on defense matters. "We want Japan to expand its capability within the present US-Japanese security framework—not to rearm in any major sense, but to contribute more to its own defense and to our overall conventional military deterrent." Brown warned that the Japanese were unlikely to quicken their "steady tortoise-like pace" on defense since they did not perceive the Soviet Union or the PRC as real threats. Ideally, Brown suggested, within five years the Japanese ought to be able to perform their own air defense role, broaden their ASW coverage, assume a greater share of Northern Pacific sea lane defense, and improve their logistics capabilities. Carter pressed Fukuda but received only vague assurances.<sup>99</sup>

The basic pattern of high-level meetings between U.S. and Japanese leaders saw Carter administration officials, especially Brown, pushing for qualitative improvements in Japanese defenses that would require more spending and the assumption of greater responsibilities; the Japanese promised to do so but cited the difficulties. Progress was slow, but there was some movement on Japanese attitudes. Brzezinski noted that “a new climate of opinion is apparent in Japan on defense issues. The opposition parties no longer confine themselves to criticizing government decisions. The editorial boards of the major newspapers now accept the need for enhanced defense capabilities.”<sup>100</sup>

Not all in Washington were so bullish about increasing Japanese defense capabilities and expanding them for regional deterrence. The JCS feared “adverse Japanese reactions” and downplayed Japan’s potential for regional defense, recommending instead concentrating on Japan’s contribution “for the direct defense of Japan.” In spring 1978 the Joint Chiefs successfully opposed as impractical, costly, and unnecessary a proposal by Deputy Secretary Duncan to upgrade the U.S. military structure in Japan so that it would work more easily with the Japanese on defense cooperation. The JCS displayed a better feel for Japanese inclinations. Determined to push Tokyo to assume a bigger defense role, OSD and the White House tended to overemphasize evidence of Japanese willingness to be pushed.<sup>101</sup>

From Tokyo, Brown reported in November 1978 to the president on “abundant evidence of a substantial increase in US-Japan defense cooperation”: \$100 million in additional financial assistance (over the annual \$700 million) for defense sharing for U.S. forces in Japan; joint U.S.-Japanese military planning to commence within the month; and Japanese purchases of F-15s, antisubmarine and maritime surveillance P-3 Orion aircraft, and airborne early warning E-2C Hawkeye aircraft (enhancing their defense and offsetting in some part the large trade surplus Japan enjoyed with the United States). Assuring the president that U.S.-Japan security relations “are in excellent shape,” with improvements to come, Brown enthusiastically concluded: “I sense in Tokyo a more self-assured Japan, proud of its economic accomplishments, and eager to translate that strength into a more substantial regional and global role. . . . The Japanese are conducting themselves more and more like a major power.”<sup>102</sup>

Brown’s optimism was not shared by his adviser on NATO affairs (soon to be under secretary for policy), Robert Komer, who was “stunned by how little we still

let Japan get away with paying for its own defense” and how “we have let them take us for a free ride for so long, and have only recently gotten around to trying even modestly to change things.”<sup>103</sup> Komer’s views were too overstated for Brown, but he did win the secretary over to a systematic and consistent program of persuasion and pressure on the Japanese. Brown commissioned a broad review of U.S.-Japanese relations headed by a retired Foreign Service officer and former U.S. ambassador to Korea, Richard L. Sneider. The study concluded that the United States must demonstrate that greater defense efforts by Japan would not result in reduced U.S. efforts to defend East Asia (especially withdrawal from Korea or reduction of naval forces in the Pacific). The study, calling for a low-key, indirect approach, recommended that the United States define more precisely Japan’s defense mission and role, provide specific assurances of support, and permit Japan greater use of U.S. bases for which they were being asked to share costs. Brown hoped that once the study’s guidelines were refined, he could employ them in future meetings with the Japanese.<sup>104</sup>

Komer definitely agreed with one of the study’s points: “We aren’t going to get enough movement out of the Japanese until we start politely suggesting to them what specific additional measures they might take in the common interest.” Komer believed that Japan’s projected defense program for 1980–1984 was “not moving nearly as fast as we might hope.” Looking at a later, more definitive version of that program, Assistant Secretary for Program Analysis and Evaluation Russell Murray suggested it “was well reasoned and balanced” and that “some of the most serious present weaknesses of the Self-Defense Forces will be corrected, although probably less quickly than they should be.” Japanese purchases of air defense systems, increased patrol capability with P-3C aircraft, and new Japanese antitank and anti-landing craft systems were all positive developments. Still, deficiencies remained in JSDF’s combat readiness and sustainability. The Japanese Defense Agency (JDA) needed little convincing to spend more money, but the more powerful foreign and finance ministries presented obstacles. In conclusion, Murray recommended “a coordinated USG effort to push for increased HNS [Host Nation Support], cost-sharing, full-funding of the mid-range plan [Defense Plan for 1980–1984], and better cooperation between the JDA and other ministries.” Additional efforts required “quiet, patient approaches,” all advice with which Brown fully agreed.<sup>105</sup>

After his October 1979 trip to Tokyo and Hokkaido, Brown reported to the president that Japanese fiscal restraints caused by recession and inflation would

limit the rate of increase or might even decrease Japan's FY 1980 defense budget as well as slow down its 1980–1984 defense plan. Brown “pushed hard to minimize any such effect” during his trip, but the weakening of the Liberal Democratic government in a recent election did not bode well. After viewing JSDF exercises in Hokkaido, Brown told Carter that “they have some good new equipment, but the quantities are small” and stressed “the real need for us [is] to concert strategy, operational plans, and equipment interoperability with them.”<sup>106</sup>

To engage the Japanese in joint defense planning was another DoD objective. In November 1978 the Japanese cabinet approved military discussions between the commander of U.S. Forces in Japan and the chairman of the Japanese Joint Staff Council in February 1979. These talks resulted in joint planning, a joint threat assessment, and eventually a U.S.-Japan planning directive leading to Contingency Plan (CONPLAN) 5098 for defense against a direct attack on Japan and the use of Japanese facilities to support the defense of the ROK and other countries threatened. Brown and Komer (now under secretary of defense for policy) saw the potential of CONPLAN 5098 for expanding the JSDF's role in local ground and air defense immediately around the home islands, freeing up U.S. forces formerly dedicated to Japan's defense for deployment elsewhere, especially in the Indian Ocean and Persian Gulf areas.<sup>107</sup>

The JCS did not see the same potential, recommending allocation in war plans of two full U.S. Army divisions to Japan as well as the one Marine amphibious force (MAF) already stationed on Okinawa to help defend Japan under CONPLAN 5098. In May 1980 Brown suggested that the president was unlikely to accept such contingent force allocation. For political reasons—“to help move Japan towards assuming the predominant role in its own defense”—Brown suggested assigning the two Army divisions to defend Japan, but he insisted the MAF on Okinawa be reserved for reinforcement of South Korea. Although they agreed, the JCS warned that the change could prove counterproductive, causing Japan to lessen its defense effort on the theory that the threat was not as great.<sup>108</sup>

As for defense spending, Komer pressed Brown to insist that the Japanese, at the very least, stand by their late 1979 commitments to 6 percent real growth for the next four years and to keep 1980 defense spending at 0.9 percent of GNP. Komer considered 6 percent growth a bare minimum, “unimpressive when starting from such a low base,” and the 0.9 percent, “woefully inadequate by anyone's count.”<sup>109</sup>



A Japanese Defense Ministry official welcomes U.S. Ambassador Mike Mansfield and Secretary of Defense Harold Brown during Brown's visit to Japan, 12 December 1980. (RG 330, NARA II)

In several meetings with Japanese officials in 1980, Brown focused on the mid-range 1980–1984 defense plan, obtaining promises from JDA that it would fight for a yearly 9.7 percent increase in the defense budget. In December 1980 Brown learned that the Japanese Finance Ministry would consider only a 6.6 percent increase, which would be eaten up by increased personnel costs (2.5 percent) and inflation (3.8 percent). Brown commented: “I hope the Japanese Finance Ministry is prepared to defend Japan from external attack,” because such a cut would “deeply affect US ability to help do so” and would encourage redeployment of U.S. forces to Southwest Asia.<sup>110</sup>

Brown's temporary exasperation with Japanese defense spending clouded the modest success he had achieved: the establishment of high-level contingency planning, ongoing bilateral military discussions, and, to a lesser extent, Japanese acceptance of the need for some increase in defense spending. Given their post-World War II pacifist tradition, the absence of a realistic threat, and the economic adversities of the late 1970s, persuading the Japanese to do more than defend themselves, let alone take on defense of the East Asia region, was bound to be an extraordinarily difficult and frustrating experience.



## Philippine Base Negotiations

The U.S.-Japan alliance was a post-WWII collaboration. The close but sometimes stormy U.S.-Philippines relationship dated back to 1898. The two American bases in the Philippines, Clark Air Base and Naval Base Subic Bay, were key logistical assets during the Korean and Vietnam wars. Few questioned their strategic importance during those wars, but by the end of the conflict in Southeast Asia, Ford administration officials held different views about how the Philippines should be compensated for their use, who should have sovereignty over them, and how many U.S. forces should be stationed there, not to mention the tricky issue of legal jurisdiction over U.S. base personnel. Most Filipinos believed that the United States should pay “rent” for the bases; the United States preferred to count its considerable military assistance and foreign military sales credits to the Philippines as compensation. In 1975 the Ford administration began negotiations to revise the base agreement. With the talks stalemated after his defeat in 1976, President Ford broke off negotiations in December 1976 and left the problem to his successor.<sup>111</sup>

Four days after Carter assumed office, President Ferdinand Marcos sent an informal message about getting base negotiations back on track: “a ‘quiet, no fanfare’ visit by a ‘high powered individual’ in the new U.S. administration who could sit down with the President [Marcos] alone and in secret and say ‘let’s get down to business.’”<sup>112</sup> Carter did not take the bait, but on 26 January 1977 he issued PRM 14 calling for a broad review of Philippine base negotiations under the chairmanship of DoD.<sup>113</sup> In early April, OSD submitted its response to PRM 14, noting that Clark was the only major operational USAF installation in the Southwest Pacific capable of responding to incidents in the region, and that Subic Bay was crucial to the Seventh Fleet. The Pentagon paper presented four basic choices. Option A consolidated facilities on Clark and gave up Camp John Hay—one-third of the base—merely matching Ford’s last offer. Option B called for “Filipinization” of the bases, that is, gradual transfer of management and control of facilities and release of some additional land at Clark to the Philippines. Option C contemplated major reductions in USAF functions by removing them or turning them over to the Philippines, and transfer of most of the land at Clark. Option D would relinquish the bases outright.<sup>114</sup>

At a PRC meeting on 21 April 1977, all agreed that Marcos did not want the United States out. He needed the bases to prop up the faltering Philippine economy.

Compensation and a strong affirmation of the U.S. defense commitment appealed to him. The Policy Review Committee agreed that Subic Bay was essential and Clark was “highly desirable.” Of first importance was access to facilities. Filipinization and consolidation were possible, but Brown and his Pentagon colleagues balked at paying Marcos rent for the right to defend the Philippines, noting that a shift from MAP/FMS credits could cause problems on Capitol Hill. No one suggested giving Marcos an automatic security commitment. All agreed that there was “no reason for haste”; better to let Marcos set the negotiating pace. Taking charge of an interagency task force on base compensation, Brown ordered the Air Force and the Navy to suggest personnel reductions at Clark and Subic.<sup>115</sup>

At the end of August 1977 Brown reported that the task force favored Filipinization because its elements had measurable monetary value that could be added to the compensation package—the worth of returned facilities, defense cooperation, direct-hire, contractual services, and the transfer of excess property—which together allowed the United States to make an offer near or above the Ford administration’s \$500 million. The task force reiterated opposition to rent as a bad precedent for other base negotiations; it would diminish mutuality in U.S.-Philippine relations, and it was rife with congressional complications. Recommending a total package for negotiations of between \$490 million and \$620 million, the task force suggested that U.S. negotiators remain as close as possible to the lower figure. As for personnel reductions, the Air Force was prepared to reduce its presence by 25–30 percent at Clark; and the Navy, by 5–7 percent at Subic over the next three years.<sup>116</sup> However, the JCS strongly recommended to Brown, who agreed, that they defer the reductions because their implementation along with withdrawals from Korea would send an adverse signal about U.S. commitment to the security of East Asia and the Western Pacific.<sup>117</sup>

Before the task force report was officially approved Marcos formally requested a resumption of base negotiations. The State Department sent Holbrooke to Manila, where he obtained from Marcos agreement to drop the idea of rent. In late September 1977 Marcos’ wife, Imelda, came to Washington to deliver the Marcos price for dropping this demand: improved radar and air defense coverage over the southern half of the Philippines’ “soft underbelly”; better aircraft and patrol boats, with guided missiles with a range of up to 300 miles; and an integrated U.S.-Philippine defense plan.<sup>118</sup>

Directly to Mrs. Marcos and in a letter to her husband in late October, Carter reiterated acceptance of Philippine sovereignty over the bases. He agreed to examine the adequacy of current defense planning for the Philippines and produce a joint assessment of Manila's defense requirements. Neither OSD nor the JCS were exactly sure what revised U.S.-Philippine defense cooperation would entail, although both foresaw more consultation.<sup>119</sup>

In November 1977 Morton Abramowitz, political adviser to CINCPAC, headed an interagency group that identified compensation and reduction issues and made recommendations. The group urged taking advantage of the changed attitude in the Philippines. As for the size of the compensation figure, the representatives split but agreed on a package of Filipinization, joint air control, increased Filipino employment on the bases, shared perimeter security responsibility, and return of Camp John Hay as an opening offer. The group recommended two-year personnel reductions of 15 percent at Clark and 5 percent at Subic Bay. The JCS signed on but opposed the 5 percent reduction at Subic.<sup>120</sup>

As DoD prepared for base negotiations, the president eliminated the \$18.1 million grant MAP assistance and the \$18.5 million FMS credits for the Philippines from the FY 1979 budget. While this action pleased human rights advocates, who disliked the increasing authoritarianism under Marcos since his declaration of martial law in 1972, Brown told Carter that it was not the way to begin base negotiations. The president restored the cuts but insisted that further grants be offered as *quid pro quo*s for the bases and be phased out over the term of the base agreement.<sup>121</sup> After the two sides agreed to set aside the Philippines' criminal jurisdiction issue, the negotiations were now, as Armacost noted, on the "fast track."<sup>122</sup>

At the PRC meeting on 28 February 1978, with Duncan attending for Brown, the participants refined the five-year compensation figures: \$150 million in security supporting assistance—but not as a precedent for other base negotiations; \$30 million–\$50 million in MAP to be phased out in FY 1981; and \$200 million–\$250 million in FMS credits for a total of between \$380 million and \$450 million. Since these figures depended on congressional approval, Ambassador to the Philippines David D. Newsom presented the figure not as a binding commitment, but as a best effort to obtain funding from Congress.<sup>123</sup> Marcos counteroffered and the two sides negotiated for the next month.<sup>124</sup> In May 1978, during his trip to Southeast Asia, Mondale stopped in Manila to talk with Marcos, who was reportedly disappointed

with the approximate \$400 million U.S. package. Mondale proceeded to “sweeten the offer” by \$50 million more in MAP and FMS credits, but his real accomplishment was to convince Marcos to move the negotiations to a military-to-military basis, thus paving the way for progress on the important operational and jurisdictional questions, such as delineation of base areas, perimeter security, and role of the Filipino and American base commanders.<sup>125</sup> In October 1978 Senator Daniel K. Inouye (D-HA) had a heart-to-heart talk with Marcos in Manila about why the U.S. president could only promise aid on an annual—not multiyear—basis and how much Congress was likely to appropriate.<sup>126</sup> After the Inouye visit, Vance told Carter in late December that “we have a Philippines base agreement in our grasp” provided Carter was prepared to increase security assistance by another \$50 million, bringing the total package to \$500 million over the five years. Inouye strongly agreed and Carter approved. Carter informed Marcos that “the Executive Branch” would “make its best effort to obtain appropriations for the Philippines” for the \$500 million figure.<sup>127</sup>

On 7 January 1979 Foreign Minister Carlos P. Romulo and the new U.S. ambassador, Richard W. Murphy, signed the agreement, which was only an amendment to the 1947 base agreement, thus not requiring Senate approval, but of course needing congressional funding for the “best effort.” The agreement recognized Philippine sovereignty and stipulated that the Philippine flag would be flown over the bases, while the American flag would be flown in front of and inside U.S. buildings, and as part of public ceremonies. The agreement redefined boundaries, releasing well over half of the acreage of both bases (although the United States retained rights to use some it), and established responsibilities for the respective base commanders, including Philippine control of perimeter security.<sup>128</sup>

The issue of sovereignty was the symbolic crux of the agreement. Marcos attended flag raising ceremonies at both Clark and Subic Bay, declaring them to be the conclusion “of a task begun 80 years ago by Philippine independence leader Emilio Aguinaldo.” For its part, the Carter administration never really considered abandoning the bases. Instead it made a good faith effort to meet Philippine demands for compensation, jurisdiction, more control, and return of land at a time when Marcos was increasingly unpopular among U.S. human rights and democracy advocates. OSD, the Navy, Air Force, and JCS retained what they believed they needed: use of the base facilities to anchor support of U.S. forces in the Western Pacific and the Indian Ocean, with only minimal reductions in personnel.<sup>129</sup>



Philippines President Ferdinand Marcos and his wife, Imelda Marcos (both center), attend the official turnover ceremony at Clark Air Force Base, Philippines. Flanking them are U.S. Ambassador to the Philippines Richard Murphy, left, and JCS Chairman General David Jones (USAF), right. (RG 330, NARA II)

OSD and Brown were instrumental in the Carter administration's four major East Asian initiatives, three of them genuine policy achievements. The most lasting success was normalization of relations with China and the withdrawal of military facilities and personnel from Taiwan. The United States established diplomatic and to a much lesser extent military relations with the largest East Asian military power. Of less immediate-term significance, but still important, Brown made modest progress in convincing the Japanese to rearm, assume more defense responsibility, and engage in joint defense planning with the United States. Finally, the Philippine bases agreement revised the leasing terms of Clark and Subic Bay bases to the mutual satisfaction of Manila and Washington, at least for the time being. Unfortunately, the administration's Korean policy was a disaster, both in the aborted withdrawal scheme and in the reaction to events after the Park assassination. Carter bears much of the responsibility for the Korea debacle because of his determination against all military and congressional advice to effect withdrawal, and his lack of interest in

subsequent Korean developments after the withdrawals were suspended. Brown found himself in the unenviable position of attempting to implement a policy in Korea that he believed was premature and ill-timed. Although the secretary tried to revise the president's withdrawal plan, he was obligated to implement it and did so conscientiously. It fell to Congress, the military, and the intelligence community to lead the public and private fight against the pullout of U.S. forces. After the reversal of his withdrawal policy, Carter left Korean policy to his subordinates, including Brown—often the point man—who were constantly dealing with unanticipated crises, which, in their composite effect, soured Washington's relations with Seoul. The Carter administration's hopes for human rights and democracy in South Korea remained unfulfilled. Sadly, the Korean failures overshadowed the other significant successes that the Carter administration achieved in East Asia.

## NATO Conventional Forces

BY THE TIME PRESIDENT-ELECT JIMMY CARTER chose Harold Brown as secretary of defense in January 1977, NATO had expanded to 15 members. Despite a few crises, the alliance had remained relatively stable since its inception in 1949. Even when President Charles de Gaulle withdrew French forces from the integrated command in Europe in 1966, France still held membership and remained obligated under Article V of the treaty to consider an attack on any alliance member an attack on itself. As a result of France's withdrawal, however, NATO's Supreme Headquarters Allied Powers Europe (SHAPE) moved from Paris to Brussels. Greece also left the NATO command, in 1974, in protest over the Turkish invasion of Cyprus, but it too retained its collective security responsibilities. Although these withdrawals strained NATO, in 1977 the real threats to the alliance and its effectiveness arose from domestic opposition within member countries and a Soviet–Warsaw Pact military buildup.<sup>1</sup>

Western European governments took full advantage of NATO's shield to prosper economically and politically but failed to varying degrees to increase their military contributions to the alliance commensurate with their growing prosperity, choosing instead to allocate resources to social welfare programs. After almost 30 years, Europeans took peace and stability mostly for granted while occasionally worrying about the possibility of nuclear war. They discounted the danger of a Warsaw Pact attack, forged their own better relations with Moscow and its East European allies, and encouraged *détente* between the Soviet Union and the United States. If Cold War tensions threatened war in Europe, the NATO Europeans preferred to trust the alliance's nuclear deterrence rather than endure a conventional war in their backyards. U.S. officials continued to have difficulty convincing members to increase their conventional military budgets and capabilities to counter a

nonnuclear attack. In the view of many Americans, especially Congress, NATO members were not pulling their weight.<sup>2</sup>

For its part, the United States had recently emerged from the long Vietnam War, during which the Defense Department shifted substantial resources from NATO to Southeast Asia. The Nixon administration had tried to rectify a decade of neglect of European issues, including the decline of NATO's conventional capabilities, by declaring 1973 the year of Europe, but war in the Middle East and the subsequent Watergate scandal doomed the initiative. NATO deficiencies were there for all to see. Air Force Chief of Staff General David Jones, the former commander of USAF Europe, told Secretary of Defense Donald Rumsfeld in July 1976 that domestic politics drove the NATO allies' defense budgets and force-structure decisions. Jones described NATO's weapon systems as inadequate, fragmented, uncoordinated, duplicative, and often competitive. Communications were even worse, with national analog and digital systems and NATO systems overlapping each other. Jones cited the example of both NATO and West German communications towers on the same German hills. Command, control, and intelligence suffered from the same problem of myriad systems with national-only defense orientations. President Gerald Ford's secretaries of defense, James Schlesinger and Rumsfeld, sought to correct NATO conventional warfare inadequacies, but their efforts were far from successful.<sup>3</sup>

To make matters worse, the Soviet Union and its East European allies made impressive military strides. In the last ten years the Soviet Union had improved its tactical nuclear weapons and its conventional forces in the European theater. Yet NATO had failed to match or offset these Soviet improvements. The alliance's technological edge and its lead in theater nuclear weapons, which many defense analysts believed compensated for the Soviet bloc's numerical superiority in men and weapons, was fast eroding. DoD Director of Net Assessment Andrew Marshall maintained that there existed in early 1977 a "rough standoff in the overall capability of theater nuclear forces of NATO and the Pact." In conventional forces the scales had tipped in favor of the East. Creating a rough balance sheet, Marshall figured that the Warsaw Pact enjoyed numerical superiority in troops, divisions, tanks, armored personnel carriers, antitank missile launchers and guns, artillery and multiple rocket launchers, and air-defense, reconnaissance, and ground-attack aircraft (see table 9). NATO held numerical superiority only in tactical nuclear weapons, both artillery and air-delivered, and helicopters.



**Table 9. Military Balance in Europe, NATO and Warsaw Pact**

	Quantitative Balance		
	1965	1970	1975
Personnel ( <i>thousands</i> )	800/750 (220/320)	770/820 (180/390)	780/920 (190/480)
Divisions	26/53 (5/22)	25/58 (4/27)	25/58 (4/27)
Tanks <sup>a</sup>	5,800/12,600 (1,600/6,200)	6,000/14,600 (1,400/8,000)	6,100/16,000 (1,400/9,100)
APC <sup>b</sup>	10,600/11,900 (2,800/6,000)	13,300/15,000 (2,900/7,700)	14,700/17,600 (3,700/11,000)
Antitank Weapons <sup>c</sup>	2,500/1,900 (700/700)	3,200/3,400 (600/1,300)	4,500/6,100 (2,400/3,400)
Artillery Weapons <sup>d</sup>	1,800/3,700 (600/1,700)	1,900/5,400 (550/2,700)	2,589/5,695 (500/2,800)
Air Defense Weapons <sup>e</sup>	1,600/3,200 (400/900)	2,200/4,900 (700/2,100)	3,200/4,800 (700/2,300)

**Key**

NATO/Warsaw Pact  
(US/Soviet)

Source: Rear Adm. M. Stasser Holcombe to Harold Brown, attaching table, folder NATO 320.2 (16 March–July) 1977, box 74, SecDef Files, Acc 330-80-0017, WNRC.

<sup>a</sup> Includes medium and heavy tanks (e.g., U.S. M60 series, Soviet T-55, T-62, T-72).

<sup>b</sup> Includes tracked and wheeled vehicles used for infantry combat, reconnaissance, and command.

<sup>c</sup> Includes vehicle and ground mounted AT missile launchers and guns. Includes those armored fighting vehicles, counted above, which mount an antitank guided missile system.

<sup>d</sup> Includes tube artillery and multiple rocket launchers.

<sup>e</sup> Includes air defense missile systems and guns.

Beyond troops and weapons, the Warsaw Pact had the advantage of choosing the time, place, and nature of an attack; more standardized weapons across Soviet bloc forces; a more tightly organized and better-protected chain of command; a sophisticated and extensive chemical and biological arsenal; and a readily available reserve force. For its part, NATO enjoyed the advantages of defense on familiar terrain and superior alliance cohesion once the fighting started. Although the Warsaw Pact had a 5,400 to 4,500 advantage in the number of tactical aircraft, Marshall



The Soviet Union’s conventional combat equipment known as the Big 7. (RG 330, NARA II)

stated that NATO probably offset its disadvantage with the quality of its aircraft and their weapons, operational doctrines, and skilled pilots, crews, and aircraft control. The West had relied on its superior technology, but Marshall feared the technological gap was lessening. By 1976 the Soviets had introduced a new battle tank, a sophisticated combat infantry vehicle, two models of self-propelled armored field artillery, new antitank weapons, the most comprehensive ground-based air defense system in the world, and at least five new combat aircraft. Intelligence estimates later in 1977 confirmed Marshall’s assessment. The East could mount a rapid conventional attack on NATO. If the conflict escalated to theater nuclear weapons, the Warsaw Pact would be at least competitive.<sup>4</sup>

These conclusions mirrored studies undertaken before 1977 by Supreme Headquarters Allied Powers Europe, the Army, Congress, and the RAND Corporation and even found their way into a popular book. SHAPE’s Supreme Allied Commander Europe (SACEUR), General Alexander Haig, cited the need for the “Three R’s”: *readiness*, including training, maintaining supplies, and prepositioning supplies and equipment; *rationalization* of NATO planning, training,

and standardization of procedures and equipment; and rapid *reinforcement* by American, Canadian, and European reserves. The Army's secret report, prepared by retired Lt. Gen. James F. Hollingsworth, pointed out inadequacies in NATO's conventional warfighting strategy in Central Europe. There would be no time for a protracted war allowing for reinforcement by sea. NATO planners should expect a quick campaign with little warning. To counter this threat Hollingsworth called for a "lean-forward strategy" that concentrated robust conventional forces at advanced positions to stop Warsaw Pact invaders at the West German border.<sup>5</sup> The congressional study, under the direction of NATO expert Senator Sam Nunn and Senator Dewey Bartlett, completed in 1976 but released in January 1977, publicly sounded alarm bells about conventional war in Europe. The report concluded (much like Hollingsworth's) that the Warsaw Pact had the ability to mount a blitzkrieg-type attack by 58 divisions with no more than 48 hours' warning (described as "from virtually a standing start") that would cut through the North German plain so quickly NATO would not have time to reinforce conventional troops and would be forced to use theater nuclear weapons to prevent losing large parts of West Germany. The report provided a long list of alliance deficiencies: virtually no prepositioned reserve equipment stocks; inadequate deployment of forces; only half the ammunition stocks and storage required; units having to move through German urban areas to storage sites to pick up ammunition before deploying to defensive positions; inadequate air defense; and insufficient airlift to bring reinforcements from North America quickly.<sup>6</sup>

The RAND Corporation's earlier study, released in November 1976 as *Alliance Defense in the Eighties (AD-80)*, covered similar ground on NATO weaknesses, but it provided a new solution beyond just spending more money. RAND analysts concluded that while NATO had manpower and resource investments roughly equal to the pact, the alliance was not getting as good a return in military power. While NATO's higher personnel costs was one reason, 14 separate national force structures (including France, but not Iceland which was without a military) with their own administrations, weapons, arsenals, R&D programs, and training programs encouraged waste and duplication. Rather than spend more money and compound the inefficiencies, the RAND study recommended that NATO leaders encourage coalition planning and procedural reforms so that the alliance operated as an interdependent coalition.<sup>7</sup>

RAND's advice resonated with the incoming Carter administration's view that reorganization and structural reform could solve most problems. At the urging of McGeorge Bundy, national security adviser to Presidents John Kennedy and Lyndon Johnson, Brown chose Robert Komer as his unofficial NATO adviser and later his formal special assistant for NATO. As Bundy told Brown, "Komer isn't everyone's cup of tea, because he can be abrasive and impatient. . . . But underneath all this surface stuff Komer is a rare bird: extraordinarily hard working, bright, and devoted quite single-mindedly to the U.S. national interest." Bundy considered Komer the premier NATO expert. Based in part on this glowing recommendation, Brown asked Komer to "help me push it [NATO reform] through the bureaucracy." Such a challenge appealed to Komer, who was the principal author of the RAND study. He tirelessly labored in his hard-charging style to transform the RAND recommendations into U.S. and eventually NATO policy. For almost the next three years, until his appointment as under secretary of defense for policy, he focused like a laser on NATO policy, tracking its every twist and turn, bombarding Brown with advice and literally a hundred information and action memoranda, recommendations, and insights almost every month. Brown read them all and often filled the margins with comments.<sup>8</sup>

### **The Carter Administration's Review of NATO**

During the 1976 presidential campaign, Carter outlined ways to correct the conventional warfare asymmetries between NATO and the Warsaw Pact. He called for integration of new technology (including miniaturization) into weapon systems and more precision-guided bombs. He advocated reorganization of NATO weapons procurement (emphasizing standardization and rationalization); a shift in troop deployments to increase the U.S. commitment to NATO; and agreement on the mutual and balanced force reductions (MBFR) with the Soviet Union, which the Nixon and Ford administrations had been negotiating. Once elected, Carter promised a review of European and NATO policy.<sup>9</sup>

In early February 1977 Carter's Presidential Review Memorandum 9 directed a comprehensive review of European policy, one part of which required identifying the major issues confronting NATO. The review asked for recommendations to invigorate the organization politically, examining the validity of the alliance's basic military posture, strategy, and tactics in light of changes in the military balance

in Europe—with special reference to warning time for a Warsaw Pact attack and Soviet improvements. PRM 9 asked whether the administration should consider engaging the alliance itself in a review of NATO strategy and doctrine.<sup>10</sup>

Brown and Komer worried that the State Department would not produce sufficiently dynamic recommendations on NATO. To Komer, the initial State draft “sure has an old familiar musty smell, even to this tired old nose. It really doesn’t convey any sense of urgency or leadership or initiative commensurate with NATO’s importance to us.” As the work progressed, Komer and the Office of the Assistant Secretary of Defense for International Security Affairs, then working with State on drafting the response, assured Brown that the study was improving, DoD’s interests were protected, and the exercise would not cause problems for the Pentagon.<sup>11</sup>

The 2 March 1977 PRM study contained three main NATO recommendations. The United States would seek alliance agreement on undertaking a “Wise-Men’s study” drawn from distinguished citizens of the NATO countries to chart the alliance’s future political and military course and to generate public support for NATO reform. A second recommendation proposed a limited set of initial, economically practical, quick fixes for conventional defense that the NATO defense ministers could agree on in principle to get reform rolling. Finally, the plan anticipated a full NATO review of defense issues, such as force structure, planning, standardization, and mechanisms to implement the changes. The review would not question the policy of flexible response (NATO doctrine of defending Europe by any combination of strategic nuclear weapons, tactical nuclear weapons, or conventional forces as necessary) but would explore ways to make that strategy more effective. Asked by Brown if the Pentagon could live with the response to PRM 9, Komer replied “yes” because it consisted of “inoffensive” and “descriptive prose followed by a few broad and generalized policy prescriptions,” allowing DoD to take the initiative. Unimpressed, Brown commented it was “rather fudge-like. The section on NATO defense matters in particular should be far more specific.” Questioning whether a wise-men’s study could be considered a solid accomplishment, Brown suggested that the call for the initial quick fixes aim for “commitments,” not “goals.” Komer informed the secretary that ISA had actually worked with his encouragement to keep the NATO section general, thus reserving for DoD the task of formulating specific programs.<sup>12</sup>

## DoD and NATO's Long-Term Defense Plan

Brown came around to Komer's view and supported his idea of drafting both short-term and long-term defense plans for NATO. Having worked on NATO issues for three years at RAND, Komer had definite ideas about the alliance's future. In his stark view, NATO had succeeded as an alliance but failed as an institution. Purportedly dedicated to coalition strategy, NATO never developed a corresponding posture; it paid lip service to interdependence but failed in actuality to achieve it. While the United States provided leadership for NATO, Komer believed the U.S. military relied too heavily on a "go-it-alone syndrome" to defeat the Warsaw Pact solely with U.S. conventional forces, instead of "thinking NATO."<sup>13</sup>

In early April 1977 Komer presented Brown with an extensive NATO action program, which owed much to his RAND conclusions that the alliance did not allocate its combined resources efficiently. Komer proposed a collective effort that would bring the rest of NATO forces up to U.S. capabilities, but at a price European parliaments could afford. His recommendations for specific programs and implementation agreements would force members to choose among competing priorities. The old standby approach of goals and targets had failed to achieve real progress, producing nothing more than "paper" solutions such as resolutions, communiques, promises, and studies. NATO needed larger financial commitments from its members to their defense establishments. Furthermore, Komer saw as first priority defense against a Warsaw Pact blitzkrieg—a defense that emphasized quality of personnel and weaponry over quantity—for NATO could never outnumber the Warsaw Pact.

Komer identified 10 programs or priorities essential for NATO's future: readiness; reinforcement; rationalization; reserve mobilization; a revamping of NATO's maritime posture; command, control, and communications (C3); air defense; electronic warfare; logistics cooperation; and modernization of theater nuclear weapons. He proposed that NATO planners use his concept to create a long-term defense program focusing on the above priorities, with special emphasis on programming and follow-through machinery. At the next NATO Defense Planning Committee (DPC) meeting of alliance defense ministers, Brown would raise both Komer's ideas of the long-term and short-term plans, including "quick fixes" in NATO anti-armor and war reserves, and allied reinforcement. Each program would have a "NATO program manager" to oversee implementation. Brown said he would "broadly endorse" Komer's action plan.<sup>14</sup>

Not every American official involved in NATO policy was as supportive of Komer's approach as Brown was. SACEUR Haig believed that Komer and Brown were attempting too much, pushing European governments that faced economic difficulties and political instabilities too fast and too far. To Haig, "successive waves of criticism would be counterproductive"; he preferred a slower piecemeal approach. Later in April, Komer claimed that Haig "is now signed on" to the plan, but Haig still had some doubts, especially about focusing quick fixes on NATO's central front while ignoring its weaker northern flank comprising Norway, Iceland, and the North Atlantic sea lanes and the southern flank comprising Greece, Italy, Turkey, and the Mediterranean sea lines of communication.<sup>15</sup> Although JCS Chairman General George Brown was supportive, JCS planners pointed out problems—the plan was too ambitious and too abrupt; it required extensive consultations with NATO allies. While program managers worked well in the U.S. bureaucracy, the Joint Chiefs worried they might not in NATO's. Reinforcement depended on availability of shipping, which they thought Komer wrongly took for granted.<sup>16</sup>

On the other hand, the secretaries of the Army and Air Force were enthusiastic about the plan. Although the secretary of the Navy was also supportive, he worried that Komer's call for revamping NATO maritime strategy required a false choice between sea control and power projection. To the Navy, sea control was integral to power projection and vice versa. Secretary of State Cyrus Vance, fully supportive, recommended the plan to the president as a "cogent conceptual starting point" with "imaginative specific proposals." Carter's national security adviser, Zbigniew Brzezinski, "was in accord with the general thrust" of the report, which he thought would provide "a useful framework to guide development of a NATO defense plan in the coming year." Concerning what issues to highlight for the president before he attended the North Atlantic Council (NAC) meeting in May 1978, Secretary Brown pointed to the plan's "emphasis on programmatic measures designed to get greater allied contributions in practice, and to engender a higher degree of allied cooperation," adding that NATO had "always been long on lofty rhetoric; I am trying to get greater performance."<sup>17</sup>

One way was to push the NATO heads of government to take an active and visible interest in the alliance. Foreign ministers generally attended NAC meetings, but since Carter was already participating in the seven-nation economic summit in London in early May, he agreed to stay an additional day for the opening session of

the NAC on 8 May 1977. Other NATO heads followed suit. The president used the session to consult with his counterparts and appease the smaller NATO member leaders. He suggested a broad review of the implications of recent and foreseeable changes for the alliance (either by NATO wise men or the NAC itself), a review by defense ministers of needed conventional defense improvements through existing alliance machinery, and an examination of planning and organization required for reform.<sup>18</sup> Carter called for elimination of waste and duplication between national defense programs, a two-way trade in defense equipment between the United States and NATO allies, cooperation among European NATO members in defense production, and a North American and European effort to standardize NATO equipment. The president stressed combination, coordination, and cooperation among NATO allies to strengthen conventional defense, introduce new technology, and emphasize readiness.<sup>19</sup>

The summit participants accepted Carter's challenge, authorizing their defense ministers to develop the Long-Term Defense Plan (LTDP) and oversee implementation of the program. When the defense ministers met later in May 1977, at Brown's urging, they resolved to increase defense expenditures by 3 percent over inflation (real growth) annually. The "three per cent solution," as it came to be called, ran against the grain of Carter's commitment to defense cuts, but it coincided with his administration's emphasis on reallocating defense spending to NATO-related programs. Brown used the mid-May 1977 DPC meeting to shore up support among members stricken by economic troubles—Britain, Turkey, and Portugal—that had expressed reluctance about their ability to fulfill their commitments to the dramatic, albeit nonbinding, pledge.<sup>20</sup>

Also at the DPC meeting, defense ministers authorized the NATO bureaucracy to form 10 task forces (corresponding to Komer's 10 key issues) to initiate the LTDP, as well as the short-term initiatives for improving anti-armor defense, selected war reserves, and force readiness by the end of 1978. The NATO wise-men study, discounted by Brown, fell by the wayside, as NATO officials chose instead to focus on specifics. While DoD had officially passed the ball to NATO, the United States continued to drive initiatives and progress on the LTDP. Brown informed Carter: "Our plan is to stay at least one step ahead of the NATO action by providing US views sufficiently in advance of NATO actions to permit us to exercise a strong influence on the NATO development of the initiatives, without giving the entire program a



‘made-in-USA’ label.’ The LTDP also encouraged U.S. purchase of European defense systems, but despite some preliminary progress, Brown warned the president that Congress was all for a NATO transatlantic weapons trade in theory, except when European weapon systems would replace—either actually or potentially—those made in the USA by American workers. What was really needed, Brown believed, was a major U.S. purchase of a European system.<sup>21</sup>

In September 1977 Komer reported some hopeful signs: the Army’s acceptance of OSD pressure for early reinforcement in Europe, improved sustainability for the NATO center region, and Director of Defense Research and Engineering William Perry’s withholding of funding for procurement of many items until the military services convinced him there was no European NATO alternative. Brown commented that he would believe these accomplishments when they actually produced tangible results, not just promises. Komer, much less sanguine about the long-term defense plan, noted that U.S. “shadow” task forces monitoring NATO task forces had been “pedestrian indeed.” Komer agreed that the Europeans would not enthusiastically buy into the plan until they “see the color of our money—whether we are serious about Buy European and the two-way street.”<sup>22</sup>

After the DPC meeting in December 1977, Brown briefed the president on progress, citing as “the single most important decision” plans to increase the U.S. ability to reinforce NATO from its current capability to move one Army division and 40 air squadrons within 10 days of a deployment decision to moving five divisions and 60 squadrons within the same timeframe by October 1982. Short-term NATO initiatives showed “promising results,” but the secretary warned that success required overcoming vested interests and “go-it-alone” national programming. Finally, Brown reminded Carter that these improvements could not be accomplished by greater efficiencies alone; they would cost money and gradual increases in spending.<sup>23</sup>

In early January Carter stopped in Belgium as part of an overseas trip. At a North Atlantic Council meeting he promised “real increases in United States defense spending,” but without a percentage figure. Carter’s commitment to the “3 percent solution” had and would continue to suffer from his tendency to dilute it. As one NSC staffer recalled, the president told Brzezinski that he would “kiss your ass” if Brzezinski could prove that Carter had agreed to the figure. The NSC staff dredged up the statements and communiqués of the relevant NATO meetings to

find that Brown, not Carter, had signed the document. It remained a struggle for Brown to convince the president to keep the pledge that he had made on the president's behalf. Still, at Brussels Carter unveiled plans to increase rapid reinforcement of NATO and announced that the United States would add 8,000 U.S. Army troops in Europe. Carter formally proposed a summit-level NAC meeting in Washington in late May 1978 to assess the results of the LTDP initiative.<sup>24</sup>

During the first months of 1978, hundreds of NATO staff members in 10 task forces backed up by other officials in NATO capitals labored to improve the 10 long-term categories. Their success, Komer suggested, would be measured by their focus "on programs not words" and by how many NATO nations actually committed to the programs. The biggest disappointment to "Mr. NATO," as Komer dubbed himself, was U.S. inability to live up to the president's rhetoric of NATO procurement as a "two-way street." The administration approached the forthcoming May 1978 NATO Summit without purchasing a single major European weapon system or granting any new dual production licenses. Brown noted that what success NATO had achieved in 1977 owed a great deal to Komer's efforts.<sup>25</sup>

Worries about the two-way street were legitimate, but Komer's concern that the NATO international staff would water down the plan proved unwarranted. NATO planners drafted a plan that met with general approval in the Pentagon. The JCS rejected only 21 of the 200-plus recommendations outright and suggested that less than one-tenth required further study or definition. Other DoD components produced similar assessments.<sup>26</sup> At first glance the cost of the 15-year plan seemed large, an estimated \$83 billion, but closer analysis revealed this figure represented only about 3 percent real growth in anticipated defense spending for all NATO members for the next decade and a half. Still, problems remained. Denmark and Norway would have to increase military spending by 15 percent to shore up NATO's weak northern flank. The United States had already programmed almost 80 percent of its share in its existing five-year defense program, but the allies had allotted only 40 percent over the same five-year span.<sup>27</sup>

While most of the LTDP's recommendations urged qualitative improvements or reorganization of procedures, Assistant Secretary of Defense (PA&E) Russell Murray highlighted the most critical and of highest priority: armor/anti-armor improvements; war reserve stock for readiness; increased prepositioning of equipment for U.S. ground forces; accelerated deployment of a Canadian Air/Sea Transportable Group

to Norway; cargo modification of wide body passenger aircraft for reinforcements; improved maritime command, control, and communications; better air defense for warships; and better NATO mining capabilities for maritime strategy. Air defense required better identification of friend or foe, better C3 capability, and better balanced all-weather interceptor capability. NATO desperately needed an integrated communications system; low-cost communications electronic countermeasures for ground forces, and electronic warfare drones to counter Soviet–Warsaw Pact air defenses; a 30-day supply of ground munitions; and a SACEUR-controlled common war reserve stockpile above the 30-day level for logistics.<sup>28</sup> Once the task forces completed these reports “the real bargaining will begin” over money, Komer predicted. He recommended that Brown convince his fellow NATO defense ministers that the total cost of the LTDP over 15 years would not “break the bank at Monte Carlo.”<sup>29</sup>

### The Washington NATO Summit

Held during the last two days of May 1978, the Washington NATO Summit gave highest-level approval and endorsement of the NATO plan but also dealt with other key issues. A preview of what to expect had taken place at the DPC meeting in Brussels in mid-May 1978. Brown reported to the president that while defense ministers accepted the importance of the Long-Term Defense Plan, many qualified their support because they might have lacked the resources to pay for full implementation. At least, Brown told Carter, they had adopted a program rather than merely a set of general goals. The next step—implementation and follow-up—would be a hard sell to NATO defense ministers and staffs, who feared the plan meant supranational direction of their national defense programs. Brown cited his efforts to dispel this misconception, urging Carter to do the same at the summit, lest the LTDP be relegated to “the status of fond hopes.”<sup>30</sup>

At the Defense Policy Council meeting Brown spoke individually with his NATO counterparts in the hopes of generating momentum for the plan. He met with mixed success. The Dutch found it politically impossible to move another brigade from the Netherlands to northern Germany, leaving them as the only NATO member with just a single brigade forward. Their defense minister did promise that his government would allocate 3 percent real growth in defense spending. West German Defense Minister Hans Apel told Brown that he could not convince the Bundestag (West Germany’s parliament) to fund its share of a NATO airborne warning and control system,

a clear inference that it would not happen until the United States bought more defense systems and equipment from West Germany. The Belgian defense minister reported his government opposed Hawk missiles on its soil (creating a 60km gap in the NATO Hawk air defense belt), was unwilling to fulfill its 3 percent pledge, would not accept a hardened headquarters at SHAPE, and was waffling on its funding for AWACS. The minister admitted to Brown he felt like resigning.<sup>31</sup> Brown told the president that the real problem at the summit would be to convince NATO members to pay for the plan and “to accept the unprecedented degree of multinational cooperation central to the LTDP.”<sup>32</sup> Brown specifically urged Carter to confront the Belgian prime minister in open session with the charge of weakening the alliance.<sup>33</sup>

Also a priority issue was buying European, the two-way street Brown and Komer emphasized. Finally, the United States was well positioned, as it had just agreed to place the German 120-millimeter gun on its XM1 tank and had awarded a contract to five German automotive companies for a total purchase of almost 11,000 administrative use vehicles (trucks, buses, vans, tractors, and forklifts) over the next seven years at a total cost of \$110 million to \$120 million. The United States also had purchased Belgian machine guns and British anti-runway munitions, as well as nuclear, biological, and chemical protective clothing. On the negative side, progress remained slow on efforts to rationalize European defense industries and to improve cooperation of development, production, and procurement of defense equipment within the alliance.<sup>34</sup>

The Washington NATO Summit in May 1978, long on rhetoric, promises, and good intentions, fell short on accomplishments. Heads of government meeting for just two days were limited in what they could accomplish. They could encourage plans already in progress and attempt to persuade recalcitrant NATO colleagues. They could not initiate new programs without first engaging the slow-moving NATO bureaucracy. The president talked a strong game, lauding the LTDP as “an unprecedented attempt by NATO to look across a longer span of years than ever before. It seeks a more cooperative course, as the only sensible way to improve our defenses without unnecessary increases in defense spending.” He promised that the United States would do its part while challenging the allies to do theirs. He reiterated U.S. determination to use nuclear weapons to defend Europe in an effort to dispel fears that the LTDP heralded a lessening of the U.S. strategic nuclear commitment.<sup>35</sup>

The administration hoped that after the summit the issue of NATO's conventional forces would receive high-level consideration and NATO allies would commit themselves fully to the plan. Unfortunately, this did not occur for a variety of related reasons. The 1979 fall of the shah and the rise of the revolutionary Islamic government in Iran (not to mention the administration's later preoccupation with the Iran hostage crisis), and the Soviet invasion of Afghanistan in the same year, shifted the attention of Carter officials from Europe to the Middle East and Southwest Asia.<sup>36</sup>

Inflation proved a second determinate of policy. By 1980 it reached record levels in the United States and problem levels in Europe. To make matters worse, inflation merged with slow economic growth to morph into "stagflation" in the late 1970s. Allocating more money for the NATO plan fell victim to bad economic conditions. Struggling to keep the 3 percent real growth pledge, most alliance members gravitated to the lower cost requirements of the LTDP and eschewed the expensive, really significant ones.<sup>37</sup>

Concerns about conventional armaments were in good part overshadowed by NATO deployment of theater nuclear weapons in response to the newly deployed Soviet SS-20 missiles. The public outcry, especially among nuclear opponents in Western Europe, which swirled around the neutron bomb controversy, distracted West European leaders (see chapter 15). Finally, two key DoD personnel changes took their toll. Haig retired as SACEUR in June 1979 to test the waters for a possible run for the Republican nomination for president. Despite some differences with OSD and Komer over NATO policy, Haig had been a dynamic and forceful commander in Europe and strong proponent of improvement in conventional warfighting. In October 1979 Komer became under secretary of defense for policy, with his additional responsibilities diluting his focus on NATO. In spite of all good intentions, NATO's adoption of the Long-Term Defense Plan, which seemed a high-water mark at the time, receded like the falling tide. Consummation of most goals recommended by the plan happened only partially, or not at all.<sup>38</sup>

### **Tank Guns and the Two-Way Street**

The NATO Long-Term Defense Plan placed special priority on improving standardization and interoperability of NATO national weapon systems. A major obstacle to that goal was the disparity between the U.S. military-industrial complex and that of its NATO allies. European production of weapon systems for the U.S. military faced

formidable obstacles. Congress and the military services often opposed purchases of European weapons on the grounds that not only were U.S. weapons better and cheaper, but U.S. forces should have American-made weapons and equipment. A case in point concerned the new battle tank for NATO. In 1974 Secretary of Defense James Schlesinger and his German counterpart Georg Leber agreed to test the German Leopard II tank against the American XM1 (to be produced under the name Abrams tank) to determine the better tank for both countries to use in Europe. The Leopard lost, but the Germans cried foul, questioning the objectivity of the test and interpreting the results as actually favoring their tank. Given Germany's well-deserved reputation for tank building, many German officials could only assume that the U.S. Army would never accept a non-American tank no matter how good. To salvage some part of the interoperability program, Secretary of Defense Donald Rumsfeld and Leber agreed in July 1976 that the Germans would supply the gun for both tanks and the Americans the engine, subject to U.S. testing of the German smoothbore 120mm gun versus the U.S. rifled 105mm gun. Testing continued into 1977.<sup>39</sup>



The XM1 tank (the experimental version of the Abrams tank) on the test range, December 1979. (RG 330, NARA II)

The tank gun decision had, in Komer's view, "escalated far beyond a technical one. It has become a major political test of German machismo, of Alliance solidarity, of Leber's own future, and even of [the] Executive Branch vs Congress."<sup>40</sup> To Congress, the 105mm rifled gun was made in America by American workers. To the Army, the 105mm gun possessed some advantages: it was lighter and imposed less strain on the whole weapon system; a smaller 105mm shell allowed the tank to carry more rounds while providing extra space for crew "fightability"; and at 3,000 meters (the maximum expected combat range in Central Europe) the two guns were basically equal. The proof would come in the testing of both guns, scheduled for completion by the end of 1977.<sup>41</sup>

Army tests confirmed that the German gun was better for the long term, particularly for dealing with the rising threat posed by advances in Soviet armor expected in the mid-1980s. While it would be more expensive, as Brown informed Carter, "the German 120mm gun is competitive with and in some ways superior to the U.S. 105mm. The extra margin provided by the German 120mm with its growth potential is probably worth the additional 2–5% total cost of investment," but without a favorable agreement on licensing costs, "we are too vulnerable in the Congress."<sup>42</sup>

In January 1978 Brown sent Under Secretary of the Army Walter B. LaBerge to Bonn to negotiate the final deal. To pass "Congressional scrutiny," Brown thought there should be U.S. payment to the German manufacturer for tube and ammunition design; German payment to the United States for breech and penetrator technology; and a free exchange of the technical data package, as was U.S. practice. "Politically," Brown noted, "we need to keep our payments on production for our own forces limited to what we actually use, and to a modest dollar level."<sup>43</sup> LaBerge's mission did not resolve all issues. Although the Army announced at the end of January 1978 the decision to recommend to Congress U.S. development of the 120mm smoothbore for adaption to the XM1 tank, U.S.-German negotiations dragged on for another 10 months until resolved by Bonn's negotiators and Under Secretary of Defense William Perry.<sup>44</sup>

The agreement meant that after 1984, the second series XM1 tanks would carry the German gun (the first series XM1 tanks would go into production in 1979 with a 105mm gun). The significance of the decision to mount the 120mm gun on XM1 tanks went far beyond the cost of the guns or even the U.S. commitment to the NATO two-way street. As Brown told the president, German Defense Minister Hans Apel

had made it very clear that the Defense Committee of the Bundestag would not approve the hefty West German funding portion of the far more expensive U.S.-produced AWACS for NATO countries until there was agreement on the tank gun.<sup>45</sup>

### NATO's Airborne Warning and Control System

The NATO AWACS program was unique since the alliance had never before agreed to pool its resources to buy a major weapon system to own and operate collectively. The system was also a big-ticket item—initially about \$75 million per unit, with a 1976 estimated total cost of over \$3 billion for 32 “Model B” specially fitted AWACS aircraft and associated support facilities. Already in production, the U.S. plane was expensive. Mounted on a Boeing 707 aircraft, AWACS’ large round radome circulated every 10 seconds providing 360-degree radar surveillance. The system could detect low-flying aircraft that NATO’s land-based air defense systems could not. It extended coverage up to 220 nautical miles while flying at 29,000 feet (providing approximately 15 minutes more warning time). It possessed superior radar capable of resisting electronic countermeasures, a good but limited command and control capability, and a TV downlink of surveillance and tracking information that could be transmitted to land-based command and control centers.<sup>46</sup>



A NATO E-3A Sentry AWACS aircraft, October 1982. (RG 330, NARA II)



In June 1976 NATO defense ministers decided the project was too expensive and asked for a less costly program deploying fewer planes and a less expensive (and less capable) version at a cost of just under \$2.5 billion. They agreed that experts could begin negotiations on cost-sharing and industrial collaboration. Beyond the problem of affordability (the experts later reduced the total cost to \$2.15 billion thanks to U.S. concessions, programmed changes, and creative accounting), the project faced uncertainties: How would NATO members apportion the cost of the program; would all NATO members sign on; and which ones would reap economic benefits from production and deployment?<sup>47</sup>

The United States and Germany were expected to pick up the greatest share of the cost, with Great Britain the next largest contributor. British Minister of Defense Frederick Mulley encountered pressure from trade unions, colleagues in the Labor Government, and domestic public opinion to produce Britain's own early maritime airborne warning aircraft, Nimrod.<sup>48</sup> If Mulley could get a definitive answer on how to share the financial burden, he might be able to make the case for AWACS, thus holding off the British advocates for Nimrod. An answer proved impossible because other NATO governments could not decide on the sharing burden that quickly. At the end of March 1977 Mulley told Brown that the British would go ahead with Nimrod to replace their out-of-date maritime warning aircraft. A disappointed Brown responded that he hoped the 11 planned Nimrods could be made as interoperable as possible with AWACS.<sup>49</sup> The British were out, but would France, Greece, or Italy be willing to join? French officials hinted they might consider picking up their share—the fourth largest in early tentative planning—but they never did. Greek funding was also questionable, but not crucial since its share was small. Facing virtual bankruptcy, the Italians could offer only a token \$1 million per year.<sup>50</sup>

West Germany provided the key to NATO's funding of AWACS. Since the withdrawal of the French from the NATO command structure and the economic slide of Great Britain in the 1970s, the Bonn government had become the principal European NATO member. Still, West Germans bridled at being asked to shoulder so large a share of NATO AWACS. Since the United States was already producing AWACS, little incentive existed for the Germans or other NATO allies to purchase the system. They did not have to reject AWACS, but merely to delay until the United States completed its buy of the aircraft or closed the production line. Either the United States would deploy the planes to Europe unilaterally or NATO members

could provide token compensation and/or support. What the Europeans chose to ignore was the mood of the U.S. Congress, which was not prepared to fund the project without foreign cost sharing. Only with European support would U.S. workers continue to build AWACS.<sup>51</sup>

On 31 January 1977 Brown responded to Leber's concerns that the cost of the program was too high for Germany by encouraging the Bonn government to accept its projected \$617 million share of funding. His answer caused the secretary to complain that "Leber is asking for everything except reunification" as the price of the German share of AWACS.<sup>52</sup> Leber and Brown met for the first time in Washington in mid-March 1977. Both Komer and holdover Assistant Secretary of Defense (ISA) Eugene McAuliffe recommended a compromise solution on German funding.<sup>53</sup> After the meetings, Brown reported to the president that Leber toured the AWACS aircraft and although impressed, still thought the German share too much. Brown wrote, "He [Leber] told me in confidence that he has yet to convince Chancellor [Helmut] Schmidt and the rest of the Cabinet, but will try to do so." Brown believed "that Leber has neither the political capital nor the funds (before the early 1980s) to agree now on a full program."<sup>54</sup> Brown's meeting with Schmidt in July produced a similar result. The chancellor complained that "some U.S. military people had pushed the German military too hard, too often." Bundestag members—Schmidt had only a slim majority in the parliament—complained "that AWACS was being forced down their throats." Brown explained to Carter that while Schmidt accepted the military need, AWACS presented him with a tricky political problem.<sup>55</sup>

There were only a few ways to resolve Schmidt's conundrum. The United States could assume a bigger share of the funding; NATO could deploy fewer aircraft and reduce costs in other ways; other nations could assume more of the financial burden; and the United States could make other dramatic gestures to West Germany. All of these fixes occurred before West Germany signed on. In autumn 1977 Leber stated that if the AWACS program was limited to 18 aircraft and its main operating base was located anywhere in the Federal Republic of Germany, he thought he could sell it to his government. Since no alliance member had a problem with the principal location, basing proved a valuable building block.<sup>56</sup> The Italians also played a key role. Brown urged them that "with a defense budget well over \$4 billion per annum, surely Italy can find \$4–6 million annually." He also promised the Italians a forward AWACS operating base. The perennially cash-strapped Italians stepped up

and agreed to pay their allotted share of \$106.1 million (although they would only pay \$5 million annually through 1983 and then make up the difference between 1984 and 1987).<sup>57</sup> Other NATO members had already signed on to their shares, leaving Germany the chief holdout. Brown told the president that Schmidt, even if persuaded to act, could not get approval from the Bundestag before June (after the 1978 NATO Summit in Washington).<sup>58</sup>

The summit came and went without an AWACS agreement. In late October 1978 the new German defense minister in the Schmidt government, Hans Apel, agreed to request Bundestag approval of German participation in the program and assume \$560 million of a total \$1.85 billion cost. (The U.S. share was \$770 million, and the third largest contributor, Canada, had already agreed to \$180 million.) Apel's decision came only after the United States agreed to purchase the German 120mm tank gun and to buy German administrative vehicles for the U.S. Army in Germany—dramatic gestures of U.S. commitment to buying European. Brown warned the president that to get to this point had taken “eighteen months, and we're not out of the woods yet.”<sup>59</sup> The Bundestag agreed to the funding. It looked as if the saga of negotiations over NATO AWACS was finally ending.<sup>60</sup>

In Washington, the Office of Management and Budget considered the U.S. share too generous and doubted Congress would fund it or amend the 1976 Arms Export and Control Act to allow the United States to provide \$50 million in program-related services for NATO AWACS. Brzezinski convinced the president that OMB's fears were unfounded since Congress had already authorized and approved funds for the program (they could be spent when at least one NATO member funded AWACS), and would probably find a way to make the services available. After “a great deal of arm twisting, particularly of the Germans,” Brzezinski argued that refusal to fund the U.S. portion of the program would damage alliance revitalization and kill Brown's credibility with NATO allies.<sup>61</sup>

Ultimately, in early December 1978, 11 defense ministers at the Defense Policy Council meeting signed a multilateral memorandum of understanding on NATO AWACS, subject to their respective parliaments' willingness and ability to fund the program over the next seven years. Brown described the December meeting as “the most successful session I have attended,” citing the AWACS agreement, the ministers' reaffirmation of the 3 percent increase in real defense spending pledge, and their commitment to follow through agreements on the LTDP. The secretary suggested that the

alliance was “demonstrating a significant measure of resolution and confidence rarely exhibited in the past ten to fifteen years.” Two days later the NAC foreign ministers created the charter and organization to run the AWACS program.<sup>62</sup>

Brown’s enthusiasm for the DPC meeting proved well founded. The NATO AWACS program represented one of the high-water marks of alliance cooperation. Nonetheless, it took three more years to iron out the funding details. There was no denying the success of AWACS production and deployment. Aircraft arrived ahead of schedule and under budget. NATO crews and personnel worked together to deploy the 18 planes, although modification of NATO’s ground-based air defense network to interface with AWACS took longer to accomplish than expected and depot-level maintenance issues proved troublesome. In 1986 Great Britain reluctantly wrote off much of its investment in the ill-fated Nimrod and agreed to purchase six AWACS. In the same year the French purchased three systems. NATO AWACS became the most visible and among the most useful interoperable weapon systems in the NATO arsenal.<sup>63</sup>

### **Rapid Reinforcement and Armaments Cooperation**

The same success could not be claimed for efforts to ensure that in the event of a conventional Warsaw Pact attack, NATO would receive rapid and sufficient reinforcements from North America. SACEUR Haig and both the NATO short-term and long-term plans placed heavy emphasis on improving rapid reinforcement. The question remained: How much and how quickly would implementation of those plans actually improve the situation?

Every year DoD staged a military exercise to test the ability of U.S. forces to deploy to Europe and operate in the field. During REFORGER (Return of Forces to Germany) in late 1977, one mechanized brigade deployed personnel by air and equipment by sea to Germany. A second mechanized brigade, plus additional smaller combat and support units, deployed personnel by air and drew from prepositioned equipment maintained in West Germany. The Air Force airlifted approximately 12,500 personnel to Europe through points of entry in Belgium, the Netherlands, and Luxembourg, where they picked up their sea-lifted or prepositioned equipment. When these units arrived, they joined 25,000 U.S. VII Army Corps troops already stationed in Germany, along with NATO allied units, in field maneuvers in Bavaria. In all, 76,000 U.S. and allied personnel took part.<sup>64</sup>

A member of the White House National Security Council staff, James Thompson, observed portions of REFORGER 1977 and summarized his major conclusions for Carter. The prepositioned equipment had been stored in humidity-controlled warehouses, and 97 percent of the vehicles cleared the gate without maintenance, causing Thompson to conclude that prepositioning equipment was the most cost-effective method of deploying equipment to Europe. As for readiness, most staff officers told Thompson that Army procedures, especially loading combat vehicles with ammunition, went well and were improving. The same could not be said for communications. Outdated and incompatible gear meant the Army and Air Force had trouble talking to each other; voice communications were often garbled, and some secure communications had to be manually encoded and decoded, wasting time. Interoperability of weapons for U.S. and German forces went smoothly thanks to extensive preparation and a large number of liaison officers on hand, but Thompson wondered how well U.S. and German units would operate in the wake of an attack without this careful planning and oversight. At Carter's instructions, Brown read Thompson's analysis. The secretary noted next to the summary of the REFORGER 1977 communications problems, "He's *right*."<sup>65</sup>

A substantial exercise, REFORGER represented only a small approximation of the real thing. Such exercises are usually preordained to succeed, given the planning that goes into them. In October 1978 the JCS designed and scheduled three related exercises to evaluate U.S. full mobilization in response to a Warsaw Pact attack. Nifty Nugget, Petit Nugget, and Rex-78 were paper/computer exercises (no troops or supplies actually moved) that involved high-level Defense officials (Under Secretary of Defense for Policy Stanley Resor acted as secretary of defense) and officials from civilian agencies. The exercises tested thousands of functions and relationships; many passed with flying colors, but at its most basic level—could the United States move the troops and equipment to Europe—it failed miserably. In addition, Petit Nugget exposed glaring gaps between DoD and civilian agencies. Rex-78 indicated that U.S. industry was not prepared for mobilization. In simulated exercise Nifty Nugget, the Air Force and Navy attempted to "move" 400,000 troops and 350,000 tons of equipment, ranging from medical supplies to heavy weapons, from the United States to reinforce U.S. first-line units in Europe (many of them understrength). Technical and computer foul-ups ruled supreme. Much of the equipment theoretically never got there. For example, one airlift team received 27

validated requests to send the same unit to 27 different places. Equipment that did hypothetically arrive was too late and too little, and was theoretically expended in a war in which most of the 400,000 U.S. troops in the NATO theater “died.”<sup>66</sup> Senior officers and the JCS found the exercise highly revealing. The computer-simulated test indicated that from 200,000 to 500,000 troops never made it to the battlefield. As one three-star general put it to Komer, “We couldn’t actually go to war if we had to!” Brown informed the president “that in a real mobilization and deployment to Europe we would have extremely serious planning, management, and resources deficiencies.” The secretary promised to use the feedback on the exercises to fix the most glaring deficiencies as soon as possible.<sup>67</sup>

The exercise gave proof that the system was broken and needed repair. Study of the lessons of Nifty Nugget continued to the end of Brown’s tenure. As a first step,



An M60 tank and its crew take part in REFORGER training exercises in Germany, July 1978. (RG 330, NARA II)

the secretary established a Mobilization Steering Group under Komer to create a new master plan and foster military-civilian cooperation for mobilization. In 1979 Brown established the Joint Deployment Agency as an arm of the Joint Staff to integrate the three military transportation agencies (Military Airlift Command, Military Sealift Command, and Military Traffic Management Command) into a single Joint Deployment System. Airlift capabilities received a shot in the arm. On the civilian side, the creation of the Federal Emergency Management Agency at least held out hope that civilian-military relations might improve during mobilization.<sup>68</sup>

At Carter's insistence, DoD held another mobilization exercise, Proud Spirit, in November 1980, although this one tested only a theoretical response to a crisis in Europe, not war-making. The exercise was much less challenging than Nifty Nugget. For example, it assumed that most of the million U.S. nationals in Europe would find their way home in an orderly manner at the onset of the crisis, thus avoiding one of Nifty Nugget's horrendous failures: a simulated free-for-all as U.S. civilians arrived en masse at U.S. military bases in Europe clamoring to be evacuated stateside. Still, during Proud Spirit computers crashed and airlifters failed to connect with their simulated loads at U.S. bases. After the 13-day exercise, Brown saw some improvement based on his reforms, but he admitted that additional work was needed. NATO's reinforcement and U.S. mobilizations problems would not disappear anytime soon.<sup>69</sup>

Brown undertook another long-term NATO initiative by charging Perry to work with other NATO armament directors to encourage alliance cooperation in research, development, and production of weapons. The United States spent \$12 billion annually on military research and development. The other NATO allies expended only \$4 billion. (France, Germany, and Britain spent about \$1 billion each, with the rest of NATO making up the last \$1 billion.) Such a disparity meant that the West European allies could not compete effectively with America in developing high-technology weapons. More than a matter of money, other NATO members were not efficiently using what they invested because their R&D programs overlapped. They diluted their efforts across a whole spectrum of systems to compete with the United States and each other. Their smaller production volume made their weapon systems more expensive. To promote domestic jobs and third-country sales they often produced lower quality equipment than they could buy from America.<sup>70</sup>

The “two-way street,” buy-European efforts encouraged by Brown, Komer, Perry, and others in DoD made NATO allies feel better about their imbalance in weapons procurement with the United States, but did nothing to rectify the systemic NATO inefficiency in R&D, production, and deployment of better weapons. The solution, according to Perry and Brown, was the “family of weapons concept” to induce West Germany, Britain, and France to produce the best equipment for NATO in their proven areas of specialization. The United States would take the lead in developing one member of the family while one or more NATO allies would tackle others. As potential examples Brown cited the next generation of antitank weapons, air-to-air missiles, antiship missiles, and air-to-ground weapons. In the antitank category, the Army was planning to develop a replacement for the TOW (tube-launched, optically tracked, wire-guided) missile at an R&D cost of \$250 million and the shoulder-fired antitank Dragoon missile at a similar R&D cost. Perry suggested to his NATO counterparts that the United States develop one system and a European consortium another, with each side agreeing not to compete and to share data, thus cutting R&D costs in half and allowing European consolidation of production to reduce unit cost.<sup>71</sup>

Brown and Perry championed dual production and coproduction of weapon systems that allowed NATO allies to produce U.S.-developed weapons under license, thus obviating the need to buy the U.S. versions. DoD had signed agreements for coproduction of the AIM-9L Sidewinder (heat-seeking air-to-air missile), Modflir (night vision device), and Copperhead (laser-guided artillery shell). Perry was negotiating similar arrangements for the Stinger (heat-seeking, hand-held, surface-to-air missile) and the Patriot (surface-to-air missile). U.S. production of the Franco-German Roland (short-range surface-to-air missile) was already agreed on. Dual or coproduction had the obvious advantages. Europeans could focus their limited R&D budgets on weapons not similar to those the United States already produced. They could have larger production runs for weapons they developed because the United States planned to purchase them. Such an arrangement facilitated NATO interoperability of equipment. The downside included possible leaks of technology and possible transfer of related technologies to NATO allies, who might then use U.S. technology to compete favorably with the United States in other nonmilitary fields. Still, Brown thought the advantages far outweighed the risks. Carter agreed, offering to help further the “family of weapons” and dual-production efforts.<sup>72</sup>



Not all of these initiatives worked out as hoped. The West Europeans never coproduced the Stinger because of opposition from the State Department about providing such sensitive technology, even to a NATO ally. Brown convinced Vance to allow sales to West Germany, but not coproduction.<sup>73</sup> While the United States engaged in coproduction of the West European–designed Roland short-range surface-to-surface missile, the Army did not adopt it for large-scale service and U.S. industry did not produce a large number of Rolands. In Europe the Franco-German missile enjoyed more success.<sup>74</sup> Congress and organized labor generally looked askance at coproduction, seeing the immediate loss of American jobs. Also, Komer believed that for bureaucratic, parochial, and nationalistic reasons NATO armament bureaucrats themselves resisted the idea. Much of DoD, Komer suggested, did not take seriously the commitment to the two-way street, coproduction, standardization, and interoperability of NATO weapons, seeing the initiatives as fads promoted by Brown and his OSD staff. Like so much of NATO reform, armaments cooperation often took two steps forward, three steps back.<sup>75</sup>

### **Mutual and Balanced Force Reductions**

Another way to improve NATO's conventional posture was to negotiate reductions of alliance and Warsaw Pact troops in Europe, theoretically lessening the pact's advantages in numbers. Inheriting the ongoing negotiations for mutual and balanced force reductions that had been taking place in Vienna since October 1973, Carter embraced the concept as part of his general policy toward Europe and NATO.<sup>76</sup> At first glance mutual and balanced force reductions seemed contradictory to the goal of increasing NATO's conventional military capabilities, but the argument held that the reductions would be mutual and balanced and therefore not affect the balance in Central Europe. By insisting on reducing Soviet manpower and tank advantage, MBFR might thus improve the balance in NATO's favor. An initial attraction of MBFR to the Nixon administration had been its effect in blunting congressional demands for unilateral withdrawals of U.S. forces from Europe, since negotiated reductions seemed preferable to unilateral cuts. To Moscow, MBFR represented a bargaining chip to convince the West to agree to the accords stemming from the Conference on Security and Cooperation in Europe (CSCE) held in Helsinki, a series of reforms to lessen potential conflict and tension in Europe and ostensibly codify and guarantee human rights. Most important for Moscow, CSCE

legitimized Eastern European borders. With the signing of the CSCE agreement in 1975, the Soviets came to view MBFR as the military side of détente, but even as congressional pressure for U.S. troop withdrawal from Europe waned, MBFR negotiations continued at a snail-like pace.<sup>77</sup>

The lack of progress was not surprising. MBFR talks consisted of cumbersome multilateral negotiation involving 19 nations. Seven NATO countries (West Germany, Belgium, Luxembourg, the Netherlands, Britain, Canada, and the United States) and four Warsaw Pact members (East Germany, Poland, Czechoslovakia, and the Soviet Union) with forces in Central Europe—defined as West and East Germany, Poland, Czechoslovakia, and the Low Countries—were designated as Direct Participants. The rest of the NATO and Warsaw Pact members—less France and Iceland who opted out—were Special Participants. In reality, Washington, Moscow, and Bonn were the key players. The West favored incremental and asymmetrical reductions; the East opted for equal cuts across the board. Before 1977 NATO negotiators had proposed in a first stage that the Warsaw Pact remove a Soviet tank army of five divisions (68,000 troops and 1,700 tanks) in return for a reduction of 29,000 U.S. troops. In a second phase, the West anticipated reducing both alliances to 700,000 ground troops and 900,000 air and ground troops combined. In December 1975 NATO sweetened the deal by offering to withdraw 1,000 tactical nuclear weapons as well as 54 nuclear-capable F-4 aircraft and 36 Pershing missile launchers (then considered expendable). The East counter-proposed a single agreement to reduce all air, ground, and air-defense forces by 17 percent in three stages over three years. In February 1976 the East accepted that U.S. and Soviet reduction would go first, suggesting that 300 U.S. and 300 Soviet tanks could be included in a first stage. Still the two sides remained far apart.<sup>78</sup>

On his second day in office, 21 January 1977, Carter ordered an interagency examination (PRM 6) of the MBFR negotiations. The resulting study was more of a review of negotiating positions and each side's interests and objectives than recommendations for a new policy. At an early February 1977 Special Coordination Committee meeting, attended by Brown, Duncan, and Lynn Davis for OSD, committee members generally agreed that congressional pressure for U.S. troop withdrawals had abated, but the European allies still faced heavy budget pressures to reduce their force levels. MBFR could help ward off these pressures. Since the Warsaw Pact buildup of recent years was not in troops or tanks but in the overall

quality of weapons, the participants suggested retooling the basic concept of MBFR. All agreed on West Germany's role as crucial, since the Soviets had as a primary objective not just to constrain a U.S. buildup but also a West German one. The committee also agreed on the need for an eventual modification to the U.S. position, since the common ceiling of 900,000 forces would require the Warsaw Pact to enact reductions two to three times greater than NATO's—an idea not likely to appeal to Moscow. As usual the participants recommended more study.<sup>79</sup>

Further study of mutual and balanced force reductions failed to produce a U.S. negotiating strategy. Wary of any changes in the MBFR negotiating position and suspicious of Soviet data on actual force strengths, the JCS and the U.S. delegation to the talks believed that the Soviets were purposely understating their troops in Central Europe.<sup>80</sup> In July 1977 Schmidt suggested to Carter that MBFRs be taken in stages. Instead of a whole frontline Soviet tank army, the Soviets could withdraw the equivalent of five divisions of 68,000 men and 1,700 tanks. Under pressure from the left wing of the Social Democratic Party, Schmidt vowed to take MBFR out of the “the jungle of experts” and get the negotiations moving. Carter proved amenable.<sup>81</sup>

In September 1977 the SCC reviewed the data issue of how many Warsaw Pact troops were in Central Europe. The “irreducible minimum” of the disparity between U.S. and Soviet estimates was at least 100,000 and more probably 160,000 troops. The West Germans were prepared to present Schmidt's initiative to the East before the data issue was resolved. The SCC agreed with the Germans that while the Soviets would not have to reduce a tank army up front, their reductions would have to be in units of division size; two-thirds of U.S. reductions (29,000) would be in units or subunits (including platoons). The committee recommended presenting the German initiative to NATO.<sup>82</sup>

The JCS and Army soon expressed serious doubts about this decision, although JCS Chairman General Brown apparently failed to raise them at the SCC meeting. They argued unsuccessfully for an NSC review of the issue. These doubters received powerful support when Senator Nunn strongly opposed the proposed concessions on the grounds that the whole point of MBFR was to eliminate a frontline Soviet tank army in East Germany, a major part of the Warsaw Pact's ability to launch a blitzkrieg attack. Furthermore, Nunn opposed the reduction in what he assumed were U.S. combat and combat support units as weakening NATO against the threat that the revised proposal would leave undiminished. The OSD staff predicted that the

Soviets would undoubtedly withdraw 1,700 “junk” World War II tanks as opposed to “first-line” ones. They also warned that reductions in manpower could not be verified and would come from rear echelon troops, probably from Poland and Czechoslovakia.<sup>83</sup> After talking to Secretary Brown and Brzezinski, Carter assured Nunn that the German proposal was part of a package involving an accurate inventory of troops on both sides that contemplated step-by-step reductions toward equality of forces, with the Soviets making the larger reductions. The president noted that “we are a long way from agreement.”<sup>84</sup> Carter asked Brown to talk to Nunn. The secretary reported that Nunn feared that focusing on manpower would create “an essentially cosmetic arrangement which would create a false sense of *détente*” given the problems of verification of manpower withdrawals and clandestine reintroduction. Brown disagreed, but he failed to convince the doubting senator.<sup>85</sup>

Carter was right about the MBFR timetable. NATO consultation was time consuming. Not until April 1978 did alliance negotiators in Vienna propose the West German package. When the Soviets counter-proposed in June 1978, it looked as if there might be some basis for an understanding on a common ground forces ceiling of 700,000 and a ground and air force ceiling of an additional 200,000 (900,000 total). There would be withdrawal and limitation of Soviet tanks as well as U.S. tactical nuclear elements. But there were still problems, primarily that Eastern bloc data required the pact to withdraw only 105,000 troops. NATO’s estimates required reducing the number of Eastern bloc troops to 262,000 to reach the 700,000 ceiling. Accepting Warsaw Pact data, the West would be reducing by 15 percent and the East by 7 percent.<sup>86</sup>

As the Carter administration prepared to respond to the proposal, DoD officials raised a red flag: MBFR could undercut the Long-Term Defense Plan, which aimed to revitalize NATO’s conventional forces.<sup>87</sup> The SCC decided in August 1978 that it was time to smoke out the Soviets’ faulty data. The committee considered two approaches: provide Western intelligence as of January 1976 to the East (favored by State, OSD, and ACDA) or provide only intelligence approximations (CIA’s choice since it protected its sources and methods), and (as the JCS suggested) insist that the East must table additional and more accurate data. Brzezinski chose the first option, provided the British and West Germans agreed. This focus on data essentially postponed a substantive response to the Eastern counterproposals.<sup>88</sup>

Growing doubts about mutual and balanced force reductions continued in the Pentagon. Under Secretary Resor (a former U.S. MBFR negotiator) favored a series of ongoing reassessments of MBFR. Komer, Haig, and the JCS all argued for a major reassessment of the negotiations, reiterating that the deal would harm NATO's reforms and did not take into consideration Soviet improvements in war-fighting capabilities.<sup>89</sup> Furthermore, basic geography favored the East. U.S. troops had to withdraw across the Atlantic; the Soviets merely had to fall back across the East German and Polish or Czech borders, and their ability to slip forces back in was much too easy. Proponents of a reassessment argued that MBFR appealed to the Soviets because they would slow down NATO progress on building up conventional forces. If the East wanted an agreement it would have to make more concessions.<sup>90</sup>

In late December 1978, anticipating Carter's meeting with Soviet leader Leonid Brezhnev to sign the SALT II accords, Brown informed the president that MBFR stood "at a critical juncture." He suggested that Carter could press Brezhnev for larger Eastern reductions to meet the common ceilings based on real parity and insist on better Eastern data, but the secretary doubted Moscow would do much bargaining before the SALT treaty was ratified.<sup>91</sup> Of course, SALT II stalled because of fierce Senate opposition and then killed by the Soviet invasion of Afghanistan. After the hostile reception to SALT II, the Carter administration revised its criteria for arms limitation agreements to make them more acceptable to critics. Within this environment and with Iran and Afghanistan dominating the international scene, MBFR began to move to the backburner.

Brown enjoined ISA to chair an in-house review of MBFR and tapped Deputy Assistant Secretary of Defense (ISA) Lynn Davis to undertake it. Her report coincided with the major JCS concerns that the current negotiating position was seriously deficient in light of recent Warsaw Pact military posture improvements, that henceforth MBFR should focus exclusively on conventional weapons (not embroiling MBFR in NATO's negotiations and plans to improve its theater nuclear forces in Europe), and that verification be a prerequisite.<sup>92</sup>

While DoD decided that current MBFR policy was a no-win game, State and ACDA still believed an agreement remained attainable and useful. At a mid-September 1979 SCC meeting, Deputy Secretary of State Warren Christopher and ACDA's representative at the meeting, Spurgeon Keeny, argued for large NATO reductions to obtain maximum Soviet concessions. Secretary Brown and JCS

Chairman General Jones countered that the United States should avoid reductions lest they imperil NATO's conventional weapons improvements, although if absolutely required, they should amount to less than 10,000 troops. Brzezinski fashioned a compromise at 13,000 U.S. troops for 30,000 Soviet forces and a reduction of 1,200 Warsaw Pact tanks for the removal of 1,000 U.S. nuclear warheads (but without reference to delivery systems). In October 1979 Brezhnev offered a unilateral withdrawal of 20,000 Soviet troops and 1,000 Soviet tanks from East Germany (considered a beginning of phase one without any agreement, verification, or agreed data). In early December the West tabled its proposal—without reference to nuclear warheads or tanks. In the same month the United States announced withdrawal of 1,000 nuclear warheads as a reciprocal gesture to Brezhnev's offer, but refused to consider the 20,000 troops/1,000 tanks offer as part of MBFR.<sup>93</sup>

Even with these unilateral offers, MBFR could not move forward. To NATO, the Soviet troop data was still flawed. The verification problem persisted. MBFR was essentially subordinate to SALT II negotiations, with neither side really committed to concessions and both hoping for an agreement that would give them the edge. Brown, far more involved in SALT negotiations, had confessed half-jokingly to Carter that he did not always follow the details of the MBFR negotiations. MBFR was essentially a "technicians" negotiation with political leaders occasionally asked to make policy decisions.<sup>94</sup> Although both sides offered some concessions, no consensus emerged on which to base an arms limitation agreement. Brown and OSD approached MBFR cautiously and constructively but ultimately realized that a conventional arms limitation agreement in Europe that conceded to the Soviet Union a serious manpower advantage was not worth pursuing. MBFR negotiations continued during 1980 but made little progress, to the disappointment of virtually no one in DoD.

### **NATO's Southern Flank**

NATO's Long-Term Defense Plan and the allies' unwillingness to be beguiled by Soviet MBFR "unilateral" concessions meant that the conventional defense posture on the central front, if not improving, was at least not losing much ground to the Warsaw Pact. The same could not be said for the shambles of NATO's southernmost flank. In 1974 Greece and Turkey had almost come to blows over control of the Aegean Sea and Cyprus (inhabited by warring Greek and Turkish Cypriot communities). When Turkey invaded Cyprus and partitioned the island in 1974, the Greeks

left the NATO command structure in protest, thus closing Greek military bases to NATO forces and preventing the home porting of the Sixth Fleet. In response to the invasion and partition, and at the urging of Greek-American congressmen and the Greek-American lobby (there was no corresponding Turkish lobby), Congress imposed an arms embargo on Turkey, since it had used U.S. supplied weapons without American authorization in Cyprus. The Turks responded by voiding U.S. security agreements and suspending NATO-related operations, except at Incirlik, the main NATO base in Turkey.<sup>95</sup>

During the 1976 presidential campaign, Carter played to the Greek-American voters, creating the expectation that once in office he would tilt in favor of the new, leftist and democratic Greek government that took power after the Turkish invasion of Cyprus. A Cyprus settlement and reintegration of Greece into NATO became a Carter administration goal. The president ordered through PRM 5, 21 January 1977, an interagency review of Cyprus and Aegean policy as well as relations with Greece and Turkey. Quite rightly, Carter viewed a settlement in Cyprus as key to strengthening relations between Greece and Turkey and between them and the United States. Carter's policy moved ahead on three fronts: a Cyprus settlement; better military relations with Greece—especially signature of the U.S.-Greek Defense Cooperation Agreement (DCA); and the lifting of the arms embargo on Turkey, as well as obtaining congressional approval of a DCA with Turkey. At Carter's behest, former secretary of defense and presidential troubleshooter Clark M. Clifford attempted to mediate the Cyprus dispute, but a settlement and reunification of the island eluded Carter just as it had his predecessors.<sup>96</sup>

Repairing the damage with Turkey also met with difficulties mainly because of congressional opposition. One pressing reason to restore the military relationship was to reopen intelligence collection facilities in Turkey, whose operations were suspended by the Ankara government after the embargo. The collection centers were crucial to assessing Soviet missile and space launches, force deployments, nuclear detonations, and air defense, as well as verifying the SALT agreements. In early January 1978 Brown, with support from the JCS and SACEUR Haig, informed the president that unless something was done for the Turks the military situation on NATO's southern flank would continue to deteriorate and Turkey might well leave the alliance. Disciplined and well-trained Turkish troops, greatly hindered by WWII-vintage military equipment, were no match for the Soviet armed forces.

Young officers expressed frustration and resentment that NATO underappreciated their frontline contribution to guarding the southern flank. Brown told Carter that the Turks “are irked because we appear to be acting at the bidding of Greece,” which was stalling on signing its own DCA in order to hold up the U.S.-Turkish accord: “We should not let them [the Greeks] control our relations with Turkey in so crude a manner.” If Carter asked Congress to approve lifting the embargo and signing a Turkish DCA, Brown promised his support as well as that of the JCS and Haig.<sup>97</sup>

Carter and the White House remained wary. The Greek-American congressional caucus led by Senator Paul S. Sarbanes (D-MD) and Democratic Representative John Brademas of Indiana staunchly opposed a DCA with Turkey until the Turks showed visible signs of progress on Cyprus. The White House eventually accepted OSD’s view. In June 1978 Brown promised Turkish Prime Minister Bulent Ecevit that the administration would push for the DCA and lifting the arms embargo, “since we are ‘in this together.’” Brown encouraged Ecevit to make conciliatory statements and gestures, especially reiterating promises that the U.S.-Turkish intelligence relationship could resume after the embargo was lifted.<sup>98</sup>

OSD and the White House focused on persuading Congress to lift the arms embargo. Brown, Haig, and other DoD officials lobbied key members, many of whom were sympathetic to the administration’s case but wanted political cover from the Greek-American lobby.<sup>99</sup> In summer 1978 both the House and Senate voted in favor of lifting the ban provided progress occurred on a Cyprus settlement. In return Turkey opened its bases to NATO and resumed the intelligence relationship with Washington. Lifting the embargo was a symbolic measure; what really mattered was the kind of military assistance and grant aid Washington could provide to Ankara. One JCS estimate concluded that Turkey would need \$1 billion per year over the next 10 years to get its armed forces up to NATO standards. Such a huge figure was out of the question, so the JCS settled on a scaled-down security assistance package of \$300 million per year, including \$30 million in military grant aid. The State Department argued that Congress would not agree even to the \$30 million figure in grant aid given the lack of progress on Cyprus. Vance, Brown, and Brzezinski decided in December 1979 not to press for a large assistance program, which was bound to fail on Capitol Hill and thereby worsen relations with Turkey, but to focus instead on liberal and large foreign military sales credits under favorable terms.<sup>100</sup>



In 1980 the economic and political situation in Turkey had deteriorated, and in September the military overthrew the civilian government. Any chances that Congress would consider military grant aid evaporated; Turkey received none in FY 1981. With as much as 25 percent to 60 percent of its major weapon systems inoperable and 50 percent of its NATO-dedicated aircraft unfit to fly, Turkey was unable to fulfill its role in NATO strategy. Komer suggested that “Turkey’s current security requirements (and NATO missions) are wholly unrealizable at any likely level of funding—especially when economic aid must take priority.” It was time to rethink the defense of the southern flank and revise Turkey’s role. Without a capable Turkish military, the southern flank would remain NATO’s weakest link. The reopening of Turkish bases to NATO and the resumption of intelligence relations, although important, in no way solved the underlying problem. Turkey remained the weak NATO member, but without congressional support Brown and OSD could do little to help.<sup>101</sup>

Greece was a different case. Congress remained sympathetic to the Greek government, which had reinstated NATO use of Greek bases in 1976 despite remaining out of the NATO command structure. Greece and the United States initialed a DCA in July 1977, but then Athens refused to sign it, fearing it would pave the way for U.S. congressional approval of the U.S.-Turkish DCA and expedite lifting the arms embargo on Ankara. In the end, both the United States and Greece lived with an interim solution whereby NATO had access to Greek bases and U.S. military aid, and credit sales to Greece and Turkey followed their traditional 10 to 7 ratio in military assistance favoring Greece. The larger issue for NATO was whether Greece would return to its command structure, on what terms, and how would Turkey react? At the suggestion of NATO Secretary General Joseph Luns, Haig began negotiations with Athens and Ankara for Greece’s reintegration into NATO. The negotiations proved long and difficult, especially because the Turks objected to Greece resuming NATO’s command and control of the Aegean Sea. Haig retired before the talks concluded. His successor as SACEUR, General Bernard Rogers, persevered and hammered out a compromise based on a modified version of a formula worked out in June 1978 by Haig and General Ioannis Davos, chief of the Greek Armed Forces. The new so-called Rogers Plan postponed the issue of potential operational control of the Aegean. Just before the 1980 presidential election, the Carter administration, with an eye toward the Greek-American vote, made

a push to help persuade the Greeks to accept the Rogers Plan. The Turkish military government was amenable. Greece rejoined the NATO command structure in late October 1980. With Greece once more fully in NATO and Turkish bases open to the alliance, the southern flank was stronger in some small measure.<sup>102</sup>

In examining NATO's conventional forces, weapons, equipment, readiness, and reinforcement capacity the question remained: Was NATO better prepared for a potential Warsaw Pact conventional attack in 1980 than it had been at the onset of Brown's tenure? The answer is yes, although not as well prepared as Brown, Komer, NATO planners, and other NATO political leaders would have liked. The momentum generated by NATO's Long-Term Defense Plan slowed in the last two years of the Carter administration, so the plan could only be considered a qualified success. The main culprits were stagflation, Afghanistan, and Iran. Under the dual burdens of high inflation and low economic growth, none of the NATO members, not even the West Germans, could allocate the resources required to fulfill the demands of the LTDP to expand NATO's conventional punch. The best that can be said for the "3 percent solution" was that it set a benchmark, without which NATO members would have probably reduced their contributions even more for conventional forces. Iran, Afghanistan, the Persian Gulf, and the Middle East drew Carter and OSD away from NATO and Europe. Furthermore, conventional war in Europe was a hypothetical; requirements such as the All-Volunteer Force, the Rapid Deployment Joint Task Force for use in the Middle East and Persian Gulf, and the MX missile were more pressing realities. Nonetheless, NATO's ability to move and use enhanced conventional weaponry and equipment improved. Better armor and anti-armor, better air control and defense, better aircraft, quicker mobilization, more rapid reinforcement, more airlift, updated communications, more prepositioning of arms and equipment, and some success in standardization and interoperability were all positives. The much-maligned Carter White House and the Brown Pentagon, characterized as weak on defense by Ronald Reagan and the Republicans during the 1980 presidential campaign, laid the foundation for NATO resurgence. The money allocated in the last Carter Defense budgets materialized in the early 1980s in the form of better training, readiness, modernization of weapon systems, and a stronger force structure. Blamed for allowing NATO conventional forces to deteriorate, in fact, the Carter administration in many ways began to rectify the problem.<sup>103</sup>

As for mutual and balanced force reductions, Carter came to see them as a nonstarter, basically because OSD, supported by JCS, convinced him that an essentially cosmetic conventional arms limitation in Central Europe, desired by State and ACDA, was a mistake. On NATO's southern flank, the reintegration of Greece into the alliance and the reestablishment of a military relationship with Turkey, although not as substantial as DoD would have liked, were both positives, although hardly solutions to the nagging problem of a weak southern flank. All in all, NATO had undergone some essential improvements. Still, the Soviet Union and Warsaw Pact continued to modernize. NATO had to improve merely to keep up.



## NATO and the Theater Nuclear Forces

DURING THE FIRST THREE DECADES of the Cold War, U.S. presidents and secretaries of defense sought unsuccessfully, despite persistent efforts, to persuade the North Atlantic Treaty Organization to match conventional weapons and troop numbers of the Warsaw Pact. Presidents Harry Truman and Dwight Eisenhower sought to create a European Defense Community (including rearmed West German forces) to shore up the conventional defense of Europe. France's rejection of the proposal in 1954 and the resulting political and economic burden of stationing large numbers of U.S. troops in Europe convinced the Eisenhower administration to adopt a policy of massive nuclear retaliation against a Warsaw Pact attack on any NATO member. Extending this nuclear policy, the United States stationed tactical nuclear weapons in the homelands of many NATO allies, starting in the early 1950s with the introduction of nuclear weapons on tactical aircraft and the introduction of the 280mm atomic cannon into West Germany, soon followed by battlefield surface-to-surface missiles. During the late 1950s the United States upgraded its theater nuclear forces (TNFs) in Europe by deploying Thor intermediate-range ballistic missiles (IRBMs) in Great Britain. In addition, the Army stationed its Redstone short-range, surface-to-surface, nuclear-capable missiles in Europe. Thus, the European TNFs joined U.S. strategic weapons as part of the arsenal of massive retaliation.<sup>1</sup>

Secretary of Defense Robert McNamara influenced the Kennedy administration to move away from the concept of massive retaliation toward flexible response, a more graduated strategy involving a conventional weapons response, followed by the use of tactical and theater nuclear armaments, and finally a full U.S. strategic nuclear rejoinder to a Warsaw Pact attack. The goal was to react selectively and proportionally to varying levels of enemy attack, reserving all-out nuclear war as a last resort. But

flexible response made the West Europeans nervous. They worried that the United States was lessening its commitment to defend Western Europe with its strategic forces by seeking to limit war with the Soviet Union to conventional hostilities or a nuclear exchange on European soil, in effect, to fight the Russians to the last West European. They preferred to have Moscow and Washington use nuclear weapons on each other's homeland, even if a Soviet conventional invasion of Western Europe initiated the war. While most European leaders evinced suspicion of flexible response, at least one remained adamantly opposed. President Charles de Gaulle of France felt massive retaliation should not be abandoned, and it was one of his reasons for leaving the NATO command structure in 1966, creating a French strategic nuclear *force de frappe* that could retaliate independently against a Soviet attack.<sup>2</sup>

Why did most West European leaders favor the U.S. commitment to defend Europe with strategic forces and look askance at flexible response? First and foremost, they believed that the threat of a U.S. strategic nuclear response would be a sufficient deterrent against a Warsaw Pact attack. Second, they were convinced that if an attack came from the Eastern bloc, the fighting would rapidly move to all-out nuclear warfare. Finally, they rationalized that the U.S. strategic nuclear umbrella relieved them of the need to build up their conventional armed forces, thus freeing up government revenues for social programs.<sup>3</sup>

While all for a robust U.S. strategic nuclear force, European NATO leaders held mixed feelings about U.S. tactical nuclear weapons in Europe. There were political reasons for this ambivalence. Within European NATO societies a large segment of their left-leaning populace opposed nuclear weapons, especially if stationed on their soil. This antinuclear sentiment presented an important European domestic political problem. Yet NATO's political leadership realized that tactical nuclear weapons in Europe guaranteed that the United States would not abandon them and would not decouple the defense of Europe from the defense of the United States, so they accepted the weapons in spite of the political flak. When, after the Cuban missile crisis in 1962, DoD assigned the three ballistic missile submarines, for a total of 48 Polaris missiles, stationed in the Mediterranean to the supreme allied commander, Europe, Washington assured NATO allies that the Polaris deployment made the withdrawal of Jupiter missiles from Europe possible. In 1971 the United States increased this SLBM commitment to NATO to 150 missiles on submarines in the Atlantic Ocean and the Mediterranean Sea. Three submarines would be permanently

in the Mediterranean, thus fortifying the concept of a three-component flexible response: conventional forces, the U.S. strategic nuclear force, and theater nuclear and tactical forces in Europe.<sup>4</sup>

Of the three components, Washington held tactical and theater nuclear weapons in least regard. The United States had improved its strategic nuclear capabilities, especially submarine-launched ballistic missile forces, but afforded its tactical and theater nuclear weapon force in Europe scant attention. In fact, McNamara considered TNFs of more political rather than military importance, a visible signal that the United States was prepared to defend its NATO allies. Despite efforts in the late 1960s and early 1970s to improve NATO's conventional defenses, the manpower and fiscal requirements of the Vietnam War limited significant improvement of U.S. conventional forces for the defense of Europe. NATO's aging tactical nuclear weapons, such as bombs for aircraft, warheads for short- and intermediate-range missiles, nuclear artillery shells, demolition munitions for land mines, and atomic bazookas, helped but did not redress the conventional defense gap. Yet it only offset the gap through the prospect of nuclear war.<sup>5</sup>

For its part, the Soviet Union countered NATO in Europe with deployment of its own theater nuclear forces in the 1950s and early 1960s—intermediate-range, nuclear-capable bombers and liquid fueled SS-4 medium-range ballistic missiles (MRBMs) and SS-5 IRBMs able to reach all of Western Europe but not the continental United States. These missiles were inaccurate, relegating them to city busters. By the late 1960s these Soviet weapons had become even more obsolete and vulnerable than the similar Thors and Jupiters phased out by the United States in 1963. After some less than fully successful deployments of modified Soviet IRBMs, Soviet weapon designers in the mid-1970s developed an updated missile based on the first two stages of the SS-16, their first road-mobile and solid-propellant ICBM (it never entered service). It was succeeded by the successful mobile SS-20 Saber IRBM (Russian name: RSD-10 Pioneer), a solid-fueled, accurate, rapid-reaction missile with three multiple independently targetable reentry vehicles, or MIRVs. In addition, in the 1970s, the Soviet Union upgraded its bomber force by developing the Backfire (Russian name: Tu-22M Tupolev), a supersonic, sweep-wing, medium-to-long-range bomber capable of attacking the territory of all European NATO allies. To many Western military analysts, the Backfire coupled with the SS-20, first deployed in 1977, represented a Soviet attempt to gain theater nuclear superiority in Europe.<sup>6</sup>

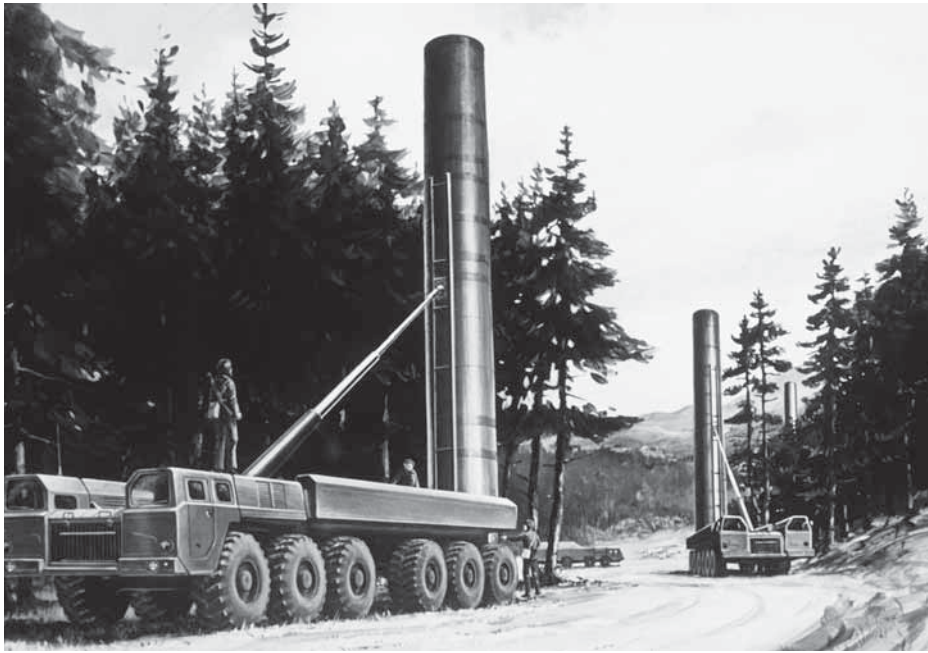

Artist's conception of SS-20 Saber mobile intermediate-range ballistic missile systems in launch position. (*Soviet Military Power*, 1985, RG 330, NARA II)

## The Neutron Bomb

Carter came to the presidency having imbibed a deep antipathy for nuclear weapons that influenced his decisions on their development, deployment, and possible use. Still, he had to accept, albeit reluctantly, the central place they occupied in U.S. military strategy. Almost immediately into his term, he had to cope with the problem of nuclear forces in Europe.

In the 15 years before January 1977, the United States had made some improvements to its TNFs in Europe. The Army introduced the Pershing I, a solid-fueled MRBM (range of 500–750 nautical miles or 580–860 miles) into West Germany during 1963–1964. In 1969–1970 it deployed the Pershing IA, with quicker reaction and faster launch times. In the 1970s three nuclear-powered ballistic missile submarines equipped with MIRVed SLBMs (400 warheads) replaced the Polaris-equipped SSBNs operating under SACEUR command in the Mediterranean, out of Rota, Spain. The Carter administration doubled the number of long-range, nuclear-capable, all-weather F-111 fighter-bombers to 164. Stationed in Great Britain, these bombers could penetrate deep into the Soviet Union.<sup>7</sup>





Shaded area indicates the target range and coverage of SS-20 mobile missiles. (*Soviet Military Power*, 1982, RG 330, NARA II)

But one weapon modernization that seemed routine to the military caused the greatest public controversy, seriously disrupting U.S.-European relations, at least for a time. Inherited from previous administrations, this modernized weapon, the neutron bomb—more accurately called an enhanced radiation weapon (ERW)—had been under development at the Energy Research and Development Agency (ERDA), a government agency responsible for developing nuclear weapons and naval reactors. Designed to replace aging atomic artillery shells and short-range missile nuclear warheads of the 1950s in the Army's tactical battlefield nuclear arsenal, ERWs were more accurate, more reliable, required less fissionable material, and produced smaller nuclear explosions (about one-tenth of similar warheads), while yielding high levels of lethal radiation. This combination made them ideal for use against the Warsaw Pact's armored units and their crews, which were prime targets for NATO planners. Since they caused less collateral damage to buildings and other infrastructures, they seemed well suited for use against a potential Warsaw Pact attack in congested



A Pershing II battlefield support missile is fired from its launcher vehicle on the McGregor Range in New Mexico, November 1982. (RG 330, NARA II)

areas of West Germany. ERWs could be mounted as warheads on the Army's mobile surface-to-surface Lance tactical missile or placed in an 8-inch artillery shell and fired from a self-propelled howitzer.<sup>8</sup> It seemed like a natural fit. Enthusiastic about the weapon's technical characteristics and unaware of the potential for political backlash, the White House and OSD leaders strongly supported its development and plans for deployment.

When ERDA inadvertently released the still-secret existence of enhanced radiation weapons in a fiscal year 1978 budget submission to Congress, the Carter White



Test firing of a ground-launched cruise missile from its transporter-erector launcher, November 1982. (RG 330, NARA II)

House and Brown faced a public relations nightmare. *Washington Post* defense journalist Walter Pincus, who noticed the still-classified term “enhanced radiation” weapon, began to investigate. In June 1977 he published the first of a series of articles charging that ERWs were killer weapons designed to spare property and irradiate people through the release of neutrons.<sup>9</sup> Antinuclear proponents and peace activists quickly dubbed these weapons as immoral products of the military-industrial complex. For their part, NATO allies worried that ERWs, which lowered the threshold for nuclear use by minimizing physical damage, would make it more likely that a tactical nuclear war would be fought in Western Europe. The Soviet Union saw a wonderful propaganda advantage handed to them. The suitability and morality of the ERW issue became a cause célèbre, fought out in articles, columns, political cartoons, and editorials of U.S. and European newspapers. The ERW issue mobilized antinuclear activists and peace movements across the United States and Western Europe, especially in West Germany.<sup>10</sup>

Aware of this near hysteria, the Carter administration hoped to correct public misperceptions about enhanced radiation weapons and persuade Congress to keep funding the project. At the recommendation of National Security Adviser Zbigniew Brzezinski and OMB Director Bert Lance, Carter authorized continued funding of the program and a campaign to blunt congressional efforts to derail it.<sup>11</sup> Nevertheless, before giving his final approval for production, the president requested a “more detailed review of tactical nuclear weapons and ‘enhanced radiation’ weapons.”<sup>12</sup> DoD made the case for ERWs. First, they would increase the ability to inflict significant military damage on the Warsaw Pact (especially armor), enhancing the credibility of U.S. deterrence. Second, if deterrence failed and the weapons had to be used, they would minimize damage and casualties to individuals not in the immediate target area, including friendly troops and civilians. Finally, an aggressor against NATO would be faced with uncertainty as to whether NATO would use ERWs against forward echelons. Uncertainty was a key NATO military tactic.<sup>13</sup>

In August 1977 Brown reviewed for Carter the requirements for tactical nuclear weapons, including employment of ERWs. He recommended modernizing tactical nuclear weapons since they made an essential contribution to deterring a Warsaw Pact attack. According to Brown, modernization should not require higher yields but should result in more responsive and effective weapons that caused fewer casualties to civilians and friendly troops and were less susceptible to

a nonnuclear attack from the Warsaw Pact. Improved ERW weapons would force the pact to disperse its forces—making these forces less vulnerable to enhanced radiation weapons—which in turn would make defense against a conventional attack with its nonnuclear forces easier for NATO. Should a conventional defense fail, tactical ERWs on artillery and missiles would threaten Warsaw Pact frontline troops and provide the possibility of a limited, controlled escalation.<sup>14</sup>

Unfortunately for DoD, countering misunderstandings about the neutron bomb required a public relations campaign with the governments of NATO allies and the U.S. and West European public. Brown and DoD officials tried to remove the demonizing high-radiation-people-killer label from ERWs. While they enjoyed success in convincing the U.S. Congress not to halt development, they made little headway with the public in the United States and Europe. The Pentagon never overcame the misperception about the neutron bomb. It was too long a line of reasoning for most of the public to follow. The opposition's line, "saves buildings, kills people," was more persuasive. Brown recommended that Carter approve development and production of three types of ERWs—the Lance Mod-3 warhead, the 8-inch nuclear artillery projectile, and if technically feasible, the 155mm nuclear artillery projectile. Secretary of State Cyrus Vance, Brown, and Brzezinski discussed ERWs with the president in mid-August 1977, reiterating the need to consult with the European NATO allies. Brzezinski later recalled an uneasy feeling that Carter was uncomfortable with enhanced radiation weapons, given his emphasis on arms control and nuclear nonproliferation in his 1976 presidential campaign. Worried about his image if he deployed these weapons, the president was not prepared to take all the potential flak for the decision. The Europeans would have to step up or the United States would "use European disinterest as a basis for a negative decision." The president did not approve production and deployment, but he authorized consultation with NATO allies before he made a decision.<sup>15</sup>

Assistant Secretary of Defense (ISA) David McGiffert led a mission to consult with the West Germans and other NATO allies. He optimistically reported that the Germans, while concerned that they not be identified as the principal recipient and partner in deployment of ERWs, seemed receptive to the idea. Other NATO members reacted positively as well.<sup>16</sup> In reality, the West Germans were the only ally that really mattered, because the West German border with East Germany was the only place where ER warheads on short-range Lance missiles and field artillery would

be militarily significant. As became clear from further consultations, McGiffert had been overly optimistic. West German Chancellor Helmut Schmidt and other NATO leaders were too vulnerable to criticism from domestic political opposition and from the Soviet Union. They suggested that United States go ahead with the decision to produce. Future NATO consultations would decide on deployment in Europe. In effect, the Europeans were delaying the decision to deploy.<sup>17</sup>

Carter was not about to take the lead without a West European commitment to deploy. His advisers explored ways to make enhanced radiation weapons more acceptable to the NATO allies. Brown suggested not deploying them if the Soviets agreed to forgo deployment of SS-20 MRBMs. Since the Soviets were unlikely to agree, their opposition would provide cover for the Europeans to accept deployment. A second idea, supported by Vance and Stanley Resor, the chief negotiator at the mutual and balanced force reduction talks, was to fold ERWs into the MBFR talks with the objective of trading them for reductions in Warsaw Pact tanks. Brown strongly opposed the latter idea, stating that the only reasonable tradeoff was the SS-20s themselves. Six hundred tanks or anything else in MBFR talks would not be worth the exchange.<sup>18</sup> For its part, the Soviet Union would no doubt consider that an ERW trade for the SS-20 would be an equally bad deal for them because the SS-20, with its three half-megaton warheads, was far more destructive than a neutron bomb. Each SS-20 warhead would produce over twice the lethal radiation levels and 10 times the damage.<sup>19</sup>

At a Special Coordination Committee meeting in mid-November 1977 on enhanced radiation weapons, JCS Chairman General George Brown, Secretary of Energy James Schlesinger, and Brzezinski joined Brown in opposing the MBFR ploy. The group recommended to Carter proceeding with production, obtaining from the NATO allies, especially West Germany, an agreement to accept ERWs as a precondition to production, and raising the idea of holding back ERW deployment if the Soviets refrained from deploying SS-20s.<sup>20</sup>

After talking to West German Defense Minister Georg Leber, Brown reported to the president: "The Germans have not yet shown a willingness to announce a decision that would share the political responsibility for allied ERW policy—and give weight and urgency to an arms control initiative. I believe we should continue to press for an integrated US-Allied decision." After clarification from the West German ambassador, Brown reported that Leber was suggesting that the United States first announce a decision to produce the weapons. Then the Bonn government would announce

its support of the decision, but not its acceptance of deployment in West Germany. Washington would offer to negotiate a halt to ERW production as part of an arms control deal. If the Soviets rejected the proposal, the West Germans “would be able politically to agree to ERW deployment on FRG [Federal Republic of Germany] soil.”<sup>21</sup>

For the remainder of winter 1977–1978, U.S. and European NATO officials consulted on the issue. In late March 1978 Brown and Vance reported to Carter that an agreement was about to be finalized by the NATO Permanent Representatives at the North Atlantic Council meeting of 22 March 1978. The three-part deal required the United States to begin production and offer to forgo ERW deployment if the Soviets did the same for the SS–20. Then NATO members would accept deployment of the weapons if within two years the arms control talks on the tradeoff proved unsuccessful. On a fishing vacation in Saint Simons Island, Georgia, when he received the recommendation, Carter rejected the deal. He instructed Brown, Vance, and Brzezinski to call it off and do nothing.<sup>22</sup>

The North Atlantic Council deferred meeting until Carter returned to Washington, DC, and met with Vance, Brown, and Brzezinski, all of whom, as Brzezinski recalled, pressed the president not to back out of the agreement lest he seriously undermine NATO and appear weak. Adamant, Carter said that he was not going to be remembered as the president who approved nuclear weapons that killed only people (an oversimplification Carter admitted, but that was the popular perception). Nothing could persuade him. The president also resented that Schmidt and the European allies had maneuvered it so that it looked like a solely U.S. decision.<sup>23</sup>

Brzezinski tried to limit the damage, suggesting that the president not announce that he was simply rejecting ERW production, since it would be seen as giving in to Soviet pressure and propaganda. Nor should Carter blame the European NATO allies—recriminations would only damage the alliance. Brzezinski suggested using the arms control negotiations for limitation of SS–20s in return for non-deployment of the ERW, so as to let the allies down gracefully.<sup>24</sup> In early April 1978 both Brown and Brzezinski again encouraged Carter not to definitely halt the ERW modernization of Lance missiles and artillery shells. Having picked up newspaper leaks and hints that Carter was about to halt ERW production, Schmidt and his Security Council ostensibly agreed to deploy them on West German soil. Brown suggested to Carter that the “FRG moves will tend to make . . . you personally take all the heat for a ‘no.’” This could expose the president to charges that he had made yet “another

unilateral restraint,” which could undermine popular and congressional support for other foreign and national security policy objectives, such as SALT II and the Panama Canal Treaties. The secretary urged Carter to modernize Lance while keeping open the option to install the ERW features—producing warheads without committing to install the elements that made them enhanced radiation weapons, but designed so the ER function could be easily added. For the Lance missile this was technically feasible. With the 8-inch shell it was more difficult—preliminary military views held that without ER the artillery shell’s yield would be too low for effective anti-armor use. Brown urged Carter to announce that while he was deferring ERW production, he was going ahead with modernization of tactical nuclear weapons, but his eventual decision would depend on undefined Soviet restraint. On the following day Brzezinski sent the president a similar recommendation.<sup>25</sup>

Carter made a public announcement to that effect on 7 April 1978, noting he had ordered DoD to proceed with modernization of the Lance missile nuclear warhead and the 8-inch artillery shell (despite the problems with non-ERW yield), “leaving open the option of installing the enhanced radiation elements.”<sup>26</sup> Brzezinski later felt strongly that the president was making a terrible mistake—the worst of the first 14 months of his presidency—and he claimed that neither Vance nor Brown supported ERWs as forcefully as they should have, and that Vice President Mondale ducked the issue altogether.<sup>27</sup>

A series of unaddressed technical questions posed four options for the president. If the modernization of weapons went hand in hand with the fabrication and filling of tritium reservoirs (one of the necessary ERW elements), then all Lance warheads and shells could be converted to ERWs within a few months. If the reservoirs were unfilled, but the tritium was fabricated, the force could be fully converted in about a year. Unfilled reservoirs and no fabrication of tritium would require over two years for the conversion of all the warheads and shells; no reservoirs or tritium would lengthen the time span to 71–75 months. Carter chose to produce and store the reservoirs, but not produce additional tritium for them. The president noted that no matter how things went at the Moscow SALT II Summit, the production schedule could be adjusted accordingly.<sup>28</sup> On 13 October 1978 Carter directed DoD to initiate production of the existing designs for the Lance missile warhead (W70 Mod 3) and the 8-inch artillery shell (W79) that could accept enhanced radiation elements. He also directed the Department of Energy (DoE) to produce concurrently and store

separately the tritium reservoirs necessary for the conversion, but neither fill them nor earmark any tritium especially for the reservoirs at the time.<sup>29</sup>

In summary, it seems that without clear-cut support from the European allies, Carter was unwilling to produce ERWs, falling back on his natural default stance: opposition to nuclear proliferation and nuclear weapons in general. Schmidt and other European leaders were not without blame, although they encountered considerable pressure from peace and antinuclear groups, their political oppositions, and from within their own parties or coalitions. Brown was hardly as equivocal in his support of these weapons as Brzezinski has charged, but having made a strong case and lost it, he fell into line with the president's directions. At the time, pundits and critics of Carter considered the decision not to produce the neutron bomb a serious mistake, even a fiasco, by an inexperienced chief executive too ready to seek the intellectual comfort of his own moral high ground. The consequences would supposedly be dire: loss of confidence in the United States among the European allies and loss of respect from the Kremlin. In retrospect, the damage was not lasting. The modernization of longer-range theater nuclear weapons, the Pershing II IRBM and the Gryphon ground-launched cruise missile were more significant and eventually, after some difficulty, more successful.<sup>30</sup>

### **Modernization of Long-Range Theater Nuclear Forces**

Long-range theater nuclear forces, called "gray area systems" by strategic arms limitation negotiators, because they did not appear in either the SALT or the mutual and balanced force reduction negotiations, initially complicated the SALT II negotiations until Carter and his advisers decided to address them in SALT III (the planned follow-on to SALT II). Air-launched cruise missiles were included in the SALT II Protocol, which restricted their range to 2,500 kilometers during the two-year protocol. Carter hoped that a successful SALT II would lead to a similar limitation and eventual elimination of both long-range TNFs and short-range nuclear battlefield weapons in Europe. For his part, Helmut Schmidt, who closely followed SALT II negotiations, held a different view. In October 1977, in a public address to the International Institute for Strategic Studies in London, he suggested that while a U.S.-Soviet SALT II agreement would strengthen the security of the two superpowers, it would leave Western Europe vulnerable to attack by the Warsaw Pact. Since Washington and Moscow both possessed secure second-strike capability, neither was likely to use





President Jimmy Carter and West German Chancellor Helmut Schmidt at the White House, 14 July 1977. (Carter Presidential Library)

nuclear weapons first, thus negating the idea of a nuclear response to a conventional attack in Europe. Schmidt feared that the Soviet Union could deploy SS-20 IRBMs without limit since they were not intercontinental missiles, therefore not restricted by SALT II, leaving Western Europe susceptible to Warsaw Pact diplomatic and military pressures. Schmidt suggested that the United States either curb the SS-20 threat through an arms control agreement with Moscow (his preference and what he later claimed he stressed most in the speech) or provide NATO with much more credible long-range theater nuclear forces.<sup>31</sup>

Schmidt's speech resonated in high-level consultations between Assistant Secretary McGiffert and his NATO counterparts in the so-called High Level Group. They agreed on the need for "evolutionary adjustment" (i.e., modest increase) in NATO's long-range TNFs. At the time, only SACEUR's submarine-launched Poseidon missile reentry vehicles and a small number of the dual-capable, land-based aircraft could strike targets in the western military districts of the Soviet Union. Four DoD programs under development could redress the deficiency: ground-launched cruise missiles, the longer-range submarine-launched cruise missiles, Pershing II extended-range missiles, and theater-based medium-range ballistic missiles. Air-launched cruise missiles, still under study, provided another alternative.<sup>32</sup>

An added incentive for NATO to modernize its long-range TNF systems came from political change in Spain. The new Spanish Socialist government announced its intention to evict by 1979 U.S. nuclear submarines from the Rota Naval Base, located strategically on the Atlantic near the entrance to the Mediterranean, making future deployment of SLBMs assigned to the defense of Europe more difficult. With Rota unavailable, nuclear submarines would have to redeploy to Holy Loch, Scotland, or Charleston, South Carolina, increasing transit time and potentially forcing the United States to limit the number of submarines operating in the Mediterranean.<sup>33</sup> Nevertheless, the need for modernization of land-based theater nuclear weapons was not shared by all in the United States or by other NATO member nations, where disarmament proponents hoped to limit long-range TNFs. The Carter administration in June 1978 initiated Presidential Review Memorandum 38 for Brzezinski's NSC staff to tackle. This required examination of long-range theater nuclear capabilities, including the political and military aspects of increasing their capabilities, as well as their possible inclusion in future arms control negotiations.<sup>34</sup>

The resulting study—long on description and background with tables and charts, but short on recommendations—disappointed DoD officials.<sup>35</sup> Special Assistant for NATO Robert Komer told Under Secretary of Defense for Policy Stanley Resor, Brown, and Deputy Secretary Charles Duncan that a "credible NATO deterrence in the 80's demands a long range theater nuclear capability to complement our emphasis on conventional defense. . . . This won't be easy, because PRM #38 so feebly and ambivalently presents many key issues affecting NATO that one would hardly know so much was at stake." Komer elaborated that the reduction from U.S. strategic superiority to parity with the Soviets lessened European confidence in the

U.S. nuclear umbrella over NATO, especially with Soviet deployment of SS-20s. He recommended a “medium-sized GLCM force” in Europe as a remedy. Brown agreed but was not prepared to say how big a deployment was needed.<sup>36</sup>

The participants at an August 1978 SCC meeting, attended by Duncan (Brown was out of Washington), discussed two strategies to enhance the long-range TNF: treat the problem as a political issue, fashioning a temporary solution that overcame domestic European opposition, or respond with a twin strategy of hardware modernization and arms control. Reading the briefing paper for the meeting, Brown favored the latter course. Although not as convinced as Brown and DoD of the serious need for long-range theater nuclear weapons able to strike the Soviet Union, the SCC members recommended modernization combined with an arms control initiative in SALT to reduce these weapon systems on both sides.<sup>37</sup>

In October 1978 State and DoD officials consulted with the NATO allies, discovering that the West Germans were anxious to include long-range TNFs into SALT III by negotiating reductions on all missiles with ranges over 1,000 kilometers. Bonn believed that Washington could trade reductions of U.S. strategic nuclear warheads for limits on Soviet theater intermediate-range nuclear systems. Ultimately, the German proposal remained untested as Carter’s electoral defeat precluded negotiations of SALT III. In talks with DoD officials, NATO allies remained wary of potentially targeting Moscow with these new weapons, but they considered favorably the idea of adding 200–600 warheads to the theater nuclear force, often called “Euromissiles.” Unwilling to operate any system that could strike Moscow, the West Germans insisted that the weapons be under U.S. control. However, deployment of these weapon systems on West German soil would be “a matter for the highest German authorities to decide.”<sup>38</sup> These consultations resulted in a consensus on the rough numbers of new warheads but not where to deploy them and how to choose their targets.

Negotiations with the NATO allies continued through fall 1978 and winter 1979. Carter met in January 1979 with three key leaders—Schmidt, French President Valéry Giscard d’Estaing, and British Prime Minister James Callaghan—in Guadalupe, a French island in the Caribbean, to discuss multiple issues, of which TNF was just one. According to Carter, Schmidt was in a “very bad mood.” Brzezinski recalled the chancellor warning about the Soviet SS-20 threat to Western Europe, but worrying about his “political problem” with the proposed solution. Of the four leaders, Schmidt was the least prepared to act; he insisted that he could

not deploy long-range TNF weapons unless another continental NATO ally agreed to deploy them. He also required pursuit of parallel track of disarmament, thus providing him some cover from the antinuclear political left in West Germany.<sup>39</sup>

In February 1979 Brzezinski updated the president on his own informal follow-up consultations in Europe. The allies had agreed to resolve the deployment issue by the end of 1979, but only if there was a related arms initiative (the so called “dual-track option”), and only if the United States joined in an effort to help moderate political debate in West Germany. Unprepared to take the foreground, the Germans preferred to defer to Washington to play its traditional leadership role in nuclear deployment and arms control. The only viable options placed Pershing IIs or cruise missiles in West Germany, the Benelux, Italy, and Great Britain. All Europeans agreed that long-range TNF arms control should be negotiated only in SALT III. After another briefing in March 1979, Carter instructed Brzezinski: “We should be firm & supportive, but not ‘take over’ the lead nor become a supplicant.”<sup>40</sup>

The president’s advice proved impossible to follow. The United States had to take the lead. Brown and Vance informed Carter later in May 1979 that the West Europeans were hardly united on modernization of long-range TNFs. Each country faced substantial domestic political and popular opposition further stirred up by Soviet propaganda. While forging a NATO consensus would not be easy, Brown and Vance expected it to emerge by the end of the year. But they needed the president’s personal role, especially with the West German chancellor, who, notwithstanding his call for action in London in 1977, was still wavering in the face of his domestic problems. Brown did his part during a meeting with Schmidt in Bonn. After the room cleared at the secretary’s request, Brown laid it on the line to Schmidt in language he later described as “too assertive and close to being impolite.” Brown recalled that he told Schmidt: “The American president can afford to have the German chancellor unhappy with him, but the German chancellor really can’t afford to have the American president unhappy with *him*. So, let’s try to find a way through this for your benefit as much as ours.” Schmidt was not pleased. Carter agreed to add his personal influence to ease the West Europeans’ and especially Schmidt’s problem, but his follow-through was less than stellar from Schmidt’s point of view. The German chancellor was shocked when Carter failed to raise the TNF issue with Soviet leaders at the Vienna SALT II Summit in June 1979. Schmidt thought that the

president had not eased his political problem of domestic opposition to introducing theater nuclear forces into West Germany.<sup>41</sup>

### **The Modernization Program**

In June 1979 the president directed Brown and DoD to develop plans for modernization that offered options for altering NATO's TNF structure, including the mix of weapon systems and the countries where they would be deployed. In early July 1979 the secretary presented a plan that mixed Pershing II missiles (exclusively in West Germany) with GLCMs in Germany, Britain, Italy, the Netherlands, and Belgium. OSD recommended 476 new warheads on 200 launchers (108 Pershing IIs and 92 GLCM transporters capable of launching four cruise missiles each) at a total projected cost in 1979 dollars of \$370 million for additional research and development, \$1,391 million for procurement, and \$240 million per year for operations and maintenance, with the NATO allies paying for some of the infrastructure and security. Brown recommended fewer warheads on cruise missiles in Italy, Belgium, and the Netherlands than in Great Britain on the grounds that the three allies faced political opposition which larger numbers could only exacerbate. The increased number for the British reflected what DoD saw as a favorable political climate there. It would also help the Germans. The rough equivalence of the two countries' contributions would make them coequal major NATO partners. The Joint Chiefs recommended 572 warheads on 108 Pershing IIs and 116 launchers with four cruise missiles each (464 cruise missiles). Brown noted that "either [OSD's or JCS's recommendation] is reasonable."<sup>42</sup>

The SCC reviewed the two proposals. At the recommendation of Deputy National Security Adviser David Aaron—the NSC staff member most engaged with the issue—the committee favored the JCS figure of 572 warheads on the grounds that the NATO allies would probably shrink the numbers, but they did not. While the allies would be offered dual-key deployment (one U.S. key and one ally key to arm the system), the committee was convinced that none of the allies would want it. The five affected allies would ease the financial burden of the deployment by providing the required infrastructure and ongoing security for the systems. Most important, the modernization would take place without increasing the number of warheads in Europe. For every new warhead introduced an older one would be withdrawn. Finally, TNF arms control would be included

in SALT III negotiations, with a NATO position hammered out by the end of the year. Carter approved.<sup>43</sup>

Obtaining agreement to deploy GLCMs and Pershing IIs in NATO countries proved no easy matter. The Dutch parliament opposed deployment of any new weapons on their territory. The Belgians were faltering, the Danes pushed for a six-month delay, and the Norwegians expressed less than fully firm support. The West Germans remained helpful but still emphasized the arms control track. Only Great Britain and Italy stayed firmly on board.<sup>44</sup> The Soviets continued to bombard Western European Communist and left-wing political parties, peace groups, and front organizations with anti-TNF propaganda, reinforcing the existing popular belief that more and better nuclear weapons in Europe meant less security for Europeans.<sup>45</sup> To allay these pressures, the United States agreed unilaterally to withdraw 1,000 warheads—most of them on obsolete Honest John rockets—from the NATO area as an integral part of long-range TNF modernization, leaving approximately 6,000 warheads still there.<sup>46</sup>

After attending the NATO Nuclear Planning Group meeting in The Hague in November 1979, Brown reported to the president that all but the Dutch were on board.<sup>47</sup> This paved the way for the NATO defense and foreign ministers meeting at a special session of the North Atlantic Council to publicly announce the decision to modernize and deploy the Pershing II and cruise missiles, with 108 Pershing II missiles and 464 cruise missiles and their warheads replacing 572 older nuclear systems. Brown's observation that everyone was on board proved overly optimistic. The Dutch parliament postponed a decision on deployment for two years; the Belgians, for six months (both were later extended). Neither Norway nor Denmark accepted the weapons on their territories. Still, the West German requirement not to go it alone had been met—Great Britain and Italy agreed to deploy. The consensus of the Europeans, especially the Germans, held that their agreement to deploy was contingent on at least talking with the Soviet Union about TNF arms control.<sup>48</sup> Brown sent McGiffert, who had ably led the consultation process in NATO's High-Level Group, a personal note giving him "the real credit for the successful outcome on LRTNF modernization." The timetable for modernization meant that none of the deployments could take place until 1983, so there remained time for the agreement to unravel or the unlikely possibility that arms control with the Soviet Union might succeed.<sup>49</sup>

### Discussions with the Soviets on TNF Reductions

Brown himself had no illusions about forging a unified NATO position on theater nuclear arms control, the second of the dual tracks. In August 1979 he commented: "I think we'll find this negotiation with the Allies a long and hard one. We need patience, persistence, and determination; we also need to be firm at times."<sup>50</sup> As for Soviet receptiveness, Washington had little expectation that Moscow was serious about reducing its long-range TNFs. But as Vance later candidly admitted, the real impetus for the arms control track was to provide cover for the approval of deployment of modernized TNF weapons in West Germany, Italy, and Great Britain and to encourage the Netherlands, Denmark, and Norway, where antinuclear sentiment was strong, to accept them.<sup>51</sup>

Carter probably would not have agreed with his former secretary of state's conclusion. He believed that TNF arms control was possible, another step to his dream of a world free of nuclear weapons, but the negotiations with the Soviets during the rest of 1980 proved unproductive. In October 1979 Soviet General Secretary Leonid Brezhnev proposed to reduce an undetermined number of unspecified Soviet MRBMs and medium-range bombers in the western Soviet Union in return for cancellation of NATO's GLCM and Pershing II missile deployment, a deal that NATO could hardly accept since it had worked so hard to get its members to agree to such modernization. Furthermore, the Soviets had already deployed an initial group of SS-20s, which were three times more accurate than SS-4s and six times more than SS-5s. No doubt the Soviets would trade these obsolete missiles in any negotiations and retain the SS-20s. In addition, Backfire bombers had much greater range than the older medium-range Badger and Blinder bombers (the ones that the Soviets would reduce). Washington saw the deal as a propaganda ploy to derail the NATO decision to modernize its TNFs. Moscow would trade off Soviet weapons of little value, hardly a serious offer.<sup>52</sup>

The Soviets next hinted that revocation or even suspension of the NATO decision to deploy new TNFs could be a precondition for future arms control talks. Indicative of how easily things might go wrong, prior to his July 1980 trip to Moscow to meet with Brezhnev, Schmidt floated a similar proposal for a three-year moratorium on the deployment of Pershing IIs and GLCMs in return for a freeze on deployment of SS-20s. The chancellor reasoned that since the Pershing IIs could not be deployed until 1983, no harm would come from a temporary moratorium. Brown adamantly

opposed such a freeze, believing it would be difficult to verify, could result in the halting of the construction of NATO facilities for Pershing IIs and ground-launched cruise missiles, and could perpetuate the Soviet lead in long-range TNFs and create a permanent imbalance. Any short-term advantages, such as initiating theater nuclear arms control negotiations, halting further SS-20 deployment, scoring a coup in Moscow for Schmidt, or shoring up the left wing of his party before anticipated elections in West Germany, were not worth the risk. At the instigation of Brown, Brzezinski, and the new secretary of state, Edmund Muskie, Carter sent Schmidt a letter accusing him of going “soft” on long-range TNF modernization. Angered at being criticized, Schmidt took Carter to task at the Venice economic summit in June 1980. The president responded calmly to the chancellor’s heated remarks, but the already testy personal relationship between the two leaders worsened.<sup>53</sup>

After Schmidt visited Moscow in July, Brezhnev agreed to talk about the limitation of TNFs without preconditions, but he rejected a freeze on SS-20 deployments and insisted the Soviet delegation had the right to raise the issue of forward-based systems—primarily U.S. nuclear-capable aircraft stationed in Western Europe and on aircraft carriers in nearby waters that could reach the Soviet Union. The Soviets would not limit the talks solely to long-range missiles as the United States preferred. Given these differences, it seemed remote that preliminary talks would prepare the groundwork for discussing a reduction of long-range nuclear missiles in Europe during SALT III negotiations, expected to occur during a possible Carter second term.<sup>54</sup>

Were the Soviets serious about arms control for theater nuclear forces? A former CIA Soviet analyst, Raymond L. Garthoff, suggested they were. He argued that Soviet modernization consisted not of an increase but rather a replacement of obsolete missile launchers and bombers. Furthermore, the extremely accurate Pershing II missiles would reduce the flight time of attacks on targets in the Soviet Union to 6–10 minutes from West Germany compared with 25–30 minutes for ICBMs launched from the United States. To Moscow, Pershing IIs looked ominously like first-strike weapons that could attack its command, control, and communication centers, thus preventing the Soviet military from launching its own missiles on warning of an immediate attack. Also, from the Soviet point of view, the French *force de frappe*, British nuclear forces, and U.S. SLBM and forward-based systems gave NATO a decided superiority in theater nuclear weapons.<sup>55</sup>



Although preliminary talks took place in Geneva from October through November 1980, the two sides remained far apart. The United States did not budge from its formal position that the talks be limited to missiles—SS-4s, SS-5s, and SS-20s versus GLCMs and Pershing IIs. The Soviets insisted that sea-based missile systems and aircraft systems (including the dual-capable tactical F-111 bombers based in Britain, and carrier-based A-6 and A-7 attack aircraft) be included in the talks. French and British nuclear forces would not be limited, but the Soviet Union demanded as compensation for their presence lower levels for U.S. theater nuclear forces than for Soviet ones. Not surprising, these talks made no progress and recessed. After the November presidential elections, Ronald Reagan's victory meant there was little point in resuming them during the remainder of the Carter term.<sup>56</sup>

Under the Reagan administration the talks, renamed the Intermediate Nuclear Force (INF) negotiations, restarted in November 1981 but failed to overcome the differences between the two sides. When the United States deployed the Pershing IIs and GLCMs in West Germany in 1983, the Soviets walked out of the INF talks. Deliberations resumed in 1985 under a drastically changed U.S.-Soviet relationship. Reagan's "evil empire" had become a government with which he could do business. In 1987 President Reagan and Soviet General Secretary Mikhail Gorbachev signed an INF treaty eliminating all intermediate and shorter range missiles, their associate launchers, equipment, and support facilities, not just in Europe but worldwide, with strict verification procedures.<sup>57</sup>

Carter's dream of eliminating nuclear weapon systems in Europe partially came to pass. While there were many reasons for the success of the INF Treaty—not the least the actual Reagan deployment of INFs in 1983—the Carter administration started the ball rolling by obtaining NATO agreement to station long-range TNFs in Europe, and coupling it with a dual-track approach that included arms limitation negotiations. Carter and his administration, including Brown, deserve credit for the part they played in a process that eventually resulted in one of the Reagan administration's major nuclear arms elimination agreements.

On enhanced radiation nuclear weapons, Carter seemed to place his concept of morality over modernization of a promising weapon, and also gave the European allies mixed signals. In February 1981 President Reagan's Secretary of Defense Caspar Weinberger announced that DoD would deploy enhanced radiation warheads on Lance missiles and in nuclear shells, apparently without Reagan's approval. This

move upset the European allies, Secretary of State Alexander Haig, and the State Department. Reagan agreed in August 1981 to produce the weapons but keep them in the United States.<sup>58</sup> Subsequently introduced into Europe, they were retired after the end of the Cold War. Carter's decision to develop the capability to upgrade to ERWs made the Reagan decision to produce and deploy the ERWs technically easier, ensuring that production would proceed more rapidly. Still, Carter's last-minute decision not to deploy is often cited as one of his greatest missteps. It was hardly a deft policy decision, but its ramifications were not permanent. It damaged President Carter much more than it damaged U.S. security.<sup>59</sup>

Continuity existed in the area of nuclear arms limitation policy between the Carter and Reagan administrations. Notwithstanding Reagan's and the Republicans' much-proclaimed opposition to SALT II, the new administration abided by its provisions and built on them in the renamed Strategic Arms Reduction Talks (START). The same arms-control pattern followed for theater nuclear weapons, where the Reagan administration succeeded in INF talks in its second term. Reagan accomplished what the Carter administration had essentially viewed as a long shot and primarily as a way to persuade NATO allies to accept deployment of long-range theater nuclear weapons. Reagan came to power convinced that the Soviet Union could not be trusted, but events and experience transformed his view. In 1977 Carter saw great prospects for U.S.-Soviet détente, but as he dealt with the Soviet leaders and experienced their adventurism in Africa, Central America, and most important Afghanistan, his view of them hardened. Reagan's conversion in his second term to achieving drastic reduction in nuclear weapons paved the way for Carter's dream of a world less dominated by the ability of Washington and Moscow to destroy each other in a superpower nuclear conflict. It was an improbable turn of events.

## Conflict and Confrontation in Africa

THE END OF COLONIALISM IN AFRICA in the decades after World War II eventually created almost 50 newly independent countries. The borders of these African states, set by Europe's leaders in the 19th and early 20th centuries, often had little relationship to ethnicity, religion, or language—a problem for a continent where tribal loyalties remained strong. The major European powers—Great Britain, France, Portugal, and Belgium—had a mixed record of preparing their African dependencies for independence. The British relied mostly on indirect rule; the French, on creating Francophile elites; and the Belgians and Portuguese did virtually nothing. Lack of a democratic tradition, limited economic infrastructure, the absence of a broadly educated population, and the dearth of other tools necessary for organizing a modern state too often conspired to relegate African states to one-party rule under charismatic independence leaders or military dictatorships. The added complication of European settlers created minority white governments in South Africa and Rhodesia. The Portuguese colonies of Angola and Mozambique only achieved their independence in the mid-1970s, sparking civil wars, which became enmeshed in surrogate conflicts between the East and West. Cold War tensions, racialism, strongman rule, civil wars, insurrections, military coups, corruption, counterproductive economic decisions, and lack of rule of law plagued much of Africa's post-independence history.<sup>1</sup>

The United States, much to the annoyance of its European allies, espoused the devolution of colonial empires to indigenous rule in Africa and elsewhere after 1945. By the late 1970s American leaders recognized that Africa was not solely a European problem, for events there could affect U.S. interests elsewhere, especially in the Middle East and the Persian Gulf. The Carter administration had high hopes

for Africa, but with the Soviet Union and Cuba actively supporting insurgencies and Marxist states, the United States had to decide what its military, as well as political, role on the continent would be.<sup>2</sup>

Africa had not loomed large for the U.S. defense establishment. Before 1977 the Department of Defense played a limited and subsidiary role. After the murder of Congo's charismatic Marxist leader Patrice Lumumba in 1961, the United States stepped up secret operations in the newly independent nation to support anticommunist Congolese politicians and then to help consolidate the power of General Joseph Désiré Mobutu, who became president of Zaire (as he renamed the Congo). DoD officials had little equity or interest in the Congo—or the rest of Sub-Saharan Africa for that matter—save providing support as required in diplomatic and intelligence operations directed from the State Department, CIA, and the White House. Officials at State and CIA engaged in diplomatic and covert efforts, which they believed would prevent the Congo from “going Communist” and aligning itself with the Soviet bloc.<sup>3</sup>

This pattern of covert response to Marxist threats, with only minimal DoD participation, replayed in the mid-1970s when civil war broke out among three major liberation groups in Angola seeking to assume control from Portugal's colonial rule. The United States secretly financed and armed one faction that lost to the Cuban and Soviet supported group, the Popular Movement for the Liberation of Angola, which by 1976 controlled the capital Luanda and much of the countryside but still faced opposition from other insurgent factions in the interior and on the borders. Faced with an investigation that resulted in a 1976 congressional prohibition against future covert operations in Angola, the Ford administration accepted the inevitable and ended its secret programs there.<sup>4</sup>

President Jimmy Carter had a new vision for Africa, free from East-West confrontation and secret proxy wars. He wished to promote human rights and economic development, peacefully end apartheid (the South African racial system that separated inhabitants of European descent and black Africans into two unequal societies), and promote democracy and majority rule in southern Africa. He intended to channel African nationalism toward positive goals and worry less about communism within liberation movements. Unfortunately events intervened to complicate Carter's plans. Africa never became a priority for most administration officials. But some of its regional conflicts, in which Soviet and Cuban troops either assisted or participated as combatants in military campaigns against pro-Western African states, convinced

anti-Soviet hard-liners, especially National Security Adviser Zbigniew Brzezinski, that Soviet adventurism must be challenged. In a broader context, Brzezinski maintained these Soviet actions posed a test of U.S. national will. The president, Secretary of Defense Harold Brown, Secretary of State Cyrus Vance, and most OSD, State, and NSC African specialists initially opposed Brzezinski's view. They eventually accepted limited U.S. military involvement in the Horn of Africa and East Africa, not so much because of the threat Cuban and Soviet proxies posed there or to send Moscow a message as Brzezinski recommended, but because of the vulnerability of the West in the Persian Gulf, Indian Ocean, and Southwest Asia after the fall of the Shah in Iran in early 1979. The loss of Iran brought home the need for military access and facilities in the African littoral of the Indian Ocean and Gulf of Aden.<sup>5</sup>

### **First Challenges: Zaire and the Horn of Africa**

Just two months into his presidency, Carter and his advisers faced a decision whether to provide military support to President Mobutu Sese Seko (as he preferred to be called) of Zaire, who presided over a ramshackle government that operated continuously on the brink of chaos. Although the country was blessed with mineral wealth, corruption and the ineptitude of the Mobutu government, strong European mining interests, separatist and ethnic tendencies within Zaire, and the hostile presence of a Marxist regime in neighboring Angola perpetuated Zaire's instability and virtual lack of governability. In March 1977 Mobutu urgently requested three M60A1 tanks (a 1963 upgraded version of the M60 tank), and one M88A1 tank retriever to help turn back an invasion of Zaire's mineral-rich Shaba province (formerly the breakaway Katanga province) by Katangese rebels, who had taken sanctuary in Angola after their mid-1960s secession collapsed. That their invasion originated across the border in newly Marxist Angola gave some credence to Mobutu's claim that the Soviets and Cubans were behind it. The small invasion force, estimated to be at most 2,000, advanced on Kolwezi, the major mining town in Shaba. Zaire's army seemed incapable of stopping it.<sup>6</sup>

The Joint Chiefs of Staff opposed providing M60A1 tanks on the grounds that diversions of a few such tanks in previous years for other allies "have had a cumulative effect which has caused significant adverse impact on the readiness posture of US Forces." If a political decision resulted in giving tanks to Mobutu, the JCS recommended the older M48A5 tanks.<sup>7</sup> But Carter was not prepared to give Mobutu



President Mobutu Sese Seko of Zaire greets Air Force Brig. Gen. Archer Durham as he begins his departure from Washington, DC, December 1981. (RG 330, NARA II)

any tanks, accepting Secretary Vance's recommendation that Zaire should not be allowed to escalate into an East-West confrontation. The president limited aid to Zaire to nonlethal items and spare parts for previously furnished equipment.<sup>8</sup> What Zaire needed most was ammunition (especially for M16 rifles), which DoD was not prepared to provide for fear of being entangled with Mobutu. Brzezinski agreed, warning that such a decision "would commit us far more deeply than the small steps taken to date."<sup>9</sup> When the State Department suggested a three-way deal whereby Zaire used U.S. foreign military sales credits to buy petroleum, oil, and lubricants, thus freeing up Zaire's foreign exchange for the purchase of M16 ammunition from the Belgians, Brown commented, "I believe I could live with the 3-way arrangement."<sup>10</sup> According to an NSC staffer, "The President is not anxious to become greatly involved in Mobutu's war." The ammunition shortage eased when the French and Belgians stepped forward with sales and grants of ammunition and other supplies. The crisis passed for the time being when the French persuaded the Moroccan government to send a 1,500-man peacekeeping force to Shaba and airlifted the troops in. The Katangese rebels and those who had supported them slipped back into Angola.<sup>11</sup>

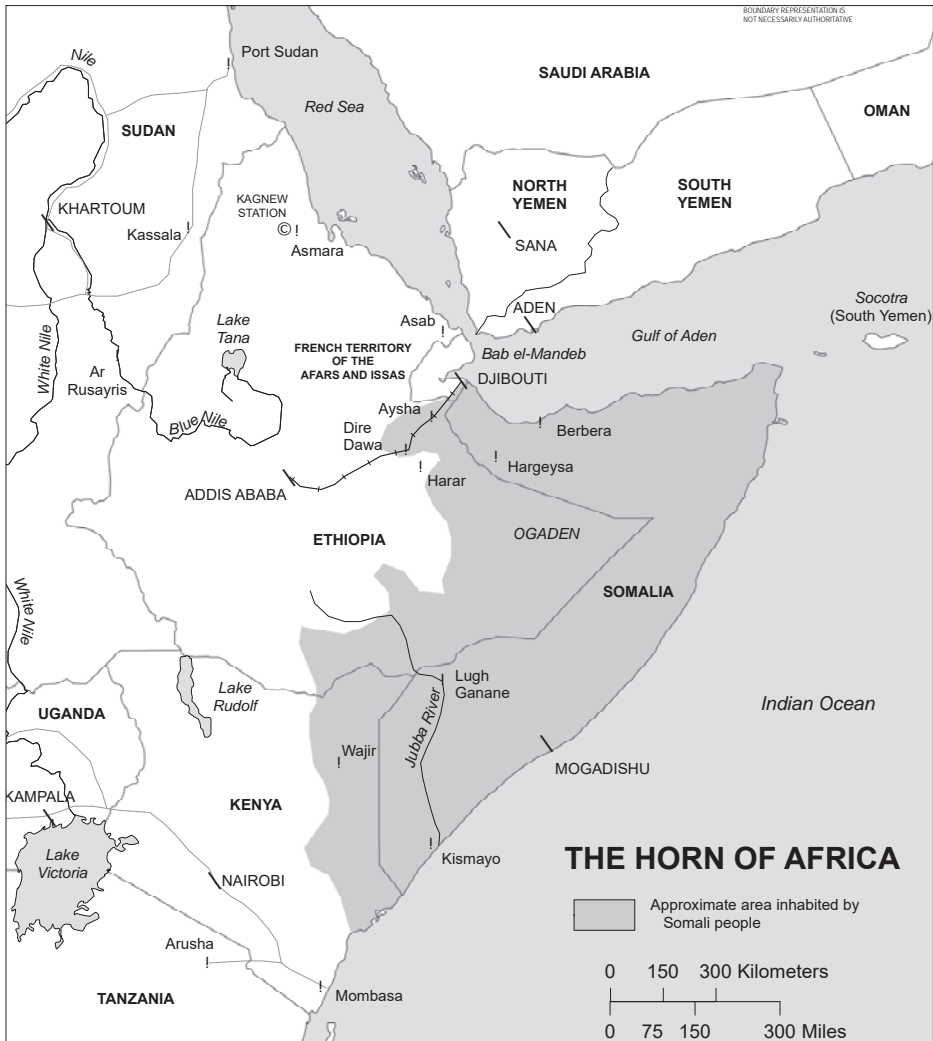

giscarto.com

The Carter administration thus avoided escalation of a regional incident into a Cold War confrontation, but Shaba had been an easy call. Even Brzezinski was cautious. The second challenge arose in the Horn of Africa during a conflict between Ethiopia and Somalia over the Ogaden, a huge winter pasturing area inhabited by Muslim Somalis who had grazed their herds there for centuries. European powers at the beginning of the 20th century recognized the Ogaden as part of Ethiopia. When Somalia turned to the Soviet Union for military assistance in reclaiming its “lost” territory, it created a conflict with great danger of superpower confrontation.

The Horn of Africa (Ethiopia, Somalia, and the French protectorate Djibouti, which became independent in 1977) was in a transition period. In the early 1970s Africa's oldest monarchy, Ethiopia, underwent a revolution led by Marxist military officers including Lt. Col. Mengistu Haile Mariam. They forced Emperor Haile Selassie to abdicate in 1974 and formed a military revolutionary council that took power. Ethiopian elites fled the country. In December 1976 Ethiopia signed an arms supply agreement with the Soviet Union. Formerly one of America's staunchest allies in Africa, Ethiopia joined the Soviet camp. Somalia, still essentially a Soviet client, began to look more favorably on the United States as the Soviet Union increased military support of Ethiopia.<sup>12</sup>

With the revolution in Ethiopia and the ensuing revolt of the Muslim Eritrean province against the Christian-dominated government in Addis Ababa, Ford administration officials called for the closing of the U.S. naval communications' Kagnev Station in Asmara, Eritrea's provincial capital. It fell to the Carter administration to make the final decision. Under Haile Selassie, the station at one time housed over 3,000 Americans and their dependents, but it had become redundant as a communications relay site by 1977. With only 39 U.S. personnel stationed there, Kagnev's sole function was to serve as a link supporting worldwide presidential communications. The station exerted no discernable military or political influence in Ethiopia and its presidential communication support services could move elsewhere. In the midst of a civil conflict between Ethiopians and insurgent Eritrean rebels, U.S. personnel at Kagnev could well become hostages or face other dangers. In March 1977 Secretary Brown recommended closing Kagnev, and Brzezinski agreed. Brown asked State to initiate negotiations with Iran to relocate the site to Tehran.<sup>13</sup>

The Kagnev closing represented unfinished business of the Ford presidency. In early 1977 the Carter administration grappled with the fast-changing situation in Ethiopia and Somalia. Although moving quickly toward close relations with Moscow, Ethiopia still had a U.S. Military Assistance Advisory Group in Addis Ababa, and most of Ethiopia's military equipment was American. At a Policy Review Committee meeting on 11 April 1977, Brown and other members agreed that the United States should gradually terminate all military aid to Addis Ababa. Given Ethiopia's political instability and unpredictability, the committee also recommended that for the safety of Americans stationed there the Ethiopian government not be informed. Carter overruled the PRC, insisting that Mengistu's pro-Soviet/



Cuban stance required that U.S. military aid should be terminated immediately and the Ethiopian government informed.<sup>14</sup> Brown opposed this sudden end of military assistance, but it all became academic on 23 April, when the Ethiopian government gave the United States 72 hours to close the MAAG, U.S. Information Agency operations, and the Asmara Consulate as well as to reduce the embassy to a skeleton staff. At the end of April the administration cancelled all arms shipments to Ethiopia, including those in the pipeline, and ended all credits for arms sales.<sup>15</sup>

Ironically, Somalia, Ethiopia's major rival, still had Soviet advisers in-country and its army deployed only Soviet weapons and equipment. Taking advantage of Ethiopia's troubles in Eritrea, the Somali government supported an irregular force, the West Somalia Liberation Front, which invaded the Ogaden in April 1977. The Somali irregulars soon controlled most of the area except the region's major town of Harar and the railhead of Dire Dawa. Although not happy about Somali-supported cross-border irredentism, Carter and Vice President Mondale met with the Somali ambassador, who requested U.S. military assistance. The Carter administration refused to give military support as long as Somali guerrillas held the Ogaden. However, Carter told the ambassador that the United States would "work with the Saudis and our European allies to see that Somalia has adequate defense capabilities without relying on the Soviet Union." To the Somalis this was a promise. When Somalis made a specific request in early July 1977, the Carter administration agreed "in principle" to allow other countries (Saudi Arabia, Iran, Sudan, Egypt, and Western European allies) to provide defensive weapons of U.S. origin, but the subsequent U.S. discovery that Somali regular army forces had deployed to the Ogaden derailed the deal.<sup>16</sup>

In November 1977 the Somali government expelled Soviet advisers, renounced its treaty of friendship with Moscow, and broke relations with Cuba. Somalia strongman President Mohammed Siad Barre hoped this would change the administration's position on military assistance, but Washington stood firm: Somali troops in the Ogaden meant no U.S. weapons. Still, the Soviet-Cuban presence in Ethiopia continued to grow. U.S. intelligence reports indicated that at the urgent request of Mengistu's military council the Soviet Union had been airlifting men and materiel to Ethiopia. The head of the Soviet military mission, General Vasilli I. Petrov, directed a resupply operation from the Soviet Union and Angola of 650 new Soviet and Cuban military advisers (with some of the Cubans intended for a combat role), raising total Soviet and Cuban personnel in Ethiopia to more than

500 and 1,200 respectively. More were on the way. The Soviets also airlifted equipment, supplies, and advanced weaponry. Other reports suggested that Petrov was encouraging Ethiopia to attack northern Somalia to force a withdrawal from the Ogaden.<sup>17</sup> The Carter administration undertook diplomatic consultations in the hopes that African or Middle East states might broker a peace in the Horn; it also maintained tenuous contacts with Mengistu on the slim chance of persuading him to back away from Moscow, but neither effort produced results.<sup>18</sup>

As a precaution, Brzezinski asked Secretary Brown for a contingency assessment of the United States' ability to sustain and prevail in a military confrontation with the Soviets in the Horn of Africa. JCS Chairman General George Brown provided an estimate of the firepower the United States could bring to the Horn: 24 F-4s from the U.S. European Command within 20 hours; 72 F-4s and their support within 84 hours; a cruiser task force, a helicopter carrier, and a Marine amphibious unit (1,200 Marines) from the Mediterranean within eight days. An airborne battalion combat team (1,100 troops) could deploy from Italy within two days, but it would take 14 days to deploy the 82nd Airborne Division (15,000 troops), 18 days for the 101st Airborne (18,000 troops), and 14–19 days for an aircraft carrier group from Japan.<sup>19</sup> This contingency planning, however, did not presage action. NSC African area staffer Paul B. Henze viewed this inaction as a plus, noting, "We avoided the knee-jerk reaction of jumping into a military relationship" and kept "*all our options open*," notwithstanding pressure from Saudi Arabia and the Shah of Iran for greater U.S. involvement.<sup>20</sup>

### **Shaba II and the Ethiopian Offensive in the Ogaden**

Zaire's control of Shaba faced another threat in May 1978. Tension grew on the Angolan-Zaire border. Zaire's continued support for the antigovernment insurgent forces in Angola's south and a campaign of South African bombing attacks on Namibian rebels in sanctuary sites deep in Angola provoked the Angolan government of Antonio Agostinho Neto, which responded by unleashing the Katangese rebels on Shaba. This time a force of 4,000 Katangese took Kolwesi, where over 2,500 European and 88 U.S. mining technicians worked.<sup>21</sup> Without security for Zaire's foreign civilian technicians, the already shaky mining-based economy of Zaire faced economic disaster. The consensus in Washington held that the United States would have to support an international peacekeeping force headed by the Belgians and French.<sup>22</sup> Brown urged,



“If we fail to supply logistics support, as distinct from combat support or even advisers, I believe we will be seen . . . as all words and no actions.”<sup>23</sup> The president approved the use of C-141s to airlift French and Belgian troops to Kolwesi to evacuate civilians, transport fuel and communications equipment, and move French military equipment from Corsica to Lubumbashi in Zaire. Later, in May and June, U.S. C-141s flew French forces out of Shaba and brought in a multilateral African peacekeeping force to replace them. From 16 May to 16 June 1978, the U.S. Air Force airlifted a total of 1,302 passengers in or out of Shaba and brought in 2,457 short tons of cargo.<sup>24</sup>

The multilateral force under Moroccan Colonel Lobaris calmed the situation in Shaba’s mining towns. Although the troops failed to expel the rebels, they dispersed and reduced them to banditry and cattle rustling. Equally important, the force

curbed somewhat the undisciplined Zairian army's looting in and around Kolwezi.<sup>25</sup> More than in the first invasion, U.S. intelligence concluded that the second invasion, dubbed Shaba II, could not have been undertaken without the knowledge, support, and training of the Katangese by Cubans in Angola. Carter publicly charged Cuba with knowledge of and failure to prevent the operation. Brown suggested that the Cubans supplied logistics and training. Vance was not convinced.<sup>26</sup>

If the hand of Havana and Moscow in the second invasion of Zaire was hidden or absent, such was not the case in the Horn of Africa. Soviet and Cuban advisers, equipment, and weapons continued to pour into Ethiopia. While Somali irregulars supported by the Somali army had enjoyed success in the Ogaden during most of 1977, at the end of the year they found themselves in a military stalemate with Ethiopian forces stiffened with Cuban advisers and Soviet equipment. In January 1978 the Ethiopian counteroffensive began, supported by two Cuban combat brigades and additional superior Soviet-supplied weaponry. By the end of February 1978, the Somali occupation of most of the Ogaden collapsed and the Somalis were in full retreat. Officials in Washington worried that the advancing Ethiopians would not stop at the Somali border, invading Somalia itself, but the Russians and Ethiopians made it clear that retaking the Ogaden was their sole objective. Ethiopian troops would not cross into Somalia.<sup>27</sup>

Anticipating an Ethiopian invasion, a team from the JCS and the Office of Assistant Secretary of Defense for International Security Affairs had prepared options in January for U.S. assistance to Somalia without U.S. combat personnel or advisers. Assistant and Deputy Assistant Secretaries (ISA) David McGiffert and Walter Slocombe questioned the objectives of such an exercise. Was it to prevent a Soviet takeover of Ethiopia; to support self-determination for the Ogaden; to defend Somalia and Djibouti; to teach the Cubans a lesson; or some other objective? "If we don't know what we want to happen, we won't know how to distance ourselves from results about which we don't really care," they suggested.<sup>28</sup> In late January the Special Coordination Committee (the NSC subcommittee chaired by Brzezinski) met and concluded that "the U.S. Government should be cautious about taking actions that would in themselves encourage a sense of crisis or confrontation with the Soviets or that would commit us prematurely to positions that could limit our flexibility." The SCC recommended continued contingency planning for possible U.S. military responses, including deployment of a U.S. naval force to the Red Sea

and use of U.S. military intelligence channels to sound out Iranians, Saudis, Egyptians, and Sudanese about their willingness to support Somalia.<sup>29</sup>

On 23 February 1978 Director of Central Intelligence Stansfield Turner reported at an NSC meeting that there were nearly 10,000 Cubans in Ethiopia, including a mechanized infantry brigade and 40 Cuban pilots. Turner added that over the last two months 19 Soviet ships had arrived in Ethiopian ports with supplies. Admittedly, not all of this effort was directed at Somalia; some of it supported the war against Eritrean separatists, who were receiving substantial support from other Muslim nations including Saudi Arabia, Sudan, and Iran. Nevertheless, the military situation in the Ogaden had turned sharply against Somalia. For DoD, the major question was whether to send a U.S. carrier task force to the East African coast. Brzezinski recalled that he desperately wanted to dispatch the force; Vance remembered opposing it. Brown sided with Vance. According to Brzezinski, a cautious Brown would authorize a carrier task force only if it had a specific purpose. Brown agreed with Vance that a "bluffing game" in the Horn would be a mistake. Why would the United States send a carrier yet not launch the aircraft? Carter vetoed a potential deployment but expressed willingness to consider moving a carrier task force to Diego Garcia, the U.S. base in the eastern Indian Ocean (apparently to appease his national security adviser).<sup>30</sup> As long as Somali troops still occupied the Ogaden, Carter would not allow Muslim countries to ship U.S.-originated weapons to the Somalis. Should the Somalis agree to withdraw, the Carter administration would consult with Congress to authorize weapon transfers. An Ethiopian invasion of Somalia would eliminate these proscriptions. If Somalia's allies become involved in countering the Ethiopian invasion of Somalia, either by providing air support or troops, the United States would protect them from Soviet threats or retaliation.<sup>31</sup>

For the next two and a half months Brown attended all but one of six SCC meetings on the situation in the Horn to discuss and weigh the various diplomatic missions and efforts. State consulted with pro-Western regional allies to resolve the crisis.<sup>32</sup> In response to increasing requests for assistance from Somalia, the Special Coordination Committee recommended, and Brzezinski initially agreed, to send a military survey team to Somalia to discuss communications, transportation, and light antitank weapons.<sup>33</sup> Brown had another suggestion that he made directly to Carter: initiate talks with the People's Republic of China to demonstrate U.S. displeasure at Soviet adventurism in Africa. This struck a responsive chord with

Brzezinski, an advocate of the “China card” (cooperating with China to offset the Soviet Union), who was becoming increasingly concerned about Soviet actions in the Horn, a view not shared by Vance. The military dialogue with China eventually happened, but too late to have any effect on Moscow’s actions.<sup>34</sup>

The Ethiopian-Cuban success in retaking the Ogaden should have freed Carter and his advisers from one moral dilemma: providing military aid to Somalia when it was in possession of Ethiopian territory. Of course, it proved not that simple. Somalia continued to operate an estimated 15,000–20,000 irregulars who crossed back and forth over the border to engage the estimated 75,000–80,000 Ethiopian troops plus 8,000 Cubans in the Ogaden and vicinity. Somali officers and enlisted troops formed a central unit inside Somalia to support and coordinate the guerrilla effort. Inside the Ogaden, Somali officers and enlisted men acted as military advisers to the irregulars. The general intelligence assessment held that for domestic reasons Siad Barre could not “turn off the valve” of direction and supplies to these guerrillas.<sup>35</sup>

Given this state of affairs, the Policy Review Committee, the NSC subcommittee made up of Carter’s principal advisers including Brown, recommended at the end of July 1978 that the president hold back the U.S. military survey team from Somalia and tell Siad Barre that the reversal was in reaction to his support for the guerrillas in Ogaden. Economic development assistance, a U.S. September naval visit, a military attaché assigned to Mogadishu (without authority to discuss military aid), and possibly advanced military training in the United States for one or two Somali officers remained on the table.<sup>36</sup>

U.S. policy toward the Horn of Africa in 1977 and 1978 was a 20th-century version of the British Empire’s 19th-century policy of “masterful inaction” on the northwest frontier of India: lots of talk, study, consultation, a few tentative decisions mostly delayed or rescinded—all resulting in no actual military response. Brzezinski recalled his frustration as he argued for military action, but no one in the Pentagon, State Department, or even his own African adviser on the NSC staff, Paul Henze, supported the call to arms. Ironically, events outside the Horn of Africa conspired to generate new interest in Somalia—the January 1979 fall of the Shah of Iran and the December 1979 Soviet invasion of Afghanistan. These two developments brought genuine U.S. interests in play and persuaded U.S. officials to reassess the military position in the Persian Gulf and Indian Ocean. Somalia and other friendly states in East Africa became candidates for U.S. support as key

administration officials saw their potential as part of a framework for security in the Persian Gulf and western Indian Ocean (see chapter 11).<sup>37</sup>

### **Soviets and Cubans in Africa**

Although the Carter administration sought a new look at Somalia and East Africa as part of a broader strategy, the Soviets and Cubans in Africa required their attention. By early 1978 both countries were deeply involved in Africa. They helped consolidate the Neto regime in Angola and then successfully turned around Ethiopia's failing wars against Eritrean separatism and Somali irredentism. Carter and his advisers realized they had a problem. Generally speaking, Cubans (many of the rank and file soldiers of African descent) seemed to interact well with Africans, who found them simpatico. The Soviet Union effectively used Cubans as proxies, serving as advisers, pilots, and artillery support, among other combat roles. In the arena of low-level African conflict, Cubans earned a reputation for prowess and efficiency. The question facing Washington was how to rein them in.

Brown and ISA suggested that the leaders of the Non-Aligned Movement—Cuba was a member in good standing—might be able to convince Cuban leader Fidel Castro that assuming the mantle of third world leader to which he aspired meant dropping the mantle of a “Soviet stooge” in Africa. Looking to the movement's summit meeting in Havana in 1979, Brown and ISA saw an opportunity to persuade his fellow nonaligned states to put pressure on Castro.<sup>38</sup> It was a somewhat naïve idea, which underestimated the nonaligned world leaders' propensity for self-deception and unwillingness to take a stand against any other member. Along similar lines, the intelligence community proposed a plan of covert action to “enlighten” Cubans about the cost of Castro's intervention in Africa. Slocombe argued that without a parallel overt program, the covert proposal was not worth the effort. Nevertheless, the United States engaged in secret efforts to discredit Cuba with third world countries and to undermine Cuban domestic support for its African adventures.<sup>39</sup>

Looking for a broader solution, the president issued Presidential Review Memorandum 36 on 23 July 1978, directing the national security bureaucracy to undertake a review of the Soviet and Cuban presence in Africa, assess its threat, and recommend ways to combat it.<sup>40</sup> This was Brzezinski's issue. He would have liked to direct the study, but the general policy nature of the assessment meant Vance oversaw the review and State produced the response to PRM 36. Brown, also not

happy, feared State would act “too slowly” and “try to use the study to delay even those actions . . . we have already begun to do.” Brown still hoped to use the non-aligned states to shame Cuba into better behavior.<sup>41</sup>

The secretary’s concern about delay proved correct. State labored over the study and did not submit it for NSC review until late September 1978. The sense of urgency dissipated. Fighting in the Horn of Africa lessened with Ethiopian victories, and the second Shaba invasion had been neutralized by the African multilateral peacekeeping force. Still, the problem remained. The study estimated there were 42,000 to 47,000 Cuban civilian and military personnel in Africa (20,000 combat troops and 5,000 civilians in Angola; 17,000 troops in Ethiopia; and 500 military advisers in Mozambique). Together with about 15,000 Soviet military and civilians, Moscow and Havana provided military aid programs, training, planning, and actual combat operations. Cuba’s stronger ideological bent occasionally rubbed against the more opportunistic Soviet approach, but the PRM 36 study saw their relationship in Africa as basically symbiotic.<sup>42</sup>

The State study presented six “instruments” for combating Soviet/Cuban involvement comprising diplomatic efforts, economic assistance, military measures, support from allies and friends, economic and financial incentives and disincentives, and public diplomacy. Military measures had to be employed with the other instruments but could not include dispatch of U.S. combat troops. The military options to help those African nations engaged against the Cubans envisioned logistical support, U.S. Navy port visits, joint training exercises, and increased surveillance of Cuban aircraft, ship, and other movements. The paper presented a range of options from the status quo to additional diplomatic support, economic and military assistance, and logistical support for African peacekeeping efforts to a robust campaign against Soviet/Cuban adventurism in Africa. This third option would link better U.S.-Soviet bilateral relations outside Africa to Soviet/Cuban action in Africa. It would include U.S. and allied sanctions against Cuba, substantial increase in sophisticated military assistance to African states under threat, encouragement of African peacekeeping forces, and creation of a consortium of African/European/Arab states to combat Soviet/Cuban incursions in Africa.<sup>43</sup>

The early October 1978 NSC meeting to discuss the State Department response to PRM 36 proved anticlimactic. Brzezinski and Vance squared off. If not prepared



to combat Soviet/Cuban adventurism in Africa and link it to SALT II and other U.S.-Soviet issues, Brzezinski recommended cutting Africa loose. Vance argued for maintaining the status quo. Carter approved Vance's position, which put a hold on future military measures. The Soviets and Cubans were still in Africa and available for other operations.<sup>44</sup>

### **Somalia, Kenya, and the Middle East**

The fall of the Shah of Iran in January 1979 changed the Middle East security picture dramatically. No longer could the United States rely on Iran as a pillar of security in the Persian Gulf and beyond as it had under the Nixon administration; nor could it count on the twin pillars of Iran and Saudi Arabia as it did during the later Nixon and Ford years. The Carter administration decided to replace Iran with a framework for security that tied together allied countries on the littoral of the Indian Ocean and offered U.S. forces access in the event of a regional conflict. Kenya, Somalia, and Oman provided potential sites for increased U.S. military presence. Already one of the largest recipients of U.S. military assistance in Africa, Kenya agreed in June 1980 to allow U.S. air and naval access to selected ports and airfields. A similar agreement with Oman followed. The only complication in Kenya arose over an exception from Carter administration policy of prohibiting sales of advanced weapons to lesser-developed countries. When important U.S. security interests emerged, policy adjusted. The administration made an exception and allowed Kenya to receive 32 helicopters armed with optically tracked wire-guided missiles. The problem country remained Somalia.<sup>45</sup>

In August 1979 Brown suggested that the Somali port of Berbera (on the Red Sea coast across from Aden and east of Djibouti), with its 15,000-foot, Soviet-constructed concrete airfield, provided an ideal landing site for U.S. P-3 maritime patrol aircraft engaged in aerial surveillance of the Gulf of Aden. The secretary envisioned U.S. naval visits and a limited bunkering arrangement, monthly P-3 flights out of Berbera or Mogadishu, and possible improvements to Berbera's port financed by the U.S. Agency for International Development or the Saudis. Of course, Siad Barre wanted U.S. military assistance in return and would likely not cease his guerrilla campaign in the Ogaden.<sup>46</sup> State opposed the idea. NSC staffer for Africa Paul Henze noted how the Pentagon's argument, that the Soviet-built Somali facilities were so good that the United States could not afford not to use them, begged the

question of why they needed to be upgraded. To Henze, the proposal represented a slippery slope at the bottom of which Washington would find itself tied to the disreputable Somali strongman.<sup>47</sup>

Sporadically over the next 10 months the Carter administration debated the Brown proposal. Somalia was hardly a high-priority issue. Vance suggested in late October 1979 that it was time to sell defensive weapons, specifically two C-130 transport aircraft, transportation and engineering equipment, and radar, and to dispatch a military survey team to Somalia to advise on additional sales of nonlethal equipment. In addition, the U.S. Army Corps of Engineers would undertake projects to upgrade Somali transportation infrastructure provided the Saudis financed them.<sup>48</sup> Brown supported the plan, but he recommended a delay in sending the survey team until the Saudis provided firm assurances that they would pay for additional purchases.<sup>49</sup> ISA stressed the need to make sure the Saudis bankrolled infrastructure improvements in Somalia, hoping that modest U.S. military assistance would prime the Saudi money pump.<sup>50</sup>

The plan was not without its critics. One of the leading U.S. analysts of the Horn predicted, "If we want to have the Addis Embassy stormed and occupied, all we have to do is give military aid to Somalia . . . after the way things have gone in Tehran, he's [Mengistu] likely to feel he could get away with it!"<sup>51</sup> Nevertheless the proposal proceeded, albeit slowly and tentatively. The survey team visited Somalia in March 1980 to find Siad Barre's armed forces deficient in virtually everything—air defense, air force, anti-armor, mechanized infantry, coastal patrol, and communication. The embassy in Mogadishu concurred with the assessment: Somalia lacked an offensive military capability and would have difficulty defending itself from outside attack. Given these problems, McGiffert recommended scaling back and delaying military assistance and construction of Somali facilities.<sup>52</sup> Brown proposed "to go ahead as planned, but not up the ante." The secretary commented: "I held my nose when we [first] decided to go ahead" because the United States needed access to facilities in Kenya, Oman, and Somalia; a U.S. access to the Soviet-built Berbera facility provided "political value"; and because a U.S. ally, Egyptian President Anwar Sadat, supported Siad Barre. Carter agreed with Brown and approved moving ahead on the access agreement with Somalia.<sup>53</sup>

Somali-Ethiopian skirmishes continued in the Ogaden. Then, in mid-1980, Siad Barre used regular forces to invade.<sup>54</sup> For McGiffert, this was the last straw,

convincing him of the need to pull back on the negotiations for access to Somalia's facilities. Ethiopia was more strategically important; the Somali facilities were "militarily useful" but not "vital." McGiffert questioned the value of denying Somali facilities to the Soviets when they were already firmly ensconced in Ethiopia and Yemen. Moreover, President Sadat's "brave words" about coming to Somalia's defense were just that. If Ethiopia attacked Berbera only U.S. troops could defend it. Brown commented: "I disagree with this approach—we can't back out. . . . My limitation on commitment would be no U.S. ground troops."<sup>55</sup> Carter's advisers agreed with Brown at an SCC meeting where consensus emerged: to back out of the agreement with Somalia would be a "major black eye for [the] US." All doubted the Ethiopians and Cubans would attack Berbera as they had never yet crossed a recognized border in the Horn. The SCC saw value in denying Berbera to the Soviets and providing an access and base failsafe if relations with Oman and Kenya, where the United States had access agreements, "went sour."<sup>56</sup>

The issue received the highest level of consideration at a mid-June 1980 meeting with the president in attendance. Secretary of State Edmund Muskie (Vance had resigned over the Iran hostage rescue mission) explained that his department favored negotiating for the use of facilities at Berbera. The United States would offer \$40 million in foreign military sales of defensive weapons to Somalia and provide a generalized security commitment, with an explicit understanding that the United States would not bail out Siad Barre from the consequences of his "adventures in the Ogaden." Carter "found Siad Barre to be an unsavory character" and stated he would rather lose Berbera than go to war over it. Muskie agreed, admitting that he rued the day the negotiations began, but Brown argued that Berbera was useful, although less significant once access agreements had been signed with Kenya and Oman. Nevertheless, Brown said he would "stay with our present position" to "use the facilities but not invest in them." Without being "trapped" into a sizable investment in the event of war, the U.S. presence might well deter a conflict in the Horn of Africa. Carter admitted that West German Chancellor Helmut Schmidt was "constantly hectoring him on the importance of Somalia." Brzezinski's advice was to stay the course, but Carter, not fully convinced, suggested as a final step consultations with major European allies.<sup>57</sup>

As noted by the president, the more the United States supported Siad the more likely he was to be emboldened in the Ogaden and the more likely Ethiopia

would retaliate by crossing into Somalia. Most of Brown's staff expressed skepticism about the strategic value of Somalia and worried that defending it would be a "tall order." Brown took a different view: "We could not sit idle if Ethiopia invades Somalia, anyway at least not w/o major political penalty."<sup>58</sup> When U.S. intelligence picked up reports that the Soviets had warned the Ethiopians not to invade Somalia, and when Siad ordered the withdrawal of regular Somali forces from the southern Ogaden, the way was clear for U.S.-Somali negotiations.<sup>59</sup> The NSC urged caution. As one staffer observed, "I sense no strong lust to give them everything they want in State, or even in Defense—except for people such as [Robert] Komer [under secretary of defense for policy], who want to give them the moon and then some."<sup>60</sup> While Komer was clearly an advocate, Brown also thought that Somalia was important, not so much for regional considerations, but in the broader context of security in the Persian Gulf and as a test of U.S. toughness following the unsuccessful Iran hostage rescue operation and the Soviet invasion of Afghanistan. The United States and Somalia signed a two-year deal for \$40 million in military assistance and \$137 million in economic assistance, but Congress cut military assistance in half and refused to approve the sale as long as Somali guerrillas in the Ogaden received support from Mogadishu. Not until two years later, during the Reagan presidency, did U.S. defensive military equipment finally arrive in Somalia.<sup>61</sup>

### **The Pariahs: South Africa and Rhodesia**

Carter took office with clear ideas about southern Africa. He hoped to end apartheid in South Africa, complete the process for majority rule in Rhodesia in conjunction with the British, and end the status of Namibia (formerly South-West Africa) as a virtual colony of South Africa. For the most part Brown shared these goals, but the Pentagon's longstanding institutional and strategic relations with South Africa complicated Carter's policy. On his second day in the White House, Carter directed the State Department to review U.S. policy toward South Africa, Rhodesia, and Namibia.<sup>62</sup> Defense was not asked to draft any specific part of the response. At the PRC meeting in February 1977 to discuss the results of the review, Deputy Secretary Duncan added his support for the basic consensus that Rhodesia, South Africa, and Namibia should be treated as separate issues, judging each on its own merits. The committee opposed putting aside South Africa's domestic racial problems to

concentrate on Rhodesia and Namibia. For South Africa, it would no longer be business as usual; the United States would press the country to get its racial house in order. For Rhodesia, Washington would encourage a new round of negotiations between the white minority government of Ian Smith and the Zimbabwean independence groups fighting him. The United States would also encourage negotiations between South Africa and the liberation organizations fighting for independence for Namibia.<sup>63</sup> The only dissenter, JCS Chairman General George Brown, maintained that South African President John Vorster represented the key to a Rhodesian settlement; pushing him on apartheid could prove counterproductive and difficult to explain to the American public.<sup>64</sup>

After an NSC meeting in early March 1977, Carter approved a new policy toward South Africa to end apartheid and create a multiracial democratic society.<sup>65</sup> The president directed Vance to design a plan to promote the progressive transformation of South African society. He ordered Secretary of the Treasury W. Michael Blumenthal to work with U.S. corporations to limit their activities in South Africa. In the military realm, the ongoing arms embargo would be tightened by including in the embargo dual-purpose items, such as executive aircraft that could perform military functions. Carter enjoined U.S. agencies to terminate relationships with South Africa that were inconsistent with his new policy.<sup>66</sup> For DoD, these prohibitions called into question the role of defense attachés in South Africa and whether the Eastern Test Range Tracking Station in South Africa used to monitor satellite launches should be reactivated. Speaking for the administration, Brzezinski directed that the station remain deactivated and a search begun for an alternative location outside South Africa.<sup>67</sup>

After extended discussion and then recommendations from the PRC in October 1977, Carter terminated the sale of all items destined for use by South African military or police, including “gray area” sales of civilian equipment that could have military applications. In another decision that impacted the Pentagon, the president recalled the naval defense attaché from Pretoria.<sup>68</sup> Also in October, Carter prohibited expansion of intelligence-sharing with South Africa, specifically refusing to grant licenses for exporting ocean surveillance equipment to Pretoria. This prohibition hit Pentagon intelligence organizations hard, denying them access to South African information on shipping and naval operations around the Cape of Good Hope, already a busy maritime shipping lane that would become even more

crucial should the Egyptians close the Suez Canal again as they did from 1967 to 1976. The Joint Staff vigorously but unsuccessfully opposed the removal of a defense attaché because of its impact on U.S. intelligence capabilities.<sup>69</sup>

Over the next six months, DoD severely reduced U.S.–South African military contacts, retaining the prohibition against use of the USAF tracking station near Pretoria and not allowing specially instrumented aircraft to perform tracking functions out of South Africa. No U.S. naval ship visited a South African port without ISA approval. South Africa received no security assistance materiel, training, grants, and credits or sales, and South African police received no commodities and technical data. The State and Commerce Departments scrutinized commercial sales of military-related items. South African citizens could not attend U.S. military schools or take DoD correspondence courses. Ceremonial contacts, official visits, letters of congratulation or similar correspondence, and research cooperation were prohibited without ISA approval. DoD would not support financially, logistically, or otherwise sporting events where South Africans participated; it discouraged private participation by U.S. service personnel on leave.<sup>70</sup>

Ending cooperation on nuclear power provided another means of isolating South Africa. During the 1950s and 1960s, South Africa had been a major supplier of uranium to the United States, and in return the United States helped Pretoria develop a peaceful nuclear energy and research program. The South Africans by their actions did not help their cause from Washington's point of view. In August 1977 the intelligence community concluded that "the South African Government plans to proceed through the various stages of a nuclear program, including testing a nuclear weapon."<sup>71</sup> In that same month Soviet intelligence revealed a nuclear weapons testing site in the South African portion of the Kalahari Desert. The international community faced the specter of an Afrikaner nuclear bomb. Carter ordered a demarche to South Africa to insist that it sign the Nuclear Nonproliferation Treaty, immediately cut off the supply of weapons-grade uranium exports to South Africa previously allowed, delayed any future export of U.S. equipment for South African uranium enrichment facilities pending further study, and made it clear to Pretoria that the United States would continue to monitor the Kalahari site. Although the Vorster government denied any nuclear weapons program or intentions, U.S. intelligence concluded that "South Africa will continue down the nuclear weapons path" and that denials to that effect were probably false.<sup>72</sup>

Then, in September 1979, a U.S. satellite picked up a double flash of light in the southern hemisphere in the area of South Africa. U.S. intelligence had high confidence it was a nuclear test but could not confirm it with the detection devices it had in the area. Furthermore, releasing information about the incident would reveal the extent of U.S. intelligence capabilities. As Brown commented, “The proof is *weak* in terms of public usability,” but the whole situation “makes me quite uneasy.”<sup>73</sup> The administration worried about the incident, but it was unprepared to call out the South Africans publicly. Brown commissioned a study by experts under the direction of Nobel Prize winner physicist Luis W. Alvarez. They concluded the flash was almost surely a natural event, not a nuclear test. Such a finding, however, did not rule out a South African nuclear program to build a bomb. At a 24 October PRC meeting, Brown, Duncan, McGiffert, and others agreed that “South Africa could possibly be ready to explode a nuclear device in a couple of weeks.” The PRC participants discussed and prepared for additional sanctions against South Africa.<sup>74</sup> Notwithstanding U.S. concern, the South African government continued to develop secretly its nuclear program. One expert on this effort concluded that by 1981 South Africa was a “de facto nuclear state.”<sup>75</sup> The question of a South African nuclear bomb threatened a resolution of the conflict in South Africa. In attempting to slow nuclear proliferation in South Africa and in its general policy of sanctions against Pretoria, the Carter administration failed to make much headway. In Rhodesia it enjoyed some success.

The Carter administration’s role in seeking a settlement of the conflict between the white settler government of Rhodesia and the opposing Zimbabwean guerrilla forces was essentially a matter of diplomatic negotiations undertaken by the United States, the U.K., the so-called Front Line African States (Botswana, Mozambique, Tanzania, and Zambia), which supported the Zimbabwean guerrillas, and South Africa, which threw in its lot with the white Rhodesia government. While ISA kept Brown and Duncan apprised of Rhodesian developments, DoD’s actual role was secondary. The secretary and deputy secretary tended to defer to State, NSC, Commerce, or other agencies in interdepartmental meetings on Rhodesian/Zimbabwean issues. There was one major exception. At ISA’s suggestion, in October 1978 Brown urged the president to consider “the Mugabe option,” encouraging Robert Mugabe, head of the Zimbabwean African National Union, to join with the white settler-dominated multiracial government. DoD

considered the other major Zimbabwean political figure, Joshua Nkomo, head of the Zimbabwean African People's Union, too dependent on Cuban and Soviet support. State showed no enthusiasm for the idea.<sup>76</sup>

In March 1979 Deputy Secretary Duncan reprised the "Mugabe option," suggesting that Mugabe's participation in internationally monitored elections might break the current deadlock by at least involving one leader of the African Patriotic Front (the united political organization of the Zimbabwean guerrilla movements) in a new all-parties settlement.<sup>77</sup> State dismissed the idea. Such a policy would destroy a comprehensive settlement and be viewed by Nkomo and the Front Line States as a sellout by Mugabe, resulting in civil war between the two major guerrilla groups along the 1970s' Angolan model, with increased Soviet/Cuban involvement. State and Vance held out for UN-supervised elections acceptable to both Mugabe and Nkomo.<sup>78</sup> In September 1979 the parties signed an agreement ending Rhodesia's unilateral independence, reestablishing British rule, implementing a cease-fire, and setting terms for an impartial election, which Mugabe won when it was held in February 1980. As for Namibia, DoD's role was secondary as the Carter administration unsuccessfully tried to use the United Nations and diplomatic pressure to persuade South Africa to relinquish its de facto control of the country (it finally did so in 1991). In neither Rhodesia-Zimbabwe nor Namibia did Soviet/Cuban forces play a major role, thus avoiding a direct superpower confrontation.<sup>79</sup>

### **Morocco and Western Sahara**

For the Pentagon, most of North Africa (excluding Egypt, which was considered part of the crucial Middle East) was a backwater. Its primary focus in Africa's Mediterranean littoral was Morocco, whose relationship with the United States had been long and close. Before it was a French protectorate, Morocco was one of the first nations to do business with the young United States, signing a treaty of friendship in 1786. French-led Moroccan troops fought on the same side as U.S. doughboys, including Brown's father, in World War I and GIs in World War II. After it gained independence from France in 1956, Morocco formed its relationship with the West and the United States. Morocco provided naval and air facilities, but by 1977 they were being phased out as obsolete. Nonetheless, Morocco maintained its importance as a potential access point for U.S. military forces, especially to reinforce the



Persian Gulf or the Middle East. Furthermore, Morocco had played a stabilizing role in Zaire, providing the bulk of two African peacekeeping forces. While Morocco under King Hassan II was no democracy, the Carter administration looked upon it as a moderate government that enjoyed the support of its populace and was the least anti-Israel of the North African states.<sup>80</sup>

There was just one fly in the ointment. In 1976 Morocco annexed half of the former colony of Spanish Sahara—Mauritania got the other half—and both became engaged in a guerrilla war against the Algerian-backed Polisario guerrillas who sought independence for Western Sahara. Morocco did the bulk of the fighting as Mauritania had limited resources. While the United States recognized Morocco's and Mauritania's administrative control of Western Sahara, it did not recognize their sovereignty.<sup>81</sup> This distinction meant that Morocco's use of F-5 aircraft in Western Sahara and Mauritania against the Polisario contravened U.S. statutory requirements that U.S.-supplied weapons be used only for defense of the country to which they were sold or given. Undeterred, the Moroccan government requested OV-10 Bronco aircraft, turboprop light attack/surveillance planes designed for counterinsurgency, and AH-1 Cobra attack helicopters. While DoD and State favored the sale, opposition by congressional leaders and the controversy over U.S. aircraft sales to the Middle East convinced the Carter administration to delay any decision on the Moroccan sales.<sup>82</sup>

After the dispatch of Moroccan troops as peacekeepers in Zaire for a second time in 1978, State, DoD, and the NSC staff all agreed it was time to sell arms to Morocco. In May 1978 the administration completed a policy review of North Africa (PRM 34) that advocated closer U.S. alignment with Morocco and a more active U.S. role in promoting a settlement of the Western Sahara issue. When the Policy Review Committee met to discuss the study, Brown advocated that Morocco could use U.S.-supplied weapons, including OV-10s and AH-1s, in Mauritania against the Polisario (but not in the Western Sahara that Morocco or Mauritania claimed). State proposed and DoD readily agreed that since the Polisario guerrillas, supported by Algeria with its Soviet weapons, had taken the fight to Mauritanian soil, Morocco could use U.S. supplied F-5 aircraft to defend Mauritania within that country's borders. The United States would make clear that this decision did not imply U.S. recognition of Moroccan or Mauritanian sovereignty over Western Sahara and that it still favored self-determination based on a negotiated settlement. Carter approved.<sup>83</sup>

The PRC also recommended and the president approved in June 1978 the sale of 24 Cobras to Morocco provided its F-5 aircraft were withdrawn from the Western Sahara or the dispute was resolved successfully, which was unlikely. In January 1980 the United States informed King Hassan that the first shipment of six Cobra helicopters (manufactured under license in Italy) were on their way.<sup>84</sup> In March 1979 PRC members agreed that the dispute could not be settled militarily, given Morocco's economic problems, the military stalemate, and the kingdom's ineffective leadership. All agency representatives at the PRC meeting favored granting Morocco's request for \$6 million in F-5 spare parts, except the Arms Control and Disarmament Agency, which claimed the parts would not make a difference and were a technical violation of the 1960 bilateral agreement prohibiting their use except for the defense of the kingdom. State and Defense saw no violation since they were parts and spares, not new weapons.<sup>85</sup> The prohibition of the 1960 agreement against the use of U.S. equipment outside Morocco still applied to the sale of Cobras, which remained stalled. Then the Polisario did Morocco a favor by attacking its territory. To Brown, Vance, and Brzezinski, the proscriptions no longer applied. Morocco was defending itself and Washington could liberalize the transfer of U.S. military supplies and equipment to Rabat.<sup>86</sup> Still, the PRC concluded that Morocco could not defeat the Polisario; a negotiated settlement seemed the best solution once the military situation had stabilized. To stabilize the fighting, the Defense



Two AH-1 Cobra helicopters make ready for takeoff, March 1977. (RG 330, NARA II)

Department would send Morocco 6 Broncos and the 24 Cobras with TOW missiles, plus associated training and technical assistance. As Deputy Secretary of Defense Graham Claytor told the PRC, he and Brown supported “going all the way to help Morocco” lest an important part of North Africa be destabilized, but King Hassan had to undertake negotiations on a Western Sahara settlement before receiving the first arms shipment. The PRC and the president agreed.<sup>87</sup>

In October 1980 Brown, Brzezinski, and Muskie approved the sale of 108 M60A3 tanks to Morocco. After the November presidential election, State expressed serious second thoughts about arming Hassan on the grounds that it encouraged his intransigence in Western Sahara. State suggested delaying the decision to deliver the first six OV-10 aircraft and the sale of tanks until the next administration took office. Notwithstanding strong pressure from Brown, Brzezinski, and the NSC staff, the State Department continued to obstruct the sales ostensibly because of the Iran hostage negotiations, but according to NSC staffers “more likely” because State’s Director of Policy Planning W. Anthony “Tony” Lake, Assistant Secretary of State for African Affairs Richard M. Moose, U.S. Representative to the UN Donald F. McHenry, and others “don’t like Morocco’s stance on the Western Sahara question.”<sup>88</sup> U.S. sales of weapons to Morocco could not be considered a case of “masterful inaction,” but rather just inaction. Although Carter’s advisers including Brown agreed on a number of occasions in PRC meetings that they should proceed and the president agreed, nothing happened. The need for Congress to approve the sales was one reason, but the malaise surrounding the Carter administration at the end of its term—in good part because of the overriding demands of the Iran hostage crisis—also had a debilitating effect.

In general Carter’s policy toward Africa, so hopeful in 1977, had achieved only a few limited successes by January 1981. South Africa was still practicing apartheid; Namibia was still under Pretoria’s de facto control, and Morocco had no new U.S. weapons. What successes there were, such as propping up Mobutu’s control of Shaba, the Zimbabwean elections and independence, and the stabilization of the Somalia-Ethiopian conflict, constituted achievements for which the United States could claim at best partial credit. As all U.S. presidents and their advisers usually discovered, the need to respond to day-to-day crises and adverse developments proved the enemy of grand policy. Such was the case in Africa, where decisions with strategic or long-term implications always took a backseat to more immediate issues.

Taking the long view, even the successes that the Carter administration achieved proved transitory. In Zimbabwe after his election, Robert Mugabe soon lapsed his dictatorial rule, which lasted for decades. Under his control, Zimbabwe gradually degenerated into an economic and human rights debacle. Mobutu continued as “president for life” of Zaire until 1997 when he was forced into exile by his political opposition. The Congo, as it was renamed, imploded into civil war and anarchy. After the Somali military overthrew Siad Barre in 1991, Somalia plunged into warring factions and provided a new definition of a failed nation. This abject record does not imply that these developments are traceable to Carter’s decisions, but the fate of Africa from 1977 to 1980 is an object lesson in how difficult and complex that continent’s problems could be. For differing reasons, Carter and Brezinski pushed for more involvement in Africa: the national security adviser did so from motives of realpolitik, while the president’s motivation stemmed from primarily humanitarian and social justice concerns. Such a combination overwhelmed Brown’s pragmatism and caution. The best that can be said for U.S. policy in Africa during the Carter years is that the administration, including Brown and the Pentagon, were committed to a one-man, one-vote democracy in southern Africa and the end of racial separation and discrimination. Whether or not the U.S. policy of sanctions and isolation played a significant role in the downfall of apartheid, South Africa eventually did become the multiracial, democratic country Carter had envisioned.

## The All-Volunteer Force and the Legacy of Vietnam

THE VIETNAM WAR BROUGHT TO A HEAD the long simmering issue of conscription for the U.S. armed forces. The inequalities of the Selective Service System contributed greatly to the growing opposition to the war and the bitter division that gripped the nation. The deferment system postponed service for those enrolled in undergraduate and graduate courses at colleges or universities, allowing many to avoid service indefinitely, if not altogether. It also granted exemptions for those with wives and children and those employed in broadly defined critical industries. Critics charged that single young men from lower socioeconomic groups unable to afford or qualify for a college education found themselves drafted in disproportionate numbers. The Nixon administration recognized conscription as both a societal and political problem. As the Republican presidential candidate, Richard Nixon had promised in 1968 to end the draft if elected. In December 1969 his administration and Congress instituted a national lottery system for potential draftees, essentially eliminating all exemptions.

The Selective Service lottery was a stopgap measure. The Nixon administration studied replacing the draft with an all-volunteer force. Nixon's defense secretary, Melvin R. Laird, named former Defense Secretary Thomas S. Gates Jr. to head a presidential commission to explore it. The commission endorsed the move to all-volunteer. As the fighting in Vietnam dragged on and took a heavier toll in blood and spirit, Nixon sought to blunt antiwar opposition by drawing down American participation, focusing on Vietnamization and fulfilling his promise to end the draft. In July 1973 Congress and the administration established the All-Volunteer Force (AVF).<sup>1</sup>

The shift to an all-volunteer force held out the promise of a U.S. military different from the one of the Vietnam War years. After an optimistic start, toward the end of the Ford administration the AVF confronted problems relating to the quantity

and quality of recruits, retention of trained personnel, and rising costs associated with a volunteer military. In addition, the final years of the Vietnam War had cast a dark shadow over the U.S. armed forces, which were now struggling to overcome drug abuse, racial strife, a breakdown in discipline, and low morale.<sup>2</sup>

When President Jimmy Carter and Defense Secretary Harold Brown took office, well-meaning critics still questioned the desirability of professional armed forces in a democracy, seeing a value in an armed force at least partially composed of draftees rather than all professionals. Furthermore, the AVF was expensive because of the need to attract and retain volunteers and faced difficulty in filling its manpower quotas. Basic issues had to be resolved if the AVF was to succeed: the three “R’s” (recruitment, retention, and reserves), the three “M’s” (manpower, morale, and minorities), and the role of women in the military—only one aspect of a larger debate about the role of women in society at the time.<sup>3</sup>

By the end of the Carter presidency, the AVF remained unproven and its challenges unresolved. It still faced severe manpower shortages in the National Guard and reserves, although its active-duty forces had overcome their shortfall problems. Nevertheless, the services encountered considerable difficulty in attracting qualified recruits with high school diplomas and high scores on the enlistment qualifications tests. AVF opponents asked how it would attract the people it needed to maintain and deploy the new high-technology weapon systems and equipment that dominated warfare. In 1980 the Carter administration faced criticism from its own Army chief of staff, General Edward C. “Shy” Meyer, who testified before Congress: “Right now . . . we have a hollow army. Our forward deployed forces are at full strength in Europe, Panama, Korea. Our tactical forces in the United States are some 17,000 under strength. Therefore, anywhere you go in the United States, except for the 82nd Airborne Division, you will find companies and platoons that are zeroed out.” Having units stateside that were seriously understrength did not bode well for the All-Volunteer Army. Furthermore, Meyer’s criticism seemed to corroborate Republican presidential candidate Ronald Reagan’s charge that Carter and Brown had let the U.S. defense structure deteriorate.<sup>4</sup>

There was truth to Reagan’s assertion. The All-Volunteer Force was proving more expensive than anticipated, and recruiting during the Carter years became a serious problem. Initially Congress inadequately funded recruitment, bonuses, and benefits necessary to attract and retain volunteers. The U.S. military did not engage in any successful operation during the Carter years. Its highest profile mission, the Iran

hostage rescue attempt, ended in fiasco and further damaged the public image of the military. Brown and the Pentagon leadership undertook a campaign to broaden the appeal of military service and increase recruitment of women and minorities. In 1980 the Army's recruiting command underwent a transformation to a new, more dynamic leader. Former critics of the AVF in the Senate came to its rescue with a successful amendment to the fiscal year 1981 Defense Appropriation Act that significantly raised military pay and benefits, making military service more attractive. In the last years of the Carter presidency, Brown and Defense sought to rectify the deficiencies of the armed forces. They did not always succeed, but they passed to their successors an all-volunteer force better than the one they had inherited.<sup>5</sup>

### **Assessing the All-Volunteer Force**

The decision to change the armed forces to all volunteers occurred in two stages in the early 1970s. In 1971 the Nixon administration accepted the recommendation of the Gates Commission to fix the inequitable military pay system at the lowest enlisted ranks. Twenty percent of the pool of young men drafted each year received substantially lower salaries than most of their equivalents in the civilian sector. After having served two or more years, they returned to civilian life considerably behind their non-drafted peers in terms of pay and career advancement. In November 1971 Congress raised pay significantly for first-term military service to civilian market wage, paving the way for the AVF and greatly increasing the personnel costs of the armed forces.<sup>6</sup>

According to a RAND Corporation study prepared for the new Carter administration, these revised pay scales allowed the AVF to work reasonably well during the four years after its formal establishment. The military attracted new recruits and met their quotas; the recruits had greater educational attainment and scored better on mental aptitude tests than their drafted predecessors. In addition, the All-Volunteer Force attracted a higher number of African Americans, in part because they faced greater unemployment and lower pay than young white men and women in the civilian job market. According to the study, these findings did not mean that the AVF was drawn from the poor and downtrodden. There were as many recruits from middle- and upper-income groups as there had been during the draft lottery. The rural-urban makeup remained about the same as it was under the draft.<sup>7</sup>

The challenge for OSD and Assistant Secretary of Defense for Manpower, Reserve Affairs, and Logistics (MRA&L) John White, according to the RAND study, was to

manage and institutionalize the AVF, including enticing first termers to make the military a career. To do this the compensation, promotion, and retirement systems had to be integrated and modernized, changing the focus for promotion from time in grade to accomplishment.<sup>8</sup> Brown supported these goals, but commented: "I suspend judgment on whether we can make it [the AVF] work through the 1980s." As the secretary pointed out, the services had the responsibility for retaining first timers, but he also believed reform of the military retirement system was necessary to allow for "some equivalent vested benefit for people with (say) 10 years' service."<sup>9</sup>

As one of his first requirements, Brown tasked White (a former RAND vice president) with assessing DoD's use of manpower. In mid-1977 White reported two main conclusions. First, DoD could reduce its requirement for male recruits by as much as 15–20 percent by enlisting more women, converting administrative military positions to civilian jobs, and reducing the attrition of first-term enlistees. If successful, the AVF could weather the 1980s in the face of a declining pool of young males in the overall population. Second, reducing the number of bases and base services, always politically difficult, would reduce unnecessary costs, thus freeing money for personnel, but base closings required support from the services and Brown himself.<sup>10</sup>

In its first two years under Brown, OSD remained cautiously confident that it could make the AVF work even during the anticipated difficulties of the 1980s. A glossy version of White's study without the recommendations appeared in a DoD public relations periodical in September 1977. While admitting that success with the active forces was not matched by the chronically undermanned reserves, the study still judged the AVF a success.<sup>11</sup> Unconvinced, influential senators such as Senate Armed Services Committee Chairman John Stennis, defense expert Sam Nunn, and Edward Kennedy believed the AVF was costing too much and failing to attract the best recruits. These critics advocated a return to the draft.<sup>12</sup>

Nunn's Senate Armed Services Subcommittee on Manpower and Personnel held hearings in 1977 and 1978. Nunn believed that the AVF had only performed as well as it did because recruit pay rose in inflation-adjusted terms by 193 percent from 1964 to 1973, as opposed to a real rise of 11 percent for comparable civilian blue-collar workers. Given high unemployment during that period, the AVF offered an attractive job alternative. With the civilian job market improving, the last quarter of 1976 saw a recruiting shortfall of 15 percent for the Marines and 6 percent for the Army. Furthermore, the Pentagon could not continue to provide such generous



enlistment bonuses and pay increases without serious impact on its budget. Particularly alarming to Nunn, the number of enlistees who left the services before their normal terms expired was greater than the number who served their full terms. As for the reserves, the picture was dire: a 52,000 shortfall from the authorized ceiling and 180,000 below in the Individual Ready Reserve (those reservists not assigned to reserve or active units), but available for mobilization.<sup>13</sup> The General Accounting Office calculated that the AVF had cost the United States an extra \$3 billion a year since 1973. The Pentagon countered that returning to the draft would save only \$500 million per year. Confusion and dueling statistics reigned.<sup>14</sup> An AVF supporter, Wisconsin congressman and future secretary of defense Les Aspin bluntly characterized the case of unnamed critics for a *Washington Post* reporter: They held that the AVF was “too dumb, too black, too small, and too expensive.”<sup>15</sup>

The Carter administration undertook two major internal reviews of the AVF, one by the Office of Management and Budget and one by OSD (MRA&L). In April 1978 OMB sent its assessment to the president, stressing that the AVF had met its “quantitative and qualitative goals for the active force (but not for the Army Reserves and National Guard.)” Absent changes, the AVF faced an expensive future given the predicted shrinking pool of male recruits for the 1980s. If the services did not delay lowering the passing grade for the entrance exam, DoD would have to spend \$14 billion more per year by 1985 to maintain current quantity and quality of manpower to attract more voluntary enlistments. Apart from recruiting more women—which the services were already doing—OMB’s best solution was to reduce active-duty force levels by contracting out support functions.<sup>16</sup>

**Table 10. Projected Population Estimates, FYs 1976–2000 (millions)**

Year	Males Age 17	Males Ages 17 to 21
1976	2.1	10.7
1980	2.1	10.7
1985	1.8	9.6
1990	1.6	9.0
1995	1.8	9.7
2000	2.1	10.3

Source: Memo, Christine Dodson to Richard Hutchenson, 28 April 1978, folder ND19 (1/20/77–12/31/78), box ND-33, Subject File, White House Central Files: Executive, Carter Presidential Library.

The Pentagon's own study, White's decidedly upbeat "America's Volunteers: A Report on the All-Volunteer Armed Forces," released publicly at the end of 1978, concluded that the AVF was at least as capable as the draft-era military. It had the same number of high school graduates in FY 1977 as in FY 1964 (69–68 percent), and the mental group IV (of below average entrance test scores) percentage had decreased from 25 percent of the armed forces in FY 1968 to 5 percent in FY 1977. The report omitted the fact that enlistments in the top mental groups, I and II as well as the high average (IIIA), had plummeted. On the plus side, desertions, courts martial, and nonjudicial punishments declined. The report admitted that the attrition rate for first-time enlisted was 40 percent in FY 1977 as opposed to 25 percent in FY 1974 and conceded that the reserves needed more personnel and funding. While accepting that the AVF cost \$3 billion (OMB's figure) more per year than if the draft had continued, the report noted that the costs derived mostly from the 1971 pay increases for junior enlisted personnel. Since enlisted personnel earned near minimum wage (including food and housing), there was no good argument to roll back their pay. While recommending a more responsive standby draft in the event of a "major protracted war in Europe," the study did not support a return to conscription for either active or reserve forces. Emphasizing the positive and downplaying the negative, the study was aimed at convincing critics that the AVF was working.<sup>17</sup>

### **Recruitment and Retention**

In 1979 the problems that OSD had papered over with optimistic reports could not be ignored any longer. Early in the year the secretary received the bad news. None of the services had achieved their recruiting objectives for the first time since 1973. Only the Marine Corps managed a rise in enlistments of high school graduates. The other services' male accessions declined about 12 percent. What went wrong? MRA&L had a number of theories: the improvement in the job market; more young men enrolling in federal government job training; the end of the GI Bill's educational benefits in 1976 and its replacement by a less generous program; too much emphasis on recruiting high school graduates; bad publicity for the AVF from the congressional debate on its future; and poor living conditions for military personnel overseas. With little prospect of additional funds from Congress, MRA&L declared that "recruiting prospects for the balance of the year are highly uncertain."<sup>18</sup>

By the end of 1979 Brown had passed the president additional bad news. Second term retention rates of midcareer personnel were dropping alarmingly for all services except the Marines, whose rates had always been consistently low (44 percent in FY 1975 to 47 percent in FY 1979). The Army had dropped to 48 percent in FY 1979 from a high of 57 percent in FY 1975; the Navy, to 51 percent from 65 percent in the same fiscal years; and the Air Force, to 53 percent from 68 percent. According to the secretary, the services would have to recruit more personnel at a time when they were already failing to meet quotas, causing a drop in the readiness of the armed forces. Brown proposed larger bonuses for those with skills that were in shortest supply; better wages overall (even the administration's proposed 7.4 percent cost of living pay increase for FY 1981 did not keep up with inflation); and severing the ties between civil service and military pay scales to allow military pay to rise. Lastly, as commander in chief the president should provide positive leadership to improve military life by supporting DoD personnel initiatives in Congress and defending military personnel against unjust or inaccurate criticisms. The secretary suggested that a retirement ceremony at the White House for a senior enlisted member of the armed forces would hold great symbolic value. In effect, Brown was challenging the president to stand up for the armed forces. Carter promised to do his part, but the results were disappointing.<sup>19</sup>

**Table 11. Second Term Retention Rates (%), FYs 1975–1979**

Fiscal Year	Army	Navy	Marine Corps	Air Force
1975	57	65	46	68
1976	55	63	44	65
1977	53	59	47	65
1978	49	54	44	57
1979	48	51	46	53

Source: Memo, Harold Brown to Jimmy Carter, 27 December 1979, folder 340, 1979, box 39, SecDef Files, Accession 330-82-0204, WNRC.

Not surprising, the person formerly in charge of manpower at the Pentagon, John White, who had become deputy director of OMB, questioned OSD's retention figures. White stated that while second term retention rates were down, the career force (personnel with over four years' service) retention ratio obscured an increase in real numbers from 1974 to 1979. The rate of decrease was due to the total enlisted force itself having been reduced by 100,000. Although White endorsed the

secretary's call for presidential support of the military, White cautioned that "the military leadership" was not doing itself any good by undervaluing and denigrating military compensation. It was hard to recruit when the Pentagon maintained in congressional testimony that service members were woefully underpaid.<sup>20</sup>

For his part, Carter did not take Brown's implied criticism well. While promising to help alleviate the retention problem among midterm military personnel, offering his personal support of men and women in the military, and countering unjust and inaccurate criticism, Carter added the following paragraph: "The constant drum of negative statements from Defense Department officials and top military officers regarding U.S. capability is a severe depressant on morale. A coach would never denigrate his own athletic team as a ploy to increase budget allotments." The president then declared that "excessively frequent transfers" should be eliminated and added the personal observation: "You should assess other factors involved in low enlistment problems. When I served in the Navy, money was not the predominant concern."<sup>21</sup> With presidential thinking like this, Brown could hardly feel optimistic.

In early 1980 Brown had to make an embarrassing admission to an already skeptical Carter: "The accuracy of our enlistment qualification mental test scores is seriously in question for the All-Volunteer Force era (that is, since 1972). . . . The current test itself does not appear to have been accurately calibrated." As a result, there had been "significant over-grading of recruits who should have been categorized in the lower mental ability levels."<sup>22</sup> The secretary also admitted to "widely-reported cheating," where some recruiters under heavy pressure to meet their quota had falsified records about high school graduation, coached potential recruits for the entrance test, or concealed information such as police records or medical problems.<sup>23</sup> The inevitable devastating public revelation of personnel problems came when Robert B. Pirie, White's replacement at the Pentagon, acknowledged publicly to a congressional committee that the test had not been properly "normed"—the process whereby raw scores were calibrated with a representative number of similar young Americans. Nunn and the critics of the AVF had been right: OSD assurances that the AVF was smarter than it had been under the draft had been wrong.<sup>24</sup>

There was some good news among the generally poor findings. In March 1980 Brown reported to the president that enlistments had risen 28 percent over the previous year, notwithstanding DoD's market surveys continuing to "show a low

propensity among youth to enlist.” There was a problem, however, as the secretary admitted: “The recent increase is the result of the Services accepting many more high school drop outs. (Indeed, if present trends continue, more than half the Army’s FY 80 male recruits will be high school dropouts.)” Reenlistment rates held steady, but the Army’s rose from 43 percent to almost 51 percent (spurred on by sharply increasing reenlistment rates of first-term African-American soldiers from 55.5 percent to 63.5 percent).<sup>25</sup>

In June 1980 the national jobless rate rose from 5.7 percent to 7.6 percent as a recession took hold. Brown assured the president that “contrary to the impression created by recent press reports, I have not initiated a campaign of recruiting the unemployed.” High unemployment helped recruiting, but the secretary assured the president that DoD was after “those individuals who do not normally encounter employment difficulties”—apparently those individuals recently unemployed through no fault of their own, but with good skills. Brown concluded: “If we capitalize on the present recruiting opportunity, we can make substantial long-term gains in solving our manpower problems while also having a modest favorable effect on the unemployment problem.”<sup>26</sup>

In the second half of 1980 the recruiting picture turned brighter, especially for the Army. The consensus of historians and observers of the All-Volunteer Army held that much of the improvement in recruiting was the work of one man, Maj. Gen. Maxwell R. Thurman, assigned by Army Chief of Staff General Meyer to head the Army Recruiting Command in November 1979 and to clean up the mess. A successful career officer who held himself and those he commanded to high standards, Thurman was a “hands-on,” “take charge” kind of leader who brought an extra dimension to his work. A bachelor, he lived and breathed his Army career, working well into the night for days on end. With Thurman in charge, Army recruitment improved. He insisted that officers, not just sergeants, actually recruit. He familiarized himself with advertising methods and theory, choosing the Army’s marketing slogan, “Be All You Can Be,” its most iconic and successful sales pitch, which lasted until 2000. Under Thurman the Recruiting Command gained new energy. The recession of the late 1970s and early 1980s and the rising pay for service no doubt contributed, but after 1980 recruitment surged.<sup>27</sup>

In August 1980 Brown informed the president that active-duty end strength stood at 2,035,000 as of July 1980, 6,000 above DoD’s planned total and 12,000 above

the previous year's strength on the comparable date. The secretary admitted that "recruiting continues to be a challenge," but all services except the Marine Corps exceeded their objectives through July 1980. The Marines concentrated on recruiting high school graduates rather than dropouts—a conscious decision to pursue quality over quantity—and this accounted for their shortfall, which the secretary promised to overcome by the end of the year. While recruits so far numbered 50,000 in FY 1980—19 percent above the previous year—the rate of high school graduates had dropped (except for the Marines), with the Army experiencing the sharpest decline—48 percent high school graduates as opposed to 63 percent in the previous year.<sup>28</sup> The quantity manpower crisis seemed solved; it would take more work to achieve quality.

### Women in the All-Volunteer Force

The All-Volunteer Force was not yet all it could be. Attracting more women seemed a way to solve some of its problems. Women recruits were more likely to be high school graduates and scored higher on



Army Maj. Gen. Maxwell Thurman, commander of the U.S. Army Recruiting Command. (RG 330, NARA II)

**GO FROM  
HIGH SCHOOL TO  
FLIGHT SCHOOL.**

With over 8,500 aircraft, the Army needs twice as many pilots as the nation's largest airline.

That's why, if you have what it takes, you could qualify for the Army's Warrant Officer Flight Training Program. It's a rigorous 40-week long course of study where you earn both your pilot's wings and an appointment as an Army Warrant Officer. What's more, you can enter the program with a high school diploma.

If you want an opportunity where there are no other's the limits, call toll free 800-421-4422. In California, call 800-252-0011. Alaska and Hawaii, 800-423-2244. Better yet, visit your nearest Army Recruiter, listed in the Yellow Pages.



**ARMY.  
BE ALL YOU CAN BE.**

SEE US AT: 1980  
Sign Up Today!  
853-444-4422  
800-421-4422  
National Future Orientation Campaign, 1981  
**NW Ayer Incorporated**

(Courtesy NW Ayer Advertising Records, Archives Center, National Museum of American History, Smithsonian Institution)

aptitude tests. Furthermore, a long tradition of women serving in the military existed. The services had recruited women since 1917, albeit in limited numbers and in support roles. During World War I, and even more so during WWII, women joined the armed services and performed mostly administrative functions in addition to their traditional role of nursing. While they wore uniforms and held ranks, they were organized into separate or auxiliary organizations such as the Women's Army Corps (WAC), the Navy's Women Accepted for Volunteer Emergency Service (WAVES), or the Marine Corps Women's Reserve. In 1948 Congress gave women regular military status but limited their number to 2 percent of the armed services. Also, in 1948, the establishment of the Women in the Air Force (WAF) allowed women to perform ground duties, mostly clerical or medical.

The 1960s and 1970s saw the rise of the women's movement. In 1972 Congress passed the Equal Rights Amendment (ERA), but it failed to gain sufficient support from state legislatures for ratification. Still, women began to make progress in the civilian workplace. In this mid-1970s environment, the WACs, WAVES, Marine Corps Women's Reserve, and WAFs seemed anachronisms—if not more than a little patronizing. As long as military women were in separate organizations, their status reinforced the perception they were different and not equal. In 1975 the Marine Corps opened all assignments to women except those related to combat (infantry, artillery, armor, pilots, and aircrews). In 1976 the Navy and the Air Force integrated women into their regular services in support roles; in 1978 the Army followed suit by disestablishing the WAC and including women in the regular Army in noncombat roles.<sup>29</sup>

OSD had traditionally overseen policy on women in the services through the mechanism of the Department of Defense Advisory Committee on Women in the Services (DACOWITS), a group of nongovernment, prominent professional women who advocated for supporting and expanding women's roles in the services. But the rise of the women's movement and the need for more enlistees regardless of gender spurred the changes for women in the military.<sup>30</sup> When it integrated African Americans into the military in 1948, DoD was ahead of the societal curve, but in the mid-1970s it lagged behind on recruiting and utilizing women.

The Pentagon had been studying women in the military well before the end of the draft, and when Brown took charge he ordered yet another review. Entitled "Use of Women in the Military" and completed in summer 1977, the study

concluded that while the proportion of women in the services had increased from 0.8 percent in 1966 to 5.3 percent in 1976 (with most of the growth coming after 1971), DoD could reach a considerably higher number than the expected over 150,000 women in the armed forces by FY 1981. The study's author, Navy Commander Richard W. Hunter, concluded women would be better recruits and save money, since highly skilled and educated women required fewer enlistment incentives than similarly prepared men. The services had been ignoring the pay gap and turning away highly qualified women, but all of them were now planning to increase the number of women in their ranks. The Army anticipated the largest growth in female service members, the Air Force was a close second, and the number of women Marines was expected to more than double from FY 1976 to FY 1982. The Navy would follow suit, but its growth after FY 1983 was restricted by a law prohibiting women from serving on ships. In light of all the benefits outlined by Hunter, DoD began to question if this law should be changed or repealed. Brown commented: "We should be able to do this—& go even further in some cases (e.g. Navy)."<sup>31</sup>

Many skeptics assumed large numbers of women in the services would diminish readiness, but the Hunter study disabused this view. Women with small children did not leave the services in disproportionate numbers. Even when pregnancy discharges for women were counted, it was men, not women, who cost the services more time. The per capita loss for men was higher, the report claimed, due to alcohol, drug abuse, absence without leave, and desertion. Women rarely faced disciplinary actions, were on average one year older than their male counterparts, held high school diplomas at a higher rate (91.7 percent compared with 62.9 percent of male recruits), and scored 10 points better on entrance examinations. Of those women who came on duty during FY 1973, 70 percent remained on active duty as of June 1976, compared with only 64 percent of men. At least in these ways, women were as reliable, if not more so, as men.<sup>32</sup>

Such findings resonated with the president, a strong advocate of women's rights and the ERA.<sup>33</sup> In November 1977, after reading a Brookings Institute study written by former Pentagon official Martin Binkin and Col. Shirley J. Bach, USAF, the president asked Brown for his view of their observation that the Air Force could potentially comprise 76 percent women without any changes to current laws barring their participation in combat. Carter saw the Air Force as a good fit



**Table 12. Number of Women on Active Duty, FYs 1976–1982 (thousands)**

	Actual			Projected				
	FY 76	FYTQ*	FY 77	FY 78	FY 79	FY 80	FY 81	FY 82
<b>Army</b>								
Officers	4.8	5.1	5.9	6.7	7.3	7.9	8.5	9.0
Enlisted	43.9	44.4	46.3	48.4	50.4	50.4	50.4	50.4
Subtotal	48.7	49.5	52.2	55.1	57.7	58.3	58.9	59.4
<b>Navy</b>								
Officers	3.5	3.6	3.8	4.0	4.2	4.4	4.6	4.8
Enlisted	19.2	19.3	19.6	20.5	22.5	24.7	26.4	28.5
Subtotal	22.7	22.8	23.5	24.5	26.7	29.1	31.0	33.3
<b>Air Force</b>								
Officers	4.8	5.0	5.4	5.8	6.5	7.2	7.9	8.6
Enlisted	29.2	31.0	34.6	40.2	42.3	44.3	46.3	48.2
Subtotal	34.0	36.0	40.0	46.0	48.8	51.5	54.2	56.8
<b>Marine Corps</b>								
Officers	0.3	0.4	0.4	0.5	0.5	0.6	0.6	0.6
Enlisted	3.1	3.1	3.5	3.7	4.6	5.3	5.8	6.7
Subtotal	3.4	3.5	3.9	4.2	5.1	5.8	6.3	7.3
<b>DoD Total</b>								
Officers	13.1	14.1	15.5	17.0	18.5	20.1	21.6	23.0
Enlisted	95.4	97.8	104.0	112.8	119.8	124.7	128.9	133.8
Total	108.5	111.9	119.5	129.8	138.3	144.8	150.5	156.8

\*The Fiscal Year Transitional Quarter (1 July 1976–30 September 1976) was a one-time adjustment, after which the fiscal year period went from 30 September to 1 October.

Source: Memo, John White to Harold Brown, 10 June 1977, folder 320.2 (Jun-Dec) 1977, box 33, SecDef Files, Accession 330-80-0017, WNRC.

for women. It took only recruits with high test scores; nearly 100 percent of its enlistees were high school graduates; and it did not have major retention or disciplinary problems. Since most large Air Force bases were in the United States, Air Force personnel enjoyed living arrangements that did not approximate combat or arduous sea duty. Carter suggested that if women filled many more positions in the Air Force, the pool of better-qualified men would be enlarged for the Army, Navy, and Marine Corps.<sup>34</sup>

Taking his cue from Robert Pirie, the principal deputy at MRA&L, Brown responded that the Binkin-Bach study indicated 320,000 positions in the Air Force could be filled by men or women, but no analysis had been made of filling them predominately with women. Regarding the president's specific suggestion, Brown maintained that the Air Force could not absorb such large numbers of women.

It took years of training and experience to develop noncommissioned officers. A too-rapid rate of growth in the number of women would result in an imbalance of women at the junior ranks. Brown and Pirie suggested that highly qualified women applicants, if turned away by the Air Force, would be unlikely to enlist in the other services. The Air Force was the most “civilian-like,” especially in peacetime, and therefore most attractive to women. In any case, Brown added, the most glaring recruiting shortage categories were in combat posts, which were off limits to women.<sup>35</sup>

The real limiting factor, of course, was that women were prohibited by law and tradition from combat, the definition of which was far from precise. The 1977 Hunter study asked whether a service could remain combat ready, able to deploy and fight, if it had a large percentage of women denied a combat role. The services had defined combat roles as broadly as possible to limit women’s participation, but in the 1970s the old concept of women as “typewriter soldiers” was changing. In an amendment to the FY 1978 Defense authorization legislation, Wisconsin Senator William Proxmire proposed that women be allowed to serve on noncombat ships and that the secretary of defense decide whether women might be employed in combat duty.<sup>36</sup> Brown suggested that there could be more roles for women: “I believe that there are some roles that are not going to be appropriate for women. Infantry in combat is one example. I think there are others, some of which have been described as combat related, and therefore barred, aboard ship, for example, which clearly women can fill at least as well as men.” New technology in warfare was changing as were attitudes toward the gray areas between combat and noncombat. The services preferred to allow the secretary to define the appropriate roles for women in combat-related roles, not have Congress legislate it.<sup>37</sup>

While the times were definitely changing, the changes were modest and incremental. Gradually and in small numbers women flew support aircraft, undertook missile duty, and served on seagoing ships. In October 1977 six women completed Air Force undergraduate navigator training and received assignments on refueling tanker aircraft, transport aircraft, and reconnaissance aircraft. In August 1978 five female officers and enlisted women graduated from missile training and joined the previously all-male crews that manned the Strategic Air Command’s Titan IIs.<sup>38</sup> In 1978 the Army enrolled 16 women officers and 25 women warrant officers in flight training, many of who would fly helicopters. The Navy had relied on women

## SOME OF OUR BEST MEN ARE WOMEN.



If there's one place where opportunity is genuinely equal, it's in the Army. Because in the Army, people get assignments based on ability. And they get ahead the same way.

With few exceptions (mainly in Combat Specialties), women have the same skill training programs to choose from as men. And the same opportunities for promotion.

If you've always wanted to drive a truck, or be a carpenter and drive nails, no one will stand in your way.

On the other hand, if you've always wanted to learn how to cook. Or type. Or take dictation, well, you can do that, too. If you're willing to compete with men.

But whatever you decide to do in the Army, remember, everyone is judged on ability and how hard one works. Isn't that the way it should be?

For more information about the hundreds of equal opportunities in today's Army, send one of the postcards, or call toll free: 800-43-1234. In New York, call 800-942-1990.

**JOIN THE PEOPLE  
WHO'VE JOINED THE ARMY.**

(Courtesy NW Ayer Advertising Records, Archives Center, National Museum of American History, Smithsonian Institution)

aviators since 1972. The most controversial issue was women on ships. The pressure to allow women on Navy ships was mounting in Congress, the courts, and DoD. In 1979 Congress passed, with the Navy's encouragement, legislation allowing women to serve permanently on selected noncombat ships and to be assigned for up to 180 days' temporary duty on ships not expected to become involved in combat during their time aboard. The Navy initially assigned 55 women officers and 375 women sailors to 21 ships in both the Atlantic and Pacific Fleets. Such a policy would require changes in attitudes of many sailors and reconfiguration of ships to create separate living quarters and facilities for women. The Army, which planned to recruit the most women, found it difficult to define their roles in combat. Given differences in physical strength and supposed variance in gender traits, Army leaders questioned whether women could meet the same training requirements as men. The issue, as judged by the sheer number of articles and columns in America's newspapers and journals, proved a topic of wide popular concern and debate.<sup>39</sup> The White House suggested that the Army was defining combat too broadly, denying women occupational slots, and therefore limiting advancement to roles that would not involve "close combat."<sup>40</sup>

Another salient factor in the debate was the 381 women who entered the nation's military academies in 1976 and were about to become officers in June 1980.<sup>41</sup> What career paths would open to them as well as the many more women who would receive commissions as Reserve Officer Training Corps officers at colleges and universities? OSD and Brown tended to be pragmatic and evolutionary in their approach, making changes as small as possible and pushing the envelope outward, often against strong opposition from within the services, from the political sector, and from conservative groups. The impetus for increasing the number of women in the services—as well as continuing high-profile attendance of women at the academies—stemmed not so much from ideology (although the secretary favored equal rights for women as did the president) as from necessity—not enough male volunteers meant opportunities for more women. But for many in America these changes had ideological implications. To these opponents, Carter and the Pentagon seemed hell-bent on pushing women's rights and changing the role of women in society even to the point of hurting the military and national security to obtain their objective. When Ronald Reagan became president in 1981, he ordered a pause in recruitment of women, in clear deference to the backlash that had emerged against the ERA and the increasing role of women in the military.<sup>42</sup>

Changing the roles of women in the services proved to be a long, drawn-out process, but the military services were not alone in dealing with the challenge. As secretary of defense Brown had an opportunity to make a mark by selecting and promoting civilian women working for the Pentagon. Before 1977 the DoD civilian workforce was virtually totally male-dominated. At the higher senior executive levels women were almost nonexistent. During his tenure Brown made a few key high-profile female appointments, such as Deanne Siemer as DoD general counsel, Lynn Davis as director of NSC affairs in ISA; M. Kathleen Carpenter as deputy assistant secretary of defense for equal opportunity in MRA&L; and the promotion of Antonia Chayes from assistant secretary of the Air Force to under secretary. Nevertheless, at the end of 1980 the higher echelons of OSD remained very much a male preserve. The gender climate had changed only marginally since 1950 when Secretary of Defense George C. Marshall named Anna M. Rosenberg assistant secretary of defense for manpower and personnel.<sup>43</sup>

### African Americans in the All-Volunteer Force

After the 1971 pay raise, in anticipation of the creation of the All-Volunteer Force in 1973, African-American men and women joined the services in increasing numbers. By October 1979 the Army was 30 percent black; the Air Force, just over 15 percent; the Marine Corps, more than 20 percent; and the Navy, less than 10 percent. Blacks comprised about 12 percent of the U.S. population at the time. The Army and the Marines had seen considerable rises in African Americans since 1964; the increases for the Air Force and the Navy were less significant. Although the armed forces had been officially desegregated since 1948

and open to all who could meet entrance requirements, African Americans were hardly welcomed initially with open arms. The military services reflected American society as a whole. Even in the 1970s race was often the source of conflict, prejudice, discrimination, and misunderstanding.

The Carter administration was committed to equal opportunity and, when needed, affirmative action. The president had won the overwhelming support of African-American voters in his 1976 campaign, in part based on his willingness to appoint blacks to jobs in the Georgia state government when he was governor. As president, he appointed African Americans to key positions. With encouragement from the White House, Brown chose Clifford Alexander as secretary of the Army, the first African American to serve in that position. A fervent supporter of the All-Volunteer Army, Alexander was quick to suggest that criticism of the quality of the recruits could be code for racism. He pointed out that the Army's aptitude tests, especially its "mental category scores," were stacked against African Americans

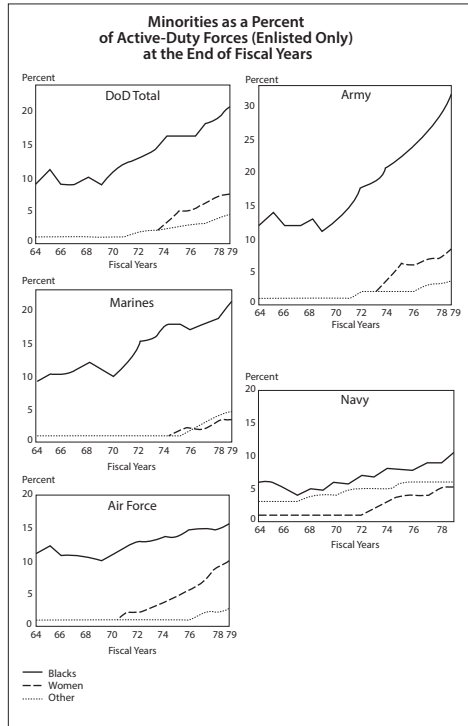

Source: Memo, Harold Brown to Jimmy Carter, 27 December 1979, folder 340 1979, box 39, SecDef Files, Acc 330-82-00204, WNRC.



Secretary of the Army Clifford Alexander, 4 October 1979. (OSD Historical Office)

because the verbal and math sections of the test were geared toward the educated white middle class.<sup>44</sup> Alexander had a point, but by 1979 most of the enlistees in the Army—both white and black—fell into the lower level of mental aptitude test categories. Actually, a higher percentage of blacks recruited into the Army had high school diplomas than their white counterparts (76 percent to 65 percent in 1978 and 65 percent to 54 percent in 1979).<sup>45</sup> The services preferred recruits with high school diplomas not only because the credential indicated a better academic profile, but also because high school graduates served out their full term of enlistment at a higher rate than nongraduates.<sup>46</sup>

For African Americans the Army became the preferred service.<sup>47</sup> The Marines were also receptive; the Air Force wanted blacks as long as they possessed high school diplomas. The Navy was not the first choice of most. African Americans remembered when they were relegated to serving as cooks, mess attendants, or deck hands; they did not rush to join the most traditional service, which they viewed as

resistant to change. The Navy failed to approximate American society as a whole, a stated goal for DoD during the Carter years. In 1978 blacks in the Navy represented only 8.9 percent of the total enlisted force and 1.6 percent of the officers' corps at a time when African Americans comprised 12 percent of the U.S. population.<sup>48</sup> Secretary of the Navy Graham Claytor responded by naming Alexander A. Silva, a former Navy petty officer and General Accounting Office employee, as deputy assistant secretary of the Navy for equal opportunity.<sup>49</sup> Such a standard bureaucratic response produced a little improvement, but the Navy had some rough sailing in the late 1970s. Members of racist organizations like the Ku Klux Klan sought to organize aboard Navy ships. Civil right proponents charged that the Navy systematically discriminated against African Americans by denying them positions in favor of less-qualified whites. The Navy cracked down on racist organizations and symbols. It established a remedial education program to allow the undereducated, both white and black, to join the service and then after finishing the course to apply for specialty skill school, the pathway to better jobs in the Navy.<sup>50</sup>

The heart of the matter was that all of the services, not just the Navy, reflected an American society that struggled since the founding of the nation with issues of race and gender. What was remarkable was not that racism, discrimination, or male chauvinism occurred in some parts of the armed forces, but that the Pentagon and service leadership were determined to overcome these prejudices since the creation of the Defense Department in 1947. The same cannot be said for homosexuality. OSD and the services were not prepared to accept openly gay service personnel, although Brown maintained they had in effect a *de facto* policy akin to President William J. Clinton's "don't ask don't tell" policy. As he later recalled, "Absent overt activity, it was tacitly accepted as long as people performed their duties well." However, the secretary was unwilling to make the leap from this assertion to acceptance of gays during his tenure. When Representative Barney Frank (D-MA) asked Brown why gays could not serve openly in the military, the secretary gave the standard answer: close quarters made homosexuality incompatible with discipline, morale, and good order. As one of its last acts in January 1981, OSD revised its directive on Enlisted Administrative Separations to make discharge of homosexuals virtually mandatory. The new language provided only limited grounds for retention on appeal. The appellant had to prove affirmatively that his or her homosexual conduct was a "departure from his or her usual behavior . . . was

not likely to reoccur, was not accompanied by force or coercion . . . [and] that the member was not a homosexual or bisexual.” Speaking for OSD, Deputy Secretary Claytor stated that he “firmly believed the most important aspect of our policy is the ability to keep homosexuals out of the service and to separate them promptly in the event they are in fact enlisted or commissioned.”<sup>51</sup>

Like most institutions, DoD put the best light on its efforts and downplayed its failings. Looking at its treatment of minorities, mostly African Americans (although Hispanics and Asian Americans were beginning to join in meaningful numbers), and women from 1948 to 1980 on the whole, few other American institutions could match the Pentagon’s accomplishments. The services by and large successfully integrated women and minorities into their ranks. For gay service members, their time had not yet come.

### **Draft Registration**

The Gates Commission in 1971 recommended that the All-Volunteer Force be supported by a standby draft, a means of mobilizing a second tier of manpower in the event of a protracted conventional conflict. The Nixon and Ford administrations studied the issue but could not come to any decision as to what an emergency call-up system should look like. Should the Selective Service System with its local boards be maintained or should a new mechanism, one that would rely on a one shot or periodic registration of males as potential draftees, be created? In the end, the Selective Service remained in deep standby mode with peacetime registration suspended, reflecting the Army’s new emphasis on forward defense of Europe augmented with the National Guard and Army Reserve. Many wondered if a conventional war in Europe would be over or would go nuclear before new volunteers or draftees could be trained.<sup>52</sup>

When the Carter administration took over, the president ordered a reorganization of the U.S. government to increase efficiency and reduce costs. The reorganization project recommended folding the austere standby Selective Service System (fewer than 100 full-time employees with help from reservists) into DoD, suggesting it could become independent and active when needed, but it did not recommend active registration of potential draftees.<sup>53</sup> There was still no consensus on the issue. The Joint Chiefs favored peacetime registration, as did advocates of a return to the draft, especially in Congress.<sup>54</sup> Many proponents of the AVF viewed the pressure



for peacetime registration as a Trojan horse for the return of the draft. In January 1979 Brown informed Carter that Chairman of the JCS General David Jones, Commandant of the Marine Corps General Louis Wilson, and Secretary of the Army Alexander had all spoken out in favor of resumption of registration. Brown provided the president his view: "In order to improve readiness of the Selective Service System, I think it is likely that we will want to have either registration or some form of improved record keeping about draft-age youth, using existing records." Not prepared to resume registration yet, Brown raised a new issue by recommending also registering women when the time was right. The secretary made the suggestion "because if there is a national emergency requiring conscription we would want to have that information about women even if the service required of them did not include military service." Carter indicated that he agreed with Brown, but then wrote: "I told Harold Brown to handle the military registration and draft question that Sam Nunn is pushing, and to leave me out of it."<sup>55</sup>

While Brown and Carter agreed on the need for draft registration, the secretary was in no hurry to initiate it. MRA&L Principal Deputy Secretary Pirie remained highly skeptical of the idea. Admitting there were good arguments for it, he suggested that a national debate over registration would confuse and even divert focus from the more important issue of training the necessary manpower. To Pirie, "the case for peacetime registration is flawed at the core." If pushed now in Congress, it could lose, sending a bad signal to allies, enemies, and the American public, possibly retarding efforts to reinstate registration when it was really needed.<sup>56</sup> As of March 1979 Congress had before it seven bills that required either peacetime induction or registration. Brown favored a report from the president to Congress "on reasons why he did or did not reinstate registration."<sup>57</sup>

While Congress failed to pass legislation to reinstitute registration in 1979, it did add to the FY 1981 Defense Authorization Act a requirement that the administration report to Congress on the issue by January 1980.<sup>58</sup> To this end, the president ordered an internal review of Selective Service reform that dealt with other related issues, including peacetime registration of both men and women.<sup>59</sup> In late December 1979 the Soviet Union invaded Afghanistan, causing the administration to look for ways to show its disapproval and demonstrate strength and determination in face of this challenge. According to the new director of the Selective Service, Bernard D. Rostker, Counsel to the President Lloyd Cutler recommended that Carter announce

he was reinstating draft registration and reforming the Selective Service System as a signal to Moscow.<sup>60</sup> The president did so in his State of the Union address on 23 January 1980. The next day Carter's press secretary revealed that the president would decide within a month whether to include in his request the authority to register women.<sup>61</sup>

In early February 1980 the administration reported to Congress a plan to register all males born in 1960 and 1961 and then proceed to continuous registration of men as they turned 18 years old. To register, an individual would complete and hand in a short form (name, address, sex, birth date, and social security number) available at local post offices. The Selective Service System would acknowledge receipt to the person who registered but would not issue draft cards, give physical examinations, or classify the registrant as fit or unfit. Selective Service would receive upgraded computer capacity to process the registrants and funding and procedures for recruiting and training local draft board members over the next 18 months, thus becoming prepared to assess claims and appeals should a draft be needed. DoD's Military Enlistment Processing Command and Selective Service would share a joint computer center. If mobilization occurred, the Enlistment Command would assure orderly movement from registration to physical examination, classification, induction, and training.<sup>62</sup> As a White House Press Office background report conceded, this was a change from the administration's autumn 1979 position opposing peacetime registration. The background report stated that, given how Selective Service reform could take a year, the Soviet invasion of Afghanistan demanded draft registration, a more rapid response.<sup>63</sup> Brown characterized registration as a "precautionary step in case sometime from now a crisis should develop," reiterating his support for registering women but noting that did not mean they would be drafted.<sup>64</sup>

Registering women for the draft would require new legislation. Reinstating draft registration for men was simple since the president already had the legislative authority to do so by proclamation. To process all those forms from 19- and 20-year-olds the Selective Service needed money from Congress. The amount was small, \$13.3 million (\$8.6 million to register about four million men at a cost of \$2 per head and \$4.7 million to upgrade the system's computers), but the congressional and national debate about the issue proved extensive and divisive. The five months it took to persuade both Houses of Congress to fund registration reignited national debates about conscription versus volunteers and the role of women in the military.

The debate also briefly reinvigorated the antiwar movement, and became part of the presidential campaign of 1980.<sup>65</sup>

In June 1980, four months into the debate, OMB staffer Harrison Wellford reviewed the strategy for Director James McIntyre and Deputy John White. He noted that things were going well operationally, but warned: “In terms of public and Congressional attitudes, however, our position has eroded since the period immediately following the Soviet invasion of Afghanistan.” Wellford ticked off the problems: the U.S. public and allies had adjusted to the Soviet *fait accompli*; the economic downturn took the spotlight off international and national security affairs; the media coverage of a draft memorandum from the new Selective Service director suggesting registration was not needed; and the opposition to registration from all three presidential challengers to Carter—Democratic Senator Edward Kennedy (MA); Republican Representative John Anderson (IL), running as an independent; and former Republican governor of California Ronald Reagan. Whether individuals should be able to indicate that they desired conscientious objector status became an issue. “Defense has deployed its Congressional forces to accomplish this [Senate passage by 16 June to accompany House passage on 22 April],” Wellford noted, “but as of now the prognosis is pessimistic.”<sup>66</sup>

The administration had jettisoned the idea of registering women, realizing that it would only complicate an already complex debate. Contrary to Wellford’s pessimism, the Senate passed the legislation funding registration on 12 June, overcoming a filibuster organized by Senator Mark Hatfield (R-OR) and defeating attempts to add a conscientious-objector checkoff. Support for the bill crossed party and ideological lines.<sup>67</sup>

Antidraft and antiwar groups promised demonstrations when registration took place in late July 1980 and urged young men to boycott the process in protest, hoping that the Vietnam protest movement would rise again. When the day arrived, demonstrations were sporadic. Rostker announced that 93 percent of those required to register did so. The White House, OSD, and the Selective Service System had pulled off a societal change against what some thought to be long odds. Registration passed a Supreme Court review of the act’s constitutionality a year later. Although the draft was not reinstated, men from 18 to 25 were required to register.<sup>68</sup>

Looking back on this episode, might it have squandered presidential and OSD capital, always in short supply in Congress? There was no great enthusiasm in DoD

for registration except in the JCS. Brown thought it necessary but hardly crucial, accepting it only when Carter decided on it as an international signal to show U.S. resolve in the face of the Soviet invasion of Afghanistan. Furthermore, it seems fair to conclude that Carter miscalculated when he followed Cutler's advice about sending a message to Moscow; the five-month process of obtaining congressional approval of draft registrations hardly demonstrated a drastic response.

### **Pay Compensation and Retirement Reform**

Among the factors that account for morale in military organizations, pay and benefits rank high. The All-Volunteer Force aided the shift in the image of military service from patriotic obligation to a job opportunity, but OSD and the White House did not see eye to eye on military pay. Carter did not view military pay as a primary factor in attracting personnel. Almost all experts disagreed with him, suggesting, as Brown came to believe, that military personnel were undercompensated, and if they were paid more, they would be more likely to reenlist. Carter and Brown did agree that the military retirement system was counterproductive, unfair, and too expensive. Under the retirement system, military personnel only became vested in their pensions after 20 years, with no partial vesting along the way. This was "cliff vesting"—all or nothing. It was a system designed to encourage a 20-year career. For those with less than 20 years' service, there was no pension. Those who stayed for 20 years received retirement pay of 50 percent of their highest salary for life, and those who stayed longer received an additional 2.5 percent of their highest salary per additional year of service (up to 100 percent at 40 years of service), adjusted semiannually for inflation. A service member who enlisted at 18 could retire on half pay at 38 and then get another job—often working for the U.S. government—and ultimately earn another pension.<sup>69</sup>

DoD had been studying the military compensation and retirement systems periodically since 1948. In June 1977 Carter established the nine-member President's Commission on Military Compensation (PCMC), headed by Charles J. Zwick, to review previous studies and make recommendations. In its report in April 1978 the PCMC confirmed what everyone knew. The pension system was inequitable for those who left before 20 years. The report also found that cliff vesting at 20 years inhibited effective and flexible force management and suggested that superiors were reluctant to separate ineffective subordinates as they approached 20 years' service. The Zwick

commission recommended vesting retirement after 10 years based on an average of the salary in the retiree's three highest-paying years (similar to civilian federal workers' "high-three average pay"), but also recommended deferring pensions until 55, 60, or 62 depending on years of service. Military pensions would be partially integrated with social security payments. Those serving 30 to 35 years would receive increased annuities. The Zwick plan would encourage more enlistees to remain serving for 10 to 12 years and also incentivize personnel to stay more than 30 years. The commission admitted that some of those who had vested after 10 years would be less likely to reenlist to reach 20 years of service, but they would be offset by retention of those serving up to 10 to 12 years, resulting in uniformed services that were young and vigorous but still had a strong contingent of older and experienced personnel.<sup>70</sup>

The services strongly opposed these recommendations on the grounds that they would reduce the standard pension, making a military career less attractive. Brown generally favored the commission's recommendations, but there was little hope that he could bring the uniformed military around to his way of thinking. As McIntyre told the president in November 1978, "it appears that the eventual Defense position, particularly in the retirement area, will differ significantly from the Commission's recommendations and will not constitute a truly substantial reform of the type which you and many of your advisers have sought." He warned it would require a strong personal commitment from Carter to convince the service chiefs and secretaries to support legislation and then push it through Congress.<sup>71</sup>

Carter was unable to provide that impetus. In July 1979 Brown unveiled DoD's legislative proposal to revise the military retirement system, stressing the similarities with the commission's recommendations, but conceding that some differences existed. Under the proposed system, all personnel serving 10 years would be eligible for a DoD pension beginning at age 60; the pension would be comparable to that of civilians in federal service, increased with length of service, adjusted for inflation, and integrated with social security. Those who retired at 20 years would receive 37.5 percent of their salary as opposed to the then-current 50 percent. Current members would have the option of being grandfathered out of the new system. After 2000 this system would reduce DoD's pension costs by an estimated 25 percent.<sup>72</sup>

Given the lukewarm response of the uniformed services, it was unlikely that Congress would enact DoD's pension reforms in toto. In 1980 the Congress increased military pay from 7 percent requested by the Pentagon to 11.7 percent

in FY 1981 and 14.3 percent in FY 1982 to account for inflation and attract better recruits. As part of the package, the Pentagon computed pensions based on the high three-year average for those entering the service after 8 September 1980 and staying for 20 years. The new pensions were calculated as a percentage of the average pay of the last 36 months (as opposed to the existing system that calculated retirement pay as a percentage of the highest yearly salary). Savings over the old system were figured at 13 percent. Congress adopted this plan, along with generous pay increases, in the FY 1981 and FY 1982 Defense Authorization Acts.<sup>73</sup> The reform fell short of Carter administration goals, but it was all that the services and Congress would accept.

As a result, the military pension system remained the most generous in federal service, but as the Zwick commission had suggested, pensions were not always a big factor in recruitment. More influential for morale and first-time reenlistment were pay and bonuses. Brown had displayed some hesitancy about large pay raises. He was quick to point out that take-home pay did not tell the whole story. Such benefits as housing and subsistence allowances, post-exchange privileges, health care, special sea or flight pay, and other bonuses had to be factored into the equation. As Carter's man at the Pentagon, the secretary felt an obligation to hold the line on personnel costs.<sup>74</sup>

Brown made his case to the president on behalf of the services. In early July 1979 he informed Carter: "Within the last two months the Joint Chiefs and Service Secretaries have intensified their urgings that a higher than the [originally requested] 5.5% pay raise [later changed to 7 percent] be granted to the military." If the FY 1979 pay ceiling was extended into FY 1980, the secretary saw problems: "Recruiting and retention are beginning to be of concern as military pay loses ground both against the cost of living and against competing civilian opportunities." While suggesting that the cap should be held for FY 1980 (Carter underlined this), Brown advised that pressures "to catch up, or at least not fall further behind in FY 1981, on military pay are growing at a disturbing fashion."<sup>75</sup>

Pirie asked Brown in July 1979 if he wanted a study on pay compensation, warning the secretary that the result would add to the pressure for a substantial military pay raise, beyond the 7 percent the White House had then approved under congressional pressure. "Does this disturb you?" Pirie asked. Brown responded: "I think we should go ahead with such a study despite the increased . . . pressure it

would bring.” Pirie’s November 1979 study of the inadequacy of pay made a strong case for better compensation, noting that inflation had taken a toll. Military real income also lagged behind civilian income, with the gap between them widening by 7 percent to 15 percent since 1972 in various comparison studies. The bad news was that to return to 1972 real income would cost \$2 to \$4 billion dollars in the next fiscal year. OMB and the White House had already balked at spending even \$650 million for better housing and pay as recommended by OSD.<sup>76</sup>

Citing Pirie’s study, the JCS reminded Brown that the real buying power and standard of living of military personnel had dropped dramatically, with average disposable income falling to 11.5 percent of total income in 1979 from the 22.5 percent it had been in 1973. Military servicemen and women earned 7 percent to 19 percent less than their civilian counterparts in similar jobs. Air Force pilots and mechanics were leaving in droves to fly or maintain commercial aircraft. The 7 percent pay raise, in the JCS view, represented only a down payment. Without more pay and benefits, they warned, the United States was “approaching a crisis that will severely challenge its ability to staff programmed forces and to maintain readiness at acceptable levels.”<sup>77</sup>

During 1980 a heavy drumbeat of articles appeared in newspapers and news magazines, reinforcing the concern about the inadequacy of military pay. In March 1980, in the *Washington Post*, former Defense Secretary Melvin Laird called for an across-the-board 17 percent military pay raise applied to all compensation as well as better benefits for housing, moving, special skills, and doubling of the bonus to take on combat roles.<sup>78</sup> On Capitol Hill the pressure was also mounting. In February 1980 Senators Nunn and John W. Warner (R-VA) introduced an amendment to a military pay and benefits package that added \$486 million to the budget, busting Congress’ own budget ceiling for FY 1980.<sup>79</sup>

In May 1980 the Congressional Budget Office dismissed Carter’s 7 percent pay raise and other related proposals as “insufficient to meet the service needs for enlisted recruits and maintain recruit quality in 1980 and 1981.” Pirie proposed that Brown call White at OMB to say that more military pay had to be reprogrammed into the budget. The secretary agreed. McIntyre reported to Carter: “Harold . . . considers the amendment [Nunn-Warner] so important to the military community, and to our military capability and readiness, that he is prepared to reprogram whatever is necessary to fund it.”<sup>80</sup>

Facing reelection, a public outcry, and strong pressure from Brown and the rest of DoD, Carter gave in and endorsed the Nunn-Warner amendment. The president informed Brown: "As you know from our previous discussions, I am committed to the principle that a career in the military should be at least as rewarding as a career elsewhere in our society." He instructed the secretary to support the Nunn-Warner amendment, encourage Congress to enact other related proposals, and improve military health care, including dental care for dependents. He also assured Brown of his willingness to separate civilian pay from military pay.<sup>81</sup> Aboard the aircraft carrier USS *Nimitz*, Carter told 6,500 sailors and marines returning from nine months' sea duty in the Persian Gulf that he would support the amendment. Carter then went one better, requesting funding of \$1 billion for what was dubbed the "Fair Benefits Package."<sup>82</sup> By late August 1980 Congress agreed on a military benefits package of \$790 million. Carter signed it into law (P.L. 96-343) on 8 September. Under its provisions service members who lived off base received a variable housing allowance to help them afford housing in expensive areas, more generous moving expenses, a 15 percent increase in sea pay, a 25 percent increase in flight pay, and increased food allowances. In the FY 1981 Defense Authorization Bill (H.R. 6974, P.L. 96-342) Congress granted the military an 11.7 percent pay raise.<sup>83</sup>

Had Carter seen the light? Or, as some have suggested, was it an election ploy? Most service members did not care if the president was rewarding them to help his reelection. They saw the prospect of decent housing and a better quality of life, making military service a more attractive career. Then, like the majority in the country, they generally voted for Ronald Reagan. Neither Carter nor Brown received much credit for these improvements. The president's change of mind came too late and under too much pressure from Congress. Reagan and his campaign associates had successfully branded the Carter administration as antidefense even though the president had supported more defense spending and better pay in his last two budgets for FY 1981 and FY 1982. As the Carter presidency ended, recruitment and retention both increased substantially. The All-Volunteer Force had reached stable ground on the road to becoming an institution. The Carter administration inherited in 1977 an All-Volunteer Force still unable to recruit the quality personnel it needed. By the end of 1980 the Pentagon and the large pay raises enacted by Congress provided the impetus for a revived AVF that emerged during the Reagan years.



## Pardons and Upgrades

The All-Volunteer Force was a product of the Vietnam War. Yet other legacies of that conflict still haunted American society in 1977, and were especially evident in issues like how to deal with draft dodgers, deserters, and those who had received less than honorable discharges during the Vietnam War for reasons of conscience. Also left unresolved were the fates of those still missing in action in Southeast Asia. To put Vietnam behind them, the Department of Defense and the Carter administration made some difficult and controversial decisions—such as providing no-strings-attached pardons to draft evaders; allowing those with less than honorable discharges, including deserters, to have them upgraded; reclassifying missing in action as deceased; and reinstating draft registration. None of these actions in themselves solved the problems. It would take time for the Vietnam wounds to heal.

The Ford administration had begun the process in 1974 by allowing draft dodgers amnesty if they reaffirmed their allegiance to the United States and worked two years in a public service job. Few evaders took advantage of the program. On his first working day in office, Carter unconditionally pardoned violators of the Selective Service Act for the period between 4 March 1964 and 18 March 1973, essentially pardoning those who had evaded the draft during the Vietnam War while ignoring a larger group who had deserted from military service during the same time period.<sup>84</sup> To a rousing chorus of boos, candidate Carter had announced his intention to offer these pardons at the national convention of the American Legion in Seattle in August 1976.<sup>85</sup> These pardons did not sit well with those who had served in Vietnam or America's other wars. At the same time, they offended some former anti-Vietnam war opponents because the action did not include deserters from the services.<sup>86</sup>

Before the inauguration, Brown and the OSD transition team had not been involved in the Vietnam pardons initiatives. University of Notre Dame president the Reverend Theodore M. Hesburgh, CSC, sent both the president-elect and secretary-designate Brown (via McGeorge Bundy) his university's study on the issue. Brown sent Carter his comments, highlighting "three sets of problems" to be considered. First was the question of how to deal with small groups who served in Vietnam with distinction—even a few wounded heroes—who later received unfavorable discharges and those who served well but because of medical problems also received undesirable discharges. Second was the challenge of pardoning

in such a way that their employment records not show the discharge. Finally, and most difficult, was the question of how to differentiate between those whose dishonorable discharges were a result of their disobeying regulations based on their opposition to the war and those who received dishonorable discharges for non-antiwar offenses—including being “persistent trouble makers.” This last group should not be just automatically upgraded to general discharges, according to Brown, but rather should have their cases reviewed individually.<sup>87</sup>

Carter’s announcement of 21 January did not address the third problem highlighted by Brown—what to do about deserters and those who had received dishonorable or general discharges (“bad paper” as it was known informally) during the Vietnam War. To the dismay of some former antiwar activists who had wanted them included in the pardon package, the president tasked DoD with preparing a study and recommendations to resolve the issue. The easiest way to accomplish the job would be to upgrade automatically “bad paper” discharges by category, including military “absentees” (deserters) who took dishonorable discharges in lieu of prosecution. But in August 1976, Carter had stated that deserters would have to be reviewed on a case-by-case basis.<sup>88</sup>

The Joint Chiefs looked with a jaundiced eye on anything that granted “blanket or categorical upgrade discharges in a way that failed to utilize the existing system, including the statutory boards established by the Congress and which operated under Military Department guidelines.” Blanket or categorical upgrades could have an adverse impact on military discipline, the Chiefs insisted. Specifically, such upgrading would “erode compliance with military orders,” encourage absenteeism and desertion, “reduce the recognition for honorable service of the vast majority of former Service members who successfully completed their military duty,” make desertion or evasion “a viable option . . . in the event of a future mobilization,” and finally “provide the cloak of respectability” to those whose military offenses did not relate to the Vietnam War. The Chiefs asked Brown to pass their views to the president.<sup>89</sup>

A none-too-pleased Brown commented: “I will be glad to transmit this position to the President as the Joint Chiefs['] idea of compassion.” The secretary noted that the “JCS (unlike the services) have no responsibility in carrying out an upgrading program” and “there is a time lapse effect. Most of these offenses are pre-1970. Brown considered that “seven years of trouble followed by rehabilitation is not an incentive to desert.”<sup>90</sup>

Brown clearly perceived that the JCS favored maintaining military discipline over Carter's spirit of reconciliation. After further consultation with and approval by the Chiefs and the services, DoD created a plan that kept to the spirit of a case-by-case review but created criteria by which many applicants' requests could be automatically upgraded. Those who received undesirable discharges by administrative action could have their discharges upgraded automatically if they were wounded as a result of military action, successfully completed an assignment in Southeast Asia or the Western Pacific in support of the war, or had had a successful active military career for two years prior to discharge. Also eligible were former service members who had undesirable discharges, but who completed alternative service or were excused from such service under President's Ford clemency program. For those who did not meet the automatic criteria, the boards would consider factors such as their civilian record of good citizenship since discharge, whether they were from a "deprived background," whether "personal distress" or "conscience" led to the act causing their discharge, or if there were extenuating circumstances because of drug or alcohol abuse. The plan granted wide latitude to the review boards in keeping with the president's "spirit of forgiveness and compassion." Some prohibitions remained: those who deserted in a combat zone were not eligible and those with charges other than desertion, especially acts of violence, would be still be subject to possible prosecution.<sup>91</sup>

DoD estimated that 60,000 of the approximately 70,000 deserters who had accepted dishonorable discharges could get automatic upgrades to general discharge. Of the estimated 92,000 servicemen with dishonorable discharges for acts other than desertion, many could automatically upgrade (DoD could give no estimate of numbers). Of the almost 260,000 who received general discharges, their fates would be decided on a case-by-case basis. A dishonorable discharge disqualified a veteran from benefits while a general discharge did not, but the latter still carried a social stigma that could impact adversely on employment prospects.<sup>92</sup>

The six-month-long program was a dismal failure. Only about 800 of the estimated 4,560 military deserters who accepted dishonorable discharges in lieu of prosecution took part in the program. Of the 432,000 with less than honorable discharges, only about 16,000 (with 8,600 cases still pending) had their discharges successfully upgraded to general or honorable.<sup>93</sup> In October 1977 Congress passed a law denying veterans' benefits to those who had their discharges upgraded under

the program, which the president reluctantly signed, removing one major incentive for those affected. Notably, the president's son, Chip Carter, who received a general discharge in late 1970 when he and other classmates were caught smoking marijuana at the Navy Nuclear Power School at Idaho Falls, felt it inappropriate to apply because of his relationship to the president.<sup>94</sup> The pardon and upgrade program did little to heal the wounds of the war. Was it because the wounds had already scarred over; or was it, as critics from the left charged, that the program offered too little; or was it, as critics from the right held, too generous?<sup>95</sup> Whatever the case, it did not work, but there were other legacies of the war that remained to be addressed.

### **Missing in Action and Reclassification**

Foremost among these other issues was the matter of the missing in action (MIA) in Southeast Asia. By the late 1970s the fate of MIAs had become a hot rail in U.S. politics in good part because of a lobbying group, the National League of Families, and strong support from a few members of Congress. To the families of the approximately 1,300 servicemen still missing in Southeast Asia, the lack of knowledge about their kin was difficult to bear. There were also about 1,000 already declared dead, but whose remains had not been recovered. No doubt many families harbored a forlorn hope that their relatives were being secretly held as prisoners of war in Vietnam and Laos. DoD could offer resolution of their status as deceased only by obtaining remains or reliable information on those remains. The problem was that the Socialist Republic of Vietnam sought to use the MIA issue to extract concessions from the United States, most significantly the economic reconstruction aid that they believed President Nixon had promised them.<sup>96</sup>

Early in his administration Carter appointed Leonard Woodcock, then president of the United Automobile Workers, to serve as a special envoy to Hanoi as the head of a presidential commission on the missing in action. The primary purpose of the commission's trip to Hanoi, according to Secretary of State Cyrus Vance, was "to obtain the best possible accounting for MIAs and return of the remains of our dead." Other issues such as normalization of relations or Vietnam membership in the United Nations were secondary.<sup>97</sup>

No one in Washington expected Hanoi to yield information easily. The North Vietnamese lacked the technical expertise and funds to conduct extensive searches for remains. They provided 11 certified remains of MIAs and an unidentified 12th

body later discovered to be Vietnamese. DoD's representative on the commission described it as "the minimal response we could have expected from the Vietnamese." It also became clear that the Vietnamese were not about to release great stores of information or remains of Americans until they saw what the United States was prepared to offer in return. The only cause for optimism—beyond resolution for the families of the 11—was that Hanoi agreed to unlink economic aid (which it termed war reparations) from information on MIAs and those known to be killed but whose bodies had not been recovered.<sup>98</sup>

Negotiations with the Vietnamese dragged on, with Assistant Secretary of State for East Asian and Pacific Affairs Richard Holbrooke leading the effort without much success.<sup>99</sup> In late 1979 the Defense Intelligence Agency received a promising lead from a Vietnamese government mortician that the Vietnamese had information on 400 remains. In addition, many Southeast Asian refugees reported hearsay evidence or claimed to be eyewitnesses of live Americans in Vietnam and Laos. DIA diligently pursued these leads. Unfortunately, refugee reports of live sightings proved self-serving fabrications or cases of mistaken identity. Accounting for MIAs in Southeast Asia was a long and tedious operation, providing only occasional solace to families of the missing.<sup>100</sup>

A more immediate concern to DoD involved the decision to reclassify MIAs as dead. In April 1977 the president asked Brown: "What are we doing to expedite reclassification of Viet Nam MIA's?"<sup>101</sup> The secretary explained that since mid-1973 the Pentagon had conducted status reviews of the missing only on written request of the next of kin or conclusive evidence of death, such as return of remains. To Brown, continuing to carry lost servicemen as MIAs "puts pressure on us to make concessions to Hanoi." Flexibility was possible since "an accounting that confirmed death by direct evidence validates a declaration or presumption of death for a missing serviceman, but it is not a legal prerequisite to such a status change. . . . Given the overwhelming probability that none of the MIAs ever will be found alive, I believe the time has come to allow the Secretaries of the Army, Navy, and Air Force to exercise their responsibilities for status reviews as mandated by law even though we have not received a full accounting." Brown warned this would not sit well with the families of the missing and the MIA hawks in Congress.<sup>102</sup>

Brown's prediction was well founded. The National League of Families picked up rumors of the policy change and made their opposition known to Deputy

Secretary Charles Duncan. To the families and their allies, such a status review would decrease leverage on Hanoi. On a personal level, if an MIA was declared dead and if ultimately his remains were later returned from Southeast Asia there would be two death experiences, “an unnecessary hardship on the next-of-kin.”<sup>103</sup>

Nevertheless, Brzezinski and Vietnam specialists at the State Department agreed with Brown’s plan for MIA status reviews, suggesting that for many families this process would provide welcome closure. Although DoD did not mention it, Brzezinski noted that the change in status would save DoD money, since MIA widows and families would no longer receive their kin’s monthly paycheck but would be eligible for survivor benefits. Most important, however, he agreed that there was no evidence that any MIA was still alive. Carter accepted Brown’s recommendations, but he insisted upon having the final say when DoD would make the public announcement.<sup>104</sup>

In July 1977 DoD headed an interagency group that prepared a detailed plan to initiate and then make public the decision to begin status reviews of MIAs. Brzezinski assured the president that “reinstitution of case reviews under this plan will be done humanely and in a proper fashion.” Since the House of Representatives soundly defeated an amendment to the Defense Appropriations Bill, which would have blocked the plan, Brzezinski considered that “the political risks seemed acceptable.”<sup>105</sup> Carter approved and DoD announced the decision in mid-August 1977, stating that the action “in no way alters the U.S. Government’s intent to obtain as full an accounting as possible of our servicemen, whether missing or deceased.”<sup>106</sup> Vietnam continued to periodically provide remains (those of 22 Americans were released in September); by October about 700 men remained in MIA status.<sup>107</sup> The status reviews continued throughout the Carter administration, as did negotiations with the Vietnamese, but diplomatic relations were not established. In March 1980 Brown updated the president on the status reviews, noting that DoD had completed most of them and would soon change to deceased the status of all remaining MIAs.<sup>108</sup> Those actions did not bring the MIA issue to a close. It would remain significant for many years to come.<sup>109</sup>

### **The Code of Conduct**

Vietnam also brought about a change in the code of conduct for U.S. prisoners of war (POWs). After the Korean War, DoD responded to the American POW experience in North Korea by creating an advisory committee, which recommended

that President Dwight Eisenhower sign Executive Order 10631 (17 August 1955) establishing a code of conduct and appropriate training for military personnel. Among other provisions, it required the POW to provide his interrogator with only name, rank, service number, and date of birth—the “big four.”<sup>110</sup> This code of conduct did not fare well during the Vietnam War when POWs held by Hanoi suffered almost unimaginable hardships; inevitably some cracked under the harsh pressure and torture.<sup>111</sup>

In March 1976 OSD asked for a review of the code of conduct from a Defense Review Committee headed by a civilian but made up of distinguished military officers. After extensive interviews, many with former POWs from the Vietnam and Korean conflicts and from World War II, the committee recommended in December 1976 changes to Article V of the code. The original article read: “When questioned, should I become a prisoner of war, I am *bound* to give *only* name, rank, service number and date of birth. I will evade answering further questions to the utmost of my ability. I will make no oral or written statements disloyal to my country and its allies and harmful to their cause.” The committee recommended two changes: “required” in lieu of “bound” (less ambiguous) and removal of “only” so that the sentence read: “I am *required* to give rank, name, service number and date of birth” on the theory that it allowed more flexibility and latitude. Explaining the changes to Carter, Counsel to the President Robert Lipshutz noted: “The reason for the change is to provide a more uniform understanding to POW’s of their responsibility and to reduce guilt feelings in prisoners who are coerced into giving more than name, rank, service number and date of birth, thereby helping them resist demands for further information.”<sup>112</sup> In addition, the committee recommended clarification of command authority “to provide the senior service member command authority over all other service members in captivity” regardless of the branch of service, to provide consistent and uniform training for potential POW experiences (the services had provided different training and policy instructions causing friction and tension among POWs), and better debriefing of former prisoners to ensure that violations of the code would be reported to the proper authorities.<sup>113</sup> OSD fully accepted these recommendations, proposing to the president two new executive orders as drafted by the Review Committee to strengthen the code of conduct accordingly. Carter agreed and promulgated the orders on 3 November 1977.<sup>114</sup>

While DoD and Carter made a good faith effort to heal the wounds of the Vietnam War, they achieved only partial success. It would take time for those who served in Vietnam to receive the honor, respect, and gratitude of the nation for their service in a controversial and unpopular war. An important step in the process was approval by Congress of a privately funded Vietnam Veterans Memorial on the National Mall at the urging of Vietnam veterans themselves. Carter signed the legislation (P.L. 96-297) on 1 July 1980 in the Rose Garden of the White House. The monument itself, with its simple black walls and inscribed names of the fallen, designed by Yale University undergraduate Maya Ying Lin, when completed and dedicated in November 1982, provided eloquent testimony to those who died in that far away conflict in Southeast Asia.<sup>115</sup>

The Vietnam War and its aftermath revealed in bold relief the enormously complex human dimension of the military experience. Chronic and interacting problems of race, gender, the draft, morale, reenlistment and retention, compensation and retirement, and the enduring bitterness and the search for ways to mitigate the legacy of Vietnam challenged the Department of Defense and the nation.



Visitors to the Vietnam Veterans Memorial on the National Mall in Washington, DC, pay their respects on 12 December 1982, the day before the official dedication. (RG 330, NARA II)



During the four years of the Carter presidency, the president and secretary faced up to these problems squarely, devoting to them their time and attention. Although their efforts on behalf of the military and their families were not always as successful as they hoped, their intentions were to heal the wounds of an unpopular conflict.

During the Carter years the Pentagon's efforts to improve and energize the All-Volunteer Force met with mixed success. Brown and his team attracted more women recruits than in the past and utilized them more effectively. While opening up additional military occupational specialties to female service members, the number of women serving in combat-related jobs was still limited. Combat specialties were still off the table and would remain so for years to come. Women began to graduate from the military academies during these years, but their impact would not be felt for some time. Minorities, especially African Americans, continued to join and serve in greater numbers. The armed forces provided an avenue for upward mobility for minorities and the economically disadvantaged. Brown and his team remained com-



The *Three Soldiers* statue was added to the Vietnam Veterans Memorial in 1985. (RG 330, NARA II)



The Vietnam Women's Memorial, also located near the Wall memorial, was dedicated on 11 November 1993. (RG 330, NARA II)

mitted to achieving an equal-opportunity armed force, but like all social changes progress was incremental, advancing in fits and starts. Recruitment and retention problems remained until 1980 when economic recession and the expected military pay raises encouraged more people to join. Attempts at pension reform proved unsuccessful in the face of opposition from the services. As for integrating gays into the military, the issue was never attempted. The Brown team in 1980 reaffirmed the ban of homosexuality. Their action reflected societal norms at the time, especially within the military. The reinstatement of registration for 18-year-old men resolved a potential problem of the Cold War. In a protracted conflict with the Soviet bloc there had to be a mechanism to transition from the AVF to a draft. It was good planning, although never required. In the final analysis, Brown's Pentagon handed the AVF to the next administration in better shape than it inherited it, but there was still more work to make it the force that it is today.

## Making the Case: Defense Budgets for Fiscal Years 1981 and 1982

DURING THE PREPARATION of the fiscal year 1981 Defense budget and President Carter's lame duck budget for FY 1982, the growing perception of an enhanced Soviet military threat had a greater impact than at any other time during the Carter administration. When preparing the previous FY 1980 budget in 1978, Defense Secretary Brown had sent the president confidential and personal assessments on the need to increase the Pentagon budget in light of the Soviet military challenge. Although the president gave these warnings a fair hearing, he remained skeptical, and continued to hold down defense spending. By 1980 Carter had accepted, albeit grudgingly and sometimes with ill grace, that spending had to increase for defense. The president reportedly told one White House aide: "Harold's been a horse's ass on defense budgets. He's caused me more work and took a hard line and never yielded." With the FY 1981 budget, Carter yielded. While his shift on defense spending was not as dramatic as President Harry Truman's in 1949 and 1950, which followed the National Security Paper 68 strategic review and the outbreak of the Korean War, it was still a major change of attitude.<sup>1</sup>

Critics of Carter, if they recognized the FYs 1981 and 1982 budgets as turning points, credit the president's opponents in Congress, national security intellectuals outside government in foundations and organizations (lobbying groups such as Paul Nitze's Committee on the Present Danger), and Ronald Reagan, the 1980 Republican Party presidential candidate, for sounding the alarm. These critics saw a naïve, moralistic, and antidefense president shocked by Soviet and Cuban adventurism in Africa, Central America, and most important, Afghanistan, abruptly abandoning détente with Moscow to win reelection and save SALT II.<sup>2</sup>

Such domestic political and international considerations obviously had an impact, but the real impetus for change came from a midterm internal reassessment of the strategic relationship between the United States and the Soviet Union, which clearly preceded the Soviet invasion of Afghanistan as well as the Sandinista success in Nicaragua. Harold Brown and his staff helped frame this reassessment, which persuaded the president to accept more robust defense policies, but they did not act alone. They enjoyed powerful allies in National Security Adviser Zbigniew Brzezinski and his National Security staff; the Joint Chiefs of Staff, who eventually went public with their concerns about the need for more defense spending; and key pro-defense members of Congress, who used the budget authorization and appropriation process to increase Pentagon expenditures.

During 1979 and 1980 the Carter administration and Congress laid the groundwork for what would be known as the Reagan revolution in defense. It was not just a matter of Carter increasing the FYs 1981 and 1982 Defense budgets; the president and his close advisers, often at Brown's urging, made decisions that caused major changes in defense acquisitions and national security strategy. They upgraded NATO's conventional forces to counter the Warsaw Pact's superiority; agreed to build a mobile MX missile to compensate for Minuteman missile vulnerabilities expected in early 1980s; and developed the Trident missile and ballistic missile submarine programs. The Pentagon under Carter and Brown accelerated the development of stealth aircraft technology; obtained NATO agreement to deploy Pershing II missiles and ground-launched cruise missiles in Europe to counter the Soviet SS-20 mobile, medium-range ballistic missiles; emphasized conventional and nuclear cruise missiles; authorized Brown's countervailing nuclear targeting strategy in Presidential Decision 59; created the Rapid Deployment Joint Task Force to improve U.S. response to crises and threats in the Persian Gulf and Middle East; revamped the patchwork of command, control, and communications (C3) for a nuclear conflict; regularized procedures for continuity of government during such a conflict; and normalized U.S.-Sino relations with a speed and efficiency that stunned the Kremlin. These were only the most significant accomplishments. Robert Gates, the director of central intelligence under President George H. W. Bush and secretary of defense for Presidents George W. Bush and Barack Obama, put it succinctly: "Regardless of Carter's enthusiasm or lack of it for some (or even most) of these measures, the cumulative impact was to provide a strong foundation for Ronald Reagan to build on."<sup>3</sup>

There was great continuity between the final years of the Carter administration and the Reagan presidency, contrary to messages of Carter's weakness on defense that Reagan hammered home during the 1980 presidential election. Admittedly, Reagan was willing to spend more money on defense than Carter. Any initiative Carter refused to do during his first two years—build the B-1 bomber, deploy enhanced radiation weapons (neutron bombs), or increase military pay—the new Republican president embraced. Reagan also ventured where Carter never thought to go, such as the strategic defense initiative (dubbed “Star Wars”), and a likeminded Congress appropriated significantly more money for the Pentagon. Still, a dispassionate look at Carter's record for his last two years recognizes both great similarities with his successor as well as the crucial fact that Carter began much of what the Reagan administration carried out. The Reagan revolution in defense began under Carter in 1979 and 1980.

### **Reassessing the Soviet Threat**

In early 1977 the Carter administration had undertaken a broad review of U.S. policy toward the Soviet Union with Presidential Review Memorandum 10, which included a net assessment of the relative strengths and weaknesses of the two superpowers. The study was prepared under the direction of Brzezinski by Harvard professor Samuel Huntington and National Security Council staff (see chapter 5). At the end of 1978 Brzezinski instituted another net assessment, only this time without the knowledge of the rest of the bureaucracy, and with no publicity. Brzezinski asked Brown and Vance to comment on it, requesting that the secretaries “keep [it] to a highly restricted distribution, if any at all.” The Comprehensive Net Assessment of 1978, as it was called, held that the broad conclusions of the June 1977 PRM 10 net assessment remained valid. There still existed a rough and asymmetrical military equivalence between the two superpowers, with the United States enjoying significant nonmilitary advantages in economic strength, technology, diplomatic access and support, and political appeal. The new assessment confirmed that the U.S.-Soviet relationship would continue as one of both cooperation and competition.<sup>4</sup>

While stating that neither side had gained much military advantage during the previous two years, the assessment concluded that “trends in the balance either changed direction or were intensified.” Most significant for DoD, the assessment stated: “The pro-Soviet trend in the strategic balance which existed in January

1977 has now intensified so as possibly to call into question the future of essential equivalence.” While the United States remained ahead in nonmilitary trends—with the key exceptions of technology and covert operations—“the trends in the military components of national power . . . all favor the Soviet Union, except for a mixed trend in the NATO–Warsaw Pact military balance.”<sup>5</sup>

Brown’s response to the 1978 net assessment encapsulated his strategic thinking. The secretary believed that in the realm of nonmilitary power the 1978 net assessment “paints too optimistic a picture of our current position.” Admitting that “the President’s personal involvement and moral leadership have given the US again an image of decency and fairness in world affairs,” Brown warned that “we cannot count on friendship alone to preserve US interests. . . . We live in a less benign world than we did two years ago, and we face increased chances for major political and economic setbacks.” The continuing vulnerability of oil from the Persian Gulf—as well as the possibility of a large rise in the price of crude oil even without a disruption—remained Brown’s foremost concern. With its own burgeoning oil industry, the Soviet Union did not face these problems.<sup>6</sup>

On the question of military balance, Brown stated: “I believe your assessment may be in some places too stark (on strategic forces) and in others too optimistic (general purpose forces).” In a worst-case scenario of a Soviet attack in 1982 on U.S. strategic forces, and a subsequent U.S. retaliatory response, the Soviets would have 10 percent more deliverable warheads and vastly more nuclear megatonnage after the exchange. Brown doubted that the United States would “ride out” such a Soviet attack, but even if it did, the United States would still have 3,000 remaining deliverable strategic nuclear warheads. The secretary wondered what the Soviets would gain by such an attack. With warning of an attack or by increasing its bomber alert in the 1980s, the United States could increase its ability to strike back. By the mid to late 1980s, the secretary contended, the Trident and MX missiles would shift the balance in favor of the United States. Brown acknowledged problems with the U.S. strategic position—command, control, and communication difficulties and Soviet advantages in many measures of strategic force capability and in theater nuclear forces—as “particularly troubling.” He continued: “I therefore think we need to increase our strategic force programs above what is now approved. . . . But I do not feel that the nation is now in peril because of the strategic balance.”<sup>7</sup> As usual, Brown took a measured approach, even in the face of the intelligence community

assessment that the Soviet Union had upgraded its missile forces and increased dramatically its number of strategic reentry vehicles. The secretary saw trouble on the horizon, but he did not see a “present danger.”<sup>8</sup>

Brown also warned that Brzezinski was perhaps too optimistic about the NATO–Warsaw Pact conventional military balance. NATO’s long-term development plan offered a “great step forward, but . . . as yet only [a] promise.” NATO had a long way to go. The United States would have to spend 40 percent more on defense annually and increase expenditures by 3 percent real growth per year (NATO’s elusive goal) to equal the Soviet Union’s conventional expenditures.<sup>9</sup> The secretary’s assessment reflected the U.S. intelligence community’s conclusion that Soviet defense spending was rising each year at a rate of between 4 percent and 5 percent.<sup>10</sup>

Two additional wild cards—inflation that robbed the United States and its allies of real growth in defense spending and a new Soviet across-the-board commitment to military technology—made the situation look grim. Brown pronounced Moscow’s results impressive and worrisome: a new guidance system for its SS–18 and SS–19 intercontinental ballistic missiles that matched the accuracy of the U.S. Minuteman III; a submarine-launched ballistic missile comparable to the Trident I, the SS–N–18, with seven reentry vehicles; and a new fighter aircraft with look-down, shoot-down radar missile systems capable of engaging four low-altitude aircraft simultaneously (similar to the best U.S. system under development). The Soviet high-energy laser program, for which Brown stated they were spending \$1 billion a year on research and development and moving close to prototype weapons, was leaving the United States far behind. The Soviet Union was catching up in military systems technology heretofore the ace in the hole for the United States and NATO allies. Unless the administration acted, the balance would shift to Moscow, and Soviet leaders would be more likely to confront than cooperate. The men in the Kremlin had to know conclusively they could not succeed in a military conflict with the West. “Today our military forces are marginal for such deterrence,” the secretary concluded, “tomorrow they may be inadequate.”<sup>11</sup>

Brzezinski and Brown agreed to hold an NSC meeting with the president to discuss the Comprehensive Net Assessment for 1978.<sup>12</sup> At the meeting, on the afternoon of 4 June 1979, Brzezinski cited key conclusions:

- The United States enjoyed nonmilitary advantages, some of which were growing.
- U.S. allies’ support, if forthcoming enough, could offset Soviet military power.

- Unsteady regional balances outside of NATO favored Moscow.
- The United States faced adverse strategic nuclear trends; “apparent insufficiency” in strategic power loomed for Washington in the early 1980s.
- This strategic gap could potentially encourage assertive Soviet behavior.
- The United States needed to reverse these trends to deter Soviet assertiveness.

Secretary of State Cyrus Vance generally agreed, but he suggested that trends outside NATO were “uncertain” rather than “uncertain-to-adverse,” and that in the early 1980s U.S. strategic power would be “roughly equivalent” rather than “inferior” to the Soviet Union. Brown disagreed, stating that “as a result of the long standing greater investment effort made by the Soviets, by 1985 they will have greater strength . . . in almost every military category, and . . . we should prepare ourselves to live with this.” The Joint Chiefs were extremely worried, according to General David Jones, who had frankly told Brown that he was “incapable of expressing their concerns strongly enough.”<sup>13</sup>

The president seemed the only one unconvinced by the assessment, suggesting that the perception of U.S. weakness was the fault of the “people in the room” who created the problem by “excessive concentration on our weaknesses.” Carter, the skeptic, often relied on his gut feelings in the face of the onslaught of intelligence findings. To the president, the Soviets had serious problems: multiple adversaries such as the United States, NATO, and China—a situation the United States did not face. Nevertheless, at the rest of the meeting and the follow-up later that evening on the MX missile system, the president agreed to deploy new theater nuclear weapons in Europe and to deploy a verifiable MX missile. Still, Carter retained some healthy intuitive skepticism, noting that he was unsure how many submarines were needed to carry Trident missiles and whether to build the Trident II missiles.<sup>14</sup>

The 1978 net assessment of the Soviet threat reflected a consensus among intelligence agencies that the Soviet Union posed a real military threat to the United States and that its weapons technology and production was improving rapidly. Where the intelligence agencies differed was not on this basic premise, but on the nature of the threat and whether the balance was tipping toward Moscow. The Central Intelligence Agency downplayed the effectiveness of Soviet capabilities, although it still regarded them as a serious threat. The Defense Intelligence Agency and military intelligence services, with their focus on weaponry, concluded that Soviet Union military capabilities represented an extremely dangerous threat. Ever since the late



1940s, the military services and DIA (after its establishment in 1961) intelligence analysts had tended to assess the Soviet threat on the high side, favoring worst-case scenarios. Carter adamantly believed that they did so to bolster DoD claims for a larger share of the U.S. federal budget.<sup>15</sup>

### **Formulation of the FY 1981 Budget in DoD**

The concerns expressed by Brown and Brzezinski at the NSC meeting and the debate over the net assessment of 1978 found expression in the FY 1981 budget formulation in the Pentagon. As usual, the Joint Chiefs started off the process with the Joint Strategic Planning Document for 1981–1988, which was the successor to the Joint Strategic Operations Plan, and called for more spending in virtually every area. For strategic forces, the JCS recommended accelerating the MX program by a year, producing two ballistic missile submarines rather than one per year, reviving the B–1 bomber in 1983, and increasing production of fissionable materials to ensure an adequate nuclear stockpile. For general purpose forces, they recommended filling out 5 of the Army’s programmed 16 divisions; acquiring 198 additional high performance tactical F–15 Eagle fighters for the Air Force; an additional 11 surface combatants and 2 nuclear *Los Angeles*-class attack submarines for the Navy; and amphibious shipping to support a lift capacity of 1.66 percent of Marine amphibious forces. To fulfill the JCS list the administration would have to increase DoD total obligational authority by 5 percent real growth per year, rather than the 2.5 percent of the previous year. Although more realistic and less marred by service strife than previous annual submissions, the JSPD still seemed like an unchecked wish list.<sup>16</sup>

The Office of the Secretary of Defense then prepared its initial contribution to force structure and budget planning for the next five years, the Consolidated Guidance with an accompanying fiscal guidance. As usual, Brown assigned the acerbic and iconoclastic Russell Murray, his assistant secretary for program analysis and evaluation, the task of telling the Joint Chiefs, the military services, and Defense agencies what they needed to do within the confines of the fiscal guidance. After they saw his first draft of the CG, their response was predictable. As Murray put it, “By far the dominant theme in the Service and JCS comments on the CG is that the fiscal guidance is inadequate to carry out national policy and strategy.” The JCS direly predicted that the proposed CG force structures for the next five years were “likely to involve high risk of failure of deterrence and of defeat should deterrence fail.”

The Navy stated it failed to see how it could reach “minimal conformance with the policy section” with the funds it would receive. The Air Force viewed the guidance as “overly optimistic” about its capabilities and contended that its force structure was not flexible or mobile enough to meet its worldwide requirements. The Army felt that the “forces envisioned by the CG will not support our national strategy,” and the funds would not even support the inadequate forces projected in the CG.<sup>17</sup>

Another innovation of the Carter administration involved review of the Consolidated Guidance by the Policy Review Committee, one of the two principal subgroups of the NSC. DoD expected input from the NSC staff and other interested agencies during PRC discussions of the CG and the fiscal guidance. Once blessed by the PRC, the Consolidated Guidance would have an administration-wide imprimatur. In preparing for this meeting, Murray admitted that the Five-Year Defense Program for 1981–1985 outlined in the CG was “underpriced,” because it assumed optimistic inflation rates, because some of its programs purposely were underfunded, and because funding was insufficient to provide the required readiness. The first step toward meaningful discussion required calculating the amount of additional monies needed to correct these deficiencies. The second and much more difficult step involved making cuts in other forces and expenditures to fit within the fiscal guidance. Murray recommended that the secretary could not and should not attempt the latter at the PRC meeting.<sup>18</sup>

As Brown’s staff prepared briefing materials for the PRC meeting of 14 May 1979 they raised two key questions: How likely were U.S. programmed forces for 1981–1985 able to meet the requirements of the basic national security objectives laid out in PD 18, especially the requirement that the United States maintain an overall military balance with the Soviet Union as favorable as the one that existed in August 1977? Second, could the United States afford the required forces to meet this goal within the president’s overall fiscal guidance? To answer the first question, DoD examined strategic forces, NATO, the Persian Gulf, and Korea.<sup>19</sup>

As NSC staff members Victor Utgoff and Jake Stewart explained, Brzezinski and his deputy, David Aaron, were “quite familiar with” the strategic forces story: trends running against the United States until the mid-to-late 1980s when MX, Trident, and air-launched cruise missiles would right the balance. The Warsaw Pact would still enjoy a major conventional force edge in 1985, but the theater nuclear balance was changing. While the Soviet’s tactical nuclear artillery gave them an

advantage in the short range, the long-range balance was expected to shift with deployment of Pershing II missiles and GLCMs in Western Europe in the mid-1980s, offsetting the Soviet SS-20 mobile missiles. The Persian Gulf remained vulnerable because of U.S. deficiencies in timely transportation—sealift and airlift capabilities. Revised intelligence estimates for North Korean ground forces and equipment indicated that the situation in the peninsula was worse than thought. As for the second question, the NSC staffers stated that “DOD’s message here is short and not sweet—we have underestimated, and apparently are continuing to underestimate, the rate of inflation . . . from about 1.5% too low in 1980 to about .5% too low in 1985.” The result would be a total \$65 billion dollar shortfall by 1985.<sup>20</sup>

The PRC discussion followed the outline of the Pentagon’s briefing papers, with committee members warning that given the deterioration in the strategic balance, the United States could find itself strategically outgunned in the early 1980s—akin to what the Soviet Union faced during the Cuban missile crisis. In addition, acting JCS Chairman General Bernard Rogers reported that Army computer studies indicated that NATO would be unable to stop an all-out Warsaw Pact conventional attack. As for the Middle East and Persian Gulf, the United States would be hard pressed to project power, especially in the event of a simultaneous crisis in NATO. From a military viewpoint, Korea looked bleak, but the new relationship with China ameliorated the situation somewhat. In discussing funding increases, the consensus held that 5 percent real growth per year increases were needed, but were “not politically feasible.” To make matters worse, underestimating inflation and underpricing weapon systems and other expenditures would result in a \$40 billion plus shortfall over the next five years even if the Pentagon budget was increased 3 percent real growth per year. The Office of Management and Budget estimated the federal tax burden would reach over 20 percent of GNP in 1981, “unprecedented in peacetime.” The recession and potential increases in the deficit (\$13 billion–\$15 billion for 1981) would ensure that money would be tight. Within these constraints, the PRC concluded that the Pentagon would have to prioritize its requirements.<sup>21</sup>

Setting priorities was what DoD’s Planning, Programming, and Budgeting System, introduced by Defense Secretary Robert McNamara in 1962, was all about. As a first step, each service prepared a program objective memorandum and submitted it to Brown in mid-May 1979. Navy Secretary Graham Claytor noted in his POM the Navy’s priorities: operational readiness, force modernization, and where

possible force growth. But the greatest concern was the Navy's inability to sustain its marginal force numbers through the 1980s. Claytor suggested that the Navy was "moving towards a Navy of less than 360 ships and about two-thirds our current aircraft." Brown commented in the margin: "We need either to build ships more efficiently or more modestly." At the basic or minimum levels, Claytor judged, "we surrender maritime superiority to the Soviets in this decade." It was not just ships or planes. Recruiting manpower for the next five years posed a problem. Claytor noted that a "first class petty officer or Marine Staff Sergeant now earns less than a San Francisco grocery check-out clerk." Brown commented: "per hour in cash, not in kind [benefits]." Claytor recommended funding for the Marine AV-8B vertical takeoff and landing aircraft, knowing that Brown and the chief of naval operations opposed it, but that Congress and the Marine Corps commandant wanted it. In summary, Claytor concluded: "While I believe that the POM-81 programs maintain fleet readiness and some modernization, I am seriously disturbed by the impending reduction in naval forces driven by the lack of adequate resources." He worried about the 1980s and, given the slow pace of construction in shipbuilding, the fast approaching 1990s. "Despite your [Brown's] personal commitment" to maritime superiority, Claytor concluded, "we cannot effectively support it with inadequate resources."<sup>22</sup>

The Navy had been singing this same old song since the beginning of the Carter presidency, convinced that it was being shortchanged by a president ill-disposed to his former service and a similarly inclined secretary of defense. The sailors had a point. A former submariner, Carter had little use for a large surface Navy. If pressed, he might agree to spend tight money on *Ohio*-class submarines. Brown consistently warned that building large numbers of surface warships with all the bells and whistles would be a mistake.<sup>23</sup>

The Army faced a more receptive secretary and White House. Its POM for 1981-1985 focused on NATO's combat readiness, support of NATO's long-term defense plan, and the Rapid Deployment Joint Task Force (a White House priority). Still, the Army saw problems that required more funding: recruiting enough skilled soldiers and paying for related quality-of-life costs, NATO reinforcement, and overall modernization. Secretary of the Army Clifford Alexander stated that modernization was frustrated by a lack of resources that required such retrograde changes from FY 1979 as reduced procurement rates for General Support Rocket Systems, M1 tanks, infantry fighting vehicles, Black Hawk helicopters, and a delay

until November 1983 of the initial operating capability in Europe of the Patriot missile system.<sup>24</sup>

The Air Force felt optimistic about its POM for 1981–1985, since its focus on modernization of the strategic deterrent—the MX missile and ALCMs carried by B–52s—was one of the administration’s highest priorities. Still, the Air Force anticipated a need for more funding through 1985 and beyond. The POM asked for increased resources to rectify shortfalls in readiness caused by inflation cutting into the Air Force’s second highest priority, operations and maintenance. The Air Force also suggested that emphasis on increasing the strategic deterrent came at the expense of modernization of the tactical air forces and improvement in airlift, a necessity if general purpose forces were to have more mobility to meet future potential regional crises. Acting Secretary Hans Mark concluded that the requirements of strategic force modernization meant that general purpose and support programs would suffer.<sup>25</sup>

In August 1979 Brown responded to the service POMs with his program decision memoranda.<sup>26</sup> The issues raised in these PDMs are best viewed through the prism of the services’ reclaims, which reveal what they really cared about. Not surprisingly the new secretary of the Navy, Edward Hidalgo, and his deputy, James Woolsey (Claytor had become deputy secretary of defense), expressed the most concern. They complained that the Navy, was taking the brunt of cuts to pay for the strategic force modernization. According to Hidalgo, Brown had assured the Navy that the cuts it had suffered during the previous Carter years would be temporary. Now they seemed a “firmly established and deeply disturbing trend.” To Hidalgo and Woolsey, the PDM failed to modernize amphibious lift capacity and jeopardized maintenance of the existing 1.15 Marine amphibious force lift capacity. On other levels the PDM affected shipbuilding and aviation, as it also failed to support the approved force level of 90 attack submarines; did not support the mix of surface ships needed for carrier battle groups; proposed only 55 new ships and 4 conversions at the basic level against the 67 and 4 conversions the Navy had in the previous year’s FYDP; and failed to support Navy and Marine aviation.<sup>27</sup>

For their part, Brown and OSD sought to change the Navy’s shipbuilding plan, calling for a diverse mix of ships in its strike forces—attack submarines and CG–47 (*Ticonderoga* class) guided missile cruisers equipped with the Aegis combat system—while drastically cutting the number of the smaller FFG–7 (*Perry* class) frigates. They expected U.S. allies to pick up the slack by building their own destroyers and

frigates for convoy escort duty, resulting in a decline in funding for shipbuilding in the 1981–1985 FYDP. The Navy was not pleased, noting in its reclama that “the net effect is to present a program that contrasts sharply with what many members of the Senate are trying to tell the administration.”<sup>28</sup>

The Army initially reduced its reclamationas to 20, several of which related to the All-Volunteer Army—more recruiting money, enlistment bonuses, better housing, and more funding for junior officer travel. It opposed OSD efforts to convert 10,000 combat service support billets to combat over the five-year period. As for weapon systems, it objected to OSD’s plan to eliminate procurement of the target-locating advanced scout helicopter, reduce the number of Roland surface-to-air defense missile fire units from 180 to 95, give a lower priority on funding the 155mm nuclear projectile, and defer procurement of the Hellfire missile for a year.<sup>29</sup>

Army Chief of Staff General Shy Meyer provided a precise view of what was troubling the Army: its inability to support NATO combat forces in the early days of a war with the Warsaw Pact. U.S. commanders in Europe were skeptical of the concept of Host Nation Support, an idea promoted by Brown and OSD. These military leaders believed that the current level of active combat support forces invited risk of combat failure. As Meyer characterized it, the “sinews of support” were missing. Host nations or U.S. reserve components were not yet able to pick up the slack. Brown commented that Meyer made a good case and passed the memorandum to his staff.<sup>30</sup>

New Air Force Secretary Hans Mark used his reclama to argue for more support for tactical air forces and to question OSD’s decision to replace F–4 Phantoms, F–111D Aardvarks, and F–15 Eagles in inventory or in future acquisition programs with what Mark considered a less capable aircraft, the F–5 rather than F–15s. By placing the procurement of 60 F–15s in the most expensive enhanced band, rather than the basic or minimum band, OSD was in effect giving up on acquiring more of “the most capable air-to-air fighter in the world.” Under zero-based budgeting DoD submitted three options: enhanced, basic, and minimum. The president and OMB were unlikely to add the F–15s to their budget proposal to Congress if the aircraft were in the wish-list band. Although Mark considered tactical aircraft “the single most important issue that we need to discuss,” he had other concerns, including a \$100 million cut in research and development funding, cuts in recruitment and advertising despite the Air Force’s first-ever shortfall in recruiting, a need for more

E-3A Sentry AWACS aircraft, and reductions in pilot flight training. Nevertheless, the Air Force probably realized that it had emerged relatively unscathed in this initial budget exercise.<sup>31</sup>

Murray felt disheartened by the services' response. Instead of using their rec-lamas "to bring up any PDM decisions they feel are so bad that they deserve your [Brown's] personal reconsideration," they used them to "to argue with everything you've just decided," often descending into "sheer trivia." Brown commented: "Services have 90 minutes and I'll listen to whatever they argue during that session. I'll also address those and the out of court settlements—not everything they list."<sup>32</sup>

Brown's sessions with the services resulted in an amended program decision memorandum that went out under the name of the new deputy secretary, Graham Claytor. The Navy received additional funds in the enhanced band for Trident II missile development and modification of *Ohio*-class submarines to carry them. In both the basic and enhanced bands OSD allowed more funding for sea-launched cruise missiles as a potential supplement for NATO's long-range theater nuclear force modernization. The Navy's hope for better naval aviation remained unrealized. Brown did not increase the Navy's shipbuilding program. Recruiting costs were increased to allow for inflation. The Army's plea for more combat service support resulted in an OSD decision not to convert 2,300 spaces to combat in FY 1981 and a decision to study the issue of Host Nation Support in Europe. OSD provided some funding for scout helicopters, more Hellfire missiles, and additional Roland fire units. Army recruitment, enlistment bonuses, and family housing received more money. The Air Force's concern over tactical fighters was somewhat alleviated when OSD moved procurement of the 60 F-15 aircraft from the enhanced to basic band for FYs 1981 and 1982 and tentatively delayed the retirement of F-111Ds until FY 1982. The Air Force's AWACS program received higher priority, but pilot training required further study. The process had worked about as well as could be expected, but an undertone of discontent from all of the services and the JCS conveyed their belief that they had not been afforded the funding needed to do the job of defending the United States.<sup>33</sup>

### Negotiations with the White House

With these decisions, OSD was prepared to negotiate with the White House and the Office of Management and Budget. Both had been keeping an eye on the DoD budget

process by examining the relevant memoranda and issue papers. Brown asked Murray to prepare for the president a list of highlights of what the administration could get for the FYs 1981–1985 Defense budgets at the basic level of just under 4 percent real growth. In the strategic area, the list included MX missile development resulting in operational units available in 1986 and all Minuteman missile improvements completed by 1985. At the end of the five years, 80 percent of the 150 B–52Gs would be armed with 12 cruise missiles each. Strategic communications, command, and control would undergo a major upgrade. Trident missiles would be deployed in refitted older SSBNs in 1980, replacing the shorter-range and less sophisticated Poseidon missiles. The ballistic missile submarine USS *Ohio*, first in its class of larger submarines, would be launched in 1981, with one SSBN funded each year through FY 1983. A new nuclear ballistic missile attack submarine would be launched in FY 1984 and thereafter 1½ nuclear SSBNs produced per year. For theater nuclear forces, the first Pershing IIs would be operational in FY 1983; all 198 would deploy to Germany by the end of FY 1985. GLCMs, operational by December 1983, would arrive in hard shelters in five European countries by the end of FY 1986.<sup>34</sup>



The nuclear-powered ballistic missile submarine USS *Ohio*, with its missile tubes open on deck, was the first of its class to carry the Trident missiles, November 1981. (RG 330, NARA II)



As for conventional forces, the Army would activate three new tank battalions, establish a new national training center in 1980, and purchase 3,900 M1 tanks and 3,700 new armored personal carriers by the mid-1980s. Under the five-year plan, 10 maneuver battalions (6 tank and 4 mechanized) in existing divisions would be activated and 5 existing infantry battalions would be converted to tank or mechanized. In 1981 the Army would receive Copperhead semi-active, laser-guided 155mm projectiles. In 1985 it would receive 180 General Support Rocket System launchers, 1,000 AH-1S helicopters equipped with TOW missiles and 300 attack helicopters equipped with Hellfire missiles. Air defense by FY 1985 would include 100 Patriot and 100 Roland SAM units, improved air defense and antiaircraft guns, and 1,100 Stinger man-portable SAM launchers. Sustainability and Reserve Readiness would be improved.<sup>35</sup>

The Air Force would receive 900 new or converted aircraft—none of them F-5s—a 38 percent increase in cockpit training, and an increase in combat readiness of fighters and crews over five years by a rate of 6.6 percent per year. For mobility, the Air Force would take delivery of its first KC-10 Extender refueling tankers in FY 1981, allowing long-range deployment of tactical aircraft. By FY 1982 C-5 transports would be modified to extend their service; and C-141 transports would be stretched to increase their capacity by 30 percent with added air refueling completed by FY 1982. For its general purposes forces, the Navy would get the 67 ships it asked for, 24 active P-3 maritime patrol aircraft equipped with Harpoon antiship missiles, and about 800 tactical aircraft, including for the Marines, by FY 1985. The Marine Corps amphibious lift capabilities would see only marginal improvements—two new dock landing ships in FY 1983 and FY 1985.<sup>36</sup>

Brown explained his change of heart on naval ship construction to the president, noting that he had been under heavy pressure from Secretary of State Vance (a World War II Navy veteran), Congress, and even OMB to increase the number of ships planned for FYs 1981–1985. “As you are aware,” Brown stated, “both for cost and other reasons, sizing the fleet is a complex analytical exercise. But if the Navy is given a fixed number, they have *no* incentive to keep the cost per ship down.” Nevertheless, the secretary suggested that he might add a few more ships: “There is no question but that our surface Navy is stretched thin.” Carter saw the memorandum but made no comment.<sup>37</sup>

Brown briefed congressional leaders on the Five-Year Defense Program, stressing the commitment to 3 percent or better real growth at the basic level, a

theme he reiterated in public addresses in Boston. The secretary also noted for the president the success of linking a strong DoD program for FY 1981 to the ratification of the SALT II Treaty. In late October 1979 Brown highlighted the FY 1981 budget and the FYs 1981–1985 FYDP for key members of Congress prior to their vote on the ratification of SALT II.<sup>38</sup> Carter later threw cold water on the secretary's efforts in a handwritten private letter: "Be *very* careful not to get you & me boxed in on what a 'basic' program is for the '81 defense budget. Excessive expectations within DoD & Congress could cause me serious problems when I have to assess broader budget and economic problems."<sup>39</sup>

Brown received a better reception when he previewed the Pentagon budget at a PRC meeting on 8 November 1979. Outlining a budget at the basic level for the FYDP between 4 and 4.5 percent real growth, the secretary noted that such an increase would require almost \$116 billion more in defense spending over the next five years (\$34 billion for naval forces, \$30 billion for improvements to NATO, \$29 billion for strategic forces, \$16.3 billion for the Rapid Deployment Joint Task Force, and \$6.2 billion for intelligence) than the FY 1980 budget provided. The PRC members agreed to the funding allocation, which would get the RDJTF off to a strong start. They also discussed naval shipbuilding especially whether to construct expensive Aegis-equipped ships that afforded air defense for carriers or to procure inexpensive frigates in greater numbers. The majority, including Brown, held that Aegis ships were the better choice. Brown asked the participants (except OMB Director James McIntyre whose answer he already knew) to state from a foreign policy view their preferred budget level; they agreed 4.5 to 5 percent real growth was better than 3 percent.<sup>40</sup>

After the PRC meeting, the secretary sent a strong plea to the president: "Over the past five years or so, the analysis [of the US-Soviet military balance] has developed a familiar ring: the balance is still all right, but the trend is unfavorable, and we'll be in trouble soon if we don't do something about it. I've said it often enough myself, and meant it." Brown noted that in deciding the DoD budget for a particular year some programs were delayed, others cut because of a requirement for "hard choices and the actual bottom line. . . . That procedure has gone as far as—and possibly further—than is prudent. It must stop. We cannot risk one more year of temporizing. We must face the serious military imbalances that have grown so large, and resolve to remedy them starting now."<sup>41</sup>

Commenting on Brown's advice and priorities, Brzezinski noted that DoD sought to protect its crucial new nuclear programs, such as the long-range theater nuclear force and the MX, by placing them well within the minimum band. As a result, procurement for general purpose forces "has been pushed to the margin." OMB's answer was to push for less capable systems or to cut back on procurement programs related to U.S. support for NATO in the hope that member nations would increase their share of the burden. As for the debate on Aegis-equipped cruisers versus frigates, Brzezinski also opted for ships equipped with the Aegis combat system as the only answer to the threat from Soviet Backfire bombers. He supported procuring more tactical fighters, better war reserve stocks, and both British AV-8B Harriers and Franco-German Roland SAMs as a commitment to NATO's two-way street and upgrading the RDJTF (Brzezinski's special concern). As for the budget level, Brzezinski thought OMB's figures were too low and "would kill SALT outright" in the Senate, but he considered DoD's too high. He recommended \$156 billion in total obligational authority and \$143.6 billion in outlays for FY 1981, a growth rate of 5.8 percent in TOA and 4.1 percent in outlays. In conclusion, Brzezinski warned: "If we go for less, I do not believe we will have the broad consensus to support both SALT and an adequate yet prudent defense program . . . a consensus that has eluded us since the war in Vietnam."<sup>42</sup>

The actual figures finally accepted by Carter for submission to Congress came very close to Brzezinski's: \$158.7 billion in TOA and \$142.7 billion in outlays for FY 1981, with major increases for the subsequent years through FY 1985, when TOA would be \$248.9 billion and outlays \$224.8 billion.<sup>43</sup> What accounted for Jimmy Carter's decision to agree to more money for defense? While spending a quiet Christmas at Camp David with only his wife, Rosalynn, and daughter Amy, Carter held a budget meeting with OMB, agreeing to hold the federal deficit to \$15 billion but making "a strong commitment to defense." Early in 1980 Carter told congressional leaders that defense spending had declined during the 1970s but had risen in real terms since he took over, and would continue to rise until 1985.<sup>44</sup>

Carter cut short his stay at Camp David to deal with the Soviet invasion of Afghanistan, seen in Washington as an act of aggression by Moscow, but one that confirmed rather than initiated the president's decision to increase defense spending. In mid-November, Counsel to the President Lloyd Cutler, one of Carter's most trusted advisers, had come down squarely in support of Brzezinski's and

Brown's recommendations. Cutler viewed 4.1 percent growth in outlays and 5.8 percent growth in TOA as necessary for the defense of the United States. It "should satisfy the senators who have made their SALT [ratification] vote contingent on Presidential action to fund these programs." Anything less than 4 percent would not win over the senators.<sup>45</sup> Then, on 11 December 1979, OMB fell in line, and McIntyre reported that he and Brown had agreed on budget figures for FY 1981. After Brown consulted with members of the Senate, the figures for FY 1982 to FY 1985 budgets were adjusted upward. These decisions predated the Soviet invasion. The recommendations of Brown, Brzezinski, and Cutler, along with McIntyre's agreement, plus the desire to provide support for SALT II ratification (a lost cause after the Soviet invasion of Afghanistan), changed Carter's instinctive skepticism to grudging support of stronger DoD programs.<sup>46</sup>

### **Congress and the FY 1981 Budget**

In late 1980, for the first time in 13 years, both Houses of Congress increased the level of DoD spending above the administration's request. Pro-defense members on Capitol Hill believed their add-on appropriations to the FY 1981 Defense budget had forced the president to accept more spending. Congress appropriated \$159.7 billion in TOA, \$5.2 billion more than the administration's revised recommendation. While the FY 1981 budget deliberations did not start officially until January 1980, when the administration submitted its FY 1981 budget to Congress, the Senate jump-started the debate during its hearings on the SALT II Treaty ratification in July 1979. Leading defense expert Democratic Senator Sam Nunn from Georgia insisted that the price of his support for SALT II ratification was 5 percent real growth in the Defense budget. The Senate passed a budget resolution (albeit non-binding) to permit the 5 percent increase; it remained to be seen if both Houses of Congress would appropriate such an increase. Brown and Claytor took charge of negotiations with Nunn and likeminded colleagues in the Senate, meeting with them in late November and early December 1979.<sup>47</sup> After inching the fiscal guidance for TOA beyond 5 percent in real growth, Brown cited for Carter public opinion, such as the Harris Poll of September 1979, which concluded that 60 percent of voters favored higher defense spending and only 9 percent wanted reductions. Congress and the public were of like mind. In mid-December 1979 Carter agreed to Nunn's 5 percent figure.<sup>48</sup>

The congressional budget process required two separate final votes, one authorizing major expenditures and a later one actually appropriating money for DoD for FY 1981. In addition, the House and Senate Budget Committees initially set budget guidelines for DoD spending—which by this time were mostly viewed as a very rough guide—and Congress also separately funded military construction and could vote supplemental appropriations if required.<sup>49</sup>

While the FY 1981 Defense Authorization Bill (H.R. 6974) for weapons procurement, research and development, and civil defense made its way through Congress with less heated controversy than in previous years, battle lines did form over funding for weapons authorizations. Carter and Brown asked for \$30.3 billion for new weapons. Congress appropriated almost \$35.8 billion, with the Navy the principal recipient of congressional largesse. Congress added \$2 billion more than the administration requested for naval shipbuilding and another \$2 billion among the three services for new aircraft and spare parts. Congress also specifically authorized reactivation of two mothballed ships, the aircraft carrier USS *Oriskany* and the battleship USS *New Jersey*, to increase U.S. naval presence in the Persian Gulf and Indian Ocean. Consideration of the MX missile saw little of the controversy of previous years (except over the daunting problem of where and how to deploy the system), but the battle over the B-1 bomber continued, with congressional proponents trying to authorize funding to make the B-1's design and technology the model for a new cruise missile carrier.<sup>50</sup> See table 13, page 560.

Early in the process Carter tried to head off these additions by sending an OMB- and DoD-drafted letter to Senate Armed Services Committee Chairman John Stennis to oppose a \$600 million add-on to rework the B-1 as a cruise missile carrier, renamed the Strategic Weapons Launcher (SWL). While not ruling out the B-1 as a potential candidate, in the administration's view, the B-52s with cruise missile capability could meet the nation's needs for now and "any effort to create a second [to the B-52], extremely costly cruise missile platform is both premature and unnecessarily expensive." As for the *Oriskany* and *New Jersey* reactivations, not only would it be "inefficient to apply hundreds of millions of dollars to resurrect 1940's technology for only a few short years of stretched operation," but both ships would require thousands of crew members, further aggravating the already serious personnel shortages in the Navy. The president objected to funding another 24 F/A-18 aircraft for the Navy beyond the 48 already requested on the grounds

**Table 13. Defense Weapons Authorizations, FY 1981 (\$ millions)**

	Administration Request	Conference Authorization
<b>Procurement</b>		
Aircraft	14,221	16,592
Missiles	6,554	7,087
Ships	6,179	8,363
Tracked Combat Vehicles	2,291	2,359
Torpedoes	170	387
Other Weapons	895	982
Subtotal	30,310	35,770
<b>Research and Development</b>		
Army	3,235	3,248
Navy/Marine Corps	4,866	5,113
Air Force	7,033	7,160
Defense Agencies	1,345	1,368
Subtotal	16,479	16,889
<b>Civil Defense</b>		
Education Benefits	0	75
Total	46,909	52,853

Source: *Congressional Quarterly Almanac*, 1980, vol. 36 (Washington, DC: Congressional Quarterly, 1981), 47.

that the \$492 million cost would come at the expense of operating and maintaining existing aircraft. Finally, Carter opposed the committee's earmarking \$907 million for two additional *Los Angeles*-class nuclear-powered fast attack submarines and \$495 million for two more guided missile frigates. The administration's request already included four frigates, which it considered sufficient; instead of moving ahead with the *Los Angeles*-class, the administration planned to design a new class of attack submarine.<sup>51</sup>

In late May 1980 the Joint Chiefs and Chairman General David Jones publicly broke with the president and secretary of defense over the size of the defense authorization budget, the first time this had happened during the Carter administration. In open testimony before the House Armed Services Investigative Subcommittee, chaired by Representative Samuel Stratton, the Joint Chiefs gave their personal opinions that defense spending was inadequate to meet the Soviet threat. Army Chief of Staff General Shy Meyer grabbed the headlines by contending that the country had a "hollow Army," and adding that the current Carter budget did not meet the Army's needs for the 1980s. As Meyer explained, U.S. forces in Europe and Korea were not hollow, but Army divisions in the continental United States, with the

exception of the 82nd Airborne Division, were seriously depleted. He feared that the Army's ability to modernize was being shortchanged. Marine Corps Commandant General Robert H. Barrow responded bluntly when asked if the Carter 1981 budget was adequate: "in a word, no." Deputy Chief of Naval Operations Admiral James D. Watkins (subbing for CNO Admiral Thomas B. Hayward) was more politic, suggesting that the FY 1981 budget "fell short of Navy's requirements." Air Force Chief of Staff General Lew Allen Jr., suggested "increased defense spending is required to adequately match the increased danger." Jones, considered the Carter-Brown man on the JCS, stated that were he a member of Congress, "I would not vote against the national defense part" of the budget that then included \$6.2 billion more than the administration requested. The Chiefs had definitely crossed the line.<sup>52</sup>

In his report to the president, Brown tried to put the best light on the JCS actions. Stratton was trying "to drive a wedge between the Administration and the Chiefs." Brown suggested that "this morning's headlines on the hearing need to be placed in the context of the general points Dave Jones and the Service Chiefs made." According to Brown, the JCS believed that "more money could usefully be spent on defense, but some add-ons proposed by authorizing committees were not desirable" and their proposed cuts in research and development, procurements, and readiness to offset the add-ons would be harmful. Brown reminded the president that the JCS were military advisers, not politicians setting government-wide priorities: "The media accounts have left the distinct impression that the Chiefs have 'broken' with the Administration, and we need to work hard to dispel this notion." OSD sources soon leaked stories that Brown felt no "heartburn" with the JCS who were just doing their jobs. Whatever was said in public did not reflect the slow burn that the president was feeling toward his military advisers. Carter wrote privately to Brown expressing his anger toward the Navy in particular, but with the Pentagon generally: "The performance of the Navy (DoD) people on the hill yesterday was abominable. . . . It does not help you or me for military or civilian personnel to help prepare 'white papers,' look the other way with tongue in cheek, or actively support such action by the Congress as demothballing old battleships."<sup>53</sup>

This flap with the JCS proved a setback to the campaign by Brown and the president to oppose unwanted increases. In March 1980 the secretary had met with congressional leaders to discourage them from insisting on such increases. In May and June he and Carter wrote letters to key congressmen to make the case.

In July Brown met with Stennis and HCAS Chairman Melvin Price in hopes of rectifying the imbalances in the House and Senate defense authorization bills in conference.<sup>54</sup> When the House and Senate completed their conference report on H.R. 6974 in mid-August 1980, Brown and Carter could see only limited evidence of the success of their efforts. The conference committee allocated \$300 million for development and \$75 million for production of a new cruise missile carrier, be it the B-1, a variant of the B-1, or the already-in-service FB-111 Aardvark. Whoever was president, Carter or Reagan, would make the choice after January 1981. The conferees supported the Navy by authorizing two new *Los Angeles*-class submarines, adding two guided missile frigates and a minesweeper, and reactivating the *Oriskany* and the *New Jersey*.<sup>55</sup>

In addition, Brown could not slow conferee demands for an additional \$2 billion for aircraft—12 more F/A-18 Hornets for the Navy, 12 more F-15 Eagles for the Air Force, and 6 more utility C-12 planes and 8 UH Black Hawk helicopters for the Army. The only aircraft authorizations not increased by the conferees were for development of the C-X transport cargo planes and production of KC-10 cargo and refueling aircraft, both destined for the RDJTF. Congressional thinking held that fast sealift was better and more efficient than airlift. To make good on its contention that sealift was better, Congress authorized eight commercial fast container cargo ships that could transport equipment from the United States to the Persian Gulf in half the time of existing sealift. In a related development, Brown persuaded the conference committee to include \$55 million for modification of commercial aircraft as military cargo planes to be deployed in an emergency.<sup>56</sup>

As for manpower costs and benefits, the conference settled most issues without much controversy. Military personnel received an 11.7 percent cost of living increase to compensate for raging inflation. The conferees authorized higher reenlistment bonuses, better flight and sea pay, more generous medical benefits, increased moving expenses, and an experimental program in military education that allowed the government to forgive federal student loans in return for military service. Over DoD's objections, service pensions would be based on average pay over a service members three highest earning years, not the final salary at retirement.<sup>57</sup>

Brown's opposition to some of the congressional add-ons, such as activation of the *Oriskany* and the *New Jersey* or attempts to keep the B-1 alive by marrying it to cruise missiles, were justified. Other congressionally imposed increases were



privately welcomed in the Pentagon. Looking at the Defense Authorization Act as a whole, neither the NSC nor OSD staff thought it presented any problems. While it authorized more money for weapons than requested, it was “very supportive” of OSD and Carter administration policies, meeting DoD preferences for most weapon systems.<sup>58</sup> Brown told Carter that the conference committee’s quick resolution of disputes in a week was a “remarkable achievement.”<sup>59</sup> OMB Director McIntyre recommended that the president sign the act “notwithstanding the excessive appropriations authorizations.”<sup>60</sup> On 8 September 1980 Carter approved H.R. 6974 as P.L. 96-342.<sup>61</sup>

The president signed the Defense Authorization Act while Congress was deliberating on the FY 1981 Defense Appropriations Bill (H.R. 8105). Although the legislators on Capitol Hill maintained their prerogatives to adjust and shift priorities in the Pentagon budget, the appropriations bill occasioned less controversy than in many previous years even though it took place during a presidential election campaign in which Republicans consistently charged that Carter was shortchanging the nation’s defenses. Still, the president’s changes of mind on how much to spend and how big the budget deficit should be did nothing to dispel the charges that he was wobbly on defense, frustrating pro-defense Democrats in Congress and complicating OSD’s task.<sup>62</sup>

The appropriations bill provided OSD and the White House the opportunity to scale back some of the add-on authorizations they opposed by convincing Congress not to fund the authorized weapon systems they did not need and to restore cuts to programs they deemed necessary.<sup>63</sup> They had little success. Congress in early December 1980 agreed on an FY 1981 TOA of \$159.7 billion (\$5.2 billion more than requested). Most of the money went for tactical aircraft and additional ships, development of a new bomber to carry cruise missiles, increases for operating expenses, and an increase in benefits for service personnel. The conferees slashed the Carter R&D budget by almost half a billion dollars. The FY 1981 appropriation was not the whole story. Carter expected to ask Congress for a \$7 billion supplemental request in early January 1982, including \$3 billion to fund the pay raise promised to military service personnel in the Defense Authorization Act and to offset inflation, especially rising fuel prices.<sup>64</sup>

The conferees had to reconcile the House-passed \$157.5 billion appropriations bill with the Senate’s \$161.1 billion version. They chose the more generous Senate

funding (\$1.2 billion) for military benefits rather than the House's (\$713 million) and restored \$100 million to the recruiting and advertising budget cut by the House. The Army received \$135.9 million to buy components for the XM1 tank (evenly splitting the difference between the lower House and the higher Senate figures), and the conferees also split the difference between the House's higher and the Senate's lower figure for modernizing existing M60 tanks, deciding on \$75.3 million. The Army received \$140 million to procure components for new radar-guided anti-aircraft guns. As for Army operations and maintenance, the conference committee agreed to the Senate's \$50 million addition to the \$926 million that the administration requested to reduce the maintenance backlog and make the Army less "hollow."<sup>65</sup>

For the Navy, both the House and Senate agreed on adding \$889.4 million to the Carter budget request for one additional attack submarine and two more frigates. The conferees provided \$113.9 million to design a new class of guided missile destroyers. They cut House funding of \$112 million for unscheduled overhauls of three ships and \$60 million to refit three WWII destroyers. The administration and the House remained at odds over the value of older destroyers. Navy reservist Congressman William Chappell, the major congressional proponent of using the Naval Reserves to man older destroyers for potential convoy duty, convinced the House to pass a provision prohibiting the Navy from phasing out these destroyers, but the conference committee decided to replace them with 24 modern frigates over the next five years, the first four to be launched and then manned by reservists in FY 1982. DoD could not convince Congress that part-time reservist crews did not work well in new destroyers.<sup>66</sup> Renovation of the WWII aircraft carrier *Oriskany* and the battleship *New Jersey*, of similar vintage, was not acted on until the supplemental was passed in August 1981, when money was appropriated for the *New Jersey*, but not the *Oriskany*.<sup>67</sup>

The Air Force's budget fared well in conference. The committee funded development of a manned strategic bomber at the requested \$300 million (eliminating the \$75 million provision to procure components), but it required the administration to come back to Congress if it wanted to buy those components from the \$300 million it had funded. MX missile funding was cut by only \$60 million from the administration's request for \$1.5 billion. The conferees decided to fund less than half (\$35 million) of the administration's request for development of the CX cargo

plane for the Rapid Deployment Joint Task Force, in keeping with their preference for fast sealift, for which they funded \$285 million to buy or lease eight commercial container ships.<sup>68</sup>

Analyzing the final budget, the NSC “found no major surprises,” even though the bill provided \$5.1 billion more than requested. They judged that “the additional funds are primarily for pay and allowance increases for military personnel or production rate increases for weapon systems and spares.”<sup>69</sup> Knowing that Reagan had every intention of increasing defense spending, faced with virtually unanimous recommendations from all his advisers including Brown, and aware of growing public support for increased defense spending, Carter signed the Department of Defense Appropriations Act of 1981 into law as P.L. 96-527 on 15 December 1980.<sup>70</sup>

### **The FY 1982 Defense Budget**

While Congress debated the FY 1981 defense authorization and appropriation bills, Brown and OSD prepared the FY 1982 DoD budget with the expectation that the Carter team would shepherd it through Congress during the president’s second term. As usual, the Joint Chiefs got the first shot with their Joint Strategic Planning Document, submitted to the secretary in late December 1979. At this point in the planning process the lines had been clearly drawn. The JCS still believed that the Carter administration had not provided enough resources, especially to meet the non-NATO contingencies envisioned in PD 18, the administration’s basic national security directive (see chapter 5). Using their risk reduction formula that stressed the greatest threats, the JCS gave their highest priority to improving C3, readiness and mobility of forward deployed and early deploying forward forces for Europe, more R&D on an antiballistic missile defense, a new penetration bomber (not the B-1), and improvements to the FB-111 bomber since it was not constrained by the SALT II agreement. The JCS still stoutly maintained that their collective advice in the JSPD was worth serious consideration by the president and secretary of defense. There is little evidence that it received such attention.<sup>71</sup>

The same could be said about the previous year’s Consolidated Guidance—and its more specific policy-related section called the Defense Policy Guidance (DPG). In charge of the CG drafting as usual, Murray admitted he had allowed the previous document to run much too long and wondered “how many of the senior members of the department found the time to plow through its 63-page bulk.” This

year things would be different. Without the extraordinary demands that SALT II placed on the secretary, Murray hoped this version could be Brown's document and half the length.<sup>72</sup>

Previous DPGs had received poor receptions at the NSC, where Victor Utgoff and Jasper Welch noted that they "were so bad as to be largely ignored—they were full of motherhood statements and rarely set any priorities for the Services." The FY 1982 version, drafted by Under Secretary of Defense for Policy Robert Komer and his deputy, Walter Slocombe, "was in a completely different league." It argued for a "coalition strategy," recommended a countervailing strategy for nuclear strategic forces, focused on defending NATO's central front without shorting the Rapid Deployment Joint Task Force, and accepted that a NATO–Warsaw Pact war could not be fought simultaneously with a lesser conflict—there would have to be some acceptable degrading of NATO capacity. As for the Navy, the DPG did not follow completely the standard Navy line that it must be able to attack the Soviet Union on every naval front once a conflict began.<sup>73</sup>

The Consolidated Guidance included the DPG but went into far more detail and specifics. Much like its DPG section, the CG had as its core a few key concepts. As Murray had previewed them to Brown, they included simultaneity—the eventual goal to deploy forces in simultaneous crises in Central Europe and the Middle East or Persian Gulf—which Brown thought possible by 1990, but with "major progress" by 1985. Murray suggested that the CG should push "heavying up" the Army divisions to match the mechanized Red Army ground force structure in Europe. The issue of amphibious assault revolved around the Marines' desire for bigger and heavier divisions with more, faster, and better ships per division, including LCACs (landing craft air-cushioned), characterized by Murray as "exotica," without reducing their 1.15 Marine amphibious force lift capability. Brown suggested that the CG hold to the five-year program of three LSD–41s and LCACs, "if it works out." The secretary commented that "we may not need a full 1.15 MAF Amphib assault indefinitely," but he favored leaving it as a goal until 1985. As for tactical air, Brown believed DoD already had "enough force structure & modernization . . . and . . . fielding . . . all sorts of complex & expensive systems will be unlikely unless they work better & cheaper than has ever been the case." The Navy was always the bitterest critic of previous CGs. This time Murray hoped to "frame the words [in the CG] in a way that will avoid all the hoo-hah of past years,"

suggesting more priority on the use of the Navy in non-NATO contingencies and less on defense of North Atlantic sea lines of communication, especially since the RDJTF was a natural for maritime strategy. Brown agreed. Murray recommended that the CG tackle the problem of attracting and retaining military personnel. The secretary thought it worth a try.<sup>74</sup>

The service secretaries and the JCS had a chance to comment on the Consolidated Guidance and suggest revisions. As usual, they tended to view the guidance from the standpoint of their particular needs, often pronouncing its requirements too demanding and its accompanying fiscal guidance inadequate for the tasks outlined. In this vein, the JCS stated that the CG failed to close the gap between strategy and resources, underestimated Soviet capabilities, overestimated those of the United States and its allies, and emphasized readiness at the expense of force modernization and sustainability.<sup>75</sup> After spending a weekend going over the revised version of the CG (and admitting he could spend every weekend for the rest of 1980 working on it) and meeting with the service secretaries and JCS, Brown sent out the revised version in late March for use in the preparation of the services' POMs. One week later the fiscal guidance for 1982–1986 went to the relevant recipients. It pegged inflation for FY 1982 at 8.7 percent for purchases and 8.5 percent for personnel pay, declining in FY 1986 to 6.3 percent and 7.2 percent, respectively. TOA and outlays at the three bands (minimum, basic, and enhanced) underwent major increases over the 1981–1985 Five-Year Defense Program (see table 14, page 568).<sup>76</sup>

The service POMs reflected this new emphasis on increased DoD spending. The dire warnings of previous years were mostly absent. The Navy noted that under the guidance it could improve force readiness significantly, but it still complained that except at the enhanced level the modernization of forces and the equipment replacement programs were insufficient—not enough new ships, not enough aircraft, not enough modernization and equipment replacement for the Marines, and too little money to improve retention, especially of midcareer enlisted personnel.<sup>77</sup> The Air Force POM, reflecting the heightened concern about the Soviet invasion of Afghanistan and the new threat to the Middle East and the Persian Gulf, required new emphasis on near-term capability, involving funding for readiness, sustainability, and supportability, which meant less spending on force modernization and improvements. Given the Middle East, Persian Gulf, and Southwest Asia situation, the Air Force needed to develop and expand its airlift capability to allow it to move

**Table 14. DoD Fiscal Guidance, FYs 1981–1986 (FYDP \$ billions)**

	FY 81	FY 82	FY 83	FY 84	FY 85	FY 86
<b>Army</b>						
Minimum	–	41.51	43.61	47.29	49.84	52.80
Basic	39.23	43.75	46.58	51.08	54.42	58.25
Enhanced	–	45.95	49.40	54.66	58.77	63.50
<b>Navy</b>						
Minimum	–	55.48	60.20	65.92	73.00	80.38
Basic	51.04	58.31	63.88	70.70	79.16	88.13
Enhanced	–	61.21	67.69	75.65	85.48	96.06
<b>Air Force</b>						
Minimum	–	51.70	58.30	62.39	68.07	73.93
Basic	47.29	54.36	61.87	66.92	73.82	81.06
Enhanced	–	57.07	65.59	71.60	79.72	88.36
<b>Defense Agencies &amp; Defense Wide</b>						
Minimum	–	32.70	39.48	46.49	53.43	61.84
Basic	24.20	33.12	39.96	47.03	54.02	62.52
Enhanced	–	33.40	40.25	47.33	54.34	62.83
<b>DoD Total</b>						
Minimum	–	181.39	201.59	222.09	244.34	268.95
Basic	161.76	189.54	212.29	235.73	261.42	289.96
Enhanced	–	197.63	222.93	249.24	278.31	310.75

Source: Folder 100.54 (6 March–3 March) 1980, box 13, SecDef Files, Accession 330-82-0216, WNRC.

and support the RDJTF. It held the line on modernization of strategic forces and noted that retaining high-quality people remained a problem. Operations in space, especially overhead satellite reconnaissance intelligence, took on new importance in such areas as Angola, Ethiopia, Afghanistan, and Iran, all of which were no longer accessible by ground.<sup>78</sup> The Army's POM billed itself as the best program within the fiscal guidance, but it noted spending limits significantly interrupted planned modernization and did "not produce the total Army the Nation needs." The Army suggested an alternative affecting only 1 percent of its TOA at the basic level but producing critical differences in the long run.<sup>79</sup>

The process continued as it had in previous years. After the secretary, deputy secretary, and the Defense Resources Board (DRB), a new player in the process, reviewed the service and Defense agency POMs, the secretary sent them his program decision memoranda, which the services and the agencies reclaimed. Finally, the secretary sent out his amended decision memoranda. This time DoD

faced serious pressure from the White House to provide adequate support for the Rapid Deployment Joint Task Force. Responding to a request from Brzezinski on where DoD stood on support of the RDJTF, Claytor noted that the service POMs “were highly responsive to the Consolidated Guidance directive that readiness be improved at the expense of modernization and force structure, if necessary.” Any unit that went to Southwest Asia would be “highly effective upon arrival.” Claytor then listed ways the FYs 1982–1986 FYDP supported the RDJTF at the minimum level without an adverse impact on NATO and strategic programs, including an austere level of support for a 3½-division force that could defend Kuwait and Saudi Arabia from an invader other than the Soviet Union (Iraq was the logical candidate). To do more would cost considerably more. The POMs provided for improvements at Diego Garcia; the DRB recommended full funding of facilities in the Azores (Lajes), Oman, Kenya, and Egypt (Ras Banas). Originally there was no funding for Rapid Deployment Joint Task Force exercises, but the DRB successfully recommended more funds for such exercises each year and for the presence of two naval carrier task forces in the Indian Ocean. The Navy POM included funding to support seven near-term prepositioning ships at Diego Garcia, which would equip and support a 12,000-man Marine amphibious battalion. While the eight fast commercial ships would be funded in fiscal FY 1981, their conversions to military specifications would be funded in the FYs 1982–1984 budgets. At DRB suggestion, the Air Force POM was revised to fund conversion of 37 of 52 commercial aircraft to emergency cargo carriers through FY 1986.<sup>80</sup>

On 25 July 1980 Carter held the “spring” review of the entire budget in an hour-long meeting, which hardly provided time to make any real decisions but rather served as a way to raise some of the issues that would be decided in the “fall” budget review. Commenting on the DoD budget to the president, Brzezinski stated: “You are going to have to make some very hard choices in finalizing this budget. . . . The basic problem is that the required force readiness and RDF capabilities that appear necessary in this new era of Soviet aggressiveness (combined with unforeseen cost increases in some defense programs and in military compensation) cost more than your current fiscal guidance for 82 can hope to support.” It was not just a matter of “a rigorous budget scrub,” as McIntyre suggested. Brzezinski maintained there were three alternatives: increase the FY 1982 budget guidance by \$5 billion and the FY 1982–1986 period by \$50 billion to \$75 billion; slow the rate of longer-term

improvements for some theater areas, particularly NATO; reduce research and development, and delay some major procurement programs.<sup>81</sup>

When the “fall” budget review occurred in late November and early December 1980, Carter was a lame duck president and Brown was a secretary on the way out (although he never intended to stay for a second term had Carter won). The discussions of the FY 1982 budget at NSC levels assumed a more philosophical and freewheeling approach, since the administration knew they would not have to shepherd it through Congress. Brown had OSD produce legacy papers on national security issues. The Special Coordination Committee discussed the first paper at its meeting in late November 1980. Although not a budget meeting per se, the participants reviewed geopolitical and strategic challenges with the budget very much in mind. Displeased with the DoD paper, Secretary of State Edmund Muskie suggested that if the military situation was as desperate as Brown suggested, the administration should have said so during the election campaign. Had it misled the American people? Brown took exception, recalling that these problems had been discussed in the campaign. Brown and McIntyre then crossed swords when the OMB director charged DoD with “‘phoneying’ the books on the threat and the problems” to increase the funding for FYs 1982–1986. Brown countered that “real, real growth” to meet inflation would require quite large deviations as compared with OMB’s projected “real growth,” which did not. The two men agreed to continue the debate when the PRC met in early December on the DoD budget.<sup>82</sup>

The SCC then turned the DoD’s “legacy” issues. Would the 1980s pose significantly greater risk of major regional or global conflict than the 1970s? The consensus held that they would, with the unspoken assumption being that the Persian Gulf–Indian Ocean area was the likely flash point, but discussion focused also on Yugoslavia’s centrifugal forces and possible Soviet exploitation of them. Since the United States could not defend simultaneously its interests in NATO, the Persian Gulf, and Far East theaters, which region should receive priority? A related question was how best to fill the Persian Gulf–Indian Ocean power vacuum. Brown stated that some in the Pentagon thought that any policy that did not meet the requirements of NATO and the Persian Gulf simultaneously was inadequate. Brown disagreed with this thinking; he would give priority to the Gulf and Southwest Asia as the United States gave priority to Europe over the Pacific in World War II. The SCC then discussed possible contingencies, concluding that the Soviets would mobilize



in Central Europe, a “feint” as Brown called it, and then attack in the Persian Gulf. Muskie asked whether the United States was already not shifting its priorities to the Gulf. Brzezinski replied that the shift was an emerging policy not yet fully developed. Brown noted that DoD was adding 3 divisions to the 3½ already obligated to defend the Gulf, but it would come at the expense of NATO and “the Europeans will have to take up the slack.” Muskie doubted they would.<sup>83</sup>

What Far East strategy would best serve to relieve pressure from the Soviet Union on Europe and the Gulf? The DoD solution called for Japanese rearmament, Japan’s assumption of security responsibility for Korea, and sale of defensive weapons to China. Brzezinski had little faith in the Japanese rearming. Director of Central Intelligence Stansfield Turner suggested ignoring the Far East. Brown conceded that in a three-front war East Asia would get the lowest priority. Still, Brzezinski and Brown agreed that there were “low key things” to improve the U.S.-China relationship, which could be increased if the Soviets “do inflammatory things.” Brown summed up the answer to the next question of how to get friends and allies to do more for the common defense: just keep nagging them. How to maintain both adequate modernization and a technological edge in weapon systems generated an exchange between Brown and Brzezinski on the leakage of technology to the Soviets. The group did not have time to discuss the final two questions: how to solve the manpower crisis in the armed forces and how could nondefense agencies best interact with DoD efforts.<sup>84</sup>

On 2 December the group assembled again at a PRC meeting chaired by Brown to focus specifically on the Defense budget. They had another DoD think paper that compared “moderate” improvement against “major” improvement in the military balance by 1985, or alternatively by 1995. Unlike previous papers, this one had as its goal simultaneous defense of U.S. interests in Europe, Southwest Asia (including the Gulf), and the Far East. Its main message was that the costs of achieving moderate progress by 1987 would not be large: a 12 percent increase in currently programmed defense spending for the United States and its friends and allies, plus an additional 3 percent to 4 percent increase in manpower. The effect on the U.S. inflation rate was judged to be infinitesimal ( $1/10$  of a percent). The increase would drop unemployment by  $2/10$  to  $4/10$  of a percent and raise GNP growth by  $3/10$  of a percent. The downside: the deficit would rise by 30 percent to 45 percent.<sup>85</sup>

Turner noted that the DoD paper indicated that the military balance would start to tilt the U.S. way from 1981 to 1987, earlier than other estimates. Brown replied that such an assumption was only one measure, based on availability of U.S. cruise missiles and SLBMs, and might have overestimated their effectiveness. Turner suggested this shift would encourage the Soviets to rebase their missiles in a mobile mode and attempt to create defenses against cruise missiles. CJCS General Jones thought the paper underestimated the difficulties in strategic balance, especially given U.S. deficiencies in C3. Both Brown and McIntyre raised problems about increasing manpower. To Brown, the key issue in the paper was what the U.S. could expect from its allies and how to encourage them to do more. He suggested, and the group agreed, that if the allies failed to rise to the challenge, then the United States should reallocate its forces away from NATO.<sup>86</sup>

While Carter's FY 1982 budget would be revised upward by the Reagan administration, it represented a major increase in defense spending. The OMB staff—if not McIntyre himself—believed that it must go beyond the current guidance of \$190 billion in TOA. The NSC staff suggested that a “reasonable track” figure of \$205 billion in TOA would allow for continuation, but not acceleration, of all approved strategic weapon programs; similar continuation of approved aircraft production; maintaining a five-year shipbuilding program with special focus on increasing the naval presence in the Indian Ocean; providing 12 percent real growth in research, development, and test and evaluation; and allowing minor adjustments in military pay on top of the large cost-of-living increase. The result would be 9½ percent real growth in defense spending during FYs 1981 and 1982 over FY 1980. DoD's estimate for the basic level, slightly less than \$203 billion, would, after an anticipated budget scrub, be reduced to \$199 billion. At this lesser level the combatant shipbuilding program and Navy and Air Force aircraft procurement suffered.<sup>87</sup>

Carter was not buying into everything NSC and DoD suggested, but he did agree to a substantial Defense budget of \$196.4 billion in TOA and \$180 billion in outlays. Even after adding an FY 1981 supplemental request of \$6.3 billion to FY 1981 TOA budget, FY 1982 was \$25.2 billion more than the previous year (see table 15). Such a jump caused one journalist to ask the secretary at his budget briefing if he had not “left behind for Ronald Reagan a political minefield” as President Ford did with the Carter administration, with deferrals of procurement of conventional weapon systems. Brown answered no, rather he left a set of priorities with readiness

**Table 15. DoD Budget Totals, FYs 1980–1982 (\$ billions)**

	FY 1980 Actual	FY 1981 Estimate	FY 1982 Estimate	FY 1981–82 Increase
<b>Current Dollars</b>				
Total Obligational Authority	142.2	171.2	196.4	25.2
Budget Authority	142.6	170.3	195.7	25.4
Outlays	132.8	157.6	180.0	22.4
<b>Constant FY 1982 Dollars</b>				
Total Obligational Authority	172.9	186.5	196.4	9.9
Budget Authority	173.4	185.5	195.7	10.2
Outlays	162.5	172.5	180.0	7.5

Source: *Public Statements of Harold Brown, Secretary of Defense, 1980–1981*, 6:2089, OSD Historical Office.

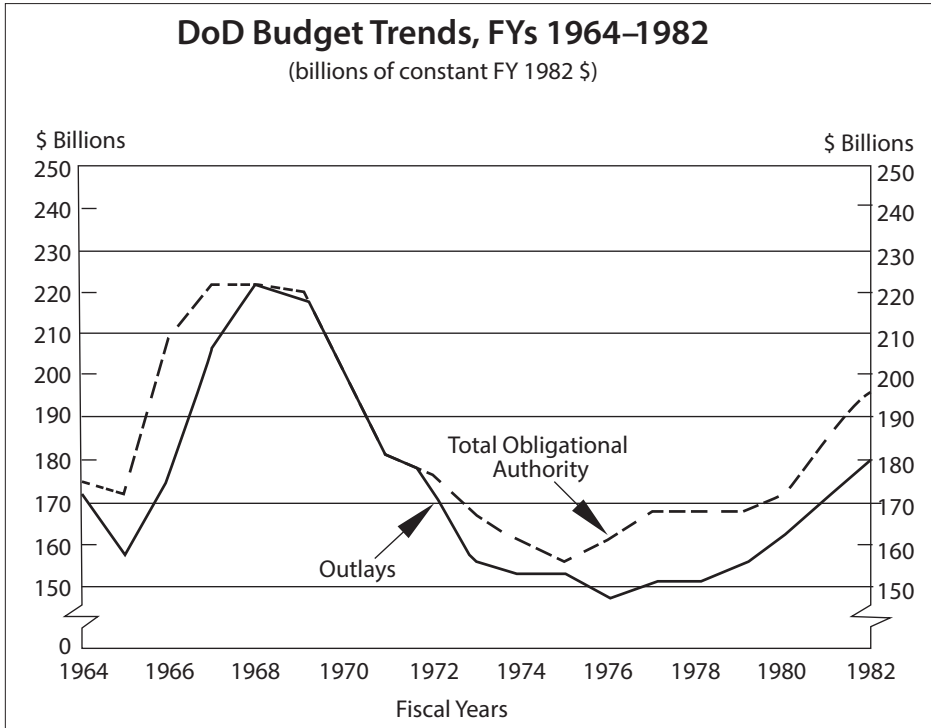

Source: *Public Statements of Harold Brown, Secretary of Defense, 1980–1981*, 6:2091, OSD Historical Office.

first and modernization of general purpose and strategic forces second. It was a well-balanced resource decision.<sup>88</sup>

The budgets for FYs 1981 and 1982 clearly reflected a change of emphasis by the Carter administration, if not a reluctant conversion by the president himself. Admittedly, Carter felt no joy in increasing defense spending. Yet he was under political, congressional, domestic, and administration (especially from Brown and the JCS) pressure to do so. The two estimated TOA budgets for FYs 1981 and 1982 provided, respectively, \$29 billion and \$54.2 billion more than the actual TOA budget for FY 1980 in current dollars (in constant FY 1982 dollars, the rise constituted a substantial \$13.6 billion and \$23.5 billion respectively).<sup>89</sup> The inexperienced Georgia governor of 1977, who came to the Oval Office promising to cut DoD spending by \$5 billion to \$7 billion, had for FY 1982 requested the largest Defense budget adjusted for inflation since the final days of the Vietnam War. Changing Carter's mind took the efforts of many in his administration, especially Brown whose warnings about the shifting U.S.-Soviet military balance were reinforced by similar messages from Brzezinski. The political necessity to increase defense funding in order to obtain SALT II ratification by Congress; growing aggressiveness by the Soviet Union, especially in Afghanistan; the hostage crisis and the threat of a militant Iran; and the resignation of Secretary Vance (the most pro-détente member of the Cabinet) all contributed. Which one was the most persuasive? The president weighed them all, shifting his priorities as he went. SALT ratification in 1979 seemed the major reason for increased defense spending. While the 1979 Soviet invasion of Afghanistan and the 1980 presidential election campaign influenced spending, the most sustained and persuasive pressure for greater defense expenditures came from Brown and the Pentagon. A combination of events and domestic pressures provided the impetus for Carter's reversal on defense spending and for a military posture transformation that bequeathed a strong defense foundation to the Reagan administration.

## A Revolution in Military Warfare: The Offset Strategy

ON TAKING OFFICE HAROLD BROWN and Director for Defense Research and Engineering William Perry (later under secretary of defense for research and engineering) faced two demanding problems in planning for a potential conventional war against the Soviet Union. First was the massive and highly effective Soviet air defense system, comprising long-range, fixed early-warning radar systems able to pick up aircraft hundreds of miles away, sophisticated shorter-range systems able to further identify the attackers, advanced interceptor air-defense aircraft, and radar-guided surface-to-air missile systems and antiaircraft guns able to track and shoot down attackers. These air defenses were not an untested threat. North Vietnam had employed Soviet-supplied systems to exact a large toll of U.S. combat aircraft during the Vietnam War. In its October 1973 war with Egypt and Syria, Israel's sophisticated U.S.-built jets flown by highly skilled Israeli pilots suffered 109 losses in 18 days to Soviet radar-guided SAM missiles and antiaircraft guns fired by Syrians and Egyptians, who had only modest training. Using the same tactics prescribed for U.S. pilots, the Israelis made low-speed evasive maneuvers, which increased their vulnerability to antiaircraft fire. When Pentagon analysts extrapolated Israel's loss ratio and applied it to a U.S.-Soviet air conflict in Europe, they determined that U.S. tactical air would be destroyed within 17 days. The Brown and Perry response was to support development of aircraft invisible to radar as a way to negate the expensive and formidable Soviet air defense system.<sup>1</sup>

The second problem for Brown and Perry was the Warsaw Pact's three-to-one lead in conventional assault weapons, including tanks, artillery pieces, and armored personnel carriers. Presented with the possibility of a Warsaw Pact blitzkrieg assault on West Germany, the United States and its NATO partners would be hard-pressed

to halt the advance without resorting to nuclear weapons. Long aware of these dangers, former Secretaries of Defense James Schlesinger and Donald Rumsfeld approved development of conventional weapon systems to counter them. However, Brown and Perry devised the “offset strategy,” which used technology not only to build better weapon systems but to create a “force multiplier” that gave both existing and new conventional weapons a competitive edge by combining them with modern digital electronics to improve command, control, communications, and intelligence, or C3I; electronic and other countermeasures; defense suppression; and precision guidance. This “synergistic application of improved technologies,” as one historian of military technology described it, provided the basis for a revolution in warfighting that Brown, Perry, the Air Force, the Army, and defense contractors conceived and developed in the late 1970s. The offset strategy sought to force the Soviet Union to compete in areas of technology where it was weak. Development and acquisition of new systems began in late 1979 and continued in earnest in the 1980s. The fruits of the offset strategy paid off when U.S. forces deployed this technology against Iraq’s Soviet-supplied weaponry. To Brown and Perry’s satisfaction, the military revolution proved its worth in the Gulf War, contributing to the rollback of Saddam Hussein’s invasion of Kuwait in 1991.<sup>2</sup>

Brown and Perry stood at the top of a pyramid of thousands of contract engineers, DoD research and development personnel, and acquisition officers who conceived, developed, built, and acquired the weapons and system of systems that brought about this military revolution. The ultimate managers, they made the final decisions, gave military contractors the go-ahead, and freed up the money. Brown delegated authority for execution of the offset strategy to Perry, in whom he had the utmost confidence. As Brown recalled, it was “a very close and fruitful collaboration. . . . Sometimes, the ideas and impetus came from me. Sometimes [they] came from him. In general, I would say that he was the person in the Office of the Secretary of Defense who actually executed most of these things. He and I kept close enough touch and thought enough alike so that he had very considerable latitude doing that.”<sup>3</sup> These were two men on the same wavelength.

### **Stealth Technology**

When asked to name their major accomplishment in weapons development, Perry and Brown both responded that it was stealth technology, a system of design and

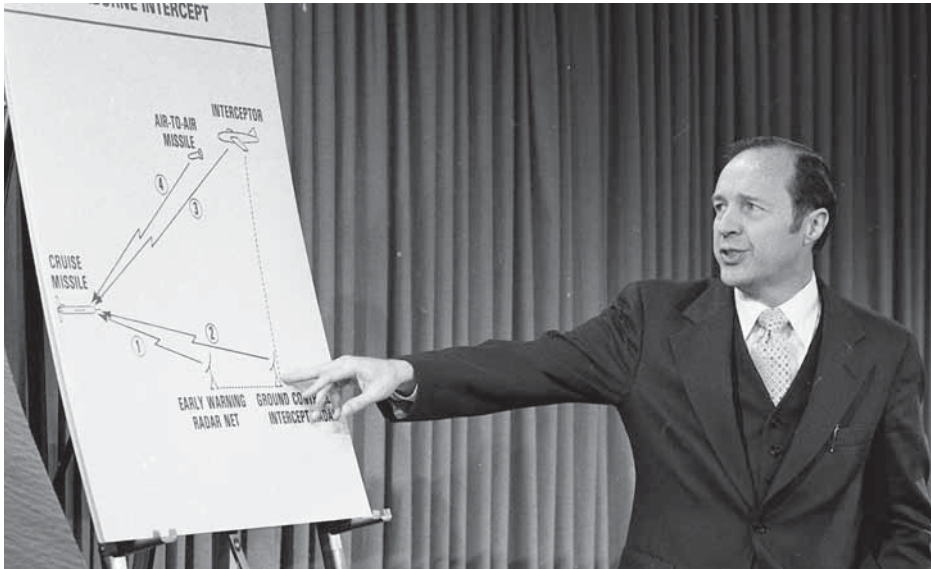

Under Secretary of Defense for Research and Engineering William Perry explains cruise missile intercepts to the press, 14 November 1978. (OSD Historical Office)

manufacturing innovations that could make an aircraft, missile, ship, submarine, or even a tank virtually invisible to radar. Since the development of radar in the late 1930s and its use in World War II, attack aircraft had steadily lost the element of surprise. The pendulum had tilted toward defense. As radar became more advanced and more integrated into defense systems, the challenges to an air assault became more daunting. If an aircraft could not be detected by radar, it would have a tremendous advantage.<sup>4</sup>

DoD under Brown did not initiate the program to develop stealth, but it was the first to see the significance of this new technology, funneling money and high-level support to convert a small sideline project into a major weapons program, the core innovations of which were later applied to other weapon systems.<sup>5</sup> The first practical result was the F-117A stealth fighter, an ugly and aerodynamically pedestrian aircraft with one exceptional feature: invisibility to radar. That ability made it one of the most significant developments in military aviation. The story of the F-117A has been well told, but it is worth revisiting to comprehend how much Brown, Perry, and other DoD officials in the Defense Advanced Research Projects Agency meant to its success.<sup>6</sup>

By the time Brown and Perry inherited the stealth project, code-named Have Blue, Lockheed Corporation's Skunk Works (officially Lockheed Advanced Devel-

opment Programs), the most secret and successful U.S. aerospace contracting operation, had won a competition with Northrop Corporation to produce a one-quarter-scale wood model of an aircraft that when enlarged to full size would have a radar cross section (RCS) the size a golf ball. So infinitesimal was the model's radar signature that the supposedly radar-invisible pole on which it perched had to be redesigned because it registered so brightly in comparison that it corrupted the test's findings.<sup>7</sup>

Making an aircraft or other objects appear small on a radar screen had proved a complicated and difficult challenge in light of the continual advances in radar technology. The return of a radar beam represents the amount of electromagnetic energy reflected by the target, which in turn determines the size of the target shown on the radar screen. For example, a B-52 bomber might appear to be the size of a large barn when viewed from the side by advanced radar; an F-15 tactical fighter can register as large as a two-story house with an attached garage. Based on a theory published in an open source paper by the chief scientist at the Moscow Institute of Soviet Radio Engineering, Skunk Works engineers determined that a plane composed entirely of flat and angular surfaces would diminish the radar cross section of the aircraft because the radar's reflected signal would be directed away from its source, and therefore never detected. The concept earned the moniker "Hopeless Diamond." The technology to diminish further the radar signature of planes already existed. The CIA had used surface coatings to absorb radar waves to good effect on its Lockheed-designed and built U-2 and SR-71 Blackbird reconnaissance planes. Have Blue's second prototype had similar paint applied to decrease its RCS; below the skin, the prototype's absorbing reentrant triangles (also used in the SR-71) trapped radar, bouncing it back from triangle to triangle, thus dissipating the reflection of energy.<sup>8</sup>

Perry's predecessor during Secretary Donald Rumsfeld's tenure, Director of Research and Engineering Malcolm Currie, had performed good missionary work with the Air Force on behalf of Have Blue in 1976. The service was not keen on the aircraft, believing that a slow and unmaneuverable stealth fighter designed only to fly at night hardly fit its concept of a sleek, speedy attack plane. Those who saw it dubbed it the "cockroach," which it resembled. Furthermore, Air Force officials feared that it would compete for money with the Advanced Fighter Program, which became the F-16, and the controversial B-1 penetration bomber. Currie cut a deal





Lockheed's Skunk Works director, Ben Rich, with the F-117A Nighthawk stealth fighter behind him. (Used by permission of Lockheed Martin Corporation)

with Air Force Chief of Staff General David Jones and the head of the Air Force Systems Command, General Alton D. Slay, that Have Blue funding would not come out of existing programs, such as the F-16 or B-1.<sup>9</sup>

When Brown asked Perry to shepherd the project through development to production, Lockheed's Skunk Works was building two proof-of-concept prototypes 38 feet long (half the size of the eventual F-117A). They were deliberately kept small and simple with no frills. But Brown and Perry had another objective—a stealth bomber. According to Ben R. Rich, the director of Skunk Works, Perry told General Slay that “this stealth breakthrough is forcing me into a snap decision. We can't sit around and play the usual development games here. Let's start small with a few fighters and learn lessons applicable to building a stealth bomber.” Rich did not believe this tactic would disrupt Air Force efforts to gain approval to replace B-52 bombers with the B-1. In fact, one of Perry's aides warned Rich not to lobby for the stealth bomber lest Slay and the Air Force oppose it as a threat to the B-1.<sup>10</sup>

As long as Have Blue development was a shoestring operation—its final cost, including some Lockheed cost-sharing, was only \$54.6 million—it did not pose

much of a challenge to other Air Force development and acquisition projects. Perry and Brown abided by the Currie deal with Generals Jones and Slay. In June 1977 Perry established a small project office composed of five officers who performed liaison with Lockheed and kept the secretary and under secretary fully apprised. The head of the project team reported directly to Perry, who could run interference for the project with or without Brown. A highly secret program, the operation was marked by cooperation between the contractor and DoD.<sup>11</sup>

Lockheed built its first half-size prototypes using already existing engines and other current systems and began flight testing to see if the aircraft passed Air Force capability specifications while retaining virtual RCS invisibility. In early June 1977 National Security Adviser Zbigniew Brzezinski secretly flew out to a remote base to view the prototype. According to Rich, "I let him [Brzezinski] kick Have Blue's tires and peer into the cockpit." After Rich briefed him on the program, Brzezinski asked penetrating questions: How much stealth was enough? Could the technology be applied to other aircraft without starting from scratch? How long would it take for the Russians to reverse engineer the diamond-shape structure if they got a model of the aircraft? How long before the Soviets developed counterstealth technology? Could stealth be applied to cruise missiles launched 2,000 miles from the Soviet border and could CMs reach their targets before detection? Rich answered, noting especially that without a cockpit CMs would be sleeker and thus even stealthier than Have Blue by an order of magnitude (10 times better) and would be invulnerable to Soviet air defenses, as opposed to 40 percent estimated projected losses for the B-1. As he left, Brzezinski asked if he should tell the president that stealth technology represented a significant breakthrough. Rich answered it would change the way air wars would be fought in the future, negating the Soviet's costly investment in ground-to-air defense. Nothing the Soviets possessed could stop a stealthy attack. When Carter cancelled the B-1 bomber at the end of the month, Rich believed he had played a large part in the decision.<sup>12</sup>

Testing of the prototypes continued, but as usual problems emerged. The first prototype aircraft crashed in July 1978 when a hard landing attempt bent one of the landing gears; on the second landing try the gear failed to deploy so the pilot took the aircraft back up to 10,000 feet, only to have one engine run out of fuel. Before the other engine went dry, the pilot ejected.<sup>13</sup> The prototype went down with only one more test to go; almost all test results were in and were good. As Perry told Brown,

the “failure was not related to the special features of the airplane.” As far as Perry was concerned, Have Blue had earned a passing grade. He recommended moving to a follow-on program that described expected performance, created a schedule for production, and estimated the program cost. Perry, who had already earmarked some “‘soft’ reprogramming of FY 76 and FY 77 money to get started,” expected to reprogram FY 1979 money later in the year. To help shake loose the funding, two officials from the Office of Management and Budget received briefings on the top secret black program and viewed the prototype for themselves at the end of June.<sup>14</sup>

In late July 1978 Perry informed Brown that since “the special aircraft [their non-codeword designation for Have Blue] program is back on track,” he saw no need to build a third prototype, “but rather to direct all of our resources to proceeding to an improved (larger) aircraft” using the stealth technology learned from the prototypes.<sup>15</sup> In September, Perry reiterated that data from computer models and in-flight collection, plus extensive measurements on a full-scale model of the stealth fighter, justified proceeding “with confidence” to development and limited production of a fighter the size of the F-15. Perry and Brown were also keen to develop a small stealth bomber (F-111 size), but the Program Analysis and Evaluation office reported that its design was flawed and could not be fixed by “tweaking.” Perry took note of the PA&E’s recommendation to go back to the drawing board on the bomber. His advice: “An optimum strategy is to start the A [stealth fighter] development immediately and deploy one or two squadrons in NATO by 1983 (for air defense suppression to enhance survivability of our conventional aircraft).” This would, in Perry’s view, “serve as a stepping stone to a strategic aircraft” (the stealth bomber) whose development would begin in FY 1980, with initial operational capability in 1985. Perry had confidence that the Air Force would support this plan, but he noted that the commander in chief of the Strategic Air Command (SAC), General Richard Ellis, feared that the fighter “will sop up our resources and we will never get to a strategic aircraft.” Perry estimated that the projected 100 stealth fighters would cost \$1 billion dollars (\$10 million each), while 150–200 small stealth bombers would cost more than \$5 billion (\$30 million to \$40 million each). To fund research and development for these aircraft in FY 1979, as well as for accelerated development of a cruise missile, Perry needed about \$250 million of which only \$80 million was already funded. Congress would have to provide additional funds, and that meant informing more people about the program, potentially compromising its security.<sup>16</sup>

According to Rich, debate on where to apply stealth technology had ensued among Air Force top officials and OSD principals. SAC wanted a stealth bomber, and a stealth cruise missile to be carried on non-stealth bombers, while the Tactical Air Command (TAC) favored the stealth fighter. Secretary of the Air Force Hans Mark, a former NASA official, generally favored missiles over bombers. General David Jones recommended developing both: the cruise missile for SAC and the stealth fighter for TAC.<sup>17</sup> Brown and Perry agreed with his recommendation.

Perry and Brown convinced the relevant cleared members of Congress to fund the project initially out of FY 1979 money. Lockheed signed a sole-source contract in November 1978 to build five test stealth fighters, with the first to be delivered by July 1980, at a total cost of about \$350 million for all five (the unit price would go down as production increased). The aircraft would meet the radar cross section efficiency of the first wooden model as well as the Air Force's requirements for performance, range, structural capability, maneuverability, and bombing accuracy. Brown decided to make the process "technology limited" as opposed to "funding limited," that is, to allow money to be reprogrammed to the project on an as-needed basis to keep pace with development of the aircraft. He transferred oversight of the program from DARPA to the Air Force, with normal development and prototyping stages eliminated.<sup>18</sup> The inevitable design and technical problems delayed the initial first flight to June 1981 and the operational capability date to October 1983, both in the next administration's term.<sup>19</sup> Yet Perry and Brown had encouraged an impressive process, shortening the development time of the prototypes and then overseeing the F-117A from contract almost to first flight of the production model in just under four years.

Lockheed hoped to build on its success with the F-117A to obtain a contract to develop and build a stealth bomber. In June 1978 Rich made his pitch to Perry and Eugene Fubini, head of the advisory Defense Science Board (more important, Brown's former deputy for research and engineering in the early 1960s and trusted confidante). According to Rich, DoD was enthusiastic about the concept. In early September 1978 Brown recommended that Carter approve the development of a stealth bomber, with a range and payload similar to the Soviet Backfire but able to penetrate Soviet defenses because of low detectability radar features, improved countermeasures, and enhanced defensive systems. Used in tandem with cruise missiles on conventional bombers, the stealth bomber would prove especially effective because the "fixes" required for Soviet



F-117 Nighthawk prototype in flight. (Used by permission of Lockheed Martin Corporation)

air defenses to combat cruise missiles would be at cross-purposes for the bomber (and vice versa). Brown estimated full-scale development of the stealth bomber could begin in 1979; the aircraft could be operational by 1984. The secretary reminded the president that the possibility of such a new bomber was one of the reasons the B-1 was not being built.<sup>20</sup>

Cancellation of the B-1 bomber had been extraordinarily costly for the Rockwell Corporation. The Department of Defense historically has taken measures to help prime defense contractors avoid insolvency, particularly when contract cancellations were at the root of a firm's financial difficulties, as was the case with Rockwell. As Rich described it, "The open secret in our business was that the government practiced a very obvious form of paternalistic socialism to make certain that its principal weapons suppliers stayed solvent and maintained a skilled workforce." As the Carter administration prepared to leave office, Perry told Rich that the bomber contract would be too big a job for the Skunk Works alone, which was already overextended on various stealth projects. He advised Lockheed to find a partner for joint development of a stealth bomber. Lockheed and Rockwell joined forces, but lost the contract competition. The new Reagan administration, seeking a longer-range and bigger

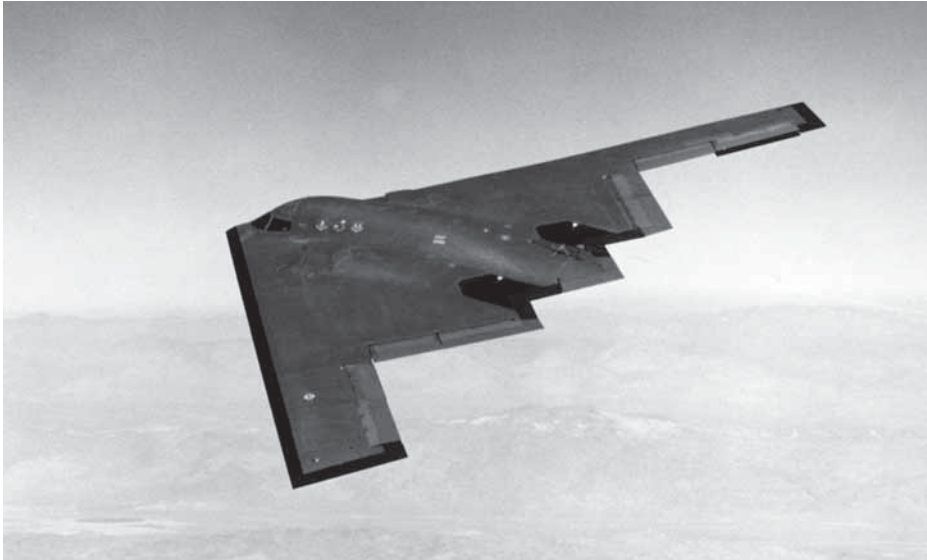

A Northrop Grumman B-2 bomber on its fifth test flight, September 1989. (RG 330, NARA II)

stealth bomber than the original small bomber, chose the Northrop Corporation to develop and produce a larger stealth bomber based on its flying wing aerodynamic concept. The result was the very sleek, very stealthy, and very expensive B-2 bomber.<sup>21</sup>

Stealth technology also applied to weapons other than aircraft. Rich realized that the same angular surfaces that deflected radar could also deflect sonar. Why not build a stealth submarine? When Rich floated the idea to the Navy in 1978 he met rejection. The stealth submarine would probably lose two or three knots in speed and looked like an underwater version of the *Monitor* or the *Merrimac* of Civil War fame. The Navy was not interested.<sup>22</sup>

Undeterred, Rich pitched the idea of a stealth surface ship using the concept of an experimental small water area, twin hull (SWATH) catamaran already built by the Navy. Perry agreed that the SWATH, which had the advantages of stability in rough seas and more speed than conventional ships, was a good candidate for stealth technology. He authorized DARPA to award Lockheed a contract to study the concept. Skunk Works engineers applied the lessons of the stealth fighter concept to the SWATH catamaran, an unimpressive-looking ship but one virtually invisible to radar, with its propellers located in the completely submerged pontoon-like hulls, which were designed to cut down on noise and wake. Since U.S. aircraft carriers and their escorts were vulnerable to the Soviet Backfire bombers equipped with

the new look-down, shoot-down radar missiles, Rich and Perry thought the stealth catamaran, code-named Sea Shadow, would be the logical counter to that threat. Armed with Patriot missiles, it could operate undetected hundreds of miles ahead of the carriers and shoot down Soviet bombers. It was a much more cost-effective weapon than the Aegis missile defense system that the Navy was putting on new frigates. In Rich's view, "Why go after the arrows? Go after the shooter." Impressed enough to approve Sea Shadow over the Navy's opposition, Perry told Chief of Naval Operations Admiral Thomas Hayward in the fall of 1978, "We are going to build this ship; the only question is whether the Navy is going to be part of it." The under secretary assured Hayward that the money would not come out of the Navy's already tight shipbuilding funds. A one-third-scale Sea Shadow, constructed under the tightest security in California, performed well in tests, evading aircraft radar up to a range of one and a half miles, well after its Patriot missiles could have shot down any enemy airplane.<sup>23</sup>

Despite the successful testing, the Navy remained unenthusiastic about Sea Shadow. Rich charged that the Navy was hidebound and bureaucratic, failing to



A full-size prototype of Sea Shadow, the Navy's experimental stealth ship, in San Francisco Bay, August 1993. (RG 330, NARA II)

recognize its potential, an opinion not without some truth. As DARPA historians have pointed out, the Navy did not have a tradition of experimental ships, preferring to build a ship of a new class and modify and improve it in subsequent versions, a standard evolutionary approach to ship construction programs.<sup>24</sup> The revolutionary design of Sea Shadow, its single-threat justification, and its small crew (as few as four) proved too much for the Navy to swallow. Perry recalled: “The Navy’s view was ‘who needs it?’ Even if they can do it [make a ship invisible to radar], we don’t need it. We’ve got a stealthy ship. It’s called a submarine.”<sup>25</sup> A full-size prototype was constructed and tested in the 1980s, but without Perry to champion it the vessel never joined the fleet. Still, its technology has been applied to subsequent ships, including three *Zumwalt*-class guided missile destroyers.

### Assault Breaker

The dramatic modernization of Soviet conventional military forces in Europe in the 1970s provided Moscow advantages on the ground: a mobile field army air defense that included sophisticated SAM-8s and new rapid-fire guns; effective command and control, fire-control, and electronic warfare systems unmatched by those of the United States or NATO; new Soviet armored fighting vehicles, tanks, and armed personnel carriers with improved guns, night vision devices, and protective systems against chemical, biological, and radiological weapons; improved artillery with greater range and firepower than U.S. artillery; rocket launchers; and mine-laying capability. Soviet ground attack aircraft had increased their payload by fourfold and range by two and a half. These improvements gave the Soviets the ability to “achieve dominance in deployed military technology in the 1980s.”<sup>26</sup> Brown and his assistant for NATO affairs, Robert Komer (later under secretary of defense for policy), as well as key experts in Congress, such as Senator Sam Nunn, were determined to counter these Soviet advantages. Brown placed Perry in charge of the technological response to this Soviet challenge.

The principal research and development initiative Perry and DARPA conceived to counter the Soviet threat went under the name Assault Breaker. They designed it to bring together a combination of existing weapon systems, weapons in development, and those still on the drawing board to achieve capabilities more than the sum of their individual systems, creating what Perry called a “force multiplier.” The under secretary described the ultimate objective of Assault Breaker: “to be



# Assault Breaker Concept Against Stand-Off Armored Forces

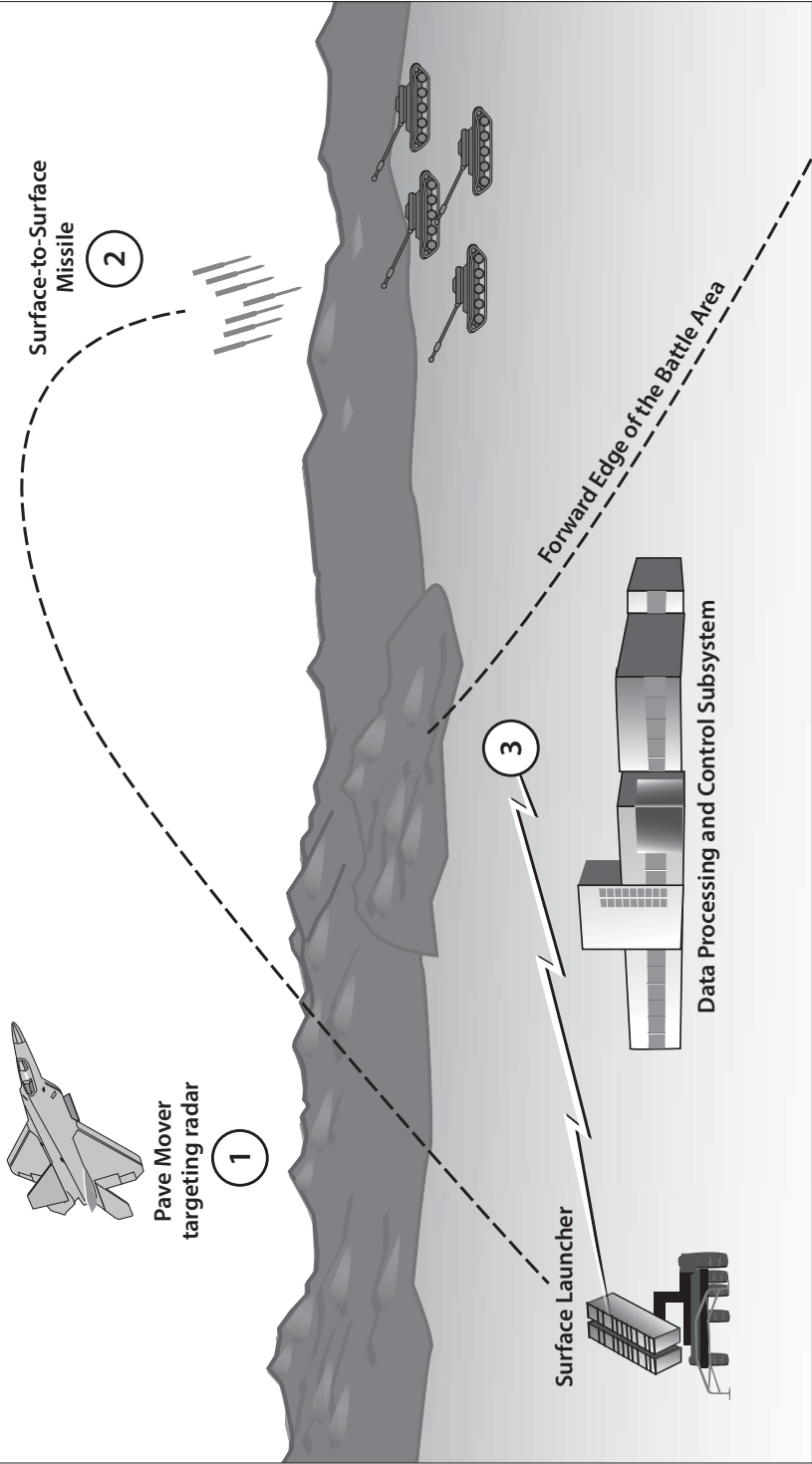

able to see all high value targets on the battlefield at any time; to be able to make a direct hit on any target we can see, and to be able to destroy any target we can hit."<sup>27</sup> Achieving dominance over the battlefield required deploying sensors, computer programs, high-speed digital communications, and guidance and precision munitions to attack and destroy hard mobile targets, especially tanks and other mechanized equipment, operating day and night in all weather conditions. What the Airborne Warning and Control System did for air warfare, Perry and Brown hoped Assault Breaker would do for ground combat.<sup>28</sup>

Its success rested on the development of precision-guided weapons that required three separate technologies: target sensors, precision guidance, and multiple conventional warheads. Sensor technology would allow soldiers to see targets on the battlefield under all conditions—fog, cloud, and night—using forward-looking infrared night vision and advanced radar that could take a picture of the ground scene. Developing precision-guided rockets, artillery shells, and bombs to replace conventional barrage weapons increased accuracy and efficiency. The ultimate objective was technology that would allow precision weapons to operate on a “fire-and-forget” mode. Once fired, the so-called smart bomb would find and destroy the target on its own. A related development, the improved design of kinetic energy penetrators, allowed for more effective attacks on super-tough armor. Used in conjunction with precision-guided cluster munitions that fired a large number of bomblets from a single warhead, the system would greatly improve firepower effectiveness against tanks or other targets.<sup>29</sup>

In 1977 Perry approved the development of another system that would make Assault Breaker’s vision possible: the joint services’ Battlefield Exploitation and Target Acquisition (BETA) project, an attempt to demonstrate the feasibility of computer systems capable of processing tactical battlefield information and fusing it into real-time critical intelligence. DARPA provided the funding and technical direction. The goal was to survey hundreds of thousands of “elements of interest” by Army and Air Force sensor systems, and then almost immediately “filter, correlate, and aggregate all available information . . . and report on a much smaller number, perhaps thousands of ‘high interest’ potential targets.”<sup>30</sup>

In August 1978 Perry gave DARPA management responsibility for Assault Breaker, creating a flag officer-level steering group to assure that the project maintained momentum.<sup>31</sup> As Perry told Brown in August 1978: “In order to stop the second and third echelons [of a Warsaw Pact attack through the Fulda Gap

in West Germany] with conventional weapons, we need to ‘see deep’ and ‘shoot deep’; that is, detect and place precision weapons on targets 30 to 50 KM [kilometers] behind the FEBA [forward edge of the battle area].” Perry continued: “Assault Breaker and BETA are major initiatives to accomplish these goals in five years.” Rather than spending 10 times as much on the traditional strategy of massive tactical air attacks and/or use of heavy divisions, for a “few billion dollars,” Perry suggested, NATO could disable the rear echelons of the Warsaw Pact.<sup>32</sup>

In September 1978 Brown briefed the president on Assault Breaker: “This program is a new initiative intended to break up an assault of massed armor without using nuclear warheads. It applies the MIRV [multiple independently targetable reentry vehicle] concept to tactical forces: a tactical missile is launched at a column of tanks; as it approaches the column, its warhead separates into 20 or 30 bomblets, each of which has a heat seeker which guides that bomblet to an individual tank.” While development had just begun, the secretary expected a field demonstration of the system by 1981 and production by 1983.<sup>33</sup>

Unlike stealth technology, which resulted in actual aircraft, Assault Breaker’s components as initially tested did not produce joint services weapon systems, as Brown had predicted to the president. Rather, it provided a concept that was integrated into programs of the services on their own initiative. The Air Force developed precision anti-armor munitions. The Army focused on helicopter- and ground-delivered precision systems such as the nonnuclear Lance missile, the General Support Rocket System, and terminally guided munitions. With the major exception of the Joint Surveillance and Target Attack Radar System (JSTARS), a late 1980s Army and Air Force combined project to develop an Assault Breaker-type targeting system, there was little joint effort among the services. Nevertheless, on their own, the services developed and produced multiple weapon systems based on the Assault Breaker concept.<sup>34</sup>

Another technological development that the Brown administration at DoD deserves credit for is the NAVSTAR Global Positioning System (GPS), which has had great military significance. In its commercial applications, it has revolutionized navigation and transportation. According to Perry, in 1978 he discovered that funding for GPS was about to be zeroed out of the DoD budget. The Program Analysis and Evaluation office under Russell Murray proposed terminating it because it was unproven and expensive—it would eventually require 24 satellites. PA&E thought the money could better be spent on tanks and aircraft. Brown had approved PA&E’s

recommendation, but Perry resolved to fight the decision. He went to Kirtland Air Force Base in New Mexico and met with the program manager for the NAVSTAR GPS, looked him in the eye, and asked whether this program was really going to work. The manager arranged a demonstration. At that time there were only four satellites, but at the right time of day they were aligned over Kirtland. Perry jumped into a helicopter that took off, flew around, and then landed on the circle from which it lifted off. When Perry learned that the helicopter had been “blinded,” and the pilot was navigating entirely by GPS, he realized immediately the military utility of the system, especially for the development of smart weapons—those that seek out and destroy targets on their own. Returning to Washington, Perry convinced Brown to keep the program alive. The secretary successfully fought the budget battles with OMB, which wanted to limit NAVSTAR to three satellites, and Congress.<sup>35</sup>

Although not an early advocate of NAVSTAR, Brown became enthusiastic about its prospects. He reported to the president in early 1980: “Tests have confirmed the truly impressive capabilities of this system—blind landing without any other navigation aids, blind bombing within 10 meters CEPs [Circular Error Probable of the target], and air drop of paratroopers and supplies to within 10 to 25 meters of the intended impact point.” Such results justified achieving limited operational capacity for the system as soon as possible, rather than waiting for 18 satellites to be in place by 1987. Later in 1980 GPS was in full-scale development and scheduled to be operational by mid-1982. The system now is a crucial element of civilian infrastructure.<sup>36</sup>

Through DARPA, DoD also moved forward on the Advanced Research Projects Agency Network (ARPANET), later transformed into the Internet. ARPANET received support from DARPA over a long period of time beginning in the mid-1960s, when Brown was director of defense research and engineering, and continuing through the 1970s and 1980s. Originally designed to allow scientists to share research findings and data, its growth and impact has been phenomenal. Without DoD’s continued support through DARPA over a number of administrations, the Internet would not have arrived as quickly as it did, and the world would be a much different place.<sup>37</sup>

### **Cruise Missile Development**

A mix of old and new technologies, the cruise missile had a profound impact on the Cold War and beyond. DoD under Brown became a major proponent of the CM as both a strategic and conventional weapon. The Carter administration was not the

first to see the value of the CM; nor was the cruise missile a new technology. The German V-1 “buzz bomb” of the last year of World War II was a cruise missile, although it was short-range and essentially a barrage weapon with a miss range of three to five miles. After the war, into the 1960s, the United States developed and deployed cruise missiles, but they eventually took a back seat to intercontinental ballistic missiles. In the early 1970s two improvements made CMs strategic contenders. First, the development of a small, fuel-efficient turbine engine gave the CM a range of 1,500 to 2,000 kilometers depending on speed and fuel density. Second, a terrain contour matching (TERCOM) system allowed the subsonic CM to check, recalculate, and correct its flight path with the aid of a small onboard computer using a digital contour map in its database. With an onboard radar altimeter and TERCOM, the missile flew low (20 meters over water, 50 meters over hills, and 100 meters over mountains). With its small radar cross section, a tiny engine giving off little heat for infrared-seeking SAM missiles to hone in on, and its ability to fly at low altitudes, the CM presented a formidable challenge. Its accuracy proved three times better than the most accurate ICBM. CMs could deliver 250-kiloton nuclear warheads, making them capable of destroying hardened targets. Furthermore, they were cheap; the cost of defending against them was 10 times higher.<sup>38</sup>

The Carter administration inherited two cruise missile development programs from the Ford administration: the submarine-launched Tomahawk CM (which in a slightly modified version could also be air-launched) and the air-launched cruise missile. When Carter cancelled the B-1 bomber in favor of CMs on B-52s, the ALCM program took on new urgency. DoD had two options: General Dynamics Corporation’s Tomahawk air-launched cruise missile (TALCM) and Boeing Company’s ALCM. In mid-July 1977 the president warned Brown that he was “not convinced” of the need for both and that “we certainly cannot afford to waste money on duplicative systems.”<sup>39</sup> While the two systems were similar and used common components, the General Dynamics TALCM was further along in testing and had a longer range but never had been launched from a plane. The Boeing ALCM had yet to be modified in its long-range version, but in its original form it had been “cold-launched” (the missile was ignited after being dropped from an aircraft), as it would be from a B-52.<sup>40</sup>

In his reply to the president on 19 August, Brown argued that it would be premature to select one system at that time, nor could DoD defend the selection

of either missile to Congress or in a potential lawsuit from the losing contractor. The secretary proposed dual development with a fly-off in late 1979 to determine which system to produce. He expected “the life cycle cost of the program would be less with a competitive fly off” despite increased R&D costs of \$200 million to \$300 million, since each contractor would attempt to produce a superior missile at lower unit cost.<sup>41</sup> When Carter approved the dual program at the highest national security priority (Brick Bat), DoD established the Air Force/Navy Joint Cruise Missile Program Office to oversee the dual production and competition.<sup>42</sup>

After the tests concluded in December 1979, Brown informed the president that both designs of the competing ALCMs, the Boeing AGM-86B and the General Dynamics AGM-109, had successfully met their design integrity and performance requirements. Of 20 tests, each contractor had 6 successful flights; the other flights resulted in 6 partial successes and 2 failures, providing enough data for a decision on which model to choose.<sup>43</sup> In March 1980 Secretary of the Air Force Hans Mark announced that Boeing had won the contract. As Brown explained it to Carter, the Boeing AGM-86’s guidance software system was more accurate, its aerodynamic performance and flight control system performed better over rough terrain, and it promised to be easier to maintain than the General Dynamics AGM-109. Brown informed Carter that Boeing would be awarded a contract for 225 missiles in FY 1980 with an option for 480 in FY 1981 (the total buy of ALCMs for B-52s was planned at 3,418 missiles by FY 1986), with the first ALCM on a B-52G available in September 1981 and a fully ALCM-equipped B-52G squadron deployed by December 1982. The ALCM effectively resuscitated the aging B-52. No longer required to lumber into formidable Soviet air defenses, the B-52 could stand off at hundreds of kilometers and fire its missiles. Brown and Perry also oversaw the development of rotary launchers and extra pylons for the B-52, allowing each aircraft to carry 20 missiles.<sup>44</sup> The Reagan administration continued and expanded the program, reviving the B-1 bomber as a CM carrier, and also deploying sea- and ground-launched cruise missiles in the early 1980s. Conventional and strategic cruise missiles became potent weapons in the U.S. arsenal. Four administrations, Nixon, Ford, Carter, and Reagan, share the credit for the cruise missile, but Brown and Carter provided the crucial impetus by choosing the ALCM over the B-1. OSD and Brown then pushed the program forward to testing and the decision to buy the Boeing ALCM.



An AGM-86 air-launched cruise missile in flight, November 1979. (RG 330, NARA II)



An AGM-109 Tomahawk air-launched cruise missile after ground impact, August 1979. (RG 330, NARA II)

## Defense Legacy

Brown and Perry's initiatives, Assault Breaker and the stealth F-117 Nighthawk fighters, both enjoyed success in actual combat (not against the Soviets but against Soviet weapons in Iraq in the 1991 Gulf War). The cruise missile programs also applied new technology to an old weapon and were effective, in conventional form, during post-Cold War conflicts. GPS, a program of obvious military significance, and the ARPANET, an almost serendipitous payoff resulting in the Internet, were triumphs of DoD-sponsored technology that now play a central role in the civilian economy. What was the broader DoD legacy under Brown?

In late December 1980 Brown sent the president a memorandum assessing his and DoD's overall record with the hope that it would benefit the new administration. The secretary noted that the United States had underinvested in defense technology during the Vietnam War and in the immediate post-Vietnam period. During that same period the Soviets had spent \$240 billion more in equipment and technology than the United States. The Carter administration reversed the process with "four annual real—after inflation—defense expenditures." Brown was putting the best light on the conversion of a reluctant president that really occurred during the last two years of his term, since the first two years saw minimal real growth. The United States could not afford to compete with the Soviet Union in equipment and divisions, so it would have to use its ace in the hole, technology, to equip U.S. and allied forces to outperform their Soviet counterparts.<sup>45</sup>

In October 1978 Brown suggested to the president that "heavying up" active U.S. Army forces represented another solution—albeit an expensive one when compared to the offset strategy—to the Soviet conventional threat. If U.S. divisions enjoyed the protection and cover provided by increased numbers of tanks, armored personnel carriers, and self-propelled artillery, they could match their Warsaw Pact counterparts. Such heavy divisions possessed mobility, allowing the United States and its allies to get enough units to the expected breakthrough points. The goal was to have a majority of active and reserve heavy mechanized divisions by 1984. Brown also foresaw the need for such heavy divisions in the Middle East and Persian Gulf if a regional war with the Soviet Union occurred there. Furthermore, these heavy divisions were needed to support South Korea's light divisions should the North Koreans attack. In addition to "heavying up," DoD embarked on a weapons modernization and augmentation program



specifically for the Central European battlefield: increasing the number of 15mm self-propelled artillery tubes by a third; introducing new weapons, most prominently M1 tanks and a new infantry fighting vehicle with antitank guided missiles; and development of advanced Apache attack helicopters with Hellfire antitank missiles; Patriot SAM missiles; and Copperhead laser-guided artillery shells.<sup>46</sup>

While no single administration can claim sole credit for the new weapons and systems that transformed warfare in the 1990s—prior to 1977 development of a major weapon system usually took 10 to 15 years from the decision on full-scale engineering to initial operational capability—DoD under Brown moved development of key new conventional weapon systems forward. In August 1980 Brown reported to the president: “Management improvements in the past three years have significantly shortened the time we expect for the completion of such cycles.” The secretary expected “that major programs such as the ALCM, F-18 [aircraft], M-X [missile], and Multiple Launch Rocket System now are expected to average only six years” thanks to “carefully controlling limited production and development testing on a concurrent basis.”<sup>47</sup> This effort did not go unappreciated in the White House. Carter recalled that “the major thrust of our Defense Department under Brown . . . was the development of new and highly sophisticated weapon systems, including precision bombs and missiles and stealth aircraft that could not be detected by radar.”<sup>48</sup> Aware of the value of this revolution in military affairs, begun in the 1975–1980 period, the Reagan administration continued or enlarged almost every conventional weapons program it inherited.

In the realm of strategic weapons, the Carter-Brown team was politically vulnerable, beset by a well-organized and persuasive U.S. domestic campaign for an enhanced strategic arsenal against the growing Soviet threat. During the 1980 presidential

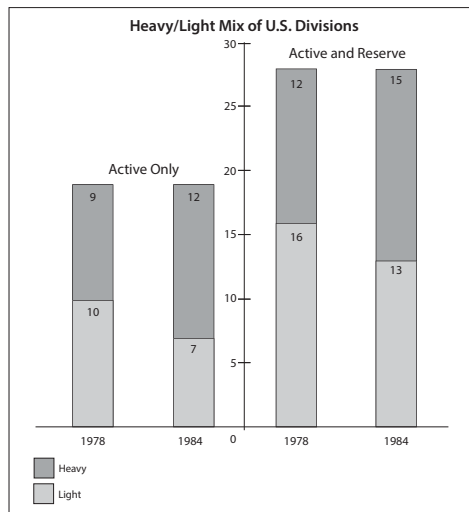

Source: Memo, Harold Brown to Jimmy Carter, 25 October 1978, Declassified SecDef Files, CD-2, 000CF6A.pdf, WNRC.

election campaign, Reagan hammered home the concerns of such lobbying groups as the Committee on the Present Danger, effectively creating the perception that Carter was weak on strategic weapons programs. This could arguably have been true in 1977, but by 1980 Brown and DoD had taken corrective steps. As the secretary informed the president, the United States had been in danger of losing its strategic lead to the Soviets in 1977 because of their 15-year buildup of strategic forces and the obsolescence of U.S. 1960s-era strategic forces. To right this growing imbalance, DoD and Brown modernized the triad (airborne bombers, seaborne missiles, and land-based ICBMs). The decision to arm B-52s with cruise missiles rather than build the B-1 bomber, although controversial, was the right choice in the secretary's estimation. As Brown noted, "the cruise missile poses a fundamental problem for the Soviets by forcing them to deal with a larger number of targets with very small radar signatures, as opposed to a few bombers with large signatures."<sup>49</sup>

As for submarine systems, the United States enjoyed a decided edge over the Soviet Union. The Ford administration, in Brown's view, "correctly hedged to a degree against a future antisubmarine threat by initiating development of a quieter submarine (*Ohio*-class) and the development of a longer range missile with more accuracy and more warheads (Trident I)." Management and funding problems delayed the introduction of the new submarine—only the *Ohio* was then undergoing sea trials in late 1980—but the Carter administration had more success in converting older submarines to carry Trident I missiles.<sup>50</sup>

To resolve the problem of survivability of Minuteman ICBMs, Carter and OSD authorized completion of the design of the MX missile but failed to settle the issue of how to base it. It left the basing decision to the Reagan administration, which found itself reduced to placing 50 MX Peacekeepers in hardened Minuteman silos. The best that could be said for the MX in the basing mode was that it was a bargaining chip able to be traded in subsequent strategic arms reduction negotiations. The strategic arms record of the Carter-Brown team was substantial, but Brown remained determined not to fund it by depriving conventional weapons programs, believing that acquiring strategic weapons beyond ensuring essential equivalence (thus discouraging a Soviet surprise attack) should not come at the expense of conventional forces, where he and OSD felt that the United States was most vulnerable.<sup>51</sup>

One influential figure, even more bullish on OSD's strategic modernization program, former Director of Central Intelligence and future Secretary of Defense

Robert Gates, wrote in 1997 that the Carter-Brown “record on defense . . . looks stronger from a distance of 15 years—indeed, it looks as it must have to the Soviets at the time.” Gates further elaborated that “whatever may have been Carter’s attitude or rhetoric, he continued the strategic modernization programs begun under his predecessors for the air-launched cruise missile, the MX, completion of the MIRVing of Minuteman, the Trident ballistic missile submarine and new submarine-launched missile.” Gates found it significant that with the exception of the B-1, “Carter sustained virtually every major US strategic modernization program and began an important new one [stealth technology].” Gates suggested that the “perception of new US strategic power and strength in the first half of the 1980s . . . was, in fact, Ronald Reagan reaping the harvest sown by Nixon, Ford, and Carter.”<sup>52</sup> Without detracting from the contributions of former Secretaries of Defense Melvin Laird, James Schlesinger, and Donald Rumsfeld, Brown and his team deserve the lion’s share of the credit.

The NATO alliance remained a focal point for Brown and his NATO point man Robert Komer during all four years. The irksome battle to convince, cajole, and shame NATO members—not to mention the reluctant Japanese—into spending more money on their own defense (the annual 3 percent real growth pledge) was never-ending, often resulting more in words than substance, especially since the United States in the initial Carter years had to juggle its own budget figures to prove it was meeting the pledge. The NATO Long-Term Defense Program, a well-conceived response with committees churning out action plans and mileposts, could only be as good as the NATO members’ willingness to implement it. The allies’ effort inevitably fell victim to slippage. The Carter administration did obtain NATO members’ agreement to modernize theater nuclear weapons in Europe, a considerable achievement. The Brown-Perry initiative to collaborate with NATO partners in designing new weapons and the promotion of the concept of “families of weapons,” where Europe would take the lead in some systems and the United States in others, resulted essentially in token efforts, notwithstanding the best efforts of Brown and Perry to breathe life into the programs.<sup>53</sup>

Recognizing the problem of deploying U.S. troops promptly to meet the threats to U.S. interests worldwide, Brown and OSD undertook to resolve it. Their broad approach, for which National Security Adviser Zbigniew Brzezinski equally shares credit, signified definitively that Europe might not be the only place the United

States might have to fight the Soviets. Creation of the rapid deployment force with its infrastructure of prepositioned ships, better airlift, improvements at the base at Diego Garcia in the Indian Ocean, and cooperation of friendly countries in the Persian Gulf and Indian Ocean littoral areas put the United States in a strategic position to defend these regions. Ironically, OSD considered war with the Soviet Union in the Middle East and Persian Gulf as the most likely possibility, quite reasonably expecting neither the end of the Cold War nor the wars against Saddam Hussein in Kuwait and Iraq and the Taliban in Afghanistan.

The U.S. troops who fought in Kuwait, Iraq, and Afghanistan in the 1990s and 2000s were superbly trained and equipped, and reasonably well-compensated. This transformation of the armed forces has its roots deep in the Carter administration. As Brown told the president, “Our armed forces today are better able to carry out their assigned missions than they have been at any time since the Vietnam War.” The secretary cited the shift to heavy divisions, additional combat support units, investment in modernization, buildup of spare parts and war reserves, increased readiness including fewer maintenance backlogs, improved sealift and airlift capability, and better training. Thanks to the congressionally mandated 11.7 percent pay increase, Carter’s Fair Benefits package, and the Nunn-Warner amendment, the prospect of acquiring more experienced and higher-caliber recruits serving for longer terms.<sup>54</sup>

So why has the public perception of Carter and by extension Brown and OSD become one of weakness on defense? Carter deserves some of the blame because of his initial reluctance to spend money on defense and his early antidefense-spending rhetoric. Throughout his presidency, unless pushed by Brown and others, Carter would often revert to his tendency to see defense spending as “a bottomless pit” and to consider arms control and disarmament the better solution. The “great communicator” Ronald Reagan hammered home the message in 1980 that Carter was soft on defense, which much of the voting public seemed to accept and which hawkish defense advocates—who had been arguing as much since 1976—enthusiastically reinforced. For all his talents, Brown was no match for Reagan on the stump. His attempts to defend his and the president’s defense record may have made some headway on Capitol Hill but had little effect on public perception.

In September 1978 Brown sent the president a memorandum that went to the heart of the perception problem. Looking at cancellations and deferrals of major

and even minor programs (B-1, veto of funding for a nuclear carrier, the neutron bomb, and cutbacks and postponements in shipbuilding), which Brown conceded were “made for sound programmatic reasons,” the secretary still concluded that “cumulatively they have combined with the relative paucity of new starts [of weapon systems] to convey the impression, both to our allies and to some of our own public, of unreciprocated unilateral restraint—our detractors would say, unilateral disarmament.” Brown’s solution was “to begin some systems that can be identified as initiatives of this Administration,” emphasizing the need to go to full-scale development, production, and deployment as the best way to counter the perception. Brown listed potential candidates: the MX with a mobile launch point; the stealth bomber; production of modernized 8-inch shells and Lance nuclear warheads that could be converted to enhanced radiation weapons; the 2,500km-range, ground-launched cruise missiles and extended-range Pershing II missiles for Europe; tactical cruise missiles of the 1,000km range; the cannon-launched laser-guided Copperhead projectile; Assault Breaker; the advanced medium range air-to-air missile (the first “fire and forget” missile); and Surface Towed Array Surveillance System for detecting and tracking submarines.<sup>55</sup>

Not all of these programs went into production, but over the next two years Carter either supported or at least offered no opposition to most of them. In addition, Brown and OSD, with strong support from Congress, convinced the president to increase overall defense spending. The overthrow of the shah, the Soviet invasion of Afghanistan, and Soviet adventurism in Africa were obviously contributing factors in changing the president’s mind. Brown and his staff at OSD, Brzezinski and the pro-defense hawks at the National Security Council, likeminded members of Congress, and the Joint Chiefs of Staff all shared the credit. To Carter, however, the foremost and most immediate pressure came from Brown, who perpetually advocated more defense spending, often on expensive new high-technology weapon systems designed to offset current Soviet military advantages.

While the Brown-Perry offset strategy is perceived today as a model for future defense policy, it is important to recognize that its success did not appear until the overwhelming American victory in the Gulf War of 1991. In the early 1980s, and even later, American defense intellectuals, such as Democratic Senator Gary Hart of Colorado, looked with a certain amount of envy at the Soviet’s ability to mass

produce reliable “soldier-proof” weapons that functioned well without the “gold plating” of American systems. The weapons that entered the production pipeline in the 1970s and early 1980s, they feared, were too expensive to purchase in large numbers, unreliable, and vulnerable to relatively cheap, precision-guided munitions. In addition, the new systems were, critics charged, too sophisticated to be maintained by AVF personnel. These fears proved unfounded as the armed forces adapted to new technology, which in many cases was simpler to use.

Looking at the offset strategy from the longer term, the successes of the Brown and Perry program was a major achievement. Much of the new military support systems of the Carter years were designed around revolutionary advances in science and engineering—ones that transformed the very nature of competition between the United States and the Soviet Union. Furthermore, the Reagan administration built upon the offset foundation, continuing and expanding the strategy. Thus the Reagan revolution in defense that changed the public perceptions of U.S. military strength and purpose, hailed by Reagan’s proponents as responsible for winning the Cold War, actually began under Carter. For starting this revolution, credit belongs to Brown and the principal staff of the Office of the Secretary of Defense.

## The 1980 Election and Transition

IN 1976 CANDIDATE JIMMY CARTER ran a successful marathon campaign, outlasting his rivals for the Democratic Party's presidential nomination and then narrowly defeating incumbent President Gerald Ford. Four years later Carter might have hoped for the easy road to renomination that many previous presidents had enjoyed. Unfortunately the man from Plains was vulnerable. The country suffered from a weak economy plummeting into recession, rampant inflation, and rising unemployment, coupled with a host of foreign policy issues: the stalemate in hostage negotiations, stalled arms control initiatives—including the failure to ratify the SALT II Treaty—an abandoned policy of détente with the Soviet Union, and concern among Israelis and their U.S. supporters over Carter's effort at evenhandedness in the Middle East and support of friendly Arab states. Massachusetts Senator Edward Kennedy mounted a challenge to the president from the left based on policy differences and personal dislike, entering the race for the nomination and eventually winning five of the final eight primaries but not gaining enough delegates to secure the nomination. Carter defeated Kennedy, but he still faced the Republican candidate, former California governor Ronald Reagan.<sup>1</sup>

In 1980, to the surprise of many pundits, defense and national security policy issues dominated much of the presidential election campaign, with Reagan and his surrogates excoriating Carter as weak on defense to the point of endangering national security. These charges proved too much for Defense Secretary Harold Brown, who joined the campaign fray. Despite his professions to the contrary, Brown crossed the traditional line enjoining, or at least inhibiting, secretaries of defense from engaging in partisan presidential politics. Brown challenged Reagan and his surrogate defense experts, hardly a role the secretary relished or one in

which he felt comfortable. When the Carter administration released information on the existence of stealth technology and its plans for nuclear warfighting, reporters and columnists almost unanimously regarded both announcements as political ploys to counter Reagan's charges. Neither announcement proved decisive. Reagan won in a landslide. After the election, the DoD transition to the new administration was less than fully successful. While Brown and Deputy Defense Secretary Graham Claytor connected well, or at least politely, with Secretary-designate Caspar Weinberger, the same did not hold true between the Republican defense transition team and Brown's staff.<sup>2</sup>

Brown completed his four-year tenure at a job considered a graveyard of reputations with his basically intact. He maintained good relations with the rest of the Carter team. More important, he and his colleagues at the Office of the Secretary of Defense laid a foundation on which the next administration was able to build, starting and shaping what would become known as the Reagan-Weinberger revolution in defense. For this head start, Brown has received little credit.

### **Brown Joins the Political Fight**

Campaigning in Texas and Tennessee in May 1980, Reagan attacked the Carter-Brown claim that the U.S. defense establishment was "second to none" with the rejoinder, "It is already second to one—the Soviet Union." The mid-July Republican National Convention included as part of the party's platform a call for military superiority over the Soviet Union.<sup>3</sup> At the Commonwealth Club in Oakland, California, and in San Bernardino before the World Affairs Council, Brown presented the same version of a speech defending the administration's defense and national security policies and countering Republican charges. Without mentioning Reagan by name ("some have promised military superiority over the Soviet Union"), Brown reaffirmed that the United States and its allies were second to none but declared that "comprehensive military superiority for either side—absolute supremacy, if you will—is a military and economic impossibility—if the other side is determined to prevent it. . . . There can be no winner in an all-out arms race." To the secretary, claims that Washington could outspend Moscow, forcing it to give up the arms race to avoid hardships on Soviet civilian society, represented "wishful thinking of the highest order." Reagan's promise of superiority called into question Brown's basic strategy of essential equivalence and overlooked his successful efforts in 1979



and 1980 to persuade the president to increase defense spending to maintain that balance. In a news conference before the speech, Brown told journalists that anyone—again he refused to name Reagan—“who says that the United States is weak and the Soviet Union is predominant is playing fast and loose with the facts and I’ll let you fit the clothing to the individual.” Reagan’s rejoinder: “Since when has it been wrong for America to be first in military strength? How is military superiority dangerous?”<sup>4</sup>

It did not take long for journalists to note that Brown had strayed from the traditional secretary of defense model of remaining aloof from “partisan skirmishing.” Brown vehemently denied the charge, claiming the speeches were “just part of the job.”<sup>5</sup> He could point to other secretaries who had defended their records during presidential elections, especially Robert McNamara during the 1964 Johnson-Goldwater campaign, but it was a matter of degree. Brown defended his and Carter’s defense record with gusto.

Before making these speeches in California, Brown and Secretary of Energy Charles Duncan (former deputy defense secretary) spent a weekend at Bohemian Grove, the rural encampment of San Francisco’s elite Bohemian Club (where Brown was a member), where leaders in business, science, the arts, politics, and government spent weekends listening to talks and discussing key issues, a sort of Chautauqua meeting for the rich and powerful. Brown’s old Lawrence Livermore Laboratory colleague, Edward Teller, gave a talk supposedly on nuclear energy, but in Brown’s words, he “delivered a scathing attack on the Administration’s foreign, defense, and energy policies. He grossly misstated facts, and indicated that only the election of Reagan held any hope for America’s survival.” Although Teller’s talk violated the club’s professed practice of nonpartisanship “as well as good taste,” in Brown’s view, the largely pro-Reagan audience received it well. Later, Brown and Duncan engaged Teller in an informal debate. “I believe we shook him,” Brown reported to the president, suggesting that while their rebuttal audience was small, the word spread within the encampment.<sup>6</sup>

Not all of Brown’s battles were against Republicans. At the Democratic Party National Convention in August 1980, a Carter delegate from Oregon introduced an amendment to the party platform prohibiting deployment of the MX missile system. Carter wrote and circulated to the delegates a letter defending the system. Brown readied a task force of himself, Secretary of the Army Clifford Alexander,

Secretary of the Navy Edward Hidalgo, and Under Secretary of the Air Force Antonia Chayes to descend on the convention to explain defense issues and lobby for the MX, but he nixed the idea after concluding the act would be overkill. Instead, only Brown and George M. Seignious, director of the Arms Control and Disarmament Agency, made the case for the MX. After convention delegates defeated the amendment, the secretary congratulated the president: “The Administration’s strong and efficient effort on behalf of the MX in New York sent a very positive signal to people in Defense. . . . With the MX plank resolved, the national security platform on which you will be campaigning is sound, reasonable, and persuasive.” Carter thanked Brown for his help.<sup>7</sup>

### **The Announcements: PD 59 and Stealth**

Although confident about defending their record, Brown and Carter apparently decided to take no chances. Immediately before the Democratic Convention in New York and after informing Carter of his intention, Brown announced the administration’s new nuclear warfighting strategy, as outlined in the top secret document Presidential Directive 59, which called for selective attacks on targets that would hit the Soviet political and military leadership where it would hurt most—key government and military assets (see chapter 5). This strategy change would, in Brown’s view, enhance deterrence. PD 59 did not contemplate a first strike, but in Brown’s words, it “conveys to the Soviets that any or all of the components of Soviet power can be struck in retaliation, not only their urban-industrial complex.” Newspaper reports on the new policy tended to be factual, laboring over how to describe the new nuclear targeting strategy and how it differed from preceding policies—although one respected newspaper editorialized that the administration announcement “looks suspiciously like an effort to out-Reagan Reagan.”<sup>8</sup>

Then immediately after the convention, Brown announced that the United States had achieved a technological breakthrough that altered the military balance between Moscow and Washington: stealth technology. Begun in the Ford administration, it could make fighter aircraft, bombers, cruise missiles, or other weapon systems invisible to radar. Brown and Under Secretary for Research and Engineering William Perry engaged in a full-court press on development of this technology, initially producing two half-size prototype aircraft that could fly undetected by radar (see chapter 19). While PD 59 proved a little too esoteric for most people, Reagan

and the Republicans seized upon the public acknowledgment of stealth technology as a blatant attempt to beef up a weak defense record and an unconscionable leak of top secret security information for political purposes. Reagan charged Brown and Carter with a “cynical misuse of power and a clear abuse of the public trust” that gave the Soviets “a 10 year head start” on developing counter weapons to a stealth aircraft that would not be operational until the 1990s. Singling out Brown, Reagan declared that the secretary had leaked “some of the most tightly classified, most highly secret weapons information since the Manhattan Project” in a “transparent effort to divert attention from the Administration’s dismal defense record.”<sup>9</sup>

It was not as simple as Reagan charged. As Brown told the president on 22 August 1980, he had been forced to issue a public statement on stealth because “the leaks about our advanced technology accelerated this week.” Moreover, Congress would be asked to expand funding for the program and leaks would be inevitable. Still, the secretary had not expected mainstream media to pick up the information so soon. He assured the president that his announcement provided none of the technical detail that would help an adversary counteract or create its own similar technology. Hardly a secret, the stealth concept had been reported on in technical journals and newsletters such as *Aerospace Daily*, *Commerce Business Daily*, and *Aviation Week* in 1975 and 1976, no doubt avidly read by Soviet intelligence analysts. During the Carter years, hundreds of contract personnel worked on the project, 40 members of Congress and their staff received briefings, and funding had increased 100 fold since 1977. Now that leaks were appearing in major newspapers, more would inevitably occur, according to Brown. As more members of Congress learned of stealth technology, Brown and his OSD team also feared that congressional supporters of the B-1 bomber would view the stealth program as a threat to any revival of the B-1.<sup>10</sup>

Particularly galling to OSD were charges that Perry had leaked stealth information, when in fact, in June 1978, he had persuaded Ben Schemmer, editor of the *Armed Forces Journal*, not to reveal the existence of stealth technology and some of its technical data. For more than two years Schemmer had sat upon the information as long as it was not published elsewhere. In summer 1980 leaks about the technology began to emerge again in both technical journals and the mainstream media, most prominently in George C. Wilson’s 14 August 1980 *Washington Post* article. Perry consented to Schemmer publishing one day before the formal announcement

on 22 August, convincing him to omit about a dozen particulars that the under secretary considered classified.<sup>11</sup>

While the Pentagon press correspondents accepted that the secretary had not really released any secrets, Assistant Secretary for Public Affairs Tom Ross informed Brown that correspondents believed his announcement was politically motivated.<sup>12</sup> The story had legs, continued to roil, and became personal after Republican accusations. An uncharacteristically emotional Brown told reporters that Reagan's remarks on stealth "were a combination of factual error and gross distortions." Noting that he had worked on highly classified national security projects for "nearer 35 than 30 years," including the hydrogen bomb and intercontinental ballistic missiles, he knew "about keeping secret information secret, about what can be kept secret, what can't, for how long and what kinds of things are important for security." Brown continued: "As a scientist, I am offended by Governor Reagan's cavalier attitude toward the facts. As a public official, I am indignant at his reckless distortions about a program which we managed to keep secure, even as to any widespread knowledge of its existence and magnitude for over three years." Brown concluded that Reagan was trying "to divert attention from a very significant achievement" of the administration and the defense industry.<sup>13</sup> The vehemence of "someone who is probably among the shyest of prominent public officials" struck one journalist as odd, but he conceded that "Mr. Brown . . . cut and parried with a certain relish."<sup>14</sup>

Still, his argument proved a losing cause. Few journalists and editorial writers accepted Brown's defense. The Republicans kept up pressure, producing such supposed experts as former Secretary of State Henry Kissinger and former National Security Adviser Brent Scowcroft as well as former President Ford to chastise the secretary and the president. Carter countered by accusing Reagan of "cheap politics" and "irresponsible behavior," but to little effect with the media. The impact of this short but intense political slugfest on the voters is impossible to tell, but it came to dominate for at least a month the larger debate on national defense. It is hard to imagine that it did the Carter campaign any good.<sup>15</sup>

Brown became increasingly uncomfortable with charges that he was politicizing his office. He had his staff compile public statements by former Secretaries Melvin Laird, James Schlesinger, and Donald Rumsfeld—all Republicans—purporting to show they were also "political."<sup>16</sup> Similar but less personal and heated controversies arose over Republican charges that Brown was hiding the fact that

a majority of Army divisions, Navy carriers, and half of the Air Force F-15 wings were unready for combat by DoD's own rating standards. Defending administration defense policy during a speech in El Paso in early October 1980, the secretary tried to correct this accusation, noting that the reports were based on misinterpretations of the military "C-rating" system," a very incomplete measure of combat capacity and readiness, whose standards had been raised recently. A C rating meant an Army division was unable to perform its full combat mission in one or more categories, not that it could not fight. Six out of 13 Navy aircraft carriers had received C ratings, but as Brown noted, combat ready was "an impossible standard, because no one has yet designed an aircraft carrier—or any other ship for that matter—that never needs maintenance or a crew that never needs leave or additional training." Moreover, the Air Force's F-15 wings stood at 92 percent (excluding a training wing) combat ready, not at 50 percent as the press reported.<sup>17</sup>

As Election Day neared, the campaign discourse shifted to the economy. In the late October presidential debates, Reagan delivered a devastating blow. Looking straight into the camera with an expression of sincere sorrow, the governor asked: "Are you better off than you were four years ago? Is it easier for you to go and buy things in the stores than it was four years ago? Is there more or less unemployment than there was four years ago? Is America as respected throughout the world as it was? Do you feel that our security is as safe, that we're as strong as we were four years ago?" According to Chief of Staff Hamilton Jordan, the Carter staff complained that Reagan was a "goddamn actor" but still believed that the president had won the debate. They were whistling in the dark as the polls and newspapers of the next day confirmed.<sup>18</sup>

Still, even after the post-debate bump for Reagan, the Democrats' own poll predicted a virtual dead heat (the Republican pollsters gave Reagan a growing lead). All of this could change, most assumed, if the Iranians released the hostages.<sup>19</sup> Deputy Secretary of State Warren Christopher's negotiations for their release were getting close; the Iranian parliament, the Majlis, would meet on 2 November apparently to make a decision. Carter suspended his campaign to return to Washington to monitor the situation. On 30 October, Hamilton Jordan, then Carter's campaign manager, asked Christopher if the hostages could be released before Election Day. "They could, Ham," Christopher replied, "but I doubt it and sure don't count on it."<sup>20</sup> A last-hour pre-election release of the hostages, which the Reagan campaign feared and on which Carter's campaign team hung their final hopes, never materialized.

The president went on television to announce the “significant development” of the Majlis taking responsibility for the hostages and promising their release, but he could offer no prediction as to when the hostages would return home.<sup>21</sup> The next day Carter returned to the campaign. The Iranians refused to release the hostages before the election, waiting more than two months until Inauguration Day. In the early hours of the morning of 4 November, Democratic Pollster Pat Caddell reported that the bottom had fallen out of Carter’s effort. The undecided voters were flooding to Reagan, indicating a big Republican victory. Later that evening broadcast newscasters reported that Carter had lost. The president conceded before the polls on the West Coast closed.<sup>22</sup>

### **Transition**

The last responsibility of an administration is to prepare its successor for the more pressing issues that it will have to face. The outgoing president invites the president-elect for a transition briefing, with accompanying press photographs, thus beginning the passing of the torch. Brown and his staff prepped a long list of policy issues hitting on four categories for Carter to discuss with Reagan on 20 November. The first covered security matters. Given the greater likelihood of conflict with the Soviet Union in the 1980s, Brown recommended emphasizing readiness even at the expense of modernization. He stressed defense of the Persian Gulf and Indian Ocean, increased defense spending by European NATO members and Japan, encouragement of China to provide a more effective counterweight to the Soviet Union, and U.S. and Soviet compliance with the unratified SALT II agreements until they could be modified or new ones negotiated.<sup>23</sup>

In the second category, international trouble spots, Brown warned of a coup from the right against the Sandinista government in Nicaragua and Cuban military intervention to aid the Sandinistas and revealed U.S. plans to stop the Cubans. To forestall a Soviet invasion of Poland in response to the Solidarity Movement, Brown suggested debt relief for the Polish government to ease tensions and allow the government to meet Solidarity’s demands. Brown recommended that the new administration sell fully equipped F-15s and early warning surveillance aircraft to Saudi Arabia, but the latter not until 1985.<sup>24</sup>

As for the third set of issues, budget and personnel, Brown cautioned making pronouncements before fully studying the FY 1982 budget. He recommended

against an across-the-board DoD civilian hiring freeze and warned that ending the newly instituted draft registration would require the administration to pay a high political price if the need to restore it came later. Brown also recommended that Carter encourage Reagan to target pay increases selectively to meet specific needs, rather than instituting a general increase in military compensation.<sup>25</sup>

Lastly, in the development and procurement category, Brown recommended undertaking a full review before making public statements about any new, simpler, cheaper, quicker, and environmentally less obtrusive MX basing solution. As for a new penetration bomber, he suggested waiting for the completion of a comprehensive study that would give consideration to stealth alternatives. Brown emphasized the importance of the United States maintaining its technological lead over the Soviets—5 to 10 years in vital basic technologies such as computers, microelectronics, and jet engines. To keep this lead, he called for increasing defense funding for fundamental scientific research.<sup>26</sup>

This was a tall order for Carter to cover in his hour-long meeting with President-elect Reagan in the Oval Office. With the exception of the budget and personnel issues, Carter covered Brown's points. Reagan listened, making only a few comments, which Carter later characterized as campaign speech retreads. Carter offered Reagan a note pad, but the president-elect chose not to take notes. Later he asked for and received copies of Carter's notes—only brief reminders on 3-by-5 cards. The meeting demonstrated the differences between the two men: the down-in-the-weeds, detail-oriented president and a big-picture delegator. According to Carter, the only substantive comment Reagan made pertained to South Korea, when he expressed envy for President Chun Doo Hwan's authority to shut down South Korean universities and crack down on student demonstrators. Carter considered his successor unengaged, noting "it had been a pleasant visit, but I was not sure how much we had accomplished."<sup>27</sup>

It should come as no surprise that Carter underestimated Reagan, considering him an amiable and genial lightweight whose celebrity and acting skills somehow propelled him to the White House. Carter had been warned that although Reagan "may not have a first-class mind or be a deep thinker, he is not dumb." Reagan possessed shrewdness, a characteristic Carter apparently ignored. When White House aides asked how the meeting went, a deadly serious Carter supposedly said that during the briefing on the hostages in Iran, Reagan

mostly listened, but “when I finished, he said: ‘What hostages?’” Carter’s staff had a good laugh.<sup>28</sup>

Unlike Carter and Reagan, Brown and Defense Secretary-designate Caspar Weinberger had cordial but not close relations. Weinberger offered to allow Brown to stay on in the Pentagon “for a while” (Brown declined). Still, the two did not in any way bond. As Brown recalled, “He didn’t like me and I didn’t like him, but we were very polite to each other.” Typical of Brown’s style and sense of propriety, when asked by a reporter if Weinberger’s status as an “amateur” might not cause problems with the military, Brown responded that the last “amateur” to fill the job was Robert McNamara whose impact had been impressive. Brown reported to the president that on his return trip from Seoul and Tokyo in mid-December 1980, he had stopped in California for a two-hour discussion with Weinberger, who also met with Deputy Secretary Claytor in Washington. In California, Brown went over four highly classified programs, including cruise missiles development, but Weinberger showed little interest in these weapon systems. Nevertheless, Brown assured Carter the transition was “proceeding smoothly.” OSD expected “a great deal of communication with Cap [Weinberger] and his representatives during the coming month, when they are designated.”<sup>29</sup>

In reality, Brown and OSD were disappointed with Weinberger’s designated representatives headed by William Van Cleave, a former member of Team B, the nongovernment experts who assessed the Soviet threat in 1976 (see chapter 2). Van Cleave, who had been principal foreign and national security adviser during Reagan’s presidential campaign, and the transition team considered the Carter-Brown foreign and defense policies unmitigated disasters and believed they had nothing to learn from their predecessors.<sup>30</sup> Brown’s recollection of Van Cleave was that “he was terrible.” People in the Pentagon complained that his team was more interested in learning details about sensitive war plans than in facilitating a smooth transition. Suspecting that the team “had taken on a life of its own,” Weinberger asked Van Cleave when he would be finished. “Oh, possibly by next June,” Van Cleave breezily answered. Cap “the Knife” fired him and the team. When Reagan’s chief of staff, Edwin “Ed” Meese III, asked if the Van Cleave transition team had been useful, Weinberger answered: “It was not useful to me in developing the President’s program; it was, in fact, the source of a number of problems.” Asked if there were any problems with the Carter officials, Weinberger responded that they were “extremely helpful.”<sup>31</sup>



Although lame ducks after the election, the Carter White House and Department of State were fully engaged in the hostage negotiations with Iran. OSD and Brown were putting the finishing touches on the FY 1982 budget, the secretary's annual report to Congress on FY 1982 budget, and the Five-Year Defense Program for FYs 1982–1986. The annual report so emphasized the Soviet military threat in the 1980s that a neoconservative like Van Cleave could have written it. One journalist described it as the “most somber assessment yet of the military capabilities and intentions of the Soviet Union.”<sup>32</sup>

In mid-December 1980 Carter called together his National Security Council for its last meeting, billed as a legacy assessment that might be helpful to the incoming administration. Carter dominated the meeting, noting the threat of a possible Soviet invasion of Iran during the 1980s. He insisted that the United States must make it clear to Moscow that it would oppose an invasion, considering it an act that could lead to a conventional or even a nuclear war with the West. Carter also reprised the necessity—long articulated by Brown and Under Secretary of Defense for Policy Robert Komer—of the European NATO allies and Japan contributing more to the defense of the West, especially given the U.S. emphasis on countering the danger to the Persian Gulf. The president lectured “that the demands for defense expenditures comprise a bottomless pit which we can never fill,” returning to the old charge that the Joint Chiefs and DoD civilians denigrated U.S. military capabilities in order to extract more money from Congress. To Carter, such ploys hurt the country and affected allies' confidence in America. Moreover, the president believed that “the chorus of lamentations from the Pentagon and defense contractors that we are weak and impotent” might encourage the Soviets to make a catastrophic misjudgment leading to military confrontation.<sup>33</sup>

Carter deplored Reagan's suspicion of China and his support for Taiwan, asking council members to convince the new administration of the value of friendship with the PRC as a political and military offset to the Soviet Union. The president reiterated his commitment to arms control. He then suggested that “if we can buy at least five or six years' time in getting along with the Soviets, even on the basis of a shaky *détente*, the trends will be in our favor,” reflecting OSD's contention that by mid-1985, with the MX, cruise missiles, and Trident submarine-launched ballistic missiles, the strategic balance would shift back in the United States' favor.<sup>34</sup>

On 15 January 1981 the president and First Lady Rosalynn Carter hosted a farewell dinner at the Metropolitan Club in Washington for the Cabinet and the senior White House staff. With the passage of time since the election defeat and with the aid of drinks, to use the words of one attendee, "We were all among friends, and didn't have to worry about being gracious losers." Cabinet officers traded stories about their difficulties with Reagan transition teams. Brown lamented that conservatives would be taking over the government, noting, "They are putting people in charge of arms control that are *opposed* to arms control!" According to Hamilton Jordan, "Brown made a touching toast to the peace that America had enjoyed during the past four years." Carter was the first president since Warren Harding whose tenure did not see a single U.S. service member die in combat, a fact of which Carter himself was very proud. Of course, lives were lost in accidents, most notably the Iran hostage rescue mission.<sup>35</sup>

January 1981 was a time for goodbyes as the OSD staff met informally, and Brown and Claytor were hosted by the Joint Chiefs at a farewell dinner. On 16 January the president gave Brown and others the Medal of Freedom.<sup>36</sup> Inauguration Day, January 20, had special meaning for Carter and his team, for the hostage negotiations had been successful and the hostages were on their way home. The next day Carter met them as a private citizen. The election had been a great disappointment to Carter, particularly because he could not understand the appeal of Ronald Reagan.<sup>37</sup> Although Brown had jumped into the political fray, he was never comfortable in that role but rather felt compelled to do so because of what he considered unfair criticism and outright untruths about his defense record. Furthermore, as the defense secretary for the four years of the Carter presidency, Brown stood out as the logical spokesman for defense and national security issues. The other potential advocate, National Security Adviser Zbigniew Brzezinski, made few public appearances or statements during the campaign, presumably because of the negative public perception of him.<sup>38</sup> Loyalist Brown played his part but was perhaps not as regretful as the president about the defeat at the polls because he had decided not to stay on for a second Carter administration. Considering McNamara's tenure, Brown concluded four years were enough, observing that "friends come and go, but enemies accumulate." The longer one stayed in the job, the more likely one was to "mistake familiarity for wisdom."<sup>39</sup>

After his years in the limelight, Brown embarked on a less hectic life as a distinguished visiting professor at the Johns Hopkins School of Advanced International Studies and then as director of the university's Foreign Policy Institute, later as a counselor at the Center for Strategic and International Studies, as an adviser to DoD and other government and nongovernment organizations, and as a member of the board of directors of major U.S. corporations. His output of columns, articles, and books on national security issues was thoughtful and provided prescriptions for the future. He commented in newspapers and journals on national security issues throughout the 1980s and 1990s. Often called upon for advice by Congress, Weinberger, and later presidents and secretaries of defense, Brown remained a perceptive and measured observer of national security issues.<sup>40</sup>



## In Retrospect

WHEN HE BECAME A PRIVATE CITIZEN on 21 January 1981, Harold Brown had served four years in arguably the most difficult post in the Cabinet. One longtime observer called it a “nearly impossible job.”<sup>1</sup> In March 1981 at the University of Michigan Business School, citizen Brown lectured on “‘Managing’ the Defense Department—Why It Can’t Be Done,” in which he concluded that the Pentagon cannot not be “‘managed’ like a business, but “it could be led so as to preserve most effectively our national security interests.”<sup>2</sup> As secretary, Brown introduced a number of innovations in the organization and leadership of the Department of Defense. Early in his tenure, he faced a span-of-control problem that stretched his time very thin. In 1977 he reorganized OSD by farming out responsibility for the Defense Intelligence Agency and other Defense agencies to the under secretaries and certain assistant secretaries. Some assistant secretaries were made responsible to under secretaries. Nevertheless, these agencies and offices ultimately remained under his authority.<sup>3</sup> It took an extraordinary individual to work with and/or supervise these sources of power and influence. Brown accomplished this task surprisingly well by working hard at getting along with other key DoD players.

Brown centralized control of defense policy in his office as effectively as any secretary of defense before him, with the exception of Robert McNamara, but without the negative reaction that McNamara sometimes experienced. Although a centralizer, he did not seek to impose his views on all policy decisions. One of Brown’s strengths was his openness to new or differing ideas and opinions. Those who made a good and rational argument to him—in writing with lots of supporting data—would receive a fair hearing. His copious notes on memoranda from the staff

indicated his willingness to consider alternative policies, but he was also quick to point out difficulties and inconsistencies. He devoured graphs, charts, equations, and columns of figures, often catching deeply embedded mistakes. Least at ease in his representational duties, such as handing out awards or recognizing services and achievements, he labored to engage in the small talk that lubricates such occasions. Still, almost all of those who worked with him on a day-to-day basis held him in high regard.

Early in his tenure critics charged that Brown lacked a larger conception of America's role in the world.<sup>4</sup> That failing, such as it was, derived in good part from the nature of his job. Few secretaries had much time to articulate a long-term strategy or a world plan: as secretary he was responsible for dealing with a vast bureaucracy, the Soviet Union, NATO and Europe, the Persian Gulf, and Southwest Asia. He oversaw weapons development and production, formulated budgets (often juggling three DoD fiscal year budgets at once), and worked with the National Security Council to develop foreign and security policy. Nevertheless, Brown and his OSD staff articulated some basic themes that revealed their world view. First, the Soviet Union's multiple years of modernizing its conventional and strategic weapons posed a real danger to the United States and its allies. To counter the conventional threat to Europe, Brown and Perry built on new research and development in weapon systems to create what came to be known as the offset strategy, employing U.S. prowess in high technology to counter the Soviet advantage in men and weapons.

For the strategic nuclear balance, Brown and OSD stressed "essential equivalence," warning that it was not static. The Soviet intercontinental ballistic missile threat to the U.S. Minuteman missile force required a counterweight. The secretary promoted air-launched cruise missiles and the MX missile as the answers. The Soviet intermediate-range nuclear missile endangered NATO's theater nuclear defense of Europe. Brown and OSD responded by securing Western European agreement to deploy the longer-range Pershing II nuclear missiles and cruise missiles. Deployment was scheduled for a second Carter term. With the emergence of the Persian Gulf and Southwest Asia as areas of potential friction between the two superpowers, Brown and OSD established the Rapid Deployment Joint Task Force and created a network of arrangements whereby U.S. forces could have access to bases and supplies to bring military power rapidly to the area. Brown supported both the existing modernization and improvement program for the

nuclear submarine-launched intercontinental missile force and the introduction of Trident-equipped submarines and Trident II missiles.

The secretary's prior experiences shaped his view of DoD's role in the larger formulation of national security policy. Of all the secretaries, Brown came to the job with the most Pentagon experience, eight years under Secretaries of Defense Robert McNamara and Clark Clifford. He had witnessed McNamara's four-year ascendancy and triumph and then his descent into disillusionment and failure during the second term.<sup>5</sup> Although Brown began his tenure initially wary of jumping too deeply into the policy process, he had little choice given the requirements of his new job and the ideological standoff between Brzezinski and Vance over foreign policy. He often became the man in the middle, siding with one or the other. As the Carter presidency took shape and the Soviet threat increased, Brown increasingly allied with Brzezinski. Although Brown had never served in the military, he spent almost his entire career in the defense world, first as a nuclear designer and administrator in weapons laboratories and then as a McNamara Pentagon official, experiencing the Cold War firsthand over three decades.

An avid reader of history, Brown believed that policymakers could learn from the past. He employed his long government experience and expertise to draw conclusions that reinforced his recommendations for future policies. When asked what defining experiences shaped his early education, he recalled a joint U.S. history and literature course at the Bronx High School of Science, mentioning specifically Vernon Parrington's three-volume *Main Currents in American Thought*, a liberal-progressive interpretation of American history.<sup>6</sup> Like many people with scientific backgrounds, Brown was optimistic, seeing rationality, science, and technology as forces for good and progress, an outlook that also shaped his view of history and the role that the United States played in it.

### **Relations with the President, the White House, and State**

Notwithstanding occasional exasperation over Defense budgets and expensive weapon systems, Carter admired and respected his secretary of defense. "Harold understood the cutting edge of technology; I didn't," the president recalled. "But I'm an engineer by training and I think my attitude toward things like this [decisions on weapon systems] is to make a list, compare, establish priorities, and cost-out things, and I thoroughly enjoyed that role."<sup>7</sup> This methodology earned the president

a reputation for attention to detail, subjecting him to criticism that he could get lost in it. Brown also mastered huge amounts of detail. He admitted that he had to fight against the tendency, lest it overwhelm him.<sup>8</sup>

The skills that the president admired in his secretary did not mean that Carter always accepted Brown's recommendations. Contrary to popular belief, Carter was usually not indecisive; rather he had a stubborn streak. Once he had made up his mind, it took a lot of argumentation to persuade him to change. The difficult campaign that Brown, the JCS, defense intelligence, and the military commanders in South Korea undertook to convince the president not to withdraw U.S. combat troops from South Korea was one example of Carter's intransience. Another was Carter's resistance to Brown's consistent arguments after 1979 urging an increase in defense spending.

Furthermore, Carter could be a difficult boss. He held some ideas very strongly—human rights, arms control, the need for social services, and fiscal integrity. Convincing him of the need to accept policies that might undermine these principles could be hard. For example, after Brown and DoD undertook a concerted campaign to persuade the American public and NATO governments to accept enhanced radiation nuclear weapons (neutron bombs) on European soil, Carter concluded that his moral sense precluded deploying such weapons—and furthermore that he had never given the go-ahead for such a decision.<sup>9</sup>

The point of greatest contention, however, arose from Carter's profound belief that the Pentagon and military were always after a larger slice of the federal pie. To get their budget share, the president charged that on numerous occasions DoD magnified the national security threat and downplayed the military's ability to counter it. Suspicion about military spending was hardly a unique viewpoint for a president (recall Truman's budget cutting before the Korean War and Eisenhower's military-industrial complex warning). But Carter's strong opposition to military spending made the job of Brown and OSD that much more difficult and the success that they ultimately enjoyed more impressive. To be fair, Carter's suspicion of OSD's threat estimates, and even more so of the services, had some merit, because they tended to accept and present worst-case threats to U.S. security as their considered judgments.

Brown fashioned good relations with the White House and Zbigniew Brzezinski whose viewpoint on the Soviet threat and the need for defense spending, if not



for forceful military action, he generally shared. Brown recalled in 2012 Brzezinski as “friendly though at times prickly” and “a brash, ingenuous, and opinionated newcomer to a senior government office, rather than the elder statesman he is now.” Nonetheless, Brown was not close to the national security adviser, in contrast to his 15-year friendship with Vance. While the policy and personal tension between Brown and Brzezinski never reached the level of those between Brzezinski and Vance, Brown and the national security adviser had their differences. Friction also existed between the NSC and OSD staffs. Brzezinski’s military assistant, Maj. Gen. William Odom, could be critical of DoD, but Brown and his OSD staff generally worked well with the National Security Council staff.<sup>10</sup>

Traditionally, OMB was a potential critic of the Pentagon whose requests for more defense spending could require reprogramming that resulted in less for other government agencies and threatened to increase the deficit. However, Brown recalled that the top leadership at OMB—Bert Lance until his resignation, James McIntyre who replaced him, and Deputy OMB Director John White (former assistant secretary of defense for manpower)—were sympathetic to DoD. The skeptical staffers at OMB were the real problem for DoD’s requests for spending increases. The strongest opposition to the Pentagon’s budget, according to Brown, came from Carter’s domestic affairs staff and from Vice President Walter Mondale, who sometimes opted for domestic spending over defense when it came down to a choice between the two.<sup>11</sup> Brown maintained excellent relations with Vance, a good friend and former colleague in OSD under McNamara, although he did not always support State’s policies, especially toward the Soviet Union.<sup>12</sup> With Vance’s short-term successor, Edmund Muskie, Brown got off on the wrong foot over PD 59, never creating the kind of relationship he enjoyed with Vance.

At meetings of the National Security Council and its subgroups, the Policy Review Committee and the Special Coordination Committee, Brown was a presence but not a dominant figure like Brzezinski or even Vance. Brown took the lead only when the topic discussed was clearly DoD’s responsibility. A consummate team player, he made his case but accepted the consensus or the presidential verdict. If he believed he was right, he was more likely to raise the issue again formally than seek ways to go around the collective decision of the administration and the president. He was no bureaucratic infighter like his predecessor Melvin Laird.

### The Joint Chiefs, Office of the Secretary of Defense, and the Armed Forces

Brown maintained good relations with the Joint Chiefs of Staff. Like his predecessors, he met with them weekly in their conference room (the “tank”) and with the chairman on a daily basis.<sup>13</sup> In looking back on his relationship, Brown realized that the Chiefs “didn’t regard me as a military professional of their own sort. I think they understood that I was very experienced in quasi-military matters. . . . They came to regard me as somebody with whom they would at least level, and even if they didn’t agree with me, they would accept certain decisions.”<sup>14</sup> When Brown and the JCS did not see eye to eye, he gave them a fair hearing and passed their advice on to the president, although if he disagreed with it he would often do so without comment for the president, in effect a signal. When Brown absolutely had to deliver JCS support, as on the Panama and SALT treaties, the Camp David Accords, and normalization of relations with China, he did so. Only in the partisan presidential election months of late 1980, seeing opportunities for shaping the national conversation, did the Chiefs stray from the administration’s positions, not quite toeing the



Secretary Brown and the Joint Chiefs of Staff, 21 November 1978: Sitting, left to right, Deputy Secretary Charles Duncan, Brown, JCS Chairman General David Jones (USAF); standing, left to right, General Louis Wilson (USMC); Admiral Thomas Hayward (USN); General Lew Allen (USAF); and General Edward Meyer (USA). (OSD Historical Office)

line that Carter's FY 1982 Defense budget was enough. The lure of Ronald Reagan proved too great for military leaders, who felt Carter was not approving enough resources for defense.

With his first chairman of the JCS, Air Force General George Brown, the secretary had a long personal relationship, although he recalled him as "a little bit more stiff-necked" and "old school" than his successor, General David Jones (also USAF), with whom he had also established strong and close relations. General Brown was chairman when Secretary Brown assumed office. Jones was his choice to succeed Brown.<sup>15</sup> Looking back on his choice, the secretary recalled that what appealed to him about Jones was his commitment to joint operations rather than exclusively to his own service and his focus on arms competition with the Soviet Union, a decided asset when assessing the impact of strategic arms limitation decisions.<sup>16</sup> Jones had his critics, some of whom suggested his chairmanship represented a "payoff" for not opposing the decision to cancel the B-1 bomber. For his part, the president remained skeptical of the JCS as his military advisers, rarely seeking and even more rarely following their advice.<sup>17</sup> This skepticism put Brown in a difficult situation. Carter's unwillingness to increase the Defense budget or approve certain high-profile weapon systems (B-1 bomber or nuclear aircraft carrier) thrust Brown in the role of the bearer of bad news to the chairman and his colleagues.

Many OSD staff members came from scientific backgrounds. Brown's partnership with Director (later under secretary) of Defense Research and Engineering William Perry, an entrepreneur and Ph.D. mathematician of extraordinary talents, proved symbiotic and fruitful. Brown avidly read Perry's weekly reports on new developments in weaponry and technologies, perhaps somewhat wistfully as the secretary remembered when he served in that role under Robert McNamara. Gerald Dinneen, who ran DoD's vast communication network, was a Ph.D. mathematician specializing in that field of technology. Brown gave him full rein to do his job. The head of the Program Analysis and Evaluation office, Russell Murray, an aeronautical engineer, proved useful to Brown. Murray could be provocative and contrary. While these were traits Brown himself did not usually exhibit, he valued Murray for these abilities even if he did not always follow the PA&E's advice. Brown also appreciated the head of the Office of Net Assessment, Andrew Marshall, who served the secretary as an intelligence adviser on the Soviet Union. Within ISA, Brown was closer to Principal Deputy Assistant Secretary Walter Slocombe, because of his

day-to-day work on SALT and other issues, and to Director of NSC Affairs Lynn Davis, a protégé who worked with the NSC staff, than he was to David McGiffert, who headed the ISA office. Lastly, there was Robert Komer, who began as Brown's temporary special adviser on NATO and ended up as his under secretary for policy. Cutting through bureaucratic red tape, spewing forth multiple short, readable, opinionated memoranda every day on military strategy and planning, "Blowtorch Bob" Komer was an acquired taste, but one that Brown came to value highly.<sup>18</sup>

The service secretaries comprised a formidable group of senior officials. The offices had a strong tradition as a training ground for higher positions in the Pentagon. Six service secretaries of the 1940s to 1960s became deputy secretaries and three went on to become secretaries of defense: James Forrestal (although he was Secretary of the Navy before 1947), Thomas Gates, and Brown himself.<sup>19</sup> Brown's belief that the Navy's future was in smaller, less expensive, and more technologically advanced ships put him squarely at odds with Secretary of the Navy Graham Claytor and his successor, Edward Hidalgo. Yet the Brown-Claytor personal relationship was strong. Certainly, one of Brown's most attractive traits was his willingness to accept opposition without taking it personally. The secretary believed in Claytor's abilities so strongly that he convinced the president not to promote him from acting to permanent secretary of transportation, but return him to the Pentagon to become deputy secretary of defense. Brown recalled that with his previous deputy secretary, Charles Duncan, "we clicked right from the beginning." Duncan became his "alter ego." Whereas Brown could be impatient and allow his displeasure to show in his facial expressions, Duncan remained imperturbable.<sup>20</sup> Much to Brown's dismay Carter named Duncan secretary of energy in July 1979. Secretary of the Army Clifford Alexander served the entire four years. The first black service secretary, Alexander had a special interest in African Americans who were joining the Army in increasing numbers. His attempts to go directly to Congress and the White House to further his interests and those of the Army annoyed Brown. When former NASA official Hans Mark became secretary of the Air Force in July 1979, Brown had a closer relationship with him than with his predecessor, John Stetson.<sup>21</sup>

The uniformed services traditionally provided a powerful challenge to the secretary of defense. Much of DoD's history since 1947 has been the tug-of-war between the secretary and the services, with the secretary increasingly gaining power over

the years.<sup>22</sup> At its most basic level, the services fought to obtain the weapons and personnel—force structures—that they believed they needed. The secretary and his staff had to ensure that the demands were reasonable and necessary. The tension was built in. Brown and OSD did not always win. For example, Brown fought a behind-the-scenes campaign to prevent the Marine Corps from buying more Harrier jets, a vertical takeoff plane that was difficult to fly and of limited capability. Try as he did, the secretary could not stop the Harrier. The services were not adversaries, but they were not always allies.

To help deal with the competing sources of power within DoD, Brown relied on people outside the department for advice. Many of these informal advisers were scientist colleagues from the past. Loud and boisterous Herbert York, Brown's mentor and the man he succeeded as director of Livermore Lab and as director of defense research and engineering, remained a friend and his closest adviser. The most influential was probably Brown's former deputy at Defense Research and Engineering in the 1960s, Eugene Fubini. Italian-born and educated as a physicist and electrical engineer, the diminutive (five feet tall in his shoes) and charismatic Fubini was Brown's unofficial talent scout, finding promising candidates to serve at DoD. As the longtime head of the Defense Science Board, Fubini proffered official advice to the secretary as well as his own personal perspectives. He had virtually unlimited access to Brown; he could call or walk into the secretary's office without appointment. Fubini provided an unofficial contact with the defense industry, to which he often served as a consultant.<sup>23</sup> These advisers not only supplied Brown with scientific and technical recommendations but gave him more general advice about personnel and policies. They provided a valuable resource beyond the confines of the administration.

While Brown felt fully at ease with former colleagues and friends such as Fubini and York, he did not have the common touch. To the two million active-duty personnel, Brown remained a distant star; he was not a secretary who felt confident chatting with the troops. His trips to the field, whether to the Korean DMZ or military facilities, were part of the job but not a role that he relished or in which he excelled. While Brown was clearly aware of the less than satisfactory living conditions and social strains of the All-Volunteer Force, they remained to him in part an abstraction. To Brown's credit, he tried to engage the president in providing more visible signals of White House support for military personnel, such

as presidential awarding of medals or attendance at retirement ceremonies, but Carter proved unenthusiastic.

### **Brown as Diplomat**

Brown fared well in official discussions with high-level foreign officials. Still, he had no desire to become a duplicate secretary of state, recalling that he was not one of those in whom there was “a Secretary of State inside striving to break out,” adding wryly, “two of them were enough already”—an obvious jab at Brzezinski.<sup>24</sup> Although a reluctant diplomat, the nature of his duties increasingly required that he assume certain foreign policy and foreign relations functions. Secretaries of defense dutifully attended the NATO annual defense ministers meetings and other NATO planning meetings. When foreign defense ministers or key military leaders came to Washington, they always stopped at the Pentagon for a meeting with the secretary. This was a standard part of the job.

By the 1970s, however, U.S. dealings with allies and nonaligned but friendly nations increasingly concerned military relationships. Brown perceived DoD’s role as supporting foreign policy, but increasingly foreign relations were of a military and strategic nature, especially foreign military assistance and sales. The secretary of state and the president theoretically made the foreign military sales and military assistance decisions, but in practice Brown had a clear policy role. DoD’s official responsibility was implementation, the details of which often became the focus of negotiations.

There were U.S. allies, not just NATO members, whose relations with the United States became inseparable from their defense and national security. South Korean and Japanese defense officials institutionalized their military relations with the United States into annual consultative meetings with the secretary and his advisers. Brown made a special effort with the Japanese to encourage them to spend more—a goal of 1 percent of GNP—on their own defense and to take on more regional defense responsibilities. With Saudi Arabia and Israel, military sales (also credits and grants for the Israelis) constituted a key component of the relationship. Brown played an equally important role in the burgeoning military relationship with Egypt, working with his Egyptian counterpart on the U.S. military assistance program.

During the last two years of his presidency, Carter came to rely on Brown as an envoy, a man he could send abroad to explain administration policies. Both after the Camp David Peace Accords agreement in 1978 and the fall of the Shah of Iran

in 1979, Brown embarked on Middle East trips to reassure allies in the region. The actual impact of such missions defied exact measurement, but personal relationships could be an important and valuable tool of diplomacy. Brown worked closely with Western European leaders to win their acceptance of Pershing II nuclear missiles stationed on their soil. He made a crucial trip to meet with the Saudi Crown Prince to explain U.S. policy and limits on rearming the Saudi Air Force. The secretary traveled to Beijing in January 1980 specifically to explore the expansion of a U.S.-China military relationship and to coordinate policies toward the Soviet invasion of Afghanistan. Finally, Brown was sent to Seoul to dissuade the South Korean generals from executing a key dissident leader, who later became the first democratically elected president of the Republic of Korea.

Brown was not always successful. The Japanese, formal and respectful, endlessly promised to do more, but their results did not always meet their assurances or the expectations of the secretary. With the South Koreans, Brown's diplomacy became increasingly undiplomatic as the generals under Chun Do Hwan cracked down on political opponents. The Chinese wanted military technology that Washington was unprepared to give them; they showed less interest in the weapons the United States was ready to provide. It was not all deadly seriousness. In June 1980 Brown took Geng Biao, secretary general of the Chinese Communist Party's Military Commission (in 1981 he became defense minister), to the White House. About to view the Star Wars movie *The Empire Strikes Back*, Carter invited Brown and Geng to watch it with the White House staff and their families. After witnessing laser beam weapons, death rays, and exploding space ships, Brown jokingly assured Geng that the United States had not yet developed these weapons so they could hardly sell them to Beijing.<sup>25</sup> With Israel and Egypt, the military relationship usually boiled down to what and how much military assistance the United States was prepared to give. Brown was a hard bargainer. The 1978 Camp David Peace Accords resulting in a peace between Egypt and Israel required increased military assistance to both former combatants. The negotiations to remove Israeli airfields from the Sinai and build new ones in the Negev were Brown's specific contribution to the Carter Middle East peace process. In the Middle East, the secretary often found himself limiting grandiose expectations, as with the Sinai airfields, Egypt's hopes of F-16 aircraft, and Saudi desires for arming their U.S.-provided F-15s with the latest technology and upgrades.

## Relations with Congress

The Pentagon can only spend what Congress appropriates. Brown enjoyed good relations with a Congress controlled by his own political party during his four-year tenure. But that hardly meant that DoD received a blank check. Most of the Pentagon's congressional successes came after gaining hard-won bipartisan support. Like all secretaries, Brown spent a good part of his time preparing testimony and appearing on Capitol Hill. He attempted to keep good relations with the key congressional defense chairmen, experiencing his share of successes and failures.

His reputation as a scientist, his long experience at the Pentagon, and his mastery of weapon systems served him well on Capitol Hill. Yet Brown faced a Congress that was changing. The era of the old committee system (especially the Senate and House Armed Services Committees), ruled with an iron hand by mostly southern chairmen, was passing. Young senators such as Sam Nunn who specialized in military affairs and developed individual expertise challenged Brown and his staff. A critic of SALT II and defense hawk, Senator Scoop Jackson provided a powerful voice in opposition to much of the administration's strategic arms limitation policies. A group of congressional Young Turks within the Democratic Party fought to limit defense spending and redirect it toward social programs. As Republican congressmen realized that the public's perception of Carter's national security record could help their party retake the White House in 1980, they became less cooperative and more critical, taking the secretary to task for defense "failures."

Perhaps Brown was too optimistic that rationality could win over politics and constituency interests. For example, the Carter administration desperately wanted to close bases across the United States, since many served no real military function except to provide jobs for constituents in congressional districts. The White House changed the terminology, calling the closures "base realignments" and named Brown as the point man and final arbiter in an effort to isolate the White House and president from the unpopular decisions and inevitable local opposition. A reinvigorated Economic Adjustment Committee chaired by the secretary of defense sought to coordinate federal assistance to communities affected by closings. The Pentagon considered closing or realigning up to 30 bases, but the White House balked at announcing the potential bases before the 1978 congressional elections. Instead the base closings and realignments would be reviewed by DoD, OMB, and the General Services Administration. In the end, according to Brown, very few bases were realigned or closed.<sup>26</sup>



It also became ever more obvious that the rationale for a weapon system was not always its utility, cost, or need, but the fact that its parts were manufactured in the district of key members of Congress. The decision to persuade Congress to cancel the B-1 bomber and the defeat of a congressional attempt to override the president's veto of another nuclear aircraft carrier in 1978 were bruising victories. Yet the administration faced compromises and defeats on other weapon systems. Over his four years Brown remained diligent and straightforward in his testimony on Capitol Hill, winning some battles and losing others.

Brown retired from office convinced that he had left the national security of the United States better than he found it. Although the rapid advances in expensive military technology compounded money difficulties, Brown's success in increasing FY 1981 and FY 1982 Defense budgets, including more research and development, better application of technology to new weapon systems, and some hard but better choices in deciding requirements for weapons acquisition, provided a firm foundation for the next administration. Caspar Weinberger, whose experience with national security and military affairs paled into insignificance compared with Brown's, had a much easier time than Brown as secretary. At least at first, Weinberger found himself in the enviable situation of having strong White House, congressional, and popular support for increasing defense spending, unencumbered by the fears of deficits that had made Brown's task more difficult.

Brown had his strengths and successes as well as his flaws and failures, but overall he was a more effective defense secretary with a more significant impact than the media and historians have acknowledged. Jimmy Carter's plunging post-presidential reputation—rightly or wrongly merited—acted as deadweight, pulling Brown's standing down with him. Brown deserves high marks as a manager and consummate team player. He was also innovative in his application of technology, especially in his approach to the conventional and strategic defense of Europe and acquisition of such offset weapons as the cruise missile and the stealth fighter. Carter and Brown are always compared with Reagan and Weinberger, who forged a strong national commitment for defense spending and deployed new weapon systems that they and their proponents claim won the Cold War. Yet nearly all of these systems, with the exception of the theoretical Strategic Defense Initiative ("Star Wars"), were under development or actually deployed during the Carter administration. Even the major ones that Carter cancelled, the B-1 bomber and the neutron bomb, remained

in research and development, allowing them to be easily resuscitated during the 1980s. Reagan and Weinberger are rightly credited for changing the trajectory of defense, but it could not have happened without the work of Brown and his OSD staff. They provided the strong foundation on which their successors built a solid defense posture. The Reagan revolution in defense began during the later years of the Carter administration.

## — A B B R E V I A T I O N S —

AAH	Advanced Attack Helicopter
ABM	Antiballistic Missile
ACDA	Arms Control and Disarmament Agency
AFB	Air Force Base
AFPC	Armed Forces Policy Council
AID	Agency for International Development
AIMS	Alternative Integrated Military Strategies
AIPAC	American Israel Public Affairs Committee
ALCM	Air-Launched Cruise Missile
APC	Armored Personnel Carrier
APDM	Amended Program Decision Memorandum
ARPANET	Advanced Research Projects Agency Network
ASAT	Antisatellite
ASW	Antisubmarine Warfare
ATSD	Assistant to the Secretary of Defense
AVF	All-Volunteer Force
AWACS	Airborne Warning and Control System
BBV	Brzezinski, Brown, Vance
BETA	Battlefield Exploitation and Target Acquisition
C3	Command, Control, Communications
C3I	Command, Control, Communications, and Intelligence
Caltech	California Institute of Technology
CBU	Cluster Bomb Unit
CEP	Circular Error Probable
CFC	Combined Forces Command
CG	Consolidated Guidance
CIA	Central Intelligence Agency
CINCEUR	Commander in Chief, European Command

CINCLANT	Commander in Chief, Atlantic Command
CINCPAC	Commander in Chief, Pacific Command
CJCS	Chairman, Joint Chiefs of Staff
CM	Cruise Missile
CMC	Cruise Missile Carrier
CMH	U.S. Army Center of Military History
CNO	Chief of Naval Operations
COB	Contingent Operating Base
COMUSKOREA	Commander U.S. Forces, Korea
CONPLAN	Contingency Plan
CORDS	Civil Operations and Revolutionary Development Support
CQ	<i>Congressional Quarterly</i>
CRAF	Civil Reserve Air Fleet
CRS	Congressional Research Service
CSCE	Conference on Security and Cooperation in Europe
CSGN	Nuclear-Powered Strike Cruiser
CTB	Comprehensive Test Ban
CTOL	Conventional Takeoff and Landing
CVN	Nuclear-Powered Carrier
CVV	Conventionally Powered Aircraft Carrier
CW	Chemical Weapon/Warfare
D	Democrat
DACOWITS	Defense Advisory Committee on Women in the Services
DARPA	Defense Advanced Research Projects Agency
DCI	Director of Central Intelligence
DDR&E	Director of Defense Research and Engineering
DDRS	Declassified Documents Reference System
DEFCON	Defense Condition
DepSecDef	Deputy Secretary of Defense
DIA	Defense Intelligence Agency
DMZ	Demilitarized Zone
Doc	Document
DoD	Department of Defense
DoE	Department of Energy

DoT	Department of Transportation
DPC	Defense Planning Committee (NATO)
DPG	Defense Policy Guidance
DSARC	Defense Systems Acquisition Review Council
ECM	Electronic Countermeasures
EO	Executive Order
ERA	Equal Rights Amendment
ERDA	Energy Research and Development Agency
ERW	Enhanced Radiation Weapon
ESF	Emergency Security Funding
ESL	Electromagnetic Systems Laboratory
EUCOM	European Command
FEBA	Forward Edge of Battle Area
FEMA	Federal Emergency Management Agency
FMS	Foreign Military Sales
FRG	Federal Republic of Germany
<i>FRUS</i>	<i>Foreign Relations of the United States</i>
FY	Fiscal Year
FYDP	Five-Year Defense Program
GAO	Government Accounting Office
GDIP	General Defense Intelligence Program
GLCM	Ground-Launched Cruise Missile
GNP	Gross National Product
GPO	Government Printing Office/Government Publishing Office as of 12/2014
GPS	Global Positioning System
H	U.S. House of Representatives
HARM	High-Speed Antiradiation Missile
HCA	House Committee on Appropriations
HCAS	House Committee on Armed Services
HCFA	House Committee on Foreign Affairs
HNS	Host Nation Support
H.R.	U.S. House of Representatives
HSCA	House Subcommittee on Appropriations

ICBM	Intercontinental Ballistic Missile
IMET	International Military Education and Training
INF	Intermediate Nuclear Force
IRBM	Intermediate-Range Ballistic Missile
ISA	International Security Affairs
JCS	Joint Chiefs of Staff
JCSM	Joint Chiefs of Staff Memorandum
JDA	Japanese Defense Agency
JFM	Joint Force Memorandum
JSDF	Japanese Self-Defense Forces
JSOP	Joint Strategic Objectives Plan
JSPD	Joint Strategic Planning Document
JSTARS	Joint Surveillance and Target Attack Radar System
JTF	Joint Task Force
km	Kilometer
LANTCOM	Atlantic Command
LC	Library of Congress
LCAC	Landing Craft Air-Cushioned
LOS	Law of the Sea
LRTNF	Long-Range Theater Nuclear Forces
LSD	Landing Ship Dock
LTDP	Long-Term Defense Plan
Ltr	Letter
MAAG	Military Assistance Advisory Group
MAF	Marine Amphibious Force
MAP	Military Assistance Program
MAP	Multiple Aim Point
MBB	Muskie, Brown, Brzezinski
MBFR	Mutual and Balanced Force Reduction
MBT	Main Battle Tank
MCM	Mine Countermeasure
MER	Multiple Ejector Rack
MIA	Missing in Action
MIDEASTFOR	Middle East Force (U.S.)

MILAG	Military Advisory Group
MILCON	Military Construction
MILGP	Military Group
MIRV	Multiple Independently Targetable Reentry Vehicle
MIT	Massachusetts Institute of Technology
MLBM	Modern Large Ballistic Missile
MRA&L	Manpower, Reserve Affairs, and Logistics
MRBM	Medium-Range Ballistic Missile
Msg	Message
Mtg	Meeting
MTT	Mobile Training Team
MX	Missile Experimental
NAC	North Atlantic Council
NASA	National Aeronautics and Space Administration
NATO	North Atlantic Treaty Organization
NIE	National Intelligence Estimate
NMA	National Military Advisers
NPT	Nuclear Nonproliferation Treaty
NRO	National Reconnaissance Office
NSA	National Security Agency
NSC	National Security Council
NSDM	National Security Decision Memorandum
NTPS	Near-Term Prepositioning Ship
NUWEP	Nuclear Weapons Employment Policy
OAS	Organization of American States
O&M	Operations and Maintenance
OMB	Office of Management and Budget
ONA	Office of Net Assessment
OPEC	Organization of the Petroleum Exporting Countries
OPIC	Overseas Private Investment Corporation
OSD	Office of the Secretary of Defense
OSD/HO	Office of the Secretary of Defense/Historical Office
OSTP	Office of Science and Technology Policy (White House)
PACOM	Pacific Command

PA&E	Program Analysis and Evaluation
PCC	Panama Canal Commission
PCMC	President's Commission on Military Compensation
PD	Presidential Directive
PEO	Program Evaluation Office
PHM	Patrol Hydrofoil Missile
P.L.	Public Law
PNE	Peaceful Nuclear Explosions
POL	Petroleum, Oil, and Lubricants
POM	Program Objective Memorandum
POW	Prisoner of War
PPBS	Planning, Programming, and Budgeting System
PPGM	Planning and Program Guidance Memorandum
PR	Public Relations
PRC	People's Republic of China
PRC	Policy Review Committee
PRC-I	Policy Review Committee-Intelligence
PRM	Presidential Review Memorandum
R	Republican
RCS	Radar Cross Section
R&D	Research and Development
RDF	Rapid Deployment Force
RDJTF	Rapid Deployment Joint Task Force
RDT&E	Research, Development, and Test and Evaluation
REDCOM	Readiness Command (U.S.)
Rem	Roentgen Equivalent Man
RG	Record Group
RIF	Reductions in Force
RO/RO	Roll On/Roll Off (ship)
ROC	Republic of China
ROK	Republic of Korea
RPG	Rocket-Propelled Grenade
RV	Reentry Vehicle
S	U.S. Senate



SALT	Strategic Arms Limitation Talks
SAM	Surface-to-Air Missile
SCA	Senate Committee on Appropriations
SCAS	Senate Committee on Armed Services
SCC	Special Coordination Committee
SCC-I	Special Coordination Committee-Intelligence
SCFR	Senate Committee on Foreign Relations
SecDef	Secretary of Defense
SHAPE	Supreme Headquarters Allied Powers, Europe
SIOF	Single Integrated Operational Plan
SLBM	Submarine-Launched Ballistic Missile
SLCM	Sea-Launched Cruise Missile
SNDV	Strategic Nuclear Delivery Vehicles
SOSUS	Sound Surveillance System
SOUTHCOM	Southern Command
SRAM	Short-Range Attack Missile
SSBN	Ballistic Missile Submarine (Nuclear Powered)
START	Strategic Arms Reductions Talks
SWL	Strategic Weapons Launcher
STS	Space Transportation System
SWATH	Small Waterplane Area Twin Hull
TAC	Tactical Air Command
TALCM	Tomahawk Air-Launched Cruise Missile
Telcon	Telephone Conversation
TERCOM	Terrain Contour Matching
TF	Task Force
TFX	Tactical Fighter Experimental
TNF	Theater Nuclear Force
TOA	Total Obligational Authority
TOW	Tube-Launched Optically-Tracked Wire-Guided Missile System
USA	United States Army
USAF	United States Air Force
USD/P	Under Secretary of Defense for Policy
USD/R&E	Under Secretary of Defense for Research and Engineering

USAID	United States Agency for International Development
USIA	United States Information Agency
USMC	United States Marine Corps
USN	United States Navy
UTTAS	Utility Tactical Transport Aircraft System
VBB	Vance, Brown, Brzezinski
V/STOL	Vertical/Short Takeoff and Landing
VTOL	Vertical Takeoff and Landing
WAC	Women's Army Corps
WAF	Women in the Air Force
WAVES	Women Accepted for Volunteer Emergency Service
WH	White House
WHCF	White House Central Files
WHS	Washington Headquarters Services
WNRC	Washington National Records Center
WP	Warsaw Pact
WSAG	Washington Special Actions Group
ZBB	Zero-Based Budgeting

## NOTES

### 1. The Carter Administration Takes Charge

1. Randall Balmer, *Redeemer: The Life of Jimmy Carter* (New York: Basic Books, 2014), 51–74; Burton I. Kaufman, *The Presidency of James Earl Carter* (Lawrence: University of Kansas Press, 1993), 15; Jeffrey M. Jones, Gallup News Service, “Nurses Remain Atop Honesty and Ethics List,” <[www.gallop.com/poll/20254/nurses-remain-atop-honesty-ethics-list.aspx](http://www.gallop.com/poll/20254/nurses-remain-atop-honesty-ethics-list.aspx)>, accessed 5 Mar 2009.

2. Carter grew up in Archery, an unincorporated farming hamlet just outside the Plains town limits. Jimmy Carter, *An Hour Before Daylight: Memoirs of a Rural Boyhood* (New York: Simon & Schuster, 2001), 13–17.

3. Harold Brown, interview by Edward Keefer, Washington, DC, 1 Oct 2012, 1–3, Oral History Collection, OSD/HO; Harold Brown, with Joyce Winslow, *Star Spangled Security: Applying Lessons Learned Over Six Decades Safeguarding America* (Washington, DC: Brookings Institution Press, 2012), 5, 62, 243.

4. Jimmy Carter was proud of his intellectual accomplishments to the point where he would sometimes embellish them. For example, in his official biography, he added one point to his class ranking (making it 60 instead of 59) at the Naval Academy, and told columnist Jack Anderson (and later official DoD historians) that he was a finalist for a Rhodes scholarship for Georgia when his principal biographer insists that Carter did not even make it to the interview stage. Betty Glad, *Jimmy Carter: In Search of the Great White House* (New York: W. W. Norton & Co., 1980), 492–493; Jimmy Carter, interview by Alfred Goldberg and Maurice Matloff, Atlanta, GA, 12 Mar 1986, 4, Oral History Collection, OSD/HO; Bernard Weinraub, “The Browning of the Pentagon,” *New York Times Sunday Magazine*, 29 Jan 1978, 44.

5. Herbert F. York, *Making Weapons, Talking Peace: A Physicist’s Odyssey from Hiroshima to Geneva* (New York: Basic Books, 1987), 71–72. According to Edward Teller, the combination of H-bombs and Polaris-equipped submarines created the ultimate deterrent of the time: a solid fuel missile difficult to shoot down and placed on a submarine difficult to detect. “Fifty Years of Innovation through Nuclear Weapons Design,” *Science and Technology Review* (Jan/Feb 2002): 1–4, <<https://str.llnl.gov/str/JanFeb02/JanFeb50th.html>>, accessed 23 Feb 2009.

6. York, *Making Weapons, Talking Peace*, 205. York also recalls that Gilpatric and Brown were both directors of the Aerospace Corporation, where Brown impressed

Gilpatric, who also recommended Brown to McNamara. Herbert F. York, interview by Maurice Matloff, La Jolla, CA, 31 Dec 1984, 51–52, Oral History Collection, OSD/HO.

7. Roger Trask and Alfred Goldberg, *The Department of Defense, 1947–1997: Organization and Leaders* (Washington, DC: OSD Historical Office, 1997), 96.

8. Rickover's query became the title for Carter's presidential campaign memoir, *Why Not the Best?* published in 1975. During the 1976 presidential campaign, Carter claimed he became a nuclear engineer, but in fact he only audited two noncredit graduate courses at Union College. Still, he did have considerable on-the-job training and experience with nuclear reactors during his time in the Rickover program. Glad, *Jimmy Carter*, 58–68; Jimmy Carter, *Why Not the Best?* (Nashville, TN: Broadman Press, 1975), 41–60.

9. Carter, *Why Not the Best?* 60–61.

10. Glad, *Jimmy Carter*, 86–92, 99, 107.

11. Kaufman, *Presidency of James Earl Carter*, 8–11; Balmer, *Redeemer*, 28–32. Peter Pyhrr of Texas Instruments popularized zero-based budgeting in an article in the *Harvard Business Review*. In 1973 Carter contracted with Pyhrr to introduce it into the Georgia state budgets. Thomas D. Lynch, *Public Budgeting in America*, 3rd ed. (Englewood Cliffs, NJ: Prentice Hall, 1990), 51–52.

12. Kaufman, *Presidency of James Earl Carter*, 19–20. On the election, see Jules Witcover, *Marathon: The Pursuit of the Presidency, 1972–1976* (New York: Viking Press, 1977). Carter was the first southerner to win the presidency since Lyndon Johnson in 1964. The other 20th-century southerner was Woodrow Wilson, born in Virginia and raised in the Deep South, but more associated with New Jersey through his presidency of Princeton University and governorship of the Garden State.

13. The best appreciation of Carter religious convictions and how they shaped his presidency is Balmer, *Redeemer*.

14. Harold Brown, interview by Alfred Goldberg and Maurice Matloff, Washington, DC, 28 Feb 1992, 2, Oral History Collection, OSD/HO; Zbigniew Brzezinski, *Power and Principle: Memoirs of the National Security Adviser, 1977–1981* (New York: Farrar Straus Giroux, 1983), 5–7.

15. John Prados, *Keepers of the Keys: A History of the National Security Council from Truman to Bush* (New York: William Morrow, 1991), 384–385; Bourne quoted in Jack Nelson, "Caltech's Brown Reported Picked as Defense Chief," *Los Angeles Times*, 11 Dec 1978, A1.

16. Carter quoted in Hamilton Jordan, *Crisis: The Last Year of the Carter Presidency* (New York: G. P. Putnam's Sons, 1982), 45.

17. Brown with Winslow, *Star Spangled Security*, 85–98

18. *Ibid.*, 128, 182.

19. Brian J. Auten, *Carter's Conversion: The Hardening of American Defense Policy* (Columbia: University of Missouri Press, 2008), 90–97.

20. *Foreign Relations of the United States [FRUS], 1977–1980*, vol. 6, *Soviet Union*, ed. Melissa Jane Taylor (Washington, DC: GPO, 2013), 18–20 (doc 60), 29–32 (doc 10), 32–34 (doc 11), 38 (doc 12).

21. Brown interview, 28 Feb 1992, 2:2; Nicholas Thompson, *The Hawk and the Dove: Paul Nitze, George Kennan, and the History of the Cold War* (New York: Picador, 2009), 252–253.

22. UPI “Carter Ends Two Days of Interviews for Cabinet Jobs,” *Los Angeles Times*, 8 Dec 1976, A2; Nelson, “Caltech’s Brown Reported Picked as Defense Chief,” cited note 15.

23. Jimmy Carter, *Keeping Faith: Memoirs of a President* (New York: Bantam Books, 1982), 55; Harold Brown, interview by Alfred Goldberg and Ronald Landa, Washington, DC, 4 Mar 1994, Oral History Collection, OSD/HO, 8; Brown interview, 28 Feb 1992, 4.

24. Brown as quoted in Charles Mohr, “Carter Bids Cabinet Fulfill Pledges, But Doubts Rise on Defense Cut,” *New York Times*, 28 Dec 1976, in OSD Historical Office, comp., *Public Statements of Harold Brown, Secretary of Defense, 1977*, 1:12; memo for correspondents, 28 Dec 1976, box 65, Biographical Files, OSD/HO; Harold Brown and John Stennis, interview by Bruce Morton, CBS Morning News, 30 Dec 1976, *Brown Public Statements 1977*, 1:19.

25. Carter, *Keeping Faith*, 55; Charles Duncan, interview by Alfred Goldberg and Roger Trask, Houston, TX, 17 May 1996, 4, Oral History Collection, OSD/HO.

26. According to Carter, Schlesinger wanted to be secretary of state, and failing that, secretary of defense. Carter interview, 12 Mar 1986, 11. Kenneth H. Bacon, “Carter Picks Physicist Harold Brown, Arms Control Advocate, to Run Pentagon,” *Wall Street Journal*, 22 Dec 1976, 2; Richard Dudman, “Harold Brown Is Known as Weapons Specialist,” *St. Louis Post Dispatch*, 22 Dec 1976, 3B.

27. Editorial quoted in Anthony Lewis, “The Cold Warriors,” *New York Times*, 16 Dec 1976, 47.

28. Rowland Evans and Robert Novak, “Reviewing Dr. Brown’s Record,” *Washington Post*, 15 Dec 1976, 15. Ironically, one critical liberal, who could not forgive Brown’s support of increased bombing of North Vietnam during his tenure as secretary of the Air Force, characterized him as a “reliable organization man,” who displayed “mindless acceptance of the universe beyond his well-equipped laboratory.” Roger Morris, “Harold Brown: Competence Isn’t Enough,” *Washington Star*, 9 Jan 1977, 3D.

29. Brown interview, 28 Feb 1992, 5; Senate Committee on Armed Services (SCAS), *Nominations of Harold Brown and Charles W. Duncan, Jr.: Hearing*, 95th Cong., 1st sess., 11 Jan 1977, 7–8.

30. *Ibid.*, 8, 12, 14, 34.

31. *Ibid.*, 10–11, 15–16, 23, 25.

32. *Ibid.*, 48–49, 55–56. Carter had tried to dodge the B–1 bomber issue during the presidential campaign, but he finally submitted a white paper to the Democratic platform drafting committee opposing it. Nick Kotz, *Wild Blue Yonder: Money, Politics, and the B–1 Bomber* (New York: Pantheon Books, 1988), 144, 152. The discussion on personnel costs was, of course, about the All-Volunteer Force. According to Rumsfeld, from FY 1964 to FY 1976 total defense personnel costs rose from 47.6 percent to 60.4 percent of the Defense budget. In FY 1977 they dropped slightly to 58 percent. Donald H. Rumsfeld,

“The All Volunteer Force,” *The Journal of the Institute for Social Economic Studies* 2, no. 2 (Spring 1977): 9–10.

33. UPI, “Brown Passes 1st Hurdle in Senate,” *Los Angeles Times*, 14 Jan 1977, 6.

34. Brown quoted in Charles A. Stevenson, *SECDEF: The Nearly Impossible Job of Secretary of Defense* (Washington, DC: Potomac Books, 2006), 31; Richard A. Stubbing, with Richard A. Mendel, *The Defense Game: An Insider Explores the Astonishing Realities of America’s Defense Establishment* (New York: Harper & Row, 1986), 338; Walter S. Poole, *Adapting to Flexible Response, 1960–1968*, vol. 2 of History of Acquisitions in the Department of Defense series (Washington, DC: OSD Historical Office, 2013), 350–355. For background on the B–70, see Lawrence S. Kaplan, Ronald D. Landa, and Edward J. Drea, *The McNamara Ascendancy, 1961–1965* (Washington DC: OSD Historical Office, 2006), 59–60.

35. Brown interview, 28 Feb 1992, 14–15.

36. Lee Lescaze and George C. Wilson, “Brown: Experiences, Brilliant, Arrogant, Hawkish—and Dovish,” *Washington Post*, 22 Dec 1976, 4; Harold Brown, interview by Walter S. Poole and Walton S. Moody, Washington, DC, 28 Jan 2004, 14–15, U.S. Army Center for Military History.

37. Harold Brown, interview by Morgan of USIA, 8 Apr 1977, 1–2, box 65, Subject Files, OSD/HO; Weinraub, “Browning of the Pentagon,” 49.

38. Quoted in Weinraub, “Browning of the Pentagon,” 29 Jan 1978, 61; John Kester, interview by Alfred Goldberg and Roger Trask, Washington, DC, 14 Apr 1998, 35, Oral History Collection, OSD/HO; Walter Slocombe, interview by Edward Keefer, Washington, DC, 7 Feb 2013, 3–4, Oral History Collection, OSD/HO; Colin L. Powell, with Joseph E. Persico, *My American Journey* (New York: Random House, 1995), 237. Brown felt the sting of Powell’s criticism, noting “That’s not how I felt, but that was his impression.” Brown with Winslow, *Star Spangled Security*, 67.

39. Brown with Winslow, *Star Spangled Security*, 67–68.

40. Harold Brown, interview by Alfred Goldberg and Roger Trask, Washington, DC, 4 Dec 1981, 3, Oral History Collection, OSD/HO; Jim Taylor, “Harold Brown: Fourteenth Secretary of Defense,” *Armed Forces Magazine*, Feb 1977, 32–33. Brown confirmed the story, but noted, “She made too much of it.” Brown interview, 1 Oct 2012, 3.

41. Note, Chairman of the Joint Chiefs of Staff (CJSC) Jones to Brown, 15 Sep 1979, folder 020 SD, box 7, SecDef Files, Acc 330-82-0204.

42. Author’s conversation with Brown, 17 Sep 2013; Kester interview, 14 Apr 1998, 37.

43. Brown interview, 4 Dec 1981, 2; Weinraub, “The Browning of the Pentagon,” 14; John Kester, “Taking Aim at Rumsfeld,” *Washington Ways*, *Washingtonian Magazine*, Feb 2005, 37.

44. *Public Papers of the Presidents: Jimmy Carter, 1977* (Washington, DC: GPO, 1977), 1:368–369; memo, Brown for Carter, 14 Feb 1977, folder FG 13, 1/20/77–4/30/77, Subject Files, box FG-106, White House Central Files (WHCF): Executive, Jimmy Carter Presidential Library and Museum, Atlanta, GA [hereafter Carter Library]; William J. Perry, *My Journey at the Nuclear Brink*, Stanford Security Studies Imprint (Stanford, CA: Stanford

University Press, 2015), 28–29; Robert W. Komer, interview by Alfred Goldberg, Roger Trask, and Stuart Rochester, Washington, DC, 25 Mar 1981, 28, Oral History Collection, OSD/HO. Komer was prescient in 1981; in 1992 President Bill Clinton chose Perry to be secretary of defense.

45. Perry, *My Journey*, 31. Perry figures he lost about \$1 million on the deal.

46. *Carter Public Papers 1977*, 1:247.

47. *Ibid.*, 151; Brown interview, 28 Feb 1992; Powell, *My American Journey*, 238.

48. DoD News Release No. 132-77, 30 Mar 1977, *Brown Public Statements 1977*, 8:2902; Brown interview, 28 Feb 1992, 5; Powell, *My American Journey*, 236–237.

49. *Carter Public Papers 1977*, 1:549–550; Alexander F. Remington, *Washington Post* Obituaries: Russell Murray II, 30 Jan 2009, B7; Brown interview, 4 Mar 1994, 14.

50. *Carter Public Papers 1977*, 1:246–47.

51. *Ibid.*, 90–91; Brown interview, 28 Feb 1992, 7–8, 17.

52. *Carter Public Papers 1977*, 1:65–66.

53. *Brown Public Statements 1977*, 4:1558–1559; Air Force Link, Biographies, John C. Stetson, <[www.af.mil/bios/bio\\_print.asp?bioID+7256&page=1](http://www.af.mil/bios/bio_print.asp?bioID+7256&page=1)>, accessed 6 Mar 2009; Hans M. Mark, <[www.af.mil/bios.asp?bioID=6299](http://www.af.mil/bios.asp?bioID=6299)>, accessed 30 Mar 2009. The “oil and water” characterization comes from Hans Mark, interview by Alfred Goldberg and Ronald Landa, Washington, DC, 4 Aug 1999, 30, Oral History Collection, OSD/HO.

54. Andrew Krepinevich and Barry Watts, *The Last Warrior: Andrew Marshall and the Shaping of Modern American Defense Strategy* (New York: Basic Books, 2015), 1–119.

55. *Brown Public Statements 1977*, 8:2886–2887, 2925; Brown interview, 4 Mar 1994, 14–15; Kester interview, 14 Apr 1998, 31; Powell, *My American Journey*, 235–236.

56. Brown interview, 28 Feb 1992, 24; David S. McLellan, *Cyrus Vance, American Secretaries of State and Their Diplomacy* series (Totowa, NJ: Rowman & Littlefield, 1985), 1–3, 9; Marilyn Berger, “Cyrus R. Vance, a Confidant of Presidents, Is Dead at 84,” *New York Times*, 13 Jan 2002, <<http://query.nytimes.com/gst/fullpage.html?res+940E0DBI-1738F930A24752C0A9649C8B>>, accessed 6 Mar 2009; OSD Historical Office, comp., *Department of Defense Key Officials: 1947–1992* (Washington, DC: 1992), 13, 22; Carter, *Keeping Faith*, 50.

57. Zbigniew Brzezinski, interview by Marie Allen, 20 Feb 1981, 1–2, Exit Interview Project, Carter Library, <[www.jimmycarterlibrary.gov/library/exitInt/exitBrzsk.pdf](http://www.jimmycarterlibrary.gov/library/exitInt/exitBrzsk.pdf)>, accessed 31 Mar 2009. Prados, *Keeper of the Keys*, 381–383; Steven F. Szabo, “The Professor” in *Zbig: The Strategy and Statecraft of Zbigniew Brzezinski*, ed. Charles Gati (Baltimore, MD: The Johns Hopkins University Press, 2013), 208–209. Gati’s collection of essays and reminiscences is the closest thing yet to a separate biographical and intellectual study of Brzezinski comparable to Jeremy Suri’s *Henry and the American Century* (Cambridge, MA: Harvard University Press, 2007). There is an extensive biographical section on Brzezinski’s early years in Wikipedia, <[http://en.wikipedia.org/wkwi/Zbigniew\\_Brzezinski](http://en.wikipedia.org/wkwi/Zbigniew_Brzezinski)>, accessed 9 Mar 2009.

58. As Brzezinski told an interviewer, “I always wanted the job . . . for a very simple reason. It was a more important job.” Brzezinski interview, 20 Feb 1981, 4; Brzezinski, *Power and Principle*, 11; Carter, *Keeping Faith*, 51–53. Although the smallest of the Cabinet agencies, State was often characterized by presidents as a sprawling bureaucracy dominated by highly qualified but maverick professionals intent on promoting their own personal foreign policies.

59. Brzezinski, *Power and Principle*, 44–47; “prickly” quote from Zbigniew Brzezinski, interview by Alfred Goldberg and Maurice Matloff, Washington, DC, 6 Oct 1986, 10, Oral History Collection, OSD/HO. DCI Stansfield Turner shared one of Brzezinski’s criticisms: While crediting Brown with “one of the most incisive minds” he had ever encountered and the ability to dissect problems and come to conclusions at “terrifying” speed, Turner noted that “Harold would interrupt. Anticipating what the speaker was about to conclude, he would offer his opinion before the speaker actually had made his case.” Admiral Stansfield Turner, *Burn Before Reading: Presidents, CIA Directors, and Secret Intelligence* (New York: Hyperion, 2005), 161.

60. Brown interview, 4 Mar 1998, 15–16; Brown with Winslow, *Star Spangled Banner*, 42.

61. Brzezinski, *Power and Principle*, 57–60; Brzezinski is often cited as the source for the “Lone Ranger” characterization, but he insisted that it was George Ball. Brzezinski interview, 6 Oct 1986, 3.

62. Brzezinski, *Power and Principle*, 61–62; PD 1, “Establishment of Presidential Review and Directive Series/NSC”; PD 2, “The National Security Council System,” both dated 20 Jan 1977, Presidential Directives and Presidential Review Memoranda, Carter Library, <[www.jimmycarterlibrary.gov/documets/pddirectives/pd01.pdf](http://www.jimmycarterlibrary.gov/documets/pddirectives/pd01.pdf) and [pd02.pdf](http://www.jimmycarterlibrary.gov/documets/pddirectives/pd02.pdf)>, accessed 8 Mar 2009.

63. Vance claimed that he “opposed this arrangement from the beginning.” He also recalled that he tried to convince Carter to allow the PRC or SCC members to review the PDs or decision memoranda before they were issued, but the president stated such an arrangement that would ensure leaks. He offered that any PRC or SCC member could come to the White House to review the PD or action memorandum prior to its issuance. Given the time demands on department heads, Vance found this mechanism to be impractical. Cyrus Vance, *Hard Choices: Critical Years in America’s Foreign Policy* (New York: Simon & Schuster, 1983), 37. Brown quoted in Brzezinski, *Power and Principle*, 66.

## 2. The FY 1978 Defense Budget and the B–1 Bomber Decision

1. Memo, Brown for Carter, 26 Jan 1977, folder 110.01 (Jan) 1977, box 18, SecDef Files, Acc 330-80-0017, WNRC; John Dillin, “Soviet power may bar Pentagon cut,” *Christian Science Monitor*, 10 Feb 1977, 1.

2. Stubbing with Mendel, *Defense Game*, 343–344. A 15-year defense analyst at OMB, Stubbing helped prepare the briefing materials and attended the meeting. Presidential Daily Diary, 31 Jan 1977, Carter Library. Attachment D, list of participants, Presidential Daily Diary, folder 1/20/77–1/31/77, Backup Material, box PD 1, Carter Library.



3. Memo for Record, NSC Meeting of 27 Jan 1977 by Quetsch, 1 Feb 1977, 0000CEC0.pdf. CD-2, Declassified SecDef Files, WNRC.

4. Rumsfeld had his congressional staff count the amount of time that DoD officials spent testifying in calendar year 1976 before congressional committees: 1,425 hours before 75 committees or subcommittees. Not all the testimony was on the budget. Donald H. Rumsfeld, *Annual Defense Department Report, Fiscal Year 1978* (Washington, DC: GPO, 17 Jan 1977), 6.

5. Lawrence J. Korb, “The Price of Preparedness: The FY 1978–1982 Defense Program,” *AEI Defense Review* 3 (Jun 1997): 2. The quote is from the classic study by former DoD official Alan C. Entoven and Wayne K. Smith, *How Much Is Enough: Shaping the Defense Program, 1961–1969* (Santa Monica, CA: RAND Corporation, 1971).

6. Raymond L. Garthoff, *Détente and Confrontation: American-Soviet Relations from Nixon to Reagan*, rev. ed. (Washington, DC: Brookings Institution, 1994), 607–608; Stubbing with Mendel, *Defense Game*, 12–13. Former CIA Deputy Director Ray S. Cline called Team B a “kangaroo court of outside critics all picked from one point of view,” quoted in Stubbing with Mendel, *Defense Game*, 12.

7. Garthoff, *Détente and Confrontation*, 594–596, 604. The new committee was named after the first “Committee on the Present Danger” formed in 1950 to promote and encourage a defense buildup against the Soviet Union.

8. *Public Papers of the Presidents: Gerald R. Ford, 1976* (Washington DC: GPO, 1979), 3:2939 (quotes).

9. Ford cleaned house in October 1975 by dropping among others Secretary of Defense James Schlesinger, whose insistence on defense spending caused friction with Congress. He tapped Rumsfeld as Schlesinger’s successor; Stevenson, *SECDEF*, 159–162.

10. Rumsfeld, *Annual Defense Department Report, FY 1978*, Executive Summary, 3.

11. Statement by Rumsfeld before a press conference, 18 Jan 1977, OSD Historical Office, comp., *Public Statements of Donald Rumsfeld, Secretary of Defense, 1975–1977*, 9:3859 (quote).

12. Stubbing with Mendel, *Defense Game*, 341 (quote).

13. Korb, “Price of Preparedness,” 9–15. Critics pointed out that given these compatibility raises, military personnel should not be given free food, clothing, housing or housing allowances, medical care, and retirement at half pay after 20 years. But Congress resisted any cuts to military benefits. Louis Kraar, “Why Defense Costs are Headed Up,” An Agenda for the New Administration, A Series of Eight Articles Reprinted from *Fortune*, Apr 1977, 41.

14. Rumsfeld, *Annual Defense Department Report, FY 1978*, B-3, C-13, C-14.

15. News Release No. 17-77, 17 Jan 1977, Table 11, *Rumsfeld Public Statements 1975–1977*, 9:3440. In FY 1978 DoD had 104 different weapon systems in production and 31 in research and development. The variety of weapons in production was large: 29 separate aircraft, 29 different missiles, 15 types of ships, 10 different combat vehicles, and 21

miscellaneous programs like communication satellites and torpedoes. Korb, “Price of Preparedness,” 11–12.

16. Rumsfeld, *Annual Defense Department Report, FY 1978*, 190.

17. Korb, “Price of Preparedness,” 12–14; General George S. Brown, *United States Military Posture for FY 1978*, 20 Jan 1977, 12, 71, 81–84.

18. Korb, “Price of Preparedness,” 16; Rumsfeld, *Annual Defense Department Report, FY 1978*, 268–271, 268 (chart VI-I).

19. “What Defense Chiefs Told Carter: Pentagon’s Inside Size-Up of U.S. Military Power,” *U.S. News & World Report*, 17 Jan 1977, 11–13.

20. Briefing of the President by the JCS, scheduled for 13 Jun 1977, folder 020JCS 1977, box 1, SecDef Files, Acc 330-80-0016, WNRC; memo, Brown for Carter, 14 Jan 1977, 0000D4B2.pdf, CD-2, Declassified SecDef Files.

21. Glen Asner, “A Brief History of the Defense Budget Process” (MS), 22 Feb 2005, 31–32; “The Department of Defense and the Budget Process” (MS) (no author indicated), Oct 1985, 17–19; both in OSD/HO; Auten, *Carter’s Conversion*, 127.

22. Memos, Brown for Alexander, Claytor, Stetson et al., 21 Jan 1977; Lance to Brown, 21 Jan 1977: both in folder 100.01 (Jan) 1977, SecDef Files, Acc 330-80-0017.

23. House Committee on Armed Services (HCAS), *Fiscal Year 1978 Authorization for Military Procurement, Research and Development, and Active Duty, Selected Reserve and Civilian Personnel Strengths: Hearings*, 95th Cong., 1st sess., 25 Jan 1977, 360, 365, 490; Senate Subcommittee on Appropriations, *Department of Defense Appropriations for Fiscal Year 1978: Hearings*, 95th Cong., 1st sess., 31 Jan and 1 Feb 1977, 24–29, 178–217.

24. SCAS, *Fiscal Year 1978 Authorization for Military Procurement, Research and Development, and Active Duty, Selected Reserve and Civilian Personnel Strengths: Hearings*, 95th Cong., 1st sess., 24 Feb 1977, 645.

25. Memo, Brown for Carter, 26 Jan 1977, cited in note 1; memo, Brzezinski for Utgoff, 26 Jan 1977 (quote), folder Budget, FY 78 Budget Revisions: 2/77, box 9, Subject File, Brzezinski Material, National Security Affairs, Carter Library.

26. Memos, Brown for Carter, 18 Feb 1977; Brzezinski for Brown, 21 Feb 1977, w/Carter approval: both in folder Budget, FY78 Budget Revisions, 2/77, box 9, Subject File, Brzezinski Material, National Security Affairs, Carter Library.

27. Korb, *Price of Preparedness*, 25–29.

28. News Release No. 72-77, “FY 1978 Amended Department of Defense Budget,” 22 Feb 1977, *Brown Public Statements 1977*, 3:1037–1041.

29. *Ibid.*

30. Message from Ford to Congress, 17 Jan 1977, enclosed in Subcommittee on Defense, House Committee on Appropriations (HCA), *Second Budget Rescission Bill for Fiscal Year 1977: Hearings*, 95th Cong., 1st sess., Feb 1977, 2–27; Brown testimony, *ibid.*, 34–36.

31. *Ibid.*, 42, 71, 76–77, 82.

32. *Congressional Quarterly* [CQ] *Almanac*, 1977, vol. 33 (Washington, DC: Congressional Quarterly, [1977]), 397–398; David Binder, “House Rebuffs Navy on Nuclear Carrier, Supporting Carter,” *New York Times*, 4 Mar 1977, A1.

33. Memo, Brown for Carter, 25 Feb 1977 (quotes), 0000B3F3.pdf., CD-1, Declassified SecDef Files.

34. SCAS, *Fiscal Year 1978 Authorization . . . : Hearings*, 24 Feb 1977, 593, 607–609. The cost for remaining 325 F–15 would rise from \$1.2 million to \$1.28 million per aircraft.

35. *Ibid.*, 610–612, 616–617 (quote); George G. Wilson, “Pentagon Cutbacks Face Hill Test This Week,” *Washington Post*, 1 Mar 1977, A2.

36. SCAS, *Fiscal Year 1978 Authorization . . . : Hearings*, 24 Feb 1977, 623, 632–634 (quote); Auten, *Carter’s Conversion*, 133.

37. SCAS, *Fiscal Year 1978 Authorization . . . : Hearings*, 24 Feb 1977, 642–643 (quotes).

38. *Ibid.*, 645 (quote).

39. Memo, Brown for Carter, 25 Feb 1977 (quote), 0000B3F3.pdf., CD-1, Declassified SecDef Files.

40. Asner, “Brief History of Defense Budget Process,” 31–33.

41. *CQ Almanac 1977*, 33:192–193.

42. “Administration Blamed for Budget Flap,” *Los Angeles Times*, 28 Apr 1977, A1 (quotes); “Mr. Carter vs. Congress,” *Chicago Tribune*, 4 May 1977, B2; memos, Duncan for Carter, 25 Mar 1977 (quote), 0000B3F7.pdf; Brown to Carter, 29 Apr 1977 (quote), 0000B3F9.pdf: both in CD-1, Declassified SecDef Files. Brown’s 26 April letter to Burluson is attached to memo, Stempler for Moore, 29 Apr 1977, folder 032 LA Reports, box 8, SecDef Files, Acc 330-80-0017.

43. *CQ Almanac 1977*, 193–198. Defense spending was little changed from the first nonbinding resolution, with the exception of revisions made by both House and Senate Budget Committees to reflect Carter’s cancellation of the B–1 bomber, *ibid.*, 200.

44. *Ibid.*, 332–235.

45. *Ibid.*, 334.

46. *Ibid.*; memo, Carter for Brown, 16 Feb 1978, folder 1978 ELF (thru 1980), box 61, Brown Papers, Library of Congress (LC).

47. *CQ Almanac 1977*, 337–338.

48. *Ibid.*, 338–339. Secretary of the Navy Graham Clayton and his staff came up with an alternative to Seafarer, using only 130 miles of buried antennae and two existing sites in Michigan and Wisconsin to produce a good, extremely low-frequency, short-message service for submarines in the Atlantic, Pacific, and Mediterranean. The new proposal would require only 14 miles of new right of way in Michigan and would allow submarines to receive messages while moving at high speed and at low depth, thus reducing detectability. Memo, Brown for Carter, 3 Jun 1977, 0000B3FD.pdf, CD-1, Declassified SecDef Files.

49. George Wilson, “Pentagon Will Confront More Critical Congress as Old Warhorses Quit,” *Washington Post*, 5 Nov 1976; memo, Brown for Carter, 13 May 1977 (quote), 0000B3FB.pdf, CD- 1, Declassified SecDef Files.

50. *CQ Almanac 1977*, 340–341.

51. *Ibid.*, 341–342; *Carter Public Papers 1977*, 2:1439.

52. *CQ Almanac 1977*, 264, 267–269; memo, Brown for Carter, 24 Jun 1977 (quote), CD-1, 0000B3FF.pdf, Declassified SecDef Files, WNRC.

53. *CQ Almanac 1977*, 269–273.

54. *Ibid.*, 274–275

55. *Ibid.*, 275–276; *Carter Public Papers 1977*, 2:1651.

56. Kaplan, Landa, and Drea, *McNamara Ascendancy*, 59–60, 115–116; Robert J. Art and Stephen E. Ockenden, “The Domestic Politics of Cruise Missile Development, 1970–1980,” in Richard K. Betts, ed., *Cruise Missiles: Technology, Strategy, Politics* (Washington, DC: Brookings Institution, 1981), 363–364

57. Art and Ockenden, “Domestic Politics of Cruise Missile Development,” 364–365, cited in note 56; Nick Kotz, *Wild Blue Yonder: Money, Politics, and the B–1 Bomber* (New York: Pantheon Books, 1988), 113–114. Kotz’s book, based on extensive interviews, newspaper research, available official documents, and congressional testimony, is an excellent and useful account. “Controversy over the B–1 Bomber Program,” *Congressional Digest* 55, no. 12 (Dec 1976): 293–295. The *Digest* presents a side-by-side pro- and anti-debate on the B–1, along with background information on the issue based on congressional testimony of April and May 1976, speeches, and submissions to the Democratic platform committee.

58. Kotz, *Wild Blue Yonder*, 140–145; Nicholas Wade, “Battle of the B–1 Bomber,” *Washington Post*, 31 Jul 1977, A21.

59. Ltr, Brown to Culver, 20 May 1976 (quotes), folder B–1 Bomber, box 26, Brown Papers, LC; Kotz, *Wild Blue Yonder*, 152, 156–157 (quote); Wade, “Battle of the B–1 Bomber,” A21. Opponents of the B–1 bomber believed that the Joint Strategic Bomber Study (JSBS) was so loaded in favor of the B–1 that they dubbed it the “Joint Strategic BS.” Kotz, *Wild Blue Yonder*, 161.

60. Kotz, *Wild Blue Yonder*, 157.

61. Proxmire’s quote from remarks delivered on the Senate Floor, 19 May 1976; Goldwater’s quote from remarks on the Senate Floor, 11 May 1976, and McGovern’s quote from remarks on the Senate Floor, 1 Apr 1976: all reproduced in “Controversy over the B–1 Bomber Program,” 297, 300, 309.

62. Kotz, *Wild Blue Yonder*, 160 (quote), based on an interview with Doc Watson of Rockwell; General David C. Jones, interview by Alfred Goldberg and Maurice Matloff, Arlington, VA, 26 Aug 1987, 20 (quote), Oral History Collection, OSD/HO.

63. Draft Study, “Modernization of the Strategic Bomber Force,” 29 Apr 1977, folder 452 B–1 (May–20 Jun) 1977, box 52, SecDef Files, Acc 330-80-0017; Kotz, *Wild Blue Yonder*, 161–162. The Soviet Union was developing a “look down, shoot down” interceptor system

that could track and shoot down from a higher altitude low flying aircraft irrespective of ground clutter. George Brown, *U.S. Military Posture for FY 1978*, 27.

64. Study, “Modernization of the Strategic Bomber Force,” 16 May 1977, folder 452 B-1 (May–20 June) 1977, box 52, SecDef Files, Acc 330-80-0017; Kotz, *Wild Blue Yonder*, 163; Art and Ockenden, “The Domestic Politics of Cruise Missile Development,” in Betts, ed., *Cruise Missiles*, 373–374.

65. Kotz, *Wild Blue Yonder*, 162–163, based on interviews with Hillary and Anderson of Rockwell.

66. *Ibid.*, 163.

67. Memos, Selin for Brown, 12 May 1977, folder 452 B-1 (May–20 Jun) 197, box 52; York for Brown, 26 Apr 1977, folder 452 B-1 (Jan-Apr) 1977, box 53: both in SecDef Files, Acc 330-80-0017; Kotz, *Wild Blue Yonder*, 164, based on interview with Selin.

68. Betts, *Cruise Missiles and U.S. Policy*, 4; Art and Ockenden, “Domestic Politics of Cruise Missile Development,” *ibid.*, 362–373.

69. The quote from Goldwater on the floor of the Senate, 11 May 1976, is reproduced in “Controversy over the B-1 Bomber Proram,” 296, cited in note 57.

70. Memo, McGiffert for Brown, 31 May 1977 (quotes), 0000D00C.pdf, CD-2, Declassified SecDef Files.

71. Memo, Utgoff for Brzezinski, 31 May 1977, folder B-1, 6/1–10/77, box 6, Subject File, Brzezinski Materials, National Security Affairs, Carter Library; Kotz, *Wild Blue Yonder*, 164–165 (quote); Kotz’s account of Aaron’s pressure on Utgoff is based on interviews with White House officials.

72. Carter, *Keeping Faith*, 81 (quote).

73. Memo, Moore for Carter, 9 Jun 1977, folder ND 1, 5/1/77–6/30/77, Subject File, box ND-1, WHCF: Executive, Carter Library; Kotz, *Wild Blue Yonder*, 166–167 (quote).

74. Memo, Moore for Carter, 9 Jun 1977 (quotes), cited in note 73; Carter’s Daily Diary, 14, 15, 21 Jun 1977, Carter Library 1977; Kotz, *Wild Blue Yonder*, 167.

75. Brown interviews, 4 Dec 1981, 17–18 (quote); 28 Jan 2004, 16–17 (quote).

76. Memo, Brzezinski for Carter, undated (quote), folder B-1, 6/1–10/77, box 6, Subject File, Brzezinski Materials, National Security Affairs, Carter Library; Kotz, *Wild Blue Yonder*, 167–168; Hendrick Smith, “Problems of a Problem Solver,” *New York Times, Sunday Magazine*, 8 Jan 1978, 8.

77. Kotz, *Wild Blue Yonder*, 169–170. Quote by Mondale based on Kotz’ interview with him. Stubbing with Mendel, *Defense Game*, 348.

78. Kotz, *Wild Blue Yonder*, 170, is based on Eizenstat’s diary notes for 27 June.

79. Carter interview, 12 Mar 1986, 26–27 (quotes), OSD/HO; Carter, *Keeping Faith*, 82 (quote).

80. *Carter Public Papers 1977*, 2:1197 (quotes). Brown held a press conference the next day and stressed that he still believed in manned bombers, but that proven cruise missile

technology on B–52 or other platforms was the better choice at the better price. Brown’s 1 July press conference transcript is in *Brown Public Statements 1977*, 5:1856–1857.

81. Kotz, *Wild Blue Yonder*, 171–173 (quotes). White House reactions are based on Kotz’ interviews with Mondale, Eizenstat, Jody Powell, and Hamilton Jordan; memo, Brown for Carter, 8 Jul 1977 (quote), CK3100074557, Declassified Documents Reference System (DDRS).

82. Memo, Brown for Carter, 8 Jul 1977 (quote), CK3100074557, DDRS.

83. Kotz, *Wild Blue Yonder*, 175–177.

84. *CQ Almanac 1977*, 276.

85. Brown Press Conference, 4 Oct 1977, 6–7, *Brown Public Statements 1977*, 8:2717; Norman Kempster, “Pentagon Stalling on B–1,” *Los Angeles Times*, 5 Oct 1977, A1.

86. Flynt quoted in Associated Press, “House Delays as Backers Try to Revive B–1,” *Los Angeles Times*, 6 Oct 1977, A1; Kotz, *Wild Blue Yonder*, 178.

87. Brown interviews, 4 Mar 1994, 11 (quote); 28 Jan 2004, 16–17 (quote); Graham Claytor, interview by Alfred Goldberg and Roger Trask, Washington, DC, 8 Jan 1981, 26 (quote), Oral History Collection, OSD/HO.

88. Harold Brown, interview by Edward Keefer, 1 Oct 2012, *ibid.*

89. Brzezinski, *Power and Principle*, 45–46 (quote).

### 3. Latin America

1. Three overviews of U.S. relations with Latin America, all critical of the U.S. role, are Robert A. Pastor, *Exiting the Whirlpool: U.S. Foreign Policy Toward Latin America and the Caribbean*, 2nd ed. (Boulder, CO: Westview Press, 2001); Stephen G. Rabe, *The Killing Zone: The United States Wages the Cold War in Latin America* (New York: Oxford University Press, 2011); and Walter LaFeber, *Inevitable Revolutions: The United States in Central America*, 2nd ed. (New York: W.W. Norton, 1993).

2. The Canal Zone comprised 647 square miles including tidal waters, extended generally for five miles on either side of the canal, and had an estimated American population of 37,500. The Canal Company employed 13,139 persons (27% Americans and the rest Panamanians). From 1951 to 1973, the canal met its operating costs but was forced to raise its tolls thereafter, the first increase since 1916. Memo, Watson and Frank for the Cabinet, providing background material on the Panama Canal Treaties, 25 Aug 1977, 0000CB30.pdf, CD-2, Declassified SecDef Files, WNRC. The return of the canal and zone has been studied extensively; see J. Michael Hogan, *The Panama Canal in American Politics: Domestic Advocacy and the Evolution of Policy* (Carbondale: Southern Illinois University Press, 1986); Walter LaFeber, *The Panama Canal: The Crisis in Historical Perspective*, rev. ed. (New York: Oxford University Press, 1989); and George D. Moffet III, *The Limits of Victory: The Ratification of the Panama Canal Treaties* (Ithaca: Cornell University Press, 1985). Two detailed memoirs are William J. Jordan, *Panama Odyssey* (Austin: University of Texas Press, 1984) and Sol M. Linowitz, *The Making of a Public Man: A Memoir* (Boston: Little Brown, 1985).

3. Carter, *Keeping Faith*, 155–156; PRM 1, “Panama,” 21 Jan 1977, PD01536, Digital National Security Archive (DNSA), <nsarchive.gwu.edu>; memo, Brzezinski for Vance, Brown et al., 27 Jan 1977, folder Panama 821 (Mar–15 Jul) 1977, box 78, SecDef Files, Acc 330-80-0017, WNRC. Even before taking office, designated Carter administration officials including Brown met and decided on the terms for a review of Panama policy. Memo, Brzezinski for Brown, Vance et al., 12 Jan 1977, CK3100581459, DDRS.

4. Memo, Davis for Vance, Brown et al., 26 Jan 1977, w/attached response to PRM 1, “Policy Review Memorandum: Panama,” PD01537, DNSA; memo, Jordan for Acting Director Inter-American Affairs, 12 Jul 1977, folder Panama Canal Treaty: Documents on Negotiations and Implementation, 1976–1980, Panama Canal Documents, 1976–1980, box 426, Subject Files, OSD/HO. While technically 510 of the 523 warships of the Navy could transit the canal, the 13 carriers required multiple escorts and could not go around South America without them; thus, the figures were misleading.

5. Memo, Brown for Carter, 29 Aug 1977, folder Panama 821 (27 Sep–10 Nov) 1977, box 77, SecDef Files, Acc 330-80-0017.

6. Memo, Davis for Vance, Brown et al., 26 Jan 1977, cited in note 4.

7. *Ibid.*, Tab 4, 15 Jan 1977 (quote).

8. Jorden, *Panama Odyssey*, 343–344; Memo of Record of PRC Meeting, 27 Jan 1977 (quotes), folder Panama 381 (Jan–Feb) 1979, box 78, Acc 330-80-0017; memo, Dolvin for Pastor, 31 Jan 1977, 3100104729, DDRS; memo, Brzezinski for Vance, Brown et al., 27 Jan 1977 (quotes), cited in note 3.

9. Joint Chiefs of Staff Memorandum (JCSM) 223-77 for SecDef, 20 May 1977, folder Panama Canal Treaty: Documents on Negotiation and Implementation, 1976–1980, Panama Canal Documents, 1977–1980, box 427, Subject Files, OSD/HO.

10. Carter, *Keeping Faith*, 157; Vance, *Hard Choices*, 146.

11. The U.S. military had been present in the isthmus since 1903. In 1917 the Panama Canal Department was activated as a geographic command of the Army. In 1941 it became the Caribbean Defense Command, and in 1963 was redesignated as SOUTHCOM. The smallest unified command, SOUTHCOM was responsible for the defense of the canal and zone as well as military relations with the rest of Central and South America, where it had 17 small military advisory teams. The bulk of SOUTHCOM’s forces were in the zone—7,500 Army, 2,500 Air Force, and under 1,000 Navy personnel, plus their 17,000 dependents. Fact Sheet, United States Southern Command, 15 Sep 1977, Briefing Book for Carter Visit to Panama, 16–17 Jun 1978, folder Panama Canal Treaty: Documents on Implementation, 1977–1978, President’s Trip, 16–17 Jun 1978, box 418, Subject Files, OSD/HO; General McAuliffe, interview in *Army Times*, 16 May 1977, 71.

12. Jorden, *Panama Odyssey*, 376–380; Background on Land and Waters Issue, n.d. [22 Jul 1977?], folder Panama Canal Treaty: Documents on Negotiations, 1975–1977, PRC Meeting Briefing Book, 22 Jul 1977, box 424, Subject Files, OSD/HO; Mary Russell, “House Reverses Itself, Votes To Implement Canal Treaties,” *Washington Post*, 27 Sep 1979, A2.

13. Linowitz, *Making of a Public Man*, 164–165 (quote); Carter, *Keeping Faith*, 158; Betty Glad, *An Outsider in the White House: Jimmy Carter, His Advisors, and the Making of American Foreign Policy* (Ithaca: Cornell University Press, 2009), 92.

14. The story of the ratification fight has been told in great detail. The most focused on ratification are Moffett, *Limits of Victory*, and Hogan, *The Canal in American Politics*; Jordan, *Panama Odyssey*, devotes chapters 17–19 to it.

15. Carter, *Keeping Faith*, 152 (quote). Both Carter and Vance devote chapters to the negotiation and ratification of the canal treaties; see *Keeping Faith*, 152–185; Vance, *Hard Choices*, 140–147. Brzezinski, who played a smaller role in the drama, treated the entire episode in summary fashion; see Brzezinski, *Power and Principle*, 134–139.

16. Carter, *Keeping Faith*, 162; Glad, *An Outsider in the White House*, 97. For a Department of State, Bureau of Public Affairs strategy for supporting the treaties, see memo, Schuker for Aragon, 17 Jun 1977, CK 3100009347, DDRS. Reports to the president on DoD official public speaking in support of the treaties are in memos, Brown for Carter, 26 Aug 1977, 0000CB30.pdf, CD-1; 19 Sep 1977, 0000B403.pdf, CD-2: both in Declassified SecDef Files; memo, Brown for Carter 23 Aug 1977, folder 020 DoD, May–Dec 1977, box 5, SecDef Files, Acc 330-80-0017.

17. Statement by H. Brown, Senate Committee on Foreign Relations (SCFR), *Panama Canal Treaties: Hearings*, 27 Sep 1977, 96–107 (quotes).

18. For Brown's help and the "uniforms" quote, see, Carter, *Keeping Faith*, 155, 162. Moorer, as quoted by AP, "Canal pact held to open door to Reds," *Baltimore Sun*, 29 Sep 1977, 1. The 100,000 figure was revised downward in summer 1977 to 36,000 troops, in good part because the best Cuban troops (the most likely invaders) were in Africa. A SOUTHCOM force of 9,500 troops could be quickly reinforced from the United States. The canal could be defended. Steven L. Rearden, with Kenneth R. Foulkes Jr., *The Joint Chiefs of Staff and National Policy, 1977–1980*, History of the Joint Chiefs of Staff series (Washington, DC: Office of Joint History, Office of the CJCS, 2015), 119.

19. Glad, *Outsider in the White House*, 95–96.

20. Perceived wisdom among much of the traditional media, most Carter administration officials, and Senate treaty supporters in 1978 was that while the public initially overwhelmingly opposed return of the canal (77% to 15%, with 8% undecided, according to an antitreaty-sponsored poll conducted by Opinion Research Corporation in May 1977), the Carter administration's PR campaign reversed public opinion to the point where it garnered a majority of public support (some claims were for a 2 to 1 majority). In his extensive chapter 4, "Panama and Public Opinion," Moffett challenges this misperception, claiming that before, throughout, and well after the ratification process, a majority opposed return and that opposition" remained almost completely static. Despite one of the most extensive public relations efforts undertaken on any foreign-policy issue in American history, public attitudes never budged." Moffett, *Limits of Victory*, 116.

21. Memo, Brown for Carter, 10 Mar 1978, 0000B437.pdf, CD-1, Declassified SecDef Files.



22. Biographical profile of Torrijos, undated, Briefing Book for Carter Visit to Panama, 16–17 Jun 1978, folder Panama Canal Treaty: Documents on Implementation, 1977–1980, President’s Trip, 16–17 Jun 1978, box 418, Subject Files, OSD/HO; Carter, *Keeping Faith*, 167.

23. Info memo, 14 Oct 1977, CK3100128039, DDRS. Both Carter and Brzezinski saw this unattributed intelligence memorandum.

24. Linowitz, *Making of a Public Man*, 199–203. The text of the treaties and related documents are in Department of State, *American Foreign Policy: Basic Documents, 1977–1980* (Washington, DC: GPO, 1983), 1384–1403, 1412–1421.

25. Memo, McIntyre for Carter, 27 Jul 1978, folder Panama Canal Treaty: Documents on Implementation, 1977–1981, DoD Original Treaty Implementation, box 416, Subject Files, OSD/HO.

26. Jimmy Carter, interview by Charles O. Jones et al., 29 Nov 1982, 22 (quote), Presidential Projects, Jimmy Carter, Presidential Oral History, Academic Programs, Miller Center, <[http://webstorage3.mcpa.virginia.edu/poh/transcripts/ohp\\_1982\\_1129\\_carter.pdf](http://webstorage3.mcpa.virginia.edu/poh/transcripts/ohp_1982_1129_carter.pdf)>, accessed 31 Mar 2009.

27. Carter, *Keeping Faith*, 182; Talking Paper for McGiffert for use in congressional hearings on Legislation to Implement the Panama Canal Treaty, n.d. [Mar 1979]; Fact Sheet, Implementing Legislation—Major Issues, 8 Feb 1979: both in folder Panama Canal Treaty: Documents on 1978 Presidential Trip, Congressional Hearings, McGiffert Briefing Book, Hearing HFAC, 3/79, box 426, Subject Files, OSD/HO; Carter interview, 29 Nov 1822.

28. Fact Sheet, Canal Treaty Implementing Legislation, 27 Mar 1979, folder Panama Canal Treaty: Documents on 1978 Presidential Trip, Congressional Hearings, McGiffert Briefing Book, Hearing HFAC [House Foreign Affairs Committee], 3/79, box 426, Subject Files, OSD/HO; memo, McIntyre for Carter, 27 Jul 1978, cited in note 25.

29. Memo, Brown for Carter, 27 Jul 1979, 0000B421.pdf, CD-1, Declassified SecDef Files.

30. Mary Russell, “House Turns Down Bill to Implement Canal Treaty,” *Washington Post*, 21 Sep 1979, A1; “Hill Conferees Swiftly Reach Compromise on Canal,” 25 Sep 1979, 3; A. O. Sulzberger Jr., “House Enacts Bill to Carry Out Terms of Panama Canal Treaty,” 27 Sep 1979, *New York Times*, A1. Congress insisted that retirement costs of canal employees (\$205 million) be paid for from canal tolls, lowering the cost of the total net cap for implementation of the treaty from \$870.7 million to \$665.7 million. Memo, Dolvin for Wacker, 17 Oct 1979, folder Panama Canal Treaty: Documents on Negotiations and Implementation, 1976–1980, Panama Canal Treaty Documents, 1977, 1980, box 427, Subject Files, OSD/HO.

31. Glad, *Outsider in the White House*, 105–106.

32. The definitive official account of the Panama operation is Lawrence A. Yates, *The U.S. Intervention in Panama: Operation Just Cause, December 1989–January 1990* (Washington, DC: U.S. Army Center for Military History, 2014).

33. PRM 17, “Review of U.S. Policy Toward Latin America,” 26 Jan 1977, PD01553, DNSA.

34. Talking Paper for Duncan, 23 Mar 1977, folder Panama Canal Treaty: Documents on Negotiations, 1973–1980, Panama Canal Documents, 1973–1980, box 425, Subject Files, OSD/HO.

35. *Congressional Quarterly Almanac*, 1976, vol. 32 (Washington, DC: Congressional Quarterly, 1977), 213–233.

36. Summary of Conclusions and Minutes of PRC Meeting, 24 Mar 1977, CK31000156243 and CK3100146753 (quote): both in DDRS. Earlier, in March, the Department of State undertook an analysis that concluded that cancellation of U.S. military sales credits to human rights offenders in Latin American would not greatly impact U.S. sales, because during 1975–1976 the United States provided only one-seventh of the \$2.3 billion sold to Western Hemisphere countries. Memo, Brzezinski for Carter, 18 Mar 1977, CK3100687330, DDRS.

37. *Carter Public Papers 1977*, 1:611–617.

38. JCSM 305 for SecDef, 20 Jul 1977, folder L, 1977, box 71, SecDef Files, Acc 330-80-0017.

39. JCSM 41-77 for SecDef, 16 Dec 1977, *ibid.*; JCSM 168-78 for SecDef, 16 May 1978, folder L, 1978, box 59, Acc 330-81-0202; memo, Komer for Brown, 31 Jul 1980, folder L, 1980, box 11, Acc 330-82-0217, WNRC.

40. Memo, Pastor for Brzezinski, 14 Mar 1977 (quote), CK3100151607, DDRS.

41. Minutes of PRC Meeting, 24 Mar 1977 (quote), cited in note 36.

42. Memos, McGiffert for Brown, 4 Mar 1978; Brown for Carter, 9 Mar 1978 (quote): both in folder B, 1978, box 54, SecDef Files, Acc 330-81-0202.

43. Brzezinski, *Power and Principle*, 128 (quote).

44. Memo, McGiffert for Brown, 25 Apr 1978; ltr, Brown to Vance, 25 Apr 1978 (quote): both in folder B, 1978, box 54, SecDef Files, Acc 330-81-0202.

45. Ltr, Vance to Brown, 9 Jun 1978, *ibid.*

46. Ltr, Sayre to Brown, 23 Apr 1980, folder B, 1980, box 4, SecDef Files, Acc 330-82-0217; memo, Komer for Brown, 17 Oct 1980, 0000D3AD.pdf, CD-2, Declassified SecDef Files; memo, Komer for Claytor, 24 Nov 1980 (quote), folder B, 1980, box 4, SecDef Files, Acc 330-82-0217.

47. P.L. 95-92, 91 Stat. 619–620 (4 Aug 1977).

48. Ltr, Brown to Vance, 17 Mar 1979 (quote); memo, McGiffert for Brown, 15 Mar 1979: both in folder Argentina, 1978, box 52, SecDef Files, Acc 330-81-0202.

49. Ltr, Vance to Brown, 1 May 1978; memo, McGiffert for Brown, 5 May 1978; ltr, Brown to Vance, 9 May 1978; ltr, Vance to Brown, 3 Jun 1978: all *ibid.*

50. The government of Argentina still admitted to holding 3,400 state-of-siege prisoners, and arrests detentions continued. While it released 275 political prisoners in the first six months of 1978, it imprisoned 297 in the same period. Memo, Brzezinski for Carter, 13 Jul 1978 (quote), CK3100117377, DDRS.

51. Memo, McGiffert for Brown, 13 Jul 1978 (quotes), folder Argentina, 1978, box 52, SecDef Files, Acc 330-81-0202.

52. Ltr, Brown to Vance, 17 Jul 1978, w/attached ltr, Agousti to Jones 28 Jun 1978, 0000D0BA.pdf, CD-2, Declassified SecDef Files; ltr, Vance to Brown, 18 Aug 1978, folder Argentina, 1978, box 52, SecDef Files, Acc 330-81-0202.

53. Ltr, Brown to Vance, 22 Aug 1978, folder Argentina, 1978, box 52, SecDef Files, Acc 330-81-0202.

54. This decision provoked a difference of opinion within the NSC staff over Argentine policy. Pastor saw U.S. overall policy toward Argentina—especially the military relationship—as “disastrous . . . dribbling out decisions rather than agreeing to a strategy.” NSC human rights specialist Jessica Tuchman Matthews disagreed, suggesting that she had no idea what an “overall ‘strategy’” would be, and whenever the United States attempted to broker a deal by offering a quid pro quo for better human rights, the Argentines invariably balked in spite of promises. Memos, Pastor for Brzezinski and Aaron, 25 Sep 1978, CK3100116851; Matthews for Brzezinski, 25 Sep 1978, CK3100116853: both in DDRS.

55. Talking Paper for Brown and Jones for 14 May 1978 PRC Meeting, folder Argentina, 1980, box 2, SecDef Files, Acc 330-82-0217; memo, Christopher for Carter, 19 Jun 1980, CK3100135823, DDRS.

56. Brzezinski provided the following figures: “disappearances’ dropped from the thousands to 500 in 1978, 44 in 1979, and even lower in 1980.” At Carter’s request, President Videla released opposition newspaper publisher Jacob Timmerman. Brzezinski, *Power and Principle*, 128–129.

57. Summary of Conclusions at PRC Meeting, 14 May 1980 (quote); folder PRC 141, Argentina, 5/14/80, box 80, NSC Institutional Files, 1977–1981, Carter Library; memo, Bowdler for Kramer et al., 19 May 1980, CK3100680919, DDRS.

58. Memo, Muskie for Carter, 18 Oct 1980, folder Mtgs Muskie, Brown, Brzezinski [MBB], 10/80–1/81, box 34, Subject File, Brzezinski Donated Material, Carter Library.

59. Memo, Claytor for Carter, 27 Oct 1980 (quotes), *ibid*.

60. Memos, Thornton for Brzezinski, 28 Oct 1980; 18 Nov 1980; Brzezinski for Aaron and Denend, 19 Nov 1980: all *ibid*. Viola delayed his trip until March 1981 so as to meet with President Reagan. Department of State, Office of the Historian, Visits by Foreign Leaders of Argentina, <<http://history.state.gov/departmenthistory/visits/argentina>>, accessed 16 Aug 2011.

61. Ltr, Brown to Vance, 9 Oct 1979 (quote); memo, Brown for Carter, 24 Oct 1979 (quote): both in folder C, 1979, box 7, SecDef Files, Acc 330-82-0205.

62. Memo, Brzezinski for Vance, 27 Nov 1979, CK3100496688, DDRS.

63. For Brzezinski’s view of human rights and Chile, see Brzezinski, *Power and Principle*, 128–129. Pastor, the NSC’s Latin America staff director, epitomized the human rights position by noting “it would be a terrible embarrassment to the President if we proceeded with ‘business as usual’” after condemning Chile for the “heinous crime of international terrorism [Letelier assassination].” Memo, Pastor for Brzezinski, 20 Feb 1980, folder Mtgs

Vance, Brown, Brzezinski [VBB], 1/80–2/80, box 34, Subject File, Brzezinski Donated Material, Carter Library.

64. Memo, Komer for Brown, 22 Feb 1980 [Conf.], folder C, 1980, box 4, Acc 330-82-0217; memos, Thornton for Brzezinski, 13 Feb 1980; 19 Feb 1980: both in folder Mtgs VBB, 1/80–2/80, box 34, Subject File, Brzezinski Donated Material, Carter library.

65. Memo, Pastor for Brzezinski, 20 Feb 1980 (quote), cited in note 63.

66. Memo, Pastor for Brzezinski, 10 Jun 1980 (quotes), folder Mtgs MBB, 5/80–6/80, box 34, Subject File, Brzezinski Donated Material, Carter Library. Nevertheless, Hidalgo made the trip to Mexico, Panama, Argentina, Brazil, and Venezuela in late June and early July. He reported that the Argentine military “implore” understanding of their “tragic ‘civil war’ on terrorism” and suggested that this was an “auspicious opportunity for rapprochement.” Memo for Record by Hidalgo, 10 Jul 1980, folder 333 (Jan-Aug) 1980, box 31, SecDef Files, Acc 330-82-0216.

67. Memo, Pastor for Brzezinski, 10 Jun 1980, folder Mtgs MBB, 10/80–1/81, box 34, Subject File, Brzezinski Donated Material, Carter Library; msg 308888464, State to Embassy Santiago, 20 Mar 1980, CK3100494997, DDRS.

68. Brown with Winslow, *Star Spangled Security*, 182.

69. Memo, Pastor for Brzezinski, 8 Mar 1977, CK3100510787, DDRS; PD 6, “Cuba,” 15 Mar 1977, PRO01346, DNSA; memo, Brzezinski for Mondale, Vance, Brown et al., 18 Aug 1977, CK3100106759, DDRS.

70. For a firsthand account of these negotiations, see Wayne S. Smith, *The Closest of Enemies: A Personal and Diplomatic Account of U.S.-Cuban Relations Since 1957* (New York: W. W. Norton, 1987), 101–127. Smith was the State Department’s director of Cuban affairs and then the head of the U.S. interests section in Havana after 1979.

71. Evening Notes for Aaron, 8, Sep 1978, CK3100693106; memos, Bowdler for Vance, 15 Sep 1978; CIA Acting National Intelligence Officer for Pastor, 10 Nov 1978: all in DDRS. The MiG–23 D and F models could not be distinguished by U.S. reconnaissance cameras, but the presence of nuclear weapons left a telltale radiation trail that U.S. equipment could detect. Smith, *Closest of Enemies*, 163–164.

72. Originally an AP dispatch, “Soviet Mig 23s Seen In Cuba,” *Washington Post*, 31 Oct 1978, A16, the story gained traction when columnists Evans and Novak—arch opponents of SALT II—picked up the story in two of their *Post* columns on 15 November and 8 December 1978: “Cuba’s Mig23s,” A19, and “Those Cuban MIGS,” A19. In the first they quoted from Brown’s memorandum. Their slant was that the Soviets could not be trusted and the Carter administration was sweeping the MiG–23 issue under the rug. The *Washington Post* came to the administration’s rescue with an editorial suggesting that the leak of Brown’s memo to Carter of 23 October was specifically designed to impede the prospects for ratification of SALT II. “A New ‘Cuban Missile Crisis?’” *Washington Post*, 17 Nov 1978, A18.

73. Brzezinski, *Power and Principle*, 346 (quote).

74. Vance, *Hard Choices*, 132–133; Garthoff, *Détente and Confrontation*, 682; *Carter Public Papers 1978*, 2:2100–2101

75. Memos, Huntington for Brzezinski, 22 Nov 1978, CK3100133057; Brzezinski for Carter, NSC Weekly Report 98, 25 May 1979, CK3100470056: both in DDRS. Brzezinski noted that in 1970, after the flap over Soviet submarines at Cienfuegos, the Soviets agreed to keep their submarines from calling at Cuban ports “in an operational capacity.”

76. Memo, Brown for Brzezinski, 14 May 1979, 0000D51C.pdf, CD-2, Declassified SecDef Files.

77. Memo, Brown for Brzezinski, w/attached ISA background paper, 22 Jun 1979, folder Cuba (Jan-Aug) 1979, box 9, SecDef Files, Acc 330-82-0205.

78. Memo, Odom for Brzezinski, Jun 1979, folder Mtgs Brzezinski, Brown, Vance [BBV], 4–8/79, box 32, Subject File, Brzezinski Material, National Security Affairs, Carter Library.

79. Memo, Brzezinski for Carter, NSC Weekly Report 98, 25 May 1979, cited in note 75

80. Memos, Brown for Brzezinski, 1 Aug 1979; Brzezinski for Brown, 10 Aug 1979; Brzezinski for Vance, 5 Sep 1979: all in folder Cuba (Sep) 1979, box 8, SecDef Files, Acc 330-82-0205.

81. Memo, Owen for Carter, w/attached memo, Vance for Carter, both 29 Aug 1979, CK3100044600; White Paper on Presence of Soviet Troops in Cuba, 28 Sep 1979, CK3100079157: all in DDRS.

82. CIA Report, 3 Sep 1979, “Reports on Soviet Ground Forces Combat Brigade in Cuba,” CK3100688069; General Report, 14 Sep 1979, CK3100688079: both in DDRS.

83. Garthoff, *Détente and Confrontation*, 913. Garthoff allots a chapter to the Soviet Brigade incident, 913–934. David D. Newsom, *The Soviet Brigade in Cuba: A Study in Political Diplomacy* (Bloomington: Indiana University Press, 1987) provides a case-study of it.

84. Memo, Owen for Carter, w/attached memo, Vance for Carter, both 29 Aug 1979; White Paper, 28 Sep 1979, cited in note 81.

85. For Carter’s speech on the brigade and SALT II, see *Carter Public Papers*, 2:1802–1806. DCI Turner later blamed the National Security Agency for trying to get credit for the “scoop” of the brigade and not allowing other intelligence components to analyze it. Stansfield Turner, “The stupidity of ‘intelligence’ (the real story behind that Soviet combat brigade in Cuba),” *Washington Monthly*, 1 Feb 1986, reprinted at <www.thefreelibrary.com>, accessed 8 Sep 2011.

86. The other five proposals were intelligence sharing; combating Cuba in the non-aligned movement; preventing Cuba from obtaining a temporary seat on the UN Security Council or hosting a UN Conference on Trade and Development Summit; sending a clear signal to the USSR of U.S. concern about Cuban activities in the Caribbean and Central America; and using Cuban-American and U.S. cultural tours and Hollywood films to influence Cuban society. Memo, Vance, Brown, Brzezinski for Carter, n.d. [24 Sep 1979], folder Cuba (Sep) 1979, box 8, SecDef Files, Acc 330-82-0205; PD 52, “U.S. Policy to Cuba,” 16 Oct 1979, PD01401, DNSA.

87. Memo, Brown for Brzezinski, 30 Oct 1979, folder Cuba (Oct-Dec) 1979, box 8, SecDef Files, Acc 330-82-0205. Guantanamo had been on permanent lease to the United

States since 1903, and under the agreement confirmed in 1934, the United States had a legal right to stay as long as it wanted. The Castro regime waged a propaganda campaign opposing the U.S. presence at Guantanamo, claiming the agreement was imposed by force on Cuba in 1903. In September 1979, 357 marines, nearly 2,000 sailors, and 20 Coast Guard and Air Force service members served there, as well as over 3,500 dependents and civilian personnel who lived on the base. In the discussion on countering Cuban influence, the question of reinforcing Guantanamo arose. OSD calculated it would take four days to airlift four infantry battalions (5,000 marines) and, if required, an Army airborne brigade (3,000 troops). USAF fighter aircraft could deploy in three days to bases in southern Florida. The reinforcement would cost \$5 million to transport the troops and redeploy the aircraft; to billet them permanently in Guantanamo and South Florida would cost \$30 million annually. Reinforcement exercises provided a cheaper alternative and would convey the same message to Cuba and the Soviet Union. Memo, Brzezinski for Carter, 27 Sep 1979, CK3100490616, DDRS.

88. Memos, Murphy for Brown, 19 Jan 1980; Brown to Brzezinski, 2 Feb 1980: both in folder Caribbean, 1980, box 5, SecDef Files, Acc 330-82-0217.

89. Memo, Brzezinski for Brown, 12 Feb 1980; OSD Paper reacting to the Brzezinski memo, n.d.: both *ibid*; memo, Pastor for Brzezinski, 11 Jun 1979, CK3100515036, DDRS.

90. Memo, Brown for Carter, 14 Feb 1980], folder Cuba (Jan-May) 1980, box 6, SecDef Files, Acc 330-82-0217.

91. Carter, *Keeping Faith*, 533–534.

92. Memo, Spiro for Palmieri, 30 Jul 1980, folder Cuba (Jul) 1980, box 6, SecDef Files, Acc 330-82-0217.

93. Memo, Carter for Brown, 6 Jun 1980, w/attached memo of understanding, 4 Jun 1980: both *ibid*.

94. Memo, Brzezinski for Mondale, Vance, Brown et al., 2 Jul 1980 (quote), *ibid*.

95. Memo, Brown for Brzezinski, 11 Jul 1980, *ibid*.

96. Memo, Brzezinski for Brown, 2 Jul 1980, *ibid*.

97. Memo, Brzezinski for Carter, 7 Aug 1980, CK3100092170, DDRS. The “undesirable” Cuban refugee population included approximately 1,700 identified confessed criminals housed in federal correction institutions, 1,500 “confirmed mental cases,” 1,500 refugees with serious chronic medical problems, and 2,000 teenagers “categorized as uncontrollable.” Memo of Record of Mini SCC Meeting, 20 Aug 1980, folder Cuba (Aug) 1980, box 6, SecDef Files, Acc 330-82-0217. The JCS presented five options: (1) clandestine return via sealift in a larger ship accompanied by Navy SEALs who would escape with the Coast Guard crew in small boats after leaving the ship in Cuban waters; (2) a smaller, multiple vessel clandestine sealift along the same model but with fewer U.S. personnel; (3) small-scale clandestine insertion by a single C-130 aircraft; (4) large-scale clandestine insertion by air (18 C-130 aircraft would land in Cuba under cover of darkness); and (5) overt return of criminals by unarmed U.S. vessel, with a Coast Guard crew, after prior notice to Cuba. Memo, Brown for Brzezinski, 1 Aug 1980, w/attached CM 6676-80 for SecDef, 11 Jul 1980, *ibid*.

98. Memos, Brzezinski for Carter, 27 Aug 1980, CK31005511486, DDRS; Claytor for Brown, n.d. [28 Aug 1980], folder Cuba (Sep-Dec) 1980, box 6, SecDef Files, Acc 330-82-0217; Dodson for Mondale, Vance, Brown et al., 3 Sep 1980, w/attached Summary of Conclusions of SCC Meeting, 28 Aug 1980, *ibid.*

99. Memo of Record of Mini SCC Meeting, 20 Aug 1980, cited in note 97; memo, Dodson for Brown et al., 3 Sep 1980, w/attached Summary of Conclusions, folder Cuba (Sep-Dec) 1980, box 6, SecDef Files, Acc 330-82-0217.

100. Memo, Pustay for Aaron, 12 Sep 1980, folder Cuba (Sep-Dec) 1980, box 6, SecDef Files, Acc 330-82-0017.

101. Memo, Aaron for Vance, Brown, and Goldschmidt, 1 Oct 1980, *ibid.*; Smith, *Closest of Enemies*, 234

102. Memo, Moore for Palmieri, 19 Sep 1980, folder Cuba (Sep-Dec) 1980, box 6, SecDef Files, Acc 330-82-0017.

103. See Robert A. Pastor, *Condemned to Repetition: The United States and Nicaragua* (Princeton, NJ: Princeton University Press, 1987). The Sandinistas took their name from General Augusto César Sandino, a popular guerrilla leader and political figure executed in 1934 by Anastasio Somoza's father. For background on Anastasio Somoza, see Anthony Lake, *Somoza Falling* (Boston: Houghton Mifflin, 1989), 8–24.

104. Information Paper for Brown, 12 Sep 1978, folder Nicaragua, 1978, box 66, SecDef Files, Acc 330-81-0202; Pastor, *Condemned to Repetition*, 71–73.

105. Memcon of Mini SCC Meeting, 4 Sep 1978, CK3100129155, DDRS; memo, Resor for Duncan, 12 Sep 1978, folder Nicaragua, 1978, box 66, SecDef Files, Acc 330-81-0202; Summary of Conclusions of SCC Meeting, 12 Sep 1978, CK3100129162, DDRS.

106. Memo, McGiffert for Brown and Duncan, 30 Sep 1978, folder Nicaragua, 1978, box 66, SecDef Files, Acc 330-81-0202.

107. McAuliffe reported to Brown that while the Sandinistas received only limited support from Cuba, they used Costa Rica and Honduras as sanctuaries and received direct assistance from Panama and Venezuela. Unsigned ISA paper for Brown, n.d., w/attached analysis of McAuliffe's quarterly report to Brown and the report, 6 Oct 1978: all *ibid.*

108. Briefing Paper for Brown for 31 Oct 1978 PRC Meeting; memos, McGiffert for Brown, 1 Nov 1978; 14 Nov 1978; Dodson for Vance, Brown et al., 20 Nov 1978, w/attached Summary of Conclusions of PRC Meeting, 13 Nov 1978: all *ibid.*

109. Joint Talking Paper for Brown and Jones, n.d. [26 Dec 1978], *ibid.*; Anastasio Somoza, as told to David Cox, *Nicaragua Betrayed* (Boston: Western Islands, 1980), 328–329; Testimony by McAuliffe, 7 Jun 1979, House Committee on Merchant Marine and Fisheries, Subcommittee on Panama Canal, *Panama Gunrunning: Hearings*, 96th Cong., 1st sess., 1979, 172–174.

110. Memo, Dodson for Vance, Brown et al., 2 Feb 1979, w/attached action memo, Brzezinski for Vance, Brown et al., 1 Feb 1979; Summary of Conclusions of PRC Meeting, 16 Jan 1979: all in folder Nicaragua, 1978, box 66, SecDef Files, Acc 330-81-0202.

111. Talking Paper for SecDef and CJCS for 11 Jun 1979 PRC Meeting (quotes); memo, Tarnoff for Brzezinski, n.d., w/attached study of U.S. policies toward Central America, in response to PRM 46, “Review of U.S. Policy Toward Central America,” folder Central America (11 Jun 1979), box 7, SecDef Files, Acc 330-82-0205.

112. Minutes of PRC Meeting, 11 Jun 1979, CK3100554508, DDRS. The PRC instructed the JCS and DoD to “immediately explore contingency options for US policy based on the assumption that the centralized power in Nicaragua could disintegrate soon.” Summary of Conclusions of PRC Meeting, 11 Jun 1979, EL01325, DNSA. The JCS had hoped they might be asked to plan some sort of military intervention in Nicaragua—multilateral with the U.S. in the lead—but their planning was limited to evacuation of U.S. and third-country nationals.

113. Memos, Pastor for Brzezinski, 19 Jan 1979, CK3100634337; 21 Jun 1979, CK3100662730: both in DDRS; unattributed memo, 5 Oct 1979, folder NATO 471.61 (Jul-Dec) 1979, box 19; memo, Carlucci for Brown, 17 Aug 1979, folder Cuba (Jan-Aug) 1979, box 9: both in SecDef Files, Acc 330-82-0205.

114. Somoza with Cox, *Nicaragua Betrayed*, 238–239.

115. Pastor, *Condemned to Repetition*, 147–148; Jimmy Carter, *White House Diary* (New York: Farrar, Straus and Giroux, 2010), 333–334. No official accounts of these quasi-NSC breakfast meetings—similar to Lyndon Johnson’s Tuesday lunch meetings—have been found (beyond Brzezinski’s yet unreleased journal and a brief summary of the state of play in Carter’s diary), but Pastor’s account is based on Brzezinski’s journal, which Brzezinski read to him on 17 July 1985. Pastor then checked with Brown, Vance, and Carter, but none could remember what was discussed at the meeting. Pastor, *Condemned to Repetition*, 345.

116. Minutes of SCC Meeting, 25 Jun 1979 (quote), CK3100511433, DDRS.

117. Memos, McGiffert for Brown, n.d. [21 Jun 1979]; Brown for Carter, 25 Jun 1979 (quote): both in folder 337 WH (Aug-Dec), box 38, SecDef Files, Acc 330-82-0204.

118. Msg, DAO Managua to JCS/DIA, 152240Z Jul 1979, folder Jul 1979, SecDef Cables, OSD/HO. There was a postscript to the fall of Somoza. The United States continued diplomatic relations with the new Sandinista government and even convinced Congress to authorize \$75 million in economic aid to help offset Cuban influence in Managua. The aid could only be given if the administration certified that the Sandinistas were not harboring or providing assistance to terrorists or promoting violence in other countries (i.e., El Salvador). State argued there was no conclusive proof, but the CIA and DoD were not so sure. Ultimately Brown and Turner went along with the State and NSC position that certification was possible. Two memos, Pastor for Brzezinski, 3 Sep 1980, CK3100061945 and CK3100062369; memo, Brzezinski for Carter, 9 Sep 1980, CK3100084077: all in DDRS. In November 1980 U.S. intelligence picked up credible reports of a possible coup by moderate elements. The SCC discussed possible U.S. military contingencies, but the coup never happened. Minutes of SCC Meeting, 13 Nov 1980, CK3100106127, DDRS.

119. The first quote is from a strategy paper sent by Tarnoff for Brzezinski, 1 Aug 1979, EL01327, DNSA; the second is from McGiffert’s “Notes on El Salvador Problem,” 18 Oct 1979, folder El Salvador 1979, box 9, SecDef Files, Acc 330-82-0205.



120. Memo, Vance for Carter, 9 Jan 1979, CK3100498306, DDRS; memo, “Threats to Government Stability in El Salvador,” 30 Jul 1979, folder El Salvador 1979, box 9, SecDef Files, Acc 330-82-0205. U.S. intelligence predicted in early August 1979 that younger, reform-minded military would overthrow Romero. “El Salvador: Coup Plotting,” Aug 1979, ESO00005, DNSA.

121. Summary of Conclusions of PRC Meeting, 2 Aug 1979, CK31200561234, DDRS.

122. Memo, Vance for Carter, 26 Dec 1979, EL00648, DNSA.

123. Talking Paper for Brown, 28 Jan 1980, folder El Salvador 1980, box 7, SecDef Files, Acc 330-82-0217; Summary of Conclusion of SCC Meeting, 28 Jan 1980, CK3100480184; Minutes of SCC Meeting, 28 Jan 1980, CK3100480137: both in DDRS.

124. Agenda for SCC Meeting, 15 Feb 1980, ES00440, DNSA.

125. Memos, Brzezinski for Carter, 16 Feb 1980, w/Carter’s comments, CK3100697221, DDRS; Kramer for Brown, 13 Mar 1980, folder El Salvador 1980, box 7, SecDef Files, Acc 330-82-0217.

126. Memo, Pastor for Brzezinski, 13 Mar 1980 (quote), EL01356, DNSA.

127. DoD Issue Summary for 15 Mar 1980 SCC Meeting on El Salvador, folder El Salvador 1980, box 7, SecDef Files, Acc 330-82-0217.

128. Memo, Brown for Carter, 8 Oct 1980, folder Mtgs MBB, 10/80–1/81, box 34, Subject File, Brzezinski Donated Material, Carter Library; memo, “DCI’s Comments on DoD Memorandum of October 8, 1980, subj: Countering Insurgency in El Salvador,” 28 Oct 1980, CK31005145872, DDRS.

129. The assassination of six members of a legal leftist umbrella political group by an extreme rightist group preceded the murder of Americans by a week. At State’s and against DoD’s recommendations, Carter placed policy toward El Salvador under review. Memo, Kramer for Brown, 5 Dec 1980, 0000D3B0.pdf, CD-2, Declassified SecDef Files. The murder of the nuns and their companions tipped the balance for suspension. See Carter, *Keeping Faith*, 585–586.

130. Memos, Pastor for Aaron and Brzezinski, 11 Dec 1980, CK3100105907; Pastor for Brzezinski, 21 Dec 1980, w/attached Summary of Conclusions and Minutes of SCC Meeting, 11 Dec 1980, CK3100105910: both in DDRS; memo, Brzezinski for Brown and Muskie, 29 Dec 1980, folder El Salvador 1980, box 7, SecDef Files, Acc 330-82-0217.

131. Memo, Brown for Carter, 30 Dec 1980, folder El Salvador 1980, box 7, SecDef Files, Acc 330-82-0217.

132. Memos, Aaron for Carter, 12 Jan 1981, EL01365; Brown for Carter, 16 Jan 1980, 0000CB39.pdf: both in CD-2, Declassified SecDef Files; Carter for Muskie, 16 Jan 1981, EL01215, DNSA.

#### 4. Reorganization and Reassessment of the Department of Defense

1. Memo, Brown for Carter, 15 Feb 1977, folder Memos to President, box 91, Brown Papers, LC. Longtime DoD administration official “Doc” Cooke believed the “span of

control argument . . . is somewhat of a myth.” As he told Kester, in practice only 15 officials had regular access to the secretary and during the previous four years he doubted that the 13 Defense agency directors, who officially reported to the secretary, met with him more than a dozen times. Memo, Cooke for Kester, 17 Mar 1977, folder 020 DoD, Jan–Apr 1977, box 5, SecDef Files, Acc 330-80-0017, WNRC.

2. Kester interview, 15 Apr 1998, 21–22; Kester interview, 14 Apr 1998, 42; Brown interview, 28 Feb 1992, 13.

3. David Binder, “Consolidation of Pentagon Posts Reported Being Planned by Brown,” *New York Times*, 24 Jan 1977, 1. Formerly there were assistant secretary-level officials for telecommunications, command, and control; intelligence; manpower and reserve affairs; and logistics. There was an additional change: the assistant secretary for legislative affairs became a special assistant with the same responsibilities. Alice C. Cole, Alfred Goldberg, Samuel A. Tucker, Rudolph A. Winnaker, eds., *The Department of Defense: Documents on Establishment and Organization, 1944–1978* (Washington, DC: OSD Historical Office, 1978), 240.

4. Memos, Brown for Carter, 11 Feb 1977, 0000B3F2.pdf; 25 Feb 1977, 0000B3F3.pdf; 4 Mar 1977, 0000B3F4.pdf: all on CD-1, Declassified SecDef Files, WNRC.

5. Ltrs, Brown to O’Neill, Mondale, and Stennis: all dated 7 Apr 1977, box 610, Subject Files, OSD/HO.

6. HCAS, Subcommittee on Investigations, *Hearings on H.R. 6582*, 96th Cong., 1st sess., 23 May 1977, 12; Cole et al., *DoD Documents 1944–1978*, 259–260. The changes were embodied in P.L. 95-140, 91 Stat. 1172 (1977).

7. Brown broached with Carter the idea of appointing Paul Nitze under secretary of defense for policy, but the president was adamant that the hawkish Nitze was not going to serve in his administration. The problem, according to Brown, was that Nitze made a terrible impression on Carter during the meeting with defense experts in Plains in July 1976. Although they differed on policy, Brown and Nitze respected each other. Email exchange between author and Harold Brown, 21 Aug 2013; Thompson, *The Hawk and the Dove*, 252–254. Brown’s search for an outsider included civil rights lawyer Burke Marshall, former presidential counsel Harry McPherson, diplomat Thomas Enders, and former Acting Secretary of State Lawrence Eagleburger. Email exchange between author and Harold Brown, 24 Aug 2013; Bernard Weinraub, “Pentagon Club Closed Ranks to Shut Our Resor,” *New York Times*, 18 Mar 1978, E6; Brown interview, 4 Dec 1981, 22.

8. Brown statement for News Correspondents, 18 Jul 1977, *Brown Public Statements 1977*, 5:1885A; Bernard Weinraub, “Brown Reduces His Defense Staff, But Many Get Jobs in New Agency,” *Washington Post*, 10 Dec 1977, 14. Referring to the article, Brown wrote: “Doc Cooke is a fine fellow, but not an advocate of cuts in personnel—see today’s Weinraub article about how he has (as we knew) ‘stashed’ away the people cut from OSD.” Memo, Cooke for Duncan, 9 Dec 1977, w/Brown’s comment, folder 020 DoD (Oct-Dec) 1977, box 5, SecDef Files, Acc 330-80-0017. Mike Causey, “Puzzling Reorganization,” *Washington Post*, 7 Oct 1978, B2.

9. Turner, *Burn Before Reading*, 158–160.

10. PRM 11, “Intelligence Structure and Mission,” 22 Feb 1977, <[www.jimmycarter-library.gov/documentd.prmemorandums/prm11](http://www.jimmycarter-library.gov/documentd.prmemorandums/prm11)>, accessed 23 Jul 2013. In 1975 and 1976, the Senate Select Committee to Study Governmental Operations with Respect to Intelligence (commonly known as the Church Committee) published 14 reports and hearings on operations and abuses of U.S. intelligence agencies in response to the information revealed in the 1973–1974 Watergate scandal and other allegations by investigative journalists. The most notable committee reports were the Interim Report, *Alleged Assassination Plots Involving Foreign Leaders*, 94th Cong., 2nd sess., Report No. 91-465, 10 Nov 1975; and Final Report, *The Investigation of the Assassination of President John F. Kennedy: Performance of Intelligence Agencies*, Book V, Select Committee, 94th Cong., 2nd sess., 23 Apr 1976. The committee also published *The National Security Agency and Fourth Amendment Rights: Hearings*, 94th Cong., 1st sess., vol. 5, S. Res. 21, 29 Oct and 6 Nov 1975,

11. Talking Paper for Brown’s meeting with Carter, 2 Jun 1977, folder Intelligence, box 47, Brown Papers, LC; Carter Daily Diary, 2 Jun 1977, Carter Library.

12. Executive Summary of draft response to PRM 11, undated, folder Intelligence, box 47, Brown Papers, LC.

13. Notes on PRM 11 meeting, 15 Jun 1977, *ibid*.

14. Notes on SCC Meeting on PRM 11, 28 Jun 1977, *ibid*.

15. Ltr, Brown to Carter, 7 Jul 1977 (quotes), folder Secretary Brown Eyes Only, 1977–1978, box 22, Brown Papers, LC; memo, Brown for Carter, transmitting JCSM 297-11, 16 Jul 1977, 0000CA2A.pdf, CD-1, Declassified SecDef Files; ltr, Brown to Carter, 22 Jul 1977, folder Secretary Brown Eyes Only, box 22, Brown Papers, LC.

16. PD 17, “Reorganization of the Intelligence Community,” 4 Aug 1977, <[www.jimmycarterlibrary.gov/documents/pddirectives/pd17](http://www.jimmycarterlibrary.gov/documents/pddirectives/pd17)>, accessed 23 Jul 2013.

17. Note from Fubini to Brown, w/Brown’s comment (quote), 22 Aug 1977, folder 350.09 (Sep) 1977, box 41, SecDef Files, Acc. 330-80-0017.

18. Memos, Duncan for Brzezinski, 14 Nov 1977; Siemer and Murphy for Brown, 8 Dec 1977: both in folder 350.09 (Nov-Dec) 1977, box 41, SecDef Files, Acc 330-80-0017.

19. Memo, Duncan for Service Secretaries et al., folder 010 OSDF, 5 Jan 1978–May 1978, Records of Chairman of the Joint Chiefs of Staff (CJCS) General George Brown, Acc 218-92-0032, National Archives and Records Administration (NARA) II, College Park, MD.

20. Memo, Carter for Brown, 20 Sep 1977, w/Brown’s comments, folder 020 DoD, May–Sep 1977, box 5, SecDef Files, Acc 330-80-0017.

21. DoD News Release No. 529-77, 17 Nov 1977, box 559, Subject Files, OSD/HO. Two related studies impacted DoD but did not focus on it exclusively: *National Security Policy Integration* study, under former NSC staffer Phillip Odeen; and *Federal Preparedness and Response to Disasters* study, under the coordination of Greg Schneiders of the White House. The Odeen study, not completed until September 1979, called for greater

interagency cooperation on national security policy formulation and implementation in response to growing criticism that the Carter administration lacked coherence and was unable to translate the differing opinions of its principal national security officials into a unified national security and foreign policy. *National Security Policy Integration*, Sep 1979, 1–5, box 560, Subject Files, OSD/HO; Harold Brown, *Department of Defense Annual Report, FY 1980*, 310–311; *Presidential Reorganization Project, Department of Defense Reorganization Studies*, n.d., 21–22, box 560, Subject Files, OSD/HO.

22. Cover ltr, Ignatius to Brown, 1 Jun 1978 to *The Departmental Headquarters Study*, 1 Jun 1978, box 560, Subject Files, OSD/HO; Archie D. Barrett, *Reappraising Defense Organization: An Analysis Based on the Defense Organization Study of 1977–1980* (Washington, DC: National Defense University Press, 1983), 56–60. Including the secretary, deputy secretary, three service secretaries, and Joint Chiefs as statutory members, the AFPC was supposed to be the military equivalent of the NSC. Its informal membership ballooned to 40 people. As a result, its function became merely informational rather than advisory. Information Paper, “Armed Forces Policy Council,” 19 Jul 2010, Subject Files, OSD/HO.

23. Steadman, *Report to the Secretary of Defense on the National Military Command Structure*, 3, 52–53, box 560, Subject Files, OSD/HO.

24. *Ibid.*, 64–65, 69–77; Barrett, *Reappraising Defense Organization*, 48–56.

25. Rearden with Foulkes, *JCS and National Policy 1977–1980*, 14–15.

26. *Ibid.*, 2.

27. Donald B. Rice, *Defense Resource Management Study: Final Report* (Washington, DC: GPO, 1979), 6–9, 24, 33–34; Barrett, *Reappraising Defense Organization*, 61–66.

28. Rice, *Defense Resource Management Study*, 27, 32, 34–37. For the origins, establishment, and working of the PPBS, see Kaplan, Landa, Drea, *McNamara Ascendancy*, 72–95.

29. Rice, *Defense Resource Management Study*, 94, 112.

30. *Ibid.*, 61–64, 75–77.

31. Memo, Szanton for Beckel and Schneiders, 29 Mar 1979, folder FG 13, 1/1/79–3/31/79, box FG-107, Subject File, WHCF: Executive, Carter Library. OMB Director McIntyre characterized the Steadman report as a “substantial contribution,” in improving professional military advice, but thought the Ignatius report “less promising” in that its recommendations were unlikely to reduce layering at OSD and tended to blur distinctions between the service secretaries and OSD. Memo, McIntyre for Carter, 2 Aug 1978, folder FG 13, 10/16/78–12/31/78, box FG-107, Subject File, WHCF: Executive, Carter Library.

32. Memo, Brown for Carter, 7 Jul 1978, 0000B443.pdf, CD-1, Declassified SecDef Files; memo, Brown for Military Secretaries et al., 7 Apr 1979, folder 100.5, 1979, box 10, SecDef Files, Acc 330-82-0204; Goldberg and Trask, *DoD 1947–1997*, 38–44.

## 5. Defining National Security Policy

1. For the OSD role in preparation of NSC 68 (as well as NSC 20/4 Paper of 1948), see Steven L. Rearden, *The Formative Years, 1947–1950* (Washington, DC: OSD Historical

Office, 1984), 521–536. For DoD’s and Eisenhower’s New Look, see Richard M. Leighton, *Strategy, Money, and the New Look, 1953–1956* (Washington, DC: OSD Historical Office, 2001), 184–230. For Kennedy’s flexible response, see Kaplan, Landa, and Drea, *McNamara Ascendancy*, 293–322. For OSD and Nixon policies, NSSM 3/NSDM 16, and NSDM 242, see Richard A. Hunt, *Melvin Laird and the Foundation of the Post-Vietnam Military* (Washington, DC: OSD Historical Office, 2015), 256–259, 281. For NSDM 242, see Walter S. Poole, *The Joint Chiefs of Staff and National Policy, 1973–1976*, vol. 11 of the History of the Joint Chiefs of Staff series (Washington, DC: Office of Joint History, Office of the CJCS, 2015), 46–47; and William Odom, “The Origins and Design of Presidential Decision-59: A Memoir,” 176–177, in Henry D. Sokolski, ed., *Getting MAD: Nuclear Mutual Assured Destruction, Its Origins and Practice*, Strategic Studies Institute, Nov 2004, <[www.strategicstudiesinstitute.army.mil/pdffiles/PUB585.pdf](http://www.strategicstudiesinstitute.army.mil/pdffiles/PUB585.pdf)>, accessed 25 Sep 2012.

2. Brown with Winslow, *Star Spangled Security*, 1–3.

3. Harold Brown, “Strategic Force Structure and Strategic Arms Limitations,” address before the Institute of American and Canadian Studies of the Soviet Academy of Sciences, Mar 1975, reproduced in Joint Committee on Defense Production, *Hearings: Civil Preparedness and Limited Nuclear War*, 28 Apr 1976, 130–139.

4. *Ibid.*, 133.

5. *Ibid.*, 139.

6. Auten, *Carter’s Conversion*, 90–96. As for the primacy of nuclear submarines, Carter considered them the “most important strategic element in the entire defense mechanism of our country” and an “adequate deterrent,” even a “superb” one. Auten, 91. Supporters of the triad (strategic bombers, ICBMs, and SLBMs) argued that relying solely on SLBMs would allow the Soviet Union to concentrate much of its strategic defense resources on antisubmarine warfare, thus making nuclear submarines more vulnerable much sooner. Carter hammered away during the presidential campaign that Nixon’s SALT I and the Ford administration’s Vladivostok SALT II informal framework were not really arms control, because they allowed the two sides to build up to an agreed number of strategic weapons.

7. For Carter’s desire to reevaluate national security and his imprecision in defining it (he used the terms “strategic” and “long range planning” often interchangeably), see *ibid.*, 87–88.

8. PRM 10, “Comprehensive Net Assessment and Military Force Posture Review,” 18 Feb 1977, CK3100543732, DDRS. While PRM 10 was actually only the request for the study, it became the de facto title of the interagency report. Memo, Utgoff for Brzezinski, 14 Apr 1977, folder PRM 10 [1 of 8], box 28, NSC Institutional Files, 1977–1981, Carter Library.

9. Stubbing with Mendel, *Defense Game*, 360; memos, Davis for Brown, 7 Feb 1977, 0000C881.pdf, CD-1; Brown for CJCS Brown, Perry et al., 3 Mar 1977, 0000D2E1.pdf, CD-2: both in Declassified SecDef Files, WNRC; memo, Brown for Vance, Brzezinski et al., 15 Feb 1977, CK 3100544810, DDRS.

10. PRM 10, 18 Feb 1977, CK3100543732, DDRS.

11. Memo, Hornblow for Brown, Vance et al., 10 Mar 1977, folder 381 (Jul-Dec) 1977, box 1, SecDef Files, Acc 330-80-0016, WNRC.

12. Memo, Davis for Brown, 21 Mar 1977, 0000D31D.pdf, CD-2, Declassified SecDef Files; memo, Brzezinski for Carter, 7 Apr 1977, CK3100551130, DDRS; Carter Daily Dairy, 7 Apr 1977, Carter Library; memo, Brown for Vance, Lance, Brzezinski et al., 6 May 1977, folder 381, 1977, box 2, SecDef Files, Acc 330-80-0016; Auten, *Carter's Conversion*, 161; memo, Brown for Vance, Lance, Brzezinski et al., 9 May 1977, enclosing 9 May draft of the AIMS, 0000D2BD.pdf, CD-2, Declassified SecDec Files.

13. Memo, Brown for Vance, Lance, Brzezinski et al., 9 May 1977.

14. Ltr, Christopher to Brown, 12 May 1977 (quotes), folder 381 (Jun) 1977, box 2, SecDef Files, Acc 330-80-0016.

15. MJCS 151-77 for SecDef, 16 May 1977, folder 381 (May–3 Jun) 1977, box 47, SecDef Files, Acc 330-80-0017.

16. Memo, Brzezinski for Carter, 18 May 1977, CK 3100547255, DDRS.

17. Notes by Thompson and Utgoff, meeting 19 May 1977, folder PRC 025, PRM 10 (military portion), 7/13/77, box 63, NSC Institutional Files, 1977–1981, Carter Library.

18. Memo, Brown for Vance, Lance et al., 25 May 1977, folder 381 (May–3 Jun) 1977, box 47, SecDef Files, Acc 330-80-0017.

19. Quoted in Janne E. Nolan, *Guardians of the Arsenal: The Politics of Nuclear Strategy* (New York: Basic Books, 1989), 131.

20. Memos, Woolsey for Davis and Murray, 27 May 1977, 1–2 Jun 1977; Summary of DoD Comments on PRM 10, n.d. [c.28 Jun 1977]: all in folder 381 (Jul-Dec) 1977, box 46, SecDef Files, Acc 330-80-0017.

21. Memos, Murray for Brown, 17 and 22 Jun 1977: both *ibid*.

22. Memo, White for Brown, 27 Jun 1977, *ibid*.

23. Memos, Cotter for Brown, 27 Jun 1977; Perry for Brown, 28 Jun 1977: both in folder 381 Jun 1977, box 2, SecDef Files, Acc 330-80-0016.

24. Memo, Komer for Brown, 25 Jun 1977, folder 381 (Jul-Dec) 1977, box 46, SecDef Files, Acc 330-80-0017.

25. Memo, Marshall for Brown, 27 Jun 1977, *ibid*.

26. MJCS 198-77 for SecDef, 27 Jun 1977, *ibid*.

27. Summary of DoD Comments on PRM 10, cited in note 20.

28. Lynn E. Davis, “Limited Nuclear Options: Deterrence and the New American Doctrine,” Adelphi Paper No. 121. One liberal columnist colorfully described the reaction to Davis among pro-defense lobby groups: “Some fairly vicious things were said around Washington about Lynn Davis. . . . Not only [was she] a woman . . . unable to understand the need for a strong defense . . . she was also a New Left peacenik. . . . One would have thought that her section of PRM-10 had advocated a Gandhian policy of nonviolent resistance.” Alan Wolfe, “Carter’s New Defense Budget,” *The Nation*, 18 Feb 1978, 167.

29. Nolan, *Guardians of the Arsenal*, 132.

30. Brown later mentioned many of these factors, still staunchly defending Davis. In retrospect, he admitted that he “should have provided her a number-two man experienced in DoD infighting. Harold Brown, interview by Edward Keefer and Erin Mahan, Washington, DC, 11 Feb 2011, 39–40, Oral History Collection, OSD/HO; Brown comment to author, 5 Aug 2016.

31. Memos, Marshall for Brown, 27 Jun 1977; Brown for McGiffert, 29 Jun 1977: both in folder 381 (Jul-Dec) 1977, box 46, SecDef Files, Acc 330-80-0017; memo, Aaron for Brown 28 Jun 1977, folder 381 Jun 1977, box 2, SecDef Files, Acc 330-80-0016.

32. Memo, Brown for Vance, Lance, Brzezinski et al., 6 Jul 1977 (quote), CK31000056945, DDRS.

33. Notes of Brown/JCS Meeting, 25 Aug 1977, folder 010 OSD, 1 Jun 1977–Dec 1977, Records of CJCS General Brown, Acc 218-92-0032, NARA II.

34. Agenda for PRC Meetings on PRM10, attached to PRM Study, 6 Jul 1977, *ibid.*

35. Memo, Thomson for Utgoff to Brzezinski, 6 Jul 1977 (quotes), CK3100152016, DDRS.

36. *Ibid.* (quote).

37. *Ibid.* (quote).

38. *Ibid.* (quote).

39. Summary of Conclusions of PRC Meeting, 8 Jul 1977, CK300142176, DDRS.

40. *Ibid.*

41. Summary of Conclusions and Minutes of PRC Meeting, 13 Jul 1977, folder PRC 025, PRM 10 (military portion), 7/13/77, box 63, NSC Institutional Files, 1977–1981, Carter Library. In late September 1978 Carter asked Brown about abandoning the ICBM leg of the triad and strengthening the two remaining legs (bombers and SLBMs). Brown foresaw “disastrous consequences” on international and domestic perceptions if the United States went to the dyad. In addition, elimination of the ICBM leg would diminish military capabilities, such as independence from tactical warning and the ability to ride out a Soviet first strike, endurance after an initial exchange, quick hard-target kill capability, good C3, and warfighting ability to use limited amounts of strategic forces. As Brzezinski told the president, Brown made “a forceful case for modernizing our strategic force posture with M-X/MAP.” Memos, Brown for Carter, 23 Oct 1978; Brzezinski for Carter, n.d. [after 23 Oct 1978]: both in folder Missiles, 11/78–4/79 Missiles, box 43, Subject File, Brzezinski Donated Material, Carter Library.

42. NSDM 242, 17 Jan 1974, *FRUS 1969–1976*, vol. 35, *National Security Policy, 1973–1976*, ed. M. Todd Bennett (Washington, DC: GPO, 2014), 142–145.

43. Brown with Winslow, *Star Spangled Security*, 177.

44. Summary of Conclusions and Minutes of PRC Meeting, 13 Jul 1977, folder PRC 025, PRM 10 (military portion), 7/13/77, box 63, NSC Institutional Files, 1977–1981, Carter Library.

45. Memo, Brown for Carter, 17 Aug 1977 (quote), folder 381 (17 Aug) 1977, box 1, SecDef Files, Acc 330-80-0016.

46. Memo, Davis for Brown, 26 Jul 1977, w/Brown's written comments (quotes), folder 381 (Jul-Dec) 1977, box 46, SecDef Files, Acc 330-80-0017; Stubbing with Mendel, *Defense Game*, 361.

47. Krepinevich and Watts, *Last Warrior*, 125–128, 134.

48. *Ibid.*, 129–133.

49. Andrew Marshall, interview by Alfred Goldberg and Maurice Matloff, Washington, DC, 15 Jun 1992, 17–19, Oral History Collection, OSD/HO; Brown with Winslow, *Star Spangled Security*, 16.

50. Krepinevich and Watts, *Last Warrior*, 130; Marshall interview, 15 Jun 1992, 20.

51. Memo, Brzezinski for Carter, w/Carter's comments, 20 Aug 1977, folder PD 18 [1], box 13, NSC Institutional Files, 1977–1981, Carter Library

52. PD 18, "U.S. National Strategy," 24 Aug 1977 (quote), folder 81 (Jul-Dec) 1977, box 1, SecDef Files, Acc 330-80-0016.

53. *Ibid.* (quote).

54. *Ibid.*

55. Evans and Novak, "Conceding Defeat in Europe," *Washington Star*, 4 Aug 1977, A19 (quote); Richard Burt, "Secret Carter Study of Soviet Threat," *Washington Post*, 6 Jan 1978, A1, A6; *Brown Public Statements 1977*, 7:2485–2492.

56. Stubbing with Mendel, *Defense Game*, 361 (quote).

57. Brzezinski, *Power and Principle*, 177–178 (quotes). Former OMB defense analyst Richard Stubbing argued that Brown missed an opportunity to refine Carter's policies of weapons procurement, force structure, disarmament, nonproliferation, and human rights into a coherent national security policy, allowing policy decisions to drift back to Brzezinski and the NSC. Stubbing with Mendel, *Defense Game*, 360–361. The question remains whether, given internal DoD opposition to the study, Brown had the desire or ability to accomplish such a feat. He was not the preeminent strategic thinker in the administration, nor was he inclined to try to dominate policy formulation or lead DoD beyond where it was prepared to go.

58. Minutes of SCC Meeting, 4 Aug 1977, folder SCC 024 PRM 10 [10], 8/4/77, box 87, NSC Institutional Files, 1977–1981, Carter Library. The five were nuclear targeting, ICBM modernization, secure strategic reserve target acquisition, sustainability for U.S./NATO/other allies versus the Soviet bloc and its other allies, and strategic naval planning. Memo, Brown for Brzezinski, 3 Nov 1977, folder 381 (Jul-Dec) 1977, box 46, SecDef Files, Acc 330-80-0017.

59. Memo, Brzezinski for Brown, 24 Aug 1977, folder 381 (Jul-Dec) 1977, box 1, SecDef Files, Acc 330-80-0016.

60. NSDM 242, "Policy for Planning the Employment of Nuclear Weapons," 17 Jan 1974, folder Nuclear War Doctrine: Limited Option (LNO) and Regional Option (RNO), box 47, Subject File, Brzezinski Material, National Security Affairs, Carter Library.

61. Odom, "Origins and Design of Presidential Decision-59," in Sokolski, *Getting MAD*, 183–185.



62. *Ibid.*, 185–186.

63. Memos, McGiffert for Brown, 18 Aug 1977; Brown for Carter, 19 Aug 1977: both in folder Targeting Study, Background, box 28, Brown Papers, LC; Odom, “The Origins and Design of Presidential Memorandum-59,” in Sokolski, *Getting MAD*, 177–189.

64. Memo, Marshall and Slocombe for Brown, 1 Feb 1978, folder A-381 1978, box 52, SecDef Files, Acc 330-81-0202; Nolan, *Guardians of the Arsenal*, 135.

65. Krepinevich and Watts, *Last Warrior*, 135–136.

66. Policy Guidance for the Employment of Nuclear Weapons (NUWEP), Oct 1980, document 21 in National Security Archive Electronic Briefing Book No. 390, “Jimmy Carter’s Controversial Targeting Directive PD-59 Declassified,” DNAS, <[www.gwu.edu/~nsarchiv/nukevault/ebb390/](http://www.gwu.edu/~nsarchiv/nukevault/ebb390/)>, accessed 25 Sep 2012.

67. Summary of Major Findings and Recommendations of the Nuclear Targeting Planning Review, Nov 1978, folder Targeting Study #4, box 28, Brown Papers, LC.

68. *Ibid.*; NUWEP, Oct 1980, cited in note 66.

69. CM 150-78 for ASD(ISA), 21 Nov 1978, folder 381, 1978, box 1, SecDef Files, Acc 330-81-0442, WNRC.

70. Memo, Huntington for Brzezinski, 1 Aug 1978, folder PD 18 [4], box 14, NSC Institutional Files, 1977–1981, Carter Library.

71. Memo, Utgoff for Brzezinski, 3 Aug 1978, *ibid.*

72. Memo, Odom for Brzezinski, 15 Aug 1978, folder PD 18 [3], box 14, NSC Institutional File, 1977–1981, Carter Library.

73. Ltr, Sloss to Brown, 29 Dec 1978, folder A-381, 1978 box 52, SecDef Files, Acc 330-81-0202.

74. Memo, Slocombe for Brown, 27 Mar 1979, folder 320.2 Strategic, 1979, box 1, SecDef Files, Acc 330-82-0271, WNRC. The debate was reactivated in 2012 when the Digital National Security Archive presented a collection of declassified documents on PD 59, “Jimmy Carter’s Controversial Targeting Directive PD-59 Declassified,” DNSA. See Brown’s comment “A Countervailing View,” in *Foreign Policy*, 24 Sep 2012, and the response of William Burr of the National Security Archive, “Nuclear Fight Club,” in *Foreign Policy*, 27 Sep 2012, <[www.foreignpolicy.com/articles/2012/09/24/a\\_countervailing\\_view](http://www.foreignpolicy.com/articles/2012/09/24/a_countervailing_view)> and <[www.foreignpolicy.com/articles/2012/09/27/nuclear\\_fight\\_club](http://www.foreignpolicy.com/articles/2012/09/27/nuclear_fight_club)>, accessed 19 and 25 Sep 2012 respectively.

75. Summary of Conclusions of SCC Meeting, 4 Apr 1980; Minutes of SCC Meeting, 4 Apr 1980: both in “Jimmy Carter’s Controversial Targeting Directive PD-59 Declassified,” DNSA.

76. PRM 32, “Civil Defense,” 30 Sep 1977, folder 384 (16 Sep–15 Nov) 1978, box 47, SecDef Files, Acc 330-80-0017; PD 41, “U.S. Civil Defense Policy,” 29 Sep 1978, folder 384 (2 Aug–Dec) 1978, box 4, SecDef Files, Acc 330-81-0202. For PD 53, National Security Communications Policy, 15 Nov 1979, see <[www.jimmycarterlibrary.gov/documents.pddirectives/pres\\_directive.phtml](http://www.jimmycarterlibrary.gov/documents.pddirectives/pres_directive.phtml)>, accessed 6 Jun 2011. PD 58, “Continuity of Government,” 30 Jun 1980, folder 381, 1980, box 2, SecDef Files, Acc 330-82-0285, WNRC. PD 58 is briefly described in Brzezinski,

*Power and Principle*, 457; and Odom, “Origins and Design of Presidential Decision-59,” in Sokolski, *Getting MAD*, 189–190.

77. “Chronology of the PD 59 Decision, 4 September 1980, Declassified,” DNSA.

78. Memos, Ellis for Brown, 8 Feb 1980; JCSM 49-80 for Brown, 21 Feb 1980: both in folder A-381 (Jan–13 Sep) 1980, box 1, SecDef Files, Acc 330-82-0284, WNRC; Brown, *DoD Annual Report, FY 1981*, 5–6.

79. Memos, Brzezinski for Brown, 26 Mar 1980; Brown for Brzezinski, 16 Apr 1980: both in folder A-381 (Jan–13 Sep) 1980, box 1, SecDef Files, Acc 330-82-0284.

80. Memo, Odom for Brzezinski, 24 Jul 1980, “Jimmy Carter’s Controversial Targeting Directive PD-59 Declassified,” DNSA.

81. Memo, Brown for Brzezinski, 20 May 80, folder A-381 (Jan–13 Sep) 1980, box 1, Acc 330-82-0284; “Chronology of the PD 59 Decision,” 4 Sep 1980, cited in note 77.

82. PD 59, “Nuclear Weapons Employment Policy,” 25 Jul 1980, folder A-381 (Jan–13 Sep) 1980, box 1, SecDef Files, Acc 330-82-0284.

83. *Ibid.*

84. “The PD 59 Affair,” editorial, *Washington Post*, 22 Aug 1980, A14; Jeremy Stone (Director of Federation of American Scientists), “Two Paths to Nuclear Strategy,” *Washington Post*, 16 Sep 1980, A17.

85. Memo, Komer for Brown, 11 Aug 1980, folder Secretary Brown, Eyes Only, Jul–Dec 1980, box 106, Brown Papers, LC; Fred Kaplan, *Wizards of Armageddon* (New York: Simon & Schuster, 1983), 383–384.

86. The NSC staffers were Odom; Utgoff; Maj. Gen. Jasper A. Welch Jr, USAF, a physicist and former chief of USAF’s systems analysis, on detail to the NSC Defense Coordination Staff; and Fritz W. Ermarth, a Soviet specialist on loan from CIA—a more conservative group than most Carter administration NSC staffers. Prados, *Keeper of the Keys*, 411; Brzezinski, *Power and Principle*, 458.

87. Brzezinski, *Power and Principle*, 459.

## 6. SALT II and the MX Missile Decision

1. Mark Perry, *Four Stars* (Boston: Houghton Mifflin, 1989), 264–266; Brzezinski, *Power and Principle*, 157.

2. Memo, Brown for Carter, 28 Jan 1977, folder HB memos to the President, box 91, Brown Papers, LC.

3. For the Brezhnev-Ford discussions at Vladivostok and the resulting aide-memoire (the Vladivostok understanding), see *FRUS 1969–1976*, vol. 33, *SALT II 1972–1980*, ed. Erin R. Mahan (Washington, DC: GPO, 2013), 381–389 (doc 88), 402–403 (doc 91). The extent of Soviet advances in strategic forces and their intentions caused a split in the intelligence community, which resulted in the so-called Team A and Team B exercise in 1976 (see chapter 1). For the key findings of the competing teams, see *FRUS 1969–1976*,

vol. 35, *National Security 1973–1976*, ed. M. Todd Bennett (Washington, DC: GPO, 2014), 781–803 (docs 170–171).

4. Brown's statement before the Arms Control Subcommittee of SCAS, 8 Nov 1977, folder USSR 388.3 (Nov-Dec) 1977, box 4, SecDef Files, Acc 330-80-0016, WNRC; Strobe Talbot, *Endgame: The Inside Story of SALT II* (New York: Harper & Row, 1979), 18–27, 32–37.

5. Talbot, *Endgame*, 50.

6. PRM 2, "SALT," 24 Jan 1977, folder USSR 388.3 (Jan-Feb) 1977, box 5, SecDef Files, Acc 330-80-0016; also printed in *FRUS 1969–1976*, 33:649 (doc 147).

7. Slocombe, Notes of SCC Meeting, 3 Feb 1977, folder USSR 320.2, 1977, box 4, folder USSR 388.3 (Jan-Feb) 1977, box 5, SecDef Files, Acc 330-80-0016; Summary Report of this meeting printed in *FRUS 1969–1976*, 33:652–654 (doc 149). The Soviets favored the 600km limit because much of the U.S. population lived on the coasts; most Soviet population centers were located inland. With the 600km limit, the Soviet's would enjoy an advantage. Brown's comment to the author, 11 Aug 2016.

8. Summary of SCC Meeting, 25 Feb 1977, CK3100044795, DDRS; also printed in *FRUS 1969–1976*, 33:661–662 (doc 152); Summary of SCC Meeting, 2 Mar 1977, CK3100048103, DDRS. Brown took the lead in these meetings—Brzezinski remembers him as dominating them. Brzezinski, *Power and Principle*, 158.

9. Few contemporary records exist for the 12 March 1977 principals-only SCC meeting. One is Brown's own cryptic handwritten notes of 12 March 1977, which he passed to Slocombe. Folder USSR 388.3, Mar 1977, box 5, SecDef Files, Acc 330-80-0016. As for support of the comprehensive/deep cuts proposal, see Vance, *Hard Choices*, 49; Brzezinski, *Power and Principle*, 158–159. Brown also favored the idea but had his doubts about how the Soviets would receive it.

10. Brown's notes, 12 Mar 1977, cited in note 9. Brzezinski says that Brown's position on cruise missile limits of 2,500 kilometers was meant to bring the JCS on board for the proposal. Brzezinski considered it too tough. Brzezinski, *Power and Principle*, 159–160.

11. Carter Daily Diary, 19 Nov 1977, Carter Library; PD 23, "Standing Consultative Commission," 10 Nov 1977, and PD 7, "SALT Negotiations," 23 Mar 1977: both in folder USSR 383.3, Mar 1977, box 5, SecDef Files, Acc 330-80-0016; also printed in *FRUS 1969–1976*, 33:684–686 (doc 156); Brzezinski, *Power and Principle*, 159–160; Garthoff, *Détente and Confrontation*, 888.

12. PD 7, 23Mar 1977.

13. JCSM 78-77 and JCSM 79-77 (w/H. Brown's comments) for SecDef, both 10 Mar 1977: both in folder USSR 388.3, Mar 1977, box 5, SecDef Files, Acc 330-80-0016. Brown sent JCSM 78-1977, "SALT Principles," to Carter without comment or endorsement; memo, Brown for Carter, 18 Mar 1977, *ibid*.

14. *Carter Public Papers 1977*, 1:447, 503; Vance, *Hard Choices*, 53.

15. Vance, *Hard Choices*, 53–57; Brzezinski, *Power and Principle*, 162–164; Garthoff, *Détente and Confrontation*, 889–892.

16. Talbot, *Endgame*, 85.

17. Brzezinski, *Power and Principle*, 166; Garthoff, *Détente and Confrontation*, 894.

18. Memo, Brzezinski for Mondale, Brown et al., 11 Apr 1977, folder USSR 388.3, Apr 1977.5, SecDef Files, Acc 330-80-0016: also printed in *FRUS 1969–1976*, 33:689–690 (doc 158).

19. Memo, Brzezinski for Vance, Brown, and Warnke, 26 Apr 1977, w/attached Minutes of SCC Meeting, 23 Apr 1977, folder USSR 388.3, Apr 1977, SecDef Files, Acc 330-80-0016: also printed in *FRUS 1969–1976*, 33:699–670 (doc 163).

20. Brzezinski, *Power and Principle*, 167.

21. Memo, Brown for Carter, 22 Apr 1977 (quote), folder SALT: Modified Proposal, Apr 1977, box 15, Brown Papers, LC. Brown also favored the 2,500km range because if wide-bodied transport aircraft were used as cruise-missile carriers, they would be more vulnerable to extended Soviet air defense than B-52s and would need to launch their cruise missiles further from Soviet borders. With a 600km range, Moscow (about 750 kilometers from the Soviet border) would be protected. Brown with Winslow, *Star Spangled Security*, 117. The president did not accept Brown's recommendation. Draft memo of the 23 Apr 1977 SCC Minutes w/Brown's revisions, folder USSR 388.3, Apr 1977, box 5, SecDef Files, Acc 330-80-0016.

22. Memo, Brown for Carter, 25 Apr 1977, w/Carter's comments, folder USSR 388.3, Apr 1977, box 5, SecDef Files, Acc 330-80-0016.

23. Memo, Brzezinski for Carter, n.d., Summary Report of SCC Meeting, 7 Jun 1977, folder USSR 388.3 (May-Jul) 1977, *ibid.*: also printed in *FRUS 1969–1976*, 33:724–728 (doc 170).

24. Brzezinski, *Power and Principle*, 168.

25. Memos, Slocombe for Brown, 27 May 1977; 25 Jul 1977: both in folder USSR 388.3 (May-Jul) 1977, box 4, SecDef Files, Acc 330-80-0016.

26. Talbot, *Endgame*, 111.

27. Memo, Brown for Brzezinski, 7 Jun 1977, folder USSR 388.3 (May-Jun) 1977, box 4, SecDef Files, Acc 330-80-0016.

28. Memo, Carter for Mondale, Vance, Brown et al., 25 Aug 1977, folder USSR 388.3 (Aug-Oct) 1977, *ibid.*: also printed in *FRUS 1969–1976*, 33:740–741 (doc 174). The term “maximum system operational range” was shorthand for the U.S. definition of cruise missile range in negotiations with the Soviets. Did 600 kilometers or 2,500 kilometers mean the distance between the launch point and the target “as the crow flies” (the U.S. preference), or a limit of 600 kilometers or 2,500 kilometers on the total distance covered as the cruise missile zigged and zagged following its terrain-matching guidance system (the Soviet preference)? OSD experts calculated that to hit a target at 2,500 kilometers, the cruise missiles would have to fly 3,750 kilometers, a 50 percent “wobble” factor. Brown and DoD wanted the treaty to account for this extra requirement. Talbot, *Endgame*, 183–184. The Bison and Bear were 1950s vintage subsonic intercontinental bombers (akin to the U.S. B-52s).

29. Memo for the Record, NSC Meeting, 6 Sep 1977; PD 20, “U.S. SALT Position,” 9 Sep 1977: both in *FRUS 1969–1976*, 33:753–755 (doc 178), 755–757 (doc 179); memo, Brown for Brzezinski, 6 Sep 1977, folder USSR 388.3 (Aug-Oct) 1977, box 82, SecDef Files, Acc 330-80-0017, WNRC.

30. Memo, Brown for Brzezinski, 23 Sep 1977, folder USSR 388.3 (Aug-Oct) 1977, box 4, SecDef Files, Acc 330-80-0016. The JCS views on mobile ICBMs and Backfires are in JCSM 370-77 and JCSM 371-77 for SecDef, both dated 21 Sep 1977, *ibid*.

31. Memo, Brown for Brzezinski, 27 Sep 1977, *ibid*. The JCS views on the issues are in JCSM 369-77 for SecDef, 23 Sep 1977, *ibid*. A 600km ranged GLCM fired from Poland could reach well into West Germany, but a 600km GLCM fired from West Germany could not reach the Soviet Union. The Soviets wanted ALCMs counted against the MIRVed launcher subceiling, because with a multiple-warhead payload they could function as MIRVed ICBMs.

32. Vance, *Hard Choices*, 59–61 (quote); Brzezinski, *Power and Principle*, 169; Garthoff, *Détente and Confrontation*, 897–899.

33. Memo, Brown for Carter, 6 Oct 1977, folder USSR 388.3 (Aug-Oct) 1977, box 4, SecDef Files, Acc 330-80-0016. The JCS views were in JCSM 375-77 for SecDef, 23 Sep 1977, *ibid*.

34. Memo, Brown for Carter, 29 Nov 1977 (second quote), w/Brown's comments (first quote), folder USSR 388.3, Nov-Dec 1977, *ibid*. The JCS concerns are in CM 1711-77 and JCSM 440-77 for SecDef, both dated 21 Nov 1977, *ibid*.

35. *Ibid*.

36. Brzezinski, *Power and Principle*, 317.

37. Memo, Vance and Warnke for Carter, 28 Dec 1977, folder USSR 388.3 (11 Nov-Dec) 1977, box 82, SecDef Files, Acc 330-80-0017.

38. Memo, Brown for Carter, 6 Jan 1978, folder USSR 388.3 (Jan) 1978, box 5, SecDef Files, Acc 330-81-0212, WNRC: also printed in *FRUS 1969–1976*, 33:798–805 (doc 191). Under the launcher rule, 120 silos at Derazhnya and Pervomaisk could theoretically be counted as non-MIRVed if the United States accepted Soviet assurances that the missiles were not MIRVed—something Washington was unprepared to do.

39. Brzezinski, *Power and Principle*, 325.

40. Memo, Brzezinski for Mondale, Vance, Brown et al., 14 Mar 1978, transmitting Summary of Conclusions of SCC Meeting, 6 Mar 1978, folder USSR 388.3 (Feb-Mar) 1978, box 5, SecDef Files, Acc 330-81-0212, w/Brzezinski's note saying that Carter favored OSD/JCS position on conventional cruise missiles in the treaty: also printed in *FRUS 1969–1976*, 33:809–810 (doc 194); memo, Brown for Carter, 10 Mar 1978 (quote), folder 471.94 (Jan-May) 1978, box 45, SecDef Files, Acc 330-81-0202, WNRC.

41. Garthoff, *Détente and Confrontation*, 902.

42. Memo, Brown for Carter, "SALT II: Strategy for Completing the Process," w/ attached memo, Vance and Warnke for Carter, 25 Mar 1978, folder USSR 388.3 (Feb-Mar) 1978, box 5, SecDef Files, Acc 330-81-0212: both also cited and summarized in *FRUS 1969–1976*, 33:820 (doc 197n3).

43. *Ibid*., 899–901; Vance, *Hard Choices*, 99–104.

44. Memo, Brown for Carter, 27 May 1978, w/Carter's comments, folder USSR 388.3 (Apr-May) 1978, box 5, SecDef Files, Acc 330-81-0212.

45. *Ibid.*

46. Summary of Conclusions of SCC Meeting on SALT, 5 Jul 1978; 21 Jul 1978: both in folder USSR 388.3 (Jan-Jul) 1978, *ibid.*: the former printed in *FRUS 1969–1976*, 33:853–855 (doc 206); memo, Brown for Carter, 3 Aug 1978, folder USSR 388.3 (Aug-Sep) 1978, box 4, SecDef Files, Acc 330-81-0212: also printed in *FRUS 1969–1976*, 33:862–866 (doc 209); speech by Brown before the American Legion Convention, 22 Aug 1978, *Brown Public Statements 1978*, 6:2332–2333.

47. Memo, Brown for Turner, 6 Sep 1978, folder USSR 388.3 (Aug-Sep) 1978, box 4, SecDef Files, Acc 330-81-0212.

48. Overview Talking Paper for Brown for SCC Meeting, 26 Oct 1978, folder USSR 388.3 (Oct) 1978, *ibid.*

49. Memo, Warnke for Carter, 21 Sep 1978, folder USSR 388.3 (Aug-Oct) 1978, box 71, SecDef Files, Acc 330-81-0202.

50. Memo, Brzezinski for Carter, 29 Sep 1978, folder USSR 388.3 (Oct) 1978, box 4, SecDef Files, Acc 330-81-0212: also printed in *FRUS 1969–1976*, 33:886–889 (doc 217); Summary of Conclusions of SCC Meeting, 3 Nov 1978, folder USSR 388.3 (Nov-Dec) 1978, box 4, SecDef Files, Acc 330-81-0212: also printed in *FRUS 1969–1976*, 33:907–909 (doc 223); Vance, *Hard Choices*, 107. For the explanation of a “wiggle” factor see note 28.

51. Memo, Brzezinski for Carter, 29 Sep 1978; Summary of Conclusions of SCC Meeting, 3 Nov 1978. Turner wanted an outright ban on encrypting telemetry; the JCS held that telemetry was too important to allow for ambiguity, and Brown concurred. Memo, JCS for Brown, JCSM 56-79, 27 Feb 1979, w/Brown’s comments, folder USSR 388.3 (Jan-Feb) 1979, box 25, SecDef Files, Acc 330-82-0205, WNRC; Vance, *Hard Choices*, 107–112. Brzezinski recalled how he informed Vance by open telephone of Carter’s decision to strengthen the language when the national security adviser was in Moscow in late December meeting with Gromyko. Brzezinski, *Power and Principle*, 329–330.

52. Memo, Slocombe for Brown, 27 Dec 1978, folder USSR 388.3 (Nov-Dec) 1978, box 4, SecDef Files, Acc 330-81-0212. For other reports of the Vance-Gromyko meeting, see *FRUS 1969–1976*, 33:881–886 (doc 215). The environmental shelters had been constructed in 1973 to shield U.S. workers upgrading silo covers of Minuteman II missiles at Malmstrom Air Force Base in Montana from harsh winter conditions, and they remained for the most part intact. The Soviets claimed this was a violation of SALT I. When the Soviets agreed to cease to press the issue of indistinguishability of Minuteman II and III silos at Malmstrom, Brown ordered, in May 1979, that shelters no longer be used. Talbot, *Endgame*, 114–117; memo, Brown for Jones, 11 May 1979, folder M, 1979, box 15, SecDef Files, Acc 330-82-0204, WNRC.

53. Garthoff, *Détente and Confrontation*, 904.

54. Summary of Conclusions of SCC Meetings, 12 Jan, 23 Jan, 12 Feb, 5 Mar, and 21 Mar 1979: all in folder USSR 388.3, 1979, box 2, SecDef Files, Acc 330-82-0270, WNRC. The Summary of Conclusions of the 12 January SCC meeting is printed in *FRUS 1969–1976*, 33:925–926 (doc 232). The results of the 23 January SCC meeting are incorporated into

ibid., 830–834 (docs 202 and 203); and the Summary of Conclusions of the 21 March SCC meeting are summarized in ibid., 940n1 (doc 237).

55. Memo, Brown for Carter, 19 Apr 1979, folder USSR 388.3 (Mar–Apr) 1979, box 25, SecDef Files, Acc 330-82-0205. On 11 March 1979 Brezhnev sent Carter a letter in which he stressed the “right” to encrypt information not regulated by the agreement. Brown suggested “the less one knows about the subject the worse it [the 11 March letter] sounds.” When Carter sent Brezhnev a letter on 27 March trying to nail down agreement on better verification, the Soviet leader referred to his 11 March letter. Ibid.

56. Memo, Brown for Carter, 17 Mar 1979, folder USSR 388.3, 1979, box 2, SecDef Files, Acc 330-82-0270; JSCM 77-79, 16 Mar 1979.

57. Memos, Brown for Carter, 6 Jun 1979, w/Carter’s comments (quote); Brown for Carter, 12 Jun 1979: both in folder USSR 388.3 (11 Jun–25 Jun) 1979, box 25, SecDef Files, Acc 330-82-0205.

58. Ltr, Brown to Carter, 12 Jun 1979, folder SALT File, Eyes Only, 1979, box 106, Brown Papers, LC.

59. Carter Daily Diary, 13 Jun 1979, Carter Library. No other record of this brief meeting has been found. Carter had met earlier with Brown and the JCS on 6 October 1978. He recalls that “they seemed satisfied with my answers” to their list of technical questions. Carter adds, “I could understand the reluctance of the Joint Chiefs of Staff about making an endorsement before all our final positions had been defined. I needed them with me, however, and later decided to make the Chairman a member of our summit delegation.” Carter, *Keeping Faith*, 222. Brown recalled it was his idea to take the CJCS to Vienna. Harold Brown, interview by Alfred Goldberg and Ronald Landa, Washington, DC, 1 Mar 1993, 28, Oral History Collection, OSD/HO.

60. Brown interview, 1 Mar 1993, 28. During a meeting between Brezhnev and Carter with Brown and others attending, the president presented his objectives for SALT III and then, at the Soviet leader’s request, hand wrote a summary on a yellow legal pad and gave it to Brezhnev. Such a tactic alarmed Brown, who passed a note to Brzezinski suggesting that giving the Soviets such a list would encourage them to ask for more in SALT III negotiations. White House Chief of Staff Hamilton Jordan sent a similar note. Brzezinski, *Power and Principle*, 342. The list given to Brezhnev is in Carter, *Keeping Faith*, 253. For Carter’s account of the summit, see ibid., 242–261.

61. The treaty, protocol, and accompanying documents are in *Carter Public Papers 1979*, 1:1051–1079.

62. President’s address before a joint session of Congress, 18 Jun 1979, ibid., 1090.

63. Memo, Brown for Carter, 1 Aug 1979, folder Alpha Channel File, 12/78–7/79, box 11, Brown Papers, LC; Brzezinski, *Power and Principle*, 345.

64. Brzezinski, *Power and Principle*, 345–353; Vance, *Hard Choices*, 350 (quote); Carter, *Keeping Faith*, 262–264; Brown interview, 1 Mar 1993, 21 (quote).

65. The fatal flaws as summarized by Vance were allowing the Soviets 308 heavy missiles; not including Backfire in the SNDV aggregate; not insisting on adequate verification

procedures; establishing precedents for limits on CM in SALT III; and not requiring enough deep cuts in MIRVed ICBMs. Vance, *Hard Choices*, 352. With the exception of the last, these issues were not settled until late in or at the end of the negotiations. SALT II critic Paul Nitze cited most of these flaws, except verification. He thought the treaty was so weighted in favor of the Soviets: “I could see no real reason why they should want to cheat.” Paul H. Nitze, with Ann M. Smith and Steven L. Rearden, *From Hiroshima to Glasnost: At the Center of Decision, A Memoir* (New York: Globe Weidenfeld, 1989), 360–363.

66. Garthoff noted that July 1978 was perhaps a lost opportunity for an early settlement, suggesting that the Soviet proposal for no new ICBMs might have led, as Gromyko later suggested, to the Soviets’ accepting one new ICBM, with MIRVs or a single warhead, a move that could have resulted in an early agreement. Garthoff, *Détente and Confrontation*, 900.

67. Dan Caldwell, “The SALT II Treaty,” in Michael Krepon and Dan Caldwell, eds., *The Politics of Arms Control Treaty Ratification* (New York: St. Martin’s Press, 1991), 333, cites five problems with ratification: timing, shortcomings of the Carter administration, indifferent public opinion and effective opposition from interests groups, Senate-executive branch relations, and aggressive Soviet activities and other external events affecting the U.S. public assessment of the Carter administration. Caldwell expands on this thesis in *The Dynamics of Domestic Politics and Arms Control: The SALT II Treaty Ratification Debate* (Columbia: University of South Carolina Press, 1991), 333.

68. An exhaustive, yet readable account of the MX is John Edwards’ *Superweapon: The Making of the MX* (New York: W. W. Norton, 1982).

69. Note, Reed to Duncan, 27 Jan 1977, transmitting USAF study, “The Advanced ICBM M-X,” Jan 1977, Executive Summary [1, 3], folder M, 1977, box 65, SecDef Files, Acc 330-80-0017.

70. Edwards, *Superweapon*, 133–138, 140–143; memo, Press for Carter, 2 Dec 1977, w/Report of OSTP [Office of Science and Technology Policy] Panel on MX Missile, w/Carter’s comments, CK3100081001, DDRS; Bernard Weinraub, “Carter Cuts Funds for Development of Mobile Missiles,” *New York Times*, 26 Dec 1977, 1, 10.

71. Memos, Perry for Brown, 15 Mar (quote), folder 320.2 Strategic, 1978; Perry for Brown, 20 Mar 1978 (quote, emphasis in original), folder 020 DDR&E, 1978: both in box 1, SecDef Files, Acc 330-81-0212. Estimated cost for the Trident II missile (in the design stage) and the MX (in the advance development stage) was \$6 billion each. Brown figured the common missile would offer a significant net savings.

72. Memo, Brown for Carter, 31 Mar 1978, folder MX 471.94 (Jun-Dec) 1978, box 3, SecDef Files, Acc 330-81-0212.

73. Memo, Brown for Carter, 16 Dec 1978 (quote), folder MX 471.94 (Jan-Dec) 1978, box 61, SecDef Files, Acc 330-81-0202; memo, Brzezinski for Carter, 9 Nov 1978, folder Weekly Reports to President, box 41, Subject File, Brzezinski Donated Material, Carter Library; Edwards, *Superweapon*, 147–149. Established in 1969, the Defense Systems Acquisition Review Council evaluated major defense systems at key milestones in their development. The committee’s membership consisted in 1978 of the under secretary for research and



engineering (the chair and executive); the assistant secretaries for program analysis and evaluation; manpower, reserve affairs and logistics; communications, command, control, and intelligence; and the comptroller. It reported to the secretary on the readiness of the system and its suitability to proceed to the next stage in the acquisition life cycle. Fox, *Defense Acquisition Reform*, 47–49; David D. Acker, *Defense Acquisition Review Process: A History and an Evaluation*, abstract, 436–445, <[www.dtcimil.dtcitr/fulltext/u2/p002822.pdf](http://www.dtcimil.dtcitr/fulltext/u2/p002822.pdf)>, accessed 8 Jul 2014.

74. Memo, Brzezinski for Carter, 18 Dec 1979, folder Missiles, 11/78–4/79, box 43, Subject File, Brzezinski Material, National Security Affairs, Carter Library; memos, Brzezinski for Brown, 27 Jan 1979, folder MX (Jan–24 Mar) 1979, box 16, SecDef Files, Acc 330-832-0205; Brzezinski for Brown, 3 Apr 1979, w/note, Carter for Brown and Brzezinski, 3 Apr 1979, folder 471.94 (Mar–20 Apr) 1979, box 48, SecDef Files, Acc 330-82-0204. The differences between MAP and MSP are relatively small; the former theoretically required more time to move the missiles after verification, thus creating a larger window of opportunity for a potential Soviet attack. Both systems required large tracts of land. Lauren H. Holland and Robert A. Hoover, *The MX Decision: A New Direction in U.S. Weapons Procurement Policy?* (Boulder, CO: Westview Press, 1985), 75–78.

75. Memo, Brzezinski for Carter, 8 May 1979, w/Summary of Conclusions of PRC Meeting, 4 May 1979: both in folder PRC 104, MX Basing, 5/10/79, box 74, NSC Institutional Files, 1977–1981, Carter Library; memo, Zeiberg for Brown and Duncan, 30 Apr 1979, with report on “ICBM and Strategic Force Modernization,” 30 Apr 1979, folder 471.94 (21 Mar–May) 1979, box 48, SecDef Files, Acc 330-82-0204; Edwards, *Superweapon*, 148.

76. Summary of Conclusions of PRC Meeting, 10 May 1979, folder PRC 105, MX Basing, 5/10/79, box 74, NSC Institutional Files, 1977–1981, Carter Library; Edwards, *Superweapon*, 184–185

77. Memo, Brown for Carter, 2 Jun 1979, folder 471.94, 1979, box 2, SecDef Files, Acc 330-82-0271, WNRC.

78. Edwards, *Superweapon*, 159–161. The advantages of the common missile were that it was lighter, easier to transport (by air or ground), and could be deployed in Minuteman silos or on ballistic missile submarines.

79. Memo, McIntyre for Brzezinski, 6 Jun 1979, folder 471.74, 1979, box 2, SecDef Files, Acc 330-82-0271.

80. Memo, Brzezinski for Carter, 3 Jun 1979; Minutes of NSC Meeting, 4 Jun 1979 (quote): both in folder NSC 00019, Strategic Arms Policy and Relations with the USSR/PRC, box 56, NSC Institutional File, 1977–1981, Carter Library. Brzezinski, *Power and Principle*, 334–337 (quote); Edwards, *Superweapon*, 189–196.

81. Memo, Dodson for Vance, Brown et al., 9 Aug 1979; Summary of Conclusions of PRC Meeting, 7 Aug 1979: both in folder PRC-121, MX Basing Mode, 8/7/79, box 77, NSC Institutional Files, 1977–1981, Carter Library; memo, Brzezinski for Carter, 4 Sep 1979; Minutes of NSC Meeting, 5 Sep 1979 (quote): both in folder NSC 021, MX Basing, box 56, *ibid.*

82. Edwards, *Superweapon*, 204–205.

83. Memo, McIntyre for Carter, 6 Sep 1979, folder MX (6 Sep–10 Nov) 1979, box 16, SecDef Files, Acc 330-82-0205.

84. Memo, Chayes for Brown, 29 Aug 1979, folder MX (Aug–5 Sep) 1979, *ibid*.

85. Memos, Brown for Carter, 7 Sep 1979, 0000B424.pdf, CD-1, Declassified SecDef Files; memo, Brown for Carter, 26 Feb 1980 (quote), attached to memo, Brzezinski for Carter, 27 Feb 1980, folder Missiles, 10/79–3/80, box 43, Subject File, Brzezinski Material, National Security Affairs, Carter Library.

86. Of the team, Perry and Under Secretary of the Air Force Antonia H. “Toni” Chayes were the most optimistic, Assistant Secretary of Defense for Public Affairs Thomas Ross was in the middle, and Assistant Secretary for Legislative Affairs Jack Stempler and Secretary of the Air Force Hans Mark were pessimistic. Ltr, Mark to Brown, 29 Feb 1980, folder Sec. Brown, Eyes Only, Jan-Jun 1980, box 106, Brown Papers, LC; memo, Utgoff and Welch for Brzezinski, 31 Mar 1980, folder Mtgs MBB, 3/80–4/80, box 34, Subject File, Brzezinski Donated Material, Carter Library.

87. Memo, Brown for Carter, 2 May 1980, 0000B462.pdf, CD-1, Declassified SecDef Files; memo, Brzezinski for Carter, 24 Jun 1980, folder Missiles, 4–9/80, box 43, Subject File, Brzezinski Material, National Security Affairs, Carter Library. According to Perry’s recollection, after the forum, he “knew that the MX basing was a lost cause.” Perry, *My Journey*, 50

88. George Wilson, “Joint Chiefs Chairman Says U.S. Needs Mobile Missile,” *Washington Post*, 26 Jul 1978, 7.

89. Martin Walker, *The Cold War: A History*, 1st American ed. (New York: Henry Holt, 1995), 233–237; World Crude Oil Production, Top Producing Countries, 1960–2010 (chart), <<http://eia.doe.gov/emeu/aer/pdf/pages/Sec11-10.pdf>>; Monthly Crude Oil Prices, 1946 to 2010 (chart) <[http://inflationdata.com/inflation/image/charts.Oil/Inflation\\_Adj\\_Oil\\_Prices\\_Chart.htm](http://inflationdata.com/inflation/image/charts.Oil/Inflation_Adj_Oil_Prices_Chart.htm)>; both accessed 5 May 2011.

## 7. Arms Control and Global Issues

1. For Carter’s evangelical roots and their application to foreign policy, see Balmer, *Redeemer*, i–xxvii, 75–91.

2. Harold Brown, *Thinking About National Security: Defense and Foreign Policy in a Dangerous World* (Boulder, CO: Westview Press, 1983), 190; Department of State, “Treaty between the United States of America and Soviet Union on the Limitation of Underground Nuclear Tests,” Jul 1974, <[www.state.gov/global/arms/treaties/ttbt.html](http://www.state.gov/global/arms/treaties/ttbt.html)>, accessed 30 Apr 2012.

3. “Summary of JCS Positions and Statements on Nuclear Proliferation, Weapons, and Materials,” 30 May 1980, prepared by Historical Division, Joint Secretariat, JCS, w/ attached Summary of JCSM 52-77 to SecDef, 1 Mar 1977, CK3100592284, DDRS; briefing memo, Brzezinski for Carter, 22 Mar 1977, folder DoD 3/77, box 4, Agency File, Brzezinski Material, National Security Affairs, Carter Library.

4. PRM 16, “Nuclear Testing,” 25 Jan 1977, PRO01432, DNSA; memo, Marcum for Brzezinski through Utgoff, 22 Mar 1978, folder DoD 3/77, box 4, Agency File, Brzezinski Material, National Security Affairs, Carter Library.

5. If Carter followed the briefing memo of 22 March 1977 (see note 3), he would have made these points. The meeting was held on 23 March 1977 at the White House. Carter Daily Diary, 23 Mar 1977, Carter Library.

6. Memo, Brown for Brzezinski, 1 Oct 1977 (quotes), 0000CAF4.pdf, CD-2, Declassified SecDef Files, WNRC.

7. Summary of JCSM 119-78 for SecDef, 18 Apr 1978, attached to “Summary of JCS Positions . . .,” cited in note 3.

8. Summary JCSM 188-78 to SecDef, 30 May 1978, *ibid.*

9. Memo, Dodson for Mondale, Vance, Brown et al., 22 May 1977, w/attached PD 38, “Comprehensive Test Ban,” 20 May 1978, Presidential Directives and Presidential Review Memoranda, Carter Library, <[www.jimmycarterlibrary.gov/documents/pddirectives/pres-directive.phtml](http://www.jimmycarterlibrary.gov/documents/pddirectives/pres-directive.phtml)>, accessed 20 May 2014.

10. Memo, Brown for Carter, 1 Jun 1978 (quotes), folder A-400.112 Test Ban (1 Jan–15 Mar) 1978, box 52, SecDef Files, Acc 330-81-0202, WNRC; Summary of JCSM 188-78 for SecDef, 30 May 1978, attached to “Summary of JCS Positions . . .,” cited in note 3.

11. Garthoff, *Détente and Confrontation*, 832–883.

12. Memo, McGiffert for Brown, 18 Sep 1978, w/attached paper, “Outstanding CTB Issues,” 18 Sep 1978, folder A-400.112 Test Ban (Jun-Dec) 1979, box 53, SecDef Files, Acc 330-81-0202; memo, Brzezinski for Mondale, Vance, Brown et al., 25 Sep 1978, CK3100129934, DDRS.

13. Memo, Brown for Brzezinski, 19 Sep 1978, CK3100145729, DDRS.

14. Garthoff, *Détente and Confrontation*, 833–835; Brzezinski, *Power and Principle*, 172n.

15. NSDM 345, “U.S. Anti-Satellite Capabilities,” 18 Jan 1977, CK3100554302, DDRS; Garthoff, *Détente and Confrontation*, 835–836; Arms Control Association, *Arms Control and National Security: An Introduction* (Washington, DC: Arms Control Association, 1989), 87–89; Hans Mark, *The Space Station: A Personal Journey* (Durham, NC: Duke University Press, 1987), 83–85.

16. JSCM 307-77 for SecDef, 29 Jul 1977, folder USSR 471.97, 1977, box 5, SecDef Files, Acc 330-80-0016, WNRC.

17. Brown, *Thinking About National Security*, 194. Brown noted that the Soviets did use satellites for ocean surveillance. He also warned that a few antisatellite weapons could wreak havoc on U.S. intelligence and communications capabilities.

18. PRM 23, “A Coherent U.S. Space Policy,” 28 Mar 1977, Presidential Review Memoranda, Carter Library, <[www.jimmycarterlibrary.gov/documents/prmemorandum/prm23.pdf](http://www.jimmycarterlibrary.gov/documents/prmemorandum/prm23.pdf)>, accessed 20 Mar 2014.

19. Memo, Brown for Brzezinski, 27 Jun 1977, folder 471.96, 1977, box 2, SecDef Files, Acc 330-80-0016.

20. Memo, Brzezinski for Vance, Brown, Lance et al., 23 Sep 1977, folder 471.96 Alpha, 1977, box 56, SecDef Files, Acc 330-80-0017, WNRC.

21. PD 39, “Instructions to the U.S. Delegation to the ASAT Talks . . .” 6 Jun 1978, PRO01382, DNSA.

22. Memo, Brown for Brzezinski, 28 Feb 1978, folder 388.3, 1978, box 1, SecDef Files, Acc 330-81-0442, WNRC; memo, Carter for Vance, Brown et al., 10 Mar 1978, PRO01377; PD 45, “Instructions to the U.S. Delegation to ASAT Talks . . .” 22 Jan 1979, PRO01390: both in DNSA.

23. Memo, Brown for JCS, Perry, McGiffert et al., 22 May 1979, folder 471.96 (Apr-Jun) 1978, box 46, SecDef Files, Acc 330-81-0202.

24. Msg 305, York (in Helsinki) to Brown, 13 Jun 1978; msg 307, York (in Helsinki) to Brown 15 Jun 1079: both in SecDef Cables, Jun 1978, OSD/HO; “Instructions to the U.S. Delegation to ASAT Talks . . .” 6 Jun 1978, cited in note 21.

25. Garthoff, *Détente and Confrontation*, 836–837.

26. Memo, Vance and Seignious for Carter, 6 Jun 1979, folder 471.96 (Jan-Jul) 1979, box 48, SecDef Files, Acc 330-82-0204, WNRC.

27. Memo, Dodson for Vance, Brown, McIntyre et al., 16 Jun 1979, w/attached Summary of Conclusions of Mini SCC Meeting, 10 Jun 1979, folder 471.96, 1980, box 2, SecDef Files, Acc 330-82-0285, WNRC.

28. Arms Control Association, *Arms Control and National Security*, 87–91; Garthoff, *Détente and Confrontation*, 837.

29. Mark, *Space Station*, 71; Peter Hays, “NASA and the Department of Defense: Enduring Themes in Three Key Areas,” in Steven J. Dick and Roger D. Launius, eds., *Critical Issues in the History of Spaceflight* (Washington, DC: NASA Office of External Relations, History Division, 2006), 222–226.

30. Ltr, Lance to Brown, 19 Sep 1977, folder 471.96 (Aug-Dec) 1977, box 56, SecDef Files, Acc 330-80-0017.

31. Ltr, Duncan to McIntyre, 2 Nov 1977; memo, Dinneen for Brown, 10 Nov 1977, w/ attached paper, “Space Shuttle”: all *ibid*.

32. Mark, *Space Shuttle*, 71–73; Hays, “NASA and the Department of Defense,” 226–227; T. A. Heppenheimer, *Development of the Space Shuttle, 1972–1981*, vol. 2 of *History of the Space Shuttle* (Washington, DC: Smithsonian Institution Press, 2002), 346–349. A fifth shuttle, *Endeavour*, was built after the loss of the *Challenger*.

33. Memo, Mark for Brown, n.d., folder 471.96 (Jan-Jul) 1979, box 48, SecDef Files, Acc 330-82-0204; ltr, McIntyre to Mark and Lovelace, 15 Jan 1979, CK3100493466, DDRS.

34. Ltr, Mark to Brown, 31 May 1979 (quote, emphasis in original), folder 471.96 (Jan-Jul) 1979, box 48, SecDef Files, Acc 330-82-0204; ltrs, Mark to Brown, 12 Nov 1979, 5 Mar 1980; memo, Mark for Brown, 7 Apr 1980 (quotes): all in folder 471.96 (Jan-May) 1980, box 45, SecDef Files, Acc 330-82-0216, WNRC.

35. Arms Control Association, *Arms Control and National Security*, 127–128, 130–131.

36. PRM 27, “Chemical Warfare,” 19 May 1977, CK3100116874, DDRS. Brown’s comments (quote) are on a copy of PRM 27, folder Biological and Chemical Warfare, box 66, Brown Papers, LC.

37. Brown’s comments, SCC Meeting, 7 Jun 1977 (quote) and response to PRM 27: both in folder 370.67 CBR (Jun) 1977, box 45, SecDef Files, Acc 330-80-0017.

38. Talking Paper for SecDef and CJCS for SCC Meeting, 8 Jun 1977, *ibid*.

39. Summary of PRC [*sic.*, SCC] Meeting, 8 Jun 1977 (quotes), CK3100115507, DDRS. One of the leading advocates of arms control on the NSC staff, Jessica Tuchman Matthews, informed Brzezinski that the JCS “wanted a formal opportunity to complain about what they see as our policy of ‘inadvertent unilateral disarmament’, which translates as ‘not modernizing the CW force’ (i.e., building the binary facility at Pine Bluff).” Memo, Tuchman for Brzezinski, 7 Jun 1977, CK3100116881, DDRS.

40. Memo, Brzezinski for Carter, 13 Jun 1977, CK3100117430; PD 15, “Chemical Warfare,” 16 Jun 1977, CK3100116885: both in DDRS.

41. Memo, Brown for Service Secretaries et al., 22 Aug 1977, 0000CAD0.pdf, CD-2, Declassified SecDef Files.

42. Ltr, Brown to Vance, 22 Nov 1977 (quote), folder 370.64 CBR (Aug-Dec) 1977, box 45, SecDef Files, Acc 330-80-0017.

43. Memo, Brown for Brzezinski, 4 Oct 1979, folder 370.64 (Oct-Dec) 1979, box 42, SecDef Files, Acc 330-82-0204.

44. Talking Paper for Brown for 8 Nov 1979 PRC Meeting, w/Brown’s comment, folder 110.01, 1979, box 1, SecDef Files, Acc 330-82-0271, WNRC.

45. Brown’s comments on JCSM 191-80 for SecDef, 15 Jul 1980, folder Biological/Chemical Warfare, box 61, Brown Papers, LC.

46. Memo, Brown for Turner, 9 Sep 1980, 0000CE1A.pdf, CD-2, Declassified SecDef Files.

47. Summary of Conclusions of PRC Meeting, 2 Dec 1980, folder 110.01 (1–3 Dec) 1980, box 15, SecDef Files, Acc 330-82-0216.

48. Brown, *Thinking About National Security*, 194–195.

49. Arms Control Association, *Arms Control and National Security*, 131; Arms Control Association, “The Chemical Weapons Convention (CWC) at a Glance,” <[www.armscontrol.org/factsheets/cwclang](http://www.armscontrol.org/factsheets/cwclang)>, accessed 8 May 2012.

50. Talking Paper for SecDef and CJCS, 9 Apr 1980, State Department Paper on “Planning for Non-Proliferation Strategy for 1980 and Beyond”; Memo for Record by Slocombe, 10 Apr 1980 (quote): both in folder 383.3 (Jan–15 May) 1980, box 3, SecDef Files, Acc 330-82-0217.

51. Talking Paper for Brown and Jones, 19 May 1980; note by MacDonald, 6 Jun 1980: both in folder 383.3 (16 May–Dec) 1980, box 3, SecDef Files, Acc 330-82-0217; Carter Daily Diary, 6 Jun 1980, Carter Library.

52. PRM 12, “Arms Transfer Policy Review,” 28 Jan 1977, PD01548, DNSA.

53. Memo, McAuliffe for Duncan, 24 Feb 1977, folder 091.3 (Jan-Mar) 1977, box 10, SecDef Files, Acc 330-80-0017.

54. Response to PD 12, n.d., *ibid.*

55. Memo, Brown for Brzezinski, 3 May 1977, folder 091.3 (May-Jul) 1977, box 10, SecDef Files, Acc 330-80-0017.

56. PD 13, “Conventional Arms Transfer Policy,” 13 May 1977, PD01507, DNSA.

57. Memo, Duncan for Carter, 21 Sep 1977, folder 091.3 (Aug-Oct) 1977, box 10, SecDef Files, Acc 330-80-0017.

58. Memo, Slocombe for Brown, 2 Sep 1977, w/Brown’s comment (quote, emphasis in original), *ibid.*

59. Memo, Aaron for Duncan, 23 Nov 1977, folder 091.3 (1–25 Jan) 1978, box 10, SecDef Files, Acc 330-80-0202.

60. Memo, Brzezinski for Vance and Brown, 8 Nov 1977, CK3100098608, DDRS; Discussion Paper for 10 Jan 1978 PRC Meeting, attached to memo, Dodson for Mondale, Vance, Brown et al., 9 Jan 1978, folder 091.3 (1–25 Jan) 1978, box 10, SecDef Files, Acc 330-80-0202.

61. ISA/Joint Staff briefing memo for SecDef and CJCS Brown for 26 Jan 1978 PRC Meeting, folder 091.3 (26 Jan–Feb) 1978, box 9, SecDef Files, Acc 330-82-0202.

62. Memo, Brzezinski for Vance, Brown, Lance et al., 1 Feb 1978, w/attached Summary of Conclusions of PRC Meeting, 26 Jan 1978, folder 091.3 (26 Jan–Feb) 1978, box 9, SecDef Files, Acc 330-82-0202.

63. Memo, Christopher for Carter, 5 May 1978, w/Carter’s comments (quote, emphasis in original), CK3100511914, DDRS; memos, Vance for Carter, 6 Nov 1978, CK3100509587; Brzezinski for Carter, 6 Nov 1978, CK3100473728: both w/Carter’s comments (quotes), DDRS.

64. Memos, Vance and Brown for Carter, 14 Aug 1979 (quotes); Brzezinski for Vance and Brown, 11 Sep 1979, w/Carter’s comments (quote): both in folder 091.3 (Aug-Nov) 1979, box 9, SecDef Files, Acc 330-82-0204.

65. Brzezinski in *Power and Principle*, 144–145, places the increase in U.S. sales from 1977 to 1980 at 14 percent, the three major Western Europeans and United Kingdom at 78 percent, and the Soviets at 55 percent.

66. Memo, Brown for Carter, 28 Nov 1979, folder 091.3 (Aug-Nov) 1979, box 9, SecDef Files, Acc 330-82-0204.

67. Memo, Brown for Muskie, 22 Jul 1980, folder 100.53 (20–30 Jul) 1980, box 10, SecDef Files, Acc 330-82-0216; *Congressional Quarterly Almanac*, 1980, vol. 36 (Washington, DC: Congressional Quarterly, 1981), 199.

68. Memo, Brown and Vance for Carter, 19 Dec 1978, folder 091.3 (Dec) 1978, box 8, SecDef Files, Acc 330-81-0202.

69. Memo, McGiffert for Brown, 30 Mar 1979, 0000C893.pdf, CD-1, Declassified SecDef Files, WNRC.

70. Memos, Brown for Carter, 14 Dec 1979 (quote), 0000C88B.pdf; Brown for Carter, 17 Dec 1979, 0000C88A.pdf; both *ibid.*; memo, McGiffert for Brown, 13 Dec 1979, folder 091.3 (Dec) 1979, box 9, SecDef Files, Acc 330-82-0204.

71. *CQ Almanac 1980*, 36:199.

72. Memos, Brown for Muskie, 22 Jul 1980, folder Mtgs MBB, 7/80–9/80; Brown for McIntyre, 25 Sep 1980, folder Mtgs MBB, 10/80–1/81; both in box 23, Subject File, Brzezinski Donated Material, Carter Library.

73. Memos, Kimmitt for Brzezinski, 29 Oct 1980; Odom for Brzezinski and Aaron, 29 Oct 1980; both *ibid.*; memo, Komer for Brown, 29 Oct 1980, 0000BF5C.pdf, CD-1, Declassified SecDef Files.

74. Memo, Brown for Carter, 2 Dec 1980 (quote), 0000D3C8.pdf, CD-2, Declassified SecDef Files.

75. *Congressional Quarterly Almanac, 1981*, vol. 37 (Washington, DC: Congressional Quarterly, 1982), 166, 182–183.

76. *Carter Public Papers 1977*, 1:656 (quote).

77. Memo, Babione for Brown, 31 Jan 1977, folder 463 (1 Jan–15 Feb) 1977, box 55, SecDef Files, Acc 330-80-0017.

78. Memo, Deputy SecDef for Service Secretaries et al., 17 Nov 1978, w/attached “DoD Shale Oil Task Force Final Report,” 5 Oct 1978, folder 010 OSD, 8 Jun 78–27 Feb 79, box 4, Official Records of CJCS General David Jones, Acc 218-92-0030, NARA II; Harold Brown, “The Energy Crisis and National Defense Policy,” *Commanders Digest*, 12 May 1977, 5; memo, White for Brown, 25 Oct 1977, folder 463 (Oct–14 Nov) 1977, box 54, SecDef Files, Acc 330-80-0017; News Release No. 579-79, 3 Dec 1979, “U.S. Army Saves Energy in FY 70,” folder 363 (Nov-Dec) 1979, box 46, SecDef Files, Acc 330-82-0204.

79. Memo, Brown for Alexander, 16 Jan 1981, 0000CB3A.pdf, CD-2, Declassified SecDef Files.

80. The Cabinet Committee to Combat Terrorism met only once. Its lower-level working group, chaired by the State Department, remained active for the next five years coordinating interagency efforts and raising issues, but it did not generate much high-level interest in counterterrorism policy. Talking Paper for Secretary Brown and JCS Chairman General Brown for 1 Sep 1977 SCC Meeting, folder 000.1-0010 (Jan-Nov) 1977, box 1, SecDef Files, Acc 330-89-0017. In mid-September 1977 the Carter administration replaced the Cabinet Committee with an NSC/SCC Working Group on Terrorism. An Executive Committee chaired by a State Department representative (Ambassador Anthony Quainton assumed the chair) replaced the CCCT’s working group. The directive did not give the new NSC/SCC Working Group and Executive Committee management responsibility of incidents. They were charged with policy recommendations and interagency coordination. Memo, Brzezinski for Mondale, Vance, Brown et al., 16 Sep 1977, CK31000591191, DDRS.

81. Memo, Brown for Carter, 4 May 1977, 00000D2C3, pdf, CD-2, Declassified SecDef Files. Carter commented on another copy of the memorandum: “Good-Set high performance standards.” Folder 000.1 thru 010, 1977, box 1, SecDef Files, Acc 330-80-0017.

82. PRM 30, “Terrorism,” 2 Jun 1977, PD1564, DNSA; Talking Paper cited in note 80 (quote).

83. Note, Carter to Brown and Brzezinski, 18 Oct 77, folder DoD 10–11/77, Agency File, Brzezinski Material, National Security Affairs, Carter Library.

84. CM 1676–77 for SecDef, 25 Oct 1977, folder 000.5 (Jan–Nov) 1977, box 1, SecDef Files, Acc 330-80-0017; Working Paper for CJCS Brown, 11 Jan 1978, folder 000.5 (Jan–Apr) 1978, box 1, SecDef Files, Acc 330-81-0202.

85. Memo, Duncan for Brzezinski, 26 Jun 1978, folder 000.5 (May) 1978, box 1, SecDef Files, Acc 330-81-0202.

86. Memo, Odom for Quainton, McGiffert et al., 6 Oct 1978, CK3100595520, DDRS.

87. JCSM 166-80 for SecDef, 7 Jun 1980, folder 320.2 (Jun) 1980, SecDef Files, Acc 330-82-0216; memo, Brown to Jones, 15 Aug 1980, w/attached JCSM 214-80 to SecDef, 9 Aug 1980, folder 010 OSD, 1 Aug 1980–31 Oct 1980, box 5, Official Records of CJCS General Jones, Acc 218-92-0030.

88. United Nations, Division for Ocean Affairs and Law of the Sea, “The United Nations Convention on Law of the Sea (a historical perspective),” <[www.un.org/depts/los/convention\\_agreements/convention\\_historical\\_perspective.htm](http://www.un.org/depts/los/convention_agreements/convention_historical_perspective.htm)>, accessed 27 Mar 2014; James B. Morrell, *The Law of the Sea: A Historical Analysis of the 1982 Treaty and Its Rejection by the United States* (Jefferson, NC: McFarland, 1992), 59–65; memo, Tuchman and Denard for Aaron, 26 Sep 1977, CK3100479960, DDRS.

89. JCSM 5-77 for SecDef, 25 Jan 1977; ltr, Duncan to Vance, 2 Mar 1977 (quote): both in folder 801.2 (Jan–15 May) 1977, box 60, SecDef Files, Acc 330-80-0017.

90. Ltr, Christopher to Duncan, 1 Apr 1977, *ibid*.

91. Ltr, Richardson to McGiffert, 18 Aug 1977, folder 801.2 (16 May–Dec) 1977, *ibid*.

92. JCSM 411-77 for SecDef, 25 Nov 1977, *ibid*.

93. Ltrs, Duncan to Christopher, 14 Feb 1978; Richardson to Duncan, 5 Jul 1978: both in folder 801.2, 1978, box 51, SecDef Files, Acc 330-81-0202.

94. Memo, Irish for McGiffert, 5 July 1978, *ibid*.; memo, Brown for Carter, 7 Jul 1978 (quotes), CK3100099983, DDRS.

95. Memo, Smith for Aaron, 26 Oct 1978, w/attached paper, “Navigational Freedom and US Security Interests,” folder DoD 11/79, box 6, Agency File, Brzezinski Material, National Security Affairs, Carter Library; memo, Thornton for Aaron, 2 Nov 1979, CK3100136429, DDRS.

96. Ltr, Claytor to Brzezinski, 7 Nov 1979 (quote); memo, Brzezinski for Duncan 23 Nov 1979: both in folder 801.2 (May–Dec) 1979, SecDef Files, Acc 330-82-0205.

97. Memo, McGiffert for Jones, 19 Jul 1980, folder 801.2 (Jan–Aug) 1980, box 2, SecDef Files, Acc 330-82-0217.

98. Ltr, Carter to Brzezinski, 14 Feb 1977, CK3100073408, DDRS; Carter, *Keeping Faith*, 217.

99. CIA memo, “Soviet capabilities . . . in the Indian Ocean,” 11 Aug 1977, CK3100685139, DDRS; memo, Hornblow for Mondale, Vance, and Brown, 29 Apr 1977, w/attached response



to PRM 25, “Arms Control in Indian Ocean Area,” n.d., folder Indian Ocean 092 (Jan-Aug) 1977, box 68, SecDef Files, Acc 330-80-0017.

100. PRM 25, 7 Apr 1977, PR01438, DNSA; response to PRM 25, n.d., cited in note 99; Talking Paper for SecDef and CJCS for 4 May 1977 SCC Meeting, folder Indian Ocean 092 (Jan-Aug) 1977, box 68, SecDef Files, Acc 330-80-0017.

101. Summary of Conclusions of SCC Meeting, 4 May 1977; memo, Brzezinski for Mondale, Vance, Brown et al., 17 Jun 1977, w/attached Summary of Conclusions of SCC Meeting, 14 Jun 1977: both *ibid*. Brzezinski apparently felt defensive, abruptly suggesting that if agencies had a problem with demilitarization, they should send a dissent to the president. The agencies got the message. *Ibid*.

102. Memo, Warnke for Carter, 5 Jul 1977, *ibid*.

103. Memo, Brown for Brzezinski, 19 Aug 1977, w/attached JCS Paper, “Arms Control in the Indian Ocean,” n.d., folder Indian Ocean 092 (Aug-Dec) 1977, box 68, SecDef Files, Acc 330-80-0017.

104. Brzezinski, *Power and Principle*, 174–175.

105. Memo, Dodson for Mondale, Vance, Brown et al., 19 Sep 1977, w/attached Summary of Conclusions of SCC Meeting, 14 Sep 1977 (quote), folder Indian Ocean 092, 1977, box 3, SecDef Files, Acc 330-80-0016.

106. Memo, Brzezinski for Vance, Brown, Warnke et al., 20 Sep 1977, folder Indian Ocean 092 (Aug-Dec) 1977, box 68, SecDef Files, Acc 330-80-0017.

107. Memo, Brzezinski for Carter, 30 Nov 1977, CK3100634884, DDRS; memos, Warnke for Carter, 10 Oct 1977, 15 Dec 1977: both in folder Indian Ocean 092 (Aug-Dec) 1977, box 68, SecDef Files, Acc 330-80-0017.

108. Memo, Brown for Brzezinski, 17 Jan 1978, folder Indian Ocean, 1978, box 57, SecDef Files, Acc 330-81-0202; memo, Brown for Carter, 4 Feb 1979, w/attached JCSM 24-78 to SecDef, 30 Jan 1978: both in 0000D237.pdf, CD-2, Declassified SecDef Files.

109. Memo, Warnke for Carter, 2 Mar 1978, folder Indian Ocean, 1978, box 57, SecDef Files, Acc 330-81-0202.

110. PD 50, “Arms Control Decision Process,” 14 Aug 1979, Presidential Directives and Presidential Review Memoranda, Carter Library, <<http://jimmycarterlibrary.gov/documents/pddirectives/pd50.pdf>>, accessed 27 Mar 2014. The directive puzzled many in the administration. The JCS hoped it was the beginning of a repudiation of Carter’s previous arms control bias. They suggested an interagency study on it. JCSM 285-79 for SecDef, 21 Sep 1979, folder 388.3, 1978, box 43, SecDef Files, Acc 330-82-0204. OSD opposed the idea, noting PD 50 was already being used as criteria; no further study was required. Memo, Claytor for Jones, 29 Feb 1980, folder 388.3, 1978, box 39, SecDef Files, Acc 330-82-0216. For suggestions of the intent of PD 50 (appearance of toughness for the election, SALT ratification, or slapping ACDA on the wrist), see Garthoff, *Détente and Confrontation*, 817.

## 8. The FY 1979 Budget and the Future of the Navy

1. Richard Burt, “U.S. Defense Debate Arises Over Whether Focus on Europe Neglects Other Areas,” *New York Times*, 24 Mar 1978, A3; Bernard Weinraub, “Navy Sees It Must Shape Up to Go On Shipping Out,” *New York Times*, 19 Feb 1978, E5. In its talking points on the FY 1979 budget for use in bilateral discussions, the NSC staff stated, “The FY 1979 defense budget reflects the high priority being given to NATO’s defense needs.” Memo, Utgoff and Thompson for Aaron, 25 Jan 1978, folder FI 4/FI 13, 1/1/78–6/30/78, box FI-13, Subject File, WHCF: Executive, Carter Library.

2. This tension between OSD and the Navy over carriers, carrier aircraft, and the threat posed by the Soviet Navy, discussed in this chapter, was reported on in the press. See UPI, “Vertical Takeoff Jet For Marines Faces A Denial of Funds,” *New York Times*, 27 Nov 1977, 38; Claton Fritchey, “The Navy We Need Vs. the Navy We’ve Got,” *Washington Monthly*, Mar 1978, 38; “Navy: All Engines Slow,” *Newsweek*, 10 Apr 1978.

3. For press reports of congressional opposition to OSD’s budget for the Navy, see George Wilson, “Navy Faces Hill Salvo Over ’79 Defense Budget,” *Washington Post*, 7 Feb 1978, A2; Gary Hart, “Against Reducing America’s Naval Strength,” *New York Times*, 10 Apr 1978, E19. The public justification for the president’s 17 August 1978 veto of congressional authorization for CVN is in a White House Press Office, Office of Media Liaison Background Report, “The Defense Appropriation Authorization Act; The President’s Veto,” folder Defense, 8/78, Plains File, Carter Library. The veto is discussed later in the chapter.

4. For discussion of McNamara and the PPBS, see Kaplan, Landa, and Drea, *McNamara Ascendancy*, 72–95.

5. Rearden, *Council of War*, 393.

6. Memo, Aldridge for Brown, w/Brown’s notes, 4 Mar 1977, folder 100.54 (Jan–15 Apr) 1977, box 14, SecDef Files, Acc 330-80-0017, WNRC. The fiscal guidance is attached to memo, Brown for JCS and Secretaries of Military Departments, 2 Mar 1977, *ibid.* The PPGM became overtaken by the far more extensive OSD/NSC-directed national security reexamination under PRM 10. For discussion of PRM 10, see chapter 5.

7. Rearden with Foulkes, *JCS and National Policy 1977–1980*, 339.

8. Memo, Aldridge for Brown, w/Brown’s notes, 4 Mar 1977, folder 100.54 (Jan–15 Apr) 1977, box 14, SecDef Files, Acc 330-80-0017; memo, Brown for JCS and Secretaries of Military Departments, 11 Mar 1977, JCS 2456.988,551 (11 Mar 1977), cited in Rearden with Foulkes, *JCS and National Security 1977–1980*, 251.

9. Memo, Aldridge for Brown, w/Brown’s notes, 4 Mar 1977, folder 100.54 (Jan–15 Apr) 1977, box 14, SecDef Files, Acc 330-80-0017.

10. JFM 79-86 for Brown, 19 May 1977, JCS 2458/993,577 (26 Apr 1977), cited in Rearden with Foulkes, *JCS and National Security 1977–1980*, 252.

11. Memo, Brown for DDRE et al., 21 May 1977, folder 100.54 (11 May–Jul) 1977, box 12, SecDef Files, Acc 330-80-0017.

12. Memo, Alexander for Brown, 6 May 1977 (quote), folder 100.54 (6 May) 1977; Executive Summary of Army POM, FY 1979–1983, n.d. [6 May 1977], folder 100.54 (Army

POM) 1977: both in box 14, *ibid.*; memos, Brown for Alexander, 16 Aug 1977, folder 100.54 (1–23 Aug) 1977; Alexander for Brown, 22 Aug 1977 (“antithetical” quote), folder 100.54 (1–23 Aug) 1977; Murray for Brown, 24 Aug 1977, folder 100.54 (24 Aug–6 Sep) 1977; Brown for Alexander, 12 Sep 1977, folder 100.54 (6 Sep–Dec) 1977: all in box 12, *ibid.*; Frank L. Jones, *Blowtorch: Robert Komer, Vietnam and American Cold War Strategy* (Annapolis, MD: Naval Institute Press, 2013), 230.

13. Executive Summary of USAF POM, vol. 1, 9 May 1977 (quote on “logical cruise missile carrier”), folder 100.54 (12 May) 1977, USAF POM, box 13; memo, Stetson for Brown, 3 Aug 1977 (quote), folder 100.54 (11 May–Jul), box 12: all in SecDef Files, Acc 330-80-0017.

14. Memo, Brown for Stetson, 16 Aug 1977, folder 100.54 (1–23 Aug) 1977; memos, Stetson for Brown, 22 Aug 1977; Murray for Brown, 23 Aug 1977; Brown for Stetson, 12 Sep 1977: all in folder 100.54 (7 Sep–Dec) 1977, box 12, *ibid.*

15. The most difficult and delayed were Litton Systems’ Ingalls Shipbuilding Division in Pascagoula, Mississippi, under contract for \$4.05 billion for amphibious ships and destroyers and General Dynamics’ Electric Boat Division, Groton, Connecticut, with a \$7 billion contract for SSN attack submarines. Litton and General Dynamics claimed in their lawsuits that they were losing \$500 million to \$600 million on these contracts and the future of their construction projects was in jeopardy. Memo, Claytor for Duncan, 22 Nov 1977, folder 560.5 (May–Dec) 1977, box 58, SecDef Files, Acc 330-80-0017.

16. Memos, Claytor for Brown, 11 Nov 1977 (quote); Claytor for Murray, 18 Nov 1977 (quote): both in folder 560 (Aug–Dec) 1977, box 57, *ibid.*

17. Memo, Claytor for Brown, 31 May 1977 (quote), w/attached Overview of the POM, folder 100.54 (11 May–Jul) 1977, box 12, *ibid.* Murray contended that the Navy’s enthusiasm for V/STOL was based on the realization that the possibility of obtaining a \$2 billion *Nimitz* CVN during Carter’s presidency was small. To protect sea-based tactical airpower, the Navy was considering carriers even smaller than the midsize 90,000-ton CVV (perhaps only 20,000 tons), which would have no catapults and arresting gear to assist takeoff and landing, thus requiring V/STOL. Murray thought V/STOL and small carriers inefficient and a bad idea. Memo by Murray, prepared after a meeting with Claytor, 25 Apr 1977, folder 452 V-2, 1977, box 54, *ibid.*

18. Memo, Brown for Claytor, 16 Aug 1977, folder 100.54 (1–23 Aug) 1977, box 12, *ibid.*

19. Memos, Woolsey for Brown, 23 Aug 1977, folder 100.54 (1–23 Aug) 1977; Murray for Brown, 6 Sep 1977, folder 100.54 (24 Aug–6 Sep) 1977; Brown for Claytor, 12 Sep 1977, folder 100.54 (7 Sep–Dec) 1977: all in box 12, *ibid.*

20. Bernard Weinraub, “Analysts Say Navy Skimped on Planes to Buy F-14’s,” *New York Times*, 30 Aug 1977, 16.

21. *Ibid.*; George Wilson, “Memo Raps Navy on Spending for F-14,” 29 Aug 1977, *Washington Post*, A1, A5 (quote); George Wilson, “Carrier Admirals See Grim Omens in New Budget,” *ibid.*, 7.

22. Memo, Woolsey for Brown, 10 Dec 1977, folder 452 F–18 (Jan–Dec) 1977, box 53, SecDef Files, Acc 330-80-0017. Woolsey also maintained in his memo that even the A–7E, without the F–18’s twin engines or its maneuverability, if re-engined, would in the Navy’s view be a reasonable substitute for the F–18, which when fully loaded lost most of its speed and agility compared with the A–7E.

23. Memo, Claytor for Brown, 1 Nov 1977; PA&E Evaluation of “AV–8B vs A–18 for Marine Corps Light Attack Forces,” 24 Nov 1977; memo, Claytor for Brown, 25 Nov 1977: all in folder 452 V-8, 1977, box 54, SecDef Files, Acc 330-80-0017.

24. DoD News Release 421-77, 8 Sep 1977; memo, Claytor for Brown, 6 Oct 1977: both *ibid.*; Bernard Weinraub, “Pentagon Chief Tentatively Backs Budget Rise to \$130 Billion in ’79,” 11 Nov 1977, *New York Times*, 1. Note to Brown from his secretary and Brown’s note on it, 29 Nov 1977, folder 452 F–18 (Jun–Dec) 1977, box 53, SecDef Files, Acc 330-80-0017.

25. DoD Budget for FY 1979, “Program Acquisition Costs by Weapon System,” 23 Jan 1978, 16–17.

26. Memo, Lance for Carter, 4 Mar 1977, folder FI 4/FG 13, 1/20/77–6/30/77, box FI-13, Subject File, WHCF: Executive, Carter Library.

27. Ltr, Wacker to McOmber, 23 Mar 1977, folder 110.01 (4–31 Mar) 1977 (“many inherent features similar to ZZB” quote), box 17, SecDef Files, Acc 330-80-0017; David O. Cooke, interview by Alfred Goldberg and Maurice Matloff, Washington, DC, 20 Dec 1989, 9 (“extra work” quote); Harold Brown, interview by Alfred Goldberg and Maurice Matloff, Washington, DC, 8 Oct 1992, 23 (“plants” and ‘roots” quote): both in Oral History Collection, OSD/HO. Carter recalled that DoD opposed ZBB “vociferously.” Carter interview, 12 Mar 1986, 6, 23; memo, Brown for Secretaries of Military Departments et al., 23 Apr 1977, folder 334 AFPC (Jan–Jun) 1977, box 39, SecDef Files, Acc 330-80-0017; memo, Brown for Carter, 19 Apr 1977 (assurance to Carter quote), 0000B3F9.pdf, CD-1, Declassified SecDef Files. ZBB was much less than its name implied; it was never a zero start game nor did it generate large savings. Thomas P. Lauth, “Zero Base Budgeting in Georgia State Government: Myth and Reality,” *Public Administration Review* 38, no. 5 (Sep–Oct 1978): 423, 430; Frank D. Draper and Bernard T. Pitsvada, “ZBB-Looking Back after Ten Years,” *Public Administration Review* 41, no. 1 (Jan–Feb 1981): 77, 80; Virendra S. Sherlekar and Burton V. Dean, “An Evaluation of the Initial Year of Zero-Base Budgeting in the Federal Government,” *Management Science* 26, no. 8 (Aug 1980): 750.

28. Memo, Murray for Brown, 7 Jul 1977 (quote), w/Brown’s comments, folder 100.54 (11 May–Jul) 1977, box 12, SecDef Files, Acc 330-80-0017.

29. Carter Daily Diary, 2 Jun 1977 (quotes), Carter Library; memo, Brzezinski for Carter, 1 Jun 1977, w/attached 15 NSC issue papers, CK3100543586, DDRS.

30. The NSC staff noted that PRM 10’s Contingency Assessment indicated that 12 carriers were needed (four in Mediterranean, six in the North Atlantic, two in the Pacific) in a NATO–Warsaw Pact war and that OMB’s plan would expose NATO flanks and leave Pacific LOCs, as well as Alaska and Hawaii, unprotected. Medium-size CVVs would be deployable in Africa and Korea but probably not in the Middle East and most definitely not

on NATO flanks. Issue #12, NSC issue papers, attached to memo, Brzezinski for Carter, 1 Jun 1977, cited in note 29.

31. Ltr, Lance to Brown, 12 Jul 1977, w/Brown's written questions and Wacker's attached answers (quotes), 15 Jul 1977, folder 110.01 (Jul) 1977, box 16, SecDef Files, Acc 330-80-0017.

32. Memo, Brown for Carter, 14 Dec 1977, folder 100.01 (14 Dec–21 Dec) 1977, *ibid*.

33. Memos, Komer for Brown, 2 Nov 1977; Murray for Brown, 16 Nov 1977; McGiffert for Brown, 22 Nov 1977: all in folder 092 NATO (Jul-Dec) 1977, box 73; memos, Brown for Carter, 2 Dec 1977, folder 110.01 (21 Nov–5 Dec) 1977, box 16; Brown for Carter, 10 Dec 1977 (quote), folder 110.01 (14 Dec–21 Dec) 1977, box 17: all *ibid*. For discussion of the 3 percent pledge, see chapter 14; for PD 18, see chapter 5.

34. Carter Daily Diary, 16 Dec 1977, Carter Library; memos, Jayne for Brown, 20 Dec 1977, folder 110.01 (14 Dec–21 Dec) 1977; Quetsch for Brown, 28 Dec 1977, folder 110.01 (22 Dec–31 Dec) 1977: both in box 16, SecDef Files, Acc 330-80-0017; Carter's FY 79 Budget message to Congress, 20 Jan 1978, *Carter Public Papers 1978*, 1:187. The inflation figure of 6.5 percent is from the Bureau of Labor Statistics.

35. Memo, Jayne for Duncan, 4 Nov 1977, w/Brown's comments, attaching OMB draft study, folder 560 (Aug-Dec) 1977, box 57, SecDef Files, Acc 330-80-0017. CVNs were expensive because each carrier group required four nuclear escort vessels and two nuclear protective submarines at an approximate total cost of about \$7.2 billion (not counting other support ships and aircraft).

36. Memos, Claytor for Brown, 11 Nov 1977 (quote); Claytor for Murray, 18 Nov 1977 (quote): both in folder 560 (Aug-Dec) 1977, box 57, *ibid*. Why OMB included the basically unrelated issues of a CGN-42, a cable-laying ship, and tenders was beyond Claytor's understanding; he noted in his 11 November memo their deletion from the FY 1979 budget was "off-hand" with "little by the way of supporting rationale."

37. Memo, Murray for Brown and Duncan (quotes), w/Brown's comments, 18 Nov 1977, *ibid*.

38. Memo, Brown for Carter, 1 Dec 1977, *ibid*. As for the nuclear Aegis cruiser (CGN-42) and the cable-laying ship, Brown recommended authorization of both in FY 1979 but reduced the number of destroyer tenders to one in FY 1979 and another in FY 1980 or 1981.

39. Brown's quote is from his press briefing on FY 1979 DoD budget, 23 Jan 1978, folder CY78/FY79 DoD Budget, box 802, Subject Files, OSD/HO. Carter's quote is from his budget message, 20 Jan 1978, *Carter Public Papers 1978*, 1:187.

40. Brown's press briefing, 23 Jan 1978; Norman Kempster, "\$126 Billion Defense Outlay Stresses NATO Commitments," *Los Angeles Times*, 24 Jan 1978, B12; Bernard Weinraub, "Higher Outlay Emphasizes Buildup in Aid to NATO," 24 Jan 1978, *New York Times*, 17; Kenneth Bacon, "Defense Budget of \$115.2 Billion Proposes Banquet for European Forces, Normal Diet for Rest of Military," *Wall Street Journal*, 24 Jan 1978, 3; George Wilson, "Carter's 'NATO Budget' Indicated Shift in Military Focus," *Washington Post*, 15 Jan 1978, A6.

41. DoD News Release 17-78, 23 Jan 1978, folder CY78/FY79 DoD Budget, box 802, Subject Files, OSD/HO; John Behuncik, Heritage Foundation, “The Carter Defense Budget, FY 1979,” 3 Mar 1978, 10–12, <<http://hdl.handle.net/10207/8870>, 10-11>, accessed 11 Jan 2010.

42. DoD News Release 17-78, 23 Jan 1978; Behuncik, “Carter Defense Budget,” 12–13. The 15 ships to be procured in FY 1979 included one Trident missile launch submarine (\$1,659.2 million), eight guided missile frigates (\$1,547.9 million), one attack submarine (\$474.4 million), one destroyer tender (\$322.6 million), one cable repair ship (\$192.1 million), and three T-AGOS surveillance ships (\$98.4 million). Program Acquisition Costs by Weapon System for DoD FY 79 Budget, *Brown Public Statements 1978*, 1:121–133.

43. Brown admitted this was a difficult decision; Senators Gary Hart, Barry Goldwater, Wendell R. Anderson (D-MN), and Vice President Mondale supported it, as did Brown’s military assistant, Rear Adm. Carl Thor Hanson, who thought, because of its speed, the SES “in a cargo ship role . . . could put Sov subs back to German WWII battery sub problem” and would also “give young naval officers something to look forward to as an alternative to the nuclear navy.” Ltrs, Goldwater, Hart, Anderson to Brown, 15 Dec 1977; Brown to Hart, 20 Jan 1979; notes, Brown to Duncan, 29 Dec 1977; Hansen to Brown, 25 Nov 1977 (quotes): all in folder 560 (Aug-Dec) 1977, box 57, SecDef Files, Acc 330-80-0017.

44. How to judge the U.S.-USSR naval balance proved difficult. Number of ships or combined full load displacement were crude measurements (the Soviet Union enjoyed a 5 to 1 advantage in ships—mostly small, short-range coastal defense vessels that were inefficient and obsolete—while the United States had a 20 percent advantage in displacement tonnage). The Navy contended that while the absolute size of the Soviet Navy was shrinking, it was modernizing and producing “sophisticated, offensively oriented seagoing platforms.” The Navy concluded that the “Soviet Navy has completed the transition from a coastal force to a first-rate, worldwide, naval power—and it continues to improve.” Net Assessment of the United States and Soviet Navies, NA-77, vol. 1, 5, 12–13, folder USSR 560, 1977, box 83, *ibid*.

45. DoD News Release 17-78, cited in note 41; Behuncik, 14–15, cited in note 41.

46. “Close aide” quoted in Richard Burt, “Officials Say Carter Has Won Unparalleled Sway Over Defense Policy,” *New York Times*, 28 Jan 1978, 7.

47. Evans and Novak, “The Defense Budget’s Message to the World,” *Washington Post*, 29 Dec 1977, A19 (quote); “A Prudent Defense Budget,” *New York Times* editorial, 24 Feb 1978, A26 (quote). The conservative *Chicago Tribune* editorialized that the budget “could well serve as a blueprint for disaster . . . that short changes defense,” *Chicago Tribune*, 25 Jan 1978, B2.

48. Kenneth Bacon, “Sugar Daddy to the Navy,” *Wall Street Journal*, 14 Mar 1978, 22.

49. Brown quoted in Bernard Weinraub, “Defense Chief Vexed by Criticism in Navy,” *New York Times*, 17 Feb 1978, D11.

50. George Wilson, “Navy Boss Says New Study Supports ‘Midi’ Carriers,” *Washington Post*, 22 Feb 1978, 5; Norman Kempster, “Navy Secretary May Break with Carter Over Size, Role of Fleet,” *Los Angeles Times*, 3 Apr 1978, 20.

51. Wire Services, “Navy battles to retain supremacy, but the enemy is Carter,” *Philadelphia Inquirer*, 6 Apr 1978, 3 (quote); Charles Corddry, “Navy management faulted in ship-plan failure,” *Baltimore Sun*, 29 Mar 1978, 12; George Wilson, “Navy Told to Fix Shipbuilding Problems Before Expecting Money for New Fleet,” *Washington Post*, 29 Mar 1978, A2 (quote). A former Air Force officer who received his Air Force Academy diploma from then-Secretary of the Air Force Brown in 1966, Jayne was the associate director of the 85-person defense section at OMB. Bernard Weinraub, “Young Aide Shapes Defense Policy,” *New York Times*, 15 Apr 1978, 9 (quote).

52. Memo, Claytor for Brown, 20 Mar 1978, w/attached Executive Summary of SEA-PLAN 2000 (quotes); ltr, Claytor to Magnuson, 17 Mar 1978, w/attached Assessment Sea Based Air Platforms Project Report (quotes), Feb 1978: both in folder 560.1 (17 Feb 1978), SecDef Files, Acc 330-81-0202, WNRC.

53. Charles Corddry, “Navy secretary ‘invites’ nuclear-carrier okay,” *Baltimore Sun*, 28 Mar 1978, 3. At the forum Claytor explicitly criticized Brown’s staff people who “use systems analysis as a cover for what is really a subjective judgment”—a clear jab at Murray and PA&E. Woolsey stated that it was a mistake to limit the Navy to 400 to 450 ships since the threats the Navy would face in 30 years could be every different. Bernard Weinraub, “Dispute Over Navy Role Termed Biggest Defense Fight Since 1949,” *New York Times*, 4 Apr 1978, 16 (quote).

54. Memos, Brown for Carter, 10 Mar 1978 (quote), 0000B437.pdf; Brown for Carter, 24 Mar 1978 (quote), 0000B439.pdf: both in CD-1, Declassified SecDef Files.

55. Norman Kempster, “Fears of Declining U.S. Seapower Told,” *Los Angeles Times*, 7 Apr 1978, B10 (quote). Holloway also suggested that Congress transfer money earmarked for construction of a Trident-equipped submarine in FY 1979 to the construction of a *Nimitz*-class CVN. George Wilson, “House Navy Panel Threatens Subpoena of 2 U.S. Officials,” *Washington Post*, 7 Apr 1978, A25. The two “enemies” of the Navy, Jayne and Murray, were not subpoenaed.

56. Memo, Brown for Carter, 10 Mar 1978 (quotes), w/attached memo, Brown for Brzezinski, 8 Mar 1978 (quote), 000B437.pdf, CD-1, Declassified SecDef Files.

57. Carter speech, *Carter Public Papers 1978*, 1:529–535. Brzezinski informed Carter that polls indicated that since late 1976 Americans were increasingly dissatisfied with how U.S. military power compared with that of the Soviet Union: 41 percent in late 1976, 55 percent in spring 1978. Memo, Brzezinski for Carter, 4 Aug 1978, folder Weekly Reports to the President, 61–71, box 41, Subject File, Brzezinski Donated Material, Carter Library.

58. Memo, Brown for Carter, 28 Apr 1978, 000B43B.pdf, CD-1, Declassified SecDef Files.

59. *Ibid.*; memos, Brown for Carter, 5 May 1978, 0000B43C.pdf; Duncan for Carter, 19 May 1978, 0000B43E.pdf: both *ibid.*

60. Memo, Brown for Carter, 12 May 1978 (quote), 0000.B43D.pdf, *ibid.*

61. *Congressional Quarterly Almanac, 1978*, vol. 34 (Washington, DC: Congressional Quarterly, 1979), 325–326.

62. *Ibid.*; memo, Brown for Carter, w/Carter's comments, 26 May 1978, folder 020 DoD (11 Apr–May) 1978, box 6, SecDef Files, Acc 330-81-0202.

63. *Ibid.* (quotes); memo, Brown for Carter, 2 Jun 1978 (quote), 0000B440.pdf, CD-1, Declassified SecDef Files.

64. Memos, Brown for Carter, 2 Jun 1978, 000B440.pdf; Brown for Carter, 9 Jun 1978 (quote), 0000B441.pdf: both in CD-1, Declassified SecDef Files. The text of the Chicago speech is in News Release 289-70, 6 Jun 1978 (quotes), *Brown Public Statements 1978*, 6:2147–2154.

65. Memo, Brown for Carter, 9 Jun 1978, 000B441.pdf, CD-1 Declassified SecDef Files; Press release No. 289-70, 6 Jun 1978 (quotes), *Brown Public Statements 1978*, 6:2147–2154.

66. *CQ Almanac 1978*, 34:331–332 (quotes); memo, Brown for Carter, 14 Jul 1978, folder Jul 18, 1978 [No. 1], box 95, Presidential Handwriting File, Office of Staff Secretary, Carter Library.

67. *CQ Almanac 1978*, 34:335–336.

68. *Ibid.*, 336.

69. Memo, Brown for Carter, 16 Aug 1978, folder 110.01 (1–16 Aug) 1978, box 15, SecDef Files, Acc 330-81-0202.

70. Carter Daily Diary, 16 and 17 Aug 1978, Carter Library; memo, McIntyre for Carter, n.d. [mid-Aug 1978], folder DoD 7–8/78, box 5, Agency File, Brzezinski Material, National Security Affairs, Carter Library; Don Oberdorfer, “President Weighs Veto of Weapons Procurement Bill,” *Washington Post*, 17 Aug 1978, A1 (quotes); briefing memo for Carter, 16 Aug 1978, folder FI 4/FG 13, 7/1/78–8/31/78, box FI-13, Subject File, WHCF: Executive, Carter Library.

71. Memo, Moe for Carter, 18 Aug 1978, folder FI 4/FG 13, 7/1/78–8/31/78, box FI-13, Subject File, WHCF: Executive, Carter Library; memo, Brown for Carter, 1 Sep 1978, 0000B448.pdf, CD-1, Declassified SecDef Files.

72. Ltrs, Price to Carter, 3 Aug 1978 (quote); Carter to Price, 1 Sep 1978 (quotes): both in folder FI 4/FG 13, 9/11/78–9/30/78, box FI-14, Subject File, WHCF: Executive, Carter Library.

73. Ltr, Brown to O’Neill, 31 Aug 1978 (quote), folder FY 79 DoD Authorization (2), box 803, Subject Files, OSD/HO.

74. Memo, Rafshoon for White House Staff, 21 Aug 1978 (quotes, emphasis in original), folder FI 4/FG 13, 7/1/78–8/31/78, box FI-13, Subject File, WHCF: Executive, Carter Library. Indicative of the success of this campaign, Rafshoon reported that newspaper editorials had been running about 9 to 1 in favor of the veto. Memo, Rafshoon for White House Staff, 25 Aug 1978, *ibid.*

75. *CQ Almanac 1978*, 34:340.

76. *Ibid.*, 341–42; memos, Brown for Carter, 8 Sep 1978, 0000B449.pdf; 15 Sep 1978, 0000B44A.pdf; 22 Sep 1978, 0000B44B.pdf; 29 Sep 1978, 0000B44C.pdf: all in CD-1, Declassified SecDef Files; George Wilson, “Fight Starts Over Use of Nimitz Money, Pentagon Wish List,” *Washington Post*, 13 Sep 1978, A6; Wilson, “Senate Panel Rejects Pentagon Wish List,” *Washington Post*, 15 Sep 1978, A3.



77. *CQ Almanac 1978*, 133–138.

78. *Ibid.*, 141–142.

79. *Ibid.*, 132, 143–145; memo, Brown for Carter, 13 Oct 1978, 0000B44D.pdf, CD-1, Declassified SecDef Files.

80. *CQ Almanac 1978*, 132; memo, Brown for McIntyre, 4 Nov 1978, folder 110.01 (3 Nov–15 Nov) 1978, box 14, SecDef Files, Acc 330-81-0202.

81. Memos, Brown for Carter, 2 Feb 1978, 0000B0F.pdf; 2 Mar 1978 (quote), 0000B413.pdf: both in CD-1, Declassified SecDef Files.

82. Memos, Brown for Carter, 16 Mar 1979, 0000B414.pdf; 30 Mar 1979, 6 (quote), 0000B417.pdf; 9 Apr 1979, 0000B418.pdf: all in CD-1, Declassified SecDef Files; *Congressional Quarterly Almanac*, 1979, vol. 35 (Washington, DC: Congressional Quarterly, 1980), 438–439.

83. *CQ Almanac 1979*, 35:439–442.

84. Memos, Brown for Carter, 4 May 1969 (quote), 0000B419.pdf; Brown for Carter, 13 Jul 1979 (quote), 0000 B41F: both in CD-1, Declassified SecDef Files. The Iranian destroyers proved politically contentious because Stennis, in whose state they were being built, insisted that he had a promise from Brown that all four would be acquired in FY 1979, rather than two in FY 1979 and two in FY 1980 as the House voted and OMB supported. Robert Kaiser, “Senate Adds Ships To ’79 Arms Budget,” *Washington Post*, 4 May 1979, A13.

## 9. The Middle East Peace Process

1. For DoD and the secretaries of defense and the Middle East, 1969–1976, see Hunt, *Melvin Laird and the Foundation of the Post-Vietnam Military*, 477–483, and Walter S. Poole, *The Decline of Détente: Elliot Richardson, James Schlesinger, and Donald Rumsfeld, 1973–1977* (Washington, DC: OSD Historical Office, 2016), 7–9. As for Camp David, to paraphrase John F. Kennedy, success has many authors. Much has been written about the Camp David Peace Accords by contemporary officials involved in them. See Carter, *Keeping Faith*, 273–429; *White House Diary*, 216–245 (containing the president’s diary entries during the meetings); and *The Blood of Abraham: Insights into the Middle East* (Boston: Houghton Mifflin, 1985), 43–45, 167–170; Brzezinski, *Power and Principle*, 83–122, 234–288; Vance, *Hard Choices*, 159–255; William B. Quandt, *Camp David: Peacemaking and Politics* (Washington, DC: Brookings Institution, 1986), 168–258; and *Peace Process: American Diplomacy and the Arab-Israeli Conflict Since 1967*, 3rd ed. (Berkeley: University of California Press, 2005), 177–242; Moshe Dayan, *Breakthrough: A Personal Account of the Egypt-Israel Peace Negotiations* (London: Weidenfeld and Nicholson, 1981), 149–190; Ezer Weizman, *The Battle for Peace* (Toronto: Bantam Books, 1981), 340–382; Mohamed Ibrahim Kamel, *The Camp David Accords: A Testimony by Sadat’s Foreign Minister* (London: KPI, 1986), 294–369.

2. Carter, *Keeping Faith*, 282 (quotes); *White House Diary*, 38–39.

3. Memcon, Sadat and Brown, 5 Apr 1977, folder Egypt 1977, box 66, SecDef Files, Acc 330-80-0017, WNRC. For the summary of this discussion by Sadat for Carter, see *FRUS*

1977–1980, *Arab-Israeli Dispute, January 1977 to August 1978*, vol. 8, ed. Adam M. Howard (Washington, DC: GPO, 2013), 8:184–185 (doc 27).

4. Memo, Brzezinski for Vance and Brown, 29 Apr 1977, folder Egypt 1977, box 66, SecDef Files, Acc 330-80-0017.

5. Memo, Brown for Vance and Brzezinski, 14 Dec 1977, 0000CB20.pdf, CD-2, Declassified SecDef Files, WNRC.

6. Memo, Vance and Brown for Brzezinski, n.d. [c. 23 Dec 1977], 0000CB12.pdf, *ibid.*

7. Memo, Brown for Carter, 7 Feb 1978, w/attached memcon, Brown and Sadat, 6 Feb 1978, folder Egypt 091.112 (Oct-Dec) 1978, box 55, SecDef Files, Acc 330-81-0202, WNRC.

8. Memcon, Brown and Gamasy, 7 Jul 1978, *ibid.*

9. Memo, McAuliffe for Brown, 3 Feb 1977, folder 091.3 Israel (Jan-Apr) 1977, box 70, SecDef Files, Acc 330-80-0017.

10. *Ibid.*; for Ford’s decision memorandum on military assistance to Israel, see *FRUS 1969–1976*, vol. 26, *Arab-Israeli Dispute, 1974–1976*, ed. Adam M. Howard (Washington, DC: GPO, 2012), 423–424 (doc 101), 917–919 (doc 26).

11. Memo, Holcombe for Brzezinski, 9 Feb 1977, folder 091.3 Israel (Jan-Apr) 1977, box 70, SecDef Files, Acc 330-80-0017.

12. Memo, McAuliffe for Brown, 3 Feb 1977, cited in note 9.

13. PRM 3, “Middle East,” 21 Jan 1977, PD01538, DNSA.

14. Minutes of PRC Meeting, 4 Feb 1977, *FRUS 1977–1980*, 8:5–19 (doc 3).

15. Minutes of NSC Meeting, 23 Feb 1977, *ibid.*, 122–130 (doc 16).

16. Memo, Holcombe for White House Cabinet Secretary, 3 Mar 1977, folder Israel 1977, box 69, SecDef Files, Acc 330-80-0017.

17. Carter, *Keeping Faith*, 279–280; Brzezinski, *Power and Principle*, 90; Vance, *Hard Choices*, 173.

18. Memo, Slocombe for Brown, 27 Mar 1977, folder Israel 1977, box 69, SecDef Files, Acc 330-80-0017.

19. Ltr, Brown for Vance, 20 Apr 1977, w/enclosed Review of Israel’s F-16 Request, Apr 1977, 0000D209.pdf, CD-2, Declassified SecDef Files.

20. Memo, McGiffert for Brown, 31 May 1977, folder Israel 1977, box 69, SecDef Files, Acc 330-80-0017.

21. Memos, Duncan for Brzezinski, 15 Feb 1977, 9 Mar 1977 (quote); Brzezinski for Duncan, 16 Apr 1977: all in folder 471.6, 1977, box 55, SecDef Files, Acc 330-80-0017. Unlike high-explosive weapons that used blast and fragmentation, CBU-72/B used a mixture of fuel (ethylene oxide aerosol) and ambient air to blast as a kill mechanism. Carter prohibited their sale to any nation and ended their production. Since the Israelis had used nonfuel-air explosive cluster bombs (CBU-71s) against Lebanese civilians, Carter readily agreed with Duncan’s suggestion to deny additional sales to Israel. Brzezinski, *Power and Principle*, 91.

22. Minutes of PRC Meeting, 10 Jun 1977, *FRUS 1977–1980*, 8:297–308 (doc 40).

23. *Ibid.*; memo, Holcombe for Aaron, 10 Jun 1977, folder Israel 091.3 (Jan-Aug) 1977, box 70, SecDef Files, Acc 330-80-0017; ltr, Brown to Vance, 20 Jun 1977, 0000CA455.pdf, CD-1, Declassified SecDef Files; memo, Dodson for Mondale, Vance, and Brown, 20 Jun 1977, w/attached discussion paper, folder Middle East 092 (Jun) 1977, box 72, SecDef Files, Acc 330-80-0017. The discussion paper is summarized in *FRUS 1977–1980*, 8:318n2, doc 43.

24. Summary of Conclusions of PRC Meeting, 25 Jun 1977, *FRUS 1977–1980*, 8:317–318 (doc 43).

25. Carter, *Keeping Faith*, 290–291; Brzezinski, *Power and Principle*, 98–101. To Carter's disappointment, upon his return home Begin approved new Israeli settlements in the occupied West Bank.

26. Memo, Brown for Carter, 22 Jul 1977, 0000B400.pdf, CD-1, Declassified SecDef Files.

27. Memo, Brzezinski for Vance and Brown, 22 Jul 1977, 0000CAB8.pdf, *ibid.*

28. A typical assessment to this end was National Intelligence Estimate (NIE) 35/36-1-77, 2 Aug 1977, "Middle East Military Balance," folder Middle East 320.2, 1977, box 72, SecDef Files, Acc 330-80-0017.

29. Memo, Brown for Brzezinski, 15 Dec 1977, folder Israel, 1977, box 69, *ibid.*

30. JCSM 473-77 for SecDef, 29 Dec 1977, folder Israel, 1977, box 3, SecDef Files, Acc 330-80-0016, WNRC.

31. Carter, *Keeping Faith*, 299–300; Brzezinski, *Power and Principle*, 115–120.

32. Memo, Thomas for Hanson, 15 Dec 1977, folder Israel, 1977, box 69, SecDef Files, Acc 330-80-0017.

33. Memo, McGiffert for Brown, 7 Jan 1978, folder Israel 091.3 (Jan-Jun) 1978, box 57, SecDef Files, Acc 330-81-0202.

34. Memo, Brzezinski for Vance and Brown, 3 Mar 1978, w/attached Summary of Conclusions of PRC Meeting, 27 Feb 1978, folder Israel 091.2, 1978, box 3, SecDef Files, Acc 330-81-0212, WNRC; also printed in *FRUS 1977–1980*, 8:1022–1023 (doc 220).

35. Memcon, Brown and Weizman, 8 Mar 1978 (quotes); draft memo, Vance and Brown for Carter, 10 Mar 1978: both in folder Israel 091.112, 1978, box 57, SecDef Files, Acc 330-81-0202. Weizman hoped for a warmer reception from Brown, whom he described as "my own opposite, reserved and shy," "almost incapable of small talk" and "a descendant of the Jewish people who had grown away from his roots." For Weizman's extended and atmospheric account of their meeting, see *Battle for Peace*, 233–236, 238–240, 242–248.

36. Memo, Brzezinski for Vance and Brown, 11 Mar 1978, folder Israel, 1978, box 3, SecDef Files, Acc 330-81-0212.

37. Memo, Brzezinski for Brown, 23 Mar 1978, w/attached Israeli list, folder Israeli 091.3 (Jan-Jun) 1978, box 57, SecDef Files, Acc 330-82-0202.

38. Memo, Duncan for Brzezinski, 13 Apr 1978, *ibid.*

39. In their first meeting, Sadat shrewdly told Carter he would not ask for F-5 aircraft, although Egypt needed them, since such forbearance would further the peace process. His words were music to Carter's ears. Carter, *Keeping Faith*, 284; *White House Diary*, 39.

40. Brzezinski, *Power and Principle*, 247–248.

41. Memo, Brzezinski for Carter, 15 Dec 1977, w/Carter's comment, folder Middle East 1977, box 72, SecDef Files, Acc 330-80-0017; Carter, *White House Diary*, 122.

42. Memos, McGiffert for Brown, 10 Jan 1978, folder Middle East 1978, box 60; Brown for Carter, 27 Jan 1978, folder Middle East 452, box 61: both in SecDef Files, Acc 330-81-0202. Concluding that the Ford administration had promised the Saudis an advanced fighter of their choice, the Carter administration decided it was obligated to sell the kingdom the F-15s as they requested. Memo, Brown for Brzezinski, 21 May 1977, 0000CA5A.pdf, CD-1, Declassified SecDef Files. On 25 May 1977 the Saudis requested 60 F-15s. Ltr, Brown to Vance, 4 Jun 1977, folder Saudi Arabia 400–499, 1977, box 79, SecDef Files, Acc 330-80-0017. The JCS approved the deal and Brown agreed. JCSM 206-77 for SecDef, 11 May 1977; ltr, Brown to Vance, 15 Aug 1977: both *ibid*.

43. Memo, Powell for Cabinet, 27 Feb 1978, w/attached background report, “Arms Sales-Mideast,” folder Middle East 1978, box 60, SecDef Files, Acc 330-81-0202. Brzezinski refers to an increase of planes for Egypt and attributes it to Carter's pique over Israeli settlements and his fondness for Sadat. Brzezinski, *Power and Principle*, 248. In fact, Egypt received 50 (not 60 as recommended by DoD) F-5s, but at an accelerated delivery schedule. Israel's allotment dropped from DoD's recommended 125 to 75 F-16s and 25 to 15 F-15s.

44. Carter, *White House Diary*, 194–195; Brzezinski, *Power and Principle*, 247–249 (quote).

45. Intelligence assessment, 21 Apr 1978, CK3100720278, DDRS. As of March 1978, Israel had 160 F-4s, 255 A-4s, and 9 F-15s (all three aircraft types were of U.S. origin) as well as 70 French-made Mirages and 80 Israeli-produced (with major U.S. components) Kfir fighter bombers. Egypt had 460 fighters, mostly obsolescent MiG-21s. Its 20 MiG-23s were all grounded for lack of spare parts.

46. Carter, *White House Diary*, 194–195; memo, Brown for Carter, 7 Jul 1978, 0000B443.pdf, CD-1, Declassified SecDef Files.

47. Carter, *White House Diary*, 195 (quote).

48. Brzezinski, *Power and Principle*, 251–252; Carter, *Keeping Faith*, 316; *White House Diary*, 210.

49. *Carter Public Papers 1978*, 2:1393.

50. Quandt, *Camp David*, 217–218; Rearden with Foulkes, *JCS and National Policy 1977–1980*, 82.

51. Carter Daily Dairy, 15 Sep 1978, Carter Library; Carter, *Keeping Faith*, 391–393, 391 (quote); *White House Diary*, 236–238; Quandt, *Camp David*, 238–239; Kamel, *Camp David Accords*, 352–357. According to Kamel, Vance and Brown rushed to Sadat's cabin 10 minutes before Carter to engage the Egyptian president in general conversation apparently to prevent him from leaving.

52. Brzezinski, *Power and Principle*, 267. Later in the afternoon of 15 September, Brown joined Vance and Brzezinski in a meeting with Weizman, Israeli Foreign Minister Moshe Dayan, and Attorney General Aaron Barak to discuss the Sinai withdrawal and the bases.

Carter had insisted to Brzezinski prior to the meeting that the bases deal would require a full Israeli withdrawal (including settlements) from the Sinai.

53. Ltr, Brown to Weizman, 28 Sep 1978, folder Israel 000.1-329, 1978, SecDef Files, Acc 330-81-0202.

54. Memo, Brown for Carter, 20 Oct 1978, w/Carter's comment, folder DoD 10/78, box 5, Agency File, Brzezinski Material, National Security Affairs, Carter Library.

55. Memo, Brown for Carter, 27 Oct 1978, folder Israel 000.1-329, 1978, box 57, SecDef Files, Acc 330-81-0202.

56. Memo, McGiffert for Brown, 26 Oct 1978, *ibid.*

57. Memo, Brown for Carter, 16 Dec 1978, w/attached draft executive summary of the DoD-Israeli Airbase Survey Team Report, Dec 1978, *ibid.*; Frank N. Schubert, *Building Air Bases in the Negev: The U.S. Army Corps of Engineers in Israel, 1979–1982* (Washington, DC: Office of History, Corps of Engineers and U.S. Army Center of Military History, 1992), 2–13.

58. Quoted in Brzezinski, *Power and Principle*, 276.

59. Memo, Chayes for Brown, 3 Jun 1980, folder Israel (Jan-Jul) 1980, box 9, SecDef Files, Acc 330-82-0217, WNRC. The story of the Corps of Engineers' effort in the Sinai is outlined in detail in Schubert, *Building Air Bases in the Negev*. The costs went some \$20 million over the final \$1.038 billion budget, *ibid.*, 270, 273–274.

60. Memo, Brown for Carter, 2 Feb 1979, folder Secretary Brown, Eyes Only, Jan-Jun 1979, box 21, Brown Papers, LC; ltr, Carter to Brown, 9 Feb 1979 (quotes), folder DoD 1–2/79, box 5, Agency File, Brzezinski Material, National Security Affairs, Carter Library.

61. Ltr, Carter to Brown, 9 Feb 1979 (quote), folder DoD 1–2/79, box 5, Agency File, Brzezinski Material, National Security Affairs, Carter Library; memo, Brown for Carter, 19 Feb 1979, w/Carter's comment, folder Middle East (Feb 1–23) 1979 (quotes), box 15, SecDef Files, Acc 330-82-0205, WNRC; Brown with Winslow, *Star Spangled Security*, 75, 147–148.

62. Ltr, Carter to Brown, 9 Feb 1979, folder DoD 1–2/79, box 5, Agency File, Brzezinski Material, National Security Affairs, Carter Library.

63. Ltr, Carter to Brown, 9 Feb 1979, *ibid.*; memo, Brown for Carter, 19 Feb 1979, w/Carter's comment, folder Middle East (1–23 Feb) 1979, box 15, SecDef Files, Acc 330-82-0205.

64. Memo, Brown for Carter, 19 Feb 1979 (quote), w/Carter's comment, folder Middle East (1–23 Feb) 1979, box 15, SecDef Files, Acc 330-82-0205.

65. *Ibid.* (quotes).

66. Carter, *White House Diary*, 294.

67. Memo, Ermarth for Aaron and Brzezinski, 21 Feb 1979, folder DoD 1–2/79, box 5, Agency File, Brzezinski Material, National Security Affairs, Carter Library.

68. Memo, Brown for Carter, 3 Mar 1979, folder Middle East (24 Feb–15 Mar) 1979, box 15, SecDef Files, Acc 330-82-0205.

69. *Ibid.*

70. Memo, Brown for Carter, 6 Mar 1979, *ibid.*

71. Memo, Brown for Carter, 13 Mar 1979 (quote), *ibid.*

72. Carter, *Keeping Faith*, 424, and White House Diary, 303; Brzezinski, *Power and Principle*, 283–285, Vance, *Hard Choices*, 249–252. The five major issues resolved during the trip to Egypt and Israel were as follows: Egypt’s demand for a note that the treaty was part of the comprehensive settlement; Egypt’s demand that under the treaty it could come to the aid of an Arab state that was the victim of aggression; Egypt’s demand for a target date for elections in the West Bank and Gaza; Israel’s insistence that Egypt exchange ambassadors one month after the interim withdrawal from the Sinai; and Begin’s demand that Egypt agree to a multiyear commitment to sell Sinai oil to Israel. *Ibid.*, 245–246.

73. Memo, Brown for Carter, 14 Mar 1979, folder Israel (Jan-Jun) 1979, box 12, SecDef Files, Acc 330-82-0205; ltr, Brown to Ali, 23 Mar 1979; memo, McGiffert for Brown, 9 Jun 1978: both in folder Egypt (Jan-Jul) 1979, box 9, SecDef Files, Acc 330-82-0205. The 14 March memo and the 23 March letter are printed in *FRUS 1977–1980*, vol. 9, *Arab-Israeli Dispute, August 1978 to December 1980*, ed. Alexander R. Wieland (Washington, DC: GPO, 2014), 729–732 (doc 206); 783–784 (doc 224), respectively.

74. Bernard Weinraub, “Requests by Israel for Arms Approved, Egyptian Package Tentatively Set,” *New York Times*, 21 Mar 1979, A5; Graham Hovey, “U.S. Puts Off Jet Sale to Egypt After Saudis Delay on Paying Costs,” *New York Times*, 7 Jul 1979, A1; Egyptian Air Force, “F-4E Phantom II,” <<http://www.egfighters.freehostng.net/fa.html>>, accessed 25 Oct 2011.

75. Memo, Brown for Carter, 14 Mar 1979, cited in note 73.

76. Memo, Brown for Vance, Brzezinski, and McIntyre, 24 Mar 1979, folder Middle East (16 Mar–31 Mar) 1979, box 15, SecDef Files, Acc. 330-82-0205.

77. Memo, Brown and Vance for Carter, 19 Jul 1979, folder Egypt (Jan-Jul) 1979, box 9, *ibid.*: also printed in *FRUS 1977–1980*, 9:878–880 (doc 268).

78. Memo, Hunter, Sick, and Kimmit for Brzezinski, 19 Sep 1979, CK3100151474, DDRS.

79. Minutes and Summary of Conclusions of PRC Meeting, 20 Sep 1979, CK3100147712, *ibid.*; memo, Brzezinski to Carter, 27 Sep 1979, *FRUS 1977–1980*, 9:956–958 (doc 292).

80. Memo, Brzezinski for Vance and Brown, 1 Oct 1979 (quote, emphasis in original) folder Egypt (Aug-Dec) 1979, box 9, SecDef Files, Acc 330-82-0205.

81. Memo, Brzezinski for Carter, 7 Nov 1979, w/attached State-DoD memo, 17 Oct 1979, CK3100095327, DDRS: also printed in *FRUS 1977–1980*, 9:985–993 (doc 301).

82. Memo, McIntyre for Carter, 8 Nov 1979, CK3100095337, DDRS.

83. Memo, Brzezinski for Vance and Brown, 8 Nov 1979, folder Egypt (Aug-Dec) 1979, box 9, SecDef Files, Acc 330-82-0205.

84. Memo, Brown and Vance for Carter, 3 Dec 1979, *ibid.* The NSC staff went even further, suggesting raising the ceiling to \$2.6 billion against which Egypt could borrow, thereby committing the U.S. to \$800 million in FMS credits for years beyond FY 1982. Memo, Kimmit for Brzezinski, 22 Jan 1980, folder Mtgs MBB, 1/80–2/80, box 34, Subject File, Brzezinski Donated Material, Carter Library.

85. Memo, McGiffert for Brown, 15 Jan 1980, folder Egypt (Jan-Feb) 1980, box 7, SecDef Files, Acc 330-82-0217.

86. Memo, Brown for Carter, 28 Jan 1980, CK3100111510, DDRS; also printed in *FRUS 1977–1980*, 9:1069–1071 (doc 329). For Brzezinski’s covering summation of the issues, see *ibid.*, 1078–1082 (doc 331).

87. Memo, Smith for McGiffert, 17 Jan 1980, folder Egypt (Jan-Feb) 1980, box 7, SecDef Files, Acc 330-82-0217.

88. Memo, Brown for Carter, 28 Jan 1980, cited in note 86.

89. *Ibid.*, w/Carter’s approval. The president also “approved” two of the options suggested by Brown and a third one should Egypt insist on F-15s. Memo, Brzezinski for Vance, Brown, and McIntyre, 9 Feb 1980, CK3100111515, DDRS. The problem was that Brown and OSD did not want McGiffert, who was heading a team to negotiate the assistance program with Egypt, to be tied down in his negotiations in Cairo. The “approved” options became only “illustrative.”

90. Memo, Brown for Carter, 29 Feb 1980, 0000B45C.pdf, CD-1, Declassified SecDef Files.

91. Memo, McGiffert for Brown, 28 Dec 1979 (quote), folder Israel (Oct-1979), box 12, SecDef Files, Acc 330-82-0205.

92. Memo, McGiffert for Brown, 26 Dec 1979, *ibid.*; memo, Saunders for Vance, 26 Dec 1979, 0000D368.pdf, CD-2, Declassified SecDef Files. Congress ultimately added another \$200 million in FMS credits. Memo, McGiffert for Brown, 20 Aug 1980, 0000D367.pdf, CD-2, Declassified SecDef Files.

93. Memo, Kramer for Brown, n.d. [28 Apr 1980], folder Israel (Jan-Jul) 1980, SecDef Files, Acc 330-82-0217; memo, Tarnoff to Brzezinski, 26 Apr 1980, CK3100105169, DDRS.

94. Memo, Brzezinski for Christopher, 1 May 1980, *ibid.* Israel built only three prototypes of the Lavi, never put the plane into production because of its high costs, and cancelled the project on 30 August 1978, <[www.israeli-weapons.com/weapons/aircraft/lavi/Lavi.html](http://www.israeli-weapons.com/weapons/aircraft/lavi/Lavi.html)>; Ruud Deurenberg, “Israel Aircraft Industries (IAI) Lavi,” <[www.jewishvirtuallibrary.org/jsource? society\\_ &\\_ Culture/lavi.html](http://www.jewishvirtuallibrary.org/jsource? society_ &_ Culture/lavi.html)>; both accessed 13 Oct 2011. For a detailed account of the fate of the Lavi during the Reagan administration, see Dov Zakheim, *Flight of the Lavi: Inside a U.S.-Israeli Crisis* (London: Brassey’s, 1996).

95. Memo, Brown for Brzezinski, 21 May 1977, folder Saudi Arabia 400-499, 1977, box 79, SecDef Files, Acc 330-80-0017.

96. Ltr, Brown to Vance, 15 Aug 1977 (quote), w/attached memo JCSM 300-77 for SecDef, 18 Jul 1977, 0000CAB4.pdf, CD-1, Declassified SecDef Files; memo, Slocombe for Brown, 18 May 1977 (quote), w/Brown’s comment, 0000BF2C.pdf, CD-1, Declassified SecDef Files.

97. Ltr, Brown to Sparkman, 9 May 1978, folder Saudi Arabia (Nov-Dec) 1980, box 16, SecDef Files, Acc 330-82-0217; Carter, *White House Diary*, 194–195; Brzezinski, *Power and Principle*, 249.

98. William B. Quandt, *Saudi Arabia in the 1980s: Foreign Policy, Security, and Oil* (Washington, DC: Brookings Institution, 1981), 137–157.

99. Msg 1751, Embassy Jidda to State, 3 Mar 1979; msg 06831, JCS to CINCREM, 072226Z Mar 1979: both in folder Mar 1979, SecDef Cables, OSD/HO; memo, Brown

for Carter, 2 Mar 1979, 0000B413.pdf, CD-1, Declassified SecDef Files; memo, Carter for Brown and Vance, 7 Mar 1979, folder Mar 1979, SecDef Cables, OSD/HO; memo, Brown for Carter, 16 Mar 1979, 0000B414.pdf, CD-1, Declassified SecDef Files. Brown reported to Carter that the Saudis “were extremely pleased” with the intelligence from the SR-71 flights. Memo, Brown for Carter, 30 Mar 1980, 00008417.pdf, *ibid*.

100. Memo, Brzezinski for Vance, Brown et al., 2 May 1979, w/attached Summary of Conclusions of PRC Meeting, 27 Apr 1979, folder Saudi Arabia (May-Dec) 1979, box 21, SecDef Files, Acc 330-82-0205.

101. NIE 36.6-79, “Saudi Arabia in the 1980s,” n.d. [c. 7 Dec 1979], folder Saudi Arabia 1979, box 2, SecDef Files, Acc 330-82-0270, WNRC.

102. Memo, Brzezinski for Brown 6 Jun 1979, w/attached msg 4245, Embassy Jidda to State, 10 Jun 1979 (quotes), w/Brown’s comments (quote); memo, Brown for Carter 18 Jun 1979: all in folder Saudi Arabia (May-Dec) 1979, box 21, SecDef Files, Acc 330-82-0205.

103. Memo, Brzezinski for Vance and Brown, 14 Mar 1980 (quote), folder Mtgs MBB, 3/80–4/80, box 34, Subject File, Brzezinski Donated Material, Carter Library.

104. Memos, McGiffert to Brown, 12 Mar 1980, quoting from msg 01674, Embassy Jidda to State, 12 Mar 1980; Brzezinski for Vance and Brown, 14 Mar 1980: both in folder Saudi Arabia (Jan-Jun) 1980, box 17, SecDef Files, Acc 330-82-0217.

105. Brown’s handwritten comments on Brzezinski’s memo, 14 Mar 1980 (quote), cited in note 102.

106. Note, Carter to Brzezinski, 20 Mar 1980 (quote), folder Mtgs MBB, 3/80–4/80, box 34, Subject File, Brzezinski Donated Material, Carter Library.

107. Memo, Sick for Brzezinski, 6 Mar 1980, *ibid*.

108. Memo, Sick for Brzezinski, 10 Jun 1980, folder Mtgs MBB, 5/80–6/80, *ibid*.

109. Memo, Brzezinski for Vance and Brown, 12 Jun 1980, w/enclosed ltr, West to Carter, 3 Jun 1980; paper, “Saudi Arabia—an Assessment as of Jun 1, 1980”: both in folder Saudi Arabia (May-Jun) 1980; McGiffert for Brown, 2 Apr 1980, w/Brown’s comment, folder Saudi Arabia (Apr) 1980, box 17, SecDef Files, Acc 330-82-0217.

110. Ltr, Muskie for Brown, 17 Jun 1980, w/Brown’s comment, folder Saudi Arabia (May-Jun) 1980, *ibid*.

111. Memo, Brown for Vance and Brzezinski, 16 Jun 1980, folder Mtgs MBB, 5/80–6/80, box 34, Subject File, Brzezinski Donated Material, Carter Library; memos, Brown to Carter, 18 Jun 1980; Brown to Carter, “F-15 Items for Saudi Arabia,” 18 Jun 1980: both in folder Saudi Arabia (May-Jun) 1980, box 17, SecDef Files, Acc 330-82-0217.

112. Memo, Brown for Carter, 18 Jun 1980 (quote, emphasis in original), cited in note 111.

113. Msg, Brown for Carter, 27 Jun 1980 (quotes), folder Saudi Arabia (Jul-Sep) 1980, box 17, SecDef Files, Acc 330-82-0217.

114. Memcon, Brown and Sultan, 26 Jun 1980, *ibid*.

115. *Ibid* (quote).

116. Memo, Sick for Brzezinski, 2 Jul 1980 (quote), *ibid*.



117. Memo, Brown for Brzezinski, 7 Jul 1980 (quote), *ibid.*

118. Msg 17467, Embassy Tokyo to State, 1 Oct 1980, CK3100524702, DDRS; memo, Brown for Carter, 1 Oct 1980, folder Alpha Channel File, 9/1/80–12/31/80, box 106, Brown Papers, LC.

119. *Carter Public Papers 1980–1981*, 2:2431 (quotes). Brown publicly reaffirmed the president’s statement—he could hardly do otherwise. News Conference, Seattle, WA, 28 Oct 1980, *Brown Public Statement 1980–1981*, 4:2012.

120. DoD Paper, “Saudi Equipment Requests,” n.d. [c.16 Dec 1980], folder Saudi Arabia (Nov–Dec) 1980, box 16, SecDef Files, Acc 330-82-0217; memo, Brzezinski for Carter, 5 Nov 1980, “Daily Report,” CK31000600042, DDRS.

121. Memo, Brown for Brzezinski, 17 Nov 1980, w/attached memcon, Jones and Sultan meeting, 12 Nov 1980 (quote), folder Alpha Channel File, 9/1/80–12/31/80, box 106, Brown Papers, LC.

122. Carter, *Keeping Faith*, 578–580.

123. Msg, OSD to Embassy Riyadh, 260235Z Nov 1980, w/enclosed ltr, Brown to Sultan, 26 Nov 1980 (quote): both in folder Saudi Arabia (Nov–Dec) 1980, box 16, SecDef Files, Acc 330-82-0217.

124. Msg, OSD to Embassy Riyadh, 122106Z Jan 1981, w/enclosed ltr, Brown to Sultan, 12 Nov 1981, 0000D3C7.pdf, CD-2, Declassified SecDef Files.

## 10. Iran and the Hostage Crisis

1. The man behind the television coverage of the crisis was the newly installed head of ABC News Operations, Roone Arledge, who had revolutionized television coverage of sports (*Wide World of Sports* and *Monday Night Football*). Arledge saw drama in the hostage crisis—as well as a way to cut into Johnny Carson’s ratings at NBC—and he played it for all it was worth. David Farber, *Taken Hostage: The Iran Hostage Crisis and America’s First Encounter with Radical Islam* (Princeton, NJ: Princeton University Press, 2005), 137–139. CBS anchor Walter Cronkite also noted on each evening newscast the number of days the hostages were held in captivity.

2. For U.S. Iran relations, see Barry Rubin, *Paved with Good Intentions: The American Experience and Iran* (New York: Oxford University Press, 1980); James A. Bill, *The Eagle and the Lion: The Tragedy of American-Iranian Relations* (New Haven: Yale University Press, 1988); Gary Sick, *All Fall Down: America’s Tragic Encounter with Iran* (New York: Random House, 1985); and David Crist, *The Twilight War: The Secret History of America’s Thirty-Year Conflict with Iran* (New York: Penguin Press, 2012).

3. Ambassador-designate to Iran William Sullivan asked Brown how the president felt about arms sales to Iran. Brown replied: “The President has distaste for all these Human Rights violators, but his distaste is circumscribed by the realities of global politics.” Memcon, Brown and Sullivan, 13 May 1977, folder Iran 091.112, 1977, box 69, SecDef Files, Acc 330-80-0017, WNRC.

4. DIA Background Paper for Brown, “Iranian Military Organization,” Nov 1977, *ibid.*

5. Memo, McAuliffe for Rumsfeld, 26 Nov 1976, 0000C917.pdf, CD-1, Declassified SecDef Files, WNRC; memo, McGiffert for Brown, 14 May 1977, w/attached F-18L study, 12 May 1977, folder 452 F-18 (Jan-May) 1977, box 53, SecDef Files, Acc 330-80-0017. The F-18L was not strengthened for carrier landing, nor did it need folding wings, thus it was lighter than the F-18A.

6. Ltr, Brown to Vance, 10 Jun 1977, folder Iran 452, 1977, box 69, SecDef Files, Acc 330-80-0017.

7. Memos, Brown for Brzezinski, 15 Apr 1977, w/attached background paper, “AWACS (E-3) for Iran,” n.d.; Brown for Brzezinski, 3 May 1977, w/attached background paper, “Iranian Air Defense Systems (AWACS),” n.d. (quote): both *ibid.* The AWACS’ ability to “lookdown” all but eliminated the clutter problem and required only 2,500 personnel to operate, maintain, and guard the planes as opposed to 62,500 personnel required for the full 40 Seek Sentry sites.

8. Carter, *Keeping Faith*, 435; Rearden with Foulkes, *JCS and National Policy 1977–1980*, 46.

9. Vance, *Hard Choices*, 319–320.

10. Memo, McGiffert for Brown, 8 Jul 1977, w/attached memos, Denend for Brzezinski, 7 Jul 1977 and 19 Jul 1977, w/attached “Talking Paper for SecDef Meeting with Senators,” folder Iran 413.77 (Jan-Jul) 1977, box 69, SecDef Files, Acc 330-80-0017.

11. Carter, *Keeping Faith*, 435. Deputy Assistant Secretary of Defense (ISA) Leslie A. Janka agreed with the president, telling Brown, “Senator Culver had his act together and the Executive Branch did not.” Memo, Janka for Brown, 1 Aug 1977, w/attached note by Brown, folder Iran 413.77 (Aug-Dec) 1977, box 69, SecDef Files, Acc 330-80-0017. Brown’s response was to get right on the issue.

12. The six assurances to safeguard AWACS technology were the AWACS sale would not include encipherment gear; special U.S.-Iranian security precautions would be instituted to protect the AWACS; the AWACS would be used only for defense; additional sales of advanced aircraft to Iran must consider the “multiplier effect;” Iranian crews would be trained in the United States, and U.S. personnel would go to Iran only for special and limited duty; and the State and Defense Departments would study Iran’s capacity to absorb high technology without U.S. technicians. Memo, Brown for Carter, 29 Aug 1977, w/attached “AWACS Assurances,” n.d., folder Iran 413.77 (Aug-Dec) 1977, box 69, SecDef Files, Acc 330-80-0017; Vance, *Hard Choices*, 320.

13. Memo, Brown for Carter, 23 Sep 1977, folder 020 DoD (May-Sep) 1977, box 5, SecDef Files, Acc 330-80-0017.

14. *FRUS 1969–1976, Documents on Iran and Iraq, 1969–1972*, vol. E-4, ed. Monica Belmonte (Washington, DC: 2006), docs 84, 116, 126, 180, 217, 230, <<http://history.state.gov/historicaldocuments/frus1969-76ve04>>, accessed 1 Dec 2011; *FRUS 1973–1976*, vol. 37, *Iran and Iraq, 1973–1976*, ed. Monica Belmont (Washington, DC: GPO, 2012), 35–38 (doc 11), 160–162 (doc 47), 344–346 (doc 120), 346–367 (doc 121), 436–439 (doc 146), 551–557 (doc 184), 560–561 (doc 186).

15. Vance, *Hard Choices*, 321–322; Carter, *White House Diary*, 135 (quote, emphasis in original).

16. Memo, McGiffert for Brown, 14 Nov 1977; memcon, Brown and Shah, 15 Nov 1977: both in folder Iran 091.112, 1977, box 69, SecDef Files, Acc 330-80-0017.

17. Memo, Brown for Carter, 18 Nov 1977, folder 020 DoD, Oct 1977, box 5, *ibid.*; Brown with Winslow, *Star Spangled Security*, 74–75.

18. Memcon, Carter and Shah, 16 Nov 1977, 10:30 a.m., folder Iran 091.1132, 1977, box 69, SecDef Files, Acc 330-80-0017.

19. Memo, McGiffert for Brown and Duncan, 28 Jun 1978, folder Iran 091.3, 1978, box 3, SecDef Files, Acc 330-81-0212, WNRC.

20. Memo, Dodson for Mondale, Vance, Brown et al., 12 Jul 1978, w/attached Summary of Conclusions of PRC Meeting, 5 Jul 1978, folder Iran 091.3, 1978, box 57, SecDef Files, Acc 330-81-0202, WNRC.

21. Memo, Duncan for McGiffert, 8 Jul 1978, folder Iran 452 1978, *ibid.*

22. Memos, Brown for Carter, 3 Aug 1978; Vance for Carter, 3 Aug 1978; msg 5918, State to Tehran, 11 Aug 1978: all *ibid.*

23. DCI Turner frankly admitted this intelligence failure: “We let him [Carter] down badly with respect to our coverage of the Iranian scene. Turner blamed both himself and his agency for being “asleep,” noting that a draft NIE estimate produced eight months after rioting began in Iran stated that the shah would survive for another 10 years. Turner, *Burn Before Reading*, 180–181. Brown cites the U.S. intelligence community’s agreement with the shah that the Iranian intelligence organization, SAVAK, would supply intelligence. Obviously, SAVAK did not emphasize serious opposition and/or evidence of impending dissolution of the regime; independent intelligence came mostly from academics, which, Brown noted, the U.S. intelligence leadership discounted. Brown interview, 1 Mar 1993, 16. Sick was scathing about the value of the CIA’s intelligence—“sheer gobbledygook masquerading as informed judgment.” Sick, *All Fall Down*, 92–93.

24. Msg 10383, Embassy Tehran to State, 24 Oct 1978, folder Oct 1979, SecDef Cables, OSD/HO.

25. Charles Duncan, interview by Alfred Goldberg and Roger Trask, 17 May 1996, 6–7, Oral History Collection, OSD/HO.

26. Information Paper for SecDef for use at the 2 Nov 1978 SCC Meeting, folder Iran 092 (Jan–Nov) 1978, box 57, SecDef Files, Acc 330-81-0202.

27. Brzezinski, *Power and Principle*, 362–364; Sick, *All Fall Down*, 67–68.

28. Memo, Brzezinski for Brown and Jones, 7 Nov 1978, folder Iran 092, 1978, box 3, SecDef Files, Acc 330-81-0212; msg 2914, State to Embassy Tehran, 30 Jan 1979, folder Jan 1979, SecDef Cables, OSD/HO. In December 1978 the JCS presented Brown with options to protect “high sensitivity” equipment in Iran, Phoenix missiles, and radar systems for F-14s, as well as “medium sensitivity” items such as the Hawk and Harpoon missiles, which were subject to reverse engineering. Options that appealed to Brown included monetary rewards to pro-American Iranian military personnel for return of the equipment and defection

with equipment if a Marxist government emerged in Iran. Should the Soviets intervene to support a Marxist government, Brown would consider military action to destroy the equipment. Memo, Resor for Brown, 21 Dec 1978, w/Brown's comment and w/attached memos, Murphy for Resor, 21 Dec 1978; Shutler for Resor, 13 Dec 1978: all in folder Iran 092, 1978, box 3, SecDef Files, Acc 330-81-0212.

29. Msg 210-78, Duncan to Brown (in Brussels), 6 Dec 1978, folder Iran 092 (Dec) 1978, box 57, SecDef Files, Acc 330-81-0202. The largest group of official personnel comprised U.S. military/DoD civilian/contractor personnel and their dependents. Brown estimated that 1,600 (one third of the DoD military and civilian dependents) would take advantage of the voluntary evacuation. Memo, Brown for Carter, 8 Dec 1978, 0000B454.pdf, CD-1, Declassified SecDef Files. In January 1979 Vance ordered the evacuation of all U.S. official dependents as well as all nonessential military and U.S. civilian employees from Iran; U.S. citizens working for private companies were urged to depart likewise. Vance estimated the total to be 45,000. Vance, *Hard Choices*, 340. The total number of U.S. official personnel evacuated as cited by the USAF history was 5,801. Daniel L. Haulman, *The United States Air Force and Humanitarian Airlift Operations, 1947–1994* (Washington, DC: Air Force History and Museum Program, 1998), 360–361.

30. Brzezinski, *Power and Principle*, 369, 371–372, 374–375; Vance, *Hard Choices*, 330–332.

31. Memo, McGiffert for Brown, 28 Dec 1978, w/Brown's comment, folder Iran 092 (Dec), 1978, box 57, SecDef Files, Acc 330-81-0202.

32. Summary of Conclusions of SCC Meeting, 28 Dec 1978, folder Iran 092 (Dec) 1978, box 5; Summary of Conclusions of Mini SCC Meeting, 29 Dec 1978, folder Iran (1–12 Jan) 1979, box 12: both in SecDef Files, Acc 330-82-0204, WNRC. The mini SCC group suggested that the JCS move the task force to Singapore as a precautionary measure; they did so, but the decision was leaked incorrectly as a move into the Indian Ocean, causing a media ruckus and annoying Carter, who had not approved the initial deployment. Sick, *All Fall Down*, 127–128.

33. Vance, *Hard Choices*, 335; Sick, *All Fall Down*, 127, 131. Duncan recalled that he and CJCS Jones recommended Huyser. Duncan interview, 17 May 1996, 7. Huyser had worked in Iran and knew the shah and many of his generals. His commander, General Al Haig, was not keen to let him go on the grounds that the mission was either “to execute a *coup* in favor of the shah or keep the troops in the barracks,” a “political job” not right for a military man. Alexander Haig, interview by Alfred Goldberg and Ronald Landa, Washington, DC, 2 May 1996, 50, Oral History Collection, OSD/HO; Crist, *Twilight War*, 7–8.

34. Brzezinski, *Power and Principle*, 379.

35. Carter, *White House Diary*, 272, 277 (quotes); Carter, *Keeping Faith*, 446. Brown interview, 1 Mar 1993, 16. Both Sick and Sullivan described this “curious dual track” (Sick's characterization) as sometimes “we felt we must have been talking to two different cities.” Sick, *All Fall Down*, 139; Sullivan, *Mission to Iran*, 229–230. A career Foreign Service officer with a strong sense of his own worth, Sullivan did not appeal to the president. The ambassador's advice to encourage the shah to leave and establish relations with Khomeini or his allies conflicted with Carter's idea that the shah and the army were key to stability in Iran.

36. Memo, Brown for Carter, 10 Jan 1979, w/Carter's comment, folder Iran, Reports from Huyser, 1/79, For the President and Brzezinski Only, box 87, Meetings File, Staff Material, National Security Affairs, Carter Library. At Sullivan's recommendation, Vance asked the president to allow him to establish informal communications with Khomeini, but Carter vetoed the idea. Vance, *Hard Choices*, 336–337. Sullivan sent a telegram to Foggy Bottom saying he thought the president was making a "gross mistake." Sullivan, *Mission to Iran*, 222–225. For a short biographical sketch of Khomeini, see David Harris, *The Crisis: The President, the Prophet, and the Shah—1979 and the Coming of Militant Islam* (New York: Little Brown, 2004), 33–43.

37. Brzezinski felt uneasy about "the slippery slope of one civilian government followed by another somewhat more to the left." If that occurred, he recommended a military coup "with U.S. backing." Memo, Brzezinski for Carter, 13 Jan 1979, w/attached msg 824, Embassy Tehran, Huyser to Brown and Jones, 13 Jan 1979, folder Iran, Reports from Huyser, 1/79, For the President and Brzezinski Only, box 87, Meetings File, Staff Material, National Security Affairs, Carter Library.

38. Memo, Brown for Carter, 13 Jan 1979 (quotes), *ibid.* Brzezinski recounts this exchange as evidence that he and Brown were of like mind. Brzezinski, *Power and Principle*, 383–384. Huyser recalled Brown's instruction to support the civilian government as a first priority and a coup was only justified if worse came to worst. General Robert E. Huyser [USAF Ret.], *Mission to Tehran* (New York: Harper & Row, 1986), 104–105. A number of times Huyser recounted he was "mystified," "troubled," or "puzzled" by Brown's instructions and observations, suggesting that miscommunication between the two men occurred. For accounts of Huyser's puzzlement, see *ibid.*, 89, 105, 154, 169.

39. D'Estaing replied that Khomeini had no plans to leave France and go to Iran but was bent on overthrowing the Bakhtiar government. Carter, *White House Diary*, 277–278.

40. Brzezinski, *Power and Principle*, 384; memo, Brown for Carter, 17 Jan 1979 (quotes), folder Iran, Reports from Huyser, 1/79, For the President and Brzezinski Only File, box 87, Meetings File, Staff Material, National Security Affairs, Carter Library. Huyser recalled that he suggested to Brown that bloodshed should "be kept in perspective. . . . But just as in battle, you must weigh losses against gains. Some 10,000 deaths now could save a million lives later." Huyser, *Mission to Tehran*, 142. If Huyser was really suggesting that magnitude of casualties, it was hardly what Brown or Carter wanted to hear.

41. Memo, Brown for Carter, 22 Jan 1979, folder Iran, Reports from Huyser, 1/79, For the President and Brzezinski Only, box 87, Meetings File, Staff Material, National Security Affairs, Carter Library.

42. Memos, Duncan for Carter, 29 Jan 1979; Brown for Carter, 30 Jan 1979: both *ibid.*

43. Msg, von Marbod to Brown et al., 311204Z Jan 1979, folder Iran (27 Jan–5 Feb) 1979, box 12, SecDef Files, Acc 330-82-0205, WNRC. Eric von Marbod negotiated a gradual drawdown of the U.S. military sales program in Iran. Sick, *All Fall Down*, 148–149. According to Brzezinski, Huyser and the Iranian generals calculated that while 500–1,000 Iranian rank and file military were moving to the Khomeini or opposition camp each day, these desertions were out of a force of 500,000. The coup was still possible. Brzezinski, *Power and*

*Principle*, 384. CJCS Jones later stated that by the time the coup was finally discussed it was too late to act. He was not convinced that soldiers would follow their commanders' orders. General David C. Jones, interview by Alfred Goldberg and Maurice Matloff, Arlington, VA, 21 Oct 1987, 17–18, Oral History Collection, OSD/HO. Brown agreed with Jones that the Iranian generals “dithered around without any great confidence that they would be obeyed by the troops” and that Khomeini and the fundamentalists had “won over the bulk of the population and were beginning to have the same effect among the non-commissioned officer corps.” Brown recalled there was “some talk of a coup among American policymakers, there wasn’t very much in Tehran.” Brown interview, 1 Mar 1993, 16–17.

44. Msg, Huyser to Brown, 311209Z Jan 1979, folder Iran (27 Jan–5 Feb) 1979, box 12, SecDef Files, Acc 330-82-0205; memo, Jones for Brown, 2 Feb 1979, folder Iran, Reports from Huyser, 1/79, For the President and Brzezinski Only, box 87, Meetings File, Staff Material, National Security Affairs, Carter Library.

45. Sullivan as cited in memo, Newsom for Vance, 2 Feb 1979, folder Iran-Mtgs [2/1/79–2/17/79], box 12, Geographic File, Brzezinski Donated Material, Carter Library.

46. Memo, Brown for Carter, 3 Feb 1979, folder Iran, Reports from Huyser, 2/79, For President and Brzezinski Only, box 87, Meetings File, Staff Material, National Security Affairs, Carter Library.

47. Memcon, Carter et al. w/Huyser, 5 Feb 1979, *ibid.*; Brown with Winslow, *Star Spangled Security*, 76.

48. Bill, *Eagle and the Lion*, 263–265.

49. Memo, Brown for Carter, 3 Feb 1979; memcon, Carter et al. w/Huyser, 5 Feb 1979: both in folder Iran, Reports from Huyser, 2/79, For President and Brzezinski Only, box 87, Meetings File, Staff Material, National Security Affairs, Carter Library.

50. Memo, von Marbod for Brown, 9 Feb 1979, w/attached memo, Graves for Wacker and Murray, 9 Feb 1979, folder Iran (6 Feb–14 Feb) 1979, box 11, SecDef Files, Acc 330-82-0205.

51. Msg, Gast to Jones and Huyser, 131205Z Mar 1979 (quote), folder Mar 1979, Sec-Def Cables, OSD/HO; memo, McGiffert for Brown, 28 Jul 1979, folder 337 White House (Aug-Dec) 1979, box 38, SecDef Files, Acc 330-82-0204. Turner recalled that listening posts were closed in Iran soon after Khomeini returned to Iran. Stansfield Turner, *Terrorism and Democracy* (Boston: Houghton Mifflin, 1991), 22–23. Iranian Air Force F–14s saw service in the Iran-Iraq War. Tom Cooper, “Persian Cats: How Iranian air crews, cut off from U.S. technical support, used the F–14 against Iraqi attackers,” <[www.airspacemag.com/military-aviation/persiancats.html](http://www.airspacemag.com/military-aviation/persiancats.html)>, accessed 12 Dec 2011.

52. “The Hostages and the Casualties,” <[www.jimmycarterlibrary.gov/documents/list\\_of\\_hostages.phtml](http://www.jimmycarterlibrary.gov/documents/list_of_hostages.phtml)>, accessed 10 Nov 2011.

53. These figures are taken from the topic descriptions of the Carter Library’s list of SCC and NSC meetings. See also Brzezinski, *Power and Principle*, 477–478.

54. Brzezinski, *Power and Principle*, 477.

55. *Ibid.*, 482–483.

56. Memos, Brown for Carter, both 19 Nov 1979 (quote): both in folder Alpha Channel File, 10/24/1979–3/31/1980, box 106, Brown Papers, LC; Brzezinski, *Power and Principle*, 483; Carter, *Keeping Faith*, 466.

57. Memo, Brown for Carter, 1 Dec 1979, folder Alpha Channel File, 10/27/1979–3/31/1980, box 106, Brown Papers, LC, w/Carter's comments. A copy of this memorandum without Carter's comments is in folder Iran [1/79–12/79], box 11, Geographic File, Brzezinski Donated Material, Carter Library.

58. Memo, Brzezinski for Mondale, Vance, and Blumenthal, 5 Dec 1979, CK31000536175, DNSA.

59. Antonio J. Mendez, "A Classic Case of Deception: CIA Goes Hollywood," *Studies in Intelligence* (Winter 1999–2000), <[www.cia.gov/center-for-the-study-of-intelligence/csi-publications/csi-studies/winter99-00/art1.html](http://www.cia.gov/center-for-the-study-of-intelligence/csi-publications/csi-studies/winter99-00/art1.html)>, accessed 3 Mar 2013. See also Antonio Mendez, with Matt Baglio, *Argo: How the CIA and Hollywood Pulled Off the Most Audacious Rescue in History* (New York: Penguin Books, 2013); Robert Wright, *Our Man in Tehran: The Truth Behind the Secret Mission to Save Six Americans during the Iran Hostage Crisis and the Foreign Ambassador Who Worked with the CIA to Bring Them Home* (New York: Other Press, 2011); Brown with Winslow, *Star Spangled Security*, 77; and Turner, *Burn Before Reading*, 174–176.

60. Turner, *Terrorism and Democracy*, 101; Brzezinski, *Power and Principle*, 486.

61. Carter, *White House Diary*, 415.

62. Jordan, *Crisis*, 249. The quotes are as Jordan rendered them.

63. Brzezinski, *Power and Principle*, 487–488; Carter, *Keeping Faith*, 459–460; Jordan, *Crisis*, 52 (quotes). According to Turner, Jones—who had been acting CJCS during the rescue of U.S. hostages on the ill-fated and high-casualty *Mayaguez* rescue—was also pessimistic about a successful rescue in Iran. Turner, *Terrorism and Democracy*, 32.

64. Brzezinski, *Power and Principle*, 488; Mark Bowden, *Guests of the Ayatollah: The First Battle in America's War with Militant Islam* (New York: Atlantic Monthly Press, 2006), 138.

65. [*Iran Hostage*] *Rescue Mission Report* [hereafter Holloway Report], Aug 1980, 20–21, <[www.history.navy.mil/research/library/online-reading-room/title-list-alphabetically/i/iran-hostage-rescue-mission-report.html](http://www.history.navy.mil/research/library/online-reading-room/title-list-alphabetically/i/iran-hostage-rescue-mission-report.html)>, accessed 15 Nov 2011. The report details the planning and execution of the operation, but with intelligence sources and methods not included. It provides the best account of the operation—albeit after the fact—but it was based on extensive research and interviews done soon after the operation. The problem with documenting such an operation was that it continued to evolve as the planners interacted with the soldiers who were training to implement it and the political leaders who ultimately had to approve it. The plan of one day was not the same as the plan next week or next month. Bowden, *Guests of the Ayatollah*, 229.

66. Memo, Odom for Brzezinski and Aaron, 2 Nov 1979, Chron 11/1–19/1979, box10, General Odom File, Brzezinski Material, National Security Affairs, Carter Library.

67. Carter, *White House Diary*, 418; Jordan, *Crisis*, 255 (quotes).

68. Carter Daily Diary, 22 Mar 1980, Carter Library; Brown interview, 1 Mar 1993, 19; Bowden, *Guests of the Ayatollah*, 254; Col. Charlie A. Beckwith (Ret.) [USAF] and Donald Knox, *Delta Force: The U.S. Counter-Terrorist Unit and the Iran Hostage Rescue Mission* (New York: Harcourt Brace Jovanovich, 1983), 253–256; Carter, *Keeping Faith*, 509–510.

69. Carter, *Keeping Faith*, 504. Turner was surprised to discover the pilot had an artificial leg, but he was assured he was the Agency's best flyer. Three men did the reconnaissance flight, two Agency personnel and an Air Force officer to ensure their core sample of the landing site was done correctly—to Turner's annoyance. Turner, *Burn Before Reading*, 178–179; *Terrorism and Democracy*, 101–102; Bowden, *Guests of the Ayatollah*, 391–392.

70. Memo, Brzezinski for Carter, 10 Apr 1980, folder Iran, Hostage Mission, 11/79–7/80, President and Brzezinski Only, box 87, Meetings File, Staff Material, Carter Library.

71. The role of the CIA in the rescue operation was substantial as revealed by Turner and the president. In addition to the reconnaissance plane to Desert One, the CIA sent agents to Tehran who scouted the embassy, assessed how well it was guarded, and rented a warehouse from which to house the rented getaway trucks that would rendezvous with the rescue team at Desert Two. Turner recalled that CIA officers first pointed out the risk of landing at an Iranian air base near Tehran to launch the assault on the embassy. Turner, *Burn Before Reading*, 170, 177–178; Carter, *Keeping Faith*, 509. Turner identified the source as an embassy cook, who left Tehran on 23 April on the same flight as a CIA agent. Based on delivery of breakfasts that morning, he indicated that 45 hostages were in the chancellery and the remaining ones were in the U.S. ambassador's residence (not counting the three at the Iranian Foreign Ministry). Turner, *Terrorism and Democracy*, 118.

72. Wright, *Our Man in Tehran*, 212, 219–220; Memorial for Richard Meadows, n.d., <[www.specialforces.org/sfalx/rjm.htm](http://www.specialforces.org/sfalx/rjm.htm)>, accessed 21 Mar 2013. During the Vietnam War, Meadows led covert raids into North Vietnam and the operationally successful Son Tay Prison raid that failed to free U.S. POWs in North Vietnam (they had been moved). After retiring from the Army in 1977, Meadows was recruited by Beckwith to aid in planning for Eagle Claw. He volunteered to go to Tehran in March 1980. The CIA reportedly had doubts about him, but DoD prevailed. Initially his cover was to be that of a Portuguese businessman, but his language skills were weak. Instead he went in as an Irish businessman, employing the none-too-authentic Irish brogue that most Americans can affect. His team included Delta Force Rangers and a Farsi speaking U.S. airman. Bowden, *Guests of the Ayatollah*, 390–391.

73. Brzezinski, *Power and Principle*, 492–493; Carter, *Keeping Faith*, 506–509; Sick, *All Fall Down*, 292.

74. Vance, *Hard Choices*, 409–411; Brown interview, 1 Mar 1993, 20 (quote); Brzezinski, *Power and Principle*, 493–494. Carter chose Brown as the first person with whom to discuss Vance's replacement. Brown recommended Maine Senator Edmund Muskie with Warren Christopher as his second choice—the president's own inclination. Carter, *White House Diary*, 423.

75. Brzezinski, *Power and Principle*, 493–495.



76. Jordan, *Crisis*, 254–257, 262–263. The quotes are as Jordan rendered them. Beckwith remembered Christopher as the official most concerned about casualties. Later in the day, speaking to Jordan, Beckwith ebulliently vaunted the cohesiveness of his force as “a bunch of red-blooded American soldiers who lived together, ate together, and screwed together, and if necessary died together.” Beckwith and Knox, *Delta Force*, 4–8. Brzezinski recalled that Lt. Gen. John Pustay, Jones’ assistant, whispered to Aaron at a meeting that the mission was light on helicopters having only seven (six being the minimum needed and one spare). The number was raised to eight. Brzezinski, *Power and Principle*, 495. Turner provided Vaught’s casualty estimate, based on Deputy DCI Carlucci’s account of the meeting. Turner, *Terrorism and Democracy*, 113–114.

77. Carter Daily Diary, 16, 18, 21 Apr 1979, Carter Library; Carter, *White House Diary*, 419–420; *Keeping Faith*, 511–513; Brzezinski, *Power and Principle*, 495–496; Jordan, *Crisis*, 265.

78. Brzezinski, *Power and Principle*, 496.

79. *Ibid.* (quote); Carter, *Keeping Faith*, 514 (quote).

80. See Beckwith and Knox, *Delta Force*, 185–284; Col. James H. Kyle, USAF (Ret.), with John R. Eidson, *The Guts to Try: The Untold Story of the Iran Hostage Rescue Mission by the On-Scene Desert Commander* (New York: Orion Books, 1990); Holloway Report, 64; Paul B. Ryan, *The Iranian Rescue Mission: Why It Failed* (Annapolis, MD: Naval Institute Press, 1985), 65.

81. Kyle, *The Guts to Try*, 236, 239. Kyle provides a minute-by-minute account of the rescue mission, with maps and formations of the various aircraft in flight and on the ground. Beckwith and Knox, *Delta Force*, 265; Ryan, *Iranian Rescue Mission*, 65.

82. Holloway Report, 9; Ryan, *Iranian Rescue Mission*, 67–75. The mission has been second-guessed many times. Sick noted (based on the Holloway Report’s findings) that the warning signal on other RH–53Ds indicating a possible crack in rotor blade often blinked and did not in 43 previous cases indicate a crack. Clearly Sick thought that helo no. 6 should have proceeded. Sick, *All Fall Down*, 296.

83. Beckwith and Knox, *Delta Force*, 268–270; Carter, *Keeping Faith*, 515.

84. Carter Daily Diary, 24 Apr 1980, Carter Library; Carter, *Keeping Faith*, 514–515; Brzezinski, *Power and Principle*, 497.

85. Holloway Report, 9. Helo 2 was able to make it to Desert One with a leaking and eventually frozen hydraulic system because it had a backup system. If the backup pump had failed, the helicopter would have crashed. Ryan, *Iranian Rescue Mission*, 83–84.

86. Beckwith and Knox, *Delta Force*, 277. Brzezinski was the principal armchair quarterback who suggested at the time that the mission should proceed with five helicopters, based no doubt on new intelligence from the key source that almost all the hostages were located in the embassy compound’s chancellery building, and therefore the assault team could go with fewer helos. Beckwith mistakenly assumed that Vaught was second-guessing him. Brzezinski, *Power and Principle*, 498; Ryan, *Iranian Rescue Mission*, 86–88.

87. As quoted in Jordan, *Crisis*, 272.

88. Kyle, *The Guts to Try*, 294–299; Beckwith and Knox, *Delta Force*, 278–279; Ryan, *Iranian Rescue Mission*, 87; Final Report Special Operations Review Group, Jul 1980, 19, folder Iran (Aug) 1980, box 2, SecDef Files, Acc 330-82-0284, WNRC. They also left classified material on the helicopters, which had no self-destruct mechanism on board.

89. Carter, *Keeping Faith*, 516–518; Brzezinski, *Power and Principle*, 498–499; Jordan, *Crisis*, 273–274; Brown with Winslow, *Star Spangled Security*, 78. The exchange between Brown and the president on notifying the families is as quoted in Jordan, *Crisis*, 274. The Iranians sent the remains of the personnel killed at Desert One to the United States in late April 1980, insisting that there were nine, not eight bodies (giving rise to the claim that one of the dead was part of the contingent of Iranian volunteers who took part in the rescue). Memo, Brown to Jones, 28 Apr 1980, folder 010 OSD, 1 Mar 80–28 May 80, box 4, Official Records of CJCS General Jones, Acc 218-92-0030, NARA II.

90. Brown with Winslow, *Star Spangled Security*, 79–80; *Brown Public Statements 1980–1981*, 4:1432.

91. Jordan, *Crisis*, 290, quotes as rendered by Jordan.

92. For examples of erroneous information, see John K. Cooley, “How the failure of three helicopters changed history,” *Christian Science Monitor*, 28 Apr 1980, 14; George C. Wilson and Douglas B. Feaver, “Copters’ Sand Screens Removed Before Iran Raid,” *Washington Post*, 30 Apr 1980, A1 (an incorrect assumption because none of the helicopter engines suffered problems during the rescue); John J. Fialka, “Rescue Copter Carrying Parts Turned Back,” *Washington Star*, 1 May 1980, A1, which asked if helo no. 5 was carrying an extra hydraulic pump (it was not); or Steven Strasser, Thomas DeFrank, Eleanor Cliff, and Toby Clifton, “The Plan: How It Failed,” *Newsweek*, 5 May 1980, 27–28, 30, 35–36.

93. Brown sent a report of the mission to the Senate Armed Services Committee on 6 May 1980 and briefed the committee in closed session on 8 May 1980. Ltr, Brown to Stennis, 6 May 1980, w/attached JCS Executive Summary of rescue operation, folder Iran (1–5 May) 1980, box 9, SecDef Files, Acc 330-82-0217, WNRC; also printed in *Brown Public Statements 1980–1981*, 4:1453–478. Brown was reticent to disclose details of the operation beyond the first day’s disaster at Desert One, because soon after the failure, planning began for a second rescue attempt that would use many of the same or similar resources and techniques.

94. Beckwith and Knox, *Delta Force*, 288–290.

95. Jones interview, 21 Oct 1988, 19. Brzezinski harbored a suspicion that the operation could have proceeded with five helicopters. When he suggested this scenario to Beckwith, the colonel answered, “I wouldn’t be here today. It would have been a disaster.” Beckwith and Knox, *Delta Force*, 292–293. In 1982 Brzezinski wrote in his memoirs, “I could not suppress the suspicion that in the case of two of the helicopters—the one that went down and the one that turned back—an excess of prudence contributed to the outcome.” Brzezinski, *Power and Principle*, 499. Turner joined Brzezinski in noting that in the three helicopter decisions, each of the pilots “made his choice on the side of safety. . . . Together they push me to the conclusion that an understandable emphasis in the U.S. military on safety in peacetime has carried over to combat situations.” To Turner, there needed to be someone more willing to take a “calculated risk.” Turner, *Terrorism and Democracy*, 137.

96. Holloway Report.

97. Brown interview, 1 Mar 1993, 19–20; Brown with Winslow, *Star Spangled Security*, 81. When asked if the upcoming presidential election influenced administration decisions, Brown responded: “It may have influenced the rescue decision, but I don’t think it determined it.” Brown interview, 1 Mar 1993, 21.

98. Holloway Report, 13–14, 19–20.

99. Brown as quoted in Jordan, *Crisis*, 278; Holloway Report, 58.

100. Holloway Report, 32.

101. *Ibid.*, 33–34. The Holloway Report concluded, with some qualifications, that 10 or 11 helicopters would have been possible but would not have guaranteed success of the mission. Yet it would have at least moved the rescuers beyond Desert One.

102. The Holloway Report (42–43) concluded that it would have been better to use C–130s as pathfinders. It also noted that helo no. 5 was only 100 nautical miles and 55 minutes from Desert One when the pilot aborted the mission. There were only 55 nautical miles and 25 minutes more of dust. Had he known, the pilot stated he would have continued the flight. *Ibid.*, 45. The report listed and analyzed 23 issues (most of which were alternative courses of action for the mission). *Ibid.*, 11–56.

103. *Ibid.*, Executive Summary, vi.

104. Brzezinski, *Power and Principle*, 499; Turner, *Terrorism and Democracy*, 127; Sick, *October Surprise: America’s Hostages in Iran and the Election of Ronald Reagan* (New York: Times Book, Random House, 1991), 20–21, 135–136; Richard Secord, with Jay Wurts, *Honored and Betrayed: Irangate, Covert Affairs, and the Secret War in Laos* (New York: John Wiley & Sons, 1992), 148–163; memo, Brzezinski for Carter, 24 Jul 1980, folder Iran, Hostage Mission, 11/79–7/80, For President and Brzezinski Only, box 87, Meetings File, National Security Affairs, Carter Library.

105. Brown interview, 1 Mar 1993, 20.

## 11. Southwest Asia and the Framework for Persian Gulf Security

1. The government that came to power in April 1978 took on the nomenclature of Communists, addressing each other as “comrades,” creating a politburo, and instituting “democratic” land reform, educational reform, secularization, liberation of women, and sending young and eager officials to the countryside to implement these reforms—usually with disastrous effect. Garthoff, *Détente and Confrontation*, 981–989; Edgar O’Ballance, *Afghan Wars 1839–1992: What Britain Gave Up and the Soviet Union Lost* (London: Brassey’s, 1993), 79, 82.

2. Garthoff, *Détente and Confrontation*, 990–991.

3. Gates’ *From the Shadows* has an extensive account of the planning for covert operations in Afghanistan, 143–149. A former DCI and former secretary of defense, Gates put the initial funding at \$500,000. See also Steve Coll, *Ghost Wars: The Secret History of the*

*CIA, Afghanistan, and Bin Laden from the Soviet Invasion to September 10, 2001* (New York: Penguin Press, 2004), 42–46.

4. Memos, Murphy through Komer for Brown, 29 Nov 1979, w/attached Talking Paper for Brown; Komer for Brown, 1 Dec 1979 (quote), w/Brown's comments: both in folder 370.64, 1979, box 1, SecDef Files, Acc 330-82-0271, WNRC.

5. Paper for Komer/Turner meeting, 18 Dec 1979, w/Murphy's comments, folder 337 CIA 1979, *ibid.*; memo, Brzezinski for Carter, 26 Dec 1979, CK3100098562, DDRS.

6. Carter described the invasion at the time as “a radical departure from the reticence the Soviets have shown since they overthrew the government in Czechoslovakia” and the “most serious international development that's occurred since I've been president.” Carter, *White House Diary*, 382, 387–388.

7. Brown's handwritten notes of NSC Meeting, 28 Dec 1979, folder A 1979, box 6, Sec-Def Files, Acc 330-82-0205, WNRC; memo, Brzezinski for Mondale, Vance, and Brown et al., 2 Jan 1980, 3 Jan 1980, CK310098571, DDRS; Garthoff, *Détente and Confrontation*, 1054, 1058, 1060–1062; Brzezinski, *Power and Principle*, 429–432.

8. Memo, Brown for Brzezinski, 3 Jan 1980, 000CDGE.pdf, CD-2, Declassified SecDef Files, WNRC.

9. Msg WH80010, Brown to Brzezinski, 4 Jan 1980, folder China (Reds) 1980, box 1, SecDef Files, Acc 330-82-0284, WNRC.

10. Memcon, Brown and Deng, 8 Jan 1980, CK3100374514, DDRS. While the decision to send Brown to China predated the Soviet invasion, his trip became a major vehicle for demonstrating publicly that Washington and Beijing were consulting privately as a means of exploring U.S.-PRC cooperation in supporting both the Afghan resistance and Pakistan. Undated DoD paper for SCC Meeting, 2 Jan 1980, “Afghanistan: Harold Brown's Trip to China,” folder Afghanistan, box 1, SecDef Files, Acc 330-82-0284.

11. Memo, Dodson for Mondale, Muskie, Brown et al., 2 Jul 1980, w/attached memo, Turner for Brzezinski, 30 Jun 1980, folder Pakistan (14 Apr–) 1980, SecDef Files, Acc 330-82-0217, WNRC.

12. Memo, Brown for Brzezinski, 18 Jul 1980, folder Egypt (May-Jul) 1980, box 7, *ibid.* The Egyptians were willing to swap SA-7s for Stinger missiles, but the latter would not be in production for a few years.

13. Summary of SCC Meeting, 2 Jan 1980, *FRUS 1977–1980*, vol. 6, *Soviet Union*, ed. Melissa Jane Taylor (Washington, DC: GPO, 2013), 725; Francis Fukuyama, RAND Note N-15797-RG, “The Future of the Soviet Role in Afghanistan, Sep 1980,” AF0001042, DNSA. Fukuyama reported that the main weapon of the insurgents was a homemade version of the .303-caliber, bolt-action Lee-Enfield rifle. Captured AK-47s were highly prized but seldom used as automatics because of the high cost of ammunition. *Ibid.*, 8, 11, 14.

14. Memo, Komer for Murphy et al., 23 Aug 1980, folder Afghanistan (Mar–) 1980, box 2, SecDef Files, Acc 330-82-0217.

15. See O'Ballance, *Afghan Wars*, 115–196. A popular account is George Crile, *Charlie Wilson's War: The Extraordinary Story of How the Wildest Man in Congress and a Rogue*

*CIA Agent Changed the History of Our Times* (New York: Grove Press, 2003), which was made into a motion picture.

16. S. M. Burke and Lawrence Ziring, *Pakistan's Foreign Policy: An Historical Analysis*, 2nd ed. (Oxford: Oxford University Press, 1990), 432–446. An excellent account by the former Carter administration NSC staffer for South Asia is Thomas P. Thornton, “Between the Stools? U.S. Policy towards Pakistan during the Carter Administration,” *Asian Survey* 22, no. 10 (Oct 1982): 959–977.

17. In July 1977 Carter ordered that all arms sales to South Asia “encourage the process of normalization and reconciliation between Pakistan and India” and “not stimulate an arms race in that region.” Memo, Brzezinski for Vance, Brown, and Turner, 1 Jul 1977, folder Pakistan 1979, box 20, SecDef Files, Acc 330-82-0205. In January 1979 Brzezinski clarified U.S. arms supply policy to India and Pakistan, noting that “types of military equipment made available to either India or Pakistan can also be made available to the other and the US sales approach will be evenhanded. This does not imply that identical types or equal amounts of equipment must be sold to the two countries.” Memo, Brzezinski for Vance, Brown et al., 2 Jan 1979, *ibid.*

18. Memo, Komer for Brown and Claytor, 25 Oct 1979, folder Pakistan 1979, box 20, SecDef Files, Acc 330-82-0205.

19. Summary of Conclusions of PRC Meeting, 30 Nov 1979, *ibid.*

20. Memo, McGiffert for Brown and Claytor, 8 Jan 1980, CK3100534414, DNSA.

21. Memo, Brzezinski for Vance, Brown, McIntyre, 9 Jan 1980, folder Pakistan (1 Jan–16 Apr) 1980, box 14, SecDef Files, Acc 330-82-0217; Brzezinski, *Power and Principle*, 448.

22. Brzezinski, *Power and Principle*, 449; memos, Komer for Brown, 14 Feb 1980, folder Pakistan (1 Jan–16 Apr) 1980, box 14; Komer for Brown, 20 Feb 1980, folder Asia (Jan-Feb) 1980, box 2: both in SecDef Files, Acc 330-82-0217.

23. Memo, McGiffert for Brown, 9 Feb 1980, folder Pakistan (1 Jan–16 Apr) 1980, box 14, *ibid.*

24. Memo, Dodson for Mondale, Muskie, and Brown, 2 Jul 1980, w/attached memo, Turner for Brzezinski, 30 Jun 1980, folder Pakistan (14 Apr–) 1980; memo of meeting w/ Zia (quote), 26/27 Aug 1980, folder Pakistan (17 Apr–Dec) 1980: both *ibid.*

25. Memos, Dodson for Vance, Brown et al., 24 Apr 1980, w/attached Summary of Conclusions of PRC Meeting, 21 Apr 1980 (quote); Komer for Brown, 21 Apr 1980; memo of meeting w/Zia, 26/27 Aug 1980 (quote): all in folder Pakistan (17 Apr–Dec) 1980, *ibid.* State opposition to the M60 tanks is shown in a memo, Tarnoff for Mondale, Brown et al., 21 Apr 1980, *ibid.*

26. DoD Summary Talker for PRC Meeting, 17 Jul 1980, folder Pakistan (17 Apr–Dec) 1980, box 14, *ibid.*

27. Memo, Brown for Carter, 29 Sep 1980, *ibid.*; Summary of Conclusions at PRC Meeting, 29 Sep 1980, w/Carter's comments, CK3100594988, DDRS.

28. Memo, Brzezinski for Muskie and Brown, 30 Sep 1980, folder Pakistan (17 Apr–Dec) 1980, box 14, SecDef Files, Acc 330-82-0217.

29. Memo, Brown for Carter, 1 Oct 1980, *ibid.*

30. Carter, *White House Diary*, 470.

31. See Carter, *Keeping Faith*, 91–124, for the president’s account of his energy policy.

32. A miniscule horseshoe island in the Chagos Archipelago, Diego Garcia was about 2,000 miles from the Strait of Hormuz. Originally leased from Great Britain in 1966 as a communications center, the British agreed to allow the United States to dredge the harbor, extend the air base runway to 12,000 feet, and build POL (petroleum, oil, lubricant) storage, a fuel pier, ammunition storage facilities, and barracks. By 1980 Diego Garcia was a full-blown base able to accommodate aircraft carriers, U.S. transport aircraft (C-5 and C-141), P-3 maritime patrol planes, and B-52 bombers. Amitav Acharya, *U.S. Military Strategy in the Gulf* (London: Routledge, 1989), 97–99.

33. From the Mediterranean, the United States had considerably more power—the Sixth Fleet’s 2 aircraft carriers, 14 surface combatants, 4 attack submarines, 5 amphibious ships with a Marine amphibious unit (1,800 strong), plus logistics and support ships. But the Sixth Fleet could primarily project power on the Middle East’s Mediterranean littoral (Egypt, Israel, Lebanon, Syria, and land-locked Jordan).

34. For discussion of PRM 10, “Comprehensive Net Assessment and Military Force Posture Review,” and PD 18, “U.S. National Strategy,” see chapter 5.

35. Brzezinski, *Power and Principle*, 443–444.

36. JCSM 282-78 for SecDef, 7 Sep 1978, w/Brown’s comments, folder Middle East 092, 1978, box 60, SecDef Files, Acc 330-81-0202, WNRC.

37. Memo, Duncan for Carter, 9 Nov 1978, w/Carter’s comment (quote), folder Middle East 333, 1978, box 61, *ibid.*

38. Brzezinski, *Power and Principle*, 444; memo, Brzezinski for Carter, 15 Jan 1979, CK3100594045, DDRS.

39. Michael R. Gordon and General Bernard E. Trainor, *The Generals’ War: The Inside Story of the Conflict in the Gulf* (Boston: Little, Brown, 1995), 6–9. A summary of the extensive planning and actions for the Persian Gulf Security Framework is in a memo, Brzezinski for Muskie, Brown et al., 3 Jun 1980, folder Persian Gulf (Jun-Jul) 1980, box 15, SecDef Files, Acc 330-82-0217.

40. Memo, Brown for Carter, 7 Mar 1979, folder Middle East (24 Feb–15 Mar 1979), box 15, SecDef Files, Acc 330-82-0205. The show of force was diminished by the fact the aircraft were unarmed.

41. Memo, Brown for Carter, 11 Jul 1979 (quote), folder Mtgs VBB, 8/79–9/79, box 33, Subject File, Brzezinski Donated Material, Carter Library. In a subsequent memorandum for Carter, Brown and Vance suggested that deploying naval forces and increasing the MIDEASTFOR would be the least controversial action; increased support requirements would probably engender *quid pro quos* from the littoral states; and TacAir and Marine deployments would be most controversial. Memos, Brown and Vance for Carter, 17 Aug 1979; Brzezinski for Vance and Brown, 17 Aug 1979: both in folder Middle East (26 Jul–Sep) 1979, box 15, SecDef Files, Acc 330-82-0205.

42. Schlesinger also favored an immediate and continuous U.S. naval presence (a carrier force with Marines) in the Indian Ocean. Disinclined to drawn down naval presence in the Mediterranean or Pacific to accomplish a full-time naval presence, Brown recommended moving deliberately and studying alternatives, such as land-based activities (joint tactical air and ground-based exercises) or even a U.S. base in the Gulf. Brown argued that “the issue is not yet ripe for decision,” as recommended by Schlesinger. Memo, Brown for Carter, 25 Sep 1979, 0000CF75.pdf, CD-2, Declassified SecDef Files.

43. According to Brzezinski, Vance and Christopher were skeptical of the idea. Brzezinski, *Power and Principle*, 444.

44. Summary of Conclusions of SCC Meeting, 14 Jan 1980, CK3100107311, DDRS; memo, Brzezinski for Mondale, Vance, and Brown, 5 Dec 1979, folder O 1979, box 19, SecDef Files, Acc 330-82-0205; memo, Brzezinski for Vance and Brown, 7 Dec 1979 (quote), folder DoD 12/79, box 6, Agency File, Brzezinski Material, National Security Affairs, Carter Library.

45. Memo, Brown for Carter, 10 Dec 1979, folder Alpha Channel File, 10/27/79–3/31/80, box 106, Brown Papers, LC. Ras Banas is the easternmost point in Egypt, closest to the Persian Gulf.

46. Memo, Brown for Carter, 21 Dec 1979, folder Secretary Brown, Eyes Only, Jul–Dec 1979, box 11, *ibid*. Slocombe was the OSD official sent to Egypt to check out Ras Banas. He thought it “perfect.” Crist, *Twilight War*, 41.

47. Memo, Brzezinski for Brown, 28 Jan 1980, w/attached paper, “Consultative Security Framework for the Middle East,” 28 Feb 1979, folder Alpha Channel File, 10/27/79–3/31/80, box 106, Brown Papers, LC. The agreement with Egypt eventually floundered when Congress refused to provide military construction funds for Ras Banas without a formal, signed agreement, which the Egyptian government was not prepared to do. Acharya, *U.S. Military Strategy in the Gulf*, 106.

48. Brown’s comments (quotes) on attached paper, cited in note 47.

49. *Carter Public Papers 1980–1981*, 1:197–198 (quotes); Brzezinski, *Power and Principle*, 443–445; statement released by DoD, 27 Apr 1980, folder 560.1, 1980, box 46, SecDef Files, Acc 330-82-0216, WNRC. These extended deployments (*Nimitz* nearly five months, *Coral Sea* nearly four months) were without port visits, depriving crews of relaxation and recreation and ships of major port-based maintenance. CM 622-80 for SecDef, 24 May 1980, folder Indian Ocean (Apr–) 1980, SecDef Files, Acc 330-82-0217. Brown recalls that he suggested in a telcon with Brzezinski adding the phrase “including military force.” Brown’s comment to author, 13 Oct 2016.

50. Jones estimated that Soviet tactical aircraft based in Afghanistan could reach the Strait of Hormuz; Soviet armored ground forces could reach the Arabian Sea through Baluchistan in 10 to 12 days if unopposed; Soviet ground troops could reach Kuwait’s oilfield through Iran in the same timeframe; using sealift from the Black Sea and transiting the Suez Canal, Soviet troops could be in the Persian Gulf in 21 days; or one Soviet airborne division (8,000 troops with organic armor vehicles) could land in the Persian Gulf in two or three days if all Soviet airlift capabilities were employed. Summary of Conclusions of SCC Meeting, 14 Jan 1980, cited in note 44.

51. Ibid.

52. Memo, Ermath and Welch for Brzezinski, 22 Jan 1980, folder Mtgs VBB, 1/80–3/80, box 34, Subject File, Brzezinski Donated Material, Carter Library; memo, Brown for Carter, 18 Jan 1980, 000B458.pdf, CD-1, Declassified SecDef Files.

53. Memo, Dodson for Mondale, Vance, Brown et al, 28 Feb 1980, w/attached Komer paper, “Security Framework for Southwest Asia (A DoD Viewpoint),” 27 Feb 1980, folder Persian Gulf (Jan-Feb) 1980, box 15, SecDef Files, Acc 330-82-0217; memo, Odom for Brzezinski, 11 Mar 1980, folder SCM 113, 3/10/80, folder Komer Paper #4, box 122, NSC Institutional File, 1977–1981, Carter Library.

54. Memo, Brown for Carter, 2 May 1980, folder Egypt (May-Jul) 1980, box 7, SecDef Files, Acc 330-82-0217.

55. Memo, Brown for Muskie, 31 Jul 1980, folder Egypt (May-Jul) 1980, box 7, *ibid.*

56. Summary of Conclusions of SCC Meeting, 4 Aug 1980, CK3100595010, DDRS.

57. Memo, Brown to Carter, 2 May 1980, CK431000577971, DDRS; JCSM 187-80 for ASD (ISA), 10 Sep 1980; memcon, Brown and Murbarak, 15 Oct 1980: both in folder Egypt (Aug-Dec) 1980, box 6, SecDef Files, Acc 330-82-0217.

58. PD 63, “Persian Gulf Security Framework,” 15 Jan 1981, folder PD/NSC 63, box 24, NSC Institutional Files, 1977–1981, Carter Library.

59. Brown reported on Persian Gulf security initiative in a memo, Brown for Brzezinski, 21 Nov 1980, folder Persian Gulf (Nov) 1980, box 15, SecDef Files, Acc 330-82-0217. Carter approved the purchase of the seven-ship preposition force (including two RO/RO ships) and authorized negotiations to buy the eight fast container ships. Memo, Carter for Brown, 19 Feb 1980, *ibid.* A former OMB defense analyst claimed that the \$278 million cost of the eight ships, plus the \$600 million to upgrade them to military specification, was a bargain; the ships were able to carry as much equipment at 5 percent of the acquisition costs as a fleet of 160 C–130 cargo planes could transport in a month. Stubbing with Mendel, *Defense Game*, 40.

60. For PRM 10 and PD 18, see chapter 5.

61. Memos, Brzezinski for Brown, 9 and 30 Jul 1979: both in folder 320.2 RDF (Jan–16 Oct) 1979, box 31, SecDef Files, Acc 330-82-0204, WNRC.

62. Memos, Brown for Brzezinski, 31 Jul 1979 w/Carter’s comment; Brzezinski for Brown, 3 Aug 1979, (quote): both *ibid.*

63. Memo, McGiffert for Brown, 28 Jul 1979, *ibid.*

64. Memo, Brown for Brzezinski, 16 Aug 1979 (quote), *ibid.*

65. Memo, Brzezinski for Carter, n.d., folder PD 18 [4], box 14, NSC Institutional Files, 1977–1981, Carter Library; Summary of Conclusions of SCC Meeting, 22 Feb 1980, CK3100594994, DDRS. Brzezinski told the president that “missing from Harold’s appraisal of our current and projected capability . . . is any sense of the dynamics of employing such a force.” For example, Brzezinski continued, while the leading elements of a ready battalion of the 82nd Airborne could be en route to a crisis in less than 18 hours, the force comprised only 800 lightly equipped soldiers on foot, which would have trouble securing or defending a single large airfield. If the United States deployed the three to four divisions earmarked



for a limited conflict, it would equal one-quarter of the U.S current active land force, a logistics problem not easy solved.

66. Edward J. Drea et al., *The History of the Unified Command Plan, 1946–2012* (Washington, DC: Joint History Staff, Office of the CJCS, 2013), 38–42.

67. JCSM 270-79 for SecDef, 29 Aug 1979, folder 320.2 RDF (Jan–16 Oct) 1979, box 31, SecDef Files, Acc 330-82-0204, cited in Drea, *History of the Unified Command*, 40n14; Crist, *Twilight War*, 41–42.

68. Memo, Brown for Jones, 22 Oct 1979, folder 320.2 1979, box 30, SecDef Files, Acc 330-82-0204; also cited in Drea, *History of the Unified Command*, 40n15; memo, Brown for Jones, 10 Nov 1979 (quote), folder 320.2 1979, box 31, SecDef Files, Acc 330-82-0204.

69. JCSM 318-79 for SecDef, 15 Nov 1979, w/Brown's comment, 29 Nov 1979; memo, Brown for Carter, 21 Dec 1979: both in folder 320.2 RDF (17 Oct–) 1979, box 31, *ibid.*; JCSM 18-80 for SecDef, 18 Jan 1980; memo, Brown for Jones, 26 Jan 1980: both in folder 320.2 RDF 1980, box 30, SecDef Files, Acc 330-82-0216.

70. Memo, Odom for Brzezinski, 11 Jan 1980, folder Rapid Reaction Forces, 3/77–3/80, box 51, Subject File, Brzezinski Material, National Security Affairs, Carter Library; memo, Odom for Brzezinski, 8 Mar 1980, CK31005949, DDRS.

71. Memos, Brown for Carter, 26 Jan and 18 Feb 1979, w/Carter's comments on the latter: both in folder 320.2 RDF 1980, box 30, SecDef Files, Acc 330-82-0216.

72. Memo, Brown for Carter, 6 Mar 1980, folder Mtgs VBB, 3/80–4/80, box 34, Subject File, Brzezinski Donated Material, Carter Library.

73. Note, Carter to Brown, 20 Mar 1980, *ibid.*

74. JCSM 205-80 for SecDef, 25 Jul 1980, folder 320.2 RDF 1980; memo, Brown for Carter, 1 Apr 1980, folder 322 (Apr–) 1980: both in box 30, SecDef Files, Acc 330-82-0216.

75. Memo, Brown for Carter, 4 Aug 1980, w/Carter's comment, folder 320.2 RDF 1980, box 30, *ibid.*

76. Brzezinski, *Power and Principle*, 451–452.

77. Memo, Brown for Jones, Komer, and Murray, 18 Sep 1980, folder 320.2 RDF 1980, SecDef Files, Acc 330-82-0216.

78. Memo for the Record by Bovey, 23 Oct 1980, w/attached paper, *ibid.* In a question and answer session during the presidential campaign on October 24, Carter stated, "We have pre-positioned material for 10,000 marines to use if we need to bring them into that troubled region of the world [Persian Gulf], and 500 airplanes already have pre-positioned fuel and armaments to use if we have to." *Carter Public Papers 1980–1981*, 3:2439.

79. Gary Sick, "An American Perspective," in Paul Jabbar et al., *Great Power Interests in the Persian Gulf* (New York: Council on Foreign Relations, 1989), 32 (quote); Crist, *Twilight War*, 44. Schlesinger's criticism is in James Schlesinger, "Rapid (?) Deployment (?) Force (?)," *Washington Post*, 24 Sep 1980, 27 (quotes).

80. Brzezinski, *Power and Principle*, 454.

## 12. The FY 1980 Budget and the Conversion of Harold Brown

1. Auten, *Carter's Conversion*, 3. For a theoretical discussion of how and why governments undergo changes, see Charles Herman, "Changing Course: When Governments Choose to Redirect Foreign Policy," *International Studies Quarterly* 34, no. 1 (Mar 1990): 3–21.

2. For the case that the Chiefs were making a serious effort, see Rearden, *Council of War*, 393. Murray's response to the JSOP was typical of OSD civilians. See note 7.

3. Memos, Brown for CJCS and Service Secretaries, 26 Oct 1977, folder 100.5, 1977, box 12; Duncan for Carter, 14 Oct 1977(quote), folder 020 OSD, Oct 1977, box 5: both in SecDef Files, Acc 330-80-0017, WNRC; memo, Brown for Carter, 28 Oct 1977 (quote), 0000B406.pdf, CD-1, Declassified SecDef Files, WNRC. The press perceived the CG as an attempt by Brown to reestablish the kind of control Secretary McNamara had over the budget during his tenure. Bernard Weinraub, "Stricter Controls on Pentagon Budget Ordered by Brown," *New York Times*, 29 Oct 1977, 49; UPI, "Brown pulls up reins on Pentagon," *Christian Science Monitor*, 14 Nov 1977, 14. With Carter's encouragement, Brown successfully wrestled control from the services over their budgets. The services gained a second chance to insert their agendas into the process once Congress took up the Pentagon budget.

4. Extensive comments on the various drafts of the CG by the military departments, JCS, and others are in folder 100.54 (6 Sep–Dec) 1977, box 12, SecDef Files, Acc 330-80-0017; folder 100.54, 1978, box 1, SecDef Files, Acc 330-81-0212; folder 100.54 (15 Feb–28 Feb) 1978 and folder 100.54 (Mar–Apr) 1978: both in box 12, SecDef Files, Acc 330-81-0202, WNRC.

5. Memo, Murray for Brown, w/Brown's comment, 21 Feb 1978 (quotes), folder 100.54 (15 Feb–28 Feb) 1978, box 12, SecDef Files, Acc 330-81-0202.

6. CM 1814 for SecDef, 15 Feb 1978 (quote), folder 100.54, 1978, box 1, SecDef Files, Acc 330-81-0212, WNRC.

7. Note, Murray to Brown, 23 Feb 1978, (quotes), folder 100.54 (15 Feb–28 Feb) 1978, box 12, SecDef Files, Acc 330-81-0202.

8. Memo, Brown for Carter, 10 Mar 1978 (quotes), *ibid*.

9. "Summary of Major Issues and Features of the DoD Consolidated Guidance for FY80–84," n.d. (quote), attached to memo cited in note 8.

10. *Ibid*. (quote).

11. *Ibid*.

12. *Ibid*.

13. *Ibid*.

14. Memo, Murray for Brown, 5 May 1978, folder 100.54, 1978, box 1, SecDef Files, Acc 330-81-0212.

15. Memo, Brown for Carter, 5 May 1978 (quote), *ibid*.

16. Memo, Brzezinski for Carter, 9 May 1978, folder NSC Meetings No. 10, 5/10/78–5/11/78, box 1, Staff Material, National Security Affairs, Carter Library.

17. Memo for the Record by Brzezinski, 10 May 1978, *ibid*.

18. Minutes of NSC Meeting, 10 May 1978 (quotes), *ibid*.

19. Memo, Brown for Carter, 11 May 1978, w/attached questions and answers w/ Carter's handwritten comments (quotes), folder Private, Budget, box 11, Brown Papers, LC; memo, Murray for Brown, 9 May 1978, folder 100.54, 1978, box 1, SecDef Files, Acc 330-81-0212.

20. Memo, Brown for Carter, 11 May 1978, w/attached questions and answers with Carter's handwritten comments (quotes), folder Private, Budget, box 11, Brown Papers, LC.

21. *Ibid.* (quotes); memo, Murray for Brown, 9 May 1978, folder 100.54, 1978, box 1, SecDef Files, Acc 330-80-2012.

22. Memo, Brown for Carter, 13 Aug 1978, folder Defense Program Guidance, box 77, Brown Papers, LC.

23. Memo, Alexander for Brown, 23 May 1978, w/attached POM for FY 80–84, folder 100.54 (23 May 1978), Army POM, box 12, SecDef Files, Acc 330-81-0202; memo, Aaron for Carter, 21 Jul 1978, folder Weekly Reports to the President, Reports 61–71, box 11, Subject File, Brzezinski Donated Material, Carter Library.

24. Memo, Stetson for Brown, 23 May 1978, w/attached Executive Summary of POM, folder 100.54 (23 May 1978) AF POM, 1978, box 11, SecDef Files, Acc 330-81-0202; memo, Aaron for Carter, 21 Jul 1978, cited in note 23. The MAP system was essentially a shell game in which some silos would hold ICBM missiles and some were dummies. In deep trenches missiles could move between sites, thus requiring the Soviet Union to target all sites. Other potential variants envisioned missiles in aircraft ready to take off upon warning and launch their missiles in midair from different sites or a system of underground protective shelters linked by roads, the so-called racetrack system.

25. Memo, Claytor for Brown 23 May 1978, w/attached Executive Summary of POM, folder 100.54 (23 May 1978) Navy POM, 1978, box 11, SecDef Files, Acc 330-81-0202; memo, Aaron for Carter, 21 Jul 1978, cited in note 23.

26. Memos, Duncan for Alexander, 25 Jul 1978; Alexander for Brown, 7 Aug 1978; Brown for Alexander, 21 Aug 1978: all in folder 100.54 (Jun-Jul) 1978, box 10, SecDef Files, Acc 330-81-0202

27. Memos, Duncan for Stetson, 25 Jul 1978; Stetson for Brown, 8 Aug 1978; Brown for Stetson, 21 Aug 1978: all *ibid.*

28. Memos, Duncan for Claytor, 25 Jul 1978; Claytor for Brown, 7 Aug 1978; Brown for Claytor, 21 Aug 1978: all *ibid.* Brown recalled he was not a proponent of V/STOL and tried his best to sink the program. Harold Brown, interview by Edward Keefer and Erin Mahan, Washington, DC, 11 Feb 2011, 14–16, Oral History Collection, OSD/HO.

29. Memo, Aaron for Carter, 28 Jul 1978 (quotes), folder Weekly Reports to the President, Reports 61–71, box 41, Subject File, Brzezinski Donated Material, Carter Library. “Goldwatching” was also known as the “Washington Monument maneuver.”

30. Memo, Brown for Carter, 5 May 1978, folder 100.54, 1978, box 1, SecDef Files, Acc 330-81-0212.

31. Memo, Jones for Brown, 12 Aug 1978 (quotes), folder Defense Program Guidance, box 77, Brown Papers, LC.

32. Memos, Brown for Carter, 13 Aug 1978 (quotes), folder Budget, box 4; Brown for Carter, 15 Sep 1978, folder Private, Budget, box 11: all *ibid*.

33. JCSM 284-78 for SecDef, 23 Aug 1978, w/Brown's comments (quote), folder 100.01 (17 Aug–31 Aug) 1978, box 15, SecDef Files, Acc 330-81-0202.

34. Memo, Brown for Carter, 26 Sep 1978, folder 337 WH, 1978, box 1, SecDef Files, Acc 330-81-0210, WNRC; Brzezinski, *Power and Principle*, 18; Carter Daily Diary, 29 Sep 1978, Carter Library.

35. Memos, Brown for Carter, 30 Nov 1978; Vance for Carter, 30 Nov 1978: both in folder 110.01 (16 Nov–7 Dec) 1978, box 14, SecDef Files, Acc 330-81-0202. Suspecting that Carter felt he had been stuck with a 3 percent commitment he never intended to make, Brzezinski told the president that he owed a 3 percent real growth budget to the Europeans (especially British and Germans) who “went to bat” for the NATO pledge. Furthermore, it would ensure Carter's credibility as the leader of the Western world and convey U.S. determination. Memo, Brzezinski for Carter, 5 Dec 1978, folder Defense Budget [1/78], box 22, Subject File, Brzezinski Donated Material, Carter Library.

36. Memo, Brown for Carter, 2 Dec 1978, folder 110.01 (16 Nov–7 Dec) 1978, box 14, SecDef Files, Acc 330-81-0202; Carter Daily Diary, 2 Dec 1978, Carter Library.

37. Note, Carter for Brown, 6 Dec 1978 (quotes), folder Private, Budget, box 11, Brown Papers, LC.

38. Memos, Brown for Carter, 16 Dec 1978, folder 100.01 (13 Dec–19 Dec) 1978; McIntyre for Carter, 18 Dec 1978, folder 110.01 (20 Dec–23 Dec) 1978: both in box 13, SecDef Files, Acc 330-81-0202; Carter Daily Diary, 18 and 19 Dec 1978, Carter Library.

39. Memo, McIntyre for Carter, 18 Dec 1978, folder 110.01 (20 Dec–23 Dec) 1978, box 13, SecDef Files, Acc 330-81-0202. OMB and DoD had a major disagreement on how to calculate real growth in outlays based on differing views of how fast DoD could spend its money. DoD projected \$137.7 billion in TOA would provide \$123.2 billion in outlays (3% real growth); OMB calculated \$134 billion in TOA would produce \$122.9 billion in outlays (2.7% real growth). Memo, Brzezinski for Carter, 18 Dec 1978, folder Budget: FY 1980 Defense Budget Meeting, 12/18/78, box 10, Subject File, Brzezinski Material, National Security Affairs, Carter Library.

40. Bernard Weinraub, “Jordan and Rafshoon Said to Back Pentagon Head in Debate Over Budget,” *New York Times*, 5 Dec 1978, A1; Jack Nelson, “Carter's Aides Fight Pentagon, Budget Increase,” *Los Angeles Times*, 30 Nov 1978, B1; Nelson, “Carter Bows to Pressure, Cuts Defense Spending Plan,” *Los Angeles Times*, 23 Dec 1978, A1, 6; Hedrick Smith, “President's Economic Bind,” *New York Times*, 6 Dec 1978, D17.

41. *Carter Public Papers 1979*, 1:98; Press Briefing by Brown, 22 Jan 1979, *Brown Public Papers 1979*, 1:259–61.

42. Brzezinski supported Brown's figure, recommending \$137–138 billion in TOA to the president. Memo, Brzezinski for Carter, 21 Dec 1978, folder DoD, 11–12/78, box 5, Agency File, Brzezinski Material, National Security Affairs, Carter Library.

43. Memos, Brown for Carter, 26 Jan 1979, 0000B40E.pdf; 2 Feb 1979 (quote), 000B40F.pdf; 9 Feb 1979, 0000B410.pdf; 23 Feb 1979, 0000B412.pdf; 2 Mar 1979, 0000B413.pdf: all in CD-1, Declassified SecDef Files.

44. Memo, Brown for Carter, 11 May 1979 (quote), 0000B14A.pdf, *ibid*.

45. Memos, Brown for Carter, 18 May 1979, 0000B41B.pdf; 25 May 1979, 0000B41C.pdf: both *ibid*.

46. Memo, Brown for Carter, 14 Sep 1979 (quotes), 0000B235.pdf, *ibid*. OMB Director McIntyre agreed that the “politics . . . for the most part went the other way.” Memo, McIntyre for Carter, n.d., folder Budget, DoD, 78–79, box 10, Subject File, Brzezinski Material, National Security Affairs, Carter Library.

47. *CQ Almanac 1979*, 443, 448.

48. *Ibid.*, 452–454.

49. *Ibid.*, 453–454.

50. The rise in oil prices also made conventional carriers more expensive to operate, lessening the cost gap between them and CVNs. Memo, Brown for Carter, 21 Sep 1979, 0000B426.pdf, CD-1, Declassified SecDef Files. For the cost of the CVNs, see memo, Brown for Carter, 21 Sep 1979, w/attached Point Paper on CVs versus CVNs, folder 560.1, 1979, box 2, SecDef Files, Acc 330-82-0205, WNRC.

51. Memo, Eizenstat for Carter, 8 Nov 1979, folder FI 4/FG 13, 5/1/79–4/30/79, box FI-14, Subject File, WHCF: Executive, Carter Library; *Carter Public Papers 1979*, 2:2107; *CQ Almanac 1979*, 455.

52. Memo, Brown and McIntyre for Carter, 10 Sep 1979, folder FI 4/FG 13, 5/1/79–4/30/80, box FI-14, Subject File, WHCF: Executive, Carter Library; ltr, Carter to Hollings, 14 Sep 1979, *ibid*; *CQ Almanac 1979*, 178–180.

53. Memo, Brown for Carter, 3 Aug 1978, 0000B422.pdf, CD-1, Declassified SecDef Files.

54. *CQ Almanac 1979*, 249–253.

55. *Ibid.*, 253–254.

56. *Ibid.*, 255

57. *Ibid.*, 255–256

58. *Ibid.*, 256.

59. *Ibid.*, 256–257.

60. *Ibid.*, 257.

61. *Ibid.*

62. Memo, Eizenstat for Carter, 21 Dec 1979, folder FI/FG13, 5/1/7–4/30/80, box FI-14, Subject File, WHCF: Executive, Carter Library; *Carter Public Papers 1979*, 2:2282

63. Indicative of Carter’s and Brown’s different views was a “key message” in which the president insisted the U.S. delegation deliver to their Soviet counterparts at the SALT II signing in June 1979: “Soviet defense programs have gone beyond the point of legitimate defense needs and that the U.S. will have no choice but to take some matching steps unless the trend is halted.” Brown, however, commented, “Too soft, we are taking some matching

steps now & will have to carry them out except in the very unlikely event that present Sov pgms [programs] *reverse*.” Memo, Brzezinski for Brown et al., 13 Jul 1979 (quotes), folder USSR 092, 1979, box 23, SecDef Files, Acc 330-82-0205.

64. Garthoff, *Détente and Confrontation*, 877–882. Garthoff was a former CIA Soviet analyst for the Office of National Estimates, which generally held that Soviet military capabilities were over estimated at DoD by Brzezinski and by the NSC staff.

### 13. Readjustment in East Asia

1. Hunt, *Melvin Laird*, 349–355. The modernization plan was called the Forces Improvement Plan. For his part, Carter floated his intention to withdraw troops early in the Democratic presidential primary campaign. Don Oberdorfer, “Carter’s Decision on Korea Traced to Early 1975,” *Washington Post*, 12 Jun 1977, A15; Oberdorfer, *The Two Koreas: A Contemporary History* (Reading, MA: Addison-Wesley, 1997), 85–86. In March 1976 Carter announced his decision formally. Jules Witcover, “Carter Says Race Has Narrowed to Him and Jackson,” *Washington Post*, 21 Mar 1976, A7; and “Jimmy Carter, The Candidate and the Issues: An Interview,” *Washington Post*, 21 Mar 1976, 23, B5 (quote). For the Ford criticism, see Associated Press, “Ford Criticizes Carter on Korean Troop Pullout,” *Los Angeles Times*, 2 Sep 1976, B8. Vance noted in his memoirs that “Americans paid . . . little attention” to Carter’s Korean campaign pronouncements, but “Asians reacted in shock.” Vance, *Hard Choice*, 128.

2. Harold Brown, interview by Alfred Goldberg and Ronald Landa, 12–13 (quote), 1 Mar 2003, Washington, DC, Oral History Collection, OSD/HO; Brown with Winslow, *Star Spangled Security*, 171 (quote).

3. PRM 13, “Korea,” 26 Jan 1977, PD01549, DNSA; response to PRM 13, 15 Mar 1977, folder 092 Korea, 1977, box 70, SecDef Files, Acc 330-80-0017, WNRC.

4. Joe Wood, “Persuading a President: Jimmy Carter and American Troops in Korea,” *Studies in Intelligence*, 40:4, 99–100; Oberdorfer, *Two Koreas*, 101–102.

5. Memo, Armacost for Brzezinski, 9 Feb 1977 (quote, emphasis in original), CK3100502092, DDRS.

6. Memcon, Carter and Vessey, 18 Feb 1977 (quote), folder Korea 000.1-199, 1977, box 70, SecDef Files, Acc 330-80-0017. The meeting lasted from 4:00 to 4:30 p.m. Carter Daily Diary, 18 Feb 1977, Carter Library. Vessey recalls that when he “objected to Brown about the administration’s plan, he immediately got me an audience with the President. I had long and serious interaction with him.” General John W. Vessey, interview by Alfred Goldberg and Maurice Matloff, 21 Mar 1990, 3–4, Washington, DC, Oral History Collection, OSD/HO. Vessey informed Singlaub of this conversation. Maj. Gen. John K. Singlaub (Ret.), with Malcolm McConnell, *Hazardous Duty: An American Soldier in the Twentieth Century* (New York: Summit Books, 1991), 383.

7. Memo for Record of PRC Meeting, 12 Apr 1977, CK3100147775, DDRS. Those unnamed dissenters were Brown, Turner, and probably JCS Chairman General George Brown. Secretary Brown later told OSD historians that “the two people who were negative

[in NSA meetings] about it [withdrawal] were Stan Turner and me.” Brown interview, 1 Mar 1993, 12. Secretary Brown was perhaps forgetting CJCS Brown’s opposition.

8. Memo for Record of NSC Meeting, 27 Apr 1977 (quote), CK3100499724; memo, Brzezinski for Carter, 3 May 1977, CK3100500081: both in DDRS.

9. Ibid. Carter was predisposed to withdrawal well before this meeting. In March 1977, he wrote Vance and Brzezinski: “Park must understand: a) American forces will be withdrawn. Air cover will be continued. b) US-Korean relations as determined by Congress and American people are at all-time low ebb. c) Present military aid support and my reticence on human rights issue will be temporary unless Park voluntarily adopts some open changes re political prisoners.” Note, Carter to Vance and Brzezinski, 5 Mar 1977, folder ROK, 1–4/77, box 43, Country File, Brzezinski Material, National Security Affairs, Carter Library.

10. Memo, Brown for CJCS, 26 Apr 1977, 000D312.pdf, CD-2, Declassified SecDef Files, WNRC; msgs, JCS to CINCPAC, 281858Z Apr 1977, CK3100111623; CINCPAC to JCS, 011957Z May 1977 (quote), CK3100119115; 052017Z May 1977 (quote), CK3100124436; 110344Z May 1977 (quote), CK3100111625; COMUSKOREA to CINCPAC, 151330Z May 1977, CK31000111627: all in DDRS.

11. Brown with Winslow, *Star Spangled Security*, 173; PD 12, “U.S. Policy in Korea,” 5 May 1977, folder Korea 320.2, 1977, box 3, SecDef Files, Acc 330-80-0016, WNRC.

12. JCSM 216-77 for Sec Def, 14 May 1977, folder Korea 320.2, 1977, box 3, SecDef Files, Acc 330-80-0016.

13. Memo, Armacost for Brzezinski, 2 Feb 1977, folder ROK, 1–4/77, box 43, Country File, Brzezinski Material, National Security Affairs, Carter Library. Singlaub testified before the Subcommittee on Investigations of the House Armed Services Committee on 25–26 May 1977. For Singlaub’s account of the entire imbroglio, see Singlaub with McConnell, *Hazardous Duty*, 381–413.

14. Memo, Duncan for Carter, 16 May 1977, CK3100494717, DDRS. According to the plan, after 1980 U.S. combat troops would consist of a division headquarters and a separate brigade consisting of two armored battalions, a cavalry squadron, and two mechanized infantry battalions, supported by a composite artillery battalion and appropriate combat support elements. For its part, the ROK required 14 additional artillery battalions, 17 TOW antitank companies, 2 Hawk missile battalions, and 106 military helicopters.

15. Oberdorfer, “Carter Decision on Korea Traced to Early 1975,” *Washington Post*, 12 Jun 1977, 15; Oberdorfer, *Two Koreas*, 85–86.

16. Memcon, Brown and Brzezinski, 26 Jan 1977, CK3100483835; Memo for Record by Brzezinski, 29 Jan 1977, CK3100474333: both in DDRS.

17. See William Beecher, “Secret arms pull out was plan for Korea,” *Boston Globe*, 28 Jul 1978, 1.

18. Memo, Brown for Carter, 29 Apr 1977, 000B3F9.pdf, CD-1, Declassified Sec-Def Files; memcon, Carter, Brown, Brzezinski et al., 21 May 1977, 9:30–10:30 a.m., CK3100500089, DDRS.

19. Memo, General Brown and Habib for Carter, CK100105174, DDRS; CM 1477-77 for Brzezinski, 9 Jun 1977, folder Korea 320, 1977, box 3, SecDef Files, Acc 330-80-0016.

20. Memo, Brzezinski for Brown and Vance, 31 May 1977, CK31000497073, DDRS; memcon, Carter, Mondale, Brown, Vance, General Brown, Habib, Brzezinski et al., 10 Jun 1977, 9:45–10:00 a.m., CK3100480353, DDRS.

21. Memo, Armacost for Brzezinski, 29 Jun 1977 (quotes), w/Brzezinski's handwritten comments, CK3100490458, DDRS; memo, Brzezinski for Carter, 1 Jul 1977 (quote), folder NSC Weekly Report 19, Weekly Reports to President, 16–31, box 41, Subject File, Brzezinski Donated Material, Carter Library.

22. Memos, Brown for Carter, 12 Jul 1977, CK3100145706; Brown and Vance for Carter, 13 Jul 1977, CK3100105178; memcon, Carter, Brown, Brzezinski, Armacost, 14 Jul 1977, CK3100500095: all in DDRS; memo, Brzezinski for Carter, 13 Jul 1977, folder ROK, 7–9/77, box 43, Country File, Brzezinski Material, National Security Affairs, Carter Library.

23. Memo, Armacost for Brzezinski, 29 Jul 1977, CK3100504719; ltr, Carter to Park, 20 Jul 1977, CK100126639: both in DDRS; memo, Brown for Carter, n.d., folder Korea 337, 1977, box 3, SecDef Files, Acc 330-80-0016. Attached is a memcon of a private meeting between Brown and Park, 25 Jul 1977.

24. Memo, Brown for Carter, 17 Jun 1977, 0000B3FE.pdf, CD-1, Declassified SecDef Files.

25. Memo, Brzezinski for Carter, 21 Jul 1977, folder ROK, 7–9/77, box 43, Country File, Brzezinski Material, National Security Affairs, Carter Library; memo, Brown for Carter, 22 Jul 1977, 0000B400.pdf, CD-1, Declassified SecDef Files.

26. Memo, Brzezinski for Carter, 7 Sep 1977 (quotes), CK3100500100, DDRS. The proposed legislation was attached to a memo, Brown for Carter, 26 Aug 1977, 0000CAC3.pdf, CD-1, Declassified SecDef Files.

27. Memo, Holbrooke, Armacost, Oskenberg, and Abramowitz for Brown, Vance, and Brzezinski, 4 Apr 1978, CK3100511434, DDRS.

28. Memcon, Brown, Vance, Brzezinski, 11 Apr 1978, CK3100496701, *ibid*.

29. Memo, Brzezinski to Carter, 18 Apr 1978 (quote), CK3100505091, DDRS; memo, Brzezinski for Carter, 19 Apr 1978, folder ROK, 1–6/78, box 44, Country File, Brzezinski Material, National Security Affairs, Carter Library; Carter Daily Diary, 20 Apr 1978 Carter Library.

30. *Carter Public Papers 1978*, 1:768.

31. *CQ Almanac 1978*, 417–418, 420–424; ltr, Brown to Vance w/copy to Brzezinski, 14 Oct 1978, 0000D0E8.pdf, CD-2, Declassified SecDef Files; memos, Brown for Carter, 28 Oct 1978, CK3100104576; Brzezinski for Carter w/Carter's disapproval, 1 Nov 1978, CK3100117770; Platt for Tuchman Mathews, 19 Oct 1978, CK3100519389: all in DDRS.

32. Memcon, Park, Brown, and Gleysteen, 7 Nov 1978, CK3100509548, DDRS.

33. Memo, Platt for Brzezinski, 13 Nov 1978, CK3100517021, DDRS; msg 4511, Embassy Seoul to State, 9 Nov 1978, folder Nov 1978, SecDef Cables, OSD/HO.

34. Memo, Marshall for Brown, 6 Sep 1978, 0000D0D3.pdf, CD-2, Declassified SecDef Files.



35. Wood, “Persuading a President,” 107–109. Both Brown and Carter later expressed skepticism of the IC’s Korea work. Carter stated, “I got a totally different assessment from the Defense intelligence agencies and from the CIA . . . have never been convinced of the total accuracy of that report [Defense Intelligence’s], but I had to accept it.” Carter interview, 12 Mar 1986, 17. Brown told OSD historians in 1993, “What really undermined it in the end was an intelligence assessment, the validity of which I still have some uncertainty about.” Brown interview, 1 Mar 1993, 13.

36. Don Hirst, “North Korea Has Ground Unit Edge,” 1, 21, *Army Times*, 8 Jan 1979; Richard Burt, “New Studies Raise U.S. Estimate of North Korean Strength,” *Washington Post*, 4 Jan 1979, 8; Obderdorfer, “North Korean Army Now Ranked Fifth-Largest in World by U.S.,” *New York Times*, 14 Jan 1979, 9.

37. Defense Intelligence Report, “North Korean and South Korean Military Capabilities and Vulnerabilities: A Comparative Analysis,” Interim Update (quote), Jan 1979, folder 820 Korea, box 45, Official Records of CJCS General Jones, Acc 218-92-0030, NARA II; Wood, “Persuading a President,” 109–110. The intelligence community completed a final assessment in March 1979 basically confirming the Interim Update. OSD/NET Assessment, “The Military Balance in Korea,” folder Mar 1979, SecDef Cables, OSD/HO.

38. Memo, Platt for Brzezinski, 17 Jan 1978, CK3100519391, DDRS.

39. Memcon, Carter, Nunn, Glenn, Hart, Brzezinski et al., 23 Jan 1979 (quote), CK3100511104, *ibid.* As early as March 1978, Nunn privately warned a NSC staffer that the president needed to delay his withdrawal for a year. Memo, Brzezinski for Carter, 3 Mar 1978, folder Weekly Reports to the President, 42–52, box 41, Subject File, Brzezinski Donated Material, Carter Library.

40. PRM 45, “U.S. Policy toward Korea,” 22 Jan 1979, PR001441, DNSA. The PRM stated it owed its existence to the new intelligence, normalization of relations with the PRC, the PRC–Japanese Peace Treaty, better U.S.–Japanese relations, and South Korea’s accelerated industrialization and greater defense sufficiency.

41. Memo, Platt for Brzezinski, 6 Jun 1979 (quote), CK3100147779; Summary of Conclusions at PRC Meeting, 8 Jun 1979, CK3100147884: both in DDRS.

42. Memcon, Carter, Brown, Vance, Brzezinski, Park, Choi Kyu-ha et al., 30 Jun 1979, 11 a.m.–12:20 p.m., CK3100 511398, *ibid.* Carter was engaging in some loose rounding off: 3,000 (the tentative withdrawal figure was actually 3,300) troops represented 7 percent of the U.S. authorized U.S. troop level of 42,000. Vance, *Hard Choices*, 129; William H. Gleysteen Jr., *Massive Entanglement, Marginal Influence: Carter and Korea in Crisis* (Washington, DC: Brookings Institution Press, 1999), 46–47; Oberdorfer, *Two Koreas*, 106, includes the note-passing anecdote.

43. Memcon, Carter, Park, and Gleysteen, 30 Jun 1979, 12:23–1:30 p.m., CK3100110798, DDRS.

44. Vance, *Hard Choices*, 130; Gleysteen, *Massive Entanglement*, 47–49; Oberdorfer, *Two Koreas*, 107.

45. Memos, Brzezinski for Carter, 12 Jul 1979, CK3100514579; Brown for Brzezinski, 6 Oct 1979, CK3100467908: both in DDRS; *Carter Public Papers 1979*, 2:1275–1276.

46. Memo, Brown for Carter, 11 Oct 1979, 0000D574.pdf, CD-2, Declassified SecDef Files; memo, Vance for Carter, 12 Oct 1979, CK3100109054, DDRS; memos, Brzezinski for Carter, 12 Oct 1979; Brzezinski for Vance, 15 Oct 1979: both in folder ROK, 7–12/79, box 44, Country File, Brzezinski Material, National Security Affairs, Carter Library; memos, Brzezinski for Vance, 20 Oct 1979 [includes Carter quote], CK3100514585; Platt for Brzezinski, 24 Oct 1979, CK3100519394: both in DDRS; Gleysteen, *Massive Entanglement*, 52.

47. For convincing explanations of the assassination, see Gleysteen, *Massive Entanglement*, 53–62, and Oberdorfer, *Two Koreas*, 113–115.

48. State circular msg to all diplomatic posts, 26 Oct 1977, CK3100489352, DDRS; msg 281155, State to Embassy Tokyo, 27 Oct 1979, folder Sep 1979, SecDef Cables, OSD/HO; Carter Daily Diary, 26–27 Oct 1979, Carter Library; Oberdorfer, *Two Koreas*, 111; Gleysteen, *Massive Entanglement*, 132–133.

49. For Chun's background, see Oberdorfer, *Two Koreas*, 119–121. For hour-by-hour accounts of the coup, see Gleysteen, *Massive Entanglement*, 77–83, and John A. Wickham, *Korea on the Brink: From the "12/12 Incident" to the Kwangju Uprising, 1979–1980* (Washington, DC: National Defense University Press, 1999), 53–66. What particularly galled Gleysteen and Wickham was that they spent the night of the coup in the command bunker of the Combined Forces Command in Yongsan in central Seoul without information or influence on events. Oberdorfer, *Two Koreas*, 117–118. In his immediate post-coup report, Gleysteen correctly observed that "we have just been through a coup in all but name." Msg 18811, Embassy Seoul to State, 13 Dec 1979, reproduced in Gleysteen, *Massive Entanglement*, 210–212.

50. Msg, Brown to Wickham, 221921Z Dec 1979, 0000D3A1.pdf, CD-2, Declassified SecDef Files. For differences between Wickham and Gleysteen, see Gleysteen, *Massive Entanglement*, 86, and Wickham, *Korea on the Brink*, 67–68.

51. In January 1980 Brown disapproved holding even a mini-Special Consultative Meeting as suggested by McGiffert and ISA; memo, McGiffert for Brown, 29 Jan 1980, w/Brown's disapproval, 0000CD9E.pdf, CD-2, Declassified SecDef Files. Brown stuck to his decision when CINCPAC pushed in August to reschedule the SCM in 1980. Brown noted on the cable: "This is a political decision; my judgment is that we not now schedule any meeting. Chon [Chun] and his colleagues have done nothing to accommodate our concerns." Marginal comments on msg, CINCPAC to JCS and Brown, 072110Z Aug 1980, folder Aug 1980, SecDef Cables, OSD/HO.

52. Msg, COMUSKOREA to CINCPAC, 180993Z Mar 1980, folder Mar 1980, SecDef Cables, OSD/HO; see also Gleysteen, *Massive Entanglement*, 87. For the countercoup possibility, see Gleysteen, *Massive Entanglement*, 93–97; Wickham, *Korea on the Brink*, 77–79.

53. Memo, Gregg for Brzezinski, 20 May 1980, folder Mtgs MBB, 5/80–6/80, box 23, Subject File, Brzezinski Donated Material, Carter Library.

54. Gleysteen and Wickham present extensive accounts of the Kwangju Uprising and related developments with special emphasis on their actions, *Massive Entanglement*,

127–143; *Korea on the Brink*, 127–149. In June 1989 the Department of State released a White Paper, “United States Statement on the Events in Kwangju, May 1980.” The statement and appendix are reproduced in Wickham, *Korea on the Brink*, 193–228. See also Oberdorfer, *Two Koreas*, 124–133.

55. Initially the ROK claimed only 30 killed in retaking Kwangju. “United States Gov’t Statement on Events in Kwangju, Republic of Korea, in May 1980, 19 Jun 1989, sec. 62, <<http://seoul.usembassy.gov/backgroundunder.html>>, accessed 17 Jan 2013; Gleysteen, *Massive Entanglement*, 131; Wickham, *Korea on the Brink*, 148. In a reinvestigation in 1995, the new ROK government raised the estimate to 240. Oberdorfer, *Two Koreas*, 129.

56. The statement to CNN is not included in the extract of the session in *Carter Public Papers 1980–1981*, 2:1017–19; the quote as cited is in Gleysteen, *Massive Entanglement*, 148.

57. Brown’s marginal comment on msg, COMUSKOREA to SecDef et al., 289500Z Jun 1980, folder Jun 1980, SecDef Cables, OSD/HO.

58. Sam Jameson, “U.S. Support Claimed for South Korea’s Chon, But State Dept. Disavows Military Officials Remarks on Presidency, *Los Angeles Times*, 8 Aug 1980, B18–19. The story, also filed by Terry Anderson of AP, was picked up by other American and Korean papers. According to Wickham, Carter and Muskie were angry with him and kept him in Hawaii without instructions to return to the ROK. Wickham offered to resign, but CINCPAC Admiral Robert L.J. Long sent personal messages of support for Wickham to Brown, Holbrooke, and CJCS Jones. Wickham was allowed to return to Seoul. Wickham, *Korea on the Brink*, 155–163. Gleysteen also claims to have put in a good word for Wickham to Holbrooke and Jones. Gleysteen, *Massive Entanglement*, 163.

59. The options were (a) reduce the security relationship three possible ways (resume withdrawals, curtail official security cooperation, stop joint exercises); (b) inform the ROK that the security arrangement was up for review if Kim’s death sentence was not commuted; and (c) stay with the current policy of persuasion. Memo, Brown for Vance and Brzezinski, 12 Aug 1980, 0000D3A0.pdf, CD-2, Declassified SecDef Files. The CIA felt options “a” and “b” could lead among other things to a coup against Chun and would allow North Korea to exploit the split between the United States and the ROK. Memo, Turner for Brzezinski, 15 Sep 1980, folder ROK, 9/80–1/81, box 44, Country File, Brzezinski Material, National Security Affairs, Carter Library. Brzezinski informed Carter that Brown’s options “are in my view likely to be counterproductive,” and CIA’s assessments of the potential damages “valid.” Carter wrote, “Hold options for possible use, J.” Memo, Brzezinski for Carter, 16 Sep 1980, w/Carter’s instruction, folder ROK, 9/80–1/81, box 44, Country File, Brzezinski Material, National Security Affairs, Carter Library.

60. Msg 4232, State to Embassy Seoul, 5 Dec 1980, CK3100105195; msg 16596, Embassy Seoul to State, 13 Dec 1980, CK3100109098; both in DDRS.

61. Richard Holbrook and Michael Armacost, “A Future Leader’s Moment of Truth,” *New York Times*, 24 Dec 1997, A17. There was also a threat from the Reagan team of “serious consequences,” which the Chun government apparently took more seriously than the Carter administration’s threats. Richard Allen, “On the Korea Tightrope, 1980,” *New York Times*, 21 Jan 1998, 17.

62. Critics have charged that Brzezinski was anti-Soviet, in keeping with an Eastern European émigré's mistrust of the Soviet Union. Brzezinski disagreed when he told the president, "I do not favor playing the China card. For one thing, there is not a single 'China card' but many. . . . The . . . U.S.-Chinese relationship stands on its own feet, and thus is not a *tactical* matter." Brzezinski went on to say that in containing Russian assertiveness "the Chinese connection is useful." Memo, Brzezinski for Carter, 5 Oct 1979 (quote, emphasis in original), CK3100483284, DDRS.

63. Memos, Brown for Carter (quote) and for Brzezinski, 9 Feb 1977: both in folder China (Reds) 092 (Jan-May) 1977, box 66, SecDef Files, Acc 330-80-0017; Record of SecDef/JCS Meeting, 25 Aug 1977, folder 010 OSD, 1 Jun 77–Dec 77, box 8, Official Records of CJCS General Brown, Acc 218-92-0032; memo, McAuliffe for Brown, 1 Feb 1977, 0000D010.pdf, CD-2, Declassified SecDef Files.

64. Brown interview, 1 Mar 1993, 10; memos, Brown for Carter, 8 Feb 1977, w/attached CM 1282-77 for Brown, 7 Feb 1977; Brzezinski for Brown, 16 Feb 1977: both in folder China (Reds) 092 (Jan-May) 1977, SecDef Files, Acc 330-80-0017.

65. Memos, Brown for Carter, 8 Feb 1977; Brzezinski for Brown, 16 Feb 1977: both cited in note 64. PRM 24, "Peoples Republic of China," 5 April 1977, called for a review of benefits and costs of improved relations with the PRC, advantages and disadvantages of normalization or failure to normalize, the minimum requirements from the PRC for peaceful settlement of the Taiwan issue, and options or scenarios for normalization. PR01437, DNSA.

66. Memos, Brown for Brzezinski, 4 Oct 1977; Oskenberg for Brzezinski, 11 Nov 1977, w/Aaron's comments (quote, emphasis in original): both in folder China (PRC), 10/77–1/78, box 8, Country File, Brzezinski Material, National Security Affairs, Carter Library.

67. Brown's note on the covering page of the Department of State response to PRM 24, n.d., folder China (Reds) 092 (Jul-Dec) 1977, box 66, SecDef Files, Acc 330-80-0017; Summary of Conclusions of PRC Meeting, 27 Jun 1977 (quotes), folder China (Reds) 092, 1977, box 3, SecDef Files, Acc 330-80-0016; Vance, *Hard Choices*, 79–83; Carter, *Keeping Faith*, 190–192; Brzezinski, *Power and Principle*, 201–202.

68. Memcon, Brzezinski, Vance, Brown et al., 11 Apr 1978, CK3100496701, DDRS.

69. Memo, Brzezinski for Carter, 18 Apr 1978, CK3100505091, *ibid.*

70. Memcon, Brzezinski and Deng Xiaoping, 21 May 1978, CK310155890, *ibid.*; Brzezinski, *Power and Principle*, 201–219.

71. Memo, Armacost for Brown, 7 Sep 1978, 0000D0D5.pdf, CD-2, Declassified SecDef Files; JCSM 335-78 for Brown, 20 Nov 1978, folder PRC Normalization [12/18/78–12/31/78], box 9, Geographic File, Brzezinski Donated Material, Carter Library.

72. Memos, Brown for Carter, 9 Dec 1978 (quote); Brown for Jones, 2 Dec 1978 (quote): both in folder PRC Normalization [12/18/78–12/31/78], box 9, Geographic File, Brzezinski Donated Material, Carter Library.

73. Brzezinski, *Power and Principle*, 231.

74. *Carter Public Papers 1978*, 2:2264–2266 (quotes). For Carter's account of the Deng visit, see *Keeping Faith*, 202–211.

75. Note, Carter to Brown, Vance, and Brzezinski, 9 Sep 1979, folder PRC, Mtg w/Deng [1/9/78–10/3/79], box 9, Geographic File, Brzezinski Donated Material, Carter Library.

76. Memo, Brown for Carter, 16 Sep 1979, 0000CF73.pdf, CD-2, Declassified SecDef Files.

77. Memo, Brzezinski for Carter, 18 Sep 1979, CK3100162520, DDRS; memo, Vance for Carter, 9 Dec 1979, folder PRC, Alpha [12/78–1/80], box 9, Geographic File, Brzezinski Donated Material, Carter Library; memo, Brown for Carter, 13 Dec 1979, *FRUS 1977–1980*, vol. 13, *China*, ed. David P. Nickles (Washington, DC: GPO, 2013), 1017–1020 (doc 283), 1018 (quote, emphasis in original); Vance, *Hard Choices*, 390–391.

78. Memo, Carter for Vance and Brown, 17 Dec 1979, folder PRC, Alpha [12/78–1/80], box 9, Geographic File, Brzezinski Donated Material, Carter Library; memo, Brown for Carter, 29 Dec 1979, 0000CF70.pdf, CD-2, Declassified SecDef Files; msg, Bovet to Brown, 4 Jan 1980, folder Jan 1980, SecDef Cables, OSD/HO.

79. Brown with Winslow, *Star Spangled Defense*, 152–155. For an almost complete set of the discussions between Brown, Dinneen, McGiffert, and corresponding Chinese officials during the three-day visit, see CK3100474793, CK3100474503, CK3100474509, CK3100474531, CK3100474545, CK3100474522, and CK3100474559, DDRS.

80. Memcon, Brown and Deng, 8 Jan 1980, CK3100374514, DDRS; Brown interview, 1 Mar 1993, 1.

81. Memcon, Brown, Geng Biao et al., 29 May 1980. For Biao's first meeting with Brown on 27 May, see CK3100131454; for the meeting with Mondale on 28 May, see CK3100159496; all in DDRS.

82. For seminal studies, see Ross Y. Koen, *The China Lobby in American Politics* (New York: Harper & Row, 1974); Stanley D. Bachrack, *The Committee of One Millions: China Lobby Politics, 1953–1971* (New York: Columbia University Press, 1976); and E. J. Kahn Jr., *The China Hands: America's Foreign Service and What Befell Them* (New York: Viking Adult, 1975).

83. The Nixon-Kissinger opening to China and the subsequent Ford-Kissinger relations with Beijing are extensively documented in *FRUS 1969–1976*, vol. 17, *China, 1969–1972*, ed. Steven E. Phillips (Washington, DC: GPO, 2006); and vol. 18, *China, 1973–1976*, ed. David P. Nickles (Washington, DC: GPO, 2006). For policy implications of the U.S.-PRC normalization for Taiwan, see *FRUS 1977–1980*, 13:995–1000 (doc 276).

84. Ltrs, Soong to CJCS, 12 Oct 1977; Brown to Soong, 13 Dec 1977: both in folder 820 Taiwan, box 50, Official Records of CJCS General Jones, Acc 218-92-0030; see also Rearden with Foulks, *JCS and National Policy 1977–1980*, 148–149.

85. DJSM 1098-78 for McGiffert, 10 Jul 1978; J-5M-1131-78 for McGiffert, 12 Jul 1978: both in folder China-ROC, 6–10/78, box 11, Country File, Brzezinski Material, National Security Affairs, Carter Library.

86. Memo, Vance for Carter, 8 Jul 1978 (this memo was later withdrawn), CK3100510419, DDRS. PD 13, “Conventional Arms Transfer Policy,” dated 13 May 1977, stipulated that arms transfers of advanced weapons would be the exception rather than the norm in foreign policy; and dollar limits would be imposed on sales except to NATO allies, Japan, Israel, Australia, and New Zealand (see chapter 7).

87. Memo, Aaron for Brown, Vance, Warnke, Turner, and Jones, 9 Aug 1978, folder China-ROC, 6–10/78, box 11, Country File, Brzezinski Material, National Security Affairs, Carter Library; memos, Mathews and Denend for Brzezinski, 10 Jul 1978, CK3100109761; Denend and Oskenberg for Brzezinski, 18 Jul 1978, CK3100106234; Denend and Oskenberg for Brzezinski, 28 Jul 1978, w/Brzezinski's approval; CK3100109763: all in DDRS.

88. Memos, Brzezinski for Carter, 29 Sep 1978, w/Carter's comments, CK3100010293; McIntyre for Carter, 2 Oct 1978, CK3100048748: both in DDRS; memo, Brzezinski for Brown and Vance, 6 Oct 1978, folder China-ROK, 6–10/78, box 11, Country File, Brzezinski Material, National Security Affairs, Carter Library.

89. Memo, Brzezinski for Carter, 26 Oct 1978, CK3100111050, DDRS.

90. Memos, Brown for Brzezinski, 6 Apr 1978, CK310007998; Brzezinski for Brown, 3 Aug 1978, CK3100107374: both in DDRS.

91. Memos, Brown for Brzezinski, 23 Dec 1978, CK3100104617; McGiffert for Chairman, SCC Ad Hoc Group on China, 9 Jan 1979, CK3100131553: both in DDRS.

92. Three memos, Armacost for Chairman, SCC Ad Hoc Group on China, all dated 15 Feb 1979, CK3100131557, CK3100131560, and CK3100131563 respectively: all in DDRS.

93. Brown with Winslow, *Star Spangled Security*, 150–151.

94. Testimony by Jones, SCFR, *Taiwan: Hearings*, 96th Cong., 1st sess., 22 Feb 1979, 740; *CQ Almanac 1979*, 99 (quotes), 104–105.

95. CINCPAC Command History, 1980, 17 Sep 1981, 2:461–462; AP, "US to Let Firms Discuss Sales of FX Jet to Taiwan," *Washington Post*, 13 Jun 1980, 15; Robert L. Downen, *The Tattered China Card: Reality or Illusion in United States Strategy?* (Washington, DC: Council for Social and Economic Studies, 1984), 75–77.

96. For a description of Carter's pre-presidential commitment to Japan, see Auten, *Carter's Conversion*, 108–109.

97. Briefing for Brown re Mihara visit, "An Analysis of the Strengths and Vulnerabilities of the Japanese Self Defense Forces," 13 Sep 1977, folder Japan 091.112, 1977, box 3, SecDef Files, Acc 330-80-0016.

98. Poole, *JCS and National Policy 1973–1976*, 231. With an annual budget of \$6.1 billion, the JSDF was the fourth largest nonnuclear armed force in the world comprising 13 active army divisions, 364 combat aircraft, and 60 major combatant ships (destroyer-type and larger). Rearden with Foulkes, *JCS and National Policy 1977–1980*, 159–160.

99. Memo, Brown for Carter, 10 Mar 1977 (quotes), 0000D2D1.pdf, CD-2, Declassified SecDef Files; memcon, Carter, Fukuda et al., 21 Mar 1977 CK3100500057, DDRS.

100. Memo, Brzezinski for Carter, 16 Sep 1977, CK3100483637, DDRS.

101. JCSM 306-77 for SecDef, 20 Jul 1977, folder Japan 300-899, 1977, box 70, SecDef Files, Acc 330-80-0017; Rearden with Foulks, *JCS and National Policy 1977–1980*, 160.

102. Msg, Brown to Carter, 091524Z Nov 1978, folder Nov 1978, SecDef Cables, OSD/HO.

103. Memos, Komer for Murray and Wolfowitz, 17 Jan 1979 (quotes), 0000B933.pdf; Komer for Armacost, 19 Apr 1977 (quote), 0000BBB5.pdf: both in CD-1, Declassified SecDef Files.

104. Ltr, Brown to Brzezinski and Vance, 9 Jun 1979, 0000B933.pdf, CD-2, *ibid.*
105. Memos, Komer for Brown, 17 Sep 1979, JA00595; Murray for Brown, 12 Oct 1979, JA00607: both in DNSA.
106. Msg, Brown to Carter, 201420Z Oct 1979, folder SecDef Cables, OSD/HO.
107. CINCPAC Command History, 1979, 14 Nov 1980, 153. Brown also noted that given Japan's oil imports came exclusively from there, the Persian Gulf was "even more vital to Japan than the US." Memo, Brown for CJCS, 3 Nov 1979, folder 820 Japan, 30 Jun–24 Nov 1980, box 44, Official Records of CJCS General Jones, Acc 218-92-0030.
108. Memo, Brown for CJCS, 7 May 1980, 0000D39D.pdf, CD-2, Declassified SecDef Files; Rearden, *The Joint Chiefs of Staff and National Policy, 1977–1980* (Washington, DC: Joint History Office, 2002), 211–213.
109. Memo, Komer for Brown, 30 Dec 1979, 0000D393.pdf, CD-2, Declassified SecDef Files.
110. Memo, Platt for Brown, 23 Dec 1980, JA00803, DNSA.
111. William E. Berry Jr., *U.S. Bases in the Philippines: The Evolution of a Special Relationship* (Boulder, CO: Westview Press, 1989), chap. 4.
112. Msg, TIDFIR DB-315/00768-77, 24 Jan 1977, folder 1/21–1/31/77, 1/21–1/31/77, SecDef Cables, OSD/HO.
113. PRM 14, "Philippine Base Negotiations," 26 Jan 1977, PD01551, DNSA.
114. Covering memo, Hornblow for NSC members, 8 Mar 1977, transmitting OSD response to PRM 14, 7 Mar 1977, folder Philippines 323.3 (Jan-Jun) 1977, box 78, SecDef Files, Acc 330-0017; memo, Armacost for Brzezinski, 20 Apr 1977, CK3100510895, DDRS. Armacost also suggested that withdrawal of the 2nd Division from the South Korea and the rise of Soviet naval power in the Pacific precluded any major U.S. withdrawal from the Philippines.
115. Summary of PRC Meeting, 21 Apr 1977, CK3100510319, DDRS.
116. Memo, Slocombe for Brown, 23 Aug 1977, 0000CAC4.pdf, CD-2, Declassified SecDef Files; memo, Brown for Brzezinski, 25 Aug 1977, folder Philippines 323.3 (Jul-Dec) 1977, box 78, SecDef Files, Acc 330-80-0017; memos, Claytor for Brown, 13 Jun 1977, PH00986; Stetson for Brown, 1 Jul 1977, PH00988: both in DNSA. Duncan informed Carter of these actions. Memo, Duncan for Carter, 2 Sep 1977, 0000B404.pdf, CD-1, Declassified SecDef Files.
117. JCSM 348-77 for SecDef, 19 Aug 1977; JCSM 422-77 for SecDef, 3 Nov 1977: both in folder Philippines 323.3 (Jul-Dec) 1977, box 78, SecDef Files, Acc 330-80-0017.
118. Ltr, Marcos to Carter, 25 Sep 1977, CK3100497261; memcon, Carter, Imelda Marcos et al., 5 Oct 1977, CK310047736: both in DDRS. The request for radar and air defense was principally in response to the secessionist threat in Mindanao in the south and for aircraft and patrol boats as a way to support Philippine claims to the Spratley Islands, 250 miles away.
119. Ltr, Carter to Marcos, 27 Oct 1977, CK3100497261, DDRS; JCSM 412-77 for Brown, 3 Nov 1977, folder Philippines, 1977; memo, McGiffert for Brown, 9 Nov 1977, folder Philippines 323.3 (Jul-Dec) 1977: both in box 78, SecDef Files, Acc 330-80-0017.

120. Memo, McGiffert for Brown, 9 Nov 1977, 0000CAF9.pdf, CD-2, Declassified SecDef Files; memo, Brown for Brzezinski, 12 Nov 1977, folder Philippines 323.3 (Jul-Dec) 1977, box 78, SecDef Files, Acc 330-80-0017.

121. Memo, Slocombe for Brown, 13 Dec 1977, 0000CB19.pdf, CD-2, Declassified Sec-Def Files; memo, Brown for Carter, 17 Dec 1977, folder Philippines 323.3 (Jul-Dec 1977), box 78, SecDef Files, Acc 330-80-0017.

122. Memo, Armacost for Brzezinski, 10 Feb 1977, CK3100499784, DDRS.

123. Summary of Conclusions of PRC Meeting, 28 Feb 1978, CK3100536389, *ibid.*

124. Memos, Armacost for Brzezinski, 21 Mar 1977, CK3100279945; 3 Apr 1977, CK3100510922: both *ibid.*

125. Memo, Mondale to Carter, 26 Apr 1978, CK3100514414, *ibid.*; Berry, *U.S. Bases in the Philippines*, 203–205.

126. Memo, Platt for Brzezinski, 3 Nov 1978, CK3100469872; memcon, Carter, Inouye et al., 17 Nov 1978, CK3100480547: both in DDRS.

127. Memo, Vance for Carter, 29 Dec 1978 (quote), CK3100058883; ltr, Carter to Marcos, 4 Jan 1979 (quote), CK3100511475: both *ibid.*

128. Msg 00469, Embassy Manila to State, 8 Jan 1979, PH01399; msg 03476, Embassy Manila to State, 16 Feb 1979, PH01409; msg 017007, State to Embassy Lisbon, 21 Jan 1979, PH001430: all in DNSA.

129. Embassy Manila to State, 16 Feb 1979 (quote), cited in note 128.

#### 14. NATO Conventional Forces

1. See Lawrence S. Kaplan, *The Long Engagement: NATO's First Fifty Years* (Westport, CT: Praeger, 1999); and Stanley R. Sloan, *NATO, The European Union, and the Atlantic Community* (Lanham, MD: Rowman & Littlefield, 2003), 13–56. The original 12 NATO nations—Belgium, Canada, Denmark, France, Iceland, Italy, Luxembourg, the Netherlands, Norway, Portugal, the United Kingdom, and the States—were joined by Greece (1952), Turkey (1952), and West Germany (1955).

2. See Francis J. Gavin, *Gold, Dollars, & Power: The Politics of International Monetary Reform, 1958–1971* (Chapel Hill: University of North Carolina Press, 2004); and John S. Duffield, *Power Rules: The Evolution of NATO's Conventional Force Posture* (Stanford, CA: Stanford University Press, 1995).

3. Memo, Jones for Rumsfeld, 13 Jul 1976, attached to memo, Komer for Brown, 4 Feb 1977, in which Komer suggested that Jones' memo was “must weekend reading” since it was by someone “who lived the NATO problem for at least three tours in Europe.” Folder NATO 092 (Jan-Jun) 1977, box 73, SecDef Files, Acc 330-80-0017, WNRC.

4. “The Military Balance in Europe (NATO and Warsaw Pact)” (quote), prepared by Marshall, sent on 6 May 1977 to the NSC for background to Carter's NATO speech, 10 May 1977, folder NATO 320.2 (16 Mar–Jul) 1977, box 74, *ibid.* The CIA estimate, “The Balance of Forces on Central Europe,” SR 77-10100, August 1977, confirmed Marshall's assessment but



concluded that NATO's faults and vulnerabilities did not mean the alliance was "fragile" or unable to deter the pact. Folder NATO 320.2 (Aug-Dec) 1977, *ibid.* While mostly agreeing with CIA's conclusions, DIA suggested the Agency's estimate tended to maximize NATO capabilities and minimize those of the Warsaw Pact to confirm its conclusions. Memo, Robertson for Military Assistant to Duncan, 23 Sep 1977, *ibid.*

5. Alexander Haig, with Charles McGarry, *Inner Circles: How America Changed the World, A Memoir* (New York: Warner Books, 1992), 525–526. The JCS prepared an assessment of the five most important Hollingsworth recommendations, on which Brown commented that JCS should take more cognizance of Hollingsworth's views. JCSM 41-77 for SecDef, 15 Feb 1977, folder NATO 320.2 (15 Jan–Mar) 1977, box 74, SecDef Files, Acc 330-80-0017; John Finney, "U.S. Is Reassessing Strategy in Europe," 24 Sep 1976, *New York Times*, 7 (quote).

6. *NATO and the New Soviet Threat: Report of Senator Sam Nunn and Dewey F. Bartlett to the SCAS*, 24 Jan 1977, 4–6, 12–13, 15, attached to memo, Margolis for Brown, 17 Mar 1977, summarizing it, folder NATO 320.2 (15 Mar–Jul) 1977, box 74, SecDef Files, Acc 330-80-0017. In 1978 British soldier and former commander of the British Army of the Rhine Sir John Hackett headed a team that produced a bestselling book on both sides of the Atlantic. Based on their specialized knowledge of weapons and tactics, and the portrayals of individuals in the fight, the book offers a counterfactual account of a war between the Warsaw Pact and NATO. In their scenario NATO initially lost much of Western Europe. Eventually the West rallied and turned the tide. Sir John Hackett et al., *The Third World War, August 1985: A Future History* (New York: Macmillan, 1978).

7. A copy of the RAND Report is in Rand Reports, box 38, Brown Papers, LC; Duffield, *Power Rules*, 213–214; Robert Komer, "Origins and Objectives" *NATO Review* 26 (Jun 1978), 10–12.

8. Ltr, Bundy to Brown, 12 Jan 1977 (quote), folder 020 SD-Brown (B), box 7, SecDef Files, Acc 330-0-0017; Robert Komer, interview by Alfred Goldberg, Roger Trask, and Stuart Rochester, Washington, DC, 25 Mar 1981, 3–4, Oral History Collection, OSD/HO; Jones, *Blowtorch*, 233.

9. Auten, *Carter's Conversion*, 104–106.

10. PRM 9, "Comprehensive Review of European Issues," 1 Feb 1977, folder NSC 334 (Jan-Apr) 1977, 020, SecDef Files, Acc 330-80-0017.

11. Memo, Komer for Davis and Glitman, 23 Feb 1977, 0000C5DD.pdf, CD-1, Declassified SecDef Files, WNRC; memo, McAuliffe for Brown, 1 Mar 1977, folder Europe 092 (Jan–15 Apr) 1977, box 66, SecDef Files, Acc 330-89-0017.

12. Study in response to PRM 9, "Comprehensive Review of European Issues," w/ Brown's comments, folder Europe 092 (Jan–15 Apr) 1977, box 66, SecDef Files, Acc 330-80-0017; memos, Komer for Brown, 2 Mar 1977, 0000B72B.pdf; Komer for Brown, 7 Mar 1977, 0000B721.pdf: both in CD-1, Declassified SecDef Files.

13. Undated paper by Komer, "What is NATO—And How Do We Make It Work?" folder 344 AFPC (Jan-Jun) 1977, box 35, SecDef Files, Acc 330, 80-0017.

14. Memo, Brown for Service Secretaries, CJCS et al., 11 Apr 1977, attaching Komer's NATO Action Plan, n.d., folder NATO 092 (Jan-Jun) 1977, box 73, *ibid*.

15. Backchannel msg 1093, Haig to Brown, 9 Apr 1977 (quote), folder NATO 320.2 (15 Mar–Jul) 1977, box 74, *ibid*. Komer described this response as “leave it all to me and SHAPE, and don't muddy the waters too much.” Memos, Komer for Brown, 8 Apr 1977 (quote); 21 Apr 1977 (quote): both in folder NATO 092 (Jan-Jun) 1977, box 73, *ibid*.

16. CM 1401-77 for SecDef, 29 Apr 1977, folder 092 NATO (Jan-Jun) 1977, *ibid*.

17. Memos, Alexander for Brown, 20 Apr 1977; Martin for Brown, 20 Apr 1977; Claytor for Brown, 19 May 1977; Vance for Carter, 5 May 1977; Brzezinski for Brown, 19 Apr 1977 (quote); Brown for Brzezinski, 23 Apr 1977 (quote): all *ibid*.

18. Memo, Brzezinski and Owen for Carter, w/Carter's approval and comments, 9 Mar 1977, folder NATO, 2–3/77, box 11, Agency File, Brzezinski Material, National Security Affairs, Carter Library.

19. Carter remarks at the first session of the NATO Ministerial Meeting, 10 May 1977, *Carter Public Papers 1977*, 1:848–852.

20. Vance, *Hard Choices*, 65. The actual language of the communique reads “an annual increase in real terms should be aimed at by all member countries. This . . . should be in the region of three percent.” Quoted in Foreign Policy Research Institute Staff, *The Three Per Cent Solution and the Future of NATO* (Philadelphia, PA: Foreign Policy Research Institute, 1981), 28.

21. Memo, Brown for Carter, 30 Jun 1977 (quote), folder NATO 000.1-199, 1977, box 73, SecDef Files, Acc 330-80-0017.

22. Memo, Komer for Brown, 9 Sep 1977, w/Brown's comments, 0000B768.pdf, CD-1, Declassified SecDef Files.

23. Memo, Brown for Carter, 10 Dec 1977 (quotes), folder NATO 092, (Jul-Dec) 1977, box 73, SecDef Files, Acc 330-80-0017.

24. Carter's Remarks to NAC, 6 Jan 1978, *Carter Public Papers 1978*, 1:36–38 (quote). Another reason Carter did not mention the 3 percent figure was because the issue was still being fought out between the OMB and DoD. In the end, the FY 1979 budget provided only 3 percent real increase in outlays (see chapter 4). The anecdote about “ass kissing,” is from James Thomson, “The Evening Report,” in Gati, ed., *Zbig*, 121. The 8,500 figure is from a memo, Siena for Slocombe, 17 Jan 1978, folder NATO 320.2 (Jan-Apr) 1978, box 63, SecDef Files, Acc 330-81-0202, WNRC. Komer later complained to Brown that the Carter announcement was wrong; the 8,000 increase of the Army in Europe was “merely a reallocation of existing ceilings, mostly to flesh out existing units to a higher standard of readiness.” Brown commented that putting the people and equipment where they would do the most good would increase modernization. Memo, Komer for Brown, 6 Feb 1978, w/Brown's comments, 0000B739.pdf, CD-1, Declassified SecDef Files.

25. Memos, Komer for Brown (quote), 10 Jan 1978, w/Brown's comment, folder NATO 092 (Jan–10 Mar) 1978; Komer for Brown, 15 May 1978, folder NATO 092 (May-Dec) 1978;

Komer for Brown, 28 Apr 1978, folder NATO 092 (Jan-Apr) 1978: all in box 62, SecDef Files, Acc 330-81-0202.

26. Memos, Komer for Brown and Komer for Goodby and Thomson, both 13 Mar 1978, 0000C4DA.pdf, CD-1, Declassified SecDef Files.

27. Memo, Komer for Brown, 11 Mar 1978, 0000C4DD.pdf, CD-1, *ibid.*; memo, Murray for Brown, 14 Mar 1978, folder 092 (Jan-Aug) 1978, box 9, SecDef Files, Acc 330-81-0202. In the latter memo, Murray estimated the U.S. share for the LTDP was only 2 percent of its total defense plan for 1979–1983 and 7 percent for the allies.

28. Memo, Murray for Brown, 14 Mar 1978, cited in note 27.

29. Memo, Komer for Brown, 15 Mar 1978 (quote), 0000B781.pdf, CD-1, Declassified SecDef Files.

30. Msg, Brown to Carter, 19 May 1978 (quote), folder NATO 334 DPC, 1978, box 64, SecDef Files, Acc 330-81-0202.

31. *Ibid.*; memo, Komer for Brown, 16 May 1978, *ibid.*

32. Memo, Brown for Carter, 16 Mar 1978, 0000B77F.pdf, CD-1, Declassified SecDef Files.

33. Memo, Brown for Carter, 26 May 1978, folder NATO 092.3 (May-Dec) 1978, box 62, SecDef Files, Acc 330-81-0202.

34. Memo, Christopher for Carter, n.d., folder NATO 092.3 (31 May) 1978, *ibid.*; DoD News Release No. 268–78, 24 May 1978, folder NATO 401-499, 1978, box 65, *ibid.*

35. Carter's Remarks at North Atlantic Alliance Summit, 31 May 1978, *Carter Public Papers 1978*, 1:1019–1021.

36. See chapter 10 for events after the fall of the shah and chapter 11 for the U.S. reaction to the Soviet invasion of Afghanistan.

37. According to the Department of Labor's Bureau of Statistics, inflation in the United States was 7.6% for 1978, 11.3% for 1979, and 13.5% for 1980. The GDP of the United States grew 5.3% in 1978, 3.1% in 1979, and 0.2% in 1980. In West Germany, the inflation increased much less—about 3% in 1978, 2.3% in 1979, and 5% in 1980—while the West German GDP grew about 2.9% in 1978, 4% in 1979, and 1% in 1980. The West German figures are taken from "The 'Great Inflation': Lessons for Monetary Policy," *European Central Bank Bulletin* (May 2010): 103.

38. Haig with McCarry, *Inner Circles*, 544–555; *DoD Key Officials 1947–2004*, 25.

39. Memo, Komer for Brown, 9 Mar 1977, folder NATO 451.6, 1977, box 76, SecDef Files, Acc 330-80-0017; John Finney, "Rift With Germans Over Tank Widening," *New York Times*, 8 Mar 1977, A7; memcon, Brown and Leber, 15 Mar 1977, 0000D325.pdf, CD-2, Declassified SecDef Files.

40. Memo, Komer for Brown, 16 Mar 1977 (quote), folder NATO 451.6, 1977, box 76, SecDef Files, Acc 330-80-0017.

41. Memo, McAuliffe for Brown, 17 Mar 1977, *ibid.*

42. Memo, Duncan for Carter, 30 Dec 1977, 0000B40B.pdf, CD-1, Declassified Sec-Def Files; memos, Komer and Cooper for Brown, 13 Jan 1978; Brown for Brzezinski, 19

Jan 1978: both in folder NATO 451.6 (Jan-Jun) 1978, box 65, SecDef Files, Acc 330-81-0202; memo, Brown for Carter, 20 Jan 1978 (quote), 0000B433.pdf, CD-1, Declassified SecDef Files.

43. Memo of telcon, Brown and Leber, 20 Jan 1978, folder NATO 451.6 (Jan-Jun) 1978, box 65; memo, Brown for Carter, 27 Jan 1978 (quote), folder 020 DoD (Jan-Feb) 1978, box 6: both in Sec Def Files, Acc 330-81-0202.

44. DoD News Release No. 53–78, 31 Jan 1978, folder NATO 451.6 (Jan-Jun) 1978, box 65, *ibid*. The sticking points in the negotiations proved to be German restrictions on sale of the gun to “Leopard countries” (thus limiting U.S. ability to sell the XM1 with the 120mm gun to many NATO allies), royalty payments to German manufactures of \$25 million up front, and payment for data rights. The final agreement contained no marketing restrictions even to “Leopard countries”; the United States would pay a \$30 million license fee to the Germans in two installments and \$4 million for supplementary technical data. Memos, Perry for Brown, 17 Nov and 22 Nov 1978: both in folder NATO 451.6 (Jul-Dec) 1978, *ibid*.

45. Watervliet Arsenal in New York performed the production work; Chrysler Corporation adapted the turret and converted the gun’s design to U.S. manufacturing processes and maintenance techniques. Memo, McGiffert for Brown et al., 9 Feb 1978, w/fact sheet on tank gun decision, folder NATO 451.6 (Jan-Jun) 1978, *ibid*; memo, Brown for Carter, 1 Dec 1978, 0000B452.pdf, CD-1; Brown comment on memo from McAuliffe for him, 5 Mar 1977, 0000D2D3.pdf, CD-2: both in Declassified SecDef Files.

46. Arnold L. Tessmer, *Politics of Compromise: NATO and AWACS* (Washington, DC: National Defense University Press, 1988), xiii–xiv, 2–4. AWACS could also detect some fast-moving ground vehicles and surface ships.

47. *Ibid.*, 1, 5–19. Tessmer provides a detailed account of NATO negotiations for funding of AWACS based on documents and interviews. Memo, Buc for Holcombe, 11 Feb 1977, w/attached Study of AWACS, 11 Feb 1977, folder NATO 333, 1977, box 75, SecDef Files, Acc 330-80-0017; DoD/Joint Staff talking points for Mondale, 22 Jan 1977, *ibid*.

48. The British economy was in a slide, and the Callaghan Labor Government faced an insurgency in Northern Ireland, a growing political challenge from Margaret Thatcher’s Conservative Party, and an aerospace industry in need of more work. Tessmer, *Politics of Compromise*, 22–23.

49. Ltrs, Mulley to Brown, 30 Mar 1977; Brown to Mulley, 31 Mar 1977: both in folder NATO 413.77 (Mar) 1977, box 76, SecDef Files, Acc 330-80-0017.

50. Memo, McAuliffe for Brown, 11 Feb 1977, 0000D2FD.pdf, CD-2, Declassified SecDef Files.

51. PA&E raised this issue in a memo, Aldridge for Brown, 11 Mar 1977, folder NATO 413.77 (Mar) 1977, box 76, SecDef Files, Acc 330-80-0017.

52. Ltr, Brown to Leber, 31 Mar 1977, 0000D300.pdf, CD-2, Declassified SecDef Files; ltr, Leber to Brown, 25 Feb 1977, w/Brown’s comments, folder NATO 413.77 (Jan-Feb) 1977, box 76, SecDef Files, Acc 330-80-0017.

53. Memo, Komer for Brown, 14 Mar 1977, 0000B726.pdf, CD-1, Declassified SecDef Files; memo, McAuliffe for Brown, 12 Mar 1977, folder Germany 091.112 (Jan-Dec) 1977, box 67, SecDef Files, Acc 330-80-0017.

54. Memo, Brown for Carter, 18 Mar 1977, 0000B3F6.pdf, CD-1, Declassified SecDef Files; memcons, Leber and Brown, 15 and 16 Mar 1977: both in folder Germany 091.112 (Jan-Dec) 1977, box 67, SecDef Files, Acc 330-80-0017.

55. Memcon, Schmidt and Brown, 21 Jul 1977, folder Germany 091.112 (Jan-Dec) 1977, box 67, SecDef Files, Acc 330-80-0017; memo, Brown for Carter, 15 Jul 1977 (quotes), folder 020 DoD, May-Sep 1977, box 5, *ibid*.

56. Memo, Duncan for Carter, 7 Oct 1977, 0000B403.pdf, CD-1, Declassified SecDef Files.

57. Ltr, Brown to Ruffini, 15 Apr 1978, folder NATO 413.77 (Jan-Apr) 1978, box 65, SecDef Files, Acc 330-80-0017; ltrs, Brown to Ruffini, 29 Apr 1978, 0000C008.pdf; 12 May 1978, 0000C009.pdf: both in CD-1, Declassified SecDef Files; Tessmer, *Politics of Compromise*, 84–88.

58. Memo, Brown for Carter, 12 May 1978 (quotes), 0000B43D.pdf, CD-1, Declassified SecDef Files.

59. Memo, Brown for Carter, 3 Nov 1978 (quote), 0000B44F.pdf, *ibid*

60. Memo, Komer for Brown, 11 Jul 1978, folder NATO 413.77 (May-Jul) 1978, box 65, SecDef Files, Acc 330-81-0202. Tessmer, *Politics of Compromise*, covers the entire 1977–1978 negotiations in detail.

61. Memo, Brzezinski for Carter, 2 Dec 1979 (quote), folder NATO, 10/8–2/79, box 11, Agency File, Brzezinski Material, National Security Affairs, Carter Library.

62. Memo, Brown for Carter, 8 Dec 1978 (quotes), folder 020 DoD (16 Oct–Dec) 1978, box 5, SecDef Files, Acc 330-81-0202. The non-signatory NATO members were Britain, France, Iceland (no military), and Greece (the Greeks signed later in December 1978). Tessmer, *Politics of Compromise*, 143.

63. Tessmer, *Politics of Compromise*, 159–164. Brown notes that NATO AWACS reinforced the alliance’s southern flank during the Iraqi invasion of Kuwait, and supported NATO missions in the Balkans in the 1990s and in Libya in 2012. Brown with Winslow, *Star Spangled Security*, 139.

64. Memo, Holcomb for Aaron, 6 Jul 1977, folder Germany 339–399, 1977, box 68, SecDef Files, Acc 330-80-0017; memo, Brzezinski for Carter, 23 Sep 1977, CK3100573347, DDRS.

65. Memo, Holcomb for Aaron, 6 Jul 1977, cited in note 64; memo, Brzezinski for Brown, w/Brown’s comment (quote, emphasis in original), 29 Sep 1977, folder Germany 335–339, 1977, box 68, SecDef Files, Acc 330-80-0017.

66. Memo, Danzig for Komer et al., 7 Feb 1978, w/attachment, “A Review of Military Mobilizations Plans,” Report to the House Armed Services Committee, 30 Jan 1978, 0000C078.pdf, Declassified SecDef Files; James W. Canan, “Up From Nifty Nugget,” *Air Force Magazine*, Sep 1983, from digital archives, <[www.airforce-magazine.com/MagazineArchive/Pages/1983/September](http://www.airforce-magazine.com/MagazineArchive/Pages/1983/September)>, accessed 25 Aug 2010; James K. Matthews and Cora J. Holt, *So Many, So Much, So Far, So Fast: United States Transportation Command and*

*Strategic Deployment for Operation Desert Shield/Desert Storm* (Washington, DC: Joint History Office, Office of CJCS and Research Center, U.S. Transportation Command, 1996), 1.

67. Memos, Komer for Brown, 25 Oct 1978 (quote), 0000B989.pdf; Brown for Carter, 3 Nov 1978 (quote), 0000B44F.pdf: both in CD-1, Declassified SecDef Files.

68. Memo, Brown for Carter, 6 Dec 1979, w/Carter's comment, folder 353 (Sep-Dec) 1979, box 41, SecDef Files, Acc 330-82-0204, WNRC.

69. Memo, Brzezinski for Carter, 4 Jan 1980, folder Weekly Reports to the President, 121–135, box 42, Subject File, Brzezinski Donated Material, Carter Library; Canan, "Up From Nifty Nugget" (quote), cited in note 66.

70. Memo, Brown for Carter, 7 Jul 1978, 000B443.pdf, CD-1, Declassified SecDef Files; memo, Brown for Carter, 18 Sep 1978, folder NATO, 6–9/78, box 12, Agency File, Brzezinski Material, National Security Affairs, Carter Library.

71. Memo, Brown for Carter, 18 Sep 1978, w/Carter's comment, cited in note 70.

72. Ibid. Dual production involved a NATO partner assembling a complete system on its own, often in parallel to a U.S. production line. Coproduction usually included the United States and its partners handling different aspects of the production process.

73. Ltrs, Brown to Vance, 18 Sep 1977; Christopher to Brown, 30 Sep 1977: both in folder 806 NATO, box 38, Official Records of CJCS General Brown, Acc 218-92-0032, NARA.

74. Andreas Parsch, "Euromissile/Hughes/Boeing MIM-115," *Directory of U.S. Military Rockets and Missiles* <[www.designation-systems.net/dusrm/m-115.html](http://www.designation-systems.net/dusrm/m-115.html)>, accessed 19 Oct 2010.

75. Memos, Komer for Brown, 26 Jan 1979, 0000B819.pdf; Komer for Perry, 1 May 1979, 0000BBCD.pdf: both in CD-1, Declassified SecDef Files.

76. Brzezinski, *Power and Principle*, 151.

77. Garthoff, *Détente and Confrontation*, 533–537.

78. Memo, Clarke for Brown, 27 Jan 1977, folder NATO 320.2 MBFR (Jan–14 Sep) 1978, box 74, SecDef Files, Acc 330-80-0017; Garthoff, *Détente and Confrontation*, 536. An account of the negotiations from 1973 to 1980 based primarily on public sources is John G. Keliher, *The Negotiations on Mutual and Balanced Force Reductions: The Search for Arms Control in Central Europe* (New York: Pergamon Press, 1980), especially pages 49–82.

79. Memo, Brzezinski for Carter, w/attached Summary of Conclusions of SCC Meeting, 7 Feb 1977, CK31000073354, DDRS.

80. Rearden, *Council of War*, 439–440. The Soviets countered that many of their troops in Central Europe performed functions similar to the 120,000 West German civilians involved in administrative and housekeeping functions for the alliance, as well as NATO air force personnel involved in air defense. Keliher, *Negotiations*, 121.

81. Memos, Clark for Brown, 4 Aug 1977; McGiffert for Brown, 10 Sep 1977; Slocombe for Brown, 13 Sep 1977: all in folder NATO 320.2 MBFR (Jan–14 Sep) 1977, box 74, SecDef Files, Acc 330-80-0017.

82. Memo, Brzezinski for Vance, Brown et al., 22 Sep 1977, folder NATO 320.2 MBFR (15 Sep–Dec) 1977, *ibid.*

83. Ltr, Nunn to Carter, 27 Oct 1977; Talking Paper for Duncan and General Brown for 15 Sep 1977 SCC meeting; memo, McGiffert for Brown, 3 Nov 1977: all in folder NATO 320.2 MBFR (15 Sep–Dec) 1977, *ibid.*

84. Ltr, Carter to Nunn, 31 Oct 1977, *ibid.*

85. Memo, Brown for Carter, 14 Nov 1977, *ibid.*

86. Memo, Dodson for Vance, Brown et al., 4 Aug 1978; Talking Paper for Secretary Brown and CJCS Brown, 8 Aug 1978, w/Brown's comments: both in folder NATO 320.2 MBFR (4 Aug 1978), box 64, SecDef Files, Acc 330-81-0202.

87. Ltr, Huntington to Brzezinski, 9 Aug 1978, folder PD 18, 1/74–9/8, box 36, General Odom File, Brzezinski Donated Material, Carter Library; PA&E Paper, "Revaluation of the West's MBFR Position" [15 Aug 1978], folder NATO 320.2 MBFR (Jul-Dec) 1978, box 63, SecDef Files, Acc 300-81-0202.

88. Memo, Brzezinski for Vance, Brown et al., 11 Aug 1978, folder NATO 320.2 MBFR, (Jul-Dec) 1978, box 63, SecDef Files, Acc 300-81-0202.

89. Memo, Resor for Brown, 8 Nov 1978, *ibid.*

90. JCSM 338-78 for SecDef, 21 Dec 1978, *ibid.*

91. Memos, Brown for Carter, 14 Dec 1978; Brown for Carter, 23 Dec 1978: both *ibid.*

92. ISA Paper, "MBFR Principles/Objectives, n.d., folder NATO 320.2 MBFR (Jul–17 Sep) 1979, box 17, SecDef Files, Acc 330-82-0205, WNRC.

93. Summary of Conclusions of SCC Meeting, 18 Sep 1979, folder SCC Mtgs, box 17, National Security Affairs, Staff Office, Meetings File, Carter Library; Keliher, *Negotiations on MBFR*, 82–89.

94. In his 14 December 1978 memo for Carter, cited in note 85, Brown observes that if Carter understood the MBFR issues and positions, "I envy you."

95. Theodore A. Couloumbis, *The United States, Greece, and Turkey: The Troubled Triangle* (New York: Praeger, 1983), 137–139, 150. For Greek-Turkish tension over the Aegean, see S. Victor Papacosma, "Greece and NATO," in Lawrence S. Kaplan, Robert W. Clawson, and Raimondo Luraghi, eds., *NATO and the Mediterranean* (Wilmington, DE: Scholarly Resources, 1985), 198–202.

96. Clark Clifford, with Richard Holbrooke, *Counsel to the President: A Memoir* (New York: Random House, 1991), 625–628; Carter, *Keeping Faith*, 51; Brzezinski, *Politics and Power*, 53; PRM 5, "Cyprus/Aegean," 21 Jan 1977, Documents, Presidential Review Memorandum, Carter Library, <[www.jimmycarterlibrary.gov/documents/prmremorandum/prm05.pdf](http://www.jimmycarterlibrary.gov/documents/prmremorandum/prm05.pdf)>, accessed 7 Apr 2014; draft response to PRM 5, w/DoD revisions, undated, folder Cyprus, 1977, box 66, SecDef Files, Acc 330-80-0017.

97. Draft response to PRM 5, n.d., cited in note 96; memo, McGiffert for Brown, 2 Feb 1978, folder Turkey 091.3 (Jan-Dec) 1978, box 69, SecDef Files, Acc 330-81-0202; memo, Brown for Carter, 18 Jan 1978, *FRUS 1977–1980*, vol. 21, *Cyprus; Turkey; Greece, 1977–1980*,

ed. David Zierler (Washington, DC: GPO, 2014), 333–334 (quotes) (doc 106); ltr, Gundersen to General Brown, 25 Jul 1977, folder Turkey, 1977, box 80, SecDef Files, Acc 330-80-0017.

98. Memo, Slocombe for Brown, 20 Mar 1978, folder Turkey 091.3 (Jan-Dec) 1978, box 69, SecDef Files, Acc 330-81-0202; memo, McGiffert for Brown, 22 Mar 1978, 0000D400.pdf, CD-2, Declassified SecDef Files; memcon, Brown and Ecevit, 5 Jun 1977, *FRUS 1977–1980*, 21:371–374 (doc 118), 371 (quote); briefing memo, McGiffert for Brown, 3 Jun 1978, folder 1978, box 68, SecDef Files, Acc 330-81-0202.

99. Ltr, Brown to Cannon, 19 Jul 1978, folder 091.3 Turkey (Jan-Dec) 1978, box 69, SecDef Files, Acc 330-81-0202; memo, Brown for Carter, 9 Jun 1978, 0000B441.pdf, CD-1, Declassified SecDef Files; memo, Duncan for Carter, 23 Jun 1978, folder 020 DoD (2 Jan–15 Jul) 1978, box 5, SecDef Files, Acc 330-81-0202; memos, Brown for Carter, 30 Jun 1978, 0000B442.pdf; Brown for Carter, 14 Jul 1978, 0000B444.pdf; Brown for Carter, 21 Jul 1978, 0000B445.pdf: all in CD-1, Declassified SecDef Files. According to Brown's 23 June memo to Carter, Haig met with 15 congressional leaders, including Representative John J. Rhodes Jr. (R-AZ) and Senator Robert C. Byrd (D-WV), who most supported lifting the embargo but were unwilling to be publicly associated with it.

100. Theodore A. Couloumbis, *United States, Greece, and Turkey*, 106–107; editorial note, *FRUS 1977–1980*, 21:380–382 (doc 121); Rearden with Foulks, *JCS and National Policy 1977–1980*, 196.

101. Couloumbis, *United States, Greece, and Turkey*, 153–154, 160; JCSM 430-77 for SecDef, 10 Nov 1977, folder Turkey, 1977, box 80, SecDef Files, Acc 330-80-0017; memo, Komer for Brown, 25 Jun 1979, 0000BBA6.pdf, CD-1, Declassified SecDef Files.

102. Couloumbis, *United States, Greece, and Turkey*, 141–143; msgs, Haig to Brown, 141355Z Feb 1979; Haig to Brown, 060925Z May 1978; Haig to Brown, 131052Z Jun 1979; Haig to Brown, 290756Z Jun 1978: all in folder Feb–Jun 1978, SecDef Cables, OSD/HO; msg, Haig to Brown and Jones, 16 Jun 1979, *FRUS 1977–1980*, 21:585–586 (doc 191); Rearden with Foulks, *JCS and National Policy 1977–1980*, 197–198; Papacosma, “Greece and NATO,” in Kaplan, Clawson, and Luraghi, *NATO and the Mediterranean*, 204–207; memo, Wexler for Brzezinski, 2 Oct 1980 (doc 207); ltr, Brown to Averoff, 10 Oct 1980 (doc 208); msg 12732, Embassy Athens, 18 Oct 1980 (doc 209); editorial note (doc 210): all in *FRUS 1977–1980*, 21:628–632.

103. Duffield, *Power Rules*, 222–223. While strong on U.S. defense, the Reagan administration was less committed to pressing NATO allies to enhance their conventional forces, except for prepositioning of equipment and German logistical support of U.S. forces in Germany.

## 15. NATO and the Theater Nuclear Forces

1. Leighton, *Strategy, Money and the New Look*, 438, 551; Robert J. Watson, *Into the Missile Age, 1956–1960* (Washington, DC: OSD Historical Office, 1997), 511–523, 539–543. See also Jeffrey A. Larsen, “The Future of U.S. Non-Strategic Nuclear Weapons and Implications for NATO,” report for NATO Public Diplomacy Division, 31 Oct 2006, 12–13.



2. West German Chancellor Helmut Schmidt put it this way, “It seemed almost blasphemous to Europeans to hear the talk of ‘theater [nuclear] weapons,’ meaning theater of war. Seventy-five million Germans were said to be living at the center of the imagined ‘theater of war,’ and it was easy to imagine that . . . the ‘theater’ would essentially remain limited to the two German states.” Helmut Schmidt, *Men and Powers: A Political Retrospective* (New York: Random House, 1989), 186; Drea, *McNamara, Clifford, and the Burdens of Vietnam*, 293–296, 388–391.

3. See note 2, chapter 14.

4. Memo, Brown for Carter, 2 Jan 1979, folder NATO 560.3, 1979, box 2, SecDef Files, Acc 330-82-0202, WNRC. Great Britain in 1952 and France in 1960 had developed their own nuclear weapons as a failsafe to the U.S. nuclear umbrella. Arms Control Association, *Arms Control and National Security*, 102.

5. Drea, *McNamara, Clifford, and the Burdens of Vietnam*, 389.

6. Garthoff, *Détente and Confrontation*, 942–943, 958–963. Colin A. Hempstead and William E. Worthington Jr., eds., *Encyclopedia of 20th-Century Technology* (New York: Routledge: 2004), 2:687.

7. Garthoff, *Détente and Confrontation*, 936; Kaplan et al., *McNamara Ascendancy*, 370–371.

8. Memo, Dodson for Humphrey, Sparkman, and Stennis, 13 Jul 1977, folder Lance 471.94, 1977, box 72, SecDef Files, Acc 330-80-0017, WNRC. If the neutron bomb released 8,000 rem (roentgen equivalent man), the exposed recipient would suffer nervous shock immediately and death within a day or two, with no ability to perform any functions until death. Dietrich Schroerer, *Science, Technology and the Nuclear Arms Race* (New York: John Wiley & Sons, 1984), 275.

9. Walter Pincus, “Neutron Killer Warhead Buried in ERDA Budget,” *Washington Post*, 6 Jun 1977, A1, A9; and “Carter Weighing Radiation Warhead,” *Washington Post*, 7 Jun 1977, A5, are the first two in the series.

10. Garthoff, *Détente and Confrontation*, 937–938.

11. Memo, Lance and Brzezinski for Carter, 21 Jun 1977, folder Enhanced Radiation Weapons and Radiological Warfare, 6–8/77, box 16, Subject File, Brzezinski Material, National Security Affairs, Carter Library

12. Memo, Brzezinski for Brown, 23 Jun 1977 (quote), folder Lance 471.94, 1977, box 72, SecDef Files, Acc 330-80-0017.

13. Note, Holcombe to Brzezinski, 24 Jun 1977, w/attached “Factsheet: Improved Lance ER Warhead,” folder Lance 471.94, 1977, box 72, SecDef Files, Acc 330-80-0017; memo, Brown for Carter, 8 Jul 1977, CK3100145702, DDRS; memo, Duncan for Brzezinski, 8 Jul 1977, folder NATO 471.94 (Jan-Jul) 1977, box 77, SecDef Files, Acc 330-80-0017.

14. Memo, Brown for Carter, 12 Aug 1977, folder Enhanced Radiation Weapons and Radiological Warfare, 6–8/77, box 16, Subject File, Brzezinski Material, National Security Affairs, Carter Library; memo, Brzezinski to Carter, 15 Aug 1977, w/Carter’s comment, *ibid.*

15. *Ibid.*; Brzezinski, *Power and Principle*, 302 (quote).

16. Memo, Brown and Vance for Carter, 23 Sep 1977, folder Enhanced Radiation Weapons and Radiological Warfare, 6–8/77, box 17, Subject File, Brzezinski Material, National Security Affairs, Carter Library.

17. Memo, Dodson for Vance, Brown et al., 12 Nov 1977, w/attached “Discussion Paper: Enhanced Radiation Warheads,” folder NATO 471.94. 1977, box 4, SecDef Files, Acc 330-80-0016, WNRC; Brzezinski, *Power and Principle*, 302.

18. Memo, Brown for Carter, 8 Nov 1977, folder Lance 471.94, 1977, box 72, SecDef Files, Acc 330-80-0017.

19. Memo, Brzezinski for Carter, n.d. [16 Jan 1978?], folder Enhanced Radiation Weapons and Radiological Warfare, 9/77–1/78, box 17, Subject File, Brzezinski Material, National Security Affairs, Carter Library.

20. Summary of Conclusions of SCC Meeting, 16 Nov 1977, folder SCC041, MBFR, ER Weapons Talks, 11/22/77, box 90, NSC Institutional Files, 1977–1981, Carter Library.

21. Memo, Brown for Carter, 8 Dec 1977 (quotes), folder Enhanced Radiation Weapons and Radiological Warfare, 9/77–1/78, box 17, Subject File, Brzezinski Material, National Security Affairs, Carter Library.

22. Memos, Vance and Brown for Carter, n.d. [18 Mar 77?], w/Carter’s comment; Brzezinski for Carter, 18 Mar 1978, w/Carter’s comment: both in folder Enhanced Radiation Weapons and Radiological Warfare, 2–4/78, box 17, Subject File, Brzezinski Material, National Security Affairs, Carter Library.

23. Brzezinski, *Power and Principle*, 304–305. Carter wrote in his 20 March 1978 diary entry: “A lot of momentum had been generated to produce and deploy these neutron bombs. My cautionary words since last summer have pretty well been ignored, and I was aggravated. The general sense is that it [ERW] protects buildings and kills people. That’s a gross oversimplification, but I decided to work out a way to cancel the idea without giving an image of weakness to our European allies, who don’t want it anyhow.” Carter, *White House Diary*, 179. Three days later Carter met with Callaghan who told him that Britain would not deploy them, and it would be a great relief if the United States did not produce them. *Ibid.*, 180.

24. Memo, Brzezinski for Carter, 24 Mar 1978, folder Enhanced Radiation Weapons and Radiological Warfare, 2–4/78, box 17, Subject File, Brzezinski Material, National Security Affairs, Carter Library.

25. Memo, Brown for Carter, 3 Apr 1978 (quotes), folder Lance 471.94 (Jan–Apr) 1978, box 60, SecDef Files, Acc 330-81-0202; memo, Brzezinski for Carter, 4 Apr 1978, folder Defense, ER Warhead, 3/78–7/78, box 22, Subject File, Brzezinski Donated Material, Carter Library. Carter wrote on Brzezinski’s memorandum: “Zbig—I have to say that you never give up.” Haig remembers telephoning the president to recommend the production of ERWs. Carter told him: “I’ll meet you halfway. We produce the neutron bomb, but we won’t deploy it.” Haig with McCarry, *Inner Circles*, 533.

26. *Carter Public Papers 1978*, 1:702 (quote).

27. Brzezinski, *Power and Principle*, 305–306. Brzezinski also complained that he told Vance and his press secretary, Hodding Carter (no relation to the president), in confidence how he felt, and that Hodding Carter must have leaked it. *Ibid.*, 305.

28. Memo, Brzezinski for Carter, 11 Oct 1978, w/Carter's comment, folder Enhanced Radiation Weapons and Radiological Warfare, 5/78–7/80, box 17, Subject File, Brzezinski Material, National Security Affairs, Carter Library.

29. Memo, Brzezinski for Vance, Brown, Schlesinger, 13 Oct 1978, folder Lance 471.94 (16 Jul) 1978, box 60, SecDef Files, Acc 330-81-0202.

30. Garthoff, *Détente and Confrontation*, 939; Lawrence S. Kaplan, *NATO Divided, NATO United: The Evolution of an Alliance* (Westport, CT: Praeger, 2004), 80–81.

31. Helmut Schmidt, "The 1977 Alastair Buchan Memorial Lecture," 28 Oct 1978, *Survival* 20 (Jan–Feb 1978): 3–5; Schmidt, *Men and Powers*, 188–189; William Leonard, "'Closing the Gap': Euromissiles and President Carter's Weapons Strategy for Western Europe (1977–1979)," 21 Dec 2010, CSIS, 6, <<http://csis.org/publication/closing-gap-euromissiles-and-president-carters-nuclear-weapons>>, accessed 23 Feb 2012.

32. Memo, Dodson for Mondale, Vance, Brown et al., 18 Aug 1978, w/attached response to PRM 38, "Long-Range Theater Nuclear Forces," 19 Aug 1978, reproduced in William Burr, ed., *The Thirtieth Anniversary of NATO's Dual-Track Decision: The Road to the Euromissiles Crisis and the End of the Cold War*, doc 1, <<http://nsarchive.gwu.edu/nukev-ault/ebb301/>>, accessed 5 Feb 2014.

33. Memo, Brown for CJCS et al., 3 Jun 1978, folder NATO 471.61 (Jan–Dec) 1978, box 65, SecDef Files, Acc 330-81-0202; CM 1637-77 for SecDef, 27 Sep 1977, folder 806 NATO, box 38, Official Records of CJCS General Brown, Acc 218-92-0032, NARA II.

34. PRM 38, 22 Jun 1978, <<http://www.jimmycarterlibrary.gov/documents/prmemorandus/prm38.pdf>>, accessed 3 Sep 2014.

35. Response to PRM 38, 19 Aug 1978, cited in note 32.

36. Memos, Komer for Brown, 21 Aug 1978, w/Brown's comment; Komer for Resor, 21 Aug 1978 (quotes): both in folder NATO 471.61 (Jan–Dec) 1978, box 65, SecDef Files, Acc 330-81-0202.

37. Talking Paper for SecDef and CJCS for 22 Aug 1978 SCC Meeting, w/Brown's comments, folder NATO 471.61 (Jan–Dec) 1978, box 66, *ibid.*; memo, Brzezinski for Vance, Brown et al., 2 Sep 1978, w/attached Summary of Conclusions of SCC Meeting, 23 Aug 1978, folder NATO 471.61, 1978, box 4, SecDef Files, Acc 330-81-0212, WNRC.

38. Memos, Tarnoff for Brzezinski, 17 Oct 1978; McGiffert for Brown, 26 Oct 1978: both in folder NATO 471.61 (Jan–Dec) 1978, box 65, SecDef Files, Acc 330-81-0202; memo, Aaron for Carter, 26 Oct 1978 (quote), folder NATO, 10/78–2/79, box 13, Agency File, Brzezinski Material, National Security Affairs, Carter Library.

39. Garthoff, *Détente and Confrontation*, 946–47; Carter, *White House Diary*, 272 (quote); Brzezinski, *Power and Principle*, 295 (quote); Schmidt, *Men and Powers*, 190.

40. Memo, Brzezinski for Carter, 13 Feb 1979, folder Alpha Channel Files, 12/79–7/79, box 4, Brown Papers, LC; memo, Brzezinski for Carter, 24 Mar 1979, w/Carter's comment, folder SCC 150, TNF, 3/23/79, box 102, NSC Institutional Files, 1977–1981, Carter Library.

41. Memo, Vance and Brown for Carter, 9 May 1979, folder NATO 471.61 (Jan-Jun) 1979, box 19, SecDef Files, Acc 330-82-0205, WNRC; memo, Brzezinski for Vance and Brown, 18 May 1979, folder NATO, 10/78–2/79, box 13, Agency File, Brzezinski Material, National Security Affairs, Carter Library; Brown with Winslow, *Star Spangled Security*, 140; Schmidt, *Men and Power*, 74–75. At DoD's suggestion, Carter wrote Schmidt a personal letter on 18 September 1979 encouraging "firm resolve in NATO with the theater nuclear force." Memo, Brown for Carter, 14 Sep 1979; ltr, Carter to Schmidt, 18 Sep 1979: both in folder Germany (Sep) 1979, box 10, SecDef Files, Acc 330-82-0205.

42. Memo, Brown for Brzezinski, 1 Jun 1979, w/attached "Talking Points: TNF Modernization," folder NATO 471.61 (Jan-Jun) 1979, box 19, SecDef Files, Acc 330-82-0205; memo, Brown for Carter, 5 Jul 1979 (quote), folder TNF, 7/6/79, box 104, NSC Institutional Files, 1977–1981, Carter Library; Talking Paper for Brown and Jones for SCC Meeting, 5 Jul 1979, folder NATO 471.61 1979, box 2, SecDef Files, Acc 330-82-0270, WNRC.

43. Memo, Brzezinski for Carter, 6 Jul 1979, w/Carter's "OK," folder TNF, 7/6/79, box 104, NSC Institutional Files, 1977–1981, Carter Library; Garthoff, *Détente and Confrontation*, 948.

44. Brown notes of foreign policy breakfast w/Carter, 7 Dec 1979; DoD paper, "Country Status" [of TNF support], 9 Dec 1979: both in folder 471.63 (Jul-Dec) 1979, box 19, SecDef Files, Acc 330-82-0205.

45. An unattributed memo, "Soviet Campaign Against TNF Modernization in Europe," n.d. [seen by Brown and Komer on 25 Oct 1979], concluded that while the Soviet campaign was in full force, "opposition to TNF in Europe stems from a variety of matters and is only in small part the product of Soviet propaganda efforts." Ibid.

46. Garthoff, *Détente and Confrontation*, 953.

47. Memo, Brown for Carter, 14 Nov 1979, folder Secretary Brown, Eyes Only, Jul-Dec 79, box 11, Brown Papers, LC.

48. Joint NATO communiqué, 12 Dec 1979, Department of State, *American Foreign Policy: Basic Documents*, 494–496; Garthoff, *Détente and Confrontation*, 953.

49. Ltr, Brown to McGiffert, 15 Dec 1979, folder NATO 471.61 (Jul-Dec) 1979, box 19, SecDef Files, Acc 330-82-0205.

50. Memo, Slocombe for Brown, 3 Aug 1979, w/Brown's comment (quote), *ibid.*

51. Vance, *Hard Choices*, 392

52. Garthoff, *Détente and Confrontation*, 951–952; Wilfried Loth, trans. by Robert F. Hogg, *Overcoming the Cold War: A History of Détente, 1950–1991* (Basingstoke, UK: Palgrave Macmillan, 2002), 155; "NATO Modernizing Theater Nuclear Forces," Nov 1979, *Gist*, Bureau of Public Affairs, Department of State, folder NATO, Jul-Dec 1979, box 99, Subject Files, OSD/HO.

53. Garthoff, *Détente and Confrontation*, 955; memo, Brown for Carter, 13 Jun 1980, w/attached papers, "The Schmidt Proposal" and "Implications of a Deployment Moratorium

for Soviet and NATO Programs,” n.d., folder 381 (26 Mar–30 Jun) 1980, box 39, SecDef Files, Acc 330-82-0216, WNRC; Carter, *Keeping Faith*, 535–538; Brzezinski, *Power and Principle*, 309–310, 462–463. Schmidt was apparently so angered that he included in his memoirs large verbatim accounts of his conversation with Carter at Venice on the issue. Schmidt, *Men and Powers*, 209–217.

54. Memos, Slocombe for Brown, 4 Sep 1980; Dodson for Vance, Brown et al., 9 Sep 1980, w/attached Summary of Conclusions of SCC Meeting, 4 Sep 1980: both in folder NATO 471.61 (Aug 1980), box 13, SecDef Files, Acc 330-82-0217, WNRC.

55. Garthoff, *Détente and Confrontation*, 968, 970.

56. *Ibid.*, 956–957.

57. Arms Control Association, *Arms Control and National Security*, 105–108.

58. Raymond Garthoff, *The Great Transition: American-Soviet Relations and the End of the Cold War* (Washington, DC: Brookings Institution, 1994), 35; Alexander M. Haig Jr., *Caveat: Realism, Reagan, and Foreign Policy* (New York: Macmillan, 1984), 86–88.

59. Nolan, *Guardians of the Arsenal*, 135, believes Carter fumbled the decision. Garthoff, *Détente and Confrontation*, 939, suggests it was an “impulsive decision” and a “fiasco” that undermined West European confidence in the alliance but was compensated for by support for long-range TNF modernization. Citing congressional hawks’ opposition to the decision, Burton Kaufman concludes it “represented a significant setback in alliance relations that was not quickly resolved.” Kaufman, *Presidency of James Earl Carter*, 95–96. Surprisingly and significantly, in his second memoir after *Caveat*, Haig recounts that while Carter was “the most morally consistent President the nation has known since Wilson,” his compromise on ERWs “mollified Schmidt and maintained the strategic advantage the weapons represented.” Haig with McGarry, *Inner Circles*, 532–533.

## 16. Conflict and Confrontation in Africa

1. For an overview, see Crawford Young, *The Postcolonial State in Africa: Fifty Years of Independence, 1960–2010* (Madison: University of Wisconsin Madison, 2012).

2. Specialist histories of Carter’s African policy include for the Horn of Africa, Donna R. Jackson, *Jimmy Carter: Cold War Policy in Ethiopia and Somalia* (Jefferson, NC: McFarland, 2007); for southern Africa, Piero Gleijeses, *Visions of Freedom: Havana, Washington, Pretoria and the Struggle for Southern Africa* (Chapel Hill: University of North Carolina Press, 2013), which has chapters on the Carter years; and for Zimbabwe, Andrew DeRoche, *Black, White, and Chrome: The United States and Zimbabwe, 1953–1998* (Trenton, NJ: Africa World Press, 2001), which covers Carter’s efforts to end black-white conflict in Rhodesia.

3. The murder of Lumumba has been one of history’s great murder mysteries. Documentation in *FRUS 1964–1968*, vol. 23, *Congo, 1960–1968*, eds. Nina D. Howland et al. (Washington, DC: GPO, 2013), indicates that the CIA was taken by surprise. This volume covers extensively the U.S. role in supporting pro-Western Congolese politicians, especially Mobutu. A Belgium parliamentary investigation suggested some role by Belgian officials, but that Congolese opponents of Lumumba pulled the trigger, and at whose

direct encouragement remains murky. Belgian House of Representatives, *Parliamentary Inquiry on the Circumstances of the Assassination of Patrice Lumumba and on the Possible Involvement of Belgian Politicians*, Report of the Commission of Inquiry, 16 Nov 2001, as summarized by Steven R. Weissman, “Opening the Secret Files on Lumumba’s Murder,” *Washington Post*, 21 Jul 2002, reprinted at <[www.africawithin.com/Lumumba.murder\\_of\\_lumumba.htm](http://www.africawithin.com/Lumumba.murder_of_lumumba.htm)>, accessed 21 Sep 2011. What is clear is that no Western official was sorry to see Lumumba dead.

4. See *FRUS 1969–1976*, vol. 28, *Southern Africa, 1969–1976*, ed. Myra Burton (Washington, DC: GPO, 2011), 336–480 (docs 137–191).

5. Carter, *Keeping Faith*, 150; Glad, *Jimmy Carter*, 241; Peter Schraeder, *United States Policy Toward Africa: Incrementalism, Crisis and Change* (Cambridge, Cambridge University Press, 1994), 87.

6. Evening Notes for President, 10 Mar 1977, CK3100650544; Evening Notes for Brzezinski, 11 Mar 1977, CK3100 690226: both in DDRS; Zaire Updates, 17, 21, 28, and 29 Mar 1977, folder W, X, Y, Z 1977, box 83, SecDef Files, Acc 330-80-0017, WNRC. Bad blood existed between Angola and Zaire because Mobutu had cooperated with the United States in opposing the Popular Movement’s campaign for power.

7. JCSM 74-77 for SecDef, 8 Mar 1977, *ibid.* (quote).

8. Vance, *Hard Choices*, 70–71. Brzezinski admitted that the struggles in Zaire and Angola were subject to two contradictory conclusions: a post-colonial Africa was collapsing and the United States should not become involved; or the Soviets were challenging pro-Western African governments as part of an East-West struggle. Brzezinski attested to the latter conclusion but did not at this point recommend directly confronting the Soviets in Africa, relying instead on diplomatic leverage, trade denials, and other indirect pressures. Memo, Brzezinski for Carter, 1 Apr 1977, National Security Report 7, CK3100162536, DDRS.

9. National Security Report 5, Brzezinski to Carter, 18 Mar 1977, CK3100466119, DDRS.

10. Note by Brown (quote) on memo, Hanson for Holcomb, 21 Mar 1977, folder W, X, Y, Z 1977, box 83, SecDef Files, Acc 330-80-0017.

11. Info Memo, McGiffert for Brown, 16 Apr 1977, folder 337 WH, 1977, box 1, SecDef Files, Acc 330-80-0016, WNRC; memo, Odom for Brzezinski, 18 Mar 1977, CK3100600909, DDRS. For more background on the first Shaba incident, see Garthoff, *Détente and Confrontation*, 687–689.

12. For documents on U.S. policy toward the Ethiopian revolution and the Horn of Africa during 1973–1976, see *FRUS 1969–1976*, vol. E-6, *Africa 1973–1976*, docs 77–171, <<http://history.state.gov/historicaldocuments/frus1969-76ve06>>. See also Vance, *Hard Choices*, 72–75.

13. Memos, Henze for Brzezinski, 31 Mar 1977, CK3100143367; Brown for Brzezinski, 21 Mar 1977, CK3100107967: both in DDRS; memos, Brzezinski for Brown, 1 Apr 1977; JCSM 66-77 for SecDef, 2 Mar 1977; SecDef for CJCS, 15 Apr 1977: all in folder E-F, 1977, box 66, SecDef Files, Acc 330-80-0017; ltr, Brown to Vance, 19 Dec 1977, 0000CB18.pdf, CD-2, Declassified SecDef Files, WNRC. All U.S. dependents were withdrawn from the

Kagnew Station in November 1976 after two U.S. personnel were killed by land mines and Eritrean insurgents kidnapped five other U.S. citizens.

14. Memo, Brzezinski for Brown and Vance, 19 Apr 1977, w/attached note by Carter, 19 Apr 1977, folder DoD 4–5/77, box 4, Agency File, Brzezinski Material, National Security Affairs, Carter Library.

15. Memo, Brown for Brzezinski, 21 Apr 1977, folder E-F, 1977, box 66, SecDef Files, Acc 330-80-0017; memo, Henze for Brzezinski, 22 Apr 1977, CK3100147721, DDRS; Garthoff, *Détente and Confrontation*, 697. Brown recalled that Ethiopian forces took over the consulate in Asmara without notice. JCS Chairman General Brown called him off the tennis court to obtain authorization for the military unit there to destroy classified documents. Brown's comment to author, 6 Dec 2016.

16. Memcons, Mondale and Addou, 13 May 1977, CK3100477427; Carter and Addou, 16 Jun 1977 (quote), CK3100143623; Summary of Conclusions of PRC Meeting, 25 Aug 1977, CK3100483339: all in DDRS; Vance, *Hard Choices*, 73–74 (quote).

17. Vance, *Hard Choices*, 74; CIA intelligence information cables, 14 Dec 1977, CK3100141406 and CK3100141404, DDRS.

18. Memo, Henze for Brzezinski, 21 Jan 1978, CK3100143542, DDRS.

19. *Ibid.*; CM 1796-78 for SecDef, 30 Jan 1978, folder Africa 092, 77, box 2, SecDef Files, Acc 330-80-0017.

20. Memo, Henze for Brzezinski, 12 Jan 1977 (quotes, emphasis in original), CK3100143369, DDRS. Brown reflected that neither the Siad Barre nor Mengestu regimes were that important to Moscow, and that Castro's aspirations to be a world player pushed Soviet involvement in the Horn with a corresponding U.S. reaction. The situation changed with the fall of the Shah of Iran and the need for a new access to defend the Persian Gulf. Brown's comment to author, 6 Dec 2016,

21. Garthoff, *Détente and Confrontation*, 689–690. Schraeder, *United States Foreign Policy Toward Africa*, 92, 285, cites the figures of technicians based on House of Representatives testimony.

22. Memos, Murphy for Duncan, 22 May 1978; 23 May 1978: both in folder Zaire, 1978, box 72, SecDef Files, Acc 330-80-0202, WNRC; memo, Brzezinski for Carter, 26 May 1978, CK3100072850, DDRS.

23. Memo, Brown for Carter, 30 May 1978, folder Zaire, 1978, box 72, SecDef Files, Acc 330-81-0202.

24. Memo, Smith for Brown and Duncan, 1 Jun 1978, *ibid.*; Memo for Record by Scholtes, 16 Jun 1978, folder Jun 1978, box 56, SecDef Cables, OSD/HO.

25. Memo, Murray for McGiffert, 10 Aug 1978, folder Zaire, 1978, box 72, SecDef Files, Acc 330-81-0202.

26. Memo, Turner for Carter, 2 Jun 1978, *ibid.*; *Carter Public Papers 1978*, 1:1092–1093. In his memoirs, Vance described this intelligence as “ambiguous” and “not very good.” *Hard Choices*, 90. When asked about the intelligence after the start of the second invasion, Brown concluded “that the Cubans and the Angolans were very clearly engaged in training,

and equipping and supplying logistics for the FNLC [Front for the National Liberation of the Congo] forces that invaded Zaire, not once, but twice.” Brown, interview by Ike Pappas, *Face the Nation*, CBS, 4 Jun 1978, *Brown Public Statements 1978*, 4:2143. No U.S. official accused the Cubans of taking part in the invasion.

27. Garthoff, *Détente and Confrontation*, 703–707; Jeffrey A. Lefebvre, *Arms for the Horn: U.S. Security Policy in Ethiopia and Somalia, 1953–1991* (Pittsburgh, PA: University of Pittsburgh Press, 1991), 177–178.

28. Memo, McGiffert for Brown, 26 Jan 1978 (quote), folder Africa 091 (Jan–9 Feb) 1978, box 52, SecDef Files, Acc 330-81-0202.

29. Memos, Brzezinski for Brown et al., 31 Jan 1978, w/Summary of Conclusions of SCC Meeting, 26 Jan 1978 (quote); Brown for Brzezinski 2 Feb 1978: both *ibid*.

30. Minutes of NSC Meeting, 23 Feb 1978, CK3100129506, DDRS; Brzezinski, *Power and Principle*, 182–183; Vance, *Hard Choices*, 87. The SCC meeting of 22 Feb 1978 was a dress rehearsal for the NSC meeting. See Minutes of SCC Meeting, 22 Feb 1978, CK3100111020, DDRS.

31. Memo, Brzezinski for Brown et al., 24 Feb 1978, w/attached PD 32, “Horn of Africa,” folder Africa 092 (11 Feb–Mar) 1978, box 50, SecDef Files, Acc 330-81-0202; also in DNSA, PD01522.

32. The SCC meetings of 2, 10, 16, 27 Mar; 7 Apr; 15 May 1978. The SCC meeting record for 2 March 1978 is CK31000114208, DDRS; the rest are in folders Africa 092 (11 Feb–Mar) 1978 and Africa 092 (Apr–May) 1978, box 52, SecDef Files, Acc 330-81-0202. Brzezinski admitted that he unsuccessfully used these SCC meetings to press for linkage between SALT II and other initiatives toward Moscow and Soviet-Cuban operations in Ethiopia. Brzezinski, *Power and Principle*, 182.

33. Memos, McGiffert for Brown, 15 May 1978, folder Africa 092 (Apr–May) 1978, box 52; Brzezinski for Brown and Vance, 17 May 1978, folder Somalia, 1978, box 69: both in SecDef Files, Acc 330-81-0202.

34. Memo, Brown for Carter, 11 Mar 1978, folder China (Reds) 092, 1978, box 65, *ibid*. Brzezinski recalled that “throughout the late fall of 1977 and much of 1978 I was very much alone in the U.S. government in advocating a stronger response: Vance insisted that this issue was purely a local one, while Brown was skeptical of the feasibility of any U.S. countermoves.” Brzezinski, *Power and Principle*, 179.

35. Memo, Dodson for Brown et al., 31 Jul 1978, w/attached intelligence assessment of Ethiopian-Somali Situation, 27 Jul 1978, folder Africa 092 (Jun–Sep) 1978, box 53, SecDef Files, Acc 330-81-0202.

36. Memo, Henze for Brzezinski, 28 Jan 1978, CK31000147892, DDRS; memo, Dodson for Brown et al., 4 Aug 1978, w/attached Summary of Conclusions of PRC Meeting, 31 Jul 1978, folder Somalia, 1978, box 69, SecDef Files, Acc 330-81-0202, WNRC.

37. For discussion of the framework for security in the Persian Gulf, see chapter 11.

38. Memo, Brown for Vance and Brzezinski, 10 Apr 1978, folder Africa 092 (Apr–May) 1978, box 52, SecDef Files, Acc 330-81-0202.



39. Memos, Slocombe for [name deleted], 25 Apr 1978; Slocombe for Brown, 27 Apr 1978, w/attached Memorandum of Notification, 14 Apr 1978: all in folder Intelligence: Special Activities Working Group, box 8, Brown Papers, LC; memo, Dodson for Brown et al., 20 Nov 1978, folder Africa 092 (Oct-Dec) 1978, box 52, SecDef Files, Acc 330-81-0202.

40. PRM 36, “Soviet/Cuban Presence in Africa,” 23 May 1978, folder Africa 092 (Apr-May) 1978, SecDef Files, Acc 330-81-0202; also in PD01572, DNSA.

41. Ltr, Brown to Vance, 11 May 1978, w/Brown’s comments on attached draft outline for study in response to PRM 36, 0000D001.pdf, Declassified SecDef Files.

42. Memo, Dodson for Brown et al., 29 Sep 1978, w/attached study in response to PRM 36, 18 Aug 1978, CK3100159101, DDRS. While the Soviet party leadership saw developing nations (especially strategically located Ethiopia) as potential members of their ideological and political orbit, Castro (who met both Mengistu and Siad in early 1977, when trying to mediate their Ogaden war) saw Ethiopia as a “real revolution” with land reform for peasants, conflict with the petit bourgeois and feudalists, and the beginning of a Communist Party. To Castro, external non-progressive forces operated from Somalia, the Sudan, and Eritrea to threaten the Ethiopian revolution. Castro believed Mequistu was a serious Marxist, while Siad was only a general educated under colonialism for whom socialism was “just an outer shell.” Castro quoted in Jonathan Haslam, *Russia’s Cold War: From the October Revolution to the Fall of the Wall* (New Haven: Yale University Press, 2011), 312–314.

43. Memo, Dodson for Brown et al., 29 Sep 1978, w/attached study in response to PRM 36, cited in note 42.

44. Vance, *Hard Choices*, 91–92.

45. Evening Report for Brzezinski, 16 Jan 1979, CK3100590186, DDRS; Acharya, *U.S. Military Strategy in the Gulf*, 104. Kenya received \$20 million to \$25 million in U.S. military assistance per year. Kenyans wanted more, including F-5 aircraft, armed personnel carriers, and other advanced weapons totaling up to \$230 million. A State and Defense team sent to Nairobi concluded that Kenya’s chronic balance of payments problems and the questionable ability of its armed forces to absorb such weapons and aid precluded a more ambitious program. Memo Tarnoff to Brzezinski, 27 Feb 1980, folder SCC Mtg File (14 Feb 80–19 Mar 80), box 58, Official Records of CJCS General Jones, Acc 218-92-0030, NARA II.

46. Memo, Brown for Brzezinski, 14 Aug 1979, CK3100111806, DDRS.

47. Memo, Henze for Brzezinski, 24 Aug 1979, CK3100162380, *ibid*.

48. Memo, Vance for Carter, 28 Oct 1979, folder S, 1979, box 321, SecDef Files, Acc 330-82-0205, WNRC.

49. Ltr, Brown to Vance, 8 Nov 1979, *ibid*.

50. Memo, McGiffert for Brown, 3 Nov 1979, *ibid*.

51. Memo, Henze to Brzezinski, 15 Nov 1979 (quote), CK3100504762, DDRS.

52. Memo, McGiffert for Brown, 10 Apr 1980, folder Somalia, 1980, box 17, SecDef Files, Acc 330-82-0217, WNRC; Department of State, Bureau of Intelligence and Research report, 17 Mar 1980, CK31000669865, DDRS.

53. Comment by Brown on McGiffert memo, 10 Apr 1980, cited in note 53; memo, Brzezinski for Brown and Vance, 16 Apr 1980, folder Somalia, 1980, box 17, SecDef Files, Acc 330-82-0217.

54. Memo, Henze for Brzezinski, CK3100151737, DDRS.

55. Memo, McGiffert for Brown, 7 Jun 1980 (quote), w/Brown's comments (quote), folder Somalia, 1980, box 17, SecDef Files, Acc 330-82-0217.

56. Memo, Komer for Brown and Claytor, 9 Jun 1980 (quote), folder Somalia, 1980, box 17, SecDef Files, Acc 330-82-0217.

57. Memcon, Carter, Vance, Brown et al., 18 Jun 1980 (quotes), CK3100148696, DDRS.

58. Ibid (quote); briefing paper w/Brown's comments (quote), [12 Jul 1980], folder Eyes Only, Jul-Dec 1980, Brown Papers, LC. Komer was the exception.

59. Memos, Henze for Brzezinski, 23 Jul 1980, CK3100517169; 25 Jul 1980, CK31000487167: both in DDRS.

60. Memo, Henze for Funk, 15 Aug 1980 (quote), CK3100481767, DDRS.

61. Garthoff, *Détente and Confrontation*, 732.

62. PRM 4, "South Africa and Rhodesia Negotiations," 21 Jan 1977, PRO01407, DNSA.

63. Summary of Conclusions and Minutes of SCC [sic. PRC] Meeting, 8 Feb 1977, CK3100062420; memo, Brzezinski for Vance and Brown, 9 Feb 1977, w/Carter's comments, CK3100062443: both in DDRS.

64. The NSC minutes cited in note 65 quote Secretary Harold Brown as speaking at the meeting. He did not attend. The views ascribed to Secretary Brown are those of CJCS General Brown. Memo, Brzezinski for Vance and Brown, 9 Feb 1977, cited in note 65.

65. Both Brown and Duncan attended the meeting; neither said anything. Summary of Conclusions of NSC Meeting, 3 Mar 1977, CK31000061998; Minutes of NSC Meeting, 3 Mar 1977, CK3100062002: both in DDRS.

66. PD 6, "Southern Africa," Mar 1977, PRO01345, DNSA; memo, Brzezinski for Carter, 1 Apr 1977, CK3100062446, DDRS.

67. Memo, Brzezinski for Vance and Brown, 7 Sep 1977, folder South Africa 092 (Jul-Dec) 1977, box 79, SecDef Files, Acc 30-80-0017. The USAF recommended as an alternative using two specially instrumented aircraft to monitor the flight in early November. Ltr, Reed to Churchill, 30 Sep 1977, folder South Africa, 1977, *ibid*. That request was denied by NSC on the grounds that any support for the monitoring "must be entirely disconnected from South Africa." Memo, Brzezinski for Vance and Brown, 4 Nov 1977, folder South Africa 092 (Jul-Dec) 1977, box 79, SecDef Files, Acc 330-80-0017.

68. Summary of Conclusions of PRC Meeting, 22 Jul 1977, folder South Africa 092 (Jul-Dec) 1977, box 79, SecDef Files, Acc 330-80-0017; Summary of Conclusions of PRC Meeting, 20 Sep 1977, CK3100147901, DDRS; memo, Brzezinski for Vance, Brown et al., 25 Oct 1977, folder South Africa 092 (Jul-Dec), box 79, SecDef Files, Acc 330-80-0017. The U.S. defense attaché's office in Pretoria included an attaché from each service, two assistant attachés, seven enlisted men, and three local employees. As for the arms embargo on South Africa, the Nixon-Ford administrations had relaxed restraints on "gray area sales" and sales

on nonlethal dual-use items (such as executive aircraft or computers). Memo, Dodson for Mondale, Vance, Brown et al., 19 Jul 1977, CK3100062014, DDRS.

69. Memo, Brzezinski for Vance, Brown, and Turner, 24 Oct 1977, folder South Africa 350.09, 1977, box 4, SecDef Files, Acc 330-80-0016, WNRC; DoD Talking Paper for PRC Meeting, 22 Jul 1977, folder South Africa 092, 1977, *ibid*.

70. Memo, Duncan for Service Secretaries et al., 18 Mar 1978, folder South Africa, 1978, box 68, SecDef Files, Acc 330-81-0202.

71. Interagency Intelligence Assessment, “South Africa: Policy Considerations Regarding a Nuclear Test,” 18 Aug 1977 (quote), CK3100697804, DDRS.

72. Memos, Dodson for Mondale, Vance, Brown et al., 24 Aug 1977, w/attached Discussion Paper on South African Nuclear Issue; Dodson for Brown, Turner, and Schlesinger, 15 Sep 1977: both in folder South Africa, 1977, box 79, SecDef Files, Acc 330-80-0017

73. Memo, Dodson for Vance, Brown et al., 22 Oct 1979, folder South Africa, 1979, box 21, SecDef Files, Acc 330-82-0205. Seymour Hersh, *The Samson Operation: Israel’s Nuclear Arsenal and American Foreign Policy* (New York: Random House, 1991), 271–283, claims that Israel and South Africa conducted the test with an Israeli nuclear artillery shell, and that it was the third of three (the first two had gone undetected because of atmospheric conditions), and the Carter administration ultimately decided to cover up the incident. While not ruling out Israeli–South African collaboration thesis, Anna-Mart Van Wyk, a historian of South Africa’s nuclear policy, maintains the incident “remains a mystery to this day.” Anna-Mart Van Wyk, “South Africa’s Nuclear Programme and the Cold War,” *History Compass* 8, no. 7 (Jul 2010), <<http://online.library.wiley.com/doi/10.1111/j.1478-0542.2010.00699.x/full>>, accessed 15 Sep 2011.

74. Summary of Conclusions of PRC Meeting, 24 Oct 1977 (quote), CK3100062459; memo, Dodson for Tarnoff, 28 Oct 1977, CK3100062059: both in DDRS. Brown now thinks the flash was a meteorite. Brown’s comment to author, 6 Dec 2016.

75. Van Wyk, “South Africa’s Nuclear Programme and the Cold War,” cited in note 75.

76. Memo, Brown for Carter, 7 Oct 1978, folder Africa 092, 1978, box 81, SecDef Files, Acc 330-81-0202. For a CIA assessment of the solid white minority support for Ian Smith, see National Intelligence Assessment Center memo, 31 Jan 1979, CK3100639508, DDRS.

77. Ltr, Duncan to Newson, 20 Feb 1979, folder Rhodesia, 1979, box 21, SecDef Files, Acc 330-82-0205.

78. Ltr, Newson to Duncan, 19 Mar 1979, *ibid*.

79. For the Carter administration and Zimbabwe, see DeRoche, *Black, White and Chrome*, 243–310; for Namibia, see Ronald Dreyer, *Namibia and Southern Africa: Regional Dynamics of Decolonization, 1945–90* (London: Kegan Paul International, 1994), 116–119; Sabina Ann Fischer, *Namibia Becomes Independent: The U.S. Contribution to Regional Peace* (Zurich: Forschungsstelle für Sicherheitspolitik und Konfliktanalyse, 1992), 24–41. For U.S. public statements on Namibia, see Department of State, *American Foreign Policy: Basic Documents*, 1161–1233.

80. For surveys of Morocco, see Susan Gilson Miller, *A History of Modern Morocco* (Cambridge: Cambridge University Press, 2013); and C. R. Pennell, *Morocco Since 1830: A History* (New York: New York University Press, 2001).

81. Memo, Quandt for Brzezinski, 15 Sep 1977, CK3100113721, DDRS; Garthoff, *Détente and Confrontation*, 735–736; John Damis, *Conflict in Northwest Africa: The Western Sahara Dispute* (Stanford, CA; Hoover Institution Press, 1983), 119–120.

82. PRM 34, “North Africa,” 14 Apr 1977, PD01569, DNSA; memos, Dodson for Mondale, Vance, and Brown et al., 18 May 1978, w/attached response to PRM 34, folder Africa 092 (Apr–May) 1978; McGiffert for Brown, 6 Jun 1978, folder Africa 092 (Jun–Sep) 1978: both in box 52, SecDef Files, Acc 330-81-0202.

83. Memos, McGiffert for Brown, 18 May 1978, w/Brown’s comments; Dodson for Mondale, Vance, and Brown et al., 18 May 1978, cited in note 84; Brzezinski for Vance, Brown et al., 24 Jun 1978: all in folder Africa 092 (Apr–May) 1978, box 52, SecDef Files, Acc 330-81-0202.

84. Memo, Brzezinski for Vance, Brown et al., 24 Jun 1978, cited in note 83; memo, Vance for Carter, 30 Jan 1980, CK31000498559, DDRS.

85. Memo, Dodson for Vance, Brown et al., 30 Mar 1979, folder Morocco, 1979, box 16, SecDef Files, Acc 330-82-0205.

86. Memo, Brzezinski for Brown and Vance, 7 Aug 1979, *ibid*.

87. Memos, Claytor for Brzezinski, 17 Oct 1979; Minutes of PRC Meeting on North Africa, 16 Oct 1979 (quote); Brzezinski for Vance, Brown, and Seignious, 19 Oct 1979: all *ibid*.

88. Memos, Rentschler for Brzezinski, 16 Dec 1980; Kimmit and Rentschler for Brzezinski, 6 Jan 1981: both in folder Mtgs MBB, 10/80–1/81, box 34, Subject File, Brzezinski Donated Material, Carter Library; memo, Marbod for McGiffert, 24 Dec 1980, CK3100145715, DDRS.

## 17. The All-Volunteer Force and the Legacy of Vietnam

1. For documentation on the draft and Selective Service reform, see *FRUS 1969–1976*, vol. 34, *National Security Policy, 1969–1972*, ed. M. Todd Bennett (Washington, DC: GPO, 2011), 218–221 (docs 53, 54), 469–474 (doc. 131), 479–497 (docs 133, 134, 135), 501–507 (docs 138, 139), 629–640 (doc 161). See also Hunt, *Melvin Laird and the Foundation of the Post-Vietnam Military*, 363–393; Bernard Rostker, *I Want You! The Evolution of the All-Volunteer Force* (Santa Monica, CA: RAND Corporation, 2006), 265–303.

2. The Army suffered the most from the late Vietnam War breakdown, but the Navy was not immune. Critics dubbed it a floating race riot. Some of the most publicized racial incidents in the Navy in the early 1970s took place aboard aircraft carriers *Kitty Hawk* in October 1972 and *Constellation* in November 1970 and fleet oiler *Hassayampa* in October 1970; at Naval Training Center, Great Lakes, in July 1970; Naval Air Station Keflavik, Iceland, in October 1970; and Naval Air Station Midway in November 1972. Memo, Woolsey for Duncan, 21 Jun 1979, folder 340, 1979, box 39, SecDef Files, Acc 330-82-0204, WNRC.

3. Beth Bailey, *America's Army: Making the All-Volunteer Force* (Cambridge, MA: Belknap Press, 2009), 1–23.

4. The term “hollow army” (later called “hollow force”) is a direct quote from Meyer’s testimony before the HCAS’s Investigations Subcommittee on 29 May 1980. While qualified and relating to only U.S. based forces, in a presidential election year, it achieved great notoriety. It has remained a convenient metaphor for those who oppose defense cuts and was revived during the presidency of William J. Clinton. Frank L. Jones, “A Hollow Army” Reappraised: President Carter, Defense Budgets, and the Politics of Military Readiness,” *The Letort Papers* (Carlisle, PA: U.S. Army War College, 2012), 1–65, 7 (quote). Three months after his testimony, Meyer announced plans to transfer 6,900 sergeants from Europe and Korea (both were over 100 percent of authorized strength) to the continental United States, as well as other morale-boosting measures for the Army. Richard Halloran, “Army to Shift troops to Bolster Readiness for Combat,” *New York Times*, 16 Sep 1980, 1,

5. Baily, *America's Army*, 172–197.

6. The most exhaustive bureaucratic and legislative history of the AVF is Rostker, *I Want You!* An excellent shorter account stressing the social changes that molded the AVF is Bailey, *America's Army*, cited in note 1.

7. Ltr, White to Sullivan, 14 Mar 1977, w/attached “Major Manpower Issues,” 14 Mar 1977, folder 320.2 (Jan-Jul) 1977, box 33, SecDef Files, Acc 330-80-0017, WNRC.

8. Ibid.

9. Ibid., w/Brown’s comments.

10. Memo, White for Brown, 10 Jun 1977, folder 320.2 (Jun-Dec) 1977, ibid.

11. John White, “The All-Volunteer Force Reassessed,” *Commanders Digest* 20, no. 15 (1 Sep 1977): 3–11.

12. Mark K. Arnold, “The Draft Revisited: Volunteer Army Is Under Attack,” *National Observer*, 5 Feb 1977, 2; George Will, “Profile of an Army,” *Washington Post*, 30 Jan 1977, C7.

13. Martin Hoffman and Sam Nunn, “Is the All-Volunteer Military a Success?” *Baltimore Sun*, 12 Mar 1977, 14.

14. Rostker, *I Want You!* 370–371.

15. Aspin quoted by Warren Rogers, “The All-Volunteer Army’s Bleak Future,” *Washington Post*, 6 Aug 1977, D12.

16. Memo, McIntyre for Carter, 13 Apr 1978, folder ND 19, 1/20/77–12/31/77, box ND-53, Subject Files, WHCF: Executive, Carter Library.

17. MRA&L, “America’s Volunteers: A Report of the All-Volunteer Armed Forces,” 31 Dec 1978, 186 (quote), folder 340, 1979, box 39, SecDef Files, Acc 330-82-0204. Also available at <[www.dtic.mil/cgi-bin/GetTRDDoc/ADA101903](http://www.dtic.mil/cgi-bin/GetTRDDoc/ADA101903)>, accessed 19 Mar 2012; Rostker, *I Want You!* 385.

18. Memo, Pirie for Brown, 7 Feb 1979, folder 340, 1979, box 39, SecDef Files, Acc 330-82-0204.

19. Memo, Brown for Carter, 29 Dec 1979, folder ND 7, 1/1/80–1/20/80, box ND-8, Subject File, WHCF: Executive, Carter Library; memo, Pirie for Brown, 29 Dec 1979, indicating that Pirie had drafted it, folder 340, 1979, box 39, SecDef Files, Acc 330-82-0204.

20. Memo, White for Welch, 4 Jan 1980, folder ND 7, 1/1/80–1/20/80, box ND-8, Subject File, WHCF: Executive, Carter Library.

21. Memo, Carter for Brown, 29 Feb 1979, *ibid.* Brzezinski and domestic adviser Stuart Eizenstat supported Brown's campaign to "enhance both the real and perceived value of a military career." Memo, Simons and Eizenstat for Carter, 23 Feb 1980, *ibid.* The Carter memo, which Brown held closely, was leaked to the *Armed Forces Journal*, presumably in the hope it would play well with the troops. It produced the opposite effect, however, as most service members considered it a slur on their patriotism. Brown's comment to author, 6 Dec 2016.

22. Memo, Brown for Carter, 22 Feb 1980, 000B45C.pdf, CD-1, Declassified SecDef Files, WNRC,

23. *Ibid.* (quote); AP, "Recruiting Ousters by Army Total 427," *New York Times*, 20 Nov 1979, 18; "Recruiting Scandals: Symptom of Trouble for Volunteer Forces," *U.S. News & World Report*, 16 Oct 1979, 41–42.

24. Rostker, *I Want You!* 392–400; Bailey, *America's Army*, 123–126.

25. Memo, Brown for Carter, 21 Mar 1980, folder DoD, 3–4/80, box 6, Agency File, Brzezinski Material, National Security Affairs, Carter Library.

26. Memo, Brown for Carter, 13 Jun 1980, folder DoD 5–7/80, box 7, Agency File, Brzezinski Material, National Security Affairs, Carter Library. The unemployment figures are from the Bureau of Labor Statistics, <<http://data.bls.gov/pdq/SurveyOutputServlet>>, accessed 7 Jun 2012.

27. For glowing accounts of Thurman's success, see Rostker, *I Want You!* 386–392, 389 (quotes), and Bailey, *America's Army*, 175–194.

28. Memo, Brown for Carter, 15 Aug 1980, folder DoD 8–9/80, box 7, Agency File, Brzezinski Material, National Security Affairs, Carter Library.

29. Bettie J. Morden, *The Women's Army Corp, 1945–1978* (Washington, DC: U.S. Army Center of Military History, 1990), provides a definitive official account of women in the WAC. Bailey, *America's Army*, 136–139. A comprehensive analysis is Maj. Gen. Jeanne Holm, USAF (Ret.), *Women in the Military: An Unfinished Revolution*, rev. ed. (Novato, CA: Presidio Press, 1993).

30. Before 1967 only 2 percent of the military could be women, no woman could attain a permanent rank beyond lieutenant colonel, women could not command men, and married women or women with children under 18 could not enlist. In 1967 Congress passed a law removing the 2 percent ceiling and the limit on rank, in good part because of DACOWITS lobbying. Bailey, *America's Army*, 140–141.

31. Tab A to memo, White for Brown, 8 Jun 1977, w/Brown's comment, folder 320.2 (Jun-Dec) 1979, box 33, SecDef Files, Acc 330-80-0017; Holm, *Women in the Military*, 252–254. The Hunter study presented some eye-popping statistics: the Army spent \$3,700

to recruit a highly qualified man versus \$150 for a comparable woman. Even in the Air Force, the best recruiter of high-quality talent, the differential was \$870 to \$150. Potential savings could amount to \$1 billion annually by 1982, according to Hunter.

32. Morden, *The Women's Army Corps*, 377.

33. Carter, *White House Diary*, 253–254.

34. Memo, Pirie for Hanson, 29 Nov 1977, w/attached paper, “U.S. Air Force,” w/Carter’s comments, folder 320.2 Alpha, 1977, box 33, SecDef Files, Acc 330-80-0017.

35. Memo, Brzezinski for Carter, 2 Dec 1977, w/attached memo, Brown for Carter, 1 Dec 1977, folder ND 8, 1/20/77–1/20/81, box ND-29, Subject File, WHCF: Executive, Carter Library. The other glaring shortage was in Navy engineering, not a field to which women gravitated.

36. Morden, *Women's Army Corps*, 381–382.

37. Response by Brown at a News conference, 10 Mar 1979, *Brown Public Statements 1978*, 4:1554–1555; Holm, *Women in the Military*, 274.

38. DoD News Release No. 473-77, 12 Oct 1977, folder Women 1977–1978, box 1108, Subject Files, OSD/HO; AP, “Women Join Air Force Missile Crews,” *Washington Star*, 13 Aug 1978, 3.

39. DoD News Release No. 577-78, 24 Oct 1978; SECNAV Instruction 13000.12, 18 Apr 1978: both in folder Women 1977–1978, box 1108, Subject Files, OSD/HO; Timothy Robinson, “Barring Women From Navy Ships Is Struck Down,” *Washington Post*, 28 Jul 1978, 1; “Women May Yet Save the Army,” *Time*, 30 Oct 1978, 38; Holm, *Women in the Military*, 317–324.

40. Memo, Eisenstat for Pirie, 5 Mar 1980, folder FG 13, 1/1/8–1/31/80, box FG-107, Subject File, WHCF: Executive, Carter Library.

41. The figures were 229 graduates from West Point, 55 from Annapolis, and 97 from Colorado Springs. Mary Ann Giordano, “Army Braces for Women Officers,” *New York News*, 27 May 1980, 7; Chip Brown, “Women Midshipmen Begin New Era,” *Washington Post*, 29 May 1980, 28; “First Women at U.S. Air Force Academy, updated 31 May 2007, <[www.af.mil/news/story.asp?storyID=123055380](http://www.af.mil/news/story.asp?storyID=123055380)>, accessed 5 Jun 2012.

42. Bailey, *America's Army*, 165–171.

43. Henry Mitchell, “Any Day,” *Washington Post*, 3 Aug 1979, D1; Trask and Goldberg, *DoD 1947–1997*, 65.

44. Bailey, *America's Army*, 118–119.

45. The figures for high school graduation rates are taken from Charles C. Moskos, “Race in the United States Military: Symposium,” *Armed Forces and Society* (Summer 1980): 592.

46. According to Army statistics, 1,400 high school dropouts yielded 940 soldiers by the end of the first six months; 1,000 high school graduates produced the same number. Bailey, *America's Army*. 119.

47. That was certainly the conclusion of longtime defense reporter George Wilson, “Blacks in Army: Staying and Advancing,” *Washington Post*, 10 Jul 1978, 1.

48. AP, “Navy Anti Bias Efforts Get Push after Bakke,” *Baltimore Sun*, 9 Jul 1978, 3.

49. DoD News Release No. 433-78, 18 Aug 1978, folder African Americans, box 1108, Subject Files, OSD/HO.

50. Bernard Weinraub, “A.C.L.U. Says Navy Rejects Blacks Who Are Qualified for Recruitment,” *New York Times*, 15 Jun 1979, 12; UPI, “Shipboard Racial Fights Spark Navy Klan Probe,” *Washington Post*, 22 Jul 1979, B3; AP, “Pentagon Official Report ‘a New Racism’ in Military,” *New York Times*, 24 Jul 1979, 10; AP, “Navy Acts to Eliminate Racist Groups on Ships,” 29 Aug 1979, *Philadelphia Inquirer*, C3; George Wilson, “Navy Moves to Improve Minorities Lot,” *Washington Post*, 30 Aug 1979, 7.

51. Brown with Winslow, *Star Spangled Security*, 211; memo, DepSecDef to Service Secretaries and CJCS, 16 Jan 1981, folder 010 OSD, 8 Jan 1981–22 Jan 1981, box 5, Official Records of CJCS General Jones, Acc 218-92-0030, NARA II. The only concession in the directive was that that homosexuality alone did not require a dishonorable discharge. When separated from the service for their sexuality, homosexuals who did not engage in other dischargeable actions (such as violence) could receive honorable discharges. Bernard Rostker et al., *Sexual Orientation and U.S. Military Personnel Policy: Options and Assessment* (Santa Monica, CA: RAND Corporation, 1993), 7–8.

52. Roskter, *I Want You!* 418–423.

53. *Ibid.*, 424. The figures for the size of the Selective Service are from “Presidential Recommendations for Selective Service Reform,” A Report to Congress Prepared Pursuant to P.L. 96-107, 11 Feb 1980, folder ND 19, 2/1/80–2/10/81, box ND-54, Subject File, WHCF: Executive, Carter Library.

54. George Wilson, “Brown Suggests Registering Women for Draft,” *Washington Post*, 30 Jan 1979, 1.

55. Memo, Brown for Carter, 19 Jan 1979 (quotes), 0000B415.pdf, CD-1, Declassified SecDef Files; Carter, *White House Diary*, 326 (quote).

56. Memo, Pirie for Brown, 19 Jan 1979, folder 327, 1979, box 36, SecDef Files, Acc 330-82-0204.

57. Memo, Pirie for Brown, 27 Mar 1979, w/Brown’s comments, *ibid.*

58. Memo, McIntyre for Blumenthal, Brown et al., 15 Oct 1979, folder ND 19, 1/20/77–12/31/79, box ND-54, Subject File, WHCF: Executive, Carter Library; Rostker, *I Want You!* 428.

59. PRM 47, “President’s Plan for Selective Service System Reform,” 12 Oct 1979, folder 327, 1979, box 36, SecDef Files, Acc 330-82-0204.

60. Rostker, *I Want You!* 435–436. White at OMB, Eisenstat at the White House, and Pirie at DoD opposed draft registration. Pirie told Brown it was a “crummy idea,” but the secretary ordered Pirie to write the paragraph for the president’s speech announcing the decision. Quoted in *ibid.*, 346.

61. *Carter Public Papers 1980–1981*, 1:198; Special to NYT, “Defense Secretary Backs Registration for Women,” 29 Jan 1979, *New York Times*, 6.

62. “Presidential Recommendations for Selective Service Reform,” cited in note 53.



63. “Selective Service Revitalization,” Background Report by Office of Media Liaison, The White House Press Office, 7 Feb 1980, folder ND 19, 1/20/77–/20/81, box ND-53, Subject File, WHCF: Executive, Carter Library.

64. Brown quote in interview with *US News & World Report*, 11 Feb 1980.

65. It was not even new money, just a case of transferring funds from the Air Force to the Selective Service System. Rostker, *I Want You!* 439–441; *CQ Almanac 1980*, 36:39.

66. Memo, Wellford for White and McIntyre, 2 Jun 1980, folder ND 19, 1/20/77–1/20/81, box ND-53, Subject File, WHCF: Executive, Carter Library.

67. *CQ Almanac 1980*, 36:39, 46.

68. *Ibid.*, 45; Rostkor, *I Want You!* 444–447.

69. Such “double dipping,” as it was called, concerned Carter. Retired regular military officers employed as civil servants by the federal government could receive the first \$4,000 of their pension plus one-half of the remainder of their retirement pay in addition to their civilian salaries. Noncommissioned officer and lower ranks received salaries and full retirement pay. OMB estimated there were 5,000 former officers and 141,000 retired military personnel in federal civilian service. Memo, Eizenstat and Johnston for Carter, 3 Aug 1977, folder ND 7-5, 1/20/77–12/31/78, box ND-15, Subject File, WHCF: Executive, Carter Library.

70. Charles A. Henning, “Military Retirement Reform,” 17 Nov 2011, Congressional Research Service Report for Congress, 1; Rex Hudson, “A Summary of Major Military Retirement Proposals, 1976–2006,” November 2007, Report by the Federal Research Division, LC, 22–24.

71. Memo, McIntyre for Carter, 15 Nov 1978, folder ND 7-5, 1/20/77–12/31/78, box ND-15, Subject File, WHCF: Executive, Carter Library.

72. DoD News Release No. 357-79, 19 Jul 1979, *Brown Public Statements 1979*, 6:2215–2217. For more details on the proposals, see information paper “Military Compensation Reform Proposals,” Jul 1978; and Pirie news conference, 19 Jul 1979: both in folder Military Retirement System, 1978–1980, box 1105, Subject Files, OSD/HO. The plan was unveiled in the official Pentagon magazine, “DoD’s New Proposed Military Retirement Plan,” *Command Policy* 2, no. 7 (Jul 1979): 3–12. Brown recalled that he almost obtained JCS approval for the reform, but CNO Admiral Hayward balked and the plan failed. Brown’s comment to author, 6 Dec 2016.

73. Henning, “Military Retirement Reform,” cited in note 70.

74. Memo, Brown for Carter, 6 Jul 1979, 0000B41E.pdf, CD-1, Declassified SecDef Files.

75. *Ibid.*

76. Pirie and Brown as quoted in Rostker, *I Want You!* 401–402; memo, Pirie for Brown, 19 Oct 1979, folder 110.01, 1979, box 1, SecDef Files, Acc 330-82-0271, WNRC.

77. JCSM 369-79 for SecDef, 5 Nov 1979 (quote), folder 110.01, 1979, *ibid.*; David R. Griffiths, “Retention of Highly Trained Poses Serious Problem,” *Aviation Week & Space Technology* 5 (Nov 1979): 42–44.

78. Kenneth H. Bacon. “A Shortage of Skills Is Hurting the Armed Forces As Higher Civilian Pay Lures Away Personnel,” *Wall Street Journal*, 25 Mar 1980, 48; “Who’ll Fight For America?” *Time*, 9 Jun 1980, 24; Norman Kempster and Robert C. Toth, “Lure of Civilian Pay Puts Heavy Drain on Military,” *Los Angeles Times*, 8 Sep 1980, 1; and Nina Bondarook, “Low Military Pay Cited as Morale Problem,” *Colorado Springs Gazette-Telegraph*, 24 Nov 1980, B1, are representative accounts of the problems. Melvin Laird, “It’s Time for a Big Pay Raise . . .,” *Washington Post*, 10 Mar 1980, A27.

79. *CQ Almanac 1980*, 36:72.

80. Congressional Budget Office as quoted in Rostker, *I Want You!* 405; McIntyre as quoted, *ibid.*, 406.

81. Ltr, Carter to Brown, 23 May 1980, folder Brown, Harold, box 1, Name File, WHCF: Executive, Carter Library.

82. *Carter Public Papers 1980–1981*, 1:971–972; Rostker, *I Want You!* 406.

83. *CQ Almanac 1980*, 36:72, 64.

84. Presidential Proclamation 4483, 21 Jan 1977, *Carter Public Papers 1977*, 1:5.

85. Helen Dewar, “Legionnaires Boo Carter’s Plan to Pardon Draft Evaders,” *Washington Post*, 15 Aug 1976, A1, A4.

86. *Ford Public Papers 1974*, 1:136–140; Douglas Kneeland, “Dole Attacks Carter on Pardon for Draft Evaders,” *New York Times*, 26 Aug 1976, 22; Tip Marlow of the Veterans of Foreign Wars and Louise Ranson, affiliate director of Americans for Amnesty, interview by Robert McNeil, *McNeil/Lehrer Report*, Online News Hour Special Report, 21 Jan 1977, <[www.pbs.org/newshour/bb/asia/vietnam/vietnam\\_1-21-77.html](http://www.pbs.org/newshour/bb/asia/vietnam/vietnam_1-21-77.html)>, accessed 19 Jun 2012; Jeff Sallot, “Deserters Call Carter Plan Too Little, Too Late and a Sham,” *Washington Post*, 1 Feb 1977, A18.

87. Ltr, Brown to Carter, 8 Jan 1977 (quotes), w/attached ltr, Bundy to Brown, 27 Dec 1976, w/Brown’s comment, folder Handwriting File, 1/21/77, box 4, Office of the Staff Secretary, Carter Library.

88. Charles Mohr, “Carter Aides to Plan Study on Deserters,” *New York Times*, 28 Jan 1977, 11.

89. JCSM 53-1977 for SecDef, 4 Mar 1977, folder 020 DoD, May-Sep 1977, box 5, SecDef Files, Acc 330-80-0017.

90. Brown’s comments, *ibid.*

91. DoD News Release No. 127-77, 28 Mar 1977, *Brown Public Statements 1977*, 4:1543–1545.

92. AP, “Upgrading of Over 432,000 Discharges Authorized by Defense Secretary Brown,” *Los Angeles Times*, 28 Mar 1977, A1; Special to NYT, “Carter Authorizes Pentagon to Review 432,000 Discharges,” *New York Times*, 29 Mar 1977, 1, 4; Charles Mohr “Most Deserters Will Be Eligible for Upgrading,” *New York Times*, 2 Apr 1977, 1, 12.

93. AP, “Pentagon Ends Drive on Discharge Review,” *New York Times*, 5 Oct 1977, 10.

94. *Ibid.*; Charles Babcock, “Carter Signs Curb on Upgraded Vets Benefit Eligibility,” *Washington Post*, 9 Oct 1977, 1, A12.

95. Nancy Steadman versus G. V. Montgomery, “How Carter’s Amnesty Program Looks Now: It Stopped Too Short. It Went Too Far,” *Christian Science Monitor*, 16 May 1979, 22.

96. Vernon E. Davis, *The Long Road Home: U.S. Prisoner of War Policy and Planning in Southeast Asia* (Washington, DC: OSD Historical Office, 2000), 406–429, 545. As Davis makes clear, figures on MIAs were ambiguous and never precise.

97. Memo, Vance for Carter, 14 Feb 1977, w/attached memo, Brzezinski for Carter, 17 Feb 1977, folder MIA, 1–2/77, box 44, Subject File, Brzezinski Material, National Security Affairs, Carter Library.

98. Memo, Shields for Brown, 10 May 1977, w/attached memo, Slocombe for Brown, 12 May 1977, folder Viet 764 (Jan-May) 1977, box 883, SecDef Files, Acc 330-80-0017.

99. Memo, Vance for Carter, n.d. [29 Nov 77?], folder Vietnam, 1977, *ibid.*

100. Memo, Kelln for Oksenburg, 23 Nov 1979, folder MIA, 4/77–9/80, box 44, Subject File, Brzezinski Material, National Security Affairs, Carter Library; memo, Armacost for Brown, 20 Dec 1979, folder Viet, 1979, box 26, SecDef Files, Acc 330-82-0205, WNRC.

101. Note, Carter to Brown, 29 Apr 1977, folder Viet 704 (Jan-May) 1977, box 83, SecDef Files, Acc 330-80-0017.

102. Memo, Brown for Carter, 26 May 1977, w/attached memo, Brzezinski for Carter, 15 Jun 1977, folder MIA, 4/77–9/80, box 44, Subject File, Brzezinski Material, National Security Affairs, Carter Library.

103. Memo for record by Slocombe, 10 Jun 1977, folder Viet 704 (Jun) 1977, box 83, SecDef Files, Acc 330-80-0017.

104. Memo, Brzezinski for Carter, n.d., w/attached memo, Brown for Carter, 26 May 1977, folder ND 7-1, 1/20/77–1/20/81, box ND-14, Subject File, WHCF: Executive; memo, Brzezinski for Brown, 16 Jun 1977, folder MIA, 4/77–9/80, box 44, Subject File, Brzezinski Material, National Security Affairs: both in Carter Library.

105. Memo, Brzezinski for Carter, 22 Jul 1977, folder MIA 4/77–9/80, box 44, Subject File, Brzezinski Material, National Security Affairs, Carter Library.

106. DoD News Release No. 380, 77, 16 Aug 1977, folder VN-POWs & MIAs, 1977, box 376, Subject Files, OSD/HO.

107. Memo, Juengling for Matheny, 26 Oct 1977, w/attached paper for Vice President Mondale, “POW/MIA Issue,” folder Viet 704 (Jun-) 1977, box 83, SecDef Files, Acc 330-80-0017.

108. Memo, Brown for Carter, 14 Mar 1980, folder DoD, 3–4/80, box 6, Agency File, Brzezinski Material, National Security Affairs, Carter Library.

109. The idea of men still held prisoner in Southeast Asia lived on in the popular imagination in the 1980s, fired up by Hollywood rescue movie sagas, those raising money for private rescue operations, or researchers promising to find evidence of MIAs. Congress also continued to keep the issue alive with hearings and reports. Progress really began after Vietnam and the United States established relations in 1992, when both countries cooperated in good faith in the effort. The United States committed hundreds of millions

of dollars to on-site searches in Vietnam and Laos and on extensive forensic tests on the remains uncovered there, at least representing a partial debt to those families of service members who never returned.

110. Report of the Defense Review Committee for the Code of Conduct, Historical Summary and Background, n.d. [Dec 1976], folder 250 (23–30 Jul) 1977, box 29, SecDef Files, Acc 330-80-0017; “The U.S. Fighting Man’s Code,” Nov 1955: both *ibid*.

111. The definitive account is Stuart I. Rochester and Frederick Kiley, *Honor Bound: The History of American Prisoners of War in Southeast Asia, 1961–1973* (Washington, DC: OSD Historical Office, 1998).

112. Memos, Lipshutz for Carter, 31 Oct 1977 (quote, emphasis in original); Duncan for Carter, 25 Jul 1977 (quote): both in folder ND 7-2, 1/20/77–1/20/81, box ND-15, Subject File, WHCF: Executive, Carter Library.

113. Memo, Ahearne for Rumsfeld, 17 Dec 1976, folder 250 (Jan–Mar) 1977, box 30, SecDef Files, Acc 330-80-0017. According to reports of testimony before the committee, the Army and Marines interpreted the code of conduct literally, the Navy less so, and the Air Force encouraged fabrications and stratagems against interrogators. Ted Gup, “Revision of Code for POWs Is Proposed,” *Washington Post*, 17 Jul 1977, 1.

114. Memo, Duncan for Carter, 25 Jul 1977, cited in note 112; Executive Orders 12017 and 12018: both in 3 Nov 1977, *Carter Public Papers 1977*, 2:1958–1969.

115. *Carter Public Papers 1980–1982*, 2:1268–1271. The Vietnam Veterans Memorial, The Wall-USA, <<http://thewall-usa.com/information.asp>>, accessed 2 Jul 2012. The memorial was not without controversy, with some insisting that an American flag and a sculpture of the *Three Soldiers* be added, which was subsequently done. In 1993 the Vietnam Women’s Memorial was erected near the Wall memorial.

## 18. Making the Case: Defense Budgets for Fiscal Years 1981 and 1982

1. The Carter “horse’s ass” quote is cited in Stevenson, *SECDEF*, 127, and is originally from Stuart Eisenstat’s diary at the Carter Library in Atlanta. NSC 68 reevaluated the military balance, Soviet intentions, and national security strategy in light of the shocks of 1949 (the “loss” of China and the detonation of a Soviet atomic bomb). NSC 68 is generally credited with providing the justification for large increases in the Defense budget and institutionalizing Cold War competition with the Soviet Union. The Korean War accelerated the requirements of NSC 68 and globalized the Cold War. For DoD and NSC 68, see Rearden, *Formative Years 1947–1950*, 521–536.

2. Many critics of Carter have focused on his personal flaws and foreign policy failures, completely overlooking his defense policy. Included in this group are Gaddis Smith, *Morality, Reason, and Power: American Diplomacy in the Carter Years* (New York: Hill and Wang, 1986), 241–247; and Richard Thornton, *The Carter Years: Toward a New Global Order* (New York: Paragon House, 1991), 539–543, who characterizes Carter’s efforts to curb inflation while increasing military expenditures as a “defense budget shell game.” Glad, *Outsider in the White House*, 236, acknowledges Carter’s late-term concern about the Soviet threat

but sees it as an accommodation with the hawks in the foreign policy community. David Skidmore, *Reversing Course: Carter's Foreign Policy, Domestic Politics, and the Failure of Reform* (Nashville: Vanderbilt University Press, 1996), 101–103, makes the case that Carter's change of heart was politically motivated to win reelection. Caldwell, *Dynamics of Politics and Arms Control*, 114–115, 196–197, suggests that Carter's conversion to a stronger defense, especially acceptance of the MX, was the price for ratification of the SALT II Treaty. Conservative critics Colin S. Gray and Jeffrey G. Barlow, "Inexcusable Restraint: The Decline of American Military Power in the 1970s," *International Security* 10, no. 2 (Autumn 1985): 27–67, fault Carter for never realizing the need for more defense, although much of their evidence came from public statements and testimony by Brown calling for more defense spending. They portray Brown as a feeble voice crying in the wilderness. Auten, *Carter's Conversion*, 257–258, argues that Carter's transformation in 1979 was a conscious course correction, stressing his modernization of the strategic force structure (especially the MX) and decision to deploy theater nuclear weapons in Europe, but then ignoring Carter's last two FYs 1981 and 1982 Defense budgets.

3. Robert M. Gates, "Defense and Arms Control in the Carter Administration," *Studies in Intelligence* 41, no. 3 (1997): 41–43 (quote). Gates reiterates this theme in *From the Shadows*, 176–179.

4. Memo, Brzezinski for Brown, 11 Apr 1979 (quote), w/attached "Comprehensive Net Assessment 1978," folder Alpha Channel File, 12/78–7/79, box 11, Brown Papers, LC.

5. *Ibid.* (quotes). The discovery of huge oil deposits in western Siberia's forested swamps set off the boom in the Soviet oil industry. Not only was Moscow a net exporter of oil in the 1970s, after 1973 the price of crude skyrocketed. Stephen Kotkin, *Armageddon Averted: The Soviet Collapse, 1970–2000* (Oxford: Oxford University Press, 2001), 15.

6. Memo, Brown for Brzezinski, 30 Apr 1979, folder Alpha Channel File, 12/78–7/79, box 11, Brown Papers, LC.

7. *Ibid.* (quotes).

8. Later, at the end of the Cold War, some intelligence analysts concluded that during the 1978–1988 decade the U.S. intelligence community continually and consistently overestimated the number of Soviet strategic reentry vehicles actually deployed. See Raymond L. Garthoff, "Estimating Soviet Military Intentions and Capabilities," 5:13, in Gerald K. Haines and Robert E. Leggett, eds., *Watching the Bear: Essays on CIA's Analysis of the Soviet Union*, <[www.cia.gov/library/center-for-the-study-of-intelligence/csi-publication/books-and-monographs/watching-the-bear-essays-on-cia-analysis-of-the-soviet-union/index.html](http://www.cia.gov/library/center-for-the-study-of-intelligence/csi-publication/books-and-monographs/watching-the-bear-essays-on-cia-analysis-of-the-soviet-union/index.html)>, accessed 17 Apr 2012. Garthoff was discussing National Intelligence Estimates prepared by CIA but reflecting the intelligence community as a whole.

9. Memo, Brown for Brzezinski, 30 Apr 1979 (quote), cited in note 6.

10. In 1982 the CIA revised the estimate to an average 2 percent since 1976 with almost flat growth in weapons procurement. Garthoff, "Estimating Soviet Capabilities and Intentions," 5:14, cited in note 8. If Gartoff's estimates were right, Brown was working with faulty intelligence, but no member of the intelligence community during the Carter years dissented from the basic premise of a strong defense commitment.

11. Memo, Brown for Brzezinski, 30 Apr 1979 (quote), cited in note 6.
12. Memo, Brzezinski for Brown, 1 May 1979, folder Alpha Channel File, 12/78–7/79, box 11, Brown Papers, LC.
13. Summary of Conclusions of NSC Meeting, 4 Jun 1979 (quotes), 3–4:20 p.m.; Minutes of NSC Meeting, 4 Jun 1979, 6 p.m.: both in folder NSC 0019, 6/4/79, Strategic Policy and Relations with the USSR, box 56, NSC Institutional Files, 1977–1981, Carter Library. In retrospect, Brown considered the situation “not that risky,” but on the basis of then available intelligence, he believed his views in 1979 were justified. Brown’s comment to author, 6 Dec 2016.
14. *Ibid.* (quotes).
15. The divergence between CIA and DIA reached a climax on 16 December 1980, with NIE 11–3/8–80, “Soviet Capabilities for Strategic Nuclear Conflict Through 1990,” which resulted in a split estimate between CIA and DIA/Services’ intelligence organizations. Furthermore, DIA argued that CIA should not be producing net assessments. That was DoD’s job. Garthoff, “Estimating Soviet Capabilities and Intentions,” 5:15, cited in note 8.
16. Rearden with Foulkes, *JCS and National Policy 1977–1980*, 355–356.
17. Memo, Murray for Brown, 14 Mar 1979 (quotes), folder 100.54 (11 Mar–Apr) 1979, box 11, SecDef Files, Acc. 330-82-0204, WNRC.
18. Memo, Murray for Brown, 17 Apr 1979 (quote), *ibid.*
19. Memo, Stewart and Utgoff for Aaron and Brzezinski, 10 May 1979, CK3100469911, DDRS.
20. *Ibid.* (quote).
21. Summary of Conclusions of PRC Meeting, 14 May 1979 (quotes), folder PRC 106, DoD CG, 5/14/79, box 75, NSC Institutional Files, 1977–1981, Carter Library.
22. Memo, Claytor for Brown, 17 May 1979 (quotes), folder 100.54 (17 May 1979), box 12, SecDef Files, Acc 330-82-0204.
23. These attitudes and trends are discussed in more detail in chapter 8, “FY 1979 Budget and the Future of the Navy.”
24. Memo, Alexander for Brown, 18 May 1979, folder 100.54 (18 May 1979), box 12, SecDef Files, Acc 330-82-0204.
25. Memo, Mark for Brown, 18 May 1979, *ibid.*
26. Three memos, Brown for Alexander, Mark, and Hidalgo, all dated 2 Aug 1979: all in folder 100.54 (1–15 Aug) 1979, box 14, *ibid.*
27. Memos, Hidalgo for Brown, 7 Aug 1979 (quote); Woolsey for Brown, 15 Aug 1879: both *ibid.*
28. Memo, Murray for Brown, 20 Aug 1979, folder 100.54 (20 Aug) 1979, box 15, *ibid.*; memo, Hildago for Brown, 7 Aug 1979 (quote), cited in note 27.
29. Memos, Alexander for Brown, 15 Aug 1979, folder 100.54 (1–15 Aug) 1979; Murray for Brown, 20 Aug 1979, folder 100.54 (16–28 Aug) 1979: both in box 14, *ibid.*
30. Memo, Meyer for Brown, 21 Aug 1979, folder 100.54 (21 Aug) 1979, box 15, *ibid.*

31. Memo, Mark for Brown, 16 Aug 1979 (quotes), folder 100.54 (16 Aug) 1979, *ibid*.
32. Memo, Murray for Brown, 20 Aug 1979 (quotes), w/Brown's comments (quote), folder 100.54 (16–28 Aug) 1979, *ibid*.
33. Three memos, Claytor for Hidalgo, Alexander, and Mark, all dated 29 Aug 1979: all in folder 100.54 (28–31 Aug) 1979, box 14, *ibid*.
34. Memo, Brown for Carter, 5 Sep 1979, folder Secretary Brown, Eyes Only, Jul-Dec 1979, box 11, Brown Papers, LC.
35. *Ibid*.
36. *Ibid*.
37. Memo, Brown for Carter, 26 Oct 1979 (quotes), 0000B42A.pdf, CD-1, Declassified SecDef Files, WNRC.
38. Memos, Brown for Carter, 21 Sep 1979, 0000B426.pdf; 12 Oct 1979, 0000B428.pdf; 26 Oct 1979, 0000B42A.pdf: all *ibid*.
39. Ltr, Carter to Brown, 6 Nov 1979, folder Secretary Brown, Eyes Only, Jul-Dec 1979, box 11, Brown Papers, LC.
40. Summary of Conclusions and Detailed Minutes of PRC Meeting, 8 Nov 1979: both in folder PRC 129, FY-81 Defense Budget [1], box 78, NSC Institutional Files, 1977–1981, Carter Library.
41. Memo, Brown for Carter, n.d. [15 Nov 1979] (quotes), folder DoD, 11/97, Agency File, box 6, Brzezinski Material, National Security Affairs, Carter Library
42. Memo, Brzezinski for Carter, 15 Nov 1979, *ibid*. (quotes).
43. DoD News Release No. 24–80, 28 Jan 1980, “FY 1981 Department of Defense Budget,” 3, *Brown Public Statements 1980–1981*, 1:53.
44. Carter, *White House Diary*, 381, 397 (quote).
45. Memo, Cutler for Carter, 16 Nov 1979 (quote), folder SecDef Cables, Nov 1979, OSD/HO.
46. Memo, McIntyre for Carter, 11 Dec 1979, CK3100062360, DDRS.
47. *CQ Almanac 1980*, 36:37, 185; Robert G. Kaiser, “Senate Votes for 5% Defense Increase,” *Washington Post*, 19 Sep 1979, A1, A13. During November 1979 OSD officials finalized an understanding on the budget and SALT II with Senate defense hawks and others. Brown met with Nunn, former Secretary of State and National Security Adviser Henry Kissinger, Secretary of Energy James Schlesinger (former secretary of defense), and Senators Robert Byrd and John Stennis. Brown and McIntyre then met with Senator Alan Cranston and about 10 other members of his SALT group. During early December 1979 Claytor met with a bipartisan group of 15 senators at Senator John Warner's house. Memos, Brown for Carter, 23 Nov 1979, 0000B42.pdf; Brown for Carter, 7 Dec 1979, 0000B42E.pdf: both in CD-1, Declassified SecDef Files.
48. Memo, Brown for Carter, 7 Dec 1979, 0000B42E.pdf, CD-1, Declassified SecDef Files. The administration usually cited real growth in outlays (3.3%) and TOA (just over 5%) separately; TOA was the larger figure and a better indicator of future commitments.

See White House Office of Media Liaison, “U.S. Defense Policy for the 1980s,” 7 Feb 1980, folder FI 4/FG 13, 5/1/79–4/30/80, box FI-14, Subject File, WHCF: Executive, Carter Library.

49. The first budget resolution of June 1980 set defense outlays at \$153.7 billion and TOA at \$171.3 billion. The second supposedly more binding resolution on November 1980 pegged outlays at \$159.3 billion and TOA at \$172.7 billion. *CQ Almanac 1980*, 36:117, 121.

50. *Ibid.*, 47–48, 53.

51. Ltr, Carter to Stennis, 15 May 1980 (quotes), folder FI 4/FG 13, 5/1/80–8/31/80, box FI-14, Subject File, WHCF: Executive, Carter Library.

52. HCAS, Subcommittee on Investigations, *National Defense Funding Levels for Fiscal Year 1981: Hearing*, 96th Cong., 2nd sess., 29 May 1980, quotes on 5, 11, 14, 15, 18; George C. Wilson, “Joint Chiefs of Staff Break With Carter on Budget Planning for Defense Needs,” *Washington Post*, 30 May 1980, A1, A16.

53. Memo, Brown for Carter, 30 May 1980 (quotes), folder DoD, 5–7/80, box 7, Agency File, Brzezinski Material, National Security Affairs, Carter Library; AP, “Joint Chiefs’ Money Plea Was Within the Rules, Secretary Brown Feels,” *Washington Post*, 31 May 1980 (quote), A9; ltr, Carter to Brown, 2 Sep 1980 (quotes), folder Harold Brown, confidential/personal, box 22, Brown Papers, LC.

54. Memos, Carter for Brown, 7 Mar 1980, 28 Mar 1980, 0000B45E.pdf., Declassified SecDef Files; memo, Lynk for Eizenstat, 24 Jun 1980, folder FI 4/FG 13, 5/1/80–8/31/80, box FI-14, Subject File, WHCF: Executive, Carter Library; George Wilson, “President, Brown Attack House Defense Additions,” *Washington Post*, 23 May 1980, A1, A16; memo, Brown for Carter, 18 Jul 1980, CK 3100078492, DDRS.

55. *CQ Almanac 1980*, 36:63.

56. *Ibid.*, 63–64.

57. *Ibid.*

58. Memo, Aaron for McIntyre, 29 Aug 1980 (quote), folder FI 4/FG 13, 5/1/80–8/31/80, box FI-14, Subject File, WHCF: Executive, Carter Library; memo, Stempler for Brown, 19 Aug 1980, folder 110.01 (Aug–15 Sep) 1980, box 16, SecDef Files, Acc 30-82-0216, WNRC.

59. Memo, Brown for Carter, 1 Aug 1980, folder DoD, 8–9/80, box 7, Agency File, Brzezinski Material, National Security Affairs, Carter Library.

60. Memo, McIntyre for Carter, 2 Sep 1980, folder FI 4/FG 13, 5/1/80–8/31/80, box FI-14, Subject File, WHCF: Executive, Carter Library.

61. *Carter Public Papers 1980*, 2:1715

62. George Wilson, “Nunn Raps Carter on Defense Flip-Flops,” *Washington Post*, 3 Jun 1980, A2.

63. Memo, Eisenstat for Carter, 6 Sep 1980, folder FI 4/FG 13, 9/1/8–1/20/81, box FI-14, Subject File, WHCF: Executive, Carter Library.

64. *CQ Almanac 1980*, 36:185–186

65. *Ibid.*, 196–197.

66. *Ibid.*



67. In addition, \$139 million was appropriated to begin renovating the battleship Iowa. *CQ Almanac 1981*, 37:202, 204. *New Jersey* and *Iowa* eventually became museums; *Oriskany* was sunk as an artificial reef for fish.

68. *CQ Almanac 1980*, 36:196–197.

69. Memo, Welch and Russell for Brzezinski, 11 Dec 1980 (quotes), folder FI 4/FG 13, 9/1/80–1/20/81, box FI-14, Subject File, WHCF: Executive, Carter Library

70. *Carter Public Papers, 1980*, 3; 2823.

71. Memo, Lawson for Brzezinski, 14 Jan 1980, folder JCS, 1/79–2/80, box 10, Agency File, Brzezinski Material, National Security Affairs, Carter Library.

72. Memo, Murray for Brown, 10 Oct 1979, folder 100.54 (1 Sep–31 Dec) 1979, box 15, SecDef Files, Acc 330-82-0204.

73. Memo, Welch and Utgoff for Aaron, 11 Jan 1980 (quotes), folder DoD, 1/80, box 6, Agency File, Brzezinski Material, National Security Affairs, Carter Library.

74. Memo, Murray for Brown, 27 Dec 1979 (quotes), w/Brown's comments, folder 100.54 (1 Sep–31 Dec) 1979, box 15, SecDef Files, Acc 330-82-0204.

75. JCSM 65-80 for SecDef 14 Mar 1980, folder 100.54(6 Mar–31 Mar) 1980, box 13, SecDef Files, Acc 330-82-0216.

76. Memo, Murray for Brown, 6 Feb 1980, w/Brown's comments, 0000CD64.pdf., CD-2, Declassified SecDef Files; memos, Brown for Service Secretaries et al., 24 Mar 1980, 1 Apr 1980: both in folder 100.54 (6 Mar–31 Mar) 1980, box 13, SecDef Files, Acc 330-82-0216.

77. Memo, Hildalgo for Brown, 22 May 1980, folder 100.54 (22 May) 1980, box 10, SecDef Files, Acc 330-82-0216.

78. Memo, Mark for Brown, 19 May 1980, folder 100.54 (17–21 May), 1980, *ibid.*

79. Memo, Vessey for Brown, 16 May 1980 (quote), folder 100.54 (16 May), 1980, *ibid.*

80. Memo, Claytor for Brzezinski, 21 Jul 1980 (quotes), folder 100.54 (20–30 Jul) 1980, *ibid.*

81. Carter Daily Diary, 25 Jul 1980, Carter Library; memos, Brzezinski for Carter, 24 Jul 1980 (quotes); McIntyre for Carter, 24 Jul 1980: both in folder DoD, 5–7/80, box 7, Agency File, Brzezinski Material, National Security Affairs, Carter Library.

82. Memo, Brzezinski for Carter, 25 Nov 1980 (quotes), w/attached Summary of Conclusions of SCC Meeting, 25 Nov 1980, folder Miscellaneous Mtgs, 3/78–11/80, box 23, Subject File, Brzezinski Donated Material, Carter Library.

83. *Ibid.*

84. *Ibid.*

85. Memo, Utgoff, Shoemaker, Welch for Brzezinski and Aaron, 1 Dec 1980, folder PRC 158, Defense Budget, 12/2/80, box 82, NSC Institutional Files, 1977–1981, Carter Library.

86. Summary of Conclusions at PRC Meeting, 2 Dec 1980, folder 110.01 (1–3 Dec) 1980, box 15, SecDef Files, Acc 330-82-0216.

87. Memo, Welch for Brzezinski, 18 Nov 1980, folder DoD, 11–12/80, box 7, Agency File, Brzezinski Material, National Security Affairs, Carter Library.

88. The figures for the 1981 and 1981 budget come from attachments to DoD News Release No. 15-81, 15 Jan 1981, *Brown Public Statements 1980–1981*, 6:2089. Brown’s description of priorities and exchange with the journalist is from his news conference of 15 Jan 1980. *Ibid.*, 2074–2076.

89. *Ibid.*, 2084.

## 19. A Revolution in Military Warfare: The Offset Strategy

1. Ben R. Rich and Leo Janos, *Skunk Works: A Personal Memoir of My Years at Lockheed* (Boston: Little Brown, 1994), 16–18; David C. Aronstein and Albert C. Piccirillo, *Have Blue and the F-117A: Evolution of the “Stealth Fighter”* (Reston, VA: American Institute of Aeronautics and Astronautics, 1997), 11–12. In the 1970s the United States used then-current countermeasures, but they were expensive and resource draining. For example, the 1972 U.S. Air Force attack on Hanoi’s heavily defended Paul Doumer bridge by 16 F-4s required 8 more F-4s to drop chaff, 4 electronic countermeasures aircraft, and 15 F-105G Wild Weasel aircraft to attack SAM radar sites. Richard Van Atta et al., *Transformation and Transition: DARPA’s Role in Fostering an Emerging Revolution in Military Affairs*, vol. 2, *Detailed Assessments*, IDA Paper P-3698 (Alexandria, VA: Institute for Defense Analyses, Nov 2003), I-1 (quote).

2. William J. Perry, “Desert Storm and Deterrence,” *Foreign Affairs* 70, no. 4 (Fall 1991): 66–69 (quotes); “Perry on Precision Strike,” *Air Force Magazine* 80, no. 4 (Apr 1977), <[www.airforcemag.com/MagazineArchive/Pages/1997/April%201997/0497perry.aspx](http://www.airforcemag.com/MagazineArchive/Pages/1997/April%201997/0497perry.aspx)>, accessed 25 Jul 2012; Perry, *My Journey*, 41–42; Van Atta et al., *Transformation and Transition: DARPA’s Role in Fostering an Emerging Revolution in Military Affairs*, vol. 1, *Overall Assessment*, IDA Paper P-3698 (Alexandria, VA: Institute for Defense Analyses, Apr 2003), 10–11. Brown confessed “some personal satisfaction in seeing some of the weapons which I was personally associated with pay off in the Gulf today.” Brown quoted in Walter S. Mossberg, “High-Tech, Low-Tech Success in War So Far Owes Much to Jimmy Carter’s Defense Planning,” *Wall Street Journal*, 22 Jan 1991, 16. While “smart bombs” played a decisive role in the opening Gulf War air campaign, 90 percent of the bombs dropped during the conflict were “dumb” ones. Rick Atkinson, *Crusade: The Untold Story of the Gulf War* (New York: Houghton Mifflin, 1993), 99–100.

3. Brown interview, 11 Feb 2011, 6 (quote). Perry admitted that he had been “apprehensive,” because he was doing Brown’s old job, but recalled Brown was a “great boss” who did not “micromanage,” giving Perry “a lot of flexibility and just guidance on what to do . . . [he] let me sink or swim on my own pretty much.” William Perry, interview by Edward Keefer and Philip Shiman, 21 Jun 2012, 1, Washington, DC, Oral History Collection, OSD/HO; Perry, *My Journey*, 35–36 (quote).

4. Brown interview, 11 Feb 2011, 2–3; Perry interview, 21 Jun 2012, 8. Perry’s answer was more definitive, describing it as “number one.” Brown mentioned it first when asked about the most significant weapon systems developed during his tenure. For an account

of pre-1977 Have Blue attempts to reduce radar cross section, see Aronstein and Piccirillo, *Have Blue and the F-117A*, 2–10

5. Brown interview, 11 Feb 2011, 2.

6. Aronstein and Piccirillo's *Have Blue and the F-117A* is a technical history of the project. Rich and Janos, *Skunk Works*, is a readable memoir full of anecdotes.

7. Rich and Janos, *Skunk Works*, 35–36. Because of faulty test data not noticed by a DoD technician administering the test, the radar cross section measured as the size of a ball bearing rather than a golf ball. Lockheed used that data effectively by rolling a ball bearing across the desks of Air Force officers to demonstrate the RCS of their model. They should have rolled a golf ball.

8. Rich and Janos, *Skunk Works*, 21–22; Jon Lake, *Jane's How to Fly and Fight in the F-117A Stealth Fighter* (London: Harper Collins, 1997), 54–55.

9. Van Atta et al., *DARPA's Role in Fostering an Emerging Revolution in Military Affairs*, vol. 2, *Detailed Assessments*, I-4; Lake, *F-117A Stealth Fighter*, 55.

10. Rich and Janos, *Skunk Works*, 64 (quote).

11. Perry interview, 21 Jan 2012, 17–18; Aronstein and Piccirillo, *Have Blue and the F-117A*, 35–36, 46.

12. Rich and Janos, *Skunk Works*, 64–66 (quote).

13. *Ibid.*, 59–60; Aronstein and Piccirillo, *Have Blue and the F-117A*, 44–45. The pilot of the second prototype also bailed out during a test flight in July 1979 after indications of hydraulic failure, again with only a few tests flight to go, but by that time the decision to proceed with production had already been made.

14. Memo, Perry for Brown, 13 Jun 1978 (quotes), folder 020 DDR&E, 1978, box 1, SecDef Files, Acc 330-81-0212.

15. Memo, Perry for Brown, 25 Jun 1978 (quotes) *ibid.*

16. Memo, Perry for Brown, 11 Sep 1978 (quotes), *ibid.*

17. Rich and Janos, *Skunk Works*, 66.

18. *Ibid.*, 68–71; Van Atta et al., *DARPA's Role in Fostering an Emerging Revolution in Military Affairs*, vol. 2, *Detailed Assessments*, I-6; Aronstein and Piccirillo, *Have Blue and the F-117A*, 59–60.

19. Aronstein and Piccirillo, *Have Blue and the F-117A*, “Have Blue and Senior Trend Time Table,” 276–277.

20. Rich and Janos, *Skunk Works*, 302–303; memo, Brown for Carter, 11 Sep 1978, folder Secretary Brown, Eyes Only, 77–78, box 22, Brown Papers, LC.

21. Rich and Janos, *Skunk Works*, 306–309 (quote).

22. *Ibid.*, 271–273 (quotes).

23. *Ibid.*, 273–278 (quotes); Perry interview, 21 Jun 2012, 12.

24. Van Atta et al., *DARPA's Role in Fostering an Emerging Revolution in Military Affairs*, vol. 2, *Detailed Assessments*, II-7–II-8.

25. Perry interview, 21 Jun 2012, 12–13 (quote). Asked if the Navy’s view was legitimate, Perry agreed it had some merit, but thought Sea Shadow had a mission that would still be relevant today. “It was not a technical failure”; he maintained, “it was a policy failure.”

26. Testimony by Curry, SCA Subcommittee, *Department of Defense Authorization for Appropriations for Fiscal Year 1977: Hearings*, 94th Cong., 2nd sess., 3 Feb 1976, 888–889 (quote).

27. Testimony by Perry, SCAS, *Department of Defense Authorization for Appropriations for Fiscal Year 1979: Hearings*, 95th Cong., 2nd sess., 3 Mar 1978, 5599 (quote).

28. Juan Cameron, “Bill Perry Keeps the Pentagon’s Barrels Loaded,” *Fortune*, 10 Mar 1980, 63; Perry, *My Journey*, 39–40.

29. Test by Perry, 21 Mar 1978, cited in note 27, 5598–5599.

30. Richard Van Atta et al., *DARPA Technical Accomplishments*, vol. 2, *An Historical Review of Selected DARPA Projects*, IDA Paper P-2429 (Alexandria, VA: Institute for Defense Analyses, Apr 1999), 6–2 to 6–3 (quotes).

31. *Ibid.*, 5–5; Van Atta et al., *DARPA’s Role in Fostering an Emerging Revolution in Military Affairs*, vol. 1, *Overall Assessment*, 20–21.

32. Memo, Perry for Brown, 29 Aug 1978 (quotes), folder 020 DDR&E, 1978, box 1, SecDef Files, Acc 330-81-0212.

33. Memo, Brown for Carter, 11 Sep 1978 (quote), folder 320.2 Strategic, 1978, *ibid.*

34. Van Atta et al., *DARPA’s Role in Fostering an Emerging Revolution in Military Affairs*, vol. 1, *Overall Assessment*, 21–22.

35. Perry interview, 21 Jun 2012, 6–9; Perry, *My Journey*, 40–41.

36. Memo, Brown for Carter, 15 Feb 1980 (quote), 0000B45B.pdf, CD-1, Declassified SecDef Files; “Summary of Major Programs in Research, Development, and Acquisition, Fiscal Year 1980,” folder 400.13 (Jan–24 Jun) 1979, box 45, SecDef Files, Acc 330-82-0204.

37. Perry interview, 21 Jun 2012, 6–7; Brown with Winslow, *Star Spangled Security*, 31; Barry Leiner, Vinton Cerf, David Clark, Robert Kahn et al., *Brief History of the Internet* <[www.internetsociety.org/internet/what-internet/history-internet/brief-history-internet](http://www.internetsociety.org/internet/what-internet/history-internet/brief-history-internet)>, accessed 6 May 2013.

38. Ronald Huisken, *The Origin of the Strategic Cruise Missile* (New York: Praeger Scientific, 1981), 3–12

39. Memos, Carter for Brown, n.d. [13 Jul 1977], and 5 Aug 1977 (quotes): both in folder 471.94 (May–Aug) 1977, box 56, SecDef Files, Acc 330-80-0017.

40. “Point Paper on Continuation of Both ALCM and Tomahawk Programs,” w/ attached memo, Brown for Carter, 20 Jul 1977, *ibid.*; Kenneth P. Werrell, *The Evolution of the Cruise Missile* (Maxwell AFB, AL: Air University Press, 1985), 178.

41. Memo, Brown for Carter, 19 Aug 1977 (quote), folder Brown Memos to President, box 91, Brown Papers, LC. The modification of the Boeing ALCM for longer range was relatively straightforward: the addition of two sections. Modifying the TALCM dropped from a B–52 was also “a straightforward engineering task.”

42. Memo, Perry for Stetson and Claytor, 30 Sep 1977, folder 471.94 (Sep-Dec) 1977, box 56, SecDef Files, Acc 330-89-0017; memo, Brzezinski for Brown, 31 Jan 1978, w/attached memo, Brown for Carter, 26 Jan 1978, folder ND 18 1/1/78–2/28/78, box ND-50, Subject File, WHCF: Executive, Carter Library.

43. Memo, Brown for Carter, 15 Feb 1980, 0000045B.pdf., CD-1, Declassified SecDef Files; Memo, Brown for Carter, 26 Feb 1980, folder 471.94 (Jan-Apr) 1980, box 44, SecDef Files, Acc 330-82-0216.

44. Memo, Brown for Carter, 28 Mar 1980, folder DoD, 3–4/80, box 6, Agency File, Brzezinski Material, National Security Affairs, Carter Library; Perry, *My Journey*, 47.

45. Memo, Brown for Carter, 23 Dec 1980 (quotes), folder Transition: Issues for President-Elect, box 80, Brown Papers, LC.

46. Memo, Brown for Carter, 25 Oct 1978, 0000CF6A.pdf, CD-1, Declassified SecDef Files. As Brown pointed out in this memo, while light units had better strategic mobility (they weighed 30% less and were easier to transport to the battlefield), once in the field they had 30% less firepower, poor tactical mobility, and vulnerability to heavy Warsaw Pact units.

47. Memo, Brown for Carter, 1 Aug 1980 (quotes), folder DoD 8–9/80, box 7, Agency File, Brzezinski Material, National Security Affairs, Carter Library.

48. Carter, *White House Diary*, 450 (quote).

49. Memo, Brown for Carter 23 Dec 1980 (quote), folder Transition: Issues for President-Elect, box 80, Brown Papers, LC.

50. Ibid. (quote); Perry, *My Journey*, 46–47.

51. Ibid.

52. Gates, “Defense and Arms Control in the Carter Administration,” 41–42 (quotes).

53. Memo, Brown for Carter, 23 Dec 1980, cited in note 45. Brown later suggested that the agreement by NATO members to place CMs and Pershing IIs on their territory and the actual deployment in the early 1980s were crucial in convincing the Soviets, especially Mikhail Gorbachev, that Moscow could not dominate Western Europe and had to reform “a dysfunctional and sclerotic Soviet economy.” Brown further suggested that Reagan’s Strategic Defense Initiative was not the key factor, as some have claimed, but rather it was the CMs, Pershing IIs, and the U.S. revolution in military technology of the late 1970s that convinced the Soviets. Brown with Winslow, *Star Spangled Security*, 140–141.

54. Memo, Brown for Carter, 23 Dec 1980 (quotes), cited in note 45.

55. Memo, Brown for Carter, 11 Sep 1978 (quotes), folder DoD 10/78, box 5, Agency File, Brzezinski Material, National Security Affairs, Carter Library.

## 20. The 1980 Election and Transition

1. Glad, *Outsider in the White House*, 170–174. For an in-depth discussion of the election, see Jack W. Germond and Jules Witcover, *Blue Smoke and Mirrors: How Reagan Won and Why Carter Lost the Election of 1980* (New York: Viking Press, 1981).

2. For the announcements and a discussion of the transition, see pages 605–612.

3. Lou Cannon, “Reagan, Talking Tough, Calls Carter Deceptive on Defense,” *Washington Post*, 2 May 1980, A2 (quotes); Michael Getler, “Brown: Arms Superiority Out of Reach,” *Washington Post*, 29 Jul 1980, A5.

4. DoD News Release No. 312-80, 28 Jul 1980 containing text of Brown’s remarks, *Brown Public Statements 1980–1981*, 5:1703 (quote); Brown’s news conference, 28 Jul 1980, *ibid.*, 1712 (quote); Reagan, quoted in Lou Cannon, “Reagan Asserts U.S. Security Is in Jeopardy,” *Washington Post*, 21 Aug 1980, A2.

5. Richard Halloran, “More Bucks, More Bang?” *New York Times*, 3 Aug 1980, A2; Brown quoted in Campaign Notes, “Brown: Not Out Stumping,” *Washington Post*, 18 Aug 1980, A4.

6. Memo, Brown for Carter, 1 Aug 1980 (quotes), folder DoD, 8–9/80, box 7, Agency File, Brzezinski Material, National Security Affairs, Carter Library.

7. Timothy D. Schellhardt, “Polishing the Platform: President Wins Nomination and Support of Kennedy After Agreeing to Back Job Stimulus Plan,” *Wall Street Journal*, 14 Aug 1980, 2; George C. Wilson, “Pentagon Cancels Its Invasion of Democratic Convention,” *Washington Post*, 6 Aug 1980, A6; Warren Weaver, “Carter Endorses ’80 Democratic Platform With Few Reservations,” *New York Times*, 14 Aug 1980, B1; memo, Brown for Carter, 15 Aug 1980, w/Carter’s comment, folder DoD, 8–9/80, box 7, Agency File, Brzezinski Material, National Security Affairs, Carter Library.

8. Memo, Brown for Carter, 8 Aug 1980 (quote), folder DoD, 8–9/80, box 7, Agency File, Brzezinski Material, National Security Affairs, Carter Library. Although Brown announced the policy on 20 August, OSD officials briefed journalists on it earlier. Richard Burt, “Carter Said to Back Plan for Limiting Any Nuclear War,” *New York Times*, 6 Aug 1980, A1. The text of the speech, given at the Naval War College in Newport, Rhode Island, is in DoD News Release No. 344–80, 20 Aug 1980, *Brown Public Statements, 1980–1981*, 5:1751–1759. Post-speech news accounts include Richard Burt, “Brown Says ICBM’s May Be Vulnerable to Russians Now,” *New York Times*, 21 Aug 1980, A1; Walter Mossberg, “Fighting a Nuclear War,” *Wall Street Journal*, 27 Aug 1980, 14; editorial, “No Longer MAD?” *Christian Science Monitor*, 11 Aug 1980, 24 (quote).

9. AP, “Stealth Alters Military Balance, Brown Declares,” *Los Angeles Times*, 2 Aug 1980, A1; Richard Burt, “Brown Says Radar-Evading Planes Shift Military Balance Toward U.S.,” *New York Times*, 23 Aug 1980, 1, 12; Burt, “U.S. Security and Politics,” *New York Times*, 29 Aug 1980, 16; Albert Hurt, “Reagan Accuses White House of Leaking U.S. Security Data for Political Purposes,” *Wall Street Journal*, 3 Sep 1980, 6 (quotes); Douglas E. Kneeland, “Reagan Assails Carter Over Disclosure of Secret Plane,” *New York Times*, 5 Sep 1980, A19 (quotes).

10. Memo, Brown for Carter, 22 Aug 1980 (quote), 0000B469pdf, CD-1, Declassified SecDef Files, WNRC; DoD papers, “Stealth Taking Points,” 11 Sep 1980; and “Chronology of Pre-1977 Publications Relating to Stealth,” 11 Sep 1980, attached to memo, Friendly for Powell, 11 Sep 1980, folder ND 1, 3/2/78–1/20/81, box ND-1, Subject File, WHCF: Executive, Carter Library. The straw that supposedly broke the camel’s back was the George C. Wilson

article, “Carter to Support New Bomber,” *Washington Post*, 14 Aug 1980, A1, A17. Brown’s comment to author, 6 Dec 2016.

11. Memo, Brown for Carter, 29 Aug 1980, folder DoD, 8–9/80, box 7, Agency File, Brzezinski Material, National Security Affairs, Carter Library; testimony by Perry, HCAS, Subcommittee on Investigations, *Leaks of Classified National Defense Information—Stealth Aircraft: Hearings*, 96th Cong., 2nd sess., 4 Sep 1980, 59–62.

12. Memo, Brown for Carter, 5 Sep 1980, folder DoD, 8–9/80, box 7, Agency File, Brzezinski Material, National Security Affairs, Carter Library.

13. News conference by Brown, 5 Sep 1980, *Brown Public Statements 1980–1981*, 5:1834 (quotes); Special to NYT, “Brown Responds to Reagan View on Plane Report,” *New York Times*, 6 Sep 1980, 1, 8.

14. Richard Halloran, “Defense Secretary Fires Some Political Missiles,” *New York Times*, 7 Sep 1980, A2 (quotes).

15. Editorial, “Stealth,” *Washington Post*, 7 Sep 1980, D6; editorial, “No Stealth or Shame,” *Wall Street Journal*, 9 Sep 1980, 32; Jack Anderson, “Violating Secrecy to Preserve It,” *Washington Post*, 8 Sep 1980, B13; Douglas E. Kneeland, “Kissinger Backs Reagan on Secret Plane Charge,” 6 Sep 1980, *New York Times*, 8; Campaign Notes, “Ford Attacks Disclosures on Stealth,” *Wall Street Journal*, 9 Sep 1980, A3; Ira C. Eaker, “Melvin Laird vs. Harold Brown,” *Air Force Times*, 8 Sep 1980, 1; George C. Wilson, “‘Stealth’ Case Dismays Experts,” *Washington Post*, 11 Sep 1980, A6; Steven R. Weisman, “President Denies Harming Security Over Secret Plane,” *New York Times*, 10 Sep 1980, B5 (quotes).

16. Memo, Brown for Carter, 12 Sep 1980, 00000B46B.pdf, CD-1, Declassified SecDef Files, WNRC.

17. Memos, Brown for Carter, 3 Oct 1980, 00000B46C; Brown for Carter, 10 Oct 1980, 000B46D, *ibid.*; Stephen Webbe, “Defense Debate: Are US Forces ‘Combat Ready?’” *Christian Science Monitor*, 24 Oct 1980, 3; Richard Halloran, “Debate on Army’s Readiness,” *New York Times*, 18 Oct 1980, 7; DoD New Release No. 416-80, 9 Oct 1980, containing prepared text of El Paso speech, 9 Oct 1980, *Brown Public Statements 1980–1981*, 6:1934–1946 (quotes).

18. Reagan as quoted in Germond and Witcover, *Blue Smoke and Mirrors*, 281 (quote); Jordan, *Crisis*, 356–358, 357 (quote).

19. Germond and Witcover, *Blue Smoke and Mirrors*, 291–292.

20. Christopher as quoted in Jordan, *Crisis*, 358.

21. *Carter Public Papers 1980–1981*, 3:2650 (quote).

22. Jordan, *Crisis*, 365–366; Germond and Witcover, *Blue Smoke and Mirrors*, 299–300; Carter, *White House Diary*, 479–480. At the time Carter thought the massive slippage of support was because the electorate realized the hostages were not coming home. *Ibid.*, 379. Gary Sick, the Carter NSC staff expert on Iran, who also worked for Ford and Reagan, charged that members of the Reagan campaign team made promises to the Iranians of weapons and other support if they did not release the hostages until after the election. See Sick, *October Surprise*.

23. Memo, Brown for Carter, 19 Nov 1980, folder Transition: Issues for President-elect, box 80, Brown Papers, LC.

24. Ibid.

25. Ibid.

26. Ibid.

27. Carter, *White House Diary*, 486–487; *Keeping Faith*, 577–578 (quote).

28. Jordan, *Crisis*, 302, 399 (quote).

29. Memo, Brown for Carter, 19 Dec 1980 (quotes), folder DoD, 11–12/80, box 7, Agency File, Brzezinski Material, National Security Affairs, Carter Library; Brown interview, 1 Oct 2012, 22.

30. Len Colodny and Tom Shachtman, *The Forty Years War: The Rise and Fall of the Neocons from Nixon to Obama* (New York: Harper Perennial, 2009), 275, 285.

31. Caspar W. Weinberger, *Fighting for Peace: Seven Critical Years in the Pentagon* (New York: Warner Books, 1990), 41n3 (quotes).

32. The massive report was not written by Brown but by his OSD staff, yet he put his imprimatur on it as did most secretaries. Report of Secretary of Defense Harold Brown to the Congress, 19 Jan 1981, *Brown Public Statements 1980–1981*, 6:2120–2276; 7:2120–2472; Richard Halloran, “Brown Offers Somber Parting View of Soviet Goals,” *New York Times*, 20 Jan 1981, A24 (quote).

33. Carter, *Keeping Faith*, 587–589 (quotes); *White House Diary*, 495–496.

34. Carter, *White House Diary*, 495–496 (quote).

35. Jordan, *Crisis*, 387–388 (quotes, emphasis in original); memo, Moe for Carter, 25 Oct 1979, folder ND 7-1, 9/1/79–1/20/81, box ND-7, Subject File, WHCF: Executive, Carter Library.

36. Other Medal of Freedom recipients were former Chief Justice Earl Warren, UN Ambassador Andrew Young, Deputy Secretary of State Warren Christopher, Judge Elbert Tuttle, Mrs. Robert McNamara, Director of Consumer Affairs Esther Peterson, founder of the American Civil Liberties Union Roger Baldwin, and CBS anchorman Walter Cronkite. Carter, *White House Diary*, 509.

37. On Inauguration Day, Carter characterized Reagan as an “affable and decent man, remarkably old in his attitudes. His life seems to be governed by a few anecdotes and vignettes that he has memorized. He doesn’t seem to listen when anybody talks to him. . . . He’ll have to rely heavily on his advisors and subordinates to make the ultimate policy decisions.” Ibid., 513.

38. When introduced at the Democratic Convention after Carter received the nomination, Brzezinski had been roundly booed by the Democrat’s faithful. Jordan, *Crisis*, 333.

39. Brown’s remarks at a seminar on volume 6 in the Secretaries of Defense Historical Series, Edward Drea, *McNamara, Clifford, and the Burdens of Vietnam, 1965–1969*, 10 Apr 2010 (quotes), held at the National Archives, [www.c-spanvideo.org/program/?305378-1/defense-department-leadership-vietnam-war](http://www.c-spanvideo.org/program/?305378-1/defense-department-leadership-vietnam-war).



40. In 2013 Brown published *Star Spangled Security* (with Joyce Winslow). Part memoir, part prescription for the future, it sums up his long career as a public servant, teacher, consultant, corporate and think tank director, and trustee of RAND Corporation and the Center for Strategic and International Studies.

## 21. In Retrospect

1. Stevenson, *SECDEF*, 3 (quote).

2. Harold Brown, “Managing the Defense Department—Why It Can’t Be Done,” William K. McNally Lecture, University of Michigan Graduate School of Business Administration, 25 Mar 1981, 12 (quote), folder Ex SecDef, Brown, box 70, Subject Files, OSD/HO.

3. See chapter 2 for a discussion of these reforms and changes.

4. Stubbing with Mendel, *Defense Game*, 340.

5. Brown remained extremely impressed by McNamara, “a man I would put in a category apart from all others.” In retrospect, Brown believes McNamara was grooming him to be a future secretary of defense, recalling that “he toyed with the idea of recommending” Brown to be director of Central Intelligence and then promoted him to secretary of the Air Force. Brown with Winslow, *Star Spangled Security*, 66.

6. The observation about history in high school is from a Brown interview, 1 Oct 2012, 3–4.

7. Carter interview, 12 Mar 1986, 8 (quotes).

8. Brown recalled that the president “got into much more detail than I would have thought profitable for him. In some ways, of course, that’s an expression of style, and it’s not different from my own style, so I can’t really fault him.” Brown interview, 4 Dec 1981, 17.

9. Brown maintains that he, Brzezinski, and Vance got ahead of the president on this issue, and that the president had never signed off on it. Brown interview, 1 Oct 2012, 26.

10. Memo, Smith for Komer and Perry, 24 Jul 1980, w/attached NSC criticism of DoD (i.e., too long development cycles, overemphasis of optimization, too much concentration on the European Central Front, and weak productivity in support for maintenance and readiness) [both Conf.]. Komer commented on these criticisms to Odom in his attached response. Folder 020 DoD, 1980, box 5, SecDef Files, Acc 330-82-0216, WNRC.

11. Brown interview, 1 Oct 2012; Brown with Winslow, *Star Spangled Security*, 14–15.

12. Brown interview, 4 Dec 1981, 15; Brown with Winslow, *Star Spangled Security*, 14, 42–43.

13. Harold Brown, interview by Alfred Goldberg and Maurice Matloff, 28 Feb 1992, 18.

14. Brown interview, 4 Dec 1981, 6, 50 (quotes).

15. Brown interview, 28 Feb 1992, 19. Brown was spared a difficult decision on whether to extend George Brown as CJCS. The general publicly noted that Israel was not as much of a strategic asset to the United States in the Middle East as its proponents claimed, causing a spate of criticism. *Ibid.* Unfortunately, General Brown contracted cancer and retired. Brown with Winslow, *Star Spangled Defense*, 55.

16. Brown with Winslow, *Star Spangled Security*, 56–57.

17. Rearden, *Council of War*, 392–393. Brown’s decisions to name Air Force General Lew Allen to replace Jones as Air Force chief of staff and Admiral Thomas Hayward to replace the retiring Admiral James Holloway as CNO were viewed by some as a downgrade of the JCS. With a Ph.D. in physics, Allen was essentially a scientist. Hayward was a naval aviator with a specialty in program analysis. Neither had a reputation outside their services.

18. Brown with Winslow, *Star Spangled Security*, 48–49.

19. *Ibid.*, 104.

20. *Ibid.*, 47 (quotes); Brown interview, 4 Mar 1994, 8–9,

21. Brown interview, 4 Mar 1994, 11.

22. Trask and Goldberg, *DoD 1947–1997*, 50–51.

23. Perry interview, 21 Jun 2012, 5; Brown with Winslow, *Star Spangled Security*, 63–64.

24. Brown interview, 11 Feb 2011, 18–19.

25. Harold Brown, “It May Be Plausible—and It May Be Ineffective,” *Washington Post*, 27 Mar 1983, B8, B28.

26. Memos, Watson for Jordan et al., 13 Mar and 25 Apr 1978; Carter for Brown et al., 27 Mar 1978: all in folder ND 9, 8/1/77–5/31/78, box ND-29, Subject File, WHCF: Executive, Carter Library. Brown recalled that the Philadelphia shipyard was closed, but the decision to do so had been made by the previous administration. Brown interview, 1 Oct 2012, 23.

———— NOTES ON SOURCES ————  
AND SELECTED BIBLIOGRAPHY

THIS HISTORY RELIES IN GOOD PART on four basic primary sources: the Official Records of the Office of the Secretary of Defense (OSD), Record Group 330, at the Washington National Records Center (WNRC), Suitland, Maryland, which covers Harold Brown and his principal assistants from January 1977 to January 1981; the files of President Jimmy Carter at his presidential library and museum in Atlanta, Georgia; the papers of Harold Brown held at the Library of Congress, Manuscript Division, Washington, DC; and the Records of the Chairman of the Joint Chiefs of Staff (JCS), in Record Group 218, particularly those of General George S. Brown, USAF (1974–1978), and General David C. Jones, USAF (1978–1982), at the National Archives and Records Administration (NARA II), College Park, Maryland.

Another valuable source is the extensive OSD Historical Office Oral History Collection, a series of interviews conducted by the staff from 1981 to 2013. These core interviews are augmented by those from the Carter Presidential Library and other institutions. Other worthwhile records maintained by the OSD Historical Office are the Biographical, Chronological, and Subject Files, which include cables to and from Secretary of Defense Brown—not a complete collection, but a valuable one—and records on matters of concern to the Office of the Secretary of Defense, such as the Panama Canal Treaties, the All-Volunteer Force, and the Cuban refugee crisis. The Subject Files also contain the compilation of official DoD reports, press briefings, and other official communications as well as an extensive file of relevant newspaper articles assembled from 1977 through January 1981. Online collections of major newspapers from the Carter years supplement the OSD holdings.

Fifteen volumes of the Department of State's magisterial series *Foreign Relations of the United States* [FRUS] that cover the Carter administration were published in time for preparing this book. Two other useful official collections are the 29 edited volumes of the *Public Statements of Harold Brown, Secretary of Defense*, a facsimile collection prepared by the OSD Historical Office, and the 9 volumes of the *Public*

*Papers of the Presidents: Jimmy Carter*, containing a selection of his key speeches, press conferences, and statements. Finally of note is the Department of State's *Basic Documents, 1977–1980*, a collection of unclassified papers relevant to foreign policy. Two published secondary sources by Steven Rearden were invaluable: *The Joint Chiefs of Staff and National Policy, 1977–1980* (2015, with Kenneth Foulkes), based on his 2002 classified history; and the comprehensive *Council of War: The History of the Joint Chiefs of Staff, 1942–1991* (2012), with a chapter on the Carter years.

As anyone who has done primary research knows, the Internet has become a powerful research tool. Online collections are easy to use and growing in scope and importance, but they are not yet a substitute for research in the relevant paper collections at key depositories. Of special mention among the Internet sources are the Declassified Documents Reference System, containing many key declassified documents from the Carter White House, and the equally important Digital National Security Archive, with declassified records from the White House and other executive agencies like State and Defense.

## Manuscript Collections

Jimmy Carter Presidential Library and Museum, Atlanta, GA

Brzezinski Donated Material

Geographic File

Subject File

Daily Diary of President Jimmy Carter (including backup material)

National Security Affairs

Brzezinski Material

Agency File

Brzezinski Office File

Country File

General Odom File

Meetings File

Subject File

Trip File

Staff File

Defense Security, Ermarth File

Office

National Security Council Institutional Files, 1977–1981

National Security Council Meetings

## President's Files

Plains Files

Staff Secretary's File

## White House Central Files: Executive

Subject File

## Library of Congress, Manuscript Division, Washington, DC

## Harold Brown Papers

Unprocessed collection containing office and personal files of Harold Brown as well as files of his special assistant for NATO affairs, Robert Komer (later under secretary for policy); his principal deputy assistant secretary of defense for international security affairs with special responsibility for SALT II, Walter Slocombe (later deputy secretary of defense for policy); and Special Assistant John Kester.

## National Archives and Records Administration (NARA) II, College Park, MD

Records of the U.S. Joint Chiefs of Staff, Record Group 218, Office of the Chairman of the Joint Chiefs of Staff

Official Records of Chairman General George Brown

Official Records of Chairman General David Jones

## Office of the Secretary of Defense, Historical Office, Washington, DC

Biographical Files

Chronological Files

Oral History Collection

Subject Files

## Washington National Records Center, Suitland, MD

Official Records of Secretary of Defense Harold Brown and his Principal Assistants, Record Group 330

**Executive Branch Documents and Reports**

Brown, General George S., USAF, Chairman of the Joint Chiefs. *United States Military Posture for FY 1978*. 20 January 1977.

Carter, Jimmy. *Public Papers of the Presidents of the United States: Jimmy Carter, 1977*. Books 1–2. Washington, DC: Government Printing Office, 1977, 1978.

———. *Public Papers of the Presidents of the United States: Jimmy Carter, 1978*. Books 1–2. Washington, DC: Government Printing Office, 1979.

———. *Public Papers of the Presidents of the United States: Jimmy Carter, 1979*. Books 1–2. Washington, DC: Government Printing Office, 1980, 1981.

- . *Public Papers of the Presidents of the United States: Jimmy Carter, 1980–1981*. Books 1–3. Washington, DC: Government Printing Office, 1981, 1982, and 1982 respectively.
- Cole, Alice C., Arthur Goldberg, Samuel A. Tucker, and Rudolph A. Winnaker, eds. *The Department of Defense: Documents on Establishment and Organization, 1944–1978*. Washington, DC: OSD Historical Office, 1978.
- Ford, Gerald R. *Public Papers of the Presidents of the United States: Gerald R. Ford*. Book 3. Washington, DC: Government Printing Office, 1979.
- Ignatius, Paul R. *Department Headquarters Study: A Report to the Secretary of Defense*. DoD Reorganization Study Project, 1 June 1978.
- Office of the Secretary of Defense. Historical Office, comp. *Department of Defense Key Officials, 1947–2004*. Washington, DC: OSD Historical Office, 2004.
- . *Public Papers of Harold Brown, Secretary of Defense, 1977–1981*. 29 vols. Washington, DC: OSD Historical Office, n.d.
- Presidential Recommendations for Selective Service Reform*. Report to Congress Prepared Pursuant to P.L. 96-107. 11 February 1980. White House Central Files: Executive, Carter Presidential Library.
- President's Reorganization Project [coordinator Gregory Schneiders]. *Federal Preparedness and Response to Disasters*. N.d. Subject Files, Organization of DoD, OSD Historical Office.
- President's Reorganization Project [coordinator Philip Odeen]. *National Security Policy Integration*. September 1979. Subject Files, Organization of DoD, OSD Historical Office.
- Rice, Donald B. *Defense Resource Management Study: Final Report*. Washington, DC: Government Printing Office, 1979.
- Steadman, Richard C. *Report to the Secretary of Defense on the National Military Command Structure*. July 1978. Subject Files, Organization of DoD, OSD Historical Office.
- Trask, Roger R., and John P. Glennon, eds. *The Department of Defense: Documents on Establishment and Organization, 1978–2003*. Washington, DC: OSD Historical Office, 2008.
- U.S. Department of Defense. *America's Volunteers: A Report on the All-Volunteer Armed Forces*. Office of the Assistant Secretary of Defense (Manpower, Reserve Affairs and Logistics). 31 December 1978.
- . *Annual Report for Fiscal Year 1978 by Secretary of Defense Donald H. Rumsfeld*. 1977.
- . *Annual Report for Fiscal Year 1980 by Secretary of Defense Harold Brown*. 1979.
- . *Program Acquisition Costs by Weapons System, Department of Defense Budget for Fiscal Year 1978*.
- . *Program Acquisition Costs by Weapons System, Department of Defense Budget for Fiscal Year 1979*.
- . *Report of the Defense Review Committee for the Code of Conduct*. 1976.
- . *[Iran Hostage] Rescue Mission Report (Holloway Report, unclassified version)*. August 1980. [www.history.navy.mil/research/library/online-reading-room/title-list-alphabetically/i/iran-hostage-rescue-mission-report.html](http://www.history.navy.mil/research/library/online-reading-room/title-list-alphabetically/i/iran-hostage-rescue-mission-report.html).

- U.S. Department of State. *American Foreign Policy: Basic Documents, 1977–1980* (Washington, DC: Government Printing Office, 1983).
- . *Foreign Relations of the United States, 1969–1976*. E vol. 4, *Documents on Iran and Iraq, 1969–1972*, edited by Monica Belmonte. Washington, DC: 2006. [http://history.state.gov/historical documents/frus1969-76ve04](http://history.state.gov/historicaldocuments/frus1969-76ve04).
- . *Foreign Relations of the United States, 1969–1976*. E vol. 6, *Documents on Africa, 1973–1976*, edited by Laurie Van Hook and Peter Samson. Washington, DC: 2006. <http://history.state.gov/historical documents/frus1969-76ve06>.
- . *Foreign Relations of the United States, 1969–1976*. Vol. 17, *China, 1969–1972*, edited by Steven E. Phillips. Washington, DC: Government Printing Office, 2006.
- . *Foreign Relations of the United States, 1969–1976*. Vol. 18, *China, 1973–1976*, edited by David P. Nickles. Washington, DC, GPO, 2006.
- . *Foreign Relations of the United States, 1969–1976*. Vol. 26, *Arab-Israeli Dispute, 1974–1976*, edited by Adam M. Howard. Washington, DC: Government Printing Office, 2012.
- . *Foreign Relations of the United States, 1969–1976*. Vol. 28, *Southern Africa*, edited by Myra Burton. Washington, DC: Government Printing Office, 2011.
- . *Foreign Relations of the United States, 1969–1976*. Vol. 33, *SALT II, 1972–1980*, edited by Erin R. Mahan. Washington, DC: Government Printing Office, 2013.
- . *Foreign Relations of the United States, 1969–1976*. Vol. 34, *National Security Policy, 1969–1972*, edited by M. Todd Bennett. Washington, DC: Government Printing Office, 2011.
- . *Foreign Relations of the United States, 1969–1976*. Vol. 35, *National Security Policy*, edited by M. Todd Bennett. Washington, DC: Government Printing Office, 2014.
- . *Foreign Relations of the United States, 1973–1976*. Vol. 37, *Iran and Iraq, 1973–1976*, edited by Monica Belmont (Washington, DC: Government Printing Office, 2012).
- . *Foreign Relations of the United States, 1977–1980*. Vol. 2, *Human Rights and Humanitarian Affairs*, edited by Kristin Ahlberg. Washington, DC: Government Printing Office, 2013.
- . *Foreign Relations of the United States, 1977–1980*. Vol. 6, *Soviet Union*, edited by Melissa Jane Taylor. Washington, DC: Government Printing Office, 2013.
- . *Foreign Relations of the United States, 1977–1980*. Vol. 8, *Arab-Israeli Dispute, January 1977–August 1978*, edited by Adam M. Howard. Washington, DC: Government Printing Office, 2013.
- . *Foreign Relations of the United States, 1977–1980*. Vol. 9, *Arab-Israeli Dispute, August 1978–December 1980*, edited by Alexander R. Wieland. Washington, DC: Government Printing Office, 2014.
- . *Foreign Relations of the United States, 1977–1980*. Vol. 13, *China*, edited by David P. Nickles. Washington, DC: Government Printing Office, 2013.

- . *Foreign Relations of the United States, 1977–1980*. Vol. 21, *Cyprus; Turkey; Greece, 1977–1980*, edited by David Zierler. Washington, DC: Government Printing Office, 2014.
- . *Principal Officers of the Department of State and United States Chiefs of Mission, 1778–1990*. Washington, DC: The Department, 1991.
- . *Travels of the Presidents*. Department of State Publication 9825, Office of the Historian, Bureau of Public Affairs. January 1991. [http://history.state.gov/department history/travel/president.carter-jimmy](http://history.state.gov/department%20history/travel/president.carter-jimmy).
- . *United States Government Statement on the Events in Kwanju, Republic of Korea, in May 1980*, Embassy Seoul Backgrounder, 19 June 1989. <http://seoul.usembassy.gov/backgrounder.html>.
- . *Visits by Foreign Leaders to the United States*. <http://history.state.gov/departmenthistory/visits>.
- White House Press Office. Office of Media Liaison. “U.S. Defense Policy for the 1980s.” 7 February 1980.

## Congressional Documents and Reports

### Hearings

- U.S. Congress. Joint Committee on Defense Production. *Civil Preparedness and Limited Nuclear War: Hearings*. 94th Cong., 2nd sess., 28 April 1976
- U.S. Congress. House of Representatives. Committee on Appropriations. Subcommittee on Defense. *Second Budget Rescission Bill for Fiscal Year 1977: Hearings*. 95th Cong., 1st sess., 17 February 1977.
- . Committee on Armed Services. *Hearings on H.R. 6582*. 96th Cong., 1st sess., 23 May 1977.
- . Committee on Armed Services. *National Defense Funding Levels for Fiscal Year 1981: Hearing*. 96th Cong., 2nd sess., 29 May 1980.
- . Committee on Armed Services. Subcommittee on Investigations. *Leaks of Classified National Security Information—Stealth Aircraft: Hearings*. 96th Cong., 2nd sess., 27 August; 4, 16 September; and 1 October 1980.
- . Committee on International Relations. U.S. House of Representatives. *Proposed Panama Canal Treaties: Hearings*. 95th Cong., 1st sess., 26 September 1977.
- . Committee on Merchant Marine and Fisheries. Subcommittee on Panama Canal. *Panama Gunrunning: Hearings*. 96th Cong., 1st sess., 6, 7 June; 10 July 1979.
- U.S. Congress. Senate. Committee on Appropriations. Subcommittee. *Department of Defense Appropriations for Fiscal Year 1977: Hearings*. 94th Cong., 2nd sess., 2 February 1976.
- . Committee on Appropriations. Subcommittee. *Department of Defense Appropriations for Fiscal Year 1978: Hearings*. 95th Cong., 1st sess., 31 January, 1 February 1977.
- . Committee on Armed Services. *Department of Defense Authorization for Fiscal Year 1979: Hearings*. 95th Cong., 2nd sess. 28 February; 7, 9, 14, 16, 21 March 1978.



- . Committee on Armed Services. *Fiscal Year 1978 Authorization for Military Procurement, Research and Development, and Active Duty, Selected Reserve and Civilian Personnel Strengths: Hearings*. 95th Cong., 1st sess., 25 January, 24 February 1977.
- . Committee on Armed Services. *NATO and the Soviet Threat, Report of Sen. Sam Nunn and Sen. Dewey F. Bartlett*. Washington, DC: Government Printing Office, 24 January 1977.
- . Committee on Armed Services. *Nominations of Harold Brown and Charles W. Duncan, Jr.: Hearing*. 95th Cong., 1st sess., 11 January 1977.
- . Committee on Foreign Relations. *Taiwan: Hearings*, 96th Cong., 1st sess. February 1979.

### Reports

- Congressional Budget Office. "Planning U.S. General Purpose Forces: The Tactical Air Forces," Budget Issue Paper. Washington, DC: U.S. Congress, January 1977.
- Henning, Charles A. *Military Retirement Reform: A Review of Proposals and Options for Congress*. Congressional Research Service, 17 November 2011.
- Library of Congress. Federal Research Division. *A Summary of Major Military Retirement Reform Proposals, 1976–2006*. November 2007.
- U.S. Congress. Senate. Committee on Armed Services. *NATO and the Soviet Threat, Report of Sen. Sam Nunn and Sen. Dewey F. Bartlett*. Washington, DC: Government Printing Office, 24 January 1977.

### Interviews

Jimmy Carter Presidential Library and Museum, Atlanta, GA

- Brzezinski, Zbigniew, Interview by Marie Allen. Washington, DC, 20 February 1981.  
[www.jimmycarterlibrary.gov/library/exitInt/exitBrzsk.pdf](http://www.jimmycarterlibrary.gov/library/exitInt/exitBrzsk.pdf).

John F. Kennedy Presidential Library, Boston MA

- Carter, Jimmy. Interview by Brian Williams. "Vietnam and the Presidency." Boston, MA, 28 January 2004. [www.jfklibrary.org/JFK+library+and+Museum/Vietnam and+the+President.htm](http://www.jfklibrary.org/JFK+library+and+Museum/Vietnam+and+the+President.htm).

Miller Center, University of Virginia, Charlottesville, VA

- Carter, Jimmy. Interview by Charles O. Jones, H. Clifton McCleskey, Kenneth W. Thompson, James Sterling, Richard Neustadt, David B. Truman, Richard F. Fenno Jr., and Erwin C. Hargrove. Plains, GA, 29 November 1982. [http://webstorage3.mcpa.virginia.edu/poh/transcripts/ohp\\_1982\\_1129\\_carter.pdf](http://webstorage3.mcpa.virginia.edu/poh/transcripts/ohp_1982_1129_carter.pdf).
- Brzezinski, Zbigniew, with Madeleine Albright, Madeleine, Leslie G. Denend, and William Odom. Interview by Inis Claude, Charles Jones, Robert Strong, Kenneth Thompson, James W. Sterling, Ewin Hargrove, Richard C. Melanson, Robert Pranger, and David B. Truman. [Charlottesville, VA] 18 February 1982. [http://webstorage3.mcpa.virginia.edu/poh/transcripts/ohp\\_1982\\_00218\\_brzezinski.pdf](http://webstorage3.mcpa.virginia.edu/poh/transcripts/ohp_1982_00218_brzezinski.pdf).

## Office of the Secretary of Defense Historical Office, Washington, DC

- Brown, Harold. Interview by Alfred Goldberg and Roger Trask. Washington, DC, 4 December 1981.
- . Interview by Alfred Goldberg and Maurice Matloff. Washington, DC, 28 February 1992.
- . Interview by Alfred Goldberg and Maurice Matloff. Washington, DC, 8 October 1992.
- . Interview by Alfred Goldberg and Ronald Landa. Washington, DC, 1 March 1993.
- . Interview by Alfred Goldberg and Ronald Landa. Washington, DC, 4 March 1994.
- . Interview by Alfred Goldberg and Ronald Landa. Washington, DC, 1 March 2003.
- . Interview by Edward C. Keefer and Erin R. Mahan. Washington, DC, 11 February 2011.
- . Interview by Edward C. Keefer. Washington, DC, 1 October 2012.
- Brzezinski, Zbigniew. Interview by Alfred Goldberg and Maurice Matloff. Washington, DC, 6 Oct 1986.
- . Interview by Roger Trask and Maurice Matloff. Washington, DC, 25 February 1987.
- Carter, Jimmy. Interview by Alfred Goldberg and Maurice Matloff. Atlanta, GA, 12 March 1986.
- Claytor, W. Graham, Jr. Interview by Alfred Goldberg and Roger Trask. Washington, DC, 8 January 1981.
- Cooke, David O. Interview by Alfred Goldberg and Maurice Matloff. Washington, DC, 20 December 1989.
- Duncan, Charles W. Interview by Alfred Goldberg and Roger Trask. Houston, TX, 17 May 1996.
- Haig, General Alexander M., Jr. Interview by Alfred Goldberg and Ronald Landa. Washington, DC, 2 May 1996.
- Jones, General David C. Interview by Alfred Goldberg and Maurice Matloff. Arlington, VA, 26 August 1987.
- . Interview by Alfred Goldberg and Maurice Matloff. Arlington, VA, 21 October 1987.
- Kester, John G. Interview by Alfred Goldberg and Roger Trask. Washington, DC, 14 April 1998.
- . Interview by Alfred Goldberg and Roger Trask. Washington, DC, 15 April 1998.
- Komer, Robert W. Interview by Alfred Goldberg, Roger Trask, and Stuart Rochester. Washington, DC, 25 March 1981.
- Mark, Hans. Interview by Alfred Goldberg and Ronald Landa. Washington, DC, 4 August 1999.
- Marshall, Andrew W. Interview by Alfred Goldberg and Maurice Matloff. Washington, DC, 15 June 1992.

- . Interview by Alfred Goldberg and Maurice Matloff. Washington, DC, 29 Jun 1992.
- McGiffert, David E. Interview by Alfred Goldberg and Roger Trask. Washington, DC, 30 Apr 1998.
- Murray, Russell II. Interview by Alfred Goldberg and Roger Trask, Washington, DC, 23 July 1998.
- Perry, William J. Interview by Alfred Goldberg, Roger Trask, and Stuart Rochester. Washington, DC, 17 December 1980.
- . Interview by Alfred Goldberg, Roger Trask, and Stuart Rochester. Washington, DC, 9 January 1981.
- . Interview by Alfred Goldberg and Rebecca Welch. Washington, DC, 18 October 2004.
- . Interview by Edward Keefer and Phillip Shiman. Washington, DC, 21 June 2012.
- Powell, General Colin L. Interview by Alfred Goldberg and Stuart Rochester. Arlington, VA, 11 February 1998.
- . Interview by Alfred Goldberg and Stuart Rochester. Arlington, VA, 26 August 1999.
- Slocombe, Walter B. Interview by Edward Keefer. Washington, DC, 7 February 2013.
- Vessey, General John W. Interview by Alfred Goldberg and Maurice Matloff. Washington, DC, 21 March 1990.
- York, Herbert F. Interview by Maurice Matloff. La Jolla CA, 31 December 1984.
- U.S. Army Center of Military History, Washington, DC
- Brown, Harold. Interview by Walter Poole and Walton Moody. Washington DC, 28 January 2004.

### Published Memoirs

- Beckwith, Col. Charlie A., USAF (Ret.), and Donald Knox. *Delta Force: The U.S. Counter-Terrorist Unit and the Iran Hostage Rescue Mission*. San Diego: Harcourt Brace Jovanovich, 1983.
- Brown, Harold, with Joyce Winslow. *Star Spangled Security: Applying Lessons Learned Over Six Decades Safeguarding America*. Washington, DC: Brookings Institution Press, 2012.
- Brzezinski, Zbigniew. *Power and Principle: Memoirs of the National Security Adviser, 1977–1981*. New York: Farrar, Straus and Giroux, 1983.
- Carter, Jimmy. *The Blood of Abraham: Insights into the Middle East*. Boston: Houghton Mifflin, 1985.
- . *An Hour Before Daylight: Memories of a Rural Boyhood*. New York: Simon & Schuster, 2001.
- . *Keeping Faith: Memoirs of a President*. Toronto: Bantam Books, 1982.

- . *White House Diary*. New York: Farrar, Straus and Giroux, 2010.
- . *Why Not the Best?* Nashville, TN: Broadman Press, 1975.
- Clifford, Clark, with Richard Holbrooke. *Counsel to the President: A Memoir*. New York: Random House, 1991.
- Dayan, Moshe. *Breakthrough: A Personal Account of the Egypt-Israel Peace Negotiations*. London: Weidenfeld and Nicolson, 1981.
- Gates, Robert M. *From the Shadows: The Ultimate Insider's Story of Five Presidents and How They Won the Cold War*. New York: Simon & Shuster, 1996.
- Gleysteen, William H., Jr. *Massive Entanglement, Marginal Influence: Carter and Korea in Crisis*. Washington, DC: Brookings Institution Press, 1999.
- Haig, Alexander M., Jr. *Caveat: Realism, Reagan, and Foreign Policy*. New York: Macmillan, 1984.
- , with Charles McGarry. *Inner Circles: How America Changed the World, A Memoir*. New York: Warner Books, 1992.
- Huyser, General Robert E., USAF (Ret.). *Mission to Tehran*. New York: Harper & Row Publishers, 1986.
- Jordan, Hamilton. *Crisis: The Last Year of the Carter Presidency*. New York: G. P. Putnam's Sons, 1982.
- Jorden, William J. *Panama Odyssey*. Austin: University of Texas Press, 1984.
- Kamel, Mohamed Ibrahim. *The Camp David Accords: A Testimony*. London: Kegan Paul International, 1986.
- Kyle, Col. James H., USAF (Ret.), with John R. Eidson. *The Guts to Try: The Untold Story of the Iran Hostage Mission by the On-Scene Desert Commander*. New York: Orion Books, 1990.
- Linowitz, Sol M. *The Making of a Public Man: A Memoir*. Boston and Toronto: Little, Brown, 1985.
- Mark, Hans. *The Space Station: A Personal Journey*. Durham, NC: Duke University Press, 1987.
- Mendez, Antonio, and Matt Baglio. *Argo: How Hollywood Pulled Off the Most Audacious Rescue in History*. New York: Penguin Books, 2013.
- Nitze, Paul H., with Ann M. Smith and Steven L. Rearden. *From Hiroshima to Glasnost: At the Center of Decision, A Memoir*. New York: Grove Weidenfeld, 1989.
- Odom, William, "The Origins and Design of Presidential Decision-59: A Memoir." In *Getting Mad: Nuclear Mutual Assured Destruction, Its Origins and Practice*, edited by Henry D. Sokolski. Carlisle, PA: Strategic Studies Institute, November 2004. [www.strategicstudiesinsitute.army.mil/pdf/files/pub585.pdf](http://www.strategicstudiesinsitute.army.mil/pdf/files/pub585.pdf).
- Perry, William J. *My Journey at the Nuclear Brink*. Stanford, CA: Stanford Security Studies, Imprint of Stanford University Press, 2015.
- Powell, Colin L., with Joseph E. Perisco. *My American Journey*. New York: Random House, 1995.

- Powell, Jody. *The Other Side of the Story*. New York: William Morrow, 1984.
- Rich, Ben R., and Leo Janos. *Skunk Works: A Personal Memoir of My Years at Lockheed*. Boston: Little, Brown, 1994.
- Schmidt, Helmut. *Men and Powers: A Political Retrospective*. Translated by Ruth Hein. New York: Random House, 1989.
- Richard Secord, with Jay Wurts. *Honored and Betrayed: Irangate, Covert Affairs, and the Secret War in Laos*. New York: John Wiley & Sons, 1992.
- Singlaub, Maj. Gen. John K., U.S. Army (Ret.), with Malcolm McConnell. *Hazardous Duty: An American Soldier in the Twentieth Century*. New York: Summit Books, 1991.
- Somoza, Anastasio. *Nicaragua Betrayed*. As told to Jack Cox. Boston: Western Island Publishers, 1980.
- Stubbing, Richard A., with Richard A. Mendel. *The Defense Game: An Insider Explores the Astonishing Realities of America's Defense Establishment*. New York: Harper & Row, 1986.
- Sullivan, William H. *Mission to Iran*. New York: W. W. Norton, 1981.
- Turner, Admiral Stansfield, U.S. Navy (Ret.). *Burn Before Reading: Presidents, CIA Directors, and Secret Intelligence*. New York: Hyperion, 2005.
- . *Terrorism and Democracy*. Boston: Houghton Mifflin, 1991.
- Vance, Cyrus. *Hard Choices: Critical Years in America's Foreign Policy*. New York: Simon & Schuster, 1983.
- Weinberger, Caspar W. *Fighting for Peace: Seven Critical Years in the Pentagon*. New York: Warner Books, 1990.
- , with Gretchen Roberts. *In the Arena: A Memoir of the 20th Century*. Washington, DC: Regnery Publishing, 2001.
- Weizman, Ezer. *The Battle for Peace*. Toronto: Bantam Books, 1981.
- Wickham, John A. *Korea on the Brink: From the "12/12 Incident" to the Kwangju Uprising, 1979–1980*. Washington, DC: National Defense University Press, 1999.
- York, Herbert F. *Making Weapons, Talking Peace: A Physicist's Odyssey from Hiroshima to Geneva*. New York: Basic Books, 1987.

## Other Documentary Collections and Reports

- Belgian House of Representatives. *Parliamentary Inquiry on the Circumstances of the Assassination of Patrice Lumumba and on the Possible Involvement of Belgian Politicians*. Report of the Commission of Inquiry, 16 November 2001.
- Burr, William. *Jimmy Carter's Controversial Nuclear Targeting Directive PD-59 Declassified*. National Security Archive Electronic Briefing Book No. 390, 14 September 2012. [www.gwu.edu/~nsarchiv/nukevault/ebb309](http://www.gwu.edu/~nsarchiv/nukevault/ebb309).
- Fukuyama, Francis. "The Future of the Soviet Role in Afghanistan: A Trip Report." RAND Note N-1579-RC, September 1980. Digital National Security Library, item no. AF10442.

- Larsen, Jeffrey A. "The Future of U.S. Non-Strategic Nuclear Weapons and Implications for NATO: Drifting Toward the Foreseeable Future. NATO Public Policy Division, 31 October 2006.
- Van Atta, Richard H., Alethia Cook, Ivars Gutmanis, Michael J. Lippitz, Jasper Lupo, Rob Mahoney, and Jack H. Nunn. *Transformation and Transition: DARPA's Role in Fostering an Emerging Revolution in Military Affairs*. Vol. 2, *Detailed Assessments*. IDA Paper P-3698. Alexandria, VA: Institute for Defense Analyses, November 2003.
- Van Atta, Richard H., Michael J. Lippitz, Jasper C. Lupo, Rob Mahoney, and Jack H. Nunn. *Transformation and Transition: DARPA's Role in Fostering an Emerging Revolution in Military Affairs*. Vol. 1, *Overall Assessment*. IDA Paper P-3698. Alexandria, VA: Institute for Defense Analyses, April 2003.
- Van Atta, Richard H., Sidney Reed, and Seymour J. Deitchman. *DARPA Technical Accomplishments*. Vol. 2, *An Historical Review of Selected Projects*. IDA Paper P-2429. Alexandria, VA: Institute for Defense Analyses, April 1991.

## Books

- Abernnathy, M. Glenn, Dilys M. Hill, and Phil Williams, eds. *The Carter Years: The President and Policy Making*. New York: St. Martin's Press, 1984.
- Acharya, Amitav. *U.S. Military Strategy in the Gulf*. London: Routledge, 1989.
- Arms Control Association. *Arms Control and National Security: An Introduction*. Washington, DC: Arms Control Association, 1989.
- Aronstein, David C., and Albert C. Piccirillo. *Have Blue and the F-117A: Evolution of the "Stealth Fighter."* Reston, VA: American Institute of Aeronautics and Astronautics, 1997.
- Atkinson, Rick. *Crusade: The Untold Story of the Gulf War*. Boston: Houghton Mifflin Company, 1993.
- Auten, Brian J. *Carter's Conversion: The Hardening of American Defense Policy*. Columbia, MO: University of Missouri Press, 2008.
- Bailey, Beth. *America's Army: Making the All-Volunteer Force*. Cambridge, MA: Belknap Press of Harvard University Press, 2009.
- Balmer, Randall. *Redeemer: The Life of Jimmy Carter*. New York: Basic Books, 2014.
- Barrett, Archie D. *Reappraising Defense Organization: An Analysis Based on the Defense Organization Study of 1977-1980*. Washington, DC: National Defense University Press, 1983.
- Berry, William E., Jr. *U.S. Bases in the Philippines: The Evolution of a Special Relationship*. Boulder, CO: Westview Press, 1989.
- Betts, Richard K. *Cruise Missiles and U.S. Policy*. Washington, DC: Brookings Institution, 1982.
- , ed. *Cruise Missiles: Technology, Strategy, Politics*. Washington, DC: Brookings Institution, 1981.
- Bill, James A. *The Eagle and the Lion: The Tragedy of American-Iranian Relations*. New Haven, CT: Yale University Press, 1988.

- Binkin, Martin, and Jeffrey Record. *Where Does the Marine Corps Go From Here?* Washington, DC: Brookings Institution, 1976.
- Bowden, Mark. *Guests of the Ayatollah: The First Battle in America's War with Militant Islam.* New York: Atlantic Monthly Press, 2006.
- Brown, Harold. *Thinking about National Security: Defense and Foreign Policy in a Dangerous World.* Boulder, CO: Westview Press, 1983.
- , ed. *Toward Consensus in Foreign Policy & Defense Policy.* Washington, DC: The Johns Hopkins Foreign Policy Institute, [1989].
- Brown, Harold, and Lynn E. Davis. *Nuclear Arms Control Choices.* SAIS Papers in International Affairs 5. Boulder, CO: Westview Press, 1984.
- Burke, S. M., and Lawrence Ziring. *Pakistan's Foreign Policy: An Historical Analysis.* 2nd ed. Karachi: Oxford University Press, 1990.
- Caldwell, Dan. *The Dynamics of Domestic Politics and Arms Control: The SALT II Treaty Ratification Debate.* Columbia: University of South Carolina Press, 1991.
- Charlton, Michael. *From Deterrence to Defence: The Inside Story of Strategic Policy.* Cambridge, MA: Harvard University Press, 1987.
- Cohen, Sam. *The Truth About the Neutron Bomb: The Inventor of the Bomb Speaks Out.* New York: William Morrow, 1983.
- Colodny, Len, and Tom Shachtman. *The Forty Years War: The Rise and Fall of the Neocons from Nixon to Obama.* New York: Harper Perennial, 2009.
- Congressional Quarterly Almanac, 1977*, vol. 33. Washington, DC: Congressional Quarterly, 1977.
- , 1978, vol. 34. Washington, DC: Congressional Quarterly, 1979.
- , 1979, vol. 35. Washington, DC: Congressional Quarterly, 1980.
- , 1980, vol. 36. Washington, DC: Congressional Quarterly, 1981.
- , 1981, vol. 37. Washington, DC: Congressional Quarterly, 1982.
- Coll, Steve. *Ghost Wars: The Secret History of the CIA, Afghanistan, and Bin Laden from the Soviet Invasion to September 10, 2001.* New York: Penguin Press, 2004.
- Coulombis, Theodore A. *The United States, Greece, and Turkey: The Troubled Triangle.* New York: Praeger, 1983.
- Crile, George. *Charlie Wilson's War: The Extraordinary Story of How the Wildest Man in Congress and a Rogue CIA Agent Changed the History of Our Times.* New York: Grove Press, 2003.
- Crist, David. *The Twilight War: The Secret History of America's Thirty-Year Conflict with Iran.* New York: Penguin Press, 2012.
- Damis, John. *Conflict in Northwest Africa: The Western Sahara Dispute.* Stanford, CA: Hoover Institution Press, 1983.
- Davis, Lynn E. *Limited Nuclear Options: Deterrence and the New American Doctrine.* Adelphi Paper 121. London: International Institute for Strategic Studies, 1976.

- Davis, Vernon E. *The Long Road Home: U.S. Prisoner of War Policy and Planning in Southeast Asia*. Washington, DC: OSD Historical Office, 2000.
- DeRoche, Andrew. *Black, White, and Chrome: The United States and Zimbabwe, 1953–1998*. Trenton, NJ: Africa World Press, 2001.
- Destler, I. M., Leslie H. Gelb, and Anthony Lake. *Our Own Worst Enemy: The Unmaking of American Foreign Policy*. New York: Simon & Schuster, 1984.
- Dick, Steven J., and Roger D. Launius, eds. *Critical Issues in the History of Spaceflight*. Washington, DC: National Aeronautics and Space Administration, Office of External Relations, History Division, 2006.
- Downen, Robert L. *The Tattered China Card: Reality or Illusion in United States Strategy?* Washington, DC: Council for Social and Economic Studies, 1984.
- Drea, Edward J. *McNamara, Clifford, and the Burdens of Vietnam, 1965–1969*. Washington, DC: OSD Historical Office, 2011.
- Drea, Edward J., Ronald H. Cole, Walter S. Poole, James F. Schnabel, Robert J. Watson, and Willard J. Webb. *History of the Unified Command Plan, 1946–2012*. Washington, DC: Joint History Staff, Office of the Chairman of the Joint Chiefs of Staff, 2013.
- Dreyer, Ronald. *Namibia and Southern Africa: Regional Dynamics of Decolonization, 1945–90*. London: Kegan Paul International, 1994.
- Duffield, John S. *Power Rules: The Evolution of NATO's Conventional Force Posture*. Stanford, CA: Stanford University Press, 1995.
- Edwards, John. *Superweapon: The Making of the MX*. New York: W. W. Norton, 1982.
- Ekwe-Ekwe, Herbert. *Conflict and Intervention in Africa: Nigeria, Angola, Zaire*. New York: St. Martin's Press, 1990.
- Fallows, James. *National Defense*. New York: Random House, 1981.
- Farber, David. *Taken Hostage: The Iran Hostage Crisis and America's First Encounter with Radical Islam*. Princeton, NJ: Princeton University Press, 2005.
- Farrell, Theo. *Weapons without a Cause: The Politics of Weapons Acquisition in the United States*. New York: St. Martin's Press, 1997.
- Fischer, Sabrina Ann. *Namibia Becomes Independent: The U.S. Contribution to Regional Peace*. Zurich: Forschungsstelle für Sicherheitspolitik und Konfliktanalyse, 1992.
- Foreign Policy Research Institute Staff. *The Three Per Cent Solution and the Future of NATO*. Philadelphia, PA: Foreign Policy Research Institute, 1981.
- Fox, J. Ronald. *Defense Acquisition Reform, 1960–2009: An Elusive Goal*. Washington, DC: U.S. Army Center of Military History, 2010.
- Fredland, J. Eric, Curtis L. Gilroy, Roger D. Little, and W. S. Sellman, eds. *Professionals on the Front Line: Two Decades of the All-Volunteer Force*. Washington, DC: Brassey's, 1996.
- Gati, Charles, ed. *Zbig: The Strategy and Statecraft of Zbigniew Brzezinski*. Baltimore: The Johns Hopkins University Press, 2013.



- Garthoff, Raymond L. *Détente and Confrontation: American-Soviet Relations from Nixon to Reagan*. 2nd ed. Washington, DC: Brookings Institution, 1994.
- . *The Great Transition: American-Soviet Relations and the End of the Cold War*. Washington, DC: Brookings Institution, 1994.
- Gavin, Francis J. *Gold, Dollars, & Power: The Politics of International Monetary Reform, 1958–1971*. Chapel Hill: University of North Carolina Press, 2004.
- Germond, Jack W., and Jules Witcover. *Blue Smoke and Mirrors: How Reagan Won and Why Carter Lost the Election of 1980*. New York: Viking Press, 1981.
- Glad, Betty. *An Outsider in the White House: Jimmy Carter, His Advisors, and the Making of American Foreign Policy*. Ithaca: Cornell University Press, 2009.
- . *Jimmy Carter: In Search of the Great White House*. New York: W. W. Norton, 1980.
- Gordon, Michael R., and General Bernard E. Trainor. *The Generals' War: The Inside Story of the Conflict in the Gulf*. Boston: Little, Brown, 1995.
- Hackett, Sir John, et al. *The Third World War, August 1985: A Future History*. New York: Macmillan, 1978.
- Haines, Gerald K., and Robert E. Leggett, eds. *Watching the Bear: Essays in CIA's Analysis of the Soviet Union*. Washington, DC: Center for the Study of Intelligence, 2001. [www.cia.gov/library/center-for-the-study-of-intelligence/csi-publications/books-and-monographs/watching-the-bear-essays-on-cia-analysis-of-the-Soviet-Union/index.html](http://www.cia.gov/library/center-for-the-study-of-intelligence/csi-publications/books-and-monographs/watching-the-bear-essays-on-cia-analysis-of-the-Soviet-Union/index.html).
- Harris, David. *The Crisis: The President, the Prophet, and the Shah—1979 and the Coming of Militant Islam*. New York: Little, Brown, 2004.
- Haslam, Jonathan. *Russia's Cold War: From the October Revolution to the Fall of the Wall*. New Haven: Yale University Press, 2011.
- Haulman, Daniel L. *The United States Air Force and Humanitarian Airlift Operations, 1947–1994*. Washington, DC: Air Force History and Museum Program, 1998.
- Hempstead, Colin A., and William E. Worthington, eds. *Encyclopedia of 20th-Century Technology*. New York: Routledge, 2004.
- Heppenheimer, T. A. *History of the Space Shuttle*. Vol. 2, *Development of the Shuttle, 1972–1981*. Washington, DC: Smithsonian Institution Press, 2002.
- Hersh, Seymour M. *The Samson Option: Israel's Nuclear Arsenal and American Foreign Policy*. New York: Random House, 1991.
- Hogan, J. Michael. *The Panama Canal in American Politics: Domestic Advocacy and Evolution of Policy*. Carbondale, IL: South Illinois University Press, 1986.
- Holland, Lauren H., and Robert A. Hoover. *The MX Decision: A New Direction in U.S. Weapons Procurement Policy?* Boulder, CO: Westview Press, 1985.
- Holm, Maj. Gen. Jeanne, USAF (Ret.). *Women in the Military: An Unfinished Revolution*. Rev. ed. Novato, CA: Presidio Press, 1993.
- Huisken, Ronald. *The Origin of the Strategic Cruise Missile*. New York: Praeger Scientific, 1981.

- Hunt, Richard A. *Melvin Laird and the Foundation of the Post-Vietnam Military, 1969–1973*. Washington, DC: OSD Historical Office, 2015.
- Jabber, Paul, Gary Sick, Hisahiko Okazaki, and Dominique Moïsi. *Great Power Interests in the Persian Gulf*. New York: Council on Foreign Relations, 1989.
- Johnson, Maxwell O. *The Military as an Instrument of U.S. Policy in Southwest Asia: The Rapid Deployment Joint Task Force, 1979–1982*. Boulder, CO: Westview Press, 1983.
- Jones, Frank L. *Blowtorch: Robert Komer, Vietnam, and American Cold War Strategy*. Annapolis, MD: Naval Institute Press, 2013.
- Kaplan, Fred. *Wizards of Armageddon*. New York: Simon & Schuster, 1983.
- Kaplan, Lawrence S. *The Long Engagement: NATO's First Fifty Years*. Westport, CT: Praeger, 1999.
- . *NATO Divided, NATO United: The Evolution of an Alliance*. Westport, CT: Praeger, 2004.
- , Ronald D. Landa, and Edward J. Drea. *The McNamara Ascendancy, 1961–1965*. Washington, DC: OSD Historical Office, 2006.
- , Robert W. Clawson, and Raimondo Luraghi, eds. *NATO and the Mediterranean*. Wilmington, DE: Scholarly Resources Inc., 1985.
- Kaufman, Burton I. *The Presidency of James Earl Carter, Jr.* Lawrence: University Press of Kansas, 1993.
- Keliher, John G. *The Negotiations on Mutual and Balanced Force Reductions: The Search for Arms Control in Central Europe*. New York: Pergamon Press, 1980.
- Korn, David A. *Ethiopia and the United States and the Soviet Union*. Carbondale and Evansville IL: Southern Illinois University Press, 1986.
- Kotkin, Stephen. *Armageddon Averted: The Soviet Collapse, 1970–2000*. New York: Oxford University Press, 2001.
- Kotz, Nick. *Wild Blue Yonder: Money, Politics, and the B-1 Bomber*. New York: Pantheon Books, 1988.
- Krepinevich, Andrew, and Barry Watts. *The Last Warrior: Andrew Marshall and the Shaping of Modern American Defense Strategy*. New York: Basic Books, 2015.
- Krepon, Michael, and Dan Caldwell, eds. *The Politics of Arms Control Treaty Ratification*. New York: St. Martin's Press, 1991.
- LaFeber, Walter. *Inevitable Revolutions: The United States in Central America*. 2nd ed. New York: W. W. Norton, 1993.
- . *The Panama Canal: The Crisis in Historical Perspective*. Updated ed. New York: Oxford University Press, 1989.
- Lake, Anthony. *Somoza Falling*. Boston: Houghton Mifflin, 1989.
- Lake, Jon. *Jane's How to Fly and Fight in the F-117A Stealth Fighter*. London: Harper Collins Publishers, 1997.
- Ledeem, Michael, and William Lewis. *Debacle: The American Failure in Iran*. New York: Alfred Knopf, 1981.

- Lefebvre, Jeffrey A. *Arms for the Horn: U.S. Security Policy in Ethiopia and Somalia, 1953–1991*. Pittsburgh, PA: University of Pittsburgh Press, 1991.
- Leighton, Richard M. *Strategy, Money and the New Look, 1953–1956*. Washington, DC: OSD Historical Office, 2001.
- Lohbeck, Kurt. *Holy War, Unholy Victory: Eyewitness to the CIA's Secret War in Afghanistan*. Washington, DC: Regnery Gateway, 1993.
- Loth, Wilfried. *Overcoming the Cold War: A History of Détente, 1950–1991*. Translated by Robert F. Hogg. Basingstoke, UK: Palgrave Macmillan, 2002.
- MacLellan, David S. *Cyrus Vance*. Vol. 20 in *The American Secretaries of State and Their Diplomacy*. Totowa, NJ: Rowman & Allanheld, 1985.
- Matthews, James K., and Cora J. Holt. *So Many, So Much, So Far, So Fast: United States Transportation Command and Deployment for Operation Desert Shield/Desert Storm*. Washington, DC: Joint History Office, Office of the Chairman of the Joint Chiefs of Staff and Research Center, U.S. Transportation Command, 1996.
- Miller, Susan Gilson. *A History of Modern Morocco*. Cambridge: Cambridge University Press, 2013.
- Moens, Alexander. *Foreign Policy Under Carter: Testing Multiple Advocacy Decision Making*. Boulder: Westview Press, 1990.
- Moffet, George D., III. *The Limits of Victory: The Ratification of the Panama Canal Treaties*. Ithaca, NY: Cornell University Press, 1985.
- Montgomery, Tommie Sue. *Revolution in El Salvador: Origins and Evolution*. Boulder, CO: Westview Press, 1982.
- Morden, Bettie J. *The Women's Army Corps, 1945–1978*. Washington, DC: U.S. Army Center of Military History, 1990.
- Morrell, James B. *The Law of the Sea: A Historical Analysis of the 1982 Treaty and Its Rejection by the United States*. Jefferson, NC: McFarland, 1992.
- Muravchik, Joshua. *The Uncertain Crusade: Jimmy Carter and the Dilemmas of Human Rights Policy*. Washington, DC: American Enterprise Institute for Public Policy, 1986.
- Newsom, David D. *The Soviet Brigade in Cuba: A Study in Political Diplomacy*. Bloomington: Indiana University Press, 1987.
- Nolan, Janne E. *Guardians of the Arsenal: The Politics of Nuclear Strategy*. New York: Basic Books, 1989.
- O'Ballance, Edgar. *Afghan Wars 1839–1992: What Britain Gave Up and the Soviet Union Lost*. London: Brassey's, 1993.
- Oberdorfer, Don. *The Two Koreas: A Contemporary History*. Reading, MA: Addison-Wesley, 1997.
- Pastor, Robert A. *Condemned to Repetition: The United States and Nicaragua*. Princeton, NJ: Princeton University Press, 1987.
- . *Exiting the Whirlpool: U.S. Foreign Policy Toward Latin America and the Caribbean*,

- 2nd ed. Boulder, CO: Westview Press, 2001.
- Pennell, C. R. *Morocco Since 1830: A History*. New York: New York University Press, 2001.
- Perry, Mark. *Four Stars*. Boston: Houghton Mifflin, 1989.
- Poole, Walter S. *Adapting to Flexible Response, 1960–1968*. Vol. 2 of History of Acquisitions in the Department of Defense series. Washington, DC: OSD Historical Office, 2013.
- . *The Decline of Détente: Elliot Richardson, James Schlesinger, and Donald Rumsfeld 1973–1977*. Washington, DC: OSD Historical Office, 2015.
- . *The Joint Chiefs of Staff and National Policy, 1973–1976*. Washington, DC: Office of Joint History, Office of the Chairman of the Joint Chiefs of Staff, 2015.
- Porter, Bruce D. *The USSR in Third World Conflicts: Soviet Arms and Diplomacy in Local Wars, 1945–1980*. Cambridge: Cambridge University Press, 1984.
- Prados, John. *Keepers of the Keys: A History of the National Security Council from Truman to Bush*. New York: William Morrow, 1991.
- Pringle, Peter, and William Arkin. *SIOP: The Secret U.S. Plan for Nuclear War*. New York and London: W. W. Norton, 1983.
- Quandt, William B. *Camp David: Peacemaking and Politics*. Washington, DC: Brookings Institution Press, 1986.
- . *Peace Process: American Diplomacy in the Arab-Israeli Conflict Since 1967*, 3rd ed. Washington, DC: Brookings Institution Press; Berkley: University of California Press, 2005.
- . *Saudi Arabia in the 1980s: Foreign Policy, Security, and Oil*. Washington, DC: Brookings Institution, 1981.
- Rabe, Stephen G. *The Killing Zone: The United States Wages the Cold War in Latin America*. New York: Oxford University Press, 2011.
- Rearden, Steven L. *Council of War: A History of the Joint Chiefs of Staff, 1942–1991*. Washington, DC: National Defense University Press; Joint History Office, Office of the Director, Joint Staff, Joint Chiefs of Staff, 2012.
- . *The Formative Years, 1947–1950*. Washington, DC: OSD Historical Office, 1984.
- , with Kenneth R. Foulks Jr. *The Joint Chiefs of Staff and National Policy, 1977–1980*. Washington, DC: Office of Joint History, Office of the Chairman of the Joint Chiefs of Staff, 2015.
- Rochester, Stuart I., and Frederick Kiley. *Honor Bound: A History of American Prisoners of War in Southeast Asia, 1961–1973*. Washington, DC: OSD Historical Office, 1998.
- Rostker, Bernard. *I Want You! The Evolution of the All-Volunteer Force*. Santa Monica, CA: RAND Corporation, 2006.
- . *Sexual Orientation and U.S. Military Personnel Policy: Options and Assessment*. Santa Monica, CA: RAND Corporation, 1993.
- Rubenstein, Alvin Z., ed. *The Great Game: Rivalry in the Persian Gulf and South Asia*. New York: Praeger, 1983.

- Rubin, Barry. *Paved with Good Intentions: The American Experience in Iran*. New York: Oxford University Press, 1980.
- Ryan, Paul B. *The Iranian Rescue Mission: Why It Failed*. Annapolis, MD: Naval Institute Press, 1985.
- Sarkesian, Sam C., ed. *Defense Policy and the Presidency: Carter's First Years*. Boulder, CO: Westview Press, 1979.
- Schraeder, Peter J. *United States Foreign Policy Toward Africa: Incrementalism, Crisis and Change*. Cambridge: Cambridge University Press, 1994.
- Schroeder, Dietrich. *Science, Technology and the Nuclear Arms Race*. New York: John Wiley & Sons, 1984.
- Schubert, Frank N. *Building Air Bases in the Negev: The U.S. Army Corps of Engineers in Israel, 1979–1982*. Washington, DC: Office of History, Corps of Engineers and U.S. Army Center of Military History, 1992.
- Sick, Gary. *All Fall Down: America's Tragic Encounter with Iran*. New York: Random House, 1985.
- . *October Surprise: America's Hostages in Iran and the Election of Ronald Reagan*. New York: Times Book, Random House, 1991.
- Skidmore, David. *Reversing Course: Carter's Foreign Policy, Domestic Politics, and the Failure of Reform*. Nashville, TN: Vanderbilt University Press, 1996.
- Sloan, Stanley R. *NATO, the European Union, and the Atlantic Community*. Lanham, MD: Rowman & Littlefield, 2003.
- Smith, Gaddis. *Morality, Reason, and Power: American Diplomacy in the Carter Years*. New York: Hill and Wang, 1986.
- Smith, Wayne. *The Closest of Enemies: A Personal and Diplomatic Account of U.S.-Cuban Relations Since 1957*. New York: W. W. Norton, 1987.
- Sorrels, Charles A. *U.S. Cruise Missile Programs: Development, Deployment and Implications for Arms Control*. Oxford, UK: Brassey's, 1983.
- Stevenson, Charles A. *SECDEF: The Nearly Impossible Job of Secretary of Defense*. Washington, DC: Potomac Books, 2006.
- Strong, Robert A. *Working in the World: Jimmy Carter and the Making of American Foreign Policy*. Baton Rouge: Louisiana State University Press, 1993.
- Talbot, Strobe. *Endgame: The Inside Story of SALT II*. New York: Harper & Row, 1979.
- Tessmer, Arnold L. *Politics of Compromise: NATO and AWACS*. Washington, DC: National Defense University Press, 1988.
- Thompson, Kenneth W., ed. *The Carter Presidency: Fourteen Intimate Perspectives of Jimmy Carter*. Portraits of American Presidents. Lanham, MD: University Press of America, 1990.
- Thompson, Nicholas. *The Hawk and the Dove: Paul Nitze, George Kennan, and the History of the Cold War*. New York: Picador, 2009.

- Thornton, Richard C. *The Carter Years: Toward a New Global Order*. New York: Paragon House, 1991.
- Trask, Roger R., and Alfred Goldberg. *The Department of Defense, 1947–1991: Organization and Leaders*. Washington, DC: OSD Historical Office, 1997.
- Van Atta, Dale. *With Honor: Melvin Laird in War, Peace, and Politics*. Madison: University of Wisconsin Press, 2008.
- Walker, Martin. *The Cold War: A History*. 1st American edition. New York: Henry Holt, 1993.
- Watson, Robert J. *Into the Missile Age, 1956–1960*. Washington, DC: OSD Historical Office, 1997.
- Werrell, Kenneth P. *The Evolution of the Cruise Missile*. Maxwell Air Force Base, AL: Air University Press, 1985.
- Wright, Robert. *Our Man in Tehran: The True Story behind the Secret Mission to Save Six Americans during the Iran Hostage Crisis and the Foreign Ambassador Who Worked with the CIA to Bring Them Home*. New York: Other Press, 2011.
- Yates, Lawrence A. *The U.S. Intervention in Panama: Operation Just Cause, December 1989–January 1990*. Washington, DC: U.S. Army Center for Military History.
- Zakheim, Dov. *Flight of the Lavi: Inside a U.S.-Israeli Crisis*. London: Brassey's, 1996.
- Zubok, Vladislav M. *A Failed Empire: The Soviet Union in the Cold War from Stalin to Gorbachev*. Chapel Hill: University of North Carolina Press, 2007.

## Articles

- Acker, David. D. *Defense Acquisition Review Process: A History and an Evaluation*, abstract, 436–445. [www.dtc.mil/dtci/tr/fulltext/u2/p002822.pdf](http://www.dtc.mil/dtci/tr/fulltext/u2/p002822.pdf).
- Arms Control Association, “The Chemical Weapons Convention (CWC) at a Glance.” [www.armscontrol.org/factsheets/cwcglance](http://www.armscontrol.org/factsheets/cwcglance).
- Brown, Harold. “A Countervailing View: No, We Did Not Think We Could Win a Nuclear War.” *Foreign Policy/National Security*, 24 September 2012. [www.foreignpolicy.com/articles/2012/09/24/a\\_countervailing\\_view](http://www.foreignpolicy.com/articles/2012/09/24/a_countervailing_view).
- . “Economic and National Security.” *Orbis* 26, no. 2 (Summer 1982): 381–390.
- . “The Impact of the Energy Crisis on National Defense.” *Commanders Digest* 20, no. 10 (12 May 1977): 3–8.
- . “New Nuclear Realities.” *The Washington Quarterly* 31, no. 1 (Winter 2007–2008): 7–22.
- . “Transatlantic Security.” *The Washington Quarterly* (Autumn 1995): 77–81.
- . “The United States and Japan: High Tech is Foreign Policy.” *SAIS Review* (Summer/Fall 1989): 1–14.
- . “U.S. Security Policy in Southeast Asia: A Case Study in Complexity.” The John Hopkins Foreign Policy Institute, April 1981, 1–14.
- Behuncik, John G. “The Carter Defense Budget, FY 1979.” Heritage Foundation, 3 March 1978, 1–24. <http://hdl.handle.net/10207/8870>.

- Brinkely, Douglas. "The Rising Stock of Jimmy Carter: The 'Hands On' Legacy of Our Thirty-Ninth President," *Diplomatic History* 20, no. 4 (Fall 1996): 505–529.
- Brzezinski, Zbigniew. "Presidential Debate." *Foreign Policy* (March/April 2010). [www.foreignpolicy.com/articles/2010/2/22/presidential-debate](http://www.foreignpolicy.com/articles/2010/2/22/presidential-debate).
- Burr, William. "Nuclear Fight Club: What Would Jimmy Carter Do?" *Foreign Policy/National Security*, 27 September 2012. [www.foreignpolicy.com/articles/2012/09/27/nuclear\\_fight\\_club](http://www.foreignpolicy.com/articles/2012/09/27/nuclear_fight_club).
- Caldwell, Dan. "The SALT II Treaty." In *The Politics of Arms Control Treaty Ratification*, edited by Michael Krepon and Dan Caldwell, 279–353. New York: St. Martin's Press, 1991.
- Canan, James W. "Up From Nifty Nugget." *Air Force Magazine*, September 1983. [www.air-force-magazine.com/MagazineArchives/Pages/1983/September%201983](http://www.air-force-magazine.com/MagazineArchives/Pages/1983/September%201983).
- "Controversy Over the B-1 Bomber Program." *Congressional Digest* 55, no. 12 (December 1976): 289–314.
- Davis, Lynn E. "Limited Nuclear Option: Deterrence and the New American Doctrine." Adelphi Paper No. 121 (1976): 1–22.
- Department of Defense. "DoD's New Proposed Military Retirement Plan." *Command Policy, The Official Magazine of the Department of Defense* 2 (July 1979): 2–12.
- Derurenberg, Ruud. "Israeli Aircraft Industries (IAI) Lavi." *Jewish Virtual Library*. 1–13. [www.jewishvirtuallibrary.org/jsource/Society\\_&\\_Culture/lavi.html](http://www.jewishvirtuallibrary.org/jsource/Society_&_Culture/lavi.html).
- Draper, Frank D., and Pitsvada, Bernard T. "ZBB-Looking Back After Ten Years." *Public Administration Review* 41, no. 1 (January-February 1981): 76–83. [www.jstor.org/stable/975727](http://www.jstor.org/stable/975727).
- European Central Bank. "The 'Great Inflation': Lessons for Monetary Policy." *European Central Bank Bulletin*, May 2010, 99–110.
- Gates, Robert M. "Defense and Arms Control in the Carter Administration." *Studies in Intelligence* 41, no. 3 (1997): 37–51.
- Gray, Colin S., and Jeffrey G. Barlow. "Inexcusable Restraint: The Decline of American Military Power in the 1970s." *International Security* 10, no. 2 (Autumn 1985): 27–69. [www.jstor.org/stable/2538827](http://www.jstor.org/stable/2538827).
- Herman, Charles F. "Changing Course: When Governments Choose to Redirect Foreign Policy." *International Studies Quarterly* 34, no. 1 (March 1990): 3–2. [www.jstor.org/stable/2600403](http://www.jstor.org/stable/2600403).
- Jones, Frank L. "A Hollow Army' Reappraised: President Carter, Defense Budgets, and the Politics of Military Readiness." *The Letort Papers*. Carlisle, PA: U.S. Army War College, 2012, 1–65.
- Komer, Robert W. "NATO's Long Term Defence Programme: Origins and Objectives." *NATO Review* 3 (June 1978): 9–12.
- Korb, Lawrence J. "The Price of Preparedness: The FY 1978–1982 Defense Program." *AEI Defense Review* 3 (June 1977): 2–43.

- Kraar, Louis. "Why Defense Costs Are Headed Up." A Series of Eight Artcled Reprinted from *Fortune* (1977): 34–42.
- Lauth, Thomas P. "Zero-Base Budgeting in Georgia State Government: Myth and Reality." *Public Administration Review* 38, no. 5 (September-October 1978): 420–430. www.jstor.org/stable/975500.
- Leonard, William. "'Closing the Gap': The Euromissiles and President Carter's Nuclear Weapons Strategy for Western Europe (1977–1979)." Center for Strategic & International Studies, 1–20. <http://csis.org/publication/closing-gap-euromissiles-and-president-carters-nuclear-weapons-strategy>.
- Meade, Walter R. "The Carter Syndrome." *Foreign Policy* (January/February 2010). www.foreignpolicy.com/articles/2009/12/18/the\_carter\_syndrome.
- Mendez, Antonio J. "A Classic Case of Deception, CIA Goes Hollywood." *Studies in Intelligence* (Winter 1999–2000): 1–15. www.cia.gov/library/center-for-the-study-of-intelligence/csi-publication/csi-studies/winter99-00/art1.html.
- Moskos, Charles C., Jr. "Symposium: Race in the United States Military." *Armed Forces and Society* (Summer 1980): 586–593.
- Niksch, Larry A. "U.S. Troop Withdrawal from South Korea: Past Shortcomings and Future Prospects." *Asian Survey* 21, no. 3 (March 1981): 325–341. www.jstor.org/stable/2643728.
- Odeen, Philip A. "Organizing for National Security." *International Security* 5, no. 1 (Summer 1980): 111–129. www.jstor.org/stable/2538496.
- Perry, William J. "Desert Storm and Deterrence." *Foreign Affairs* 70, no. 4 (Fall 1991): 66–82.
- . "Perry on Precision Strike." *Air Force Magazine*, April 1997. www.airforce-magazine.com/MagazineArchive/Pages/1977/April%201997/0497perry.aspx.
- Schemmer, Benjamin. "Army Equipment Shortages Soar Faster Than Budget Is Going Up." *Armed Forces Journal* (May 1977): 25–27.
- Schmidt, Helmut. "The 1977 Alastair Buchan Memorial Lecture." *Survival* (January-February 1979): 2–10.
- Sherlekar, Virenda S., and Burton V. Dean. "An Evaluation of the Initial Year of Zero-Base Budgeting in the Federal Government." *Management Science* 26, no. 8 (August 1980): 750–772. www.jstor.org/stable/2630294.
- Stevens, Simon. "'From the Viewpoint of a Southern Governor': The Carter Administration and Apartheid, 1977–81." *Diplomatic History* 36, no. 5 (November 2012): 843–880.
- Thornton, Thomas P. "Between the Stools? U.S. Policy towards Pakistan during the Carter Administration." *Asian Survey* 22, no. 10 (October 1982): 959–977. www.jstor.org/stable/2643754.
- Turner, Stansfield. "The Stupidity of 'Intelligence' (The Real Story behind the Soviet Combat Brigade in Cuba)." *Washington Monthly*, February 1986, 29–32. www.thefreelibrary.com/The+stupidity+of+%22intelligence.%22+(the+real+story+behind+that+Soviet...a04118413.



- United Nations, Division for Ocean Affairs and Law of the Sea. "The United Nations Convention on Law of the Sea (A Historical Perspective)." [www.un.org/depts/los/convention\\_agreements/convention\\_historical\\_perspective.html](http://www.un.org/depts/los/convention_agreements/convention_historical_perspective.html).
- Van Wyk, Anna-Mart. "South Africa's Nuclear Programme and the Cold War." *History Compass* 8, no. 7 (July 2010): 562–572. <http://onlinelibrary.wiley.com/doi/10.1111/j.1478-0542.2010.00699.x/full>.
- Walker, Breck, " 'Friends, but Not Allies'—Cyrus Vance and Normalization of Relations with China." *Diplomatic History* 33, no. 4 (September 2009): 579–594.
- Weissman, Stephen R. "Opening the Secret Files on Lumumba's Murder." *Washington Post*, 21 July 2002. [www.africawithin.com/limumba/murder\\_of\\_lumumba.htm](http://www.africawithin.com/limumba/murder_of_lumumba.htm).
- White, John P. "The All-Volunteer Force Reassessed," *Commanders Digest* 20, no. 15 (1 September 1977): 3–12.
- Wood, Joe. "Persuading a President: Jimmy Carter and American Troops in Korea." *Studies in Intelligence* 40, no. 4 (1996): 97–113.

### Unpublished Papers

- Asner, Glen. "A Brief History of the Defense Budget Process." Washington, DC: OSD Historical Office, 2005.
- Office of the Secretary of Defense. Historical Office. "The Department of Defense and the Congressional Budget Process." Washington, DC: February 1985.



## INDEX

*Italicized page numbers indicate illustrations, maps, and tables.*

- A-4 Skyhawk attack aircraft, 231, 236, 251, 274
- A-6E Intruder bomber, 367, 367, 475
- A-7E Corsair attack aircraft: FY 1978  
Defense budget and, 35, 36, 38, 44, 45, 48;  
FY 1979 Budget and, 223, 235
- A-10 Thunderbolt attack aircraft, 33, 231,  
367, 367, 387
- Aaron, David L., 25, 54–55, 97, 131, 135, 150,  
200, 304, 361, 396, 471
- Abdullah, Col. Fahad bin, 280
- Abramowitz, Morton I., 386, 413
- Addabbo, Joseph P., 46
- advanced attack helicopter (AAH), 36, 39,  
40, 45
- Advanced Logistics System, 37
- Advanced Research Projects Agency Net-  
work (ARPANET), 590, 594
- Aegis antiaircraft and antimissile system,  
556–557; cruiser, 32, 37–38, 42, 44, 45, 221,  
222, 231, 236, 238, 551; destroyer, 38, 42,  
45, 234, 367
- Afghanistan: Soviet invasion of, 79, 168–169,  
213, 279, 280, 302, 319, 321–327, 349, 378,  
401, 431, 447, 523–526, 541, 542, 556, 557,  
599, 625; U.S. policy and, 322–327
- AFL-CIO, 12
- Africa, 477–502: Soviet Union, Cuba and,  
489–491, 541; Horn of, 481–484, 481,  
486–489, 491–494, 501–502
- African Americans, 7–8, 20, 505, 511, 513,  
519–522, 539
- AGM-86B air-launched cruise missile (Boe-  
ing), 592, 593
- AGM-109 Tomahawk air-launched cruise  
missile (General Dynamics), 53, 591–592,  
593. *See* Tomahawk air-launched cruise  
missile (TALCM)
- Agousti, General Orlando Ramon, 79
- AH-1S Cobra attack helicopter, 254–255,  
257, 499–501, 500
- Airborne Warning and Control System  
(AWACS), 278; foreign military sales and,  
201; FY 1978 Defense budget and, 36, 37,  
39, 43; FY 1979 Defense budget and, 245;  
FY 1980 Defense budget and, 336; FY  
1981 Defense budget and, 553; Iran and,  
286–288, 290, 299; NATO and, 434–438;  
Persian Gulf and, 360; Saudi Arabia and,  
276, 278, 280–282; South Korea and,  
384–385, 391. *See also* E-3/E-3A Sentry  
(AWACS) aircraft
- aircraft carriers, 37–38, 43, 45, 48, 216–217,  
221, 227, 229–230, 233–234, 235–236,  
237–238, 240, 245, 364–366, 367, 368, 371,  
374, 607, 621, 627. *See also* CV; CVN; CVV;  
and specific aircraft carriers and classes  
by name
- Air Force Reserve, 39
- Aldridge, Edward C. “Pete,” Jr., 52–53
- Alexander, Clifford L., Jr., 20, 67, 359, 519–520,  
520, 523, 550, 603, 622, 603–604, 622
- Ali, Kamal Hassan, 269
- Allen, General Lew, Jr., 562, 621
- Allen, Richard, 394
- Allende, Salvador, 62
- Alliance Defense in the Eighties* (AD-80),  
421–422
- All-Volunteer Force (AVF), 13, 31, 34, 216,  
503–530, 539–540; African Americans  
and, 519–522; Air Force and, 509, 509, 513,  
514–516, 515, 518, 519, 519, 520, 529; Army  
and, 504–505, 506, 507, 509, 509, 511–517,  
515, 519, 519, 520–523, 552; assessments of,  
505–508; draft registration and, 522–526;  
Marine Corps and, 506, 508–509, 509,  
512–515, 515, 519, 519, 520, 523; Navy  
and, 509, 509, 513, 514, 515, 516–517, 519,  
519–521; pay and retirement reform and,  
526–530; recruitment and retention for,  
508–512; women and, 512–518

- Alternative Integrated Military Strategies (AIMS), 121–133, 123
- American Friends Service Committee, 49
- American Institute in Taiwan, 404–405
- Anderson, Admiral George W., Jr., 70
- Anderson, John, 525
- Anderson, Robert, 52–53
- Angola, 477–480, 483–484, 486, 489–490, 498
- Anti-Ballistic Missile (ABM) Treaty, 148
- antisatellite (ASAT) negotiations, 188–191, 212
- apartheid, 478, 494–495, 501, 502
- Apel, Hans, 429, 433–434, 437
- Argentina, 78–80
- Armacost, Michael H., 379, 384–386, 398–399, 413
- Armed Forces Journal*, 605–606
- arms control, 8, 24, 125, 126, 183–191, 193–202, 209–213, 324, 386, 462, 464, 467, 468, 469, 470, 471, 472, 473, 474, 476, 598, 601, 611, 618; Brown and, 10, 13, 14, 127, 183–184, 213, 463–464, 469, 473, 474, 612. *See also* Strategic Arms Limitation Talks (SALT); Strategic Arms Reduction Talks (START)
- Arms Control and Disarmament Agency (ACDA), 132, 137, 139, 141, 153–154, 160, 163–164; antisatellite negotiations and, 189–190; chemical weapons and, 194; foreign military sales and, 201; Indian Ocean and, 210–211; NATO conventional forces and, 446–447, 453; nuclear test ban and, 186–187; Pakistan and, 329, 332; South Korea and, 388; Taiwan and, 404
- Arms Export and Control Act (P.L. 94-329), 75, 437
- Armstrong, John, 379, 387
- Aspin, Leslie “Les,” 44, 236–237, 507
- Assault Breaker, 586–590, 587
- Atlantis* space shuttle, 192
- AV-8B Harrier II vertical takeoff aircraft: FY 1979 Defense budget and, 217, 222, 224–225, 225, 230–231, 239, 242; FY 1980 Defense budget and, 361, 365, 366–367, 367, 370, 372
- B-1 bomber, 13, 33–60, 36, 45, 51; 1976 presidential election and, 49–50; Carter’s decision on, 50–58; congressional approval of Carter’s B-1 decision, 58–60; FY 1979 Defense budget and, 216, 219–220, 235, 238–239; FY 1981 Defense budget and, 543, 547, 559, 562; FY 1982 Defense budget and, 565; Office of Net Assessment and, 134; overview, 48–50
- B-2 stealth bomber, 59, 60, 584
- B-52 Stratofortress bomber, 13–14, 33, 48, 50–54, 53, 55, 57–58, 60, 134, 360, 366, 367, 551, 554, 559, 578, 579, 591, 592, 596
- Backfire bomber. *See* Tupolev Tu-22M
- Bakhtiar, Shapour, 294–295
- Ball, George W., 24
- ballistic missile submarine. *See* SSBN
- Bangladesh, 327
- Barrow, General Robert H., 561
- Bartlett, Dewey F., 39, 421
- Battlefield Exploitation and Target Acquisition (BETA), 588–589
- Bazargan, Mehdi, 297
- Beckel, Robert G., 58
- Beckwith, Col. Charles “Charging Charlie,” 303–304, 304, 309, 312–313, 316
- Begin, Menachem, 247, 254–256, 258, 261–262, 268–270, 274, 276
- Belgium, 427, 430, 438, 444, 471–472, 477, 480, 484–485
- Bennett, Charles E., 233–234
- Bentsen, Lloyd M., Jr., 12
- Big 7, 420
- Biological and Toxin Weapons Convention, 193
- Black Hawk helicopter, 361, 550
- Boeing Company, 49, 287, 434, 591–592
- Bowdler, William G., 93, 98
- Brademas, S. John, 58, 450
- Bradley fighting vehicle, 46, 280
- Brammer, Robert, 49
- Brazil, 77–78
- Brezhnev, Leonid I., 153, 160, 164–166, 167, 188–189, 209, 212, 324, 447–448, 473, 474
- Bronx High School of Science, 3, 4, 617
- Brooke, Edward W., 225
- Brown, Abraham “Buster,” 2, 3, 498
- Brown, Colene, 15, 16, 21, 401
- Brown, Deborah, 401
- Brown, General George S., 35, 38, 65, 70–71, 76, 102, 127, 130, 147, 353, 380, 383; Africa and, 484, 495; Harold Brown and, 621; NATO conventional forces and, 425, 445; NATO theater nuclear forces and, 463
- Brown, Gertrude, 2, 3
- Brown, Harold: Afghanistan and, 324–325; African Americans and, 505, 519, 539, 622;

- All-Volunteer Force and, 504–506, 508–516, 518–519, 521, 523–524, 526–530, 539, 623; antisatellite negotiations and, 189–190; appointment as secretary of defense, 2, 12; Argentina and, 78, 80; arms control and, 13, 183–184, 213; Assault Breaker and, 586, 588–590, 594; B-1 decision and, 55–57, 60, 627; Camp David Accords and, 247, 261–263, 263, 625; career after Department of Defense, 613; Carter's relationship with, 617–618; chemical weapons and, 193–196; Chile and, 80–82; China and, 325–326, 395–402, 397; confirmation of, 11–15; Congress and, 626–627; cruise missiles and, 590–592; Cuba and, 85, 87–88, 486, 489–490; defense legacy of, 594–599, 611, 615–628; Defense reorganization and, 101–102, 104–116, 615; Defense team of, 18–21; Delta Force and, 206–207; diplomacy and, 624–625; early career, 4–5, 9–10, 15–16, 18, 217–218; early years, 2–4; education, 3–4; Egypt and, 248–251, 249, 258, 266–269, 271–273, 625; El Salvador and, 97–99; enhanced radiation weapon and, 460–466, 627; essential equivalence and, 10, 13, 120, 124–125, 354, 596, 602, 616; foreign military sales and, 199–202, 624; FY 1978 Defense budget and, 27, 28, 34, 38, 41, 44, 46–47, 50, 351; FY 1979 Defense budget and, 215–242, 244–246, 351; FY 1980 Defense budget and, 351–359, 361–366, 368, 370, 373–375; FY 1981 Defense budget and, 541–563, 565, 573–574; FY 1982 Defense budget and, 565–568, 570–574; gays in the military and, 521, 540; Horn of Africa and, 482–484, 487, 488, 491–494; Huyser mission to Iran and, 294–296; Indian Ocean and, 210–212; Iran and, 285–319; Iran coup consideration and, 295–297; Iran rescue mission and, 300, 302–319, 315; Iran weapons sales and, 286–291; Israel and, 252–258, 257, 260–70, 624; Japan and, 378, 406–410, 410, 415, 624–625; JCS and, 620–621; South Korea and, 378–395, 416, 624; Law of the Sea and, 208; marriage of, 15, 16; as member of national security team with Brzezinski, Vance, 21–26, 617, 618–619; Middle East peace and, 247, 283; Middle East trip of, 265–268; Military Assistance Program and, 203–204, 624; military responses to Iran hostage crisis and, 298–302; Morocco, Western Sahara and, 498–501; MX missile and, 170–180, 609, 616; National Security Council and, 619; NATO and, 417, 422–430, 433–452, 460–466, 468–475, 608, 624; Nicaragua and, 93, 95–96; nuclear non-proliferation and, 197; nuclear test ban and, 185–188; offset strategy and, 575–576, 576–583, 586, 588–592, 599–600; Pakistan and, 330–331; Panama Canal and, 63–64, 69, 71, 73; Persian Gulf and, 334–341; personality of, 14–17, 23, 623–624; Philippines and, 412–413; presidential campaign (1980) and, 601–608; RDJTF and, 343–348, 616; Reagan administration transition and, 608–613; role of in defining Carter's national security policy, 118–145; SALT I and, 118, 148, 183–184; SALT II and, 154–169, 180–181, 608, 620; Saudi Arabia and, 258, 266–267, 275–283, 624; as secretary of the Air Force, 6, 7, 10, 12, 14–16, 118, 217–218; service secretaries and, 622; Shah's regime and, 292–293; Sinai and, 264; South Korea and, 378–395, 416, 624; space program and, 191–192; stealth technology and, 576–583, 594, 602, 604–607, 609; Taiwan and, 402, 404–405; veto of FY 1979 Defense authorization bill and, 217, 237, 239–242, 245–246; Vietnam War legacy and, 531–533, 535–536; women in the military and, 505, 513–516, 523–524, 518, 539; world view of, 8–14, 616–617; Zaire and, 480, 484–485
- Brzezinski, Zbigniew, 9, 11, 57; Afghanistan and, 324; antisatellite negotiations and, 189; chemical weapons and, 194–195; China and, 395–399; comprehensive/deep cuts proposal and, 149–150; Cuban, Soviet forces in Africa and, 489, 490–491; defense legacy of Carter administration and, 597–599; Defense reorganization and, 109–110; enhanced radiation weapon and, 461–466; foreign military sales and, 199–202; FY 1978 Defense budget and, 227, 235, 240; FY 1979 Defense budget and, 357, 363, 364, 368; FY 1981 Defense budget and, 542–543, 545–548, 557–558; FY 1982 Defense budget and, 569, 571, 574; Horn of Africa and, 481, 482, 484, 486–488, 393; Indian Ocean and, 212; Iran hostage crisis and, 290, 292, 294–296, 298–302, 300, 304–310, 312; Japan and, 407; Latin America

- and, 76–77, 80–82, 85–88, 97; Law of the Sea and, 208–209; as member of national security team with Brown, Vance, 22–26; Middle East and, 250–259, 249, 260–277, 263, 278–283; Military Assistance Program and, 203; Morocco, Western Sahara and, 500–501; MX decision and, 173–174, 176, 179; NATO conventional forces and, 425, 427, 437, 446, 448, 450; NATO theater nuclear forces and, 461–466, 468–470, 474; nuclear nonproliferation and, 197; nuclear test ban and, 187; Pakistan and, 329; Persian Gulf and, 333–339; presidential campaign (1980) and, 612; RDJTF and, 342–343, 345, 348–349; role of in defining Carter's national security policy, 118, 120–121, 124, 127–131, 135–139, 141–145; SALT II and, 154–156, 159–160, 163, 166, 168–169; South Africa and, 495; South Korea and, 379–391, 393; stealth technology and, 580; Taiwan and, 403–404; Vietnam War legacy and, 536; Zaire and, 480
- Buckley, William F., Jr., 70
- Budget. *See* FY 1978 Defense budget, FY 1979 Defense budget, FY 1980 Defense budget, FY 1981 Defense budget, FY 1982 Defense budget
- Bundestag, 429, 433–434, 437
- Bundy, McGeorge, 422, 531
- Bunker, Ellsworth, 67
- Burke, Admiral Arleigh A., 70
- Burleson, Omar, 41
- Bush, George H. W., 29, 196, 542
- Bush, George W., 542
- Byrd, Robert C., 279
- C-130 Hercules transport aircraft: FY 1978 Defense budget and, 42–43, 45; FY 1979 Defense budget and, 235; Iran and, 305, 306, 310–314, 313, 316–317; Middle East and, 235, 248, 250–251, 268–269
- C3I. *See* Command, Control, Communications, and Intelligence
- California Institute of Technology (Caltech), 5, 53, 118
- Camp David, 56, 175–176, 391. *See also* Camp David Accords
- Camp David Accords, 244, 247, 261–265, 271, 282
- Canada: American hostages in Iran and, 301
- Cannon, Howard W., 39–40
- Caribbean joint force, 87
- Carney, Admiral Robert B., 70
- Carpenter, M. Kathleen, 518
- Carr, Milton R. "Bob," 44, 237
- Carter, Amy, 557
- Carter, Chip, 534
- Carter, James Earl "Jimmy," Jr.: Afghanistan and, 323–327; Africa and, 478–480, 482–483, 485–489, 491–489, 501–502; African Americans and, 519; All-Volunteer Force and, 504, 509–512, 514–515, 523–530, 538; antisatellite negotiations and, 188–190; B-1 decision and, 55, 57, 60, 580, 591; Camp David Accords and, 261–264; chemical weapons and, 194; China and, 325–326, 377, 395–401, 397, 611; comprehensive/deep cuts and, 149–153; cruise missile development and, 591–592; Cuba and, 62, 86, 89–90, 489, 491; defense legacy of, 594–599, 611; defense spending cut proposals and, 11–13, 27–28, 27, 126; Defense reorganization and, 101, 107–111, 113, 115–116; early years of, 2–4; education of, 3–4; Egypt and, 248, 250, 258, 271–273, 283; Egyptian-Israeli peace and, 267–270; El Salvador and, 97, 99; energy and, 204; enhanced radiation weapon and, 461–466; foreign affairs experience of, 8–9; foreign military sales and, 198–199, 201–202; FY 1978 Defense budget and, 27–28, 33–36, 38–50, 52, 55–60; FY 1979 Defense budget and, 215–217, 219–220, 226–228, 230–241, 245–246; FY 1980 Defense budget and, 351–352, 354, 356–359, 362–364, 368–370, 375; FY 1981 Defense budget and, 541–547, 550, 555–565; FY 1982 Defense budget and, 569–574; Horn of Africa and, 482–483, 487–488, 492–493; Huyser mission to Iran and, 293–297; Indian Ocean and, 210–211; Iran and, 285–319; Iran arms sales and, 286–291; Iran hostage crisis and, 302–305, 308–315; Iran hostage crisis legacy for, 285, 316–319; Israel and, 253–255, 257, 253–258; Japan and, 406, 408–409; Latin America policy and, 62–64, 75–76, 99–100; Law of the Sea and, 209; marriage of, 7; Middle East aircraft/weapons sales and, 258–259, 265, 267; Middle East peace and, 247, 261–264, 270–271, 283; Middle East policy and, 333–334; Middle East policy review and, 252–253; military responses to Iran hostage crisis and,

- 298–302; Morocco, Western Sahara and, 499, 501; MX missile and, 169–176, 178–180, 603–604, 611; NATO conventional forces and, 417, 422–423, 425–430, 433, 436–437, 439–450, 452–453; NATO theater nuclear forces and, 461–476; naval career of, 7, 119, 510; Nicaragua and, 95–96, 99; nuclear test ban and, 184–188; Olympic Games and, 325; Pakistan and, 321, 328, 330–331, 331; Panama Canal and, 63–65, 68–75, 69; perceived weakness of, 598–599; Persian Gulf and, 333–336, 338, 341; Philippines and, 377, 411, 413–414; Plains, Georgia, and, 7, 364; political career of, 7–8; presidential campaign (1976) and election of, 2, 11; presidential campaign (1980) and, 601–608; race and, 7–8, 478, 502; RDJTF and, 342–343, 345–348; Reagan administration transition and, 602, 608–613; religious beliefs of, 8, 183; role of in defining Carter's national security policy, 117–121, 124, 126–127, 132–135, 138, 142–145; SALT II and, 147, 148–155, 157, 159–169, 167, 180–181, 183, 324, 464–466, 470–471, 476, 601; Saudi Arabia and, 274–275, 279, 281–283; South Korea and, 377–391, 389, 393–395, 415–416; space program and, 191; stealth technology and, 602, 604–607; Taiwan and, 377, 402–405; terrorism and, 206–207; Vietnam War legacy and, 8, 531–534, 536–538; women in the military and, 514–515, 517, 518, 524; world view of, 8–11, 618; Zaire and, 479–480, 485–486, 501–502
- Carter, Rosalynn, 7, 262, 400, 557, 612
- Carter Doctrine, 204, 322, 338–339, 348
- Case, Clifford P., 55
- Casey, William J., 327
- Castro, Fidel, 62, 70, 71, 82, 83, 86, 88–89
- catamaran, small water area, twin hull (SWATH), 584. *See also* Sea Shadow stealth catamaran
- Causey, Norman M. "Mike," 106
- CBU-71 cluster bomb, 254, 255
- CBU-72 fuel-air explosive cluster bomb, 252, 253, 254
- Cederberg, Elford A., 39
- Central Intelligence Agency (CIA), 29, 30, 87, 88, 99, 107, 108, 132, 267, 271, 301, 308, 314, 315, 316, 317, 379, 387, 446, 474, 478, 546, 578
- Central Treaty Organization, 327, 334
- Cha Ji Chul, 391
- Challenger* space shuttle, 192
- Chappell, William V., Jr., 54, 564
- Chayes, Antonia H. "Toni," 179, 518, 603–604
- chemical warfare, 193–196
- Chemical Weapons Convention, 196
- Chile, 62, 80–82
- China, 23, 377, 395–402, 487–488
- Christopher, Warren M., 76, 95, 124, 292, 296, 307, 386, 447, 607
- Chun Doo Hwan, 390–395, 395, 609, 625
- Church, Frank F., 86, 169
- Church Committee, 21
- civil defense, 42–44, 45, 46, 111, 115, 132–133, 139–140, 142, 144, 148, 236, 239, 355, 364, 366, 367, 368, 369, 373
- Clark Air Base, 411–415, 415
- Claytor, W. Graham, Jr., 59, 90, 197, 208, 309, 327; African Americans and, 521; appointment as secretary of Navy, 19–20; Argentina and, 78–80; Brown and, 622; FY 1979 Defense budget and, 221, 224–225, 230, 233–234; FY 1980 Defense budget and, 360; FY 1981 Defense budget and, 549–550, 551, 553, 558; FY 1982 Defense budget and, 569; gays in the military and, 522; Morocco, Western Sahara and, 501; Persian Gulf and, 333–334, 336; Reagan administration transition and, 602, 610, 612
- Clifford, Clark M., 449, 617
- Clinton, William J., 196, 521
- code of conduct, 536–537
- Cohen, William S., 388
- Columbia* space shuttle, 192, 193
- Columbia University, 4, 21–22, 120, 172
- Command, Control, Communications, and Intelligence (C3I), 19, 418, 576
- Commander in Chief, Atlantic Command (CINCLANT), 86
- Commander in Chief, European Command (CINCEUR), 344, 346
- Commander in Chief, Pacific Command (CINCPAC), 381
- Commander of U.S. Forces in Korea (COMUSKOREA), 380–381, 384
- Committee on the Present Danger, 30–31, 541, 596
- Comprehensive Net Assessment of 1978, 543–547
- comprehensive test ban (CTB) treaty, 184–188

- Congo. *See* Zaire
- Congressional Control and Impoundment Act, 40
- conscription. *See* All-Volunteer Force, draft registration, Selective Service System
- Consolidated Guidance (CG), 352–359
- Cooke, David O. “Doc,” 106, 226
- Costa Rica, 91
- Cotter, Donald, 125, 194
- Cranston, Alan M., 55
- cruise missiles, 13, 35, 38, 43–44, 45, 47, 51–52, 53, 54–60, 134, 355; air-launched (ALCM), 47, 55, 57, 150, 160, 220, 232, 353, 360, 361, 374, 466, 468, 548, 591–593, 593, 597, 616; development of under Carter administration, 590–593, 610; FY 1980 Defense budget and, 353, 355, 360–361, 366, 371, 374; ground-launched (GLCM), 47, 154, 157, 231, 361, 374, 460, 466, 468, 469, 471–473, 475, 542, 592, 599; sea-launched (SLCM), 32, 154, 157, 158, 161, 162, 163, 164, 164, 468, 553, 591
- CSGN (nuclear-powered strike cruiser), 32, 36
- Cuba, 62, 82, 83, 84–91, 89, 99–100; Africa and, 489–491, 541; missile crisis in, 456, 549; refugees from, 88–91, 168–169; Yemen and, 333
- Culver, John C., 50, 55, 238, 287
- Currie, Malcolm R., 34, 578–580
- Cutler, Lloyd, 368, 523–524, 526, 557–558
- CV (conventionally powered aircraft carrier), 366
- CVN (nuclear-powered aircraft carrier), 37–38, 43, 44, 47–48, 217, 230, 234, 236, 237, 238, 239, 240, 241, 242, 245, 366, 368, 370, 371, 372
- CVV (conventionally powered aircraft carrier, medium size), 37–38, 43, 44, 221, 230, 231, 234, 236, 237, 241, 242
- Cyprus, 22, 417, 448–450
- Davis, Lynn E., 20, 21, 54, 125–127, 129, 133, 137, 447, 622
- Davos, General Ioannis, 451
- Dayan, Moshe, 262
- DC-10 tanker aircraft, 239
- Defense Advanced Research Projects Agency (DARPA), 577, 582, 584, 586, 588, 590
- Defense Intelligence Agency (DIA), 87, 106–107, 110, 535, 546–547
- Defense Organization Study, 110–115, 139
- Defense Research and Engineering (DR&E): Brown as director of, 4–5; 6, 134; Perry’s appointment as director of, 18; Defense reorganization and, 101
- Defense Resource Management Study*, 113–115
- Defense Resources Board, 115, 568–569
- de Gaulle, Charles, 417, 456
- Delta Force. *See* Special Forces Operational Detachment Delta
- Democratic National Convention (1980), 602, 603–604
- Deng Xiaoping, 164, 325–326, 398–402, 400
- Denmark, 428, 473
- Departmental Headquarters Study, 110–113, 115
- Department of Defense Advisory Committee on Women in the Services (DACOWITS), 513
- Department of Defense: Carter’s reorganization of, 101–116
- Department of State, 77, 79, 81; Africa and, 478–479; antisatellite weapons and, 189–190; chemical weapons and, 194–195; China and, 396–397; Cuba and, 83; foreign military sales and, 198–201, 204; Horn of Africa and, 482, 487–491, 493–494; Indian Ocean and, 210; Law of the Sea and, 207–209; Morocco, Western Sahara and, 499–501; national security policy formulation and, 137, 141; NATO conventional forces and, 424, 425, 443, 447–448, 450, 453; nuclear nonproliferation and, 197; nuclear test ban and, 185–187; Taiwan and, 403–405; terrorism and, 205–206; Zaire and, 480
- Derazhnya and Pervomaïsk missile silos, 155–156, 159–160
- Desert One: collision at, 313
- deterrence (nuclear), 118–119, 136, 143–144
- Diego Garcia: FY 1982 Defense budget and, 569; Horn of Africa and, 487; Persian Gulf security and, 333, 335–336, 338, 340–342, 340; RDJTF and, 348–349, 598
- Dinneen, Gerald P., 19, 401, 621
- Discovery* space shuttle, 192
- Djibouti, 346, 482, 486, 491
- Dobrynin, Anatoly, 85, 153, 155, 165
- Donovan, Hedley, 9
- Doran, Robert K., 57
- Downey, Thomas J., 44
- draft: *See* All-Volunteer Force, draft registration, Selective Service System
- draft registration, 522–526
- Dragoon missile, 442
- Duncan, Charles W., 11–15, 18, 21, 185; Brown and, 622; chemical warfare and, 194; Coca-



- Cola and, 11, 13–14; Defense reorganization and, 102, 107, 109–110, 112, 114, 115; Delta Force and, 206; energy and, 205; FY 1978 Defense budget and, 27, 38, 41; FY 1979 Defense budget and, 219, 227, 240; FY 1980 Defense budget and, 359, 360–361, 365; Iran and, 290–294; Japan and, 407; Latin America and, 76, 93–95; Law of the Sea and, 207; Middle East and, 258, 261, 275; NATO conventional forces and, 444; NATO theater nuclear forces and, 468–469; nuclear test ban and, 185; Persian Gulf and, 333–334; Philippines and, 413; presidential campaign (1980) and, 603; role of in defining Carter's national security policy, 127, 132; SALT II and, 164; South Korea and, 383, 386; Vietnam War and, 535–536
- E-2 Hawkeye early warning aircraft, 252, 407
- E-3/E-3A Sentry (AWACS) aircraft, 278, 286, 287, 336, 434, 553
- Ecevit, Bulent, 450
- Egypt: Africa and, 483, 487, 492, 496, 498; arms, equipment for, 244, 248, 250, 253, 258–260, 268–273; Camp David Accords and, 247, 261–265; IMET and, 248, 250–251; Middle East peace and, 247–273, 333, 335; Persian Gulf security and, 335–338, 341–342; RDJTF and, 347–348; Sinai and, 263–265
- 82nd Airborne Division, 504
- Eisenhower, Dwight, 117, 119, 455, 537
- Eitam: Israeli air base at, 263–264, 265
- Eizenstat, Stuart E., 50, 56–57
- Electromagnetic Systems Laboratory, 18
- Ellis, General Richard H., 139, 581
- El Salvador, 88, 96–99
- energy, 204–205
- enhanced radiation weapon, 458–466, 543
- Enterprise* space shuttle, 192
- E.O. Lawrence Radiation Laboratory, 4–5, 5, 6, 186, 603
- Equal Employment Opportunity Commission, 20
- Equal Rights Amendment (ERA), 513–514, 518
- Ermarth, Fritz W., 267–268
- essential equivalence, 10, 13, 120, 124–125, 136, 174, 231, 354, 359, 362, 374, 543–544, 596, 602, 616
- Ethiopia, 333, 338, 346, 481–484, 486–489, 491–494, 501–502
- European Defense Community, 455
- Evans, Rowland, 136
- Eztion: Israeli air base at, 263–264
- F-4/F-4D/F-4E Phantom II attack aircraft, 251, 269, 270, 286, 289–291, 403, 444, 484, 552
- F-5 fighter, 202, 248, 249, 250, 258, 269, 278, 286, 289, 391, 403, 404, 552, 555
- F-14 Tomcat fighter, 33, 45, 151, 217, 222–225, 224, 235, 236, 238, 250, 366–367, 367, 372
- F-15 Eagle fighter: Egypt/Israel and, 251–252, 252, 258–260, 268–269, 272–274; FY 1978 Defense budget and, 33, 36, 37, 39, 43, 45, 46; FY 1979 Defense budget and, 236; FY 1980 Defense budget and, 360–361, 367, 367, 372; FY 1981 Defense budget and, 547, 552–553, 562; Reagan administration transition and, 608; Saudi Arabia and, 274–283, 277; stealth technology and, 578, 581
- F-16 Fighting Falcon fighter, 33, 45, 203, 221, 231, 236, 244; FY 1980 Defense budget and, 367, 367; Pakistan and, 328, 330–332; South Korea and, 385–387, 392; Taiwan and, 403–404
- F-18/F-18A/F-18L/F/A-18 Hornet fighter, 33, 45, 217, 221–225, 223, 231, 235, 236, 238, 274, 286–287, 361, 367, 367, 372, 403, 559, 562, 595
- F-111 Aardvark fighter-bomber, 58, 175, 220, 221, 299, 371, 458, 475, 552, 553, 562, 565
- F-117 Nighthawk stealth fighter, 577, 579, 579, 582, 583, 594
- Federal Emergency Management Agency (FEMA), 89, 115, 441
- Fernbach, Sidney, 5
- flexible response, 423, 455–457
- Flynt, John J., 59
- force de frappe*, 456, 474
- Ford, Gerald R., 2, 8, 12, 37, 188, 572, 601, 606
- foreign military sales (FMS), 198–204; Latin America and, 77, 81–82, 88, 94, 96–97; Middle East and, 251–274; Morocco and, 498–501; Pakistan and, 327, 330–331; Somalia and, 493; Zaire and, 479–480
- Forrestal, James V., 17, 622
- France, 417, 421, 435, 438, 441, 442, 444, 456, 455–456, 469, 474, 477, 480, 482, 484–485, 498
- Frank, Barney, 521
- Fubini, Eugene G., 109, 623
- fuel-air explosive systems, 252, 254
- Fukuda, Takeo, 406

- Fukuyama, Francis, 326
- FY 1978 Defense budget, 27–60; A–7E and, 35, 36, 38, 44, 45; Air Force and, 31, 33, 37, 39, 42–43, 46, 48–59; Army and, 31, 33–35, 39–40, 42–43, 46; authorization act for, 42–46; B–1 and, 48–60; Carter’s modifications to, 33–37, 36; congressional hearings on, 38–42; cruise missiles and, 13, 35, 38, 43–44, 45, 47, 51–52, 53, 54–60; CVN and, 37–38, 43, 47–48; Ford-Rumsfeld, 27, 29–33, 54, 215; Navy and, 31–38, 42–48; passage of appropriations bill for, 46–48; rescissions to, 37–38
- FY 1979 Defense budget, 215–246; A–7E and, 223, 235; Air Force and, 216, 220–222, 227, 231–232, 242, 245, 250; Army and, 216, 218–220, 232, 235, 239; AV–8B Harrier II and, 217, 222, 224–225, 230–231, 239, 242, 623; Carter’s veto of, 239–242, 245; criticism of, 232–233; CVN and, 216–217, 229–230, 234, 236–242, 245; differing priorities and, 217–226; F–14 and, 217, 222–225, 224, 235, 236, 238, 250; F–18 and, 217, 221–225, 223, 231, 235, 236, 238; Marine Corps and, 217–218, 222, 224–225, 235, 243; NATO and, 215–217, 219–221, 228, 231, 233, 239, 244–246; Navy and, 215–219, 221–225, 227, 229–246; SALT and, 219, 235; supplemental bill and, 242–245; views of Brown, Carter on, 215–216, 245–246
- FY 1980 Defense budget, 351–375; Air Force and, 353, 355, 359–361, 365, 367, 369, 371; Army and, 353, 355, 359, 361, 364, 369, 370–371; Congress and, 365–374; Consolidated Guidance and, 352–359; ICBMs and, 342, 355, 357–358, 360, 361, 363–366, 367, 371–374; Navy and, 353–355, 357–358, 360–361, 364, 365–368, 369, 370–372; passage of, 372–373; POMs and, 359–361
- FY 1981 Defense budget, 541–565, 573–574; Air Force and, 551, 552–553, 555, 564; Army and, 550–551, 552, 553, 554–555, 564; authorization act for, 523, 559, 563; Comprehensive Net Assessment and, 543–547; Congress and, 558–565; Defense Department formulation of, 547–553; F–15 and, 547, 552–553, 562; MX missile and, 542, 544, 546–548, 551, 554, 557, 559, 564; Navy and, 549–550, 551–552, 553, 555, 559–562, 564; Rapid Deployment Joint Task Force (RDJTF) and, 542, 550, 556, 557, 562, 564–565; SSBNs and, 542, 546, 550, 547, 553, 554, 554; White House and, 553–558
- FY 1982 Defense budget: Carter administration’s, 541–543, 565–574; Rapid Deployment Joint Task Force (RDJTF) and, 566–569; Reagan administration transition and, 608
- Gamasy, General Mohammed Abdel Ghani al-, 250–251
- Garn, Edwin J., 39
- Garthoff, Raymond L., 474
- Gast, Maj. Gen. Philip C., 296, 298, 303, 304, 309
- Gates, Robert, 542, 596–597
- Gates, Thomas S., Jr., 503, 622
- Gates Commission, 505, 522
- Geisel, Ernesto, 77
- General Dynamics, 49, 591–592
- General Support Rocket System, 39, 550, 555, 598
- Geneva Protocol, 193
- Geng Biao, 40, 625
- Georgia Tech, 3
- Germany, Federal Republic of, 121, 136; NATO conventional forces and, 418, 421, 429–430, 432–452; NATO theater nuclear forces and, 458–464, 466–475
- Giaimo, Robert N., 41
- Glenn, John H., 388, 390
- Gleysteen, William H., 388–389, 392–394
- Goldwater, Barry M., 13, 39, 51, 54–55, 368
- Goldwater-Nichols Department of Defense Reorganization Act, 115
- Gorbachev, Mikhail, 180, 475
- Graham, Lt. Gen. Daniel O., 29
- Great Britain, 322–333, 340–341; Africa and, 477, 488, 494, 498; NATO conventional forces and, 426, 430, 435, 438, 441, 442, 444; NATO theater nuclear forces and, 455, 458, 469–475
- Greece, 417, 425, 435, 448–452
- Gregg, Donald, 393
- Gromyko, Andrei, 85, 155–157, 161, 163–164, 166
- Grumman Aerospace Corporation, 222, 367
- Guatemala, 96
- Habib, Philip C., 383–384
- Haig, General Alexander M. “Al,” Jr., 283, 420, 425, 431, 438, 447, 449–451, 476
- Haile Selassie, 482
- Harriman, W. Averell, 22

- Hart, Gary W., 235, 238, 388, 599–600  
 Hassan II, 499–501  
 Hatfield, Mark O., 371, 525  
 Hawk missile system, 36, 39  
 Hayward, Admiral Thomas B., 561, 585, 620  
 Hébert, F. Edward, 44  
 Helsinki: antisatellite negotiations in, 189–190  
 Henze, Paul B., 484, 488, 491–492  
 Hidalgo, Edward, 81, 551, 603–604, 622  
 Hillary, Gary, 52  
 Hodges, Luther H., 79–80  
 Holbrooke, Richard C., 386, 398, 412, 535  
 Hollings, Ernest F. “Fritz,” 368–369  
 Hollingsworth, Lt. Gen. James F., 421  
 Holloway, Admiral James L., III, 38, 71, 234, 316–318  
 Honduras, 92, 96  
 hotline, 324  
 House Committee on Appropriations (HCA), 37, 46, 365, 370  
 House Committee on Armed Services (HCAS), 102, 384; Brown and, 626; FY 1978 Defense budget and, 38, 40–44; FY 1979 Defense budget and, 233–235, 237, 241, 244; FY 1980 Defense budget and, 365–366; FY 1981 Defense budget and, 560–562  
 House Committee on the Budget, 40–41  
 Hua Guofeng, 401  
 human rights, 10–11; Africa and, 478, 502; Argentina and, 78–80, 91, 99; Brazil and, 77, 91; Central America and, 91, 99–100; Chile and, 82, 91, 99–100; Iran and, 286–287; Korea and, 381, 386–387, 389–391, 394, 416; national security policy and, 135; Pakistan and, 328; Panama and, 71; Philippines and, 413–414; views of Carter and Brown, 82  
 Hunter, Richard W., 514, 516  
 Huntington, Samuel P., 121, 135, 140, 543  
 Huyser, General Robert E., 293; mission to Iran, 293–297  
 hydrofoil, 36  
 Ignatius, Paul R., 110–113, 112, 115  
 Incirlik air base, 449  
 India: Pakistan and, 327–332  
 Indian Ocean, 209–213  
 Inman, Admiral Bobby R., 314  
 Inouye, Daniel K., 414  
 intelligence reorganization, 106–110  
 intercontinental ballistic missile (ICBM), 13, 171; Carter administration’s legacy and, 596; comprehensive/deep cuts proposal and, 147, 148–152; FY 1978 Defense budget and, 33–34, 50; FY 1980 Defense budget and, 342, 355, 357–358, 360, 361, 363–366, 367, 371–374; national security formulation and, 117–118, 132–133, 138, 140; SALT II and, 155–159, 161–162, 165, 168–169, 170–176, 179–180. *See also* MX ballistic missile; Minuteman ballistic missile  
 Intermediate Nuclear Force (INF) Treaty negotiations, 475–476  
 International Military Education and Training (IMET): Brown’s views of, 203–204; Egypt and, 248, 250–251; Latin America and, 75, 77, 94, 96–97  
 International Security Affairs (ISA), 18, 20, 85, 93, 102, 395, 486, 489, 492, 496, 497  
 International Security Assistance Act, 386  
 Iran, 285–319; Africa and, 479, 482, 483, 484, 487, 488, 491, 493, 494, 501; arms sales to, 286–291; Canada-backed rescue operation in, 301; cancellation of weapons sales to, 298; coup considered in, 297; hostage crisis in, 298–319, 611; hostage rescue attempt in, 302–316; 306, 307; human rights and, 286–287; Huyser mission to, 293–297; legacy of hostage rescue attempt in, 316–319, 611; oil and, 285, 291–293, 297, 299; revolution in, 322; shah’s departure from, 295  
 Israel, 95, 199; arms, equipment for, 201–202, 244, 251–258, 266–274; Camp David Accords and, 261–263; Middle East peace and, 247–274, 283; Sinai and, 263–265; terrorism and, 205–206  
 Italy, 425, 435, 436, 470–473  
 Jackson, Henry M. “Scoop,” 13, 30, 83, 232, 626  
 Japan, 406–410  
 Japanese Defense Agency (JDA), 408, 410  
 Japanese Self-Defense Forces (JSDF), 406, 408  
 Javits, Jacob K., 55  
 Jayne, Edward R. “Randy,” 226, 233  
 Jewish Americans: Middle East peace and, 252, 259, 261  
 Johnson, Lyndon B., 2, 5, 8, 10, 12, 20–22; national security policy and, 117; U.S.-Latin American relations and, 62–63  
 Joint Chiefs of Staff (JCS): Afghanistan and, 321; All-Volunteer Force and, 522–523, 525–526,

- 528–529; antisatellite negotiations and, 189–190; arms control and, 213; chemical weapons and, 194–195; China and, 396, 398–399; comprehensive/deep cuts proposal and, 147, 149, 151–153; Defense reorganization and, 101, 108, 111, 113; foreign military sales and, 201; FY 1978 Defense budget and, 40; FY 1979 Defense budget and, 216–219; FY 1980 Defense budget and, 351–353, 354, 357, 359, 362–363, 373; FY 1981 Defense budget and, 542, 546–547, 549, 553, 560–561; FY 1982 Defense budget and, 565, 567, 572–574; Indian Ocean and, 210–211; Iran and, 287, 292, 302–303, 315–318; Japan and, 407, 409; Latin America and, 76, 86, 91; Law of the Sea and, 207–209; Marine Corps commandant as member of, 113; Middle East and, 255, 268, 271, 274, 282, 333–334; MX decision and, 170, 174–175, 179; NATO conventional forces and, 425, 428, 439–440, 445–450, 453; NATO theater nuclear forces and, 463, 471; nuclear test ban and, 184–188; Pakistan and, 321; Persian Gulf and, 333–334, 336, 338, 341; Philippines and, 412–414; RDJTF and, 344–347; role of in defining Carter's national security policy, 124–128, 130, 136, 139–140, 142; SALT II and, 156–158, 160, 165–166, 168; South Korea and, 380–384, 386, 388; Taiwan and, 403–405; terrorism and, 206; Vietnam War legacy and, 532–533
- Joint Deployment Agency, 441
- Joint Surveillance and Target Attack Radar System (JSTARS), 589
- Jones, General David C., 52, 57, 59, 79, 95, 113, 140; chemical weapons and, 195; FY 1980 Defense budget and, 357, 362, 363, 365; FY 1981 Defense budget and, 546, 560–561; FY 1982 Defense budget and, 572; Iran and, 294, 296, 298–299, 301–304, 308–310, 312, 314, 316; Korea and, 386; NATO conventional forces and, 418, 448; Persian Gulf security and, 338–339; Philippines and, 415; SALT II and, 160, 163, 165–166; Saudi Arabia and, 282; stealth technology and, 578–580, 582; Taiwan and, 405
- Jordan, Hamilton W., 11, 23, 95; Camp David Accords and, 261; FY 1980 Defense budget and, 364, 366; Iran and, 299, 301–303, 312, 315, 317; Korea and, 386; Panama Canal and, 69; Reagan campaign/administration and, 607, 612
- Jupiter ballistic missile, 456–457
- Kagnew Station, 482
- Katanga, 479–480, 484, 486
- KC–10 Extender tanker/cargo aircraft, 367, 367, 555, 562
- KC–135 Stratotanker tanker aircraft, 220–221, 239, 254, 277, 299
- Keeny, Spurgeon M., Jr., 132, 160, 163, 447
- Kelley, Lt. Gen. Paul X., 345, 345, 346
- Kennedy, Edward M., 8, 81, 506, 525, 601
- Kennedy, John F., 2, 6, 9, 21; U.S.-Latin American relations and, 62–63, 76; national security policy and, 117
- Kennedy-class* aircraft carrier (CV), 366
- Kester, John G., 15, 21, 101–102
- Khan, Mohammad Daoud, 321, 322
- Khomeni, Ayatollah Ruhollah, 291, 294–298, 300, 302, 305, 308
- Kim Dae Jung, 390, 393–395
- Kim Jae Kyu, 391
- Kim Yong Sam, 391
- Kirbo, Charles H., 11
- Kissinger, Henry A., 20, 24, 30, 63, 70, 118, 148–149, 232, 247, 255, 274, 606
- Komer, Robert W., 18, 78, 104, 105, 125, 196; Afghanistan and, 324, 326–327; Brown and, 622; FY 1979 Defense budget and, 228, 246; Horn of Africa and, 494; NATO and, 422–431, 433, 436, 440–443, 447, 451–452, 468–469, 586, 597, 611; Pakistan and, 327, 329–330; Persian Gulf and, 333–334, 336, 340–341; Philippines and, 407–409
- Koppel, Ted, 285
- Korea, Democratic People's Republic of. *See* North Korea
- Korea, Republic of. *See* South Korea
- Koreagate scandal, 381, 385, 387
- Kwangju Uprising, 390, 393–394
- Kyle, Col. James H., 312
- LaBerge, Walter B., 433
- Laingen, Lowell Bruce, 305
- Laird, Melvin R., 20, 232, 503, 529, 597, 606, 619
- Lance, Thomas B. "Bert," 27, 28, 462, 619
- Lance tactical missile, 35, 36, 39, 43, 45, 46, 460, 462–465, 475
- Latin America: 61–69; Carter's advocacy for human rights in, 62, 71, 99–100; U.S. policy toward, 75–77, 99–100
- Law of the Sea (LOS), 207–209
- Leber, Georg, 432–433, 436, 463

- Lee Soon Ja, 395  
 Leggat, Robert L., 44  
 LeMay, General Curtis E., 14  
 Lemnitzer, General Lyman L., 70  
 Leopard II tank, 432  
 Letelier, Orlando, 80  
 Linowitz, Sol, 67–68  
 Livermore, California. *See* E.O. Lawrence  
 Radiation Laboratory  
 Lockheed Advanced Development Programs.  
*See* Skunk Works  
 Long, Admiral Robert L., 70, 392  
 Los Angeles-class submarine, 32, 37, 547, 560, 562  
 Lumumba, Patrice, 478  
 Luns, Joseph, 451
- M60/M60A1/M60A3 tank, 419, 440; FY 1978  
 Defense budget and, 33, 42–43, 45, 46–47; FY  
 1979 Defense budget and, 203, 231, 235, 236,  
 239, 242; FY 1980 Defense budget and, 366,  
 367, 371, 372; FY 1981 Defense budget and,  
 564; Israel, supplied to, 251, 253, 258, 268,  
 269, 270; Morocco, supplied to, 501; Pakistan,  
 supplied to, 330; South Korea, requested by,  
 385; Zaire, requested by, 479–480
- M113 armored personnel carrier, 236, 248,  
 254, 275
- Macmillan, Harold, 10  
 Mahon, George H., 55, 59, 234, 236–238, 240  
 Manpower, Reserve Affairs, and Logistics  
 (MRA&L), 505–518, 515, 518, 523  
 Mansfield, Mike, 410  
 Marcos, Ferdinand, 411–414, 415  
 Marcos, Imelda, 412–413, 415  
 Mariam, Mengistu Haile, 482  
 Marine Corps, 113  
 Mark, Hans M., 20, 59, 192–193, 582, 592, 622  
 Marshall, Andrew W., 20, 104, 106, 125, 127,  
 133–135, 139, 387, 418–420, 621  
 Massachusetts Institute of Technology (MIT), 19  
 massive retaliation, 455–456  
 Mathews, Jessica Tuchman, 386  
 MATMON B, 251–252  
 MATMON C, 255–258, 266–268  
 McAuliffe, Eugene, 436  
 McAuliffe, Lt. Gen. Dennis P. “Phil,” 70, 73,  
 93–94, 252  
 McDowell, Colene D. *See* Colene Brown  
 McGiffert, David E., 18, 127, 194; B–1  
 decision and, 54; China and, 401; Defense  
 reorganization and, 104, 105; FY 1979  
 Defense budget and, 228; Horn of Africa  
 and, 486, 492–493; Iran and, 286, 293;  
 Latin America and, 79, 94; Middle East  
 and, 256, 264, 273–274, 278; NATO theater  
 nuclear forces and, 462–463, 468, 472;  
 Pakistan and, 328–330; RDJTF and, 343  
 McGovern, George S., 51, 55, 57, 232  
 McIntyre, James T., 175, 192, 205, 240, 244,  
 364, 368, 525, 527, 529; FY 1981 Defense  
 budget and, 556, 558, 563; FY 1982 Defense  
 budget and, 569, 570, 572  
 McNamara, Robert S., 5, 6, 12, 14, 18–19, 48,  
 145, 217–218, 232, 455, 457, 549, 603, 610,  
 612, 615, 617, 619, 621  
 Meadows, Richard J. “Dick,” 308  
 media, 141, 143–144  
 Merkava tanks, 252–253, 255, 258  
 Meyer, General Edward C. “Shy,” 504, 511, 552,  
 560, 620  
 Michigan: Seafarer submarine communica-  
 tions system and, 42–43, 47  
 Middle East, 130, 332–342  
 MiG–23 Flogger fighter, 83, 84, 85, 87, 386  
 Military Advisory Group (MILAG), 75  
 Military Assistance Program (MAP), 203–204,  
 404–405, 413–414  
 minorities: military service of, 504–505, 519,  
 522, 539. *See also* African Americans  
 Minuteman ballistic missile, 13–14; FY 1978  
 Defense budget and, 31, 33, 38–40, 42; FY  
 1979 Defense budget and, 220–221, 232; FY  
 1980 Defense budget and, 355, 365, 371; FY  
 1981 Defense budget and, 542, 545, 554; MX  
 decision and, 170–175, 171, 172, 180; national  
 security policy and, 132, 140; SALT II and,  
 148, 151–152, 155, 161–162, 164  
 missile frigate. *See* *Oliver Hazard Perry*-class  
 frigate  
 missing in action (MIA): Vietnam War and,  
 534–536  
 MIT. *See* Massachusetts Institute of Technology  
 Mobile Training Team (MTT), 97  
 Mobilization Steering Group, 441  
 Mobutu Sese Seko (Joseph-Désiré Mobutu),  
 478–480, 480, 501  
 Moffitt, Ronni, 80  
 Mondale, Walter F., 11, 23, 95, 150, 154,  
 191; B–1 decision and, 56–57; China and,  
 397–398, 397, 400; FY 1979 Defense budget

- and, 237, 240; Iran and, 299, 304, 307, 312; Middle East and, 261–262; opposition to Defense budget, 619; Philippines and, 413–414
- Monroe Doctrine, 61
- Moorer, Admiral Thomas H., 70
- Mossadegh, Mohammad, 285
- Mozambique, 477, 490, 497
- Mubarak, Hosni, 271, 273, 336, 341
- Mugabe, Robert, 497–498, 502, 323–324, 326, 327, 329, 332
- mujahideen, 323–324, 326, 327, 329, 332
- Mulley, Frederick, 435
- multiple aim point (MAP), 161, 162, 173
- multiple ejection rack (MER), 279, 281–282
- multiple independently targetable reentry vehicle (MIRV), 33, 373, 458, 475, 597; MX decision and, 170, 176; SALT II and, 148–162, 165
- Murphy, John M. “Jack,” 73
- Murphy, Richard W., 414, 415
- Murray, Russell II, 19, 125, 127, 194; Brown and, 621; FY 1979 Defense budget and, 218, 226, 228, 230; FY 1980 Defense budget and, 352–354, 357; FY 1981 Defense budget and, 547–548, 553, 554, 565–567; Japan and, 408
- Muskie, Edmund S., 44, 80, 82, 143, 197, 204, 474, 619; Africa and, 493, 501; Egypt base proposal and, 341; FY 1982 Defense budget and, 570–571; RDJTF and, 347–348
- mutual and balanced force reductions (MBFR), 443–448
- mutual assured destruction, 119, 138–139
- mutual assured retaliation, 10
- MX missile, 35–45, 36, 45, 56, 132, 172, 176, 178; Carter administration’s decision on, 169–180; Carter administration’s legacy and, 596; Democratic National Convention and, 603–604; FY 1979 Defense budget and, 219, 232, 236, 244–245; FY 1980 Defense budget and, 355, 357, 360, 361, 363–366, 367, 371–372, 374; FY 1981 Defense budget and, 542, 544, 546–548, 551, 554, 557, 559, 564
- Namibia, 484, 494–495, 498, 501
- National Aeronautics and Space Administration (NASA), 20, 191–193
- National Front (Iran), 294
- National Guard, 504
- National Intelligence Tasking Center, 109
- National Reconnaissance Office (NRO), 106, 108, 110
- National Security Agency (NSA), 106–107, 108, 110, 314, 317, 379
- National Security Council (NSC): Afghanistan and, 321, 323–324; Africa and, 479–480, 484, 486, 487–488, 490–491, 493–495, 497, 499, 501; antisatellite negotiations and, 189; Defense reorganization and, 107–109, 112; final meeting of Carter’s, 611; foreign military sales and, 199–200; FY 1978 Defense budget and, 27–28; FY 1979 Defense budget and, 227, 233, 253; FY 1980 Defense budget and, 354, 357, 359; FY 1981 Defense budget and, 545–549, 556, 563, 565; FY 1982 Defense budget and, 566, 570–572; Iran and, 292–293, 298, 301–309; Latin America and, 76–77, 79, 81, 85, 88, 90; Law of the Sea and, 207; Middle East and, 253, 258, 261, 267, 271–272, 281; Military Assistance Program and, 204; nuclear test ban and, 185; Pakistan and, 327–329; Persian Gulf and, 334, 336–337, 341; RDJTF and, 342; role of in defining Carter’s national security policy, 117, 120–121, 127–133, 135, 137–138, 140–144; under Carter, 24–25; under Nixon, Ford, 20, 24
- NATO. *See* North Atlantic Treaty Organization
- Naval Academy (U.S.), 3
- Naval Reserve, 36, 43–44
- NAVSTAR Global Positioning System (GPS), 589–590
- Nedzi, Lucien N., 44
- Negev: Israeli bases in, 262–265, 283
- Netherlands, 429, 438, 444, 471–473
- Neto, Antonio Agostinho, 484, 489
- neutron bomb. *See* enhanced radiation weapon
- Newsom, David D., 78, 413
- Nicaragua, 88, 91–96, 99, 542
- Nifty Nugget exercise, 439–441
- Nike Zeus antiballistic missile defense system, 10
- Nimitz*-class aircraft carrier (CVN), 37–38, 216–217, 229, 230, 234, 366
- Nimrod maritime early warning aircraft, 435, 438
- Nitze, Paul H., 11, 29, 70, 541
- Nixon, Richard M., 1–2, 8, 12, 20, 232; All-Volunteer Force and, 503, 522; chemical weapons and, 193; China policy and, 402; MX missile and, 170; national security policy and, 118; SALT and, 148; U.S.-Latin American relations and, 62–63; Vietnam War and, 534

- Nkomo, Joshua, 498
- Non-Aligned Movement, 489
- Noriega, General Manuel, 71, 74
- North Atlantic Council, 425, 427, 464, 472
- North Atlantic Treaty Organization (NATO), 26, 417–476; 1978 Washington summit of, 429–431; AWACS and, 434–438; Carter’s review of, 422–423; conventional forces and, 417–453; enhanced radiation weapon and, 458–466; flexible response and, 423, 455; FY 1979 Defense budget and, 215–217, 219–221, 228, 231, 233, 239, 244–246; in national security policy, 119, 121–126, 128–133, 136; long-term defense plan and, 424–429; mutual and balanced force reductions and, 443–448; rapid reinforcement and armaments cooperation of, 438–443; southern flank of, 448–452; tank gun decision and, 431–434; theater nuclear forces and, 455–476; two-way street and, 431–434
- North Korea, 121, 197–198, 209, 216, 378–379, 383, 386–388, 391, 536–537, 549, 594, 609, 618
- Northrop Grumman Corporation, 403–406, 578, 584
- Norway, 425, 428–429, 472, 473
- Novak, Robert, 136
- nuclear nonproliferation, 196–198; Pakistan and, 321
- Nuclear Nonproliferation Treaty, 196–197, 496
- nuclear-powered aircraft carrier. *See* CVN
- nuclear test ban, 9–10. *See also* comprehensive test ban (CTB) treaty
- nuclear war: Carter administration and, 137–142
- nuclear weapons, 9–10; NATO and theater, 455–476; tactical, 455–466, 475. *See also* Strategic Arms Limitation Talks (SALT); Strategic Arms Reduction Talks (START)
- Nunn, Samuel Augustus “Sam,” 168–169, 368, 387–388, 421, 445–446, 506–507, 510, 523, 529, 530, 558, 626
- Obama, Barack, 542
- Odom, Brig. Gen. William E., 86, 138–140, 141, 143, 303, 334, 619
- Office of International Security Affairs, 75, 298
- Office of Management and Budget (OMB): All-Volunteer Force and, 507–509, 525, 529; Brown and, 619, 626; Defense reorganization and, 110; energy and, 205; FY 1978 Defense budget and, 27–29; FY 1979 Defense budget and, 215, 217–218, 221, 225–230, 232–233, 240, 244–245; FY 1980 Defense budget and, 351–352, 354, 357, 363, 364, 368; FY 1981 Defense budget and, 549, 552–553, 555–559, 563; FY 1982 Defense budget and, 569–570, 572; Military Assistance Program and, 204; NATO and, 437; space program and, 191–193
- Office of Net Assessment (ONA), 20, 133–135, 621; Brown’s use of, 134–135
- offset strategy: 575–600; Assault Breaker and, 586–590; Carter, Brown’s legacy and, 594–599; cruise missile development and, 590–593; stealth technology and, 576–586, 627
- Ogaden, 481–484, 486–489, 491–494, 501–502
- Ohio*-class submarine, 32, 44, 174, 175, 231, 355, 358, 550, 553, 554, 554, 596
- oil embargo (1973), 332, 349
- Oksenberg, Michel, 386
- Oliver Hazard Perry*-class frigate (FFG-7), 32, 43–44, 551
- Olympic Games (1980), 325
- Oman, 335, 336, 338, 340, 341, 491–493, 569
- O’Neill, Thomas P. “Tip,” 41, 58, 225, 241
- Operation Just Cause, 74
- Organization of American States (OAS), 61
- Organization of the Petroleum Exporting Countries (OPEC), 332
- Pacific Command (PACOM), 333, 335, 346, 347
- Pahlavi, Shah Mohammad Reza, 285–301, 289, 319; arms sales and, 286–291
- Pakistan, 321, 327–332; East. *See* Bangladesh
- Palestine Liberation Organization (PLO), 99
- Panama, 99, 202. *See also* Panama Canal
- Panama Canal: 62–69; Army reluctance to relinquish control of, 67; Brown and Brown formula, 66; China policy and, 397–398; Treaties, implementation of, 72–75; Treaties, negotiation of, 63–69; Treaties, provisions of, 68; Treaties, ratification of, 69–72
- pardons (presidential): Vietnam War and, 531–534
- Paris Peace Talks, 22
- Park Chung Hee, 380–381, 384–385, 387–391, 389, 395, 415
- Pastor, Robert A., 76–77, 81, 97
- Patriot surface-to-air missile, 442, 585, 595
- Peace Corps, 93

- peaceful nuclear explosion (PNE), 184–186
- People's Republic of China (PRC). *See* China
- Perry, William J., 18, 32, 42–44, 102, 104–105, 125, 127, 170, 173–174, 178, 180, 194; Assault Breaker and, 586, 588, 589–590; Brown and, 621; defense legacy of Carter administration and, 594, 597, 599–600; NATO and, 427, 433, 441–442, 597; offset strategy and, 575–576; stealth technology and, 576, 577, 579, 579–587
- Perry-class* frigate. *See* *Oliver Hazard Perry-class* frigate
- Perry-class* frigate
- Pershing II ballistic missile, 47, 231, 239, 245, 359, 361, 371–372, 374, 444, 458, 460, 466, 468, 470–475, 542, 549, 554, 616
- Persian Gulf, 131, 332–342, 544; 1991 war in, 334–335, 349; Horn of Africa and, 477, 479, 488–489, 491, 494, 495
- Pervomaisk. *See* Derazhnya and Pervomaisk missile silos
- Petit Nugget exercise, 439
- Petrov, Vasilli I., 483
- Philippines, 411–414
- PHM hydrofoil. *See* hydrofoil
- Pinochet, Augusto, 80–81
- Pipes, Richard E., 29
- Pirie, Robert B., 510, 515–516, 523, 528–529
- Planning, Programming, and Budgeting System (PPBS), 111, 114, 218–219, 226, 549–550
- Poland, 22
- Polaris ballistic missiles, 10, 158, 232, 456
- Policy Review Committee (PRC): Afghanistan and, 322, 328–330; Africa and, 482, 488, 494–495, 497, 499, 500–501; Carter administration and, 24–25; Carter's national security policy and, 127–128, 130–132; chemical weapons and, 196; Consolidated Guidance and, 548–549; Defense reorganization and, 107–109; foreign military sales and, 200–201; FY 1981 Defense budget and, 548–549, 556; FY 1982 Defense budget and, 556, 570–571; Iran and, 290, 292, 318; Latin America and, 64, 66, 76, 79–80, 93–94, 97; Middle East peace and, 254, 256, 271–272, 275–276; MX missile and, 174–176; Persian Gulf and, 334–336; Philippines and, 411–413; South Korea and, 380, 388, 393
- Portugal, 426, 477, 478
- Poseidon ballistic missile, 232, 468, 554
- Powell, Colin L., 15, 19, 21, 292
- Powell, Jody, 261, 299, 338
- presidential campaign/election (1976), 2, 9, 21, 30, 49–50, 601
- presidential campaign/election (1980), 143–144, 281, 601–608
- Presidential Directive (PD): PD 1, 25; PD 2, 25; PD 12, 381–384, 388; PD 13, 199–201, 286–287, 388, 403; PD 17, 108–109; PD 18, 135–137, 144, 228, 333, 342–343, 353–355, 357–358, 548, 565; PD 38, 186; PD 41, 142; PD 50, 212; PD 53, 142; PD 58, 142; PD 59, 142–144, 604–608, 604; PD 63, 341–342
- Presidential Review Memorandum (PRM): PRM 1, 64–66; PRM 2, 149–150; PRM 3, 252–253; PRM 5, 449; PRM 6, 444; PRM 9, 422–423; PRM 10, 120–133, 137, 140, 144, 333, 342, 543; PRM 11, 107–108; PRM 12, 198–199, 288; PRM 13, 379–380, 383, 388; PRM 14, 411; PRM 16, 185; PRM 17, 75; PRM 24, 396; PRM 34, 499; PRM 36, 489–491; PRM 38, 468–469; PRM 45, 388; PRM 46, 94–95
- President's Commission on Military Compensation, 526–528
- Press, Frank, 172, 191
- Price, C. Melvin, 44, 237, 240–241
- Program Analysis and Evaluation (PA&E), 19, 219, 222–225
- Program Objective Memorandum (POM), 219, 220, 221, 356–357, 359–361, 549–551
- Proud Spirit mobilization exercise, 441
- Proxmire, William, 50, 371, 516
- Pueblo* crisis, 22
- Quanbeck, Alton, 50
- Rabin, Yitzak, 253–254
- RAND Corporation, 20, 111, 420–422, 424, 505, 506
- Rangers (Army), 206, 250–251, 303, 305, 310
- Rapid Deployment Joint Task Force (RDJTF), 342–349; FY 1981 Defense budget and, 542, 550, 556, 557, 562, 564–565; FY 1982 Defense budget and, 566–569
- Reagan, Ronald, 30, 60, 180, 327, 394; All-Volunteer Force and, 504, 525, 530; chemical weapons and, 196; Military Assistance Program and, 204; nuclear strategy and, 143–144; Panama Canal and, 64; presidential campaign (1980) of, 601–608; revolution in defense and, 542–543, 574, 602, 628; Saudi



- Arabia and, 281–282; strategic defense initiative and, 191; transition team of, 608–613; women in the military and, 518
- recruitment and retention, 508–512
- Reserve Officer Training Corps, 518
- Resor, Stanley R., 92, 104, 104–105, 134, 439, 447, 463, 468
- retirement (military): FY 1978 budget and, 32; reform of, 526–530
- Return of Forces to Germany (REFORGER) exercise, 438–439, 440
- Rex-78 exercise, 439
- RF-4C Phantom II reconnaissance aircraft, 221
- RH-53D Sea Stallion helicopters: Iran hostage rescue attempt and, 306, 310–311, 310, 311, 313, 317
- Rhodesia, 494–498, 501–502
- Rice, Donald B., 113–115, 114
- Rich, Ben R., 579–580, 579, 582–585
- Richardson, Elliot L., 208
- Rickover, Hyman G., 7, 38
- Rockwell International Corporation, 49, 52, 57, 583
- Rogers, General Bernard W., 166, 451, 549
- Rogers, William D., 98
- Rogers Plan, 451–452
- Roland missile, 366, 367, 442–443, 552, 553, 555, 557
- Romero, Carlos Humberto, 96–97
- Romero, Oscar, 97
- Romulo, Carlos P., 414
- Roosevelt, Franklin D., 61
- Roosevelt, Theodore, 61
- Ross, Thomas B., 18–19, 606
- Rostker, Bernard D., 523–524, 525
- Rumsfeld, Donald H., 27, 30–31, 133–134, 252, 418, 432, 576, 578, 597, 606
- Sadat, Anwar, 247–251, 249; arms for Israel and, 253, 255–256; arms sales/aid and, 266–273, 283; Camp David Accords and, 261–263, 263; Persian Gulf security and, 336, 338; Saudi Arabia and, 276; U.S. aircraft and, 258
- SALT. *See* Strategic Arms Limitation Talks
- Sandinistas, 88, 91–96, 99
- Sarbanes, Paul S., 450
- Saud, Prince Sultan bin Abdulaziz al-, 279–283
- Saudi Arabia: arms, equipment for, 201–202, 250, 258–260, 265–283, 325; Horn of Africa and, 483–484, 491, 492; oil and, 205, 266, 274, 276, 278, 280–281. *See also* Persian Gulf
- Sayre, Robert M., 77–78
- Schemmer, Ben, 605–606
- Schlesinger, James R., 12, 187, 232, 336, 418, 432, 463, 575, 597, 606, 606
- Schmidt, Helmut, 436–437, 445, 463–464, 466–470, 467, 473–474, 493
- Schroeder, Patricia S., 44
- Schuller, Rear Adm. Gordon J., 78
- Scowcroft, Brent, 606
- Seafarer submarine communications system, 43–44, 46–47
- sea-launched cruise missiles, 154, 157, 553
- Sea Plan 2000, 233–234, 360
- Sea Shadow stealth catamaran, 585–586, 585. *See also* catamaran, small water area, twin hull (SWATH), 584
- Secord, Brig. Gen. Richard V., 318
- Secretary of the Air Force: Brown as, 6, 7, 10, 12, 14–16, 53; Brown's appointment of, 20
- Secretary of the Army, 20
- Secretary of the Navy, 19
- Security Consultative Meeting (SCM, 1977), 384–385, 393–394
- Seiffert, Lt. Col. Edward R., 312
- Selective Service System, 365, 503, 522–526, 531
- Selin, Ivan, 53
- Senate Committee on Appropriations (SCA), 47, 365, 370–371
- Senate Committee on Armed Services (SCAS), 11–14; Brown's confirmation and, 11–14, 19; FY 1978 Defense budget and, 39, 40, 42, 43, 44; FY 1979 Defense budget and, 234–235, 241, 244; FY 1980 Defense budget and, 365–366, 368; FY 1981 Defense budget and, 559, 562; Manpower and Personnel Subcommittee of, 506–507; Panama Canal and, 72
- Senate Committee on Foreign Relations, 86
- Senate Committee on the Budget, 41
- Senate Select Committee to Study Governmental Operations with Respect to Intelligence Activities. *See* Church Committee
- Shaba, 479–481, 484–486, 490, 501
- Siad, Mohammed Barre, 483, 488, 491–494, 502
- Sick, Gary, 281, 306, 318
- Siemer, Deanne, 518
- Sinai: Israel's withdrawal from, 247, 261–266, 265, 268, 283
- Singlaub, Maj. Gen. John K., 382–383
- Skunk Works, 577–579, 583–584

- Slay, General Alton D., 579–580
- Slocombe, Walter B., 20–21, 486, 489, 566, 621
- Sloss, Leon, 139–144
- Smith, Rosalynn. *See* Rosalynn Carter
- Smith, Lt. Gen. William Y., 127
- Snyder, Col. Donald, 392
- Somalia, 333, 336, 338, 340, 341, 346, 481–484, 486–489, 491–494, 501–502
- Somoza, Anastasio, 91–93
- South Africa, 494–498, 501–502
- Southeast Asia Treaty Organization, 327
- South Korea, 13, 22, 128, 130–131, 136–137, 202, 218–219, 355–356, 365, 377–395, 406, 409, 412, 415–416, 504, 537, 548–549, 571, 594, 623–625
- Soviet Union: Afghanistan and, 79, 168–169, 213, 279, 280, 302, 319, 321–327, 325, 349, 378, 401, 431, 447, 523–526, 541, 542, 556, 557, 599, 625; Africa and, 477–479, 481–484, 486–494, 496, 497–499; All-Volunteer Force and, 523–526, 540; antisatellite negotiations and, 188–193; arms sales and, 201–202; B-1 bomber and, 48–49, 51–57, 60; Brown's, Carter's views toward, 10–11; Brown's legacy and, 616–618, 621, 625; Carter's national security policy and, 117–145, 543–547; chemical weapons and, 193–196; China and, 377, 395–398, 400–402, 405, 406, 611, 625; Comprehensive Net Assessment of 1978 and, 543–547; Cuba and, 82–88; enhanced radiation weapon and, 461, 463–465; FY 1978 Defense budget and, 29–31, 33–35, 43, 46; FY 1979 Defense budget and, 216–218, 221–223, 229, 231–233, 235, 238, 244–246; FY 1980 Defense budget and, 351–352, 353, 354–358, 359–360, 362–363, 365, 371, 372, 373–374; FY 1981 Defense budget and, 542, 543–547, 548–550, 556–560; FY 1982 Defense budget and, 566, 567, 569–572, 573–574; grain sales to, 79, 325; Indian Ocean and, 209–211; Iran and, 287–288, 290, 292, 298, 307, 319, 321, 347–348; Latin America and, 62, 79, 80–88; Middle East and, 248–249, 254, 267–269, 275, 279–281, 332–342, 349; mutual and balanced force reductions and, 443–448; MX missile and, 169–179; NATO conventional forces and, 417–420, 422–423, 431, 433, 443–448, 449, 453; NATO theater nuclear forces and, 456–458, 461, 463–465, 466–476; North Korea and, 378, 386, 391, 394; nuclear test ban and, 9–10, 184–188; offset strategy and, 575, 580, 582–586, 592, 594–600; Pakistan and, 328–332, 348; presidential election (1980) and, 601–605; Reagan transition and, 608–611; SALT II and, 147–169, 180–181
- space shuttle. *See* Space Transportation System
- Space Transportation System (STS), 191–193
- Spain, 458, 468
- Special Coordination Committee (SCC): Afghanistan and, 323–324; Africa and, 493; Brown's role in, 619; Carter and, 24; Carter's defense legacy and, 570–571; chemical weapons and, 193–194; Defense reorganization and, 107–108; Indian Ocean and, 210–211; Iran and, 292–293, 298; Latin America and, 85–86, 95, 99; mutual and balanced force reductions and, 444–447; NATO theater nuclear forces and, 463, 468–469, 471; nuclear war and, 141; Persian Gulf and, 334–336, 338–339; RDJTF and, 347; SALT II and, 149–151, 153–154, 156, 160, 162, 164; terrorism and 206
- Special Forces Operational Detachment Delta, 206–207; Iran hostage rescue attempt and, 303, 305, 309, 311, 314
- Spruance*-class destroyer, 43–44, 244
- SR-71 Blackbird reconnaissance aircraft, 84, 275, 578
- SS-20 Saber intermediate-range ballistic missile, 457, 458, 459, 463–464, 467, 469, 473–475, 542, 549
- SSBN (nuclear-powered ballistic missile submarine), 4, 31, 32, 36, 45; Brown's role in developing, 4; FY 1980 Defense budget and, 358, 360, 361, 365, 367, 367, 370, 372–374; FY 1981 Defense budget and, 542, 546, 547, 550, 553, 554, 554. *See also* *Ohio*-class submarine
- stagflation, 431, 452
- Steadman, Richard C., 111–113, 112, 115
- stealth technology, 576–586
- Stempler, Jack L., 19
- Stennis, John C., 11–12, 18–19, 44, 55, 58–59, 234–237, 240, 506, 559, 562
- Stetson, John C., 20, 359–360, 622
- Stinger missile, 39, 442–443
- Strategic Arms Limitation Talks (SALT), 5, 13; SALT I, 148; SALT II, 13, 20–21, 23, 30, 74, 84, 86, 147–170, 173, 175–176, 179–181, 324,

- 395, 447, 465, 466–467, 469–470, 472, 474, 476, 541, 556, 574
- Strategic Arms Reduction Talks (START), 476, 596
- strategic defense initiative, 191, 54, 627
- Stratton, Samuel S., 102, 560–561
- Subic Bay (Naval Base), 411–415
- submarine-launched ballistic missile (SLBM), 10, 119, 133, 152, 232, 355, 373, 456–458, 468, 474, 554. *See also* Polaris ballistic missile; Poseidon ballistic missile; and Trident ballistic missile
- Sudan, 483, 487
- Sullivan, William H., 293–294, 296, 305
- Supreme Allied Commander Europe (SACEUR), 420, 425, 429, 431, 438, 449–451, 456, 458, 468
- surface-to-air missile (SAM), 51, 326
- Surut, Maj. Gen. Lee E., 78
- Tack, Juan Antonio, 63
- tactical fighter experimental (TFX), 14
- Taiwan, 377, 402–405
- Taraki, Nur Muhammad, 323
- Taylor, General Maxwell D., 70
- Teller, Edward, 5, 6, 603
- terrain contour matching (TERCOM), 591
- terrorism, 205–207
- Thompson, James, 128–129
- Thor intermediate-range ballistic missile, 455, 457
- Three Soldiers* statue, 539
- Thurman, Maj. Gen. Maxwell, 511, 512
- Ticonderoga*-class guide missile cruiser (CG-47), 551
- Tighe, Lt. Gen. Eugene M. I., 387
- Tomahawk air-launched cruise missile (TALCM), 53, 591–592, 593. *See* AGM-109 Tomahawk air-launched cruise missile (General Dynamics)
- Toon, Malcolm, 85
- Torrijos Herrera, Omar, 64–65, 67–68, 69, 71–72, 74
- Total Obligational Authority (TOA): AIMS and, 129; FY 1978 Defense budget and, 30, 33, 35, 40–41; FY 1979 Defense budget and, 227–228, 242, 244; FY 1980 Defense budget and, 364–365, 369–370, 372–374; FY 1981 Defense budget and, 547, 557–558, 563; FY 1982 Defense budget and, 567–568, 572–573, 573
- Tower, John G., 13
- Trident ballistic missile, 32, 596, 597, 617; FY 1978 Defense budget and, 44, 45; FY 1979 Defense budget and, 219, 222, 231, 235, 236, 239; FY 1980 Defense budget and, 355, 361, 364, 365, 366, 367; FY 1981 Defense budget and, 542, 544, 545, 546, 548, 553, 554, 554; MX decision and, 173–175; offset strategy and, 611; SALT II and, 152, 159. *See also* Ohio-class submarine
- Trilateral Commission, 9
- Truman, Harry S., 117, 402, 541
- tube-launched, optically tracked, wire-guided (TOW) missile, 442
- Tudeh Party, 295, 297
- Tupolev Tu-22M Backfire bomber, 13, 149–158, 151, 160–161, 163–165, 167–169, 223, 457, 473
- Turkey, 334, 337, 338, 417, 425, 426; NATO and, 448–453
- Turner, Stansfield M.: Defense reorganization and, 106–110; FY 1982 Defense budget and, 571–572; Horn of Africa and, 487; Iran hostage crisis and, 287, 291–292, 297–299, 301, 304, 308–309; Korea and, 380, 386–387; Latin American and, 87, 95, 98; MX decision and, 176; SALT II and, 162; space program and, 192
- “two-way street” arms procurement, 426–428, 430–434
- U-2 reconnaissance aircraft, 578
- Uniformed Services University of the Health Sciences, 35, 36, 37
- United Press International, 383
- University of Chicago, 20
- U.S. Agency for International Development (USAID), 93–94, 491
- U.S. Information Agency (USIA), 93
- U.S. Middle East Force (MIDEASTFOR), 333, 338
- U.S. Military Group (MILGP), 81, 82, 94
- U.S. Readiness Command (REDCOM), 206
- U.S. Southern Command (SOUTHCOM), 66, 91, 93
- U.S.-Taiwan Mutual Security Treaty, 377, 397, 399, 402
- USS *Coral Sea* aircraft carrier, 338, 339
- USS *Eisenhower* aircraft carrier, 37
- USS *Enterprise* aircraft carrier, 37
- USS *Kitty Hawk* aircraft carrier, 299

- USS *Long Beach* guided missile cruiser, 37–38
- USS *New Jersey* battleship, 559, 562, 564
- USS *Nimitz* aircraft carrier: 229, 339, 530; Iran hostage rescue attempt and, 306, 310, 311; Persian Gulf security and, 338
- USS *Oriskany* aircraft carrier, 559, 562, 564
- Utgoff, Victor A., 54–56, 128–129, 140, 548, 566
- Utility Tactical Transport Aircraft System (UTTAS), 43, 45
- Vance, Cyrus R., 9; Afghanistan and, 324; chemical weapons and, 195; China and, 395, 397–398, 397, 400–401; comprehensive/deep cuts proposal and, 149–150, 153; Cuban, Soviet forces in Africa and, 479, 487–488, 492–493; enhanced radiation weapon and, 462–465; foreign military sales and, 198, 201; FY 1978 Defense budget and, 27; FY 1980 Defense budget and, 357, 363, 364, 368, 374; FY 1981 Defense budget and, 543, 546, 555, 574; Horn of Africa and, 487–488, 492–493; Indian Ocean and, 211; Iran hostage crisis and, 286, 288, 290–292, 294, 296, 299, 301, 304, 306–309, 312–313; Japan and, 406; Latin America and, 78–79, 81–82, 85–88; Law of the Sea and, 207; as member of national security team with Brzezinski, Brown, 21–25, 617; Military Assistance Program and, 203; Morocco and, 500; MX decision and, 172; NATO conventional forces and, 425, 443, 450; NATO theater nuclear forces and, 462–465, 470, 473; nuclear test ban and, 185; South Korea and, 380–381, 383, 385–391; Philippines and, 414; SALT II and, 153–161, 163–166, 169; Taiwan and, 404; Vietnam War legacy and, 534; Zaire and, 479–480
- Vance, Gay, 21
- Van Cleave, William, 610–611
- Vaught, Maj. Gen. James E., 303, 309, 312
- vertical/short takeoff and landing (V/STOL) aircraft, 43, 45, 372; FY 1979 Defense budget and, 216–217, 221–222, 230–231, 234–235, 236, 238–239, 242–243. *See also* AV–8B Harrier II vertical takeoff and landing (VTOL) aircraft, 32, 370
- Vessey, General John W., Jr., 380, 382, 382
- Vietnam, 99, 195
- Vietnam Veterans Memorial, 538–539, 538, 539
- Vietnam War, 1, 8, 22, 31, 117, 323, 411, 418, 457; code of conduct and, 536–537; legacy of, 503–504, 525, 531–540, 594; missing in action and, 534–536; pardons and, 531–534
- Vietnam Women's Memorial, 539
- Viola, General Robert E., 80
- Virginia*-class cruiser, 44, 221
- Vladivostok summit (1974), 148–150, 152–153, 219
- Vorster, John, 495–496
- VTOL. *See* vertical takeoff and landing
- Wacker, Fred P., 226–227
- Warner, John W., 529
- Warnke, Paul C., 149–150, 153, 155, 159–160, 210–211, 388
- Warsaw Pact: Afghanistan and, 326; Carter's national security policy and, 121–124, 123, 128–129, 130–131, 133, 136; chemical weapons and, 195; East Asia and, 378; FY 1978 Defense budget and, 47; FY 1979 Defense budget and, 216, 219, 231; FY 1980 Defense budget and, 355; FY 1981 and 1982 Defense budgets and, 542, 544–545, 548–549, 552, 566; NATO conventional forces and, 417–424, 419, 429, 438–439, 443–448, 452–453; NATO theater nuclear forces and, 455–456, 459, 461–463, 466–467; offset strategy and, 575–576, 588–589, 594; RDJTF and, 344; SALT II and, 161. *See also* Soviet Union
- Washington Headquarters Services (WHS), 106, 115–116
- Washington NATO summit (1978), 429–431
- Washington Post*, 106, 137, 382, 507, 605
- Watergate scandal, 1–2, 8, 418
- Wayne, John “Duke,” 71
- Weinberger, Caspar W., 283, 475, 602, 610, 613, 627–628
- Weizman, Ezer, 256, 257, 262–263, 273–272
- Wellford, Harrison, 525
- West, John C., 275–276, 278
- White, John, 125, 505–506, 508, 509–510, 525, 529, 619
- Wickham, General John A., 392–394, 392
- Wilson, Charles H., 44
- Wilson, General Louis, 523
- Wolfowitz, Paul D., 334
- women: military service and, 13, 365, 504, 505, 506, 507, 512–518, 515, 517, 519, 519, 522, 523, 524, 525, 539
- Wood, Archie, 50

- Woolsey, R. James, Jr., 223, 551  
Wright, James C. "Jim," Jr., 58, 236–237
- XB–70 bomber, 14  
XM1 Abrams tank: FY 1978 Defense budget  
and, 33, 42, 45, 46–47; FY 1979 Defense  
budget and, 231, 236, 239, 241–242; FY 1980  
Defense budget and, 359, 361, 363, 366, 367,  
372; FY 1981 Defense budget and, 550, 555,  
564; NATO and, 430–434, 432
- Yemen, 275, 325, 333, 338, 346  
York, Herbert F., 4, 53, 190
- Zaire, 478–481, 484–486, 485, 499, 502  
Zeiberg, Seymour L., 174  
zero-based budgeting (ZBB), 8, 226–228, 272, 363  
Zhuo Lin, 400  
Zia-ul-Haq, Muhammad, 329–331, 331  
Zimbabwe. *See* Rhodesia  
Zumwalt, Admiral Elmo R., Jr., 70  
*Zumwalt*-class guided missile destroyer, 586  
Zwick, Charles J., 526–528





