



Water Solutions

FilmTec™ Reverse Osmosis Membranes Technical Manual

Version 2

January 2020

NOTICE: The information provided in this literature is given in good faith for informational purposes only. DuPont assumes no obligation or liability for the information presented herein. NO WARRANTIES ARE GIVEN; ALL IMPLIED WARRANTIES OF MERCHANTABILITY OR FITNESS FOR A PARTICULAR PURPOSE ARE EXPRESSLY EXCLUDED.

Table of contents

1	Basics of Reverse Osmosis and Nanofiltration	9
1.1	Historical Background	9
1.2	Desalination Technologies and Filtration Processes	9
1.3	Principle of Reverse Osmosis and Nanofiltration	12
1.4	Membrane Description	15
1.5	Membrane Performance	16
1.6	FilmTec™ Membrane Safe for Use in Food Processing	17
1.7	Element Construction	18
1.8	Element Characteristics	19
2	Water Chemistry and Pretreatment	22
2.1	Introduction	22
2.2	Feedwater Type and Analysis	23
2.3	Scale Control	28
2.3.1	Introduction	28
2.3.2	Acid Addition	29
2.3.3	Scale Inhibitor Addition	30
2.3.4	Softening with a Strong Acid Cation Exchange Resin	30
2.3.5	Dealkalization with a Weak Acid Cation Exchange Resin	31
2.3.6	Lime Softening	32
2.3.7	Preventive Cleaning	32
2.3.8	Adjustment of Operating Variables	32
2.4	Scaling Calculations	33
2.4.1	General	33
2.4.2	Calcium Carbonate Scale Prevention	35
2.4.2.1	Brackish Water	35
2.4.2.2	Seawater	39
2.4.3	Calcium Sulfate Scale Prevention	43
2.4.4	Barium Sulfate Scale Prevention /8/	45
2.4.5	Strontium Sulfate Scale Prevention	45
2.4.6	Calcium Fluoride Scale Prevention	46
2.4.7	Silica Scale Prevention	49
2.4.8	Calcium Phosphate Scale Prevention	54
2.5	Colloidal and Particulate Fouling Prevention	56
2.5.1	Assessment of the Colloidal Fouling Potential	56
2.5.2	Media Filtration	58
2.5.3	Oxidation-Filtration	58
2.5.4	In-Line Filtration	59
2.5.5	Coagulation-Flocculation	60
2.5.6	Microfiltration/Ultrafiltration	60
2.5.7	Cartridge Microfiltration	60
2.5.8	Other Methods	61
2.5.9	Design and Operational Considerations	61
2.6	Biological Fouling Prevention	61
2.6.1	Introduction	61
2.6.2	Assessment of the Biological Fouling Potential	62
2.6.2.1	Culture Techniques	63
2.6.2.2	Total Bacteria Count	63
2.6.2.3	Assimilable Organic Carbon (AOC)	63
2.6.2.4	Biofilm Formation Rate (BFR)	64
2.6.3	Chlorination / Dechlorination	64
2.6.4	Sodium Bisulfite	67
2.6.5	DBNPA	67
2.6.6	Combined Chlorine	68
2.6.7	Other Sanitization Agents	68
2.6.8	Biofiltration	68
2.6.9	Microfiltration/Ultrafiltration	69
2.6.10	Ultraviolet Irradiation	69

2.6.11	Use of Fouling-Resistant Membranes	69
2.7	Prevention of Fouling by Organics	69
2.8	Prevention of Membrane Degradation	69
2.9	Prevention of Iron and Manganese Fouling	70
2.10	Prevention of Aluminum Fouling	71
2.11	Treatment of Feedwater Containing Hydrogen Sulfide	71
2.12	Guidelines for Feedwater Quality	73
2.13	Summary of Pretreatment Options	74
3	System Design	77
3.1	Introduction	77
3.2	Batch vs. Continuous Process	81
3.3	Single-Module System	82
3.4	Single-Stage System	83
3.5	Multi-Stage System	84
3.6	Plug Flow vs. Concentrate Recirculation	85
3.7	Permeate Staged (or Double-Pass) System	88
3.8	Special Design Possibilities	90
3.9	Membrane System Design Guidelines	92
3.9.1	Membrane System Design Guidelines for 8-inch FilmTec™ Elements	94
3.9.2	Membrane System Design Guidelines for Midsize FilmTec™ Elements	96
3.10	Temperature and Pressure Limits for 8-inch FilmTec™ Seawater RO Elements	97
3.10.1	Elements with Standard Endcaps	98
3.10.2	Elements with iLEC™ Interlocking Endcaps	98
3.11	The Steps to Design a Membrane System	99
3.12	System Performance Projection	103
3.12.1	System Operating Characteristics	103
3.12.2	Design Equations and Parameters	105
3.13	Testing	109
3.13.1	Screening Test	109
3.13.2	Application Test	109
3.13.3	Pilot Tests	110
3.14	System Components	110
3.14.1	High Pressure Pump	110
3.14.2	Pressure Vessels	110
3.14.3	Shutdown Switches	111
3.14.4	Valves	112
3.14.5	Control Instruments	112
3.14.6	Tanks	112
3.15	Materials of Construction, Corrosion Control	114
3.16	System Design Considerations to Control Microbiological Activity	115
3.17	System Design Suggestions for Troubleshooting Success	116
4	Loading of Pressure Vessels	118
4.1	Preparation	118
4.2	Element Loading	118
4.3	Shimming Elements	120
4.4	Element Removal	122
4.5	Interconnector Technology for 8-inch Diameter FilmTec™ Elements	123
4.5.1	New Interconnector Advantages	123
4.5.2	Summary of Large Element Interconnectors	124
4.6	Installing an Element Spacer	125
5	System Operation	126
5.1	Introduction	126
5.2	Initial Start-Up	126
5.2.1	Equipment	126
5.2.2	Pre-Start-Up Check and Commissioning Audit	127
5.2.3	Start-Up Sequence	128
5.2.4	Membrane Start-Up Performance and Stabilization	130
5.2.5	Special Systems: Double Pass RO	130
5.2.6	Special Systems: Heat Sanitizable RO	130
5.3	Operation Start-Up	131
5.4	RO and NF Systems Shutdown	131

5.5	Adjustment of Operation Parameters	132
5.5.1	Introduction	132
5.5.2	Brackish Water	132
5.5.3	Seawater	132
5.6	Record Keeping	133
5.6.1	Introduction	133
5.6.2	Start-Up Report	133
5.6.3	RO Operating Data	133
5.6.4	Pretreatment Operating Data	136
5.6.5	Maintenance Log	136
5.6.6	Plant Performance Normalization	136
6	Cleaning and Sanitization	141
6.1	Introduction	141
6.2	Safety Precautions	142
6.3	Cleaning Requirements	142
6.4	Cleaning Equipment	143
6.5	Cleaning Steps	144
6.6	Cleaning Tips	145
6.7	Effect of pH on Foulant Removal	146
6.8	Cleaning Chemicals	147
6.9	Cleaning Procedure for Specific Situations	147
6.9.1	General Considerations	147
6.9.2	Sulfate Scale	147
6.9.3	Carbonate Scale	148
6.9.4	Iron Fouling	149
6.9.5	Organic Fouling	150
6.9.6	Biofouling	151
6.9.7	Emergency Cleaning	151
6.10	Sanitizing RO/NF Membrane Systems	152
6.10.1	Introduction	152
6.10.2	Hydrogen Peroxide and Peracetic Acid	152
6.10.3	Chlorinated and Other Biocidal Products	153
6.10.4	Heat Sanitization	153
7	Handling, Preservation and Storage	154
7.1	General	154
7.2	Storage and Shipping of New FilmTec™ Elements	154
7.3	Used FilmTec™ Elements	155
7.3.1	Preservation and Storage	155
7.3.2	Re-wetting of Dried Out Elements	155
7.3.3	Shipping	156
7.3.4	Disposal	156
7.4	Preservation of RO and NF Systems	156
8	Troubleshooting	157
8.1	Introduction	157
8.2	Evaluation of System Performance and Operation	158
8.3	System Tests	160
8.3.1	Visual Inspection	160
8.3.2	Type of Foulant and Most Effective Cleaning	160
8.3.3	Localization of High Solute Passage	160
8.3.3.1	Profiling	160
8.3.3.2	Probing	161
8.4	Membrane Element Evaluation	163
8.4.1	Sample Selection	163
8.4.2	System Optimization Services (SOS)	164
8.4.3	Visual Inspection and Weighing	164
8.4.4	Vacuum Decay Test	164
8.4.5	Performance Test	165
8.4.6	Cleaning Evaluation	166
8.4.7	Autopsy	166
8.4.8	Membrane Analysis	167
8.5	Symptoms of Trouble, Causes, and Corrective Measures	167

8.5.1	Low Flow	167
8.5.1.1	Low Flow and Normal Solute Passage	168
8.5.1.2	Low Flow and High Solute Passage	169
8.5.1.3	Low Flow and Low Solute Passage	172
8.5.2	High Solute Passage	173
8.5.2.1	High Solute Passage and Normal Permeate Flow	173
8.5.2.2	High Solute Passage and High Permeate Flow	174
8.5.3	High Pressure Drop	174
8.5.4	Troubleshooting Grid	177
9	Addendum	178
9.1	Terminology	178
9.2	Conductivity of Ions	191
9.3	Conductivity of Solutions	192
9.4	Conversion of Concentration Units of Ionic Species	194
9.5	Conversion of U.S. Units into Metric Units	196
9.6	Ionization of Carbon Dioxide Solutions	196
9.7	Osmotic Pressure of Sodium Chloride	197
9.8	Osmotic Pressure of Solutions	197
9.9	Testing Chemical Compatibilities with FilmTec™ Membranes†	198
9.9.1	Summary	198
9.9.2	Test Equipment	199
9.9.2.1	Flat Cell Unit	199
9.9.2.2	Element Test Units	200
9.9.3	Antiscalants	200
9.9.3.1	Microbiological Growth Test	200
9.9.3.2	Membrane Compatibility Test	201
9.9.4	Coagulants and Flocculants	201
9.9.5	Cleaning Chemicals	201
9.9.5.1	Two-Hour Cleaning Test	202
9.9.5.2	Two-Week Soak in Cleaning Solution	202
9.9.6	Biocides	202
9.9.6.1	Option 1 – One-Week Continuous Operation Test	203
9.9.6.2	Option 2 – 1,000-Hour Continuous Operation Test	203
9.9.7	Membrane Preservatives	204
9.10	Accelerated Start-Up Technique for Dry Membranes	204
9.10.1	Summary	204
9.10.2	Step 1: Pre-Flushing	204
9.10.3	Step 2: Soaking	205
9.10.4	Step 3: Post-Flushing	205

Table of figures

Figure 1. Major desalination processes	10
Figure 2. Crossflow membrane filtration	10
Figure 3. Ranges of filtration processes	11
Figure 4. Overview of osmosis	12
Figure 5. Reverse osmosis process	13
Figure 6. Performance vs. pressure	14
Figure 7. Performance vs. temperature	14
Figure 8. Performance vs. recovery	14
Figure 9. Performance vs. feedwater salt concentration	14
Figure 10. Schematic cross-section of a FilmTec™ thin-film composite membrane	15
Figure 11. Barrier layer of the FT30 aromatic polyamide membrane	15
Figure 12. Barrier layer of the aromatic/aliphatic polyamide nanofiltration membrane	16
Figure 13. Construction of spiral-wound FilmTec™ RO Membrane Element	19
Figure 14. Cross-section of a permeate water tube through the side glue lines of the leaves	19
Figure 15. Nomenclature of elements < 8 inches	19
Figure 16. Major water types being treated by RO and NF	23
Figure 17. pH versus methyl orange alkalinity/free CO ₂	37
Figure 18. Langelier saturation index	38
Figure 19. Conversion of calcium and alkalinity to pCa and pAlk	41
Figure 20. “K” versus ionic strength and temperature	42
Figure 21. K _{sp} for CaSO ₄ versus ionic strength /9/	44
Figure 22. K _{sp} for BaSO ₄ versus ionic strength /10/	47
Figure 23. K _{sp} for SrSO ₄ versus ionic strength /10/	48
Figure 24. K _{sp} for CaF ₂ versus ionic strength /11/	49
Figure 25. Solubility of SiO ₂ versus temperature /16/	52
Figure 26. SiO ₂ pH correction factor /16, 17/	53
Figure 27. Critical phosphate concentration under various pH at 25°C	55
Figure 28. Apparatus for measuring the silt density index	57
Figure 29. Continuous RO process	81
Figure 30. Batch RO process	81
Figure 31. Single-module system	83
Figure 32. Single-stage system	83
Figure 33. Two-stage system	84
Figure 34. Two-stage system with internal concentrate recirculation	85
Figure 35. System salt passage for a plug flow and a concentrate recirculation system	87
Figure 36. Tapered recirculation system	87
Figure 37. Permeate staged system	88
Figure 38. Temperature and Pressure Limits for Elements with Standard Endcaps	98
Figure 39. Temperature and Pressure Limits for Elements with iLEC™ Interlocking Endcaps	98
Figure 40. Typical two-stage configuration for spiral-wound RO/NF elements	103
Figure 41. Individual element performance in a system 2:1 array of 8-inch BW30 elements (example)	104
Figure 42. Shim and placement on vessel adapter at feed end of pressure vessel	121
Figure 43. O-ring cross-section of 2 O-ring and “dog-boned” interconnector ends	123
Figure 44. Product water tube misalignment	124
Figure 45. Element spacer properly installed in a pressure vessel	125
Figure 46. Typical RO/NF system	130
Figure 47. Cleaning system flow diagram	143
Figure 48. Effect of pH on the removal of calcium carbonate	146
Figure 49. Effect of pH on the removal of biofouling	146
Figure 50. Conductivity profile	162
Figure 51. Permeate probing apparatus for spiral-wound membrane	163
Figure 52. Vacuum decay test	165
Figure 53. Picture of biofilm on membrane surface	168
Figure 54. Picture of feed spacer with biofilm	169
Figure 55. Picture of iron fouled feed side of an element with telescoping damage and signs of mechanical force	170
Figure 56. Picture of scaled membrane surface with imprints from the feed spacer	171
Figure 57. Picture of membrane with permeate backpressure damage	174

Figure 58. The endcap has been pushed off	175
Figure 59. High pressure drop due to biofouling has pushed out the feed spacer	175
Figure 60. Picture of damaged fiberglass shell	175
Figure 61. Conductivity of ionic solutions at 77°F (25°C)	192
Figure 62. Conductivity of ionic solutions at 77°F (25°C)	193
Figure 63. Ionization of carbon dioxide solutions as functions of the pH at 77°F (25°C)	196
Figure 64. Osmotic pressure of sodium chloride	197
Figure 65. Osmotic pressure of solutions	197
Figure 66. Flow schematic	199

Table of tables

Table 1. Factors influencing reverse osmosis performance	15
Table 2. Performance of some FilmTec™ Membranes	17
Table 3. FilmTec™ Element types	21
Table 4. Standard test conditions for FilmTec™ Elements	21
Table 5. Standard seawater composition	24
Table 6. Inorganic composition of seawater with different salinity	24
Table 7. Salinity and conductivity of seawaters	25
Table 8. Examples of brackish water composition	26
Table 9. Water analysis for RO/NF	27
Table 10. Standard procedures relevant to water analysis for RO/NF applications	28
Table 11. Solubility products of sparingly soluble inorganic compounds	29
Table 12. Feedwater Analysis	34
Table 13. Low solubility phosphate compounds	54
Table 14. Various fouling indices	56
Table 15. Guidelines for feedwater quality	73
Table 16. Pretreatment options for scaling and fouling	74
Table 17. System design information	79
Table 18. Water analysis for reverse osmosis/nanofiltration	80
Table 19. Comparison of plug flow and recirculation systems	85
Table 20. Special Design Possibilities	91
Table 21. Design guidelines for 8-inch FilmTec™ Elements in water treatment applications	94
Table 22. Design guidelines for FilmTec™ Elements in light industrial and small seawater applications	96
Table 23. Design guidelines for FilmTec™ Elements in small commercial applications	97
Table 24. Number of stages of a brackish water system	100
Table 25. Number of stages of a seawater system	100
Table 26. Design equations for projecting RO system performance: individual element performance	106
Table 27. Design equations for projecting RO system performance: system average performance	107
Table 28. Symbol definitions	108
Table 29. Maximum dynamic permeate backpressure for pressure vessels with FilmTec™ Elements	111
Table 30. Provisions against undue operating conditions	111
Table 31. Composition of stainless steels	115
Table 32. FilmTec™ interconnector (coupler) summary	124
Table 33. Reverse osmosis operating log (example)	135
Table 34. Factors for estimating TDS from conductivity	136
Table 35. pH range and temperature limits during cleaning	142
Table 36. Recommended feed flowrate per pressure vessel during high flowrate recycle	144
Table 37. Simple cleaning solutions	147
Table 38. Sulfate scale cleaning solutions	148
Table 39. Carbonate scale cleaning solutions	149
Table 40. Iron fouling cleaning solutions	149
Table 41. Organic fouling cleaning solutions	150
Table 42. Biofouling cleaning solutions	151
Table 43. Symptoms, causes and corrective measures	177
Table 44. Conductivity of ions expressed as $\mu\text{S}/\text{cm}$ per meq/l, infinitely diluted	191
Table 45. Conductivity of solutions, acids, alkalies and salts 77°F (25°C) expressed as $\mu\text{S}/\text{cm}$ per meq/L	192
Table 46. Conductivity correction factors	192
Table 47. Conversion factors for the conversion of concentration units of ionic species	194

1 Basics of Reverse Osmosis and Nanofiltration

1.1 Historical Background

Since the development of reverse osmosis (RO) and ultrafiltration (UF) as practical unit operations in the late 1950's and early 1960's, the scope for their application has been continually expanding. Initially, reverse osmosis was applied to the desalination of seawater and brackish water. Increased demands on the industry to conserve water, reduce energy consumption, control pollution and reclaim useful materials from waste streams have made new applications economically attractive. In addition, advances in the fields of biotechnology and pharmaceuticals, coupled with advances in membrane development, are making membranes an important separation step, which, compared to distillation, offers energy savings and does not lead to thermal degradation of the products.

Basic membrane research is the foundation of FilmTec™ Corporation. Since the creation of the FilmTec™ FT30 membrane, new products have been developed and existing products have undergone enhancements in their ability to improve permeate quality and lower the total cost of water.

In general, RO membranes now offer the possibility of higher rejection of salts at significantly reduced operating pressures, and therefore, reduced costs. Nanofiltration membrane technology provides the capability of some selectivity in the rejection of certain salts and compounds at relatively low operating pressures.

FilmTec™ Corporation was founded in Minneapolis USA in 1977. After evolving product changes and company development between 1981 and 1984, the FilmTec™ Corporation became a wholly owned subsidiary of The Dow Chemical Company in August 1985.

With the intent to assure a continuous, consistent, high quality supply of FilmTec™ products to the rapidly growing reverse osmosis and nanofiltration markets, DuPont has committed significant capital and other resources to upgrade and expand its manufacturing capabilities at FilmTec™. The adoption of ISO quality assurance programs coupled with investment in advanced manufacturing techniques and equipment, intending to ensure high levels of product performance and consistency.

1.2 Desalination Technologies and Filtration Processes

FilmTec™ reverse osmosis (RO) and nanofiltration (NF) membrane technologies are widely recognized to offer highly effective and economical process options. From small-scale systems, through to very large-scale desalination, RO and NF can handle most naturally occurring sources of brackish and seawaters. Permeate waters produced satisfy most currently applicable standards for the quality of drinking waters.

RO and NF can reduce regeneration costs and waste when used independently, in combination or with other processes, such as ion exchange. They can also produce very high quality water, or, when paired with thermal distillation processes, can improve asset utilization in power generation and water production against demand.

Figure 1 gives an approximate representation of the salinity range to which the main desalination processes can be generally applied economically.

The most typical operating range of the four major desalination processes is shown in Figure 1. Also shown is typical operating ranges for several generic FilmTec™ membrane types.

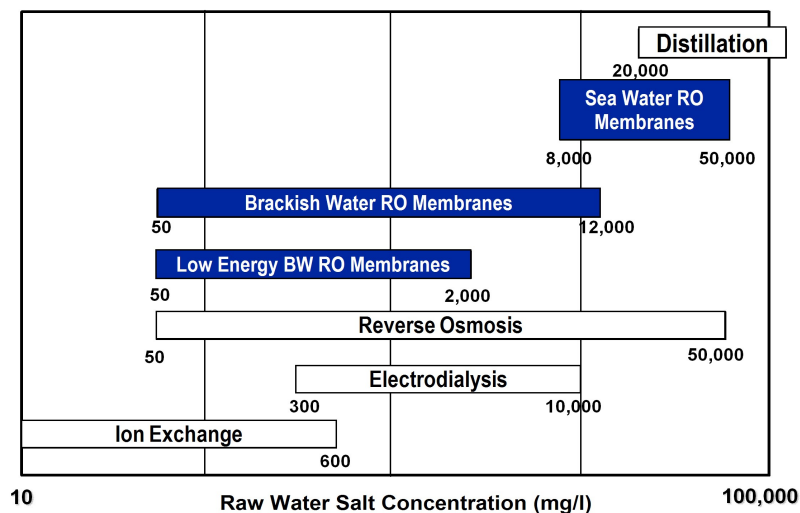

Figure 1. Major desalination processes

The various filtration technologies which currently exist can be categorized on the basis of the size of particles removed from a feed stream. Conventional macrofiltration of suspended solids is accomplished by passing a feed solution through the filter media in a perpendicular direction. The entire solution passes through the media, creating only one exit stream. Examples of such filtration devices include cartridge filters, bag filters, sand filters, and multimedia filters. Macrofiltration separation capabilities are generally limited to undissolved particles greater than 1 micron.

For the removal of small particles and dissolved salts, crossflow membrane filtration is used. Crossflow membrane filtration (see Figure 2) uses a pressurized feed stream which flows parallel to the membrane surface. A portion of this stream passes through the membrane, leaving behind the rejected particles in the concentrated remainder of the stream. Since there is a continuous flow across the membrane surface, the rejected particles do not accumulate but instead are swept away by the concentrate stream. Thus, one feed stream is separated into two exit streams: the solution passing through the membrane surface (permeate) and the remaining concentrate stream.

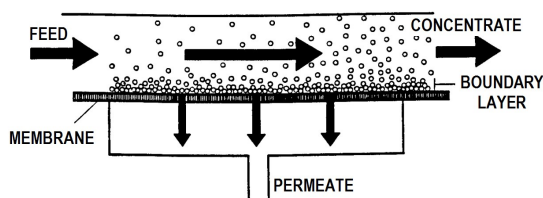

Figure 2. Crossflow membrane filtration

There are four general categories of crossflow membrane filtration: microfiltration, ultrafiltration, nanofiltration, and reverse osmosis.

Microfiltration (MF)

Microfiltration removes particles in the range of approximately 0.1 – 1 micron. In general, suspended particles and large colloids are rejected while macromolecules and dissolved solids pass through the MF membrane. Applications include removal of bacteria, flocculated materials, or TSS (total suspended solids). Transmembrane pressures are typically 10 psi (0.7 bar).

Ultrafiltration (UF)

DuPont's ultrafiltration modules provide macro-molecular separation for particles ranging in size from approximately 20 – 1,000 Å (up to 0.1 micron). All dissolved salts and smaller molecules pass through the membrane. Items rejected by the membrane include colloids, proteins, microbiological contaminants, and large organic molecules. Most UF membranes have molecular weight cut-off values between 1,000 and 100,000. Transmembrane pressures are typically 15 – 100 psi (1 – 7 bar).

Nanofiltration (NF)

Nanofiltration refers to a speciality membrane process which rejects particles in the approximate size range of 1 nanometer (10 Å), hence the term “nanofiltration.” NF operates in the realm between UF and reverse osmosis. Organic molecules with molecular weights greater than 200 – 400 are rejected. Also, dissolved salts are rejected in the range of 20 – 98%. Salts which have monovalent anions (e.g., sodium chloride or calcium chloride) have rejections of 20 – 80%, whereas salts with divalent anions (e.g., magnesium sulfate) have higher rejections of 90 – 98%. Typical applications include removal of color and total organic carbon (TOC) from surface water, removal of hardness or radium from well water, overall reduction of total dissolved solids (TDS), and the separation of organic from inorganic matter in specialty food and wastewater applications. Transmembrane pressures are typically 50 – 225 psi (3.5 – 16 bar).

Reverse Osmosis (RO)

Reverse osmosis is among the finest levels of filtration available. The RO membrane generally acts as a barrier to all dissolved salts and inorganic molecules, as well as organic molecules with a molecular weight greater than approximately 100. Water molecules, on the other hand, pass freely through the membrane creating a purified product stream. Rejection of dissolved salts is typically 95% to greater than 99%, depending on factors such as membrane type, feed composition, temperature, and system design.

The applications for RO are numerous and varied, and include desalination of seawater or brackish water for drinking purposes, wastewater recovery, food and beverage processing, biomedical separations, purification of home drinking water and industrial process water.

Also, RO is often used in the production of ultrapure water for use in the semiconductor industry, power industry (boiler feedwater), and medical/laboratory applications. Utilizing RO prior to ion exchange (IX) can substantially reduce operating costs and regeneration frequency of the IX system. Transmembrane pressures for RO typically range from 75 psig (5 bar) for brackish water to greater than 1,200 psig (84 bar) for seawater.

The normal range of filtration processes is shown in Figure 3.

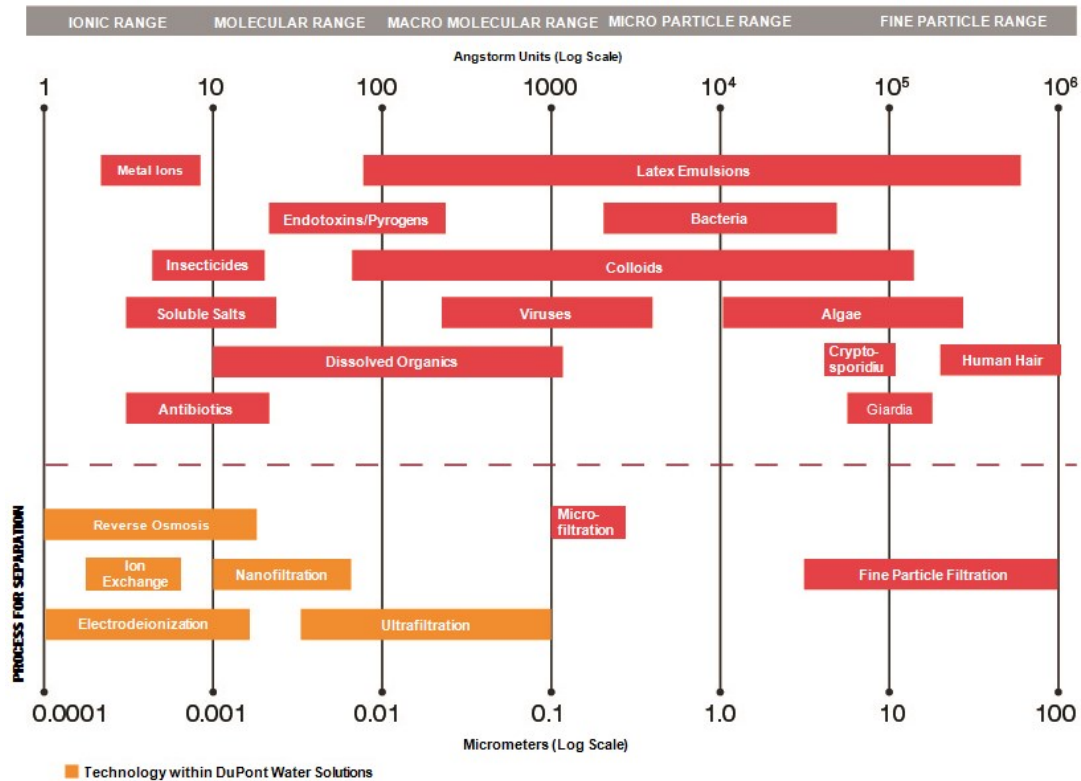

Figure 3. Ranges of filtration processes

1.3 Principle of Reverse Osmosis and Nanofiltration

How Reverse Osmosis Works

The phenomenon of osmosis occurs when pure water flows from a dilute saline solution through a membrane into a higher concentrated saline solution.

The phenomenon of osmosis is illustrated in Figure 4. A semi-permeable membrane is placed between two compartments. "Semi-permeable" means that the membrane is permeable to some species, and not permeable to others. Assume that this membrane is permeable to water, but not to salt. Then, place a salt solution in one compartment and pure water in the other compartment. The membrane will allow water to permeate through it to either side. But salt cannot pass through the membrane.

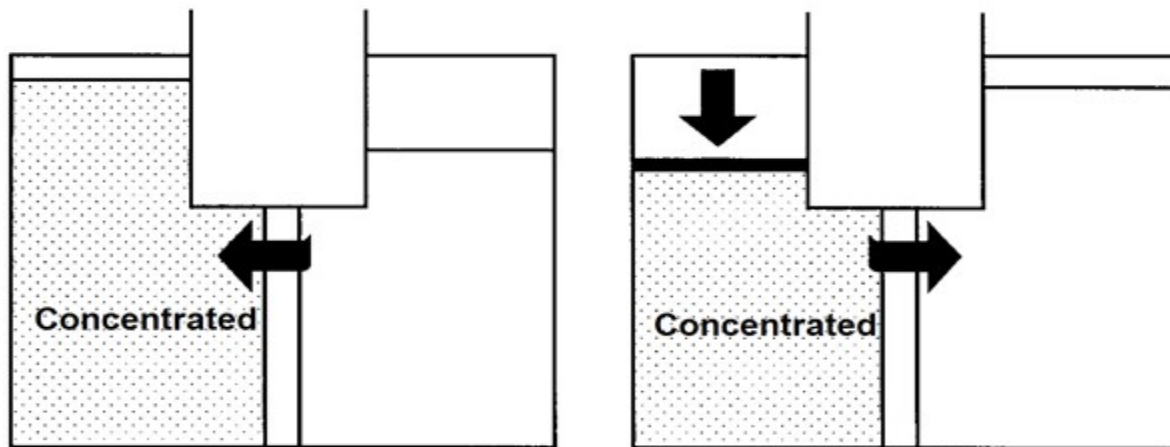

Osmosis

Water diffuses through a semi-permeable membrane toward region of higher concentration to equalize solution strength. Ultimate height difference between columns is "osmotic" pressure.

Reverse Osmosis

Applied pressure in excess of osmotic pressure reverses water flow direction. Hence the term "reverse osmosis".

Figure 4. Overview of osmosis

As a fundamental rule of nature, this system will try to reach equilibrium. That is, it will try to reach the same concentration on both sides of the membrane. The only possible way to reach equilibrium is for water to pass from the pure water compartment to the salt-containing compartment, to dilute the salt solution.

Figure 4 also shows that osmosis can cause a rise in the height of the salt solution. This height will increase until the pressure of the column of water (salt solution) is so high that the force of this water column stops the water flow. The equilibrium point of this water column height in terms of water pressure against the membrane is called osmotic pressure.

How Nanofiltration Works

If a force is applied to this column of water, the direction of water flow through the membrane can be reversed. This is the basis of the term reverse osmosis. Note that this reversed flow produces a pure water from the salt solution, since the membrane is not permeable to salt.

The nanofiltration membrane is not a complete barrier to dissolved salts. Depending on the type of salt and the type of membrane, the salt permeability may be low or high. If the salt permeability is low, the osmotic pressure difference between the two compartments may become almost as high as in reverse osmosis. On the other hand, a high salt permeability of the membrane would not allow the salt concentrations in the two compartments to remain very different. Therefore the osmotic pressure plays a minor role if the salt permeability is high.

How to Use Reverse Osmosis and Nanofiltration in Practice

In practice, reverse osmosis and nanofiltration are applied as a crossflow filtration process. The simplified process is shown in Figure 5.

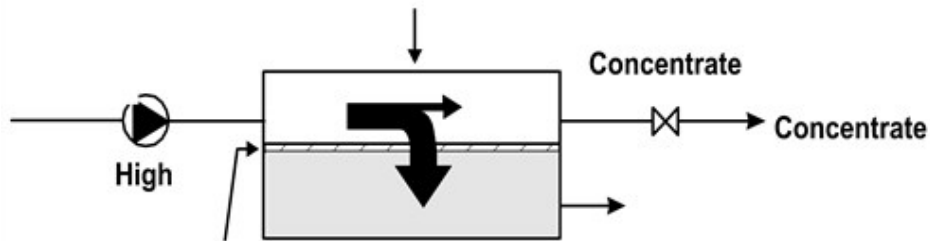

Figure 5. Reverse osmosis process

With a high pressure pump, feedwater is continuously pumped at elevated pressure to the membrane system. Within the membrane system, the feedwater will be split into a low-saline and/or purified product, called permeate, and a high saline or concentrated brine, called concentrate or reject. A flow regulating valve, called a concentrate valve, controls the percentage of feedwater that is going to the concentrate stream and the permeate which will be obtained from the feed.

The key terms used in the reverse osmosis / nanofiltration process are defined as follows.

Recovery - the percentage of membrane system feedwater that emerges from the system as product water or "permeate". Membrane system design is based on expected feedwater quality and recovery is defined through initial adjustment of valves on the concentrate stream. Recovery is often fixed at the highest level that maximizes permeate flow while preventing precipitation of super-saturated salts within the membrane system.

Rejection - the percentage of solute concentration removed from system feedwater by the membrane. In reverse osmosis, a high rejection of total dissolved solids (TDS) is important, while in nanofiltration the solutes of interest are specific, e.g., low rejection for hardness and high rejection for organic matter.

Passage - the opposite of "rejection", passage is the percentage of dissolved constituents (contaminants) in the feedwater allowed to pass through the membrane.

Permeate - the purified product water produced by a membrane system.

Flow - Feed flow is the rate of feedwater introduced to the membrane element or membrane system, usually measured in gallons per minute (gpm) or cubic meters per hour (m^3/h). Concentrate flow is the rate of flow of non-permeated feedwater that exits the membrane element or membrane system. This concentrate contains most of the dissolved constituents originally carried into the element or into the system from the feed source. It is usually measured in gallons per minute (gpm) or cubic meters per hour (m^3/h).

Flux - the rate of permeate transported per unit of membrane area, usually measured in gallons per square foot per day (gfd) or liters per square meter and hour (L/m^2h).

Factors Affecting Reverse Osmosis and Nanofiltration Performance

Permeate flux and salt rejection are the key performance parameters of a reverse osmosis or a nanofiltration process. Under specific reference conditions, flux and rejection are intrinsic properties of membrane performance. The flux and rejection of a membrane system are mainly influenced by variable parameters including:

- pressure
- temperature
- recovery
- feedwater salt concentration

The following graphs show the impact of each of those parameters when the other three parameters are kept constant. In practice, there is normally an overlap of two or more effects. Figure 6, Figure 7, Figure 8 and Figure 9 are qualitative examples of reverse osmosis performance. The functions can be understood with the Solution-Diffusion-Model, which is explained in more detail in Section 3.12.2. In nanofiltration, the salt rejection is less depending on the operating conditions.

Not to be neglected are several main factors which cannot be seen directly in membrane performance. These are maintenance and operation of the plant as well as proper pretreatment design. Consideration of these three 'parameters', which have very strong impact on the performance of a reverse osmosis system, is a must for each OEM (original equipment manufacturer) and end-user of such a system.

Pressure

With increasing effective feed pressure, the permeate TDS will decrease while the permeate flux will increase as shown in Figure 5.

Temperature

If the temperature increases and all other parameters are kept constant, the permeate flux and the salt passage will increase (see Figure 6).

Recovery

Recovery is the ratio of permeate flow to feed flow. In the case of increasing recovery, the permeate flux will decrease and stop if the salt concentration reaches a value where the osmotic pressure of the concentrate is as high as the applied feed pressure. The salt rejection will drop with increasing recovery (see Figure 7).

Feedwater Salt Concentration

Figure 9 shows the impact of the feedwater salt concentration on the permeate flux and the salt rejection.

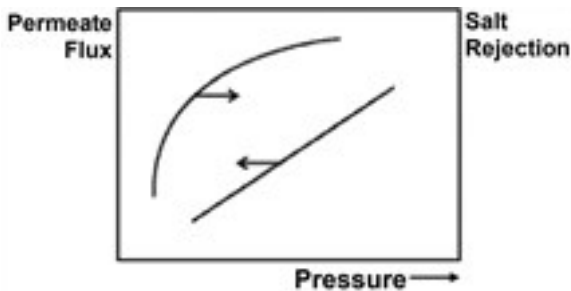

Figure 6. Performance vs. pressure

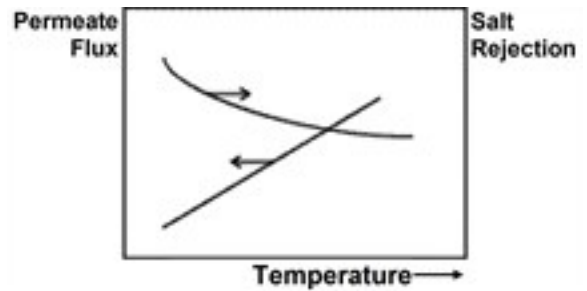

Figure 7. Performance vs. temperature

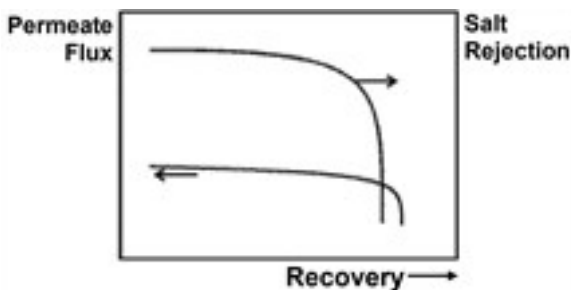

Figure 8. Performance vs. recovery

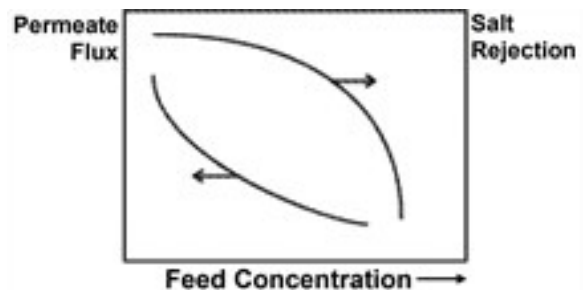

Figure 9. Performance vs. feedwater salt concentration

Table 1 shows a summary of the impacts influencing reverse osmosis plant performance.

Table 1. Factors influencing reverse osmosis performance

Increasing	Permeate Flow	Salt Passage
Effective pressure		↓
Temperature		
Recovery	↓	
Feed salt correction	↓	
Increasing	Decreasing ↓	

1.4 Membrane Description

The FilmTec™ membrane is a thin-film composite membrane consisting of three layers: a polyester support web, a microporous polysulfone interlayer, and an ultra-thin polyamide barrier layer on the top surface. Each layer is tailored to specific requirements. A schematic diagram of the membrane is shown in Figure 10.

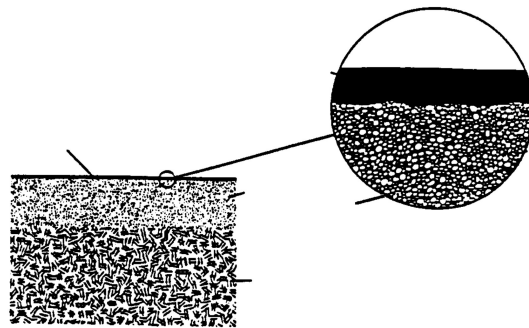

Figure 10. Schematic cross-section of a FilmTec™ thin-film composite membrane

Polyamide, Microporous Polysulfone, Polyester Support Web, Ultra-thin Barrier Layer
0.2 μm, 40 μm, 120 μm

FilmTec™ produces two different types of polyamide membranes for use in water purification. The first is the FT30 chemistry, which is an aromatic polyamide and is used in all FilmTec™ reverse osmosis membranes and the NF90 nanofiltration membrane patented by John Cadotte at FilmTec™ in 1969. The second type is a mixed aromatic, aliphatic polyamide used in all nanofiltration membranes and was also initially developed by John Cadotte at FilmTec™. Thirty years of further innovations at FilmTec™ have led to the broadest range of nanofiltration and reverse osmosis membranes in the industry. FilmTec™ membranes cover a flux performance range from 0.04 – 0.55 gfd/psi (1 – 14 l/m²h bar). This 14-fold difference in water permeability is covered by two polyamide types with small changes in composition and larger changes in the water content of the membrane: the aromatic FT30 membrane and the aliphatic/aromatic nanofiltration membrane. The latter type is sometimes referred to as polypiperazine membrane.

Figure 11 represents the approximate structure of the FT30 aromatic polyamide membrane. The presence of both amine and carboxylate end groups are shown.

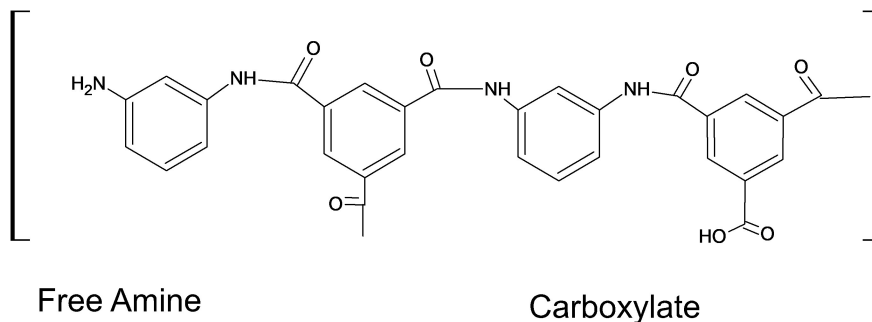

Figure 11. Barrier layer of the FT30 aromatic polyamide membrane

The FT30 membrane is an aromatic polyamide made from 1,3 phenylene diamine and the tri-acid chloride of benzene. This remarkably chemically resistant and structurally strong polymer contains carboxylic acid and free (not reacted) amines at different levels. High chemical stability makes it the most durable and easy to clean membrane material available.

The approximate structure of most of the FilmTec™ nanofiltration membrane is shown in Figure 12. This is an aromatic/aliphatic polyamide with amine and carboxylate end groups.

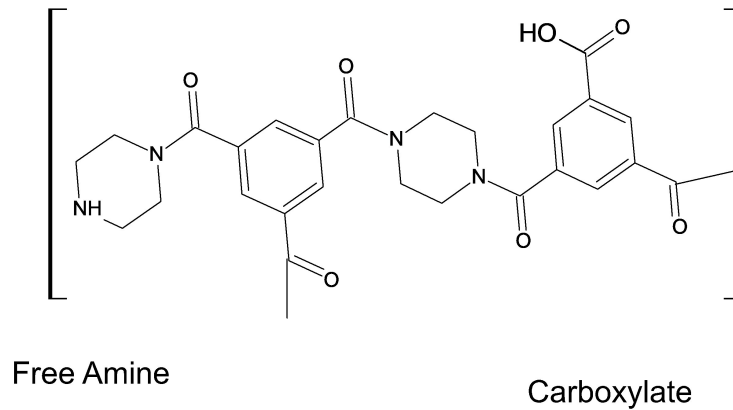

Figure 12. Barrier layer of the aromatic/aliphatic polyamide nanofiltration membrane

Because of the trace additives and the different dissociation constants of the piperazine found in this polymer we are able to have a wider range of both monovalent and divalent salts transporting through this polymer. This has allowed us to design a wide range of nanofiltration membranes that have different salt selectivity for different separations.

The major structural support is provided by the non-woven web, which has been calendered to produce a hard, smooth surface free of loose fibers. Since the polyester web is too irregular and porous to provide a proper substrate for the salt barrier layer, a microporous layer of engineering plastic (polysulfone) is cast onto the surface of the web.

The polysulfone coating is remarkable in that it has surface pores controlled to a diameter of approximately 150 Å. The barrier layer, about 2,000 Å thick, can withstand high pressures because of the support provided by the polysulfone layer. The combination of the polyester web and the polysulfone layer has been optimized for high water permeability at high pressure.

The barrier layer is relatively thick; making FilmTec™ membranes highly resistant to mechanical stresses and chemical degradation.

1.5 Membrane Performance

FilmTec™ thin-film composite membranes give excellent performance for a wide variety of applications, including low-pressure tap water use, seawater desalination, brackish water purification, chemical processing and waste treatment. This membrane exhibits excellent performance in terms of flux, salt and organics rejection, and microbiological resistance. FilmTec™ Elements can operate over a pH range of 2 – 11, are resistant to compaction and are suitable for temperatures up to 45°C. They can be effectively cleaned at pH 1 and pH 13, depending on temperature. Their performance remains stable over several years, even under harsh operating conditions.

The membrane shows some resistance to short-term attack by chlorine (hypochlorite). The free chlorine tolerance of the membrane is < 0.1 ppm. Continuous exposure, however, may damage the membrane and should be avoided. Under certain conditions, the presence of free chlorine and other oxidizing agents will cause premature membrane failure. Since oxidation damage is not covered under warranty, FilmTec™ recommends removing residual free chlorine by pretreatment prior to membrane exposure. Please refer to Section 2.6.3 for more information.

The parameters which characterize the performance of a membrane are the water permeability and the solute permeability. The ideal reverse osmosis membrane has a very high water permeability and a zero salt permeability. The ideal nanofiltration membrane has also a very high water permeability, but the ideal permeability of solutes might be zero or some positive value, depending on the solute and on the application; for example zero permeability for pesticides and 50% permeability for calcium ions.

Membrane systems are typically designed and operated at a fixed average flux, see Section 3.1, *Membrane System Design*. Membranes with a high water permeability require a low feed pressure and thus a low energy to operate at a given flux. Table 2 shows a comparison of the performance of different membranes based on a given flux as typically encountered in membrane systems.

Table 2. Performance of some FilmTec™ Membranes

	SW30HR	BW30	XLE	NF270
Feed pressure (psi)	370	150	70	50
Feed pressure (bar)	25	10	5	3.5
Rejection (%)				
Sodium chloride NaCl	99.7	99.4	98.6	80
Calcium chloride CaCl ₂	99.8	99.4	98.8	50
Magnesium sulfate MgSO ₄	99.9	99.7	99.2	99.3

At 18 gfd (30 L/m²h), 2,000 mg/L solute concentration, 25°C, pH 7-8, 10% recovery per 40-inch element.

As a general rule, membranes with a high water permeability (low feed pressure) also have a higher salt permeability compared to membranes with lower water permeability. The permeability of solutes decreases (the rejection increases) with an increase in the:

- **degree of dissociation:** weak acids, for example lactic acid, are rejected much better at higher pH when the dissociation is high
- **ionic charge:** e.g., divalent ions are better rejected than monovalent ions
- **molecular weight:** higher molecular weight species are better rejected
- **nonpolarity:** less polar substances are rejected better
- **degree of hydration:** highly hydrated species, e.g., chloride, are better rejected than less hydrated ones, e.g., nitrate
- **degree of molecular branching:** e.g., iso-propanol is better rejected than n-propanol.

1.6 FilmTec™ Membrane Safe for Use in Food Processing

Under the food additive provision of the Federal Food, Drug and Cosmetic Act, contact surfaces of components used in the production of food, including water, must comply with established regulations set forth by the U.S. Food and Drug Administration (FDA) in order to receive approval for safe use. In accordance with its long-standing commitment to quality, petitions were submitted to the FDA for the FilmTec™ FT30 reverse osmosis membrane and all FilmTec™ NF membranes for evaluation and approval.

The procedure for FDA approval is rigorous and thorough. First, a food additive petition must be submitted to the FDA. This petition includes information about the chemical identity and composition of the component and its physical, chemical and biological properties. The petitioner must also describe the proposed use of the component, including all directions, recommendations and suggestions. Data must be included which establish that the component will have the intended effect when used in this manner. In addition, experimental data must show the extent that the component directly or indirectly affects the safety of the food with which it comes in contact. The petition must finally analyze the environmental impact of the manufacturing process and the ultimate use of the component.

The FDA evaluates the petition for the specific biological properties of the component and its demonstrated safety for the proposed use. The data and experimental methods are also evaluated for adequacy and reliability. As a guideline for this evaluation, the FDA uses the principles and procedures for establishing the safety of food additives stated in current publications of the Nation Academy of Sciences–National Research Council.

Reverse osmosis and nanofiltration membranes received FDA clearance for use in processing liquid foods and in purifying water for food applications. This clearance is published in the Code of Federal Regulations under Title 21, Section 177.2550, Reverse Osmosis Membranes. The FT30 reverse osmosis membrane as well as all nanofiltration membranes comply with this regulation.

1.7 Element Construction

FilmTec™ Membranes are thin-film composite membranes packed in a spiral-wound configuration. Spiral-wound designs offer many advantages compared to other module designs, such as tubular, plate-and-frame and hollow-fiber module design for most of the reverse osmosis applications in water treatment. Typically, a spiral-wound configuration offers significantly lower replacement costs, simpler plumbing systems, easier maintenance and greater design freedom than other configurations, making it the industry standard for reverse osmosis and nanofiltration membranes in water treatment.

The construction of a spiral-wound FilmTec™ Membrane Element as well as its installation in a pressure vessel is schematically shown in Figure 13. A FilmTec™ Element contains from one, to more than 30 membrane leaves, depending on the element diameter and element type. Using DuPont's unique automated manufacturing process, each leaf is made of two membrane sheets glued together back-to-back with a permeate spacer between them. DuPont's automated process produces consistent glue lines about 1.5 in (4 cm) wide that seal the inner (permeate) side of the leaf against the outer (feed/concentrate) side. There is a side glue line at the feed end and at the concentrate end of the element, and a closing glue line at the outer diameter of the element. The open side of the leaf is connected to and sealed against the perforated central part of the product water tube, which collects the permeate from all leaves. The leaves are rolled up with a sheet of feed spacer between each of them, which provides the channel for the feed and concentrate flow. In operation, the feedwater enters the face of the element through the feed spacer channels and exits on the opposite end as concentrate. A part of the feedwater—typically 10 – 20%— permeates through the membrane into the leaves and exits the permeate water tube.

When elements are used for high permeate production rates, the pressure drop of the permeate flow inside the leaves reduces the efficiency of the element. Therefore, FilmTec™ Elements have been optimized with a higher number of shorter membrane leaves and thin and consistent glue lines. The FilmTec™ Element construction also optimizes the actual active membrane area (the area inside the glue lines) and the thickness of the feed spacer. Element productivity is enhanced by high active area while a thick feed spacer reduces fouling and increases cleaning success. Such precision in element manufacture can only be achieved by using advanced automated precision manufacturing equipment. A cross-section of a permeate water tube with attached leaves is shown in Figure 14.

In membrane systems the elements are placed in series inside of a pressure vessel. The concentrate of the first element becomes the feed to the second element and so on. The permeate tubes are connected with interconnectors (also called couplers), and the combined total permeate exits the pressure vessel at one side (sometimes at both sides) of the vessel.

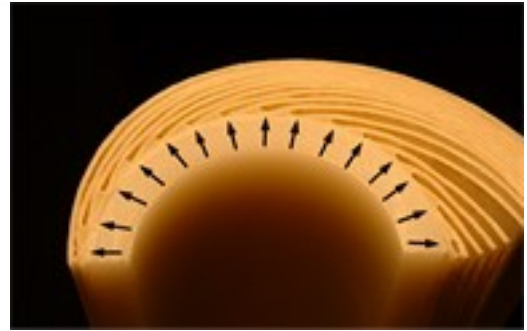
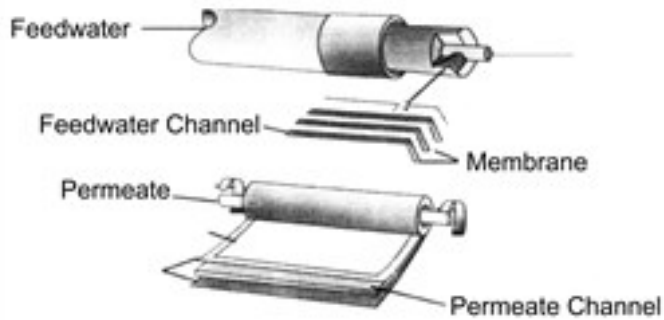

Figure 14. Cross-section of a permeate water tube through the side glue lines of the leaves



Figure 13. Construction of spiral-wound FilmTec™ RO Membrane Element

1.8 Element Characteristics

FilmTec™ Elements cover a wide range of applications. They can be characterized by membrane type, outer wrap, size and performance. The nomenclature of FilmTec™ Elements provides some of this information.

Nomenclature

Elements less than 8 inches in diameter are named according to Table 3. The first part of the name indicates the membrane and its typical use; for example, BW30 is a Brackish Water FT30 membrane used for brackish water. The second part of the name indicates the element size; for example 2540 is an element with a diameter of 2.5 inches and a length of 40 inches.

The element nomenclature for FilmTec™ Elements is for example as follows:

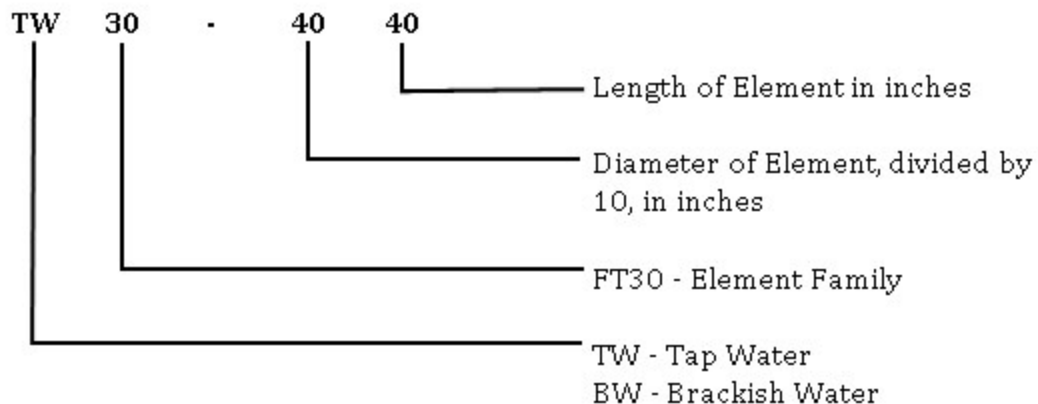

Figure 15. Nomenclature of elements < 8 inches

Eight-inch elements are always 8 inches in diameter and 40 inches in length. They are named according to the actual active membrane area in square feet, for example the BW30-400 element has an active membrane area of 400 square feet.

Some elements types have an extension to their name, e.g., FF or FR. These stand for special element or membrane features:

FR: Fouling Resistant
FF: Fullfit

Membrane

The following membrane types are used with FilmTec™ Elements:

- NF270 – high productivity nanofiltration membrane for removal of organics with medium salt and hardness passage
- NF200 – nanofiltration membrane for high atrazine and TOC rejection, medium calcium passage
- NF90 – nanofiltration membrane for 90% salt removal, high removal of iron, pesticides, herbicides, TOC
- NF – nanofiltration membrane used in non-water applications
- TW30 – High rejection brackish water FT30 membrane, typically used for Tap Water RO
- TW30LP – Low Pressure version of the TW30 membrane
- BW30 – High rejection Brackish Water FT30 membrane for brackish water RO
- RO – Reverse Osmosis membrane used in fullfit elements for sanitary applications
- HSRO – Heat Sanitizable version of the RO membrane used in fullfit elements
- BW30LE – Low Energy version of the BW30 membrane
- SG30 – Semiconductor Grade FT30 membrane for ultrapure water RO
- SG30LE – Low Energy version of the SG30 membrane
- XLE – EXtremely Low Energy RO membrane for lowest pressure brackish water RO
- SW30 – SeaWater RO membrane, typically used for low salinity or cold seawater RO and high salinity brackish water RO
- SW30HR – SeaWater RO membrane with High salt Rejection, typically used for single pass seawater desalination
- SW30HRLE - SeaWater RO membrane with High salt Rejection, typically used for Low Energy seawater desalination
- SW30XLE – membrane for SeaWater desalination with eXtremely Low Energy consumption

Element Size

The standard length of a membrane element is 40 inches (1,016 mm). For small and compact systems shorter elements are available, such as 14 inches (356 mm) and 21 inches (533 mm).

Home Drinking Water RO elements are 12 inches long and 1.8 inches in diameter to fit into nominal 2-inch I.D. housings.

The standard diameter of FilmTec™ Elements is 2.5, 4 and 8 inches (61 – 99 – 201 mm). They are sized to fit into 2.5, 4 and 8 inch pressure vessels respectively.

Element Outer Wrap

The outer wrap of FilmTec™ Elements is tape, fiberglass or a polypropylene mesh. Tap water and home drinking water RO elements are tape-wrapped, all other elements except fullfit elements are fiberglass wrapped. Fiberglass adds more physical strength to the element for operation under harsh conditions. Fullfit elements have a designed bypass during operation to minimize stagnant areas; such elements are optimal for applications requiring a sanitary design.

Element Performance

The performance of all FilmTec™ Elements is stated on their respective product information data sheets. An overview about the available sizes and their flow performance range is shown in Table 3.

Table 3. FilmTec™ Element types

Element type	Diameter (inch)	Permeate flow ¹ at standard test conditions		Maximum operating pressure	
		(gpd)	(L/h)	(bar)	(psi)
NF270	2.5, 4, 8	850 – 14,700	134 – 2,300	41	600
NF200	2.5, 4, 8	460 – 8,000	73 – 1,260	41	600
NF90	2.5, 4, 8	525 – 10,300	83 – 1,620	41	600
TW30	1.8	24 – 100	3.8 – 16	21	300
TW30, TW30HP	2, 2.5, 4	100 – 3,200	16 – 500	41	600
BW30	2.5, 4, 8	750 – 10,500	120 – 1,660	41	600
BW30LE	4, 8	2,000 – 11,500	320 – 1,830	41	600
XLE	2.5, 4, 8	330 – 13,000	52 – 2,040	41	600
SW30	2.5, 4	150 – 1,950	24 – 300	69	1,000
SW30HR	8	6,000	950	84	1,200
SW30HRLE	8	7,500	1,200	84	1,200
SW30XLE	8	9,000	1,400	69	1,200

¹Varying with different element dimensions and test conditions.

The standard element test conditions vary depending on the membrane type. summarizes the test conditions used to specify the performance of FilmTec™ Elements.

Table 4. Standard test conditions for FilmTec™ Elements

Element type	Feedwater	Temperature	Pressure		pH	Recovery	Test time
			psi	bar			
NF200 NF270 NF90	MgSO ₄ , 2,000 ppm	77°F (25°C)	70	4.8	8	15%	20 min
NF200 NF270	CaCl ₂ , 500 ppm	77°F (25°C)	70	4.8	8	15%	20 min
NF90	NaCl, 2,000 ppm	77°F (25°C)	70	4.8	8	15%	20 min
LPTW	Tap water, 250 ppm	77°F (25°C)	50	3.45	8	15%	20 min
BW30LE	NaCl, 2,000 ppm	77°F (25°C)	150	10.3	8	15%	20 min
XLE	NaCl, 500 ppm	77°F (25°C)	100	6.9	8	15%	20 min
TW30 BW30	NaCl, 2,000 ppm	77°F (25°C)	225	15.5	8	15%	20 min
SW30	NaCl, 32,000 ppm	77°F (25°C)	800	55	8	10% [†]	20 min
SW30HR	NaCl, 32,000 ppm	77°F (25°C)	800	55	8	8%	20 min

[†] 8% for 2.5-inch and 4-inch diameter elements.

2 Water Chemistry and Pretreatment

2.1 Introduction

To increase the efficiency and life of reverse osmosis and nanofiltration (RO/NF) systems, effective pretreatment of the feedwater is required. Selection of the proper pretreatment will maximize efficiency and membrane life by minimizing:

- Fouling
- Scaling
- Membrane degradation

Optimizing:

- Product flow
- Product quality (salt rejection)
- Product recovery
- Operating & maintenance costs

Fouling is the accumulation of foreign materials from feedwater on the active membrane surface and/or on the feed spacer to the point of causing operational problems. The term fouling includes the accumulation of all kinds of layers on the membrane and feed spacer surface, including scaling. More specifically, colloidal fouling refers to the entrapment of particulate or colloidal matter such as iron flocs or silt, biological fouling (biofouling) is the growth of a biofilm, and organic fouling is the adsorption of specific organic compounds such as humic substances and oil on to the membrane surface. Scaling refers to the precipitation and deposition within the system of sparingly soluble salts including calcium carbonate, barium sulfate, calcium sulfate, strontium sulfate and calcium fluoride.

Pretreatment of feedwater must involve a total system approach for continuous and reliable operation. For example, an improperly designed and/or operated clarifier will result in loading the sand or multimedia filter beyond its operating limits. Such inadequate pretreatment often necessitates frequent cleaning of the membrane elements to restore productivity and salt rejection. The cost of cleaning, downtime and lost system performance can be significant.

The proper treatment scheme for feedwater depends on:

- Feedwater source
- Feedwater composition
- Application

The type of pretreatment system depends to a large extent on feedwater source (i.e., well water, surface water, and municipal wastewater). In general, well water is a consistent feed source that has a low fouling potential. Well water typically requires a very simple pretreatment scheme such as acidification and/or antiscalant dosing and a 5- μm cartridge filter.

Surface water, on the other hand, is a variable feedwater source that is affected by seasonal factors. It has a high-fouling potential, both microbiological and colloidal. Pretreatment for surface water is more elaborate than pretreatment for well water. Additional pretreatment steps often include chlorination, coagulation/flocculation, clarification, multimedia filtration, dechlorination, acidification and/or antiscalant dosing.

Industrial and municipal wastewaters have a wide variety of organic and inorganic constituents. Some types of organic components may adversely affect RO/NF membranes, inducing severe flow loss and/or membrane degradation (organic fouling), making a well-designed pretreatment scheme imperative.

Once the feedwater source has been determined, a complete and accurate analysis of the feedwater should be made. The importance of a feedwater analysis cannot be overemphasized. It is critical in determining the proper pretreatment and RO/NF system design.

Finally, the application often determines the type or extent of RO/NF pretreatment required. For example, pretreatment in an electronics application might be much more sophisticated than for a municipal system due to the different product water quality requirements.

Pretreatment is a continuous water treatment process upstream of a continuous membrane process. Water treatment chemicals may be dosed continuously or intermittently during operation of the RO/NF system. Any off-line application of chemicals (i.e., when the system is not in production mode) is described in Section 6.1, Cleaning and Sanitization.

2.2 Feedwater Type and Analysis

The major water types being treated by RO/NF can be roughly characterized from the total dissolved solids (TDS) content and the organic load (total organic carbon, TOC), see Figure 16.

- Very-low-salinity, high-purity waters (HPW) coming from the first RO systems (double-pass RO system) or the polishing stage in ultrapure water (UPW) systems with TDS up to 50 mg/L.
- Low-salinity tap waters with TDS up to 500 mg/L.
- Medium-salinity groundwater with high natural organic matter (NOM) and TDS up to 5,000 mg/L.
- Medium-salinity brackish waters with TDS up to 5,000 mg/L.
- Medium-salinity tertiary effluent with high TOC and biological oxygen demand (BOD) levels and TDS up to 5,000 mg/L.
- High-salinity brackish waters with TDS in the range of 5,000 – 15,000 mg/L. Seawater with TDS in the range of 35,000 mg/L.

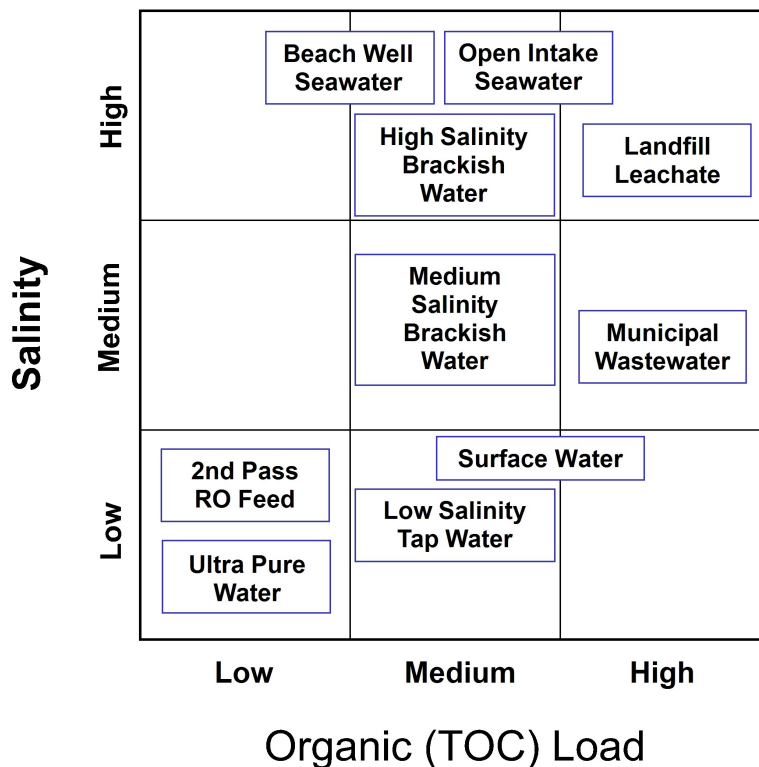

Figure 16. Major water types being treated by RO and NF

Seawater

Seawater with TDS of 35,000 mg/L is considered standard seawater constituting, by far, the largest amount of water worldwide. The composition is nearly the same all over the world. The actual TDS content may, however, vary within wide limits from the Baltic Sea with 7,000 mg/L to the Red Sea and Arabian Gulf with up to 45,000 mg/L. The actual compositions can be proportionally estimated from the standard seawater composition (Table 5). The water from seashore wells, however, depending on the soil, influx from inland, etc., can often have salinity and composition quite different from water taken from the sea itself.

Table 5. Standard seawater composition

Ion	Concentration (mg/L)
Calcium	410
Magnesium	1,310
Sodium	10,900
Potassium	390
Barium	0.05
Strontium	13
Iron	< 0.02
Manganese	< 0.01
Silica	0.04 - 8
Chloride	19,700
Sulfate	2,740
Fluoride	1.4
Bromide	65
Nitrate	< 0.7
Bicarbonate	152
Boron	4 - 5
Other	
TDS	35,000 mg/L
pH	8.1

In Table 6 and Table 7, some chemical and physical characteristics of seawaters with different salinity are shown.

Table 6. Inorganic composition of seawater with different salinity

Water	K (ppm)	Na (ppm)	Mg (ppm)	Ca (ppm)	HCO ₃ (ppm)	Cl (ppm)	SO ₄ (ppm)	SiO ₂ (ppm)
Standard seawater - 32,000 ppm	354	9,854	1,182	385	130	17,742	2,477	0.9
Standard seawater - 35,000 ppm	387	10,778	1,293	421	142	19,406	2,710	1.0
Standard seawater - 36,000 ppm	398	11,086	1,330	433	146	19,960	2,787	1.0
Standard seawater - 38,000 ppm	419	11,663	1,399	456	154	20,999	2,932	1.0
Standard seawater - 40,000 ppm	441	12,278	1,473	480	162	22,105	3,086	1.1
Standard seawater - 45,000 ppm	496	13,812	1,657	539	182	24,868	3,472	1.2
Standard seawater - 50,000 ppm	551	15,347	1,841	599	202	27,633	3,858	1.4

Table 7. Salinity and conductivity of seawaters

Location	Salinity TDS ppm	Conductivity K $\mu\text{S}/\text{cm}$	Factor K/TDS $\mu\text{S}/(\text{cm} \cdot \text{ppm})$
South Pacific	< 36,000	< 51,660	1.43 – 1.44
Gran Canaria (Atlantic Ocean)	37,600	53,280	1.42
Sardinia (Mediterranean Sea)	40,800	57,240	1.40
Bahrain	42,500	59,350	1.40
Egypt (Red Sea)	44,000	62,990	1.38

The characteristic features of seawater have to be considered in the design and operation of the pretreatment and the reverse osmosis process. As a consequence of the high salinity of seawater involving a high osmotic pressure, the recovery of the system is limited to typically 40 – 50% in order to not exceed the physical pressure limits of the membrane element, or to limit the energy consumption associated with higher feed pressures at higher recoveries, or to limit the salinity and/or the boron concentration in the product water. Seawaters from open intakes may cause biofouling of the RO membranes if no biofouling prevention measures are in place (see Section 2.6.1, Biological Fouling Prevention).

Brackish Water

The composition of brackish waters is of extremely wide variation, and a water analysis is a must for a good process design. Several examples of brackish water analyses are given in Table 8.

In brackish water treatment, the factor limiting recovery is mainly of a chemical nature (i.e., precipitation and scale formation by compounds such as calcium carbonate or calcium sulfate). The potential for biofouling is also another limiting factor in brackish water treatment. A number of methods are available to assess the biological fouling potential (see Section 2.6.2, *Assessment of the Biological Fouling Potential*). In industrial and municipal wastewater treatment, a wide variety of organic and inorganic constituents may be present. Thus, the limiting factors are sometimes governed by additional characteristics of feedwaters, for example the organic matter or the phosphate scaling potential.

Table 8. Examples of brackish water composition

Parameter	Unit	Well water ^a	Well water ^b	Lake water ^c	Surface water ^d	Pretreated tertiary effluent ^e
Calcium	mg/L	84	113	54	102	40 – 64
Magnesium	mg/L	6	2.7	23	11	—
Sodium	mg/L	36	23	87	20	150 – 200
Potassium	mg/L	3.3	2	6.6	4	—
Iron	mg/L	< 0.05	0.2	0.05	ND – 015	0.02 – 0.09
Manganese	mg/L	0.01	0.1	< 0.01	< 0.01	< 0.05
Barium	mg/L	0.07	0.1	0.09	—	0.01 – 0.1
Strontium	mg/L	0.7	1	1	—	0.2 – 1
Ammonium	mg/L	< 0.05	—	—	0.3	22 – 66
Aluminum	mg/L	0.02	—	0.02	ND – 0.15	0.03
Chloride	mg/L	45	52	67	33	150 – 500
Bicarbonate	mg/L	265	325	134	287	48.8 – 97.6
Sulfate	mg/L	24	8	201	56	120 – 160
Nitrate	mg/L	4.3	4	<1.0	15	40 – 60
Fluoride	mg/L	0.14	0.7	—	0.25	0.7 – 0.7
Phosphate	mg/L	< 0.05	0.6	0.01	1.2	6.1 – 12.2
Silica	mg/L	9	11	3.1	7 – 17	6 – 10
Hydrogen Sulfide	mg/L	—	1.5	—	—	ND
TDS	mg/L	478	377	573	400	500 – 1,300
TOC	mg/L	1.5	10	3.6	2.4	20 – 30 (COD)
Color	Pt	< 5	40	—	< 5	13 (Hazen)
Turbidity	NTU	—	—	—	2 – 130	0.4 – 1.7
pH	—	7.5	7.4	8.2	8	6.6 – 7.4
Conductivity	µS/cm	590	—	879	400 – 700	700 – 2,200
Temperature	°C	12	23 – 28	—	3 – 25	25 – 35

1. Well water: Germany
2. Well water: The Turnpike Aquifer in Florida (design of the Boynton Beach, FL Membrane Softening Water Treatment, Proc. AWWA Annual Conference, Eng. And Op., 139 (1992))
3. Lake Mead, Nevada (2000)
4. River Oise, France
5. Tertiary effluent: industrial water in Jurong Island, Singapore (Water Reclamation – The Jurong Island Experience – SUT Seraya using Fouling Resistant RO Membrane to Reclaim Wastewater, IDA, Bahrain (2002))

With such wide variation in feedwater quality, the first step is to know the water characteristics. Before a projection of an RO or NF system design can be run, a complete and accurate water analysis must be provided. A water analysis form (Table 9) must be completed and balanced to electroneutrality (i.e., anion and cation concentrations must be identical when stated in terms of the calcium carbonate equivalent). If the water analysis is not balanced, the addition of either Na⁺ or Cl⁻ to achieve electroneutrality is recommended.

Table 9. Water analysis for RO/NF

Sample identification:

Feed source:

Conductivity: pH: Temperature (°C):

Feedwater analysis:	NH ₄ ⁺	CO ₂
Please give units (mg/L as ion	K ⁺	CO ₃ ²⁻
or ppm as CaCO ₃ or meq/L)	Na ⁺	HCO ₃ ⁻
	Mg ²⁺	NO ₃ ⁻
	Ca ²⁺	Cl ⁻
	Ba ²⁺	F ⁻
	Sr ²⁺	SO ₄ ²⁻
	Fe ²⁺	PO ₄ ²⁻
	Fe (tot)	S ²⁻
	Mn ²⁺	SiO ₂ (colloidal)
	Boron	SiO ₂ (soluble)
	Al ³⁺	

Other ions:

TDS (by method):

TOC:

BOD:

COD:

AOC:

BDOC:

Total alkalinity (m-value):

Carbonate alkalinity (p-value):

Total hardness:

Turbidity (NTU):

Silt density index (SDI):

Bacteria (count/ml):

Free chlorine:

Remarks:

(odor, smell, color, biological activity, etc.)

.....

.....

Analysis by:

Date:

Ba²⁺ and Sr²⁺ must be analyzed at the 1 µg/L (ppb) and 1 mg/L (ppm) level of detection, respectively. It is also important that the temperature be given as a range rather than an absolute value. Temperature variation can impact the scaling potential of an RO system, especially when silica and bicarbonate levels in the feedwater are high.

After the membrane system is in service, the feedwater should be analyzed on a regular basis so that the pretreatment and the plant operation can be adjusted accordingly. Many standards are available for water analysis techniques. It is recommended to use the standards of ASTM International (www.astm.org) or the latest edition of "Standard Methods for the Examination of Water and Wastewater"/1/.

A guide for water analysis for reverse osmosis applications is given in ASTM D 4195 /2/; this can be applied to nanofiltration as well. A listing of the relevant ASTM procedures and Standard Methods for the Examination of Water and Wastewater are given in Table 10.

Table 10. Standard procedures relevant to water analysis for RO/NF applications

	ASTM	Standard Methods /1/
Calcium and magnesium	D 511	3500-Ca, Mg
Chloride	D 512	4500-Chloride
Carbon dioxide, bicarbonate, carbonate	D 513	4500-Carbon dioxide, 2320
Phosphorus	D 515	4500-P
Sulfate	D 516	4500-Sulfate
Aluminum	D 857	3500-Al
Manganese	D 858	3500-Mn
Silica	D 859	4500-Silica
Dissolved oxygen	D 888	4500-O
Iron	D 1068	3500-Fe
Fluoride	D 1179	4500-Fluoride
COD	D 1252, D 6697	5220
Residual chlorine	D 1253	4500-Cl
pH	D 1293	4500-pH value
Lithium, potassium, sodium	D 1428, D 3561	3500-Li, Na, K
Ammonia nitrogen	D 1426	45--NH ₃
Particulate and dissolved matter	D 1888	2560
Turbidity	D 1889	2130
Total organic carbon (TOC)	D 2579, D 4129, D 4839, D 5904	5310
Arsenic	D 2972	3500-As
Boron	D 3082	4500-B
Strontium	D 3352	3500-Sr
Practices for sampling water	D 3370	1060
Nitrite - nitrate	D 3867	4500-Nitrogen
Silt density index	D 4189	—
Barium	D 4382	3500-Ba
Microbiological contaminants in water	F 60	—
Oxidation-reduction potential (ORP)	D 1498	2580
BOD	—	5210
AOC	—	9217

2.3 Scale Control

2.3.1 Introduction

Scaling of RO/NF membranes may occur when sparingly soluble salts are concentrated within the element beyond their solubility limit. For example, if a reverse osmosis plant is operated at 50% recovery, the concentration in the concentrate stream will be almost double the concentration in the feed stream. As the recovery of a plant is increased, so is the risk of scaling.

Due to water scarcity and environmental concern, adding a brine (RO concentrate) recovery system to increase recovery has become more popular. To minimize precipitation and scaling, it is important to establish well-designed scale control measures and avoid exceeding the solubility limits of sparingly soluble salts. In an RO/NF system, the most common sparingly soluble salts encountered are CaSO₄, CaCO₃, and silica. Other salts creating a potential scaling problem are CaF₂, BaSO₄, SrSO₄, and Ca₃(PO₄)₂. Solubility products of sparingly soluble inorganic compounds are listed in Table 11.

Table 11. Solubility products of sparingly soluble inorganic compounds

Substance	Formula	Temp. °C	Solubility product	Negative log K_{sp}
Aluminum hydroxide	$Al(OH)_3$	25	3×10^{-34}	33.5
Aluminum phosphate	$AlPO_4$	25	9.84×10^{-21}	20
Barium carbonate	$BaCO_3$	25	2.58×10^{-9}	8.6
Barium sulfate	$BaSO_4$	25	1.1×10^{-10}	10
Calcium carbonate	$CaCO_3$	25	Calcite: 3.36×10^{-9}	8.5
			Aragonite: 6×10^{-9}	8.2
Calcium fluoride	CaF_2	25	3.45×10^{-11}	10.5
Calcium phosphate	$Ca_3(PO_4)_2$	25	2.07×10^{-33}	32.7
Calcium sulfate	$CaSO_4$	25	4.93×10^{-5}	4.3
Iron(II) hydroxide	$Fe(OH)_2$	25	4.87×10^{-17}	16.3
Iron(II) sulfide	FeS	25	8×10^{-19}	18.1
Iron(III) hydroxide	$Fe(OH)_3$	25	2.79×10^{-39}	38.6
Iron(III) phosphate dihydrate	$FePO_4 \cdot 2H_2O$	25	9.91×10^{-16}	15
Lead carbonate	$PbCO_3$	25	7.4×10^{-14}	13.1
Lead fluoride	PbF_2	25	3.3×10^{-8}	7.5
Lead sulfate	$PbSO_4$	25	2.53×10^{-8}	7.6
Magnesium ammonium phosphate	$MgNH_4PO_4$	25	2.5×10^{-13}	12.6
Magnesium carbonate	$MgCO_3$	12	2.6×10^{-5}	4.58
		25	6.82×10^{-6}	5.17
Magnesium fluoride	MgF_2	18	7.1×10^{-9}	8.15
		25	5.16×10^{-11}	10.3
Magnesium hydroxide	$Mg(OH)_2$	18	1.2×10^{-11}	10.9
		25	5.61×10^{-12}	11.25
Magnesium phosphate	$Mg_3(PO_4)_2$	25	1.04×10^{-24}	24
Manganese hydroxide	$Mn(OH)_2$	18	4.0×10^{-14}	13.4
		25	2×10^{-13}	12.7
Strontium carbonate	$SrCO_3$	25	5.6×10^{-10}	9.25
Strontium sulfate	$SrSO_4$	17.4	3.8×10^{-7}	6.42
Zinc carbonate	$ZnCO_3$	25	1.46×10^{-10}	9.84

The following design practices can be used to prevent scaling of a membrane.

2.3.2 Acid Addition

Most natural surface and ground waters are almost saturated with $CaCO_3$. The solubility of $CaCO_3$ depends on the pH, as can be seen from the following equation:

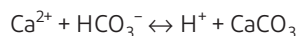

By adding H^+ as acid, the equilibrium can be shifted to the left side to keep calcium carbonate dissolved. Use food-grade quality acid.

Sulfuric acid is easier to handle and in many countries more readily available than hydrochloric acid, however, additional sulfate is added to the feed stream, potentially causing sulfate scaling (Sections 2.4.3, 2.4.4, 2.4.5).

CaCO₃ tends to dissolve in the concentrate stream rather than precipitate. This tendency can be expressed by the Langelier Saturation Index (LSI) for brackish waters and the Stiff & Davis Stability Index (S&DSI) for seawaters. At the pH of saturation (pH_s), the water is in equilibrium with CaCO₃.

The definitions of LSI and S&DSI are:

$$\text{LSI} = \text{pH} - \text{pH}_s \text{ (TDS} < 10,000 \text{ mg/L)}$$
$$\text{S\&DSI} = \text{pH} - \text{pH}_s \text{ (TDS} > 10,000 \text{ mg/L)}$$

where the methods predicting pH_s are different for LSI and S&DSI (see Section 2.4.2.1).

To control calcium carbonate scaling by acid addition alone, the LSI or S&DSI in the concentrate stream must be negative. Acid addition is useful to control carbonate scale only.

2.3.3 Scale Inhibitor Addition

Scale inhibitors (antiscalants) can be used to control carbonate scaling, sulfate scaling, and calcium fluoride scaling. There are generally three different types of scale inhibitors: sodium hexametaphosphate (SHMP), organophosphonates and polyacrylates.

SHMP is inexpensive but unstable compared to polymeric organic scale inhibitors. Minor amounts adsorb to the surface of microcrystals, preventing further growth and precipitation of the crystals. Food-grade quality SHMP should be used. Care must be taken to avoid hydrolysis of SHMP in the dosing feed tank. Hydrolysis will not only decrease the scale inhibition efficiency, but also create a calcium phosphate scaling risk. Therefore, SHMP is generally not recommended.

Organophosphonates are more effective and stable than SHMP. They act as antifoulants for insoluble aluminum and iron, keeping them in solution. Polyacrylates (high molecular weight) are generally known for reducing silica scale formation via a dispersion mechanism.

Polymeric organic scale inhibitors are also more effective than SHMP. Precipitation reactions may occur, however, with negatively charged scale inhibitors and cationic polyelectrolytes or multivalent cations (e.g., aluminum or iron). The resulting gum-like products are very difficult to remove from the membrane elements. For dosage rates on all antiscalants, please contact the antiscalant manufacturers. Overdosing should be avoided. Make certain that no significant amounts of cationic polymers are present when adding an anionic scale inhibitor.

In RO plants operating on seawater with TDS in the range of 35,000 mg/L, scaling is not as much of a problem as in brackish water plants because the recovery of seawater plants is limited by the osmotic pressure of the concentrate stream to 30 – 45%. For safety reasons, however, a scale inhibitor is recommended when operating above a recovery of 35%.

2.3.4 Softening with a Strong Acid Cation Exchange Resin

In the ion exchange softening process, the scale-forming cations, such as Ca²⁺, Ba²⁺ and Sr²⁺, are removed and replaced by sodium cations. The resin is regenerated with NaCl at hardness breakthrough. The pH of the feedwater is not changed by this treatment and, therefore, no degasifier is needed. Only a little CO₂ from the raw water is present that can pass into the permeate, creating a conductivity increase there. The permeate conductivity can be lowered by adding some NaOH to the softened feedwater (up to pH 8.2) to convert residual carbon dioxide into bicarbonate, which is then rejected by the membrane. The rejection performance of the FT30 membrane is optimal at the neutral pH range.

With ion exchange resins, the removal efficiency for Ca²⁺, Ba²⁺, and Sr²⁺ is greater than 99.5%, which usually eliminates any risk of carbonate or sulfate scaling.

Softening with a strong acid cation exchange resin is effective and safe, provided the regeneration is done properly. It is used mainly in small- or medium-size brackish water plants, but not in seawater plants.

A drawback of this process is its relatively high sodium chloride consumption, potentially causing environmental or economic problems. With AmberLite™ ion exchange resins and a counter-current regeneration technique such as UPCORE™ or AMBERPACK™ system, it is possible to minimize the sodium chloride consumption to 110% of the stoichiometric value.

2.3.5 Dealkalization with a Weak Acid Cation Exchange Resin

Dealkalization with a weak acid cation exchange resin is used mainly in large brackish water plants for partial softening to minimize the consumption of regeneration chemicals.

In this process, only Ca^{2+} , Ba^{2+} , and Sr^{2+} associated with bicarbonate alkalinity (temporary hardness) are removed and replaced by H^+ , thus lowering the effluent pH to 4–5. Because the acidic groups of the resin are carboxylic groups, the ion exchange process stops when the pH reaches 4.2, where the carboxylic groups are no longer dissociated. It is, therefore, only a partial softening. Only those scale-forming cations are removed that are bound to bicarbonate. This process, therefore, is ideal for waters with high bicarbonate content. The bicarbonate is converted into carbon dioxide:

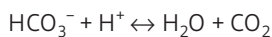

In most cases, carbon dioxide is not desired in the permeate. It can be removed by degassing either in the permeate or in the feed stream.

Degassing the permeate is favored where a potential for biofouling is suspected (e.g., surface waters, high TOC, high bacteria counts). A high CO_2 concentration on the membranes helps to keep bacteria growth low. Degassing the feed is preferred when optimum salt rejection is the priority. Removing CO_2 also leads to an increase in pH (see equation above), and at $\text{pH} > 6$ the rejection is better than at $\text{pH} < 5$.

The advantages of dealkalizing with a weak acid cation exchange resin are:

- For regeneration, acid of not more than 105% of the stoichiometric value is needed. This minimizes operating costs and environmental impact.
- The TDS value of the water is reduced (by the removal of bicarbonate salts) by either the amount of hardness or alkalinity, whichever is lower. Accordingly, the permeate TDS value is also lower.

The disadvantages are:

- Residual hardness.

If complete softening is required, a sodium exchange process with a strong acid cation exchange resin can be added, even in one vessel (layered bed). The overall consumption of regenerant chemicals via thoroughfare regeneration is still lower than softening with a strong acid cation exchange resin alone. Due to the higher investment costs, however, this combination will only be attractive for plants with high capacity. Another possibility to overcome this drawback of incomplete softening is to dose an antiscalant into the dealkalized water.

- Variable pH of the treated water.

The pH of the dealkalized water ranges from 3.5 – 6.5 depending on the degree of exhaustion of the resin. This cyclic pH variation makes it difficult to control the salt rejection of the plant. At $\text{pH} < 4.2$, the passage of mineral acid may increase the permeate TDS content. It is therefore recommended that more than one filter be used in parallel and regenerated at different times to minimize the variability in pH. Other possibilities to avoid extremely low pH values are CO_2 removal or pH adjustment by NaOH afterwards.

2.3.6 Lime Softening

Lime softening can be used to remove carbonate hardness by adding hydrated lime:

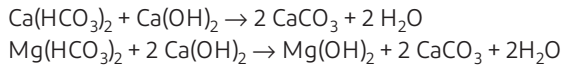

The noncarbonate calcium hardness can be further reduced by adding sodium carbonate (soda ash):

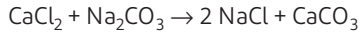

The lime-soda ash process can also be used to reduce the silica concentration. When sodium aluminate and ferric chloride are added, the precipitate will include calcium carbonate and a complex with silicic acid, aluminum oxide, and iron.

With the hot lime silicic acid removal process at 60 – 70°C, silica can be reduced to 1 mg/L by adding a mixture of lime and porous magnesium oxide.

With lime softening, barium, strontium, and organic substances are also reduced significantly. The process requires a reactor with a high concentration of precipitated particles serving as crystallization nuclei. This is usually achieved by upflow solids-contact clarifiers. The effluent from this process requires media filtration and pH adjustment prior to the RO elements. Iron coagulants with or without polymeric flocculants (anionic and nonionic) may be used to improve the solid-liquid separation.

Lime softening should be considered for brackish water plants larger than 200 m³/h (880 gpm). More details are described in water treatment textbooks. /3, 4, 5/

2.3.7 Preventive Cleaning

In some applications, scaling is controlled by preventive membrane cleaning. This allows the system to run without softening or dosage of chemicals. Typically, these systems operate at low recovery in the range of 25%, and the membrane elements are replaced after 1 – 2 years. Accordingly, these systems are mainly small single-element plants for potable water from tap water or seawater. The simplest way of cleaning is a forward flush at low pressure by opening the concentrate valve. Short cleaning intervals are more effective than long cleaning times (e.g., 30 seconds every 30 minutes).

Cleaning can also be carried out with cleaning chemicals as described in Section 6.1 In batch processes like wastewater treatment, cleaning the membranes after every batch is common practice.

The cleaning procedure, cleaning chemicals, and frequency of cleaning need to be determined and optimized case by case. Special care has to be taken not to allow a scaling layer to develop over time.

2.3.8 Adjustment of Operating Variables

When other scale-control methods do not work, the operating variables of the plant have to be adjusted in such a way that scaling will not occur. The precipitation of dissolved salts can be avoided by keeping their concentration below the solubility limit. This is accomplished by reducing the system recovery until the concentrate concentration is low enough.

Solubility depends also on temperature and pH. In the case of silica, increasing temperature and pH increases its solubility (see Section 2.4.7). Silica is usually the only reason for considering adjustment of operating variables for scale control because these adjustments have economic drawbacks (energy consumption) or other scaling risks (CaCO₃ at high pH).

For small systems, a low recovery combined with a preventive cleaning program might be a convenient way to control scaling.

2.4 Scaling Calculations

2.4.1 General

Scaling calculations must be carried out in order to determine whether a sparingly soluble salt presents a potential scaling problem in an RO system. The calculation procedures described in this section are adapted from the corresponding ASTM standards, cited in the references /6, 7, 8/. To determine the scaling potential, you need to compare the ion product IP_c of the considered salt in the concentrate stream with the solubility product K_{sp} of that salt under conditions in the concentrate stream. Generally, scale-control measures are not needed if $IP_c < K_{sp}$.

The ion product IP of a salt A_mB_n is defined as

$$IP = [A]^m[B]^n \quad \text{Eq. 1}$$

where:

[A], [B] = molal concentrations of the corresponding ions

For the concentration ranges present in RO applications, molal concentrations (mol/kg) can be considered equivalent with molar concentrations (mol/L).

The concentration of ion species in the concentrate stream is usually not known, but can easily be estimated from the concentration in the feed stream by multiplication with the concentration factor CF. The concentration factor is derived from the recovery Y (expressed as a decimal):

$$CF = \frac{1}{1-Y} \quad \text{Eq. 2}$$

where the rejection is assumed to be 100%.

The solubility product K_{sp} is generally also expressed in molal concentrations and is dependent on ionic strength and temperature as shown in the figures of this section.

The temperature in the concentrate stream is about the same as in the feed stream.

The ionic strength of the feedwater is:

$$I_i = \frac{1}{2} \sum m_i z_i^2 \quad \text{Eq. 3}$$

where:

m_i = molal concentration of ion i (mol/kg)

z_i = ionic charge of ion i

Where the water analysis is not given in molal (or molar) concentrations, the conversion is as follows:

$$m_i = \frac{c_i}{1,000 MW_i} \quad \text{Eq. 4}$$

where:

c_i = concentration of ion i in mg/L

MW_i = molecular weight of ion i

Having calculated the ionic strength I_f of the feed stream with Eq. 3, the ionic strength I_c of the concentrate stream is obtained from:

$$I_c = I_f \left(\frac{1}{1-Y} \right) \quad \text{Eq. 5}$$

With the ionic strength of the concentrate stream, the solubility product K_{sp} of scaling salt can be obtained (see Sections 2.4.2.1, 2.4.3, 2.4.4, 2.4.5, 2.4.6, and 2.4.7) (see below).

- [Calcium Carbonate Scale Prevention](#) (Form No. 45-D01552-en)
- [Calcium Sulfate Scale Prevention](#) (Form No. 45-D01553-en)
- [Barium Sulfate Scale Prevention](#) (Form No. 45-D01554-en)
- [Strontium Sulfate Scale Prevention](#) (Form No. 45-D01555-en)
- [Calcium Fluoride Scale Prevention](#) (Form No. 45-D01556-en)
- [Silica Scale Prevention](#) (Form No. 45-D01557-en)

Calculation example of the ionic strength of the concentrate (I_c):

Table 12. Feedwater Analysis

Ion	mg/L	mol/L	mol/kg
Ca ²⁺	200	5.0	× 10 ⁻³
Mg ²⁺	61	2.51	× 10 ⁻³
Na ⁺	388	16.9	× 10 ⁻³
HCO ₃ ⁻	244	4.0	× 10 ⁻³
SO ₄ ²⁻	480	5.0	× 10 ⁻³
Cl ⁻	635	17.9	× 10 ⁻³

The ionic strength I_f of the feedwater is

$$I_f = \frac{1}{2} \left[4 \left([\text{Ca}^{2+}] + [\text{Mg}^{2+}] + [\text{SO}_4^{2-}] \right) + \left([\text{Na}^+] + [\text{HCO}_3^-] + [\text{Cl}^-] \right) \right]$$

$$I_f = \frac{1}{2} \left\{ 4 \left[(5.0 + 2.51 + 5.0) \times 10^{-3} \right] + \left[(16.9 + 4.0 + 17.9) \times 10^{-3} \right] \right\}$$

$$I_f = 0.0444$$

With a recovery of, for example, 75% ($Y = 0.75$), the ionic strength of the concentrate becomes

$$I_c = 0.0444 \left(\frac{1}{1-0.75} \right)$$

$$I_c = 0.178$$

2.4.2 Calcium Carbonate Scale Prevention

2.4.2.1 Brackish Water

For brackish waters with TDS < 10,000 mg/L in the concentrate stream, the Langelier Saturation Index (LSI) is used to express the scaling potential for calcium carbonate /6/.

The following data are needed to calculate the LSI of the concentrate stream (LSI_c):

Ca_f = Calcium concentration in feed as CaCO₃, mg/L

TDS_f = Concentration of total dissolved solids in the feed, mg/L

Alk_f = Alkalinity in feed as CaCO₃, mg/L

pH_f = pH of the feed solution

T = Temperature of the feed solution

Y = Recovery of the reverse osmosis system, expressed as a decimal

Calculations

1. Calculate the calcium concentration in the concentrate stream, Ca_c, as CaCO₃ in mg/L:

$$Ca_c = Ca_f \left(\frac{1}{1-Y} \right) \quad \text{Eq. 6}$$

2. Calculate the total dissolved solids in the concentrate stream, TDS_c in mg/L:

$$TDS_c = TDS_f \left(\frac{1}{1-Y} \right) \quad \text{Eq. 7}$$

3. Calculate the alkalinity in the concentrate stream, Alk_c, as CaCO₃ in mg/L:

$$Alk_c = Alk_f \left(\frac{1}{1-Y} \right) \quad \text{Eq. 8}$$

4. Calculate the free carbon dioxide content (C) in the concentrate stream by assuming that the CO₂ concentration in the concentrate is equal to the CO₂ concentration in the feed: C_c = C_f. The concentration of free carbon dioxide in the feed solution is obtained from Figure 19 as a function of the alkalinity and the pH of the feed solution.

5. Calculate the pH of the concentrate stream (pH_c) using the ratio of alkalinity Alk_c to free CO₂ in the concentrate, Figure 19.

6. From Figure 19 obtain: pCa as a function of Ca_c, pAlk as a function of Alk_c, "C" as a function of TDS_c and temperature (temperature of the concentrate is assumed equal to temperature of the feed solution).

7. Calculate pH at which the concentrate stream is saturated with CaCO₃ (pH_s) as follows:

$$pH_s = pCa + pAlk + "C" \quad \text{Eq. 9}$$

8. Calculate the Langelier Saturation Index of the concentrate (LSI_c) as follows:

$$LSI_c = pH_c - pH_s \quad \text{Eq. 10}$$

Adjustments of LSI_c

In most natural waters, LSI_c would be positive without pretreatment. To control CaCO₃ scaling, LSI_c has to be adjusted to a negative value, except if adding a scale inhibitor (Section 2.3.3) or preventive cleaning (Section 2.3.7) is applied.

The conditions for CaCO₃ scale control are:

LSI_c < 0 when no antiscalant is added

LSI_c ≤ 1 when 20 mg/L sodium hexametaphosphate is in the concentrate stream

LSI_c > 1 possible with polymeric organic scale inhibitors. For the maximum LSI_c and required dosages, please refer to the scale inhibitor manufacturer's literature.

If LSI_c is not within the above conditions, adjustments can be made by one of the following means. A new LSI_c can then be calculated:

- The recovery, *Y*, can be lowered and LSI_c can be calculated as above by substituting a new value for the recovery.
- Decreasing the calcium concentration in the feed solution by means of sodium cycle ion exchange. This will increase the pCa and will therefore decrease the LSI_c. Softening will not change the alkalinity or pH of the feed solution and the slight change in TDS_f may be considered negligible. After softening, the LSI_c can be calculated as above using the lower value for calcium concentration.
- Adding acid (HCl, CO₂, H₂SO₄, etc.) to the feed solution changes the Alk_f, C_f, and pH. The slight change in TDS_f can usually be neglected. Acid addition will decrease the LSI_c; however, since many variables change with acidification, trial and error computations are required to determine the amount of acid needed to obtain the desired LSI_c. The number of trial and error computations required to determine the amount of acid needed can be reduced greatly by using the pH_s calculated in Eq. 9. Since pH_c will usually be 0.5 units higher than the pH_f, the first computation can be made with an acidified feed solution that is 0.5 units lower than the pH_s.

For an assumed pH (pH_{acid}), obtained from addition of acid to the feed solution, obtain the ratio of Alk_{acid}/C_{acid} from Figure 19. From this ratio, Alk_f and C_f, calculate the mg/L of acid used (*x*). For example, for H₂SO₄ addition (100%):

$$\frac{\text{Alk}_{\text{acid}}}{C_{\text{acid}}} = \frac{\text{Alk}_f - 1.02x}{C_f + 0.90x} \quad \text{Eq. 11}$$

Calculate the total alkalinity of the acidified feedwater (Alk_{acid}) and the CO₂ content in the acidified feedwater (C_{acid}) as follows:

$$\text{Alk}_{\text{acid}} = \text{Alk}_f - 1.02x \quad \text{Eq. 12}$$

$$C_{\text{acid}} = C_f + 0.90x \quad \text{Eq. 13}$$

Using Alk_{acid} and C_{acid} for the new pH, calculate the LSI_c.

If HCl (100%) is used for acidification, Eq. 11 is:

$$\frac{\text{Alk}_{\text{acid}}}{C_{\text{acid}}} = \frac{\text{Alk}_f - 1.37y}{C_f + 1.21y} \quad \text{Eq. 14}$$

where:

y = HCl (100%), mg/L

Reverse Osmosis and Nanofiltration in Operation

Once a reverse osmosis or nanofiltration system is operating, the Langelier Saturation Index can be directly calculated from the analysis of Alk_c, Ca_c, TDS_c, and pH_c of the concentrate stream and compared with the projected LSI_c.

Use of Computers

The LSI_c and the acid dosage required to adjust a certain LSI_c can be determined using a personal computer and the WAVE (Water Application Value Engine) computer program. The WAVE computer program can be downloaded here, <http://www.dupont.com/water/design-software.html>.

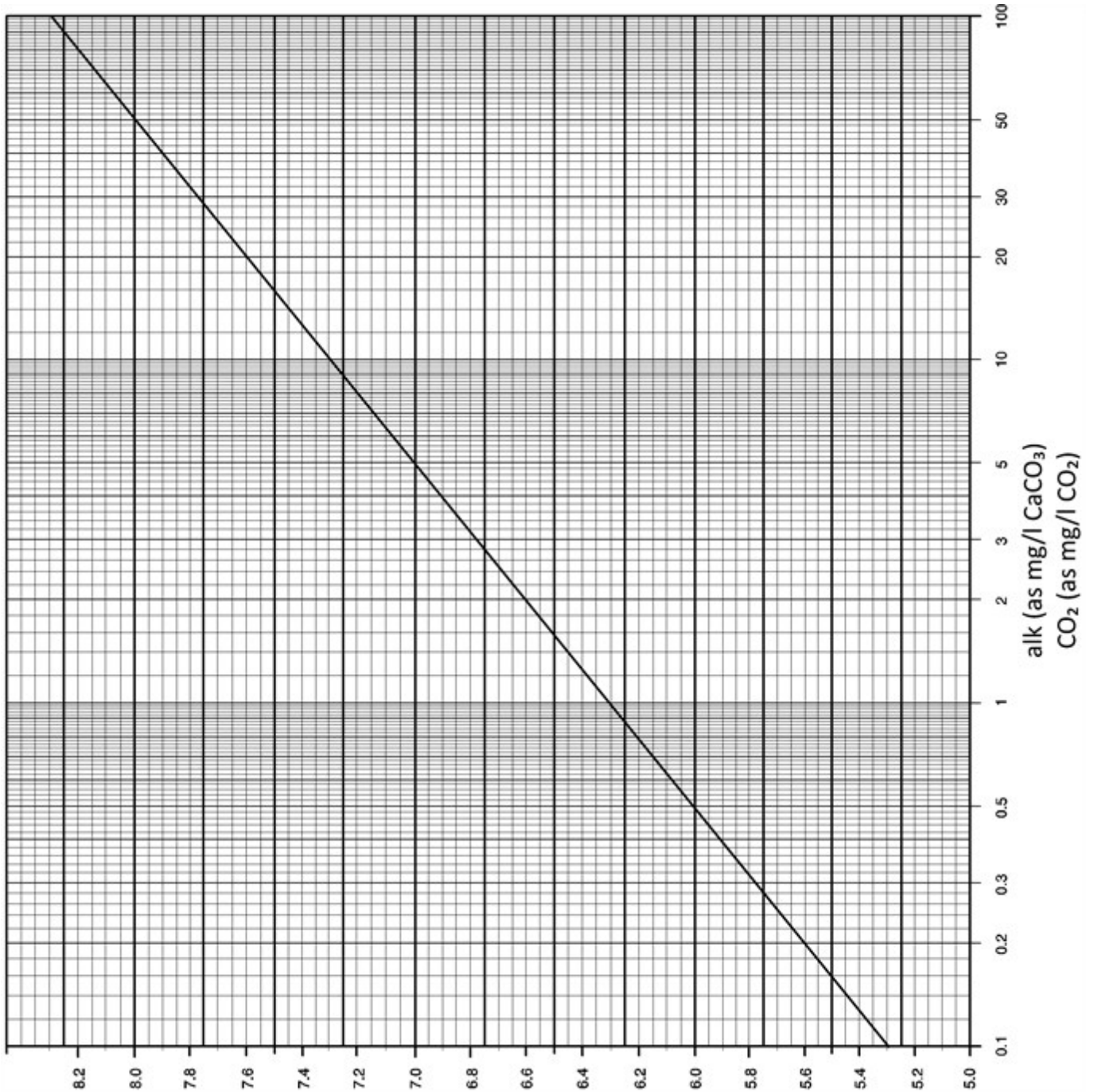

Figure 17. pH versus methyl orange alkalinity/free CO₂

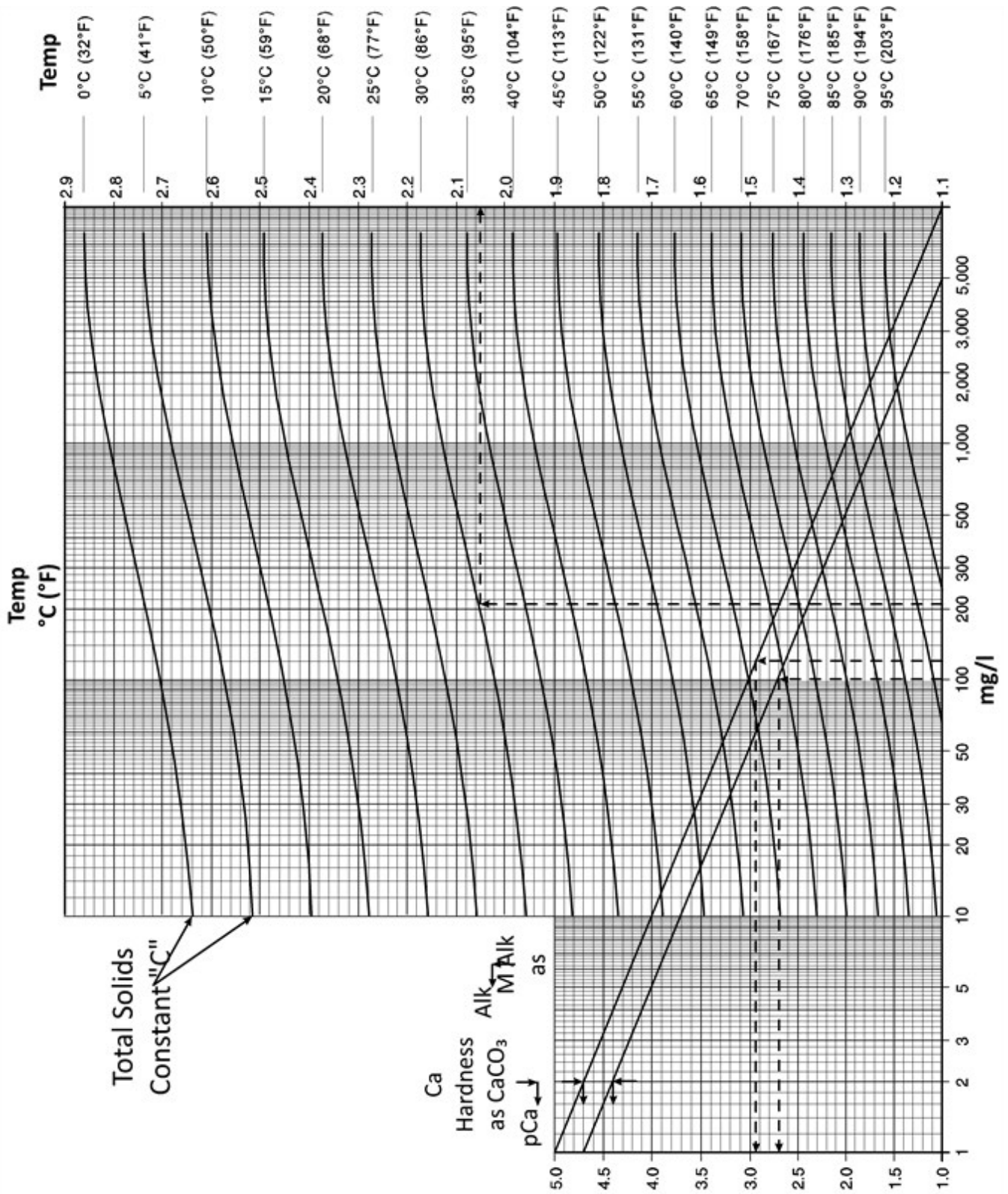

Figure 18. Langelier saturation index

2.4.2.2 Seawater

For high-salinity brackish waters with TDS > 10,000 mg/L in the concentrate stream and for seawaters, the Stiff & Davis Stability Index (S&DSI) is used to express the scaling potential for calcium carbonate. The data needed to calculate the S&DSI of the concentrate stream are the same as the data needed to calculate the LSI (Section 2.4.2.1). Additionally, the molal concentrations of all ions in the feed solution are required, at least of all major ions (i.e., Ca^{2+} , Mg^{2+} , Na^+ , K^+ , HCO_3^- , SO_4^{2-} , and Cl^-).

Calculations /7/

1. Calculate the calcium concentration in the concentrate stream, Ca_c , as CaCO_3 in mg/L:

$$\text{Ca}_c = \text{Ca}_f \left(\frac{1}{1-Y} \right) \quad \text{Eq. 15}$$

2. Calculate the alkalinity in the concentrate stream, Alk_c , as CaCO_3 in mg/L:

$$\text{Alk}_c = \text{Alk}_f \left(\frac{1}{1-Y} \right) \quad \text{Eq. 16}$$

3. Calculate the ionic strength of the feed stream (I_f):

$$I_f = \frac{1}{2} \sum m_i z_i^2 \quad \text{Eq. 17}$$

4. Calculate the ionic strength of the concentrate stream (I_c):

$$I_c = I_f \left(\frac{1}{1-Y} \right) \quad \text{Eq. 18}$$

5. From Figure 23, obtain pCa as a function of Ca_c and pAlk as a function of Alk_c . From Figure 24, obtain "K" as a function of concentrate ionic strength and feed temperature.

6. Calculate the pH at which the concentrate stream is saturated with CaCO_3 (pH_s) as follows:

$$\text{pH}_s = \text{pCa} + \text{pAlk} + "K" \quad \text{Eq. 19}$$

7. Calculate the free carbon dioxide content (C) in the concentrate stream by assuming that the CO_2 concentration in the concentrate is equal to the CO_2 concentration in the feed: $C_c = C_f$. The concentration of free carbon dioxide in the feed solution is obtained from Figure 19 as a function of the alkalinity and the pH of the feed solution.

8. Calculate the pH of the concentrate stream (pH_c) using the ratio of alkalinity (from Eq. 16) to free CO_2 in the concentrate (from Step 7), Figure 17.

9. Calculate the Stiff and Davis Stability Index of the concentrate (S&DSI_c) as follows:

$$\text{S \& DSI}_c = \text{pH}_c - \text{pH}_s \quad \text{Eq. 20}$$

Adjustments of S&DSI_c

The S&DSI_c in the concentrate stream will be positive with most natural high-salinity waters. In order to prevent CaCO₃ precipitation and scaling, the S&DSI_c has to be adjusted to a negative value by acid dosing. The S&DSI_c can remain positive, however, if CaCO₃ precipitation is prevented by the dosage of a scale inhibitor (see Section 2.3.3). For the maximum allowed S&DSI_c and the required dosage, please refer to the scale inhibitor manufacturer's literature.

If the S&DSI_c is unacceptable based on the above recommendation, adjustments can be made by one of the following means. A new S&DSI_c can then be calculated.

- The recovery can be lowered and the S&DSI_c can be calculated as above by substituting a new value for the recovery.
- Decreasing the calcium and alkalinity concentrations in the feed solution by means of lime or lime-soda ash softening will increase the pCa and pAlk and will therefore decrease the pH_s.
- Addition of acid (HCl, CO₂, H₂SO₄, etc.) to the feed solution either with or without lime or lime-soda ash softening changes the Alk_f, C_f, and pH. The slight change in I_f can usually be ignored. Acid addition will decrease the S&DSI_c; however, since many variables change with acidification, trial and error computations are required to determine the amount of acid needed to obtain the desired S&DSI_c.

These computations have been described already in the previous section (Section 2.4.2.1, *Brackish Water*). For seawater systems, a dosage of typically 10 mg/L sulfuric acid is required to achieve a pH_f of about 7 and a negative S&DSI in the concentrate.

RO/NF in Operation

Once an RO or NF system is operating, the S&DSI_c can be directly calculated from the analysis of Alk_c, Ca_c, pH_c, and I_c of the concentrate stream and compared with the projected S&DSI_c.

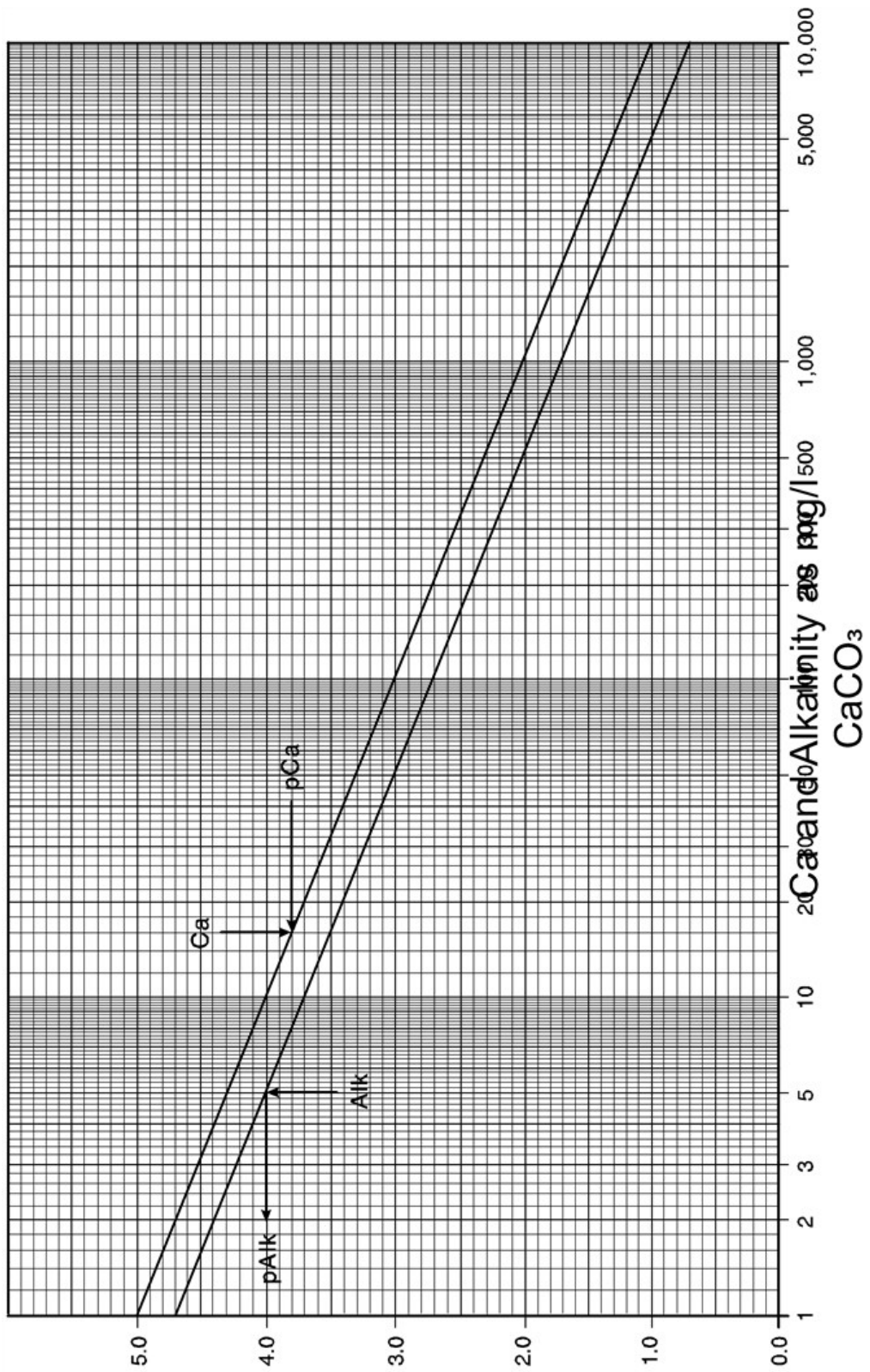

Figure 19. Conversion of calcium and alkalinity to pCa and pAlk

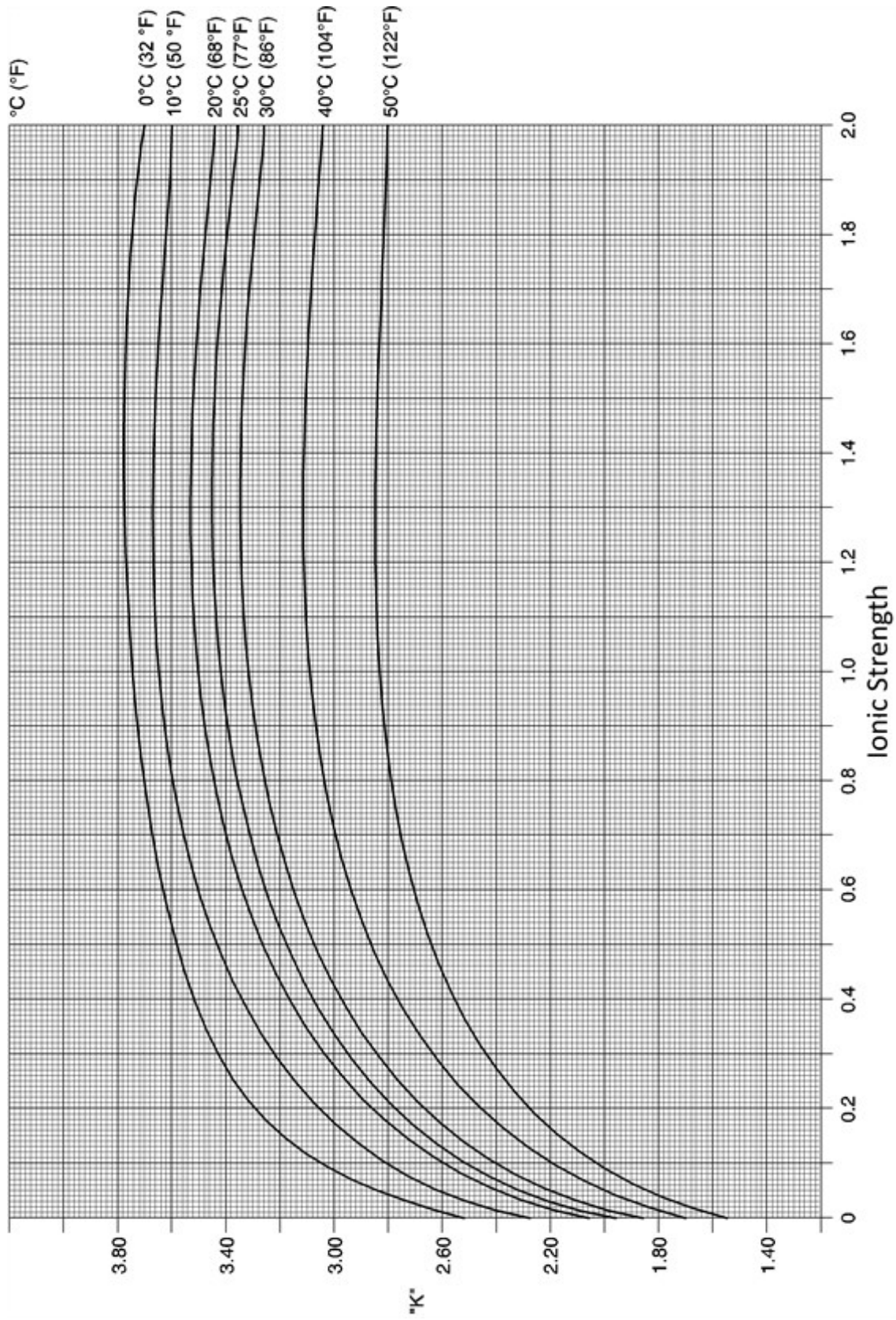

Figure 20. "K" versus ionic strength and temperature

2.4.3 Calcium Sulfate Scale Prevention

For the determination of the calcium sulfate scaling potential, a complete feedwater analysis is required. Calculation /8/

Calculation /8/

1. Calculate the ionic strength of the concentrate stream (I_c) following the procedure described in Section 2.4.1:

$$I_c = I_f \left(\frac{1}{1-Y} \right) \quad \text{Eq. 21}$$

2. Calculate the ion product (IP_c) for CaSO_4 in the concentrate stream:

$$I_c = I_f \left(\frac{1}{1-Y} \right) \quad \text{Eq. 22}$$

$$IP_c = \left[(m\text{Ca}^{2+})_f \left(\frac{1}{1-Y} \right) \right] \left[(m\text{SO}_4^{2-})_f \left(\frac{1}{1-Y} \right) \right]$$

where:

$(m\text{Ca}^{2+})_f = M \text{Ca}^{2+}$ in feed, mol/L

$(m\text{SO}_4^{2-})_f = M \text{SO}_4^{2-}$ in feed, mol/L

3. Compare IP_c for CaSO_4 with the solubility product (K_{sp}) of CaSO_4 at the ionic strength of the concentrate stream, Figure 21. If $IP_c \geq K_{sp}$, CaSO_4 scaling can occur, and adjustment is required. For a safe and conservative pretreatment design, adjustment should be made if $IP_c > 0.8 K_{sp}$.

Calculation Example (continued from Section 2.4.1):

$$I_c = 0.178$$

$$IP_c = \left[4(5 \times 10^{-3}) \right] \left[4(5 \times 10^{-3}) \right] = 4 \times 10^{-4}$$

$$K_{sp} = 4.4 \times 10^{-4} \text{ (from Figure 21)}$$

$IP_c = 0.9 K_{sp}$ therefore adjustments are required.

Adjustments for CaSO_4 Scale Control

- If the IP_c for CaSO_4 is less than $0.8 K_{sp}$, a higher recovery can be used with respect to CaSO_4 scaling. Reiteration of the calculations at higher recovery can be used to determine the maximum conversion with respect to CaSO_4 scaling.
- If the IP_c for CaSO_4 is greater than $0.8 K_{sp}$, a lower recovery must be used to prevent scaling. Reiteration of the calculations at lower recovery can be used to determine the allowable recovery with respect to CaSO_4 scaling.
- If the maximum allowable recovery is lower than desired, strong acid cation exchange resin softening (Section 2.3.4) or weak acid cation exchange resin dealkalization (see Section) can be used to remove all or part of the Ca^{2+} . This will permit higher recovery of the reverse osmosis system with respect to CaSO_4 scaling.
- Lime softening with lime or lime plus soda ash (see Section 2.3.6) will decrease the Ca^{2+} concentration and thus permit higher recovery with respect to scaling by CaSO_4 .
- Addition of a scale inhibitor to the feed stream permits operation of the RO system above the K_{sp} value, when adequate scale inhibitor is added according to the scale inhibitor manufacturer's instructions.

KSP for CaSO₄ at 25°C (77°)

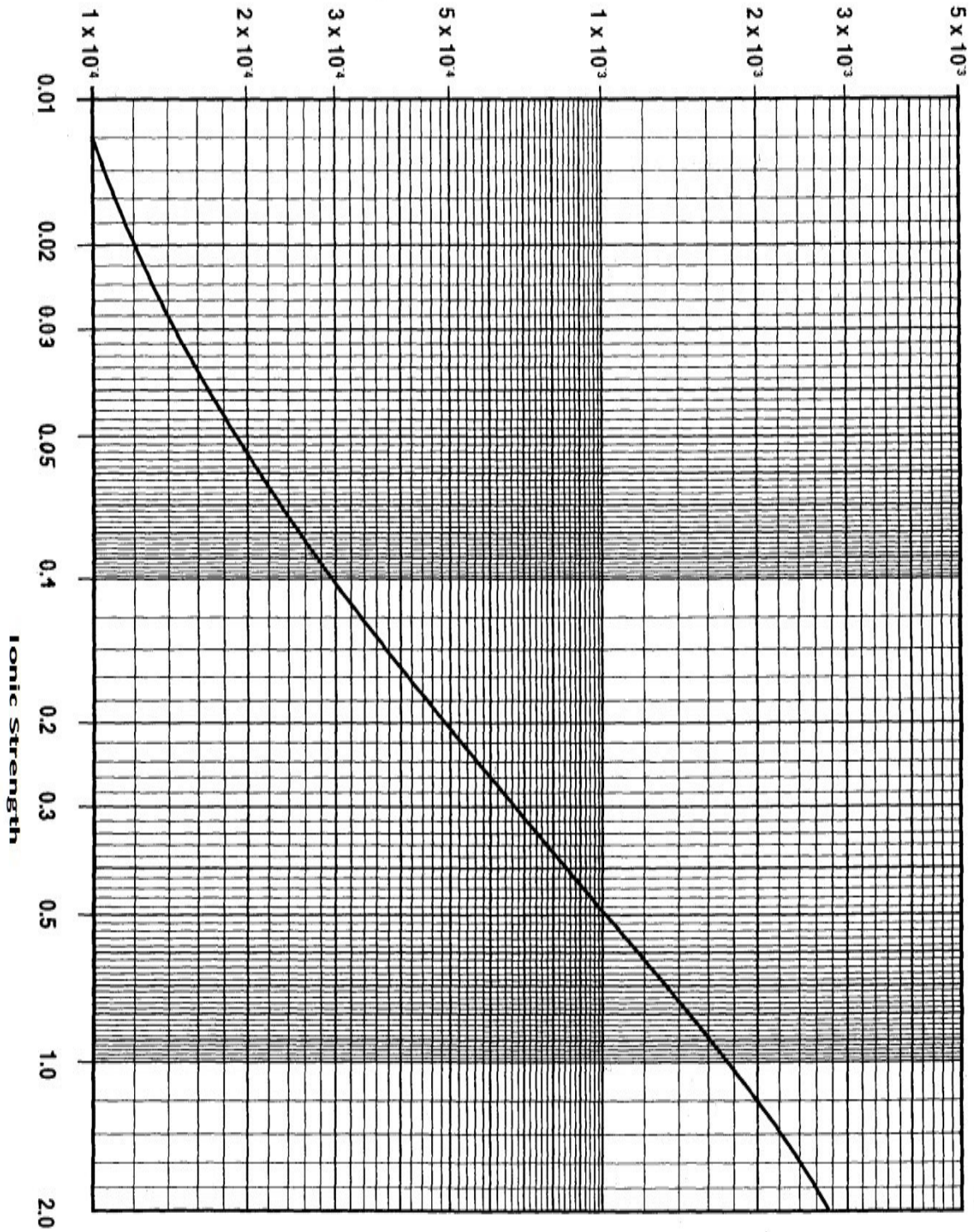

Figure 21. Ksp for CaSO₄ versus ionic strength /9/

2.4.4 Barium Sulfate Scale Prevention /8/

Barium sulfate is the most insoluble of all alkaline-earth sulfates. When present in water, it may lead to massive precipitation, possibly acting as a catalyst for calcium sulfate and strontium sulfate scaling.

In most natural waters, barium is present at a level that would cause barium sulfate precipitation in the concentrate stream. The critical feed concentration of barium may be as low as < 15 µg/L in seawaters, < 5 µg/L in brackish waters or even < 2 µg/L if sulfuric acid is dosed to brackish waters.

Calculation /8/

Prediction of BaSO₄ scaling potential is performed in the same way as the previously described procedure for CaSO₄.

1. Calculate the ionic strength of the concentrate stream (I_c) following the procedure described in Section 2.4.1:

$$I_c = I_f \left(\frac{1}{1-Y} \right) \quad \text{Eq. 23}$$

2. Calculate the ion product (IP_c) for BaSO₄ in the concentrate stream:

$$IP_c = \left[(mBa^{2+})_f \left(\frac{1}{1-Y} \right) \right] \left[(mSO_4^{2-})_f \left(\frac{1}{1-Y} \right) \right] \quad \text{Eq. 24}$$

where:

(mBa²⁺)_f = M Ba²⁺ in feed, mol/L

(mSO₄²⁻)_f = M SO₄²⁻ in feed, mol/L

3. Compare IP_c for BaSO₄ with the solubility product (K_{sp}) of BaSO₄ at the ionic strength of the concentrate stream, Figure 22. If IP_c ≥ K_{sp}, BaSO₄ scaling can occur, and adjustment is required.

Adjustments for BaSO₄ Scale Control

The adjustments discussed in Section 2.4.3 for CaSO₄ scale control apply as well for BaSO₄ scale control.

2.4.5 Strontium Sulfate Scale Prevention

Calculation /8/

Prediction of SrSO₄ scaling potential is performed in the same way as the previously described procedure for CaSO₄:

1. Calculate the ionic strength of the concentrate stream (I_c) following the procedure described in Section 2.4.1:

$$I_c = I_f \left(\frac{1}{1-Y} \right) \quad \text{Eq. 25}$$

2. Calculate the ion product (IP_c) for $SrSO_4$ in the concentrate stream:

$$IP_c = \left[(mSr^{2+})_f \left(\frac{1}{1-Y} \right) \right] \left[(mSO_4^{2-})_f \left(\frac{1}{1-Y} \right) \right] \quad \text{Eq. 26}$$

where:

$(mSr^{2+})_f = M Sr^{2+}$ in feed, mol/L

$(mSO_4^{2-})_f = M SO_4^{2-}$ in feed, mol/L

3. Compare IP_c for $SrSO_4$ with the solubility product (K_{sp}) of $SrSO_4$ at the ionic strength of the concentrate stream, Figure 23. If $IP_c \geq 0.8 K_{sp}$, $SrSO_4$ scaling can occur, and adjustment is required.

Adjustments for $SrSO_4$ Scale Control

The adjustments discussed in Section 2.4.3 for $CaSO_4$ scale control apply for $SrSO_4$ scale control as well.

2.4.6 Calcium Fluoride Scale Prevention

Fluoride levels in the feedwater of as low as 0.1 mg/L can create a scaling potential if the calcium concentration is high. The calculation of the scaling potential is analogous to the procedure described in Section 2.4.3 for $CaSO_4$.

Calculation

1. Calculate the ionic strength of the concentrate stream (I_c) following the procedure described in Section 2.4.1:

$$I_c = I_f \left(\frac{1}{1-Y} \right) \quad \text{Eq. 27}$$

2. Calculate the ion product (IP_c) for CaF_2 in the concentrate stream:

$$IP_c = \left[(mCa^{2+})_f \left(\frac{1}{1-Y} \right) \right] \left[(mF^-)_f \left(\frac{1}{1-Y} \right) \right]^2 \quad \text{Eq. 28}$$

where:

$(mCa^{2+})_f = M Ca^{2+}$ in feed, mol/L

$(mF^-)_f = M F^-$ in feed, mol/L

3. Compare IP_c for CaF_2 with the solubility product (K_{sp}) of CaF_2 at the ionic strength of the concentrate stream, Figure 24 //11/. If $IP_c \geq K_{sp}$, CaF_2 scaling can occur, and adjustment is required.

Adjustments for CaF_2 Scale Control

The adjustments discussed in Section 2.4.3 for $CaSO_4$ scale control apply as well for CaF_2 scale control.

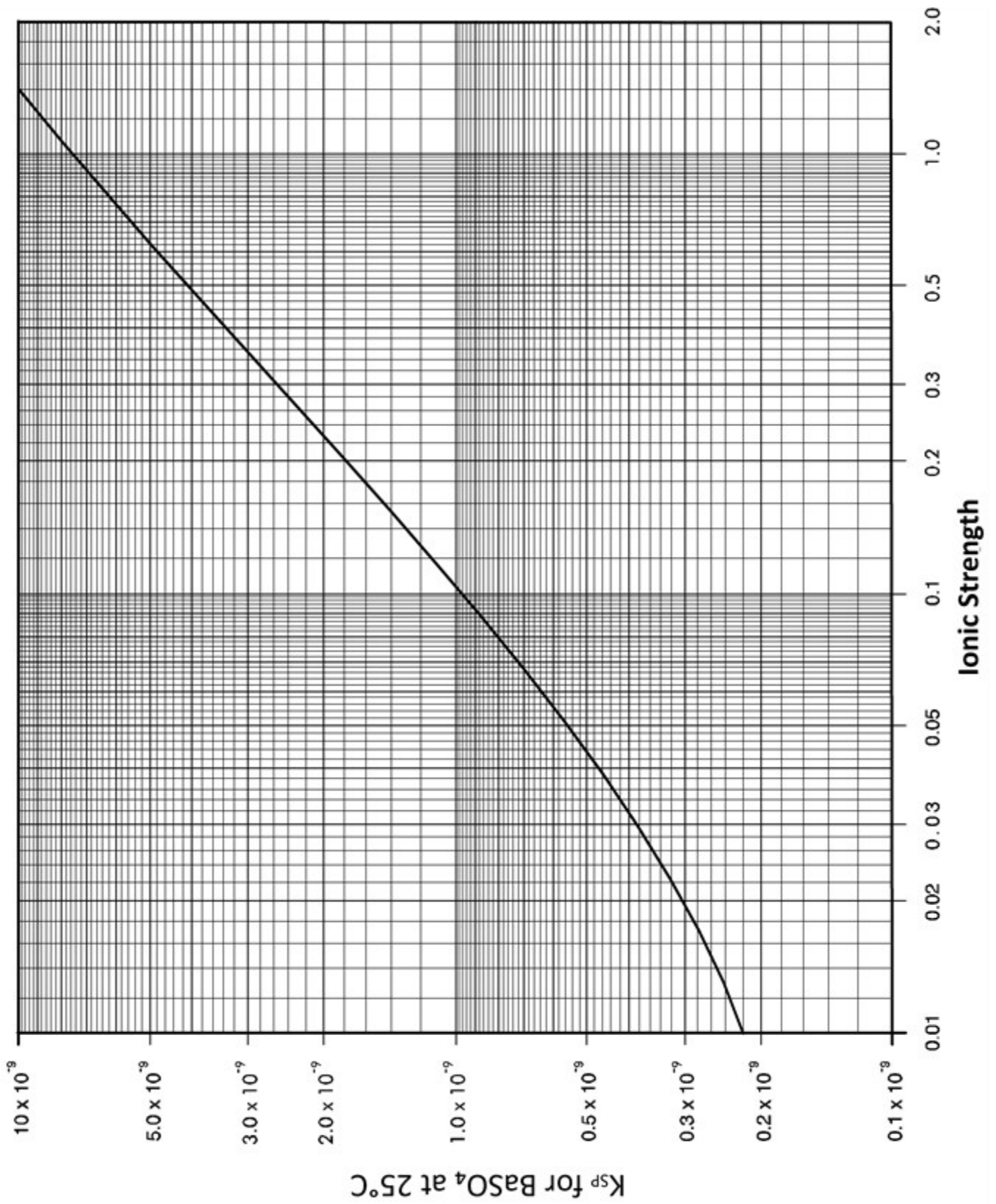

Figure 22. K_{sp} for BaSO_4 versus ionic strength / 10/

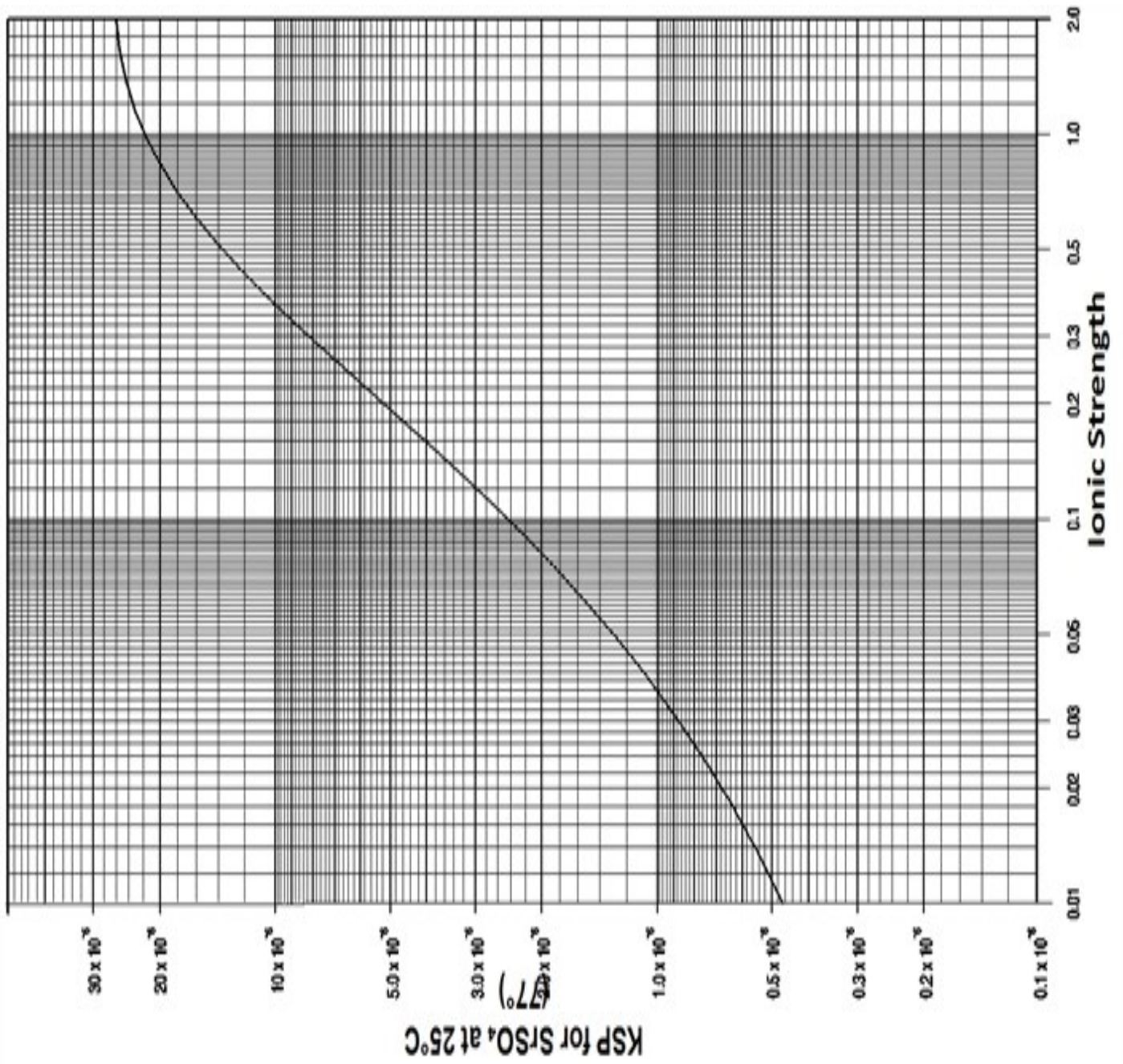

Figure 23. K_{sp} for SrSO_4 versus ionic strength / 10/

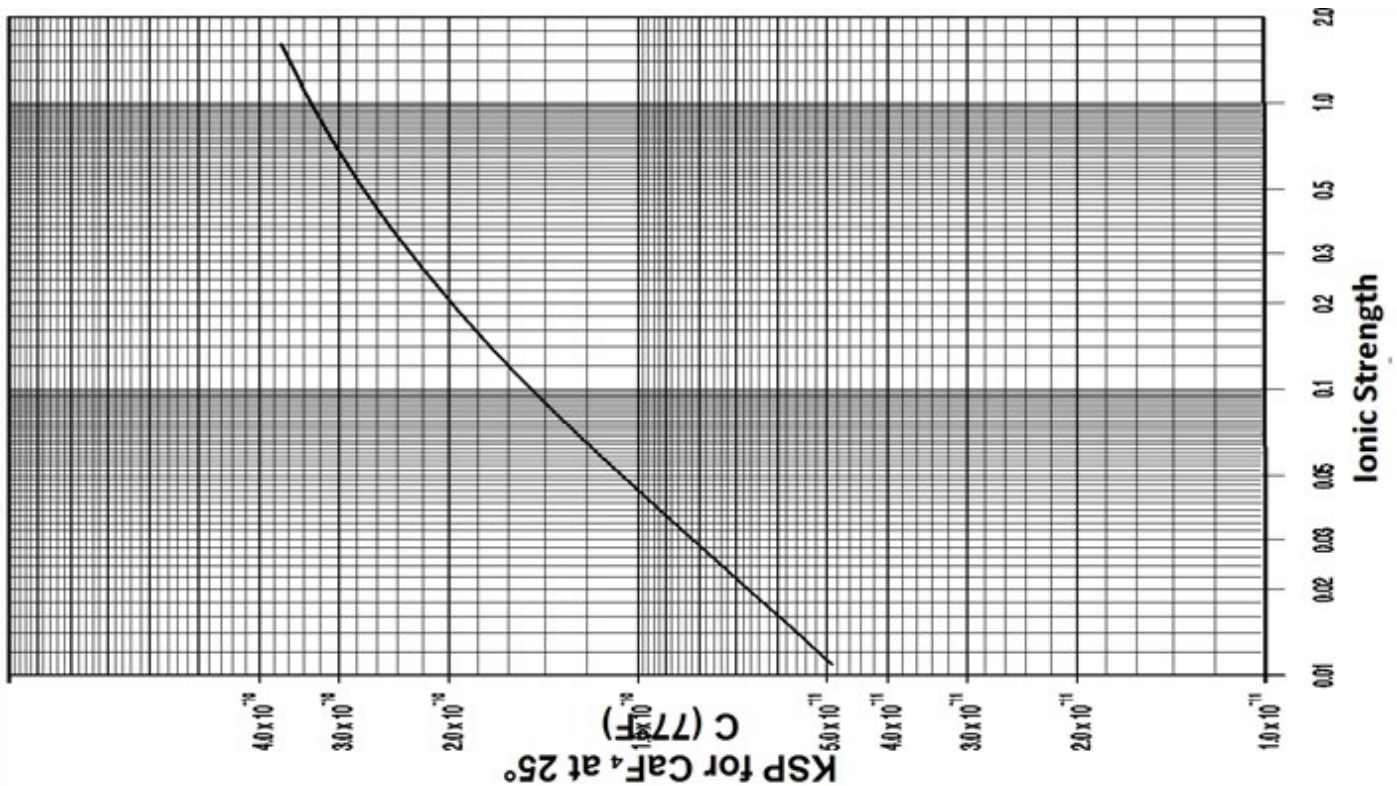

Figure 24. K_{sp} for CaF_2 versus ionic strength /11/

2.4.7 Silica Scale Prevention

Dissolved silica (SiO_2) is naturally present in most feedwaters in the range of 1 – 100 mg/L. The prevailing forms of silica are meta silicic acids as $(\text{H}_2\text{SiO}_3)_n$ with low n numbers. Since silicic acid is a weak acid, it is mostly in the undissociated form at or below a neutral pH. Supersaturated silicic acid can further polymerize to form insoluble colloidal silica or silica gel, which can cause membrane scaling. The maximum allowable SiO_2 concentration in the concentrate stream is based on the solubility of SiO_2 .

The scaling potential for the concentrate stream will be quite different from that of the feed solution because of the increase in the concentration of SiO_2 and the change in pH. It can be calculated from the feedwater analysis and the RO operating parameters.

As the pH exceeds neutral, silicic acid dissociates into the silicate anion $(\text{SiO}_3^{2-})_n$. This can react with calcium, magnesium, iron, manganese or aluminum to form insoluble silicates.

It was indicated that aluminum is the most powerful precipitant of silicic acid /12/, and the occurrence of silica scaling is mostly correlated with the occurrence of aluminum or iron /13/. It has been reported that, when Al^{3+} and Fe^{3+} coexist in the pretreated feedwater, silica is precipitated even below its saturation /14, 15/. Both Al^{3+} and Fe^{3+} , therefore, must be less than 0.05 mg/L in the feedwater, even if the silica level is below saturation. Since Al^{3+} and Fe^{3+} salts are used for coagulation in municipal and other industrial water processing, frequent and accurate measurements of these ions are needed even though the feedwater itself does not contain high levels of aluminum and iron ions. Fouling with metal silicates may occur from a chemical reaction and precipitation process (scaling), and also from colloidal fouling with submicron particles entering the membrane system. Feedwater acidification and preventive acid cleanings are possible measures in cases of a metal silica scaling potential. If colloidal silica and silicates are present in the feedwater, a flocculation/filtration process and/or a fine grade pre-filter (1 μm or less) should be chosen.

The scaling potential of soluble silica (silicic acid) in the absence of trivalent metal cations can be calculated as follows. The calculation requires the following data for the feed solution (after acid addition, if acid is used for control of calcium carbonate):

- SiO₂ concentration
- Temperature
- pH
- Total alkalinity

Calculation / 16/

1. The SiO₂ concentration in the concentrate stream is calculated from the SiO₂ concentration in the feed solution and the recovery of the reverse osmosis system:

$$\text{SiO}_{2c} = \text{SiO}_{2f} \left(\frac{1}{1-Y} \right) \quad \text{Eq. 29}$$

where:

SiO_{2c} = silica concentration in concentrate as SiO₂, mg/L

SiO_{2f} = silica concentration in feed as SiO₂, mg/L

Y = recovery of the reverse osmosis system, expressed as a decimal

2. Calculate the pH of the concentrate stream from the pH of the feed stream using the procedure given in Section 2.4.2.1.
3. From Figure 25, obtain the solubility of SiO₂ as a function of temperature (SiO₂ temperature). The temperature of the concentrate is assumed equal to the temperature of feed solution. If the temperature of the water is known to vary, use the minimum temperature for calculations.
4. From Figure 26, obtain the pH correction factor for the concentrate pH calculated in Step 2.
5. Calculate the solubility of SiO₂ corrected for pH (SiO_{2corr}) by multiplying the solubility of SiO₂ obtained in Step 3 by the pH correction factor obtained in Step 4.
6. Compare the silica concentration in the concentrate (SiO_{2c}) obtained in Step 1 with the silica solubility (SiO_{2corr}) obtained in Step 5. Once a reverse osmosis system is operating, the scaling potential of SiO₂ can be directly calculated from the analysis of the concentrate stream and compared with the projected scaling potential calculated above. If SiO_{2c} is greater than SiO_{2corr}, silica scaling can occur and adjustment is required.

Adjustments for Scale Control

- If SiO_{2c} is less than $\text{SiO}_{2\text{corr}}$, a higher recovery can be used with respect to scaling by silica. Reiteration of the calculations at higher recovery can be used to determine the maximum conversion with respect to scaling by silica.
- If SiO_{2c} is greater than $\text{SiO}_{2\text{corr}}$, a lower recovery must be used to prevent scaling. Reiteration of the calculations can be used to determine the allowable recovery with respect to scaling by silica.
- If the maximum allowable recovery is lower than desired, lime plus soda ash softening employing either magnesium oxide or sodium aluminate can be used in the pretreatment system to decrease the SiO_2 concentration in the feed stream (see Section 2.3.6) and thus permit higher conversion with respect to scaling by silica. It is important that the softening process be performed properly in order to prevent formation of insoluble metal silicates in the reverse osmosis system.
- Since the solubility of silica increases below a pH of about 7.0 and above a pH of about 7.8, pH adjustment with either acid or base can permit a higher recovery with respect to silica scaling. For the high pH, however, CaCO_3 scaling must be prevented.
- The maximum allowable recovery with respect to silica scaling can be increased significantly by increasing the water temperature using a heat exchanger. The maximum temperature permitted for continuous use is 45°C.
- Scale inhibitors such as high molecular weight polyacrylates can also be used to increase the solubility of silica.

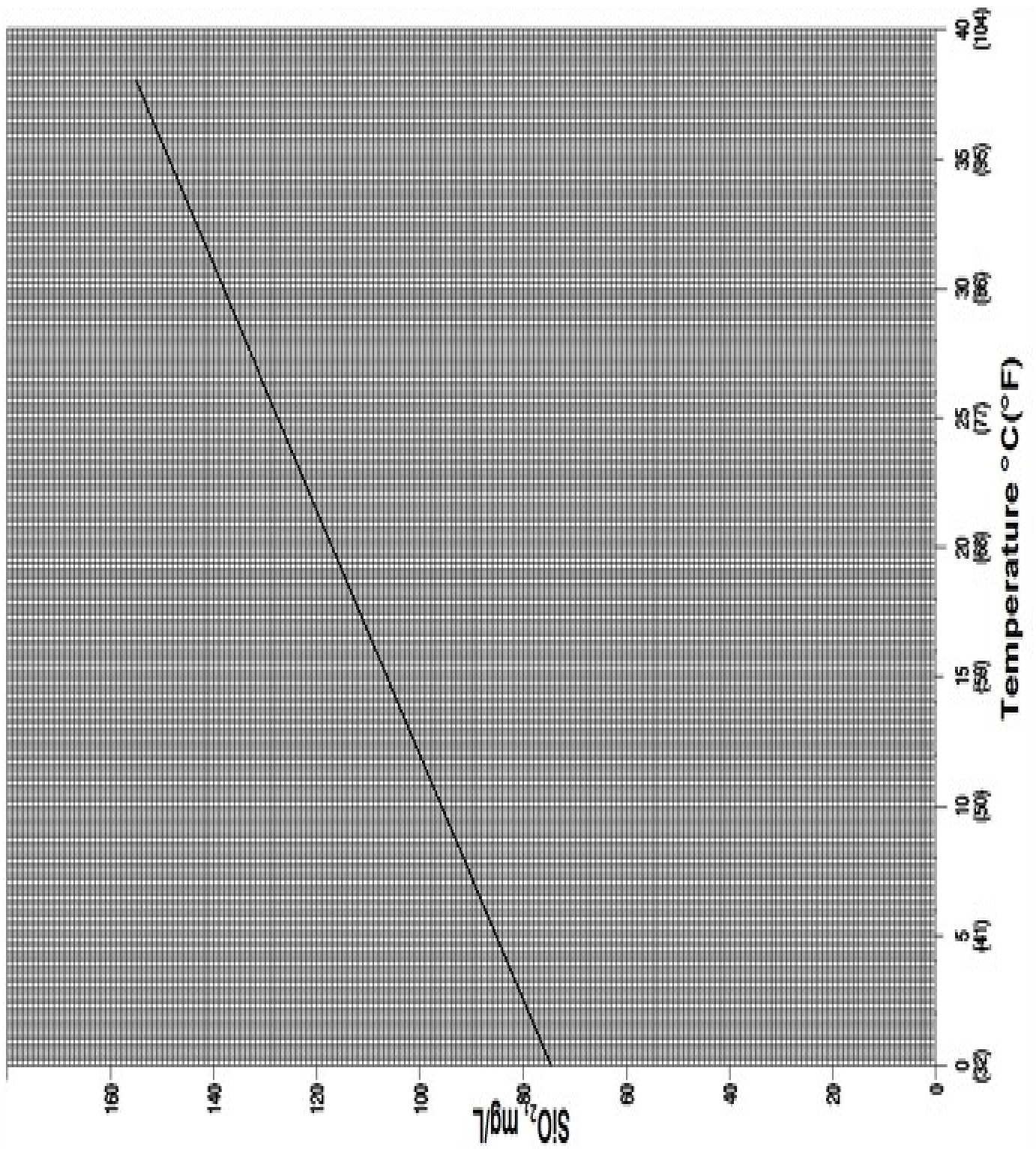

Figure 25. Solubility of SiO₂ versus temperature /16/

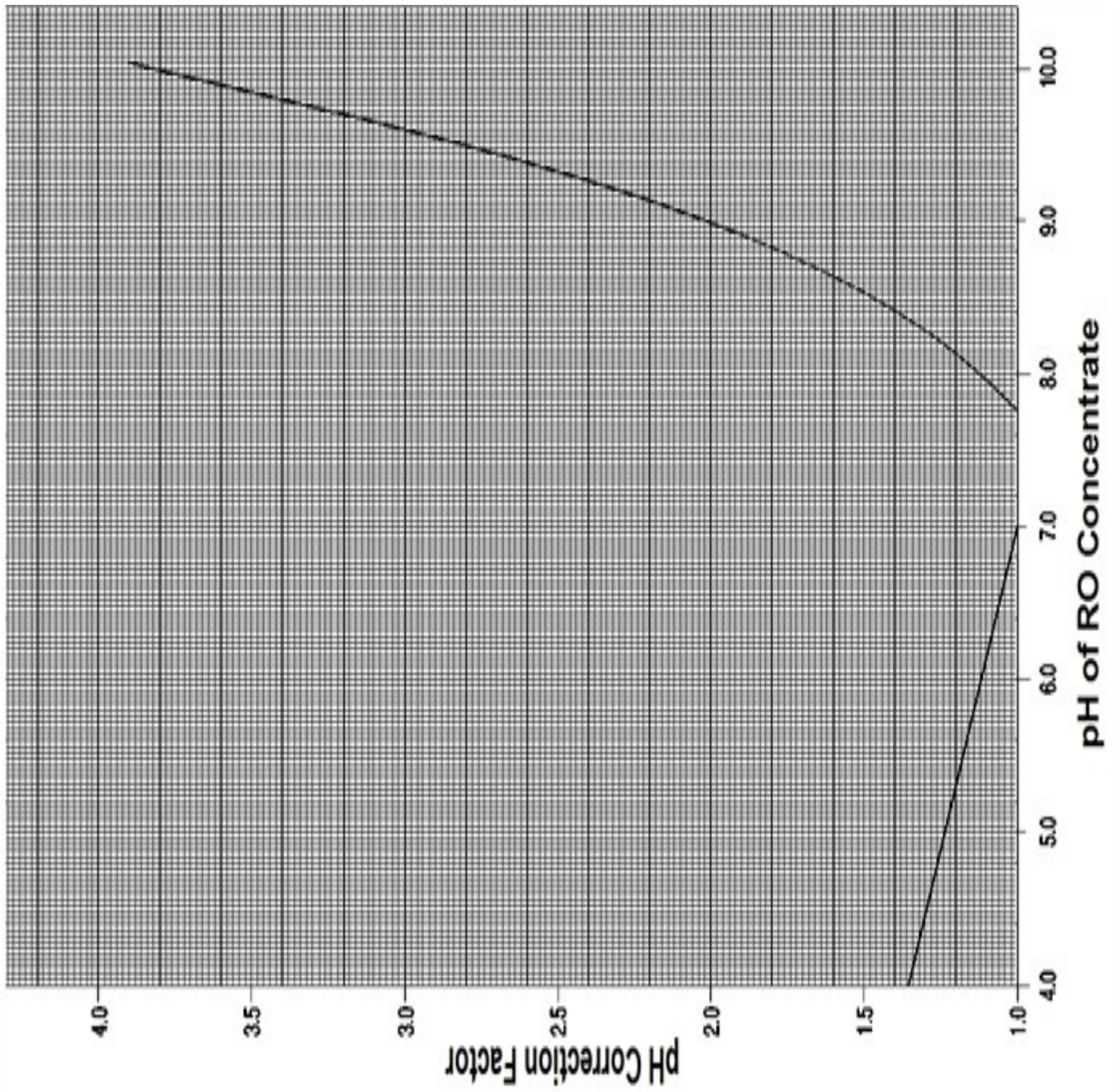

Figure 26. SiO₂ pH correction factor /16, 17/

2.4.8 Calcium Phosphate Scale Prevention

Calcium phosphate fouling was not common until reverse osmosis technology was widely applied to municipal wastewater. Due to water shortages, municipal wastewater recycle or reuse has become one a major application area of reverse osmosis. Along with this new application, preventive actions for calcium phosphate scaling are needed.

Phosphorus is a common element in nature and is widely distributed in many minerals. In natural water and wastewater streams, phosphorus compounds exist in the following forms: /18/

- Particulate phosphate
- Orthophosphate (PO_4^{3-}): Orthophosphates may be present as H_3PO_4 , H_2PO_4^- , HPO_4^{2-} , and PO_4^{3-} depending on pH. H_2PO_4^- and HPO_4^{2-} are the prevailing species in neutral wastewater.
- Polyphosphates: Important components in textile washing powders and other detergents. Depending on the product, they may contain 2 – 7 P atoms.
- Organic phosphorus: Phosphorus is an essential element for living organisms.
- The most common mineral form of phosphorus is apatite, which is a calcium phosphate with variable amounts of OH^- , Cl^- , and F^- (hydroxy-, chloro-, or fluoroapatite). Some other phosphate minerals contain aluminum and/or iron. Because of their low solubility, the following phosphate compounds can be considered as causes of phosphate scaling in an RO/NF operation (see Table 13).

Table 13. Low solubility phosphate compounds

Compound	Formula	pK_{sp}
Brushite	$\text{CaHPO}_4 \cdot 2\text{H}_2\text{O}$	6.68
Calcium phosphate	$\text{Ca}_3(\text{PO}_4)_2$	28.9
Octacalcium phosphate	$\text{Ca}_8\text{H}(\text{PO}_4)_6 \cdot 3\text{H}_2\text{O}$	46.9
Hydroxyapatite	$\text{Ca}_5(\text{PO}_4)_3\text{OH}$	57.74
Fluoroapatite	$\text{Ca}_5(\text{PO}_4)_3\text{F}$	60
Magnesium ammonium phosphate	MgNH_4PO_4	12.6
Aluminum phosphate	AlPO_4	20
Iron phosphate	FePO_4	15

Calcium phosphate and apatites are less soluble in neutral and alkaline conditions and dissolve in acid /18/. Aluminum and iron phosphates, however, are less soluble at moderately acidic conditions. Thus it is important to remove aluminum and iron in a pretreatment step as well. Because of the complexity of phosphate chemistry, it is not easy to predict a threshold level of phosphate scaling. The calcium phosphate stability index (SI), however, was proposed by Kubo et al /19/. The calcium phosphate stability index is determined by the levels of calcium and phosphate present, pH, and temperature. A negative SI signifies a low potential for calcium phosphate scaling; a positive value indicates the potential for calcium phosphate scaling. SI is determined by the following equation:

$$SI = pH_a - pH_c \tag{Eq. 30}$$

where:

pH_a = actual pH of a feedwater

pH_c = critical pH calculated by the following experimental equation:

$$pH_c = \frac{11.755 - \log(\text{CaH}) - \log(\text{PO}_4) - 2 \log t}{0.65} \tag{Eq. 31}$$

where :

CaH = Calcium hardness as ppm CaCO_3

PO_4 = Phosphate concentration as ppm PO_4

t = Temperature as $^{\circ}\text{C}$

Figure 27 shows the effect of critical phosphate concentrations of $\text{Ca}_3(\text{PO}_4)_2$ scaling on feed calcium hardness and pH based on the equation.

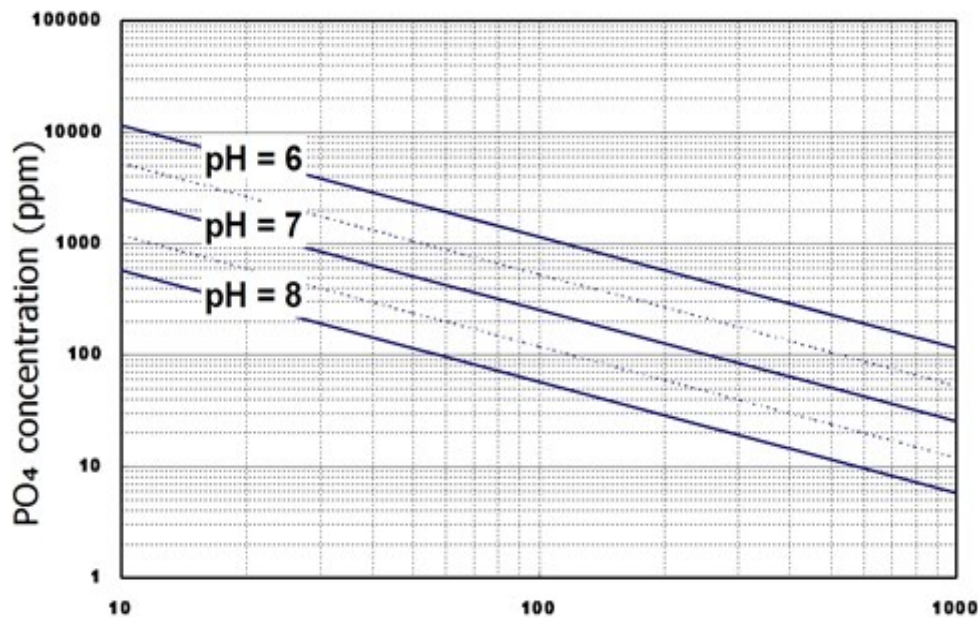

Figure 27. Critical phosphate concentration under various pH at 25°C

Note: When feedwater contains high levels of fluoride, ammonia and aluminum, critical phosphate concentration might be lowered due to formation of fluorapatite, aluminum phosphate, etc.

To minimize the risk of phosphate scaling, it is important to reduce not only orthophosphate, but also calcium, fluoride, and aluminum concentration. A low feed pH helps to control phosphate scaling. Appropriate commercial antiscalants good for phosphate scaling are also available.

Phosphate scaled membranes are best cleaned at low pH (see [Chapter 6](#)).

2.5 Colloidal and Particulate Fouling Prevention

2.5.1 Assessment of the Colloidal Fouling Potential

Colloidal fouling of RO elements can seriously impair performance by lowering productivity and sometimes salt rejection. An early sign of colloidal fouling is often an increased pressure differential across the system.

The source of silt or colloids in reverse osmosis feedwaters is varied and often includes bacteria, clay, colloidal silica, and iron corrosion products. Pretreatment chemicals used in a clarifier such as aluminum sulfate, ferric chloride, or cationic polyelectrolytes are materials that can be used to combine these fine particle size colloids resulting in an agglomeration or large particles that then can be removed more easily by either media or cartridge filtration. Such agglomeration, consequently, can reduce the performance criteria of media filtration or the pore size of cartridge filtration where these colloids are present in the feedwater. It is important, however, that these pretreatment chemicals become incorporated into the agglomerates themselves since they could also become a source of fouling if not removed. In addition, cationic polymers may coprecipitate with negatively charged antiscalants and foul the membrane.

Several methods or indices have been proposed to predict a colloidal fouling potential of feedwaters, including turbidity, Silt Density Index (SDI) and Modified Fouling Index (MFI). (see Table 14) The SDI is the most commonly used fouling index.

Table 14. Various fouling indices

Index	Definition or method
Turbidity	<p>Turbidity is an expression of the optical property of water that causes light to be scattered and absorbed rather than transmitted in straight lines through the sample. Turbidity is caused by suspended and colloidal particulate matter such as clay, silt, finely divided organic and inorganic matter, plankton and other microscopic organisms.</p> <p>Test methods for turbidity of water are described in ASTM D1889 /20/, in ASTM D6698 /21/ and Chapter 2130 of <i>Standard Methods for the Examination of Water and Wastewater 20th Editions /1/</i>.</p> <p>Turbidity is often used for online control of particle filtration processes. The turbidity of feedwater to RO/NF should be less than 1 NTU as one of the minimum requirements of feedwater.</p>
SDI	<p>The Silt Density Index (SDI) can serve as a useful indication of the quantity of particulate matter in water and correlates with the fouling tendency of RO/NF systems. The SDI is calculated from the rate of plugging of a 0.45 µm membrane filter when water is passed through at a constant applied gauge pressure. The method is described below. For more details refer to ASTM D4189 /22/.</p> <p>SDI is sometimes referred to as the Fouling Index (FI)</p>
MFI	<p>The Modified Fouling Index (MFI) is proportional to the concentration of suspended matter and is a more accurate index than the SDI for predicting the tendency of a water to foul RO/NF membranes. The method is the same as for the SDI except that the volume is recorded every 30 seconds over a 15 minute filtration period. The MFI is obtained graphically as the slope of the straight part of the curve when t/V is plotted against V (t is the time in seconds to collect a volume of V in liters). For more details refer to Schippers et al. /23/.</p> <p>A MFI value of < 1 corresponds to a SDI value of about < 3 and can be considered as sufficiently low to control colloidal and particulate fouling.</p> <p>More recently, UF membranes have been used for MFI measurements. This index is called MFI-UF in contrast to the MFI_{0.45} where a 0.45 µm membrane filter is used /24/.</p>

Measuring these indices is an important practice and should be carried out prior to designing an RO/NF pretreatment system and on a regular basis during RO/NF operation (three times a day is a recommended frequency for surface waters).

Equipment:

Figure 28 shows the equipment needed to measure SDI, including

- 47 mm diameter membrane filter holder
- 47 mm diameter membrane filters (0.45 µm pore size)
- 10 – 70 psi (1 – 5 bar) pressure gauge
- needle valve for pressure adjustment

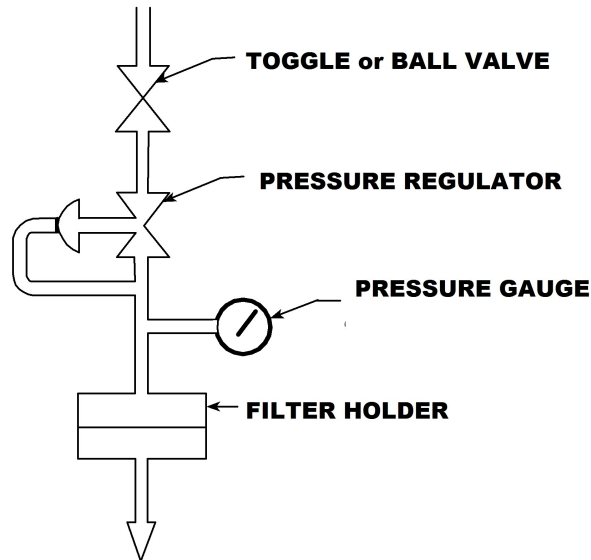

Figure 28. Apparatus for measuring the silt density index

Procedure

1. Assemble the apparatus as shown in Figure 28 and set the pressure regulator at 207 kPa (30 psi or 2.1 bar).
2. Place the membrane filter carefully on its support.
3. Make sure the O-ring is in good condition and properly placed. Replace the top half of the filter holder and close loosely.
4. Bleed out trapped air, close the valve and tighten the filter holder.
5. Open the valve. Simultaneously, using a stopwatch, begin measuring the time required for the flow of 500 mL. Record the time t_i . Leave the valve open for continued flow.
6. Measure and record the times to collect additional 500 mL volumes of sample, starting the collection at 5, 10, and 15 minutes of total elapsed flow time. Measure the water temperature and check the pressure as each sample is collected.
7. After completion of the test, the membrane filter may be retained for future reference. Alternatively, the filter may be left in operation after the test until clogged in order to collect suspended matter for analysis with analytical methods.
8. Calculation:

$$SDI_T = \left(1 - \frac{t_i}{t_f}\right) \cdot \frac{100}{T}$$

Eq. 32

where:

T = total elapsed flow time, min (usually 15 min, see Note)

t_i = initial time required to collect 500 mL of sample, sec

t_f = time required to collect 500 mL of sample after test time T, sec (usually 15 min)

Note: For this test method, $1-(t_i/t_f)$ should not exceed 0.75. If $1-(t_i/t_f)$ exceeds this value, use a shorter time for T; (i.e., 5 or 10 minute measurements in Step 6).

The guideline is to maintain SDI_{15} at ≤ 5 . To minimize the fouling, however, SDI_{15} at < 3 is recommended. A number of pretreatment technologies have proven effective in SDI reduction, including media filtration (such as sand/anthracite), ultrafiltration and crossflow microfiltration. Polyelectrolyte addition ahead of filtration sometimes improves SDI reduction.

Methods to prevent colloidal fouling are outlined in the following.

2.5.2 Media Filtration

The removal of suspended and colloidal particles by media filtration is based on their deposition on the surface of filter grains while the water flows through a bed of these grains (filter media). The quality of the filtrate depends on the size, surface charge, and geometry of both suspended solids and filter media, as well as on the water analysis and operational parameters. With a well-designed and operated filter, a $SDI_{15} < 5$ can usually be achieved.

The most common filter media in water treatment are sand and anthracite. The effective grain size for fine sand filter is in the range of 0.35 – 0.5 mm, and 0.7 – 0.8 mm for anthracite filter. In comparison to single sand filter media, dual filter media with anthracite over sand permit more penetration of the suspended matter into the filter bed, thus resulting in more efficient filtration and longer runs between cleaning. The design depth of the filter media is a minimum of 31 inches (0.8 m). In the dual filter media, the filters are usually filled with 20 inches (0.5 m) of sand covered with 12 inches (0.3 m) of anthracite.

There are two types of filters employed, gravity and pressure filters. As the filter vessel for pressure filtration is designed for pressurization, a higher pressure drop can be applied for higher filter beds and/or smaller filter grains and/or higher filtration velocities. The design filtration flowrates are usually 4 – 8 gpm/ft² (10 – 20 m/h), and the backwash rates are in the range of 16 – 20 gpm/ft² (40 – 50 m/h). The available pressure is usually about 16 ft (5 m) of head for gravity filters, and 30 psi (2 bar) to more than 60 psi (4 bar) for pressure filters. For feedwaters with a high-fouling potential, flowrates of less than 4 gpm/ft² (10 m/h) and/or second pass media filtration are preferred. If the flowrate has to be increased to compensate for one filter that goes out of service, the flowrate increase must be gradual and slow to prevent the release of previously deposited particles.

During operation, influent water to be filtered enters at the top of the filter, percolates through the filter bed, and is drawn off through the collector system at the bottom. Periodically, when the differential pressure increase between the inlet and outlet of the pressure filter is 4 – 9 psi (0.3 – 0.6 bar), and about 4.6 ft (1.4 m) for the gravity filter, the filter is backwashed and rinsed to carry away the deposited matter. Backwash time is normally about 10 minutes. Before a backwashed filter is placed back into service, it must be rinsed to drain until the filtrate meets the specification.

Frequent shutdowns and start-ups should be avoided to minimize the release of previously deposited particulate matter. Design and operational details of media filtration are available in water treatment textbooks /3, 4/.

2.5.3 Oxidation-Filtration

Some well waters, usually brackish waters, are in a reduced state. Typically, such waters contain divalent iron and manganese, sometimes hydrogen sulfide and ammonium, but no oxygen; therefore, they are also called anoxic. Often the oxygen has been used up (e.g., by microbiological processes) because the water is contaminated with biodegradable organic substances, or the water is from a very old aquifer.

One method of handling anoxic waters is to oxidize iron and manganese by air, sodium hypochlorite or potassium permanganate (KMnO_4). The hydroxides formed can then be removed by media filtration. Hydrogen sulfide will be oxidized to elemental sulfur that can be removed by media filtration as well.

Oxidation and filtration can be accomplished in one step by using a filter media with the ability to oxidize divalent iron and manganese by electron transfer. Greensand is such a granular medium, which is a green (when dry) mineral glauconite. It can be regenerated with KMnO_4 when its oxidizing capability is exhausted. After regeneration, the residual KMnO_4 has to be thoroughly rinsed out to avoid oxidation damage of the membranes. This technique is used when < 2 mg/L Fe^{2+} is present in the raw water. For higher Fe^{2+} concentrations, KMnO_4 can be continuously dosed into the inlet stream of the filter. In this case, however, measures have to be taken to ensure that no permanganate can reach the membranes (e.g., by installation of a carbon filter) (see Section 2.6.3, *Chlorination/Dechlorination*).

Birm filtration has also been used effectively for Fe^{2+} removal from RO feedwater. With birm filtration a pH increase and consequently a shift in the LSI value might occur, so care should be taken to avoid CaCO_3 precipitation in the filter and in the RO system.

Instead of media filtration, microfiltration or ultrafiltration (see Section 2.5.6) can be used to remove small iron and manganese hydroxide particles formed from an oxidation process. This is a rather new technology for iron and manganese removal.

The pretreatment of anoxic waters is described in more detail in Section 2.9 and Section 2.10.

2.5.4 In-Line Filtration

The efficiency of media filtration to reduce the SDI value can be markedly improved if the colloids in the raw water are coagulated and/or flocculated prior to filtration. In-line filtration can be applied to raw waters with a SDI only slightly above 5. The optimization of the method, also named in-line coagulation or in-line coagulation-flocculation, is described in ASTM D 4188 /25/. A coagulant is injected into the raw water stream, effectively mixed, and the formed microflocs are immediately removed by media filtration.

Ferric sulfate and ferric chloride are used to destabilize the negative surface charge of the colloids and to entrap them into the freshly formed ferric hydroxide microflocs. Aluminum coagulants are also effective, but not recommended because of possible fouling problems with residual aluminum. Rapid dispersion and mixing of the coagulant is extremely important. An in-line static mixer or injection on the suction side of a booster pump is recommended. The optimum dosage is usually in the range of 10–30 mg/L, but should be determined case by case.

To strengthen the hydroxide microflocs and thereby improving their filterability, and/or to bridge the colloidal particles together, flocculants can be used in combination with coagulants or alone. Flocculants are soluble high molecular weight organic compounds (e.g., linear polyacrylamides). Through different active groups, they may be positively charged (cationic), negatively charged (anionic), or close to neutral (nonionic).

Coagulants and flocculants may interfere with an RO membrane indirectly or directly. Indirect interference occurs when the compound forms a precipitate that is deposited on the membrane. For example, channeling of the media filter may enable flocs to pass through and deposit on the membrane. A precipitate can also be formed when concentrating the treated feedwater, such as when aluminum or ferric coagulants are added without subsequently lowering pH to avoid supersaturation in the RO stage. Furthermore, reaction with a compound added after the media filter can cause a precipitate to form. This is most noticeable with antiscalants. Nearly all antiscalants are negatively charged and will react with cationic coagulants or flocculants present in the water. The membranes in several RO plants have been heavily fouled by a gel formed by reaction between cationic polyelectrolytes and antiscalants.

Direct interference occurs when the compound itself affects the membrane resulting in a flux loss. The ionic strength of the water may have an effect on the interference of the coagulant or flocculant with the membrane. If so, the result at brackish water conditions could be different from that at seawater conditions. To minimize the risk of direct or indirect interference with the RO membrane, anionic or nonionic flocculants are preferred rather than cationic flocculants. Overdosing must be avoided.

2.5.5 Coagulation-Flocculation

For raw waters containing high concentrations of suspended matter resulting in a high SDI, the classic coagulation-flocculation process is preferred. The hydroxide flocs are allowed to grow and settle in specifically designed reaction chambers. The hydroxide sludge is removed, and the supernatant water is further treated by media filtration.

For the coagulation-flocculation process, either a solids-contact type clarifier (see also Section 2.3.6 *Lime Softening*) or a compact coagulation-flocculation reactor may be used. For details, please refer to the general water treatment textbooks /3, 4/.

2.5.6 Microfiltration/Ultrafiltration

Microfiltration (MF) or ultrafiltration (UF) membrane substantially removes suspended matter and, in the case of ultrafiltration, also dissolved organic compounds depending on their molecular mass and on the molecular mass cut-off of the membrane. Hence, an SDI < 1 can be achieved with a well-designed and properly maintained MF or UF system. There is both dead-end and crossflow filtration. Dead-end filtration has two streams, inlet and outlet. 100% of the feed passes through the UF or MF filter medium (i.e., 100% recovery). In crossflow filtration, there are three streams: feed, concentrate, and permeate. In UF and MF hollow-fiber membranes, there are two different types of configurations: flow can be from outside-in or inside-out. For outside-in configuration, there is more flexibility in the amount of feed to flow around the hollow fibers, whereas inside-out configuration has to consider the pressure drop through the inner volume of the hollow fibers. Inside-out configuration, however, offers much more uniform flow distribution through the bore of hollow fiber compared to the outside-in configuration. Crossflow UF/MF systems operate at high recovery and flux rate and so backwashing and air-scouring techniques are frequently used to reduce fouling.

If a chlorine-resistant membrane material is used (e.g., polysulfone or a ceramic membrane), chlorine can be added to the wash water in order to retard biological fouling. A review on microfiltration and ultrafiltration processes is given by Porter /26/.

2.5.7 Cartridge Microfiltration

A cartridge filter with an absolute pore size of less than 10 µm is the suggested minimum pretreatment required for every RO system. It is a safety device to protect the membranes and the high pressure pump from suspended particles. Usually it is the last step of a pretreatment sequence. A pore size of 5 µm absolute is recommended. The better the pre-filtration the less RO membrane cleaning required. If there is a risk of fouling with colloidal silica or with metal silicates, cartridge filtration with 1 – 3 µm absolute pore size is recommended. The filter should be sized on a flowrate according to the manufacturer's recommendation and replaced before the pressure drop has increased to the permitted limit, but at least every 3 months.

Backflushable filters as final safety filters are generally not recommended because of their risk of breakthrough in case of a malfunction of their backflush mechanism, their lower efficiency and the higher biofouling risk. Backflushable fine filters may be used upstream of the cartridge filters to protect them. They are however, no substitute for disposable cartridges.

The cartridge filter should be made of a synthetic non-degradable material (e.g., nylon or polypropylene) and equipped with a pressure gauge to indicate the differential pressure, thereby indicating the extent of its fouling. Regular inspections of used cartridges provide useful information regarding fouling risks and cleaning requirements.

If the differential pressure across the filter increases rapidly, it is an indication of possible problems in the raw water supply or in the pretreatment process. The filter provides some degree of short-term protection for the membranes while corrective action is taking place.

Replacing cartridge filters more often than every 1 – 3 months usually indicates a problem with the pretreatment. The cartridge filter, however, is not meant to be a major component for the removal of high amounts of filterable solids. This would not only be an inefficient use of rather expensive filters, but would probably lead to premature failure of the membrane system due to the high probability that some of the unwanted material will break through. An alternative approach would be to use a second cartridge with larger pore size upstream.

2.5.8 Other Methods

Methods to prevent colloidal fouling other than those described in the previous sections also exist.

Lime softening has already been described as a method for silica removal (Section 2.3.6). Removal of iron and colloidal matter are further benefits.

Strong acid cation exchange resin softening not only removes hardness, but it also removes low concentrations of iron and aluminum that otherwise could foul the membrane. Softened water is also known to exhibit a lower fouling tendency than unsoftened (hard) water because multivalent cations promote the adhesion of naturally occurring colloids, which are usually negatively charged. The ability to minimize iron depends on the Fe species present. Fe^{2+} and Fe^{3+} are substantially removed by the SAC resin and, if in excess of 0.05 ppm, have a tendency to foul the membrane and catalyze its degradation. Colloidal or organo-Fe-complexes are usually not removed at all and will pass through into the product water. Insoluble iron-oxides are, depending on their size, filtered out depending on the flowrate and bed-depth used.

When dealing with higher concentration of ferrous iron, one needs special care to avoid ferric iron fouling. It was reported that addition of SMBS was able to prevent membrane fouling

Antifoulants: certain scaling inhibitors, also called antifoulants, can handle iron. This pretreatment process can be used for relatively low concentrations of iron.

2.5.9 Design and Operational Considerations

The prevention of colloidal fouling is not only a matter of the proper pretreatment selection, but also of the system design and operation. As an extreme example, surface water could be pretreated by coagulation-flocculation and ultrafiltration. The RO system could then operate with a high permeate flux, and almost no cleaning would be required. If the same water, however, is just filtered with cartridge filtration, then the RO system would need much more membrane area, and more frequent cleaning and maintenance would be required. A poor pretreatment process can be partially compensated for by adding more membrane area and modifying the system (see Section 3.1, *System Design*), and by more frequent and/or harsh cleaning. On the other hand, improving the pretreatment system means lower membrane costs.

To minimize the pretreatment effort and/or improve the feedwater quality, the best available raw water quality should be used. The location of the intake of surface water, including seawater, is of paramount importance. Contamination of the raw water with wastewater effluent may cause serious problems in the RO plant. A deep well close to the shore or the river is preferred. If an open intake is required, it should be located well away from the shore and some meters below the water surface.

New wells often release suspended matter in the first days of operation. Care must be taken that wells are properly rinsed out. Fouling by iron oxide is also a common problem. It can be avoided by selecting noncorrosive materials (see Section 3.15, *Materials of Construction, Corrosion Control*).

2.6 Biological Fouling Prevention

2.6.1 Introduction

All raw waters contain microorganisms such as bacteria, algae, fungi, viruses, and higher organisms. The typical size of bacteria is about 1 μm . Microorganisms can be regarded as colloidal matter and removed during pretreatment as discussed in Section 2.5.1. The difference between microorganisms and non-living particles, however, is the ability of microorganisms to reproduce and form a biofilm under favorable conditions.

Microorganisms entering a RO/NF system find a large membrane surface where dissolved nutrients from the water are enriched due to concentration polarization, thus creating an ideal environment for the formation of a biofilm. Biological fouling of the membranes may seriously affect the performance of the RO system. The symptoms are an increase in the differential pressure from feed to concentrate, finally leading to telescoping and mechanical damage of the membrane elements (see Section 8.5.3, *High Pressure Drop*), and a decline in membrane flux. Sometimes, biofouling develops even on the permeate side, thus contaminating the product water.

A biofilm is difficult to remove because it protects its microorganisms against the action of shear forces and biocidal chemicals. In addition, if not completely removed, remaining parts of a biofilm lead to a rapid regrowth. Biological fouling prevention is therefore a major objective of the pretreatment process. The control of microbiological activity is also part of system design (see Section 3.16, *System Design Considerations to Control Microbiological Activity*, in the system operation (see [Chapter 5](#), *System Operation*), in the sanitization of systems (see Section 6.10.1, *Sanitizing Membrane Systems*) and in the preservation of systems (see Section 7.4, *Preservation of RO and NF Systems*).

The various methods to prevent and control biological fouling are described in Sections 2.6.3 to 2.11. Each method has specific advantages, but the optimum strategy is a combination of the different concepts.

The most successful approach is the limitation or removal of nutrients for microorganisms from the water in order to limit biological growth. This can be achieved with biofiltration - see Section 2.6.8. The continuous addition of oxidation chemicals such as chlorine may increase the nutrient level because organic substances may be broken down to smaller biodegradable fragments. Dosing chemicals such as antiscalants or acids must be carefully selected because they may also serve as nutrients.

Other methods are based on chemicals that have a biocidal effect on microorganisms. These sanitization chemicals are applied during the normal operation of the plant either as a continuous dosage to the feedwater stream or preferably as a discontinuous (intermittent) dosage in certain intervals. Preventive treatments are much more effective than corrective treatments because single attached bacteria are easier to kill and remove than a thick, aged biofilm. Typical treatment intervals are one to four per month, but they can be as short as one per day, depending on the feedwater quality (e.g., wastewater) or the permeate quality required (e.g., pharmaceutical-grade water). A third application mode is the off-line application using separate cleaning equipment. This mode is dealt with in Section 6.10.1, *Sanitizing Membrane Systems*.

The attachment of bacteria to a membrane surface and their growth can be minimized by a surface modification of the membrane. This concept is available with the FR (Fouling Resistant) series of FilmTec™ Membrane Elements – see Section 2.6.11.

Other physical methods are targeted to remove microorganisms in the feedwater with microfiltration or ultrafiltration (see Section 2.6.9) or to kill them with UV radiation (see Section 2.6.10).

2.6.2 Assessment of the Biological Fouling Potential

The potential for biological fouling should be assessed during the project phase so that the system can be designed accordingly. Warm surface waters generally have a higher biofouling potential than cold well waters. The regular assessment of the microbiological activity of the feedwater should also be part of the operating discipline of an existing plant so that any increase of the microbiological activity can be responded to at an early stage.

Some techniques require water sampling, whereas others use online monitors. Sampling of microbiological activity can be done using presterilized sampling containers. If the laboratory equipment needed for analysis of the microbiological samples is not available at the RO plant site, an adequate laboratory should be found to perform the needed analysis not later than 8 hours after sampling. Samples should be stored in a refrigerator.

The minimum number of sampling points required is listed below:

1. Intake (surface) or well, before addition of any chemicals.
2. After a clarifier, settling pond, sludge contact unit, or similar sedimentation process.
3. After filtration units (sand, multimedia, activated carbon, or other).
4. Just before the membranes, after addition of chemicals (normally after cartridge filtration).
5. Concentrate stream.
6. Permeate stream.

The frequency of sampling and analysis depends on the risk of biofouling. For surface water plants, a daily check of the feedwater (point 4) and a weekly check of all points are recommended.

2.6.2.1 Culture Techniques

The concentration of bacteria in water is directly related to the biological fouling potential of the water. The number of colony forming units (CFU) is a quantitative expression of the number of culturable microorganisms in a water sample. It is determined according to Part 9000 of the Standard Methods /1/ by filtering a measured quantity of water through a membrane filter. Subsequently, the organisms thus retained on the filter surface are cultured on the appropriate nutrient medium to develop colonies, which are then observed and counted at low power magnification. Different media are used for different microorganisms and different water types.

The main advantage of this method is that it can be performed easily without expensive equipment. The test results, however, are only available after up to seven days, and the counted colonies may represent as little as 1 – 10% or less of the total bacteria count (TBC). Nevertheless, culture techniques are still valuable as indicators of the level and the trend of the biological fouling potential.

They can be applied to monitor the water quality from the intake through the subsequent treatment steps up to the concentrate stream and the permeate. An increase of the CFU is an indication of an increased biofouling potential.

2.6.2.2 Total Bacteria Count

The total bacteria count (TBC) is determined with direct count techniques. These employ filtration of the water sample and counting the retained microorganisms on the filter plate directly under a microscope. To make the microorganisms visible, they are stained with acridine orange and viewed with an epi-illuminated fluorescent microscope /28/.

Thus, an accurate count of total microorganisms is obtained immediately. The types of microorganisms can be assessed and differentiated from debris particles. Direct count methods are preferred, because they are much faster and more accurate than culture techniques.

The concentrations of microorganisms in raw water, in the feed stream, and in the concentrate stream are helpful numbers for assessing biological fouling potential. Other factors, however, like the concentration and the kind of nutrients or growth promoting substances may be more important for the development of a biofilm.

2.6.2.3 Assimilable Organic Carbon (AOC)

The AOC test addresses the growth potential of microorganisms in a given water sample with given nutrients. It is a bioassay with two well-defined pure cultures. From the maximum growth level of the two individual strains the AOC concentration is calculated and expressed as $\mu\text{g/L}$ of acetate C equivalents. The procedure is described in Part 9217 of the Standard Methods /1/. *Vrouwenvelder et al.* observed severe biofouling in cases where the feedwater had AOC values exceeding $80 \mu\text{g/L}$ /29/. *Nederlof et al.* proposed a standard of $10 \mu\text{g/L}$ to prevent biological fouling /30/, but in some cases biofouling may be possible with AOC values even below $10 \mu\text{g/L}$ /29/.

2.6.2.4 Biofilm Formation Rate (BFR)

The BFR value is determined with an online operated biofilm monitor at a continuous flowrate of 0.2 m/s. The accumulation of active biomass measured as ATP (adenosinetriphosphate) on the surface of glass rings in this monitor is determined as a function of time /32/. BFR values exceeding 100 pg/cm² ATP were observed with severe biofouling, and BFR values of less than 1 pg/cm² ATP were measured in cases of stable operation without any cleaning needs /29/. The BFR value is most closely correlated with the degree of biofouling in a membrane plant /31/.

2.6.3 Chlorination / Dechlorination

Chlorine (Cl₂) has been used for many years to treat municipal and industrial water and wastewaters to control microorganisms because of its capacity to inactivate most pathogenic microorganisms quickly. The effectiveness of chlorine is dependent on the chlorine concentration, time of exposure, and the pH of the water. Chlorine is used for treating potable water where a residual chlorine concentration near 0.5 mg/L is commonly used. In an industrial water treatment scheme, fouling of water intake lines, heat exchangers, sand filters, etc., may be prevented by maintaining a free residual chlorine concentration of 0.5 – 1.0 mg/L or higher, dependent on the organic content of the incoming water.

Chlorination for RO/NF pretreatment has been applied usually where biological fouling prevention is required (i.e., typically for surface waters). Chlorine is added continuously at the intake, and a reaction time of 20 – 30 min should be allowed. A free residual chlorine concentration of 0.5 – 1.0 mg/L should be maintained through the whole pretreatment line. Dechlorination upstream of the membranes is required, however, to protect the membranes from oxidation.

FilmTec™ membrane can withstand short-term exposure to free chlorine (hypochlorite); however, its resistance is limited. The membrane can be used successfully in installations where system upsets result in temporary exposure to free chlorine. Eventual degradation may occur after approximately 200 – 1,000 hours of exposure to 1 ppm concentrations of free chlorine.

The rate of chlorine attack depends on various feedwater characteristics. Under alkaline pH conditions, chlorine attack is faster than at neutral or acidic pH. Chlorine attack is also faster when iron or other transition metals are present either in the water or on the membrane surface; these metals catalyze membrane degradation. Because of the risk of membrane oxidation, chlorine is not recommended for intentionally sanitizing membrane systems.

Continuous chlorination and dechlorination of the feedwater has been standard for years. Biofouling problems downstream of the point of dechlorination, however, are quite common. It is believed that chlorine reacts with the organic matter in the water and breaks it down to more biodegradable fragments. Since there is no chlorine present on the membranes, microorganisms can grow with an enhanced nutrient offering, unless the system is sanitized very frequently. Therefore, the continuous chlorination/dechlorination method is becoming less popular.

Instead of continuous chlorination, chlorine is preferably applied off-line to the pretreatment section periodically. During off-line chlorination, the feedwater has to be sent to drain prior to reaching the membranes. Before the system goes into operation again, all chlorine containing feedwater has to be rinsed out carefully, and the absence of chlorine must be verified (e.g., by monitoring of the oxidation-redox potential (ORP)).

Chlorination Chemistry

Chlorine is most commonly available as chlorine gas and the hypochlorites of sodium and calcium. In water, they hydrolyze instantaneously to hypochlorous acid:

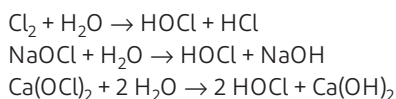

Hypochlorous acid dissociates in water to hydrogen ions and hypochlorite ions:

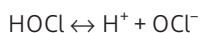

The sum of Cl_2 , NaOCl , Ca(OCl)_2 , HOCl , and OCl^- is referred to as free available chlorine (FAC) or free residual chlorine (FRC), expressed as mg/L Cl_2 . As discussed later, chloramines are formed from the reaction of chlorine with ammonia compounds present in the water. These chlorine-ammonia compounds are referred to as combined available chlorine (CAC) or combined residual chlorine (CRC). The sum of free and combined available/residual chlorine is called the total residual chlorine (TRC).

$$\text{TRC} = \text{FAC} + \text{CAC} = \text{FRC} + \text{CRC}$$

The germicidal efficiency of free residual chlorine is directly related to the concentration of undissociated HOCl . Hypochlorous acid is 100 times more effective than the hypochlorite ion OCl^- . The fraction of undissociated HOCl increases with decreasing pH.

At pH 7.5 (77°F (25°C), 40 mg/L TDS), only 50% of free residual chlorine is present as HOCl , but 90% is present at pH 6.5. The fraction of HOCl also increases with decreasing temperature. At 41°F (5°C), the HOCl mole fraction is 62% (pH 7.5, 40 mg/L TDS). In high-salinity waters, less HOCl is present (30% at pH 7.5, 25°C, 40,000 mg/L TDS).

Chlorine Demand

A part of the chlorine dosage reacts with ammonia nitrogen to combined available chlorine in a series of stepwise reactions:

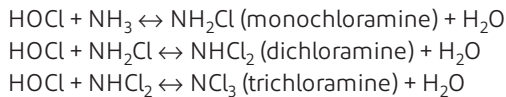

These reactions are governed primarily by pH and chlorine-to-nitrogen weight ratio. Chloramine also has a germicidal effect, albeit lower than that of chlorine.

Another part of the chlorine is converted to nonavailable chlorine. This chlorine demand is caused by the reaction with reducing agents such as nitrite, cyanide, sulfide, ferrous iron, and manganese. Chlorine is also consumed by the oxidation of organic compounds present in the water.

To determine the optimum chlorine dosage, best point of injection, pH, and contact time to prevent biofouling, ASTM D 1291 /33/ should be applied to a representative water sample. For further details, the Handbook of Chlorination /34/ is recommended.

Seawater

The major difference between the chlorination chemistry of seawater and that of brackish water is the presence of bromide in seawater in concentrations of typically 65 mg/L. Bromide reacts rapidly with hypochlorous acid to form hypobromous acid:

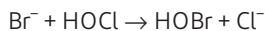

Thus, in chlorinated seawater the biocide is predominantly HOBr rather than HOCl .

Hypobromous acid then dissociates to hypobromite ion as follows:

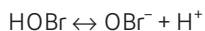

HOBr dissociation is less than HOCl dissociation. At pH 8, where 72% of HOCl is dissociated, about 17% of HOBr is dissociated. In other words, effective treatment can be performed at a higher pH than in brackish water, where no bromide is present.

Both hypobromous acid and hypobromite ions interfere with free residual chlorine measurements and are included in the free residual chlorine value.

The reactions of HOBr with other compounds of the water are analogous to the reactions of HOCl . Bromamines and brominated compounds are the reaction products.

Dechlorination

When RO or NF membrane is used in the RO/NF process, the feed must be dechlorinated to prevent oxidation of the membrane. FilmTec™ membranes have some chlorine tolerance before noticeable loss of salt rejection is observed. The first sign of chlorine attack on RO/NF membrane is loss of membrane flux followed by an increase in membrane flux and salt passage. Eventual degradation may occur after approximately 200 – 1,000 hours of exposure to 1 mg/L of free chlorine (200 – 1,000 ppm-h tolerance). The rate of chlorine attack depends on various feedwater characteristics. Under alkaline pH conditions, chlorine attack is faster than at neutral or acidic pH. An acidic pH is preferred for better biocidal effect during chlorination. Chlorine attack is also faster at higher temperatures and higher concentrations of heavy metals (e.g., iron), that can catalyze membrane degradation. Since oxidation damage is not covered under warranty, FilmTec™ recommends removing residual free chlorine by pretreatment prior to exposure of the feedwater to the membrane. Other oxidizing agents such as chlorine dioxide, hydrogen peroxide, ozone, and permanganate are capable of damaging RO/NF membranes also if not used properly.

Residual free chlorine can be reduced to harmless chlorides by activated carbon or chemical reducing agents. An activated carbon bed is very effective in the dechlorination of RO feedwater according to following reaction:

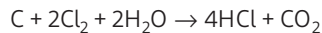

Sodium metabisulfite (SMBS) is commonly used for removal of free chlorine and as a biostatic. Other chemical reducing agents exist (e.g., sulfur dioxide), but they are not as cost-effective as SMBS.

When dissolved in water, sodium bisulfite (SBS) is formed from SMBS:



SBS then reduces hypochlorous acid according to:

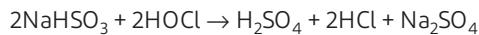

In theory, 1.34 mg of sodium metabisulfite will remove 1.0 mg of free chlorine. In practice, however, 3.0 mg of sodium metabisulfite is normally used to remove 1.0 mg of chlorine.

The SMBS should be of food-grade quality and free of impurities. SMBS should not be cobalt-activated. Solid sodium metabisulfite has a typical shelf life of 4 – 6 months under cool, dry storage conditions. In aqueous solutions, however, sodium bisulfite can oxidize readily when exposed to air. A typical solution life can vary with concentration as follows:

Concentration (wt%)	Solution life
10	1 week
20	1 month
30	6 months

Although the dechlorination itself is rapid, good mixing is required to ensure completion. Static mixers are recommended. The recommended injection point is downstream of the cartridge filters in order to protect the filters by chlorine. In this case, the SMBS solution should be filtered through a separate cartridge before being injected into the RO feed. Dechlorinated water must not be stored in tanks.

When RO/NF membranes are fouled with heavy metals such as Co and Cu, residual SBS (up to 30 ppm) partially converts to oxidants under the presence of excessive oxygen. When there is a heavy potential for metal fouling, SBS dosing amount control must be optimized and oxidation conditions of the concentrate must be monitored by an oxidation-reduction potential (ORP) meter /35/.

The absence of chlorine should be monitored using an oxidation-reduction potential (ORP) electrode downstream of the mixing line. 175 – 200 mV threshold readings of the ORP have been typically applied. The electrode signal shuts down the high pressure pump when chlorine is detected.

2.6.4 Sodium Bisulfite

Sodium bisulfite can be added into the feed stream (for a limited time period) during normal plant operation. This intermittent application is often referred to as shock treatment. In a typical application, 500 – 1,000 mg/L NaHSO₃ is dosed for 30 minutes.

Use only sodium metabisulfite (food-grade) that is free of impurities and not cobalt-activated. The treatment can be carried out on every 24 hours or only when biogrowth is suspected. The efficiency of such treatment should be studied. The permeate produced during dosage will contain some bisulfite, depending on the feed concentration, the membrane type and the operating conditions. Depending on the permeate quality requirements, the permeate can be used or discarded during shock treatment.

Bisulfite is effective against aerobic bacteria but not against anaerobic microorganisms. Therefore, the efficiency of the shock treatment should be carefully assessed using the techniques described in Section 2.6.2.

2.6.5 DBNPA

DBNPA (2,2, dibromo-3-nitrilo-propionamide) has the following characteristics:

- Compatible with the membrane
- Fast acting
- Cost effective
- Acceptable transportation, storage, stability and handling characteristics
- Broad spectrum control (e.g., planktonic and sessile organisms); algae control is seasonal and situational
- Biodegradable

There are several DBNPA-based products available. For more information about DBNPA or to find a supplier, refer to the DuPont Biocides website at <http://microbialcontrol.dupont.com/>.

In RO systems operating with biologically active feedwater, a biofilm can appear within 3 – 5 days after inoculation with viable organisms. Consequently, the most common frequency of sanitization is every 3 – 5 days during peak biological activity (summer) and about every 7 days during low biological activity (winter). The optimal frequency for sanitization will be site-specific and must be determined by the operating characteristics of the RO system.

The standard method to apply DBNPA is slug (intermittent) dosing. The amount of DBNPA used depends on the severity of the biological fouling. With a water less prone to biological fouling, using 10 – 30 mg/L of the active ingredient for 30 minutes to 3 hours every 5 days can be effective. Because DBNPA is deactivated by reducing agents (such as sodium bisulfite used for chlorine removal), a higher concentration of DBNPA will be required if there is residual reducing agent in the feedwater. The concentration of DBNPA should be increased by 1 ppm of active ingredient for every ppm of residual reducing agent in the RO feedwater. To remove the dead biofilm, an alkaline cleaning is also recommended (see Section 6.9.6, *Biofouling*). Biocides, their degradation products, and other ingredients in their formulations are not always completely rejected by RO membranes. For this reason, during slug dosing, it may be necessary to discharge the permeate during biocide injection because the permeate may contain slightly elevated levels of organics.

Note that although DBNPA is nonoxidizing, it does give an ORP response in approximately the 400 mV range at concentrations between 0.5 and 3 mg/L. For comparison, chlorine and bromine give a response in the 700 mV range at 1 mg/L, which increases with increasing concentration. This increase in ORP is normal when adding DBNPA and it is recommended the ORP set-point is by-passed during DBNPA addition.

2.6.6 Combined Chlorine

Sanitization with agents containing combined chlorine is generally not recommended. This includes such compounds as chloramine, chloramine-T, and N-chloroisocyanurate. These compounds can also slowly damage the membrane because they release small amounts of free chlorine.

- Chloramines are made from hypochlorite and ammonia. Because they are in equilibrium, there are almost always small amounts of chlorine present.
- Chloramine-T, the sodium salt of *N*-chlorotolamide, breaks down to hypochlorite in water
- Chlorine dioxide, generated on-site from chlorine and sodium chlorate, is always contaminated with free chlorine
- N-dichloroisocyanurate acts by constant release of small amounts of chlorine

If these compounds are present in the water, we recommend dechlorination prior to RO.

2.6.7 Other Sanitization Agents

Copper sulfate can be used to control the growth of algae. Typically, copper sulfate is fed continuously at concentrations of 0.1 – 0.5 ppm. pH of the water must be low (to prevent the precipitation of copper hydroxide). Generally the use of copper sulfate, however, is not recommended due to the following:

- Commercial CuSO_4 may contain some impurities detrimental to the RO membranes.
- CuCO_3 and $\text{Cu}(\text{OH})_2$ tend to precipitate outside of a given pH range of operation, causing fouling to RO devices and making CuSO_4 ineffective.
- Copper ions can have negative effects on the environment.
- CuSO_4 only works properly against a limited range of microorganisms (e.g., some algae) but has only a marginal effect on most bacteria.
- Environmental protection standards of several countries limit the discharge amount of Cu salts, making it difficult to change dosage of this chemical if the biolife situation of a given plant requires it.
- In some specific conditions, RO membrane is oxidized with persulfate generated from copper sulfate.

Ozone is an even stronger oxidizing agent than chlorine. However, it decomposes readily. A certain ozone level must be maintained to kill all microorganisms. The resistance of the materials of construction against ozone has to be considered. Usually, stainless steel is employed. Removal of ozone must be performed carefully to protect the membranes. Ultraviolet irradiation has been used successfully for this purpose.

Iodine, quaternary germicides and phenolic compounds cause flux losses and are not recommended for use as sanitization agents.

2.6.8 Biofiltration

Biofiltration is the biological treatment of water to reduce the organic constituents that either contribute directly to organic fouling or provide carbon sources for the development of biofilms on the membrane surfaces. Processes include bank filtration for river sources, soil passage and slow sand filtration. Filter beds of biologically active granular activated carbon (GAC) are widely used in public water works, where the biological activity of the carbon filter is further enhanced by treatment of the feed with ozone /3/. When such filters are operated at sufficiently low filter velocities (1 – 4 gpm/ft² or 2 – 10 m/h) and with sufficiently high beds (6.5 – 10 ft or 2 – 3 m), most of the biolife activity takes place in the upper region of the filter bed, and the filtered water is almost free of bacteria and nutrients.

Using biofiltration to prevent biofouling of RO/NF membrane systems has been demonstrated and advocated as a suitable pretreatment method by several authors /29, 30, 36, 37/.

2.6.9 Microfiltration/Ultrafiltration

Microfiltration (MF) and ultrafiltration (UF) can remove microorganisms and especially algae that are sometimes very difficult to remove by standard techniques. The MF/UF membranes should be made from a chlorine-resistant material to withstand periodic treatment with biocides. MF/UF membranes, however, do not remove the low molecular weight fractions of organic matter and other compounds that are nutrients for microorganisms. Pretreatment with MF/UF membranes helps to retard and to control the onset of biofouling, but it is no safeguard by itself.

2.6.10 Ultraviolet Irradiation

Ultraviolet (UV) irradiation at 254 nm is known to have a germicidal effect. Its application has come into use especially for small-scale plants. No chemicals are added, and the equipment needs little attention other than periodic cleanings or replacement of the mercury vapor lamps. UV treatment is limited, however, to relatively clean waters because colloids and organic matter reduce the penetration of the radiation.

2.6.11 Use of Fouling-Resistant Membranes

Use of FilmTec™ FR (Fouling Resistant) membranes can minimize or retard biofouling significantly. The combination of FR membranes and intermittent application of DBNPA has been particularly successful /38/. For more information about FilmTec™ Fouling Resistant (FR) Membrane Elements, please visit www.filmtec.com.

2.7 Prevention of Fouling by Organics

Adsorption of organic substances on the membrane surface causes flux loss, which is irreversible in serious cases. The adsorption process is favored with high molecular mass compounds when these compounds are hydrophobic or positively charged. A high pH value helps to prevent fouling, because both the membrane and many organic substances assume a negative charge at pH > 9. Organics present as an emulsion may form an organic film on the membrane surface. These organics must, therefore, be removed in pretreatment.

Organics occurring in natural waters are usually humic substances in concentrations between 0.5 and 20 mg/L TOC. Pretreatment should be considered when TOC exceeds 3 mg/L. Humic substances can be removed by a coagulation process with hydroxide flocs (Section 2.5.5), by ultrafiltration (Section 2.5.6), or adsorption on activated carbon. Removal of color from high molecular weight organics is also possible by FilmTec™ nanofiltration membranes.

Coagulation or activated carbon must also be applied when oils (hydrocarbons or silicone-based) and greases contaminate the RO feedwater at levels above 0.1 mg/L. These substances are readily adsorbed onto the membrane surface. They can be cleaned off, however, with alkaline cleaning agents if the flux has not declined by more than 15%.

In wastewater applications, the rejection and concentration of organics is a major objective. Depending on the kind of substances, organics even in the percent concentration range can be handled and must be evaluated in field tests on a case-by-case basis.

2.8 Prevention of Membrane Degradation

Apart from the fouling potential of certain substances in the RO feedwater, the chemical resistance of the FilmTec™ Membrane Element against such substances has to be taken into account. Generally, all oxidizing agents can harm the membrane and must be removed by methods described in Section 2.6.3. The membrane element is stable against most other chemicals in a pH range of 2 – 11 as long as these chemicals are dissolved and not occurring as an organic phase.

2.9 Prevention of Iron and Manganese Fouling

Iron fouling is very common. Like any fouling, it causes a performance loss of the membrane system, specifically flux loss. In addition, the presence of iron makes the membrane more susceptible to oxidation damage. Fortunately, iron fouling can be cleaned fairly easily; see Section 6.9.4. Some operators deliberately accept iron fouling up to 10% flux loss and then clean the membranes with a predetermined frequency.

Typical sources of iron fouling are

- Anoxic aquifers containing soluble divalent iron and/or manganese
- Hydroxide flocs of oxidized iron and/or manganese from raw water
- Natural organic matter (NOM) containing iron complexes
- Hydroxide flocs from coagulation process
- Corrosion products from piping materials used for the feedwater
- Silicates containing iron

The methods to prevent fouling with colloidal and particulate iron have been described in Section 2.5.1. Iron silicates have been discussed in Section 2.4.7. The pretreatment of water containing ferrous (divalent) iron is described below.

Anoxic waters typically contain divalent iron, manganese, or both. If water containing iron or manganese has taken up more than 5 mg/L of oxygen, or has been chlorinated, Fe^{2+} (ferrous) is converted into Fe^{3+} (ferric), which forms insoluble colloidal hydroxide particles that may foul RO/NF membranes. The oxidation of iron and manganese is given by:

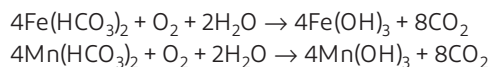

Iron fouling occurs more frequently than manganese fouling because the oxidation of iron occurs at a much lower pH. Thus, a fouling problem can be created even if the SDI is below 5 and the level of iron in the RO feedwater is below 0.1 mg/L. Waters with low alkalinity usually have higher iron concentrations than waters with high alkalinity, because the Fe^{2+} concentration is usually limited by the solubility of FeCO_3 .

One approach to avoid membrane fouling is to prevent oxidation and precipitation of iron and manganese by keeping the water in the reduced state. The exposure of the water to air or to any oxidizing agent (e.g., chlorine) through the whole RO process must be prevented. A low pH is favorable to retarding Fe^{2+} oxidation. At pH < 6 and oxygen < 0.5 mg/L, the maximum permissible Fe^{2+} concentration is 4 mg/L.

If the anoxic process is used, care must be taken to avoid:

- Oxygen leakage into the feedwater
- Reaction of iron with silica to form insoluble iron silicate
- Oxidation by iron reducing bacteria resulting in acceleration of biofilm growth and iron deposit
- Blending of ferrous iron containing water with water containing hydrogen sulfide (H_2S), since this could form an insoluble black ferrous sulfide, FeS

Regular iron cleaning (see Section 6.9.4) will be necessary with the anoxic process.

The alternative method of handling anoxic waters is by oxidation-filtration as described in Section 2.5.3.

2.10 Prevention of Aluminum Fouling

Sources of aluminum fouling are:

- Flocs carry-over from a pretreatment process using aluminum based flocculants
- Post-precipitation of aluminum flocculants due to poor pH control
- Reaction of aluminum with silica, forming aluminum silicates
- Natural mineral silt and colloidal aluminum silicates

Aluminum silicate fouling can be found in the first and last stage of RO/NF plants. Even small aluminum concentrations (like 50 ppb) may result in a performance decline due to several factors:

1. Aluminum reacts with silica. Low silica concentrations (10 mg/L) can result in aluminum silicate fouling. The use of aluminum based products in the pretreatment increases the risk of aluminum fouling significantly. Therefore, the use of aluminum based products is not recommended. Iron based products are recommended instead.
2. The solubility of the aluminum is lowest at pH 6.5. This is the pH at which the flocculation should be run. The RO/NF system should be operated preferably at pH 7 – 9 (dependent on the water analysis since calcium carbonate scaling should be avoided) to keep aluminum in solution.
3. Antiscalants containing polymers (like acrylic acid based products) are sensitive to the presence of metals like iron and aluminum. It is important to select the right antiscalant. Otherwise, the antiscalant is deactivated (poisoned) and subsequently scaling and antiscalant fouling may occur in the membrane. In addition, the antiscalant fouling can act as a nutrient for microorganisms and biofouling will occur.
4. Fine clay/sand particles. It is recommended to remove clay and sand particles in the pretreatment by either multimedia filtration, ultrafiltration or microfiltration. It may be necessary to use coagulants in order to form larger particles that can be removed by the subsequent filtration process.

To minimize aluminum fouling, it is recommended to keep aluminum in the feedwater below 0.05 mg/L.

2.11 Treatment of Feedwater Containing Hydrogen Sulfide

Some well waters, usually brackish waters, are in a reduced state typically lack of oxygen (therefore referred to as anoxic or anaerobic) and the presence of iron, manganese, ammonium and/or hydrogen sulfide (H₂S). H₂S in ground water aquifers usually occurs at concentrations of 0.5 to 5 mg/L as the result of the dissolution of minerals in geologic deposits or as anaerobic bacterial activity on organic sulfur, elemental sulfur, sulfates and sulfites. The amount of sulfide dissolved in water is pH dependent as shown in the following equations:

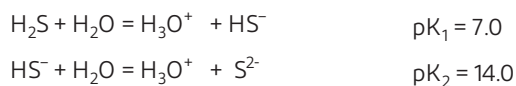

H₂S levels as low as 0.1 mg/L can adversely affect the performance of RO or NF systems.

Prevention of Potential Problems on Feed/Concentrate Side of Membrane

The presence of H₂S in feedwater exposed to oxidants (e.g., oxygen in air, chlorine) can result in the precipitation of elemental sulfur or metallic sulfides. The deposits can have a black sooty appearance or be a gray pasty residue that clogs filter cartridges and coats the feedwater piping. Not only will these precipitated solids cause a higher than normal filter cartridge replacement rate but, because the particle size for metallic sulfides and colloidal sulfur is in the sub-micron range, a significant quantity of precipitants will pass through the typical 5 micron (µm) rated filter cartridge. These suspended solids will accumulate in the feed/concentrate channel spacer of the RO or NF membrane elements, increasing the operating differential pressure. Further accumulation of sulfur and metallic sulfides on the membrane's surface will cause an increase in salt passage and a decrease in flux reducing the system efficiency.

Air can also be introduced into the feed/concentrate area in RO or NF elements as a result of siphoning in the concentrate piping. This is particularly likely when a long run of pipe is used for the concentrate line. A siphon breaker should be used to prevent creation of the partial vacuum that tends to draw water from the feed/concentrate side of the membrane again producing voids that can introduce air. Drain lines discharging directly to floor drains or trenches should be provided with a suitable air-gap to avoid contamination problems associated with “cross-connections”. The use of spring-loaded check-valves in the concentrate line will also help prevent siphoning. The piping arrangement should be designed to keep the RO or NF membrane skid assembly “flooded” and free from air during idle periods.

Colloidal sulfur may be difficult to remove. A solution of sodium hydroxide (NaOH) with a chelating agent such as EDTA is an appropriate cleaner. If the foulant is not heavily composed of elemental sulfur, a phosphoric acidic solution may be capable of dissolving out the sulfide components. High velocity permeate flushes may also be beneficial. See Section 6.1 for cleaning procedures.

Prevention of Potential Problems on Permeate Side of the Membrane

Since H_2S is a gas, it passes through the membrane barrier layer and, under certain conditions, will precipitate as elemental sulfur in the membrane microporous polysulfone substrate, polyester supporting web and permeate channel spacer. An ivory to yellowish precipitate is formed on the “backside” on the membrane composite when H_2S is exposed to an oxidizing environment, such as on shutdown when air enters the permeate side of the system. There is a tendency for a reverse flow of water from the permeate side of the membrane to the feed/concentrate side as the result of natural osmosis. This is particularly significant in high salinity waters containing > 6000 mg/L of total dissolved solids (TDS). This back-flow can introduce air into the permeate side of the membrane element. A freshwater flush is recommended, especially for feeds containing H_2S , to displace the concentrated solution as part of any shutdown sequence. This eliminates any osmotic driving force for back-flow. However, in locations that experience frequent losses of electrical power that lead to unscheduled shutdowns where flushing is not possible, a “suck-back” or “draw-back” reservoir located in the permeate piping elevated above the top pressure vessel is recommended. This draw-back tank should be of sufficient volume to makeup any back flow due to osmosis that occurs during an unscheduled shutdown (see Section 3.14.6, *Tanks*).

Sometimes a technique is used to prevent a negative transmembrane pressure (higher pressure on the permeate side than on the feed/concentrate side) greater than 5 psi (0.3 bar). This is commonly done using a dump valve to relieve pressure on the permeate line upon system shutdown. For systems with feeds containing H_2S , it must be done in such a manner so as not to allow air to be introduced into the system. Siphoning is another condition that should not be overlooked in designing the permeate piping for systems without a draw-back tank but with feeds containing H_2S . Once again, the piping arrangement should be designed to keep the RO or NF membrane skid assembly “flooded” and free from air during idle periods.

The precipitation of elemental sulfur on the permeate side does not cause immediate degradation in performance, but over time a gradual increase in feed pressure (net driving force) is observed that can eventually lead to severe loss of efficiency (decrease in specific flux). It is virtually impossible to clean this precipitate from the “backside” of the membrane and permeate channel spacer. Due to the typical aggressive nature of permeate (RO in particular), however, after correcting the situation that caused the problem, just operating the system can restore the loss in specific flux over time, provided there are no other serious fouling problems.

Pretreatment

The best pretreatment for H_2S is keeping the system under anaerobic conditions. The water must not be exposed to air (i.e., oxygen), chlorine or any other oxidizing agents from the well until it exits from the membrane system. H_2S is removed from the permeate (see ‘Posttreatment’ below). This rule applies to both brackish water and seawater and is of specific importance when iron is present in the ground water. In fact, where it might normally be satisfactory to practice oxidation/media filtration with greensand (glauconite), the presence of H_2S becomes the overriding factor that eliminates this method of iron removal from consideration.

Wells require a check valve to prevent reverse flow back into the well (exception: artesian wells). Back-flow of water into the well will tend to create a vacuum. This can produce voids that will likely cause air containing oxygen to enter the system and oxidize the H₂S. The preferred technique to prevent this is to use submersible pumps with a check valve at the pump discharge in the well. Check valves installed above ground may also work. These check valves must be “bubble tight”. If it isn't possible to prevent back-flow into the wells, then a special procedure should be employed upon start-up to automatically purge the initial flow from the well to waste. This will help extend the life of the filter cartridges as well as reduce fouling of the membrane.

Posttreatment

Since gasses including H₂S typically pass through RO and NF membranes, it is necessary to remove this objectionable contaminate from permeate as a posttreatment step. The method employed in most membrane systems is air (gas) stripping that employs a forced draft degasifier. This device uses a packed tower with counter current airflow to strip the H₂S out of the water. Note that this process will also remove any CO₂ present (increasing the pH) while saturating the permeate with oxygen, thus exacerbating the inherent aggressive nature of this water. To effectively remove sulfide with this method, it must exist as H₂S. Being pH dependent, this means that either acidification of the feed is done to achieve a permeate pH ≤ 6.0 or the permeate is acidified to this point to allow for > 90% removal.

2.12 Guidelines for Feedwater Quality

Table 15 summarizes the limits of quality parameters of the feedwater. It is recommended to respect these limits for successful operation of the membrane system. Otherwise, more frequent cleaning and/or sanitization may become necessary. The concentrations correspond to the entry to the membrane for a continuous feed stream, including any influences to the feedwater from dosing chemicals or piping materials in the pretreatment line.

Table 15. Guidelines for feedwater quality

Component	Unit	Max. level	Comments & conditions
SDI	1	5	See Section 3.1, <i>System Design Guidelines</i>
MFI _{0.45}	1	4	Target: < 1
Oil and grease	mg/L	0.1	See Section 2.7, <i>Prevention of Fouling by Organics</i>
TOC	mg/L	3	Synthetic organic compounds (SOC) have generally more adverse effects on RO/NF membranes compared with natural organic matters (NOM). - See Section 2.7, <i>Prevention of Fouling by Organics</i>
COD	mg/L	10	
AOC	µg/l Ac-C	10	Target: < 5
BFR	pg/cm ² ATP	5	Target: < 1
Free chlorine	mg/L	0.1	Under certain conditions, the presence of chlorine and other oxidizing agents will cause premature membrane failure. Since oxidation is not covered under warranty, FilmTec™ recommends removing residual free chlorine by pretreatment prior to membrane exposure. - See Section 2.6.3, <i>Chlorination / Dechlorination</i>
Ferrous iron	mg/L	4	pH < 6, oxygen < 0.5 ppm
Ferric iron	mg/L	0.05	
Manganese	mg/L	0.05	
Aluminum	mg/L	0.05	

2.13 Summary of Pretreatment Options

Table 16 summarizes the pretreatment options when specific risks for scaling and fouling are present. It is a quick reference for “possible” and “very effective” methods. A combination of “possible” methods may also be “very effective”.

Table 16. Pretreatment options for scaling and fouling

Pretreatment	CaCO ₃	CaSO ₄	BaSO ₄	SrSO ₄	CaF ₂	SiO ₂	SDI	Fe	Al	Bacteria	Oxid. agents	Org. matter
Acid addition	●							○				
Scale inhibitor antifoulant	○	●	●	●	●	○		○				
Softening with IX	●	●	●	●	●							
Dealkalization with IX	○	○	○	○	○							
Lime softening	○	○	○	○	○	○	○	○				○
Preventive cleaning	○					○	○	○	○	○		○
Adjustment of operation parameter	○	○	○	○	○	●						
Media filtration						○	○	○	○			
Oxidation filtration							○	●				
In-line coagulation							○	○	○			○
Coagulation-flocculation						○	●	○	○			●
Microfiltration/Ultrafiltration						●	●	○	○	○		●
Cartridge filtration						○	○	○	○	○		
Chlorination										●		
Dechlorination											●	
Shock treatment										○		
Preventive biocidal treatment										○		
GAC filtration										○	●	●

○ Possible ● Very effective

References

1. Standard Methods for the Examination of Water and Wastewater, 20th Edition, as published jointly by the American Public Health Association, the American Water Works Association, and the Water Pollution Control Federation
2. ASTM D 4195 – 88 (Reapproved 2003): Standard Guide for Water Analysis for Reverse Osmosis Application
3. Water Quality and Treatment, 5th Edition, Prepared by the American Water Works Association, McGraw-Hill, Inc., New York, 1999
4. Water Treatment Handbook, Degremont Company, 6th Ed 1991
5. Water Manual, WABAG, 2nd Ed. (2003)
6. ASTM D3739-94 (2003): Standard Practice for Calculation and Adjustment of the Langelier Saturation Index for Reverse Osmosis
7. ASTM D4582-91 (2001): Standard Practice for Calculation and Adjustment of the Stiff and Davis Stability Index for Reverse Osmosis
8. ASTM D4692-01: Standard Practice for Calculation and Adjustment of Sulfate Scaling Salts (CaSO₄, SrSO₄, and BaSO₄) for Reverse Osmosis
9. Marshall, W.L. and Slusher, R., “Solubility to 200°C of Sulfate and its Hydrates in Seawater and Saline Water Concentrates and Temperature, Concentration Limits,” Journal of Chemical and Engineering Data, 13(1), 83 (1968)
10. Davis, J.W. and Collins, A.G., “Solubility of Barium and Strontium Sulfates in Strong Electrolyte Solutions,” Environmental Science and Technology, 5(10), 1039 (1971)
11. Permasep B-10 Technical Information Manual, Section IV Projections, E. I. du Pont de Nemours & Co. 1980

12. Vorum, M. and Williams, R.E., "A Study of Silica in High Recovery Reverse Osmosis Systems", PB81-233587 (1979)
13. L. Dudley, "Combating the Threat of Silica Fouling in RO Plant – Practical Experiences", *Desalination & Water Reuse*, 12(4), 28 (2003)
14. S.I. Graham, R.L. Reiz, and C.E. Hickman, "Improving Reverse Osmosis Performance through Periodic Cleaning", *Desalination*, 74, 113 (1989)
15. M. Luo and Z. Wang, "Complex Fouling and Cleaning-in-Place of a Reverse Osmosis Desalination System", *Desalination*, 141, 15 (2001)
16. ASTM D4993-89 (2003): Standard Practice for Calculation and Adjustment of Silica (SiO₂) Scaling for Reverse Osmosis
17. Alexander, G.B., Hester, W.M., Iler, R.K., "The Solubility of Amorphous Silica in Water", *Journal of Physical Chemistry*, 58, 453 (1954)
18. M. Maurer and M. Boller, "Modelling of Phosphorus Precipitation in Wastewater Treatment Plants with Enhanced Biological Phosphorus Removal", *Wat. Sci. Tech*, 39(1), 147 (1999)
19. S. Kubo, T. Takahashi, H. Morinaga, and H. Ueki, "Inhibition of Calcium Phosphate Scale on Heat Exchanger: The Relation between Laboratory Test Results and Tests on Heat Transfer Surfaces", *Corrosion* 79, Paper No. 220, Atlanta (1979)
20. D1889 /ASTM D1889-00 Standard Test Method for Turbidity of Water
21. ASTM D6698-01 Standard Test Method for On-Line Measurement of Turbidity Below 5 NTU in Water
22. ASTM D4189-95 (2002): Standard Test Method for Silt Density Index (SDI) of Water
23. Schippers, J.C. and Verdouw, J.: The modified fouling index, a method of determining the fouling characteristics of water, *Desalination* 32, 137 (1980)
24. Boerlage, S.F.E., Kennedy, M, Aniye, M.P. and Schippers, J.C.: Applications of the MFI-UF to measure and predict particulate fouling in RO systems, *J. Membrane Sci.* 220, 97 (2003)
25. ASTM D4188-82 (Reapproved 1999): Standard Practice for Performing Pressure In-Line Coagulation-Flocculation-Filtration Test
26. Handbook of Industrial Membrane Technology, Ed.: Porter, M.C., Noyes Publications, Park Ridge, New Jersey, U.S.A. (1990)
27. D4455-85(2002): Standard Test Method for Enumeration of Aquatic Bacteria by Epifluorescence Microscopy Counting Procedure
28. D4454-85(2002) Standard Test Method for Simultaneous Enumeration of Total and Respiring Bacteria in Aquatic Systems by Microscopy
29. J.S. Vrouwenvelder and D. van der Kooij, Diagnosis, prediction and prevention of biofouling of NF and RO membranes, *Desalination*, 139, 65 (2001)
30. MM Nederlof, JC Kruithof, JAMH Hofman, M de Koning, JP van der Hoek, PAC Bonne, Integrated multi-objective membrane systems application of reverse osmosis at the Amsterdam Water Supply, *Desalination*, 119, 263 (1998)
31. J.S. Vrouwenvelder. In Press (2003)
32. D. van der Kooij, H.R. Veenendaal, C. Baars-Lorist, D.W. van der Klift and Y.C. Drost: Biofilm formation on surfaces of glass and teflon exposed to treated water. *Wat.Res.*, 29(7)(1995) 1655-1662
33. ASTM D1291-01: Standard Practice for Estimation of Chlorine Requirement or Demand of Water, or Both
34. White, G.C.: Handbook of Chlorination. Van Nostrand Reinhold Co., New York (2nd ed., 1986)
35. M. Nagai, H. Iwahashi, Y. Hayashi, and Y. Ogino, "The Behavior of an Oxidizing/Reducing Agent in Seawater", *Desalination*, 96, 291 (1994)

36. T. Griebe, H.-C. Flemming: Biocide-free antifouling strategy to protect RO membranes from biofouling. *Desalination* 118 (1998), 153-156
37. C.F.Wend, P.S.Steward, W.Jones, A.K.Camper: Pretreatment for membrane water treatment systems: a laboratory study. *Water Research* 37 (2003) 3367-3378
38. P. Sehn: Experiences with fouling-resistant membranes in combination with intermittent biocide dosage. 9th Aachen Membrane Colloquium March 18-20, 2003, Verlag Mainz, Aachen, ISBN 3-86130-185-7

3 System Design

3.1 Introduction

An entire reverse osmosis (RO)/nanofiltration (NF) water treatment system consists of pretreatment, the membrane process, and post-treatment. Pretreatment processes are discussed in Section 2.1, *Water Chemistry and Pretreatment*. Post-treatment is employed to achieve the required product quality. In seawater desalination, this is usually pH adjustment, rehardening, and disinfection. In the production of water for the most stringent applications, such as boiler feedwater for power plants or ultrapure water (UPW) for semiconductor manufacturing, the permeate is usually post-treated by polishing ion exchange demineralization or electrodeionization (EDI) and a polishing filter.

In this section, the membrane system is addressed. The system includes a set of membrane elements, housed in pressure vessels that are arranged in a certain manner. A pump is used to feed the pressure vessels. Instrumentation, spare parts, and tools for servicing the system are added as required. A clean-in-place (CIP) system facilitates cleaning of the membranes; this is described in Section 6.1, *Cleaning and Sanitization*.

The membrane system is a complete plant with an inlet for feedwater and outlets for permeate and concentrate. RO/NF system performance is typically characterized by two parameters: permeate (or product) flow and permeate quality. These parameters should always be referenced to a given feedwater analysis, temperature, feed pressure, and recovery to normalize for fluctuations in the operating conditions. The typical goal of the designer of an RO/NF system for a certain required permeate flow is to minimize feed pressure and membrane costs while maximizing permeate quality and recovery. In some cases, optimizing for operational costs takes precedence over capital cost optimization.

The optimal design depends on the relative importance of these aspects. The recovery of brackish water systems is limited by the solubility of sparingly soluble salts (see Section 2.4.1, *Scaling Calculations*)—90% is about the maximum. In seawater desalination, the limit of about 50% recovery is dictated by the osmotic pressure of the concentrate stream, which approaches the physical pressure limit of the FilmTec™ Seawater Element.

Membrane elements for a particular system are selected according to:

- Application (ie. standard elements or full-fit);
- System capacity (ie. element diameter);
- Feedwater TDS (ie. NF, BW or SWRO);
- Feedwater fouling potential (ie. fouling resistant elements and/or wider feed spacers); and
- Required product water quality and energy requirements (ie. low energy or high rejection element type).

Obtaining the required salt rejection is mainly a matter of membrane selection. The nanofiltration (NF), brackish water (BW), and seawater (SW) versions of the FilmTec™ Membrane have increasing salt rejections in this order. Various grades of membranes also exist within each of these three main categories, prioritizing energy requirements at one end of the spectrum and salt rejection at the other. Therefore, the NF to low-energy BW membrane is typically applied to feedwaters up to 2,000 mg/L total dissolved solids (TDS), standard BW is typically used up to 10,000 mg/L, and SW membrane is applied to high salinity feedwaters up to 50,000 mg/L. For given operating conditions, the permeate quality can be calculated.

The feed pressure needed to produce the required permeate flow for a given membrane depends on the designed permeate flux (permeate flowrate per unit membrane area). The higher the permeate flow per unit of active membrane area, the higher the feed pressure. In seawater systems the permeate flux is relatively low even at maximum allowed pressure. However, the permeate flux could be very high in brackish water systems without reaching the limit of 41st bar (600) for brackish water elements. Caution should be exercised to not increase the permeate flux with the goal of decreasing the cost for membrane elements because the flux has to be limited to minimize fouling.

From experience, the flux limit to be used in system design depends on the fouling tendency of the feedwater. A system designed with high permeate flux rates is likely to experience higher fouling rates, requiring more frequent chemical cleaning. Only experience can set the limits on permeate flux for different types of waters. When designing a membrane system for a specific feedwater, it is advantageous to know the performance of other membrane systems operating on the same water. However, quite often there are no other membrane systems for comparison. Then the system design suggestions in *Design Guidelines for 8-inch* (Section 3.9.1) and *Midsized FilmTec™ Elements* (Section 3.9.2) could be followed.

Further information required to design a system is best collected by using the forms of Table 17 and Table 18. The more complete this information, the better the system design can be optimized towards the customer's needs.

Table 17. System design information

Quotation Number:.....	Date Requested:
Date Submitted:.....	Requested By:.....
Customer/OEM:.....	
Address:.....	
Proposed Location:.....	
Brief Description:.....	
.....	
.....	
Required Product Flowrate (gpd or m ³ /h):.....	
Expected Recovery:.....	
Annual Water Temperature Range	High °C:.....
	Low °C:.....
	Design °C.....
NF/RO Plant:	<input type="checkbox"/> Indoors <input type="checkbox"/> Outdoors
Designed for Continuous Use:	<input type="checkbox"/> Yes <input type="checkbox"/> No
	If not, state needed peak hourly capacity:.....
Plant Will Be Operated By:	Enduser <input type="checkbox"/> Yes <input type="checkbox"/> No
	Trained Personnel <input type="checkbox"/> Yes <input type="checkbox"/> No
	Equipment Manufacturer <input type="checkbox"/> Yes <input type="checkbox"/> No
	Others <input type="checkbox"/> Yes <input type="checkbox"/> No
Water Source:	<input type="checkbox"/> Well Water <input type="checkbox"/> Softened Water
	<input type="checkbox"/> Surface Water <input type="checkbox"/> Filtered Effluent Water
	<input type="checkbox"/> Seawater <input type="checkbox"/> Other
Existing Pretreatment	<input type="checkbox"/> Yes <input type="checkbox"/> No SDI.....
List of Pretreatment Steps:.....	
.....	
Planned Pretreatment:.....	
Bacterial Control:	<input type="checkbox"/> Yes <input type="checkbox"/> No Dechlorination: <input type="checkbox"/> Carbon Filter
Chlorine Used:	<input type="checkbox"/> Yes <input type="checkbox"/> No <input type="checkbox"/> Na-Bisulfite
Chloramines Used:	<input type="checkbox"/> Yes <input type="checkbox"/> No <input type="checkbox"/> Other
Antiscalant Used:	<input type="checkbox"/> Yes <input type="checkbox"/> No Which One?
Desired Acidification:	<input type="checkbox"/> HCl <input type="checkbox"/> H ₂ SO ₄ <input type="checkbox"/> None
Brief Description of Other Pretreatment Steps:.....	
(e.g., clarification, flocculation, multimedia/sand filtration, etc.....	
.....	
Application:	<input type="checkbox"/> Potable Water
	<input type="checkbox"/> Industrial Supply for: <input type="checkbox"/> Boiler Feed <input type="checkbox"/> Pharma <input type="checkbox"/> UPW <input type="checkbox"/> Other
Specify Water Quality Needed after RO Treatment:.....	
.....	
State Other Desired Design Criteria:.....	
.....	
.....	

Table 18. Water analysis for reverse osmosis/nanofiltration

Sample identification:.....

Feed source:.....

Conductivity:..... pH:..... Temperature (°C):.....

Feedwater analysis: NH₄⁺..... CO₂.....

Please indicate units (mg/L as ion or ppm as CaCO₃ or meq/L)

K ⁺	CO ₃ ²⁻
Na ⁺	HCO ₃ ⁻
Mg ²⁺	NO ₃ ⁻
Ca ²⁺	Cl ⁻
Ba ²⁺	F ⁻
Si ²⁺	SO ₄ ²⁻
Fe ²⁺	PO ₄ ²⁻
Fe (total).....	S ²⁻
Mn ²⁺	SiO ₂ (colloidal).....
Boron.....	SiO ₂ (soluble).....
Al ³⁺	

Other Ions:.....

TDS (by method):.....

TOC:.....

BOD:.....

COD:.....

AOC:.....

BDOC:.....

Total Alkalinity (m-value):

Carbonate Alkalinity (p-value):

Total Hardness:

Turbidity (NTU):

Silt density Index (SDI):

Bacteria (count/mL):

Free Chlorine:

Remarks:

(odor, color, biological activity, etc.).....

.....

.....

Analysis by:

Date:

3.2 Batch vs. Continuous Process

An RO/NF system is usually designed for continuous operation in which the operating conditions of every membrane element in the plant are constant with time (neglecting minor fluctuations in feed composition, temperature, pressure, etc.). Figure 29 illustrates the continuous process mode.



Figure 29. Continuous RO process

In certain applications, when relatively small volumes (batches) of special feedwaters occur discontinuously, e.g., wastewater or industrial process solutions, the batch operation mode is preferred. The feedwater is collected in a tank and subsequently treated. The permeate is removed and the concentrate is recycled back to the tank. At the end of the batch process, a small volume of concentrate remains in the feed tank. In this mode, the operating conditions of every membrane element are changing throughout the cycle. After the resulting concentrate has been drained, the membranes are typically cleaned before the tank is filled again with a new batch. Figure 30 shows the batch operation mode.

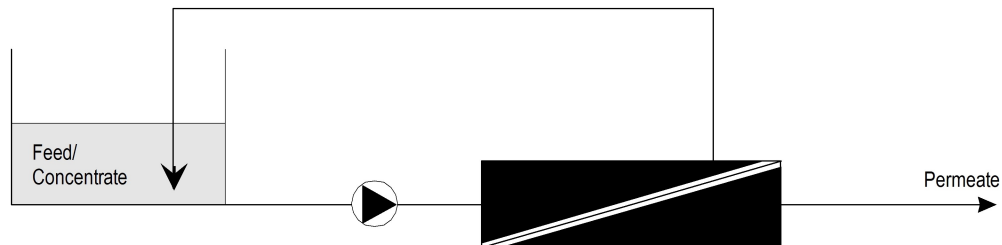

Figure 30. Batch RO process

The semi-batch mode is a modification of the batch mode. In semi-batch mode of operation the feed tank is refilled with feedwater during operation. The batch is terminated with the feed tank full of concentrate. This allows a smaller tank to be used.

Batch systems are usually designed with constant feed pressure and declining permeate flow while the feed becomes more concentrated. The guidelines given in *Design Guidelines for 8-inch* (Section 3.9.1) and *Midsized FilmTec™ Elements* (Section 3.9.2) should be applied to batch systems as well. However, the permeate flow limits provided in the guidelines may be considered conservative and may be exceeded but only if justified by preceding test runs, and if an appropriate cleaning frequency is taken into account. Be advised that operating outside of the design guidelines may impact the element warranty coverage.

The batch process has the following advantages versus the continuous process:

- Flexibility when the feedwater quality changes
- System recovery can be maximized batch by batch
- Cleaning is easily implemented
- Simple automatic controls
- Permeate quality can be controlled by termination of the process
- Permeate quality can be improved by total or partial second-pass treatment
- Favorable operating conditions for single (or low number) element systems, because the membranes are only in contact with the final concentrate for a short time
- Expansion is rather easy
- Lower investment costs

The disadvantages are:

- No continuous permeate flow
- No constant permeate quality
- Large feed tank required
- Larger pump required
- Larger power consumption
- Longer residence time for feed/concentrate
- Higher total running costs

The majority of RO systems are designed for continuous operation with constant permeate flow and constant system recovery. Variations in feedwater temperature and fouling effects are compensated for by adjusting the feed pressure. The focus of this manual is, therefore, on the continuous process.

3.3 Single-Module System

A module consists of a pressure vessel with up to eight membrane elements connected in series. The concentrate of the first element becomes the feed to the second, and so on. The product tubes of all elements are coupled and connected to the vessel permeate port. The permeate port may be located on the feed end or on the concentrate end of the vessel.

Single-module systems are chosen when only one or a few membrane elements are needed for the specified permeate flow. Figure 31 shows a module containing two FilmTec™ Elements. Feedwater enters the system through the feed valve and flows through the cartridge filter to the feed pump. Alternate means of controlling pump discharge pressure are described in Section 3.14.1, *High Pressure Pump*.

From the feed pump, the feedwater flows to the feed inlet connection of the module. The product stream should exit the module at no more than 0.3 bar (5 psi) over atmospheric pressure to avoid membrane delamination. However, higher permeate pressure is sometimes required, e.g., to feed the post-treatment section or to distribute the product without further pumping. Then the feed pressure must be increased by the required value of the permeate pressure, but the specified maximum feed pressure must be observed. In this case, extreme care must be exercised so that at any time, especially at emergency shutdowns, the permeate pressure does not exceed the feed pressure by more than 0.3 bar (5 psi). The maximum permissible permeate pressure is a feature of the pressure vessel.

Pressure drop across the module will usually amount to 0.3 – 2 bar (5 – 30 psi) from feed inlet to concentrate outlet, depending on the number of membrane elements, the feed flow velocity, and the temperature. The concentrate flowrate is controlled by the concentrate flow control valve. The system recovery is controlled by this valve and must never exceed the design set value.

In single-module systems, concentrate recycling is usually required to comply with the guidelines for element recovery. To achieve system recovery of more than 50%, a part of the concentrate exiting the module goes to drain, while the other part is recycled and added to the suction side of the feed pump, thus increasing the feed flow to the module. A high fraction of the concentrate being recycled helps reduce element recovery and thus the risk of fouling. On the other hand, it has the following drawbacks:

- Larger (more expensive) feed pump
- Higher energy consumption
- Permeate quality decreases with more concentrate being recycled and added to the feedwater
- The rinse-out time at start-up after preservation or cleaning can be long (preferably, no concentrate should be recycled during the rinse-out period)

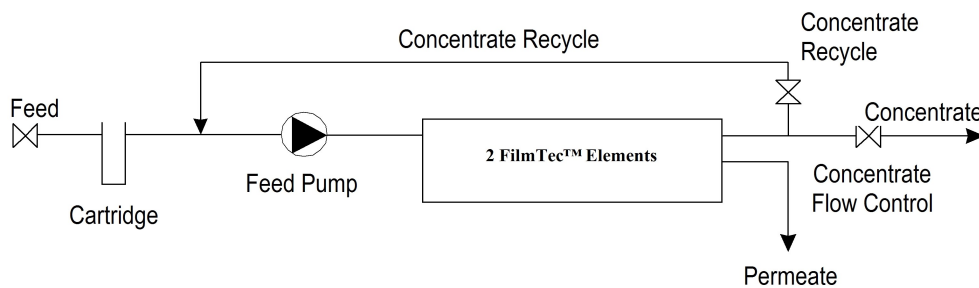

Figure 31. Single-module system

3.4 Single-Stage System

In a single-stage system, two or more modules are arranged in parallel. Modules are added to the system design as needed to achieve the design operating flux. Feed, product, and concentrate lines are connected to manifolds. Other aspects of the system are the same as in a single-module system. Single-stage systems are typically used when the system recovery is less than 50%, e.g., in seawater desalination.

An example of a single-stage system is outlined in Figure 32. Each of the three pressure vessels houses six FilmTec™ Elements.

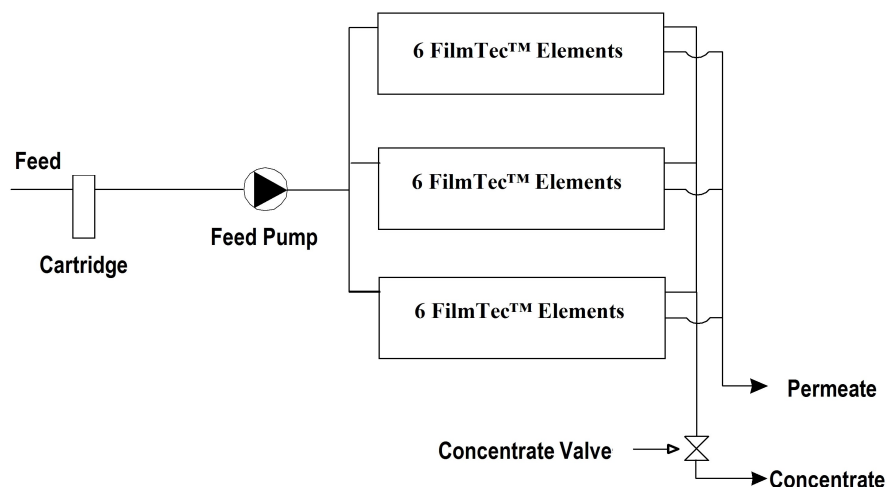

Figure 32. Single-stage system

3.5 Multi-Stage System

Systems with more than one stage are used for higher system recoveries without exceeding the single-element recovery limits. Usually two stages will suffice for recovery up to 75% (or slightly above), and three must be used for higher recovery. These numbers are based on the assumption that standard pressure vessels with six elements are used. For shorter vessels housing only three elements, for example, the number of stages has to be doubled for the same system recovery. Generally speaking, the higher the system recovery, the higher the number of membrane elements that have to be connected in series. To compensate for the permeate that is removed and to maintain an adequate concentrate flow to each stage, the number of pressure vessels per stage decreases in the direction of feed flow. Typical staging ratios for 6-element pressure vessels are 1:2 for brackish water and 1:3 for a 2nd pass, see Section 3.7, *Permeate Staged (or Double-Pass) System*. For seawater, a 2:3 ratio is common. The staging ratio is defined as the ratio of pressure vessels in two adjacent stages, upstream vessels:downstream vessels. A typical two-stage system using a staging ratio of 2:1 is shown in Figure 33.

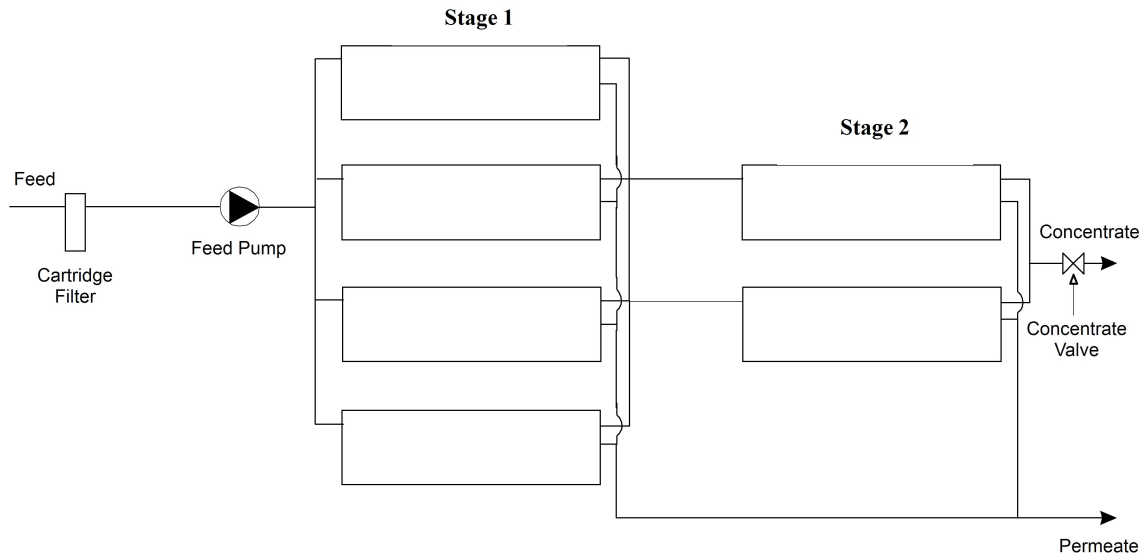

Figure 33. Two-stage system

3.6 Plug Flow vs. Concentrate Recirculation

The standard RO system design for water desalination applications is the plug flow concept. In a plug flow system, the feed volume is passed once through the system. A certain fraction Y of the feed passes through the membrane to produce permeate. The feed is gradually concentrated and exits the system at a higher concentration. Examples of plug-flow systems are shown in Figure 29, Figure 32 and Figure 33.

Concentrate recirculation is employed when the number of elements is too small to achieve a sufficiently high system recovery with plug flow. Concentrate recirculation systems can also be found in special applications like process liquids and wastewaters. In systems with internal concentrate recirculation, a fraction of the concentrate stream out of the module (or stage) is directed back to the feed side of the module (or stage) and mixed with the feed stream. Figure 31 shows a system with internal concentrate recirculation.

Multi-stage systems can also be designed with internal concentrate recirculation for each stage, using a separate recirculation pump. For example, the system shown in Figure 33 can be designed with concentrate recirculation instead of plug flow, see Figure 34 and Figure 36.

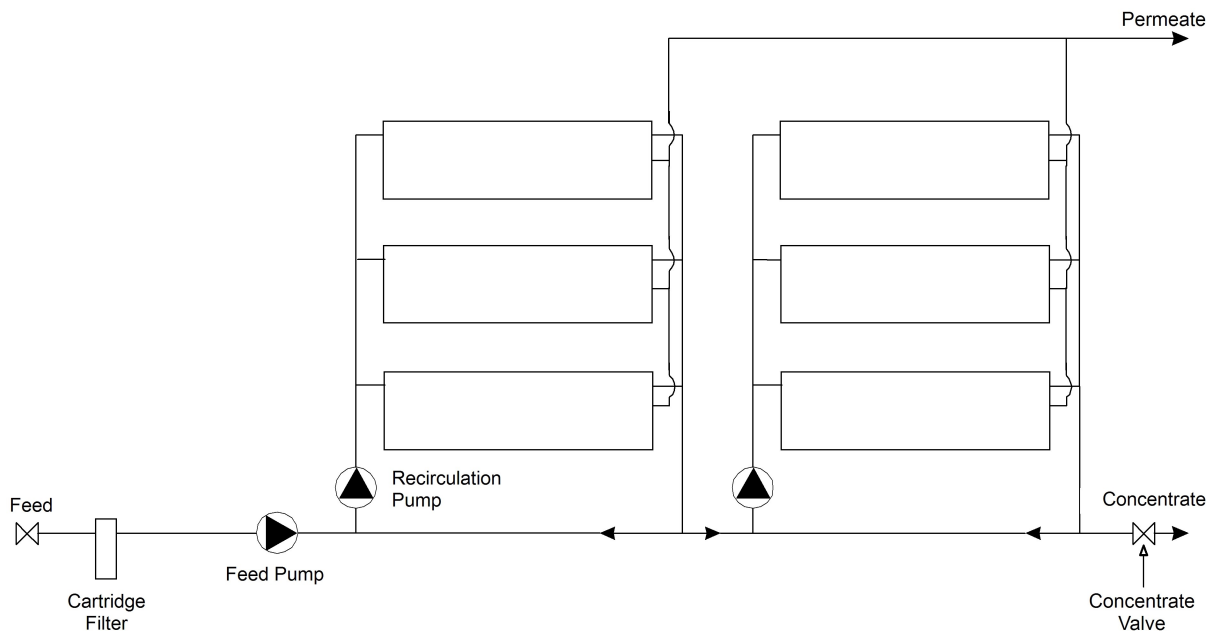

Figure 34. Two-stage system with internal concentrate recirculation

The main advantage of the recirculation concept is the defined feed flowrate to the modules regardless of the degree of fouling of preceding modules and the changes in feedwater composition. Further aspects of the recirculation concept are mentioned in Section 3.2, *Batch vs. Continuous Process* and Section 3.3, *Single-Module System*. A comparative summary is given in Table 19.

Table 19. Comparison of plug flow and recirculation systems

Parameter	Plug flow	Recirculation
Feed composition	Must be constant	Can vary
System recovery	Must be constant	Can vary
Cleaning circuit	More complicated	Simple
Compensating fouling	More difficult	Easy
Membrane pressure from feed inlet to concentrate end	Decreasing	Uniform
Power consumption	Lower	Higher (15 - 20%)
Number of pumps (investment, maintenance)	Lower	Higher
Extension, varying the membrane area	More difficult	Easy
Taking individual stages of multi-stage systems in/out of service	Not possible	Possible
System salt passage	Lower	Higher

The apparent salt passage of the system, SP_s , also called system salt passage, is defined as the concentration of a compound (may be a certain ion, an organic compound or TDS) in the permeate (C_p) related to its concentration in the feedwater (C_f):

$$SP_s = \frac{C_p}{C_f} \quad \text{Eq. 33}$$

In plug flow systems, SP_s is a function of the system recovery Y and the membrane salt passage SP_M :

$$SP_s = \frac{1 - (1 - Y)^{SP_M}}{Y} \quad \text{Eq. 34}$$

where the membrane salt passage is defined as the concentration of a compound in the permeate (C_p) related to its average concentration on the feed-concentrate side (C_{fc}):

$$SP_M = \frac{C_p}{C_{fc}} \quad \text{Eq. 35}$$

In systems with internal concentrate recirculation, however, there is an additional dependence on the Beta number β , which is defined as

$$\beta = \frac{\text{permeate flow leaving the module}}{\text{concentrate flow leaving the module}} \quad \text{Eq. 36}$$

For systems with the concentrate being partly recycled to the feed stream, the system salt passage is

$$SP_s = \frac{(1 + \beta)^{SP_M} - 1}{Y(1 + \beta)^{SP_M} - Y(1 + \beta) + \beta} \quad \text{Eq. 37}$$

For high system recoveries, the system salt passage of a recirculation system is much higher than that of a plug flow system. This is demonstrated by a sample calculation, see Figure 35. The difference is less, however, for multi-stage systems with recirculation loops for each stage. The system salt passage of such a system (for an example, see Figure 34) has to be calculated by application of Eq. 37 to each stage.

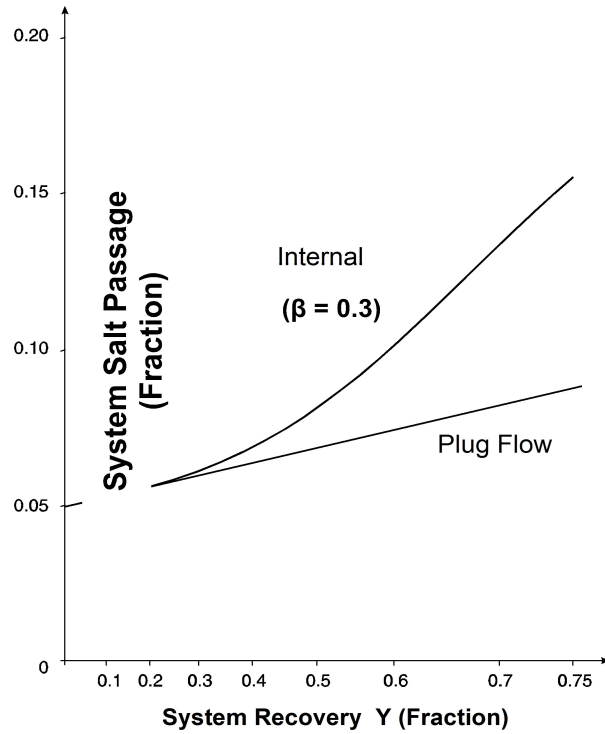

Figure 35. System salt passage for a plug flow and a concentrate recirculation system

When the recirculated concentrate stream approaches zero, the β number approaches $1/[(1/Y) - 1]$, and the recirculation system becomes a plug flow system. A compromise between plug flow and recirculation systems is the tapered recirculation system with a declining number of parallel modules per stage when viewed in feed flow direction (see Figure 36).

The recirculation pumps can be tailored in such a way that only a minor part of the concentrate exiting the stage is recycled while the major part is flowing to the next stage (or to the concentrate outlet, for the last stage). Then, the conditions are nearly plug flow, but the advantages of the recirculation still exist.

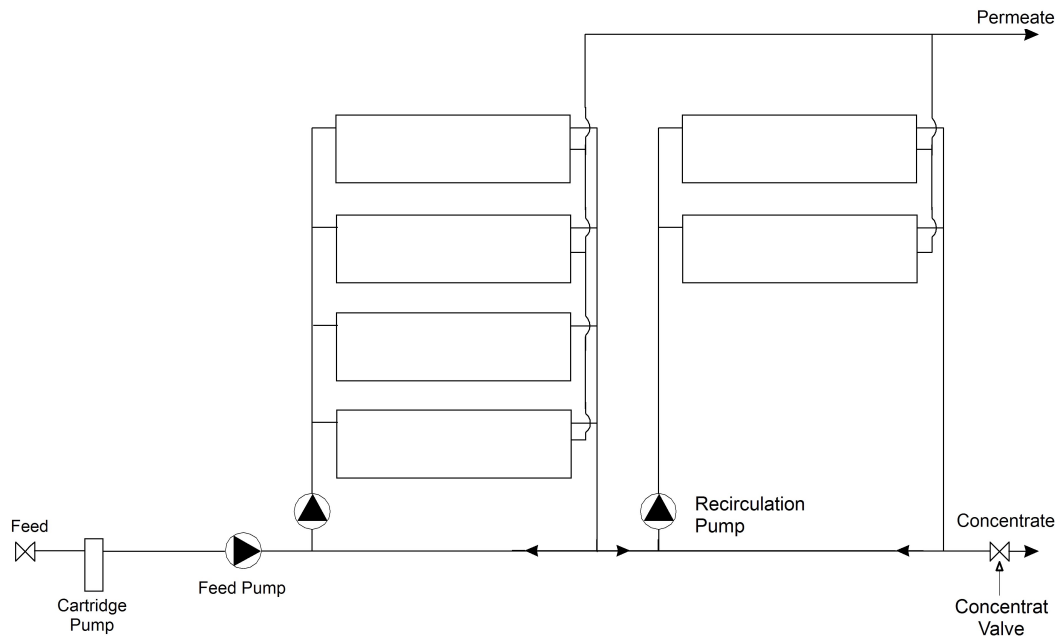

Figure 36. Tapered recirculation system

3.7 Permeate Staged (or Double-Pass) System

A permeate staged system, also known as a double-pass or 2 pass system, is the combination of two conventional RO/NF systems in which the permeate of the first system (first pass) becomes the feed for the second system (second pass). Both RO/NF systems may be of the single-stage or multi-stage type, either with plug flow or with concentrate recirculation. The production of water for pharmaceutical or medical use is a typical application of permeate staged systems.

A permeate staged system may be considered for the following reasons:

- Standard permeate quality is not sufficient
- Post-treatment with ion exchange technology is not allowed (for example, due to the use of regeneration chemicals)
- Highest possible rejection of bacteria, pyrogens, and organic matter is most important
- Consistent permeate quality

Figure 37 shows a schematic flow diagram of a permeate staged RO system. The concentrate of RO II is recycled back to the feed of RO I because its quality is usually better than the system feedwater. Because the feedwater to RO II is of high quality (RO permeate), RO II can be designed for a higher flux and recovery than RO I, therefore, fewer membrane elements are required (see Section 3.9, *Membrane System Design Guidelines*).

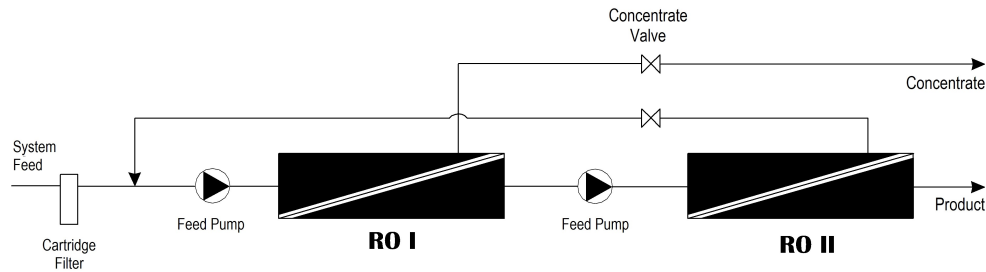
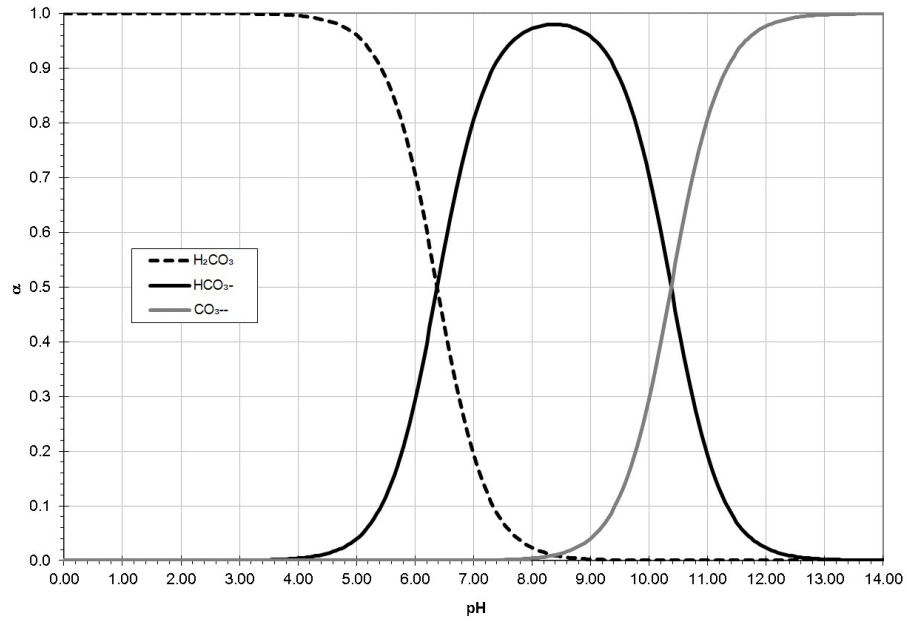

Figure 37. Permeate staged system

Instead of having a separate feed pump for the second pass, the whole system can also be operated with one feed pump, provided the maximum permissible feed pressure of the membrane element is not exceeded [(41 bar (600 psi) for BW elements)]. The second pass is then operated with the permeate backpressure from RO I. For the maximum permeate backpressure allowed, please refer to Section 3.14.2, *Pressure Vessels*. Care must be exercised that the permeate backpressure at no time exceeds the feed pressure by more than 0.3 bar (5 psi).

A surge tank can also be used to collect the permeate from the first pass. This tank must be carefully protected against dust and microbiological contamination.

The conductivity is often the most important quality parameter of the product water. Since carbon dioxide is not rejected by the membrane, it is present in the product water, where it reacts to form carbonic acid and causes the conductivity to increase. The passage of carbon dioxide can be minimized by adjustment of the feedwater pH to RO I to a value of about 8.2. At this pH, most of the dissolved carbon dioxide is converted into hydrogen carbonate (bicarbonate), which is rejected well by the membrane. Sodium hydroxide (caustic soda, NaOH) can be injected either into the permeate of RO I or into the feed of RO I. The best product water conductivity can be achieved by converting the CO₂ (or carbonic acid) to bicarbonate, which Figure 3.9 ½ illustrates is at the highest concentration in a range of pH 8.2 – 8.5, but it is also required to keep the calcium carbonate scaling potential under control. With this concept, a product conductivity of typically < 1 µS/cm can be achieved.



The recovery of RO I is normally limited by the scaling potential of the feedwater, but the recovery of RO II can be as high as 90 - 95% in order to reduce system costs. On the other hand, a more moderate recovery for RO II helps to maximize the product water quality at the expense of a larger first pass (which then has to treat the increased RO II concentrate flowrate).

3.8 Special Design Possibilities

There are a number of special design possibilities for specific requirements. Table 20 lists some of them, along with their benefits.

Special Design	Description	Figure	Benefit					
			Improve product quality	Increase system recovery	Reduce fouling	Produce different permeate qualities	Lower CAPEX	Provide for future expansion
Feedwater Bypass	In a single-pass RO system with relatively low feed TDS, bypass some of the feed and combine it with permeate.	3.1						
Permeate Blend	In a double-pass RO system, taking some of highest-quality permeate from the 1st stage of the 1st pass and blend it with the permeate of the 2nd pass, thereby reducing the flowrate to be treated by the 2nd pass.	3.2						
Permeate Split	In a double-pass RO system, withdraw permeate from ports on both ends of the pressure vessel in the 1st stage of the 1st pass (instead of withdrawing composite 1st-stage permeate from either the feed end or the concentrate end). The less-pure permeate taken from the concentrate end is further treated in the 2nd pass of a permeate-staged system, while the more-pure permeate taken from the feed end bypasses the 2nd pass and is combined with the 2nd pass permeate. The split ratio can be controlled either by permeate backpressure valves or by a physical plug in the product water tube of one of the elements.	3.3						
Hybrid	Use tighter membranes in the first stage than in the second stage.							
Internally-Staged Design (ISD)[PG(1)]	Use membranes of decreasing tightness in series within the same pressure vessel, thereby helping to hydraulically balance the system by throttling the permeate production where the feed pressure is the highest and the osmotic pressure gradient is the lowest.							
Concentrate Recovery	Also called Brine Recovery – Feed the concentrate to a second system, after proper pretreatment.							
Inter-Stage Booster Pumps ¹	Use booster pumps between stages to compensate for the osmotic pressure increase of the feed.							
Stage[CK(2)] Permeate Backpressure[PG(3)] ¹	Use declining permeate backpressure from the first to last stage, thereby throttling the lead stage where the feed pressure is the highest and the osmotic pressure gradient is the lowest.							
Separate Permeate Streams	Separate the permeate from the different stages: the permeate from the first stage has the best quality, especially when the first stage is equipped with higher rejection membranes.							
Element Spacer	Install pressure vessels that are longer than initially required, filling the free space with an element spacer that can be replaced by an element in the future.							
Higher-Duty Support Racks	Design module support racks to accommodate additional pressure vessels.							
<u>Minimum Liquid Discharge (MLD)</u> (Form No. 45-D01074-en)	Apply a core set of proven technologies, including <u>Specialty Membranes UHP RO and FilmTec™ Fortilife™ Reverse Osmosis Elements</u> (Form No. 609-50274), to achieve high water recovery wastewater with high total dissolved solids (TDS), leaving a high-quality permeate for reuse.							

1. It is also common practice to use a combination of permeate backpressure between the earlier stages, and a booster pump between later stages to achieve better energy efficiency than backpressure alone.

Table 20. Special Design Possibilities

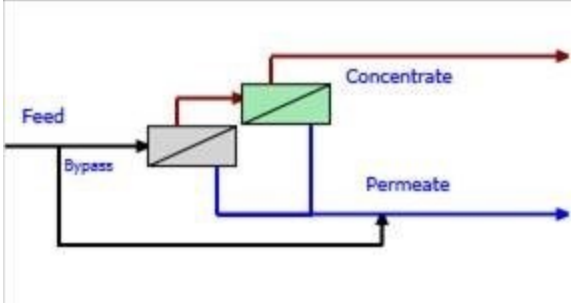
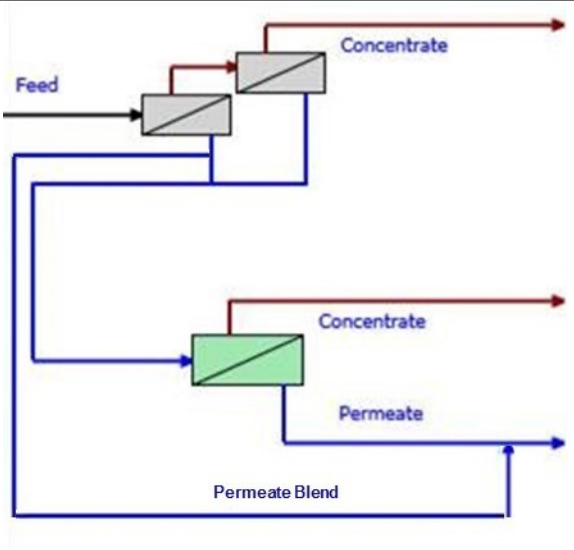
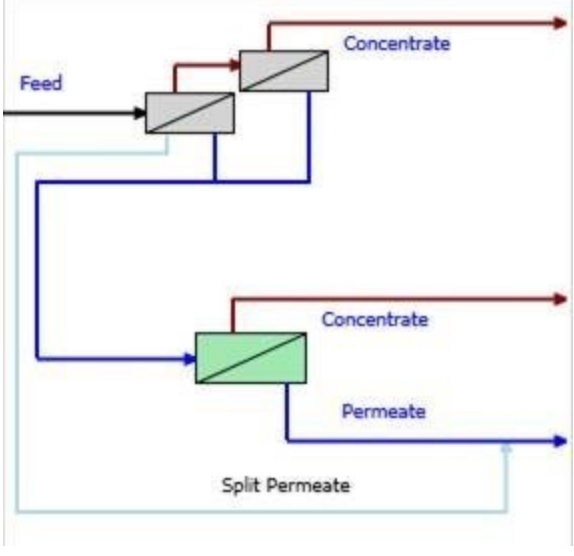
Figure	Special Design	Diagram
3.1.	Feedwater Bypass	 <p>The diagram shows a feed stream entering a two-stage membrane system. The first stage consists of two membrane modules in series. A bypass line branches off from the feed before the first module and rejoins the main line after the second module. The permeate from the second module is collected and sent to a third membrane module. The concentrate from the second module is sent to a fourth membrane module. The permeate from the fourth module is collected and sent to a final permeate outlet. The concentrate from the fourth module is sent to a final concentrate outlet.</p>
3.2.	Permeate Blend	 <p>The diagram shows a feed stream entering a two-stage membrane system. The first stage consists of two membrane modules in series. The permeate from the second module is collected and sent to a third membrane module. The concentrate from the second module is sent to a fourth membrane module. The permeate from the fourth module is collected and sent to a final permeate outlet. The concentrate from the fourth module is sent to a final concentrate outlet. The permeate from the third module is collected and sent to a final permeate blend outlet.</p>
3.3.	Permeate Split	 <p>The diagram shows a feed stream entering a two-stage membrane system. The first stage consists of two membrane modules in series. The permeate from the second module is collected and sent to a third membrane module. The concentrate from the second module is sent to a fourth membrane module. The permeate from the fourth module is collected and sent to a final permeate outlet. The concentrate from the fourth module is sent to a final concentrate outlet. The permeate from the third module is collected and sent to a final split permeate outlet.</p>

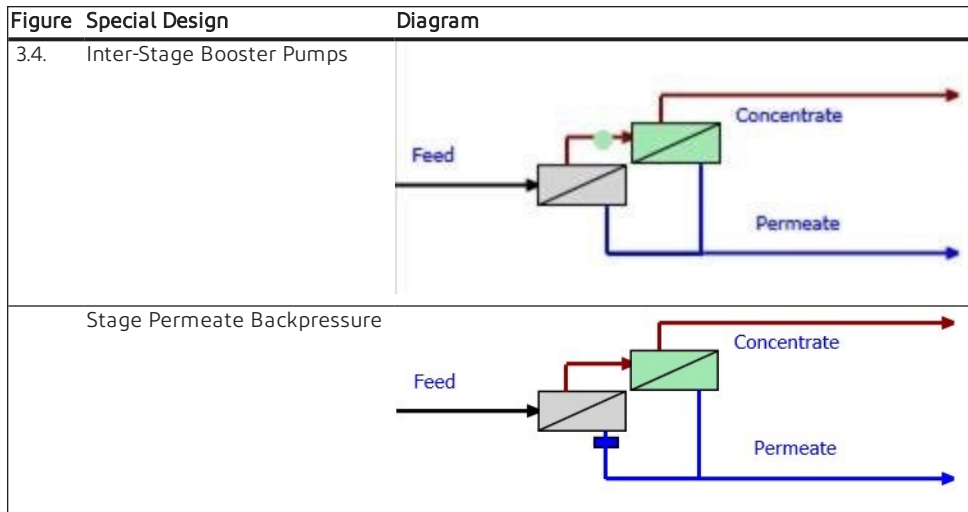

3.9 Membrane System Design Guidelines

The factor which has the greatest influence on the membrane system design is the fouling tendency of the feedwater. Membrane fouling is caused by particles and colloidal material which are present in the feedwater and are concentrated at the membrane surface. The Silt Density Index (SDI) value of the pretreated feedwater correlates fairly well with the amount of fouling material present. The concentration of the fouling materials at the membrane surface increases with increasing permeate flux (the permeate flowrate per unit membrane area) and increasing element recovery (the ratio of permeate flowrate to feed flowrate for a single element). A system with high permeate flux rates is, therefore, likely to experience higher fouling rates, requiring more frequent chemical cleaning.

A membrane system should be designed such that each element of the system operates within a range of recommended operating conditions to minimize the fouling rate and to help avoid mechanical damage. These element operating conditions are limited by the:

- maximum recovery
- maximum permeate flowrate
- minimum concentrate flowrate
- maximum feed flowrate per element

The higher the fouling tendency of the feedwater the stricter are the limits of these parameters. The proposed limits are recommended guidelines based on many years of experience with FilmTec™ membranes.

The average flux of the entire system, i.e., the system permeate flowrate related to the total active membrane area of the system, is a characteristic number of a design. The system flux is a useful number to quickly estimate the required number of elements for a new project. Systems operating on high quality feedwaters are typically designed at higher flux values, whereas systems operating on poor quality feedwaters are designed at lower flux values. However, even within the same feedwater category, systems are designed with higher or lower flux values, depending on the focus being either on minimizing the capital expenses or minimizing the long-term operational expenses. The ranges of flux values given in the tables below are typical numbers for the majority of systems.

A continuous RO/NF process designed according to the system design guidelines and with a well-designed and operated pretreatment system will show stable performance with no more than about four cleanings per year in standard applications. Exceeding the recommended limits may result in:

- more frequent cleanings
- reduced capacity
- increased feed pressure
- reduced membrane life

A moderate violation of the limits for a short time may be acceptable as long as the physical limits – the maximum pressure drop and the maximum feed pressure (refer to element product data sheet) – are not exceeded. On the other hand, a conservative approach is to anticipate a higher fouling tendency and to design the system according to the stricter limits in order to benefit from a trouble-free system operation and an increased membrane life.

3.9.1 Membrane System Design Guidelines for 8-inch FilmTec™ Elements

The following tables show the recommended guidelines for designing RO systems with 8-inch FilmTec™ Elements according to feedwater type.

Table 21. Design guidelines for 8-inch FilmTec™ Elements in water treatment applications

Feed Source	RO Permeate	Well Water	Surface Water			Wastewater (Filtered Municipal Effluent or Industrial Effluent)			Seawater			
			Surface Water with Ultrafiltration	Generic membrane filtration or advanced conventional pretreatment	Generic conventional pretreatment	Ultrafiltration	Generic membrane filtration (MBR/MF/UF)	Conventional pretreatment	Well or Open Intake with Ultrafiltration	Open Intake with generic membrane filtration or advanced conventional pretreatment	Open Intake with generic conventional pretreatment	
Feed Silt Density Index (%/min)	SDI < 1	SDI < 3	SDI < 2.5	SDI < 3	SDI < 5	SDI < 2.5	SDI < 3	SDI < 5	SDI < 2.5	SDI < 3	SDI < 5	
Maximum Element Recovery (%)	30	19	19	17	15	14	13	12	15	14	13	
Active Membrane Area	Maximum Permeate Flow, gpd											
365-ft ² elements	10,200	8,500	8,500	7,200	6,600	6,300	5,900	5,200	— Not Recommended —			
370-ft ² elements	10,200	8,500	8,500	7,200	6,600	6,300	5,900	5,200	7,800	7,400	7,000	
380-ft ² elements	10,700	8,900	8,900	7,500	6,900	6,500	6,000	5,300	7,900	7,600	7,200	
390-ft ² elements	10,920	9,200	— Not Recommended —			— Not Recommended —			— Not Recommended —			
400-ft ² elements	11,200	9,300	9,300	7,900	7,300	6,800	6,400	5,700	8,400	8,000	7,600	
440-ft ² elements	12,300	10,300	10,300	8,700	8,000	7,600	7,100	6,300	9,200	8,800	8,360	
Design Flux Range (gfd)	21 – 25	16 – 20	16 – 20	13 – 17	12 – 16	11 – 15	10 – 14	8 – 12	9 – 11	8 – 10	7 – 10	
Maximum Element Flux (gfd)	28	22.7	22.7	20	18	17	16	14	21	20	19	
Element Type	Minimum Concentrate Flowrate, gpm (m³/h)											
BW elements (365 ft ²)	10 (2.3)	13 (3.0)	13 (3.0)	13 (3.0)	15 (3.4)	16 (3.6)	16 (3.6)	18 (4.1)	— Not Recommended —			
BW elements (400 ft ² and 440 ft ²)	10 (2.3)	13 (3.0)	13 (3.0)	13 (3.0)	15 (3.4)	18 (4.1)	18 (4.1)	20 (4.6)	— Not Recommended —			
NF elements	10 (2.3)	13 (3.0)	13 (3.0)	13 (3.0)	15 (3.4)	18 (4.1)	18 (4.1)	18 (4.1)	— Not Recommended —			
Fullfit elements	25 (5.7)	25 (5.7)	— Not Recommended —			— Not Recommended —			— Not Recommended —			
SW elements	10 (2.3)	- NR -	— Not Recommended —			— Not Recommended —			13 (3.0)	14 (3.2)	15 (3.4)	
Element Type	Active Area ft² (m²)	Maximum Feed Flowrate, gpm (m³/h)										
BW elements	365 (33.9)	65 (15)	65 (15)	65 (15)	63 (14)	58 (13)	52 (12)	52 (12)	52 (12)	— Not Recommended —		
BW/NF elements	400 (37.2)	75 (17)	75 (17)	75 (17)	73 (17)	67 (15)	61 (14)	61 (14)	61 (14)	— Not Recommended —		
BW elements	440 (40.9)	75 (17)	75 (17)	75 (17)	73 (17)	67 (15)	61 (14)	61 (14)	61 (14)	— Not Recommended —		
Fullfit elements	390 (36.2)	85 (19)	75 (17)	— Not Recommended —			— Not Recommended —			— Not Recommended —		
SW elements	370 (34.4)	65 (15)	- NR -	— Not Recommended —			— Not Recommended —			63 (14)	60 (13.5)	56 (13)
SW elements	380 (35.3)	72 (16)	- NR -	— Not Recommended —			— Not Recommended —			70 (16)	66 (15)	62 (14)
SW elements	400 (37.2)	72 (16)	- NR -	— Not Recommended —			— Not Recommended —			70 (16)	66 (15)	62 (14)

Feed Source	RO Permeate	Well Water	Surface Water			Wastewater (Filtered Municipal Effluent or Industrial Effluent)			Seawater			
			Surface Water with Ultrafiltration	Generic membrane filtration or advanced conventional pretreatment	Generic conventional pretreatment	Ultrafiltration	Generic membrane filtration (MBR/MF/UF)	Conventional pretreatment	Well or Open Intake with Ultrafiltration	Open Intake with generic membrane filtration or advanced conventional pretreatment	Open Intake with generic conventional pretreatment	
Feed Silt Density Index (%/min)	SDI < 1	SDI < 3	SDI < 2.5	SDI < 3	SDI < 5	SDI < 2.5	SDI < 3	SDI < 5	SDI < 2.5	SDI < 3	SDI < 5	
Maximum Element Recovery (%)	30	19	19	17	15	14	13	12	15	14	13	
Active Membrane Area	Maximum Permeate Flow, gpd											
365-ft ² elements	10,200	8,500	8,500	7,200	6,600	6,300	5,900	5,200	— Not Recommended —			
370-ft ² elements	10,200	8,500	8,500	7,200	6,600	6,300	5,900	5,200	7,800	7,400	7,000	
380-ft ² elements	10,700	8,900	8,900	7,500	6,900	6,500	6,000	5,300	7,900	7,600	7,200	
390-ft ² elements	10,920	9,200	— Not Recommended —			— Not Recommended —			— Not Recommended —			
400-ft ² elements	11,200	9,300	9,300	7,900	7,300	6,800	6,400	5,700	8,400	8,000	7,600	
440-ft ² elements	12,300	10,300	10,300	8,700	8,000	7,600	7,100	6,300	9,200	8,800	8,360	
Design Flux Range (gfd)	21 – 25	16 – 20	16 – 20	13 – 17	12 – 16	11 – 15	10 – 14	8 – 12	9 – 11	8 – 10	7 – 10	
Maximum Element Flux (gfd)	28	22.7	22.7	20	18	17	16	14	21	20	19	
Element Type	Minimum Concentrate Flowrate, gpm (m³/h)											
BW elements (365 ft ²)	10 (2.3)	13 (3.0)	13 (3.0)	13 (3.0)	15 (3.4)	16 (3.6)	16 (3.6)	18 (4.1)	— Not Recommended —			
BW elements (400 ft ² and 440 ft ²)	10 (2.3)	13 (3.0)	13 (3.0)	13 (3.0)	15 (3.4)	18 (4.1)	18 (4.1)	20 (4.6)	— Not Recommended —			
NF elements	10 (2.3)	13 (3.0)	13 (3.0)	13 (3.0)	15 (3.4)	18 (4.1)	18 (4.1)	18 (4.1)	— Not Recommended —			
Fullfit elements	25 (5.7)	25 (5.7)	— Not Recommended —			— Not Recommended —			— Not Recommended —			
SW elements	10 (2.3)	— NR —	— Not Recommended —			— Not Recommended —			13 (3.0)	14 (3.2)	15 (3.4)	
Element Type	Active Area ft² (m²)	Maximum Feed Flowrate, gpm (m³/h)										
BW elements	365 (33.9)	65 (15)	65 (15)	65 (15)	63 (14)	58 (13)	52 (12)	52 (12)	52 (12)	— Not Recommended —		
BW/NF elements	400 (37.2)	75 (17)	75 (17)	75 (17)	73 (17)	67 (15)	61 (14)	61 (14)	61 (14)	— Not Recommended —		
BW elements	440 (40.9)	75 (17)	75 (17)	75 (17)	73 (17)	67 (15)	61 (14)	61 (14)	61 (14)	— Not Recommended —		
Fullfit elements	390 (36.2)	85 (19)	75 (17)	— Not Recommended —			— Not Recommended —			— Not Recommended —		
SW elements	370 (34.4)	65 (15)	— NR —	— Not Recommended —			— Not Recommended —			63 (14)	60 (13.5)	56 (13)
SW elements	380 (35.3)	72 (16)	— NR —	— Not Recommended —			— Not Recommended —			70 (16)	66 (15)	62 (14)
SW elements	400 (37.2)	72 (16)	— NR —	— Not Recommended —			— Not Recommended —			70 (16)	66 (15)	62 (14)

3.9.2 Membrane System Design Guidelines for Midsize FilmTec™ Elements

The following tables show the recommended guidelines for designing RO systems with 2.5 and 4-inch FilmTec™ Elements in light industrial, small commercial, and institutional applications, or for piloting large systems.

Light industrial systems in Table 22 have the same requirements as for large systems, requiring stable performance over several years. They are sometimes used for piloting large systems with continuous operation, CIP facilities and no (or minimal) concentrate recirculation. The expected membrane lifetime is more than 3 years.

Table 22. Design guidelines for FilmTec™ Elements in light industrial and small seawater applications

Feed Source	RO Permeate	Well Water	Softened Municipal	Surface	Wastewater (filtered tertiary effluent)		Seawater	
					MF ¹	Conventional	Well or MF ¹	Open Intake
Feed Silt Density Index (%/min)	SDI < 1	SDI < 3	SDI < 3	SDI < 5	SDI < 3	SDI < 5	SDI < 3	SDI < 5
Typical Target Flux, gfd (L/m ² h)	22 (37)	18 (30)	16 (27)	14 (24)	13 (22)	11 (19)	13 (22)	11 (19)
Maximum Element Recovery (%)	30	19	17	15	14	12	15	13

Element Diameter	Maximum Permeate Flowrate, gpd (m ³ /d)							
2.5-inch	800 (3.0)	700 (2.6)	600 (2.3)	500 (1.9)	500 (1.9)	400 (1.5)	700 (2.6)	600 (2.3)
4.0-inch (except fullfits and LC products)	2,200 (8.4)	1,800 (6.8)	1,600 (6.0)	1,400 (5.4)	1,300 (4.8)	1,100 (4.1)	1,600 (6.0)	1,500 (5.7)
4.0-inch diameter (LC products)	2,600 (10.1)	2,100 (8.2)	1,900 (7.2)	1,700 (6.5)	1,500 (5.7)	1,300 (5.0)	-	-
Fullfit 4040	2,500 (9.7)	2,000 (7.8)	1,800 (6.9)	1,600 (6.2)	1,400 (5.5)	1,300 (5.0)	-	-

Element Type	Minimum Concentrate Flowrate, gpm (m ³ /h) ¹							
2.5-inch diameter	0.7 (0.16)	1 (0.2)	1 (0.2)	1 (0.2)	1 (0.2)	1 (0.2)	1 (0.2)	1 (0.2)
4.0-inch diameter (except fullfits)	2 (0.5)	3 (0.7)	3 (0.7)	3 (0.7)	4 (0.9)	5 (1.1)	3 (0.7)	4 (0.9)
Fullfit 4040	6 (1.4)	6 (1.4)	6 (1.4)	6 (1.4)	6 (1.4)	6 (1.4)	NA	NA

Element Type	Maximum Feed Flowrate gpm (m ³ /h)	Maximum Pressure Drop per	
		Element psig (bar)	Maximum Feed Pressure psig (bar)
Tape-wrapped 2540	6 (1.4)	13 (0.9)	600 (41)
Fiberglassed 2540	6 (1.4)	15 (1.0)	600 (41)
Seawater 2540	6 (1.4)	13 (0.9)	1,000 (69)
Tape-wrapped 4040	14 (3.2)	13 (0.9)	600 (41)
Fiberglassed 4040	16 (3.6)	15 (1.0)	600 (41)
Seawater Fiberglassed 4040	16 (3.6)	15 (1.0)	1,000 (69)
Fullfit 4040	18 (4.1)	15 (1.0)	600 (41)

¹ MF: Microfiltration - continuous filtration process using a membrane with pore size of < 0.5 micron.

² We recommend that the pressure drop for new/clean elements be at least 20% below the maximum.

Note: The limiting values listed above have been incorporated into the WAVE software. Designs of systems in excess of the guidelines results in a warning on the WAVE report.

In Table 23, the small commercial systems typically contain 1 – 6 elements that are either regularly replaced or cleaned (every half year or year) or performance loss is acceptable. The expected element lifetime is not more than 3 years. This is a low-cost, compact solution for intermittently operated systems.

Table 23. Design guidelines for FilmTec™ Elements in small commercial applications

Feed Source	RO Permeate	Softened Municipal	Well Water	Surface or Municipal Water
Feed Silt Density Index (%/min)	SDI < 1	SDI < 3	SDI < 3	SDI < 5
Typical Target Flux, gfd (L/m ² h)	30 (51)	30 (51)	25 (42)	20 (34)
Maximum Element Recovery (%)	30	30	25	20
Maximum Permeate Flowrate, gpd (m³/d)				
2.5-inch diameter	1,100 (4.2)	1,100 (4.2)	900 (3.4)	700 (2.7)
4.0-inch diameter	3,100 (11.7)	3,100 (11.7)	2,600 (9.8)	2,100 (7.9)
Minimum Concentrate Flowrate¹, gpm (m³/h)				
2.5-inch diameter	0.5 (0.11)	0.5 (0.11)	0.7 (0.16)	0.7 (0.16)
4.0-inch diameter	2 (0.5)	2 (0.5)	3 (0.7)	3 (0.7)

Element Type	Maximum Feed Flowrate U.S. gpm (m ³ /h)	Maximum Pressure Drop per Element ¹ psig (bar)	Maximum Feed Pressure psig (bar)
Tape-wrapped 2540	6 (1.4)	13 (0.9)	600 (41)
Fiberglassed 2540	6 (1.4)	15 (1.0)	600 (41)
Seawater 2540	6 (1.4)	13 (0.9)	1,000 (69)
Tape-wrapped 4040	14 (3.2)	13 (0.9)	600 (41)
Fiberglassed 4040	16 (3.6)	15 (1.0)	600 (41)
Seawater 4040	16 (3.6)	15 (1.0)	1,000 (69)

¹We recommend that the pressure drop for new/clean elements be at least 20% below the maximum.

Note: The limiting values listed above have been incorporated into the WAVE software. Designs of systems in excess of the guidelines results in a warning on the WAVE report.

3.10 Temperature and Pressure Limits for 8-inch FilmTec™ Seawater RO Elements

Exposure of spiral-wound membrane elements to extreme conditions during RO operation can lead to reduced permeate flow, increased salt passage, and deformation or failure of element components. Consequently, FilmTec™ Elements are subject to certain operating limits, including limits on feed pressure and temperature. This document provides general temperature and pressure limits for 8 inch FilmTec™ Seawater Elements.

Important Note Regarding Your Warranty: Failure to meet the requirements set forth in this document will void your element warranty. Refer to your governing document – either product data sheet, element warranty, or system warranty – for the operating limits that apply to your elements.

3.10.1 Elements with Standard Endcaps

Most FilmTec™ Seawater RO Elements are approved for operation up to 45°C and 83 bar (1200 psi). If your planned operating conditions fall inside the shaded region in Figure 1, contact your DuPont representative for further information. If conditions include feed pressure above 42 bar (600 psi) and feed temperature above 40°C, special attention to vessel shimming is required. Refer to Section 4.3 *Shimming Elements*.

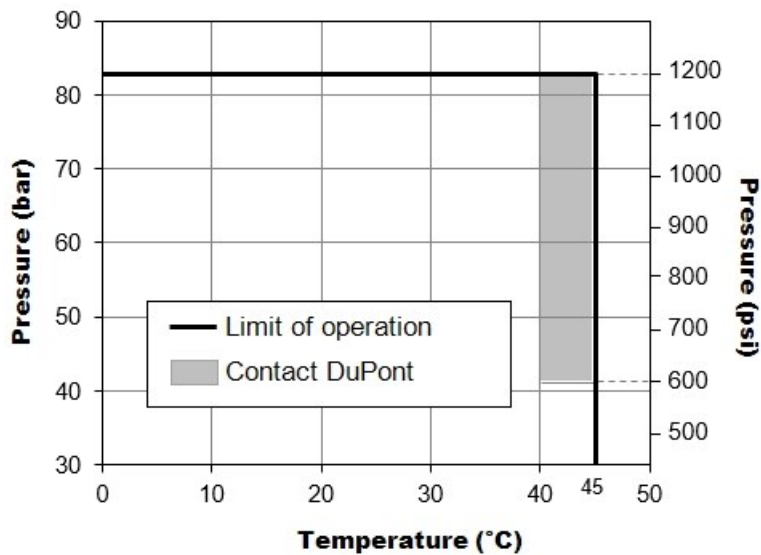

Figure 38. Temperature and Pressure Limits for Elements with Standard Endcaps

3.10.2 Elements with iLEC™ Interlocking Endcaps

Most FilmTec™ Seawater RO Elements with iLEC™ Interlocking Endcaps are approved for operation up to 45°C and 83 bar (1200 psi). If your planned operating conditions fall inside the shaded regions in Figure 2, contact your DuPont representative for further information. If conditions include feed pressure above 42 bar (600 psi) and feed temperature above 35°C, the installation of internal interconnectors (DuPont Part No. 313198) is required. The elements should be left unlocked to allow for thermal expansion and contraction. If conditions include feed pressure above 42 bar (600 psi) and feed temperature above 40°C, special attention to vessel shimming is required. Refer to Section 4.3 *Shimming Elements*.

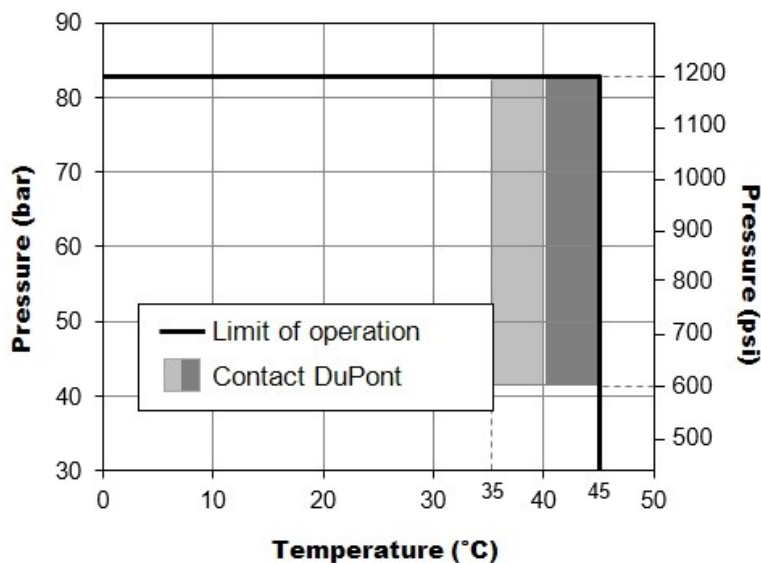

Figure 39. Temperature and Pressure Limits for Elements with iLEC™ Interlocking Endcaps

3.11 The Steps to Design a Membrane System

The following steps are taken to design a membrane system:

Step 1: Consider feed source, feed quality, feed/product flow, and required product quality

The membrane system design depends on the available feedwater and the application. Therefore the system design information according to Table 17 and the feedwater analysis according to Table 18 should be collected first.

Step 2: Select the flow configuration and number of passes

The standard flow configuration for water desalination is plug flow, where the feed volume is passed once through the system. Concentrate recirculation is common to smaller systems used in commercial applications, as well as in larger systems when the number of elements is too small to achieve a sufficiently high system recovery with plug flow. Concentrate recirculation systems can also be found in special applications like process liquids and wastewaters.

An RO system is usually designed for continuous operation and the operating conditions of every membrane element in the plant are relatively constant with time. In certain applications, however, a batch operation mode is used, e.g., in treating wastewater or industrial process solutions, when relatively small volumes (batches) of feedwater are discharged non-continuously. The feedwater is collected in a tank and then periodically treated. A modification of the batch mode is the semi-batch mode, where the feed tank is refilled with feedwater during operation. See also Section 3.2, *Batch vs. Continuous Process*.

A permeate staged (double-pass) system is the combination of two conventional RO systems where permeate of the first system (first pass) becomes the feed for the second system (second pass). Both RO systems may be of the single-stage or multi-stage type, either with plug flow or with concentrate recirculation. The production of water for pharmaceutical and medical use are typical applications of permeate staged systems. As an alternative to a second pass, ion exchange mixed bed polishing may also be considered.

Step 3: Select membrane element type

Elements are selected according to application, system capacity, feedwater salinity, feedwater fouling tendency, required rejection, and energy requirements. The standard element size for systems producing permeate greater than 2.3 m³/h (10 gpm) is 8 inches in diameter and 40 inches long. Smaller elements are available for smaller systems.

The characteristics of FilmTec™ Elements and their use in specific applications are described in Section 1.8, *Element Characteristics*.

For high quality water applications where a very low concentration of dissolved solids is required, ion exchange resins or electrodeionization (EDI) are frequently used to polish RO permeate.

Step 4: Select average membrane flux

Select the design flux, f , (gfd or L/m²-h) based on pilot data, customer experience or the typical design fluxes according to the feed source found in Section 3.9, *Membrane System Design Guidelines*.

Step 5: Calculate the number of elements needed

Divide the design permeate flowrate Q_p by the design flux f and by the membrane surface area of the selected element S_E (or m² or ft²) to obtain the number of elements N_E (usually rounding up to the nearest integer).

$$N_E = \frac{Q_P}{f \cdot S_E} \quad \text{Eq. 38}$$

Step 6: Calculate number of pressure vessels needed

Divide the number of elements N_E by the number of elements per pressure vessel, N_{EPV} , to obtain the number of pressure vessels, N_V – round up to the nearest integer. For large systems, 6-element vessels are standard, but vessels with up to 8 elements are available. For smaller and/or compact systems, shorter vessels may be selected.

$$N_V = \frac{N_E}{N_{EPV}} \quad \text{Eq. 39}$$

Although the approach described in the following sections apply for all systems, it is especially applicable for 8-inch systems with a larger number of elements and pressure vessels, which then can be arranged in a certain way. Small systems with only one or a few elements are mostly designed with the element in series and a concentrate recirculation for maintaining the appropriate flowrate through the feed/brine channels.

Step 7: Select number of stages

The number of stages defines how many pressure vessels in series the feed will pass through until it exits the system and is discharged as concentrate. Every stage consists of a certain number of pressure vessels in parallel. The number of stages is a function of the planned system recovery, the number of elements per vessel, and the feedwater quality. The higher the system recovery and the lower the feedwater quality, the longer the system will be with more elements in series. For example, a system with four 6-element vessels in the first and two 6-element vessels in the second stage has 12 elements in series. A system with three stages and 4-element vessels, in a 4:3:2 arrangement also has 12 elements in series. Typically, the number of elements in series is linked with the system recovery and the number of stages as illustrated in Table 24 for brackish water systems and Table 25 for seawater systems.

Table 24. Number of stages of a brackish water system

System recovery (%)	Number of elements in series	Number of stages (6-element vessels)
40 – 60	6	1
70 – 80	12	2
85 – 90	18	3

One-stage systems can also be designed for high recoveries if concentrate recycling is used.

In seawater systems the recoveries are lower than in brackish water systems. The number of stages depends on recovery as shown in Table 25.

Table 25. Number of stages of a seawater system

System recovery (%)	Number of elements in series	Number of stages (6-element vessels)	Number of stages (7-element vessels)	Number of stages (8-element vessels)
35 – 40	6	1	1	—
45	7 – 12	2	1	1
50	8 – 12	2	2	1
55 – 60	12 – 14	2	2	—

Step 8: Select the staging ratio

The relation of the number of pressure vessels in subsequent stages is called the staging ratio R.

$$R = \frac{N_v(i)}{N_v(i+1)} \quad \text{Eq. 40}$$

$$R = \frac{N_v(i)}{N_v(i+1)}$$

For a system with four vessels in the first stage and two vessels in the second stage, the staging ratio is 2:1. A three-stage system with four, three, and two vessels in the first, second, and third stage, respectively, has a staging ratio of 4:3:2. In brackish water systems, staging ratios between two subsequent stages are usually close to 2:1 for 6-element vessels and less than that for shorter vessels. In two-stage seawater systems with 6-element vessels, the typical staging ratio is 3:2.

The ideal staging of a system is such that each stage operates at the same fraction of the system recovery, provided that all pressure vessels contain the same number of elements. The staging ratio R of a system with n stages and a system recovery Y (as fraction) can then be calculated:

$$R = \left[\frac{1}{(1-Y)} \right]^{\frac{1}{n}} \quad \text{Eq. 41}$$

The number of pressure vessels in the first stage $N_v(1)$ can be calculated with the staging ratio R from the total number of vessels N_v .

For a two-stage system ($n = 2$) and a three-stage system ($n = 3$), the number of pressure vessels in the first stage is

$$N_v(1) = \frac{N_v}{1 + R^{-1}} \quad \text{for } n = 2 \quad \text{Eq. 42}$$

$$N_v(1) = \frac{N_v}{1 + R^{-1} + R^{-2}} \quad \text{for } n = 3, \text{ etc.} \quad \text{Eq. 43}$$

The number of vessels in the second stage is then

$$N_v(2) = \frac{N_v(1)}{R} \quad \text{Eq. 44}$$

and so on.

Another aspect for selecting a certain arrangement of vessels is the feed flowrate per vessel of the first stage and the concentrate flowrate per vessel of the last stage. Both feed and concentrate flowrates for the system are given (from permeate flowrate and recovery). The number of pressure vessels in the first stage and the number of pressure vessels in the last stage should be selected to provide a feed flowrate into the first stage and a concentrate flowrate from the last stage that follows the design guidelines for the appropriate element type, active area, and water type given in Section 3.9, *Membrane System Design Guidelines*.

Step 9: Balance the permeate flowrate

The permeate flowrate of the tail elements of a system (the elements located at the concentrate end) is normally lower than the flowrate of the lead elements. This is a result of the pressure drop in the feed/brine channel and the increase of the osmotic pressure from the feed to the concentrate. Under certain conditions, the ratio of the permeate flowrate of the lead element and the tail element can become very high:

- High system recovery
- High feed salinity
- Low pressure membranes
- High water temperature
- New membranes

The goal of a good design is to balance the flux of elements in the different positions. This can be achieved by the following means:

- Boosting the feed pressure between stages: preferred for efficient energy use
- Applying a permeate backpressure only to the first stage of a two-stage system: low system cost alternative
- Designing a hybrid system: use membranes with lower water permeability in the first positions and membranes with higher water permeabilities in the last positions: e.g., high-rejection seawater membranes in the first stage and high-productivity seawater membranes in the second stage of a seawater RO system

The need for flow balancing and the method can be determined after the system design has been analyzed with the Water Application Value Engine (WAVE).

Above and beyond the requisite of balancing flux between stages, Internally-Staged Design (iSD) may be used to hydraulically balance the flux of elements within the same pressure vessel. This is accomplished by applying membranes of decreasing tightness in series having the effect of throttling the permeate production where the feed pressure is the highest and the osmotic pressure gradient is the lowest.

Step 10: Analyze and optimize the membrane system

The chosen system should then be analyzed and refined using the Water Application Value Engine (WAVE) design program.

Example

- Feed source: brackish surface supply water, SDI < 5
- Required permeate flow = 720 m³/d (132 gpm)
- Six-element pressure vessels to be used
 1. Brackish surface supply water with SDI < 5; total permeate flow = 720 m³/d (132 gpm)
 2. Select plug flow
 3. BW element with active membrane area of 37.2 m² (400 ft²)
 4. Recommended average flux for surface supply water feed with SDI < 5 = 23.8 L/m²h (14.0 gfd)
 5. Total number of elements =

$$\frac{(132 \text{ gpm})(1440 \text{ gpd/gpm})}{(15 \text{ gfd})(365 \text{ ft}^2)} = 35 \quad \text{or} \quad \frac{(720 \text{ m}^3/\text{d})(41.67 \text{ L/h})/(\text{m}^3/\text{d})}{(33.9 \text{ m}^2)/(25 \text{ L/m}^2/\text{h})} = 35$$
 6. Total number of pressure vessels = 34/6 = 5.67 = 6
 7. Number of stages for 6-element vessels and 75% recovery = 2 (see Table 24)
 8. Staging ratio selected: 2:1. Appropriate stage ratio = 4:2
 9. The chosen system must then be analyzed using the Water Application Value Engine (WAVE) design software, which calculates the feed pressure and permeate quality of the system as well as the operating data of all individual elements. Design warnings are reported by WAVE according to the design guidelines, which are incorporated into the program. It is then easy to optimize the system design by changing the number and type of elements and their arrangement.

3.12 System Performance Projection

3.12.1 System Operating Characteristics

Before a system performance projection is run, one should be familiar with the operating characteristics of a system. These will be explained using a typical example. Figure 40 shows a two-stage system with three six-element pressure vessels using a staging ratio of 2:1.

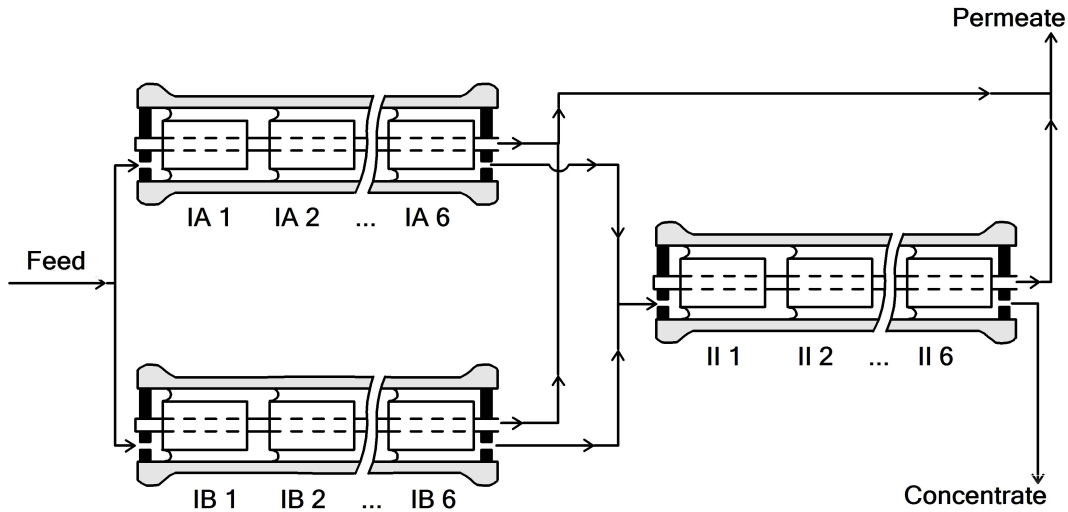

Figure 40. Typical two-stage configuration for spiral-wound RO/NF elements

Two-stage systems are generally capable of operating at an overall recovery rate of 55 – 75%. For such systems the average individual recovery rate per element will vary from 7 – 12%. To operate a two-stage system at an overall recovery much higher than 75% will cause an individual element to exceed the maximum recovery limits shown in Section 3.9, *Membrane System Design Guidelines*. When this happens, a third stage will have to be employed; this places 18 elements in series, shifting the average element recovery rate to lower values.

Since the capacity of a water treatment plant is usually defined by the required permeate flowrate, a consequence of choosing to operate at a lower recovery is that the feedwater supply will need to be increased in order to meet the specification for permeate flowrate. If two-stage systems are operated at too low a recovery (e.g., < 55%), the feed flowrates to the first-stage vessels can be too high, causing excessive feed/concentrate-side pressure drops and potentially damaging the elements. More information is available in Section 3.9, *Membrane System Design Guidelines*. As a result, systems with lower than 50% recovery will typically use single-stage configurations. Maximum flow considerations can also limit the staging ratio. It is unlikely to find systems with staging ratios greater than 3:1.

When a single RO element is run, the operating variables are readily measured, and performance can be easily correlated. When a large number of elements are combined in a system with a multiple staging configuration (i.e., combination of elements in parallel and in series) and only the inlet operating variables are known, system performance prediction becomes considerably more complex. Feed pressures and salt concentrations for each element in series are changing. The rate and extent of these changes are dependent not only on the inlet conditions and overall recovery, but also on the stage configuration, i.e., staging ratio(s).

Figure 41 illustrates the dynamic nature of predicting system performance based on the sum of individual element performances within the system. It shows how five different element performance parameters vary throughout the twelve elements in series in a 2:1 array of six-element pressure vessels. The system is operating at 75% recovery and 25°C with a feed osmotic pressure of 1.4 bar (20 psi), which roughly corresponds to a 2,000 mg/L feed TDS). The inlet feed pressure has been adjusted so that the lead BW element is producing 28.4 m³/d (7,500 gpd).

The top third of Figure 41 shows individual element permeate flows decreasing uniformly throughout the series configuration from 28.4 m³/d (7,500 gpd) in the lead element of the first stage to approximately 12.5 m³/d (3,300 gpd) in the last element of the second stage. The average element permeate flow rate is 22 m³/d (5,800 gpd).

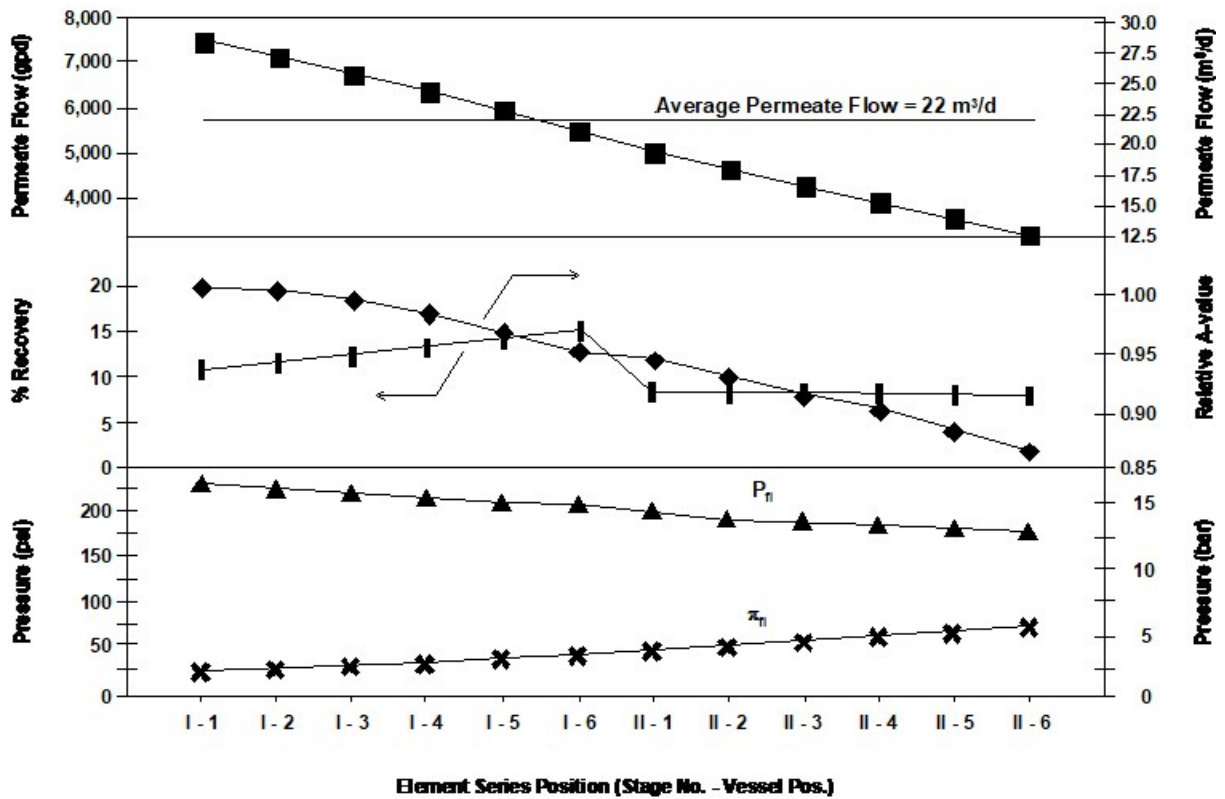

Figure 41. Individual element performance in a system 2:1 array of 8-inch BW30 elements (example)

Permeate flow decreases because the net driving pressure, $\Delta P - \Delta \pi$, is uniformly declining. (ΔP is the pressure difference between the feed side and the permeate side of the membrane; $\Delta \pi$ is the osmotic pressure difference between both sides). This is evident by looking at the two curves in the bottom third of the figure. The upper curve shows how the inlet feed pressure to each element (P_f) decreases due to the upstream concentrate-side pressure losses within each element. The bottom curve shows how the inlet feed osmotic pressure to each element (π_f) is increasing as (mostly) salt-free permeate is progressively removed by each upstream element, leaving behind a steadily increasing concentrate salt concentration. The difference between these two pressure curves is roughly equivalent to the net permeation driving force.

The middle portion of Figure 41 exhibits two subtle, but important, effects. The left-hand scale shows how individual element recovery varies within the twelve element (series) sequence. The break occurs between the first and second stages. In general, the individual recovery profile will increase in both stages but typically more strongly in the first. The system designer, utilizing RO system design software, must verify that the last element in the first stage does not exceed the appropriate recovery limit. As element recovery increases, the effective osmotic pressure at the membrane surface will be higher due to concentration polarization. This inefficiency reduces permeate flows and can lead to membrane scaling or fouling.

The other curve in the middle portion of Figure 41 (right-hand scale) illustrates an interesting phenomenon exhibited by the membrane. It shows that the relative permeate flow is an inverse function of salt concentration, decreasing at higher salinity as the net driving pressure declines (partly due to the decrease in feed-side applied pressure and also partly due to the increase in feed-side osmotic pressure). In this example, the water permeability declines by almost 15% through the series of twelve elements, and this must be taken into consideration if an accurate design for system permeate flowrate is to be obtained.

3.12.2 Design Equations and Parameters

The performance of a specified RO system is defined by its feed pressure (or permeate flow, if the feed pressure is not specified) and its salt passage. In its simplest terms, the permeate flow Q through an RO membrane is directly proportional to the wetted surface area S multiplied by the net driving pressure ($\Delta P - \Delta \pi$). The proportionality constant is the membrane permeability coefficient, known as the A-value. The familiar water permeation equation has the form:

$$Q = (A)(S)(\Delta P - \Delta \pi) \quad \text{Eq. 45}$$

The salt passage is by diffusion, hence the salt flux N_A is proportional to the salt concentration difference between both sides of the membrane. The proportionality constant is the salt diffusion coefficient, known as the B-value.

$$N_A = B(C_{fc} - C_p) \quad \text{Eq. 46}$$

where:

C_{fc} = feed-concentrate average concentration

C_p = permeate concentration

There are basically two ways to calculate the performance of a specified design: "Element-to-Element" and "Entire System".

Element-to-Element

This is the most rigorous calculation method. It is too tedious for hand calculation, but it is suitable for computer calculations. All the operating conditions of the first element must be known, including the feed pressure. Then the flow, pressure, etc., of the concentrate, which is the feed to the second element, can be calculated. After calculating the results for all the elements, the original feed pressure may be too high or low, so the trial and error process starts with a new pressure.

With the help of DuPont's Water Application Value Engine (WAVE) design software, accurate results can be obtained very quickly, making it an indispensable tool for modifying and optimizing the design of an RO or an NF system. Accordingly, the entire system calculation method will not be described here. It is also not intended to outline the process of the element-to-element computer calculation. However, the governing equations and parameters are given in Table 26.

In order to enable the determination of values for the terms A , ΔP , and $\Delta \pi$ in Eq. 45, the water permeation equation is expanded to Eq. 47. The permeate concentration can be derived from Eq. 46 after conversion into Eq. 57. The design equations are listed in Table 26, the symbol definitions in Table 28.

The subscript i in the equations of Table 26 indicates that they apply to the i^{th} element in a sequence of n elements in a series flow configuration. To accurately determine system performance, Eq. 47 is successively solved for each of the n elements starting with an inlet set of conditions. The solutions depend on mass balances around each element for salt (Eq. 51) and water (Eq. 57), as well as correlations for individual element parameters such as concentrate-side flow resistance, ΔP_{fc} (Eq. 60); temperature correction factor for water permeability, TCF (Eq. 53 and Eq. 54); polarization factor, pf_i (Eq. 55); and the membrane permeability coefficient for water, A_i (π_i) (Eq. 61, Eq. 62, and Eq. 63), which in the case of reverse osmosis membranes depends on the average concentrate concentration or, alternatively, osmotic pressure. These solutions usually involve a suitable average for the feed and permeate side hydraulic and osmotic pressures. For low recovery values typical of single element operation, an accurate solution can be obtained using a simple arithmetic average of the inlet and outlet conditions. Even so, since the outlet conditions are not known, iterative trial and error solutions are involved.

Table 26. Design equations for projecting RO system performance: individual element performance

Item	Equation	Equation Number
Permeate flow	$Q_i = A_i \bar{\pi}_i S_E (\text{TCF}) (\text{FF}) \left(P_{fi} - \frac{\Delta P_{fci}}{2} - P_{pi} - \bar{\pi} + \pi_{pi} \right)$	47
Average concentrate-side osmotic pressure	$\bar{\pi}_i = \pi_{fi} \left(\frac{C_{fci}}{C_{fi}} \right) (pf_i)$	48
Average permeate-side osmotic pressure	$\bar{\pi}_{pi} = \pi_{fi} (1 - R_i)$	49
Ratio: arithmetic average concentrate-side to feed concentration for Element <i>i</i>	$\frac{C_{fci}}{C_{fi}} = \frac{1}{2} \left(1 + \frac{C_{ci}}{C_{fi}} \right)$	50
Ratio: concentrate to feed concentration for Element <i>i</i>	$\frac{C_{ci}}{C_{fi}} = \frac{1 - Y_i (1 - R_i)}{(1 - Y_i)}$	51
Feedwater osmotic pressure	$\pi_f = 1.12 (273 + T) \sum m_j$	52
Temperature correction factor for RO and NF membrane	$\text{TCF} = \text{EXP} \left[2640 \left(\frac{1}{298} - \frac{1}{273 + T} \right) \right]; T \geq 25^\circ\text{C}$	53
	$\text{TCF} = \text{EXP} \left[3020 \left(\frac{1}{298} - \frac{1}{273 + T} \right) \right]; T \leq 25^\circ\text{C}$	54
Concentration polarization factor for 8 inch elements	$pf_i = \text{EXP}[0.7Y_i]$	55
System recovery	$Y = 1 - [(1 - Y_1)(1 - Y_2) \dots (1 - Y_n)] = 1 - \prod_{i=1}^n (1 - Y_i)$	56
Permeate concentration	$C_{pj} = B(C_{fci})(pf_i)(\text{TCF}) \frac{S_E}{Q_i}$	57

Entire System

Average values are used to calculate feed pressure and permeate quality if the feed quality, temperature, permeate flowrate and number of elements are known. If the feed pressure is specified instead of the number of elements, the number of elements can be calculated with a few iterations. Sample design equations for 8-inch reverse osmosis elements are listed in Table 27 and the symbols are defined in Table 28. It is recommended to use the WAVE design software for actual calculations.

Table 27. Design equations for projecting RO system performance: system average performance

Item	Equation	Equation Number
Total permeate flow	$Q = N_E S_E \bar{A} \bar{\pi} (\text{TCF})(\text{FF}) \left[P_f - \frac{\Delta P_{fc}}{2} P_p - \pi_f \right] \left[\frac{\bar{C}_{fc}}{C_f} p_f - (1 - \bar{R}) \right]$	20
Ratio: average concentrate-side to feed concentration for system	$\frac{C_{fc}}{C_f} = \frac{-\bar{R} \ln(1 - Y/Y_L)}{Y - (1 - Y_L) \ln(1 - Y/Y_L)} + (1 - \bar{R})$	21
Limiting system recovery	$Y_L = 1 - \frac{\pi_f (\bar{p}f)(\bar{R})}{P_f - \Delta P_{fc} - P_p}$	22
Approximate log-mean concentrate-side to feed concentration ratio for system	$\left. \frac{C_{fc}}{C_f} \right _{Y_L, \bar{R}=1} = -\frac{\ln(1 - Y)}{Y}$	23
Average element recovery	$Y_i = 1 - (1 - Y)^{1/n}$	24
Average polarization factor	$\bar{p}f = \text{EXP}[0.7\bar{Y}_i]$	25
Average concentrate-side osmotic pressure for system	$\bar{\pi}_i$	26
Average concentrate-side system pressure drop for 8-inch elements; 2 stages	$\Delta P_{fc} = 0.04 \bar{q}_{fc}^2$	58
	$\Delta P_{fc} = \left[\frac{0.1(Q/1440)}{Y N_{V2}} \right] \left(\frac{1}{N_{VR}} + 1 - Y \right)$	59
Individual 8-inch element, or single-stage concentrate-side pressure drop	$\Delta P_{fc} = 0.01 n \bar{q}_{fc}^{1.7}$	60
Membrane permeability as a function of average concentrate-side osmotic pressure	$\bar{A}(\bar{\pi}) = 0.125; \bar{\pi} \leq 25$	61
	$\bar{A}(\bar{\pi}) = 0.125 - 0.011 \left(\frac{\bar{\pi} - 25}{35} \right); 25 \leq \bar{\pi} \leq 200$	62
	$\bar{A}(\bar{\pi}) = 0.070 - 0.0001(\bar{\pi} - 200); 200 \leq \bar{\pi} \leq 400$	63
Permeate concentration	$C_p = B C_{fc} \bar{p}f (\text{TCF}) \left(\frac{N_E S_E}{Q} \right)$	64

Table 28. Symbol definitions

Q_i	permeate flow of Element i (gpd)	\sum_j	summation of all ionic species
$A_i\pi_i$	membrane permeability at 25°C for Element i , a function of the average concentrate-side osmotic pressure (gfd/psi)	Y	system recovery (expressed as a fraction) = permeate flow/feed flow
S_E	membrane surface area per element (ft ²)	$\prod_{i=1}^n$	multiplication of n terms in a series
TCF	temperature correction factor for membrane permeability	n	number of elements in series
FF	membrane fouling factor	Q	system permeate flow (gpd)
P_{fi}	feed pressure of Element i (psi)	N_E	number of elements in system
ΔP_{fc_i}	concentrate-side pressure drop for Element i (psi)	\bar{Q}_i	average element permeate flow (gpd) = Q/N_E
P_{pi}	permeate pressure of Element i (psi)	$\bar{A}\pi$	average membrane permeability at 25°C: a function of the average concentrate-side osmotic pressure (gfd/psi)
$\bar{\pi}_i$	average concentrate-side osmotic pressure (psi)	\bar{C}_{fc}	average concentrate-side concentration for system (ppm)
π_{fi}	feed osmotic pressure of Element i	\bar{R}	average fractional salt rejection for system
π_{pi}	permeate-side osmotic pressure of Element i (psi)	$\bar{\pi}$	average concentrate-side osmotic pressure for system (psi)
pf_i	concentration polarization factor for Element i	$\Delta \bar{P}_{fc}$	average concentrate-side system pressure drop (psi)
R_i	salt rejection fraction for Element i = $\frac{\text{feed conc.} - \text{perm. conc.}}{\text{feed conc.}}$	Y_L	limiting (maximum) system recovery (expressed as a fraction)
C_{fc_i}	average concentrate-side concentration for Element i (ppm)	\bar{Y}_i	average element recovery (expressed as a fraction)
C_{fi}	feed concentration for Element i (ppm)	\bar{pf}	average concentration polarization factor
C_{ci}	concentrate concentration for Element i (ppm)	\bar{q}_{fc}	arithmetic average concentrate-side flowrate (gpm) [= (1/2)(feed flow + concentrate flow)]
Y_i	recovery fraction for Element i = $\frac{\text{permeate flow}}{\text{feed flow}}$	N_V	number of six-element pressure vessels in system ($\approx N_E/6$)
π_f	treated feedwater osmotic pressure (psi)	N_{V1}	number of pressure vessels in first stage of 2-stage system ($\approx 1/3 N_V$)
T	feedwater temperature (°C)	N_{V2}	number of pressure vessels in second stage of 2-stage system ($\approx N_V/3$)
m_j	molal concentration of j^{th} ion species	N_{VR}	stage ratio ($\approx N_{V1}/N_{V2}$)

3.13 Testing

For the desalination of standard waters with a defined origin and composition, system performance can be projected with sufficient accuracy by using a computer program such as WAVE. However, in some cases, testing is recommended to support the proper system design. These include:

- Unknown feedwater quality
- Unknown variation of feedwater quality
- Special or new applications, e.g., process or wastewater effluents
- Special permeate quality requirements
- Extremely high system recoveries (> 80%)
- Large plants > 13,250 m³/d (3.5 mgd)

Testing is typically carried out at different levels:

3.13.1 Screening Test

The goal of a screening test is to select the appropriate membrane for the desired separation and to obtain a rough idea about the flux (L/m²h or gfd) and rejection properties of the membrane. A small piece of flatsheet membrane is mounted in a “cell” and exposed to the test solution using the crossflow mechanism. The method is fast, inexpensive, and requires only small quantities of test solution. However, a screening test cannot provide engineering scale-up data and long-term effects of the test solution on the membrane, nor does it provide data on fouling effects of the test solution.

3.13.2 Application Test

The application test provides scale-up data such as permeate flux and permeate quality as a function of feed pressure and system recovery. The test typically involves the evaluation of a 50 – 200 L (15 – 60 gal) sample solution, using a 2540 (2.5-inch x 40-inch) or 4040 (4.0-inch x 40-inch) sized element. The element is mounted in a test system with engineering features that allow adjustments to the feed flow, feed pressure, and feed temperature in the ranges of the element operating limits.

Determining Operating Pressure

The optimum operating pressure is determined by adjusting the feed pressure until the desired permeate quality and permeate flux rate are obtained [typically between 10 – 34 L/m²h (6 – 20 gfd)]. Sufficient feed flow should be maintained to ensure a low recovery rate (< 5%) as the membrane flux rate is increased. Permeate and concentrate streams are recycled back to the feed tank during this first test. The feed pressure at which the optimum permeate flux and permeate quality is obtained is the feed pressure used for the second test, determining the recovery rate.

Determining Concentration Factor/Recovery Rate

To aid in the determination of the maximum single-element recovery rate (permeate flow/feed flow) the second test is run in batch mode. This is done by directing the permeate stream into a second container while returning the concentrate stream to the feed tank. Both the permeate flow and permeate quality are monitored during the test. The test is stopped when the permeate flowrate has declined to an uneconomically low value or permeate quality has declined below acceptable limits. The concentration factor (CF) is then calculated by dividing the original feed volume by the remaining feed volume. The recovery rate is calculated by subtracting the remaining feed volume from the original feed volume and then dividing by the original feed volume.

Repeating the batch test will give an indication of membrane stability and fouling effects. However, long-term performance, including the assessment of cleaning procedures, can only be obtained by pilot tests.

3.13.3 Pilot Tests

A pilot test is typically run in the field on the intended feed stream in a continuous operation mode. The pilot plant should have at least one element (40-inch length is recommended). Preferably the arrangement of elements will be similar to that of the large-scale system. The permeate flow of the pilot plant should be at least 1% of the large-scale plant and should be run for a minimum of 30 days. The objective is to confirm the system design and to fine-tune operating parameters as well as to minimize the risk in large projects.

3.14 System Components

3.14.1 High Pressure Pump

The pump discharge pressure has to be controlled to maintain the designed permeate flow and not exceed the maximum allowed feed pressure, which is:

- 41 bar (600 psi) for brackish water and nanofiltration elements
- 69 bar (1,000 psi) for standard seawater elements
- 82 bar (1,200 psi) for high-rejection seawater elements

See the latest product data sheet for the candidate element to verify the correct limit.

A **positive displacement pump** cannot be throttled, so feed pressure is controlled by a backpressure valve in a bypass line from the pump discharge to the pump suction. A pulsation damper (accumulator) on the pump discharge line is used to minimize pressure surges. A relief valve is intended to ensure that the maximum allowed pressure will not be exceeded.

A **centrifugal pump** is controlled with a throttling valve on the discharge line. Fixed speed motors are used with centrifugal pumps for most membrane systems. Using a variable speed motor is an energy-saving alternative, although the cost is higher. Variable speed motors should be considered when there is greater than 5°C difference between the low and high feed-water temperatures.

In seawater systems, typically 55 – 60% of the pressurized feedwater exits the system with about 60 bar (870 psi) pressure in the concentrate stream. This energy can be recovered to decrease the specific energy demand of the system. Energy recovery methods are:

- Pelton wheel
- Reverse turning turbine
- Piston-type work exchanger

The high-pressure concentrate is fed into the energy recovery device where it produces a rotating power output. This is used to assist the main electric motor in driving the high-pressure pump. Compared to traditional pump drives, the energy recovery system represents energy savings up to 40%.

3.14.2 Pressure Vessels

Pressure vessels are available with different diameters, lengths, and pressure ratings. When selecting a pressure vessel, the chosen pressure rating must be high enough to allow for a pressure increase to compensate for irreversible fouling (typically 10% more than needed in a 3-year design).

When dynamic permeate backpressure is employed during plant operation, the limiting component for some pressure vessels is the permeate port. Materials such as polyvinylchloride (PVC) are used for the permeate port on many pressure vessels. The permeate pressure rating is a strong function of temperature, as shown in Table 29. Please consult with the manufacturer of the pressure vessel for details on the specific vessel. Note that at static conditions, i.e., with the high-pressure pump shut down, permeate backpressure must never exceed 0.3 bar (5 psi).

Table 29. Maximum dynamic permeate backpressure for pressure vessels with FilmTec™ Elements

Maximum dynamic permeate backpressure			
Temperature (°F)	Temperature (°C)	psi	bar
113	45	145	10.0
104	40	180	12.4
95	35	219	15.1
86	30	257	17.7
77	25	299	20.6
68	20	338	23.3

3.14.3 Shutdown Switches

The membrane elements must be protected against extreme operating conditions. If there is a possibility that such conditions can occur, for example, by a pretreatment upset, provisions must be made so that the membrane system is shut down to prevent damage.

Some extreme operating conditions and the provisions to prevent these are listed in Table 30.

Table 30. Provisions against undue operating conditions

Extreme operating condition	Provision
Too high feed pressure	High pressure shutdown switch in the feed line
Insufficient feed pressure	Low pressure shutdown switch in the pump suction line
Too high feed temperature	High temperature switch in the feed line
Permeate pressure exceeding feed by more than 0.3 bar (5 psi)	Pressure relief mechanism in the permeate line
Too high concentration of colloidal matter in the feed	Turbidity control in the feed line
Too high concentration of sparingly soluble salts in the feed	Dosing pumps for acid and antiscalant should be electrically interlocked with the feed pump drive High pH shutdown switch
Oxidizing agents in the feed	ORP (Oxidation Reduction Potential) control in feed line or chlorine detection monitor with automatic shutdown
Oil in the feed	Oil detector in feed line

3.14.4 Valves

The following valves are typically included in a membrane system:

- Feed inlet valve to shut down the plant for maintenance and preservation.
- Valve on the pump discharge line or bypass line to control feed pressure during operation and feed pressure increase rate during start-up.
- Check valve on pump discharge line.
- Check valve and atmospheric drain valve on permeate line to prevent permeate pressure from exceeding the feed pressure.
- Flow control valve on the concentrate line to set the recovery.
- Valve in the permeate line to provide permeate drain during cleaning and start-up.
- Valves in the feed and concentrate lines (and between stages) to connect a clean-in-place system.

3.14.5 Control Instruments

To ensure proper operation of the RO or NF system, a number of control instruments are necessary. The accuracy of all instruments is critical. They must be installed and calibrated according to manufacturer's instructions.

- Pressure gauges to measure the pressure drop across the cartridge filter, the pressure on the pump inlet line and discharge line, the feed pressure to the membrane element(s), the pressure drop between feed and concentrate of each stage, and eventually the pressure in the permeate line. Liquid-filled gauges should contain membrane-compatible fluids such as water in place of oils or other water-immiscible liquids.
- Flow meters to measure concentrate and total permeate flowrate, also permeate flowrate of each stage.
- Water meters in the permeate and feed line to log the total water volume treated and produced.
- Hour meter to log the total operating time.
- pH meter in the feed line after acidification to measure carbonate scaling potential.
- Conductivity meters in the feed line, concentrate line and permeate line to determine permeate quality and salt rejection.
- Sample ports on the feed, concentrate and permeate (total permeate and permeate of each stage) to enable evaluation of system performance. A sample port on each pressure vessel permeate outlet is recommended to facilitate troubleshooting.

3.14.6 Tanks

Storing water in tanks should generally be kept at a minimum. When tanks are used, the inlet and outlet should be placed such that no stagnant zones are permitted. The tanks should be protected from dust and microbiological contamination. In critical applications tanks are closed and vented through a HEPA-filter.

A **feed tank** is needed to provide the reaction time (20 – 30 min) when chlorine is used. The free volume of media filters can be used for this purpose as well. Feed tanks are also frequently used as a buffer to allow continuous operation of the RO or NF system (e.g., during backwash of filters). Systems that are operated in the batch or semi-batch mode require a feed tank.

A **permeate tank** is typically employed when the permeate is the product. Plant start-ups and shutdowns are initiated by low-level and high-level signals from the permeate tank. The system capacity and the tank size should be designed so that the RO or NF plant is allowed to run for several hours continuously. The less frequently the plant is shut down, the better the system performance. For high-purity water systems, a nitrogen blanket can be employed to prevent atmospheric CO₂ from dissolving into the water.

A **draw-back tank** is a small tank in the permeate line that provides enough volume for natural osmosis back-flow when the system shuts down. It is typically employed in seawater systems, but not in brackish water systems. An empty draw-back tank can cause air to be sucked back into the elements. This may create the following problems:

- Contamination of the permeate side of the membrane by airborne microbes and fungi.
- Hydraulic shocks and slugs of air that upset meters and set point controllers when the air is expelled from the system on the next start-up.
- Drying of the membrane (flux loss).
- If the feedwater is in a reduced status and contains H_2S , Fe^{2+} , Mn^{2+} , etc., the air intrusion may cause fouling of the membrane by oxidized and precipitated colloidal matter (see Section 2.11 *Treatment of Feedwater Containing Hydrogen Sulfide*).

If the product water from an RO system is chlorinated, care must be exercised to ensure that the chlorine does not migrate back to the membrane. Air breaks should be employed appropriately.

If a draw-back tank is used, its water level should be higher than the highest pressure vessel, but not exceeding 3 m (9.8 ft) from the lowest vessel. To prevent contamination, the flow is in at the bottom and out at the top, and the tank must be covered. Post-chlorination, if performed, must be done downstream of this tank.

The volume of a draw-back tank can be sized as follows:

$$V_{DBT} = (25T_E) - V_{PP}$$

where:

V_{DBT} = Volume of draw-back tank (in liters)

T_E = Number of installed elements

V_{PP} = Volume of permeate piping between pressure vessels and draw-back tank (in liters)

Dosing tanks are required when chemicals are added to the feedwater. They should be sized typically for a daily refill.

A **cleaning tank** is part of the equipment described in Section 6.1, *Cleaning and Sanitization*.

Optional Equipment

Various optional equipment and features are useful in operating and monitoring the system:

- A shutdown flush system flushes the feed-concentrate line with pretreated feedwater or with permeate after shutdown. When antiscalants are used, a flush system is mandatory.
- Alarms for
 - High permeate conductivity
 - High concentrate conductivity
 - Low feed pH
 - High feed pH
 - High feed hardness
 - High feed temperature
 - Low level in dosing tank

- Continuous recorder for
 - Feed temperature
 - Feed pH
 - Feed and permeate conductivity
 - Feed SDI
 - Feed ORP
 - Feed, permeate, and concentrate pressure
 - Permeate and concentrate flow

Ideally, a monitoring system is installed that allows on-line recording and processing of the important operating data of the system. More information is available in Section 5.6.1, *Record Keeping*.

Additional considerations include:

- Automation for soft-start motor control
- Automation for filter backwash, membrane cleanings, and plant flush outs
- Clean, dry air system including compressor, air dryer, air control stations, and complete pipe systems
- Spare parts for 1 or 2 years of normal operation
- Tools for general and special services.
- Options such as training, supervision, and maintenance.

3.15 Materials of Construction, Corrosion Control

From a corrosion point of view, a very harsh environment exists in an RO water desalination plant. Hence, the materials of construction must possess a certain degree of corrosion resistance. This is true for both the exterior parts exposed to spillage and a humid and saline atmosphere as well as for the interior of the system exposed to the wide variety of waters treated.

Although not to be underestimated, the control of exterior corrosion can usually be overcome by using a surface coating (painting, galvanizing, etc.) on materials likely to corrode (mild steel, cast iron, etc.) and by establishing a maintenance program involving periodical flush-down and cleaning, repair of leaks, etc.

Selecting materials of construction for the interior wetted system is a far more complicated task. Apart from being compatible with the pressures, vibrations, temperatures, etc., existing in an RO system, the materials must also be able to withstand potential corrosion attacks caused by the high chloride content of the feedwater and concentrate stream, the aggressive product water, and the chemicals used for applications such as membrane cleaning.

Application of nonmetallic materials such as plastics, fiberglass, etc., are widely used for preventing corrosion and chemical attacks as well in the low-pressure (< 10 bar or 145 psi) part of the RO system, as in the RO elements and pressure vessels. However, it is usually necessary to use metals for the high-pressure (10 – 83 bar or 145 – 1,200 psi) parts such as pumps, piping, and valves. Carbon and low alloy steels do not have sufficient corrosion resistance, and their corrosion products can foul the membranes.

Lined piping is usually not a realistic alternative because of the often compact piping design and relatively great amount of connections and fittings needed. **Al-bronze** can be an alternative for pumps, etc., but the risk of erosion corrosion and chemical attacks must be taken into account. The most relevant material to be used for the high-pressure parts is **stainless steel**.

The basic advantage with stainless steel is that it is very resistant to general corrosion and erosion corrosion. Stainless steel is rarely attacked by galvanic corrosion, but it will influence the attack on the other metal in a two-metal couple (e.g., copper, brass, etc.). Stress corrosion cracking of stainless steels in media containing chloride rarely occurs below 70°C (158°F) so it does not need to be considered in an RO desalination plant.

Unfortunately, some stainless steels are prone to pitting and crevice corrosion in the waters occurring in an RO plant. Pitting means localized attacks that result in holes in the metal. Pitting occurs where the passive film formed by chromium oxides breaks and chlorides can attack the bare metal. Crevice corrosion is pitting associated with small volumes of stagnant water caused by holes, gasket surfaces, deposits, and crevices under bolts, etc. In order to avoid pitting and crevice corrosion in the RO water desalination plant, the following recommendations can be given:

RO Plants with Concentrate Stream TDS below 7,000 ppm

Stainless steel type AISI 316 L with < 0.03% C is the minimum demand for the pipe system because lower grade stainless steels with higher carbon content will suffer from pitting in the welding zones (intergranular corrosion). For non-welded parts, stainless steel type AISI 316 is usually acceptable.

RO Plants with Concentrate Stream TDS higher than 7,000 ppm

Stainless steel type 904 L is recommended for pipes and bends for welding and for similar parts without crevices. Where crevices occur, such as at flange connections, in valves, in pumps, etc., stainless steel type 254 SMO or similar with ≥ 6% Mo is recommended. These two higher alloy stainless steels can be welded together without risking galvanic corrosion. Sensor elements of instruments may be coated or lined. The composition of the named stainless steels is given in Table 31.

Table 31. Composition of stainless steels

Usual designation	UNS No.	C%	Cr%	Ni%	Mo%	Cu%	N%
AISI 316	S 31600	< 0.08	16.0 – 18.0	10 – 14	2.0 – 3.0	—	—
AISI 316L	S 31603	< 0.03	16.0 – 18.0	10 – 14	2.0 – 3.0	—	—
904 L	N 08904	< 0.02	19.0 – 23.0	23.0 – 28.0	4.0 – 5.0	1.0 – 2.0	—
254 SMO	S 31254	< 0.02	19.5 – 20.5	17.5 – 18.5	6.0 – 6.5	0.5 – 1.0	0.18 – 0.22

Besides the above recommendations, general precautions must be taken during design and construction, such as:

- Design with a minimum of crevices and dead ends.
- Design the piping so that the flow velocity is above 1.5 m/s (5 ft/s). This promotes the forming and maintenance of the passive film.
- Use backing gas when welding in order to avoid the weld oxide film forming a base for crevice corrosion.
- Pickle and passivate the pipe system as this gives the optimum safety against chloride attack.
- Flush the plant with low TDS water before a shutdown period.

3.16 System Design Considerations to Control Microbiological Activity

Biofouling is one of the most common and most severe problems in the operation of RO systems. It is particularly important to control microbiological activity in plants using surface water or bacteria-contaminated water as a feed source. A properly designed system is a prerequisite for success:

- If intermediate open basins or tanks are used, provisions should be made to allow for proper sanitization at that open source and the part of the system downstream from it.
- If intermediate sealed tanks are used, their air breathing or ventilation systems should be equipped with bacteria-retaining devices (e.g., HEPA filters).
- Dead legs in the piping should be avoided by design, and when unavoidable, should be periodically sanitized.

- The components of the pretreatment system such as pipes, manifolds, filters, and retention tanks should be opaque to sunlight to avoid enhancing the biological growth.
- Stand-by devices with large surfaces, such as sand or cartridge filters, should be avoided. If they are not avoidable, drains should be installed to allow discharge of the sanitization chemicals after the devices have been sanitized, and before connecting them to the active system.
- It should be made possible to physically isolate the RO/NF section from the pretreatment by using a flange. This allows the use of chlorine for sanitizing the pretreatment section while the membranes are protected from chlorine contact. A drain valve should be installed at the lowest point close to the flange, to allow complete drainage of the chlorine solution.
- Element selection: Elements are available with features that include a special surface combined with a feed spacer thickness and/or geometry that makes them more resistant against biofouling. These fouling-resistant elements are typically selected for surface waters and tertiary effluent treatment. Other special element types are made with a fullfit configuration for applications requiring sanitary-grade membrane elements. The fullfit configuration minimizes stagnant areas and complies with FDA standards. See also Section 1, *Basics of Reverse Osmosis and Nanofiltration*, and the relevant Product Data Sheets.

3.17 System Design Suggestions for Troubleshooting Success

When considering the design and purchase of large membrane systems, there are a number of possible equipment designs and additions that can be added to help with future troubleshooting. Depending on the size and complexity of the system, some or all of these suggestions could be discussed with your system supplier. None are required for successful operation, but all make day-to-day operation and troubleshooting easier, quicker, and more effective.

Access to Load and Troubleshoot the System

Even though membrane systems are quite compact, there is often a temptation to save even more floor space by crowding equipment, pipelines, and supports so close together that access to the membrane system is limited. Ideally, one should have unrestricted access to both the feed and brine end of each and every vessel for loading, unloading, and troubleshooting of the membrane elements. When loading, at least the length of one element is necessary between the feed end of the vessels and the nearest equipment or support. When unloading, often more room could be used so that a large wooden board or some other device can be used to push the element stack toward the brine end.

Connections Allowing Probing, Profiling, and Sampling

When troubleshooting potential element problems, one of the first operations is always to attempt to localize any problem, either to a stage, a vessel, or even to an element. Having sample points on all the vessel permeate lines greatly facilitates these operations. Ideally, the permeate sample points can allow a probe tube to be passed through. Having additional sample points on the feed, the concentrate, and any inter-stage headers, can help localize problems to a stage and even allow for mass balance measurements to corroborate flow measurements and ultimately setting of the system recovery.

To control the microbiological activity, adequate sampling points should be provided to make a microbiological balance and control in the plant possible. The minimum number of sampling points required are listed below:

1. Intake (surface or well), before chlorination if any
2. After a clarifier, settling pond, sludge contact unit, or similar sedimentation process.
3. After filtration units (sand, multimedia, activated carbon, or other)
4. After dechlorination (normally after cartridge filtration)
5. Concentrate stream
6. Permeate stream

Instrumentation to Allow Performance Monitoring by Stage

Beyond simple sample points, the next step in system sophistication is to instrument the stages so that performance data can be gathered and normalized, showing day-to-day variation in the system performance against a reference condition such as start-up. Adequate instrumentation means having conductivity or TDS measurements, pressure measurements, temperature measurements, and flow measurements on the feed, concentrate, and permeate of each stage. Given this data, performance of the stage can be monitored and early signs of trouble can be easily detected from the normalized data. Even though a mass balance around the system can be used to eliminate some of the instrumentation, having all the instrumentation means that the mass balance can be used to test the internal consistency of the data and, thus, monitor the performance of the instruments.

Real-Time Online Normalization

In terms of system monitoring, online instruments feeding an ongoing and continuous normalization program is the ultimate. For very large systems, or for systems with highly variable feed conditions, real-time control may be warranted.

Provisions to Clean Each Stage Individually

Many large systems are provided with clean-in-place (CIP) systems. By providing sufficient piping and valving to clean each stage of a system individually, the cleanings will be more effective. Cleaning multiple stages together means that dirt, debris, biomass, and scale must be pushed from the first stage and through subsequent stages before exiting the system. CIP systems should also provide adequate flowrates for effective cleanings. CIP systems should also be capable to heat the cleaning solutions.

Permeate Flushing Capability

A potential system feature that can lower the frequency of cleanings is to provide for periodic permeate flushing of the system. Permeate flushing is accomplished by recycling permeate or product water through the system at a high rate to loosen and push out foulant layers before they adhere to the membrane surface. This capability is especially useful in systems handling treated wastewater.

SDI Measurement Device and Connection Points in the System

An SDI instrument is a great diagnostic tool, especially for the pretreatment end of a system. Like profiling and probing the elements can localize a potential membrane problem, an SDI instrument with connections throughout the pretreatment system can help quickly localize pretreatment problems.

Wet Lab at the Plant Site

Having the capability to do laboratory work at the plant site means that water analyses can be more easily monitored, especially for setting up and maintaining pretreatment chemical additions.

Single Element Test Unit

Having a single element test unit at the plant can be a real advantage. Suspect membrane elements can be quickly tested and judged as good or bad. In addition, cleaning strategies can be tested and proven on fouled elements before applying them on whole stages of the plant.

4 Loading of Pressure Vessels

This section provides guidelines for loading and unloading FilmTec™ Reverse Osmosis (RO) and Nanofiltration (NF) Elements. For additional loading instructions, contact the individual pressure vessel manufacturer.

4.1 Preparation

A schematic diagram of the RO system should be prepared for recording pressure vessel and element locations. It should show the entire piping system for the skid as well. To identify individual element locations, use the FilmTec™ serial numbers written on each label. This diagram will help you keep track of each individual element in the system.

The following equipment is recommended:

- Safety shoes
 - Safety glasses
 - Rubber gloves
 - Silicone lubricant (Molykote® 111 Compound recommended)
 - Allen wrench
 - Clean rags
 - Glycerin
 - Hose and water to flush vessel
 - Sponge/swab, long stick and rope to clean vessel
1. Load FilmTec™ Elements into the pressure vessels just prior to start-up.
 2. Before assembling all components, check the parts list and make sure all items are present and in the right quantities.
 3. Carefully remove all dust, dirt, and foreign matter from the pressure vessels before opening.
 4. Remove all end cap assemblies and thrust rings (if provided) from all pressure vessels in the train or system.

Note: There are several manufacturers of pressure vessels used for spiral-wound nanofiltration and reverse osmosis elements. Refer to the manufacturer's drawing for your pressure vessel during removal and installation of end cap assembly.

5. Spray clean water through the open pressure vessels to remove any dust or debris present in the vessels.

Note: If additional cleaning is required, create a swab large enough to fill the inside diameter of the pressure vessel. Soak the swab in a glycerin/water solution (50 vol%) and move it back and forth through the pressure vessel until the vessel is clean and lubricated.

4.2 Element Loading

1. Install the thrust ring in the concentrate discharge end of the vessel. Consult the manufacturer's drawing for specific information on the thrust ring positioning. This has to be done before the loading of any elements, there is a risk of not installing it properly.
2. You need to verify whether you are installing iLEC™ (Interlocking Endcap) or standard elements which require the use of a supplied interconnect.

3. It's recommended to stage the elements prior to loading and record each serial number by position so that in the future you will know where each element is located inside the pressure vessel.
4. Place the leading end of the first RO or NF element into the feedwater end of the first pressure vessel and slide it in approximately one-half of the element length. *Note:* Always load NF or RO elements into the feedwater end of the pressure vessel. Verify that the U-cup brine seal is properly seated in the end cap groove of the element such that the brine seal opens in the upstream direction.
5. To Load Standard elements: Lubricate the O-ring seals on the interconnector and the inside of the product water tube with a very thin layer of silicone lubricant. Install the interconnector into the permeate tube of the element. Glycerin may be used but is not recommended. Although glycerin lubricates during the initial installation, it quickly washes out during normal operation. Experience has shown that using a silicone lubricant applied sparingly to the bore of 8-inch elements or the permeate water tube outer sealing surface for 4-inch and 2.5-inch elements maintains the desired lubricity long after the initial start-up. For potable water and food processing applications, the silicone lubricant DuPont Corning® 111 valve lubricant and sealant, which carries both FDA and NSF approval, works quite well.
 - a. Apply a thin layer of silicone lubricant to each brine seal. When silicone is applied, as each element is installed and pushed into position this will act as a lubricant on the inside of the pressure vessel which will remain during the operation of the system making removal much easier.
 - b. Lift the next element into position and install the trailing end on the interconnector. Be very careful to hold the next element so that the weight is not supported by the interconnector, and push the element into the pressure vessel until about one-half of the element extends outside the vessel.

To load *iLEC*™ elements: A special tool is recommended which is called a ratcheting band clamp which can be ordered directly from FilmTec™. The band clamp has a heavy-duty strap that grips the element securely but will not damage the element outer shell. The band clamp is lightweight, durable, and safe. It will successfully hold the element in place no matter what substance may be on the outer fiberglass shell. *Note:* *iLEC* elements can be connected to the end plug, one of two ways, one being a special *iLEC* adapter, the other is with a standard PV adapter. It is pressure vessel manufacturer dependant, there are slight differences in each manufacturers endplug so it's essential to make sure when the parts are ordered and prior to installation.

- a. Insert the first element, downstream end first, and push it into the vessel in the same direction as the feedwater flow. Leave enough of the element protruding from the vessel to allow attachment of the ratcheting band clamp. This is a good time to check the condition of the O-ring.
- b. *iLEC* elements with *iLEC* adapters – Attach the downstream *iLEC* adapter to the male side of the first installed (last position) element and apply a very thin layer of silicone lubricant. Begin inserting the element into the vessel leaving enough of the element protruding out for the attachment of the ratcheting band clamp.
- c. Attach the second element, taking care to hold the element horizontal when applying clockwise torque. Rather than gripping the outer shell, apply torque by gripping the spokes on the upstream endcap with one hand, while supporting the element with the other hand. The ratcheting band clamp should be secured to prevent rotation.
- d. After the elements are snapped together, verify that the markings are properly aligned.
- e. By the time the third or fourth element has been installed, the ratcheting band clamp may be unnecessary. The band clamp is only required until friction generated by the installed elements is greater than the force required to snap the elements together.
- f. Push the elements deeper into the vessel. Repeat this process until all of the elements have been installed in the vessel. *Note:* On *iLECs* after connecting the last element, install the other *iLEC* adapter to the female end of the element.

Repeat these steps until all elements are loaded into the pressure vessels. The number of elements loaded into an individual vessel will depend on the length of the elements and the vessel itself. *Note:* Do not push the elements in too far, if you do, then the end plate may not fit properly and the elements may have to be reinstalled.

6. Install the downstream end cap assembly on each end of the pressure vessel:
 - a. Carefully position the downstream end cap assembly in the vessel and push the end cap assembly as a unit squarely into the end of the element. Use care when seating the O-ring seal on the adapter into the element and avoid pinching or rolling O-rings. *Note:* Make sure that the O-rings and product water tube are lubricated.
 - b. Rotate the end cap assembly to ensure proper alignment with the connecting piping.
 - c. Replace the hardware, sealing the end cap assembly in place. Refer to the pressure vessel manufacturer's drawing.
7. Push the element stack from the feed end (upstream) towards the downstream end.
8. After the elements have been installed, it may be necessary to add shims to reduce the amount of space between the face of the lead element and the face of the adapter hub. The vessel adapter internally connects the element product water tube with the permeate port on the pressure vessel. This procedure helps prevent movement and hammering of elements when the system starts and shuts down. Please refer to Section 4.3 for additional detail. Continue these steps for each pressure vessel in the train or system.
9. Install the feed end cap assembly on each of the pressure vessels like the downstream end cap assembly. Close each pressure vessel with the parts from the same vessel. Re-install any piping that was previously removed for element loading.

4.3 Shimming Elements

Pressure vessels for membrane elements are all built with a tolerance to allow for slight variations in the length of the elements. This is referred to as freeboard. In operation, the elements can slip back and forth during start-up and shutdown, causing wear to the internal seals. Additionally, the pressure vessel elongates when pressurized, which in the most extreme case could push the whole stack of elements off of the lead end adapter, resulting in a severe feed-to-permeate leak. Shimming the elements in a pressure vessel at the time they are loaded will minimize the shifting that occurs during start-ups and shutdowns and ensures that the adapters are properly seated in the permeate tubes of the lead and tail elements.

Shims themselves are plastic spacer rings (like washers), usually about 0.20 inches (5 mm) thick with an inside diameter slightly larger than the pressure vessel head end of the adapter. Figure 1 shows a drawing of a typical shim and the placement of multiple shims on the adapter between the adapter hub and the pressure vessel head. Shims are always placed on the feed end adapter, keeping the stack of elements tight against the thrust ring and end plug on the brine end of the pressure vessel.

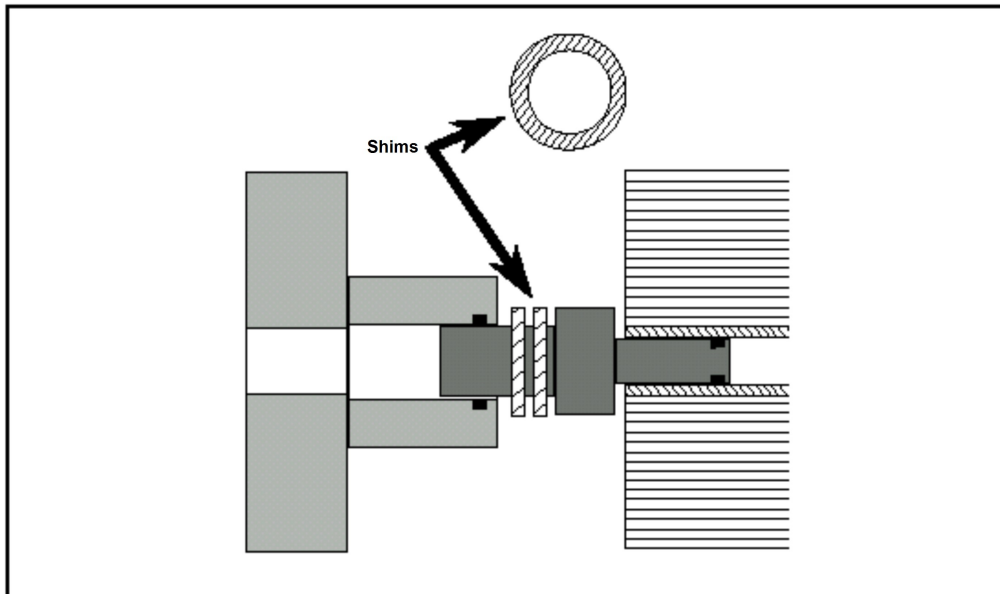

Figure 42. Shim and placement on vessel adapter at feed end of pressure vessel.

Shims can be purchased from your pressure vessel manufacturer. An alternative is to cut shims from an appropriately sized piece of polyvinylchloride (PVC) pipe. If cut from pipe, the shims must be free of burrs and must be cut parallel and flat to work correctly.

Shimming at Elevated Temperatures

Even if the elements are operated within the recommended pressure and temperature limits, a slight shortening of the elements may occur over time. For this reason, when operating at pressures above 600 psi (42 bar) together with temperatures above 40°C (104°F), regardless of the maximum pressure and temperature limits recommended, it is necessary to monitor the gap available for shims inside representative pressure vessels.

When operating at temperatures above 40°C (104°F), a disciplined monitoring program is required. This is done by opening representative pressure vessels and inspecting the length available for shims on the feed-end vessel adapter. The maximum length available for shims must not exceed 2 cm (0.8 inches). It is recommended to check 3 to 5 vessels in each stage of each train, or all of the vessels when 3 or fewer vessels are present. Checking once per week upon initial exposure to temperatures above 40°C (104°F) is recommended, with frequency decreasing rapidly once the data demonstrate little or no change.

During extended operation at temperatures above about 42°C (108°F), proper shimming may require more space for shims than is available on the end of the feed-end vessel adapter. When planning for these conditions, ask your vessel supplier about the availability of longer adapters for your vessel.

Important Note Regarding Your Warranty: Failure to maintain proper shimming will void your element warranty. Refer to your governing document – either product data sheet, element warranty, or system warranty – for the operating limits and additional voiding conditions that apply to your elements.

How to Shim

The process of shimming is performed after the membrane elements have been loaded. The element stack should be pushed completely into the vessel such that the downstream element is firmly seated against the thrust ring at the brine end of the vessel. Refer to the pressure vessel manufacturer's instructions on loading elements. From this point the procedure is as follows:

1. Remove the adapter O-ring and head seal from the feed end of these vessel components. This will assure that there is no interference from any of the sealing components and minimize the force required to "seat the head."
2. Remove the end plate and slide spacers over the head end of the adapter that fits into the permeate port. Add enough spacers so it is not possible to install the retaining rings after seating the head.
3. Remove one spacer at a time until you can just install the retaining rings. The slight remaining movement is acceptable.
4. Remove the head and reinstall the adapter O-ring and head seal.
5. Close the vessel according to the manufacturer's instructions.

4.4 Element Removal

Standard elements: Two operators are recommended when removing NF or RO elements from a train or system. Remove the element from each pressure vessel as follows:

1. Disconnect the hard plumbing at each end of the pressure vessel. Refer to the vessel manufacturer's drawing as required. Mark or tag all removed items for return to the same location. *Note:* Numbering of the endplates and reinstalling in the same vessel is very important, this makes reinstallation much easier and all the connections will line up properly.
2. Remove the heads assemblies from each end of the pressure vessel.
3. Push the NF or RO elements from the pressure vessel in the same direction as feedwater flows. Push the elements out one at a time. Support each element as it is being pushed out of the vessel until the element is free of the pressure vessel.

iLEC™ elements: With the vessel endplug removed, the downstream vessel adapter can be disconnected. This is done by reaching into the vessel and applying counter-clockwise torque to the downstream adapter.

1. Attach the optional pulling tool with a clockwise twisting motion
2. Pull the stack of elements far enough out of the vessel so that the first element can be safely removed.

Remember, elements may become disconnected inside the vessel during unloading, so use caution when pushing or pulling elements from the vessel.

3. With the element supported, de-couple the element with a counter-clockwise twist. Sometimes, it works best to face away from the vessel when unlocking.
4. Repeat this operation until the vessel is emptied. As an alternative to pulling the elements from the vessel, the entire stack can be pushed from the opposite end of the vessel with a push rod, or with replacement elements.

4.5 Interconnector Technology for 8-inch Diameter FilmTec™ Elements

The interconnector between two membrane elements is a critical item in the overall performance of a reverse osmosis or nanofiltration system. The interconnector conducts the low pressure product water from element to element and ultimately out of a pressure vessel while keeping it separate from the high pressure feed and brine solutions. The interconnector must therefore be strong enough to withstand the pressure of the feed as well as provide a perfect seal between the feed and product water.

4.5.1 New Interconnector Advantages

The “dog bone” interconnector offers three advantages over previous generations of interconnectors. The first advantage is that total seal area of the dog bone interconnector is the same as the old 4 O-ring interconnector. It is the same because the O-rings used are twice the cross-sectional diameter and the groove proportions are the same. Additionally, because the seal footprint is larger with one large O-ring, the seal is more likely to bridge defects in the sealing surface. Having one large footprint seal is an advantage over two small footprint seals. Figure 43 is a scaled drawing of two smaller O-rings and one larger O-ring having twice the cross-sectional diameter.

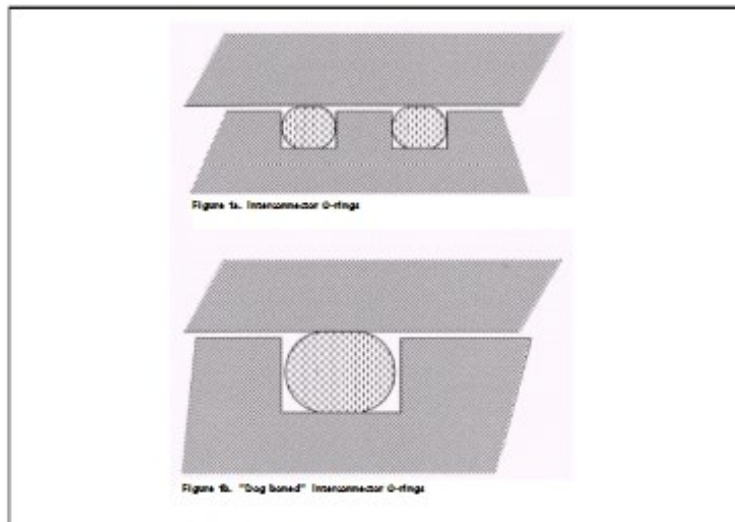

Figure 43. O-ring cross-section of 2 O-ring and “dog-boned” interconnector ends

The second advantage of the “dog boned” interconnector is that it allows for misalignment of the product water tubes of elements. The product water tube ends do not naturally line up because one end of the element has a brine seal while the other does not. The brine seal naturally centers one end of the element in the pressure vessel while the end without the brine seal sags in relation. Figure 44 illustrates the potential misalignment of two elements and shows the enlargement of the interconnector alone. Because the interconnector has only one O-ring on each end and is narrow in the middle, it is free to pivot and correct for misalignment of product water tubes.

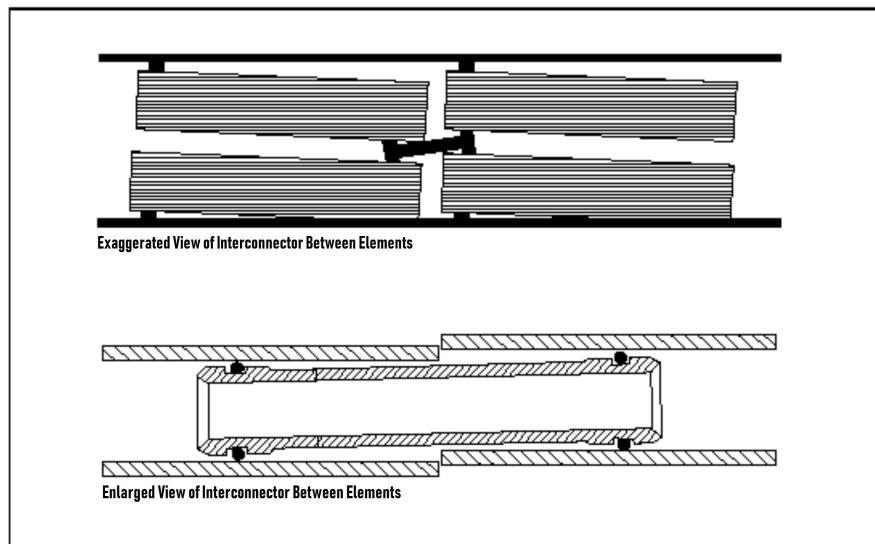

Figure 44. Product water tube misalignment

A third advantage of the “dog boned” interconnector is that the larger cross-section O-ring has less of a chance of “rolling out” of the O-ring groove. When O-ring sealed parts slide back and forth, the O-ring has a tendency to extrude into the gap between the two parts. In both the interconnector designs, the gap between the parts is the same. But since the ratio of the O-ring diameter to the gap width is much larger for the dog-boned interconnector, there is much less chance of the O-ring coming out of the groove and the seal being damaged or lost.

4.5.2 Summary of Large Element Interconnectors

Table 32 summarizes the range of interconnectors used by FilmTec™ for 8-inch-diameter elements. It shows both the part number of the interconnector and the part number and equivalence for the O-rings should they need replacement during system maintenance.

Table 32. FilmTec™ interconnector (coupler) summary

Interconnector	Interconnector part number	Replacement O-rings
Interconnector	FilmTec™ 313198 <ul style="list-style-type: none"> Used in BW30-365, BW30-400, LE-400, BW30-365-FR, BW30-400-FR, SG30-400, SW30HRLE-400, SW30HR-380, SW30HR-320, NF-400 and Maple Sap Mark I elements 	<ul style="list-style-type: none"> Each interconnector includes two 3-912 EPR O-rings (FilmTec™ part number 151705)
Low energy interconnector	FilmTec™ 259171 <ul style="list-style-type: none"> Used in BW30LE-440, XLE-440, SG30-430, NF90-400, NF270-400, and NF200-400 elements Injection molded high impact ABS 	<ul style="list-style-type: none"> Each interconnector includes two 2-218 EPR O-rings (FilmTec™ part number 216370)
Fullfit interconnector	FilmTec™ 255289 <ul style="list-style-type: none"> Used in RO-390-FF, HSR0-390-FF, and NF-390-FF elements Polysulfone 	<ul style="list-style-type: none"> Each interconnector includes two 3-912 EPR O-rings (FilmTec™ part number 151705)

4.6 Installing an Element Spacer

In some instances it is desirable to reduce the amount of water that a membrane system produces. In large systems, this is often done by turning off banks of elements. In other systems the feed pressure is reduced, but reducing the feed pressure will lower the overall water quality. Therefore, it may be necessary to remove the lead elements from a system and install element spacers instead.

An element spacer, also called a “dead man,” is simply a standard product water tube without permeate holes. Proper installation is critical to both performance and safety. Only one element spacer can be installed per pressure vessel, and it must always be installed in the first or lead element position. If placed in any other position it may crack or break due to the force being put on the product water tube.

To install the spacer:

1. Remove the first or lead position element.
2. Remove and inspect the adapter and first interconnector, making certain that the O-rings are not rolled, compression set (flat on one side), or otherwise damaged. Replace the O-rings if necessary.
3. Insert the interconnector in the spacer and push the spacer/interconnector into the second position element.
4. Insert the adapter and then replace the pressure vessel head. It may be helpful to only partially insert the interconnector and adapter to leave room to line up the parts. Alternately, a guide stick can be inserted through the permeate port on the vessel head to hold the spacer in line while the parts are pushed together.

Figure 45 shows an element spacer properly installed in a pressure vessel.

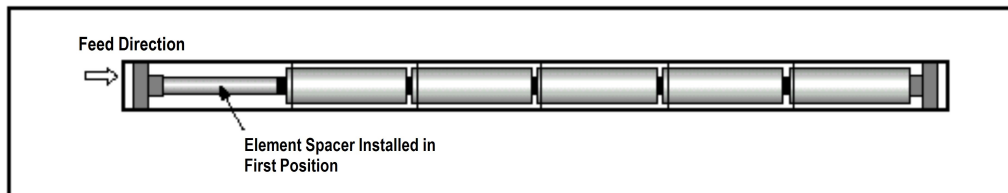

Figure 45. Element spacer properly installed in a pressure vessel

5 System Operation

5.1 Introduction

Successful long-term performance of the membrane system (NF and RO) depends on proper operation and maintenance of the system. This includes the initial plant start-up and operational start-ups and shut-downs. Preventing fouling, scaling, plugging and degradation, e.g., by oxidation, of the membranes is not only a matter of system design, but also a matter of proper commissioning and operation. Record keeping and data normalization is required in order to know the actual plant performance and to enable corrective measures when necessary. Complete and accurate records are also required in case of a system performance warranty claim

5.2 Initial Start-Up

Before initiating system start-up procedures, pretreatment checks, loading of the membrane elements, instrument calibration and other system checks should be completed.

5.2.1 Equipment

The initial system start-up is typically performed just after the element loading. The material needed for element loading is listed in Section 4.1, *Preparation*. For start-up, the following additional equipment is recommended – this should also be part of the equipment at the site:

- Safety glasses when working with chemicals
- Thermometer
- pH meter
- Conductivity meter (range: from permeate to concentrate conductivity)
- SDI measuring equipment
- Adequate chemicals for cleaning, sanitization and preservation
- Scale to weigh one element
- Spare elements
- Single element test stand (for large systems > 500 elements)
- Bottles for water samples:
 - Volume: at least 125 mL
 - Material: HDPE (high density polyethylene)
 - Number: sufficient to sample raw water, system feed, system permeate and system concentrate. In case of a system with more than one train, each train is to be sampled separately. In case of systems with more than one stage, permeate samples of the individual stages and feed/concentrate samples from in-between the stages have to be added. The operating conditions of the membrane system during sampling have to be provided.

- Analysis equipment for:
 - Total hardness
 - Calcium
 - Alkalinity
 - Chloride
 - Sulfate
 - Iron
 - Silica
 - Free chlorine
 - Redox potential
 - TOC
 - Color (a large white container may suffice to detect color in the permeate)

5.2.2 Pre-Start-Up Check and Commissioning Audit

After having loaded the elements into the pressure vessels and before starting up the membrane unit, make sure that the whole pretreatment section is working in accordance with the specifications. If the pretreatment involved changing of the chemical characteristics of the raw water, then a full analysis of the water entering the membrane unit must be made. Furthermore, absence of chlorine, turbidity and SDI must be determined.

The raw water intake must be stable with respect to:

- Flow
- SDI
- Turbidity
- Temperature
- pH
- Conductivity
- Bacteria (standard plate count)

The following checks of the pretreatment system and the membrane unit are recommended for the initial start-up (results to be included in the start-up report):

Pre-Start-Up Checklist

- Corrosion resistant materials of construction are used for all equipment from the supply source to the membrane including piping, vessels, instruments and wetted parts of pumps
- All piping and equipment is compatible with designed pressure
- All piping and equipment is compatible with designed pH range (cleaning)
- All piping and equipment is protected against galvanic corrosion
- Media filters are backwashed and rinsed
- New/clean cartridge filter is installed directly upstream of the high pressure pump
- Feed line, including RO feed manifold, is purged and flushed, before pressure vessels are connected
- Chemical addition points are properly located
- Check/anti-siphon valves are properly installed in chemical addition lines
- Provisions exist for proper mixing of chemicals in the feed stream
- Dosage chemical tanks are filled with the right chemicals
- Provisions exist for preventing the RO system from operating when the dosage pumps are shut down
- Provisions exist for preventing the dosage pumps from operating when the RO system is shut down
- If chlorine is used, provisions exist to ensure complete chlorine removal prior to the membranes
- Planned instrumentation allows proper operation and monitoring of the pretreatment and RO system (see [Control Instruments](#) (Form No. 45-D01597-en))
- Planned instrumentation is installed and operative
- Instrument calibration is verified
- Pressure relief protection is installed and correctly set
- Provisions exist for preventing the permeate pressure from exceeding the feed/concentrate pressure more than 5 psi (0.3 bar) at any time
- Interlocks, time delay relays and alarms are properly set
- Provisions exist for sampling permeate from individual modules
- Provisions exist for sampling raw water, feed, permeate and concentrate streams from each stage and the total plant permeate stream
- Pressure vessels are properly piped both for operation and cleaning mode
- Pressure vessels are secured to the rack or frame per manufacturer's instructions
- Precautions as given in Section 4, *Loading of Pressure Vessels*, are taken
- Membranes are protected from temperature extremes (freezing, direct sunlight, heater exhaust, etc.)
- Pumps are ready for operation: aligned, lubricated, proper rotation
- Fittings are tight
- Cleaning system is installed and operative
- Permeate line is open
- Permeate flow is directed to drain (In double-pass systems, provisions exist to flush first pass without permeate going through the second pass)
- Reject flow control valve is in open position
- Feed flow valve is throttled and/or pump bypass valve is partly open to limit feed flow to less than 50% of operating feed flow

5.2.3 Start-Up Sequence

Proper start-up of reverse osmosis (RO) and nanofiltration (NF) water treatment systems is essential to prepare the membranes for operating service and to prevent membrane damage due to excessive pressure/flow or hydraulic shock. Following the proper start-up sequence also helps ensure that system operating parameters conform to design conditions so that water quality and productivity goals can be achieved. Measurement of initial system performance is an important part of the start-up process. Documented results of this evaluation serve as benchmarks against which ongoing system operating performance can be measured.

Typical Start-Up Sequence

Following is the recommended RO system start-up sequence:

1. Before initiating the start-up sequence, thoroughly rinse the pretreatment section to flush out debris and other contaminants without letting the feed enter the elements. Follow the Pre-Start-up check described in Section 5.2.2, *Pre-Start-up Check and Commissioning Audit*.

2. Check all valves to ensure that settings are correct. The feed pressure control and concentrate control valves should be fully open.
3. Use low pressure water at a low flowrate to flush the air out of the elements and pressure vessels. Flush at a gauge pressure of 30 – 60 psi (0.2 – 0.4 MPa). All permeate and concentrate flows should be directed to an appropriate waste collection drain during flushing.

Air remaining in the elements and/or in the pressure vessels may lead to excessive forces on the element in flow direction or in radial direction and causing fiberglass shell cracking, if the feed pressure is ramped up too quickly (see also Section 8.1, Troubleshooting).

4. During the flushing operation, check all pipe connections and valves for leaks. Tighten connections where necessary.
5. After the system has been flushed for a minimum of 30 minutes, close the feed pressure control valve.
6. Ensure that the concentrate control valve is open.

Starting against a closed or almost closed concentrate valve could cause the recovery to be exceeded which may lead to scaling.

7. Slowly crack open the feed pressure control valve (feed pressure should be less than 60 psi (0.4 MPa)).
8. Start the high pressure pump.
9. Slowly open the feed pressure control valve, increasing the feed pressure and feed flowrate to the membrane elements until the design concentrate flow is reached. The feed pressure increase to the elements should be less than 10 psi (0.07 MPa) per second to achieve a soft start. Continue to send all permeate and concentrate flows to an appropriate waste collection drain.

If the feed pressure and/or the feed flowrate are ramped up too quickly, the housing of the elements may be damaged by excessive forces in flow direction and/or in radial direction - especially if air is in the system - leading to telescoping and/or fiberglass shell cracking (see also Section 8.1, Troubleshooting).

10. Slowly close the concentrate control valve until the ratio of permeate flow to concentrate flow approaches, but does not exceed, the design ratio (recovery). Continue to check the system pressure to ensure that it does not exceed the upper design limit.
11. Repeat steps "9" and "10" until the design permeate and concentrate flows are obtained.
12. Calculate the system recovery and compare it to the system's design value.
13. Check the addition of pretreatment chemicals (acid, scale inhibitor and sodium metabisulfite if used). Measure feedwater pH.
14. Check the Langelier Saturation Index (LSI) or the Stiff & Davis Stability Index (S&DSI) of the concentrate by measuring pH, conductivity, calcium hardness, and alkalinity levels and then making the necessary calculations.
15. Allow the system to run for one hour.

Note: Permeate obtained from first hour of operation should be discarded.

16. Take the first reading of all operating parameters.
17. Check the permeate conductivity from each pressure vessel to verify that all vessels conform to performance expectations (e.g., vessels with leaking O-rings or other evidence of malfunction to be identified for corrective action).
18. After 24 – 48 hours of operation, review all recorded plant operating data such as feed pressure, differential pressure, temperature, flows, recovery and conductivity readings (please refer to Section 5.6.1). At the same time draw samples of feedwater, concentrate and permeate for analysis of constituents.
19. Compare system performance to design values.
20. Confirm proper operation of mechanical and instrumental safety devices.

21. Switch the permeate flow from drain to the normal service position.
22. Lock the system into automatic operation.
23. Use the initial system performance information obtained in steps "16" through "18" as a reference for evaluating future system performance. Measure system performance regularly during the first week of operation to check for proper performance during this critical initial stage.

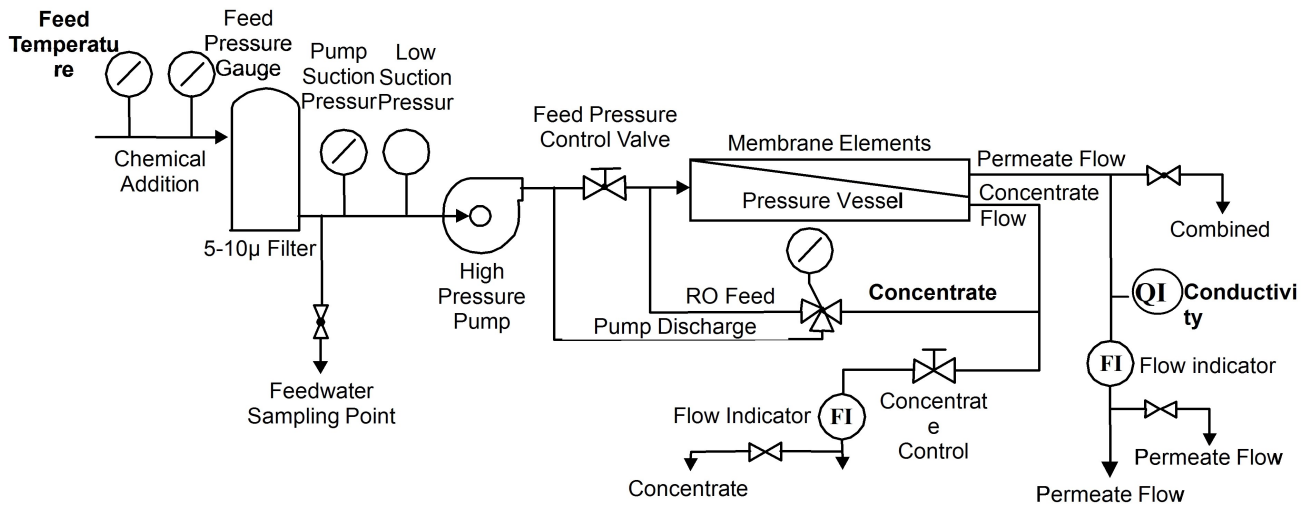

Figure 46. Typical RO/NF system

5.2.4 Membrane Start-Up Performance and Stabilization

The start-up performance of an RO/NF membrane system and the time required to reach the stabilized performance depends on the prior storage conditions of the membrane. Dry membranes and wet preserved membranes, if properly stored, reach the same stabilized performance after some hours or a few days of operation. The flow performance of wet membranes is typically stable right from the start, while dry membranes tend to start at a slightly higher flow. The salt rejection of FilmTec™ membranes in general improves during the first few hours or days of operation and remains stable then. Wet membranes stabilize faster than dry membranes.

5.2.5 Special Systems: Double Pass RO

When a double pass system is started up, the first pass system must have been in operation for at least 24 hours before the permeate of the first pass is fed to the membranes of the second pass. Otherwise a permanent flux loss of the second pass may result. The pH of the feedwater to both passes have to be adjusted for optimum results in rejection. A final product water conductivity of $< 1 \mu\text{S}/\text{cm}$ is being obtained routinely from brackish water sources with double pass BWRO membrane systems.

5.2.6 Special Systems: Heat Sanitizable RO

New HSRO heat sanitizable spiral elements must be pre-conditioned prior to initial use by exposure to hot water. Please refer to Section 6.10.4, *Heat Sanitization*. Please refer to [Heat Sanitization](#) (Form No. 45-D01632-en).

5.3 Operation Start-Up

Once a membrane system has been started up, ideally it should be kept running at constant conditions. In reality, membrane plants have to be shut down and restarted frequently. Start/stop cycles result in pressure and flow changes, causing mechanical stress to the membrane elements. Therefore, the start/stop frequency should be minimized, and the regular operation start-up sequence should be as smooth as possible. In principle, the same sequence is recommended as for the initial start-up. Most important is a slow feed pressure increase, especially for seawater plants.

The normal start-up sequence is typically automated through the use of programmable controllers and remotely operated valves. The calibration of instruments, the function of alarms and safety devices, corrosion prevention and leak-free operation have to be checked and maintained on a regular basis.

5.4 RO and NF Systems Shutdown

An RO/NF system is designed to be operated continuously. However, in reality membrane systems will start up and shutdown on some frequency. When the membrane system is shutdown, the system must be flushed preferentially with permeate water or alternatively with high quality feedwater, to remove the high salt concentration from the pressure vessels until concentrate conductivity matches feedwater conductivity. Flushing is done at low pressure (about 40 psi (3 bar)). A high feed flowrate is sometimes beneficial for a cleaning effect; however, the maximum pressure drop per element and per multi-element vessel – as stated on the FilmTec™ membranes product information sheet - must not be exceeded. During low pressure flushing, the vessels of the last stage of a concentrate staged system are normally exposed to the highest feed flowrates and therefore they show the highest pressure drop.

The water used for flushing shall contain no chemicals used for the pretreatment, especially no scale inhibitors. Therefore, any chemical injection (if used) is stopped before flushing. After flushing the system, the feed valves are closed completely. If the concentrate line ends into a drain below the level of the pressure vessels, then an air break should be employed in the concentrate line at a position higher than the highest pressure vessel. Otherwise, the vessels might be emptied by a siphoning effect.

When the high pressure pump is switched off, and the feed/concentrate side had not been flushed out with permeate water, a temporary permeate reverse flow will occur by natural osmosis. This reverse flow is sometimes referred to as permeate draw-back or suck-back. Permeate suck-back alone or in combination with a feed-side flush may provide a beneficial cleaning effect. To accommodate permeate suck-back, enough water volume should be available to prevent a vacuum from being drawn or air being sucked back into the membrane element. For dimensioning a draw-back tank, see Section 3.14.6.

If the permeate line is pressurized during operation and the system shuts down, the membrane might become exposed to a static permeate backpressure. To avoid membrane damage from backpressure, the static permeate backpressure must not exceed 5 psi (0.3 bar) at any time. Check valves or atmospheric drain valves in the permeate line can be used to safeguard the membrane. These safeguard valves need to work also and especially in case of non-scheduled shutdowns, e.g., because of a power failure, or emergency shutdowns.

When the system must be shut down for longer than 48 hours, take care that:

- The elements do not dry out. Dry elements will irreversibly lose flux.
- The system is adequately protected against micro-biological growth, or regular flushing is carried out every 24 hours.
- When applicable, the system is protected against temperature extremes.

The membrane plant can be stopped for 24 hours without preservation and precautions for microbiological fouling. If feedwater for flushing every 24 hours is not available, preservation with chemicals is necessary for longer stops than 48 hours. Please refer to Section 7.4 for further lay-up considerations.

5.5 Adjustment of Operation Parameters

5.5.1 Introduction

A membrane system is designed on the basis of a defined set of data such as the permeate flow, feedwater composition and temperature. In reality, the plant operation has to be flexible to respond to changing needs or changing conditions.

5.5.2 Brackish Water

The normal way of operating brackish water RO and NF membrane plants is to keep the flows and thus the recovery constant at the design values. Any change in the membrane flux, e.g., by temperature or fouling, are compensated by adjusting the feed pressure. However, the maximum specified feed pressure must not be exceeded, nor should too much fouling be tolerated (for cleaning, please refer to [Cleaning and Sanitization](#)).

If the feedwater analysis changes such that the scaling potential increases, the system recovery has to be decreased, or other measures have to be taken to cope with the new situation. Please refer to [Water Chemistry and Pretreatment](#).

The most common situation is that the permeate capacity of the plant has to be adjusted to the needs. Normally, the capacity is designed to meet the peak needs. Operating with overcapacity is generally not recommended. Thus, adjustment means lowering the design permeate output. The easiest way is to shut the plant down when no permeate is needed. A high start/stop frequency, however, can lower the performance and the lifetime of the membranes. A permeate buffer tank may be used to allow a more constant operation.

Reducing the feed pressure is another way to reduce the permeate flow. Preferably, this is done by using a speed controlled pump in order to save energy. Normally, the system recovery is kept constant when the permeate flow is reduced. It has to be ensured by a system analysis using the computer program, that single element recoveries do not exceed their limits (see [Section 3, System Design](#)). During low flow operation, the system salt rejection is lower than during design flow operation. Also, you must be certain that minimum concentrate flows are maintained during low flow operation.

5.5.3 Seawater

In principle, the operation parameters of seawater plants are adjusted the same way as in brackish water applications. However, the maximum allowed feed pressure as specified on the product information sheet, and the permeate TDS are often the limiting factors.

Decreasing feedwater temperature can be compensated by increasing the feed pressure up to the maximum. Once the maximum pressure is reached, a further decreasing temperature causes the permeate flow to decrease.

Increasing temperature is compensated by lowering the feed pressure. This is only possible, however, as far as the tolerated permeate TDS is not exceeded. Alternatively, increasing temperature can be compensated by taking a number of pressure vessels out of service. By reducing the active membrane area, the feed pressure and the permeate TDS are kept about constant. A system analysis has to be run to make sure that maximum element permeate flows are not exceeded. When some vessels are taken out of service, they have to be properly isolated and preserved.

An increase in the feedwater salinity can be compensated by increasing the feed pressure up to the maximum. If further pressure increase is not possible, than a lowered permeate flow and system recovery has to be accepted. A lower feedwater salinity allows to decrease the feed pressure and/or to increase the system recovery and/or to increase the permeate flow.

The adjustment of the permeate capacity to reduced needs is normally accomplished by sufficiently dimensioned permeate tanks.

Big plants are split up into a number of identical trains. Then the number of trains in service can be adjusted to the needs.

5.6 Record Keeping

5.6.1 Introduction

In order to be able to follow the performance of the RO unit, it is necessary that all relevant data are collected, recorded and kept on file. Apart from keeping track of the performance, the logsheets are also valuable tools for troubleshooting, and are needed in the cases of warranty claims.

This chapter is for general guidance only and must not be used in place of the operating manual for a particular plant. Site-dependent factors prevent specific recommendations for all record keeping. Thus, only the more general record keeping is covered here.

5.6.2 Start-Up Report

- Provide a complete description of the RO plant. This can be done using a flow diagram and equipment, instrumentation, and material list to show water source, pretreatment system, RO configuration and posttreatment system.
- Give results of checking according to check list (Section 5.2.2, *Pre-Start-up Check and Commissioning Audit*).
- Provide calibration curves of all gauges and meters based on manufacturers' recommendations.
- Record initial performance of RO and pretreatment system as provided below.

5.6.3 RO Operating Data

The following data must be recorded and logged into an appropriate logsheet at least once per shift, unless otherwise stated (see Table 33 for an example).

- Date, time and hours of operation.
- Pressure drop per filter cartridge and per stage.
- Feed, permeate and concentrate pressure of each stage.
- Permeate and concentrate flows of each stage.
- Conductivity of the feed, permeate and concentrate streams for each stage. Permeate conductivity of each pressure vessel weekly.
- TDS of feed, permeate and concentrate streams for each stage. The TDS is calculated from the water analysis. It can also be calculated from the conductivity (at 25°C) EC_{25} and an appropriate K factor:

$$TDS = K EC_{25}$$

The K factor has to be determined for each specific stream. Typical K factors are shown in Table 34.

- pH of the feed, permeate and concentrate streams.
- Silt Density Index (SDI) or turbidity of the RO feed stream, or both.
- Water temperature of the feed stream.
- Langelier Saturation Index (LSI) of the concentrate stream from the last stage (for concentrate streams < 10,000 mg/L TDS).
- Stiff and Davis Stability Index (S&DSI) of the concentrate stream from the last stage (for concentrate streams > 10,000 mg/L).

- Calibration of all gauges and meters based on manufacturer's recommendations as to method and frequency but no less frequent than once every three months.
- Any unusual incidents, for example, upsets in SDI, pH and pressure and shutdowns.
- Complete water analysis of the feed, permeate and concentrate streams and the raw water at start-up and every week thereafter.

The water analysis shall include:

- Calcium
- Magnesium
- Sodium
- Potassium
- Strontium
- Barium
- Iron (total, dissolved and ferrous)
- Aluminium (total and dissolved)
- Bicarbonate
- Sulfate
- Chloride
- Nitrate
- Fluoride
- Phosphate (total)
- Silica (dissolved)
- Total dissolved solids
- Conductivity
- pH
- TOC

Table 33. Reverse osmosis operating log (example)

Per Shift

Train #

		Design							
		Date							
		Time							
		Operating hours							
Pressure (psig)	Feed Array 1								
	Feed Array 2								
	Permeate								
	Concentrate								
Δ p (psid)	Cartridge								
	Array 1								
	Array 2								
Flow (gpm)	Feed								
	Permeate								
	Concentrate								
		Recovery (%)							
Conductivity (mS/m)	Feed								
	Permeate								
	Concentrate								
TDS (mg/l)	Feed								
	Permeate								
	Concentrate								
	Salt Passage %								
pH	Raw Water								
	Feed								
	Concentrate								
	Permeate								
Feed	Cl ₂ (mg/l)								
	SDI								
	Turbidity (NTU)								
	Temperature (°C)								
Acid	Level								
	Refill (l)								
	Consumption (g/ml ³)								
Inhibitor	Level								
	Refill (l)								
	Consumption (g/ml ³)								
Normalized	Permeate flow (gpm)								
	Salt Passage %								
		Remarks							

Table 34. Factors for estimating TDS from conductivity

Water	EC ₂₅ (mS/m)	K
Permeate	0.1 – 1	0.50
	30 – 80	0.55
Seawater	4,500 – 6,000	0.70
Concentrate	6,500 – 8,500	0.75

5.6.4 Pretreatment Operating Data

Since the RO system performance depends largely on the proper operation of the pretreatment, the operating characteristics of the pretreatment equipment should be recorded. Specific recommendations for all record keeping cannot be given, because pretreatment is site-dependent. Typically, the following items must be recorded:

- Total residual chlorine concentration in the RO feed (daily – unless known to be completely absent).
- Discharge pressure of any well or booster pumps (twice a day).
- Pressure drop of all filters (twice a day).
- Consumption of acid and any other chemicals (daily – if used).
- Calibration of all gauges and meters based on manufacturers' recommendations as to method and frequency but no less frequent than once every 3 months.
- Any unusual incidents, for example, upsets and shutdowns as they occur.

5.6.5 Maintenance Log

- Record routine maintenance.
- Record mechanical failures and replacements.
- Record any change of membrane element locations with element serial numbers.
- Record replacements or additions of RO devices.
- Record calibration of all gauges and meters.
- Record replacement or additions of pretreatment equipment, for example cartridge filters and include date, brand name and nominal rating.
- Record all cleanings of RO membranes. Include date, duration of cleaning, cleaning agent(s) and concentration, solution pH, temperature during cleaning, flowrate and pressure (for cleaning procedures see Section 6.1).

5.6.6 Plant Performance Normalization

The performance of an RO/NF system is influenced by the feedwater composition, feed pressure, temperature and recovery. For example, a feed temperature drop of 4°C will cause a permeate flow decrease of about 10%. This, however, is a normal phenomenon.

In order to distinguish between such normal phenomena and performance changes due to fouling or problems, the measured permeate flow and salt passage have to be normalized. Normalization is a comparison of the actual performance to a given reference performance while the influences of operating parameters are taken into account. The reference performance may be the designed performance or the measured initial performance.

Normalization with reference to the designed (or warranted) system performance is useful to verify that the plant gives the specified (or warranted) performance. Normalization with reference to the initial system performance is useful to show up any performance changes between day one and the actual date.

Plant performance normalization is strongly recommended, because it allows an early identification of potential problems (e.g., scaling or fouling) when the normalized data are recorded daily. Corrective measures are much more effective when taken early.

A computer program called FTNORM is available for normalizing operating data and graphing normalized permeate flow and salt passage as well as pressure drop. This program is available from our web site www.filmtec.com and requires Excel® software. Alternatively, the measured plant performance at operating conditions can be transferred to standard (reference) conditions by the following calculations:

A. Normalized Permeate Flow

$$Q_s = \frac{P_{f_s} - \frac{\Delta P_s}{2} - P_{p_s} - \pi_{fc_s}}{P_{f_o} - \frac{\Delta P_o}{2} - P_{p_o} - \pi_{fc_o}} \cdot \frac{TCF_s}{TCF_o} \cdot Q_o \quad \text{Eq. 65}$$

with P_f = feed pressure

$\frac{\Delta P}{2}$

= one half device pressure drop

P_p = product pressure

π_{fc} = osmotic pressure of the feed-concentrate mixture

TCF = temperature correction factor

Q = product flow

subscript s = standard condition

subscript o = operating condition

The temperature correction factor follows the formula:

$$TCF = \text{EXP} [2640 \times \{1 / 298 - 1 / (273 + T)\}]; T \geq 25^\circ\text{C} \quad \text{Eq. 66}$$

$$TCF = \text{EXP} [3020 \times \{1 / 298 - 1 / (273 + T)\}]; T \leq 25^\circ\text{C} \quad \text{Eq. 67}$$

$$= \text{EXP} [3020 \times \{1 / 298 - 1 / (273 + T)\}]; T \leq 25^\circ\text{C} \quad \text{Eq. 68}$$

where T = temperature as °C.

As standard conditions, we take either the design values or the conditions at initial performance as given in the start-up report, so that a fixed reference point is available.

For the osmotic pressure, different formulas are available in the literature. A valid and practical short approximation is:

$$\pi_{fc} = \frac{C_{fc} \cdot (T + 320)}{491000} \text{ bar} \quad \text{for } C_{fc} < 20000 \text{ mg/L} \quad \text{Eq. 69}$$

and

$$\pi_{fc} = \frac{0.01117 \cdot C_{fc} - 34}{14.23} \cdot \frac{T + 320}{345} \text{ bar} \quad \text{for } C_{fc} < 20000 \text{ mg/L} \quad \text{Eq. 70}$$

with C_{fc} = concentration of the feed-concentrate

C_{fc} can be calculated from following approximation:

$$C_{fc} = C_f \cdot \frac{\ln \frac{1}{1-Y}}{Y}$$

Eq. 71

where $Y = \text{recovery ratio} = \frac{\text{product flow}}{\text{feed flow}}$

$C_f = \text{TDS feed mg/Ls}$

B. The Normalized Permeate TDS is calculated from

$$C_{ps} = C_{po} \cdot \frac{P_{fo} - \frac{\Delta P_o}{2} - P_{po} - \pi_{fo} + \pi_{po}}{P_{fs} - \frac{\Delta P_s}{2} - P_{ps} - \pi_{fs} + \pi_{ps}} \cdot \frac{C_{fc_s}}{C_{fc_o}}$$

Eq. 72(2)

Terms not yet defined under A are:

$C_p = \text{product concentration as ion in mg/L}$
 $\pi_p = \text{osmotic pressure of the permeate in bar}$

Example

Values of Start-Up:

Feedwater analysis in mg/L:

Ca:	200	HCO ₃ :	152
Mg:	61	SO ₄ :	552
Na:	388	Cl:	633

Temp.:	59°F (15°C)	Pressure drop:	44 psi (3 bar)
Pressure:	363 psi (25 bar)	Permeate pressure:	14.5 psi (1 bar)
Flow:	660 gpm (150 m ³ /h)	Permeate TDS:	83 mg/L
Recovery:	75%		

Values after 3 months:

Feedwater analysis in mg/L:

Ca:	200	HCO ₃ :	152
Mg:	80	SO ₄ :	530
Na:	480	Cl:	850

Temp.:	50°F (10°C)	Pressure drop:	58 psi (4 bar)
Pressure:	406 psi (28 bar)	Permeate pressure:	29 psi (2 bar)
Flow:	559 gpm (127 m ³ /h)	Permeate TDS:	80 mg/L
Recovery:	72%		

For the standard conditions we have:

$$P_{f_s} = 363 \text{ psi (25 bar)}$$

$$\frac{\Delta P_s}{2} = 22 \text{ psi (1.5 bar)}$$

$$C_{f_s} = 1986 \text{ mg/L}$$

$$C_{f_o} = 1986 \cdot \frac{\ln \frac{1}{1-0.75}}{0.75} = 3671 \text{ mg/L}$$

$$\pi_{r_{c_s}} = 36.3 \text{ psi (2.5 bar)}$$

$$TCF_s = \text{EXP} [3020 \times \{1 / 298 - 1 / (273 + 15)\}] = 0.70$$

For the operating conditions we have:

$$P_{f_o} = 406 \text{ psi (28 bar)}$$

$$\frac{\Delta P_o}{2} = 29 \text{ psi (2 bar)}$$

$$C_{f_o} = 2292 \text{ mg/L}$$

$$C_{f_{c_o}} = 2292 \times \frac{\ln \frac{1}{1-0.72}}{0.72} = 4052 \text{ mg/L}$$

$$\pi_{r_{c_o}} = 39.4 \text{ psi (2.72 bar)}$$

$$TCF_o = \text{EXP} [3020 \times \{1 / 298 - 1 / (273 + 10)\}] = 0.58$$

Substituting these values in equations (1) gives:

$$Q_s = \frac{25 - 1.5 - 1 - 2.5}{28 - 2 - 2 - 2.7} \times \frac{0.70}{0.58} \times 127$$

$$= 636 \text{ gpm normalized flow (144 m}^3\text{/h)}$$

Compared to the start-up conditions, the plant has lost 4% capacity. This is a normal value after a period of 3 months. Cleaning is not yet necessary.

The normalized permeate TDS is derived from equation (2):

$$C_{ps} = \frac{28 - 2 - 2 - 2.72 + 0.06}{25 - 1.5 - 1 - 2.5 + 0.05} \times \frac{3671}{4052} \times 80$$
$$= 77 \text{ mg/L}$$

Compared to the initial 83 mg/L, the salt rejection has slightly improved. Such behavior is typical for the initial phase.

References

1. Youngberg, D.A.: Start-up of an RO/DI Pure Water System. Ultrapure Water, March/April 1986, 46-50.
2. ASTM D4472-89 (Reapproved 2003): Standard Guide for Record Keeping for Reverse Osmosis Systems.
3. ASTM D4516-00: Standard Practice for Standardizing Reverse Osmosis Performance Data.
4. ASTM D4195-88 (Reapproved 2003): Standard Guide for Water Analysis for Reverse Osmosis Application.
5. Walton, V.R.G.: Electrical Conductivity and Total Dissolved Solids – What is Their Precise Relationship? Desalination, 72 (1989) 275-292.

6 Cleaning and Sanitization

6.1 Introduction

The surface of a reverse osmosis (RO) membrane is subject to fouling by foreign materials that may be present in the feedwater, such as hydrates of metal oxides, calcium precipitates, organics and biological matter. The term “fouling” includes the build-up of all kinds of layers on the membrane surface, including scaling.

Pretreatment of the feedwater prior to the RO process is basically designed to reduce contamination of the membrane surfaces as much as possible. This is accomplished by installing an adequate pretreatment system and selecting optimum operating conditions, such as permeate flowrate, pressure and permeate water recovery ratio.

Occasionally, fouling of the membrane surfaces is caused by:

- Inadequate pretreatment system
- Pretreatment upset conditions
- Improper materials selection (pumps, piping, etc.)
- Failure of chemical dosing systems
- Inadequate flushing following shutdown
- Improper operational control
- Slow build-up of precipitates over extended periods (barium, silica)
- Change in feedwater composition
- Biological contamination of feedwater

The fouling of membrane surfaces manifests itself in performance decline, lower permeate flowrate and/or higher solute passage. Increased pressure drop between the feed and concentrate side can be a side effect of fouling.

Cleaning can be accomplished very effectively because of the combination of pH stability and temperature resistance of the membrane and the element components. However, if cleaning is delayed too long, it could be difficult to remove the foulants completely from the membrane surface. Cleaning will be more effective the better it is tailored to the specific fouling problem. Sometimes a wrong choice of cleaning chemicals can make a situation worse. Therefore, the type of foulants on the membrane surface should be determined prior to cleaning. There are different ways to accomplish this:

- Analyze plant performance data. Details are given in Section 8.2, *Evaluation of System Performance and Operation*.
- Analyze feedwater. A potential fouling problem may already be visible there.
- Check results of previous cleanings.
- Analyze foulants collected with a membrane filter pad used for SDI value determination (see Section 2.5.1).
- Analyze the deposits on the cartridge filter.
- Inspect the inner surface of the feed line tubing and the feed end scroll of the FilmTec™ Element. If it is reddish-brown, fouling by iron materials may be present. Biological fouling or organic material is often slimy or gelatinous.

6.2 Safety Precautions

1. When using any chemical indicated here or in subsequent sections, follow accepted safety practices. Consult the chemical manufacturer for detailed information about safety, handling and disposal.
2. When preparing cleaning solutions, ensure that all chemicals are dissolved and well mixed before circulating the solutions through the elements.
3. It is recommended the elements be flushed with good-quality chlorine-free water (20°C minimum temperature) after cleaning. Permeate water or deionized water is recommended. Care should be taken to operate initially at reduced flow and pressure to flush the bulk of the cleaning solution from the elements before resuming normal operating pressures and flows. Despite this precaution, cleaning chemicals will be present on the permeate side following cleaning. Therefore, the permeate must be diverted to drain for at least 30 minutes or until the water is clear when starting up after cleaning.
4. During recirculation of cleaning solutions, there are temperature and pH limits. Please refer to Table 35.
5. For elements greater than 6 inches in diameter, the flow direction during cleaning must be the same as during normal operation to prevent element telescoping because the vessel thrust ring is installed only on the reject end of the vessel. This is also recommended for smaller elements. Equipment for cleaning is illustrated below.

Table 35. pH range and temperature limits during cleaning

Element type	Max Temp 50°C (122°F) pH range	Max Temp 45°C (113°F) pH range	Max Temp 35°C (95 °F) pH range	Max Temp 25°C (77°F) pH range
BW30, BW30LE, LE, XLE, TW30, TW30HP, NF90	Please contact DuPont for assistance	1 – 10.5	1 – 12	1 – 13
SW30HR, SW30HR LE, SW30XLE, SW30	Please contact DuPont for assistance	1 – 10.5	1 – 12	1 – 13
NF200, NF270	Not allowed	3 – 10	1 – 11	1 – 12

6.3 Cleaning Requirements

In normal operation, the membrane in reverse osmosis elements can become fouled by mineral scale, biological matter, colloidal particles and insoluble organic constituents. Deposits build up on the membrane surfaces during operation until they cause loss in normalized permeate flow, loss of normalized salt rejection, or both.

Elements should be cleaned when one or more of the below mentioned parameters are applicable:

- The normalized permeate flow drops 10%
- The normalized salt passage increases 5 – 10%
- The normalized pressure drop (feed pressure minus concentrate pressure) increases 10 – 15%

If you wait too long, cleaning may not restore the membrane element performance successfully. In addition, the time between cleanings becomes shorter as the membrane elements will foul or scale more rapidly.

Differential Pressure (ΔP) should be measured and recorded across each stage of the array of pressure vessels. If the feed channels within the element become plugged, the ΔP will increase. It should be noted that the permeate flux will drop if feedwater temperature decreases. This is normal and does not indicate membrane fouling.

A malfunction in the pretreatment, pressure control, or increase in recovery can result in reduced product water output or an increase in salt passage. If a problem is observed, these causes should be considered first. The element(s) may not require cleaning. A computer program called FTNORM is available from FilmTec™ for normalizing performance data of FilmTec™ RO membranes. This program can be used to assist in determining when to clean and can be downloaded from our web site ([Download FT NORM](#)).

6.4 Cleaning Equipment

The equipment for cleaning is shown in the cleaning system flow diagram (Figure 47). The pH of cleaning solutions used with FilmTec™ Elements can be in the range of 1–13 (see Table 37), and therefore, non-corroding materials of construction should be used in the cleaning system.

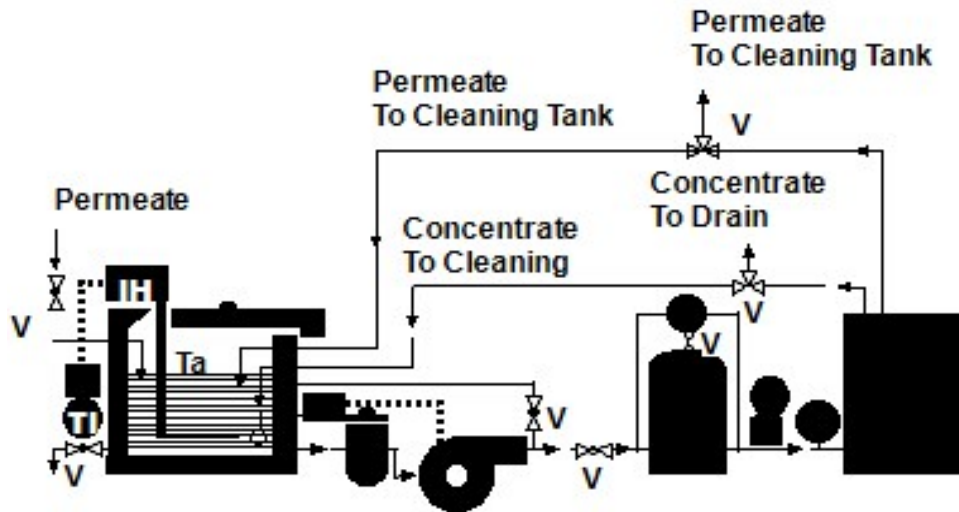

Figure 47. Cleaning system flow diagram

TANK Chemical Mixing Tank, polypropylene or FRP	DP Differential Pressure Gauge
IH Immersion Heater (may be replaced by cooling coil for some site locations)	FI Flow Indicator
TI Temperature Indicator	FT Flow Transmitter (optional)
TC Temperature Control	PI Pressure Indicator
LLS Lower Level Switch to shut off pump	V1 Pump Recirculation Valve, CPVC
SS Security Screen–100 mesh	V2 Flow Control Valve, CPVC
PUMP Low-Pressure Pump, 316 SS or non-metallic composite	V3 Concentrate Valve, CPVC 3-way valve
CF Cartridge Filter, 5-10 micron polypropylene with PVC, FRP, or SS housing	V4 Permeate Valve, CPVC 3-way valve
	V5 Permeate Inlet Valve, CPVC
	V6 Tank Drain Valve, PVC, or CPVC
	V7 Purge Valve, SS, PVC, or CPVC

1. The mixing tank should be constructed of polypropylene or fiberglass-reinforced plastic (FRP). The tank should be provided with a removable cover and a temperature gauge. The cleaning procedure is more effective when performed at a warm temperature, and it is recommended that the solution be maintained according to the pH and temperature guidelines listed in Table 35. It is not recommended to use a cleaning temperature below 20°C because of the very slow chemical kinetics at low temperatures. In addition, chemicals such as sodium lauryl sulfate might precipitate at low temperatures. Cooling may also be required in certain geographic regions, so both heating/cooling requirements must be considered during the design. A rough rule of thumb in sizing a cleaning tank is to use approximately the empty pressure vessels volume and then add the volume of the feed and return hoses or pipes. For example, to clean ten 8-inch-diameter pressure vessels with six elements per vessel, the following calculations would apply:

A. Volume in Vessels

$$V_{\text{vessel}} = \pi r^2 l; \text{ where } r = \text{radius}; l = \text{length}$$

$$V_{\text{vessel}} = \frac{3.14(4 \text{ in.})^2(20 \text{ ft})(7.48 \text{ gal/ft}^3)}{144 \text{ in.}^2/\text{ft}^2}$$

$$V_{\text{vessel}} = 52 \text{ gal/vessel}$$

$$V_{10 \text{ vessels}} = 52 \times 10 = 520 \text{ gal (1.97 m}^3\text{)}$$

B. Volume in Pipes, assume 50 ft length total; 4-in SCH 80 pipe

$$V_{\text{pipe}} = \pi r^2 l ; \text{ where } r = \text{radius}; l = \text{length}$$

$$V_{\text{pipe}} = \frac{3.14(1.91\text{in.})^2(50\text{ft})(7.48\text{gal/ft}^3)}{144\text{in.}^2/\text{ft}^2}$$

$$V_{\text{pipe}} = 30\text{ gal (0.11 m}^3\text{)}$$

$$V_{10\text{ vessels} + \text{pipe}} = 520 + 30 = 550\text{ gal (2.1 m}^3\text{)}$$

Therefore, the cleaning tank should be about 550 gal (2.1 m³).

- The cleaning pump should be sized for the flows and pressures given in Table 36, making allowances for pressure loss in the piping and across the cartridge filter. The pump should be constructed of 316 SS or nonmetallic composite polyesters.

Table 36. Recommended feed flowrate per pressure vessel during high flowrate recycle

Feed pressure ¹		Element diameter inches	Feed flowrate per pressure vessel	
psig	bar		gpm	m ³ /h
20 – 60	1.5 – 4.0	2.5	3 – 5	0.7 – 1.2
20 – 60	1.5 – 4.0	4 ²	8 – 10	1.8 – 2.3
20 – 60	1.5 – 4.0	6	16 – 20	3.6 – 4.5
20 – 60	1.5 – 4.0	8	30 – 45	6.0 – 10.2
20 – 60	1.5 – 4.0	8 ³	35 – 45	8.0 – 10.2

- Dependent on number of elements in pressure vessel.
- 4-inch fullfit elements should be cleaned at 12 – 14 gpm (2.7 – 3.2 m³/h).
- For fullfit and 440 ft² area elements.

- Appropriate valves, flow meters and pressure gauges should be installed to adequately control the flow. Service lines may be either hard-piped or hoses. In either case, the flowrate should be a moderate 10 ft/s (3 m/s) or less.

6.5 Cleaning Steps

There are six steps in the cleaning of elements:

- Make up cleaning solution.
- Low-flow pumping. Pump mixed, preheated cleaning solution to the vessel at conditions of low flowrate (about half of that shown in Table 36) and low pressure to displace the process water. Use only enough pressure to compensate for the pressure drop from feed to concentrate. The pressure should be low enough that essentially no or little permeate is produced. A low pressure minimizes redeposition of dirt on the membrane. Dump the concentrate, as necessary, to prevent dilution of the cleaning solution.
- Recycle. After the process water is displaced, cleaning solution will be present in the concentrate stream. Then recycle the concentrate and permeate to the cleaning solution tank and allow the temperature to stabilize. Measure the pH of the solution and adjust the pH if needed.
- Soak. Turn the pump off and allow the elements to soak. Sometimes a soak period of about 1 hour is sufficient. For difficult fouling an extended soak period is beneficial; soak the elements overnight for 10 – 15 hours. To maintain a high temperature during an extended soak period, use a slow recirculation rate (about 10% of that shown in Table 36).

5. High-flow pumping. Feed the cleaning solution at the rates shown in Table 36 for 30 – 60 minutes. The high flowrate flushes out the foulants removed from the membrane surface by the cleaning. If the elements are heavily fouled, a flowrate which is 50% higher than shown in Table 36 may aid cleaning. At higher flowrates, excessive pressure drop may be a problem. The maximum recommended pressure drops are 15 psi per element or 50 psi per multi-element vessel, whichever value is more limiting. Please note that the 15 psi per element or the 50 psi per multi-element vessel should NOT be used as a cleaning criteria. Cleaning is recommended when the pressure drop increases 15%. Pressure drop above 50 psi in a single stage may cause significant membrane damage.
6. Flush out. RO permeate or deionized water is recommended for flushing out the cleaning solution. Pre-filtered raw water or feedwater should be avoided as its components may react with the cleaning solution: precipitation of foulants may occur in the membrane elements. The minimum flush out temperature is 20°C.

6.6 Cleaning Tips

1. It is strongly recommended to clean the stages of the RO or NF system separately. This is to avoid having the removed foulant from stage 1 pushed into the 2nd stage resulting in minimal performance improvement from the cleaning. If the system consists of 3 stages, stage 2 and stage 3 should also be cleaned separately. For multi-stage systems, while each stage should be cleaned separately, the flushing and soaking operations may be done simultaneously in all stages. Fresh cleaning solution needs to be prepared when the cleaning solution becomes turbid and/or discolored. High-flow recirculation, however, should be carried out separately for each stage, so the flowrate is not too low in the first stage or too high in the last. This can be accomplished either by using one cleaning pump and operating one stage at a time, or by using a separate cleaning pump for each stage.

2. The fouling or scaling of elements typically consists of a combination of foulants and scalants, for instance a mixture of organic fouling, colloidal fouling and biofouling. Therefore, it is very critical that the first cleaning step is wisely chosen. FilmTec™ strongly recommends alkaline cleaning as the first cleaning step. Acid cleaning should only be applied as the first cleaning step if it is known that only calcium carbonate or iron oxide/hydroxide is present on the membrane elements.

Acid cleaners typically react with silica, organics (for instance humic acids) and biofilm present on the membrane surface which may cause a further decline of the membrane performance. Sometimes, an alkaline cleaning may restore this decline that was caused by the acid cleaner, but often an extreme cleaning will be necessary. An extreme cleaning is carried out at pH and temperature conditions that are outside the membrane manufacturer's guidelines or by using cleaning chemicals that are not compatible with the membrane elements. An extreme cleaning should only be carried out as a last resort as it can result in membrane damage.

If the RO system suffers from colloidal, organic fouling or biofouling in combination with calcium carbonate, then a two-step cleaning program will be needed: alkaline cleaning followed by an acid cleaning. The acid cleaning may be performed when the alkaline cleaning has effectively removed the organic fouling, colloidal fouling and biofouling.

3. Always measure the pH during cleaning. If the pH increases more than 0.5 pH units during acid cleaning, more acid needs to be added. If the pH decreases more than 0.5 pH units during alkaline cleaning, more caustic needs to be added.
4. Long soak times. It is possible for the solution to be fully saturated and the foulants can precipitate back onto the membrane surface. In addition, the temperature will drop during this period, therefore the soaking becomes less effective. It is recommended to circulate the solution regularly in order to maintain the temperature (temperature should not drop more than 5°C) and add chemicals if the pH needs to be adjusted.
5. Turbid or strong colored cleaning solutions should be replaced. The cleaning is repeated with a fresh cleaning solution.
6. If the system has to be shut down for more than 24 hours, the elements should be stored in 1% w/w sodium metabisulfite solution.

6.7 Effect of pH on Foulant Removal

In addition to applying the correct cleaning sequence (alkaline cleaning step first), selecting the correct pH is very critical for optimum foulant removal. If foulant is not successfully removed, the membrane system performance will decline faster as it is easier for the foulant to deposit on the membrane surface area. The time between cleanings will become shorter, resulting in shorter membrane element life and higher operating and maintenance costs.

Most effective cleaning allows longer system operating time between cleanings and results in the lowest operating costs.

Figure 48 and Figure 49 below show the importance of the selecting the right pH for successful cleaning.

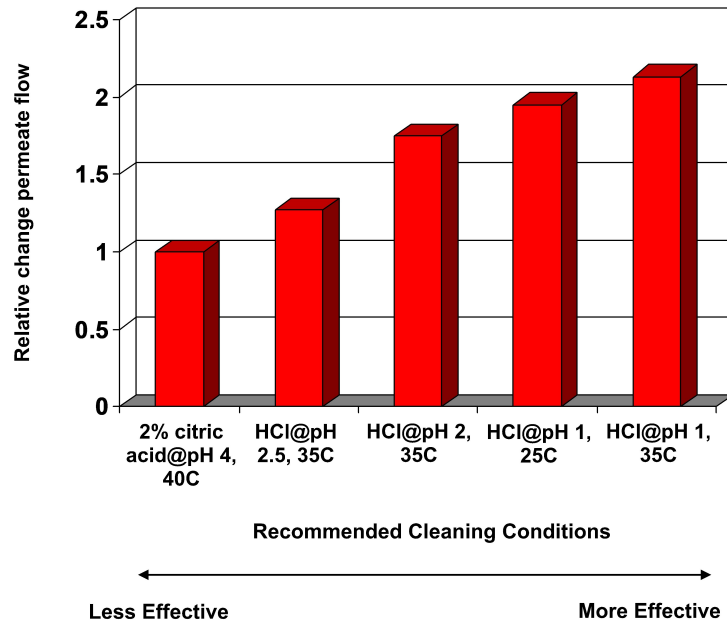

Figure 48. Effect of pH on the removal of calcium carbonate

Calcium carbonate is best removed by cleaning with hydrochloric acid at pH 1 – 2.

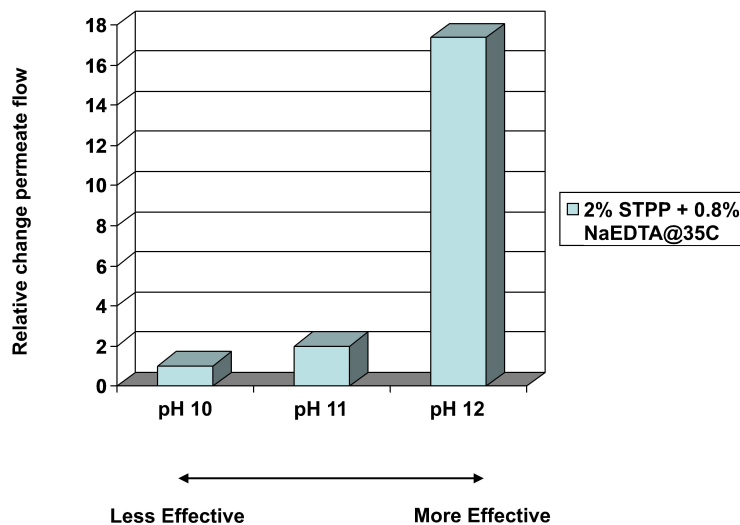

Figure 49. Effect of pH on the removal of biofouling

Biofouling is best removed by cleaning at pH 12.

6.8 Cleaning Chemicals

Table 37 lists suitable cleaning chemicals. Acid cleaners and alkaline cleaners are the standard cleaning chemicals. Acid cleaners and alkaline cleaners are the standard cleaning chemicals. The acid cleaners are used to remove inorganic precipitates including iron, while the alkaline cleaners are used to remove organic fouling including biological matter. Sulfuric acid should not be used for cleaning because of the risk of calcium sulfate precipitation. Reverse osmosis permeate or deionized water should be used for the preparation of cleaning solutions.

Table 37. Simple cleaning solutions

Foulant	Cleaner	0.1% (W) NaOH and 1.0% (W) Na ₄ EDTA, pH 12, 35°C max.	0.1% (W) NaOH and 0.025% (W) Na-DSS, pH 12, 35°C max.	0.2% (W) HCl, 25°C and pH 1 – 2	1.0% (W) Na ₂ S ₂ O ₄ , 25°C and pH 5	0.5% (W) H ₃ PO ₄ , 25 °C and pH 1 – 2	1.0% (W) NH ₂ SO ₃ H, 25°C and pH 3 – 4
Inorganic Salts (for example, CaCO ₃)				Preferred	Alternative	Alternative	
Sulfate Scales (CaSO ₄ , BaSO ₄)	OK						
Metal Oxides (for example, iron)					Preferred	Alternative	Alternative
Inorganic Colloids (silt)			Preferred		Preferred	Alternative	Alternative
Silica	Alternative	Preferred					
Biofilms	Alternative	Preferred					
Organic	Alternative	Preferred					

The temperatures and pH listed in Table 37 are applicable for BW30, BW30LE, LE, XLE, TW30, TW30HP, SW30HR, SW30HR LE, SW30XLE, SW30, and NF90 membrane elements. For more information regarding the allowed temperatures and pH for cleaning, please refer to Table 35.

Notes:

- (W) denotes weight percent of active ingredient.
- Foulant chemical symbols in order used: CaCO₃ is calcium carbonate; CaSO₄ is calcium sulfate; BaSO₄ is barium sulfate.
- Cleaning chemical symbols in order used: NaOH is sodium hydroxide; Na₄EDTA is the tetra-sodium salt of ethylene diamine tetraacetic acid; Na-DSS is sodium salt of dodecylsulfate; Sodium Laurel Sulfate; HCl is hydrochloric acid (Muratic Acid); H₃PO₄ is phosphoric acid; NH₂SO₃H is sulfamic acid; Na₂S₂O₄ is sodium hydrosulfite.
- For effective sulfate scale cleaning, the condition must be caught and treated early. Adding NaCl to the cleaning solution of NaOH and Na₄EDTA may help as sulfate solubility increases with increasing salinity. Successful cleaning of sulfate scales older than 1 week is doubtful.
- Citric Acid is another cleaning alternative for metal oxides and calcium carbonate scale. It is less effective. It may contribute to biofouling especially when it is not properly rinsed out.

6.9 Cleaning Procedure for Specific Situations

6.9.1 General Considerations

Each cleaning situation is different; therefore, specific cleaning recommendations are dependent on the type of foulant. Consult the general cleaning instructions for information that is common to all types of cleaning such as suggested equipment, pH and temperature limits and recommended flowrates; then apply the specific recommendation as needed.

6.9.2 Sulfate Scale

The following cleaning procedure is designed specifically for a system that has had sulfate scale precipitated in the elements. Sulfate scales are very difficult to clean, and if their presence is not detected early, the likelihood of cleaning success is very low. More than likely, a flow loss will occur that cannot be recovered. To regain performance of the membrane system, it may take several cleaning and soak cycles.

Cleaning Procedure

There are seven steps in cleaning elements with sulfate scale.

1. Make up the cleaning solution listed from Table 38.
2. Introduction of the cleaning solution.
3. Recycle the cleaning solution for 30 minutes.
4. Soak the elements in the cleaning solution for 1 – 15 hours.
5. High-flow pumping.
6. Flush out.
7. Restart.

Table 38. Sulfate scale cleaning solutions

Cleaning solutions	Solution
Preferred	0.1 wt% NaOH 1.0 wt% Na ₄ EDTA pH 12, 30°C maximum

Cleaning chemical formula in order used: NaOH is sodium hydroxide; Na₄EDTA is the tetrasodium salt of ethylene diamine tetraacetic acid.

For effective sulfate scale cleaning, the condition must be caught and treated early. Adding 1% NaCl to the cleaning solution of NaOH and Na₄EDTA may help because sulfate solubility increases with increasing salinity.

6.9.3 Carbonate Scale

The following cleaning procedure is designed specifically for a system that has had carbonate scale precipitated in the elements. In severe calcium carbonate scaling, the cleaning solution may have to be heated to above 35°C. Typical calcium carbonate cleaning is conducted at 20 – 25°C. The cleaning procedure is considered complete when the pH of the cleaning solution does not change during recycle and/or high flow pumping.

It may be possible to recover severely scaled elements by acid cleaning. Calcium carbonate scales dissolve easily in acids by releasing carbon dioxide. This can be observed as a foaming/bubbling reaction.

Cleaning Procedure

There are seven steps in cleaning elements with carbonate scale:

1. Make up the cleaning solution listed from Table 39.
2. Introduction of the cleaning solution.
3. **Recycle.** Recycle the cleaning solution for 10 minutes or until there is no visible color change. If at any time during the circulation process there is a color change, dispose of the solution and prepare a new solution as described in step 2. Maintain the pH for effective cleaning. Add additional cleaning chemical as needed to maintain pH.
4. **Soak.** For lightly scaled systems, a soak time of 1 – 2 hours is sufficient. Severely scaled systems can also be recovered with extended soak times. Severely scaled elements should be soaked individually outside of the pressure vessel in a vertical position. Check pH and adjust as required, or replace cleaning solution.
5. High-flow pumping.
6. Flush out.
7. Restart.

Table 39. Carbonate scale cleaning solutions

Cleaning solutions	Solution
Preferred	0.2 wt% HCl (pH 1 – 2, 35°C)
Alternative	2.0 wt% citric acid
Alternative	0.5% H ₃ PO ₄
Optional	1.0% Na ₂ S ₂ O ₄

Cleaning chemical formula in order used: HCl is hydrochloric acid (muriatic acid); H₃PO₄ is phosphoric acid, Na₂S₂O₄ is sodium hydrosulfite.

6.9.4 Iron Fouling

The following cleaning procedure is designed specifically for a system that is fouled with iron.

Cleaning Procedure

There are seven steps in cleaning elements with iron fouling.

1. Make up the cleaning solution listed from Table 40.
2. Introduction of the cleaning solution.
3. Recycle.
4. Soak. Soak times are essential for sodium hydrosulfite to be effective. Soak time will vary depending on the severity of the fouling. A typical soak time is 2 – 4 hours.
5. High-flow pumping.
6. Flush out.
7. Restart.

Table 40. Iron fouling cleaning solutions

Cleaning solutions	Solution
Preferred	1.0 wt% Na ₂ S ₂ O ₄ (pH 5, 30°C)
Alternative	2.0 wt% citric acid
Alternative	0.5% H ₃ PO ₄
Alternative	1.0% NH ₂ SO ₃ H

Cleaning chemical formula in order used: Na₂S₂O₄ is sodium hydrosulfite; H₃PO₄ is phosphoric acid; NH₂SO₃H is sulfamic acid.

Additional Information

The sodium hydrosulfite has a very pungent odor, so the room must be well ventilated. Follow all safety regulations and procedures. Contact time is key to successful cleaning. The solution will sometimes change many different colors. Black, brown, yellow are all very normal for this type of cleaning. Anytime the solution changes color, it should be disposed of and a new solution prepared. The length of time and the number of soaking periods will depend on the severity of the fouling.

6.9.5 Organic Fouling

The following cleaning procedure is designed specifically for a system that has been fouled with organic species such as humic and fulvic acids, antiscalants, or oils.

Cleaning Procedure

There are eight steps in cleaning elements fouled with organics, but the six steps are conducted first with a high pH cleaning solution and then repeated with a low pH cleaning solution:

1. Make up the desired high pH cleaning solution selected Table 41.
2. Introduction of the cleaning solution.
3. Recycle the cleaning solution for 30 minutes. If a color change occurs, dispose of the cleaning solution and prepare a fresh solution.
4. Soak.
5. High-flow pumping.
6. Flush out.
7. Repeat steps 2 through 6 with cleaning solution of HCl at pH 2.
8. Restart.

Additional Information

For maximum effectiveness, the temperature of the cleaning solutions must be above 25°C. Elevating the temperature of the cleaning solution will assist in organic removal from the membrane surface. Some organics such as oils are very difficult to remove. To remove them, experiment with different soak times for optimum effectiveness. In addition, the most effective cleaning solution usually contains a surfactant such as Na-DDS or perhaps some commercially available membrane cleaners containing surfactants or detergents that can help remove the oils. Consult your chemical supplier for their recommendation.

If the organic fouling is the result of overfeeding of a coagulant used for feedwater pretreatment, reversing the order of the cleaners can be more effective. To determine the proper order of the cleaning solutions (high pH followed by low pH or vice versa), try to gather a sample of the organic foulant from your system. With the sample, try treating it with caustic and then acid and vice versa to determine qualitatively which order of cleaning solution treatment dissolves the foulant better. If both treatments appear to work equally, it is usually better to clean with the high pH solution first.

Table 41. Organic fouling cleaning solutions

Cleaning solutions	Solution
Preferred	0.1 wt% NaOH pH 12, 30°C maximum, followed by: 0.2% HCl pH 2, 45°C maximum
Preferred	0.1 wt% NaOH 0.025 wt% Na-DDS pH 12, 30°C maximum, followed by: 0.2% HCl pH 2, 45°C maximum
Alternate	0.1 wt% NaOH 1.0 wt% Na ₄ EDTA pH 12, 30°C maximum, followed by: 0.2% HCl pH 2, 45°C maximum

Cleaning chemical formula in order used: NaOH is sodium hydroxide; HCl is hydrochloric acid (muriatic acid); Na-DDS is sodium salt of dodecylsulfate; sodium laurel sulfate; Na₄EDTA is the tetrasodium salt of ethylene diamine tetraacetic acid.

6.9.6 Biofouling

The following cleaning procedure is designed specifically for a system that has been fouled with biological matter.

Cleaning Procedure

There are seven steps in cleaning elements with biofouling:

1. Make up the cleaning solution listed from Table 42.
2. Introduction of the cleaning solution.
3. Recycle.
4. Soak.
5. High-flow pumping.
6. Flush out.
7. Restart.

Table 42. Biofouling cleaning solutions

Cleaning solutions	Solution
Preferred	0.1 wt% NaOH pH 13, 35°C maximum
Preferred	0.1 wt% NaOH 0.025 wt% Na-DDS pH 13, 35°C maximum
Alternate	0.1 wt% NaOH 1.0 wt% Na ₄ EDTA pH 13, 35°C maximum

Cleaning chemical formula in order used: NaOH is sodium hydroxide; Na-DDS is sodium salt of dodecylsulfate (sodium lauryl sulfate); Na₄EDTA is the tetrasodium salt of ethylene diamine tetraacetic acid.

Additional Information

By experience, the cleaning solution of Na₄EDTA with caustic has been found to be slightly less effective than a standard caustic solution or a solution of caustic and Na-DDS.

For any solution, contact time is critical. Several overnight soaks may be necessary to restore the system performance. After the elements are clean it is very beneficial to clean one additional time to clean off the last remaining biofilm layer on the surface of the membrane. Any remaining biofilm will tend to attract and trap dirt, so an extra cleaning will increase the time between cleanings. In the event of severe biofouling, slug dosing of a biocide may be required to enhance the results of the cleaning procedure. Please refer to Section 2.6.5 for details regarding biocide usage.

When biofouling is an operational problem, regular sanitization procedures as described in Section 6.10.1 are recommended after cleaning.

6.9.7 Emergency Cleaning

When cleaning has not been carried out in time, e.g., the differential pressure (ΔP) has already doubled, or the normalized product flow has dropped by 50%, the success of the previously described cleaning processes may be limited. If those standard cleaning techniques fail to remove the foulants, more harsh cleaning methods can be tried.

Please contact your DuPont representative for recommendations. It has to be stressed, however, that no warranty can be given on the efficiency of any cleaning, nor on the membrane performance after such cleaning attempts.

6.10 Sanitizing RO/NF Membrane Systems

6.10.1 Introduction

The sanitization of RO/NF membrane systems as described in this chapter is the application of biocidally effective solutions or hot water to the membranes while the system is offline, i.e., not in production mode. The online dosage of biocidal chemicals while the system is in production mode is dealt with in Section 2.6.1, *Biological Fouling Prevention*.

Membrane systems are sanitized in order to keep the number of living microorganisms at an acceptably low level. There are two main reasons why sanitization is required:

1. **Smooth operation.** Microorganisms may grow into a biofilm at the membrane and feed spacer surface and cause biofouling. Biofouling is a major threat to system operation, and regular sanitization is part of a strategy to control biofouling. Regular sanitization helps to keep the level of biological growth low enough to avoid operational problems. In RO systems operating with biologically active feedwater, a biofilm can appear within 3 – 5 days after inoculation with viable organisms. Consequently, the most common frequency of sanitization is every 3 – 5 days during peak biological activity (summer) and about every 7 days during low biological activity (winter). The optimal frequency for sanitization will be site-specific and must be determined by the operating characteristics of the RO system.
2. **Permeate water quality.** Some applications, for example in food and pharmaceutical industries, require a high product water quality with respect to microbiological parameters. Although RO and NF membranes are theoretically rejecting 100% of microorganisms, any minute leakage in the membrane system may allow the permeate water to get contaminated. The risk of contamination is much higher with a biofilm present on the feed side; therefore the membrane has to be kept in a sanitary state. Regular sanitizations in these applications are required to improve the microbiological quality of the permeate water, even if no operational problems are encountered.

6.10.2 Hydrogen Peroxide and Peracetic Acid

Hydrogen peroxide or a mixture of hydrogen peroxide and peracetic acid has been used successfully for treating biologically contaminated reverse osmosis and nanofiltration systems that use FilmTec™ membranes. Commercially available hydrogen peroxide/peracetic acid solutions come in a concentrated form and are diluted with RO/NF permeate to obtain a 0.2% (by weight) peroxide solution.

There are two factors that greatly influence the rate of hydrogen peroxide attack on the membrane: temperature and iron. The disinfecting solution should not exceed 77°F (25°C). FT30 membrane samples tested with 0.5% hydrogen peroxide at 34°C showed a very high salt passage after several hours. At 24°C, however, membrane samples demonstrated compatibility with 0.5% hydrogen peroxide after 96 hours.

The presence of iron or other transition metals in conjunction with hydrogen peroxide solutions can also cause membrane degradation. FT30 membrane samples were tested using a 0.15% solution of hydrogen peroxide and tap water containing iron. After 150 hours, the salt passage of the membrane began to increase dramatically. Continuous exposure at this concentration may eventually damage the membrane. Instead, periodic use is recommended.

For biologically contaminated RO systems using the FilmTec™ membrane, the following procedure for applying hydrogen peroxide solutions is recommended:

1. Any type of deposit on the membrane or other parts of the system should be removed with an alkaline cleaner before sanitizing. Removal of these deposits, which harbor microorganisms, will maximize the degree of sanitization. After alkaline cleaning, flush the system with RO permeate.
2. Clean the RO system with acid as described in Section 6.9.4 to remove any iron from the membrane surface. Flush the system with RO permeate.
3. Circulate a solution of 0.2% (by weight) hydrogen peroxide diluted with RO permeate at a temperature below 77°F (25°C) for 20 minutes. A pH of 3 – 4 gives optimal biocidal results and longer membrane lifetime.

6.10.3 Chlorinated and Other Biocidal Products

Applying free chlorine, chlorine dioxide or biocidal agents containing combined chlorine is generally not recommended, see Section 2.6.3 and Section 2.6.6.

Iodine, quaternary biocides and phenolic compounds cause flux losses and are not recommended for use as biocidal agents.

6.10.4 Heat Sanitization

The HSRO series of FilmTec™ Elements can be sanitized with hot water. It is an excellent choice for food and pharmaceutical applications. The advantages of hot water as a sanitization agent are:

- May reach areas chemicals do not (dead legs, etc...)
- Easy to validate
 - Simpler to monitor heat than chemical concentrations
 - Easier to demonstrate complete distribution of heat
- No need to rinse out chemicals
- No need to store chemicals
- Minimizes waste disposal issues
- No need to approve chemicals

New HSRO heat sanitizable spiral elements must be pre-conditioned prior to initial use by exposure to hot water. Suitable quality water must be used during all pre-conditioning steps. This water is chlorine-free, non-scaling/fouling water. RO permeate is preferred, but pre-filtered feedwater may be used. An appropriate conditioning procedure consists of the following:

- Flush to drain with suitable quality water at low pressure and low permeate flow rate.
- Recycle warm water (45°C or less) at very low pressure (< 25 psig transmembrane pressure with a maximum feed pressure of 45 psig (3 bar)).
- Introduce hot water to the system to increase temperature to 80°C (176°F).
- Keep transmembrane pressure below 25 psig (1.7 bar) when warm or hot water (45°C or higher) is being fed to the membranes.
- Maintain temperature for 60 – 90 minutes.
- Allow system to cool to 45°C or below.
- Flush to drain with suitable water quality at very low pressure (< 25 psig transmembrane pressure with maximum feed pressure of 45 psig (3 bar)).

HSRO membranes have high water permeability before they have been pre-conditioned. After pre-conditioning, they attain their specified flow and salt rejection performance during operation at normal temperature. The performance will remain stable irrespective of subsequent additional sanitization cycles. The procedure for regular sanitization may be the same as described above, but ultimately is the responsibility of the end-user. Certain industries have required sanitizing procedures that may be different from our procedures.

7 Handling, Preservation and Storage

7.1 General

FilmTec™ Membrane Elements should be handled in such a way that biogrowth and change in membrane performance during long-term storage, shipping or system shutdowns are prevented. The elements should preferably be stored and shipped outside the pressure vessels and loaded into the pressure vessels just prior to start-up.

Follow accepted safety practices when using biocide solutions as membrane preservations. Always wear eye protection. Consult the relevant Material Safety Data Sheets as supplied by the manufacturer of the chemicals.

7.2 Storage and Shipping of New FilmTec™ Elements

New FilmTec™ Elements are tested and shipped either in dry condition or as wet and preserved elements. Wet elements are preserved in a standard storage solution containing a buffered 1 wt% food-grade sodium metabisulfite (SMBS). The storage solution prevents biological growth during storage and shipping of elements. For preservative Material Safety Data Sheets please visit the Answer Center at www.dupontwatersolutions.com.

Wet elements are bagged in a durable, oxygen-barrier composite plastic bag and preservative solution is delivered prior to vacuum sealing. Precise preservative volume and high bag integrity help ensure a stable preservative environment during transportation and storage.

Dry elements are bagged and sealed in a robust plastic bag. They do not require any preservation solution, but they should be kept in their sealed bag until they are used.

Please follow these guidelines for storage of FilmTec™ Elements:

- Store inside a cool building or warehouse and not in direct sunlight.
- Temperature limits: 25°F to 95°F (-4°C to +35°C).
 - New dry elements will not be affected by temperatures below 25°F (-4°C).
 - Elements stored in 1% SMBS will freeze below -4°C, but the membrane will not be damaged, provided the elements are thawed before loading and use.
- Keep new elements in their original packaging.
- Preserved elements should be visually inspected for biological growth 12 months after shipment and thereafter every three months. If the preservation solution appears to be not clear the element should be removed from the bag, soaked in a fresh preservation solution and repacked. Refer to Section 7.3.1 for guidelines. In case no equipment for re-preservation (fresh solution, clean environment, bag sealing device) is available, the elements can be left in their original packaging for up to 18 months. When the elements are then loaded into the pressure vessels, they should be cleaned with an alkaline cleaner before the plant is started up.

7.3 Used FilmTec™ Elements

7.3.1 Preservation and Storage

Any FilmTec™ Element that has been used and removed from the pressure vessel for storage or shipping must be preserved in a preservation solution as follows:

- Use the standard storage solution of 1% food-grade SMBS (not cobalt-activated) in good-quality water (preferably reverse osmosis (RO) or nanofiltration (NF) permeate).
- Soak the element for 1 h in the solution; keep it in a vertical position so that the entrapped air can escape. Allow it to drip out, and seal it into an oxygen barrier plastic bag. We recommend reusing the original bag or original spare bags available from DuPont. Do not fill the plastic bag with the preservation solution—the moisture in the element is sufficient, and leaking bags might create a problem during transport.
- Identify the element and the preservation solution on the outside of the bag.
- The storage conditions are the same as for new elements – see Section 7.2.
- Re-preserved elements should be visually inspected for biological growth every three months. If the preservation solution appears to be not clear the element should be re-preserved and repacked as above.
- The pH of the preservation solution must never drop below pH 3. In the absence of a buffer such as is used in the original preservative for wet FilmTec™ Elements, a pH decrease can occur when bisulfite is oxidized to sulfuric acid. Therefore, the pH of the bisulfite preservation solution should be spot checked at least every 3 months. Re-preservation is mandatory when the pH is 3 or lower.
- Wear protective gloves and sleeves to avoid prolonged contact with skin and sleeves when working with preservative.

7.3.2 Re-wetting of Dried Out Elements

Elements that have dried out after use may irreversibly lose water permeability. Re-wetting might be successful with one of the following methods:

- Soak in 50/50% ethanol/water or propanol/water for 15 minutes.
- Pressurize the element at 150 psi (10 bar) and close the permeate port for 30 minutes. Take care that the permeate port is reopened before the feed pressure is released. This procedure can be carried out while the elements are installed in a system. In this case, the pressure drop from the feed side to the concentrate side must not exceed 10 psi (0.7 bar) during high pressure operation with closed permeate port – otherwise the permeate backpressure near the concentrate end will become too high. Preferably, the permeate port is not completely closed but throttled to a value equal the concentrate pressure. Then there is no need for a special pressure drop limit.
- Soak the element in 1% HCl or 4% HNO₃ for 1 – 100 h. Immerse the element in a vertical position to allow the entrapped air to escape.

7.3.3 Shipping

Unless otherwise specified, when FilmTec™ Elements have to be shipped, they must be preserved with a preservation solution according to Section 7.3.1.

Make sure that:

- The plastic bag does not leak.
- The element is properly identified.
- The preservation solution is correctly labelled.

We recommend using the original packaging with the original polystyrene foam cushions to protect the element from mechanical damage. Elements with non flush-cut product water tubes should be protected against damage to the product water tube ends.

The membrane elements will not be damaged by freezing temperatures during shipping provided the elements are thawed before loading and use.

7.3.4 Disposal

Used FilmTec™ Elements can be disposed of as municipal waste, provided:

- No preservation solution or other hazardous liquid is contained in the element.
- No depositions of hazardous substances are on the membranes (e.g., elements used in wastewater treatment).

7.4 Preservation of RO and NF Systems

The procedure of shutting down an RO/NF system has been described in Section 5.4. FilmTec™ Elements must be preserved any time the plant is shut down for more than a maximum of 48 h to prevent biological growth. Depending on the previous operational history of the plant, it will be necessary in almost all cases to clean the membranes prior to shutdown and preservation. This applies to cases when the membranes are known or assumed to be fouled.

After cleaning, the preservation should follow within the next 10 h as follows:

1. Totally immerse the elements in the pressure vessels in a solution of 1 – 1.5% SMBS, venting the air outside of the pressure vessels. Use the overflow technique: circulate the SMBS solution in such a way that the remaining air in the system is minimized after the recirculation is completed. After the pressure vessel is filled, the SMBS solution should be allowed to overflow through an opening located higher than the upper end of the highest pressure vessel being filled.
2. Separate the preservation solution from the air outside by closing all valves. Any contact with oxygen will oxidize the SMBS.
3. Check the pH once a week. When the pH becomes 3 or lower, change the preservation solution.
4. Change the preservation solution at least once a month.

During the shutdown period, the plant must be kept frost-free, and the temperature must not exceed 113°F (45°C). A low temperature is desirable.

8 Troubleshooting

8.1 Introduction

Loss of salt rejection and loss of permeate flow are the most common problems encountered in reverse osmosis (RO) and nanofiltration (NF). Plugging of the feed channels associated with pressure drop increase is another typical problem. If the rejection and/or the permeate flow decreases moderately and slowly, this may indicate a normal fouling which can be handled by proper and regular cleaning (see Section 6.1, *Cleaning and Sanitation*). An immediate decline in performance indicates a defect or misoperation of the plant. In any case, it is essential that the proper corrective measure is taken as early as possible because any delay decreases the chance of restoring the plant performance – apart from other problems that might be created by an excessively low permeate flow and/or too high permeate TDS.

A prerequisite for early detection of potential problems is proper record keeping (see Section 5.6.1) and plant performance normalization (see Section 5.6.6). This includes proper calibration of all instruments. Without accurate readings it might be too late before a problem is detected and corrected.

Once a performance decline has been identified, the first step in solving the problem is to localize the problem and to identify the cause(s) of the problem. The first step is to evaluate the performance and the operation of the system. This can be done using the data of the record keeping logsheet or of some additional on-line measurements. Then some checks and system tests should be made. Troubleshooting is much more effective if certain system features and equipment are provided, see Section 3.17, *System Design for Troubleshooting Success*. If the system data is not sufficient in determining the cause(s) and to recommend corrective action, one or more membrane elements must be taken from the plant and analyzed. Element performance analysis includes non-destructive and destructive analysis. Finally, corrective measures are taken to restore the plant performance and to avoid future problems.

Further reading: *W.Byrne (Ed.): Reverse Osmosis, Chapter 7 / 1/*.

8.2 Evaluation of System Performance and Operation

If the performance of the membrane system is not satisfactory, the first step is to evaluate the performance and the operation of the entire system. This is done on the basis of normalized plant data, see Section 5.6.6, *Plant Performance Normalization*. When the actual normalized plant performance is compared against the performance at start-up, any significant performance deterioration can be identified.

In case that the initial system performance at start-up is not satisfactory, a comparison of the actual system performance with the WAVE projected system performance under actual conditions is helpful.

WAVE is a tool used to estimate the stabilized performance of a new RO or NF system under design conditions, but it can also be used to estimate the performance of an existing RO/NF system under prevailing actual conditions. This projected performance is based on the nominal performance specification for the FilmTec™ Element(s) used in that system. A fouling factor of 1.00 in the projection is used to calculate the performance of new elements with exact nominal flowrate. A fouling factor of < 1 should be applied when making a design for long-term operation. In a real system, the elements may have a flow performance variation of ± 15% of the nominal value, or whatever variation is specified for this element type. Also the salt rejection of an individual element may be higher or lower than the nominal salt rejection (but not lower than the minimum salt rejection). Therefore, the measured stabilized performance is unlikely to exactly hit the projected performance, but for systems with more than 36 new elements it should come close.

The actual fouling factor of a stabilized new RO system with at least 36 elements should range between 0.95 and 1.05. The actual measured TDS of the permeate should be no higher than about 1.5 times the calculated TDS.

For systems with only one or a few elements, the deviation of the measured actual performance from the projected performance may become as large as the specified element performance variation.

If the normalized actual performance has deteriorated too much compared to the initial performance, or the measured actual performance does not match close enough with the projected performance, check the following:

- Are all meters, sensors and pressure gauges calibrated?

Troubleshooting Tip:

Use simple mass balance equations to confirm accuracy of flow and conductivity instruments. RO/NF systems should be operated at design flow and recovery rates in order to help ensure trouble-free operation. Damage to membrane elements can result from operation at elevated flowrates, and fouling can result from flowrates which are too low to prevent deposition of particulate matter. Scaling or fouling can occur in RO systems when operated at above design recovery rates.

Eq. 73 and Eq. 74 provide a simple method to check the accuracy of flow and conductivity meters. These equations should be used as an indicator and are not intended to replace periodic calibration of instruments. If deviation from unity is observed in Eq. 74, the accuracy of one of the meters is compromised, and calibration should be performed.

$$1. \text{ Feed flow} = \text{Permeate flow} + \text{Brine flow} \quad \text{Eq. 73}$$

$$2. \frac{(\text{Feed flow}) (\text{Feed Conductivity})}{(\text{Permeate flow}) (\text{Permeate Conductivity}) + (\text{Brine flow}) (\text{Brine Conductivity})} = 1 \pm 0.05 \quad \text{Eq. 74}$$

In order for Eq. 74 to be valid, conductivity measurements should be taken after all chemical additions and accurately reflect the feedwater.

- Has the system stabilized? It should have been in continuous operation for 24 – 72 hours when the readings are taken. Systems that have been in operation for extended time should be investigated by the evolution of the normalized system performance data. This can be done with the FTNORM program as described in Section 5.6.6, *Plant Performance Normalization*.
- Has permeate pressure been taken into account? Neglected permeate pressure results in a higher than projected feed pressure.

- Is there any significant pressure losses from the feed to the concentrate? Historically, a pressure loss was estimated in the piping of 5 psi (0.35 bar) per stage in addition to the pressure loss in the FilmTec™ Elements. Restrictions in feed or concentrate headers would result in higher pressure losses than projected. Check the distance of the pressure sensors from the feed and concentrate end of the pressure vessels. The locations of the pressure sensors should be as close as possible to the pressure vessel and in sufficient distance from valves or other places of high turbulence.
- Check the Process and Instrumentation Diagram of the system:
 - Are provisions made to avoid undue operating conditions? See Section 3.14.3 *Shutdown Switches*.
 - Are the necessary valves installed? See Section 3.14.4 *Valves*.
 - Are provisions made for efficient troubleshooting? See Section 3.17, *System Design Suggestions for Troubleshooting Success*.
 - Are provisions made to avoid siphoning of the pressure vessels during shutdown periods? See Section 5.4 *RO and NF System Shutdown*.
- Check the start-up and shut-down procedure: is it safe with respect to hydraulic shocks, permeate backpressure and back-flow of permeate? See Sections 5.2 to 5.4 for start-up and shut-down procedures.
- Check the cleaning procedure and chemicals used: is the procedure efficient and the chemicals safe with respect to membrane damage? See Section 6.1, *Cleaning and Sanitization*.
- How frequently is the system being cleaned? A high cleaning frequency (more than once per 4 – 6 weeks) may indicate a poor performance of the pretreatment or a RO/NF system operating outside of the design guidelines. As a guideline, anything from one to three chemical cleanings per year is considered good, while four and up to to six annual cleanings are typically still considered acceptable. A higher cleaning frequency is normally not justifiable and it is usually more economical to improve the pretreatment system.
- Have water analyses been performed? The conductivity is not sufficient for the calculation of TDS rejection. Particularly, carbon dioxide (CO₂) in the feedwater will pass into the permeate, create carbonic acid and increase the permeate conductivity.
- Check the application of chlorine and other oxidizing chemicals – this can indicate a potential oxidation problem.
- Check the replacement rate of pre-filters – a high replacement rate can indicate a potential fouling problem. A too low replacement rate e.g., of cartridge filters may also post a risk (sudden collapse, etc.).
- Check the SDI log sheets: the feed SDI should be consistently < 5 or < 3, depending on the system design.
- Check the scaling calculations and confirm the dosage rates of chemicals, e.g., scaling inhibitor.

If all this has been considered and the observed system performance is still outside of expectations, perform the system tests as described next.

8.3 System Tests

After the available data of the system operation and performance have been checked and investigated, the system will be inspected and tested in more detail.

8.3.1 Visual Inspection

- How clean is the plant? Mold and biogrowth in tanks and pipes are indicators of a biofouling problem. Leaking vessels may suck air when the system shuts down and lead to hydraulic shock at start-up and premature fouling, especially in SW conditions.
- Open a pressure vessel at the feed side: is there any fouling present on the face of the lead element? A biofilm on a wet surface feels slippery. Any smell? Are the elements properly shimmed (see Section 4.3, *Shimming Elements*)?
- Open a pressure vessel at the concentrate side: scaling feels like sanding paper to the touch.
- Remove the elements from one or from several vessels and check the couplers for torn, damaged or misplaced O-rings. Replace O-rings. See Section 4.5 for interconnector technology.
- Inspect the elements for fouling, scaling and mechanical damage – check at least one lead element and one tail element.

8.3.2 Type of Foulant and Most Effective Cleaning

- How does the system respond to different cleanings? The efficiency of a specific cleaning is an indication for a specific fouling problem. See Section 6.9, *Cleaning Procedure for Specific Situations*.
- How does the cleaning solution coming out of the system look? The initial cleaning solution exiting from the membrane system may contain high amounts of removed foulants. Analyze the spent cleaning chemical for metals and TOC and compare with a fresh solution. The type of foulant can be estimated from the comparison of the analyses of the used and the unused cleaning solution.

8.3.3 Localization of High Solute Passage

8.3.3.1 Profiling

If a system exhibits high solute passage, one of the first steps in troubleshooting is to localize the source. A loss in solute rejection may be uniform throughout the system, or it could be limited to the front or to the tail end of the system. It could be a general plant failure, or it could be limited to one or few individual vessels. To localize high solute passage in a system, it is first recommended to profile the system. To profile a system, all individual vessel TDS or conductivity or other relevant quality values are checked. A well-designed system contains a sample port located in the permeate stream from each vessel. Care must be taken during sampling to avoid mixing of the permeate sample with permeate from other vessels. All permeate samples are then tested for their concentration of dissolved solids with a TDS or conductivity meter. In nanofiltration applications, specific analytical methods for sulfate or other relevant compounds have to be used. The permeate samples of all pressure vessels in the same stage should give readings in the same range. Notice that from one stage to the next the average permeate TDS or conductivity usually increases, because for example the second stage is fed with the concentrate from the first stage. To determine the solute passage of all pressure vessels from their permeate concentration, the concentration of the feed stream to each stage must also be measured. The solute passage is the ratio of the permeate concentration to the feed concentration. Then the high solute passage of the system can be assigned to the first or the last stage, or to individual vessels.

8.3.3.2 Probing

If one pressure vessel shows a significantly higher permeate concentration than the other vessels of the same stage, then this vessel should be probed. The procedure allows locating a problem within a pressure vessel while online without unloading elements. Probing involves the insertion of a plastic tube (approx. ¼ inch (6 mm) in diameter) into the full length of the permeate tube (see Figure 50) in order to measure the permeate conductivity at different locations inside the pressure vessel. This can be accomplished by isolating the vessel from its permeate manifolds and use the open permeate port, or by removing the opposite end cap's permeate plug. When the permeate manifolds remain in place, it must be ensured that no permeate from other vessels can influence the probing. If the system operates with a permeate backpressure, the probed vessel must be disconnected from the system permeate; otherwise permeate from the other vessels will enter into the probed vessel.

The use of a modified tube fitting according to Figure 51 eliminates water leakage at the point of entry. This device can be used at the opposite end of the pressure vessel from the product header piping, with the permeate manifold remaining in place even under a moderate permeate backpressure. A ½-inch ball valve is connected to the permeate port. It is fitted with a ¼-inch plastic Parker tube fitting which has been modified by drilling the body to allow a ¼-inch plastic probe tubing to pass completely through the fitting. In addition a short piece (2 inches (5 cm)) of very supple thin wall gum rubber tubing which fits snugly over the end of the nylon probe tubing and protrudes approximately 1/2 inch will prevent hang-ups at the product tube adapters and the product tube interconnectors.

While the membrane system is operating at normal operating conditions, water is diverted from the permeate stream of the vessel in question. A few minutes should be allowed to rinse out the tubing and allow the membrane system to equilibrate. For an RO system, the TDS or the conductivity of the permeate sample from the tubing can then be measured with a hand-held meter and the data recorded. It is desirable to set up the conductivity meter for continuous indication utilizing a flow through cell or the arrangement shown in Figure 51. This measurement should reflect the TDS of the permeate being produced by the FilmTec™ Element at that position. For a NF system, the permeate conductivity might not be sensitive enough to localize a leakage. Instead, the sulfate concentration in the sample should be determined.

The tubing is then pulled out 6 inches (15 cm) from the end and a sample is taken to measure the conductivity at the adapter/element interface. Then the tubing is extracted eight inches (20 cm) and another sample is taken. The tubing is then withdrawn in further increments to obtain a conductivity profile (see Figure 50). The sampling locations should be every 8 inches (20 cm) so that every fifth sample marks the coupler connection for two elements. This allows for multiple measurements per element plus checking of all coupler/adapter O-rings. The tube can be marked so that the desired sampling locations can easily be accessed.

Taking a conductivity reading at 8-inch intervals for each element, allows closer scrutiny for determining exactly which O-ring seal of a coupler (interconnector) has a leak. Similarly the probe should be positioned some distance away, as well as at the end of the adapter, to check the integrity of the O-ring seal at the pressure vessel head assembly (end plug). Figure 51 illustrates this by showing how to position the probe to check for leaks at the O-ring seal for the product tube adapters in the permeate hub of the end plug. The sketch illustrates the probe at the "start" position typical for 8" elements where the normally plugged permeate port is used to connect the probing apparatus and insert the probe tubing. The dimensions will vary depending on manufacturer and model of the actual pressure vessels. It is usually recommended to open up one of the pressure vessels to determine exactly the correct dimensions for positioning the probe tube. After this is done a table should be made listing dimensionally all the locations where pauses are required during withdrawal of the probe tubing for recording conductivity measurements.

Accurately positioning the probe for these data points can be accomplished by using an additional O-ring (size 108 for ¼" O.D. tubing) as an indicator just outside the tube fitting. With the probe completely inserted to the start position, and the indicator O-ring at the outside face of the tube fitting, the measurement for the next predetermined position can be made accurately with a tape measure since the O-ring will move along with the tubing as the probe is withdrawn. Then keeping the probe stationary slip the indicator O-ring back to the tube fitting in preparation for the next withdrawal measurement. This simple trick has proved very effective in accurately positioning the probe with as many as seven elements in series.

A normal conductivity profile shows a steady increase of the permeate produced at the feed side of the pressure vessel towards the concentrate end of the vessel. An unusually large deviation from this profile locates the source of the high salt passage problem. O-ring problems are generally indicated by a step change in the conductivity profile at coupler/adaptor locations, while a marked increase outside this region points to a leakage from an element, e.g., due to a backpressure damage.

The normal (reference) conductivity profile depends also on the location of the probing tube entry and on the flow direction of the permeate out of the probed vessel. Figure 50 shows an arrangement with probing from the concentrate end of the vessel with the permeate flowing to the concentrate side as well. The first sample from the feed side end of the vessel represents the permeate produced at exactly that location. As the tube is gradually pulled out from the vessel, the sample represents the combined permeate which is produced upstream of the sample location. The last sample represents the permeate of the entire vessel.

If the vessel is connected to the permeate manifolds and/or the probing tube is inserted from the feed side of the vessel, the reference conductivity profile changes accordingly. The accuracy of the method is best where the sample is least influenced by permeate from upstream membranes. This has to be born in mind when the results are evaluated.

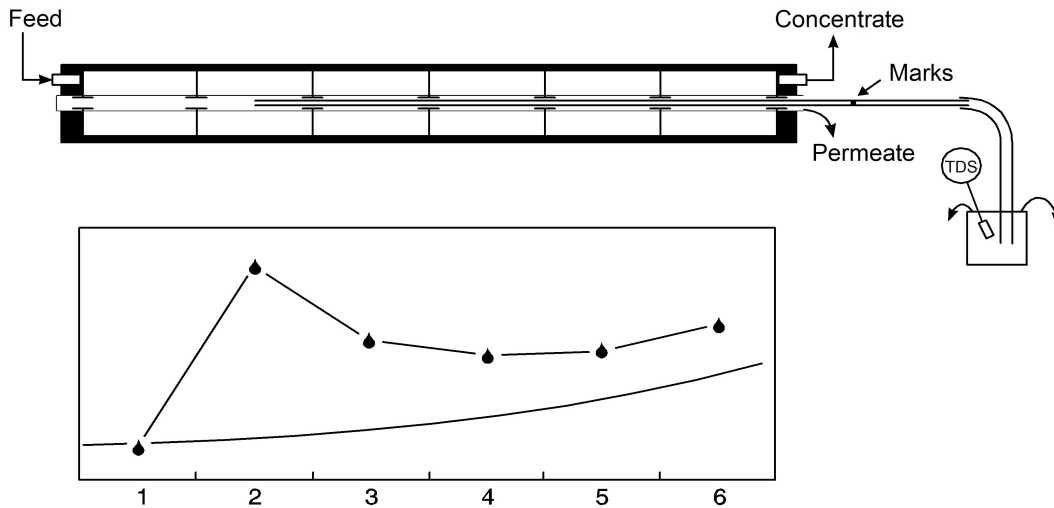

Figure 50. Conductivity profile

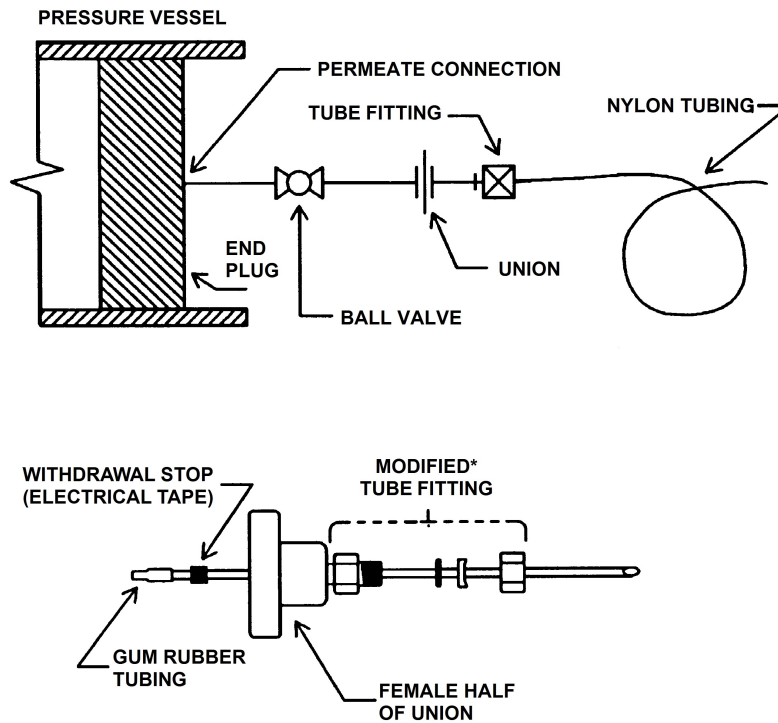

Figure 51. Permeate probing apparatus for spiral-wound membrane

Note: Tube fitting modified by extending the ¼ inch bore through the body and discarding the gripper ring.

8.4 Membrane Element Evaluation

8.4.1 Sample Selection

When the causes of a plant performance loss are not known, or when they have to be confirmed, one or more elements of the system have to be analyzed individually. The element(s) which should be analyzed are those with a step increase in the conductivity profile.

When there is a general plant failure, a front-end element or a tail-end element should be selected, depending on where the problem is located. Typical front-end problems are fouling problems; typical tail-end problems are scaling problems. When the problem cannot be localized, an element from both ends of the system should be taken.

Sampling a second element from a neighboring position is advisable when cleaning tests are planned. Then one of the elements can be used to analyze the fouling layer and to perform lab scale cleaning tests, the results of which can then be applied to the other element.

8.4.2 System Optimization Services (SOS)

FilmTec™ offers an element analysis service called System Optimization Services, including a variety of inspection, diagnostic and testing procedures. In warranty cases, the DuPont Quality Department must be involved.

The examination, testing and analysis of membrane elements can also be carried out by an external laboratory. Larger installations often have the capabilities for evaluating membrane elements at the site. A visual inspection and some simple checks at the site can provide some quick and valuable information.

The procedures which are described in the following are based on ASTM Standard Methods and Practices whenever possible. These methods are recommended for membrane element evaluation, but not all of these methods are offered by System Optimization Services. On the other hand, System Optimization Services offers some specific evaluations which are not described here. The details, the conditions and element return procedures are available from our web pages (<http://www.dupont.com/water/system-optimization-services.html>).

8.4.3 Visual Inspection and Weighing

The visual inspection of membrane elements provides information about a potential fouling or scaling problem. The element is inspected for discolorations of the outer wrapping and the fiberglass or tape wrap. The element is also inspected for any deposits or foreign matter. Telescoping and fiberglass damage would indicate excessive hydraulic loads or improper pressure vessel loading. The permeate water tube is inspected for mechanical damage which could cause salt passage. The brine seal is inspected for condition and proper installation.

8.4.4 Vacuum Decay Test

A FilmTec™ Element with a high salt passage should first be checked if leaks are present with feed/concentrate water leaking into the permeate side of the element. Leaks may occur through damage of the membrane surface itself by punctures or scratches or by delamination and physical damage of the membrane by e.g., permeate backpressure or water hammer. The vacuum decay test as described in the following may be used to detect leaks or to confirm the mechanical integrity of a FilmTec™ Element. The method is based on ASTM Standards D3923 /2/ and D6908 /3/.

The vacuum decay test is a tool to detect leaks or to confirm the integrity of FilmTec™ RO and NF Elements after they have been in operation. It can be applied to a single element or to a complete pressure vessel containing several elements. Before testing, the element has to be drained from water present in the feed channels and in the permeate leaves. The pressure vessel to be tested must not contain any water. The permeate tube of the element is evacuated and isolated. The rate of the vacuum decay indicates mechanical integrity or a leak of the membrane element. A mechanically intact element and also a chemically damaged membrane would still hold the vacuum, but a mechanically damaged membrane would not.

This test is useful as a screening procedure and is not intended as a mean of absolute verification of a leak. However, the test allows identifying leaking elements or O-rings within a short time. It also helps to distinguish between chemical membrane damage (which would not show up as a leak) and mechanical membrane damage. The test can be applied in the field to test a large number of elements when a single element test unit is not available, or if not enough time is available for performance testing.

The procedure is as follows (see Figure 52):

1. Drain the element.
2. Seal one end of the permeate tube with a suitable leak-tight cap.
3. Connect the other end of the permeate tube to a vacuum gauge and a valved vacuum source.
4. Evacuate the element to 100 – 300 mbar absolute pressure.
5. Close the isolation valve and observe the reading on the vacuum gauge. Note the rate at which the vacuum decays. A rapid decay (greater than 100 mbar pressure increase per minute) will indicate the presence of a leak.
6. Slowly release the vacuum and allow the element to reach atmospheric pressure before disconnecting.
7. The test should be repeated several times to confirm its reproducibility.

Testing a complete pressure vessel allows including the couplers and adapters into the leak test. The procedure is the same as described with the difference that the permeate port at one side of the vessel is closed, and the vacuum is pulled from the permeate port of the other side. Feed and concentrate ports may be open.

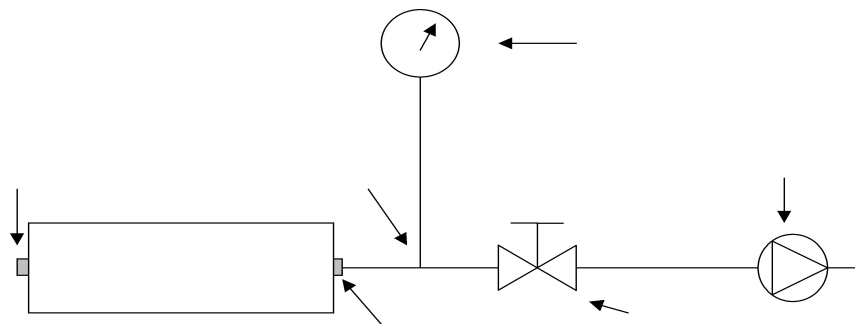

Figure 52. Vacuum decay test

8.4.5 Performance Test

The standard element performance test is used to determine the solute rejection and the permeate flowrate of a FilmTec™ Element under FilmTec™ Standard Test Conditions. The test results can then be compared with the specification of the element in question. The element performance is determined before and after any cleaning trial in order to assess the efficacy of the treatment.

The apparatus for the standard test consists of a feed holding tank equipped with a thermostated heat exchanger system to maintain the feed solution at $25 \pm 1^\circ\text{C}$, a pump to provide the required pressure and feed flowrate, and a reverse osmosis device. A detailed description is given in ASTM D4194-03 /4/. A synthetic test solution is used as feedwater. Permeate and concentrate are recycled back to the feed tank.

Sodium chloride is used as a test solute for reverse osmosis. For nanofiltration, magnesium sulfate and calcium chloride are used as well. The salt concentration and the feed pressure are given in the Standard Test Conditions in the product information sheet of the relevant FilmTec™ Element. The feed flowrate should be adjusted to obtain the element recovery as indicated in the mentioned Standard Test Conditions. The feedwater pH should be adjusted to a pH of 8 by adding HCl or NaOH. For a summary of the standard test conditions, see Section 1.8, Table 4.

The following data are recorded one hour after start-up, and repeated 2 – 3 hours after start-up, and hourly thereafter , until three successive permeate flowrates (corrected to 25°C) and salt passages agree within 5% (relative):

- Feed, concentrate, and permeate pressures
- Permeate and concentrate flows (use calibrated flow meters or a calibrated volume container and stopwatch)
- Permeate temperature
- Conductivity of feed, permeate and concentrate, or chloride content of the three streams.

The permeate flowrate should be corrected to 25°C using the formulas given in Section 6.7, Plant Performance Normalization. The salt rejection is calculated from the permeate conductivity K_p and the feed conductivity K_f :

$$\text{Rejection, \%} = \left(1 - \frac{K_p}{K_f}\right) \times 100$$

8.4.6 Cleaning Evaluation

When the permeate flowrate of the tested element is too low compared with the specified value, a cleaning can be tried. Cleaning cannot be successful however, when the membrane itself is damaged, or when the membrane is heavily fouled/scaled (typically when the permeate flow is < 50% of specification).

The cleaning evaluation includes the establishment of cleaning procedures, their realization on membrane samples and subsequent performance testing. The cleaning evaluation may be performed on membrane elements after performance testing or on membrane flatsheet coupons after the destructive autopsy. Cleaning is carried out according to the cleaning procedure described in Section 6.1, *Cleaning and Sanitation*.

When the cleaning test has proven effective, the treatment can be applied to the whole RO system.

8.4.7 Autopsy

After the previously described tests have been done, the ultimate method to determine the cause(s) of a performance loss is the destructive analysis (autopsy) of the FilmTec™ Element. The DuPont Quality Department must be involved if destructive analysis is required in warranty cases.

The element is cut lengthwise to allow the membrane to be unrolled. Two to four cuts must be made, on opposite sides, just deep enough to penetrate the element casing. The element should be unrolled carefully so as to not damage the membrane surface. The structural integrity of the leaves is inspected. The membrane is fully examined and samples of the membrane and/or of the foulant are taken for analysis or plate-and-frame tests.

Pressure Dye Test: To determine the cause(s) and the location of a salt passage, the element is operated with a pressurized dye solution prior to the autopsy. Rhodamine B can be used as a dye. A pink permeate would indicate a damaged membrane. The dyed element is autopsied and examined for the location of dye passage. Damaged areas of the membrane will attain a pink color. This evaluation allows to distinguish between chemical (e.g., oxidative) membrane damages and mechanical damages, e.g., from permeate backpressure.

8.4.8 Membrane Analysis

The morphology of deposits is determined with a stereo and standard light microscope or a scanning electron microscope (**SEM**).

Information about the chemical elements contained in the membrane or its fouling/scaling layer is obtained from Energy Dispersive X-Ray Fluorescence (**EDXRF**) Spectroscopy. Samples of the membrane “as is” and of the cleaned and rinsed membrane, and of the isolated and dried foulant/scalant can be analyzed by EDXRF. The result gives a semi-quantitative composition of chemical elements of the membrane and the foulants. This method can also furnish evidence of halogen damage to the membrane. Typical elements found are Ca, Ba, Sr, S (scaling), Fe, Si, Pb, Zn (colloidal fouling) and Cl, Br, I (oxidation damage). However, purely organic fouling and biofouling cannot be detected by this method.

ICP (Inductively Coupled Plasma Emission Spectroscopy) is being used to quantitatively determine metals and silica on the membrane surface.

Impurities which have been organically bound to the membrane surface can be identified with **ESCA** testing (Electron Spectroscopy for Chemical Analysis). This test is predominantly used to identify the source of oxidation.

Plate-and-Frame Testing is performed after the destructive autopsy. Round coupons are cut from the membrane of the autopsied element and placed in a plate-and-frame apparatus. The coupons can be cleaned or treated with different chemicals. The performance of the different plates with the differently treated membrane samples can be compared against control coupons.

Slimy deposits or foulants from the membrane surface may be scraped off and then **microbiological test** be done on these samples. The microbiological test would reveal the presence of bacteria and the kind of bacteria present which may in turn allow to devise an anti-biofouling strategy.

8.5 Symptoms of Trouble, Causes, and Corrective Measures

Trouble with the performance of an RO/NF system normally means at least one of the following:

- Loss of normalized permeate flowrate; in practice this is normally seen as a feed pressure increase in order to maintain the permeate output.
- Increase in normalized solute passage; in RO this is typically associated with an increase in permeate conductivity.
- Increase in pressure drop: the difference between feed pressure and concentrate pressure at constant flowrate becomes larger.

From such symptoms, their location and kind of occurrence, the causes of the trouble can often be determined. In the following sections, the mentioned three main troubles are discussed systematically.

8.5.1 Low Flow

If the system suffers from loss of normalized permeate flow performance and the problem can be localized, the general rule is:

- First stage problem: deposition of particulate matter; initial biofouling
- Last stage problem: scaling
- Problem in all stages: advanced fouling

A low flow performance may be combined with a normal, a high or a low solute passage. Depending on this combination, conclusions as to the causes may be drawn.

8.5.1.1 Low Flow and Normal Solute Passage

Low permeate flow associated with normal solute passage can have the following causes:

a. Biofouling and Natural Organic Matter (NOM):

Biofouling of the membranes is indicated by the following changes in the operating parameters, predominantly at the front end of the system:

- Permeate flow decreases when operated at constant feed pressure and recovery.
- Recovery decreases when operated at constant feed pressure, in cases where biofouling is advanced to large biomasses.
- Feed pressure has to be increased if the permeate flow is to be maintained at constant recovery. Increasing the feed pressure is however self-defeating when done for a long time, since it increases the fouling, making it more difficult to clean later.
- Differential pressure increases sharply when the bacterial fouling is massive or when it is combined with silt fouling. Since pressure drop across the pressure vessels can be such a sensitive indicator of fouling, it is strongly recommended that provisions for installing differential pressure monitoring devices be included for each stage in a system.
- Solute passage remains normal or even low at the beginning, increasing when fouling becomes massive.
- High counts of microorganisms in water samples taken from the feed, concentrate, or permeate stream indicate the beginning or the presence of biofouling. For proper microbiological monitoring see Section 2.6.2, *Assessment of the Biological Fouling Potential*. When biofouling is suspected, the system should be checked according to the items described in Section 3.16, *System Design Considerations to Control Microbiological Activity*.
- Biofilms feel slippery to the touch, often have a bad smell
- A quick test for biofouling is the burn test: a sample of biofilm is collected with a spatulum or the point of a knife and incinerated over the flame of a lighter. The smell of a burnt biofilm is like the smell of burnt hair. (*This is really just a quick test for an indication but not for a proof.*)

Figure 53 and Figure 54 are photos of a biofouled membrane and feed spacer, taken after element autopsy.

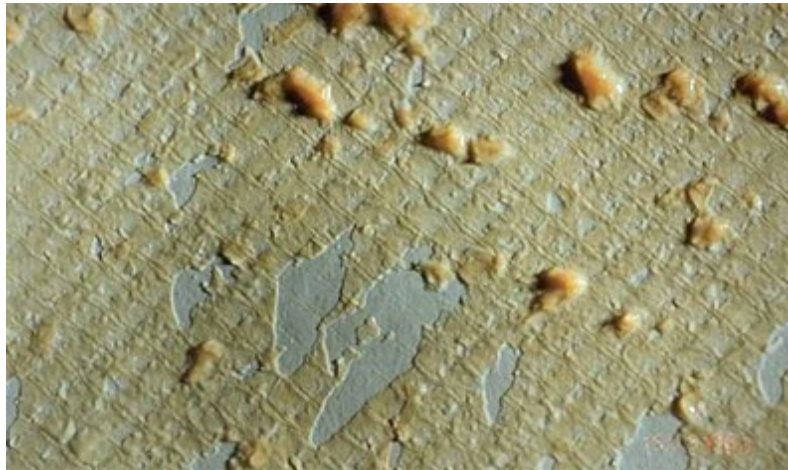

Figure 53. Picture of biofilm on membrane surface

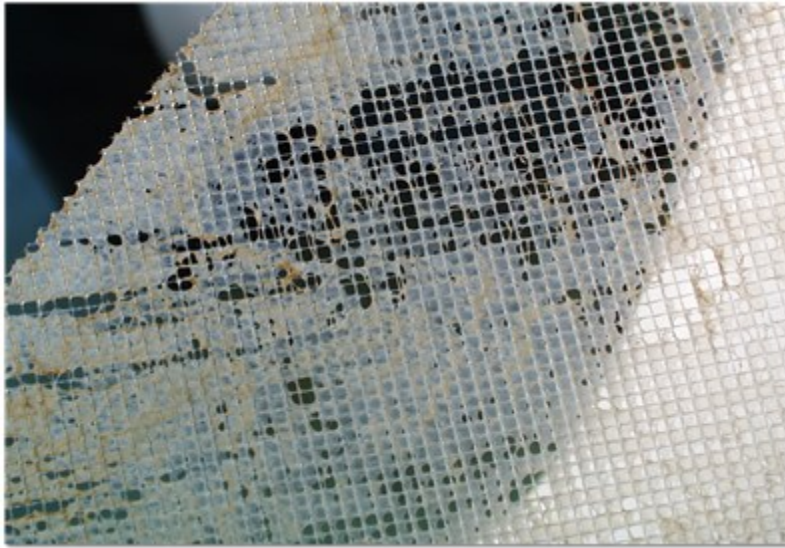

Figure 54. Picture of feed spacer with biofilm

Causes for biofouling are mostly the combination of a biologically active feedwater and improper pretreatment.

The corrective measures are:

- Clean and sanitize the entire system, including the pretreatment section and the elements. See cleaning instructions, Section 6.1 for details. An incomplete cleaning and disinfection will result in rapid re-contamination.
- High pH soak and rinse – see cleaning instructions, Section 6.1.
- The installation or optimization of the pretreatment system to cope with the fouling potential of the raw water (see Section 2.6.1, *Biological Fouling Prevention*).
- Installation of Fouling Resistant (FR) elements.

b. Aged Preservation Solution

Elements or RO systems preserved in a bisulfite solution can also become biologically fouled, if the preservation solution is too old, too warm, or oxidized by oxygen. An alkaline cleaning usually helps to restore the permeate flow. Renew preservative solution if storing elements. Store in cool, dry, dark environment.

c. Incomplete Wetting

FilmTec™ Elements that have been allowed to dry out, may have a reduced permeate flow, because the fine pores of the polysulfone layer are not wetted. The techniques to re-wet dry membranes are described in Section 7.3.2, *Re-wetting of Dried Out Elements*.

8.5.1.2 Low Flow and High Solute Passage

Low flow associated with high solute passage is the most commonly occurring condition for plant failure. Possible causes are:

a. Colloidal Fouling

To identify colloidal fouling:

- Review recorded feedwater SDIs. The problem is sometimes due to infrequent excursions or pretreatment upsets.
- Analyze residue from SDI filter pads.
- Analyze accumulations on pre-filter cartridges.
- Inspect and analyze deposits on feed scroll end of 1st stage lead elements.

b. Metal Oxide Fouling

Metal oxide fouling occurs predominantly in the first stage. The problem can more easily be localized when permeate flow meters have been installed in each array separately. Common sources are:

- Iron or aluminium in feedwater (see Section 2.9, *Prevention of Iron and Manganese Fouling* and Section 2.10, *Prevention of Aluminum Fouling*).
- Hydrogen sulfide with air in feedwater results in metal sulfides and/or elemental sulfur (see Section 2.11, *Treatment of Feedwater Containing Hydrogen Sulfide*).
- Corrosion of piping, vessels or components upstream of membrane elements.

To identify metal oxide fouling:

- Analyze feedwater for iron and aluminium.
- Check system components for evidence of corrosion.

Iron fouling can easily be identified from the look of the element – see Figure 55 for example.



Figure 55. Picture of iron fouled feed side of an element with telescoping damage and signs of mechanical force

The corrective measures are

- Clean the membrane elements as appropriate (see cleaning instructions, Section 6.1).
- Adjust, correct and/or modify the pretreatment
- Retrofit piping or system components with appropriate materials.

c. Scaling

Scaling is a water chemistry problem originating from the precipitation and deposition of sparingly soluble salts. The typical scenario is a brackish water system operated at high recovery without proper pretreatment. Scaling usually starts in the last stage and then moves gradually to the upstream stages. Waters containing high concentrations of calcium, bicarbonate and/or sulfate can scale a membrane system within hours. Scaling with barium or with fluoride is typically very slow because of the low concentrations involved.

To identify scaling:

- Check feedwater analysis for the scaling potential at prevailing system recovery.
- Analyze the concentrate for levels of calcium, barium, strontium, sulfate, fluoride, silicate, pH and Langelier Saturation Index (Stiff & Davis Saturation Index for seawater). Try to calculate the mass balance for those salts, analyzing also feedwater and permeate.
- Inspect concentrate side of system for scaling.
- Weigh a tail element: scaled elements are heavy.
- Autopsy tail element and analyze the membrane for scaling: the crystalline structure of the deposits can be observed under the microscope. A foaming reaction with acid indicates carbonate scaling. The type of scaling is identified by a chemical analysis, EDXRF or ICP analysis.
- Scaling is hard and rough to the touch, like sand paper, and cannot be wiped off.

A photograph of a scaled membrane is shown in Figure 56.



Figure 56. Picture of scaled membrane surface with imprints from the feed spacer

The corrective measures are:

- Cleaning with acid and/or an alkaline EDTA solution (see cleaning instructions, Section 6.1). An analysis of the spent solution may help to verify the cleaning effect.
- Optimize cleaning depending on scaling salts present.
- Carbonate scaling: lower pH, adjust antiscalant dosage.
- Sulfate scaling: lower recovery, adjust antiscalant dosage and type.
- Fluoride scaling: lower recovery, adjust antiscalant dosage or type.

8.5.1.3 Low Flow and Low Solute Passage

a. Compaction and Intrusion

Membrane compaction and intrusion is typically associated with low permeate flow and improved salt rejection. Compaction is the result of applied pressure and temperature compressing the membrane which may result in a decline in flux and salt passage. Intrusion is the plastic deformation of the membrane when pressed against the permeate channel spacer under excessive forces and/or temperatures. The pattern of the permeate spacer is visibly imprinted on the membrane. Intrusion is typically associated with low flow. In practice, compaction and intrusion may occur simultaneously and are difficult to distinguish from each other. Although the FilmTec™ membrane shows little compaction and intrusion when operated properly, significant compaction and intrusion might occur under the following conditions:

- high feed pressure
- high temperature
- water hammer

Water hammer can occur when the high pressure pump is started with air in the system.

Damaged elements must be replaced, or new elements must be added to the system to compensate for the flux loss. If new elements are installed together with used elements, the new elements should be loaded into the tail positions of a system to protect them from too high flux operation. New elements should be distributed evenly into parallel positions. It should be avoided to have vessels loaded exclusively with new elements installed in parallel with other vessels containing exclusively used elements. This would cause an uneven flow distribution and recovery of the individual vessels.

For example, if six elements of a 4(6):2(6) system are to be replaced, the new elements should go into position 4, 5 and 6 of each of the two vessels of the 2nd stage. Likewise, if six elements are to be added, they should go into positions 5 and 6 of the 3 vessels of the 2nd stage of an enlarged 4(6):3(6) system. If for some reason this is not possible, at least positions 1 and 2 of the first stage should not be loaded with brand new elements.

b. Organic Fouling

The adsorption of organic matter present in the feedwater on the membrane surface causes flux loss, especially in the first stage. In many cases, the adsorption layer acts as an additional barrier for dissolved salts, or plugs pinholes of the membrane, resulting in a lower salt passage. Organics with a high molecular mass and with hydrophobic or cationic groups can produce such an effect. Examples are oil traces or cationic polyelectrolytes, which are sometimes used in the pretreatment. Organics are very difficult to remove from the membrane surface.

To identify organic fouling:

- Analyze deposits from filter cartridges and SDI filter pads.
- Analyse the incoming water for oil and grease, as well as for organic contaminants in general.
- Check pretreatment coagulants and filter aids, especially cationic polyelectrolytes.
- Check cleaning detergents and surfactants.

The corrective measures are:

- Clean for organics (see cleaning instructions, Section 6.1). Some organics can be cleaned successfully, some cannot (e.g., heating oil).
- Correct pretreatment: use minimal coagulant dosages; monitor feedwater changes to avoid overdosing.
- Modify pretreatment, i.e., oil/water separators.

8.5.2 High Solute Passage

8.5.2.1 High Solute Passage and Normal Permeate Flow

High solute passage at normal permeate flow may have different causes.

a. Leaking O-Ring

Leaking O-rings can be detected by the probing technique (see *Probing* - Section 8.3.3.2). Inspect O-rings of couplers, adapters and end plugs for correct installation and as-new condition. Replace old and damaged O-rings. Also see *Interconnector Technology* - Section 4.5.

O-rings may leak after exposure to certain chemicals, or to mechanical stress, e.g., element movement caused by water hammer. Proper shimming of the elements in a pressure vessel is essential to minimize the wear to the seals (see *Shimming Elements* – Section 4.3). Sometimes, O-rings have simply not been installed, or they have been improperly installed or moved out of their proper location during element loading. For replacement O-rings, see Table 32: FilmTec™ interconnector summary in *Interconnector Technology* - Section 4.5.

b. Telescoping

FilmTec™ Elements can be mechanically damaged by an effect called telescoping, where the outer membrane layers of the element unravel and extend downstream past the remaining layers. A modest telescoping does not necessarily damage the membrane, but in more severe cases the glue line and/or the membrane can be ruptured.

Telescoping is caused by excessive pressure drop from feed to concentrate. Make sure that a thrust ring is used with eight inch elements to support the elements' outer diameters.

The operating conditions that lead to excessive pressure drop are detailed in *High Differential Pressure* - Section 8.5.3. . Telescoping damage can be identified by probing and by a leak test (see *Vacuum Decay Test* – Section 8.4.4). Replace the damaged element(s) and correct the causes.

c. Membrane Surface Abrasion

Crystalline or sharp-edged metallic particles in the feedwater may enter into the feed channels and scratch the membrane surface. This would cause salt passage increase from the lead elements. Check the incoming water for such particles. Microscopic inspection of the membrane surface will also reveal the damage. Damaged membranes must be replaced. The pre-filtration must be verified to cope with this problem. Ensure that no particles are released from the pump and the high pressure piping, and the piping has been rinsed out before the start-up.

d. Permeate Backpressure

When the permeate pressure exceeds the concentrate pressure by more than 5 psi (0.3 bar) at any time, the membrane may tear. The damage can be identified by probing and by the leak test (see *Vacuum Decay Test* – Section 8.4.4) and confirmed by a visual inspection during autopsy.

When a leaf of a backpressure damaged element is unrolled, the outer membrane typically shows creases parallel to the permeate tube, usually close to the outer glue line. The membrane delaminates and forms blisters against the feed spacer (see Figure 57). The rupture of the membrane occurs mostly in the edges between the feed-side glue line, the outer glue line, and the concentrate-side glue line.

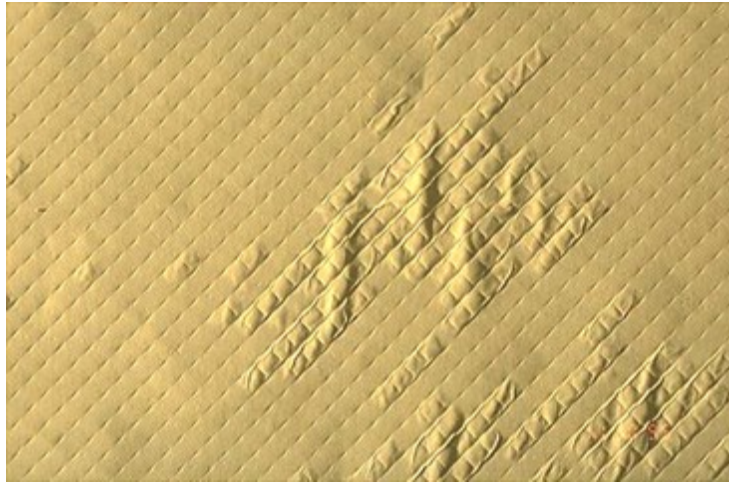

Figure 57. Picture of membrane with permeate backpressure damage

8.5.2.2 High Solute Passage and High Permeate Flow

a. Membrane Oxidation

A high salt passage in combination with a higher than normal permeate flow is mostly due to oxidation damage. When free chlorine, bromine, ozone or other oxidizing chemicals are present in the incoming water, the front end elements are typically more affected than the others. A neutral to alkaline pH favors the attack to the membrane.

Oxidation damage may also occur by disinfecting with oxidizing agents, when pH and temperature limits are not observed, or when the oxidation is catalyzed by the presence of iron or other metals (see *Sanitizing RO and NF membrane systems* - Section 6.10.1). In this case, a uniform damage is likely.

A FilmTec™ Element with just oxidation damaged membrane is still mechanically intact when tested with the *vacuum decay test* - Section 8.4.4. The chemical membrane damage can be made visible by a dye test on the element or on membrane coupons (see *Autopsy* – Section 8.4.7). Autopsy of one element and analysis of the membrane can be used to confirm oxidation damage. No corrective action is possible. All damaged elements must be replaced.

b. Leak

Severe mechanical damage of the element or of the permeate tubing can allow feed or concentrate to penetrate into the permeate, especially when working at high pressures. The vacuum test will show a distinct positive response. Possible causes are discussed in the next section.

8.5.3 High Pressure Drop

High differential pressure, also called pressure drop or ΔP from feed to concentrate, is a problem in system operation because the flux profile of the system is disturbed in such a way that the lead elements have to operate at excessively high flux while the tail elements operate at a very low flux. The feed pressure goes up which means increased energy consumption. A high differential pressure causes a high force in flow direction on the feed side of the element. This force has to be taken by the permeate tubes and, in the case of 8" elements, by the membrane scrolls and the fiberglass shells of adjacent elements in the same vessel. The stress on the last element in the vessel is the highest: it has to bear the sum of the forces created by the pressure drops of upstream elements.

The upper limit of the differential pressure per multi-element vessel is 50 psi (3.5 bar), per single fibreglassed element 15 psi (1 bar). When these limits are exceeded, even for a very short time, the FilmTec™ Elements might become telescoped and mechanically damaged.

Eight-inch elements will break circumferentially at any location of the fiberglass shell, or the endcap will be pushed out, or the spokes of the endcap will break, or the feedspacer will be pushed out from the concentrate channels. Although such damage is easily visible, it does not normally affect the membrane performance directly. However, they indicate that the differential pressure has been too high. Cracks around the endcap cause bypass of feedwater and may lead to fouling and scaling.

Photos of elements with telescoping damage are shown below.



Figure 58. The endcap has been pushed off

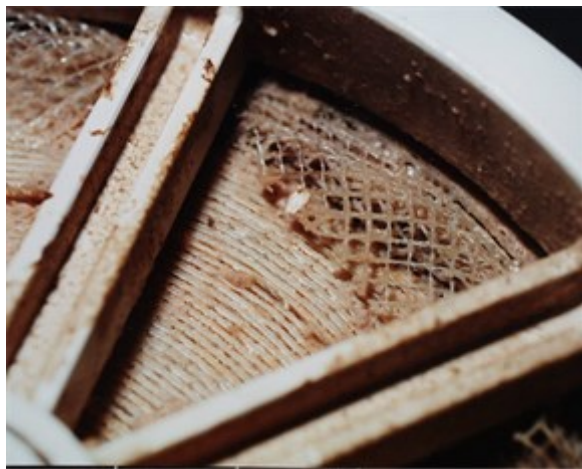

Figure 59. High pressure drop due to biofouling has pushed out the feed spacer

An increase in differential pressure at constant flowrates is usually due to the presence of debris, foulants or scale within the element flow channels (feed spacer). It usually occurs together with a decreasing permeate flow, and the causes for that have been discussed in Section 8.5.1.

An excessive pressure drop occurs when the recommended maximum feed flowrates (Section 3.9.1, Table 21, Table 22, and Table 23) are exceeded. It can also occur when the feed pressure builds up too fast during start-up (water hammer). The effect is dramatically increased with a foulant being present, especially biofilm causes a high pressure drop.

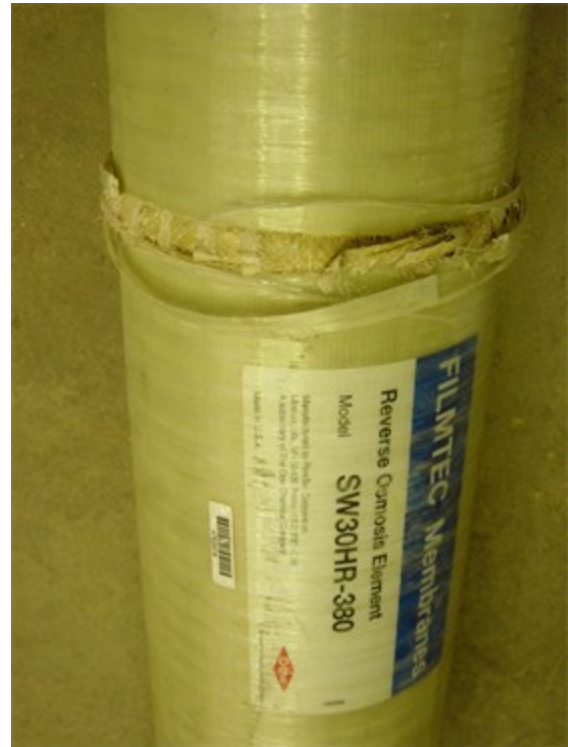

Figure 60. Picture of damaged fiberglass shell

Water hammer, a hydraulic shock to the membrane element, can also happen when the system is started up before all air has been flushed out. This could be the case at initial start-up or at operational start-ups, when the system has been allowed to drain. Ensure that the pressure vessels are not under vacuum when the plant is shut down (e.g., by installation of a vacuum breaker); otherwise air might enter into the system. In starting up a partially drained RO system, the pump may behave as if it had little or no backpressure. It will suck water at great velocities, thus hammering the elements. Also the high pressure pump can be damaged by cavitation.

The feed-to-concentrate differential pressure is a measure of the resistance to the hydraulic flow of water through the system. It is very dependent on the flowrates through the element flow channels and on the water temperature. It is therefore suggested that the permeate and concentrate flowrates be maintained as constant as possible in order to notice and monitor any element plugging that is causing an increase in differential pressure.

The knowledge of the extent and the location of the differential pressure increase provide a valuable tool to identify the cause(s) of a problem. Therefore it is useful to monitor the differential pressure across each array as well as the overall feed-to-concentrate differential pressure.

Some of the common causes and prevention of high differential pressure are discussed below.

a. Bypass in Cartridge Filters

Cartridge filters have to protect the RO system from large debris that can physically block the flow channels in the lead-end elements. Such blocking can happen when cartridge filters are loosely installed in their housing, connected without using interconnectors, or completely forgotten.

Sometimes cartridge filters will deteriorate while in operation due to hydraulic shock or the presence of incompatible materials. Cellulose-based filters should be avoided because they may deteriorate and plug the FilmTec™ Elements.

b. Pretreatment Media Filter Breakthrough

Occasionally, some of the finer media from sand, multimedia, carbon, weak acid cation exchange resin, or diatomaceous earth pretreatment filters may break through into the RO feedwater.

c. Pump Impeller Deterioration

Most of the multistage centrifugal pumps employ at least one plastic impeller. When a pump problem such as misalignment of the pump shaft develops, the impellers have been known to deteriorate and throw off small plastic shavings. The shavings can enter and physically plug the lead-end RO elements. It is suggested that the discharge pressure of RO pumps be monitored before any control valves as part of a routine maintenance schedule to see if the pump is maintaining its output pressure. If not, it may be deteriorating.

d. Scaling

Scaling can cause the tail-end differential pressure to increase. Make sure that scale control is properly taken into account (see Section 2.3.1), and clean the membranes with the appropriate chemicals (see Section 6.8). Ensure that the designed system recovery will not be exceeded.

e. Brine Seal Issues

Brine seal damage can cause a random increase in differential pressure. Brine seals can be damaged or “turned over” during installation or due to hydraulic surges. This results in a certain amount of feedwater bypass around the element and less flow and velocity through the element, thus exceeding the limit for maximum element recovery. When this occurs, the element is more prone to fouling and scaling. As a fouled element in one of several multi-element pressure vessels becomes more plugged, there is a greater tendency for the downstream elements to become fouled due to insufficient concentrate flowrates within that vessel.

In case of fullfit or heat sanitizable elements there are no brine seals installed. This is to deliberately encourage a flow around the sides of the elements to keep them free from bacterial growth. Brine seals should not be installed in plants that use fullfit elements as there is no groove in the element to keep the brine seal in place, it would eventually become dislodged and cause unpredictable problems in the system.

f. Biological Fouling

Biological fouling is typically associated with a marked increase of the differential pressure at the lead end of the RO system. Biofilms are gelatinous and quite thick, thus creating a high flow resistance. Corrective measures have been described in Section 8.5.1.1.

g. Precipitated Antiscalants

When polymeric organic antiscalants come into contact with multivalent cations like aluminium, or with residual cationic polymeric flocculants, they will form gum-like precipitants which can heavily foul the lead elements. Cleaning will be difficult; repeated application of an alkaline EDTA solution may help.

8.5.4 Troubleshooting Grid

Changes of the permeate flow, the salt passage and the differential pressure are symptoms which can be attached to specific causes in many cases. Although, the symptoms of different causes may over-lap in reality, and the symptoms are more or less pronounced in specific cases. An overview of symptoms, their possible causes and corrective measures are given in the troubleshooting grid of Table 43.

Table 43. Symptoms, causes and corrective measures

Permeate flow	Salt passage	Differential pressure	Direct cause	Indirect cause	Corrective measure
	↑	→	Oxidation damage	Free chlorine, ozone, KMnO_4	Replace element
	↑	→	Membrane leak	Permeate backpressure; abrasion	Replace element, improve cartridge filtration
	↑	→	O-ring leak	Improper installation	Replace O-ring
	↑	→	Leaking product tube	Damaged during element loading	Replace element
↓			Scaling	Insufficient scale control	Cleaning, scale control
↓			Colloidal fouling	Insufficient pretreatment	Cleaning, improve pretreatment
↓	→	↑	Biofouling	Contaminated raw water, insufficient pretreatment	Cleaning, disinfection, improve pretreatment
↓	→	→	Organic fouling	Oil; cationic polyelectrolytes water hammer	Cleaning, improve pretreatment
↓	↓	→	Compaction	Water hammer	Replace element or add elements

Increasing ↓ Decreasing → Not changing ↑ Main symptom

References

1. Wes Byrne (Ed.): Reverse Osmosis – A Practical Guide for Industrial Users. 2nd Ed. Tall Oaks Publishing Inc., 2002. Chapter 7: Troubleshooting RO Systems, pp. 437-494
2. ASTM D3923-94(2003)e1 Standard Practices for Detecting Leaks in Reverse Osmosis Devices
3. ASTM D6908-03 Standard Practice for Integrity Testing of Water Filtration Membrane Systems
4. ASTM D4194-03 Standard Test Methods for Operating Characteristics of Reverse Osmosis and Nanofiltration Devices

9 Addendum

9.1 Terminology

AAS	Atomic Absorption Spectroscopy.
AOC	Assimilable Organic Carbon.
Anionic polyelectrolyte	Usually acrylamide and acrylic copolymers, negatively charged, used for coagulation/flocculation, see Polyelectrolytes .
Anthracite	A granular hard coal used as a filtration media, commonly used as the coarser layer in dual and multimedia filters.
Antifoulant	See antiscalant .
Antiscalant	A compound added to a water which inhibits the precipitation of sparingly soluble inorganic salts.
Anti-telescoping device	A plastic or metal device attached to the ends of a spiral-wound cartridge to prevent movement of the cartridge leaves in the feed flow direction, due to high feed flows.
Array	An arrangement of devices connected to common feed, product and reject headers; that is, a 2:1 array.
ATD	See anti-telescoping device .
ATP	Adenosine triphosphate.
Autopsy	The dissection of a membrane module or element to investigate causes of unsatisfactory performance.
Availability	The on-stream time or rated operating capacity of a water treatment system.
A-value	Membrane water permeability coefficient. The coefficient is defined as the amount of water produced per unit area of membrane when net driving pressure (NDP) is unity, a unit of measurement is $\text{m}^3/\text{h}/\text{m}^2/\text{kPa}$.
Backwash	Reverse the flow of water with/without air either across or through a medium designed to remove the collected foreign material from the bed.
Bacteria	Any of a class of microscopic single-celled organisms reproducing by fission or by spores. Characterized by round, rod-like spiral or filamentous bodies, often aggregated into colonies or mobile by means of flagella. Widely dispersed in soil, water, organic matter, and the bodies of plants and animals. Either autotrophic (self-sustaining, self-generative), saprophytic (derives nutrition from non-living organic material already present in the environment), or parasitic (deriving nutrition from another living organism). Often symbiotic (advantageous) in man, but sometimes pathogenic.
Bactericide	Agent capable of killing bacteria.
Bacteriostat	Substance that prevents bacterial growth and metabolism but does not necessarily kill them.
Bank	A grouping of devices. See array, block, train, RO train .
Bar	Unit of pressure; 14.50 lbs/in ² , 1.020 kg/cm ² , 0.987 atm, 0.1 MPa.
BDOC	Biodegradable Dissolved Organic Carbon.

Bed depth	The depth of the filter medium or ion exchange resin in a vessel.
Biocide	A substance that kills all living organisms.
Biological deposits	The debris left by organisms as a result of their life processes.
Biomass	Any material which is or was a living organism or excreted from a micro-organism.
Biostat	A substance that inhibits biological growth.
Block	A grouping of devices in a single unit having common control. See Array, Bank, train .
BOD	Biological Oxygen Demand. The amount of dissolved oxygen utilized by natural agencies in water in stabilizing organic matter at specified test conditions.
Boundary layer	A thin layer at the membrane surface where water velocities deviate significantly less than those in the bulk flow.
Brackish water	Water with an approximate concentration of total dissolved solids ranging from 1,000 – 10,000 mg/L. See high brackish water, seawater .
Breakpoint chlorination	The point at which the water chlorine demand is satisfied and any further chlorine is the chlorine residual, the "free" chlorine species.
Break tank	A storage device used for hydraulic isolation and surge protection.
Brine	The concentrate (reject) stream from a crossflow membrane device performing desalination. Portion of the feed stream which does not pass through the membrane. See Concentrate .
Brine (concentrate) seal	A rubber lip seal on the outside of a spiral-wound cartridge which prevents feed by-pass between the cartridge and the inside pressure vessel wall.
Brine system staging	A process in which the concentrate, under pressure, of a group of membrane devices is fed directly to another set of membrane devices to improve the efficiency of the water separation.
B-value. Salt diffusion coefficient	The coefficient is defined as the amount of salt transferred per unit area of membrane when the difference in salt concentration across the membrane is unity. A unit of measurement is m/h.
BWRO	Brackish Water Reverse Osmosis.
CAC	Combined Available Chlorine.
Calcium carbonate equivalents (mg/L as CaCO₃)	A method for expressing mg/L as ion in terms of calcium carbonate. Concentration in calcium carbonate equivalents is calculated by multiplying concentration in mg/L of the ion by the equivalent weight of calcium carbonate (50) and dividing by the equivalent weight of the ion.
Carbonate hardness	The hardness in a water caused by carbonates and bicarbonates of calcium and magnesium. The amount of hardness equivalent to the alkalinity formed and deposited when water is boiled. In boilers, carbonate hardness is readily removed by blowdown.
Cationic polyelectrolyte	A polymer containing positively charged groups used for coagulation/flocculation, usually dimethyl-aminoethyl methacrylate or dimethyl-aminoethyl acrylate. See polyelectrolyte .
CFU	Colony forming unit; unit used in the measure of total bacteria count (TBC).
Channeling	Unequal flow distribution in the desalination bundle or filter bed.
Chelating agents	A sequestering or complexing agent that, in aqueous solution, renders a metallic ion inactive through the formation of an inner ring structure with the ion.
Chemical feed pump	A pump used to meter chemicals, such as chlorine or polyphosphate, into a feedwater supply.

Chloramine	A combination of chlorine and ammonia in water which has bactericidal qualities for a longer time than does free chlorine.
Chlorine	Chemical used for its qualities as a bleaching or oxidizing agent and disinfectant in water purification.
Chlorine demand	The amount of chlorine used up by reacting with oxidizable substances in water before chlorine residual can be measured.
Chlorine, residual	The amount of available chlorine present in water at any specified time.
Chlorine, free available	The chlorine (Cl ₂), hypochlorite ions (OCl), hypochlorous acid (OHCl) or the combination thereof present in water.
Chlorine, total available	The sum of free available chlorine plus chloramines present in water.
CIP	Cleaning-in-place.
Citric acid	C ₃ H ₄ (OH)(CO ₂ H) ₃ , membrane cleaning chemical.
Clarifier	A tank in which precipitate settles and supernatant overflows, a liquid-solids separation unit using gravity to remove solids by sedimentation.
Coagulant	Chemical added in water and wastewater applications to cause destabilization of suspended particles and subsequent formation of flocs that adsorb, entrap, or otherwise bring together suspended matter that is so fine, it is defined as colloidal. Compounds of iron and aluminum are generally used to form flocs to allow removal of turbidity, bacteria, color, and other finely divided matter from water and wastewater.
COD-chemical oxygen demand	The amount of oxygen required under specified test conditions for the oxidation of water borne organic and inorganic matter.
Colloid	A substance of very fine particle size, typically between 0.1 and 0.001 μm in diameter suspended in liquid or dispersed in gas. A system of at least two phases, including a continuous liquid plus solid, liquid or gaseous particles so small that they remain in dispersion for a practicable time.
Colony forming unit (CFU)	Unit used in the measure of total bacterial count (TBC).
Compaction	In crossflow filtration, the result of applied pressure and temperature compressing a polymeric membrane which may result in a decline in flux.
Composite membrane	A membrane having two or more layers with different physical or chemical properties. Membrane manufactured by forming a thin desalinating barrier layer on a porous carrier membrane.
Concentrate	The stream exiting a crossflow membrane device which has increased concentration of solutes and particles over the feed stream. Portion of the feed stream which does not pass through the membrane. The stream in which dissolved solids or particulates, or both, are concentrated in a membrane separation process.
Concentration Factor, CF	The ratio of the feed quantity (or feed stream) over the concentrate quantity (or concentrate stream) $CF = \frac{CB(\text{brinewater concentration})}{CF(\text{feedwater concentration})}$ <p style="text-align: right;">Eq. 75</p>

Concentration polarization	The increase of the solute concentration over the bulk feed solution which occurs in a thin boundary layer at the feed side of the membrane surface, resulting from the removal of the solvent.
Concentrate recycle	A technique for improving recovery in which a fraction of the concentrate is recycled through the membrane system.
Conductivity	The property of a substance's (in this case, water and dissolved ions) ability to transmit electricity. The inverse of resistivity. Measured by a conductivity meter, and described in microsiemens/cm or micromhos/cm, $\mu S/cm$.
Contaminant	Any foreign substance present which will adversely affect performance or quality.
Corrosion products	Products that result from chemical or electrochemical reaction between a metal and its environment.
CPU	Chloroplatinate unit (color indicator).
CRC	Combined Residual Chlorine.
Crossflow membrane filtration	A separation of the components of a fluid by semipermeable membranes through the application of pressure and flow parallel to the membrane surface. Includes the processes of reverse osmosis, ultrafiltration, nanofiltration, and microfiltration .
Dalton	An arbitrary unit of molecular weight, 1/12 the mass of the nuclide of carbon 12. Unit of measure for the smallest, size of the molecular retained by an ultrafilter.
Dead end filtration	A process in which water is forced through a media which captures the retained particles on and within it, where the process involves one influent and one effluent stream.
Deionization (DI)	The removal of ions from a solution by ion exchange.
Demineralization	The process of removing minerals from water.
Desalination	See demineralization .
Detergent	A cleansing agent; any of numerous synthetic water soluble or liquid-organic preparations that are chemically different from soaps but resemble them in the ability to emulsify oils and hold dirt in suspension.
Disinfection	The process of killing organisms in a water supply or distribution system by means of heat, chemicals, or UV light.
Dissolved solids	The residual material remaining after filtering the suspended material from a solution and evaporating the solution to a dry state at a specified temperature. That matter, exclusive of gases, which is dissolved in water to give a single homogeneous liquid phase.
Double pass RO system	RO system in which the permeate is further desalinated by a subsequent RO system.
Element	The component containing the membrane, generally replaceable, such as a spiral-wound cartridge.
ERD	Energy recovery device.
ERT	Energy recovery turbine.
FAC	Free Available Chlorine.
FDA	Food and Drug Administration (USA).
Feed	The input solution to a treatment/purification system or device, including the raw water supply prior to any treatment. The liquid entering the module.

Feed channel spacer	A plastic netting between membrane leaves which provides the flow channel for the fluid passing over the surface of the membrane and increases the turbulence of the feed-brine stream.
Feedwater	That water entering a device or process.
Ferric chloride	A coagulant, solid as FeCl_3 or liquid as $\text{FeCl}_3 \cdot 6\text{H}_2\text{O}$.
Ferric sulfate	$\text{Fe}_2(\text{SO}_4)_3 \cdot 9\text{H}_2\text{O}$, a coagulant.
Ferrous sulfate	$\text{FeSO}_4 \cdot 7\text{H}_2\text{O}$, a coagulant.
FI	Fouling Index.
Filtrate	The portion of the feed stream which has passed through a filter.
Floc	A loose, open-structured mass produced by the aggregation of minute particles.
Flocculent	Chemical(s) which, when added to water, form bridges between suspended particles causing them to agglomerate into larger groupings (flocs) which then settle or float by specific gravity differences.
Flocculation	The process of agglomerating fine particles into larger groupings called flocs.
Flux	The membrane throughput, usually expressed in volume of permeate per unit time per unit area, such as gallons per day per ft^2 or liters per hour per m^2 .
Fouling	The reduction of flux due to a build-up of solids on the surface or within the pores of the membrane, resulting in changed element performance.
Fouling index (FI)	See SDI .
FRC	Free Residual Chlorine.
Freeboard	The space above a filter bed in a filtration vessel to allow for expansion of the bed during back washing.
Free (available) chlorine	Chlorine existing as hypochlorous acid or its dissociated ions. Chlorine remaining after the demand has been satisfied.
FRP	Fiberglass reinforced plastic.
Fungus	Primitive plants distinguished from algae by the absence of chlorophyll.
GAC	Granular Activated Carbon.
GD	Gallons per day. See GPD .
GFD (GPDSF)	Unit of permeate rate or flux; gallons per day per square foot of effective membrane area.
GPD	Unit of flowrate; gallons per day. See GD .
Gravity filter	A filter through which water flows through it by gravity.
Greensand	A mineral (glauconite), used as a filtration medium. See manganese greensand .
Groundwater-water	Confined in permeable sand layers between rock or clay; that part of the subsurface water that is in the saturated zone.
Halogen	Any element of the family of the elements fluorine, chlorine, bromine and iodine (definition for purpose of this standard).
Hardness	The polyvalent-cation concentration of water (generally calcium and magnesium). Usually expressed as mg/L as CaCO_3 .

Header	See manifold .
Head loss	The reduction in liquid pressure usually associated with the passage of a solution through a filter media bed.
Heavy metals	Elements having a high density or specific gravity of approximately 5.0 or higher. A generic term used to describe contaminants such as cadmium, lead, mercury, etc. Most are toxic to humans in low concentration.
High brackish water	Water with an approximate concentration of total dissolved solids ranging from 10,000 to 30,000 mg/L. See brackish water and seawater .
High-purity water	Highly treated water with attention to microbiological, particle, organics and mineral reduction or elimination.
HPC	Heterotrophic plate count. Formerly called SPC.
HPW	High Purity Water.
Humic acid	A variety of water-soluble organic compounds, formed by the decayed vegetable matter, which is leached into a water source by runoff or percolation. Present in most surface and some ground waters. Higher concentrations cause a brownish tint. Difficult to remove except by adsorption, ultrafiltration, nanofiltration or reverse osmosis.
In-line coagulation	A filtration process performed by continually adding a coagulant to the raw feedwater and then passing the water through a filter to remove the microfloc which has been formed.
Interconnector	A device to connect adjacent membrane elements in series and to seal the product channel from the feed brine channel.
Ion exchange	A reversible process by which ions are interchanged between a solid and a liquid with no substantial structural changes in the solid; ions removed from a liquid by chemical bonding to the media.
Ionic strength	Measure of the overall electrolytic potential of a solution, the strength of a solution based on both the concentrations and valencies of the ions present.
Ionization	The disassociation of molecules into charged particles (ions).
Langelier Saturation Index, LSI	An index calculated from total dissolved solids, calcium concentration, total alkalinity, pH, and solution temperature that shows the tendency of a water solution to precipitate or dissolve calcium carbonate.
Leaf	The sandwich layer of flatsheet membrane/product channel spacer/flatsheet membrane, glued together on the sides and across the outer end in a spiral-wound element.
Lime soda softening	Use of lime and Na ₂ CO ₃ for softening water.
LSI	Langelier Saturation Index, measure of CaCO ₃ solubility in brackish waters. See S&DSI .
Manganese greensand	A manganese dioxide coated greensand used as a filter medium for removal of manganese and iron. See greensand .
Manifold	An enlarged pipe with connections available to the individual feed, brine and product ports of a desalination device.
Mass Transfer Coefficient (MTC)	Mass (or volume) transfer through a membrane based on driving force.

Membrane	Engineered thin semipermeable film which serves as a barrier permitting the passage of materials only up to a certain size, shape, or electro-chemical character. Membranes are used as the separation agent in reverse osmosis, electrodialysis, ultrafiltration, nanofiltration, and microfiltration, as disc filters in laboratories, and as pleated filter cartridges, particularly for microfiltration.
Membrane area	The active area available for micro, nano and ultrafiltration and reverse osmosis.
Membrane compaction	See compaction .
Membrane configuration	The design and shape of a given membrane element (cartridge) such as tubular, spiral-wound or hollow-fiber.
Membrane element	A bundle of spiral membrane envelopes bound together as a discrete entity.
Membrane filter	Geometrically regular porous matrix; removes particles above pore size rating by physical size exclusion.
Membrane salt passage	SP_m is the concentration of a compound in the permeate related to its average concentration on the feed/concentrate side.
Membrane softening	Use of crossflow membrane to substantially reduce hardness ions in water. See nanofiltration .
MF	Microfiltration.
MFI	Modified Fouling Index.
MGD (MGPD)	Millions of gallons per day.
Microfiltration (MF)	Filtration designed to remove particles in the approximate range of 0.05 – 2 μ m.
Microbe	Bacteria and other organisms that require the aid of a microscope to be seen.
Microorganism	See microbe .
Microsiemens	Unit of measurement of water purity by electrical conductivity; one micromho; reciprocal of resistivity. See megohm, ohm .
Milliequivalent per liter (meq/L)	A weight-volume measurement obtained by dividing the concentration expressed in milligrams per liter by the equivalent weight of the substance or ion. If specific gravity is unity meq/L is the same as epm.
Milligram per liter (mg/L)	A weight-volume measurement which expresses the concentration of a solute in milligrams per liter of solution. When specific gravity is unity mg/L = ppm. When specific gravity is not unity, mg/L divided by specific gravity of solution equals ppm.
Mixed-bed	A physical mixture of anion-exchange and cation-exchange materials.
Module	A membrane element combined with the element's housing. Pressure vessel containing membrane element(s).
Molality (m_1)	Moles (gram molecular weight) of solute per 1,000 g of solvent.
Molarity (m_1)	Moles (gram molecular weight) of solute per liter of total solution.
Molecular Weight Cut Off (MWCO)	The rating of a membrane for the size of uncharged solutes it will reject. Also referred to as nominal molecular weight cut off (NMWCO).
Multimedia filter	Filter with a bed consisting of three or more separate filter media. The coarsest, lowest density at the top and the finest, highest density at the bottom.

NaHMP	Sodium hexametaphosphate, an antiscalant.
Nanofiltration (NF)	A crossflow process with pore sizes designed to remove selected salts and most organics above about 300 molecular weight range, sometimes referred to as loose RO.
Nephelometer	A device used to measure mainly the turbidity of water with results expressed in nephelometric turbidity units (NTU). Measures light at 90°.
Nonionic polyelectrolyte	Neutral charged polymers, usually polyacrylamides, used for coagulation / flocculation. See polyelectrolytes .
Normalization	Converting actual data to a set of reference conditions in order to "standardize" operation to common base.
NF	Nanofiltration.
NOM	Natural Organic Matter.
NTU	See nephelometer .
OEM	Original equipment manufacturer.
O&M	Operation and maintenance.
Operating pressure	The gage hydraulic pressure at which feedwater enters a device.
ORP	Oxidation-Reduction Potential.
Osmosis	The spontaneous flow of water from a less concentrated solution to a more concentrated solution through a semipermeable membrane until chemical potential equilibrium is achieved.
Osmotic pressure	A measurement of the potential energy difference between solutions on either side of a semipermeable membrane. A factor in designing the operating pressure of reverse osmosis equipment. The applied pressure must first overcome the osmotic pressure inherent in the chemical solution in order to produce any flux.
Oxidation-reduction potential	The electromotive force developed by a noble metal electrode immersed in the water, referred to the standard hydrogen electrode.
Oxygen demand	The amount of oxygen required for the oxidation of waterborne organic and inorganic matter under the specified test conditions.
Parts Per Billion (ppb)	A measure of proportion by weight, equivalent to a unit weight of solute per billion unit weights of solution (approximate pg/L or mg/m ³ in dilute solutions).
Parts Per Million (ppm)	A measure of proportion by weight, equivalent to a unit weight of solute per million unit weightsof solution (approximate mg/L or g/m ³ in dilute solutions).
Pass	A treatment step or one of multiple treatment steps producing in a membrane system a product stream.
Permeable	Allowing material to pass through.
Permeate	The portion of the feed which passes through the membrane, also called product.
Permeate channel spacer	Fabric that mechanically supports the membrane and drains the permeate to the permeate tube, see product (permeate) channel spacer .
Permeate collector fabric	See Permeate channel spacer .
Permeate flux	Permeate flowrate per unit membrane area, expressed commonly as L/m ² h (or gfd).
Plant capacity	Manufacture of product per unit time, expressed as m ³ /day, m ³ /h, GPD, MGD.

Plugging factor	See fouling factor and SDI .
Polarization	See concentration polarization .
Polyelectrolyte	Synthetic (or natural) molecules, containing multiple ionic groups, used as coagulants and flocculants; available as anionic, cationic and nonionic.
Polymers	A substance consisting of molecules characterized by the repetition of one or more types of monomeric units.
Porosity	That portion of a membrane filter volume which is open to fluid flow, also known as void volume.
Posttreatment	Utilization of equipment such as degasifiers or the addition of chemicals to the product or concentrate stream to make either or both streams suitable for the desired end-use application.
Pressure filtration	Filtration performed in an enclosed pressurized filter vessel.
Pressure vessel	The vessel containing one or more individual membrane elements and designed to withstand safely the hydraulic pressure driving the separation mechanism.
Pretreatment	Processes such as chlorination, filtration, coagulation, clarification, acidification which may be used on feedwater ahead of membrane devices to improve quality, minimize scaling and corrosion potential, control biological activity.
Product channel spacer (permeate carrier)	The fabric or other material through which permeate water flows after it passes through the flat-sheet membrane.
Product staging	A process in which the permeate from one membrane plant is used as the feed to another membrane plant in order to further improve product quality.
Product tube	The tube at the center of the spiral-wound cartridge which collects permeate water
Productivity	Flowrate of product water.
Product water	Purified water produced by a process. See Permeate .
Projection	A calculation usually performed by a software package, which predicts the performance of parts or all of a water plant.
Pyrogens	Any substance capable of producing a fever in mammals. Often a bacterial endotoxin such as lipo polysaccharide generated by gram negative bacteria at destruction. Chemically and physically stable, pyrogens are not necessarily destroyed by conditions that kill bacteria.
Raw water	Water which has not been treated. Untreated water from wells, surface sources, the sea or public water supplies.
Recovery – Y (conversion)	The ratio of product quantity (permeate stream flowrate) over the feed quantity (feed stream flowrate), given as fraction or in percent.
Reject	Brine, (concentrate) stream from a desalination device. Portion of the feed stream which does not pass through the membrane.
Rejection	The ability of the membrane to hinder certain elements from passing through. Expressed as 1 minus the ratio between the concentration in the product and the feed.
Retentate	See concentrate .

Reverse Osmosis (RO)	The separation process where one component of a solution is removed from another component by flowing the feed stream under pressure across a semipermeable membrane. RO removes ions based on electro chemical forces, colloids, and organics down to 150 molecular weight. May also be called hyperfiltration.
RO	Reverse Osmosis.
RO train	One of two or more complete RO installations, including membranes and high pressure pump operating in parallel.
S&DSI	Stiff & Davis Stability Index.
Salinity	The concentration of inorganic salts in water.
Salt flux	Amount of dissolved salt passing through the membrane, moles per day per square unit of $r_{SP} = \frac{CP \times 100}{CF}$ Eq. 76
Sanitization	Reduction in the number of bacterial contaminants to safe levels. See disinfection .
Saturation	The point at which a solution contains enough of a dissolved solid, liquid, or gas so that no more will dissolve into the solution at a given temperature and pressure.
SBS	Sodium bisulfite, NaHSO ₃ .
Scale inhibitor	A chemical which inhibits the growth of micro-crystals (inhibits precipitation of sparingly soluble salts). See antiscalant .
Scaling	The build-up of precipitated salts on a surface, such as membranes, pipes, tanks, or boiler condensate tubes
SDI - Salt Density Index	An index calculated from the rate of plugging of 0.45 µm membrane filter. It is an indication of the amount of particulate matter in water, sometimes called fouling index.
S&DSI	Stiff and Davis saturation index, measure of CaCO ₃ solubility in seawater or highly saline water. See LSI .
Seawater	Water with an approximate concentration of total dissolved solids ranging from 30,000 – 60,000 mg/L. See brackish water , high brackish water .
Sedimentation	The precipitation or settling of insoluble materials from a suspension, either by gravity or artificially. For example, centrifuge, pressure.
Semipermeable membrane	A membrane which preferentially allows the passage of specific compounds while rejecting others.
SHMP	Sodium HexaMetaPhosphate. (NaHMP).
Siemens	A measure of electrical conductance in water, equivalent to a mho. See Mho , Ohm .
Slime	Biological deposits of gelatinous or filamentous matter.
SMBS	Sodium MetaBiSulfite, Na ₂ S ₂ O ₅ .
Softening	See membrane softening .
Softener	Water treatment equipment that uses a sodium based ion-exchange resin principally to remove cations as calcium and magnesium.
Solids contact clarifier	Water treating device used in lime softening, wastewater treatment and coagulation processes.

Solubility product	$[M^+]^a [X]^b / [MX]$ where the brackets indicate the concentrations of the components of the ionization equilibrium $M_a X_b \rightarrow aM^+ + bX$. For sparingly soluble salts $[MX]$ is essentially unity.
Solutes	Matter dissolved in a solvent.
Solvent	Here defined as water.
SPC	Standard (heterotrophic) plate count. Measurement method for enumerating bacteria.
Specific flux	Flux divided by net pressure driving force.
Spiral-wound cartridge	A crossflow membrane element design consisting of a product tube, flat membrane leaves, feed channel spacers, anti-telescoping devices, and brine (concentrate) seal.
Spiral-wound membrane	A flatsheet membrane with one or more feed channel spacers and barrier layers, all of which are rolled into a spiral configuration.
Stage	A sequential arrangement of pressure vessels, usually reject staged such as 2:1 array, sometimes permeate staged as in double pass RO.
Staging	See brine staging and product staging .
Standard test conditions	The parameters under which a membrane manufacturer tests devices for flow and salt rejection.
Sterilization	Destruction or removal of all viable organisms.
Stiff & Davis Stability Index, S&DSI	An index calculated from total dissolved solids, calcium concentration, total alkalinity, pH and solution temperature that shows the tendency of a water solution to precipitate or dissolve calcium carbonate. S&DSI is used primarily for seawater RO applications.
STP	Sodium triphosphate - $Na_5P_3O_{10}$, a cleaning agent.
STPP	Sodium tripolyphosphate. See STP .
Supersaturation	A state in which the inorganic salt(s) are in solution at a level higher than the respective solubility product.
Suspended solids (SS)	Solid organic and inorganic particles that are held in suspension in a liquid.
SWRO	Seawater reverse osmosis.
System salt passage	SPS is the concentration of a compound in the permeate related to its concentration in the feedwater, also called apparent salt passage.
TBC	Total Bacteria Count, the total number of viable microorganisms present in the sample, excluding anaerobic organisms.
TDS	Total Dissolved Solids, usually expressed as mg/L or ppm (parts per million).
Telescoping	The movement of the outer layers of a spiral-wound cartridge in the direction of the feed flow caused by excessive pressure drop through the feed channel spacer.
Temperature correction factor (TCF)	Defines the effect of temperature on permeate flow relative to a base temperature (25°C), is mainly a function of fluid characteristics but also membrane polymer.
Thin-film composite (TFC)	See composite membrane .
Threshold treatment	The process of stopping precipitation at the start of occurrence; usually does not stop the formation of nuclei but does inhibit growth. See antiscalant .

THM	Trihalomethanes; a group of low molecular weight molecules which can result from chlorination of organics typically found in surface water.
THMP	Trihalomethane precursors; organic molecules found in water which have the potential of reacting with chlorine to form THMs.
Thrust collar	A plastic cylinder placed between the last spiral-wound cartridge and vessel end plate to support the last cartridge in a pressure vessel against telescoping.
TOC	Total Organic Carbon, a measure of the level of organic constituents in water.
TOCI	Total organic chlorine.
TOX	Total organic halides.
TOXFP	Total organic halide formation potential.
Train	A grouping of devices. See array, bank, block .
Transmembrane pressure	The net driving force across the membrane. The hydraulic pressure differential from the feed side to permeate side less the osmotic pressure differential on each side.
TRC	Total Residual Chlorine.
Trisodium phosphate (TSP)	$\text{Na}_3\text{PO}_4 \cdot 12\text{H}_2\text{O}$, a cleaning agent.
TSS	Total suspended solids. Concentration of undissolved solids in a liquid, usually expressed in mg/L or ppm.
Turbidity	A suspension of fine particles that scatters or absorbs light rays.
Turbidity, nephelometric (NTU)	An empirical measure of turbidity based on a measurement of the light-scattering characteristics (tyndall effect) of the particulate matter in the sample.
Ultrafiltration UF	A process employing semipermeable membrane under a hydraulic pressure gradient for the separation of components in a solution. The pores of the membrane are of a size which allow passage of the solvent(s) but will retain non-ionic solutes based primarily on physical size, not chemical potential.
UPW - ultra pure water	Water generally used in semiconductor industry having specifications (chemical, physical and biological) for extremely low contaminant levels.
Ultraviolet (UV) radiation	Wavelengths between 200 – 300 nm. These wavelengths have a strong germicidal effect. The maximum effect is at 260 nm.
Viable	Ability to live or grow. For example, bacteria, plants.
VOC (Viable Organism Count)	A measure of biological activity (living or growing) in water.
VOC (Volatile Organic Compound)	An organic compound with a vapor pressure higher than water.
Water softener	A vessel having a cation resin in the sodium form that removes cations such as calcium and magnesium from water and releases another ion such as sodium. The resin is usually regenerated. See softener .
Y	Conversion, recovery.
Zero discharge	A condition whereby a facility discharges no process effluent.

$\mu\text{mhos/}$ cm	ppm	$\mu\text{mhos/}$ cm	ppm	$\mu\text{mhos/}$ cm	ppm	$\mu\text{mhos/}$ cm	ppm	$\mu\text{mhos/}$ cm	ppm	$\mu\text{mhos/}$ cm	ppm	$\mu\text{mhos/}$ cm	ppm
10	5	640	317	1,525	766	3,650	1,899	9,300	5,047	22,500	13,013	62,000	38,561
20	9	650	323	1,550	770	3,700	1,917	9,400	5,103	22,750	13,167	63,000	39,239
30	14	660	328	1,575	792	3,750	1,945	9,500	5,159	23,000	13,321	64,000	39,917
40	19	670	333	1,600	805	3,800	1,972	9,600	5,215	23,250	13,474	65,000	40,595
60	28	680	338	1,625	817	3,850	1,999	9,700	5,271	23,500	13,628	66,000	41,273
70	33	690	343	1,650	830	3,900	2,027	9,800	5,327	23,750	13,782	67,000	41,961
80	38	700	348	1,675	843	3,950	2,054	9,900	5,383	24,000	13,936	68,000	42,629
90	42	710	353	1,700	856	4,000	2,081	10,000	5,439	24,250	14,089	69,000	43,307
100	47	720	358	1,725	868	4,100	2,136	10,200	5,551	24,500	14,243	70,000	43,985
110	52	730	363	1,750	881	4,200	2,191	10,400	5,664	24,750	14,397	71,000	44,663
120	57	740	368	1,775	894	4,300	2,245	10,600	5,776	25,000	14,550	72,000	45,341
130	61	750	373	1,800	907	4,400	2,300	10,800	5,888	25,500	14,858	73,000	46,091
140	66	760	378	1,825	920	4,500	2,356	11,000	6,000	26,000	15,165	74,000	46,697
150	71	770	383	1,850	932	4,600	2,412	11,200	6,122	26,500	15,473	76,000	48,053
160	75	780	388	1,875	945	4,700	2,468	11,400	6,243	27,000	15,780	77,000	48,731
170	80	790	393	1,900	958	4,800	2,524	11,600	6,364	27,500	16,087	78,000	49,409
180	85	800	399	1,925	971	4,900	2,580	11,800	6,485	28,000	16,395	79,000	50,087
190	90	810	404	1,950	983	5,000	2,636	12,000	6,607	28,500	16,702	80,000	50,765
200	95	820	409	1,975	996	5,100	2,692	12,200	6,728	29,000	17,010	81,000	51,443
210	100	830	414	2,000	1,000	5,200	2,748	12,400	6,843	29,500	17,317	82,000	52,121
220	105	840	419	2,025	1,022	5,300	2,805	12,600	6,970	30,000	17,624	83,000	52,799
230	110	850	424	2,050	1,034	5,400	2,861	12,800	7,091	30,500	17,932	84,000	53,477
240	115	860	429	2,075	1,047	5,500	2,917	13,000	7,213	31,000	18,239	85,000	54,155
250	120	870	434	2,125	1,073	5,600	2,973	13,200	7,334	31,500	18,547	86,000	54,833
260	125	880	439	2,150	1,085	5,700	3,029	13,400	7,455	32,000	18,854	87,000	55,511
270	130	890	444	2,175	1,098	5,800	3,085	13,600	7,576	32,500	19,161	88,000	56,130
280	135	900	449	2,200	1,111	5,900	3,141	13,800	7,698	33,000	19,469	89,000	56,867
290	140	910	454	2,225	1,124	6,000	3,197	14,000	7,819	34,000	20,084	90,000	57,545
300	145	920	459	2,250	1,137	6,100	3,253	14,200	7,940	34,500	20,391	91,000	58,223
310	150	930	464	2,275	1,140	6,200	3,309	14,400	8,061	35,000	20,698	92,000	58,901
320	155	940	469	2,300	1,162	6,300	3,365	14,600	8,182	35,500	21,006	93,000	59,579
330	160	950	474	2,325	1,175	6,400	3,421	14,800	8,304	36,000	21,313	94,000	60,257
340	165	960	480	2,350	1,188	6,500	3,477	15,000	8,425	36,500	21,621	95,000	60,935
350	171	970	485	2,375	1,200	6,600	3,533	15,250	8,576	37,000	21,928	96,000	61,613
360	176	980	490	2,400	1,213	6,700	3,589	15,500	8,728	37,500	22,235	97,000	62,291
370	181	990	495	2,425	1,226	6,800	3,645	15,750	8,879	38,000	22,543	98,000	62,969
380	186	1,000	500	2,450	1,239	6,900	3,701	16,000	9,031	38,500	22,850	99,000	63,647
390	191	1,020	510	2,475	1,251	7,000	3,758	16,250	9,182	39,000	23,158	100,000	64,325
400	196	1,040	520	2,500	1,264	7,100	3,814	16,500	9,334	39,500	23,465		
410	201	1,080	540	2,550	1,290	7,200	3,870	16,750	9,486	40,000	23,773		
420	206	1,100	550	2,600	1,315	7,300	3,926	17,000	9,637	41,000	24,387		
430	211	1,120	561	2,650	1,344	7,400	3,982	17,500	9,940	42,000	25,002		
440	216	1,140	571	2,700	1,371	7,500	4,038	17,750	10,092	43,000	25,679		
450	221	1,160	581	2,750	1,398	7,600	4,094	18,000	10,247	44,000	26,357		
460	226	1,180	591	2,800	1,426	7,700	4,150	18,250	10,400	45,000	27,035		
470	231	1,200	601	2,850	1,453	7,800	4,206	18,500	10,554	46,000	27,713		
480	236	1,220	611	2,900	1,480	7,900	4,262	18,750	10,708	47,000	28,391		
490	241	1,240	621	2,950	1,508	8,000	4,318	19,000	10,852	48,000	29,069		

$\mu\text{mhos}/$ cm	ppm	$\mu\text{mhos}/$ cm	ppm	$\mu\text{mhos}/$ cm	ppm	$\mu\text{mhos}/$ cm	ppm	$\mu\text{mhos}/$ cm	ppm	$\mu\text{mhos}/$ cm	ppm	$\mu\text{mhos}/$ cm	ppm
500	247	1,260	632	3,000	1,535	8,100	4,374	19,250	11,015	49,000	29,747		
510	252	1,280	642	3,050	1,562	8,200	4,430	19,500	11,169	50,000	30,425		
520	257	1,300	652	3,100	1,589	8,300	4,486	19,750	11,323	51,000	31,103		
530	262	1,320	662	3,150	1,617	8,400	4,542	20,000	11,476	52,000	31,781		
550	272	1,340	672	3,200	1,644	8,500	4,598	20,250	11,630	53,000	32,459		
560	277	1,360	682	3,250	1,671	8,600	4,654	20,500	11,784	54,000	33,137		
570	282	1,380	692	3,300	1,699	8,700	4,710	20,750	11,937	55,000	33,815		
580	287	1,400	702	3,350	1,726	8,800	4,767	21,000	12,091	56,000	34,493		
590	292	1,420	713	3,400	1,753	8,900	4,823	21,250	12,245	57,000	35,171		
600	297	1,440	723	3,450	1,781	9,000	4,879	21,500	12,399	58,000	35,849		
610	302	1,460	733	3,500	1,808	9,100	4,935	21,750	12,552	59,000	36,527		
620	307	1,480	743	3,550	1,835	9,200	4,991	22,000	12,705	60,000	37,205		
630	312	1,500	754	3,600	1,863	9,216	5,000	22,250	12,860	61,000	37,883		

9.2 Conductivity of Ions

Table 44. Conductivity of ions expressed as $\mu\text{S}/\text{cm}$ per meq/l , infinitely diluted

Ion	68°F (20°C)	77°F (25°C)	212°F (100°C)
H ⁺	328	350	646
Na ⁺	45	50.1	155
K ⁺	67	73.5	200
NH ₄ ⁺	67	73.5	200
Mg ²⁺	47	53.1	170
Ca ²⁺	53.7	59.5	191
OH ⁻	179	197	446
Cl ⁻	69.0	76.3	207
HCO ₃	36.5	44.5	—
NO ₃ ⁻	65.2	71.4	178
H ₂ PO ₄ ⁻	30.1	36.0	—
CO ₃ ²⁻	63.0	72.0	—
HPO ₄ ²⁻	—	53.4	—
SO ₄ ²⁻	71.8	79.8	234
PO ₄ ³⁻	—	69.0	—

Source: Landolf-Börnstein 6^o edition Band II/7

9.3 Conductivity of Solutions

Table 45. Conductivity of solutions, acids, alkalis and salts 77°F (25°C) expressed as $\mu\text{S}/\text{cm}$ per meq/L

Component	Concentration in meq/l							
	Infin. diluted	0.1	0.5	1.0	5.0	10.0	50.0	100.0
HCl	426	425	423	421	415	412	399	392
HNO ₃	421	420	417	416	410	407	394	386
H ₂ SO ₄	430	424	412	407	390	380	346	317
H ₃ PO ₄	419	394	359	336	264	223	133	104
NaOH	248	247	246	245	241	238	227	221
KOH	271	270	269	268	264	261	251	246
NH ₄ OH	271	109	49	36	17	12	5.6	3.9
NaCl	126	126	124	124	121	118	111	107
Na ₂ SO ₄	130	128	126	124	117	113	97.7	90.0
Na ₂ CO ₃	124	122	120	119	112	108	93.2	86.3
NaHCO ₃	96.0	95.2	94.2	93.5	90.5	88.4	80.6	76.0
KCl	150	149	148	141	144	141	133	129

The graphs on the following page relate the conductivity of a solution containing one given chemical to the concentration of this chemical.

The conductivity of solutions at other temperatures can be calculated by multiplying conductivities at 77°F (25°C) with the correction factors in the following table. These factors are only valid for diluted solutions as they presuppose total ionic dissociation of the chemical.

Table 46. Conductivity correction factors

	32°F (0°C)	64°F (18°C)	77°F (25°C)	122°F (50°C)
HCl	0.66	0.89	1.00	1.37
H ₂ SO ₄	0.66	0.87	1.00	1.38
NaCl	0.53	0.86	1.00	1.57
NaOH	0.54	0.89	1.00	1.51
KOH	0.55	0.89	1.00	1.50

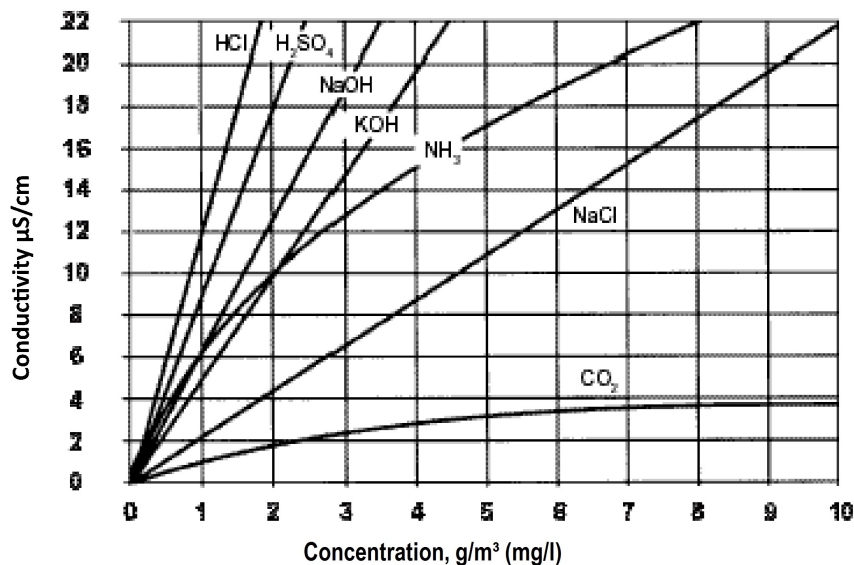

Figure 61. Conductivity of ionic solutions at 77°F (25°C)

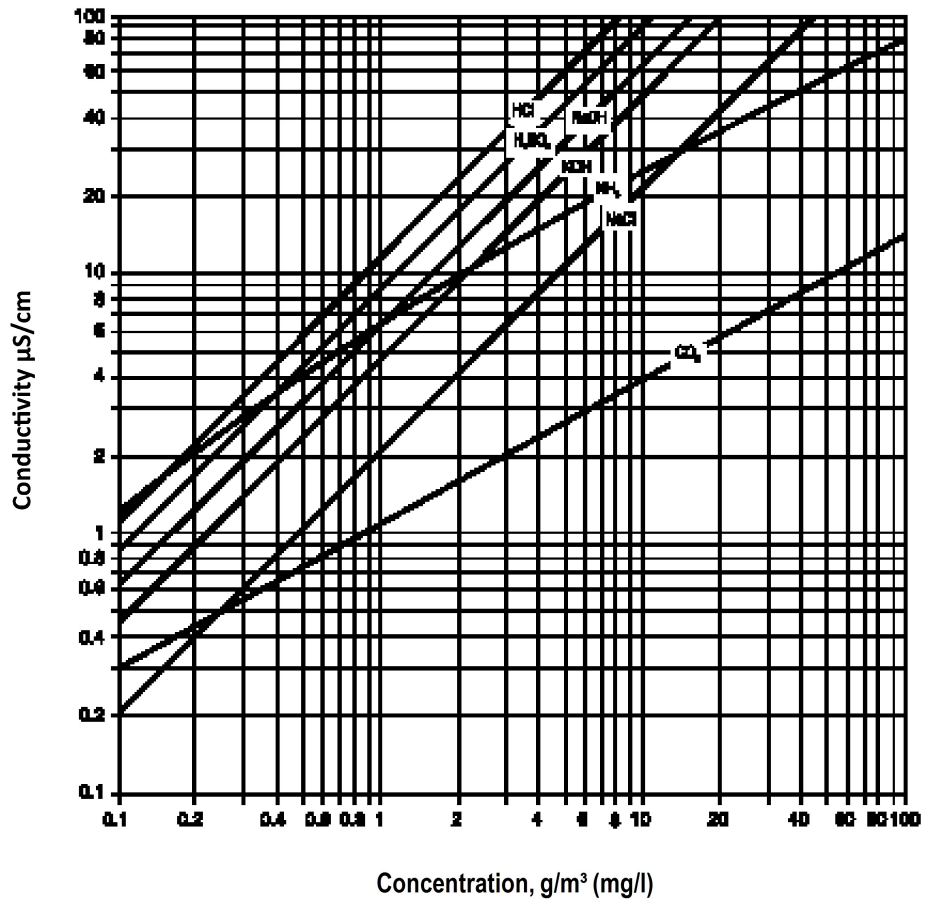

Figure 62. Conductivity of ionic solutions at 77°F (25°C)

9.4 Conversion of Concentration Units of Ionic Species

The following table gives conversion factors for the conversion of concentration units of ionic species given as gram of the ion per liter (g/L) into equivalent per liter (eq/L) or of gram of CaCO₃ equivalents per liter (g CaCO₃/L).

Table 47. Conversion factors for the conversion of concentration units of ionic species

Compound	Formula	Ionic weight	Equivalent weight	Conversion to g CaCO ₃ /L eq/L	
Positive ions					
Aluminium	Al ³⁺	27.0	9.0	5.56	0.111
Ammonium	NH ₄ ⁺	18.0	18.0	2.78	0.0556
Barium	Ba ²⁺	137.4	68.7	0.73	0.0146
Calcium	Ca ²⁺	40.1	20.0	2.50	0.0500
Copper	Cu ²⁺	63.6	31.8	1.57	0.0314
Hydrogen	H ⁺	1.0	1.0	50.0	1.000
Ferrous iron	Fe ²⁺	55.8	27.9	1.79	0.0358
Ferric iron	Fe ³⁺	55.8	18.6	2.69	0.0538
Magnesium	Mg ²⁺	24.3	12.2	4.10	0.0820
Manganese	Mn ²⁺	54.9	27.5	1.82	0.0364
Potassium	K ⁺	39.1	39.1	1.28	0.0256
Sodium	Na ⁺	23.0	23.0	2.18	0.0435
Negative ions					
Bicarbonate	HCO ₃ ⁻	61.0	61.0	0.82	0.0164
Carbonate	CO ₃ ²⁻	60.0	30.0	1.67	0.0333
Chloride	Cl ⁻	35.5	35.5	1.41	0.0282
Fluoride	F ⁻	19.0	19.0	2.63	0.0526
Iodide	I ⁻	126.9	126.9	0.39	0.0079
Hydroxide	OH ⁻	17.0	17.0	2.94	0.0588
Nitrate	NO ₃ ⁻	62.0	62.0	0.81	0.0161
Phosphate (tri-basic)	PO ₄ ³⁻	95.0	31.7	1.58	0.0315
Phosphate (di-basic)	HPO ₄ ²⁻	96.0	48.0	1.04	0.0208
Phosphate (mono-basic)	H ₂ PO ₄ ⁻	97.0	97.0	0.52	0.0103
Sulfate	SO ₄ ²⁻	96.1	48.0	1.04	0.0208
Bisulfate	HSO ₄ ⁻	97.1	97.1	0.52	0.0103
Sulfite	SO ₃ ²⁻	80.1	40.0	1.25	0.0250
Bisulfite	HSO ₃ ⁻	81.1	81.1	0.62	0.0123
Sulfide	S ²⁻	32.1	16.0	3.13	0.0625
Neutral¹					
Carbon dioxide	CO ₂	44.0	44.0	1.14	0.0227
Silica	SiO ₂	60.0	60.0	0.83	0.0167
Ammonia	NH ₃	17.0	17.0	2.94	0.0588

¹ Calculations based on conversion to monovalent species

Temperature °C	Temperature Correction Factor	Temperature °C	Temperature Correction Factor	Temperature °C	Temperature Correction Factor	Temperature °C	Temperature Correction Factor	Temperature °C	Temperature Correction Factor
10.0	1.711	14.0	1.475	18.0	1.276	22.0	1.109	26.0	0.971
10.1	1.705	14.1	1.469	18.1	1.272	22.1	1.105	26.1	0.968
10.2	1.698	14.2	1.464	18.2	1.267	22.2	1.101	26.2	0.965
10.3	1.692	14.3	1.459	18.3	1.262	22.3	1.097	26.3	0.962
10.4	1.686	14.4	1.453	18.4	1.258	22.4	1.093	26.4	0.959
10.5	1.679	14.5	1.448	18.5	1.254	22.5	1.090	26.5	0.957
10.6	1.673	14.6	1.443	18.6	1.249	22.6	1.086	26.6	0.954
10.7	1.667	14.7	1.437	18.7	1.245	22.7	1.082	26.7	0.951
10.8	1.660	14.8	1.432	18.8	1.240	22.8	1.078	26.8	0.948
10.9	1.654	14.9	1.427	18.9	1.236	22.9	1.075	26.9	0.945
11.0	1.648	15.0	1.422	19.0	1.232	23.0	1.071	27.0	0.943
11.1	1.642	15.1	1.417	19.1	1.227	23.1	1.067	27.1	0.940
11.2	1.636	15.2	1.411	19.2	1.223	23.2	1.064	27.2	0.937
11.3	1.630	15.3	1.406	19.3	1.219	23.3	1.060	27.3	0.934
11.4	1.624	15.4	1.401	19.4	1.214	23.4	1.056	27.4	0.932
11.5	1.618	15.5	1.396	19.5	1.210	23.5	1.053	27.5	0.929
11.6	1.611	15.6	1.391	19.6	1.206	23.6	1.049	27.6	0.926
11.7	1.605	15.7	1.386	19.7	1.201	23.7	1.045	27.7	0.924
11.8	1.600	15.8	1.381	19.8	1.197	23.8	1.042	27.8	0.921
11.9	1.594	15.9	1.376	19.9	1.193	23.9	1.038	27.9	0.918
12.0	1.588	16.0	1.371	20.0	1.189	24.0	1.035	28.0	0.915
12.1	1.582	16.1	1.366	20.1	1.185	24.1	1.031	28.1	0.913
12.2	1.576	16.2	1.361	20.2	1.180	24.2	1.028	28.2	0.910
12.3	1.570	16.3	1.356	20.3	1.176	24.3	1.024	28.3	0.908
12.4	1.564	16.4	1.351	20.4	1.172	24.4	1.021	28.4	0.905
12.5	1.558	16.5	1.347	20.5	1.168	24.5	1.017	28.5	0.902
12.6	1.553	16.6	1.342	20.6	1.164	24.6	1.014	28.6	0.900
12.7	1.547	16.7	1.337	20.7	1.160	24.7	1.010	28.7	0.897
12.8	1.541	16.8	1.332	20.8	1.156	24.8	1.007	28.8	0.894
12.9	1.536	16.9	1.327	20.9	1.152	24.9	1.003	28.9	0.892
13.0	1.530	17.0	1.323	21.0	1.148	25.0	1.000	29.0	0.889
13.1	1.524	17.1	1.318	21.1	1.144	25.1	0.997	29.1	0.887
13.2	1.519	17.2	1.313	21.2	1.140	25.2	0.994	29.2	0.884
13.3	1.513	17.3	1.308	21.3	1.136	25.3	0.991	29.3	0.882
13.4	1.508	17.4	1.304	21.4	1.132	25.4	0.988	29.4	0.879
13.5	1.502	17.5	1.299	21.5	1.128	25.5	0.985	29.5	0.877
13.6	1.496	17.6	1.294	21.6	1.124	25.6	0.982	29.6	0.874
13.7	1.491	17.7	1.290	21.7	1.120	25.7	0.979	29.7	0.871
13.8	1.486	17.8	1.285	21.8	1.116	25.8	0.977	29.8	0.869
13.9	1.480	17.9	1.281	21.9	1.112	25.9	0.974	29.9	0.866

Corrected Flowrate = (Measured Flowrate)*(TCF @ Feedwater Temp.)

9.5 Conversion of U.S. Units into Metric Units

1 inch (in)	= 2.54 cm	= 0.0254	m
1 foot (ft)		= 0.3048	m
1 square foot (sq ft)		= 0.0929	m ²
1 gallon (US)		= 3.785	L
1 pound per square inch (psi)		= 0.069	bar
1 gallon per minute (gpm)		= 0.227	m ³ /h
		= 0.063	L/s
1 gallon per day (gpd)		= 0.003785	m ³ /d
		= 0.158	L/h
1 million gallons per day (MGD)		= 157.73	m ³ /h
		= 3,785	m ³ /d
1 gallon per sq ft and day (gfd)		= 1.70	L/m ² h

9.6 Ionization of Carbon Dioxide Solutions

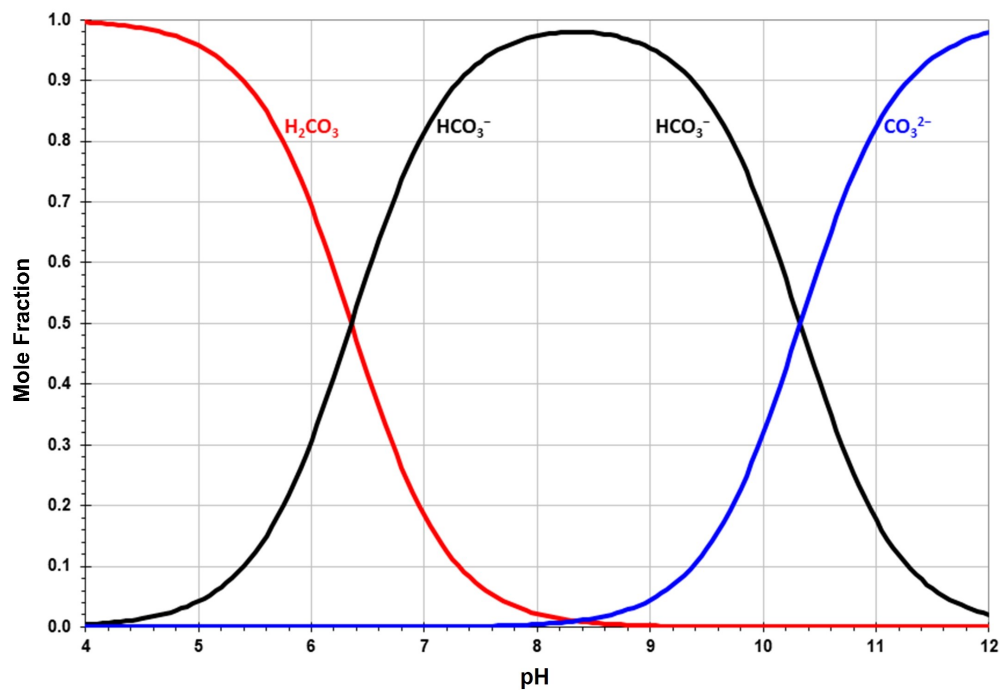

Figure 63. Ionization of carbon dioxide solutions as functions of the pH at 77°F (25°C)

9.7 Osmotic Pressure of Sodium Chloride

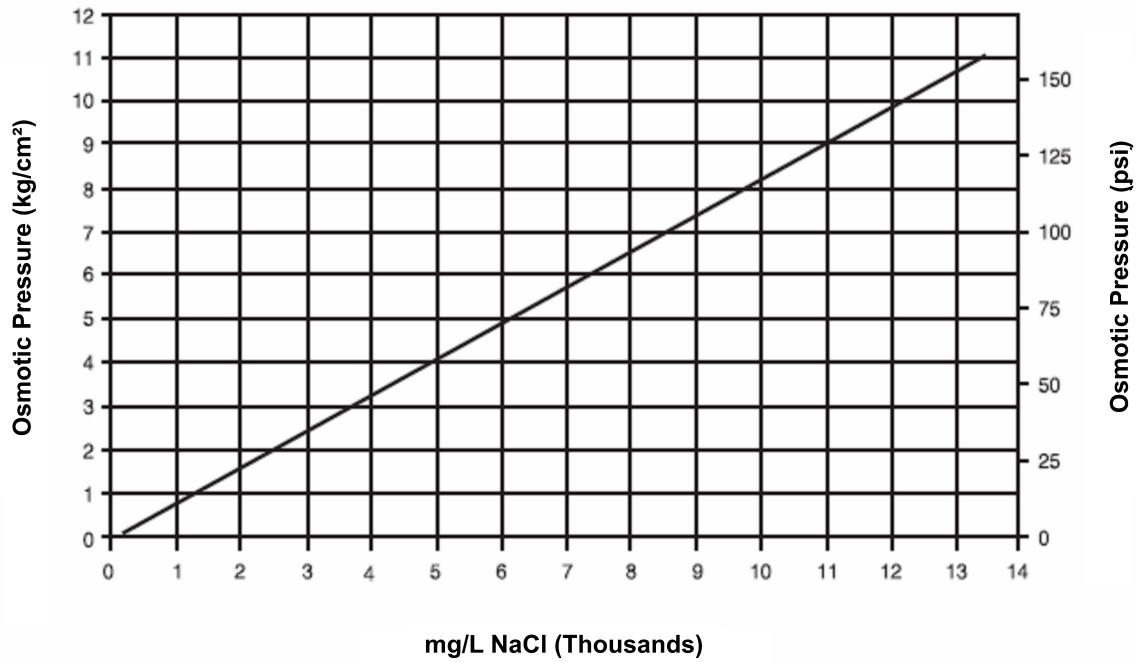

Figure 64. Osmotic pressure of sodium chloride

9.8 Osmotic Pressure of Solutions

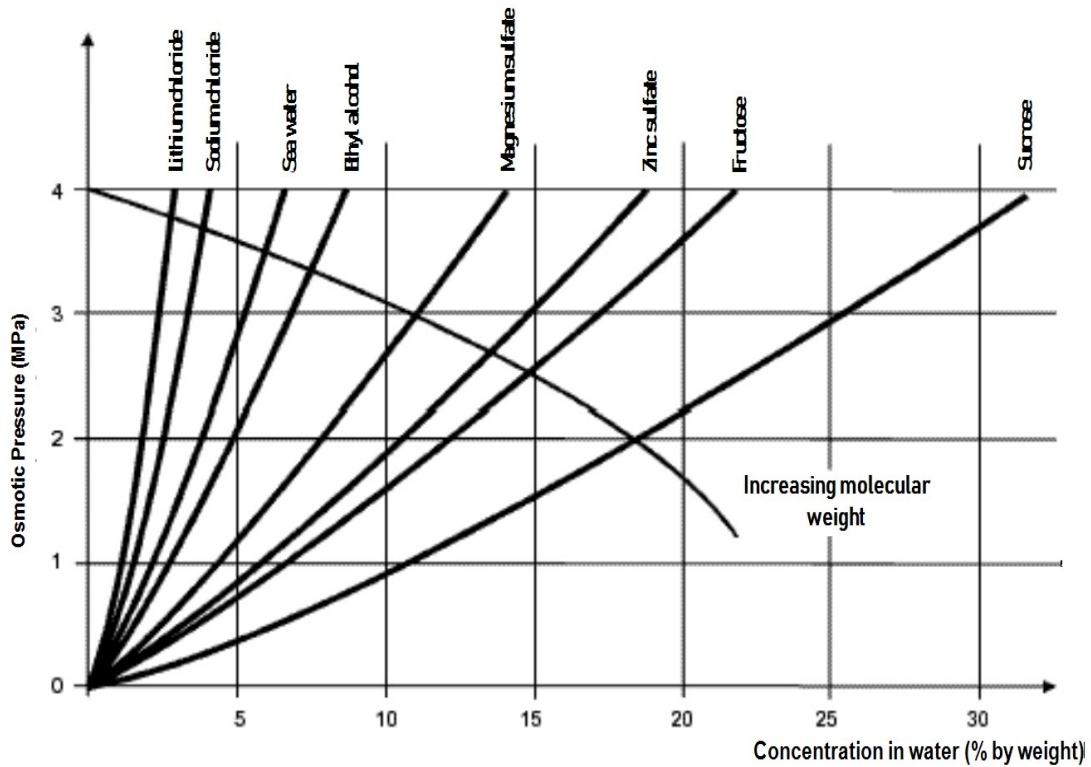

Figure 65. Osmotic pressure of solutions

9.9 Testing Chemical Compatibilities with FilmTec™ Membranes†

9.9.1 Summary

Chemicals are usually added to membrane systems to prevent and remove biogrowth and to prevent membrane fouling and scaling. These chemicals must not, by themselves, negatively affect the membrane performance. The following describes some of the testing procedures that may be used to identify whether or not these chemicals are compatible with thin-film composite membranes. These test procedures, specifically, are designed to indicate whether or not the chemical either dissolves or alters the polyamide surface of the membrane or whether the flow of product water through the membrane is affected.

Test procedures involve both: 1) the testing of membrane coupons or elements after soaking in the examined solution and 2) the continuous addition of the chemical to the membrane element during operation. Soak tests are useful in determining whether a chemical compound degrades the membrane. Meanwhile, the continuous addition of a chemical to the membrane element during operation is a means to simulate actual operating conditions using the test chemical. For example, in antiscalant compatibility determinations, a 1000-hour continuous operation test is recommended.

It is important to note that the following procedures examine only if the chemical appears to be compatible and whether detrimental effects are observed. These procedures do not determine efficacy or whether chemical has been proven useful. Also, even though the following tests are indication of compatibility, field observations and experience are, by far, the most reliable indication of compatibility and success.

It is important to note, that other test methods on compatibility determinations have been successful. Some of these methods developed by suppliers of membrane chemicals include such techniques as exposing the membrane to elevated levels of a particular chemical for a shorter period of time rather than at a normal use level for a longer period of time. Hence, the exposure in, for example, ppm-hours is the same. Other methods include examination of the membrane surface by microscopy and/or other analytical techniques that ascertain changes in or damage to the membrane. Such methods are often reliable when practiced by experienced personnel with a firm grasp of membrane technology and the chemistry of their products.

Even though a chemical may appear to be compatible, it is no indication that problems will not occur. For example, gross overfeeding of a particular chemical can foul all types of membranes through the convective deposition of a large amount of chemical onto the membrane surface. This idea can be extended to the compatibility of a particular product at a low level which may cause catastrophic effects at higher levels through its inadvertent high level addition by such practices as its continuous addition independent of whether the membrane system is in operation or not. Also, a compatible chemical may be incompatible with other chemicals used in the system. For example, cationic flocculants often can foul a membrane by their reaction with negatively charged antiscalants. Hence, it is imperative that one consider the total membrane chemical addition system and the proper integration of the various chemical products in the membrane system. Also it is important to determine whether the chemical is compatible with the materials of construction used in storage and handling equipment.

The following discussions address testing procedures for chemical compatibility in each of the following five categories:

- coagulants and flocculants
- antiscalants
- cleaning chemicals
- biocides
- membrane preservatives

9.9.2 Test Equipment

Two types of test loops have been used for laboratory chemical compatibility testing: a flat cell test unit and an element test unit.

9.9.2.1 Flat Cell Unit

The flow schematic is shown in Figure 66a. A test cell could be shut off by closing a ball valve on the permeate side. Testing could also be done on a stacked membrane plate-an-frame apparatus with a system design similar to the schematic in Figure 66a.

Standard test conditions for FilmTec™ FT30 membranes are taken from Section 1.8, Table 4. Measurements are taken about two hours after start. The brine flowrate is will depend upon the specific test cells used and should conform to recommendations of the test cell supplier.

As shown in Figure 66a, the concentrate is returned to the feed tank. The permeate is directed to a drain except for the 10 – 30 minutes, when it is collected in a beaker for measuring permeate flowrate.

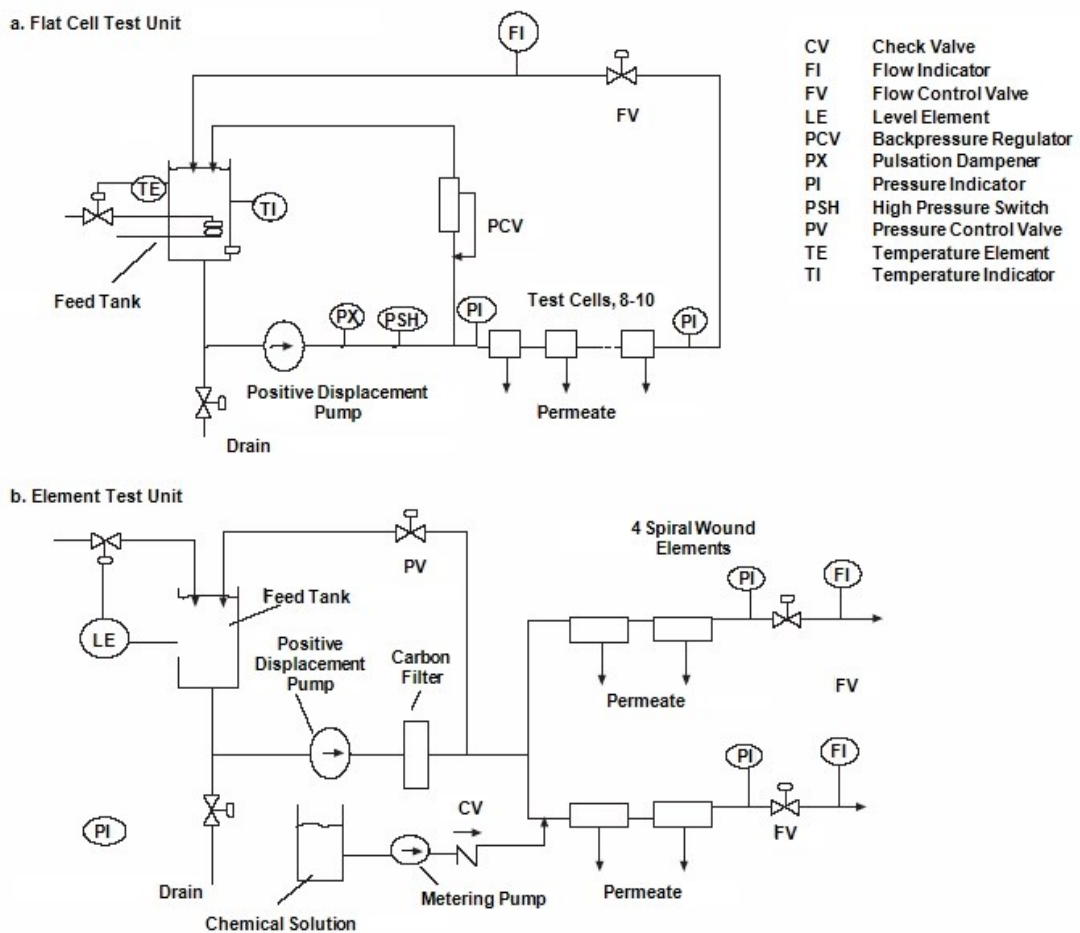

Figure 66. Flow schematic

9.9.2.2 Element Test Units

Figure 66b shows the flow schematic of the second test loop. It contains two parallel lines, each consisting of two pressure vessels in series. Small elements, such as 2.5-inch diameter by 14 inches long are often used for these tests. A metering pump adds the chemical which is tested for membrane compatibility to one of two parallel lines. The concentrates and permeates from both lines go to drain. There are two elements per line. If something in the feedwater is affecting the membrane performance, this should be noticeable for the elements in *both* lines. With this type of apparatus, one is better able to establish an effect level due to the presence of a “standard” line and a “test” line. This type of laboratory device can be expanded to, for example, a system using 8" FilmTec™ Membrane Elements operated off a side stream in a full scale membrane water treatment unit. The same schematic as shown in Figure 66b could be used.

In laboratory tests, a common feed is softened tap water with typical anion concentrations of 300 mg/L bicarbonate, 15 mg/L chloride and 11 mg/L sulfate and conductivity 550 $\mu\text{S}/\text{cm}$. It may also contain free chlorine, which must be removed by a carbon filter. Feed and permeate conductivities are measured and it is assumed that the conductivities are made up from sodium bicarbonate alone. Gage pressure is in the range of 50 – 80 psi (350 – 400 kPa), resulting in a fairly low permeate flux making it possible to operate with a fairly low water and chemical consumption. Typical feed flowrate per line has been about 0.2 – 0.4 L/minute. The feedwater temperature should be fairly constant, so there is no need for temperature control.

If the line gauge pressure is above 50 psi (350 kPa) most of the time, there is no need for the feed tank or pump.

9.9.3 Antiscalants

A suitable antiscalant must pass two tests, a microbiological growth test and a membrane compatibility test.

9.9.3.1 Microbiological Growth Test.

An antiscalant is typically transported in concentrated form. It is diluted in a tank from where it is added to the feedwater to the membrane unit. It is important that there is no microbiological growth in the antiscalant solution entering the membrane unit. Typically there is no growth in the concentrated antiscalant solution, but there can be growth when it is diluted below a certain concentration. To determine minimum concentration of antiscalant in the dilution tank, a microbiological growth test is carried out. This is normally performed by the antiscalant manufacturer.

The antiscalant is diluted with chlorine-free water to different concentrations in beakers, which are stored for one month. Typical concentrations are 1, 6, 10 and 25% as supplied. A beaker with chlorine-free water is used as control. Either the solutions are inoculated with microorganisms or the beakers are open to the air for “natural” inoculations. Microbial plate counts are taken once weekly during the one-month storage time. The lowest concentration of antiscalant for which there is a decline in plate counts with time will be the lowest concentration in the dilution tank for which the antiscalant is approved.

Preferably, the microbiological test is carried out before the 1,000-hour membrane compatibility test which is described below. The reason for this is that if there is a change in the biocide composition in the antiscalant, the membrane compatibility test has to be repeated.

9.9.3.2 Membrane Compatibility Test.

For an antiscalant to be considered compatible for use, the antiscalant must be fed to spiral-wound elements containing the membrane for 1,000 hours without loss of performance. A setup as shown in Figure 66b, or similar system, would be satisfactory for such a determination. Initially one must establish a baseline. This is achieved by operating the system for at least 12 hours without chemical addition. The test cannot be considered valid if the permeate flowrate is more than 15% below the expected value for a clean membrane. The baseline for a membrane is established without antiscalant with a test using a solution and a pressure as shown in Section 1.8, Table 4.

After the baseline is established, the antiscalant is then added continuously for at least 1,000 hours. The normalized permeate flow and salt passage or rejection should remain relatively constant during this time for the chemical to be deemed compatible. The upper concentration limit for compatibility will be the maximum concentration of the chemical in the concentration stream.

9.9.4 Coagulants and Flocculants

Coagulants and flocculants have been tested in the setup shown in Figure 66b. The elements are first operated with softened tap water for at least a day to ascertain that they are stabilized. Then the chemical to be compatibility tested is added to the feedwater to one of the two parallel lines to make up about a 5 ppm solution. If chemical addition for one week does not significantly affect the element normalized permeate rate or salt passage, the chemical is considered satisfactory.

In general, coagulants and flocculants may interfere with membranes either directly or indirectly. Indirect interference occurs when the compound forms a precipitate which is deposited on the membrane. For example, channeling of the media filter may enable flocs to pass through and become deposited on the membrane. A precipitate can also be formed when concentrating the treated feedwater, such as when aluminum or ferric coagulants are added without subsequently lowering pH to avoid supersaturation in the system itself. Furthermore, a reaction with a compound added after the media filter can cause a precipitate to form. This is most noticeable with antiscalants. Nearly all antiscalants are negatively charged and will react with cationic coagulants or flocculants present in the water. Several systems have been heavily fouled by gel formed by the reaction between cationic polyelectrolytes and antiscalants. Therefore, it is important to test all coagulants and flocculants based on the possibility that some of these products will come into contact with the antiscalant.

Direct interference occurs when the compound itself affects the membrane resulting in a flux loss. The ionic strength of the water may have an effect on the interference of the coagulant or flocculant with the membrane. To minimize the risk of direct or indirect interference with the membrane, anionic or nonionic flocculants are preferred rather than cationic ones. Overdosing must be avoided.

9.9.5 Cleaning Chemicals

As one would expect, cleaning chemicals can be used at a wide range of conditions such as cleaning frequency, cleaning time and temperature. Due to this ambiguity, the discussions on cleaning chemicals will be based on a cleaning frequency in the order of once a month or less.

The flat cell test loop, as shown in Figure 66a, with membrane coupons has been used for cleaning chemical compatibility tests.

A cleaning chemical that provides excellent cleaning performance may also degrade a membrane resulting in a decrease in the salt rejection of the membrane with time. This degradation might not be visible after only one cleaning. For determining cleaning chemical compatibility, membrane coupons (at least three) are soaked in the normal strength cleaning solution for two weeks and then tested at standard test conditions. Ideally, the temperature of the soak solution should be the maximum allowed cleaning temperature.

A cleaning chemical is considered compatible if a two-hour cleaning does not lower the membrane flux or salt rejection and a two-week soak test does not lower the salt rejection.

The steps for the Two-Hour Cleaning Test and the Two-Week Soak Test in Cleaning Solution are listed as follows:

9.9.5.1 Two-Hour Cleaning Test

1. Test the membrane at standard test conditions (Section 1.8, Table 4).
2. Clean with double the normal strength of the cleaning solution by circulating the solution over the membrane at recommended cleaning temperatures and 50 psig for two hours.
3. Rinse out the cleaning solution. Use low conductivity water for this to be able to check that both permeate side and brine side of the membranes have been rinsed out effectively.
4. Retest at the standard test conditions. Flux loss shall be less than 5% and there should be no increase in salt passage compared to the initial test in item 1 above.

9.9.5.2 Two-Week Soak in Cleaning Solution

1. Test the membrane at standard test conditions (Section 1.8, Table 4).
2. Soak the membrane in normal strength cleaning solution at normal cleaning temperature for two weeks.
3. Rinse out the cleaning solution. Use low conductivity water for this to be able to check that both permeate side and brine side of the membranes have been rinsed out effectively.
4. Repeat at test conditions according to item 1 above. There shall be no increase in salt passage compared to the initial test in item 1 above.

9.9.6 Biocides

Like cleaning chemicals, biocides can cause the membrane to lose salt rejection and/or water permeability. Biocides possibly could be in contact with the membrane continuously for a long period, e.g., biocides used for membrane storage or continuous addition to feedwater, or added intermittently, e.g., biocides used for periodical disinfection or “shock” treatments. A satisfactory biocide must not negatively affect the membrane performance during one-year contact. Like other compatibility tests, both “soak tests” and “continuous tests” are often completed to determine chemical compatibility and satisfactory performance.

An initial one-week test observing the effect of the continuous addition of a biocide on the water permeability of the membrane is often recommended. If the result is that the biocide has no negative effect on the water permeability of the membrane, a one-year soak test is then carried out.

An alternative, used more extensively in recent years, is a 1,000-hour continuous compatibility test similar to that of antiscalant testing.

All biocide tests are generally carried out at 20 – 25°C. The solution pH might have an influence on how the biocide affects the membrane, especially when the molecular structure of the biocide changes with pH or when an oxidation reaction might take place.

9.9.6.1 Option 1 - One-Week Continuous Operation Test

The continuous operation test is required when the water permeability of the membrane decreases during the soak test, which has been the case for almost all tested biocides. The test unit in Figure 66b is used for the continuous operation test. The elements are operated for at least one day before the biocide is added to make certain that the elements are stabilized.

After the elements are stabilized, the biocide is added to the feedwater to make up the maximum concentration for which the biocide will be approved. If there is no significant decrease in water permeability or salt rejection during one week of continuous biocide addition, the biocide is assumed to be a good candidate in not affecting the water permeability of the membrane and the longer term "soak test" can then be pursued.

Soak Test. The biocide solutions to be tested are placed into glass jars with lids. The concentration of the biocide is the maximum approval concentration. As controls, a jar with standard storage solution (1% sodium bisulfite solution) and an empty jar are used. About 20 coupons of each membrane type, to be tested, are placed in each jar. Two coupons of each type membrane from each jar are tested after a soak time of:

1. 1 week
2. 2 weeks
3. 4 weeks
4. 2 months
5. 4 months
6. 6 months
7. 1 year

The coupons are used only once and are discarded after the test. Some biocide solutions have a shorter lifetime than one year and these must be replaced with fresh biocide solution at suitable interim intervals.

If the salt passage of the membrane soaked in the biocide solution for one year has not increased significantly, the biocide is assumed not to degrade the membrane.

The combined data from the one-year soak test and one week continuous operation test often is enough for a decision whether to determine if a biocide is compatible. However, if one or the other test indicates questionable results, a long term continuous operation test is required, either in the laboratory or in the field.

In cases where the biocide will only be used intermittently, for example, once a week for a few hours such as in a "shock treatment", it may not be necessary to do the one-year soak test. The continuous test hours of exposure for the expected life of the membrane at the biocide dosage level may be sufficient. For example, if a biocide is used for 30 minutes per week at 400 ppm, a continuous test at 400 ppm for 130 hours (30 min/week x 52 weeks /yr. x 5 years) may be sufficient.

9.9.6.2 Option 2 - 1,000-Hour Continuous Operation Test

Similar to the test for antiscalants, for a biocide can to be considered compatible, the biocide must be fed to spiral-wound elements containing the membrane for 1,000 hours without loss of performance. Based upon recent experience, this test appears to be preferred despite its greater time requirement. A setup as shown in Figure 66b is satisfactory for such a determination. Initially one must establish a baseline. This is achieved by operating the system for at least 12 hours without chemical addition. Normally, the test cannot be considered valid if the permeate flowrate is more than 15% below the expected value for a clean membrane. The expected flow value of FilmTec™ Flatsheet RO Membranes can be derived from the published flow specification of the respective membrane element and the published value of the active membrane area of that element.

After the baseline is established, the biocide is then added continuously for at least 1000 hours. The normalized permeate flow and salt passage should remain relatively constant during this time for the chemical to be deemed compatible. The upper concentration limit for compatibility will be the maximum concentration of the chemical in the concentration stream.

9.9.7 Membrane Preservatives

Membrane preservatives are biocide solutions used to prevent biogrowth and change in membrane performance during extended storage times. Thus, the biocide used must have a long lifetime. Surfactants and/or humectants are often present in the solution to keep the membrane wet. Consequently, any of those compounds could affect the membrane negatively either directly or indirectly by interacting with other parts of the element and the formation of compounds harmful to the membrane.

A compatible membrane preservative should not exhibit any significant decrease in water permeability or salt rejection properties of the membrane element during one year storage. A means to perform the test is to store five tested elements fully immersed in the storage solution and test one of them after 2, 4, 6 and 12 months storage. A new element is tested each time and is returned to the storage solution following the test. The fifth element is included in the test as a spare to use if the test data of any of the other elements is in doubt. Two elements stored in the present storage solution, 1% sodium bisulfite, should be used as controls. These are tested at the same time as any one of the other five elements. If the membrane performance in the preservative solution is maintained, the same test should continue for years with element test once or twice yearly to learn about the lifetime of the storage solution.

Before wet elements are stored, the elements are initially soaked in the storage solution for about one hour and then drained and bagged. There should not be any biological growth in the bag or deterioration of the bagged elements performance during the shelf life of the storage solution. To examine whether another membrane preservative solution can be used for bagged element storage, elements are tested and then soaked for 1, 2 or 20 hours in the membrane preservative solution. Then the elements are drained and bagged. After 2, 6, 12, 18, 24, 36 and 48 months storage, two elements from each soak time are taken out from their bags. Microbial plate counts are taken of the storage solution in the bag, and the elements are tested. The element performance is measured both before and after permeate pressure is applied to determine whether the membrane dries when stored. Permeate pressure is most easily applied by shutting the permeate port at a feed pressure of at least 150 psi (1,000 kPa) pressure above the osmotic pressure of the feed solution. Three soak times, seven test times, and duplicate elements, result in 42 elements per storage solution to test. To save storage space, small elements are often used. Again, the 1% sodium bisulfite solution is used as a control. Since one-hour soak time is sufficient for the control, only 14 control elements are required.

9.10 Accelerated Start-Up Technique for Dry Membranes

9.10.1 Summary

The majority of FilmTec™ membranes are available shipped either wet or dry. Dry elements have lower shipping weight, longer shelf life, and easier inventory procedures with no preservative solution to monitor. Wet elements typically achieve stabilized performance up to 48 hours after start-up where dry elements may take up to 72 hours to fully stabilize. In all cases the time for the membranes to stabilize is a function of the operating conditions.

In cases where rapid start-up of dry elements is required, a three-step pretreatment technique can be used to ensure stabilized performance is achieved quickly. This technique is not a requirement but can accelerate start-up performance when time and circumstances permit.

9.10.2 Step 1: Pre-Flushing

Flush the membranes with feed water at 22-40 gpm (5-9 m³/h) per pressure vessel for 10-15 minutes. Typical flushing pressure is < 90 psi (6.2 bar). Typically, flushing is performed with the booster pump. The flush water should be RO feed quality water.

If the membranes have not been operated before, pre-flushing is critical to avoid permanent flux loss.

9.10.3 Step 2: Soaking

Soak in 1.2 % sodium metabisulfite solution (min. 1.0 %) for 10-14 days. The solution should be prepared from appropriate quality* water.

Membranes must be completely immersed in the solution, which should be introduced to the pressure vessels using the overflow technique, allowing excess solution to overflow from an opening in the system higher than the pressure vessels. The sodium metabisulfite solution must be maintained at a pH greater than 3, with temperature between 32°F (0°C) to 90°F (32°C).

9.10.4 Step 3: Post-Flushing

A) Start-up within 2 days after the soaking

Flush membranes with RO feed quality water, at a flow rate 22-40 gpm (5-9 m³/h) per pressure vessel for 60 minutes.

B) Start-up more than 2 days after soaking

If the plant will be delayed in its startup for longer than 48 hours, the elements should be flushed for 60 minutes and preserved according to the guidelines in procedure given in [Preservation of RO and NF Systems](#) (Form No. 45-D01638-en).

When handling sodium metabisulfite or other chemicals, care should be taken to use the appropriate personal protective equipment.

* appropriate quality water: Conductivity < 5,000 μ S/cm, zero free chlorine, Total bacterial count (TBC) < 50 cfu/ml (totally free of bacteria is ideal), Silt Density Index < 5.

www.dupont.com/water/contact-us

All information set forth herein is for informational purposes only. This information is general information and may differ from that based on actual conditions. Customer is responsible for determining whether products and the information in this document are appropriate for Customer's use and for ensuring that Customer's workplace and disposal practices are in compliance with applicable laws and other government enactments. The product shown in this literature may not be available for sale and/or available in all geographies where DuPont is represented. The claims made may not have been approved for use in all countries. Please note that physical properties may vary depending on certain conditions and while operating conditions stated in this document are intended to lengthen product lifespan and/or improve product performance, it will ultimately depend on actual circumstances and is in no event a guarantee of achieving any specific results. DuPont assumes no obligation or liability for the information in this document. References to "DuPont" or the "Company" mean the DuPont legal entity selling the products to Customer unless otherwise expressly noted. NO WARRANTIES ARE GIVEN; ALL IMPLIED WARRANTIES OF MERCHANTABILITY OR FITNESS FOR A PARTICULAR PURPOSE ARE EXPRESSLY EXCLUDED. No freedom from infringement of any patent or trademark owned by DuPont or others is to be inferred.

DuPont™, the DuPont Oval Logo, and all trademarks and service marks denoted with ™, SM or ® are owned by affiliates of DuPont de Nemours Inc. unless otherwise noted. ©2020 DuPont.

The Dow Diamond Logo is a trademark of The Dow Chemical Company used under license by DuPont.

