

Fast Pyrolysis and Bio-Oil Upgrading

Robert C. Brown
Iowa State University
and
Jennifer Holmgren
UOP

Fast Pyrolysis

- Rapid thermal decomposition of organic compounds in the absence of oxygen to produce liquids, char, and gas
 - Dry feedstock: <10%
 - Small particles: <3 mm
 - Short residence times: 0.5 - 2 s
 - Moderate temperatures (400-500 °C)
 - Rapid quenching at the end of the process
 - Typical yields
 - Oil: 60 - 70%
 - Char: 12 -15%
 - Gas: 13 - 25%

Bio-Oil

Pyrolysis liquid (bio-oil) from flash pyrolysis is a low viscosity, dark-brown fluid with up to 15 to 20% water



Source: Piskorz, J., et al. In Pyrolysis Oils from Biomass, Soltes, E. J., Milne, T. A., Eds., ACS Symposium Series 376, 1988.	White Spruce	Poplar
Moisture content, wt%	7.0	3.3
Particle size, μm (max)	1000	590
Temperature	500	497
Apparent residence time	0.65	0.48
Product Yields, wt %, m.f.		
Water	11.6	12.2
Gas	7.8	10.8
Bio-char	12.2	7.7
Bio-oil	66.5	65.7
Bio-oil composition, wt %, m.f.		
Saccharides	3.3	2.4
Anhydrosugars	6.5	6.8
Aldehydes	10.1	14.0
Furans	0.35	--
Ketones	1.24	1.4
Alcohols	2.0	1.2
Carboxylic acids	11.0	8.5
Water-Soluble – Total Above	34.5	34.3
Pyrolytic Lignin	20.6	16.2
Unaccounted fraction	11.4	15.2

Multiple reaction pathways for pyrolysis of cellulose

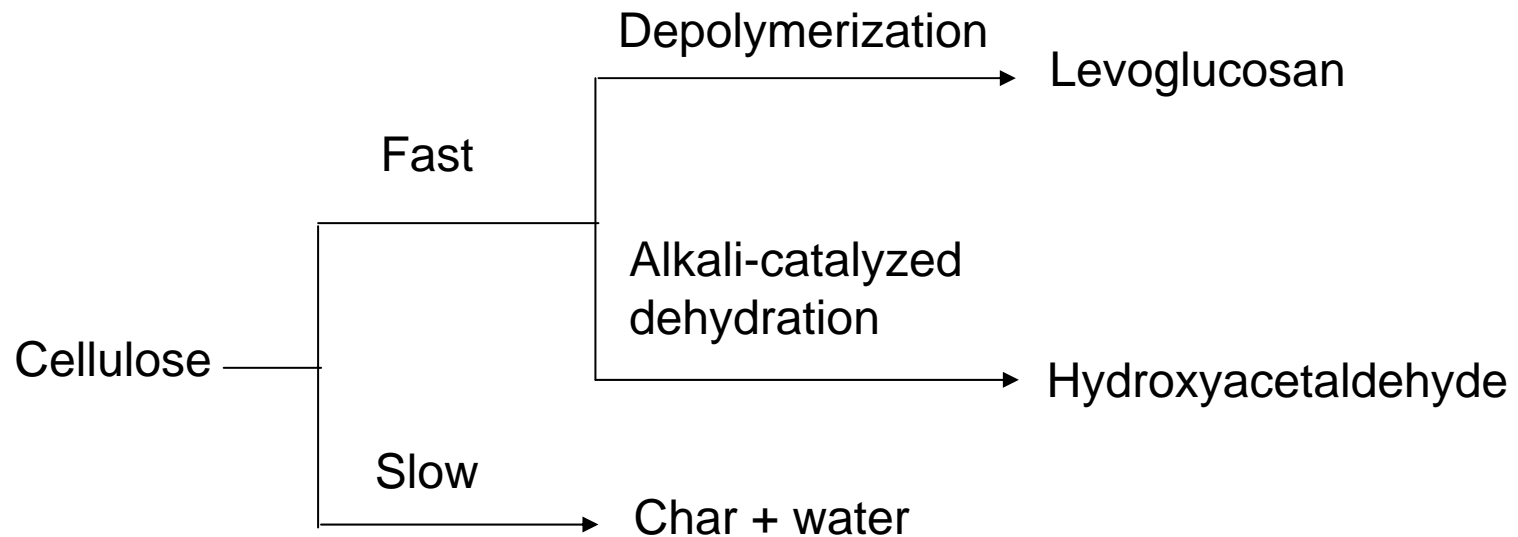

Fast Pyrolysis

- Advantages
 - Operates at atmospheric pressure and modest temperatures (450 C)
 - Yields of bio-oil can exceed 70 wt-%
- Disadvantages
 - High oxygen and water content of pyrolysis liquids makes them inferior to conventional hydrocarbon fuels
 - Phase-separation and polymerization of the liquids and corrosion of containers make storage of these liquids difficult

Several Kinds of Fast Pyrolysis Reactors

- Bubbling fluidized bed
- Circulating fluidized beds/transport reactor
- Rotating cone pyrolyzer
- Ablative pyrolyzer
- Vacuum pyrolysis
- Auger reactor

Bubbling Fluidized Bed

- Heat supplied externally to bed
- Good mass & heat transfer
- Requires small biomass particles (2-3 mm)

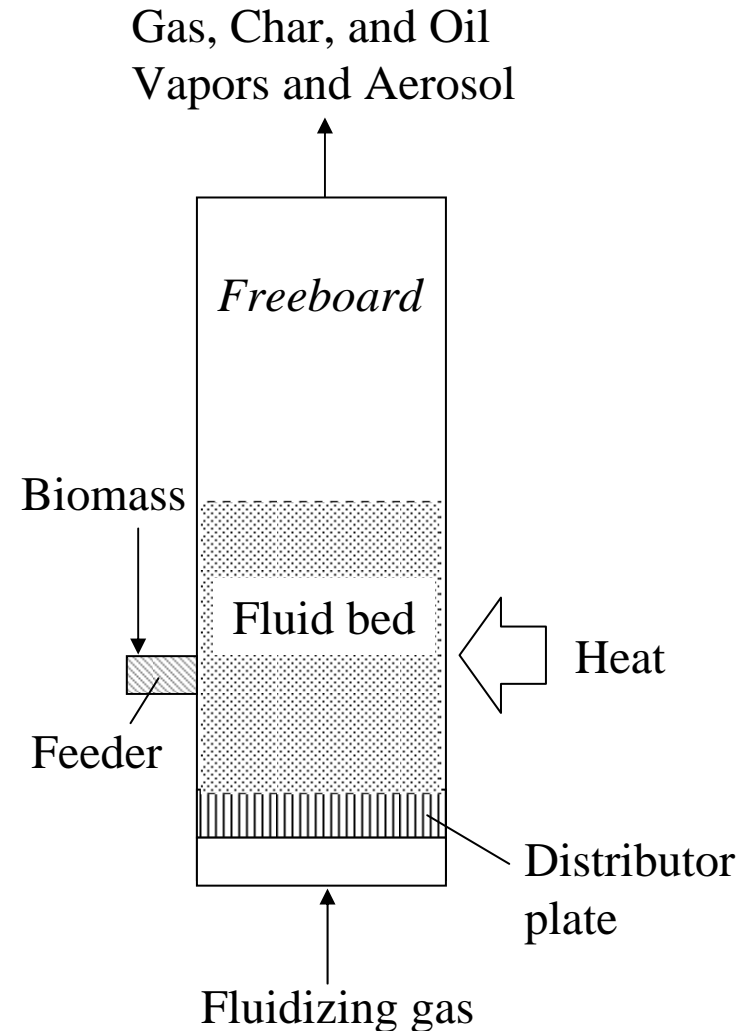

Circulating Fluidized Bed/Transport Reactor

- Hot sand circulated between combustor and pyrolyzer
- Heat supplied from burning char
- High throughputs but more char attrition

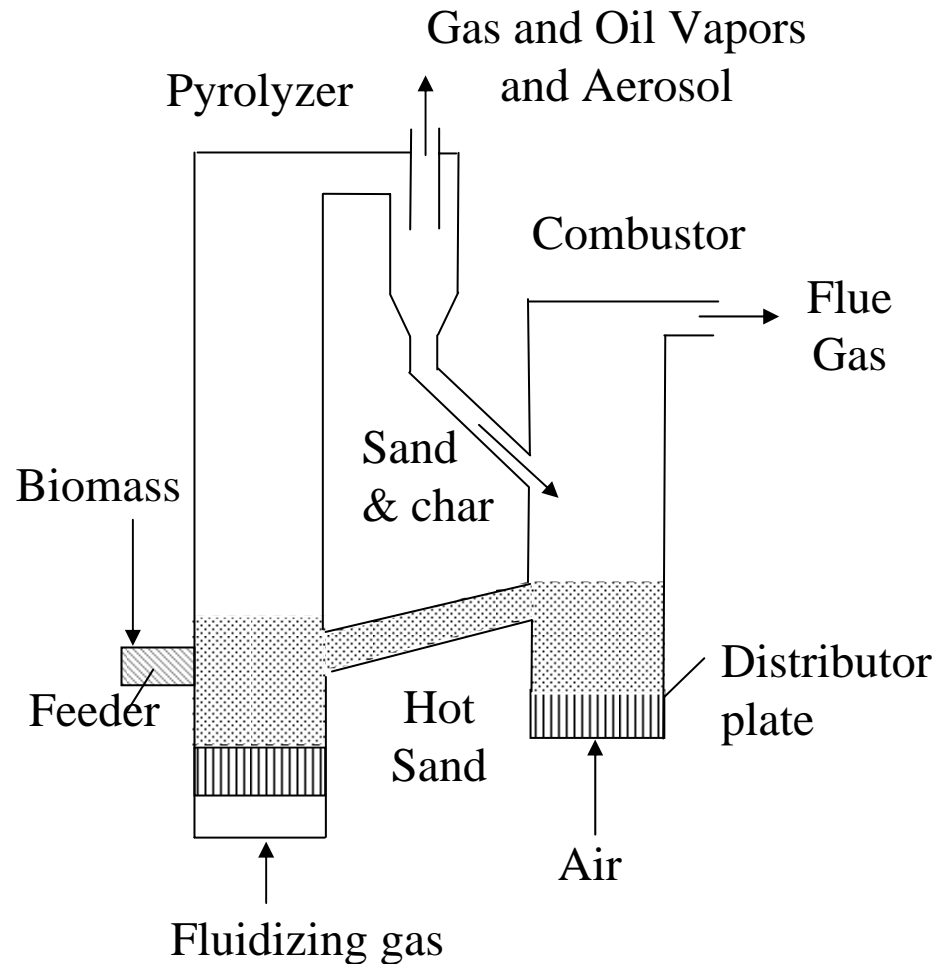

Rotating Cone Pyrolyzer

- Sand and biomass brought into contact within rotating cone
- Compact design and does not need carrier gas
- Requires very small biomass particles and is hard to scale-up

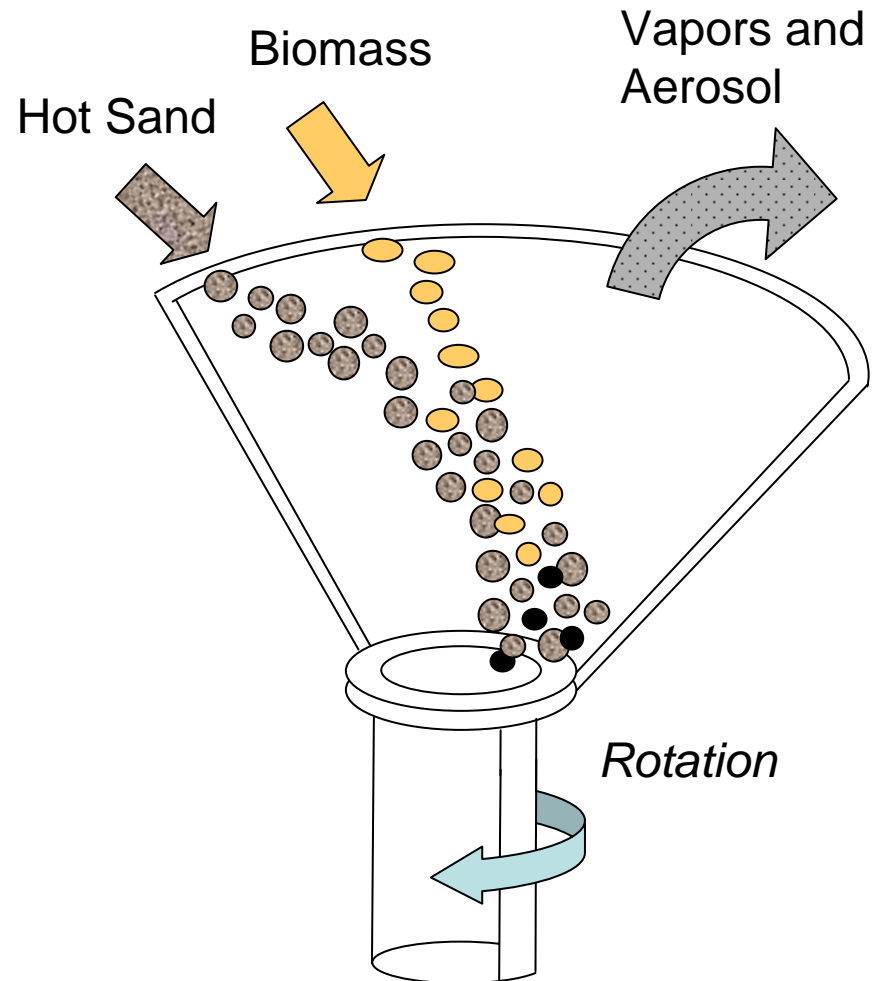

Ablative Pyrolyzer

- High pressure of particle on hot reactor wall achieved by centrifugal or mechanical motion
- Can use large particles and does not require carrier gas
- Complex and does not scale well

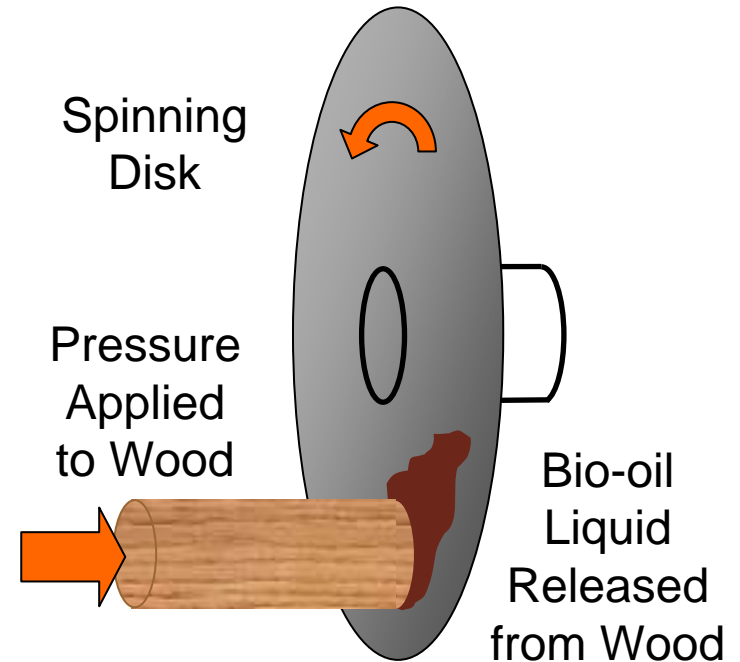

Vacuum Pyrolysis

- Biomass moved by gravity and rotating scrappers through multiple hearth pyrolyzer with temperature increasing from 200 C to 400 C
- Can use larger particles and employs little carrier gas
- Expensive vacuum pump and difficult to scale-up

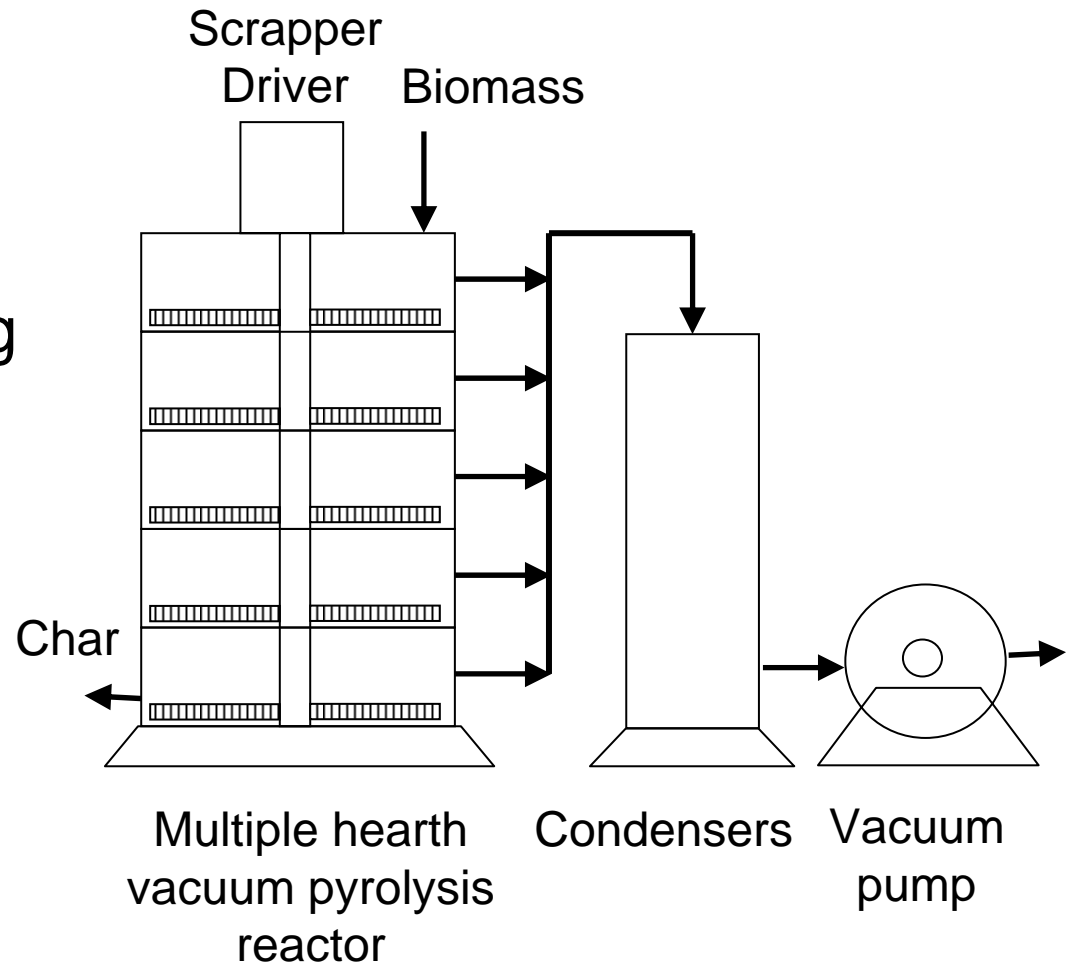

Auger Reactor

- Hot sand and biomass mixed by auger
- Suitable for small scale
- Requires hot sand heating and circulation system

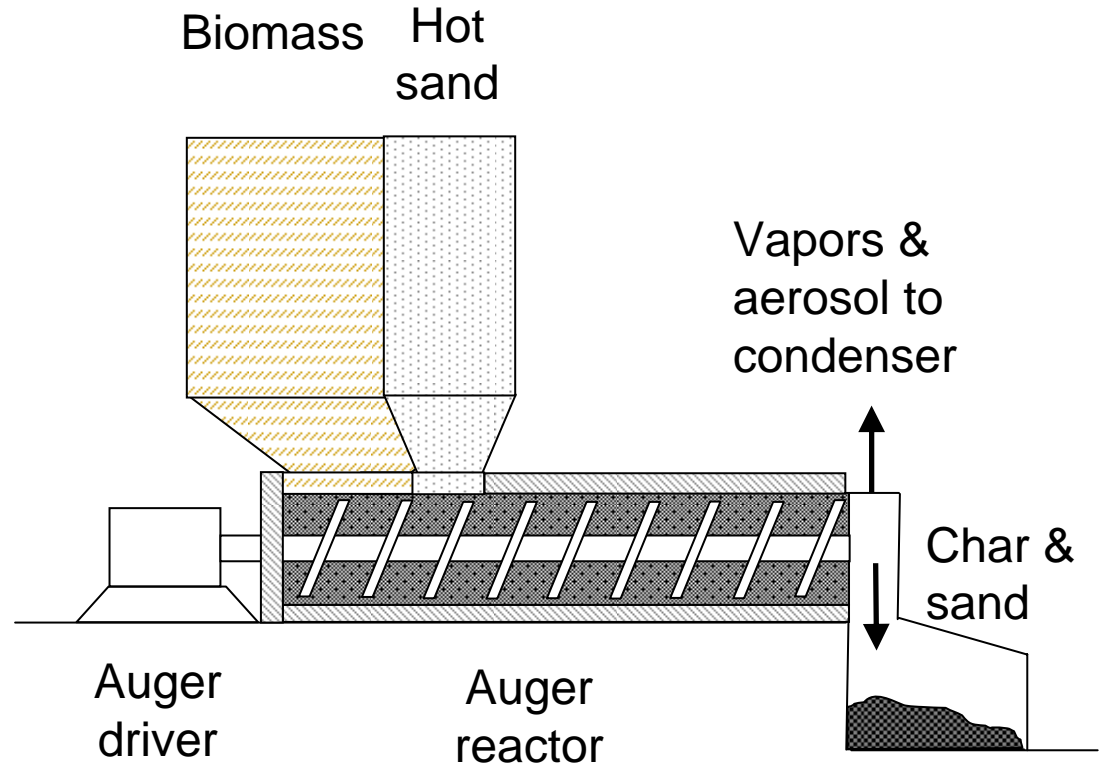

Relative Merits of Various Reactors

Property	Status	Bio-oil wt%	Complexity	Feed size	Inert gas need	Specific size	Scale up
Fluid bed	Demo	75	Medium	Small	High	Medium	Easy
CFB	Pilot	75	High	Medium	High	Large	Easy
Entrained	None	65	High	Small	High	Large	Easy
Rotating cone	Pilot	65	High	V small	Low	Small	Hard
Ablative	Lab	75	High	Large	Low	Small	Hard
Auger	Lab	65	Low	Small	Low	Medium	Easy
Vacuum	Demo	60	High	Large	Low	Large	Hard
The darker the cell color, the less desirable the process.				Lab: 1 – 20 kg h ⁻¹ Pilot: 20 – 200 kg h ⁻¹ Demo: 200 – 2000 kg h ⁻¹			

Adapted from PYNE IEA Bioenergy <http://www.pyne.co.uk>

Which will dominate?

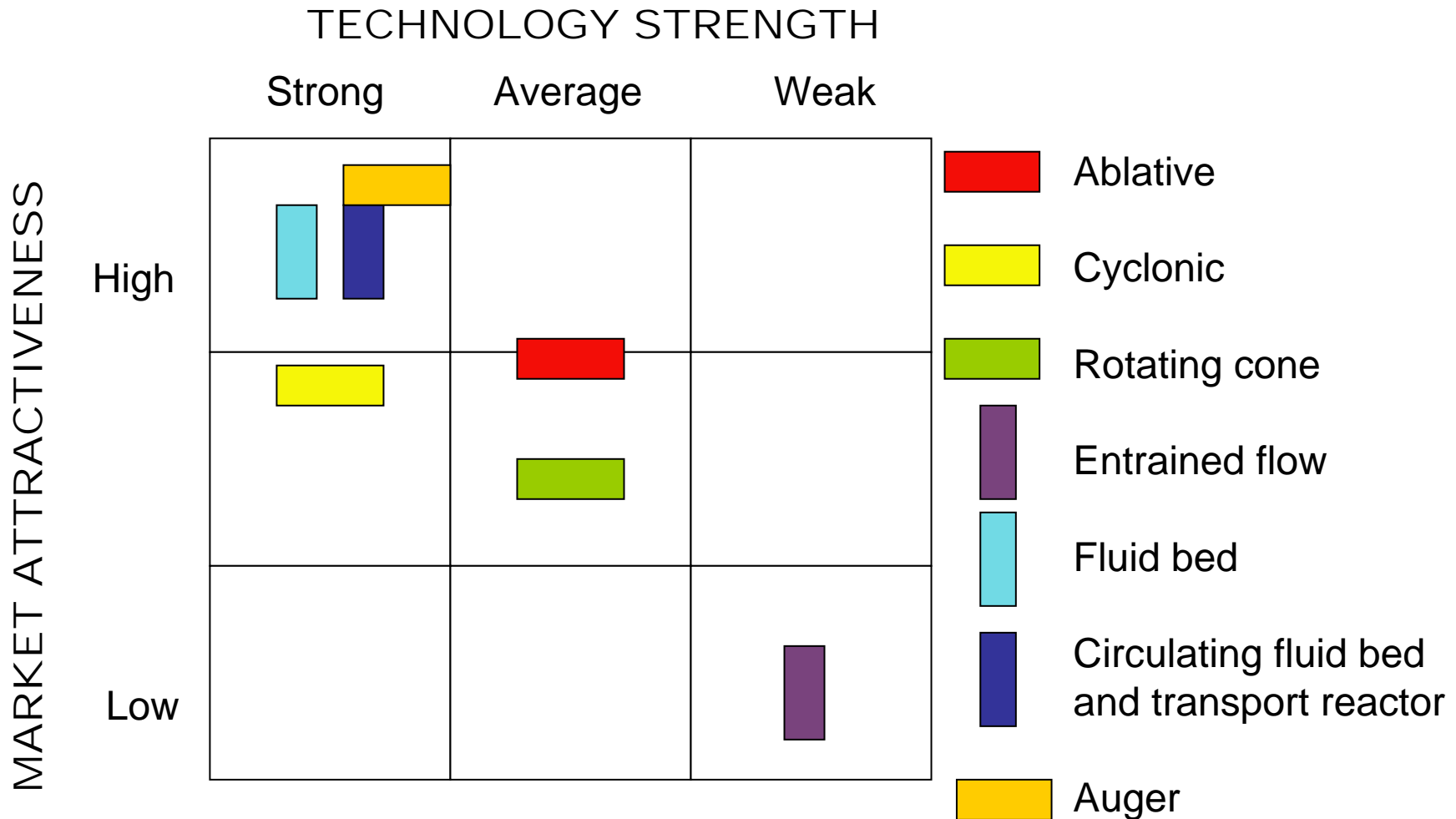

Adapted from PYNE IEA Bioenergy <http://www.pyne.co.uk>

Fast Pyrolysis System

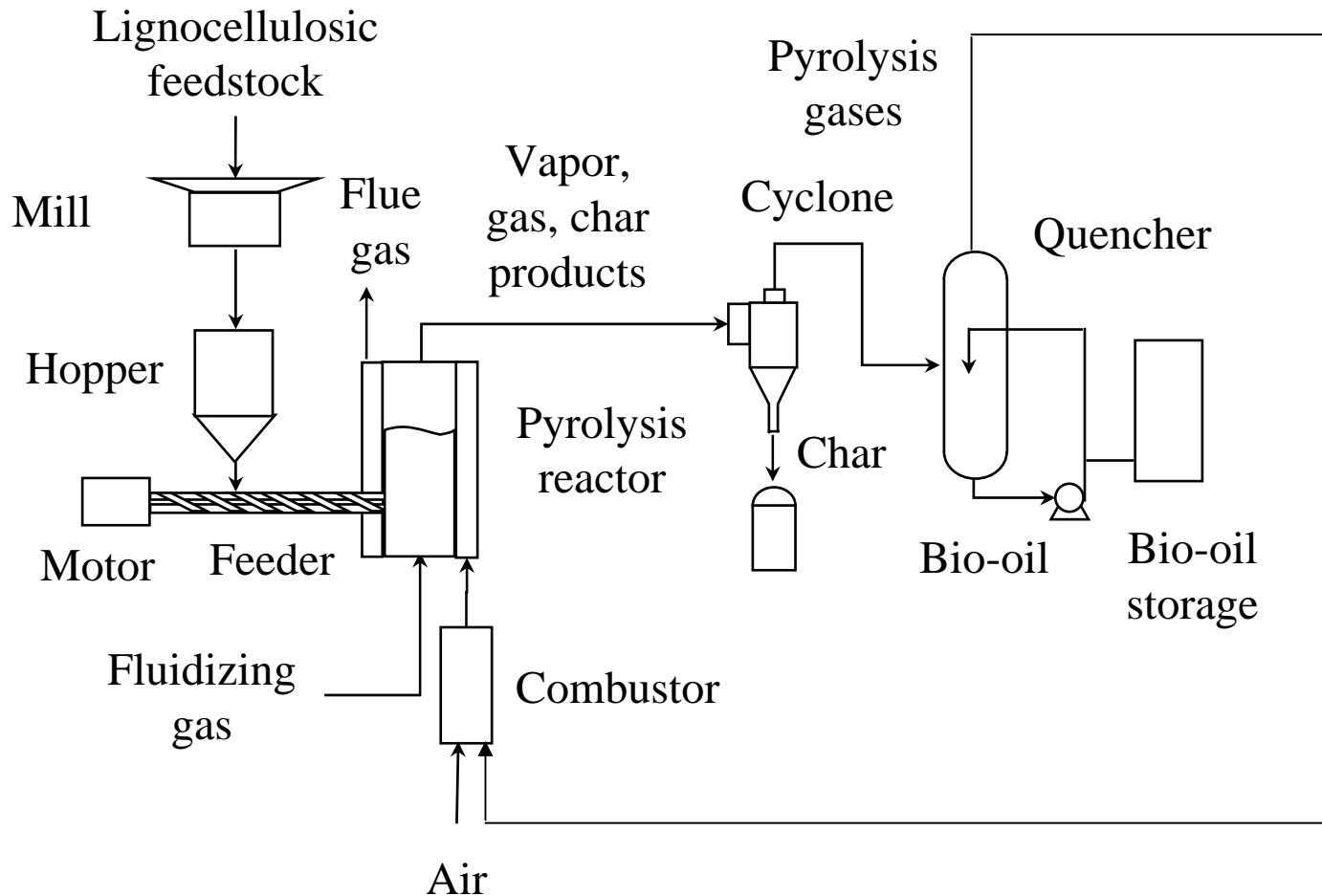

Scale

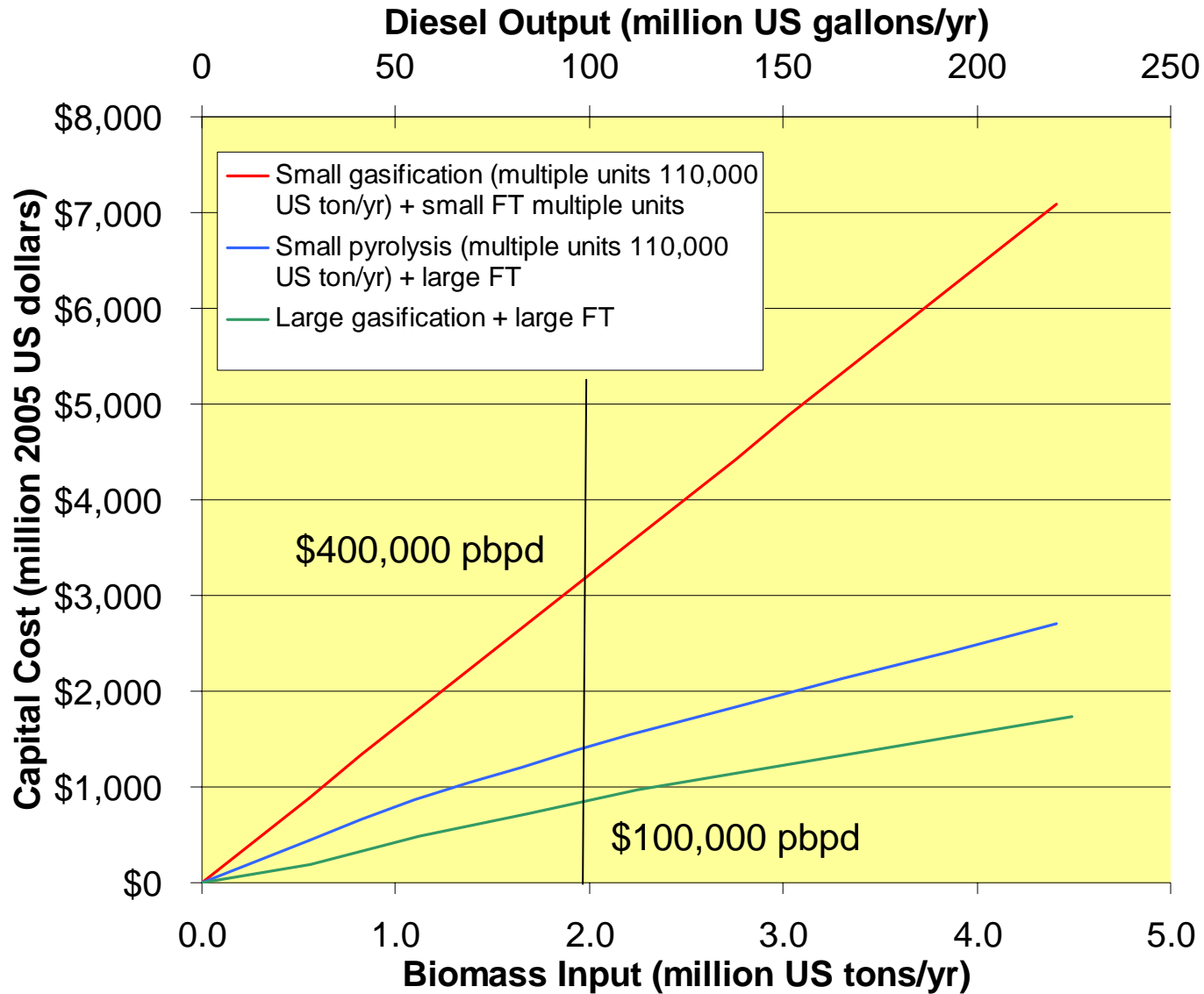

Adapted from: Bridgwater, ACS Meeting, Washington, D.C., 2005

Suitable Feedstocks

- Wide variety of feedstocks can be used
- Fibrous biomass usually employed
- Wood higher yielding than herbaceous biomass

Storage & Transportation

- Distributed preprocessing allows transport and storage as liquid
- High acidity requires storage in stainless steel or plastic
- Stability problems need to be solved

Post Processing to Motor Fuels

- Direct application of bio-oil
- Hydrocracking of bio-oil
- Gasification of bio-oil
- Fermentation of Bio-oil

Bio-Oil Burned in Diesel Engines

- Bio-oil used as directly as diesel fuel substitute
- Only suitable for stationary power applications

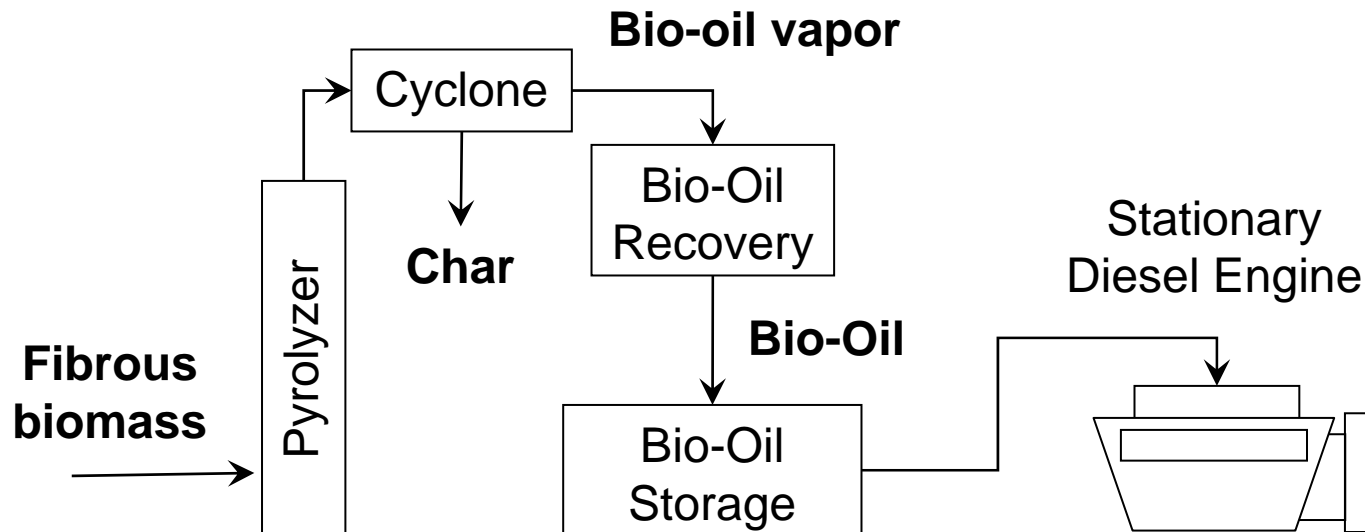

Bio-Oil Hydrocracking

- Directly converts biomass into liquid bio-oil (lignin, carbohydrate derivatives, and water) and char
- Bio-oil catalytically converted into hydrocarbon fuel (green diesel)

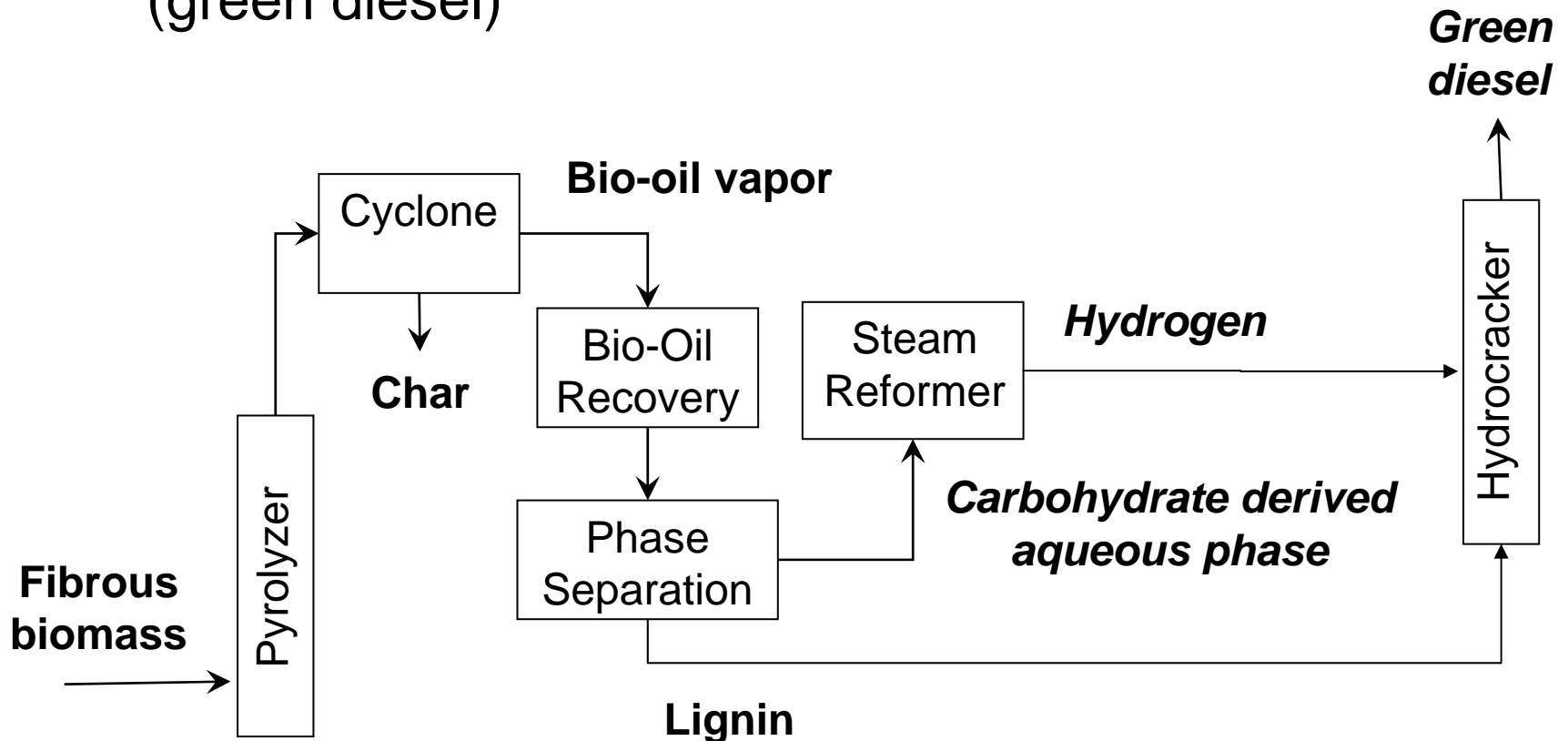

Bio-Oil Gasification

- Bio-oil and char slurried together to recover 90% of the original biomass energy
- Slurry transported to central processing site where it is gasified in an entrained flow gasifier to syngas
- Syngas is catalytic processed into green diesel (F-T liquids)

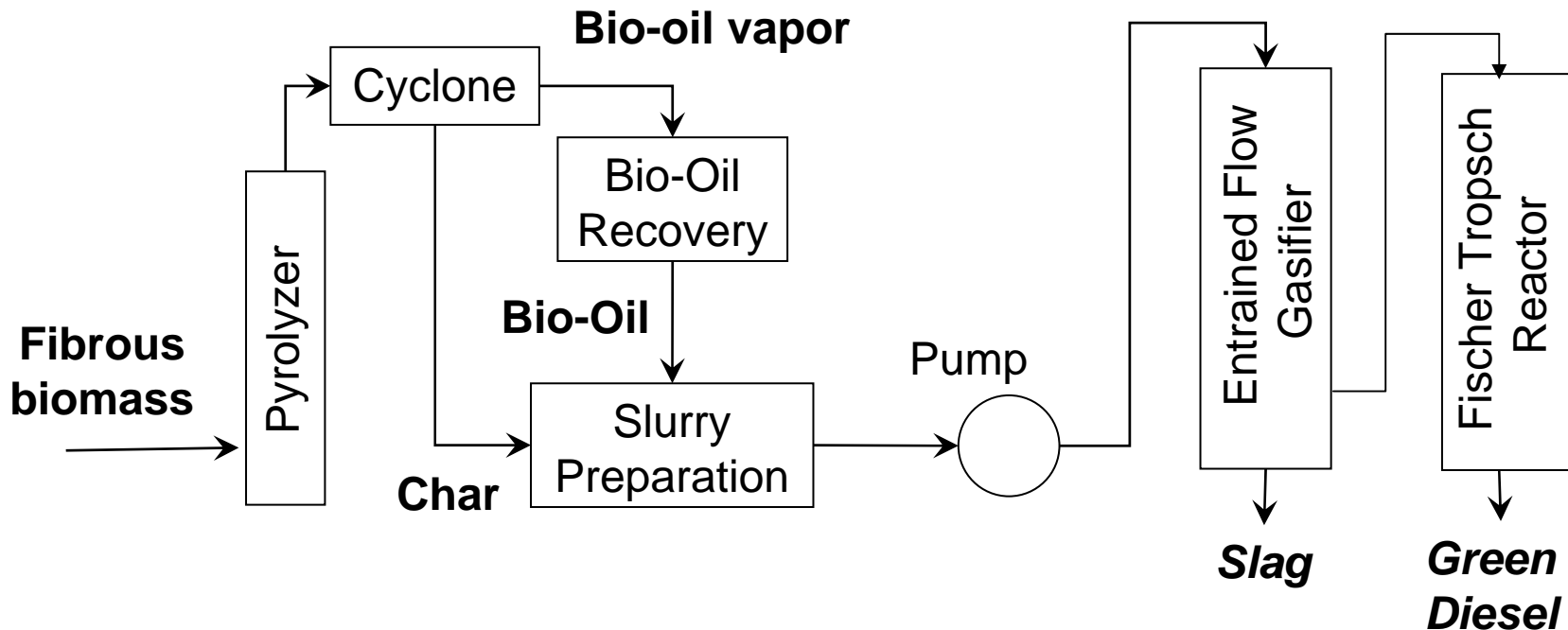

Bio-Oil Fermentation

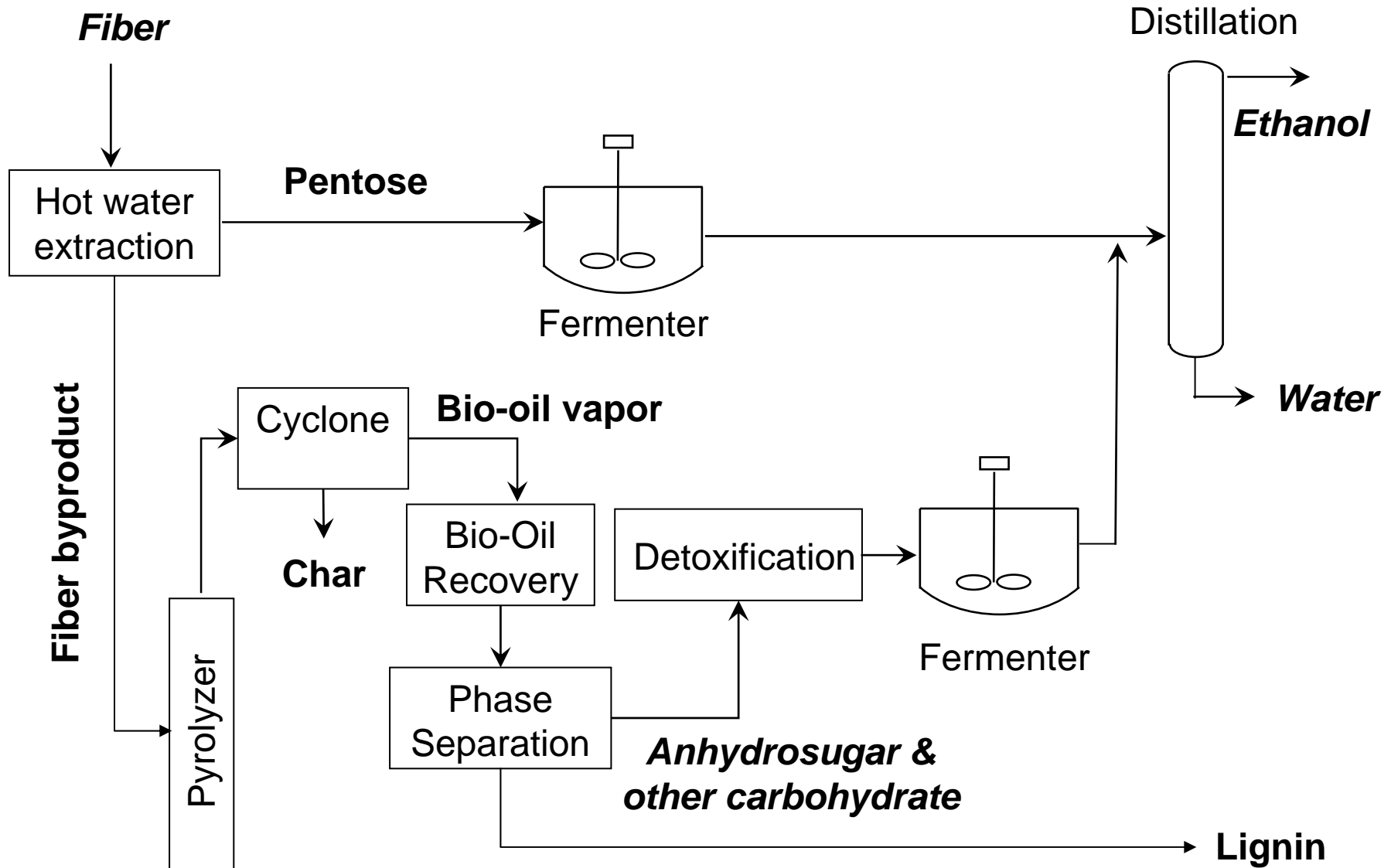

Energy Efficiency

- Conversion to 75 wt-% bio-oil translates to energy efficiency of 70%
- If carbon used for energy source (process heat or slurried with liquid) then efficiency approaches 94%

Co-Products

- Gas (CO, H₂, light hydrocarbons)
 - Can be used to heat pyrolysis reactor
- Char: Several potential applications
 - Process heat
 - Activated carbon
 - Soil amendment

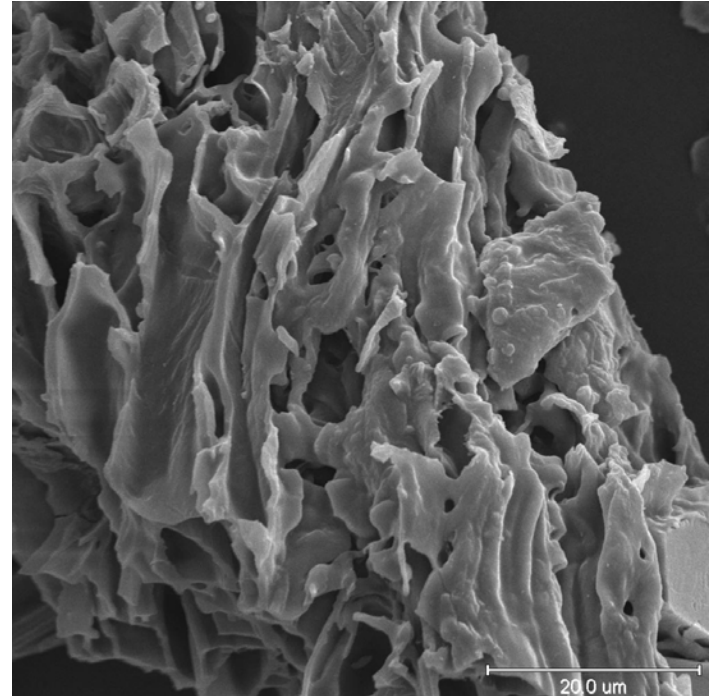

Potential Co-Products from Bio-Oil

Products of pyrolysis for several different pretreatments of cornstover (Brown et al. 2001)

	No Pretreatment	Acid Hydrolysis	Acid Wash	Acid Wash with catalyst
Products (Wt% maf)				
Char	15.8	13.2	13.2	15.9
Water	2.57	10.6	10.4	7.96
Organics	59.1	67.2	68.5	67.7
Gases	22.6	9.02	7.88	8.44
Organics (Wt %)				
Cellobiosan	trace	4.55	3.34	4.97
Levoglucosan	2.75	17.69	20.12	23.10
Hydroxy-acetaldehyde	11.57	5.97	3.73	3.93
Formic acid	2.61	Trace	Trace	0.73
Acetic acid	3.40	1.51	1.26	0.40
Acetol	4.53	trace	trace	trace
Formaldehyde	2.75	1.63	trace	0.70
Pyrolytic lignin	33.40	16.89	17.74	20.08

Quality Assurance

- Bio-oil quality issues:
 - Moisture content
 - Particulate content
 - Sulfur and nitrogen content
 - Stability

Equipment Maintenance

- Potential problems with pyrolysis equipment
 - Bed agglomeration
 - Clogging of condensers
 - ESP performance
- Catalytic reactors
 - Poisoning by sulfur and chlorine
 - Coking

Waste Streams

- Main products (gas, char, bio-oil) account for all mass of biomass feedstock

Technical Barriers

- Preparing dry, finely divided biomass particles
- Maintaining high bio-oil yields
- Improving bio-oil stability
- Determining optimal scale of facility

Alternative Fuels: Targets

WTW Energy /GHG Emissions Clusters

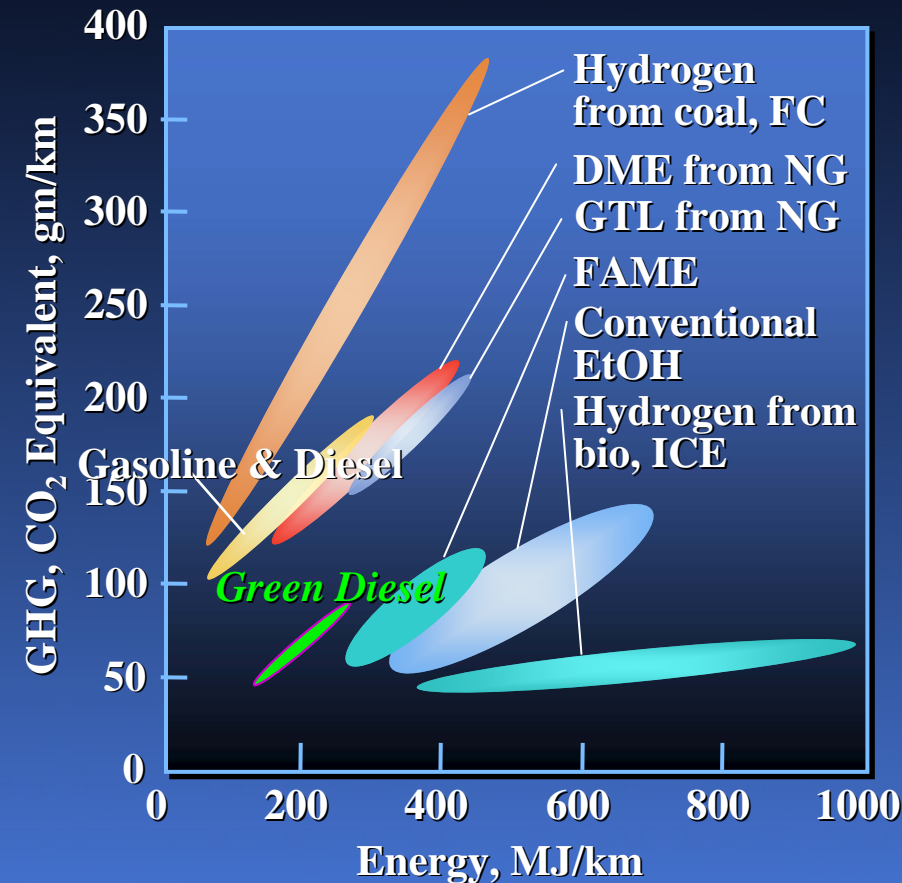

Source: CONCAWE / EU CAR /
EU Comm'n, Dec 2003

- **Alternative fuels may need to target:**
 - < 100 gm CO₂/km WTW
 - GTL, DME from gas – close, but not there yet
- **Several other alternatives in study (not shown for simplicity)**
- **Engine manufacturers developing more efficient advanced ICE's in addition to hybrids and FC's**
 - Variable DI gasoline
 - “Part Homogeneous” diesel combustion
 - “Combined Combustion” systems
 - Improve fuel efficiency

Biorenewables and Petroleum Feeds: Relative Availability

Global

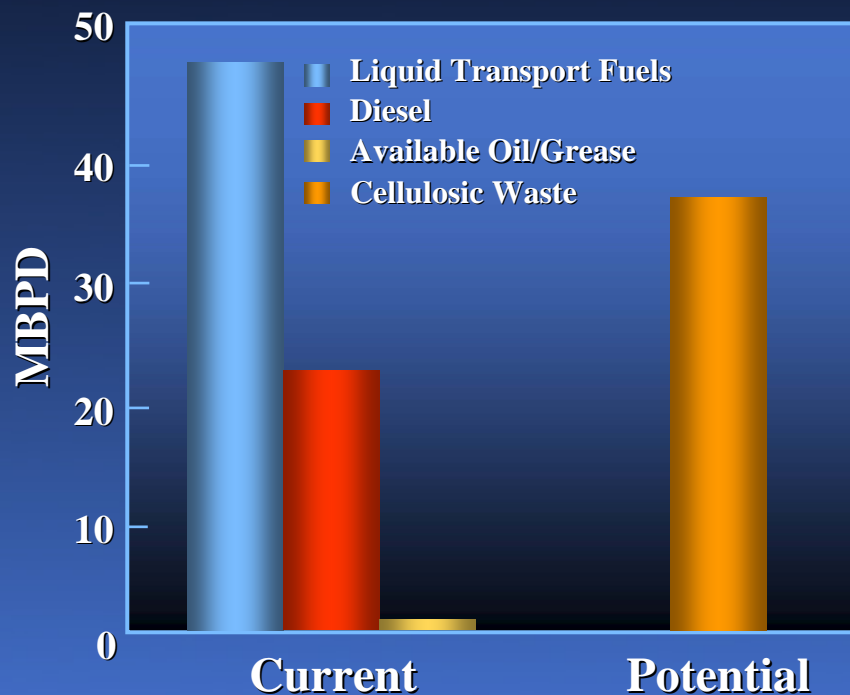

US

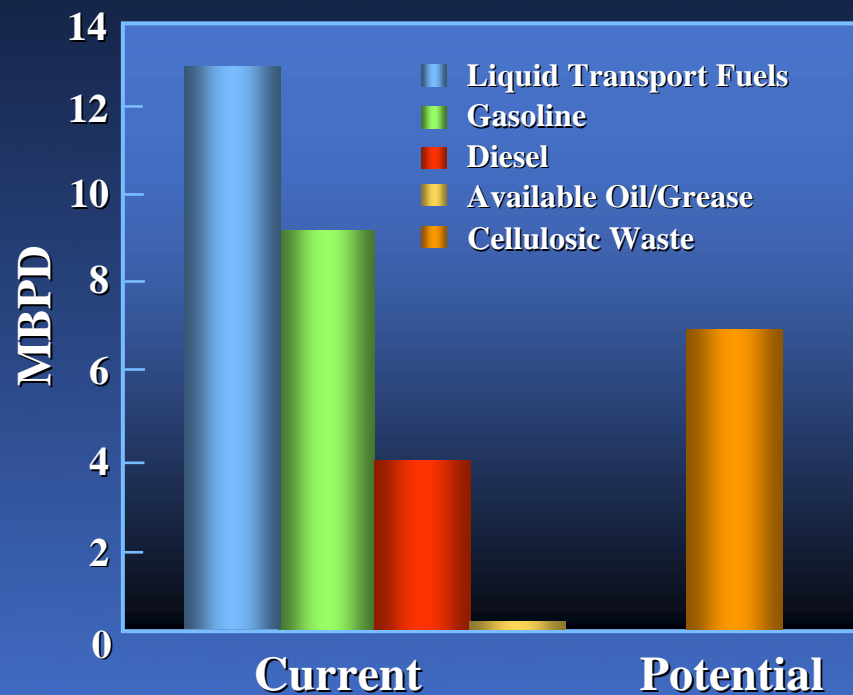

Available Cellulosic Biomass Could Make a Significant Impact in Fuels Pool

Py Oil Portfolio

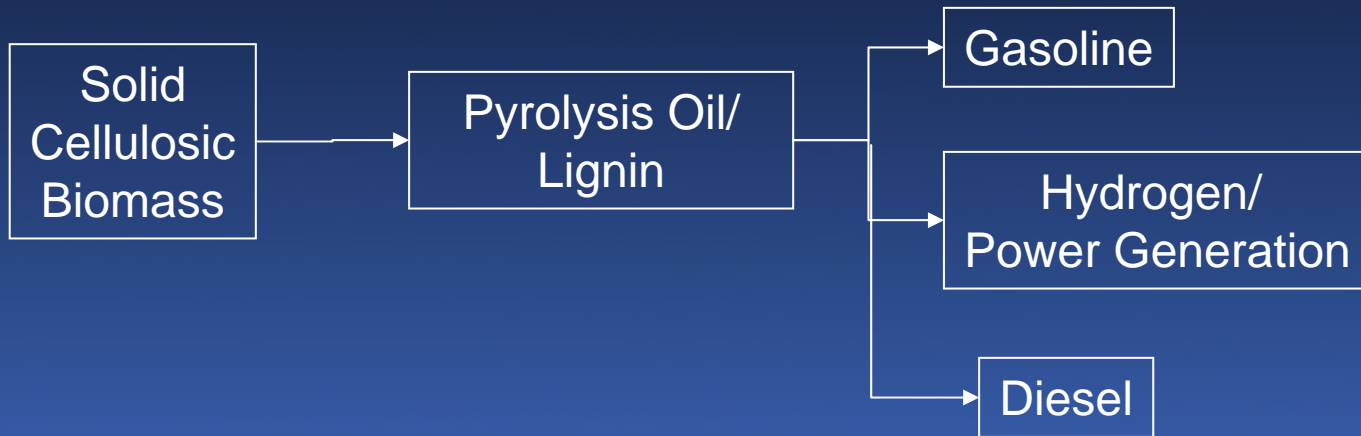

Lignin Molecular Structure

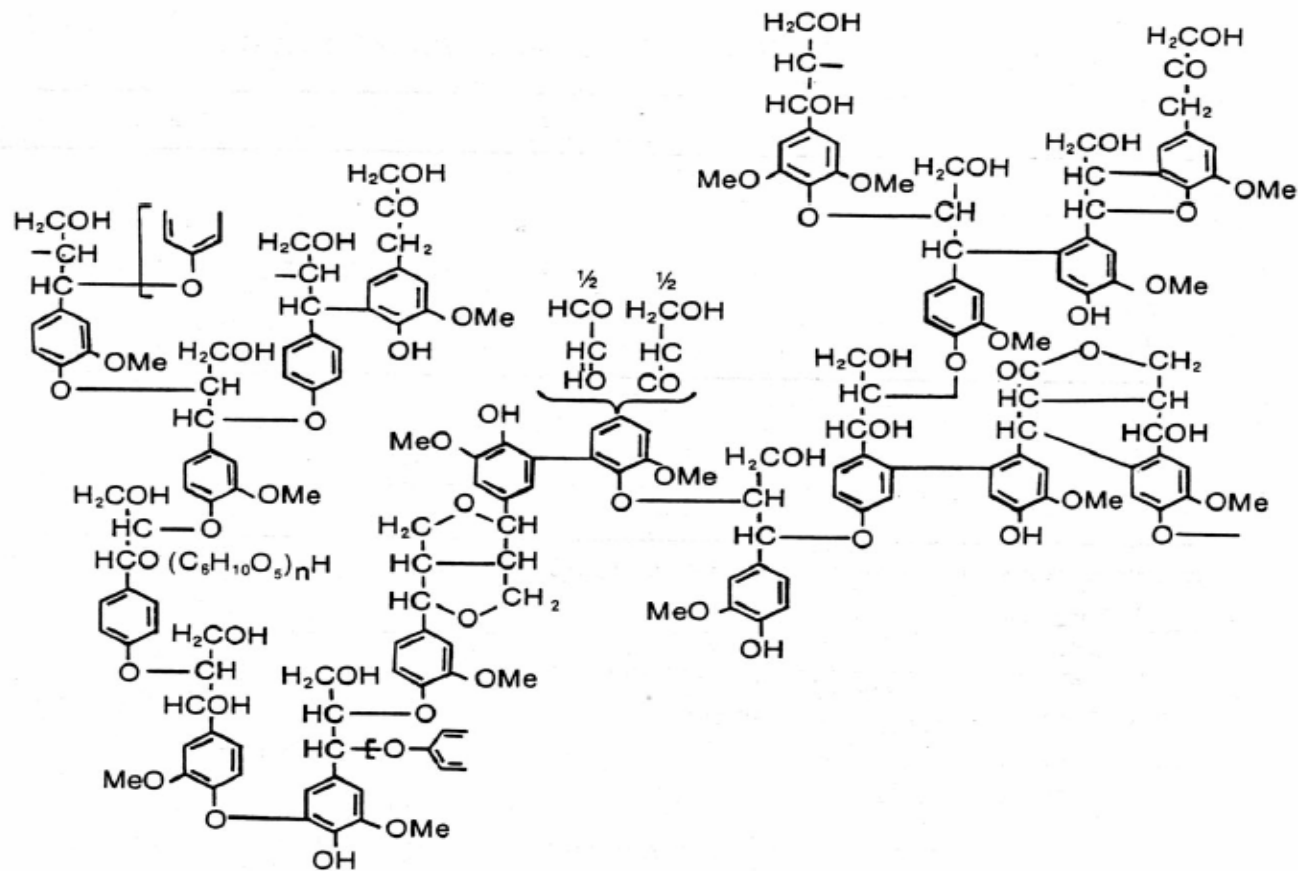

Treating Technologies

Hydrotreating

- Hydrotreating is the key process to meet quality specifications for refinery fuel products
- Removes sulfur, nitrogen, olefins, and metals using hydrogen
- Hydrogen addition also improves the quality of distillate fuels (poly aromatics, cetane, smoke point)
- Treating feedstocks for other processing units



Conversion Technologies

Hydrocracking

- Hydrocracking upgrades heavy feeds including gas oils and cycle oils into lighter, higher value, low sulfur products
- High pressure is used to add hydrogen and produce premium distillate products
- Naphtha products normally are low octane and are upgraded in a reformer
- Product volume is 10-20% higher than the feedstock



Hydrocracking Catalyst Portfolio

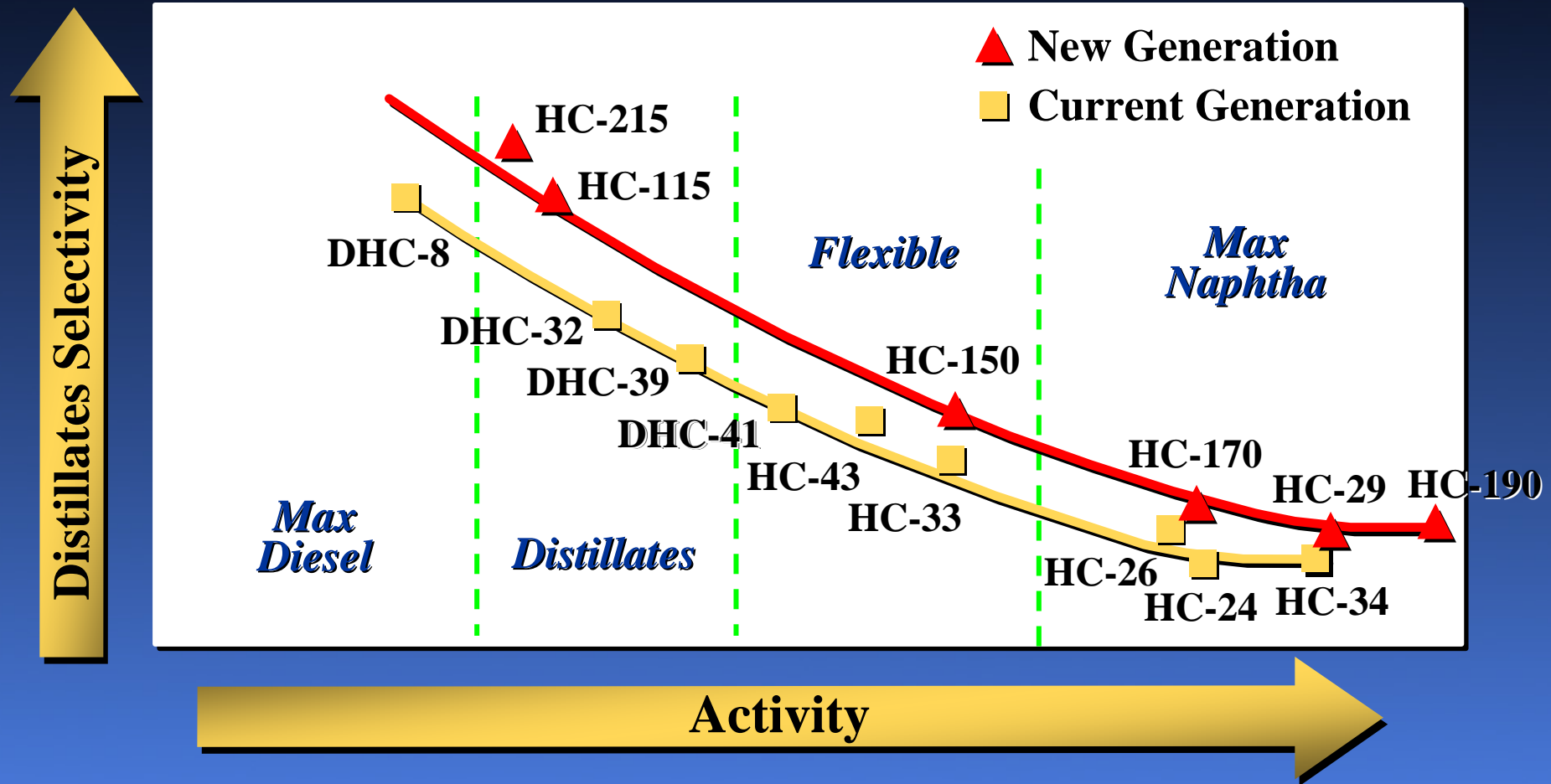

Distillate Selectivity Decreases with Increasing Activity

YE for Hydrocracking Pyrolysis Oil

Feed	Wt%	bpd
Pyrolysis Oil	100	2,250
H₂	4-5	
Products		
Lt ends	15	
Gasoline	30	1,010
Diesel	8	250
Water, CO₂	51-52	

Gasoline Production from Py Oil

(\$40/bbl crude)

Feed	\$/D	bpd
Pyrolysis Oil	40,500	2,250
H₂	25,680	21.4 T
Products		
Lt Hydrocarbons	19,303	64T/D
Gasoline	52,520	1,010
Diesel	12,000	250
Utilities	-4,800	
Net	12,843	

\$ 4.2 million/year

Hydroprocessing costs: Effect of Scale

Unit size (bpd)	Cost, \$MM	Cost/1000 bpd \$MM
30000	\$28.9	\$ 0.96
27500	\$27.4	\$ 1.00
25000	\$25.9	\$ 1.04
22500	\$24.3	\$ 1.08
20000	\$22.7	\$ 1.13
17500	\$20.9	\$ 1.19
15000	\$19.1	\$ 1.27
12500	\$17.1	\$ 1.37
10000	\$14.9	\$ 1.49
7500	\$12.6	\$ 1.68
5000	\$9.9	\$ 1.97
2500	\$6.5	\$ 2.60

HDT Capital Cost vs Capacity

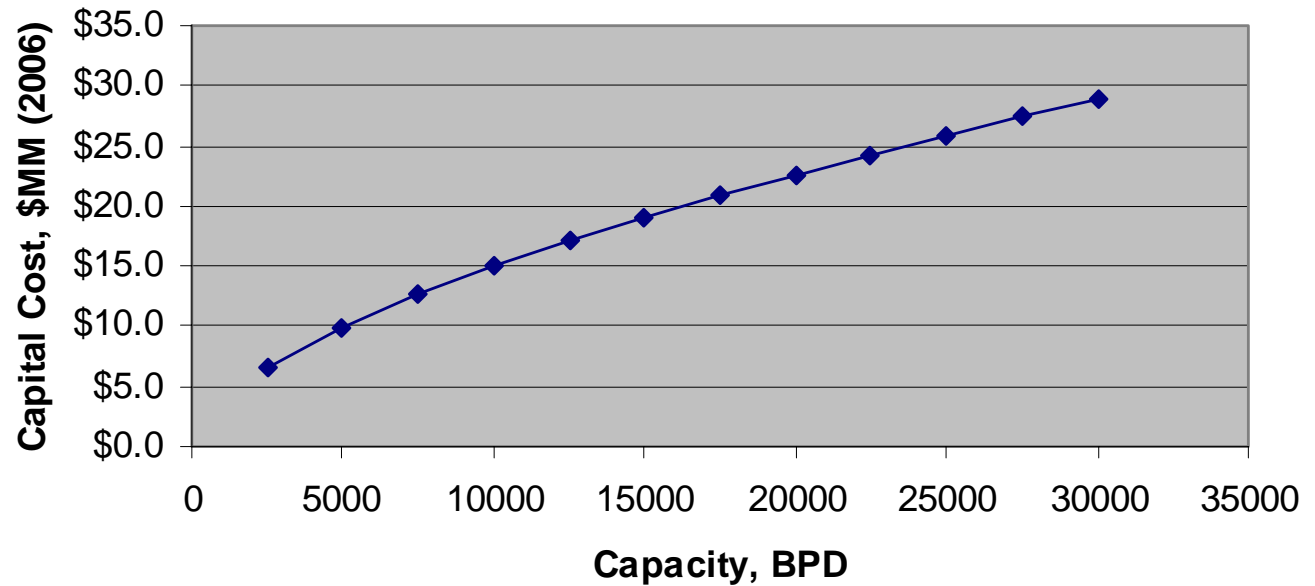

Size of Hydroprocessing Units

Dynamotive's Planned 200 tpd Plant

Dynamotive's 200 tonne/day facility (planned production)		
200	tonne/day	biomass processed
200000	kg/day	
65%	% conversion biomass to pyrolysis oil	
130000	kg/day	biooil
1.2	kg/liter	density of pyrolysis oil
108333	liter/day	
28622	gal/day	
681	bbl/day	Hydroprocessing unit

2000 bpd HC units

2500	bbl/day	
38.3	M gal/year	pyrolysis oil processed
174072	tonnes/yr	pyrolysis oil processed
65%		Conv. to biooil
267803	tonnes/yr	biomass
734	tonne/day plant	

30,000 bpd HC unit (typical refinery size)

30000	bbl/day	
459.9	M gal/year	pyrolysis oil processed
2088866	tonnes/yr	pyrolysis oil processed
65%		Conv. to biooil
3213640	tonnes/yr	biomass
8804	tonne/day plant	

Example: Potential from logging residues

41	Million dry tons logging residue available (Billion ton annual study)
10%	% water of biomass for pyrolysis unit
46	Million tons of logging residue feed
65%	% conversion to pyrolysis oil
29.6	million tons of pyrolysis oil
6519	M gallons of pyrolysis oil from logging residue
425271	bbl/day

- **~14 30,000 bpd hydroprocessing units**
 - **Estimated cost: \$405 MM**
- **~170 2500 bpd hydroprocessing units**
 - **Estimated cost: \$1105 MM**

Distributed Pyrolysis Plants; Centralized Refining

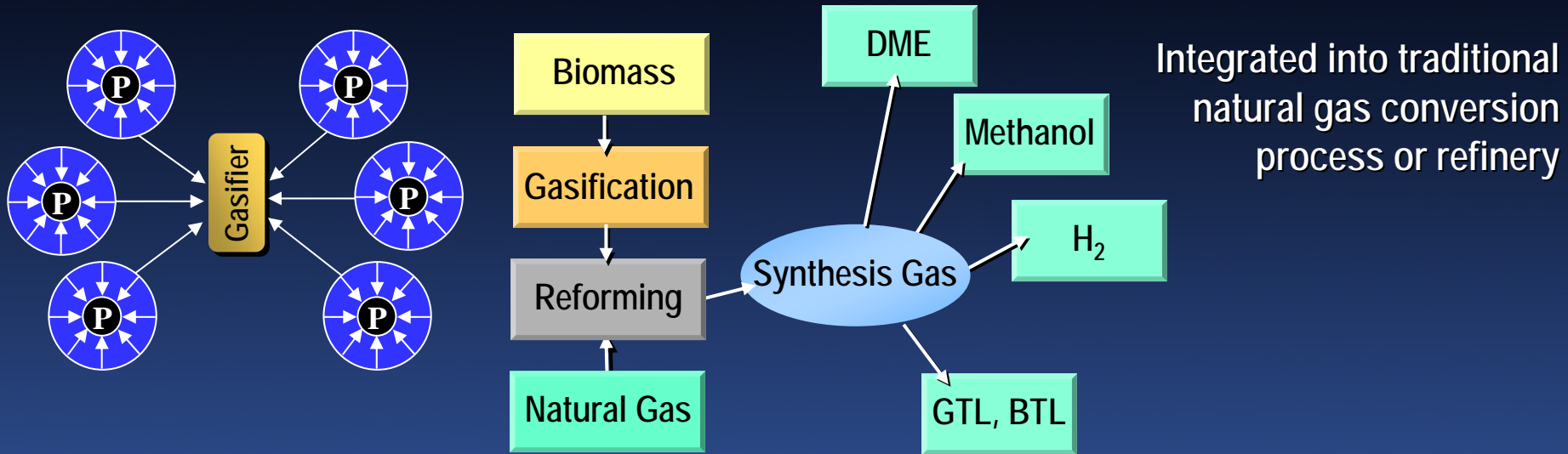

- **Key Decision: What are we planning to transport?**

Technical Barriers

- **Securing a consistent py Oil feedstock**
- **Logistics**
- **Balance of distributed vs. centralized**
- **Catalyst and process
invention/development/commercialization**

Summary

- **Vegetable oils, grease and pyrolysis oil could be feasible feedstocks for conventional petroleum refineries**
 - Other feedstocks and processing options also look promising
 - Increased volumes of biobased feedstocks required
 - Consistent source of pyrolysis oil or other lignocellulosic biomass
- **Biorenewable processing options identified are not limited to refinery integration**
 - Stand alone units possible
 - Biorefineries; Biofeedstock source
 - Portable H₂

Acknowledgements

DOE, Project DE-FG36-05GO15085

Contributors

- **MTU**
 - David Shonnard
- **NREL**
 - Stefan Czernik
 - Richard Bain

Contributors

- **PNNL**
 - Doug Elliott
 - Don Stevens
- **UOP**
 - Tom Kalnes
 - Terry Marker
 - Dave Mackowiak
 - Mike McCall
 - John Petri

Project Manager: Rich Marinangeli