

AD621736

49(638)513

DIVISION OF ENGINEERING MECHANICS
STANFORD UNIVERSITY
STANFORD, CALIFORNIA

"Optimum and Quasi-Optimum Control of
Third and Fourth-Order Systems*"

by

Irmgard Flügge-Lotz and Harold A. Titus, Jr.

Submitted to IFAC

June 1962

CLEARINGHOUSE FOR FEDERAL SCIENTIFIC AND TECHNICAL INFORMATION			
Hardcopy	Microfiche		
\$2.00	\$0.50	32	08
PROCESSING COPY			

ARCHIVE COPY

DDC
 RECEIVED
 SEP 8 1965
 RESOLV 60
 DISA E

Irmgard Flügge-Lotz
and
Harold A. Titus, Jr.
Stanford University
Stanford, California
U.S.A.

Optimum and Quasi-Optimum Control of
Third and Fourth-Order Systems*

1.3 Theory, Optimal Systems

With the help of Pontryagin's maximum principle a designer can determine for a given plant a control system which is optimum for a given performance criterion. Many papers have been devoted to the investigation of zeroing initial disturbances in minimum time, because this seemed a desirable performance. However the control of spacecraft has drawn attention to the fact that minimum fuel consumption often may be more important than minimum settling time. In some cases, the problem of control with minimum fuel consumption leads to a bang-bang control just as in the minimum time control problem. Whether this occurs or not, depends on the type of mechanical or electrical power supply.^(ref. 1) In the following we will restrict ourselves to linear systems and to performance criteria which lead to bang-bang control.

Let the system be given by

$$\dot{\vec{x}} = A\vec{x} + B\vec{u} \quad \text{or} \quad \dot{x}^i = f^i(x^j, u) \quad (1)$$

A is a constant matrix and B is a constant vector. The control function u is bounded

$$|u| \leq 1 \quad (2)$$

It is desired to go from

$$\vec{x}(0) = \vec{x}_0 \quad \text{to} \quad \vec{x}(T) = \vec{x}_f \quad (3)$$

with the performance criterion

* This research is supported by the Air Force Office of Scientific Research, Air Research and Development Command under Contract AF49(638)-513.

$$\int_0^T g(x^i) dt \rightarrow \text{minimum} \quad (4)$$

Pontryagin's maximum principle states that the Hamiltonian

$$H = \sum p_i f^i - g(x^i) , \quad (5)$$

must assume at any time an extreme value in order to satisfy the performance criterion. This extremum will be reached, if

$$u = \text{sgn} \sum (p_i b_i) \quad (6)$$

The functions p_i are the solutions of a system which is called "adjoint" to the system considered,

$$\dot{p}_i = - \frac{\partial H}{\partial x^i} = - \sum \frac{\partial f^j}{\partial x^i} p_j . \quad (7)$$

The initial conditions of the functions p_i must be chosen such that starting at \vec{x}_0 the point \vec{x}_f is reached in time T . In the minimum time case, T is not given but is made a minimum, in this case, $g(x^i) = 1$. Without specialization \vec{x}_f can be set $\vec{x}'_f = 0$.

The above procedure means that to each point \vec{x}_0 belongs a set of switching points. If it is possible to find the geometric locus of all possible switching points in a phase space, then the task of finding the initial conditions for the adjoint functions is superfluous. For second order systems without zeros this task has been achieved for the minimum time case⁽⁷⁾, several minimum error criteria⁽³⁾ and minimum fuel consumption⁽¹⁾. In this second order case the locus of the switching points is a curve which separates the phase plane in two halves. The initial u value is apparent and the only trouble is the realization

of this switching curve as a function of the phase variables. The remarkable fact is that the switching curves for minimum time and several error criteria are neighbor curves. This fact first observed that the $(1/s^2)$ plant has been used by the author to find the near square error switching curves for the $(1/s^2 + 1)$ and $(1/s^2 + 2\zeta s + 1)$ plants by merely perturbing the minimum time switching curve, and watching the change of the magnitude of the integral determining the performance.

The fact that there exists a mathematical procedure to principally compute the optimum control law, does not mean that the result of such a computation necessarily enables the designer to realize this control. He will first have to weigh the advantage of an optimum control with a possibly difficult control law against a control with a somewhat simpler switching function. Only if the advantage is great will he decide to realize the optimum law.

We shall exclude from our consideration the simplest switching function, that is the linear function. This switching function will in general lead to chatter at least near the origin of the phase space if not also in other regions of the phase space. Optimum control can also lead to chatter. The case of the performance criterion

$$\int_0^T e^2 dt, \quad (8)$$

treated by A. T. Fuller⁽²⁾, shows this clearly, but in general chatter will be avoided, if optimum control is used. In systems with linear switching functions the chatter is due to imperfections, while in systems with optimum control this chatter occurs in an ideal or perfect system

and the imperfections of the control components would only modify this chatter.

Quasi-Optimal Switching Curves for Second-Order Systems

Linear switching as an approximation of an optimum control function shall be excluded in this paper.* The question of a better approximation, then, has to be discussed. For performance criteria which do not lead to chatter near the origin, the control law requires a switching surface near the origin which is formed by portions of all possible zero trajectories. Such a requirement can be and has been easily satisfied, e.g., in second order systems with pure, imaginary poles. The first example (Fig. 1) shows an often expressed idea of approximation for a system with the transfer function $(1/s^2 + 1)$, (See ref. 5). This idea can easily be extended to systems with $(1/s^2 + 2\zeta s + 1)$, see Fig. 2. In this case the linear part of the switching curve is made parallel to the "envelope" of the cusps. In both cases one can argue, whether really much is lost by taking only part of the first cusp and the dashed lines.

Second order systems with real poles require switching curves which can be described by a simple power law. Also the number of switches can be easily determined; it is one or none (for all those instants which incidentally lie on a zero trajectory). The design problem is simple compared to systems with complex or imaginary poles.

*For details see ref (3) and (4).

Control of Third-Order Systems

For third order systems the control with minimum settling time is certainly the simplest one. Let us consider first the general equation of a system

$$e''' + a_2 e'' + a_1 e' + a_0 e = b_2 u'' + b_1 u' + b_0 u \quad (9)$$

This system has poles and zeroes. If $b_1 = b_2 \equiv 0$. We have the third order system without zeros. Switching occurs on a surface in the three-dimensional phase space.

In case of three real poles, the division of the phase space in two halves does not pose any analytical difficulties. The realization of this switching surface may pose an analog computer problem, but certainly not a digital computer problem. We, therefore, immediately concern ourselves with the problem of one real and two complex poles. This case has been treated recently in two papers (6,7). In these papers iteration procedures were described for finding the exact switching curves.

There is no doubt that the exact switching surface poses a difficult design problem, particularly if initial disturbances of any larger size would be admitted. Fortunately the experiences with the second order system can be generalized.

We will consider the system described by the equation

$$(s + \gamma)(s^2 + 2\zeta\omega s + \omega^2)e = u = \text{sgn } F, \text{ with } |\zeta| < 1 \quad (10)$$

This third order differential equation can be replaced by a system of three coupled first order equations in e , e' , and e'' . This system then can be conveniently transformed to a partially uncoupled system by the transformation

$$\vec{x} = \begin{bmatrix} \gamma & 1 + \frac{\zeta\gamma}{\omega} & \frac{\zeta}{\omega} \\ 0 & \frac{\gamma\nu}{\omega} & \frac{\nu}{\omega} \\ \omega^2 & 2\zeta\omega & 1 \end{bmatrix} \vec{e} \quad (11)$$

In the new coordinates the system (10) is described by

$$\dot{\vec{x}} = \begin{bmatrix} -\zeta\omega & \nu\omega & 0 \\ -\nu\omega & -\zeta\omega & 0 \\ 0 & 0 & -\gamma \end{bmatrix} \vec{x} + \begin{bmatrix} \zeta/\omega \\ \nu/\omega \\ 1 \end{bmatrix} u \quad (12)$$

The exact optimum control function u is given by

$$u = \text{sgn} \left(\frac{\zeta}{\omega} p_1 + \frac{\nu}{\omega} p_2 + p_3 \right) \quad (13)$$

The functions p_i are the solutions of the adjoint system

$$\left. \begin{aligned} \dot{p}_1 &= \zeta\omega p_1 + \nu\omega p_2 \\ \dot{p}_2 &= \zeta\omega p_2 - \nu\omega p_1 \\ \dot{p}_3 &= p_3\gamma \end{aligned} \right\} \quad (14)$$

Integration of this system yields

$$\left. \begin{aligned} p_1 &= m_1 e^{\omega\zeta t} \cos(\omega t + \beta_1) \\ p_2 &= m_1 e^{\omega\zeta t} \sin(\omega t + \beta_1) \\ p_3 &= m e^{-\gamma t} \end{aligned} \right\} \quad (15)$$

with m_1 , m_2 and β_1 as constants of integration. Upon introducing these expressions into eq. (13) one obtains

$$\begin{aligned}
u &= \operatorname{sgn} \left[\frac{\zeta}{\omega} m_1 e^{\zeta \omega t} \cos(\omega t + \beta_1) \right. \\
&\quad \left. - \frac{\nu}{\omega} m_1 e^{\zeta \omega t} \sin(\omega t + \beta_1) + m_2 e^{\gamma t} \right] \quad \text{or} \\
u &= \operatorname{sgn} [m_1^* e^{\zeta \omega t} \cos(\omega t + \beta_1^*) + m_2 e^{\gamma t}] \quad (16)
\end{aligned}$$

The constants m_1^* , β_1^* and m_2 depend on the given initial disturbance as mentioned earlier. Their determination causes trouble which can be avoided if a switching surface can be found.

The "Outer" Switching Surface

In the following we shall first develop a quasi-optimum switching surface for the plant with the transfer function $1/s(s^2+1)$. We shall later show how the results for this plant can be generalized.

For $\gamma = \zeta = 0$ eq. (16) simplifies to

$$u = \operatorname{sgn} [m_1^* \cos(\omega t + \beta_1^*) + m_2] \quad (17)$$

If T is assumed to be the time for zeroing an initial disturbance, one can consider the study of the motion in reverse time τ .

$$\left. \begin{aligned}
\tau &= T - t, \\
u &= \operatorname{sgn} [m_1^* \cos(\omega t - \omega T - \beta_1^*) + m_2] \\
&= \operatorname{sgn} [m_1^* \cos(\omega \tau - \beta_1^{**}) + m_2]
\end{aligned} \right\} \quad (18)$$

One can construct a trajectory in reverse time by assuming β_1^{**} and (m_1^*/m_2) . Then the switching times are determined and after T seconds one will reach a point in the phase space, which corresponds to the initial disturbance. Since $\cos(\omega \tau - \beta_1^{**}) = \cos[\omega \tau - (\omega T + \beta_1^*)]$

is a periodic function, two trajectories for which $(\omega T_1 + \beta_{11}^*) - (\omega T_2 + \beta_{12}^*) = 2\pi n$ will partially coincide and have coinciding switching points in the identical portions. In ref. (6,7) it has been shown how to find the location of these switching points in the phase space (see fig. 3). It is obvious, that it would be difficult to build up the surface on which all possible switching points for all possible β_1 , m_1^*/m_2 , T are lying. But there is no need to be very exact as soon as one is one cusp away from the origin of the phase space. Therefore it was tried to approximate the locus of the switching points in a rather primitive way. The straight lines on which the points $P_2, P_4 \dots$ and $P'_1, P'_3 \dots$ are lying (see Fig. 4) are considered as representatives of the more complicated curve which is the carrier of switching points. If one considers the ruled surface built of these lines, one obtains for $\|x\| > 1$.

$$\begin{aligned}
 u &= - \operatorname{sgn} F \\
 &= - \operatorname{sgn} \left\{ 2|x^1|x^3 + (\operatorname{sgn} x^2)[(x^1)^2 + (x^2)^2] \arccos \left[\frac{(x^1)^2 - (x^2)^2}{(x^1)^2 + (x^2)^2} \right] \right\} \\
 &\text{for } (x^1 x^3) > 0 \qquad (19)
 \end{aligned}$$

and

$$\begin{aligned}
 u &= - \operatorname{sgn} \left\{ |x^1| [x^3 - (\operatorname{sgn} x^3) \cdot \pi] + (\operatorname{sgn} x^2)[(x^1)^2 + \right. \\
 &\quad \left. + (x^2)^2] \arccos \left[\frac{(x^1)^2 - (x^2)^2}{(x^1)^2 + (x^2)^2} \right] \right\} \text{for } (x^1 x^3) < 0
 \end{aligned}$$

Figure 5 shows a sketch of the surface, it includes the x^1 and x^3 axes, however on x^3 there do not lie real switching points, because $x^1 = x^2 = 0$ yields $F = 0$, but there is no change of sign. F behaves as indicated in Fig. 6.

A word has still to be said about the switching surface close to the origin. A visualization is easy. In reverse time the phase point leaves the origin on a zero-trajectory. Each point of this zero trajectory can be considered as a switching point. That means, from each point of the two zero-trajectories a new trajectory is emerging. These new trajectories form a surface. Each point of this surface can be considered again as a potential switching point, which means as a starting point of a new trajectory portion in reverse time. As indicated earlier only the surface formed by the trajectories emanating from the two zero-trajectories will be considered. The portion of this surface, for which the distance of the surface points from the origin is smaller than a fixed value, will be used. For larger distances the surface given by eq. (19) will serve.

The limit for the use of the surface near the origin was first assumed to be given by $[(x^1)^2 + (x^2)^2 + (x^3)^2] < (2)^2$. However it soon turned out that the transition from the "outer" surface to the "inner" surface can cause trouble. Since the outer surface is not the exact switching surface, the phase point may pass, let us say, a switching from (+1) to (-1), just before transition. However this switching may bring the phase point to the (+1) side of the inner surface. Therefore a contradiction exists and a chatter occurs which causes the phase point to be trapped in the transition region. This trouble can usually be avoided by taking $[(x^1)^2 + (x^2)^2 + (x^3)^2] < 1$. Because of the flatness of the outer surface near the origin, it is even better to use $[(x^1)^2 + (x^2)^2] < 1$ as the transition condition.

The "Inner" Switching Surface

The analytic determination of the switching surface close to the origin (the "inner" surface) is somewhat troublesome, even if one considers its realization by digital or analog computer equipment. Therefore some simplifications are desired. Two possibilities are available.

First possibility: One replaces the plant transfer function

$$\frac{1}{(s + \gamma)(s^2 + 2\zeta s + 1)} \quad \text{by} \quad \frac{1}{s^3} \quad (20)$$

For the latter transfer function, the switching surface is given by

$$e_1 + \frac{1}{3} e_3^3 \pm e_3 e_2 \pm \left(\frac{1}{2} e_3^2 \pm e_2 \right)^{3/2} = 0 \quad (21)$$

with negative sign for

$$\left. \begin{array}{l} e_2 < \frac{e_3^2}{2} \\ \text{and positive sign for} \\ e_2 > \frac{e_3^2}{2} \end{array} \right\} \quad (21a)$$

In these formulas $e_1 = e$, $e_2 = \dot{e}$, and $e_3 = \ddot{e}$. The control function is given by

$$u = - \operatorname{sgn} \left[e_1 + \frac{1}{3} e_3^3 \pm e_3 e_2 \pm \left(\frac{1}{2} e_3^2 \pm e_2 \right)^{3/2} \right] \quad (22)$$

with the same rule for the signs. The deviations caused by using the model $(1/s^3)$ instead of the correct plant can be visualized in the following figures.

In Fig. 7 the zero-trajectories are given in the e_1e_2 plane for a full third order system and three possible approximations to it.

The output of the relay is either (+1) or (-1). This determines the scale of the figures. Naturally one can have more and less agreement depending on the values of γ and ζ which here are unit and zero respectively.

In Fig. 8 projections of these trajectories into the e_2e_3 plane are shown. One can see clearly that only in a rather limited region are the zero-trajectories of the approximations close to the zero-trajectory of the original system.

In Fig. 9 projections of zero-trajectories for several other third order systems are shown.

If the initial values are not too large and only one switching occurs between start and the reaching of the origin of the phase space, these curves will give an idea of how good the approximation of the optimum control will be, if the complete third order system is replaced by simpler ones.

The second possibility for control near the origin of the phase space is a modification of the surface given by Eq. (19). One applies factor N to the control function which diminishes the control effort; that means

$$u = - \operatorname{sgn} F \quad (23a)$$

will be replaced by

$$u = -N \operatorname{sgn} F \quad (23b)$$

with $N = f(\|x\|)$ as indicated in Fig. 10. A step width Δ has to be

chosen and $N_i = (i + 1)\Delta$ for $\|x\| = i\Delta + \epsilon$ with $0 < \epsilon < \Delta$. In this procedure, one may say, the neighborhood of the origin is stretched. Naturally one cannot expect to reach the absolute "zero", the final state will be a chatter around the origin. Also, one has to count on losing some time by diminishing the control effort.

Results

The Equations (19a, b) and (22) for the switching surface may look rather complicated, but they can easily be implemented with the help of a modern computer. It is expected that new miniature digital computing elements can be used in flying-objects.

A number of examples have been investigated. These examples were first constructed in reverse time by employing the exact switching points, then it was assumed that we had the initial disturbance given and we used the "approximate" switching surfaces given by equations (19) and (22) to zero this disturbance. One example is given here.

$$e_1^0 = 30.67 ; e_2^0 = 2.93 ; e_3^0 = -7.07$$

True optimum and quasi optimum switching time were practically the same.

In Fig. 11a and 11b projections of the phase trajectories are shown.

Two other examples shall be given here .

$$\left. \begin{array}{l} e_1^0 = 13 \\ e_2^0 = 13 \\ e_3^0 = 2 \end{array} \right\} \text{ i.e. } \left\{ \begin{array}{l} x_0^1 = 13 \\ x_0^2 = 2 \\ x_0^3 = 15 \end{array} \right.$$

The optimum time for this example is $T_{opt} = 31.3$, and the quasi-optimum time is $T_{q.o.} = 32.4$, at which time $|x_f^1| \leq 0.1$.

For the next example, with

$$\left. \begin{array}{l} e_1^0 = 6.63 \\ e_2^0 = e_3^0 = 0 \end{array} \right\} \text{i.e.} \left\{ \begin{array}{l} x_o^1 = 0 \\ x_o^2 = 0 \\ x_o^3 = 6.63 \end{array} \right.$$

we obtained $T_{opt} = 8.3$ and $T_{q.o.} = 8.9$ for $|x_f^1| \leq 0.1$.

Generalization

As indicated earlier, (p. 7) we have still the task of developing a quasi-optimum outer switching surface for $\gamma \neq 0$ and $\zeta \neq 0$. Let us first consider the case $\gamma = 0$ and $\zeta \neq 0$. When we compare the analytical expressions for the canonical variables as functions of time, we recognize that for $\zeta \neq 0$ in the n^{th} interval

$$x_n^2 = C_n e^{-\zeta x_n^3} \cos(vx_n^3 + \delta_n) + u_n \quad (24a)$$

with $v = \sqrt{1 - \zeta^2}$ compared to

$$x_n^2 = C_n^* \cos(vx_n^3 + \delta_n^*) + u_n \quad (24b)$$

for $\zeta = 0$. x_n^1 is similarly changed. Therefore it is indicated that eqs. (19) should change correspondingly.

$$u = -\text{sgn} \left\{ 2 |x^1| x^3 e^{+\zeta |x^3|} + (\text{sgn } x^2) [(x^1)^2 + (x^2)^2] \text{ arc cos} \left[\frac{(x^1)^2 - (x^2)^2}{(x^1)^2 + (x^2)^2} \right] \right\}$$

for $(x^1 x^3) > 0$ (25a)

and

$$u = -\text{sgn} \left\{ 2x^1 [x^3 - (\text{sgn } x^3) \pi] e^{+\xi x^3} + (\text{sgn } x^2) [(x^1)^2 + (x^2)^2] \text{arc cos} \left[\frac{(x^1)^2 - (x^2)^2}{(x^1)^2 + (x^2)^2} \right] \right\}$$

for $(x^1 x^3) < 0$ (25b)

This is a somewhat primitive generalization, because a look at the figures in (6) shows that one could apply a much more strict analysis. For instance one could build-up the switching surface out of the straight lines which are the arithmetic means between the lines $P_2, P_4 \dots$ and $P_1, P_3 \dots$ (Fig. 4). In the limiting case ($\xi \rightarrow 0$) this new line would converge into the old one.

The situation becomes more involved, when $\gamma \neq 0$. In this case

$$x_n^3 = \frac{u_n}{\gamma} + \left(x_{no}^3 - \frac{u_n}{\gamma} \right) e^{-\gamma t_n} \quad (26a)$$

compared to

$$x_n^3 = u_n t_n + C_n^* \quad \text{for } \gamma = 0 \quad (26b)$$

One sees immediately that the line connecting points $0, P_2, P_4 \dots P_{2n}$ is no longer a straight line, in spite of the fact that the projection into the $x^1 x^2$ plane may still be assumed to be straight.[†] It is possible to establish a difference equation for

$$\frac{x^3(P_{2n}) - x^3(P_{2n-2})}{x^2(P_{2n}) - x^2(P_{2n-2})} \quad (27)$$

which leads to a differential equation for the relation $x^3(x^2)$. The quasi-optimum switching surfaces $F(x^1, x^2, x^3) = 0$ then can be found. It can be realized easily with digital equipment. In the near future we intend to increase the number of examples and to compare more quasi-

[†]This assumption is in the frame of the approximation described in ref. 6 and 7.

optimum results obtained with the truly optimal results. Also, the results shall be extended to include the general case in the finite γ and finite ζ .

A Simple Fourth-Order Problem

The importance of two-axes satellite control directed our attention to a fourth order problem, described by

$$(s^2 + 2\zeta_1\omega_1s + \omega_1^2)(s^2 + 2\zeta_2\omega_2s + \omega_2^2)e(s) = u(s) \quad (28)$$

In orthogonal variables the system is given by four differential equations of first order.

$$\dot{\vec{x}} = \begin{bmatrix} -\zeta_1\omega_1 & \nu_1\omega_1 & 0 & 0 \\ -\nu_1\omega_1 & -\zeta_1\omega_1 & 0 & 0 \\ 0 & 0 & -\zeta_2\omega_2 & \nu_2\omega_2 \\ 0 & 0 & -\nu_2\omega_2 & -\zeta_2\omega_2 \end{bmatrix} \vec{x} + \begin{bmatrix} \zeta_1/\omega_1 \\ \nu_1/\omega_1 \\ \zeta_2/\omega_2 \\ \nu_2/\omega_2 \end{bmatrix} u \quad (29)$$

The control torque depends only on one control function; this clearly is a simplification for a first attack of the problem.[†] The homogeneous system is decoupled in two systems of second order. However the optimal control function u depends on both frequencies

$$u = \text{sgn}[C_1 \cos(\omega_1 \tau + \delta_1^*) + C_2 \cos(\omega_2 \tau + \delta_2^*)] \quad (30)$$

Where $\tau = T - t$ denotes again reverse time. Therefore the two second order systems are coupled through the control function u .

[†]We begin studying the case of two steering functions also.

A representation of the phase trajectory can only be made by tracing projections into the x^1x^2 and the x^3x^4 planes. An example with $\omega_1/\omega_2 = 1/3$ serves to get acquainted with the problem. In this case

$$x_i^1 = \frac{u}{\omega_1} + R_{10} \cos(\omega_1 t_i + \delta_{1i})$$

$$x_i^3 = \frac{u}{\omega_2} + R_{20} \cos(\omega_2 t_i + \delta_{2i})$$

It is obvious that the control force visible in the x^1x^2 plane is nine times larger than in the x^3x^4 plane. Figure 12a and b shows an example, which was designed in reverse time. One recognizes that also in this case an approximation of the time optimal control law is rather easily possible. This example is particularly simple in that the ratio ω_2/ω_1 is an integer. Additional more general examples are being studied.

List of Illustrations

- Fig. 1 Quasi-optimum switching curve for a $(1/s^2 + 1)$ system.
- Fig. 2 Quasi-optimum switching curve for a $(1/s^2 + 2\zeta s + 1)$ system.
- Fig. 3 Projection of the optimum switching curve in the $x^1 x^2$ plane for a $[1/s(s^2+1)]$ system.
- Fig. 4 Projections of lines joining the tips of the cusps in the $x^1 x^2$ and $x^2 x^3$ planes respectively.
- Fig. 5 Sketch of the quasi-optimum switching surface for a $[1/s(s^2 + 1)]$ system.
- Fig. 6 Sketch of the behavior of F vs. time as the x^3 axis.
- Fig. 7 Projection of the zero-trajectories in the $e_1 e_2$ plane for a full third-order system and three approximations to it.
- Fig. 8 Projection of the zero trajectories in the $e_2 e_3$ plane for a full third-order system and three approximations to it.
- Fig. 9 Projection of the zero-trajectories for several third order systems.
- Fig. 10 Sketch of multi-level control behavior near the origin of the phase space.
- Fig. 11a Projection of the optimum trajectory in the $x^1 x^2$ plane for a system with $\gamma = 0, \zeta = 0$. Initial disturbance $x^1 = e_2 = 2.93, x^2 = e_3 = -7.07, x^3 = 7.5\pi$, i.e., $e_1 = x^2 + x^3 = 30.67$.
- Fig. 11b Projection of the same trajectory in the $x^2 x^3$ plane.
- Fig. 12a Fourth order system, projection of the optimum trajectory into $x^1 x^2$ plane.
- Fig. 12b Fourth order system, projection of the optimum trajectory into the $x^3 x^4$ plane.

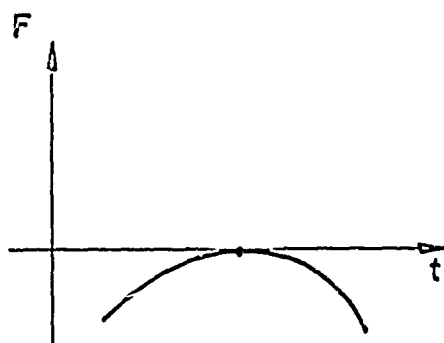
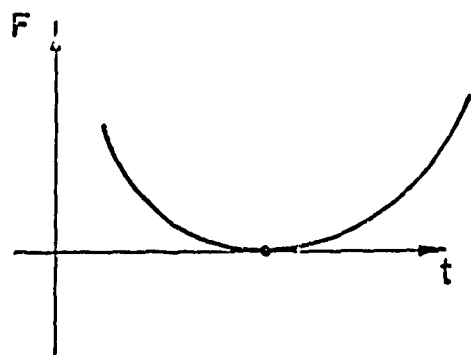
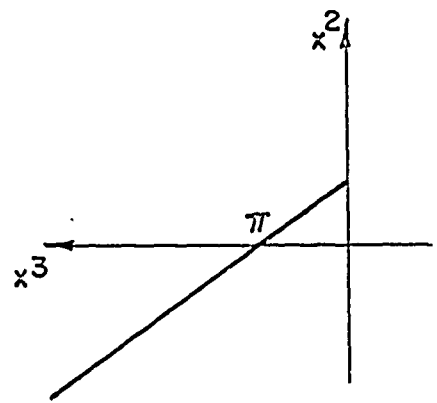
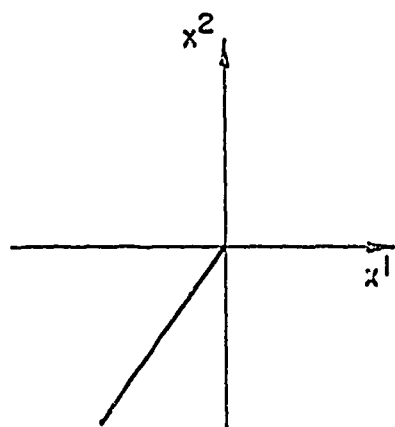
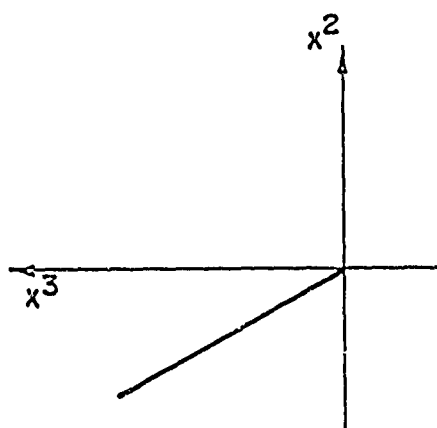
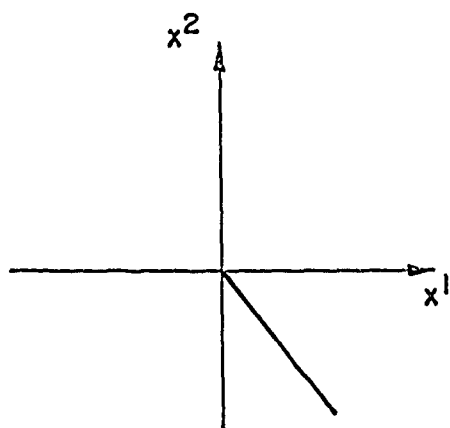
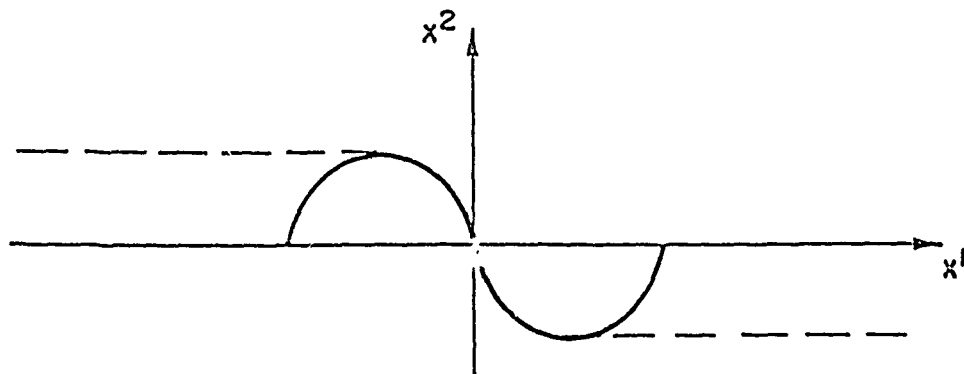

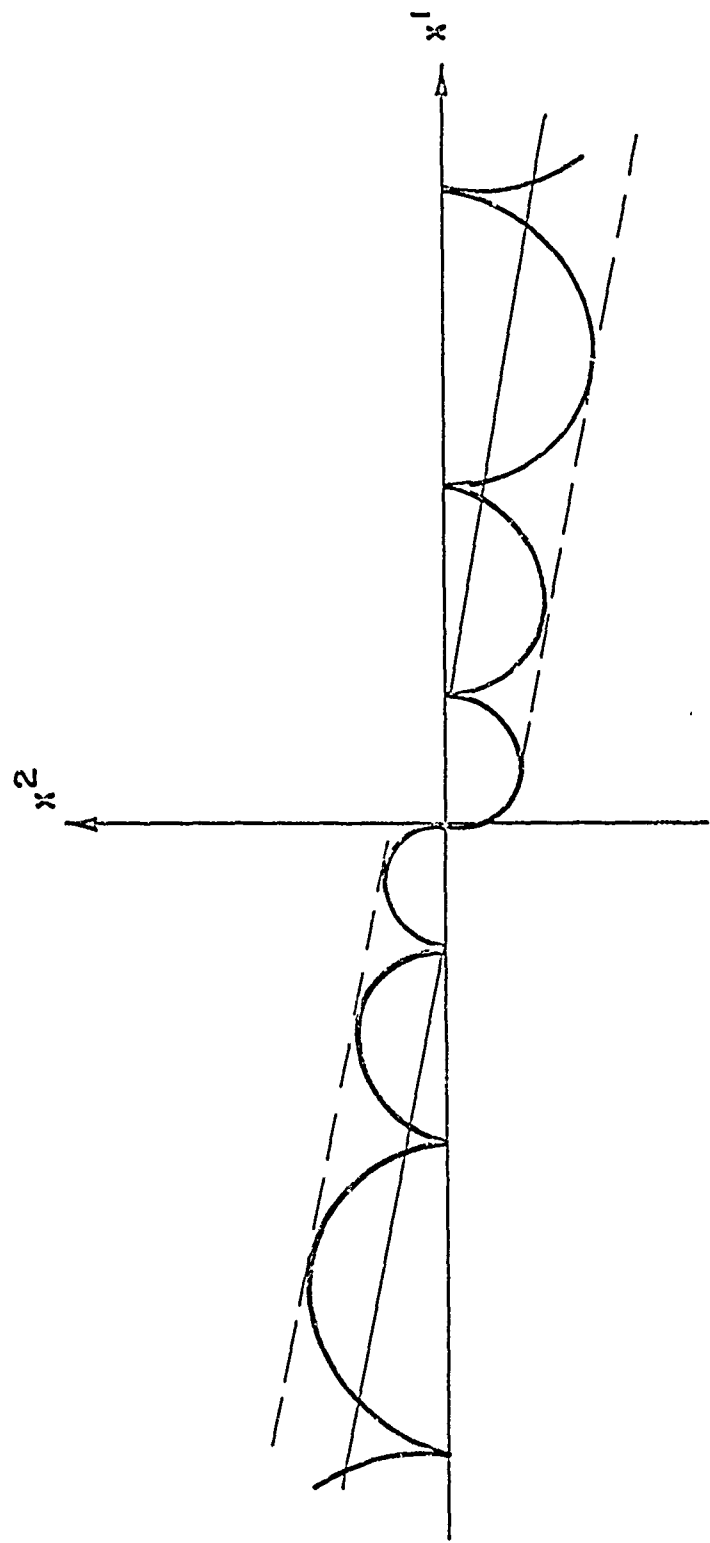

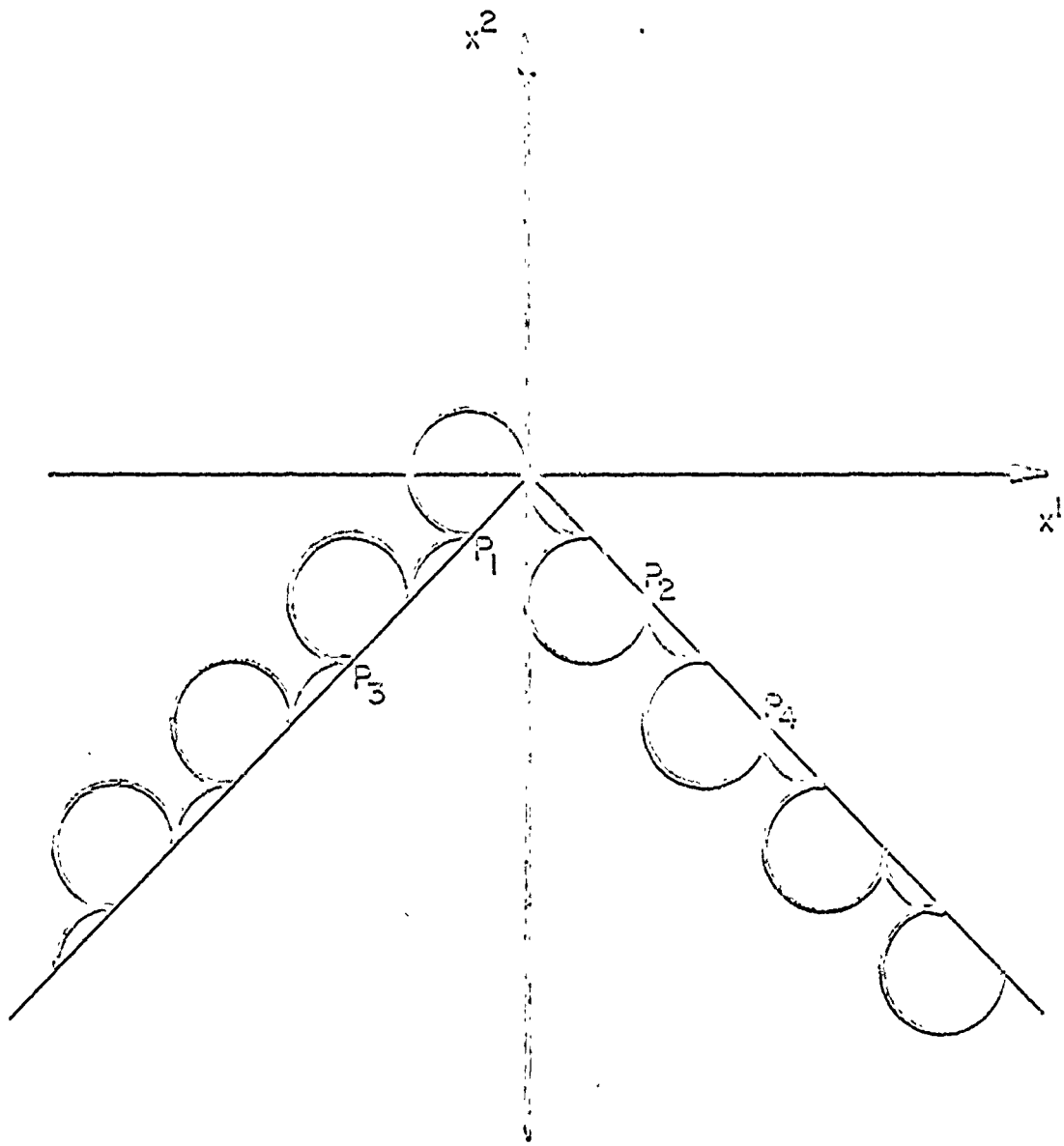

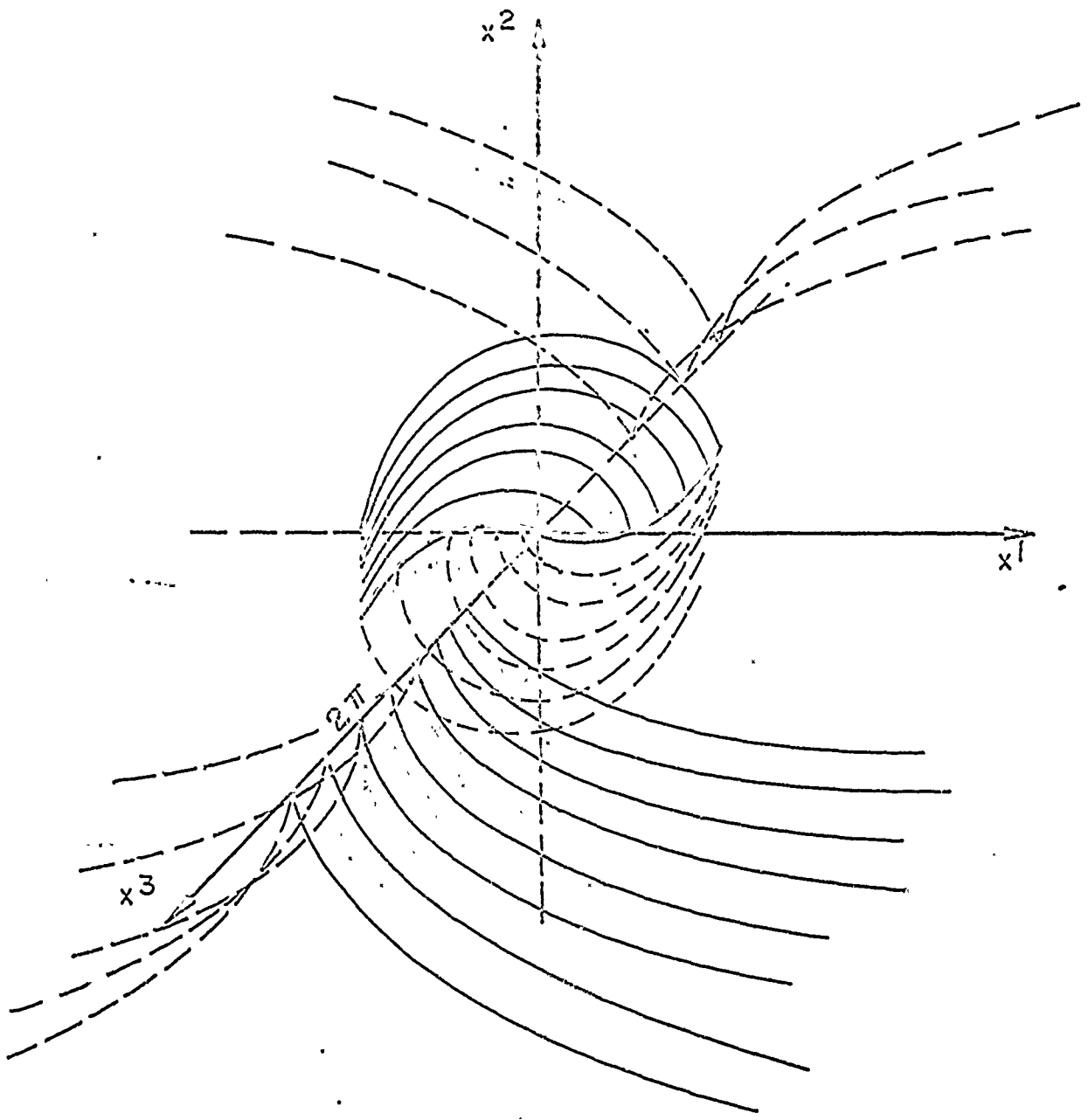

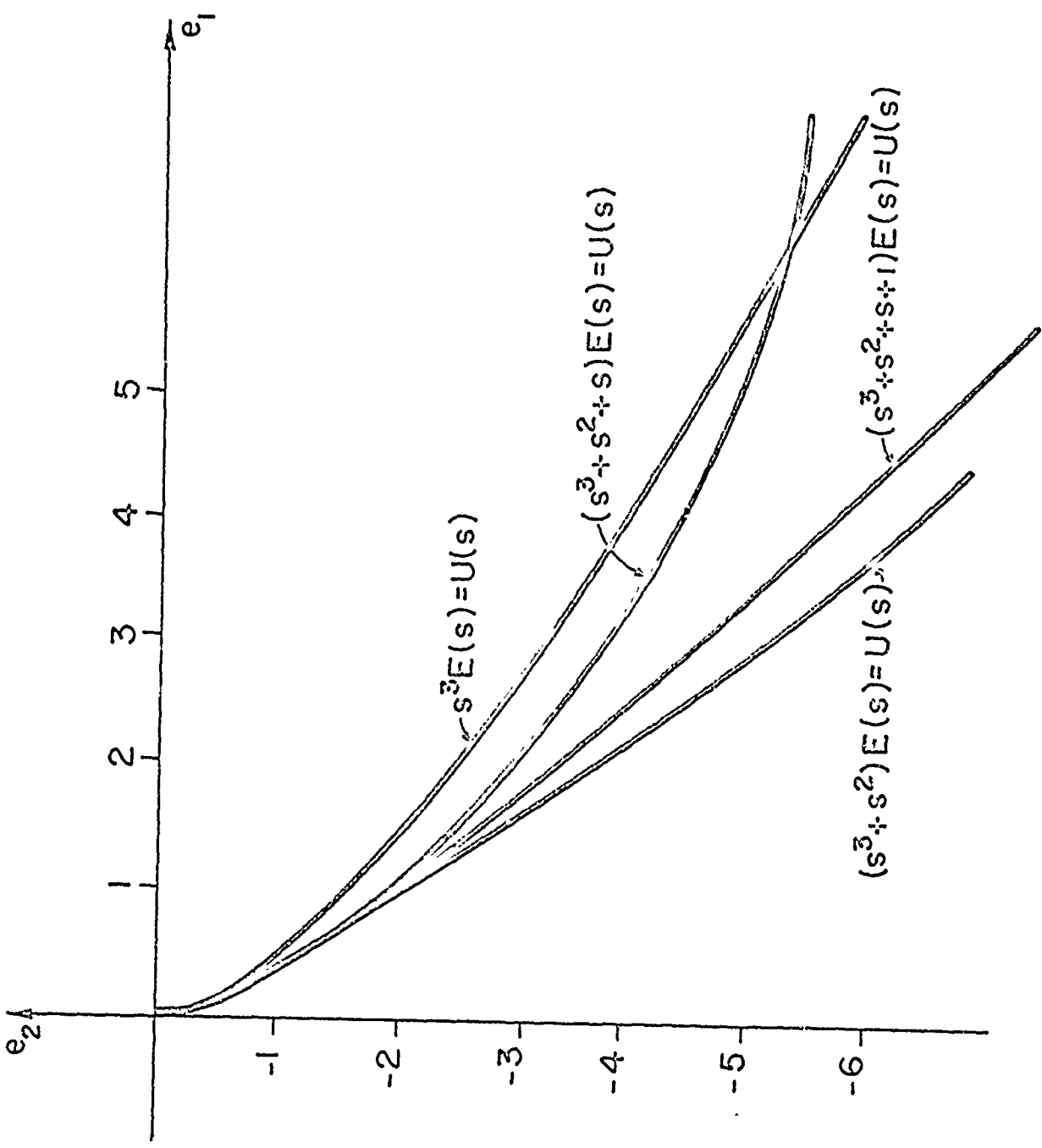

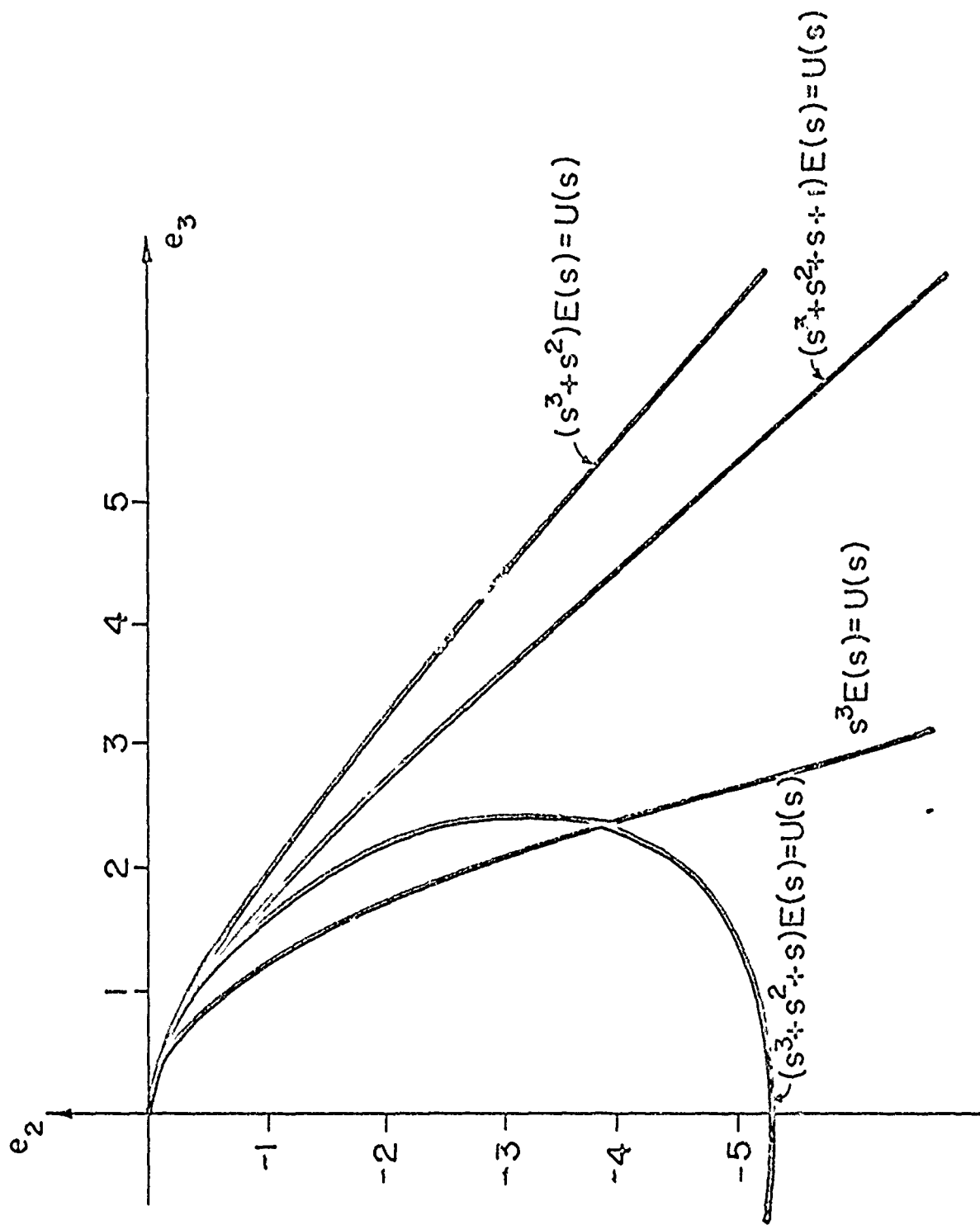

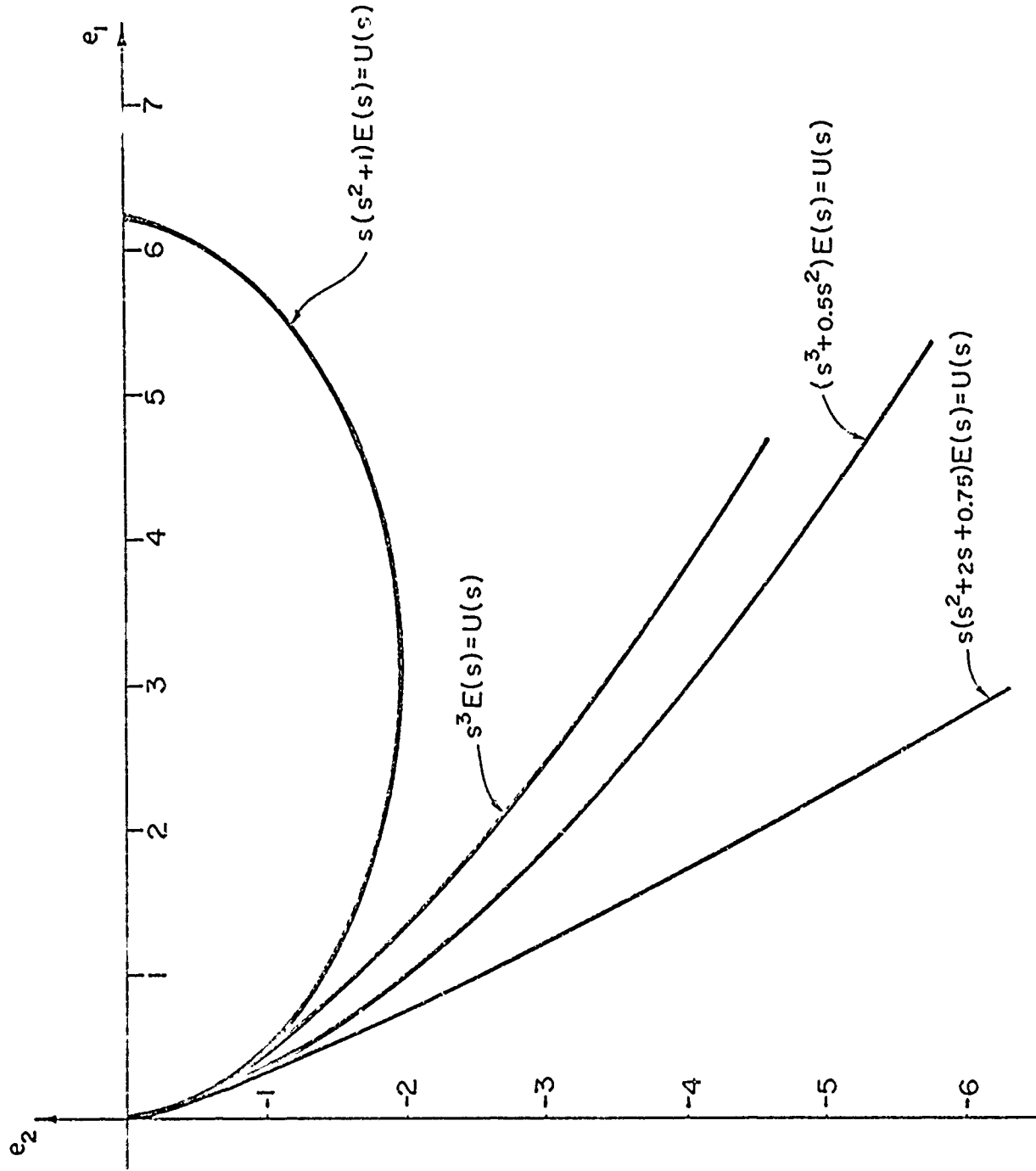

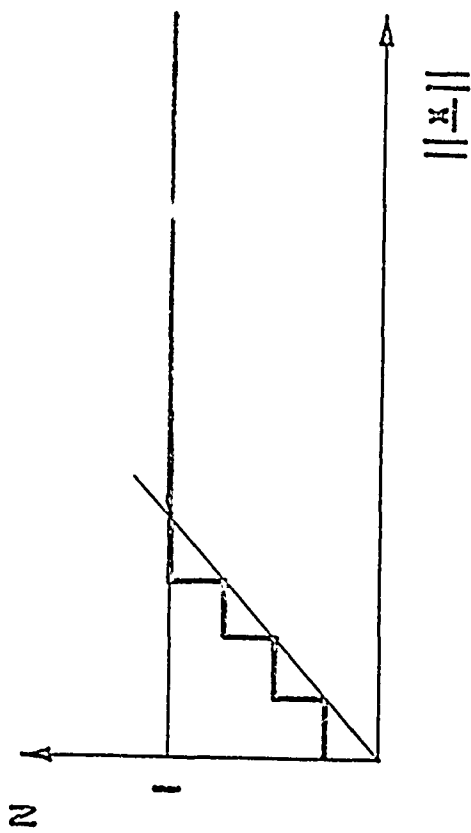

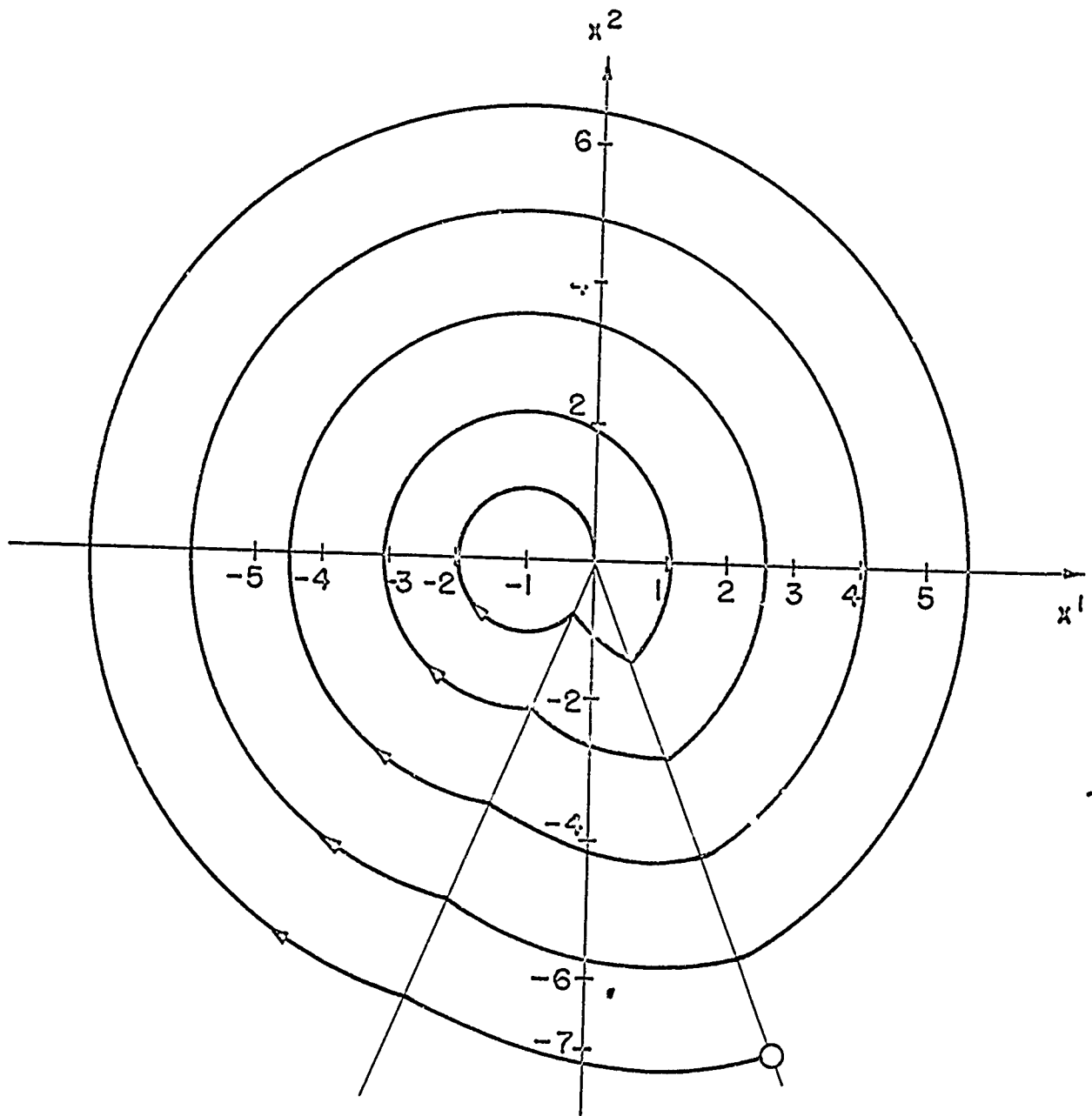

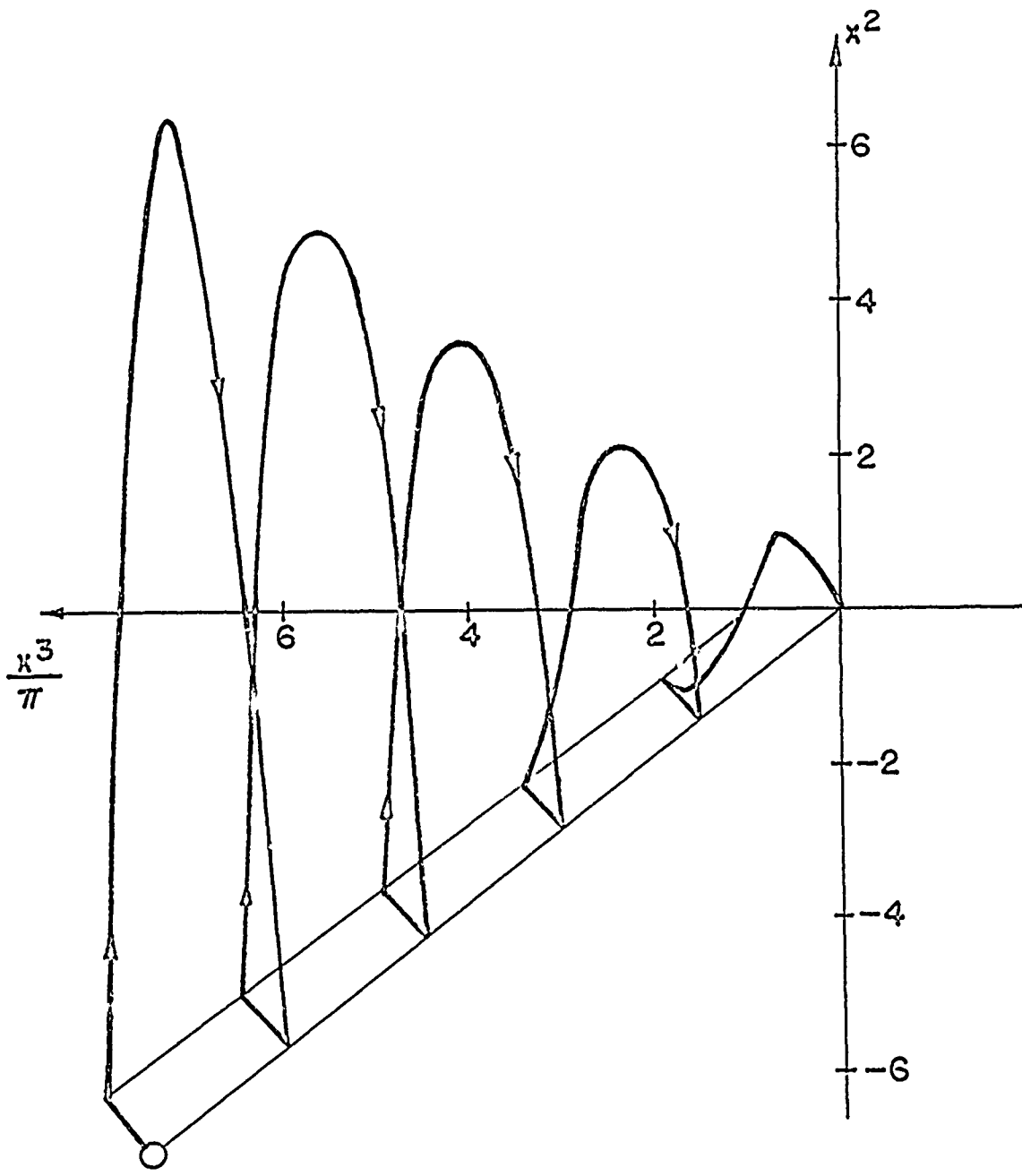

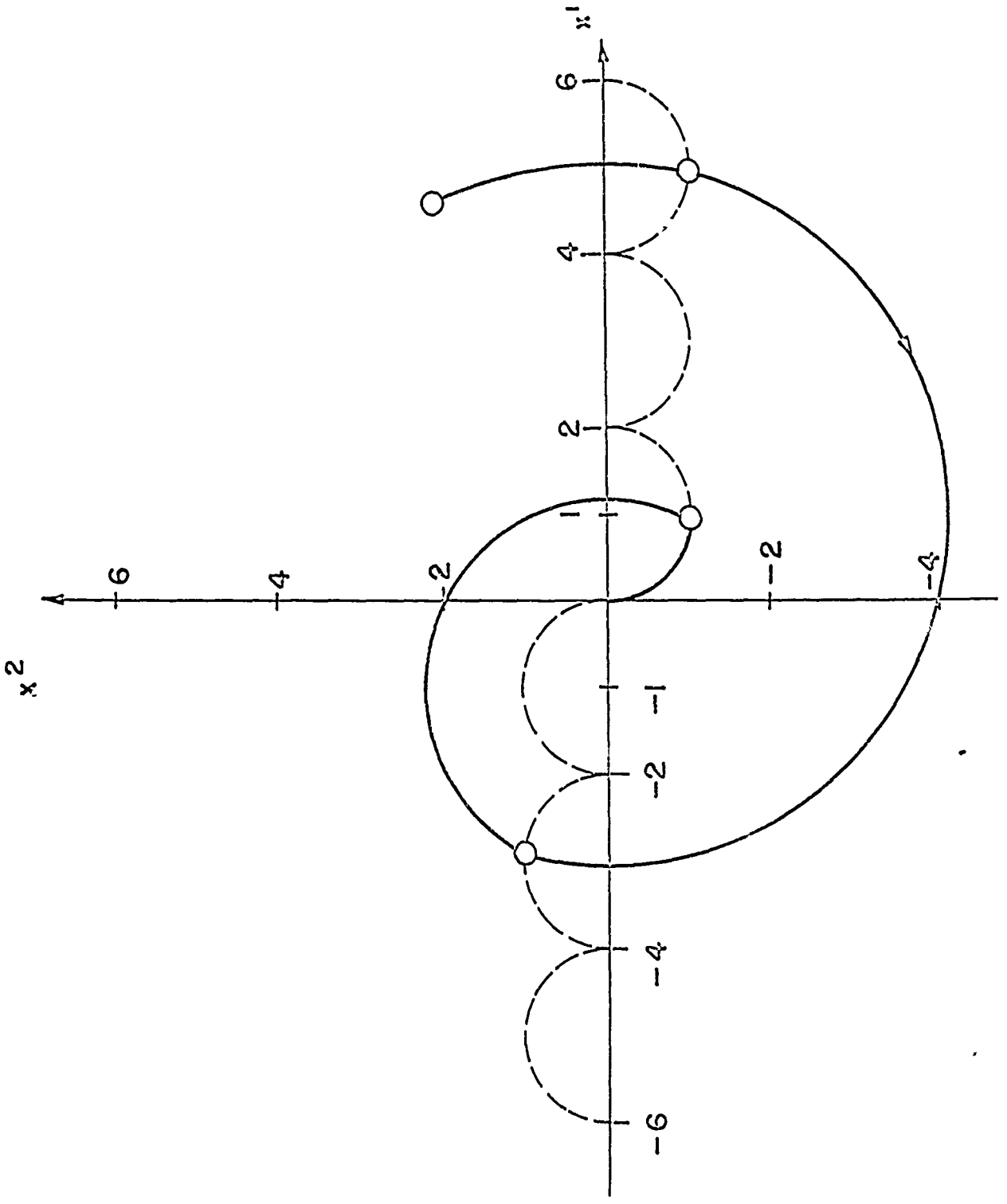

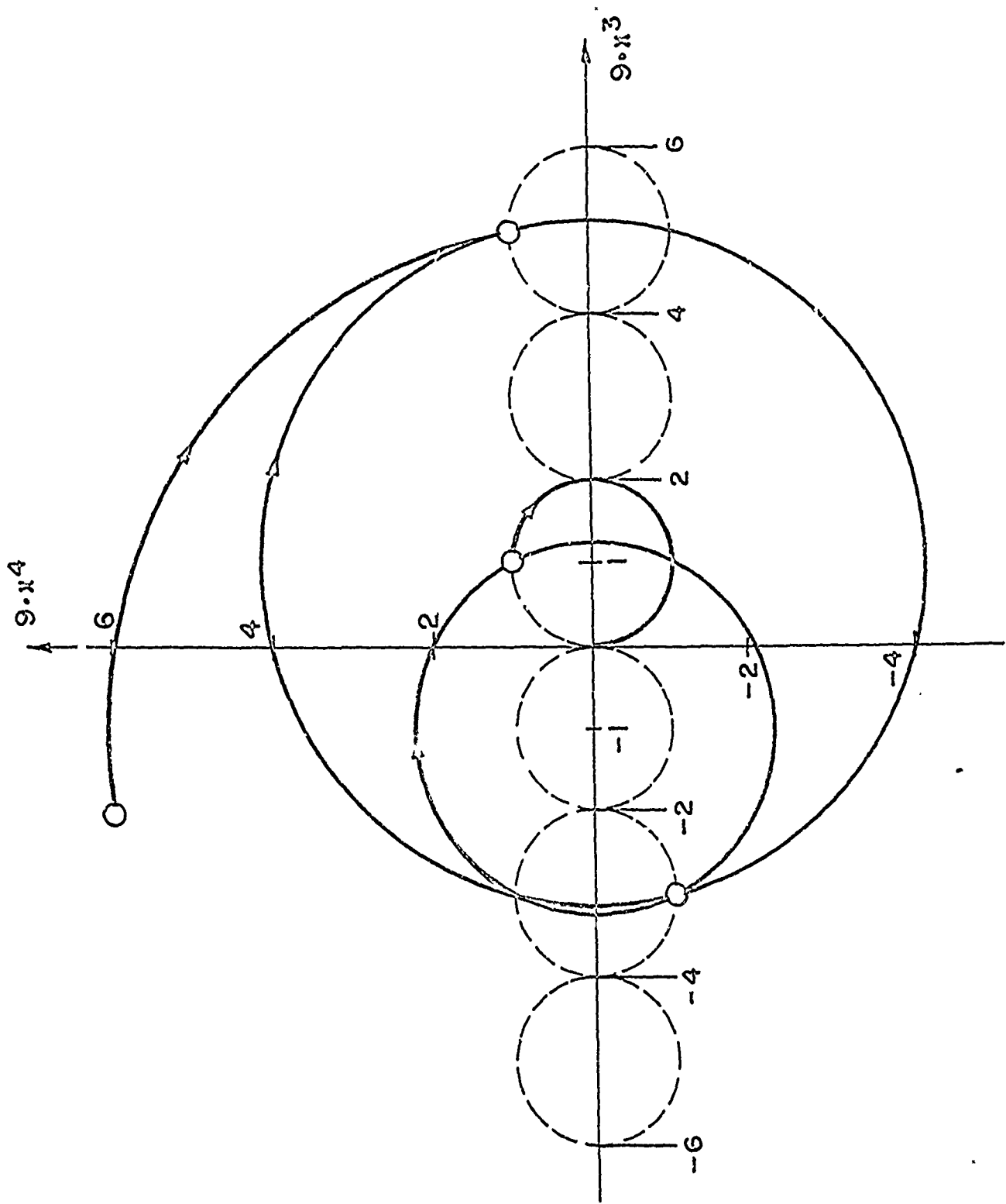

Optimum and quasi-optimum control of
third and fourth-order systems.

Irmgard Flügge-Lotz and Harold A. Titus, Jr.
Stanford University

Abstract

Pontryagin's maximum principle is used for computing the optimum control function $u(t)$ for a given plant and a given performance criterion. If $u(t)$ is bounded, the control is of the bang-bang type in many cases. If $u(t)$ is expressed as the function of the state variables, that means, $u(t) = \text{sgn } f(x^i)$, the equation $f(x^i) = 0$ determines the switching surface in the state space. In general these surfaces are not given by simple analytic functions, in particular not if the transfer function of the plant contains complex poles. If the desired final state is given by error and error derivatives being zero, this surface goes through the origin of the phase space.

Based on experiences with second-order plants, a systematic attempt has been made to approximate the exact switching surfaces for third-order plants. There is an approximation of the surface portion close to the origin (the so-called "inner" surface) and an approximation of the larger portion of the switching surface which is not close to the origin (the "outer" surface). Examples show the use of these surfaces; their results are compared to results with exactly optimum switching. They agree well.

The extension to fourth-order systems is indicated.

References

- (1) I. Flügge-Lotz and H. Marbach, "The optimal control of some attitude control systems for different performance criteria," paper to be presented at the JACC 1962 New York, to be published in the Transactions of the ASME.
- (2) Bushaw, D., "Optimal discontinuous forcing terms," Contributions to the theory of nonlinear oscillations," Vol. IV, S. Lefschetz, editor; Princeton, Princeton University Press, 1958; pp. 29-52.
- (3) A.T. Fuller, "Relay control systems optimized for various performance criteria," Automatic and Remote Control, Proceedings of the First International Congress of the International Federation of Automatic Control, Moscow 1960, published by Butterworths, London 1961.
- (4) I. Flügge-Lotz and T. Ishikawa, "Investigation of third-order contractor control systems with two complex poles without zeros NASA TN D-428, 1960.
- (5) I. Flügge-Lotz and T. Ishikawa, "Investigation of third-order contractor control systems with zeros in their transfer functions," NASA TN D-719, 1961.
- (6) H. K. Knudsen, "Maximum effort control for oscillatory elements," 1959 IRE Wescon Convention Record, Part IV, p. 116.
- (7) I. Flügge-Lotz and Mih Yin, "The optimum response of second-order, velocity-controlled systems with contactor control, ASME Transactions, Series D, Journal of Basic Engineering March 1961, p. 59.
- (8) I. Flügge-Lotz and H. A. Titus, "The optimum response of full third-order systems with contactor control," paper no.61-WA 125, presented at the ASME Winter meeting 1961, to be published in the ASME transactions.