

## Fleet Operations Workspace Core

---

### Migration Guide

# Copyright Notice

---

The information contained herein is the property of Omron Robotics and Safety Technologies, Inc., and shall not be reproduced in whole or in part without prior written approval of Omron Robotics and Safety Technologies, Inc. The information herein is subject to change without notice and should not be construed as a commitment by Omron Robotics and Safety Technologies, Inc. The documentation is periodically reviewed and revised.

Omron Robotics and Safety Technologies, Inc., assumes no responsibility for any errors or omissions in the documentation. Critical evaluation of the documentation by the user is welcomed. Your comments assist us in preparation of future documentation. Please submit your comments to: [techpubs@omron.com](mailto:techpubs@omron.com).

Copyright © 2019 by Omron Robotics and Safety Technologies, Inc. All rights reserved.

Any trademarks from other companies used in this publication  
are the property of those respective companies.

Created in the United States of America

---

# Table of Contents

---

<b>Chapter 1: Introduction</b> .....	5
<b>1.1 Fleet Topology Comparison</b> .....	5
<b>1.2 Necessary Software and Omron Parts</b> .....	7
Necessary Software .....	7
Necessary Omron Parts .....	7
<b>1.3 Related Manuals</b> .....	8
<b>1.4 Terms and Abbreviations</b> .....	9
<b>Chapter 2: Safety</b> .....	11
<b>2.1 Warnings, Cautions, and Notes</b> .....	11
<b>2.2 General Safety Precautions</b> .....	11
<b>2.3 Safety Commissioning</b> .....	12
To test E-Stop .....	12
To test the Safety Laser .....	12
<b>2.4 What to Do in an Emergency</b> .....	12
<b>2.5 Additional Safety Information</b> .....	12
<b>Chapter 3: Migration Procedures</b> .....	13
<b>3.1 Migrate an EM2100 Primary Fleet Manager Appliance from a Legacy MSS 4.X Solution to the Fleet Operations Workspace Core 1.0 Solution</b> .....	13
<b>3.2 Migrate an AMR from a Legacy Mobile Software Suite 4.X Solution to the Fleet Operations Workspace Core 1.0 Solution</b> .....	17
<b>Chapter 4: Downgrade AMRs and EM2100s to run with Legacy Solution Software</b> .....	23
<b>4.1 Downgrade a New EM2100 appliance from Fleet Operations Workspace 1.0 to Mobile Software Suite 4.9</b> .....	23
<b>4.2 Downgrade an AMR from Fleet Operations Workspace 1.0 to Mobile Software Suite 4.9</b> .....	24
<b>Appendix A: Supplemental Install Procedure for AMRs Experiencing "Upload File Invalid" Errors</b> .....	27
<b>Appendix B: Accessing Dongles on the LD Platform OEM Robot Core</b> .....	29

---

## Revision History

---

Revision code	Date	Revised Content
01	September, 2019	Original release
02	October, 2019	Added Revision History. Changed rear cover to Omron standard format for English.

# Chapter 1: Introduction

---

With the launch of the Fleet Operations Workspace (FLOW) Core software solution, Omron is providing a next generation solution for mobile robot fleets. Beginning in July, 2019, all mobile robots and Fleet Manager appliances began shipping with the FLOW Core software installed.

Customers with existing Omron mobile robot fleets can migrate their fleets to the new FLOW Core solution or remain on their existing (Legacy) Mobile Software Suite (MSS) software. For those who wish to migrate, this document details the process necessary to upgrade their existing fleet to the FLOW Core solution. For those customers who prefer to use their existing MSS solution, this document provides instructions on how to downgrade any newly purchased mobile robots or EM2100 appliances to be compatible with their existing fleet software solution.

Please read and understand this document before embarking on your migration project.

This chapter provides an overview of the process and provides recommended preparations to make your migration project go smoothly. It includes the following topics:

[1.1 Fleet Topology Comparison](#)

[1.2 Necessary Software and Omron Parts](#)

[1.3 Related Manuals](#)

[1.4 How Can I Get Help?](#)

Omron has made significant effort to minimize the hardware upgrade, network and installation process required to migrate a legacy fleet to a FLOW Core fleet. The only hardware change required is that any existing EM1100 appliances must be upgraded to EM2100 appliances. Both units fit in a standard 1U rack and can use the existing Ethernet and power connections.

All Mobile Robots can be upgraded via software without having to purchase new units.

All Local Area Network, IP Addresses, wiring and power connections remain the same.

## 1.1 Fleet Topology Comparison

The Legacy and Fleet Operations Workspace (FLOW) Core fleet topologies are very similar in that they both use Omron Mobile Robots and a Fleet Manager which interfaces with the factory systems. The Fleet Manager and mobile robots are connected to the factory network in the same way. Both systems use MobilePlanner as their principal interface but the versions are not compatible.

The Legacy versions of MobilePlanner continue to require a licensing dongle whereas MobilePlanner is included as part of the FLOW Core license. While Legacy fleets use EM1100 and the initially released EM2100 appliance to perform the Fleet Manager role, FLOW Core fleets require the EM2100 appliance running a licensed version of the FLOW Core software. Anyone running both a primary and secondary EM1100 for redundancy will still get the same functionality within FLOW Core using the new EM2100s.

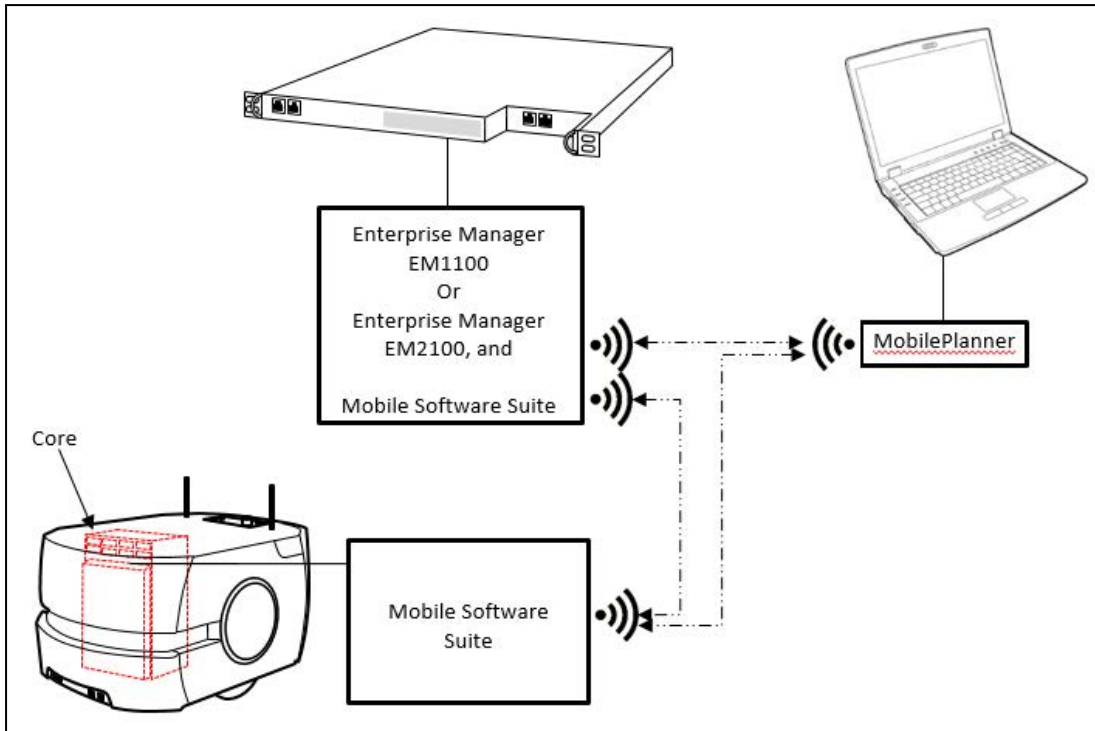

Figure 1-1. Legacy MSS Fleet Topology

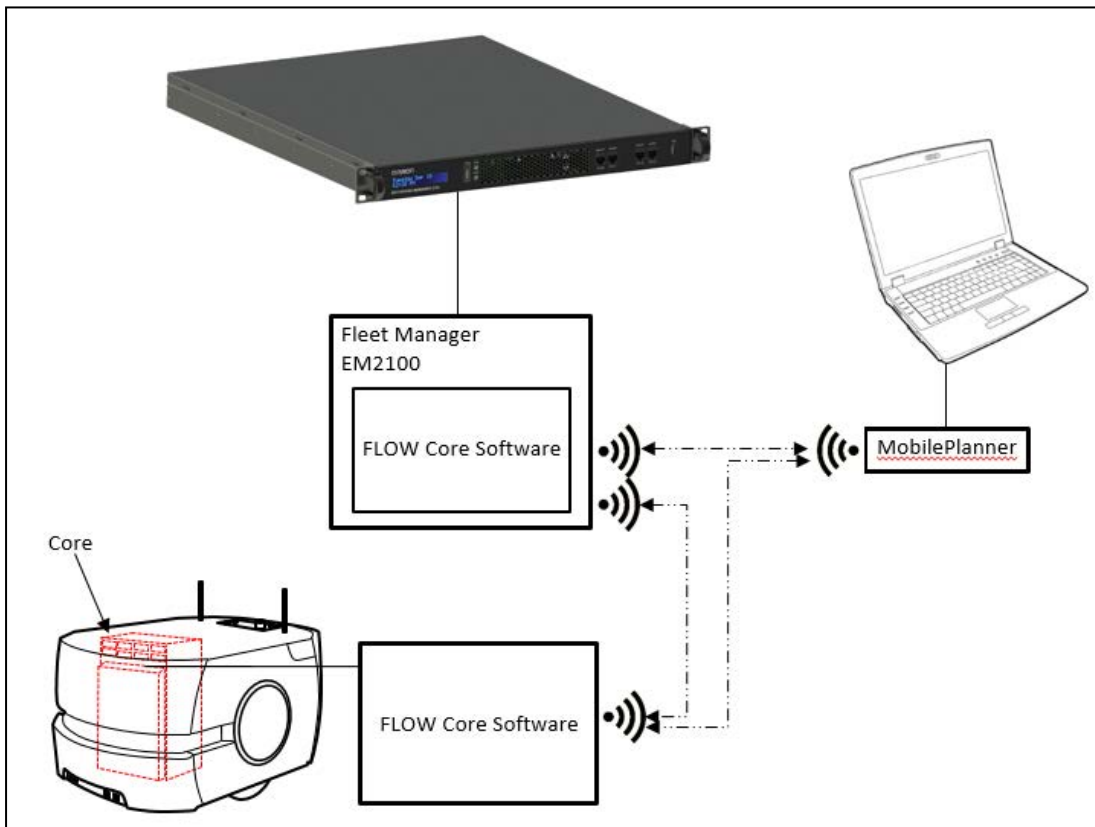

Figure 1-2. FLOW Core Fleet Topology with EM2100

## 1.2 Necessary Software and Omron Parts

### Necessary Software

The following table lists all software versions related to the migration.

Name	Note
<b>Migrating from a Legacy to Fleet Operations Workspace (FLOW) Core Solution</b>	
FLOW Core 1.0 Software	Obtain this software from your Omron representative
SetNetGo EM 5.0 Software	Obtain this software from your Omron representative
SetNetGo Robot 5.0 Software	Obtain this software from your Omron representative
SetNetGo 4.10 Recovery Software	Obtain this software from your Omron representative
MobilePlanner 5.0 Software	Obtain this software from your Omron representative  <b>NOTE:</b> You can also download MobilePlanner 5.0 software directly from the SetNetGo Web interface of an EM2100 or AMR running FLOW Core 1.0.
<b>Downgrading from Fleet Operations Workspace Core to a Legacy 4.x Solution</b>	
Mobile Software Suite (MSS) 4.x	This is the MSS software version which your fleet is running today. You may already have this software. If not, obtain the desired version from your Omron representative.
SetNetGo 4.10 Software	Obtain this software from your Omron representative
MobilePlanner 4.X Software	This is the MSS software version which your fleet is running today. You may already have this software. If not, obtain the desired version from your Omron representative.

### Necessary Omron Parts

If you are migrating your mobile robot fleet from a legacy to FLOW Core solution, we recommend that you pre-order the following Omron parts before starting the migration process.

Downgrading to a legacy solution does not require any hardware (see Note) or software license purchases unless you desire additional MobilePlanner licenses.

**NOTE:** Downgrading to a Legacy solution does not require any hardware unless your robot has only one dongle that was converted to support FLOW.

Part Number	Product Name	Quantity
20271-900	Primary Fleet Manager	Equals the replaced number of EM1100s acting as a Primary Fleet Manager
20271-901	Secondary Fleet Manager	Equals the replaced number of EM1100s

Part Number	Product Name	Quantity
		acting as a Secondary Fleet Manager
20271-800 OR 20271-806	Primary FLOW Core License, 1Yr OR Primary FLOW Core License, 5 Yr	Equal to the number of Primary Fleet Managers being purchased.
20271-802 OR 20271-807	Secondary FLOW Core License, 1Yr OR Secondary FLOW Core License, 5 Yr	Equal to the number of Secondary Fleet Managers being purchased.

### 1.3 Related Manuals

This manual describes the migration procedures for hardware and software within an Omron fleet management system. There are additional manuals which give details for the specific product(s) that you have.

The following manuals provide information about safety, related products, and advanced configurations.

*Table 1-1. Related Manuals*

Manual Title	Description
<i>Mobile Robot LD Safety Guide</i>	Describes Autonomous Mobile Robots safety aspects.
<i>EM2100 Installation Guide</i>	Describes the installation and generic connections of the EM2100 appliance.
<i>Fleet Operations Workspace Core User's Guide</i>	Describes the software that runs on the Fleet Manager appliance.
<i>Advanced Robotics Command Language Reference Guide</i>	Describes the Advanced Robotics Command Language (ARCL), which is a simple, text-based server from which you can control Omron Autonomous Mobile Robots.
<i>LD Platform OEM User's Guide</i>	Describes the operation and maintenance of the Autonomous Mobile Robots.
<i>LD Platform Cart Transporter User's Guide</i>	Describes the operation and maintenance of the Cart Transporter Autonomous Mobile Robots.
<i>LD Platform Peripherals Guide</i>	Describes various peripherals available for use with Autonomous Mobile Robots.



## 1.4 Terms and Abbreviations

This document uses the following terms and abbreviations.

Term	Description
AMR	Autonomous Mobile Robot
API	Application Programming Interface
ARCL	Advanced Robotics Command Language
Client Application	A warehouse management system, manufacturing execution system, enterprise resource planning system, or similar application that interacts with the Integration Toolkit.
EM2100 Appliance	Hardware appliance which connects all Omron autonomous mobile robots and runs the Fleet Management Software.
Fleet Manager	Elements of the FLOW Core software which controls traffic, charging, job assignment, etc. and collaborates with the client application(s) to assign and manage tasks across the mobile robot fleet.
FLOW	Fleet Operations Workspace.
Integration DB	The primary database that includes all table views.
Job	A basic activity for a robot to execute consisting of one or more Pickup or Dropoff segments.
JSON	JavaScript Object Notation.
Legacy	A system which is running a software solution prior to FLOW Core 1.0. Typically, this solution is a version of MSS 4.9 or earlier.
REST	RESTful Web Services.
SQL	Structured Query Language.
URI	Uniform Resource Identifier.



# Chapter 2: Safety

---

## 2.1 Warnings, Cautions, and Notes

Where needed, this user guide calls out critical, important, or emphasized text via special alert notifications. Below are explanations of the special alert notifications used in this manual:



**WARNING:** This indicates a potentially hazardous situation which, if not avoided, will result in minor or moderate injury, or serious injury or death. Additionally, there may be significant property damage.



**CAUTION:** This indicates a situation which, if not avoided, could result in minor or moderate injury or in property damage.

**NOTE:** Notes provide supplementary information, emphasize a point or procedure, or give a tip for easier operation.

## 2.2 General Safety Precautions

Read the installation and operation instructions, as well as the Mobile Robot LD Safety Guide, before using the equipment.

- Do not ride on the AMR.
- Do not exceed the AMR's maximum weight limit.
- Limit operation to areas with no slope.
- Do not drop the AMR, run it off a ledge, or otherwise operate it in an irresponsible manner.
- Do not get the AMR wet, or expose the AMR to rain or moisture. The AMR has an IP rating of IP40.
- Do not use power extension cords with the docking station unless properly rated.
- Do not run the AMR if hair, yarn, string, or any other items are wound around the AMR's axles or wheels.
- Never access the AMR's interior with the charger attached. Immediately disconnect the battery after opening the battery compartment door.
- Never short the battery's terminals together.
- Do not use parts (including charging docks, etc.) not authorized by Omron.

## 2.3 Safety Commissioning

EN 1525: “Safety of Industrial Trucks. Driverless Trucks and their Systems,” requires testing of the AMR’s safety systems, both before leaving the factory, and again at the customer’s site by a trained and qualified person. Safety Commissioning runs from within the MobilePlanner main menu.

### To test E-Stop

1. In the MobilePlanner main menu, select **Robot > Safety Commissioning**.
2. In the Introduction window, click the **ESTOP** radio button, then click **Next**.
3. Press the AMR’s **E-Stop** button, listen for the brakes to engage, then click **Next**.
4. Select **Yes** (or **No** if the brakes did not engage - contact your local Omron representative).

### To test the Safety Laser

1. In the MobilePlanner main menu, select **Robot > Safety Commissioning**.
2. In the Introduction window, click the **Safety Laser** radio button.
3. With the AMR in an open area (at least 2 meters clearance around front and side), press the **E-Stop** button.
4. Remove side panels, raise the wheels, and use the metal pins to hold the wheels off the ground.
5. Release the **E-Stop** button.
6. In the Safety Laser Commissioning window, click **Next**.
7. Click and hold the **Drive** button (until prompted to release), and verify Speed Zones trigger.
  - a. If the AMR fails, select **No**, and contact your local Omron representative.
  - b. If the AMR passes, select **Yes** and proceed to next step.
8. Follow the setup instructions (and place an object in front of the AMR), then click **Next**.
9. Press and hold the **Drive** button until prompted to release.
10. When the wizard informs you the E-Stop triggered, click **Continue**.

## 2.4 What to Do in an Emergency

Press the **E-Stop** button (a red push-button on a yellow background/field) and then follow the internal procedures of your company or organization for an emergency situation.

If a fire occurs, use a type D extinguisher: foam, dry chemical, or CO<sub>2</sub>.

## 2.5 Additional Safety Information

The *Mobile Robot LD Safety Guide* provides detailed information on safety for our AMRs. It also gives resources for more information on relevant standards. The safety guide ships with each AMR.

## Chapter 3: Migration Procedures

---

This chapter provides detailed instructions which will guide you through the Legacy-to-Fleet Operations Workspace (FLOW) Core migration process. Please follow these steps in the order provided in this chapter.

### 3.1 Migrate an EM2100 Primary Fleet Manager Appliance from a Legacy MSS 4.X Solution to the Fleet Operations Workspace Core 1.0 Solution

This section details the steps necessary to migrate an existing EM2100 which is being used as a Fleet Manager in an existing legacy system.

**NOTE:** If the existing legacy system is using EM1100 appliances for fleet management, you must replace them with EM2100s. In that case, we recommend purchasing pre-configured EM2100 Fleet Manager units, which come with FLOW Core installed, and no migration will be required.

To upgrade an existing EM2100 appliance running Mobile Software Suite (MSS) 4.X to the FLOW Core solution, follow these steps.

1. Download the SetNetGo (SNG) EM 5.0 and FLOW Core software onto a laptop which you will use to access the EM2100 Primary Fleet Management appliance.
2. Using the laptop, launch a browser, open the SNG Web UI, and connect to the EM2100 appliance via its existing IP address.
3. Within SNG, select the **System** Tab and select the **Upload SetNetGo OS** page from the left hand list.
4. Decide which Boot Image, A or B, you wish to replace with the new SNG 5.0 software.
5. Select **Choose File** for that boot image.
6. Navigate to the SNG 5.0 software file and select it for upload.  
The filename should appear next to the Choose File button within the SNG Web UI.
7. Click on the **Upload File** button.
8. Ensure that the boot image you have selected is now configured as the Bootable version.
9. In the Backup Image section, select **Choose File**.
10. Navigate to the SNG 4.10 Recovery software file and select it for upload.
11. Click on the **Upload File** button.
12. Once the upload is complete, reboot the EM2100 appliance by either clicking on the Reboot button in the SNG **System** tab (if enabled), or by using the power switch on the front of the EM2100 appliance.

Next, install the FLOW Core 1.0 software onto the EM2100 appliance.

13. Within the SNG Web UI select the **Software** Tab and select the **Manage Installed Software** page from the left hand list.
14. Click on the **Choose File** button at the top of the page.
15. Navigate to the FLOW Core 1.0 software file and select it for upload.  
The filename should appear next to the Choose File button.
16. Now click on the **Upload File** button.  
The FLOW Core software is now fully installed, and you can configure the operating mode of the EM2100.
17. Select the **System** tab and select the **Mode** page from the left hand column.
18. Choose the EM2100 appliance operational mode using the drop-down menu.

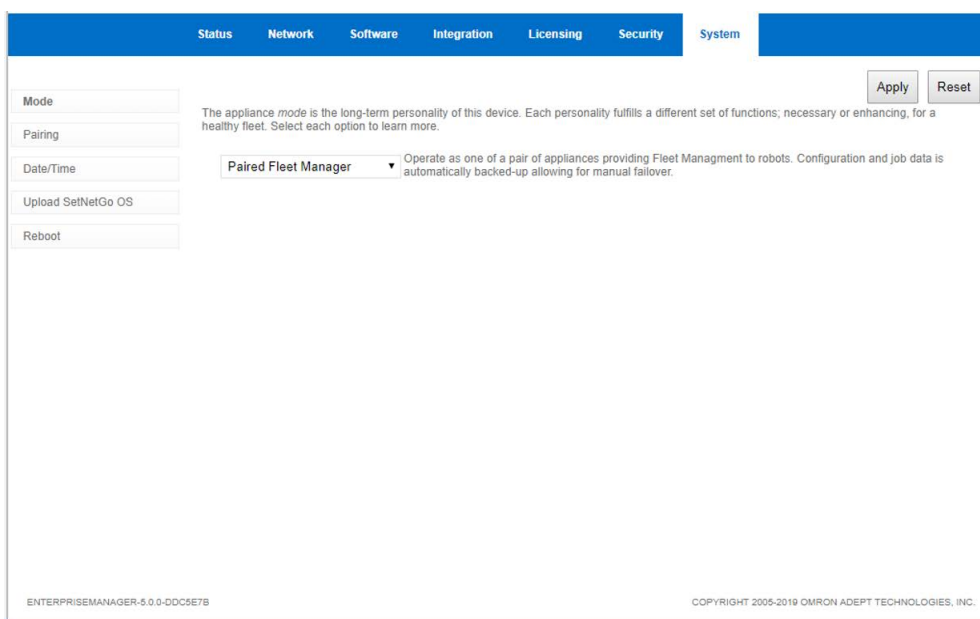

- a. If your system is using only one EM2100 appliance, select the **Standalone Fleet Manager** option, click the **Apply** button, then proceed to [Step 22](#).
- b. If your system has a second EM2100 acting as a redundant unit, then make sure the secondary is also migrated to FLOW Core software, select the **Paired Fleet Manager** option, and click the **Apply** button. Proceed to [Step 20](#).

**NOTE:** If you select the Paired Fleet Manager option, you must designate, this EM2100 as either Primary or Secondary (redundant) Fleet Manager.

19. Click the **Pairing** button (left margin) to designate the role of the EM2100 Appliance.
20. Select the pairing role for this EM2100 using the drop down menu.

If this EM2100 was previously used in a paired system, then the Secondary EM IP address will already be entered.

If this is a new installation, refer to the EM2100 Installation Manual for details on setting up the Primary and Secondary EM2100 appliances in your system.

21. You must now request a FLOW Core license entitlement from Omron.

This requires you to download and submit an identification file from the EM2100 Appliance to Omron in order to receive a FLOW Core license.

- a. Using SNG web UI Licensing tab, choose the **Download** option, then click on the **Download** button to download the .C2V file.

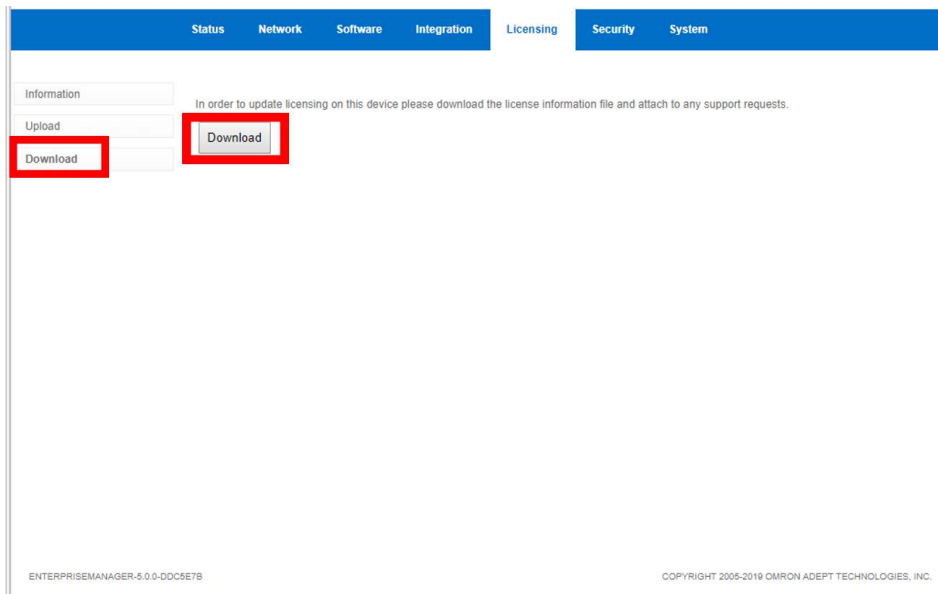

- b. The downloaded .C2V file will have the format:  
1234567890-MMM-DD-YYYY.C2V (Ex. 7769436109-MAY-21-2019)

**NOTE:** Omron recommends that you establish a specific location and folder to store these license key files so you can easily access them in the future.

- c. Send the .C2V file to your local Omron representative or integration partner and request the appropriate license for the Fleet Management mode you have selected.
22. You will receive a .V2C file with dongle ID and date that match the .C2V file which you submitted. Confirm the file names match before proceeding. If the filenames do not match, then contact your Omron representative or integration partner and report the issue.
23. Reconnect your computer to the EM2100 Fleet Management appliance using the SNG Web UI. Select the **Licensing** tab and choose the **Upload** page from the left-hand banner. Select the appropriate .V2C file and click on the **Upload File** button.



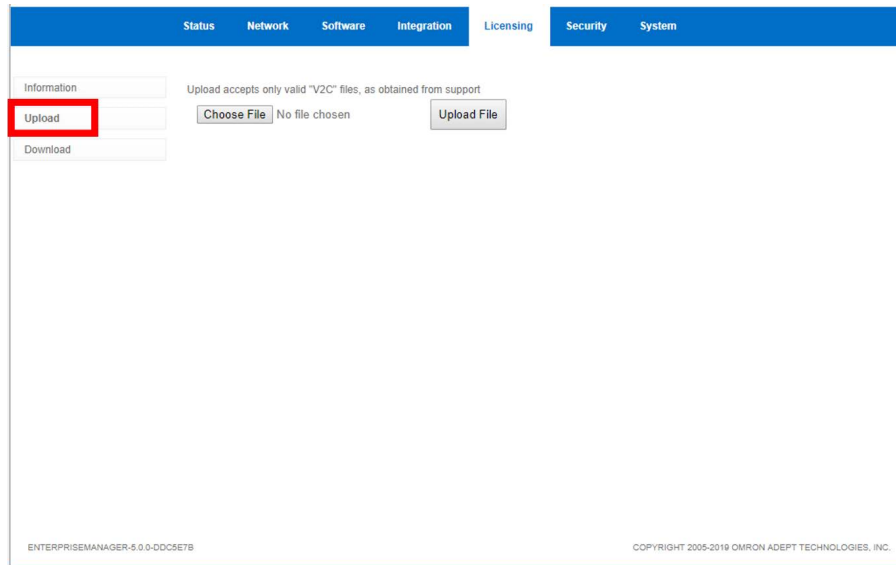

24. Now that a valid license is activated, SNG will initiate the requested mode by starting the appropriate software.

Your EM2100 appliance is now upgraded to the FLOW Core 1.0 solution and ready to be connected to your autonomous mobile robot (AMR) Fleet.

The next migration step is to upgrade your AMR fleet to the same FLOW Core software version. The next section defines this process.

**NOTE:** You can begin the next step, Migrating the AMR Fleet, before receiving and uploading the .V2C licenses to the EM2100 appliance. This helps save time when migrating.

### 3.2 Migrate an AMR from a Legacy Mobile Software Suite 4.X Solution to the Fleet Operations Workspace Core 1.0 Solution

This section defines the process for migrating your autonomous mobile robot (AMR) fleet from a Legacy Mobile Software Suite (MSS) solution to the Fleet Operations Workspace (FLOW) Core solution. Nearly all Omron mobile robots may be upgraded using the software upgrade processes described in this section.

1. Download the FLOW Core 1.0 software and the SetNetGo (SNG) Robot 5.0 software onto the laptop you will use to access the mobile robots.
2. On the laptop, open the SNG Web UI within a browser.
3. Select the System Tab and select the **Upload SetNetGo OS** page from the left hand list.
4. Decide which Boot Image, A or B, you wish to replace with the new SNG 5.0 boot image.
5. Select **Choose File** for that boot image.
6. Navigate to the SNG 5.0 software file and select it for upload.  
The filename should appear next to the Choose File button.
7. Then click on the **Upload File** button.

**NOTE:** If you receive the error message, *“The uploaded file appears to be invalid”* follow the procedure in Appendix A before proceeding.

8. Ensure that the Boot Image you have selected is now the Bootable version.
9. In the Backup Image section, select **Choose File**.
10. Navigate to the SNG 4.10 Recovery software file, select it for upload, then click on the **Upload File** button.
11. Once the upload is complete, reboot the AMR by cycling power on the robot.

Next, install the FLOW Core 1.0 software onto the AMR.

12. Within the SNG Web UI select the **Software** Tab and click on the **Manage Installed Software** page from the left hand banner list.
13. Click on the **Choose File** button at the top of the page.
14. Navigate to the **Fleet Operations Workspace Core 1.0** software file and select it for upload.

The filename should appear next to the Choose File button.

15. Then click on the **Upload File** button.

The FLOW Core software is now fully installed, and the AMR will now run as a FLOW Core unit. If you have a legacy AMR, you might need to convert the license dongle and apply a new license before the AMR can connect to the Fleet Manager.

16. Reconnect to the AMR using the SNG Web UI.
17. Within the SNG web UI, click on the **Licensing** tab.

**NOTE:** There are a select few older mobile robots which may have a security license dongle which cannot be upgraded using this software process. These few units require you to replace a dongle on the AMR core. If you have an Omron AMR with one of these older dongles, you will receive the following error message when the AMR reboots; *“Invalid License Dongle. The Dongle cannot be converted to a FLOW Compatible Dongle.”* If this happens during your AMR upgrade, refer to Appendix B for instructions on removing the AMR core and replacing the dongle before proceeding.

18. Check to see if the Convert sub-menu is displayed in the left hand banner. If it is, then continue to [step 19](#).

If there is no Convert button in the left hand banner, then jump to [step 28](#).

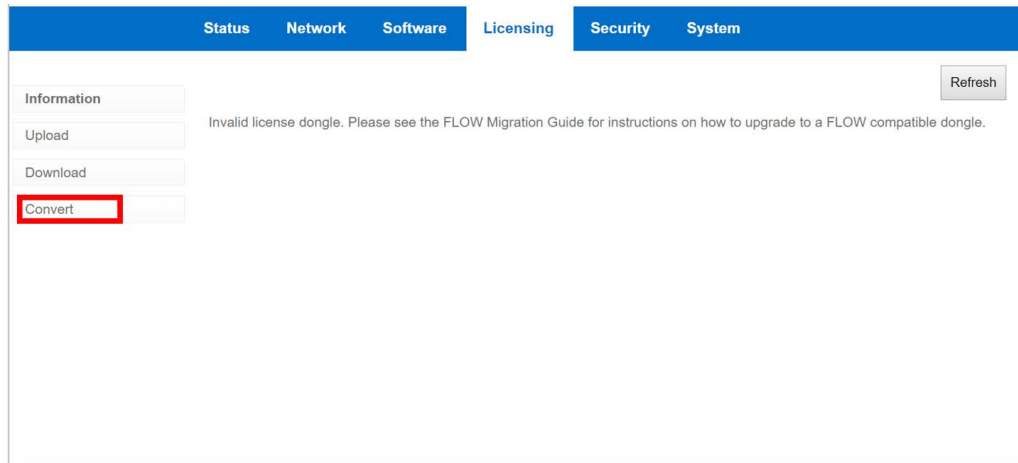

19. Proceed with the following instructions to convert your legacy dongle to a blank FLOW compatible dongle.
  - a. Click on the **Convert** option in the left margin.
  - b. Because the conversion process is irreversible, you will receive a first warning: *"This device has licensing firmware only compatible with legacy software. It may be upgraded to support Fleet Operations Workspace compatible software, but this action is irreversible."*

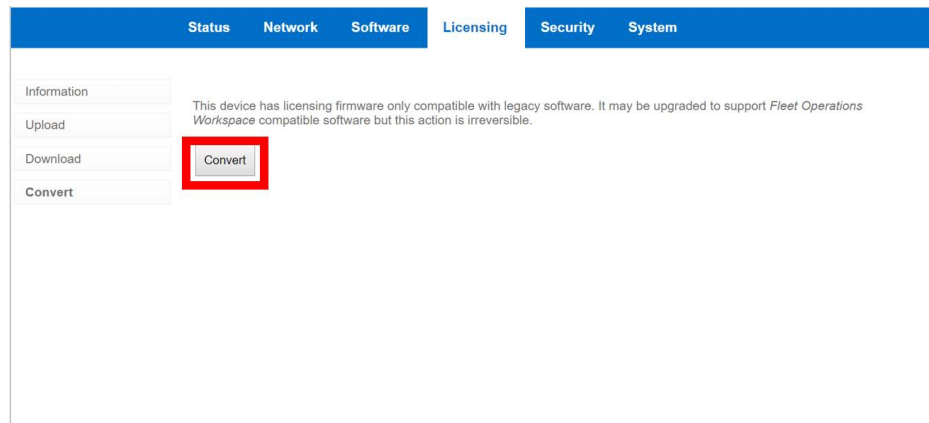

- c. Click on the **Convert** button.  
A second warning message will appear.

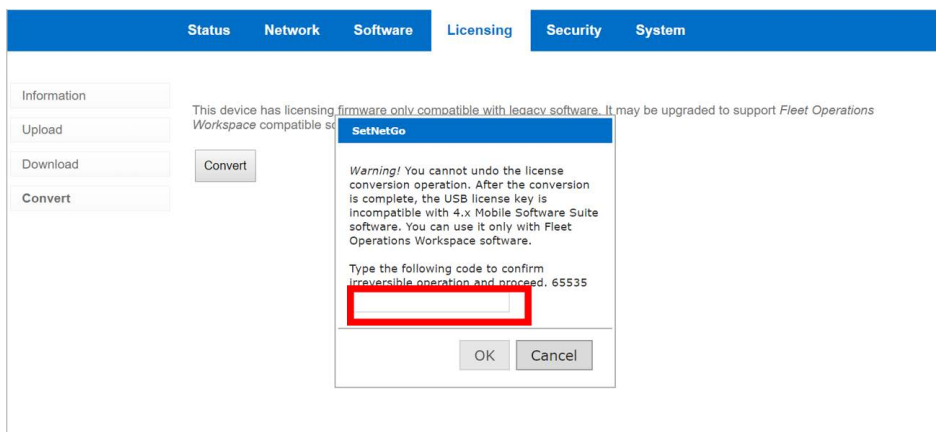

Note that this step requires you to enter a code before completing the upgrade process. After entering the code, click **Ok**.

**NOTE:** Entering an incorrect code will evoke an error message, requiring you to restart the process from step a.

- d. Enter the displayed number, and click **Ok**.

The conversion process begins. When complete, a confirmation of success message displays.

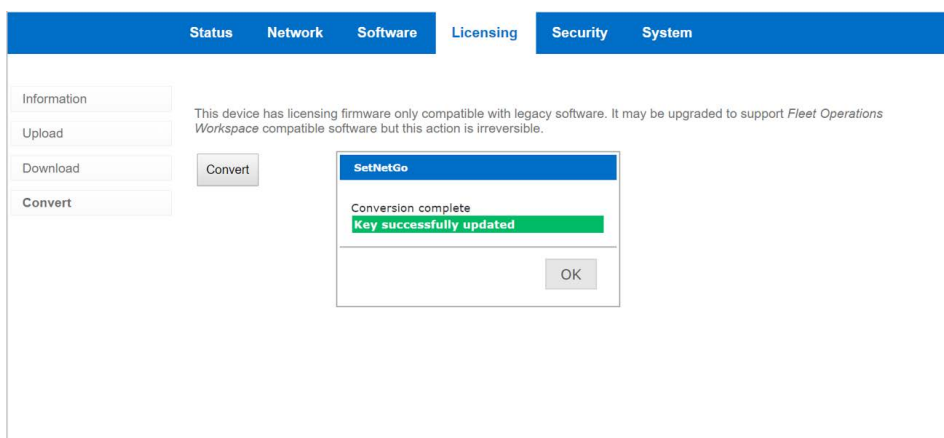

The security dongle has now been upgraded for compatibility with the FLOW Core software. The next step is to obtain and apply a license for the AMR.

- 20. Within the **Licensing** tab, click on the **Download** option in the left-hand banner section.

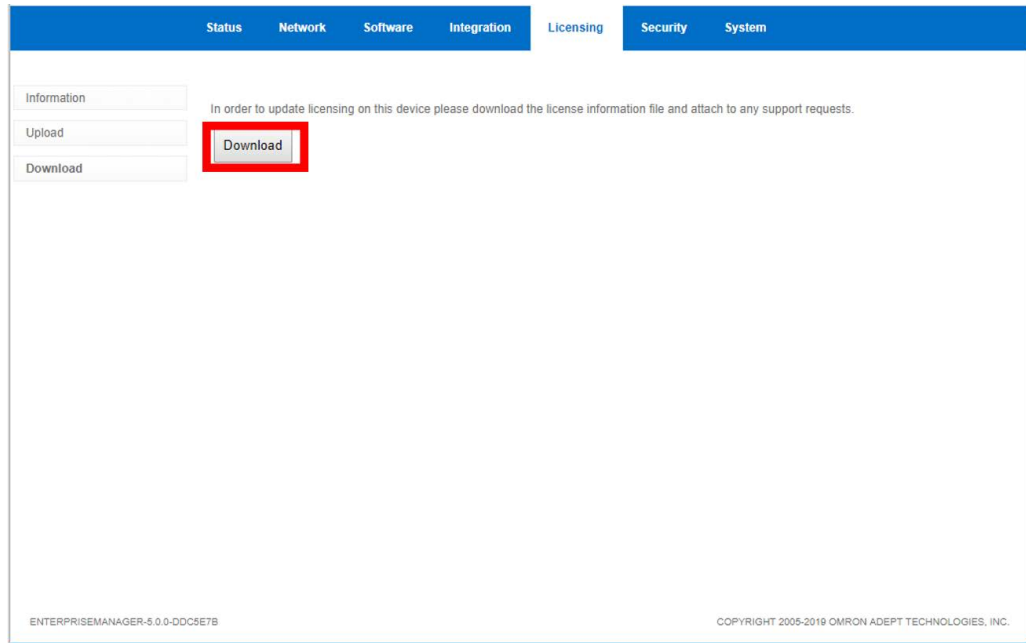

21. On the download page, click the **Download** button.

The downloaded .C2V file will have the format:

1234567890-MMM-DD-YYYY.C2V (example: 7765923100-JUN-21-2019.C2V)

**NOTE:** Omron recommends that you establish a specific location and folder to store these license key files so you can easily access them in the future. We also recommend that you reference the .C2V ID number to its particular AMR to ensure that you can quickly identify and upload the matching license activation file to that AMR.

22. Send the .C2V file to your local Omron representative or integration partner and request a robot license.  
You will receive a .V2C file with a dongle ID and Date that matches the .C2V file submitted by you.
23. Confirm that the file names match before proceeding.  
If the file names do not match, contact your Omron representative or integration partner and report the issue.
24. Reconnect your computer to the mobile robot using the SNG web UI.
25. Select the **Licensing** tab and choose the **Upload** option.
26. Click the **Choose File** button and select the appropriate V2C file.

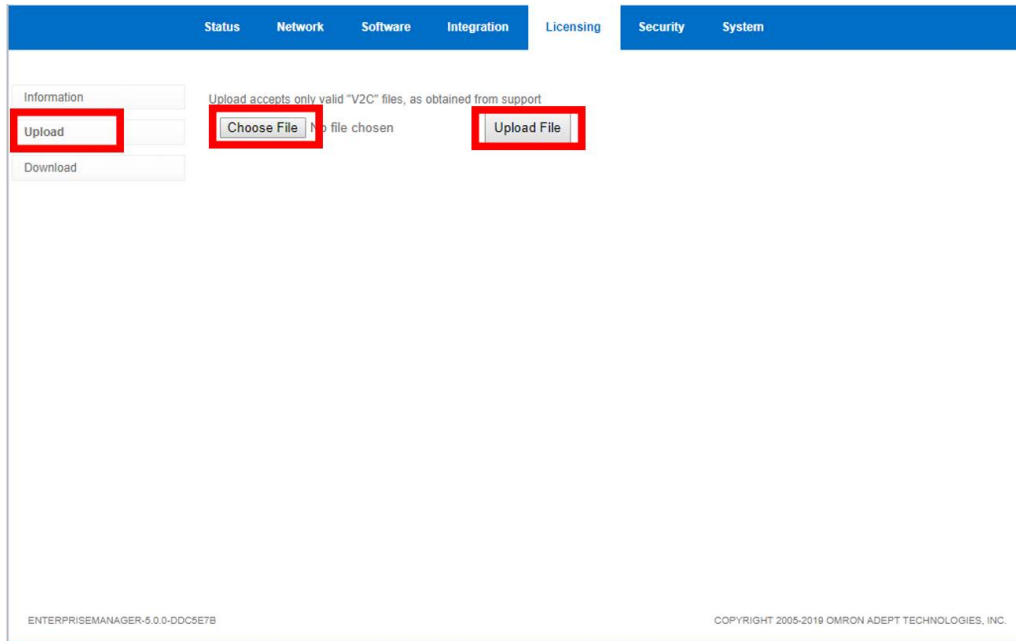

27. Once the file is chosen the SNG Web UI shows the specific filename next, click on **Upload File**.

Now that a valid license is activated, SNG will start the FLOW Core Software on your AMR.

28. Repeat this process for each AMR in the Fleet.

Once all the AMRs have been migrated to the FLOW Core solution, the Fleet Manager(s) and AMRs will communicate and are ready to be configured with any changes which might accompany the migration process.

The final step is to install MobilePlanner on the laptop and connect to the Fleet Manager.

29. Install MobilePlanner 5.0.x on your laptop.
30. Once installation is complete, you may now connect directly to the Fleet Manager (EM2100 appliance) by entering the EM2100 appliance's IP address.

Your AMR Fleet is now fully converted and is ready for operation.

# Chapter 4: Downgrade AMRs and EM2100s to run with Legacy Solution Software

---

All Omron autonomous mobile robots (AMRs) and EM2100 appliances ship with Fleet Operations Workspace (FLOW) Core software installed. In order to use newly purchased mobile robot equipment in fleets running Legacy Mobile Software Suite (MSS) 4.X software, the legacy software needs to be installed and enabled. Additionally, compatible versions of SetNetGo (SNG) and MobilePlanner must be installed in your system to ensure the new and existing AMRs interact as designed.

This chapter provides detailed instructions which will guide you through the Legacy software installation process. Please follow these steps in the order provided in this chapter.

**NOTE:** No modification to any of the AMRs in the existing fleet is required. Even though the new AMRs will be running a newer version of SetNetGo, the existing AMRs can continue to run their installed versions of SetNetGo, MSS and MobilePlanner.

## 4.1 Downgrade a New EM2100 appliance from Fleet Operations Workspace 1.0 to Mobile Software Suite 4.9

This section defines the process for downgrading a newly purchased EM2100 appliance running the Fleet Operations Workspace (FLOW) Core software to the Legacy Mobile Software Suite (MSS) solution.

1. Install the EM2100 following the EM2100 Installation Guide, and FLOW Core Software Users Guide.

This will cover setup and connecting the EM2100 to the local network. During installation, the system will assign a new network IP address which will be used during the downgrade process.

2. Download the MSS 4.X software (which the mobile robot fleet is currently using) onto the laptop which will be used to downgrade the EM2100.

You can obtain this software from your local Omron Representative.

**NOTE:** The SNG 4.10 version which you will need is already installed on the mobile robot.

3. Using the laptop, open SNG Web UI within a browser and connect to the EM2100 appliance via its existing IP address.
4. Within SNG, select the **System** Tab and select the **Upload SetNetGo OS** page from the left-hand list.
5. Select Boot Image B (which should be labeled as SNG 4.10 on the screen).
6. Reboot the EM2100 appliance by either clicking on the Reboot button in the SNG System tab (if enabled), or by using the power switch on the front of the EM2100 appliance.

Next, install the MSS 4.X software onto the EM2100 appliance. The MSS 4.X version is the version which is presently installed on the operating fleet.

7. Within the SNG Web UI, select the **Software** Tab and select the **Manage Installed Software** page from the left-hand list.
8. Click on the **Choose File** button at the top of the page.
9. Navigate to the desired MSS 4.X software file and select it for upload.  
The filename should appear next to the Choose File button.
10. Now click on the **Upload File** button.

Once the upload is complete, the EM2100 appliance will be operating with the legacy MSS 4.X software solution.

11. Confirm that the desired version of the MSS 4.X software is installed on the EM2100 by selecting the **Software** tab in the SNG Web UI.
12. Choose whether EM2100 should run as **Primary** or as **Secondary Fleet Manager**.
  - If the unit is configured as a Primary Fleet Manager, SNG will automatically start ARAMCentral and autosync.
  - If the unit is configured as a Secondary Fleet Manager, only autosync will run.

The EM2100 is now ready to connect to the existing AMR fleet for programming using MobilePlanner.

## 4.2 Downgrade an AMR from Fleet Operations Workspace 1.0 to Mobile Software Suite 4.9

This section defines the process for downgrading a newly purchased AMR running the FLOW Core software to the Legacy MSS solution.

1. Download the Mobile Software Suite (MSS) 4.X software which is currently used by all other autonomous mobile robots (AMRs) within the existing mobile robot fleet onto the laptop which will be used to downgrade the AMR.

You can obtain this software from your local Omron Representative.

2. Using the laptop, open the SNG Web UI within a browser.
3. Select the **System** Tab and select the **Upload SetNetGo OS** page from the left-hand list.
4. Select Boot Image B (which should be labeled as SNG 4.10 on the screen).
5. Reboot the AMR by either clicking on the Reboot button in the SNG System tab (if enabled), or by using the power switch on the AMR HMI Panel.

Next, install the Legacy MSS 4.X onto the AMR.

6. Within the SNG Web UI select the **Software** Tab and click on the **Manage Installed Software** page from the left hand banner list.
7. Click on the **Choose File** button at the top of the page.
8. Navigate to the MSS 4.X software file and select it for upload.



The filename should appear next to the Choose File button.

9. Then click on the **Upload File** button.

Once the upload is complete, the AMR will run as an MSS 4.X unit.

10. Reconnect to the AMR using the SNG Web UI.

11. In the SNG **Software** tab, confirm that the desired version of MSS software is installed.

The AMR is now ready to connect to the Fleet Manager (EM2100 or EM1100), and for programming using MobilePlanner.



# Appendix A: Supplemental Install Procedure for AMRs Experiencing "Upload File Invalid" Errors

---

This error indicates that this particular AMR requires an additional SetNetGo installation sequence, which involves installing an interim version of SetNetGo (version 4.10) and then installing SetNetGo 5.0.

To correctly install SetNetGo 5.0, follow the required process steps below.

1. Download the SNG 4.10 software onto a laptop which will be connecting to the mobile robots.
2. Using the laptop, open the SNG Web UI within a browser.
3. Select the **System** Tab and click on the **Upload SetNetGo OS** page from the left hand list.
4. Decide which Boot Image, A or B, you wish to replace with the new SNG 4.10 boot image.
5. Select **Choose File** for that boot image.
6. Navigate to the SNG 4.10 software file and select it for upload.  
The filename should appear next to the Choose File button.
7. Then click on the **Upload File** button.

If no error message appears the upload was successful. Cycle AMR power. Then, in the SNG Web UI, open the **System** tab (top of the Upload SetNetGo OS page) and confirm that version 4.10 is listed as the SetNetGo version. After confirming this, re-install the SetNetGo 5.0 version using the following steps:

8. In the SNG Web UI select the **System** Tab and click on the **Upload SetNetGo OS** page from the left hand list.
9. Decide which Boot Image, A or B, you wish to replace with the new SNG 5.0 boot image.
10. Select **Choose File** for that boot image.
11. Navigate to the SNG 5.0 software file and select it for upload.  
The filename should appear next to the Choose File button.
12. Then click on the **Upload File** button.

If no error message appears, the upload was successful. Cycle AMR power. Then, in the SNG Web UI, open the **System** tab and confirm that version 5.0 is listed as the SetNetGo version.

Now, return to [Step 8](#) in Section 3.2, and resume the migration process.

---

If an error message persists, please contact your local Omron representative for technical support.

## Appendix B: Accessing Dongles on the LD Platform OEM Robot Core

---

Older model Omron mobile robots may have a black dongle, installed in the mobile robot core, which cannot be upgraded during the software upgrade process. If you have received the error; “Invalid License Dongle. The Dongle cannot be converted to a FLOW Compatible Dongle.” during the upgrade process, it is likely that the mobile robot core is using a black dongle. You must replace this dongle, which requires removing the core from the mobile robot.

The following instructions detail how to remove the mobile robot core, confirm the dongle color and replace it.

**NOTE:** If the dongle in the mobile robot core is not black, there may be some other issue with that particular mobile robot. Contact your local Omron Representative for support in this case.

The LD Platform core is an enclosed unit, with internal fans as the only moving parts.

1. Order the blue replacement dongle P/N 13131-100F.

This dongle is pre-programmed with a FLOW Core autonomous mobile robot (AMR) license and it should replace the black dongle.

2. Move the payload structure out of the way, so you can access the payload bay.
3. Remove the battery door skin.
4. Unlatch and open the battery compartment door, (rear of the AMR).  
The battery compartment door can be locked. You may need to unlock it.
5. Disconnect the battery power and data cables from the rear of the battery.
6. Disconnect all of the cables attached to the top portion of the core.
7. Remove the core mounting bracket from around the core.

The bracket is two pieces; a front piece with two screws into the chassis, and a rear piece with two screws into the chassis, and four more going sideways into the core. Retain all of these screws for re-installing the core.

See the following figure:

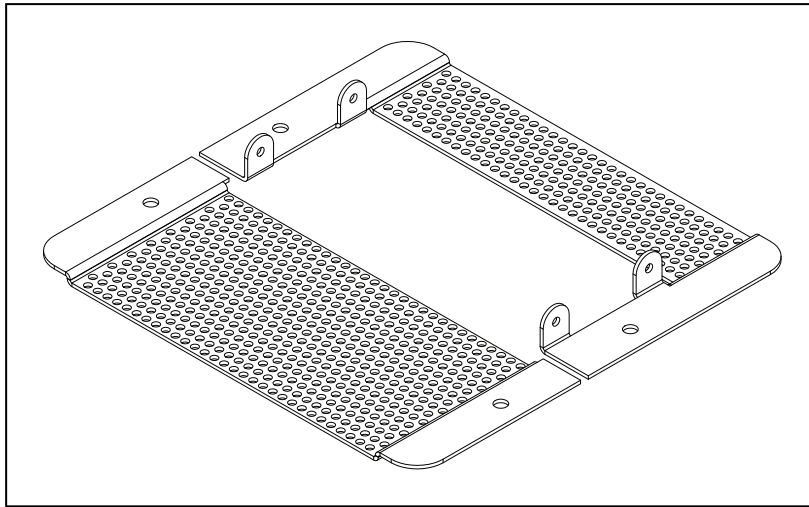

Figure 6-1. Core Mounting Bracket

**NOTE:** You might be able to reach the dongle(s) by only removing the front piece of the bracket. If not, continue with step 8.

8. Remove the Sonar 1 cable from the core.  
This cable is too short to allow the core to be lifted until the cable is removed.
9. Gently lift the core up, until you can access the dongle(s).
10. Remove the existing black dongle, and replace it with the blue dongle, P/N 13131-100F.
11. Connect the Sonar 1 cable to the core.
12. Install the core mounting brackets around the core.  
Using the screws and washers you removed from the old core, put four screws into the sides of the core, with four more going down into the platform chassis.
13. Reconnect all of the cables to the top portion of the core.
14. Reconnect the battery power and data cables to the battery.
15. Close and latch the battery compartment door.
16. Reinstall the inner rear skin.
17. Reinstall the payload structure.
18. Now, return to [step 29](#) in Section 3.2 to continue the migration process.



**OMRON Corporation Industrial Automation Company**  
Kyoto, JAPAN

Contact: [www.ia.omron.com](http://www.ia.omron.com)

**Regional Headquarters**

**OMRON EUROPE B.V.**  
Wegalaan 67-69, 2132 JD Hoofddorp  
The Netherlands  
Tel: (31)2356-81-300/Fax: (31)2356-81-388

**OMRON ASIA PACIFIC PTE. LTD.**  
No. 438A Alexandra Road # 05-05/08 (Lobby 2),  
Alexandra Technopark,  
Singapore 119967  
Tel: (65) 6835-3011/Fax: (65) 6835-2711

**OMRON ELECTRONICS LLC**  
2895 Greenspoint Parkway, Suite 200 Hoffman Estates,  
IL 60169 U.S.A.  
Tel: (1) 847-843-7900/Fax: (1) 847-843-7787

**OMRON ROBOTICS AND SAFETY TECHNOLOGIES, INC.**  
4550 Norris Canyon Road, Suite 150, San Ramon, CA 94583 U.S.A.  
Tel: (1) 925-245-3400/Fax: (1) 925-960-0590

**OMRON (CHINA) CO., LTD.**  
Room 2211, Bank of China Tower, 200 Yin Cheng Zhong Road,  
PuDong New Area, Shanghai, 200120, China  
Tel: (86) 21-5037-2222/Fax: (86) 21-5037-2200

Authorized Distributor:

© OMRON Corporation 2019 All Rights Reserved.  
In the interest of product improvement,  
specifications are subject to change without notice.

Cat. No. I636-E-01

Printed in USA  
1019 (1019)

20569-060 B