

AD-A273 073



2

ESL-TR-91-09



**ARMORED PERSONNEL CARRIER
(APC) FIREFIGHTING VEHICLE
SYSTEM**

**M. J. WILSON, J. H. STORM, G. B. SINGH,
C. W. RISINGER**

**APPLIED RESEARCH ASSOCIATES, INC.
4300 SAN MATEO BLVD, N.E., SUITE A220
ALBUQUERQUE, NM 87110**

MARCH 1992

FINAL REPORT

FEBRUARY 1991

DTIC
ELECTE
NOV 24 1993
A

**APPROVED FOR PUBLIC RELEASE:
DISTRIBUTION UNLIMITED**



**AIR FORCE ENGINEERING & SERVICES CENTER
ENGINEERING & SERVICES LABORATORY
TYNDALL AIR FORCE BASE, FLORIDA 32403**

NOTICE

PLEASE DO NOT REQUEST COPIES OF THIS REPORT FROM
HQ AFESC/RD (ENGINEERING AND SERVICES LABORATORY).
ADDITIONAL COPIES MAY BE PURCHASED FROM:

NATIONAL TECHNICAL INFORMATION SERVICE
5285 PORT ROYAL ROAD
SPRINGFIELD, VIRGINIA 22161

FEDERAL GOVERNMENT AGENCIES AND THEIR CONTRACTORS
REGISTERED WITH DEFENSE TECHNICAL INFORMATION CENTER
SHOULD DIRECT REQUESTS FOR COPIES OF THIS REPORT TO:

DEFENSE TECHNICAL INFORMATION CENTER
CAMERON STATION
ALEXANDRIA, VIRGINIA 22314

REPORT DOCUMENTATION PAGE

Form Approved
OMB No. 0704-0188

Public reporting burden for this collection of information is estimated to average 1 hour per response, including the time for reviewing instructions, searching existing data sources, gathering and maintaining the data needed, and completing and reviewing the collection of information. Send comments regarding this burden estimate or any other aspect of this collection of information, including suggestions for reducing this burden, to Washington Headquarters Services, Directorate for Information Operations and Reports, 1215 Jefferson Davis Highway, Suite 1204, Arlington, VA 22202-4302, and to the Office of Management and Budget, Paperwork Reduction Project (0704-0188), Washington, DC 20503.

1. AGENCY USE ONLY (Leave blank)		2. REPORT DATE March 1992	3. REPORT TYPE AND DATES COVERED Final 12-16 Feb 91	
4. TITLE AND SUBTITLE Armored Personnel Carrier (APC) Firefighting Vehicle System (M113a2 Firefighting System)			5. FUNDING NUMBERS C - F08635-88-C-0067	
6. AUTHOR(S) M. J. Wilson, J. H. Storm, and G. B. Singh, C. W. Risinger				
7. PERFORMING ORGANIZATION NAME(S) AND ADDRESS(ES) Applied Research Associates, Inc. 4300 San Mateo Blvd, N. E., Suite A220 Albuquerque, NM 87110			8. PERFORMING ORGANIZATION REPORT NUMBER None	
9. SPONSORING/MONITORING AGENCY NAME(S) AND ADDRESS(ES) Civil Engineering Laboratory HQ Air Force Civil Engineering Support Agency Tyndall AFB, Florida 32403-6001			10. SPONSORING/MONITORING AGENCY REPORT NUMBER ESL-TR-91-09	
11. SUPPLEMENTARY NOTES Prepared in cooperation with the U.S. Army Tank and Automotive Command (TACOM) and the U.S. Army Material Command (AMC) in support of "Desert Storm" application.				
12a. DISTRIBUTION / AVAILABILITY STATEMENT Approved for public release. Distribution unlimited.			12b. DISTRIBUTION CODE	
13. ABSTRACT (Maximum 200 words) This project evaluated the fire suppression capabilities of an M113A2 Armored Personnel Carrier (APC), modified with an internal skid-mounted fire suppression system. Six different agents were tested with the APC system to evaluate their fire extinguishing time, burnback rate, throw range, reservicing time, and ease of reservicing. To facilitate this test program, a 96 feet by 10 feet trench was constructed with a 15 inch high clay berm. JP-4 fuel (250-500 gallons) was floated on water in the trench and burned to simulate large hydrocarbon fires anticipated in combat operations during operation "Desert Storm". The M113A2 APC system, using AFFF as the superior agent, was found to be effective in combating large tactical fires.				
14. SUBJECT TERMS Hydrocarbon fuel fires, Fire extinguishing agents, AFFF, Pyrocap PVC, Phirex, Hurri-safe, Acu-lite			15. NUMBER OF PAGES 62	
			16. PRICE CODE	
17. SECURITY CLASSIFICATION OF REPORT UNCLASSIFIED	18. SECURITY CLASSIFICATION OF THIS PAGE UNCLASSIFIED	19. SECURITY CLASSIFICATION OF ABSTRACT UNCLASSIFIED	20. LIMITATION OF ABSTRACT UL	

EXECUTIVE SUMMARY

A. OBJECTIVE

The overall objective of this test series was to demonstrate the fire suppression performance of the modified M113A2 APC in suppressing simulated trench fires. The secondary objective was to evaluate six firefighting agents for use with the modified APC in a realistic wartime scenario.

B. BACKGROUND

The Middle-East situation (Operation Desert Storm) presented a unique petroleum warfare problem. Among potential Iraqi defenses were a number of dug-in trenches approximately one mile long, ten feet wide, and ten feet deep. These trenches could be fed crude oil and ignited should allied forces attempt to cross them. Operation Desert Storm was the first conflict to present a tactical problem of this type and consequently a military solution had not been formulated. The need was foreseen to suppress these fires, or at least create a path in the fire, so that a combat vehicle bridge could be dropped over the trench for the blue forces to pass without delay. To rapidly suppress these large hydrocarbon fuel fires from the ground with personnel protection from small arms fire, an M113A2 Armored Personnel Carrier (APC), integrated with a firefighting system, was determined to be the most viable option. This task was directed by AMC to TACOM. The goal was to design, develop, and fabricate a prototype fire suppression system, integrate it with an M113A2, and demonstrate its capability to extinguish large tactical fires with a suitable fire suppression agent. AMC requested Air Force assistance, through the Air Force Engineering Service Center, Fire Protection and Crash Rescue Research Branch (AFESC/RDCF), to conduct fire suppression performance tests of this system and several fire suppressing agents on simulated 10-foot wide trench fires.

C. SCOPE

This project evaluated the fire suppression capabilities of an M113A2 Armored Personnel Carrier (APC), modified with an internal skid-mounted fire suppression system. The APC is a standard U.S. Army vehicle. Using the modified APC as the agent dispensing vehicle, several different fire suppressing agents were evaluated for their ability to suppress a simulated trench JP-4 fire 10 feet wide and 96 feet long. The extinguishing time, burnback rate, throw range, reservicing time, and ease of reservicing were evaluated for each agent. Three fires were planned for each test agent in the test series with initial fuel quantities of 250 gallons and a maximum of 500 gallons being burned during any single fire.

EXECUTIVE SUMMARY
(Concluded)

D. CONCLUSION

1. The M113A2 APC, configured with the firefighting kit, as tested in this report, showed that large tactical fires can be successfully suppressed.

2. The standard military firefighting agent, Aqueous Film Forming Foam (AFFF), (MIL-F-24835C) was found to be superior to all other tested agents in extinguishing and suppressing tactical fires.

3. This system, as configured, is not only applicable to ordnance fire suppression, but (after enemy attack) it may also be used for getting firefighting equipment to off-road or debris-strewn areas that are inaccessible to standard firefighting vehicles. For example: cratered debris-strewn runways, large POL or ammunition depots, off-road aircraft crash sites, and other emergency sites inaccessible to standard wheeled firefighting vehicles. Natural disasters, such as earthquakes, hurricanes, and tornadoes are also applications for this all-terrain firefighting vehicle. A firefighting system equipped M113A2 APC can meet these exigencies.

PREFACE

This final report was prepared by the Engineering and Services Laboratory, Air Force Engineering and Services Center, Tyndall Air Force Base, Florida 32403 in conjunction with U.S. Army Tank Command (TACOM), Warren, Michigan.

Overall project management was the responsibility of Mr G.B. Singh, PM-M113/M60 FOV Office, TACOM, Warren, Michigan 48397-5000.

Mr Charles W. Risinger, AFESC/RDCF, was the Project Officer. This report presents the results of the Armored Personnel Carrier (APC) Firefighting Vehicle System tests conducted from 12-16 February 1991 at Tyndall AFB, Florida.

This Technical Report has been reviewed and is approved for publication.

CHARLES W. RISINGER
Test Director
AFESC/RDCF

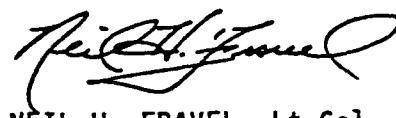
NEIL H. FRAVEL, Lt Col, USAF
Chief, Engineering Research Division

RICHARD N. VICKERS
Chief, Airbase Fire Protection
and Crash Rescue Systems Branch

FRANK P. GALLAGHER III, Colonel USAF
Director, Engineering and Services
Laboratory

THIS QUALITY INSPECTED 8

Approved	
NTIS	✓
DDI	
Executive	
Summary	
By	
Date	
A-1	

(The reverse of this page is blank)

TABLE OF CONTENTS

Section	Title	Page
I	INTRODUCTION.....	1
	A. TEST OBJECTIVES.....	1
	B. BACKGROUND.....	1
	C. MEASURES OF MERIT.....	2
	D. SCOPE.....	2
	E. TEST AUTHORITY.....	2
	F. M113A2 FIRE EXTINGUISHER SYSTEM DESCRIPTION.....	2
	G. AGENTS TESTED.....	4
	H. TEST SITE ACCESS.....	4
II	TEST DESCRIPTION.....	6
	A. INTRODUCTION.....	6
	B. FIRE EXTINGUISHMENT AND BURNBACK TESTS.....	8
	C. AGENT THROW RANGE TEST.....	8
	D. AGENT RESERVICING TEST.....	8
	E. APC VISUAL ACUITY TEST.....	8
	F. SPECIAL INSTRUMENTATION.....	9
	G. DATA COLLECTION.....	9
III	RESULTS AND CONCLUSIONS.....	10
	A. GENERAL.....	10
	B. APC FIREFIGHTING PERFORMANCE.....	11
	C. AGENT PERFORMANCE.....	13
	D. AGENT COMPARISONS.....	19
	E. ALTERNATE EXTINGUISHING METHODS.....	19
	F. SUMMARY BY ASSESSMENT PARAMETER.....	20
	G. CONCLUSIONS.....	22
APPENDIX		
A	PHOTOGRAPHS OF TYPICAL FIRE TEST OPERATIONS.....	23
B	MATERIAL SAFETY DATA SHEETS.....	28
C	ARMORED PERSONNEL CARRIER (APC) FIREFIGHTING VEHICLE SYSTEM TEST PLAN.....	40

SECTION I

INTRODUCTION

A. TEST OBJECTIVES

Test objectives for this test series were as follows:

1. Demonstrate the fire suppression performance of the modified APC in suppressing simulated trench fires.
2. Demonstrate the capability of a modified APC agent delivery system to establish and maintain a 10-15 foot wide assault path through the 96 foot long simulated fire trench. The time for the fire to burnback and close the path was measured and recorded. The purpose of this objective is to provide a more realistic simulation of the wartime scenario.
3. Evaluate the capability of each firefighting agent being tested to arrest a fire and suppress burnback in conjunction with Objectives 1 and 2.
4. Evaluate the throw range of the modified APC with each agent tested.
5. Evaluate the reservicing time and ease of reservicing of the modified APC with each agent being tested.
6. Assess the visual acuity from the APC operator's position during firefighting operations. It is anticipated that during upwind operations, agent blowing back on the vision blocks of the APC may obscure the view of the fire for the APC operator.

B. BACKGROUND

The Middle-East situation (Operation Desert Storm) presented a unique petroleum warfare problem. The Iraqi Defense created several sequential obstacles. One of which was a number of dug-in trenches approximately one mile long, ten feet wide, and ten feet deep. These trenches were fed crude oil from a central outlet with six to eight pipelines buried underground. In the battlefield scenario, Iraqi forces had full intentions of setting fire to these trenches as Allied Forces attempted to cross them. Operation Desert Storm was the first conflict to present a tactical problem of this type and consequently a military solution had not been formulated. The need was foreseen to suppress these fires, or at least create a path in the fire, so that a combat vehicle bridge could be dropped over the trench for the blue forces to pass without delay. To rapidly suppress these large hydrocarbon fuel fires from the ground with personnel protection from small arms fire, an M113A2 Armored Personnel Carrier (APC), integrated with a firefighting system, was determined to be the most viable option. This task was directed by AMC to TACOM. The goal was to design, develop, and fabricate a prototype fire suppression system, integrate it with an M113A2, and demonstrate its capability to extinguish large tactical fires with a suitable fire suppression agent. AMC requested Air Force assistance, through the Air Force Engineering Service Center, Fire Protection and Crash Rescue Research Branch (AFESC/RDCF), to conduct fire suppression performance tests of this system and several fire suppressing agents on simulated 10-foot wide trench fires.

C. MEASURES OF MERIT

The measures of merit were the capability of the modified APC and the agents being tested to rapidly suppress the fire and delay burnback for a sufficient period of time, within the limits of an on-board premixed agent supply system. The extinguishment time, quantity of agent used, burnback rates, throw range, reservicing time, and ease of reservicing were the parameters used in determining the success of the system and agents being tested. The ability of the crew to approach and extinguish the fire from an upwind position must be determined. An analysis of the success/failure of the firefighting crew, using the modified APC to combat large hydrocarbon fuel spills, must also be determined.

D. SCOPE

This project evaluated the fire suppression capabilities of an M113A2 Armored Personnel Carrier (APC), modified with an internal skid-mounted fire suppression system. The APC is a standard U.S. Army vehicle. Using the modified APC as the agent dispensing vehicle, several different fire suppressing agents were evaluated for their ability to suppress a simulated trench JP-4 fire 10 feet wide and 96 feet long. The extinguishing time, burnback rate, throw range, reservicing time, and ease of reservicing were evaluated for each agent. Three fires were planned for each test agent in the test series with initial fuel quantities of 250 gallons and a maximum of 500 gallons being burned during any single fire.

E. TEST AUTHORITY

This test was conducted to support a U.S. Army Materiel Command (AMC) requirement with potential "Desert Storm" application.

F. M113A2 FIRE EXTINGUISHER SYSTEM DESCRIPTION

A standard U.S. Army M113A2 APC was modified with a fire suppression system developed by the Amerex Corporation. A diagram of the system is shown in Figure 1. The system consists of the following components:

1. Tank.

- a. Agent Fill Volume - 250 gallons mixed
- b. Operating Pressure - 240 psig
- c. 4 inch ID opening in top with cap for filling agent concentrate and mixing the solution
- d. Drain valve in tank bottom which can also be used to fill tank with water
- e. Safety pressure relief valve in tank top
- f. Vent valve in tank top
- g. 2" shut-off ball valve to control agent flow from tank
- h. Tank ID coated with coal tar epoxy to prevent corrosion
- i. An agent level gauge

2. Pressurizing Cylinders.

Two 220 cubic foot nitrogen or air cylinders with a nominal pressure of 2,000 psig (Standard military equipment)

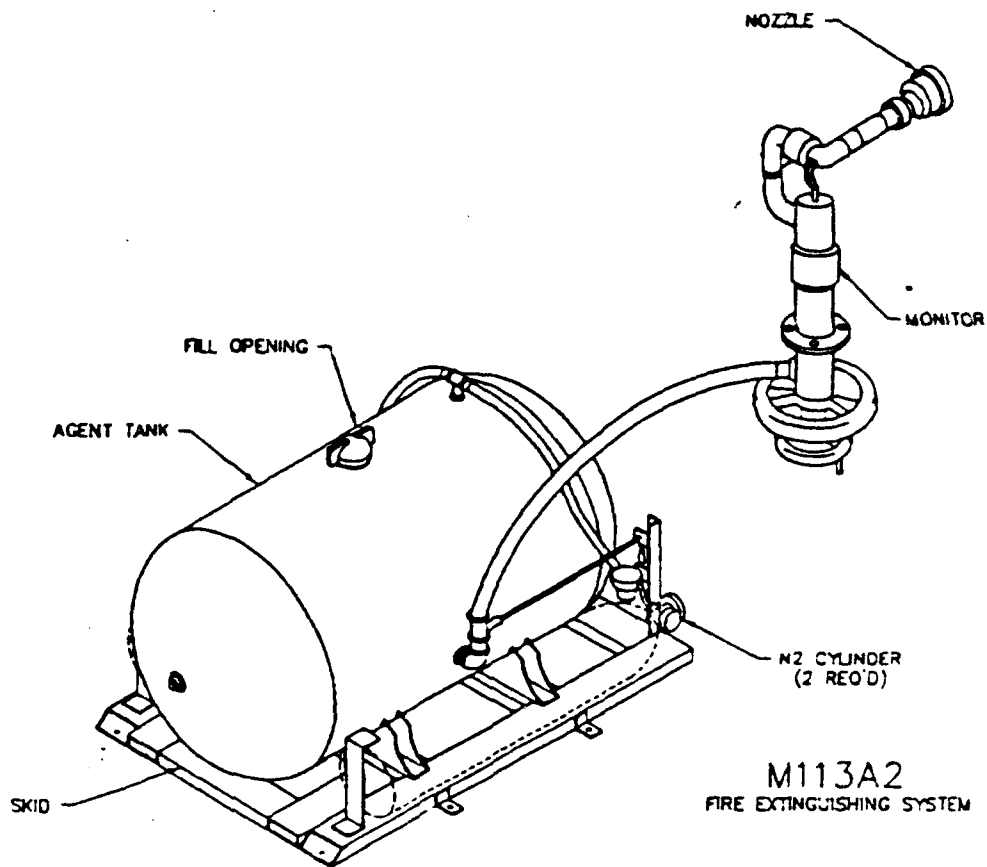

Figure 1. M113 A2 Firefighting System Diagram

3. Skid System.

a. Skid provides a means for quickly mounting the pressurizing cylinders (GFE). The cylinders may be slid into place or removed when a cylinder retaining bracket, held by two bolts, is removed.

b. System provides two high flow pressure regulators set to an operating pressure of 200 psig.

c. The agent tank is welded to the skid.

d. The skid system with tank and other components can be handled from the out board end and loaded into the APC with a fork-lift truck.

e. The skid system, with plumbing, weighs 1,220 pounds empty and 3,300 pounds full.

f. The skid system is bolted to the APC's floor plate, using existing holes.

g. The skid is designed to provide an even distribution of weight onto the floor support frame members.

4. Tank Pressurizing System.

Pressure from each of the two 220 cubic foot cylinders is fed through a high flow pressure regulator. The regulator reduces the pressure to 200 psig. The pressure feed hoses are attached to the top of the tank.

5. Agent Feed System.

A two inch ball valve is connected to the agent tank outlet. A two inch agent hose connects the ball valve to the monitor.

6. Monitor.

The monitor is installed in the right forward antenna position on the M113A2. Four bolts are used to hold it in place. The agent delivery nozzle, mounted on the monitor outlet can be rotated horizontally or elevated or depressed by controls located inside the vehicle. The controls shown in Figure 1 are being replaced by a single lever system which will permit easy operation by the vehicle commander. The turret and nozzle are controllable through approximately $+160^\circ$ horizontally and -15° to $+45^\circ$ vertically from the operator's position within the vehicle.

7. Nozzle.

Various nozzle configurations are easily accommodated.

8. System Installation.

To install the fire extinguishing system in an APC, the personnel heater system and the vehicle commander's seat must be removed. Six deck plate bolts are removed with their larger washers. The empty system is placed through the rear ramp door opening. The skid is bolted to the floor plate with six long bolts, provided. The right forward antenna position cover is removed and the monitor is installed in this opening. A two inch jumper hose is attached between the tank outlet valve and the monitor. Two supply pressure cylinders are installed. The tank is filled with agent and water and the fill cap installed. When the nitrogen cylinders are opened the system is pressurized and ready for use. System flow can be controlled by the single tank outlet valve, located within easy reach of the vehicle commander. The aiming of the fire extinguisher agent stream is also accomplished by the vehicle commander.

9. General Reservicing Procedures.

Replacement of the two pressure supply cylinders and refilling the tank with water and the liquid agent concentrate is all that is required to reservice the system. Turn around time is approximately 7 to 10 minutes for most agents tested (see "Reservicing Procedures in Section III, Paragraph B.3.) and is somewhat contingent upon the supply water flow rate, used for refilling the tank.

G. AGENTS TESTED

1. Assessment Parameters. The six agents, listed below, were assessed for their firefighting potential against the following parameters:

ASSESSMENT PARAMETERS (descending importance)

Fire-out time	Agent Availability/
Reflash resistance	Production base
Toxicity - Neat agent	Training requirements
Salt Water requirements	Agent Data - MSDS, etc.
Agent to equipment interface	Handling residue
Pyrolysis products	Cost
Neat Agent handling	

2. Agents Tested. The following agents were evaluated:

<u>AGENT TYPE</u>	<u>MANUFACTURER</u>	<u>LOCATION</u>
Pyrocap B-136	Pyrocap Inc.	Springfield, Va.
Hurri-Safe	Hurri-Safe	Birmingham, Al.
Powdered Viscous Foam	Atlantic Rim, Inc.	Manasses, Va.
AFFF (Type 6% MIL-SPEC)	3M Company	St. Paul, Mn.
Phirex	Phirex	
Acu-Lite-F	Conrad Mikulec	Auto-X Corp.

H. TEST SITE ACCESS

During all testing activities, access to the test site and immediate area was limited to government personnel, SETA support contractor personnel, technical representatives from the agent dispensing equipment manufacturer, and test agent contractor personnel. Agent contractor personnel were permitted access to the test site only during the initial test site familiarization period and when their agent was being tested.

SECTION II
TEST DESCRIPTION

A. INTRODUCTION

This test program was conducted by burning 250 or 500 gallons of JP-4 fuel in the AFESC 100-foot diameter fire test facility. One to four test fires were conducted for each test agent, at the request of the agent manufacturers. Prior to conducting test fires, two fires were conducted for equipment and procedure training and familiarization for the APC and resericing crews.

The AFESC 100-foot environmentally-safe fire test facility, located on Farmdale Road, Tyndall AFB, Florida was used for all fire tests. The facility was modified for this test series with a 15-inch high clay reinforced dam placed in the fire pit to form a rectangular bermed area 10 feet by 96 feet to simulate the trenches anticipated in the wartime scenario. A diagram of the test set-up is shown in Figure 2. Two six-foot high steel stakes were placed along the edge and centered on the trench to facilitate agent application aiming and data acquisition during the burnback portion of the test.

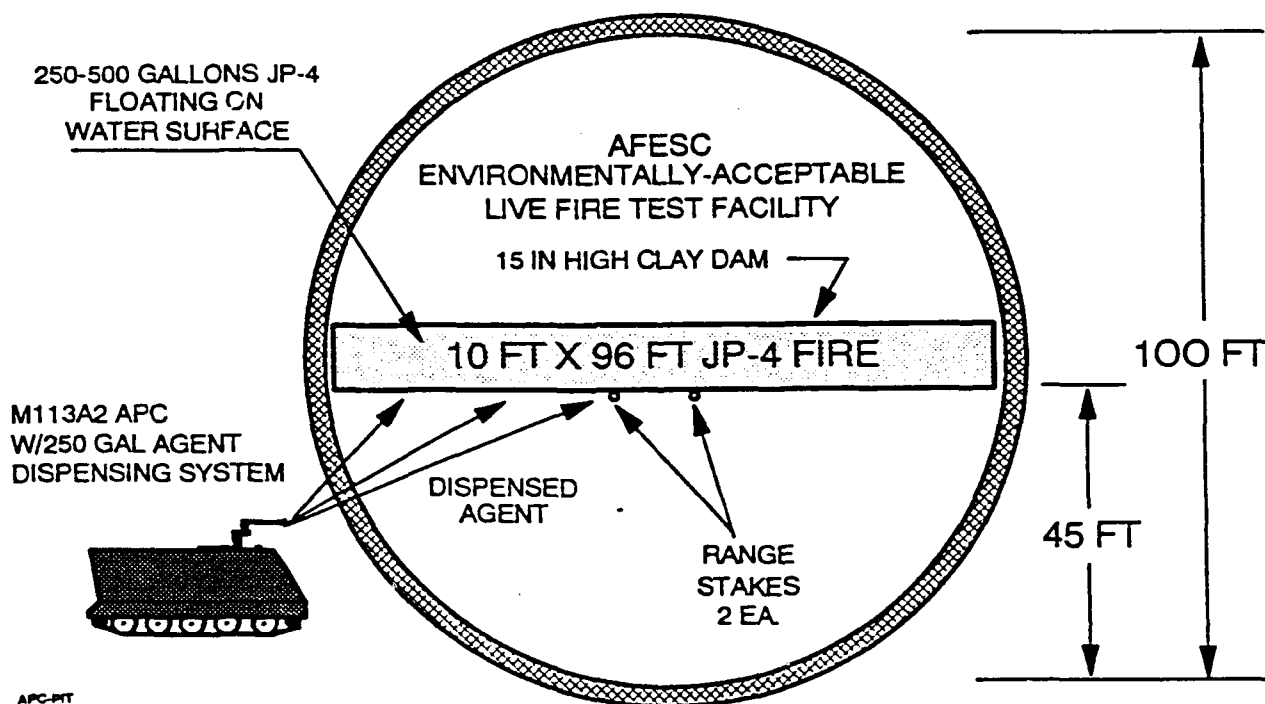

Figure 2. 100-Foot Fire Test Facility Set-Up

The modified APC was prepared before each test fire by filling the tank with 100 or 250 gallons of premixed agent, in accordance with the test matrix in Table 1. Sea water was used as the agent carrier, since this is the anticipated scenario in the operational environment. The two 220 ft³ nitrogen bottles, used to propel the agent, were replaced for each fire test to ensure that the gas supply was not depleted before an individual test was completed. The pressure regulator was adjustable to obtain the appropriate flow for the particular agent being tested, as per the agent manufacturer's specifications. This turned out to be 200 psi for all agents tested. The nozzle configuration was tailored to each individual agent manufacturer's requirements.

Sea water for use throughout this test series was pumped from the Gulf of Mexico into a 5,000 gallon tank truck and placed at the test site before the test began. Water was taken from a location near the open gulf to provide salt water with high salinity. Water for all tests was taken from the same tank truck load.

For each test fire, fuel was placed in the rectangular burn area, ignited with a torch, and followed by the modified APC attacking the fire and extinguishing a 10-15 foot assault path or all except the last 10-15 feet of the trench, as determined by the test event protocol shown in Table 1. Fire tests from both upwind and downwind positions were planned, but in the interest of consistently getting the test agents on the fire so that an objective comparison could be made, only approaches from the upwind position were made.

A USAF P-19 firefighting vehicle was manned by AFESC personnel and available at the fire test facility for all fires to cover contingencies.

Table 1. Firefighting Agent Test Matrix

<u>FIRE NO.</u>	<u>AGENT GAL.</u>	<u>FUEL GAL.</u>	<u>WIND DIRECTION</u>	<u>OBJECTIVE</u>
1	100	250	UPWIND	Extinguish 90% of trench from upwind end of trench. Measure extinguishment and burnback times.
2	100	250	UPWIND	Extinguish 90% of trench from upwind end of trench. Measure extinguishment and burnback times.
3	250	500	UPWIND	Extinguish 90% of trench from upwind end of trench. Measure extinguishment and burnback times.

After each fire test was completed the fire pit was reignited, if necessary, and permitted to burn off the residual fuel to facilitate pit clean-up for the next test. The fire pit was also flushed with water before the next fire test so that agent from the previous test would not contaminate the results of following tests.

To ensure that the residue from one agent did not contaminate the test results for a follow-on agent, the entire the agent tank and dispensing system was thoroughly flushed with water and blown clean with nitrogen at the completion of the test matrix for each agent.

B. FIRE EXTINGUISHMENT AND BURNBACK TESTS

A series of three test fires were planned for each agent being tested. Most agents were tested during three separate fires. However, at the agent manufacturer's request, some agents were tested for only one or two fires and one agent was tested during four fires. Test fires were conducted as follows:

The 10 by 96 foot trench was filled with either 250 or 50 gallons of JP-4 fuel. The Range Safety Officer then directs the ignition of the fire, observes a 30-second preburn period and commands the APC to approach the fire. The APC either approached the fire from an upwind position or was pre-positioned at the upwind end of the trench and begin dispensing agent. The objective was to extinguish all except 10-15% of the opposite end of the fire. The time to extinguish most of the trench and the burnback time were recorded. The quantity of agent used was also recorded. However, in most cases all agent on-board (100 gallons for the first fire and 250 gallons for the third fire for each agent) was used. After burnback, the fire was be permitted to burn out the remaining fuel to facilitate pit cleanup in preparation for the following test fire.

C. AGENT THROW RANGE TEST

The purpose of this test was to evaluate the throw range of the modified APC with each agent tested. The concern was that agent viscosity may effect this critical firefighting parameter. This test was conducted in conjunction with fire extinguishment tests.

D. AGENT RESERVICING TEST

The purpose of this test was to evaluate the reservicing time and ease of reservicing of the modified APC with each agent being tested, using the written instructions provided by the agent manufacturer. The test was conducted in conjunction with the fire tests described above for each of the test agents. The reservicing activity for each agent was timed and video taped. Subjective evaluations as to the ease of reservicing the system were made by reservicing personnel and recorded by the data recorder.

E. APC VISUAL ACUITY TEST

The purpose of this test was to assess the visual acuity from the operator's position in the APC during firefighting operations. This test was completed in conjunction with and throughout the fire tests. Results were based on the subjective evaluation of the system operator and recorded by the data recorder.

F. SPECIAL INSTRUMENTATION

In order to measure the maximum temperatures experienced by the APC and the occupants, the APC was instrumented with six thermocouples to measure and record temperature both inside and outside of the vehicle during firefighting operations. Two thermocouples were placed in front of the heat shield blanket, two behind the blanket, and two inside of the vehicle. An onboard recording system recorded all six channels for later data reduction and analysis. Thermocouples were also placed in and near to fire to measure maximum temperatures.

G. DATA COLLECTION

All data were recorded on preprinted data collection sheets. One fixed and one roving video camera recorded all test activities. Still camera photographs were taken throughout the test series.

SECTION III
RESULTS AND CONCLUSIONS

A. GENERAL

1. Data Presentation. This section includes the test results and conclusions of the test. Table 2 includes relevant data from the 17 fire tests conducted. Paragraph B presents the firefighting performance parameters of the APC that are irrespective of the agent used. Paragraph C presents the firefighting performance of the individual agents tested and their interaction with the APC. Paragraph D is a comparison of the agent performance for the agents tested. Paragraph E addresses two alternate extinguishing methods that were evaluated during this test series. Paragraph F is a summary by Assessment Parameter of all agents tested with overall test conclusions contained in paragraph G.

2. APC Position and Wind Data. The fire trench, constructed in the AFESC Environmentally-Acceptable Live Fire Test Facility, was oriented in a north-south direction as shown in Figure 3. Wind direction is given in degrees relative to a magnetic compass, with 360 meaning that wind is from 360 degrees, or North, as shown in Figure 3. Wind Speed is given in statute miles per hour (mph). A wind speed of 10G18 means 10 mph gusting to 18 mph with L-V denoting "light and variable" winds. The APC position relative to the fire trench is also given in degrees magnetic. In the example shown in Figure 3, the APC is applying agent from a position of approximately 340 degrees.

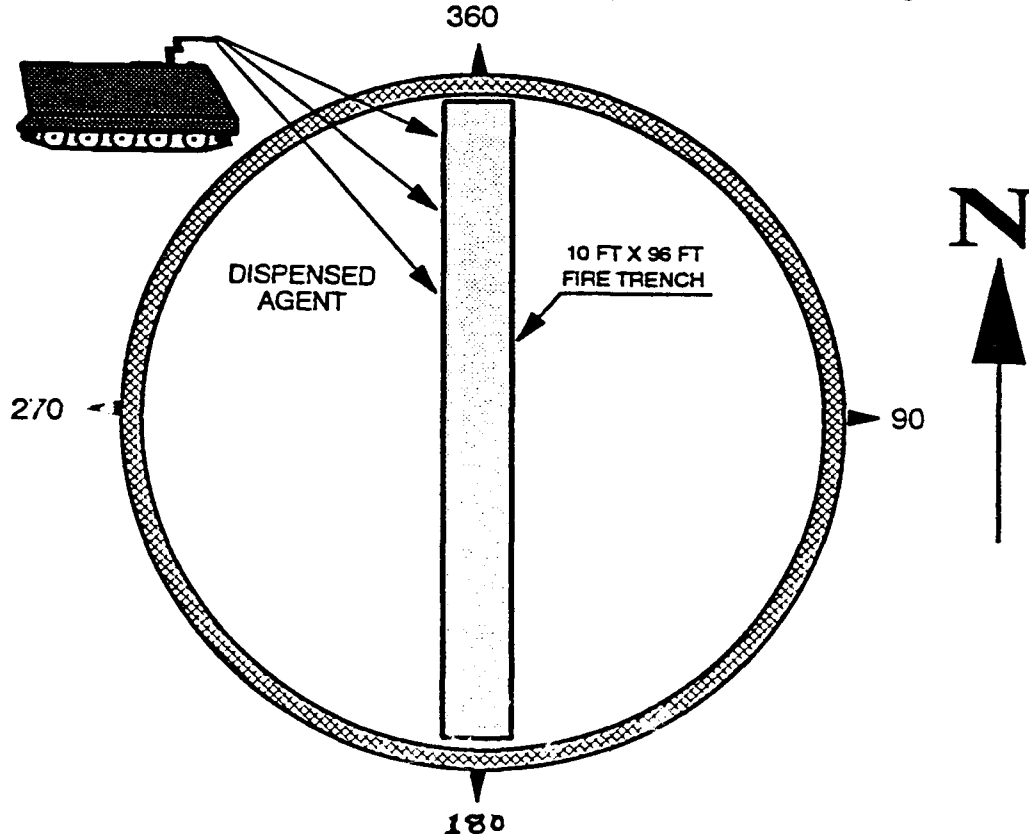

Figure 3. Fire Trench Orientation and APC Position

3. Test Data Presented in Table 2. Time data are local CDT. Agent flow rates were calculated by dividing the agent quantity used by the total dispensing time and are shown in gallons per minute (GPM). Some error exists in these rates as the total agent used was not accurately known for all tests, specifically the PVF agent where large, but unmeasured, quantities of undissolved agent remained in the APC tank after the test. The "% BURNING" column is an estimate of the percent of the trench that remained burning after all agent was expended. "EXT TIME" is the extinguishment time measured from the start of agent application until the trench was extinguished to the maximum extent obtained. "BURNBACK" time was measured from the end of agent application until the trench was fully engulfed in flames again or began burning out due to fuel exhaustion. "BURNBACK RATE" was calculated by dividing the number of feet that reignited by the time to achieve the reignition and is presented in feet per minute (ft/min). "APC MAX TEMPS" were the maximum temperatures recorded during a particular fire inside and outside of the APC.

4. Salt Water Origin and Analysis. Sea water was used as the carrier for all tested agents. Sea water for the test was taken from the Gulf of Mexico adjacent to Tyndall AFB, Florida. Water was transported from the gulf to the test site with a 5,000 gallon tank trailer. A water sample was tested at a local laboratory (The Water Spigot, Inc., Panama City, Fl) for salinity and PH factor. Following are the results of the laboratory analyses:

Salinity:	15.4 parts/thousand
pH factor:	8.0

B. APC FIREFIGHTING PERFORMANCE

1. Overall Capability. The modified APC has a maximum capacity of 250 gallons of agent and water. Using an effective agent, this quantity is adequate to extinguish a 10 foot wide trench fire 100 feet long and prevent burnback for approximately 5-6 minutes; wind being the variable factor. Using a system pressure of 200 psi, flow rates varied from 150 to 250 GPM but averaged 200 GPM. While the data shown in Table 2 would indicate the higher flow rates (250 GPM) were a result of using PVF agent, it should be noted that when using this agent, all of the agent in the tank was not expended. A considerable amount of residue remained in the tank at the conclusion of the PVF tests. Flow rate was calculated by dividing the total quantity of agent used by the total dispensing time. It was impossible to measure the quantity of the remaining solid PVF agent, and therefore the agent used. Disregarding these data, the anticipated average flow rate will be 200 GPM. Throw range also did not appear to be a function of agent type and averaged between 70 and 80 feet to the center of the foot print in a no-wind condition. A headwind will decrease this range.

2. Operator Visibility. The APC's closed circuit television system was inoperative for this test. During the first two tests conducted on 12 and 13 February, little or no agent was put on the fire. The APC operators were attempting to operate the vehicle from inside with all hatches closed. The visibility from inside the APC through the periscopes was restricted such that the monitor operator was unable to determine the location of the agent stream, resulting in not getting the stream on the fire during these early tests. The remaining fire tests were conducted with the hatch open and the operator's upper body above the vehicle while wearing a fire protection ensemble with hood. This is the recommended mode of operation.

3. Reservicing Procedures and Time Required - by Agent.

Reservicing procedures were observed, video taped, and timed throughout the test series for each agent. Three people were used for each reservicing operation.

a. AFFF, Pyrocap, Hurri-Safe, and Phirex. These four agents were essentially the same, as far the reservicing aspects are concerned. These agents are supplied in five-gallon plastic cans and mixed with water in ratios between six and fifteen percent, requiring from three to eight five-gallon cans for the 250 gallon capacity of the APC. The empty APC tank was filled with water (210 gallons for a 15 percent mixture or 235 gallons for a six percent mixture) and the agent poured into the tank from the five-gallon cans. A long-spout funnel was used to introduce the agent into the bottom of the tank to enhance mixing while impeding foaming action. After the agent was added, the tank contents were manually stirred for approximately one minute using a paddle approximately five feet long and the cap secured on top of the tank. The two nitrogen bottles were exchanged for full bottles with each reservicing. Using three people, the entire process took between 7.5 and 10 minutes, as a function of the number of cans of agent required.

b. Powdered Viscous Foam (PVF). The reservicing of this agent required minor modifications to the dispensing system. The agent manufacturer provided the necessary hardware and assisted with the system modification. The change required approximately two hours to complete. The agent was supplied as a white powder in one kilogram (2.2 pound) dissolvable plastic bags. A brown liquid activating agent was included in a separate compartment with each one kilogram agent bag. Each bag containing the white powdered agent and the activating agent in a separate compartment was further packaged in a non-dissolvable plastic bag. These plastic bags were shipped in five-gallon plastic buckets. To fully charge the 250 gallon APC tank, 100 of these PVF bags were required. The bags were opened and dropped into the APC tank one by one. The agent manufacturer accomplished this task and pierced each activator section of the bag with a pocket knife as he dropped the bags into the tank. When all 100 bags were placed in the tank the cap was replaced and water added through the monitor nozzle. The nitrogen bottles were replaced as in the previous tests. The process required 40 minutes. After the reservicing operation was completed, the APC was driven around the test area to mix the agent, at the request of the agent manufacturer. Also at the request of the agent manufacturer, the agent was allowed to stand for an additional 30 minutes to permit the agent/water mixture to fully react before beginning the next fire test. Including the manufacturer's required activation time, the entire reservicing time was one hour and 20 minutes. After the completion of the test the tank was opened to begin cleaning the system for the next test. Several large chunks of solid material and several undissolved plastic bags were found inside the tank. A vacuum truck and several flushing operations of the system with water were required to clean the system for the next test. This clean-out process required one hour and 30 minutes. Including this clean-out time, the recycle time for this agent was 2 hours and 50 minutes.

c. Acu-lite-F. This agent was mixed 50/50 with AFFF (6% type) in the APC tank. No water was used. Both the Acu-lite and the AFFF were supplied in 55 gallon drums. Drums were handled with a fork-lift and lifted

above the APC fill port to permit gravity feed of the agents into the APC tank. A two-inch hose was attached to the drums to facilitate pouring the agents into the APC tank. Nitrogen bottles were replaced as in the previous tests. The entire reservicing process required one hour and 11 minutes.

4. Temperatures Encountered.

a. Maximum APC Temperatures. Throughout the test series the APC was instrumented with six thermocouples and an on-board data recording system to measure and record the temperatures encountered during firefighting operations. Table 2, APC Test Data, includes these maximum temperatures for each fire test. The symbol "N/A" under the temperature columns indicates that temperatures were not recorded during that particular fire test. The maximum temperature encountered on the outside forward section of the APC (in front of the temperature shield blanket) was 129°F. The APC was positioned 25 feet upwind (wind blowing from behind the APC and towards the fire) of the fire. Wind velocity at the time was 7 gusting to 12 MPH. Maximum temperature encountered inside of the APC was 74°F. Ambient temperature at the time was 66°F. However, it should be noted that this 8°F increase in temperature existed before the fire. No measurable increase in interior temperature resulted from bringing the APC in close proximity with the fire.

b. Maximum Fire Temperatures. During four fires, high-temperature thermocouples were placed in and near the actual fire trench and connected to a data recording system. The maximum temperature recorded in the center of the flame was 2,100°F. Maximum temperatures in close proximity to the fire were as follows:

<u>Distance from edge of fire</u>	<u>Maximum Temp (°F)</u>
25	311
50	241
75	124

C. AGENT PERFORMANCE

Test data for all fire tests are contained in Table 2.

1. Pyrocap B-136.

a. Test Conditions

As called out in the test plan, three fires were initially conducted to evaluate this agent on 13 February 1991. Ambient temperatures were approximately 66°F with winds out of the south gusting 5-20 mph. The agent supplied had a bright green color and was mixed with sea water at a ratio of 15%. One hundred gallons of agent was prepared for the first two fires. However only 58 gallons was used during the second fire. For the third fire, 250 gallons was prepared (full APC tank). The first two fires burned 250 gallons of JP-4 each with 500 gallons being burned for the third fire. As specified by the agent manufacturer, a Task Force Tip H-V variable stream nozzle was used for all tests. Agent flow rate was approximately 200

TABLE 2. APC FIRE TEST DATA

TEST DATE	TEST NO.	AGENT NAME	AGENT MIX USED (gal)	MIX RATIO (%)	NOZZLE TYPE	FUEL QTY. (gal)	WIND DIR.	WIND SPEED (mph)	AMB. TEMP (deg F)	APC POS.	IGN TIME	AGENT DISPENSE		FLOW RATE (GPM)	% BURN-ING	EXT. TIME (sec)	BACK TIME (sec)	BURN RATE (ft/min)	APC MAX TEMPS		COMMENTS
												BEGIN	END						deg F	deg F	
2/12	1	3M AFFF	247	6	4	250	270	20	75	270	15:46:45	-----	N/A	100	N/A	N/A	N/A	N/A	80	74	No agent on fire - poor APC vis.
2/13	1	Pyrocop	100	15	1	250	200	5620	66	270	14:04:00	14:04:30	200	100	N/A	N/A	N/A	N/A	69	72	Little agent on fire - green agent
2/13	2	Pyrocop	58	15	1	250	180	5610	66	300	14:55:30	14:56:10	174	80	19	10	115.2	89	74	Partial path cleared - green agent	
2/13	3	Pyrocop	250	15	1	500	190	5610	68	140	16:04:13	16:04:50	150	80	90	20	57.6	N/A	N/A	green agent	
2/16	2	Pyrocop	250	10	2	500	30	2-4	44	360	10:56:00	10:56:43	208	30	125	55	73.3	111	53	Rapid burnback - red agent	
2/14	1	Hurri-Safe	100	6	1	250	330	5610	65	330	09:52:00	09:52:30	187	100	N/A	N/A	N/A	N/A	112	69	No extinguishment
2/14	2	Hurri-Safe	100	6	1	250	320	7612	66	330	10:39:45	10:40:18	162	90	32	15	38.4	129	73	Partial path cleared	
2/14	3	Hurri-Safe	250	6	1	500	330	7612	66	360	11:43:43	11:44:10	150	50	90	50	57.6	100	74	Partial path cleared	
2/15	1	PVF	250	Note 1	5	500	290	10622	57	290	10:02:21	10:03:09	246	100	N/A	N/A	N/A	N/A	N/A	N/A	No path or extinguishment
2/15	2	PVF	250	Note 1	6	500	310	10618	57	360	12:30:55	12:31:30	250	20	60	200	23.0	N/A	N/A	N/A	N/A
2/16	1	Phitrex	250	6	1	500	360	1-3	33	360	08:49:08	08:49:54	250	20	50	25	184.3	N/A	N/A	N/A	Rapid burnback
2/16	3	CO2/N2	Note 2	N/A	N/A	300	170	3	48	N/A	14:39:20	14:39:50	N/A	N/A	20	10	400	11.5	N/A	N/A	Rapid extinguishment
2/16	4	3M AFFF	100	6	3	300	90	5-7	50	360	Note 3	14:59:30	15:00:00	200	0	15	N/A	N/A	119	64	Fire ext - No burnback
2/16	5	3M AFFF	160	6	3	500	90	3-5	49	360	15:33:00	15:37:43	185	0	30	N/A	N/A	94	66	Fire ext - No burnback	
2/16	5a	3M AFFF	90	6	3	Note 4	90	3-5	49	90	15:48:00	15:53:30	216	80	20	250	4.6	94	66	Path opened in center of fire.	
2/16	6	Acu-lite	250	Note 5	3	500	0	L-V	40	360	18:08:34	18:10:20	188	30	80	240	16.8	N/A	N/A	N/A	Initially fire flared up.
2/22	1	3M AFFF	180	50	Note 6	500	110	5	60	180	09:26:13	09:26:50	270	0	12	600	8.6	N/A	N/A	N/A	Reignited for burnback test

* Note 1: Powered agent mixed 100 Kg to 220 gal water.
 * Note 2: Seven cardboard barrels filled with dry ice - 3 with N₂
 Agent released by initiating detonation-chord.
 * Note 3: Fire burning from previous CO2 fire test.
 300 gallons fuel added.
 * Note 4: Fuel added after Test 5 burnback and fire reattacked
 from the side to evaluate path cutting.
 * Note 5: Mixed agent (250 gal) consisted of 125 gal. Acuilite and
 125 gal. 3M AFFF (6% type), without water.
 * Note 6: P-4 bumper turret, with flow rate similar to APC (280 GPM)
 used for this test - Equipment change does not effect
 burnback time.

NOZZLES:
 1 Task Force Tip H-V Variable Stream
 2 Task Force Tip H-V Variable Stream - with 2' extension
 3 Task Force Tip F200
 4 Straight Pipe 40" x 2" diameter
 5 Straight Tip - 1" smooth bore nozzle
 6 Straight Tip - 1" smooth bore nozzle with 2' ext.

GPM. The APC was positioned beside the trench for these three fire tests with the wind approximately 90 degrees to the agent stream direction. Refer to APC position and wind data in Table 2 and the pit diagram in Figure 3 for detailed APC position and wind data.

After the first three fires were completed, Pyrocap representatives requested that they be permitted to supply more agent for one additional fire test to be conducted on 16 February. The request was granted by the government. Although Pyrocap personnel stated that all tested agents were the same, the agent supplied by Pyrocap for this test had a bright red color, as opposed to the green agent supplied for the first three Pyrocap tests. As directed by Pyrocap personnel, this agent was mixed with seawater at 10%, as opposed to the 15% mixture used on the previous Pyrocap tests. Conditions for this fourth test were light winds and a temperature of 44°F. In order to get the maximum amount of agent on the fire, this test was conducted with the APC positioned directly off the north end of the trench so that the agent stream could be applied directly to the trench. As in the third test, 250 gallons of agent was applied to the fire.

b. Agent Performance

During the first fire very little agent reached the fire. This was a result of limited visibility from the operator's position inside the APC. As a result, no extinguishment of the fire took place. The 100 gallons of agent on-board the APC was expended.

During the second fire 58 gallons of agent was applied to the center section of the fire trench. A partial path approximately 20 feet wide was opened. Extinguishment time was rapid, 19 seconds. However, burnback time was even more rapid. Agent application was ceased when the rapid extinguishment occurred to observe burnback characteristics. The path closed completely within 10 seconds.

During the third fire 250 gallons of agent was applied to the fire with a 20 foot path extinguished in approximately 90 seconds. Again, burnback was very rapid at about 20 seconds.

During the fourth Pyrocap fire test, conducted on 16 February 1991, fire extinguishment of 70% of the trench (30% remained burning) occurred in 125 seconds. Burnback time was again rapid at 55 seconds to 100% burnback.

The extinguishment time for this agent is slightly poorer than average. Its burnback suppression performance is very poor.

2. Hurri-Safe.

a. Test Conditions

Three fires were conducted to evaluate this agent on 14 February 1991. Ambient temperatures were approximately 66°F with winds out of the northwest gusting 5-12 mph. The agent was mixed with sea water at a ratio of 6%. One hundred gallons of agent was used for the first two fires with 250 gallons used for the third fire. The first two fires burned 250 gallons of JP-4 each with 500 gallons being burned for the third fire. As specified by the agent manufacturer, a Task Force Tip H-V variable stream nozzle was used

for all tests. Agent flow rate was approximately 175 GPM. The APC was positioned off the north end of the trench or slightly to the west of the north end with the wind blowing from behind the APC. Refer to APC position and wind data in Table 2 and the pit diagram in Figure 3 for detailed APC position and wind data.

b. Agent Performance

Although agent was applied to the fire, no extinguishment occurred during the first fire. As a result no burnback test was possible.

During the second fire, 10% of the trench was extinguished in 32 seconds. Burnback was very rapid and the trench was fully 100% burning again within 15 seconds.

During the third fire 250 gallons of agent was applied from the north end of the trench. Approximately 50% of the trench was extinguished in 90 seconds. Complete burnback occurred within 50 seconds.

Both extinguishing and burnback suppression performance for this agent is poor.

3. Powdered Viscous Foam (PVF).

a. Test Conditions

At the request of Atlantic Rim, Inc. personnel, two fires were conducted to evaluate this agent on 15 February 1991. Ambient temperatures were 57°F with winds out of the northwest gusting 10-22 mph. This powdered agent was mixed 220 pounds of agent to 220 gallons of seawater to produce 250 gallons of mixed agent. Two hundred and fifty gallons of agent were used for each fire. Both fires burned 500 gallons of JP-4 each. As specified by the agent manufacturer, a straight tip one inch smooth bore nozzle was used for all tests. A two foot extension was added between the monitor and the nozzle tip for the second fire to facilitate manual operation of the nozzle by Atlantic Rim personnel. Agent flow rate was approximately 250 GPM. This flow rate may be high as a considerable amount of sludge remained in the tank after each fire test. This unmeasured quantity of agent was not considered in the flow rate calculation. The APC was positioned on the west side of the trench with the wind blowing from directly behind the vehicle for the first test. During the second test the APC was positioned directly off the north end of the trench with the wind blowing from the northwest. Refer to APC position and wind data in Table 2 and the pit diagram in Figure 3 for detailed APC position and wind data.

b. Agent Performance

Although agent was applied to the fire, no extinguishment occurred during the first fire. As a result no burnback test was possible.

During the second fire, 80% of the trench was extinguished in 60 seconds. Burnback to a fully burning trench occurred in 200 seconds.

4. Phirex.

a. Test Conditions

At the request of the Navy, a single fire was conducted to evaluate this agent on 16 February 1991. Ambient temperature was 33°F with very light (1-3 mph) north winds. The agent was mixed with sea water at a ratio of 6%. Two hundred and fifty gallons of agent was used on a 500 gallon JP-4 fire. A Task Force Tip H-V variable stream nozzle was used for the test. Agent flow rate was approximately 250 GPM. The APC was positioned off the north end of the trench. Refer to APC position and wind data in Table 2 and the pit diagram in Figure 3 for detailed APC position and wind data.

b. Agent Performance

Agent was applied in two separate intervals. At the end of the original 20 second application the fire was extinguished to 50% of the full trench length. Extinguishment was rapid. However, burnback was very rapid, returning the trench to its 100% fully burning condition within 15 seconds. The remaining agent was applied in 50 seconds, extinguishing the the trench to 20% burning. Burnback was again rapid, returning the trench to 100% burning in 25 seconds. The extinguishment performance of this agent is very rapid, but its burnback suppression performance is practically non-existent.

5. Acu-lite.

a. Test Conditions

At the request of the the agent manufacturer, a single fire was conducted to evaluate this agent on 16 February 1991. Ambient temperature was 40°F with very light and variable winds. The agent was mixed 50/50 with AFFF concentrate (type 6%); 125 gallons of Acu-lite and 125 gallons of AFFF concentrate. No water was used. Two hundred and fifty gallons of agent was used on a 500 gallon JP-4 fire. A Task Force Tip F-200 nozzle was used for the test. Agent flow rate was approximately 190 GPM. The APC was positioned off the north end of the trench. Refer to APC position and wind data in Table 2 and the pit diagram in Figure 3 for detailed APC position and wind data.

b. Agent Performance

Agent was applied in two separate intervals. At the end of the original 80 second application the fire was extinguished to 30% of the full trench length. The fire burned back to 50% burning in 90 seconds. The remaining agent was applied in 10 seconds, returning the extinguishment to 30% burning. Burnback to 50% burning occurred in 90 seconds again. No further burnback occurred as fuel was exhausted. The extinguishment performance of this agent is fair. Its burnback suppression performance is also fair.

6. 3M AFFF (type 6%).

a. Test Conditions

As called out in the test plan, three fires were initially planned for the evaluation of this agent. One fire was conducted on 12 February 1991, three fires on 16 February 1991, and one fire to evaluate agent

performance when mixed at a 50% ratio with water was conducted on 22 February. Ambient temperatures were 75°F with west winds at 20 mph for the 12 February fire, 50°F and east winds at 3-7 mph for the three fires on 16 February, and 60°F and southeast winds at 5 mph for the 22 February fire. Standard 3M AFFF (type 6%) was mixed with sea water at 6% for the first four fires and 50% for the fifth fire. See Table 2 for agent and fuel quantities used for each fire. A 40 inch long by two inch diameter straight pipe nozzle was used for the 12 February test. A Task Force Tip F200 nozzle was used for the three fires conducted on 16 February. Agent flow rate was approximately 200 GPM. The APC was positioned on the north end of the trench for the first two tests on 16 February and east of the trench for the third 16 February test. Refer to APC position and wind data in Table 2 and the pit diagram in Figure 3 for detailed APC position and wind data.

The purpose of an additional AFFF test fire conducted on 22 February was to evaluate the firefighting and burnback suppression performance of AFFF when mixed at a 50% ratio with water. It was believed that this very rich mixture may provide significantly improved burnback resistance. The APC was not available on 22 February so a P-4 firefighting vehicle and its bumper turret were substituted. The flow rate of the P-4 bumper turret is approximately 280 GPM, only slightly higher than the APC system. The higher agent flow rate may have effected the extinguishment time but had no effect on burnback time, the parameter of primary concern. Two hundred and fifty gallons of premixed agent were placed in the empty main water tank of the P-4. The agent consisted of 125 gallons of water and 125 gallons of type 6% AFFF.

b. Agent Performance

During the 12 February fire no agent reached the fire. This was a result of limited visibility from the operator's position inside the APC. As a result, no extinguishment of the fire took place. The 247 gallons of agent on-board the APC was expended.

During the first fire conducted on 16 February the APC applied agent from the north end of the trench. The fire was totally extinguished in 15 seconds, consequently no burnback data were collected.

During the second fire on 16 February the APC also applied agent from the north end of the trench. The fire was totally extinguished in 30 seconds with no burnback test conducted.

During the third fire on 16 February the APC applied agent from the east side of the trench to the center section of the fire trench. A 20 foot wide path in the center of the trench was extinguished in 20 seconds. The time required for the path to burnback and close was 250 seconds, demonstrating excellent burnback suppression performance.

During Test conducted on 22 February the P-4, using its bumper turret and AFFF premixed at 50% was positioned on the south end of the trench and extinguished the entire pit in 12 seconds. The AFFF covered fuel was difficult to reignite, but reignition was eventually accomplished. After the trench was burning to 10% of its length, the burnback time was initiated. The time to burnback to 60% burning was 10 minutes. No additional burnback occurred as fuel was expended.

This agent, 6% AFFF, proved to be far superior to all other agents tests in both fire suppression time and burnback resistance. Mixing the agent at 50% with water was effective, but no more so than mixing at the prescribed 6% ratio. A comparison of agent performance parameters can be found in the following paragraph.

D. AGENT COMPARISONS

Agent reservicing times, extinguishment rates, and burnback times are shown on Table 3.

TABLE 3. AGENT COMPARISONS

AGENT	RECYCLE TIME (min)	EXTINGUISH RATE (ft/sec)	RELATIVE EXTINGUISH RATE	BURNBACK RATE (ft/min)	RELATIVE BURNBACK RATE
PYROCAP	7-10	0.59	0.13	82.0	12.42
HURRI-SAFE	7-10	0.27	0.06	48.0	7.27
PVF	170	0.64	0.14	23.0	3.48
PHIREX	7-10	1.54	0.33	184.3	27.92
ACU-LITE	70	0.84	0.18	16.8	2.55
AFFF	7-10	4.64	1.00	6.6	1.00

Times and rates are averages of all tests performed for that agent and are relative to that of AFFF. High extinguish rates and low burnback rates are desirable. As can be seen from this table, AFFF has the fastest extinguishing rate and the slowest burnback rate, by a considerable margin.

E. ALTERNATE EXTINGUISHING METHODS

1. P-19 Firefighting Vehicle.

After several of the agents tested failed to extinguish, or in some cases even a portion of, the fire, the standby P-19 firefighting vehicle was called in to complete the extinguishment. The P-19 was dispensing 3% AFFF metered through a modified precision, positive displacement, computer controlled, metering system through the roof turret. The roof turret flow rate is approximately 460 GPM. In every case, the P-19 extinguished the fire very rapidly (10-15 seconds). The P-19 used for this test, also had a prototype hardening system installed. This armoring kit will protect the vehicle and its occupants from a STANAG 2929 small munition fragment.

2. CO₂/N₂ Explosive Fire Suppression.

a. Test Conditions

At the request of the Office of the Assistant Secretary of Defense, an explosive fire suppression concept was evaluated in the same 10 by 96-foot trench as the APC tests. Seven 50 gallon cardboard barrels were evenly spaced in the northern 80 feet of the trench. The southern 15 feet of the trench were left open so that the fire would remain burning to facilitate burnback testing. Approximately 80 pounds of dry ice (frozen CO₂) were placed in each barrel. Liquid nitrogen (N₂) was placed over the dry ice in the

northern three barrels. The top and bottom of each barrel were previously equipped with 5 turn spirals of detonation chord connected together. The seven barrels were also connected with det chord which was brought to the end of the trench and connected to a detonation device. After the barrels were filled with dry ice and liquid nitrogen, as specified above, and the barrel lids replaced, the trench was filled with 300 gallons of JP-4 and ignited. After a 30 second burn the det chord was initiated. The theory was that the explosion would blow the fire out and the CO₂ pellets and liquid N₂ would suppress burnback. Ambient temperature was 48°F with very light (1-3 mph) south winds.

b. Fire Suppression Performance

All personnel were cleared from the immediate area. The fire was ignited and 30 seconds later, the detonation chord was initiated. The explosive blast immediately blew out the fire in the northern 80% of the trench. The southern 20% of the trench remained burning, as anticipated. The dry ice pellets remained in the fuel emitting CO₂, suppressing burnback. The time required to burnback to 100% burning was 400 seconds.

F. SUMMARY BY ASSESSMENT PARAMETER

The overall system evaluation was based on the following assessment parameters. These 20 parameters, along with the overall assessment for each, are listed below in descending order of importance.

1. Fire-Out Time. This parameter is a measure of the agent's capability to extinguish the fire and is measured from the beginning of agent application to the time that a predetermined portion of the fire has been extinguished. For comparative purposes, Fire extinguishment rates were calculated to give extinguishment in feet per second. AFFF was superior to all agents tested.

2. Reflash Resistance. This parameter is also called burnback time or burnback rate and is a measure of the firefighting agent's capability to prevent an extinguished fire from reigniting from an adjacent ignition source. For comparative purposes burnback rates were calculated to give burnback in feet per minute. AFFF was superior to all agents tested.

3. Toxicity - Neat Agent. This parameter was not a discriminator.

4. Heat Prostration. This was determined to be no factor in the operation of the system. In fighting 16 trench fires with the APC coming within 20 feet of the fire, the maximum temperatures encountered on the outside and inside of the vehicle, respectively, were 129°F and 74°F. A firefighters ensemble and hood will easily protect the operator from this external temperature with his upper body above the vehicle.

5. Oxygen Depravation. Due to the very limited heat build-up in and around the APC, this parameter was found to be no factor in the operation of the APC in this scenario.

6. Salt Water Requirements. All assessed/demonstrated agents appeared to be soluble in salt water. Solution composition for the agents tested varied from 6-15% agent concentrate with sea water.

7. Agent to Equipment Interface. Each agent was designed to interface with current standard firefighting equipment, with the exception that PVF required an alteration of the existing plumbing in an effort to mix the powdered agent and reduce flow restrictions. This requirement remains questionable.

8. Equipment to Vehicle Interface. Equipment to vehicle interface displayed full compatibility.

9. Force Structure Impact. This parameter was not a discriminator.

10. Throw Capability. This parameter was not a discriminator when assessing the agents under review, as it was not agent dependent. It was evaluated under APC system performance. Agent throw range for the modified APC as 70-80 feet.

11. Pyrolysis Products. This parameter was not a discriminator.

12. Neat Agent Handling. Hurri-Safe, Pyrocap, and Phirex were easily handled; no different than AFFF. However, PVF, with no clear or apparent handling and mixing instructions, appeared to be a "mix and check" procedure. Acu-lite required additional handling due to the large quantity of agent required. Acu-lite was mixed 50/50 with AFFF concentrate. With no water being used, handling 250 gallons of agent in 55 gallon barrels posed additional handling difficulties and time.

13. External Visual Acuity. This parameter was not a discriminator when assessing the agents under review, as it was not agent dependent. It was evaluated under APC system performance. Visibility from inside the APC was difficult at best. Operation of the system from the open vehicle commanders hatch corrected this problem. By wearing firefighter's ensemble and hood the otherwise exposed operator is protected from the fire.

14. Agent Availability/Production Base. With the exception of AFFF, the agents are supported by a production base. Hurri-Safe's agent is viewed as low risk, since a warm corporate production base exists for other product lines. Pyrocap is viewed as slightly higher risk; with ARI's agent being the highest risk of all. None of the agents appear to require strategic materials; however, the cryogenic manufacturing process associated with ARI is the most restrictive from both the technical and proprietary aspects.

15. Dispensing Equipment Availability/Production Base. This parameter was not a discriminator when assessing the agents, however it was evaluated with the overall system. The dispensing equipment is an assortment of commercial non-development items (NDI). There are no formal Technical Data Packages (TDP) or Technical Manuals (TM) available. However, a small quantity of systems could be assembled within 2-3 weeks without a formal TDP. If the system is adopted, the development of a formal competitive TDP will be required.

16. Training Requirements. This parameter was not a discriminator.

17. Agent Data - Material Safety Data Sheet (MSDS). This parameter was not a discriminator.

18. Handling Residue. The ARI agent, PVF, was the only agent that posed any problems with residue handling. It required special equipment and special handling after each use. This agent fouled all components of the extinguishing system and the delivery vehicle. The other agents tested, presented no additional residue handling problems as compared to AFFF.

19. RAM-D. The RAM-D of the dispensing equipment is viewed as the same for all agents except the PVF agent. In this case, the issue of residue or precipitate clogging or degrading the performance of the dispensing equipment (monitor, relief valve, control valve, and nozzle) is an issue which increases the operational risk when this agent is used.

20. Cost - (Agent and Equipment). AFFF was the lowest priced agent at \$75/250 gallon tankfull of mixed agent. Hurri-Safe was \$1,250/tankfull and Pyrocap was \$900/tankfull. ARI's agent, PVF was \$35,000/tankfull. Other agents tested were provided by their agent manufactures at no cost to the government and no cost data are available.

G. CONCLUSIONS

1. The M113A2 APC, configured with the firefighting kit, as tested in this report, showed that large tactical fires can be successfully suppressed.

2. The standard military firefighting agent, Aqueous Film Forming Foam (AFFF), (MIL-F-24835C) was found to be superior to all other tested agents in extinguishing and suppressing tactical fires.

3. This system, as configured, is not only applicable to ordnance fire suppression, but (after enemy attack) it may also be used for getting firefighting equipment to off-road or debris-strewn areas that are inaccessible to standard firefighting vehicles. For example: cratered debris-strewn runways, large POL or ammunition depots, off-road aircraft crash sites, and other emergency sites inaccessible to standard wheeled firefighting vehicles. Natural disasters, such as earthquakes, hurricanes, and tornadoes are also applications for this all-terrain firefighting vehicle. A firefighting system equipped M113A2 APC can meet these exigencies.

APPENDIX A

PHOTOGRAPHS OF TYPICAL FIRE TEST OPERATIONS

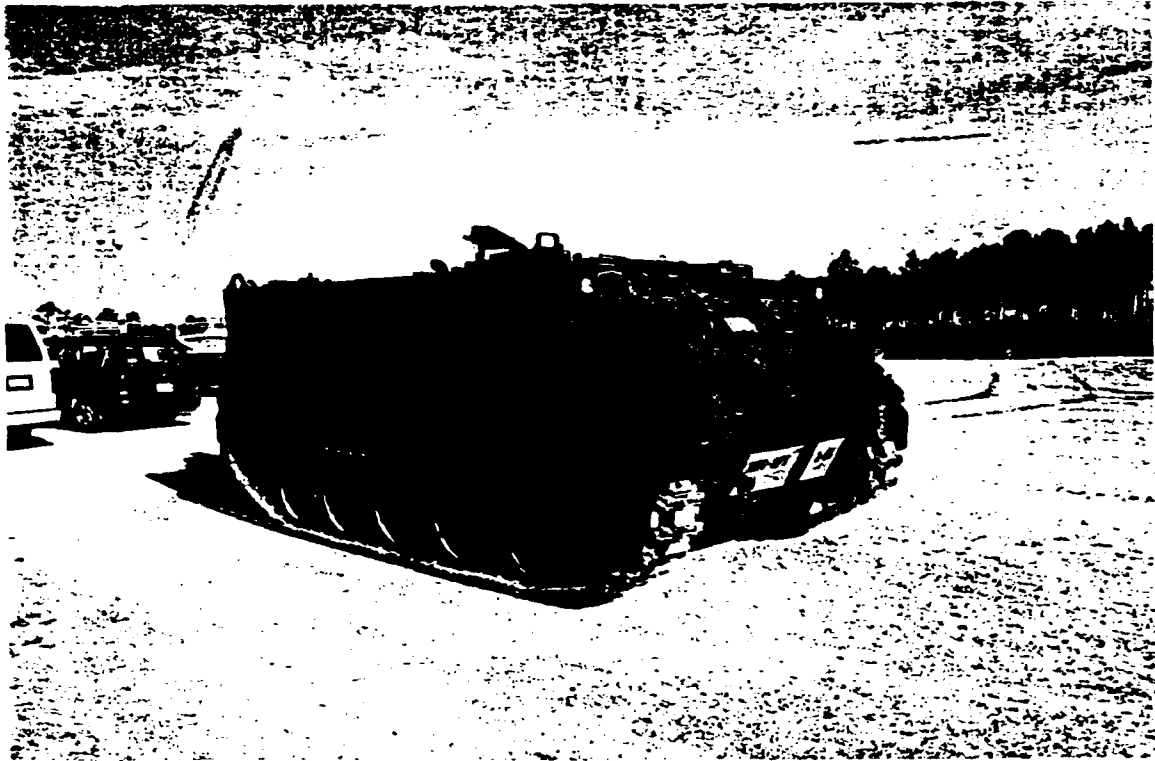

Figure A-1. Typical M113A2 Armored Personnel Carrier APC)

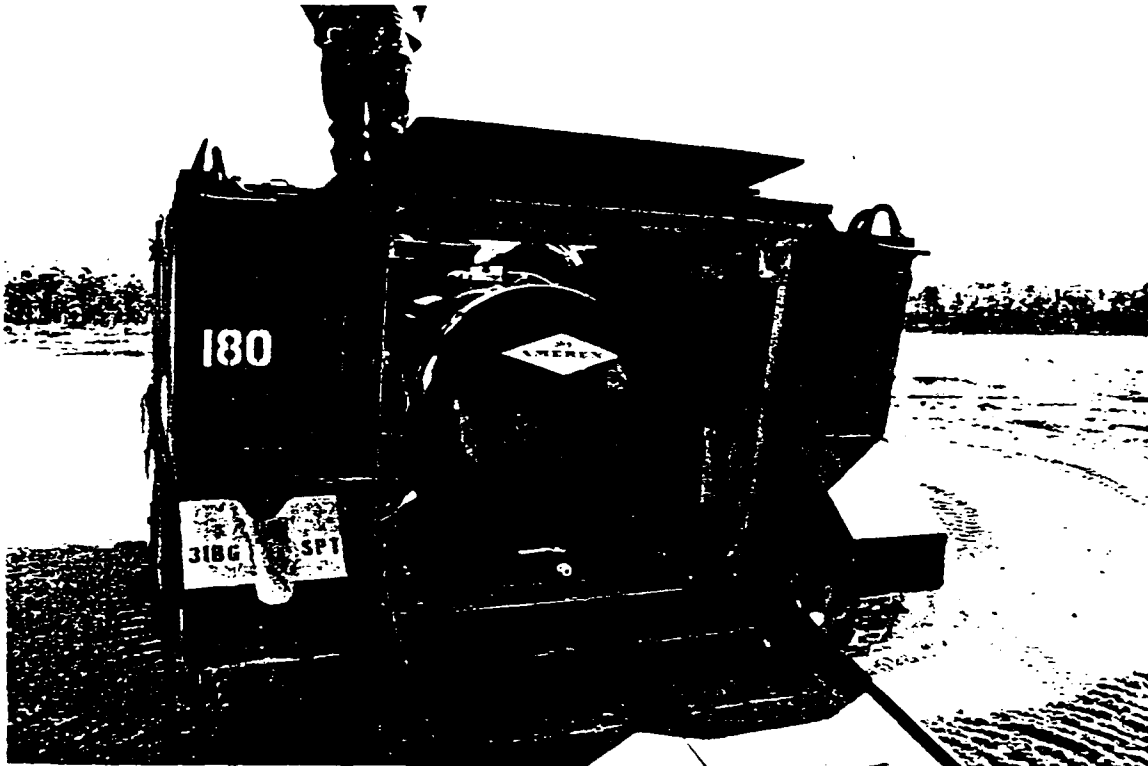

Figure A-2. M113A2 with Fire Suppression System Installed



Figure A-3. Pre-fire Trench Set-up



Figure A-4. Typical Fire Test with APC Set-up



Figure A-5. APC Applying Agent to Fire



Figure A-6. Fire trench Showing Burnback

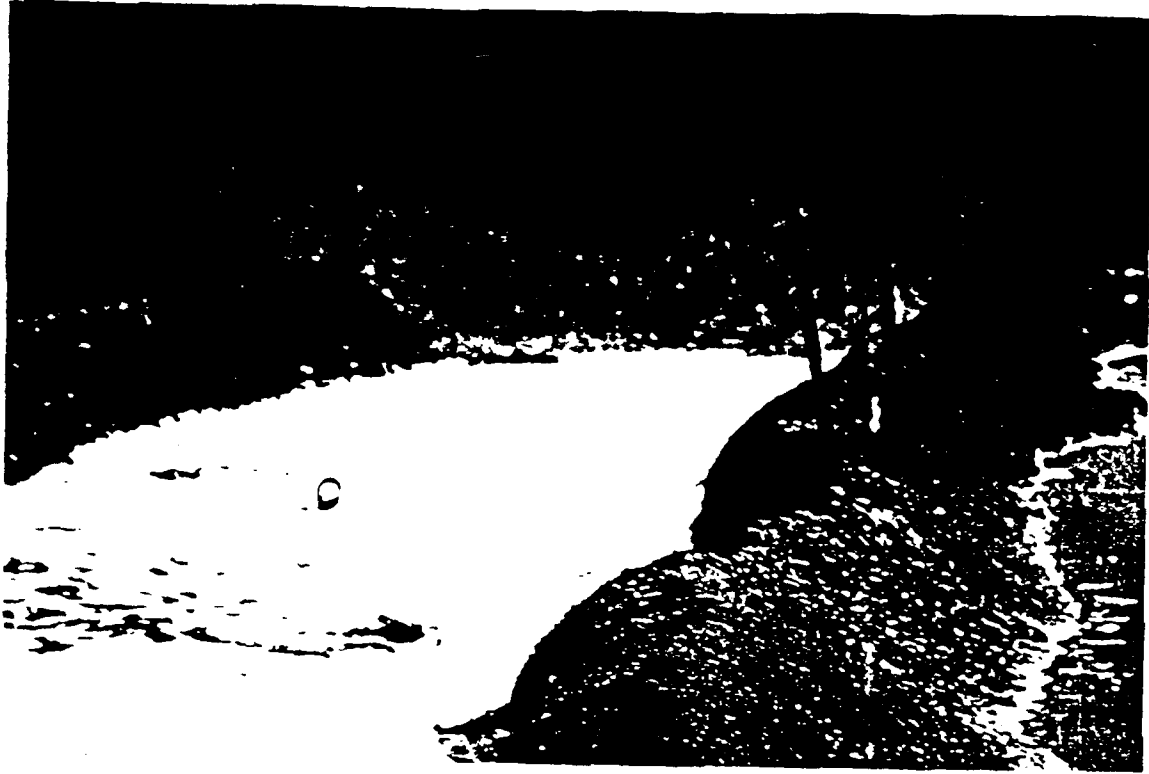

Figure A-7. Fire with Path in Center Extinguished



Figure A-8. Fire Trench After Total Extinguishment

APPENDIX B
MATERIAL SAFETY DATA SHEETS (MSDS)

Pyrocap, Inc.

MATERIAL SAFETY DATA SHEET

SECTION I	
MANUFACTURER'S NAME	Pyrocap, Inc.
ADDRESS	6551 Loisdale Ct, Suite 400, Springfield, VA 22150
EMERGENCY TELEPHONE NUMBER	(703) 922-9800 8a-5p EST. Mon-Fri except holidays
INFORMATION TELEPHONE NUMBER	(703) 522-9800 8a-5p EST. Mon-Fri except holidays
CHEMICAL NAME AND SYNONYMS	Fire Suppressant-Chemical
TRADE NAME AND SYNONYMS	Pyrocap B-126 and Pyrocap A-500
CHEMICAL FAMILY	Surfactant
FORMULA	

SECTION II - HAZARDOUS INGREDIENTS				
HAZARDOUS COMPONENTS	OSHA PEL	ACGM TLV	Other Limits Recommended	% (approx)
None				

SECTION III - PHYSICAL CHEMICAL CHARACTERISTICS			
BOILING POINT (°F)	>500	SPECIFIC GRAVITY (H ₂ O = 1)	1.03
VAPOR PRESSURE (mm Hg.)	-	PERCENT VOLATILE BY VOLUME (%)	30.15
VAPOR DENSITY (AIR = 1)	1	EVAPORATION RATE (Butyl Acetate = 1)	N/A
SOLUBILITY IN WATER	100%	MELTING POINT	-10°C
APPEARANCE AND ODOR	Viscose Liquid, Red, Mildly Pleasant Odor		

SECTION IV - FIRE AND EXPLOSION HAZARD DATA				
FLASH POINT (Method Used)	Unknown	FLAMMABLE LIMITS	N/A	CEL: N/A UEL: N/A
EXTINGUISHING MEDIA	N/A			
SPECIAL FIRE FIGHTING PROCEDURES	N/A			
UNUSUAL FIRE AND EXPLOSION HAZARDS	Unknown			

MATERIAL SAFETY DATA SHEET

SECTION V - REACTIVITY DATA			
STABILITY	UNSTABLE		CONDITIONS TO AVOID: None known
	STABLE	X	
(INCOMPATIBILITY (Materials to avoid))		Strong oxidizing agents	
HAZARDOUS DECOMPOSITION OR BYPRODUCTS		None known	
HAZARDOUS POLYMERIZATION	MAY OCCUR		CONDITIONS TO AVOID: None known
	WILL NOT OCCUR	X	

SECTION VI - HEALTH HAZARD DATA				
ROUTE(S) OF ENTRY		INHALATION? None known	SKIN? None known	INGESTION? None known
HEALTH HAZARDS (Acute and Chronic)		Will cause irritation if concentrated product comes in contact with eye		
EMERGENCY AND FIRST AID PROCEDURES		In case of contact with eyes, immediately flush eyes with copious amounts of water. If irritation persists, call a physician.		
CARCINOGENICITY:	NTP? No	IARC MONOGRAPHS? No	OSHA REGULATED? No	
SIGNS AND SYMPTOMS OF EXPOSURE		Irritation (burning/itching) of the eyes		
MEDICAL CONDITIONS GENERALLY AGGRAVATED BY EXPOSURE		None known		

SECTION VII - PRECAUTIONS FOR SAFE HANDLING AND USE	
STEPS TO BE TAKEN IN CASE MATERIAL IS RELEASED OR SPILLED	Larger amounts (more than 5 gallons) may be mopped up. Smaller amounts may be flushed away with water.
WASTE DISPOSAL METHOD	May be flushed to sewer if local ordinances do not prohibit such disposal of biodegradable detergent materials.
PRECAUTIONS TO BE TAKEN IN HANDLING AND STORING	None required
OTHER PRECAUTIONS	None

SECTION VIII - CONTROL MEASURES			
RESPIRATORY PROTECTION (Specify type)		None	
VENTILATION	LOCAL EXHAUST	None	SPECIAL
	MECHANICAL (General)	None	OTHER
PROTECTIVE GLOVES	Not normally required	EYE PROTECTION	Avoid contact
OTHER PROTECTIVE CLOTHING OR EQUIPMENT		None	
WORK/HYGIENIC PRACTICES		No special practices required	



Safer Products for a Safer World

FIRE KNIFE

FIRE KNIFE IS A FULLY AQUEOUS FORMULATION THAT FORMS AS TRUE A SOLUTION AS IS POSSIBLE.

FIRE KNIFE, WHEN USED WITH THE PROPER FAN NOZZLE, CREATES A SHEETING EFFECT THAT SEPARATES THE HEAT OF THE BURNING GASSES FROM THE POTENTIAL FUEL SOURCE THUS PREVENTING PYROLYSIS (DECOMPOSITION BY HEAT). FIRE KNIFE THUS COOLS THE SURFACE AND ELIMINATES THE DANGER OF RE-IGNITION. THESE BENEFITS ARE IMMEDIATE.

FIRE KNIFE IS MUCH LESS AFFECTED BY WIND, FROM ANY DIRECTION, THAN ANY FOAM TYPE EXTINGUISHING AGENT.

FIRE KNIFE WAS FORMULATED AS AN ALTERNATIVE AND REPLACEMENT FOR FIRE FIGHTING AGENTS THAT EMIT CHLOROFLOROCARBONS.

FIRE KNIFE IS NON-HAZARDOUS, HAS NO HARMFUL FUMES, IS COMPLETELY BIODEGRADABLE AND MAY BE DILUTED WITH EITHER FRESH WATER OR SEA WATER.

SPECIFICATIONS

pH.....	7-8
SOLUBILITY IN WATER.....	100%
SOLUBILITY IN SEA WATER.....	100%
BIODEGRADABILITY.....	100%
TOXICITY.....	NON-TOXIC NO HARMFUL FUMES
BOILING POINT.....	212 F
SPECIFIC GRAVITY.....	1.01
VOC'S.....	0

HURRI K 31 CORP.

DIVISION RES. INC.

6000 SOUTHERN INDUSTRIAL DRIVE • BIRMINGHAM, ALABAMA 35235 • TELEPHONE: 205-655-8808

**HURRI
SAFE**

Safer Products for a Safer World

FIRE KNIFE

FIRE KNIFE IS FORMULATED, FOR EASE OF COMPUTATION, AS A 20% SOLUTION. IT IS ESTIMATED THAT A 1% SOLUTION IS OPTIMUM WHEN DILUTING WITH FRESH WATER; AND INCREASES UP TO 3% WHEN DILUTING WITH SALT WATER DEPENDING UPON THE SALINITY.

MIXING: FIRE KNIFE IS FORMULATED TO BE PREMIXED TO THE DESIRED DILUTION BEFORE BEING LOADED IN THE TANK; IT IS NOT TO BE USED WITH A PROPORTIONER.

THE FOLLOWING DILUTIONS ARE GIVEN FOR 100 GALLONS OF DILUTED FIRE KNIFE:

- 1%= 5-GALLONS OF FIRE KNIFE WITH 95 GALLONS OF WATER
- 2%= 5-GALLONS OF FIRE KNIFE WITH 45 GALLONS OF WATER
- 3%= 5-GALLONS OF FIRE KNIFE WITH 28.3 GALLONS OF WATER
- 4%= 5-GALLONS OF FIRE KNIFE WITH 20 GALLONS OF WATER

APPLICATION: FIRE KNIFE IS NOT A FOAM AND SHOULD NOT BE AERATED OR USED WITH FOAM GENERATING EQUIPMENT. THE NOZZLE USED FOR APPLYING FIRE KNIFE SHOULD BE A SHEET NOZZLE OF APPROXIMATELY 20 DEGREE SPREAD. IT IS BEST APPLIED AT THE BASE OF THE FLAME WITH GOOD FORCE, SO AS TO SEPARATE THE FLAME FROM THE BURNING MATERIAL ALLOWING THE FLAME AND THE HEAT OF COMBUSTION TO CONTINUE RISING WITHOUT FURTHER HEATING OF THE FUEL. IT THEN OPERATES TO ALLOW COOLING OF THE MATERIAL AT THE SAME TIME CUTTING OFF OXYGEN.

THE POINT OF IMPACT SHOULD BE CONTINUOUSLY SHIFTED AS THE FIRE IS SEPARATED FROM THE FUEL. FIRST, ACROSS THE BASE AND THEN ADVANCED FORWARD ACROSS A HORIZONTAL SURFACE OR UP ACROSS ANY COMBUSTIBLE VERTICAL SURFACE. HOSE HANDLERS SHOULD ADVANCE AS APPROPRIATE TO KEEP FIRE KNIFE IMPINGING WITH GOOD FORCE AT THE BASE OF THE FLAME. GOOD SEPARATION ACTION WITHOUT EXCESSIVE SPLATTERING IS THE OBJECTIVE. THE ANGLE OF ATTACK DOES NOT DEPEND UPON THE WIND.

CLEAN UP: FIRE KNIFE IS NON-CORROSIVE AND HENCE EQUIPMENT CAN BE STOWED AFTER EXCESS SOLUTION HAS BEEN DRAINED.

HURRI | 32 | V CORP.
DIVISIC TRIES INC.

6000 SOUTHERN INDUSTRIAL DRIVE • BIRMINGHAM, ALABAMA 35235 • TELEPHONE: 205-655-8808

HURRI KLEEN CORP.
SUBSIDIARY OF SELF INDUSTRIES, INC.

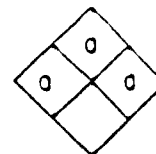

10 SOUTHERN INDUSTRIAL DRIVE
MINGHAM, ALABAMA 35225
PHONE: 205-655-8808 • FAX: 205-655-3288

MATERIAL SAFETY DATA SHEET
I. IDENTIFICATION

PRODUCT NAME: FIRE KNIFE

SYMBOLIC NAME: Aqueous Formula

DATE PREPARED: 2-1-91

STATEMENT OF
TRANSPORTATION

HAZARD CLASSIFICATION: NONE
SHIPMENT NAME: CLASS 55

II. PHYSICAL DATA

MELTING POINT, (F°)	212 F	VAPOR PRESSURE AT 20°C	NON-VOLATILE
SPECIFIC GRAVITY (H ₂ O=1)	1.01	WATER SOLUBILITY	100%
RELATIVE DENSITY (air=1)	NON-VOLATILE	DENSITY	Not Established
PERCENT VOLATILE BY VOLUME (%)	NON-VOLATILE	EVAPORATION RATE WATER=1	N/A
pH of concentrate)	7-8 pH	VOC'S (%)	NONE
APPEARANCE AND ODOR	AMBER LIQUID, CONTAINING SLIGHT BUT NOT OFFENSIVE ODOR		

III. INGREDIENTS

INGREDIENT	%	OSHA PEL	TLV (units)	HAZARD
THIS FORMULA CONTAINS NO HAZARDOUS CHEMICALS AS LISTED IN SARA, SECTION 3, 313, and 309.				
1	N/A	N/A	N/A	N/A
2	N/A	N/A	N/A	N/A
3	N/A	N/A	N/A	N/A

IV. FIRE AND EXPLOSION HAZARD DATA

FLASH POINT (test method)	NONE	FLAMMABLE LIMITS	NONE	LOWER NONE	UPPER NONE
EXTINGUISHING MEDIA	N/A				
SPECIAL FIRE FIGHTING PROCEDURES	N/A				
SPECIAL FIRE AND EXPLOSION HAZARDS	N/A				

V. HEALTH HAZARD DATA

IRITATION SOURCE	N/A
ACUTE EFFECTS OF EXPOSURE	N/A
SKIN CONTACT	N/A
RESPIRATION	N/A
EYE CONTACT	Slight irritation may be exhibited
CHRONIC EFFECTS OF REPEATED EXPOSURE	NONE
ADDITIONAL HEALTH HAZARDS	NONE

EMERGENCY AND FIRST AID PROCEDURES

ALLOWING	Induce vomiting by placing finger to throat or use ipecas.
Y	N/A
ALATION	N/A
Rinse with water for 15 minutes, if irritation occurs.	
ES TO SICIAN	This is relatively innocuous substance not expected to cause harm. Should treatment ever be required, it would be directed at control of symptoms.

VI. REACTIVITY DATA

STABILITY	STABLE: YES	UNSTABLE:	CONDITIONS TO AVOID:	N/A
COMPATIBILITY	N/A			
HAZARDOUS COMBUSTION OR DECOMPOSITION PRODUCTS	Under high temperatures, slight ammoniacal gas may evolve			
HAZARDOUS POLYMERIZATION	MAY OCCUR	WILL NOT OCCUR XXXXXX	CONDITIONS TO AVOID:	N/A

VII. SPILL OR LEAK PROCEDURES

ACTIONS TO BE TAKEN IF MATERIAL IS SPILLED	SMALL SPILLS: FLUSH WITH WATER LARGE SPILLS: ABSORB WITH SAWDUST, SAND OR EARTH.
WASTE DISPOSAL METHOD	May be disposed of in sewer system. Consult local state, county or Federal regulations for applicable laws pertaining to your areas.

VIII. SPECIAL PROTECTION INFORMATION

LABORATORY PROTECTION (type)	None
RELATION	N/A
PROTECTIVE GLOVES	N/A
PROTECTION	If splashing is expected use goggles
OTHER PROTECTIVE EQUIPMENT	N/A

IX. SPECIAL PRECAUTIONS

ACTIONS TO BE TAKEN IN HANDLING AND STORING	Keep container closed. Store in dry area
OTHER PRECAUTIONS	None



ATLANTIC RIM, Inc.
P.O. Box 3191
Manassas, VA 22110
(703) 368-4024
(703) 631-4217 FAX

MATERIAL SAFETY DATA SHEET

Product Name: POWDERED VISCOUS FOAM DS

Manufacturer:
Atlantic Rim, Inc.
P.O. Box 3191
Manassas, VA 22110
Effective Date: January 1991

Sales & Emergency Information
(703) 368-4024
(703) 631-4217

Section I: General Information

Product Number: 704-1
Product Class: Class B Fire Extinguishing Concentrate
DOT Category: Non-hazardous

Section II: Hazardous Ingredients

There are no ingredients classed as hazardous in 29 CFR 1910.120 (OSHA), or Threshold Limit Value (TLV)'s for Chemical Substances and Physical Agents in the Work Environment, American Conference of Governmental and Industrial Hygienists, or the National Toxicology Program (NTP), Annual Report on Carcinogens, or the International Agency for Research on Cancer Monographs.

Section III: Physical & Chemical Characteristics

This product is used in prepackaged, water soluble bags. Each bag is preweighed and contains activators that produce fire-fighting liquid when added to water. When used as recommended, personnel are never exposed to the contents of the sealed bags.

Boiling Point:	Not Applicable
Percent (%) Volatile by Weight:	< 1%
Evaporation Rate:	Not Applicable
Vapor Density:	Not Applicable

Section IV: Fire & Explosion Hazard Data

Flash Point:	Not Applicable
Explosive Limits:	Not Applicable
Extinguishing Media:	Not Applicable
Special Firefighting Procedures:	Not Flammable
Unusual Fire & Explosion Hazards:	None

Section V: Reactivity Data

Stability: Stable in closed container

Incompatibility: None known

Hazardous polymerization: Will not occur

Hazardous Decomposition Products: Carbon dioxide (closed chambers), Ammonia

Section VI: Health Hazard Data

In the event that an individual comes into contact with the contents of a bag (after an accident, or act of war) the following steps are recommended:

Effects of overexposure emergency and First Aid Procedures:

Eyes: Flush eyes immediately with copious quantities of water

Skin: Flush with water.

Inhalation: Avoid breathing mist.

Ingestion: If swallowed consult a physician immediately. Although powdered ingredients are non-toxic allergic reactions may occur.

Chronic Effects: None known.

Carcinogen: No ingredient of this product is considered a carcinogen by OSHA, NTP or IARC.

Section VII: Spill, Leak and Disposal Procedures

Recover material in accordance with all applicable Federal, State and Local regulations. Uncontaminated absorbent may be disposed of in an authorized landfill in accordance with Federal, State and Local regulations.

Section VIII: Protective Measures

It is recommended use the sealed, water soluble bags are used without opening. If there is an accidental or intentional destruction of bag integrity, the following measures are sufficient for protecting clean-up personnel.

Eye Protection: Wear goggles when product is carried by the wind.

Gloves: Wear gloves or wash skin after contact with the product.

Respiratory: Avoid breathing dust.

Ventilation: Not Applicable.

Other Protective Equipment: Wear protective clothing when involved with prolonged contact.

Section IX: Special Precautions

Handling & Storage: Store cartons of bags of PVF-DS in accordance with good industrial hygiene and safety practices.

Rev. 1/91

3M General Offices
 3M Center
 St. Paul, Minnesota 55144-1000
 612/733-1110
 Duns No.: 00-617-3082

00-16
 1944

MATERIAL SAFETY
 DATA SHEET



DIVISION: INDUSTRIAL CHEMICAL PRODUCTS DIVISION

TRADE NAME:

FC-206CE LIGHT WATER Brand Aqueous Film Forming Foam
 SM I.D. NUMBER: ZF-0002-0138-2 ZF-0002-0168-9 ZF-0002-4662-7 ZF-0002-4663-5
 98-0211-1393-5 98-0211-1417-2 98-0211-1501-3 98-0211-1502-1
 98-0211-4829-5 98-0211-4830-3

ISSUED: DECEMBER 20, 1990
 SUPERSEDES: NOVEMBER 29, 1989
 DOCUMENT: 10-3020-7

1. INGREDIENT	C.A.S. NO.	PERCENT	EXPOSURE		LIMITS TYPE #
			VALUE	UNIT	
Water	7732-18-5	76.0	NONE	NONE	NONE 1
Ethanol,2-(2-butoxyethoxy)- Fluoroalkyl Surfactants +(5131P, 5143P)	112-34-5 TS	15.0 < 5.0	35	ppm	TWA C NONE 1
Synthetic Detergents +(5155P, 5038P, 5167P)	TS	< 5.0	NONE	NONE	NONE 1
Urea	57-13-6	4.0	NONE	NONE	NONE 1
1H-Benzotriazole,methyl-	29385-43-1	< 0.1	NONE	NONE	NONE 1

SOURCE OF EXPOSURE LIMIT DATA:

- CMRG: Chemical Manufacture Recommended Guidelines
- NONE: None Established

NOTE: New Jersey Trade Secret Registry (EIN) 04499600-4

THIS PRODUCT CONTAINS THE FOLLOWING TOXIC CHEMICAL OR CHEMICALS SUBJECT TO THE REPORTING REQUIREMENTS OF SECTION 313 OF TITLE III OF THE SUPERFUND AMENDMENTS AND REAUTHORIZATION ACT OF 1986 AND 40 CFR PART 372:

Ethanol,2-(2-butoxyethoxy)-

2. PHYSICAL DATA

BOILING POINT:..... ca. 100.00 C
 (Initial)
 VAPOR PRESSURE:..... ca. 30.4000 mmHg
 Calc. @ R.T.
 VAPOR DENSITY: ca. 0.62 Air = 1
 Calc. @ R.T.
 EVAPORATION RATE:..... < 1.00 Butyl Acetate = 1
 SOLUBILITY IN WATER: Miscible
 SP. GRAVITY:..... ca. 1.030 Water = 1
 PERCENT VOLATILE: ca. 90.00 %
 VOLATILE ORGANICS: N/D
 pH: ca. 7.50-8.50
 VISCOSITY: N/D
 APPEARANCE AND ODOR: Clear, amber colored liquid.

3. FIRE AND EXPLOSION HAZARD DATA

FLASH POINT:..... None (Setflash CC)
 FLAMMABLE LIMITS - LEL: N/A
 FLAMMABLE LIMITS - UEL: N/A
 AUTOIGNITION TEMPERATURE: ... N/D
 EXTINGUISHING MEDIA:
 FC-206CE is a fire extinguishing agent.

Abbreviations: N/D - Not Determined N/A - Not Applicable

3M General Offices
3M Center
St. Paul, Minnesota 55144-1000
612/733-1110
Duns No.: 00-617-3082

00-16
1945

MATERIAL SAFETY
DATA SHEET

3M

MSDS: FC-206CE LIGHT WATER Brand Aqueous Film Forming Foam
DECEMBER 20, 1990

PAGE: 2 of 3

3. FIRE AND EXPLOSION HAZARD DATA (continued)

SPECIAL FIRE FIGHTING PROCEDURES:

Full protective clothing including self-contained breathing apparatus, coat, pants, gloves, boots, and bands around legs, arms and waist should be provided. No skin surface should be exposed.

UNUSUAL FIRE AND EXPLOSION HAZARDS:

Toxic by-products, including small amounts of HF, may be formed. See Section 4.

NFPA-HAZARD-CODES: HEALTH 3 FIRE 0 REACTIVITY 0

UNUSUAL REACTION HAZARD: N

4. REACTIVITY DATA

STABILITY: Stable

INCOMPATIBILITY - MATERIALS TO AVOID:

Not Applicable

HAZARDOUS POLYMERIZATION: Will Not Occur

HAZARDOUS DECOMPOSITION PRODUCTS:

Thermal decomposition may produce toxic materials including HF. Decomposition of usage concentrations does not present a hazard.

5. ENVIRONMENTAL INFORMATION

SPILL RESPONSE:

Observe precautions from other sections. Cover with absorbent material. Collect spilled material. Clean up residue with water.

RECOMMENDED DISPOSAL:

Bleed spent solutions and small product quantities, <5 gal., to a wastewater treatment system. Reduce discharge rate if foaming occurs. Incinerate bulk product in an industrial or commercial incinerator. Combustion products will include HF. Disposal alternative: Dispose of completely absorbed waste product in a facility permitted to accept chemical wastes. Since regulations vary, consult applicable regulations or authorities before disposal. U.S. EPA Hazardous Waste No.: None

ENVIRONMENTAL DATA:

COD=0.40 g/g; BOD20=0.33 g/g; 96-Hr. LC50, Killifish(Fundulus heteroclitus)=>2000 mg/l; 96-Hr. LC50 Fathead minnow(Pimephales promelas)= >2000 mg/l; Concentration inhibiting growth of green algae(Selenastrum capricornutum) by 50% = 345 mg/l; FC-206CE has no acute inhibitory effect on activated sludge respiration rate at 1000 mg/l.

SARA HAZARD CLASS:

FIRE HAZARD: No PRESSURE: No REACTIVITY: No ACUTE: Yes CHRONIC: Yes

6. SUGGESTED FIRST AID

EYE CONTACT:

Immediately flush with plenty of water. Continue for 10 minutes. Call

Abbreviations: N/D - Not Determined N/A - Not Applicable

3M General Offices
3M Center
St. Paul, Minnesota 55144-1000
612/733-1110
Duns No.: 00-617-3082

UU-10
1946

**MATERIAL SAFETY
DATA SHEET**

3M

**MSDS: FC-206CE LIGHT WATER Brand Aqueous Film Forming Foam
DECEMBER 20, 1990**

PAGE: 3 of 3

4. SUGGESTED FIRST AID (continued)

a physician.

SKIN CONTACT:

Wash affected area with soap and water.

INHALATION:

If symptoms occur, remove person to fresh air. If symptoms continue, call a physician.

IF SWALLOWED:

Give two glasses of water. Call a physician or Poison Control Center.

OTHER FIRST AID:

NONE

7. PRECAUTIONARY INFORMATION

Avoid eye contact. Avoid prolonged or repeated skin contact. Use in well ventilated areas.

SPECIAL PROTECTION:

EYE PROTECTION: Safety Glasses

SKIN PROTECTION: Rubber Gloves

VENTILATION: General ventilation is adequate.

RESPIRATORY PROTECTION: Above component exposure limits, use organic vapor cartridge respirator.

8. HEALTH HAZARD DATA

EYE CONTACT: May cause moderate irritation of eyes on contact; corneal involvement may occur, but permanent damage is not expected.

SKIN CONTACT: May cause irritation of the skin on prolonged or repeated contact. 2-(2-Butoxyethoxy)ethanol may be absorbed through the skin in harmful amounts if continuous and prolonged contact occurs.

INHALATION: Mists or vapors may cause irritation of the respiratory system. Very high concentration of vapors may cause vomiting, nausea, diarrhea, abdominal pain, pulmonary edema and stupor. Symptoms of acute overexposure may include unconsciousness; symptoms of repeated overexposure may include nystagmus, recurrent unconsciousness, hemolysis and bone marrow depression.

INGESTION: The acute oral LD50 (rat) is greater than five grams per kilogram of body weight. FC-206CE is considered practically non-toxic orally.

Abbreviations: N/D - Not Determined N/A - Not Applicable

The information on this Data Sheet represents our current data and best opinion as to the proper use in handling of this material under normal conditions. Any use of the material which is not in conformance with this Data Sheet or which involves using the material in combination with any other material or any other process is the responsibility of the user.

APPENDIX C

ARMORED PERSONNEL CARRIER (APC)
FIREFIGHTING VEHICLE SYSTEM
TEST PLAN

AIR FORCE ENGINEERING AND SERVICES CENTER
Tyndall Air Force Base, Florida 32403

ARMORED PERSONNEL CARRIER (APC)
FIREFIGHTING VEHICLE SYSTEM

12 FEBRUARY 1991

TEST PLAN

This test plan has been reviewed and approved by:

CHARLES W. RISINGER
Test Director

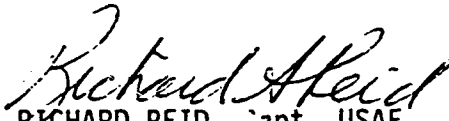
RICHARD REID, Capt, USAF
AFESC/RDCS (SAFETY OFFICER)

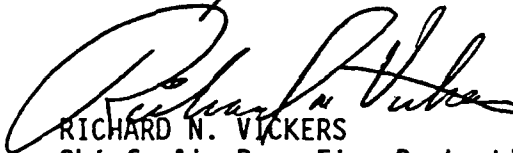
RICHARD N. VICKERS
Chief, Air Base Fire Protection
and Crash Rescue Systems Branch



Neil Fravel, Lt Col, USAF
Chief, Engineering Research Division

TABLE OF CONTENTS

Section	Title	Page
I	INTRODUCTION.....	43
	A. SCOPE.....	43
	B. BACKGROUND.....	43
	C. AUTHORITY.....	43
	D. PURPOSE.....	43
	E. TEST ITEM DESCRIPTION.....	43
	F. TEST SITE ACCESS.....	44
II	TEST OBJECTIVES AND MEASURES OF MERIT.....	45
III	MANAGEMENT AND ORGANIZATIONAL RESPONSIBILITIES.....	46
IV	TEST EXECUTION.....	47
	A. GENERAL.....	47
	B. FIRE TEST ONE.....	49
	C. FIRE TEST TWO.....	49
	D. FIRE TEST THREE.....	50
	E. AGENT THROW RANGE TEST.....	50
	F. AGENT RESERVICING TEST.....	50
	G. APC VISUAL ACUITY TEST.....	50
	H. INSTRUMENTATION AND DATA COLLECTION.....	50
V	SAFETY.....	52
VI	ENVIRONMENTAL IMPACT.....	53
ANNEX		
1	TEST SCHEDULE.....	54
2	LOGISTICS SUPPORT.....	55
3	SAFETY	57
4	LARGE-SCALE FIRE TEST PIT OPERATIONAL PROCEDURES.....	61
5	DATA COLLECTION SHEET.....	62

SECTION I
INTRODUCTION

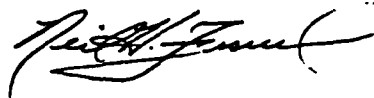
A. SCOPE

This project will evaluate the fire suppression capabilities of an M113A2 Armored Personnel Carrier (APC), modified with an internal skid-mounted fire suppression system. The APC is a standard U.S. Army vehicle. Using the modified APC as the agent dispensing vehicle, several different fire suppressing agents will be evaluated for their ability to suppress a simulated trench JP-4 fire 10 feet wide and 96 feet long. The extinguishing time, burnback rate, throw range, reservicing time, and ease of reservicing will be evaluated for each agent. A total of three fires are planned for each test agent in the test series with initial fuel quantities of 250 gallons and a maximum of 500 gallons being burned during any single fire.

B. BACKGROUND

The U.S. Army, through Army Materiel Command (AMC), has a requirement to rapidly suppress large hydrocarbon fuel fires. The system being tested, a standard Army APC, modified with a fire suppression system, and the fire suppressing agents being tested have potential applicability in this scenario. AMC has requested that the Air Force, through the Air Force Engineering Service Center, Fire Protection and Crash Rescue Research Branch (AFESC/RDCF) conduct an objective fire suppression performance test of this system and the four fire suppressing agents on simulated 10-foot wide trench fires.

C. AUTHORITY

This test is being conducted to support a U.S. Army Materiel Command (AMC) requirement with potential "Desert Storm" application.

D. PURPOSE

The purpose of this test series is to demonstrate the fire suppression capabilities of an APC modified with a self-contained fire suppression system. JP-4 pool fires configured to resemble a 10-foot wide trench will be extinguished using a variety of test fire suppressing agents.

E. TEST ITEM DESCRIPTION

A standard U.S. APC was modified with a fire suppression system developed by the Amerex Corporation. The system consists of a 250 gallon container for the premixed agent, two 220 ft³ nitrogen bottles, associated manifold and regulator to provide agent propulsion, appropriate plumbing to the external monitor and nozzle, and a TV system to allow the operator to view the fire site from his position within the APC. The turret and nozzle are controllable through approximately $\pm 160^\circ$ horizontally and -15° to $+45^\circ$ vertically from the operator's position within the vehicle. The system is skid-mounted for loading and unloading through the rear ramp door and fits completely within the vehicle.

F. TEST SITE ACCESS

During all testing activities, access to the test site and immediate area will be limited to government personnel, SETA support contractor personnel, technical representatives from the agent dispensing equipment manufacturer, and test agent contractor personnel. Agent contractor personnel will be permitted access to the test site only during the initial test site familiarization period and when their agent is being tested. Exceptions will be approved by the AFESC/RDCF Test Director.

SECTION II

TEST OBJECTIVES AND MEASURES OF MERIT

A. TEST OBJECTIVES

1. Demonstrate the fire suppression performance of the modified APC in suppressing simulated trench fires.
2. Demonstrate the capability of a modified APC agent delivery system to establish and maintain a 10-15 foot wide assault path through the 96 foot long simulated fire trench. The time for the fire to burnback and close the path will be measured and recorded. The purpose of this objective is to provide a more realistic simulation of the wartime scenario.
3. Evaluate the capability of each firefighting agent being tested to arrest a fire and suppress burnback in conjunction with Objectives 1 and 2.
4. Evaluate the throw range of the modified APC with each agent tested.
5. Evaluate the reservicing time and ease of reservicing of the modified APC with each agent being tested.
6. Assess the visual acuity from the operator's position in the APC during firefighting operations, especially during upwind agent dispensing operations. It is anticipated that agent blowing back on the vision blocks of the APC during upwind operations may obscure the view of the fire for the APC operator.

B. MEASURES OF MERIT

The measures of merit are the capability of the modified APC and the agents being tested to rapidly suppress the fire and delay burnback for a sufficient period of time, within the limits of an on-board premixed agent supply system. The extinguishment time, quantity of agent used, burnback rates, throw range, reservicing time, and ease of reservicing are the parameters to be used in determining the success of system and agents being tested. The ability of the crew to approach and extinguish the fire from an upwind position must be determined. An analysis of the success/failure of the firefighting crew, using the modified APC to combat large hydrocarbon fuel spills, must also be determined.

SECTION III

MANAGEMENT AND ORGANIZATIONAL RESPONSIBILITIES

A. MANAGEMENT

Overall test responsibility rests with the AFESC/RDCF Test Director. The Test Director will delegate authority, as necessary. Specific responsibilities for safety, instrumentation, photography, and engineering support are listed in the following paragraphs.

B. ORGANIZATIONAL RESPONSIBILITIES

1. HQ AFESC - The Air Force Engineering and Services Center is responsible for overall test management.
2. AFESC/RDCF will:
 - a. Develop, coordinate, and publish a test plan.
 - b. Provide the Test Director and Range Safety Officer.
 - c. Provide the necessary fire test facilities, AFFF agent, instrumentation and data collection systems.
 - d. Have overall test authority and be the final judge as to test protocol and relative merit of the test results.
 - e. Determine test protocols and outline test results.
 - f. Prepare a test report describing the method of test and test results.
3. U.S. Army AMC will:
 - a. Provide an on-site technical representative throughout the test period.
 - b. Provide the modified APC for the test.
 - c. Determine suitability of test results.
4. Agent Contractors will:
 - a. Provide an on-site representative during their portion of the test.
 - b. Provide adequate quantities of their agent to prepare up to 500 gallons of mixed firefighting agent for the test.

SECTION IV
TEST EXECUTION

A. GENERAL

This test program will be conducted by burning 250 to 500 gallons of JP-4 fuel in the AFESC 100-foot diameter fire test facility. Three test fires are planned for each agent being tested. An additional fire may be conducted as a contingency at the discretion of the Test Director. Prior to implementing the test, two fires will be conducted for equipment and procedure training and familiarization for the APC and reservicing crews.

The AFESC 100-foot environmentally-safe fire test facility, located on Farmdale Road, Tyndall AFB, Florida will be used for all fire tests. The facility will be modified for this test series with a 15-inch high clay reinforced dam placed in the pit to form a rectangular burn area 96 feet by 10 feet to simulate a 10-foot wide trench, as shown in Figure 1. Two six-foot high steel stakes will be centered along the length of the trench to facilitate agent application and fire extinguishment in the center portion of the trench and data acquisition during the burnback portion of the test.

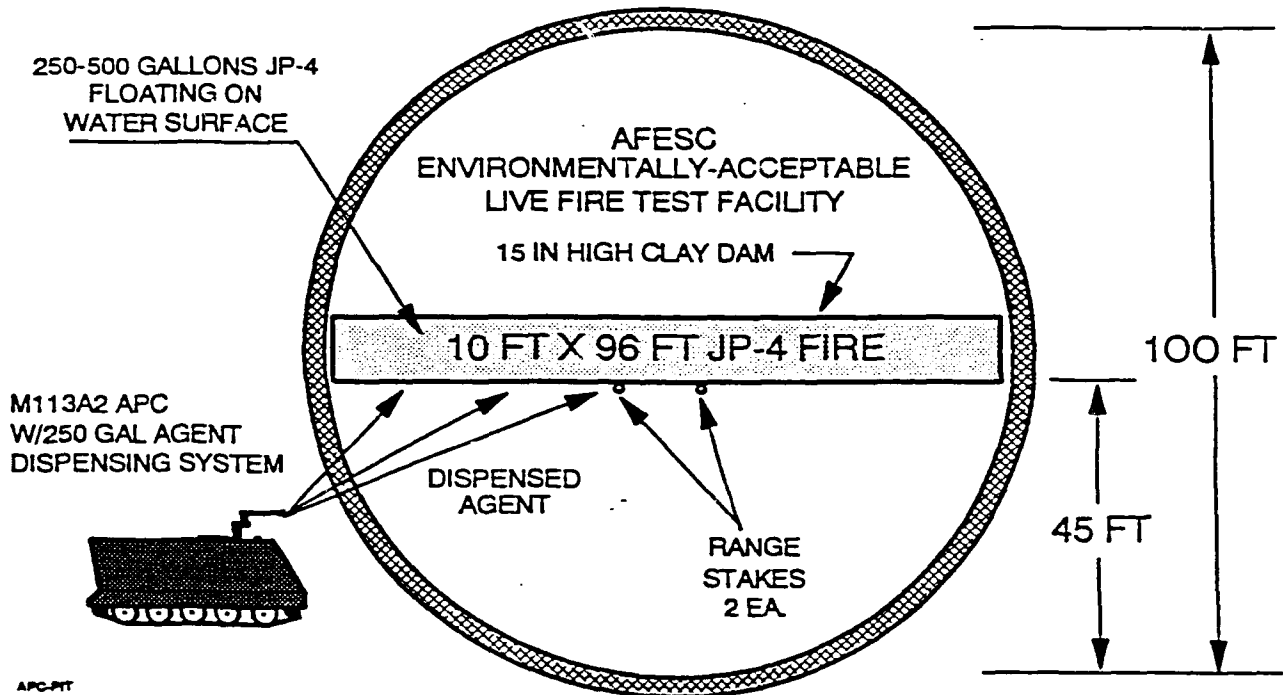

Figure 1. 100-Foot Fire Test Facility Set-Up

The modified APC will be prepared before each test fire by filling the tank with 100 or 250 gallons of premixed agent, in accordance with the test matrix in Table 1. Sea water will be used as the agent carrier, since this is the anticipated scenario in the operational environment. The two 220 ft³ nitrogen bottles, used to propel the agent, will be replaced for each fire test to ensure that the gas supply is not depleted before the test is completed. The pressure regulator will be adjusted to obtain the appropriate flow for the particular agent being tested. The nozzle configuration will be tailored to each individual agent manufacturer's requirements.

For each test fire, fuel is placed in the rectangular burn area, ignited using a torch, and followed by the modified APC attacking the fire and extinguishing all except 1-15 feet at the end of the trench or a 10-15 foot assault path, as determined by the test event protocol shown in Table 1. During separate tests, fires will be attacked from both an upwind and downwind position to simulate a realistic wartime scenario. The test matrix in Table 1 will be completed for each tested agent.

A backup USAF P-19 or P-4 firefighting vehicle will be manned by AFESC personnel and available at the fire test facility for all fires to cover contingencies. The Range Safety Officer will not permit anyone to approach the fire without his expressed consent.

Table 1. Firefighting Agent Test Matrix

<u>FIRE NO.</u>	<u>AGENT GAL.</u>	<u>FUEL GAL.</u>	<u>WIND DIRECTION</u>	<u>OBJECTIVE</u>
1	100	250	UPWIND	Establish 10-foot breaching path. Measure extinguishment and burnback times.
2	100	250	DOWNWIND	Establish 10 foot breaching path. Measure extinguishment and burnback times.
3	250	500	DOWNWIND	Extinguish 90% of trench area up to approximately 10 feet from the upwind end of the trench. Measure burnback time.

Pretest briefings will be conducted before each fire to evaluate weather conditions, discuss the results of the previous test, verify that all systems are functional, and plan the next fire test. All personnel will be at their assigned locations a minimum of 1 hour before each scheduled ignition time. Individual protective equipment will be worn by all actively involved personnel and will be tested and verified as fully operational before fuel is placed in the pit. All test materials and equipment will be set up and ready for the test a minimum of 1 hour before the scheduled ignition time. At T-30 minutes (30 minutes before ignition time) the pretest checklist, included at the end of Annex 3, will be completed to ascertain the readiness of all

functions. These functions will include, but are not limited to, safety, weather, test pit readiness, and data collections readiness. When all functions are ready, the fire will be ignited. The order to ignite the fuel will be given by the AFESC Test Director.

After each fire test is completed the fire will be reignited, if necessary, and permitted to burn off the residual fuel to facilitate pit clean-up for the next test. The fire pit will also be flushed with water before the next fire test so that agent from the previous test will not contaminate the results of following tests. A detailed checklist for large-scale fire pit operations is contained in Annex 4.

To ensure that the residue from one agent does not contaminate the test results for a follow-on agent, the entire the agent tank and dispensing system will be thoroughly flushed with water and blown clean with nitrogen at the completion of the test matrix for each agent.

B. FIRE TEST ONE

When the Test Director confirms that all systems are ready, he will direct the filling of the test trench with 250 gallons of JP-4. After The Test Director has entered the APC, the Range Safety Officer will direct ignition of the fire, observe a 30-second preburn period and command the APC to approach the fire. The APC will approach the trench from an upwind position and begin dispensing agent. The APC will attempt to establish a 10 foot assault path using the 100 gallons of agent on-board from predetermined discharge locations. The time to establish the assault path and the burnback time will be recorded. The quantity of agent used will also be recorded. After burnback, the fire will be permitted to burn out the remaining fuel to facilitate pit cleanup in preparation for the following test fire.

C. FIRE TEST TWO

When the Test Director confirms that all systems are ready, he will direct the filling of the test trench with 250 gallons of JP-4. After The Test Director has entered the APC, the Range Safety Officer will direct ignition of the fire, observe a 30-second preburn period and command the APC to approach the fire. The APC will approach the trench from an downwind position and begin dispensing agent. The APC will attempt to establish a 10 foot assault path using the 100 gallons of agent on-board from predetermined discharge locations. The time to establish the assault path and the burnback time will be recorded. The quantity of agent used will also be recorded. After burnback, the fire will be permitted to burn out the remaining fuel to facilitate pit cleanup in preparation for the following test fire.

D. FIRE TEST THREE

When the Test Director confirms that all systems are ready, he will direct the filling of the test trench with 500 gallons of JP-4. For this test the APC will be filled with 250 gallons of agent. After The Test Director has entered the APC, the Range Safety Officer will direct ignition of the fire, observe a 30-second preburn period and command the APC to approach the fire. The modified APC will approach the trench from a downwind position and begin dispensing agent. The APC will attempt to extinguish all except approximately 10 feet of the upwind end of the fire area. The extinguishment and burnback times and quantity of agent used will be recorded. After burnback, the fire will be permitted to burn out the remaining fuel to facilitate pit cleanup in preparation for the following test fire.

E. AGENT THROW RANGE TEST

The purpose of this test is to evaluate the throw range of the modified APC with each agent tested. Their is concern that agent viscosity may effect this critical firefighting parameter. This test will be conducted in conjunction with Fire Test One beginning at a distance of 150 feet using a maximum turret elevation of 30°. Thereafter the vehicle will move to closer ranges and continue the fire extinguishing test.

F. AGENT RESERVICING TEST

The purpose of this test is to evaluate the reservicing time and ease of reservicing of the modified APC with each agent being tested, using the written instructions provided by the agent manufacturer. The test will be conducted in conjunction with the fire tests described above for each of the test agents. The last reservicing activity for each agent will be timed and video taped. Subjective evaluations as to the ease of reservicing the system will be made by reservicing personnel and recorded by the data recorder.

G. APC VISUAL ACUITY TEST

The purpose of this test is to assess the visual acuity from the operator's position in the APC during firefighting operations, especially during upwind agent dispensing operations. It is anticipated that agent blowing back on the vision blocks of the APC during upwind operations may obscure the view of the fire for the APC operator. This test will be completed in conjunction with and throughout the fire tests. Results will be based on the subjective evaluation of the system operator and recorded by the data collector.

H. INSTRUMENTATION AND DATA COLLECTION

1. Instrumentation. The APC will be instrumented with six thermocouples to measure and record temperature both inside and outside of the vehicle during firefighting operations. Two thermocouples will be placed in front of the heat shield blanket, two behind the blanket, and two inside of the vehicle. Anticipated temperature ranges are up to 2,000°F on the outside of the vehicle and up to 140°F on the inside of the vehicle. An onboard recording system will record all six channels for later data reduction and analysis.

2. Data Collection. All data will be recorded on the data collection sheet contained in this Annex 5. One fixed and one roving video camera will record all test activities. Still camera photographs will be taken of selected events. All hand-recorded data, video tapes, and 35mm exposed film will be stored in a suitable government storage facility at the completion of each test day. Test data results do not constitute approval or endorsement for use of the tested product by U.S. Army or U.S. Air Force units. No data will be distributed without direction from the U.S. Army Materiel Command.

3. Salt Water Testing. Salt water for use throughout this test series will be pumped from the Gulf of Mexico into a 5,000 gallon tank truck and placed at the test site before the test begins. Water will be taken from a location as near as possible to the open gulf to provide salt water with a salinity very close to that of the Persian Gulf. The sea water from the tank truck will be tested to determine salinity and provided in the final report. Water for all tests will be taken from the same tank truck load.

SECTION V

SAFETY

A. GENERAL

Safety is an integral part of the test. The Test Director is responsible for accident prevention. Personnel and equipment safety will take precedence over test execution at all times. Special emphasis will be placed on providing thorough supervision and guidance throughout all test phases. Permission briefings will be conducted daily by the test director detailing the test procedures for the day and emphasizing safety in all test phases.

The AFESC Test Director is ultimately responsible for safety. However, during that portion of the test when the Test Director is occupied in the APC, the Range Safety Officer is responsible for range safety and the conduct of the fire test. However, the test may be suspended at any time by anyone if a safety hazard is observed. Identification of a potential safety hazard will result in test suspension until the hazard can be evaluated and corrected to the satisfaction of the Range Safety Officer.

B. IDENTIFIED HAZARD

A JP-4 open pit fire, by its very nature, is hazardous. The largest fire planned for this test series will be 96 feet by 10 feet and will burn up to 500 gallons of JP-4 for approximately 2 minutes. The approved test plan has been thoroughly examined for safety distance from surrounding objects and found to be well within safe distance limits.

C. SAFETY REPORTING

Accidents, incidents, and serious hazards will be reported in accordance with AFR 127-4 through AFESC/SEG and HQ USAFADWC/SEG. The Range Safety Officer is responsible for accident/incident reporting.

The Test Director and Range Safety Officer will ensure that all appropriate safety procedures are followed throughout all testing. Testing will be suspended if an event occurs contrary to this checklist. During the actual fire testing, observers will be located a minimum of 300 feet west of the edge of the fire pit.

Individual protective equipment will be worn the test facility operators, APC crew members, and back-up firefighting vehicle operator(s). APC crew members will also wear Self-Contained Breathing Apparatus (SCBA) during the fire tests.

Direct radio contact shall be maintained at all times preceding and during each test event between the Test Director (APC commander) and the Range Safety Officer. The Range Safety Officer will position himself to be observed by the back-up firefighting crew during the test.

Additional safety procedures are contained in Annex 3.

SECTION VI
ENVIRONMENTAL IMPACT

In accordance with AFR 19-2, Air Force Form 813 has been completed and approved. The determination has been made that this test series qualifies for a Categorical Exclusion 2y. As stated in the Form 813, it is anticipated that all evidence of visible smoke will be dispersed within two hours. Using the Air Quality Assessment Model (AQAM), initial calculations were made for the levels of particulate matter, hydrocarbons, carbon monoxide, and oxides of nitrogen for a 500 gallon fire, typical for this series. The results are contained in Table 2.

Table 2. AIR EMISSION ESTIMATES FOR LARGEST HYDROCARBON FIRES

<u>FIRE SIZE</u>		<u>AIR POLLUTANTS*</u>				
GALLONS JP-4	POUNDS JP-4	POUNDS PM	POUNDS CO	POUNDS HC	POUNDS NOx	TOTAL
500	3,250	420	184	1,048	14	1,666

APPROXIMATE TOTAL FOR TEST SERIES

5,000	32,750	4,200	1,840	10,480	140	16,660
-------	--------	-------	-------	--------	-----	--------

- * PM = Particulate Matter
- CO = Carbon Monoxide
- HC = Hydrocarbons
- NOx = Oxides of Nitrogen

Reference: A Generalized Air Quality Assessment Model for Air Force Operations, AFWL-TR-74-304, February 1975.

Any major fuel spills or other unplanned event that may affect the environment will immediately be reported to the AFESC and Tyndall AFB environmental offices.

ANNEX 1

TEST SCHEDULE

12 FEB 91

KICKOFF MTG - ALL PARTICIPANTS (9706 CONF RM)	0700
APC ARRIVES TAFB TEST SITE	0800
TEST SITE AND EQUIPMENT FAMILIARIZATION	0900
TRAINING AND TEST FIRES	1230
REVIEW DAY'S ACTIVITIES & BRIEF FIRST TEST	1530
INSTALL INSTRUMENTATION ON APC	
PIT PREPARATIONS	ALL DAY
PRE-POSITION SUPPORT MATERIALS	

13 FEB 91

DAILY PRETEST MEETING (9706 CONF RM)	0700
PREPARE APC & FIRE PIT	0800
BEGIN 3-FIRE SERIES - 3M AFFF	0900
COMPLETE 3M AFFF FIRE SERIES AND REVIEW RESULTS	1200
PREPARE APC & FIRE PIT	1300
BEGIN 3-FIRE SERIES - PYROCAP	1400
COMPLETE PYROCAP FIRE SERIES AND REVIEW RESULTS	1630

14 FEB 91

DAILY PRETEST MEETING (9706 CONF RM)	0700
PREPARE APC & FIRE PIT	0800
BEGIN 3-FIRE SERIES - FIRE KNIFE	0900
COMPLETE FIRE KNIFE FIRE SERIES AND REVIEW RESULTS	1200
PREPARE APC & FIRE PIT	1300
BEGIN 3-FIRE SERIES - PVF	1400
COMPLETE PVF FIRE SERIES AND REVIEW RESULTS	1630

15-16 FEB 91

CONTINUATION OF FIRE TESTS, AS REQUIRED	TBD
---	-----

ANNEX 2

LOGISTICS SUPPORT

A. FACILITY REQUIREMENTS

The test facility for this test is the 100 foot AFESC Fire Research Facility #1, located approximately 7 miles southeast of the main gate at Tyndall AFB, Florida. This test site will be used for all fires conducted in this series.

B. PERSONNEL REQUIREMENTS

Personnel to support this test will be provided by AFESC/RDCF, with on-site technical assistance provided by representatives from the Army, AMC, and the equipment and agent contractors, as required.

<u>Agency/Organization</u>	<u>Personnel Required</u>
AFESC/RDCF	Test Director Range Safety Officer Fire Pit Operator (2 ea) Data collector (1 ea) Video Operator (1 ea)
USAF HOSPITAL - TYNDALL AFB	Emergency Medical Care
AMC	APC operations personnel

C. MATERIAL REQUIREMENTS

Material requirements are as follows:

ITEM	QUANTITY	SOURCE
JP-4	5,000 gal.	AFESC/RDCF
Nitrogen bottles (220 ft ³)	72 ea	AFESC/RDCF
Video tape	24 cassettes	AFESC/RDCF
35 mm film	6 rolls	AFESC/RDCF
Test Agents	As req.	Agent Contractors

D. EQUIPMENT REQUIREMENTS

ITEM	QUANTITY	
APC, modified with Agent system	1	U.S. Army AMC
P-19/P-4 Fire Fighting Vehicle	1	
Portable Fire Extinguishers	4	
Protective Clothing (sets)	5	
SCBA units	4	
First Aid Kit	1	
Hand Held Radios	2	
Electric Ignition System	1	
35mm Still Frame Cameras	2	
VHS 1/2" Video Cameras	3	
Stopwatches	2	
Wind Direction Instrument	1	

ANNEX 3

SAFETY

A. PURPOSE

This Safety Plan establishes the safety areas for the large scale fire testing of the APC Firefighting System. Fire tests will be conducted at the AFESC Fire Research Facility #1 located on Farm Dale Road, Tyndall AFB, Florida. This plan identifies the agency responsible for the test area. This document contains detailed Safety Rules which govern the conduct of this test series. The Test Director or Range Safety Officer will insure adherence to all safety policies. Before conducting any live fire tests at the Fire Research Facility, the Base Fire Department Communications Center will be notified. The following documents are applicable to this test:

AFOSH 127-11 & 50, First Aid Kits
AFOSH 127-31, Personal Protective Clothing and Equipment
AFR 92-1, Paragraph 4-14, Safety Equipment for Fire Fighters
AFR 127-4, Accident Reporting

B. OVERALL SAFETY RESPONSIBILITY

HQ AFESC/RDCF, as Test Director, is responsible for enforcing the overall safety program for the test. The Test Director will maintain close coordination with the AFESC Safety Officer (AFESC/SE) and the Air Defense Weapons Center Ground Safety Officer (USAFADWC/SEG) on all safety matters.

C. GENERAL SAFETY

1. Safety Briefing. The Test Director will brief all test personnel on known safety hazards in associated with this test and test site. Supervisors will, in turn, brief their personnel on these hazards.

2. Visitors. Visitors will be permitted at the test site only with the approval of the Test Director. Visitors will be instructed on applicable safety regulations.

3. Individual Safety Responsibility. Careful attention to potential hazards associated with fire testing must be stressed at all levels of responsibility. The purpose of the safety rules outlined herein is to present the most important elements in experimenting with controlled fires. These rules do not cover all the possible hazards which may occur at the site. As new problems arise, new safety measures must be established. This Safety Plan must be strictly adhered to by all personnel. The procedures outlined in the plan shall be accepted as minimum safe conduct. Only the Test Director may authorize a deviation from this plan.

4. Vehicles. For vehicles other than fire-fighting vehicles conducting actual fire-fighting operations, speeds shall not exceed 20 mph when driving on unpaved roads. Seat belts will be used at all times while vehicles are in motion. When a vehicle is parked, the hand brake will be set and the transmission put in park or reverse. Unauthorized vehicles will not be parked in the vicinity of the fire pit during fire test operations.

5. First Aid. An adequate supply of first-aid items will be maintained at the site. These items will be properly stored and periodically inspected. All personnel will be briefed upon the locations of first aid kit/supplies. An appropriate vehicle will be designated and available to transport injured persons to the base medical center, if required.

6. Accident Reporting (Emergency).

a. Scope. The purpose of this procedure is to ensure expedient handling and care of personnel injured in an accident or disaster. All post-emergency reporting and investigation of an accident will be performed in accordance with applicable Air Force Regulations.

b. Responsibility. Each person involved in this program must be familiar with the emergency reporting procedures established by this plan and immediately implement these procedures in the event of an accident. The Test Director will insure that all personnel are familiar with this procedure.

c. Emergency Reporting Procedures. In the event of an accident at the test site, the following procedures will be followed:

(1) The Test Director will direct appropriate first aid. Caution will be exercised to prevent aggravation of an accident-related injury.

(2) Tyndall Air Force Base Hospital Ambulance Service will be notified by calling extension 911. The nature of the accident, including apparent condition of injured personnel and the location of the test site, will be reported to the medical personnel. The Test Director or the Range Safety Officer will decide whether to transfer the injured directly to a hospital or to request emergency ambulance support.

(3) The Test Director or the Range Safety Officer will determine the seriousness of the accident. If the accident is not serious enough to require emergency hospitalization or ambulance service, the injured person will be taken to a doctor or hospital by normal means of transportation.

(4) All accidents requiring emergency treatment or first aid must be reported to the AFESC Safety Officer (AFESC/SE).

D. FIRE PREVENTION, REPORTING, AND EMERGENCY PROCEDURES

This paragraph defines the responsibility for fire prevention and reporting procedures related to the test.

1. Responsibility. The Test Director will be responsible for the implementation of the procedures established by this plan. All on-site personnel must be completely familiar with these procedures to ensure proper response to an emergency.

2. Fire Prevention Procedures. The procedures listed below are to be followed in an effort to reduce chances of an uncontrolled fire. Three

portable fire extinguishers will be at the test site, and all personnel participating in the fire test will be briefed on the locations and proper use of the extinguishers.

E. TEST SITE LOCATIONS

All fire tests will be conducted at the 100 foot AFESC Fire Research Facility #1, located on Farm Dale Road. These tests be conducted in accordance with AFESC Office Instruction dated 7 April 1988, titled "Live Fire Demonstration/Tests."

F. NOTIFICATION

Before conducting a fire test, notify the Fire Department Communications Center at Extension 3-2884.

1. The Communications Center will be requested to notify the following:
 - a. Command Post - 3-2155
 - b. Air Traffic Control Tower - 3-4553
 - c. Base Hospital - 3-7514
 - d. Security Police - 3-2028
 - e. Division of Forestry - 3-2641
 - f. Base Weather - 3-2856

2. The Fire Department Communications Center will need an estimate of the duration of the live fire tests.

PRETEST CHECK LIST
TO BE USED BEFORE CONDUCTING FIRE TESTS AT
FIRE RESEARCH FACILITIES NO. 1

DATE: _____ TIME: _____

VERIFIED

PROCEDURES

- ___ Brief all personnel on proper safety procedures.
- ___ All personnel at the test site are required for the test or are an approved visitor?
- ___ Brief all personnel on accident and fire reporting procedures.
- ___ Radio or telephone communications available?
- ___ Post telephone numbers for the ambulance and fire department by the telephone or radio.
- ___ Ensure that adequate first aid kit is available.
- ___ Ensure that an emergency eye wash apparatus is available.
- ___ Ensure that all fuel valves are closed and that there are no fuel leaks prior to fuel ignition.
- ___ Ensure Individual Protective Equipment is fully charged and operational.
- ___ Secure area prior to igniting fire.

ANNEX 4

LARGE-SCALE FIRE TEST PIT OPERATIONAL PROCEDURES

The following are general procedures to be used during the operation of the 100 foot fire test pit during the APC Firefighting System Demonstration.

1. Insure all agencies are notified of test events.
2. Conduct Safety Briefing.
3. Verify all data collection equipment in place and operational.
4. Insure downrange/fire pit area clear.
5. Verify amount of fuel to be used; flow fuel in test area.
6. Start data collection.
7. Ignite fire.
8. 30-second pre-burn.
9. Conduct fire event/test.
10. Secure fire burn area/downrange.
11. Check test results.
12. Conduct post-test and facility shutdown procedures.
13. Notify all agencies that test complete & facility secure.
14. Conduct critique.
15. Document test results.

ANNEX 5

APC AND FIREFIGHTING AGENT TEST

TEST CONDUCT CHECKLIST AND DATA COLLECTION SHEET

AGENT ID: _____ MANF: _____ TEST NO: _____ DATE: _____ TIME: _____

LOT #: _____ MIXTURE RATIO: _____ INITIAL QTY: _____ gal. FINAL QTY: _____ gal.

AGENT USED: _____ gal. AGENT FLOW RATE: _____ gpm

METEOROLOGICAL DATA:

TEMPERATURE: _____ WIND: _____

TEST READINESS:

_____ Weather within limits	_____ Communications check
_____ Fire vehicles ready	_____ Ignition system ready
_____ Video cameras ready	_____ Fuel in pit
_____ Emer. Medical notified	_____ Access gate secured

CLEARANCE FOR IGNITION:

_____ Safety Officer _____ Fire Department

IGNITION TIME: _____ AGENT APPLICATION: START: _____ END: _____

INITIAL PATH CLEAR: _____ PATH BURNED CLOSED: _____ EXTINGUISH TIME: _____

90% EXTINGUISHED: _____ TOTAL BURNBACK: _____

MAXIMUM AGENT THROW RANGE: _____ WIND: DIR: _____ SPEED: _____ mph

RESERVICING TIME: _____

RESERVICING EASE - COMMENTS:

GENERAL COMMENTS: