

PROMETHEUS PROJECT

Final Report

National Aeronautics and
Space Administration

Jet Propulsion Laboratory
California Institute of Technology
Pasadena, California

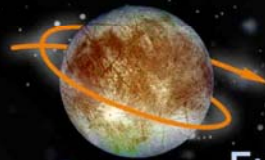

Europa



Ganymede

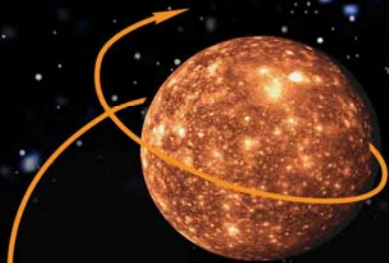

Callisto

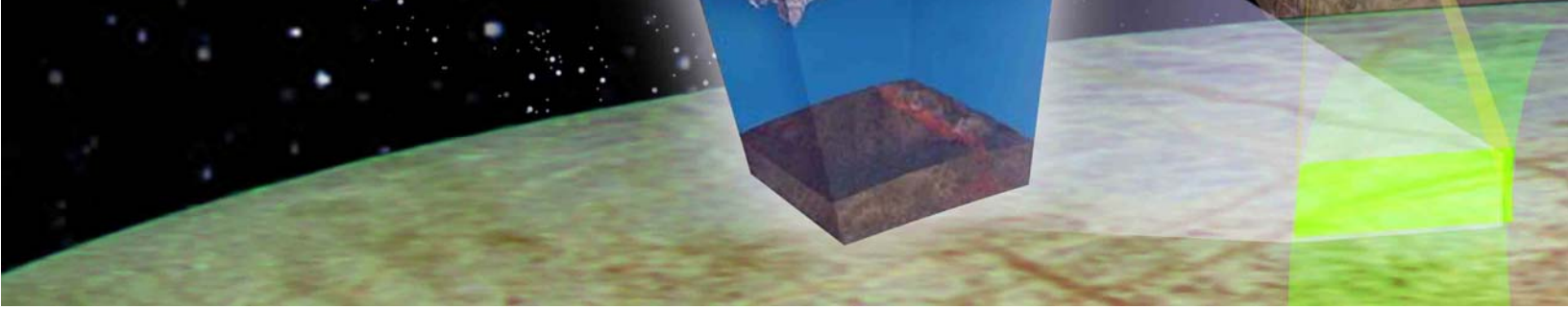
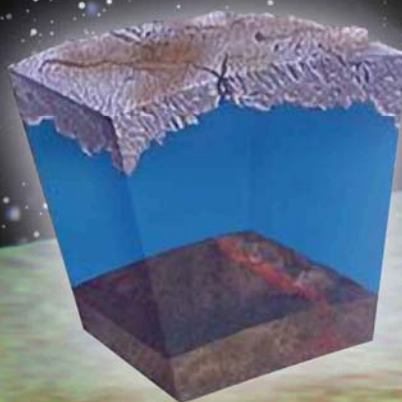
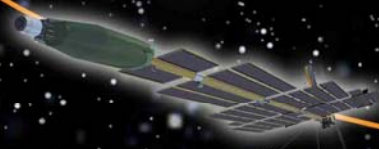

[This page intentionally left blank]

Signature Page

Name	Title	Date	Signature
Randall Taylor	Prometheus Project Closeout Manager		

[This page intentionally left blank]

Acknowledgement

The Jet Propulsion Laboratory (JPL), a division of the California Institute of Technology, manages the Prometheus Project for the National Aeronautics and Space Administration's Prometheus Nuclear Systems Program.

[This page intentionally left blank]

TABLE OF CONTENTS

1.	INTRODUCTION.....	1
1.1	Project Identification.....	1
1.2	Project Summary.....	1
1.3	Project History	2
1.4	Scope of Final Report	4
2.	OBJECTIVES AND REQUIREMENTS.....	7
2.1	Science Objectives.....	7
2.2	Technology Objectives	7
2.3	Level-1 Requirements and Mission Success Criteria	8
2.4	National Environmental Policy Act (NEPA) Compliance and Launch Approval Engineering.....	9
2.5	Project Nomenclature.....	10
2.6	JPL Institutional Requirements Compliance and Tailoring.....	11
3.	MISSION DESCRIPTION	15
3.1	JIMO Mission Overview.....	15
3.2	Follow-On Missions.....	19
4.	IMPLEMENTATION APPROACH.....	21
4.1	WBS and Products List.....	21
4.2	Implementation Summary.....	22
4.3	Acquisition and Surveillance Summary.....	23
4.4	Project/Program-Level Agreements.....	27
4.5	Project Dependencies and Inheritance	29
5.	PROJECT MANAGEMENT.....	31
5.1	Project Authority.....	31
5.2	Organization, Roles, and Responsibility.....	33
5.3	Technology Development.....	35
5.4	Risk Management	44
5.5	Reviews and Reporting.....	46
5.6	Management Controls, Tools and Support Systems	50
5.7	Public Outreach and Advocacy.....	52
5.8	Facilities.....	55

5.9	Logistics	55
5.10	End of Project Lifecycle	56
6.	PROJECT SYSTEM ENGINEERING.....	57
6.1	Project Engineering Scope	57
6.2	Project Engineering Approach	57
6.3	Project Engineering Implementation	62
7.	SAFETY AND MISSION ASSURANCE	69
7.1	Safety Management	69
7.2	Mission Assurance Management	70
8.	SCIENCE SYSTEM	85
8.1	Science System Overview.....	85
8.2	Science	87
8.3	Mission Design	93
8.4	Science Operations Module	101
8.5	Mission Module	102
9.	DEEP SPACE SYSTEM	109
9.1	DSV Design Evolution	111
9.2	Deep Space Vehicle Description	112
9.3	Spaceship Verification and Validation Plan	128
9.4	Spaceship Simulations and Testbeds	135
10.	GROUND SYSTEM	141
10.1	Ground System Overview and Operations Concept	141
10.2	Ground System Deliveries and Verification & Validation	150
10.3	Ground System Simulators & Test Beds	152
10.4	Ground System — Operations Assumptions	154
11.	LAUNCH SYSTEM.....	157
11.1	Launch Options.....	157
11.2	Phase A Studies.....	159
11.3	Baseline Launch System	161
11.4	Major Trades.....	161
11.5	Rendezvous and Docking Segment	164
12.	SCHEDULE.....	167
12.1	Top-Level Summary and Critical Path Summary.....	167

12.2	Detail Schedule Development.....	172
13.	ESTIMATES AND BUDGETS	175
13.1	Cost Analysis Requirement Description (CARD)	175
13.2	Life Cycle Cost Estimate (LCCE)	176
13.3	Funding Requirements	179
13.4	Workforce	180
APPENDIX A	— FOR FURTHER INFORMATION	181
A.1	General.....	181
A.2	Project Management	181
A.3	Requirements	182
A.4	Project Engineering.....	182
A.5	Safety	182
A.6	Mission Assurance	183
A.7	Science System	184
A.8	Deep Space Vehicle	184
A.9	Reactor	185
A.10	Technology Development:.....	185
A.11	Launch System.....	186
A.12	Ground System.....	186
A.13	Acquisition.....	186
A.14	Business	187
A.15	Public Outreach and Advocacy.....	187
A.16	Additional Prometheus Studies.....	187
A.17	Reviews (Presentation Material).....	187
APPENDIX B	— PROMETHEUS EVENTS.....	189
APPENDIX C	— KEY PERSONNEL.....	195
APPENDIX D	— RESPONSIBILITY ASSIGNMENT MATRIX	199
APPENDIX E	— MAJOR EDUCATION AND OUTREACH EVENTS	203
APPENDIX F	— ADDITIONAL PROMETHEUS STUDIES.....	205
F.1	Derivative Missions	205
F.2	Analysis of Alternatives.....	207
F.3	Fission Surface Power Study	210

FIGURES

Figure 3.1-1. Mission Overview.....	16
Figure 3.1-2. Interplanetary Transfer Through Callisto Capture.....	17
Figure 3.1-3. Jupiter Capture Through Callisto Capture (inertial view).....	18
Figure 4.1-1. WBS to Level 2 with Spacecraft System to Level 3.....	21
Figure 4.1-2. Implementation Responsibility Legend.....	22
Figure 5.1-1. Program/Project Organization (Circa March 2005).....	32
Figure 5.1-2. Project Systems Terminology.....	33
Figure 5.2-1. Prometheus Project Organization Relationships.....	34
Figure 5.2-2. Project Organization Chart.....	34
Figure 5.3-1. 2-kW Brayton Testbed.....	37
Figure 5.3-2. High-Pressure Bearing Test Rig.....	37
Figure 5.3-3. High-temperature water heat pipe testing.....	38
Figure 5.3-4. C/C to Ti brazing trials.....	39
Figure 5.3-5. HiPEP.....	39
Figure 5.3-6. NEXIS.....	40
Figure 5.3-7. 180-W Ka-band TWT.....	40
Figure 5.3-8. Ka-band 5-way Combiner.....	41
Figure 5.3-9. RAD750 Processor.....	42
Figure 5.3-10. Achieved large improvements in performance of legacy trajectory design tools.....	43
Figure 5.3-11. Fast Lyapunov Indicator (FLI) maps assist trajectory analysis in designing efficient moon-to-moon orbit transfers for the JIMO mission.....	43
Figure 5.7-1. Project Prometheus Display at JPL Open House.....	54
Figure 6.1-1. Project Engineering Scope.....	57
Figure 6.2-1. Prometheus Project Engineering Process.....	60
Figure 7.2-1. Prometheus Project Mission Assurance Organization.....	71
Figure 7.2-2. Radiation Control Process.....	73
Figure 7.2-3. Prometheus External Radiation Environment at PMSR.....	73
Figure 7.2-4. Prometheus Spaceship Design (Internal Bus Compartment View).....	74
Figure 7.2-5. Shield Mass as a Function of Composition for the Telecom Platform.....	75
Figure 7.2-6. Prometheus Spaceship Radiation Shield Mass.....	76
Figure 7.2-7. The aluminum contact surface was ruptured by heating in the silicon carbide substrate as a result of Single Event Burn-out.....	82
Figure 8.1-1. JIMO Science Data Flow Diagram.....	86
Figure 8.1-2. Science and Mission Design Office Organization.....	87
Figure 8.2-1. The JIMO mission will enable a synergistic study of the icy satellites, providing a basis to understand the Jupiter system as a whole.....	88
Figure 8.2-2. Science Organization.....	92
Figure 8.3-1. Reference Interplanetary Trajectory and Jupiter Arrival.....	94
Figure 8.3-2. Gravity Assist Trajectories.....	95
Figure 8.3-3. Orbit Lifetime Maps for Ganymede and Callisto.....	96

Figure 8.3-4. Orbit Lifetime Map for Europa.....	97
Figure 8.3-5. Capture at Callisto and Transfer to the Science Orbit.....	98
Figure 8.3-6. Transfer from Callisto to Ganymede.....	100
Figure 8.4-1. Science Operations Module Functional Block Diagram.....	101
Figure 8.5-1. Mission Module Elements.....	103
Figure 8.5-2. Mission Module Architecture.....	105
Figure 8.5-3. Mission Module Integration.....	108
Figure 9.1-1. DSV Design Evolution.....	111
Figure 9.2-1. Spaceship Overview.....	112
Figure 9.2-2. DSV Dimensions Bus Layout.....	113
Figure 9.2-3. DSV Trade Summary.....	114
Figure 9.2-4. Deep Space Vehicle Block Diagram.....	115
Figure 9.2-5. Technical Resource Margins.....	117
Figure 9.2-6. Reactor Module.....	118
Figure 9.2-7. Aerothermal Protection System Attached to Reactor Shield.....	120
Figure 9.2-9. DSV Block Diagram.....	125
Figure 9.3-1. Spaceship Verification and Validation Roadmap.....	129
Figure 9.3-2. Reactor Module Integration Concepts.....	132
Figure 9.3-3. Spacecraft Module Subsystem/Segment Testing.....	134
Figure 9.4-1. Simulation and Testbed Utilization Analysis.....	136
Figure 9.4-2. Spaceship Testbed Evolution.....	138
Figure 10.1-1. GS consists of the MOM and the POM.....	142
Figure 10.1-2. MOM Provides Tracking and Associated Services.....	143
Figure 10.1-3. POM Includes Ops Functions Specific to Prometheus Missions.....	144
Figure 10.1-4. An architectural overview of the JIMO GDS.....	146
Figure 10.1-5. GDS and flight team elements of the Prometheus/JIMO Ground System.....	147
Figure 10.1-6. Operations Organization for JIMO.....	149
Figure 10.3-1. Testbed — TTACS Configuration.....	153
Figure 11.1-1. Launch Vehicle Development Scenarios and Resultant Mission Options.....	157
Figure 11.1-2. Assumed Phase A Launch Vehicle Development and Mission.....	158
Figure 11.1-3. Probable Launch Vehicle Development and Mission.....	159
Figure 11.5-1. Docking Segment Elements.....	165
Figure 11.5-2. Spacecraft Docking Adapter Segment.....	165
Figure 11.5-3. Transfer Stage Docking Subsystem.....	166
Figure 12.1-1. Top-Level Summary.....	168
Figure 12.1-2. Project Critical Path Summary (through 2015 launch).....	169
Figure 12.1-3. Project Phase A Schedule.....	170
Figure 12.1-4. Technology Milestones.....	171
Figure 12.2-1. Schedule Update Process Flow Chart.....	174
Figure 13.1-1 JIMO CARD Development Process.....	175
Figure 13.2-1 JIMO 2015 LCCE Development Process.....	177

Figure F-1. Mars Transport Mission Example (16,000kg dry mass, 5000s Isp).	207
Figure F-2. Study Approach.	208
Figure F-3. Vehicle Concept Overview.	209
Figure F-4. Artist's concept of the FSPS.	211
Figure F-5. FSPS Components – Pre-operational (Regolith shield not shown for clarity).	213
Figure F-6. SCE Components.	214

TABLES

Table 5.4-1. Top Risk Items.	45
Table 5.5-1. Major Project Reviews.	48
Table 8.2-1. JIMO Payload Accommodation Envelope.	90
Table 8.4-1. Key Driving Requirements for the Science Operations Module.	102
Table 8.5-1. Reference Instrument Suite.	104
Table 9.2-1. Summary Mass List.	116
Table 9.2-2. Example Spacecraft Module Key Driving Requirements.	121
Table 10.1-1. GDS Components and Providing Organizations.	148
Table 10.2-1. Ground System Capability Deliveries.	151
Table 11.4-1. Launch System Key Driving Requirements.	164
Table 11.5-1. Rendezvous and Docking Trades.	165
Table 13.3-1. Actual funding, by Performing Organization, by Fiscal Year, and by Unique Project Number (UPN).	179
Table 13.4-1. Actual workforce, by Performing Organization and by Fiscal Year.	180
Table F-1. FSPS Trades.	212
Table F-2. FSPS Mass Summary.	215

1. Introduction

1.1 Project Identification

The Prometheus Project was an element of the NASA Prometheus Nuclear Systems and Technology Theme. (It was previously known as the Jupiter Icy Moons Orbiter (JIMO) Project, and its pre-project work was performed under the NASA Nuclear Systems Initiative.) The Project was authorized by the Formulation Authorization for the Project Prometheus Program, signed by the NASA Associate Administrator for Space Science, Dr. Ed Weiler, on March 18, 2003. (The Project was subsequently transferred to the NASA Exploration Systems Mission Directorate upon its establishment in February 2004.) The Agency funding unique project number for the Prometheus Project was UPN 982-00. Additional funding was provided through FY 04 on a technology development number, UPN 973-80. Work was authorized at NASA's Jet Propulsion Laboratory (JPL) via formal Task Order from NASA.

To guide the work in Phase A of the Project, a Preliminary Project Plan was executed in October 2003 by the JPL Center Director, Dr. Charles Elachi, and the Project Manager, John Casani, and the NASA Prometheus Director, Al Newhouse, and Associate Director, Ray Taylor. The Preliminary Project Plan was updated after addition of DOE Office of Naval Reactors (DOE NR) and Northrop Grumman Space Technologies (NGST) to the Project team. The updated plan was not signed by all parties due to notice that the Project would be discontinued.

1.2 Project Summary

The purpose of the Prometheus Project was described in the NASA Level 1 Jupiter Icy Moons Orbiter Requirements document. The Project was to develop a Deep Space Vehicle (DSV) for outer solar system robotic exploration missions that would combine a safe, reliable, Space Nuclear Reactor with electric propulsion. The reactor power conversion system through to the propulsion system was referred to as a nuclear electric propulsion (NEP) system. The DSV was defined to include a Payload Accommodation Envelope (PAE) with a mass capability for science instruments and supporting resources of not less than 1500 kg. Additionally, the DSV technologies (in the areas of nuclear fuel, reactor core materials and coolants, instrumentation and control, and energy conversion) were to be extensible to Lunar and Mars surface power and cargo transport missions.

In addition, the Level 1 requirements stated that the Project would execute a scientific exploration mission to the icy moons of Jupiter (Callisto, Ganymede, and Europa). This was responsive to the National Academy of Sciences' Decadal Survey report which declared Europa exploration to be the number one priority for a planetary exploration "flagship mission" for the coming decade. This mission would have been performed by combining the DSV with mission-specific hardware and software residing in the Spaceship and Ground System.

The Prometheus Project was unique in many respects, particularly the technical challenges and the organizational complexities.

In support of the NASA Vision for Space Exploration, flowing from the Nation's Space Exploration Policy, the Project was directed to develop a DSV using NEP technology. This capability would enable a new era of space exploration through increased spacecraft maneuverability and unprecedented amounts of on-board electrical energy. Significant improvements would be made in scientific measurements (including use of high-capability instruments), mission design options (including successive orbits of solar system bodies), and telecommunications capabilities (unprecedented amounts of scientific data returned from deep space). Development of this capability would require significant technology advances in seven areas: reactor, energy conversion, heat rejection, electric propulsion, high-power telecommunications, radiation-hardened components, and low-thrust trajectory tools.

This technical challenge created a corresponding management challenge. Because no one organization possessed all of the requisite expertise, capabilities, and resources to design, develop, launch, and operate the DSV and perform JIMO and other exploration missions, a multi-organizational team was established. Led by NASA's JPL, the final team included the DOE Naval Reactors Prime Contractor Team (NRPCT), five NASA Field Centers, NGST, and supporting DOE laboratories, universities, and industrial subcontractors. Details of the organization and the management techniques and agreements employed are provided in Sections 4.2 and 5.2 of this document.

Prometheus was to be developed consistent with the NASA life cycle for flight projects, according to the following schedule:

- Pre-phase A (Advanced Studies) – Nov. 2002 – Feb. 2003 (with precursor JIMT studies starting in Sept. 2002) (Completed)
- Phase A (Mission and Systems Definition) – Mar. 2003 – Sept. 2005 (Completed)
- Phase B (Preliminary Design) – Oct. 2005 – Sept. 2008
- Phase C/D (Design & Build/ATLO) – Oct. 2008 – July 2015
- Phase E (Operations) – Aug. 2015 – Sept. 2025

1.3 Project History

Prometheus Project precursor studies, referred to as Jupiter Icy Moons Tour (JIMT) studies, were performed beginning in September 2002. The three parallel studies assessed what might be done using solar power, RTG, and fission reactor power sources.

In November 2002, the NASA Administrator, Sean O'Keefe, selected the space fission reactor for further pre-project study. He directed JPL to generate, in 10 weeks, a project plan, acquisition strategy, and plan for an industry RFP, so that a JIMO project could be recommended to the Administration for submission in the FY 04 budget request to Congress. The pre-project activity was conducted under an "embargo" such that only personnel from NASA HQ, DOE NE, and JPL could participate.

On January 31, 2003, JPL and NASA program personnel briefed the Administrator. A JIMO "Databook" supported the briefing material, and included the proposed task plan,

program/project management approach, WBS, organization, contract management plan, agreements, acquisition strategy issues, acquisition plan, radiation plan, technology plan, and schedules. Additionally, a draft RFP for industry studies was completed. The Administrator accepted the recommendations and JIMO was included in the President's budget submission for FY04.

However, Congress had not completed the FY 03 budget. Rather than waiting for the FY 04 budget deliberations, Congress included JIMO as a new start in FY 03 (seven months early) with \$ 20M funding.

JPL established the JIMO Project Office to implement JIMO and received the Formulation Authorization, discussed above, on March 18, 2003. This marked the start of JIMO as an official NASA project, the beginning of Phase A.

The Project team initially consisted of JPL, NASA HQ, DOE NE, two DOE laboratories (Los Alamos and Oak Ridge) and one NASA Field Center, GRC. The Government team subsequently grew to include another DOE lab (Y-12) and four more NASA Centers (ARC, KSC, LaRC, and MSFC). The Government team began internal trade studies (Technical Baseline 1, completed in August 2003) and initiated technology development activities and planning. Three industry-led teams were placed on contract in April 2003 to perform trade studies and, later, conceptual design studies. Also in FY 03, NASA Space Science chartered a JIMO Science Definition Team (SDT) to recommend the science objectives, investigations, and measurements for the JIMO mission.

A summary of the FY 03 work was documented in the first project Annual Report.

On January 14, 2004, President Bush announced the Nation's Vision for Space Exploration, including the development of power generation and propulsion capabilities for exploration. In February 2004, Mr. O'Keefe established the NASA Exploration Systems Mission Directorate (ESMD), led by Adm. Craig Steidle, and transferred JIMO (now known as Prometheus) into ESMD. The following month, the Secretary of Energy assigned the lead for development and delivery of civilian Space Nuclear Power Systems to DOE's Office of Naval Reactors.

Also in FY 04, the SDT published its Final Report in February 2004; NR established the NRPCT; ESMD established Level 1 requirements for Prometheus; the industry teams delivered their Final Reports; and JPL issued the industry down-selection RFP on May 18, 2004 and completed source selection of NGST on September 20, 2004. An independent review of the Project by NASA and NR, the Milestone Preparation Review, was conducted in June 2004.

A summary of the FY 04 work was documented in the second project Annual Report.

In FY 05, the project successfully completed Phase A, passing the JPL Project Mission and Systems Review (PMSR) in July 2005. Supporting this review was the Prometheus reference Spaceship design and project life cycle cost estimate, 68 “gate product” documents, and an extensive library of other documentation. Prometheus also completed an Analysis of Alternatives (AoA) study for ESMD and performed planning activities for a DSV Demonstration Mission to the Moon.

However, NASA re-evaluated its priorities in light of available funding. NASA indicated that Return to Flight, International Space Station, and Crew Exploration Vehicle were the highest priority tasks for the Agency. The Agency nuclear initiatives were postponed to a large extent, and work within the nuclear systems program was reprioritized. NEP was given third priority behind nuclear surface power and nuclear thermal propulsion. Consequently the Prometheus Project was directed to not proceed into Phase B. In addition, the Project was asked to support a major Agency study, the Exploration Systems Architecture Study (ESAS), in the area of lunar surface power. The Project delivered the Lunar Fission Surface Power Station Study Final Report on August 17, 2005.

The Project was officially discontinued effective October 2, 2005. This Final Report and all project documentation are the final deliverables for the Project.

Precursors to the Prometheus Project include the Space Power-100kW (SP-100) Project, the Deep Space One (DS1) mission, the NASA Evolutionary Xenon Thruster (NEXT) project, and the X2000/Deep Space Avionics (DSA) project. SP-100 was a Department of Defense (DOD)-NASA-DOE multi-party development that provided valuable experience and technology in developing a spaceborne nuclear reactor. The DS1 mission provided valuable experience in ion-propulsion development and mission operations. NEXT is an ongoing electric-powered ion thruster development involving JPL in collaboration with GRC and MSFC. X2000/DSA provided valuable experience in identifying and developing electronics and materials that will function in an extreme radiation environment. Precursors to the JIMO mission include Project Voyager and Project Galileo. Voyager and Galileo were science explorations of Jupiter and provided considerable experience in understanding its harsh radiation environment.

More information on the Project accomplishments is summarized in this document. The key Prometheus events are summarized in Appendix B.

1.4 Scope of Final Report

This Final Report serves as an executive summary of the Prometheus Project’s activities and deliverables from November 2002 through September 2005. It focuses on the challenges from a technical and management perspective, what was different and innovative about this project, and identifies the major options, decisions, and accomplishments of the Project team as a whole. However, the details of the activities performed by DOE NR and its contractors will be documented separately in accordance with closeout requirements of the DOE NR and consistent with agreements between NASA and NR.

DOE NR was responsible for the development and delivery of civilian space nuclear power systems for the Prometheus Project. During Phase A, NR/NRPCT completed an initial feasibility study, selected a reactor and energy conversion technology concept for implementation, and developed a detailed Space Reactor Planning Estimate.

The key Project documents are listed in Appendix A, "For Further Information." Many of these documents point to other supporting Project documents.

All of these documents, as well as hundreds of other Prometheus Project plans, technical design file memos, white papers, and published technical papers, are included in the Prometheus Project Library. Interested parties may access this information contacting NASA Headquarters. Interested parties may also access this information by contacting the JPL Librarian.

[This page intentionally left blank]

2. Objectives and Requirements

The exploration objectives of the Prometheus Project were to enable a new era of space exploration through increased Spaceship maneuverability and unprecedented amounts of on-board electrical energy. This was to be accomplished by developing a Deep Space Vehicle for outer solar system robotic exploration that combines a safe, reliable, space nuclear reactor with electric propulsion. Significantly improved capability for scientific measurements, mission design, and telecommunications would have been provided.

2.1 Science Objectives

The Prometheus 1 Science Objectives were not yet identified at the time of the project termination. See section 2.3 for a description of the path forward on development of the Level 1 science requirements.

2.2 Technology Objectives

The primary Technology objective was to demonstrate safe and reliable operation of an NEP system in space.

In addition to the development of the space nuclear reactor, several other technology developments were necessary to meet the Prometheus Project objectives. The development of a power conversion system was necessary to be able to convert the energy generated by the reactor into useful electrical power and propulsion. Because not all of the energy generated by the reactor in the form of heat could be effectively converted into electrical power, development of a significant heat rejection system was needed. Although electric propulsion has been used to a limited extent previously by NASA, additional developments were needed. The overall space nuclear power plant presented unique materials reliability and compatibility issues, which required further development.

Radiation hard electronics were needed for operation of the nuclear powered spacecraft during deep space missions and operation of the instruments enabled by the availability of significant on-board electrical power. Additional capability was also needed for the high radiation environments such as those that exist in the Jovian system. Also, the higher on-board electrical power would enable more powerful science instruments and significant science return, provided high-power telecommunications capabilities could be developed. The technology development plans, strategies, and goals were identified in the Technology Development Plan Requirements.

2.3 Level-1 Requirements and Mission Success Criteria

On April 22, 2004, NASA Headquarters commissioned a Requirements Formulation Team to recommend a set of Prometheus Level-1 requirements consistent with the new Vision for Space Exploration articulated by the President in January 2004. This multi-disciplinary, multi-Center team included engineers and scientists from NASA Headquarters, GRC, Johnson Space Center (JSC), KSC, and JPL. An abbreviated “Strategy-to-Task-to-Technology” process was used in the requirements formulation.

The resulting requirements were formally signed off on May 18, 2004 and documented in the “Level 1 Jupiter Icy Moons Orbiter (JIMO) Requirements Document”. The approach, deliverables, and analyses performed by the Requirements Formulation Team were documented in the “JIMO Level-1 Requirements Formulation Team Report”.

The Prometheus Level-1 requirements are aligned with two overarching requirements that follow the Prometheus Project objectives, namely:

OR1.1: The JIMO Project shall develop a Deep Space Vehicle for outer solar system robotic exploration missions that combines a safe, reliable, Space Nuclear Reactor with electric propulsion.

OR 1.2: The JIMO Project shall execute a scientific exploration mission to the icy moons of Jupiter (Callisto, Ganymede, and Europa).

At the PMSR, the project demonstrated its plan to meet all of the Project Level-1 requirements.

The official Level-1 JIMO science requirements were planned for release after science investigation selection (resulting from a NASA Announcement of Opportunity) in Phase B. These requirements were to have been documented in the Prometheus Project Plan. A draft set of JIMO Level-1 science requirements was proposed by NASA Code S, and was documented as an appendix in the “Level 1 Jupiter Icy Moons Orbiter (JIMO) Requirements Document.”

At the PMSR, the Project demonstrated its intent to meet these draft science requirements with one exception. Requirement SR 1.3 states: “The JIMO mission shall acquire electro-optical observations of the icy satellites up to 25 cm in resolution while in mapping orbits, observations of Io up to 1 km in resolution from Callisto, and observations of Jupiter up to 10 km in resolution from Callisto”. The issue is that observations of Io up to 1 km in resolution from Callisto would require an optical imager aperture of ~3m, and this large camera would need to be mounted on the scan platform. This constituted a major driving requirement in terms of camera and scan platform size, mass and dynamics.

The intent of the requirement was to facilitate the imaging of Io throughout as much of the inter-moon transfer trajectory as possible, at as high a resolution as is practical on a Prometheus-class spaceship. A ~1 meter optical imaging aperture may be practically accommodated on a Prometheus-class spaceship, and would provide the desired 1 km resolution imaging of Io from the orbit of Ganymede (rather than Callisto), inward toward the orbit of Europa. At the time of the PMSR, Curt Neibur (JIMO Program Scientist) and John Spencer (of the JIMO Science Definition Team) verbally indicated that it may be acceptable to change this existing requirement by replacing the word Callisto with Ganymede in the Io imaging clause.

The Prometheus success criteria are defined in the Project Plan, and are split between the two key Level 1 requirements described above. For OR 1.1, full mission success was defined as providing a safe nuclear powered Deep Space Vehicle for outer solar system robotic exploration missions that accommodates a Mission Module mass of no less than 1500 kg and can maneuver around multiple destinations in a single mission. The mission success criteria for OR 1.2 would depend on the goals of the specific selected mission.

2.4 National Environmental Policy Act (NEPA) Compliance and Launch Approval Engineering

In compliance with the JPL institutional requirements, the Prometheus Project completed an “Environmental Compliance/Launch Approval Status System” (ECLASS) worksheet in Phase A. The ECLASS worksheet identified the required NEPA and Launch Approval actions for the Project. The specific actions required to comply with NEPA and obtain Launch Approval were outlined in the Prometheus Project Launch Approval Engineering Plan.

The Prometheus Nuclear Systems and Technology Program began preparation of a Tier 1 Environmental Impact Statement (EIS) applicable to NASA development of a fission reactor power system for space use. The purpose of the Tier 1 EIS and the resulting Record of Decision (ROD) was to determine if NASA would proceed with the development of a fission reactor power system. Details of the reactor design, the spacecraft, or the launch vehicle were not necessary, as they were not being decided as a result of the Tier 1 EIS. The Notice of Intent (NOI) to prepare the Tier 1 EIS was issued on March 30, 2005. Public meetings were held in Florida on April 20, 2005 and in Washington DC on April 27, 2005. NASA’s plans for proceeding with this EIS may change and the NOI may need to be revised based on the new direction of the space reactor development effort at NASA.

In addition to the Tier 1 EIS, additional NEPA documents would be required for the facility that would conduct the fabrication and testing of the nuclear system and an integration facility at KSC/CCAFS. Once the Tier 1 EIS and facility EISs were sufficiently complete, the Project was to begin development of the Prometheus 1 Tier 2, mission-specific EIS. This EIS would address the environmental impacts of conducting the first Prometheus mission. The Launch Approval Engineering Plan includes the top level schedule for NEPA Compliance activities to support the Mission. Neither the facility EISs nor the mission-specific document have been started.

The Prometheus 1 Launch Approval Engineering Plan included the high-level schedule for the safety analysis report (SAR), supporting SAR databook, radiological contingency plan, risk communication materials, and support to the Interagency Nuclear Safety Review Process. Initial meetings were held with the NRPCT to develop the integrated Launch Approval schedule, provide examples of the type of information that would be available once the launch vehicle was selected and the Spaceship design was finalized, and discuss the form of the input data on launch accident environments that would be compatible with the NRPCT safety analysis codes.

A general Risk Communication Plan was developed for the Prometheus-1 Mission. The Prometheus Risk Communication Plan outlines the strategy and process of communicating the safety risk aspects of the Project, including nuclear matters. The communication strategy and process was coordinated with the JPL Risk Communication Plan for Planetary and Deep Space Missions.

2.5 Project Nomenclature

The Prometheus Project system naming conventions were somewhat unique to reflect the overall purpose of the Project. The intent was to develop a Deep Space Vehicle with generic capabilities that could be utilized for multiple missions. The Deep Space Vehicle would remain virtually unchanged for follow-on missions, and each mission would have separately configured science-driven payloads, called Mission Modules, similar to what is currently done with separate spacecraft on a common launch vehicle. Each of the Mission Modules must fit within the Payload Accommodation Envelope available with the generic Deep Space Vehicle. As with launch vehicles, the recurring cost of follow-on missions would be minimized by maintaining strict configuration control of the DSV. The combination of the DSV and the mission-specific Mission Module was referred to as the Spaceship.

Therefore, the naming conventions for the Project were:

- Program Name: Prometheus Nuclear Systems and Technology Program
- Project Name: Prometheus Project
- Deep Space Vehicle name: Prometheus 1. The second, third and fourth DSV, if built, would be called Prometheus 2, etc.
- Mission Name: Jupiter Icy Moons Orbiter.

The Prometheus 1 Deep Space Vehicle with the JIMO-specific Mission Module was referred to as the Prometheus 1 Spaceship.

2.6 JPL Institutional Requirements Compliance and Tailoring

The Project was compliant with NASA Program and Project Management Requirements [NPG-7120.5B as a result of being compliant with JPL's Flight Project Practices (FPP) and JPL's Design, Verification/Validation, and Operations Principles for Flight Systems (Design Principles, DP). Of the many institutional requirements, there were very few deviations. Deviations to these requirements were formally documented using the JPL waiver process.

The Project had the following 12 approved waivers from JPL requirements:

1. The requirement to use the JPL Standard WBS Template and the WBS Tailoring Guidelines was waived. The JIMO Project used its WBS as an integral feature of the management process. The Project participation included a significant number of organizations, including another government agency and its contractors, and several NASA Centers. The standard WBS did not meet the management needs of the Prometheus Project.
2. The Design Principles requirement that the Spacecraft system-level power margin for cruise, mission critical, and safing modes be at least 30% at the time of PMSR, 20% at Project PDR, 15% at CDR, and 10% at ATLO Readiness Review (ARR) was waived for the Electric Propulsion Segment (EPS).

For Prometheus, the largest in-flight power demand occurs when thrusting at full capability. During this time, most of the power is delivered to the EPS. As the EPS loads are large and controlled closed loop, strict compliance with JPL Design Principles would require a major over-design. Therefore, no margins will be tracked against this load requirement. The EP loads will be defined at the input of the Power Processing Units as an Allocation. The EP loads will be managed within the Spacecraft Module. The EP loads will also not be subject to Uncertainty Allowance or Design Growth Allowance because they are treated as an Allocation within the Spacecraft Module.
3. The requirement for support agreements with foreign partners at PMSR was waived as there were no foreign partners for this project at this time (i.e., not applicable).
4. The requirement for Implementation Phase LOAs/MOUs with foreign partners was waived as there were no foreign partners, and none anticipated, at this time (i.e., not applicable).
5. The requirement to have work agreements and summary work agreements for Phase B and draft work agreements and summary work agreements for Phase C/D at the time of PMSR was waived. Prior to PMSR, NASA had indicated it intended to cancel the JIMO 2015 mission. Therefore, the requirement to have work agreements and summary work agreements for follow on phases was moot. However, the Life Cycle Cost Estimate required schedules, basis-of-estimates and resource plans for all phases. This LCCE input was used to document the work plans in lieu of formal work agreements.

6. The requirement to present the final selected science payload at the PMSR was waived. NASA did not plan to select science investigations prior to 2008 for the JIMO 2015 mission.
7. The requirement to provide the not-to-exceed cost estimate for launch services to support the JIMO mission was waived. The project baselined the launch of the JIMO mission using three upgraded EELV's, two with long duration upper stages and one with the Prometheus Spaceship. The status of the project at the time of the PMSR did not warrant expending additional funds in generating a not-to-exceed estimate.
8. The requirement to produce a Draft Detailed Mission Requirements Document (DMR) for the JIMO 2015 PMSR was waived. The IND-DSMS related "key and driving requirements" (Level 3 requirement maturity level required for PMSR) were included in the DSMS Support Agreement. The requirements in the Agreement were of sufficient detail to allow IND-DSMS to adequately understand the scope of the effort, provide a good fidelity cost estimate, and to provide an "implementation response to key and driving requirements" at the PMSR as required. Thus, a separate document with the same information was not required.
9. The requirement to use the institutionally supported Requirement Tool, DOORS, was waived. Cradle was selected as the central software for the Prometheus Project Engineering Model. This selection was the result of a project tool study. Cradle was selected because it 1) supported the required functionality for the system engineering process, 2) had superior usability, extensibility, and UML 2.0 support relative to other products, and 3) was recommended by NASA's ESMD System Engineering Tool Evaluation Team for use by all Directorate projects. Cradle included/exceeded the capabilities of DOORS. Products could be imported from DOORS to Cradle or vice versa when necessary to interface with external Project needs.
10. The FPP project priorities of personnel safety, reliability, cost, schedule, and performance were waived. Prometheus priorities were personnel safety, reliability, performance, cost, and schedule. Prometheus was a technology development and demonstration project for which successful demonstration of performance was a high priority requirement.
11. The requirement to have the Task Plan for Phase B complete and signed by CMO and NMO for the PMSR was waived because of the impending cancellation of the Project. The Task Plan was written and reviewed by CMO, but it was not subsequently submitted into the formal signature process.
12. The requirement for a 40% or more energy margin (depending on new or inherited hardware/designs) assuming an allowable depth-of-discharge (DoD) of 40% and CBE of electrical load demand, including losses at Implementation phase start was waived. JIMO will meet this requirement assuming a 70% DoD. A 70 percent depth-of-discharge is consistent with capability for batteries with a small number of discharge cycles. The batteries assumed are NiH2 and the estimated number of cycles is less than 10 in flight.

A matrix documenting the Prometheus Project compliance to JPL institutional requirements was presented at the PMSR. The PMSR is normally held at the end of Phase A (Mission and System Definition) and prior to the start of Phase B (Preliminary Design). Its purpose is to evaluate whether the preliminary planning, requirements, mission concepts and system concepts and proposed reference design are adequate for this phase of the project, and serves as a means for describing the state of completion and documentation of the Phase A products. The PMSR also evaluates whether the required gate products are in compliance with Institutional Requirements.

[This page intentionally left blank]

3. Mission Description

The Prometheus Project was charged with developing a multi-mission Deep Space Vehicle that could be used in conjunction with mission-specific Mission Modules to perform multiple deep space missions. The Project extensively studied the Jupiter Icy Moons Orbiter (JIMO) mission and looked at numerous other deep space mission options. The JIMO Mission Overview is contained in Section 3.1; a set of candidate follow-on missions are briefly described in Section 3.2. Additionally, several studies were performed to look at other mission options, including: Lunar Orbiters, Venus Orbiter, Mars Orbiter, Comet Rendezvous, Asteroid Divert, Asteroid Rendezvous, lunar and Mars surface stations, and Mars transport vehicles. These studies are summarized in Appendix F.

3.1 JIMO Mission Overview

JIMO, destined to explore the Jovian system, was designed to be the first in a series of nuclear-electric-propelled missions to the outer solar system. The primary elements of the JIMO mission consist of a JIMO Spaceship, three Step 1 launch vehicles, two transfer vehicles, and the ground-based science and engineering operations teams and facilities. The JIMO Spaceship is comprised of a Prometheus Deep Space Vehicle carrying a JIMO-unique Mission Module.

Figure 3.1-1 shows the mission overview timeline with the major events and phases, based on the 2005 Reference Trajectory completed in the summer of 2005. The JIMO Draft Mission Plan identifies details of each mission phase, including start and end triggering events, major activities planned, and a description of the type of DSN (and TDRSS) tracking coverage required.

The JIMO launch campaign was to open in May 2015 and required three separate launches. As NASA had not selected the launch vehicle(s) to be used by JIMO, the delivered mass capabilities as well as other key planning characteristics were analyzed parametrically. The baseline assumes a 37,000 kg launch vehicle capability to an altitude of 407 km at 28.5 degree inclination. That orbit is called the Earth Assembly Orbit. This orbit was chosen as a compromise that provides a large payload to orbit balanced against the need to have sufficient lifetime against atmospheric decay to accomplish all the rendezvous/docking operations.

The successful launch of the first transfer vehicle initiates the start of the Earth-Orbit Operations phase, during which the subsequent launches, the rendezvous/docking, and interplanetary injection take place. The second transfer vehicle is launched next in the campaign into an orbit that is similar to that of the first transfer vehicle. Upon successful rendezvous and docking of the transfer vehicles with each other, the JIMO Spaceship launches as early as mid-late September 2015 into that same Earth Assembly Orbit. The docked transfer vehicles subsequently rendezvous and dock with the Spaceship.

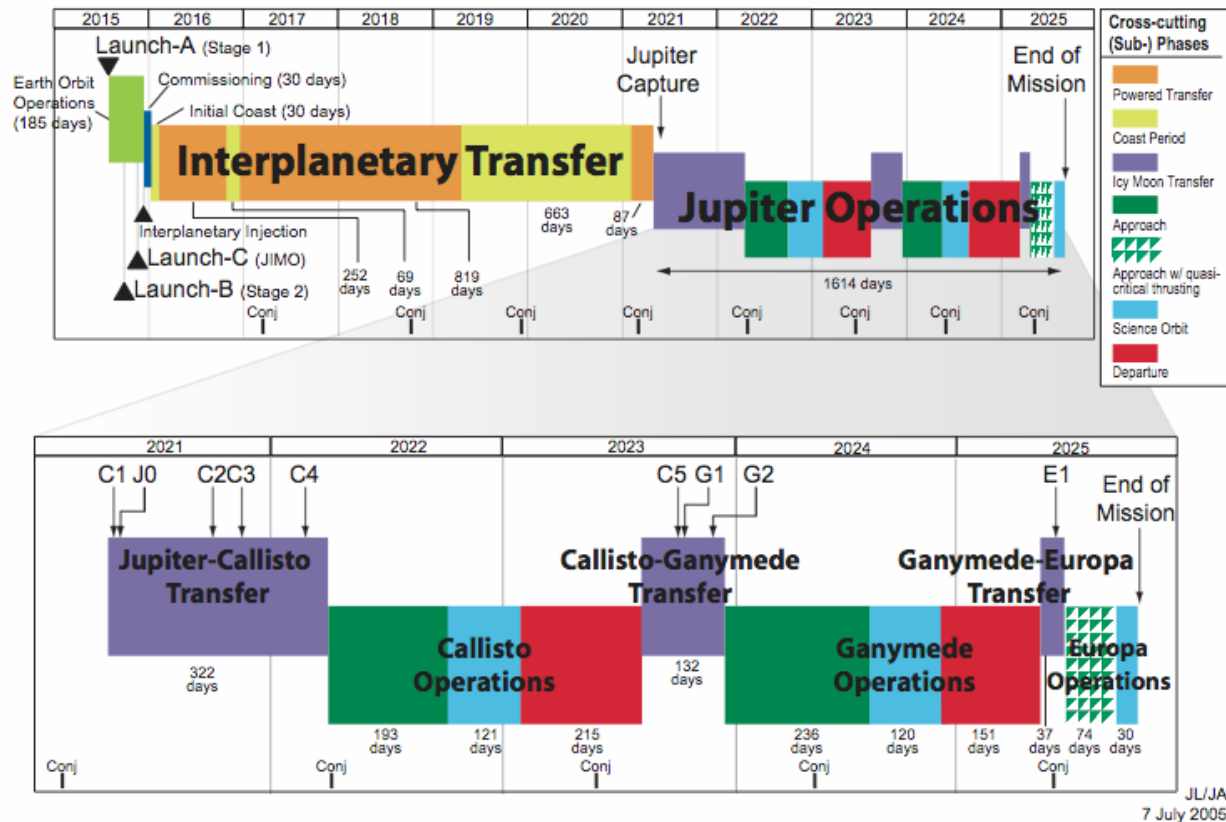

Figure 3.1-1. Mission Overview.

JIMO may spend up to a month in Earth orbit, either on its own or attached to the transfer vehicles, depending on the orbit phasing necessary to achieve the Earth-departure trajectory targets. As early as late October 2015, JIMO injects onto an interplanetary trajectory (C3=10 km²/s²). The injection period ends in mid-January 2016.

Operational scenarios for each phase of the mission were detailed to understand the implications on operational limitations and fault protection requirements. These detailed scenarios are documented in the “Space System Operational Modes Definitions.” A top-level description is included in the sections that follow.

3.1.1 Commissioning

The purpose of Commissioning is to be able to transition JIMO from an undeployed, solar powered Spaceship configuration to a configuration in which the nuclear reactor is powering the Spaceship and routine electric thrusting can begin. Commissioning involves four major activities: 1) the deployment of the main spacecraft booms and radiators and jettisoning of the aeroshell; 2) the activation of the heat rejection system and reactor startup; 3) the activation and checkout of the electric propulsion system; and 4) the jettisoning of the docking adapter and the completion of the science hardware deployment. The Commissioning phase is anticipated to take 30 days.

3.1.2 Interplanetary Transfer

The baseline trajectory is a low-thrust, direct trajectory to Jupiter with three major thrusting arcs (see Figure 3.1-2). The first and second arcs are separated by a short coast period near the first aphelion, and combine to send the Spaceship out toward the orbit of Jupiter. After roughly a year of coast, the spacecraft approaches Jupiter's orbit, and it begins the rendezvous thrust arc, which is timed so as to allow capture of the spacecraft by Jupiter several months later.

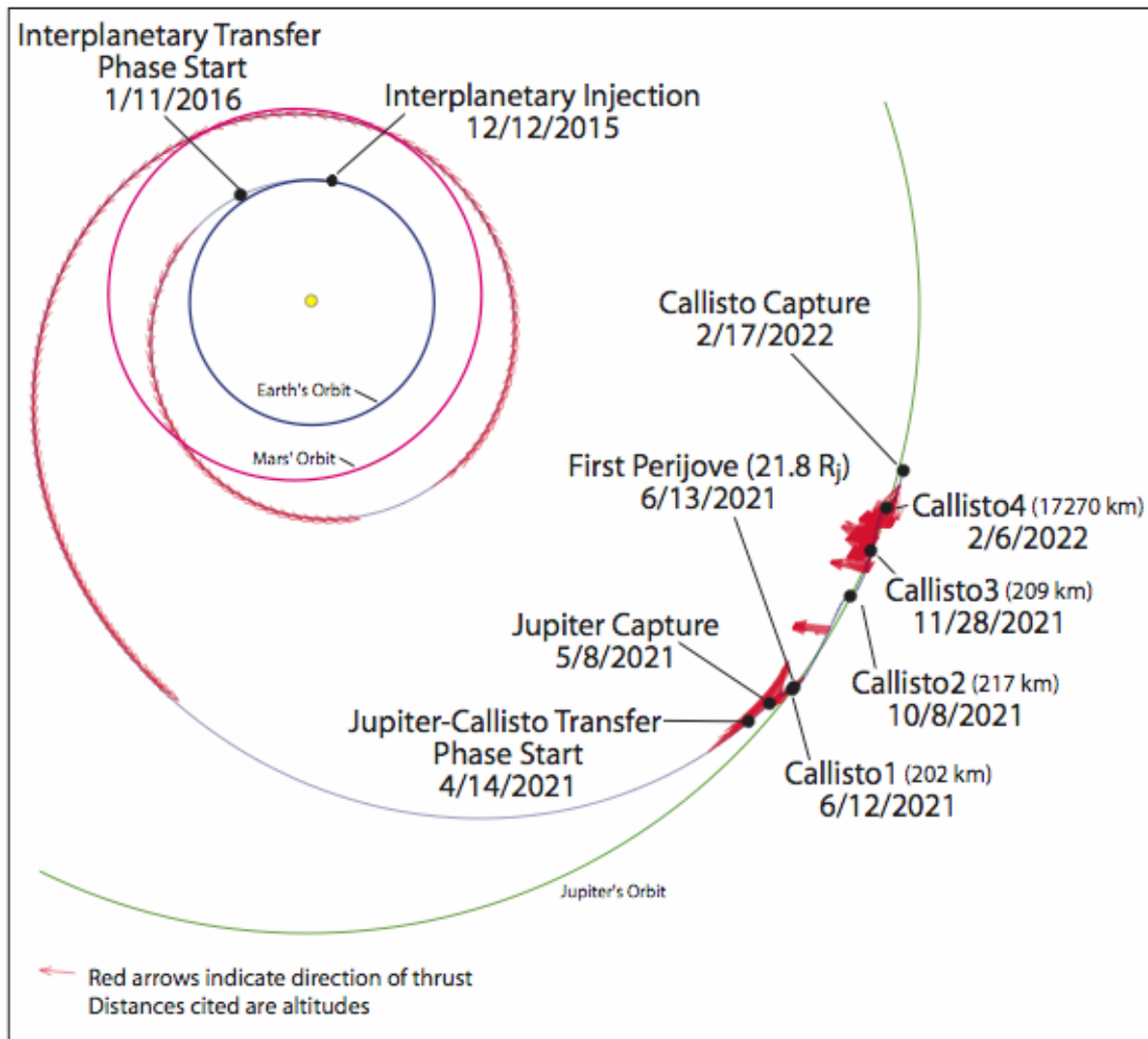

Figure 3.1-2. Interplanetary Transfer Through Callisto Capture.

3.1.3 *Jupiter Operations*

Jupiter operations begin at 60 days prior to Jupiter Closest Approach (JCA). Capture by Jupiter will occur roughly a month prior to JCA. During this approach, the Spaceship will take optical navigation images of Jupiter, Callisto and the other Galilean moons against star backgrounds to significantly improve the knowledge of Jupiter and its satellites' ephemerides. JIMO would spend over four years in the Jovian system. During that time, JIMO will spend several months in the vicinity of each of the icy Galilean moons, eventually orbiting them in turn, starting with Callisto, followed by Ganymede, then Europa. The Spaceship will be thrusting much of the time. Fields and particles science data will be gathered whenever possible, subject to thrusting constraints. A systematic Io observing campaign will be conducted by selected remote sensing instruments, again subject to constraints on attitude.

Transfer phases separate the satellite operations phases (see Figure 3.1-1). The satellite operations phases are broken into Approach, Science Orbit, and Departure sub-phases. Due to the weak control authority of the low-thrust propulsion system, and the strong gravitational perturbations due to the multi-body environment, the sensitivity of the trajectory to missed thrust can be quite high during the Approach and Departure sub-phases. At certain times during the Europa Approach phase the instantaneous orbit lifetime (defined as the time prior to escape or impact if thrusting were lost) can be as short as a few hours for optimum delta-V transfers. Constraints on the mission design and possible special robustness requirements on the Spaceship and/or mission operations teams are required to safely deal with these sensitivities. For example, higher-thrust Hall thrusters were added specifically for higher control authority during the Europa Approach phase. Figure 3.1-3 illustrates the complexity of operating in a multi-body gravity environment (these plots are for the trajectory during the Callisto Approach phase; similar plots would exist for Ganymede and Europa approaches). The departure phases are, from a trajectory standpoint, roughly the reverse of the approach phases.

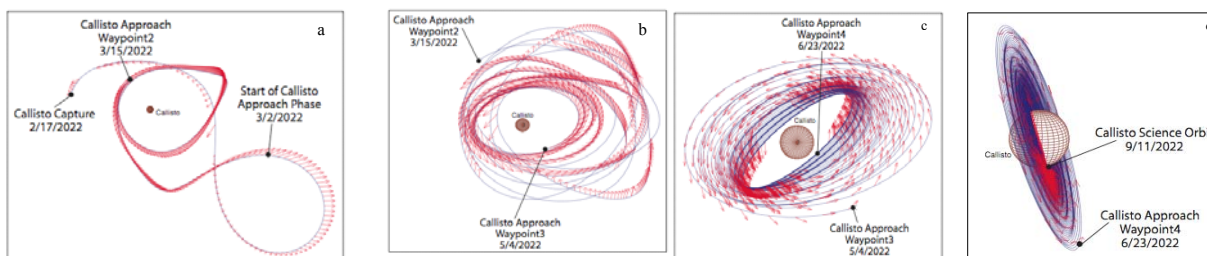

Figure 3.1-3. Jupiter Capture Through Callisto Capture (inertial view).

The Approach sub-phase ends with the Spaceship in the baseline science orbit: near-polar inclination, at a near-circular altitude orbit of 100-200 km altitude, and at a node which provides appropriate lighting coverage for the optical instruments. Satellite orbit stay durations are required (threshold values) to be 60 days at Callisto and Ganymede, and 30 days at Europa. A goal (objective values) of twice the requirement is sought, although the radiation environment at Europa will make such a goal difficult to attain. End of mission is planned with the Spaceship in science orbit at Europa.

3.1.4 *Planetary Protection*

Since Europa is a destination of biological interest as a potential habitable environment, both the orbiter and auxiliary science package must meet strict planetary protection requirements (to be supplied by the NASA Planetary Protection Officer). The requirements for planetary protection associated with a mission to Europa focus on reducing the probability of inadvertent contamination of a European ocean to less than 1×10^{-4} per mission as described in "Planetary Protection Provisions for Robotic Extraterrestrial Missions," NASA Procedural Requirements 8020.12C, Appendix A.3-"Category III/IV Requirements for Europa".

Implementation trades were completed that investigated various approaches to meeting planetary protection requirements including Europa departure to distant retrograde orbits at end of mission. Based on the results of these trades (driven by propellant mass and reliability issues), it was agreed that impacting Europa at end of mission would be an acceptable approach to pursue. Consistent with this approach it is anticipated that a combination of pre-launch dry heat microbial reduction of shielded hardware, radiation sterilization of the external surfaces from the naturally high Jovian radiation in the vicinity of Europa, and trajectory biasing would be required to satisfy planetary protection requirements.

To achieve formal Planetary Protection categorization, the Project submitted a request for categorization of the orbiter as Category III and the auxiliary science package as Category IV to the NASA Planetary Protection Officer, as documented in the Planetary Protection Category Request Memo to NASA HQ PP Officer.

Follow-on tasks that would have been pursued in the event that the Project had continued include 1) securing formal category approval from NASA and 2) preparation of a Planetary Protection Plan.

3.2 **Follow-On Missions**

The Prometheus concept is to design a DSV to enable a series of missions, with the JIMO being the first in this series. A selected set of missions requiring high performance were specified by NASA and the Nuclear Systems and Technology Program Office to assess this concept. These missions were analyzed to assess the applicability of the DSV design to potential follow-on missions:

- Saturn and its moons
 - Comprehensive exploration of Saturn and Titan,
- Neptune and its moons
 - Comprehensive study of the Neptunian system,
- Kuiper Belt Rendezvous
 - Rendezvous with and study multiple Kuiper Belt objects,
- Interstellar Precursor
 - Reach 200 AU at the heliopause nose,

- Comet Cryogenic Sample Return
 - Return a cryogenically preserved sample from a comet,
- Multi-Asteroid Sample Return
 - Study multiple asteroid types and return samples from each.

The major DSV design assumptions for follow-on missions are:

- a) The DSV technology and critical design features are fixed. Relatively simple configuration changes within the available DSV volume are allowed; e.g., radiation shields can be changed, propellant tankage may be changed.
- b) The DSV has a 20-year lifetime with a reactor energy that will support 10 years of full power operation plus 10 years of operation at reduced power. The reduced power operation is used in non-thrusting periods and is driven by the requirement to maintain acceptable temperatures throughout the power system (preliminarily assumed about 30% of full power).
- c) The DSV power system (reactor, power conversion, heat rejection) designs are fixed.
- d) The DSV ion thruster design is fixed, but the thruster nominal specific impulse is settable prelaunch in the range 6000 to 8000 s.
- e) The DSV thruster power is 180 kWe and the design Xenon tank capacity capability is 18,000 kg.

The principal findings of this study were:

1. The current Prometheus reactor and design envelope can be used for five of the six potential follow-on missions (the Interstellar Precursor mission duration is excessive).
2. The most critical parameter in enabling missions is the required total mission time; therefore most unstudied missions that do not intrinsically require very long flight times should also be feasible.
3. The use of Earth gravity assist (EGA) trajectories is required in the heliocentric phase of some of the outer solar system missions to reduce mission duration to desirable levels with realistic launch vehicle capability.

Most of the missions can be implemented comfortably within the 20 year design mission life even with substantial science mission duration at the outer planets. The Kuiper belt mission can be implemented at a single object, but multiple objects will likely require an extended mission. The 200 AU Interstellar Precursor mission intrinsically requires a very long life time; this may be practical after the DSV capability has been demonstrated on other missions, but cannot be assumed at this time.

This study validated the Prometheus concept assumption that a well designed DSV can be used to practically implement a wide variety of challenging and interesting missions.

4. Implementation Approach

4.1 WBS and Products List

The Prometheus Project used the Work Breakdown Structure (WBS) as an integral feature of the management process. The process and requirements for generation of the Prometheus WBS was described in the Preliminary Prometheus WBS Development Document, June 9, 2003. Management and oversight was distributed among JPL, NRPCT, several NASA Centers, and several subcontractors.

The Standard JPL WBS did not meet the management needs of the Prometheus Project. The Prometheus Project requirements generally followed the guidance given in MIL-HDBK-881, Work Breakdown Structure, January 2, 1998. HDBK-881 more closely met the management structure needed for the Project. Much of the text of the WBS Development document was excerpted from MIL-HDBK-881 with tailoring specific to the needs of the Prometheus Project. The Prometheus Project obtained a waiver from the JPL standard WBS structure. The Prometheus Project WBS and WBS Dictionary were accepted by NASA IPAO.

The WBS to Level 2 with the Deep Space System extended to Level 3 is shown in Figure 4.1-1.

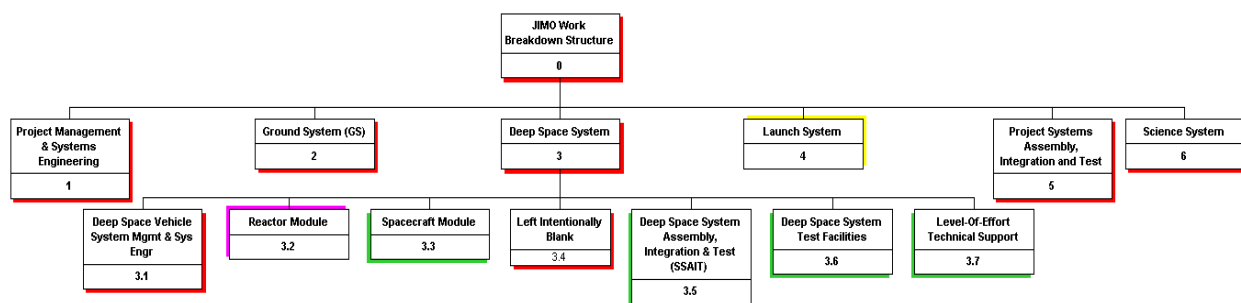

Figure 4.1-1. WBS to Level 2 with Spacecraft System to Level 3.

The NGST portion of the WBS is defined in the NGST Prometheus 1 Work Breakdown Structure and Dictionary.

The primary responsibility of the various parts of the Prometheus Project is shown by color-coding of the WBS structure. The implementation responsibility legend is shown in Figure 4.1-2.

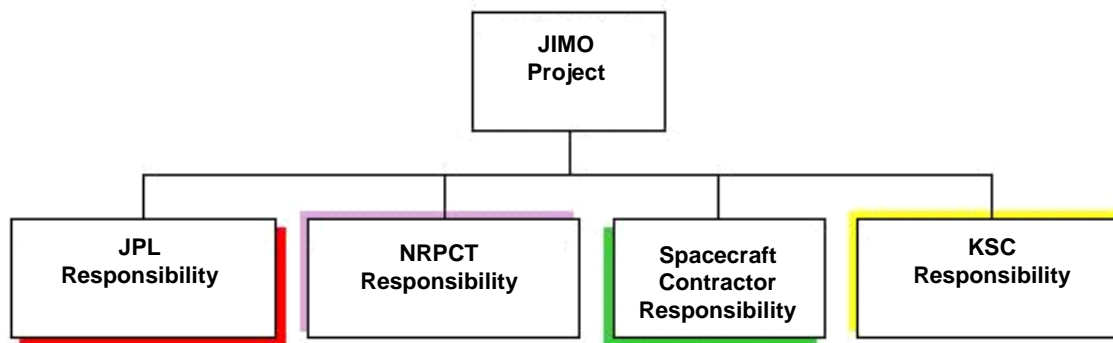

Figure 4.1-2. Implementation Responsibility Legend.

The list of the products resulting from the Prometheus Project are contained in the Project Document List.

4.2 Implementation Summary

NASA must partner with DOE when developing and implementing a DSV utilizing nuclear systems. The responsibility to develop, design, deliver, and operationally support civilian space nuclear reactors, in furtherance of NASA exploration of the solar systems and beyond as part of the Prometheus Project was assigned to the Office of Naval Reactors in DOE by Secretary of Energy Spencer Abraham (Assignment of Responsibility for NASA Civilian Space Nuclear Reactors, March 8, 2005). The relationship and responsibilities of DOE and NASA for the Project were outlined in the Memorandum of Understanding (MOU) and Memorandum of Agreement (MOA) between NASA and DOE/NR. Consistent with those documents, NASA established JPL as the Project Office with overall responsibility for Space System and Launch System development, including project planning, budget formulation, defining and authorizing scopes of work, and assessment of cost and work performance. DOE/NR was responsible for developing, designing, delivering and operationally supporting a civilian space reactor that would satisfy NASA mission objectives. In accordance with the MOA, NR established the NRPCT as the NR program organization responsible for all matters related to the space reactor and space nuclear power plant. JPL and NRPCT maintained a close peer-to-peer relationship on technical matters, with the direction to NRPCT provided solely by NR.

NR was also responsible for defining security requirements for the Project as they related to information concerning the nuclear reactor. Although the reactor was for civilian use, some reactor related technology was expected to be restricted; therefore NR developed a classification guide to be used by the project participants (see Appendix A). In addition, certain members of the project obtained DOE security clearances so that they could fully participate in the design and development of the reactor. Information concerning public health, safety, and the environment would be unclassified and releasable to the public.

The Prometheus Project Office staff performed project management, project system engineering, project safety and mission assurance, mission design, and mission operations management. A subcontract for Spacecraft Module co-design, fabrication, and integration of the entire Spaceship was issued by JPL to an aerospace contractor, NGST. This initial contract only covered Phase A/B, and was terminated at the end of Phase A. Separate contracts would have been let by NRPCT to JPL, NGST, and others for the design and fabrication of components under NRPCT's responsibility. Appropriate persons from the respective organizations handled administration and technical direction of their procurements.

JPL was to provide the Mission Module and the Small Deep Space Transponder, while the NRPCT was to provide the Reactor Module. These items were to be provided as Government-furnished equipment (GFE) to NGST.

The Prometheus Project intended to use the launch services chosen by the NASA ESMD for use with NASA exploration missions. However, alternatives that include multiple launches on existing heavy-lift expendable launch vehicles were carried as contingency.

Persons from JPL and other NASA Field Centers staffed the Prometheus Project Office. JPL representatives were to be resident at NRPCT and NGST sites starting in Phase B. In this way, the Project intended to coordinate the interface and draw upon the capabilities of the multiple Prometheus Project partners.

4.3 Acquisition and Surveillance Summary

The Project's acquisition strategy was documented in the Project Acquisition Plan. The strategy would have been updated in a final Plan before the end of Phase B. Key elements of the acquisition process execution are described below.

4.3.1 Acquisition Process

The Prometheus acquisition activity covered all Project elements, and it included from initial planning both "getting on contract" (pre-award) and "contract management" (post-award) considerations. The acquisition strategy was formulated by the Project Acquisition Team, consisting of the Project Acquisition Manager (lead), Project Manager, Spaceship Manager, Spacecraft Manager, and Subcontract Manager. The team was supported by other resources as needed, across the Government team.

The strategy was formulated and implemented according to JPL's approved process. It also complied with requirements by the NASA Management Office (NMO) at JPL for special surveillance, including advance notification of all JIMO procurement actions (JPL subcontracts, purchase orders, and modifications) exceeding \$ 100,000 and requested special briefings.

The strategy was intensively reviewed by the JPL Acquisition Strategy Review Board (twice); at an Acquisition Strategy Briefing to ESMD, NMO, NR, and others at NASA HQ on March 5, 2004; and by the Milestone Preparation Review board on June 28-29, 2004. The strategy was implemented using the performing organizations' approved practices and procedures.

The objective of the strategy was to establish the Prometheus team, co-design the conceptual Spaceship, and estimate its costs in time to support the NASA FY 06 Program Operating Plan (POP) budget submission. Guiding principles were established, the most important of which were:

- Obtain and effectively utilize the best national resources as an integrated team.
- Retain Total System Performance Responsibility (TSPR) in the Government team.

4.3.2 *Make-or-Buy Program*

The civilian space reactor, including the energy conversion segment, was to be provided, by interagency agreement, by DOE NR.

The make-or-buy decisions for the major elements of work were:

- Launch System – KSC (the NASA lead Center for launch services), utilizing launch vehicles and launch services from a TBD industry supplier
- Spacecraft Module and Spaceship I&T – Industry (NGST selected), leveraging the economies of scale and manufacturing facilities and processes necessary for the anticipated multiple-vehicle production
- Ground System – JPL (experienced in deep space navigation, communications, and data processing), supported by NGST and NRPCT
- Technology Developments – a phased responsibility, with each development assigned to an experienced Government organization through PDR, with NGST responsible for implementation post-PDR
- Mission Module – JPL (experienced in deep space science instruments and payload accommodation).

4.3.3 *Phase A Procurements*

Prometheus Phase A procurements focused on trade studies, conceptual design studies, technology development, and initiation of co-design.

- Launch Vehicle studies were issued by KSC to the EELV launch services providers, Boeing and Lockheed Martin, for two tasks: 1) study multiple launch scenarios, and 2) study long-duration upper stages.

- Science and Mission Design procurements included support for Science Definition Team (SDT) members, a NASA-issued task order to Aerospace Corp. to perform a JIMO High-Capability Instrument Study, and 11 awards against a NASA Research Announcement (NRA) for High Capability Instruments for Planetary Exploration.
- Technology Development procurements were issued by JPL, GRC, and MSFC for long-lead components and testing in many areas.
- Reactor procurements were issued by NRPCT to DOE laboratories and industry.
- Spacecraft study and co-design subcontracts are discussed in the following section.

Phase B procurements would have included selection of the JIMO science instruments and investigations pursuant to a NASA Announcement of Opportunity (AO).

4.3.4 *Spacecraft Studies*

Three industry study contracts were issued immediately after Project start. Fixed-price subcontract awards were made to teams led by Boeing, Lockheed Martin, and Northrop Grumman. (Teams included industrial subcontractors and DOE labs that were not supporting Government team study work.) The study contracts ran from April 2003 through September 2004. The industry study efforts consisted of:

- Task 1 – Trade Studies (\$ 6M each)
- Task 2 – Conceptual Design Studies (exercised option, \$ 5M each)
- Task 2A – Derivative Mission Studies (modification, \$ 800K each) to study potential use of the JIMO technologies for lunar surface power, Mars cargo transport, and Mars surface power applications.

In parallel, the Project conducted an internal Government team study. This identified major risks and cost drivers, provided a “smart buyer” capability, and produced Technical Baselines 1, 2, and 2.5. The Government team participants during this period were JPL, NASA Centers (GRC, KSC, MSFC), and specific DOE laboratories (Los Alamos, Oak Ridge, and Y-12).

Rigid study contract rules of engagement were published and enforced to ensure a level playing field for the future down selection competition. NASA Centers could only support the Government team. DOE labs were required to select whether they would work on the Government team or participate in one or more industry teams. Contactor/Government interactions were largely in a “listen only” mode, with bi-monthly progress reports and bi-monthly progress briefings. Insight and oversight were performed in accordance with a study contracts surveillance plan, and all industry team deliverables were delivered on schedule and accepted.

4.3.5 *Spacecraft Co-design Procurement*

Because of the importance and complexity of the revolutionary new-development spacecraft development, extensive procurement planning and benchmarking were performed. The

Acquisition Team reviewed appropriate regulations and practices (FAR, NASA FAR, DOD 5000, NSS 03-01), reviewed key national studies (Columbia Accident Investigation Board; Defense Studies Board “Acquisition of National Security Programs” (Tom Young Report)), dialogued with acquisition experts, and reviewed lessons learned from several JPL flight projects (including Magellan, Mars Observer, TOPEX, Mars Pathfinder, Cassini, and SIRTf). In addition, benchmarking was done with the principals for International Space Station, NPOESS, and James Webb Space Telescope. These actions provided invaluable tips and what to do, and not do, on a major program procurement.

The Project made a fundamental decision that the spacecraft be co-designed. Because no single organization possessed all of the resources necessary to complete the first-of-a-kind product and the Government team wished to retain TSPR, it was determined that an integrated Government-industry team must co-design the spacecraft through PDR. Following PDR, the industry supplier would execute the design, with Government surveillance. This decision became the primary driver in Request for Proposal (RFP) development and source evaluation and selection.

The Project utilized a disciplined RFP development process and a streamlined Source Evaluation Board (SEB) process for proposal evaluation and selection to achieve the acquisition objectives on an aggressive schedule. The RFP contained several unique features, summarized below, and was developed with inputs from all Government team organizations and all appropriate disciplines. In parallel, a procurement Risk List was generated and maintained as a living document to ensure that the procurement Statement of Work (SOW), deliverables, surveillance plan, and source evaluation plan were sufficient to manage the identified risks. Similarly, the rules of engagement were updated to control interactions between the Government team and proposers during the “brownout” and “blackout” periods. The RFP was reviewed in detail at two RFP Pre-Release Reviews (“murder boards”) and modified to incorporate comments from NASA ESMD (including Level 1 requirements), NR (just coming aboard the Project team), and industry (both written comments and 1-on-1 dialogues).

The RFP, issued on May 17, 2004, contained the following important features:

- RFP Rules of Engagement.
- Government Task Agreement Process Description (permitting industry to include NASA Centers on their proposed spacecraft teams).
- Evaluation Criteria, focusing on contractor capabilities and plans for teaming with the Government for co-design (rather than implementation approach and cost to deliver a proposed design).
- Specimen Contract for Phases A-E, including space system requirements, applicable documents, and CDRLs.
- Roles and Responsibilities exhibit, including the Responsibility Assignment Matrix.

Proposals were received on July 16, 2004. (Past Performance volumes were submitted earlier.) A senior SEB directed the proposal evaluation and selection process, reporting to an executive Management Review Group (MRG) and to the Source Selection Official (SSO), the JPL Director. Technical and management evaluations were performed by four expert panels, including JPL, GRC, and MSFC personnel. Evaluation from geographically diverse sites was facilitated by a COTS evaluation tool. Cost evaluation and probable cost formulation was performed by a Cost Committee. Past performance evaluation was performed by a Past Performance Committee. The SEB reviewed all inputs and produced its evaluation and competitive range recommendation. All proposers were included in the competitive range, and penetrating oral discussions were conducted with each team. No final proposal revisions were permitted. The SEB revised its findings based upon the orals. These were reviewed by the MRG and briefed to the SSO, who selected NGST on September 20, 2004. From proposal receipt to selection, the streamlined process took only 65 days. A letter contract was issued on September 22, 2004.

A definitive subcontract was executed on January 24, 2005. The subcontract covered Phases A and B only and was a cost-plus-fixed-fee-plus-incentive-fee-plus-award fee vehicle. By express contractual language, Phase B work could not be initiated without NASA written authorization. It was intended to award Phase C/D and up to three follow-on missions in the future, but the effort could be re-competed if that were in the best interests of the Government.

NGST delivered 37 different CDRLs during Phase A, many in support of the PMSR. In addition to co-design, other insight and oversight techniques were utilized as described in the final Surveillance Plan.

Non-procurement acquisitions (with NRPCT and NASA Centers) are covered in Section 4.4. below.

4.4 Project/Program-Level Agreements

This section summarizes the project and program level agreements that were made on Project Prometheus. These include agreements made with agencies outside NASA and those made between JPL and other NASA Centers. There were no agreements made by the Project with international contributors.

Agreements were established with other NASA Field Centers for participation on the Project. Specific roles and responsibilities were delineated in Memoranda of Agreement (MOAs) and supporting Management Plans (MPs) and Work Agreements (WAs) between JPL and the participating centers. The MOAs were signed by the JPL Director and the participating NASA Center Director. Similar MOAs were to be signed between NRPCT and the corresponding Centers for nuclear work. NASA ESMD provided funding for this work via HQ release of funding authority directly to the Center. Funds were released by NASA HQ upon the request of the JPL Project Manager. MPs were signed by the Project Manager and the participating Center Lead Manager. WAs were signed by the applicable Project System Manager and the participating Center Lead Manager. Highlights of these agreements between JPL and GRC, MSFC, ARC, KSC and the NASA IV&V Center are as indicated below:

Glenn Research Center (GRC) – GRC provided support to the Project by performing the following functions: government contract and project management; independent analysis, system engineering, verification and validation; concurrent technology development and risk reduction; and test facilities, technicians and required supporting engineering. GRC supported these functions in the following areas: mission and system analysis, electric propulsion; dynamic power conversion; heat rejection; power management and distribution; and high power telecommunications.

Marshall Space Flight Center (MSFC) – MSFC provided support to the Project by performing the following functions: government contract and project management; independent analysis, system engineering, verification and validation; concurrent technology development and risk reduction; and test facilities, technicians and required supporting engineering. MSFC supported these functions in the following areas: management and systems engineering; structures and mechanisms; space environments and interactions; mission assurance; and automated rendezvous and docking.

Ames Research Center (ARC) – ARC provided support to the Project by performing the following functions: government contract and project management; independent analysis, system engineering, verification and validation; concurrent technology development and risk reduction; and test facilities, technicians and required supporting engineering. ARC supported these functions in the following areas: reactor aeroshell analysis and design; low thrust trajectory design assessment; spacecraft autonomous – guidance navigation and control system assessment; and ground segment autonomy assessment.

Kennedy Space Center (KSC) – KSC provided support to the Project by being the lead for the Launch System. KSC conducted launch vehicle performance trades, upper stage performance evaluations, on-orbit assembly studies, and processing facility requirements development. KSC provided mission optimization studies involving launch vehicle performance trades, supported the development of the required launch vehicle data books and other support required for NEPA and launch approval compliance (MOA not finalized).

NASA IV&V Center – An agreement was put in place for the NASA IV&V Center to provide flight software independent verification and validation. All required Phase A gate products for this activity were completed.

In addition to the JPL/NASA Center agreements discussed above, documented agreements between NASA and DOE were also developed. The NASA-DOE/NR Memorandum of Understanding (MOU) and NASA ESMD-DOE/NR Space Program Office Memorandum of Agreement (MOA) established the relationship between NASA and NR to provide the Reactor Module for the Prometheus Project. A MOA was drafted for signature between the JPL director and the General Manager of KAPL on behalf of the NRPCT. This draft MOA was developed to formalize the roles and responsibilities of the two organizations for the Project. A contract between KAPL, Inc. and Caltech/JPL was in the process of being developed prior to the Project termination. It was to include the extension of Price-Anderson nuclear indemnification authority to Caltech and JPL's contractors and subcontractors, and the launch services contractor. The KAPL, Inc. contract with JPL was to be negotiated and be ready for signature early in Phase B.

4.5 Project Dependencies and Inheritance

The Prometheus Project managed the development of all technologies that were required to launch Prometheus 1 successfully and complete the mission objectives, including those multi-mission technologies applicable to follow-on Prometheus missions. This was done in order to closely coordinate the focus of those technologies to the needs of the Project. The Project technology implementation plan was based on realistic schedules for achieving critical-path technology developments and affordability. Alternative technologies were considered as needed to reduce Project technical, cost, and schedule risks, and a process was set up so that decisions concerning technology developments could be made in a timely fashion.

The baseline Prometheus 1 mission included multiple launches and on-orbit rendezvous and docking. It was also assumed that the mission would use a new launch vehicle capability developed for the NASA exploration initiative.

The Project assumed that upgrades would be made to the Deep Space Network (DSN) to enable the Ground System to handle at least 10 megabits per second at Ka-band.

The Small Deep Space Transponder was the only inheritance hardware or software from other projects identified at this stage of the project.

[This page intentionally left blank]

5. Project Management

The purpose of this section is to summarize the overall management of Project Prometheus. The following topics will be addressed:

- Project authority.
- Organization, roles and responsibilities.
- Technology development.
- Risk management.
- Reviews.
- Management controls, tools and support systems.
- Public outreach and advocacy.
- Facilities.
- Logistics.
- End of project lifecycle.

5.1 Project Authority

The Jet Propulsion Laboratory was designated lead center for the Prometheus Project in January 2003. The JPL Director appointed the Prometheus Project Manager, with the concurrence of the NASA Prometheus Nuclear Systems and Technology Program Director. The Project Manager was given full authority to conduct the Project within the scope, schedule, and budget contained in the Preliminary Project Plan.

Programmatically, the Project Manager reported to the NASA Prometheus Associate Director, who in turn reported to the Prometheus Nuclear Systems and Technology Program Director, who reported to the NASA Associate Administrator for the ESMD.

As identified in the NASA-DOE/NR Memorandum of Understanding (MOU) of August 2004, executed by the NASA Administrator and the Director of DOE/NR, by interagency agreement NR was responsible to develop, design, deliver and provide operational support for civilian space nuclear reactors for Prometheus. NR assigned this scope of work to the NRPCT. The NRPCT was comprised of staff from the Knolls Atomic Power Laboratory (KAPL), Bettis Atomic Power Laboratory (Bettis), and Bechtel Plant Machinery, Inc. (BPMI). The NRPCT was responsible for all matters related to the Reactor Module and reported directly to NR Headquarters. The Associate Administrator for Naval Reactors/DOE assigned the leadership of the NRPCT to KAPL. The KAPL General Manager appointed the NRPCT Project Manager. The NRPCT Project Manager was responsible for ensuring that the Project adhered to DOE/NR standards and regulatory requirements regarding the preparation, handling, and use of special nuclear materials and utilization of facilities as defined in the Atomic Energy Act.

Program-project organization and reporting relationships are shown in Figure 5.1-1.

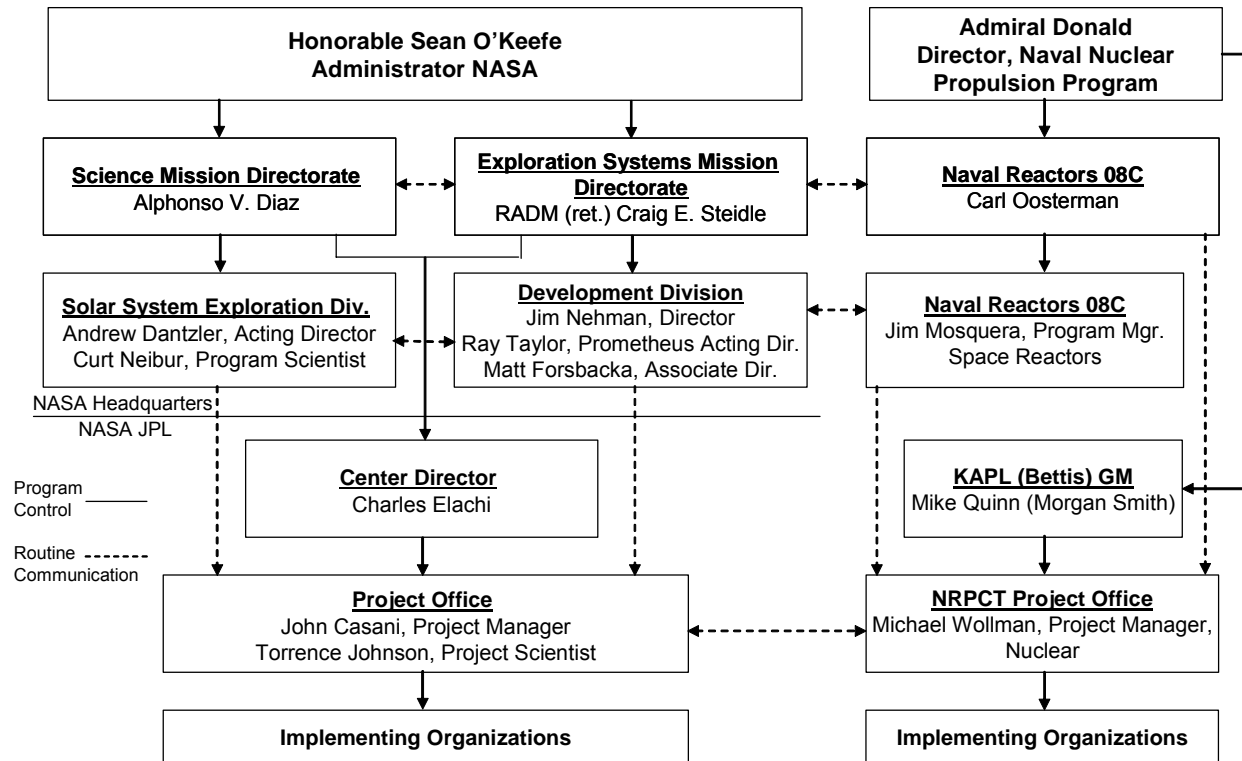

Figure 5.1-1. Program/Project Organization (Circa March 2005).

Pursuant to the MOU and a supplementing MOA executed by the NASA Associate Administrator for ESMD and the NR Program Manager for Space Reactors, funding was provided directly from NASA to NR for Prometheus work, based on the budget requirements generated by the NRPCT and approved by NR and the Prometheus Project Manager. NR/NRPCT were responsible for work performed at DOE laboratories in support of the Space Reactor and performed appropriate insight and oversight functions.

NASA provided bypass funding to the NASA Field Centers as authorized by the Prometheus Project Manager. For ARC, GRC, and MSFC, the JPL Center Director and each supporting Center Director signed a high-level MOA establishing collaboration fundamentals, and more detailed MPs were signed by the Project Manager and the applicable Center Lead for Prometheus. KSC activities were directed through the Associate AA for Launch Services at NASA, and LaRC activities were assigned through ARC. (NASA Center activities performed in support of NRPCT were implemented by bypass funding from NASA but with insight and oversight by NRPCT.)

Accountability for deliverables and associated funding flowed via the Project's WBS. All JPL/NASA activities were documented in terms of scope, schedule, budget, deliverables, and reporting in individual WAs, approved by the higher-level WBS cognizant manager.

Project systems terminology is shown in Figure 5.1-2. It shows the 4 systems in the project, which include the Launch System, the Deep Space System, the Science System and the Ground System.

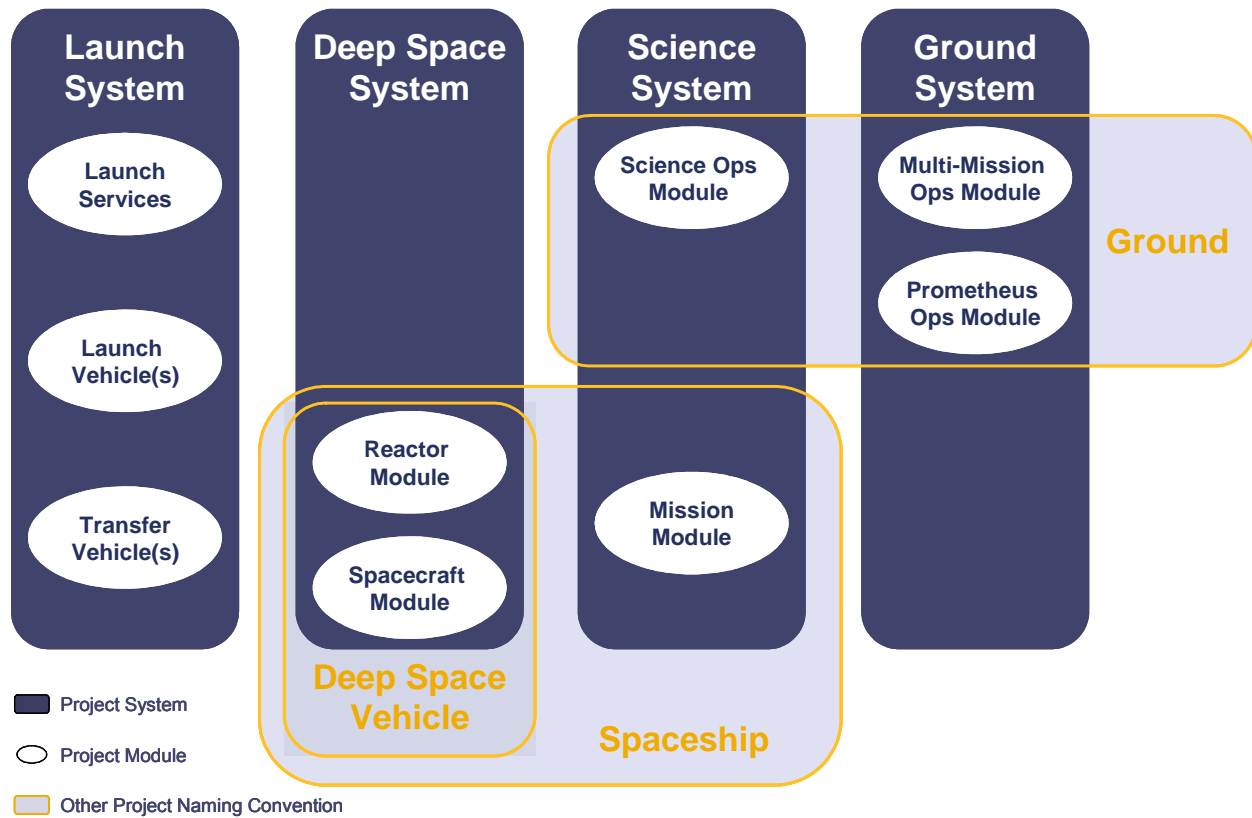

Figure 5.1-2. Project Systems Terminology.

The Project would have reported to the JPL Governing Program Management Council (GPMC) and the Agency PMC had the Project entered the transition-to-Phase B process. Because NASA discontinued the Project, no GPMC or PMC meetings were held. Similarly, the AA for ESMD would have been the approving authority for launching the flight system. In addition, approval would have been requested from the Office of the President to launch a nuclear system.

5.2 Organization, Roles, and Responsibility

The principal Prometheus NS&T Program/Prometheus Project organization relationships for funding flow and technical direction are shown in Figure 5.2-1.

The Prometheus Project Office was organized as shown in Figure 5.2-2.

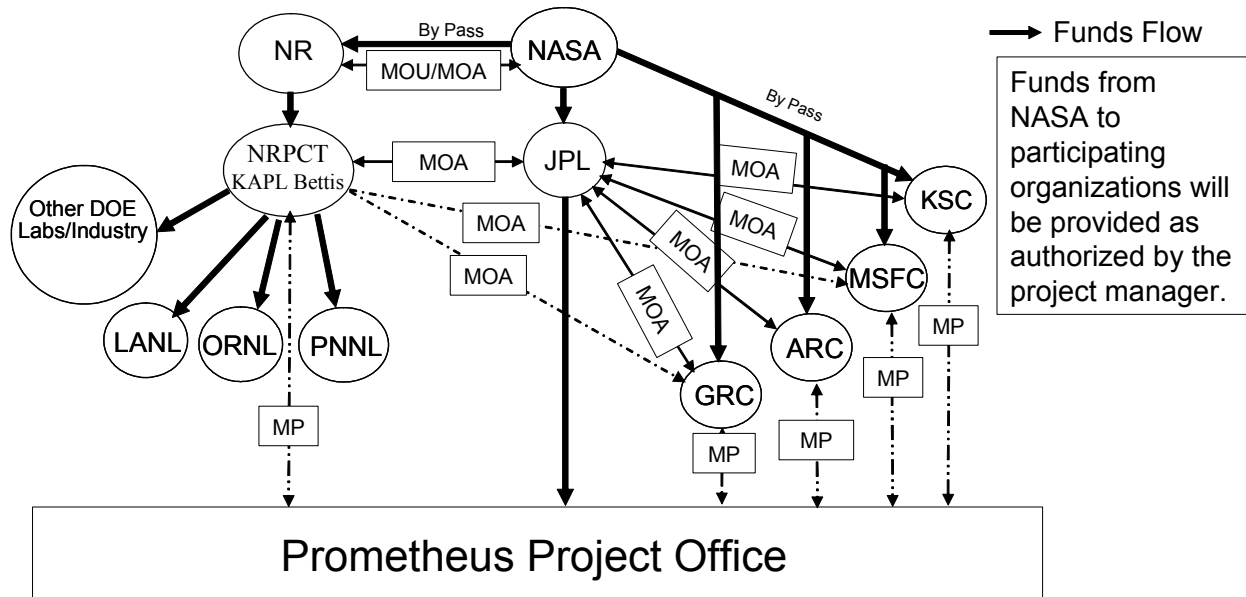

- MOU/MOA Interagency scope and commitment
- MOA Statement of agreement on areas of project participation
- MP Definition of management responsibilities, tasks and support
- By Pass Funding and Work Scope as Determined by the Project

Figure 5.2-1. Prometheus Project Organization Relationships.

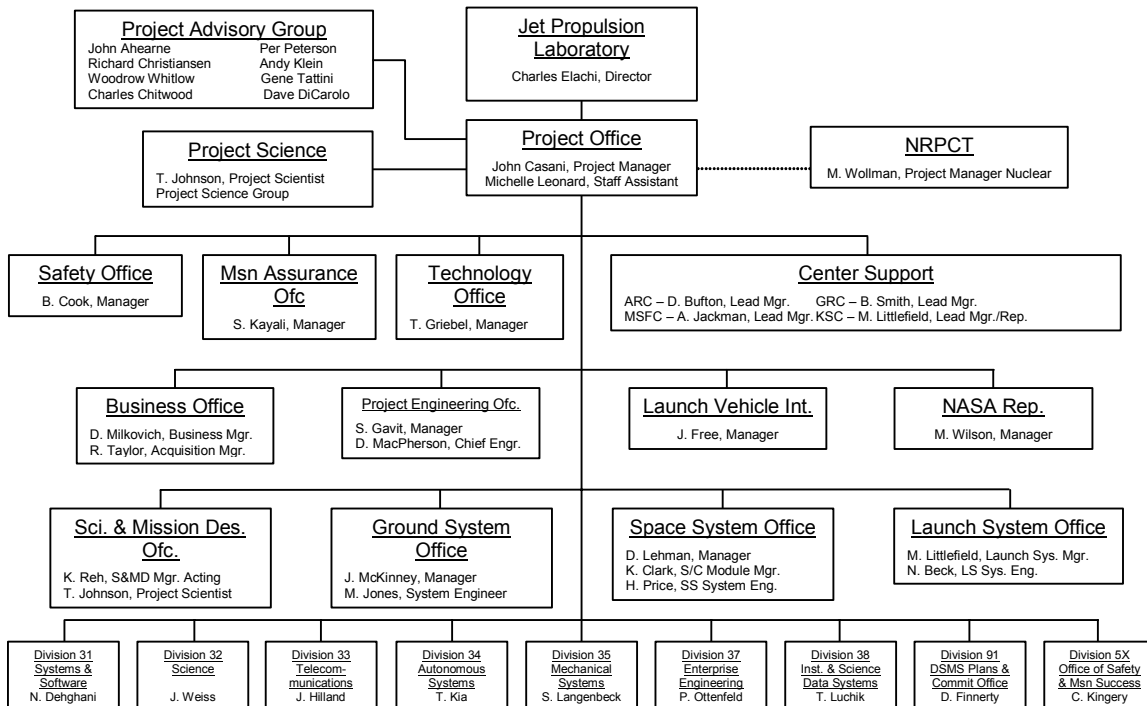

Figure 5.2-2. Project Organization Chart.

Key features of the organization included the allocation of work to the Nation's best resources (e.g., NRPCT, JPL, NASA Centers, NGST, and their subcontractors); the Project Engineering Office (PEO) led by the PEO Manager with independent technical assessment by the Project Chief Engineer; a Project Advisory Group to advise the Project Manager; and the use of Division Representatives to lead the efforts in the JPL line organizations.

Roles and responsibilities of the Project key personnel are provided in Appendix C of this report.

Because of the complex nature of the project, a detailed Responsibilities Assignment Matrix (RAM) was developed. The RAM specified which organization was responsible for each element of the WBS. This proved to be a useful tool to negotiate with the various parties and helped to ensure that assignments were clearly understood and carefully documented. See Appendix D for the detailed RAM.

5.3 Technology Development

In Project Prometheus, multiple technologies were required to be matured for spacecraft implementation. The investments were in the following specific technical areas (with associated development plans identified):

- Reactor (Space Reactor Planning Estimate) *
- Power Conversion (Space Reactor Planning Estimate) **
- Heat Rejection (Heat Rejection Technology Development Plan)
- Electric Propulsion (Electric Propulsion Technology Development Plan)
- High Power Telecommunications (High Power Telecommunications Technology Development Plan)
- Radiation Hardened Parts/Electronics (Radiation Hardened Electronics Technology Development Plan)
- Low Thrust Trajectory Tools (Low-Thrust Trajectory Tools Technology Development Plan)

* Responsibility of NRPCT

** Responsibility transitioned from Government Team to NRPCT at concept selection, April 2005

Technology development was the responsibility of the Prometheus Technology Manager, who also served as the deputy to the Spacecraft Manager. This was done to ensure that the technologies under development, which were largely related to the Spacecraft Module (except the Low Thrust Trajectory Tools development), were done in a manner that would maximize their usefulness to the final Spacecraft Module design. The status of the technology developments, including the summary Technology Milestone schedule, was reported at all Monthly Management Reviews. On a quarterly basis, the status of technology development accomplishments was provided to NASA to meet a Congressional mandate for reporting.

Because there was such a diverse and critical set of technologies to manage, the Project developed a detailed planning and review process (the Technology Development Plan Requirements Document) to ensure that the required resources would be available and to verify that the technology was on track to get to the level of maturity required at PDR. To do this, standards were set for the level of maturity required at PDR characterized by completion of development models, retirement of major development risks, resolution of major manufacturing issues, and plans for obtaining required life data. The technologists then established the criteria that would characterize that the technology element had reached the necessary level of maturity, defined the measurements to be used to check that the criteria were met, and identified the acceptance value for the measurements that needed to be met for the technology to be considered to have reached the proper level of maturity at PDR. Also, they defined two additional intermediate milestones/gates that preceded the PDR milestone, with the associated criteria, measurements, and acceptance values to show that the technology was progressing toward the required level of maturity.

In addition, the technologists developed technology readiness roadmaps of the technology maturation plans, and defined technology fallback strategy schedules with decision dates and criteria for technology readiness, with back-up plans to be implemented in the event that the technology was not progressing as required to meet the mission needs. All technology development plans were reviewed and evaluated by independent technical review teams to provide verification that the approaches defined were necessary and sufficient to meet the mission requirements.

Processes were also put in place to verify that the technology development was closely aligned with the spacecraft design activities. The initial investment portfolio was established on the basis of retiring the highest technical risks associated with a nuclear electric propulsion system operating in the Jovian environment. As the design matured and the Spaceship baseline design was established, a review was performed to assess the applicability of the investments to the new design. Finally, technologists regularly attended spacecraft design working meetings to ensure continued alignment.

5.3.1 Major Technology Accomplishments and Plans

5.3.1.1 Power Conversion

A 2 kW Brayton testbed at NASA GRC was used in conjunction with an NSTAR engine to perform the first ever Brayton/ion test. This demonstrated AC-to-DC conversion and thruster fault tolerance. The same testbed was utilized to perform a mechanical dynamics test to measure induced vibration levels and validated mechanical design codes.

An alternator-thruster integration lab was designed (see Figure 5.3-1), with a fully representative 100kW Brayton alternator with electric motor drive system (to be provided to the Government in FY06 by Hamilton Sundstrand). This laboratory was designed for evaluation of source-to-load electrical functionality and control stability.

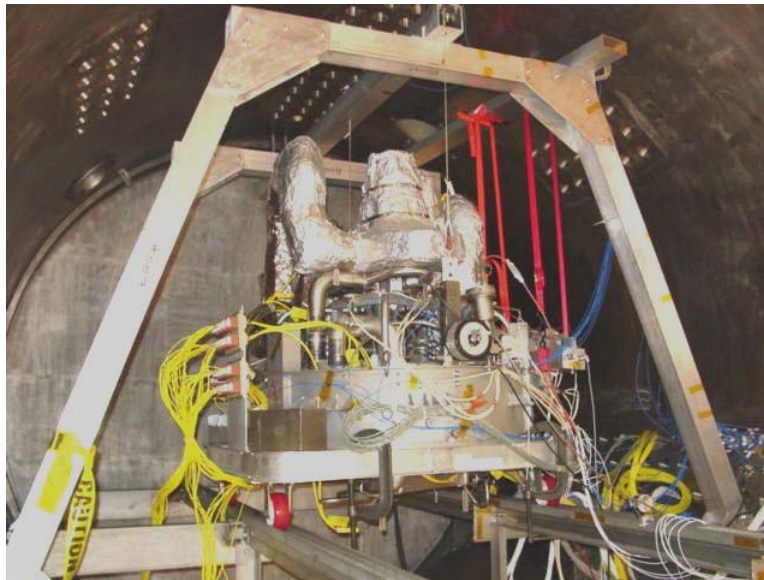

Figure 5.3-1. 2-kW Brayton Testbed.

Journal and thrust bearing startup, load capacity, power loss, and stability evaluation were performed in inert gas environments at Prometheus operating pressures, temperatures, and speeds.

Multiple materials technologies were addressed. Long-term super alloy testing of turbine wheel and duct materials including Cast Mar-M 247 in inert gas creep rigs and IN-792, Hast-X, IN-617, or MA956 in air creep rigs was performed (see Figure 5.3-2). Multiple refractory to super alloy joining trials were performed, and a low creep, Si₃N₄ turbine wheel design study was completed.



Figure 5.3-2. High-Pressure Bearing Test Rig.

Major contributors to the power conversion technology development included GRC, Hamilton Sundstrand, and Honeywell.

Detailed schedules for Brayton technologies were developed by the Government Team, including Technology Development Plans consistent with the Project guidance. However, the transition of management responsibility to the NRPCT (in April 2005) of the Brayton Power Conversion Segment superseded these plans.

5.3.1.2 Heat Rejection

Heat Rejection major accomplishments include completion of side-by-side testing of heat pipes from multiple vendors and wick designs for >500K water heat pipes (see Figure 5.3-3).

Other accomplishments include a carbon-carbon to titanium brazing trial (see Figure 5.3-4) and tensile tests for CuSiIn-1 ABA, CuSiIn ABA and TiCuSiIn-ABA. Also, high temperature organic and ceramic adhesives and characterized heat pipe saddle materials were evaluated.



Figure 5.3-3. High-temperature water heat pipe testing.



Figure 5.3-4. C/C to Ti brazing trials.

NaK/Ti and H₂O/Ti chemical compatibility testing was performed, and thermal cycle testing, neutron/proton/electron exposure and optical property measurements on radiator thermal control coatings was completed.

Major contributors to the heat rejection technology tasks included GRC and Advanced Cooling Technologies.

Key heat rejection scheduled plans for Phase B included completion of the design, fabrication and testing of representative radiation demonstration units, performance and life testing of radiator heat pipes, and completion of multiple materials and thermal control coating tests and assessments including performance and life testing by PDR.

5.3.1.3 Electric Propulsion

Major accomplishments in Electric Propulsion included completion of performance testing and 2000 hour wear tests of candidate ion thruster technologies with potentially long life components. Both NEXIS and HiPEP (Figure 5.3-5 and Figure 5.3-6) demonstrated Prometheus required Isp (6000 to 9000s), efficiencies greater than 65%, and power levels of 20 to 40 kW. Also demonstrated was the use of AC beam modules for Prometheus Voltage levels (6000 volts vs. 1100 volts for NSTAR).

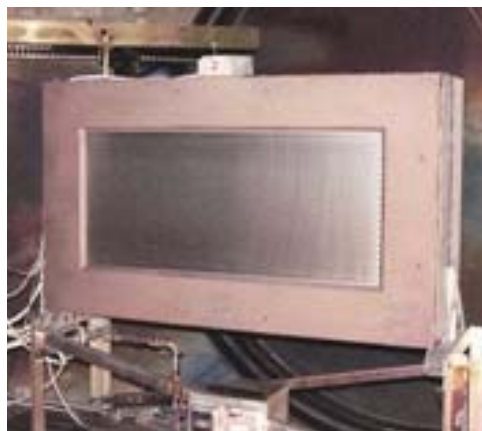

Figure 5.3-5. HiPEP.



Figure 5.3-6. NEXIS.

Major contributors to Electric Propulsion technology development included GRC, JPL, and Aerojet. The NEXIS and HiPEP thruster developments were both proceeding well; however, many features of these designs were very similar. The Prometheus Project decided, therefore, that a single thruster development would be in the best interests of the Project with regard both to economy and the concentration of available talent on a single design concept, with appropriate backups. The technical areas converged on a single thruster design for Prometheus: Heracles.

Scheduled technology activities in Electric Propulsion for Phase B included completion of HiPEP and NEXIS wear test results analysis (which would be useful in the Heracles design), completion of lab model Heracles thruster build, performance and life testing of the Heracles thruster, PPU and thruster integrated test, and life modeling of the Heracles thruster.

5.3.1.4 High Power Telecommunications

Major accomplishments in high power telecom include development of two 180-W, Ka-Band Traveling Wave Tube (TWT) units (see Figure 5.3-7), and a high voltage breadboard power supply for the TWT that operates at 440VAC. It should be noted that the Kepler project, once the termination of Prometheus was known, decided to use the TWT hardware as the baseline for its mission.



Figure 5.3-7. 180-W Ka-band TWT.

Also, an X/Ka medium gain 16 dB antenna design was completed; an X-band breadboard phase tracker was developed as well as Ka-band power combiners (see Figure 5.3-8). Finally, materials tests for radiation tolerance were completed for X/Ka-band RF cables and high gain antenna reflector coupons.



Figure 5.3-8. Ka-band 5-way Combiner.

Major contributors to the high power telecom technology development included JPL, GRC, and L3.

Major scheduled technology elements in Telecom for Phase B included developing the 250W TWT, integrating it with the high voltage power supply and qualifying the Traveling Wave Tube Amplifier (TWTA). For the transponder, plans were to design, fabricate and assemble and test the prototype transponder. Antenna activities included the design, fabrication and assembly of the full-size (3 m) Development Text Model (DTM) of the Tetra-Gregorian antenna and performance test the range. Other activities planned included developing the plan for maturing the Field Programmable Gate Array (FPGA) design to a full Rad Hard Application Specific Integrated Circuit (ASIC), and demonstrating wireless transmitter/receiver units as telemetry relays.

5.3.1.5 Radiation Hardened Electronics/Parts

Major accomplishments in Radiation Hardened Electronics include:

- Completion of qualification of the Honeywell Rad Hard ASIC fabrication line for digital and mixed signal ASICs.
- Completion of Rad Hard ASICs for IEEE 1394A and 12C data buses.
- Completion of Rad Hard power control mixed signal ASICs.
- Completion of RAD750 processor development (see Figure 5.3-9).

- Initiation of multiple memory device contracts for development of Rad Hard start-up memory, local high-speed memory, and non-volatile mass memory.

Also, radiation sensitivity analysis was initiated for the propellant management subsystem, cabling subsystem, science instrument sensor/detectors, and the attitude control system sensor/detectors. Radiation models for latch valves, multifunction valves, and pressure transducers for the propellant management system were completed. Extensive identification and testing of high-power, high-voltage parts was performed.

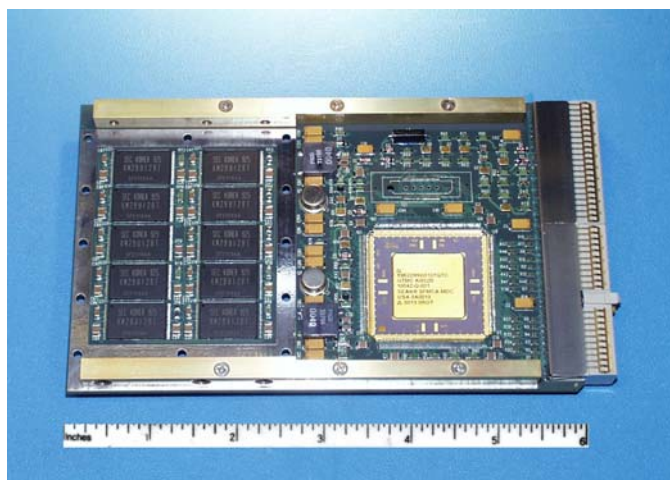

Figure 5.3-9. RAD750 Processor.

Major contributors to the rad hard technology development included JPL, Honeywell, SEAKR, GRC, Lockheed Martin, Symetrix, and Seagate.

Major scheduled activities in the rad hard technology area for Phase B included identification and test of component electronics, developing technologies where needed. For propulsion components, plans were in place to test materials and state of the art components and develop the fiber optic transducer, latch valve and multi-function valve. For high voltage parts, plans were in place to perform rectifier and switch evaluation tests. For the cables/connectors/wire area, the Project planned to irradiate and evaluate approved flight parts, high voltage parts and flexible cable assemblies in Phase B. For rad hard memory, the Project planned to perform detailed materials investigation and develop production of prototypes with required density of start-up memory, local-high speed memory, and non-volatile mass memory.

5.3.1.6 Low Thrust Trajectory Tools (LTTT)

Major accomplishments in the LTTT area include the development of heuristic control law for low-thrust spiraling phases and embedded in the trajectory tool Mystic. Also, the team developed analysis techniques and prototype tools for design of science orbits and analysis of stability. The LTTT team also developed dynamical systems-based analysis and design methods and prototype software tools, and implemented prototype software infrastructure for data sharing among trajectory design tools and between trajectory design and navigation.

LTTT achieved large improvements in performance over legacy trajectory design tools (see Figure 5.3-10).

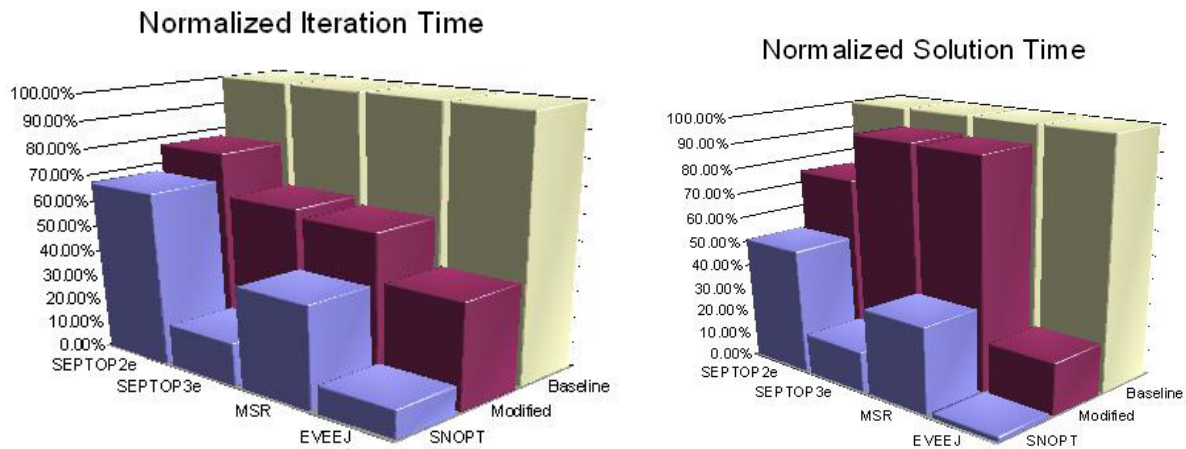

Figure 5.3-10. Achieved large improvements in performance of legacy trajectory design tools.

Major contributors to the LTTT technology development included JPL and ARC.

Scheduled plans for LTTT for Phase B included modifying legacy tools to support large parametric studies, implementing new code and procedures for deploying tools on multiple nodes of a computing cluster, and identifying and implementing methods to decouple spiraling phases from other portions for the trajectory to reduce computing time. Finally, plans were in place to complete the development of prototype software algorithms and tools to produce robust trajectory designs and applying dynamical systems techniques to apply to the preliminary design of moon-to-moon transfers (see Figure 5.3-11).

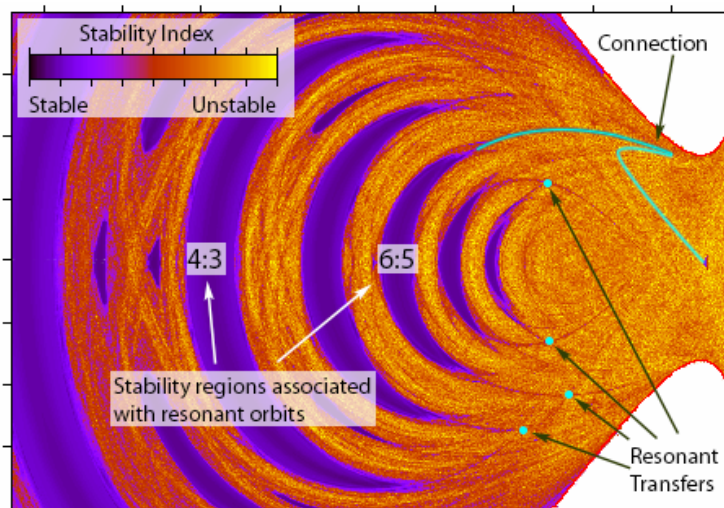

Figure 5.3-11. Fast Lyapunov Indicator (FLI) maps assist trajectory analysis in designing efficient moon-to-moon orbit transfers for the JIMO mission.

5.4 Risk Management

The primary objective of the Project risk management process was to enhance the probability of achieving the Prometheus mission success criteria within the defined Project constraints. The Prometheus Project managed risks consistent with the NASA continuous risk management (CRM) methodology described in NPG 7120.5B and those described in a document entitled Risk Management for JPL Projects (D-15951). The implementation of the Risk Management Program was the responsibility of the Mission Assurance Office. The Prometheus Project Risk Management Plan described the risk management process and how risks were to be integrated, assessed, and reported. Each Project participant was responsible for identifying and managing the risks within their area of responsibility. The risk management approach was focused on understanding and controlling the risks to successfully satisfy the agreement documented in the Project Plan for demonstrating in-space, long-life nuclear power system capability, and for acquiring and delivering to Earth the scientific information needed to satisfy the science objectives of the mission.

The risk management team was led by the Project Risk Coordination Manager with support from NGST for the Spacecraft module and NRPCT for the Reactor Module. The Risk Management Coordination Manager had the responsibility for the implementation of the risk management process and the utilization of the risk management database and tools across the Project. In accordance with the Project Risk Management Plan, a Risk Assessment Team was formed to assess the disposition of all project-level risks and make recommendations for lien incorporation and budget allocations. Specific system-level risks and associated mitigations were addressed at the system level and reported to project management.

The Prometheus Project selected a commercial product called the Active Risk Manager tool as the database to collect and track all project risk items. The project acquired a license for the database and made it available to all project personnel including participants from the NASA Centers, NGST and NRPCT. In addition, risk management process and tool utilization training sessions were conducted in small groups to provide a hands-on practice in the utilization of the tool.

A complete set of project risks were presented at the PMSR. The risk item details and the associated mitigations were addressed further at the system level portion of the PMSR. Table 5.4-1 summarizes the top risk items identified at the PMSR.

Table 5.4-1. Top Risk Items.

Description	Impact	Mitigation
Failure to meet Project schedule with resultant cost impact due to development problems with the electric propulsion design	Increased cost and schedule delays	<ul style="list-style-type: none"> • Technology Development Plan • Examine mission trade options for EP • Develop a set of key milestones • Conduct end-to-end system-level test • Validate life-prediction models through qualification and life testing
Failure to meet Project schedule with resultant cost impact due to development problems with the reactor design	Increased cost and schedule delays	<ul style="list-style-type: none"> • Technology Development Plan • Develop systems criteria • Develop a set of key milestones • Utilize proven DOE/NR practices
Failure to meet Project schedule due to development problems with the power conversion system	Schedule delay	<ul style="list-style-type: none"> • Technology Development Plan • Develop set of criteria to balance power conversion and the rest of the system • Develop comprehensive trades to match reactor performance requirements with system power distribution
Electronic components for MM don't meet radiation requirements	MM parts development and qualification. Increase shielding mass.	<ul style="list-style-type: none"> • Early identification of susceptible parts, radiation testing of candidate device technologies, radiation hardening and qualification. Same as S/C Module.
Failure to meet Project schedule due to development problems with the heat-rejection system	Schedule delay	<ul style="list-style-type: none"> • Technology Development Plan • Develop complete end-to-end thermal model of the heat-rejection system • Perform early verification test at the components, subsystem, and system levels • Conduct end-to-end system-level test • Retain adequate thermal margins
Within the project, multiple interfaces, multiple organizations at multiple sites, effecting technical and programmatic issues	Increased cost and schedule delays	<ul style="list-style-type: none"> • Engage resources and capabilities of DOE laboratories and experts • Develop a set of key milestones, gates and indicators to ensure that development issues are identified early • Collocate the appropriate people from the DOE Operation Office, DOE National Labs, NASA Centers, and NGST to the Prometheus Project Office at JPL • Seamlessly integrate DOE, DOE Labs, NASA Field, and NGST offices into a single Project organization • Enforce vigorous application of JPL Design Principles
Security classification requirements development and information sharing impede design	Increased cost and schedule delays resulting from need for redesign/retest	<ul style="list-style-type: none"> • Obtain classification guide • Train Project personnel in classification guidelines • Create personnel clearance plan • Initiate clearance process for identified personnel

Description	Impact	Mitigation
Radiation effects mitigations for parts and materials may result in excessive mass requirements	Possible unacceptable mass increase	<ul style="list-style-type: none"> • Technology Development Plan • Institute Project-wide radiation program to include Project trades and parts/materials testing • Invest in high-payoff radiation hardening technologies
Complex interfaces across contractors may result in incompatible interfaces and a system design that results in development delays and increased cost	Increased cost and schedule delays	Collocate the appropriate people from DOE, DOE National Labs, NASA Centers, and NGST to the Prometheus Project Office at JPL and seamlessly integrate into a single Project organization
Failure to meet mission lifetime requirements	Possible failure to meet all science objectives	<ul style="list-style-type: none"> • Examine mission trade options for reducing trip time to destination • Vigorous application of JPL Design Principles • Minimize life-limiting characteristics of all systems • Validate life-prediction models through qualification and life testing

5.5 Reviews and Reporting

The Project established a rigorous and comprehensive review process, consistent with JPL and NASA requirements. The Prometheus Project Review Plan describes the proposed date, readiness criteria, objectives, scope, and success criteria for project-level reviews, management reviews, NASA reviews, launch site reviews, system-level reviews, and subsystem-level reviews. The Plan also states how inheritance and peer reviews and product integrity reviews would be conducted. The top-level reviews are listed in Table 5.5-1. An asterisk indicates the reviews conducted by NASA.

Early in the project lifecycle, the Prometheus Project Advisory Group was convened by the Project Manager to inform and advise on matters relating to overall project management and to assist in resolution of specific programmatic issues and approaches for barrier knockdown. In order to keep the Advisory Council members informed of the project status, they were provided with the Project's MMRs and were invited to participate in all Quarterly Reports and major project presentations. This provided the Advisory Council members with visibility into the Project's planning activities and challenges, and helped make their recommendations and advice more relevant and applicable to the Project's needs.

A review to assess the readiness for the Prometheus Project to transition from Pre-Phase A to Phase A was conducted in May 2003. The review determined that the Prometheus Project had produced all the required gate transition products and it was recommended for transition to Phase A.

A Milestone Preparation Review, to assess the Prometheus Project readiness to meet ESMD Milestone-A, was successfully conducted in June 2004. The review was chaired by Mr. Jim Nehman of the NASA ESMD (with Carl Oosterman of DOE-NR the co-chair) and covered the Project's planning activities and compliance with NASA and JPL Institutional Requirements.

A Standing Review Board was convened by the Office of the JPL Director to help assess the Project's accomplishments and status and provide recommendations to the Director. The board was composed of NASA Center Deputy Center Directors, senior industry representatives, nuclear energy experts, and senior JPL management. The Project successfully completed with this board a 3-day PMSR held on July 19-21, 2005. This review is normally used to evaluate the preliminary planning, requirements, mission and systems concepts, and estimated life cycle cost of the project and provide a recommendation to the JPL Director for transition of the project from Phase A to Phase B. However, in light of the changes announced by NASA, and the discontinuance of the Prometheus Project, the review served as a vehicle for describing the state of the completion and documentation of the project Phase A products.

Quarterly reports were presented to the NASA ESMD and the JPL Associate Director for Flight Projects, with the Project Advisory Group in attendance. The reports included a description of the Project activities and the associated budget and schedule status. Project risks and related mitigation plans were also presented and discussed during the quarterly reports.

Monthly Project Status Reports (PSRs) were presented to the JPL Associate Director for Flight Projects with NASA ESMD participation via videoconference or in person. The reports included the latest on the technical developments and associated project budget and schedule status.

The Project conducted internal MMRs to assess the progress of all the activities in the Project. The Project staff and all the Work Element Managers provided the technical, budget and schedule status of their activities and communicated the risks or issues related to their area of responsibility. The MMRs, which were held as a videoconference, were also rotated to various NASA Centers, NRPCT and NGST sites to assure inclusion and exposure of the activities at the various locations.

In 2004, the U.S. Government Accountability Office (GAO) was asked by Congress to review the NASA Prometheus Project to determine (1) whether NASA was establishing initial justification for its investment in the Prometheus 1 Project and (2) how the Agency planned to ensure that critical technologies would be sufficiently mature at key milestones. A review of the Project both at JPL and at NASA Headquarters was performed. The GAO published in February 2005 a report: NASA's Space Vision: Business Case for Prometheus 1 Needed to Ensure Requirements Match Available Resources. The GAO recommended that NASA prepare a sound business case for Prometheus 1. NASA concurred with this recommendation.

Table 5.5-1. Major Project Reviews.

Title	Purpose	Content Summary	Timing
Project Mission & System Review (PMSR)	<ul style="list-style-type: none"> Project definition adequate to commit to NASA Requirements completed to System-Level Risks understood/addressed Credible technical approach 	<ul style="list-style-type: none"> Prelim L 1 & 2 requirements and flowdown. Prelim Project Plan & PIP (1) Baseline design for costing Prelim grass roots cost 	Prior to Phase A to B transition
Preliminary Non-Advocate Review (PNAR)*	<ul style="list-style-type: none"> Analysis of a proposed project by a non-advocate team Provides an independent assessment of the readiness of the project to initiate Phase B 	<ul style="list-style-type: none"> Preliminary Project Plan Preliminary CADRE Preliminary LCCE Preliminary WBS and Dictionary 	After PMSR
Preliminary Design Review (PDR)	<ul style="list-style-type: none"> Project readiness for implementation phase Completeness of planning Mission and System designs meet requirements with acceptable risk Technical implementation approach mature 	<ul style="list-style-type: none"> Final Project Plan & PIP Final L 1, 2, 3 reqts & flowdown Baseline Mission design Preliminary System designs Final grass roots cost 	Prior to Phase B to C/D transition
Non-Advocate Review (NAR)*	<ul style="list-style-type: none"> Analysis of a proposed project by a non-advocate team Provides an independent assessment of the readiness of the project to proceed into implementation 	<ul style="list-style-type: none"> Final Project Plan Baseline CADRE Baseline LCCE Initial PRA Final Technical Plan Final Acquisition Strategy Final S&MS Plan 	After PDR
Critical Design Review (CDR)	<ul style="list-style-type: none"> Subsystem and Payload designs meet requirements w/ acceptable risk Subsystem and V & V reqts & plans complete 	<ul style="list-style-type: none"> Baseline System design Inter-system interfaces V & V requirements & plans Earned value assessment 	Midway in Phase C, when the design is mature and prior to start of major fabrication
ATLO Readiness Review (ARR)	<ul style="list-style-type: none"> Project readiness for the start of flight system assembly, test, and launch operations (ATLO) V & V preparation status 	<ul style="list-style-type: none"> V & V procedures & status Flight system implementation status 	2 months prior to the start of flight system ATLO
Flight Readiness Review (FRR)*	<ul style="list-style-type: none"> Readiness of project and support launch services to continue with the final launch preparations Readiness to load L/V propellants 	<ul style="list-style-type: none"> Launch constraints Plans for remaining open items 	3-4 days before launch
Operations Readiness Review (ORR)	Readiness of the Mission Operations System (MOS) and Ground Data System (GDS) to support launch and flight operations.	<ul style="list-style-type: none"> Operations plans and schedules MOS facilities, staff, training, procedures, contingency plans, etc. 	2 – 3 months prior to launch

Title	Purpose	Content Summary	Timing
Mission Readiness Review (MRR)	Readiness of the Project and all Project systems to support launch and the mission	<ul style="list-style-type: none"> • Project plans, organization, and schedules for operations • State of readiness of the flight system, MOS, GDS, launch vehicle, & all interfaces 	1 – 2 months prior to launch, after the ORR
Post Launch Assessment Review (PLAR)	Post Launch readiness of Project systems to proceed with routine operations	<ul style="list-style-type: none"> • Launch and early operations performance of S/C, payload, and MOS/GDS. • Anomalies and corrective actions 	1 to 2 months post launch
Critical Events Readiness Review (CERR)	Project readiness to accomplish a mission critical event	Activity description, requirements, constraints, operations plan, risks and mitigations	Sufficiently in advance of event to allow correction of deficiencies, typically 1 to 2 months

5.6 Management Controls, Tools and Support Systems

5.6.1 Management Controls, Tools, and Support Systems

The Project Business Office integrated the management and control of budget, schedule, and technical performance, recognizing the interaction and tradeoffs among them. JPL's Plan, Manage, and Control Resources process, enabled by JPL's Resource Management System, was used to support the Project in meeting its commitments to NASA and delivering products that meet NASA's technical requirements. The Project Business Office included the following key project-level business functions:

- Performance Management
- Resources Management
- Program Operating Plan
- Funds Management and Control
- Contractor Financial Analysis and Oversight
- Cost Reporting
- Acquisition Management (see Section 4.3)

Other project team participants were responsible for providing management and control of the budget, schedule, technical performance and risk for their areas of responsibility using comparable processes and systems.

5.6.2 Performance Management

The Project planned to employ an Earned Value Management System (EVMS) beginning in Phase B, ahead of the NASA Prime Contract requirement to establish an EV system in Phase C. This plan reflected the need to gain experience with EV metrics and reporting prior to Phase C; early use of EV was also planned because of the size and complexity of the Prometheus Project and its many participants. Reporting using earned value was started during Phase A. This was an effort to introduce the basic concepts and toolsets to the project, with the more robust implementation of EV in Phase B to follow.

An integrated Project level Performance Measurement Baseline (PMB) was planned to be established as the basis for all performance assessment and reporting starting in Phase B. The Project Business Manager would control changes to the PMB. NRPCT and other project participants would develop, maintain and control internal PMBs to assist in managing their specific portions of the Project. Interface of participant specific PMBs with the Project level PMB was identified as being critical to mission success.

The project established an integrated master schedule (IMS) in accordance with NASA and JPL standards and requirements that was presented at the PMSR. The project intended to establish critical path method (CPM) analysis and reporting metrics beginning in Phase B for the entire project from this IMS on top of the schedule status requirements already established during Phase A. During the MMRs, Project integrated risk, budget, and schedule assessments were presented at the subsystem, segment, module, system, and project levels. NRPCT efforts were reported at the Reactor Module level. System Managers reported progress at the MMRs for Phase A. Working schedules were updated by the Cost Account Managers in conjunction with the Project Schedule Analyst, who updated the Project IMS on a monthly basis prior to the MMRs. The Project integrated its subcontractors' and collaborative partners' (NASA/Government) cost and scheduling data through the use of standardized software and electronic data transfer. This was done mostly through the use of Microsoft Excel, but progress was being made on a more automated system based on the JPL reporting tool Cobra.

Support for the Project within JPL came from the technical divisions. All work performed by these organizations was documented and approved via standard JPL WAs consistent with the Project plans. In addition, firm commitments were established for the scope, schedule, budget, and technical performance from other NASA/Government agencies.

5.6.3 *Resources Management*

The Prometheus Project Business Office led the business and resource control processes for the Project. This included all Project resource planning and control activities, maintenance of the Project schedule, financial control, production of cost estimates, and operation of the Project performance measurement and reporting system(s). The Project Business Office included the Project Business Manager, the Project Acquisition Manager, and resource, scheduling, and other personnel. The Project participant organizations had similar offices with similar functions appropriate to their areas of responsibility.

5.6.4 *Program Operating Plan*

The Project Business Office was the primary lead for responding to Prometheus Project guidelines called out in the Program Operating Plan (POP), NASA's overall budget planning process. The office received budget requests from the other NASA Centers and other Government agencies and developed and provided the integrated Project programmatic planning information to NASA in support of the Agency's annual budget submission to the Office of Management and Budget (OMB). NRPCT provided the Business Office with their budget requirements for inclusion in the overall Project POP, in parallel with the submittal by NRPCT to NR.

5.6.5 *Funds Management and Control*

The Project indicated, via the POP, the bypass funding requirements for both NASA and other agency contributions. The Business Office was the focal point for monitoring funds requirements across the Project. The Project Manager recommended specific bypass funding requirements through the ESMD. A process was established for the Project Manager to inform ESMD of funding requirements for each participant and when the funds were required, based on the POP and on use of project management reserve (liens).

5.6.6 *Contractor Financial Analysis and Oversight*

The Cost and Performance Analysis Group (CPAG) at JPL supported the Project by performing performance management oversight of JPL subcontractors, principally NGST but also for the larger Radiation Hardened Technology contracts. CPAG assisted the Project contract technical managers, business operations personnel, and acquisition personnel in contract management. CPAG provided Project management with analysis of subcontractor-provided cost and schedule information and assisted in decision-making by providing an early indication of potential cost and schedule problems.

5.6.7 *Cost Reporting*

Cost reports were provided to NASA on a monthly basis via monthly reports (MMR, PSR, and the JPL 533 process).

5.7 **Public Outreach and Advocacy**

The Prometheus Project had a unique opportunity to bring a science and technology focus into educating the public about energy options and the use of nuclear energy in space applications. This timely topic, along with the science to be obtained at Jupiter, would have given JPL and NASA an unprecedented and compelling story that would capture the public's interest.

It was expected that there would be significant public controversy concerning the use of nuclear reactors in space applications. There would have been a need to educate the public on the technologies involved, and to also provide the critical knowledge that would allow the public to evaluate the information and make their own reasoned assessment. The material would have been designed to provide information in an understandable fashion so that individual members of the public can accept and support what might otherwise be a confusing and controversial endeavor.

A preliminary Education/Public Engagement Program Plan was created, covering such topics as formal education, informal education, media relations, and methods to reach the general public. The plan discussed the overall goals, objectives, tools, principles, and resources that would encompass the Public Outreach and Advocacy activities through the project life cycle.

An interactive, up-to-date website would have been the first and most widely used avenue to communicate and educate the public about the Prometheus science, mission and technology. An updated website with new pictures and text was launched in April 2005. The interest in Prometheus is reflected in the number of visitors to the new website. Over 1.6 million hits were received when the new website was launched, with 28,000 unique visits. From New Zealand to the Czech Republic, Prometheus received interest from 17 different countries.

The Prometheus Project involved a diverse national team composed of universities, industry contractors, NASA Centers, and the Department of Energy Naval Reactors (NR) and NR contractors. Participants included 8 NASA Centers, 3 NR Facilities, 5 DOE Laboratories, numerous companies and universities. These organizations were located in 23 different states, making Prometheus a national endeavor. Participants included:

- NASA Centers — Ames Research Center, Glenn Research Center, Goddard Space Flight Center, Independent Verification and Validation Facility, Johnson Space Center, Jet Propulsion Laboratory, Kennedy Space Center, Langley Research Center, and Marshall Space Flight Center.
- Naval Reactor Laboratories — Bechtel Plant Machinery, Bettis Atomic Power Laboratory, and Knolls Atomic Power Laboratory.
- DOE Laboratories — Brookhaven National Laboratory, Los Alamos National Laboratory, Oak Ridge National Laboratory, Pacific Northwest National Laboratory, Sandia National Laboratory, and the Y-12 National Security Complex.
- Companies (selected) — Northrop Grumman Space Technologies, Advanced Cooling Technologies, Aerojet Corporation, Aerospace Corporation, Alliance Space Systems, bd Systems, BAE Systems, Boeing Company, EER Systems, Futron Corporation, Hamilton Sundstrand, Honeywell Solid State Electronics Center, Lockheed Martin, MOOG Inc, and Reynolds, Smith and Hill.
- Universities — Arizona State, Arkansas, Auburn, Cal Berkeley, Cal Davis, California Institute of Technology, California Polytechnic, Cal San Diego, Case Western Reserve, Central State, Colorado State, Dayton, Georgia Tech, Idaho, Indiana, Michigan, Missouri, New Mexico, Ohio State, Oregon State, Pennsylvania State, Purdue, Rensselaer Polytechnic Institute, Rice, Southern California, Stanford, Tennessee, Texas A&M, Texas State, Toledo, and Wisconsin.

To better integrate the communication and outreach efforts of such a varied group of organizations, a planning meeting was held in early 2005 to develop and an overall communication and outreach strategy for the Project. All Prometheus participants were invited. Topics covered at the meeting included industry and policy conferences of interest, possible media outlets for coverage, outreach activities, and other organizations that may have an interest in the Prometheus Project.

Subsequent to the initial communication and outreach planning meeting, weekly conference calls were established to exchange ideas and information as well as provide a forum for detailed planning of near term activities. The conference call informed participants of each others' ongoing efforts and provided a means for coordinating activities and sharing information among the diverse and geographically separated entities. Following the weekly telecons, a written summary was distributed to all organizations.

The initial outreach focus was placed on efforts to educate the public and the Congress. The Space Foundation was enlisted to help coordinate and communicate with the Congress. The Foundation arranged a briefing for the House of Representatives that included both Members and staff. Three Members attended along with 50 staffers from both personal offices and committees. A smaller venue was planned for the Senate, but was cancelled due to the Project being discontinued.

The Project supported multiple national conferences over a 3-year period focusing on the technology and scientific objectives of the Project. In addition, the Prometheus staff attended numerous specific technical conferences. A list of the major events is provided in Appendix E.

Figure 5.7-1 shows the display that was used at the JPL Open House, which had approximately 40,000 visitors. Displays and models of the spacecraft and reactor were provided at numerous public venues.

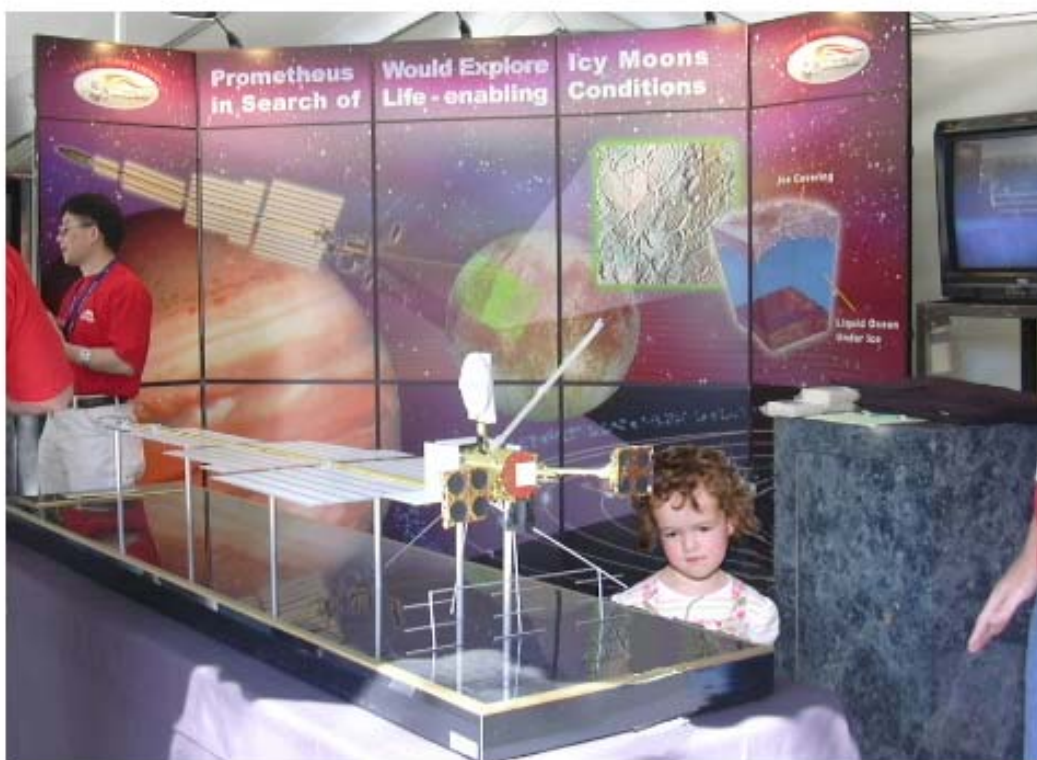

Figure 5.7-1. Project Prometheus Display at JPL Open House.

5.8 Facilities

The Project used a number of existing Government and industry facilities during Phase A of the project. These facilities were used primarily in conjunction with the technology development activities. Although some equipment disposition was required in some of these facilities, the Project had no long-term facility decommissioning responsibilities.

Initial meetings were held with NR/NRPCT, KSC, JPL and NGST regarding the facility needs at KSC for housing the Reactor Module and integration of the Reactor Module with the Spaceship. A preliminary facility feasibility study was performed. The purpose of the study was three-fold: (1) inventory and evaluate existing Kennedy Space Center (KSC) and Cape Canaveral Air Force Station (CCAFS) facilities to determine if there are currently viable candidate facilities for Prometheus spacecraft processing operations; (2) determine if existing facilities could be feasibly and economically retrofitted to meet Prometheus requirements; and (3) develop a concept and identify potential locations for a new spacecraft processing facility, should existing facilities not prove to be feasible/economical. Results of the facility study are summarized in Section 11.

5.9 Logistics

The Project planned to develop a Logistics Plan during Phase B. The Plan would have described in detail the logistics approach, including the preparation and custodianship of technical data, physical items, and software that would be used not only during subsequent phases of the JIMO mission but also for potential follow-on missions and projects, including lunar surface power applications. “Technical data” for this purpose would include plans, requirements, analyses, designs, specifications, contract and agreement documents, training materials, test procedures, and operating and maintenance manuals as well as system performance data (including test data and set-up and calibration information) and scientific data, information, and reports. The Logistics Plan would also have addressed sparing philosophy and provisions, transportation and handling, training provisions, redundant ground equipment, and sustaining engineering. Supporting the project Logistics Plan, the NGST subcontract required submission of a Spacecraft Logistics Management Plan prior to PDR. Finally, the Life Cycle Cost Estimate (LCCE) and supporting Basis of Estimate (BOE) would have been updated to reflect up-to-date knowledge of the logistics approach and associated costs. More information on the configuration management aspect of technical data is found in section 6.3.9 of this document.

Prometheus generated a great deal of “technical data” and also significant Government property during Phase A. Property was dispositioned in accordance with JPL’s approved procedures. A comprehensive library of Prometheus technical data is being provided to NASA ESMD for archiving in its electronic WindChill system.

5.10 End of Project Lifecycle

The Prometheus Project would have generated a comprehensive plan for JIMO Phase E – Operations, prior to launch. During Phase E, a project Closeout Plan would have been generated, directing actions for an orderly shutdown of activities, archiving of project documents, and dispositioning Government property. Much of this material would have been applicable to follow-on Prometheus missions, either science missions or derivative missions such as lunar surface power. With the discontinuance of the Project, however, only preliminary work was performed on the Phase E plan. More information on Phase E is provided in Section 10.4 of this document.

On August 26, 2005, JPL was directed by letter from Doug Cooke, acting manager of ESMD, to end all work effective September 2, 2005, except for listed activities at JPL and GRC to be performed through October 1, 2005. These activities were to be performed without any additional funding. The Project Office received specific contractual direction from the NMO via two Task Order modifications.

Upon direction to discontinue the Prometheus Project, the Project Office generated a Project Closeout Plan. Phase A closeout activities at JPL and its subcontractors were led by a Closeout Manager. The major activities identified in the Closeout Plan included: technology tasks work completion; personnel transition; documentation completion, archiving, and transfer; subcontracts transition-to-closeout (for the NGST subcontract and many subcontracts, purchase orders, subcontract work orders, interdivisional transfers to Caltech, and loan agreements); JPL and subcontractor property disposition; facilities decommissioning (for the Electric Propulsion laboratory at JPL); financial final reporting; security closeout; intellectual property closeout; and formal final closeout.

6. Project System Engineering

6.1 Project Engineering Scope

For Prometheus, the project organization efficiently partitioned the large project work scope. The scope of Project Engineering in this organization is shown in Figure 6.1-1. Although not the direct responsibility of Project Engineering, Project Engineering played an active role in Risk Management and had a high degree of interaction with Mission Design.

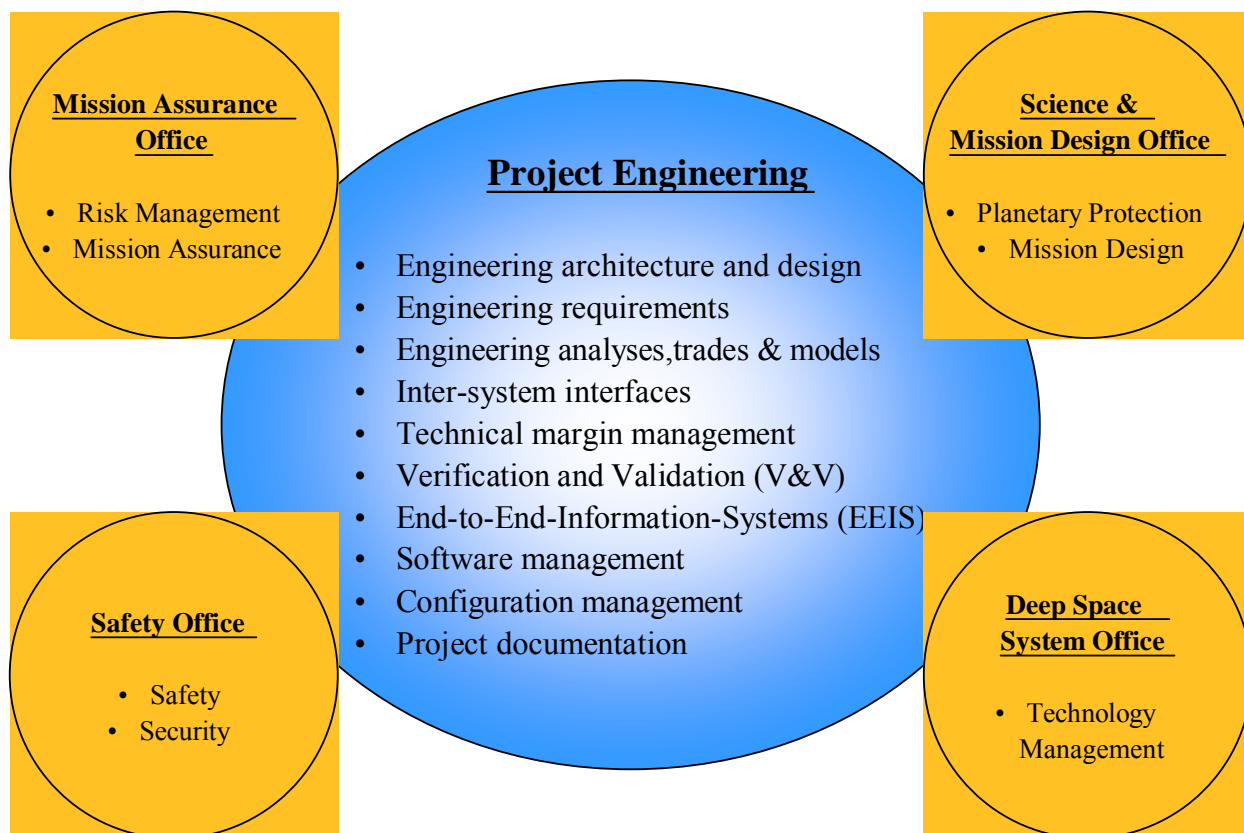

Figure 6.1-1. Project Engineering Scope.

6.2 Project Engineering Approach

The approach for execution of Project Engineering (PE) on the Prometheus Project was documented in the Project Engineering Plan. This document was released on July 15, 2005. The purpose of this document was

- To define the Prometheus Project engineering plans and processes to be implemented by the Project and its Systems
- To identify, where applicable, Prometheus Project tailoring and waivers of the JPL institutional practices and procedures for Project engineering

- To describe the roles and responsibilities, deliverables, and schedule for the Project Engineering Office

The Project Engineering Team (PET) was led by the PE Office Manager, with the Project Chief Engineer providing overall leadership for the technical design. A list of the key organizations participating in Project Engineering Office activities, and their contribution to these activities are described below:

- 1) Jet Propulsion Laboratory (JPL) – The Project Engineering Office, and each of its key Project Engineering tasks were led by JPL engineers. This included the positions of the PE Manager and the Chief Engineer.
- 2) Glenn Research Center (GRC) –GRC contributed to and provided leadership to the PE Office in two main areas: a) Project System Model - GRC was responsible for the design and development of the Space Reactor Power System (SPRS), Electric Propulsion (EP), and Mission Design Modules; GRC also contributed to the execution of the System Model for the performance of trades, and b) GRC led the Launch System Integration activities.
- 3) Marshall Space Flight Center (MSFC) –MSFC contributed to and provided leadership to the PE Office in two main areas: a) MSFC was responsible for the design and development of the Configuration and Structures Modules of the Project System Model, and b) MSFC contributed to the development of the System Engineering Process and Project Engineering Model. In particular, MSFC led the management, oversight and training of the requirements and functional modeling sections of the model.
- 4) Northrop Grumman Space Technologies (NGST) –NGST was responsible for two key “Systems Integration” tasks: a) Science System integration, and b) Deep Space System integration.
- 5) Naval Reactors Prime Contractor Team (NRPCT) – NRPCT had no direct PE role or responsibility. Because the reactor is part of the Deep Space System (DSS), their prime interface to the PE Office was through the DSS System Engineer. NRPCT participated, however, in PE activities including requirements development. This was important because of the direct interaction between the mission design and the reactor power system design.

PET Meetings were conducted on a weekly basis to facilitate communications and to work PE tasks. PET members included the PE Office and extended to those organizations that were direct participants of PE activities. This included managers and engineers representing the Science and Mission Design Office (representing science, mission planning, trajectory analysis and navigation), the Project Risk Coordinator, the NRPCT representative, and the System Engineering Lead from each of the four Project systems (Launch, Ground, Science and Deep Space System). Managers and engineers from other Project organizations (e.g., safety, mission assurance, lower-level elements, etc.) also participated in the PET as appropriate.

One of the key achievements of the PE Office was the development, documentation, and execution of a project-wide System Engineering Process. This process builds on proven JPL system engineering processes, and is also consistent with INCOSE process tasks defined in the INCOSE Systems Engineering Handbook. An overview of this process is shown in Figure 6.2-1. The process included clear deliverables and broad system data linkage. It was a trailblazer for large JPL projects and its models and lessons learned provide a framework for future projects to build on.

The Prometheus Engineering Process steps are iterative and are performed throughout the project life cycle. They apply to all Project system engineering organizations starting at the Project level (level 2) and down to at least the subsystem level (level 6). Use of this process for system engineering performed below level 6 was optional. During Phase B, each Project System (e.g. Launch System, Ground System, Deep Space System, and Science System) would have documented their plan for implementation of the Project Engineering Process.

Most products created as part of the Prometheus Engineering Process were documented in the Prometheus "Project Engineering Model." An overview of the Project Engineering Model architecture is shown in Figure 6.2-2. Model elements corresponding to the process are shown on the horizontal axis, and a view of the products from any system at Level "N" are shown on the vertical axis.

The Project Engineering Model was developed using Cradle software. This software provides the ability to model and link numerous system engineering products (e.g., requirements, functional models, component models, Product Breakdown Structures, verification and validation matrices, etc.). It also provides good extensibility and interface capability relative to other products. The software and procedures for the generation and management of the Project Engineering Model database was the responsibility of the Project Engineering Office. This office augmented Cradle with tools or scripts to achieve additional capabilities and to establish interfaces with other Project software systems.

JPL's Flight Project Practices identifies gate products and milestone reviews throughout the lifecycle including those for project engineering. These products and reviews provide measurable indicators of the project's performance and readiness to proceed to the next phase of development. They include independent review as a key construct.

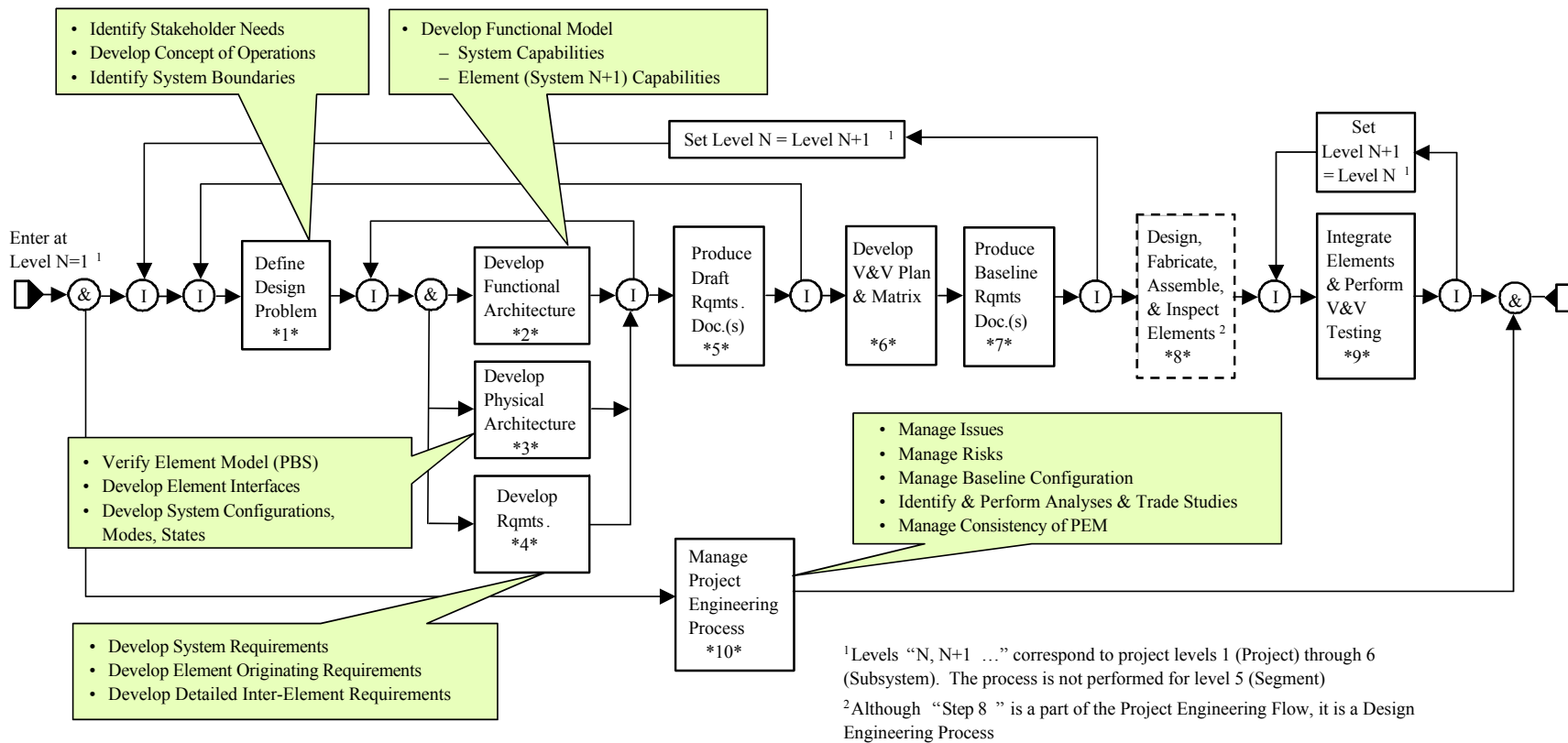

Figure 6.2-1. Prometheus Project Engineering Process.

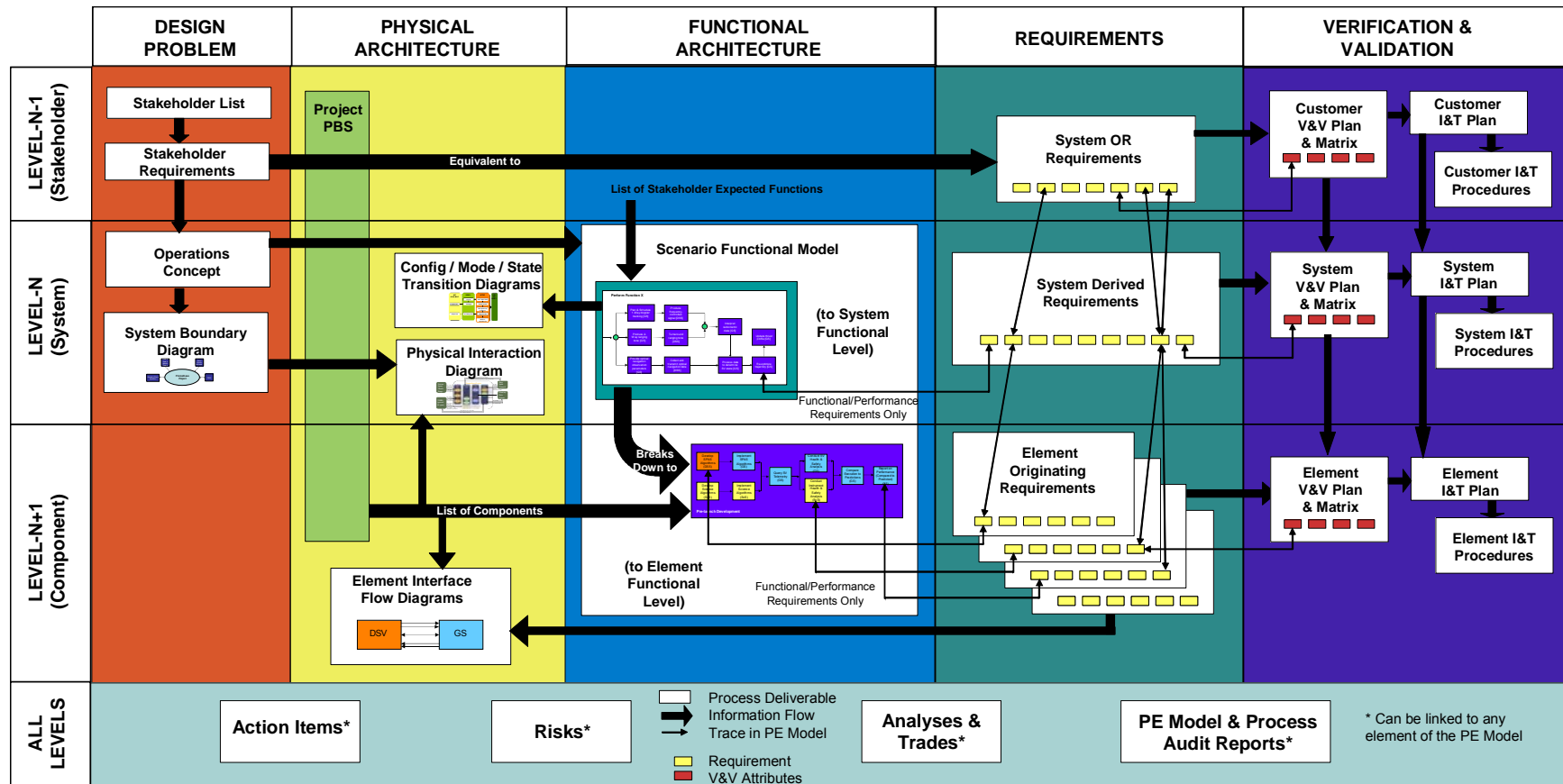

Figure 6.2-2. Project Engineering Model Architecture.

6.3 Project Engineering Implementation

The following section describes different elements of Project Engineering that contributed to the PE process. Specifically, the following topics are discussed: project documentation, project requirements, technical margin management, systems integration, End-to-End-Information-System (EEIS) design, system trades and analyses and models, software management, verification and validation, and configuration management.

6.3.1 *Project Documentation*

The project documentation architecture was established and documented as part of the Prometheus Project Engineering Plan. This architecture defined document levels, established a documentation hierarchy, and called for the provision of a Document List and Tree. The Project Document List provided a listing of all Project documents at all Project levels, and included key documentation parameters for each (e.g. title, identification number, custodian, etc.). The Project Document Tree visually demonstrated the hierarchy between all Project requirements documents, plans, and Memorandum of Agreements/Understandings at document levels 1 (Program), 2 (Project) and 3 (Systems). It also separately illustrated the relationship between and the ownership of Interface Requirements Documents (IRDs) and Interface Control Documents (ICDs) for document levels 1 to 3. Both the Project Document List and Tree were regularly posted in the Project electronic documentation repository (Docushare).

6.3.2 *Project Requirements*

The project requirements architecture was also established and documented as part of the Prometheus Project Engineering Plan. This architecture included the requirements hierarchy, interface requirements, requirements structure for follow-on missions, requirements types and standards, and the Project approach to Key Performance Parameters (KPPs).

During Phase A, the Prometheus Level 2 (project-level) requirements were delivered in two documents. The first document, the “Deep Space Vehicle Project Derived Requirements Document,” responded to the Prometheus Level-1 requirement OR1.1, namely,

OR1.1: The JIMO Project shall develop a Deep Space Vehicle for outer solar system robotic exploration missions that combines a safe, reliable, Space Nuclear Reactor with electric propulsion.

The second document, the “JIMO Project Derived Requirements Document,” responded to the Prometheus Level-2 requirements OR1.2,

OR 1.2: The JIMO Project shall execute a scientific exploration mission to the icy moons of Jupiter (Callisto, Ganymede, Europa).

As required by the Project Engineering Process, the following deliveries were also made in support of these project-level requirements: Requirements Rationale, an Operational Concept, a System Boundary Diagram, Physical Interaction Diagrams, Configuration/Mode/State Transition Diagrams, Functional Models at the scenario level, a requirements action item data base, an identification of risks resulting from the requirements process, analyses and trades. An audit of these deliveries was performed for PMSR by the Verification and Validation Engineer and is documented in the Project-Level “Project Engineering Process Audit Report.”

During Phase A, each Project System also delivered a list of Key Driving Requirements (KDR) for their area. For Prometheus, a KDR is defined as one that is both “key” and “driving”, where

- Key Requirement – A requirement allocated by a stakeholder that is considered critical to public safety, planetary protection, science goals, or a robust project system.
- Driving Requirement – A requirement identified by a lower-level element as impacting the design or implementation in a major way with respect to cost, mass, schedule, performance or architecture.

Project System KDR documents are archived in the Project Library.

6.3.3 *Technical Margin Management*

During Phase A, the project delivered a preliminary Prometheus Technical Margin Management Plan. This document included a description of roles and responsibilities, reporting and documentation, margin definitions, equations and margin policies for technical margin management. This plan was consistent with the JPL Design Principles, with two exceptions (waivers were written and approved for both; see Section 2.6): battery energy and power margin for Electronic Propulsion loads.

Some key elements of the technical margin management strategy are described below:

- The Project Engineering Manager was responsible for the overall management of Project technical margins.
- The plan called for a “Resource Trading Board” for the management of Mission Module technical and financial resources.
- The Spacecraft Contractor delivered and updated (at major reviews and at least quarterly) a Technical Resource Report that documents Project technical resources including those “owned” by other systems and models.
- Margin status summaries were reported at all Project reviews and at MMRs as required in the Project Review Plan.
- The plan called for increased margin control by adding a “Design Growth Allowance (DGA)” to the standard “Uncertainty Allowance (UA)” called for in the JPL Design Principles.

6.3.4 *Systems Integration*

Systems Integration includes the integration of each Project System (Launch System, Ground System, Science System, and Deep Space System) with the rest of the Project. During Phase A, the PE Office assigned one engineer to perform this task for each Project System. This effort focused on identifying key system interfaces, working level-2 requirements affecting that system, and performing trades and analyses related to that system's integration.

Some of the key system integration challenges in Phase A included the following:

- Deep Space System / Science System Integration - One of the key system integration challenges was to define a "Payload Accommodation Envelope (PAE)", i.e. to define those requirements on the Deep Space Vehicle (DSV) (e.g., physical, pointing, data volume, etc.) that envelope a variety of investigations that might be flown on both JIMO and follow-on Prometheus missions. This was accomplished as a joint effort between the Science Definition Team and the Project Engineering Team. A "reference" instrument suite was defined and an envelope to support that instrument suite was derived.
- Deep Space System / Launch System Integration - Another key integration challenge was the definition of operational scenarios, trades and requirements for a variety of launch vehicle capability options (e.g. different lift capabilities, number of launches, and rendezvous and docking scenarios). This effort was necessary because the JIMO launch vehicle(s) had not been selected at the time of the PMSR.

Phase A System Integration deliverables were documented in both the Project Requirements Documents, the Project Analyses and Trades List, and as part of the Project Engineering Model. During Phase B, the system integration effort would have focused on the delivery of Project System Interface Requirement Documents (IRD) and Interface Control Documents (ICD).

6.3.5 *End-to-End Information System*

The Prometheus End-to-End-Information System (EEIS) is a "virtual system" that includes a set of functions distributed throughout the Launch System, Ground System, Deep Space System and Science System. This virtual system operates to control, collect, transport, process, store, translate, and manage mission information (e.g., science, engineering, radio metric, command, and ancillary information).

Prometheus EEIS requirements were delivered as preliminary in the Prometheus Project Requirements Documents. The Prometheus EEIS Plan was delivered as a draft at the PMSR. The plan included a description of EEIS elements, operational concepts and scenarios, user services and interfaces, standards, and development plans. In support of the EEIS Plan, the Project developed an EEIS model to perform downlink data volume studies. Plans were also initiated for expanding this model in the time and data product domains to demonstrate that EEIS requirements could be met, to develop operational scenarios and strategies to enhance EEIS performance, to determine expected EEIS performance, and to support V&V by assisting in the selection of test cases to best stress the system.

Project EEIS Meetings were conducted on a weekly basis to facilitate communications and to work EEIS issues. The EEIS Team was led by the Project EEIS Engineer, and included all Prometheus organizations (including JPL, NGST and NRPCT) and Prometheus elements (including all Systems, Modules, etc.) involved in the EEIS design.

6.3.6 System Trades and Analyses

The Prometheus Project performed system trades and analyses to evaluate design alternatives in meeting customer objectives and requirements. System engineering teams (at all levels) coordinated the scope, objective, priority and resolution of each trade, consistent with their team charter. Trades were evaluated based on the following list of prioritized parameters:

- 1) Safety — Design, implementation and processes to identify, control and mitigate risk to personnel and the environment
- 2) Reliability — Successful operation of the Space System through End of Mission
- 3) Performance — Design and implementation of Project elements to return orbital data consistent with the Level 1 Objectives
- 4) Cost — Development costs through launch +30 days and Operations costs through the required life of the mission.
- 5) Schedule — Accomplishment of activities to enable launch on time

Each trade/analysis was documented in a report or memo, and approved by the responsible WBS manager. Trades / analyses were tracked at all project levels as part of the Project Trades/Analyses List and linked to the relevant elements of the Project Engineering Model. The final Project Trades Summary List and the associated analyses are archived in the Project Library (Docushare). A summary of the critical issues associated with designing NEP missions is found in “Critical Concepts in NEP Missions.”

Due to the complexity and high degree of integration between the mission and space system designs for an NEP system, the Project developed a “Systems Model” to perform trades requiring evaluation of the following parameters:

- Initial launch orbit
- Launch wet and dry masses
- Power used by the electric propulsion system
- Thruster specific impulse
- Acceleration

This model included models of elements provided by the appropriate technical organization for the following areas:

- Mission design
- Launch vehicle (LV)

- Electric propulsion (EP)
- Space Nuclear Power Plant (SNPP)
- Local radiation shielding
- Power management and distribution
- Structures and configuration
- Thermal subsystem

The Systems Model Lead implemented a configuration control process for Systems Model revisions. Each model revision includes a design description document. The final version was released as the “System Model Version 3.0 Description Report.” All System Model software versions, description documents, analyses and trades studies, are archived in the Project Library (Docushare).

6.3.7 *Software Management*

The focus of the Prometheus Software Management effort during Phase A was to:

- Establish software management practices and requirements across all Project software elements - both flight and ground
- Establish a Prometheus computational architecture
- Provide a liaison with NASA’s Software Independent Verification and Validation (IV&V) Facility.

The software management task was particularly challenging on the Prometheus Project due to the large number of organizations involved, each with their own software practices and products. Project Software Team Meetings were conducted on a weekly basis to facilitate communications and to work software issues. The Software Team was led by the Project Software Engineer and included all Prometheus organizations (including JPL, NGST and NRPCT) and Prometheus elements (including all Systems, Modules, etc.) with software deliverables.

At the time of the PMSR, a preliminary Software Management Plan was delivered. This plan:

- Established the management, development, verification and validation approach and practices for Prometheus software development.
- Defined the standards and products applicable to Prometheus software throughout the development life-cycle, and
- Described the Project Engineering Office plans for management of the software developments.

A draft Prometheus Software Requirements Document was also delivered that defined the software requirements applicable to Prometheus software executable work products. Both documents are compliant with JPL institutional policies and practices for software development.

The Project Software Engineer acted as the Project liaison with the IV&V Facility.

6.3.8 *Verification and Validation*

For Prometheus, Verification is a process that confirms that the project, its elements, its interfaces, and incremental work products comply with their documented requirements, e.g. that we have “built it right”. Validation is a process that confirms that the system, as built (or as it will be built), will satisfy the user’s needs, e.g. that we have “built the right thing”.

During Phase A, Project Verification and Validation (V&V) activities focused on developing the top-level event flow associated with assembly, test, and launch operations (ATLO). Project V&V Meetings were conducted on a weekly basis to facilitate communications and to work V&V issues. The V&V Team was led by the Project V&V Engineer, and included all Prometheus organizations (including JPL, NGST and NRPCT) and Prometheus Systems. The results of these efforts were presented at the Prometheus PMSR.

During Phase B, the Prometheus Verification and Validation Plan would have been written in compliance with JPL institutional practices and policies. This plan was to describe the Prometheus V&V approach and processes, and to document the Project-Level V&V matrix. All Prometheus Systems would have also produced system-level V&V Plans responsive to the Project-level V&V Plan.

6.3.9 *Configuration Management*

At the time of the PMSR, the PE Office delivered a preliminary Configuration Management (CM) Plan. This plan is compliant with the National Consensus Standard for CM. Key features of the plan include the following:

- At the Project-level, Prometheus uses JPL standard, institutional CM processes.
- Partners use their existing CM processes, interfacing with the JPL processes and tools in a collaborative environment.
- CM plans for all partners are reviewed and approved as part of the CM process and standard contractual activities.
- JPL manages the connectivity of these systems.
- Collaborative impact assessments of changes are required.

Prometheus established a Project-integrated, electronic change control database. All released and controlled information, as well as current design information, were kept in the JPL electronic library (Docushare). All controlled information was also documented in JPL’s Project Document Management System (PDMS). The formal change control system was to be initiated at the start of Phase B.

[This page intentionally left blank]

7. Safety and Mission Assurance

7.1 Safety Management

The challenge for the Prometheus Project was to develop a broadly based, uniform safety program that would accommodate the wide range of applicable regulations from multiple sources and provide methods for appropriately implementing those regulations by all Project participants. The consistent goal of all of these regulations is to protect public and worker health and safety and the environment, and flight hardware and facilities by identifying hazards and hazardous situations, controlling or eliminating the hazards, and taking measures to mitigate any residual risk to personnel and/or equipment.

All applicable regulations and requirements apply. The Project was required to conform to all local, state, federal, and national regulations regarding safety, including nuclear safety regulations as defined by the Department of Energy, Office of Naval Reactors. Prometheus hardware and operations were also required to comply with launch site/launch processing facilities and launch vehicle system safety requirements.

A Preliminary Prometheus Project Safety Program Plan was generated. This plan defined the safety roles and responsibilities of each of the organizations. A key aspect identified in the Project safety program was that all organizations were responsible for the health and safety of their employees at all times, regardless of their work locations. The Preliminary Prometheus Project Safety Requirements Document was also generated. This document complied with D-560, JPL Standard for System Safety, and would have been updated as the other applicable safety requirements of DOE/NR, NASA Field Centers, and other partners/contractors were identified.

Prometheus Project safety efforts were integrated across the Project, including JPL, NRPCT, NASA Field Centers, and industry partners/contractors. A Project Safety team, under the leadership of the Project Safety Manager (JPL), was charged with defining the implementation methods for assuring safety on the Prometheus Project based on all applicable requirements. Teaming was initiated through meetings with the Project participants' safety staff. The purpose of the meetings was to start identification, integration and implementation of the variety of safety requirements for all operations. Ultimately, each organization was to formally document the rules and regulations they were required to follow to assure safety in their operations, and provide an implementation plan for compliance to the applicable requirements. At facilities where multiple organizations would operate or multiple organizations would have regulatory authority, a joint set of requirements, inclusive of all of the individual requirements, would be identified. It was important that a single set of all-inclusive requirements were clearly articulated at a given facility or operation so that workers would not be confused or be given inconsistent or conflicting direction regarding safety.

Surveillance of in-house and partner/contractor safety processes would be performed by the Project Safety Office to ensure that safety processes across the Project were implemented correctly and consistently, and met requirements. A combination of insight and oversight would be used, considering such factors as risk, maturity of the organization with implementing the requirements, and the implementer's performance history.

The intent was to have documentation for assuring the public and workers that the performance of the Prometheus mission was safe and that all flight hardware, Project critical hardware, and facilities were protected. The approach to launch nuclear safety is described in section 2.4.

7.2 Mission Assurance Management

The Prometheus Mission Assurance Program was structured to assist the Project in proactively identifying, assessing and mitigating risks to ensure mission success. To this end, the Mission Assurance Team addressed a number of areas including system reliability, radiation and nuclear environmental extremes, development of advanced technologies for electrical, electronic, and electromechanical (EEE) parts, the unique environment associated with electric propulsion, the high power levels and electromagnetic compatibility and electromagnetic interference (EMC/EMI) environments anticipated, and the complex project integration task that Prometheus poses. Proven flight practices for Mission Assurance were implemented and detailed discipline requirements were developed to satisfy the Project characteristics. The unique technical and management challenges of this mission required the development and implementation of advanced practices and strategies across the various organizational boundaries.

The structure of the Prometheus Mission Assurance program included Mission Assurance management, environmental engineering, electronic parts engineering, radiation control and verification, reliability engineering, hardware and software quality engineering, IV&V, problem/failure reporting, and risk management. Requirements in these areas were established at the project level and flowed to the NRPCT, NGST and the NASA Centers for implementation and verification through the responsible organization and using the processes and systems defined by either JPL or NRPCT, as appropriate. The Project mission assurance approach and requirements were defined in detail in the Prometheus Project Mission Assurance Requirements. The JPL Flight Project Practices and the Mission Assurance-related Design Principles were utilized as a baseline in defining the appropriate Project Mission Assurance requirements.

The Mission Assurance Manager (MAM) was assigned as a member of the Prometheus Project staff and functionally reported to the Project Manager. Within the Mission Assurance Office are Assurance Managers for the Ground System, Spaceship, and Launch System, adopting a parallel structure to the Prometheus Project structure. The Spaceship was further divided to provide a Reactor Module, Spacecraft Module and Mission Module assurance manager. Each sub-tier Assurance Manager reported to the MAM. Each discipline was assigned a discipline lead, who reported to the MAM. Figure 7.2-1 details the Prometheus Mission Assurance Office Organizational structure.

The Project Mission Assurance team, under the leadership of the Mission Assurance Manager, provided early teaming and effective, clear communication to facilitate timely identification, assessment, and mitigation of risks. The Spacecraft Module Contractor, NGST, developed Mission Assurance Implementation Plans that were responsive to the Prometheus Project Mission Assurance Requirements. A mapping of the NRPCT reliability and assurance requirements and associated discipline implementation plans was conducted to ensure that Mission Assurance processes across the Project met requirements.

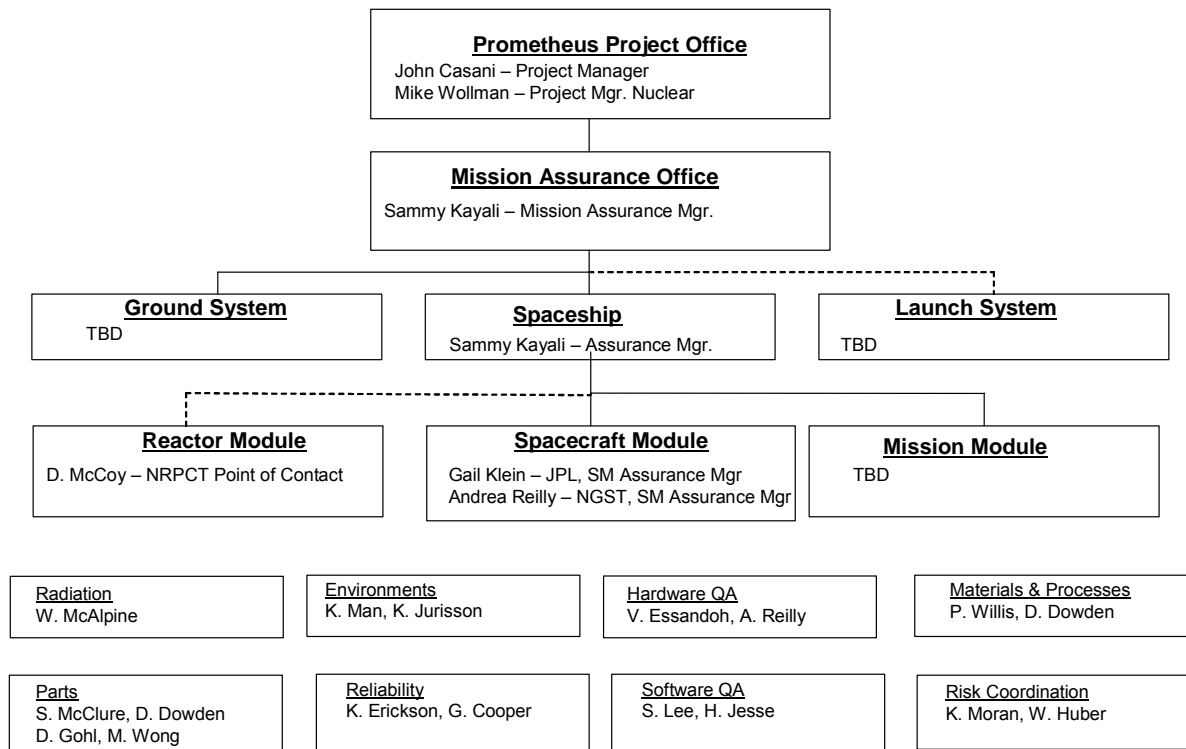

Figure 7.2-1. Prometheus Project Mission Assurance Organization.

The Spacecraft Module Assurance Manager was responsible for coordination of the mission assurance activities relating to the Spacecraft Module and to serve as the point of interface for mission assurance issues with NGST. The Mission Assurance discipline leads provided the necessary support for the establishment of requirements and associated implementation plans and to address any technical issues related to their disciplines.

An important element of the Mission Assurance Organization is to ensure compliance with Institutional Standards and Requirements. To that end, the Mission Assurance Manager and discipline leads were responsible for review and verification of compliance with the institutional Standards and project requirements under their cognizance. This information was documented in compliance matrices and reported at the PMSR.

For Phase B, the Mission Assurance Team was ready with staffing and implementation plans to support the preliminary design activities. The planned activities included the continuation of materials and microelectronics test and evaluation activities in support of the technology development tasks, initiation of parts selection activities, radiation shielding analysis to support the preliminary designs and associated system mass, utilization of fault tree analysis and other reliability tools in support of system trades, and the verification of the software processes required for the future detailed design.

7.2.1 *Radiation Mitigation*

The radiation mitigation activities for the Project required significant design and mitigation efforts across the project to ensure the success of the mission. The Prometheus Project approach, which emphasized information collection and dissemination early in the design process, was coordinated by the Project Radiation Manager. The approach was applied to piece part/material selection, circuit design, and system mitigation approaches to coordinate the radiation risk management. The intent was to design the Prometheus Spaceship to withstand radiation environments such as those at Jupiter, assuming all follow-on missions will have a less challenging radiation environment and can, therefore, reliably use the Prometheus Spaceship.

The radiation control process used in the design of Prometheus flight hardware is shown in Figure 7.2-2. Early in the design phase of the Spaceship, the majority of the radiation control process was centered on the definition of the external environment, the determination of local radiation environments for specific Spaceship hardware elements, and the determination of shielding mass required on the Spaceship. These early design activities are steps 1 through 4 in the radiation control process.

The generation of the external radiation environments was completed as part of the environmental requirements effort and was documented as part of the Environmental Requirements Document. The cumulative mission external radiation environments are shown in Figure 7.2-3 for electrons and protons.

The determination of the local radiation environment at specified spaceship hardware elements required a defined external radiation environment and a radiation mass model of the Spaceship. The radiation model of the Spaceship shielding material included the detailed physical dimensions and material composition of the Spaceship structure, locations of flight hardware assemblies within the Spaceship structure, and dimensions of the flight hardware assemblies.

The Spaceship configuration was generated through engineering activities involving the NGST and JPL design organizations. The design evolved into the Prometheus Baseline design presented in the PMSR and used to generate the radiation mass model of the Spaceship bus and telecommunications platform.

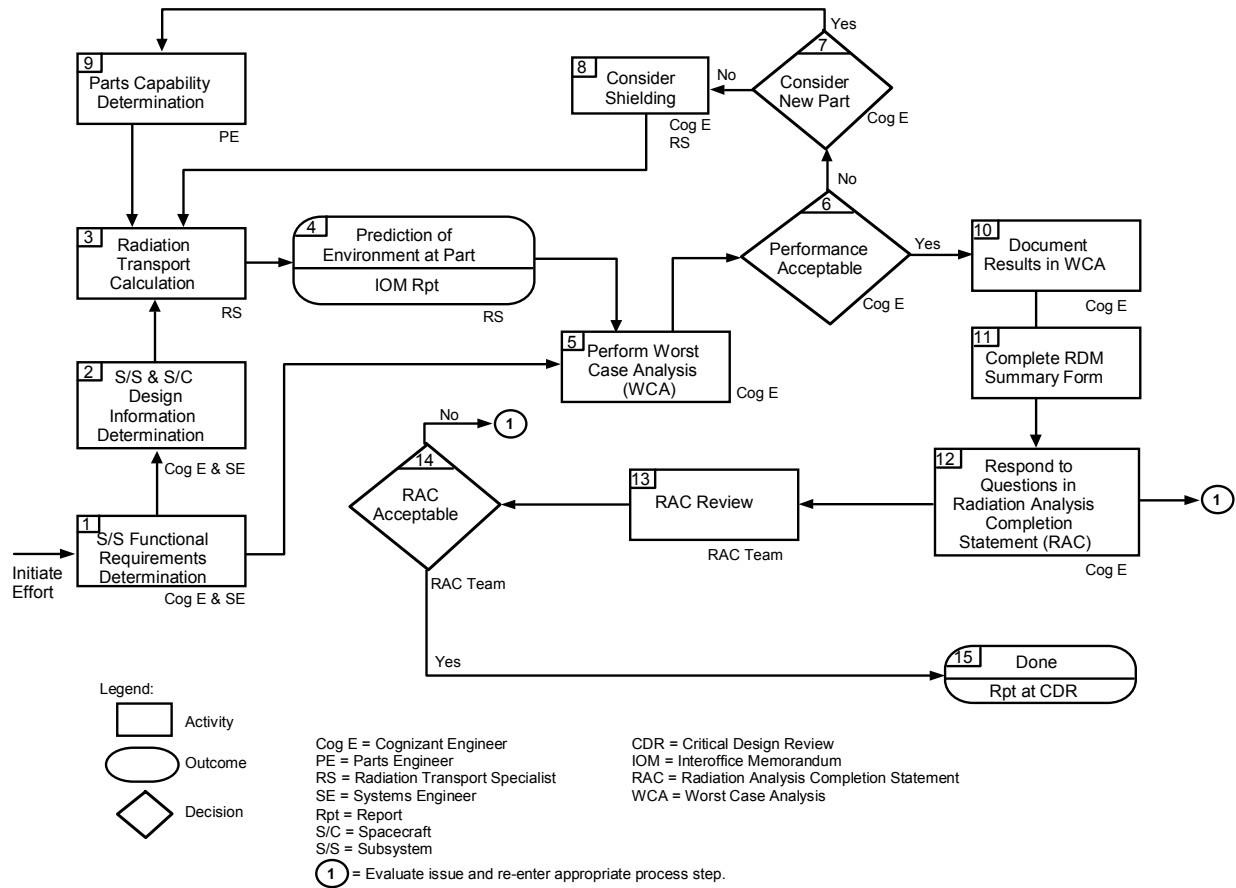

Figure 7.2-2. Radiation Control Process.

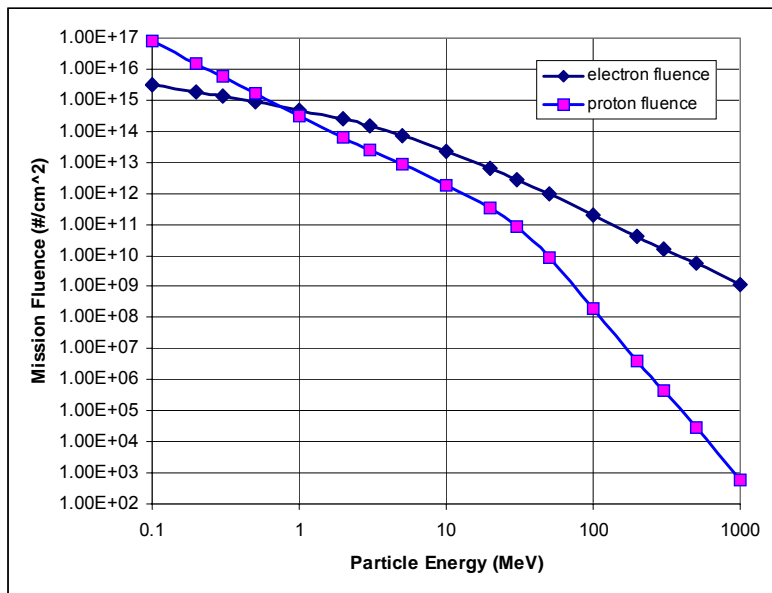

Figure 7.2-3. Prometheus External Radiation Environment at PMSR.

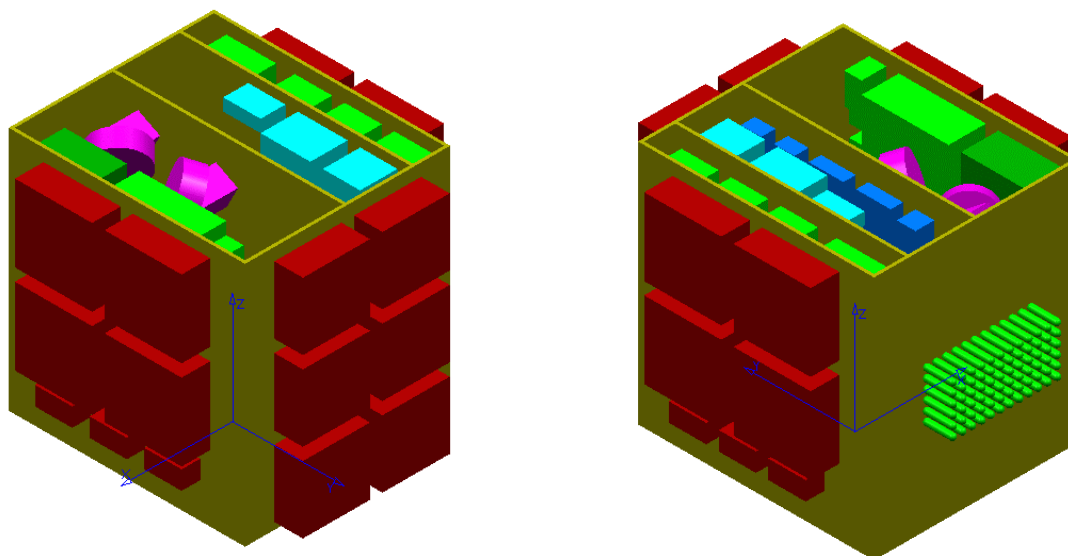

Figure 7.2-4. Prometheus Spaceship Design (Internal Bus Compartment View).

The radiation shield mass model and the external radiation environment were used to analytically calculate the local radiation environment at each electronics assembly within the Spaceship, accumulated over the lifetime of the mission. The results of the analysis indicated that the mission accumulated total ionizing dose (TID) for Spaceship electronics was typically between 1 and 3 Mrad (Si), without any margin allocated for environmental uncertainty. These accumulated TID levels were much larger than the assumed radiation capability of the electronic devices located within the Spaceship flight hardware. The assumed TID capability of the electronic devices was expected to be 0.3 Mrad (Si) for all Spaceship electronics, with the exception of the power processing unit (PPU) electronics, which were expected to have a TID capability of 1.0 Mrad (Si).

Shielding material allocation was added to the baseline Spaceship structure design to attenuate the local radiation environment in the Spaceship electronics to acceptable levels, and to accommodate the required radiation design factor of 2 to allow for uncertainty in the definition of the external radiation environment. The baseline Spaceship design of the shielding was composed of three primary areas: the shielding surrounding the external Power Processing Units (PPU) to attenuate the TID level to 0.5 Mrad (Si), the shielding surrounding the bus electronics compartment to attenuate the TID level to 0.15 Mrad (Si), and the shielding of the telecommunications platform to attenuate the TID level to 0.15 Mrad (Si). The exact configuration and material composition of the shielding was determined through a series of approximately 40 different shielding designs and a mixture of two materials. The NOVICE radiation transport code was used to model the shielding configurations and calculate the end of mission TID exposures for the Spaceship flight hardware.

The shielding material used in the analysis was initially aluminum to define the physical configuration of the shields surrounding the PPU's, bus compartment and the telecommunications electronic units. The external radiation environment surrounding Jupiter is composed of magnetically trapped protons, electrons, and heavy ions. The dominant component of the external radiation environment that causes total ionizing dose is electrons. The effectiveness of the shielding material to attenuate electron radiation increases slightly with the atomic number of the material. To achieve the minimum shield mass, an aluminum/tantalum shield material (50% aluminum by mass on the outer surface closest to the environment and 50% tantalum inside the aluminum) was used in the second phase of the shielding design analysis. It was found that the 50/50 aluminum/tantalum mixture by mass saved ~10% of the mass while giving the same radiation attenuation as the aluminum. Higher relative amounts of tantalum to aluminum in the shield material would yield greater mass savings relative to the all aluminum shielding configuration, see Figure 7.2-5, as shown for the Telecommunications Platform shielding mass. This shielding attachment design allowed for removal of the shielding mass for follow-on missions where the cumulative radiation environment was less severe.

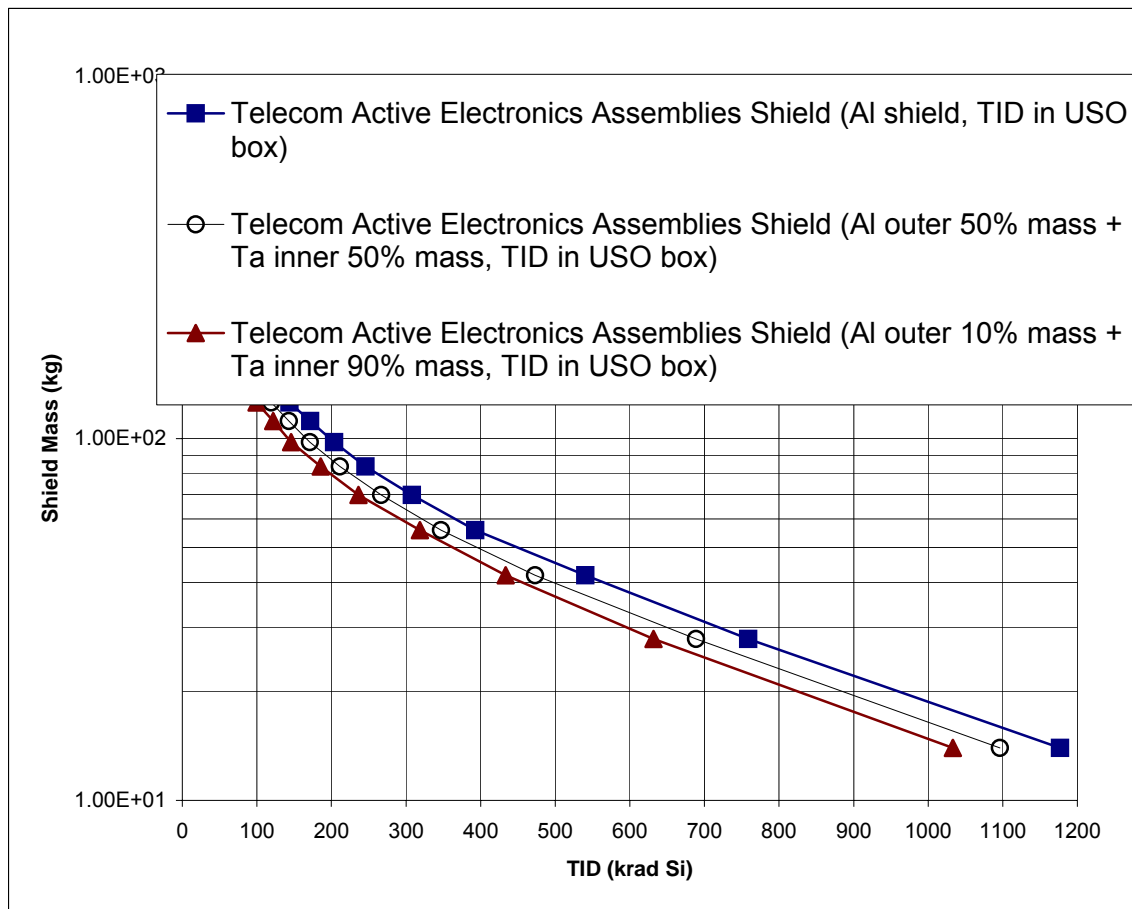

Figure 7.2-5. Shield Mass as a Function of Composition for the Telecom Platform.

The result of the radiation shielding design analysis was the amount of shield mass required on the Spaceship. A graph showing the current best estimate (CBE) of radiation shield mass at various points early in the Project is shown in Figure 7.2-6. As shown in the Figure, the radiation shield mass declined significantly over FY2005 as design maturity increased. The initial radiation shield mass estimate (2800 kilograms in October 2004) was based on a significantly larger structure than the PB1 design, caused larger surface areas to be shielded and resulted in an increase in shield mass. A better-defined structure was generated in January 2005, resulting in a decrease in the shield mass estimate (2300 kilograms in February 2005). Finally, around the PMSR, the first radiation mass model based on released engineering drawings and containing Spaceship equipment placement and using the aluminum/tantalum shielding material was used to calculate the shield mass resulting in even larger reduction in the shielding mass (1500 kilograms in September 2005).

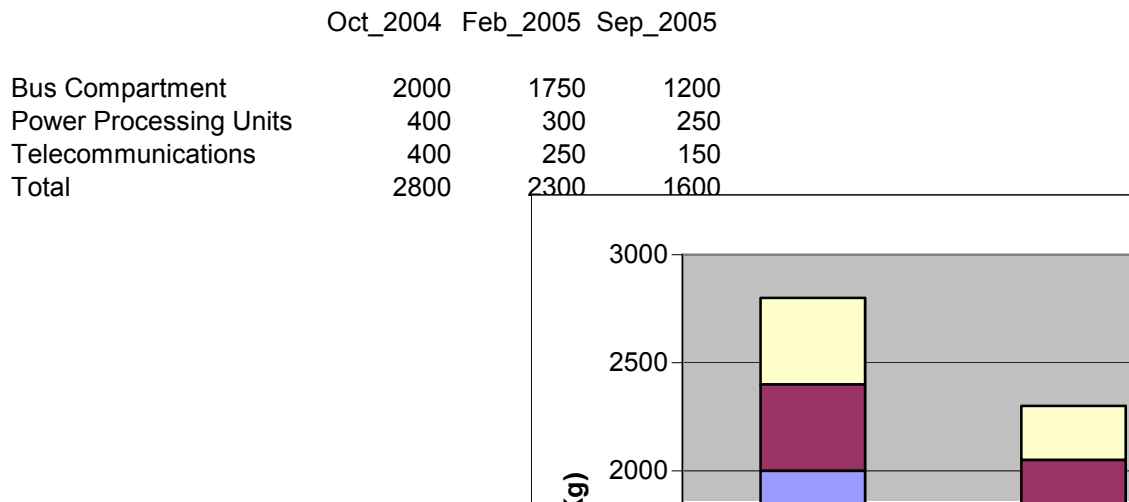

Figure 7.2-6. Prometheus Spaceship Radiation Shield Mass.

The radiation shield design process is iterative in nature, and it was expected that the radiation shielding mass would continue to decline as the design became more defined and improvements were made in the maturity of the radiation mass model. These improvements could include items such as additional mechanical details of the Spaceship structure, inclusion of the detailed internal structure of the electronics assemblies in the radiation mass model, and additional optimization of the shielding material mixture.

The radiation tolerance of the electronics in the prior discussion of radiation shielding design analysis was based on assessments of similar electronics developed for past high radiation projects, or extrapolations based on similar device performance. The same radiation tolerance knowledge was needed for dielectric materials used on board the Spaceship. In general, the material radiation tolerance in a high-energy electron environment is not well known. The majority of existing material space radiation effects tests were performed using gamma radiation. A preliminary test plan was generated to begin evaluating material performance in the expected mission radiation environment using electrons.

Exploratory electron irradiation using an electron beam was performed in the summer of 2005 at E-beam facilities in Lebanon, Ohio to begin the process of evaluating electron beam radiation test facilities, as well as to identify potential issues measuring pre and post irradiation bulk properties of polymer materials, optical glasses, and insulating materials. Initial flight-like material characterization radiation tests were planned to begin in FY2006.

In addition, radiation testing of the Composite Over-wrap Pressure Vessel (COPV) material was performed at MSFC. The COPV coupons were fabricated using flight hardware processes, and were then exposed to a 1 MeV electron beam that deposited 5, 10, 30, and 100 Mrad (Si) in the COPV material. Post irradiation mechanical strength tests show that the COPV material showed very little degradation at these irradiation levels.

A number of radiation test facilities were utilized across the nation. The facilities were selected based on the type of required radiation, the energy levels available at the facility, and the accessibility of the radiation source to the tests required for the project. The Ohio State University nuclear reactor facility provided a neutron and gamma irradiation source in support of the Radiation Hardened high power device development and characterization effort. The Cyclotron facility at Texas A&M University was utilized for heavy ion testing while facilities at Indiana University and University of California at Davis were utilized for Proton testing. In addition, the Cobalt-60 radiation test facility at JPL was utilized for Total Ionizing Dose (TID) test.

The nuclear reactor at the University of Missouri (MURR) was placed under contract as a facility that would be used as a neutron and gamma irradiation source. The MURR facility was unique in that there was a large volume irradiation chamber (approximate test volume of 12 x 12 x 24 inches), called the thermal column. Electrical power and multiple data interfaces were installed in the thermal column during 2005 to accommodate powered (or un-powered) testing of multiple large components or entire circuit boards in FY2006 and beyond.

Radiation test facilities, which address the high-energy electron environment expected during the science observations around the Jovian moons, were identified for materials and electronic device testing expected to commence in FY2006. Plasma energy electrons (electron energies of 100 keV or less) test facilities were available from JPL, MSFC, and GRC. Low energy electron test facilities (electron energies around 1 MeV) were available from JPL and MSFC. Moderate energy electron test facilities (electron energy around 5 MeV), were available at E-Beam Services in Lebanon, Ohio. High energy electron test facilities (electron energies greater than 10 MeV) were identified at RPI and at the ORELA facility at Oak Ridge National Laboratory.

Education of personnel in the effects of radiation on materials and electronics was conducted in FY2005 with radiation effects seminars held at both NRPCT facilities (Bettis and KAPL). These seminars were held over two days at each facility.

7.2.2 *Environmental Requirements*

The environmental requirements for the Prometheus Spaceship were developed in concert with the overall Project requirements and documented in the Prometheus Project Environmental Requirements Document. The environmental program was led by the Project Environments Manager to ensure the definition of the environmental requirements and the verification and validation of the implementation across the Project. NGST provided an environmental implementation plan that described how the established project environmental requirements were to be met. In addition, significant interactions were held with NRPCT personnel to ensure that the mapping of NRPCT environmental assurance requirements and practices satisfied the project requirements.

Key factors in the environmental assurance program included the significant, naturally occurring radiation levels of the JIMO mission, as well as those environments produced by the nuclear system, which exposes the hardware to neutron fluence and gamma rays. Other key factors included ion-induced contamination and EMI resultant from the electric propulsion system and its associated ion thrusters. In addition, high-power design challenges include possible interference threats from the high power distribution systems.

Design techniques to control low frequency electric and magnetic fields (LFE and LFH) were developed for wire and cable interfaces, as well as control of chassis currents due to accidental or stray currents that may arise from stray capacitances to structure or from power line or signal wiring to chassis. Avoiding spacecraft charging in the energetic plasma of Jupiter and fulfilling mission objectives in the event of resultant electrostatic discharge (ESD) events were severe design challenges, particularly with the high voltage and currents from the reactor/generator supply. Careful attention was paid to control possible high voltage breakdowns, such as corona, multipaction, and secondary arcing anywhere during the mission, but especially in the Jovian plasma environment. This was expected for the high voltage power lines from the reactor/generator to the Spaceship.

Micrometeoroid analyses were performed to minimize damage from micrometeoroid impact. Mitigation techniques were deployed to prevent catastrophic damage to the most sensitive equipment, by shielding, redundancy, strategic placement, and design. The large structure of the heat rejection radiators was particularly vulnerable to micrometeoroid damage and micrometeoroid analyses were specifically performed to assist in its design and damage mitigation.

The environmental program included defined test and analysis requirements to address the challenges of designing hardware and developing electronics that would perform their intended function considering the significant and unique environmental factors of the Project. In addition, the environmental program and its associated module and system level tests were a significant input to the overall system assembly and test planning activities. Environmental tests and analyses were defined to demonstrate that the hardware would survive the severe environments expected for the mission. Each piece of hardware was required to be environmentally verified and certified for the mission.

In compliance with NASA Earth Orbital Debris policy and guideline requirements (NPD 8710.3B and NSS 1740.14) and JPL Institutional Requirements, the Prometheus Project conducted an Initial Orbital Debris Assessment at the PMSR. The assessment report was documented in IOM 5130-2005-026.

A preliminary evaluation for the Jupiter Icy Moons Orbiter PMSR was performed to determine the orbital debris compliance status based on the above referenced documents and on a draft revision of 1740.14 possibly to be released in the next year. Information regarding the JIMO baseline mission plan that is relevant to Earth orbit operations, was used for the evaluation. It was anticipated that other future Prometheus Project mission plans might involve Earth orbit operations similar to those of the JIMO baseline plan. The evaluation was based on currently available information and allowed only a partial evaluation based on the major JIMO baseline characteristics. Much of the future compliance depends on the hardware design to be made and evaluated at future stages of the project lifecycle.

The assessment and associated report were structured to group, under a given criterion, the current compliance status for all the hardware considered including the Launch Vehicle, Orbit Transfer Vehicle, the Spacecraft, and associated large hardware items. The evaluation criteria, as described in NSS 1740.14, cover the following items:

- Minimize orbital debris release during normal operations and minimize subsequent Earth orbit lifetime.
- Avoid accidental explosions during operations in orbit and deplete stored energy at the end of hardware useful life.
- Meet criteria for controlling the effects of intentional hardware breakups.
- Avoid impacts with large objects during in-orbit lifetime.
- Mitigate effects of collisions with small debris and meteoroids that would damage command and control functions necessary for disposal operations at the end of hardware useful life.
- Dispose of Earth orbiting hardware at end of useful life by removal from Earth orbit (by natural or controlled reentry) or by storage in a safe orbit.
- Meet criteria for limiting the Earth impact hazard due to hardware that does not burn up during atmospheric reentry.
- Meet criteria for controlling the effects of long tether usage.

The preliminary analysis results indicate that the current JIMO design is either in direct compliance or is planned to be compliant with the applicable guidelines. Potential orbital debris policy influence on launch vehicle and spacecraft designs exists. Further details are provided in the report.

7.2.3 *Electronic Parts Engineering*

The electronic parts requirements for the Project were established and documented in the Prometheus Parts Program Requirements, in accordance with the established JPL Institutional Parts Program Requirements (IPPR), and tailored to address the specific radiation and reliability requirements of this mission. The electronic parts assurance activities were managed by the Prometheus Project Parts Manager to ensure the proper selection, evaluation and qualification of components in accordance with the established requirements. NGST provided an implementation plan that described how the established project parts program requirements were to be met. In addition, significant interactions were held with NRPCT personnel to ensure cognizance of the parts selection and qualification requirements and to map the NRPCT internal requirements and procedures and ensure compliance.

The challenging environment and mission duration were driving factors in the development of the selection and qualification of suitable microelectronics technologies with acceptable radiation characteristics and long-term reliability. Due to the severe radiation environment, new methods for radiation risk mitigation and component selection, test, and evaluation were employed. These methods included the utilization of innovative shielding methods, utilization of advanced radiation-hardening technologies and processes, “hardening by design” techniques, and innovative system design and operation methods. Involvement in the design activities at an early stage was critical to ensuring that the component selection and system test plans were adequate to support a mission of this magnitude.

To address the need for early and thorough evaluation of electronic devices, a component evaluation process was defined. This process was developed as a modification of the JPL and the Northrop Grumman existing processes for approving parts and addition to the Approved Parts List. In the modified process, candidate parts are submitted by the responsible design organization to an evaluation process that includes checkpoints that ensure compliance to requirements, increased standardization, and coordinated characterization and qualification test activities. As a result of this process, component worst-case parameter deltas were to be developed for each device type. These parameter deltas define the usable envelope for the device as well as provide the parameter data for worst-case analysis.

To further increase coordination and standardization across the project, the Prometheus parts program included the formation of a Parts Control Board (PCB). The PCB was comprised of members from each of the design organizations and had the responsibility for implementing the parts program requirements across the project and final parts approval. Further, the PCB maintained final approval authority for Material Review Board, failure analysis, and alert dispositions affecting electronic parts.

The Project Parts Program Manager utilized experts in microelectronics radiation effects, reliability, test, and analysis to interface with technology development teams in order to ensure a smooth development effort, determine the suitability of the selected electronic parts, and implement the required data collection, test and analysis. Throughout the activity, and with the involvement of all project partners, the microelectronics technology development activities were evaluated against specific Project needs and used to identify necessary technology investments.

Extensive internal and industry radiation-effects testing capabilities and expertise were applied in a teaming arrangement to support the needed evaluation and technology developments. Radiation test facilities at Texas A&M University, Ohio State University, Indiana University, University of Missouri, and the University of California – Davis were extensively used. In addition, improved methods for parts testing were developed to meet the mission requirements for radiation-hardened parts. The results of the radiation tests and the analysis results were published in radiation test reports, technical journals, and presented at technical conferences.

Early in the development of the program, the mission assurance parts team assisted in the identification of device technologies needed for meeting the mission radiation requirements. Technology Development activities targeted specific device technologies for early evaluation and development. The parts team performed evaluations of existing device capabilities and performed radiation and life tests on candidate devices and technologies. Specific efforts included radiation performance evaluation of high voltage power devices, high-density memory devices, analog-to-digital converters, and sensor devices, as well as long-term reliability evaluation of Application Specific Integrated Circuit (ASIC) processes.

Early in the project the need for high voltage power components was identified as a relatively new challenge due to the need for power conversion at voltages higher than is typical for space platforms. In support of the Technology Development activity in this area, parts radiation specialists performed over 40 radiation tests of high voltage components. The majority of the effort was targeted at determining the baseline capability of these selected device technologies to withstand the radiation environment. For high voltage diode needs, both silicon and silicon-carbide devices were found to have limitations depending on the application and the specific environment. Further development of radiation hardened MOSFETs would be required if voltages above 500V were to be obtained. Silicon-carbide transistors show promise but are have not yet reached the desired maturity level. Failure analysis on the SiC diode single event burnout samples found catastrophic damage as shown in Figure 7.2-7. Finally, as expected, commercial IGBTs and MOSFETs were found to be unacceptable for the Prometheus space environment.

The survivability of commercially available memory devices in high radiation environments has been a challenge for many deep space programs. The Prometheus parts radiation team performed evaluations of several emerging non-volatile memory device technologies and supported the focused technology development efforts in the project. The memory technology evaluations included chalcogenide phase transition memories, ferro-electric memories, and carbon nano-tube technologies. Radiation test of commercial computer hard drive systems confirmed the need for development of hardened control electronics to make them viable for use in the Prometheus environment.

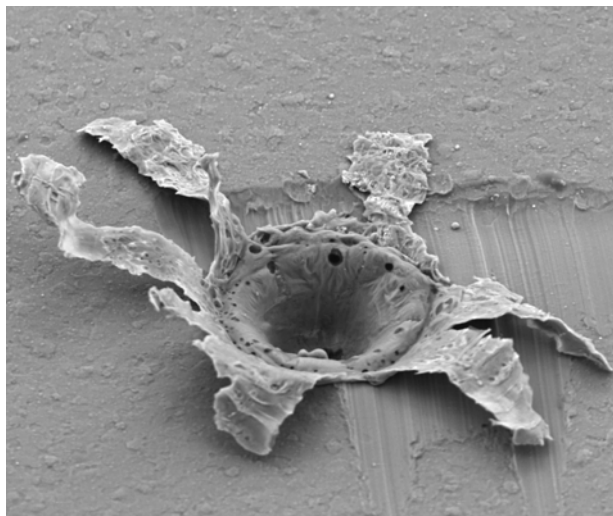

Figure 7.2-7. The aluminum contact surface was ruptured by heating in the silicon carbide substrate as a result of Single Event Burn-out.

Radiation characterization tests and evaluation of analog-to-digital devices included four currently available commercial processes as well as one developmental radiation hardened process. Tests included total dose, displacement damage, and single event effects. The commercially available processes were found not to meet target radiation requirements and a need to develop radiation-hardened devices was identified.

Development of test facilities and test systems necessary to simulate the expected application environment was an integral part of the overall radiation effort. The Rensselaer Polytechnic Institute (RPI) High Energy Electron Facility in Try, New York, was developed to support the evaluation of electronic devices and materials in conditions similar to those expected in the high-energy electron environment at Jupiter. In addition, a cryogenic temperatures test system was developed to address the needs for characterization of sensor components and systems.

7.2.4 Reliability Engineering

The Prometheus reliability assurance requirements were documented in the Prometheus Project Hardware Reliability Assurance Requirements document. The requirements were developed in accordance with the JPL Institutional Requirements and the JPL Reliability Analysis for Flight Hardware in Design document. The reliability assurance activities were managed by the Project Reliability Assurance Manager to ensure the implementation of established reliability assurance requirements and satisfy mission objectives. NGST provided an implementation plan that described how the established project reliability assurance requirements were to be met. In addition, significant interactions were held with NRPCT personnel to ensure that the mapping of NRPCT reliability assurance requirements and practices satisfied the project requirements.

In addition to the system reliability aspects of the mission, certain unique reliability issues were considered in the development of the reliability requirements. These unique issues included the Jovian environment, the nuclear reactor environment, the electric propulsion environment, and the long duration of this first-of-a-kind mission. Early involvement by the reliability engineering team in system design activities and associated system design risk analysis was essential for developing the preliminary system design presented at the PMSR. Future reliability assurance Phase B activities would have included detailed system design/risk analyses, protective and redundant system/devices/circuitry support, and minimum operating times analysis.

A System-Level Fault Tree Analysis, developed in support of the preliminary design activities, was utilized to guide system design decisions and configuration. The activity was led by the Spaceship System Engineer and required the direct and early participation of the reliability engineering team. In addition, a draft plan for utilization of probabilistic risk assessment (PRA) techniques, in accordance with established NASA Guidelines, was developed to support the overall design process.

The Problem/Failure reporting requirements were established and documented in the Prometheus Project Problem/Failure Reporting (PFR) Requirements in accordance with JPL Institutional Requirements. The requirements provided for a closed-loop, controlled method of reporting and documenting problems/failures, anomalies, and incidents throughout the Project life cycle. An automated institutional database would have been required to facilitate timely and orderly analysis, corrective action, and risk assessment of problems and failures.

7.2.5 *Quality Assurance*

The Quality Assurance requirements for the Prometheus Project were documented in the Prometheus Project Hardware Quality Assurance Requirements and Prometheus Project Software Quality Assurance Requirements documents respectively. The requirements were developed in accordance with the JPL Institutional Requirements. The Project Hardware Quality Assurance Manager managed the hardware quality assurance activities while the Project Software Quality Assurance Manager managed the software quality assurance activities. NGST provided an implementation plan that described how the established project hardware quality assurance requirements were to be met. The main effort in this phase of the project was to establish the foundation of requirements and implementation plans in preparation for the preliminary and detailed design stages.

Early involvement and participation by the Software Quality Assurance discipline in the software process planning working groups and technical reviews enabled the timely contribution to the Software Management Plan and the Software Safety/Hazard/Fault Analysis Report. Two effective working groups were the Software Process Group and the Space Nuclear Reactor Computational Architecture Group. As a result of the interactions with the working groups, the teams utilized a uniform software development process and generated a well-coordinated incremental software build schedule, including the identification of software/hardware receivables/deliverables required for integration and test. This established an excellent foundation for a quality software development process with the objective of leading to high quality software deliverables.

Software IV&V was planned to be performed by the NASA Software IV&V Facility in West Virginia which provides an independent set of services to identify software risks and to recommend mitigations to those risks. The scope of the effort to be undertaken by the NASA IV&V Facility was planned to be documented in a Prometheus-specific NASA IV&V Plan (due at Project PDR). The IV&V effort would have also considered the results of the software safety and hazards analysis with particular attention to critical issues such as autonomy and fault protection.

The Prometheus Project Software Management Plan requires a close working relationship with the NASA IV&V Facility in order to add significant value to Prometheus from the planned IV&V efforts. In support of those efforts, the 'Prometheus Software IV&V Self-Assessment was delivered per the established JPL process. Independent verification and validation of NRPCT activities were the responsibility of the Naval Reactors Program.

8. Science System

8.1 Science System Overview

The Prometheus Science System is unique to the Jupiter Icy Moons Orbiter mission and is comprised of the following elements:

SCIENCE: Includes Science Management, System Engineering, Investigation Teams, Science Plans, Interdisciplinary Science, Environmental Characterization and Instrument Acquisition

MISSION DESIGN: Includes development and planning of mission trajectories, science scenarios and navigation design as well as Planetary Protection

SCIENCE OPERATIONS MODULE: Includes planning, control, monitoring, and conduct of investigation operations and archiving of investigation science data

MISSION MODULE: Includes science instruments and accommodation equipment.

Some of the key accomplishments for the Science System are listed below:

- Completed Science Definition Team (SDT) activities resulting in recommendations on investigations, instrument types and accommodations responsive to draft Level 1 science requirements. SDT recommendations were documented in the Report of the NASA Science Definition Team for the Jupiter Icy Moons Orbiter (JIMO).
- Completed definition of Preliminary Science System Key Driving Requirements for each element of the Science System.
- Defined reference payload and developed a Payload Accommodation Envelope (PAE) for the JIMO mission.
- Developed a conceptual design of the Mission Module to meet Project requirements — Mission Module Design Description.
- Developed a complete Mission Plan with scenarios and reference trajectory for the Mission Plan of the JIMO mission.
- Completed definition of the overall science data flow as shown in Figure 8.1-1.

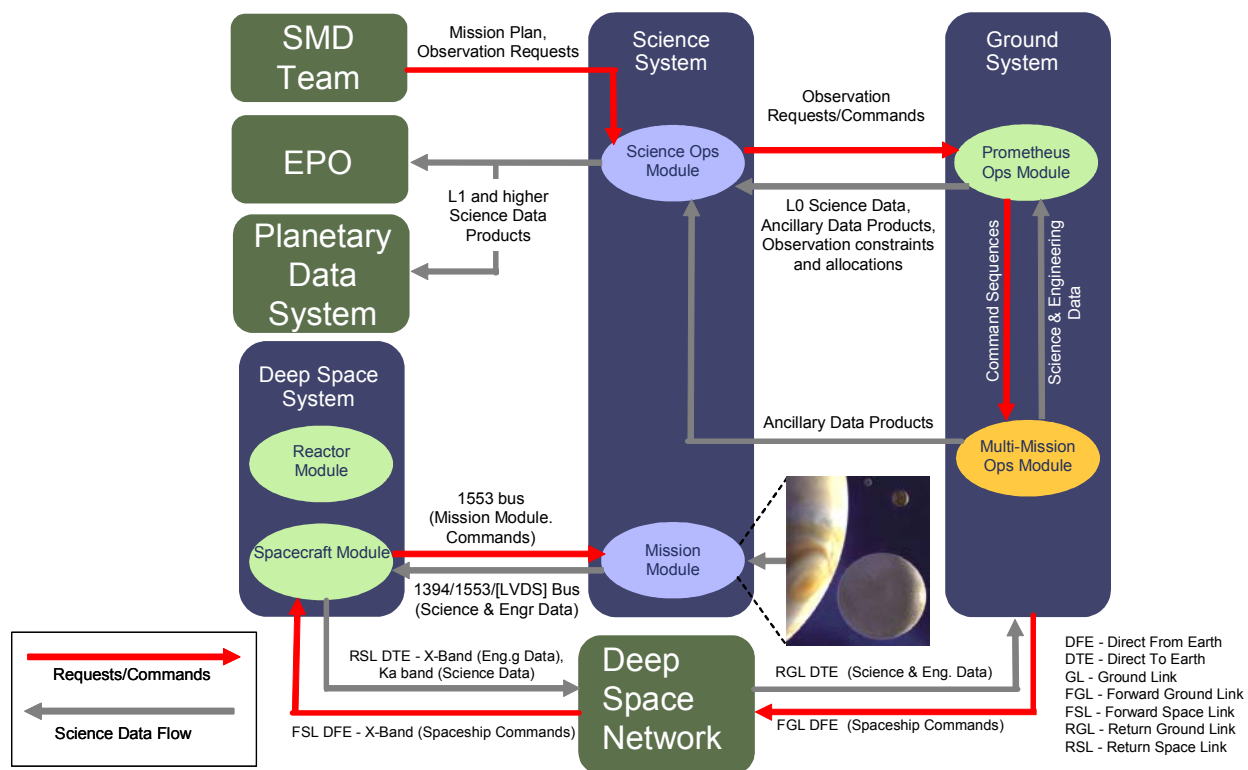

Figure 8.1-1. JIMO Science Data Flow Diagram.

Figure 8.1-2 depicts the organization of the Science and Mission Design Office for the JIMO Science System.

The SMD Office Manager reports directly to the Project Manager and is responsible for day-to-day implementation of the overall Science System. This office negotiates and manages budgets, schedules, and risk. The SMD Office Manager has technical staff that is responsible for science and system engineering of the overall Science System.

The Project Scientist is the main interface between the Project and the science community. The Project Scientist would be responsible for leading the Project Science Group (PSG) and making all the high-level decisions and tradeoffs involving science. The Project Scientist participates with the SMD Office Manager and the Project Manager in negotiating budgets and in making key Project decisions.

Reporting to the SMD Office Manager are the managers of four element offices: the Science Office, the Mission Design Office, the Science Operations Module Office, and the Mission Module Office.

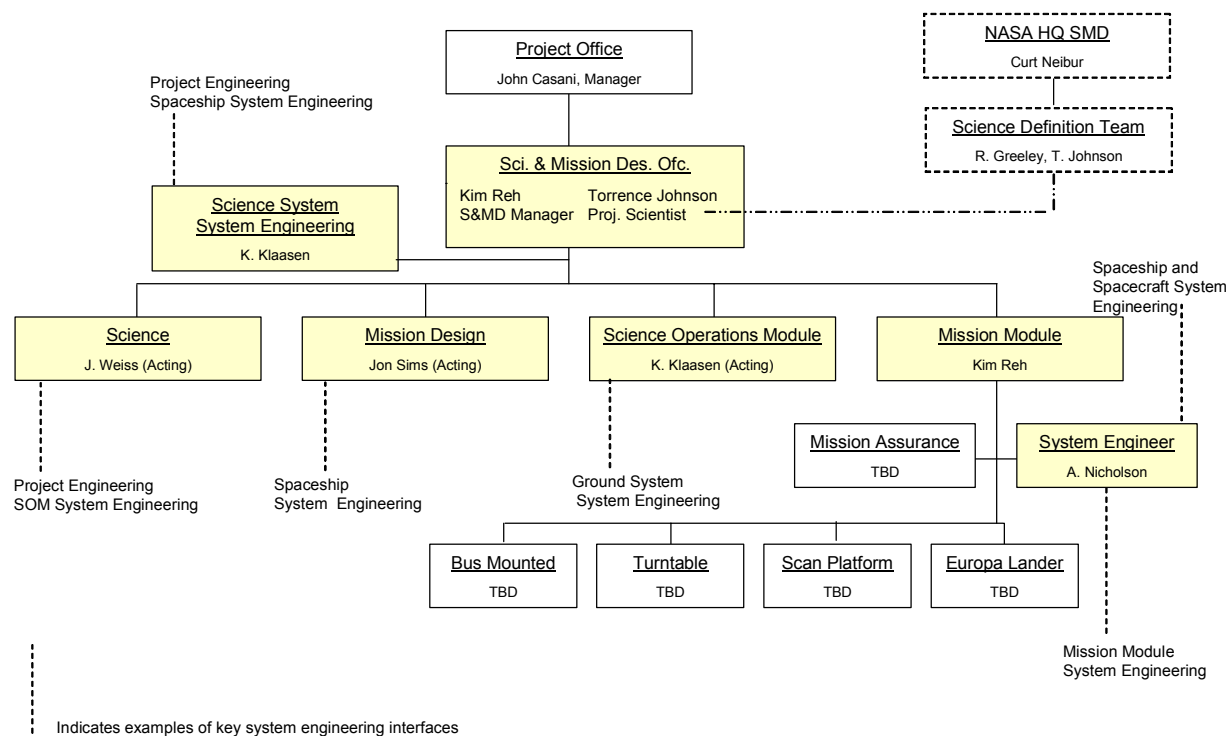

Figure 8.1-2. Science and Mission Design Office Organization.

8.2 Science

In February of 2003, NASA chartered a Science Definition Team (SDT) to establish goals and objectives for the JIMO Mission. In addition to providing recommendations on overarching science drivers, this group of scientists provided guidance on DSV accommodation of potential science payloads

8.2.1 JIMO Science Definition Team (SDT) Recommendations

The JIMO SDT completed its report outlining major goals and objectives for science to be performed in the Jupiter System in February of 2004. These recommendations are consistent with Jupiter System science outlined in the NRC Decadal Survey and served as a basis for formulating JIMO science requirements. The goals and their detailed objectives were derived by scientific specialization and include the areas of surface geology and geochemistry, interior science, astrobiology and Jupiter system science. Driving goals for each area can be summarized as follows: (1) determine the evolution and present state of the Galilean satellite surfaces and subsurfaces, and the processes affecting them, (2) determine the interior structures of the icy satellites in relation to the formation and history of the Jupiter system, and the potential “habitability” of the moons, (3) search for signs of past and present life and characterize the habitability of the Jovian moons with emphasis on Europa, and (4) determine how the components of the Jovian system operate and interact, leading to the diverse and possibly habitable environments of the icy moons.

The resulting specific investigations identified by the SDT were synthesized to derive an overarching statement for the JIMO mission:

Explore the icy moons of Jupiter and determine their habitability in the context of the Jupiter System

Within this are three well defined, crosscutting themes (Figure 8.2-1): **Oceans** (finding their locations, studying the structure of icy crusts, and assessing active internal processes), **Astrobiology** (determining the types of volatiles and organics on and near the surfaces, and the processes involved in their formation and modification), and **Jovian System Interactions** (studying the atmospheres of Jupiter and the satellites and the interactions among Jupiter, its magnetosphere, and the surfaces and interiors of the satellites).

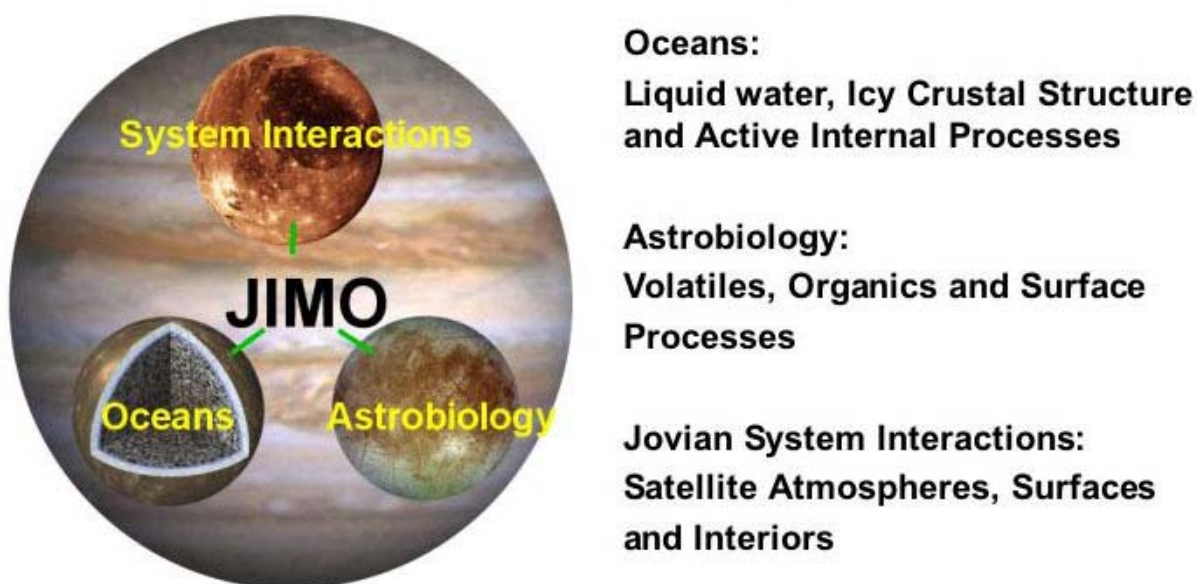

Figure 8.2-1. The JIMO mission will enable a synergistic study of the icy satellites, providing a basis to understand the Jupiter system as a whole.

8.2.2 *Europa Surface Science Package*

The Science Definition Team concluded that given the high scientific potential from a landed package and the large resources that would be committed to the JIMO mission, a Europa Surface Science Package (ESSP) should be included. In addition, the SDT recommended that up to ~25% of the science resources, in particular, mass (375 kg), could be devoted to the ESSP. Science objectives for a landed package would focus on three areas, Astrobiology, Geophysics, and geological-compositional measurements (baseline to perform investigations in all three disciplines). If a surface science package were to be flown, then, the priority is to do either of the first two objectives (Astrobiology, Geophysics), with both highly desired and the geological-compositional measurements as lower priority.

Based on the recommendations from the SDT, a study was performed by JPL in the spring of 2004 to assess the feasibility of a Europa Surface Science package. Key components of the engineering trade space included landing technique (hard landing with airbags, rough landing with crushable materials and soft landing), mission duration (3-, 7-, or 14-days), mass (150-, 300-, and 375-kg), radiation environment and power source. Results of the study showed that mass is an important driver, dictated by the basic need to remove significant delta-v during the entry, descent and landing phase of operations. As such, missions with a mass allocation of 150- and 300-kg were deemed not to be feasible. In addition, based on the study assumptions, hard landing with airbags and rough landings with crushable materials would be precluded. It was found that an ESSP with a mass allocation of 375 kg could be achieved using either targeted or un-targeted soft landing methods. For a 3-day surface operation, a battery powered lander should be able to meet the science objectives identified by the SDT. For 7- or 14-day missions the increased battery size would scale the lander beyond the mass allocation limit, but a small Radioisotope Power System (RPS) based lander could be feasible. The mass cross over between battery and RPS powered landers is expected to be around 3- to 4-days of surface operation.

This study provided an important first step in understanding the challenges associated with placing a science package on the surface of Europa. Additional analysis would be beneficial to refine margins and assumptions to better optimize the science return. Since this study did not address the specific issues of overall cost, planetary protection and surface contamination, future analysis is needed to determine how these constraints impact the trade space.

8.2.3 *Payload Accommodation Envelope*

An NEP system could facilitate a wide array of high capability instruments. It was determined that the SDT would not recommend a strawman set of instruments, but instead would provide goals and objectives that could be attained by various types of investigations, allowing the science community to define the optimal means to perform the science. The selection of investigations would be deferred until later in the mission development to provide the time necessary to bring concepts to a higher technical readiness level. To facilitate mission development, the SDT and the Project devised a Payload Accommodation Envelope (PAE) to provide a bound on resources available to potential science investigations (Table 8.2-1).

Table 8.2-1. JIMO Payload Accommodation Envelope.

Key:	Light Green:	Changes Project has accepted or proposed.
	Pink:	Proposed changes for Project to consider.
	Red:	Severe problems.
	Orange:	Problems.
	Yellow:	Issues or unknowns.

Item	Total	Bus Mounted	Scan Platform	Turntable	Aux Payload	SDT Evaluation
No. of instruments	18				1	OK
Payload Mass	1500 kg total (includes instruments, mechanisms, platforms, antennas, etc.)	Up to 1500 kg (minus Scan Platform, Turntable, and Auxiliary Payload mass)	Instruments \leq TBD kg	Instruments \leq TBD kg	375 kg (This is 25% of total payload mass per SDT direction. Space System has capability to accommodate up to 1500kg.)	OK pending resolution of open mass liens
Footprint		3 m ²	2 m ²	1 m ²	2 m ²	OK, keep in mind necessity for coolers
Volume		1.5 m ³	1 m ³	0.75 m ³	1 m ³	OK
Field of Regard		<math><2\pi</math> steradian for remote sensing instruments, centered on nadir, except for TBD objects in field-of-view at TBD locations.	View +/-90 deg along track, +/-60 deg cross track, centered on nadir, except ion engine pods, boom(s), & antennae in field-of-view at TBD locations . Gimbaled about 2 orthogonal axes in the plane perpendicular to nadir direction. Able to view bus-mounted cal targets, with at least one illuminated by sunlight.	Hemisphere centered ~90 deg from nadir, plus π sr (not necessarily axisymmetric) in other hemisphere centered >60 deg from nadir (not necessarily on turntable), except boom(s) in field-of-view at TBD locations. Spin axis perpendicular to velocity vector and perpendicular from nadir.	Clear TBD deployment path	OK
Unique structures / interfaces		\leq4 booms (two \leq10 m in length, one \leq15m plus long dipole antenna 30m tip to tip) in TBD orientation(s) (New design for longer booms - not Cassini heritage anymore)			S/C to provide interfaces only (release mechanism provided by Aux. Payload)	OK
Thermal		-20 to +50 deg C at interface, incident thermal radiation from S/C \leq1.0 W/cm ² , instruments provide replacement heaters as needed				OK?
Power	>=18 kW when not thrusting, \leq3 kW when thrusting	TBD	TBD	TBD	TBD	OK?
Telecommunications Support					None (provided by the payload)	OK
Deep Space Vehicle Pointing (control)		20 mrad			20 mrad	OK
Instrument Platform Pointing (control)			1 mrad crosstrack in science orbit, not thrusting; 2 mrad crosstrack other times; 10 mrad along track	50 mrad in all 3 axes		OK

Item	Total	Bus Mounted	Scan Platform	Turntable	Aux Payload	SDT Evaluation
Deep Space Vehicle Pointing (knowledge)		0.2 mrad at mounting plane adjacent to AACS sensors; 3 mrad elsewhere on bus; TBD at ends of booms			3 mrad	SDT wants 0.01 mrad for bus mounted.
Instrument Platform Pointing (knowledge)			0.2 mrad in science orbit, not thrusting; 0.3 mrad other times	8 mrad		OK?
Slew / turn rates			Slew rate ≥ 5 mrad/s, ≤ 2.5 μ rad/s jitter in science orbit, not thrusting; ≤ 5 μ rad/s other times	Turn rate ~ 3 RPM. Spin rate stability is not critical provided rotational position knowledge is available on board real-time.		Scan platform: Jitter should be < 50 μ rad/s (or amplitude < 10 μ rad) for science floor; < 1 μ rad/s (or amplitude < 2.5 μ rad) for baseline. Baseline jitter requirement is not met.
Sun avoidance		None	Mission Module S/W avoids sun pointing	None	None	OK

8.2.4 Science Office Management

The science office management approach has been documented in the Science Office Management Plan. It is important that the JIMO science investigators are fully involved with the Project, that they carry out their responsibilities, and that science conflicts are resolved as quickly as possible. Prior to the selection of investigations, science activities would be led by the Project Scientist, a Deputy Project Scientist, a Science Office Manager and a Science and Mission Design Office Manager. Immediately upon selection of investigations, a Project Science Group (PSG) composed of all Principle Investigators (PIs) and Interdisciplinary Scientists (ISs) would be formed.

The Project Science organization (Figure 8.2-2), within the Science and Mission Design Office, is structured to address the needs of the science investigators and required Project science support. It is the formal organization for science representation through the coordinated activities of the Investigation Scientists working directly with the Investigators and necessary science support staff to assist in the planning, coordination, operations, science data management and administration of all science functions. This structure provides in effect “one-stop-shopping” capabilities to the science community. Prometheus EPO Science Coordination would be directed by the Project Scientist and coordinated through the JPL EPO Office.

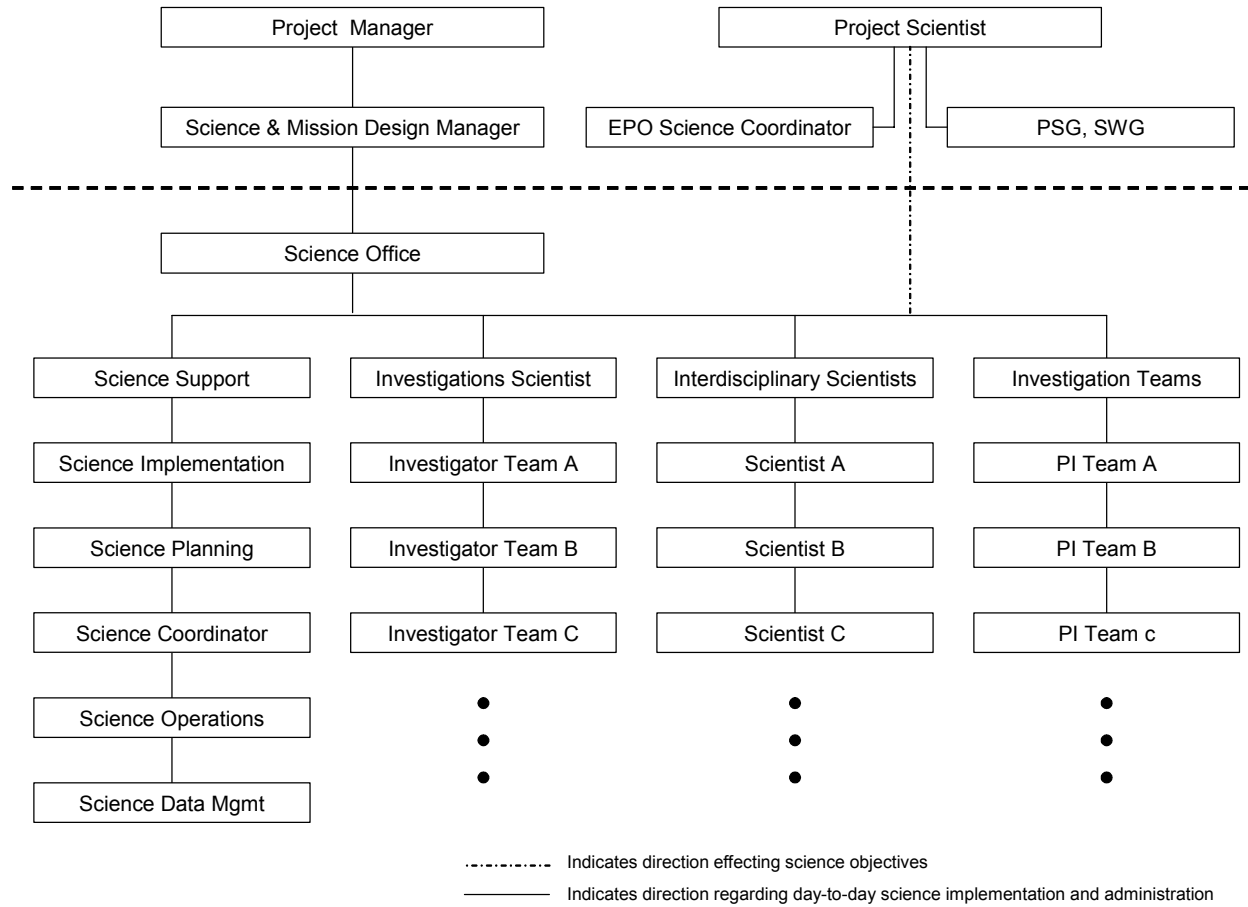

Figure 8.2-2. Science Organization.

8.2.5 *Science Data Collection, Analysis, and Archiving*

The complexity of JIMO is challenging with expected data rates orders of magnitude higher than those of the Galileo or Cassini Projects. Because of the complexity of designing observations on shared scan platforms or turntables, one or more science planning teams would be formed. These teams would interact with the various PIs and help design and integrate the observation plans. Individual science teams would be responsible for archiving calibration data and algorithms and/or calibrated or higher level products in the Planetary Data System (PDS). While it is important to move these data to the PDS as quickly as possible, it is unlikely that proper calibration and validation can be accomplished in less than 12 months. This process would be developed and overseen by a Data Archiving Working Group including representation from all science teams, the Project, and the PDS, and would be documented. NASA must prepare the PDS for the magnitude and complexity of the data sets that would be generated by JIMO to ensure that it has sufficient resources to ingest and peer review the data sets. NASA must prepare the DSN and related infrastructure for the data rates and volumes associated with JIMO. In addition to greatly increased telemetry rates, JIMO operations are likely to use nearly continuous DSN tracking, at least during the science orbits. Hence, the additional loading factor of JIMO must be factored into the mission set forecasted for the JIMO timeframe. The potential volume of JIMO data is comparable to Earth Observing System missions such as Terra. Planning should begin early in the mission development phase to ensure the necessary infrastructure to store, manage, and deliver these data.

8.2.6 *Education and Public Outreach*

It was recognized that engaging the public in the development and implementation of the Prometheus project would be a key component of mission success. The overall plans for education and public outreach are discussed in section 5.7. Upon selection of science investigations, it was intended that the Principle Investigators would prepare their own Education and Public Outreach plans, which would be coordinated through the Prometheus Project Office and NRPCT as appropriate.

8.3 **Mission Design**

A challenging aspect for low-thrust mission design in general is that the trajectory design is closely coupled with other project elements, even at an early stage. The trajectory depends upon the launch vehicle capability, the mass of the spaceship, characteristics of the power and propulsion elements, and attitude control capabilities. With JIMO being the first Prometheus mission, this coupling proved even more challenging since the system parameters had large uncertainties initially and significant external constraints as the design progressed.

An extensive database of direct interplanetary trajectories was created in order to be able to quickly perform broad trades in system parameters such as power, specific impulse (Isp), and mass. When coupled with subsystem mass models and potential launch vehicle capabilities, the database was used to explore a large trade space constrained by technological and other practical considerations and enabled focused assessment of regions with reasonable system parameters and good mission characteristics.

Several options were considered for departure from Earth. The most appropriate option depends on the capabilities of the launch vehicles being considered. One option is to launch into an orbit about the Earth and use electric propulsion to gain energy and escape the Earth (spiral out trajectory). Another option is to use the launch vehicle or a chemical transfer stage to escape the Earth. Spiraling out with electric propulsion provides more delivered mass or requires less launch vehicle capability but typically has a longer flight time. The project decided early on to escape the Earth using a chemical propulsion system. The Level 1 requirement on arrival date forced a flight time that would have been difficult to meet with a spiral out option.

Based on the analysis performed to date, a reference interplanetary trajectory was developed for the JIMO mission. This trajectory is a direct path with no planetary gravity assists (Figure 8.3-1). An extensive analysis of a variety of gravity assist options utilizing Earth, Venus, and Mars was completed. The results of one of these analyses is shown in Figure 8.3-2 for reference. The solid black line in Figure 8.3-2 is the direct case with optimized launch energy. All the other cases include at least one planetary gravity assist. There are many gravity assist options that both increase the delivered mass and decrease the flight time. Some of the Earth gravity assist options are particularly interesting because they are among the best performers and provide consistent performance at regular intervals of launch opportunities.

The injection period for the reference trajectory can be quite long without sacrificing significant performance. For example, the injection period is potentially as long as 84 days at the cost of 0.3% of delivered mass to Jupiter. If the team were to allow slightly longer transfer times for backup injection opportunities, the injection period could be extended indefinitely at a reasonable cost in performance. The mission is also extremely robust to injection vehicle delivery dispersions.

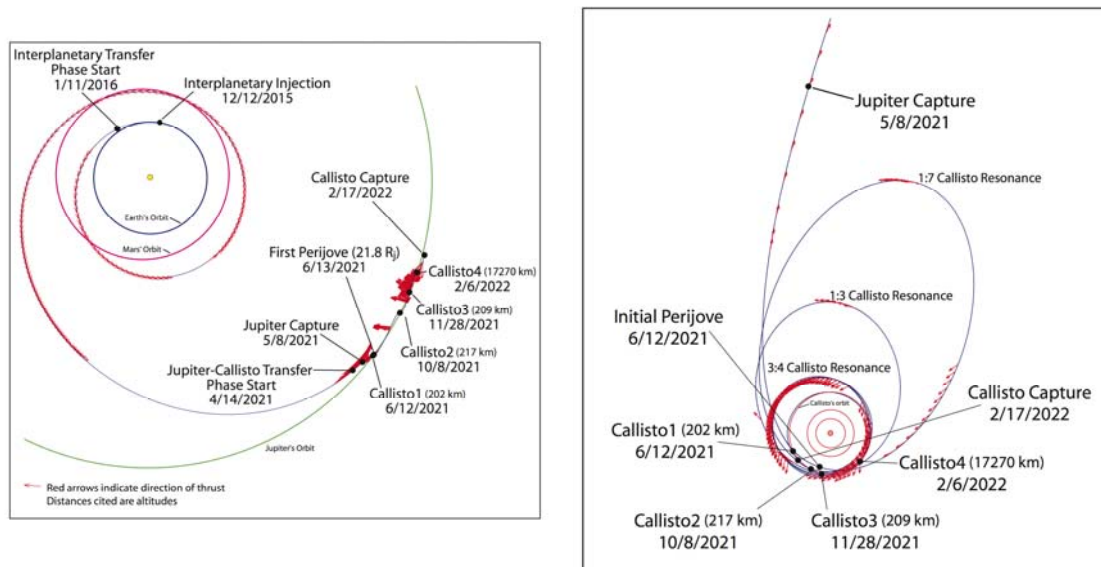

Figure 8.3-1. Reference Interplanetary Trajectory and Jupiter Arrival.

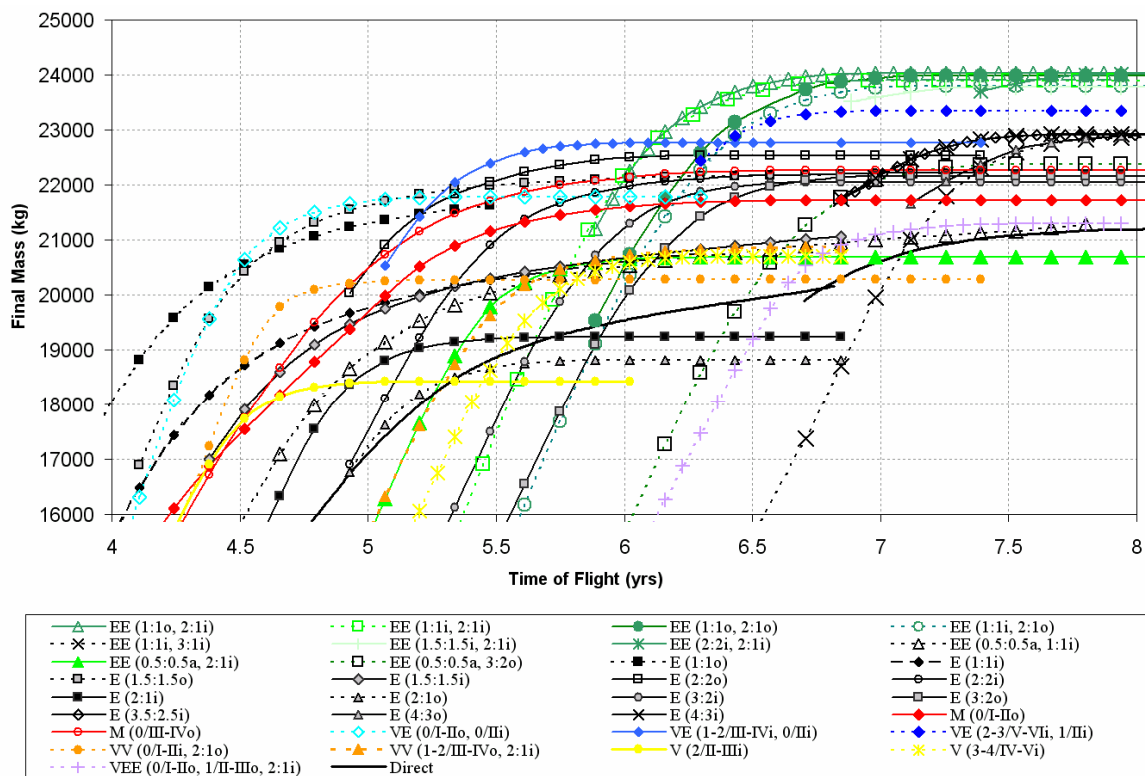

Figure 8.3-2. Gravity Assist Trajectories.

The reference trajectory flies by Callisto on the initial approach to Jupiter and uses additional Callisto gravity assists prior to capture at Callisto (Figure 8.3-1). These gravity assists reduce the required propellant for this phase of the mission by about 80% and also decrease the flight time. Gravity assist using Ganymede prior to capture at Callisto was assessed, but the results showed that Ganymede did not help when Callisto was to be the first moon orbited.

The reference trajectory orbits Callisto, Ganymede, and Europa, in that order. Orbiting Europa first, then Ganymede, then Callisto was analyzed as an alternative trajectory. Even though the mass performance of the two cases are similar, the Callisto first case has a slightly shorter flight time and lower overall radiation exposure – potentially much lower radiation depending on the end-of-mission orbit.

The dynamical environment at Jupiter is complex. The trajectories at Jupiter are governed by multiple gravitational fields and spend considerable time in regions of space in which more than one body is exhibiting significant influence on the spaceship. With appropriate design techniques, very efficient pathways can be found by taking advantage of these intricate dynamics. An additional complexity results from the very low acceleration capability of the spaceship. The combination of very limited control authority and significant multibody dynamics results in some aspects of the trajectory design being different than for any previous mission.

Capturing at a body using low-thrust propulsion is different than for high-thrust missions. The reduction in orbital energy is necessarily slower; hence, a substantial amount of time is spent in a transition region between moon escape and moon capture. During this transition, the multibody effects on the trajectory are significant, and in many cases can result in unintended surface impact in a matter of days (Figures 8.3-3 and 8.3-4) if the spaceship were to lose control. This was found to be particularly true for the case of direct capture into near-polar inclination orbits. Very stable near-equatorial, retrograde orbits were found to be satisfactory for capture, but to avoid the unstable regions, required a change in inclination at relatively low altitudes which is very costly in terms of propellant and flight time. At Callisto and Ganymede, paths to the science orbit that would not result in surface impact for at least a couple weeks were determined; however, this approach is extremely costly at Ganymede since the relatively safe region is at a much lower altitude with Ganymede being closer to Jupiter. At Europa, the relatively safe region essentially disappears within about 45 deg of the poles. Given the extremely high radiation environment at Europa, the decision was made to achieve the science orbit as quick as would be reasonably possible, allowing the lifetime to be very short in the case of unplanned missed thrusting.

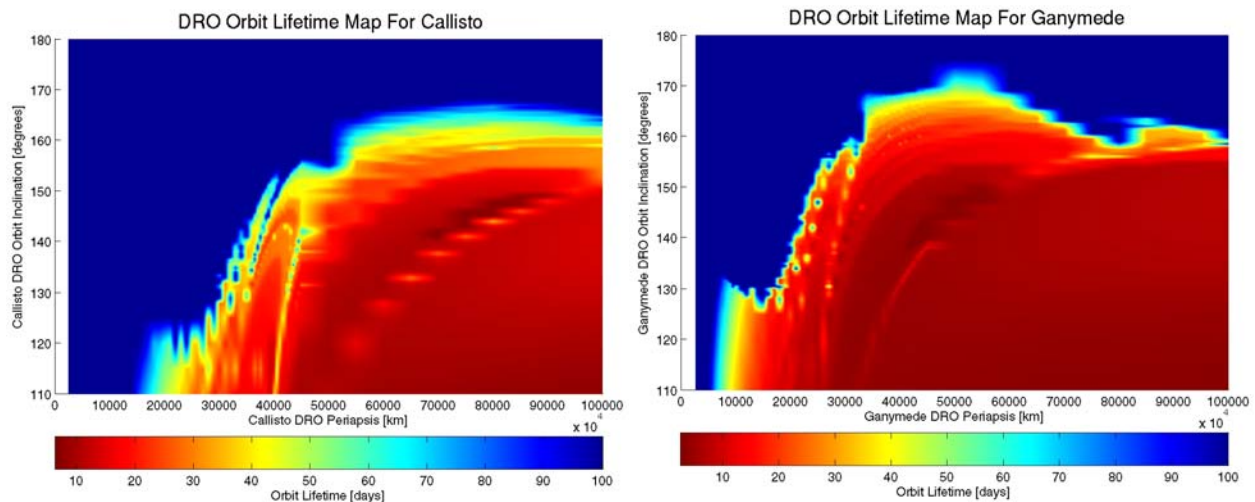

Figure 8.3-3. Orbit Lifetime Maps for Ganymede and Callisto.

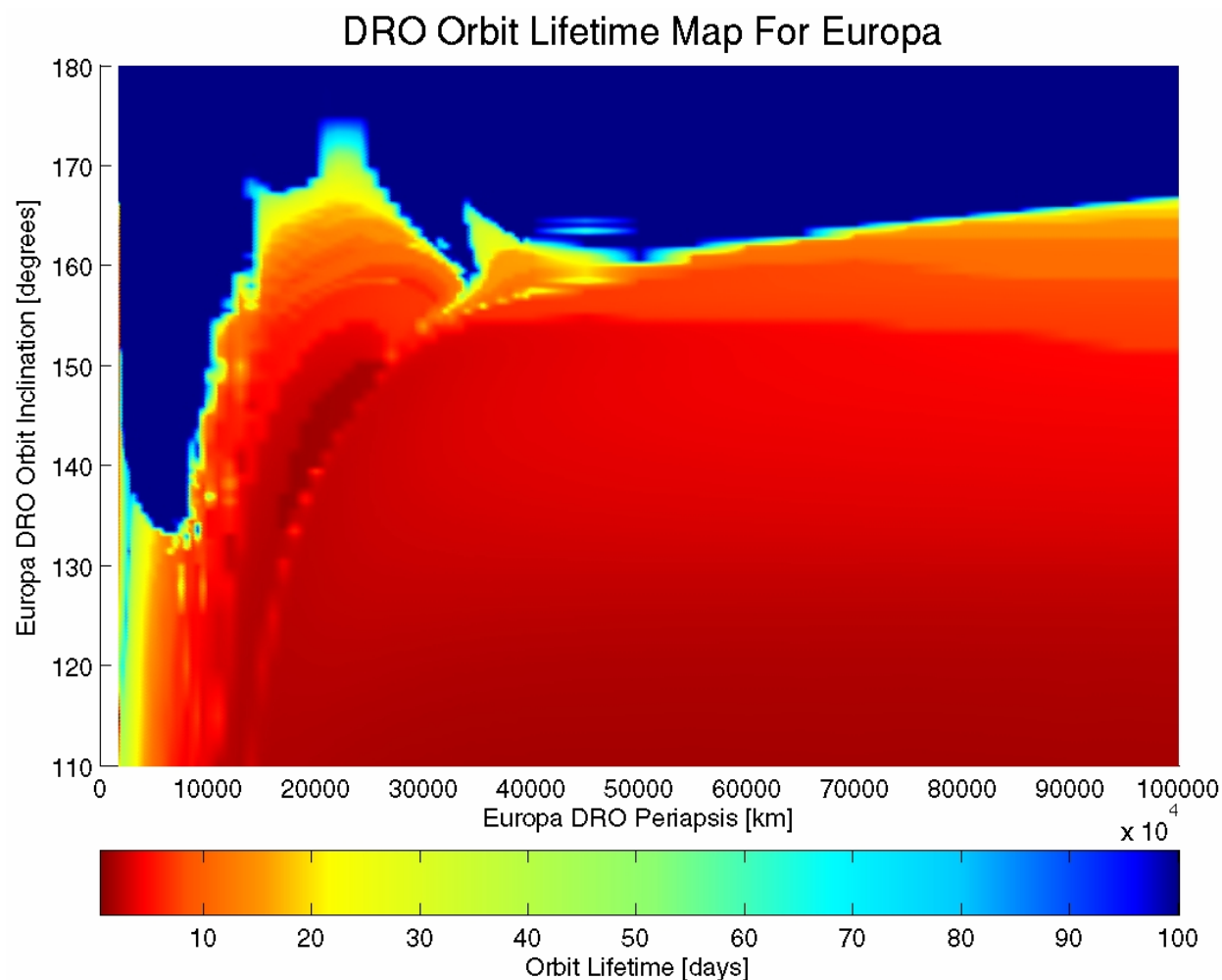

Figure 8.3-4. Orbit Lifetime Map for Europa.

Additional analysis was done to explore and discover other types of captures that would be very promising. These “manifold captures” are characterized by their approach to the moons along stable manifolds of unstable periodic orbits (of which there are many) near the moons. The manifold captures performed well in terms of propellant mass, flight time, and controllability with reasonable lifetimes.

Overall, significant trades between propellant mass, flight time, and stability for a variety of capture types were assessed. The requirements on trajectory lifetimes and acceleration levels (translational and rotational) drive the design of captures and, hence, many other aspects of the mission.

Figure 8.3-5 illustrates the capture at Callisto and transfer down to the science orbit.

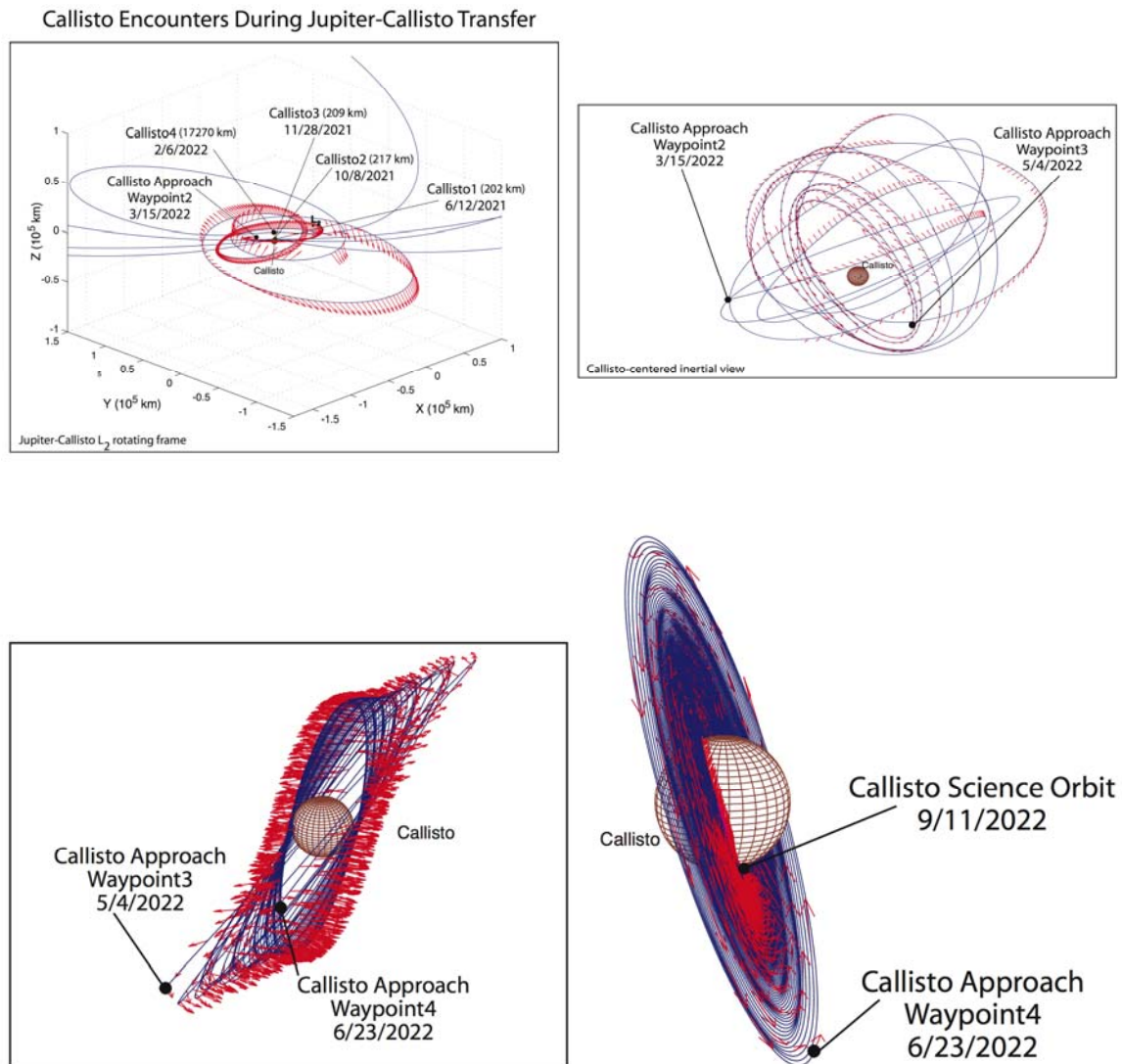

Figure 8.3-5. Capture at Callisto and Transfer to the Science Orbit.

From previous studies it was known that low-altitude orbits around the moons with inclinations within about 45 deg of the poles would be unstable due to the gravitational influence of Jupiter; that is, if left uncontrolled, they result in the spaceship impacting the moon in a relatively short time. Since Europa is the icy moon closest to Jupiter and also the smallest, the time scale for this effect is the shortest at Europa with impact occurring on the order of tens of days. Previous studies considered only a very simple gravity field for the moons, including only the effect of the J2 term. When we started considering more detailed gravity fields, we discovered that higher order terms can have a significant effect on the stability of the orbits. For example, a significant value for the J3 term makes orbits at essentially all inclinations unstable. Analysis revealed very special cases of near polar “frozen orbits” that have relatively long lifetimes, but the exact orbital conditions for these depend on details of the gravity field which would not be known until the spaceship has been at a particular moon for some period of time.

Note that the J2 and J3 terms represent normalized coefficients in the standard form used for modeling the gravitational potential of a body. They are the first two zonal harmonic (axisymmetric) terms. J2 is often associated with the oblateness effect and J3 has been called the "pear-shape" term.

Stability of the orbits also has a direct effect on science orbit maintenance and, hence, orbit determination. A trade exists between the frequency and total delta-V required for the maintenance maneuvers, with smaller, more frequent maneuvers potentially resulting in less ΔV overall. Lower total ΔV results in less total time interruption to science, but more frequent maneuvers may significantly degrade orbit determination. Selection of the precise elements for science orbits and orbit maintenance strategy remain unclear.

Transfer trajectories between the moons take advantage of multibody effects and gravity assists to reduce the required propellant for these phases of the mission by about 80%. Many different types of transfers were explored, including various combinations of resonances with the moons. The best transfers depend on the type of escapes and captures used at the moons and the available level of acceleration. The transfer from Callisto to Ganymede for the reference trajectory is shown in Figure 8.3-6.

The mission ends with the spaceship in the science orbit at Europa. Options for transferring to orbits that do not impact Europa for an extended duration (> 1000 years) were explored, but those transfers require more propellant and more time in the high radiation environment at Jupiter.

The reference trajectory satisfies all of the applicable Level 1 requirements. The delivered mass includes a Payload Accommodation Envelope with a mass capability of at least 1500 kg. Jupiter Orbit Insertion occurs on May 8, 2021, which is 5.4 years after injection. Science orbits are maintained around Callisto for 120 days (60 days required), Ganymede for 120 days (60 days required), and Europa for 60 days (30 days required).

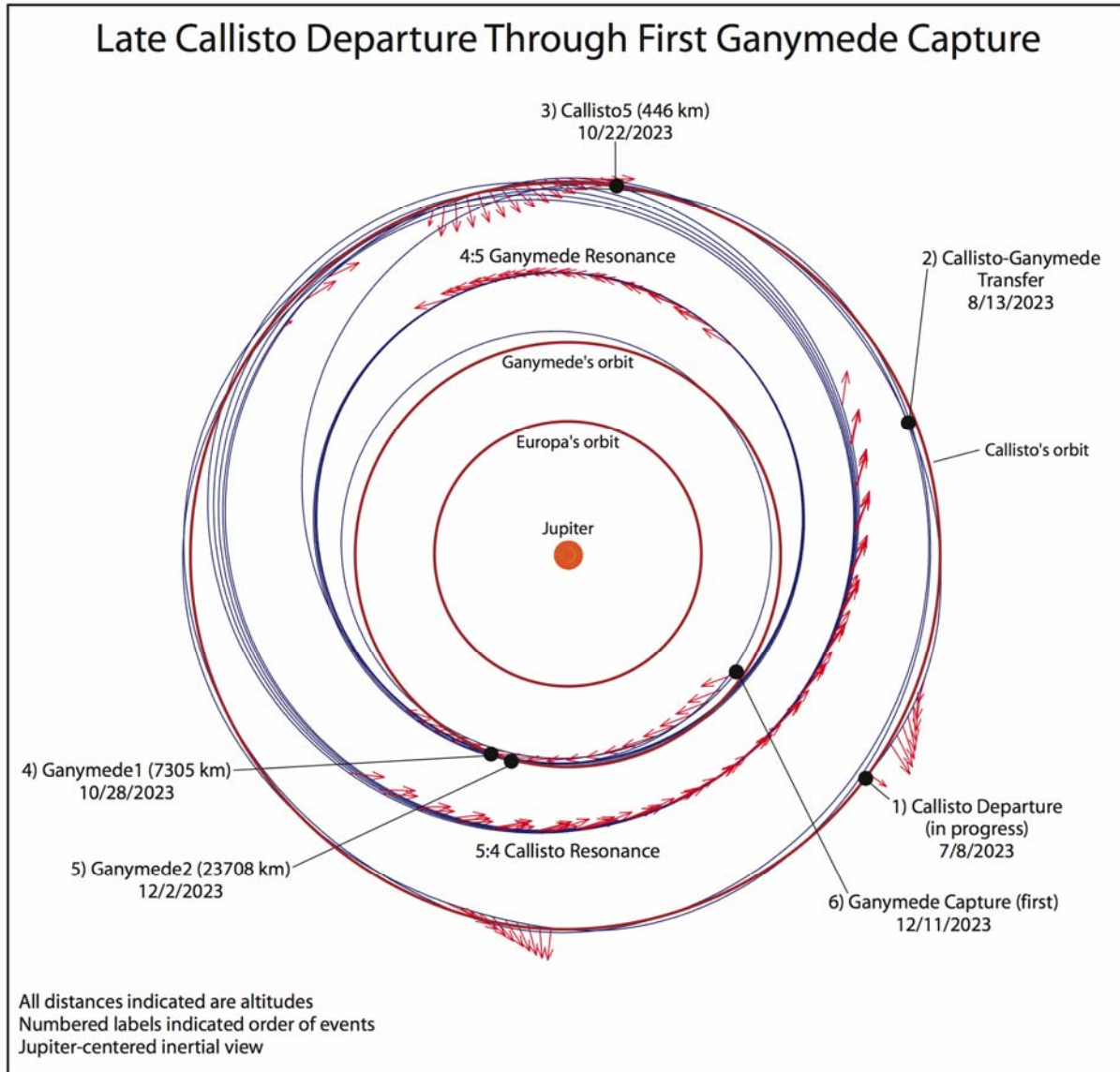

Figure 8.3-6. Transfer from Callisto to Ganymede.

8.4 Science Operations Module

8.4.1 Functional Overview

The Science Operations Module (SOM) is defined as that part of the ground element that is unique to mission science. The SOM includes science data processing, science data analysis, science data management and transfer to permanent archive, instrument operations, science planning, and science command generation functions for each of the science investigations. The major functions and data flows within the SOM as well as major external interfaces have been defined as shown in Figure 8.4-1. These functions would be implemented through each science investigation contract. Services and software tools would be available from the Deep Space Mission System (DSMS) at JPL that could be used to support those functions, if the investigator so chooses.

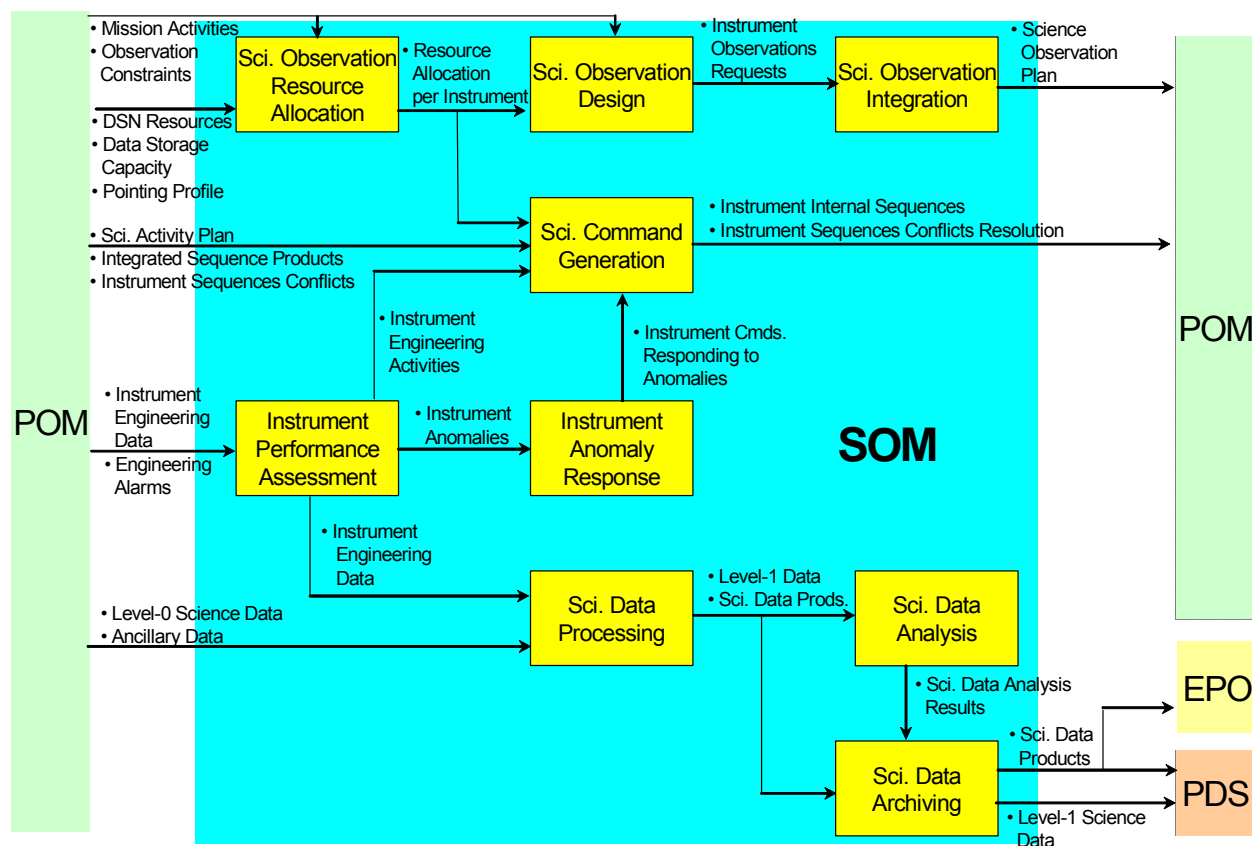

Figure 8.4-1. Science Operations Module Functional Block Diagram.

8.4.2 Requirements

Key Driving Requirements (KDRs) were derived for the SOM as shown in Table 8.4-1. These form the basis of the SOM functionality and conceptual design (implementation response).

Table 8.4-1. Key Driving Requirements for the Science Operations Module.

Rqmt #	Key Driving Requirement Text	Implementation Response
SS-027	The SOM shall plan science observations with a DSS data storage capacity of 500 Gbit.	<ul style="list-style-type: none"> • Centralized process for allocating data storage resource • Instr. Teams receive and stay within a data storage envelope
SS-028	The SOM shall produce level 2 and higher Science Data Products to meet the science objectives of the mission.	<ul style="list-style-type: none"> • Common processes, procedures, interfaces and S/W tools across all science/instrument teams • Required H/W and S/W located at science institutions
SS-029	The SOM shall transfer Level 1 and higher science data products to the PDS.	<ul style="list-style-type: none"> • Common processes, procedures, interfaces and S/W tools across all Instr. Teams to transfer products to PDS • Required H/W and S/W located at science institutions
SS-030	The SOM shall have the capability to generate a conflict-free set of Spaceship activities for each mission phase based on the Mission Plan, DSN schedule, and requests for instrument, technology and engineering activities.	<ul style="list-style-type: none"> • Instrument Teams functions: <ul style="list-style-type: none"> – Generate instrument activities and commands – Check flight rules and constraints – Internal conflict resolution – Update/maintain corresponding FSW • Centralized functions at JPL <ul style="list-style-type: none"> – Allocation of Spaceship and ground resources to experts – Integration of commands and sequences – Constraint checking and conflict resolution at system level • Flight rules and constraints <ul style="list-style-type: none"> – Implemented in S/W (where possible) – Redundant checks • Uplink Process contains strict checks and balances <ul style="list-style-type: none"> – Use of “restricted command list” – Cmd authentication – Cmd comes from a legal user

As shown in Figure 8.4-1, the SOM approach has been developed to be well integrated with the Prometheus Ground System.

8.5 Mission Module

8.5.1 Overview of Mission Module Design

The Mission Module is unique to the JIMO mission, and includes all science instruments and supporting equipment as necessary to meet science requirements. The supporting equipment includes the following: scan platform, turntable, associated electronics, booms, deployment devices, radiation shields, cabling, multi-layer insulation and thermal control devices, and flight software. A conceptual design for the Mission Module has been developed and is described in the following paragraphs. The major hardware elements of the Mission Module are illustrated in Figure 8.5-1.

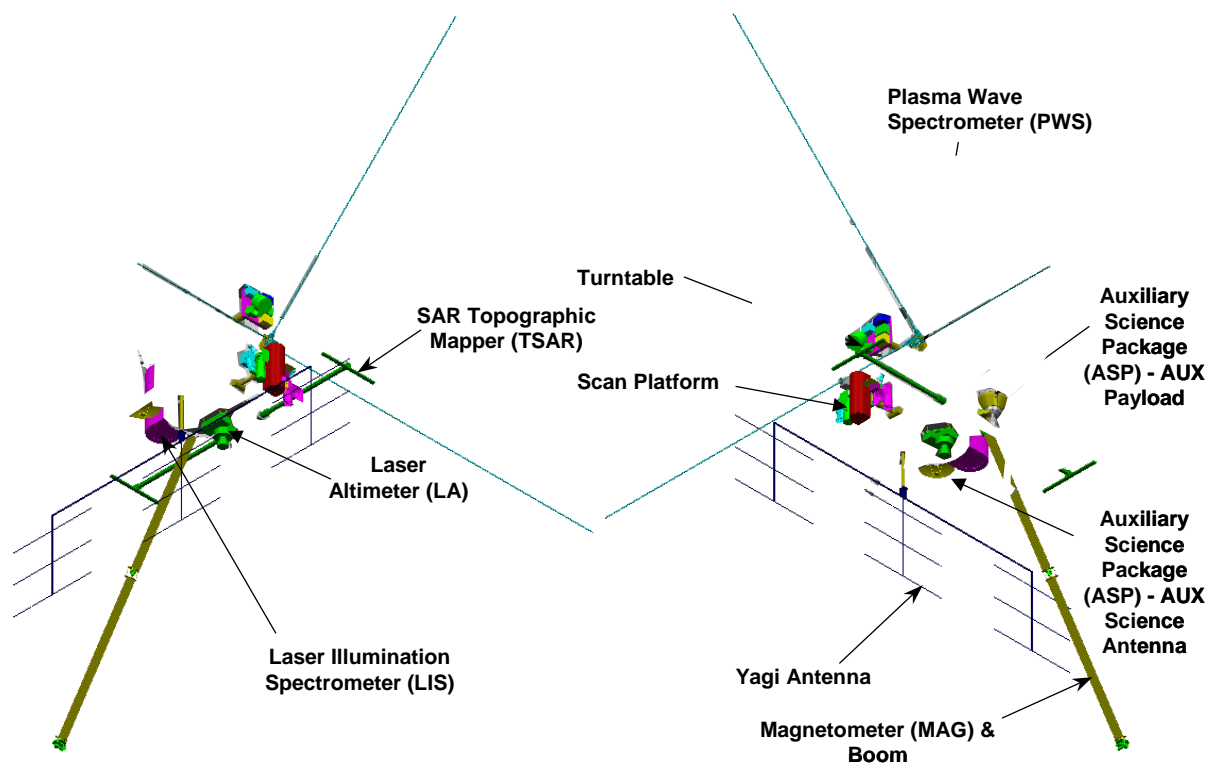

Figure 8.5-1. Mission Module Elements.

8.5.2 Science Instruments

As the science payload has not yet been defined, a reference suite of science instruments was selected for use in designing the JIMO Mission Module. These instruments are representative of the investigations that the science team envisions. The reference instrument suite (see Table 8.5-1) is discussed in detail in the Mission Module Design Description document.

The instrument suite includes the instrument set adopted for the JIMT study, supplemented by instrument suggestions from the JIMO Science Workshop at LPI in June 2003 and SDT recommendations. There are 17 instruments plus an Auxiliary Science Package, which was envisioned to be a Europa Lander. Science instruments mounted directly on the spacecraft bus will provide topographic mapping, subsurface mapping, spectrometry, altimetry and magnetic fields measurements. Multi-spectral imaging will be performed by instruments on the scan platform. Particles and fields instruments will be located on a rotating turntable.

Table 8.5-1. Reference Instrument Suite.

	Mass (kg)	Average Power Consump tion (W)	Peak Power Consump tion (W)	Location
Super High-Res Camera (SHRC)	65	100	100	scan platform
High Res Telescope (NAC)	20	5	5	scan platform
Mapping Camera (MAC)	5	5	5	scan platform
Wide-angle Camera (WAC)	3	5	5	scan platform
Hyperspectral Imager (HSI)	25	15	15	scan platform
Thermal Imager (TI)	11	14	14	scan platform
SAR Topographic Mapper (TSAR)	150	200	1400	bus-mounted (on boom)
Ice Penetrating Radar (IPR)	50	2700	13000	bus-mounted
Laser-illumination Spectrometer (LIS)	250	2500	2500	bus-mounted
Laser Altimeter (LA)	44	1400	1400	bus-mounted
Plasma Wave Spectrometer (PWS)	10	7	7	bus-mounted
Magnetometer (MAG)	3	3	3	bus-mounted (on boom)
Ion and Neutral Mass Spectrometer (INMS)	10	28	28	Turntable
Heavy Ion Counter (HIC)	3.3	7	7	Turntable
Energetic Particle Detector (EPD)	11	10	10	Turntable
Plasma Spectrometer (PS-particles)	13	11	11	Turntable
Dust Detector (DD)	5	6	6	Turntable
Auxiliary Science Package (ASP)	375			bus-mounted

As a result of investigating other outer planet missions, it was found that this suite of instruments also envelopes a variety of investigations that might be flown on follow-on Prometheus missions and was, therefore, used as the reference for developing the PAE. This was accomplished as a joint effort between the SDT and the Project Engineering Team. This PAE was used to impose requirements on the Prometheus Deep Space Vehicle as well as constraints on instrument selection. The PAE parameters and associated values are listed in Appendix C of the Mission Module Design Description Document. Among PAE parameters are mass, power, physical areas and volumes, data rates, data volume, and pointing.

8.5.3 Mission-Unique Flight Equipment

The Mission Module includes flight hardware that is unique to the JIMO mission and is required to accommodate the science instruments and their operation.

Instruments that do not require the types of motion or pointing accuracy provided by the scan platform or turntable are mounted directly on the spacecraft bus. Some may provide their own motion devices or deployment mechanisms. For example, the payload includes a pair of magnetometers, which require a long boom to get the sensors away from the magnetic influence of the spacecraft.

Radio Science investigations are accommodated using the Spacecraft Module Telecom Subsystem and High Gain Antenna (HGA).

The Scan Platform provides high-precision pointing (1 mrad control) for remote sensing instruments. It provides two-axis articulation and a near-hemispherical range of motion. It is capable of pointing 90 degrees from the spacecraft Z-axis to accommodate science data acquisition during Jovian Cruise Phases.

The Turntable provides continuous, low-rate (~3 rev/minute), 360 degree rotation for fields and particles instruments. It is located on the spacecraft bus with axis of rotation perpendicular to the nominal direction of flight in science orbit. Thus, instruments can be mounted so that sensor ports rotate through both the flight and anti-flight directions.

The spacecraft will accommodate an auxiliary science package (ASP) mounted on the side of the bus. The ASP will most likely be a Europa lander. It would provide its own spacecraft bus interface and release (deployment) device, and equipment on the spacecraft to communicate with the lander.

The Mission Module architecture is shown in Figure 8.5-2. Portions of the Spacecraft Module Command & Data Handling (C&DH) and Power Distribution & Control (PDAC) subsystems are included to provide context for the Mission Module elements.

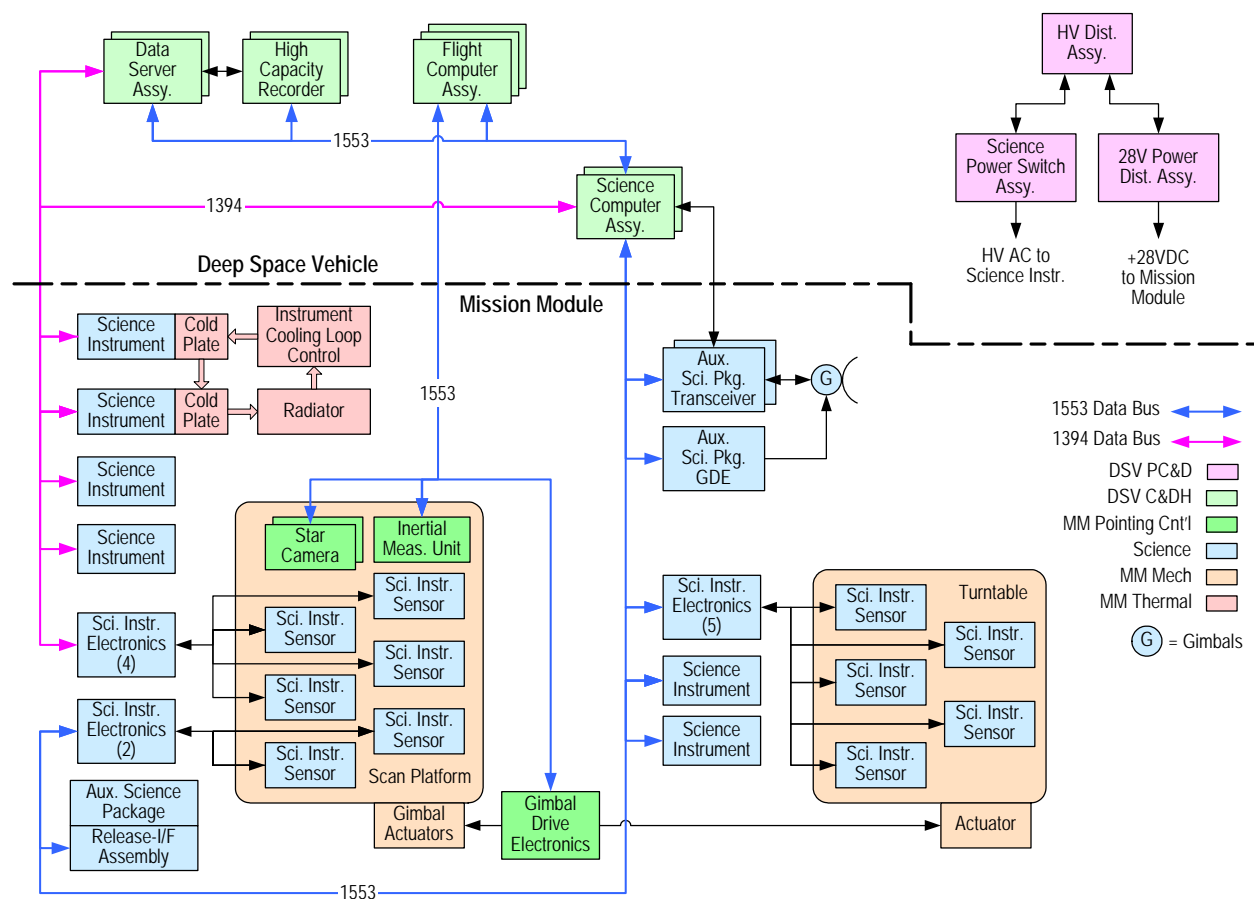

Figure 8.5-2. Mission Module Architecture.

8.5.4 *Flight Software*

Mission Module flight software consists of the software embedded within the science instruments, software that executes in the Science Computer Assembly (SCA) and pointing control algorithms for the scan platform and turntable that will be integrated with the Spacecraft Module AACS flight software. Science instrument software contributes to the functionality of an individual instrument. SCA software provides more general Mission Module functionality, such as payload sequencing and commanding, health and status monitoring, fault protection, routing and processing of engineering telemetry, some processing of science data, etc. The scan platform and turntable pointing control algorithms provide precision pointing for the instruments.

8.5.5 *Key Driving Requirements*

Level 3 key driving requirements (KDR) were developed for the Science System. Twenty-six of those KDR's are applicable to the Mission Module. The requirements for the Mission Module can be found in the Science System Key Driving Requirements document or the Mission Module Design Description document. Some examples of the requirements are:

- The MM mass shall not exceed 1500 kg. Of the 1500 kg mission module mass, 375 kg shall be allocated to a deployable surface science package and its associated mounting and communications hardware.
- The MM shall be capable of transferring data to the Deep Space System at a maximum rate of 250 Mbit/s. The aggregate data rate for all instruments shall not exceed 250 Mbps.
- The Mission Module shall be designed to operate in the total ionizing dose (TID) radiation environment specified in the Environmental Requirements Document (12 Mrad behind 100 mils of Al with RDF of 2)

Level 4 requirements have not yet been formulated. Project level 2 science accommodation requirements can be found in the Multi-Mission Project Derived Requirements and JIMO Mission Project Derived Requirements documents.

8.5.6 *Plans for Science AO and Instrument Selection*

NASA had planned to release a science investigation Announcement of Opportunity (AO) in early 2007. Constraints imposed by the payload accommodation envelope would be included in the AO. Selection of investigations/instruments was planned for January 2008. Until then, the Project elected to use the PAE as a method to capture vehicle requirements and instrument accommodation constraints in the absence of having the instruments selected until a later date. The JPL Gate Product requirement for "final selected science payload at PMSR" was waived.

8.5.7 *Mission Module Verification, Integration and Test*

Due to the numerous instruments associated with the Mission Module, there were two key requirements identified to support verification, integration and test activities. The first requirement is that each instrument would be fully acceptance tested before delivery. This provides greater flexibility as to when the instrument is integrated with the spacecraft and reduces the integration testing to verification and validation of the newly joined interfaces and high level end-to-end tests.

The second key requirement involves the logistics of instrument delivery and integration with the spacecraft. With the potential to have 18 science instruments, the integration and test activities would be overly constrained if they had to wait until all the instruments were delivered. Thus, a second requirement specifies that the I&T activities be designed to support delivery of each instrument as a separate entity and that they could be delivered at different times. This requirement imposed further design constraints on the Mission Module to support removal and replacement of simulators or instruments without impacting other installed equipment. This allows considerable flexibility in the testing and minimizes schedule risk.

Given the above items, the Mission Module integration activities focus on the integration of each instrument as a separate entity. Figure 8.5-3 shows the overall flow planned for this integration. The first integration utilizes the support structure at JPL. This allows for initial checkout of the instrument using the various testbeds prior to integration with the spacecraft module. Once the instruments have passed this initial integration, they are scheduled for integration with the spacecraft. The spacecraft ATLO flows have several windows identified when instruments could be integrated. The final window for installation occurs just prior to the spacecraft dynamics and thermal-vacuum testing.

After installation on the spacecraft, the various instruments are powered on and tested to verify their interfaces to the spacecraft module. An integrated compatibility test with the Deep Space Network (DSN) and operations control center is also performed. This test is a complete system end-to-end test, with commands and instrument sensor stimulations in and science data out at the control center via the space communications links.

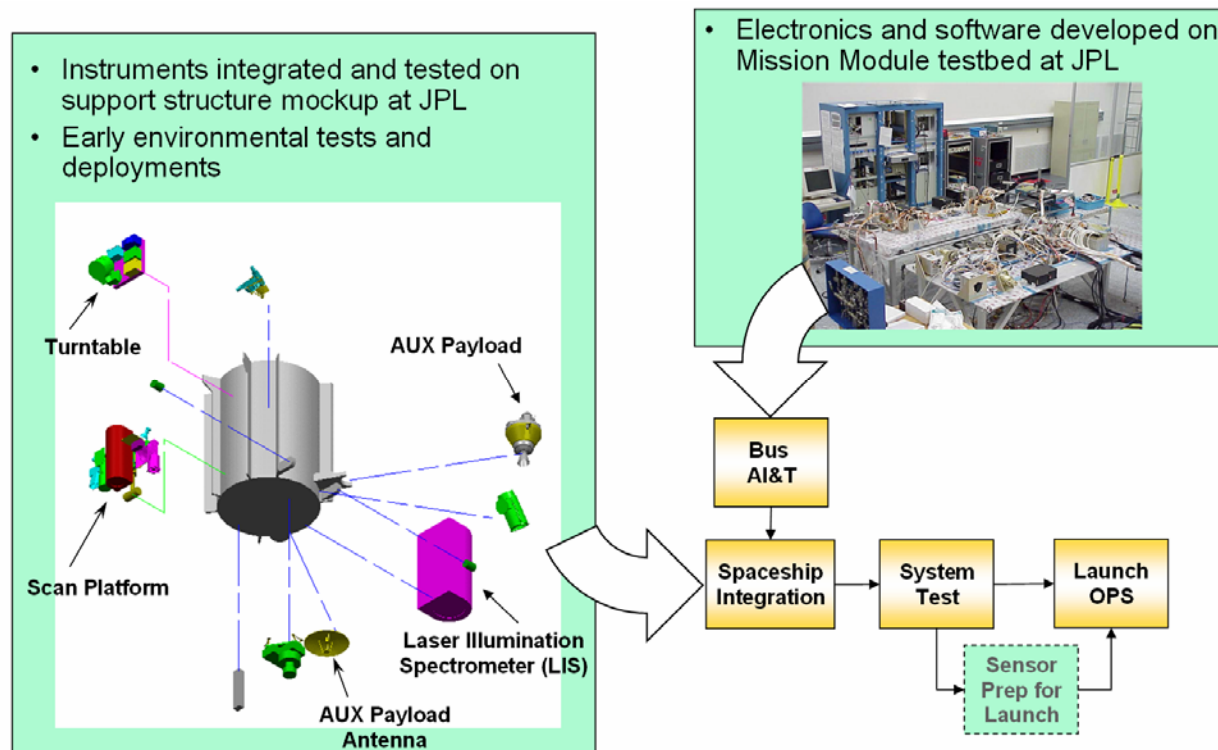

Figure 8.5-3. Mission Module Integration.

8.5.8 Mission Module Simulations and Test Beds

Although there is a list of 18 instruments for the Mission Module, the specific instruments for the JIMO mission were to be selected following the AO process. This AO and associated instrument contracts would have specified the required interface simulators and hardware. However, these simulators and hardware were not addressed in any significant detail during the Phase A activities.

A Mission Module testbed was identified to support development activities at JPL and NGST. This testbed was designed to emulate the electrical interfaces and associated communications between the instruments and the Deep Space Vehicle flight computer, science computer, and data server. This involves command and telemetry interaction via a MIL-STD-1553 data bus and several science/engineering data buses such as the IEEE 1394 (firewire) and additional MIL-STD-1553 data buses. Once module-level test activities are completed, this Mission Module testbed will be integrated into the overall spaceship testbed.

9. Deep Space System

Early in the development of the Prometheus Project it was decided that the Government team would retain Total System Performance Responsibility (TSPR) for the Deep Space System, including the Reactor and Spacecraft Modules, and the Mission Module. TSPR was implemented by exercising appropriate co-design, oversight and insight, including review and concurrence on key management and engineering documentation of all critical elements of the Deep Space System.

The Deep Space System Manager was assigned as a member of the Project staff and reported to the Project Manager. The Deep Space System Manager in turn chartered a Deep Space System Steering Panel (DSS-SP) to support him in the development of the Deep Space System. The DSS-SP was required for Prometheus because the Reactor and Spacecraft Modules have critical design/programmatic interdependencies. Due to these interdependencies, it was required that the Deep Space System be developed in a seamless fashion where all necessary design dependencies and interfaces were taken into consideration. This ensured that the collective designs of the Reactor Module and Spacecraft Module fulfilled the total set of Deep Space System requirements. The DSS-SP consisted of the following personnel:

- Deep Space System Manager: Deep Space System Steering Panel (DSS-SP) Lead, reporting to the Prometheus Project Manager (JPL)
- Spacecraft Manager (who was also the Spacecraft Contract Technical Manager) (JPL)
- Reactor Module Manager (NRPCT)
- Safety Manager (JPL)
- Space System Assurance Manager (JPL)
- Project Acquisition Manager (JPL)
- Spacecraft Contract Project Manager (Industry)
- Project Engineer (JPL)
- Space System Engineer: The Deep Space System – System Engineer who led the Deep Space System–System Engineering Team (DSS-SET) (JPL)

The charter of the DSS-SP was to provide support to the Deep Space System Manager to:

- Ensure that safety was always the number one consideration in development
- Ensure flow-down of project/mission requirements and Deep Space System requirements to the modules (Reactor and Spacecraft Modules)
- Ensure quality and completeness of interfaces between the modules
- Ensure appropriate contract management, surveillance and technical direction
- Ensure that risk management (identification and mitigation) was adequately used throughout the development effort and is consistent with an integrated Prometheus risk management approach

- Ensure that separate module cost and earned value systems were consistent with and can be integrated into a Prometheus project management approach and status report
- Ensure that critical issues in one module were evaluated for impact to the rest of the system
- Facilitate the resolution of issues between the modules
- Ensure that resources were made available to supplement developers with personnel/facilities from industry, NASA Centers, NRPCT and/or JPL to support their development to ensure mission success

The DSS-SP was supported by the Deep Space System–System Engineering Team (DSS-SET). This team was led by the Deep Space System – System Engineer with the participation by the lead System Engineers from the two modules, the Project Chief Engineer, the lead end-to-end system engineers for the Nuclear Power Plant System Engineering Team, Integration and Test System Engineering Team, Power System Engineering Team, and other engineers as necessary from the Spacecraft Contractor and the Government. The purpose of the DSS-SET was to ensure that the Deep Space System met all technical requirements of the mission, interfaces were properly addressed, and that the total Deep Space System was properly system engineered.

The charter of the DSS-SET was as follows:

- Ensure that Deep Space System requirements were adequately negotiated and flowed down from project level requirements.
- Ensure that Deep Space System requirements were adequately flowed down to the module level
- Negotiate the Interface Control Documents (ICDs) between the Deep Space System and other systems
- Ensure that the ICDs between the Deep Space System modules were adequately worked
- Manage the technical margins of the Deep Space System
- Ensure that the system design of the Deep Space System was a balance between the requirements of the mission and the risk of meeting those requirements.

The DSS-SP and the DSS-SET were put in place for Prometheus to ensure TSPR was retained by the Government, and to ensure that JPL Flight Project Practices, Design Principles, and Mission Assurance Principles were utilized as a baseline in defining the appropriate Deep Space System requirements and implementation plans.

The major plans for Phase B for the DSV would have included; 1) further incorporation of the Reactor/Power Conversion concept selection into the overall DSV, 2) continued alignment and development of critical technologies leading to acceptably small risk by PDR, 3) further design iterations based on mass and trajectory constraints and science instrument understanding, 4) exploration into preliminary design issues identified in Phase A including pointing and control, data throughput, power distribution.

9.1 DSV Design Evolution

The requirements for the Deep Space Vehicle were unlike any envisioned before. The marshalling of national talent was required to exploit the experiences of multiple organizations to achieve implementations which were viable. Thus, early in the Project, April 2003, three study contracts were awarded to pre-qualified contractors capable of providing spacecraft design and fabrication services. These companies were Boeing, Lockheed Martin and Northrop Grumman. Additionally, a Government Team was formed to study the same problem. The results of each study included pre-conceptual designs for the Spacecraft Module, Reactor Module and Mission Module based on a reference instrument suite for JIMO. Though the final contract award was based on teaming approaches as well as design concepts, each contractor (and the Government team) was given time and money to study the issues, risks and design implementation to allow the learning process to take place. This resulted in better approaches to the design as well as teaming arrangement proposals and an informed government team to evaluate the final proposals.

The Study Contracts were concluded in the Summer of 2004, roughly the same time as the responses to the Spacecraft Module Request for Proposal. NGST was awarded the Spacecraft Co-design contract in September 2004. During the months of October, November and December, the NGST Team and the Government Team worked to merge the two conceptual designs and modify them to meet evolved requirements, resulting in the Prometheus Baseline 1 (PB1) design for the Spacecraft Module. PB1, along with the NRPCT Reactor Module concept, comprises the Deep Space Vehicle design concept. Graphically, this is shown in Figure 9.1-1 below.

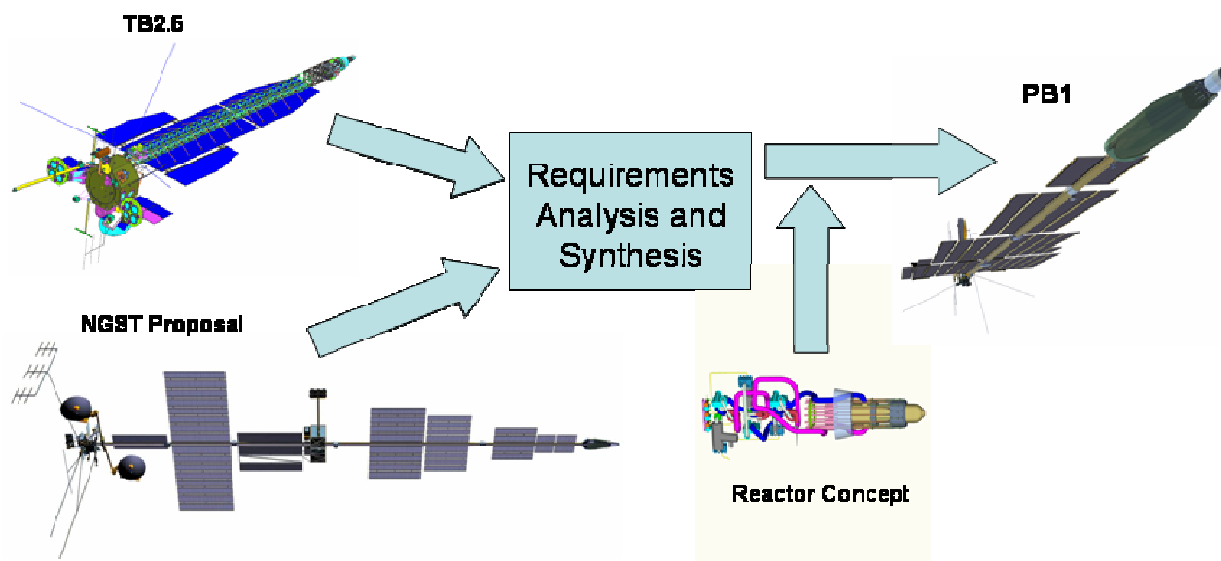

Figure 9.1-1. DSV Design Evolution.

9.2 Deep Space Vehicle Description

The Prometheus Spaceship consists of the Reactor Module, the Spacecraft Module and the Mission Module. Two elements, the Reactor Module and the Spacecraft Module, combine to be the Deep Space Vehicle (DSV). The DSV is the basic vehicle which provides the engineering functionality to support multiple missions. By adding the mission-unique Mission Module to the DSV, the Spaceship becomes capable of performing a number of diverse missions. An overview of the DSV, incorporating the JIMO Mission Module, is shown in Figure 9.2-1. A detailed description of the DSV can be found in the Spacecraft Module and Subcontractor-Provided Reactor Module Segment Design Description Document.

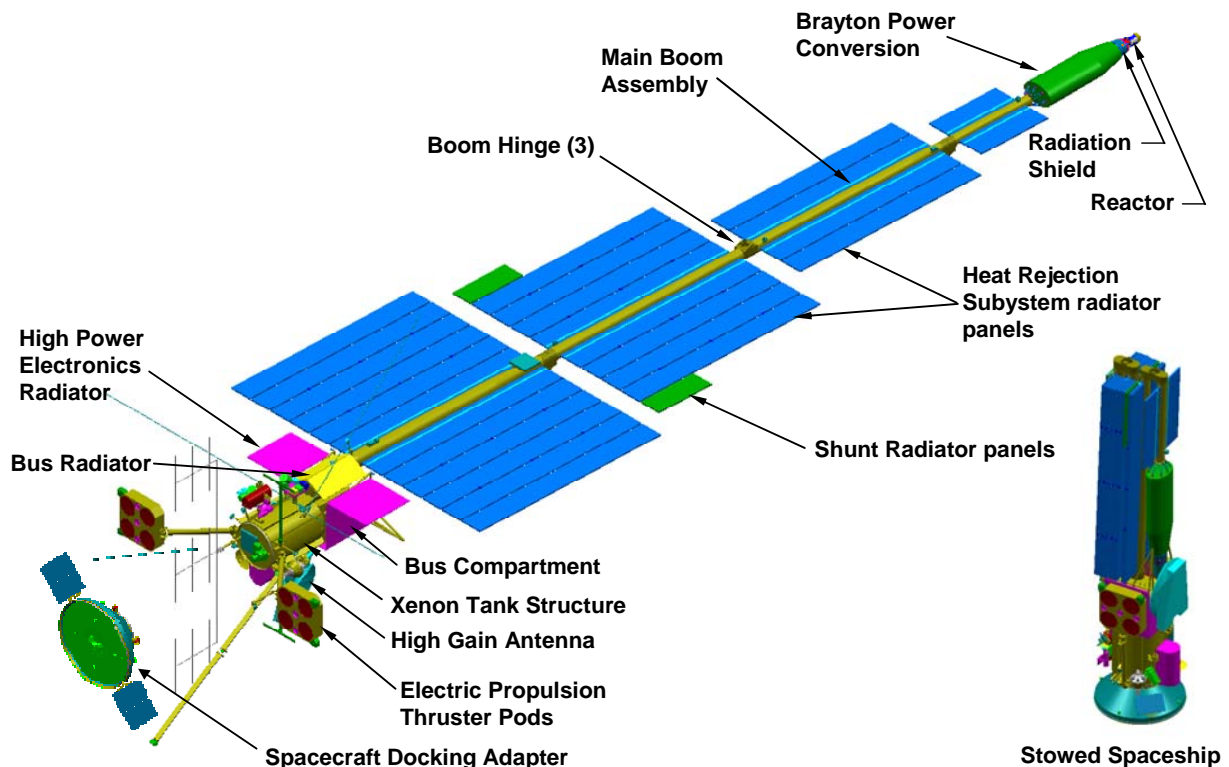

Figure 9.2-1. Spaceship Overview.

The Reactor Module, at the forward end of the DSV, comprises a high temperature gas-cooled reactor (Reactor Segment) directly coupled with redundant Brayton turboalternators for power conversion (Primary Plant Segment), producing on the order of 200 kW of electrical power. Aft of the reactor is the Radiation Shield Segment, which provides a conical shadow of reactor radiation attenuation to the remainder of the DSV. Control and monitoring for the reactor is provided by the Reactor Instrumentation and Control Segment, with elements located both in the vicinity of the reactor and in protected areas of the spacecraft bus.

Aft of the Reactor Module is the Spacecraft Module, the configuration of which is dominated by the ~43 m long main boom assembly. This boom is used to mount the radiator panels of the Heat Rejection Segment, necessary to dispose of waste heat from the Reactor Module. The main boom also provides a significant separation distance of electronic components housed in the spacecraft bus from the reactor, resulting in reduced requirements for the reactor radiation shield. At the aft end of the boom is the Spacecraft Bus Segment, which contains the majority of the electronic subsystems needed to control and operate the DSV. Main propulsion is provided by Ion and Hall thrusters mounted on two deployable thruster pods, making up the Electric Propulsion Segment of the Spacecraft Module. A spacecraft docking adapter (Docking Segment) is also included in the Spacecraft Module to support early on-orbit operations and docking with the interplanetary transfer stages. The docking adapter provides power, communications and attitude control functions for the DSV in the post-launch phases through deployment and commissioning.

Finally, the Mission Module comprises the suite of instruments and supporting elements that would be mounted to the DSV, primarily in the area of the Spacecraft Bus. The Mission Module would be unique to each mission, but would likely include common mounting elements including a scan platform and turntable.

A detailed layout of the Bus Segment of the Spacecraft Module, incorporating a reference instrument suite for the JIMO mission, is shown in Figure 9.2-2.

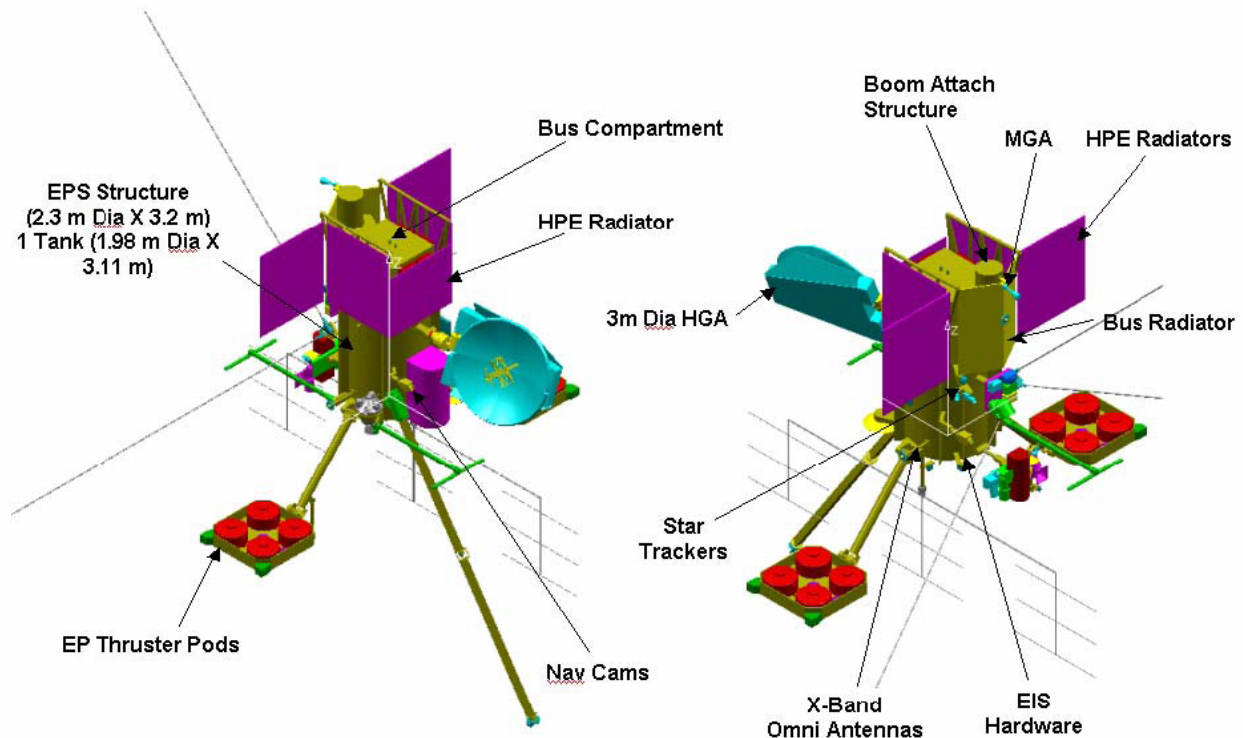

Figure 9.2-2. DSV Dimensions Bus Layout.

A number of trades were performed in the early development of the overall DSV configuration to devise an optimized design. These trades were highly interdependent in many cases and involved a combination of configuration trades and multimission-related trades that derived from extensive analysis using a system model. An illustration of the range of DSV trades performed is presented in Figure 9.2-3.

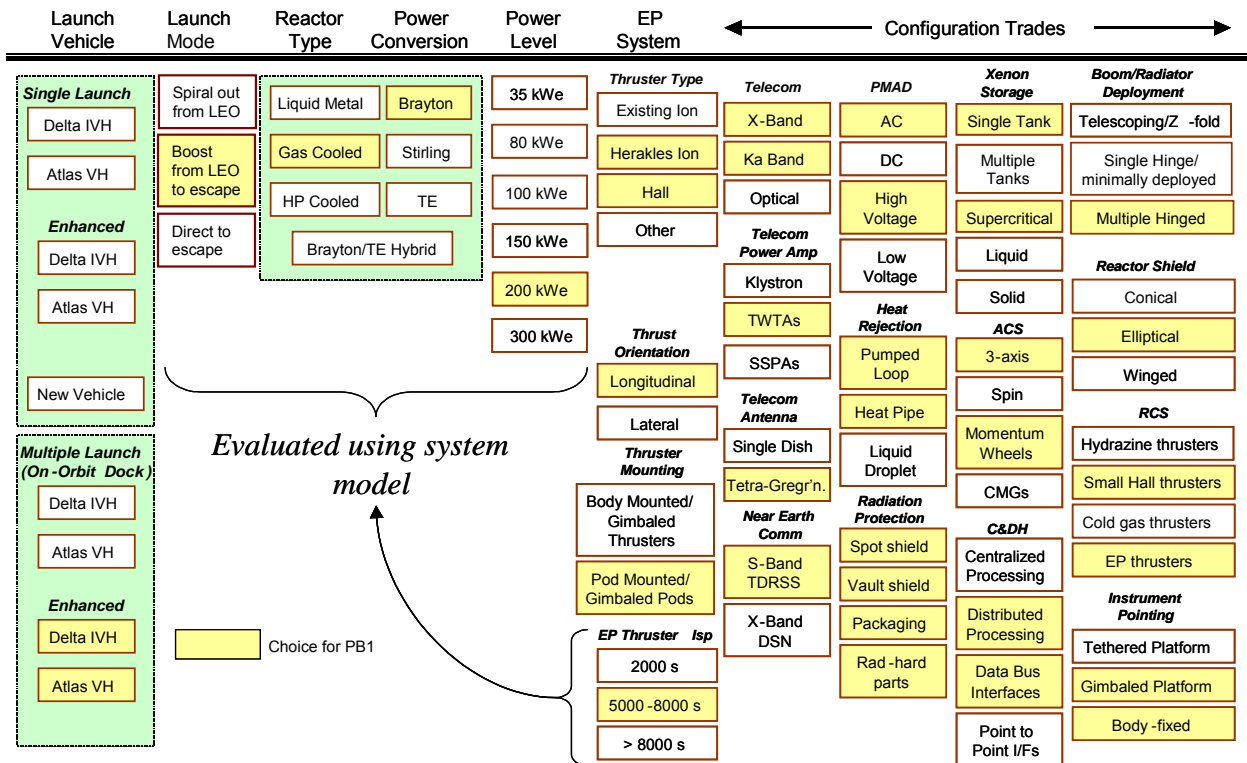

Figure 9.2-3. DSV Trade Summary.

The set of these trades led to the development of the DSV configuration illustrated in Figure 9.2-1. Details on trade studies performed in support of the Prometheus DSV development can be found in the Trade Studies Report, Volumes I and II.

A simplified DSV block diagram is shown in Figure 9.2-4.

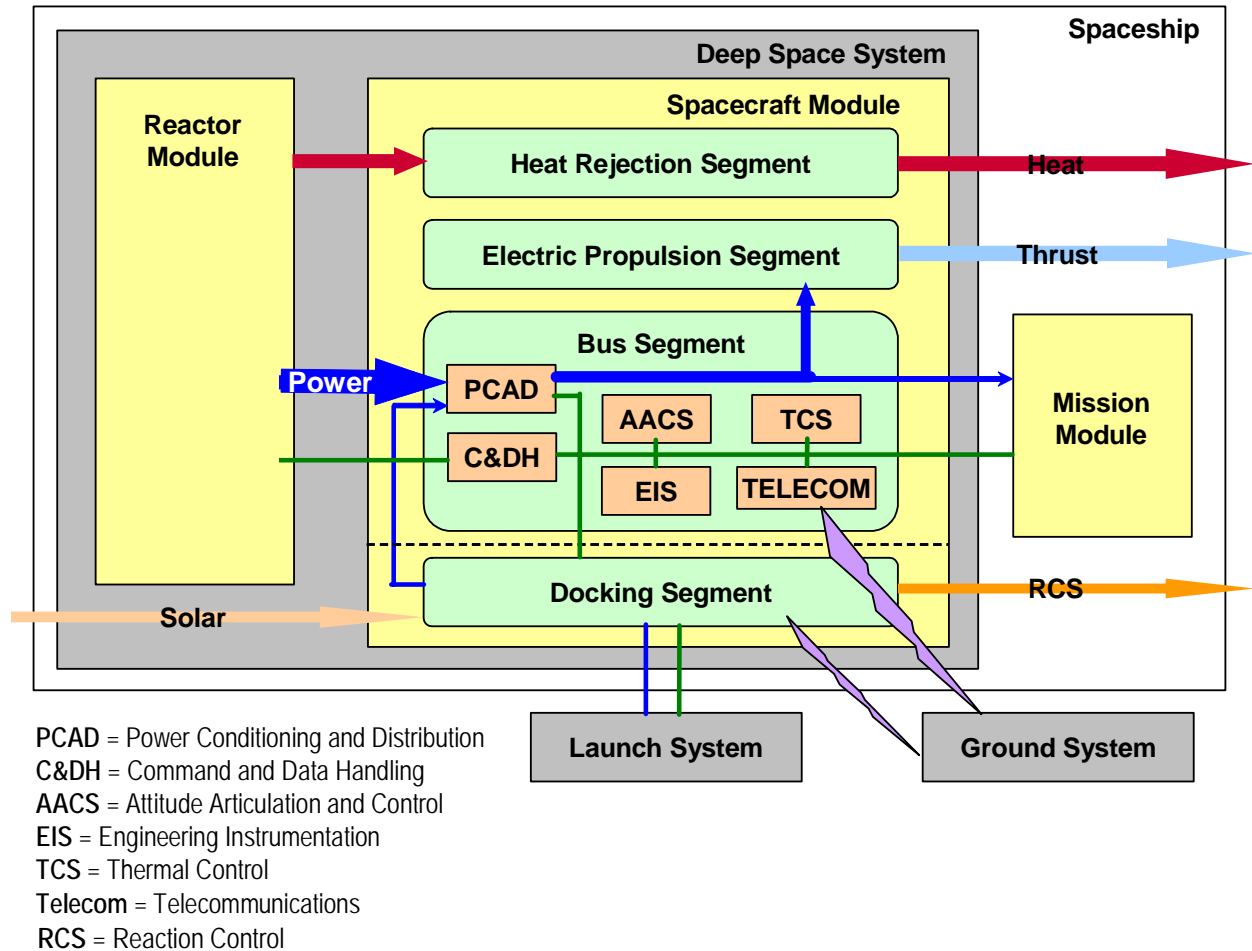

Figure 9.2-4. Deep Space Vehicle Block Diagram.

This diagram illustrates all major modules and segments of the DSV (including a breakout of the subsystems included in the Spacecraft Module Bus Segment) and their internal and external interfaces.

The Project Single Point Failure Policy requires that no single failure shall result in a significantly degraded mission or prevent the attainment of certain objectives). Thus, the Spacecraft Module has block redundant hardware in the majority of the engineering subsystems. In some specific cases, N + K type redundancy was deemed more effective where N units are required for full capability but K units are flown.

Mass estimates for the components of the DSV have been compiled in a detailed Master Equipment List (MEL). A summary mass table, showing major contributors to the subsystem level, is shown in Table 9.2-1.

Table 9.2-1. Summary Mass List.

Description	CBE Total Mass (kg)	Uncertainty Allocation %	Uncertainty Allowance (kg)	Design Growth Allowance (DGA)	Estimated Mass at Launch (EML) (CBE + UA + DGA) (kg)
Commissioned Spaceship Wet Mass	26681				35102
Commissioned Spaceship Dry Mass	15462				23102
Launch Vehicle Lift Capability					
Spaceship Wet Mass at Launch	27660	25%	6870		36375
Propellant	11220	3%	280	500	12000
Spaceship Dry Mass at Launch	16441	40%	6589	500	24375
Mission Module	1060	30%	320	120	1500
Reactor Module	3309	80%	2648	225	6182
Spacecraft Module Dry Mass (Includes APS)	12071	30%	3621	500	16193
Spacecraft Module	11961	30%	3588	500	15550
Heat Rejection Segment	2566	30%	770		3336
HRS Heat Rejection Subsystem	1553	30%	466		2019
HRS Structures & Mechanisms Subsystem	1013	30%	304		1317
Electric Propulsion Segment	1996	30%	599		2595
EPS Structures & Mechanisms Subsystem	134	30%	40		174
EPS Thermal Control Subsystem	88	30%	26		114
Ion Thruster Subsystem	396	30%	119		515
EPS Hall Thruster Subsystem	272	30%	82		353
EPS Power Processing & Control Subsystem	548	30%	165		713
EP Propellant Feed Subsystem	558	30%	167		726
Bus Segment	6530	30%	1959		8489
Bus Structures and Mechanisms Subsystem (SMS)	3418	30%	1025		4443
Bus Thermal Control Subsystem	327	30%	98		425
Bus Attitude and Articulation Control Subsystem	371	30%	111		483
Bus Power Conditioning and Distribution Subsystem	737	30%	221		958
Bus Command and Data Handling Subsystem	212	30%	64		276
Bus Telecommunications Subsystem (COMM)	134	30%	40		174
Bus Cable and Harness Subsystem (C&HS)	1265	30%	379		1644
Engineering Instrumentation Sybssystem	67	30%	20		87
Docking Segment (DKS)	869	30%	261		1130
Spacecraft Docking Adapter Subsystem	869	30%	261		1130
Reactor Module	3419	78%	2681	250	6100
Aerothermal Protection Segment	110	30%	33		143
APS Subsystem	110	30%	33		143
Reactor Module (GFP) Segments	3309		2648		5957
Reactor Core Segment	1569	80%	1255		2823
Radiation Shielding Segment	448	80%	359		807
Reactor I&C Segment	207	80%	166		373
Power Conversion Segment	1085	80%	868		1954
Turboalternator Assembly	204	80%	163		367
Recuperator Assembly	572	80%	458		1030
Gas Cooler Assembly	184	80%	147		331
Interconnect Equipment	84	80%	67		151
PCS Thermal Control Subsystem	41	80%	33		75
Mission Module	1060	30%	320	120	1500

The wet mass of the Spaceship, including a 1500 kg allocation to the Mission Module and 12,000 kg of Xenon propellant, is 36,375 kg. This mass includes a 30% mass margin, as well as specific allocations for design growth allowance as detailed in the table. Margins for the Prometheus Project are described in detail in the Technical Margins Management Plan. An example of the application of margins, including a description of the nomenclature, is presented in Figure 9.2-5.

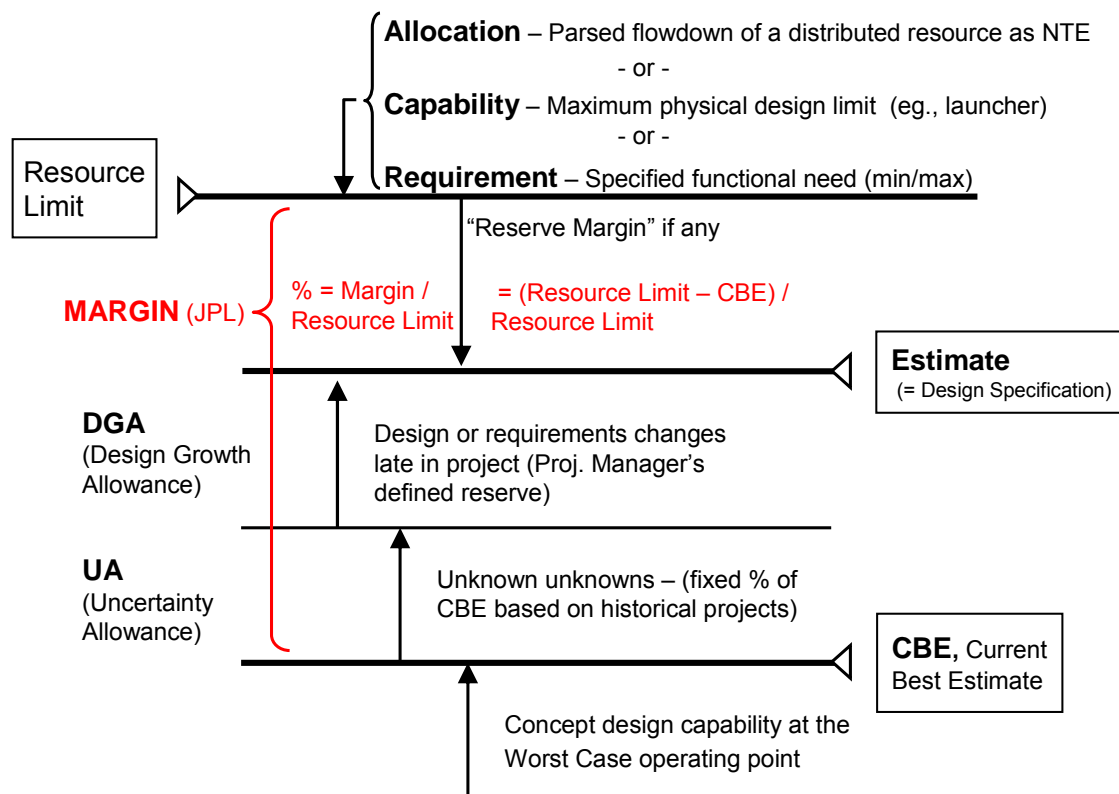

- Notes:**
- 1). CBE system = sum of CBE of each key element.
 - 2). DGA added at the system level on top of the Subsystem DGA levels.
 - 3). Margin amount shrinks to zero as project maturity improves.

Figure 9.2-5. Technical Resource Margins.

9.2.1 Reactor Module

The Reactor Module is envisioned to be the primary energy source for the Prometheus Spaceship. As described in Section 4, the NRPCT was the lead for design and delivery of the Reactor Module, and was supported by DOE national labs (primarily ORNL, LANL, PNNL, INL and Sandia) and NASA Centers (primarily GRC, JPL and MSFC). The NRPCT completed three milestones to support PMSR:

- Feasibility Study
- Concept Selection
- Space Reactor Planning Estimate

The Feasibility Study concluded that there is a design space to provide a nuclear power plant to support a deep space mission using Nuclear Electric Propulsion (NEP).

The Concept Selection determined that a direct gas-Brayton cycle nuclear power plant was the best choice to support the Prometheus NEP mission. The primary reasons for this selection were:

- Simpler, more deliverable system
- Lower likelihood of unforeseen setbacks
- Challenges appear to be solvable
- Fewer components
- Easier system to test on earth
- More extensible to surface missions
- Scalable over the range from 20kWe to 300 kWe

As shown in Figure 9.2-6, the Reactor Module consists of the following segments:

- Reactor
- Radiation Shield

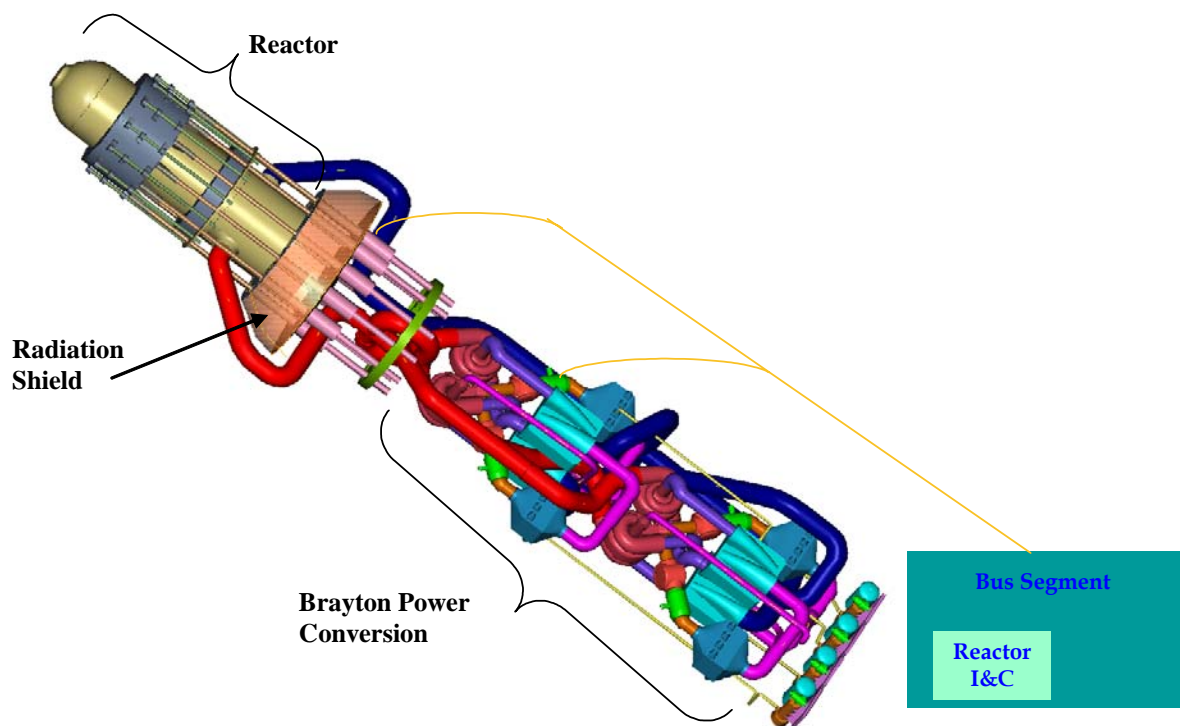

Figure 9.2-6. Reactor Module.

- Brayton Power Conversion
- Reactor Instrumentation and Control (I&C) – within the Bus Segment

The Reactor Module would be enclosed within structural support and micrometeoroid protection systems. Also, a detachable aeroshell is envisioned that could slow the reactor down and protect it from disassembly during an inadvertent atmospheric re-entry condition.

The Space Reactor Planning Estimate (SRPE) provided an initial design, development and delivery plan and resource estimate. The Reactor Module technology development planning within the SRPE focused on the main project delivery risks:

- Nuclear Fuel Material System Performance
- Reactor Neutronic Performance
- Power Plant Dynamic Performance
- Gas System Hermeticity
- Integrated System Material Compatibility
- Power Conversion System Reliability
- Radiation Hardening of Electronics

To address these risks, extensive testing would be required, including a ground test reactor. A summary of the final project status for the Reactor Module is documented in NRPCT's Final Closeout Summary Report.

9.2.1.1 Aerothermal Protection Segment

The Aerothermal Protection System (APS) design features a stand-off aeroshell (Figure 9.2-7) that provides a smooth outer mold line simplifies the prediction of the reentry aerodynamics and aeroheating. The APS uses a carbon-phenolic thermal protection system material supported by a titanium backing plate that covers only the reactor section. Within the APS is a locator beacon, to assist in locating the reactor assembly after a launch failure. The APS attaches to a titanium ring at the "hard point plane" at the reactor and radiation shield interface. The APS is jettisoned immediately before reactor start-up to eliminate potential interference with reactor operation and eliminate the need for APS materials to survive the reactor operational environment.

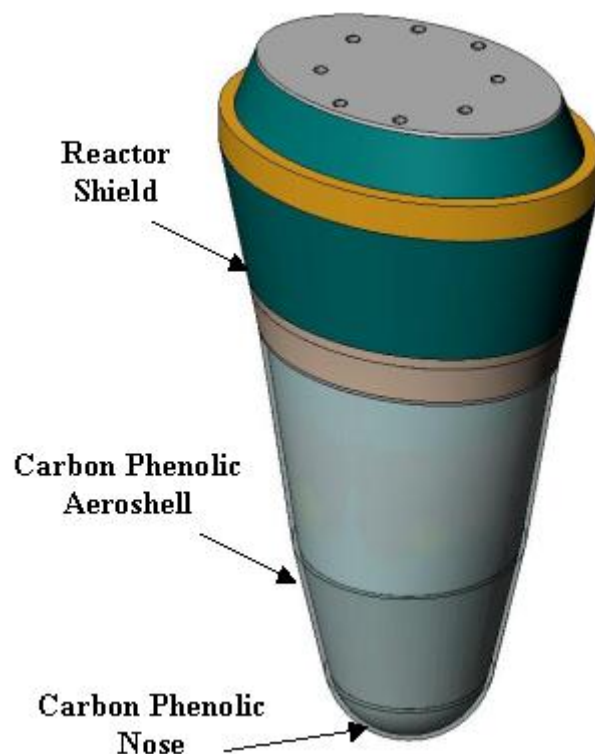

Figure 9.2-7. Aerothermal Protection System Attached to Reactor Shield.

Thought this segment is part of the reactor Module, the responsibility for the design and delivery of the APS to NRPCT lies with NGST. A co-design team of NGST and their Subcontractor, Sandia, and the government Team led by ARC, was established to work the conceptual issues. Further integration of the Government/NGST/Sandia work into the NRPCT efforts would have been required and pursued early in Phase B.

9.2.2 *Spacecraft Module*

NGST was awarded the Co-design Contract for the Spacecraft Module and the Aerothermal Protection Segment of the Reactor Module. This Contract was formed in such a way that design/management teams consisted of NGST personnel and Government personnel. Each team was led by the Design Agent organization as defined in the RAM (Appendix D). The basic structure for the co-design team and spacecraft Module organization is shown in Figure 9.2-8. This approach was utilized to assure that the best utilization of the national skill base was brought to bear on the complex and unique problem of designing this first-of-a-kind spacecraft. An additional benefit was the insight that the Government Team was able to get into the design was much higher than in a normal contracting mode by being involved in the day-to-day processes of conceptual and preliminary design.

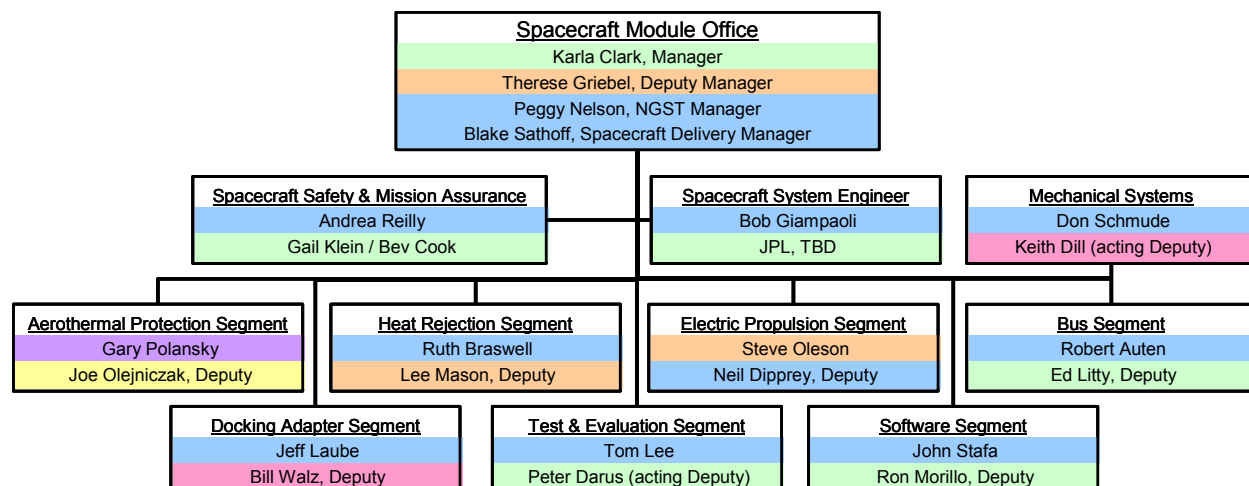

Figure 9.2-8. Spacecraft Module Organization.

The Spacecraft Module provides overall command and control of the Prometheus Spaceship and interfaces with the ground system via the uplink and downlink paths. Other functions include performing Spaceship attitude and trajectory control to execute the mission. The Spacecraft Module provides mechanical, electrical, and thermal interfaces with the Reactor Module and provides the heat rejection function. The Spacecraft Module also provides mounting interfaces for Mission Module equipment, and supplies services such as power, command and data processing, pointing, etc to the Mission Module instruments.

The Spacecraft Module was designed to meet the applicable Key Driving Requirements (KDRs) as levied by the Spaceship. A complete listing of these KDRs can be found in the Deep Space Vehicle Level 3 Key Driving Requirements Document. An example of some of those requirements that apply to the Spacecraft Module, and the implementation response, is provided in Table 9.2-2.

Table 9.2-2. Example Spacecraft Module Key Driving Requirements.

Level 3 Key Driving Requirement	Implementation Response
The Spaceship total mass at launch shall not exceed [37000] kg.	<ul style="list-style-type: none"> 12071 kg SM dry mass CBE consistent with Spaceship EML of 36375 kg
The Spaceship design (minus consumables) shall be capable of operating within specification for at least 20 years after launch.	<ul style="list-style-type: none"> Parts selection based on qualification and maturity that exhibit FIT rates that support the reliability required for a 20 year mission. Establish part derating for a 20 year mission based on failure modes analysis
The Spaceship launch configuration shall be compatible with a [5] m launch vehicle payload fairing (dynamic envelope dimensions 4.5 m diameter, 26 m height), or smaller.	<ul style="list-style-type: none"> The PB1 stowed configuration fits within a 4.5 m diameter X 26 m tall Fairing Envelope.
The Reactor Module in its full power mode shall provide total electrical output power of at least [200] kW to the Spacecraft Module.	<ul style="list-style-type: none"> Spacecraft sized for 200 kW load control.

Each Segment/Subsystem generated, and presented at the PMSR, its KDRs, functions and interfaces, operations strategy, key trades, implementation, and near-term future work plans.

The Spacecraft Module consists of five segments: the Heat Rejection Segment (HRS), Electric Propulsion Segment (EPS), Bus Segment, Docking Segment and Software Segment.

The HRS is responsible for rejecting excess thermal energy from the Reactor Module. Three subsystems make up the HRS: Structures & Mechanisms (HRS-SMS), Thermal Control Subsystem (HRS-TCS) and Heat Rejection (HRS).

The EPS is responsible for providing the electric propulsion capability. The EPS is comprised of six subsystems: Structures & Mechanisms (EPS-SMS), Thermal Control (EPS-TCS), Ion Thruster, Hall Thruster, Power Processing & Control and Propellant Feed.

The EPS includes Ion Thrusters (ITs) and Hall Effect Thrusters (HETs) mounted on two pods. Each pod contains four Ion Thrusters, three large Hall Effect Thrusters for thrust augmentation and six small Hall Effect Thrusters for attitude control. The power and Xenon fuel feeds are controlled internally in the EPS by eight Ion Thruster Power Processing Units (PPUs) and Xenon Feed Controls (XFCs) respectively, six large Hall Effect Thruster PPU and Xenon Feed Controls, and six small Hall Effect Thruster PPU and Xenon Feed Controls. AACS will control the electric propulsion valve drive electronics.

The majority of the electronic spacecraft subsystems comprise the Bus Segment of the Spacecraft Module. Those subsystems include: Attitude and Articulation Control (AACS), Command and Data Handling (C&DH), Power Conditioning and Distribution (PC&D), Bus Structures and Mechanisms (Bus-SMS), Bus Thermal Control (Bus-TCS), Telecommunications, Cable & Harness (C&HS) and Engineering Instrumentation (EIS).

The Attitude and Articulation Control Subsystem (AACS) is depicted in the right-lower corner of the block diagram. All of the AACS pointing algorithms and control loops are executed by the FCA in the C&DH subsystem. There are three Inertial Measurement Units (IMUs) and four Star Tracker Assemblies (STAs) present in the AACS. One IMU is located on the HGA and one IMU and two STAs are located on the scan platform (part of the Mission Module). AACS also controls all the Spacecraft Module Gimbal Drives and their related electronics (GDEs) (e.g. the MGA gimbal drive and deployment actuator, and the EP deployment actuators and steering gimbals). In addition, the AACS is responsible for the pointing of the electric thruster pods to maintain the appropriate Spaceship attitude and trajectory. Reaction wheels are used for control during science collection. Finally, mission unique Pointing Control System algorithms, in conjunction with the AACS components and algorithms, will control Mission Module scan platform GDEs to maintain precision platform pointing.

The Command & Data Handling (C&DH) Subsystem resides in the Bus Segment of the Spacecraft Module. Major components include the Flight Computer Assembly (FCA), Data Storage Assembly (DSA), High Capacity Recorder (HCR), Science Computer Assembly (SCA), Fault Monitoring Assembly (FMA) and Electrical Integration Assembly (EIA). The FCA controls most of the on-board spacecraft functions; it is connected to other spacecraft subsystems through a MIL-STD-1553B interface. The SCA is also connected to the same MIL-STD-1553B interface, although its primary interface is a IEEE 1394A connection. This IEEE 1394A interface connects the SCA, DSA, Mission Module and the Engineering Instrumentation Subsystem (EIS). The HCR is directly connected to the SCA through a high speed interface as well. The HCR is responsible for storing all science and engineering data for downlinking. The FMA is responsible for monitoring the FCA for faults and performing all associated fault protection functions (such as swapping computers). The Reactor Module will include its own control computer, which is part of the Reactor Instrumentation & Control (I&C) Segment. The FCA, PCAD and reactor module I&C are connected by a dedicated MIL-STD-1553B data bus.

The Power Conditioning and Distribution (PCAD) Subsystem includes the battery, High Voltage Distribution Assembly (HVDA), Power Distribution Assembly (PDA) and start inverters. The battery provides power to the Spaceship during and immediately after launch and is responsible for providing power through solar array deployment. The solar arrays are located on the docking adapter, but are controlled by the PCAD subsystem. The solar arrays will be responsible for providing power to the Spaceship prior to the completion of reactor commissioning. They have been sized to provide power for all initial Spaceship functions, as well as for start up of the nuclear reactor. The battery will supply additional power to start up the Brayton power converters.

The Telecommunications Subsystem is made up of two large assemblies in the Bus Segment and one assembly in the Docking Segment. The Bus assemblies are the high gain antenna assembly and the bus communications assembly. The third assembly, located on the docking adapter, is the S-Band assembly. The high gain antenna assembly consists of a gimbaled 3m tetragregorian antenna operating in both Ka and X bands. The Ka-portion of this is the primary deep space uplink/downlink. The bus communications assembly consists of a gimbaled X-Band medium gain antenna and three low gain antennas. The medium gain antenna is used for telemetry data, as well as commanding of the spacecraft. The low gain antennas are used for telemetry and commands near Earth. The third assembly is the S-Band assembly located on the docking adapter, which is used for telemetry and command during earth orbit operations. The entire Telecommunications Subsystem is inter-connected by a MIL-STD-1553B interface.

The Engineering Instrumentation Subsystem (EIS) is depicted in the right-upper portion of the block diagram. The main purpose of this subsystem is to provide engineering data for the analysis of the environment in and around the Spaceship to better anticipate performance and to investigate anomalies. All of the EIS instruments will be connected to the MIL-STD-1553B interface, with exception of the EP Plume Camera and Self-Inspection Camera, which must be connected to the IEEE 1394A interface due to their higher data rates.

The Docking Segment is comprised of the Spacecraft Docking Adapter Subsystem and the Transfer Stage Docking Subsystem, as well as the software needed to execute autonomous rendezvous and docking operations. The docking adapter contains solar arrays, telecommunications and other components necessary to operate the Spaceship in Low Earth Orbit. It also serves as a launch vehicle adapter, providing the interface between the Spaceship and the launch vehicle during launch.

The Software Segment consists of the software residing in the FCA and the DSA and the core portion of the software in the SCA. The FCA software performs system level command sequencing, system level and internal fault protection, decodes Spacecraft Module commands, formats spaceship telemetry, implements AACCS and Autonomous Navigation functions, and implements Spacecraft Module engineering housekeeping functions. The DSA software manages the HCR, implements file transfer and tbd management protocol and controls data compression and telemetry encoding functions. Due to the commonality of avionics hardware with the DSA and the FCA, there is a common core of software capabilities in the SCA that is provided by the Software segment (for example: device drivers and interfaces layer). The mission-unique capabilities in the SCA are provided by the Mission Module.

The Spaceship block diagram (Fig. 9.2-9) highlights major subsystem components along with their internal and external interfaces as well as internal subsystem breakdowns.

The current configuration of the Spacecraft Module represents a point design that was frozen at a conceptual stage in its development in order to allow time to prepare for the Prometheus PMSR. While it is a reasonable and cohesive design, providing accommodation of the key driving requirements imposed by the project, a number of opportunities for refinement and further study exist and were to be addressed during the Preliminary Design phase. Chief among these is the accommodation of the newly chosen Gas Cooled Reactor (GCR) design. Prior to the NRPCT selection of the GCR for Prometheus, the majority of configuration work had assumed the incorporation of a liquid metal reactor as a working baseline. The GCR-based Reactor Module brings with it the need to reassess and refine the Spacecraft Module conceptual design and its interfaces to accommodate this alternate reactor concept. The major areas of impact would be the Heat Rejection Segment and the Power Conversion Subsystem. Other minor impacts would need to be addressed as well.

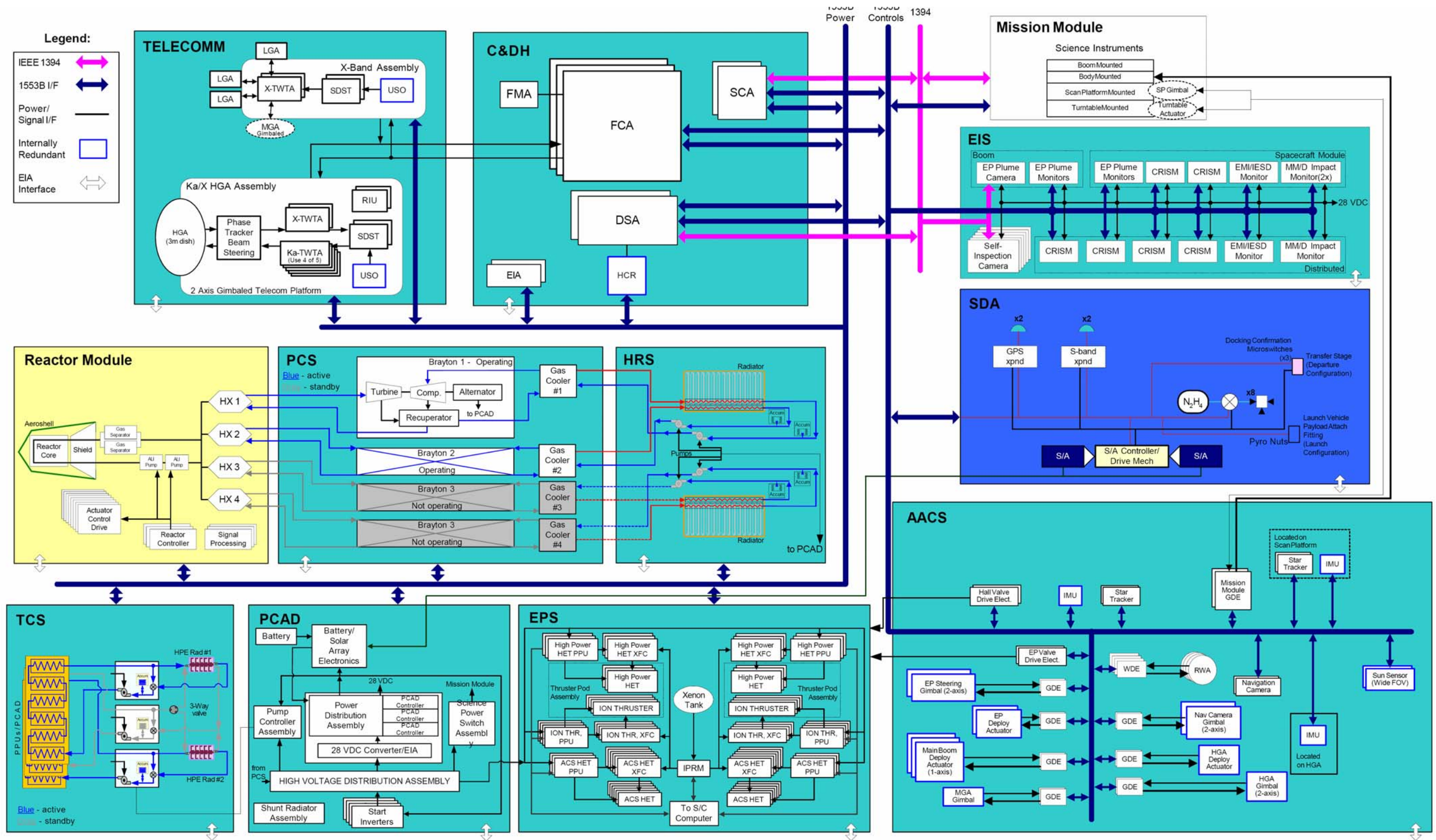

Figure 9.2-9. DSV Block Diagram.

[This page intentionally left blank]

9.2.3 *Mission Module*

The Mission Module is not a part of the DSV but the accommodation of the Mission Module drives the design requirements imposed on the DSV. The Mission Module is comprised of the science instruments and associated flight components needed to meet the science requirements. Design of the Mission Module will depend upon the science investigations to be undertaken for a particular mission. For many missions (including the JIMO mission), the Mission Module will contain the following elements (or a subset):

- Science instruments
- A scan platform for imaging instruments that require precision pointing
- A rotating turntable for particles and fields instruments
- Instrument support structure and booms
- Electronics assemblies such as star trackers, IMU and gimbal drive electronics
- Flight software

As the science payload has not yet been defined, a reference suite of science instruments was selected for use in designing the JIMO Mission Module. These instruments are representative of the investigations that the science team envisions. This suite of instruments was then used to develop a Payload Accommodation Envelope (PAE) that is representative of science payloads for all potential Prometheus missions. The PAE was used to drive out requirements on the DSV, as well as to establish constraints for the science investigations in the future.

Accommodating the instruments requires the DSV to supply a number of resources, including mass, power, physical area and volume, clear fields-of-view (FOV), data transfer rates, data storage volume, thermal interfaces, centralized data processing, pointing and commanding. There are three general locations for science instruments, with allocations for the maximum physical volumes to be occupied: the Spacecraft Module Bus (2.5 m³, including any lander or other auxiliary payload), the scan platform (1 m³) and the turntable (0.75 m³). The mass allocation for the Mission Module is 1500 kg. Power available to the payload is 3 kW when thrusting with electric propulsion, and 18 kW when not thrusting. Power is supplied in the form of 28 VDC and 440 VAC. Data storage of 500 Gbits is provided by the Spacecraft Module, with an aggregate data transfer rate of 250 Mbps from the payload to the spacecraft. Data moves back and forth between the Mission Module and the Spacecraft Module over MIL-STD-1553B and IEEE 1394A data buses. Computing capability is provided by RAD750 processors in the science computers, which are part of the spacecraft C&DH subsystem. Pointing of the spacecraft bus is the responsibility of the Spacecraft Module, while the Mission Module will take responsibility for pointing of the scan platform and turntable. However, execution of the pointing control loops will be accomplished within the spacecraft C&DH.

A more detailed description of the JIMO Mission Module can be found in the Science System section of this document (Section 8).

9.3 Spaceship Verification and Validation Plan

The Spaceship Verification and Validation (V&V) approach includes early validation that requirements are implementable and that design concepts satisfy mission objectives. The early validation is followed with formal verification to prove that all the requirements are satisfied and concludes with system validation during ATLO and on-orbit commissioning. The plan includes incremental assembly and test with significant use of testbeds incorporating mission operations components, verification by analyses using validated tools and models when test is not practical, developmental tests, pathfinders and early integration activities with ground, science and launch systems. The V&V plan includes the validation of test facilities and test support equipment models and simulations to ensure they have proven fidelity to perform verification.

The V&V approach is incremental such that the hardware and software are integrated at the lowest level possible and the systems are built up from the pieces. Thus, assemblies are integrated and tested first, then built into subsystems, then segments, then modules and finally into systems. This approach allows for the verification of DSV requirements prior to incorporating the Mission Module into the Spaceship. Multi-mission requirements can be verified before constraints imposed by the incorporation of the Mission Module are imposed.

9.3.1 *Spaceship Verification, Integration and Test*

Test activities were worked more extensively during Phase A on Prometheus than typical for other programs. This was to provide sufficient detail to ensure cost credibility given the multi-organizational nature of Prometheus. Although there were numerous telecons to coordinate V&V activities, the primary event that defined these details was a team meeting held at Kennedy Space Center on June 8-9, 2005. Two key products resulting from this meeting are the V&V Roadmap shown in Figure 9.3-1 and the detailed event flow for the Spaceship Integration and Test.

The V&V Roadmap shows the key elements of the Spaceship V&V activities and key milestones for Ground System compatibility testing. The activities include incremental assembly and test with significant use of testbeds incorporating mission operations components, simulation models, developmental tests, pathfinders, and early integration activities with the ground, science, and launch systems. This provides an integrated approach to ensure that all requirements are verified prior to launch and the system is validated through end-to-end demonstrations using both flight systems and high-fidelity simulations.

This section provides details related to the development tests, pathfinders, proto-flight test program (ATLO), and inter-system validation. Items associated with simulations and testbeds are addressed in a subsequent section.

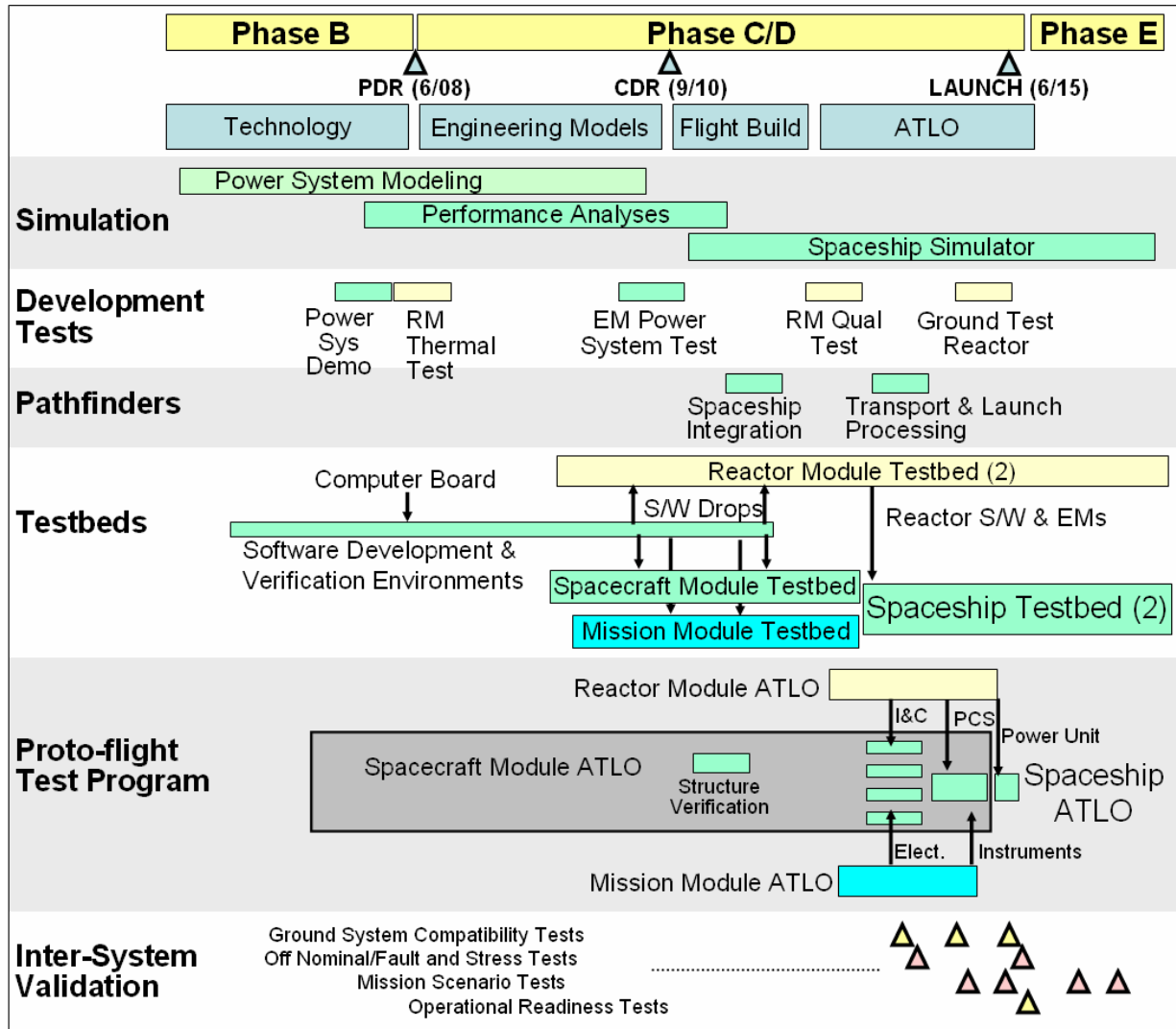

Figure 9.3-1. SpaceShip Verification and Validation Roadmap.

9.3.2 *Development Tests*

The development test activities emphasize the Reactor Module's gas cooled reactor and the associated power conversion system (PCS). There are five development tests associated with the Reactor Module that commence with an initial single string Brayton power system demonstration and evolve to a final development test utilizing the Ground Test Reactor to assess cold and hot physics parameters associated with the operation of this highly enriched nuclear reactor. This series of tests validates that a thermal-driven turbo-alternator (Brayton engine) produces electrical power to start an ion propulsion system while exchanging and rejecting excess heat loads. Details of each development test are shown below.

- Power System Demonstration Test (single string demo) (at GRC)
 - Purpose is early proof of concept for high power thruster
 - Single-string Brayton Power Conversion System (PCS)
 - Single panel Heat Rejection System (HRS)
 - Single Ion Thruster from the Electric Propulsion Segment (EPS)
 - Partial Power Conditioning and Distribution (PCAD) Subsystem
- RM Thermal Test Model (at MSFC)
 - Purpose is initial characterization of the Reactor Module
 - Electrical mock-up of the Reactor Module
 - Single-string PCS
- EM End-to-End Power System Test (full string) (at Plum Brook or JSC)
 - Purpose is first end-to-end test that validates power system design
 - Full-string (assumed to be 3 Brayton engines) PCS
 - Full HRS
 - Full PCAD Subsystem
- RM Qualification Test (at Plum Brook or JSC)
 - Purpose is qualification of Reactor Module flight design and hardware
 - Entire Reactor Module using electrical heaters
 - HRS and PCAD obtained from the End-to-End Power System Test
- Ground Test Reactor (nuclear fueled) (at tbd NRPCT facility)
 - Purpose is assessment of reactor hot and cold physics parameters
 - Primary component is the fueled reactor, other subsystems are optional

9.3.3 *Pathfinders*

Pathfinders would be used for early verification of form and fit. A pathfinder is a full-scale simulation (mockup) of hardware to verify mechanical assembly, transportation, and/or handling processes. This approach reduces program risk that could impact the program launch date.

Pathfinders are used for all system deployment operations to validate design, manufacturing, and test processes. Once deployment operations are validated, the pathfinder activity validates ATLO operations, including welding of the EM Reactor Module with the pathfinder.

9.3.4 *Spaceship AI&T*

Spaceship AI&T activities address the integration of three modules:

- Reactor Module
- Spacecraft Module
- Mission Module

Additionally, Spaceship AI&T addresses activities at the launch site. These three modules and the launch site activities are documented in the subsequent sections. A detailed graphical diagram of these AI&T activities is archived in the Project V&V Section of the Prometheus DocuShare system.

Overall V&V Spaceship V&V activities are documented in NGST Prometheus Space System V&V Plan and specific ATLO activities are documented in the NGST Spaceship Assembly, Integration, Test, and Launch Operations Plan.

9.3.5 *Reactor Module AI&T*

The Reactor Module is a gas cooled reactor with direct coupling to the Brayton Power Conversion Subsystem. It consists of the Reactor Power Unit (core, vessel, reflectors, safety rod, and control drive mechanisms), the Reactor Power Equipment (shield, piping, and Reactor Module Support Structure), Reactor Module Instrumentation and Control, Power Conversion, and Aerothermal Protection (aeroshell).

Four options were identified for integration of the Reactor Module with the Spacecraft Module, as shown in Figure 9.3-2. In each of these options, there were two steps for integrating the Reactor Module to the Spacecraft Module, with an overall goal of providing the nuclear fuel as late as deemed practical (to reduce handling efforts). The first integration step is the early integration of an initial portion of the reactor qualification model and the second step is the integration of the final fueled reactor components that would occur at Kennedy Space Center. The variation between the options depending upon how much of the Reactor Module was involved in each of these two steps.

Core Cartridge	Power Unit	Power Unit + Shield	Reactor Module
	Selected as PMSR Baseline 		
<ul style="list-style-type: none"> + Good weld access + Maximum flight H/W in system test - Power unit verification at KSC - Weld damage repair 	<ul style="list-style-type: none"> + Power unit functionality pre-validated + Early I&C test w/ SM - Weld access may be problematic 	<ul style="list-style-type: none"> + Minimize complex shield integration operations at KSC - Weld access may be problematic 	<ul style="list-style-type: none"> + Lowest temp weld - Minimum flight H/W in system test - Late system verification - Oversized radiological shipping

Figure 9.3-2. Reactor Module Integration Concepts.

As shown in the figure, the first option had maximum Reactor Module flight components in the initial integration and the final integration at KSC just involved removal of the electrical heaters and installation of the nuclear-fueled “core cartridge”. The fourth option is at the other extreme where the electrically heated EM Reactor Module is installed for the initial integration and this was completely replaced with the flight-qualified and nuclear-fueled Reactor Module during final integration at KSC. Other options were in between these two extremes.

For PMSR, the baseline approach was to integrate the qualification Reactor Module, using electrical heaters with the Spacecraft Module. The integration at KSC involves removal of the electrically heated qualification model Reactor Power Unit and installation of the fully qualified and nuclear fueled version. Then piping to the Brayton units is welded, inspected, pressure tested, and the system charged with gas coolant. This is followed by a Reactor Module electrical and performance test to verify operation in this final flight configuration. The final step is the integration of the Aerothermal Protection Subsystem (aeroshell). With the Reactor Module integrated with the Spaceship, the Reactor Module performance is verified and the Spaceship transitions to more typical launch site activities as identified in the next section.

9.3.5.1 SPACECRAFT MODULE AI&T

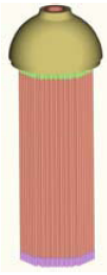
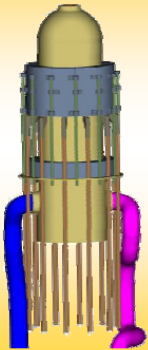
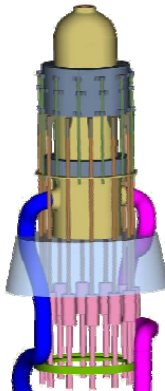
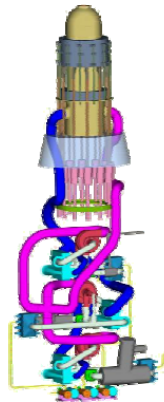
The Spacecraft Module (SM) integration consists of six elements as listed below. The testing planned for each segment and associated subsystems is summarized in Figure 9.3-3.

- Heat Rejection Segment (HRS)
- Electric Propulsion Segment (EPS)
- Bus Segment
- Docking Segment
- Aerothermal Protection Segment (Aeroshell) – provided by the Spacecraft Contractor as a part of the Reactor Module
- Flight Software Segment

The AI&T activities for all SM segments proceed in parallel, with the first segment integration activity being between the bus and the EPS segments. Prior to this, all Bus assemblies have been integrated and tested at the Bus Segment level. Similarly, the EPS has also been assembled and tested. The solar arrays are added to this combined bus and EPS for vibration testing and thermal-vacuum testing. After thermal-vacuum testing, the solar arrays are removed.

Next is integration of the HRS with the Bus and EPS. The HRS Structures and Mechanisms Subsystem provides the structural spine for the Spacecraft Module. This HRS integration consists of installation of the radiator panels on main boom sections; connecting boom segments with the deployment mechanisms; welding HRS coolant lines; and installation of the wire harness through the booms. Preliminary alignments of thrusters and sensors occur during this mechanical integration. This integration completes the majority of the Spacecraft Module integration activities.

This integrated Spacecraft Module undergoes pressure testing of the H₂O loops, electrical validation, system polarity tests, and functional performance testing. At this point the Spacecraft Module is ready for Mission Module integration and subsequent EMI/EMC, dynamics, first motion, and limited performance tests, and shipped to the Thermal-Vac facility. Following Thermal-Vac testing, it is shipped to KSC for launch activities.

Segment	Subsystem	Type		Test Levels		Description of Development Test	
		Distributed	Modular	Development	Proto-flight		New Technology
PCHRS	Heat Rejection Subsystem (HRS)		●	●	●	●	<p>HRS</p> <ul style="list-style-type: none"> • DM level functional and life testing of water heatpipes at flight-like temperatures and radiation environments • DM level functional and life testing of NaK pumps at flight-like temperatures • DM level testing of radiation tolerant materials, brazes and bonds for radiator panel assemblies <p>COMM</p> <ul style="list-style-type: none"> • Assembly level range testing (high power TWTA testing, data rate verification) • Segment AI&T & ATLO DSN compatibility testing • Segment AI&T & ATLO Ground System compatibility testing <p>SMS</p> <ul style="list-style-type: none"> • Protoflight modal survey, acoustics, and static structural tests on primary flight structure with mass models • ATLO: full deployment test, acoustic & pyro-shock tests in stowed configuration followed by first motion deployment test
	Structures and Mechanisms Subsystem (SMS)	●			●		
EPS	Ion Engines Subsystem (IES)	●		●	●	●	
	Structures and Mechanisms Subsystem (SMS)	●			●		
	Thermal Control Subsystem (TCS)	●			●		
BUS	Attitude, Articulation & Control Subsystem (AACS)	●			●		
	Power Conditioning and Distribution Subsystem (PCAD)	●			●		
	Command and Data Handling Subsystem (C&DH)	●			●		
	Reaction Control Subsystem (RCS)		●		●		
	Thermal Control Subsystem (TCS)	●					
	Communications Subsystem (COMM)		●	●	●	●	
	Structures and Mechanisms Subsystem (SMS)	●		●	●		
	Environmental Monitoring Subsystem (EMS)	●					
Cable and Harness (C&HS)	●			●			
DKS	Structures and Mechanisms Subsystem (SMS)	●			●		
	Thermal Control Subsystem (TCS)	●			●		
	Cable and Harness (C&HS)	●			●		
APS	Structures and Mechanisms Subsystem (SMS)		●		●		
	Thermal Control Subsystem (TCS)	●			●		
	Cable and Harness (C&HS)	●			●		

Figure 9.3-3. Spacecraft Module Subsystem/Segment Testing.

9.3.5.2 MISSION MODULE AI&T

The Mission Module consists of various scientific instruments, including body-mounted instruments, scan platform-mounted instruments, and turntable mounted instruments. The instruments may be delivered separately and at different times. The Spacecraft Module provides time services, a platform-mounted inertial measurement unit (IMU) and star tracker, data, power, and structure necessary for the support of the instruments. This approach preserves flexibility in Mission Module I&T. It utilizes well-defined interfaces (a key feature of modularity) to adapt to potential variability in instrument delivery time or sequence order. It utilizes instrument mass, envelope, and interface simulators where necessary so the instruments' flight support equipment and structure can be assembled and tested without waiting for any specific flight instrument. It supports removal and replacement of simulators or instruments without impacting other installed equipment.

Because the science instruments will have been fully acceptance tested before delivery to Spacecraft Module I&T, verification will focus on the newly joined interfaces. However, to the extent that built-in test equipment or features are available in the instruments, these will be exercised when necessary.

After installation, the various instruments will be powered on and tested to verify their interfaces to the spacecraft module. An integrated compatibility test with the Deep Space Network (DSN) and operations control center will also occur. This test is a complete system end-to-end test, with commands and instrument sensor stimulations in and science data out at the control center via the space communications links.

9.3.5.3 LAUNCH SITE ACTIVITIES

Spaceship I&T continues after the Reactor Module integration with a Comprehensive Performance Test to validate the integrated performance of the overall Spaceship. Next, the DSN and Ground Station Compatibility Testing validates multi-system communication. The Spaceship then proceeds to the bake-out facility for microbe sterilization. A post bake-out system test is then performed to validate that all systems perform within requirements. Next the Reaction Control System and Electric Propulsion Segment Xenon tanks are fueled followed by a launch vehicle electrical interface verification test. The fairing is installed and launch processing continues with transportation to the launch pad. The Spaceship is integrated with the booster segment of the launch vehicle. Electrical interface testing is performed through the Spacecraft Docking Adapter Subsystem (SDAS). The Spaceship is launched after Transfer Stages 1 and 2 have been launched and verified as functional.

9.4 Spaceship Simulations and Testbeds

9.4.1 Overview

In support of the Prometheus development and test activities, various simulations, testbeds, and software development environments were identified as shown in Figure 9.4-1. This figure summarizes the quantities required and also the program phase and functional area for their use. Identification of these functional areas supports a dual role in that they clarify when the item is used and also provide the initial indication of the fidelity that is needed to support that use. Subsections below provide further details on the simulations, testbeds, and software development environments.

		QTY	Allocated Functions																				
			Dev Support				V&V				ATLO Risk Red		Mission/Ops Support										
			S/C Flight Software Dev	Reactor Module I&C Dev	Mission Module Software Dev	PCAD Software Dev	C&T Database Verification	Ground Software Validation	Spaceship Flight Software Validation	Reactor Module I&C V&V	Mission Module Software V&V	S/C Flight Software V&V	Mission Seq/Cmd Block Verification	Hardware Interface Checkout	Hardware/Software Integration Checkout	EGSE Checkout	ALTO Procedure Checkout	Mission/Ops Procedure Dev	Mission/Ops Procedure Validation	Flight Software Patch Validation	Patch Upload Procedure Dev	OPS Team Training	Anomaly Investigation and re-test
Testbeds	Mission Module Testbed (MMTB)	2			x																		
	Reactor Module Testbed (RMTB)	2		x							x												x
	Spacecraft Module Testbed (SMTB)	2					x	x				x		x	x								
	Spaceship Testbed	2					x	x	x	x	x	x	x	x	x	x	x	x	x	x	x	x	x
Sim	Spaceship Simulator	6					x	x								x	x				x	x	x
SW Dev	SW Dev & Ver Environment (SDVE)	2	x		x						x											x	
	PCAD Software Dev Environment	1				x																	
	RM SW Dev & Ver Platform (SDVP)	1		x							x												

Figure 9.4-1. Simulation and Testbed Utilization Analysis.

9.4.2 Simulations

Although there are several small simulations used for various trade studies, the primary simulation for Prometheus is the end-to-end Spaceship Simulator (SSS) that models the performance of subsystems and environments for different mission phases.

SSS capabilities include simulation of:

- Mission Module science data processing and return
- Environments and solar system bodies
- Trajectory control/orbit propagation.

The primary activities supported by this simulation include numerous trade studies, parametric analyses, assessment of the mission environments, development of mission operations procedures, and requirements verification through analysis. One key benefit of the SSS regarding these activities is that it can provide faster than real-time operations allowing for alternatives to be studied in a reasonable time frame.

This simulation is a workstation-based simulation with emulation of the FCA hosting the flight software. The SSS includes a high-fidelity AACS simulation, including the Vehicle Dynamic Simulation (VDS) and simulation of sensor inputs to the flight software. Telemetry and command processing is supported by the ground system software and database. Other subsystems are simulated to the extent necessary.

9.4.3 *Testbeds*

Four system-level testbeds have been identified in support of flight hardware, software, system integration, and the validation and verification of the Spaceship and its interfaces. These testbeds include one for each of the three Spaceship Modules (Mission Module, Reactor Module, and Spacecraft Module) and a fourth testbed for the Spaceship, which is actually just the integration of the module testbeds.

Additional details associated with the Prometheus testbeds are documented in the NGST Prometheus Testbed Plan.

9.4.3.1 **Reactor Module Testbed**

The Reactor Module testbed is used to execute nominal and stressing scenarios to characterize and verify the system under a wide range of the expected operating environments. Additionally, the testbed is also used to support verification and validation of reactor operations, reactor computer software, and PCAD performance.

The testbed consists of the engineering models for the instrumentation and control and a simulation of the reactor plant. Although the PCS and reactor are not modeled thermodynamically using finite element techniques, the software simulation of the thermo-dynamics is high fidelity. The high power EPS loads and the PCS alternators are implemented in hardware, with the PCS alternators being motor driven. Engineering model thruster PPU's are included with high fidelity thruster electrical load simulators implemented in hardware.

Related to this Reactor Module testbed are several Reactor Module engineering development systems that provide additional capabilities.

9.4.3.2 **Spacecraft Module Testbed**

The Spacecraft Module testbed will be used to validate flight software (FSW) at a functional level. All FSW states, subsystem modes, and failure modes will be exercised according to the expected on-orbit operations. Interactions between on-board processing elements will be validated by evaluating the system level functionality.

The testbed is a fixed base testbed (no motion other than temporarily installed actuators) that emulates the Deep Space Vehicle using flight equivalent electronics (EMs), including flight-like harnesses. Hardware that is not permanently installed (primarily sensors and actuators) is simulated in software.

9.4.3.3 Mission Module Testbed

The Mission Module testbed is designed to emulate the electrical interfaces and associated data communications between the instruments and the DSV Flight computer, Science computer, and Data Server. This involves command and telemetry interaction via a MIL-STD-1553B data bus and several science/engineering data buses such as the IEEE 1394A (firewire) and additional MIL-STD-1553B data buses.

9.4.3.4 Spaceship Testbed

The Spaceship testbed (SSTB) emulates the Spaceship using flight equipment or equivalent and selected engineering model hardware interfaced via flight-like harnesses to simulators of all subsystems and hardware not present in the testbed.

This testbed is built up incrementally as shown in Figure 9.4-2. It begins with the spacecraft testbed as the core. Successive increments of hardware and simulations include the Reactor Module testbed (I&C EMs, reactor model, and power system) and Mission Module testbed (primarily data communication buses). Flight software drops occur incrementally as well.

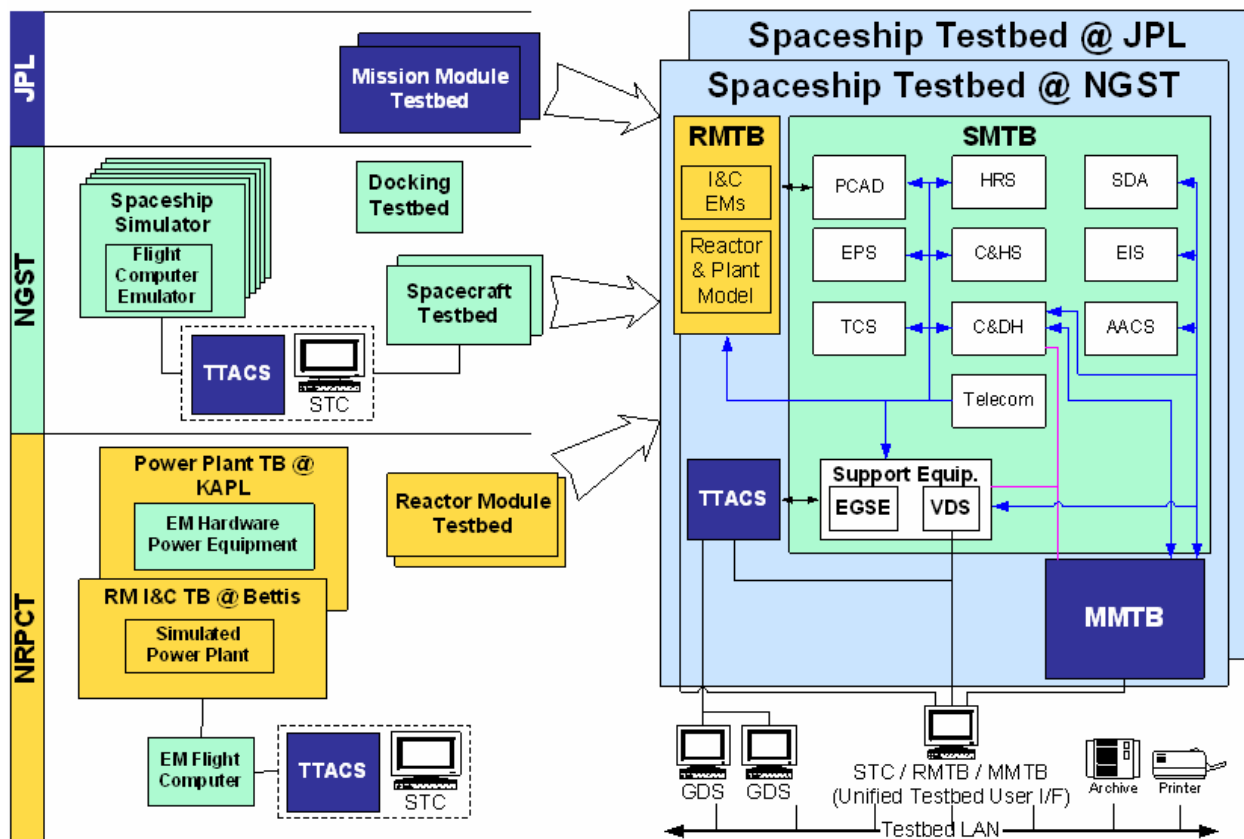

Figure 9.4-2. Spaceship Testbed Evolution.

Key capabilities of the SSTB are:

- Emulate Spaceship behavior
- Support full end-to-end testing
- Verification of timing and real-time interactions
- Testing of commands and command sequences
- Anomaly reconstruction and resolution
- ATLO test procedure development
- Spaceship emulator for Mission Operations rehearsals

9.4.4 SOFTWARE DEVELOPMENT AND VERIFICATION ENVIRONMENT

The Software Development and Verification Environment (SDVE) is a workstation-based platform for open-loop software development and testing prior to delivery for system integration. The SDVE contains a minimal compliment of C&DH hardware, beginning with early commercial-equivalent flight computers and maturing to run the flight software on EM-fidelity flight computers. Many copies of the SDVE with varying levels of flight computer hardware models will be constructed for use by project software developers including the Spacecraft Module, Reactor Module, and Mission Module teams. Similar software development environments are implemented to support the PCAD and Reactor Module software development efforts.

[This page intentionally left blank]

10. Ground System

Ground System products and deliverables developed during Phase A included the following and can be found in the Prometheus Project Archives:

- Draft DSMS Support Agreement
- Draft Ground System level 3 Requirements
- Ground System Key Driving Requirements (KDR)
- KDR Implementation Response Matrix
- Draft Prometheus Operations Module (POM) Requirements
- Preliminary Ground System Operations Concepts Document
- Ground System Document List
- TDRSS Support Feasibility Assessment Report (Trade Study)
- Ground System Integrated Schedule
- Integrated Flight Ground Development Concept & Schedule

10.1 Ground System Overview and Operations Concept

A description of the Prometheus Ground System and operations concept was developed and documented in the Preliminary Ground System Operations Concept Document. As required for the PMSR, Ground System Key Driving Requirements (KDR) were developed and documented in the Ground System Key Driving Requirements Document.

The purpose of mission operations is to plan, control, monitor, and analyze the mission activities of the Spaceship and manage and deliver to the users the mission data collected from the Spaceship. The JIMO Ground System consists of the Prometheus Ground System (GS) and the JIMO Science Operations Module (SOM) in the JIMO Science System. The Prometheus GS is the ground-based system required to conduct mission operations and consists of all of the following implementation components:

1. Personnel – Trained and certified people required to conduct mission operations
2. Procedures – Set of documented steps executed by flight team members to ensure that mission operations are conducted in a reliable, consistent, and controlled manner
3. Facilities – Offices, conference rooms, laboratories, and other work-space
4. Hardware – Ground-based communications and computing hardware and associated documentation required to conduct mission operations
5. Software – Ground-based software and associated documentation required to conduct mission operations

The personnel and procedures components of the Ground System are referred to as the “Flight Team” whereas the facilities, hardware and software components are referred to as the “Ground Data System” or GDS and support the Flight Team in execution of mission operations.

The following sections summarize the key components including key process/flow and interfaces. Updates/developments that are required for Prometheus/JIMO (especially those that are a result of Key Driving Requirements) are indicated in red in the process/flow diagrams.

The GS consists of two parts: the Multimission Operations Module (MOM) and the Prometheus Operations Module (POM). These are shown in Figure 10.1-1 which depicts their interfaces with (1) JIMO external elements, (2) Science Operations Module (SOM), and (3) each other.

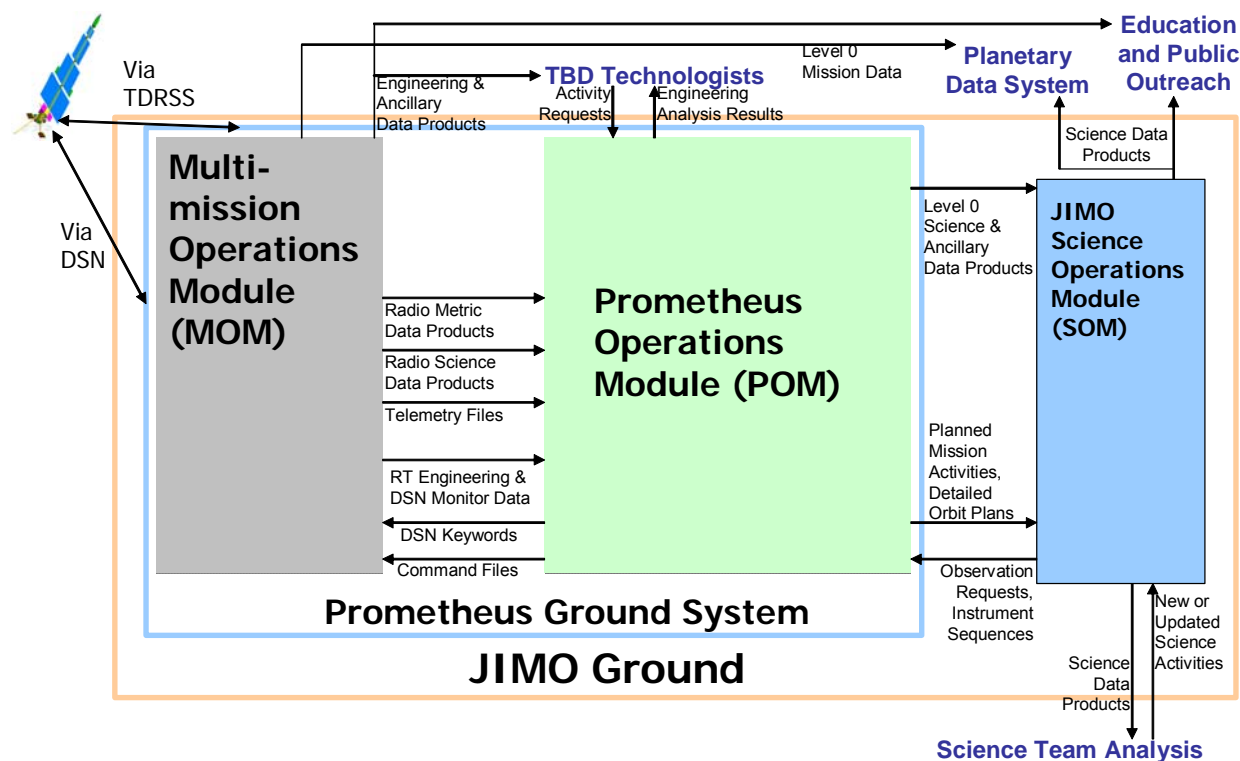

Figure 10.1-1. GS consists of the MOM and the POM.

10.1.1 Multimission Operations Module (MOM)

The MOM includes the DSN and TDRSS tracking and closely associated services. The major functions and data flows within the MOM and the major external interfaces of the MOM are shown in Figure 10.1-2.

The services closely associated with the DSN tracking are provided by the Interplanetary Network Directorate (IND) Deep Space Mission System (DSMS), not just for Prometheus/JIMO, but for other Deep Space missions. These services include: telemetry file delivery, validated radio metric data delivery, radio science, and command delivery. It is important to note that the DSN tracking and DSMS services will feature new and upgraded ground hardware and software capabilities to accommodate the enormous amount of JIMO science data. DSN upgrades will be implemented in order to receive up to TBD [50] Mbps data from Jupiter distances. In addition, upgrades to the Telemetry File Delivery Service will be implemented to handle the high data rates and data volumes of up to TBD [900] Gbits per day. The areas where upgrades will be implemented are shown in red in the figure.

Packages of DSMS software to allow access to DSMS Services and to support instrument operations are supplied to the POM and to the science investigations. Specific DSMS software (a.k.a., DSMS tools) used by the POM and the science investigations were scheduled to be defined as part of the Phase B effort leading up to the PDR and documented in the DSMS Detailed Mission Requirements (DMR) and POM requirements document. The investigations also have the option of using DSMS Services and tools to support science data processing, science data management, preparation of science data products for archive, and science planning.

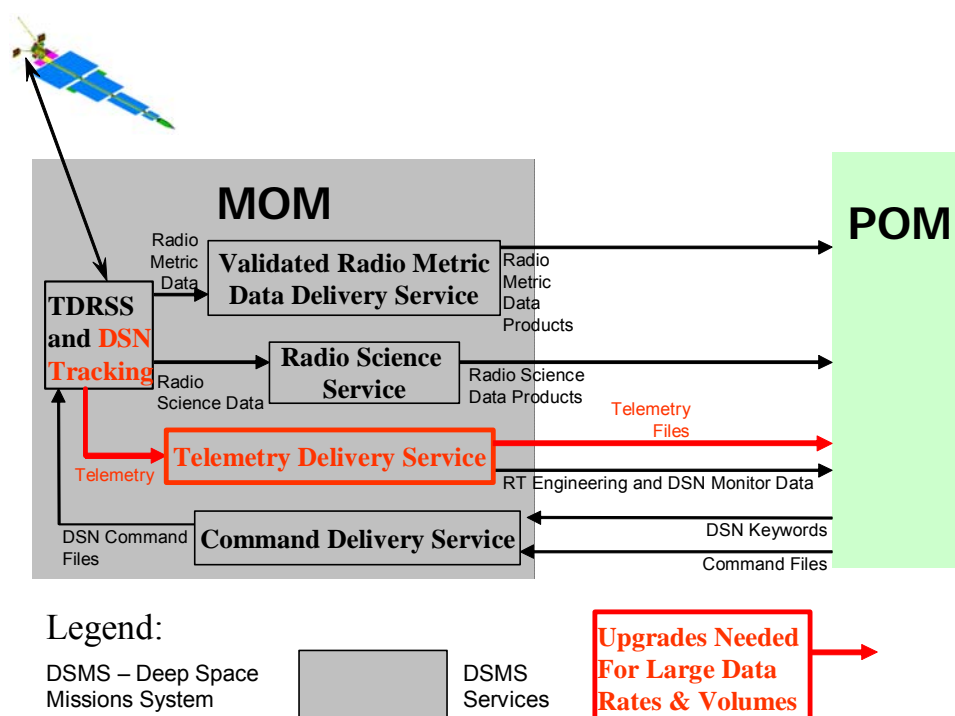

Figure 10.1-2. MOM Provides Tracking and Associated Services.

10.1.2 Prometheus Operations Module (POM)

The POM consists of the Project Flight Team personnel and supporting GDS elements that provide project operations team (i.e. Prometheus Deep Space Vehicle Flight Team) functions; specifically mission monitor and control, navigation, Spaceship engineering analysis, mission planning, sequencing, science integration and planning, and data management functions related to the operations of the DSV across the Prometheus mission set including the JIMO mission. The major functions and data flows within the POM and the major external interfaces of the POM are shown in Figure 10.1-3. The data management function will need to handle the large JIMO data volumes and is indicated in red in the figure.

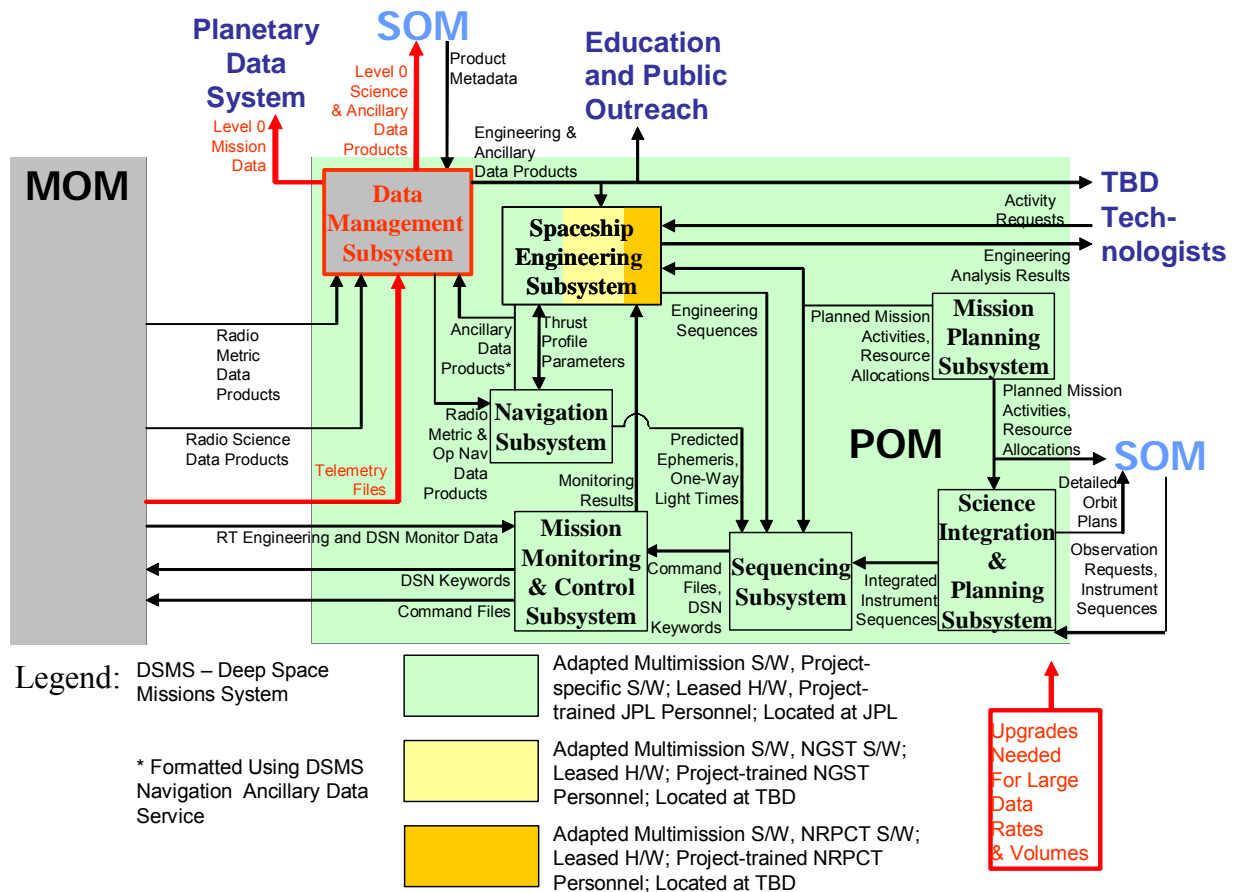

Figure 10.1-3. POM Includes Ops Functions Specific to Prometheus Missions.

10.1.3 *Ground Data System*

The Prometheus/JIMO Ground Data System (GDS) is the integrated system which contains the ground-based hardware, software, networks, telecom services and facilities needed for flight operations, as well as special ground support configurations and tools needed for support of integrated Flight-Ground development, Project I&T, Launch, Assembly, Injection, Acquisition and Commissioning. The GDS is largely part of the GS. It includes components of the GS POM, MOM and GDS-Infrastructure elements. However it also includes some components of the SOM and Launch System. Figure 10.1-4 provides an architectural overview of the GDS whereas Figure 10.1-5 illustrates the relationship between the GDS, the Flight Team, and the MOM and POM elements of the Ground System.

10.1.4 *GDS Components*

As part of the Phase A activities, the set of Prometheus GDS components and providing organization was developed and used as a basis of the LCCE costing. A list of the GDS components and providing organizations is shown in Table 10.1-1.

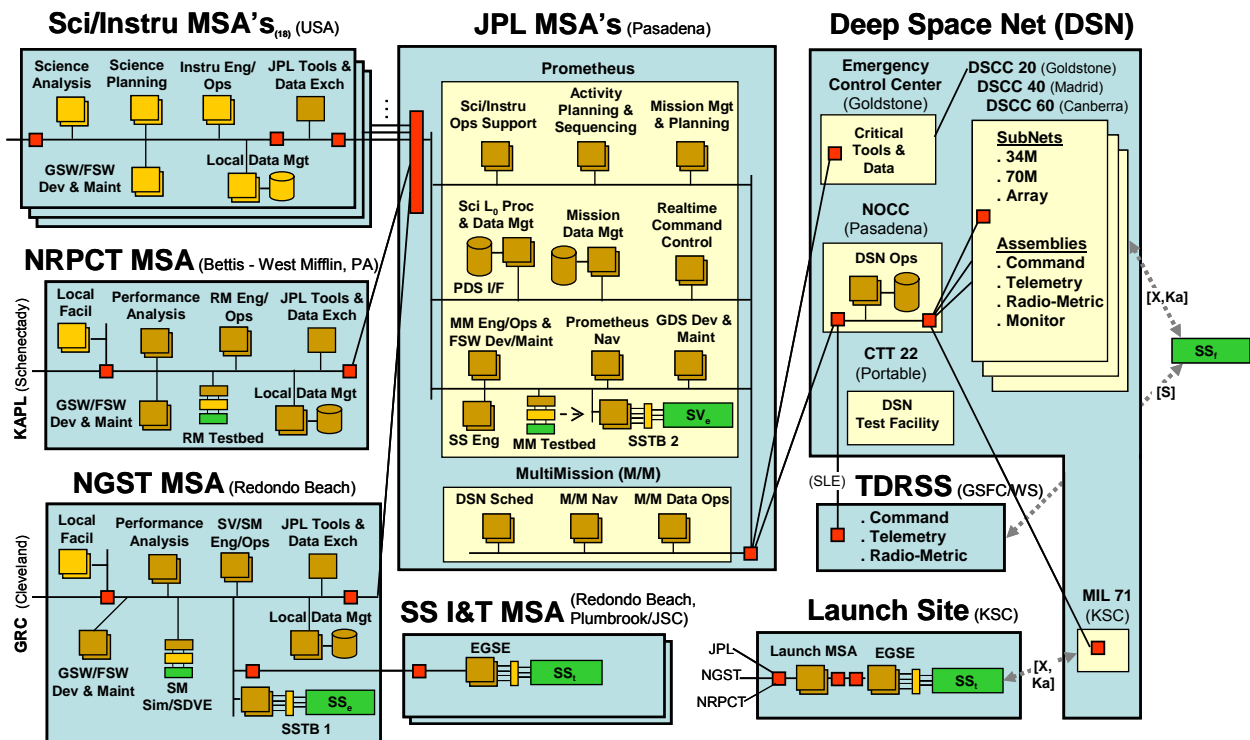
**The architectural components are:**

DSN - Deep Space Network facilities and services
 TDRSS - Tracking and Data Relay Satellite facilities and services
 JPL Prometheus MSA - JPL Prometheus Mission Support Areas
 JPL M/M MSA - JPL Multimission Mission Support Areas
 Sci/Instru MSA - Science and Instrument Ops Mission Support Areas
 NRPCT MSA - Naval Reactors Prime Contractor Team Ops Mission Support Area (incl KAPL and Bettis Teams)
 NGST MSA - Northrum-Grumman Space Technologies Mission Support Area
 SV I&T - Space Vehicle Integration and Test facility
 Launch Site Facilities
 Brown Boxes - JPL-supplied workstations and servers
 Dark Yellow Boxes - Partner-supplied workstations and services
 Green Boxes - Space Vehicle or Simulator
 Red Boxes and interconnecting lines - Networks, routers and firewalls
 Box labels - GDS hardware, software, service components (functionally-identified)

Other acronyms:

DSCC - Deep Space communications Complex
 DTF - DSN Test Facility
 EGSE - Electrical Ground Support Equipment
 FSW - Flight Software
 GRC - Glenn Research Center
 GSW - Ground Software
 Ka - Ka-band frequency
 KSC - Kennedy Space Center
 L0 - Level Zero (Science/Instrument Data)
 MIL - Merrit Island (DSCC 71 @ KSC)
 NOCC - Network Operations Control Center
 OD - Orbit Dtermination
 RM - Reactor Module
 S - S-band frequency
 SLE - Space link Extension
 SM - Spacecraft Module
 SV - Space Vehicle
 SVE - Space Vehicle engineering model
 SVE - Space Vehicle in flight
 SVE - Space Vehicle under test
 X - X-band frequency

Figure 10.1-4. An architectural overview of the JIMO GDS.

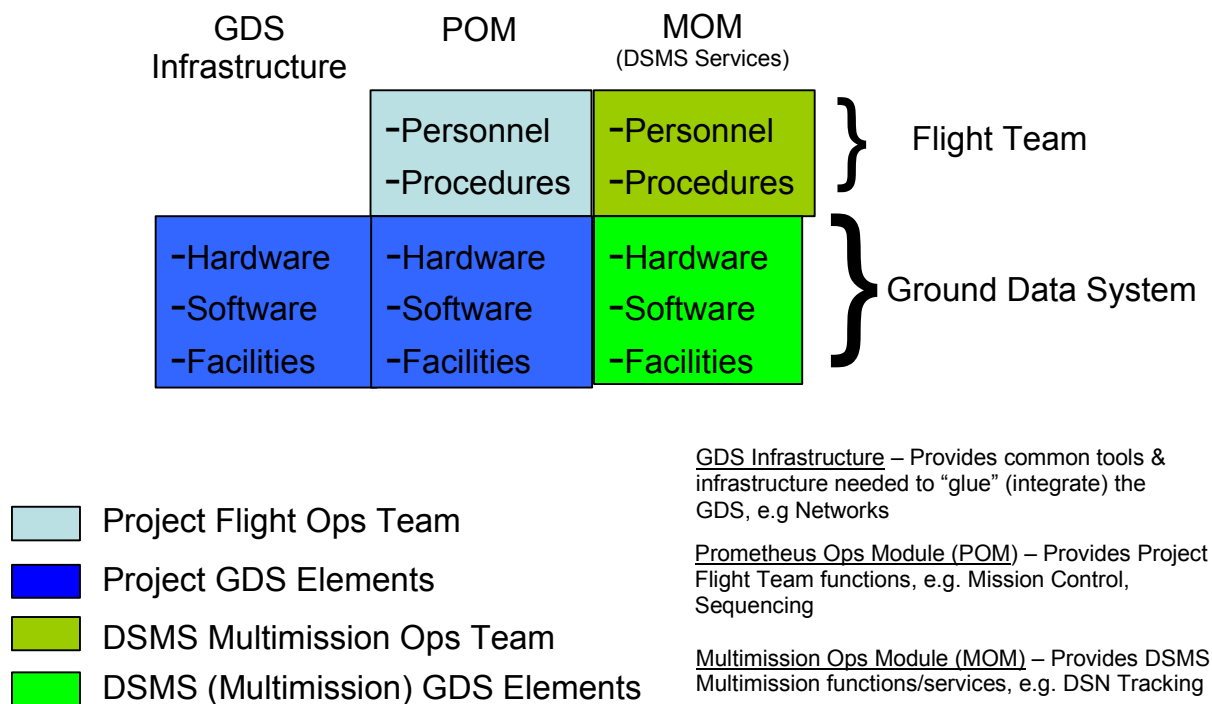

Figure 10.1-5. GDS and flight team elements of the Prometheus/JIMO Ground System.

Table 10.1-1. GDS Components and Providing Organizations.

Functional Component	Provider	Content
1. HW-Net Infrastructure	JPL TD, COTS	Incl. WS, Serv, LAN's, WAN's, IP/GP/Sci/Instru I/F, Std IP WS's
2. OS & Std App Infrs	JPL TD/IND, COTS	O/S, Secur, NetServ, Browser, SS, Email, DMD/Alarm, IT&D etc
3. DSN Tcom Serv	JPL IND	Cmd, Tlm, Radiometric, CTA-21, MIL-71, SLE to TDRS?
4. TDRS Tcom Serv	GSFC, JPL IND	Cmd, Tlm, Doppler
5. Msn Data Mgt	JPL IND/TD	Telemetry and File Databases
6. Science Data Mgt	JPL IND/TD	Science Product Databases
7. ATLO GDS (AGDS)	JPL IND/TD	TTACS, Test Data Mgt, Testbed I/F, ATLO Config, KSC Config
8. JPL MSA's	JPL GDS	Facilities: Ops, SVTB, FSW Maint Fac, Admin WS's & Nets
9. NGST MSA	NGST	Facilities: Ops, SVTB, FSW Maint Fac, Admin WS's & Nets
10. NRPCT MSA	NRPCT	Facilities: Ops, RMTB, FSW Maint Fac, Admin WS's & Nets
11. KSC MSA's	KSC	Local Facilities & LAN's, incl MIL-71 interconnections
12. Msn Mon/Ctrl Tools	JPL IND/TD	Ace Tools, DSN Sched & I/F, Cmd & Control
13. Plan'g & Seq Tools	JPL IND/TD	Sequence Gen, Integ, Validation, Check
14. Navigation Tools	JPL IND/TD	Include Low-Thrust Nav SW
15. Msn Planning Tools	JPL TD	Mission Planning Ops Tools
16. Sci Integ/Planning Tools	JPL TD	Multi-Instrument Planning/Ops Support
17. MM Ops/Eng Tools	JPL TD	Planning, Analysis, FSW/Param Maint
18. RM Ops/Eng Tools	NRPCT	Planning, Analysis, FSW/Param Maint
19. SM/SV Ops/Eng Tools	NGST	Planning, Analysis, FSW/Param Maint
20. SV Ops/Eng Tools	JPL TD	JPL SV Analysis and Oversight Tools
21. AR&D Ops/Eng Tools	NGST	Autonomous Rdvz & Docking Ops/Analysis & FSW Maint Tools
22. Sci/Instru Ops/Eng Tools	Many	Sci/Instru-specific Planning, Analysis, Instru Ops Tools

10.1.5 Operations Organization

During Phase A, a proposed Operations (Phase E) organization was developed (Figure 10.1-6) and presented at the PMSR. The organization's higher level of management is composed of three main management functions: Project Management, the Project Scientist, and the Mission Operations Management.

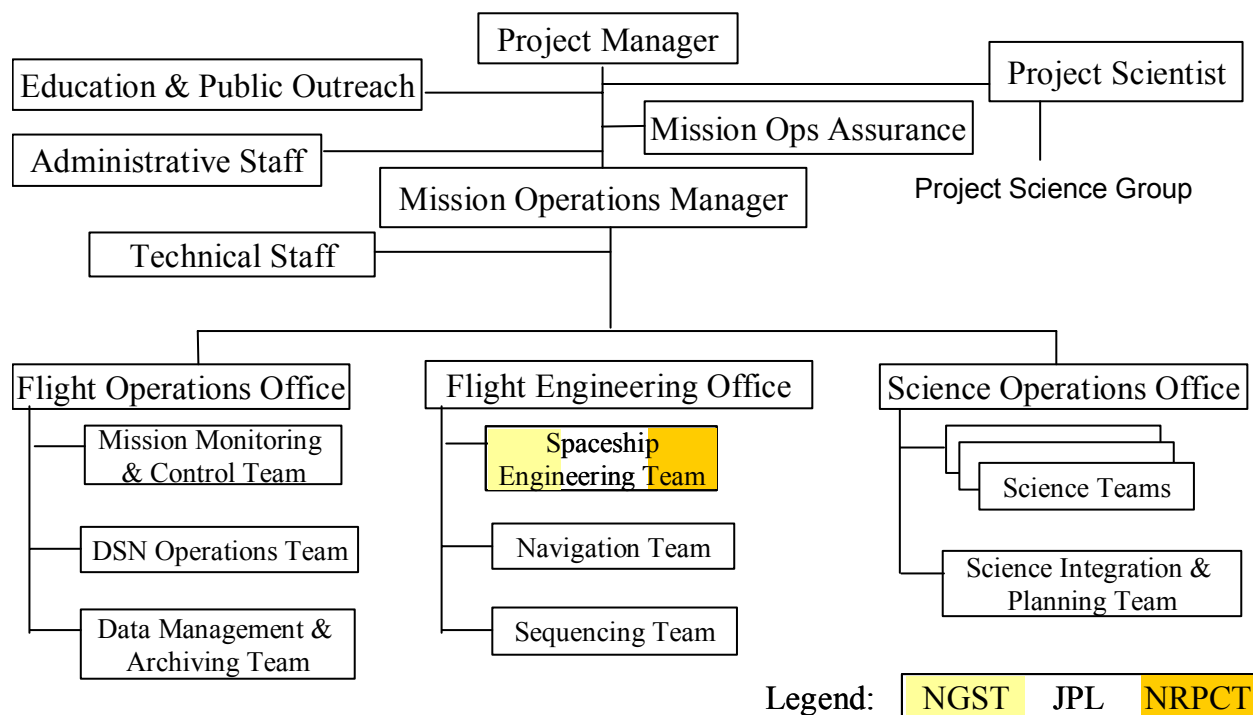

Figure 10.1-6. Operations Organization for JIMO.

Reporting to the Mission Operations Manager are the managers of three operational offices: the Flight Operations Office, the Flight Engineering Office, and the Science Operations Office.

The Flight Operations Office would be responsible for mission monitoring and control, DSN operations and maintenance, and data management and archiving. It is composed of the corresponding functional teams: Mission Monitoring & Control Team, DSN Operations Team, and Data Management & Archiving Team.

The Flight Engineering Office would be responsible for the health, safety, and performance of the Spaceship, recovery in case of a Spaceship fault, trajectory design, orbit determination, propulsive maneuver design, and command generation/integration. This office is composed of the Spaceship Engineering Team, the Navigation Team, and the Sequencing Team. The Spaceship Engineering Team is composed of members from NGST, NRPCT, GRC, and JPL.

The Science Operations Office is responsible for the health, safety, and performance of the science instruments, instrument anomaly recovery, instrument observation requests and instrument sequence generation, science data processing and analysis, and scientific publication.

10.1.6 *Operational Facilities*

The Operations facilities were shown in Figure 10.1-4. The main operational facility would be the Prometheus Mission Operations Center (Mission Support Area – MSA) at JPL. This will house between 130 to 200 people post-launch depending on the mission phase. It will also house a Space Vehicle testbed. This facility will support its maximum capacity of people only during mission phases requiring intense, time-critical operations, such as Spaceship commissioning and the science orbits at the icy moons.

In addition to the Prometheus Mission Operations Center, there will be other geographically distributed operations facilities. These are listed below.

1. An MSA and facilities at NGST housing about 40 people and one or more testbeds. Communications between this facility and the Prometheus Mission Operations Center would be via a dedicated, secured data line (such as a T3 link).
2. A MSA and facilities at a TBD NRPCT location housing about 20 people and one or more testbeds. Communications between this facility and the Prometheus Mission Operations Center would be via a dedicated, secured data line (such as a T3 link).
3. Up to 18 facilities at TBD locations to support the JIMO science investigation operations. The size of these facilities is not known. Each facility would support the following functions: science planning, instrument operations, science data processing, and science data management. Communications between each of these facilities and the Prometheus Mission Operations Center would be via a dedicated, secured data line (such as a T1 or T3 link).

10.2 **Ground System Deliveries and Verification & Validation**

Ground System (GS) "capability deliveries" are scheduled to support major project activities during development and operations. A GS capability delivery may include any or all of the following components:

- Staffed, trained and certified flight operations teams
- Documented and tested operations procedures
- Verified and validated operations and configuration products (blocks, critical sequences, dictionaries, databases, etc)
- Integrated, tested and deployed Ground Data System (GDS)

As part of the Phase A effort, an integrated Flight/Ground development schedule was developed. Specific capability deliveries consistent with this were defined in the Flight/Ground integrated schedule and the Ground System schedules were included in the Project archives; these are summarized in Table 10.2-1.

Table 10.2-1. Ground System Capability Deliveries.

Delivery ID	Date	Drivers	Content
1. TestBed Dev	6/08	SM Testbed 2, FSW 0	Rudimentary TTACS (Indiv Cmd & Low Rate TIm, no SEQ Adapt)
2. FSW Dev 1	5/09	SM Testbed 3, FSW 1	Rudimentary TTACS ..., additional test control & scripting, early Cmd/TIm DB
3. FSW Dev 2	2/10	RM, MM Testbeds, GDS Infra Dev	TTACS upgr, SS/SM PAS eng vers, Prep for RM, MM TB deploy
4. FSW Integ/MOS Dev	7/10	SM Testbed 4, RM FSW 1, MM FSW 1	Complete deployments to JPL-MM, NGST/JPL SV, NGST MM, Initial Seq Adapt, Integ Cmd/TIm/Param DB, SV/SM&MM PAS, GDS Infrastructure Prototype
5. Flight-Ground Integ	8/11	System Testbed 1, Block/Sequence Dev	Block/Sequence Definitions, Baseline AGDS Config, Seq, PAS upgrades, Science Site tools & interfaces
6. ATLO/MOS Dev	9/12	SS Funct Testing, MOS/POM Training	POM & MOM Processes, ATLO, Hi-rate TIm, Low-Thrust Nav, High-Capacity DB's, POM Science Integration & Planning, WebGDS Infrastructure, AR&D PAS
7. ATLO/Flight	6/13	ATLO, Flight ORT's	POM & MOM Teams, Full Flight Capability, AIC capability, ATLO corrections, TDRSS
8. Launch	9/14	Launch ORT's, Launch, AIC Ops	Certified Teams & Processes (Launch, AIC & Cruise), Special KSC & AIC facilities & configurations
9. Cruise	3/16	Routine Cruise Ops	Cruise Upgrade, based on early ops experience
10. Jupiter	2/20	Jupiter ORT's & Ops	Final Jupiter Ops Capability (POM, MOM, SOM, GDS), GDS Infrastructure/WS Upgrade
11. Europa	9/24	Aux P/L ORT's & Ops	Final Aux Payload Support Capability

Associated with each GS capability delivery are the following integration and test activities.

- GDS Component Verification
- GDS Integration & Deployment
- GDS Verification
- Block & Sequence Verification
- Ground System Validation

10.2.1 *Ground System Participation in Integrated Flight-Ground Development*

Due in part to the complexity of organizational and technical interfaces, Prometheus has taken special care to embrace the concepts of "Test as you Fly" and "Integrated Flight-Ground Development". In keeping with this, the Ground System development plans include:

- Early and frequent integration of flight and ground system software
- Inclusion of ground system components in flight system testbeds
- Significant upgrades to the enabling "Test-as-you-Fly" toolkit
- Heavy use of flight system testbeds in operations development
- Joint flight-ground development of command blocks and flight rules
- Integrated flight-ground schedules and plans
- Early attention to flight system/software "operability"
- Common, controlled command, telemetry and parameter databases
- Special (and early) attention to Reactor Module operations safety and data security
- Special attention to flight-ground End-to-End Information System (EEIS) design and testing

Additional details regarding Prometheus plans for "Integrated Flight-Ground Development" can be found in the following documents:

- "Ground Data System Integrated Schedule"
- "Integrated Flight-Ground Development concept"
- "EEIS Plan"

10.3 **Ground System Simulators & Test Beds**

This section describes testbeds and test facilities used, at least in part, for operations development and execution. The Ground System provides components of other testbeds used for flight system/software development. The Ground System components are described below under "Special Test Equipment and EGSE". Although the Ground System derives some benefit from these other testbeds, their primary purpose is to support flight system development, therefore they are described in Section 9.4.

10.3.1 GDS Development & Maintenance (D&M) Testbed

The GDS D&M testbed would be a geographically-distributed network of workstations, servers, software and test equipment, located at JPL, NRPCT and NGST. The GDS D&M testbed has secure interconnections to the "flight GDS" and DSMS (multimission) services. However, it is intended as a stand-alone distributed sub-network, capable of hosting capabilities under development.

10.3.2 Operations Spaceship Testbed

The Operations Spaceship testbed would be one of 2 high-fidelity flight-system testbeds, which include flight system processors (equivalents), execute flight software (SM, MM, RM) in realtime, include hardware and environment models, and include flight-like digital command and telemetry interfaces to the ground system via TTACS (described below). It evolves from a JPL-resident Mission Module/GDS testbed established in Phase B and is shared by the Ground System and mission module. NGST leads testbed development, integration and operation, with various components (flight-like hardware, TTACS, EGSE, flight software, testbed software, models, command & telemetry databases, etc) being supplied and upgraded by JPL, NGST and NRPCT.

10.3.3 Special Test Equipment and EGSE

The Ground system provides a special-purpose hardware-software subsystem which enables the integration of GDS components into flight-system testbeds and electrical ground support equipment (EGSE) used during ATLO. The subsystem is called TTACS (test telemetry and command system) or "Test-as-you-fly toolkit". It provides a functional replacement for the RF and channel/link protocol portions of the DSN (or other telecom service providers), thereby enabling interconnection of flight and GDS components, in a testbed or ATLO environment.

Figure 10.3-1 illustrates a typical TTACS configuration associated with a testbed.

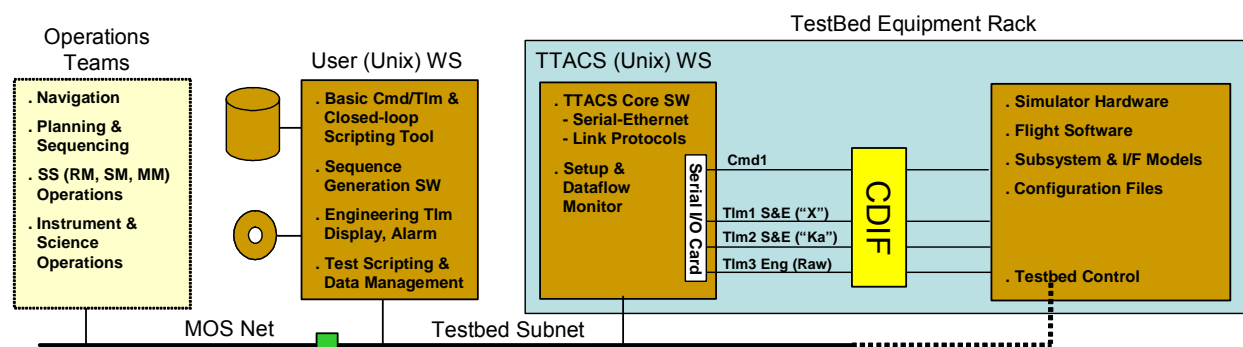

Figure 10.3-1. Testbed — TTACS Configuration.

In recognition of the importance of early flight-ground integration, Prometheus has included plans for significant upgrades to TTACS, including:

- Support for high data rates
- Low-level closed-loop command and telemetry scripting
- Induced light-time delays for team training
- Portability, user-interface and documentation
- Link protocol bypass for special test configurations

Additional information about TTACS can be found in the document: "Integrated Flight-Ground Development Concept."

10.3.4 Telecom Test Facilities

The DSN and TDRSS/GN networks provide special RF and link compatibility test facilities for use in telecom/link and EEIS testing. These include:

- DTF-21 "DSN Test Facility" mobile test trailer
- MIL-71 "DSN KSC Test Station"
- TDRSS Compatibility Test Facilities

These test facilities are primarily used to verify RF interfaces, and to perform end-to-end compatibility testing during system development, and at the launch site.

10.4 Ground System — Operations Assumptions

10.4.1 Operations Staffing Assumptions

This section describes the assumptions used to develop the flight team staffing during operations. Specific flight team staffing is documented in the LCCE estimates included in the Project Archives.

During nominal operations (cruise and orbital), most of the Flight Team will be staffed only during prime shift (8 AM to 5 PM) from Monday through Friday. Exceptions to this guideline may apply during intense operations events, such as trajectory correction, orbit trim maneuvers, reactor start up, flight software updates, and special engineering or instrument calibrations. During these critical periods the need for additional support from some of the teams might be required. For the most part, the teams will be able to plan for such support since these critical periods will be well known and included in the operations schedules. Portions of the Flight Operations Office (e.g., Mission Monitoring & Control Team and the DSN Operations Team) will support the Project in accordance with the DSN resources allocated to the Project. This support might be off prime shift and during weekends.

During encounters and fly-bys, some TBD portions of the Flight Team must be prepared to support operations for the duration of the encounter or fly-by. This support might be off prime shift and during weekends. The teams that will be required to provide such support will be well informed prior to the event through the operations schedule. The required support from each of the teams will vary depending on the encounter or fly-by. A detailed analysis would be performed by the Project during Phase C/D to determine the level of support required by each team for each of the planned encounters and fly-bys.

The Anomaly Recovery Plan determines the staffing support required during anomalies. The staffing support required depends on the anomaly or fault, and will be determined at the time of the anomaly by the Mission Operations Manager in coordination with the office and team managers. In general, the required support might be off prime shift and often during weekends. The Anomaly Recovery Plan must identify the teams that get involved in the analysis of the anomaly, as well as in the resolution of the anomaly.

10.4.2 DSN Tracking Coverage Assumptions

The Ground System is required to provide DSN and TDRSS tracking as specified in the Mission Plan. For the Phase A, the Ground System developed initial assumptions/requirements with Science and Mission Design. For example, a key assumption was that near continuous coverage was required during the near-Earth orbital operations prior to interplanetary injection due to the presence of a nuclear reactor on the Spaceship. The specific set of assumptions and draft TDRSS/DSN tracking coverage requirements are documented in the Draft Ground System level 3 Requirements and was used in development of the LCCE (for example, DSN/TDRSS tracking cost estimates).

[This page intentionally left blank]

11. Launch System

11.1 Launch Options

Prometheus never had a defined launch vehicle. In this atypical situation, the project analyzed all launch options and consequences to demonstrate feasibility independent of NASA decisions in launch vehicle development. The spectrum of options is shown in Figure 11.1-1.

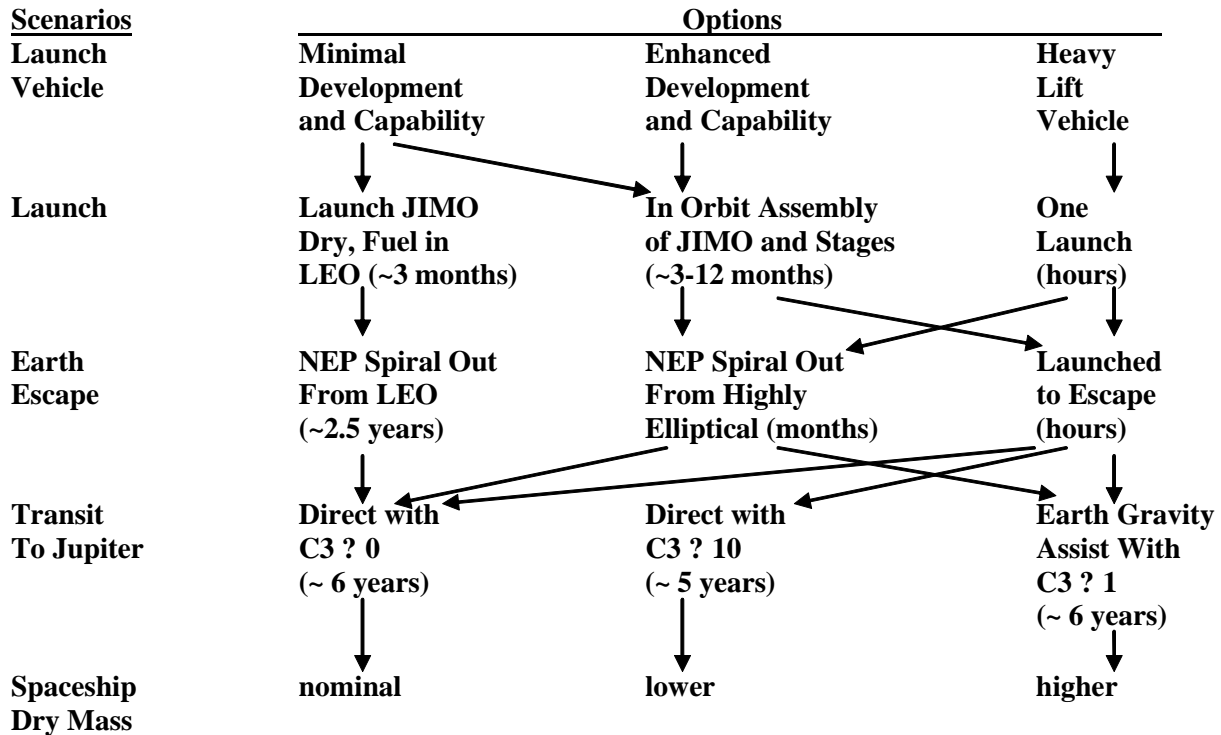

Figure 11.1-1. Launch Vehicle Development Scenarios and Resultant Mission Options.

While the alternatives shown in Figure 11.1-1 are all feasible, they are not equally attractive. Not surprisingly, increasing the launch vehicle capability simplifies everything else. The option selected for the Prometheus Phase A baseline (enhanced launch vehicle development) was stressing in the launch scenario; the resulting path through the options is shown in Figure 11.1-2.

The implementation of the Lunar Base as a primary NASA objective has led to plans for a new heavy lift launch vehicle. A launch vehicle in this class was always the Prometheus desire for mission simplification; this capability leads to the Prometheus baseline illustrated in Figure 11.1-3. The multiple paths for Earth escape is a reflection of the uncertainty in the capability of the new launch vehicle; while it is likely to provide the energy required for escape, this is not assured. However, any energy deficit will be small, placing the Spaceship in a highly elliptical orbit; the NEP thrusting time to escape from this orbit is relatively small. Thus, the two paths for Earth escape have reasonably similar consequences to the overall mission (although launch to escape is somewhat simpler and is preferred).

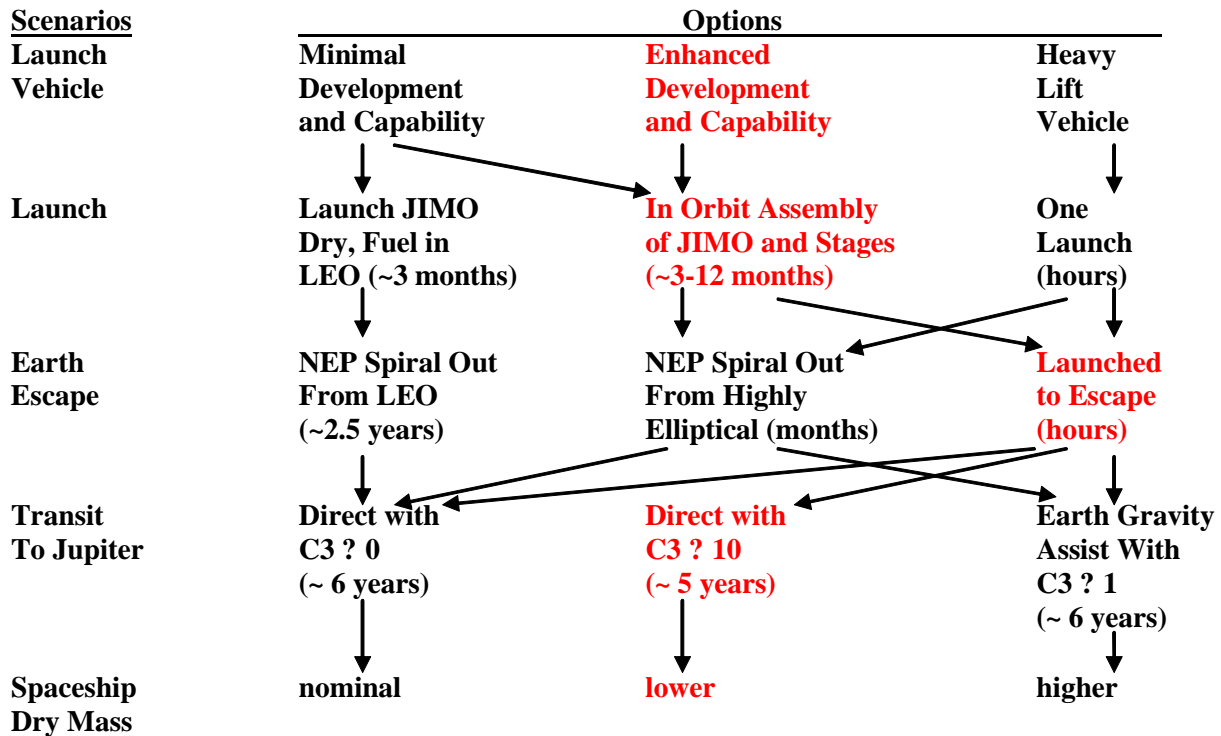

Figure 11.1-2. Assumed Phase A Launch Vehicle Development and Mission.

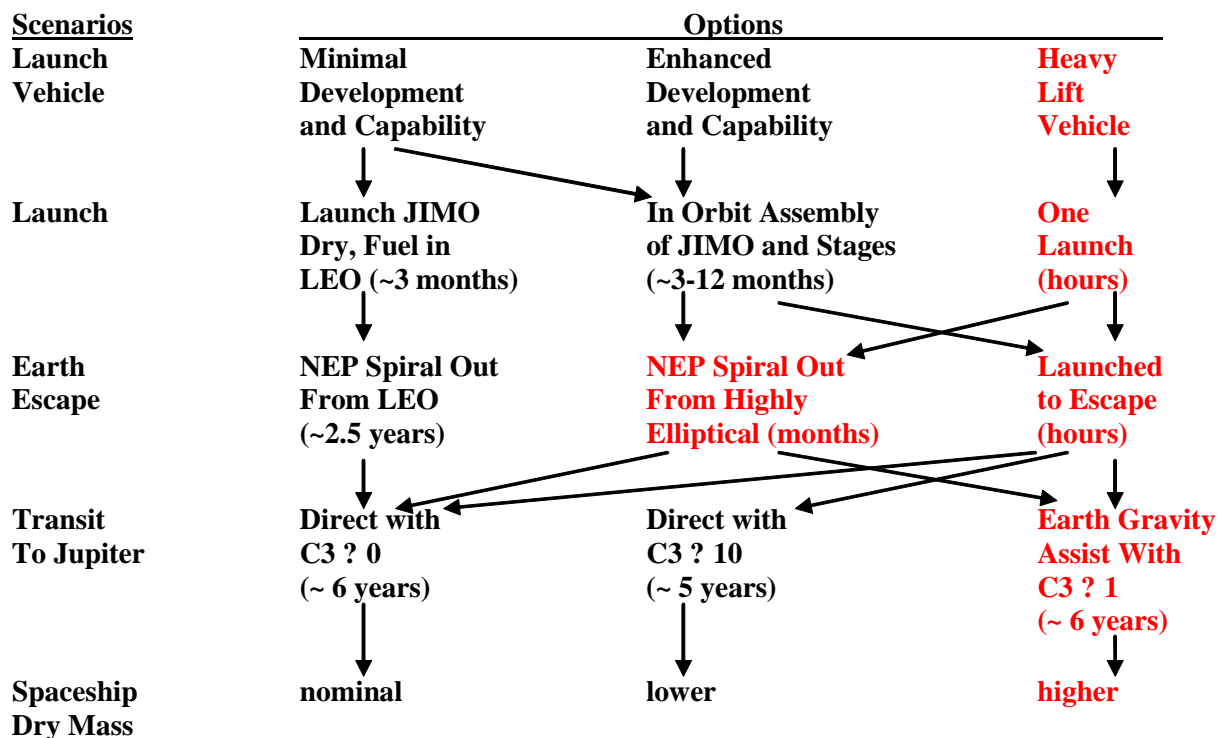

Figure 11.1-3. Probable Launch Vehicle Development and Mission.

11.2 Phase A Studies

11.2.1 Launch Vehicle

Under the NASA Launch Services (NLS) Contract, a series of studies was conducted with each of the Evolved Expendable Launch Vehicle (EELV) contractors — Boeing and Lockheed-Martin — to evaluate modifications to the existing heavy-class vehicles to support Prometheus requirements. The purpose of these studies was to assess performance enhancements, upper stage/transfer vehicle development, and operational scenarios.

1. Launch Vehicle Enhancements Studies (completed August 2003) – This set of studies evaluated upgrades to EELV-H (Atlas V and Delta IV) required to achieve a performance of up to 25 t to earth escape. In addition, upgrades required to achieve a performance of up to 45 t to 5000 km circular orbit were evaluated. Impacts to infrastructure based on enhanced vehicle configurations, along with top level schedules for implementation and rough order of magnitude (ROM) costs, were included.

- In keeping with the fleet evolution philosophy to Atlas V, Lockheed-Martin presented a growth path with incremental fleet changes (5.4m wide-body Centaur upper stage, 5.4m wide-body boosters with dual Russian built RD-180 main engines) to achieve the desired performance. Building on the existing elements of the Delta IV, Boeing presented configuration solutions specific to each desired performance class. In addition, various combinations of technology developments to the Delta IV elements (for example, advanced upper stage, new upper stage engine, aluminum lithium tanks, main engine performance enhancements with propellant densification, and graphite epoxy strap-on motors) were included as required.
2. Heavy Lift Launch Studies (completed June 2004) – As Agency priorities shifted to meet the new Vision for Exploration as outlined by President Bush in January 2004, a follow-on set of studies evaluated upgrades to EELV-H required to achieve performance of up to 135t to low earth orbit (LEO), 65t to Earth escape. This set built upon results of the enhancements studies and included infrastructure modifications and additions, implementation schedules, and ROM costs. Considerations for launch vehicle certification were also briefly addressed.
 3. Multiple Launch Scenario Studies (completed February 2005) – As Agency exploration plans evolved, it became apparent that a new, heavy-lift capability would be required. If development of this capability occurred in time to support Prometheus, it would become the baseline launch configuration. However, because an Agency decision on heavy-lift capability was not yet made, the Prometheus Project decided to develop a multiple launch scenario that would include EELV-H upgrades that could reasonably be accommodated by the Project, in the event that the heavy-lift capability was not available to support the first Prometheus mission. The multiple launch scenario studies addressed rendezvous and docking, launch and sequencing, and scheduling and logistics required to support two, three, or five launches to achieve the Prometheus missions. A key result from these studies was the recommendation from both launch vehicle contractors for an integral upper stage/transfer vehicle (as opposed to a separate upper stage and transfer vehicle) in order to optimize launch vehicle performance, utilize existing launch infrastructure and core components, reduce developmental risk, and minimize cost.
 4. Advanced Cryogenic Evolved Stage (ACES) Studies (to be completed in December 2005) – With on-orbit activities required by a multiple launch scenario, long-duration capability for the cryogenic upper stage was identified as a critical development. Existing upper stages can provide cryogenic storage capability of multiple hours; multiple launch operations would drive on-orbit times of up to one year. Technical investigations of passive thermal management options for extended on-orbit lifetimes are under evaluation. Passive thermal management hopes to achieve approximately 300 days on orbit with acceptable boil-off performance losses. In addition, the potential to supplement passive systems with active thermal management (if required) is being reviewed.

11.2.2 *Launch Site Infrastructure*

Because of the Prometheus Spaceship size and test requirements during Assembly, Test, and Launch Operations (ATLO), it was not clear as to whether existing spacecraft processing facilities available at either KSC or CCAFS would be able to support Prometheus. As a result, a preliminary facility feasibility study was performed. The purpose of the study was three-fold: (1) Inventory and evaluate existing KSC and CCAFS facilities to determine if there are currently viable candidate facilities for Prometheus spacecraft processing operations; (2) Determine if existing facilities can be feasibly and economically retrofitted to meet Prometheus requirements; and (3) Develop a concept and identify potential locations for a new spacecraft processing facility, should existing facilities not prove to be feasible/economical. Results of this study indicated that, due to size and the nuclear processing requirements, existing facilities would not be sufficient for support. A processing “campus” was sited and a footprint was developed, along with a high-level schedule and ROM cost estimate.

11.3 **Baseline Launch System**

The Prometheus Launch System consists of an upgraded EELV-H and the spacecraft processing facility for Assembly, Test, and Launch Operations (ATLO) activities at the launch site. The mass of the JIMO mission significantly exceeds the performance capabilities of the existing EELV fleet. As a result, a new heavy-lift launch vehicle would be required. It is anticipated that the Agency will develop this capability to support future exploration activities. If this new capability is available for Prometheus missions, it will be used; however, the Project baselined an upgraded EELV-H that could be reasonably accommodated within the Project, should a heavy-lift vehicle not be available.

The launch vehicle is baselined to be a “Step 1” upgraded EELV-H, capable of delivering a 40t payload with an injection energy of approximately 13-18 km²/sec². The upper stage/transfer vehicle will be long-duration (capable of on-orbit operations lasting up to one year). Section 3 describes the mission overview, including launch sequencing and on-orbit operations.

11.4 **Major Trades**

Several significant first-level trades were performed during the series of studies conducted for launch vehicle performance. Launch options using existing EELV-H, “Step 1” upgraded EELV-H (40t), “Step 2” upgraded EELV-H (70t), and super heavy-lift (>110t) vehicles to both a circular orbit and to Earth escape were conducted (see Section 12.1.). All options require an extended (longer) payload fairing, which will have some impact to launch vehicle processing infrastructure.

Existing EELV-Hs (~21-23t), while offering an immediately available launch option (i.e., no launch vehicle development), required either two launches (C3<0) or five launches (C3~8-10). However, these both would require rendezvous and docking capability development. In addition, a five-launch scenario would increase risk to mission success and require dedicated launch pad availability (potentially resulting in additional costs to either reserve the launch pad for a year or to build a dedicated launch pad). Modifications to the existing launch pad infrastructure would be required to accommodate the extended payload fairing.

“Step 1” upgraded EELV-H (~40t), baselined for Prometheus, would require three launches to low Earth orbit and provide an injection energy of approximately 13-18 km²/sec² when assembled into flight configuration. This option would result in less mission risk than the five launch scenario with a reduction in mission complexity due to fewer on-orbit operations and less on-orbit time. It also provides a less expensive alternative to development of a heavy-lift launch vehicle (although heavy-lift is operationally simpler and, therefore, potentially less risky). Rendezvous and docking capability development would be required. Modifications to the existing launch pad infrastructure would be required to accommodate vehicle upgrades and payload fairing extension.

“Step 2” upgraded EELV-H (~70t) would require two launches to obtain an injection energy of approximately 20-22 km²/sec² and reduce mission travel time. This configuration also could provide a single launch option to a circular orbit, with nuclear propulsion system activation and spiral out to the mission trajectory. However, the latter option would result in an extended flight time to Jupiter. Modifications to the existing launch pad infrastructure would be required to accommodate vehicle upgrades and payload fairing extension.

Heavy-lift launch vehicle (>110t) capability, a new development, would be able to obtain direct injection with a single launch, avoiding the costs (time and funds) and risks associated with any multiple launch scenarios. However, the development costs were prohibitive for the Prometheus Project to undertake; this would be suited as an Agency development with Prometheus using the capability if it is available to support the JIMO timeline.

During launch vehicle trades, both launch vehicle contractors (Delta IV and Atlas V) recommended that the upper stage and transfer stage be developed as an integral stage for optimum launch vehicle performance. However, this recommendation may not provide the optimum configuration for the overall project; a trade between these configurations is required.

11.4.1 *Issues*

In order to reduce development and usage costs to NASA, the modifications to the EELV-H to support Prometheus would need to be fleet changes, potentially impacting other users. The United States Air Force (USAF) is responsible for the EELV fleet and would, therefore, need to approve changes made to the fleet. However, preliminary discussions with the USAF have indicated potential mutual benefits that could be gained by some of the proposed changes. Further discussions would be required before implementation could be realized.

Multiple launch scenarios could also impact other users for extended periods of time, due to required turnaround time between Prometheus launches. As a result, additional costs could be incurred to “reserve” the launch pad during the Prometheus campaign. If this is not a viable option, a dedicated Prometheus launch pad and/or processing facilities could be required.

11.4.2 *Roles*

Preliminary discussions on roles and responsibilities among Prometheus team members were ongoing. A multiple launch scenario has ramifications for roles and responsibilities, as it does not fit the traditional launch mission. The role of the NASA Launch Services Program (launch), JPL (mission operations), and NGST (spaceship operations) would need to be defined with the added operational complexity of on-orbit operations that could potentially last up to one year.

11.4.3 *Interface Requirements Document (IRD)*

The Prometheus Spaceship to Launch System IRD was in the early stages of development. It was to include spaceship-to-launch system interface requirements, transfer vehicle-to-launch system interface requirements, and spaceship-to-transfer vehicle interface requirements.

11.4.4 *Launch Site*

The launch site for Prometheus would be the CCAFS. Modifications to the launch pad infrastructure would be required to accommodate launch vehicle upgrades and the extended payload fairing.

11.4.5 *Special Facilities*

Results of the facility feasibility study (see Section 11.2.2) indicated that existing spacecraft processing facilities at KSC and CCAFS would not be adequate to support Prometheus. A hazardous secure spacecraft processing “campus” was laid out, which included a facility for processing of the space nuclear power plant; a facility for spaceship integration, test, and encapsulation; and a personnel building. Two potential sites on KSC were identified.

11.4.6 *Key Driving Requirements (KDR)*

Four KDRs were identified for the Launch System and are listed (along with the implementation responses) in Table 11.4-1. The KDRs are documented in “Launch System Key Driving Requirements.”

Table 11.4-1. Launch System Key Driving Requirements.

Rqmt #	Key Driving Requirement Text	Implementation Response
LS_0001	The Launch System shall be capable of handling the Spaceship in such a manner that ensures the protection of people and their environment from any space nuclear reactor hazards.	Additional safety and security requirements during Assembly, Test, and Launch Operations (ATLO) for the Spacecraft Processing Facility (SPF), Launch Pad, and Payload Transporter will be assessed during Phase B.
LS_0002	The Launch Vehicle (defined as the core stage and upper stage) shall be capable of delivering a payload of [37,000] kg to a low-earth orbit of [407] km,.	Upgrade existing Evolved Expendable Launch Vehicle (EELV) Heavy Class vehicles from ~21t to ~40t capability.
LS_0003	The upper stage/transfer stage of the launch vehicle shall be capable of on-orbit operation of up to one year; two upper stages/transfer stages shall be capable of providing an injection energy of at least 10 km ² / sec ² .	Upgrade existing cryogenic upper stage capability, from hours to one year on orbit operational capability.
LS_0004	The Spacecraft Processing Facility shall be capable of supporting ATLO pathfinder operations in 2012.	Assess existing launch site payload processing facilities, potential new facility/sites to determine what will meet ATLO requirements as they are defined.

11.5 Rendezvous and Docking Segment

The three-launch implementation of Prometheus requires two on-orbit docking events; transfer-vehicle-to-transfer-vehicle and transfer-vehicle-stack-to-spacecraft. The Docking Segment includes the hardware and software to perform the two on-orbit docking events. The Docking Segment is part of the Spacecraft Module and, consequently, part of the effort under the Government/NGST co-design team. This segment is only required in the event that the multiple launch scenario is required. Trades were performed to develop a concept that would best accommodate this operational scenario as listed in Table 11.5-1.

The Docking Segment provides the hardware and unique software to support autonomous in-space rendezvous and docking operations as well as providing the interface between the Spaceship and the Launch System. The Docking Segment includes three subsystems. These are the Spacecraft Docking Adapter Subsystem (SDAS), the Transfer Stage Docking Subsystem (TSDS), as shown in Figure 11.5-1, and the Autonomous Rendezvous and Docking (AR&D) Subsystem which comprises the software element that provides control of the active docking elements during rendezvous and docking operations.

The Spacecraft Docking Adapter Subsystem serves multiple purposes. Structurally, the SDAS provides the primary interface between the Launch Vehicle and the Space System during the launch phase, and later provides the interface with the transfer stages during interplanetary injection (Figure 11.5-2).

Table 11.5-1. Rendezvous and Docking Trades.

Trade	Option	Pros	Cons
Docking Roles	Transfer Vehicle Active; DSS Passive	<ul style="list-style-type: none"> • Simplifies AACS for DSV • Minimizes AACS fuel for DSV 	<ul style="list-style-type: none"> • DSV cannot perform AR&D role
	Transfer Vehicle Active; DSV Backup	<ul style="list-style-type: none"> • Allows either element to execute AR&D • Increased Docking Opportunities 	<ul style="list-style-type: none"> • Most expensive • Reconfigure DSV for 6DOF
Docking Mechanism	Probe/Drogue	<ul style="list-style-type: none"> • Flight proven approach 	<ul style="list-style-type: none"> • Requires redevelopment of capability
	StarSys	<ul style="list-style-type: none"> • Reduced docking loads 	<ul style="list-style-type: none"> • Under development
	Three Point Docking Mechanism (TPDM)	<ul style="list-style-type: none"> • High load capacity/redundancy • Design concept optimized for JIMO application 	<ul style="list-style-type: none"> • Requires TV roll control in proximity operations • Not flight demonstrated
	Low Impact Design (LIDS)	<ul style="list-style-type: none"> • Either side Active 	<ul style="list-style-type: none"> • Under development

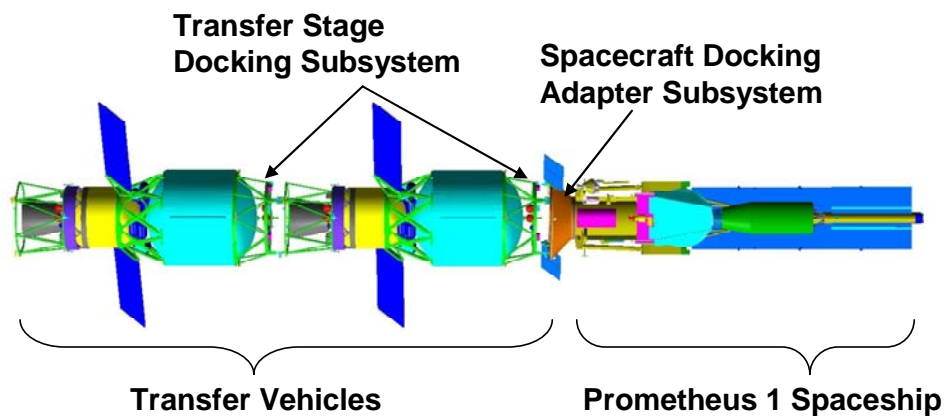
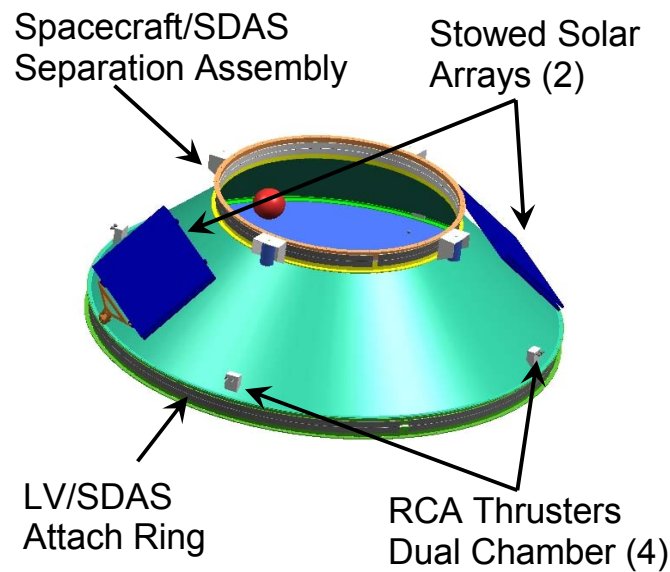
**Figure 11.5-1. Docking Segment Elements.****Figure 11.5-2. Spacecraft Docking Adapter Segment.**

Additionally, the SDAS provides all of the functions needed by the Spaceship in its pre-deployment configuration, both during earth orbit operations and following interplanetary transfer injection prior to commissioning of the Spaceship. These functions include Power, provided by a 3.6 kW deployable solar array, attitude control, provided by a monopropellant hydrazine reaction control system, and S-band communications and GPS functions to support telecommunications through TDRSS during LEO operations and support rendezvous operations.

The Transfer Stage Docking Subsystem is that portion of the Docking Segment incorporated in the Transfer Stages that performs the actual docking function, providing active docking and capture mechanisms and incorporating an advanced video guidance system including cameras and proximity sensors (Figure 11.5-3).

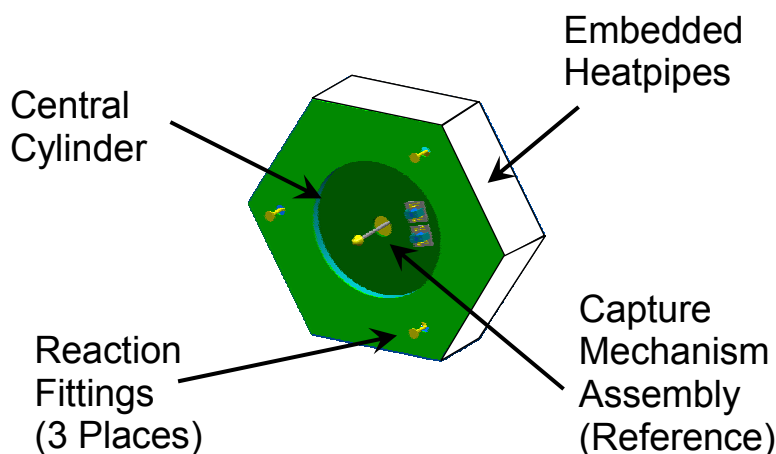

Figure 11.5-3. Transfer Stage Docking Subsystem.

In addition, the TSDS also includes S-band telecommunications to provide real-time video feed in support of docking operations.

Technology to be applied to development of the Docking Segment derives in part from the recently demonstrated DART spacecraft, and it is expected that further development of autonomous rendezvous and docking capabilities in support of the new Exploration Architecture will provide additional technologies which can benefit the Docking Segment design.

12. Schedule

12.1 Top-Level Summary and Critical Path Summary

The Prometheus Project Top-Level Schedule and the Project Critical Path Summary were prepared from the Integrated Master Schedule (IMS) (see Section 12.2). Both of these schedules were developed per NASA requirements and JPL guidelines.

1. The Top Level Schedule (Figure 12.1-1) reflects summarization of the Subsystem Level IMS, providing hierarchical schedule traceability per NASA and JPL guidelines.
2. The Project Critical Path Summary (Figure 12.1-2) reflects the project's summary level critical path through the 2015 launch date.

12.1.1 *Phase A Milestone Schedule*

The Prometheus Project Phase A Milestone Schedule (Figure 12.1-3) reflects the planned and actual dates for the key milestones and activities accomplished during Phase A. This document was a key management tool reviewed by the project team at every MMR.

12.1.2 *Technology Milestones Schedule*

The Prometheus Technology Milestones schedule (Figure 12.1-4) reflects the planned and actual dates for the key technology development activities and demonstrations during Phase A and planned for Phase B. This document was a key management tool reviewed by the project team at every MMR.

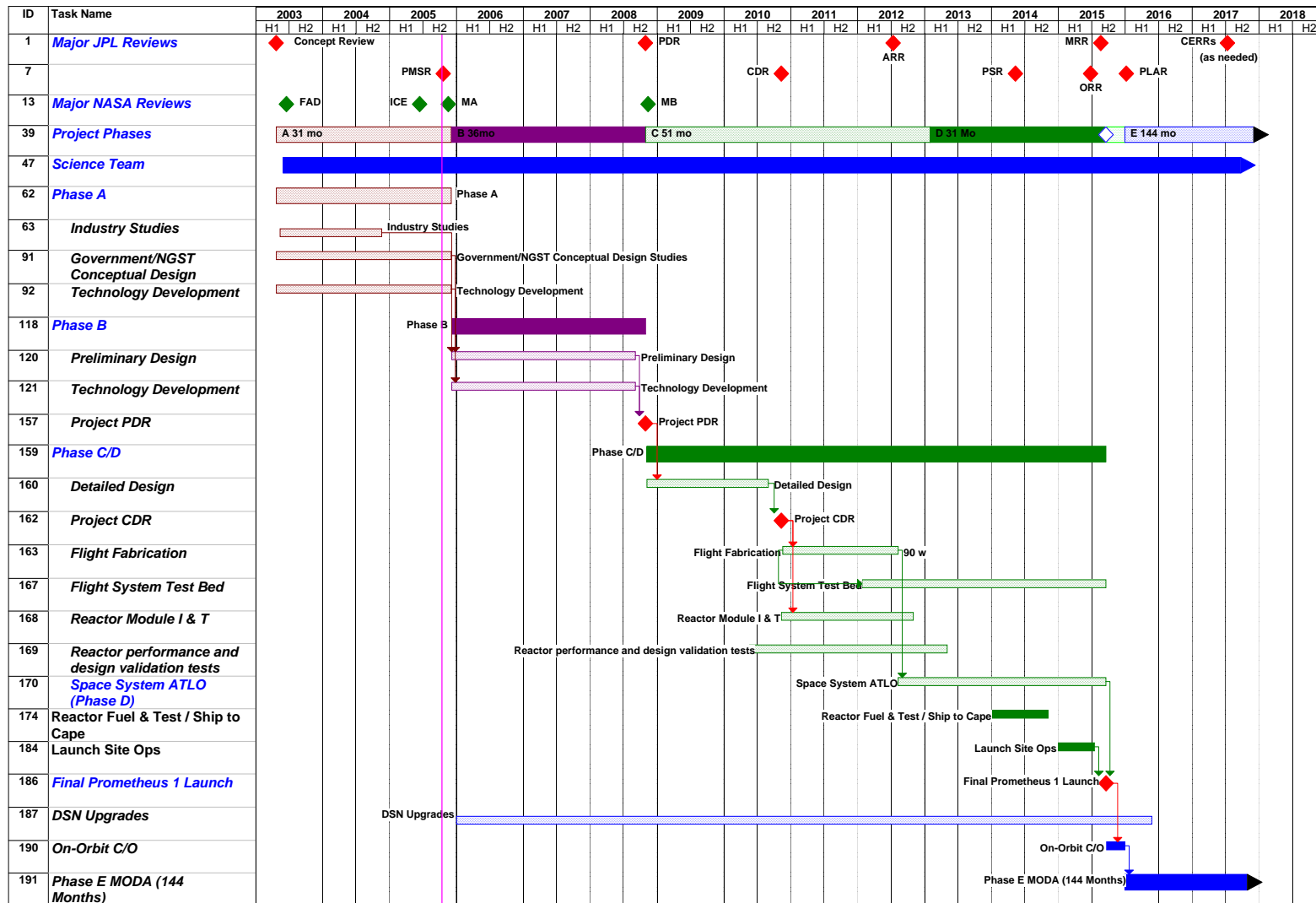

Figure 12.1-1. Top-Level Summary.

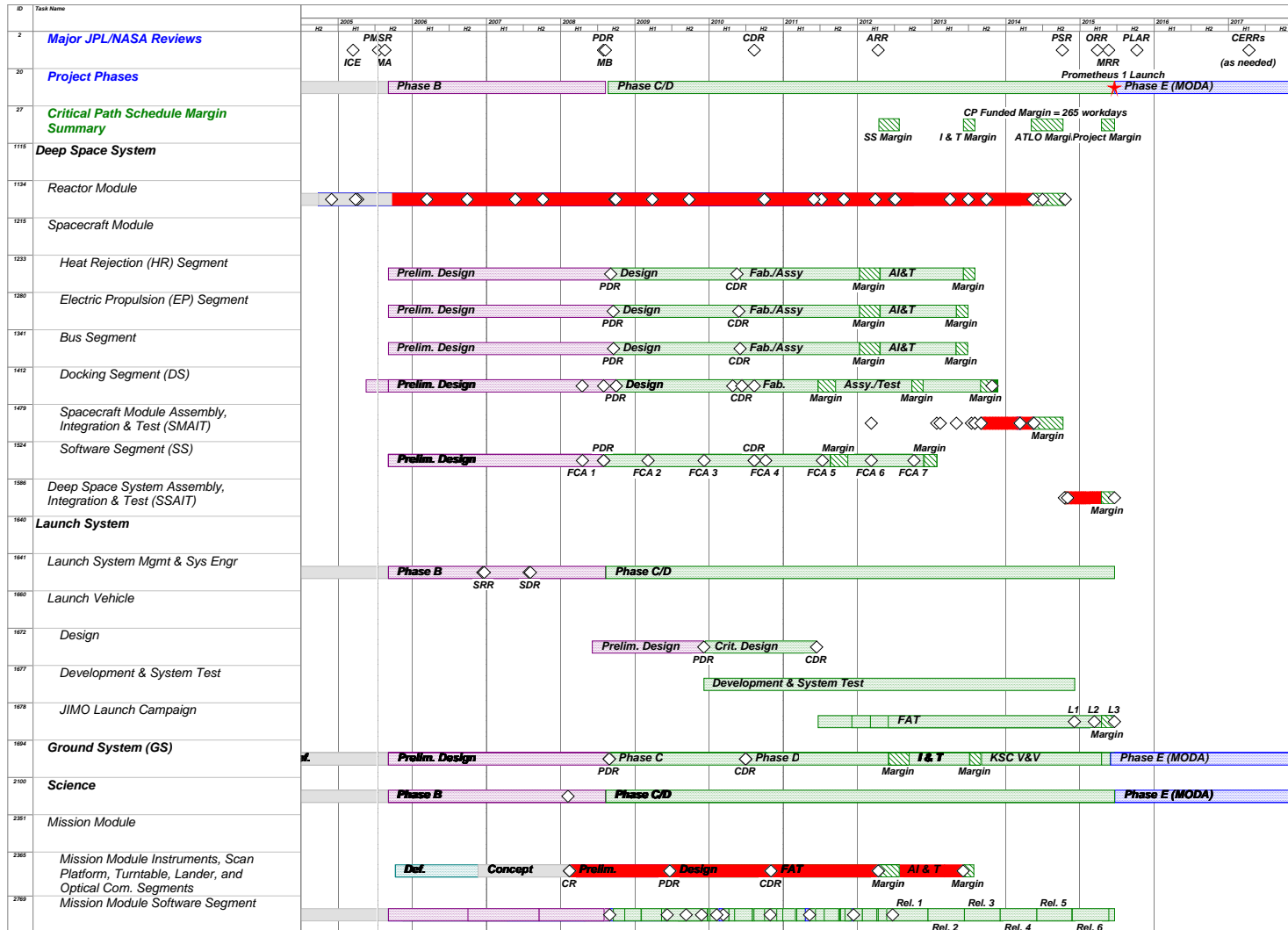

Figure 12.1-2. Project Critical Path Summary (through 2015 launch).

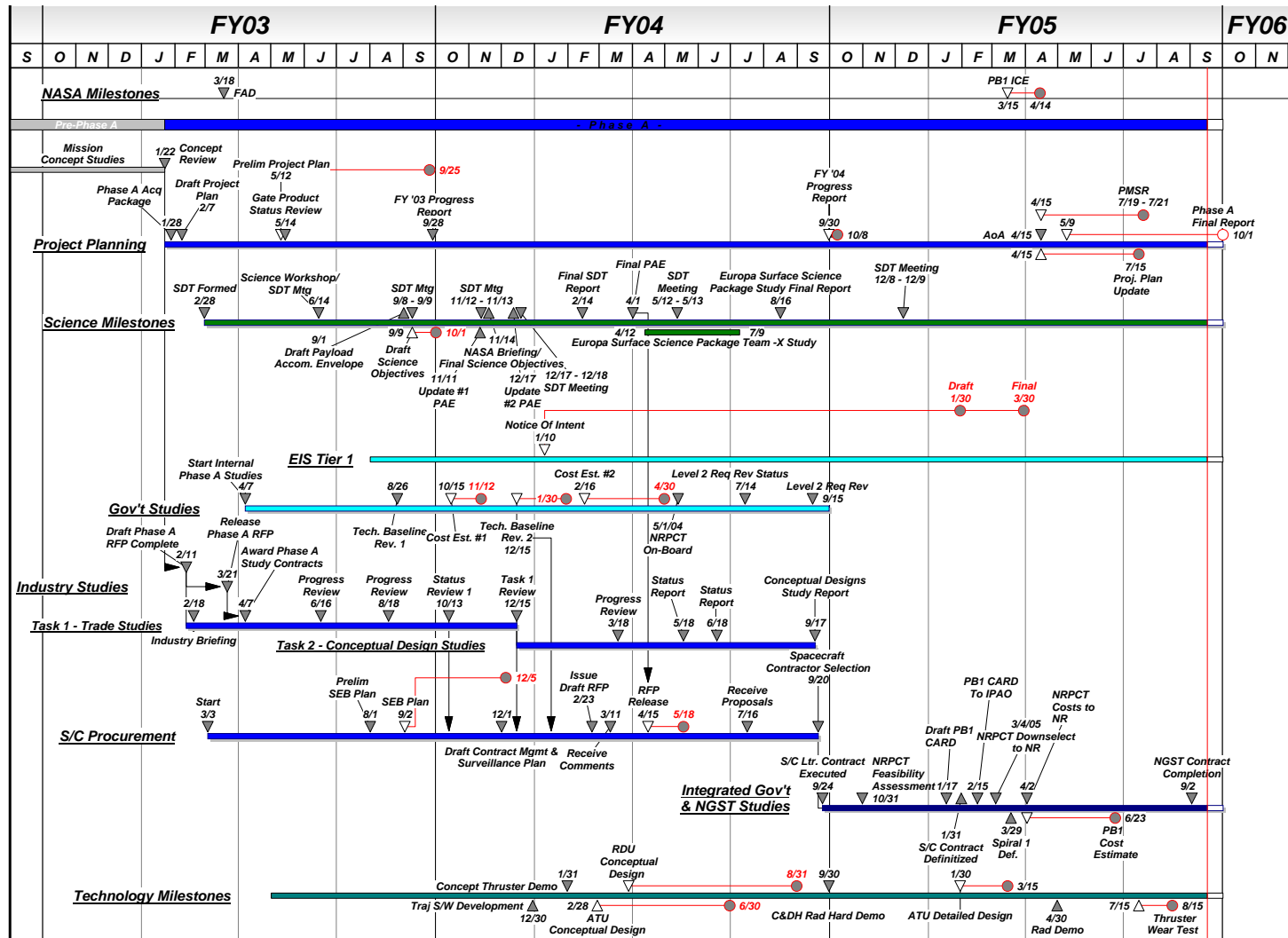

Figure 12.1-3. Project Phase A Schedule.

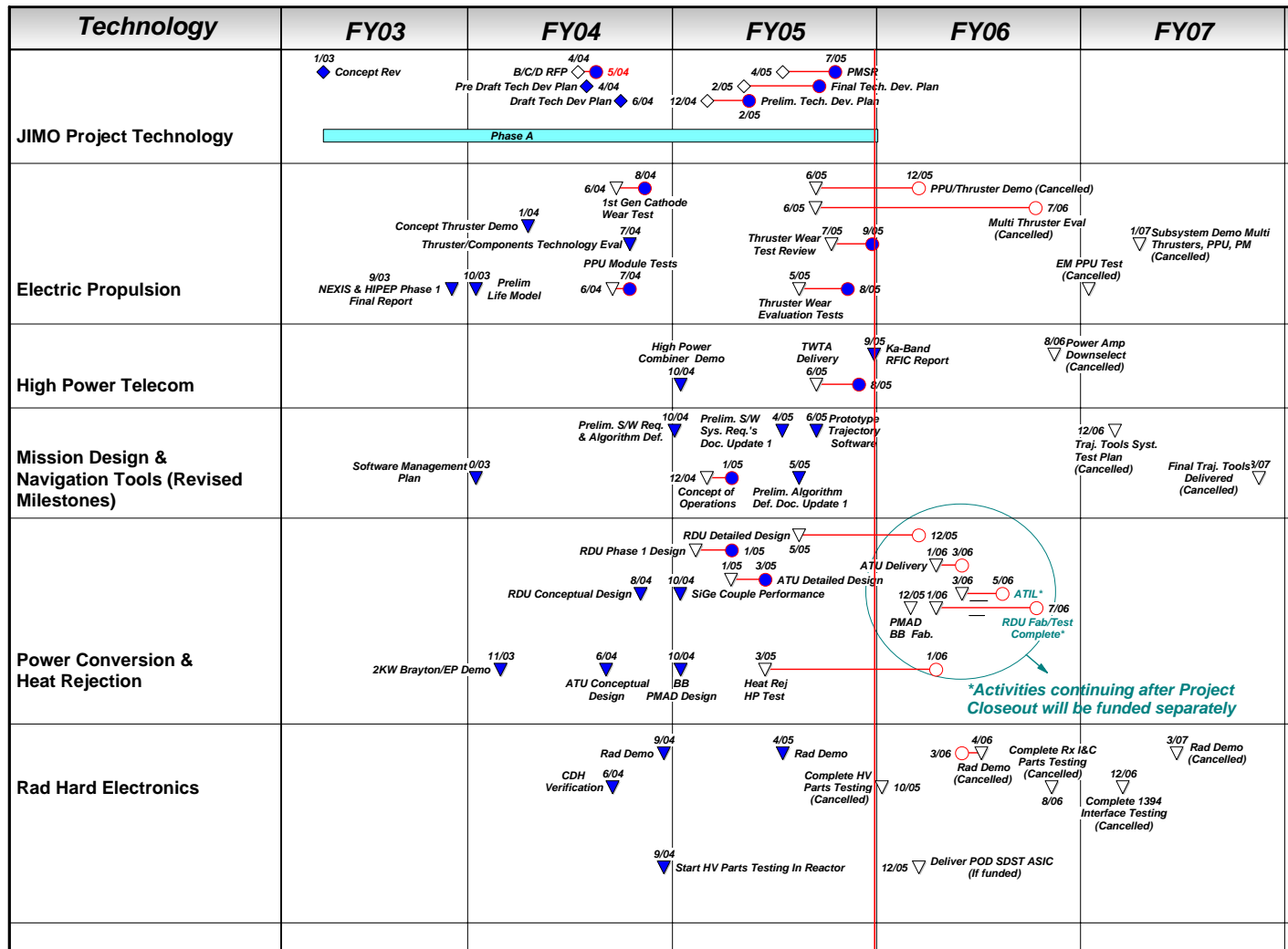

Figure 12.1-4. Technology Milestones.

12.2 Detail Schedule Development

12.2.1 Highlights

The Project IMS was developed to the subsystem level and provided identification of the scope of work applicable to the project phase and the expected period of performance for the phase.

1. The Subsystem Level IMS represents the lifecycle of the project, providing discrete activities for Phase B through C/D. Phase E is represented by summary period of performance activities and key schedule milestones as identified to date.
2. Supporting detail was represented for all subsystems.
3. Key deliverables are represented and supported by discrete activities in the Subsystem Level IMS.
4. Programmatic milestones are represented and supported by discrete activities in the Subsystem Level IMS.
5. Critical path method schedule methodology was employed. Predecessor-successor relationships are established and the Subsystem Level IMS was not artificially constrained.
6. Schedule margin periods were identified in the Subsystem Level IMS, and levels meet or exceed JPL schedule margin requirements contained in the JPL Design Principles.

The Prometheus Subsystem Level IMS was developed through accumulation and integration of schedule inputs provided by each Cost Account Manager (CAM) and Work Element Manager (WEM) from JPL, KSC, GRC, NRPCT, MFSC, Ames, and NGST.

The Master Schedule reflects a June 2015 launch date for the Prometheus spaceship and a 2025 mission completion date.

12.2.2 Critical Path

Analysis of the critical path to launch shows the Reactor Module (and associated Power Conversion) development and testing activities as the most critical path. The Mission Module is the next most critical path in the Master Schedule due to its activities being scheduled “as late as possible” to determine the latest date that an AO could be issued by NASA. The project intention was to revise the schedule once the instruments had been selected. The order of criticality for the Spacecraft Module was:

- Heat Rejection Segment
- Electric Propulsion (EP) Segment
- Bus Segment
- Docking Segment (DS).

12.2.3 *Prometheus Schedule Guidelines*

The Schedule Guidelines were implemented on all authorized/funded work activities and proposed work reflected in the LCCE.

12.2.4 *Preparation & Overall Criteria*

- CAM/WEM prepared and maintained Critical Path Method (CPM) logic schedules at the cost account manager level (minimum) in Microsoft Project. The level of detail was appropriate for the phase of the project. The depth of detailed information contained was to a level appropriate to the complexity, value, lead-time, risk, etc. of the effort.
- All activities in the schedule were linked and all schedule paths led to a deliverable item. Deliverable items include, but are not limited to, hardware, software, documents, etc.
- Durations were the planned estimates of time required to perform the tasks expressed in working days. Standard duration entry was in workdays assuming 40hr/5day workweek.
- Activities were generally planned without constraints. Exceptions included “fresh start” activities (tasks which do not depend on other activities to occur), reviews, and other milestones with firm schedule dates.
- All required System and Subsystem functional tests, environmental tests, calibration activities, and verification activities were represented in the schedule.

12.2.5 *Schedule Maintenance*

The process for maintaining project schedules is shown in Figure 12.2-1.

- Master/Official Schedule file(s) were kept by the Project Schedule Analyst (PSA) to maintain configuration management, Baseline integrity, and connection between tasks and Receivables/Deliverables.
- Each CAM updated the status of his/her schedule in Microsoft Project on a monthly basis (minimum) to maintain schedule accuracy and to measure earned value.
- Upon receipt of the updated schedule files, the PSA reconciled and incorporated the update to the IMS and initiated schedule analysis activities.
- Updated copies of the Master/Official Schedules were then placed back into the Current Schedule Files section of Docushare for general information and utilization by the responsible CAM/WEMs.

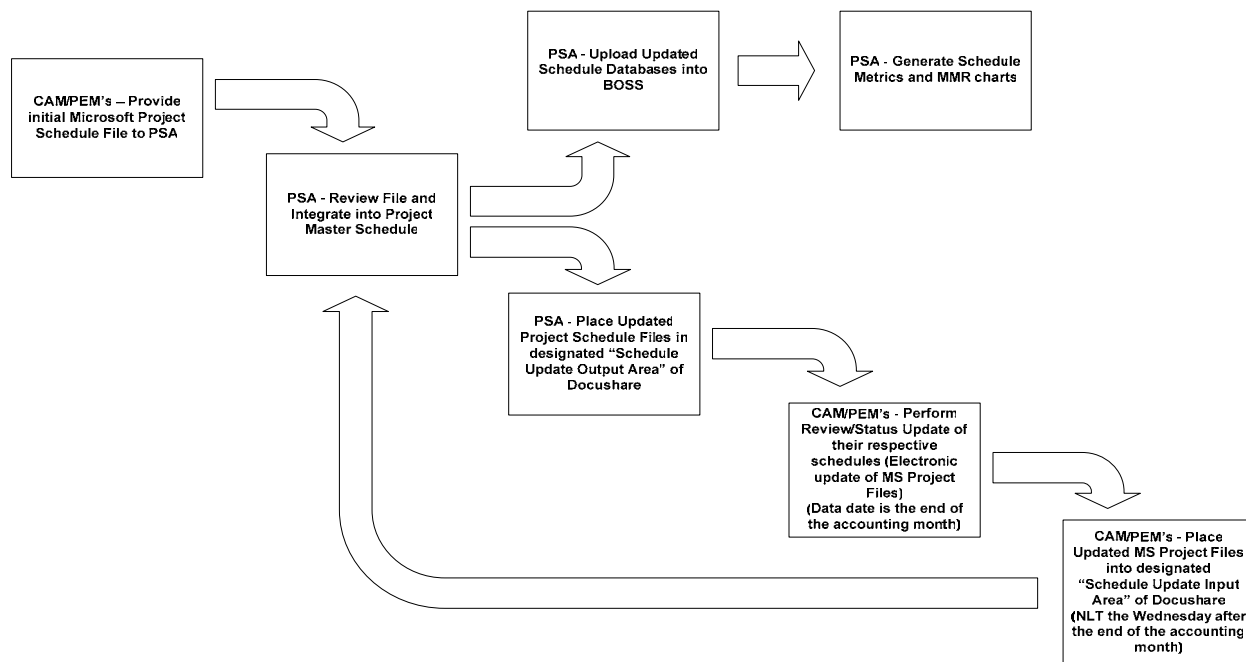

Figure 12.2-1. Schedule Update Process Flow Chart.

13. Estimates and Budgets

13.1 Cost Analysis Requirement Description (CARD)

The Prometheus Cost Analysis Requirement Description (CARD) satisfies the PMSR gate product for project costing as required by the JPL Flight Project Practices. The CARD documents the programmatic and technical baseline into a single internally consistent document that evolves over the project life cycle. The CARD consists of two parts: Part A contains general descriptive information of the project and Part B contains hardware and software technical parameters necessary to estimate the project's life cycle cost. The CARD was used by the project and NASA's Independent Program Assessment Office (IPAO) to develop independent cost estimates (ICEs) to verify and validate the project grassroots estimate. Section 13.2 describes the application of the CARD in the development of the project grassroots estimate and the ICEs under the JPL formal cost estimation process.

Figure 13.1-1 presents the JIMO 2015 CARD development process followed by the Project. The Prometheus Business Office led the development of the CARD. Coordination with the IPAO was started early in the process to ensure the content of the CARD templates met its cost estimating needs. IPAO inputs and comments were solicited for the CARD templates and were incorporated. The Business Office conducted a formal CARD kickoff meeting on January 5, 2005 in which detailed guidelines, instructions, and templates were provided to the section authors. Four major components of the CARD (Spaceship, Launch System, Ground, and Programmatic) were developed in two months.

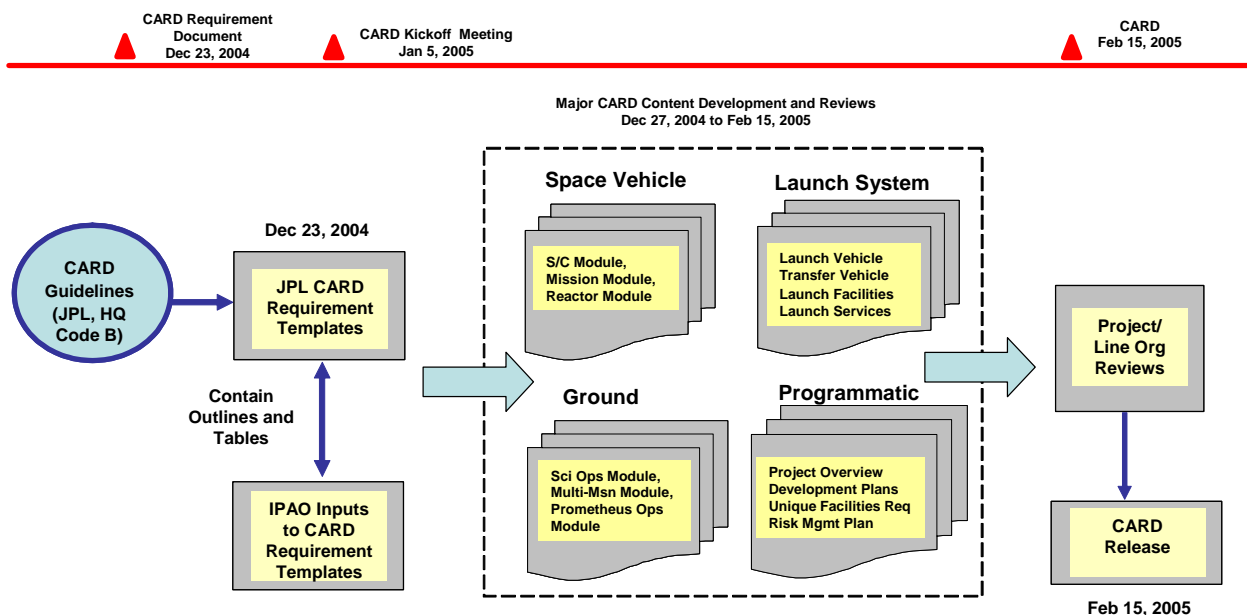

Figure 13.1-1 JIMO CARD Development Process.

Internal CARD reviews were performed by the JPL line organizations and each partner organization before the individual CARD inputs were submitted to the Project Office for final integration. The project cost engineer was responsible for collecting, verifying, and integrating the CARD inputs into the Project CARD document. The Project Office staff performed the final review and approved the project CARD document. The Project CARD was released on February 15, 2005 as the technical baseline to be used to develop the project grassroots estimate and the ICEs. In the initial briefing of the IPAO ICE, IPAO stated that Prometheus had submitted the best CARD they have seen for Defense and NASA projects.

13.2 Life Cycle Cost Estimate (LCCE)

The Prometheus Life Cycle Cost Estimate (LCCE) satisfies the PMSR gate product for project costing as required by the JPL Flight Project Practices. The LCCE documents the assumptions, development process and the cost of the JIMO 2015 mission. The LCCE is the official project cost baseline that was used for comparison with the ICEs.

Key contributors to the LCCE were; JPL, GRC, MSFC, ARC, KSC, and NGST. Per the NASA-NR agreements, NR had the sole responsibility for the development, independent review and approval of the Space Reactor Planning Estimate. This detailed estimate was developed and reviewed following standard DOE-NR policy and procedure. Once completed, the reactor estimate was provided by NR to the project. Figure 13.2-1 presents the development process for the JIMO 2015 LCCE.

The Prometheus Business Office led the LCCE effort and developed the JIMO 2015 LCCE using the JPL formal cost estimating process. The process required the use of the Project WBS and WBS dictionary and standard templates for the cost inputs, basis of estimates and cost review presentation packages. In addition to the stringent development requirements, the process also required extensive reviews by the project team, including all NASA Center/industrial partners and the development of multiple ICEs by independent sources outside of the project.

The JIMO 2015 cost estimate was developed using a grassroots methodology that began with the Project cost guidelines and the Project CARD, which captured all activities and products of the mission technical baseline and covered all phases of the project (development through operations). Each WBS element was assigned to a WBS element manager in the respective technical area to develop the detailed schedule, staffing requirements and other costs required. Metrics and recent program histories were used as a basis for many of these estimates. The Project Business Office cost engineers were responsible for collecting, verifying, and entering this data into the JPL Pricing system – the Proposal Cost Analysis Tool (PCAT) — to produce the LCCE. The estimates were documented using three essential means: Basis-of-Estimate (BOE), schedule and cost input file. Not counting the Space Reactor Planning Estimate, there were over 1,200 inputs to the LCCE.

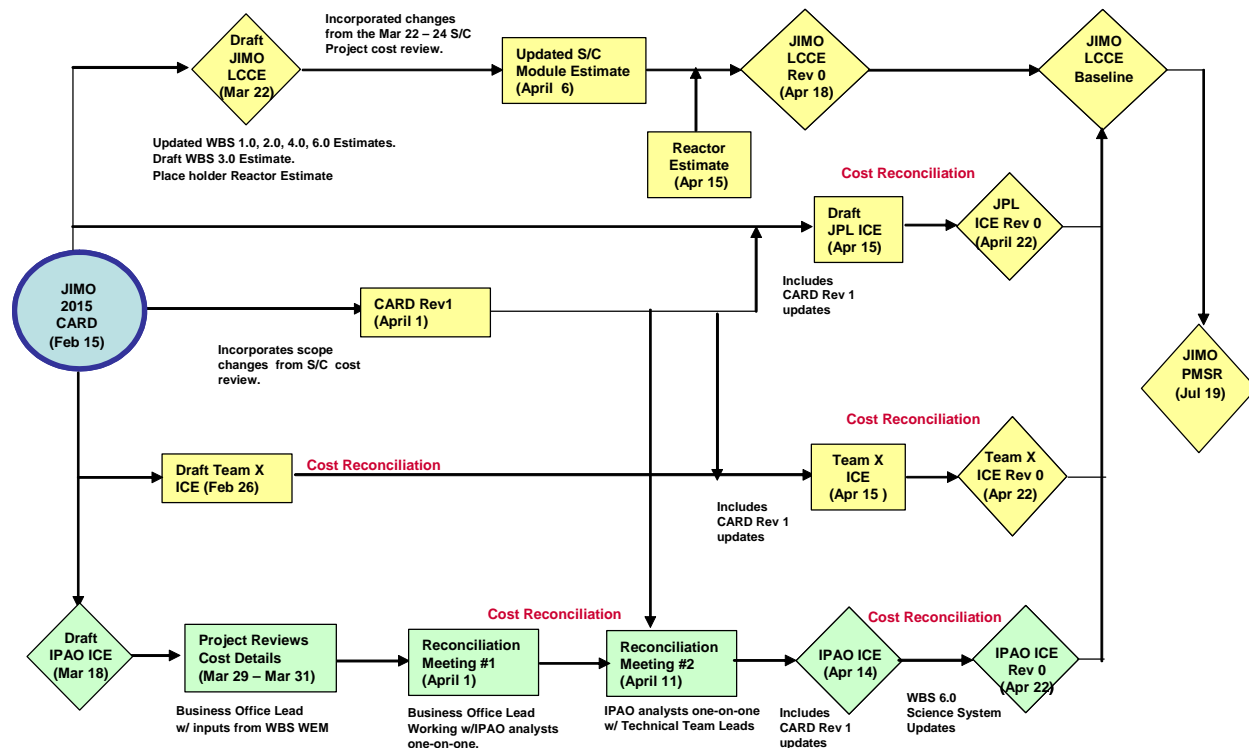

Figure 13.2-1 JIMO 2015 LCCE Development Process.

Also during the LCCE, the Prometheus Project performed initial logistics analysis for the Prometheus DSV. Each applicable BOE cognizant CAM was required to identify the number of units to be produced (flight model, engineering model, breadboard, and flight spares), including spare parts, and any units required for the applicable testbed(s) to be developed. Each CAM similarly was required to identify any required new facilities and/or facility modifications needed. Each relevant BOE was required to include Phase E work scope and associated costs through end of mission, including closeout costs. Consequently the logistics-related cost drivers were identified in detail in Phase A.

Internal cost reviews were conducted by JPL line organizations and partner organizations to ensure that the cost estimates were current, accurate, and complete before the estimates were submitted to the Prometheus Project Office for final integration into the LCCE. In addition, the Spacecraft Module roll-up estimates were reviewed by a joint JPL/NGST management team prior to submission to the Project Office. The Prometheus staff conducted detailed cost reviews for each WBS estimate. Grassroots cost estimates, basis of estimates, and the technical inputs that drove the cost estimates including cost risk were presented to the Project staff for evaluation.

In parallel with the grass roots estimation, the JPL formal cost estimating process requires the Project to develop ICEs to verify the completeness and reasonableness of the grassroots estimate. Two internal JPL estimates, the Advanced Project Design Team (Team X) ICE and the Costing Office ICE, were completed as part of the LCCE exercise. The Team X ICE was developed by a team of JPL technical experts using a “concurrent engineering environment”. The Costing Office ICE was developed by the Aerospace Corporation working closely with the JPL Costing Office.

The NASA IPAO also developed an ICE for the JIMO 2015 mission. The IPAO and their consultants from Tecolote Research were participating in the project design team meetings since October 2003. The early involvement of the IPAO team in the design process provided them invaluable insight into the evolving design trades and the latest design concept. With a clear understanding of the JIMO 2015 mission architecture, the IPAO team was able to produce a high confidence level ICE for this stage of the project.

Over a five -month period, the grassroots estimate went through numerous revisions to incorporate updates from organizational and project reviews. The three ICEs also went through several revisions to incorporate updates to the CARD. On April 18, 2005, the first completed LCCE including the reactor cost estimate, JIMO LCCE rev 0, was completed. Detailed cost reconciliations between the JIMO LCCE rev 0 and the three ICEs were conducted to identify and resolve major cost differences. The estimates were examined for completeness and reviewed to get an understanding of the differences, if any, in each of the estimates’ set of assumptions. Similarities and differences were identified and analyzed and problems of omission or duplication were resolved. Once all parties understood the cost estimates, the grassroots estimate was submitted as the official JIMO 2015 cost baseline and was presented at the PMSR.

The results of the LCCE are summarized below. The amounts shown are in real-year dollars, excluding reserve. The recommended reserve position by the project is 36% (excluding the Launch System) on phase B-D cost. The JIMO spacecraft was premised to be able to launch on any vehicle provided by NASA, funded separately from the project. The Launch System costs below are shown separately as a reference value only for a three launch scenario.

		(\$'s in Billions)					
WBS		Phase A	Phase B	Phase C/D	Phase A-D	Phase E	Total
1.0	Proj. Mgmt/Sys Eng	\$0.028	\$0.115	\$0.515	\$0.657	\$0.309	\$0.967
2.0	Ground System	0.002	0.025	0.421	0.448	1.425	1.873
3.X	Deep Space System (less WBS 3.2 & 3.3)	0.071	0.102	0.715	0.888	0.066	0.955
3.3	Spacecraft Module	0.165	0.756	3.872	4.792	0.000	4.792
3.2	Reactor Module	0.135	0.744	2.642	3.522	0.643	4.165
5.0	Project System A,I&T (Inc'l in 3.X)	0.000	0.000	0.000	0.000	0.000	0.000
Total w/o Science		\$0.400	\$1.742	\$8.165	\$10.307	\$2.444	\$12.751
6.0	Science System	0.012	0.175	1.975	2.162	1.404	3.565
Total w/ Science		\$0.412	\$1.917	\$10.140	\$12.469	\$3.848	\$16.317
4.0 Launch System		\$0.002	\$0.109	\$5.050	\$5.161	\$0.000	\$5.161

13.3 Funding Requirements

Table 13.3-1 shows the actual funding, by Performing Organization, by Fiscal Year and by Unique Project Number (UPN), as issued to the Project by NASA. Note that FY03 and FY04 funding was issued from SMD and FY05 funding was issued from ESMD.

Table 13.3-1. Actual funding, by Performing Organization, by Fiscal Year, and by Unique Project Number (UPN).

Sum of Amount		FY Funding			Grand Total
NASA Center	UPN	FY03	FY04	FY05	
ARC	982		398,000	900,000	1,298,000
	973-80			457,000	457,000
ARC Total			398,000	1,357,000	1,755,000
DOE-NE	982	8,100,000			8,100,000
	973-80		9,000,000		9,000,000
DOE-NE Total		8,100,000	9,000,000		17,100,000
DOE-NR	973		(707,555)		(707,555)
	982		15,000,000	21,925,000	36,925,000
	973-80		5,207,555	68,727,000	73,934,555
DOE-NR Total			19,500,000	90,652,000	110,152,000
GRC	982	3,400,000	14,430,000	8,500,000	26,330,000
	973-80		13,034,000	24,700,000	37,734,000
GRC Total		3,400,000	27,464,000	33,200,000	64,064,000
JPL	982	26,470,574	37,109,205	68,400,000	131,979,779
	973-80		49,130,336	29,000,000	78,130,336
JPL Total		26,470,574	86,239,541	97,400,000	210,110,115
JSC	973-80		75,000		75,000
JSC Total			75,000		75,000
KSC	982		725,000	1,000,000	1,725,000
	973-80		-		-
KSC Total			725,000	1,000,000	1,725,000
LaRC	982	56,426	172,000		228,426
LaRC Total		56,426	172,000		228,426
MSFC	982	745,000	9,275,600	9,100,000	19,120,600
	973-80		686,400	239,000	925,400
MSFC Total		745,000	9,962,000	9,339,000	20,046,000
Project Total		38,772,000	153,535,541	232,948,000	425,255,541
Other NASA Costs		419,000	1,285,000	1,790,000	3,494,000
Headquarters		680,000	8,998,800	1,949,000	11,627,800
Corporate G&A		-	7,520,000	16,000,000	23,520,000
Grand Total		39,871,000	171,339,341	252,687,000	463,897,341

13.4 Workforce

Table 13.4-1 shows the actual workforce, by Performing Organization and by Fiscal Year. Note FY05 is estimated for the full year as September, 2005 was not available at the time of this writing.

Table 13.4-1. Actual workforce, by Performing Organization and by Fiscal Year.

	Actual FTEs (in man-years)			
	FY 03	FY 04	FY 05	Total
JPL	40.1	123.5	131.8	295.3
GRC	15.9	49.0	47.0	111.9
MSFC	7.5	23.2	18.5	49.2
ARC		0.5	3.3	3.8
KSC		0.0	0.0	0.0
DOE	21.5	66.3	226.4	314.2
Total	85.0	262.5	427.0	774.5

Appendix A — For Further Information

The Prometheus Project compiled an extensive library of Project documentation, which is archived as explained in Section 1. (It is also available by contacting NASA Headquarters.)

This library includes hundreds of plans, reports, technical design file memos, white papers, published technical papers, reviews presentations packages, and more.

The following list of selected documents is intended to provide the reader with an introduction to the key documents contained in the Project archives.

A.1 General

1. Jupiter Icy Moons Orbiter (JIMO) Annual Report, 982-00012, September 29, 2003
2. Jupiter Icy Moons Orbiter (JIMO), an element of the Prometheus Program, Annual Report, 982-R06933, October 15, 2004
3. Project Document List (PDL), 982-R07199, July 15, 2005
4. Project Document Tree, 982-R07096, July 15, 2005

A.2 Project Management

1. Memorandum of Understanding Between the National Aeronautics and Space Administration and the Department of Energy (National Nuclear Security Administration – Naval Reactors) Regarding Civilian Space Reactors, August 5, 2004.
2. Memorandum of Agreement Between the National Aeronautics and Space Administration (Exploration Systems Directorate) and the Department of Energy (National Nuclear Security Administration – Naval Reactors) Regarding the Project Prometheus Jupiter Icy Moons Orbiter Mission, October 21, 2004.
3. Closeout Plan, Document 982-00134, dated September 13, 2005.
4. Formulation Authorization for the Project Prometheus Program, March 18, 2003
5. Preliminary Project Plan, 982-0001, Rev. 0, August 22, 2003
6. Preliminary Project Plan (update draft), 982-00001, Rev. 1, July 14, 2005
7. Renewed Spirit of Discovery: The President's Vision for U.S. Space Exploration, NP-2004-01-334-HQ, February 2004
8. NASA Program and Project Management Requirements, November 21, 2002 (NPG-7120.5B)
9. JPL Flight Project Practices (FPP) (JPL Rules! DocID 58032, Revision 6)
10. JPL's Design, Verification/Validation, and Operations Principles for Flight Systems (Design Principles, DP), March 3, 2003 (D-17868, Revision 2)
11. Gate Product Matrix (PMDR Only Products 7-17-2005)

12. Project Implementation Plan, 982-00111, July 13, 2005
13. Project Policies Document, 982-00057, March 25, 2004

A.3 Requirements

1. “Level 1 Jupiter Icy Moons Orbiter (JIMO) Requirements Document”, OexS-RQ-0003 (982-00088), May 18, 2004.
2. “JIMO Level-1 Requirements Formulation Team Report”, OexS-RQ-004, December 20, 2004 (982-R72632).
3. Integrated Deep Space Vehicle and JIMO Mission Project Derived Requirements – Preliminary, 982-00056, Rev. 2, September 23, 2005

A.4 Project Engineering

1. “Prometheus Project Engineering Plan”, 982-00101, July 15, 2005.
2. “Project Engineering Process Audit”, 982-R55672, July 15, 2005
3. Technical Margin Management Plan, 982-00040, July 17, 2005
4. PE Summary List (Project Analyses and Trades List), September 14, 2005
5. End-to-End Information System Plan, 982-00079, September 19, 2005
6. Prometheus Software Requirements Document, 982-00063, July 15, 2005
7. Software IV&V Self-Assessment Document, 982-00099, May 15, 2005
8. Prometheus Configuration Management (CM) Plan, 982-00027, June 15, 2005
9. “Critical Concepts in NEP Missions,” 982-00135, Rev. 0, September 27, 2005
10. System Model Version 3.0 Description Report
11. Prometheus Project Software Management Plan, 982-00046, May 15, 2005

A.5 Safety

33. “Environmental Compliance/Launch Approval Status System” (ECLASS), April 1, 2004
34. Prometheus Project Launch Approval Engineering Plan, March 1, 2005
35. Notice of Intent (NOI) to prepare the Tier 1 EIS, March 30, 2005
36. Draft Prometheus Risk Communication Plan, July 13, 2005
37. JPL Risk Communication Plan, JPL Rules Doc ID 61272, Rev. 1, March 26, 2003

A.6 Mission Assurance

1. Prometheus Project Mission Assurance Requirements (982-00035) dated July 6, 2005
2. Project Review Plan (982-00013), dated April 14, 2004
3. Prometheus Project Environmental Requirements Document (982-00029), dated July 6, 2005
4. Prometheus Project Radiation Control and Verification Requirements (982-00028), dated July 6, 2005
5. Prometheus Project Parts Program Requirements (982-00025), dated July 6, 2005
6. Prometheus Project Hardware Reliability Assurance Requirements (982-00037), dated July 6, 2005
7. Prometheus Project Problem/Failure Reporting (PFR) Requirements (982-00036) dated July 6, 2005
8. Prometheus Project Software Quality Assurance Requirements (982-00038) dated July 6, 2005
9. Prometheus Project Hardware Quality Assurance Requirements (982-00042) dated July 6, 2005
10. Prometheus Project Materials and Processes Control Requirements (982-00039) dated July 6, 2005
11. Prometheus Project Risk Management Plan (982-00009) dated December 2, 2004
12. Environmental Program Implementation Plan - Draft (982-00124) dated June 17, 2005
13. Materials and Processes Program Implementation Plan - Draft (982-00127) dated June 2, 2005
14. Parts Program Implementation Plan – Draft (982-00122) dated September 1, 2005
15. Hardware Quality Assurance Implementation Plan - Draft (982-00121) dated July 18, 2005
16. Reliability Implementation Plan – Draft (982-00123) dated July 18, 2005
17. Radiation Control and Verification Implementation Plan – Draft (982-00128) dated July 18, 2005
18. Spacecraft Module Assurance Implementation Plan –Draft (982-00125) dated July 8, 2005
19. Software Quality Assurance Implementation Plan –Draft (982-00120) dated July 7, 2005
20. End of FY'05 Report for Prometheus Project Environments (IOM 5134-2005-52) September 13, 2005
21. Reliability FY'05 End of Year Report (IOM 5131-05-134) September 29, 2005

22. End of FY05 Report for Prometheus Project SQA (IOM 5125-2005-010) September 9, 2005
23. End of FY05 Report for Prometheus Project Risk Management (IOM 5133-05-002) September 13, 2005
24. End of FY2005 Report for Spacecraft Module Assurance (IOM 5150-2005-001) August 19, 2005
25. Radiation Testing On Carbon/Epoxy Composite Materials For Composite Over Wrap Pressure Vessels (COPV) September 28, 2005
26. "Prometheus Initial Orbital Debris Assessment (PMSR)", IOM 6130-2005-026, 982-R5571, June 30, 2005,

A.7 Science System

1. Prometheus Science Office Management Plan, 982-00104, July 15, 2005
2. Science System Key Driving Requirements, 982-00114
3. Mission Plan, 982-00059
4. Planetary Protection Category Request Memo to NASA HQ PP Officer, 982-R52731
5. Mission Module Design Description, 982-00133, September 14, 2005
6. Report of the NASA Science Definition Team for the Jupiter Icy Moons Orbiter (JIMO), February 20, 2004

A.8 Deep Space Vehicle

1. NGST Prometheus Spacecraft Module & Subcontractor-provided Reactor Module Segment Design Description – Draft, Rev. B, SDRL SE-002-001B, Sept. 1, 2005.
2. NGST Prometheus Vol. I Trade Studies, July 18, 2005.
3. NGST Prometheus Vol. II Trade Studies, July 18, 2005.
4. NGST Prometheus Space System Verification & Validation Plan – Concept, SDRL TE- 001-001, April 15, 2005.
5. NGST Prometheus Space Operational Modes Definition, SDRL TD-002-001, Draft, 6/01/05
6. Deep Space Vehicle Level 3 Key Driving Requirements, 982-00098
7. NGST Phase A/B Implementation, Final, MS-017-002
8. NGST Proposal for Project Prometheus Jupiter Icy Moons Orbiter (JIMO) Project, Volume 1 – Technical/Management, July 15, 2004

A.9 Reactor

1. "Space Reactor Planning Estimate, for NR Action, " NOFORN, SPP-67510, B-SE-0091, memo from KAPL, Inc. and Bechtel Bettis, Inc to DOE-NR dated April 2, 2005. [This document contains the life cycle cost estimate for the Space Reactor and represents the technology development plan for the reactor and the power conversion element of the Spaceship.]
2. "Space Nuclear Power Plant Concept Recommendation," NORFORN, SPP-67110-0007, dated 7/27/2005.
3. "Joint DOE-NASA Classification Guide for Civilian Space Nuclear Reactors to Support NASA Project Prometheus Mission," Official Use Only, Dec. 2004.
4. "NRPCT Final Closeout Report," date TBS

A.10 Technology Development:

1. Technology Development Plan Requirements, 982-00053, Rev. 1, dated July 8, 2005.
2. "Heat Rejection Technology Development Plan," 982-00073, Rev. 1, dated 7/12/2005 (See Heat Rejection Segment section of the archive library for technology development reports.)
3. "High Power Telecommunications Technology Development Plan," 982-00066, Rev. 0, dated 6/15/2005. (See Bus Telecommunication Subsystem section of the archive library for technology development reports.)
4. "Radiation Hardened Electronics Technology Development Plan," 982-00072, Rev. 1, dated 6/15/2005. (See Radiation Hardened Component Technology section of the archive library for technology development reports.)
5. "Electric Propulsion Technology Development Plan," 982-00071, Rev. 0, dated 7/7/2005. (See Electric Propulsion Segment section of the archive library for technology development reports.)
6. "Low Thrust Trajectory and Navigation Tools Technology Development Plan," 982-00074, Rev. 0, dated 6/15/2005. (See Mission Design section of the archive library for technology development reports.)

A.11 Launch System

1. "Prometheus Project Spacecraft Processing Facility Conceptual Study," KSC-VA-7384, June 17, 2005.
2. "Launch System Key Driving Requirements," 982-00117, Rev. 0, June 20, 2005.
3. "Project Prometheus/JIMO Delta IV Launch Vehicle Enhancement Study to NASA KSC – Final Report," 16 Dec. 2003. Boeing Proprietary.
4. "Atlas Launch Systems for JIMO Evolution Impacts," 4 December 2003, Lockheed Martin Proprietary.

A.12 Ground System

1. Draft DSMS Support Agreement (DSMS Document #870-439, Rev 0, JPL D-32210, dated June 16, 2005)
2. Draft Ground System level 3 Requirements (Document #982-00131, Rev. 0, dated July 11, 2005)
3. Ground System Key Driving Requirements Document, PD # 982-00109, Rev. 0, dated July 22, 2005
4. KDR Implementation Response Matrix , dated July 15, 2005
5. Draft Prometheus Operations Module (POM) Requirements (Document #982-00130, Rev 3, dated June 30, 2005)
6. Preliminary Ground System Operations Concept Document, PD # 982-00108, Rev. 0, dated July 8, 2005
7. Ground System Document List, dated July 14, 2005
8. TDRSS Support Feasibility Assessment Report (Trade Study), dated June 15, 2005
9. Integrated Flight Ground Development Concept & Schedule, dated April 21, 2005

A.13 Acquisition

1. Project Acquisition Plan, 982-00102, July 12, 2005
2. Request for Proposal No. JIMO-2004 for Project Prometheus Jupiter Icy Moons Orbiter (JIMO) Project, May 18, 2004
3. Surveillance Plan – Prometheus Spacecraft Subcontract, 982-00106, June 23, 2005
4. "Acquisition Strategy and Source Selection for Co-designing a New-development Spacecraft," Date TBD
5. Cost Plus Fixed Fee/Incentive Fee/Award Fee Research & Development Subcontract, 982-R37956

A.14 Business

1. Work Breakdown Structure Development Requirement Document, #982-00064, June 9, 2003
2. Work Breakdown Structure, #982-00068, January 19, 2005
3. WBS Dictionary, 982-00067
4. JIMO 2015 Cost Analysis Requirement Document (CARD), #982-R52963, June 28, 2005
5. Life Cycle Cost Estimate (LCCE) Report for the JIMO 2015 Mission #982-R53013, June 27, 2005

A.15 Public Outreach and Advocacy

1. Prometheus Education and Public Engagement Plan, 982-00107

A.16 Additional Prometheus Studies

1. Lunar Fission Surface Power System Study Report, 982-R66153, August 17, 2005
2. Analysis of Alternatives (AoA) Study Report 982-R46512, April 15 2005

A.17 Reviews (Presentation Material)

1. Pre Phase A-to-Phase A Gate Transition Product Status Review
2. Acquisition Strategy Briefing
3. Milestone Preparation Review
4. Project Mission and System Review (PMSR)

[This page intentionally left blank]

Appendix B — Prometheus Events

August 2002

“Eight Day Study” conducted at NASA HQ

September 2002

Jupiter Icy Moons Tour (JIMT) Studies started

November 2002

Jupiter Icy Moons Orbiter (JIMO) Pre-project commences

January 2003

Presentation to NASA Administrator

February 2003

JIMT studies completed

JIMO New Start authorized by Congress

March 2003

Formulation Authorization signed

Science Definition Team formed

RFP for industry studies released

FY03 Cost Workshop

April 2003

Industry study contracts let

May 2003

Gate product review pre-phase A to phase A transition

Program Operation Plan (POP) submission

June 2003

Science Forum held

FY04/05 Budget Workshop held

“Reactor 101” Training

August 2003

Technical Baseline Review (of Technical Baseline-1)

Science Definition Team workshops held

September 2003

First annual report released

October 2003

Preliminary Project Plan signed

November 2003

First Technology workshop for industry

December 2004

Industry studies received

January 2004

Technical Baseline #2 completed (following 28 peer reviews)

President’s “Vision for Space Exploration” announced

February 2004

NASA creates Exploration Systems Mission Directorate (ESMD)

Prometheus transferred to ESMD

“Task 2A” for follow-on applications of JIMO spacecraft added to study contracts

Science Definition Team Final Report issued

Draft RFP for Spacecraft Co-Design issued

March 2004

Assignment of space reactor to Naval Reactors made

Second Technology Workshop for Industry

April 2004

Budget guidelines reduced

May 2004

Exploration level 0 requirements released

JIMO level 1 requirements released

RFP released for Spacecraft Co-design

Mass estimates exceed available launchers

“Typical Week in Orbit” study completed

June 2004

Program Operating Plan [POP] presented to Administrator

Mission architecture completed

Project Retreat

Milestone Preparation Review completed

July 2004

Industry derivative mission reports received

Industry proposals received

Government Accountability Office presentation

August 2004

Memorandum of Understanding with Naval Reactors signed

Decision to accept Europa impact for Planetary Protection purposes made

September 2004

Industry conceptual design final reports received

Letter contract award to Northrop-Grumman Space Technologies [NGST] made

Technical Baseline 2.5 completed

Stopped work on thermo-electric power conversion

Second Annual Report issued

October 2004

Memorandum of Agreement with Naval Reactors signed

NASA requests Analysis of Alternatives study

NRPCT Feasibility Assessment conducted

November 2004

FY 2005 budget cut 26%

JIMO launch delayed to 2017

December 2004

Draft Analysis of Alternatives submitted

January 2005

Definitive subcontract award to NGST made

February 2005

Administrator O'Keefe departs

NASA inserts Lunar Orbiter mission in 2014

JIMO mission "deferred"

CARD completed

March 2005

Reactor/power conversion method selected

NASA Administrator Michael Griffin confirmed

April 2005

Life Cycle Cost Estimate completed

Reprioritization to Lunar Surface Power directed

Space Reactor Planning Estimate conducted

Analysis of Alternatives Final Report submitted

May 2005

NASA releases new FY 2005 operating plan

Ramp up of lunar surface studies

Project initiated shutdown of JIMO

Started chemical-fuel Europa orbiter studies

July 2005

Project Mission and System Review held

August 2005

Submitted Lunar Fission Surface Power Station Study Final Report

September 2005

Project Prometheus shut down

[This page intentionally left blank]

Appendix C — Key Personnel

Prometheus Project key personnel are identified by title, name, organizational affiliation, and brief role statement. Information on supporting personnel is contained in other documentation (e.g., Work Agreements and LCCE BOEs).

Project Manager (John Casani, JPL) – responsible for the successful development and operation of the Project, including scope, schedule, budget, deliverables, and reporting authority.

NRPCT Project Manager (Michael Wollman, KAPL) – responsible for successful development and operation of the Reactor Module, as well as oversight of the Space Nuclear Power Plant.

NRPCT Deputy Project Manager (Michael Zika, Bettis) – deputy for NRPCT activity.

Project Scientist (Torrence Johnson, JPL) – responsible for the scientific integrity of the mission and for maximizing the science return from the mission, within Project constraints.

Safety Manager (Beverly Cook, JPL) – responsible for establishing the requirements and coordinating all activities relating to the health and safety of all persons working on or with Project systems and hardware, including OSHA, nuclear safety, systems safety, and safeguarding of special materials.

Mission Assurance Manager (Sammy Kayali, JPL) – responsible for establishing the Project-wide mission assurance requirements and ensuring flow down and implementation across all Project systems and implementing organizations, including environments, radiation test and characterization, microelectronics selection and test, materials and processes, hardware and software quality assurance, reliability, problem/failure reporting, risk management, and reviews.

Project Business Manager (David Milkovich, JPL) – responsible for oversight of all Project business activities, including scheduling, financial tracking and management, earned value analysis, and resource management and allocation.

Project Acquisition Manager (Randall Taylor, JPL) – responsible for Project acquisition strategy and implementation, including make-or-buy program, procurements and non-procurement agreements, and surveillance.

Project Engineering Office Manager (Sarah Gavit, JPL) – served as the Project System Engineer, responsible for establishing the Project-level (Level 2) design and technical performance requirements on the Project Systems; also responsible for Project verification and validation, software management, EEIS, and configuration management.

Chief Engineer (Duncan MacPherson, JPL) – responsible for independent technical assessment, including establishment and direction of major trade studies and technical evaluations, assessments, and analyses.

Deep Space System Manager (David Lehman, JPL) – responsible for the design, development, engineering integrity, and performance of the Deep Space System and its modules, including technical implementation requirements and plans and interface agreements with other systems. Also served as acting Project Manager in the Project Manager’s absence.

Spacecraft Manager (Karla Clark, JPL) – responsible for development of the Spacecraft Module and integration and test of the Spaceship, including implementation of co-design. Also served as Contract Technical Manager for the NGST procurement.

Deputy Spacecraft Manager (Therese Griebel, GRC) – deputy to the Spacecraft Manager. Also served as the Project Technology Manager, responsible for technology development planning and implementation.

NGST Project Manager (Peggy Nelson, NGST) – responsible for delivery of the Spacecraft Module and integration and test of the Spaceship, including implementation of co-design.

NGST Spacecraft Module Delivery Manager (Blake Sathoff, NGST) – responsible for Spacecraft Module design and development.

Ground System Manager (John McKinney, JPL) – responsible for the development and implementation of the Ground System.

Launch System Manager (Maria Littlefield, KSC) – responsible for the design, development, engineering integrity, and performance of the Launch System, including launch vehicle(s) and launch services.

Science and Mission Design Office Manager (Kim Reh, JPL) – responsible for all activities and products associated with science, mission design, science operations module and Mission Module.

Mission Operations Manager (N/A) – (This position would have been established not later than 9 months before launch, responsible for the conduct of flight operations.)

Mission Design Manager (Louis D’Amario, Jon Sims, JPL) – responsible for the development of the JIMO trajectory and navigation designs and JIMO mission scenarios and plans.

NASA Center Leads (see list below) – responsible for the planning and execution of Field Center work assignments; members of the Project Office involved in all major Project decisions. The Centers, plus LaRC, collocated a Center representative(s) at JPL during significant portions of Phase A.

- ARC (Daniel Bufton)
- GRC (Bryan Smith)
- KSC (Maria Littlefield)
- MSFC (Angela Jackman)

JPL Division Representatives (see list below) – responsible for the planning and execution of JPL Technical Division work assignments.

- 31 – Navid Dehgani
- 32 – James Weiss
- 33 – Jeffrey Hilland
- 34 – Tooraj Kia
- 35 – Sharon Langenbeck
- 37 – Paul Ottenfeld
- 38 – Tom Luchik
- 50 – Cynthia Kingery
- 91 – Dan Finnerty

[This page intentionally left blank]

Appendix D — Responsibility Assignment Matrix

Work Breakdown Structure	Requirements Agent	Design Agent (or Integration Agent)	Design Approval Authority	Design Concurrence Authority	Phase A/B			Phase C	Phase D	Work Element Manager (WEM) / Lead
					Co-location Site	Co-location Site	Co-location Site			
Prometheus	JPL	JPL	JPL	N/A	JPL	JPL	JPL	JPL/KSC	JPL	
1.0 Project Management & System	JPL	JPL	JPL	N/A	JPL	JPL	JPL	JPL/KSC	JPL	
1.1 Project Management	JPL	JPL	JPL	N/A	JPL	JPL	JPL	JPL/KSC	JPL	
1.2 Mission Assurance	JPL	JPL	JPL	N/A	JPL	JPL	JPL	JPL/KSC	JPL	
1.3 Business Operations	JPL	JPL	JPL	N/A	JPL	JPL	JPL	JPL/KSC	JPL	
1.4 Intentionally Left Blank	N/A	N/A	N/A	N/A	N/A	N/A	N/A	N/A	N/A	
1.5 Project Engineering	JPL	JPL	JPL	N/A	JPL	JPL	JPL	JPL/KSC	JPL	
1.6 Safety Management	JPL	JPL	JPL	N/A	JPL	JPL	JPL	JPL/KSC	JPL	
1.6.1 Launch Approval / NEPA	JPL/NRPCT ¹	JPL ⁴	JPL ⁵	NRPCT ²	JPL	JPL	JPL	JPL/KSC	JPL	
1.6.2 Integrated Safety Management	JPL/NRPCT ¹	JPL ⁴	JPL ⁵	NRPCT ²	JPL	JPL	JPL	JPL/KSC	JPL	
1.6.3 Intentionally Left Blank	N/A	N/A	N/A	N/A	N/A	N/A	N/A	N/A	N/A	
1.6.4 Non-Nuclear Systems Safety	JPL/NRPCT ¹	JPL ⁴	JPL ⁵	NRPCT ²	JPL	JPL	JPL	JPL/KSC	JPL	
1.7 Public Engagement	JPL	JPL	JPL	NRPCT ²	JPL	JPL	JPL	JPL/KSC	JPL	
2.0 Ground System	JPL	JPL	JPL	NRPCT ²	JPL	JPL	JPL	JPL/KSC	JPL	
3.0 Deep Space System	JPL	JPL	JPL	N/A	JPL	JPL	JPL	JPL/KSC	JPL	
3.1 Deep Space System Mgmt & System Engineering	JPL	JPL	JPL	N/A	JPL	JPL	JPL	JPL/KSC	JPL	
Nuclear Power Plant System Engineering Team	NRPCT	NRPCT	DOE-NR ³	JPL	NRPCT	NRPCT	NRPCT	SC/NRPCT/KSC	NRPCT	
Integration & Test System Engineering Team	JPL/NRPCT ¹	SC ²	JPL	NRPCT	JPL	JPL	JPL	SC/NRPCT/KSC	JPL	
End to End Power System Engineering Team	JPL	JPL	JPL	NRPCT	JPL	JPL	JPL	SC/NRPCT/KSC	JPL	
Mechanical Configuration System Engineering Team	JPL	JPL	JPL	NRPCT	JPL	JPL	JPL	SC/NRPCT/KSC	JPL	
3.2 Reactor Module	NRPCT	NRPCT	DOE-NR	JPL	NRPCT	NRPCT	NRPCT	NRPCT/KSC	NRPCT	
3.2.1 Mgmt & System Engineering	NRPCT	NRPCT	DOE-NR	N/A	NRPCT	NRPCT	NRPCT	NRPCT	NRPCT	
3.2.2 Integration Assembly and Test	NRPCT	NRPCT ³	DOE-NR	N/A	NRPCT	NRPCT	NRPCT	NRPCT	NRPCT	
3.2.3 Safety and Assurance	NRPCT	NRPCT	DOE-NR	N/A	NRPCT	NRPCT	NRPCT	NRPCT	NRPCT	
3.2.4 Testing and Evaluation of Reactor Module Materials	NRPCT	NRPCT	DOE-NR	N/A	NRPCT	NRPCT	NRPCT	NRPCT	NRPCT	
3.2.6 Test Facilities	NRPCT	NRPCT	DOE-NR	N/A	NRPCT	NRPCT	NRPCT	NRPCT	NRPCT	
3.2.6 Support Equipment	NRPCT	NRPCT	DOE-NR	N/A	NRPCT	NRPCT	NRPCT	NRPCT	NRPCT	
3.2.7 Reactor Segment	NRPCT	NRPCT	DOE-NR	JPL	NRPCT	NRPCT	NRPCT	NRPCT/KSC	NRPCT	
3.2.8 Primary Pump Segment	NRPCT	NRPCT	DOE-NR	JPL	NRPCT	NRPCT	NRPCT	NRPCT/KSC	NRPCT	
3.2.9 Radiation Shield Segment	JPL/NRPCT ¹	NRPCT	DOE-NR	JPL	NRPCT	NRPCT	NRPCT	NRPCT/KSC	NRPCT	
3.2.10 Instrumentation & Control Segment	NRPCT	NRPCT	DOE-NR	JPL	NRPCT	NRPCT	NRPCT	NRPCT/KSC	NRPCT	
3.2.11 Aerothermal Protection Segment (APS)	JPL/NRPCT ¹	SC	ARC	NRPCT	SC	SC	SC	NRPCT/KSC	ARC	
3.2.11.01 Mgmt	SC	SC	ARC	NRPCT	SC	SC	SC	NRPCT/KSC	ARC	
3.2.11.02 System Engineering	SC	SC	ARC	NRPCT	SC	SC	SC	NRPCT/KSC	ARC	
3.2.11.03 Mission Assurance	SC	SC	ARC	NRPCT	SC	SC	SC	NRPCT/KSC	ARC	
3.2.11.04 Test and Evaluation	SC	SC	ARC	NRPCT	SC	SC	SC	NRPCT/KSC	ARC	
3.2.11.05 Support Equipment	SC	SC	ARC	NRPCT	SC	SC	SC	NRPCT/KSC	ARC	
3.2.11.06 Assembly, Integration and Test	SC	SC ²	ARC	NRPCT	SC	SC	SC	NRPCT/KSC	ARC	
3.2.11.07 Intentionally Left Blank	N/A	N/A	N/A	N/A	N/A	N/A	N/A	N/A	N/A	
3.2.11.08 Intentionally Left Blank	N/A	N/A	N/A	N/A	N/A	N/A	N/A	N/A	N/A	
3.2.11.09 Intentionally Left Blank	N/A	N/A	N/A	N/A	N/A	N/A	N/A	N/A	N/A	
3.2.11.10 APS Subsystem	SC	SC	ARC	NRPCT	SC	SC	SC	NRPCT/KSC	ARC	
3.2.12 Power Conversion Segment	JPL/NRPCT ¹	NRPCT	DOE-NR	GRC	NRPCT	NRPCT	NRPCT	NRPCT/KSC	NRPCT	
3.2.12.01 Turbine, Alternator, Compr. Assly. & Recup. Subsystem	JPL/NRPCT ¹	NRPCT	DOE-NR	GRC/GSC	NRPCT	NRPCT	NRPCT	NRPCT/KSC	NRPCT	
3.2.12.02 Gas Cooler Subsystem	JPL/NRPCT ¹	NRPCT	DOE-NR	GRC	NRPCT	NRPCT	NRPCT	NRPCT/KSC	NRPCT	
3.2.12.03 Power Conversion Support Structure Subsystem	JPL/NRPCT ¹	SC	DOE-NR	JPL/GRC/NRPCT	SC	SC	SC	NRPCT/KSC	NRPCT	
3.3 Spacecraft Module	JPL	SC	JPL	N/A	SC	SC	SC	SC/KSC	JPL	
3.3.1 S/C Module Mgmt & System Engineering	SC	SC	JPL	N/A	SC	SC	SC	SC/KSC	JPL	
3.3.1.01 Spacecraft Module Project Mgmt	SC	SC	JPL	N/A	SC	SC	SC	SC/KSC	JPL	
3.3.1.02 System Engineering	SC	SC	JPL	N/A	SC	SC	SC	SC/KSC	JPL	
3.3.2 Heat Rejection Segment	JPL/NRPCT ¹	SC	GRC	NRPCT	SC	SC	SC	SC/NRPCT/KSC	GRC	
3.3.2.01 Mgmt	SC	SC	GRC	NRPCT	SC	SC	SC	SC/NRPCT/KSC	GRC	
3.3.2.02 System Engineering	SC	SC	GRC	NRPCT	SC	SC	SC	SC/NRPCT/KSC	GRC	
3.3.2.03 Mission Assurance	SC	SC	GRC	NRPCT	SC	SC	SC	SC/NRPCT/KSC	GRC	
3.3.2.04 Test and Evaluation	SC	SC	GRC	NRPCT	SC	SC	SC	SC/NRPCT/KSC	GRC	
3.3.2.05 Support Equipment	SC	SC	GRC	NRPCT	SC	SC	SC	SC/NRPCT/KSC	GRC	
3.3.2.06 Assembly, Integration and Test	SC	SC ²	GRC	NRPCT	SC	SC	SC	SC/NRPCT/KSC	GRC	
3.3.2.07 Structures and Mechanisms	SC	SC	MSFC	NRPCT	SC	SC	SC	SC/NRPCT/KSC	MSFC	
3.3.2.08 Thermal Control Subsystem	SC	SC	MSFC	NRPCT	SC	SC	SC	SC/NRPCT/KSC	MSFC	
3.3.2.09 Intentionally Left Blank	N/A	N/A	N/A	N/A	N/A	N/A	N/A	N/A	N/A	
3.3.2.10 Intentionally Left Blank	N/A	N/A	N/A	N/A	N/A	N/A	N/A	N/A	N/A	
3.3.2.11 Heat Rejection Subsystem	SC	SC	GRC	NRPCT	SC	SC	SC	SC/NRPCT/KSC	GRC	
3.3.3 Electric Propulsion Segment	JPL	PD = GRC, DD = SC	PD = GRC, DD = JPL	N/A	GRC	SC	SC	SC/KSC	PD = GRC, DD = JPL	
3.3.3.01 Mgmt	SC	SC	PD = GRC, DD = JPL	N/A	SC	SC	SC	SC/KSC	PD = GRC, DD = JPL	
3.3.3.02 System Engineering	JPL	PD = JPL, DD = SC	JPL	N/A	JPL	SC	SC	SC/KSC	JPL	
3.3.3.03 Mission Assurance	SC	SC	PD = GRC, DD = JPL	N/A	SC	SC	SC	SC/KSC	PD = GRC, DD = JPL	
3.3.3.04 Test and Evaluation	SC	SC	PD = GRC, DD = JPL	N/A	SC	SC	SC	SC/KSC	PD = GRC, DD = JPL	
3.3.3.05 Support Equipment	SC	SC	PD = GRC, DD = JPL	N/A	SC	SC	SC	SC/KSC	PD = GRC, DD = JPL	
3.3.3.06 Assembly, Integration and Test	SC	SC ²	PD = GRC, DD = JPL	N/A	SC	SC	SC	SC/KSC	PD = GRC, DD = JPL	
3.3.3.07 Structures and Mechanisms	SC	SC	MSFC	N/A	SC	SC	SC	SC/KSC	MSFC	
3.3.3.08 Thermal Control Subsystem	SC	SC	MSFC	N/A	SC	SC	SC	SC/KSC	MSFC	
3.3.3.09 EP Facilities	SC	SC	PD = GRC, DD = JPL	N/A	SC	SC	SC	SC/KSC	PD = GRC, DD = JPL	
3.3.3.10 Ion Thruster Subsystem	JPL	PD = GRC, DD = SC	GRC	N/A	GRC	SC	SC	SC/KSC	GRC	
3.3.3.11 Hall Thruster Subsystem	SC	SC	GRC	N/A	SC	SC	SC	SC/KSC	GRC	
3.3.3.12 Power Processing & Control Subsystem	JPL	PD = GRC, DD = SC	GRC	N/A	GRC	SC	SC	SC/KSC	GRC	
3.3.3.13 Propellant Feed Subsystem	SC	SC	JPL	N/A	SC	SC	SC	SC/KSC	JPL	

Notes

- JPL is the requirements agent for requirements that impact the s/c or mission modules. The NRPCT is the requirements agent for requirements that impact the reactor module.
- NRPCT has design concurrence authority for all elements that impact nuclear safety, reactor reliability, and safeguards. JPL has design concurrence authority for aspects that impact the spacecraft or mission modules.
- The lead organization in the indicated cell is the Integration Agent (vs. Design Agent)
- NRPCT is the Design Agent for products necessary to support launch approval, NEPA, system safety, etc. (e.g., Reactor Safety Analysis Report). All NRPCT design products are produced in WBS 3.2
- NR is the Design Approval Authority for design products necessary to support launch approval, NEPA, system safety, etc. (e.g., Reactor Safety Analysis Report). NR will exercise its approval authority for this WBS element through approval of NRPCT design products produced in WBS 3.2
- NR may delegate certain aspects of this responsibility to the NRPCT.

Definitions

Design Agent: The Design Agent is responsible for developing the product implementation plan, design specification, and test plan. Unless there are specific arrangements to the contrary, the Design Agent is also responsible for producing the product and for delivering it to the next higher level of assembly.

Design Approval Authority: The Design Approval Authority is responsible for approving the design, and ultimately the performance, of the Design Agent deliverables. The Design Approval Authority is also responsible for the final approval of the integration and validation testing by the Design Agent.

Design Concurrence Authority: For certain elements of the Space System, the Design Approval Authority must obtain the concurrence of the Design Concurrence Authority. In these cases, the Design Agent cannot proceed without the concurrence of the Design Concurrence Authority.

Integration Agent: The Integration Agent is responsible for leading the interface design between the products of two different design agents. The Integration Agent is responsible for preparing the necessary Interface Control Documents (ICDs) and other interface design and test plans/documentation, and for securing the concurrence of both interfacing Design Agents. The Integration Agent is also the lead for carrying out the physical integration and test of the two interfacing products.

Requirements Agent: The Requirements Agent is responsible for establishing the system requirements and validating requirements.

List of Abbreviations

JPL	- Jet Propulsion Laboratory
NRPCT	- Naval Reactors Prime Contractor Team
DOE	- Department of Energy
NR	- Naval Reactors
SC	- Spacecraft Contractor
ARC	- Ames Research Center
GRC	- Glenn Research Center
MSFC	- Marshall Space Flight Center
KSC	- Kennedy Space Center
CDR	- Critical Design Review
PD	- Preliminary Design
DD	- Detailed Design
HP	- High Power
SNPP	- Space Nuclear Power Plant

Work Breakdown Structure	Requirements Agent	Design Agent (or Integration Agent)	Design Approval Authority	Design Concurrence Authority	Phase A/B			Phase C			Phase D			Work Element Manager (WEM) (S&T Lead)
					Co-location Site	Co-location Site	Co-location Site	Co-location Site	Co-location Site	Co-location Site	Co-location Site	Co-location Site		
3.3.4 Bus Segment	SC	SC	JPL	N/A	SC	SC	SC	SC/KSC	JPL					
3.3.4.01 Mgmt	SC	SC	JPL	N/A	SC	SC	SC/KSC	JPL						
3.3.4.02 System Engineering	SC	SC	JPL	N/A	SC	SC	SC/KSC	JPL						
3.3.4.03 Mission Assurance	SC	SC	JPL	N/A	SC	SC	SC/KSC	JPL						
3.3.4.04 Test and Evaluation	SC	SC	JPL	N/A	SC	SC	SC/KSC	JPL						
3.3.4.05 Support Equipment	SC	SC	JPL	N/A	SC	SC	SC/KSC	JPL						
3.3.4.06 Assembly, Integration and Test	SC	SC ²	JPL	N/A	SC	SC	SC/KSC	JPL						
3.3.4.07 Structures and Mechanisms	SC	SC	MSFC	N/A	SC	SC	SC/KSC	MSFC						
3.3.4.08 Thermal Control Subsystem	SC	SC	MSFC	N/A	SC	SC	SC/KSC	MSFC						
3.3.4.09 Intentionally Left Blank	N/A	N/A	N/A	N/A	N/A	N/A	N/A	N/A						
3.3.4.10 Altitude & Attitude Control Subsystem	SC	SC	JPL	N/A	SC	SC	SC/KSC	JPL						
3.3.4.11 Power Conditioning & Distribution Subsystem	SC	SC	JPL bus, GRC HP	NRPCT	SC	SC	SC/KSC	JPL bus, GRC HP						
3.3.4.12 Command and Data Handling Subsystem	SC	SC	JPL	N/A	SC	SC	SC/KSC	JPL						
3.3.4.13 Telecom Subsystem	JPL	PD = JPL, DD = SC	JPL	N/A	JPL	SC	SC/KSC	JPL						
3.3.4.14 Cable and Harness Subsystem	SC	SC	MSFC	N/A	SC	SC	SC/KSC	MSFC						
3.3.4.15 Engineering Instrumentation Subsystem	JPL	SC	JPL	N/A	SC	SC	SC/KSC	JPL						
3.3.5 Docking Segment	SC	SC	MSFC	N/A	SC	SC	SC/KSC	MSFC						
3.3.5.01 Mgmt	SC	SC	MSFC	N/A	SC	SC	SC/KSC	MSFC						
3.3.5.02 System Engineering	SC	SC	MSFC	N/A	SC	SC	SC/KSC	MSFC						
3.3.5.03 Mission Assurance	SC	SC	MSFC	N/A	SC	SC	SC/KSC	MSFC						
3.3.5.04 Test and Evaluation	SC	SC	MSFC	N/A	SC	SC	SC/KSC	MSFC						
3.3.5.05 Support Equipment	SC	SC	MSFC	N/A	SC	SC	SC/KSC	MSFC						
3.3.5.06 Assembly, Integration and Test	SC	SC ²	MSFC	N/A	SC	SC	SC/KSC	MSFC						
3.3.5.07 Structures and Mechanisms	SC	SC	MSFC	N/A	SC	SC	SC/KSC	MSFC						
3.3.5.08 Thermal Control Subsystem	SC	SC	MSFC	N/A	SC	SC	SC/KSC	MSFC						
3.3.5.09 Intentionally Left Blank	N/A	N/A	N/A	N/A	N/A	N/A	N/A	N/A						
3.3.5.10 Autonomous Rendezvous & Docking Software	SC	SC	JPL	N/A	SC	SC	SC/KSC	JPL						
3.3.5.11 Transfer Stage Docking Subsystem	SC	SC	MSFC	N/A	SC	SC	SC/KSC	MSFC						
3.3.5.12 Spacecraft Docking Adapter Subsystem	SC	SC	MSFC	N/A	SC	SC	SC/KSC	MSFC						
3.3.5.13 Intentionally Left Blank	N/A	N/A	N/A	N/A	N/A	N/A	N/A	N/A						
3.3.6 S/C Module Assembly, Integration and Test	SC	SC ²	JPL	NRPCT ⁷	SC	SC	SC/KSC	JPL						
3.3.7 Test and Evaluation	SC	SC	JPL	NRPCT ⁷	SC	SC	SC/KSC	JPL						
3.3.0 Software Segment	JPL	SC, except High Level Mission S/W = JPL thru CDR (See para 7.2 of Exhibit 5)	JPL	NRPCT ⁷	JPL	SC	SC/KSC	JPL						
3.3.9 S/C Module Test Facilities	SC	SC	JPL	NRPCT ⁷	SC	SC	SC/KSC	JPL						
3.3.10 Govt Spacecraft Module Items	JPL	JPL	JPL	N/A	JPL	SC	SC/KSC	JPL						
3.3.11 S/C Module Safety & Mission Assurance	JPL	SC	JPL	NRPCT ⁷	SC	SC	SC/KSC	JPL						
3.4 Intentionally Left Blank	N/A	N/A	N/A	N/A	N/A	N/A	N/A	N/A						
3.5 Deep Space System Assembly, Integration and Test	JPL/NRPCT ¹	SC ²	JPL	NRPCT ⁷	SC	SC	SC/NRPCT/KSC	JPL						
Reactor Module to Spacecraft Module Assembly, Integration and Test	NRPCT	SC ²	DOE/NR ⁶	JPL	SC	SC	SC/NRPCT/KSC	NRPCT						
3.6 Deep Space System Test Facilities	SC	SC	JPL	NRPCT ⁷	SC	SC	SC/NRPCT/KSC	JPL						
3.7 Special Studies: Spacecraft Module (SSM)	N/A	N/A	N/A	N/A	N/A	N/A	N/A	N/A						
4.0 Launch System	JPL	KSC	KSC	KSC	N/A	KSC	KSC	KSC						
4.1 Launch System Management & Systems Engineering	KSC	KSC	KSC	N/A	KSC	KSC	KSC	KSC						
4.2 Launch Vehicle	KSC	KSC	KSC	N/A	KSC	KSC	KSC	KSC						
4.3 Launch Site Facilities	KSC/NRPCT	KSC	KSC	NRPCT ⁷	KSC	KSC	KSC	KSC						
4.4 Launch System Verification and Validation (V&V)	KSC	KSC	KSC	N/A	KSC	KSC	KSC	KSC						
4.5 Launch Services	KSC	KSC	KSC	NRPCT ⁷	KSC	KSC	KSC	KSC						
4.6 Launch Site Nuclear Operations	NRPCT	NRPCT	DOE/NR ⁶	KSC	KSC	KSC	KSC	NRPCT						
5.0 Project Systems Assembly, Integration and Test	JPL/NRPCT ¹	SC ²	JPL	NRPCT ⁷	SC	SC	SC/NRPCT/KSC	JPL						
Mission Module to Deep Space System Assembly, Integration and Test	JPL	SC ²	JPL	NRPCT ⁷	SC	SC	SC/NRPCT/KSC	JPL						
6.0 Science System	JPL	JPL	JPL	N/A	JPL	JPL	JPL/SC/KSC	JPL						

- Notes**
- JPL is the requirements agent for requirements that impact the s/c or mission modules. The NRPCT is the requirements agent for requirements that impact the reactor module.
 - NRPCT has design concurrence authority for all elements that impact nuclear safety, reactor reliability, and safeguards. JPL has design concurrence authority for aspects that impact the spacecraft or mission modules.
 - The lead organization in the indicated cell is the Integration Agent (vs. Design Agent)
 - NRPCT is the Design Agent for products necessary to support launch approval, NEPA, system safety, etc. (e.g., Reactor Safety Analysis Report). All NRPCT design products are produced in WBS 3.2.
 - NR is the Design Approval Authority for design products necessary to support launch approval, NEPA, system safety, etc. (e.g., Reactor Safety Analysis Report). NR will exercise its approval authority for this WBS element through approval of NRPCT design products produced in WBS 3.2.
 - NR may delegate certain aspects of this responsibility to the NRPCT.

Definitions

Design Agent: The Design Agent is responsible for developing the product implementation plan, design specification, and test plan. Unless there are specific arrangements to the contrary, the Design Agent is also responsible for producing the product and for delivering it to the next higher level of assembly.

Design Approval Authority: The Design Approval Authority is responsible for approving the design, and ultimately the performance, of the Design Agent deliverables. The Design Approval Authority is also responsible for the final approval of the integration and validation testing by the Design Agent.

Design Concurrence Authority: For certain elements of the Space System, the Design Approval Authority must obtain the concurrence of the Design Concurrence Authority. In these cases, the Design Agent cannot proceed without the concurrence of the Design Concurrence Authority.

Integration Agent: The Integration Agent is responsible for leading the interface design between the products of two different design agents. The Integration Agent is responsible for preparing the necessary Interface Control Documents (ICDs) and other interface design and test plans/documentation, and for securing the concurrence of both interfacing Design Agents. The Integration Agent is also the lead for carrying out the physical integration and test of the two interfacing products.

Requirements Agent: The Requirements Agent is responsible for establishing the system requirements and validating requirements.

List of Abbreviations

JPL - Jet Propulsion Laboratory
NRPCT - Naval Reactors Prime Contractor Team
DOE - Department of Energy
NR - Naval Reactors
SC - Spacecraft Contractor
ARC - Ames Research Center
GRC - Glenn Research Center
MSFC - Marshall Space Flight Center
KSC - Kennedy Space Center
CDR - Critical Design Review
PD - Preliminary Design
DD - Detailed Design
HP - High Power
SNPP - Space Nuclear Power Plant

[This page intentionally left blank]

Appendix E — Major Education and Outreach Events

Venue	Location	Date	Audience
American Institute of Aeronautics and Astronautics Joint Propulsion Conference	Huntsville, AL	July 2003	Aerospace Industry and Government Agencies
American Institute of Aeronautics and Astronautics Space Conference	Long Beach, CA	September 2003	Aerospace Industry and Government Agencies
Space Technology and Application International Forum	Albuquerque, NM	February 2004	Space Nuclear Community
JPL Open House	JPL Campus	May 2004	General Public
Farnborough International Air Show	Farnborough, UK	July 2004	Aerospace Industry and Government Agencies
American Institute of Aeronautics and Astronautics Joint Propulsion Conference	Ft. Lauderdale, FL	July 2004	Aerospace Industry and Government Agencies
American Institute of Aeronautics and Astronautics Space Conference	San Diego, CA	September 2004	Aerospace Industry and Government Agencies
Idaho Annual Science and Technology Expo	Idaho Falls, ID	September 2004	Middle and High School Students
Space Exploration Conference	Orlando, FL	January 2005	NASA, NASA Contractors Employees and Industry Partners
Space Technology and Application International Forum	Albuquerque, NM	February 2005	Space Nuclear Community
Institute of Electrical and Electronics Engineers	Big Sky, MT	March 2005	General Industry and Government Agencies
JPL Open House	JPL Campus	April 2005	General Public
Space Foundation	Capitol Hill	April 2005	Members of Congress and Staff
NEXTFEST	Chicago, IL	June 2005	Industry and General Public with Interest in Future Technologies

[This page intentionally left blank]

Appendix F — Additional Prometheus Studies

The Final Report has focused on the extensive work performed by the Project team on the Prometheus Deep Space Vehicle and the Jupiter Icy Moons Orbiter Mission, with a brief summary of follow-on science missions that were studied.

In addition, the Project was directed by NASA ESMD to perform three significant studies focused on other potential applications of the Prometheus technologies. These included, in chronological order:

- Derivative Mission Studies of lunar and Mars surface power and Mars cargo transportation applications
- Analysis of Alternatives Study of potential first DSV missions other than JIMO
- Fission Surface Power System Study of lunar power station architecture, in support of the NASA Exploration Systems Architecture Study (ESAS).

A summary of each of these studies is provided below. Detailed information is contained in the actual study reports.

F.1 Derivative Missions

F.1.1 Introduction

In addition to the applicability of the Prometheus Spaceship to advanced deep-space science missions, the technologies and infrastructure developed in the Prometheus Project would be of direct use to Project Constellation and the human-oriented goals of the new Exploration Architecture. The goal of sustained human presence in space as well as on the surface of the moon and other solar system destinations will undoubtedly result in the need for reliable high capability surface power systems and infrastructure elements that can be readily derived from the Prometheus development effort.

F.1.2 Surface Power Applications

The Prometheus power system would be the demonstration of a first generation space nuclear fission power system that would be used in future exploration applications. While the design is optimized for application to a long life deep space Nuclear Electric Propulsion (NEP) exploration vehicle, the basic elements of the power system may be applied in a configuration that could support a manned lunar base with relatively little modification of design. Should the final design incorporate materials unsuitable for operation in the Mars environment it would be possible to develop a variation of the space reactor design, using more compatible materials that would be directly applicable to sustained human presence on the surface of Mars.

To aid in assessment of the potential for application of Prometheus technology to these surface missions, the three industry study teams —Boeing, Lockheed-Martin, and NGST — were tasked with performing preliminary studies on their systems' applicability for surface use. Each team was asked to develop a power system concept for application on the lunar surface incorporating the Prometheus reactor design unchanged from its deep space application. Elements of the power conversion system were allowed to be altered as appropriate to facilitate the surface design. Electrical power was assumed to be delivered to a point of use 1 km from the reactor. Teams were also asked to discuss the challenges involved with developing a similar power system for incorporation in a Mars environment. Final results of these studies may be found in each contractor team's Final Follow-on Mission Study Report (F-FMSR).

F.1.3 Mars Transportation Vehicle

A transportation infrastructure application of Prometheus technology could consist of a Nuclear Electric Propulsion (NEP) cargo transfer vehicle operating to deliver payloads to Mars from Earth and return payloads back again. Provision of servicing and refueling capability at the Earth-Moon L1 point would allow multiple round-trips for a streamlined derivative of the basic Prometheus Space System. Preliminary estimates for such a round trip from L1 to Mars and back to L1 predict a Delta-V requirement of about 18 km/s.

Early mission design analysis was performed to estimate performance of the government study Prometheus baseline design in this application. Given the mass and performance of the Prometheus Space System, it was estimated that the total round trip time from L1 to Mars and back to L1 would take on the order of 5.6 years (assuming a 16,000 kg dry mass and 5000 kg of outbound cargo). An example of a modeled mission profile is shown in Figure F-1.

In some ways this represents a worst-case mission duration, as the modeled Spaceship retains all of the design features of JIMO, including excess environmental radiation shielding required for the Jovian mission that could be eliminated for the Mars transport applications. Additional design modifications to the JIMO-specific Spaceship configuration could result in dry mass reductions that would potentially result in further reduction of round trip transfer times. Alternatively, the basic delivery vehicle could be used to deliver much higher masses to Mars with the acceptance of longer duration flight times.

The industry study teams were tasked with evaluating their designs for application to the Mars cargo transport mission. Direction was given that the vehicle design should incorporate the Prometheus reactor power system unchanged from its baseline design, but otherwise allowing modifications to the Spaceship design to optimize the vehicle for the transport mission. The basic mission to be analyzed included multiple trips from the Earth-moon L1 point to a 400 km Mars orbit and a return to Earth-moon L1. It was to be assumed that refueling and servicing of the vehicle would be accomplished at L1. The vehicle was also to be capable of rendezvous and capture of a sample return capsule at Mars that would subsequently be returned by the vehicle to the L1 point for Earth return. The sample return payload mass was specified at 500 kg. Final results of these studies are also contained in each contractor's F-FMSR.

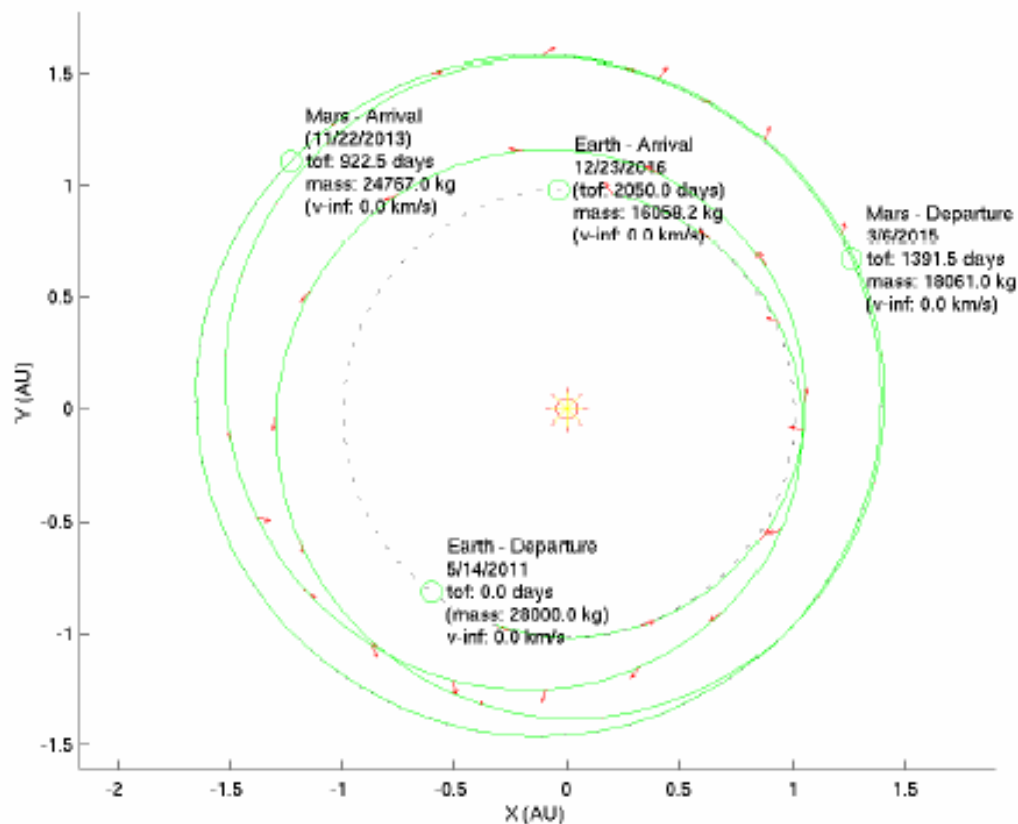

Figure F-1. Mars Transport Mission Example (16,000kg dry mass, 5000s Isp).

F.2 Analysis of Alternatives

In January 2005, NASA requested that the Project perform a study to provide NASA's Project Prometheus with options for a first space NEP vehicle as an initial mission that would enable long-duration missions of exploration to the outer planets, such as JIMO. In response to this request, an Analysis of Alternatives (AoA) study was commissioned to develop and evaluate various vehicle concept options and mission destinations for an initial mission. The study was led by JPL, with support from NASA, NGST, GRC, NRPCT, and the Aerospace Corporation. Results of the study were documented in the Analysis of Alternatives Study Report and reviewed by NASA's ESMD on April 20, 2005.

Vehicle concepts utilizing a space nuclear fission reactor to provide electrical power for propulsion were developed and assessed against measures of effectiveness (MOE) as shown in Figure F-2. Initial mission options were defined, mission designs were executed, and data on the applicability of the mission options to the vehicle concepts were developed.

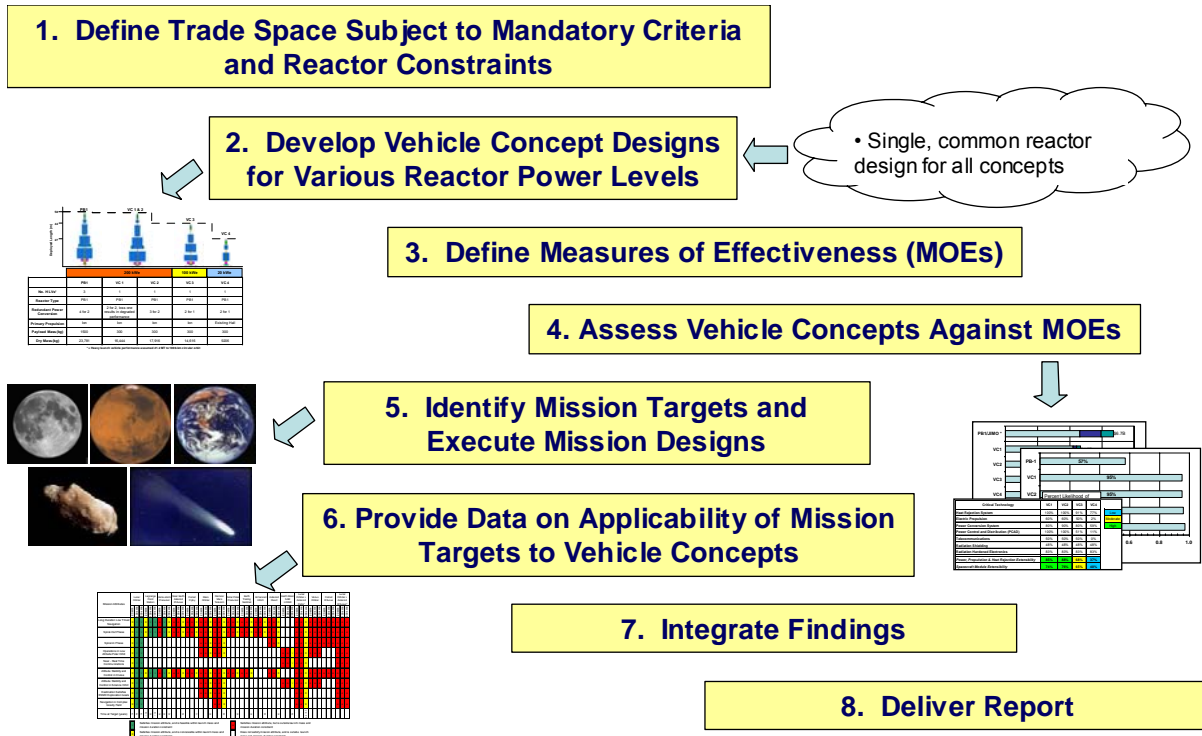

Figure F-2. Study Approach.

A set of criteria, referred to as the mandatory criteria, were introduced in order to provide top-level guidance to the study team in developing the vehicle concepts. These mandatory criteria consisted of the following:

- Demonstrate nuclear electric propulsion capability.
- Launch on a single, existing expendable launch vehicle (ELV) with a target launch date of 2014.
- Achieve full mission success criteria in less than 3 years.
- Operate in an environment more benign than JIMO.
- Meet nuclear safety requirements through end-of-mission.

The vehicle concepts developed in the AoA study used a single-reactor design operated at various power levels, up to a maximum of 200 kWe. The single-reactor design was driven by the realities of time, money, and national resources (both people and facilities) required to develop a nuclear fission reactor qualified for space applications. The 200 kWe design point was chosen based primarily on the influence of celestial mechanics and vehicle dynamics underlying orbital transfers to and from other bodies with a spacecraft possessing high moments of inertia (due to its large mass and length of the boom), but capable of producing only very low levels of acceleration due to the characteristics of low thrust (albeit high efficiency) nuclear electric propulsion.

Four vehicle concepts, operating at 20 kWe, 100 kWe and 200 kWe, were defined in the study (Figure F-3). They were intended to cover the trade space of vehicle options within the constraints of the Mandatory Criteria and without being tied to a specific mission or destination. All vehicle concepts were constructed with emphasis on near-term applications that flight-demonstrate technologies needed for JIMO and follow-on program objectives.

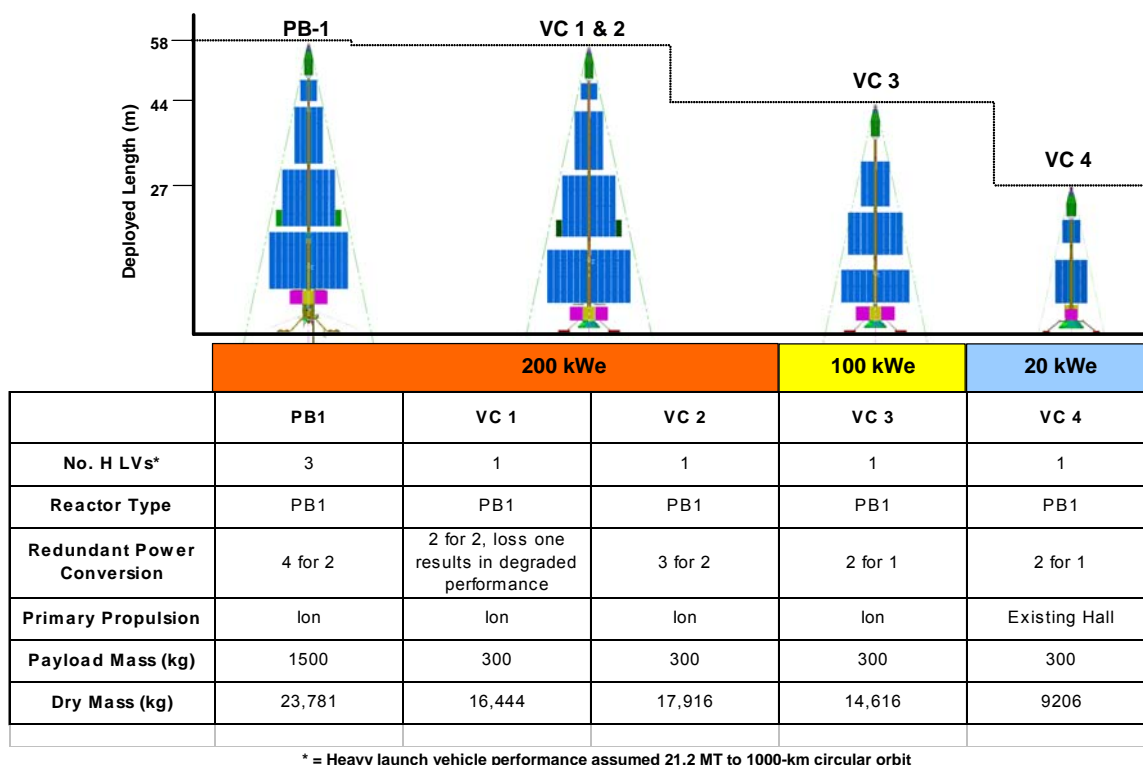

Figure F-3. Vehicle Concept Overview.

Vehicle concepts one and two (VC1 and VC2) operate at 200 kWe, and utilize many of the critical technologies (such as power conversion, propulsion and heat rejection) proposed for the JIMO baseline design (referred to as PB1). Vehicle concept three (VC3) operates at 100 kWe, and vehicle concept four (VC4) operates at 20 kWe.

The Measures of Effectiveness used to evaluate the vehicle concepts include life cycle cost, development time, development risk, and extensibility to the initial Prometheus baseline spacecraft (PB1). Cost, schedule, and development risk models were developed using multiple independent sources of data. Extensibility was based on the design features and critical enabling technologies demonstrated by each of the vehicle concepts.

In addition, initial mission options were identified and concept-level mission designs were executed within the constraints of the mandatory criteria, specifically, launch on an existing expendable launch vehicle, and a three-year maximum mission duration. The initial mission options were evaluated against a set of quantitative mission attributes that, if addressed by the initial mission, would add additional value through flight test operation of the vehicle concepts in a manner similar to that anticipated for JIMO.

The key findings of the AoA study were:

- The development cost of the initial mission spacecraft module will be significant and similar to JIMO except Vehicle Concept 4 (VC4), which costs approximately 30% less than JIMO.
- The launch and operations costs for any of the initial mission options are similar, but much smaller than related costs for the JIMO mission.
- The costs of the vehicle concepts increase as the level of extensibility to the PB1 vehicle increases. This provides a “you get what you pay for” result, allowing selection of the most desirable capability level at a given cost.
- The development time for any of the vehicle concepts is approximately 120 months, and is relatively insensitive across the vehicle concepts. The exception is PB1, which has a longer spacecraft module development time due to additional technology development in the area of radiation-hardened (rad-hard) electronics.
- The likelihood of meeting a January 2014 completion date, based on the spacecraft module development, is high for all of the vehicle concepts except PB1. The likelihood for PB1 meeting a 2014 launch date, based on the spacecraft module development, is moderate and driven by the technology development required for rad-hard electronics.
- Of the vehicle concepts studied, those designed to operate at the same power level as PB1 (i.e., VC1 and VC2) show the most extensibility to the PB1 design.
- Missions suitable for an initial mission exist for each of the vehicle concepts developed. The lunar orbiter mission can be accomplished by all of the vehicle concepts, with the largest amount of time at target, compared to the other candidate initial missions.

Detailed results of this effort are documented in the Prometheus Project Analysis of Alternatives Study Report.

F.3 Fission Surface Power Study

At the request of the Exploration Systems Mission Directorate in May 2005, a team was assembled within the Prometheus Project to provide lunar surface power architecture inputs to the NASA Administrator’s Exploration Systems Architecture Study (ESAS). The team included personnel from JPL, GRC, LaRC, JSC and NASA HQ. System engineering tasks were undertaken to investigate the design and implementation of a Fission Surface Power System (FSPS) that could be launched as early as 2019 as part of an initial Lunar Base architecture. Upon completion of work for the ESAS the Prometheus team briefed Mr. David Bartine and members of his NASA-chartered Lunar Power Study team. Subsequent to that briefing, the Prometheus team continued its study to complete a concept for an FSPS that could be integrated into a variety of potential lunar exploration architectures. Results were briefed to NASA HQ personnel in July 2005 and a Final Report was produced documenting the results of this study.

A representation of the recommended FSPS is provided as Figure F-4.

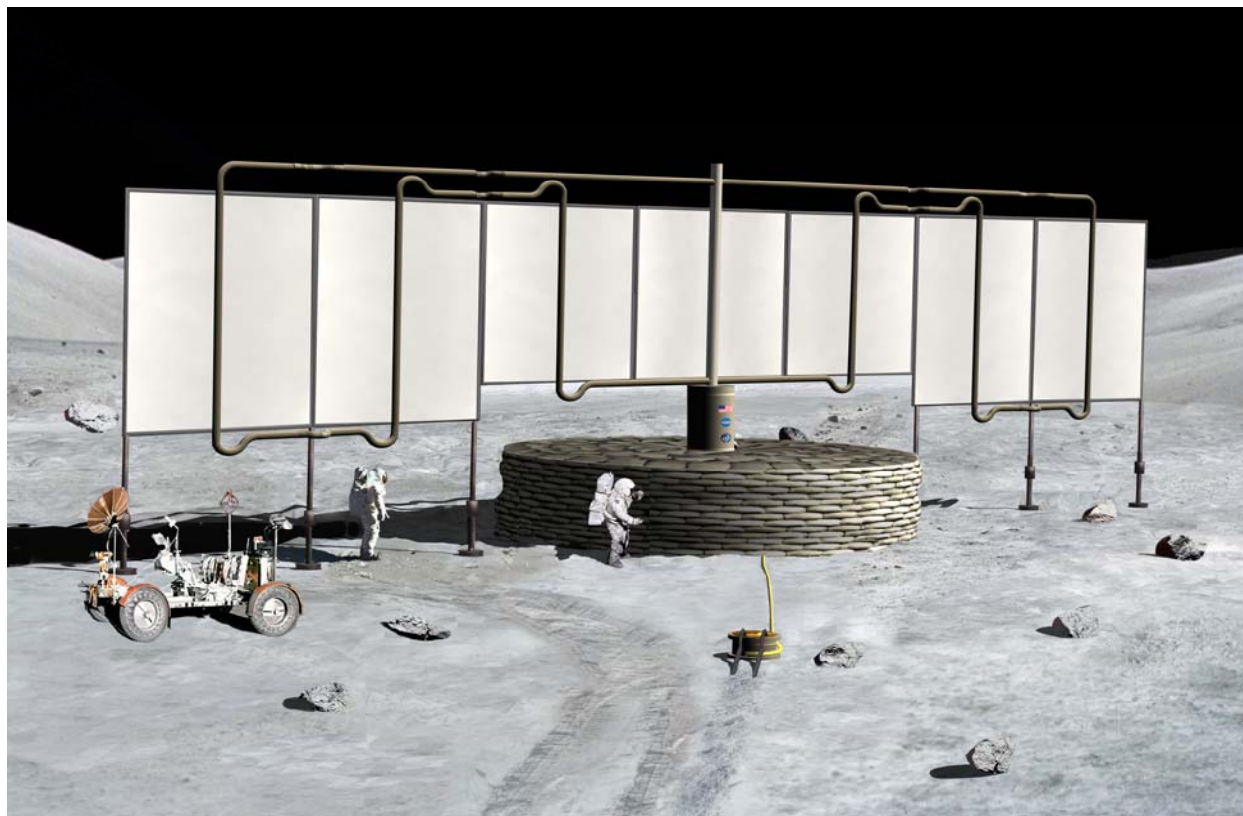

Figure F-4. Artist's concept of the FSPS.

Constraints and initial assumptions included:

- 2019 flight system availability
- 10 year lifetime
- Maximum lander capability of 15 mT down-mass (payload to the surface).
- 50 kWe FSPS total power available to the user

In the course of developing an FSPS design and implementation concept, the team investigated a wide variety of options. Major architecture trades addressed are shown in Table F-1. The implementation of an overall lunar base architecture intimately affects the outcome of many of these trades. It may not be possible to finalize an optimum point design for the FSPS independent of final base and exploration architecture decisions.

During the course of the study the Team concluded a series of “findings” that helped to narrow the trade space and guide the optimization of an FSPS design.

- Providing mobility to the reactor portion of the FSPS is a mass intensive, operationally risky endeavor. The preferred option in any implementation is to land the reactor directly at its emplacement site, relocating only those electronics elements that need to be located at the lunar base site.

Table F-1. FSPS Trades.

Trades	Implementation	Advantages	Disadvantages
Power Plant Placement	On lander	Low risk emplacement	Inhibits use of in-situ shielding Limits lander options
	On surface	Facilitates regolith shielding options	Some separation options are massive or difficult
Power Plant Mobility	Mobile Power Plant	Minimizes constraints on architecture manifesting	Implementation is massive with dubious practicality
	Stationary Power Plant	Lower mass Lower risk	Requires precision landing and site information
Shielding	Manufactured Shield Only	Low risk implementation Minimizes constraints on architecture	Requires massive manufactured shield
	Use Natural Topography without Regolith Reconfiguration	Lowers delivered mass Essentially eliminates dose at base	Limits site selection Substantial manufactured shield still needed
	Regolith shielding	Lowest delivered mass Enables maximum shielding	Requires regolith moving equipment Requires time and risk to emplace
FSPS Phasing	1st Base landing	Power is available for subsequent landings	Uncertainty in landing site characteristics Requires fully autonomous activation
	Landing after minimal Base infrastructure in place	Base assets available for FSPS deployment	Requires base to be energy-sufficient prior to FSPS landing
Crew Assistance	No	Minimizes constraints on architecture	Complicates deployments Increases risk
	Yes	Simplifies deployments Reduces risk	Requires human landing at site prior to commissioning
Radiator Configuration	Horizontal	None identified	Complex deployment Higher mass
	Vertical	Simplest deployment Lowest mass	May be more difficult to deploy at high power levels

- Other than mobility, risk is not inherently a discriminator in most implementation options.
- Human presence prior to operation during deployment and In-Situ Resource Utilization (ISRU) greatly enhances the practicality of implementing an FSPS.
- Related to human presence, the FSPS design and implementation would benefit from pre-emplacement missions to the lunar base site.

- Configurations developed in the study are compatible with current ESAS Lunar Surface Access Module (LSAM) lander concepts.
- Decommissioning through in-place abandonment appears to be a feasible option, especially in the case of a regolith-shielded FSPS.

These major findings and the other trades performed during the study have resulted in the identification of potential implementation options as well as a recommended concept for an optimal implementation of an FSPS in a lunar base architecture.

The Fission Surface Power System (FSPS) is comprised of three major components, based on location (Figure F-5). They are the Power Plant, Local Electronics, and the Station Control Electronics.

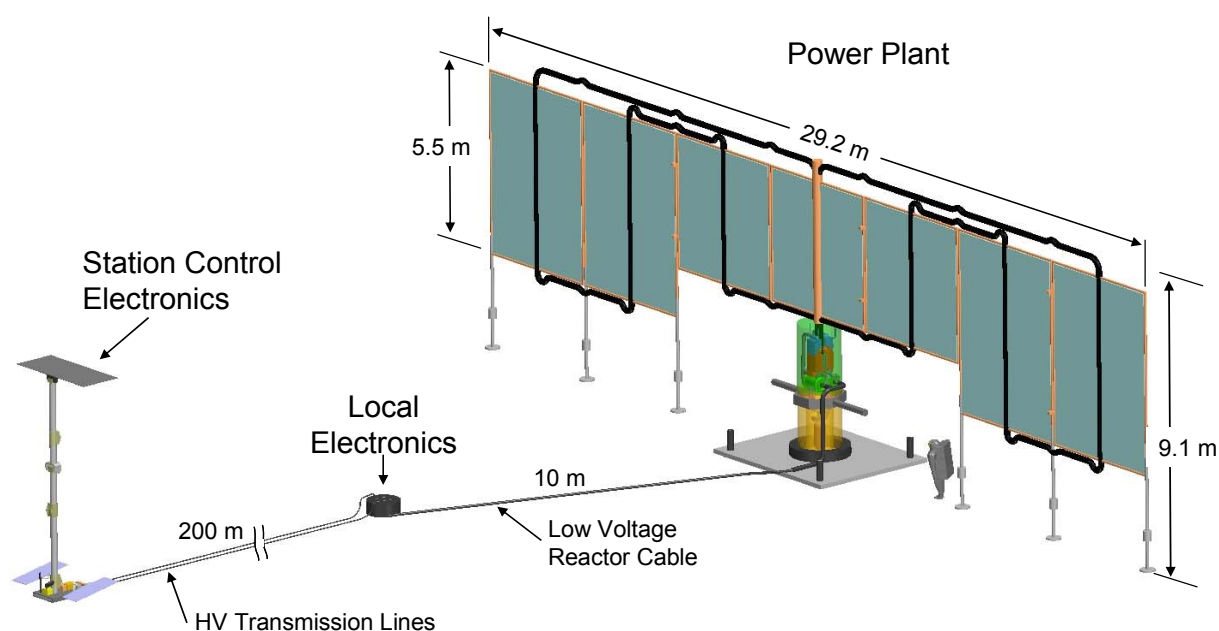

Figure F-5. FSPS Components – Pre-operational (Regolith shield not shown for clarity).

The Power Plant is that portion of the FSPS that comprises the Reactor, Shield, Power Conversion, and Heat Rejection Segments. Also included are the structural elements necessary to support the Power Plant through launch, landing, deployment and operations. Shielding to attenuate reactor generated radiation dose at the site of the human base is provided through use of in-situ resources to construct a regolith shield. The regolith shield is built using “sandbags” filled with lunar regolith gathered from the local area surrounding the FSPS emplacement site. The sandbag shield 2 m high and with an effective thickness of 3.5 m around the reactor can achieve a dose rate of 5 rem/yr at a base separation distance of 200 m, allowing minimal restriction of base activities. Further reduction in dose can be relatively easily implemented simply by augmenting the thickness of the sandbag wall.

The Local Electronics (LE) consists of the reactor controller electronics, signal multiplexer unit and transmission line voltage transformers. The LE is located 10 m from the Power Plant, a distance sufficient to reduce the total dose to Local Electronics from the reactor to less than 100 krad over the planned 10 year operating life of the FSPS. The electronics are connected to the Power Plant by a single cable incorporating redundant power and signal lines.

The bulk of the FSPS electronic subsystems are located at the site of the Lunar Base in an element designated the Station Control Electronics (SCE). The SCE (Figure F-6) is packaged as a self-contained unit and incorporates the C&DH, Telecom, and Power Conditioning and Distribution electronics which provide the interface with the base power distribution architecture. Also included in the SCE are deployable appendages that support radiators for the PCAD electronics, and the Parasitic Load Radiator, which is used to maintain a constant load on the Power Plant. The Parasitic Load Radiator is elevated on a mast in order to prevent its high temperature radiating elements from presenting a hazard to Lunar Base personnel and equipment. The SCE is connected to the Local Electronics by dual redundant high voltage (7000 Vac) transmission lines.

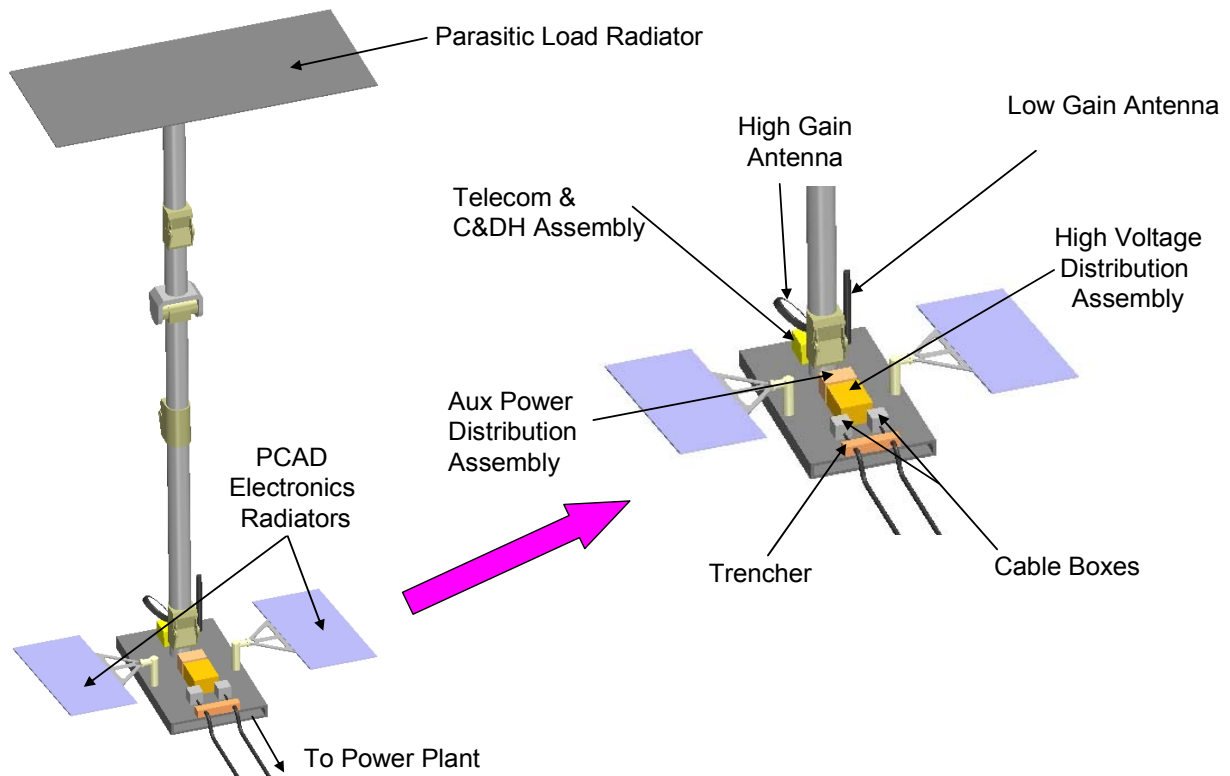

Figure F-6. SCE Components.

The Master Equipment List (MEL) for the FSPS is shown in Table F-2. Note that masses are shown with values for current best estimate (CBE), with 20% contingency ($1.2 \times \text{CBE}$), and with the standard JPL mass margin of 30%, which equates to $\text{CBE}/0.7$.

Table F-2. FSPS Mass Summary.

Element Mass	CBE		1.2 x CBE		CBE/0.7
Power Plant Elements					
Reactor	1060		1272		1514
Reactor Shield	2402		2882		3431
Power Conversion	442		530		631
Heat Rejection	722		866		1031
Mechanical/Thermal/EIS	833		1000		1190
Power Plant Total	5459		6551		7799
Other FSPS Elements					
SCE (w/o Transmission Line)	216		259		308
LE	122		146		174
HV Cable and Transformers	164		197		234
Cable Deployment	70		84		100
Bag Filler and Bags	450		540		643
FSPS Total	6481		7777		9258