

INT. 42. ND YASAR DOGU TOURNAMENT



ISTANBUL (TUR)

2014-02-15 - 2014-02-16 2014

Résultats - Results

Lutte Libre - Free-Style



**Liste des arbitres / Referee list****INT. 42. nd YASAR DOGU TOURNAMENT**

N°	Licence	Pays Country	Nom - Last Name	Prénom - First Name
		AZE	VUGAR	SHUKUROV
		BUL	KANDILAROV	LYUDMIL KIRILOV
		KGZ	SOTOUDEH	MAHMOUDREZA
		RUS	GULCHEEV	VALERIII
		TKM	HANMAMMEDOV	TAHYR
		TUN	KHEMAIS	BOUAZIZ
		TUR	BÃœYÃœKERÅŽEN	ENDER
		TUR	KARAYAZI	TÃœLAY
		TUR	KAYA	UÃœUR
		TUR	OREL	ÃœMÃœT
		TUR	YILMAZ	AYHAN
		TUR	YILMAZ	SERHAN
		USA	MUNDY	MARK RAYMOND

Nombre d'arbitres - Number of Referee

13



Liste des nations / Countries List

INT. 42. nd YASAR DOGU TOURNAMENT

STYLE FS



Pays - Country

	AZERBAIJAN	AZE
	BULGARIA	BUL
	IRAN R.I.	IRI
	ITALY	ITA
	JAPAN	JPN
	KAZAKHSTAN	KAZ
	KYRGYZSTAN	KGZ
	MACEDONIA ANC. R. YUG	MKD
	MONGOLIA	MGL
	PUERTO RICO	PUR
	RUSSIA	RUS
	TAJIKISTAN	TJK
	TUNISIA	TUN
	TURKEY	TUR
	TURKMENISTAN	TKM
	UNITED STATES	USA
	UZBEKISTAN	UZB

Nombre de nations - Number of Countries 17

**Nombre d'engagés par nation / Number of Entries By Country****INT. 42. nd YASAR DOGU TOURNAMENT****STYLE FS**

Pays - Country	125 KG	57 KG	61 KG	65 KG	70 KG	74 KG	86 KG	97 KG	TOTAL
AZE	1	1	2	2	1		2	3	12
BUL	1		1	1	1	1	1		6
IRI	2				1	2	3		8
ITA				1					1
JPN	1	2	2	2		1		1	9
KAZ		2	3		3	2	2	2	14
KGZ		2	1	1	1		1		6
MGL		2	5	3	1	2	1	1	15
MKD			1		1	1			3
PUR	1	1				1		1	4
RUS	2	3	6		1	3	2		17
TJK					1		1	1	3
TKM		2	1	1	1	1	1	1	8
TUN	1	1	1	1		1	1	1	7
TUR	6	10	10	5	6	10	11	12	70
USA	1	4	1	1		2	3	2	14
UZB						1			1
TOTAL	16	30	34	18	18	28	29	25	198

Nombre de nations - Number of Countries **17**



Liste des Engagés par pays / Entry-List By Country

INT. 42. nd YASAR DOGU TOURNAMENT

STYLE FS



AZERBAIJAN (AZE)

Chef de délégation / Team Leader :	FIRDOVSI, UMUDOV SEMEON, CTEREV
Médecin / Medical Staff :	RAUF, ALIYEV BAYAZIT, MAHMUT
Lutteur(s) / Wrestler(s) :	
125 kg	DZEBOSOV, ASLAN
57 kg	YASHAR, ALIYEV
61 kg	GALIP, ALIYEV QUVARZATILOV, AXMEDNABI
65 kg	MAGAMED, MUSLUMOV MUSTAFAYEV, AGAHUSEYN
70 kg	EMIN, AZIZOV
86 kg	IBRAHIM, YUSUBOV XALIYEV, MOGAMEDGAYI
97 kg	BAKIROV, ROMAN GAZYUMOV, KHETAG SAID, GAMIDOV

BULGARIA (BUL)

Entraîneur / Coach :	KARADUSHEV, GEORGI YANCHEV
Lutteur(s) / Wrestler(s) :	
125 kg	ENEV, ILIYA RUSEV
61 kg	CHUCHUROV, KRUM ANTONOV
65 kg	NOVACHKOV, BORISLAV STEFANOV
70 kg	KURTEV, NIKOLAY GOSHEV
74 kg	GAZI, MEHMED REMZI
86 kg	SREDKOV, GEORGI ATANASOV

IRAN R.I. (IRI)

Chef de délégation / Team Leader :	AALI, PARVIZ
Entraîneur / Coach :	TALAEI, MOHAMMAD MOHAMMADI, GHOLAMREZA SEDIGHI, NADER
Médecin / Medical Staff :	AZADBAKHT, DAVOOD
Lutteur(s) / Wrestler(s) :	
125 kg	GHASEMI, KOMEIL HGOMI AVILI, ABDOLLAH
70 kg	YARAHMADI, PEYMAN
74 kg	CHIASI CHEKA, MOSTAFA REZAEI GHALEH, MORTEZA



Liste des Engagés par pays / Entry-List By Country

INT. 42. nd YASAR DOGU TOURNAMENT

STYLE FS

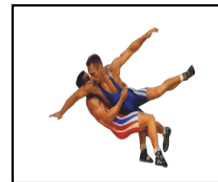

86 kg

EBRAHIMIZIVLAEI, MOHAMMAD JAVAD
KARIMIMACHIANI, ALI REZA
ZAMAN, JALAL

ITALY (ITA)

Entraîneur / Coach :

CANEVA, LUCIO

Lutteur(s) / Wrestler(s) :

65 kg

CHAMIZO, FRANK

JAPAN (JPN)

Chef de délégation / Team Leader :

KODAIRA, KIYOTAKA

Entraîneur / Coach :

FUJIYAMA, KOTARO
MATSUNAGA, TOMOHIRO

Médecin / Medical Staff :

KAWASAKI, ATSUSHI

Lutteur(s) / Wrestler(s) :

125 kg

ARAKIDA, NOBUYOSHI

57 kg

MORISHITA, FUMITAKA
TAKAHASHI, YUKI

61 kg

KAWASE, KATSUYOSHI
TAKATSUKA, NORIYUKI

65 kg

ISHIDA, TOMOTSUGU
TAKATANI, DAICHI

74 kg

TAKATANI, SOHSUKE

97 kg

YAMAGUCHI, TAKESHI

KAZAKHSTAN (KAZ)

Chef de délégation / Team Leader :

TATUBAYEV, KUTTYBEK

Entraîneur / Coach :

ALIYEV, ATABEK
KHAPAR, YESSANTAY
CHABAYEV, NURLAN
KULMAMBETOV, ARSLAN
ZADNEPRYANNYY, IGOR

Lutteur(s) / Wrestler(s) :

57 kg

ABIKENOV, YELDOS
PRIMBAYEV, BERDAKH

61 kg

AITKULOV, TIMUR
SANBAYEV, TIMUR
ZHAKSYBAY, KUANYSH

70 kg

OMAROV, SAMAT
SAKAYEV, AZAT
ZHOLAYEV, NURGALI



Liste des Engagés par pays / Entry-List By Country

INT. 42. nd YASAR DOGU TOURNAMENT

STYLE FS

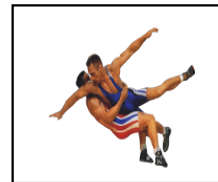

74 kg	KOKTEUBAYEV, NURDAULET NURSULTANOV, ABYLAIKHAN
86 kg	DAVLUMBAYEV, ADILET JVARIDZE, BEKA
97 kg	JVARIDZE, LEVAN KHASSANOV, AIBAR

KYRGYZSTAN (KGZ)

Chef de délégation / Team Leader :	TURGANBAEV, MELIS AIBEK, JAILOOBAEV
Entraîneur / Coach :	TABALDY ULU, SUIMONKUL MADZHINOV, RUSLANBEK

Lutteur(s) / Wrestler(s) :

57 kg	AITBEKOV, AIBEK NADYRBEEK UULU, SAMAT
61 kg	SATYMKULOV, SYPAR
65 kg	MIRAKHIMOV, AZAT
70 kg	USUPOV, SAIKBAI
86 kg	USUPOV, AIBEK

MACEDONIA ANC. R. YUG (MKD)

Entraîneur / Coach :	VRENEZI, LULZIM ALI, NAZMI
-----------------------------	-------------------------------

Lutteur(s) / Wrestler(s) :

61 kg	REXHALLARI, JASIN
70 kg	RAMADANI, METIN
74 kg	VESELOVSKI, BESMIR

MONGOLIA (MGL)

Entraîneur / Coach :	BYAMBARINCHIN, BAYARAA LUVSANDAMBA, ENKBAYAR OYUNBILEG, PUREVBAATAR TSERENBAATAR, TSOGTBAYAR
-----------------------------	---

Lutteur(s) / Wrestler(s) :

57 kg	BATBOLD, NOMIN ERDENEBAAT, BEKHBAYAR
61 kg	BAATARKHUU, USUKHBAYAR DAMDINBAZAR, TSOGTBAATAR ENKHSAIKHAN, NYAM-OCHIR NARMANDAKH, LKHAMGARMAA TUMENBILEG, TUVSHINTULGA



Liste des Engagés par pays / Entry-List By Country

INT. 42. nd YASAR DOGU TOURNAMENT

STYLE FS

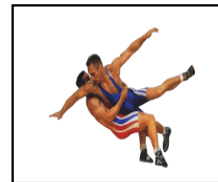

65 kg	BATCHULUUN, BATMAGNAI BATSUKH, SANCHIR GANZORIG, MANDAKHNARAN
70 kg	BUYANJAV, BATZORIG
74 kg	BATCHULUUN, ANKHBAYAR PUREVJAV, UNURBAT
86 kg	ORGODOL, UITUMEN
97 kg	DORJKHAND, KHUDERBULBA

PUERTO RICO (PUR)

Entraîneur / Coach : LANTIGUA FERMIN, FRANKLIN ALBERTO

Lutteur(s) / Wrestler(s) :

125 kg	LOPEZ MORELL, EDGARDO JUAN
57 kg	CRUZ, HECJOMAR JOEL
74 kg	SOTO CORDERO, PEDRO
97 kg	SANTOS, MARCOS

RUSSIA (RUS)

Chef de délégation / Team Leader : ALEXANDRIDIS, CHRISTANKIS

Entraîneur / Coach : SIVTCEV, IVAN
KONTOEV, GERMAN
BERISHVILI, GEORGY
SAZHIDOV, SAZHID
OMAROV, SHAMIL
BULATOV, ILDAR

Médecin / Medical Staff : TEBIEV, UMAR

Lutteur(s) / Wrestler(s) :

125 kg	KHUGAEV, ALAN TIMOFEEV, UVAR
57 kg	FLEGONTOV, VLADIMIR GABYSHEV, EVGENII IVANOV, MIKHAIL
61 kg	AMPAR, RUSTEM BEKRENEV, ANDREI DMITRIEV, EGOR MUTALIMOV, MURSHID PONOMAREV, EGOR STRUCHKOV, VASILIIY
70 kg	KASUMOV, ISRAIL
74 kg	BATYROV, Khabib MAGOMEDKHANOV, UNAKHAN OSMANOV, SHAMIL-IMAM
86 kg	GADZHIV, GAMID SADULAEV, ABDULRASHID



Liste des Engagés par pays / Entry-List By Country

INT. 42. nd YASAR DOGU TOURNAMENT

STYLE FS

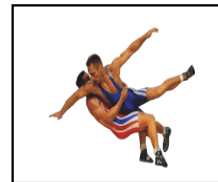

TAJIKISTAN (TJK)

Entraîneur / Coach : OLIMOV, ABDUROZIK

Lutteur(s) / Wrestler(s) :

70 kg	VOKHIDOV, SOMIRSHO
86 kg	KOMILDZHONI, SAFARALI
97 kg	ISKANDARI, RUSTAM

TUNISIA (TUN)

Chef de délégation / Team Leader : BOUSLAHI, MOHAMED

Entraîneur / Coach : KHEDRI, AHMED

Lutteur(s) / Wrestler(s) :

125 kg	TRABELSI, SLIM
57 kg	METHLOUTHI, CHEDLI
61 kg	BEN AYECH, HAYTHEM
65 kg	GHANMI, MAHER
74 kg	AYACHI, BORHANE
86 kg	RHIMI, ADNEN
97 kg	RHIMI, ROCHDI

TURKEY (TUR)

Entraîneur / Coach : TURKAYA, MEHMET

SIVRI, TURGAY

Médecin / Medical Staff : KISACIK, TAMER

Lutteur(s) / Wrestler(s) :

125 kg	AKGUL, TAHA BOZKURT, SAKIR CAKIROGLU, FATIH DEDE, YUNUS EMRE OZKARADENIZ, HAMZA SOLAKCI, MURAT
57 kg	AKGUL, SEZER ATLI, SULEYMAN CANKAYA, YAHYA DAYLAK, ZIYA GUCLU, A-ZBEKHAN KARABOGA, ALI PARLAR, HAKAN PEKER, AHMET SANCAK, MUHAMMER UZUN, NEBI
61 kg	AKTAS, MUNIR RECEP AVCI, ISMAIL BAKIR, ERHAN BULAK, SONER



Liste des Engagés par pays / Entry-List By Country

INT. 42. nd YASAR DOGU TOURNAMENT

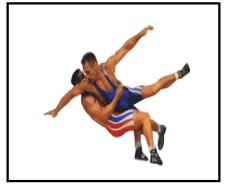

STYLE FS

	DAYLAK, M. ALI DOGAN, BURAK ERZINCANLI, MEHMET KOZAN, SELIM MERT, MURAT TOPAL, RECEP
65 kg	CETIN, ERSIN COSKUN, SERVET DEMIR, MUHAMMED KAYA, MUSTAFA KILICSALLAYAN, SELAHATTIN
70 kg	BOZKURT, ENGIN GOR, YAKUP ILKHAN, MUHAMMED KARA, NAZIM KUYUCU, MUSTAFA OZTURGUT, UGUR
74 kg	BULUT, ISMAIL COSKUN, ENDER DEMIR, MUHAMMED DEMIRCIN, BATUHAN DEMIRTAS, SONER ERTURK, MURAT GARGI, RAMAZAN GURBUZ, MUSA OZTURK, ALI YUCESOI, MUHAMMED RAGIP
86 kg	BILICI, FIRAT BILICI, AHMET BOKE, SERDAR CIHANGIROGLU, ERHAN DEMIRTAS, CANER ERDIN, FATIH KALENDER, O. FARUK KORKMAZ, NAMIK OZARSLAN, SAMET OZMEN, ABDULKADIR SUCU, AYHAN
97 kg	AKKOYUN, FARUK BOLUKBASI, IBRAHIM BONCEOGLU, ALI DEMIRTAS, BEKIR DOSLU, EMRULLAH ERINC, SALIH GUNDUZ, HUSEYIN KOSEOGLU, HAMZA MUTLU, MÃœREN SAHIN, BAKI YILDIRIM, RIZA ZEYBEK, YUSUF CAN

TURKMENISTAN (TKM)

Chef de délégation / Team Leader :	BEKDURDYEV, IBABEKIR
Entraîneur / Coach :	ANNAREJEPOV, AMANGELDI NEPESOV, ILYAS



Liste des Engagés par pays / Entry-List By Country

INT. 42. nd YASAR DOGU TOURNAMENT

STYLE FS

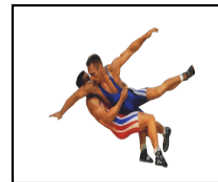

Médecin / Medical Staff : NURLYYEV, MEKAN

Lutteur(s) / Wrestler(s) :

57 kg	ATABAYEV, BERDI REJEPOV, RAMIL
61 kg	BORJAKOV, BATYR
65 kg	ORAZGYLYJOV, DOVLETMYRAT
70 kg	SHABERDIYEV, ORAZBERDI
74 kg	BAYRAMOV, DIDAR
86 kg	MELEJAYEV, YUSUP
97 kg	KARATAYEV, NURYADGY

UNITED STATES (USA)

Entraîneur / Coach : ZEKE, JONES

HRAVAT, ANDY

Médecin / Medical Staff : ROSSI, FRED

FRANKS, ROB

Lutteur(s) / Wrestler(s) :

125 kg	BRADLEY, DOMINIGUE
57 kg	ESCOBEDO, ANGEL HAZEWINKEL, SAMVEL HOCHSTRASSER, ANDREW MACKNIGHT, MARK
61 kg	KENNEDY, JIMMY
65 kg	CHAMBERLAIN, JASON
74 kg	BURNOUGHS, JORDAN MARABLE, NICHOLAS
86 kg	FOSTER, CLAYTON JORDAN, RAOMAND KEDDY, PHIL
97 kg	MICHALAK, WYNN VARNER, JACOB

UZBEKISTAN (UZB)

Entraîneur / Coach : KURBANOV, KURBAN

Lutteur(s) / Wrestler(s) :

74 kg	KURBANOV, RASHID
-------	------------------



Feuille de compétition / Competition Sheet

INT. 42. nd YASAR DOGU TOURNAMENT

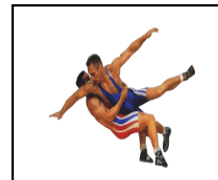

STYLE : FS 125 kg



9 AKGUL TAHA (TUR)

Classement

Cl	Pays	Nom
1	TUR	AKGUL TAHA
2	IRI	GHASEMI KOMEIL
3	USA	BRADLEY DOMINIGUE
3	TUR	DEDE YUNUS EMRE
5	RUS	KHUGAEV ALAN
5	TUR	CAKIROGLU FATIH
7	TUR	OZKARADENIZ HAMZA
8	IRI	HGOMI AVILI ABDOLLAH
9	AZE	DZEBOSOV ASLAN
10	TUR	SOLAKCI MURAT
11	BUL	ENEV ILIYA RUSEV
12	RUS	TIMOFEEV UVAR
13	TUR	BOZKURT SAKIR
14	TUN	TRABELSI SLIM
15	JPN	ARAKIDA NOBUYOSHI
16	PUR	LOPEZ MORELL EDGARDO JUAN

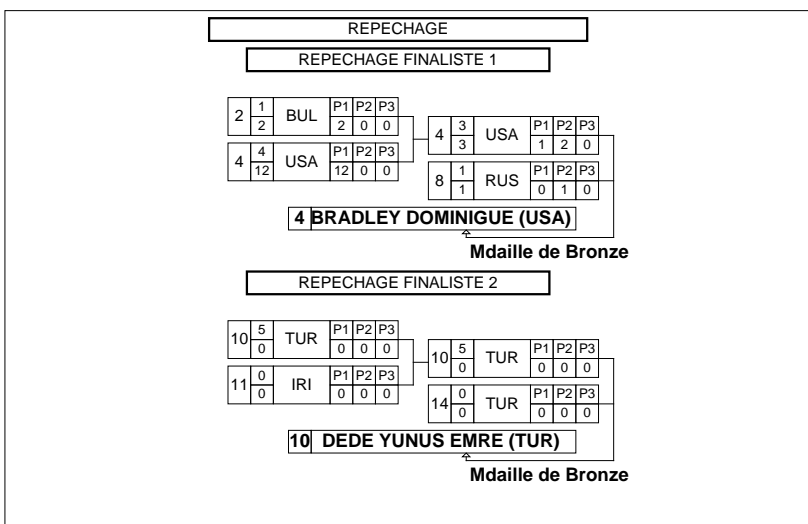



Classement

INT. 42. nd YASAR DOGU TOURNAMENT

STYLE : FS 125 kg



1 - Or / Gold



AKGUL TAHA

2 - Argent / Silver

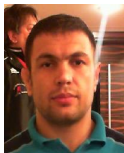

GHASEMI KOMEIL

3 - Bronze



BRADLEY DOMINIGUE

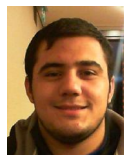

DEDE YUNUS EMRE

Classement	Nom - Name	Pays - Country
1	AKGUL TAHA	TUR
2	GHASEMI KOMEIL	IRI
3	BRADLEY DOMINIGUE	USA
3	DEDE YUNUS EMRE	TUR
5	KHUGAEV ALAN	RUS
5	CAKIROGLU FATIH	TUR
7	OZKARADENIZ HAMZA	TUR
8	HGOMI AVILI A.	IRI
9	DZEBOSOV ASLAN	AZE
10	SOLAKCI MURAT	TUR
11	ENEV ILIYA RUSEV	BUL
12	TIMOFEEV UVAR	RUS
13	BOZKURT SAKIR	TUR
14	TRABELSI SLIM	TUN
15	ARAKIDA NOBUYOSHI	JPN
16	LOPEZ MORELL E.	PUR



Classement

INT. 42. nd YASAR DOGU TOURNAMENT

STYLE : FS 57 kg



1 - Or / Gold



BATBOLD NOMIN

2 - Argent / Silver



MORISHITA FUMITAKA

3 - Bronze



TAKAHASHI YUKI

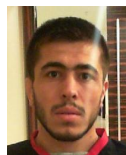

AKGUL SEZER

Classement	Nom - Name	Pays - Country
1	BATBOLD NOMIN	MGL
2	MORISHITA FUMITAKA	JPN
3	TAKAHASHI YUKI	JPN
3	AKGUL SEZER	TUR
5	NADYRBEK UULU SAMAT	KGZ
5	HOCHSTRASSER ANDREW	USA
7	AITBEKOV AIBEK	KGZ
8	ESCOBEDO ANGEL	USA
9	IVANOV MIKHAIL	RUS
10	REJEPOV RAMIL	TKM
11	DAYLAK ZIYA	TUR
12	UZUN NEBI	TUR
13	PRIMBAYEV BERDAKH	KAZ
14	MACKNIGHT MARK	USA
15	FLEGONTOV VLADIMIR	RUS
16	METHLOUTHI CHEDLI	TUN
17	ABIKENOV YELDOS	KAZ
18	YASHAR ALIYEV	AZE
19	PARLAR HAKAN	TUR
20	GUCLU Ā-ZBEKHAN	TUR
21	KARABOGA ALI	TUR
22	SANCAK MUHAMMER	TUR
23	GABYSHEV EVGENII	RUS
24	HAZEWINKEL SAMVEL	USA
25	ERDENEBAT BEKHBAYAR	MGL
26	ATLI SULEYMAN	TUR
27	CRUZ HECJOMAR JOEL	PUR
28	ATABAYEV BERDI	TKM
29	PEKER AHMET	TUR
30	CANKAYA YAHYA	TUR



Feuille de compétition / Competition Sheet

INT. 42. nd YASAR DOGU TOURNAMENT

STYLE : FS 61 kg



Classement

Cl	Pays	Nom
1	USA	KENNEDY JIMMY
2	MGL	ENKHSAIKHAN NYAM-OCHIR
3	AZE	QUVARZATILOV AXMEDNABI
3	RUS	MUTALIMOV MURSHID
5	TKM	BORJAKOV BATYR
5	JPN	TAKATSUKA NORIYUKI
7	TUR	AVCI ISMAIL
8	TUR	BAKIR ERHAN
9	TUR	AKTAS MUNIR RECEP
10	TUR	TOPAL RECEP
11	RUS	PONOMAREV EGOR
12	RUS	AMPAR RUSTEM
13	JPN	KAWASE KATSUYOSHI
14	TUR	KOZAN SELIM
15	AZE	GALIP ALIYEV
16	MGL	NARMANDAKH LKHAMGARMAA
17	RUS	BEKRENEV ANDREI
18	BUL	CHUCHUROV KRUM ANTONOV
19	KAZ	ZHAKSYBAY KUANYSH
20	KGZ	SATYMKULOV SYPAR

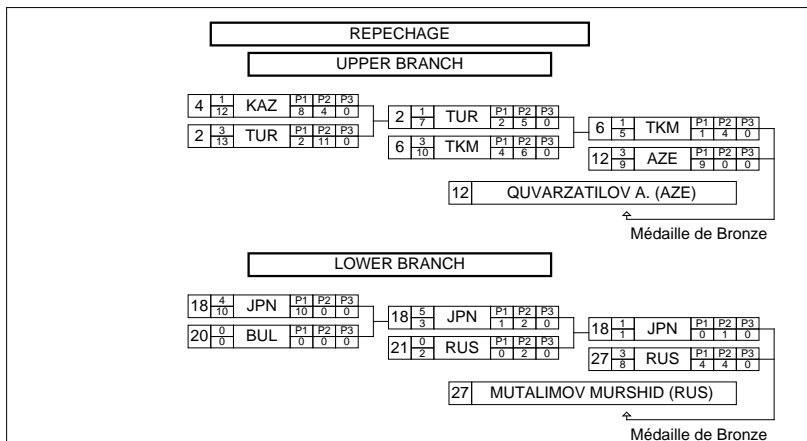

**Classement****INT. 42. nd YASAR DOGU TOURNAMENT**

STYLE : FS 61 kg

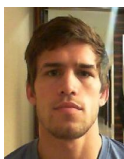
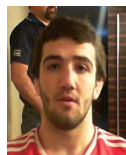
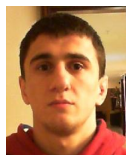
1 - Or / Gold**KENNEDY JIMMY****2 - Argent / Silver****ENKHS AIKHAN NYAM-OCHIR****3 - Bronze****QUVARZATILOV AXMEDNABI MUTALIMOV MURSHID**

<i>Classement</i>	<i>Nom - Name</i>	<i>Pays - Country</i>
1	KENNEDY JIMMY	USA
2	ENKHS AIKHAN N.	MGL
3	QUVARZATILOV A.	AZE
3	MUTALIMOV MURSHID	RUS
5	BORJAKOV BATYR	TKM
5	TAKATSUKA NORIYUKI	JPN
7	AVCI ISMAIL	TUR
8	BAKIR ERHAN	TUR
9	AKTAS MUNIR RECEP	TUR
10	TOPAL RECEP	TUR
11	PONOMAREV EGOR	RUS
12	AMPAR RUSTEM	RUS
13	KAWASE KATSUYOSHI	JPN
14	KOZAN SELIM	TUR
15	GALIP ALIYEV	AZE
16	NARMANDAKH L.	MGL
17	BEKRENEV ANDREI	RUS
18	CHUCHUROV K.	BUL
19	ZHAKSYBAY KUANYSH	KAZ
20	SATYMKULOV SYPAR	KGZ
21	SANBAYEV TIMUR	KAZ
22	STRUCHKOV VASILIIY	RUS
23	DAYLAK M. ALI	TUR
24	BAATARKHUU U.	MGL
25	DMITRIEV EGOR	RUS
26	DOGAN BURAK	TUR
26	BEN AYECH HAYTHEM	TUN
28	AITKULOV TIMUR	KAZ
29	ERZINCANLI MEHMET	TUR
30	MERT MURAT	TUR



Classement

INT. 42. nd YASAR DOGU TOURNAMENT

STYLE : FS 61 kg

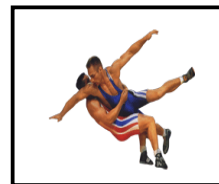

Classement	Nom - Name	Pays - Country
30	TUMENBILEG T.	MGL
32	BULAK SONER	TUR
33	REXHALLARI JASIN	MKD
33	DAMDINBAZAR T.	MGL



Feuille de compétition / Competition Sheet

INT. 42. nd YASAR DOGU TOURNAMENT



STYLE : FS 65 kg

QUALIFICATION			1/8 FINALE			1/4 FINALE			1/2 FINALE			FINALE		
1	MAGAMED MUSLUMOV (AZE)		1	3	AZE	1	3	AZE	1	3	AZE	1	3	AZE
2	NOVACHKOV B. (BUL)		2	1	BUL	2	1	BUL	2	1	BUL	2	1	BUL
3	BATCHULUUN B. (MGL)		3	1	MGL	3	1	MGL	3	1	MGL	3	1	MGL
4	CETIN ERSIN (TUR)		4	4	TUR	4	4	TUR	4	4	TUR	4	4	TUR
5	GHANMI MAHER (TUN)		5	0	TUN	5	0	TUN	5	0	TUN	5	0	TUN
6	TAKATANI DAICHI (JPN)		6	4	JPN	6	4	JPN	6	4	JPN	6	4	JPN
7	KAYA MUSTAFA (TUR)		7	3	TUR	7	3	TUR	7	3	TUR	7	3	TUR
8	ISHIDA TOMOTSUGU (JPN)		8	1	JPN	8	1	JPN	8	1	JPN	8	1	JPN
9	COSKUN SERVET (TUR)		9	3	TUR	9	3	TUR	9	3	TUR	9	3	TUR
10	CHAMBERLAIN JASON (USA)		10	1	USA	10	1	USA	10	1	USA	10	1	USA
11	MUSTAFAYEV A. (AZE)		11	3	AZE	11	3	AZE	11	3	AZE	11	3	AZE
12	KILICSALLAYAN S. (TUR)		12	1	TUR	12	1	TUR	12	1	TUR	12	1	TUR
13	BATSUKH SANCHIR (MGL)		13	1	MGL	13	1	MGL	13	1	MGL	13	1	MGL
14	ORAZGYLYJOV D. (TKM)		14	3	TKM	14	3	TKM	14	3	TKM	14	3	TKM
15	CHAMIZO FRANK (ITA)	P1 P2 P3 6 4 0	15	5	ITA	15	5	ITA	15	5	ITA	15	5	ITA
16	MIRAKHIMOV AZAT (KGZ)	P1 P2 P3 0 0 0	16	0	ITA	16	0	ITA	16	0	ITA	16	0	ITA
17	DEMIR MUHAMMED (TUR)	P1 P2 P3 0 4 0	17	0	MGL	17	0	MGL	17	0	MGL	17	0	MGL
18	GANZORIG M. (MGL)	P1 P2 P3 4 6 0	18	0	ITA	18	0	ITA	18	0	ITA	18	0	ITA

15 CHAMIZO FRANK (ITA)

Classement

Cl	Pays	Nom
1	ITA	CHAMIZO FRANK
2	AZE	MAGAMED MUSLUMOV
3	TUR	KAYA MUSTAFA
3	MGL	GANZORIG MANDAKHNRAN
5	BUL	NOVACHKOV BORISLAV STEFANOV
5	AZE	MUSTAFAYEV AGAHUSEYN
7	JPN	TAKATANI DAICHI
8	TUR	CETIN ERSIN
9	TKM	ORAZGYLYJOV DOVLETMYRAT
10	TUR	COSKUN SERVET
11	KGZ	MIRAKHIMOV AZAT
12	TUR	KILICSALLAYAN SELAHATTIN
13	USA	CHAMBERLAIN JASON
14	JPN	ISHIDA TOMOTSUGU
15	TUR	DEMIR MUHAMMED
16	MGL	BATSUKH SANCHIR
17	MGL	BATCHULUUN BATMAGNAI
18	TUN	GHANMI MAHER

REPECHAGE

REPECHAGE FINALISTE 1

2	5	BUL	P1 P2 P3 5 4 0	2	1	BUL	P1 P2 P3 0 2 0
4	0	TUR	P1 P2 P3 2 0 0	7	3	TUR	P1 P2 P3 4 2 0
7 KAYA MUSTAFA (TUR)							

Mdaille de Bronze

REPECHAGE FINALISTE 2

16	1	KGZ	P1 P2 P3 6 1 0	18	4	MGL	P1 P2 P3 18 0 0	18	5	MGL	P1 P2 P3 4 0 0
18	3	MGL	P1 P2 P3 2 8 0	14	1	TKM	P1 P2 P3 7 0 0	11	0	AZE	P1 P2 P3 0 0 0
18 GANZORIG M. (MGL)											

Mdaille de Bronze



Classement

INT. 42. nd YASAR DOGU TOURNAMENT



STYLE : FS 65 kg

1 - Or / Gold



CHAMIZO FRANK

2 - Argent / Silver

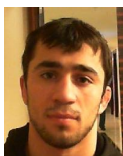

MAGAMED MUSLUMOV

3 - Bronze



KAYA MUSTAFA



GANZORIG MANDAKHNARAN

Classement	Nom - Name	Pays - Country
1	CHAMIZO FRANK	ITA
2	MAGAMED MUSLUMOV	AZE
3	KAYA MUSTAFA	TUR
3	GANZORIG M.	MGL
5	NOVACHKOV B.	BUL
5	MUSTAFAYEV A.	AZE
7	TAKATANI DAICHI	JPN
8	CETIN ERSIN	TUR
9	ORAZGYLYJOV D.	TKM
10	COSKUN SERVET	TUR
11	MIRAKHIMOV AZAT	KGZ
12	KILICSALLAYAN S.	TUR
13	CHAMBERLAIN JASON	USA
14	ISHIDA TOMOTSUGU	JPN
15	DEMIR MUHAMMED	TUR
16	BATSUKH SANCHIR	MGL
17	BATCHULUUN B.	MGL
18	GHANMI MAHER	TUN



Feuille de compétition / Competition Sheet

INT. 42. nd YASAR DOGU TOURNAMENT



STYLE : FS 70 kg

QUALIFICATION				1/8 FINALE				1/4 FINALE				1/2 FINALE				FINALE																	
1		EMIN AZIZOV (AZE)						1	4	AZE	P1	P2	P3																				
									8		8	0	0																				
2		RAMADANI METIN (MKD)						2	0	MKD	P1	P2	P3																				
									0		0	0	0																				
3		KUYUCU MUSTAFA (TUR)						3	5	TUR	P1	P2	P3																				
									6		6	0	0																				
4		OMAROV SAMAT (KAZ)						4	0	KAZ	P1	P2	P3																				
									9		9	0	0																				
5		KARA NAZIM (TUR)						5	3	TUR	P1	P2	P3																				
									8		2	6	0																				
6		SAKAYEV AZAT (KAZ)						6	1	KAZ	P1	P2	P3																				
									7		2	5	0																				
7		USUPOV SAIKBAI (KGZ)						7	0	KGZ	P1	P2	P3																				
									7		3	4	0																				
8		VOKHIDOV SOMIRSHO (TJK)						8	5	TJK	P1	P2	P3																				
									17		11	6	0																				
9		BOZKURT ENGIN (TUR)						9	0	TUR	P1	P2	P3																				
									4		4	0	0																				
10		ZHOLAYEV NURGALI (KAZ)						10	1	KAZ	P1	P2	P3																				
									0		0	0	0																				
11		ILKHAN MUHAMMED (TUR)						11	1	TUR	P1	P2	P3																				
									2		1	1	0																				
12		GOR YAKUP (TUR)						12	3	TUR	P1	P2	P3																				
									3		0	3	0																				
13		KASUMOV ISRAIL (RUS)						13	1	RUS	P1	P2	P3																				
									7		3	4	0																				
14		YARAHMADI PEYMAN (IRI)						14	3	IRI	P1	P2	P3																				
									8		5	3	0																				
15	1	SHABERDIYEV O. (TKM)	P1	P2	P3			15	1	TUR	P1	P2	P3																				
	3		2	1	0				5		2	3	0																				
16	4	OZTURGUT UGUR (TUR)	P1	P2	P3			16	0	MGL	P1	P2	P3																				
	14		8	6	0				0		0	0	0																				
17	3	BUYANJAV BATZORIG (MGL)	P1	P2	P3			17	3	MGL	P1	P2	P3																				
	2		1	1	0				6		2	4	0																				
18	0	KURTEV N. (BUL)	P1	P2	P3				0		0	0	0																				
	0		0	0	0				0		0	0	0																				

12 GOR YAKUP (TUR)

Classement

Cl	Pays	Nom
1	TUR	GOR YAKUP
2	AZE	EMIN AZIZOV
3	TUR	KUYUCU MUSTAFA
3	IRI	YARAHMADI PEYMAN
5	KAZ	ZHOLAYEV NURGALI
5	TJK	VOKHIDOV SOMIRSHO
7	MGL	BUYANJAV BATZORIG
8	TUR	OZTURGUT UGUR
9	TUR	KARA NAZIM
10	RUS	KASUMOV ISRAIL
10	KAZ	SAKAYEV AZAT
12	TKM	SHABERDIYEV ORAZBERDI
13	TUR	ILKHAN MUHAMMED
14	KAZ	OMAROV SAMAT
15	KGZ	USUPOV SAIKBAI
16	TUR	BOZKURT ENGIN
17	BUL	KURTEV NIKOLAY GOSHEV
18	MKD	RAMADANI METIN

REPECHAGE

REPECHAGE FINALISTE 1

2	0	MKD	P1	P2	P3			3	3	TUR	P1	P2	P3		
	0		0	0	0				12		0	12	0		
3	5	TUR	P1	P2	P3			8	1	TJK	P1	P2	P3		
	6		6	0	0				7		4	3	0		

3 KUYUCU MUSTAFA (TUR)

Mdaille de Bronze

REPECHAGE FINALISTE 2

11	0	TUR	P1	P2	P3			10	1	KAZ	P1	P2	P3		
	0		0	0	0				3		0	3	0		
10	5	KAZ	P1	P2	P3			14	3	IRI	P1	P2	P3		
	0		0	0	0				5		2	3	0		

14 YARAHMADI PEYMAN (IRI)

Mdaille de Bronze



Classement

INT. 42. nd YASAR DOGU TOURNAMENT

STYLE : FS 70 kg



1 - Or / Gold



GOR YAKUP

2 - Argent / Silver



EMIN AZIZOV

3 - Bronze



KUYUCU MUSTAFA

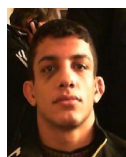

YARAHMADI PEYMAN

Classement	Nom - Name	Pays - Country
1	GOR YAKUP	TUR
2	EMIN AZIZOV	AZE
3	KUYUCU MUSTAFA	TUR
3	YARAHMADI PEYMAN	IRI
5	ZHOLAYEV NURGALI	KAZ
5	VOKHIDOV SOMIRSHO	TJK
7	BUYANJAV BATZORIG	MGL
8	OZTURGUT UGUR	TUR
9	KARA NAZIM	TUR
10	KASUMOV ISRAIL	RUS
10	SAKAYEV AZAT	KAZ
12	SHABERDIYEV O.	TKM
13	ILKHAN MUHAMMED	TUR
14	OMAROV SAMAT	KAZ
15	USUPOV SAIKBAI	KGZ
16	BOZKURT ENGIN	TUR
17	KURTEV N.	BUL
18	RAMADANI METIN	MKD



Feuille de compétition / Competition Sheet

INT. 42. nd YASAR DOGU TOURNAMENT

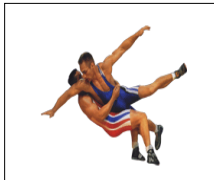

STYLE : FS 74 kg

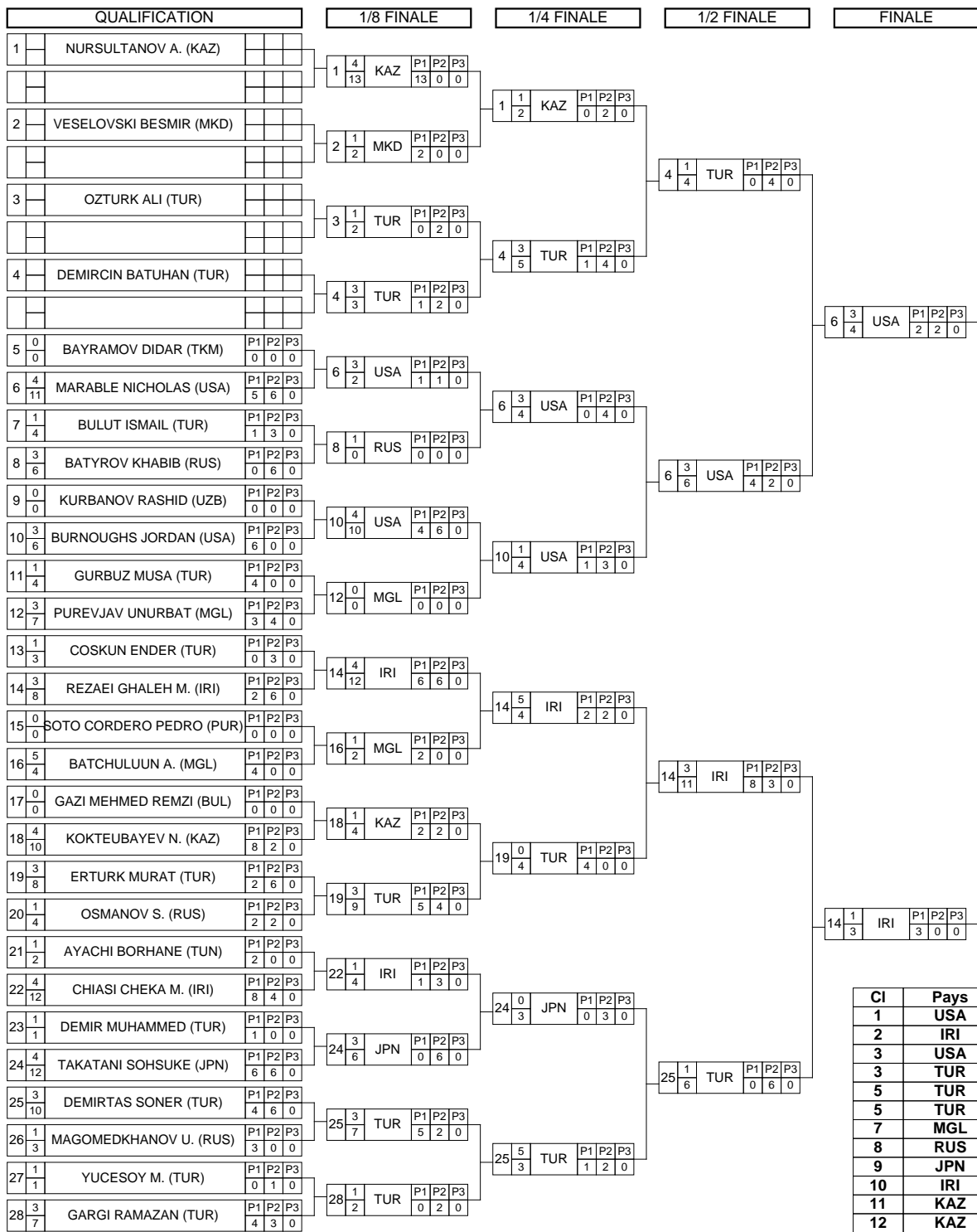

Classement		
Cl	Pays	Nom
1	USA	MARABLE NICHOLAS
2	IRI	REZAEI GHALEH MORTEZA
3	USA	BURNOUGHS JORDAN
3	TUR	DEMIRTAS SONER
5	TUR	DEMIRCIN BATUHAN
5	TUR	ERTURK MURAT
7	MGL	BATCHULUUN ANKHBAYAR
8	RUS	BATYROV Khabib
9	JPN	TAKATANI SOHSUKE
10	IRI	CHIASI CHEKA MOSTAFA
11	KAZ	NURSULTANOV ABYLAIKHAN
12	KAZ	KOKTEUBAYEV NURDAULET
13	TUR	GARGI RAMAZAN
14	MGL	PUREJVAV UNURBAT
15	TUR	COSKUN ENDER
16	TUR	BULUT ISMAIL
17	TUR	GURBUZ MUSA
18	RUS	OSMANOV SHAMIL-IMAM
19	RUS	MAGOMEDKHANOV UNAKHAN
20	TUR	OZTURK ALI
21	TUN	AYACHI BORHANE
22	MKD	VESELOVSKI BESMIR
23	TUR	YUCESLOY MUHAMMED RAGIP
24	TUR	DEMIR MUHAMMED
25	TKM	BAYRAMOV DIDAR
26	PUR	SOTO CORDERO PEDRO
27	UZB	KURBANOV RASHID
28	BUL	GAZI MEHMED REMZI

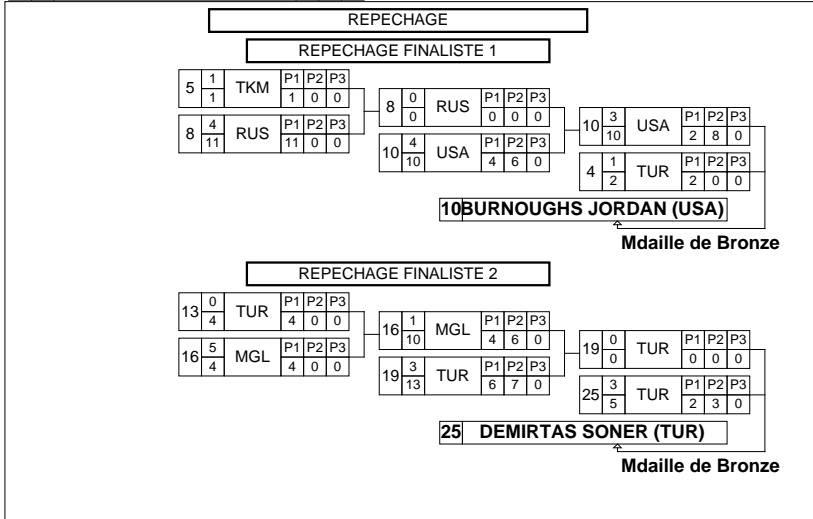



Classement

INT. 42. nd YASAR DOGU TOURNAMENT



STYLE : FS 74 kg

1 - Or / Gold

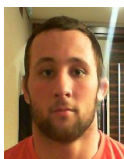

MARABLE NICHOLAS

2 - Argent / Silver



REZAEI GHALEH MORTEZA

3 - Bronze



BURNOUGHS JORDAN

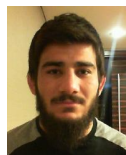

DEMIRTAS SONER

Classement	Nom - Name	Pays - Country
1	MARABLE NICHOLAS	USA
2	REZAEI GHALEH M.	IRI
3	BURNOUGHS JORDAN	USA
3	DEMIRTAS SONER	TUR
5	DEMIRCIN BATUHAN	TUR
5	ERTURK MURAT	TUR
7	BATCHULUUN A.	MGL
8	BATYROV Khabib	RUS
9	TAKATANI SOHSUKE	JPN
10	CHIASI CHEKA M.	IRI
11	NURSULTANOV A.	KAZ
12	KOKTEUBAYEV N.	KAZ
13	GARGI RAMAZAN	TUR
14	PUREVJAV UNURBAT	MGL
15	COSKUN ENDER	TUR
16	BULUT ISMAIL	TUR
17	GURBUZ MUSA	TUR
18	OSMANOV SHAMIL-IMAM	RUS
19	MAGOMEDKHANOV U.	RUS
20	OZTURK ALI	TUR
21	AYACHI BORHANE	TUN
22	VESELOVSKI BESMIR	MKD
23	YUCESoy M.	TUR
24	DEMIR MUHAMMED	TUR
25	BAYRAMOV DIDAR	TKM
26	SOTO CORDERO PEDRO	PUR
27	KURBANOV RASHID	UZB
28	GAZI MEHMED REMZI	BUL



Feuille de compétition / Competition Sheet

INT. 42. nd YASAR DOGU TOURNAMENT



STYLE : FS 86 kg

QUALIFICATION	1/8 FINALE	1/4 FINALE	1/2 FINALE	FINALE
1 KORKMAZ NAMIK (TUR)				
2 SUCU AYHAN (TUR)				
3 KALENDER O. FARUK (TUR)				
4 RHIMI ADNEN (TUN) P1 P2 P3 0 0 0				
5 KEDDY PHIL (USA) P1 P2 P3 4 10 0 0				
6 OZARSLAN SAMET (TUR) P1 P2 P3 0 0 0				
7 GADZHIV GAMID (RUS) P1 P2 P3 4 10 0 0				
8 SREDKOV G. (BUL) P1 P2 P3 1 0 0				
9 KARIMIMACHIANI A. (IRI) P1 P2 P3 4 12 2 10 0				
10 IBRAHIM YUSUBOV (AZE) P1 P2 P3 3 10 1 9 0				
11 XALIYEV M. (AZE) P1 P2 P3 1 8 0 8 0				
12 KOMILDZHONI S. (TJK) P1 P2 P3 0 0 0				
13 ORGODOL UITUMEN (MGL) P1 P2 P3 4 11 11 0 0				
14 DAVLUMBAYEV ADILET (KAZ) P1 P2 P3 5 21 8 13 0				
15 USUPOV AIBEK (KGZ) P1 P2 P3 0 18 14 4 0				
16 JORDAN RAOMAND (USA) P1 P2 P3 3 3 0 3 0				
17 BILICI FIRAT (TUR) P1 P2 P3 1 1 0 0 0				
18 MELEJAYEV YUSUP (TKM) P1 P2 P3 0 0 0 0 0				
19 JVARIDZE BEKA (KAZ) P1 P2 P3 4 11 11 0 0				
20 OZMEN ABDULKADIR (TUR) P1 P2 P3 0 2 2 0 0				
21 FOSTER CLAYTON (USA) P1 P2 P3 5 12 8 4 0				
22 ERDIN FATIH (TUR) P1 P2 P3 3 10 6 4 0				
23 CIHANGIROGLU ERHAN (TUR) P1 P2 P3 1 3 1 2 0				
24 DEMIRTAS CANER (TUR) P1 P2 P3 1 1 0 0 0				
25 BILICI AHMET (TUR) P1 P2 P3 4 12 0 12 0				
26 BOKE SERDAR (TUR) P1 P2 P3 1 7 2 5 0				
27 ZAMAN JALAL (IRI) P1 P2 P3 3 7 3 4 0				
28 SADULAEV A. (RUS) P1 P2 P3 3 8 4 4 0				
29 EBRAHIMIZVLAEI M. (IRI) P1 P2 P3 1 2 0 2 0				

28 SADULAEV A. (RUS)

Classement

Cl	Pays	Nom
1	RUS	SADULAEV ABDULRASHID
2	USA	KEDDY PHIL
3	IRI	KARIMIMACHIANI ALI REZA
3	IRI	EBRAHIMIZVLAEI MOHAMMAD JAVAN
5	TUR	SUCU AYHAN
5	USA	FOSTER CLAYTON
7	TUR	BILICI AHMET
8	USA	JORDAN RAOMAND
9	AZE	IBRAHIM YUSUBOV
10	KAZ	DAVLUMBAYEV ADILET
11	MGL	ORGODOL UITUMEN
12	RUS	GADZHIV GAMID
13	IRI	ZAMAN JALAL
14	KAZ	JVARIDZE BEKA
15	TUR	ERDIN FATIH
16	TUR	KALENDER O. FARUK
17	AZE	XALIYEV MOGAMEDGAYI
18	TUR	BOKE SERDAR
19	TUN	RHIMI ADNEN
20	TUR	CIHANGIROGLU ERHAN
21	TUR	KORKMAZ NAMIK
22	TUR	BILICI FIRAT
23	TUR	DEMIRTAS CANER
23	BUL	SREDKOV GEORGI ATANASOV
25	KGZ	USUPOV AIBEK
26	TUR	OZMEN ABDULKADIR
27	TUR	OZARSLAN SAMET
28	TKM	MELEJAYEV YUSUP
28	TJK	KOMILDZHONI SAFARALI

REPECHAGE

REPECHAGE FINALISTE 1

4 1 7 TUN P1 P2 P3 5 2 0		3 0 2 TUR P1 P2 P3 0 2 0		2 0 0 TUR P1 P2 P3 0 0 0		9 KARIMIMACHIANI A. (IRI)
3 3 12 TUR P1 P2 P3 6 6 0		2 5 7 TUR P1 P2 P3 1 6 0		9 4 10 IRI P1 P2 P3 8 2 0		

Mdaille de Bronze

REPECHAGE FINALISTE 2

29 3 2 IRI P1 P2 P3 0 2 0		29 3 6 IRI P1 P2 P3 1 5 0		29 3 8 IRI P1 P2 P3 4 4 0		29 EBRAHIMIZVLAEI M. (IRI)
27 1 1 IRI P1 P2 P3 1 0 0		25 1 1 TUR P1 P2 P3 0 1 0		21 1 5 USA P1 P2 P3 1 4 0		

Mdaille de Bronze



Classement

INT. 42. nd YASAR DOGU TOURNAMENT

STYLE : FS 86 kg



1 - Or / Gold

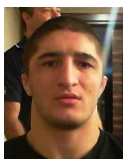

SADULAEV ABDULRASHID

2 - Argent / Silver



KEDDY PHIL

3 - Bronze

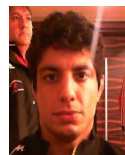
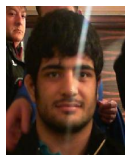

KARIMIMACHIANI ALI ~~EBRAHIMIZIVLAEI~~ MOHAMMAD JAVAD

Classement	Nom - Name	Pays - Country
1	SADULAEV A.	RUS
2	KEDDY PHIL	USA
3	KARIMIMACHIANI A.	IRI
3	EBRAHIMIZIVLAEI M.	IRI
5	SUCU AYHAN	TUR
5	FOSTER CLAYTON	USA
7	BILICI AHMET	TUR
8	JORDAN RAOMAND	USA
9	IBRAHIM YUSUBOV	AZE
10	DAVLUMBAYEV ADILET	KAZ
11	ORGODOL UITUMEN	MGL
12	GADZHIV GAMID	RUS
13	ZAMAN JALAL	IRI
14	JVARIDZE BEKA	KAZ
15	ERDIN FATIH	TUR
16	KALENDER O. FARUK	TUR
17	XALIYEV MOGAMEDGAYI	AZE
18	BOKE SERDAR	TUR
19	RHIMI ADNEN	TUN
20	CIHANGIROGLU ERHAN	TUR
21	KORKMAZ NAMIK	TUR
22	BILICI FIRAT	TUR
23	DEMIRTAS CANER	TUR
23	SREDKOV G.	BUL
25	USUPOV AIBEK	KGZ
26	OZMEN ABDULKADIR	TUR
27	OZARSLAN SAMET	TUR
28	MELEJAYEV YUSUP	TKM
28	KOMILDZHONI S.	TJK



Feuille de compétition / Competition Sheet

INT. 42. nd YASAR DOGU TOURNAMENT



STYLE : FS 97 kg

QUALIFICATION			1/8 FINALE			1/4 FINALE			1/2 FINALE			FINALE		
1		KHASSANOV AIBAR (KAZ)				1	1	KAZ	P1	P2	P3			
							5		5	0	0			
2		BONCEOGLU ALI (TUR)				2	4	TUR	P1	P2	P3			
							16		8	8	0			
3		BAKIROV ROMAN (AZE)				3	3	AZE	P1	P2	P3			
							7		4	3	0			
4		DEMIRTAS BEKIR (TUR)				4	0	TUR	P1	P2	P3			
							0		0	0	0			
5		KOSEOGLU HAMZA (TUR)				5	3	TUR	P1	P2	P3			
							10		6	4	0			
6		SAID GAMIDOV (AZE)				6	1	AZE	P1	P2	P3			
							6		4	2	0			
7		ISKANDARI RUSTAM (TKM)				7	1	TJK	P1	P2	P3			
							3		0	3	0			
8	3	GUNDUZ HUSEYIN (TUR)	P1	P2	P3	8	3	TUR	P1	P2	P3			
	3		3	0	0		5		3	2	0			
9	1	SAHIN BAKI (TUR)	P1	P2	P3	9	1	TUR	P1	P2	P3			
	2		2	0	0		5		3	2	0			
10	3	YILDIRIM RIZA (TUR)	P1	P2	P3	10	5	TUR	P1	P2	P3			
	4		4	0	0		2		2	0	0			
11	1	YAMAGUCHI TAKESHI (JPN)	P1	P2	P3	11	1	TUR	P1	P2	P3			
	3		1	2	0		1		0	1	0			
12	1	AKKOYUN FARUK (TUR)	P1	P2	P3	12	0	USA	P1	P2	P3			
	1		0	1	0		0		0	0	0			
13	3	VARNER JACOB (USA)	P1	P2	P3	13	0	USA	P1	P2	P3			
	8		2	6	0		0		0	0	0			
14	0	DOSLU EMRULLAH (TUR)	P1	P2	P3	14	0	USA	P1	P2	P3			
	0		0	0	0		0		0	0	0			
15	4	GAZYUMOV KHETAG (AZE)	P1	P2	P3	15	3	AZE	P1	P2	P3			
	10		6	4	0		9		5	4	0			
16	3	BOLUKBASI IBRAHIM (TUR)	P1	P2	P3	16	1	TUR	P1	P2	P3			
	4		3	1	0		4		0	4	0			
17	1	ZEYBEK YUSUFCAN (TUR)	P1	P2	P3	17	1	TUR	P1	P2	P3			
	1		0	1	0		4		0	4	0			
18	0	KARATAYEV NURYADGY (TKM)	P1	P2	P3	18	0	TKM	P1	P2	P3			
	0		0	0	0		0		0	0	0			
19	4	MICHALAK WYNN (USA)	P1	P2	P3	19	3	USA	P1	P2	P3			
	11		11	0	0		6		6	0	0			
20	0	DORJKHAND K. (MGL)	P1	P2	P3	20	0	MGL	P1	P2	P3			
	0		0	0	0		0		0	0	0			
21	4	MUTLU MÄCEREN (TUR)	P1	P2	P3	21	1	TUR	P1	P2	P3			
	10		10	0	0		5		4	1	0			
22	1	RHIMI ROCHDI (TUN)	P1	P2	P3	22	1	KAZ	P1	P2	P3			
	4		1	3	0		1		1	0	0			
23	3	JVARIDZE LEVAN (KAZ)	P1	P2	P3	23	3	TUR	P1	P2	P3			
	13		3	10	0		13		3	10	0			
24	5	ERINC SALIH (TUR)	P1	P2	P3	24	4	TUR	P1	P2	P3			
	4		4	0	0		11		4	7	0			
25	0	SANTOS MARCOS (PUR)	P1	P2	P3	25	0	PUR	P1	P2	P3			
	0		0	0	0		0		0	0	0			

15 GAZYUMOV KHETAG (AZE)

Classement

Cl	Pays	Nom
1	AZE	GAZYUMOV KHETAG
2	TUR	BONCEOGLU ALI
3	AZE	BAKIROV ROMAN
3	TUR	BOLUKBASI IBRAHIM
5	TUR	KOSEOGLU HAMZA
5	TUR	ERINC SALIH
7	TUR	YILDIRIM RIZA
8	USA	MICHALAK WYNN
9	TUR	GUNDUZ HUSEYIN
10	TUR	MUTLU MÄCEREN
11	KAZ	JVARIDZE LEVAN
12	USA	VARNER JACOB
13	AZE	SAID GAMIDOV
14	KAZ	KHASSANOV AIBAR
15	TUN	RHIMI ROCHDI
16	JPN	YAMAGUCHI TAKESHI
17	TJK	ISKANDARI RUSTAM
18	TUR	SAHIN BAKI
19	TUR	ZEYBEK YUSUFCAN
20	TUR	AKKOYUN FARUK
21	PUR	SANTOS MARCOS
22	TUR	DEMIRTAS BEKIR
23	MGL	DORJKHAND KHUDERBULBA
24	TKM	KARATAYEV NURYADGY
25	TUR	DOSLU EMRULLAH

REPECHAGE

REPECHAGE FINALISTE 1

1	0	KAZ	P1	P2	P3	3	3	AZE	P1	P2	P3
	0		0	0	0		6		0	6	0
3	3	AZE	P1	P2	P3	5	1	TUR	P1	P2	P3
	5		5	0	0		6		1	5	0

3 BAKIROV ROMAN (AZE)

Mdaille de Bronze

REPECHAGE FINALISTE 2

14	0	TUR	P1	P2	P3	16	3	TUR	P1	P2	P3
	0		0	0	0		6		4	2	0
16	3	TUR	P1	P2	P3	16	5	TUR	P1	P2	P3
	5		1	4	0		2		2	0	0
						10	1	TUR	P1	P2	P3
							4		2	2	0

16 BOLUKBASI IBRAHIM (TUR)

Mdaille de Bronze



Classement

INT. 42. nd YASAR DOGU TOURNAMENT



STYLE : FS 97 kg

1 - Or / Gold

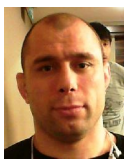

GAZYUMOV KHETAG

2 - Argent / Silver



BONCEOGLU ALI

3 - Bronze

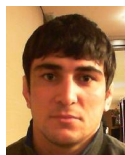

BAKIROV ROMAN



BOLUKBASI IBRAHIM

Classement	Nom - Name	Pays - Country
1	GAZYUMOV KHETAG	AZE
2	BONCEOGLU ALI	TUR
3	BAKIROV ROMAN	AZE
3	BOLUKBASI IBRAHIM	TUR
5	KOSEOGLU HAMZA	TUR
5	ERINC SALIH	TUR
7	YILDIRIM RIZA	TUR
8	MICHALAK WYNN	USA
9	GUNDUZ HUSEYIN	TUR
10	MUTLU MÃœREN	TUR
11	JVARIDZE LEVAN	KAZ
12	VARNER JACOB	USA
13	SAID GAMIDOV	AZE
14	KHASSANOV AIBAR	KAZ
15	RHIMI ROCHDI	TUN
16	YAMAGUCHI TAKESHI	JPN
17	ISKANDARI RUSTAM	TJK
18	SAHIN BAKI	TUR
19	ZEYBEK YUSUFCAN	TUR
20	AKKOYUN FARUK	TUR
21	SANTOS MARCOS	PUR
22	DEMIRTAS BEKIR	TUR
23	DORJKHAND K.	MGL
24	KARATAYEV NURYADGY	TKM
25	DOSLU EMRULLAH	TUR

