



**THE FUTURE IS
RIGHT HERE**

POSCO DAEWOO CORPORATION

CONTENTS

- 04 CEO'S MESSAGE
- 06 COMPANY HISTORY
- 08 VISION & CORE VALUES
- 09 FINANCIAL HIGHLIGHTS
- 10 BUSINESS AREAS
- 12 INTERNATIONAL TRADE
 - 14 Steel
 - 16 Non-Ferrous Metal
 - 17 Chemicals
 - 18 Machinery
 - 19 Automobile & Components
 - 20 Electronic Communications
 - 21 Food & Commodities
- 22 INVESTMENT & PROJECT ORGANIZING
 - 24 Infrastructure Project
 - 25 Energy & Industrial Plant Project
 - 26 Power Plant Project
 - 27 Hotel Project
- 28 RESOURCES DEVELOPMENT
 - 30 Oil & Gas
 - 31 Myanmar Gas Field Project
 - 32 Minerals
 - 33 Agro-Resources
- 34 CERTIFICATES · TRADEMARKS AND SOCIAL CONTRIBUTIONS
 - 36 Status of Certificates
 - 37 Introduction of Trademark
 - 38 Social Contribution
- 40 GLOBAL NETWORKS

CHALLENGING TOWARDS GLOBAL TOP COMPANY

POSCO DAEWOO is a representative 'Global Integrated Corporation' that consistently builds its company by implementing core values as 'The Excellent People,' 'Creative Challenge' and 'Reliability and Cooperation' in various business fields including international trade, investment & project organizing and resources development.



CEO'S MESSAGE



Dear Respected Customer,

First and foremost, thank you for your continued support and encouragement for POSCO DAEWOO.

Over the past half-century, the history of POSCO DAEWOO has evolved in conjunction with the economic growth of Korea. Since we joined POSCO Group in 2010, we have sought to achieve qualitative growth in trading and investment through our commitment to "quality-first management".

Looking back on our past footsteps, I strongly believe that each trial and error, as well as each achievement and triumph, has served as a solid cornerstone upon which POSCO DAEWOO now stands, prepared for a greater march forward.

Based on our expertise in trading and extensive reach of 100 networks built around the world, we are playing an instrumental role as an organizer in the infrastructure project sector. We also hold a prominent position in the resource development sector.

Our successful development of the gas field in Myanmar is the fruit of POSCO DAEWOO's challenging spirit and the unyielding efforts of our employees over the last 13 years. The significance of this project is that we have succeeded in ensuring a stable revenue source for the next 25 years, thus securing the financial resources to advance the growth of our future core businesses.

POSCO DAEWOO

Striving to become a 'Global Integrated Corporation' as a World-Class Comprehensive Business Solution Provider

Taking a leap forward to become a comprehensive business solution provider

We now aim to take another leap forward to grow from a trading company into a 'Global Integrated Corporation' as a comprehensive business solution provider that leads the global market.

To this end, we plan to place the greatest focus on our core businesses of steel-making and oil & gas and reach new heights as a major player in the global arena. For steel-making, we will enhance our solution trading capabilities. For oil & gas, we will strive to achieve continued success in our ongoing exploration and mining area development projects as we did with the Myanmar gas field. We are also planning to focus our resources on businesses of strategic importance – such as food, automobile parts, and IPP (independent power producer) – in addition to our core businesses to expand our value chain and thus improve our business competence.

Reaching out to others as a responsible corporate member of society

POSCO DAEWOO takes pride in being a leader in complying with international standards for human rights and environmental protection and in adhering to fair trade practices. We are continuing our work to make fair trade practices take firm root as an essential part of our corporate culture by implementing our Fair Trade Compliance Program. Furthermore, we are focusing on ensuring the trust and admiration of the communities we serve by sharing what we have with others and fulfilling our corporate social responsibility.

Our goal is to operate as a company that evolves in a sustained manner. To this end, we will make each and every business sector stronger and more robust through our unwavering commitment to innovation.

We ask for your continued interest in and support for POSCO DAEWOO.

Thank you.

POSCO DAEWOO Corporation
Kim Young-Sang, President and CEO



COMPANY HISTORY

POSCO DAEWOO began as a trading company called 'Daewoo Industry Co., Ltd.' in March 1967. The company was appointed as a 'general trading corporation' by Korean Government in May 1975 and has pioneered the economic development of South Korea by expanding its exports. In January 1982, the construction and the trading sector of company were integrated and it was renamed as Daewoo Co., Ltd. During the Global financial crisis hit in Korea, Daewoo Group was disbanded and divided into Daewoo International Co., Ltd. in December 2000. Until the early graduation of a work-out in December 2003, the company achieved average annual sales increases of 30%. In November 2010, it became an affiliate of the POSCO and was prepared to face the future based on its solid internal stability.

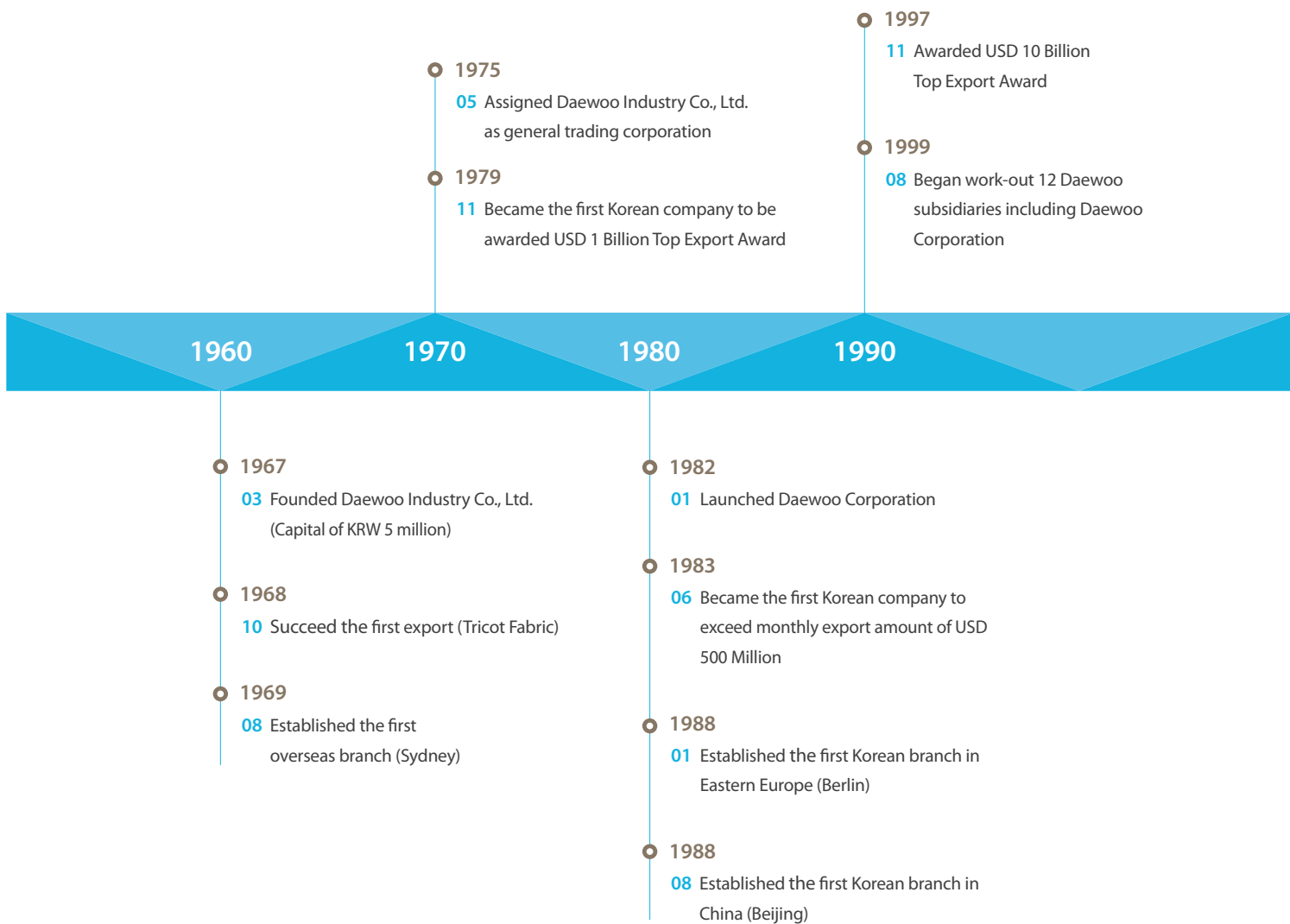

Since the 1st overseas branch was established in Sydney, Australia in August 1969, the company has 109 global networks located in 58 countries as of 2016. Particularly in 1988, the company became the first Korean corporation to penetrate into the German and Chinese markets. In March 2016, POSCO DAEWOO revised its mission statement, and is leading the global market as a part of the POSCO Group.

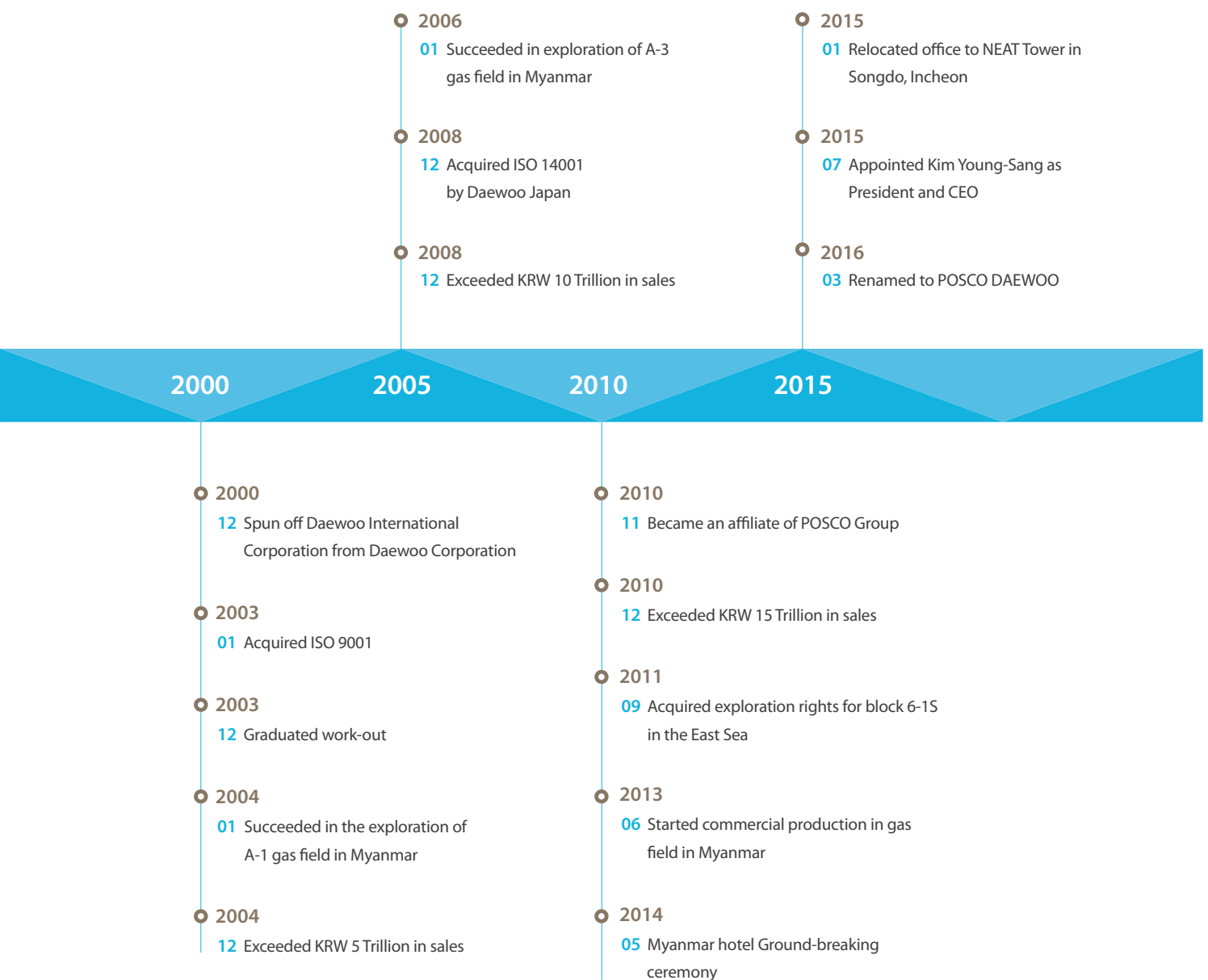

VISION AND CORE VALUES

Vision

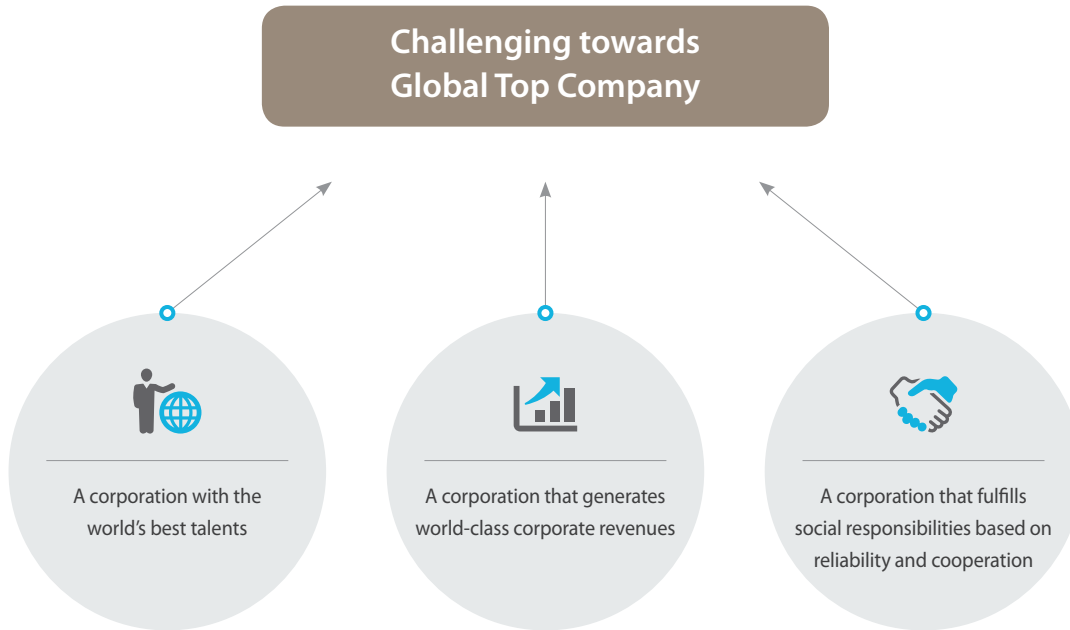

Core Values

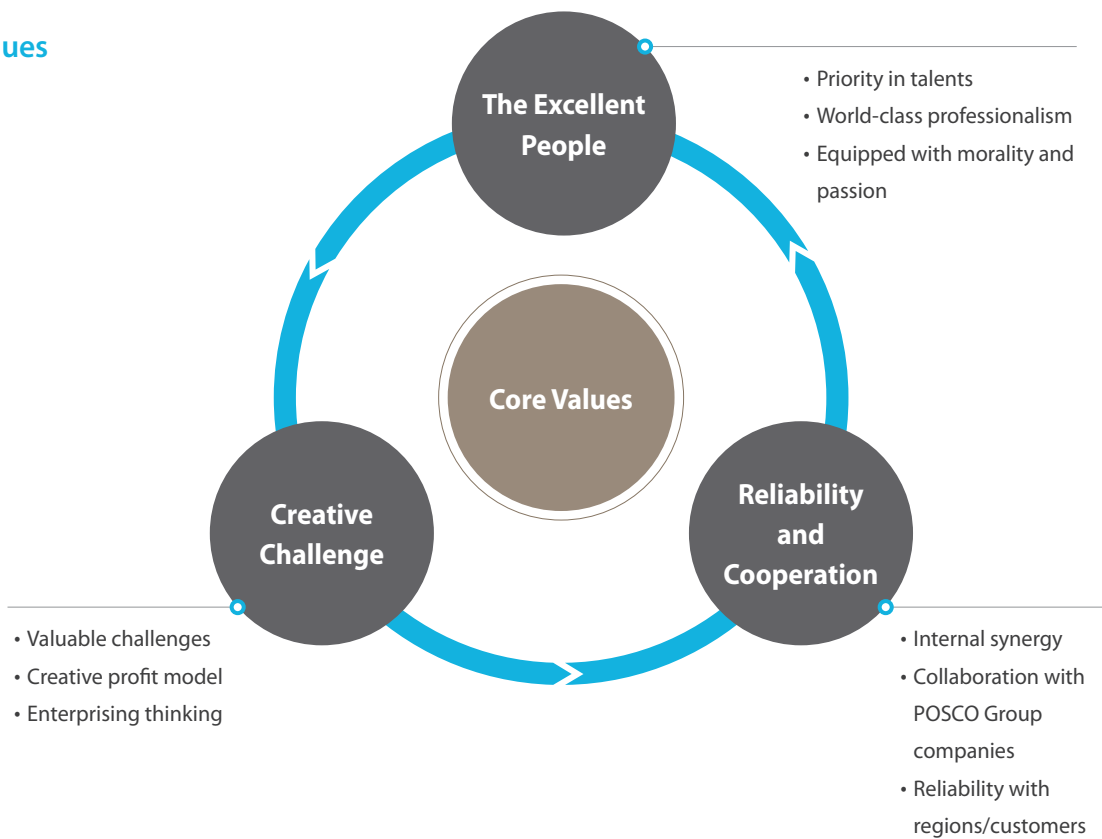

FINANCIAL HIGHLIGHTS

(Connection standard / Unit : KRW 100 Million)
As of Dec.2015

Sales Amount

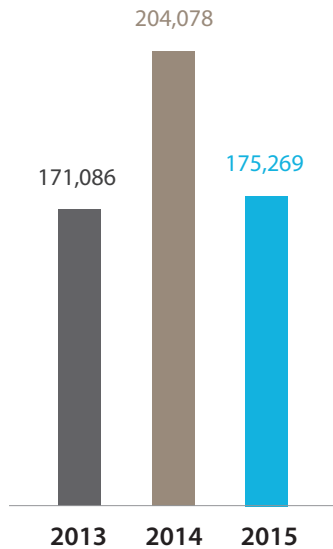

Sales Profit

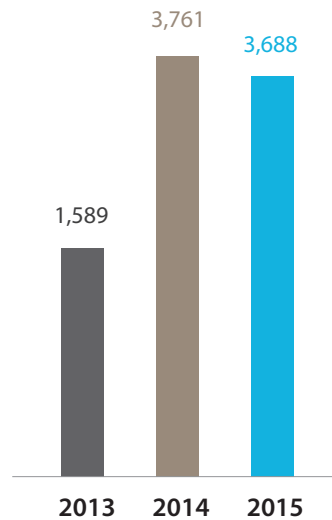

Net Profit of the Current Term

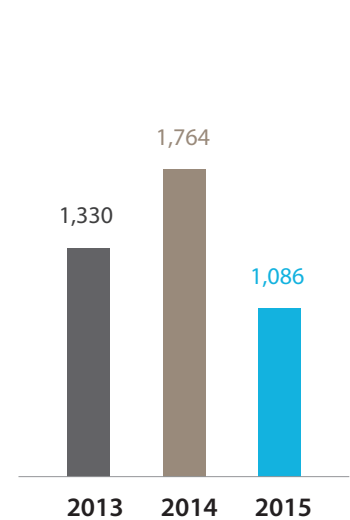

Asset / Capital / Liability

Item	2013	2014	2015
Total Asset	82,686	93,409	80,433
Total Liabilities	60,384	69,661	56,221
Total Capital	22,302	23,747	24,212
Liability Ratio(%)	270.8	293.3	232.2

Current Status of Major Shareholders

Item	Share Ratio(%)
POSCO Co., Ltd.	60.3
National Pension	4.9

Credit Rating

Evaluation group	Credit Rating
Korea Investors Service	AA-
Korea Ratings	A+
NICE Investors Service	A+

BUSINESS AREAS

The business areas of POSCO DAEWOO involve TRADING BUSINESS including imports, exports and triangular trade, INVESTMENT & PROJECT ORGANIZING BUSINESS such as power generation, plant, IT, financing and the operation of EPC(Engineering Procurement Construction), as well as RESOURCES DEVELOPMENT BUSINESS for the development, operation and sales of oil / gas, minerals and agro-resources.



INTERNATIONAL TRADE

Based on over 100 global networks that are distributed worldwide, POSCO DAEWOO is engaged in transactions with long-term outstanding partners that involve various products.



INVESTMENT & PROJECT ORGANIZING

As a project organizer in charge of planning · procurement · commissioning, POSCO DAEWOO conducts projects in the fields of power plant, railway, port, plant and IT equipment and the company is currently expanding its projects into shares investment and the operation of facilities.



RESOURCES DEVELOPMENT

POSCO DAEWOO executes overseas resource development projects in 16 countries worldwide in the fields of oil & gas, minerals and agro-resources and it is establishing a strong foothold as a global resource development corporation.

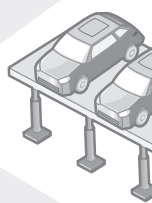
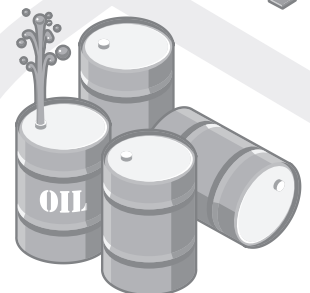
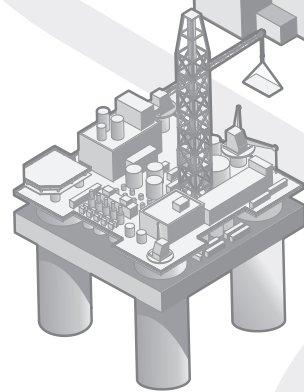
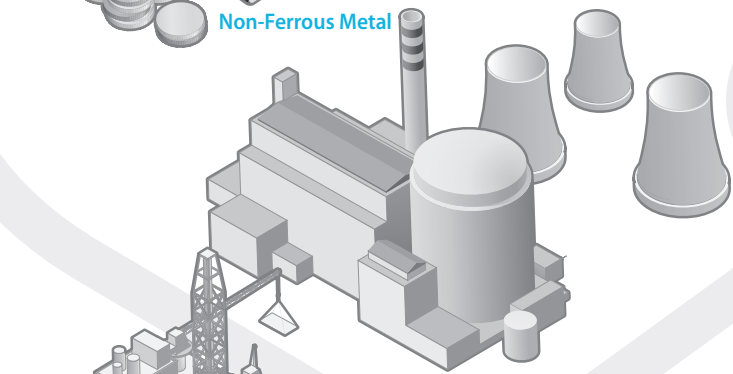
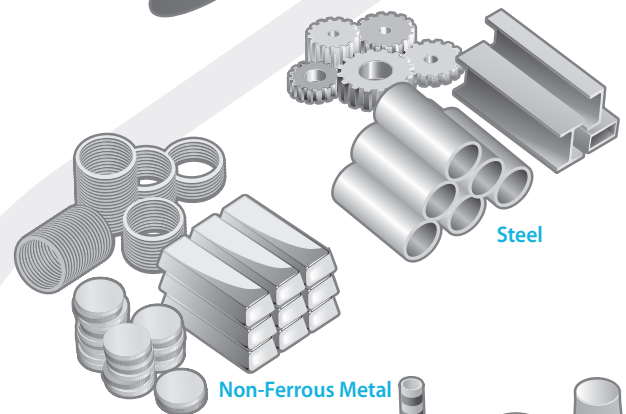
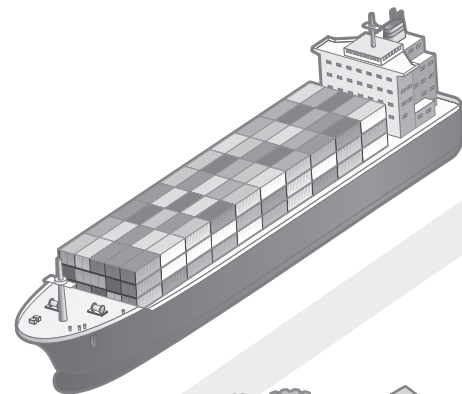

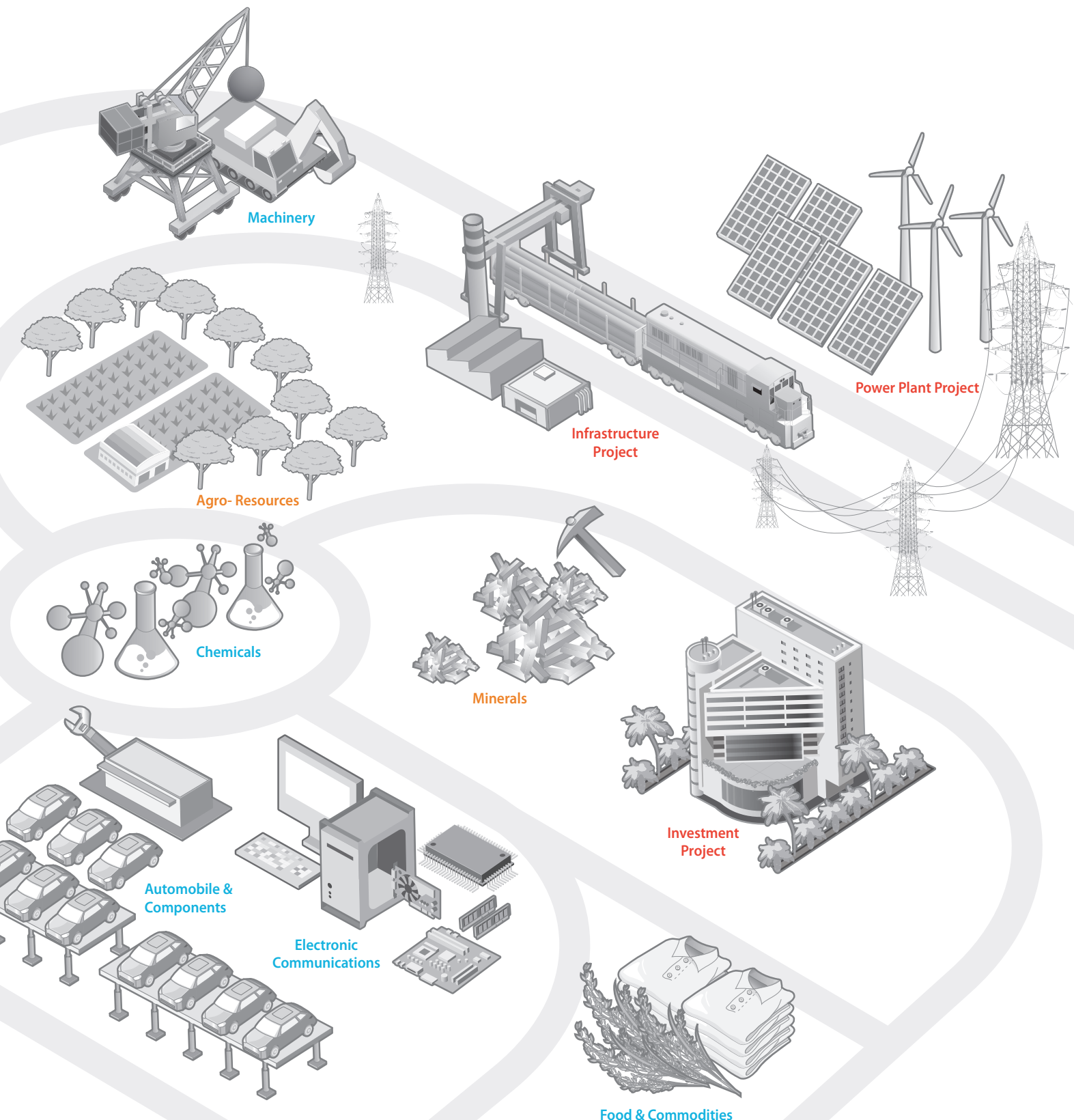

Machinery

Agro-Resources

Chemicals

Minerals

Investment Project

Electronic Communications

Automobile & Components

Food & Commodities

Infrastructure Project

Power Plant Project

INTERNATIONAL TRADE

POSCO DAEWOO is engaged in transactions with long-term outstanding partners involving various products by utilizing over 100 global networks. World-class talents have gathered to satisfy the needs of clients and through ceaseless, creative challenges towards the world market, POSCO DAEWOO will lead a bright future of global trade investment.





Steel

POSCO DAEWOO is engaged in exports, imports and triangular trading of products from top-tier steel suppliers, both domestic and overseas, including those in China, Asia, America, Europe, the Middle East and CIS, with a focus on products from POSCO, one of the largest steel manufacturers worldwide. The company is expanding globally with projects in industrial fields of construction, automobiles, plants, machinery, shipbuilding and energy, while professionally meeting the demands of diversified and segmented markets with products ranging from hot rolled steel, plate & wire rod and cold rolled steel products, to steel products in the oil and energy industry, automotive steel and special steel. In particular, the company is achieving continuous, rapid growth by expanding its business areas through strategic investments in and operations of processing centers around the world, such as in Brazil, America, Mexico, and Indonesia. Moreover, as Korea's best professional general trader in steel industries, the company is developing as the world's best trader based on its strong foundation of expertise domestically and overseas.



| Main items |

Hot Rolled Steel : Hot Rolled Steel Sheet, Pickled & Oiled Steel in Coil/Sheet

Plate & Wire Rod : Hot Rolled Steel Plate, Wire Rod, Slab

Energy Steel : Hot Rolled Steel in Coil/Plate/Pipe for API, Construction Material, Steel Pipe

Cold Rolled Steel : Cold Rolled Steel/Grain Oriented and Non-Oriented Electrical Steel/
Galvanized Steel/Electrolytic Galvanized Steel/Alu-Zinc Alloy Steel/
Aluminized Steel/Prepainted Galvanized Steel in Coil/Sheet, Tin Plate

Automotive Steel : Cold Rolled Steel/Galvanized Steel/Galvanealed Steel/
Pickled & Oiled Steel in Coil/Sheet

Special Steel : STS Cold Rolled/Hot Rolled Steel in Coil/Sheet/Pipe



POSCO DAEWOO
continuously conducts
transactions with manufacturers
around the world based on long-
term reliability and it is a window
for imports and exports for various
steel products.

Non-Ferrous Metal

POSCO DAEWOO is actively performing exports, imports and tripartite trade for non-ferrous metals which are considered as an essential material in today's industry. The company deals with various non-ferrous metal products, starting from raw materials in fundamental industries to finished goods and is expanding its business areas by continuously increasing its transaction volumes. Based on a workforce composed of outstanding trading specialists and abundant experience with the 6 major metals, the company has long strengthened its position as the best non-ferrous metal trader in Korea. In the overseas market, the company is elevating its status alongside the world's leading traders with its excellent sourcing abilities and expansion of commercial supremacy.



| Main items |

The Raw Materials of 6 Major Basic Metals(Aluminum Ingot, Electrolytic Copper, Zinc Ingot, Lead Ingot, Tin Ingot, Nickel, etc), Other Non-Ferrous Products(Titanium Raw Materials/ Products, Aluminum Products, Copper Products, etc), Non-Ferrous Scrap



Based on an outstanding workforce that excels in international trade and has a great deal of field experiences, POSCO DAEWOO is sincerely executing its role as a non-ferrous trader that leads the global market.

Chemicals

Petrochemical products are manufactured from petroleum or natural gas and refer to products that are used for chemical purposes other than fuel or lubricants. POSCO DAEWOO supplies petrochemical products in a comprehensive range starting from upstream fields such as naphtha which is a basic item in petrochemical, propylene and BTX to downstream fields such as synthetic resins, and chemical fiber synthetic rubber. By expanding long-term agreements, and in turn securing stable raw material sourcing and competitive finished goods, the company strives to ensure that the suppliers and buyers achieve mutual growth.



| Main items |

Petroleum Products(Gas Oil, Fuel Oil, etc), Olefin, Aromatics, Synthetic Fiber Intermediates, Synthetic Resins(PE, PP, ABS PVC, etc), Synthetic Rubber(SBR, BR, etc), Inorganic Chemicals, etc



The stable supply of competitive petro-chemical products and various new market channels are laying a solid foundation for the continuous growth of the petro-chemical industry.

Machinery

POSCO DAEWOO is engaged in exports of various heavy construction equipment, industrial vehicles, engines, agricultural machineries, facilities, small and medium plants, shipbuilding, aircrafts, airport equipment, railway and medical devices as well as tripartite transactions worldwide. In addition, the company is gaining credibility as a supplier of various products including power plants, processing equipment for substation construction and transmission and distribution wires. With business experiences accumulated in the fields of Economic Development Cooperation Fund (EDCF) projects, the company also exports relevant equipment and facilities.

| Main items |

Construction Equipment, Industrial Vehicle, Engine, Special Purpose Vehicle, Agriculture Machinery, Oil & Gas Energy Plants(Refinery, LNG/LPG Plant, Oil Farm), Industrial Plants(Petrochemical, Steel, Paper & Cement), Chemical Processing Equipment, Vessel & Offshore, Airport & Seaport Facilities, Rolling Stocks & Railway System, Healthcare, Water & Waste Treatment



POSCO DAEWOO
is building trust with
customers worldwide
with safe delivery and
product management
starting from industrial
machineries to various
equipment.

Automobile and Components

In 1984, POSCO DAEWOO was the first general trader in Korea to be equipped with a specialized organization for automotive component trading and it is now supplying automotive components and relevant engineering technology to over 265 customer companies in 85 countries worldwide. In particular, as an organization equipped with quality certifications such as ISO 9001, the company is dedicated to specialized exports of Original Equipment(OE) parts such as supplying engines, transmission(TM) parts, seat parts, internal and external parts, and Replacement Equipment(RE) parts such as tires and tubes to America as well as Japan and Europe. Moreover, the company is actively engaged in developing new growth based on futuristic automotive components such as parts for hybrid and electric vehicles.



| Main items |

Engine & TM Parts, Seat Parts, Interior & Exterior Parts, Tire, Battery, Wheel, Commercial Vehicle, Passenger Car



As Korea's largest specialized trading organization for automotive components that is currently engaged in trade with 85 countries worldwide, POSCO DAEWOO plays a part in contributing to the development of South Korea's automotive industry.



Electronic Communications

POSCO DAEWOO, overcoming a great wave of market changes, supplies various products worldwide in the fields of IT, communication devices as well as the electronic industry such as household appliances. The company strives to enhance value added by supplying not just simple general consumer goods, but also communication devices, systems and solutions. As a leader of combined system establishment and integration, the company is engaged in various System Integration(SI) projects.

Establishing communication infrastructure is an axis for strong growth and the company prides itself in its outstanding competitiveness as it has been awarded with projects involving Trunked Radio System(TRS), backbone network establishment in Indonesia and projects establishing high-speed Internet network in Podlaskie Providence, Poland.

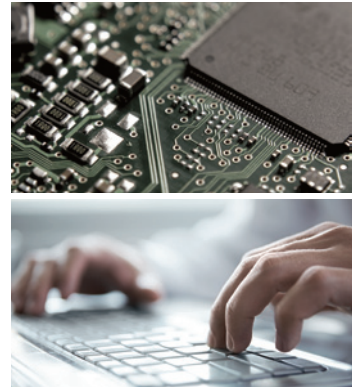

| Main items |

ICT (Smart City, ITC, TMS, Surveillance System), Backbone Network & TRS,
IT Equipment (Repeater, Fiber Optics, DAS, Filter, etc), LED Light, Terminal, Battery,
White Goods, Display Product, Set-top Box

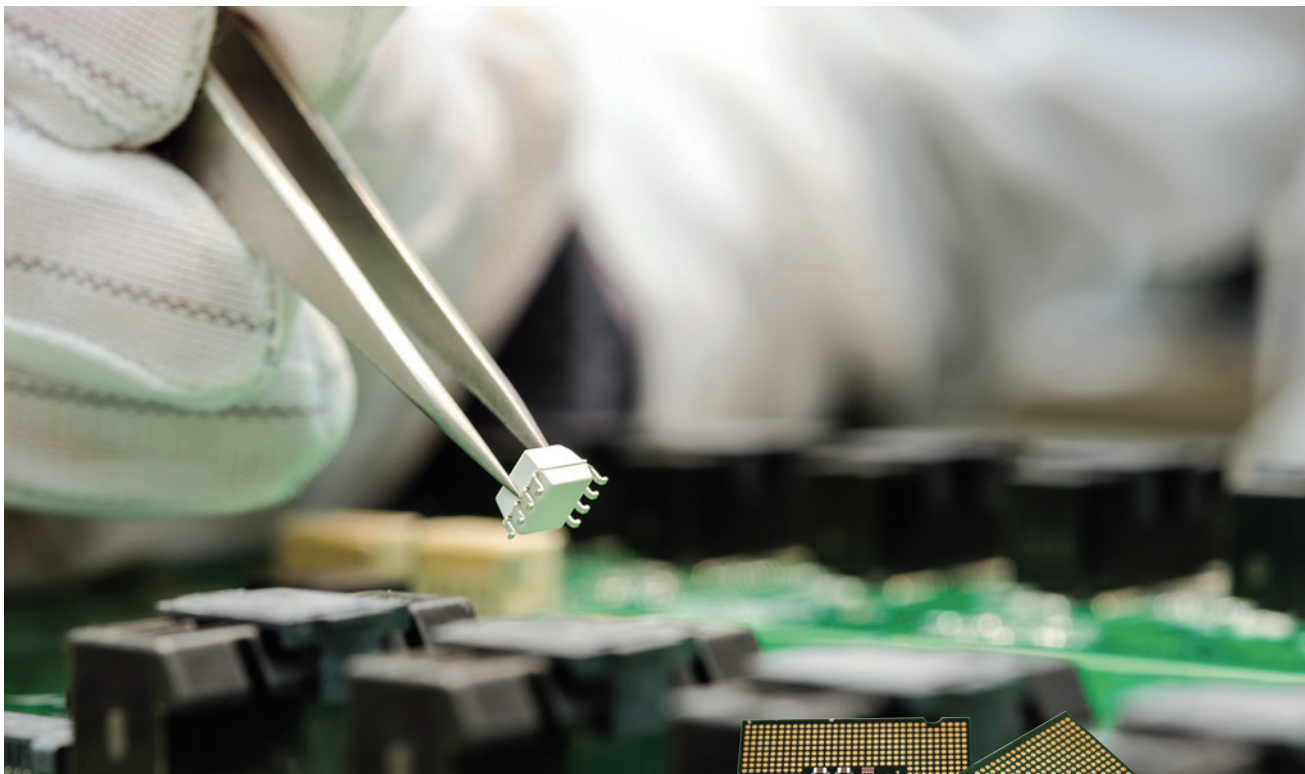

POSCO DAEWOO, as a global trader of various products in the general electronic communications, is securing outstanding competitiveness.



Food and Commodities

The food business of POSCO DAEWOO, centered on crops such as rice, wheat, corn and beans, has helped to gain abundant business experience and know-how through imports and tripartite trade over a long period of time. Following such, the company has grown into the biggest crop trader in Korea. Based on such business competence, the company has recently started investment businesses to secure overseas food resources. Considering the origins and markets per item, the company aims to establish a value chain for crops starting from the collection of crop producers to storage, processing and imports and exports at ports, ultimately generating long-term, stable revenues. Currently, the project that involves developing palm oil in Indonesia is going according to plan and investments in new businesses such as 'crop processing' in South East Asia and 'distribution business' in regions of North America, East Europe and Australia are taking place. In the future, the expansion of new items for not only major cereal crops but also for meat, fisheries, processed food, other food and industrial crops are expected to expand along with investment areas and sizes. Fiber business is involved in operating cotton manufacturing companies in 2 regions, Buhkara and Fergana because Uzbekistan has abundant raw cotton supplies. Moreover, the company is the only Korean general trader that directly produces, sells and purchases products such as cotton, synthetic filament yarn / fiber and fabric.



| Main items |

Agricultural Products : Food and Industrial Crops such as Rice, Wheat, Barley, Corn, Beans, Quinoa

Livestock Products : Milk, Pork, Mutton, Processed Meat

Fisheries : Mackerel, Prawn

Food : Beverages such as Coffee and Drinking Water, Snacks

Fiber : Spun Yarn, Fabric, Synthetic Filament Yarn · Fiber

Household Items : Fashion Accessories such as Bags and Leather, Sports and Leisure Items such as Bicycles and Helmets



POSCO DAEWOO is not only raising corporate revenue based on the most effective, stable and multi-national distribution path, but also the happiness of the global community in both production and consumption.

INVESTMENT & PROJECT ORGANIZING

The organizing business refers to identifying large-scale overseas projects by utilizing the global network, information, marketing and financial capabilities of international traders and providing total solutions to customers to optimize profit. POSCO DAEWOO, as a project organizer for Engineering Procurement Construction(EPC), executes overseas projects in the fields of power plant, railway, port, plant and IT equipment and carries out various starting from investment shares such as Independent Power Producer(IPP) to the operation and management of its facilities. As a result, in March 2013, the company was awarded the Combined Cycle Power Plant project in Talimarjan, Uzbekistan worth USD 820 million and in February 2014, it demonstrated its outstanding capabilities in the field of Combined Cycle Power Plant by being awarded the Combined Cycle Power Plant project in Algeria worth USD 1.4 billion. Moreover, the company is expanding its investments that are integrated to its trading business and also strengthening its business development for new growth in strategic regions.





Infrastructure Project

Infrastructure projects refer to businesses related to a long term Social Overhead Capital(SOC) business, such as ship, port, railroad, airport, water environment, medical and telecommunications projects. POSCO DAEWOO provides a comprehensive solution for customers across the globe starting from procuring fund through Official Development Assistance(ODA) in the development phase to forming consortiums or JVs(Joint Venture) with competitive partners to participating in international bids, being awarded EPC(Engineering Procurement Construction) and Operation & Maintenance(O&M) projects.



POSCO DAEWOO is committed to creating a better tomorrow by participating actively in various infrastructure projects as demanded in the international community.

Energy and Industrial Plant Project

Plant projects refer to comprehensive Engineering Procurement Construction(EPC) project organizing which require tangible and intangible outsourcing services including exports of products, facilities, large machines, technical assistance and know-how. POSCO DAEWOO is also involved in financing related investment businesses that include direct investments, and operation businesses in order to enhance the competitiveness of its existing EPC businesses. Its major energy and industrial plant business include petrochemical plant in the chemical sector, oil refinery, gas plant, LNG tank and tank terminal businesses. The company is also involved in industrial projects worldwide including integrated steel complexes, mini mills, process lines, paper manufacturing plants and crop plants.



POSCO DAEWOO technologies stand out worldwide. As a project organizer in the field of machinery & plants such as chemical engineering · steel · paper, POSCO DAEWOO is taking a leap forward.

Power Plant Project

The power plant business refers to fields that are related to industrial infrastructure such as power plant, transmission and distribution and renewable energy. POSCO DAEWOO is involved in businesses with Independent Power Producer(IPP) as a project developer through project organizing Engineering Procurement Construction(EPC) and director investments overseas. Furthermore, the company is taking a strong position as the best project organizer and developer with regards to power plant field such as a coal-fired power plant, gas combined power plant, combined heat power plant and a hydroelectric power plant. It is also recognized in the transmission and distribution field such as EPC projects, smart grid business and new renewable energy field.

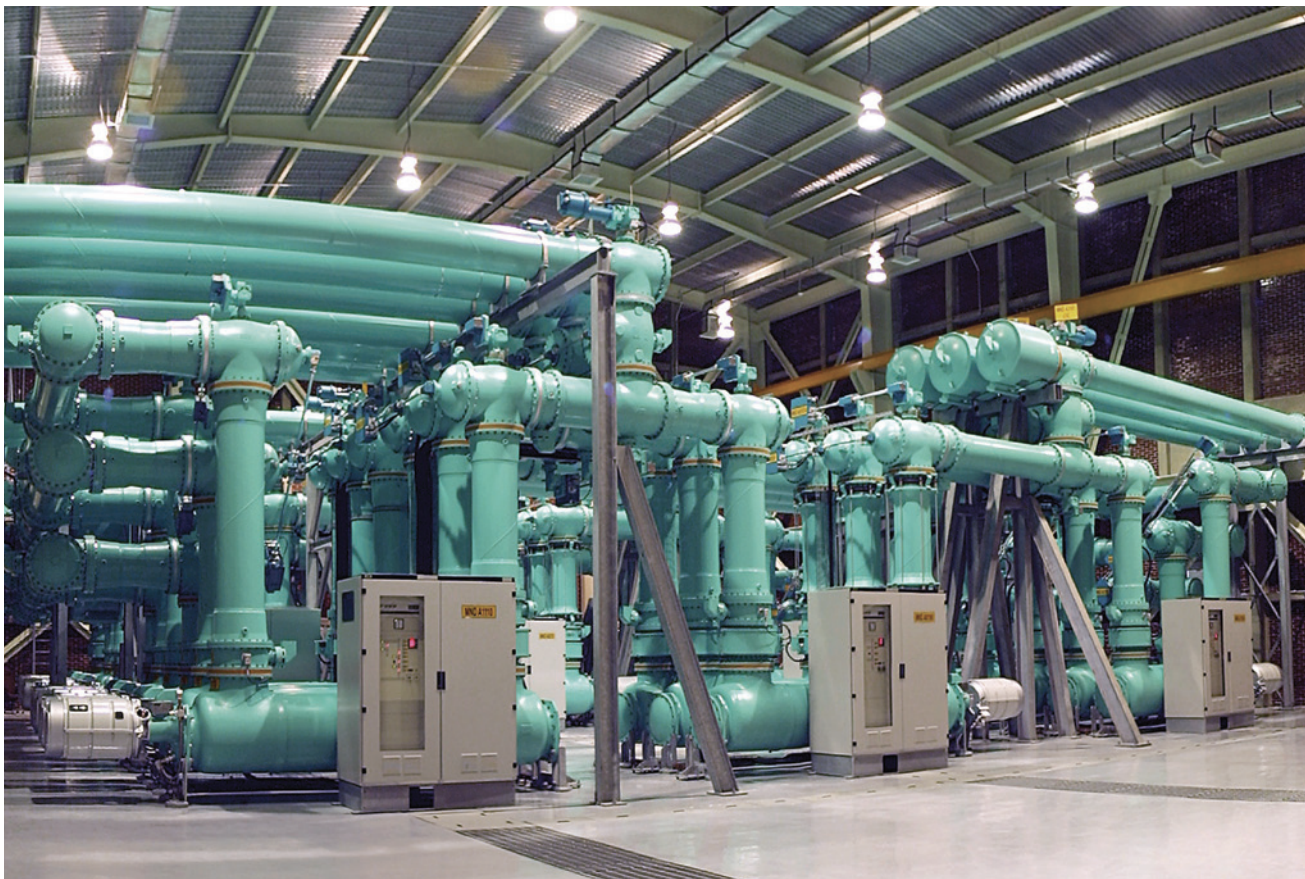

POSCO DAEWOO, a global enterprise equipped with technology is ready for the future and it is expanding its business ranges as an international project organizer and developer in the new renewable energy fields.



POSCO DAEWOO enters into hotel projects

Currently, POSCO DAEWOO is pursuing a hotel project in Yangon, Myanmar. The hotel project in Myanmar commenced in May 2014 and is expected to be completed in 2017. The hotel is located in the vicinity of Inya Lake which is the center of Yangon. This is a mega project with 1 block of luxurious 15 -floor hotel and another block with 29 floors. These 2 blocks is able to accommodate 658 rooms. The company is the first foreign private company to receive approval for land use from the Myanmar government for a real-estate investment project that involves construction and operation of a hotel. The Myanmar hotel project is significant as it will enable POSCO DAEWOO to transform itself into the best general trading and investment corporation in Korea. In the future, the company not only plans to continuously expand its business areas in international trading and resource development but to make strategic real-estate development investments.



RESOURCES DEVELOPMENT

Amidst fierce competition among countries around the world to secure resources, POSCO DAEWOO is actively engaged in resource development businesses as one to act as a future growth engine.

Starting with the investment in marine gas fields in Vietnam in 1992, POSCO DAEWOO is standing tall as a global resource developer by conducting 18 overseas resource development businesses worldwide in the fields of petroleum and gas such as bituminous coal in Narrabri, Australia, palm oil development in Indonesia, minerals and agro-resources, standing tall as a global resource developer.





Oil & Gas

POSCO DAEWOO is participating in gas field explorations and production businesses armed with Korea's top-notch technologies to uncover crude oil and natural gas. The development of petroleum gas is an important growth factor for POSCO DAEWOO and the company is involved in 8 petroleum gas projects throughout the world. Along with the crude oil production business in District 8 of Peru in 1996, the company participated in the LNG plant operation business in Oman in 1997 and has been participating in the gas production business in District 11-2 of Vietnam which went into production since 2006. Moreover, the company is unfolding gas production businesses in District A-1, A-3 of Myanmar by overseeing the entire processes of exploration, development and production as well as exploration activities in District AD-7.

In September 2011, it acquired the exploration rights from the South Korean government for block 6-1S in the East Sea of Korea and the project is currently in progress. In addition, in 2013, it acquired part of the shares within the Baptists region in Canada for the purpose of developing unconventional resources, striving to specialize in the development of petroleum gas.



With ceaseless effort and tenacity towards the world and the future, POSCO DAEWOO is elevating its status as the world's best resource developer.



The tenacity of POSCO DAEWOO, the gas field business in Myanmar

After a long journey of exploration and development processes in the gas field business in Myanmar which began in 2000, POSCO DAEWOO started production in June 2013. The minable resources of 3 gas fields, Shwe, Shwe Phyu and Mya were approximately 4 trillion cu ft.(equivalent to approximately 700 million barrels when converted to crude oil). These oil-gas fields are the biggest that have been discovered overseas by a Korean company. POSCO DAEWOO will be able to gain an average profit before tax of KRW 300~400 billion per year over the next 25~30 years and become the top resource development global integrated corporation representing Korea. The gas field business in Myanmar is a project that was only possible with the endeavor of POSCO DAEWOO executives and employees, with their strong spirit and love of challenges amidst the difficult conditions such receiving investments after the Asian financial crisis. In addition, the appropriate judgment of technicians, the faith that the management team had in the engineers, and the challenging spirit of POSCO DAEWOO have led to fast decision making which contributed to the birth of today's gas field business in Myanmar.

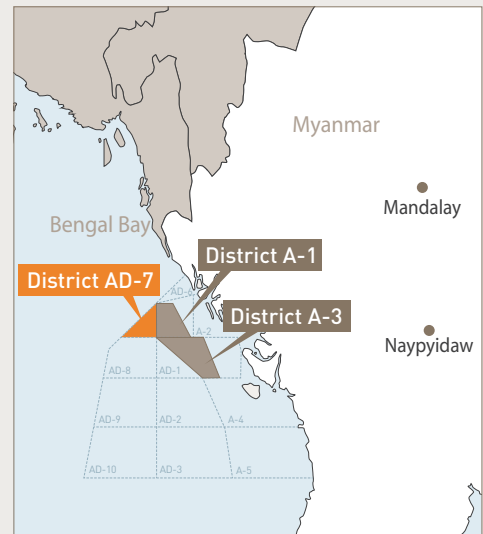

Minerals

POSCO DAEWOO is propelling the expansion of its value chain towards the highest achievable areas through investments in exploration, development and production of strategic minerals such as bituminous coal, bronze, nickel and uranium. Through this, the company expects not only to gain stable income from projects, but also to secure trade volume through off-take agreements and to enjoy synergy effects with trading organizations. Currently, the company is participating in the bronze exploration business in Shangalon, Myanmar, nickel production business in Ambatovy, Madagascar and the bituminous coal production business in Narrabri, Australia. In addition, the company will grow into a specialized mineral developer by operating mine projects continuously and investing in share participation in the future.



With the objective of reinforcing long-term and stable revenue of the company, POSCO DAEWOO is securing future resources and growth engines by actively developing mineral resources around the world.

Agro- Resources

To prepare for the food deficits, POSCO DAEWOO is concentrating on securing food resources. Recently, the company has actively participated in the overseas food resource development business in palm oil plantations of Indonesia. While doing this, the company has been acknowledged for its technology and know-how. Palm oil can be used as an intermediate material in various products such as detergent raw materials and chemical products, and also as raw materials for bio diesel which is being highlighted as a new renewable energy for the future. The company plans to contribute to creating new sources of revenue by establishing a palm value chain that involves the development, production and sales by developing palm oil plantations and farms that process Crude Palm Oil(CPO), which is a worked material. This project will assist POSCO DAEWOO to grow as a specialist for the palm industry as well. Besides that, the company is planning to expand its business scope into farming and distribution of major cereal crops such as rice and wheat.



To secure food resources, POSCO DAEWOO endeavors to develop overseas food resources such as palm oil, rice, beans, corns with a view to generate high value added resources.

CERTIFICATES · TRADEMARKS AND SOCIAL CONTRIBUTIONS

POSCO DAEWOO, as a global corporation, leads by example on corporate social responsibilities and obligations and make an effort to realize a world where everyone is happy.

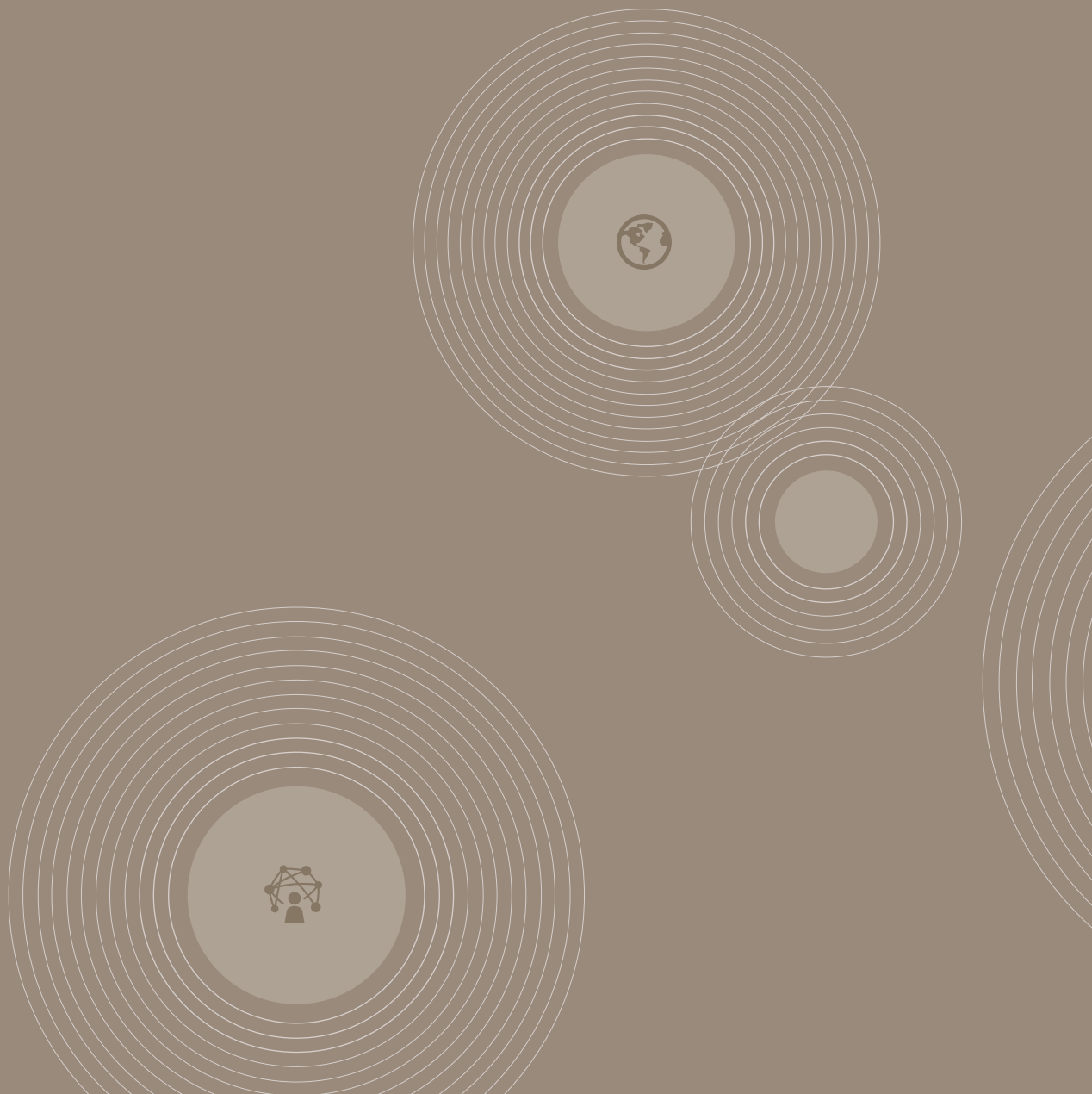

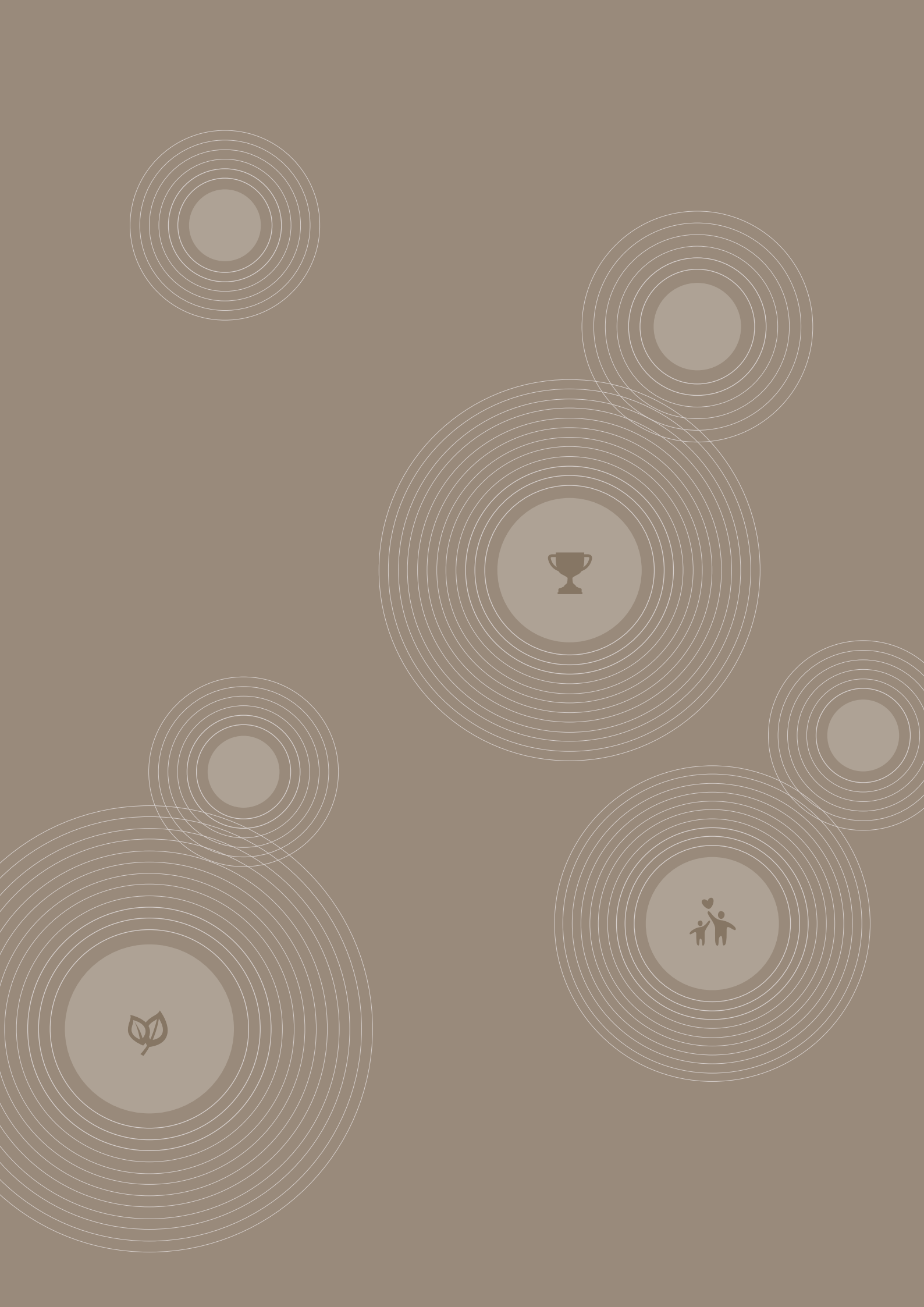

STATUS OF CERTIFICATES

POSCO DAEWOO has qualified for the stringent inspections of international societies such as the compliance of the law and safety management. As an outstanding corporation that has acquired various international certificates, POSCO DAEWOO has officially been recognized for safe management of imports and exports, providing high reliability with regards to quality and service to various overseas clients.

ISO 9001 (International Organization for Standardization)

- Acquired certificate on January 14th 2003(Automotive Component Department)
- International standard related to quality management system which is being enacted and executed by International Organization for Standardization(ISO)

- As a system which sets a standard with regards to quality assurance that is acknowledged internationally, it certifies that the product and service systems provided to customers satisfy the requirements of the regulations and that it is continuously being maintained and managed.

Company-Specific Exporter

- Acquired certificate on January 15th 2013
- Customs Approved Exporter : Refers to an exporter that is able to verify the origin and companies are categorized into certified exporter per item and per company

- To enhance the efficiency for the issuance and management of proof of origin under FTA, this system enables the customs authorities to simplify the relevant procedures and submission of attachments for exporters who have verified their ability to prove the origin of goods.
- Companies are subject to special customs benefits under main FTAs, and become certified without need for separate certification procedures with regards to all agreements that come into effect after the certification and to all new export items.

AEO (Authorized Economic Operator)

- Acquired certificate on December 31st 2013
- Refers to officially recognized companies related to trade such as importers and exporters, forwarding companies, storage operators and customer service providers that comply with regulations and carry out inspections with regards to safety-related management standards and so on

- A corporate certification system that is assigned by the relevant customs authority to companies by inspecting their compliance of the law, internal control system, financial stability and safety management sectors in accordance to the WCO's safety management standards.
- AEO certified companies are subject to benefits such as prompt customs clearance, and exemption from customs inspections.

AEO certification



AAA Grade in Compliance Program

- Acquired AAA grade on August 22nd 2014
- Refers to a company appointed by the Ministry of Trade, Industry and Energy by evaluating whether a company is equipped with systems such as organizations and regulations necessary for the import and export management of strategic goods and whether export control such as the assessment for strategic goods and application for licenses can be conducted autonomously
- Grade is categorized into A, AA and AAA with a AAA Grade being the highest grade

- Ministry of Trade, Industry, and Energy assigned(certified) companies that autonomously manage strategic materials as 'Compliance Program Traders'
- As a first company in the trading industry in Korea to acquire a AAA grade, it enjoys the privileges of simplified administration

Ministry of Trade,
Industry and Energy



Introduction of Trademark

Introduction

The five lines and the spaces between each of them in Daewoo symbol () identify five oceans and six continents respectively and the symbol largely embodies a world and implies its future oriented vision and growth. Daewoo logo (**DAEWOO**) (大宇 in Chinese characters) has the meaning of "to advance into a greater universe".



Global Usage

Daewoo trademarks have been registered in over 160 countries for more than 3500 instances, with its first registration in 1974 in Korea. Our trademarks are being widely used in various business sectors including electronics, automobile parts, machinery, construction, and transportation, and the value of our trademark is highly regarded throughout in Asia, Central and Latin America, the Middle East, and the CIS countries. As an our endeavor to protect and manage our trademarks, we actively involve in the relevant application and registration work together with the operation of a monitoring system by co-working with local experts in various countries.

- Applied for the registration of Daewoo Trademark in 1974
- Currently registered in more than 160 countries for over 3500 instances
- Enactment of the Brand Management Bylaws and operation of the Brand Management Committee

Use & Management

In accordance with the "Guidelines on the Use of the Daewoo Trademark", we are expanding the use of our corporate trademark in various business sectors such as international trading, infrastructure development, resource development, and trademark business. In addition, we are striving to improve and manage the value of our trademark through the creation of the Brand Management Bylaws and under the supervision of the Brand Management Committee.

Examples



For inquiries about trademark use : brand@posco-daewoo.com

SOCIAL CONTRIBUTIONS

Volunteer Team comprised of executives and employees

'POSCO DAEWOO Supporters' English education in children's center in Seoul · Incheon

Since 2011, POSCO DAEWOO has been conducting the 'FunFun English School' program to support children from low-income groups and multi-cultural families in Korea as a part of donating talents from executives and employees. Supports such as providing English textbooks and materials, English lecturers and native speaking teachers are offered in hopes to enhance the English learning abilities of children in children centers in Seoul and Incheon who have relatively less opportunities to learn English and to contribute to resolving polarization problems of English education. Moreover, 'POSCO DAEWOO Supporters' volunteer team consists of executives and employees of the company hosts various activities such as 'Experiencing English Village', 'English Market', and 'English Presentations' every month so that children can enhance their confidence and initiatives.

'Children Volunteer Team' engaged in volunteering activities for the regional community

POSCO DAEWOO is involved in volunteer activities for the regional community to meditate on the true definition of volunteering activities and to promote the culture of sharing by setting up a 'Children Volunteer Team' in 2012, composed of the children(elementary students) of executives and employees. The company conducts systematic training activities such as 'global citizen training' and others so that children of executives and employees who have been assigned to posts overseas can become interested in social contribution activities at both home and abroad. Furthermore, the company is conducting volunteer experiencing activities such as '1 Company 1 Village love for agriculture and giving a helping hand' and 'Handicapped Helpers', ensuring that the children volunteer team members learn the joy of sharing.

'Close Relationship Volunteer Team' supports underprivileged people

Since 2011, POSCO DAEWOO has been involved in volunteering to help the less fortunate in society via the 'Close Relationship Volunteer Team' consisting of employees and their families. In 2015, a relationship was established with a facility for mother and child protection in Seoul and changed the program to support single mothers' financial independence and emotional communication. Since 2016, volunteer programs have been run for the healthy development of children awaiting adoption whom are living in temporary shelters and foster homes across the country.



Domestic social contribution activities

Volunteers in the regional community

POSCO DAEWOO has been providing food for senior citizens living alone in the metropolitan regions as well as daily necessities for families that are in the low-income group. The company has also supported teenagers from migrated families with parental education and multicultural camps so that the teenagers can have a chance to settle down into Korean society. Following such, in 2012 at the Commemorative Event of the '13th Social Welfare Day,' the company was awarded a commendation for long-term sponsorship in the welfare businesses by the Jung-gu District Office and in 2014, and it was awarded with the 'Award for Sharing Happiness' which is a Ministerial Award from the Ministry of Welfare at the award ceremony of the 1st Sharing Happiness. POSCO DAEWOO will continue to contribute to the regional community through consistent interest in the neglected classes around us.

Practicing 1 Company 1 Village love for agriculture

To promote activate urban and rural exchanges, POSCO DAEWOO has signed a sister relationship with Saedungji Village in Gumi-ri, Yeoncheon-gun, and Gyeonggi-do. The executives and employees are practicing a love for agriculture through various exchanges such as lending a helping hand in farming, experiencing life in farms as part of team-building workshop, taking care of villages and purchasing regional specialties. As a result, the company was awarded the '1 Company 1 Village love for agriculture Award' in 2008, the '7th Prime Minister Award for farming sector' in 2012, and the 'Certificate of Rural Social Contribution' in 2014.

Overseas social contribution activities

POSCO DAEWOO is actively engaged in various overseas social contribution activities to fulfill its social responsibilities as a global corporation. In Myanmar, the company is contributing in social support projects such as new construction of a hospital, providing training support to medical teams, maintenance in education institutes, equipment support, donation of bicycles, and from 2015, free surgery for children with facial disfigurements. Support is also provided for social infrastructures and for environmental preservation such as support for recovery from disasters.

Moreover, from 2012, together with international NGOs, it has been conducting an eye surgery camp to prevent the loss of sight and to enhance eye health. Starting from Ethiopia, it provided free cataract surgeries in Cambodia, Myanmar and Indonesia in 2013 and in 2 regions in Uzbekistan from 2014.

In addition, supports are being provided to children centers in secluded areas and donations for the development of teenagers, scholarship support, visits to orphanages and volunteering activities for elderly people are being conducted by local branch in Uzbekistan.



NORTH AMERICA

NEW JERSEY

POSCO DAEWOO America Corp.
300 Frank W. Burr Blvd. Suite #23
Teaneck, NJ 07666, U.S.A.
Tel : 1-201-591-8000
Fax : 1-201-591-8092

DETROIT

POSCO DAEWOO America Corp.
900 Wilshire Dr. Suite #204
Troy, MI 48084, U.S.A.
Tel : 1-248-339-2861
Fax : 1-248-339-2897

LOS ANGELES

POSCO DAEWOO America Corp.
222 S. Harbor Blvd. Suite #1020
Anaheim, CA 92805, U.S.A.
Tel : 1-714-808-1010
Fax : 1-714-808-1081

HOUSTON

POSCO DAEWOO America Corp.
10497 Town & Country Way Suite #140
Houston, TX 77024, U.S.A.
Tel : 1-713-800-3911
Fax : 1-713-979-3952

TORONTO

POSCO DAEWOO America Corp.
100 Allstate Parkway, Suite #304, Markham
Ontario, L3R 6H3, Canada
Tel : 1-905-248-2777
Fax : 1-905-474-1870

MEXICO CITY

POSCO DAEWOO Mexico S.A. de C.V.
Paseo de los Tamarindos 400 A - 4 Piso
Colonia Bosques de las Lomas, Mexico
Tel : 52-55-5596-5757
Fax : 52-55-5596-1585

CENTRAL & SOUTH AMERICA

SAO PAULO

POSCO DAEWOO do Brasil
Av. Paulista 777, 7th Andar, Bela Vista
Sao Paulo (CEP : 013111-9114), SP, Brasil
Tel : 55-11-3285-5699
Fax : 55-11-3266-4125

BOGOTA

POSCO DAEWOO Colombia Corp.
K9 #113-52 (Torres Unidas II) Of. 1003
Bogota, Colombia
Tel : 57-1-603-0909

BUENOS AIRES

POSCO DAEWOO Corp.
Sucursal Argentina
Av. Del Libertador 6550 Piso 7 Oficina
A Capital Federal - BS.AS. Argentina
Tel : 54-11-5238-1201
Fax : 54-11-5276-8743

LIMA

POSCO DAEWOO Corp.
Sucursal Peruana
Av. Camino Real 456, Torre Real, Piso 8
San Isidro, Lima 27, Peru
Tel : 51-1-221-4244
Fax : 51-1-422-1914

PANAMA CITY

POSCO DAEWOO Corp.
Panama, S.A.
Oceania Business Plaza Torre 1000 OF.
42D Punta Pacifica Panama, Rep. de Panama
Tel : 507-282-0042

SANTIAGO

POSCO DAEWOO Corp.
Agencia en Chile
Av. Apoquindo 5,583, Oficina 122
Las Condes, Santiago, Chile
Tel : 56-2-2433-9378

BSPC

Pos-Daewoo BSPC
Mal. Rondon, 18 Sala 11
Suzano (CEP: 08674-280), SP, Brasil
Tel : 55-11-3285-5699
Fax : 55-11-3266-4125

EUROPE

MADRID

POSCO DAEWOO Corp. ESPAÑA
Oficina de Representacion
Paseo de la Castellana 135, 14-B, 28046
Madrid, Spain
Tel : 34-91-571-0563
Fax : 34-91-571-6827

ATHENS

POSCO DAEWOO Greece Agent
1st Floor Athinas 34, Voulas, Athens, Greece
Tel : 30-210-6618966

LONDON

POSCO DAEWOO Corp.
London Branch
10th Floor, CI Tower, ST, Georges Square
New Malden, Surrey, KT3 4HH, U.K.
Tel : 44-208-336-9131
Fax : 44-208-949-3783

MILANO

POSCO DAEWOO Italia S.R.L.
Centro Dir. Colleoni 5 Piano-Palazzo
Liocorno (A3) Via Paracelso 6
20864 Agrate Brianza (MB) Italy
Tel : 39-039-6411-61
Fax : 39-039-6091-887

BAKU

POSCO DAEWOO Corp.
Azerbaijan Liaison Office
C.Cabbarli 44 Str, Yasamal District, Caspian
Plaza 3, 12th Floor, Baku, Azerbaijan
Tel : 994-12-436-9713
Fax : 994-12-436-9712

WARSAW

POSCO DAEWOO Corp.
Poland Representative Office
Ul. Postepu 21A, 4th Floor, 02-676, Warsaw
Poland
Tel : 48-22-645-1575
Fax : 48-22-645-1577

BUCURESTI

POSCO DAEWOO Corp.
Reprezentanta
Jud. Ilfov, Ors. Voluntari.
Sos. Bucuresti Nord, Nr.10
Bi. Global City Park
Cladirea 021F, Et4, Romania
Tel : 40-31-7113-113

ISTANBUL

POSCO DAEWOO Corp.
Turkey Liaison Office
Eski Buyukdere Cad. Iz Plaza Giz No:9 K:7
D:21/22 34398 Maslak/Sariyer
Istanbul, Turkey
Tel : 90-212-290-7340
Fax : 90-212-290-7344

FRANKFURT

POSCO DAEWOO Deutschland GmbH
Lurgiallee 16
60439 Frankfurt am Main, Germany
Tel : 49-69-247494-110
Fax : 49-69-247494-333

PRAGUE

POSCO DAEWOO Deutschland GmbH
Prague Branch
Pobrezni 620/3
18600, Prague 8, Czech Republic
Tel : 420-224-225-538
Fax : 420-224-225-550

MONTROUGE

POSCO DAEWOO France Agent
51, Rue Fenelon, 92120 Montrouge, France
Tel : 33-1-7577-5931

MIDDLE EAST

ALGER

POSCO DAEWOO Corp.
Algeria Liaison Office
20, Micro zone d' activit , Centre d'affaire
Dar El Medina Tour 'A' 3emme Etage .16031
Hydra, Alger .
Tel : 213(0)23-54-14-43~45
Fax : 213(0)23-54-14-57

TEHRAN

POSCO DAEWOO Corp.
Iran Liaison Office
Silver Bldg., No. 4, East Sahel One
North Motahari St., Darya Ave., Saadat Abad
Tehran - Iran. P.O.Box: 14155-3531
Tel : 98-21-8869-8009
Fax : 98-21-8856-1152

AMMAN

POSCO DAEWOO Corp.
Jordan Liaison Office
Office 611, Hussein Building
Abdulla Ghoshe street 53
P.O.Box 936, Amman 11821, Jordan
Tel : 962-6-585-4171, 9171
Fax : 962-6-585-4371

CAIRO

POSCO DAEWOO Corp.
Egypt Liaison Office
7th Floor, Flat No. 701
Building No. 4, Street No. 151
Maadi, Cairo, Egypt
Tel : 202-2750-7436~8
Fax : 202-2750-7439

TEL AVIV

POSCO DAEWOO Corp.
Israel Liaison Office
15th Floor, Tel Aviv Tower, Building A
48 Menahem Behin Road
Tel Aviv 66184, Israel
Tel : 972-3-537-2292
Fax : 972-3-537-2286

KHARTOUM

General Medicines Company Ltd.
Head Office
Plot No 24, Block No 12 (B) East Elamedat
Khartoum P.O Box 11855, Khartoum, Sudan
Tel : 249-1-83-465031
Fax : 249-1-83-464741

RABAT

POSCO DAEWOO Morocco Agent
31 Avenue Lalla Meryem Souissi
Rabat, 10105 Morocco
Tel : 212-550-011682

GCC

DUBAI

POSCO DAEWOO Gulf L.L.C.
Office 305, Business Centre Building
Khalid Bin Walid Street
Bur Dubai P.O.Box 8090 Dubai, U.A.E.
Tel : 971-4-370-5509
Fax : 971-4-370-5539

DAMMAM

POSCO DAEWOO Corp.
Saudi Arabia Liaison Office
P.O.Box 77224, Al-Saeed Business Tower, 6F
Office #602. Dammam-Al-Khobar Highway
Al-Khobar 31952, Kingdom of Saudi Arabia
Tel : 966-13-814-7540~1
Fax : 966-13-814-7539

AFRICA

JOHANNESBURG

POSCO DAEWOO Corp.
South Africa Liaison Office
6th Floor, Fredman Towers, 13 Fredman Dr.
Sandown, Sandton 2196, P.O.Box 786734
Sandton South Africa
Tel : 27-11-784-1326
Fax : 27-11-784-1301

LAGOS

POSCO DAEWOO Nigeria Ltd.
12th Floor Foreshore Towers
2A Osborne Road, Ikoyi, Lagos, Nigeria
Tel : 234-1-270-1105
Fax : 234-1-270-5287

NAIROBI

POSCO DAEWOO Corp.
Kenya Liaison Office
International House 5th Floor
Mama Ngina Street P.O.Box 43739
G.P.O Nairobi Kenya
Tel : 254-20-316109

ADDIS ABABA

POSCO DAEWOO Ethiopia Agent
Bole Road Neejat Building 3rd Floor
P.O. Box 19910, Addis Ababa, Ethiopia
Tel : 251-11-5-529028

JAPAN

TOKYO

POSCO大宇ジャパン株式会社
POSCO DAEWOO Japan Corp.
24F, Marunouchi Trust Tower Main Tower
8-3, Marunouchi, 1-Chome, Chiyoda-Ku
Tokyo, 100-0005, Japan
Tel : 81-3-5220-6123
Fax : 81-3-5220-9083

OSAKA

POSCO大宇ジャパン株式会社
POSCO DAEWOO Japan Corp.
2F, POSCO Osaka Bldg.,
3-7, 2-Chome, Namba, Chuo-Ku
Osaka, 542-0076, Japan
Tel : 81-6-6213-4370
Fax : 81-6-6213-4380

NAGOYA

POSCO大宇ジャパン株式会社
POSCO DAEWOO Japan Corp.
6F Nagoya Hirokoji Building
3-1, Sakae 2-Chome, Naka-Ku
Nagoya, 460-0008, Japan
Tel : 81-52-222-3717
Fax : 81-52-222-3719

CHINA

BEIJING

POSCO DAEWOO China Co., Ltd.
9 th Floor, POSCO Center, Tower A
Hongtai East Street
Dawangjing Science and Business Park
Chaoyang District, Beijing 100102, China
Tel : 86-10-5731-2617
Fax : 86-10-6465-1531

DALIAN

POSCO DAEWOO China Co., Ltd.
Dalian Branch
Room 21F-E1, International Finance Tower
15 Renmin Road, Zhongshan District
Dalian 116001, China
Tel : 86-411-8253-0808
Fax : 86-411-8253-0070

SHENYANG

POSCO DAEWOO China Co., Ltd.
Shenyang Branch
Room 1312, Sino-Korea Center
No. 124 Huigong Street, Shenhe District
Shenyang 110013, China
Tel : 86-24-2253-4496
Fax : 86-24-2253-4529

QINGDAO

POSCO DAEWOO China Co., Ltd.
Qingdao Branch
Room A2707/2708, Top Yihe International 10
Hongkong Zhong Road
Qingdao 266071, China
Tel : 86-532-8503-0260
Fax : 86-532-8572-7588

SHANGHAI

POSCO DAEWOO Shanghai Co., Ltd.
Room 2003, Building B Dawning Center
No. 500 Hongbaoshi Road
Shanghai 201103, China
Tel : 86-21-2211-3500
Fax : 86-21-2211-3400

WUHAN

POSCO DAEWOO Shanghai Co., Ltd.
Wuhan Branch
Room 1215, Wuhan New World Trading
Tower No. 568, Jianshe Ave.
Wuhan 430022, China
Tel : 86-27-8577-0993
Fax : 86-27-8577-0992

SHANGHAI

Shanghai Lansheng Daewoo Corp.
28F, Lansheng Building
No. 8 Huaihai (M) Road
Shanghai 200021, China
Tel : 86-21-6319-0088
Fax : 86-21-6319-0099

GUANGZHOU

POSCO DAEWOO China Co., Ltd.
Guangzhou Branch
Room 3716C, Tower B, China Shine Plaza
No. 9 Linhexi Road
Guangzhou 510610, China
Tel : 86-20-3810-5398
Fax : 86-20-3810-5918

CHONGQING

POSCO DAEWOO China Co., Ltd.
Chongqing Branch
Room 1307, Building C
No. 68 Yanghe 1st Road, Jiangbei District
Chongqing 40020, China
Tel : 86-23-6302-2155
Fax : 86-23-6302-2151

MUDANJIANG

Daewoo Paper Manufacturing Co., Ltd.
No. 8, Gunghua Street, Yangming District
Mudanjiang City, Heilongjiang Prov., China
Tel : 86-453-632-3105, 5701
Fax : 86-453-633-3578

TAIPEI

POSCO DAEWOO Corp.
Taiwan Branch
10F-3, No. 89, Songren Road, Taipei 110
Taiwan, R.O.C
Tel : 886-2-8786-1522
Fax : 886-2-8786-1393

RUSSIA

MOSCOW

POSCO DAEWOO Corp.
Moscow Representative Office
Krasnopresnenskaya Naberezhnaya 12, WTC
Entrance 3, Office 1603, 123610, Russia
Tel : 7-495-258-1811 (EXT.100)
Fax : 7-495-258-1812

VLADIVOSTOK

POSCO DAEWOO Corp.
Vladivostok Representative Office
Office 606, 6th Floor, Business center, 40
Pushkinskaya St., Vladivostok, 690001, Russia
Tel : 7-423-260-8961
Fax : 7-423-260-8962

UKRAINE

KIEV

POSCO DAEWOO Corp.
Kiev Representative Office
Entrance 10, 6F, Illinska Street 8
Kyiv, 04070, Ukraine
Tel : 38-044-537-42-05, 06
Fax : 38-044-537-42-07

CENTRAL ASIA

TASHKENT

POSCO DAEWOO Corp.
Uzbekistan Representative Office
2nd Floor, 22 Oybek Street
Tashkent 100015, Uzbekistan
Tel : 998-71-150-1181~3
Fax : 998-71-150-1180

ALMATY

POSCO DAEWOO Corp.
Kazakhstan Representative Office
Room 203, 13th Floor, BC "Nurly Tau"
Block 5A, Al-Farabi Ave.
Almaty 50059, Kazakhstan
Tel : 7-727-311-5421 (EXT.101)
Fax : 7-727-311-5423

FERGANA

Daewoo Textile Fergana LLC
1, Kuvasayskaya Street
Fergana City, Uzbekistan
Tel : 998-73-223-0681~3
Fax : 998-73-223-0694~5

BUKHARA

Daewoo Textile Bukhara LLC
Alpomish Street
Bukhara City, Uzbekistan
Tel : 998-65-222-2251
Fax : 998-65-222-2276

ASHGABAT

POSCO DAEWOO Corp.
Turkmenistan Representative Office
No. 403, Oguzkent Business Center, Bitarap
Turkmenistan Ave. 231, 744000, Ashgabat,
Turkmenistan
Tel : 993-12-44-99-46, 87
Fax : 993-12-44-99-89

ASIA

YANGON

POSCO DAEWOO Myanmar Co., Ltd.
Bid No. 8, 5th Floor, Myanmar Info-Tech
(Phase3), University's Hlaing Campus
Hlaing Township, Yangon, Myanmar
Tel : 95-1-2305124~30
Fax : 95-1-521-513, 4

YANGON

POSCO DAEWOO Corp.
(Myanmar E&P)
IBC, No. 88, Pyay Road, 6 1/2 Miles Hlaing
Township, Yangon, Myanmar
Tel : 95-1-653-239
Fax : 95-1-665-040, 667-158

YANGON

Daewoo Amara Co., Ltd.
Bld No. 8, G Floor, Myanmar Info-Tech
(Phase 3), University's Hlaing Campus, Hlaing
Township, Yangon, Myanmar
Tel : 95-1-654-918, 9
Fax : 95-1-521-513, 4

SINGAPORE

POSCO DAEWOO Singapore Pte Ltd.
7 Temasek Boulevard
#27-03 Suntec Tower One Singapore 038987
Tel : 65-6333-5507
Fax : 65-6333-5508

COLOMBO

POSCO DAEWOO Sri Lanka Agent
21/8B Pagoda Cross Road Nugegoda
Sri Lanka.
Tel : 94-112-199-400
Fax : 94-112-199-401

KUALALUMPUR

POSCO DAEWOO Malaysia Sdn Bhd
1801, 18th Floor Kenanga International, Janlan
Sultan Ismail, 50250, Kuala Lumpur, Malaysia
Tel : 60-3-2161-8033
Fax : 60-2161-5790

HOCHIMINH

POSCO DAEWOO Vietnam Co., Ltd.
Suite #1507, Kumho Asiana Plaza
39 Le Duan Street, District 1
HCMC, Vietnam
Tel : 84-8-3821-7740
Fax : 84-8-3821-7750

HANOI

POSCO DAEWOO Vietnam Co., Ltd.
Hanoi Representative Office
Suite #1105, 11th Floor, Daeha Business
Center, 360 Kim Ma Street, Ba Dinh District
Hanoi, Vietnam
Tel : 84-4-3831-5220
Fax : 84-4-3831-7889

GURGAON

POSCO DAEWOO India Private Limited
515, 516 Tower A, 5th Floor, Park Centra, NH-8
Sector 30, Gurgaon 122001, India
Tel : 91-124-4498-100
Fax : 91-124-4498-128

MUMBAI

POSCO DAEWOO India Private Limited
Mumbai Office
306, Everest Grande, Mahakali Caves Road
Near Andheri MIDC, Andheri(E)
Mumbai 400093, India
Tel : 91-22-4261-7000
Fax : 91-22-4261-7010

PUNE

POSCO DAEWOO India Private Limited
Pune Office
8th Floor, 803, World Trade Centre, 1Kharadi
Opposite EON Free Zone, MIDC Knowledge
Park, Kharadi, Pune - 411014, India
Tel : 91-20-4690-8701

VIETNAM VNS-DAEWOO

VNS-DAEWOO Co., Ltd.
132 Doc Lap Street, Phu My Town
Tan Thanh District
Ba Ria-Vung Tau, Vietnam
Tel : 84-64-3890999
Fax : 84-64-3928179

PORT MORESBY

POSCO DAEWOO POWER(PNGPOM) Ltd.
P.O.Box 2803, Boroko
Port Moresby, NCD, Papua New Guinea
Tel : 675-321-1584
Fax : 675-321-2984

LAHORE

POSCO DAEWOO Corp.
Pakistan Liaison Office
16-A, Hali Road, Gulberg II, Lahore, Pakistan
Tel : 92-42-3578-6544
Fax : 92-42-3578-6544

MANILA

POSCO DAEWOO Corp.
Philippines Representative Office
Citibank Tower, 27th Floor, 8741 Paseo de
Roxas, Makati, Metro Manila, Philippines
Tel : 63-2-818-1031~2, 817-4560, 5263
811-5539
Fax : 63-2-817-5267

BANGKOK

POSCO DAEWOO Corp.
Thailand Representative Office
Unit 1901-1902, M.Thai Tower, All Seasons
Place, 87 Wireless Road, Lumpini Pathumwan
Bangkok 10330, Thailand
Tel : 66-2-654-0124~8
Fax : 66-2-654-1029

JAKARTA

POSCO DAEWOO Corp.
Indonesia Representative Office
Gedung The Energy 32th Floor SCBD lot 11A
Jl. Jend Sudirman, Kav. 52-53 Jakarta 12190
Indonesia
Tel : 62-21-2995-9070
Fax : 62-21-2995-9071

JAKARTA

PT.BIA
Suite #2903, 29th Floor, Tower1
Indonesia Stock Exchange Building
JL. Jend Sudirman Kav. 52-53
Jakarta 12190, Indonesia
Tel : 62-21-515-4142
Fax : 62-21-515-4262

DHAKA

POSCO DAEWOO Corp.
Bangladesh Liaison Office
Crystal Palace Building 10th Floor SE(D) 22
Road 140, Gulshan South Avenue
Dhaka-1212, Bangladesh
Tel : 88-02-988-1316-21
Fax : 88-02-988-2174

SYDNEY

POSCO DAEWOO Australia
Representative Office
Level 13, 50 Margaret Street
Sydney, NSW, 2000 Australia
Tel : 61-2-9290-2222
Fax : 61-2-9290-2277

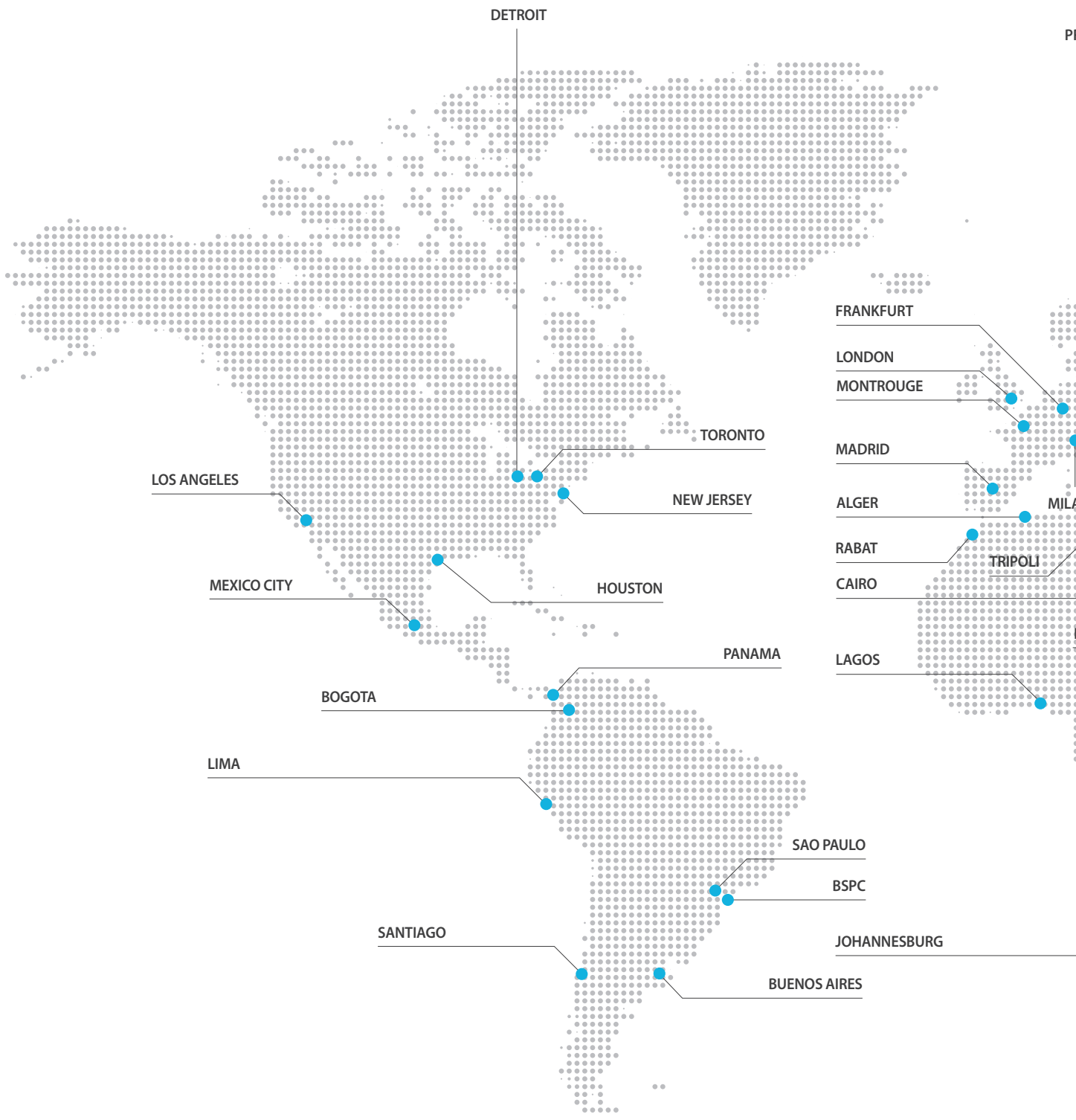

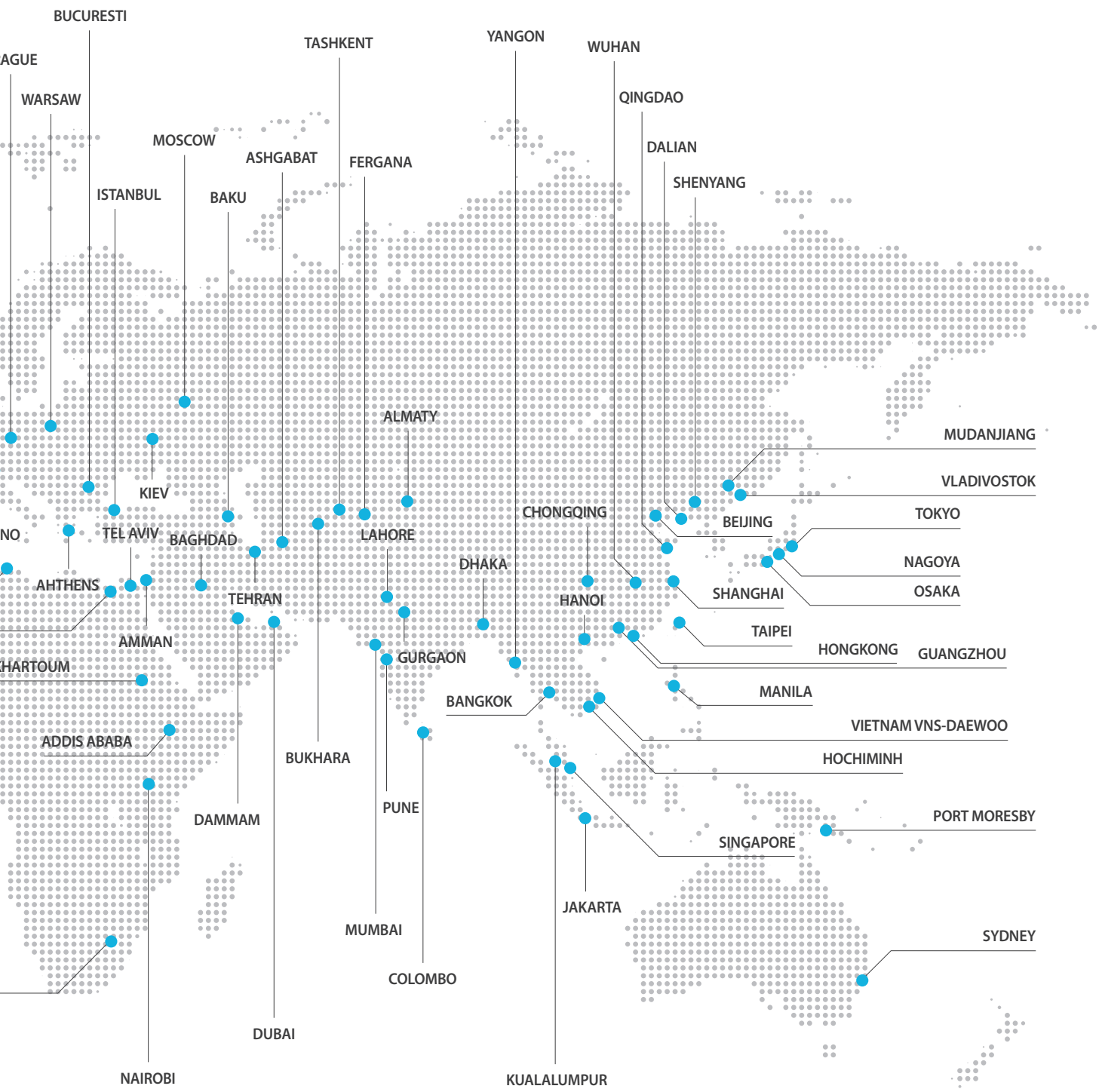



165, Convensia-daero, Yeonsu-gu, Incheon, 21998, Korea
10, Tongil-ro, Jung-gu, Seoul, 04527, Korea
Tel. +82-2-759-2114 Fax. +82-2-753-9489
www.posco-daewoo.com