

S.N.C.F.

RÉGION DU SUD-OUEST

CARNET

DE

PROFILS ET SCHÉMAS

1958

CARTE DE LA REGION SUD-OUEST

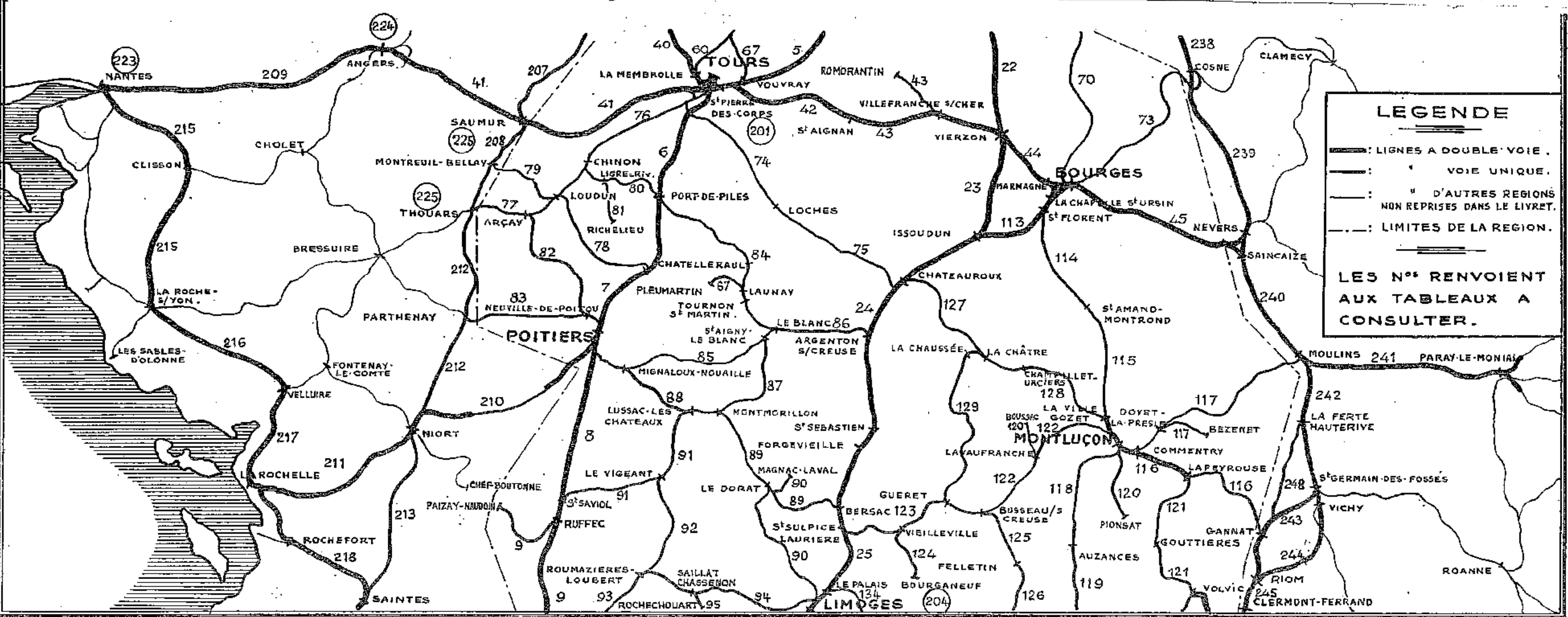
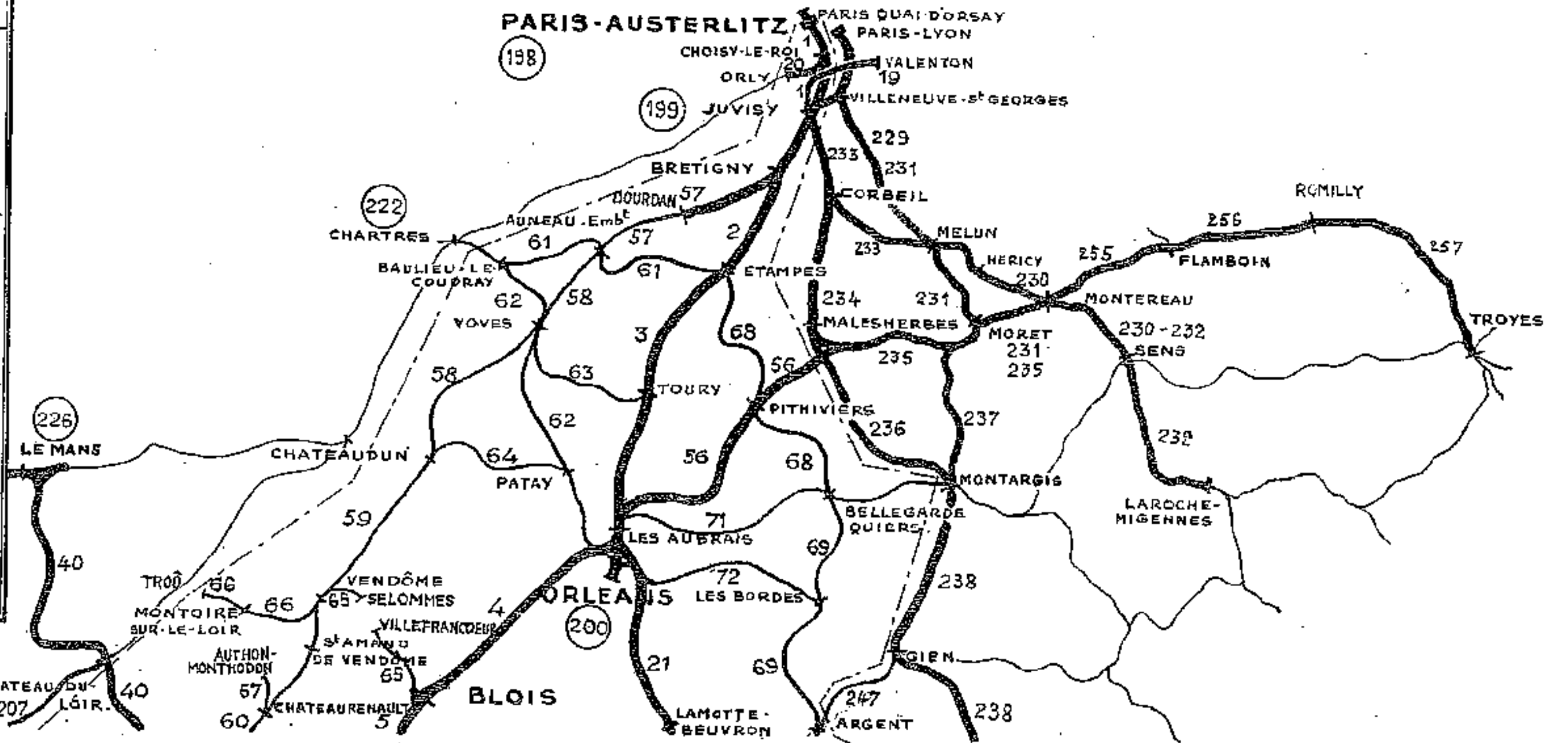
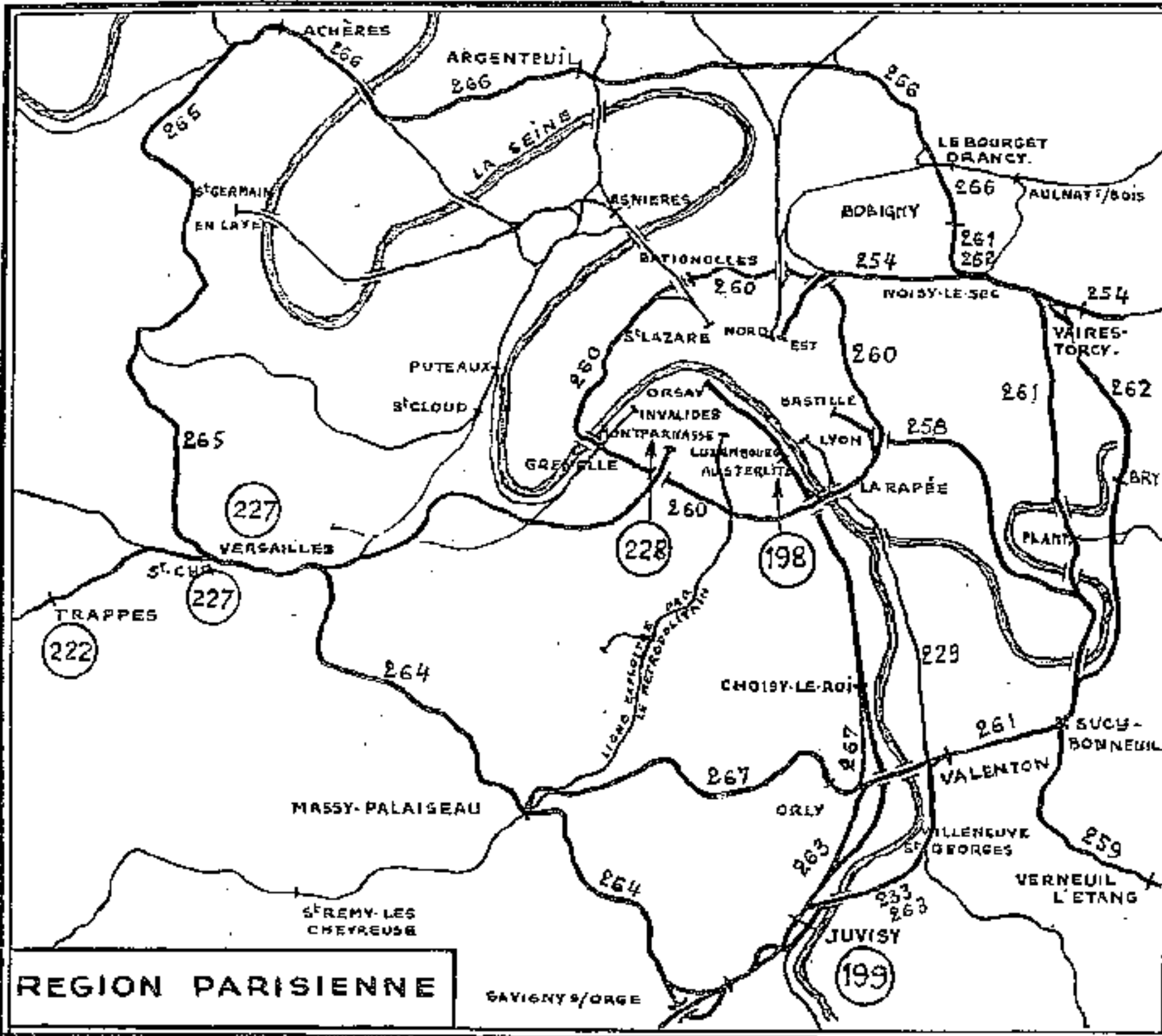

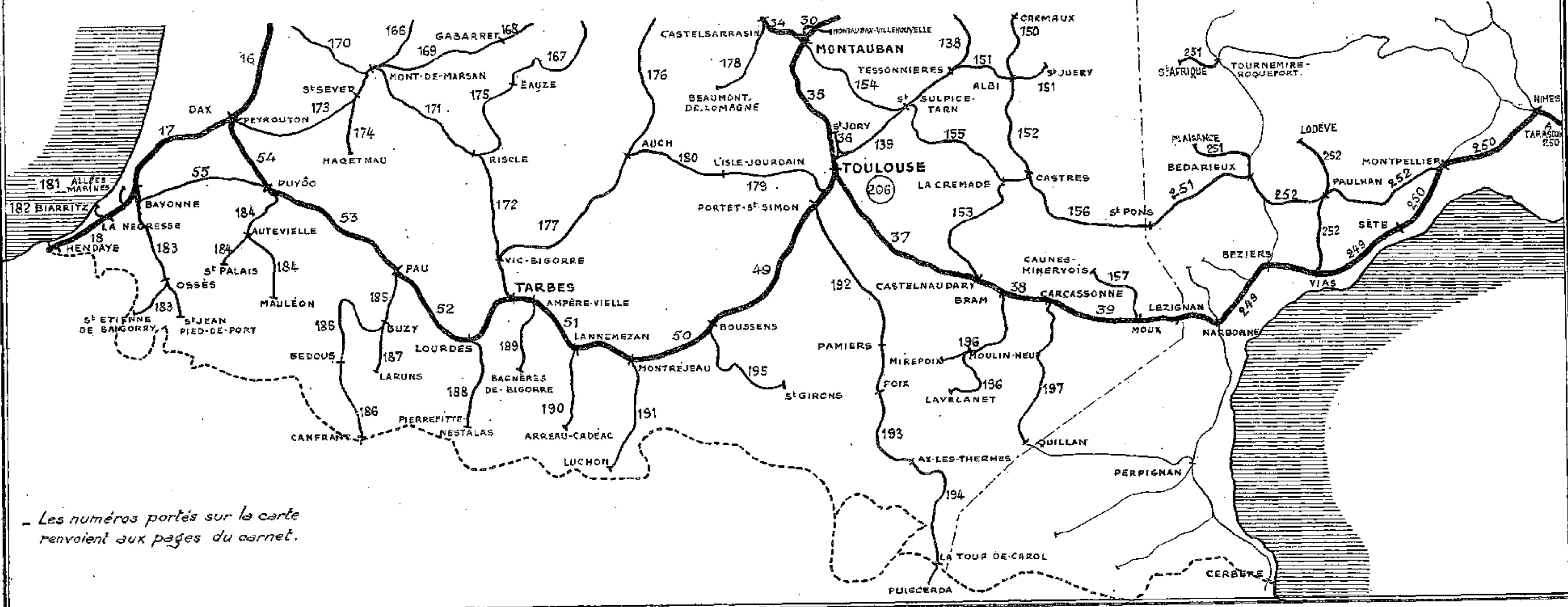
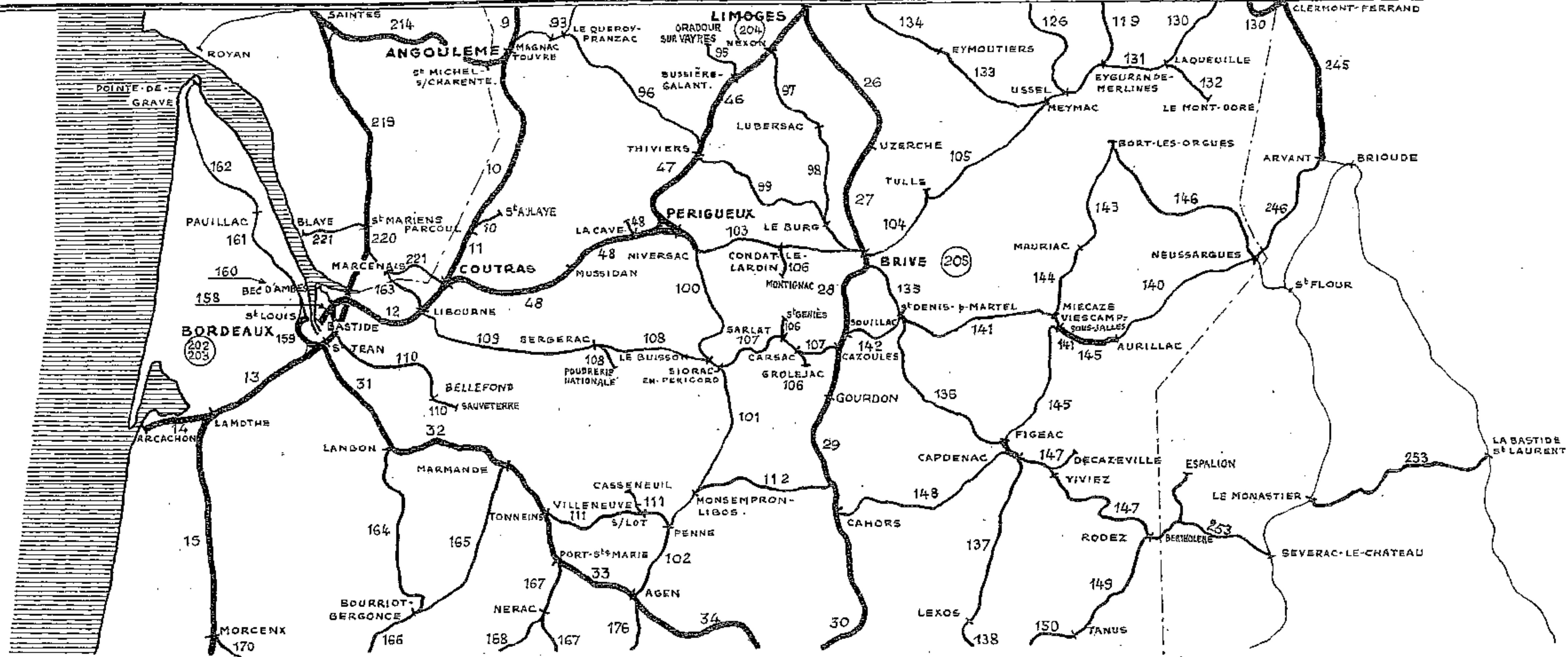

Les numéros portés sur la carte renvoient aux pages du carnet.

Abords de Paris-Austerlitz (voir 198)

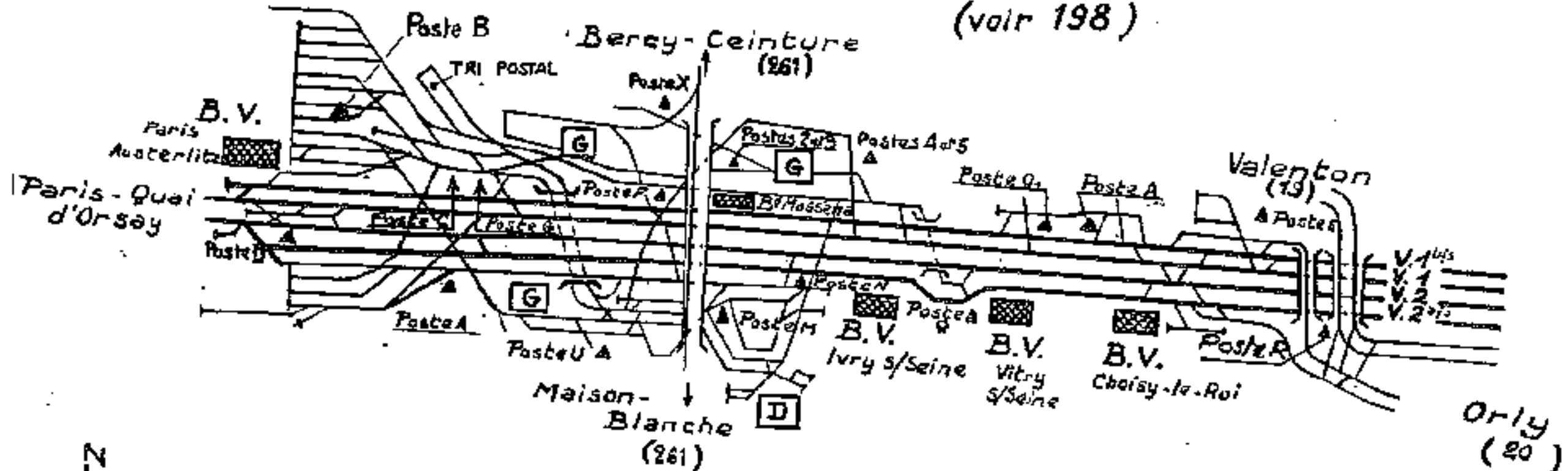

Ligne de Paris à Orléans

Section de Paris à Juvisy

Abords de Juvisy (voir 199)

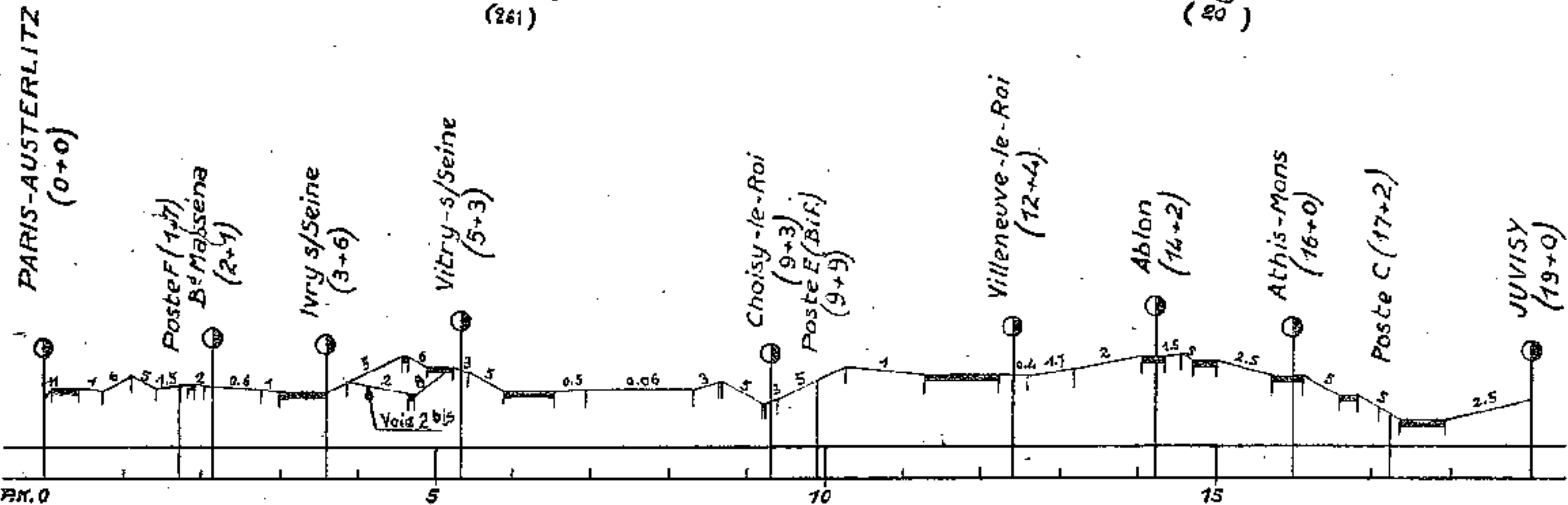
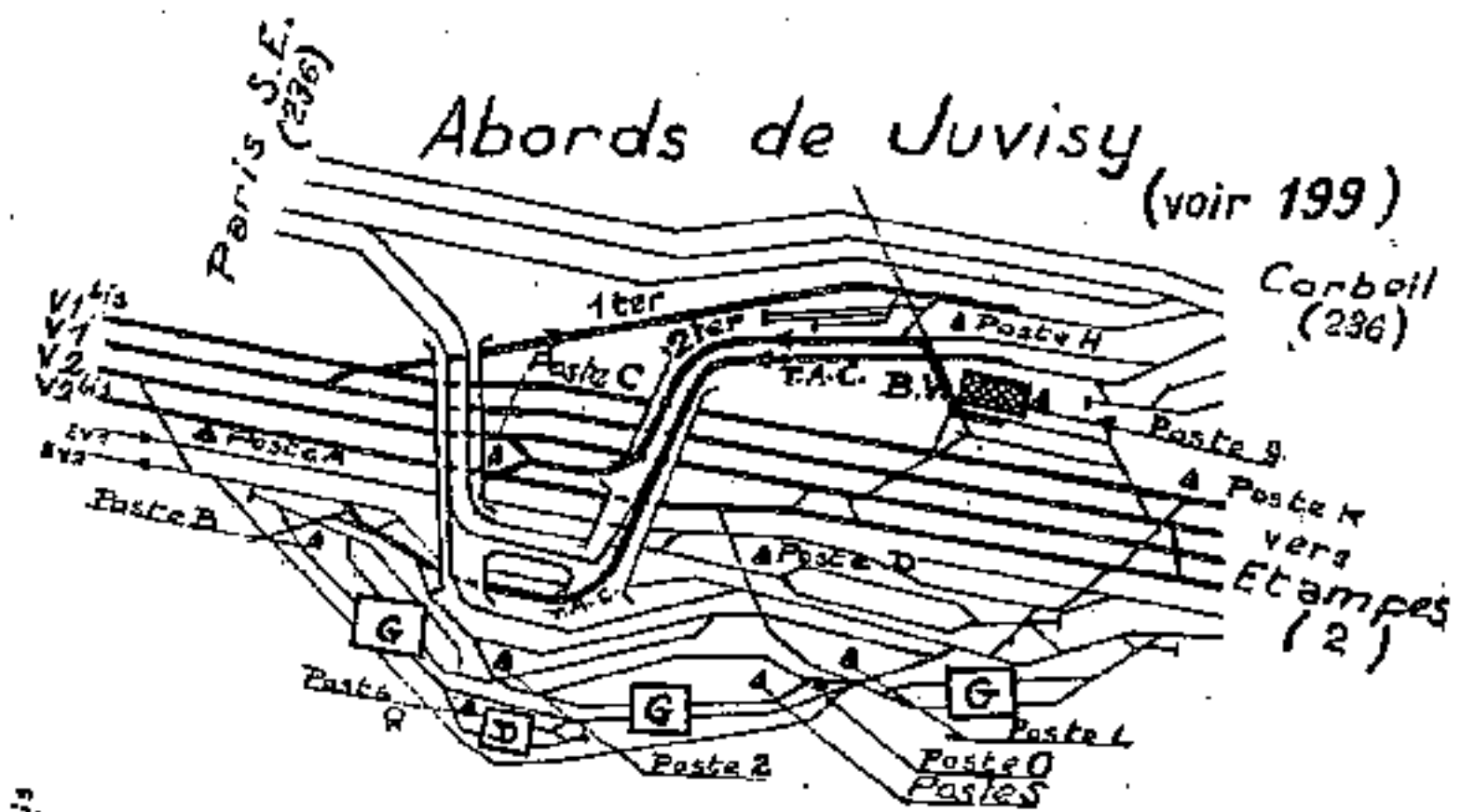

Voies de liaison S.O.-S.E. vers Carbeil

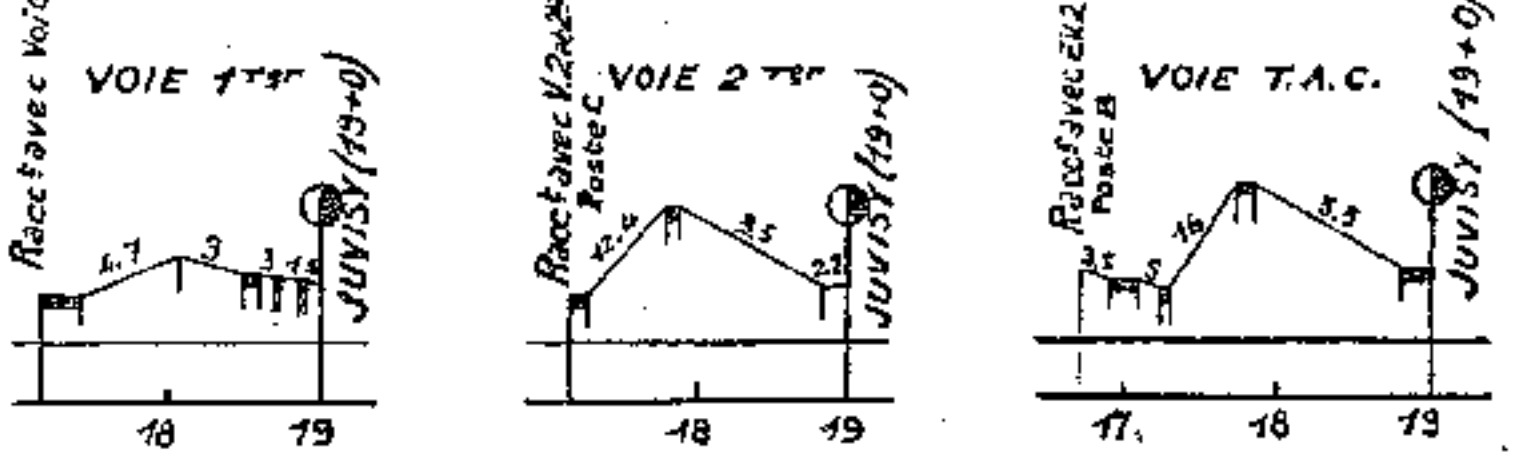

Abords d'Etampes

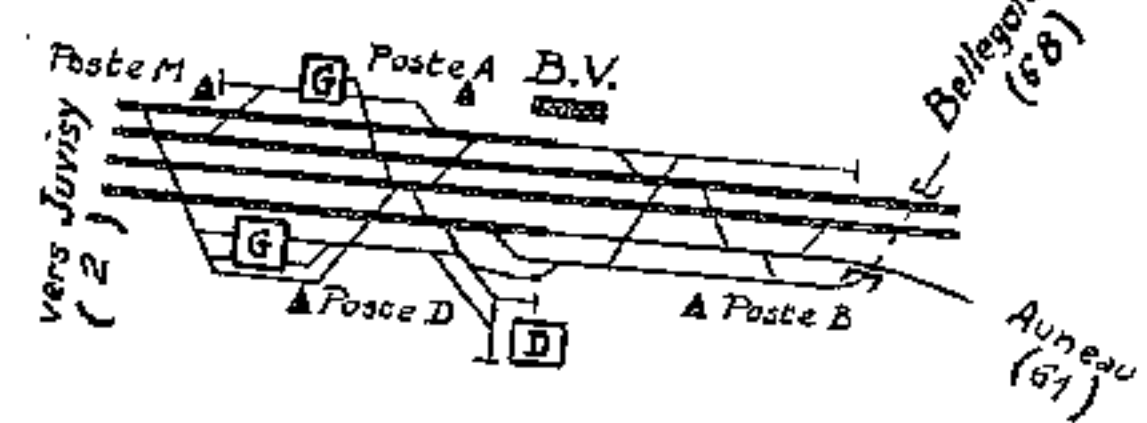

Abords de Toury

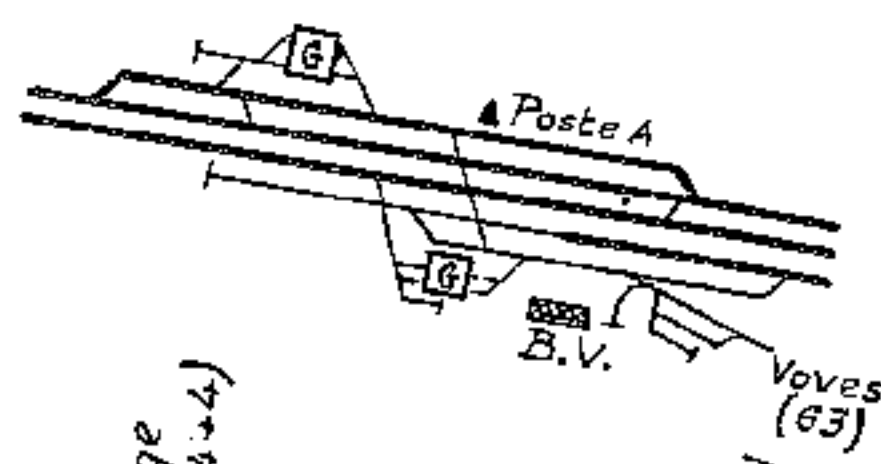

Ligne de Paris à Orléans
Section d'Etampes à Orléans

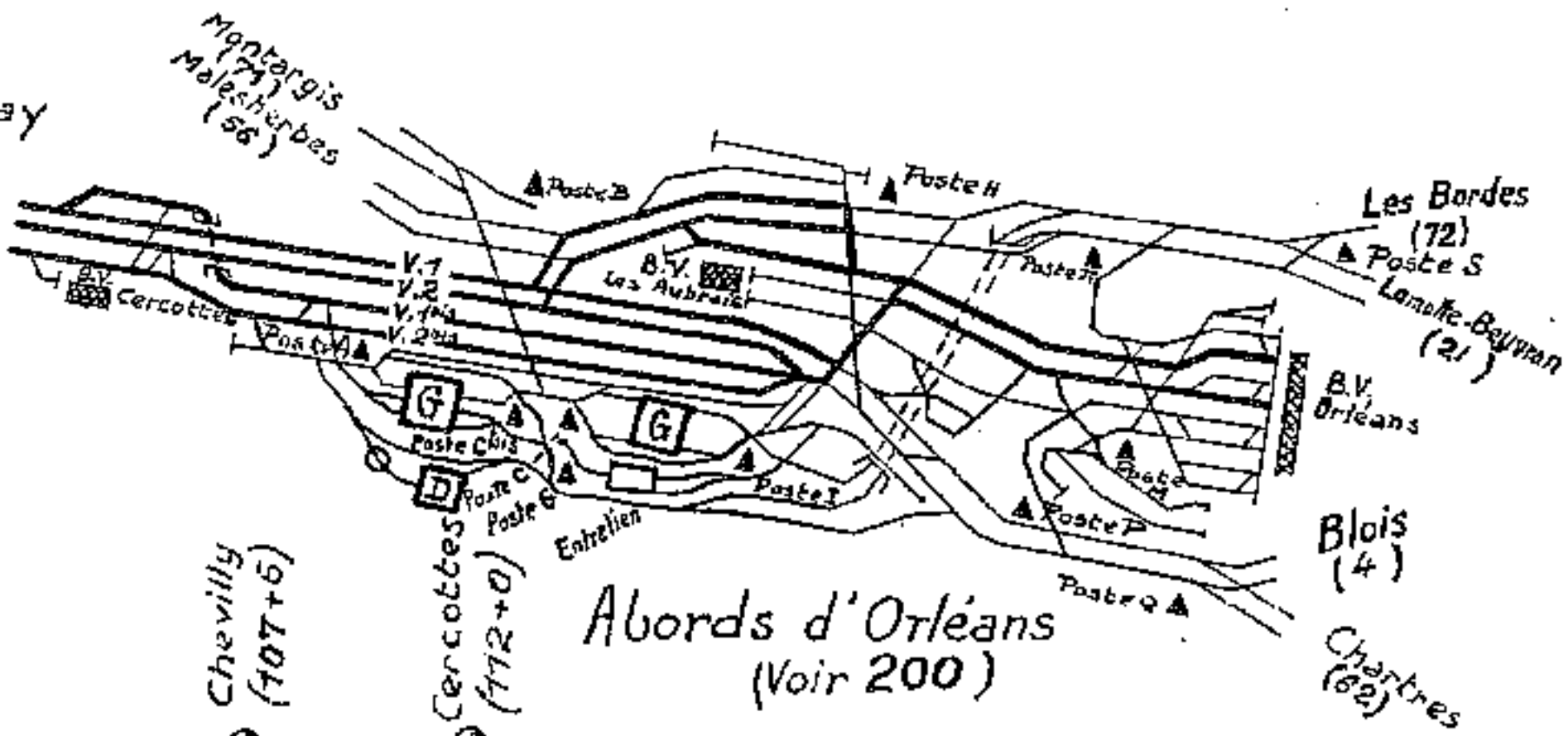
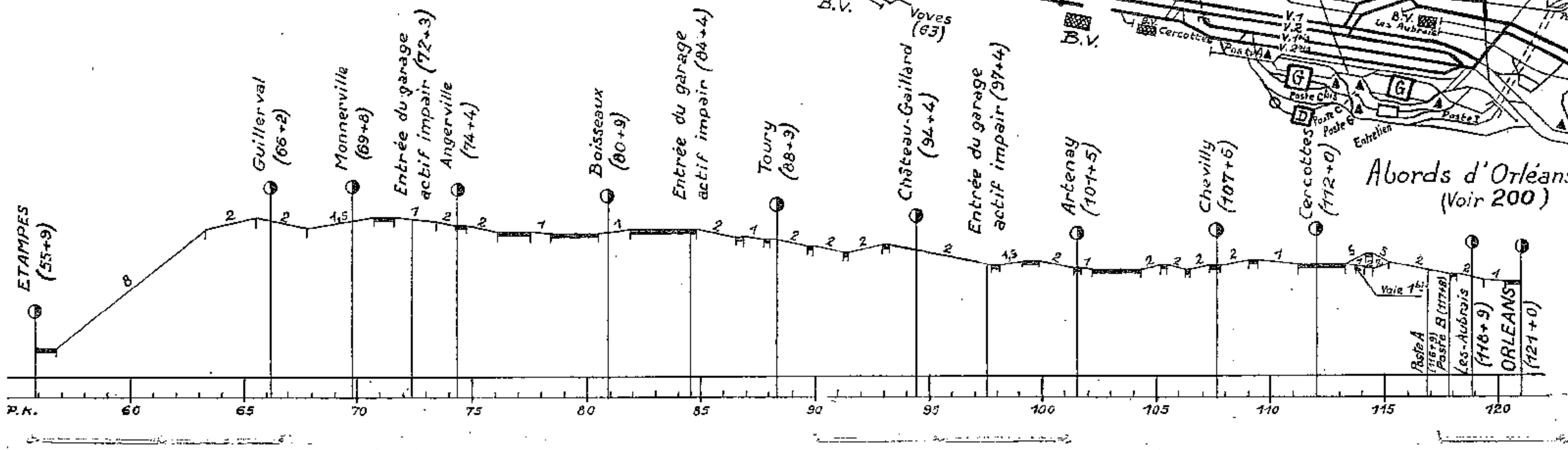

Abords de Juvisy
(Voir 199)

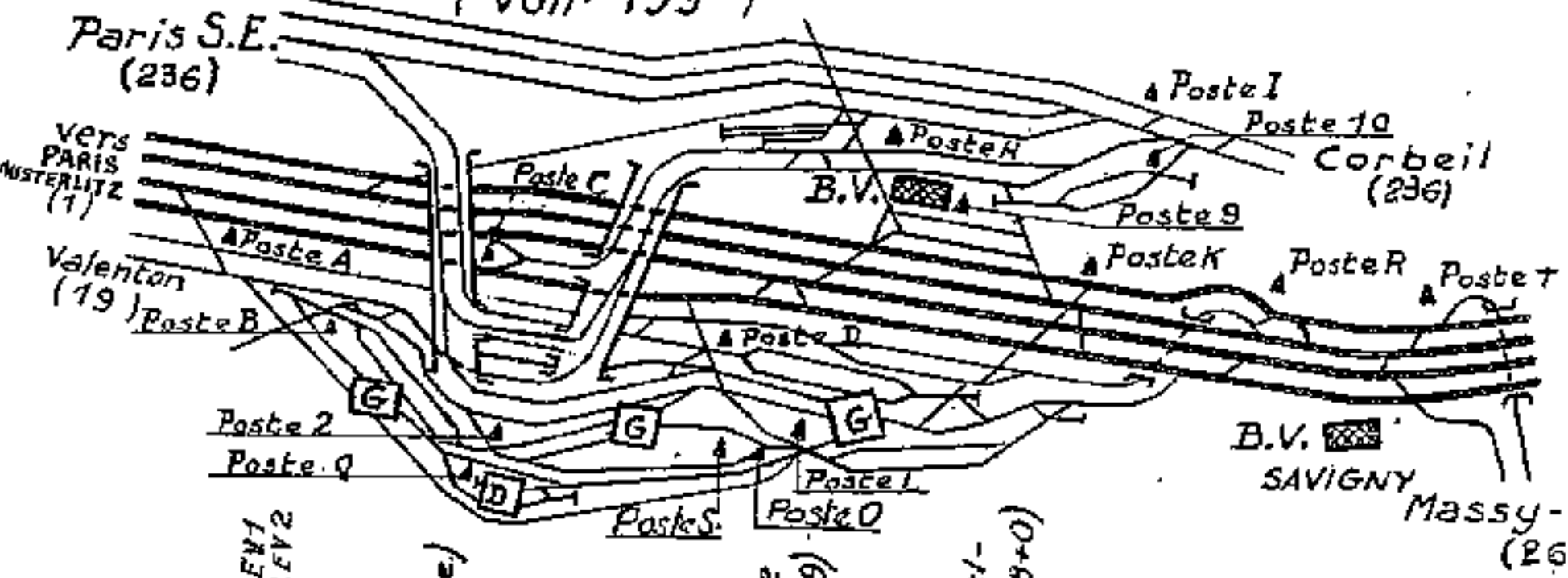

Abords de Brétigny

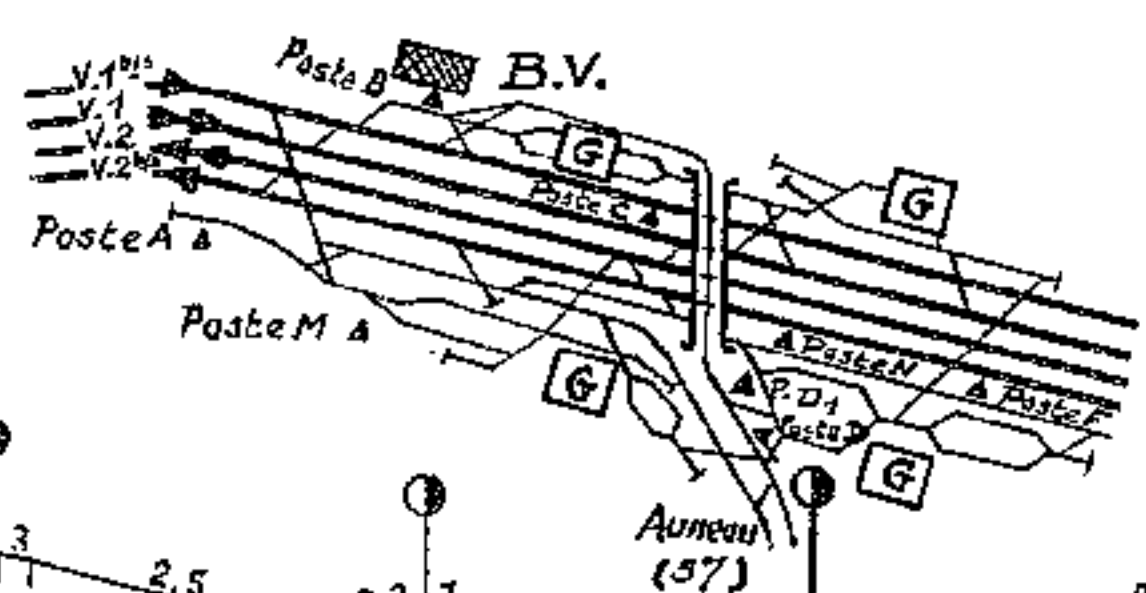

Ligne de Paris à Orléans
Section de Juvisy à Etampes

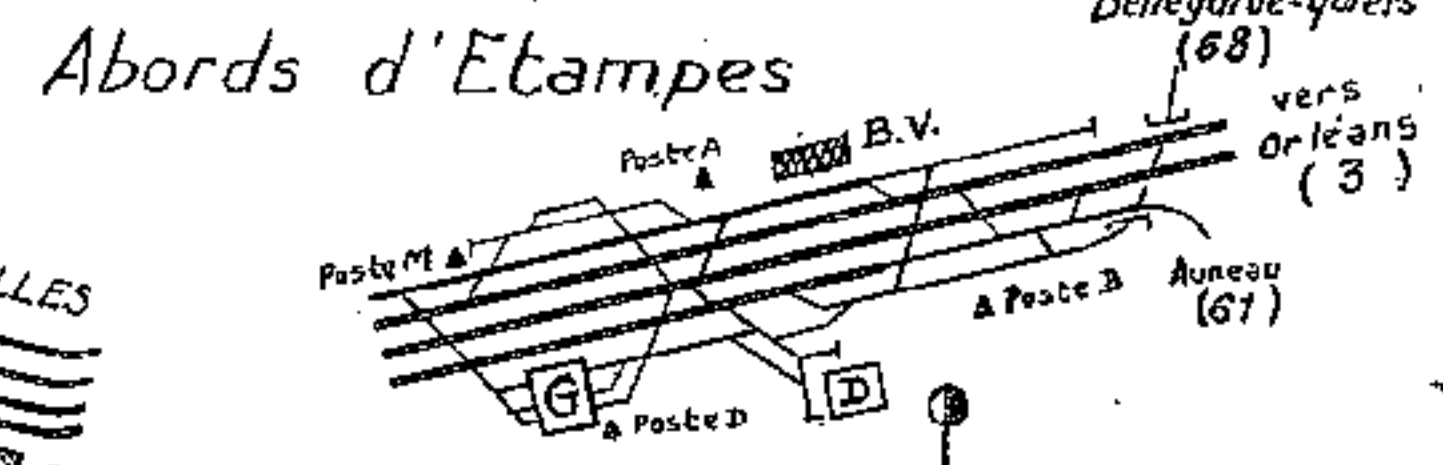
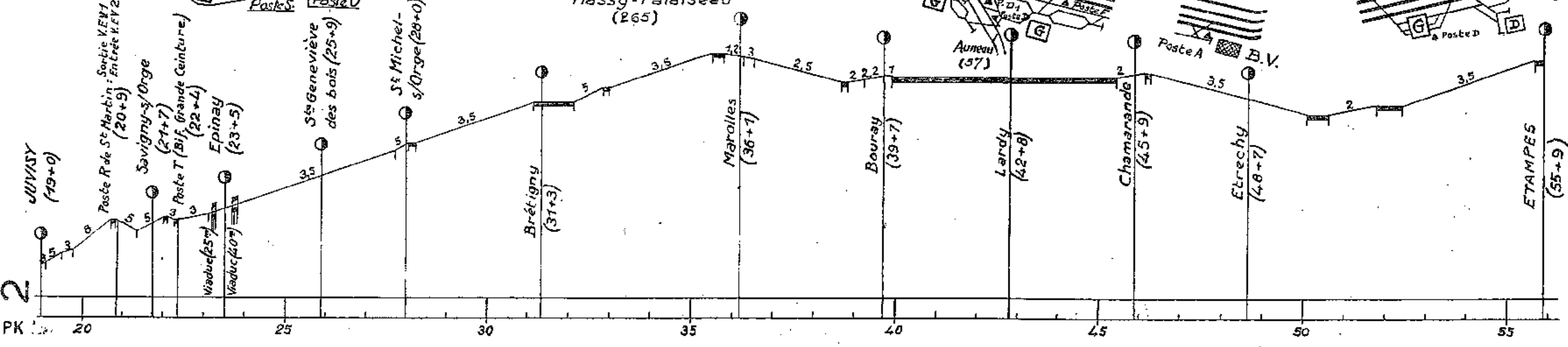

Abords de Blois

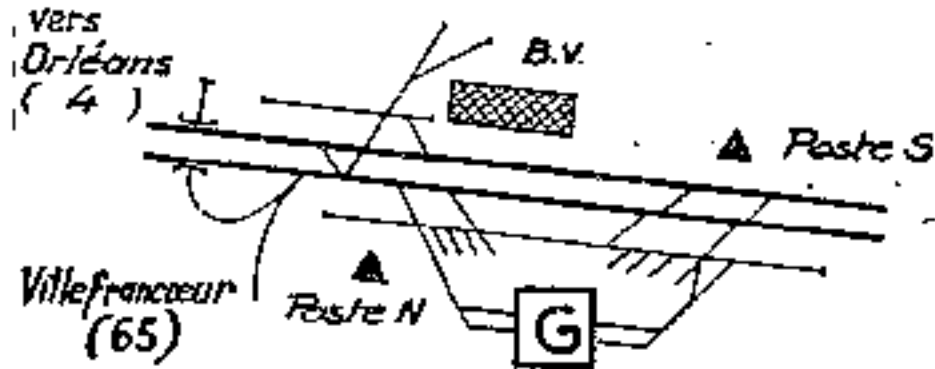

Ligne d'Orléans à Tours

Section de Blois à Tours

Abords de Vouvray

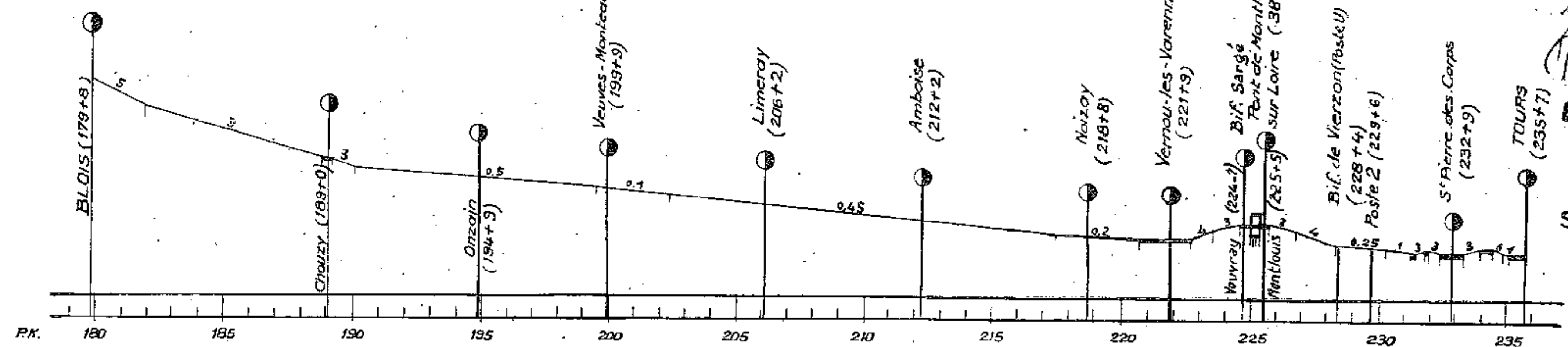
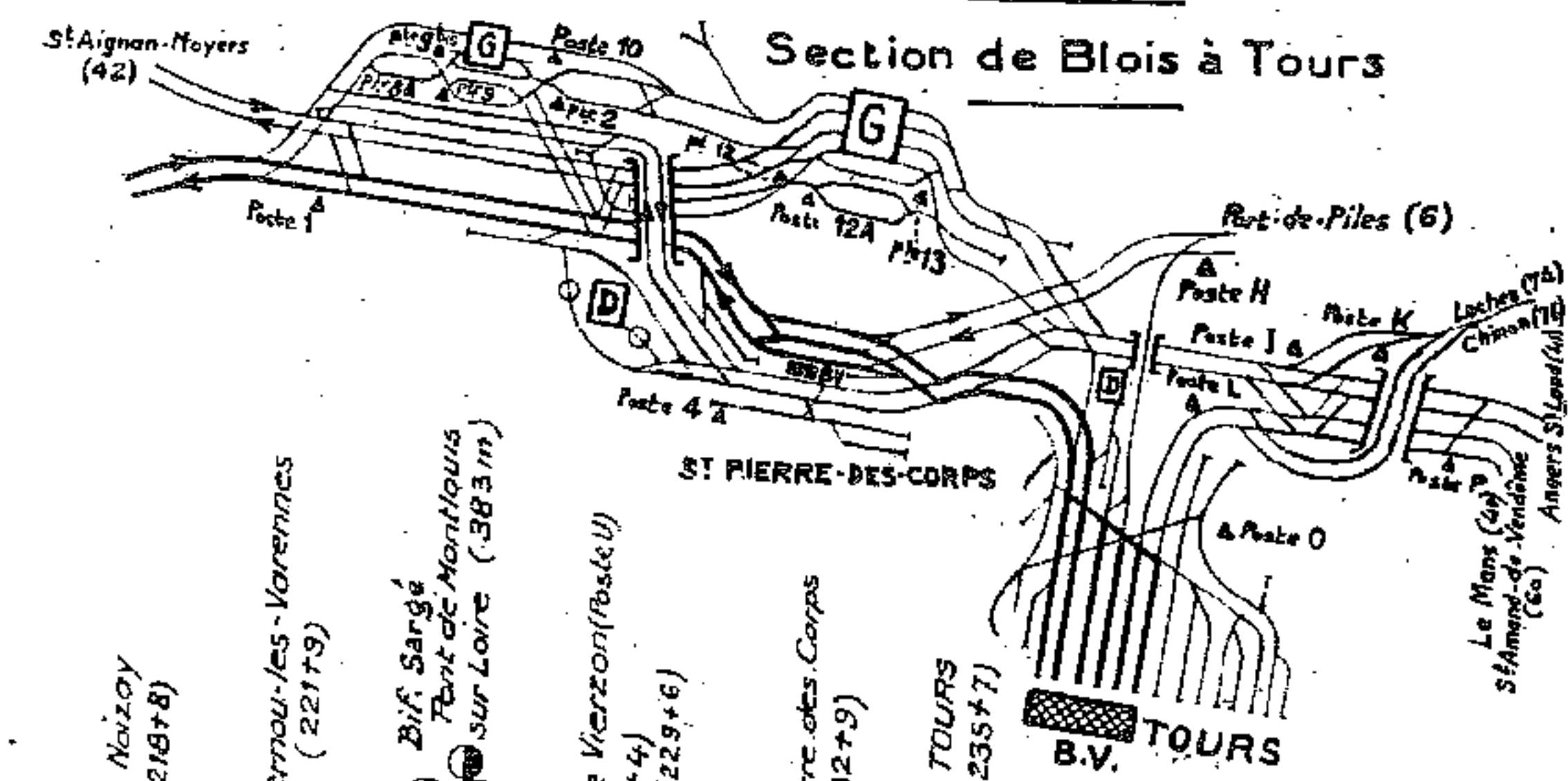
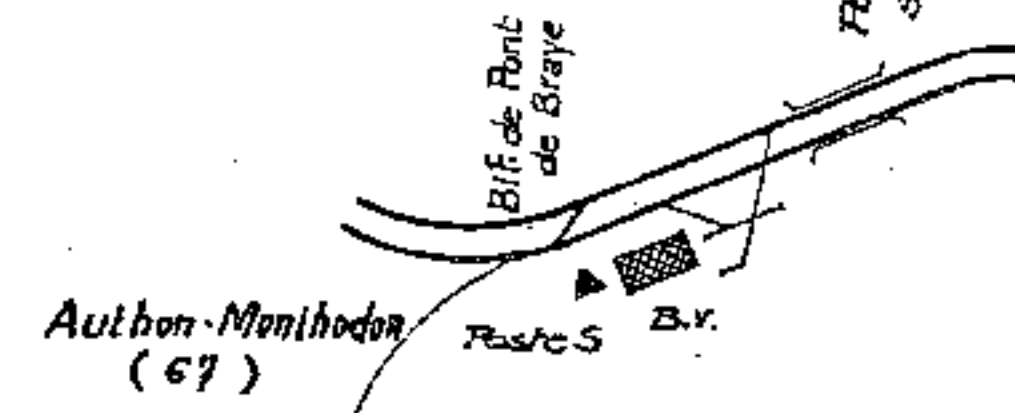

Abords de Tours -
St Pierre des Corps
(voir 201)

Abords d'Orléans (voir 200)

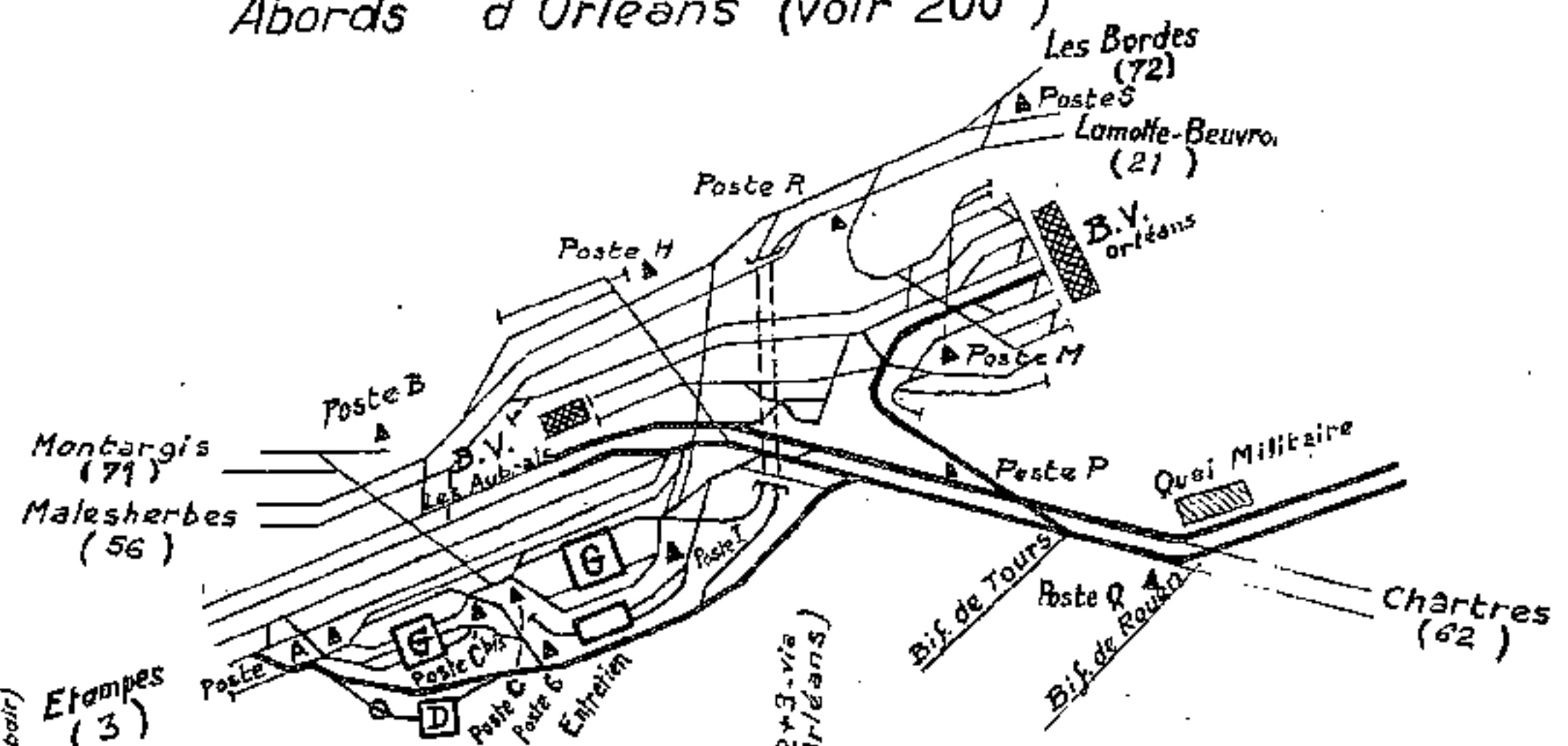

Ligne d'Orléans à Tours

Section d'Orléans à Blois

Abords de Blois

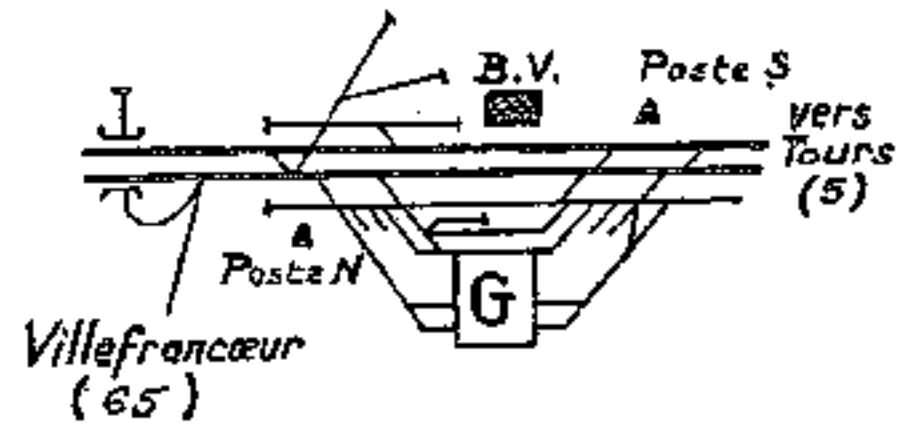

B.V.
Viaduc de Beaugency (210m)

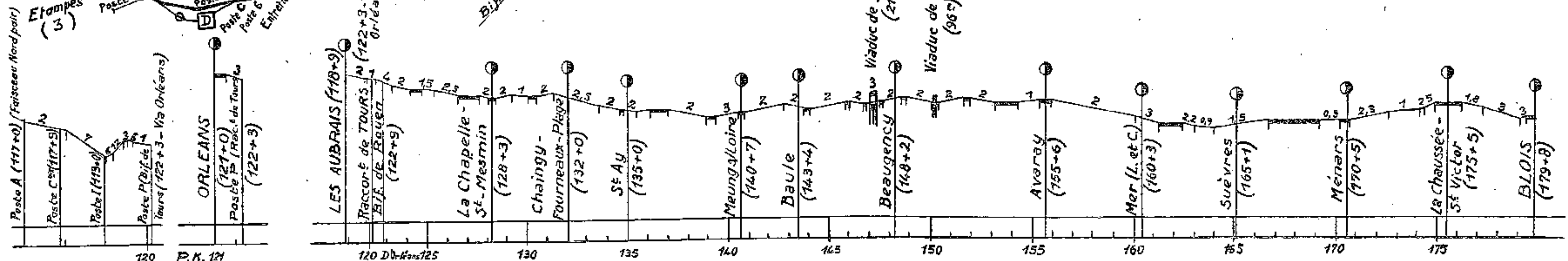

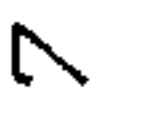

Abords de Port-de-Piles

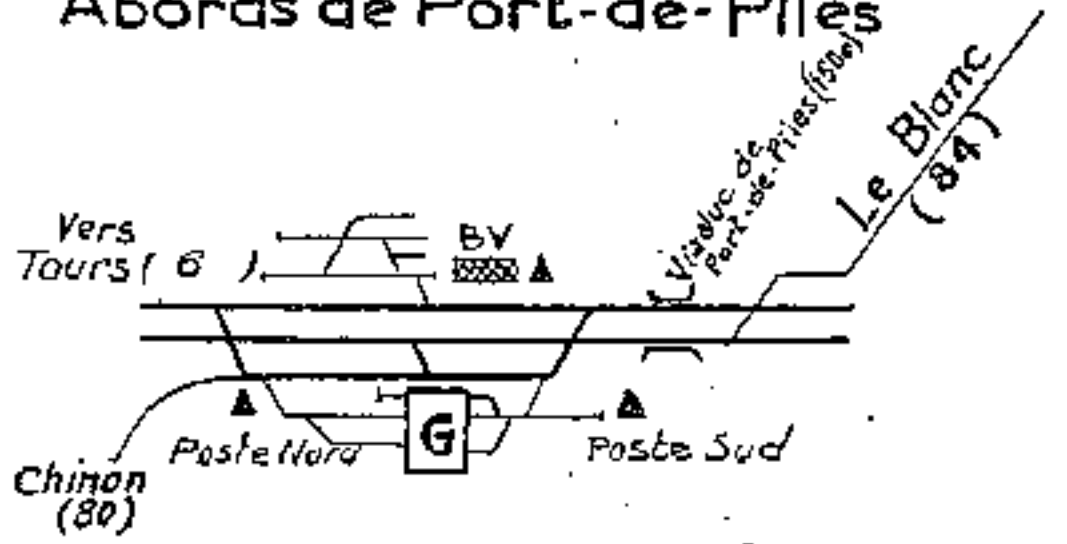

Abords de Châtellerault

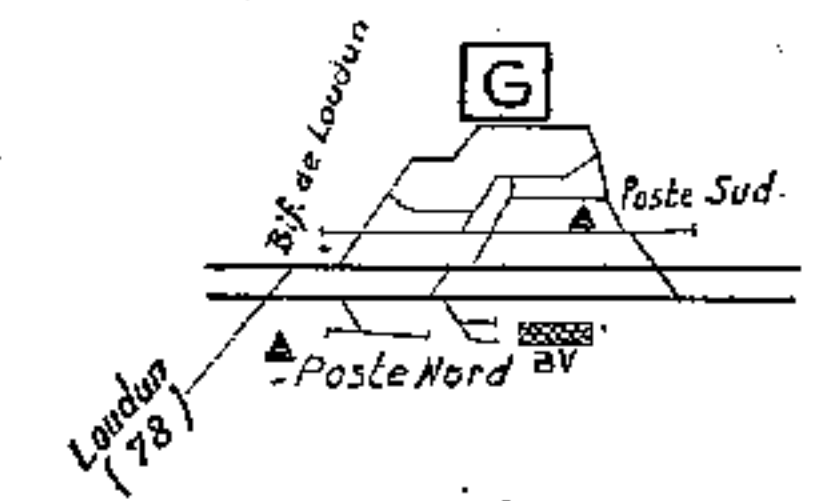

Ligne de Tours à Poitiers

Section de Port-de-Piles à Poitiers

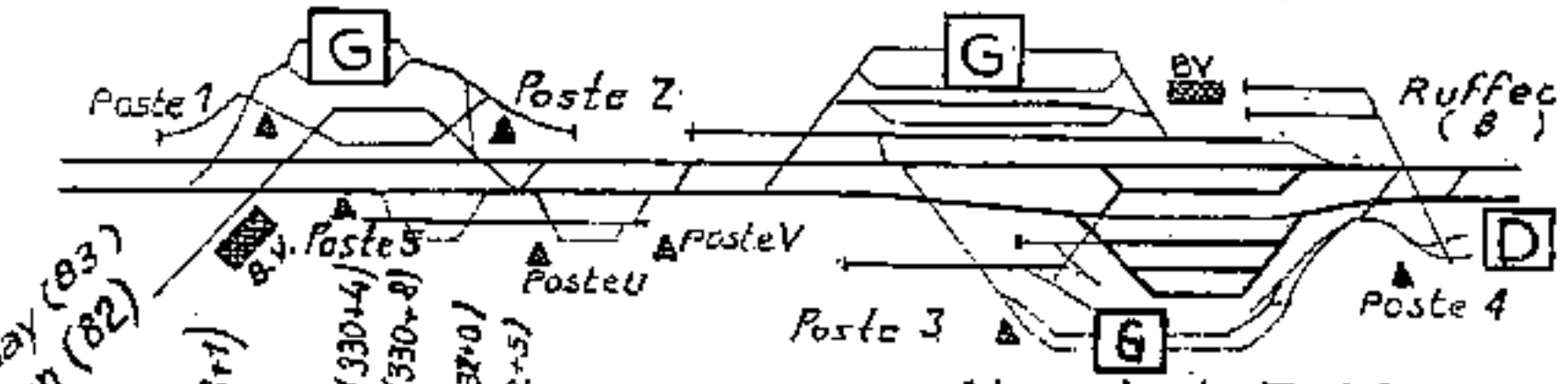

Abords de Poitiers Grand-Pont-Preuilly

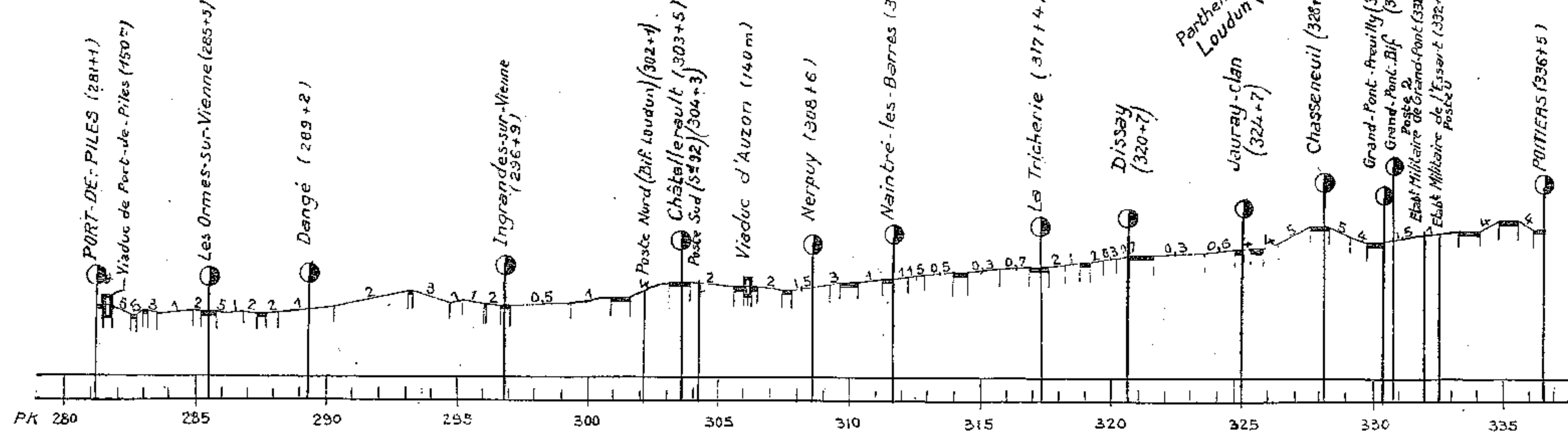

Abords de Tours - St Pierre-des-Corps (voir 201)

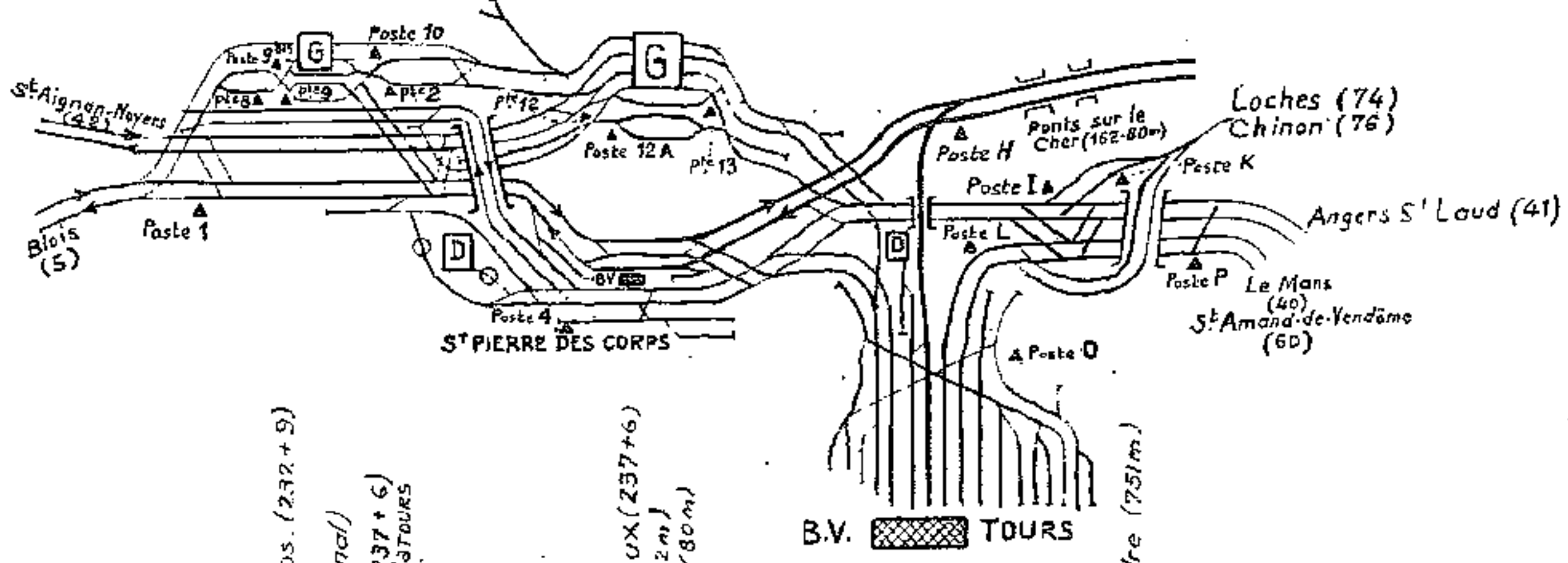

Ligne de Tours à Poitiers

Section de Tours St Pierre à Port-de-Piles

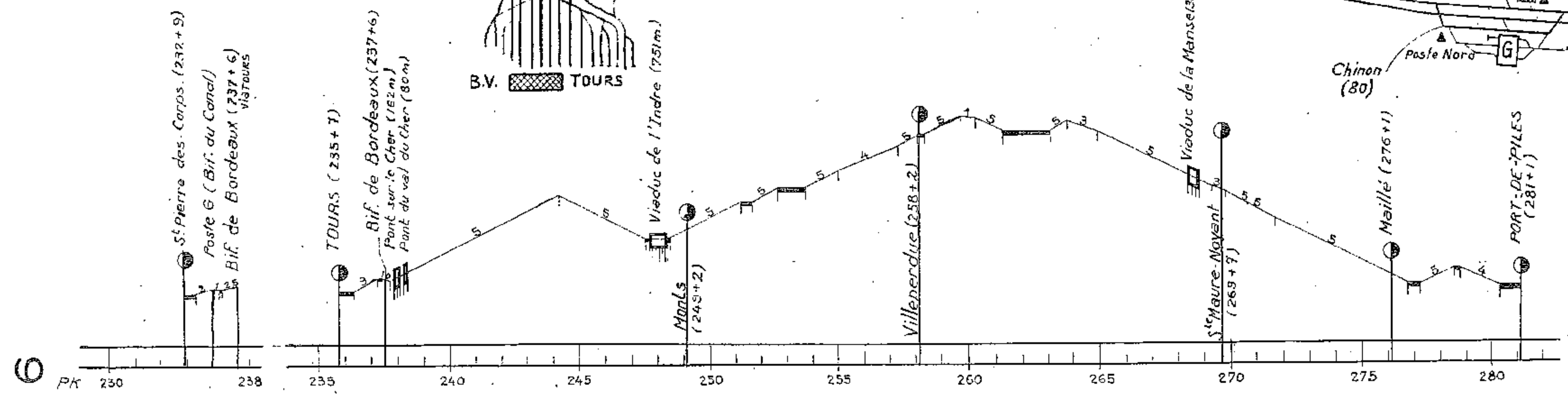
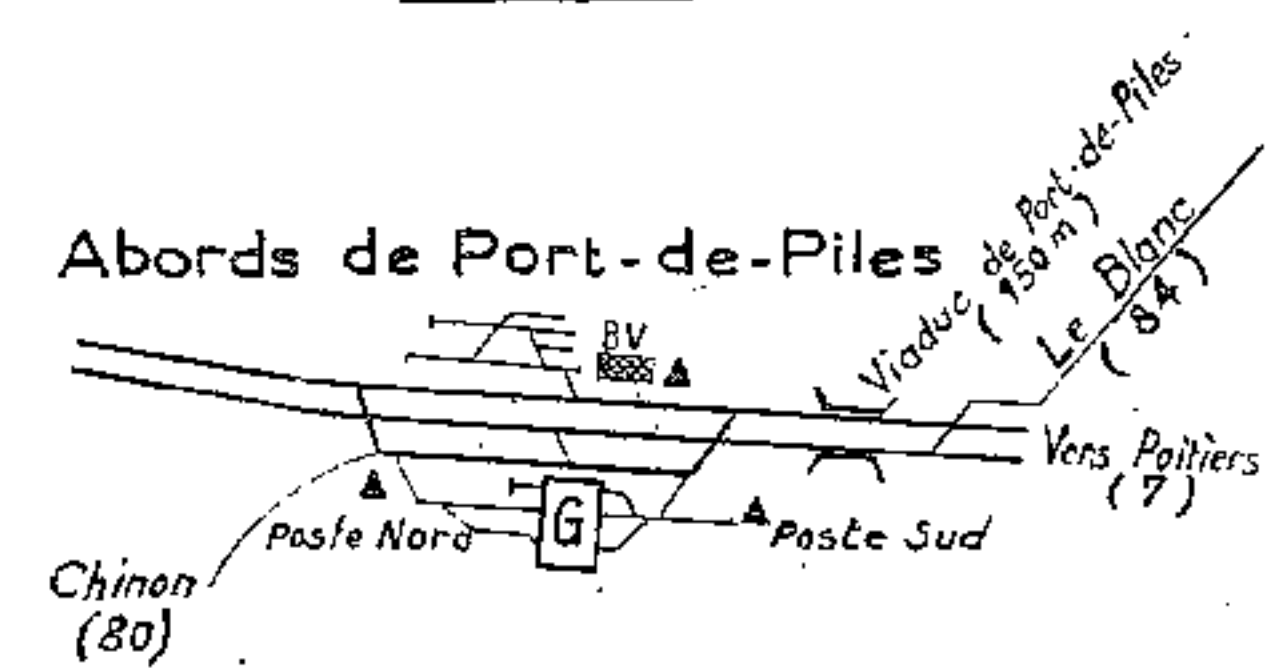

①

Ligne de Poitiers à Angoulême

Abords de Ruffec

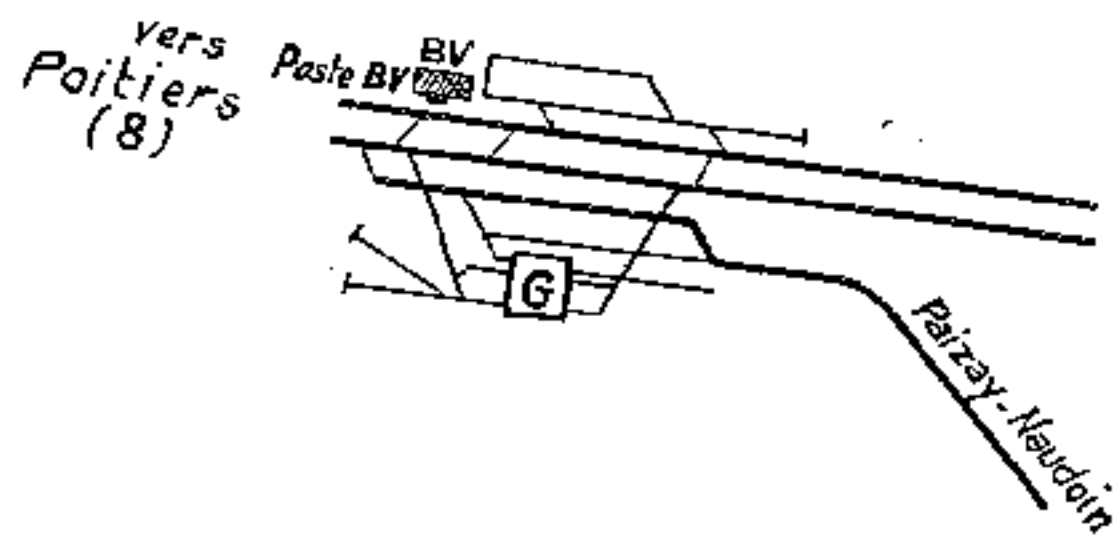

Section de Ruffec à Angoulême

Abords d'Angoulême

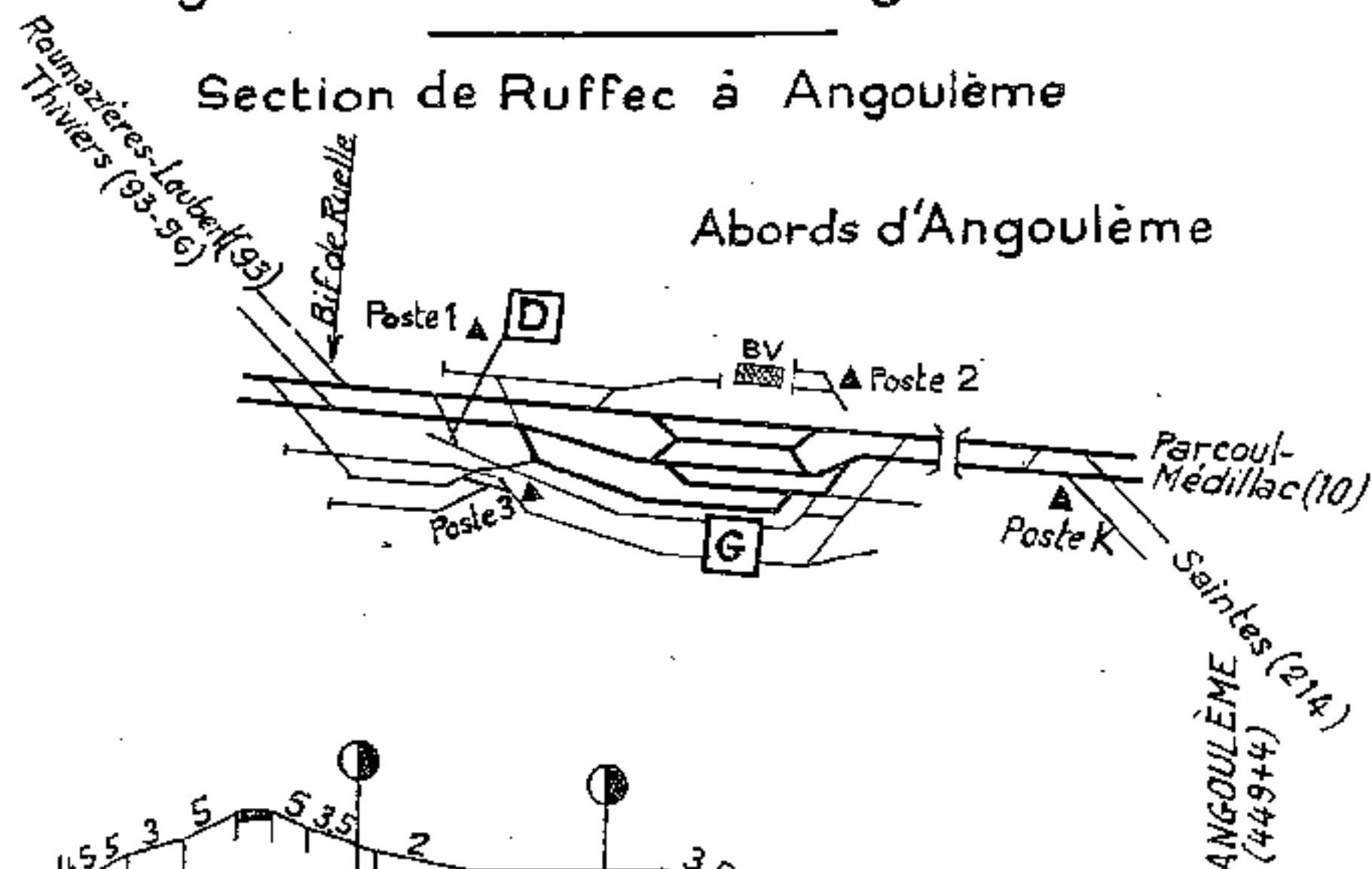

Ligne de Paizay-Naudoin à Ruffec

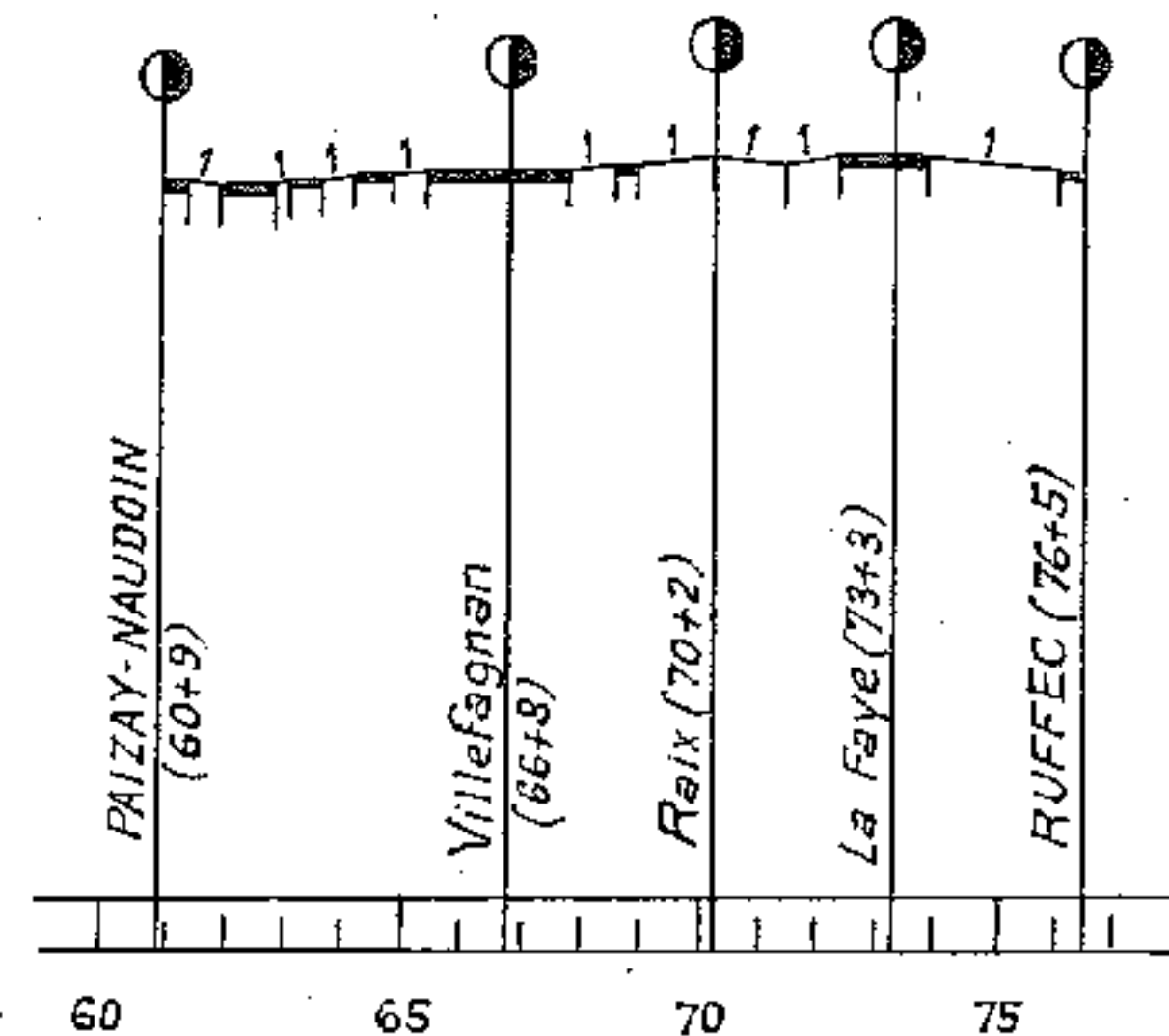
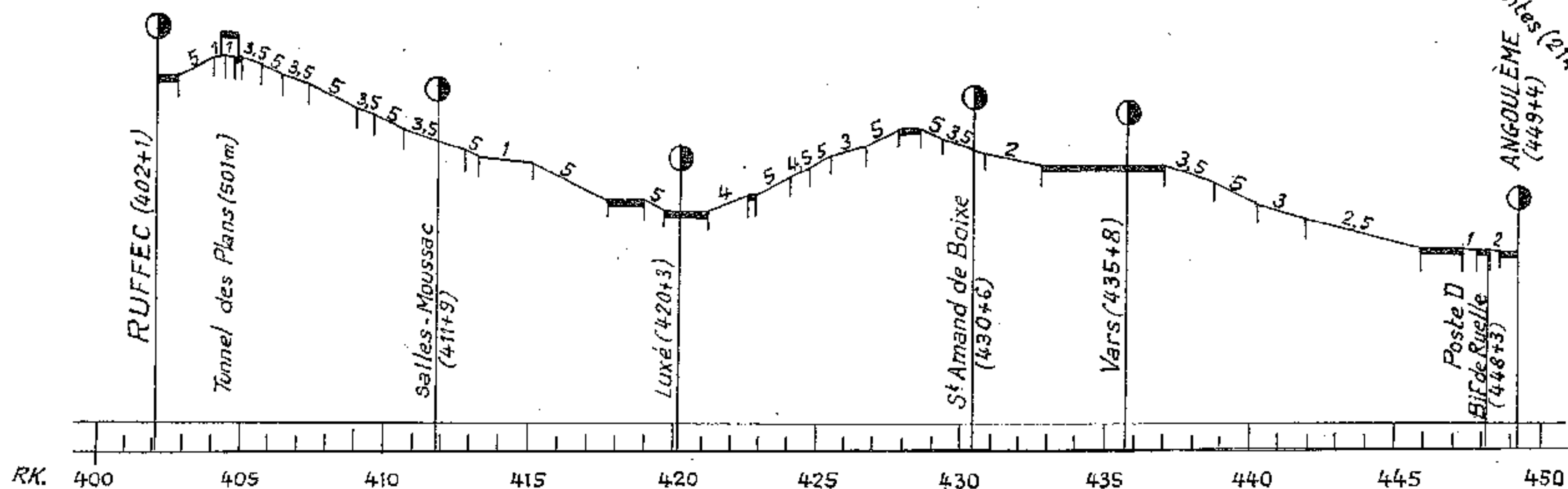

Abords de Poitiers - St. Benoit

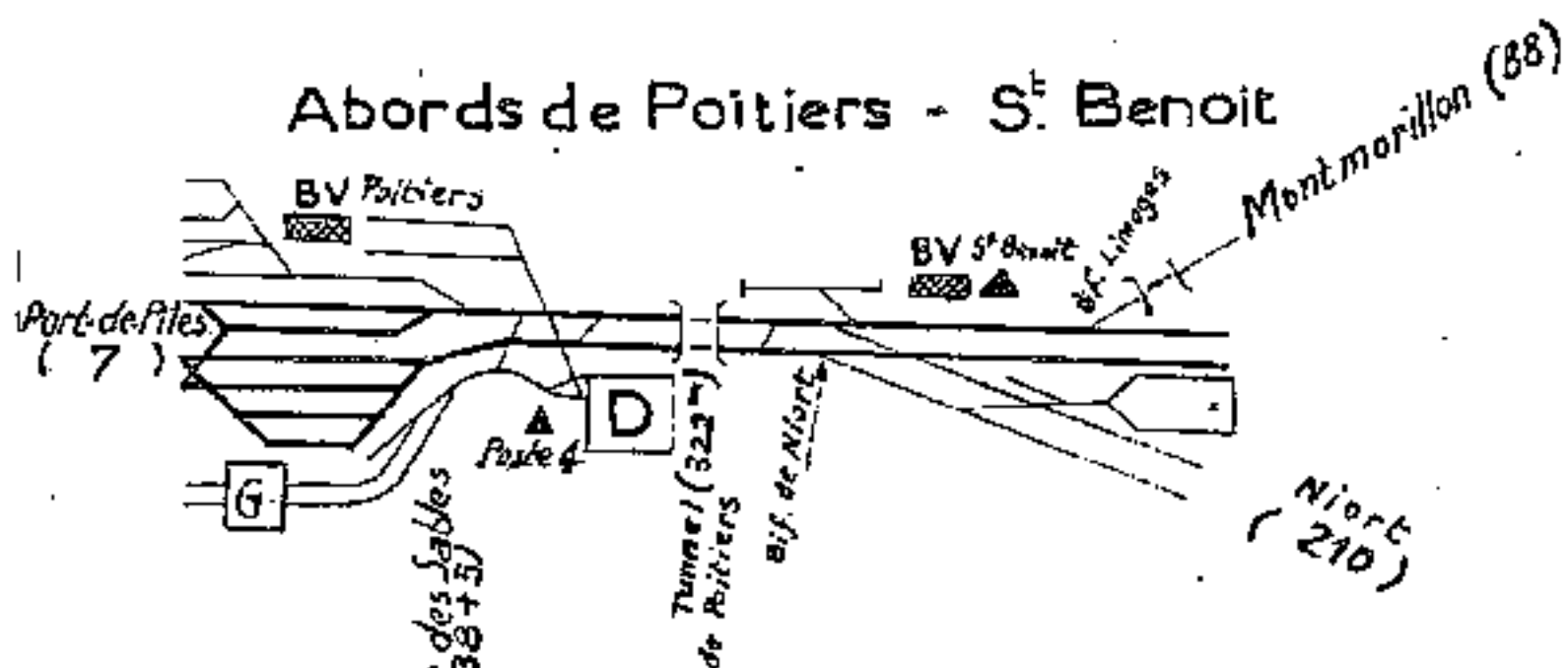

Abords de St. Savioi

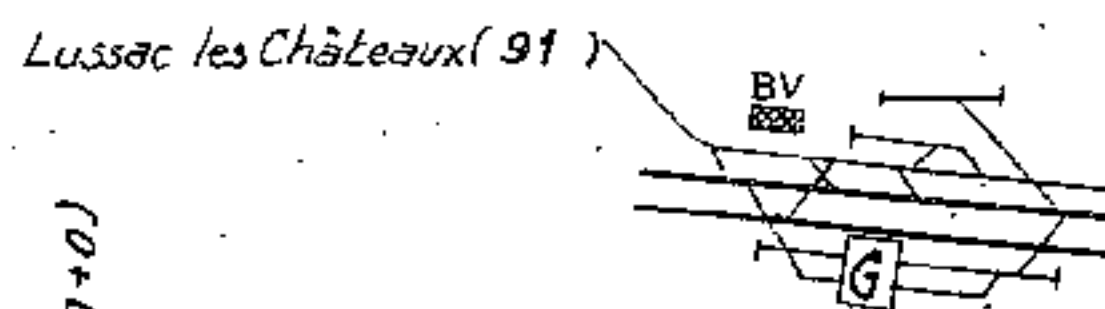

Ligne de Poitiers à Angoulême

Section de Poitiers à Ruffec

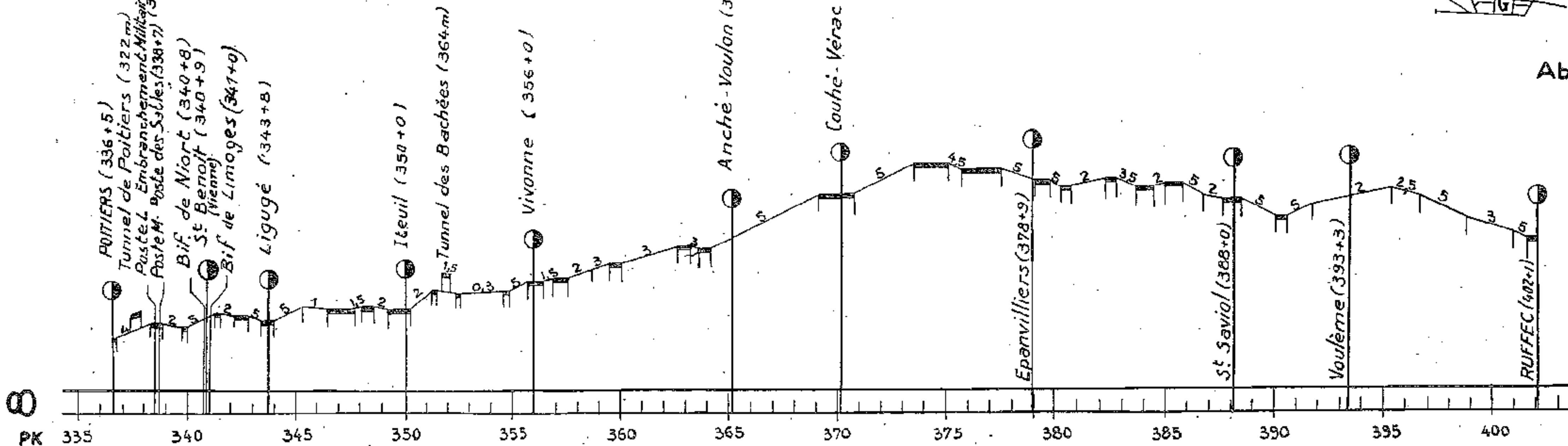
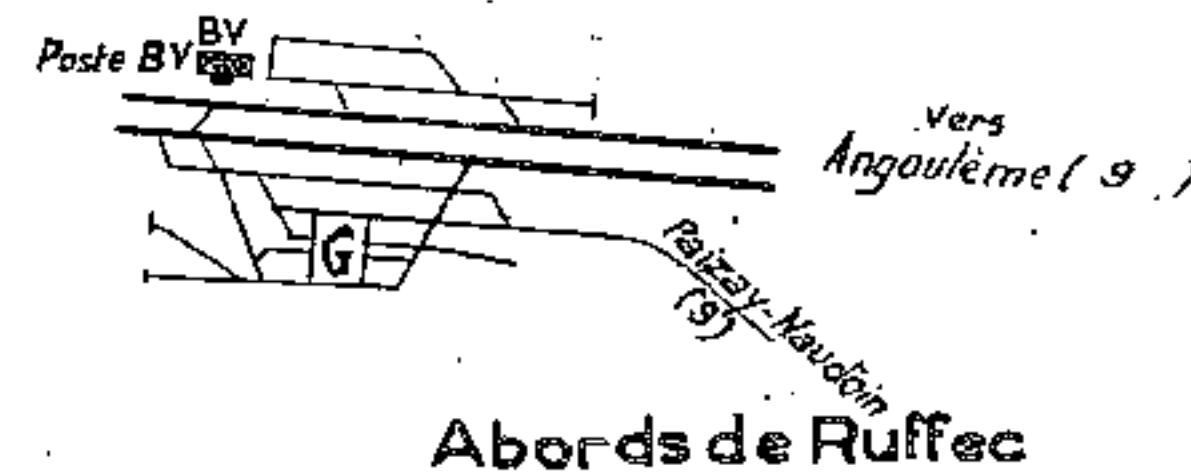

Abords de Parcou-Médillac

Ligne d'Angoulême à Bordeaux

Section de Parcou-Médillac à Libourne

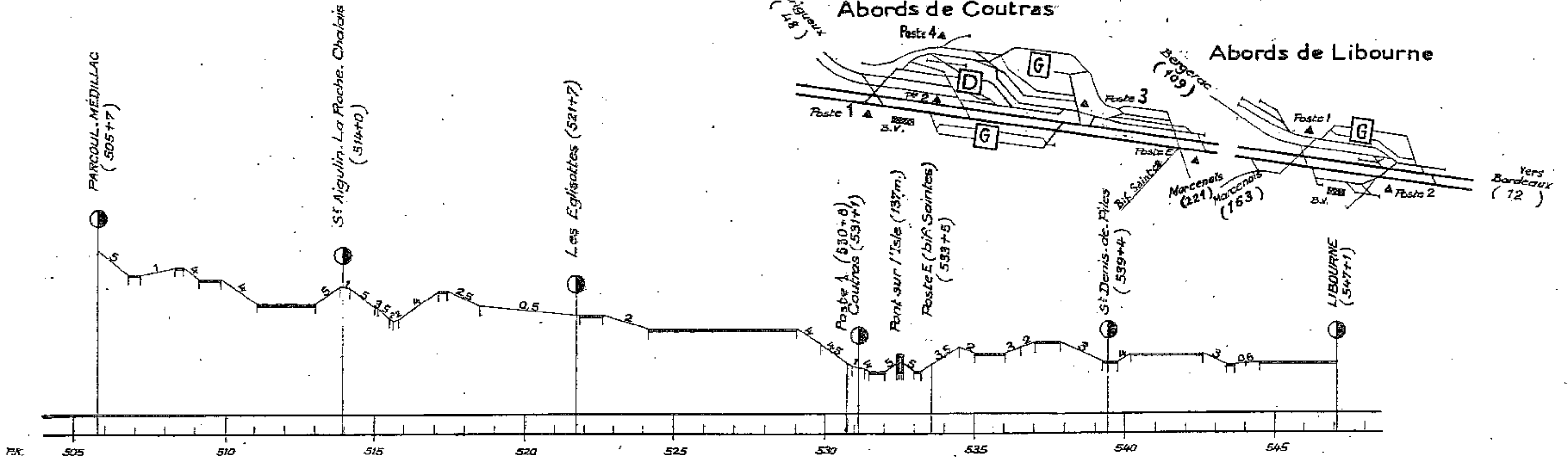

Abords d'Angoulême

Ligne d'Angoulême à Bordeaux

Ligne de St'Aulaye à Parcou-Médillac

Section d'Angoulême à Parcou-Médillac

Abords de Parcou-Médillac

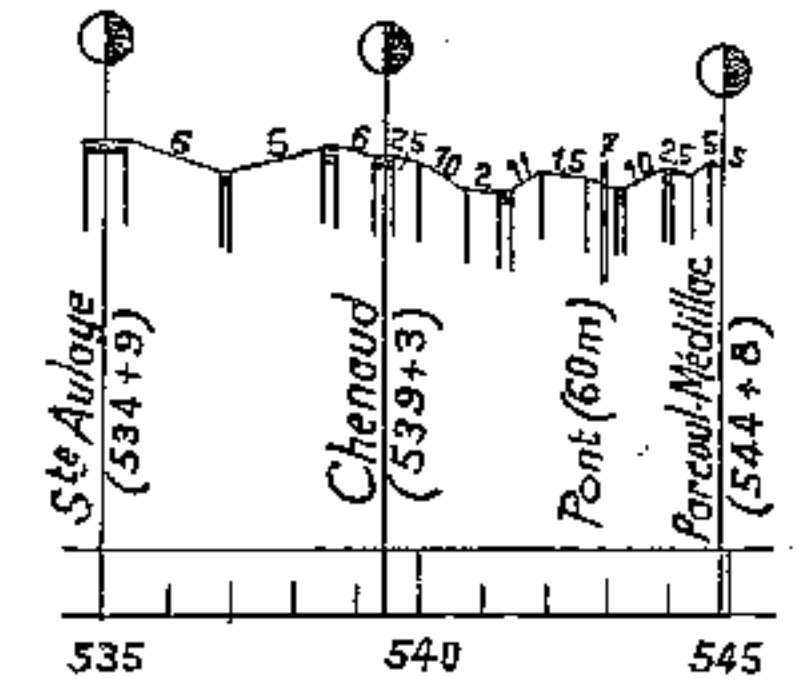
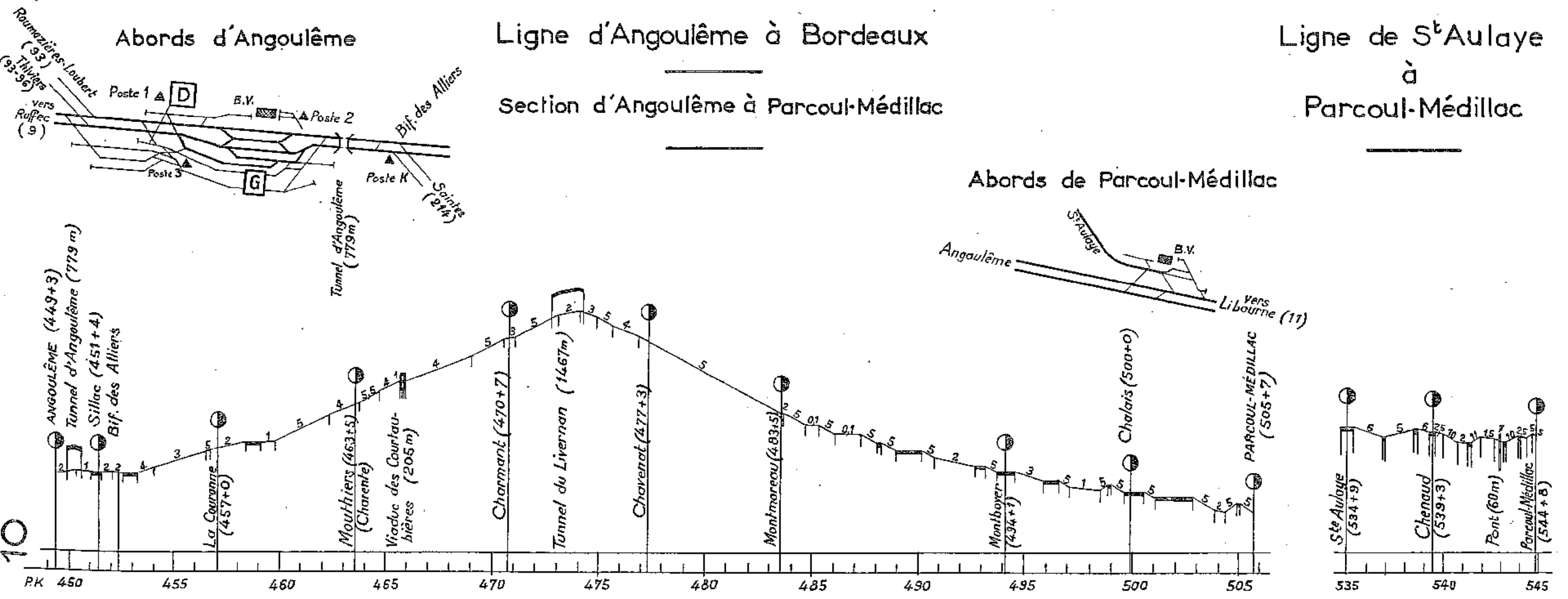

Abords de Bordeaux - S^t Jean
(voir 203)

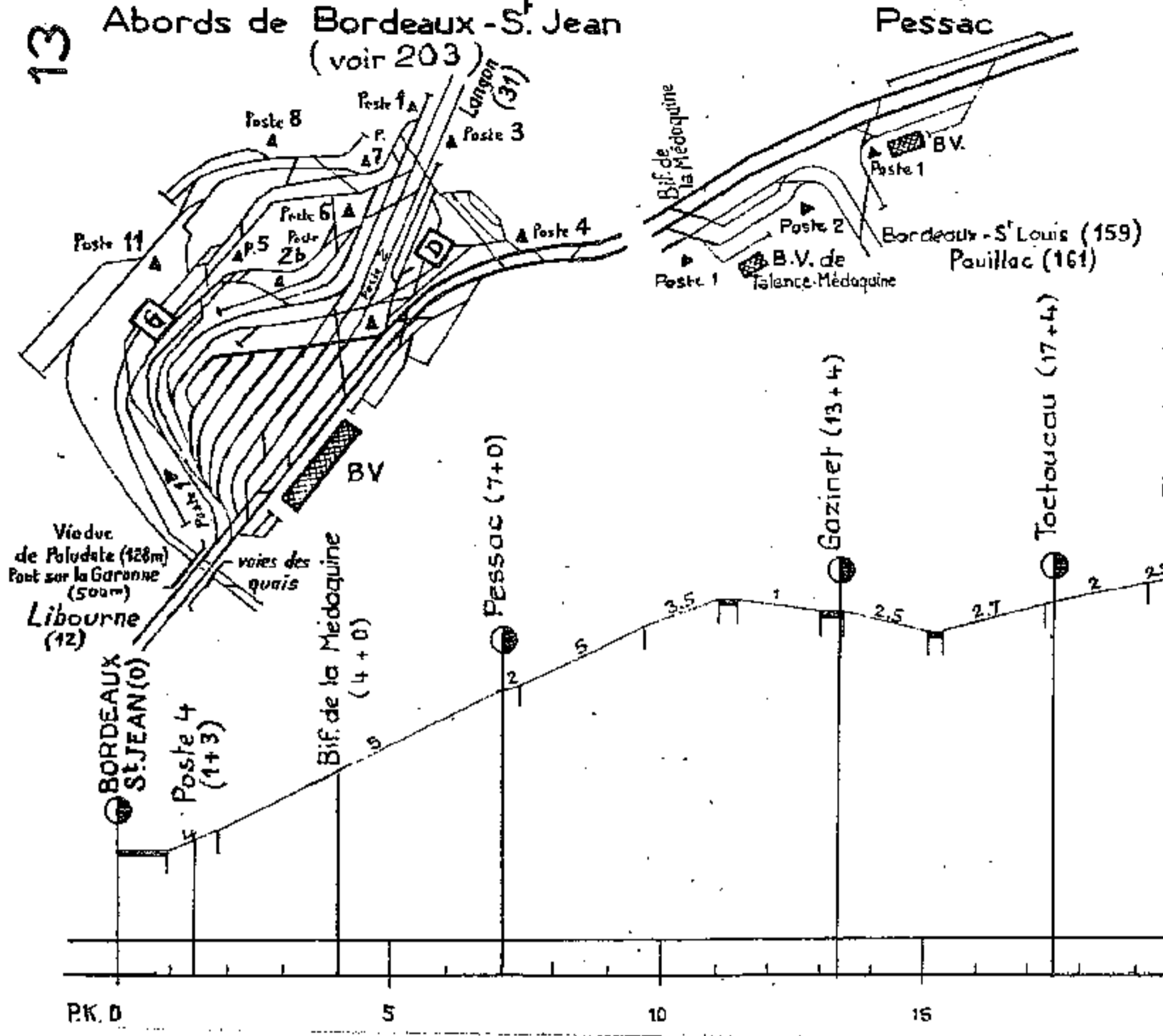

Ligne de Bordeaux - S^t Jean à Dax
Section de Bordeaux - S^t Jean à Lamothe

Abords de Lamothe

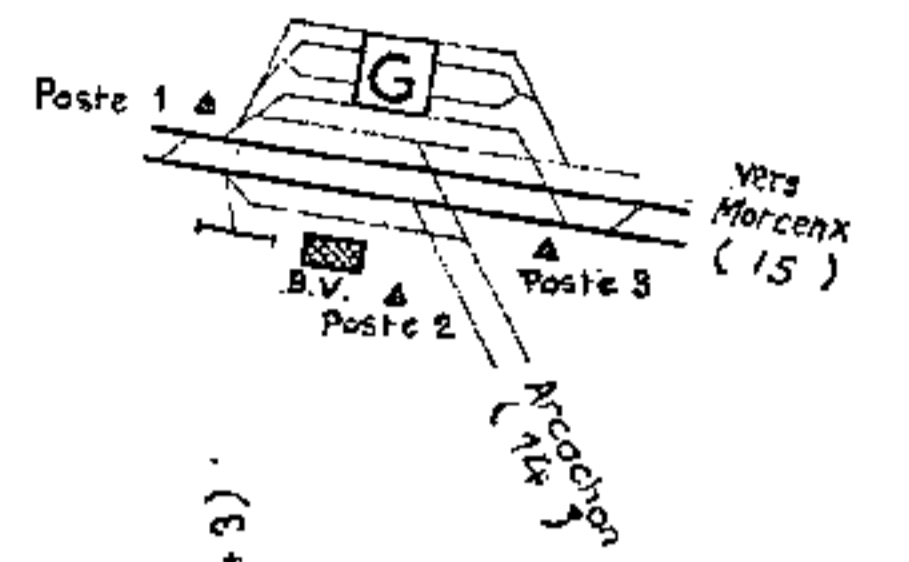

Abords de Libourne

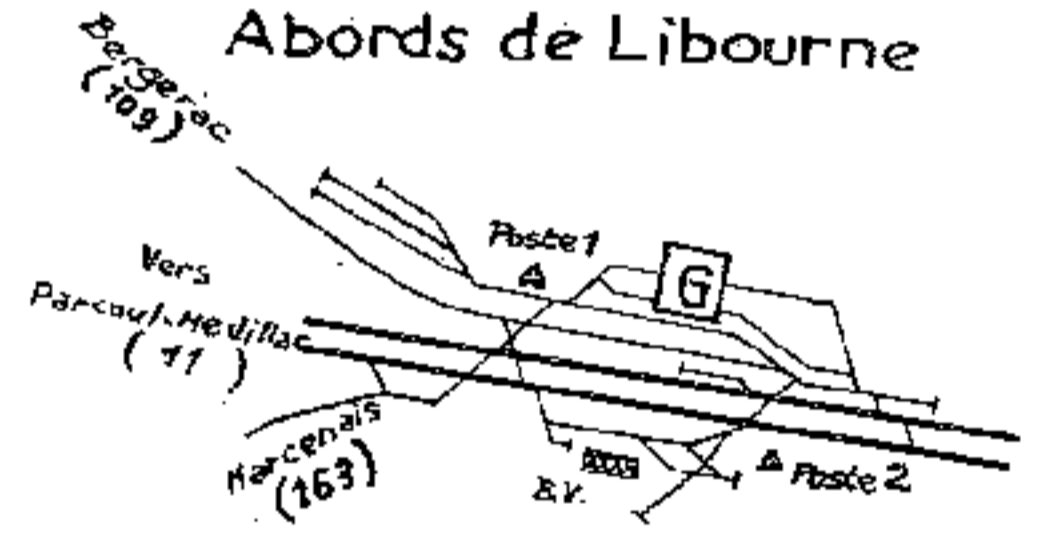

Ligne d'Angoulême à Bordeaux
Section de Libourne à Bordeaux

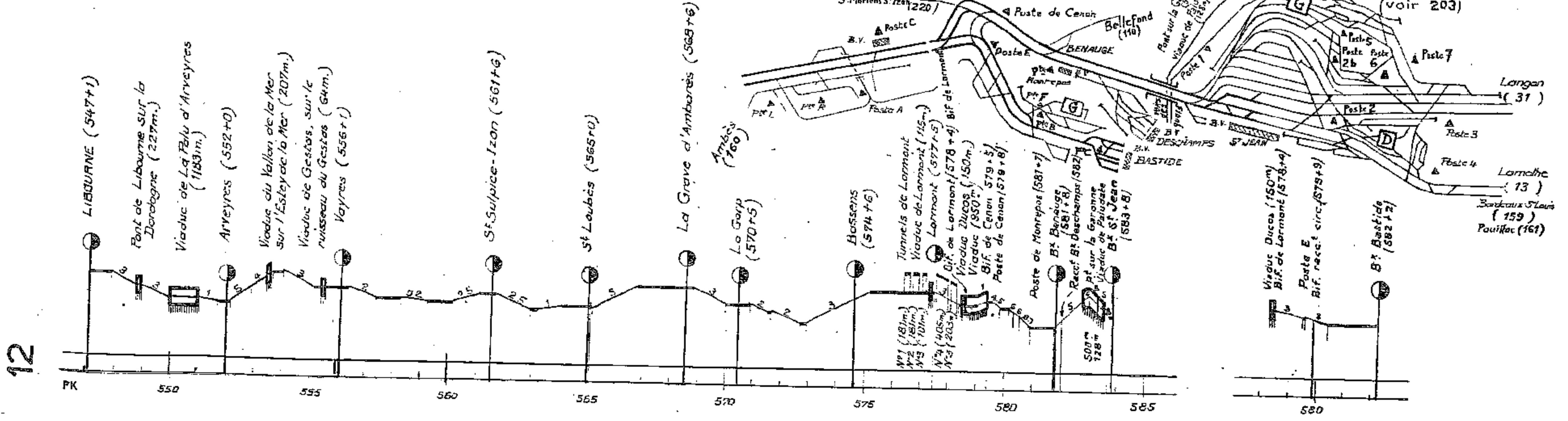

Abords de Lamothe

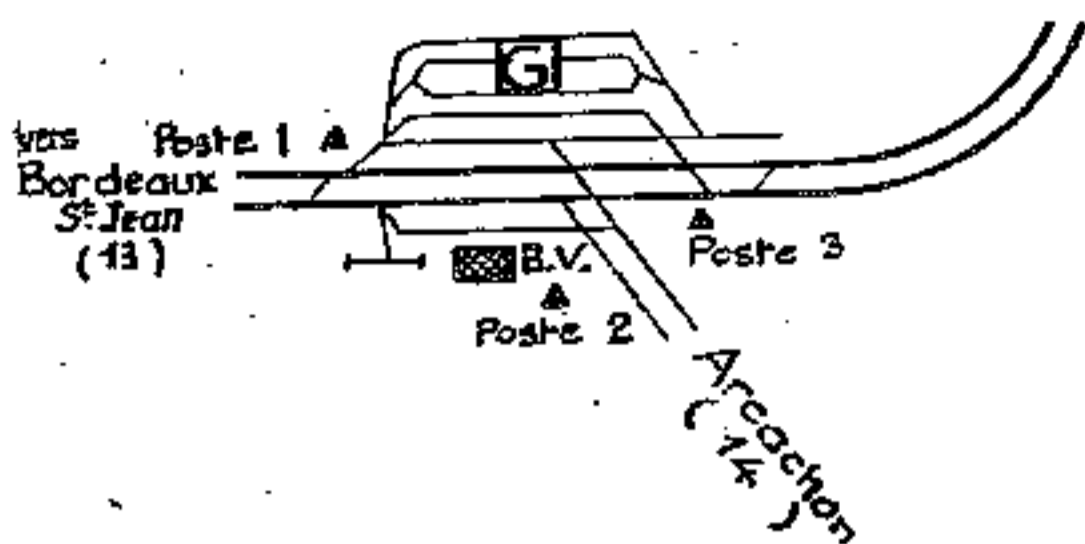

Ligne de Bordeaux-S^t Jean à Dax
Section de Lamothe à Morcenx

Abords de Morcenx

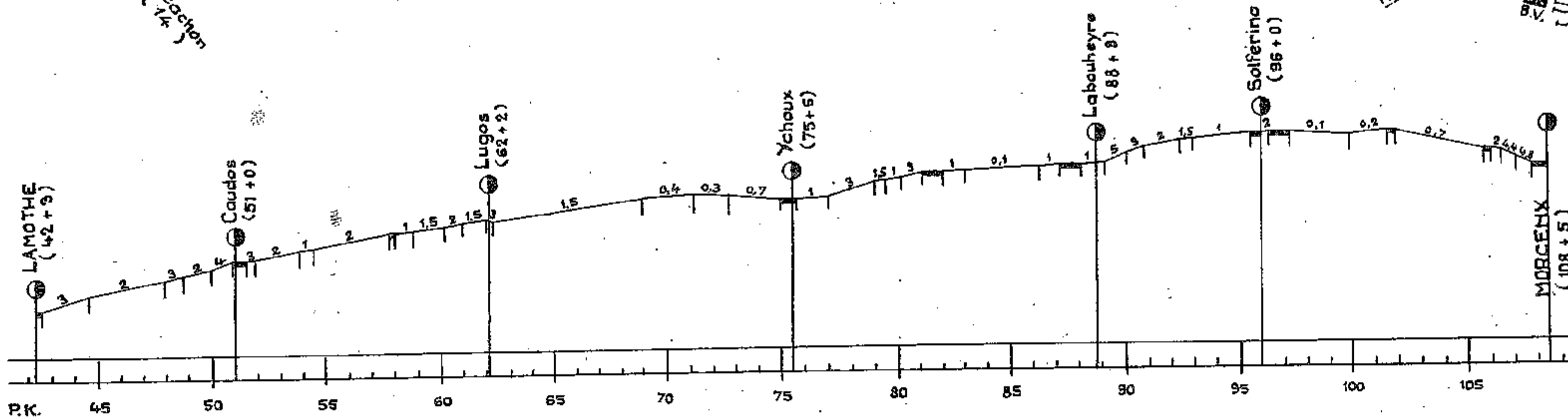

Abords de Lamothe

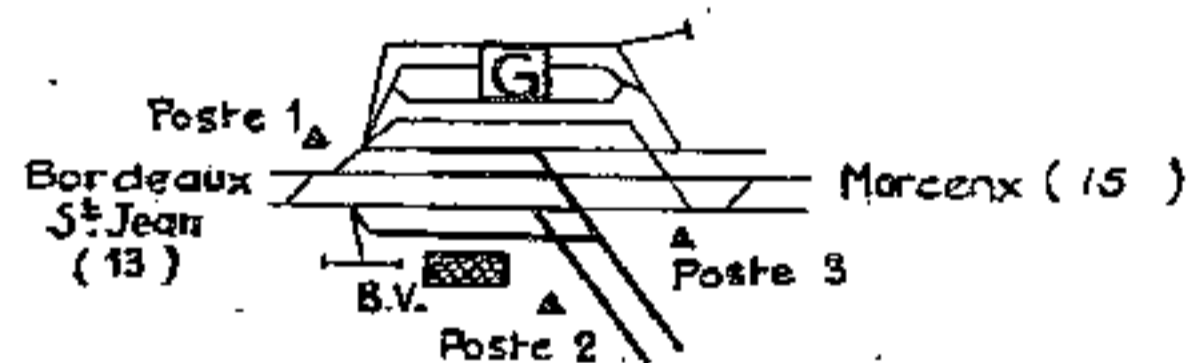

Ligne de Lamothe à Arcachon

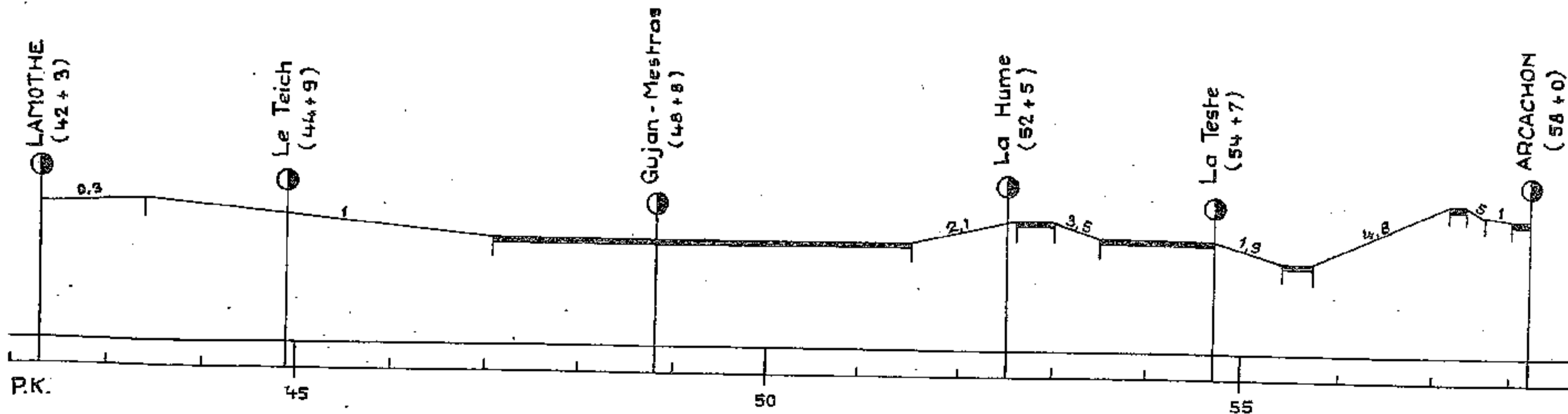

Abords de Dax

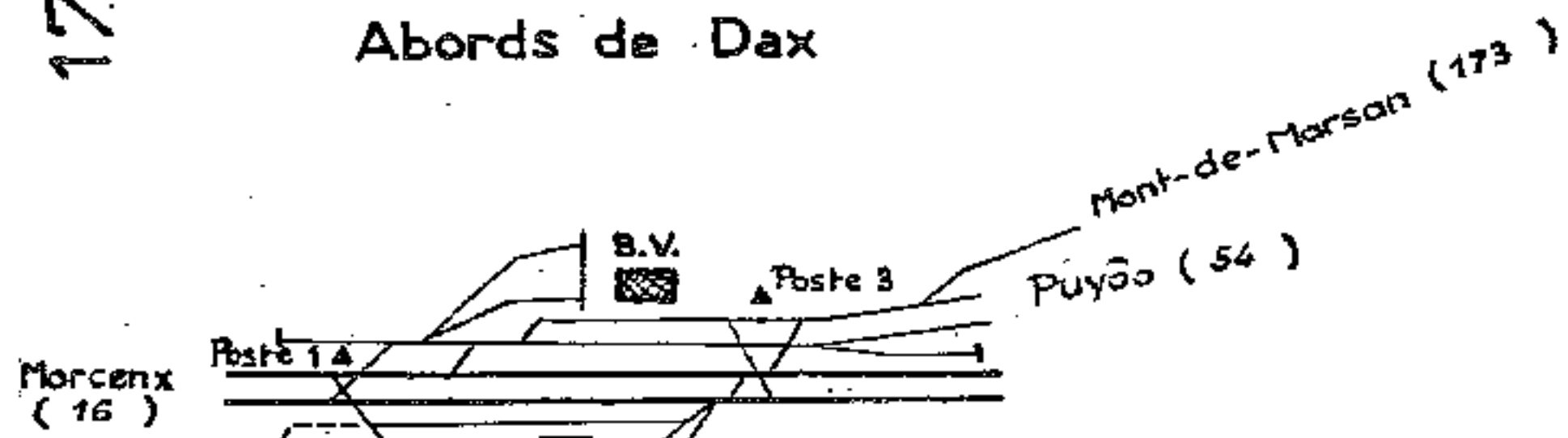

Ligne de Dax à Hendaye

Section de Dax à Bayonne

Abords de Bayonne

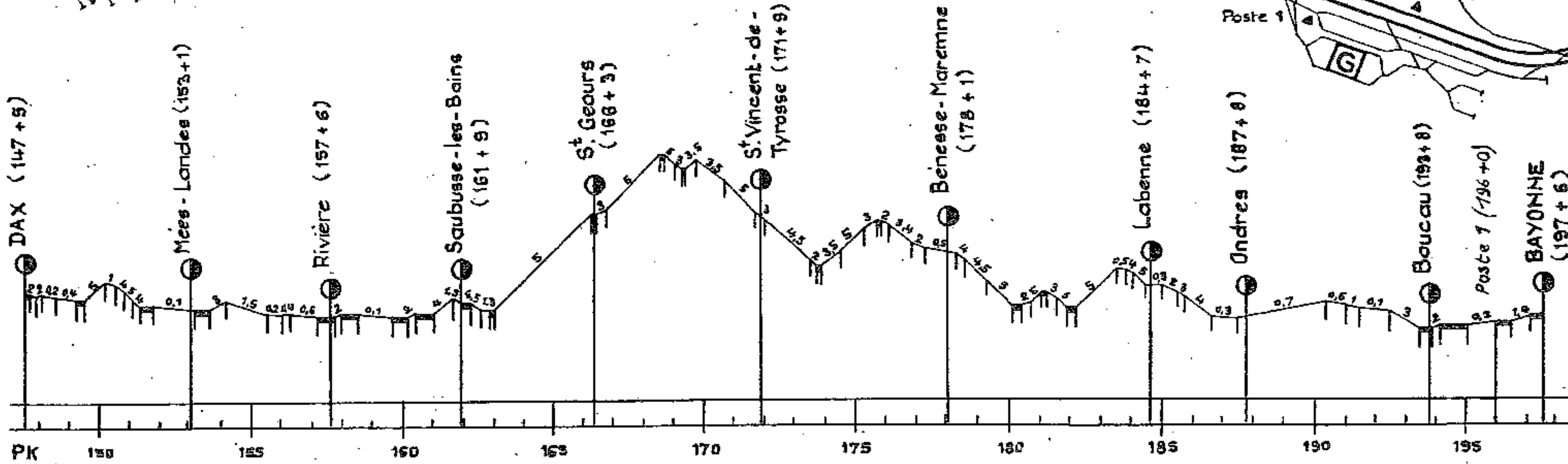
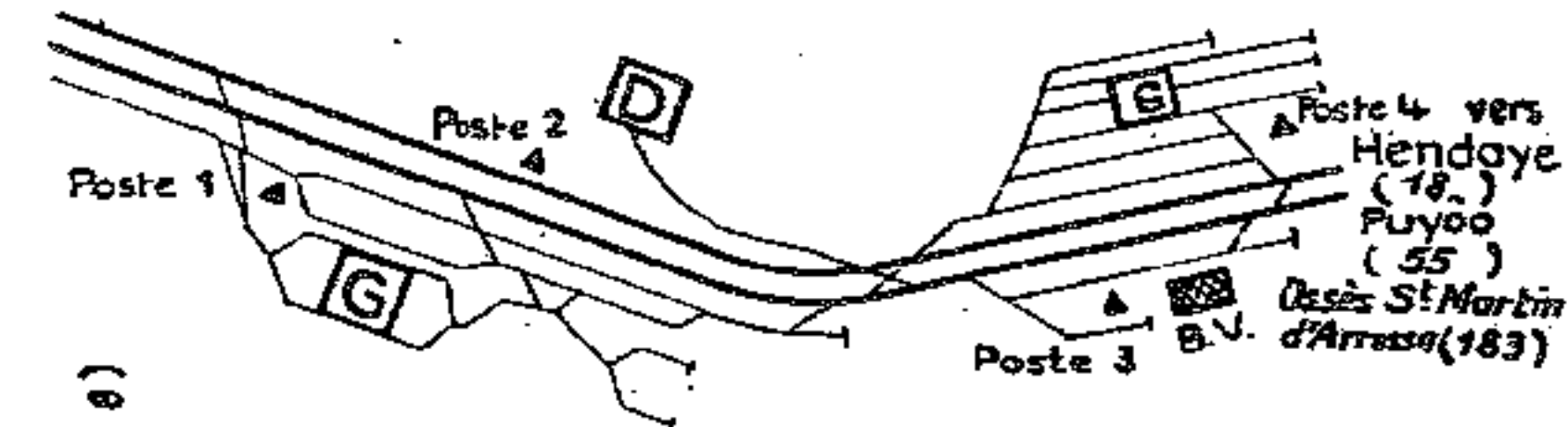

Abords de Morcenx

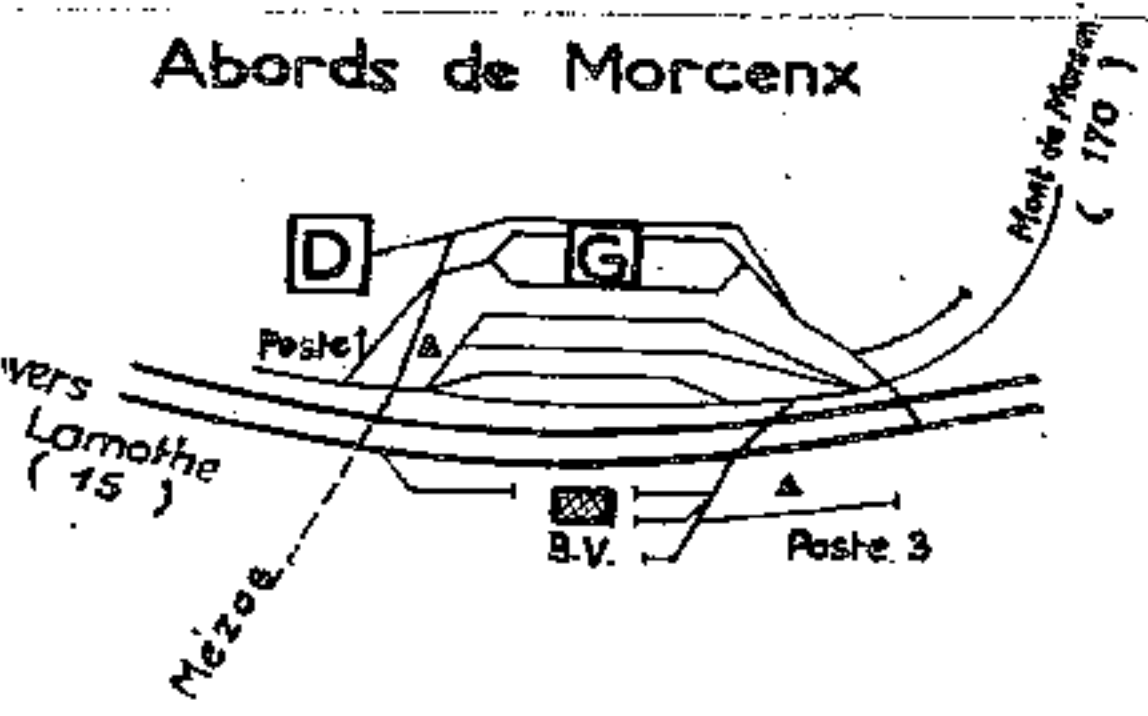

Ligne de Bordeaux-St-Jean à Dax

Section de Morcenx à Dax

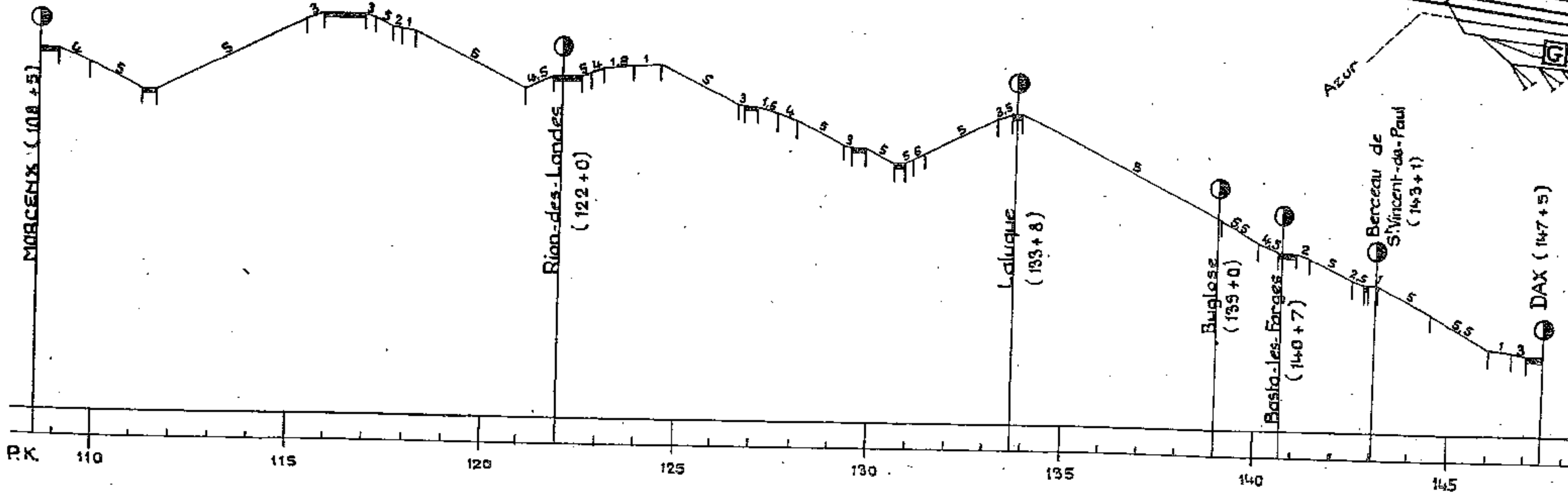
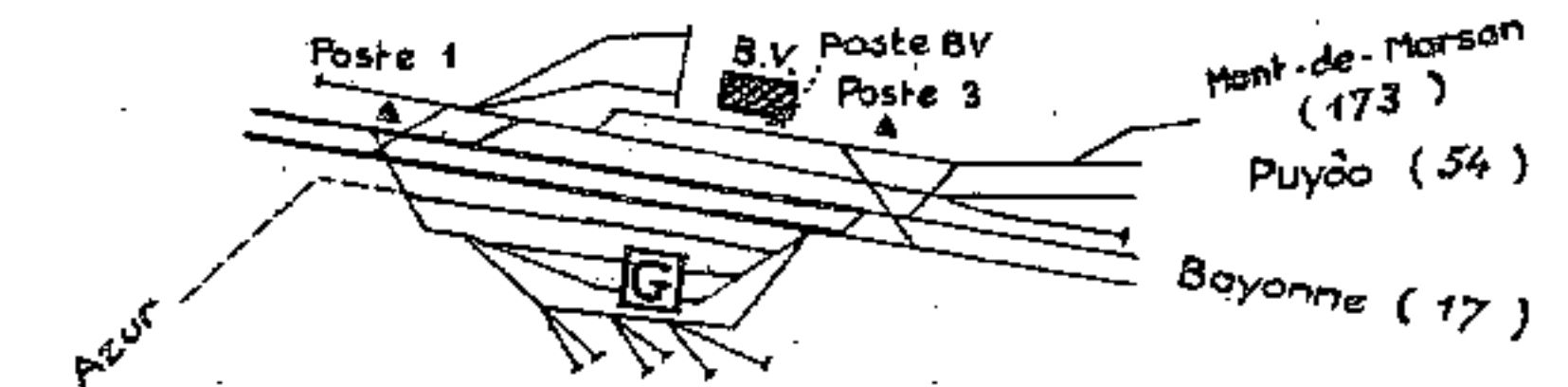

Abords de Dax

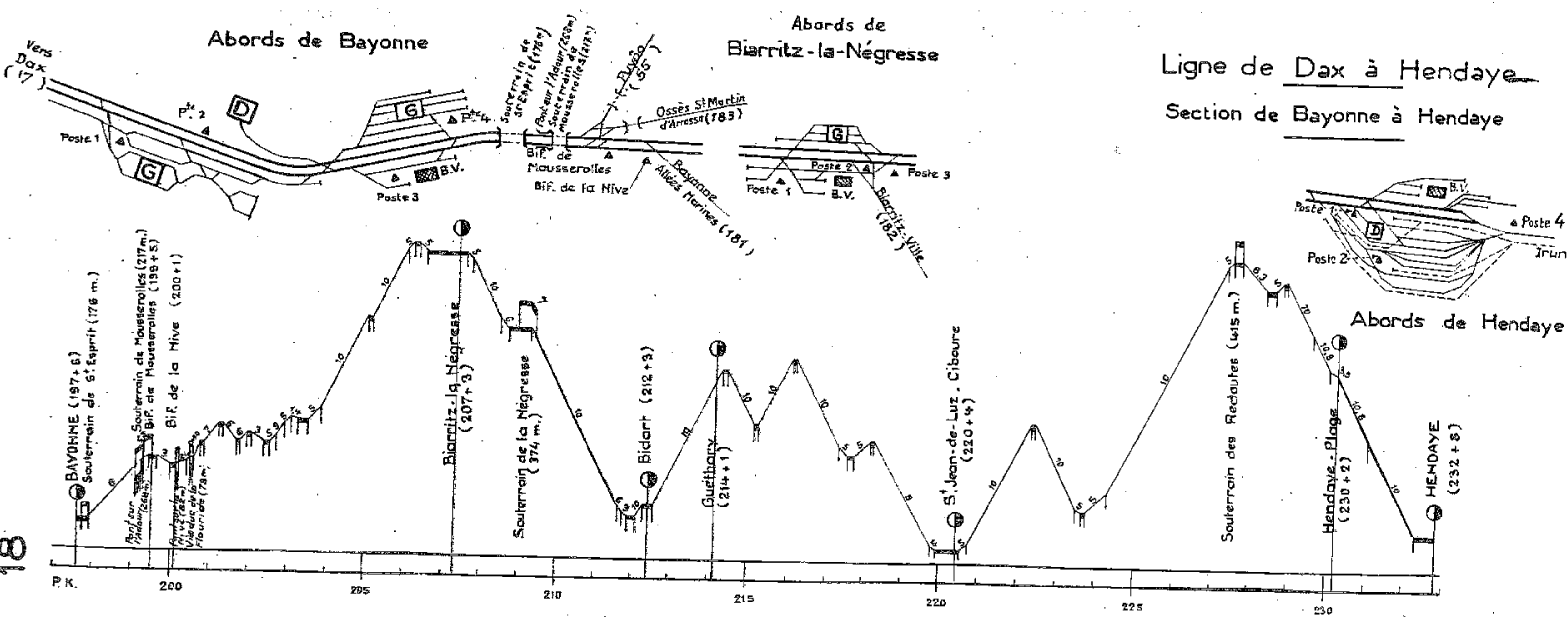
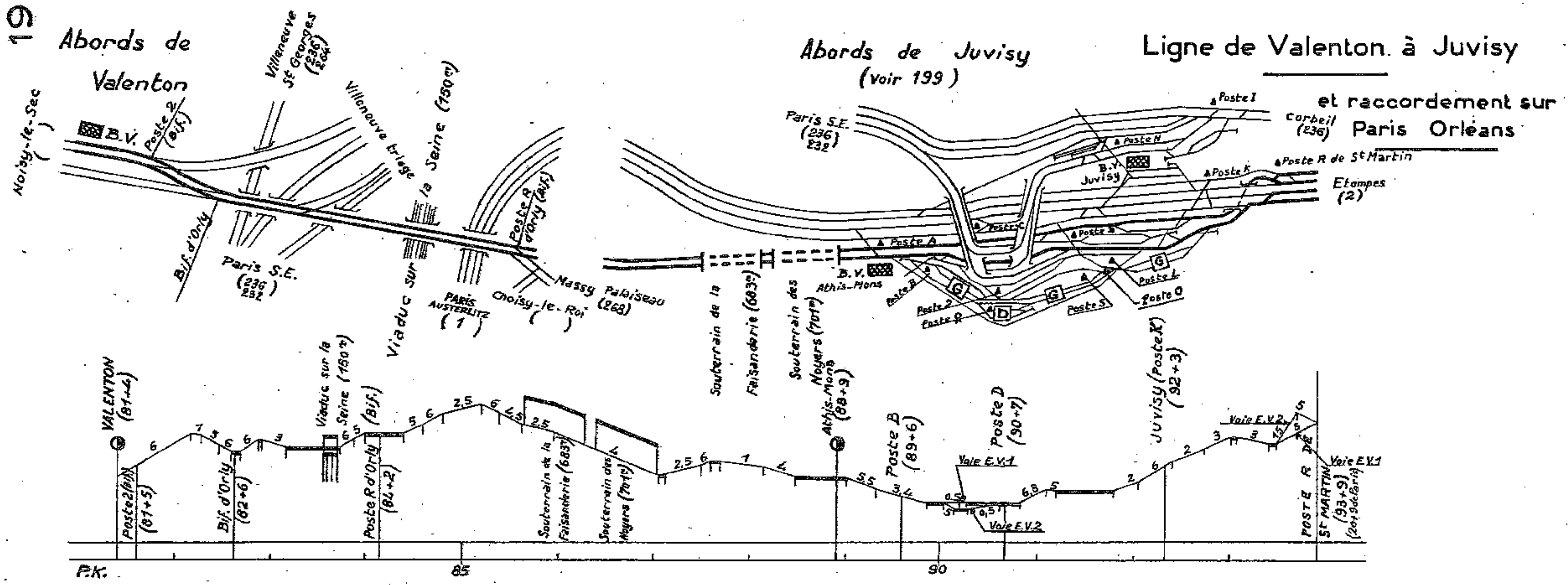

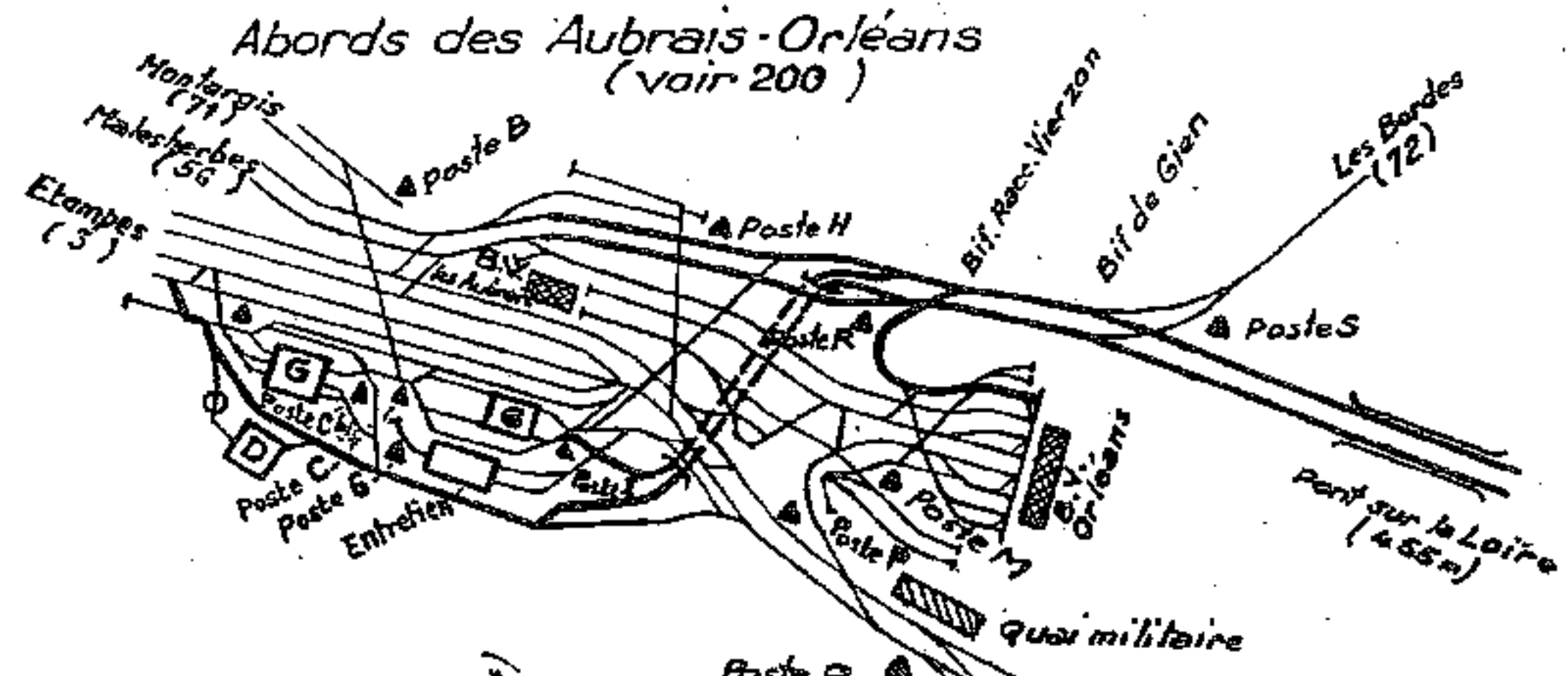

Ligne des Aubrais-Orléans à Vierzon

Section des Aubrais Orléans à Lamotte Beuvron

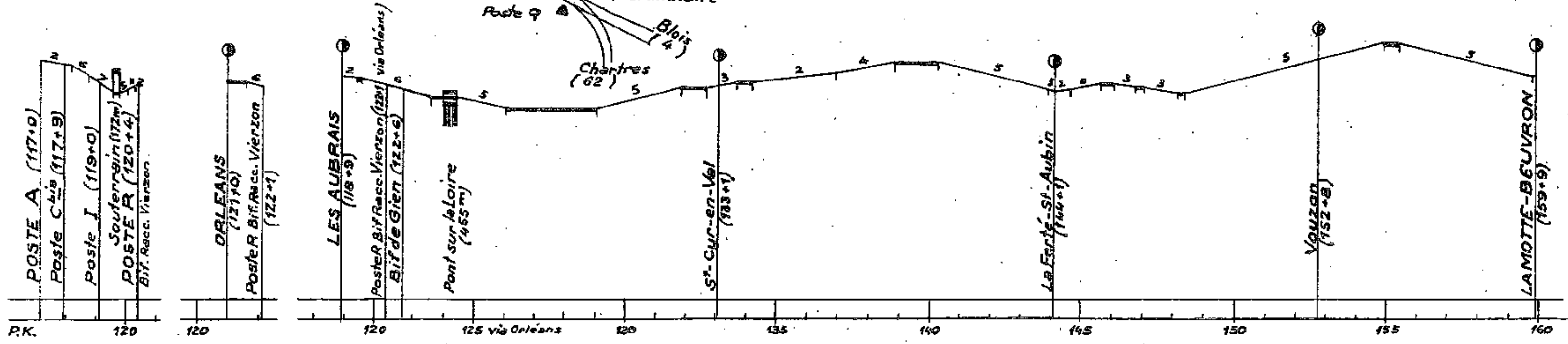

Ligne de Choisy-le-roi à Orly

Abords de Choisy-le-Roi

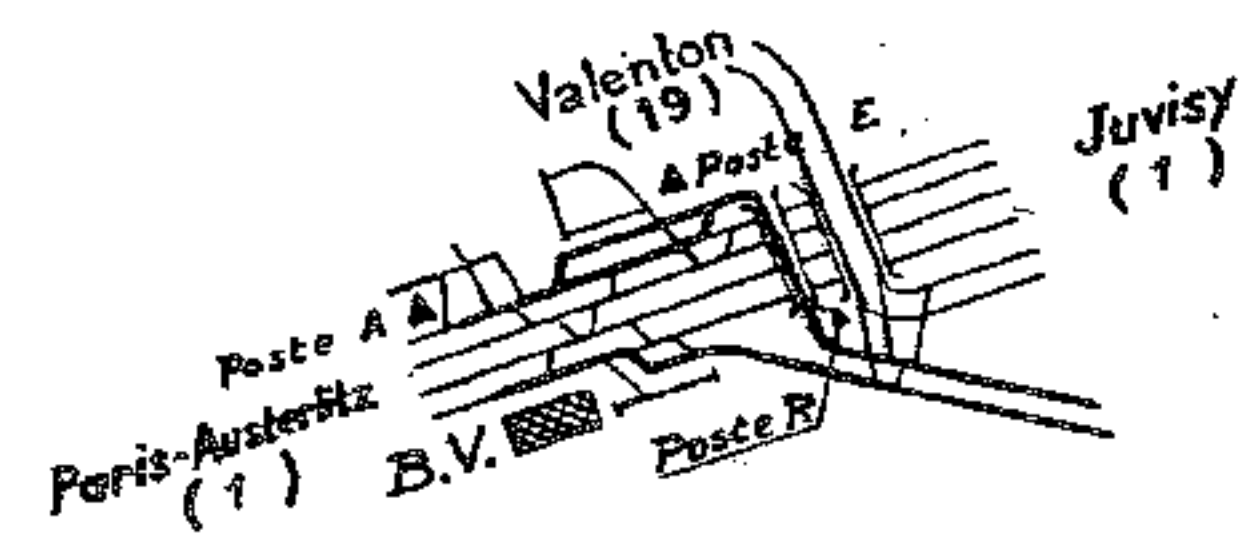

Abords d'Orly

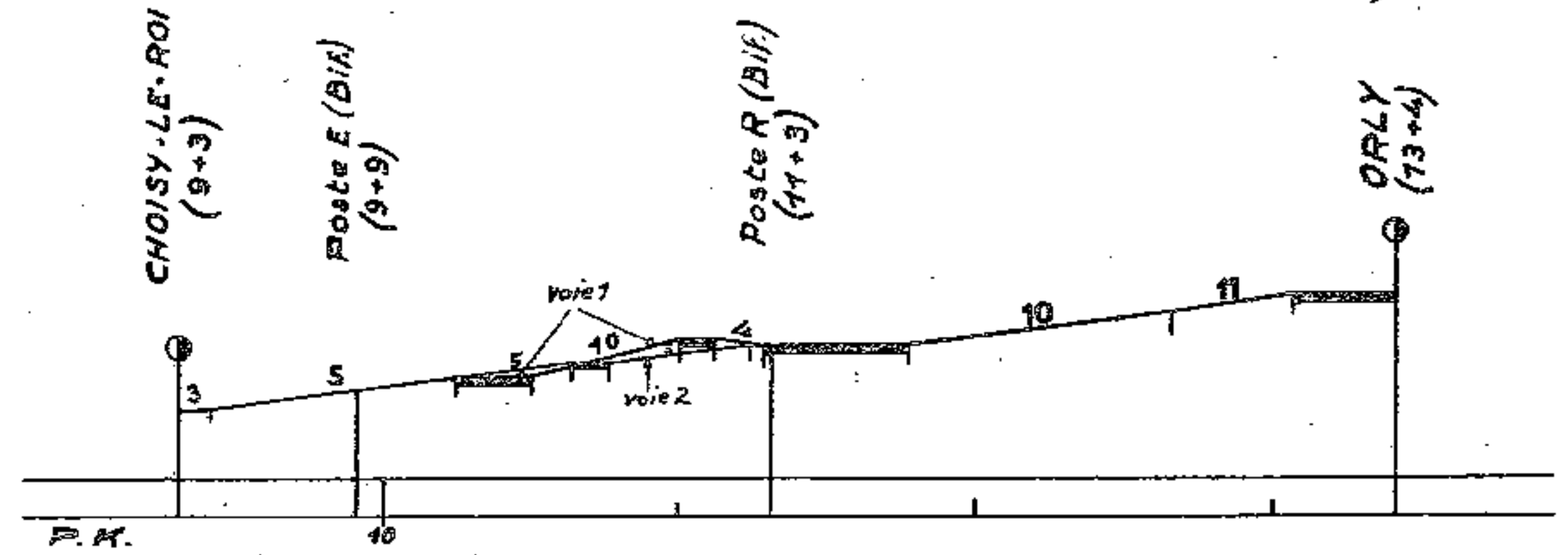
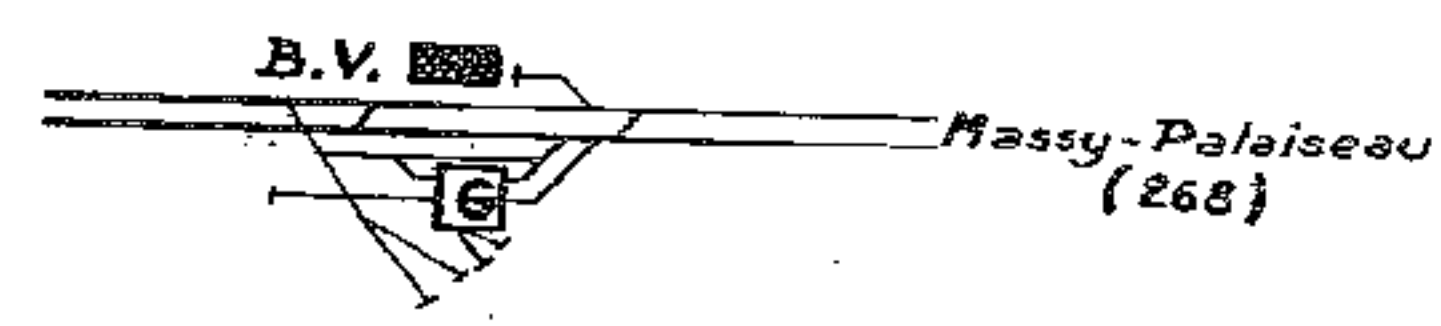

Ligne de Vierzon à Châteauroux

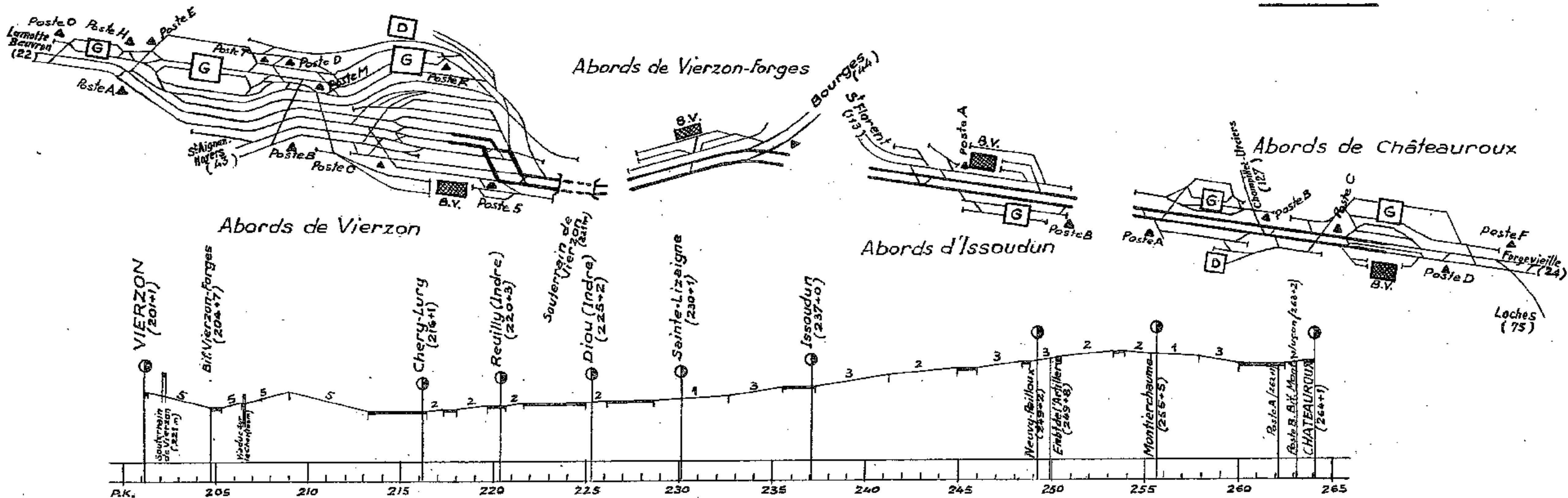

Ligne d'Orléans à Vierzon

Section de Lamotte-Beuvron à Vierzon

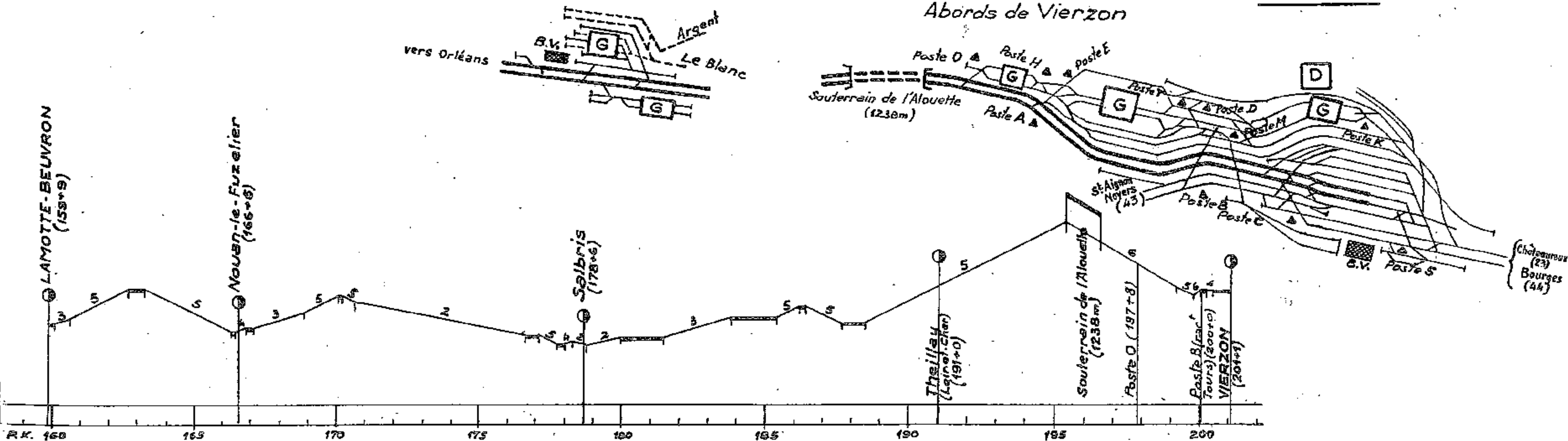

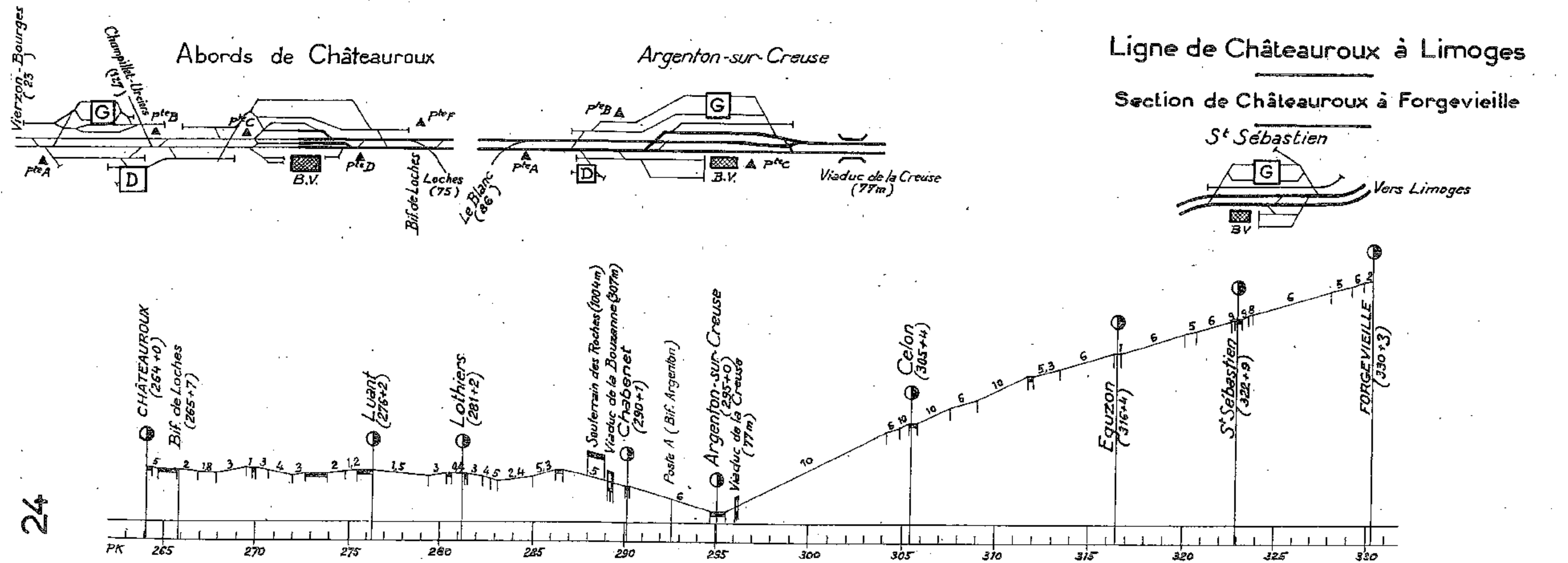
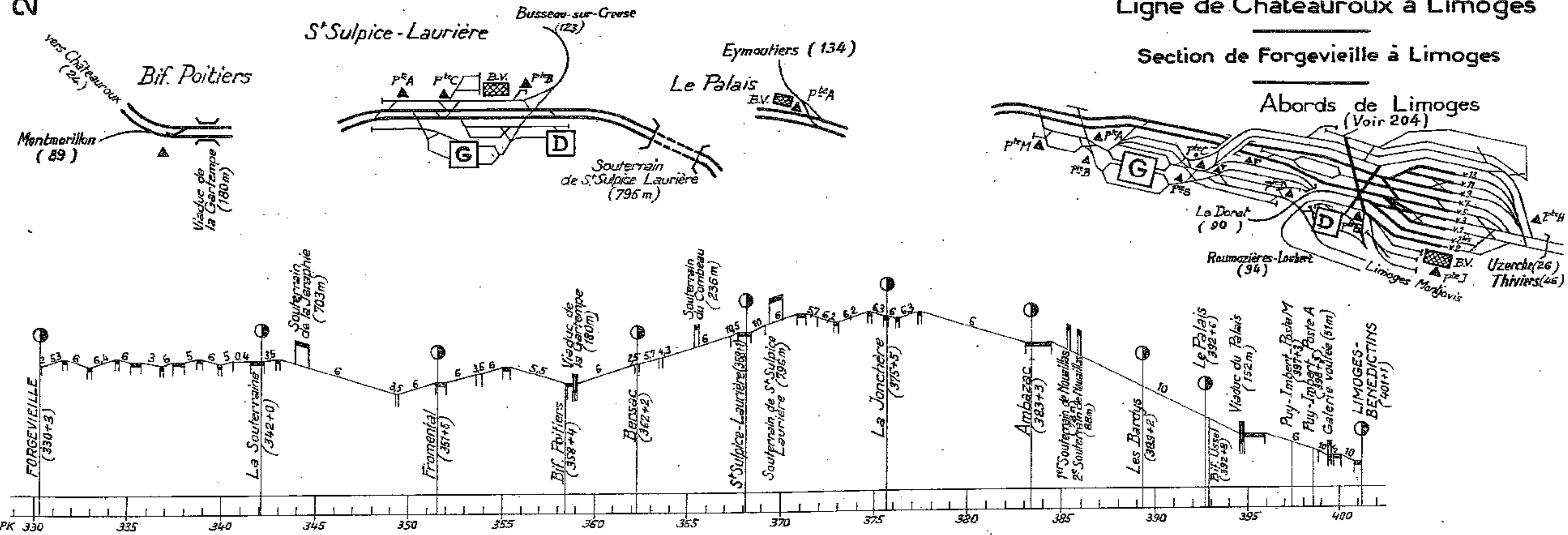

27 Abords d'Uzerche

Ligne de Limoges à Brive

Section d'Uzerche à Brive

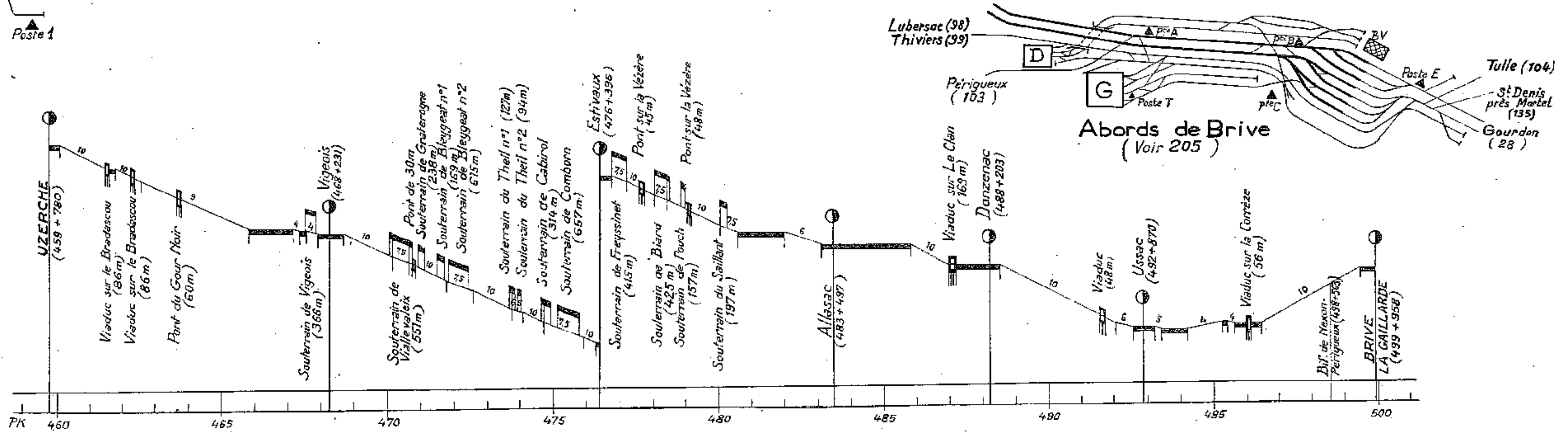
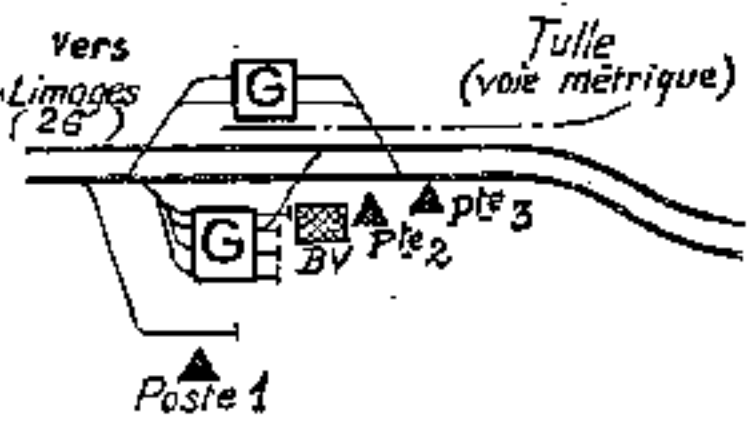

Abords de Brive
(Voir 205)

Abords de Limoges (voir 204)

Ligne de Limoges à Brive

Section de Limoges à Uzerche

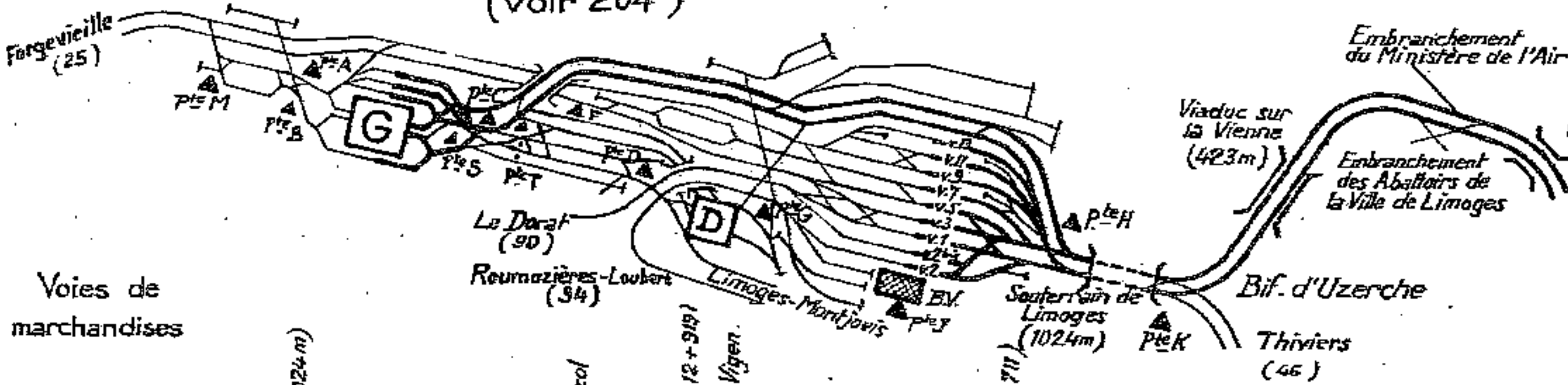

Voies de marchandises

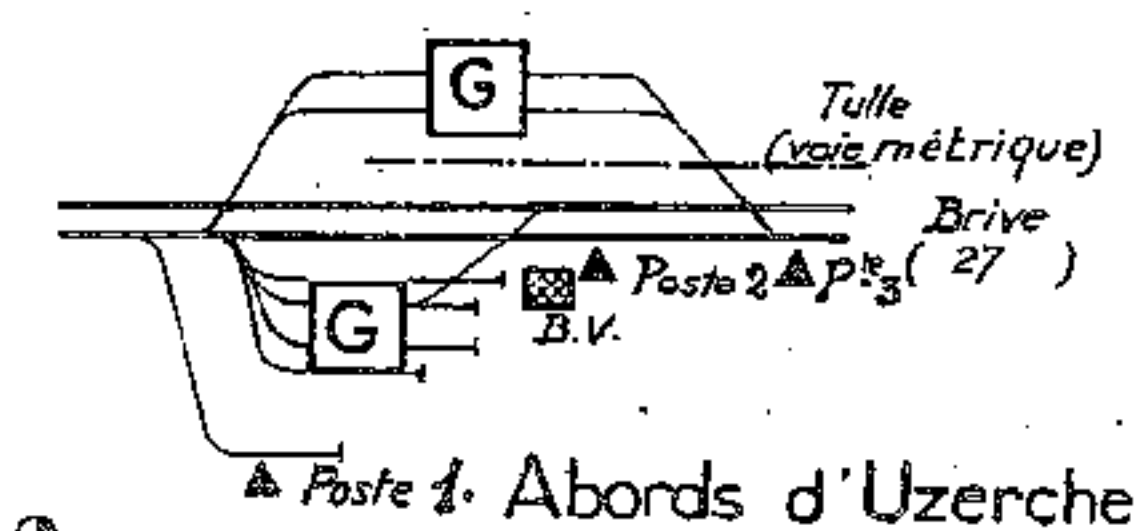
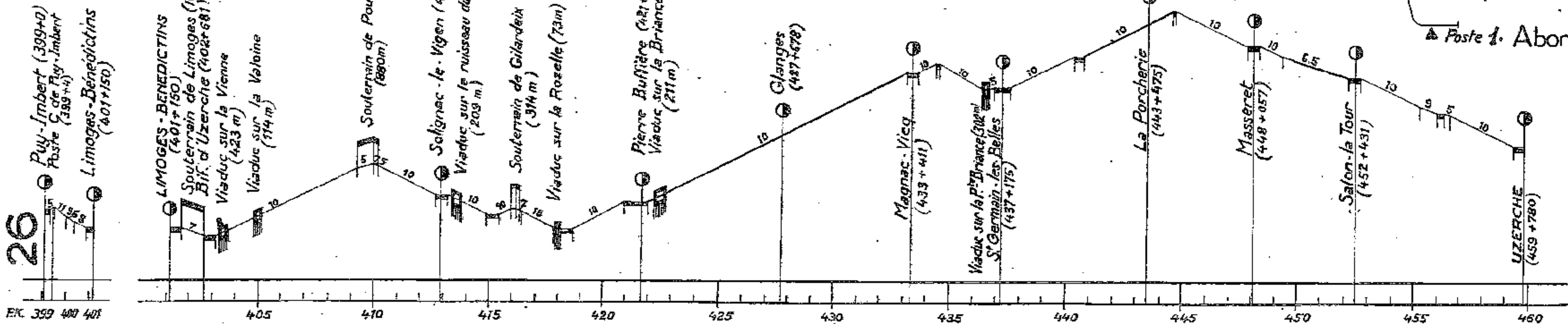

Poste 1. Abords d'Uzerche

Abords de Gourdon

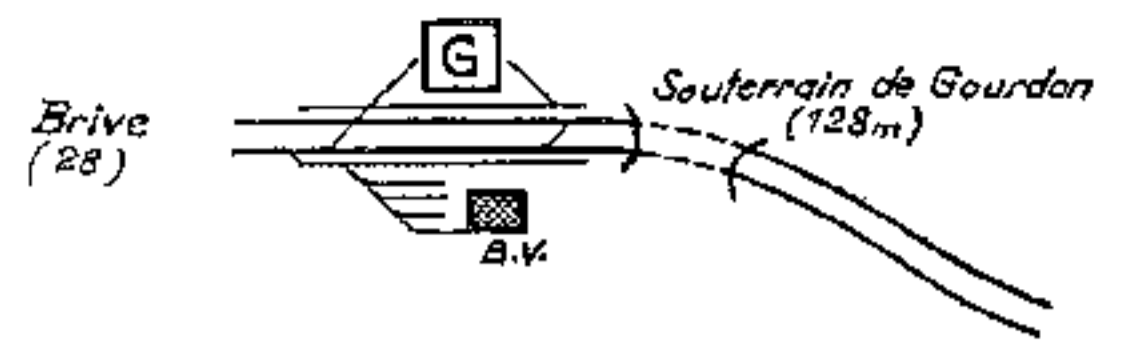

Ligne de Brive à Montauban

Section de Gourdon à Cahors

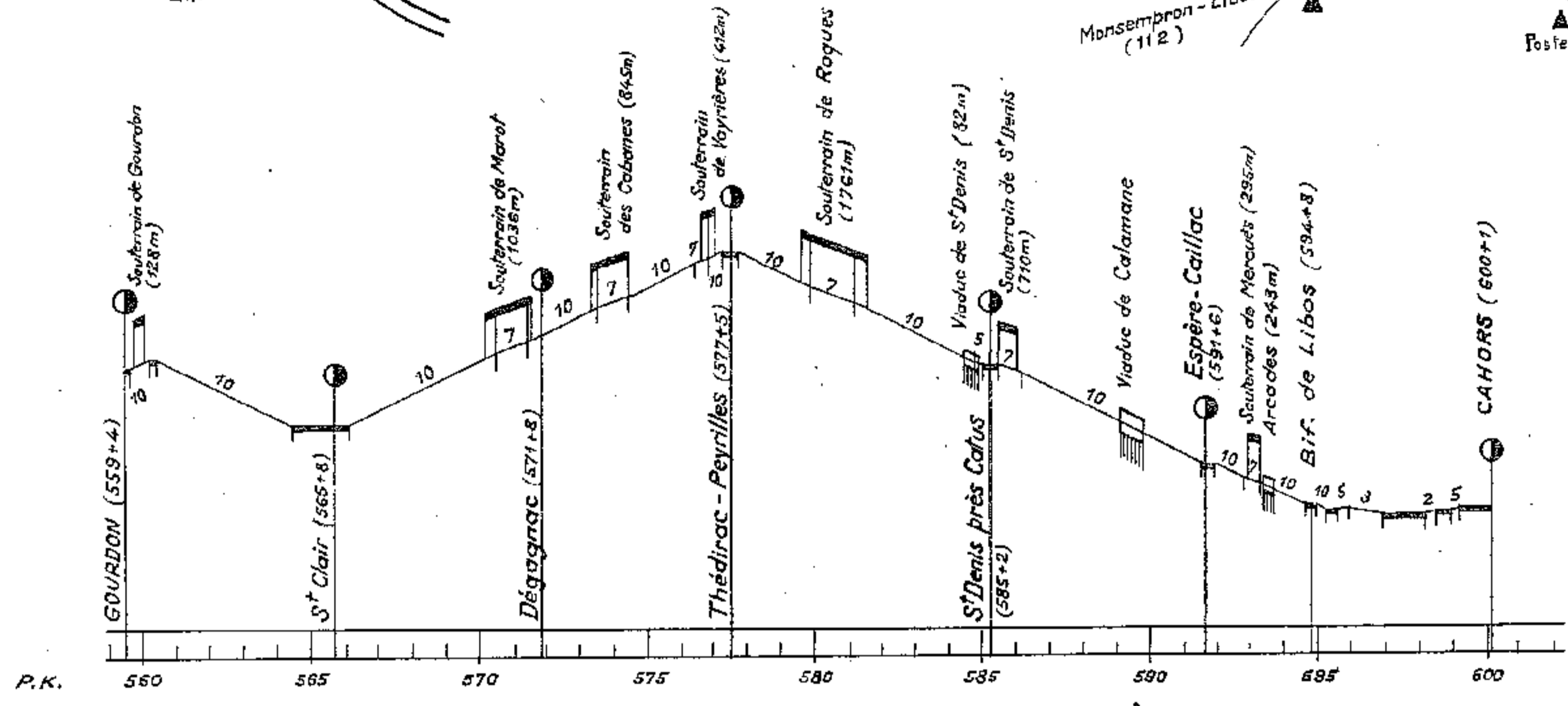

Bif. de Libos

Monsempron - Libos (112)

Poste 1

Viaduc sur le Lot (213m)

Copéjac (148)

Vers Montauban (30)

Abords de Cahors

Abords de Brive (voir 205)

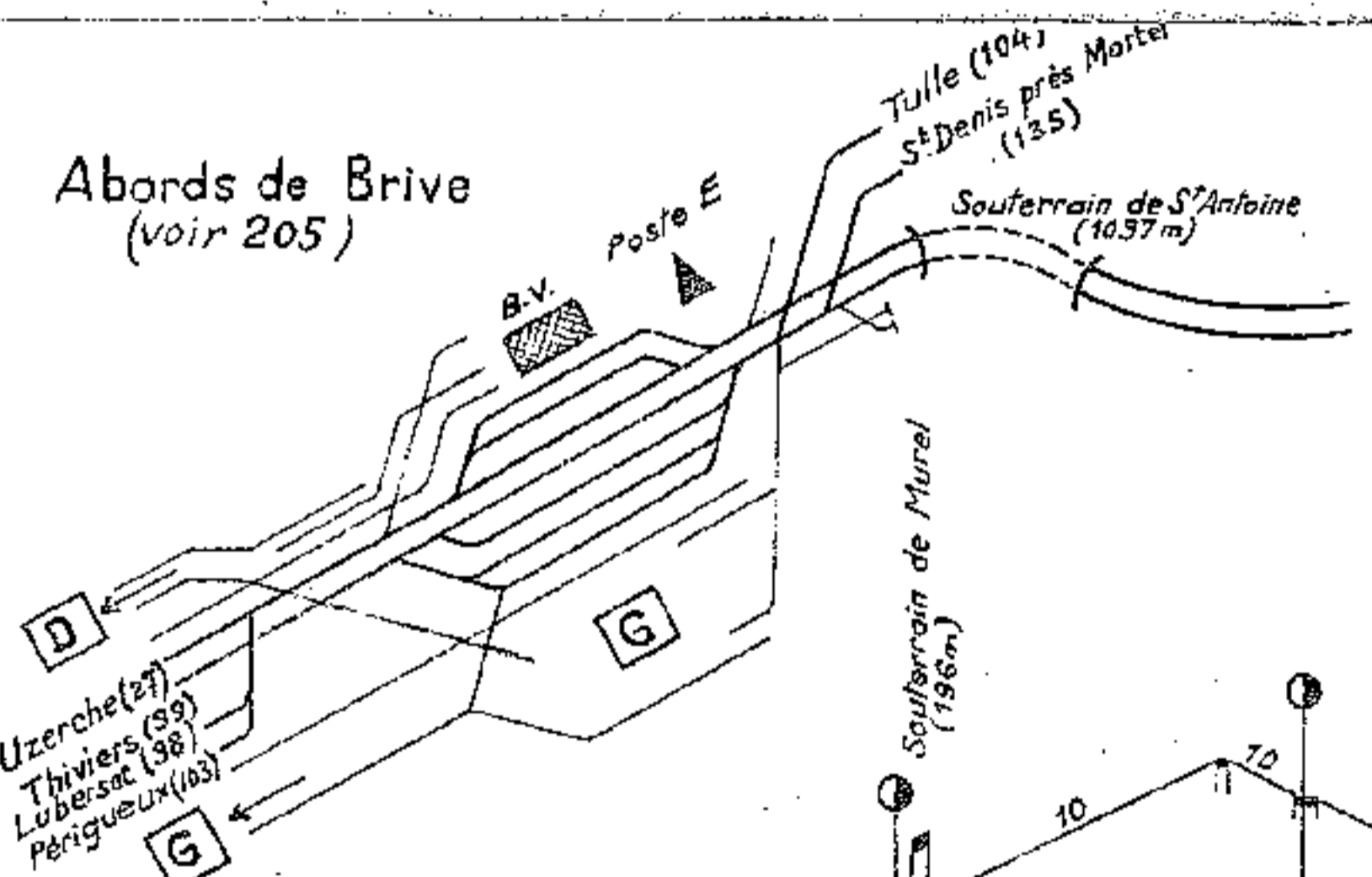

Abords de Souillac

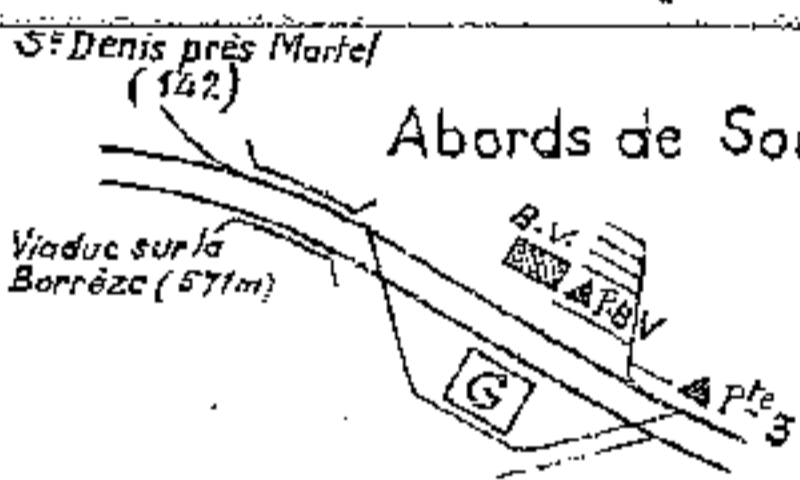

Ligne de Brive à Montauban

Section de Brive à Gourdon

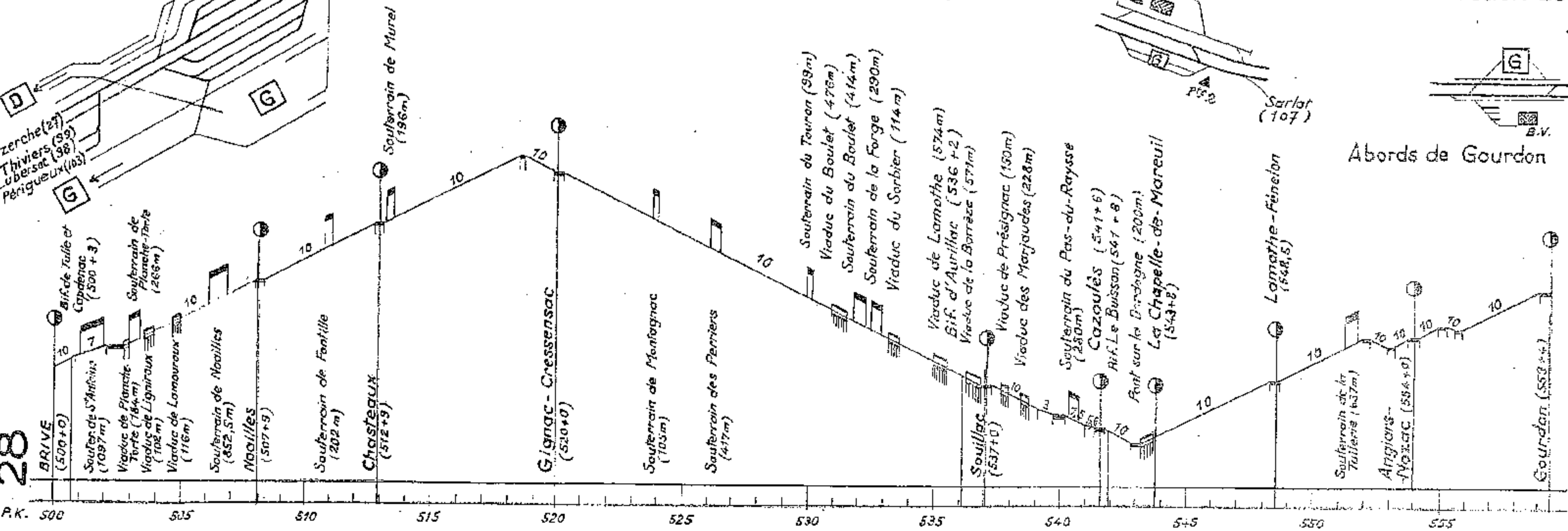

Abords de Cazoulès

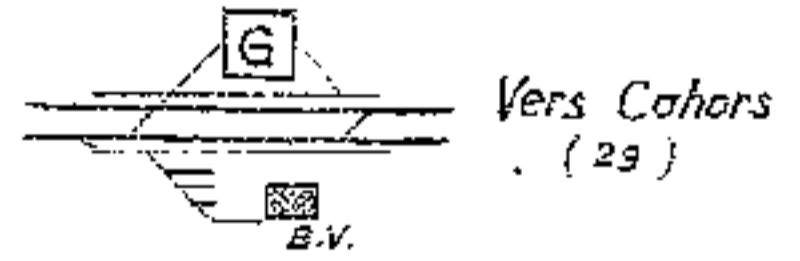
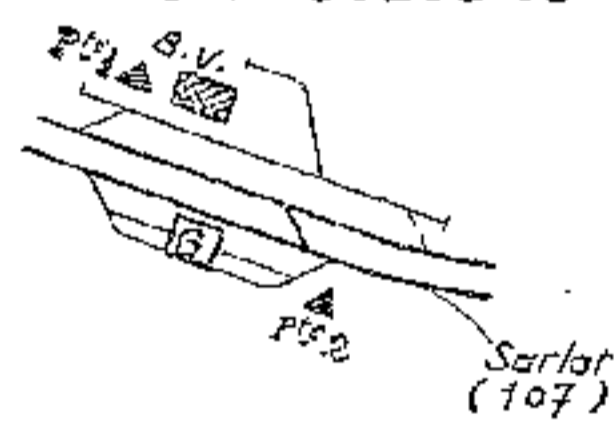

Abords de Gourdon

Abords de Bordeaux-S^t Jean voir (203)

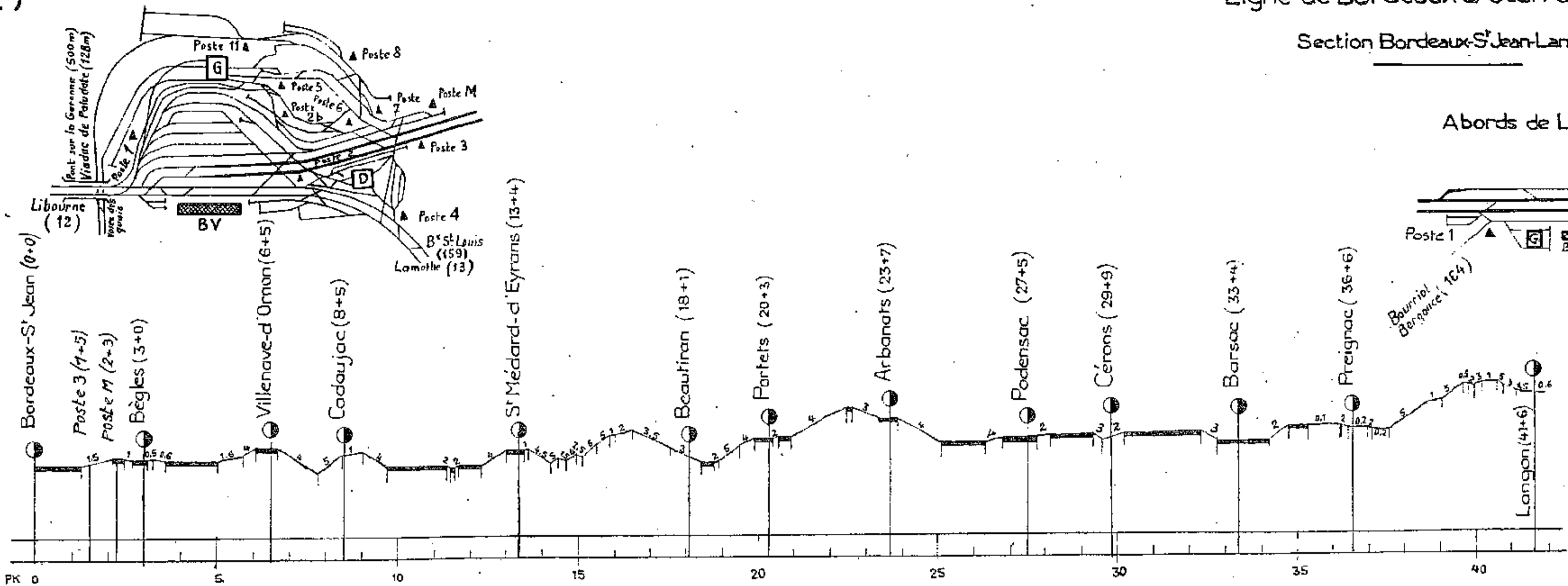

Ligne de Bordeaux-S^t Jean à Agen

Section Bordeaux-S^t Jean-Langon

Abords de Langon

Ligne de Brive à Montauban

Section de Cahors à Montauban

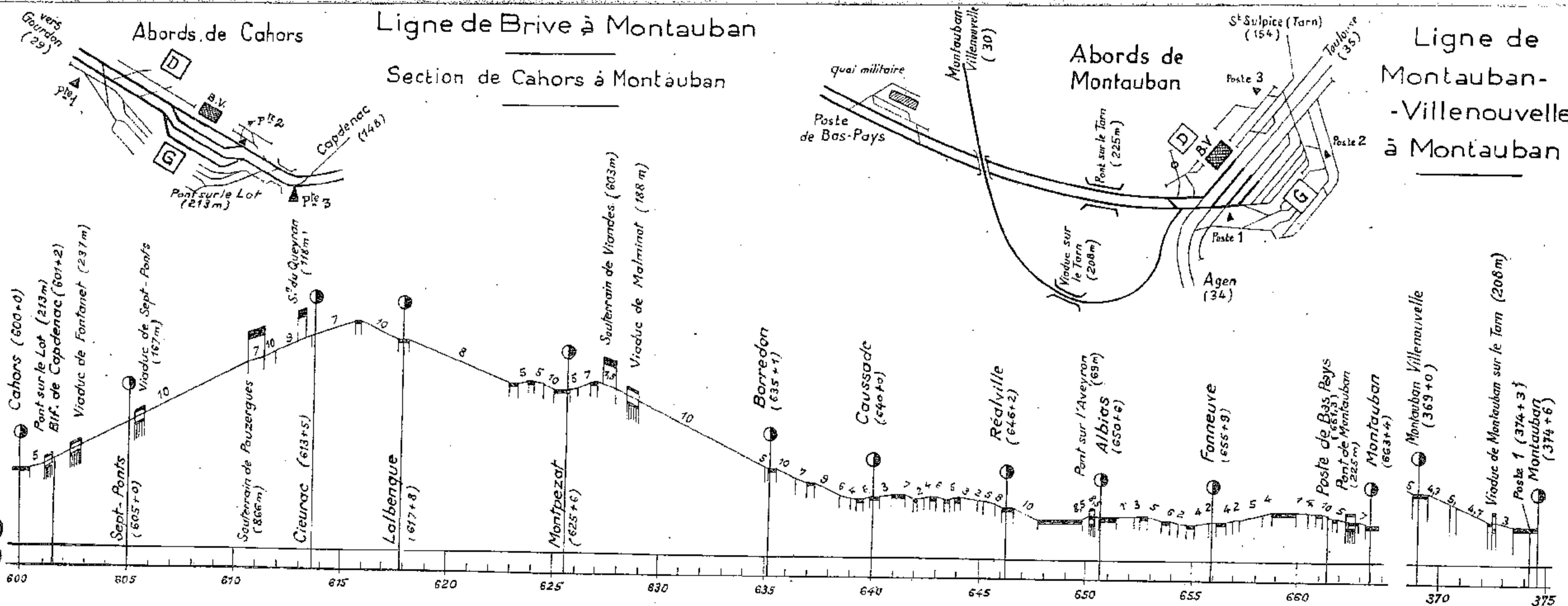

Abords de Montauban

Ligne de Montauban-Villeneuve à Montauban

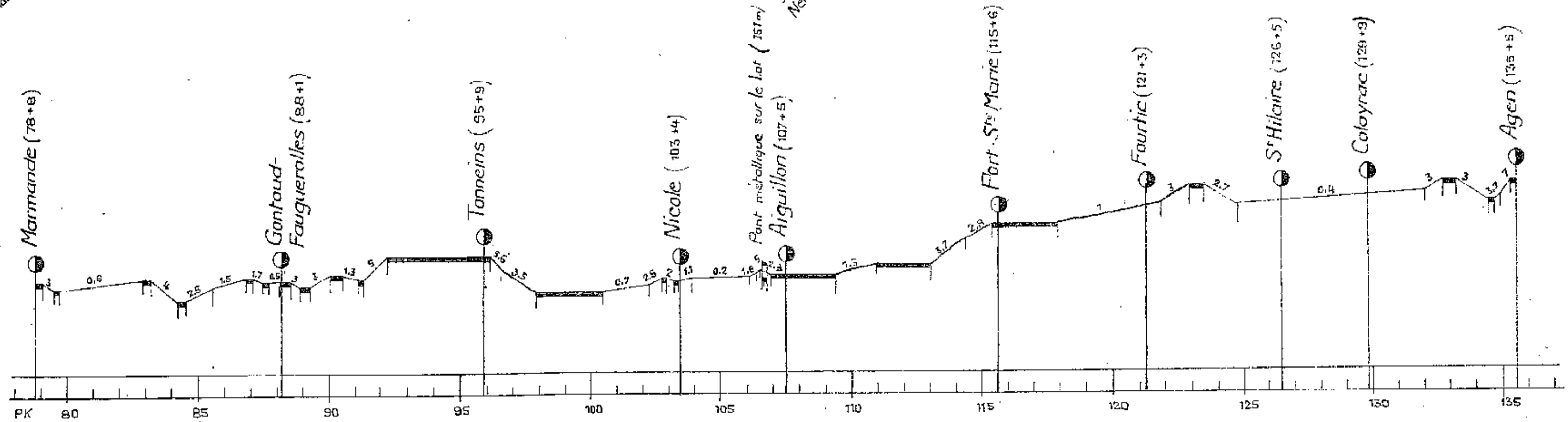
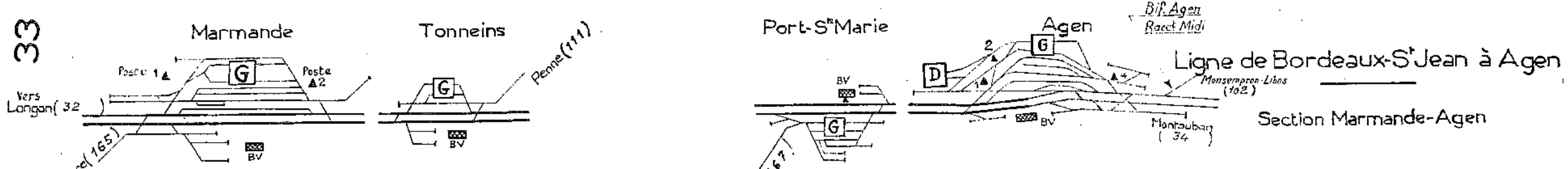

Abords de Langon

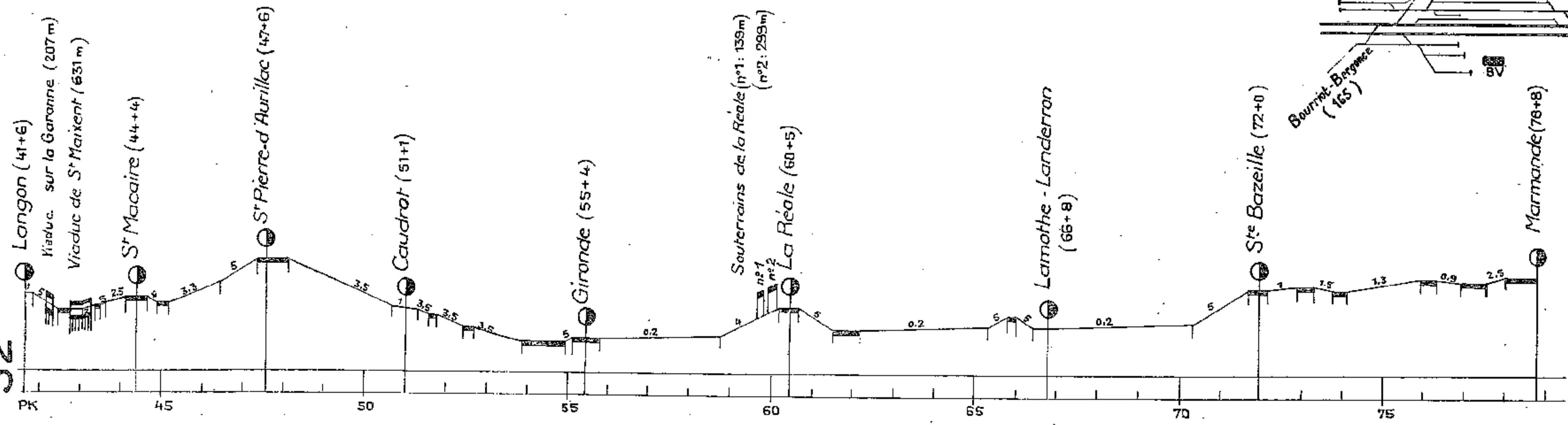
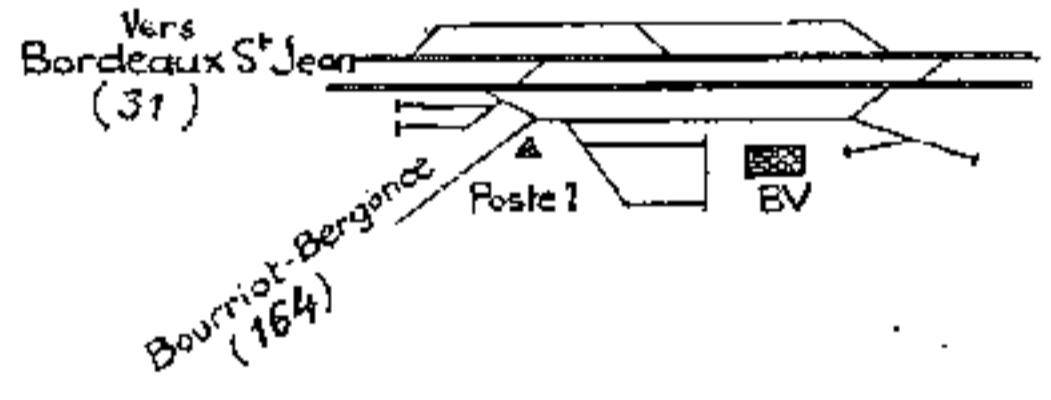

Ligne de Bordeaux-S'Jean à Agen

Section Langon-Marmande

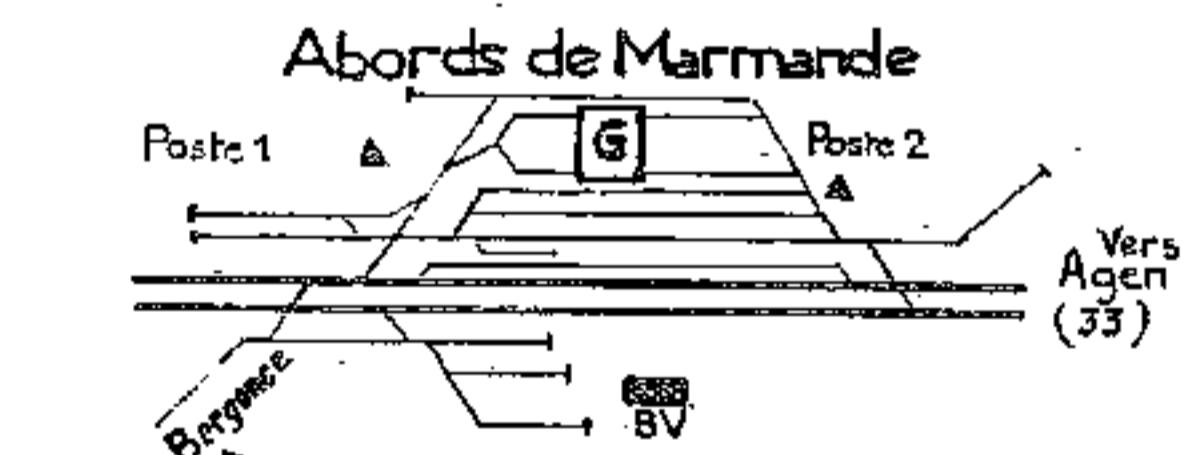

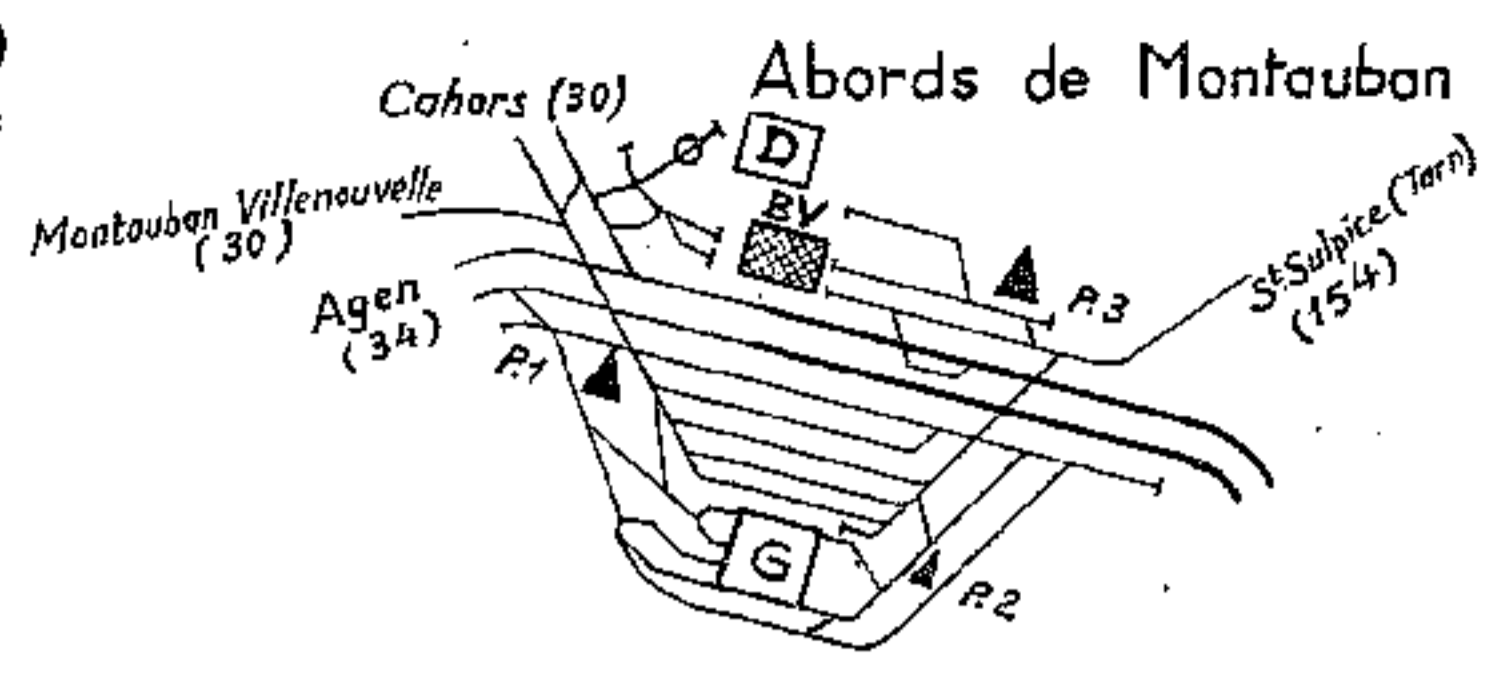

Abords de St Jory - Triage

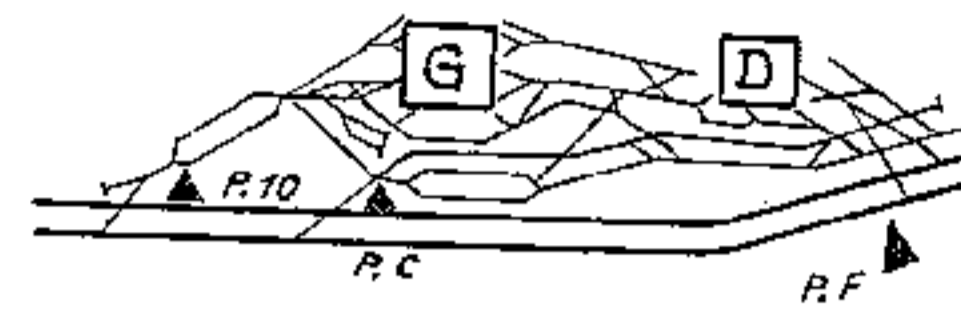

Ligne de Montauban à Narbonne

Section de Montauban à Toulouse

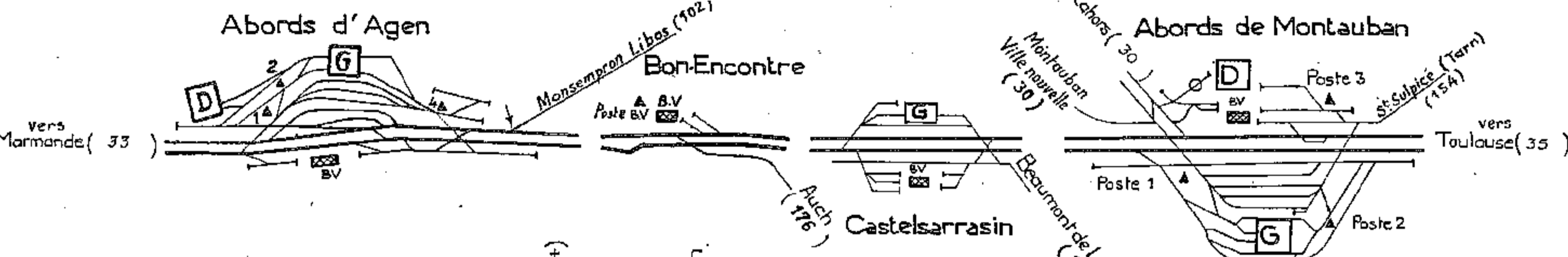
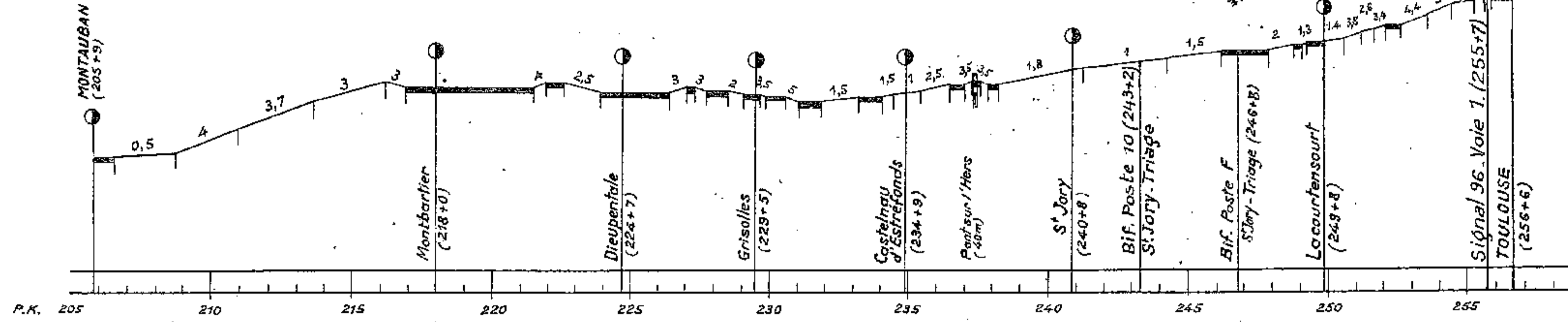
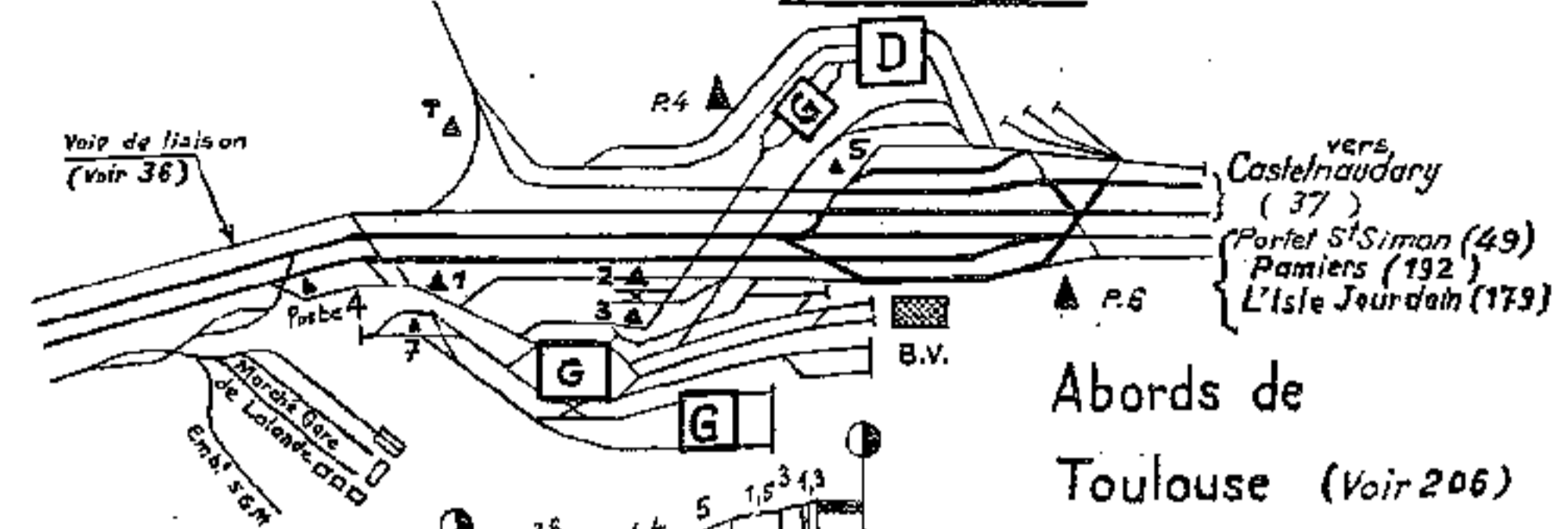

Ligne d'Agen à Montauban

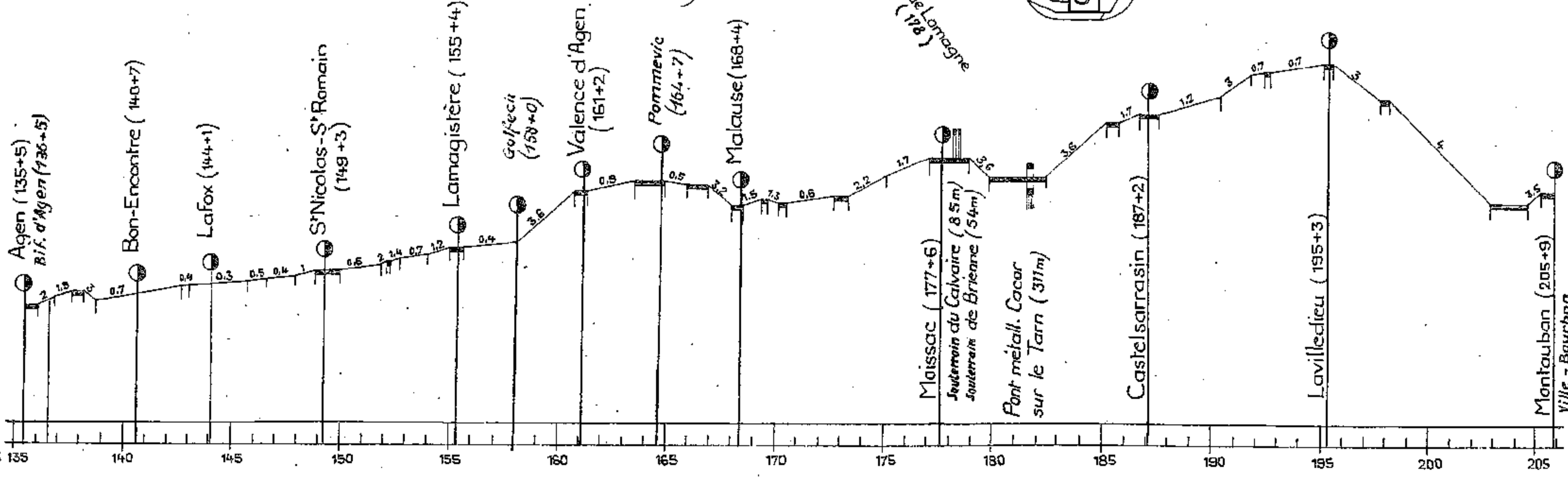

Abords de Toulouse

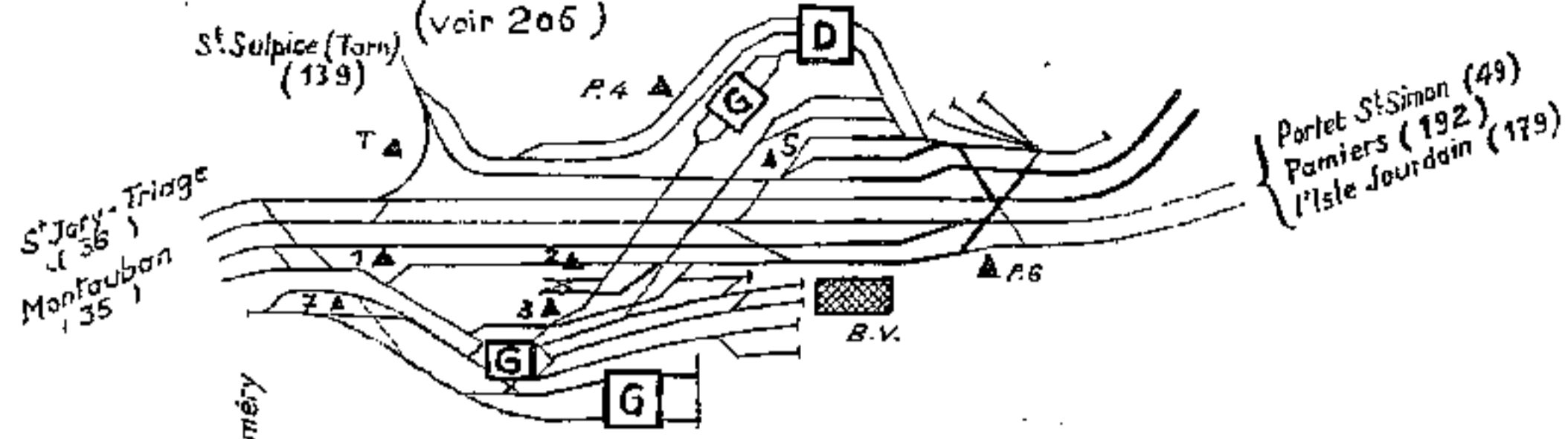

Abords de Castelnaudary

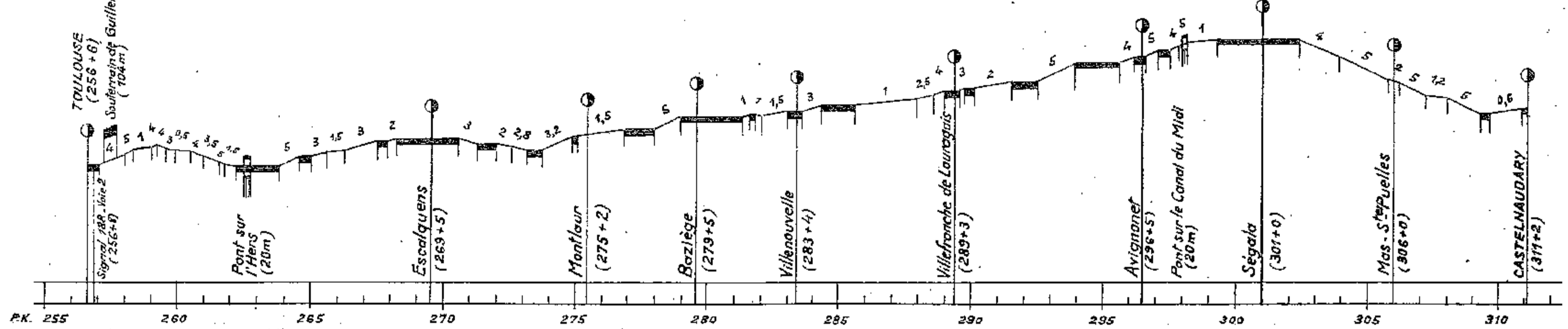
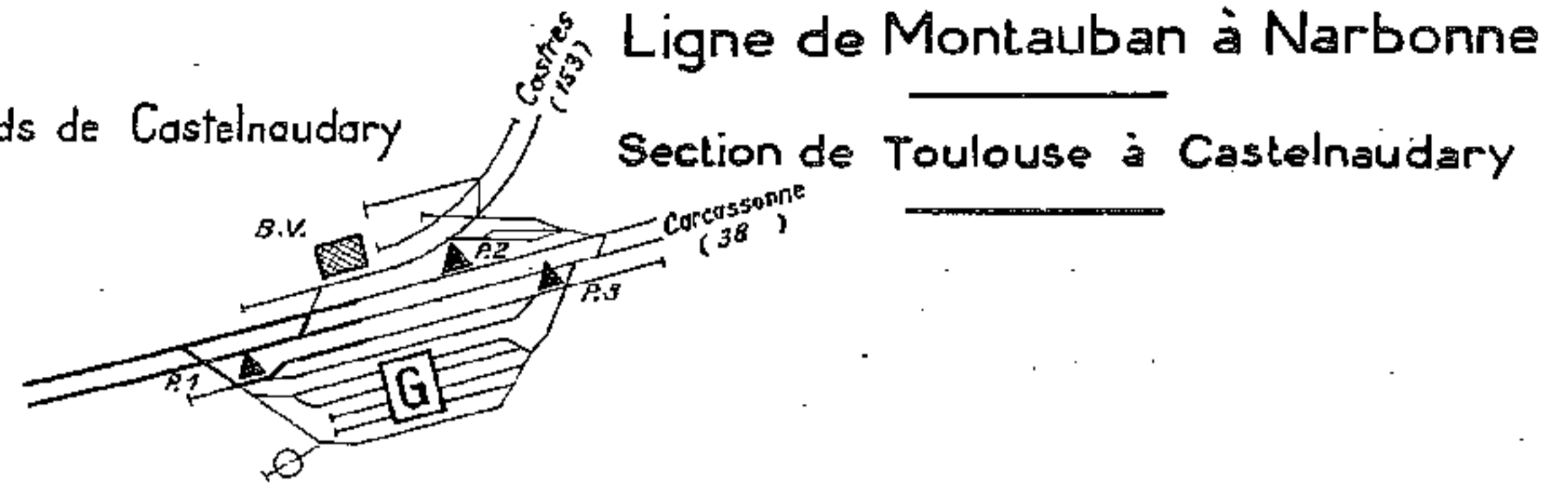

St Jory-Triage

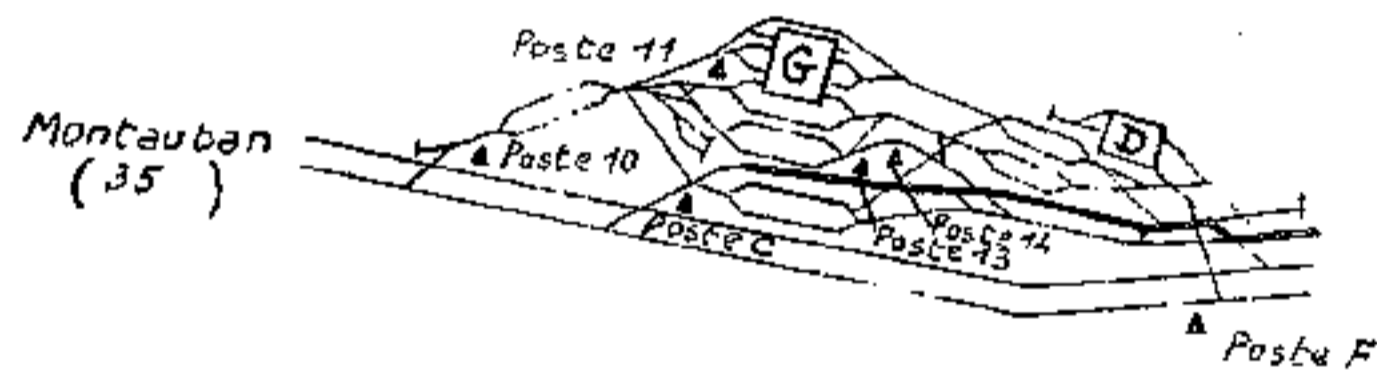

Voie de liaison St Jory-Triage - Toulouse-Matabiau

Abords de Toulouse-Matabiau (voir 206)

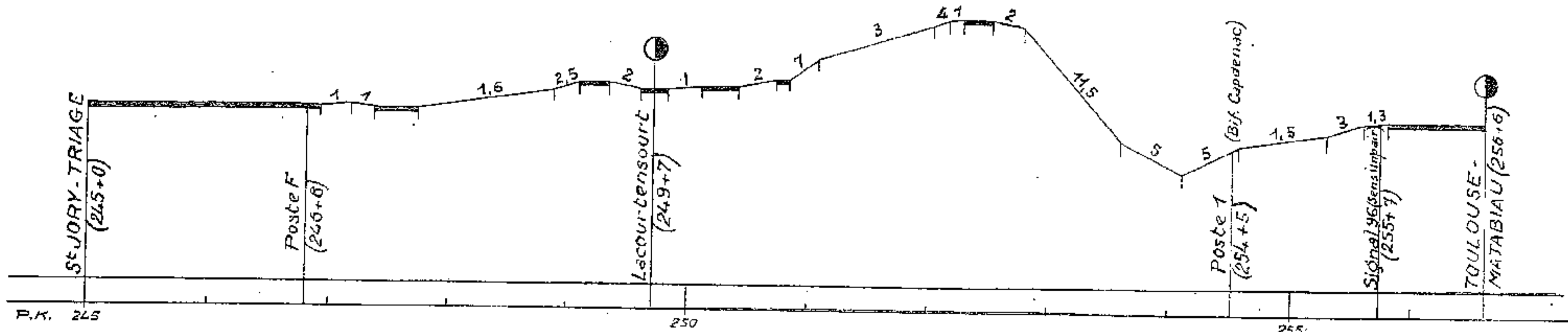
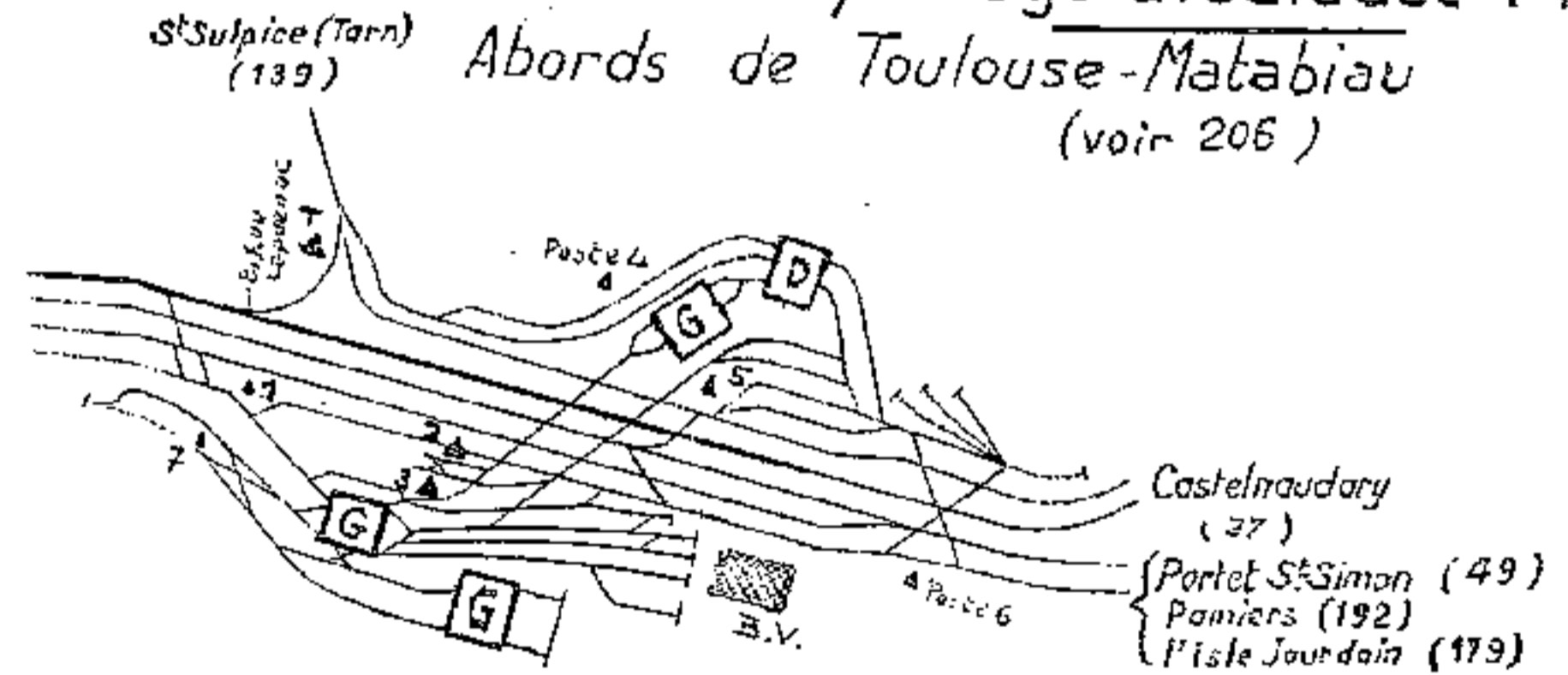

Abords de Carcassonne

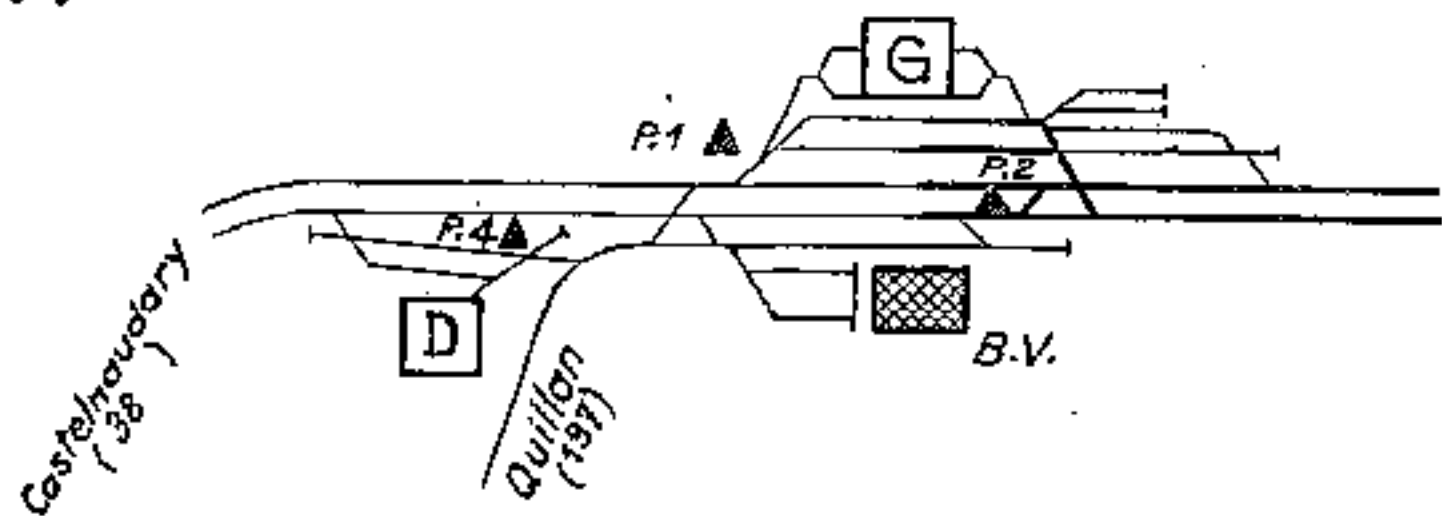

Abords de Moux

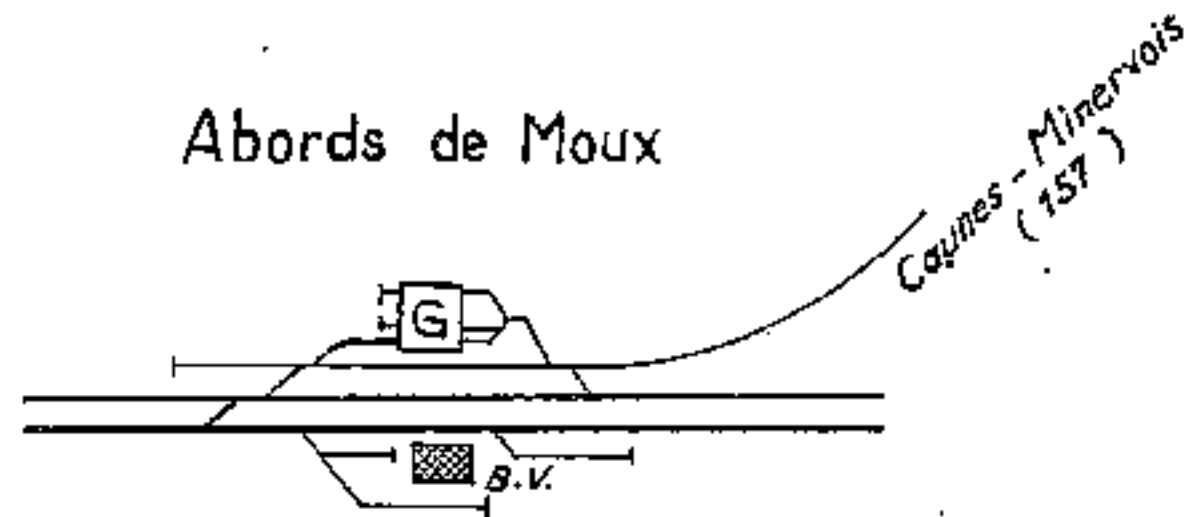

Ligne de Montauban à Narbonne
Section de Carcassonne à Narbonne

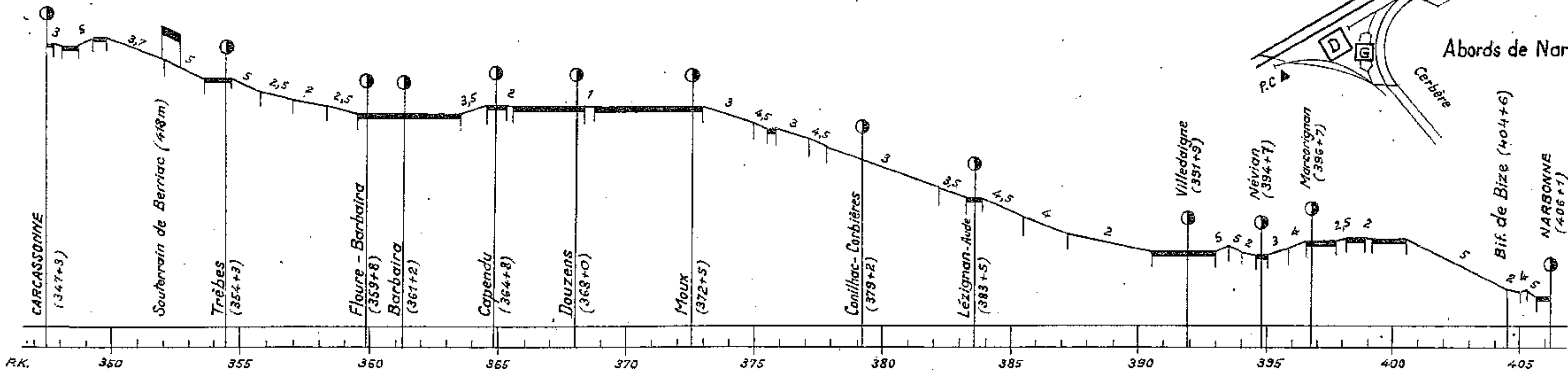
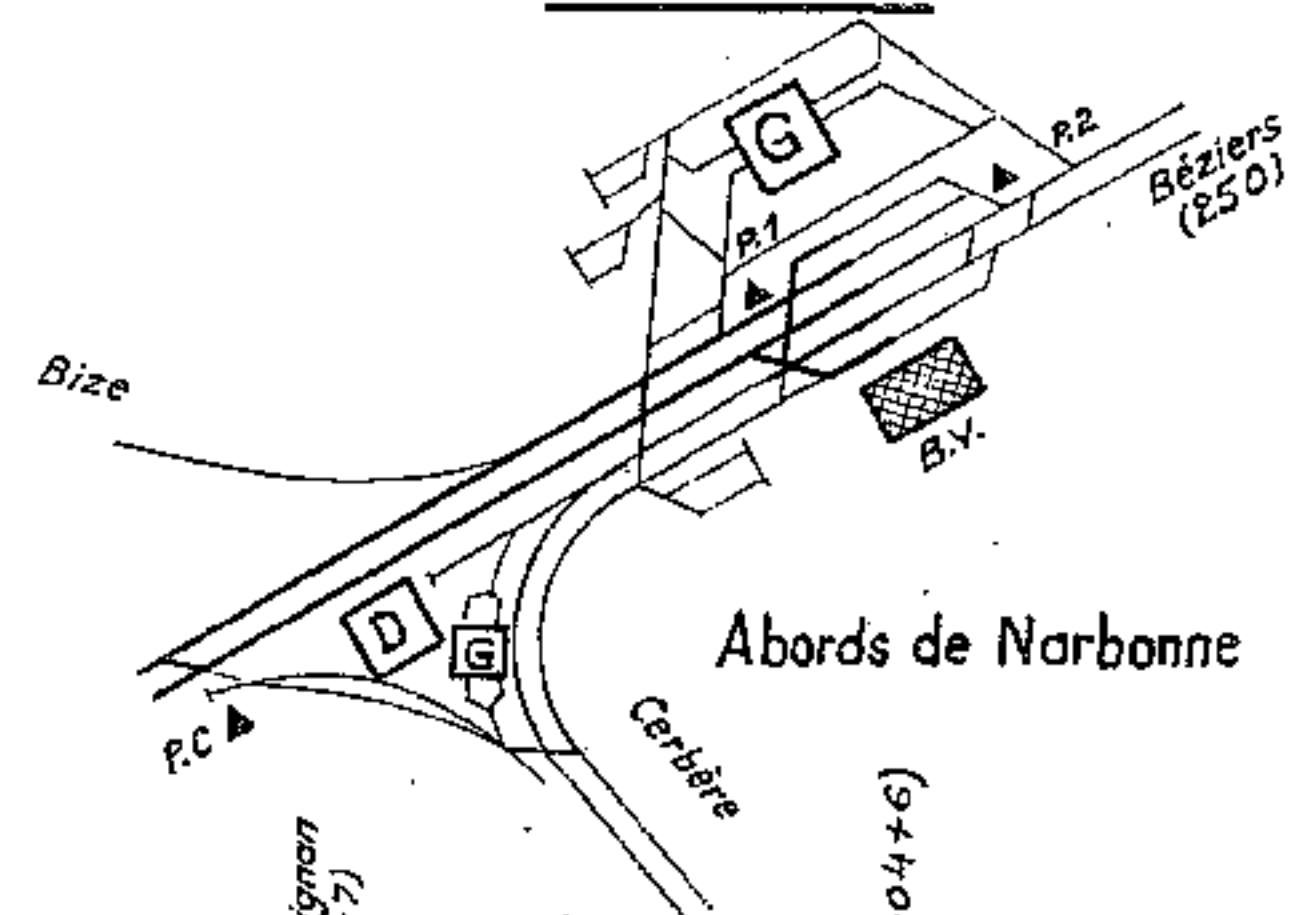

Abords de Castelnaudary

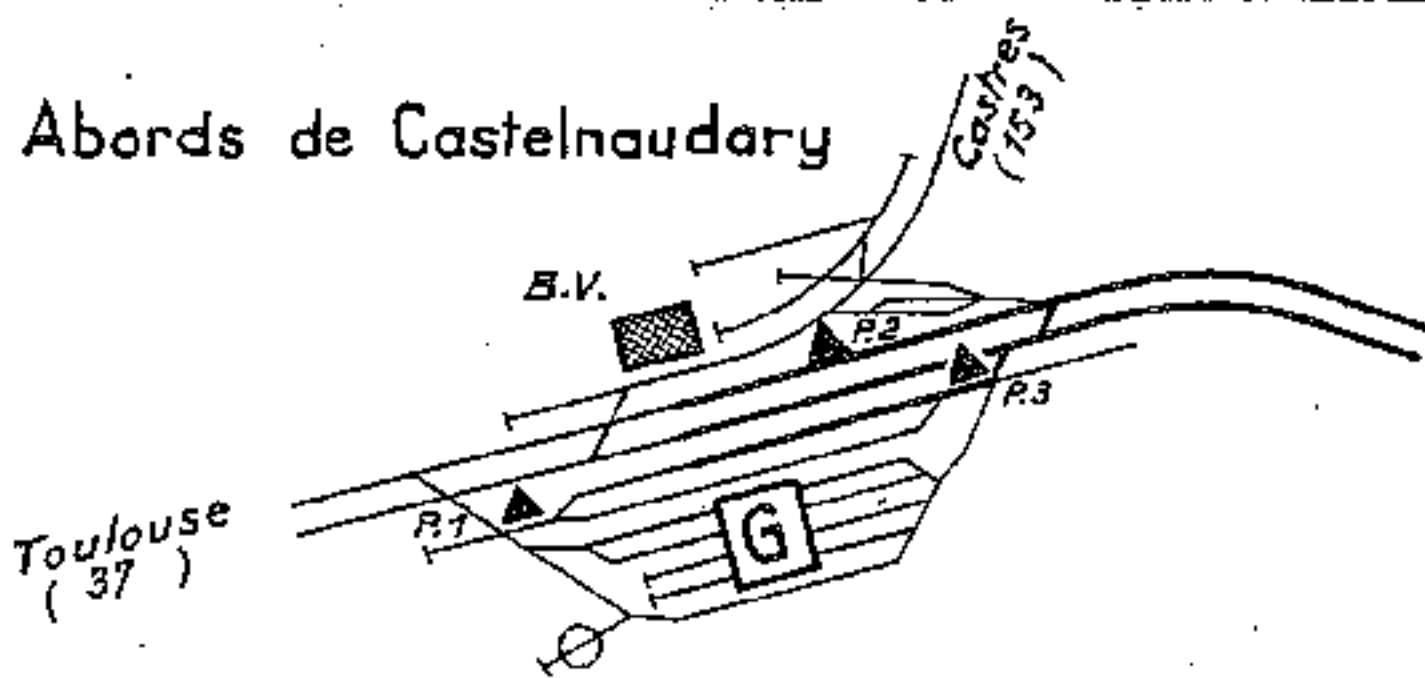

Abords de Bram

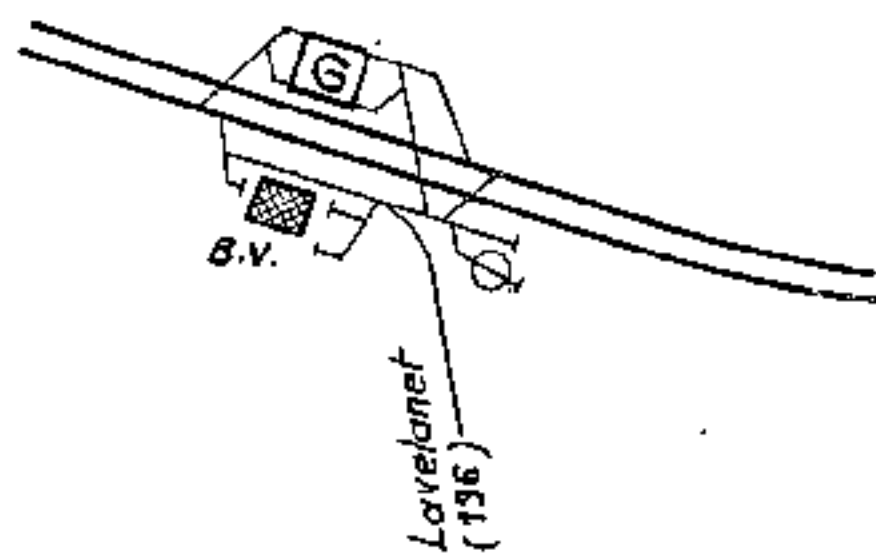

Ligne de Montauban à Narbonne
Section de Castelnaudary à Carcassonne

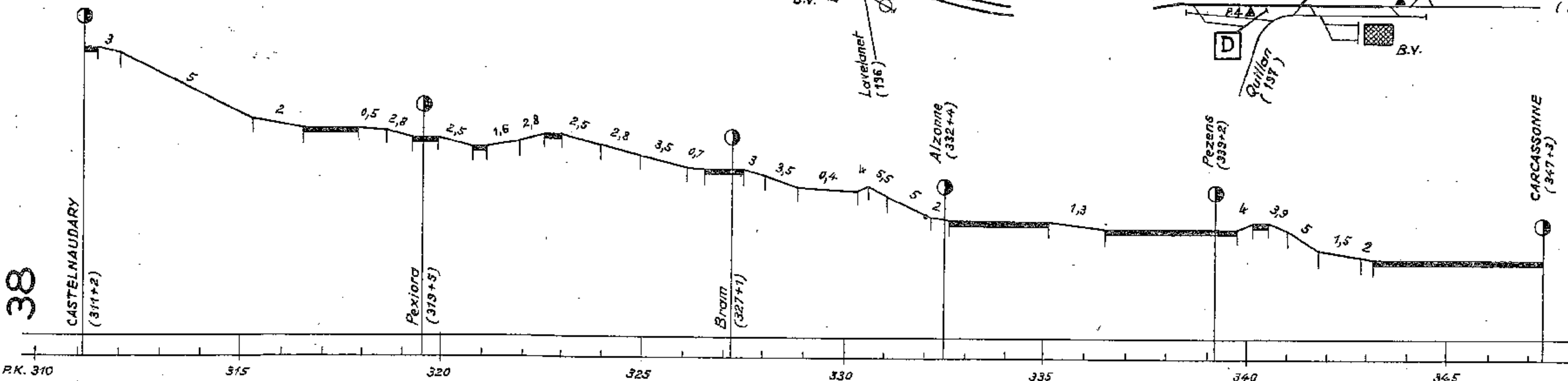
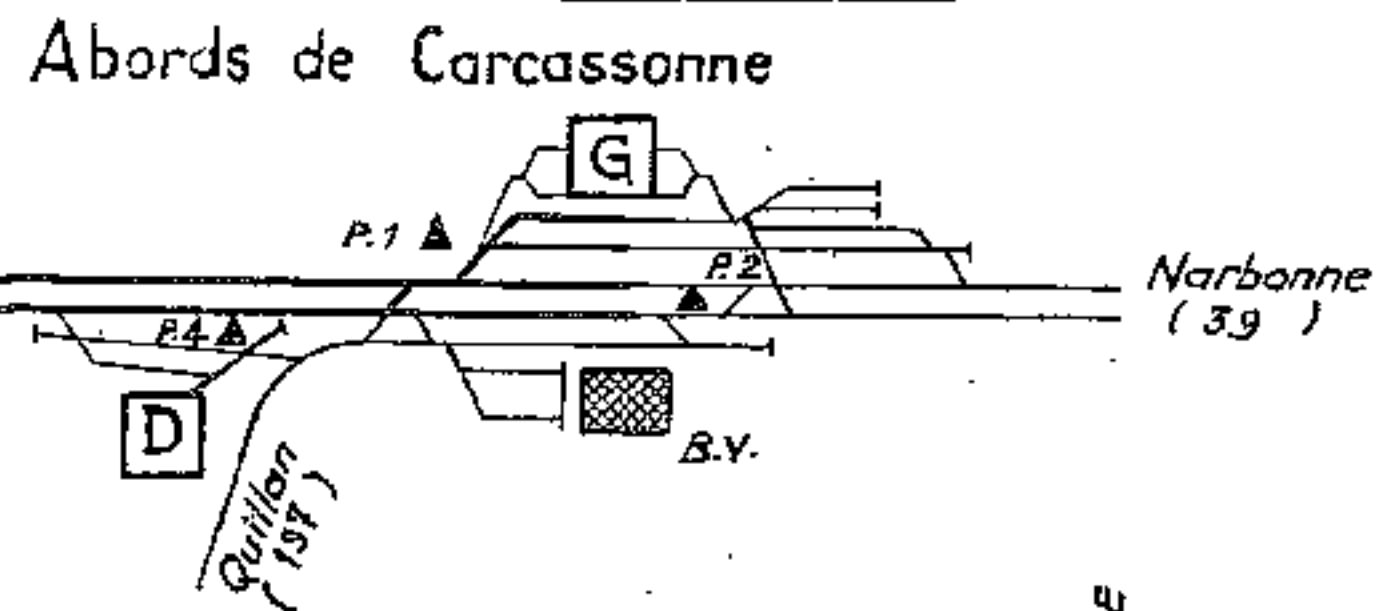

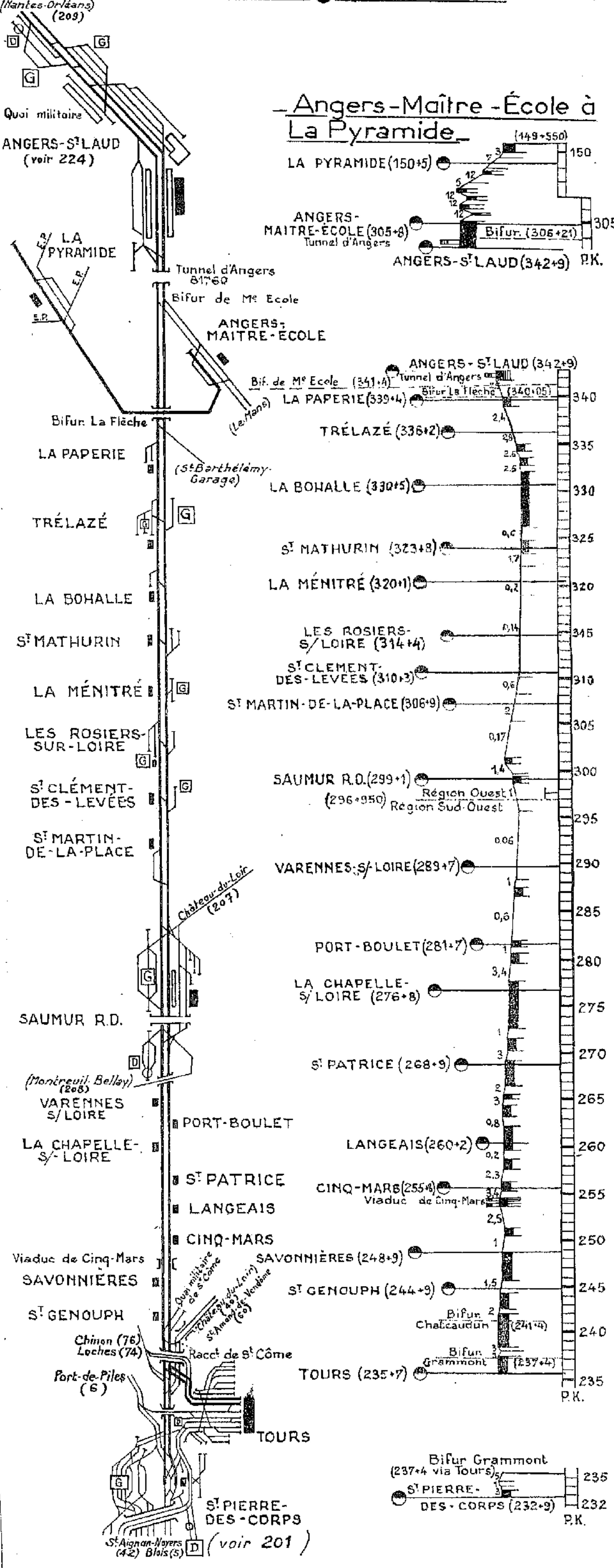
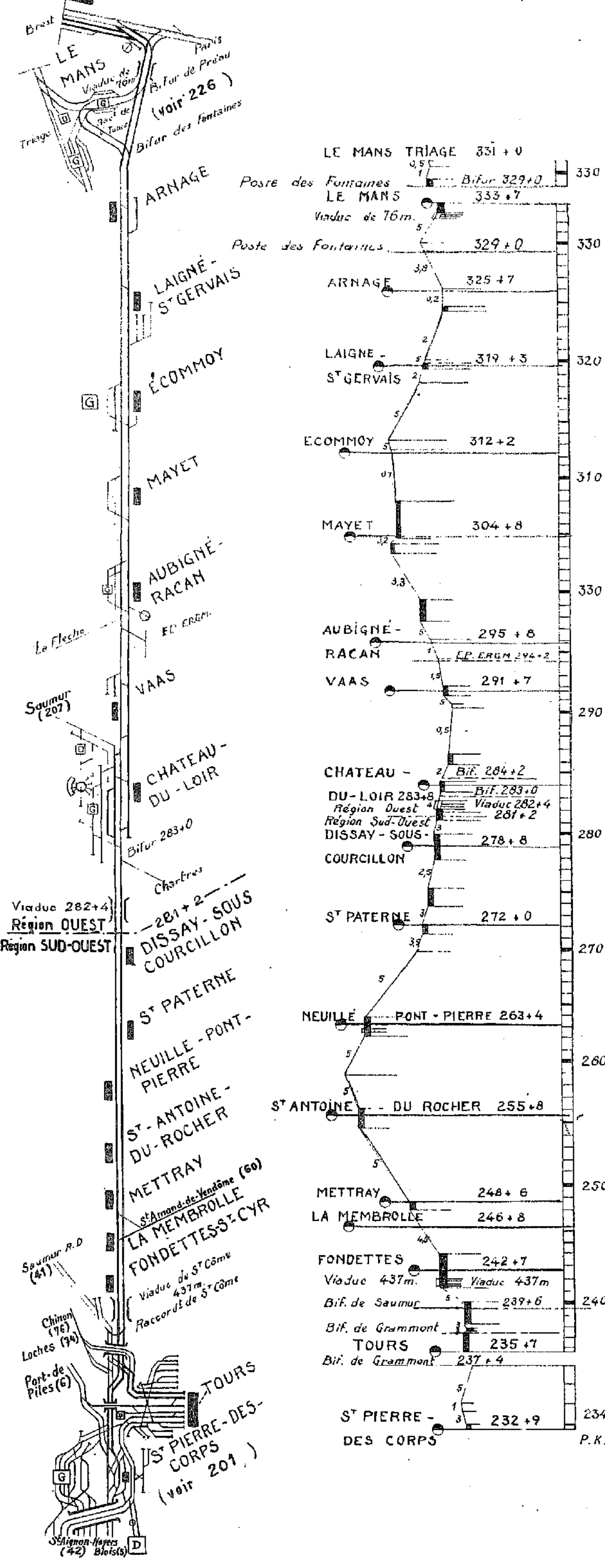

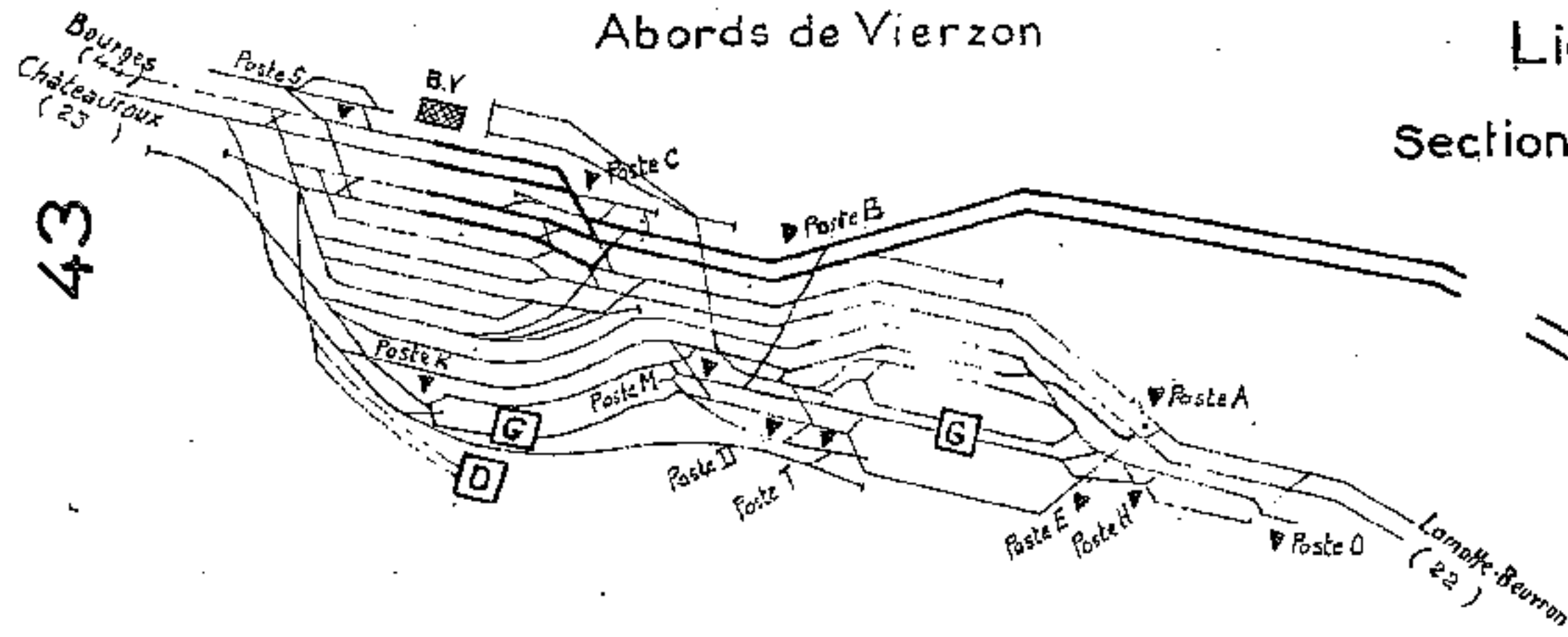

Ligne de Vierzon à Tours
Section de Vierzon à S'Aignan-Noyers

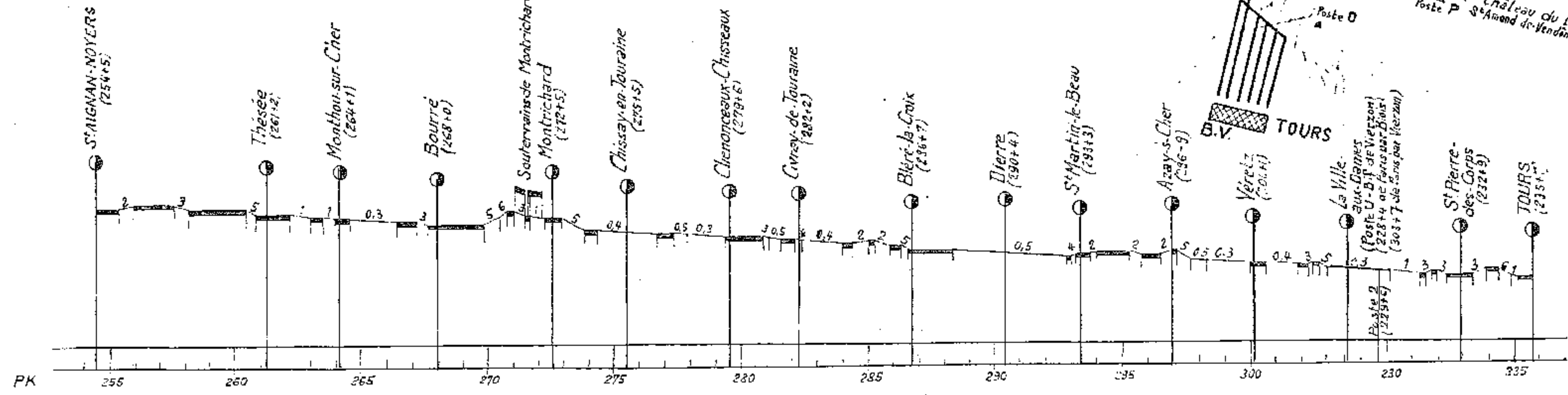
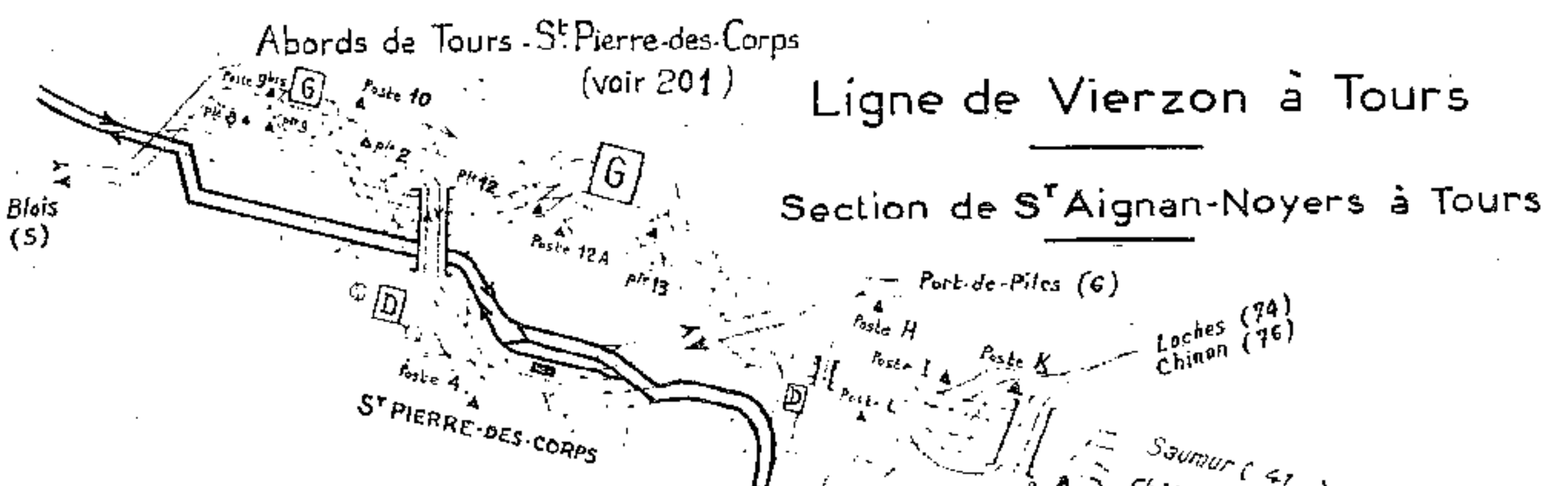
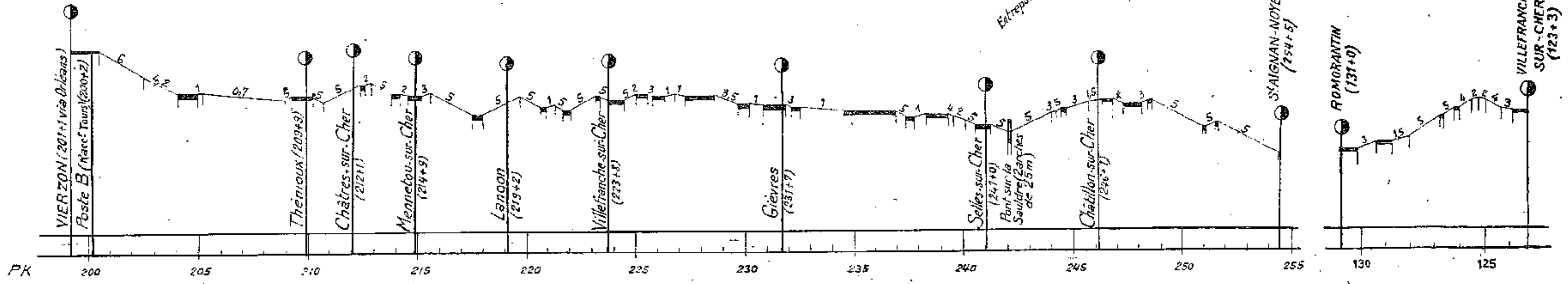
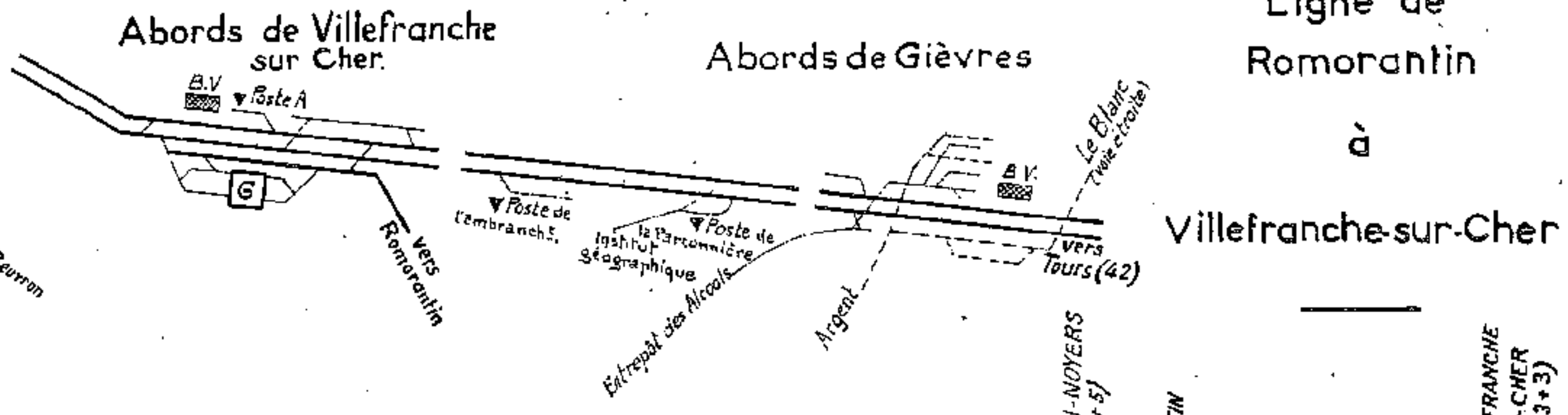

Abords de Bourges

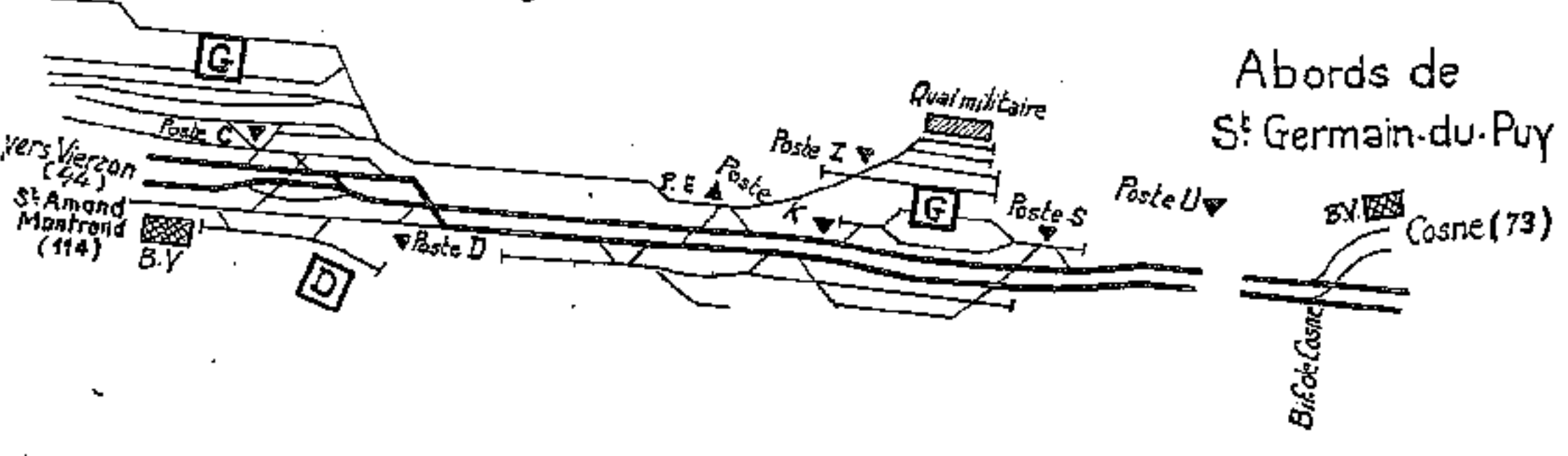

Abords de Saincaize Ligne de Vierzon à Saincaize
 Section de Bourges à Saincaize

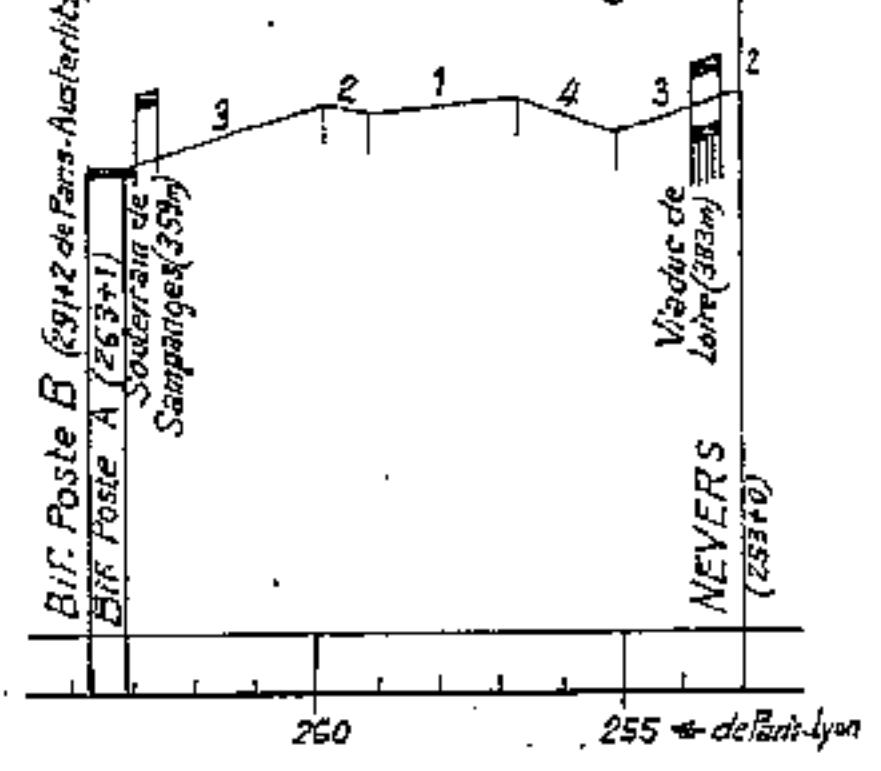
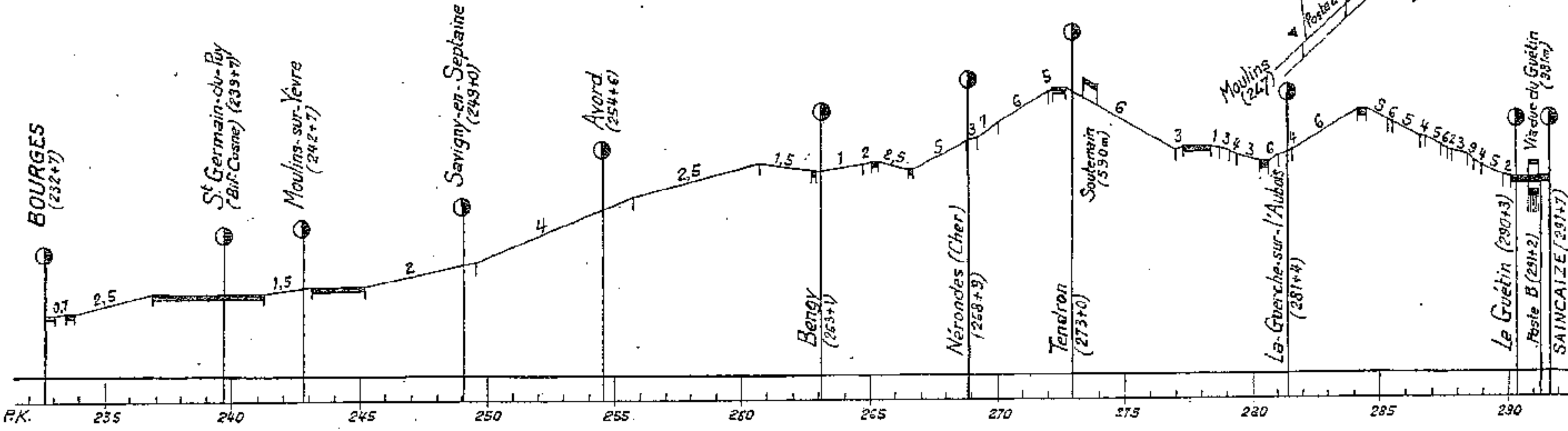
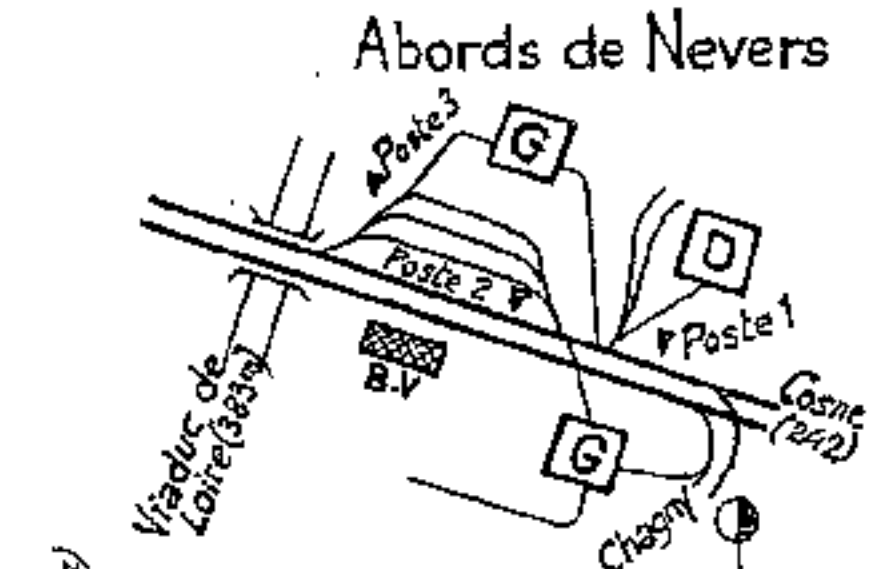
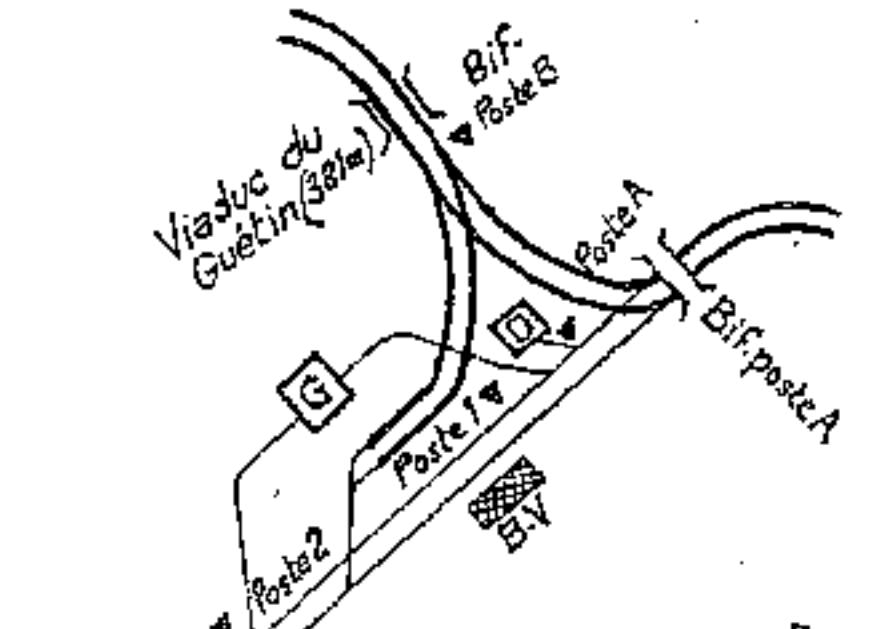

Abords de Vierzon

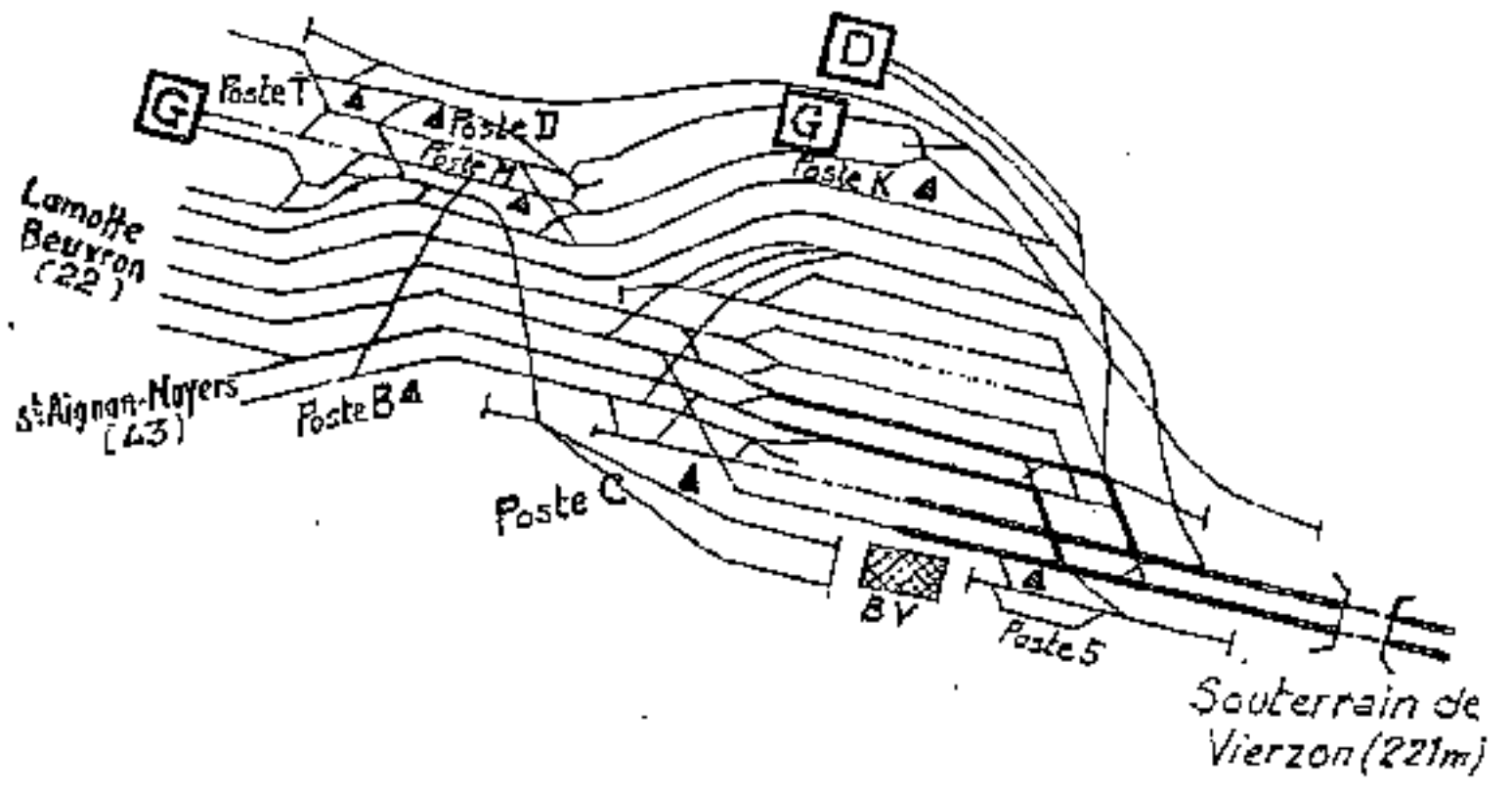

Abords de Vierzon-Forges

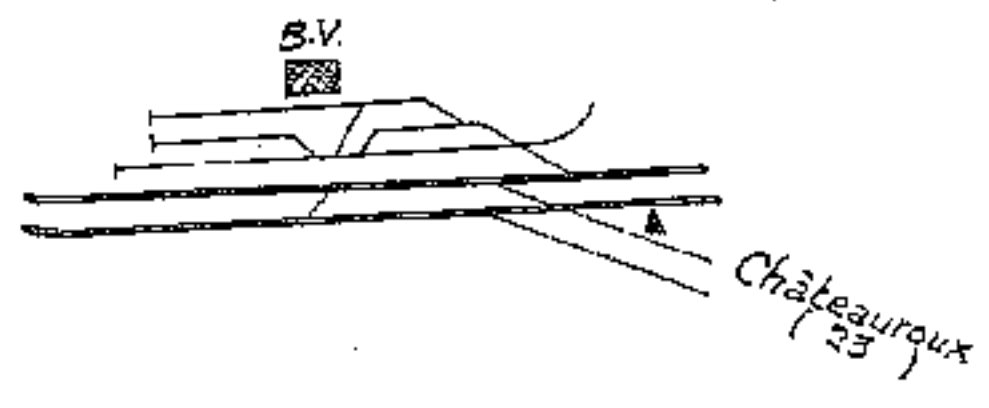

Ligne de Vierzon à Saincaize
 Section de Vierzon à Bourges

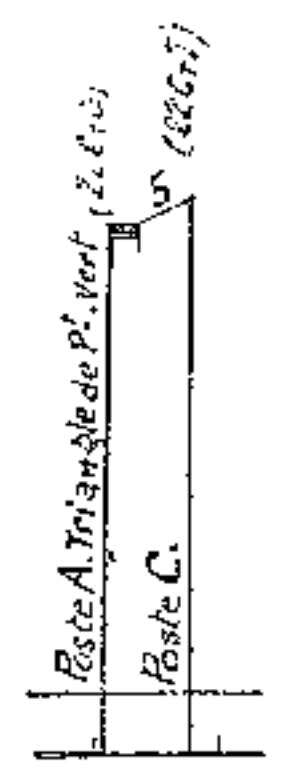
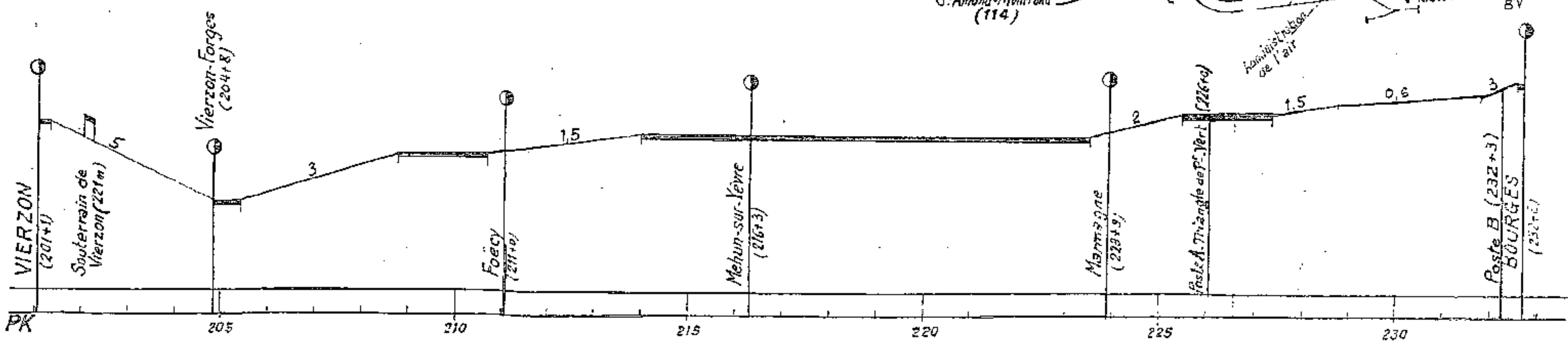
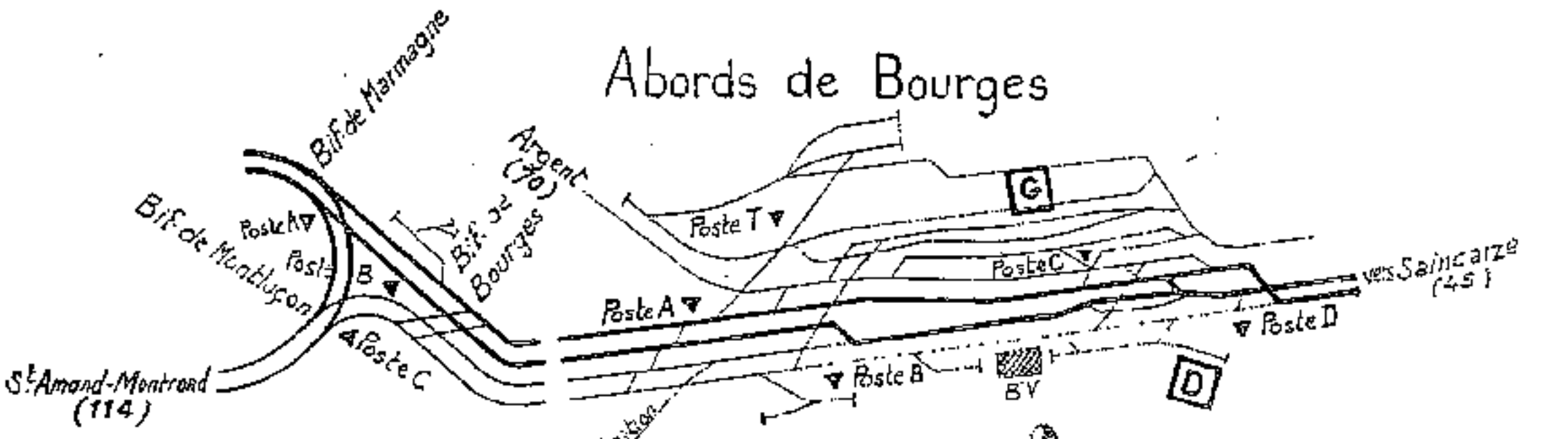

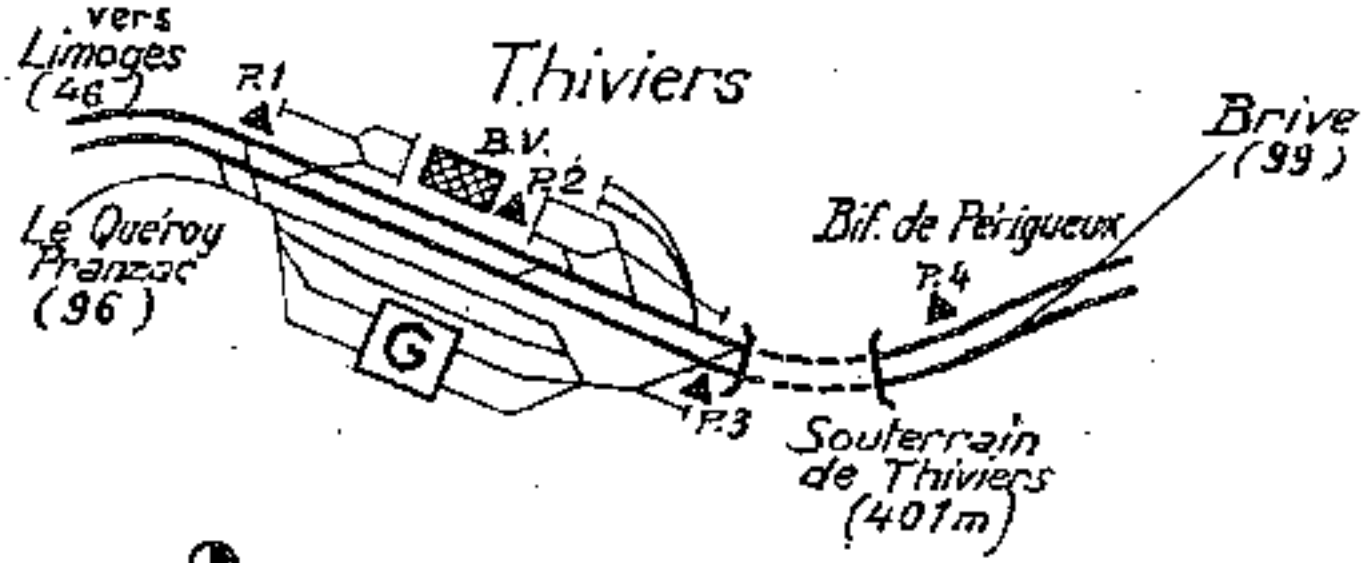

Ligne de Limoges à Périgueux

Section de Thiviers à Périgueux et Raccordement de Coutras

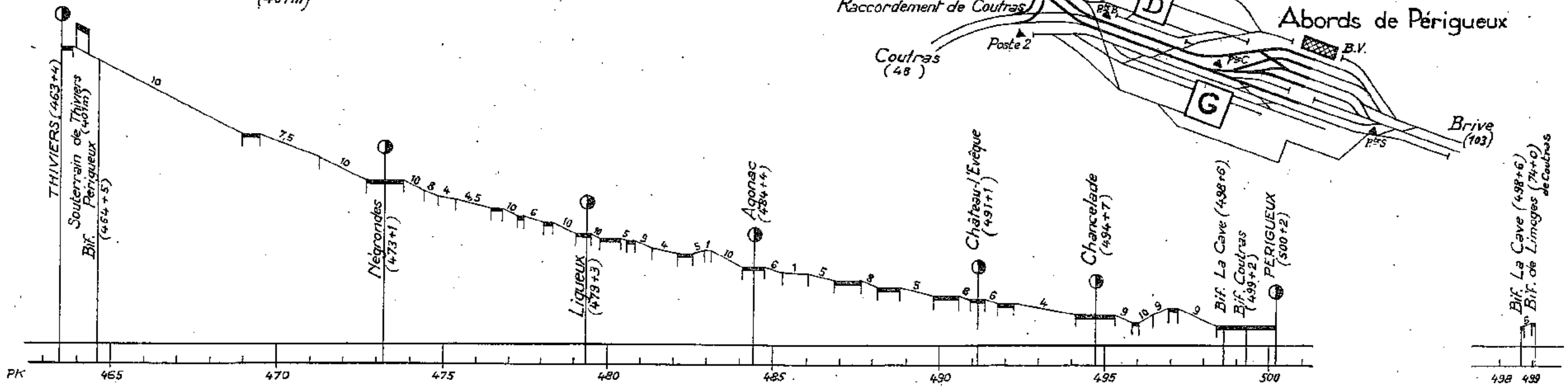
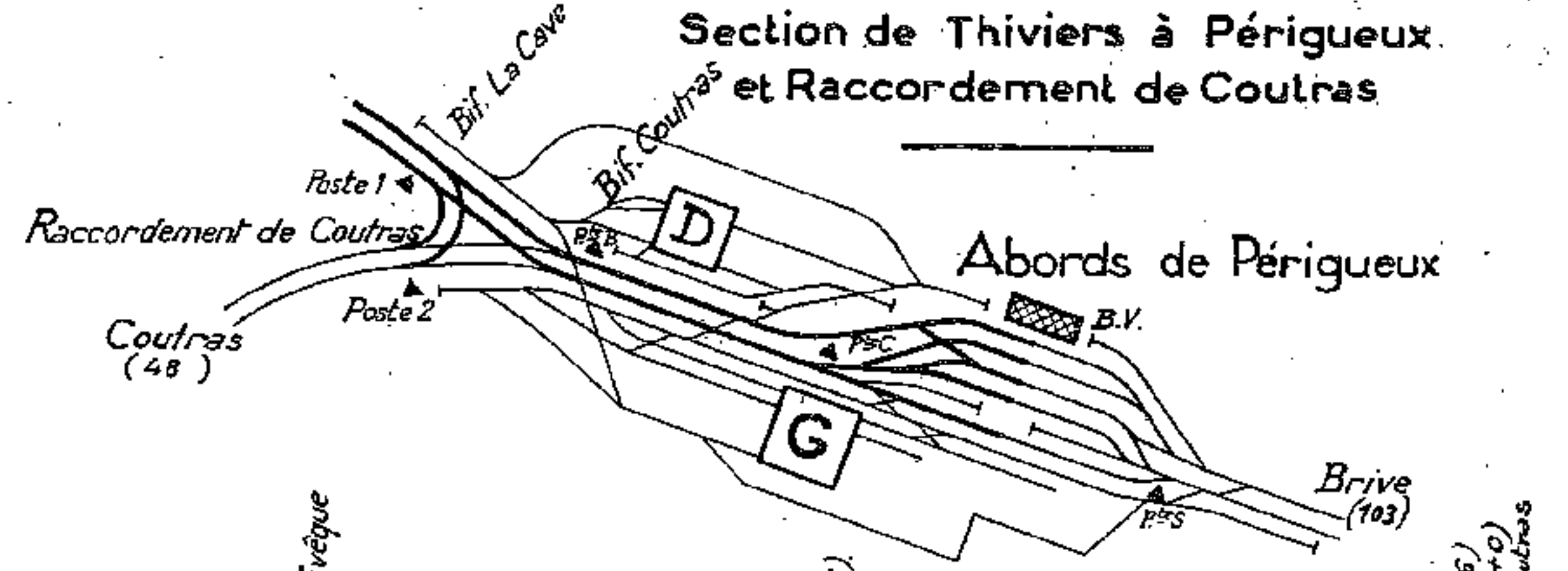

Abords de Limoges (Voir 204)

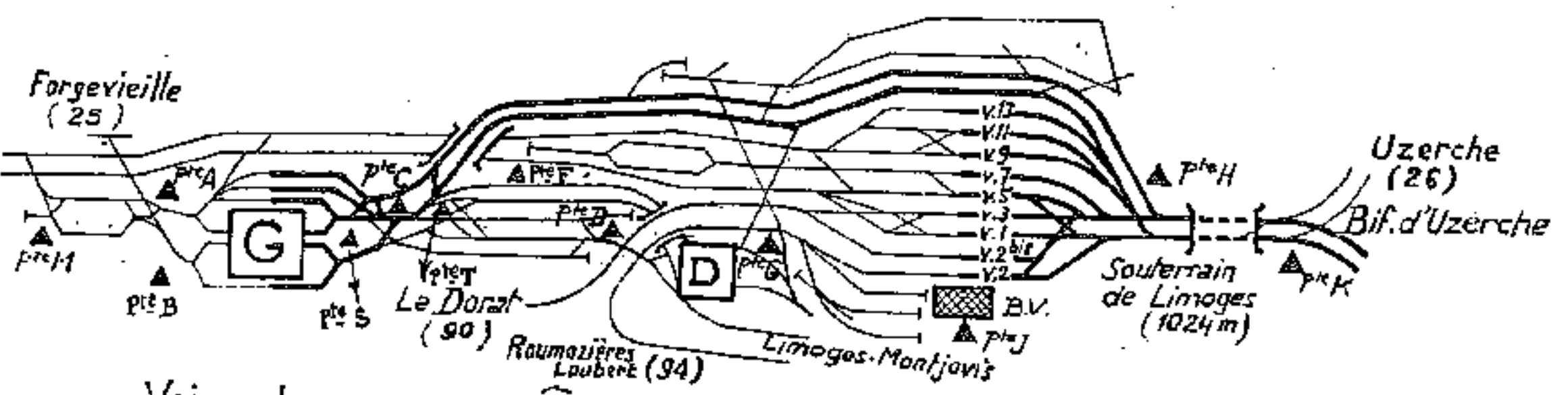

Ligne de Limoges à Périgueux

Section de Limoges à Thiviers

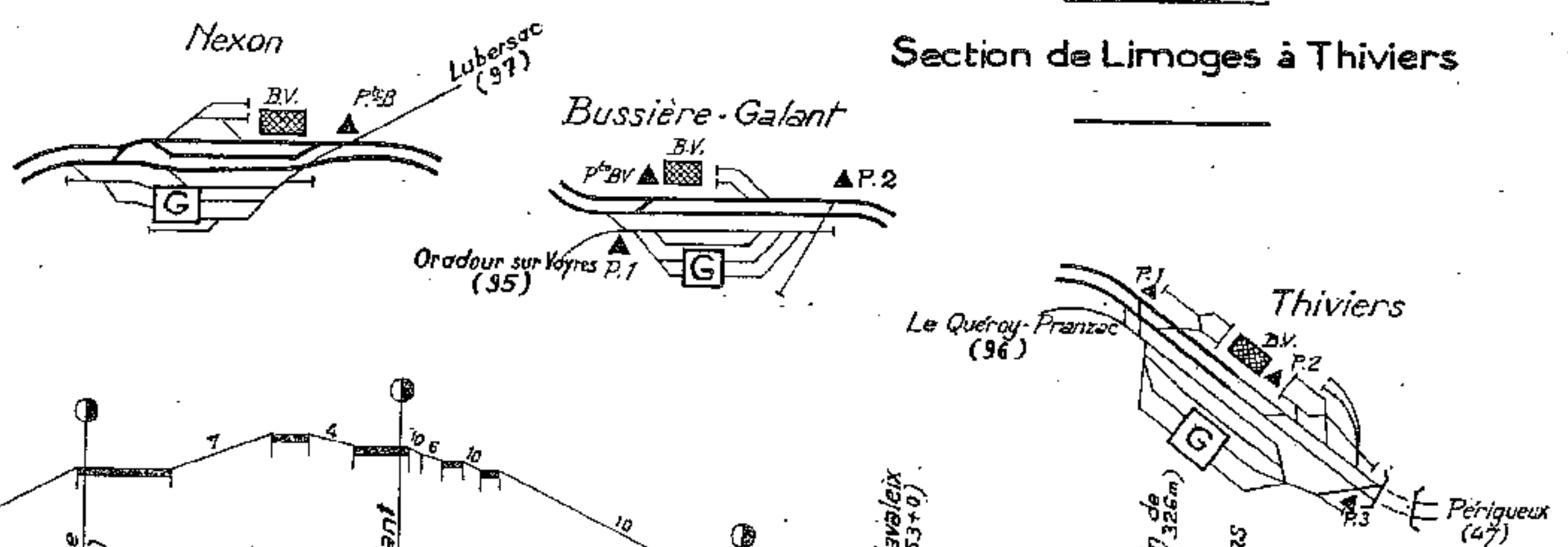

Voies de marchandises

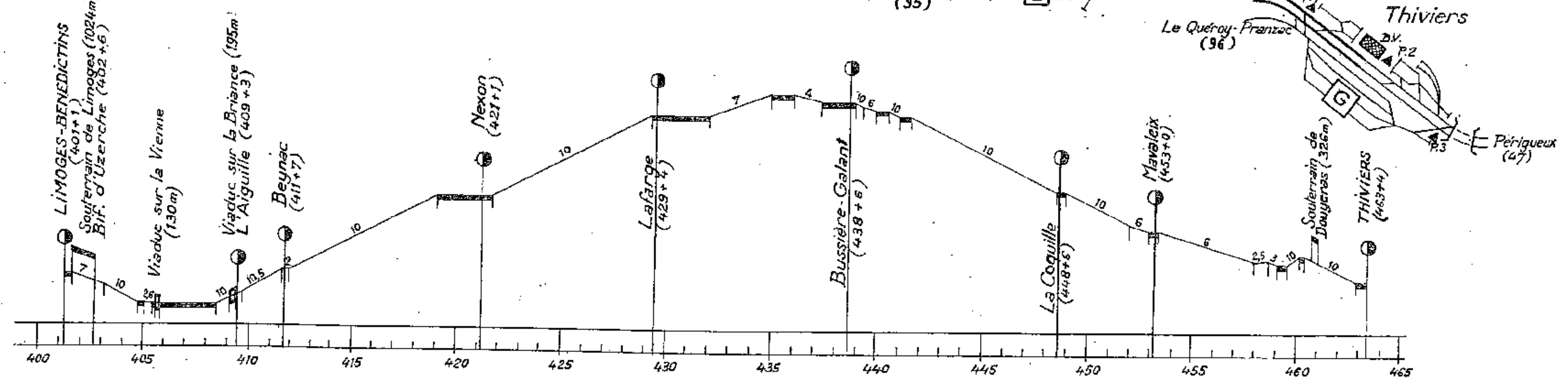
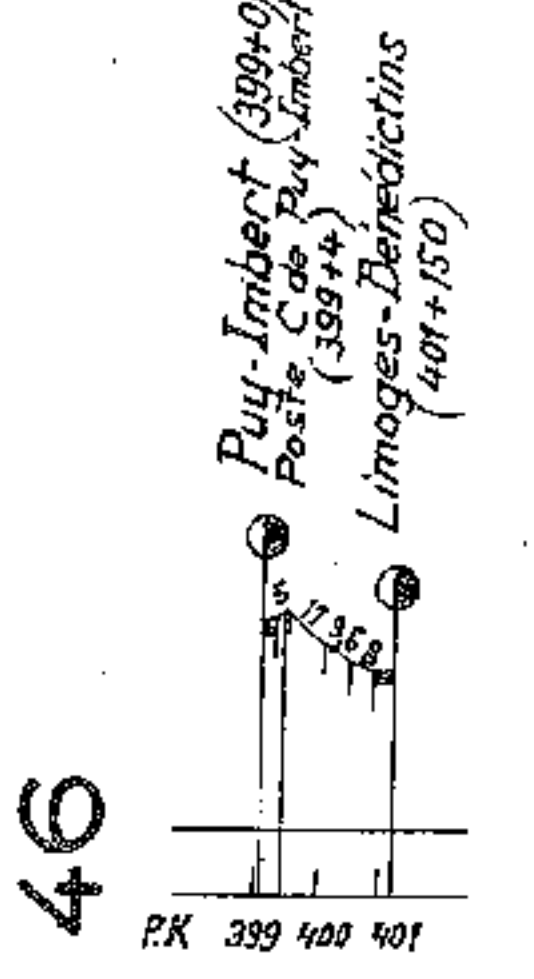

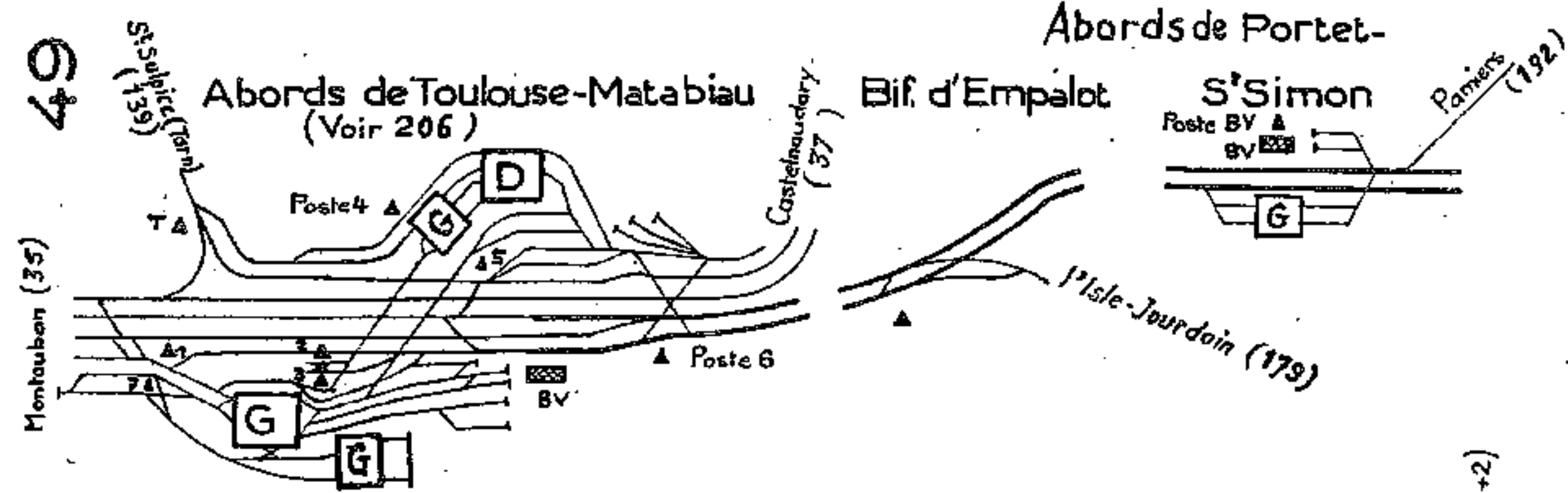

Ligne de Toulouse-Matabiau à Tarbes

Section Toulouse-Matabiau-Boussens.

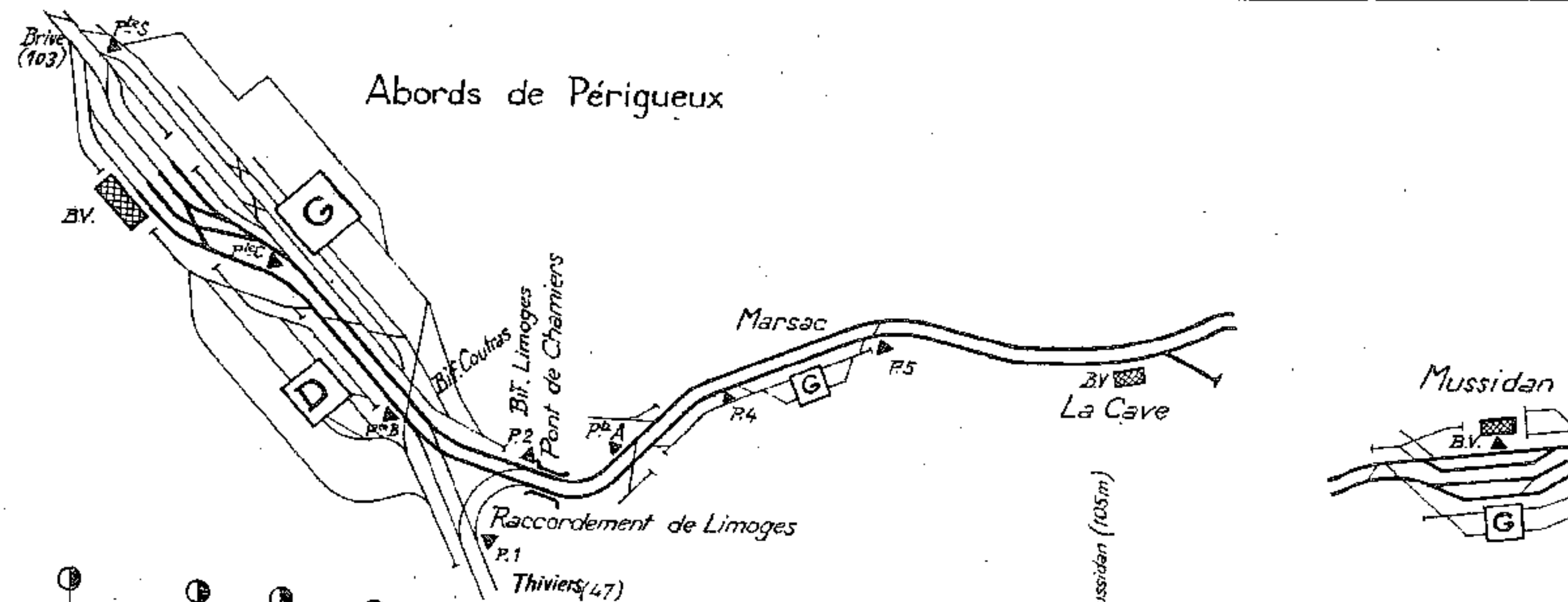
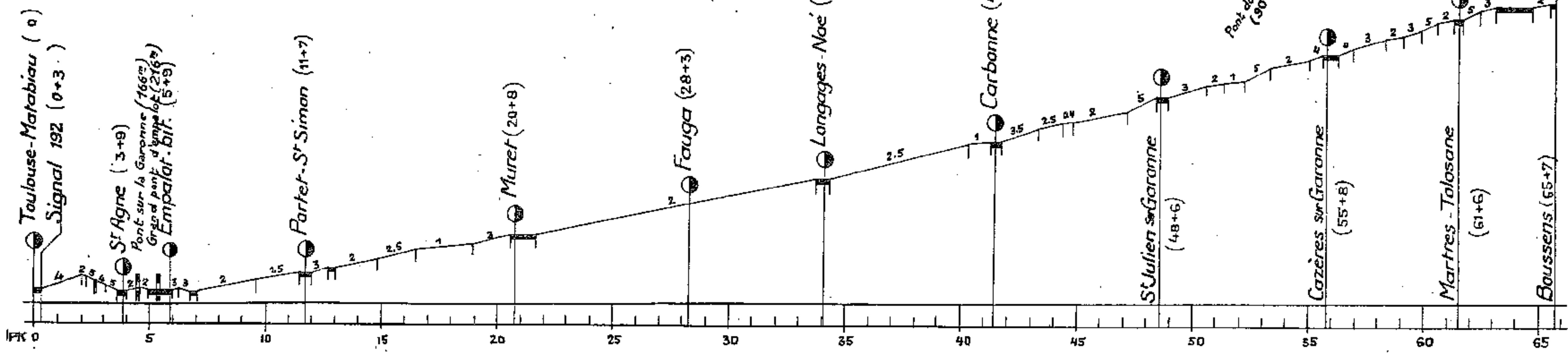

Ligne de Périgueux à Coutras

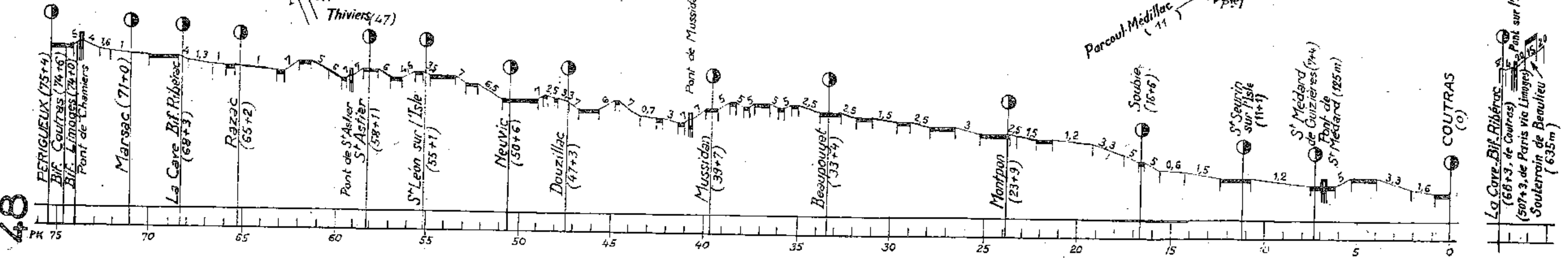

Abords de Montréjeau - Gourdan - Polignan

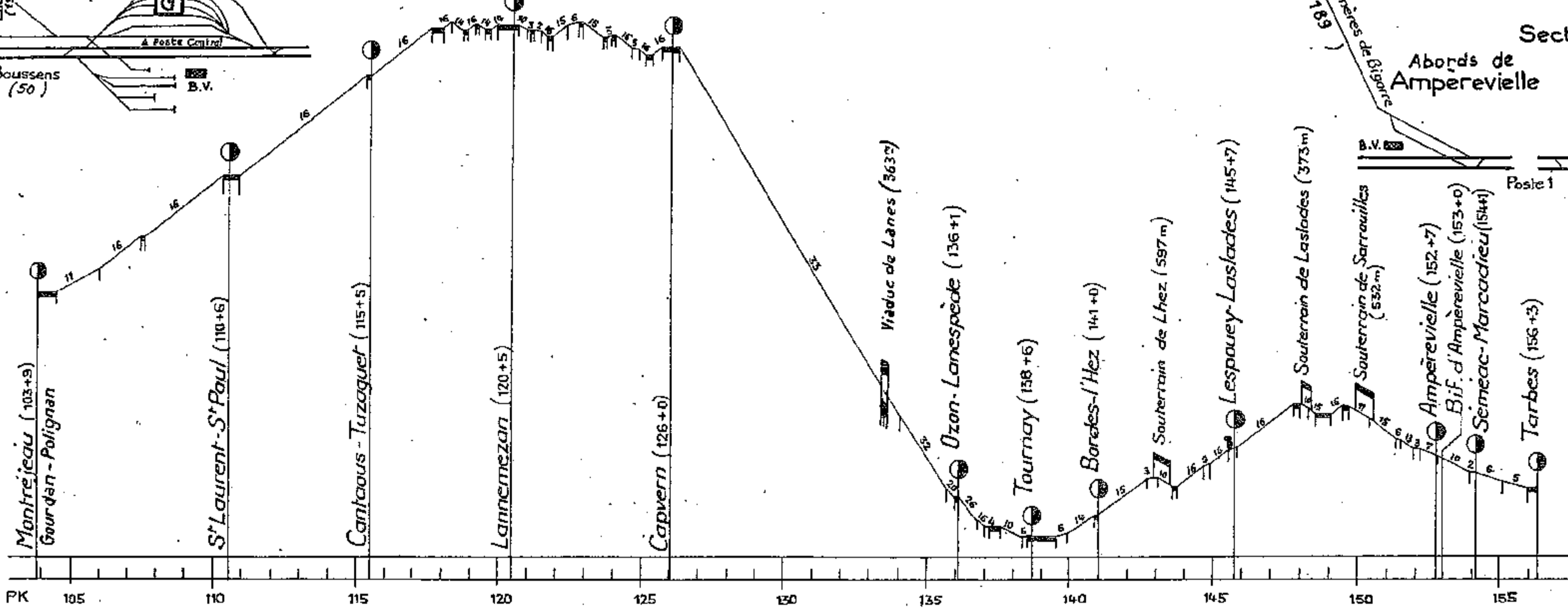
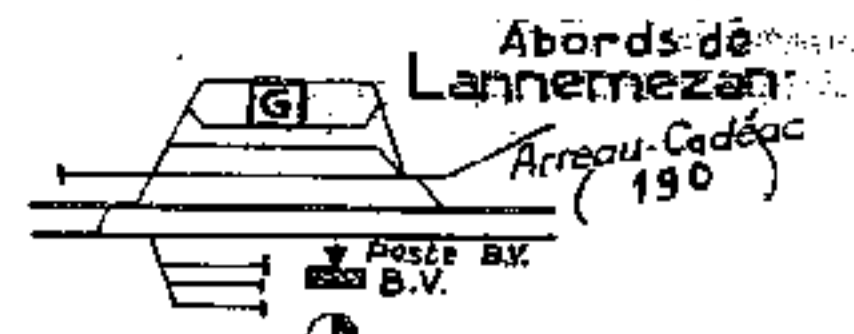
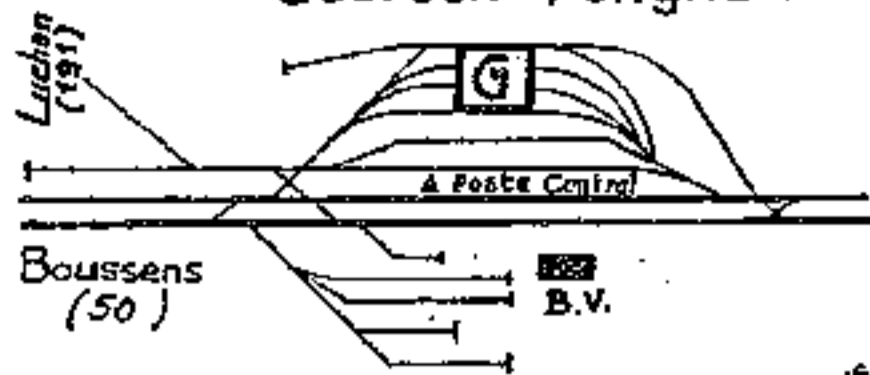

Ligne de Toulouse-Matabiau à Tarbes

Section Montréjeau-Tarbes

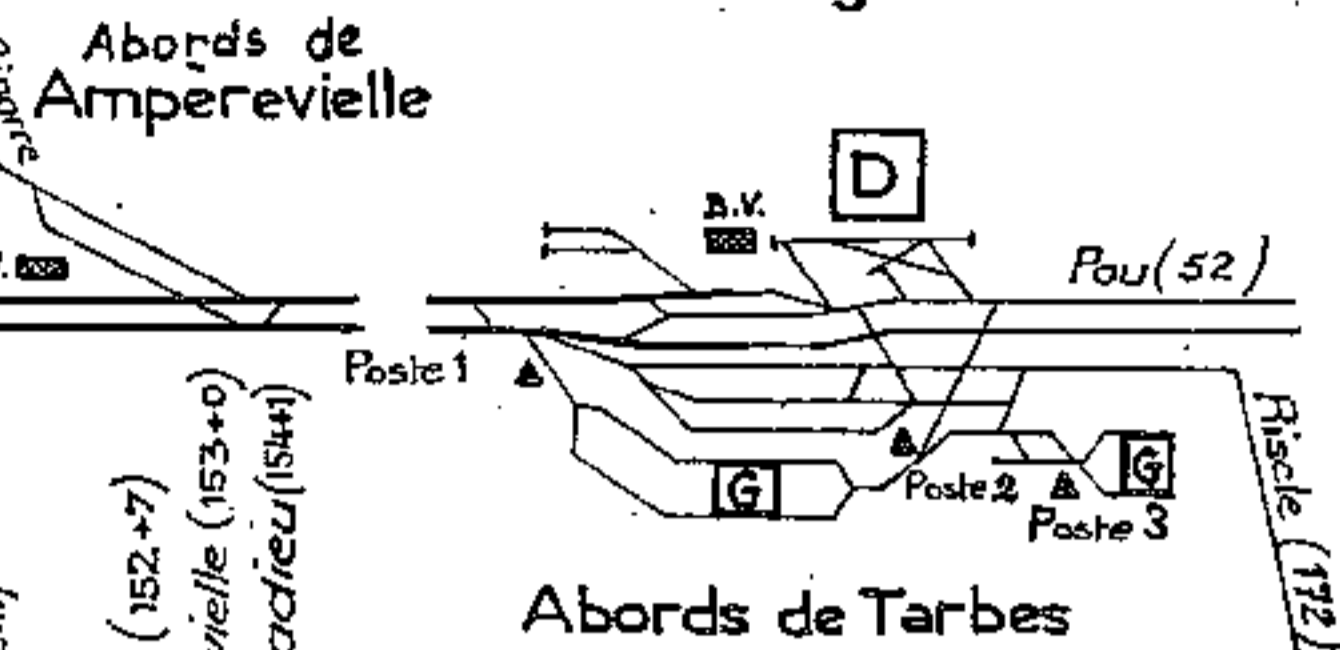

Ligne de Toulouse-Matabiau à Tarbes

Section de Boussens à Montréjeau-Gourdan-Polignan

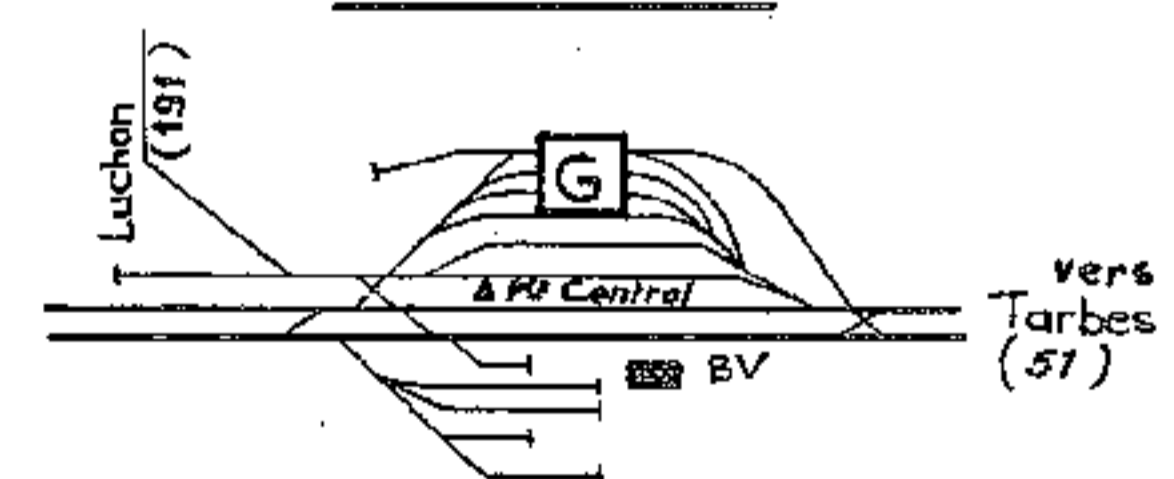
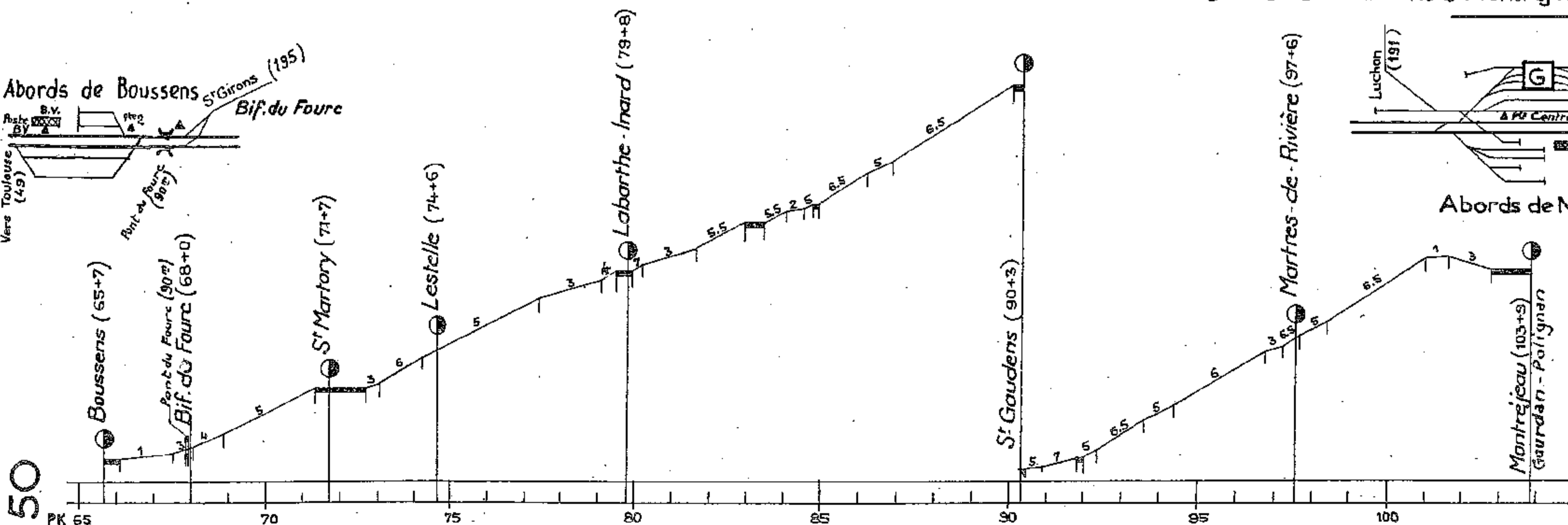
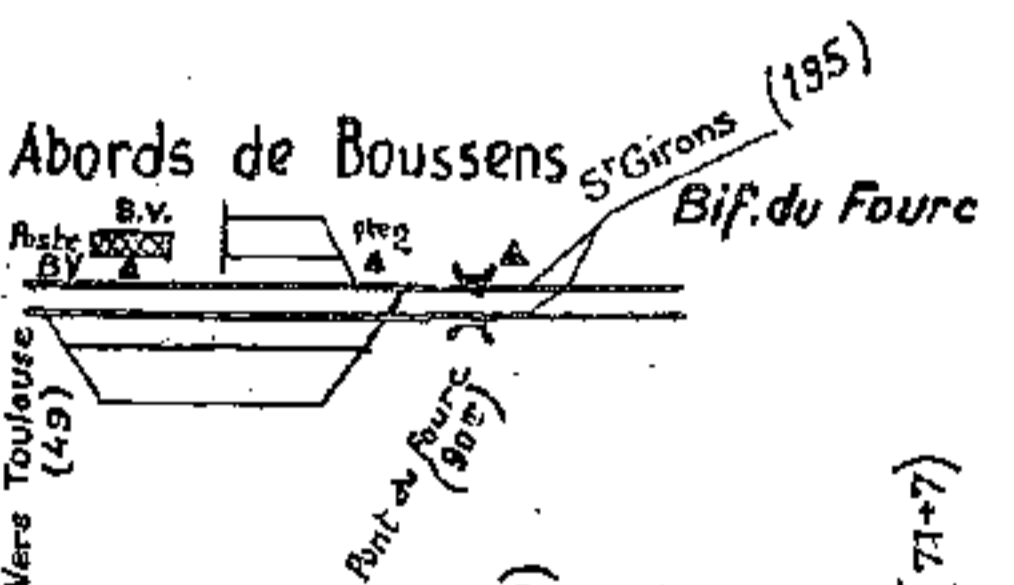

Abords de Montréjeau-Gourdan - Polignan

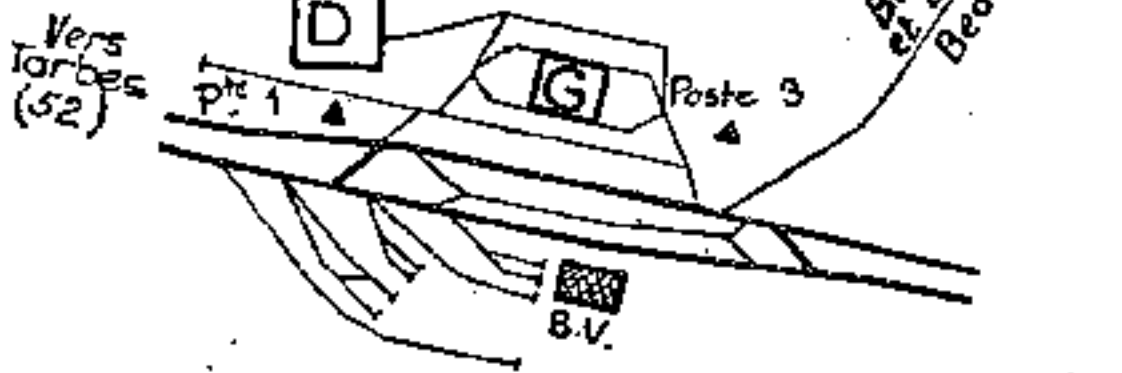

Ligne de Tarbes à Bayonne

Section Pau-Puyôo

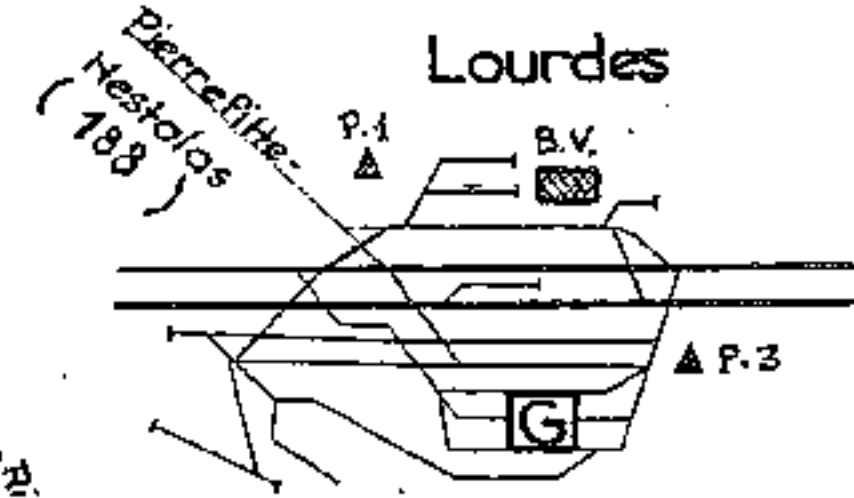
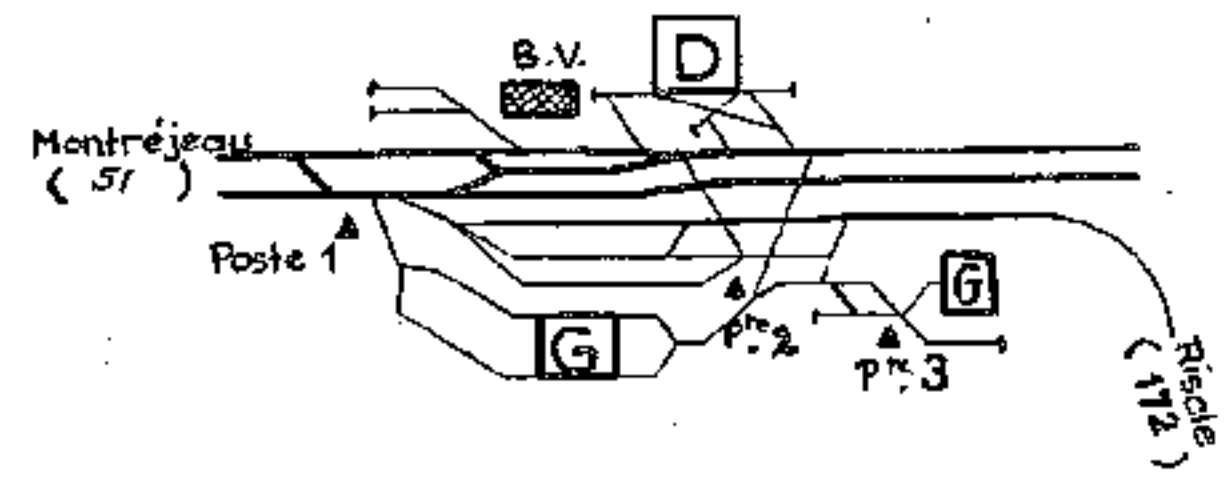
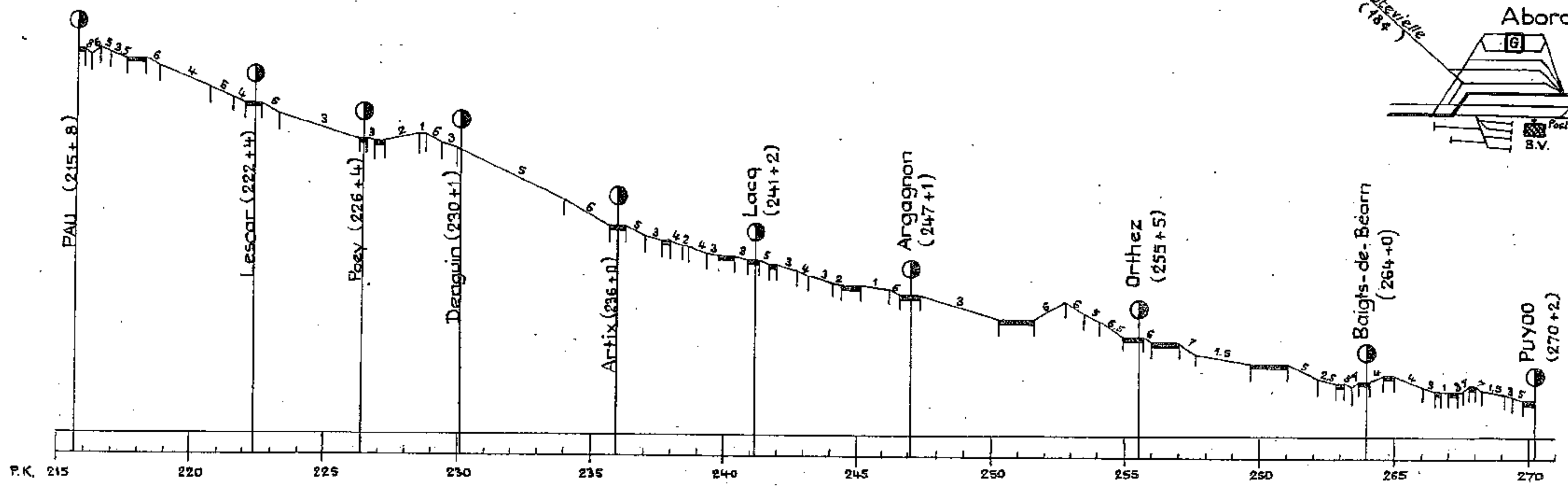
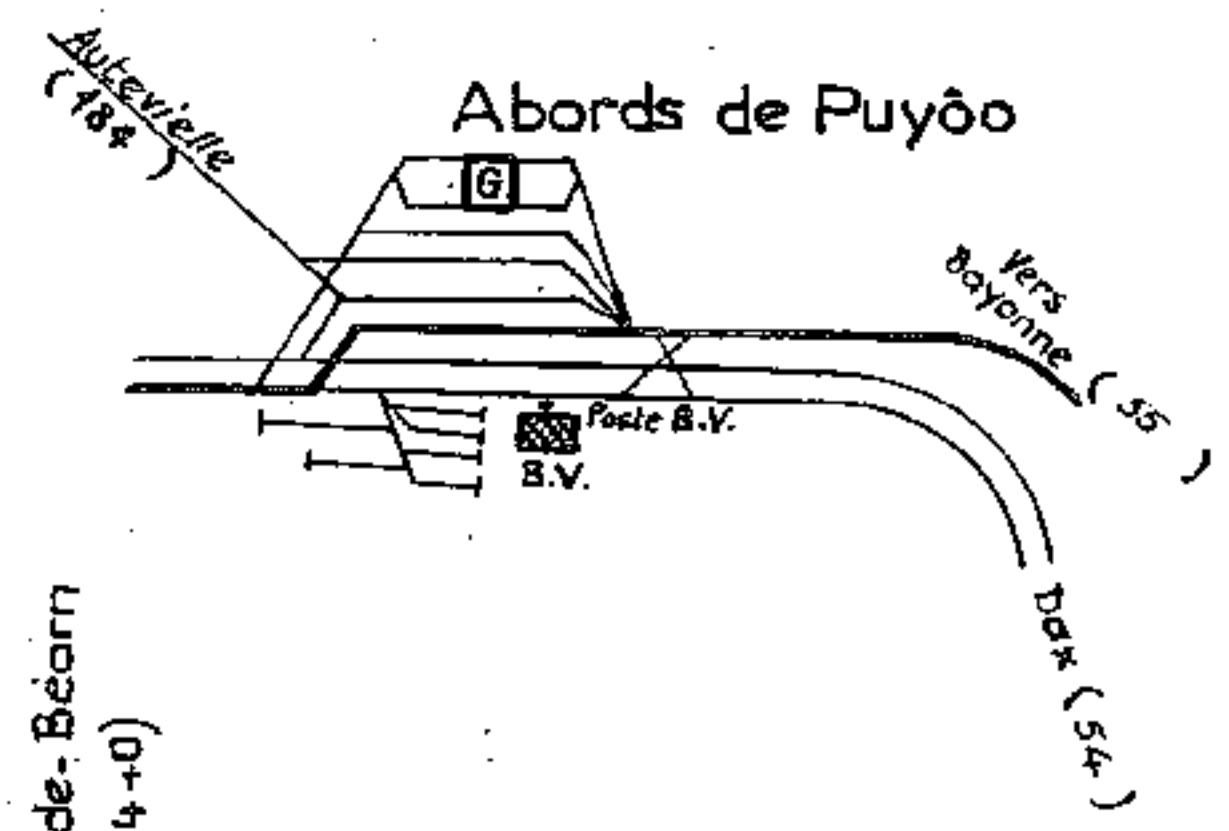

Ligne de Tarbes à Bayonne

Section Tarbes-Pau

Abords de Pau

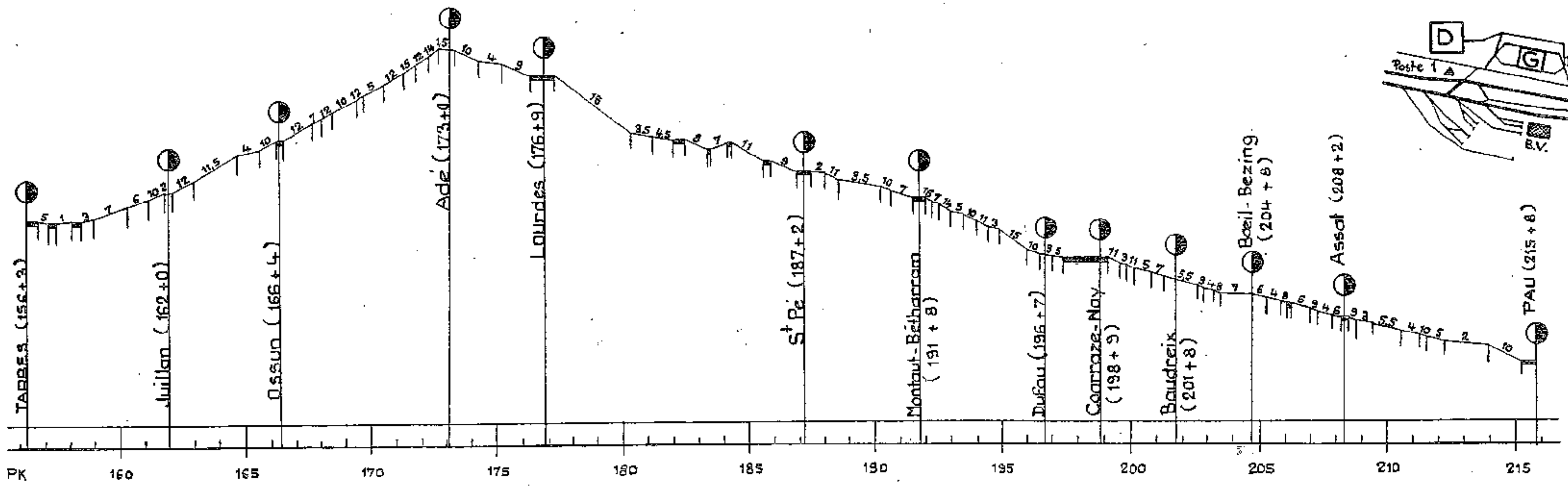
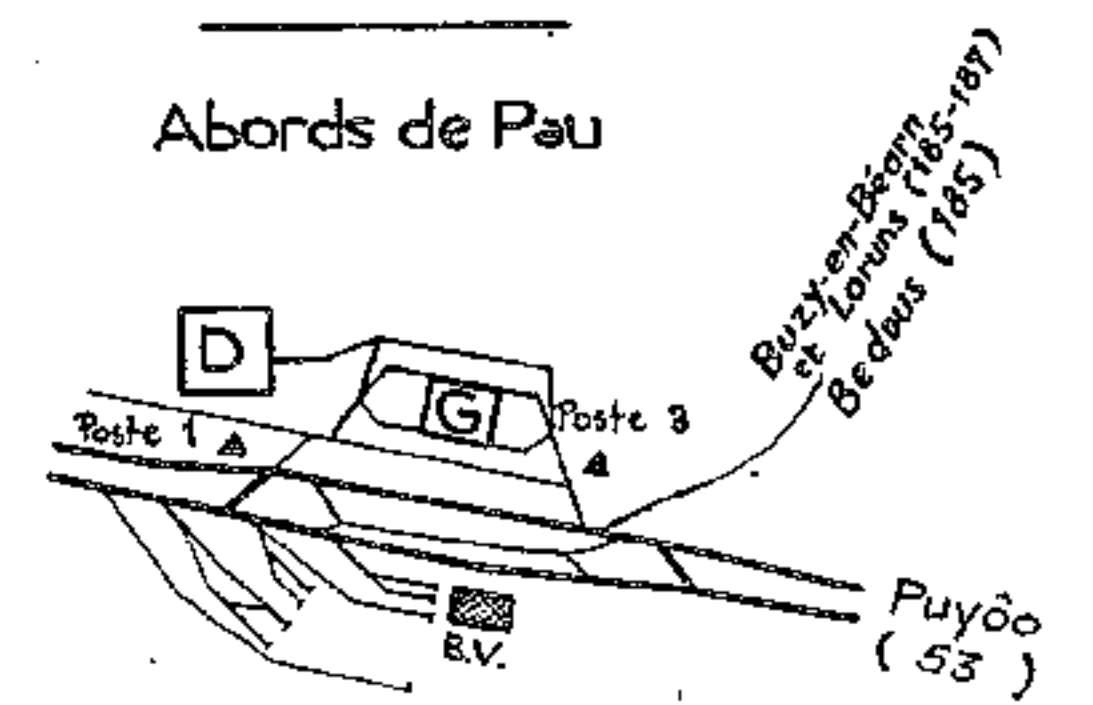

55

Abords de Puyôo

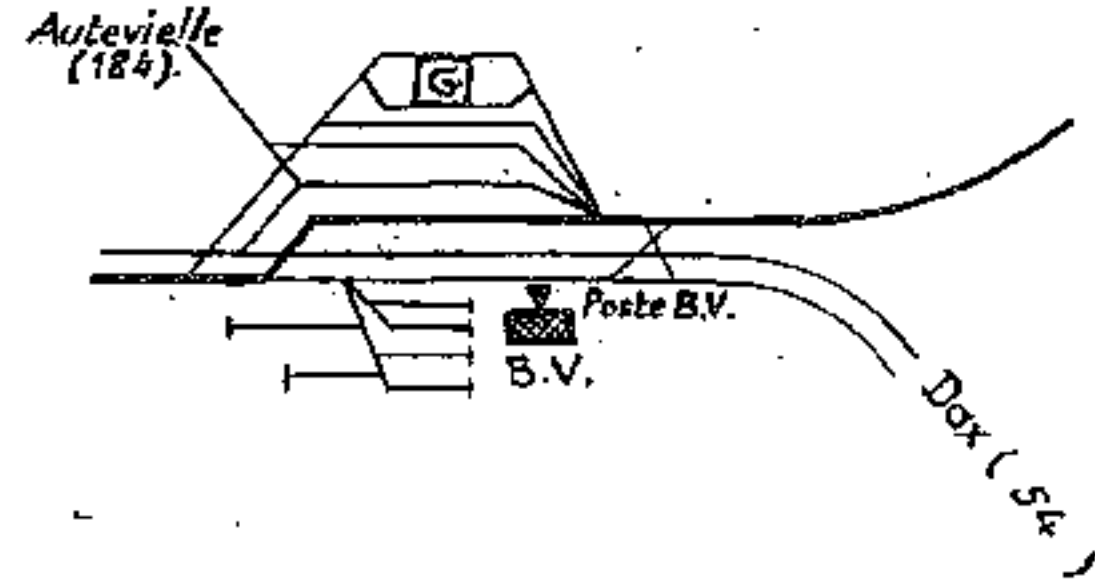

Ligne de Tarbes à Bayonne

Section Puyôo-Bayonne

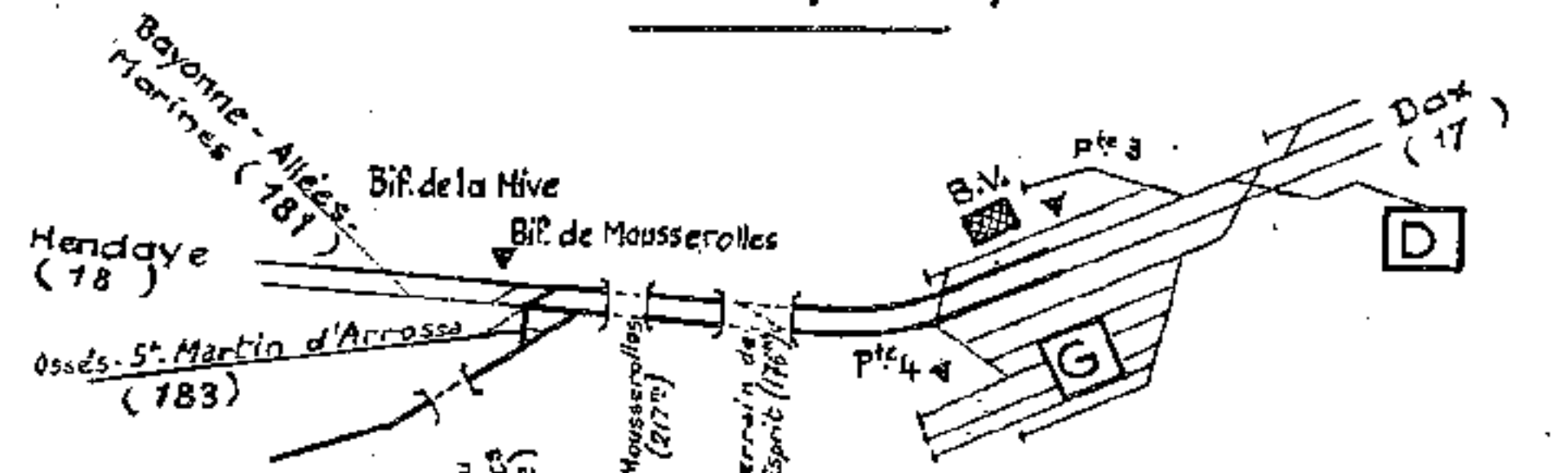
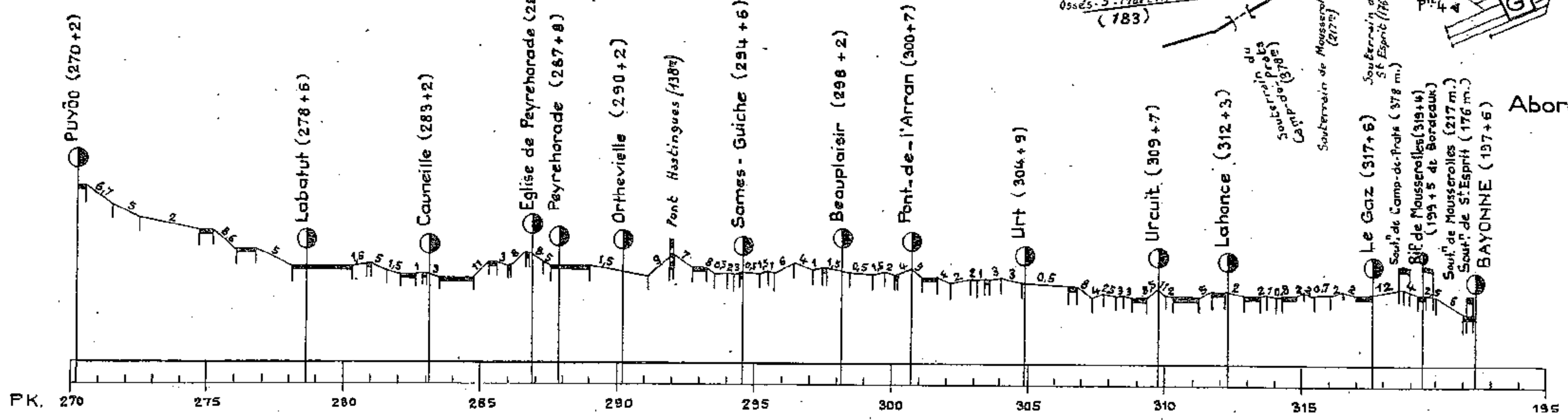

Abords de Bayonne

Abords de Puyôo

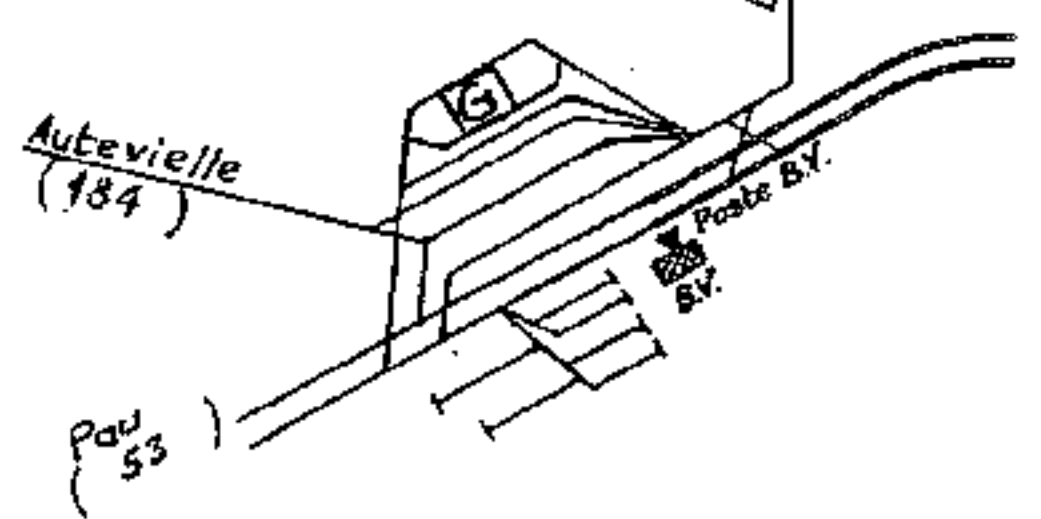

Ligne de Puyôo à Dax

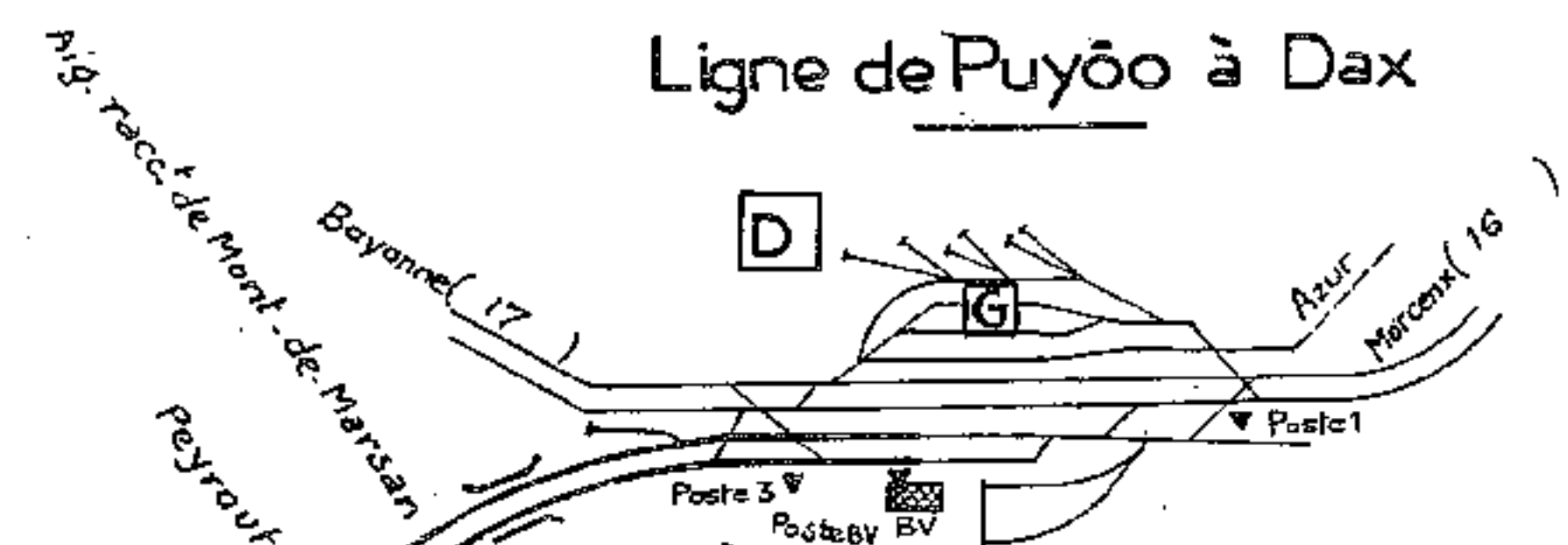
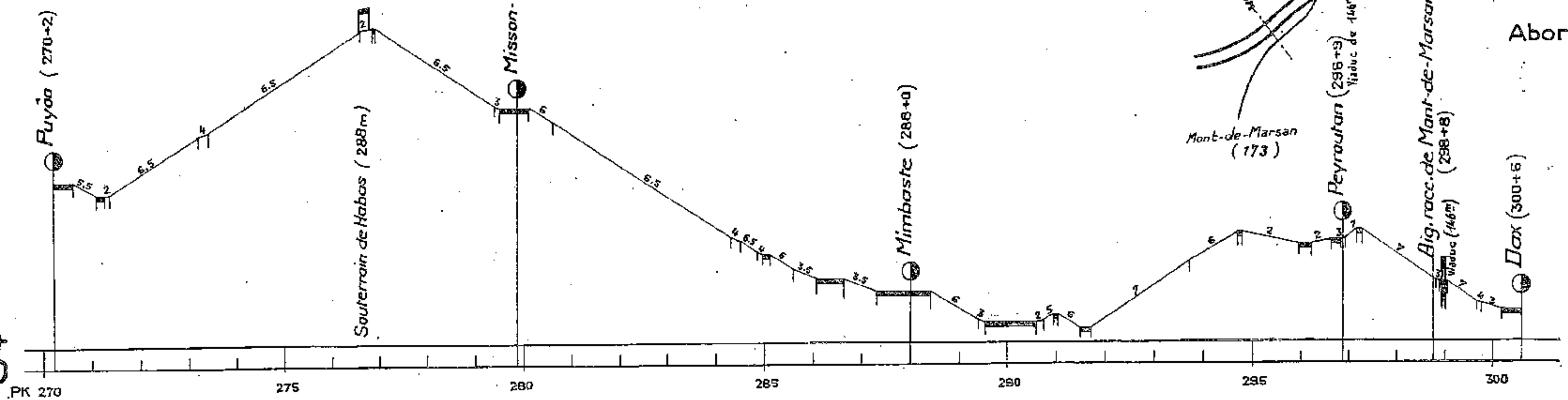

Abords de Dax

54

Ligne de Brétigny à Tours

Section de Brétigny à Auneau

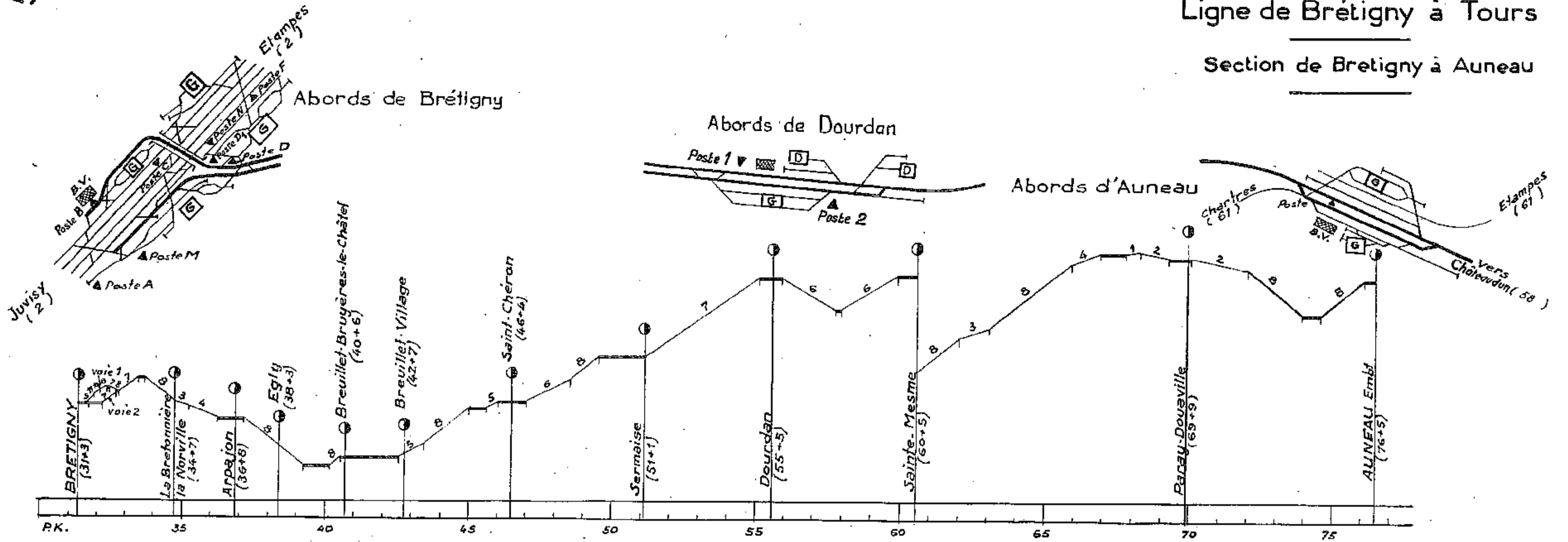

Ligne de Malesherbes à Orléans

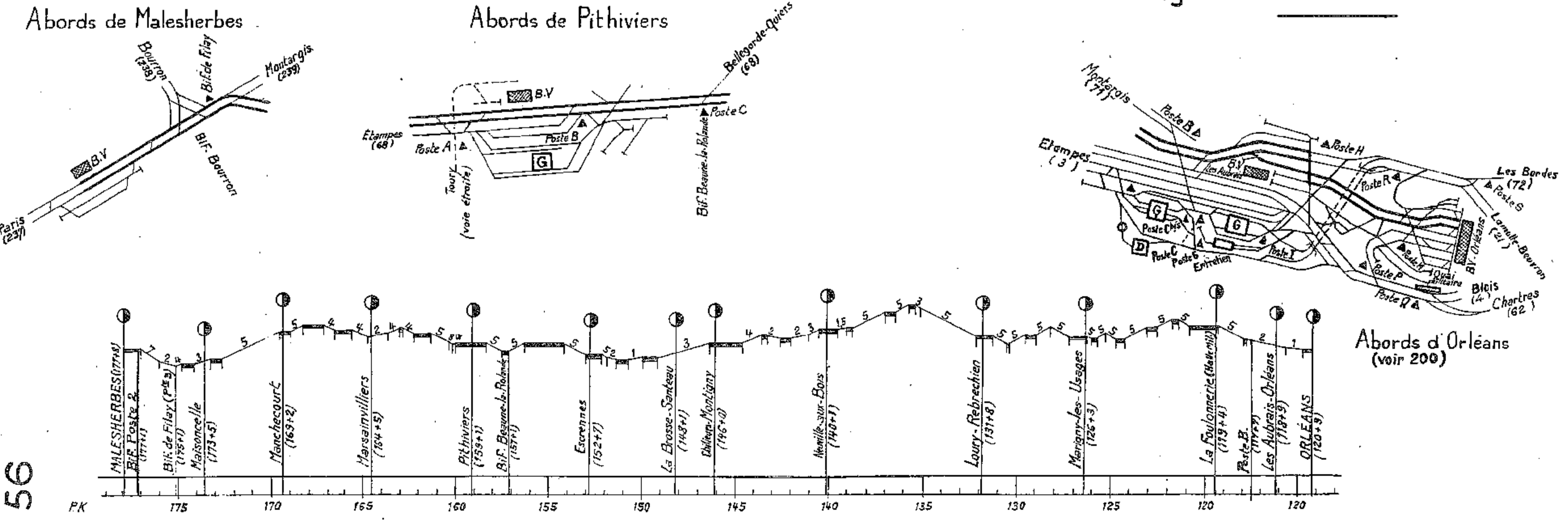

Abords de Châteaudun

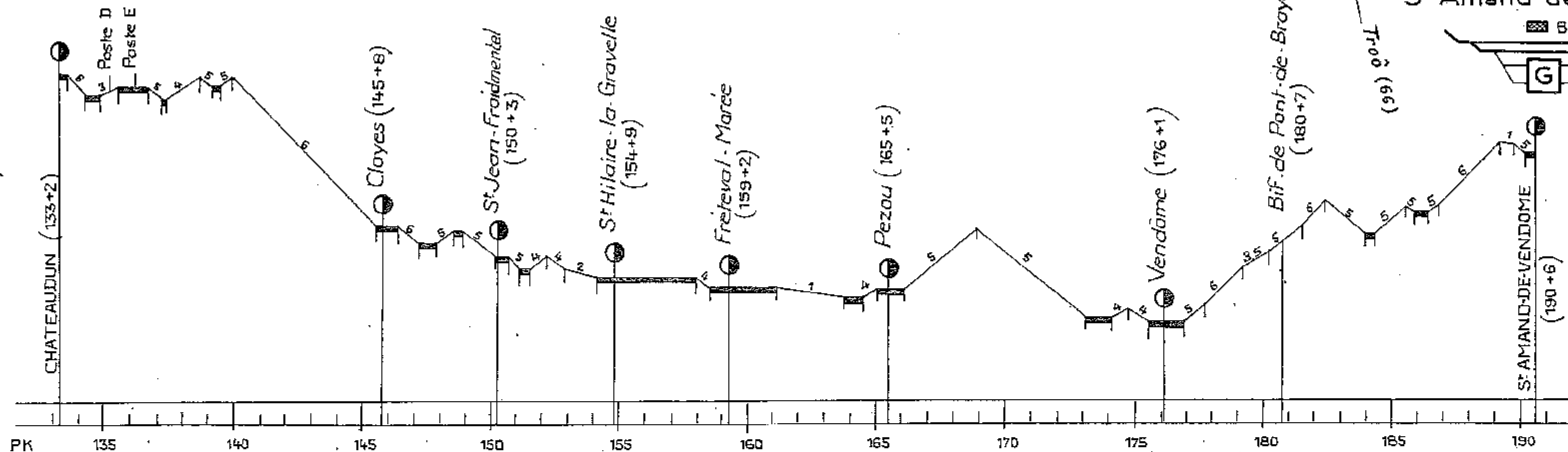
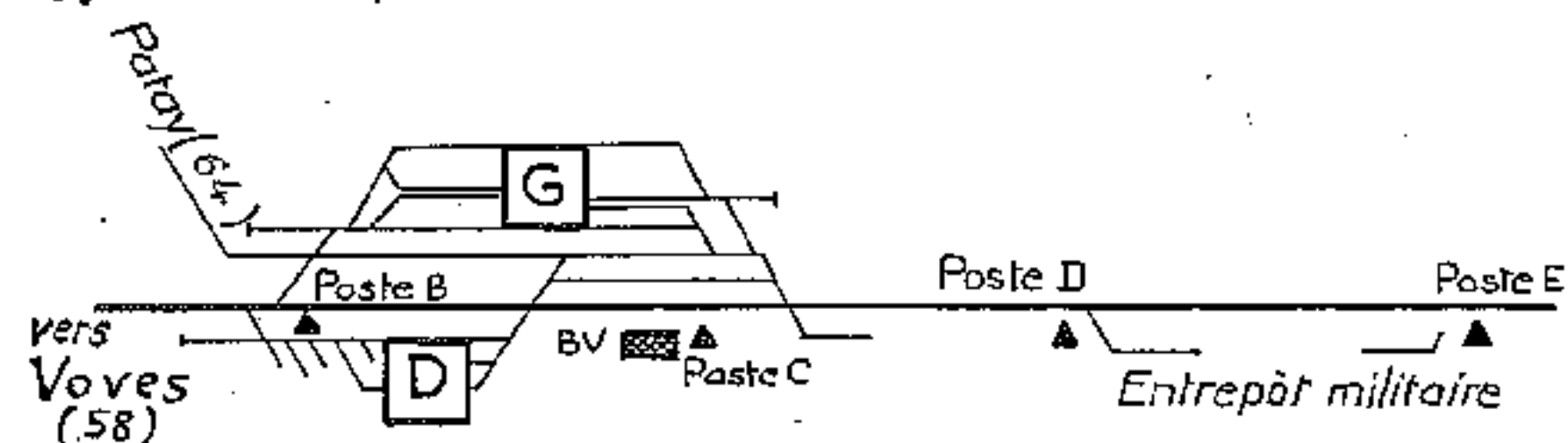

Abords de Vendôme Ligne de Brétigny à Tours

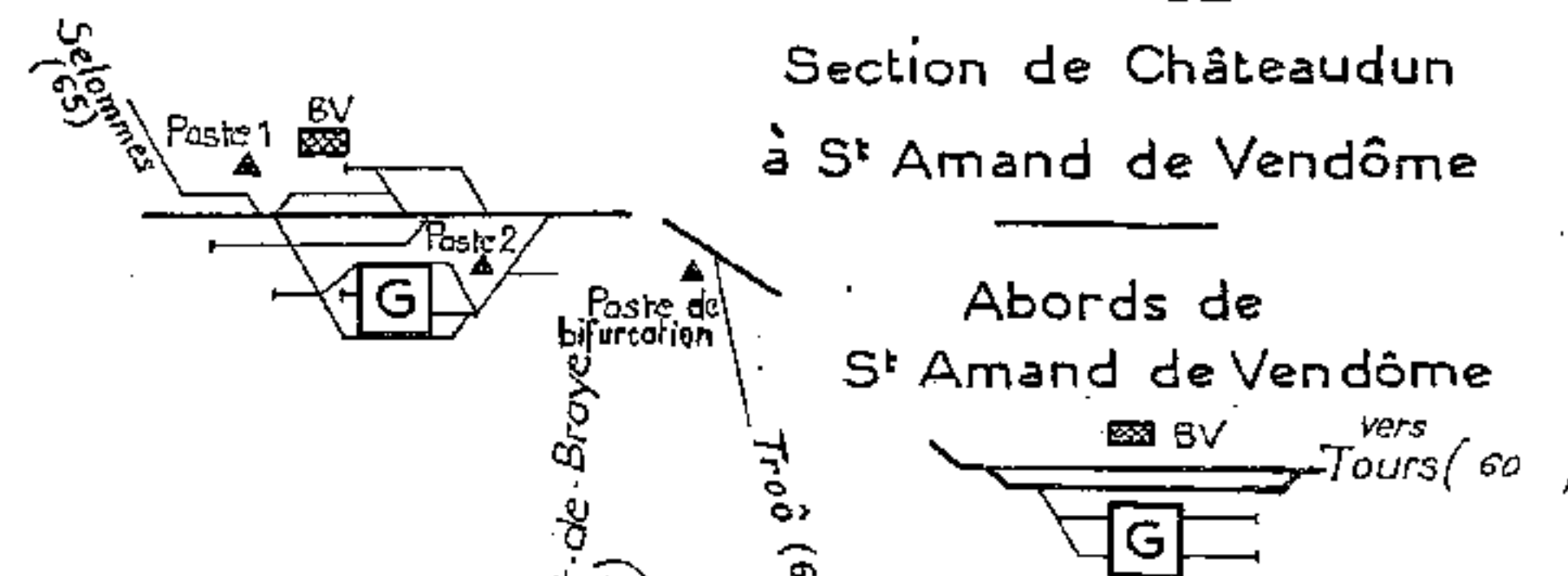

Section de Châteaudun à St Amand de Vendôme



Ligne de Brétigny à Tours

Section d'Auneau à Châteaudun

Abords d'Auneau Embt

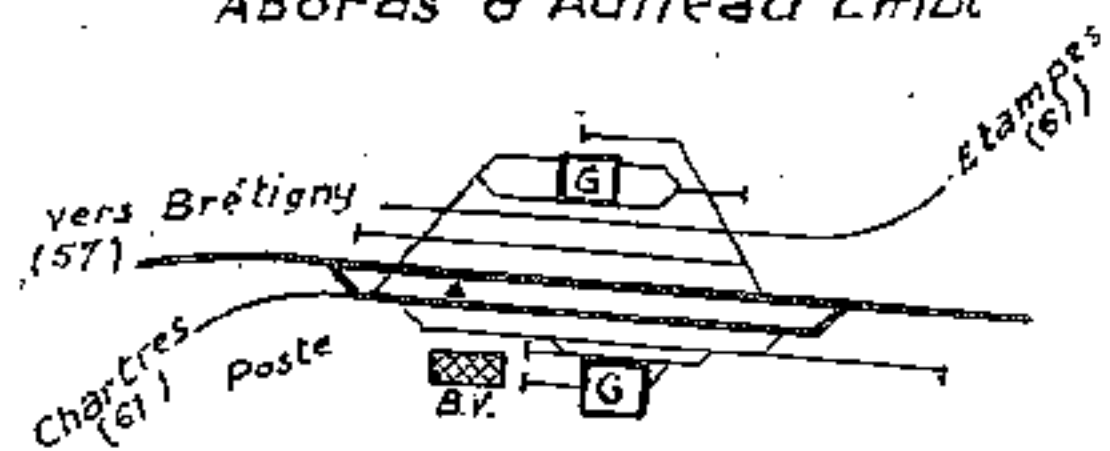

Abords de Voyes

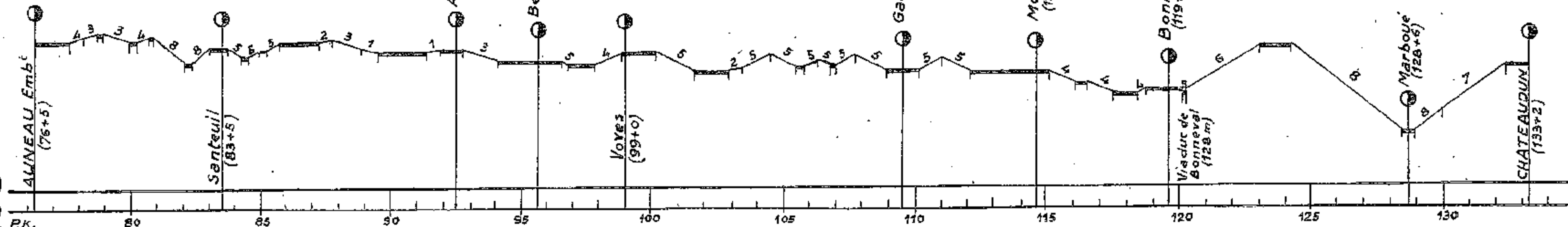
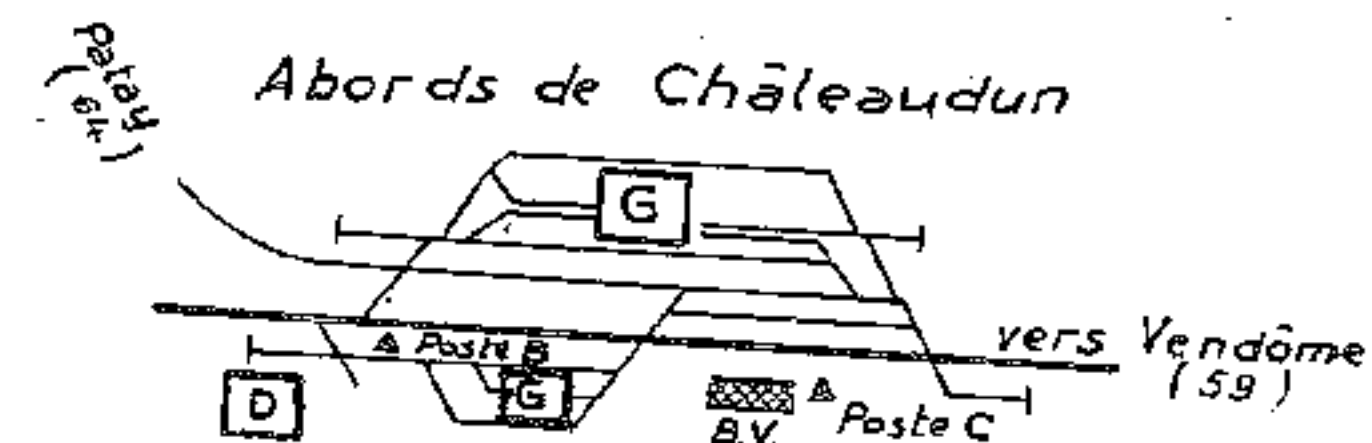
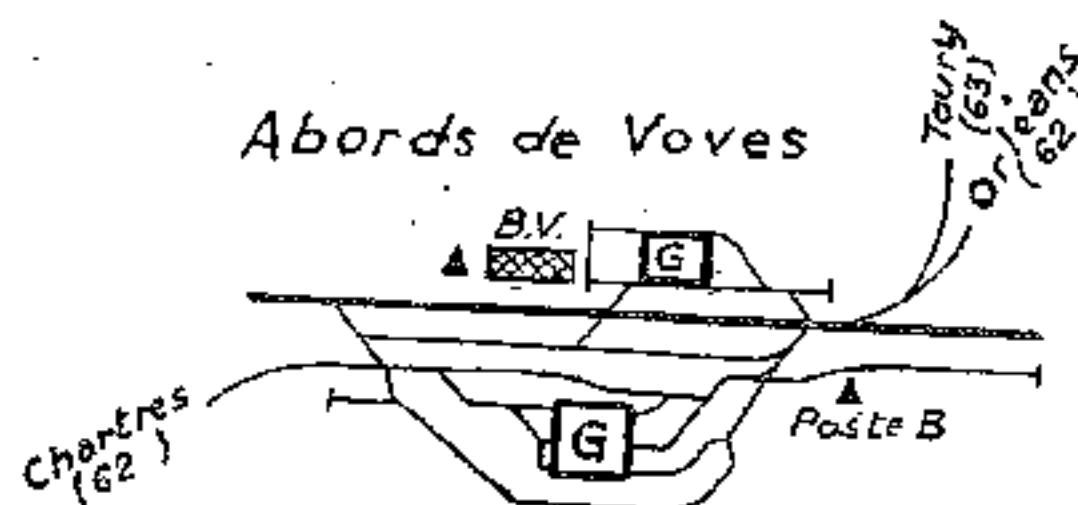

Ligne d'Etampes à Auneau et Chartres

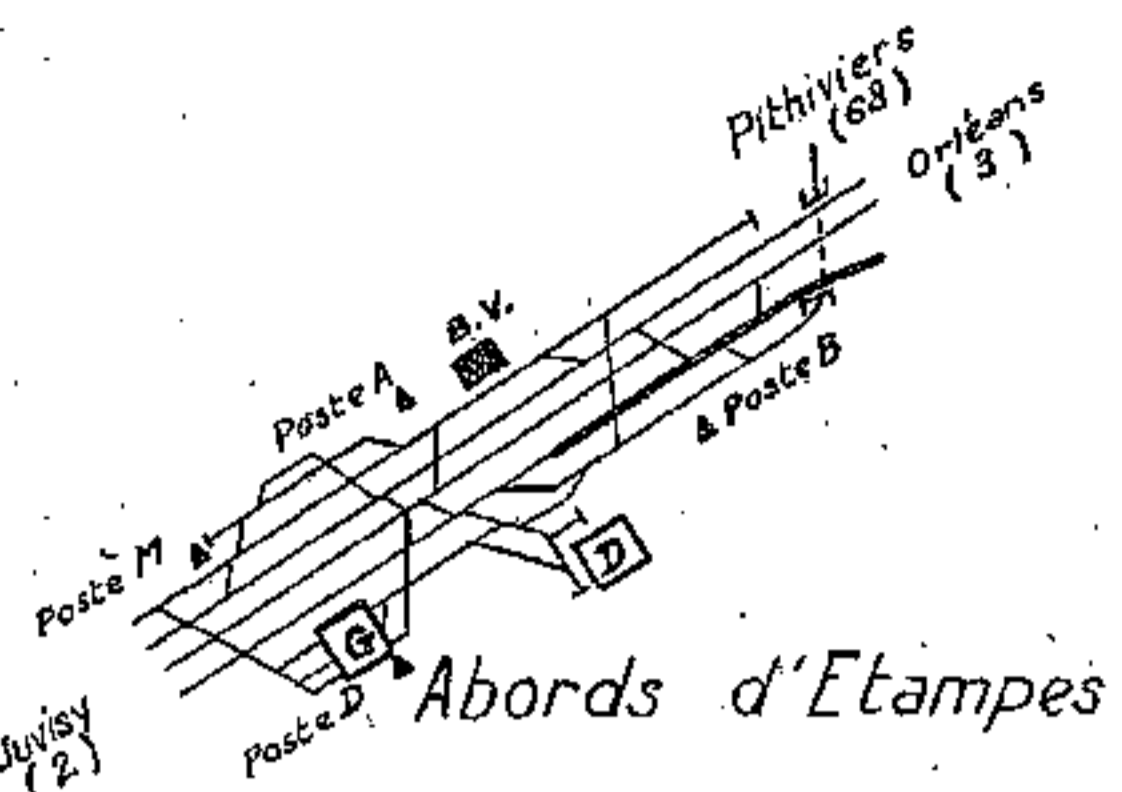

Abords d'Auneau

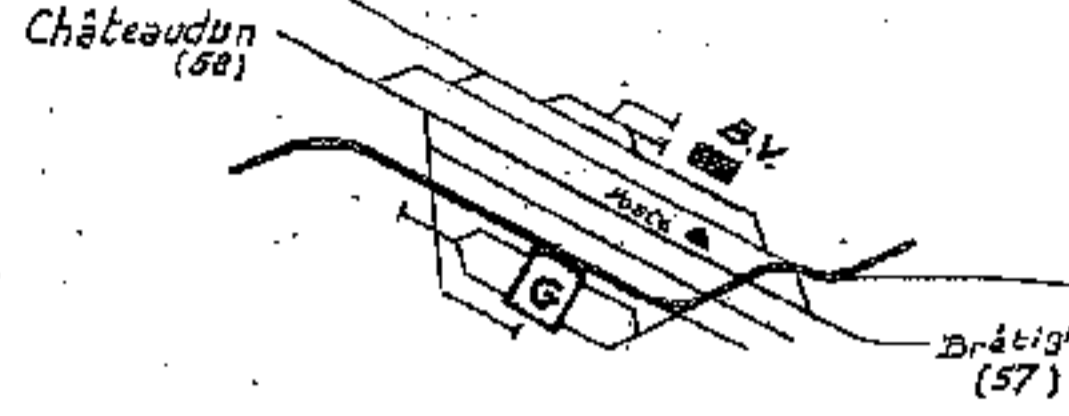

Abords de Beaulieu-le-Coudray



Abords de Chartres (Voir 222)

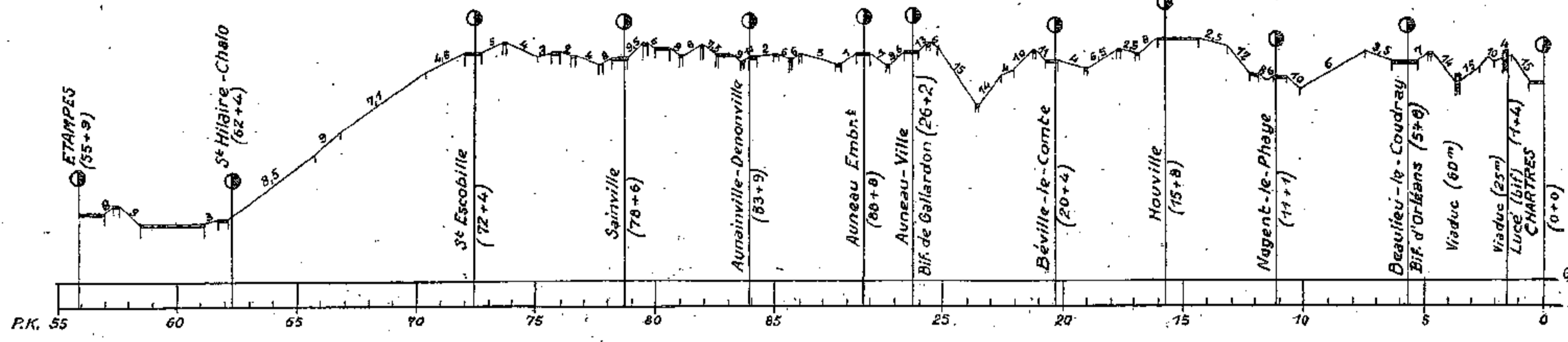
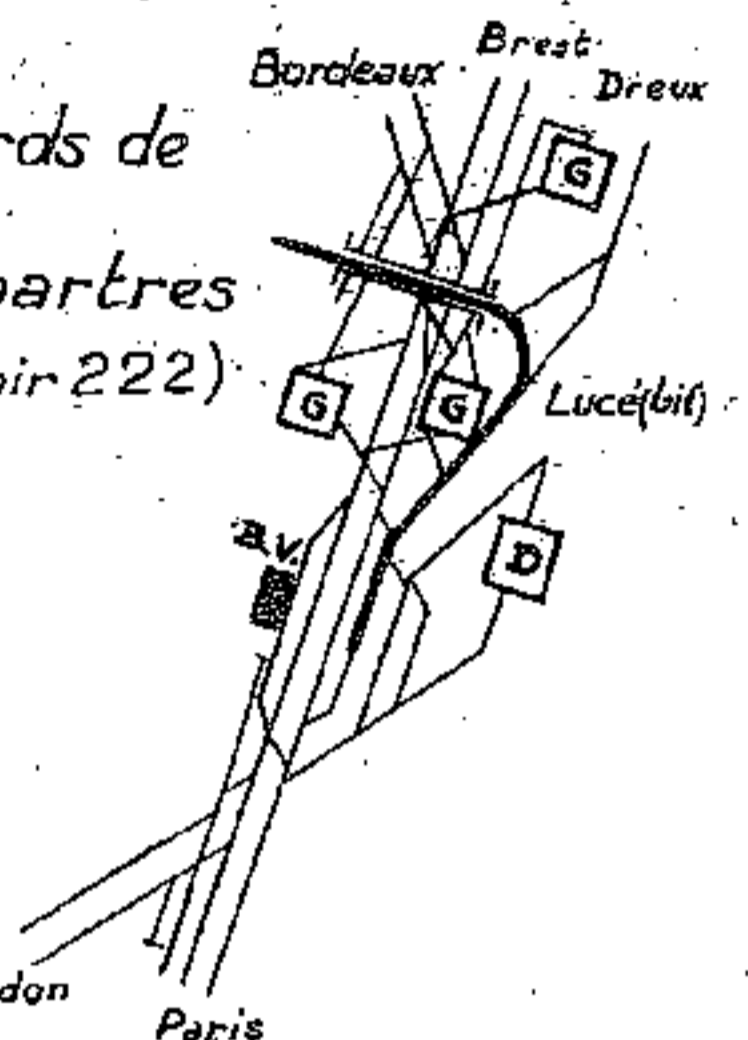

Abords de St-Amand de Vendôme

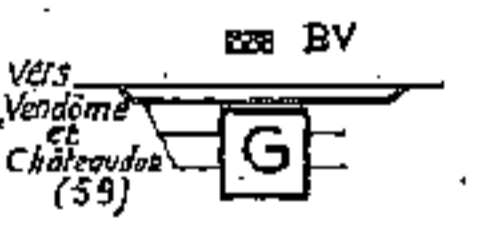

Châteaurenault

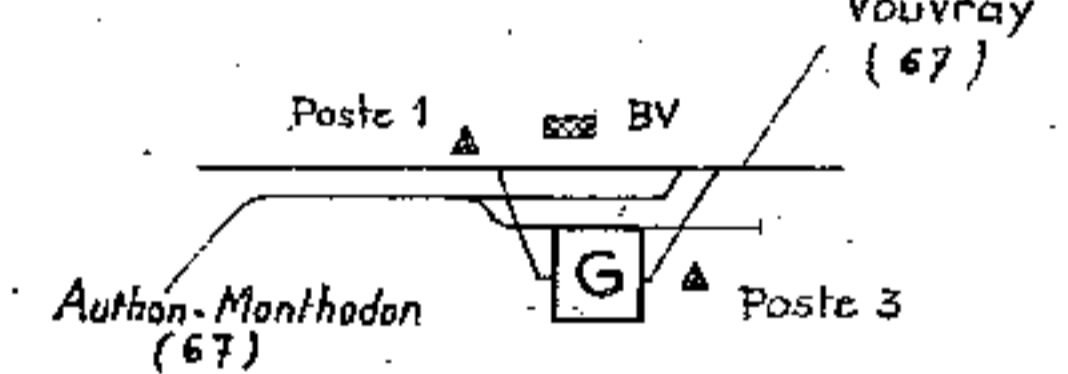

La Membrolle sur Chaisille

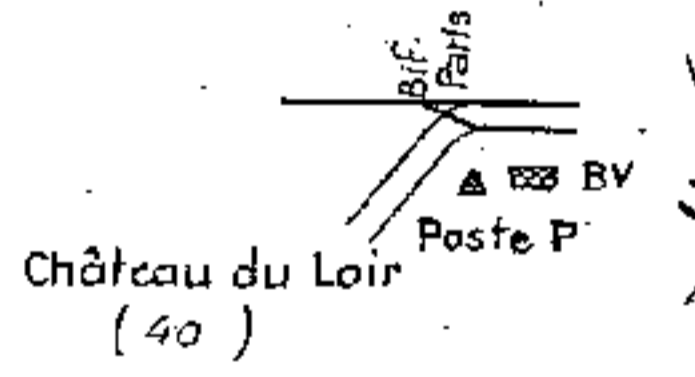

Abords de Tours St-Pierre (voir 201)

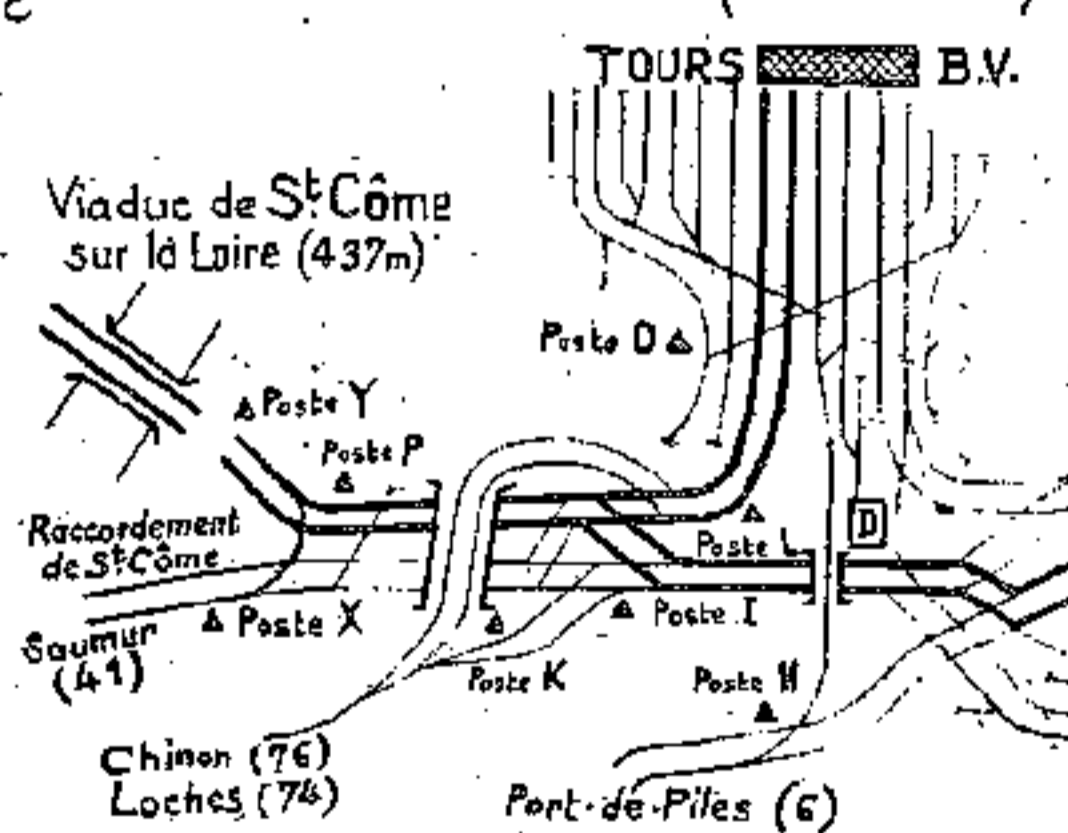

Ligne de Brétigny à Tours Section de St-Amand de Vendôme à Tours-St-Pierre (et raccordement de St-Côme)

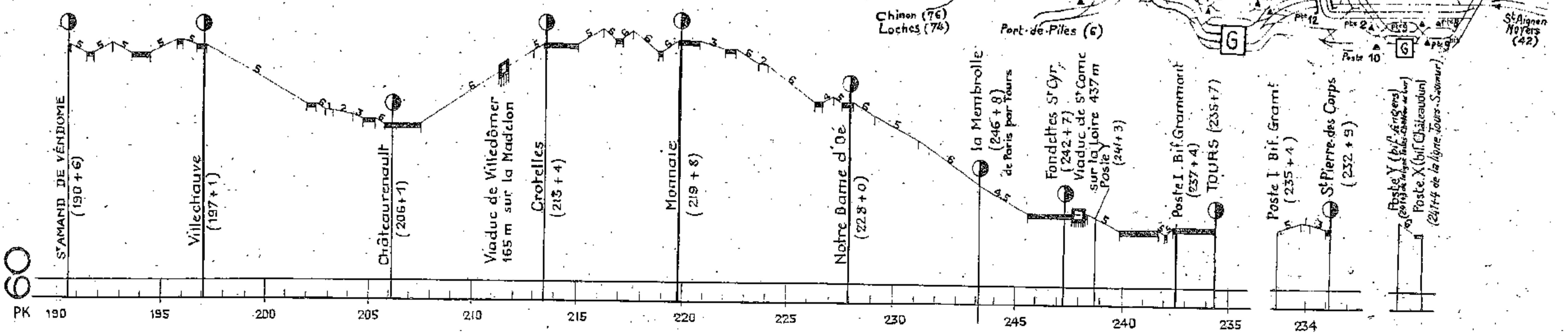
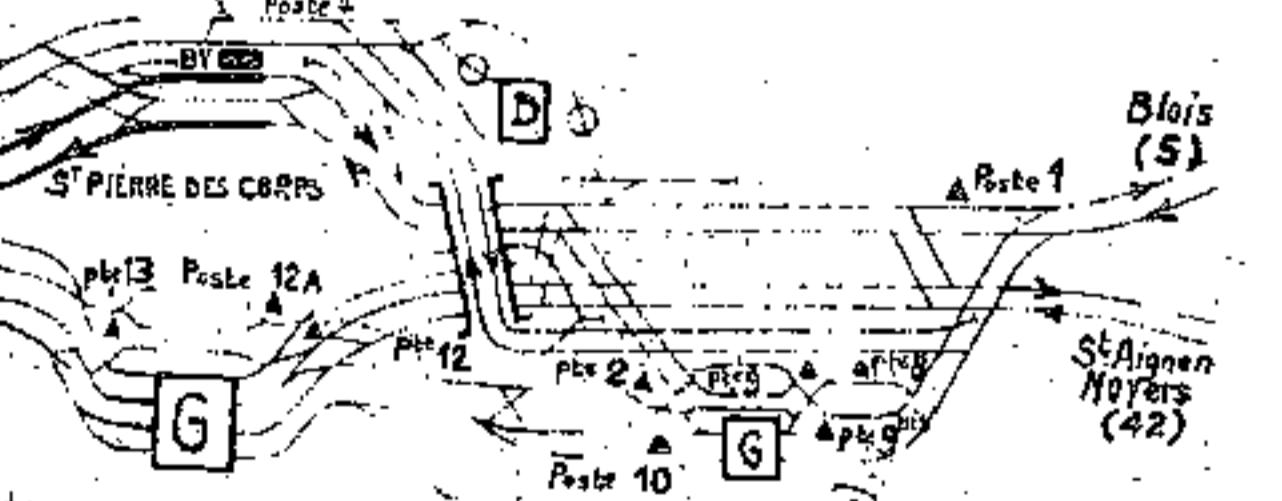

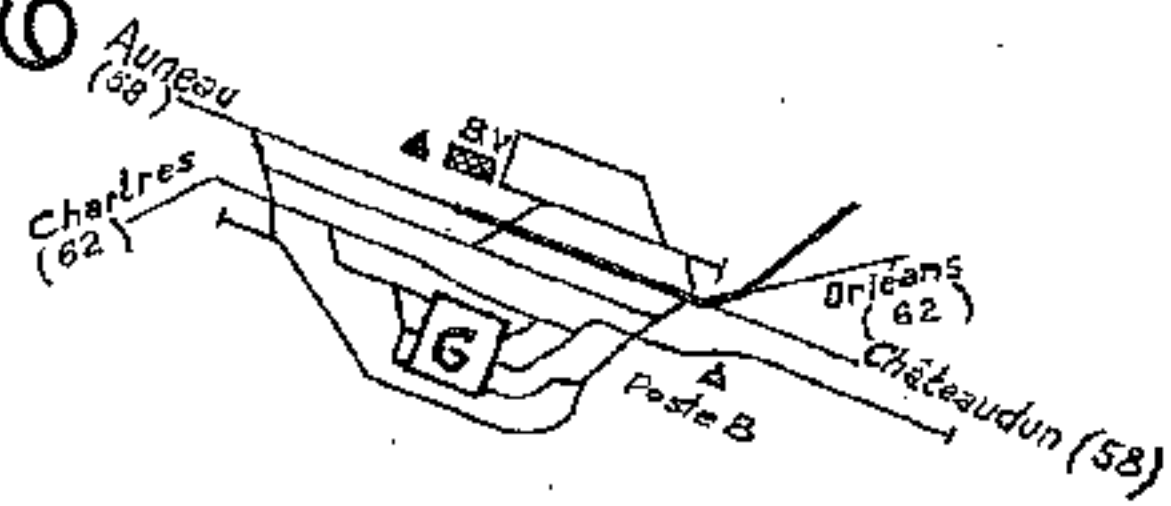

Abords de Vouves

Ligne de Vouves à Toury

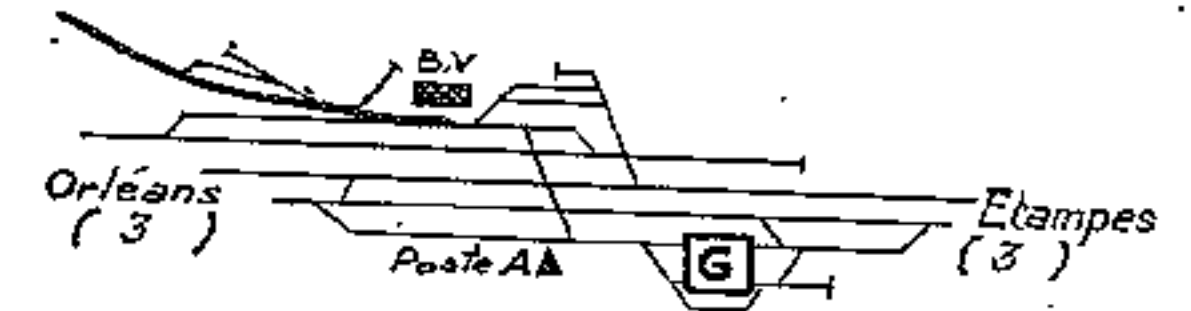

Abords de Toury

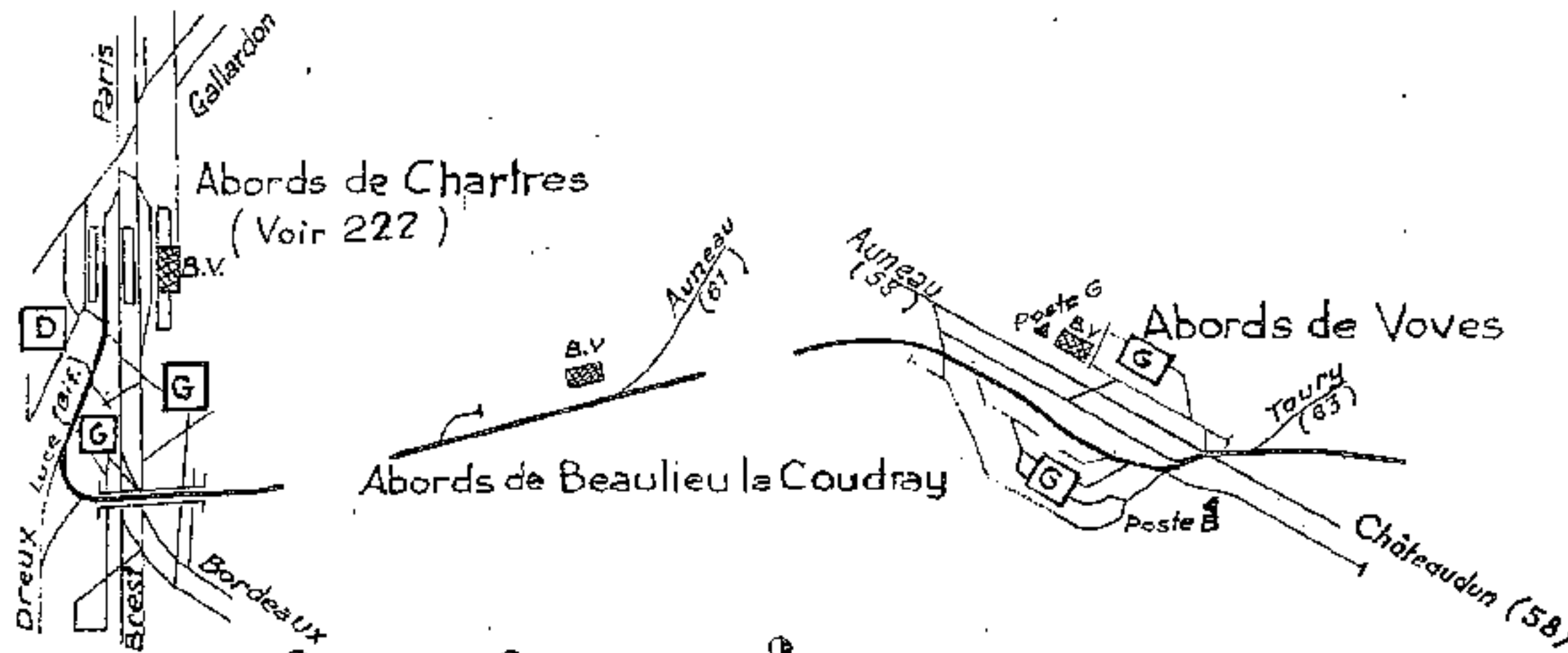
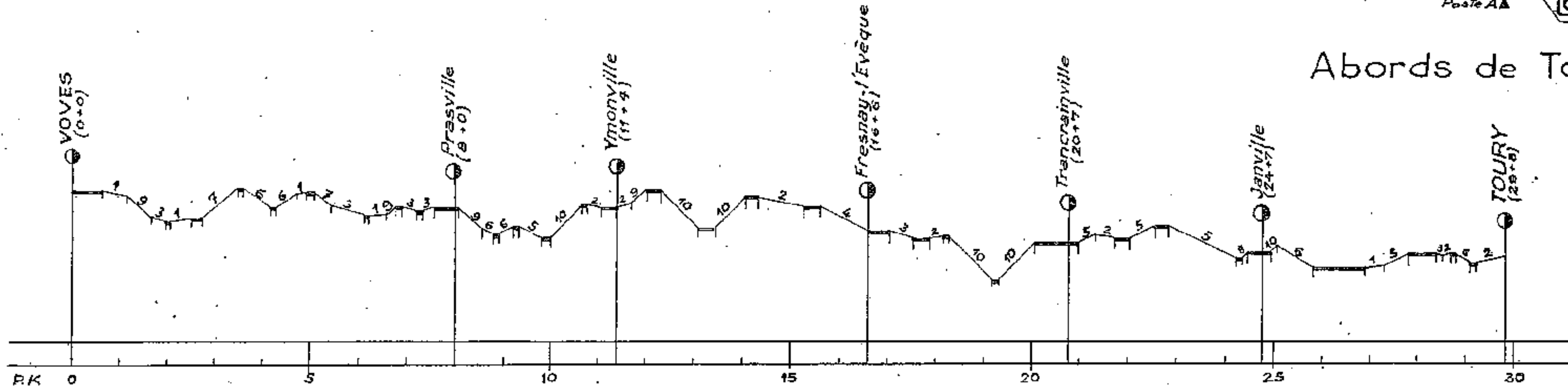

Abords de Chartres (Voir 222)

Abords de Vouves

Abords de Beaulieu la Coudray

Abords de Patay

Ligne de Chartres à Orléans

Abords d'Orléans (Voir 200) vers le triage (voir 200)

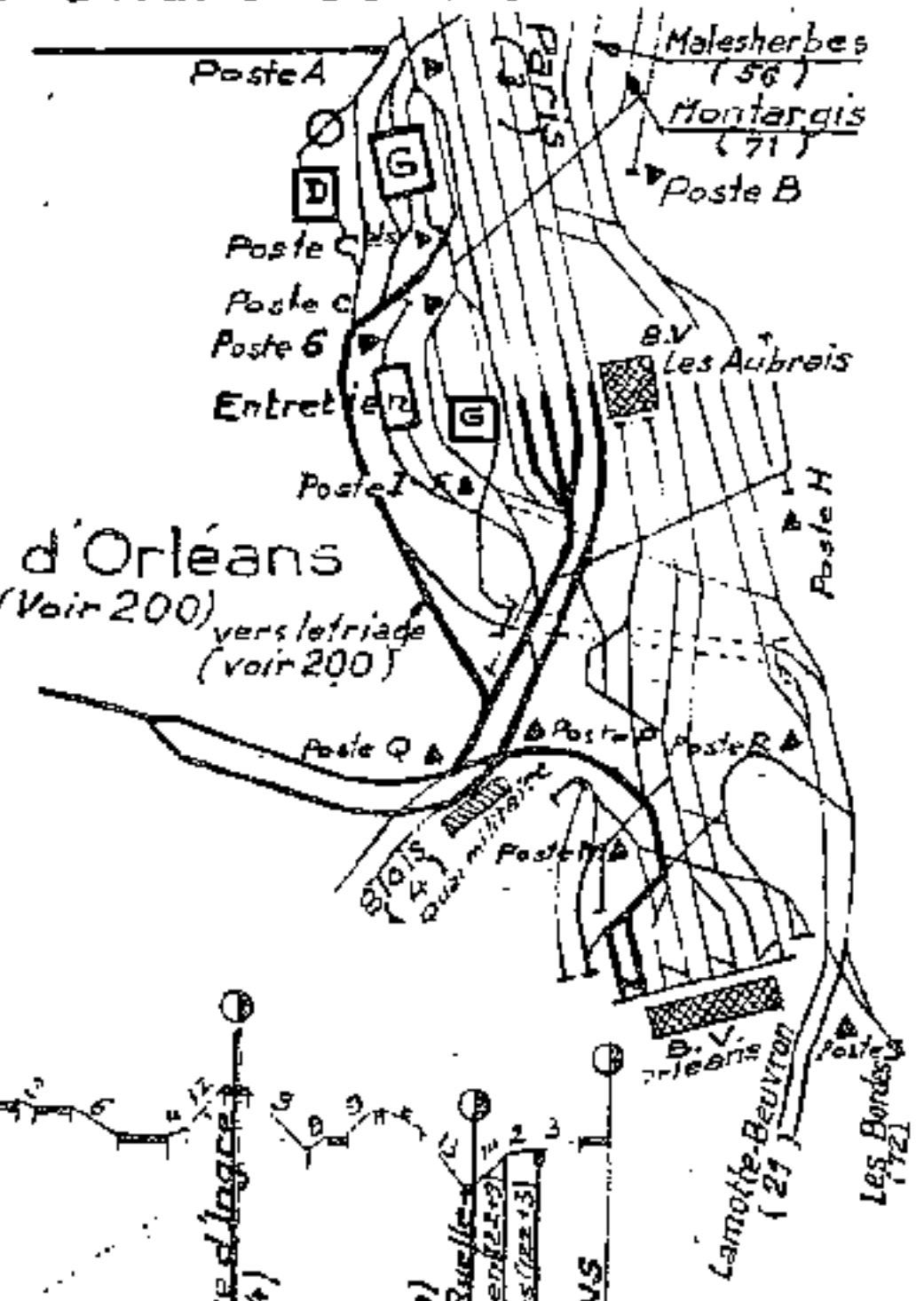
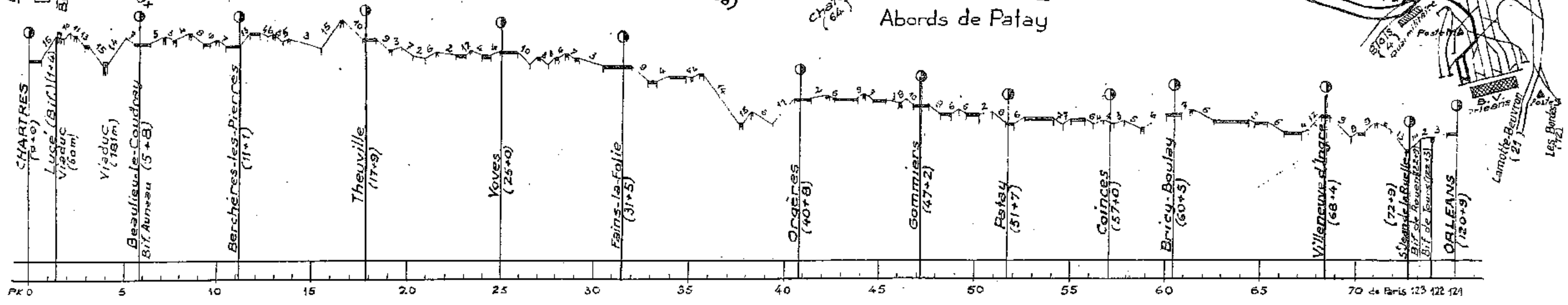

Abords de Blois

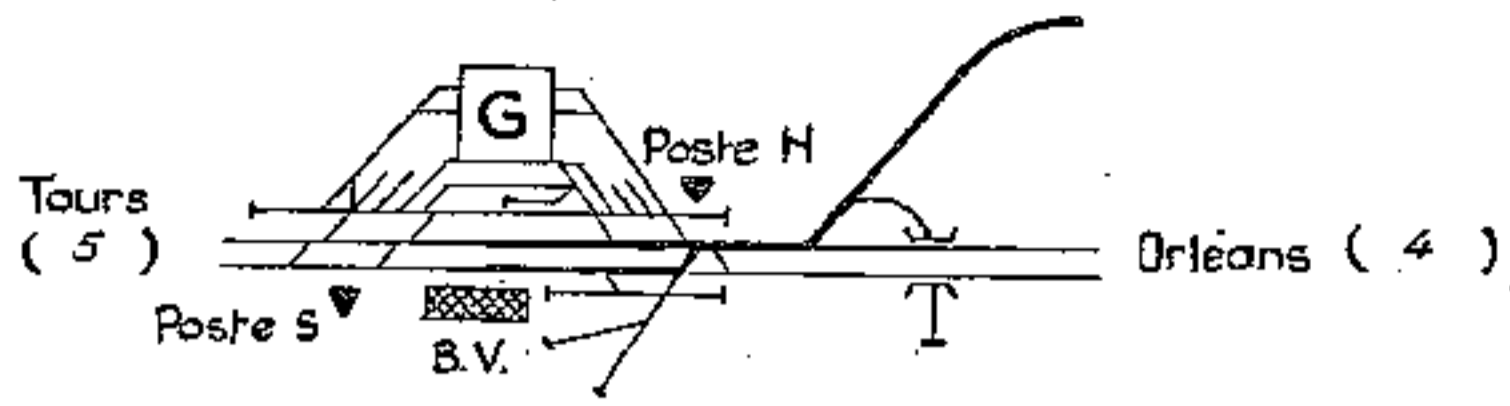

Ligne de Blois à Troô

Sections de Blois à Villefrancoeur et de Selommes à Vendôme

Abords de Vendôme

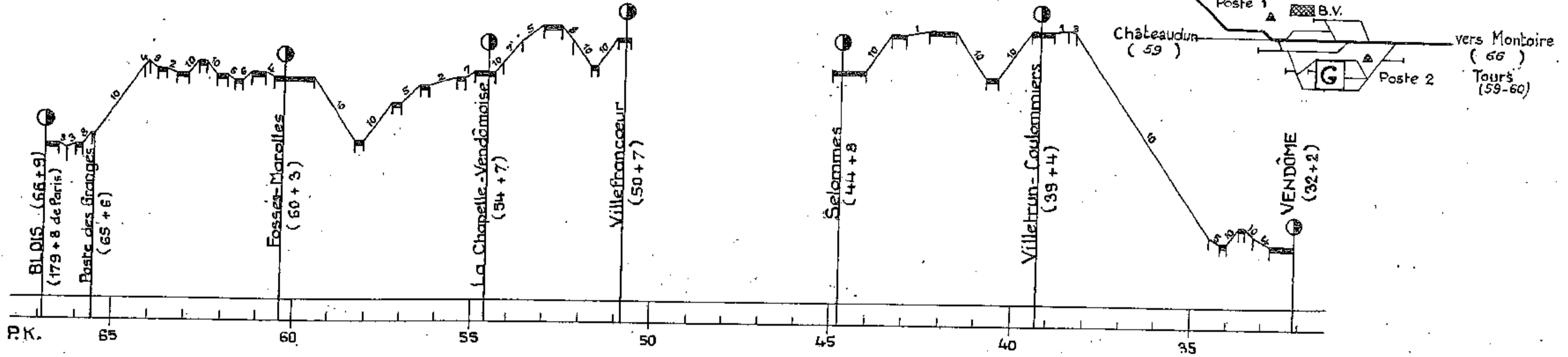

Ligne de Châteaudun à Patay

Abords de Châteaudun

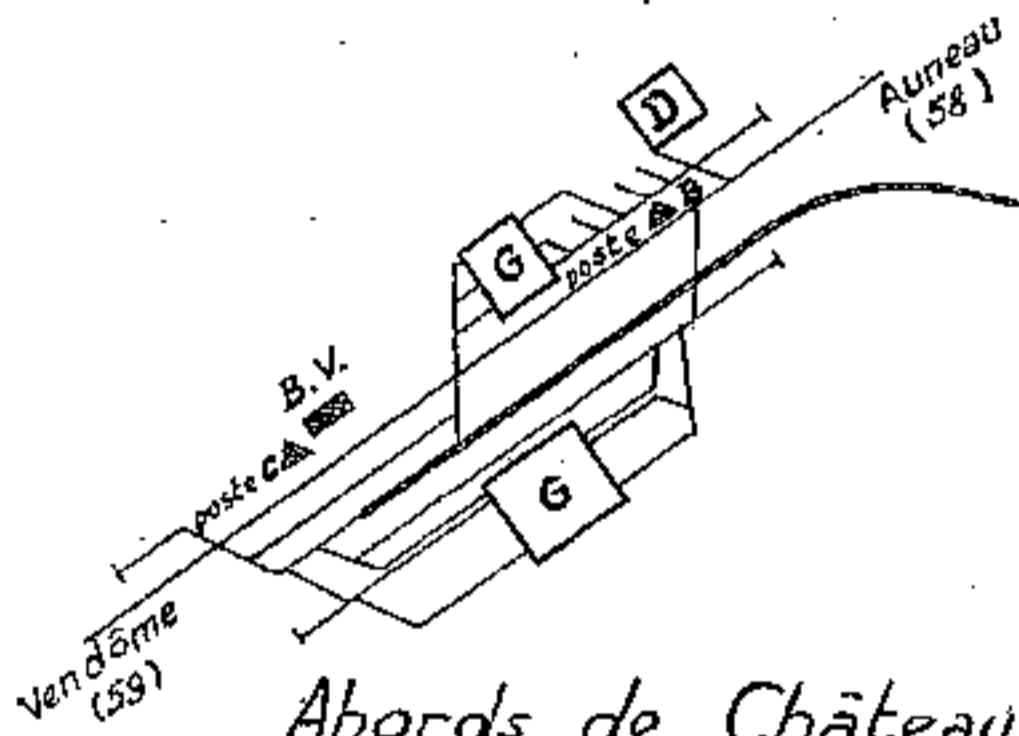

Abords de Patay

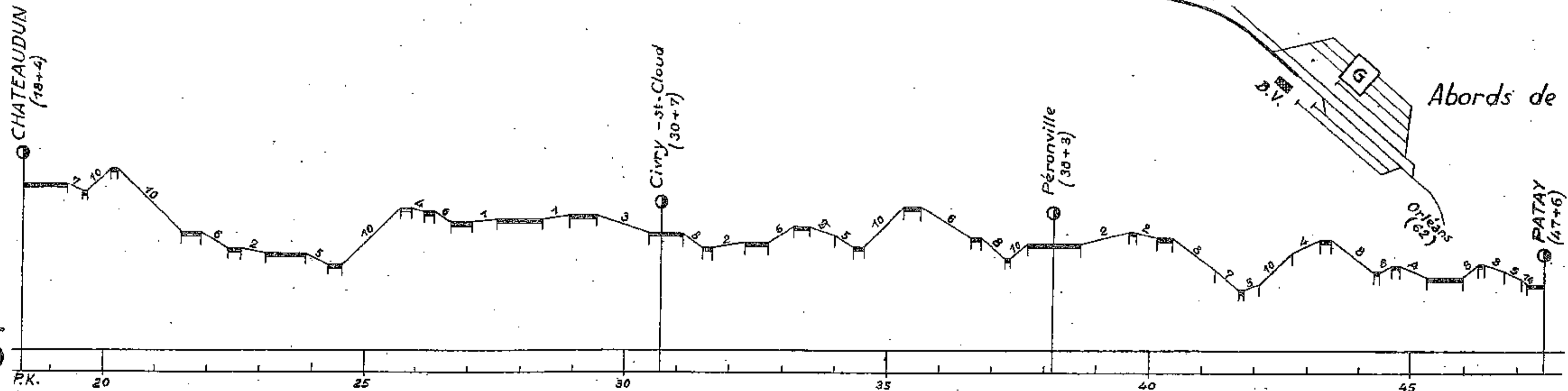

Ligne de Pleumartin à Tournon St Martin

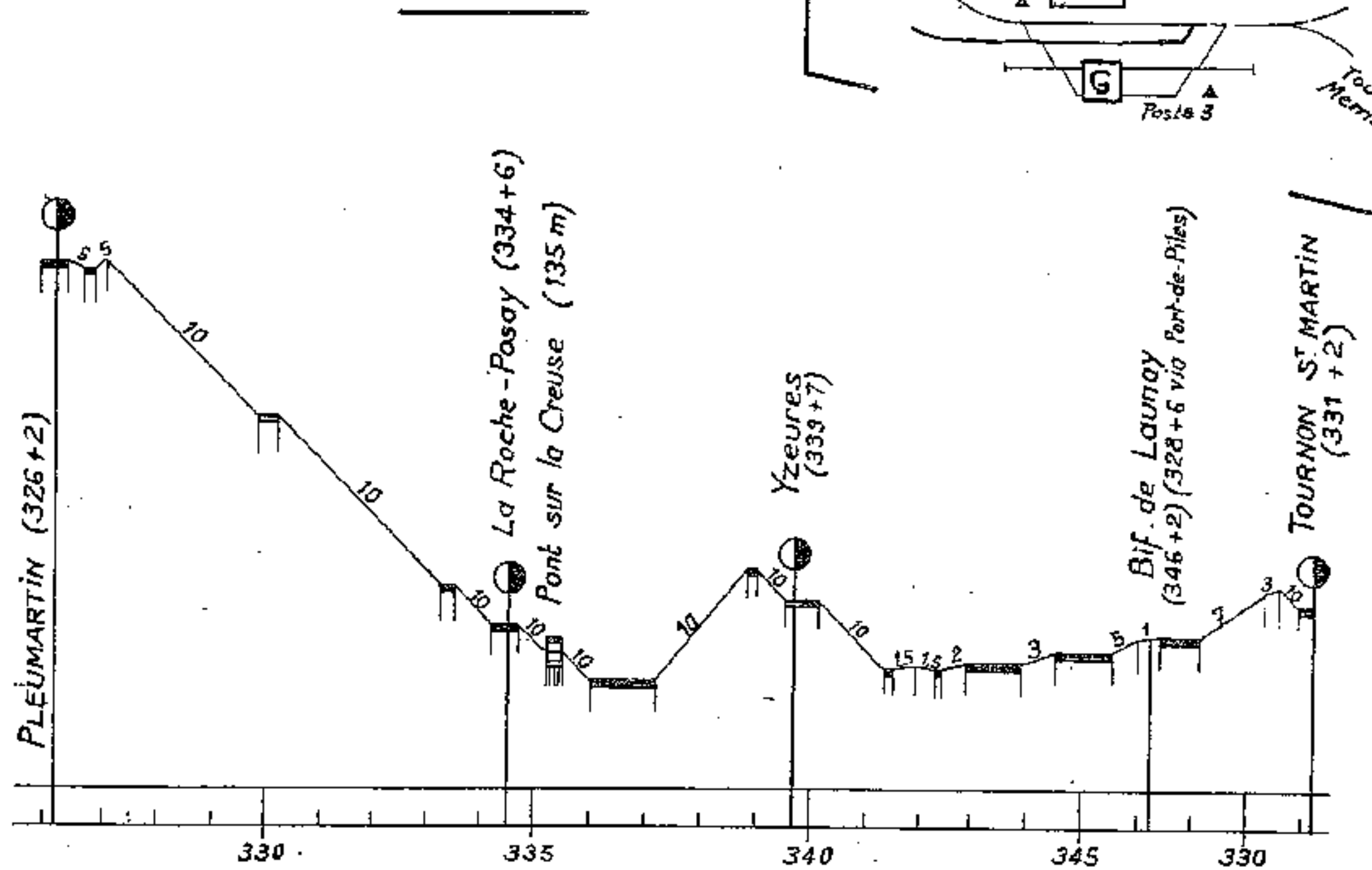

Abords de Châteaurenault

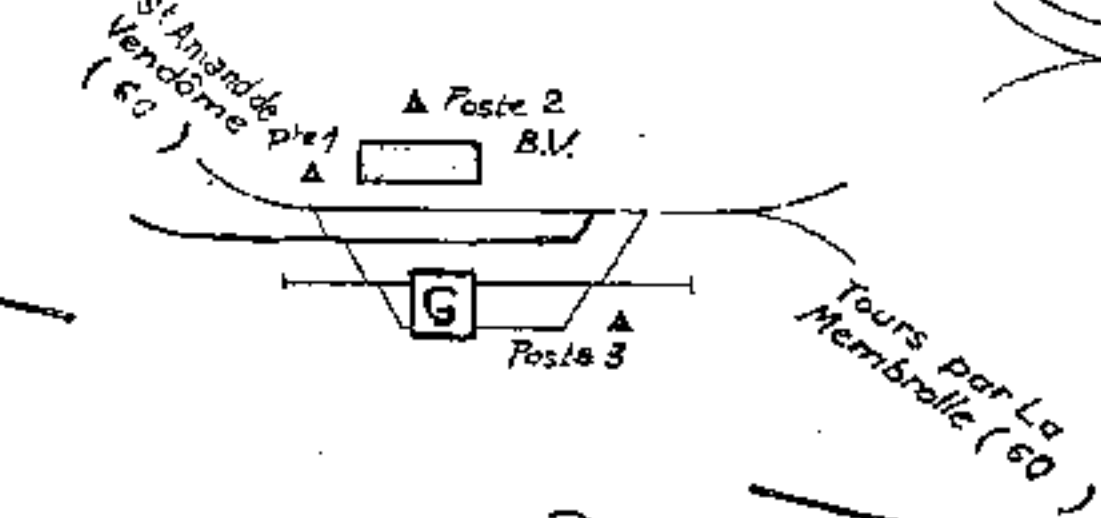

Abords de Vouvray

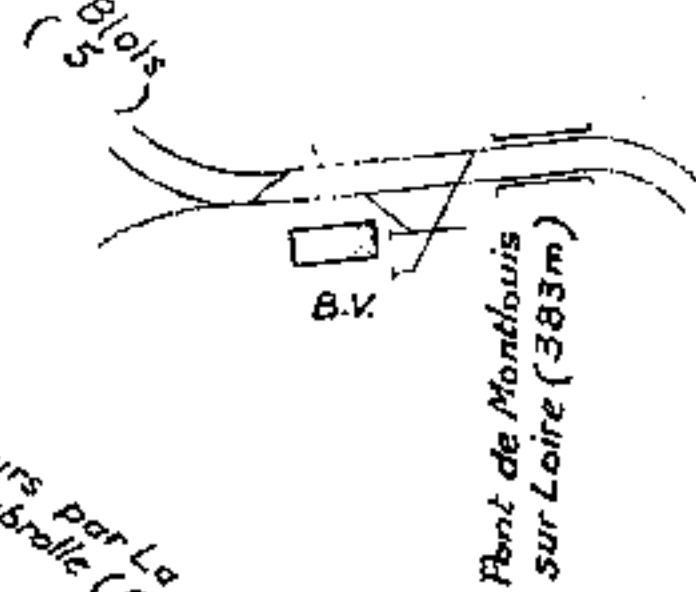

Ligne de Authon-Monthodon à Tours

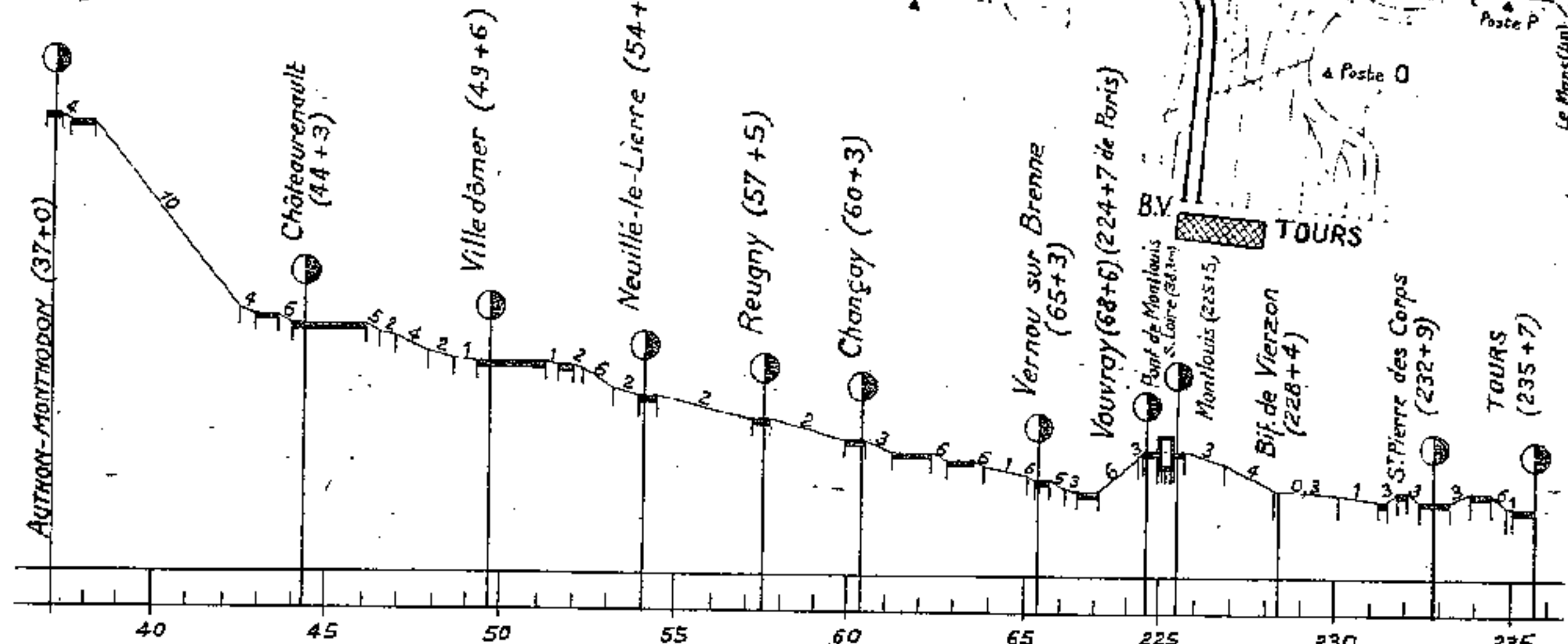

Abords de Tours St Pierre des Corps (voir 201)

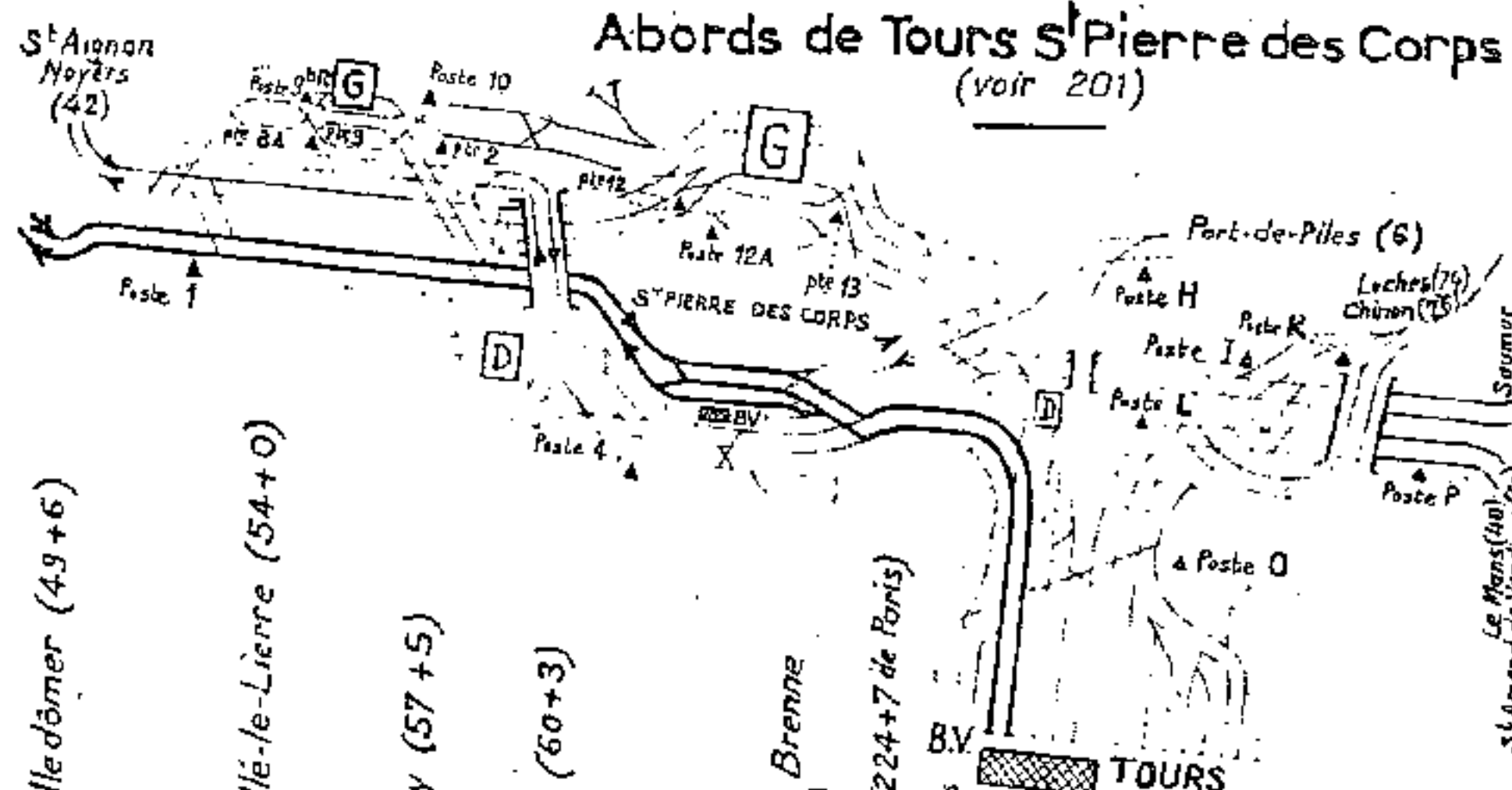

Abords de Vendôme

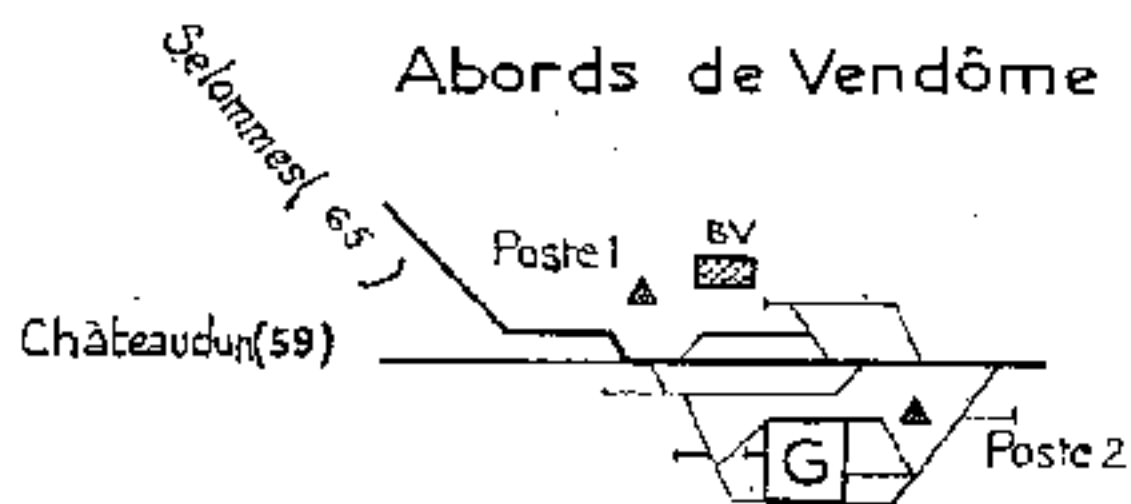

Bif. Pont de Braye

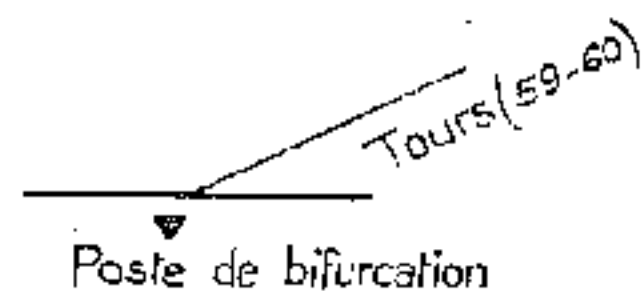

Abords de Montoire

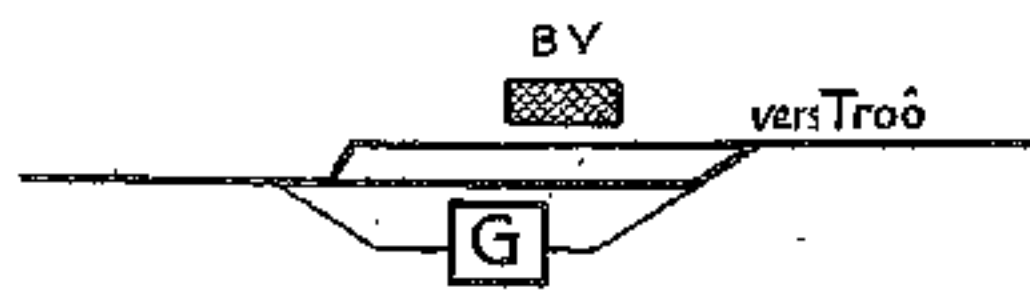

Ligne de Blois à Troô

Section de Vendôme à Troô

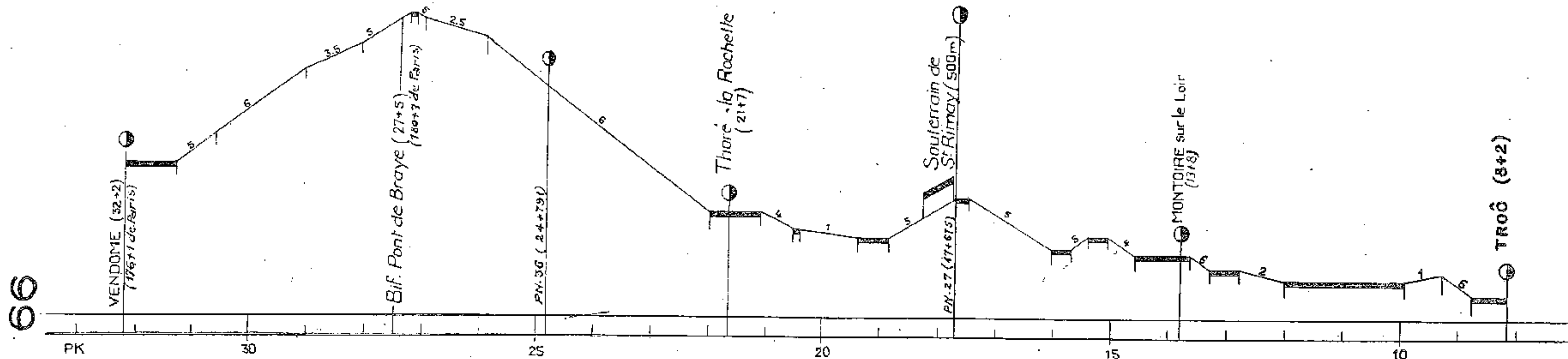

① Abords de
 ② Bellegarde-Quiers

Ligne d'Etampes à Bourges
 Section de Bellegarde-Quiers à Argent

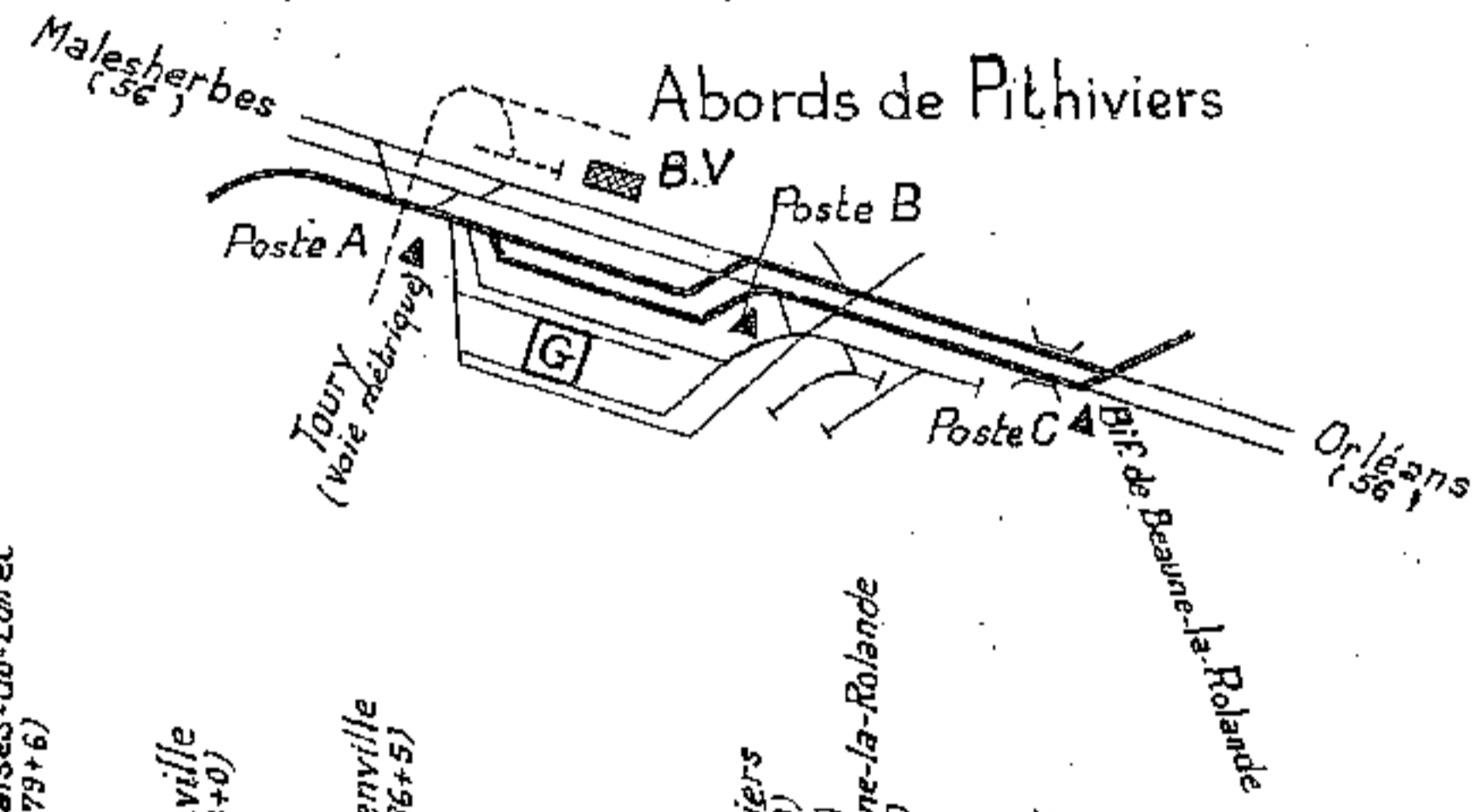
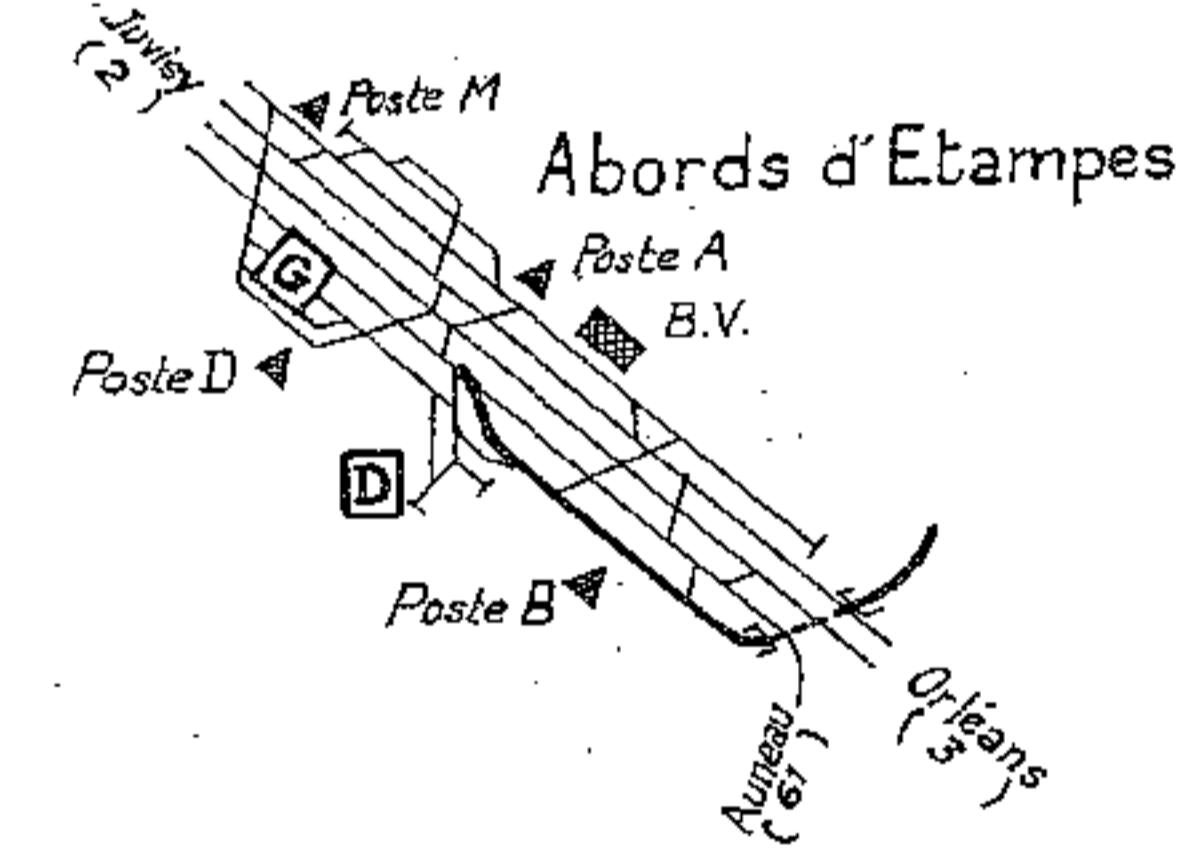
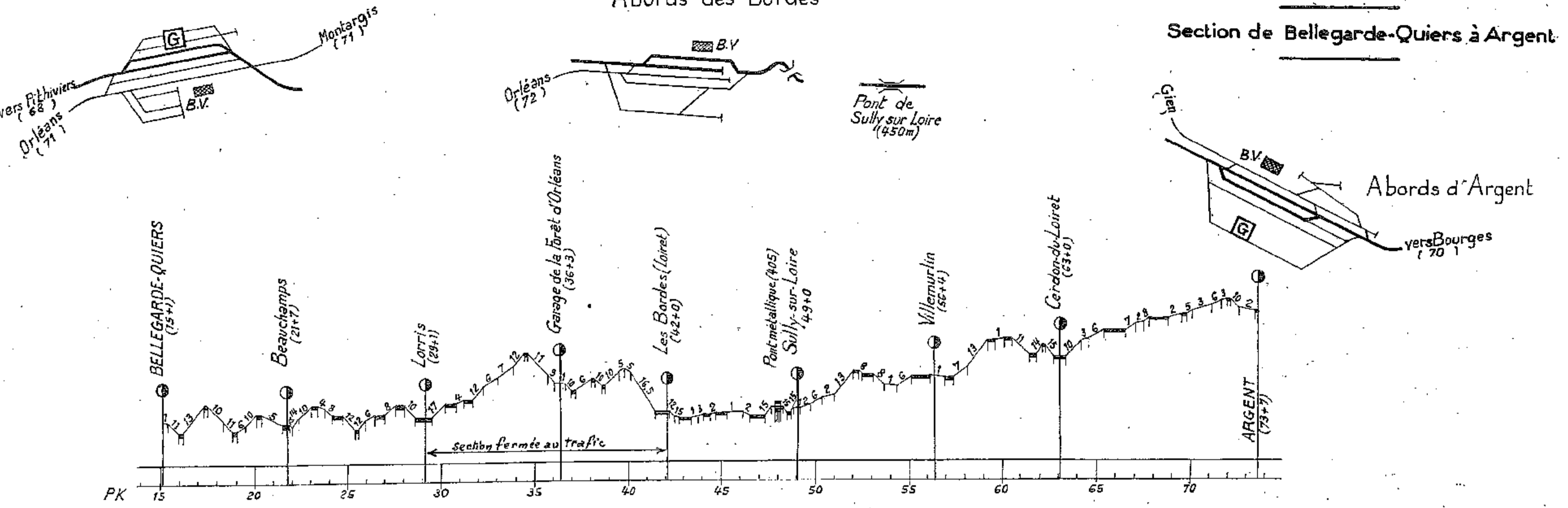

Ligne d'Etampes à Bourges
 Section d'Etampes à Bellegarde-Quiers

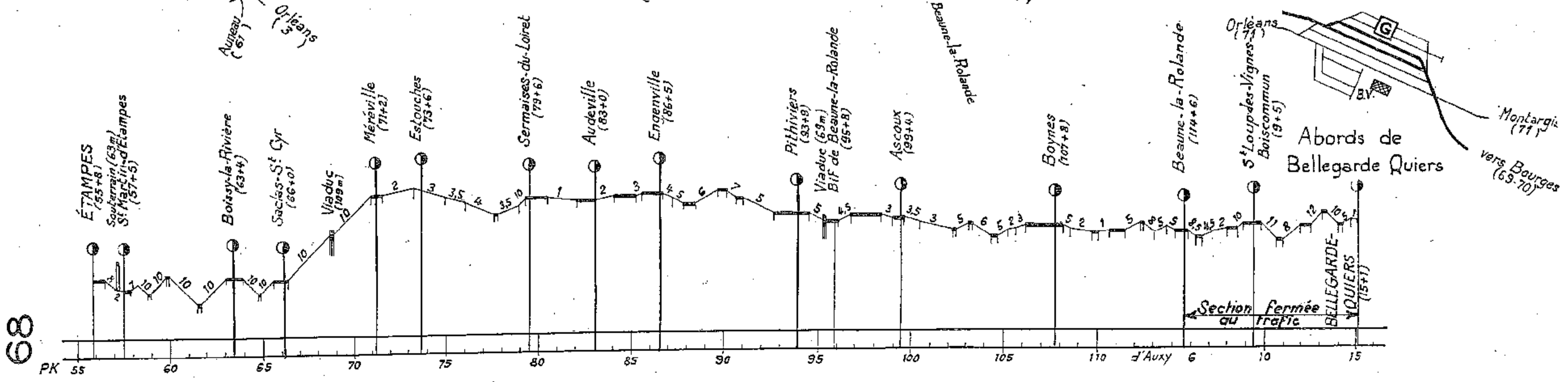

Ligne de Montargis à Orléans

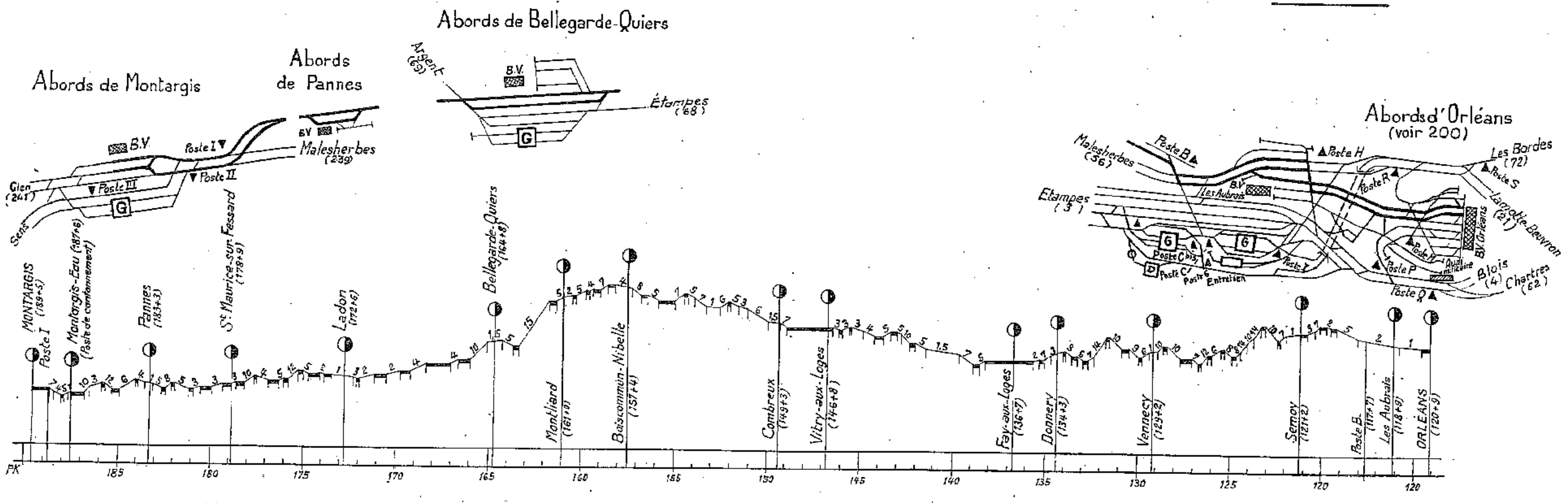

Ligne d'Etampes à Bourges

Section d'Argent à Bourges

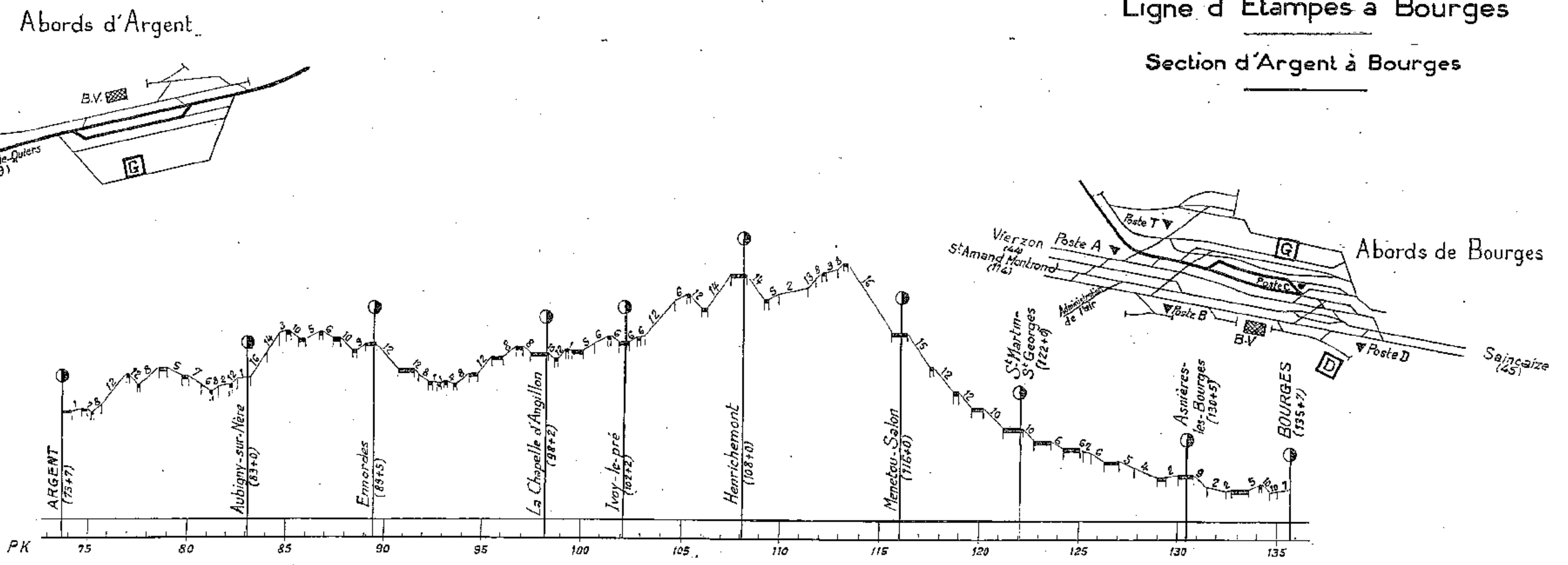

Abords de Bourges

Ligne de Bourges à Cosne

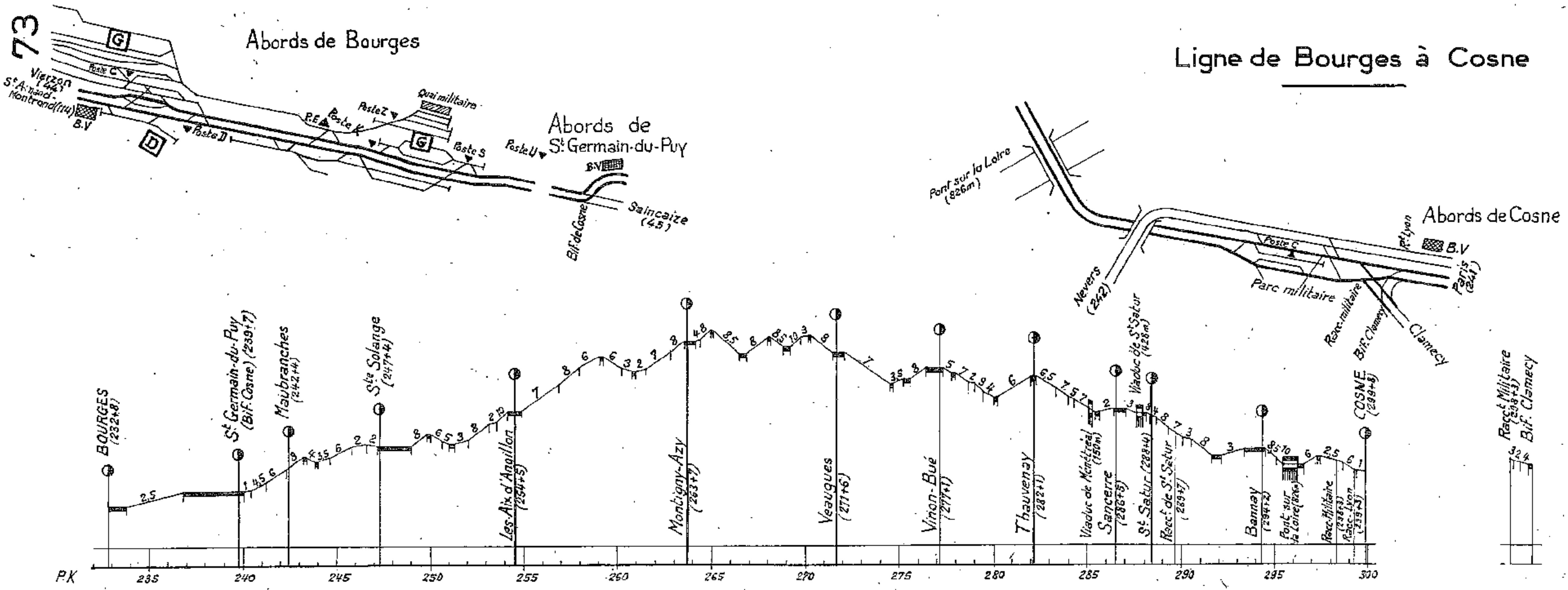

Abords des Aubrais-Orléans (voir 200)

Ligne d'Orléans aux Bordes

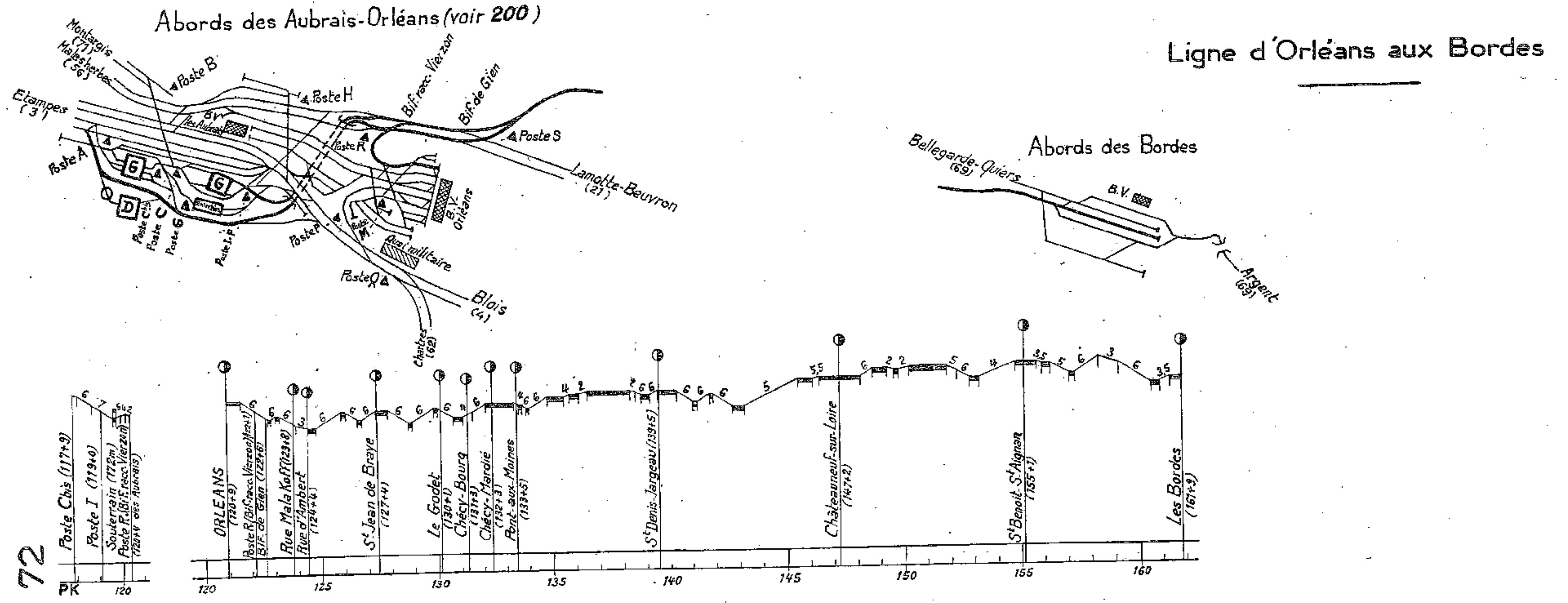

Ligne de Tours à Châteauroux

Section de Loches à Châteauroux

Abords de Loches

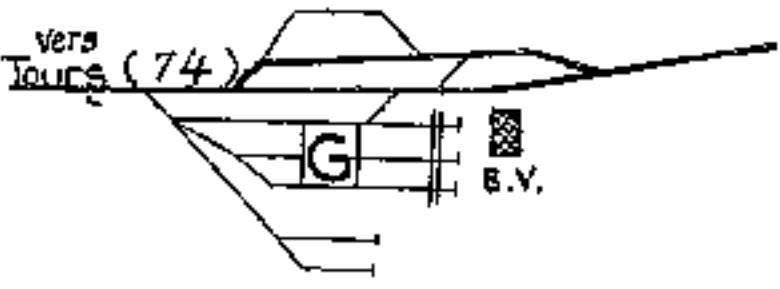

Abords de Châteauroux

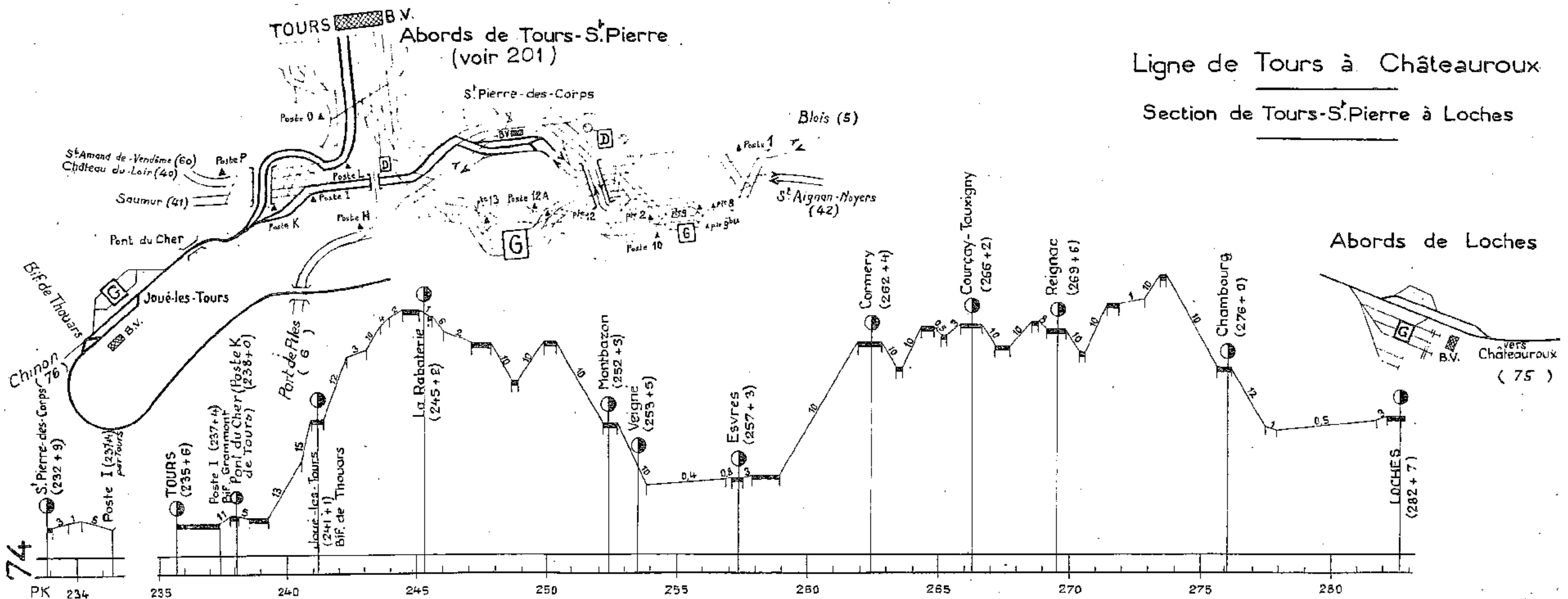
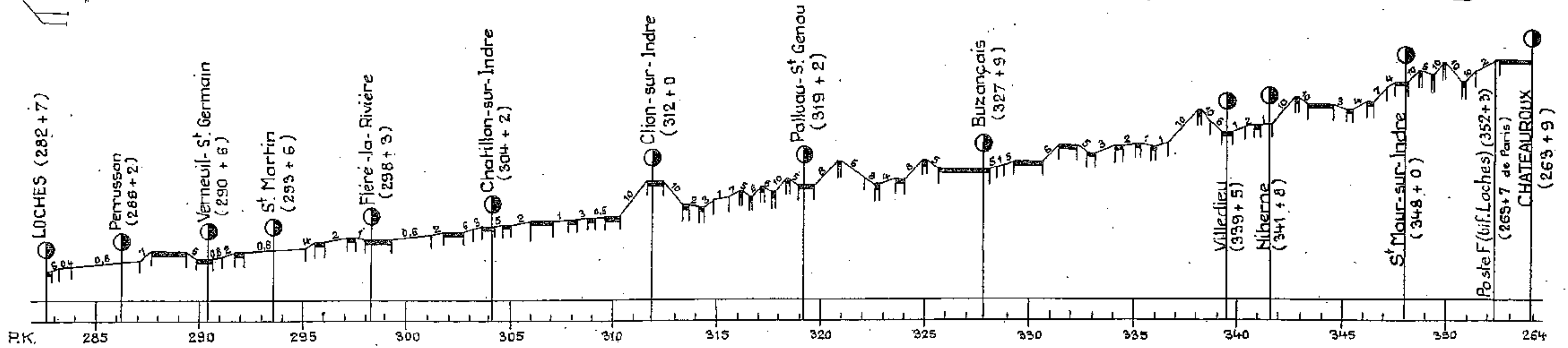
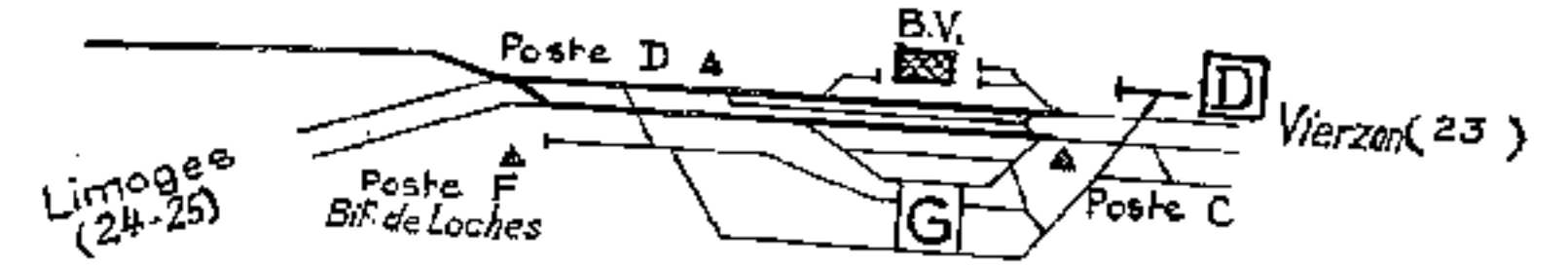

Ligne de Tours à Châteauroux

Section de Tours-S. Pierre à Loches

Abords de Tours-S. Pierre (voir 201)

Abords de Loches

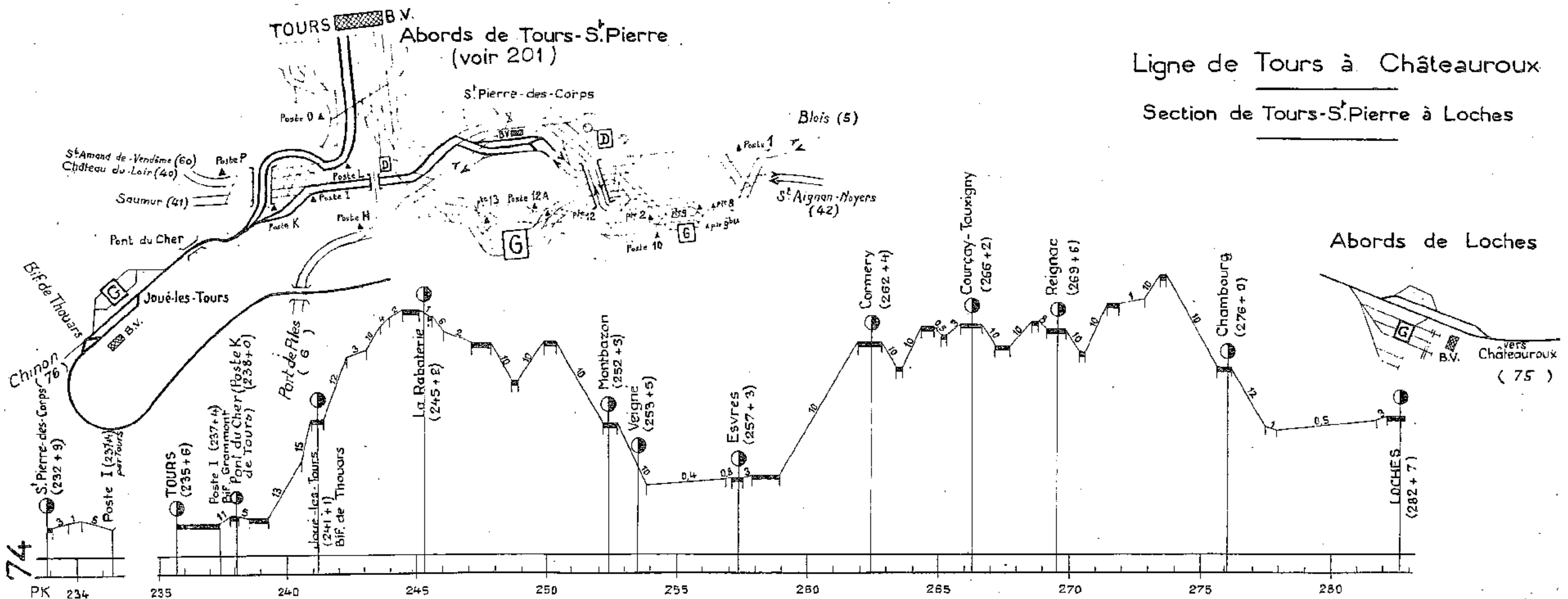

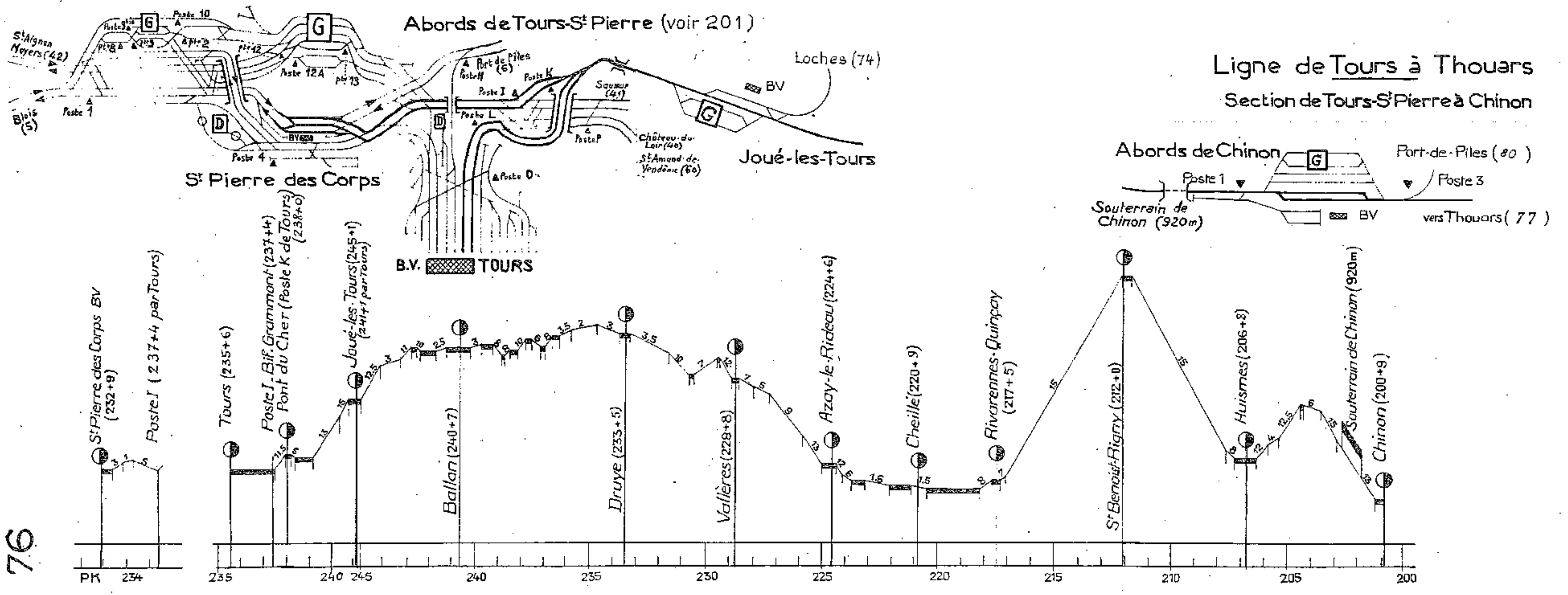
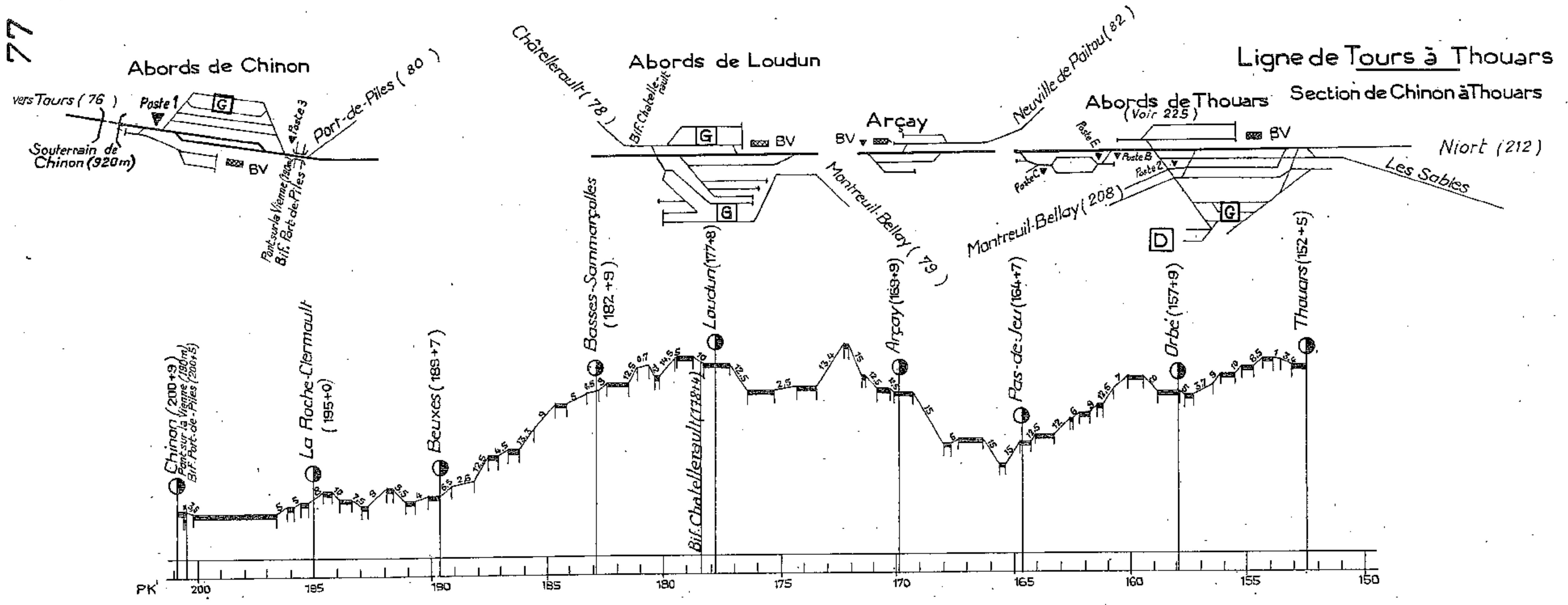

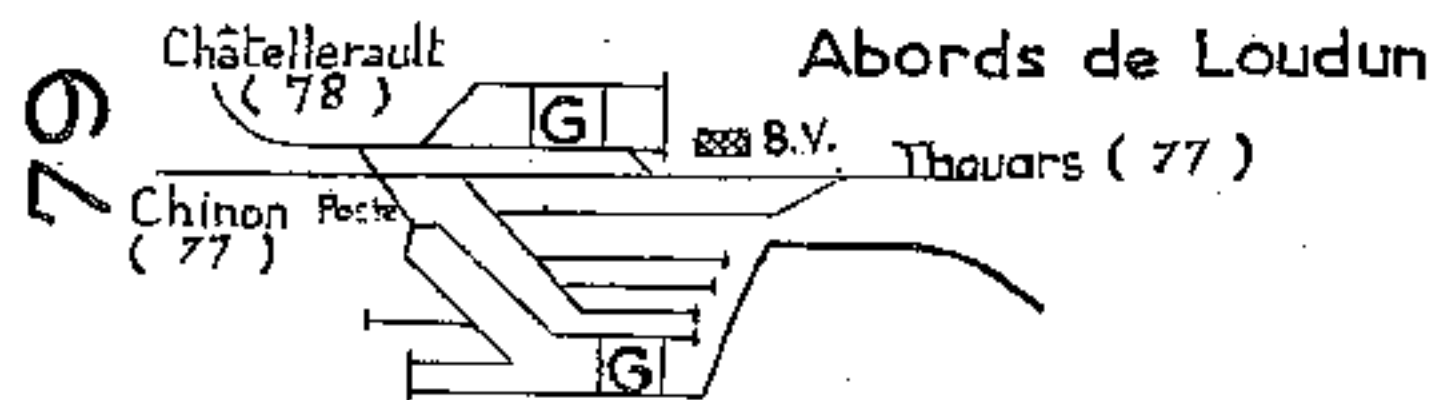

Ligne de Loudun à Montreuil-Bellay

Abords de Montreuil-Bellay

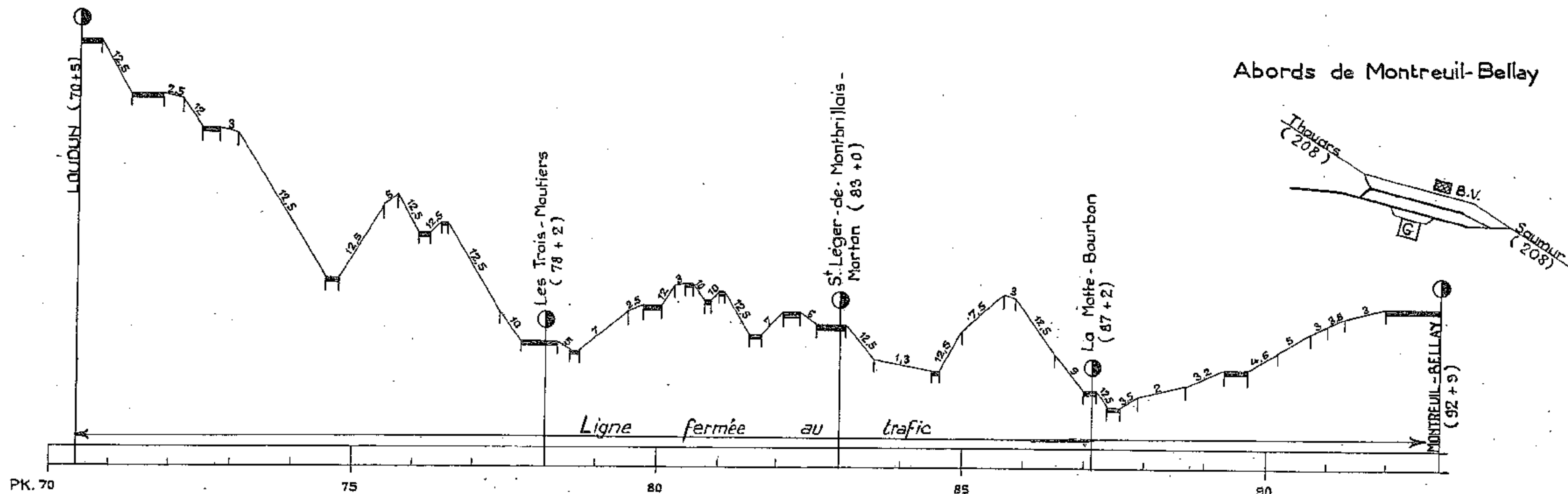

Abords de Loudun

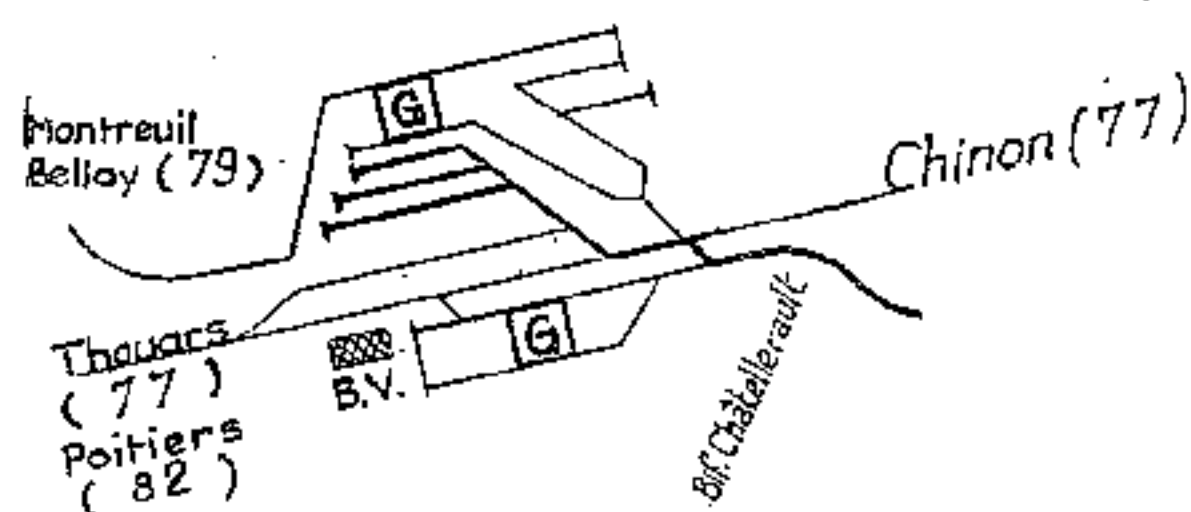

Ligne de Loudun à Châtellerault

Abords de Châtellerault

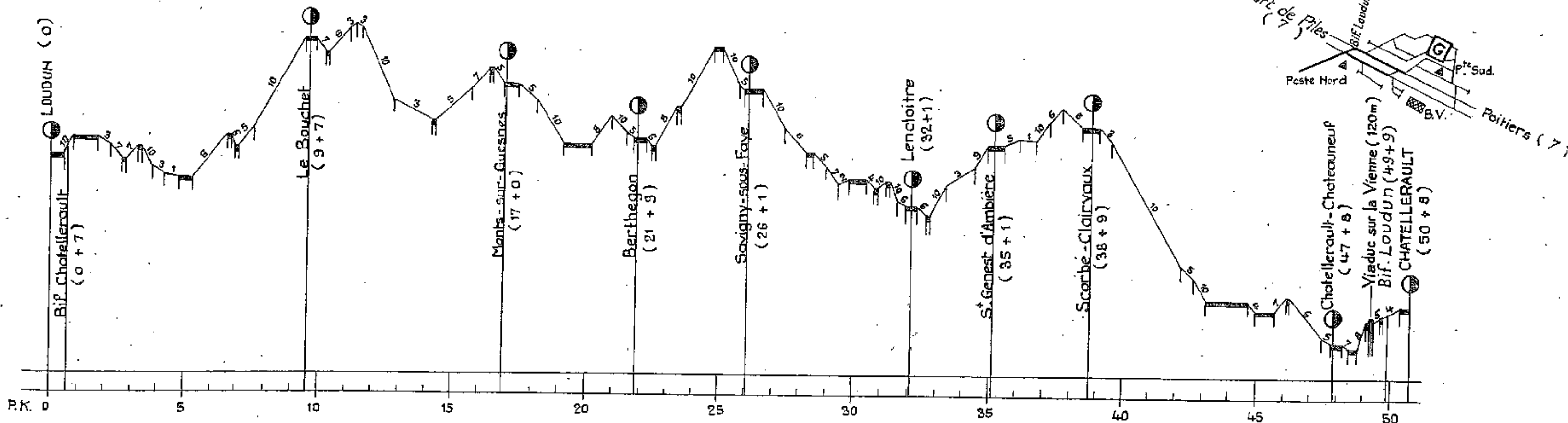

Ligne de Ligré - Rivière à Richelieu

80

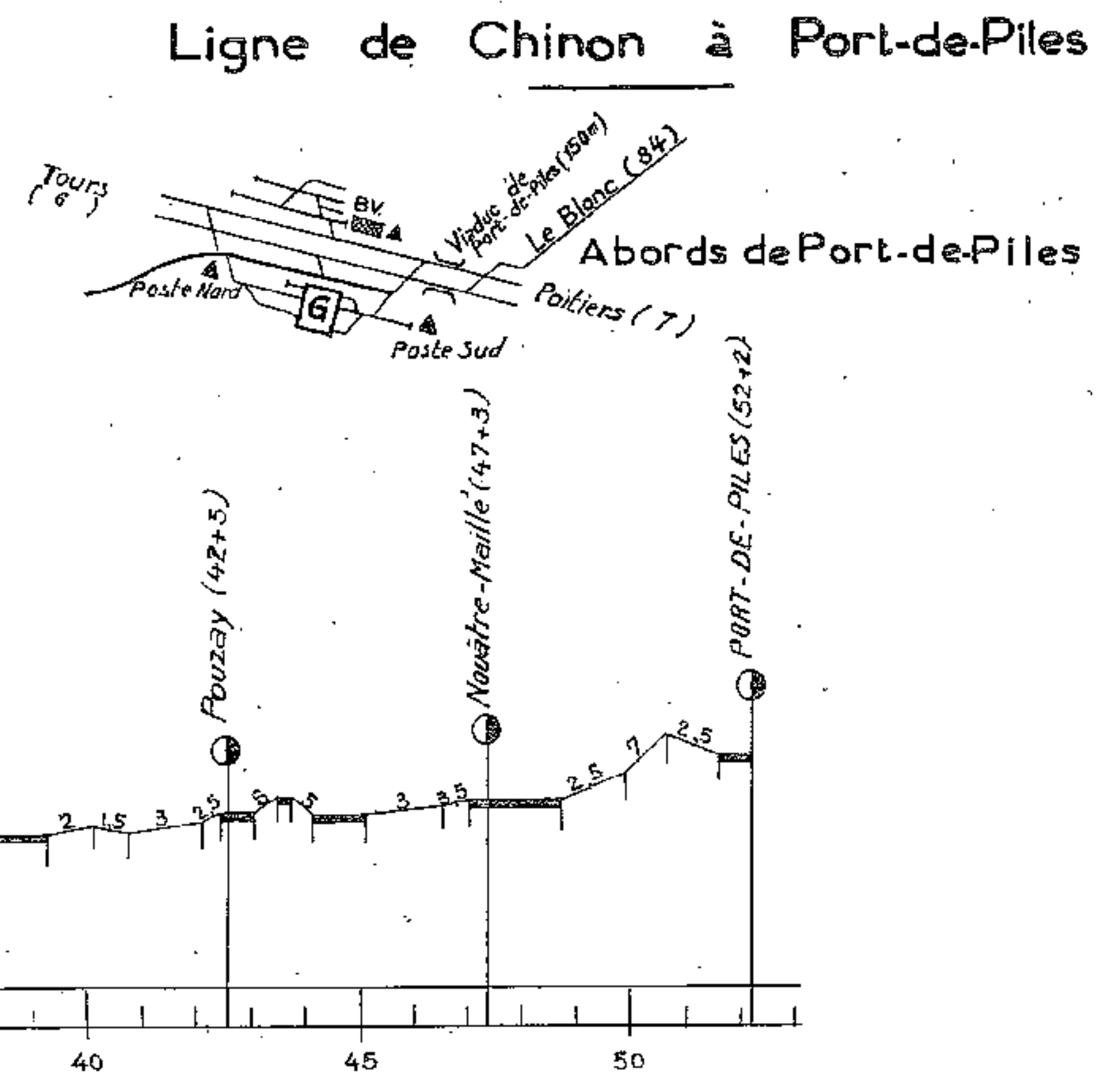
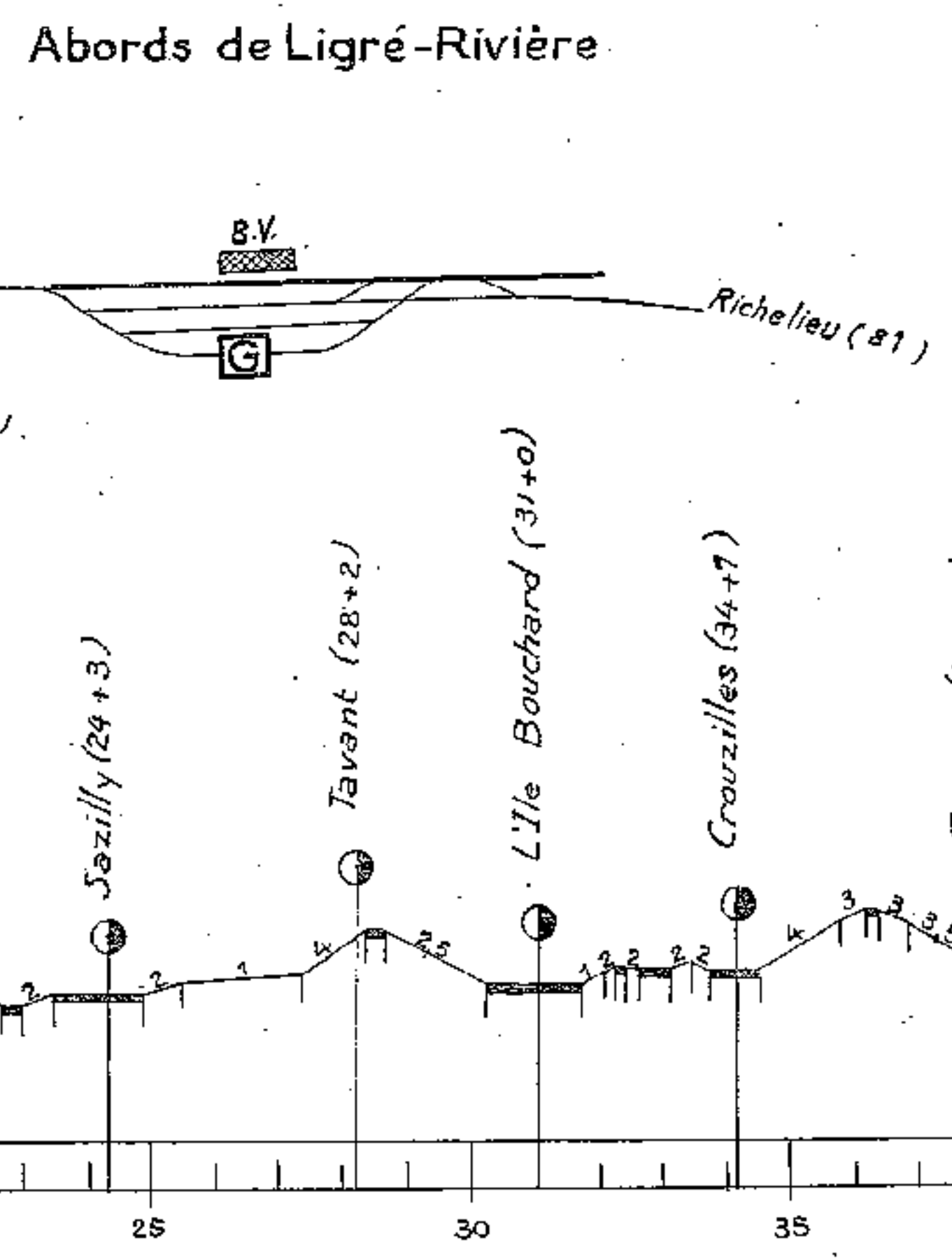
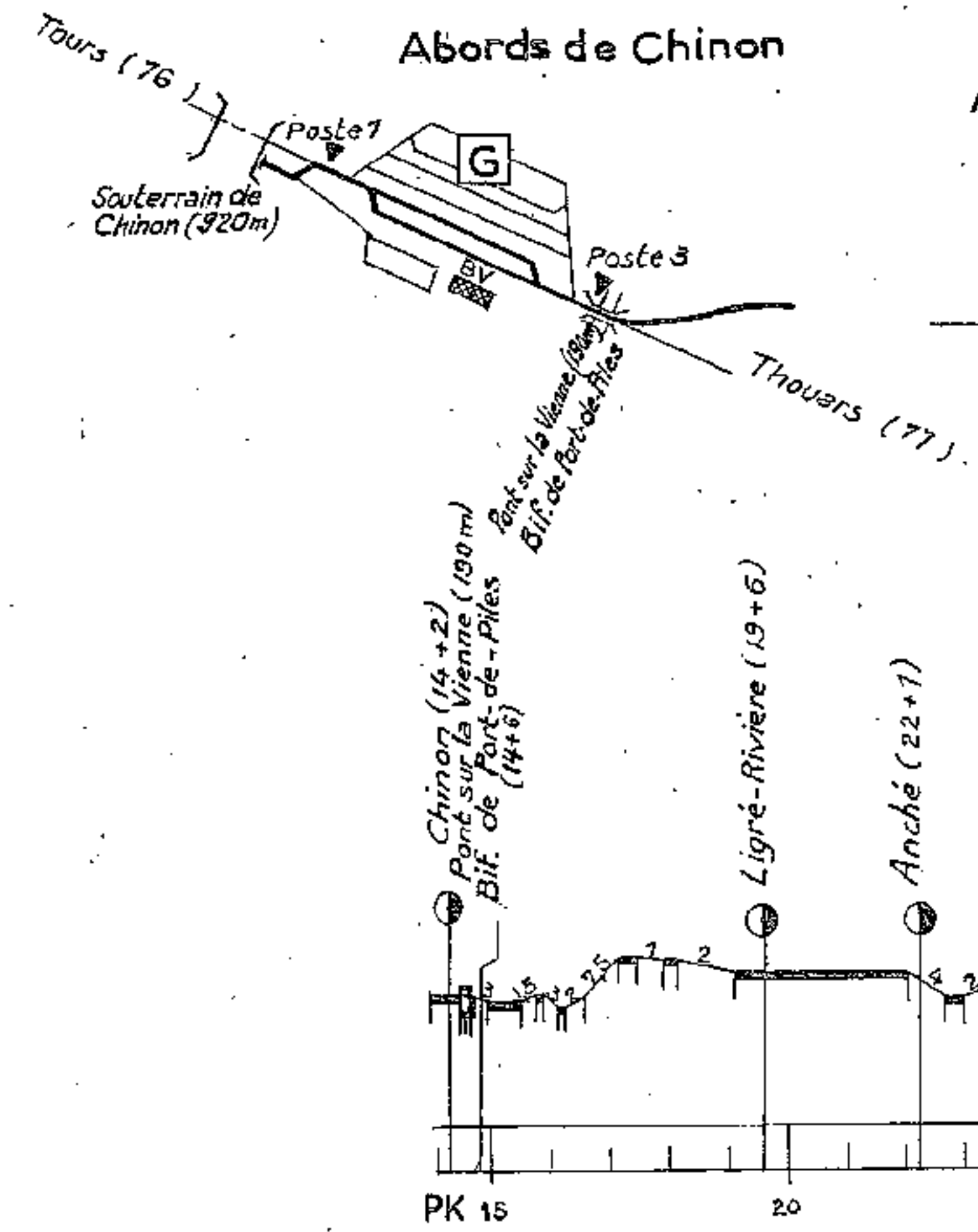
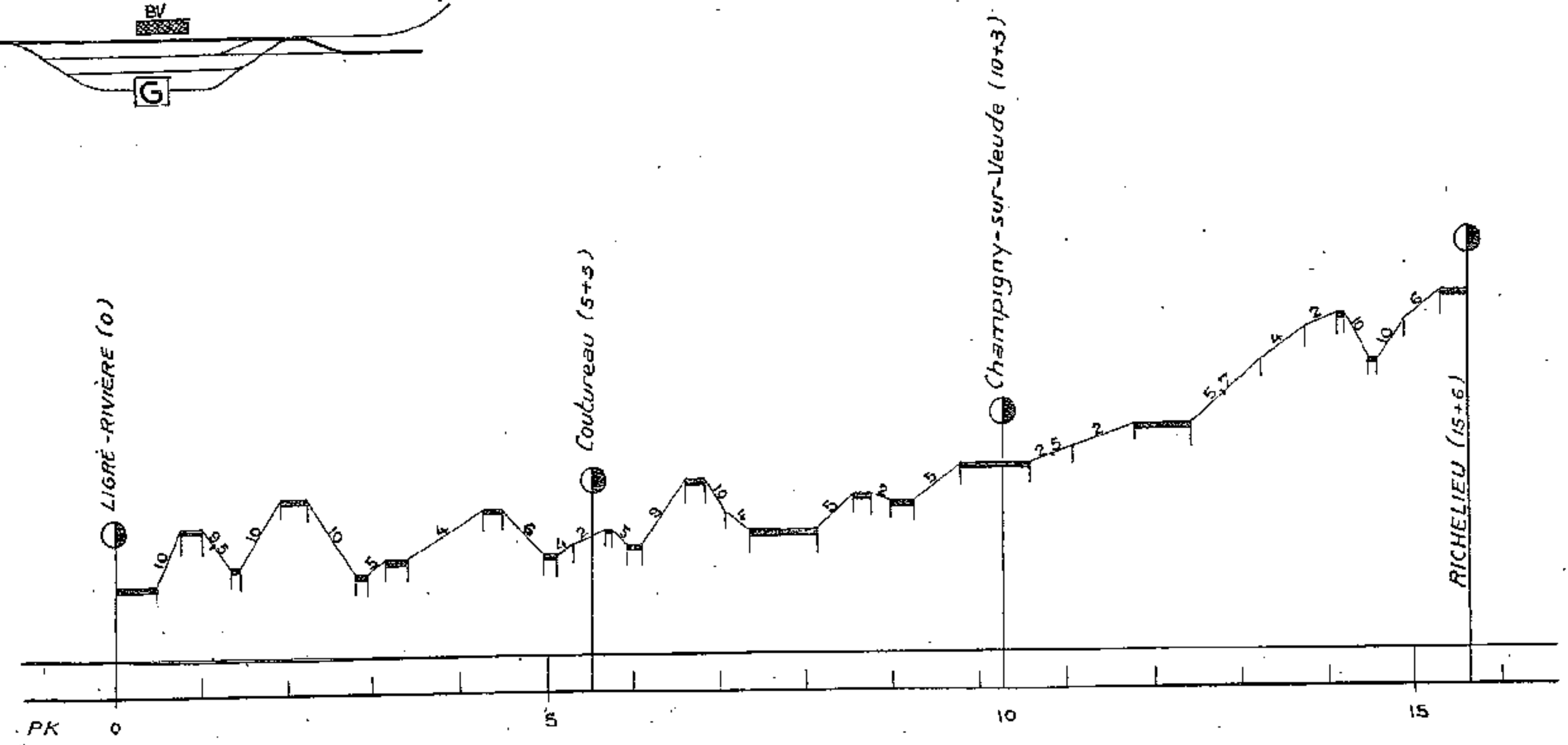
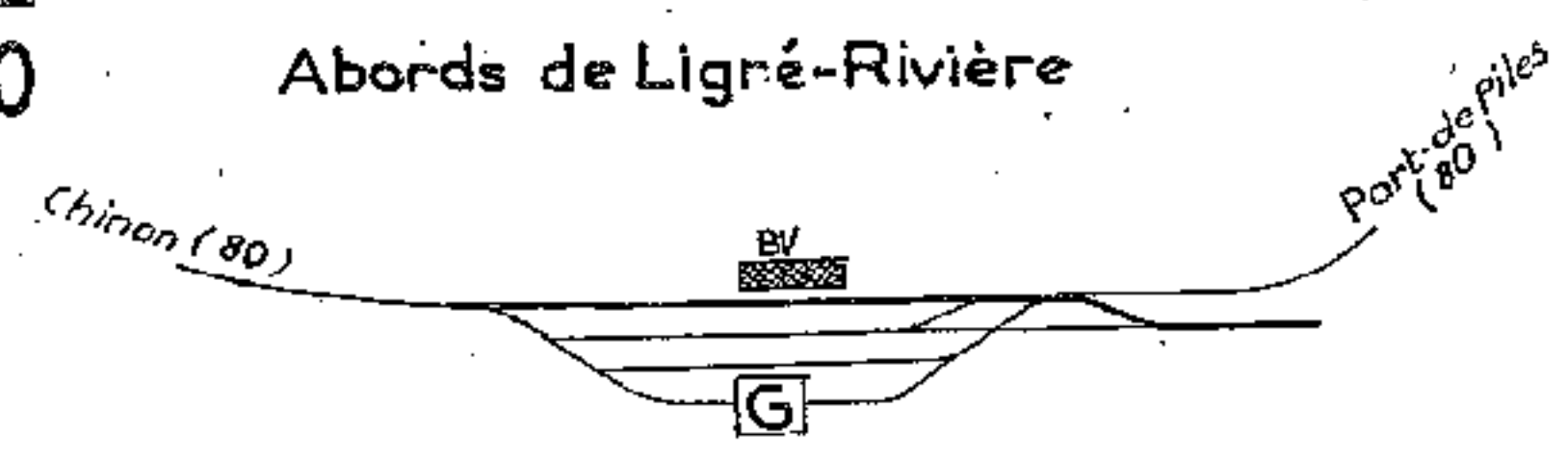

80

Parthenay

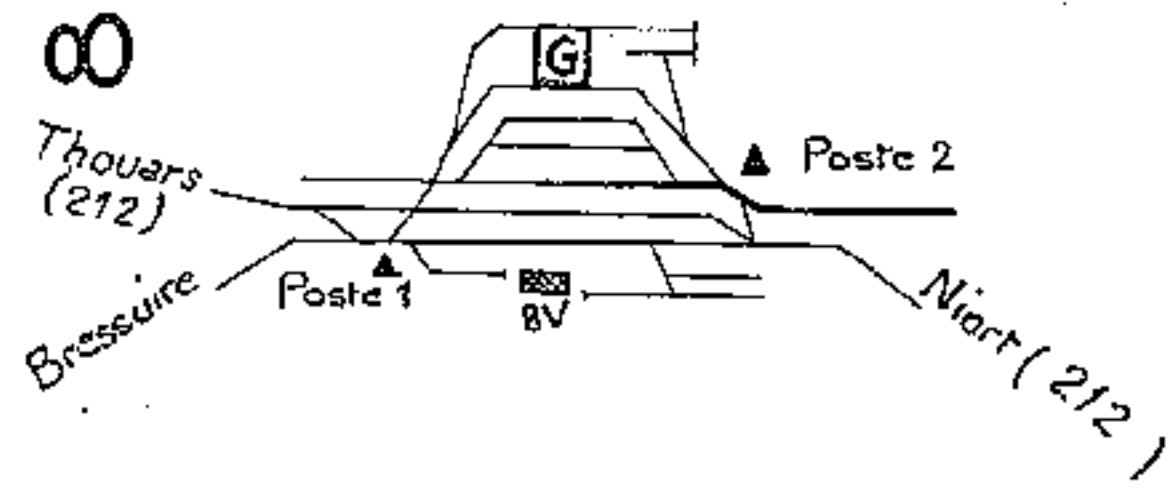

Ligne de Parthenay à Poitiers

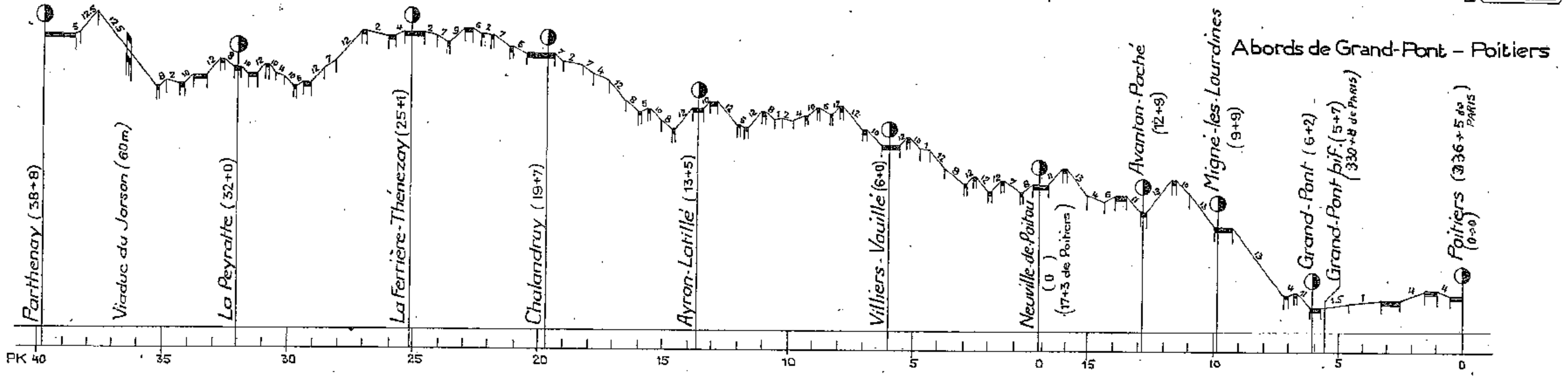
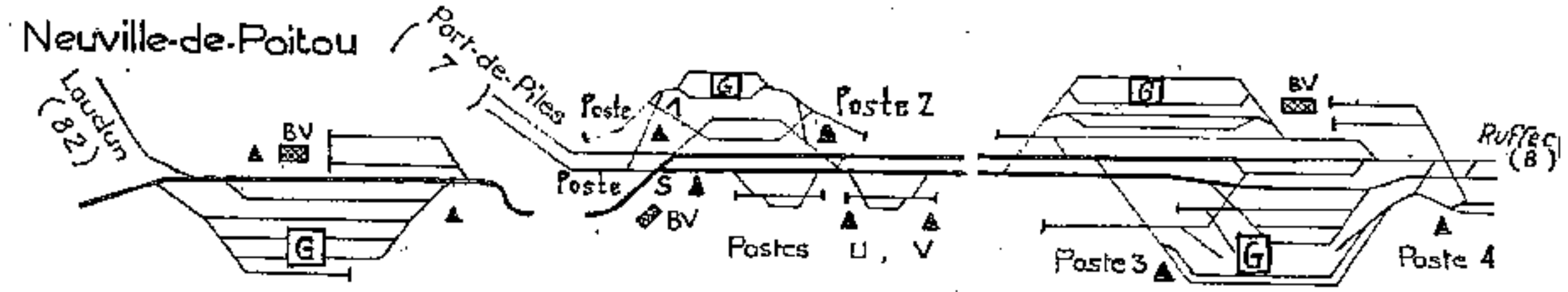

Abords de Grand-Pont - Poitiers

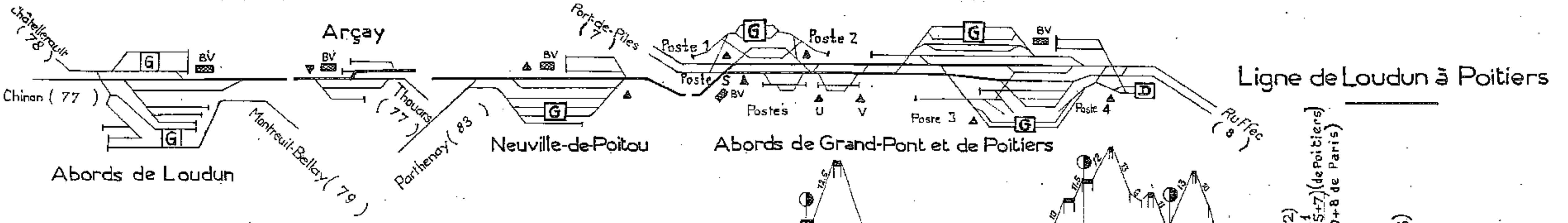

Ligne de Loudun à Poitiers

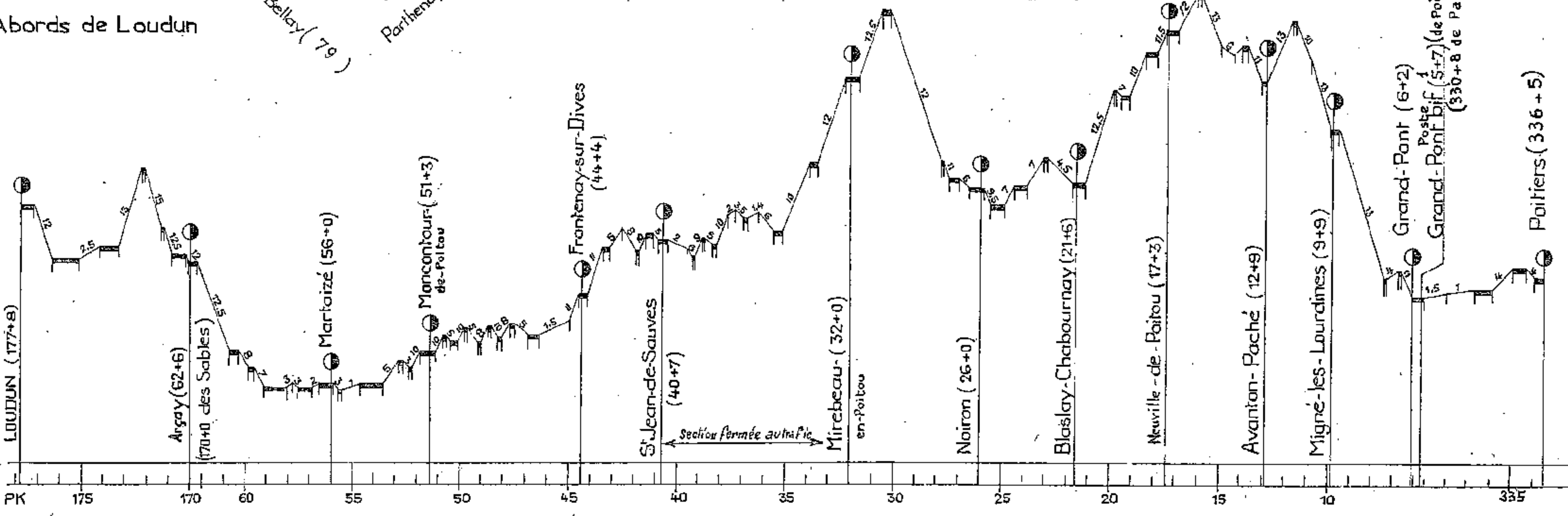

Abords de Grand-Pont et de Poitiers

Abords de Poitiers

MIGNALOUX-NOUAILLÉ

Ligne de Poitiers à Argenton

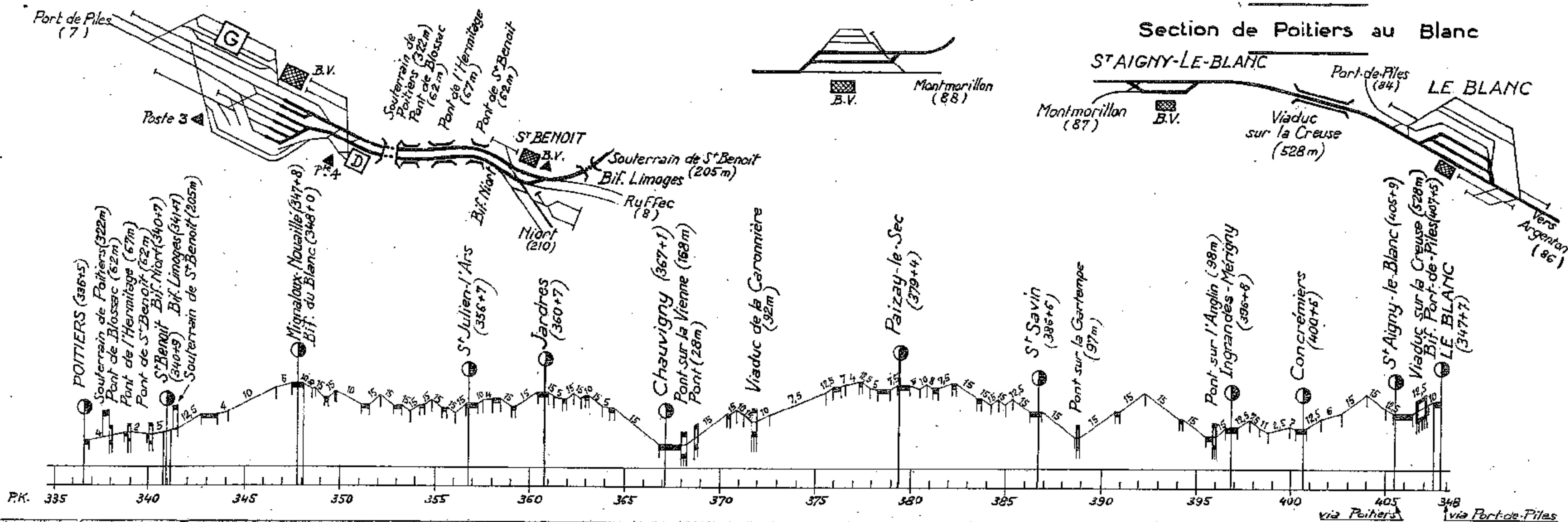

Abords de Port-de-Piles

Ligne de Port-de-Piles au Blanc

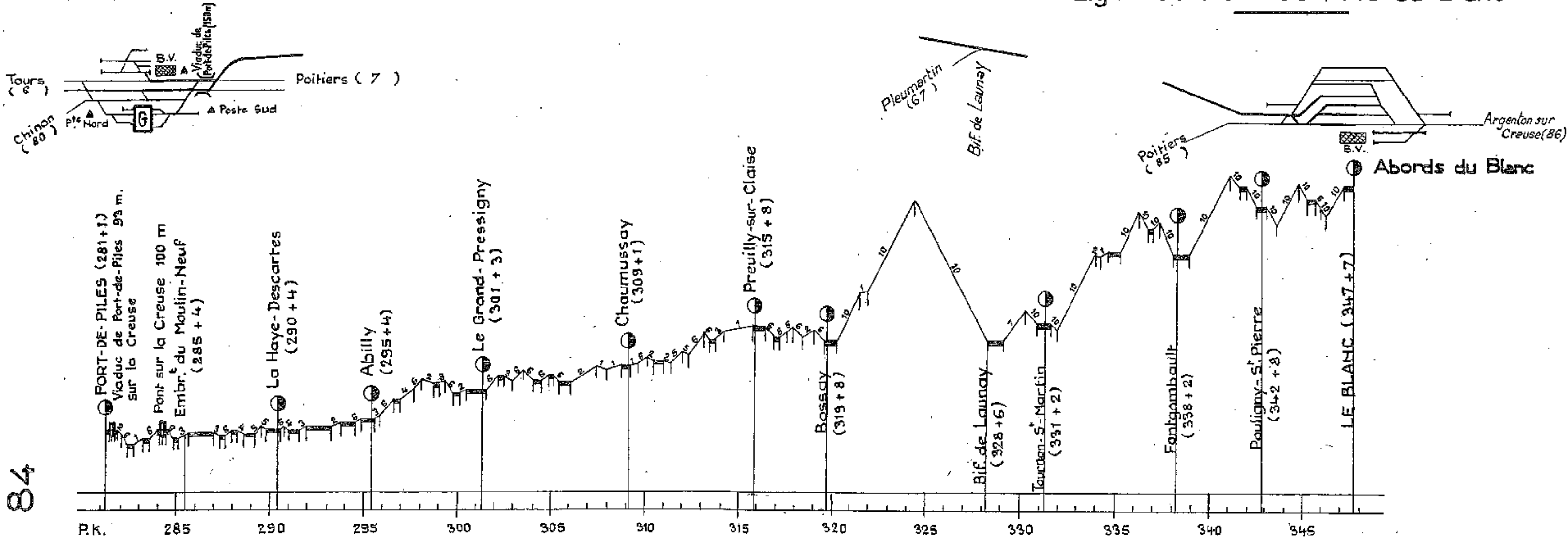

Poitiers (88)

MONTMORILLON

Ligne de Montmorillon au Blanc

Poitiers (85) ST AIGNY-LE-BLANC

Port-de-Piles (84)

Viaduc sur la Creuse (528m)

LE BLANC

St Sulpice-Laurière (89)

Pont sur la Gartempe (94m)

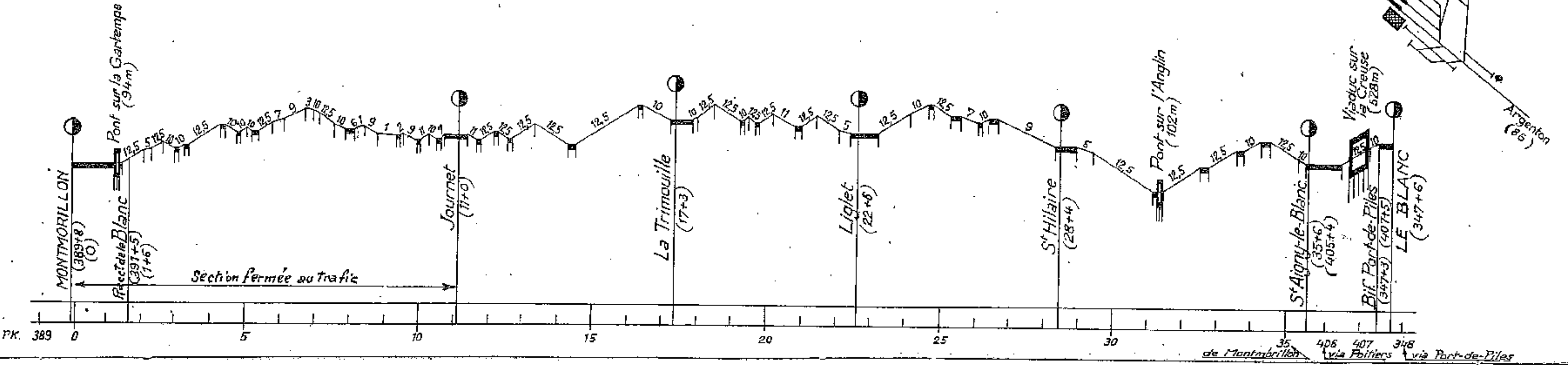

LE BLANC

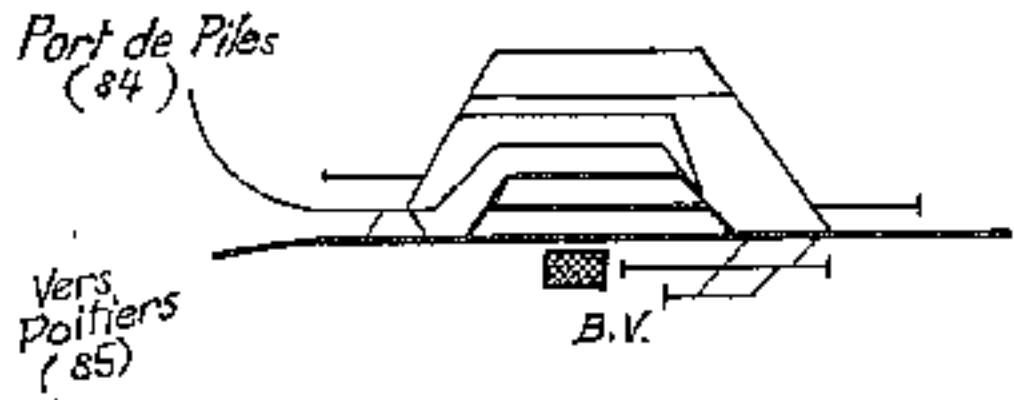

Ligne de Poitiers à Argenton

Section du Blanc à Argenton

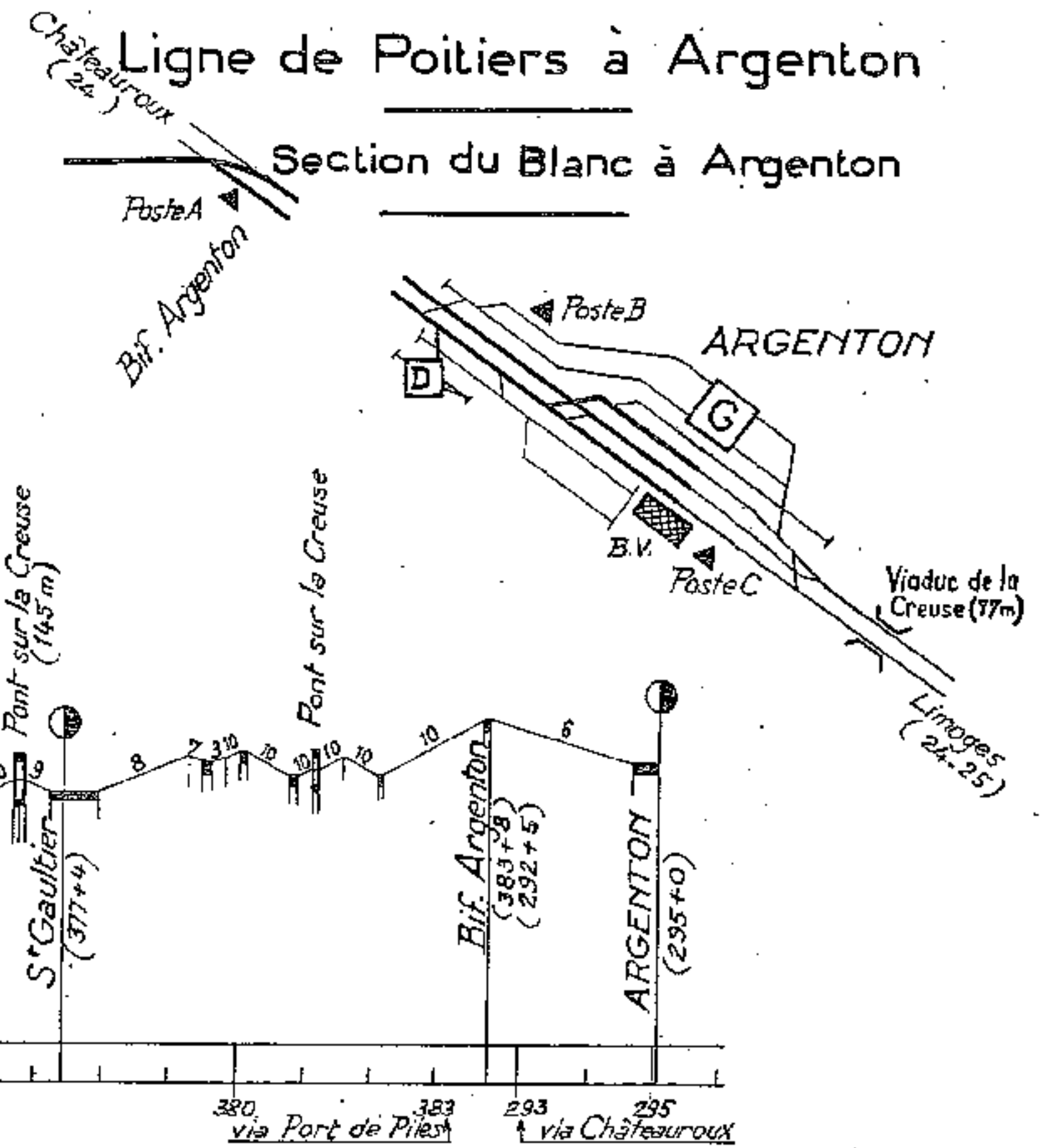

88 MONTMORILLON

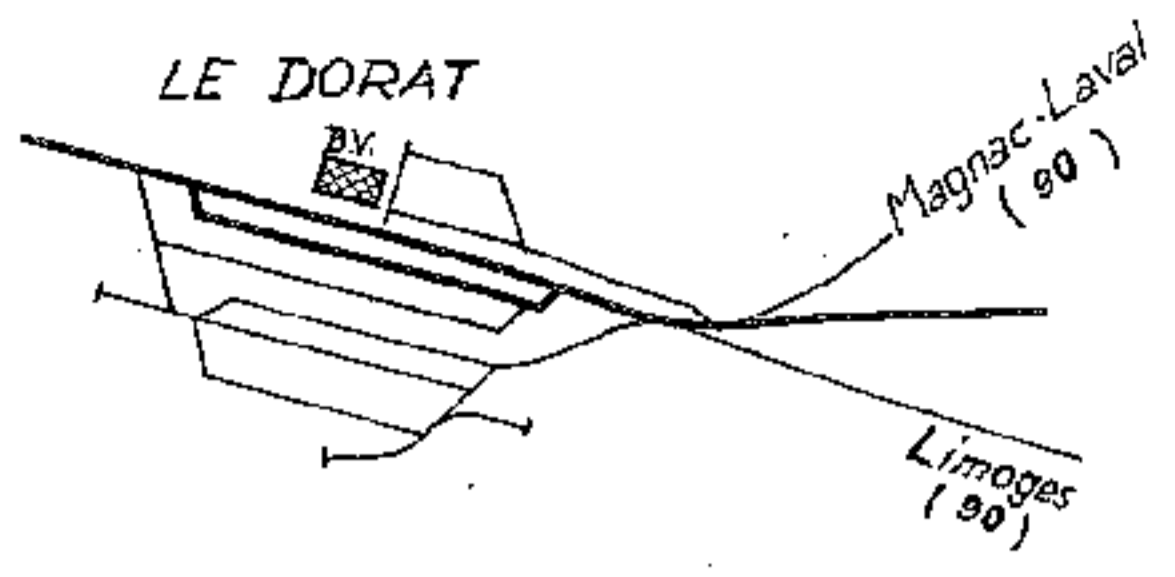
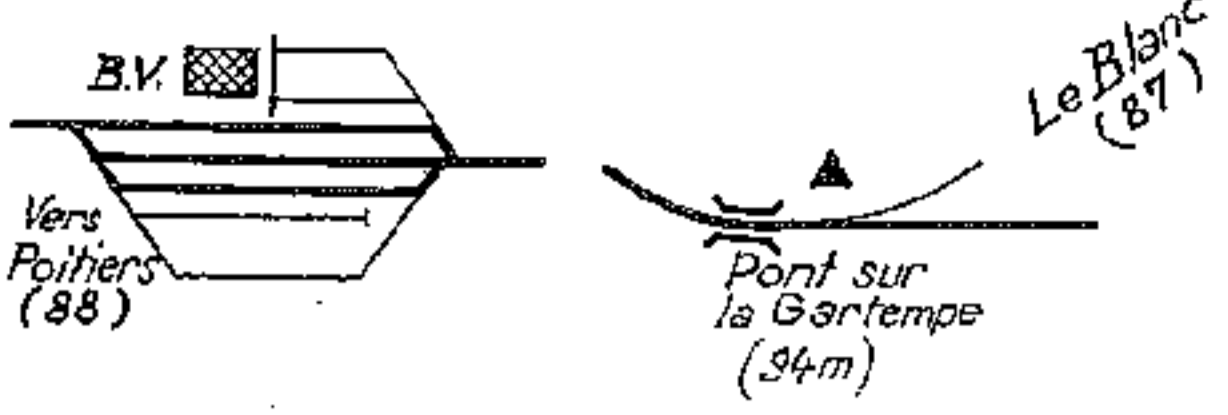

Ligne de Poitiers à S^tSulpice-Laurière
Section de Montmorillon à S^tSulpice-Laurière

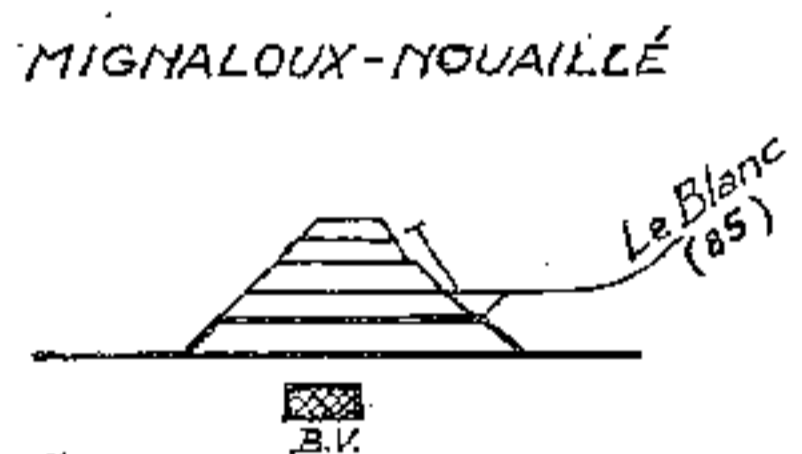
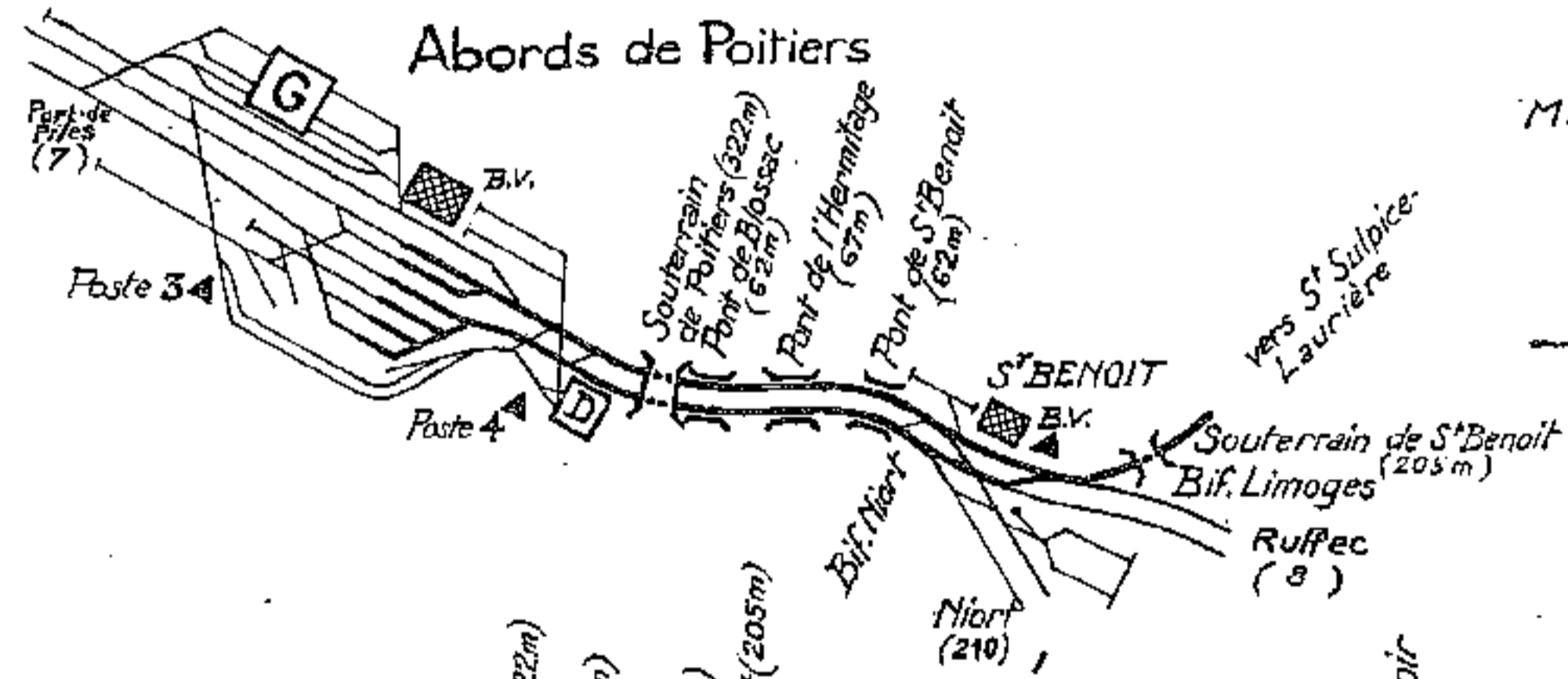
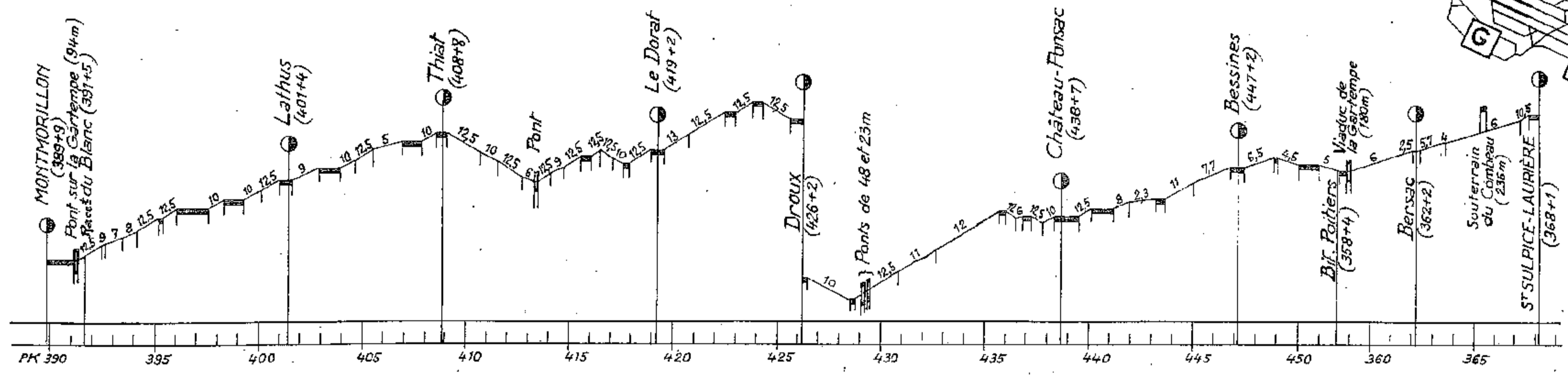
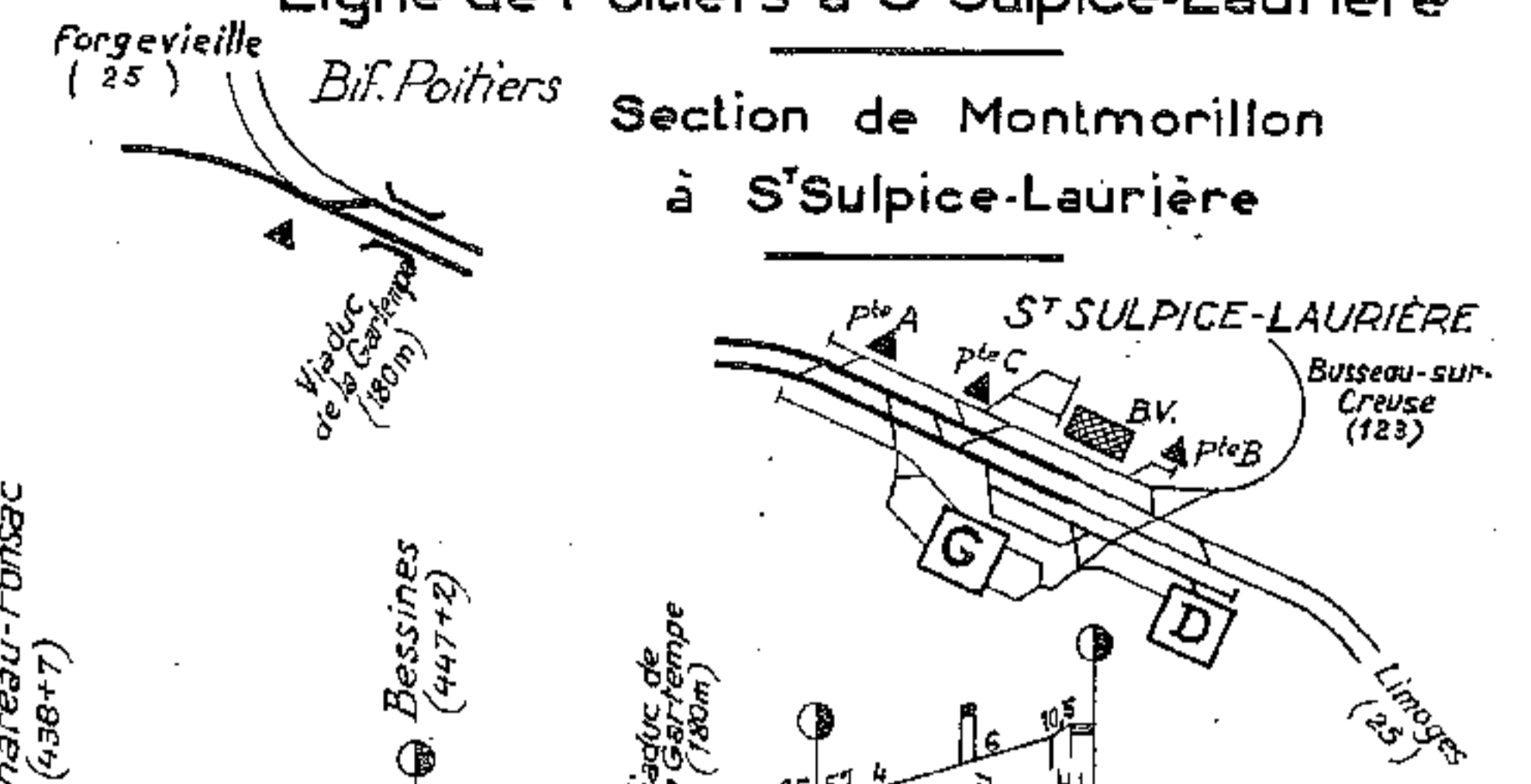

Ligne de Poitiers à S^tSulpice-Laurière
Section de Poitiers à Montmorillon

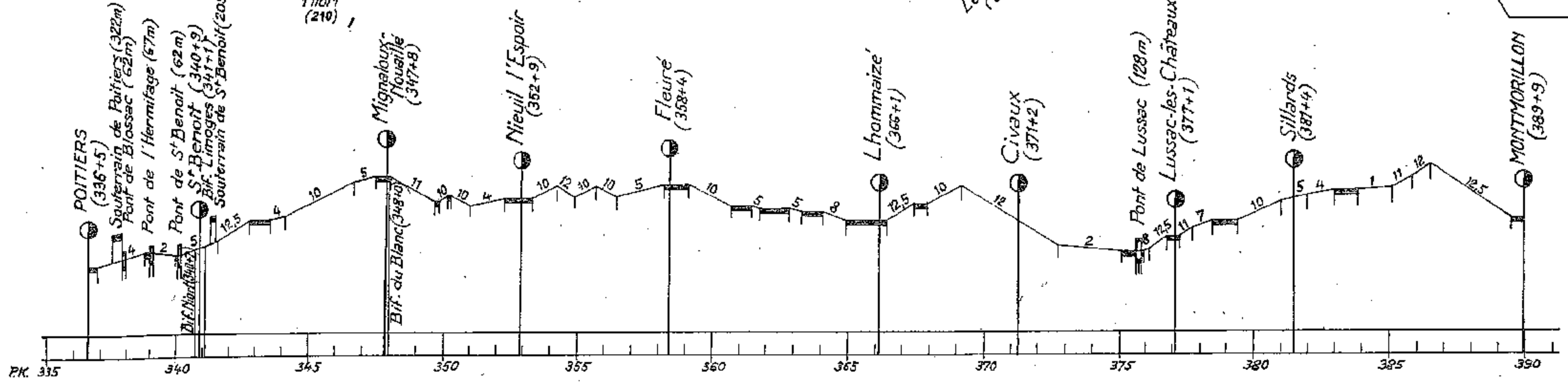
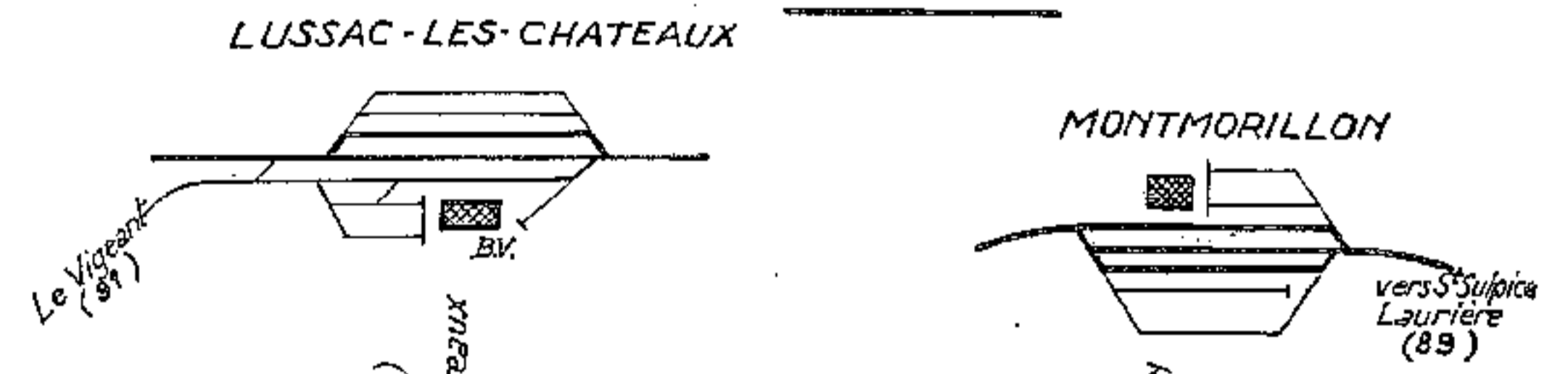

SAINT SAVIOL

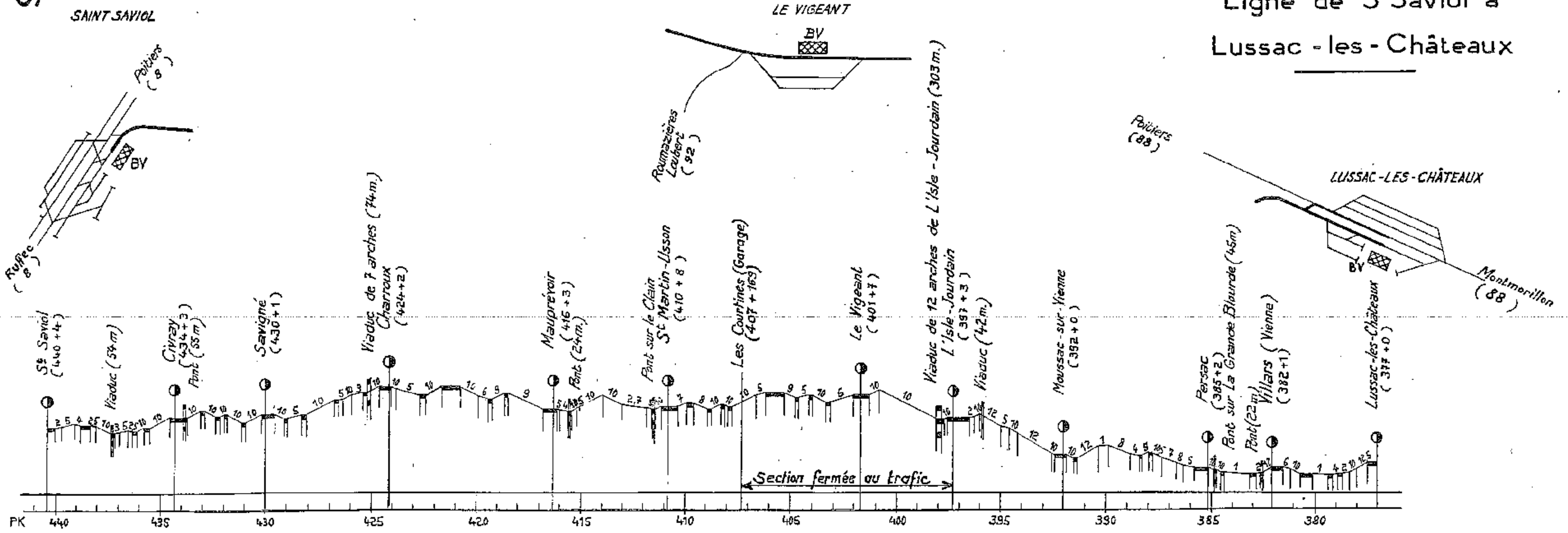
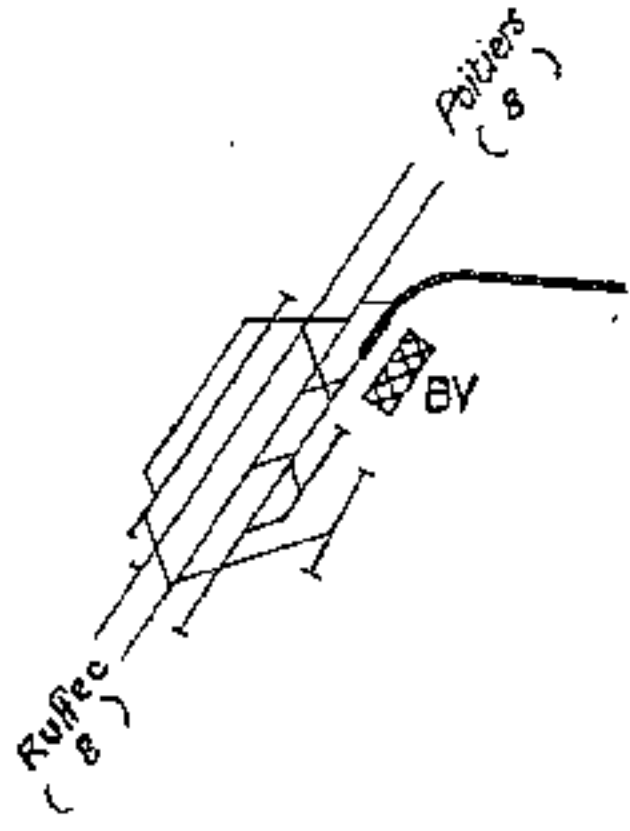

Ligne de St Saviol à Lussac - les - Châteaux

LUSSAC-LES-CHATEAUX

Montmorillon (88)

PK 440 435 430 425 420 415 410 405 400 395 390 385 380

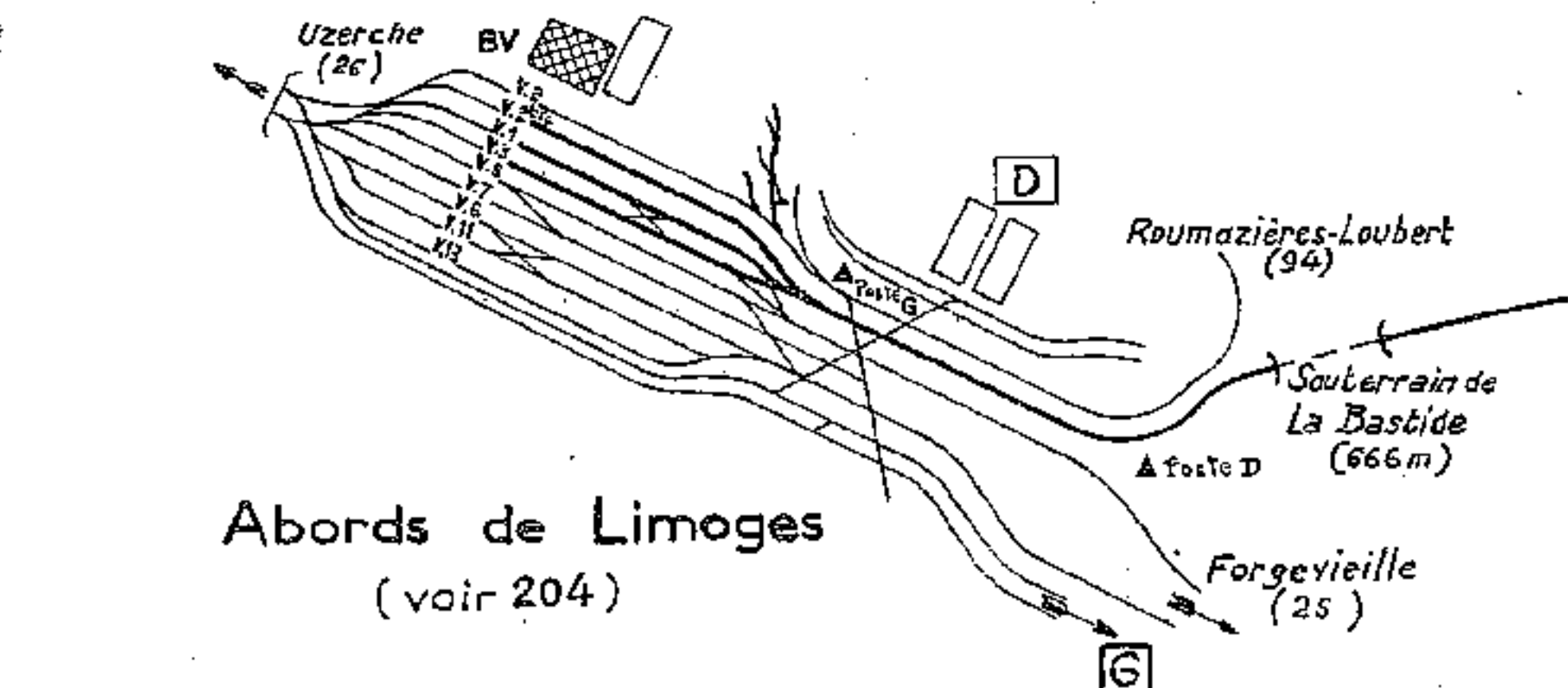

Ligne de Limoges au Dorat et Magnac-Laval

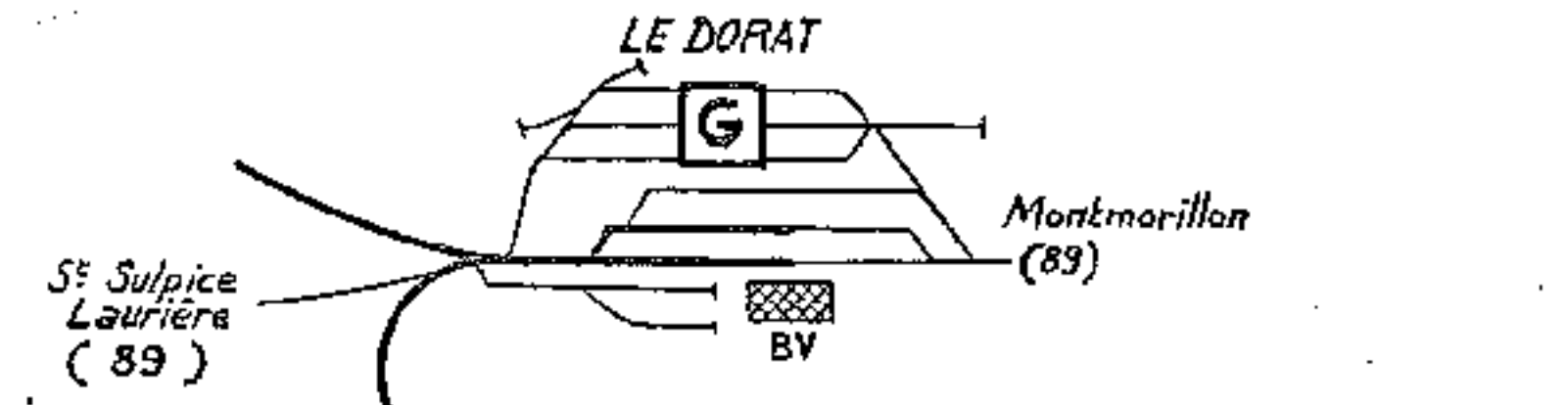

Abords de Limoges (voir 204)

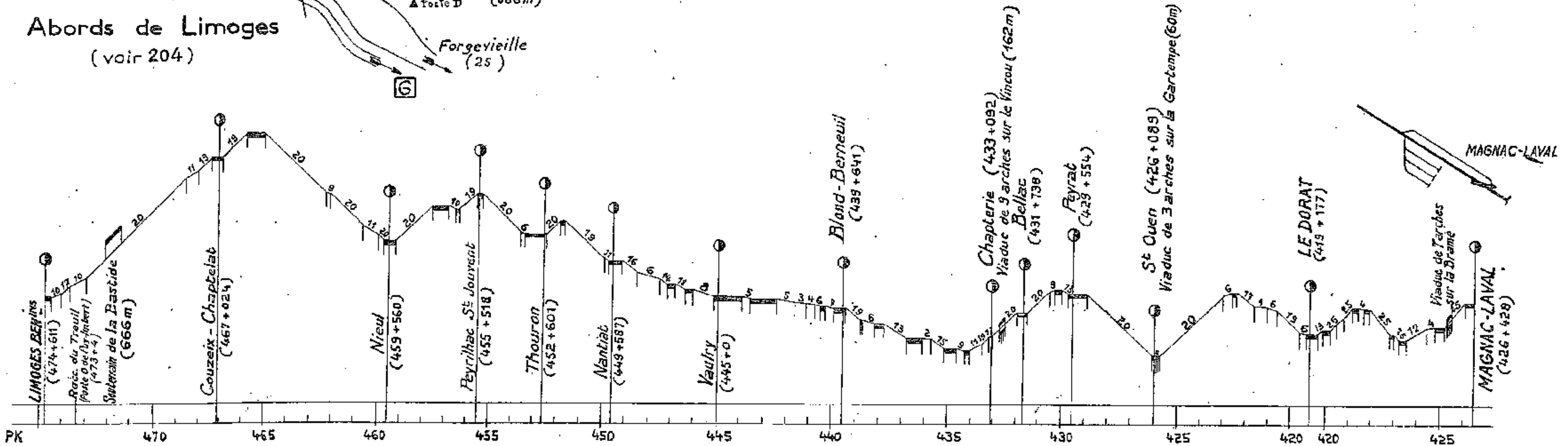

MAGNAC-LAVAL

PK 470 465 460 455 450 445 440 435 430 425 420 420 425

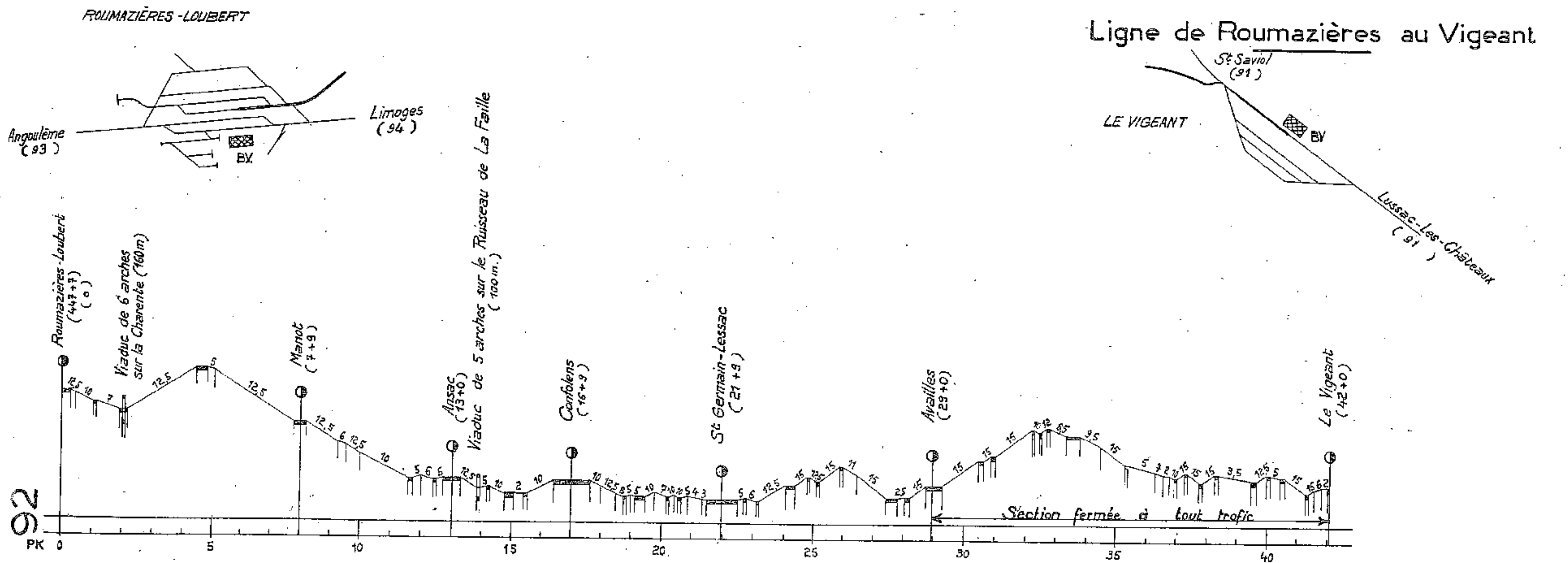
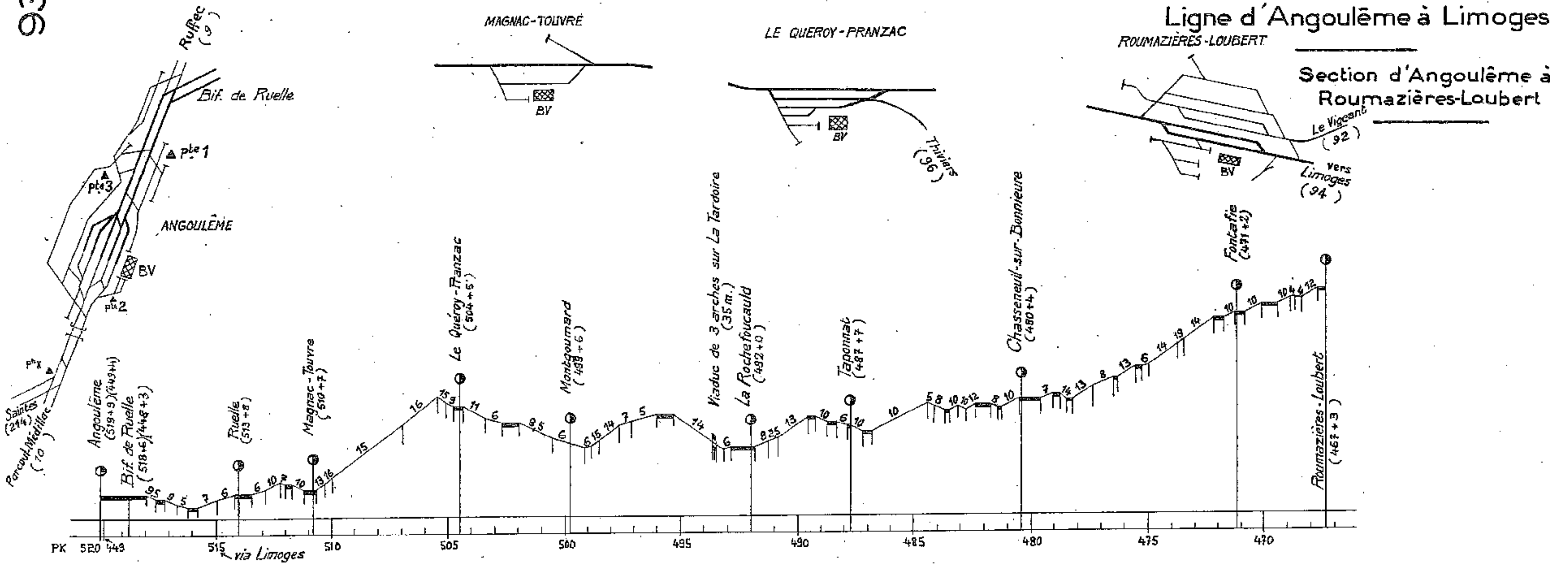

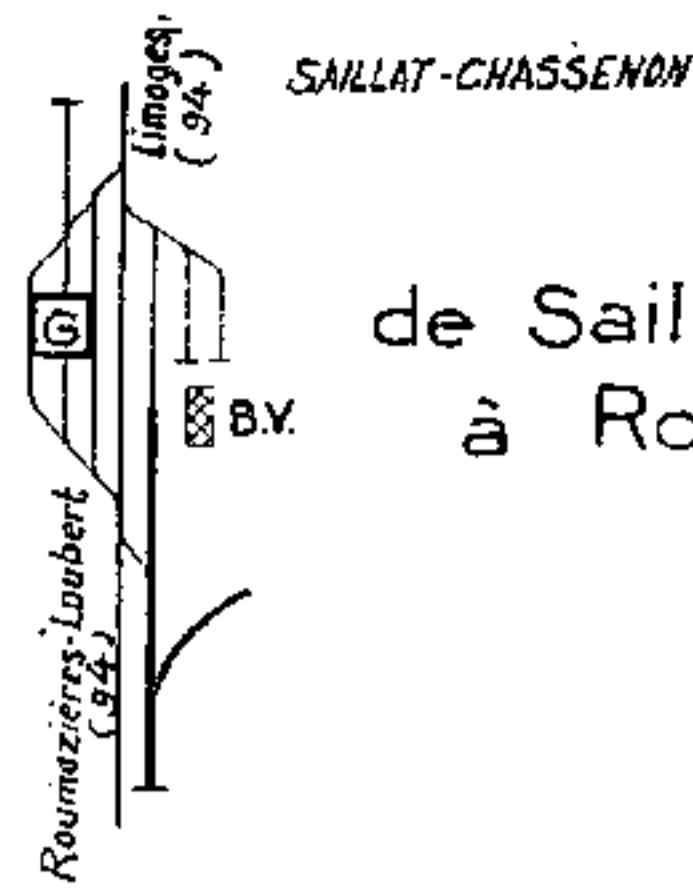

Ligne de Saillat-Chassenon à Rochechouart

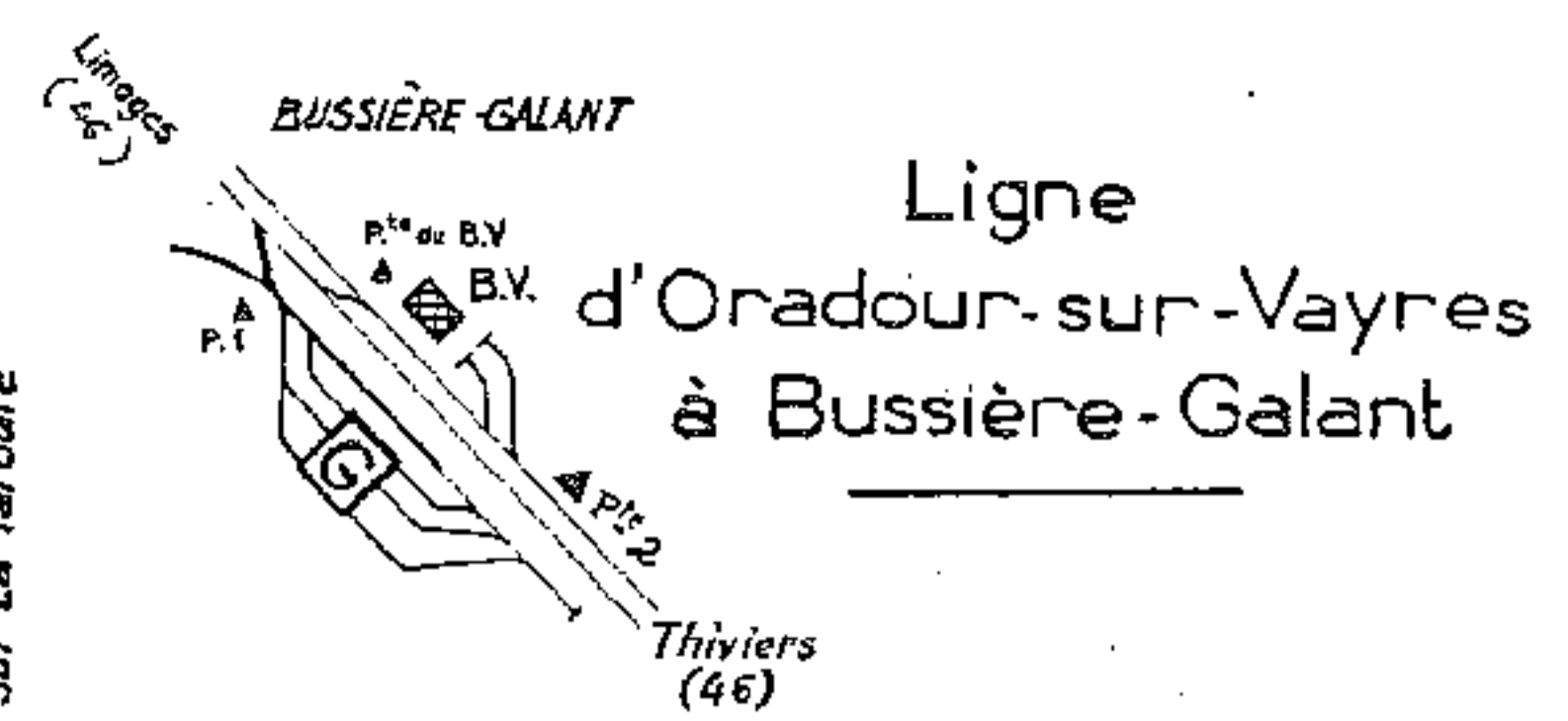
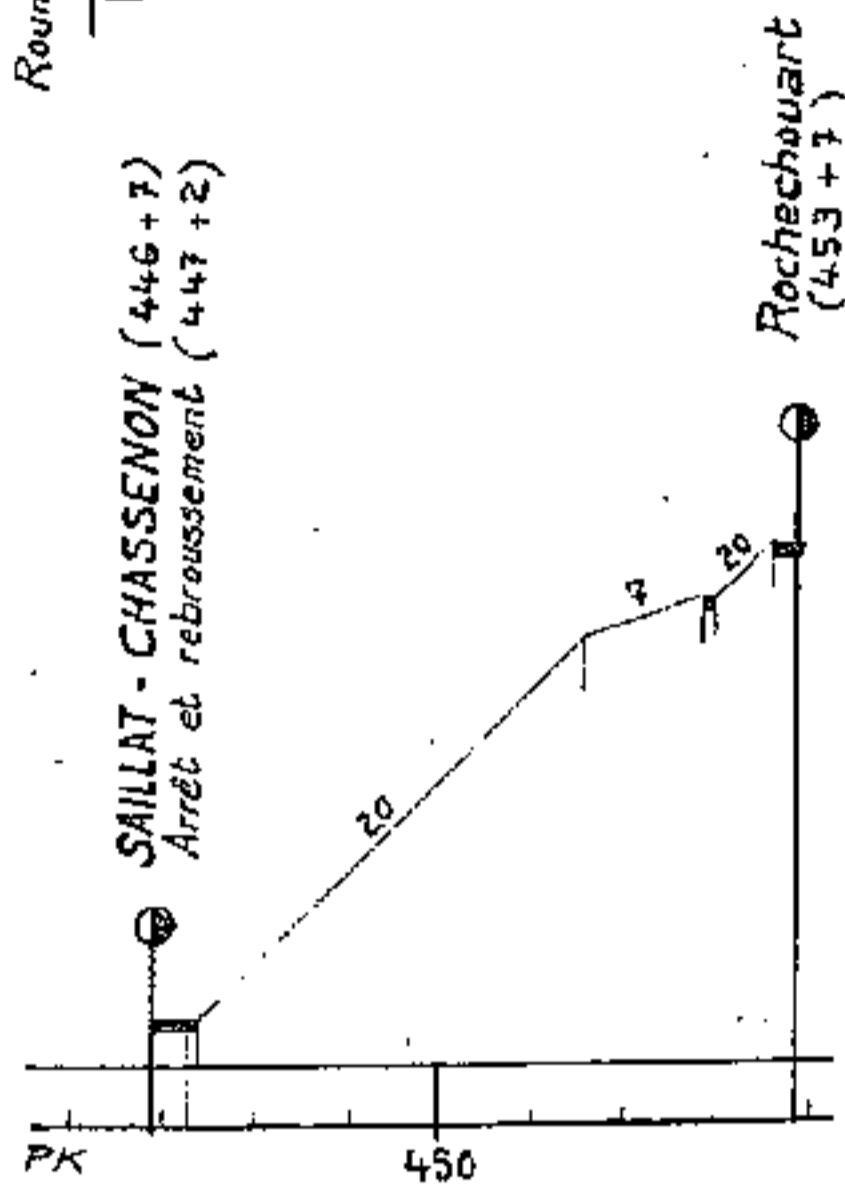

Ligne d'Oradour-sur-Vayres à Bussièrè-Galant

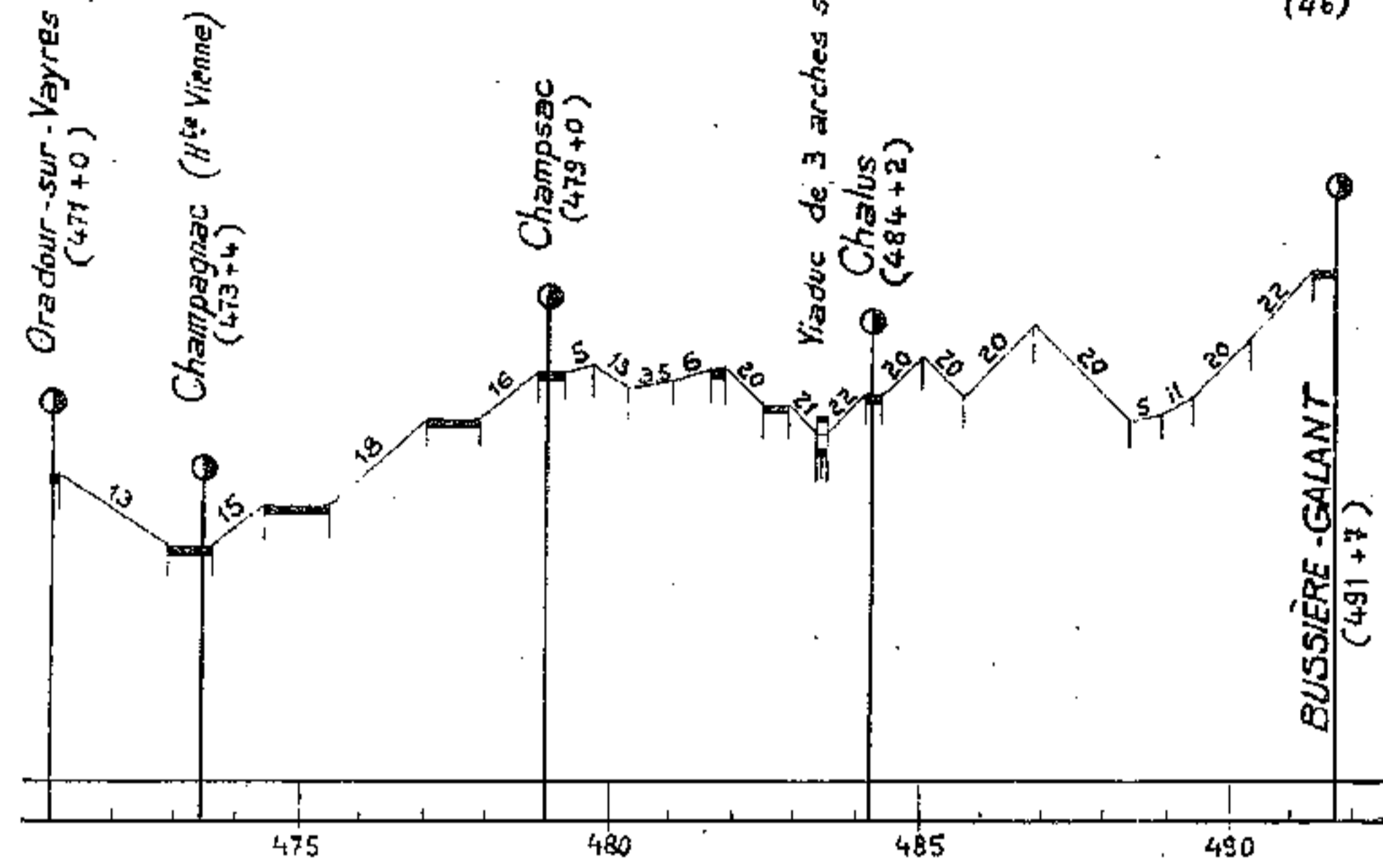

Ligne d'Angoulême à Limoges

Section de Roumazières-Loubert à Limoges-Bénédictins

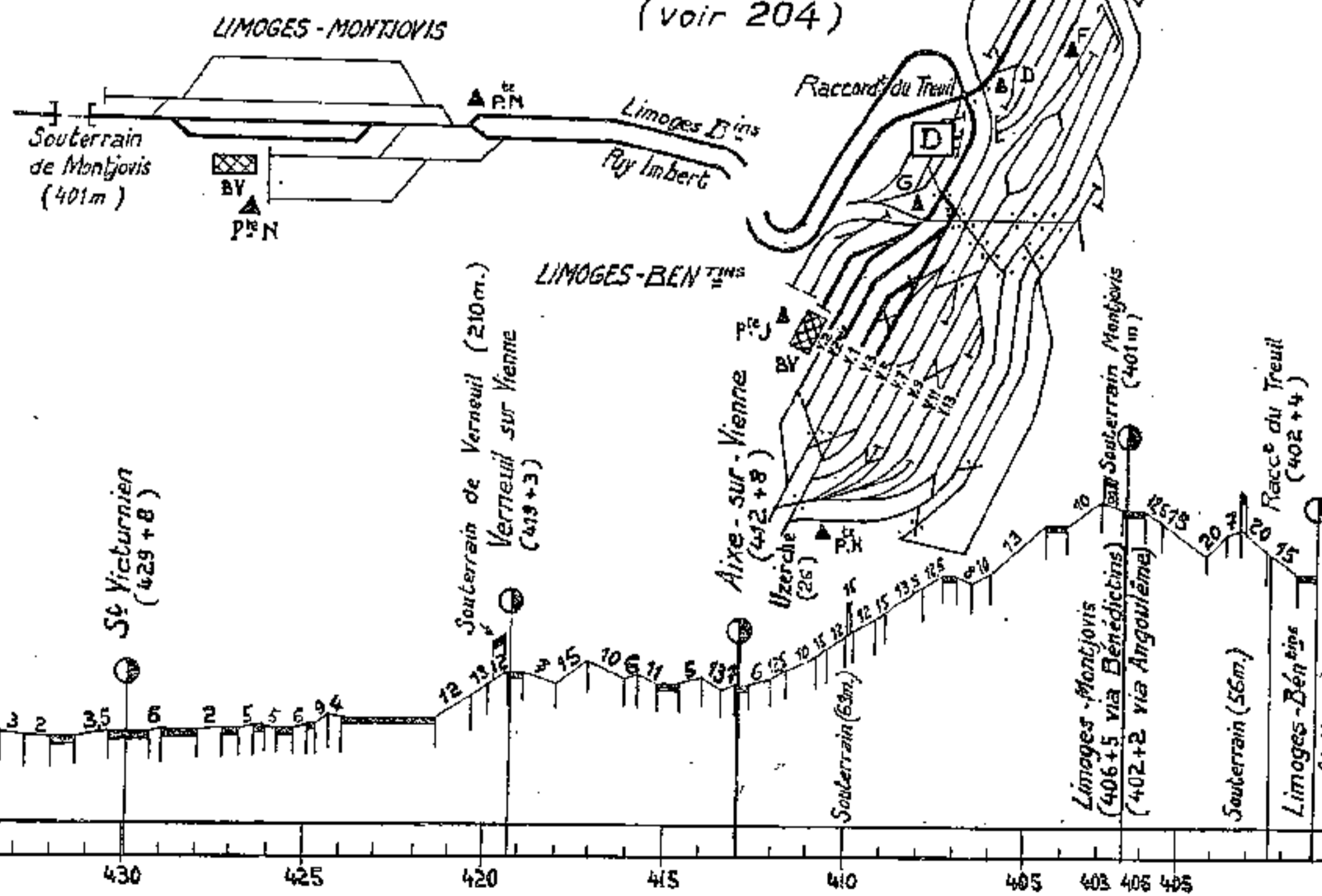
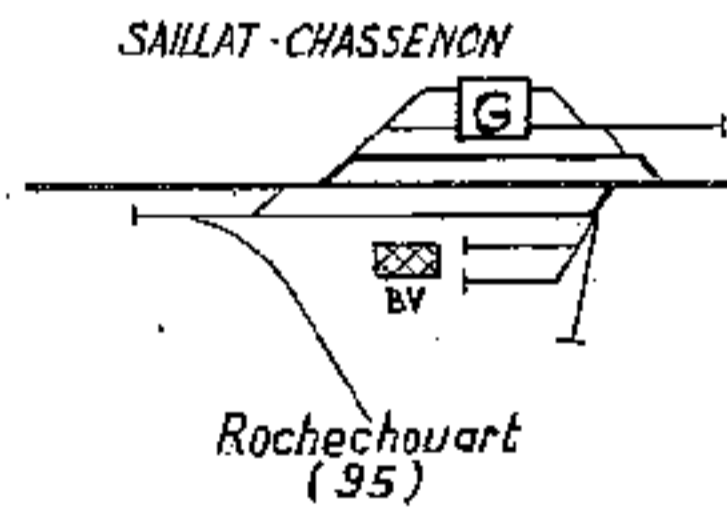
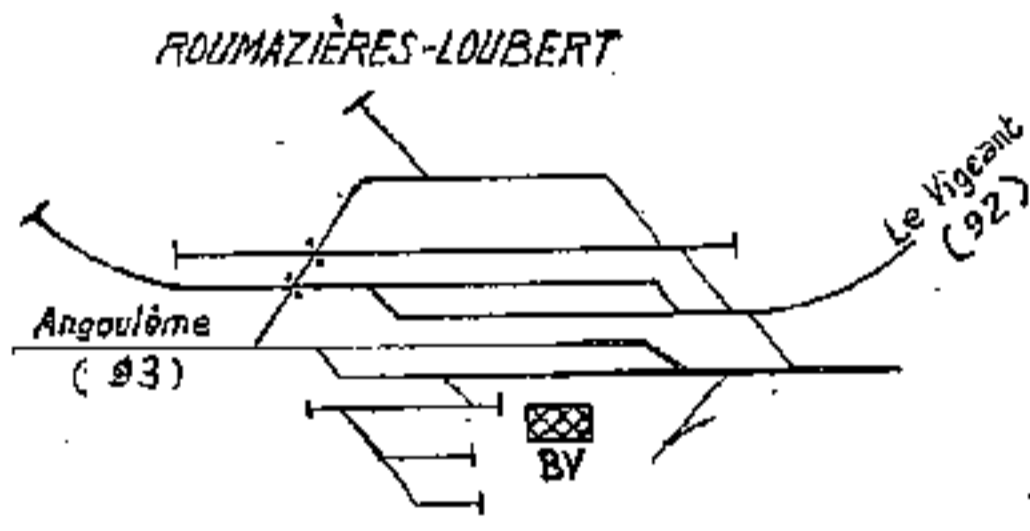

Raccordement de Limoges-Montjovis à Puy-Imbert

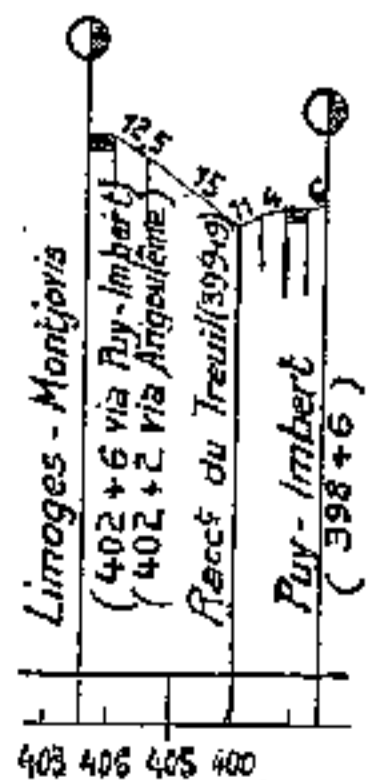

Abords de Nexon

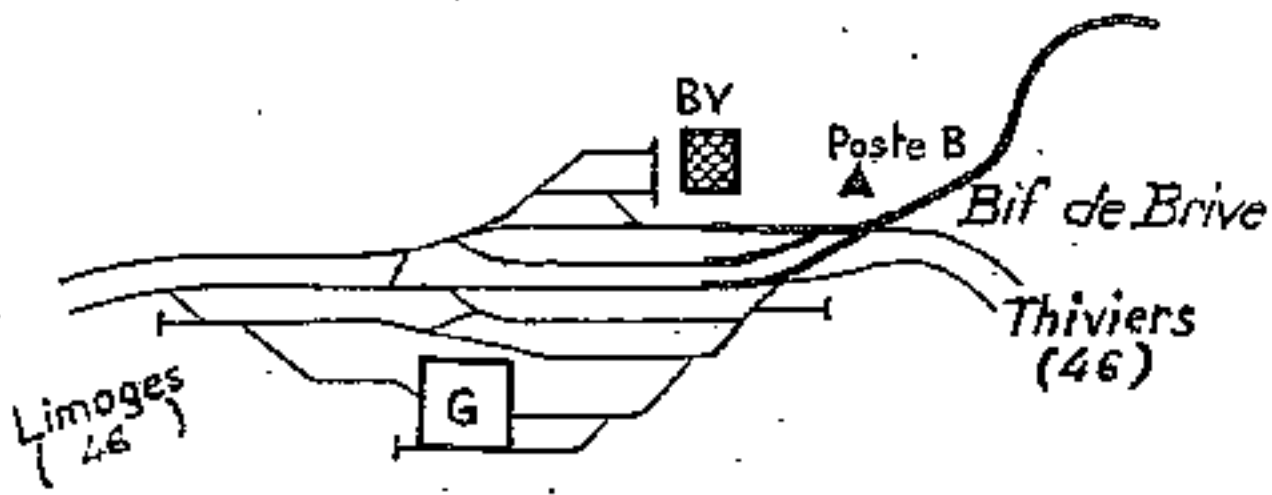

Abords de St Yrieix

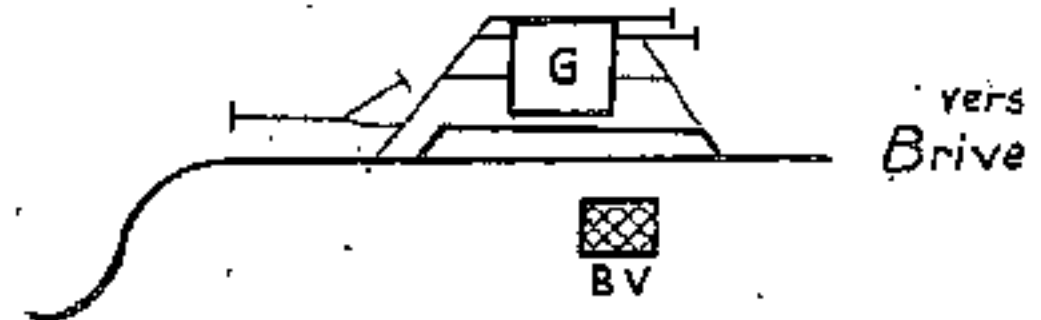

Ligne de Nexon à Brive

Section de Nexon à Lubersac

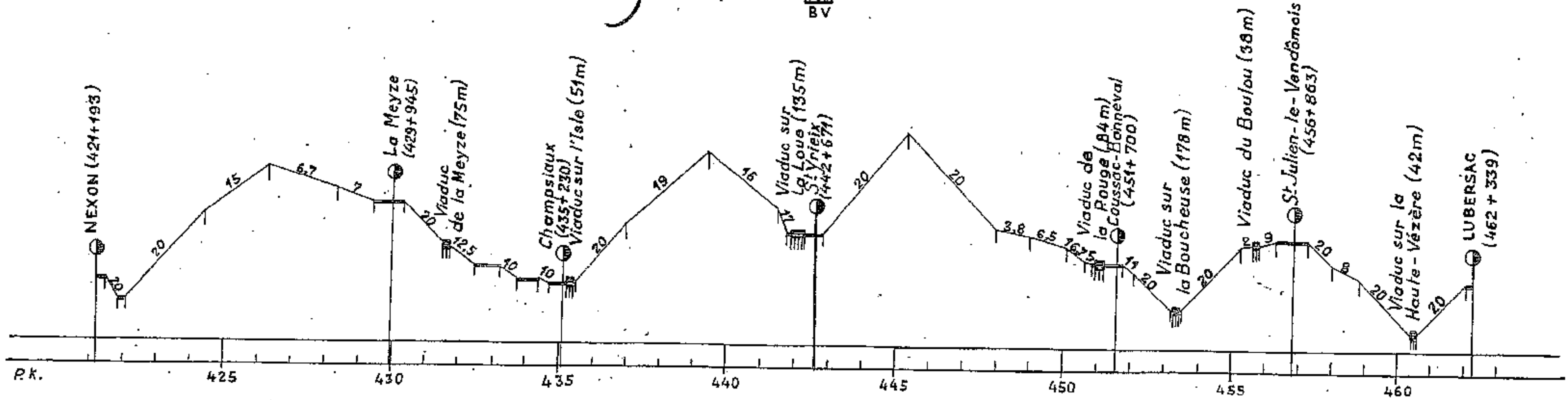

Ligne de Le Quérois-Pranzac à Thiviers

LE QUEROIS-PRANZAC

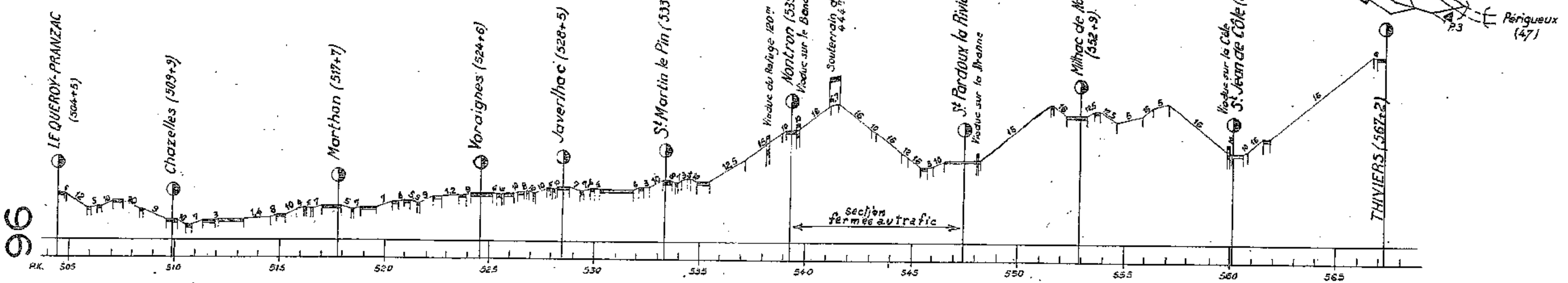
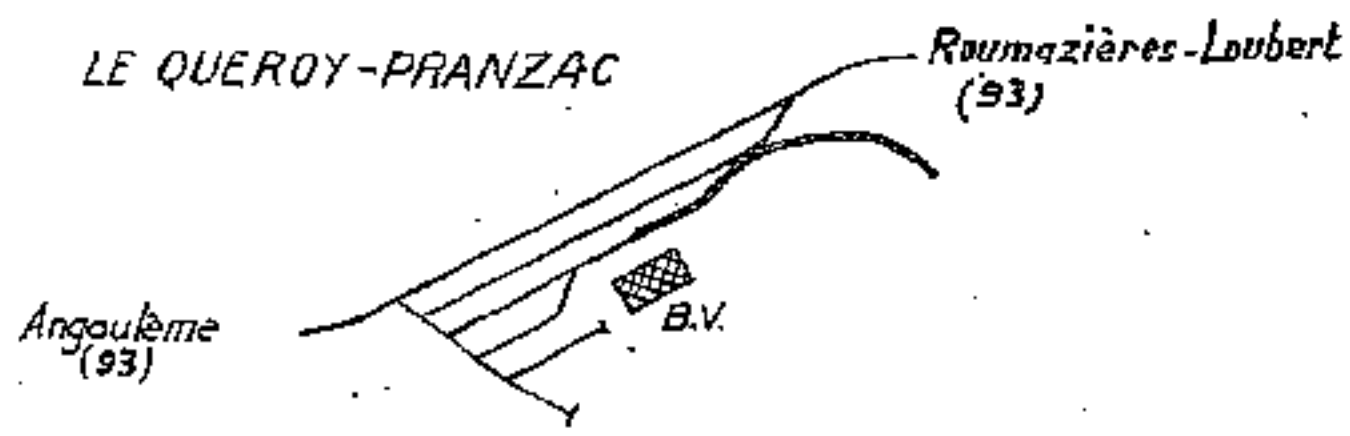

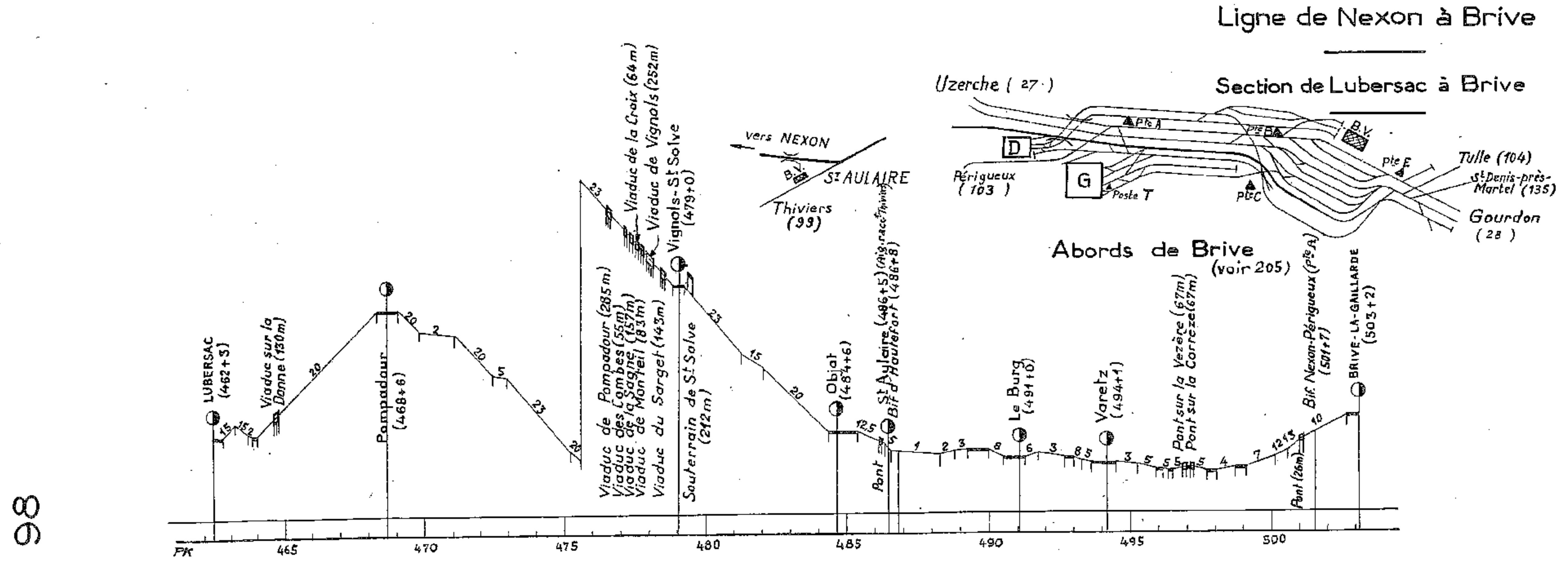
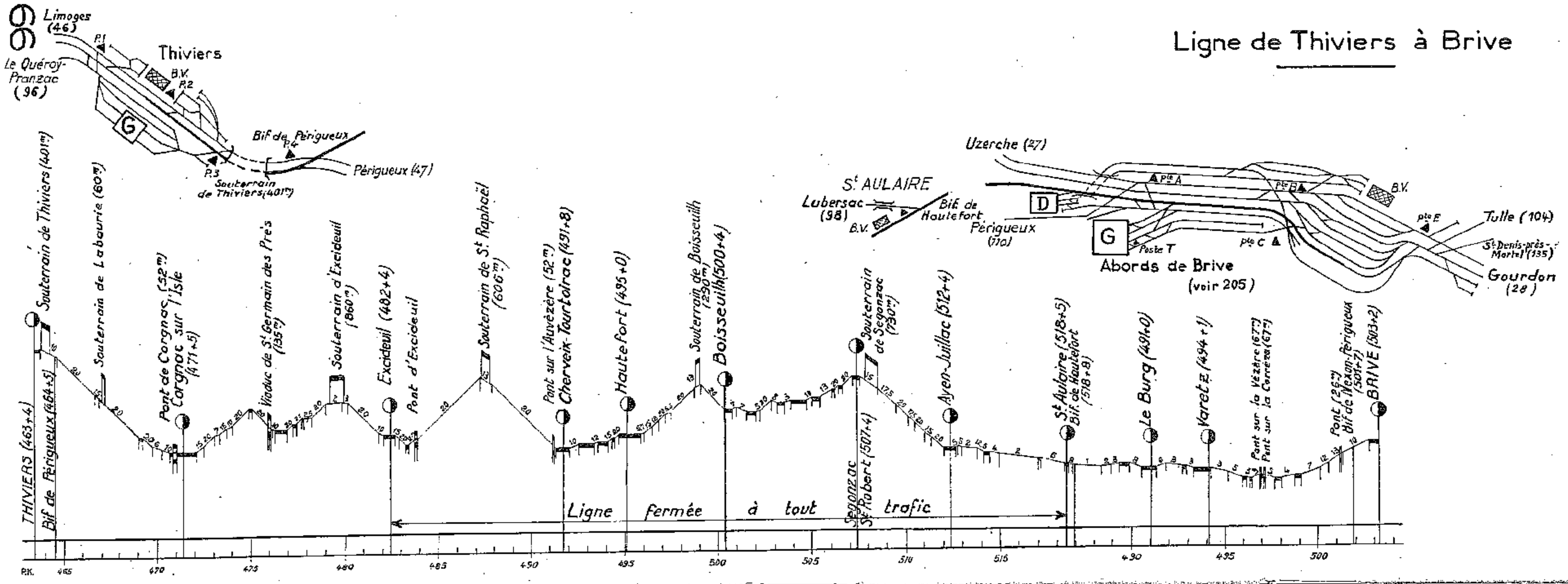

LE BUISSON

SIORAC (Bif. Sarlat)

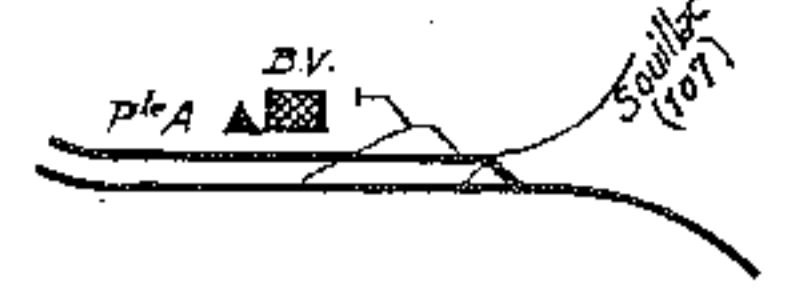
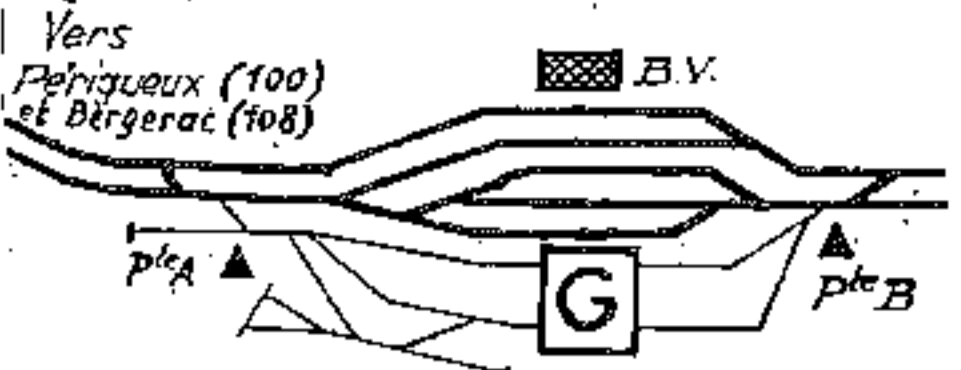

Ligne de Périgueux à Agen

Section du Buisson à Monsempron-Libos

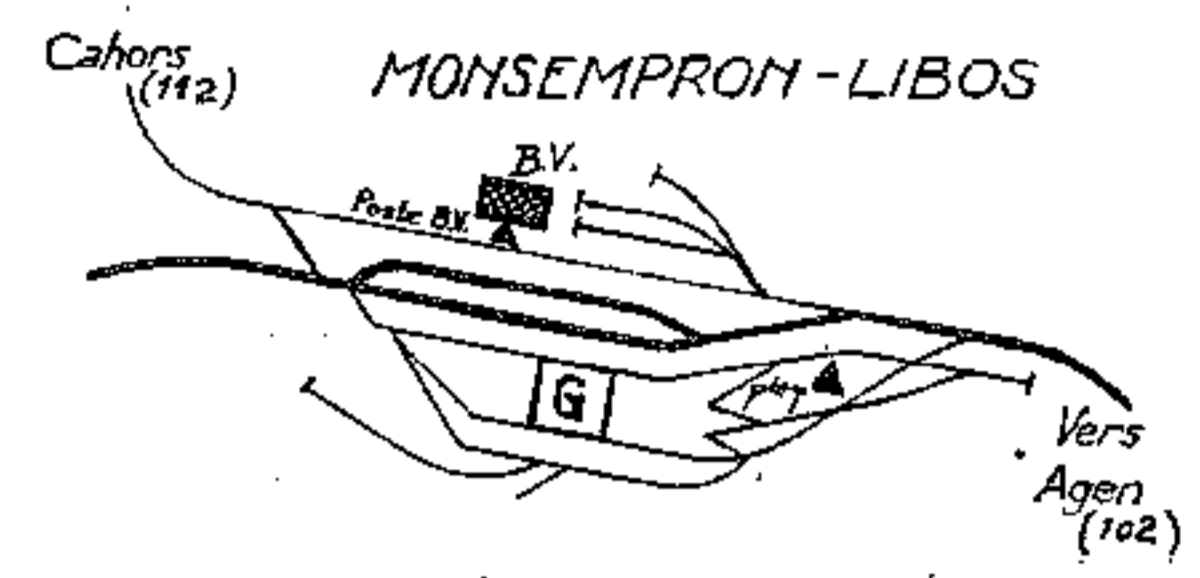
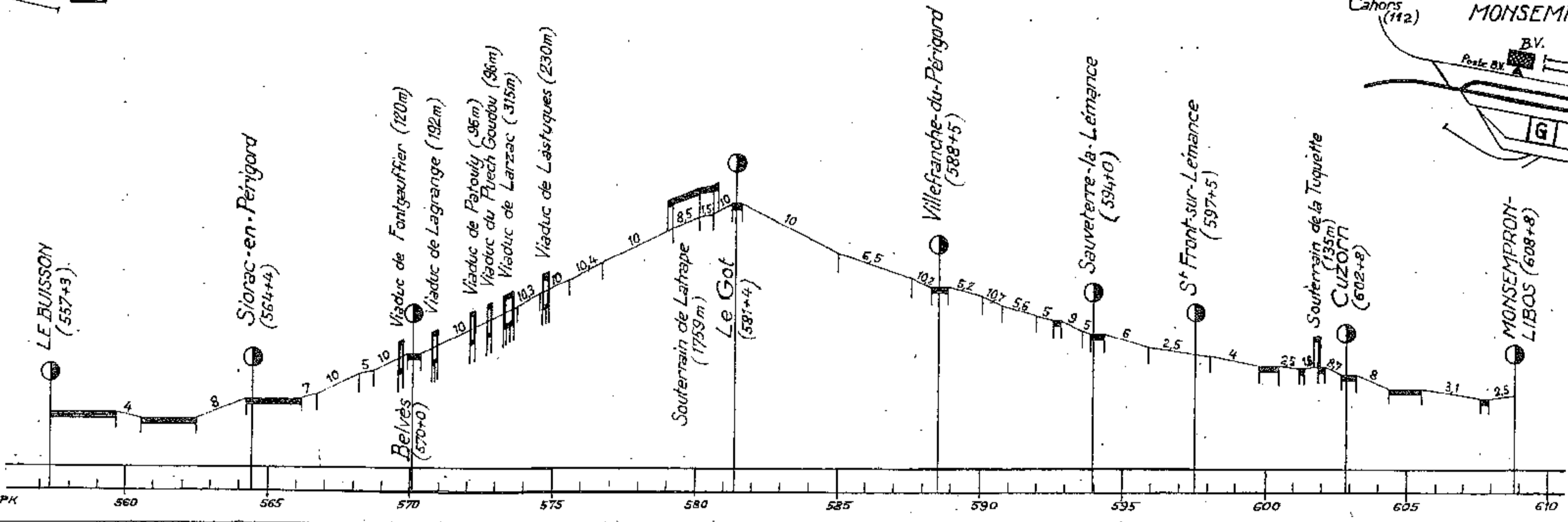

Abords de Périgueux

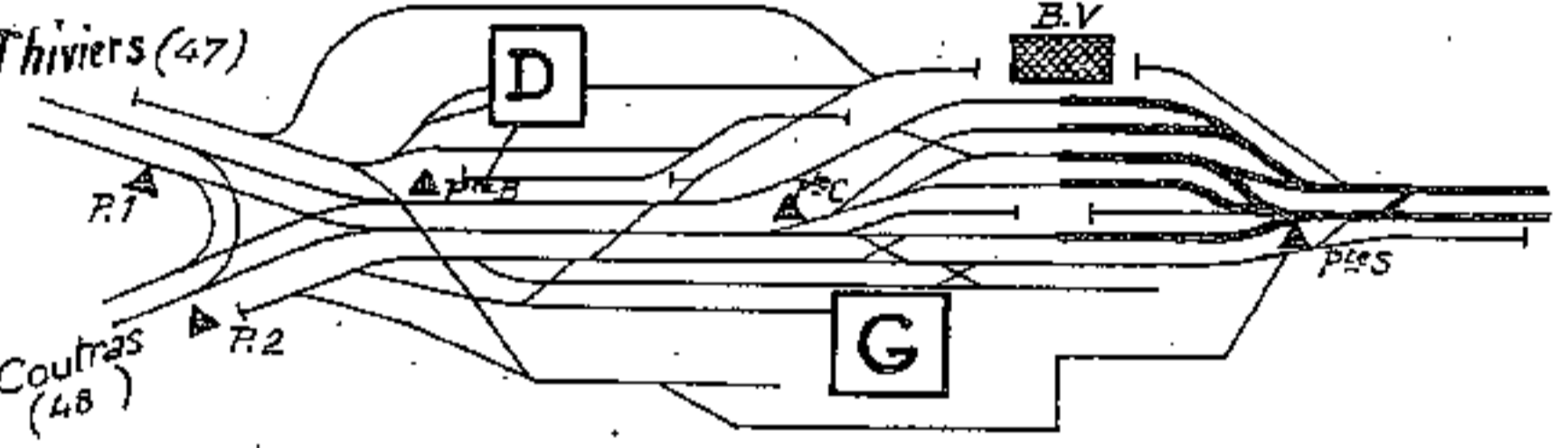

NIVERSAC

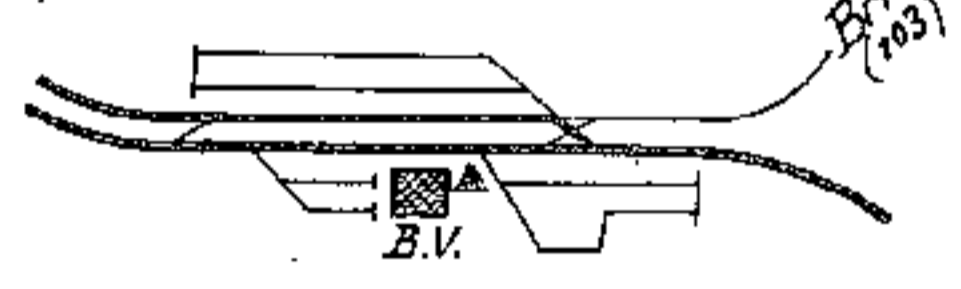

Ligne de Périgueux à Agen

Section de Périgueux au Buisson

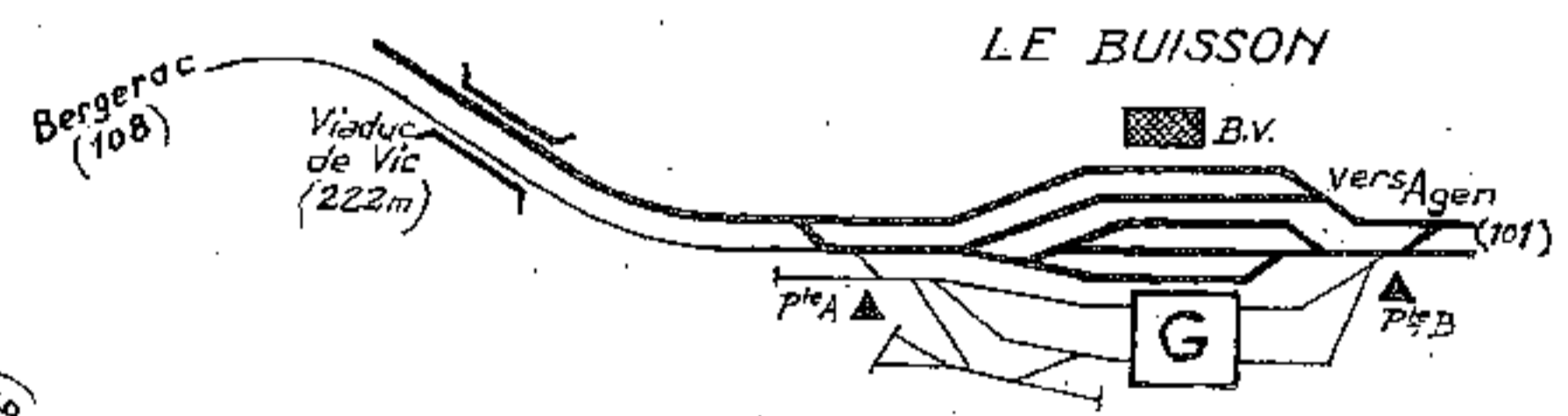
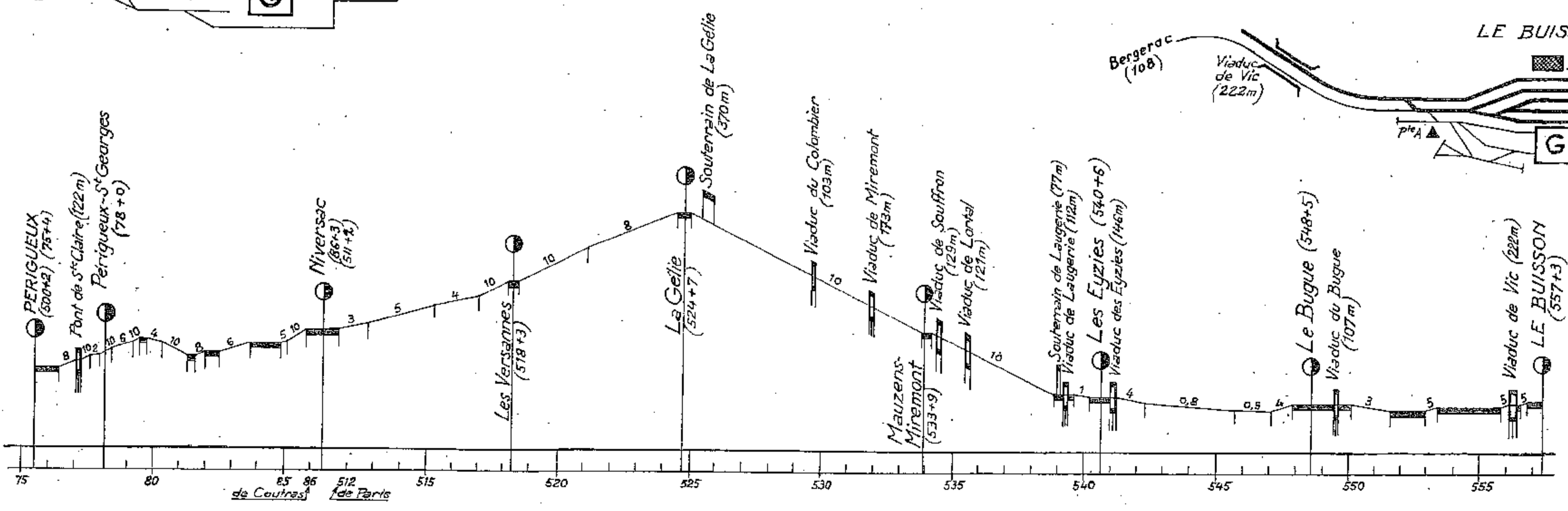

Abords de Périgueux

Ligne de Périgueux à Brive

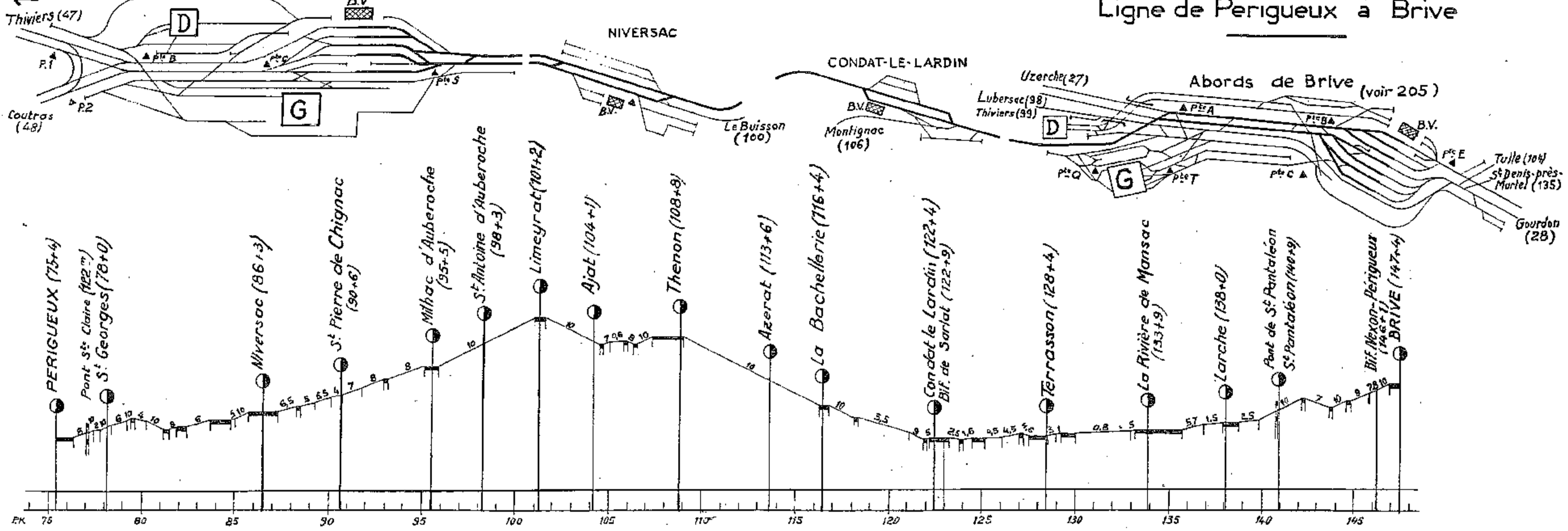

Ligne de Périgueux à Agen

Section de Monsempron-Libos à Agen

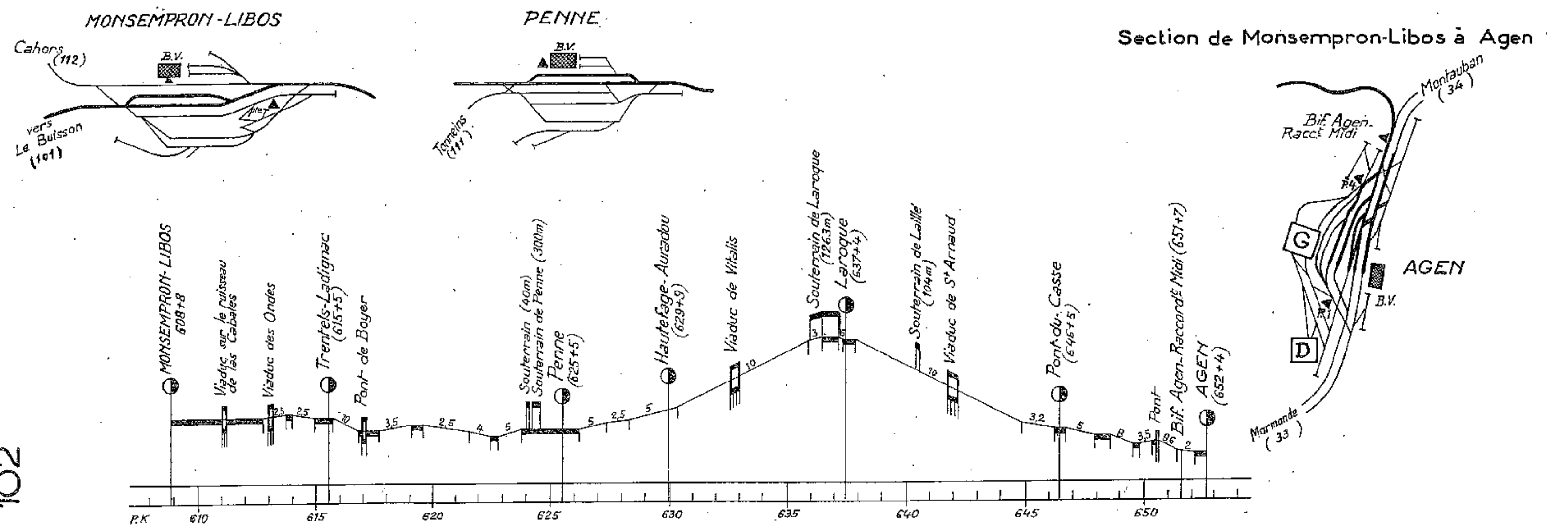

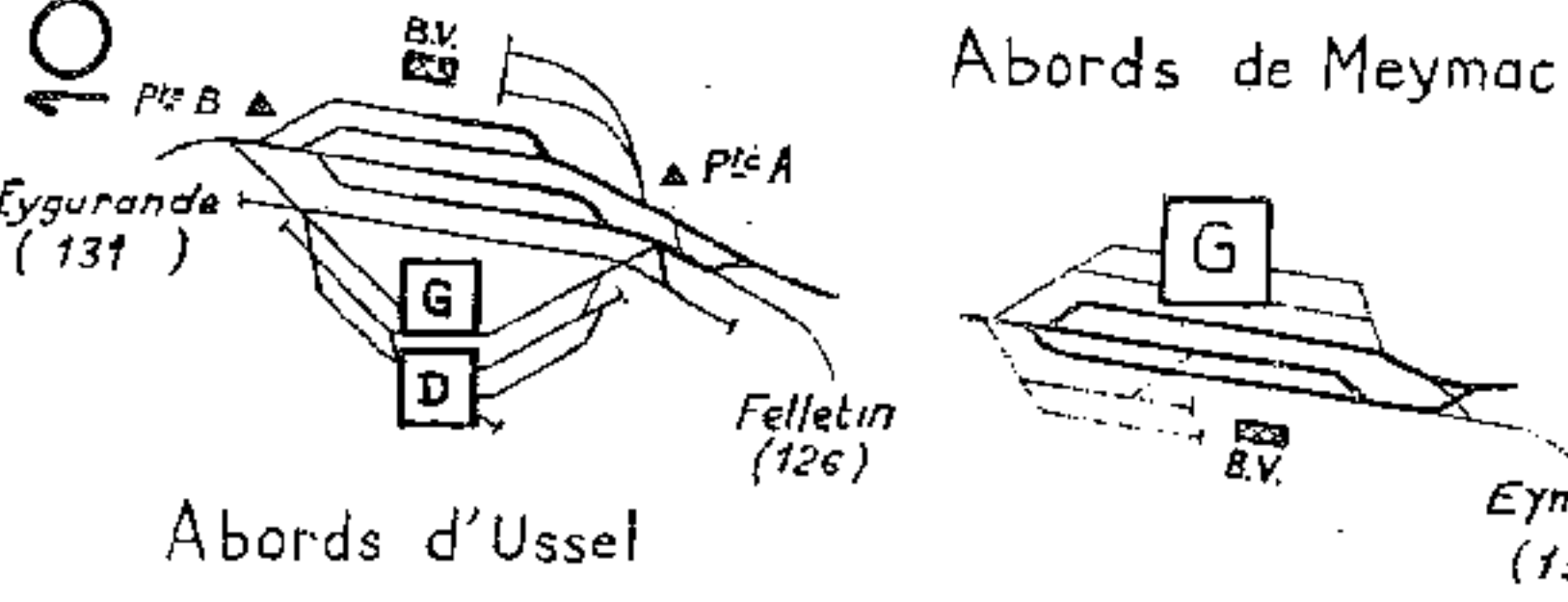

Abords de Tulle Ligne d'Ussel à Brive

Section d'Ussel à Tulle

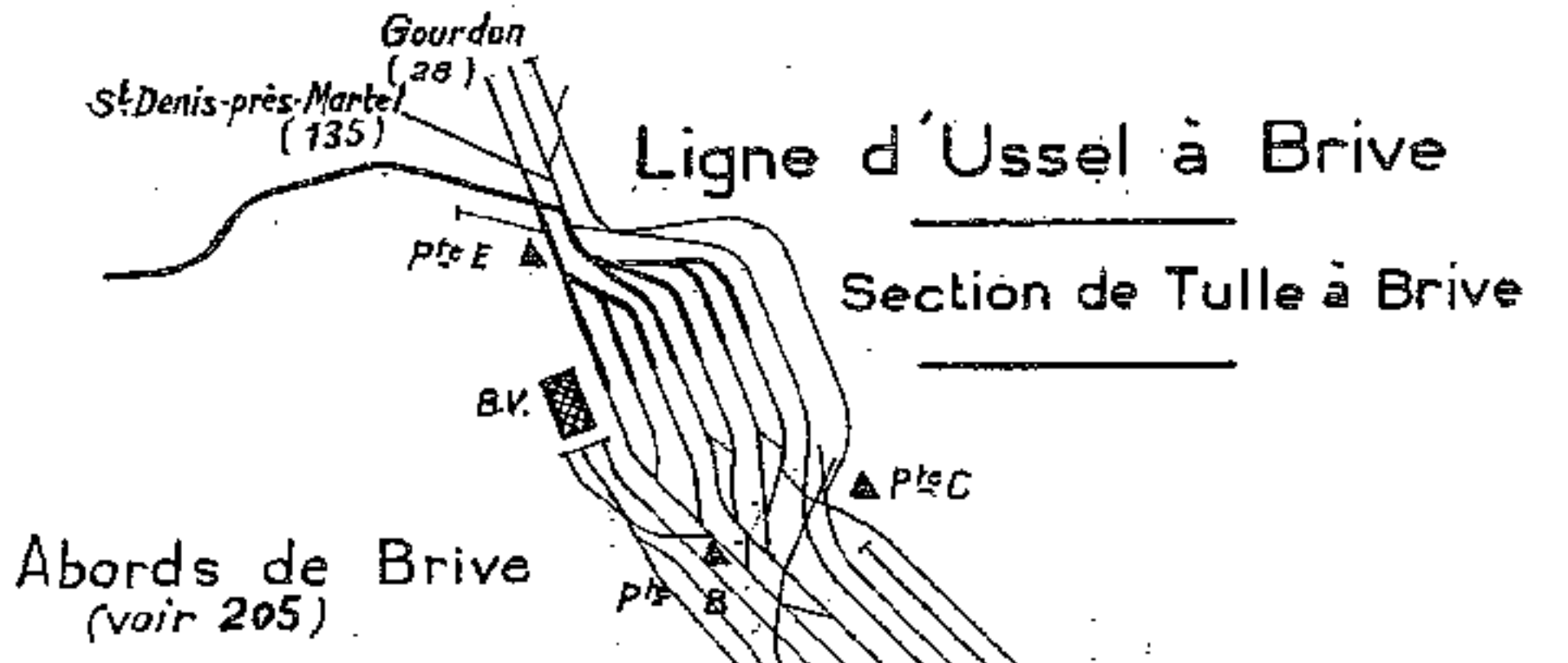
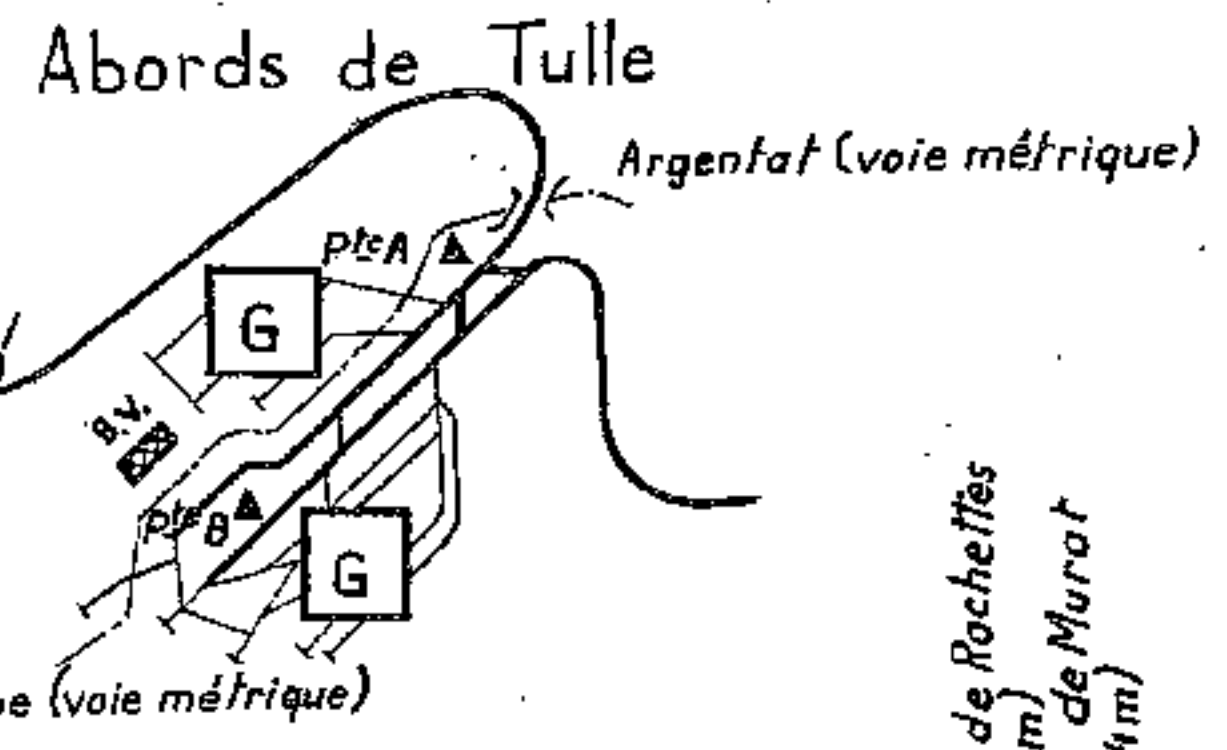
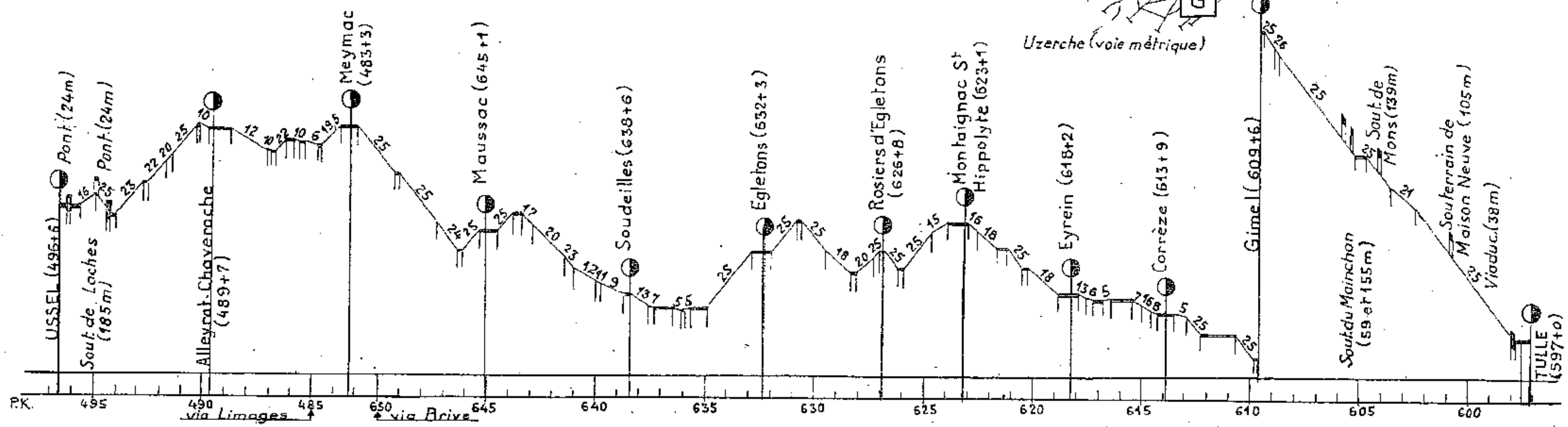
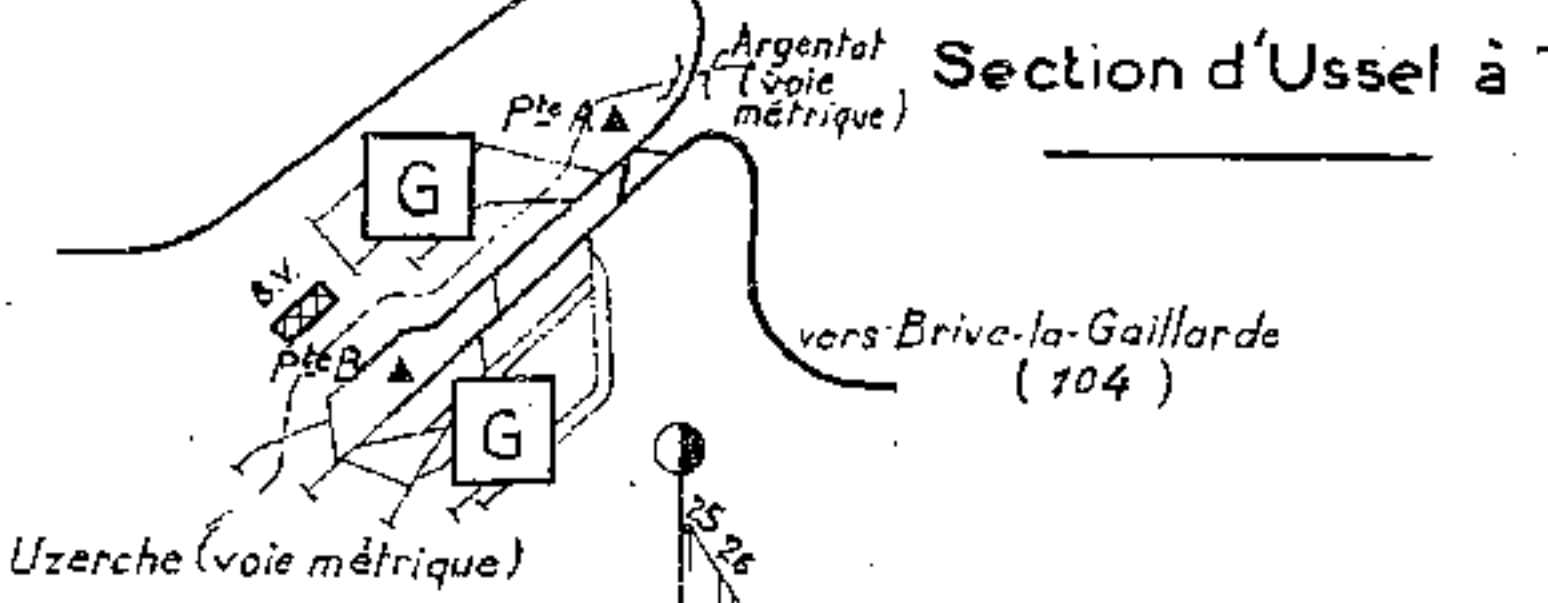

Ligne d'Ussel à Brive

Section de Tulle à Brive

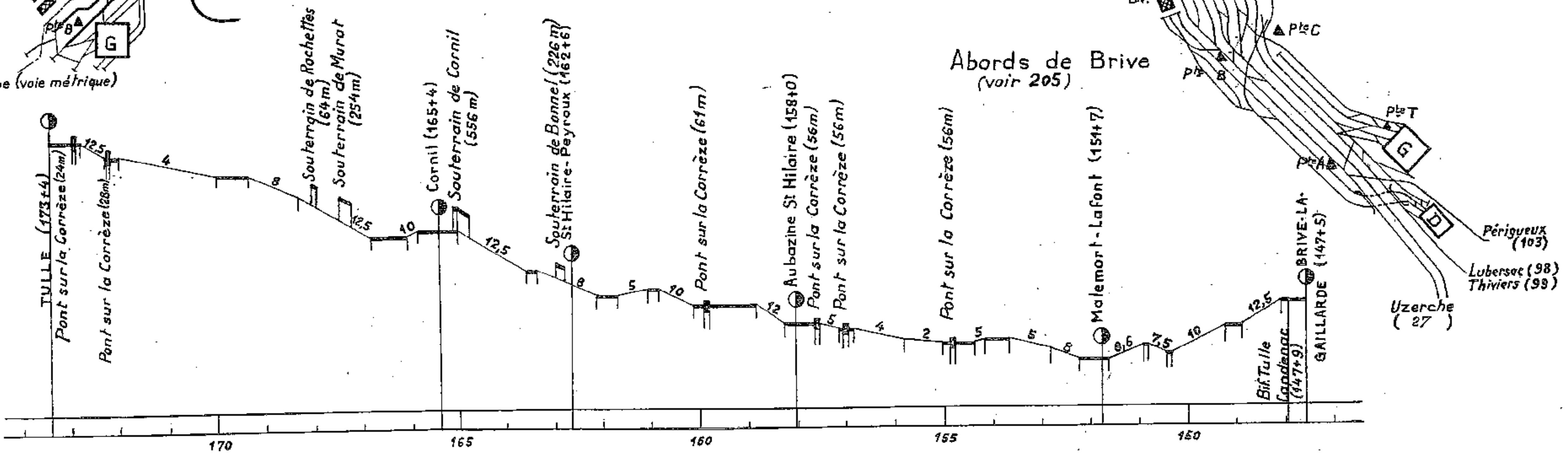

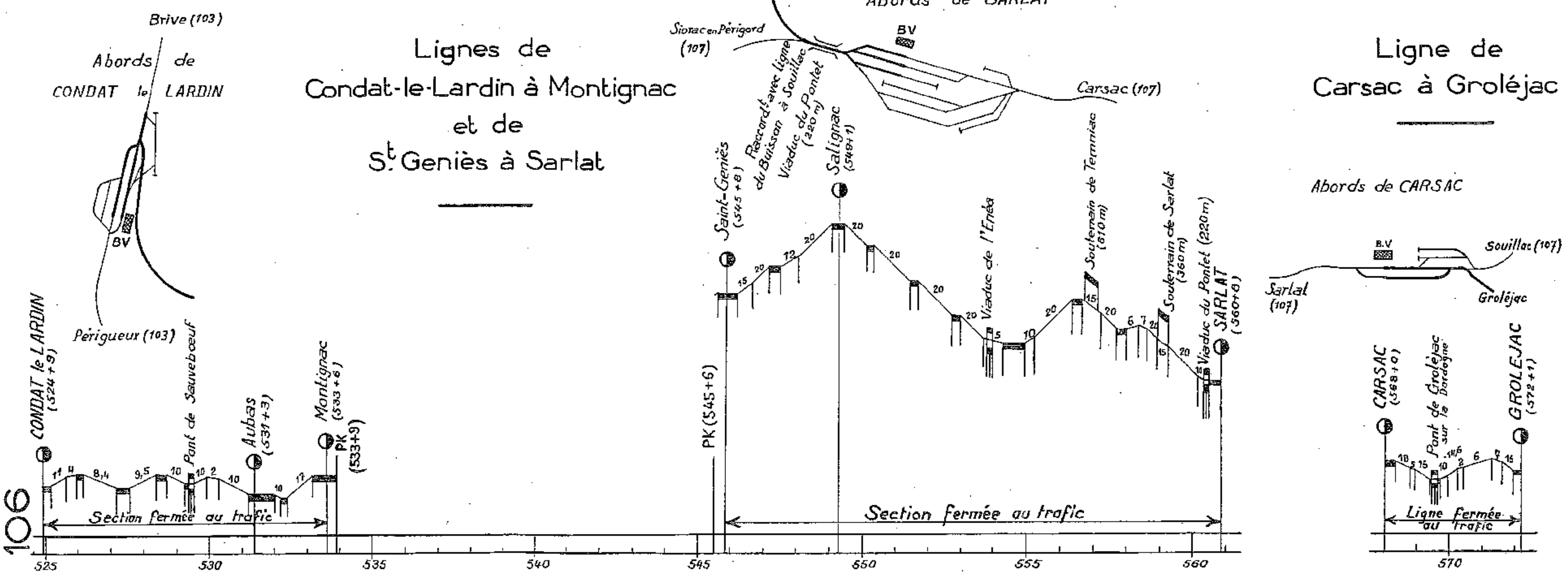
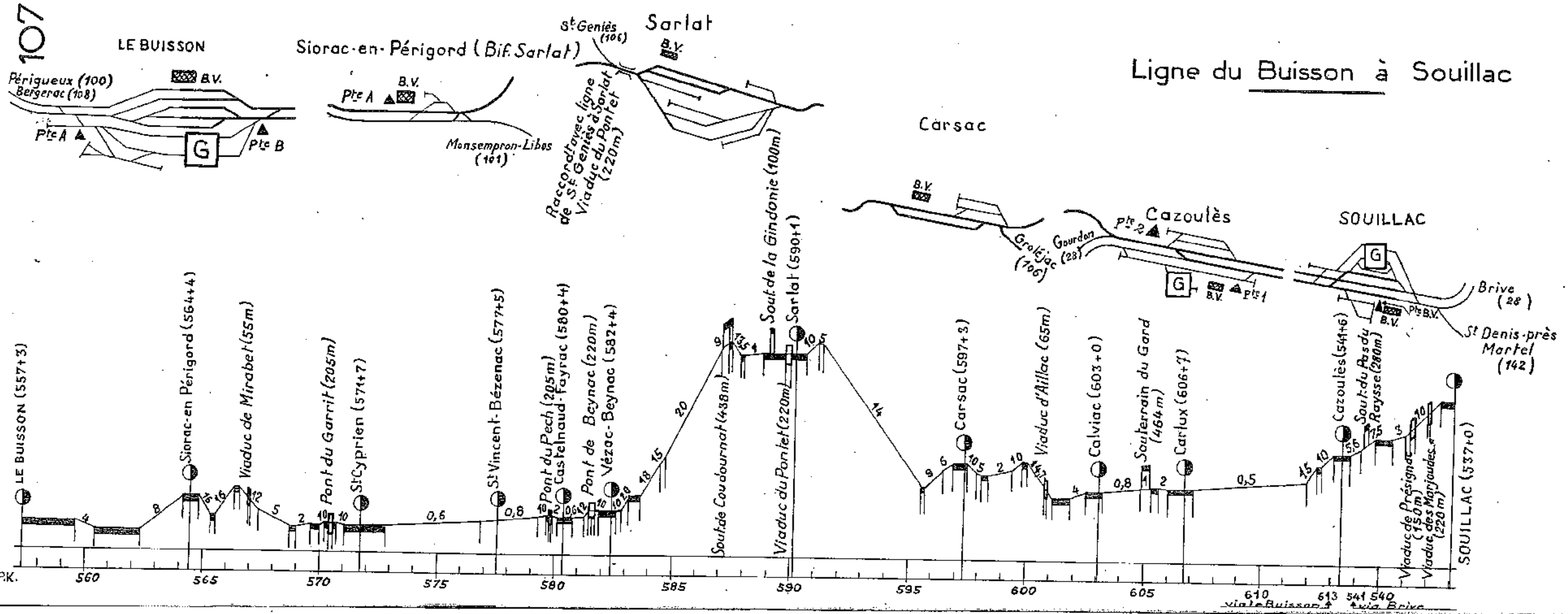

Abords de Bergerac

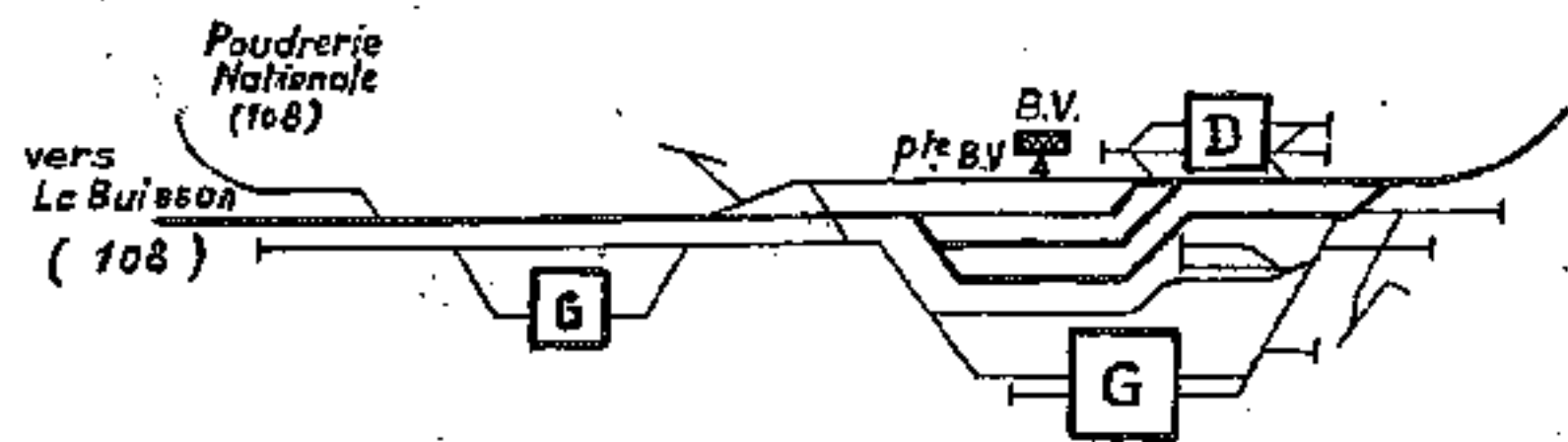

Ligne du Buisson à Libourne

Section de Bergerac à Libourne

Abords de Libourne

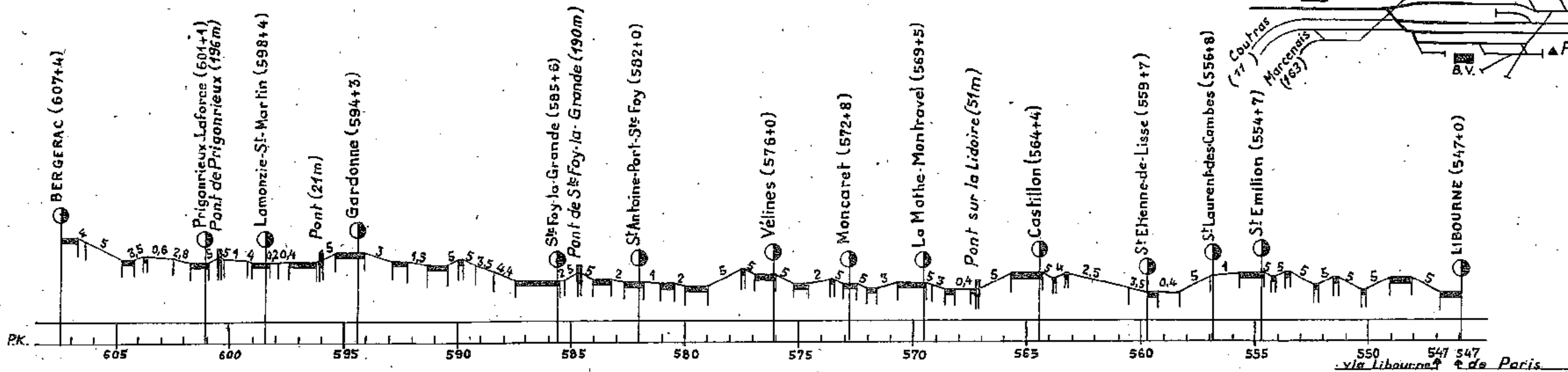
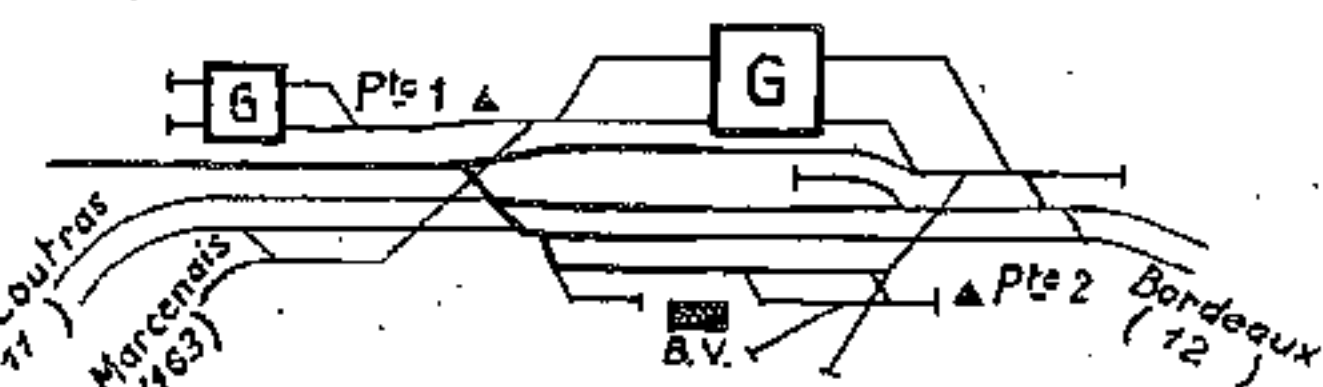

Le Buisson

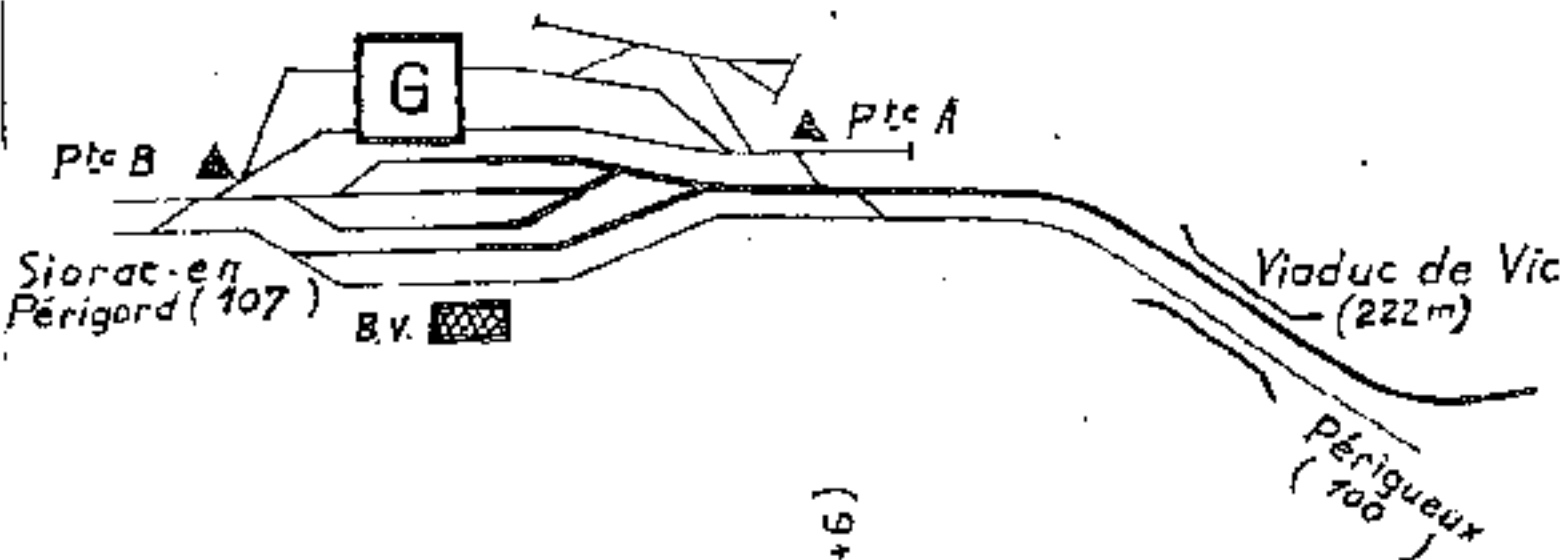

Ligne du Buisson à Libourne

Section du Buisson à Bergerac

Abords de Bergerac

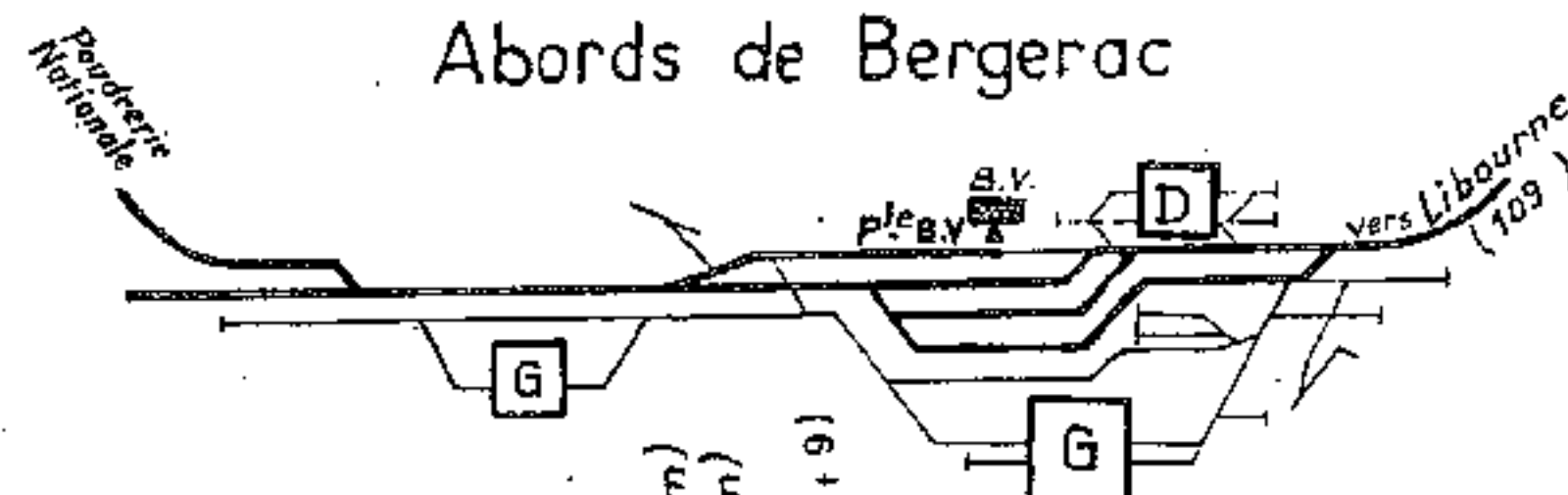

Ligne de Bergerac à la Poudrerie Nationale

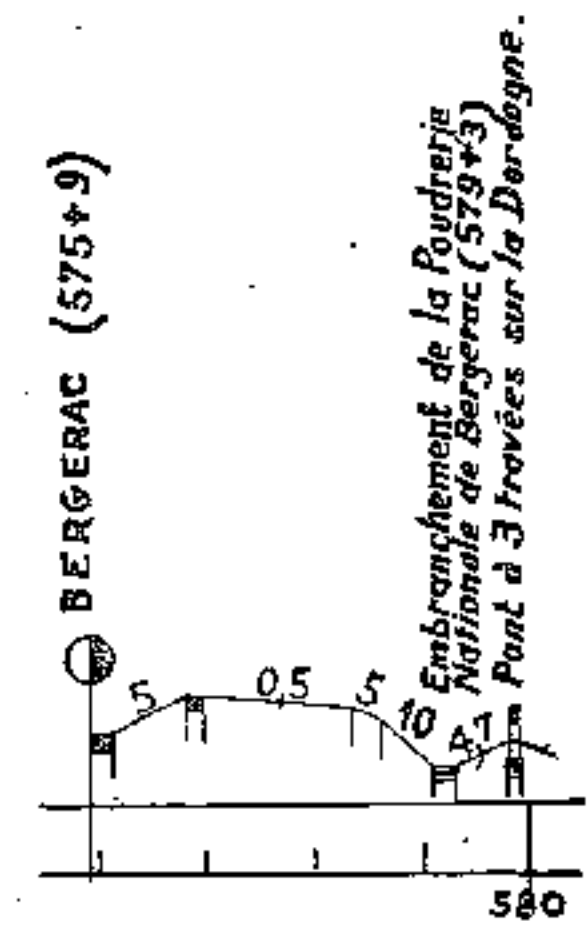
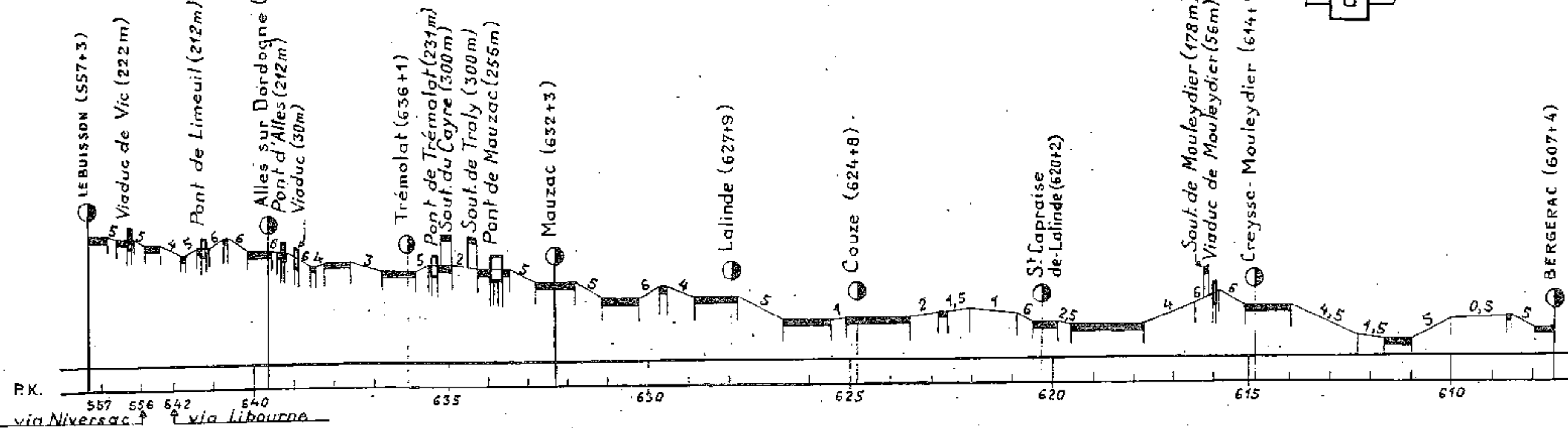

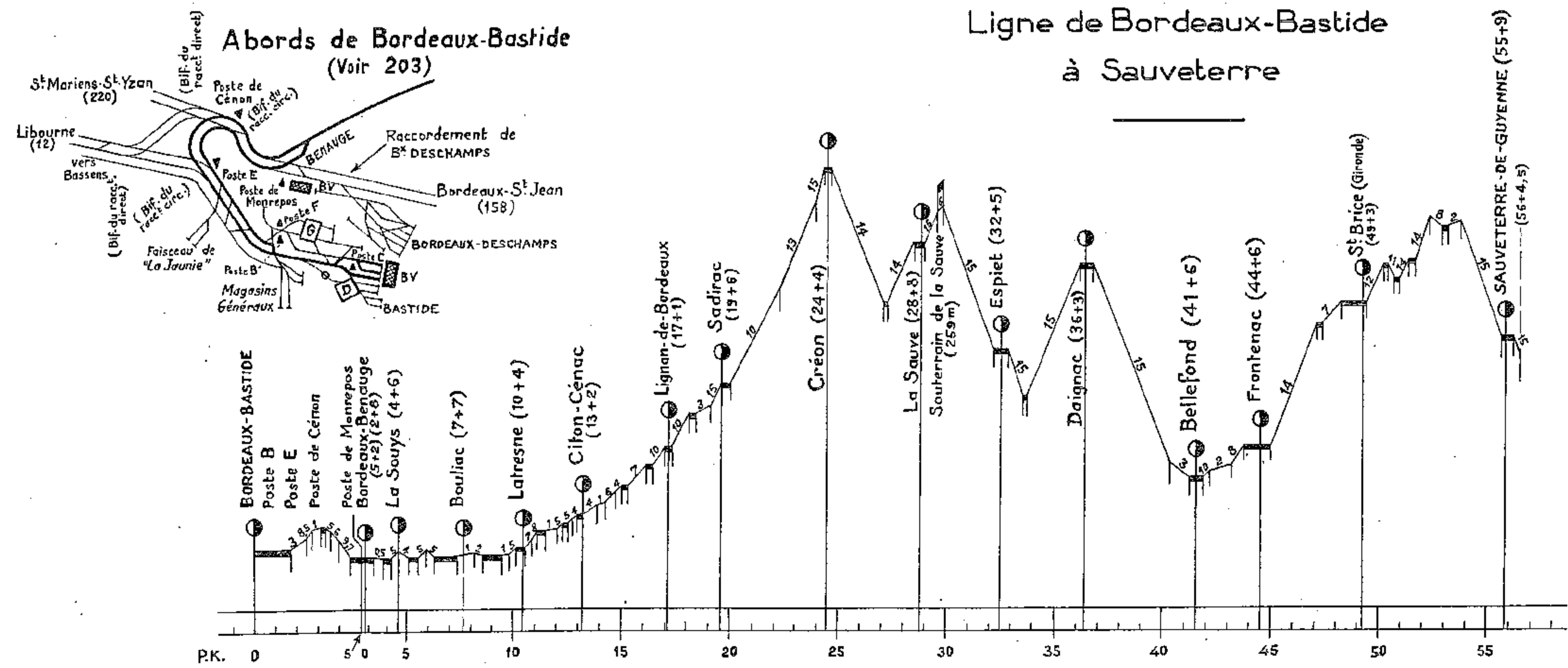
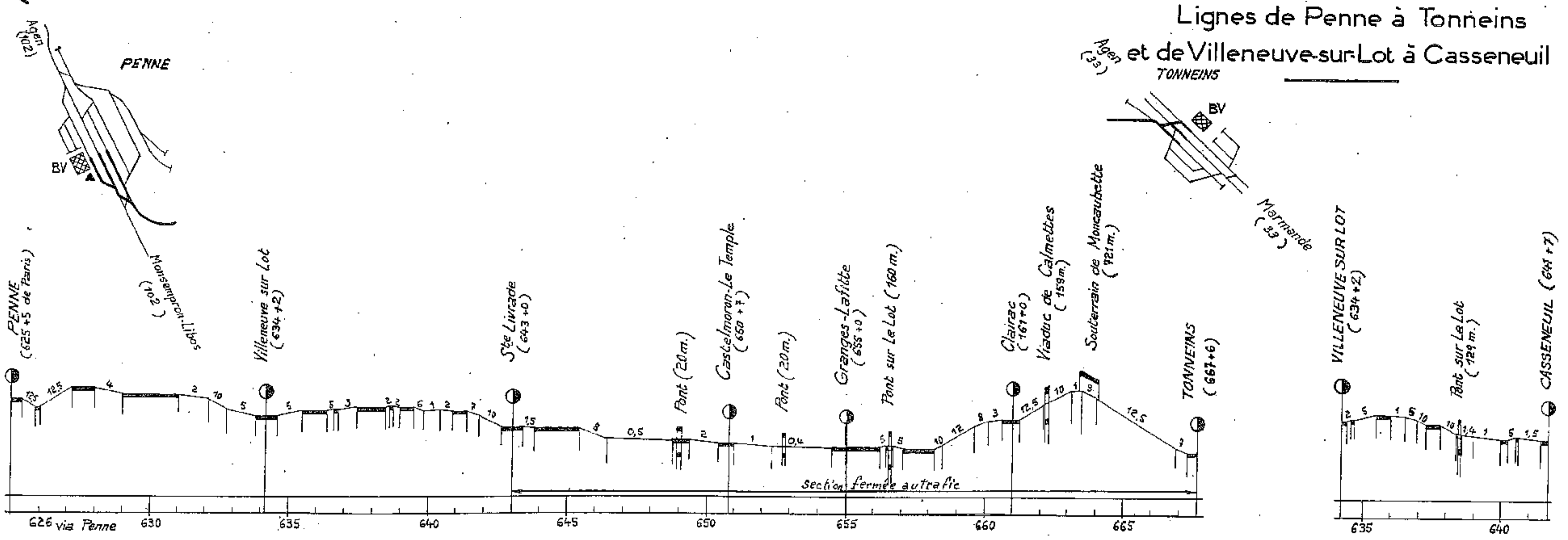

Abords de S^t Florent

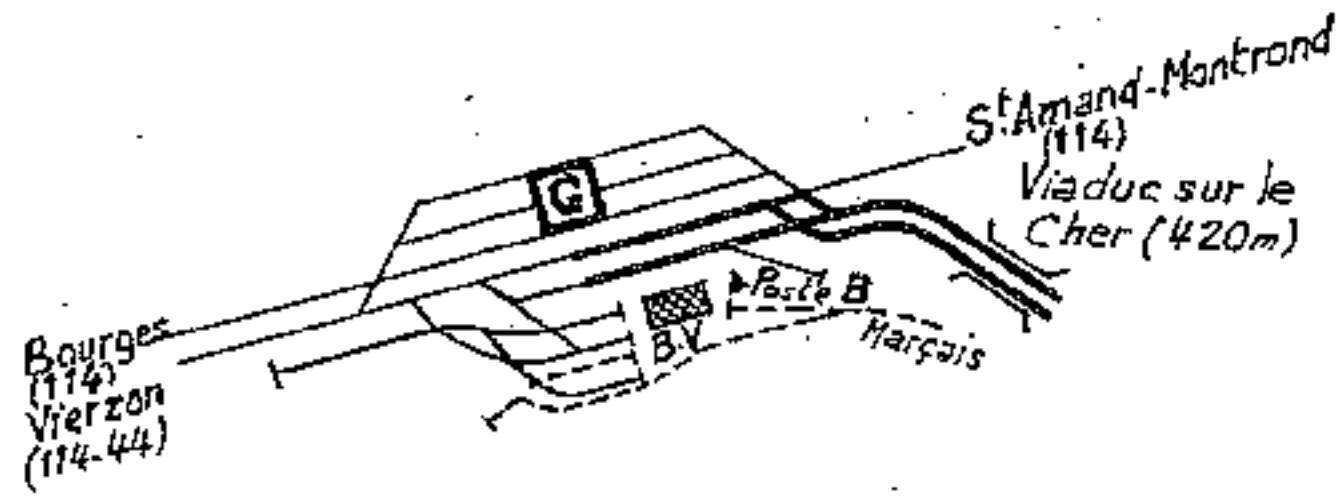

Abords d'Issoudun

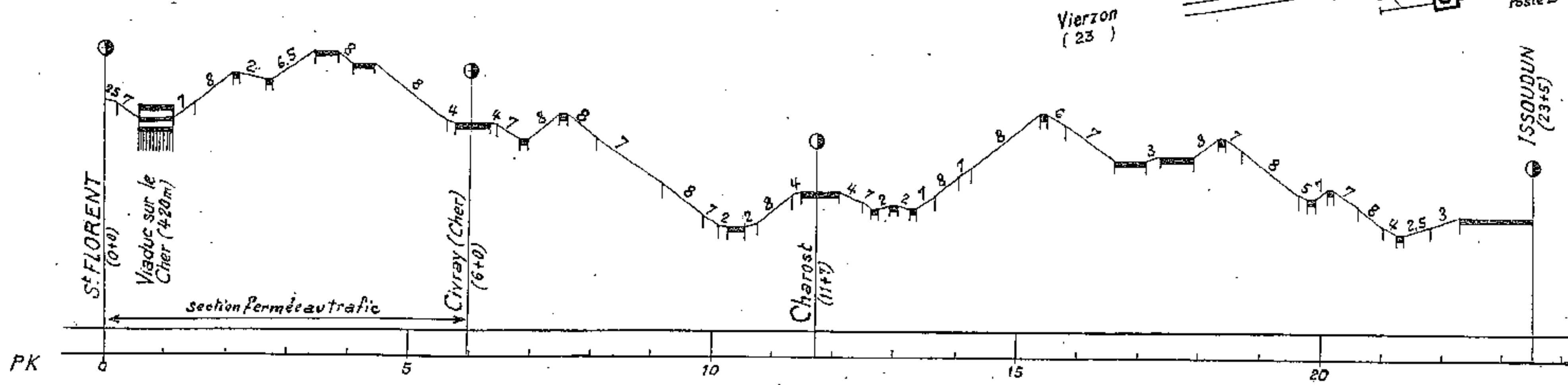
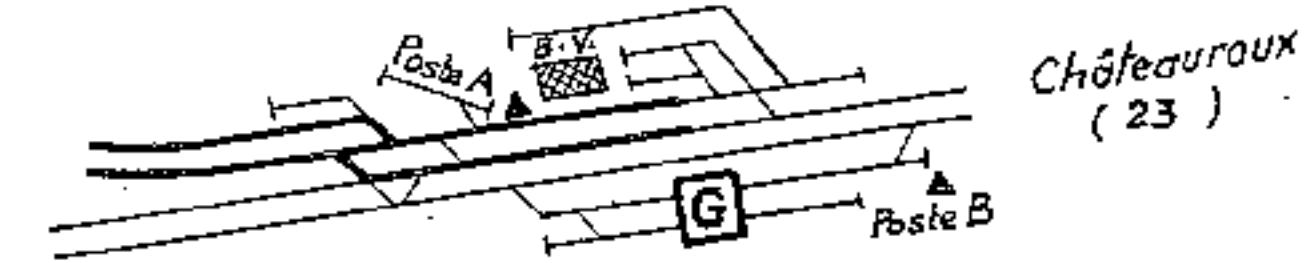

Abords de MONSEMPRON-LIBOS

Le Buisson (101)

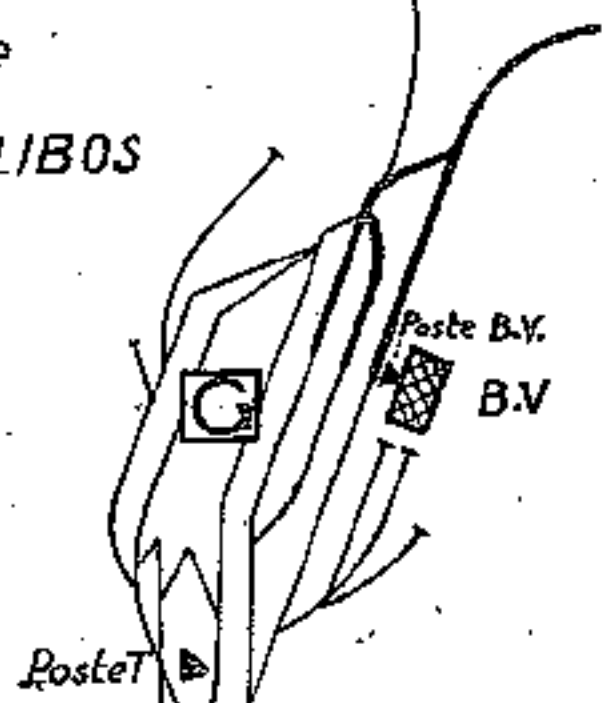

Abords de CAHORS

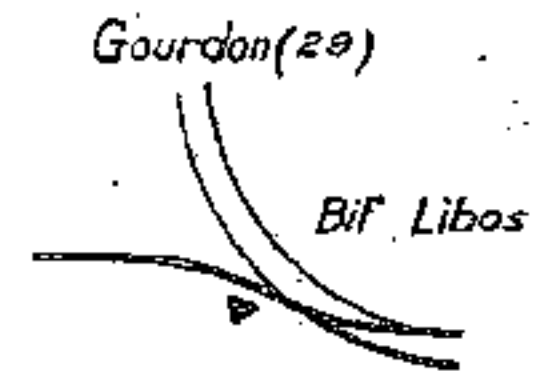

Ligne de Monsempron-Libos à Cahors

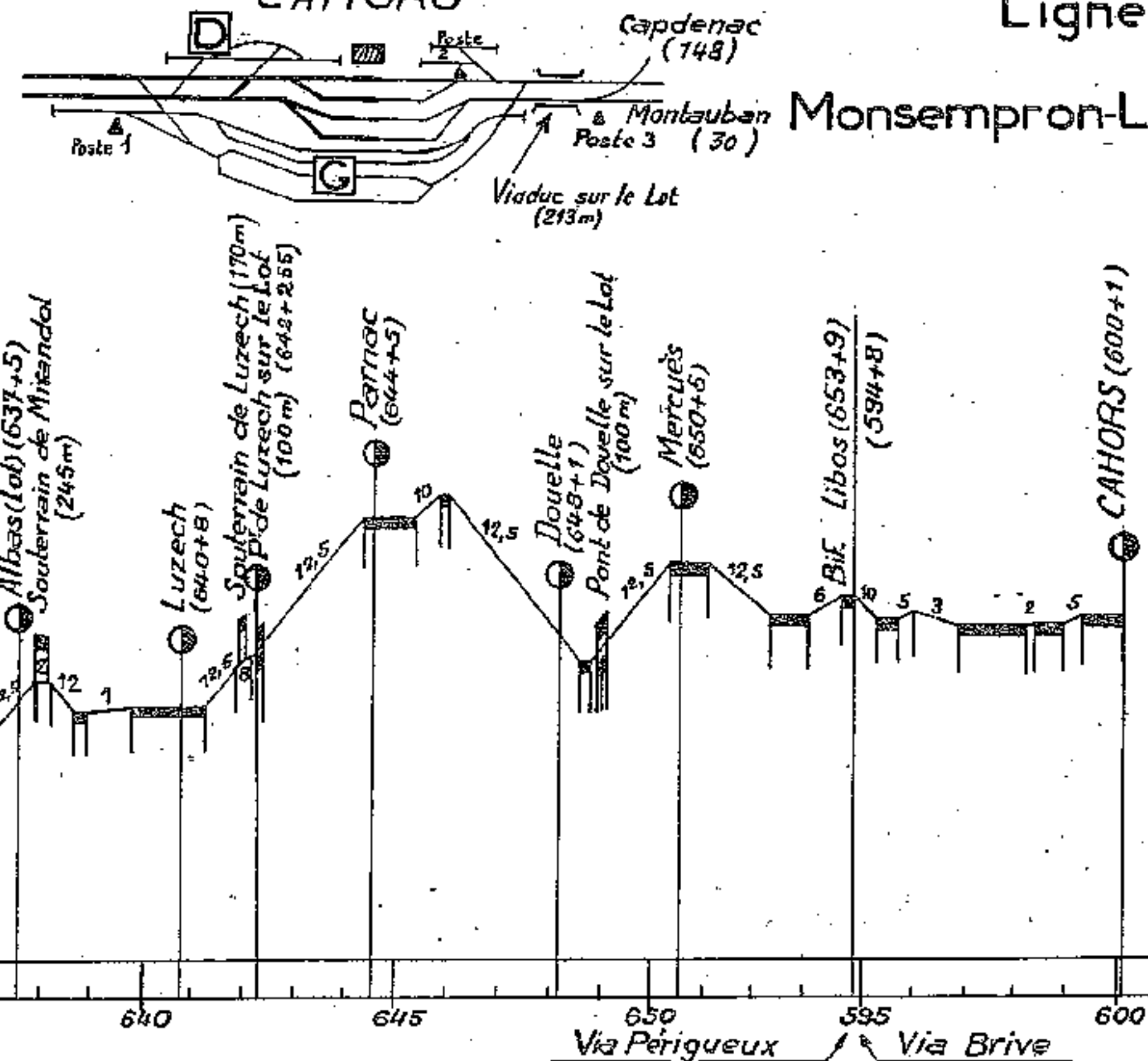

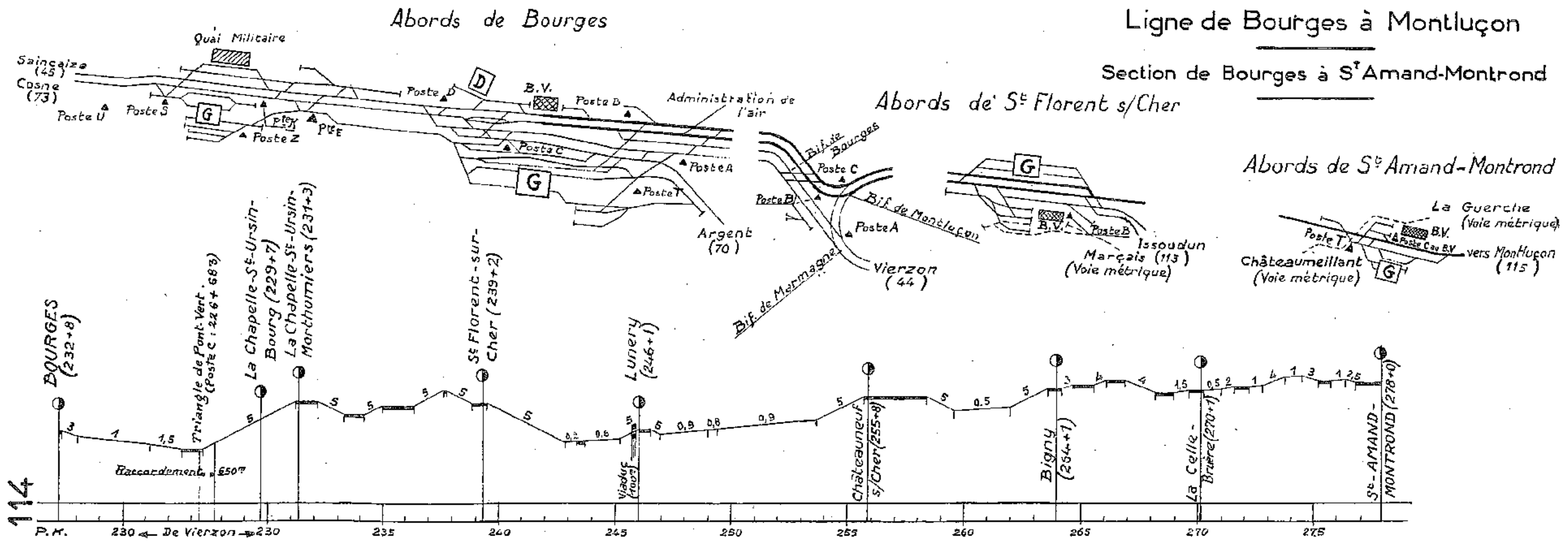
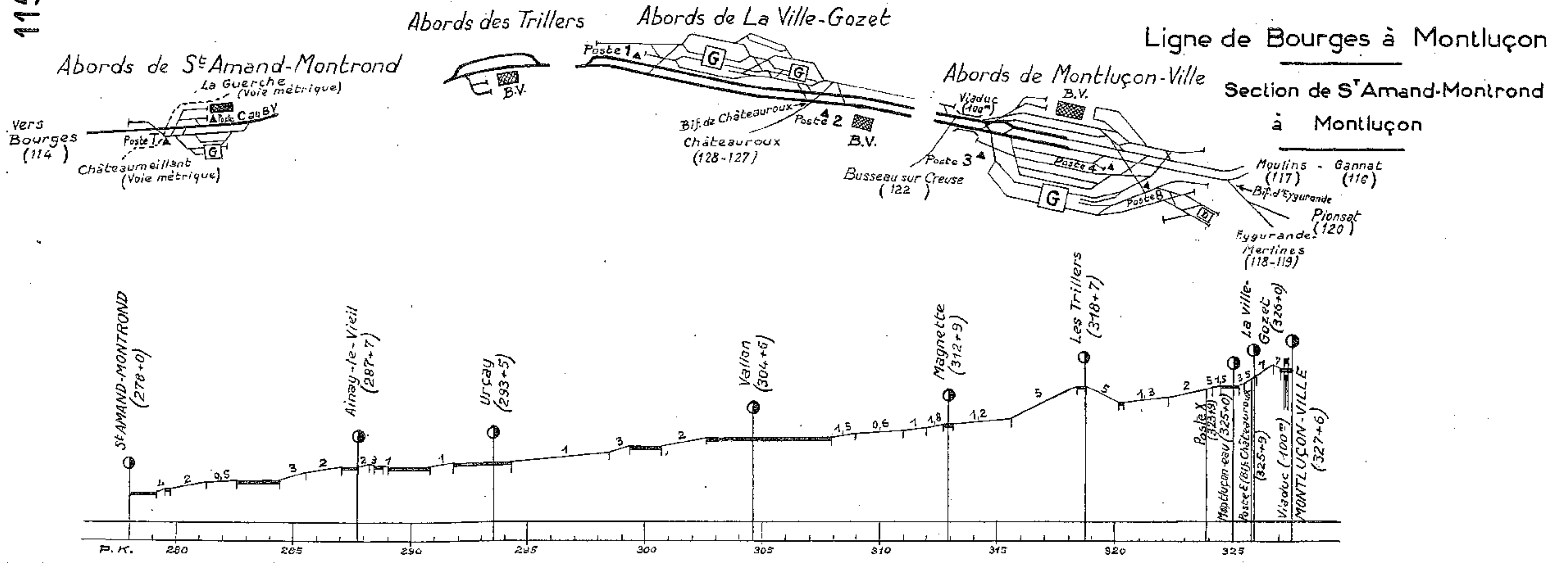

Abords de Moulins (voir

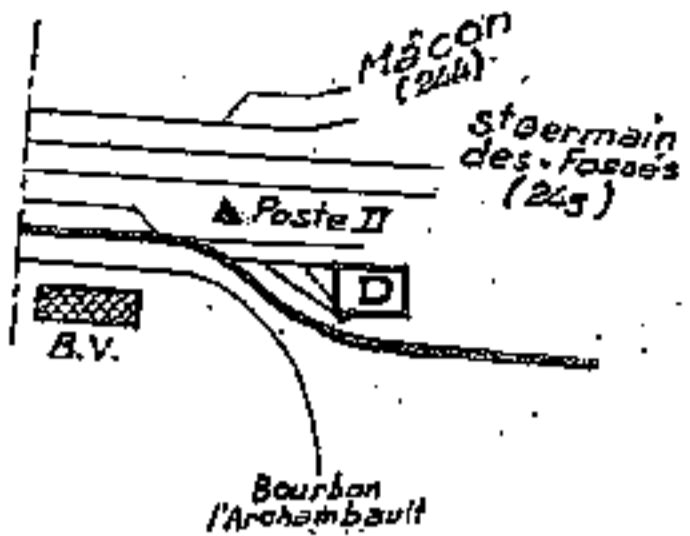

Abords de Doyet-la-Preste

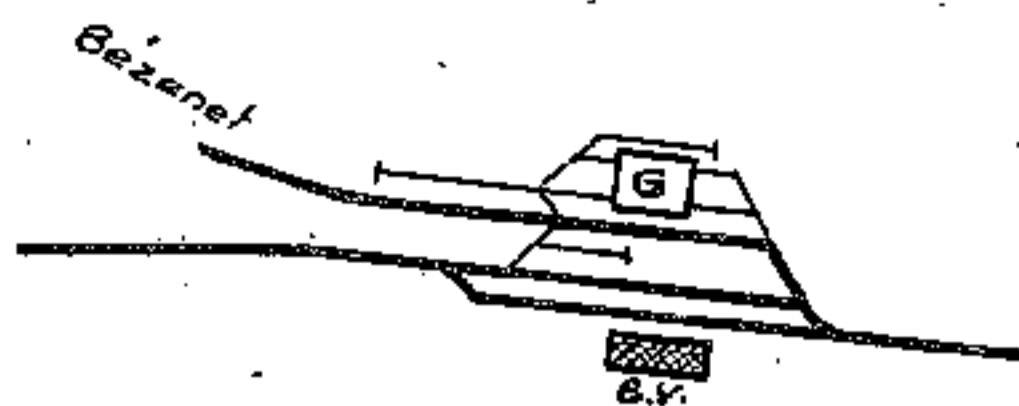

Lignes de Moulins à Commentry et de Doyet-la-Preste à Bézenet

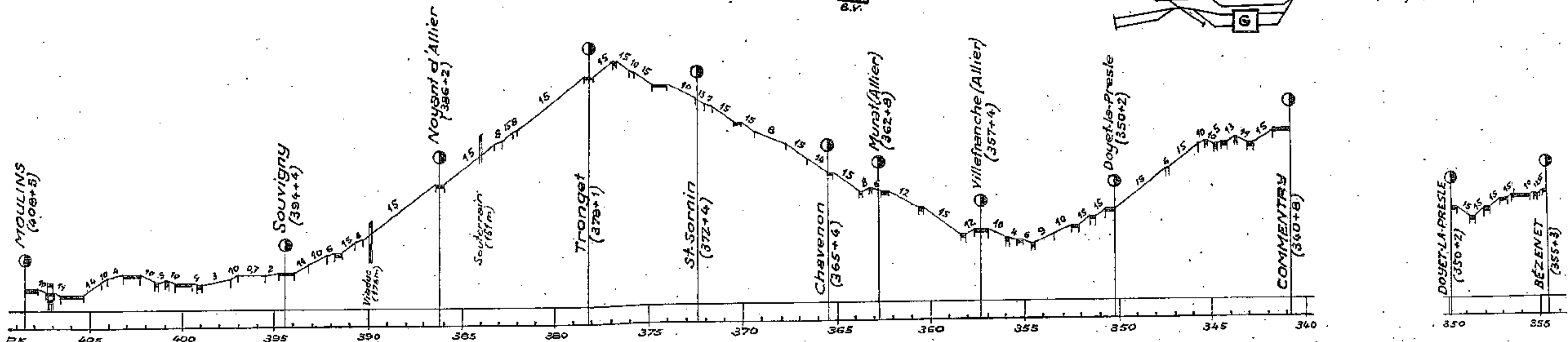
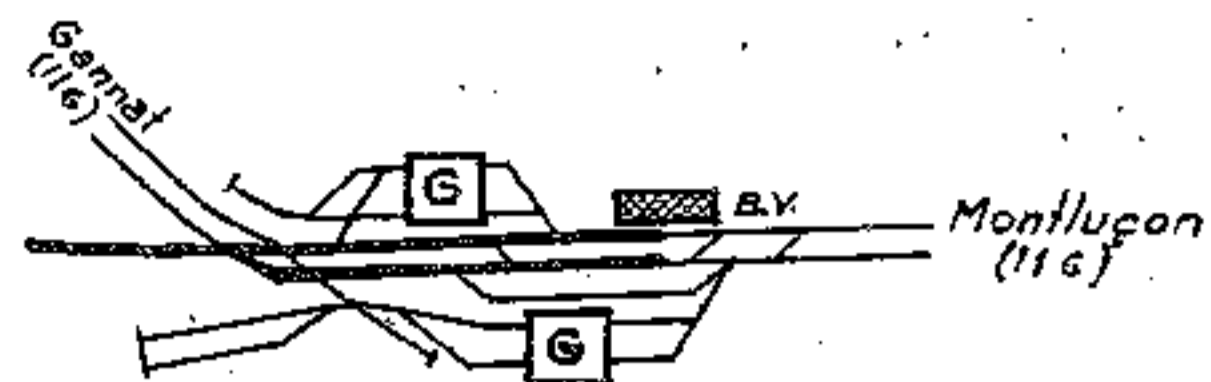

Abords de Gannat

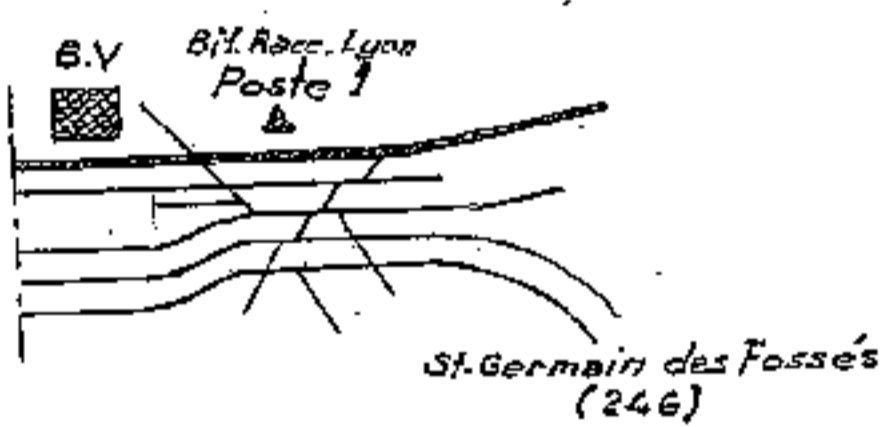

Abords de Lapeyrouse



Abords de Commentry

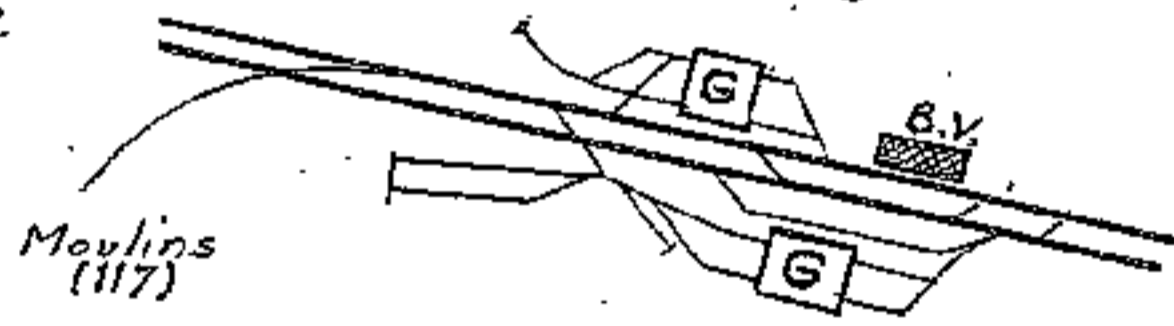

Ligne de Gannat à Montluçon

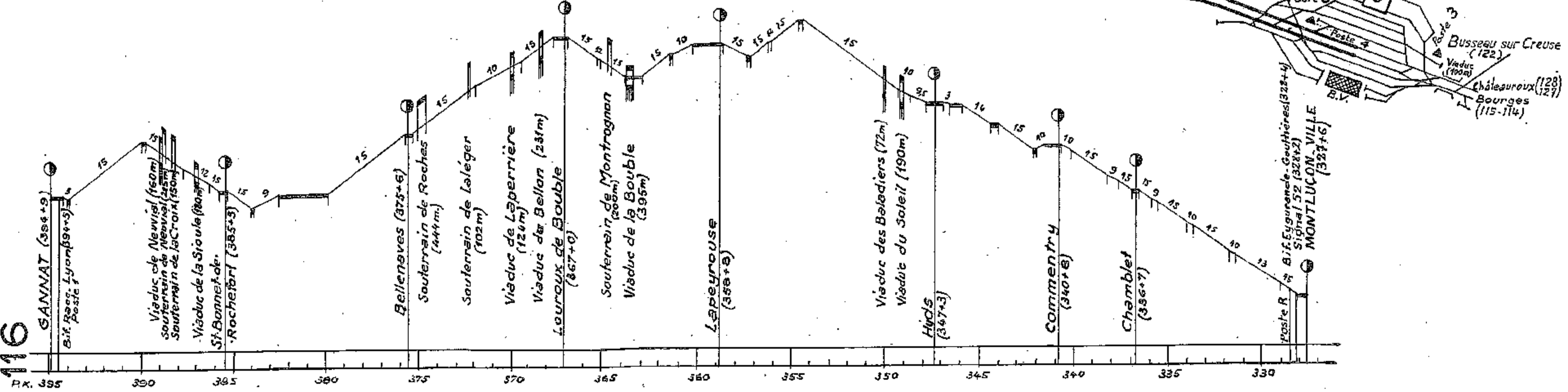
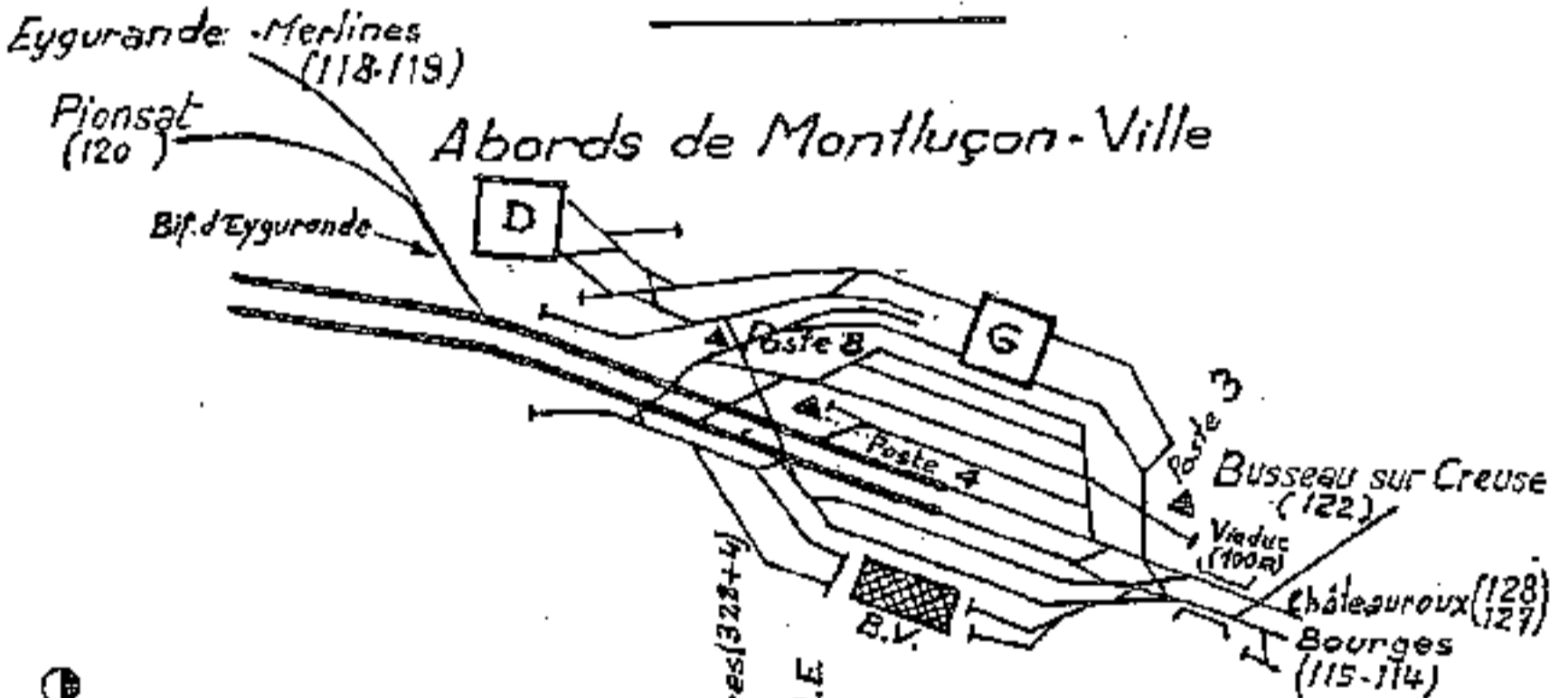

Abords d'Eygurande-Merlines

Ligne de Montluçon à Eygurande

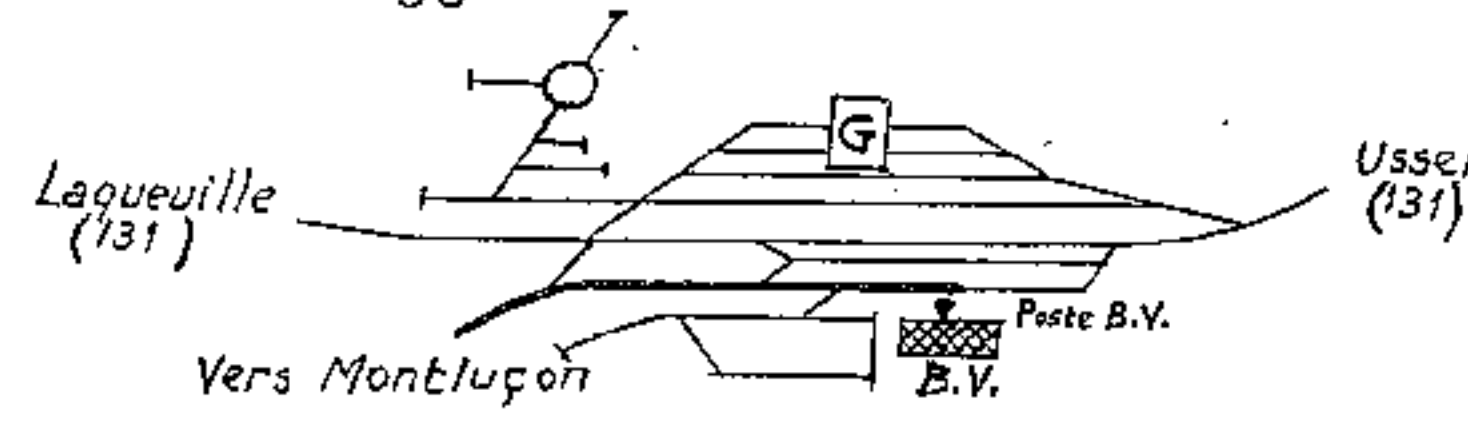

Section d'Auzances à Eygurande

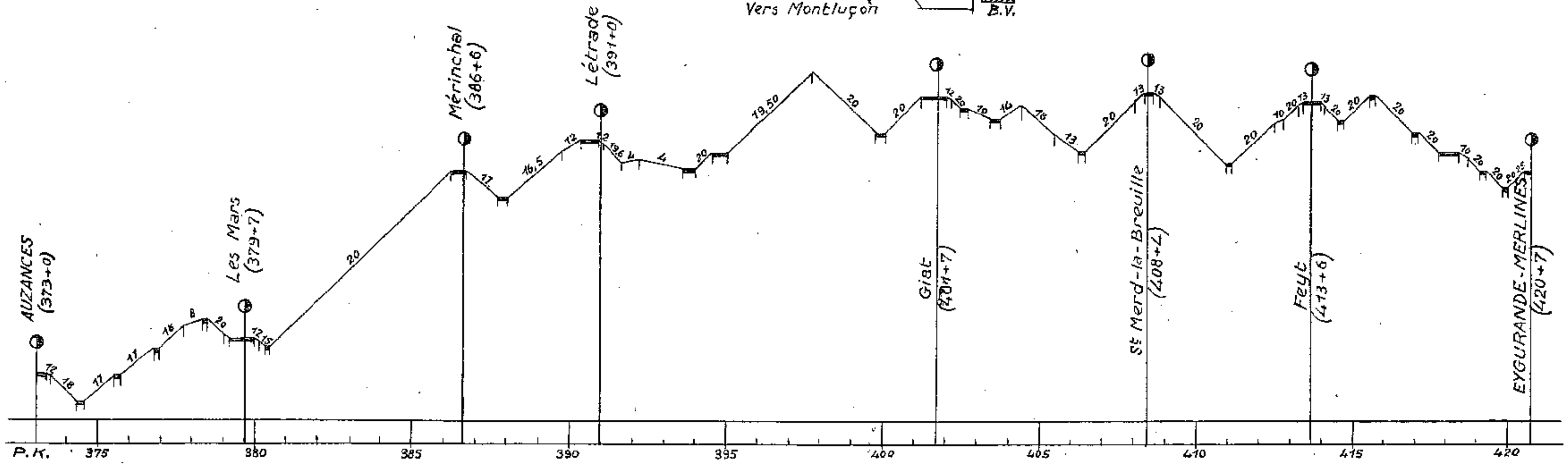

Abords de Montluçon-ville

Ligne de Montluçon à Eygurande

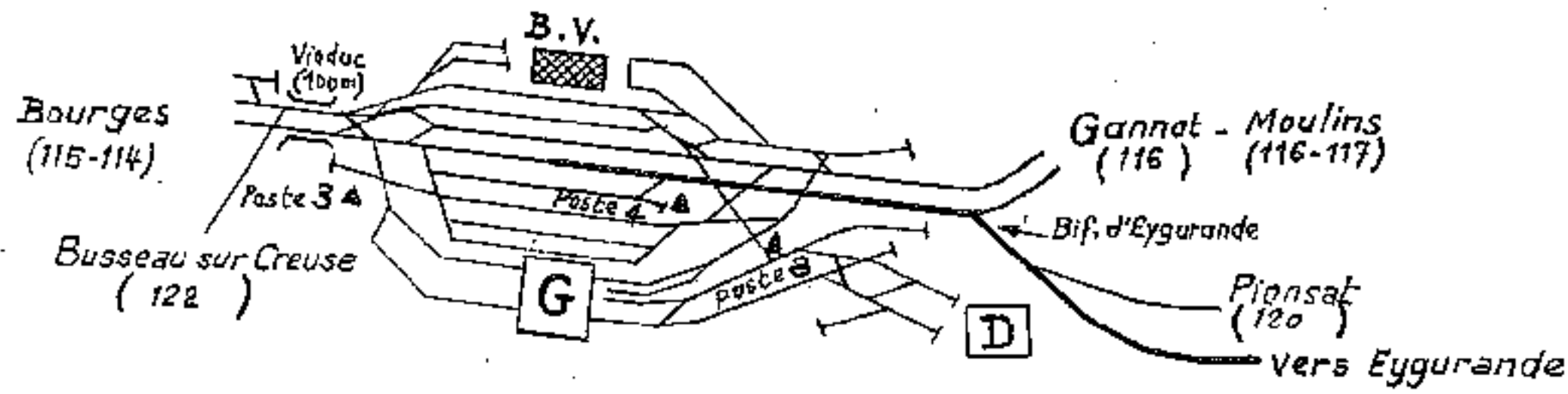

Section de Montluçon à Auzances

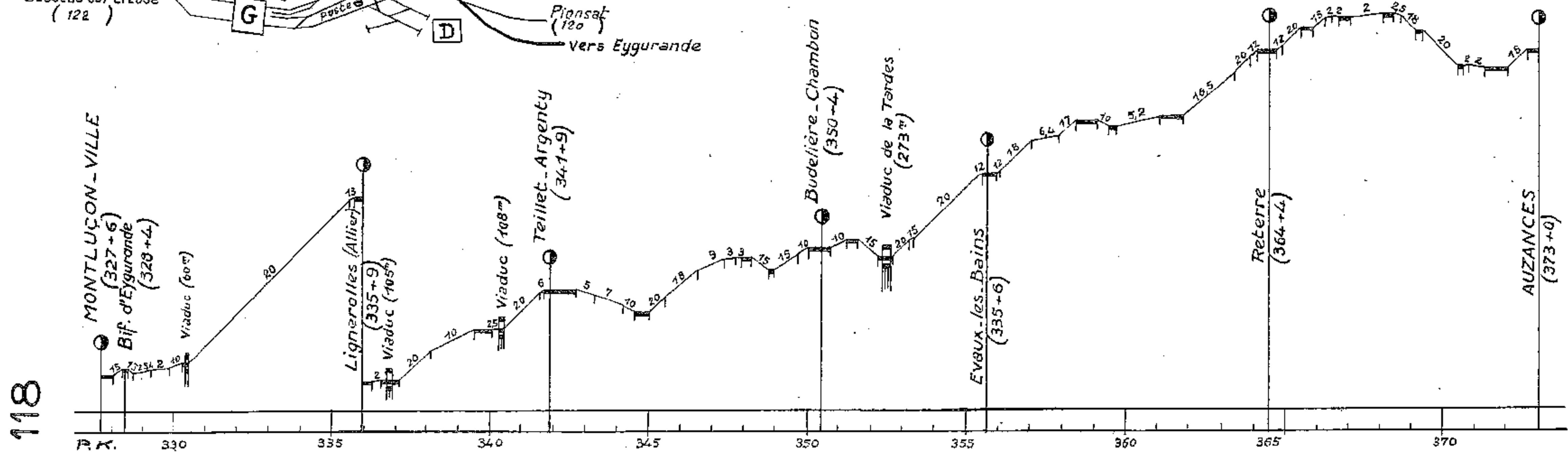

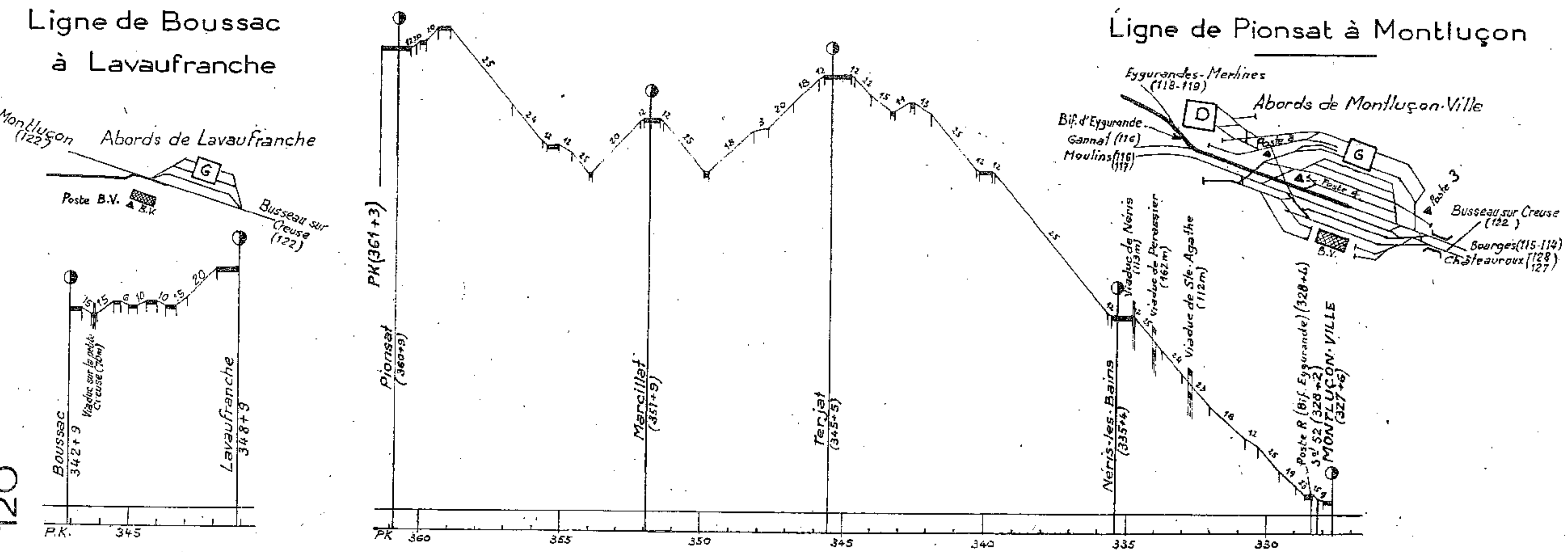
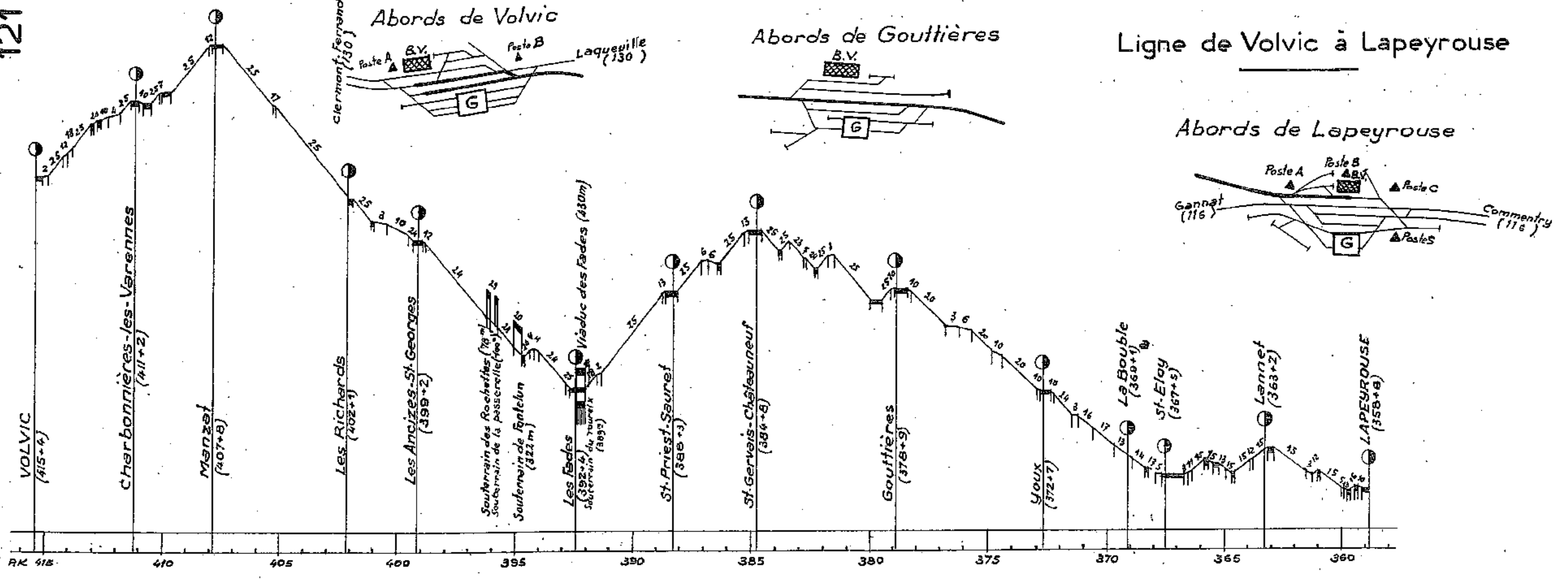

Ligne de Montluçon à S^tSulpice-Laurière

Section de Busseau-sur-Creuse à S^tSulpice-Laurière

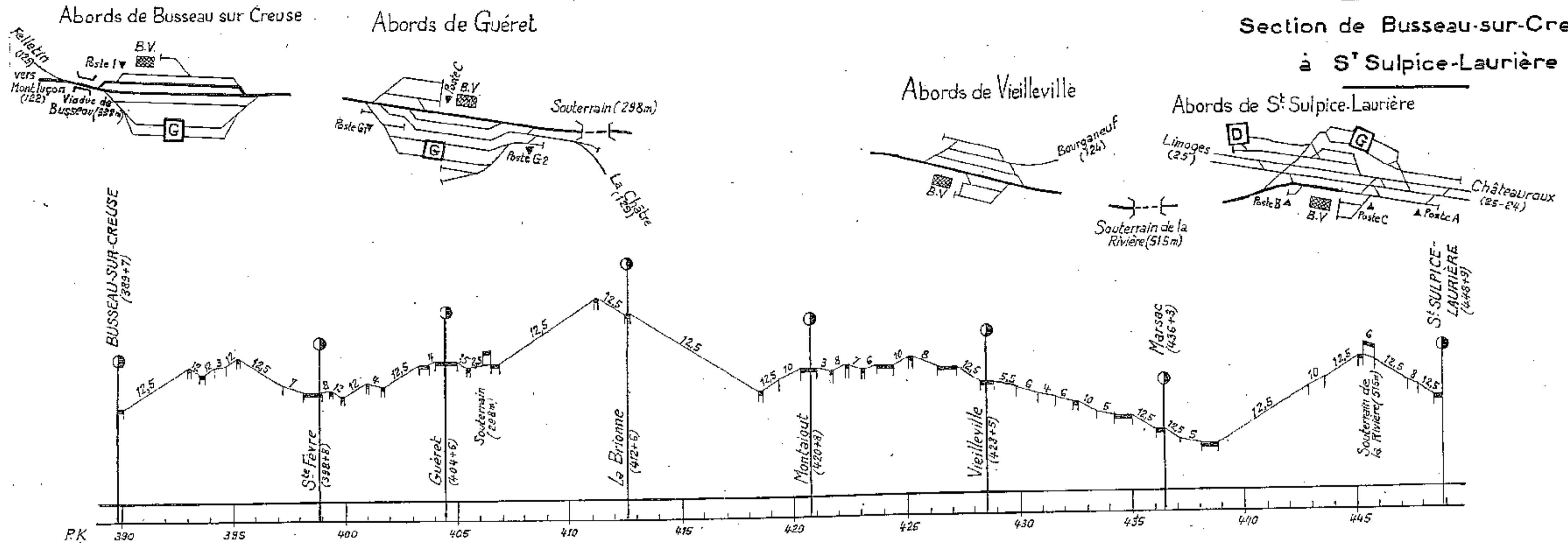

Abords de Montluçon

Abords de Lavaufranche

Ligne de Montluçon à S^tSulpice-Laurière

Section de Montluçon à Busseau-sur-Creuse

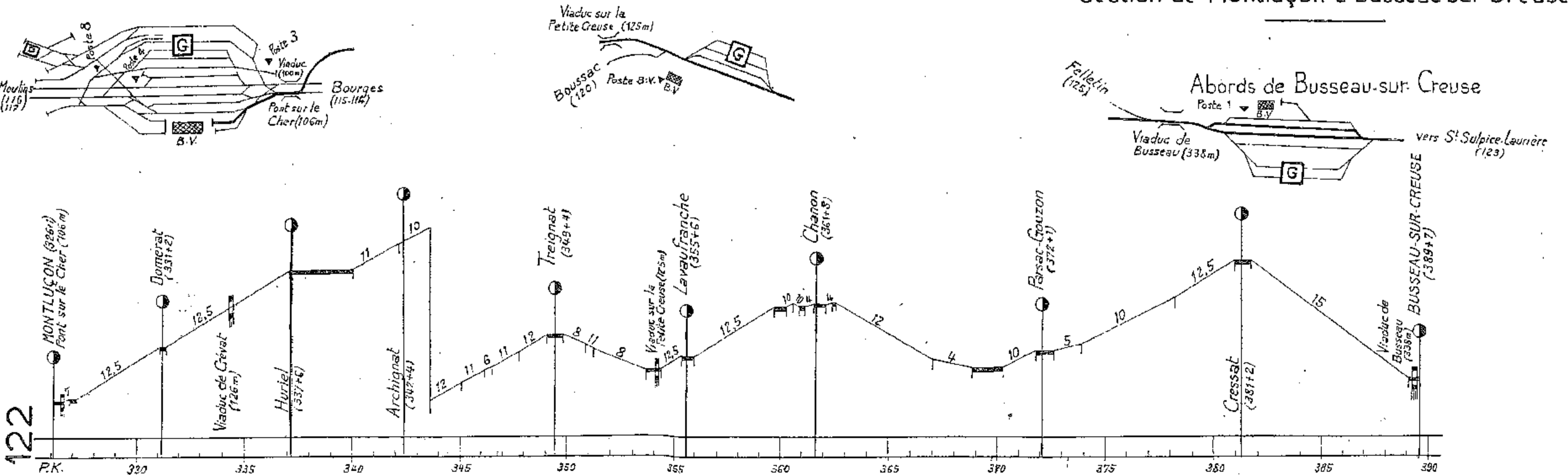

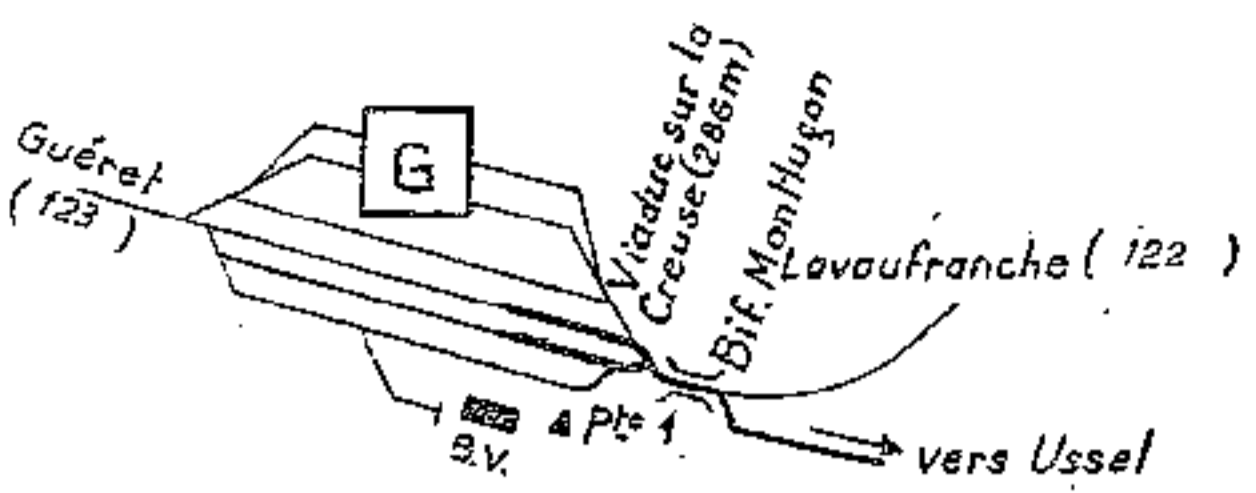

Section de Busseau-sur-Creuse à Felletin

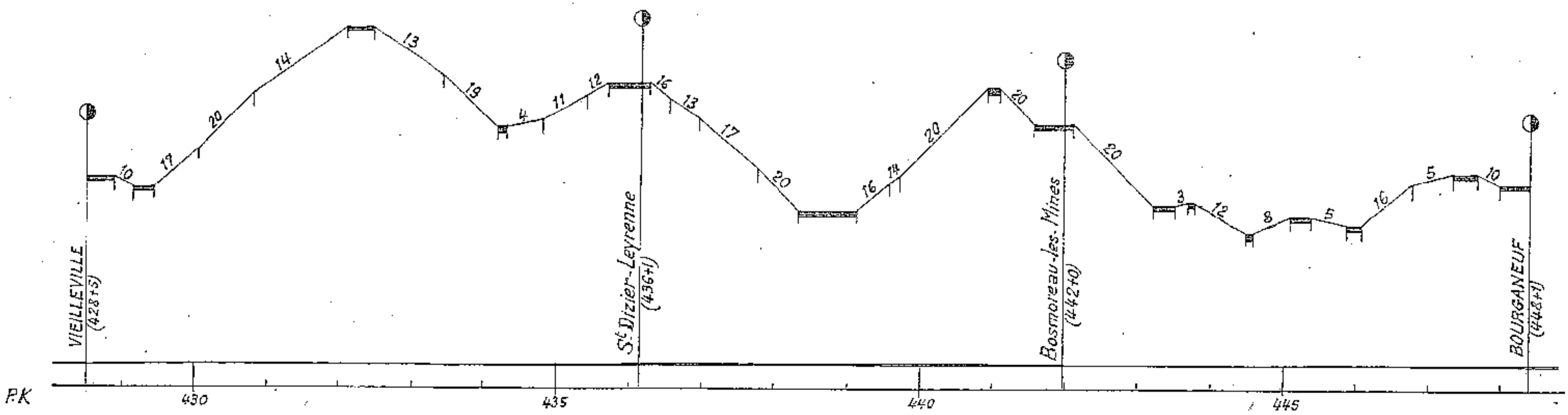
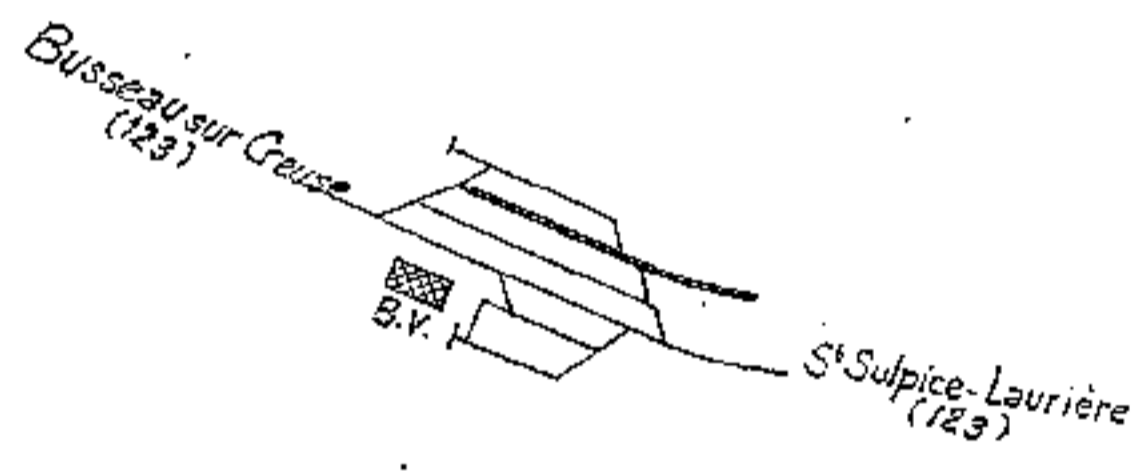
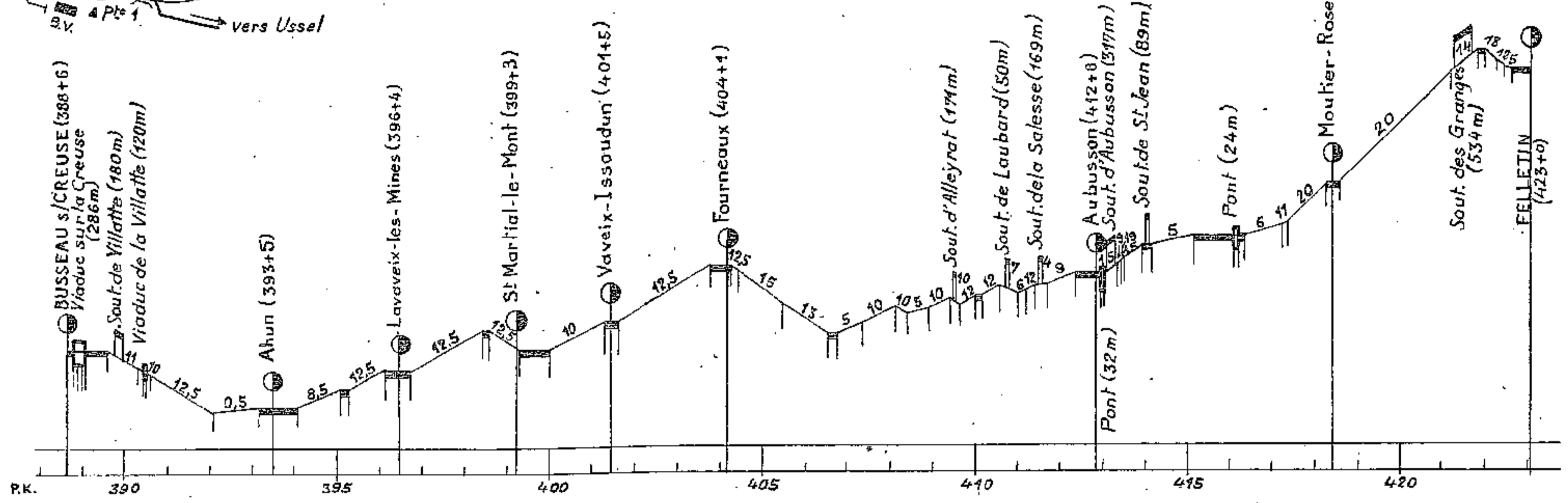

Ligne de Châteauroux à Montluçon

Section de Châteauroux à Champillet-Urciers

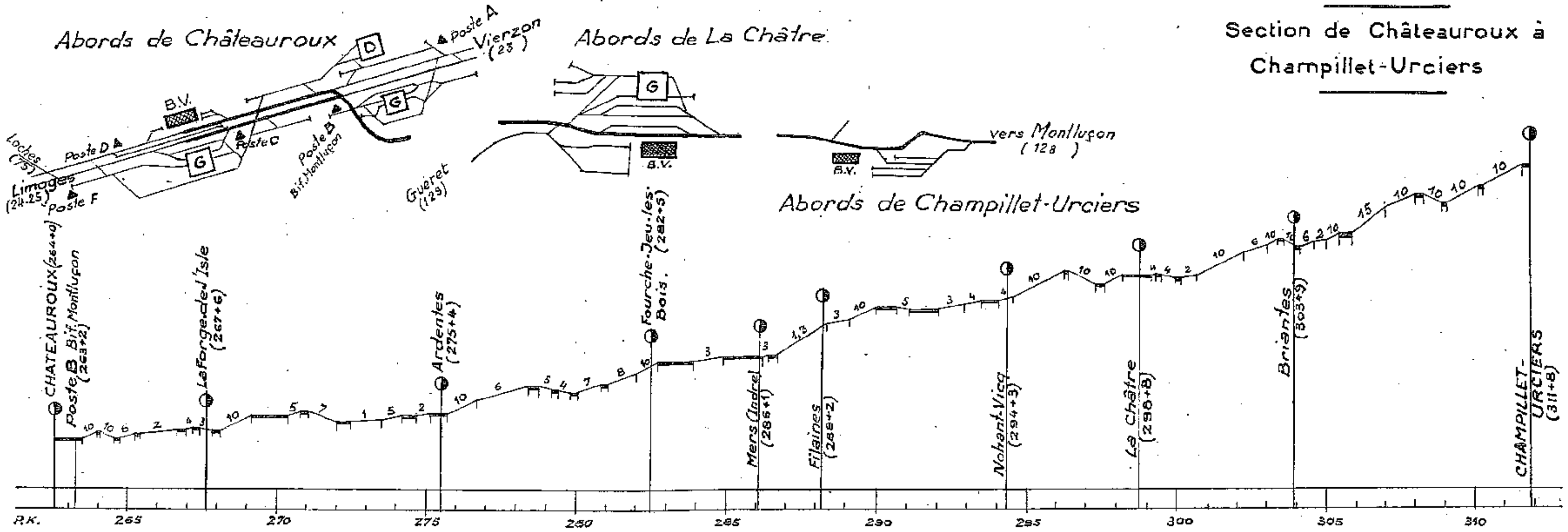

Ligne de Busseau-sur-Creuse à Ussel

Section de Felletin à Ussel

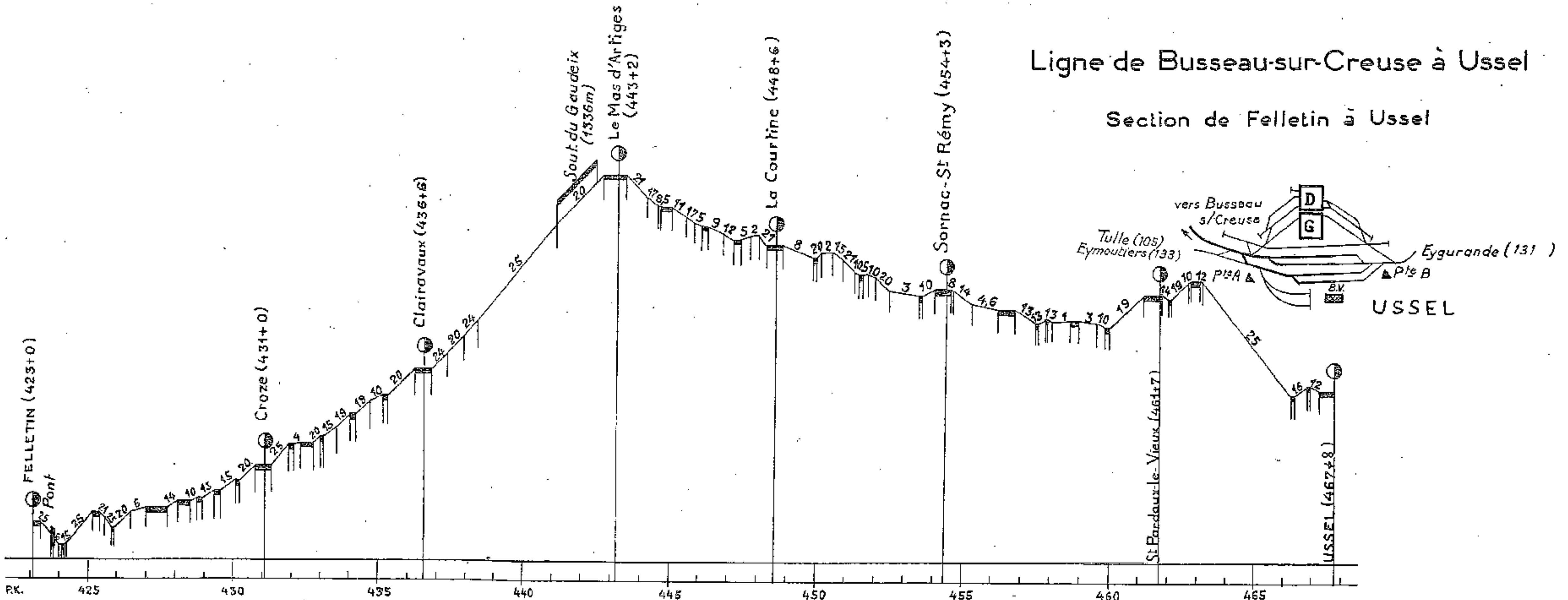

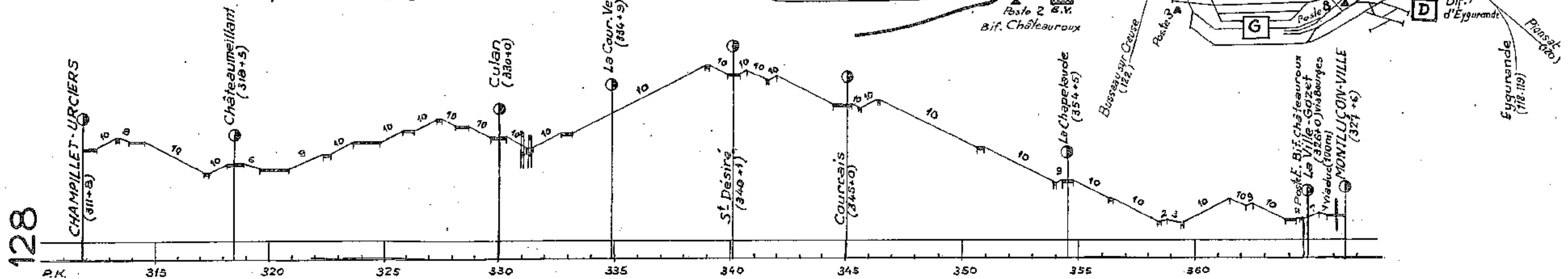
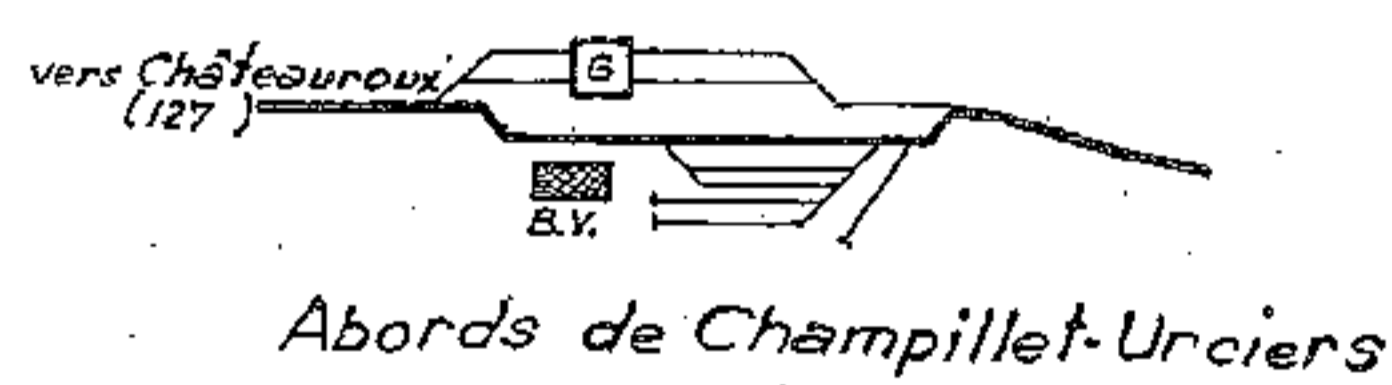
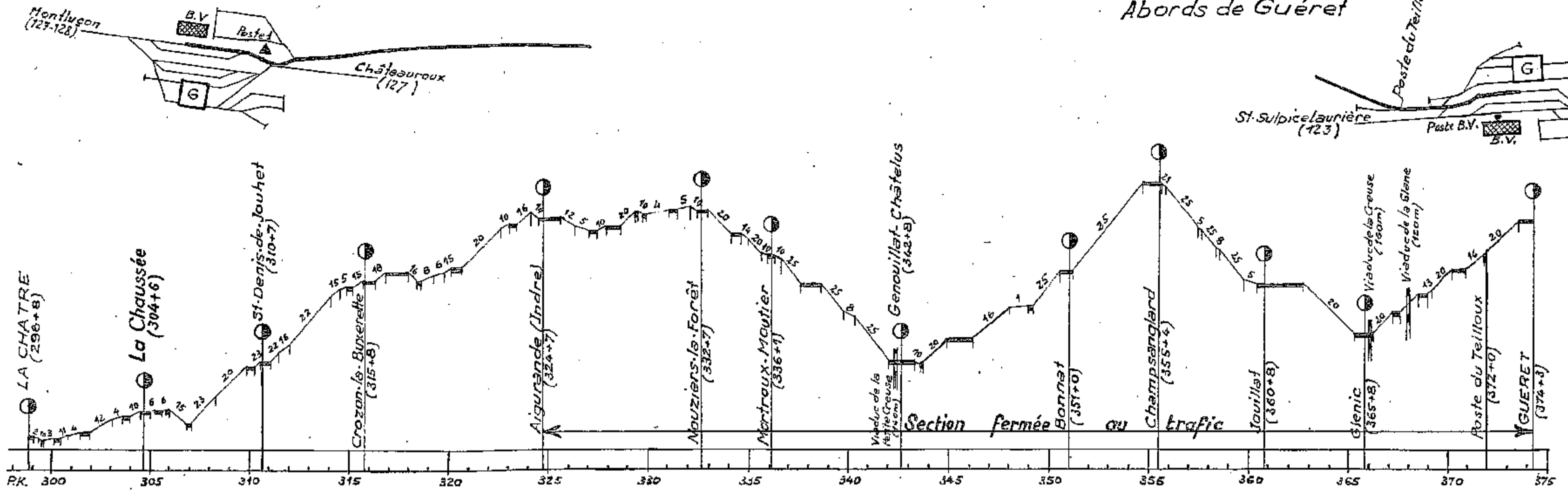

Ligne de Clermont-Ferrand à Ussel

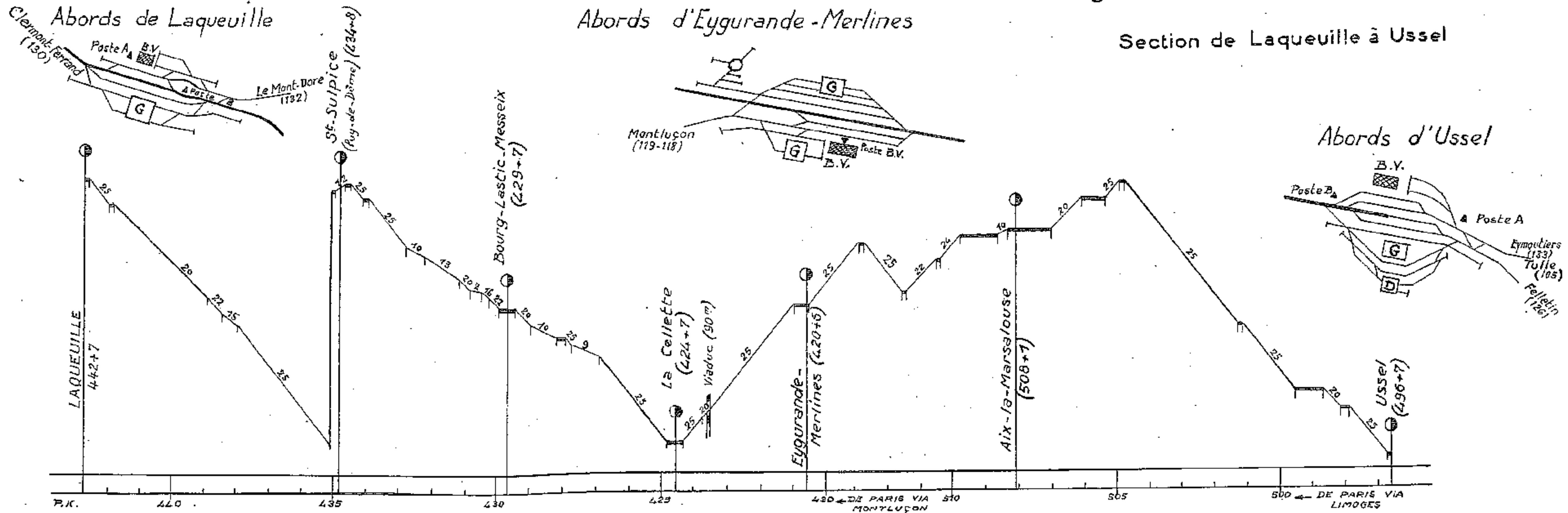

Ligne de Clermont-Ferrand à Ussel

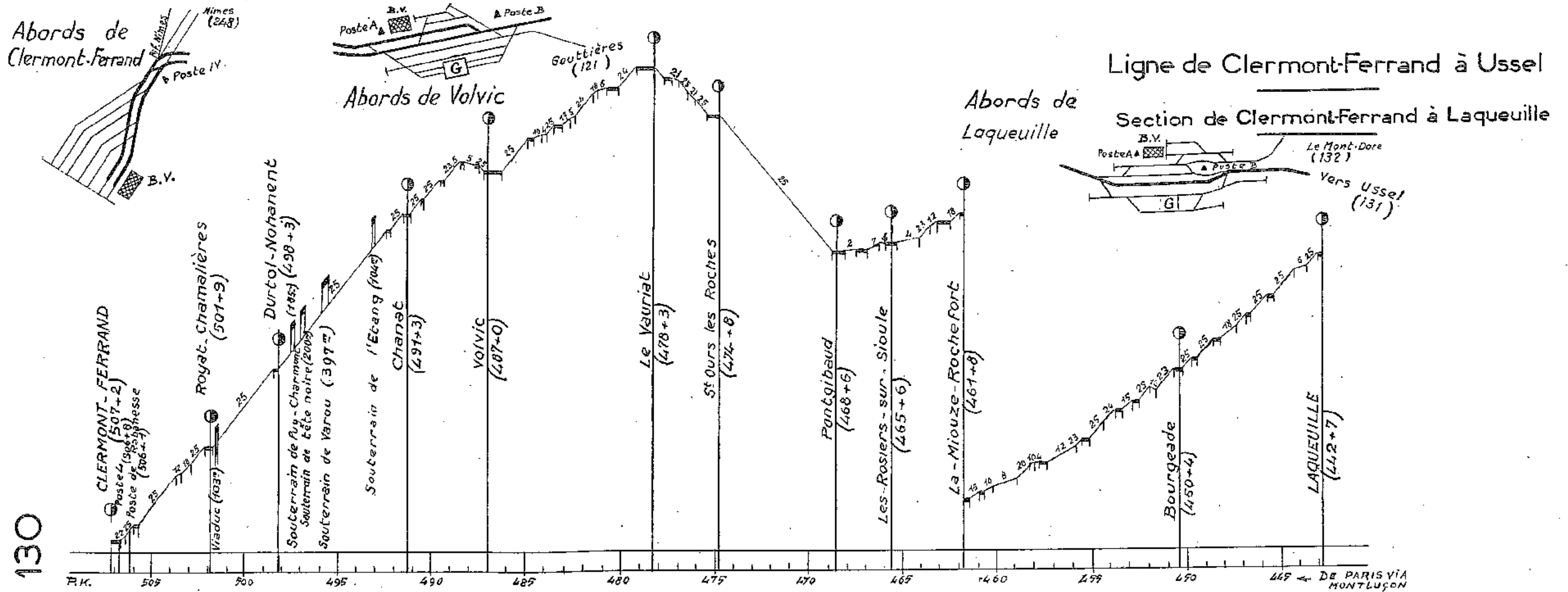

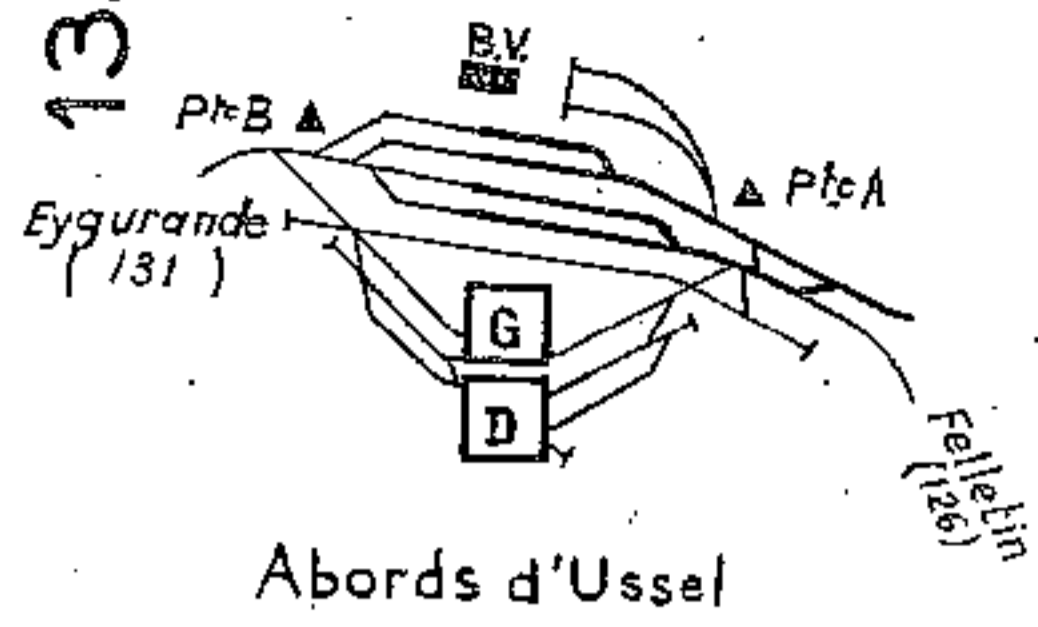

Ligne d'Ussel à Limoges
Section d'Ussel à Eymoutiers

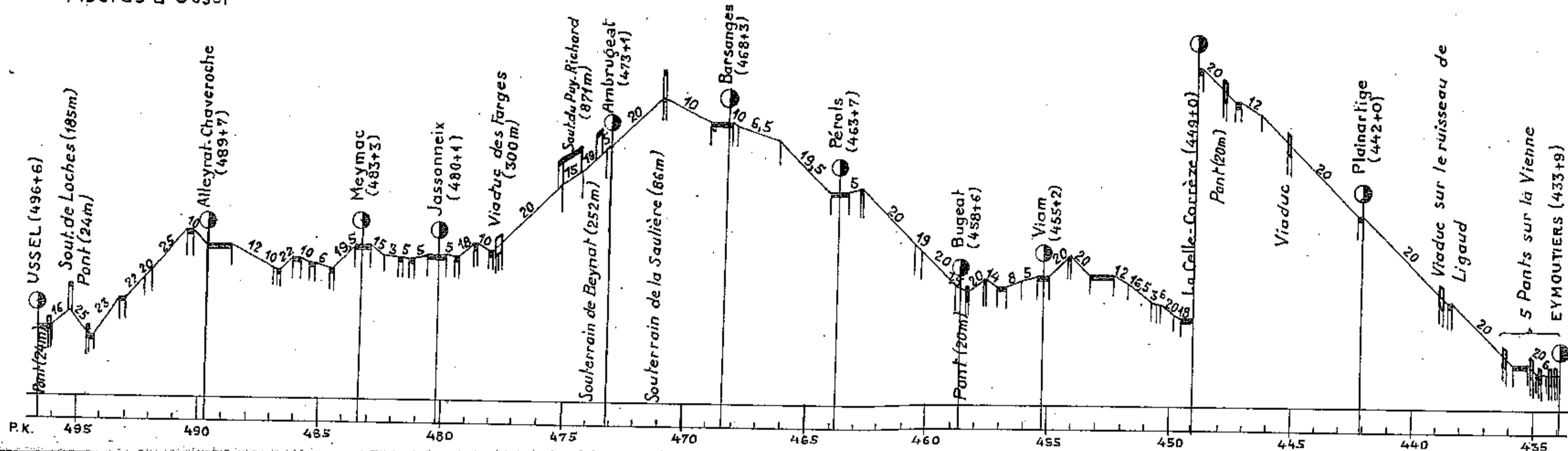

Abords de Laqueuille

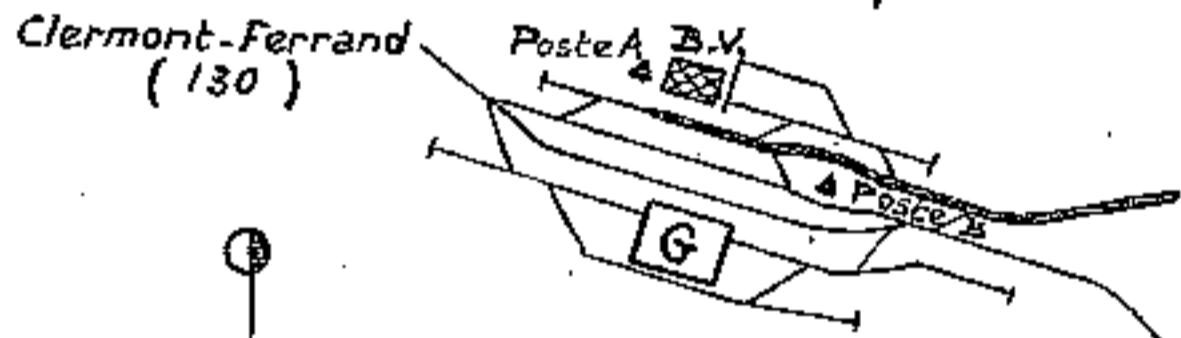

Abords du Mont-Dore

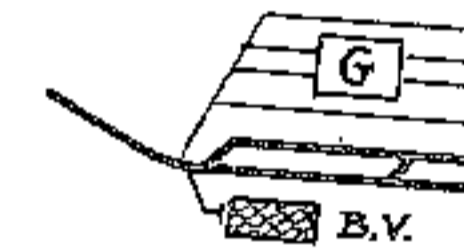

Ligne de Laqueuille
au Mont-Dore

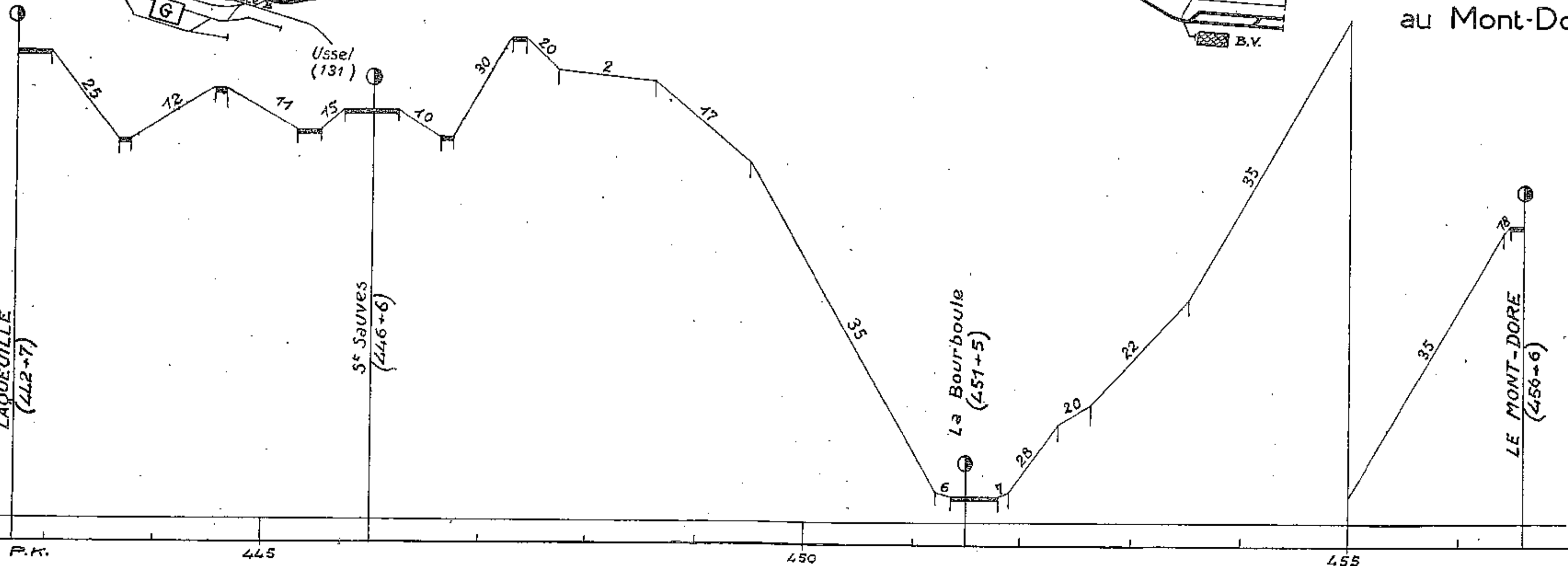

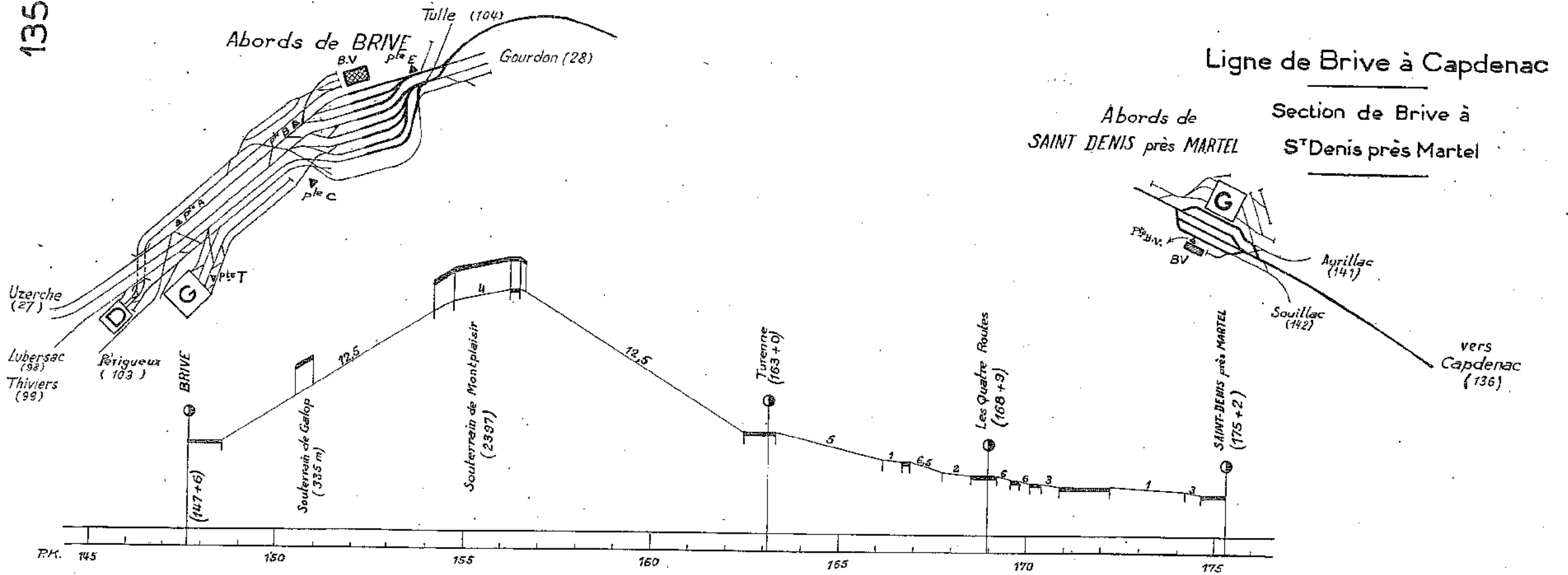

Ligne d'Ussel à Limoges

Section d'Eymoutiers à Limoges

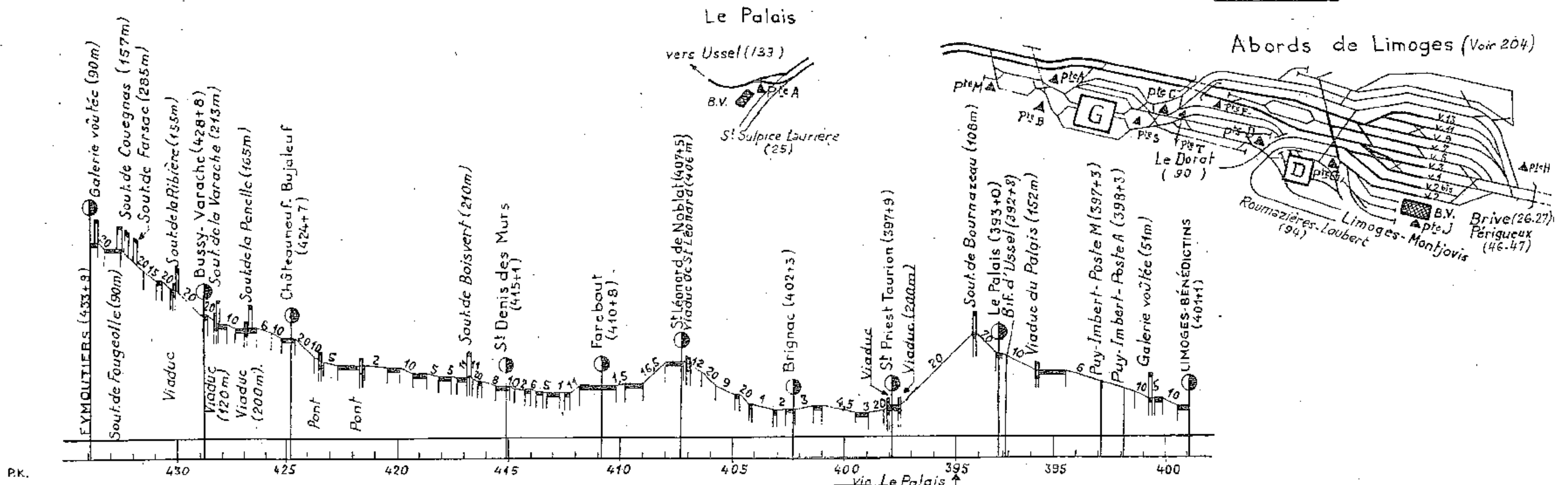

Abords de Capdenac Rodez (147)

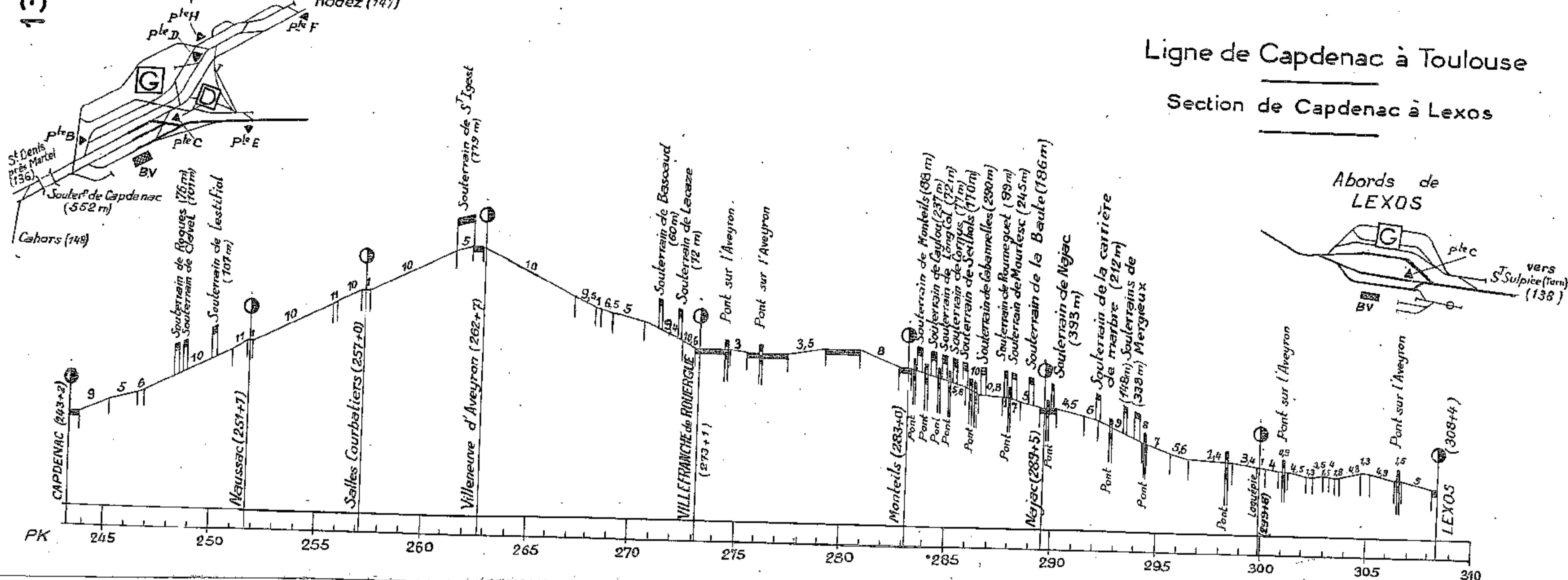

Ligne de Capdenac à Toulouse
Section de Capdenac à Lexos

Abords de SAINT DENIS près MARTEL

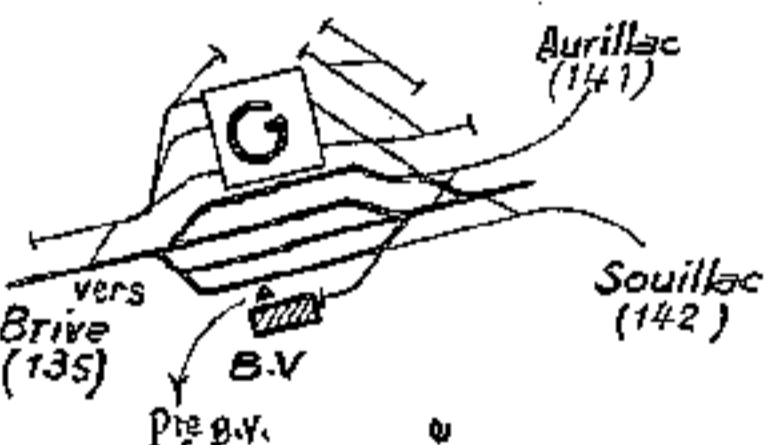

GRAMAT

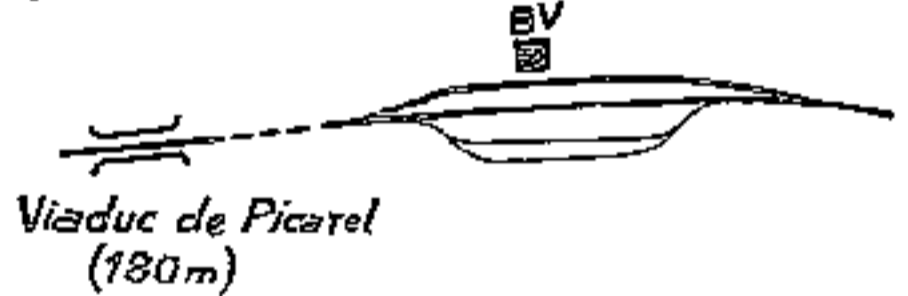

Ligne de Brive à Capdenac

Section de S^t Denis-près-Martel à Capdenac

Abords de FIGEAC

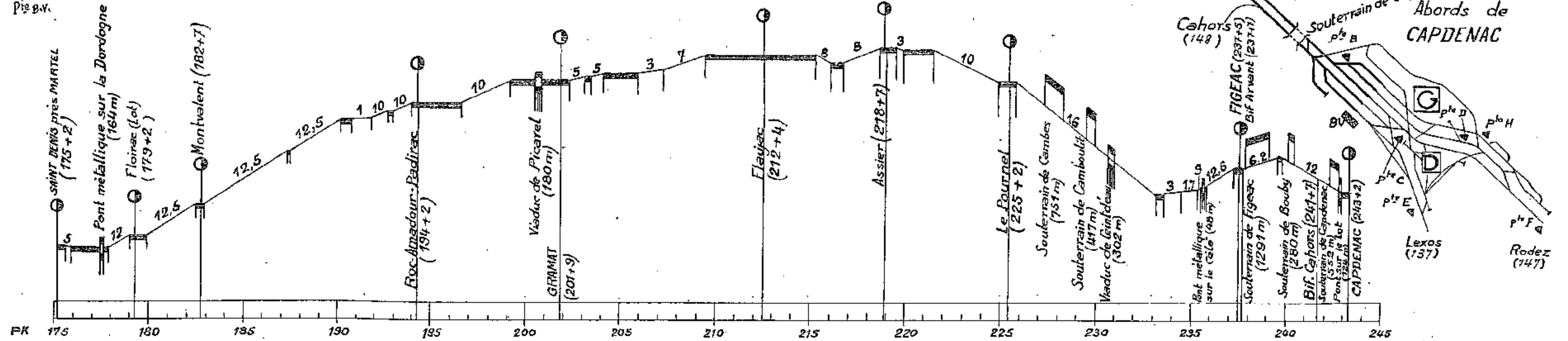
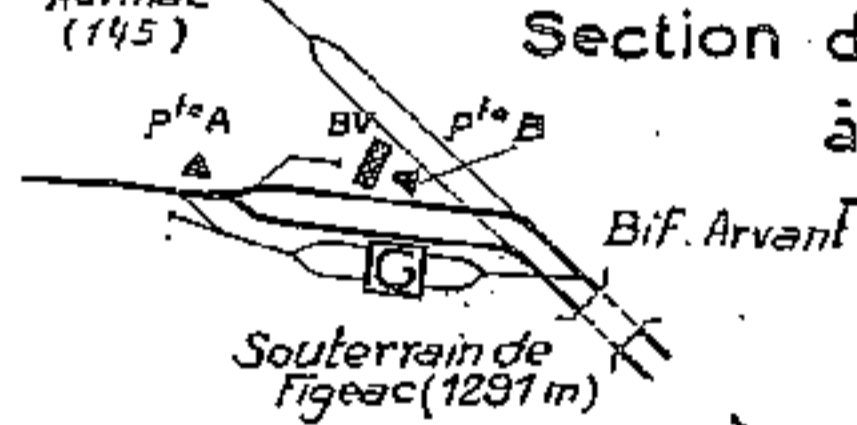

Abords de CAPDENAC

Abords de S^t SULPICE (TARN)

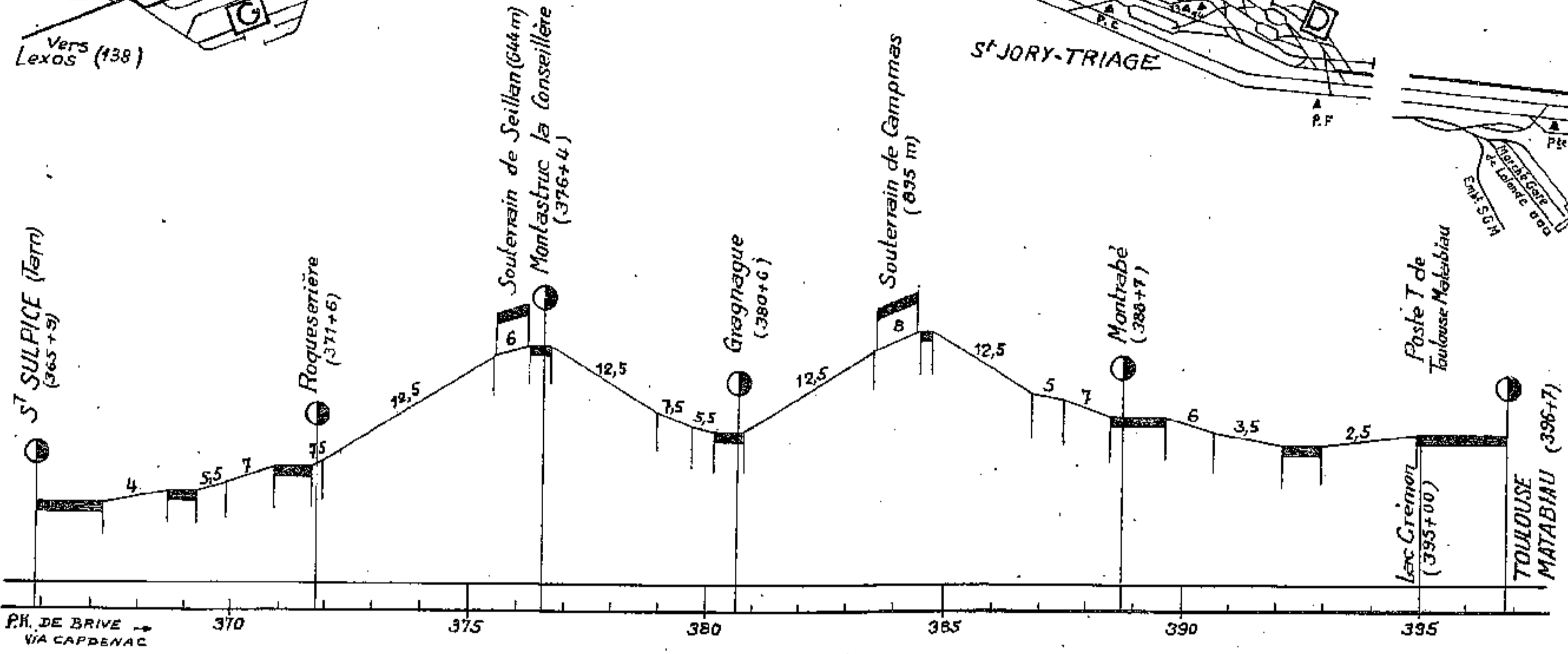
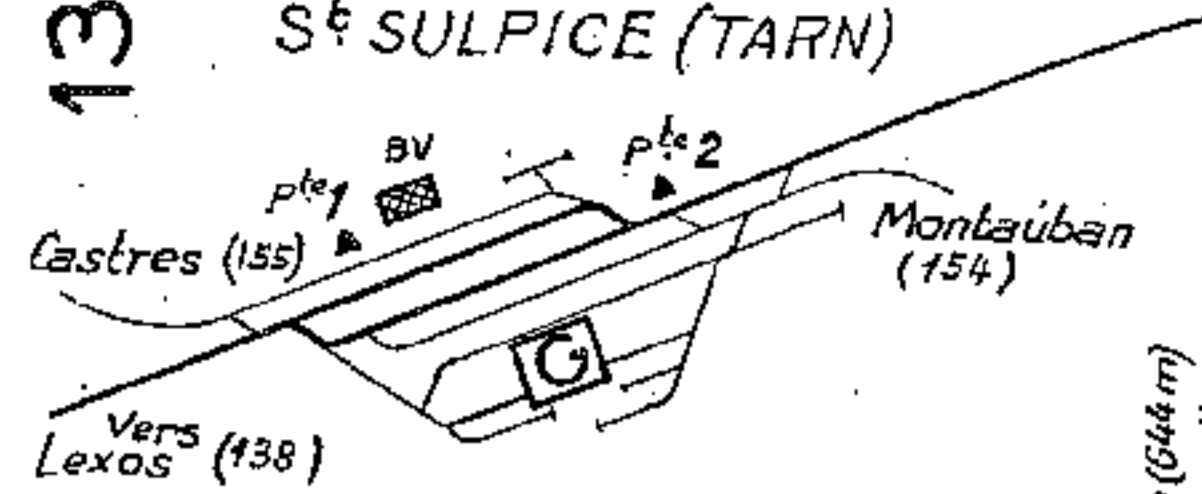

Ligne de Capdenac à Toulouse
Section de S^tSulpice (Tarn) à Toulouse

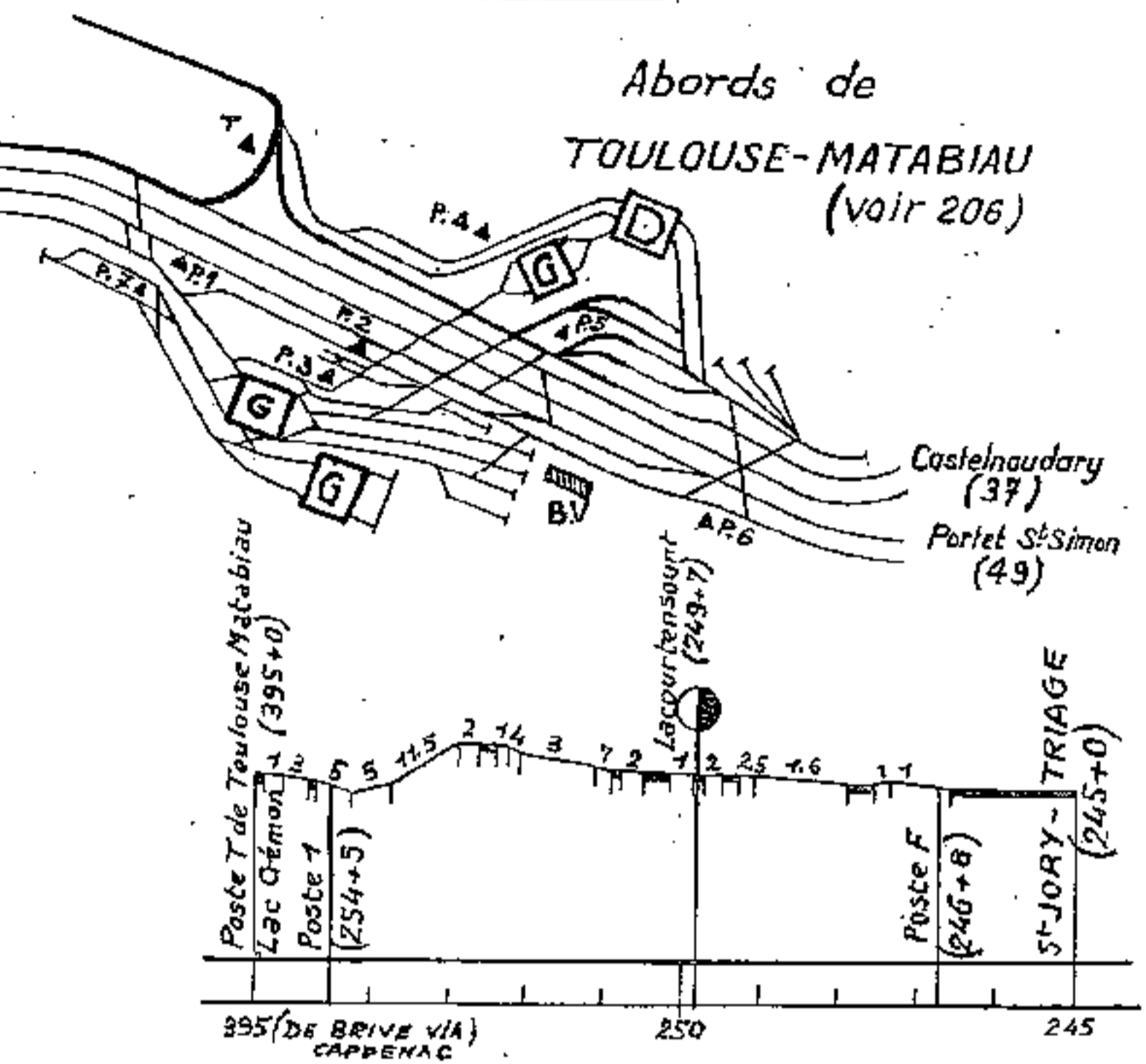

Abords de LEXOS

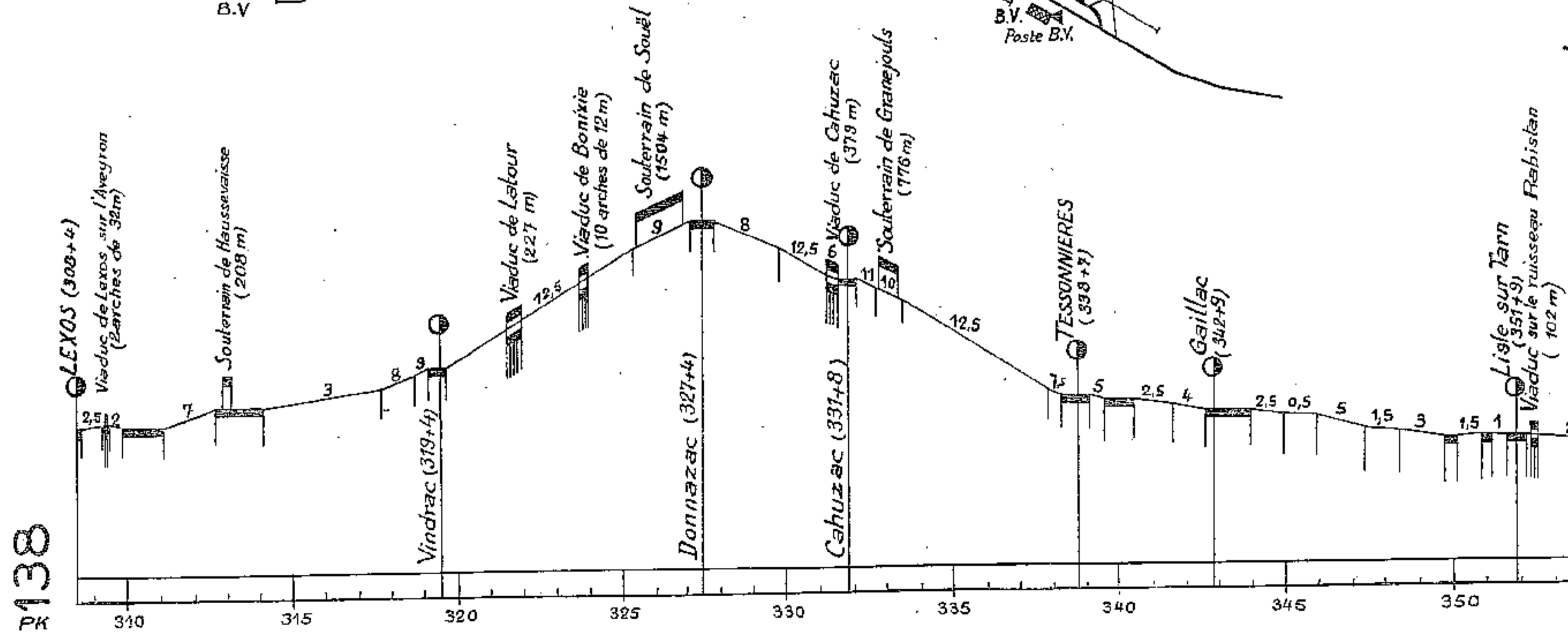
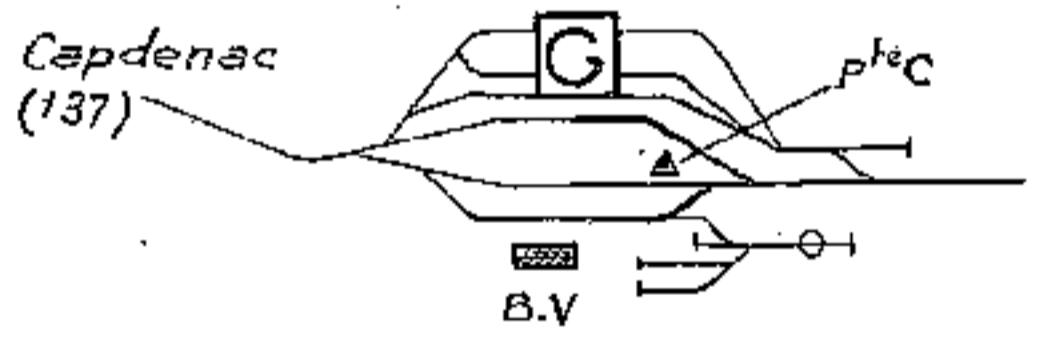

Abords de TESSONNIERES

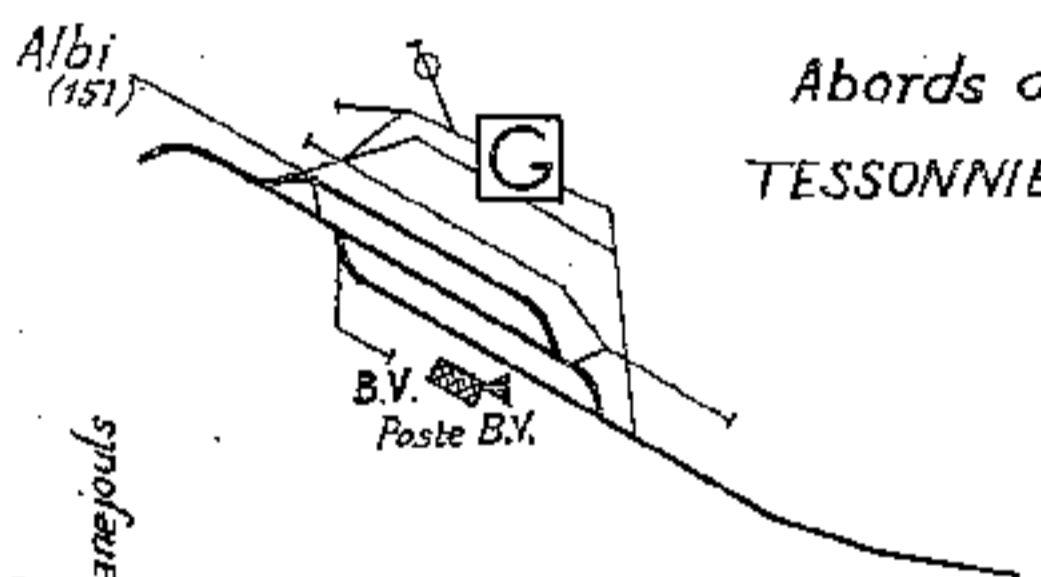

Ligne de Capdenac à Toulouse
Section de Lexos à S^tSulpice (Tarn)

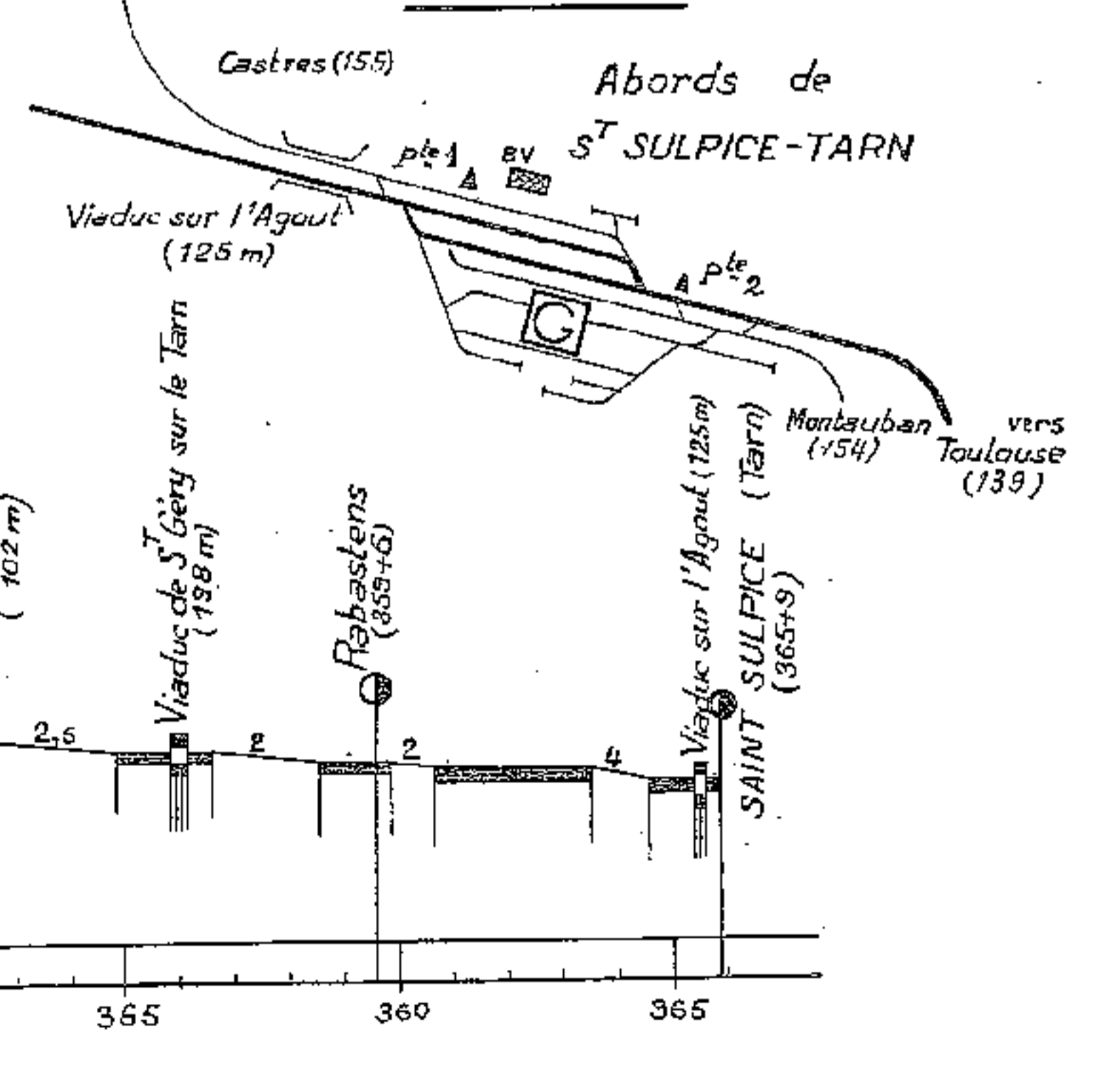

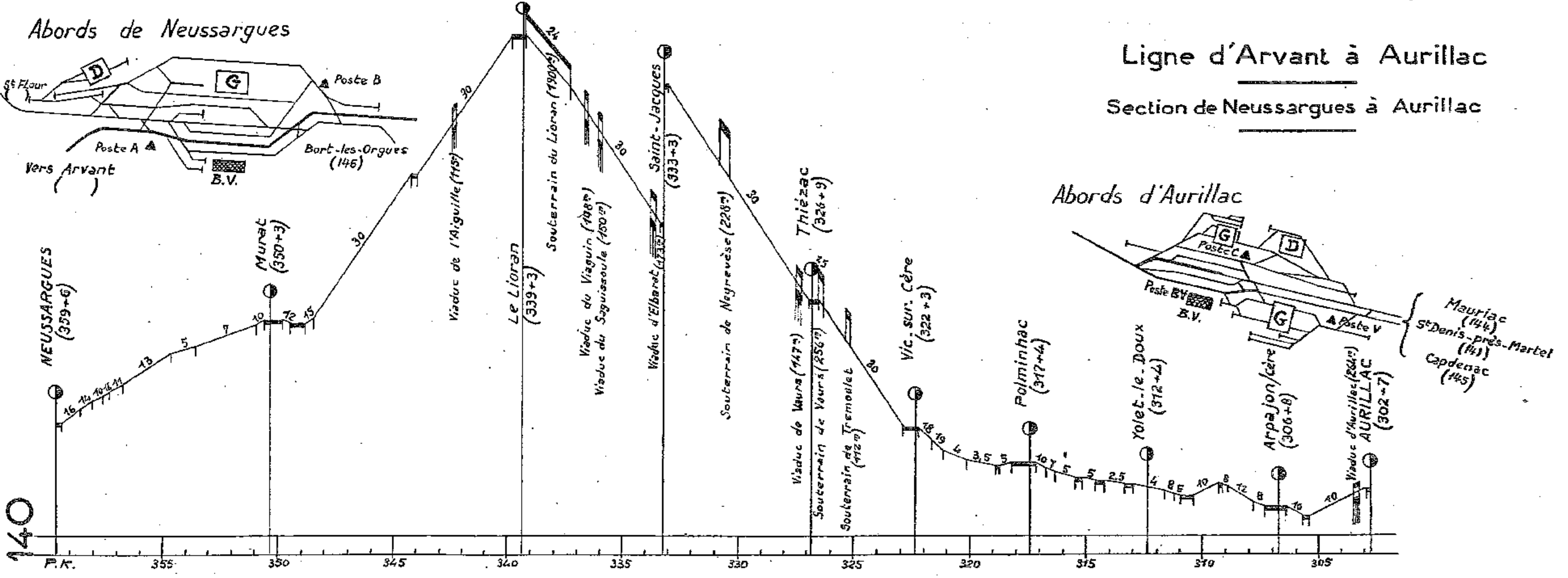
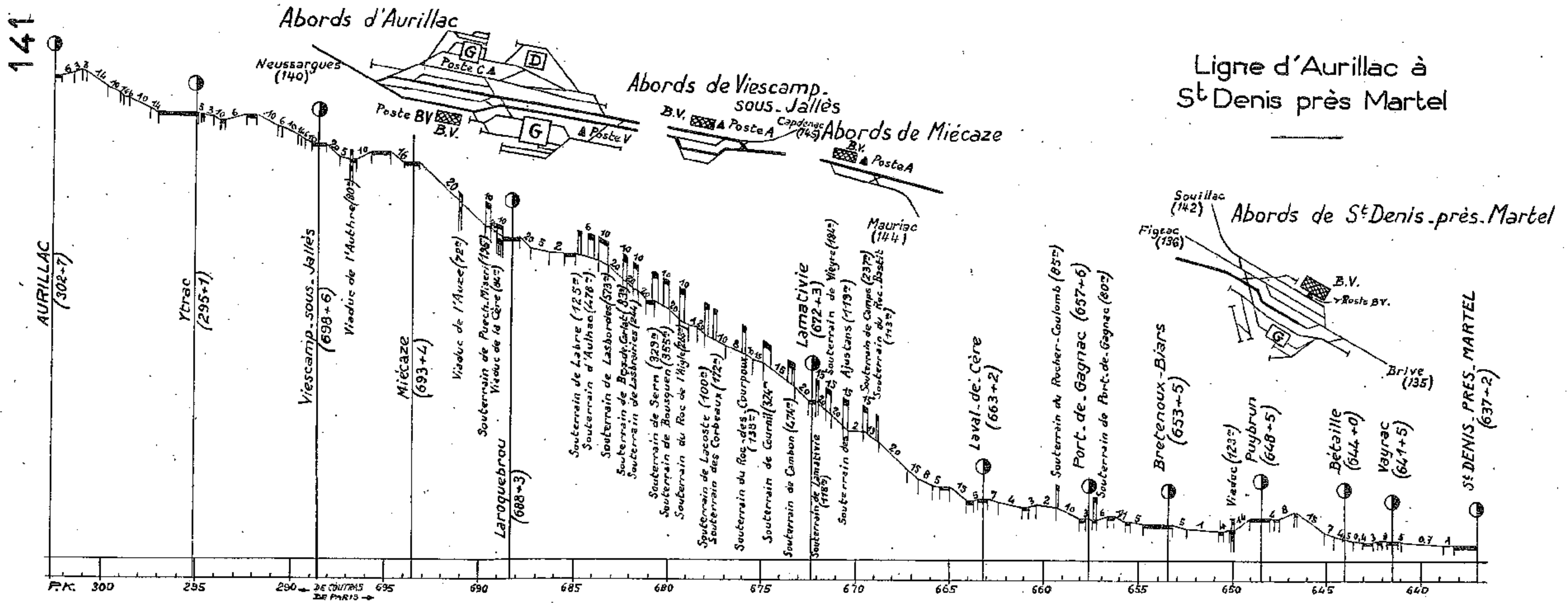

Abords de Bort-les-Orgues

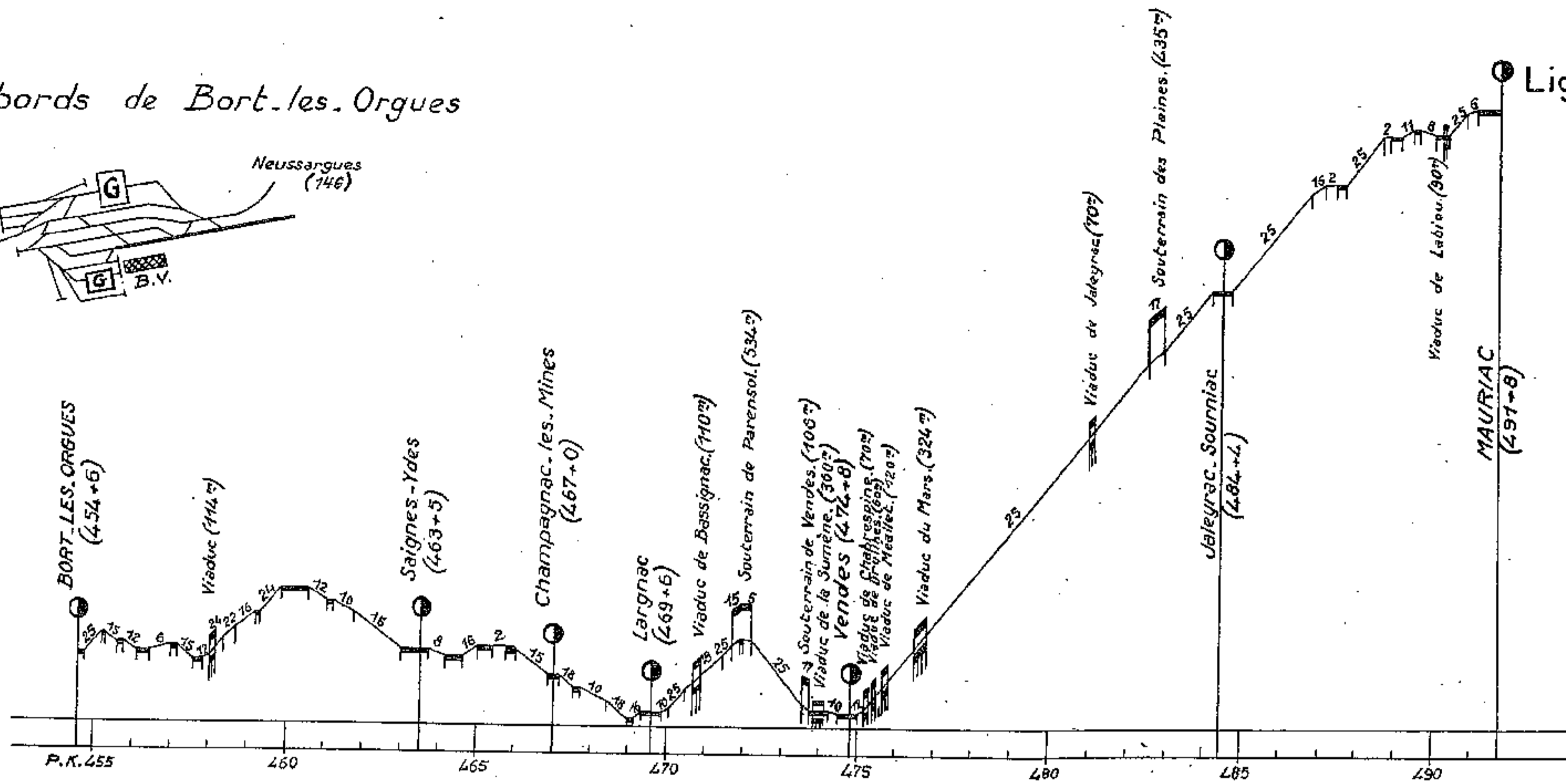
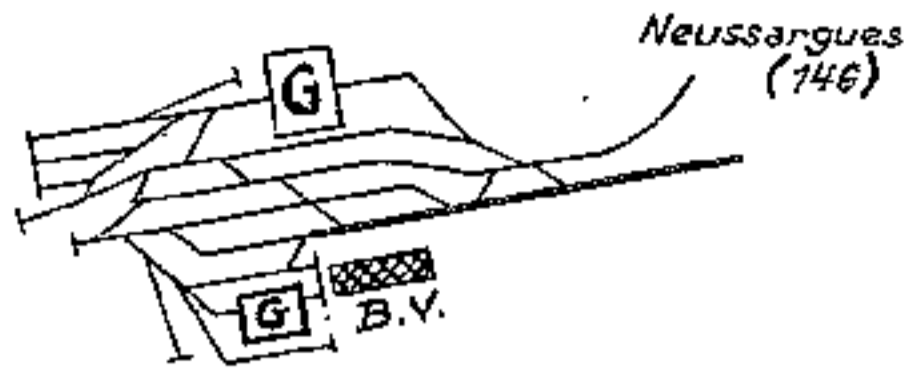

Ligne de Bort les Orgues à Aurillac
Section de Bort à Mauriac

Abords de St Denis-près-Martel

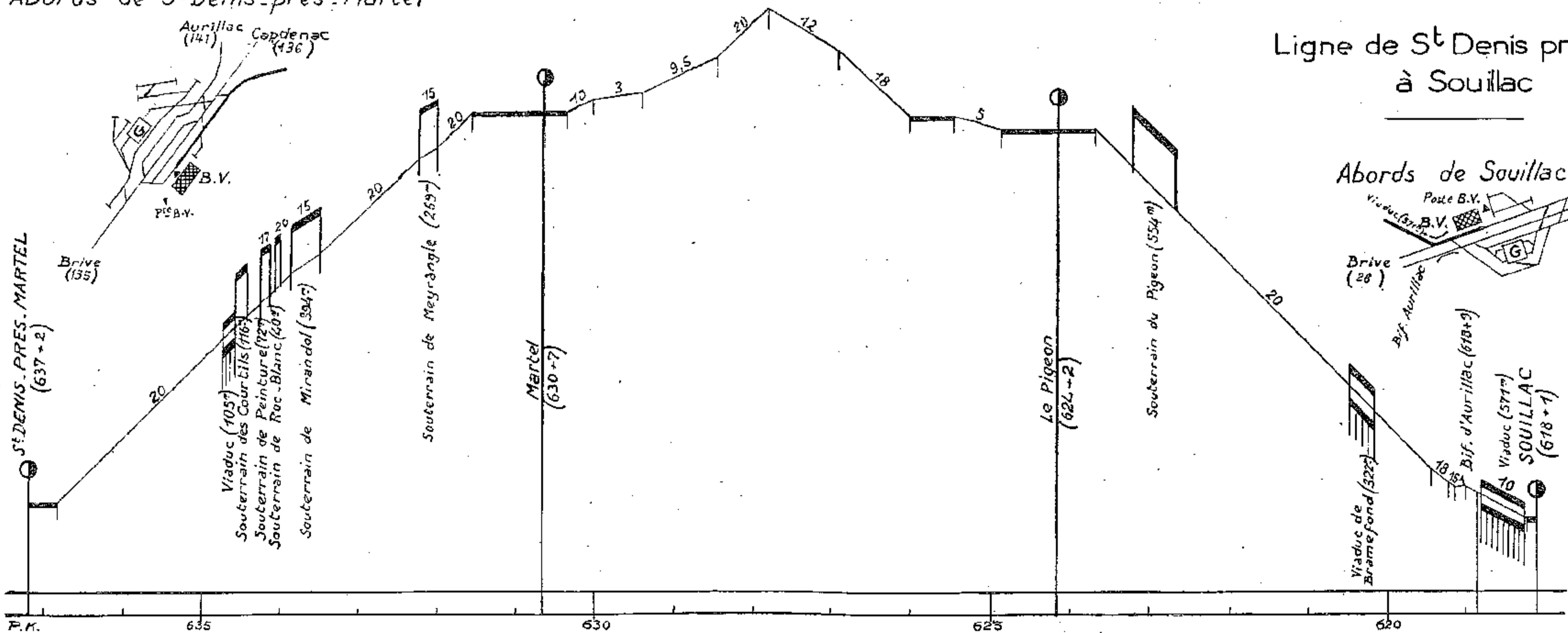
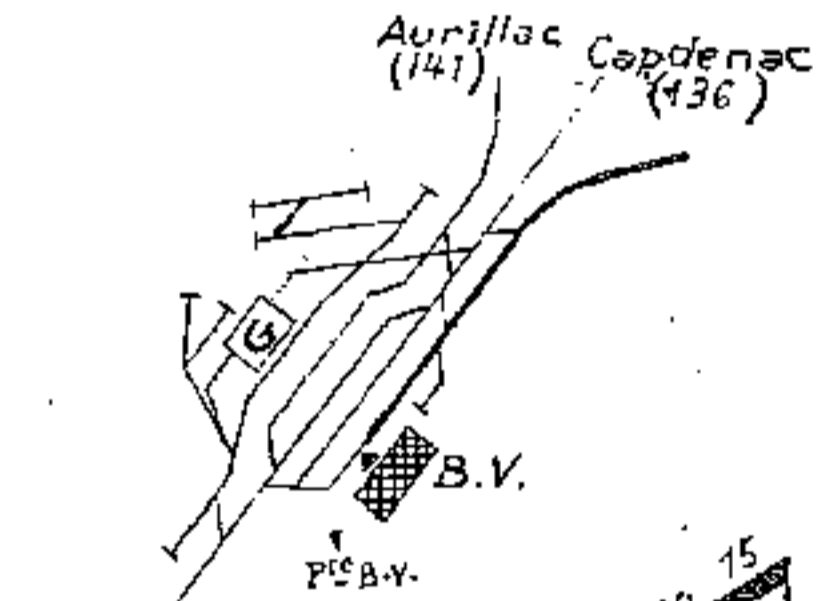

Ligne de St Denis près Martel à Souillac

Abords de Souillac

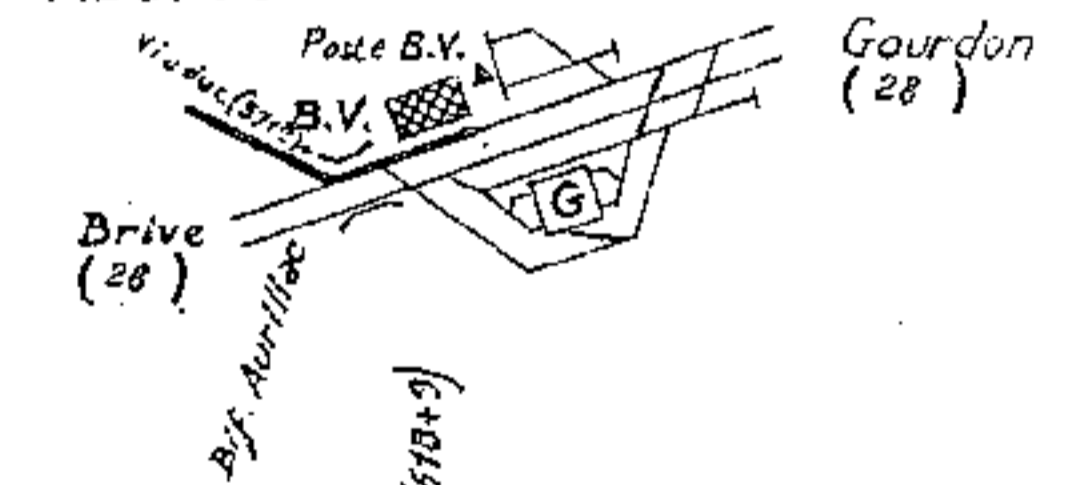

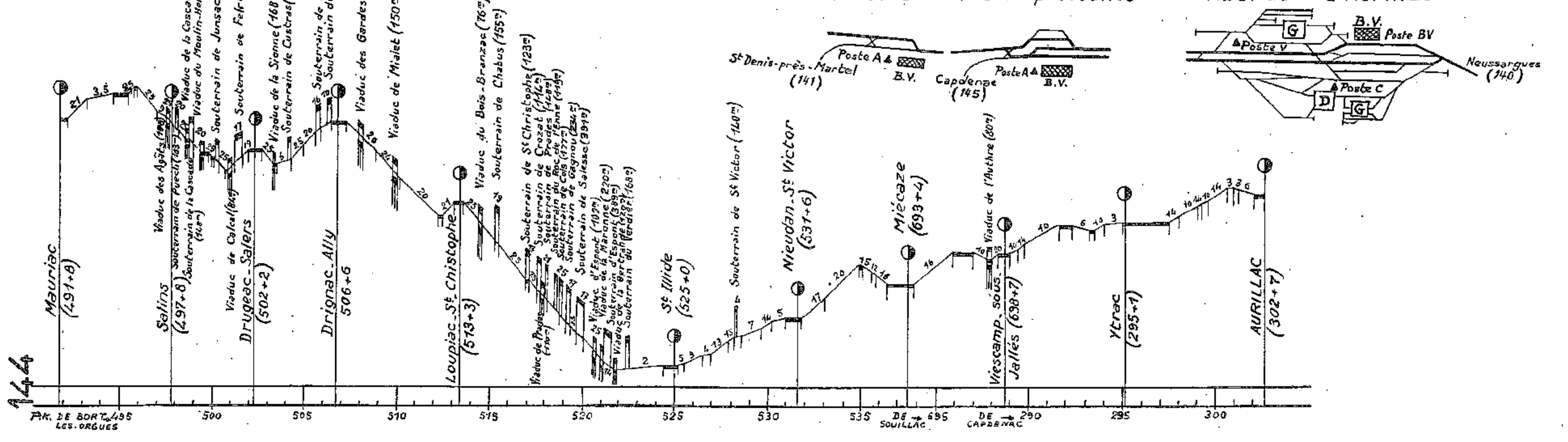
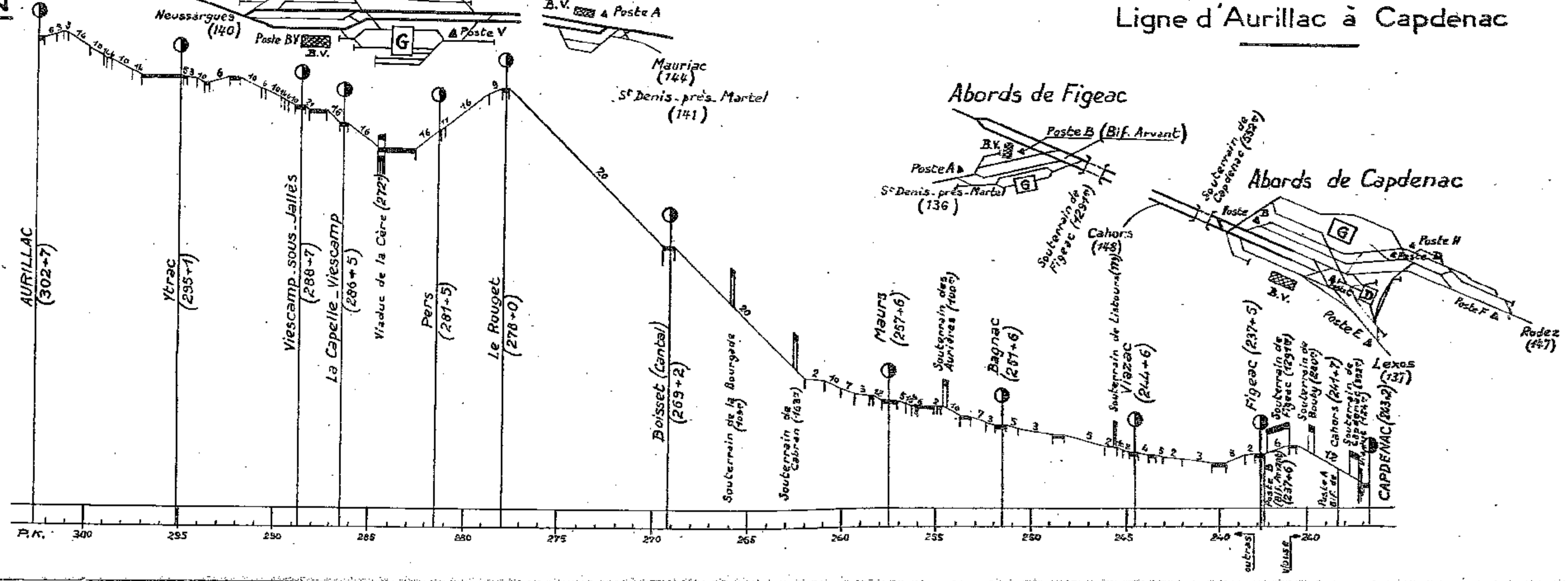

Abords de Capdenac

Abords de Viviez

Decazeville

Abords de Rodez

Lignes de Capdenac à Rodez et de Viviez à Decazeville

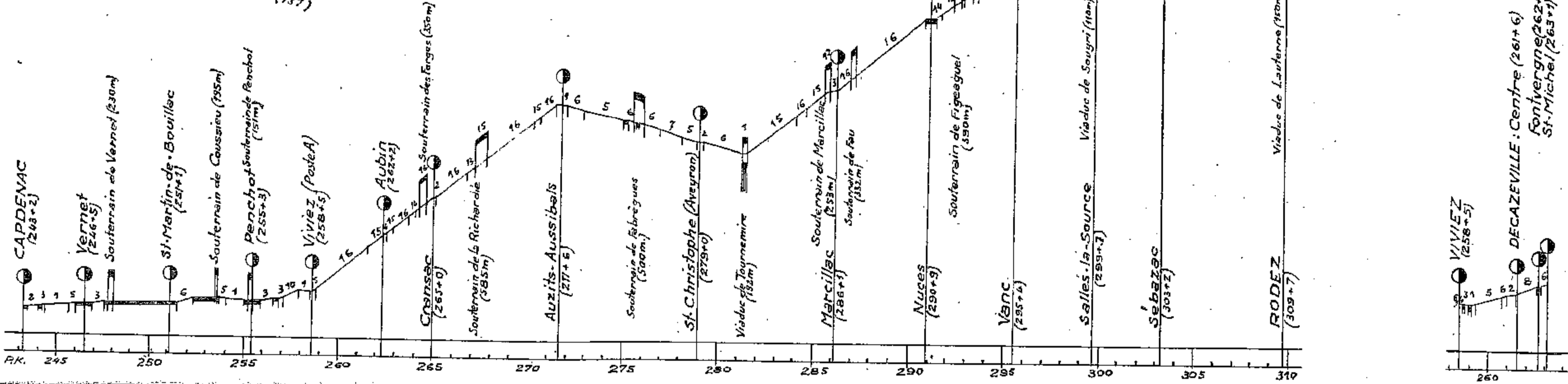
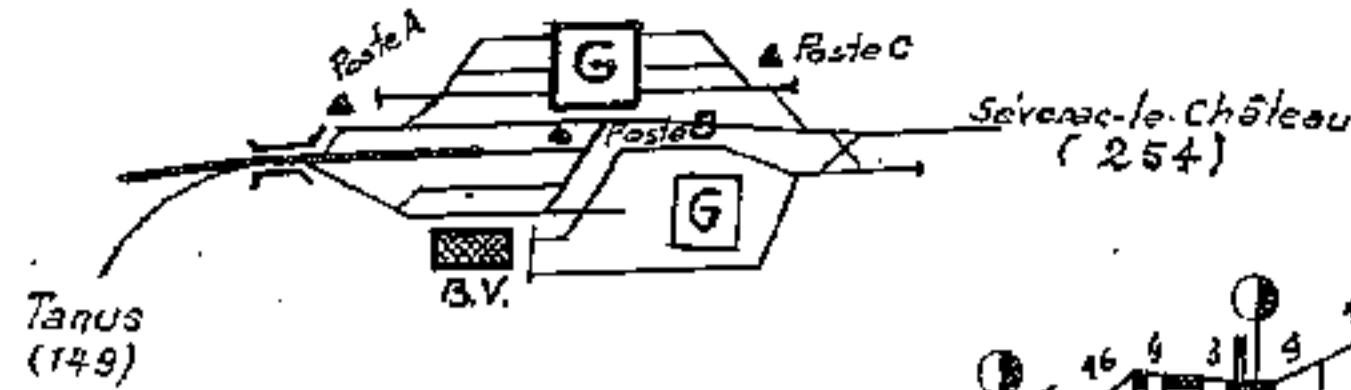
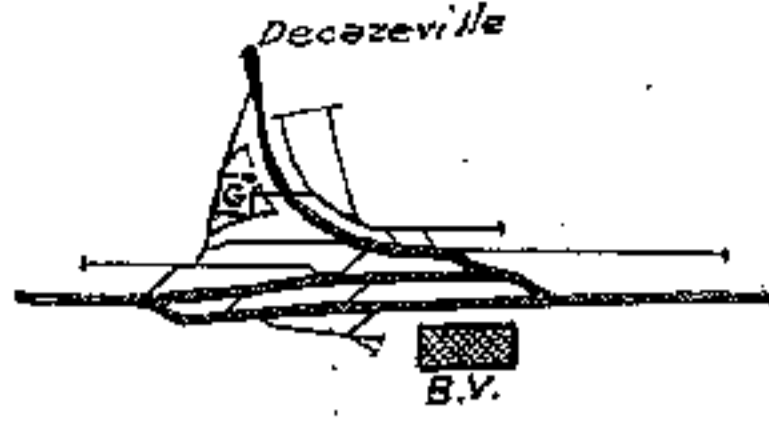
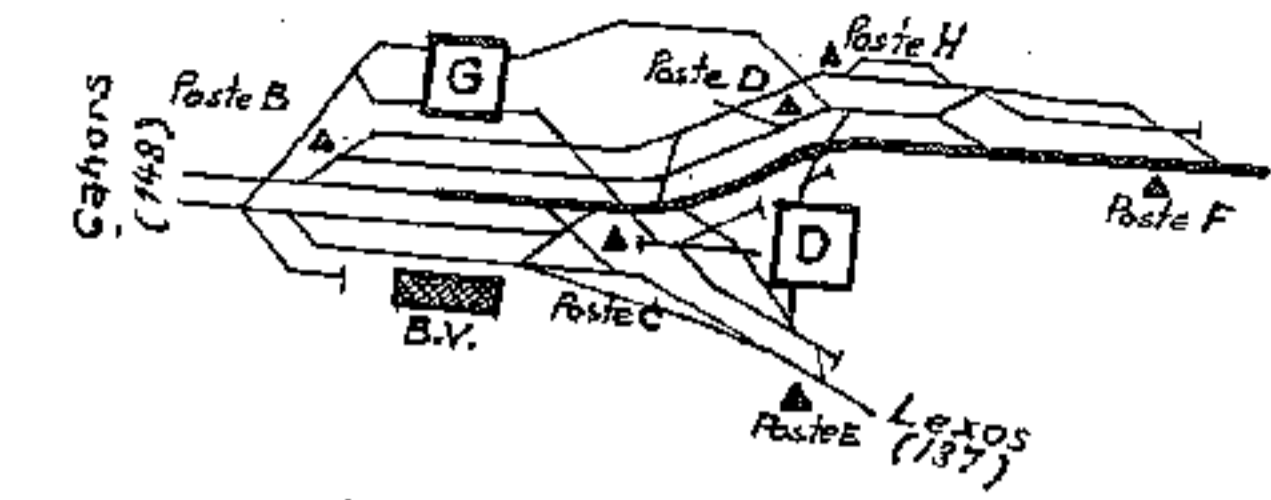

Abords de Bort-les-Orgues

Ligne de Bort les Orgues à Neussargues

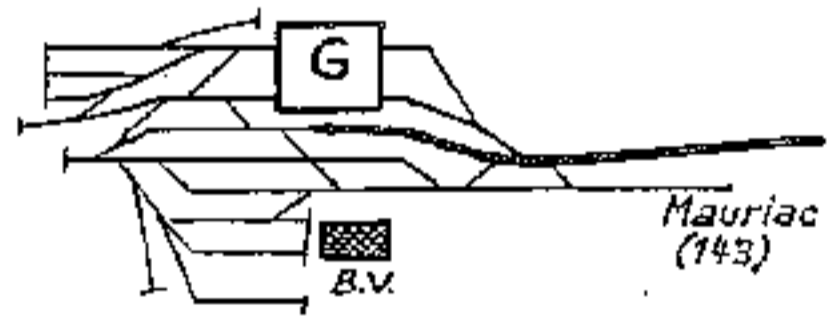

Abords de Neussargues

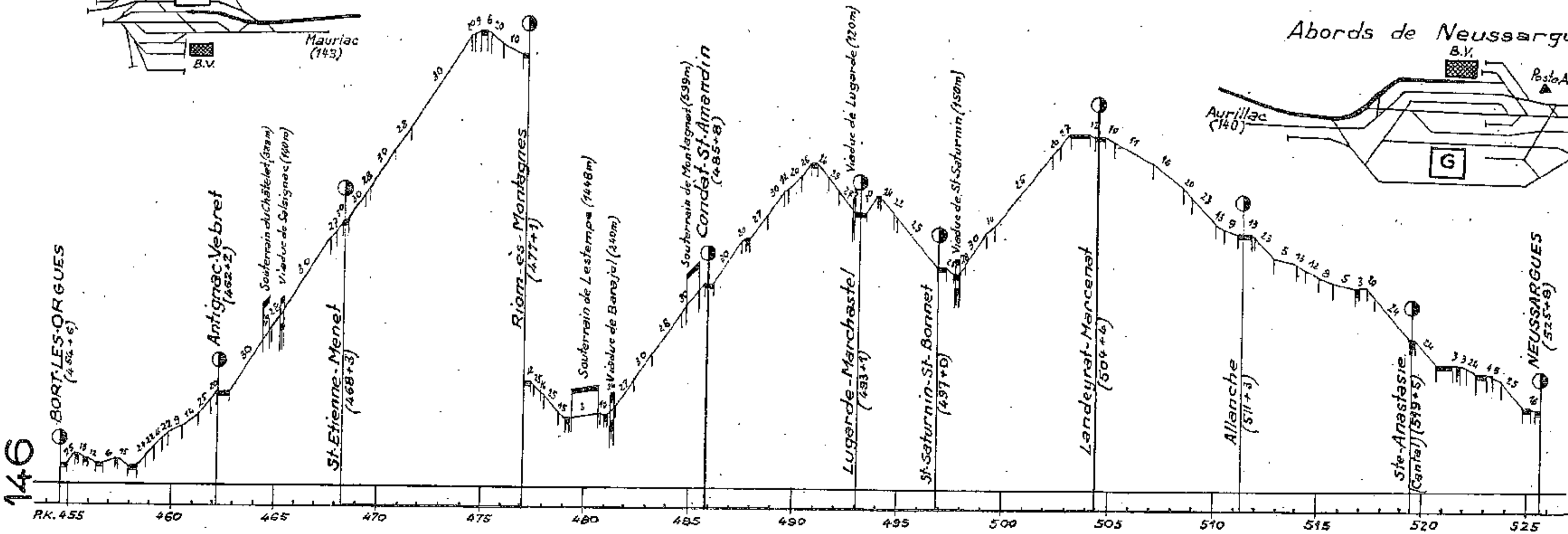
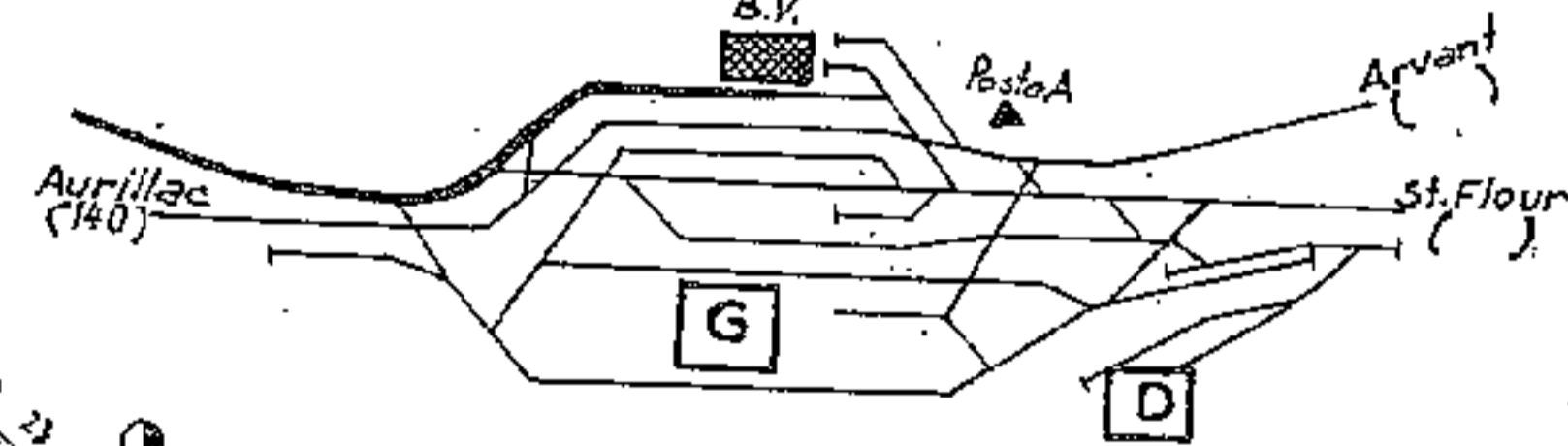

Séverac-le-Château (254)

Abords de Rodez

Ligne de Rodez à Albi-Ville

Section de Rodez à Tanus

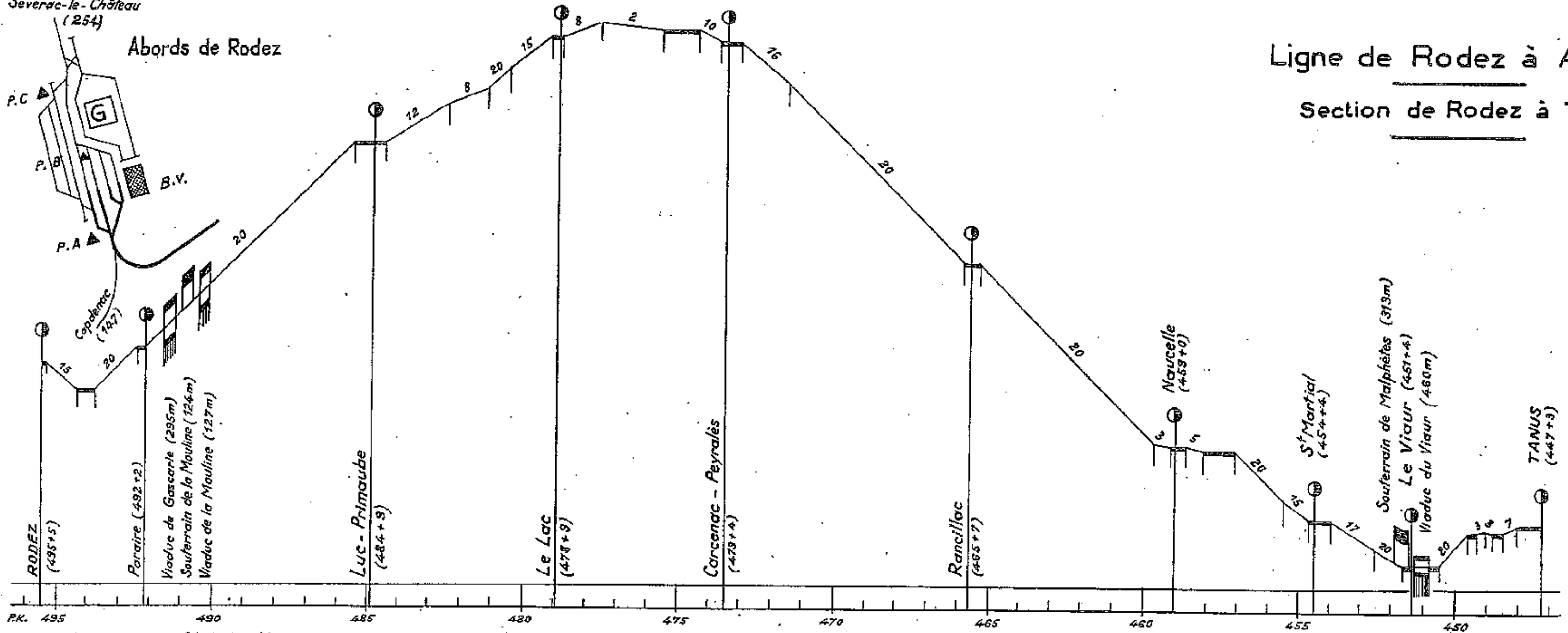

Gourdon (29)

Abords de CAHORS

Abords de CAPDENAC

Ligne de Cahors à Capdenac

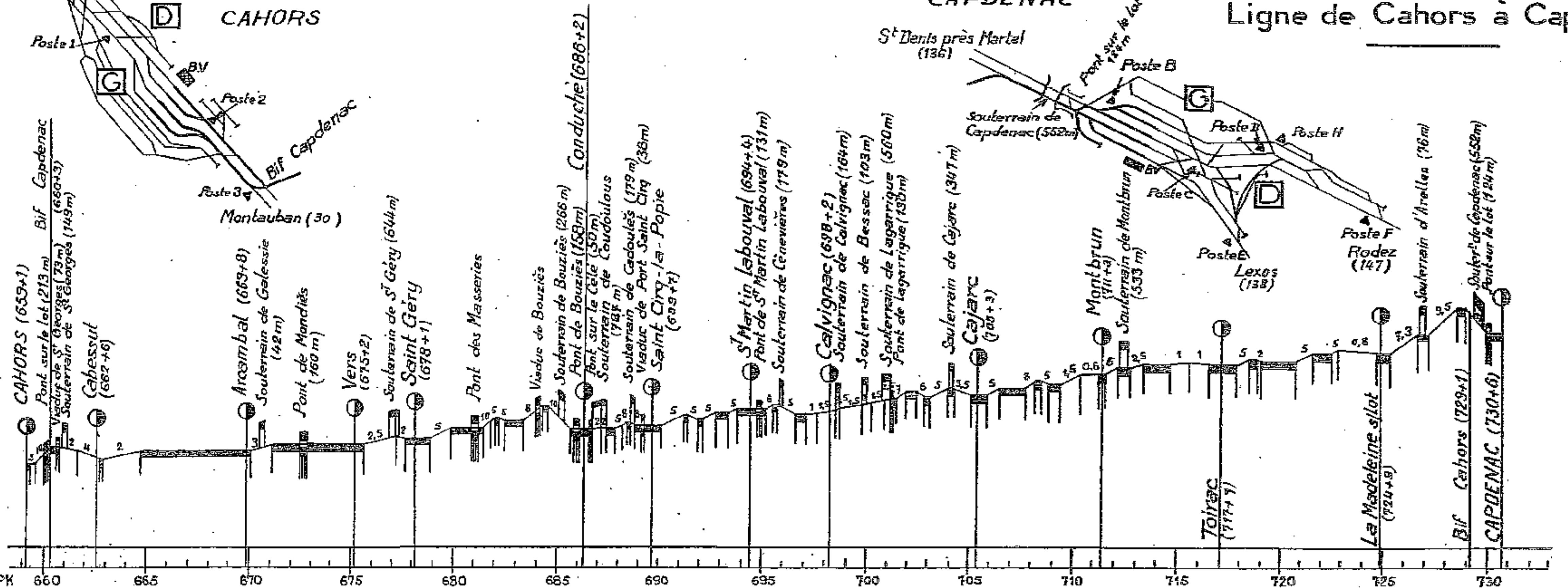

Abords d'Albi-Ville
vers S^tJuéry
Castres (152)

Abords de Tessonnières

Lignes d'Albi-Ville à Tessonnières
et d'Albi-Ville à S^tJuéry

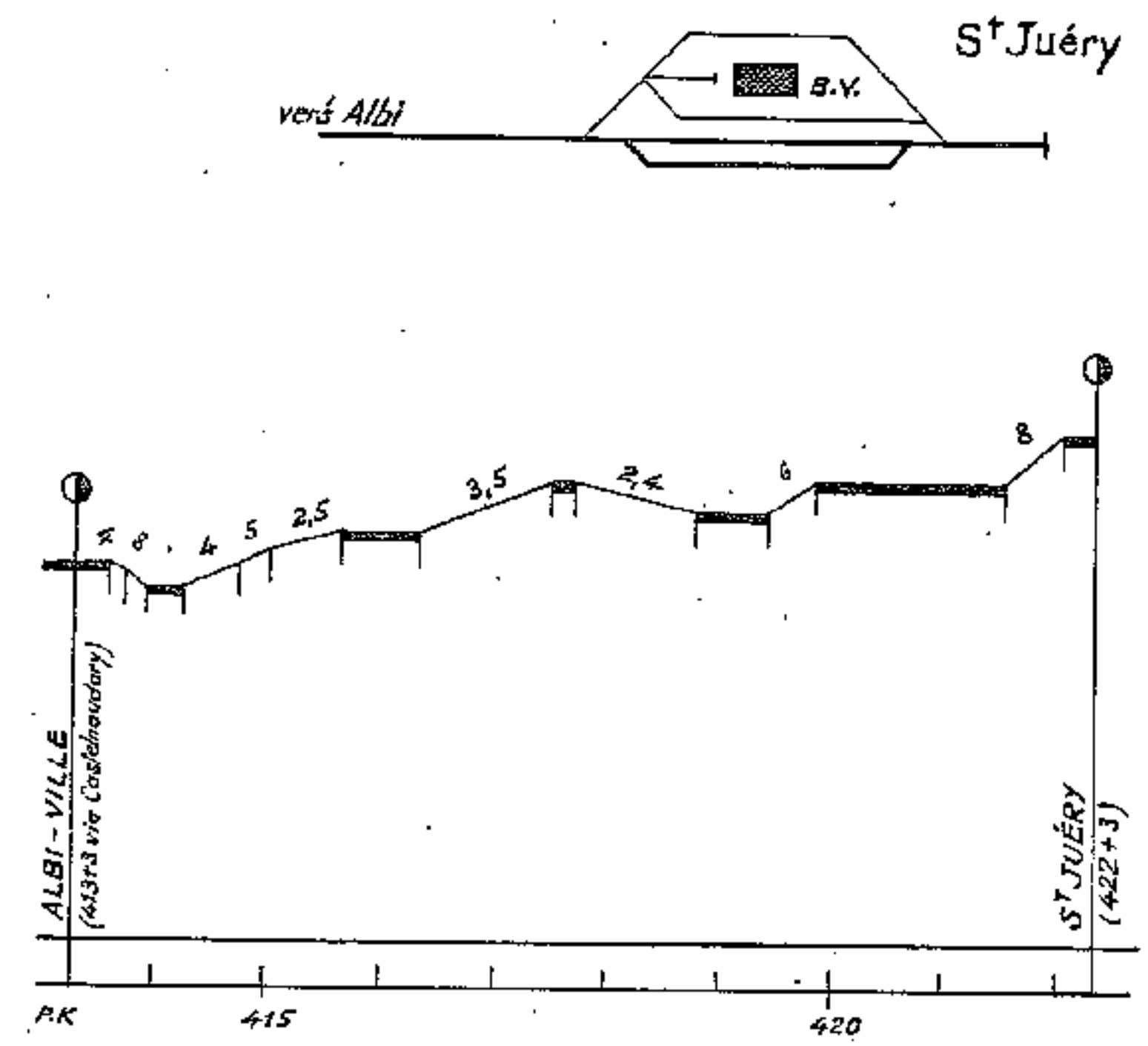
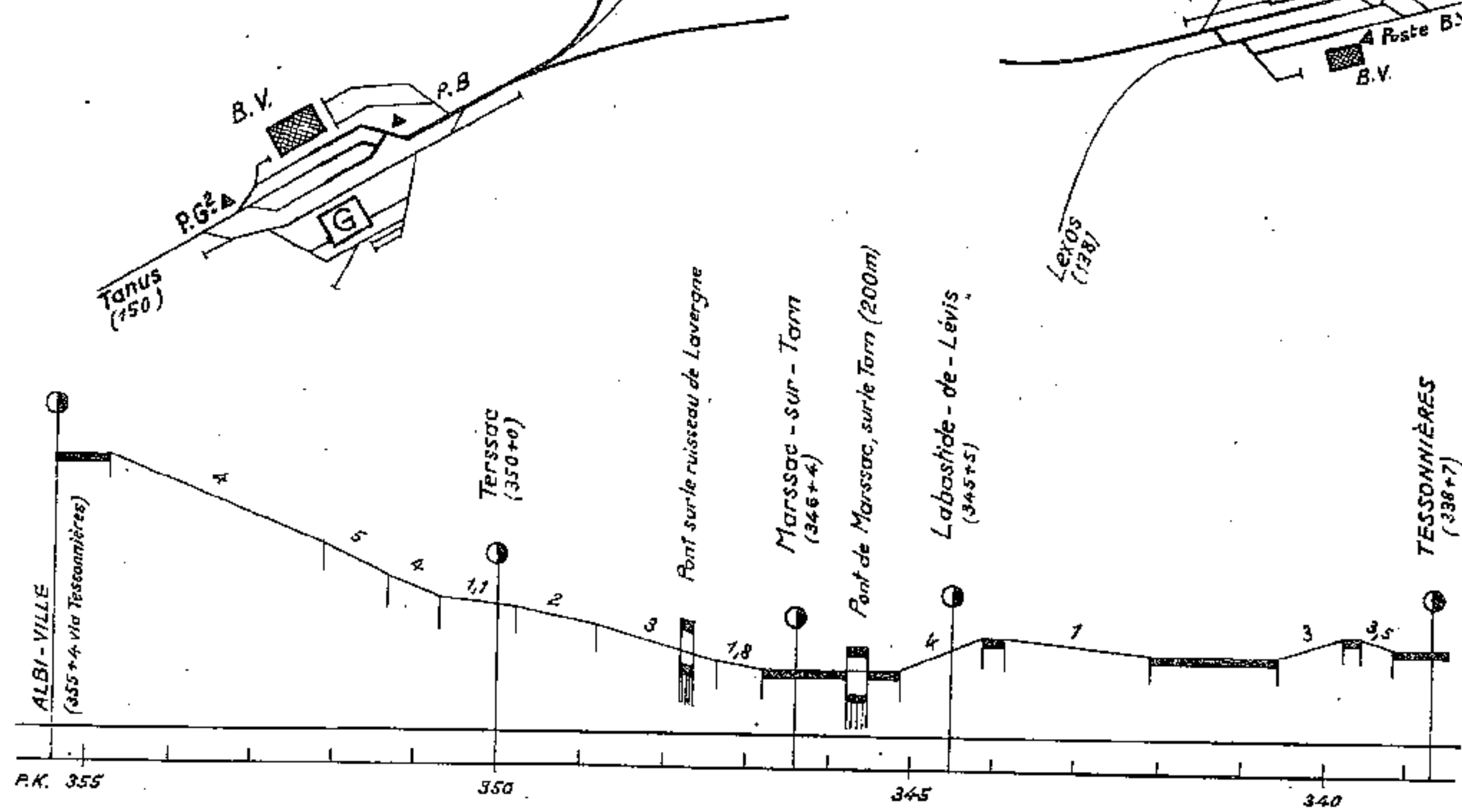

Abords de Carmaux

Ligne de Rodez à Albi-Ville

Section de Tanus à Albi-Ville

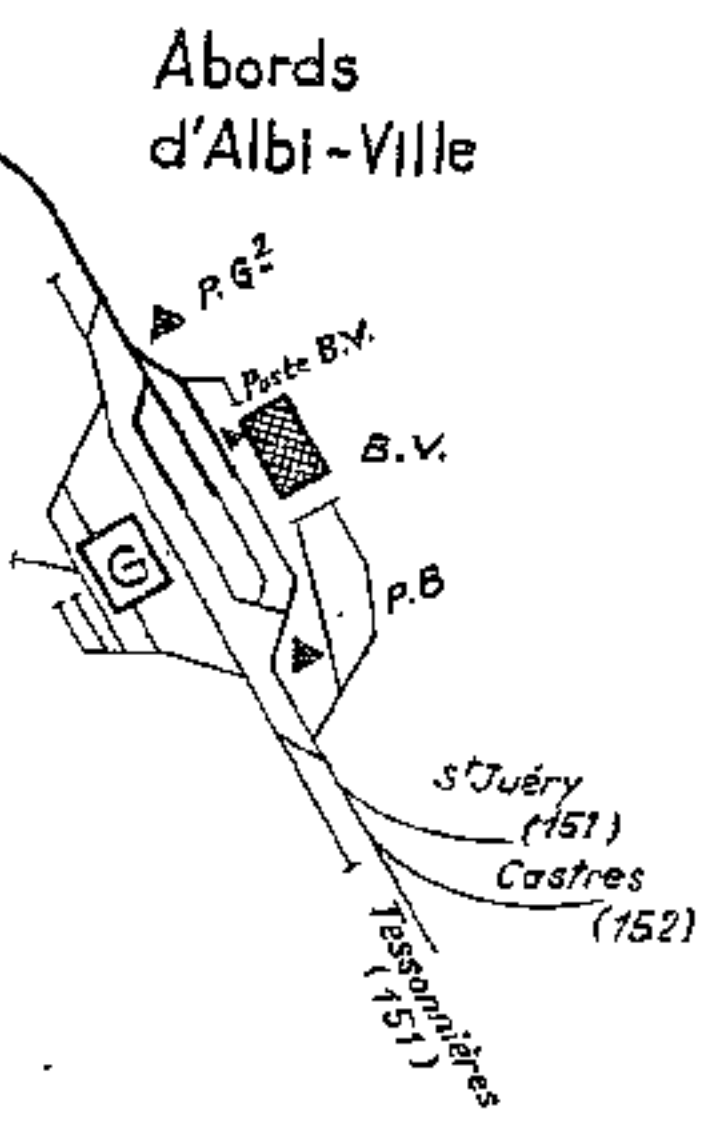
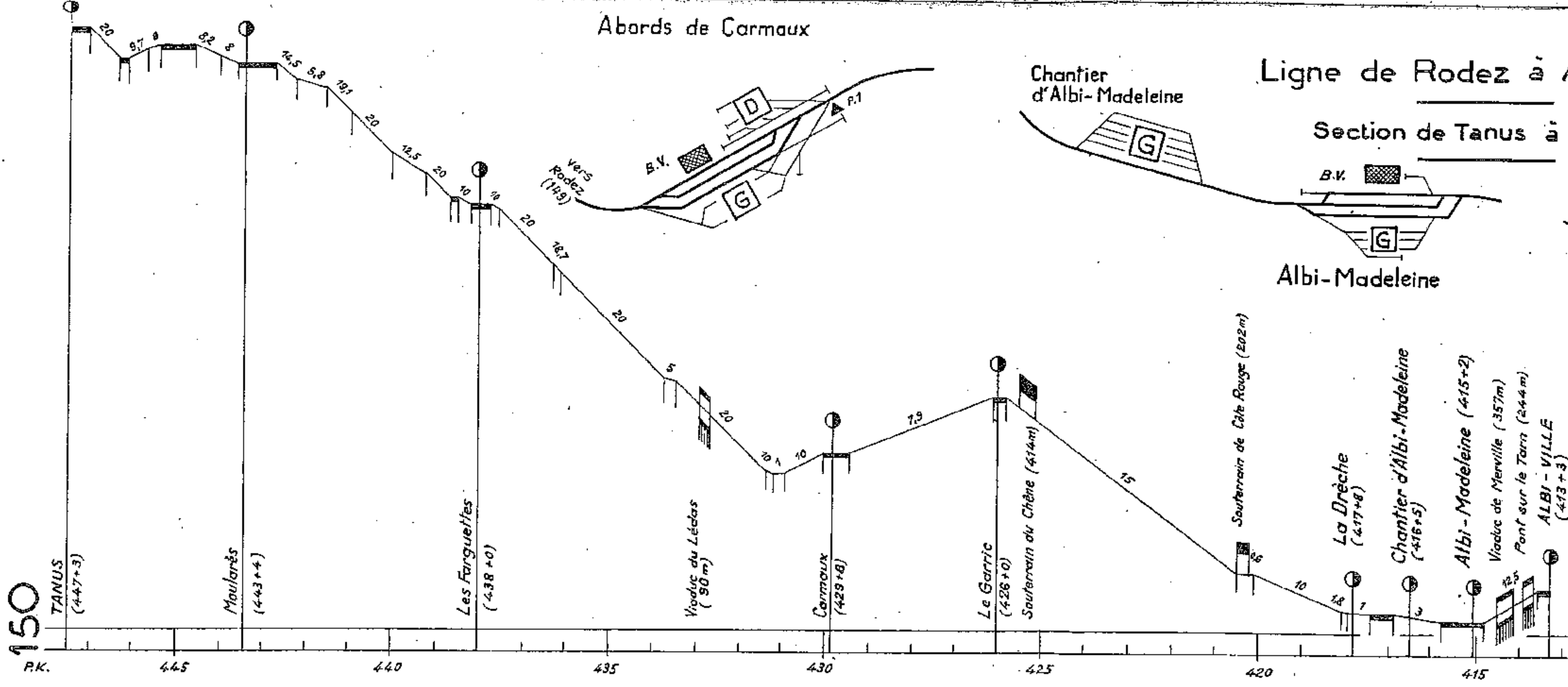

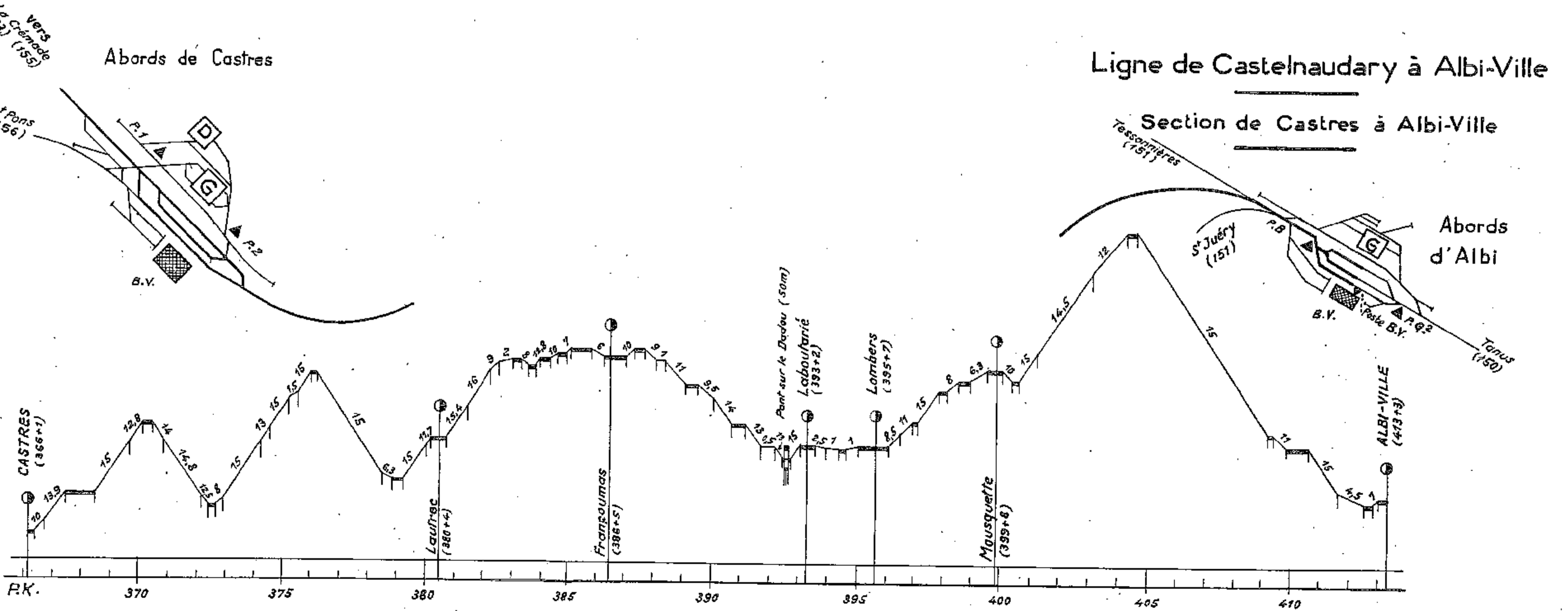
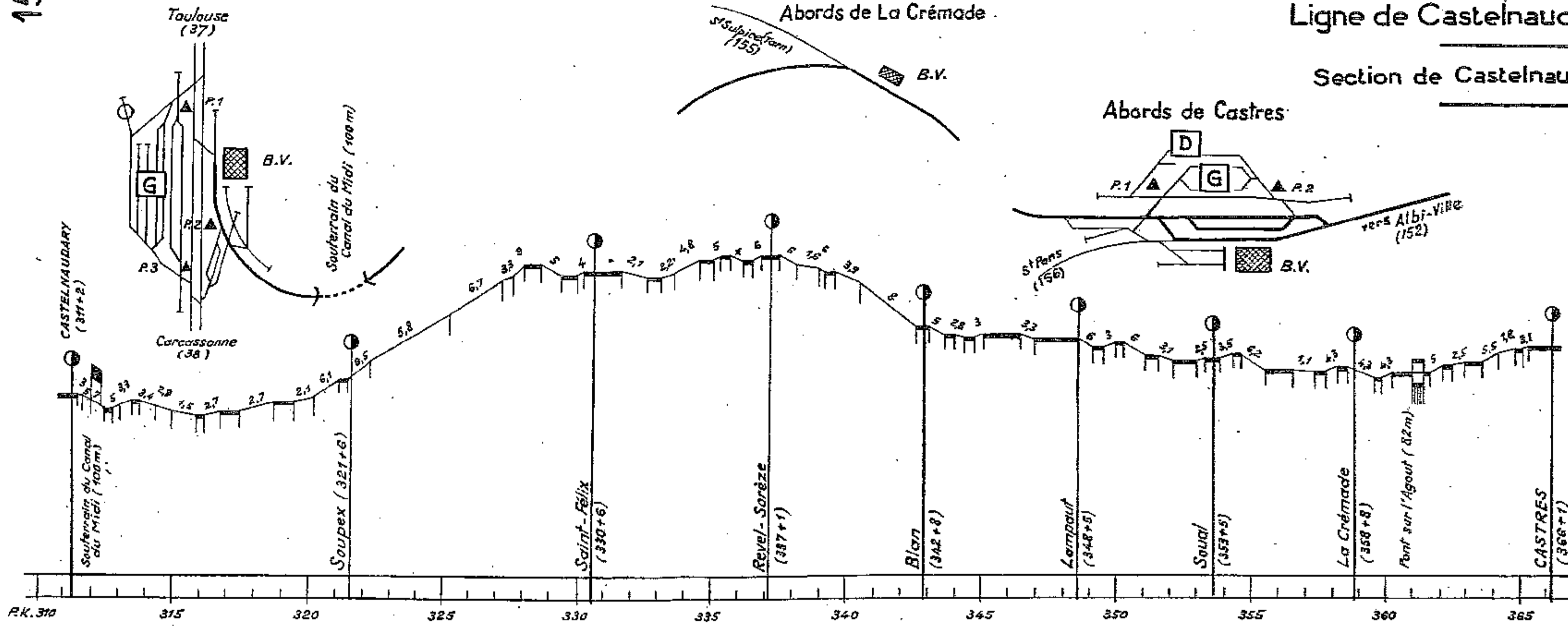

Abords de St Sulpice - Tarn

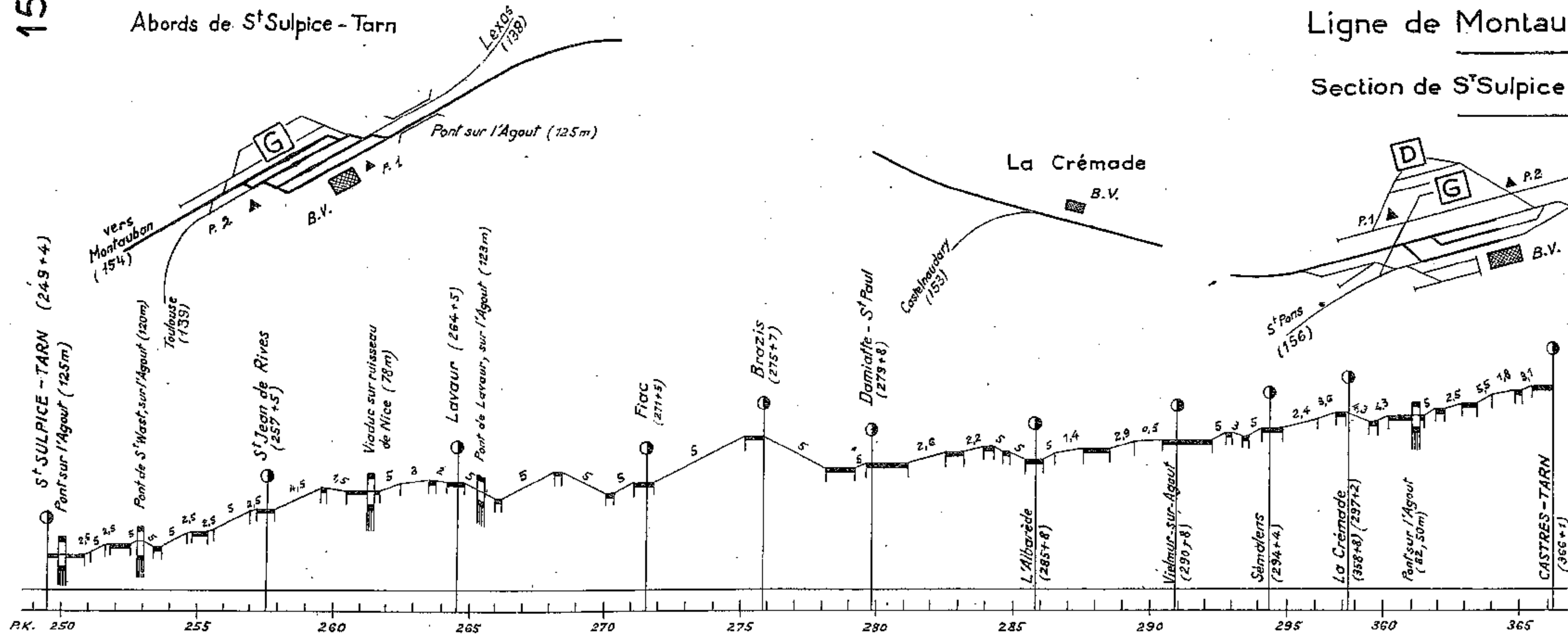

Ligne de Montauban à Castres

Section de St Sulpice (Tarn) à Castres

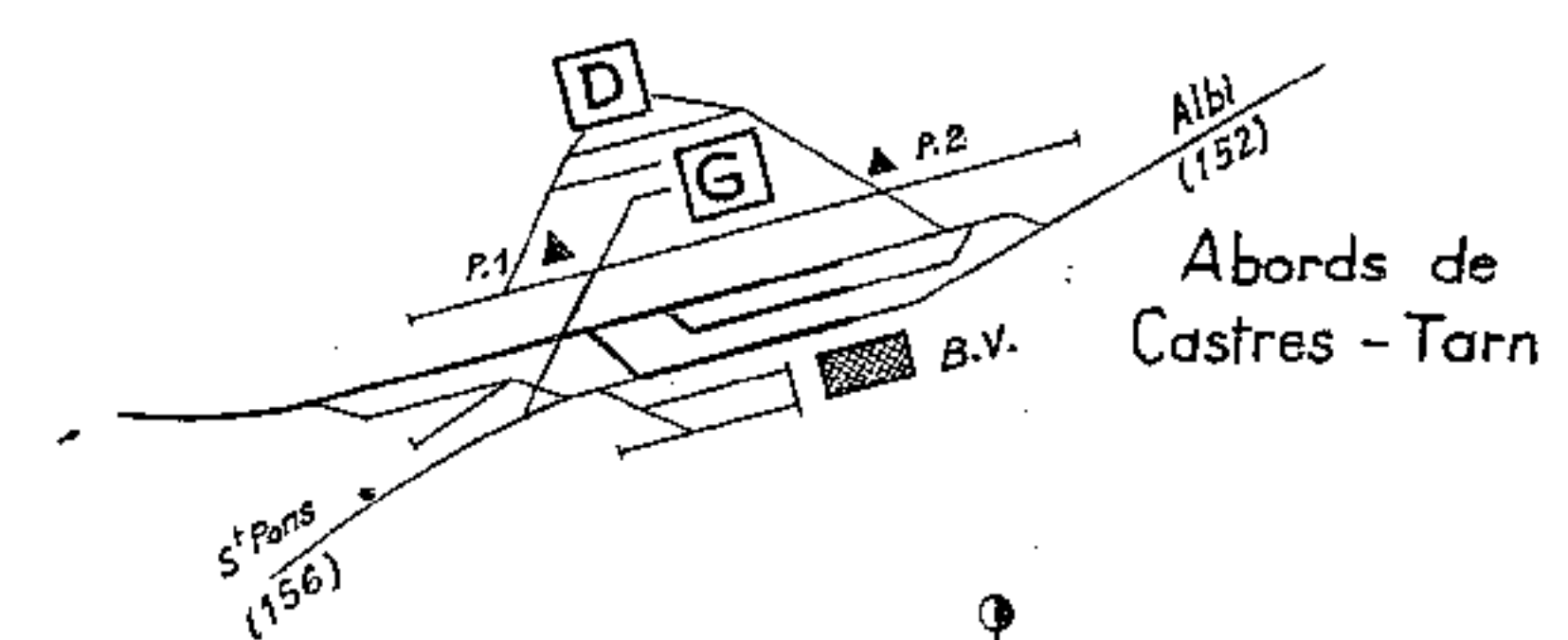

Abords de Montauban

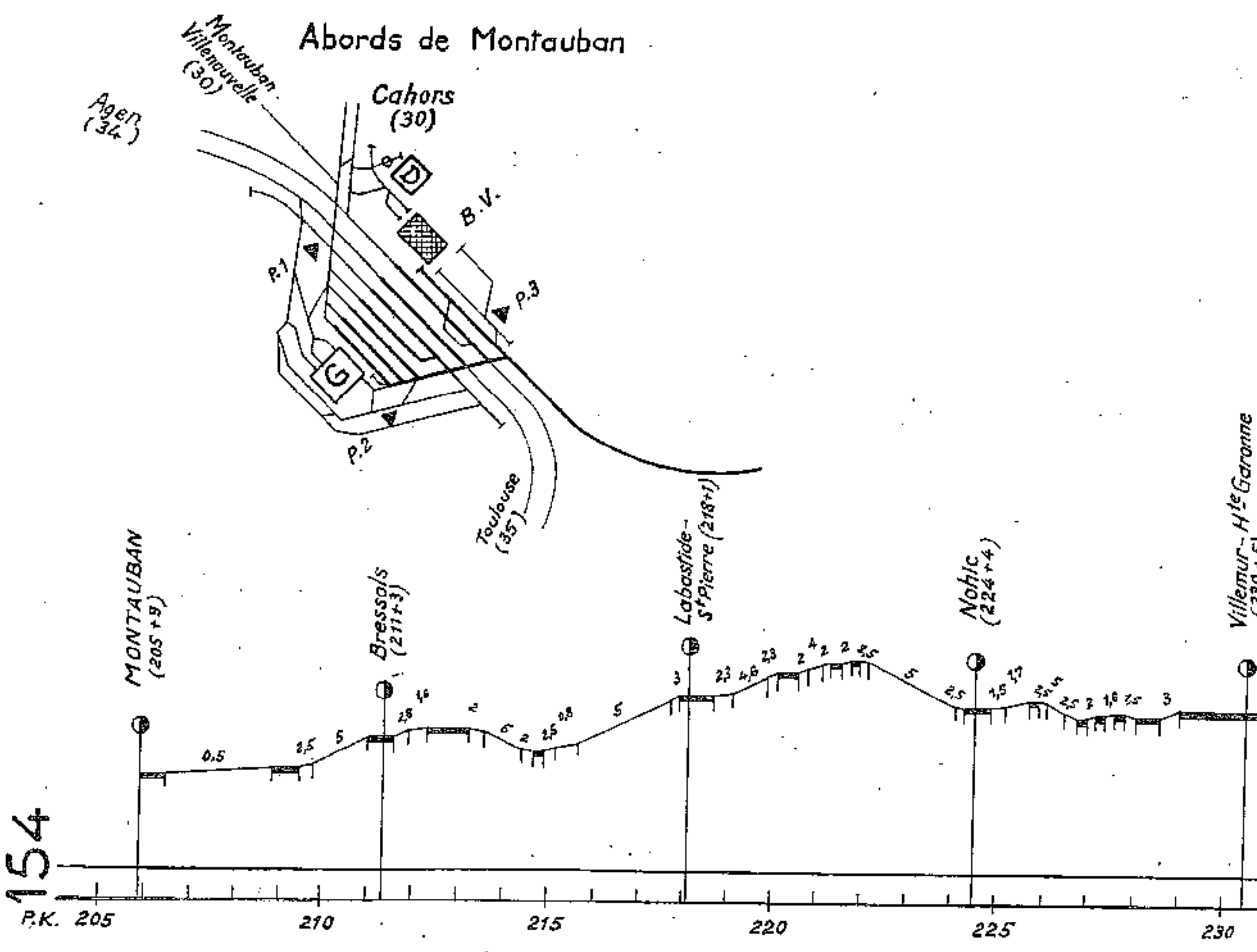

Ligne de Montauban à Castres

Section de Montauban à St Sulpice (Tarn)

Abords de St Sulpice - Tarn

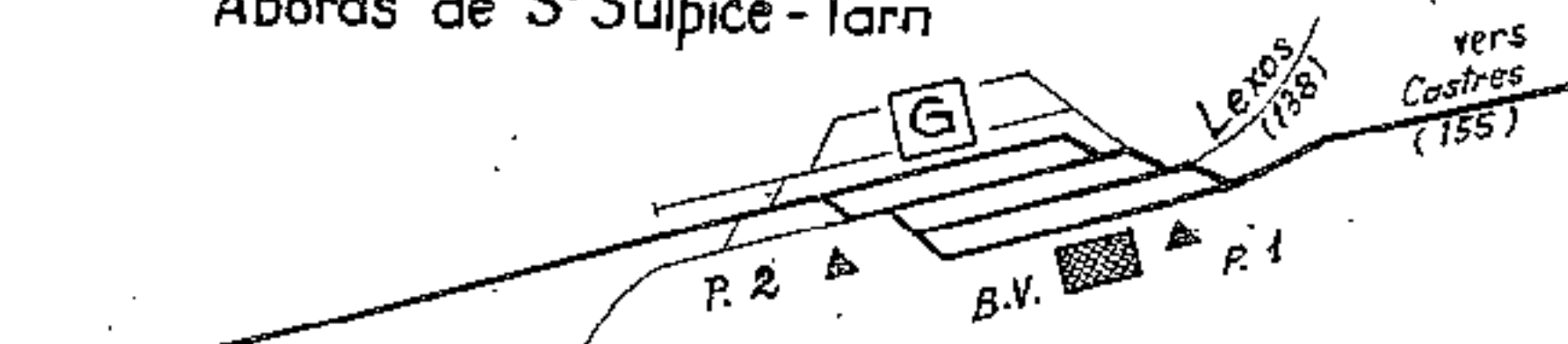

Ligne de Moux à Caunes-Minervois

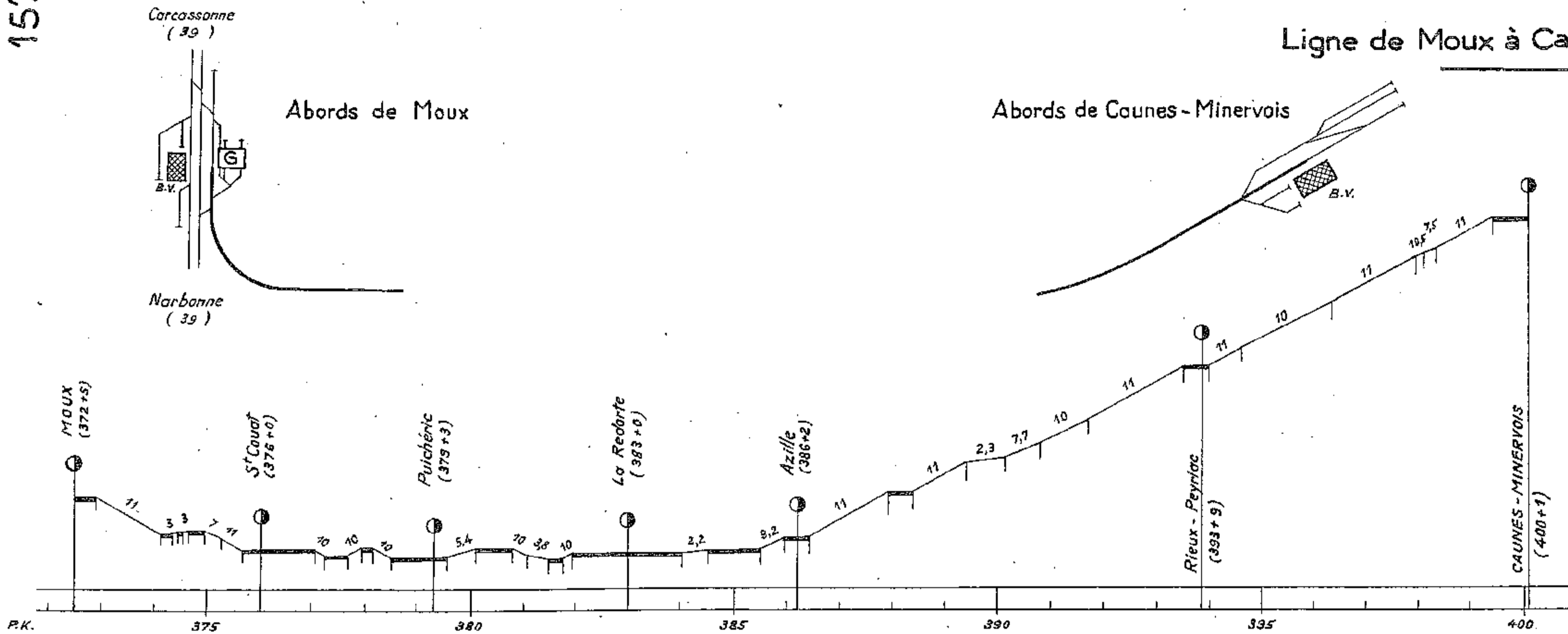

Ligne de Castres à S^t Pons

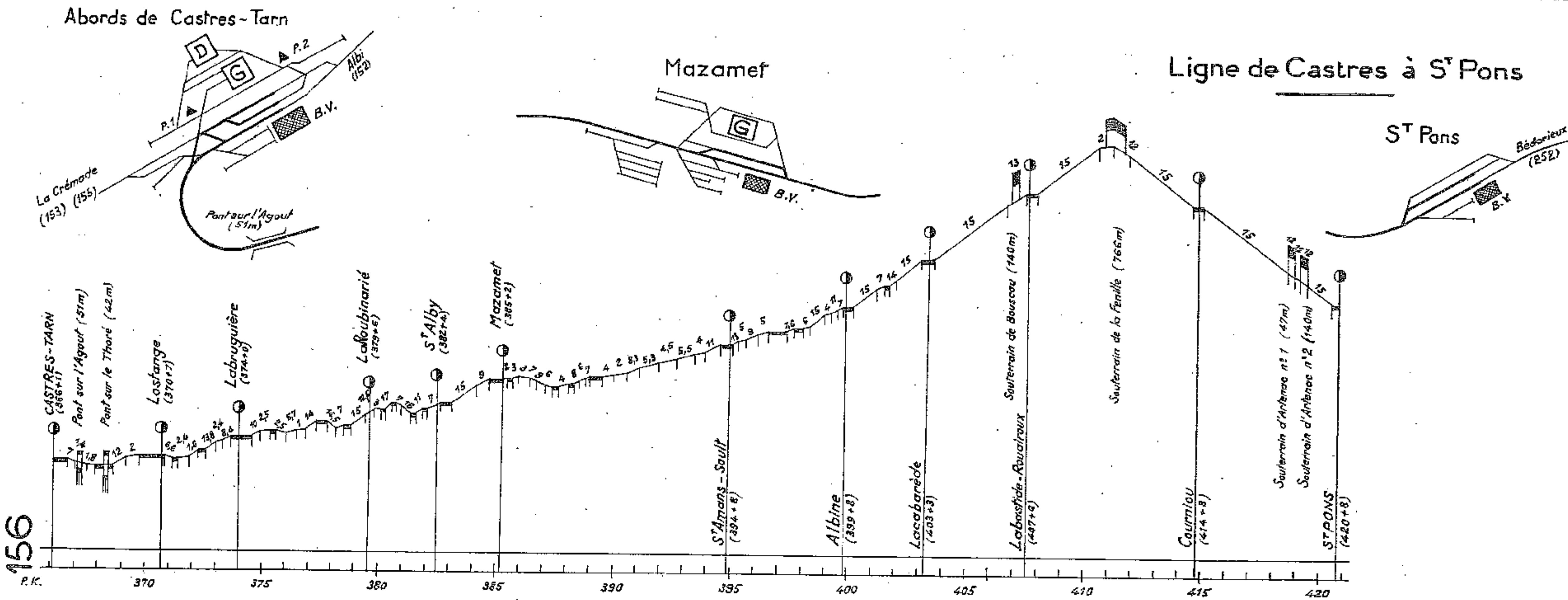

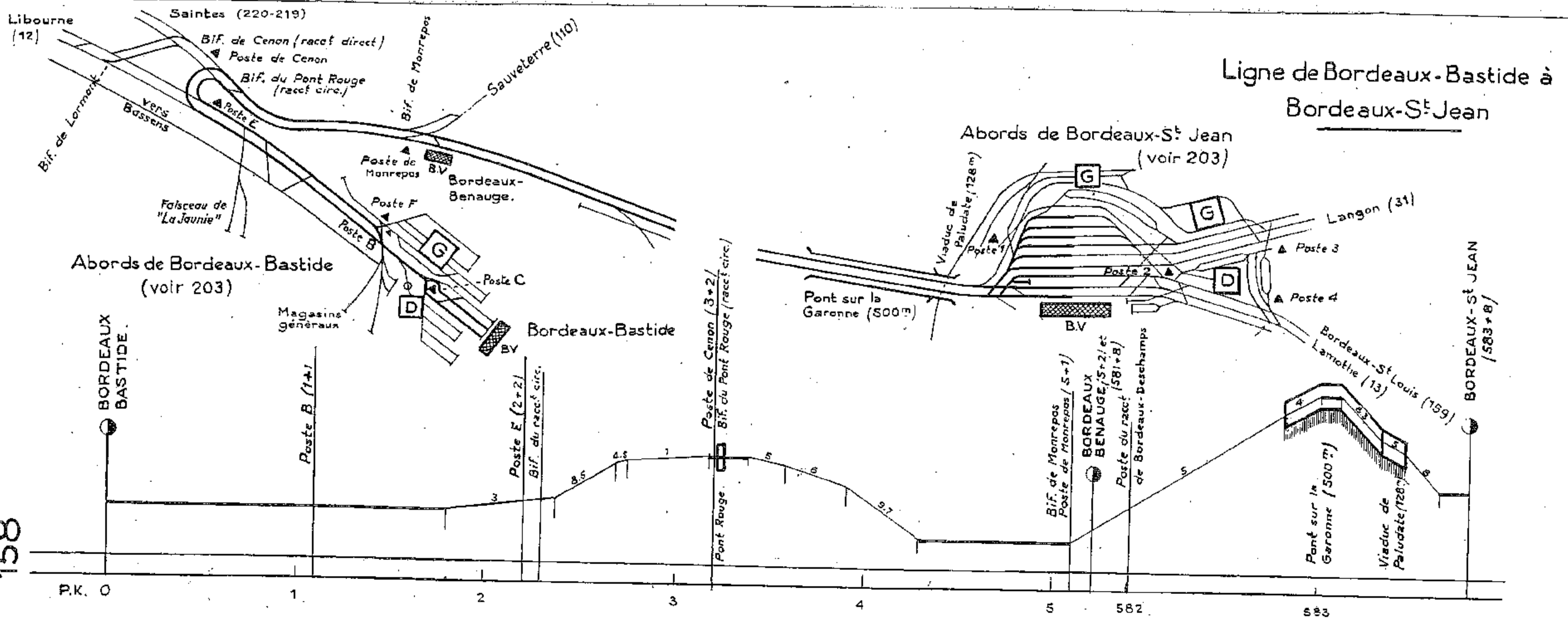
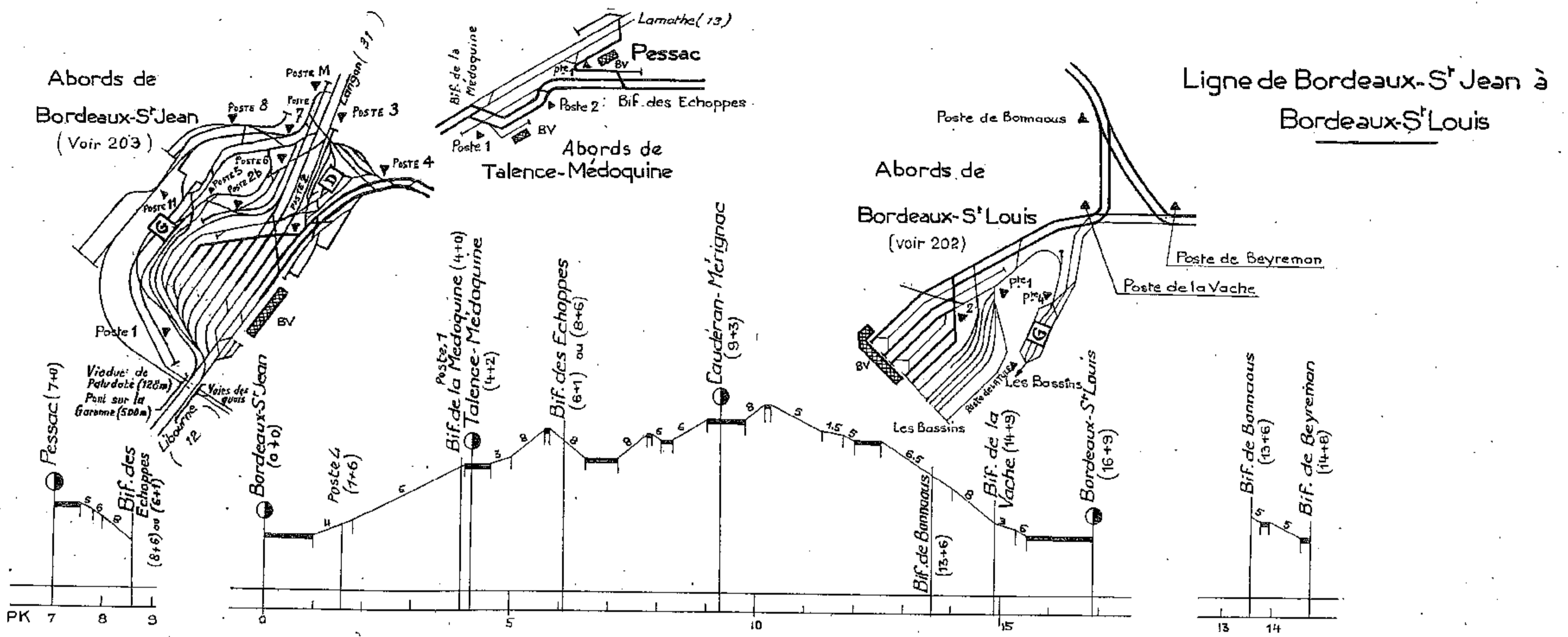

Abords de Bordeaux S^t. Louis (voir 202)

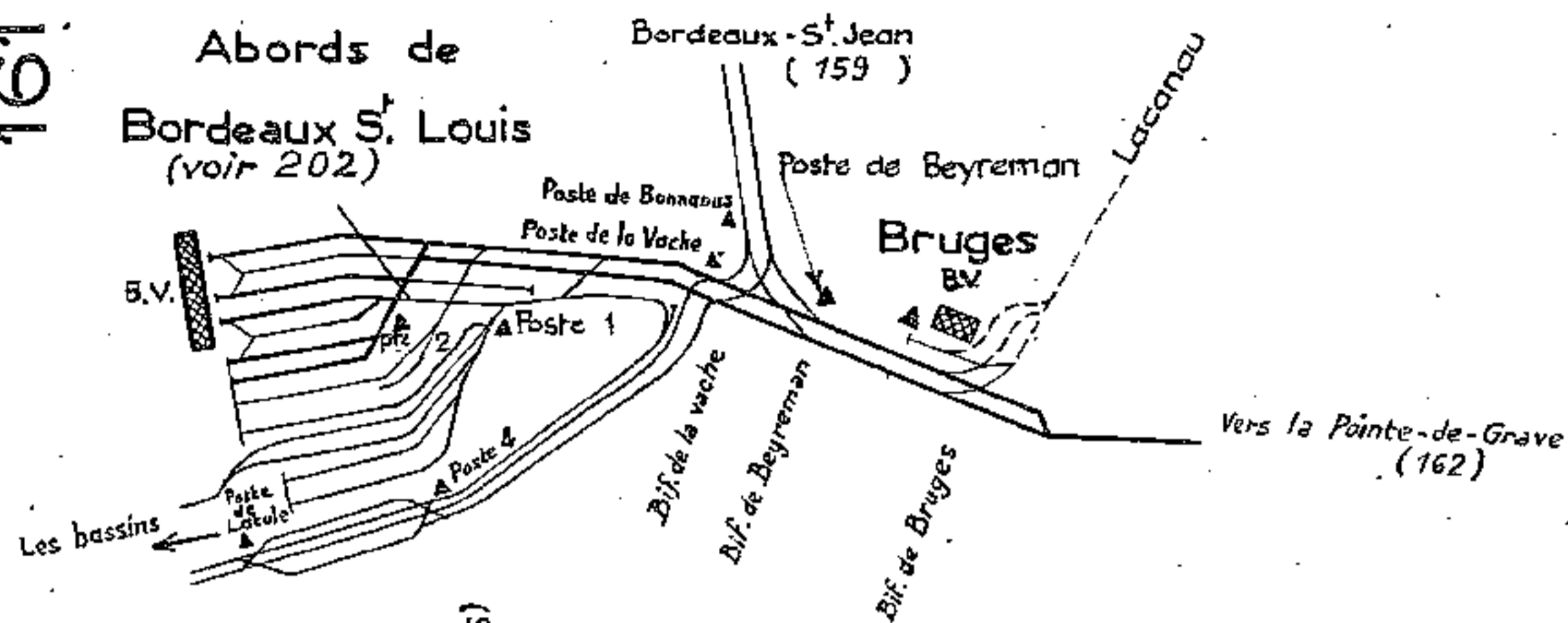

Ligne de Bordeaux-S^t.Louis à la Pointe-de-Grave

Section de Bordeaux-S^t.Louis à Pauillac

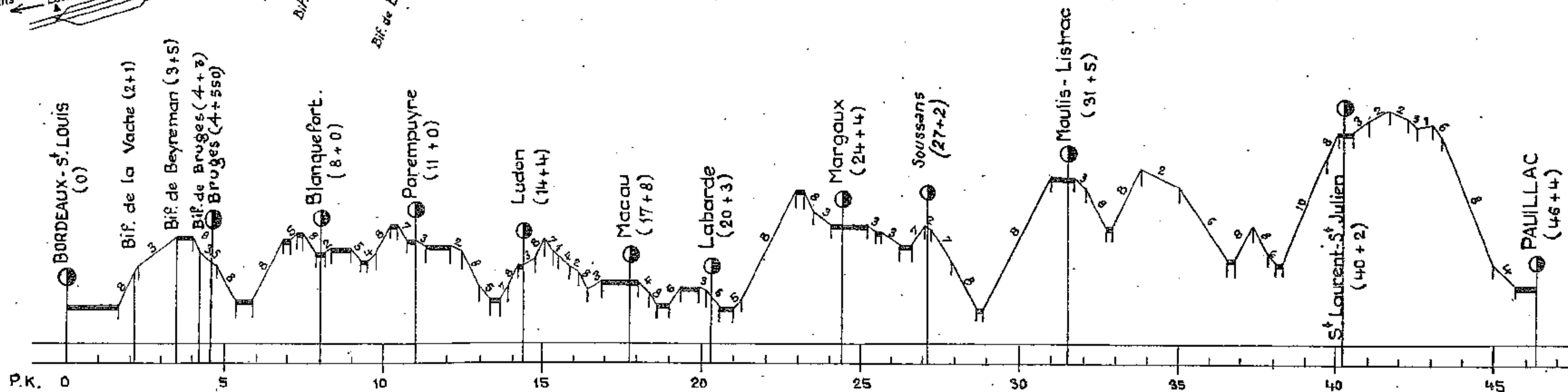

Abords de Bassens-Ville

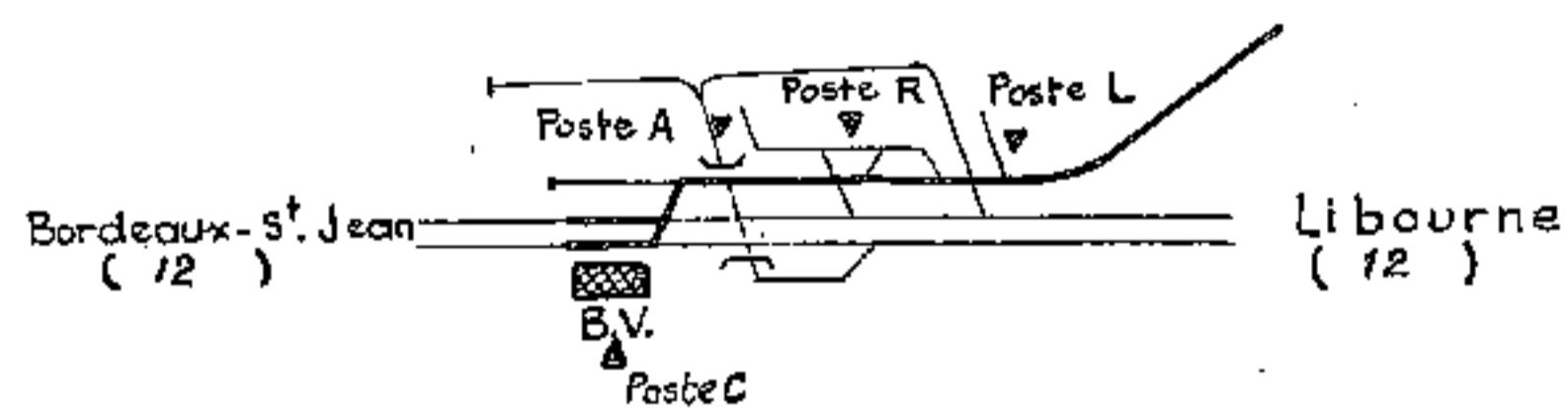

Ligne de Bassens-Ville au Bec d'Ambès

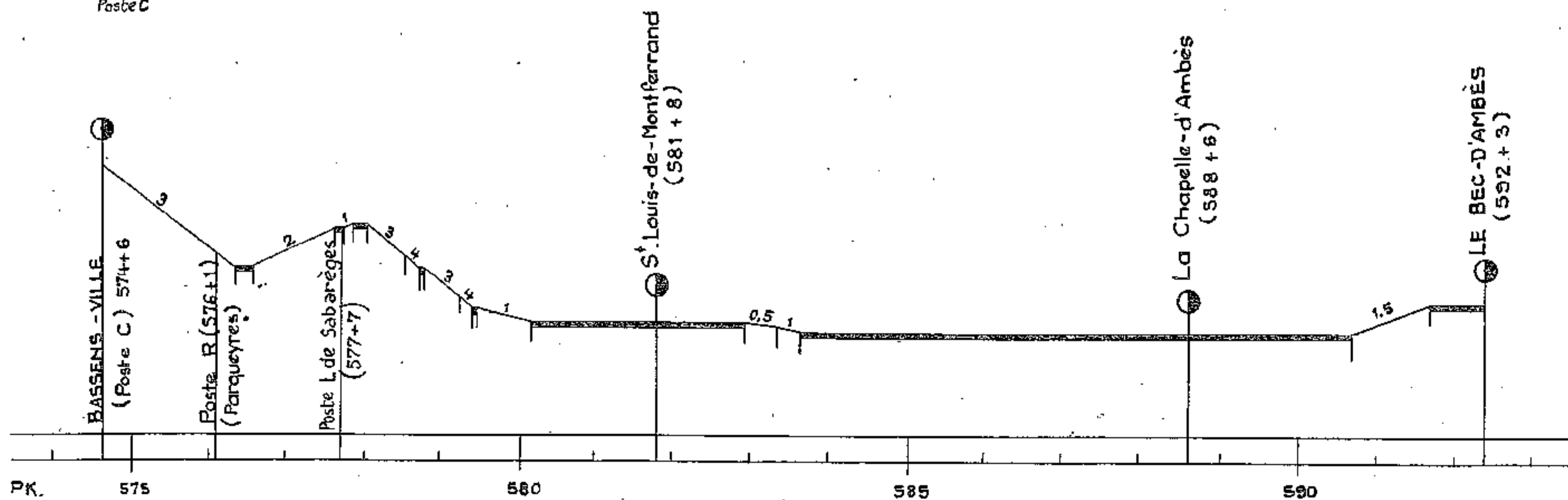

Abords de Marcenais

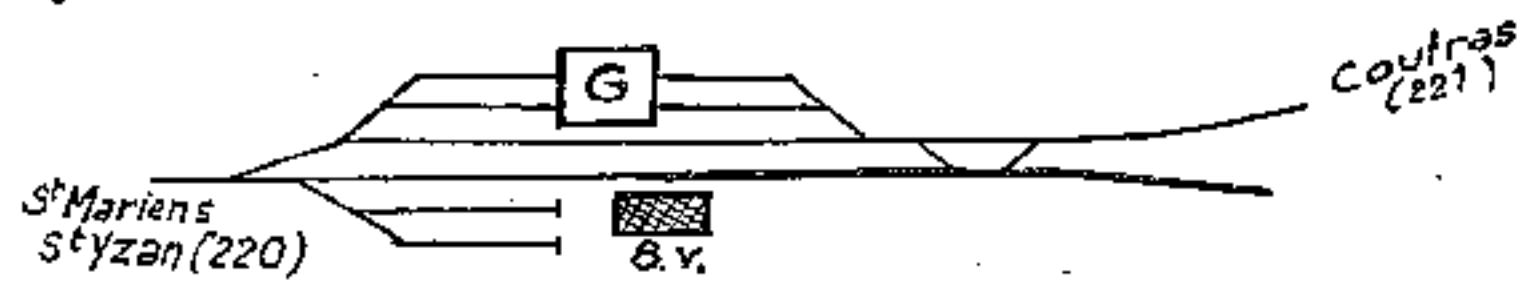

Ligne de Marcenais à Libourne

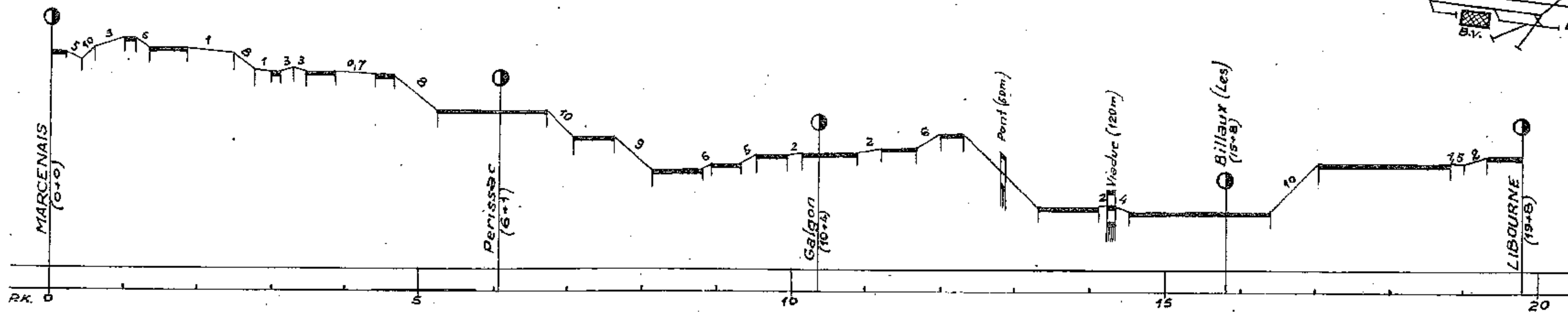

Abords de Libourne

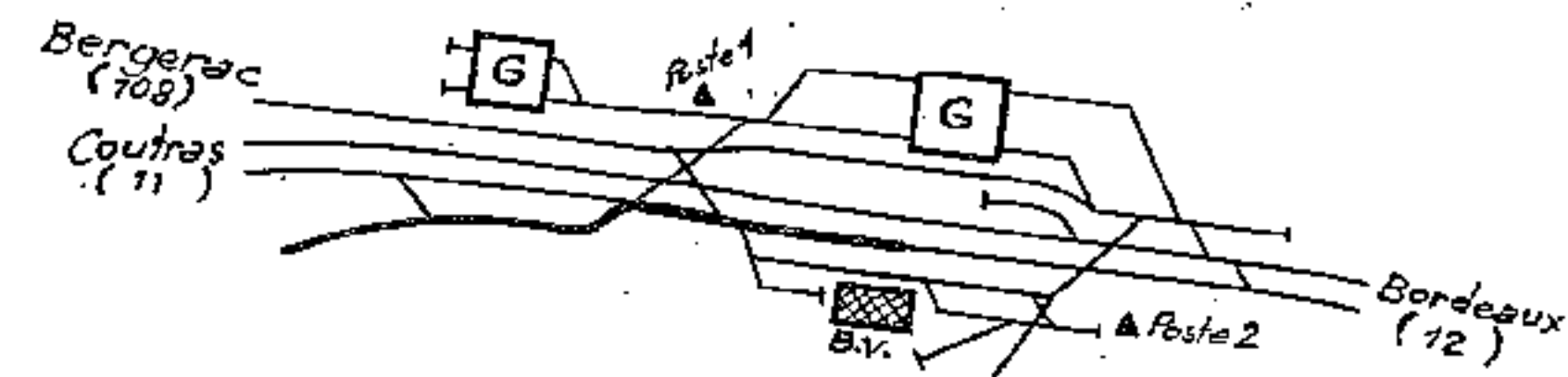

Abords de Lesparre

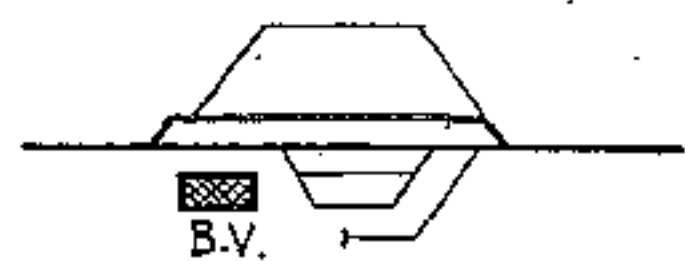

Abords du Verdon

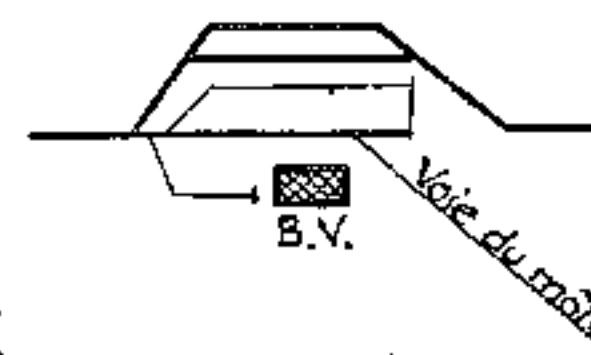

Ligne de Bordeaux-S't Louis à la Pointe-de-Grave

Section de Pauillac a la Pointe-de-Grave

Abords de la Pointe de Grave

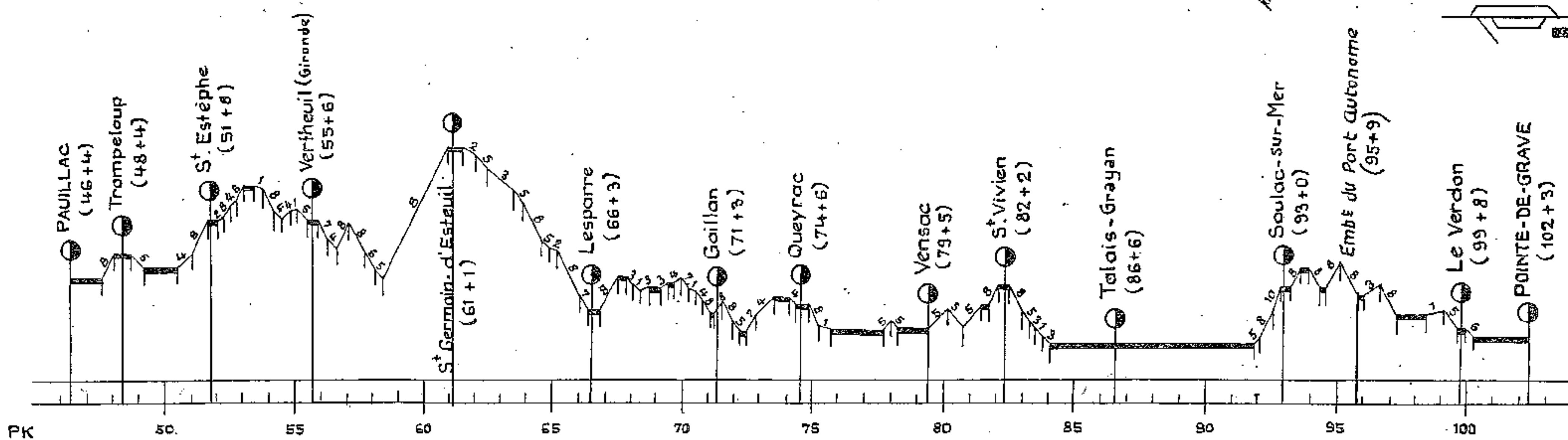
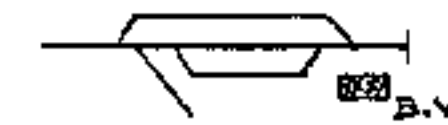

Ligne de Marmande à Mont-de-Marsan

Section de Marmande à Bourriot-Bergonce

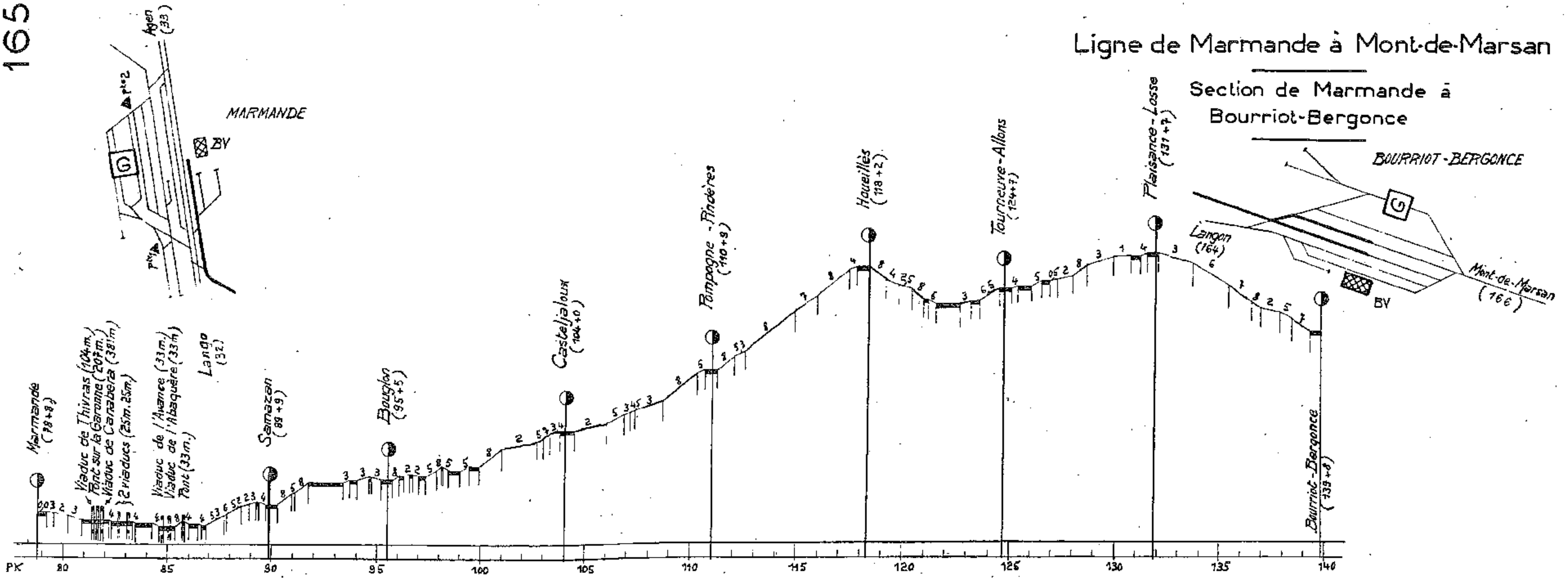

Abords de Bourriot-Bergonce

Ligne de Lango à Bourriot-Bergonce

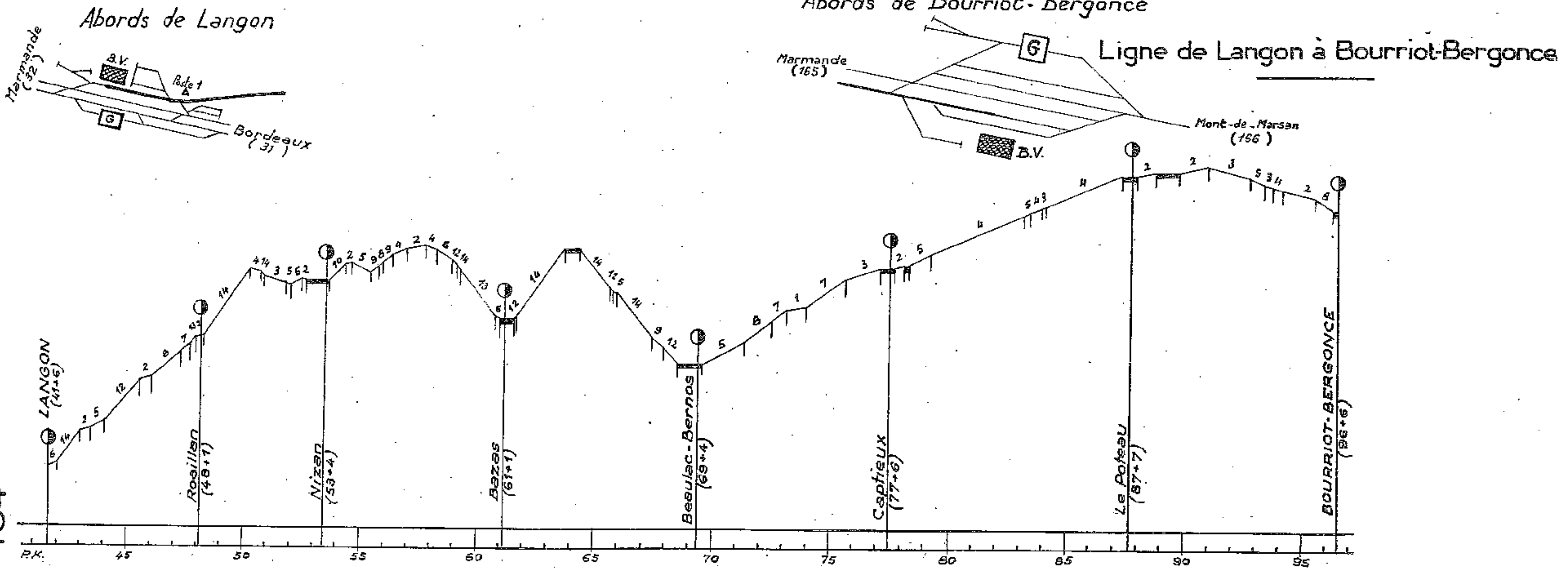

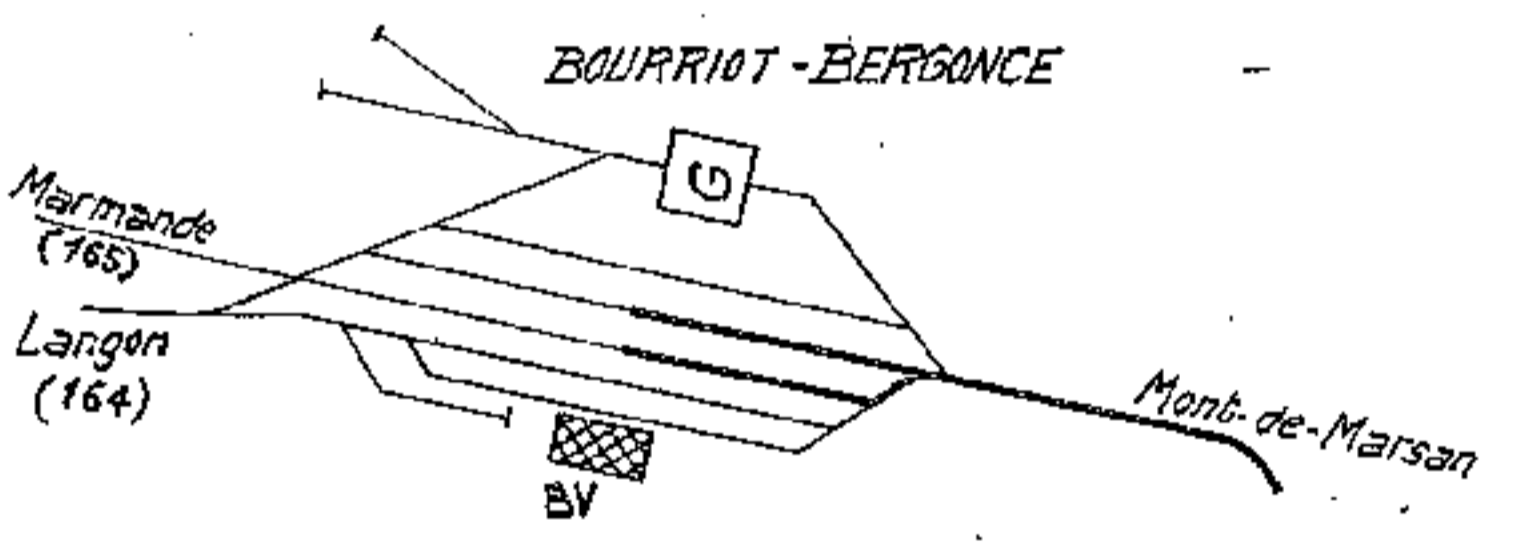
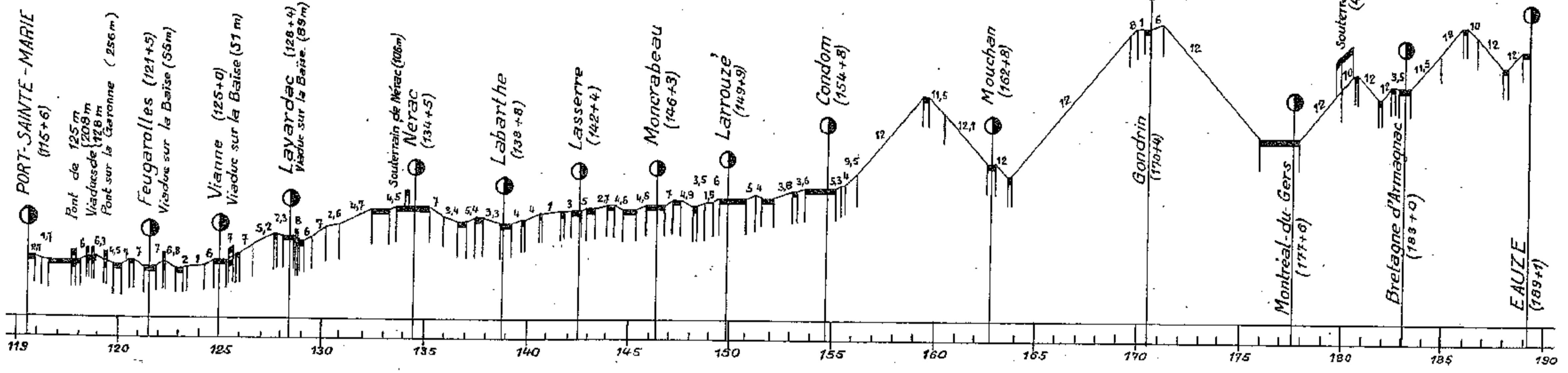
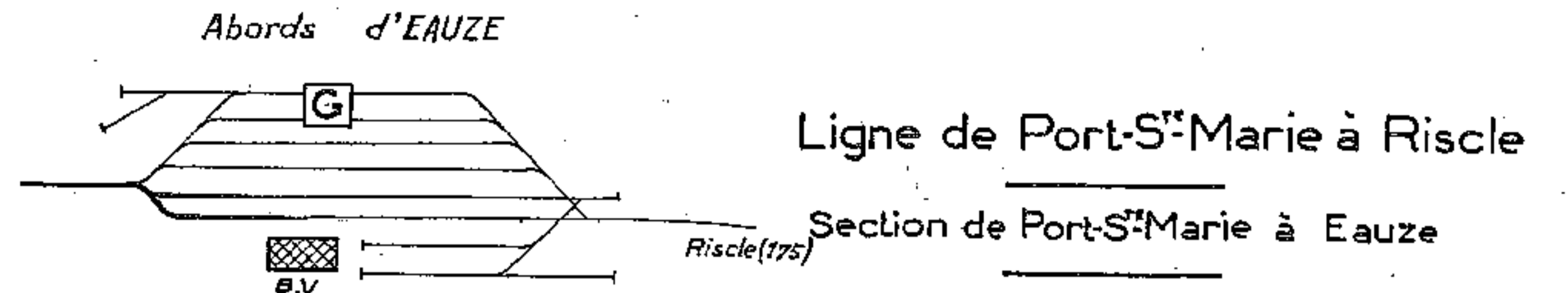
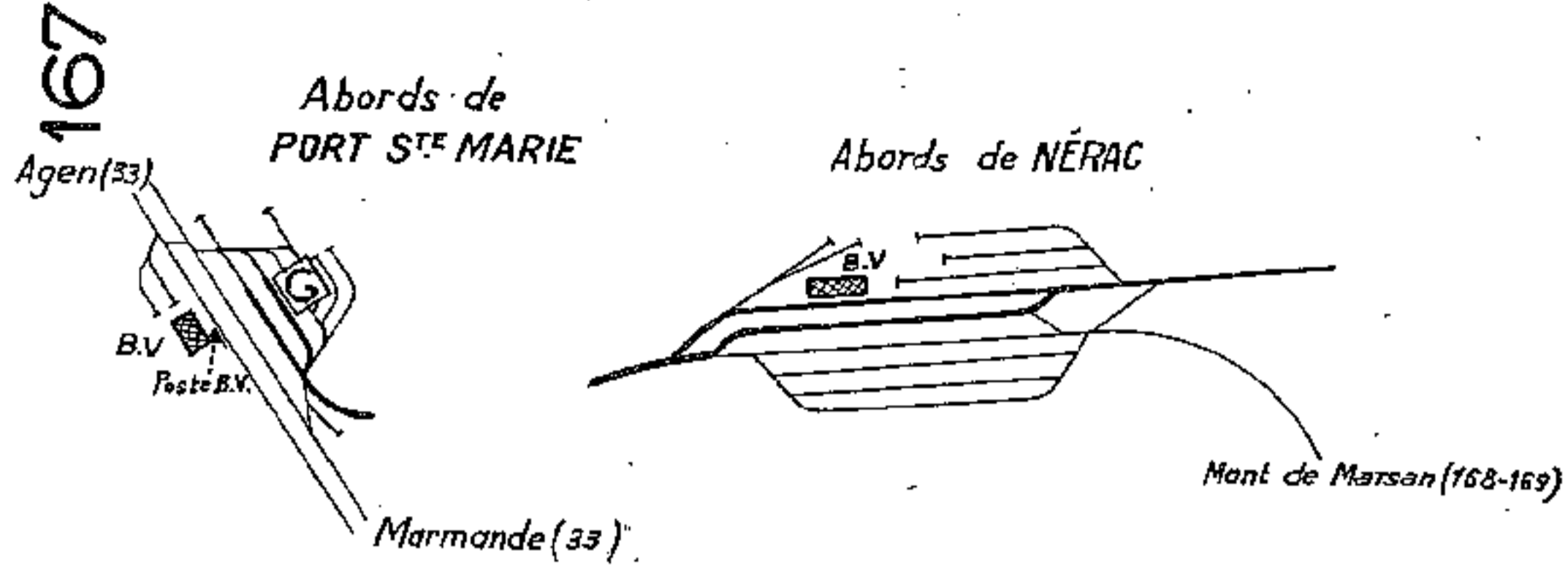

Ligne de Marmande à Mont-de-Marsan
Section de Bourriot Bergonce à Mont de Marsan

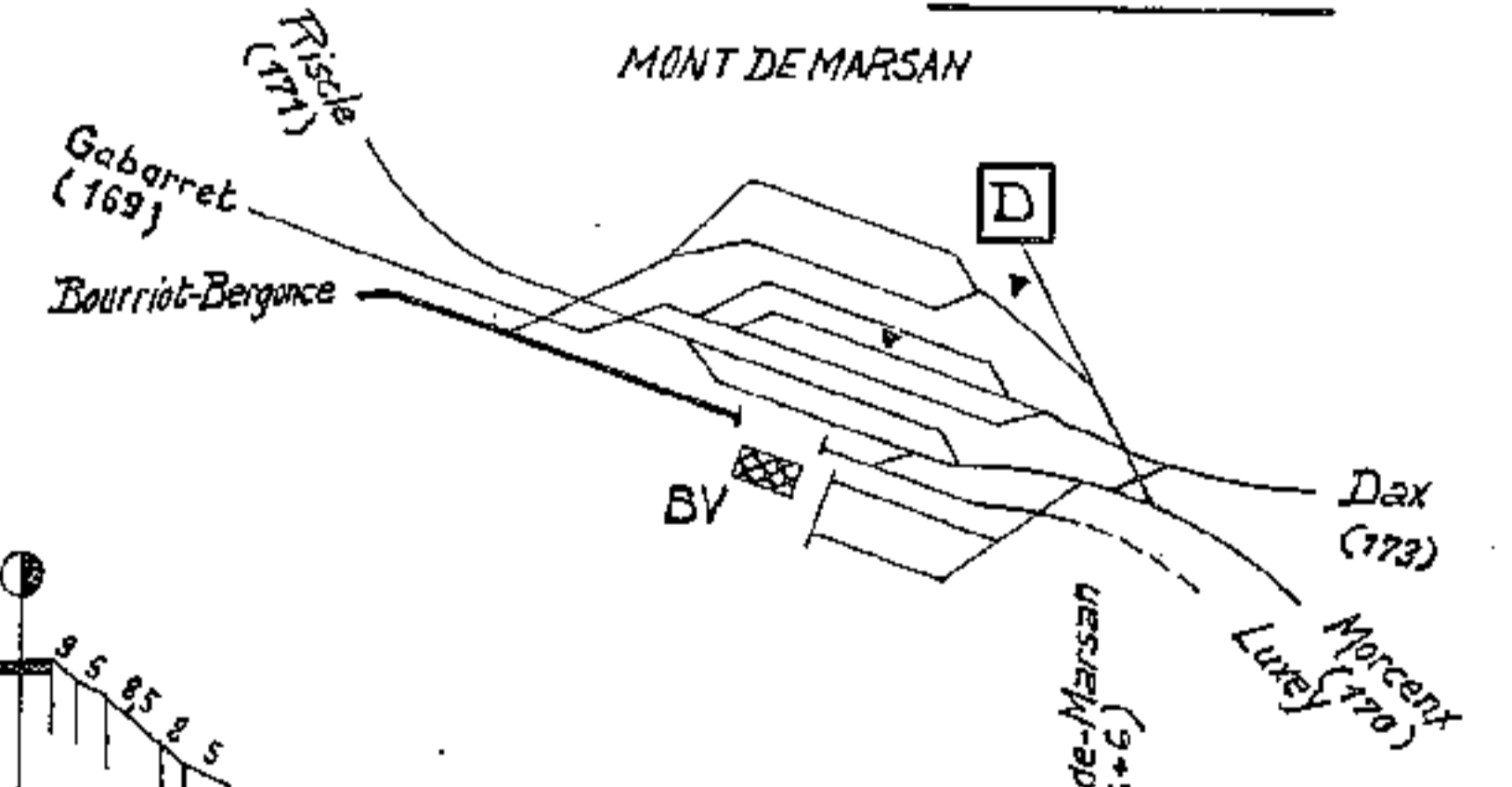
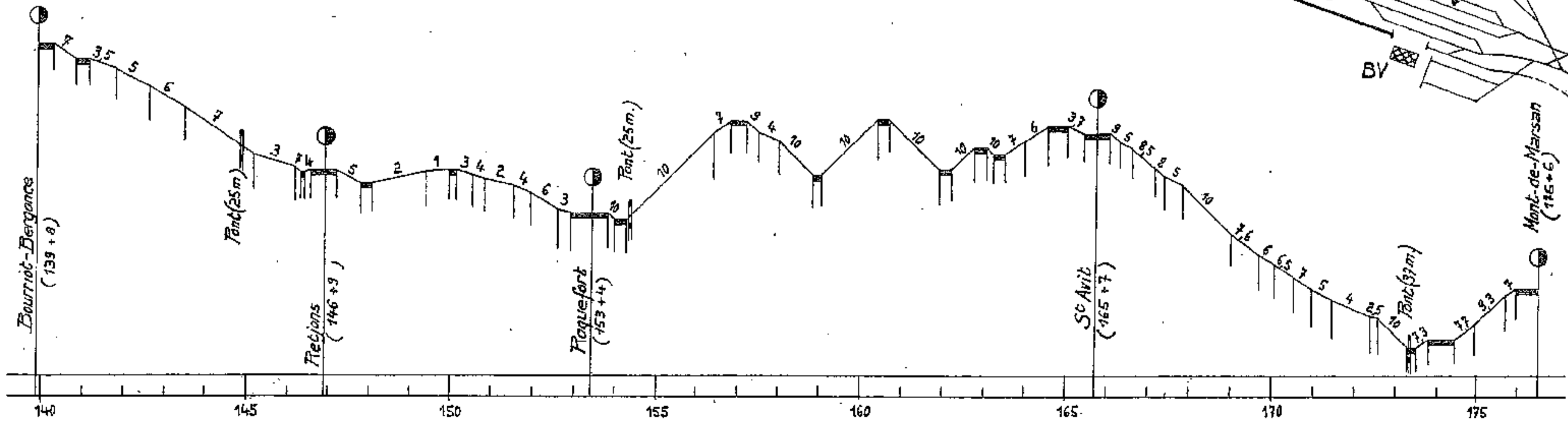

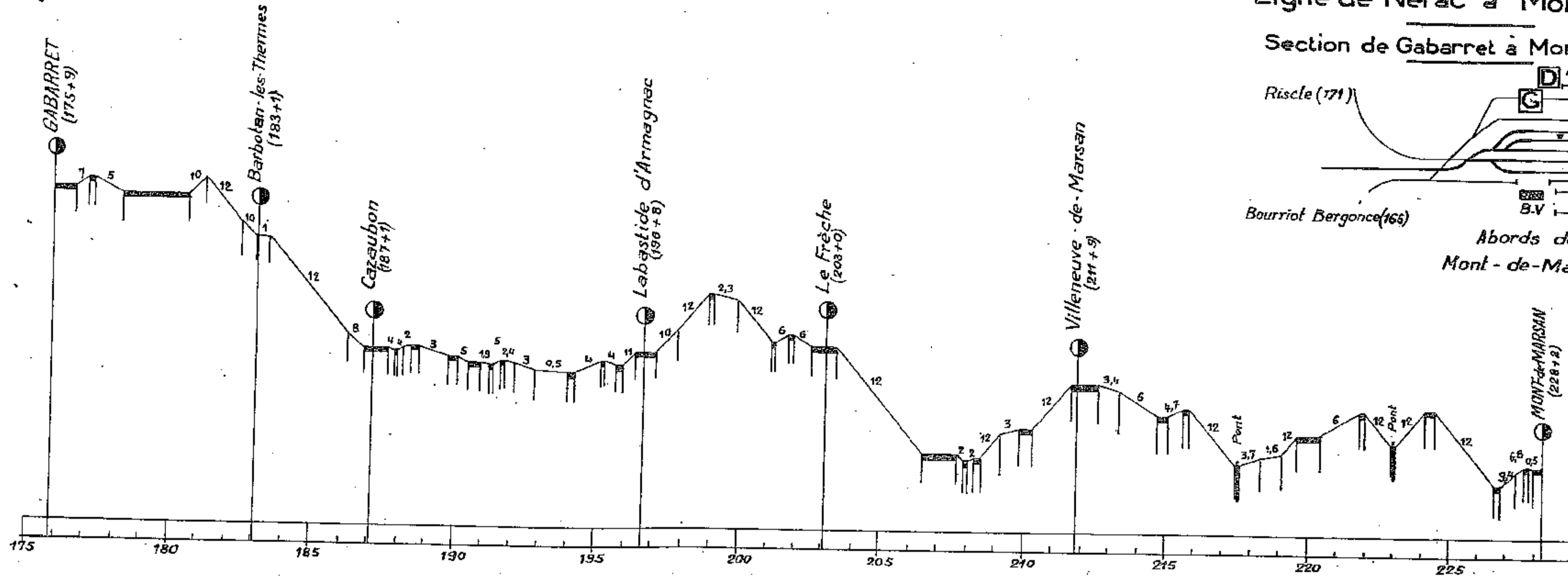

Ligne de Nérac à Mont-de-Marsan
Section de Gabarret à Mont-de-Marsan

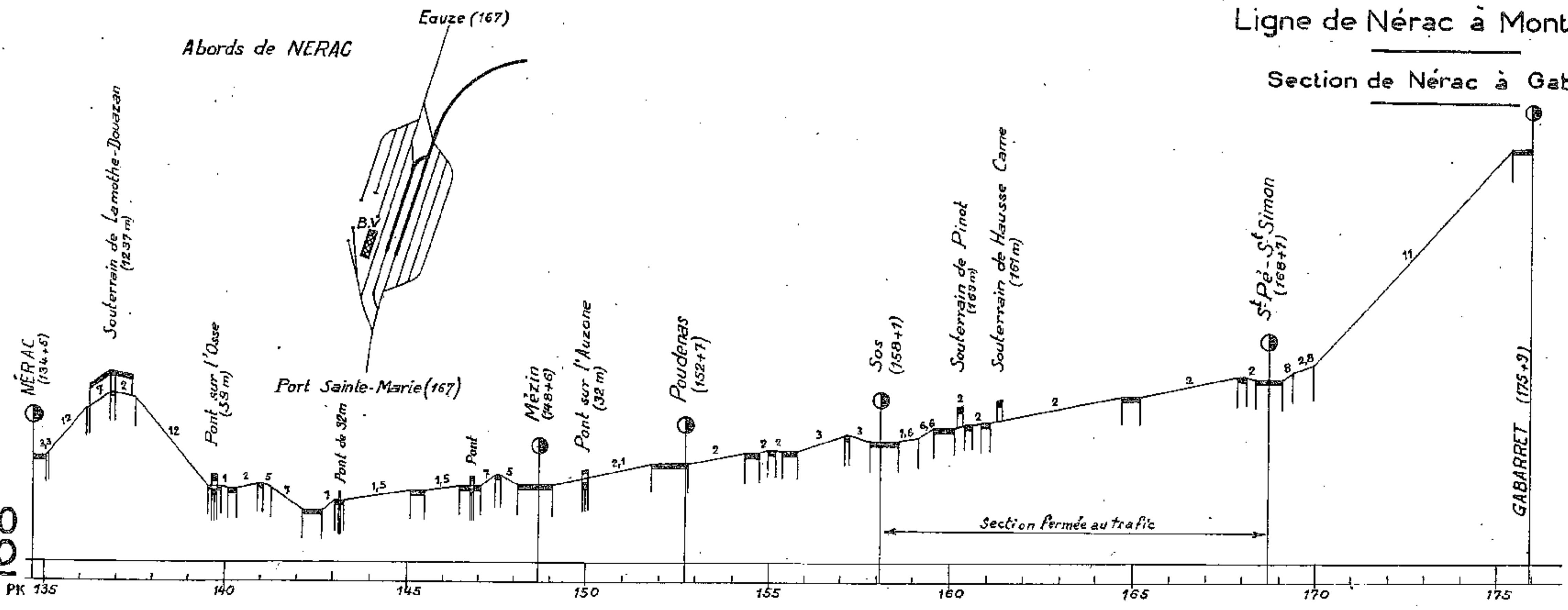
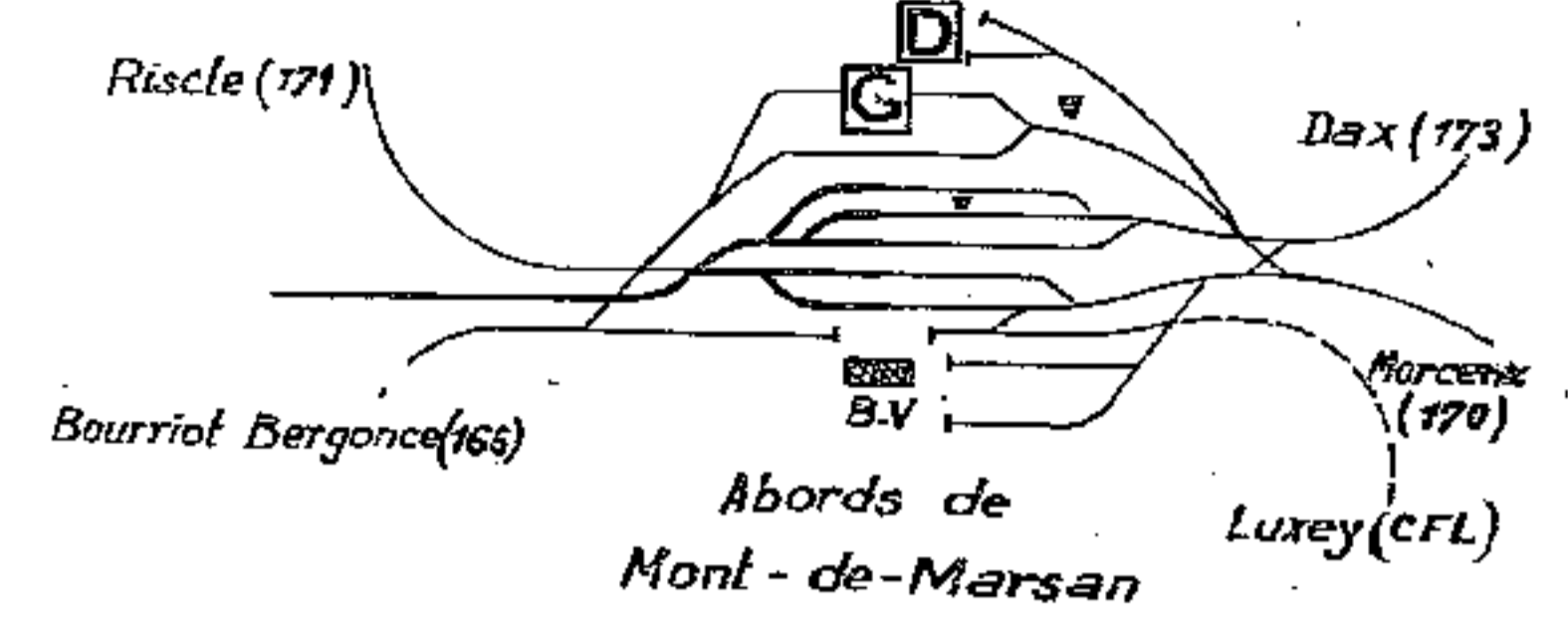

Ligne de Nérac à Mont-de-Marsan
Section de Nérac à Gabarret

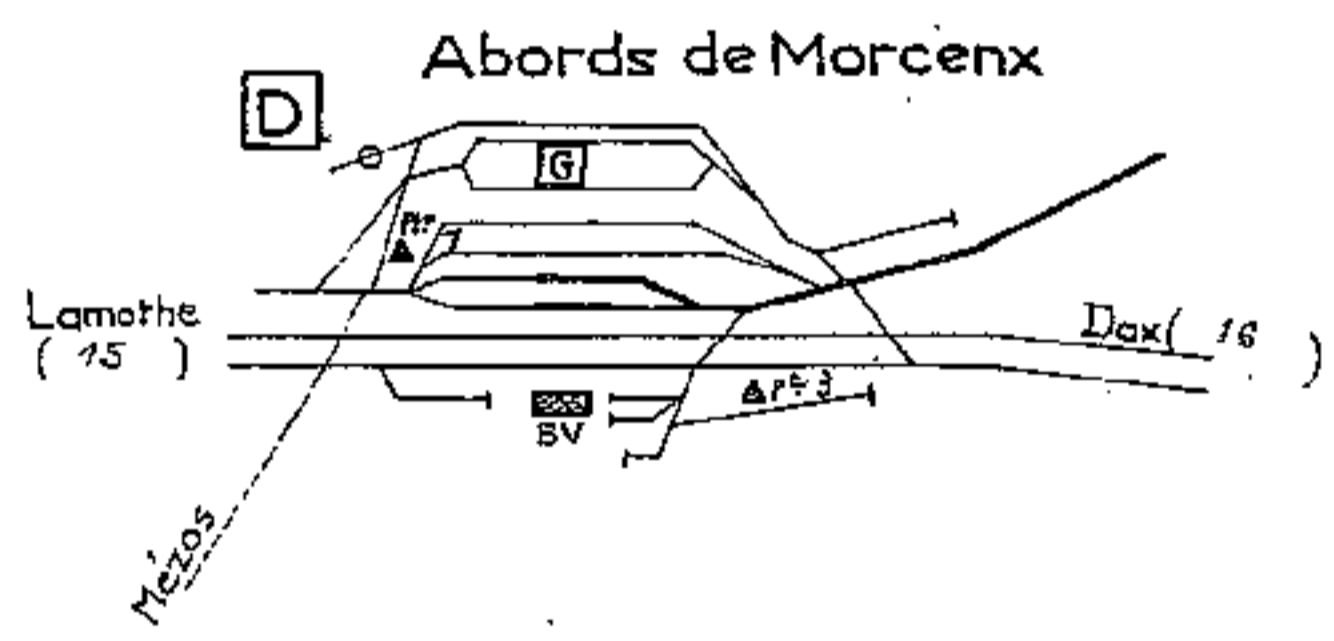
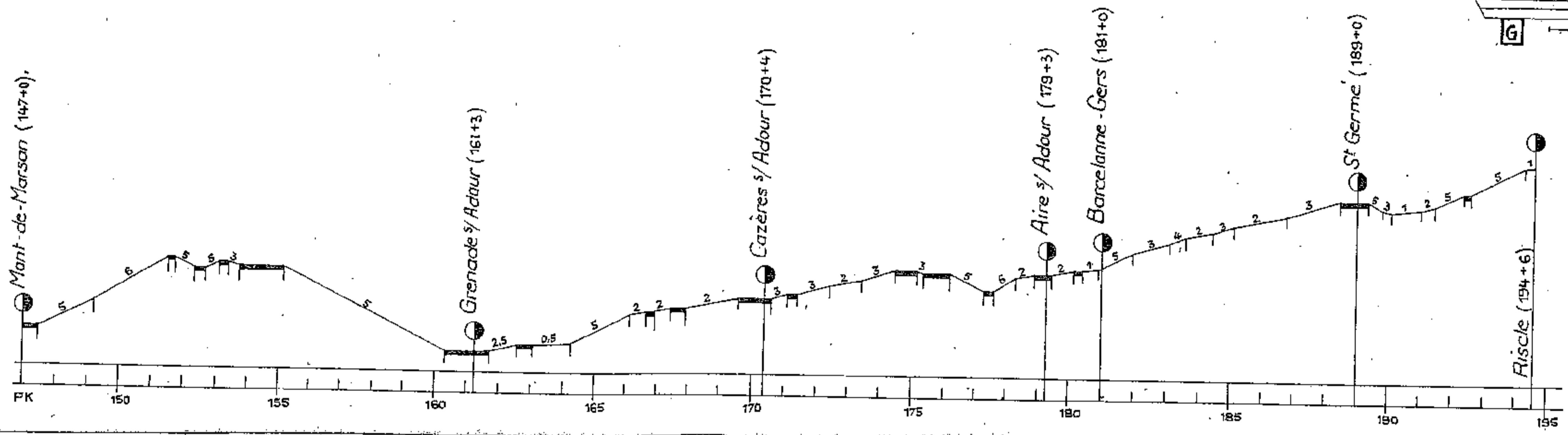
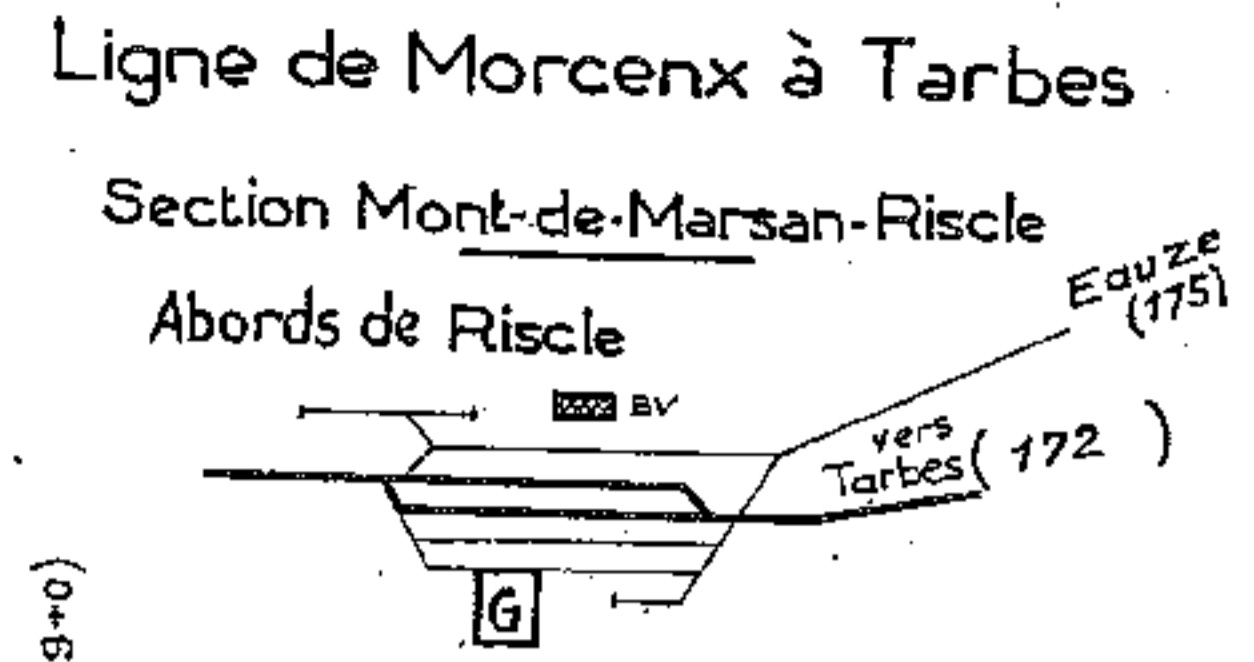
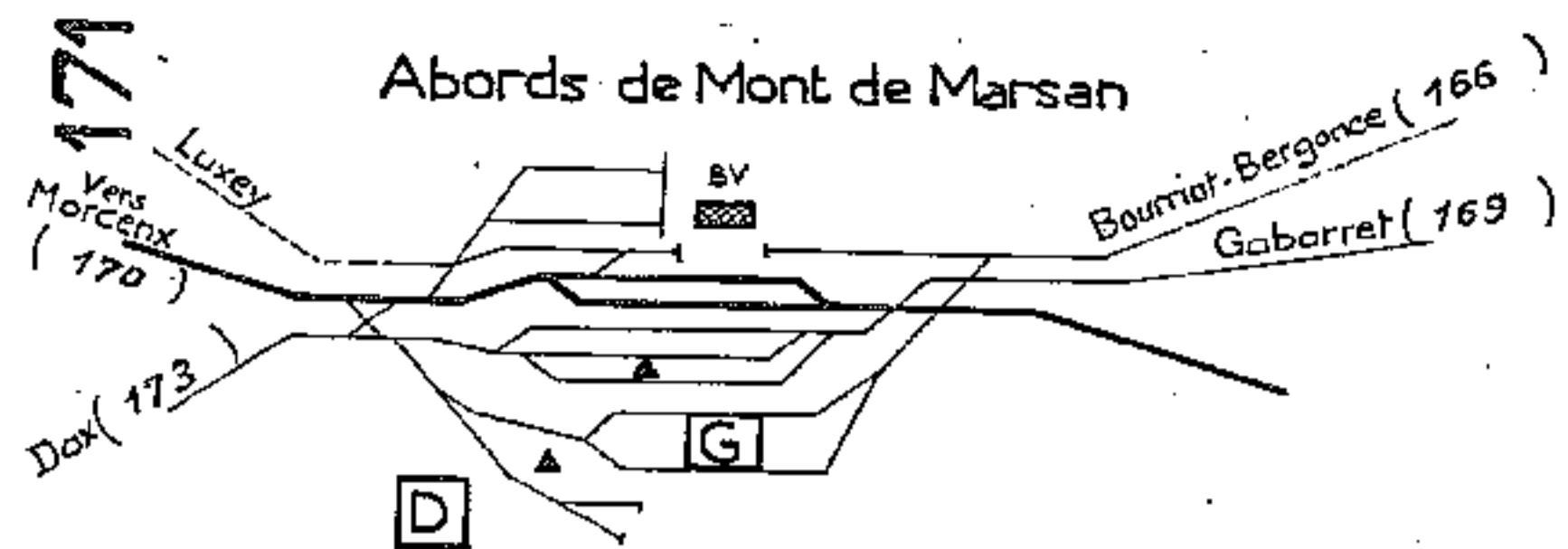

Ligne de Morcenx à Tarbes

Section Morcenx-Mont-de-Marsan

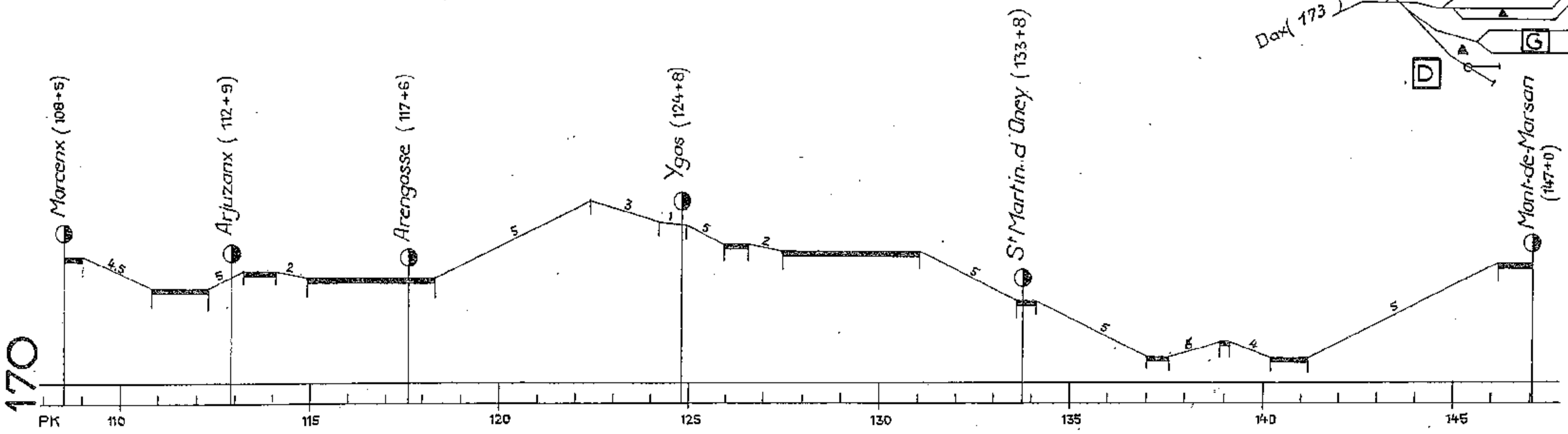
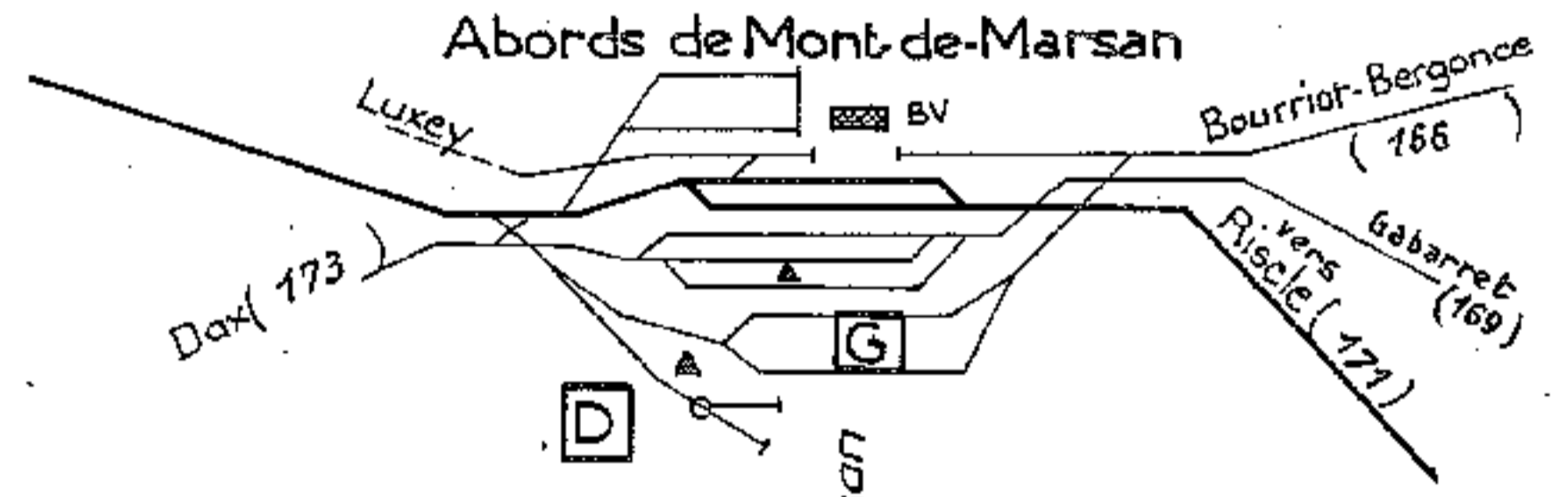

173

Ligne de Dax à Mont-de-Marsan

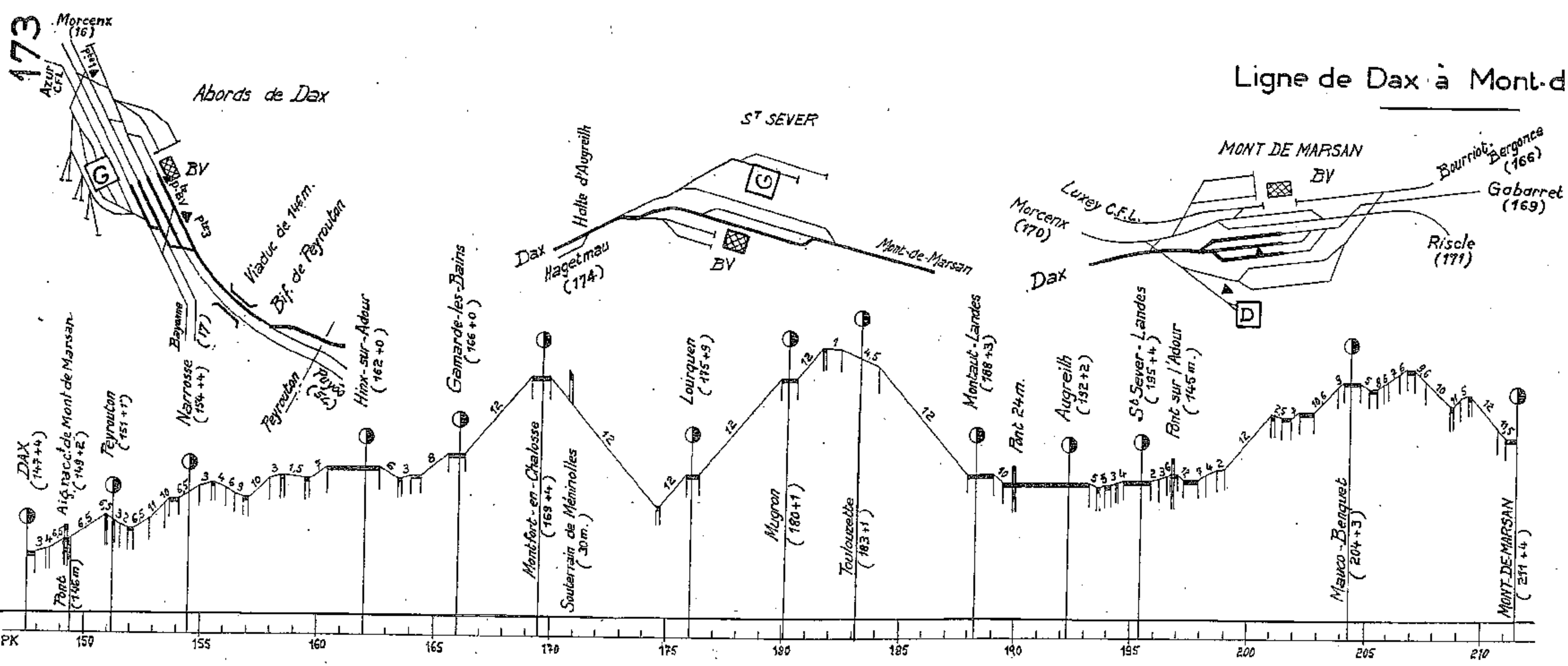

Abords de Riscle

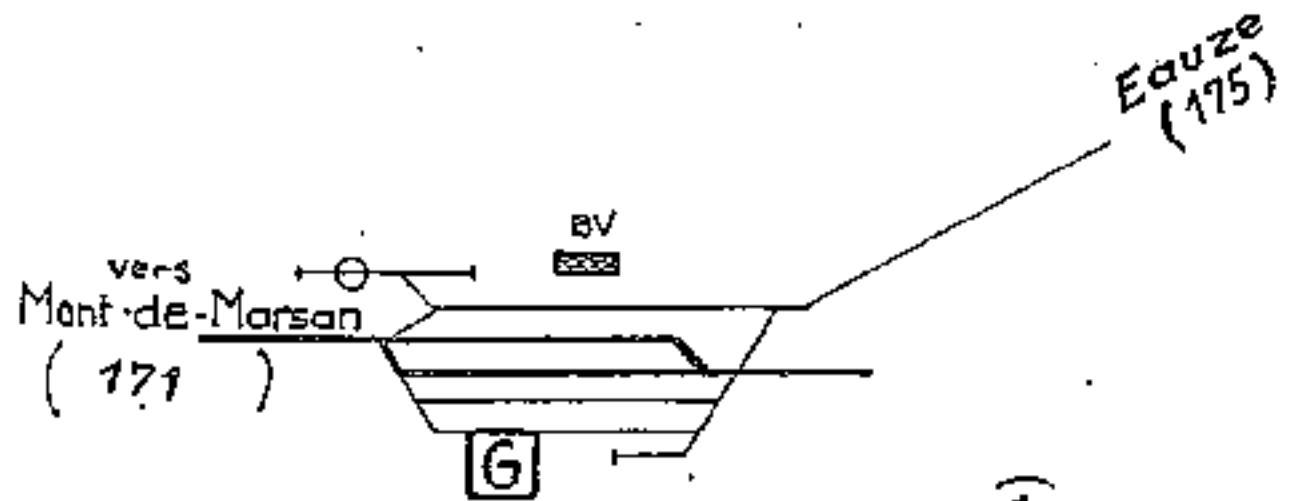

Abords de Vic-Bigorre



Ligne de Morcenx à Tarbes

Section Riscle-Tarbes

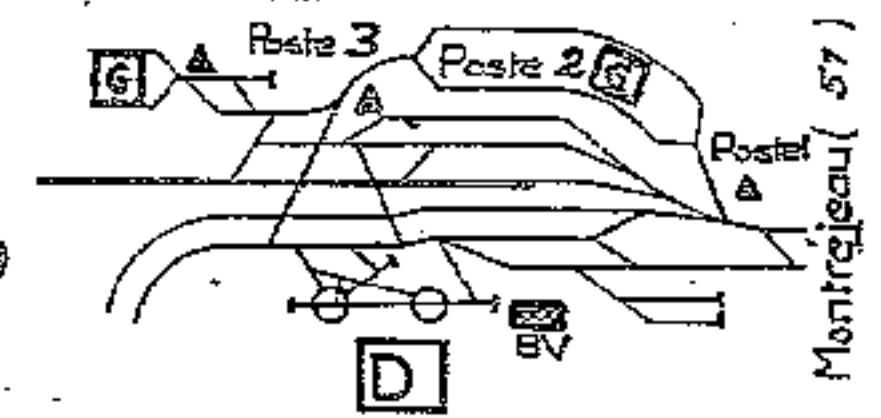
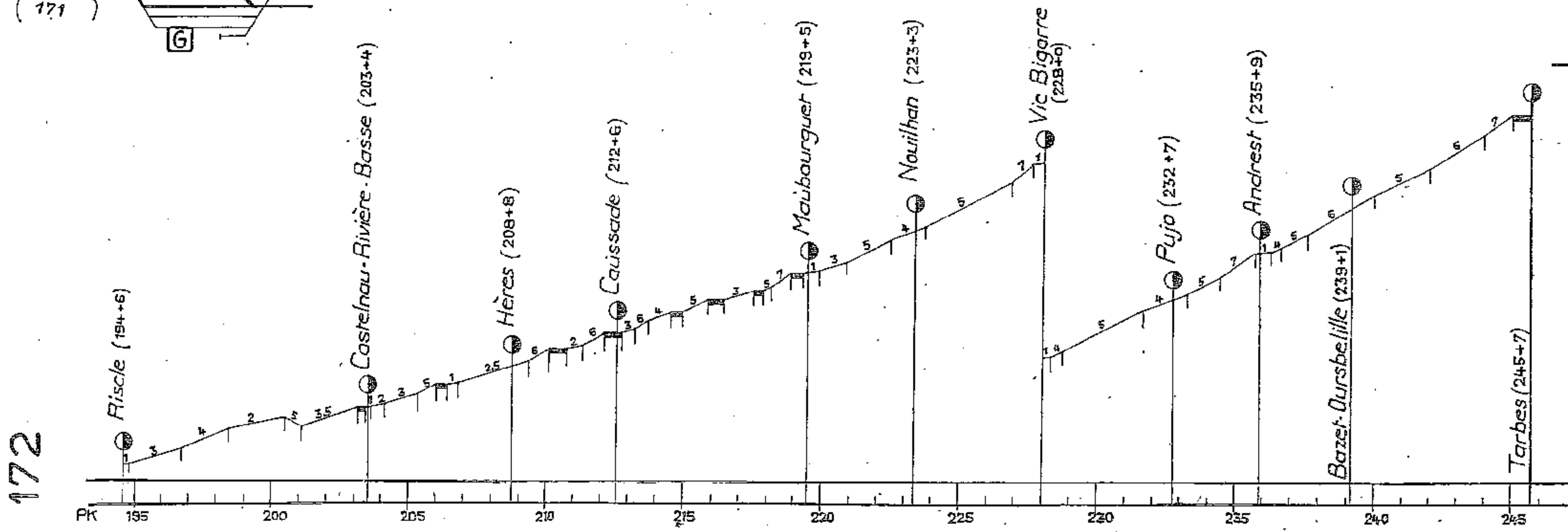

Abords de Tarbes

172

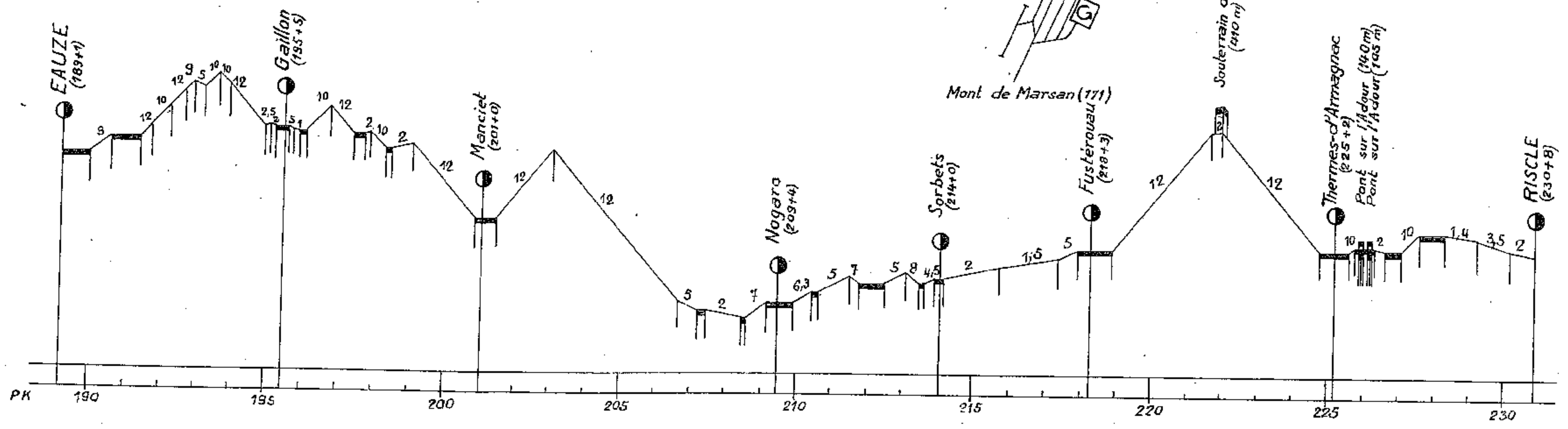
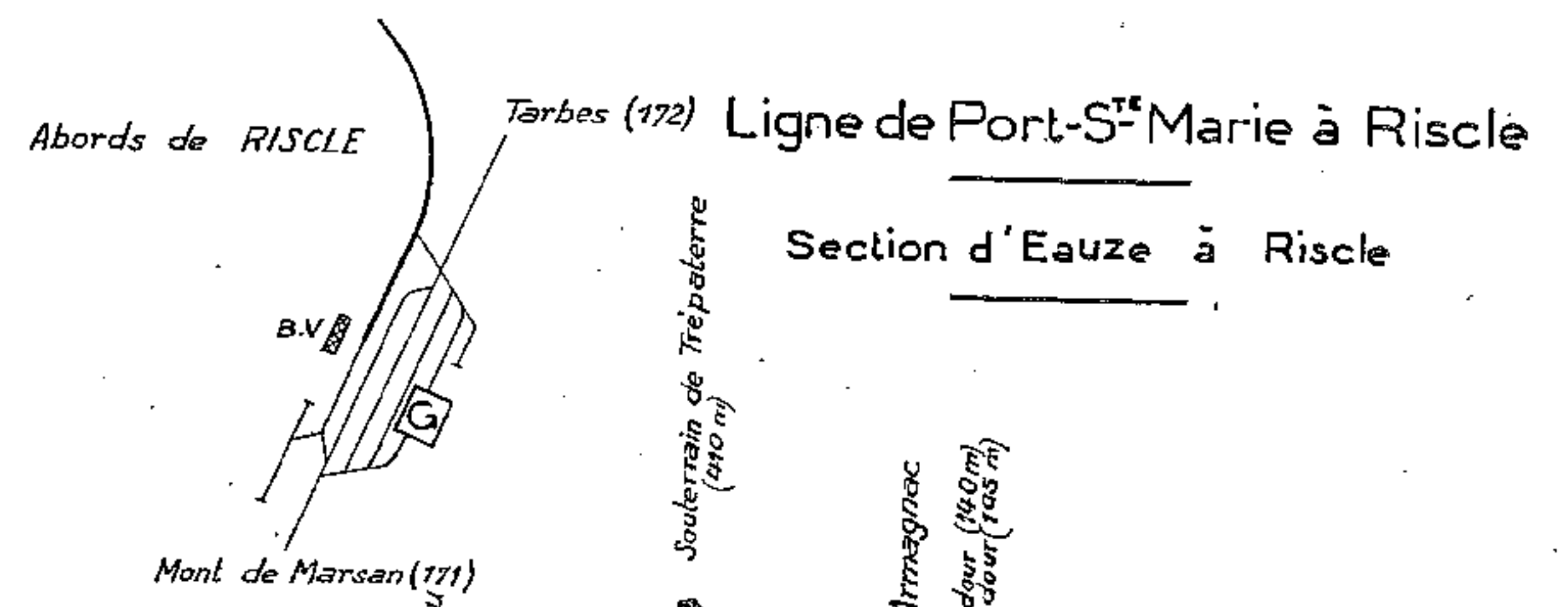
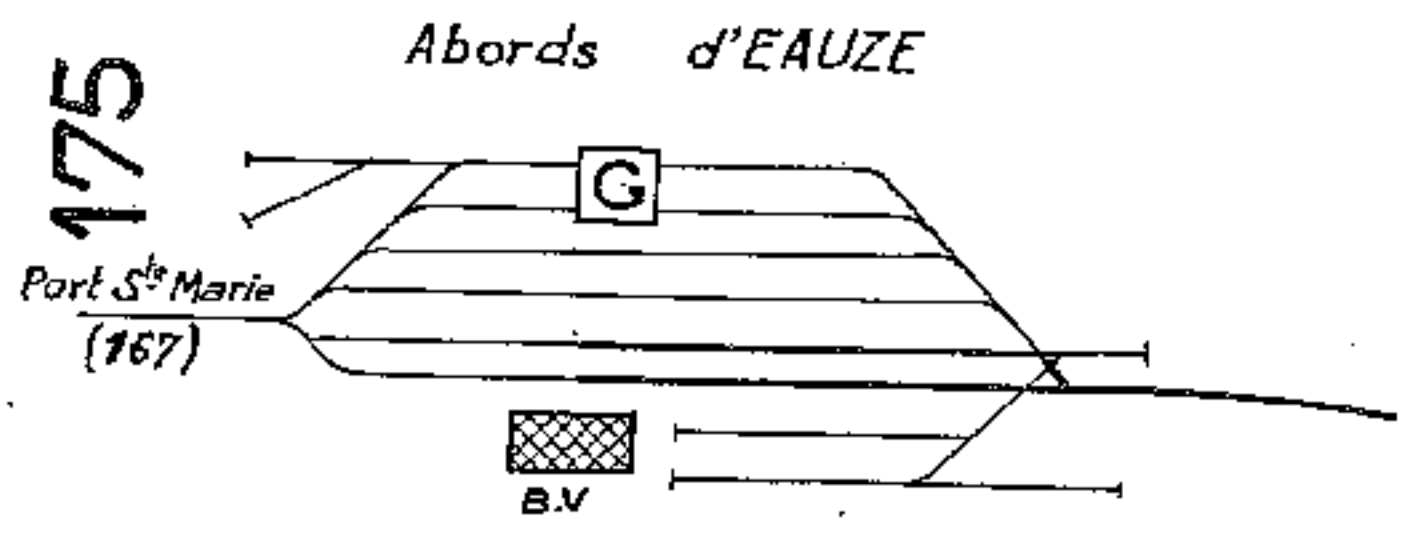

Ligne de S^t Sever à Hagetmau

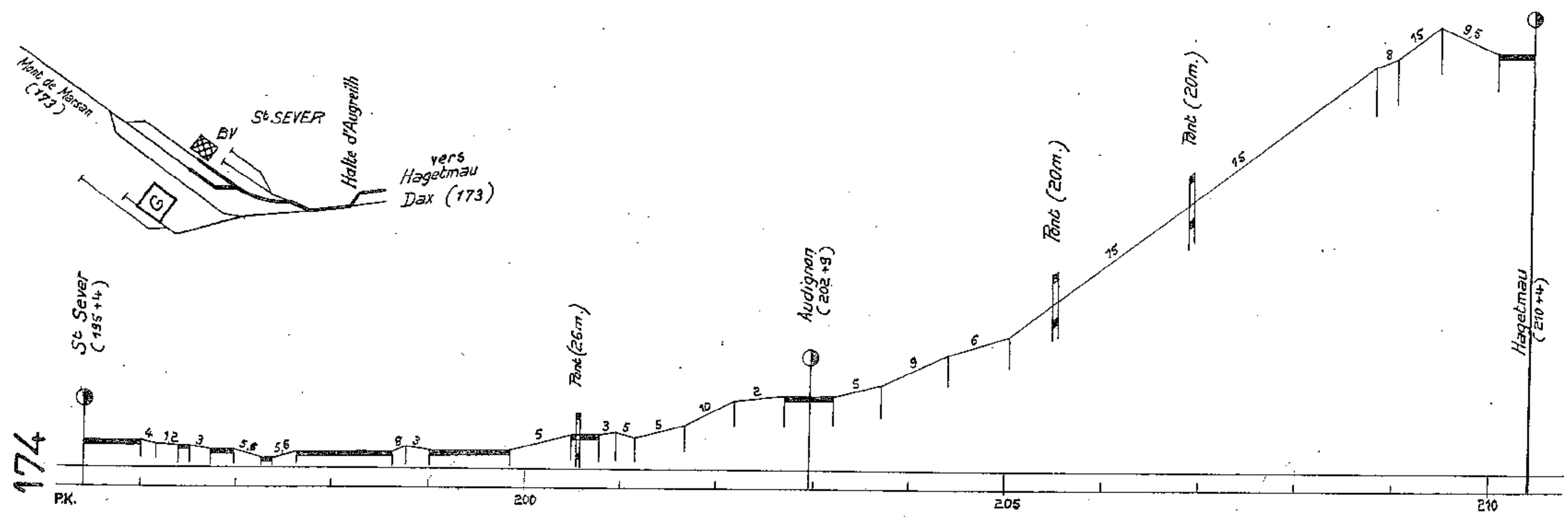

AUCH

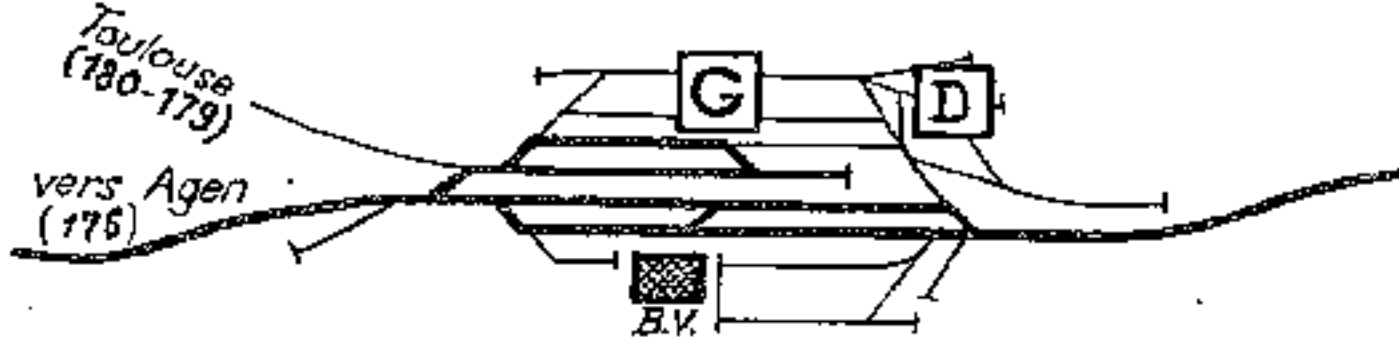

Ligne d'Agen à Vic-Bigorre

Section d'Auch à Vic-Bigorre

VIC-BIGORRE

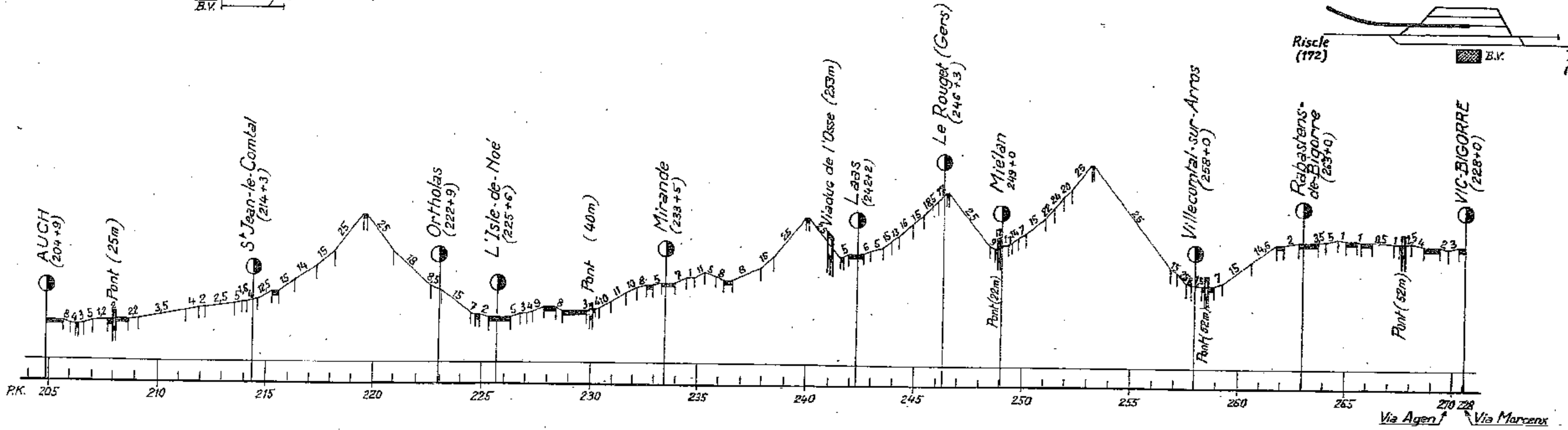

AGEN

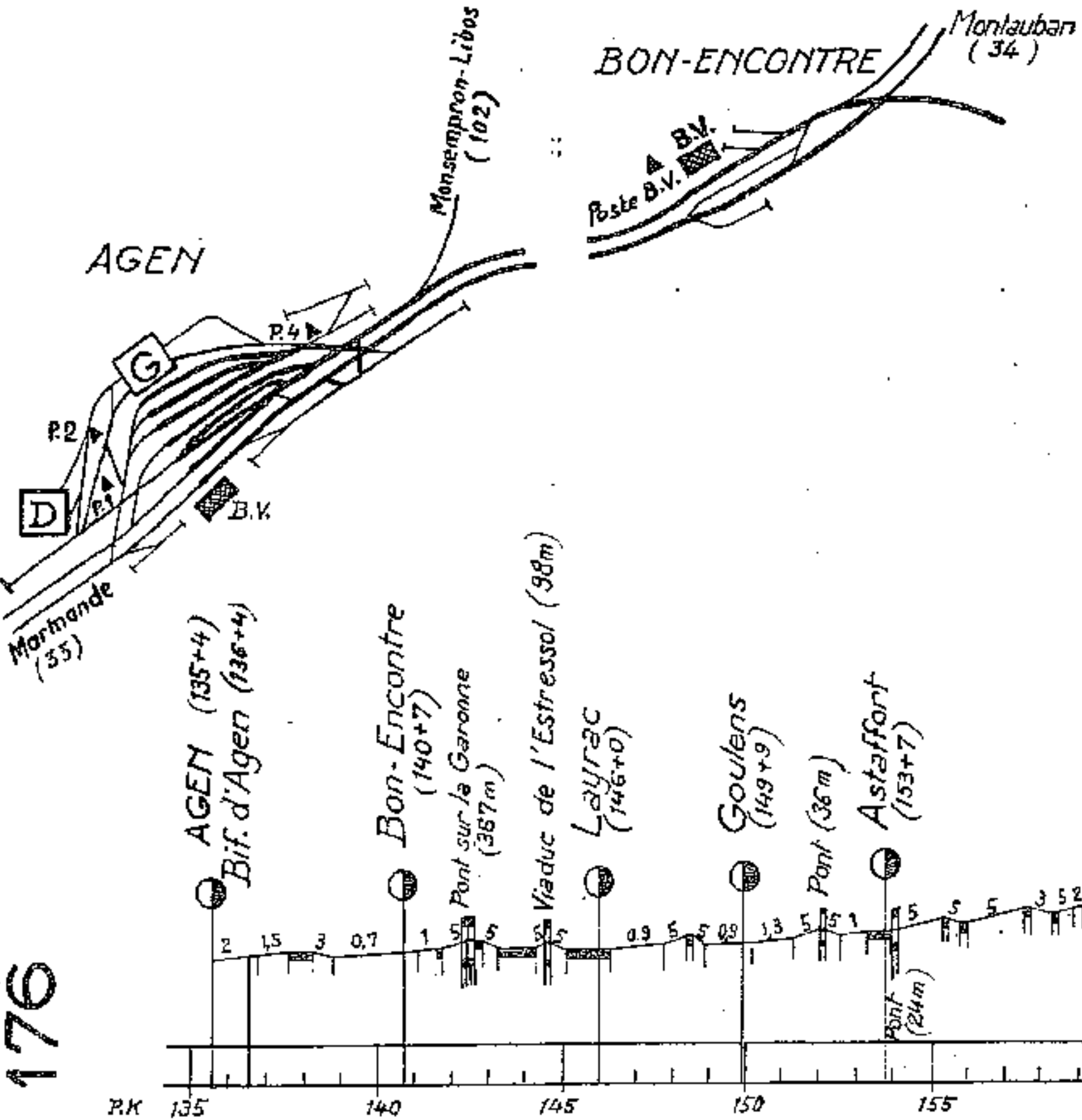

Ligne d'Agen à Vic-Bigorre

Section d'Agen à Auch

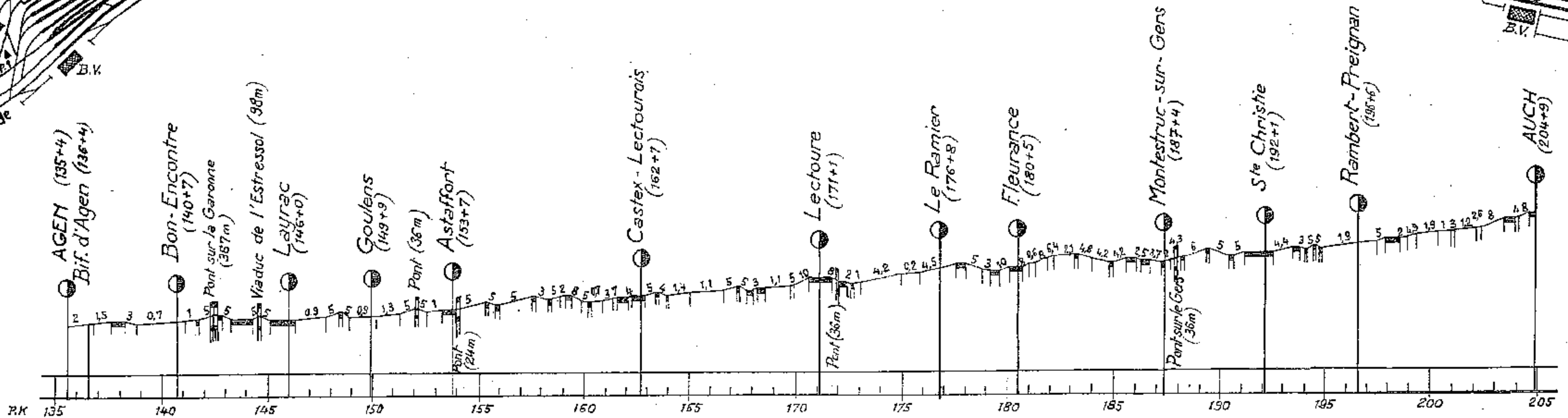
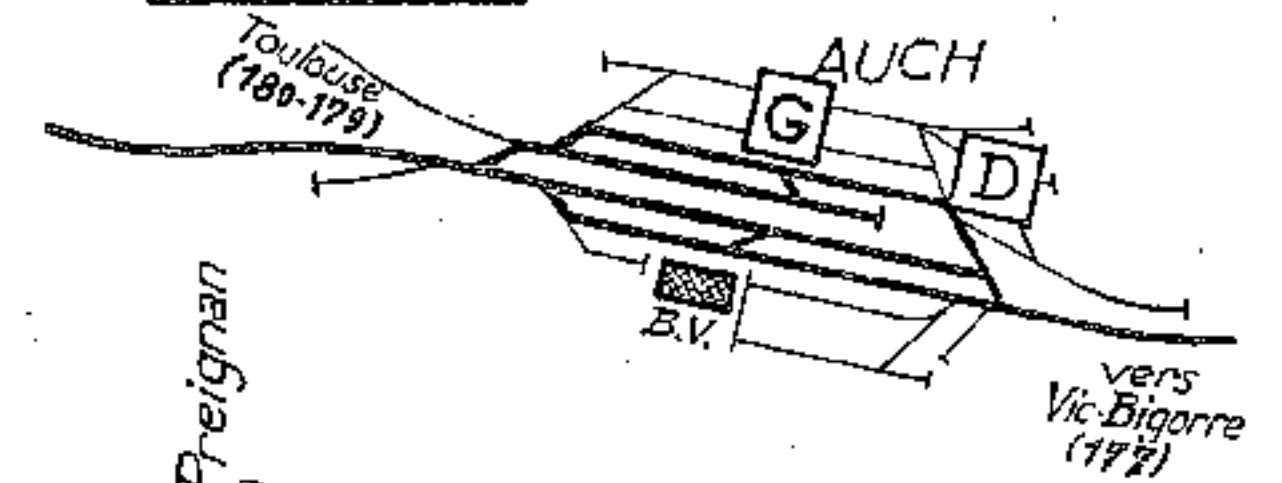

Ligne de Toulouse à Auch
Section de Toulouse à l'Isle-Jourdain

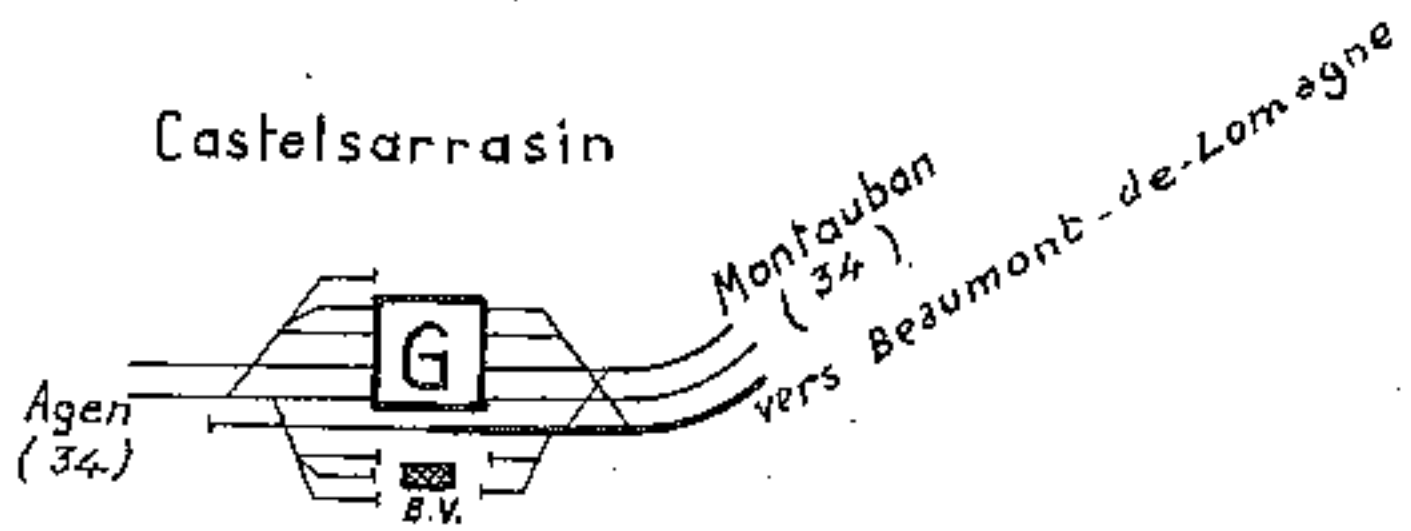
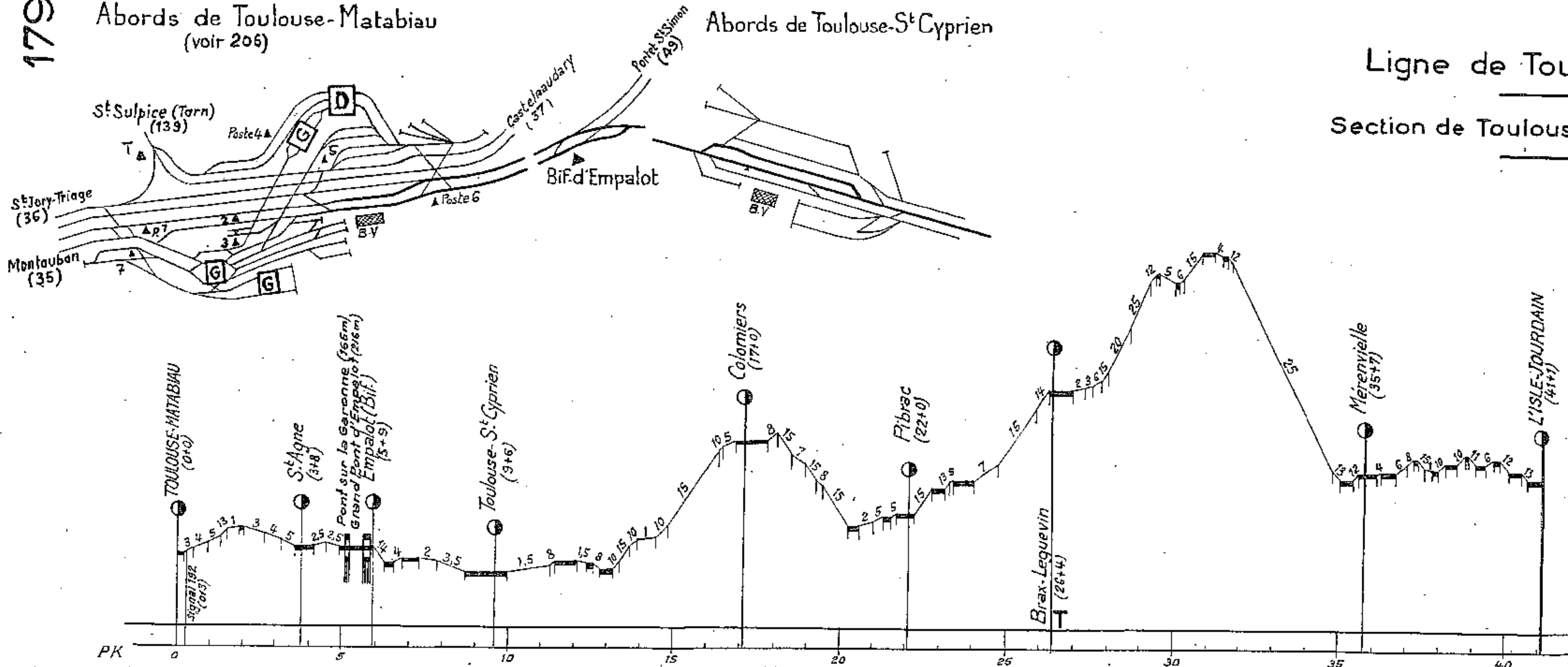

Ligne de Castelsarrasin à
Beaumont de Lomagne

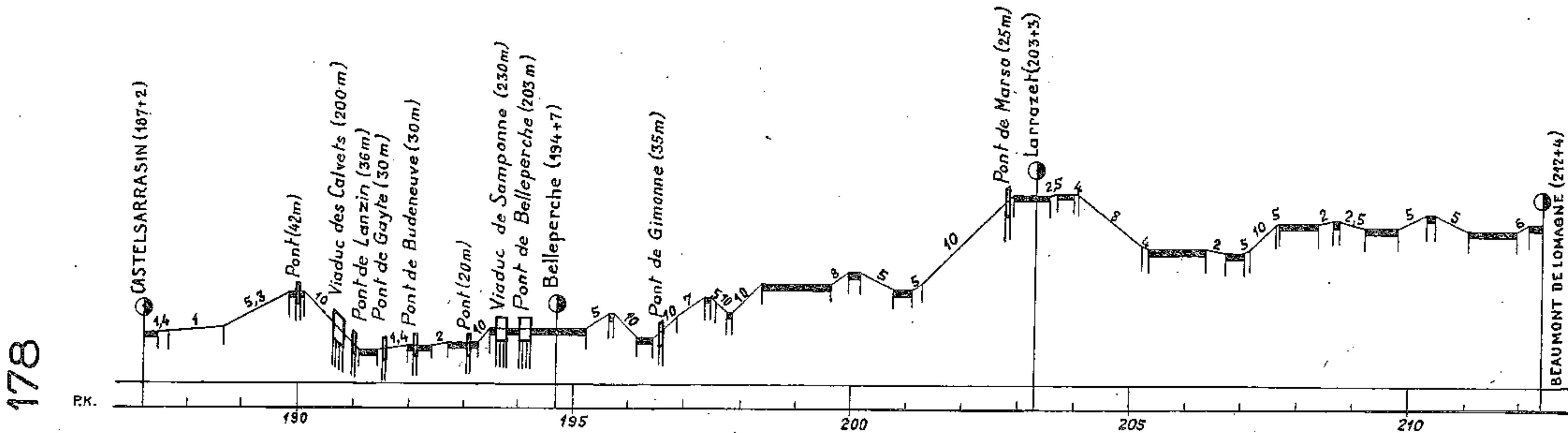

Bifurcation de la Nive

Ligne du Poste de la Nive
à Bayonne - Allées Marines

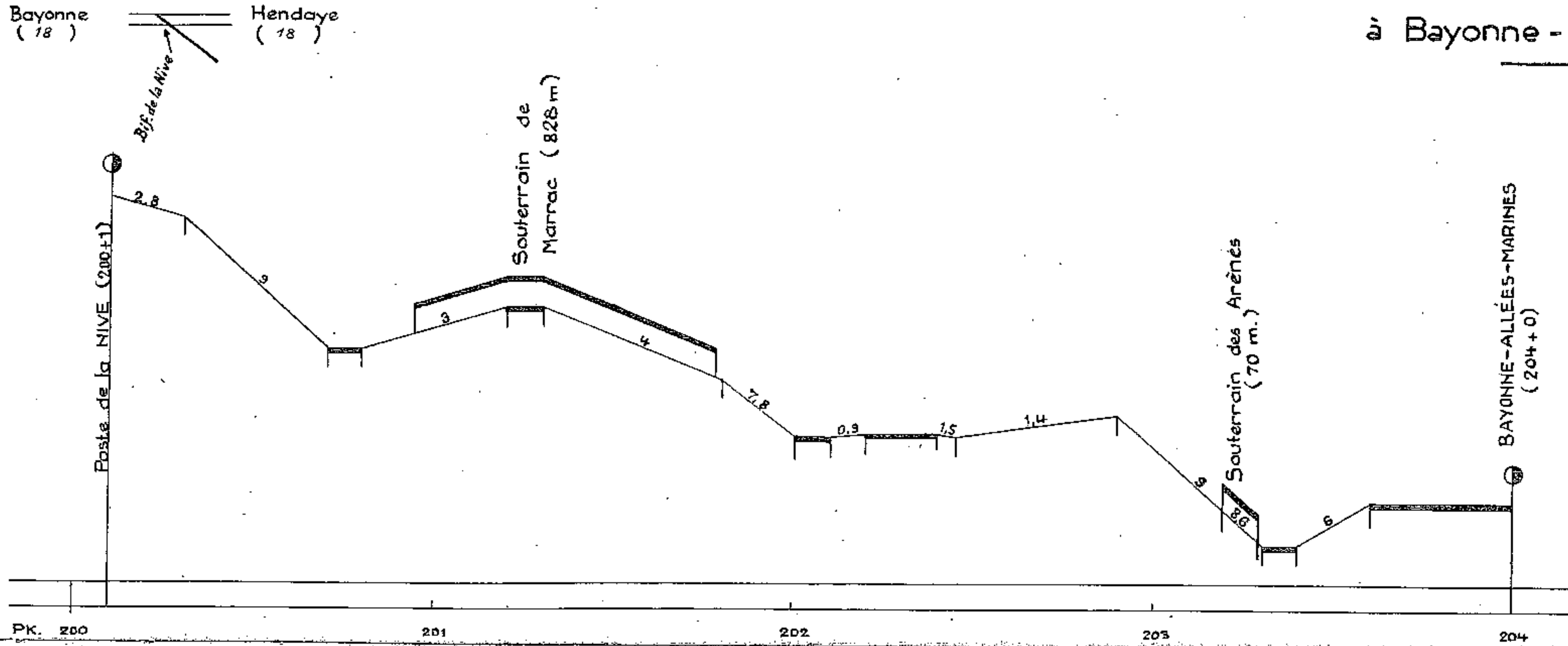

Ligne de Toulouse à Auch
Section de l'Isle-Jourdain à Auch

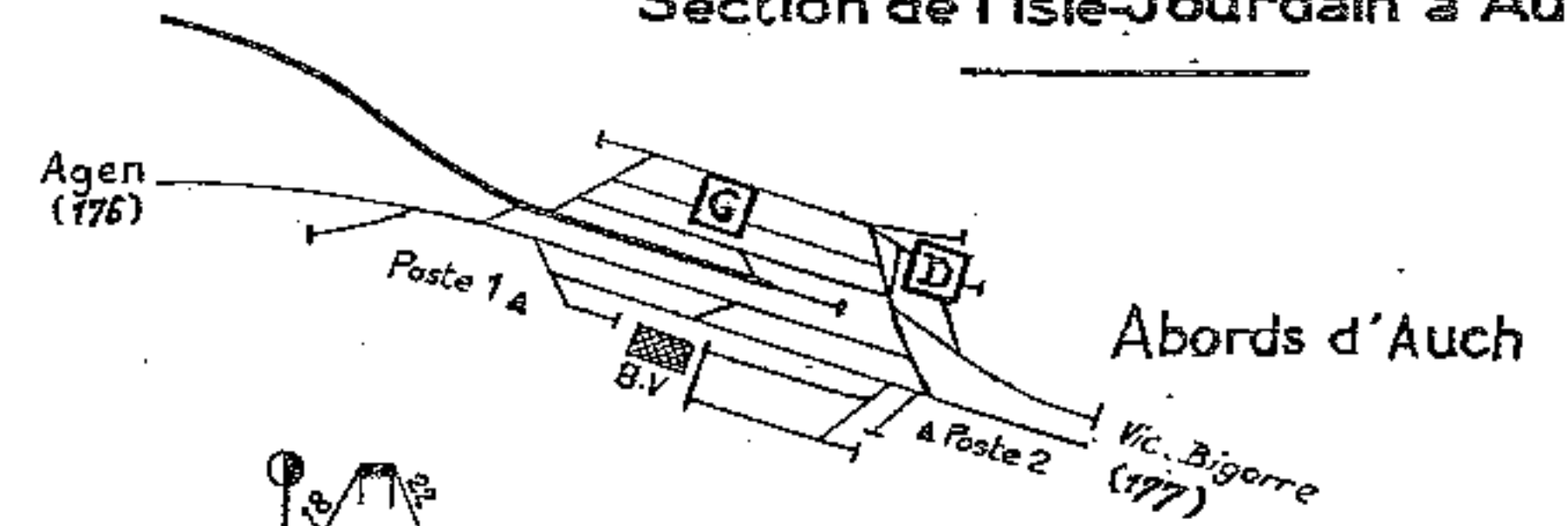
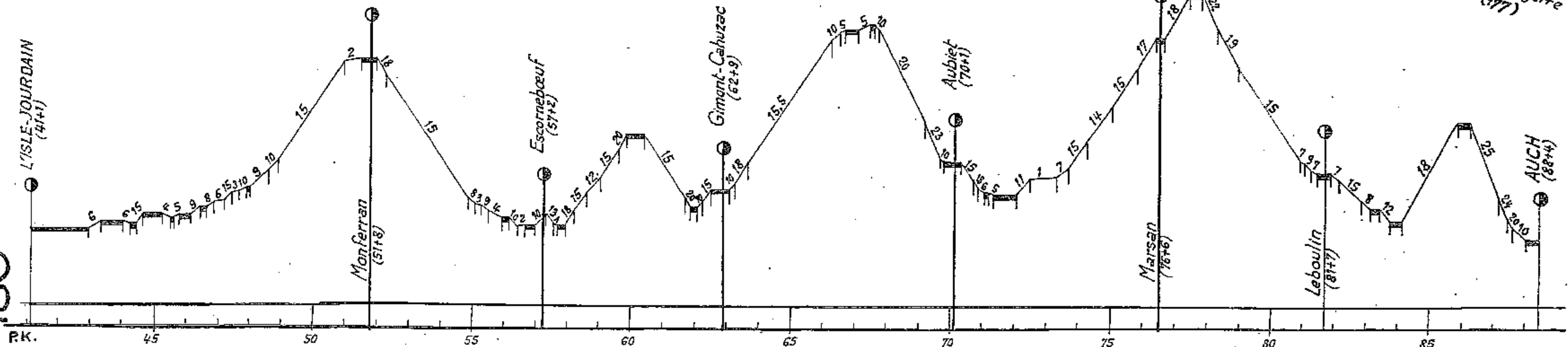

Abords de Bayonne

Abords d'Ossès-S^t-Martin-d'Arrossa

Ligne de Bayonne à S^t Jean Pied-de-Port et d'Ossès-S^t Martin d'Arrossa à S^t Etienne de Baigorri

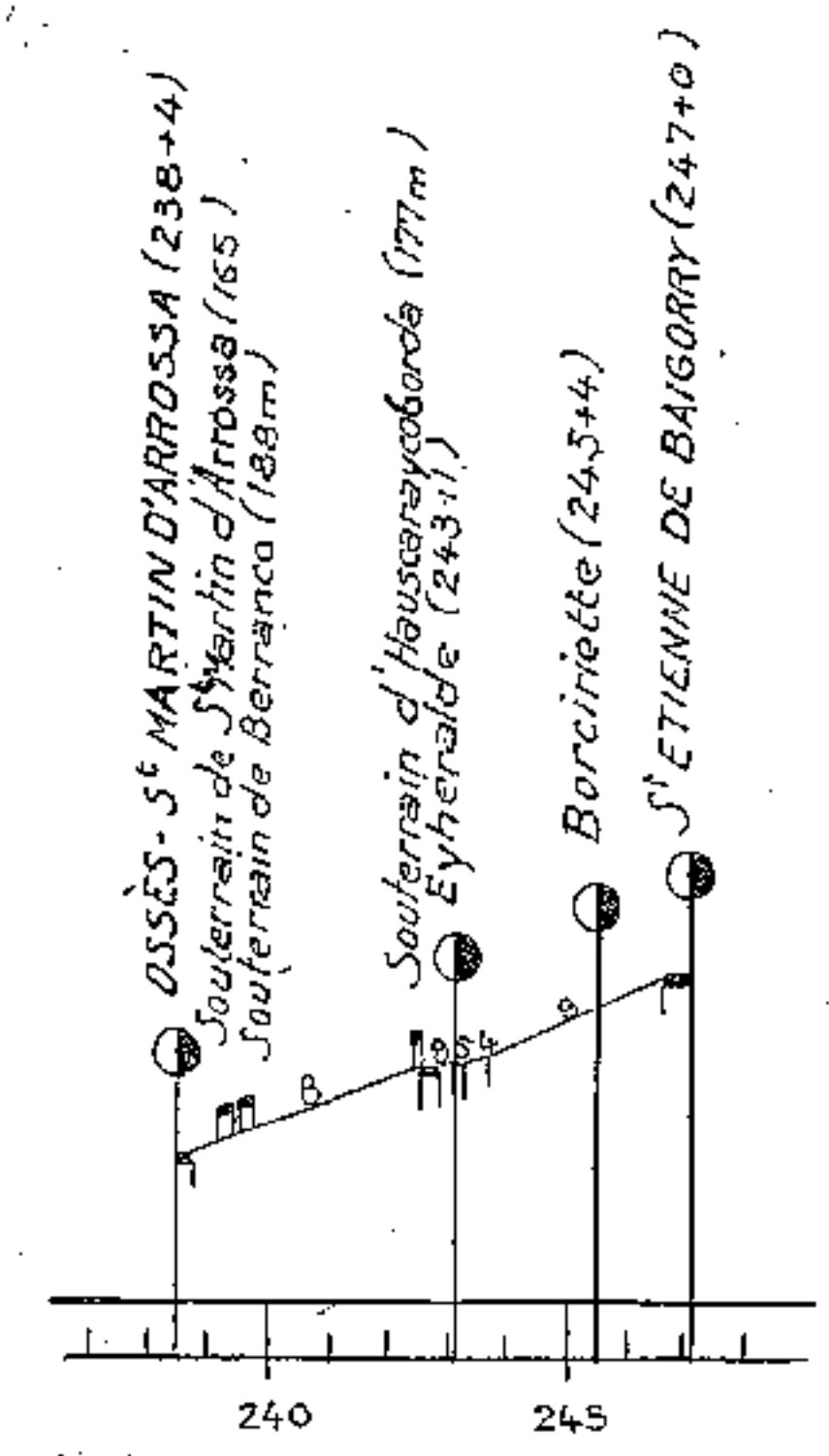
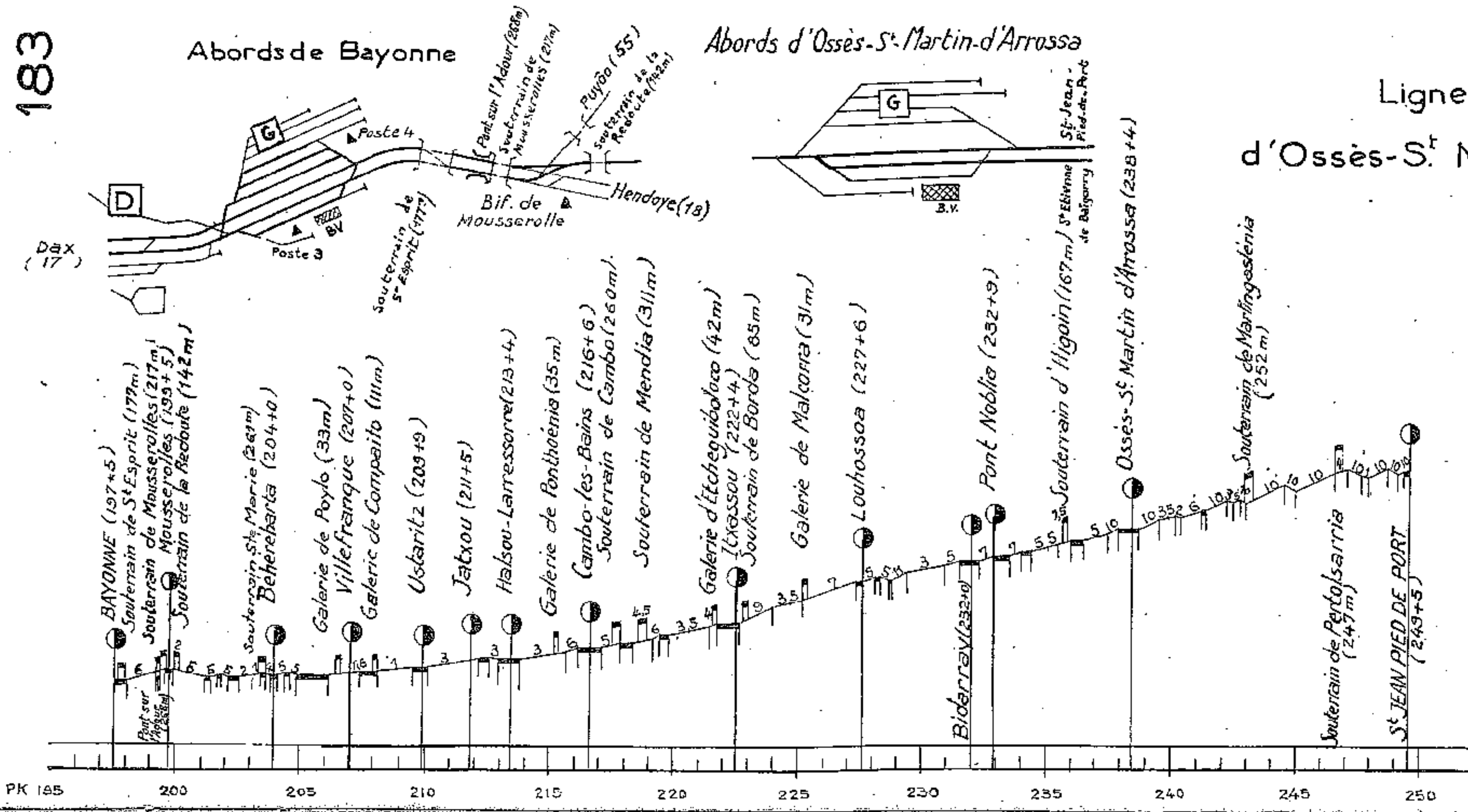

Abords de Biarritz-la-Négresse

Ligne de Biarritz-la-Négresse

à Biarritz-Ville

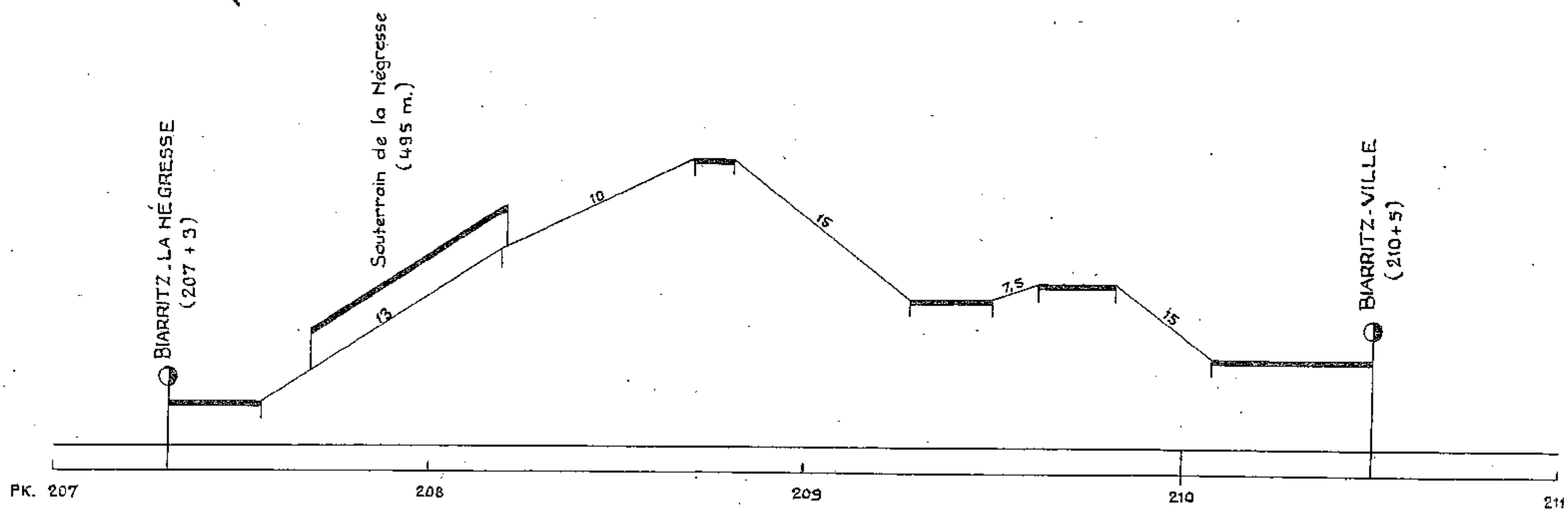
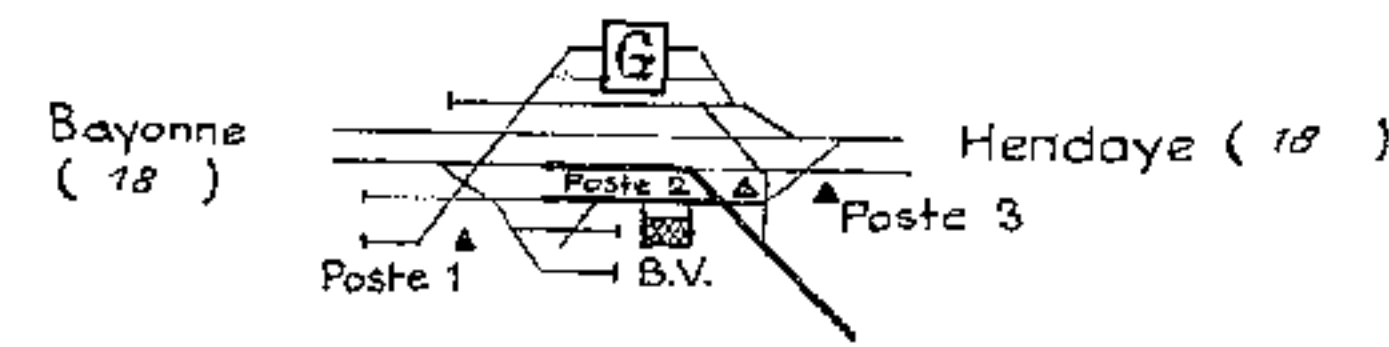

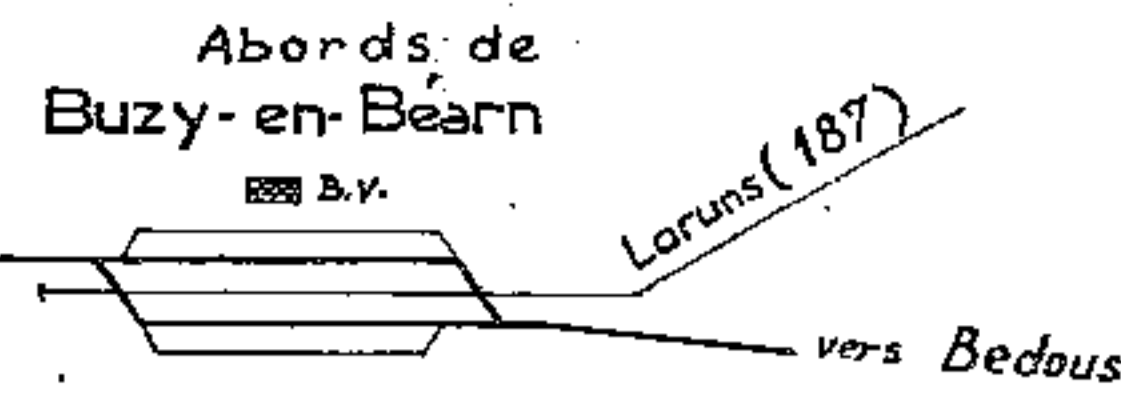
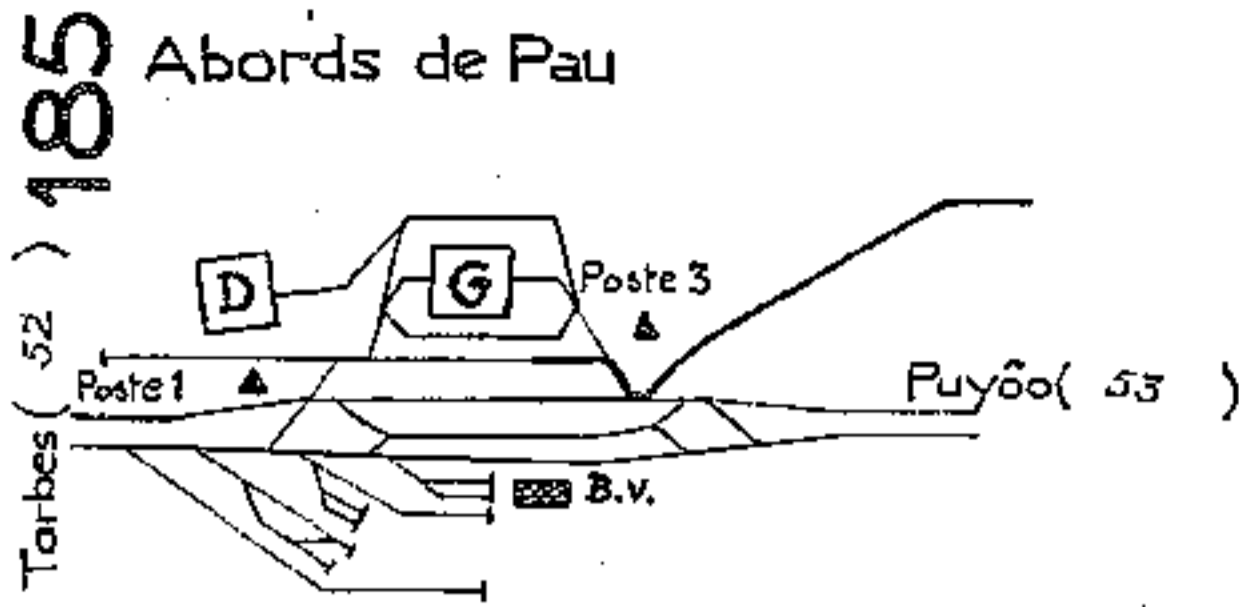

Ligne de Pau à Canfranc
Section Pau-Bedous



Abords de Puyôo

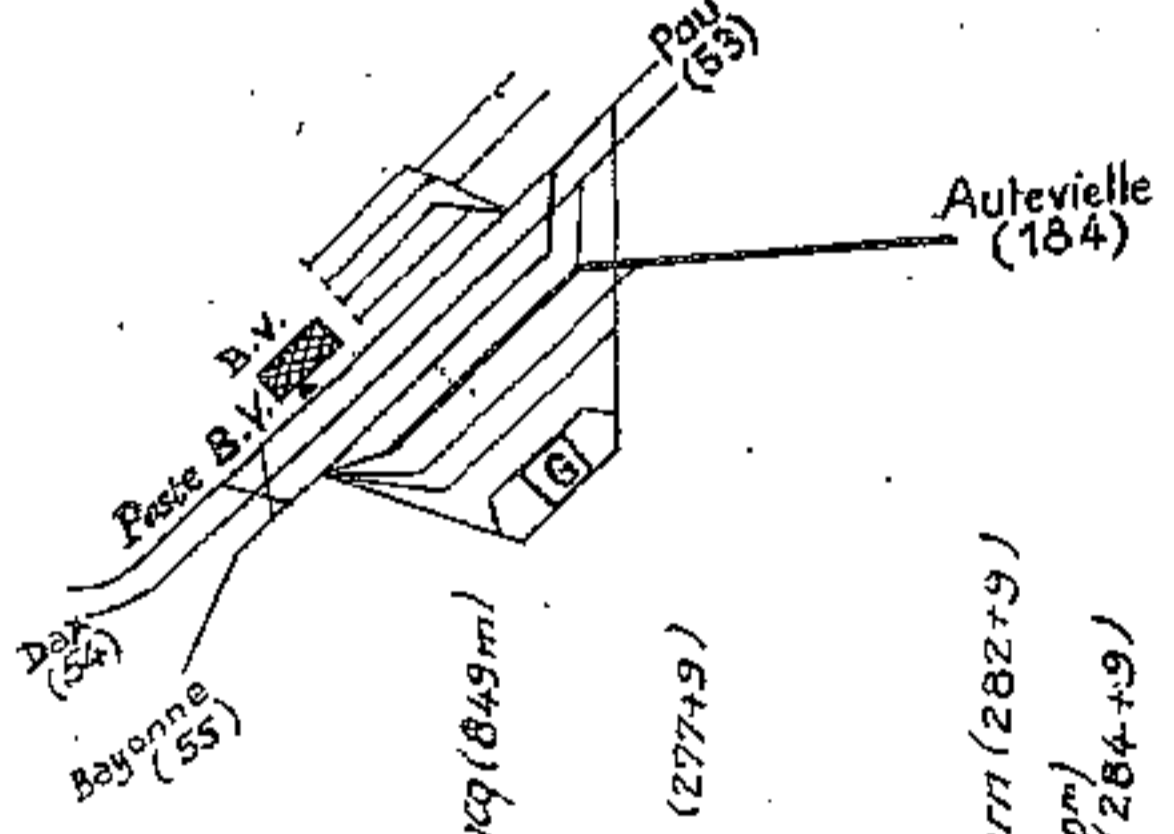

Abords d'Autevielle

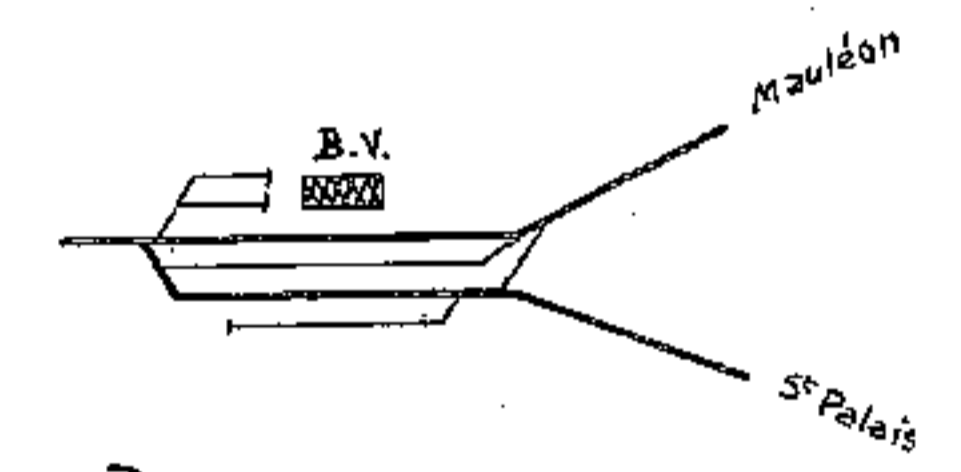

Lignes de Puyôo à Mauléon et
d'Autevielle à St Palais

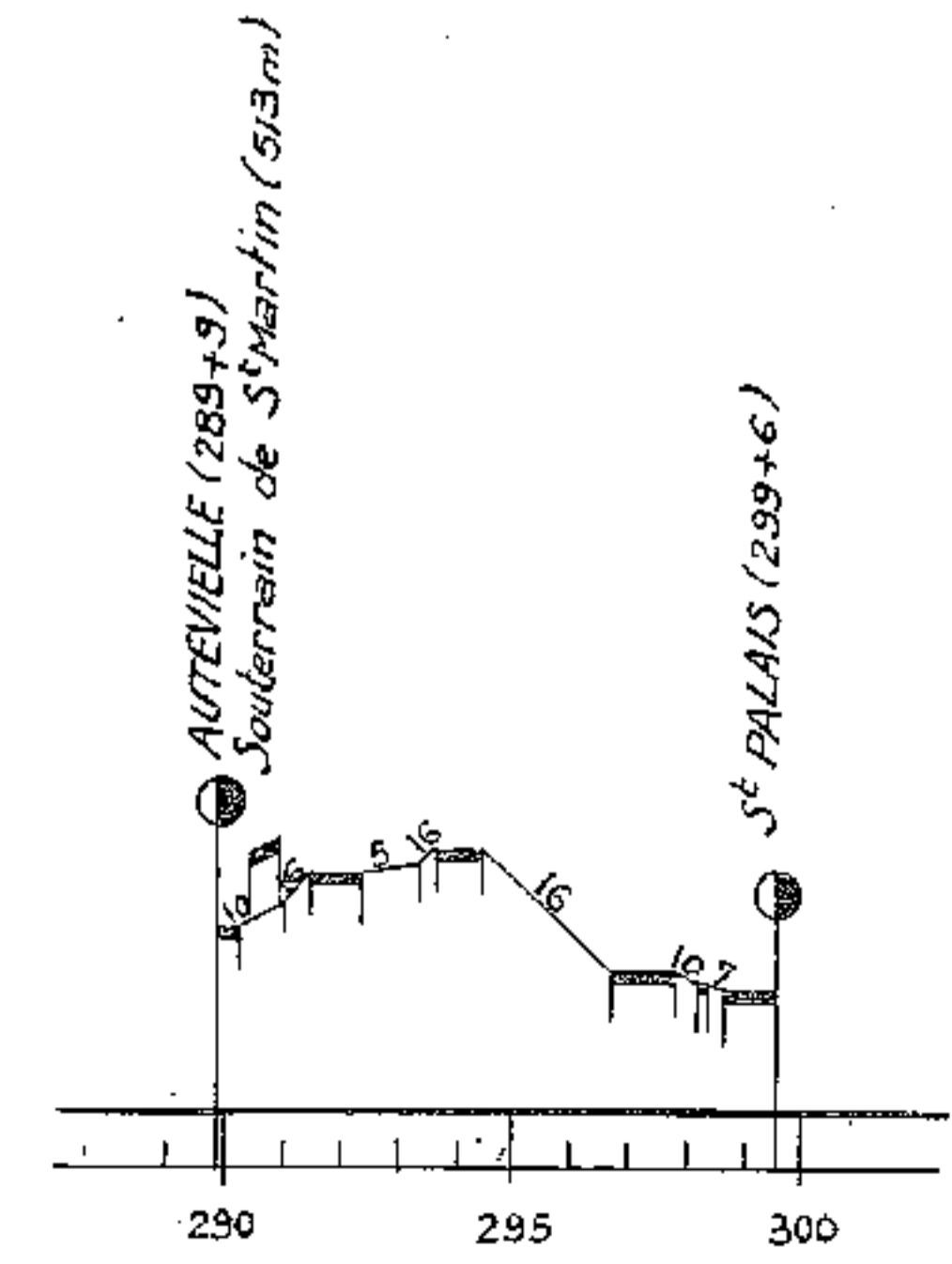
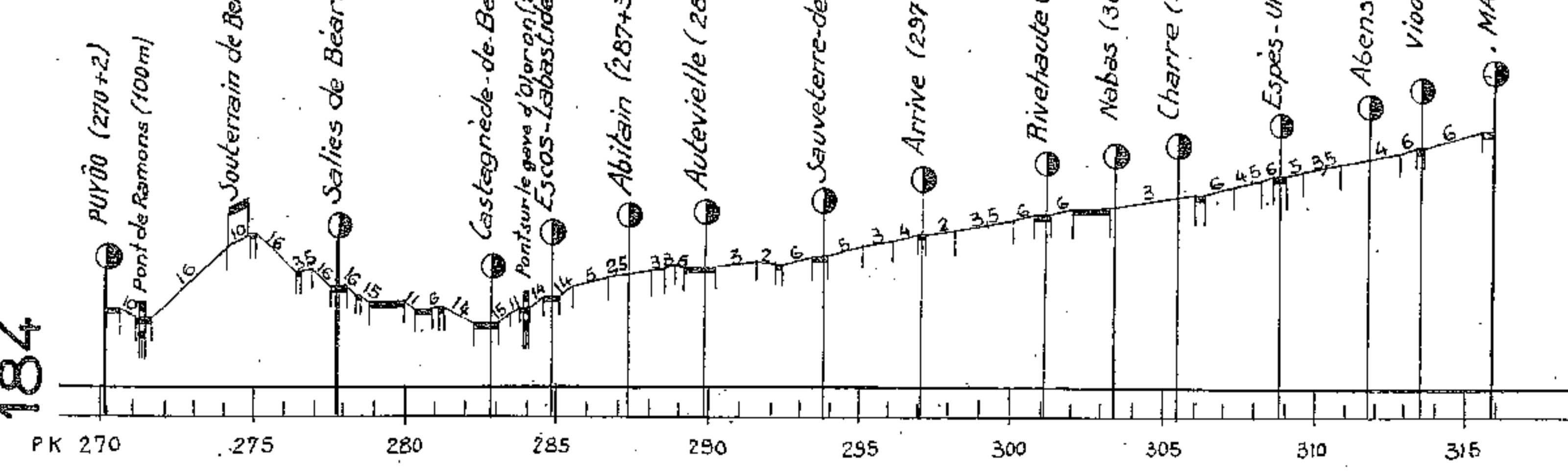

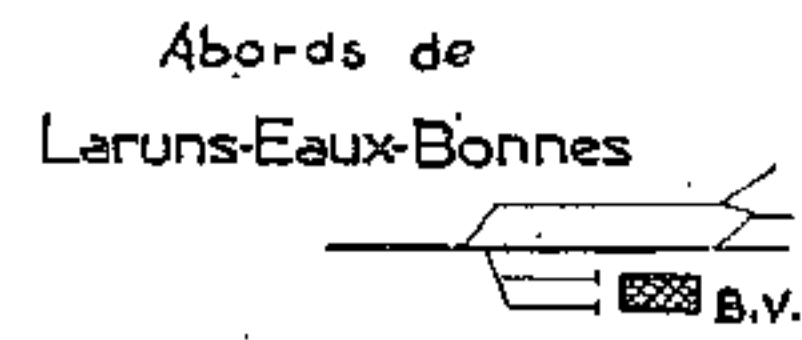
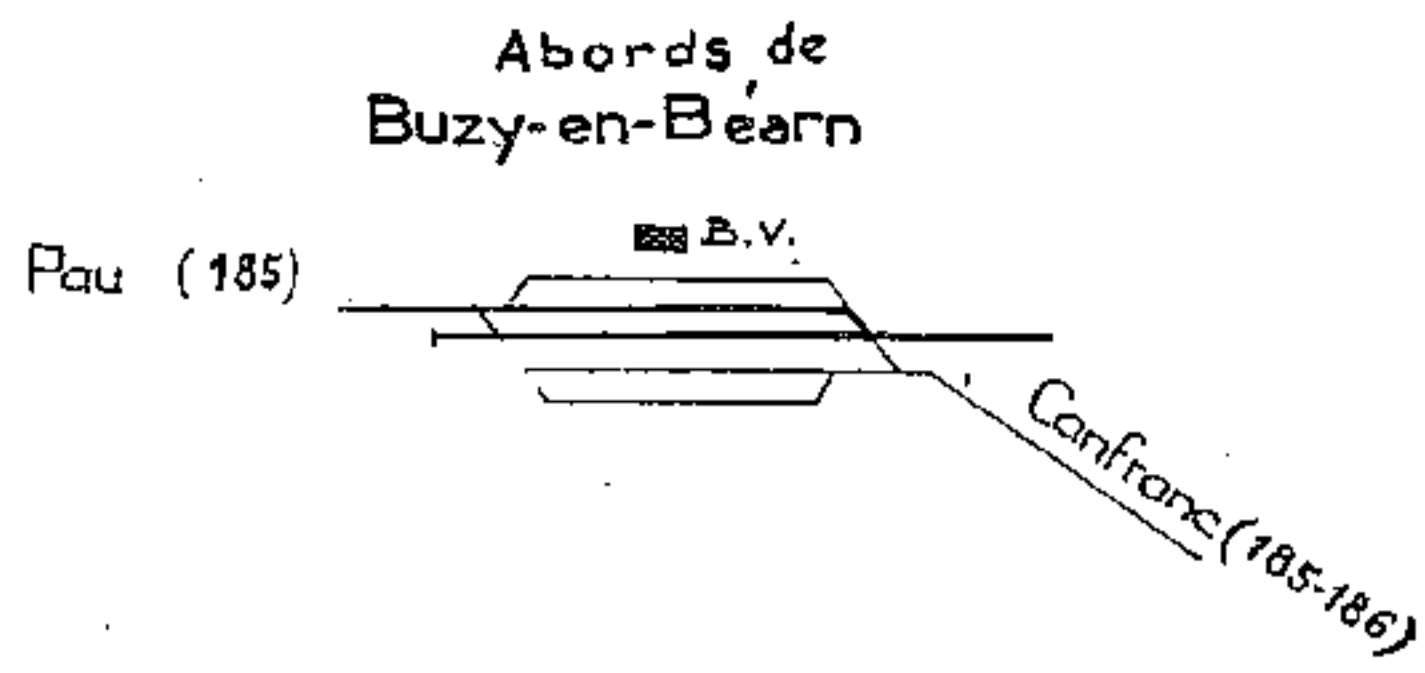

Ligne de Buzy-en-Bearn à Laruns-Eaux-Bonnes

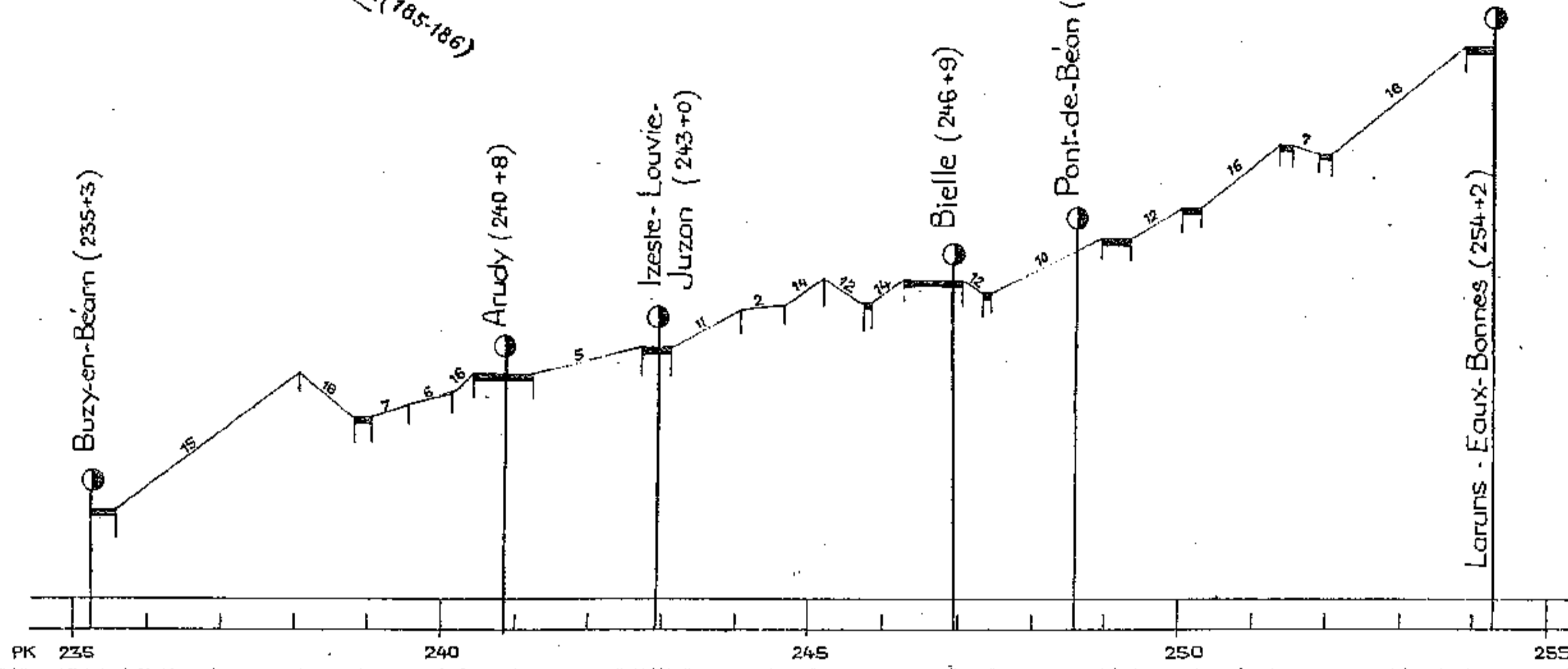

Ligne de Pau à Canfranc

Section Bedous-Canfranc

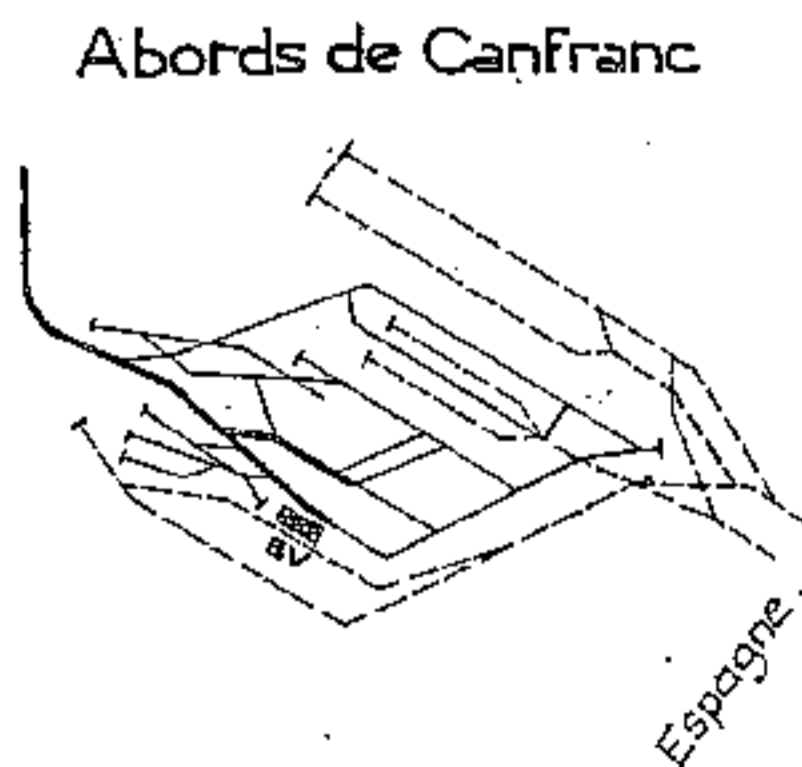
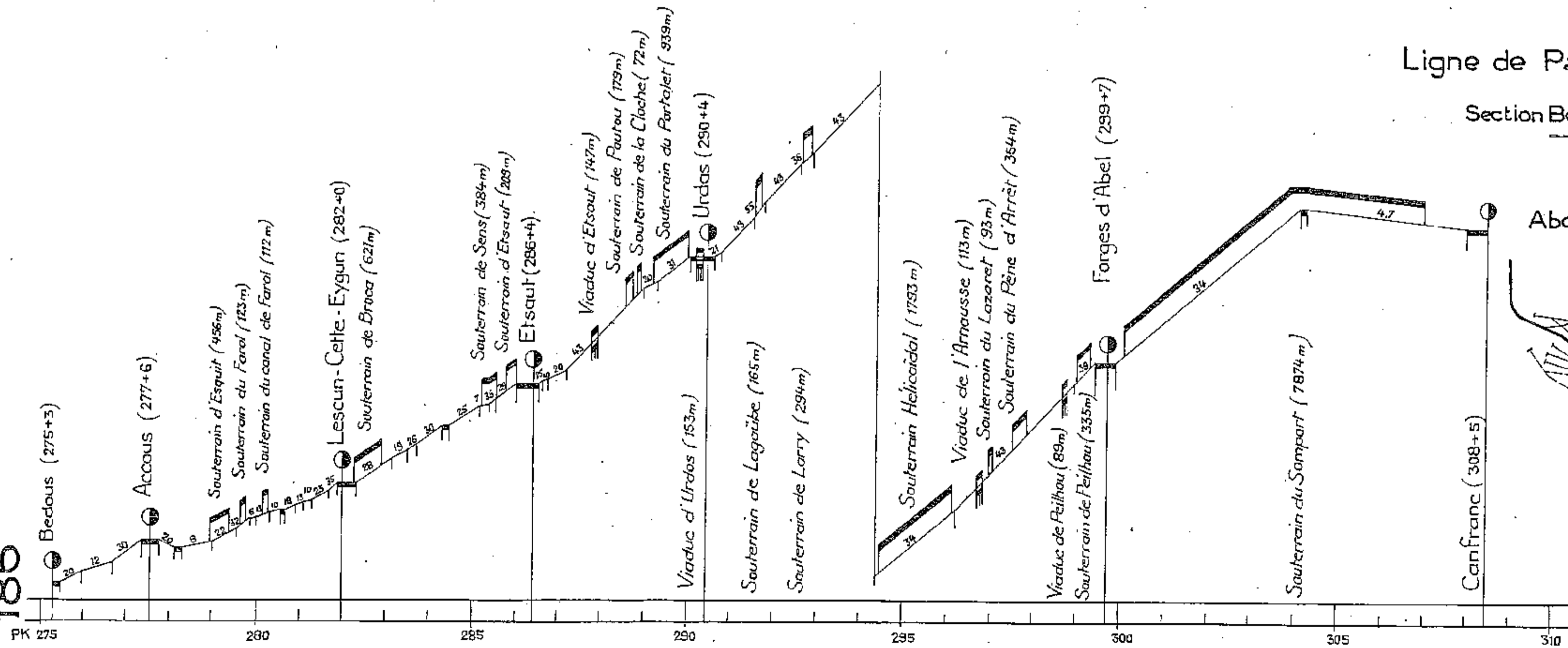

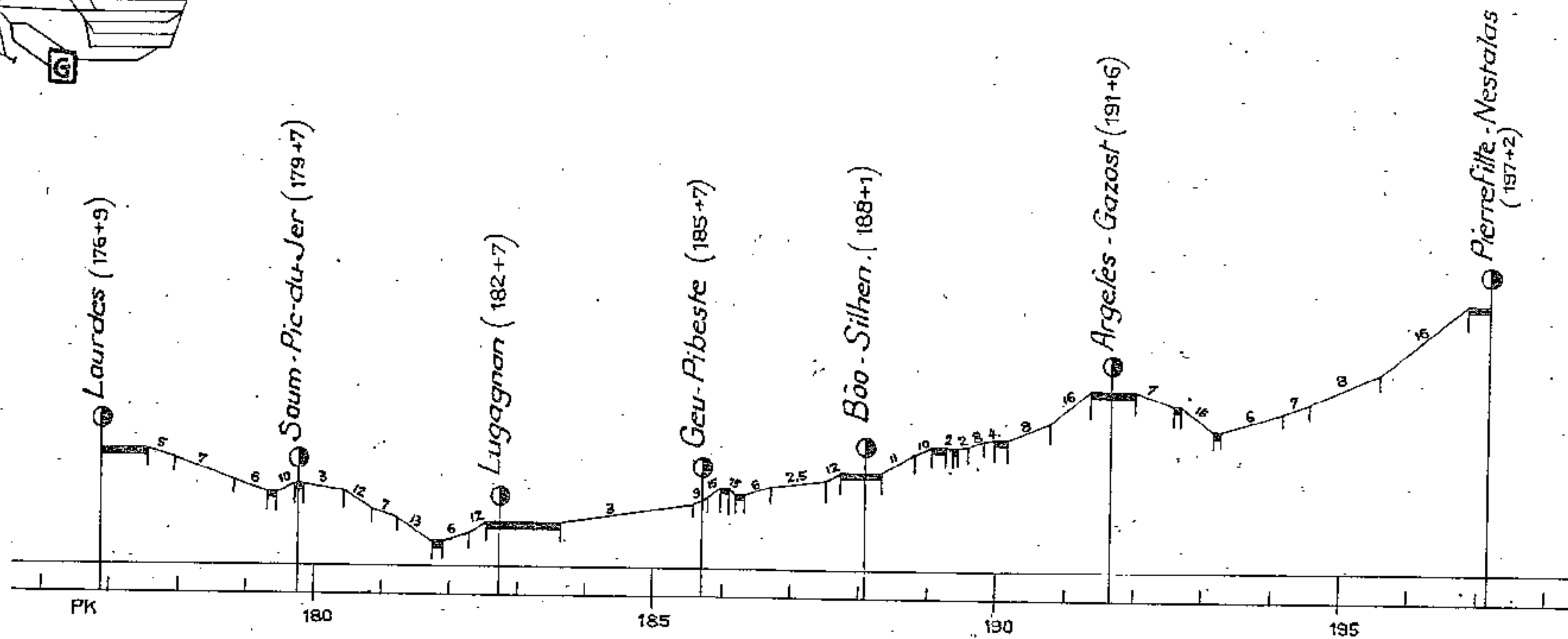
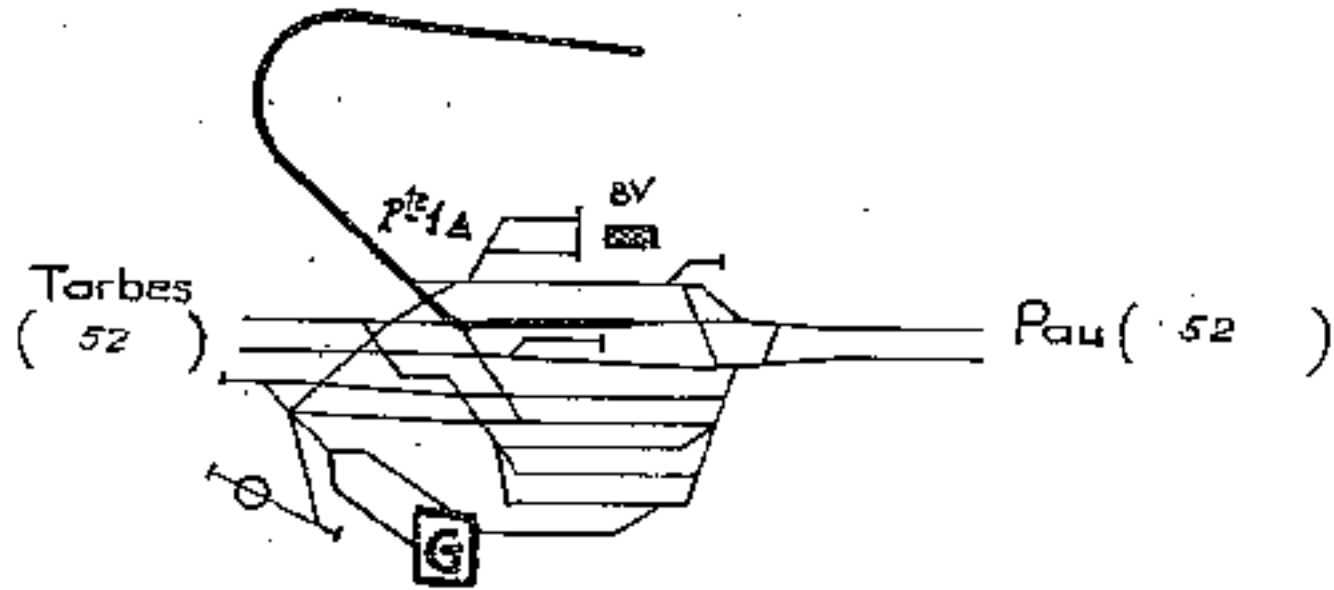
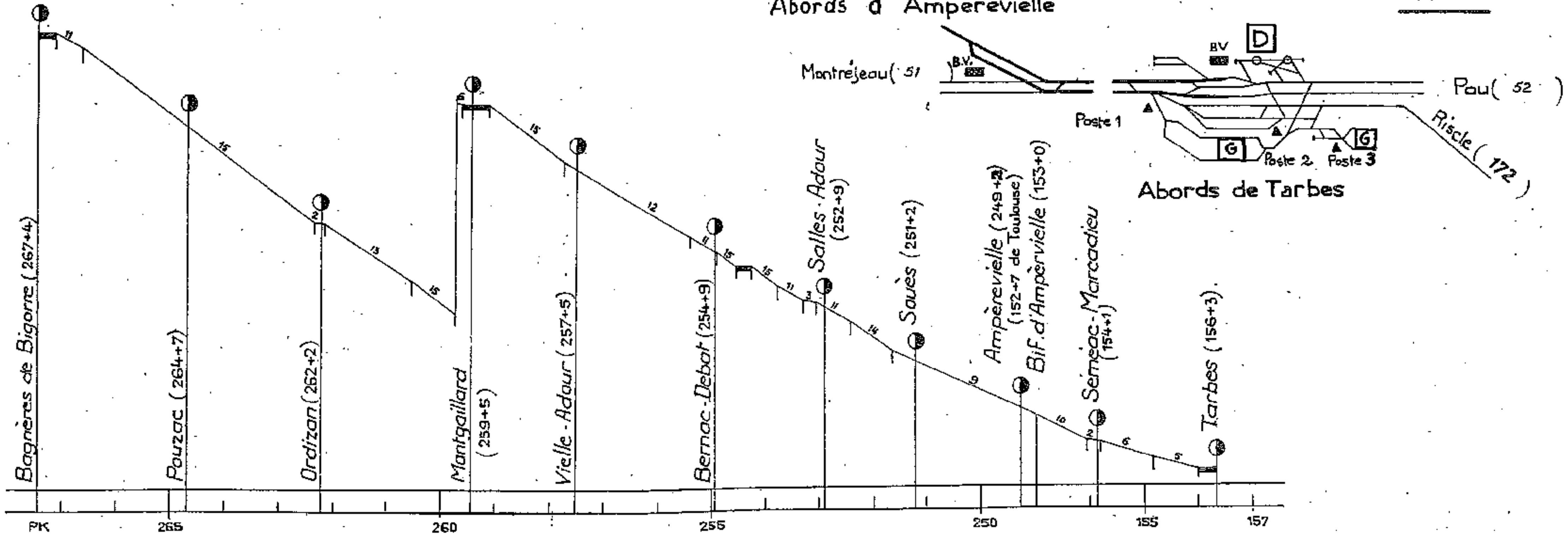
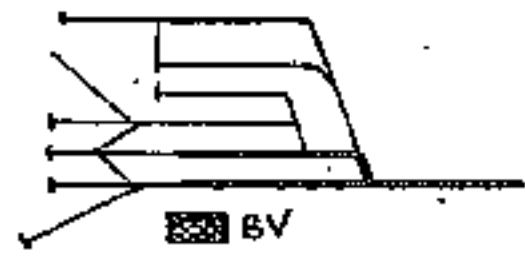

Abords de Montréjeau-Gourdan-Polignan

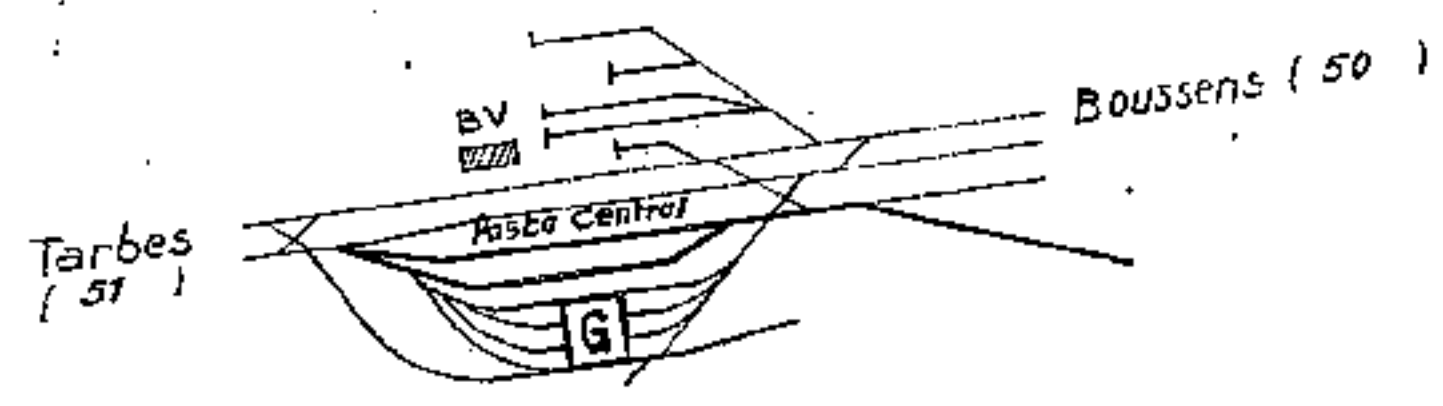

Ligne de Montréjeau-Gourdan-Polignan à Luchon

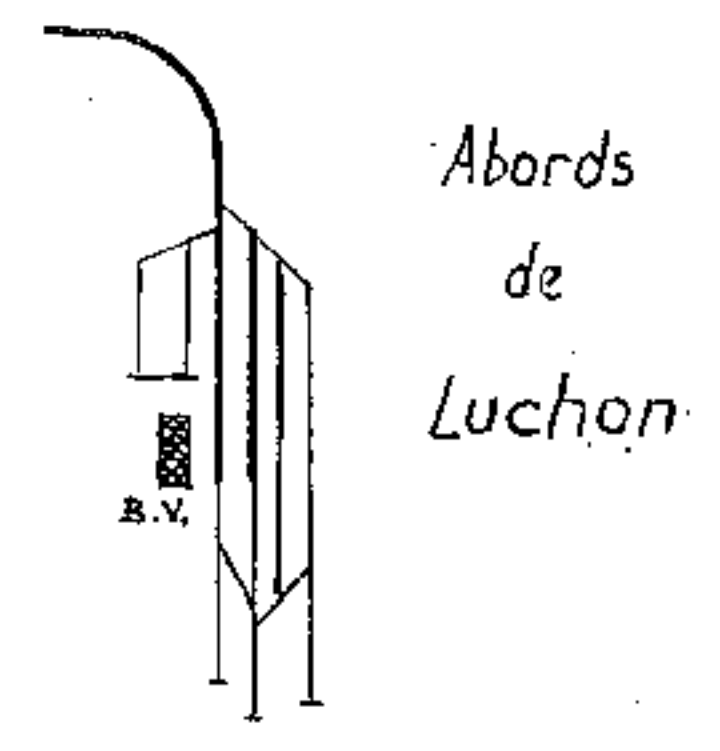
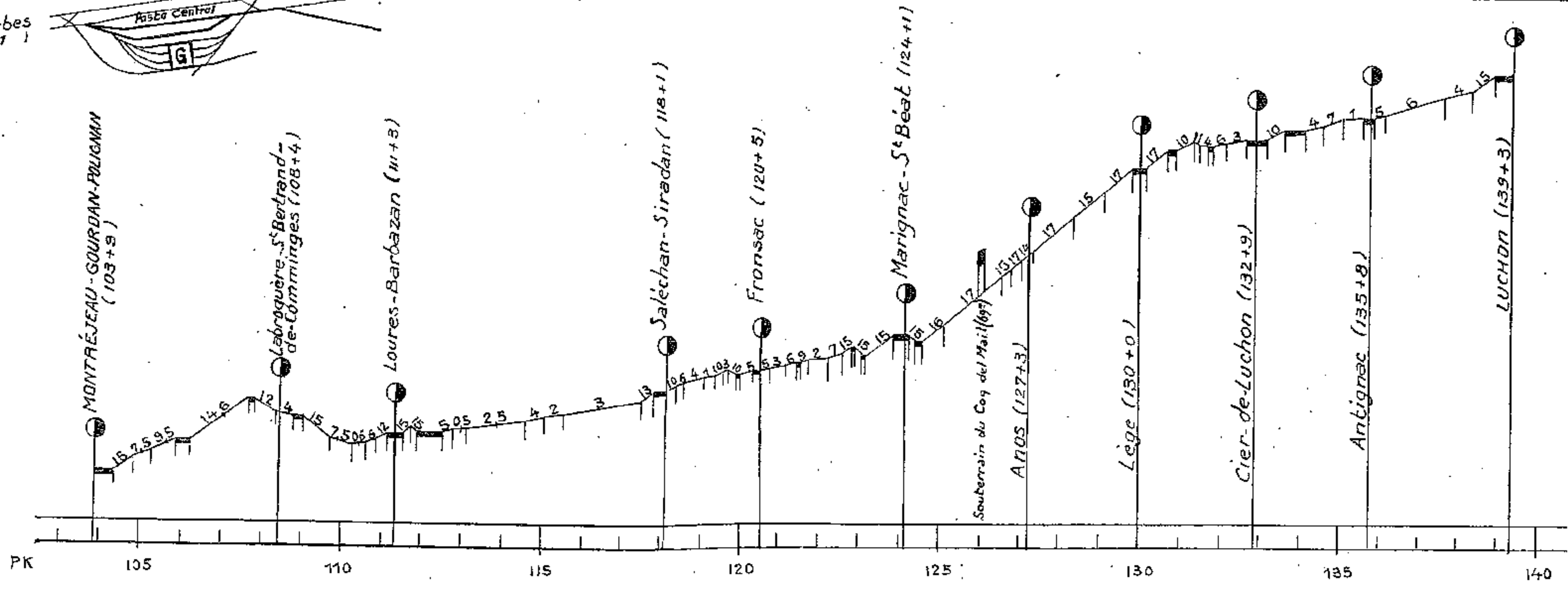

Abords de Luchon

Abords de Lannemezan

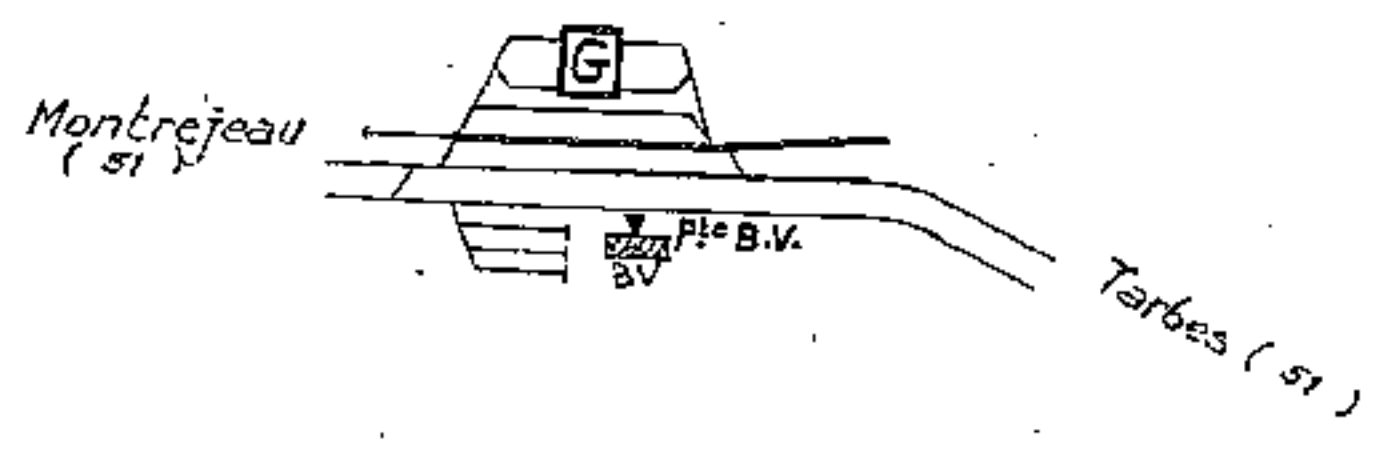

Ligne de Lannemezan à Arreau-Cadéac

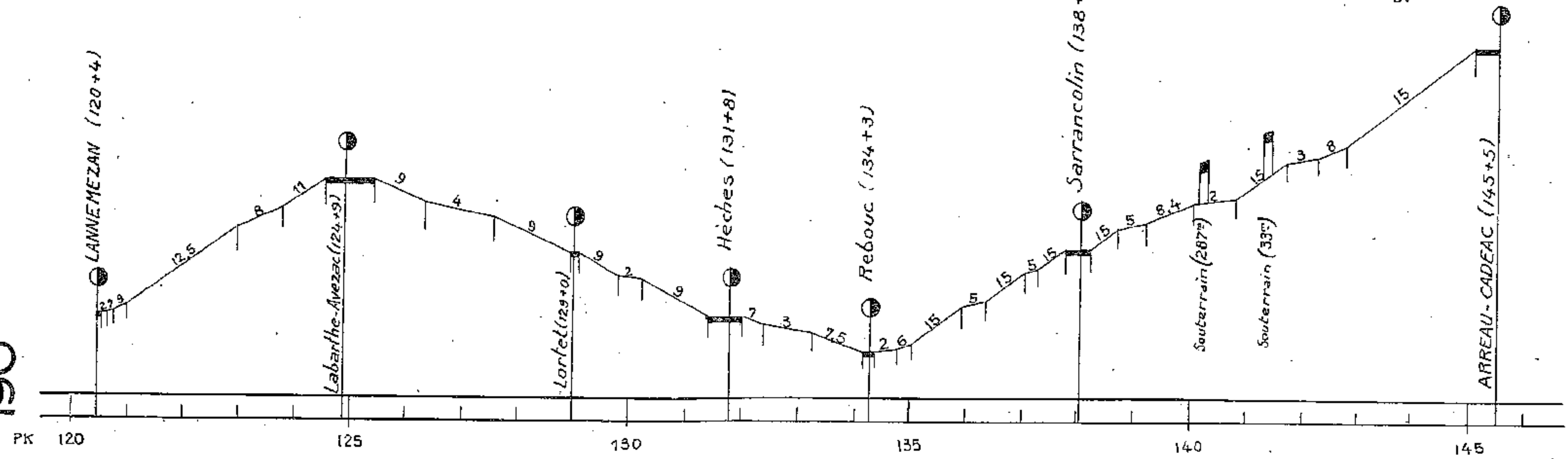

Abords d'Arreau-Cadéac

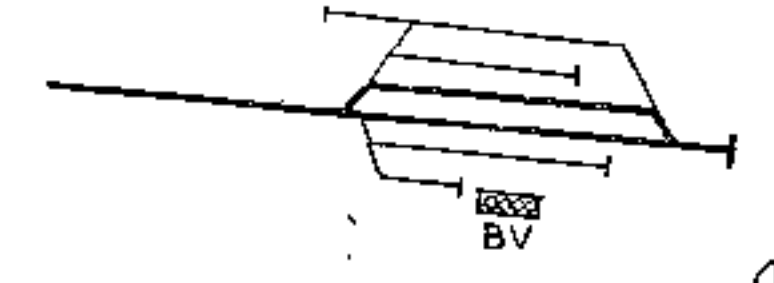

Abords de Foix

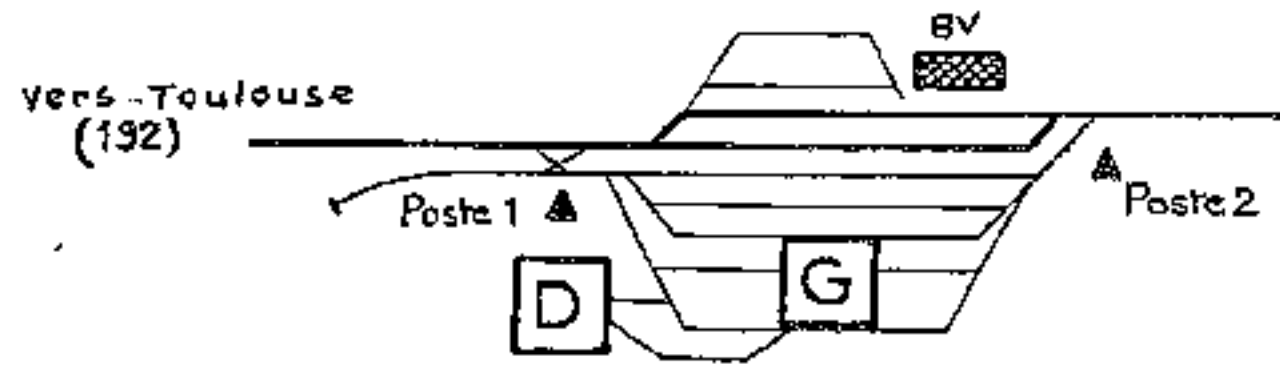

Ligne de Toulouse-Matabiau à la Tour-de-Carol et Puigcerda

Section Pamiers - Ax-les-Thermes

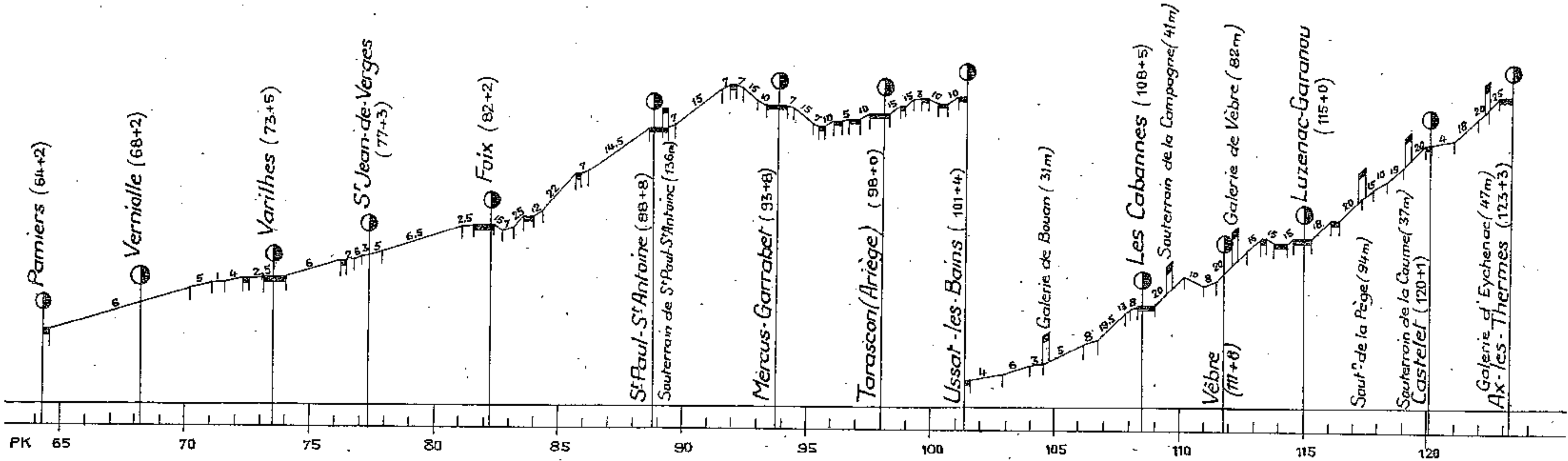

Abords de Toulouse-Matabiau

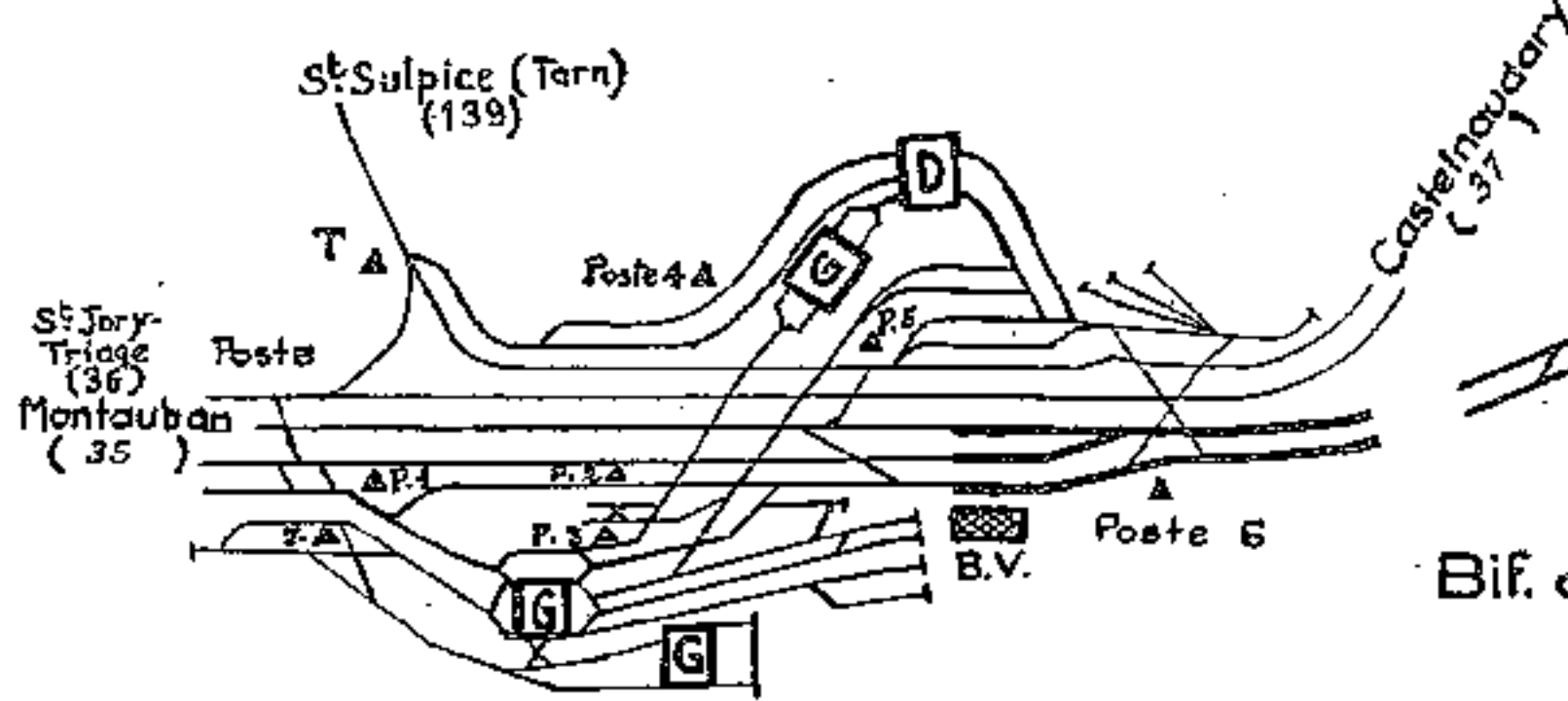

Abords de Portet-S^t Simon

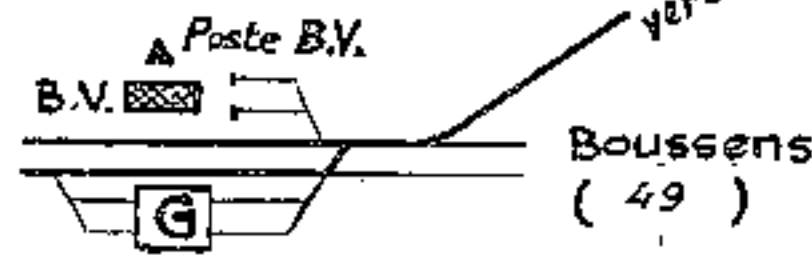

Ligne de Toulouse-Matabiau à la Tour-de-Carol et Puigcerda

Section Toulouse-Pamiers

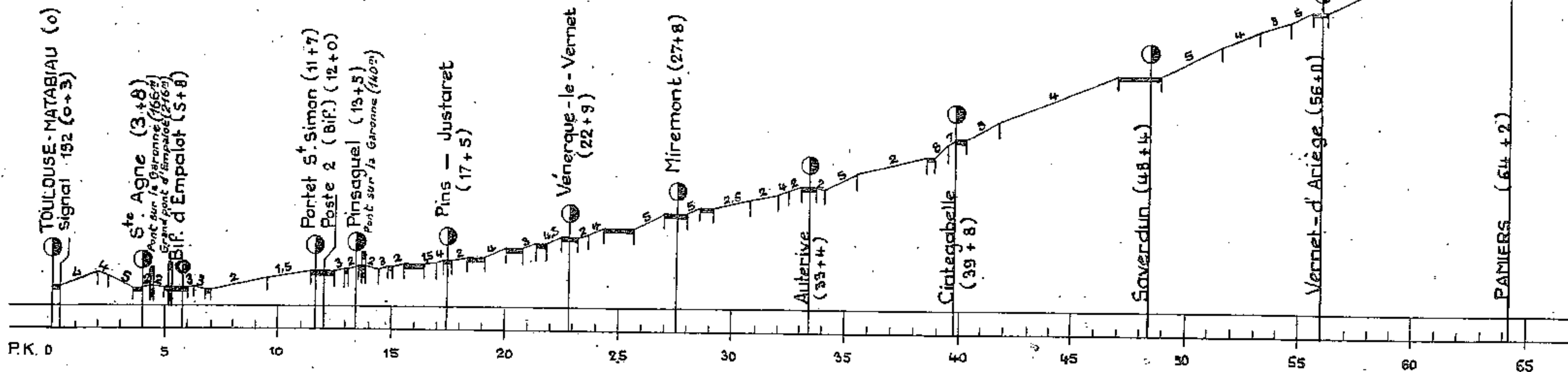

Abords de Boussens

Ligne de Boussens à St-Girons

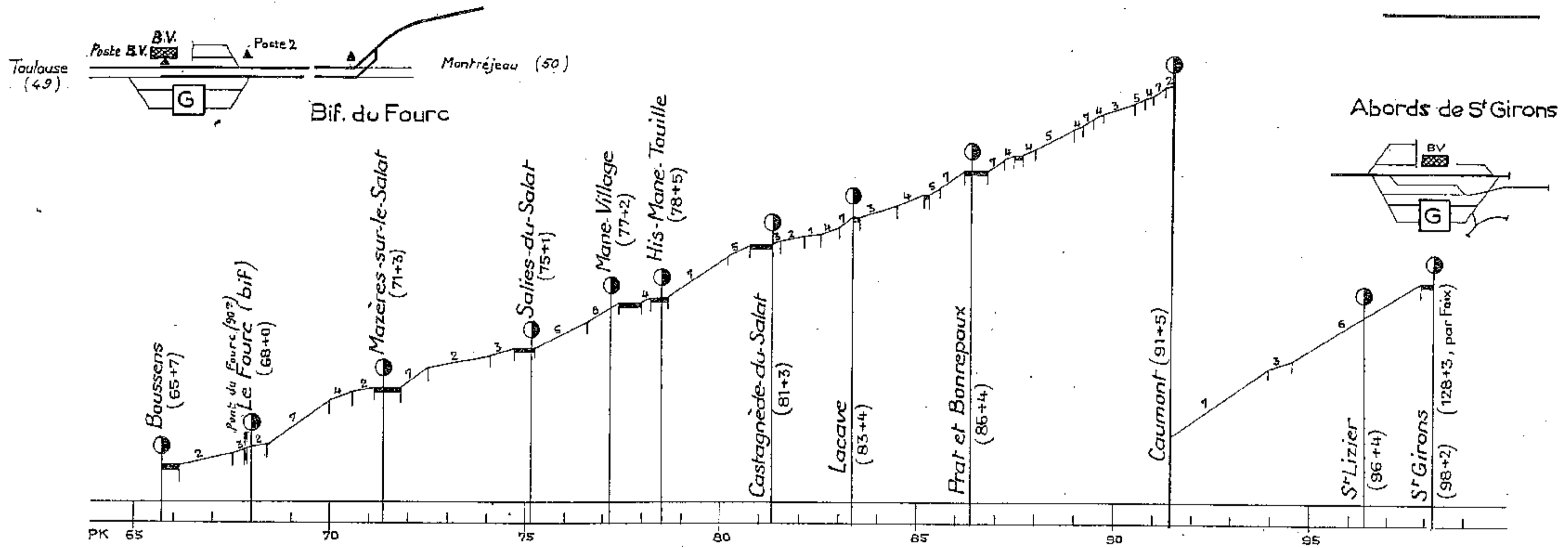

Ligne de Toulouse-Matabiau à la Tour-de-Carol et Puigcerda.

Section Ax-les-Thermes La Tour-de-Carol - Puigcerda

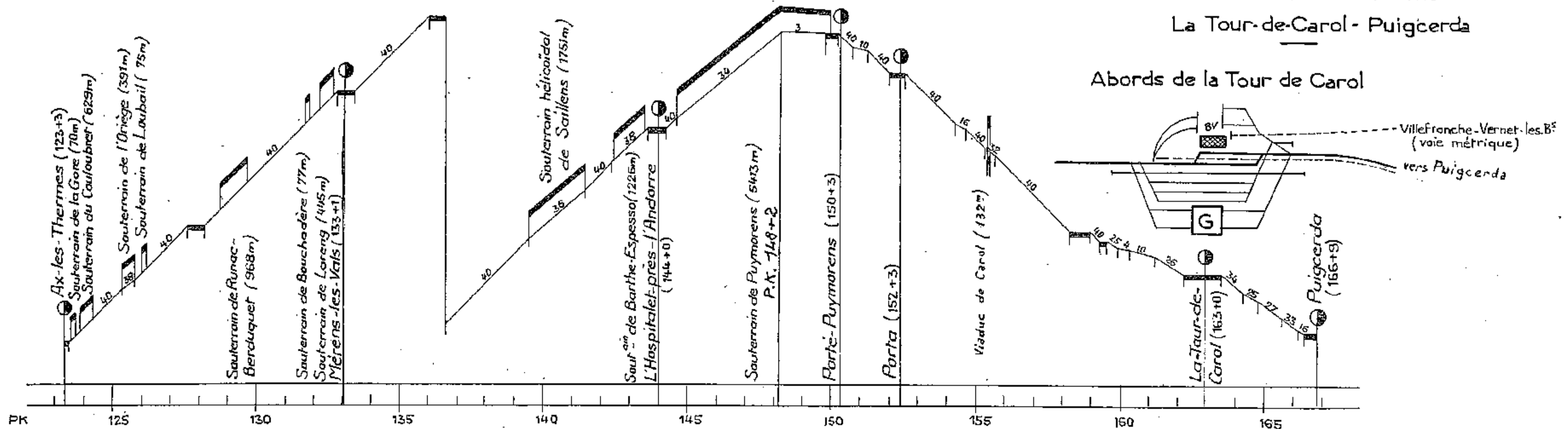

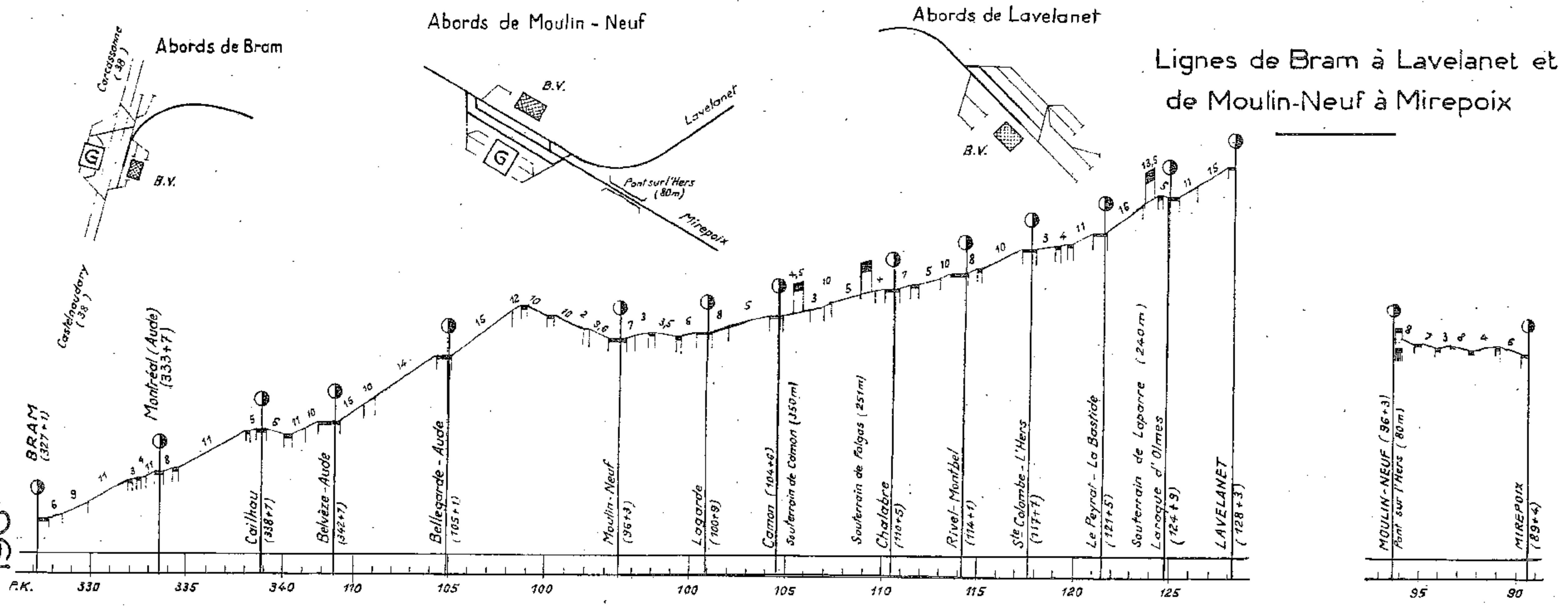
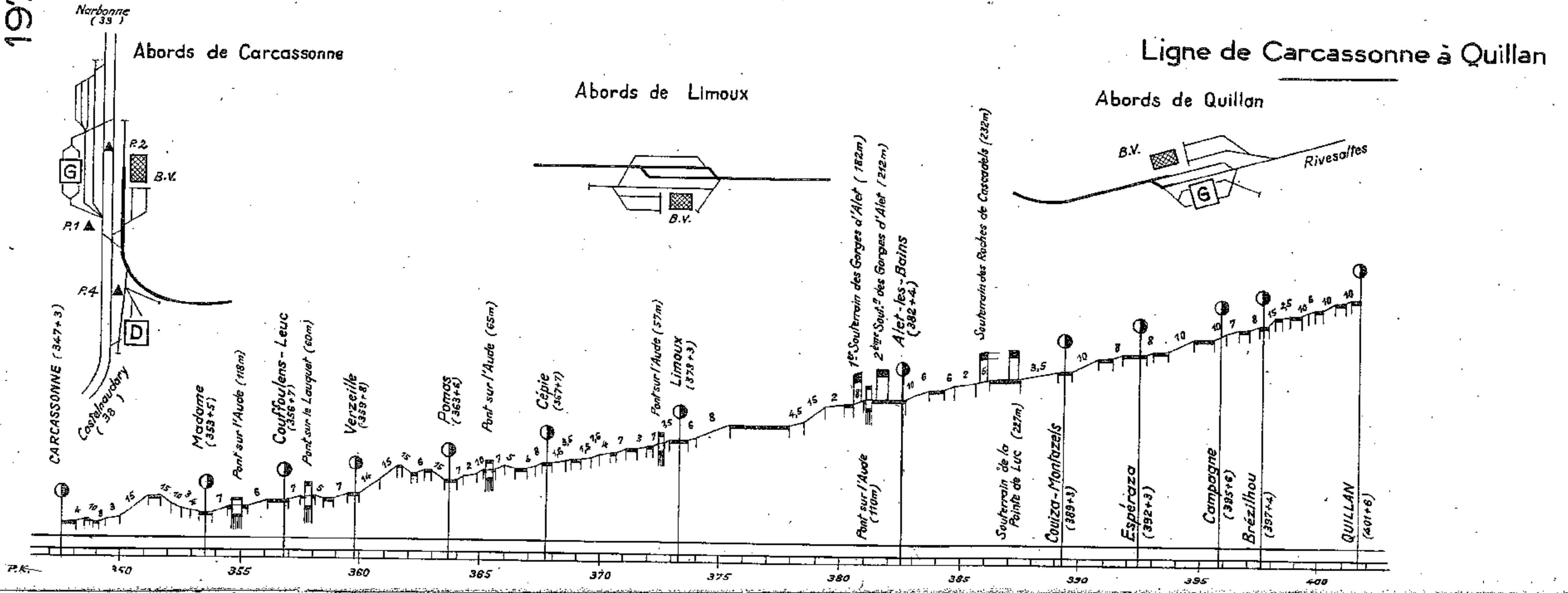

GARE DE JUVISY

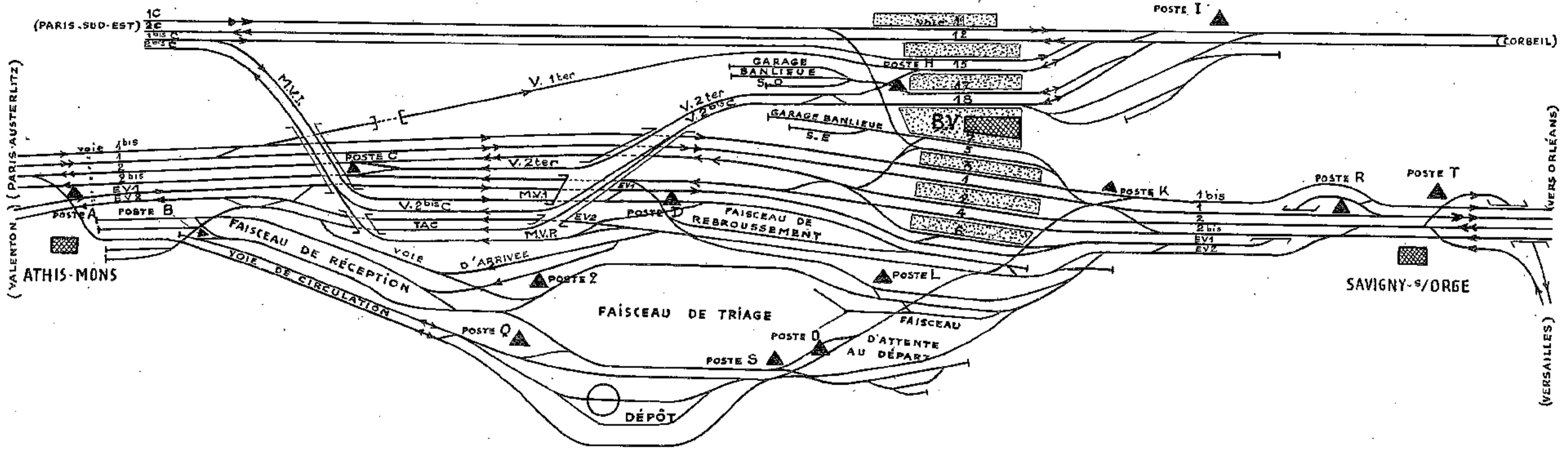

GARE DE PARIS-AUSTERLITZ

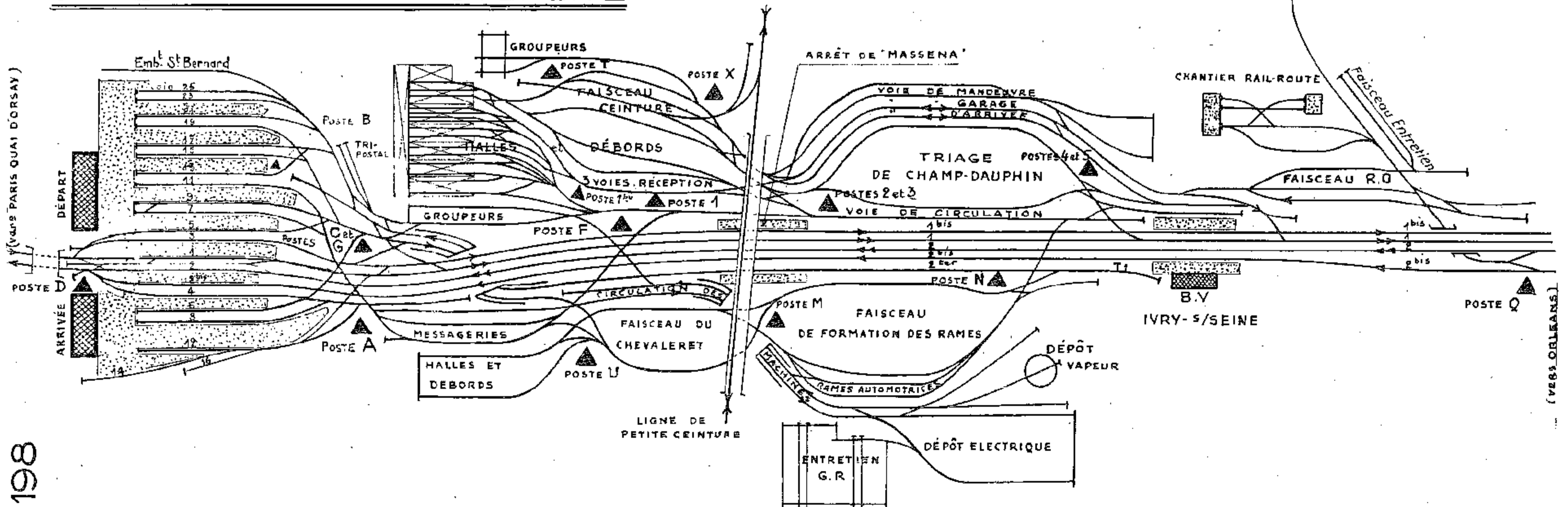

GARE DE TOURS-ST PIERRE-DES-CORPS

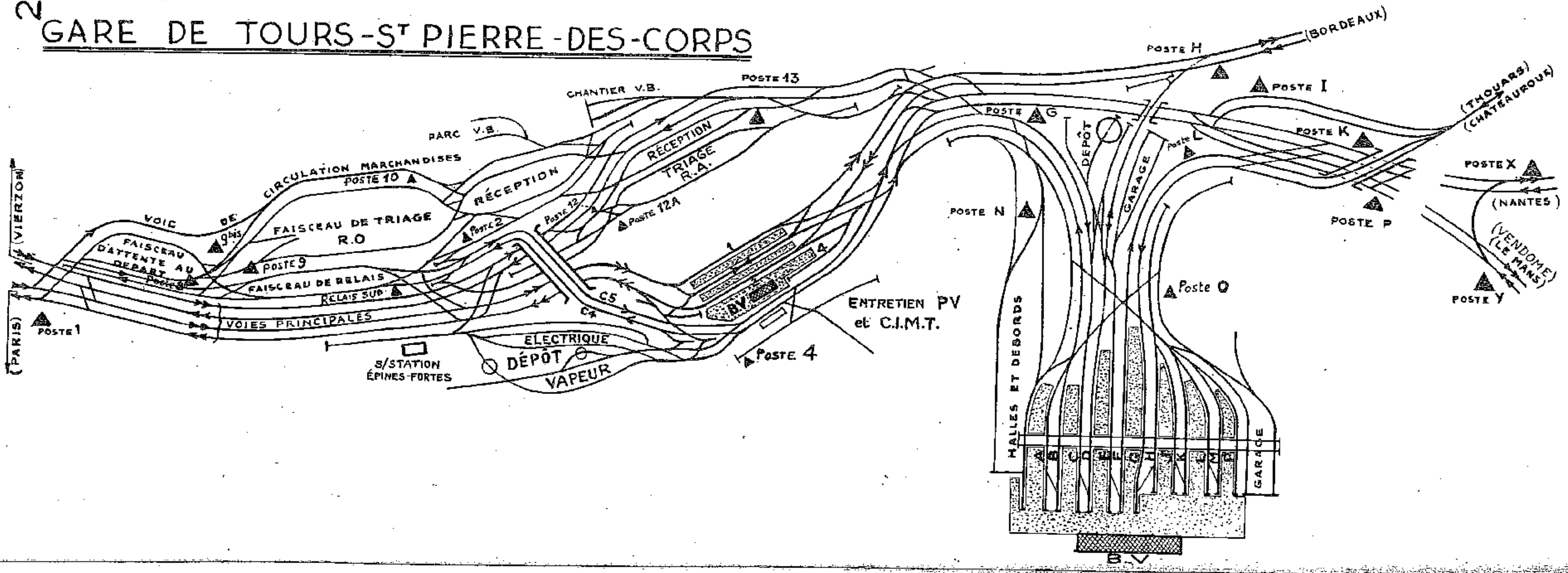

GARE DES AUBRAIS-ORLEANS

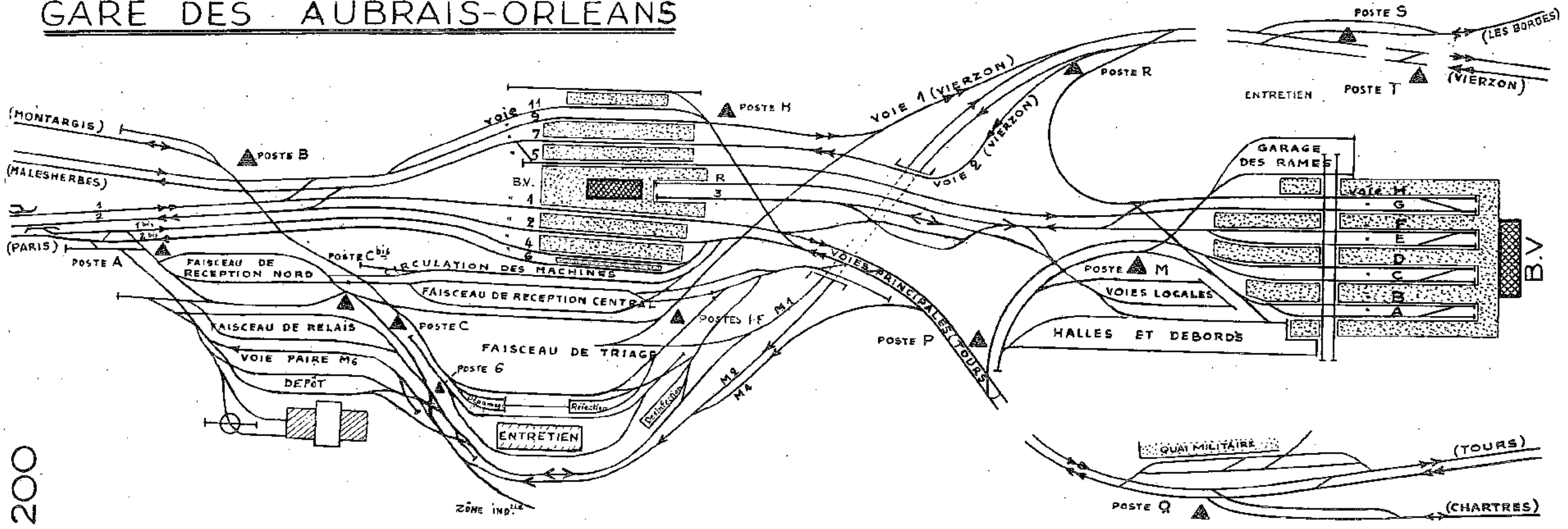

GARES DE BORDEAUX

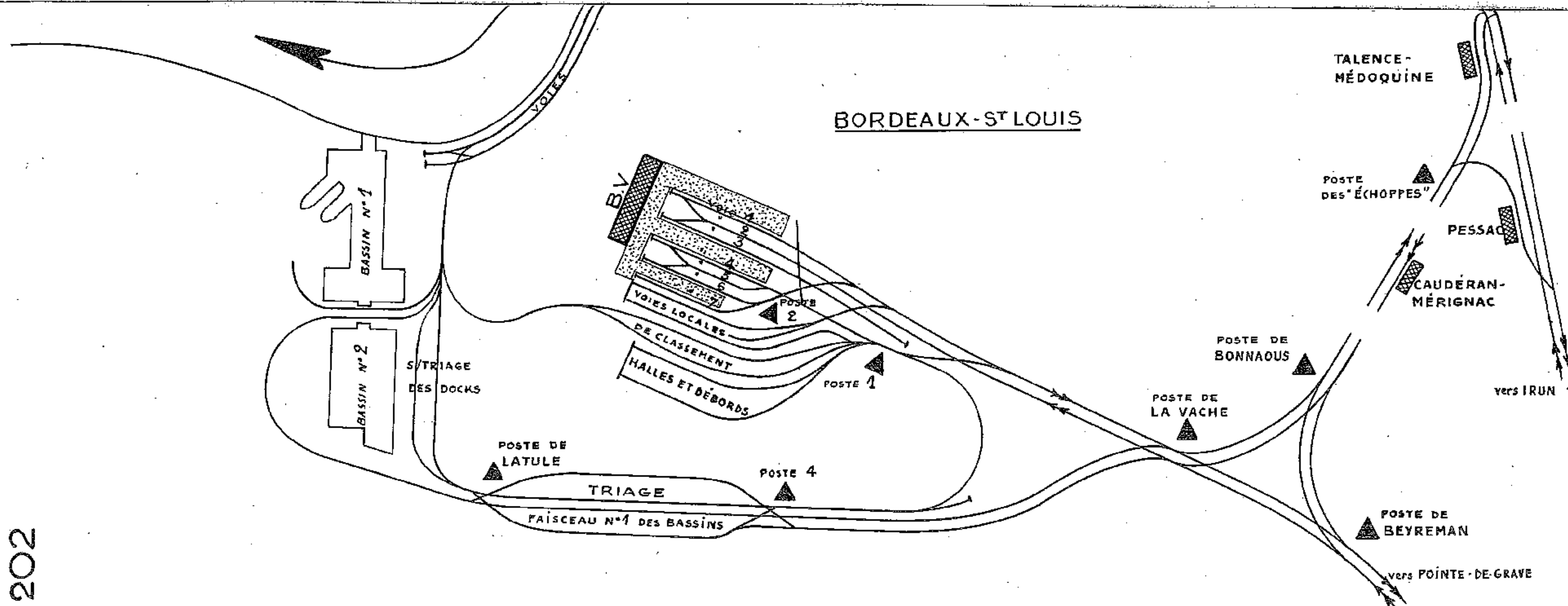
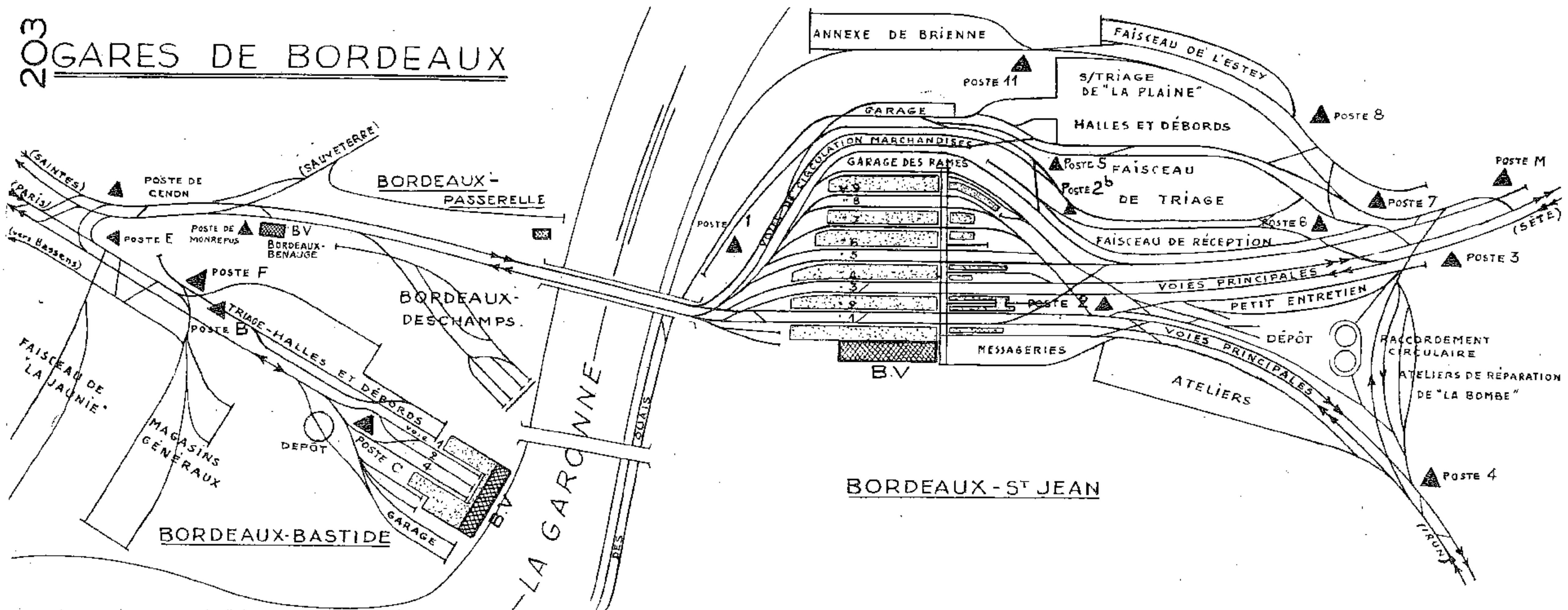

GARE DE BRIVE

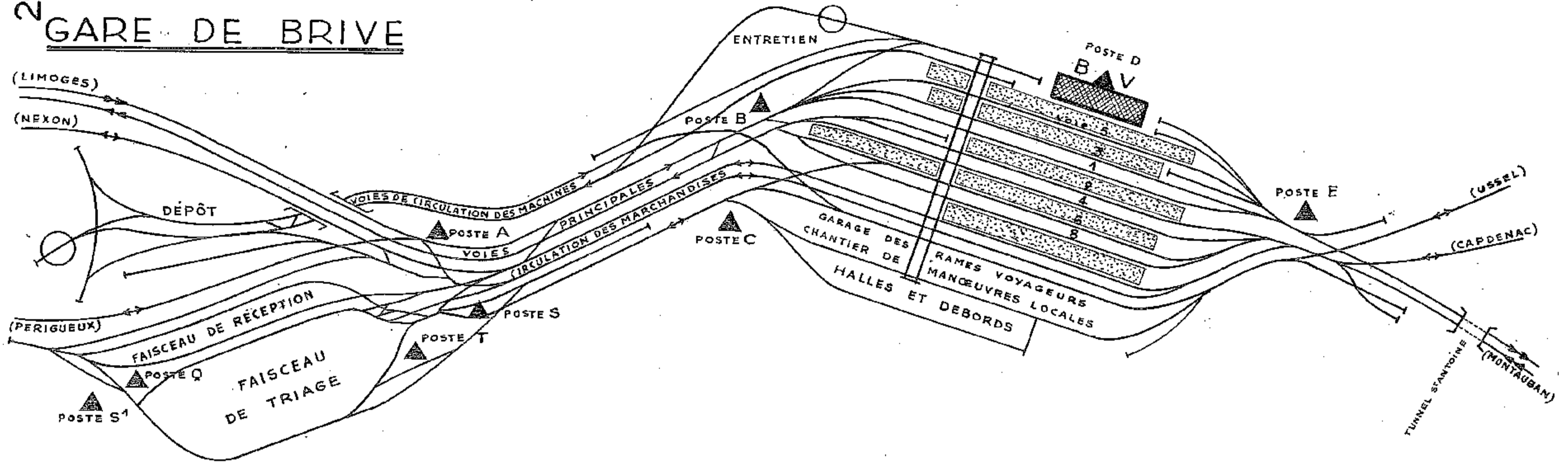

GARES DE LIMOGES

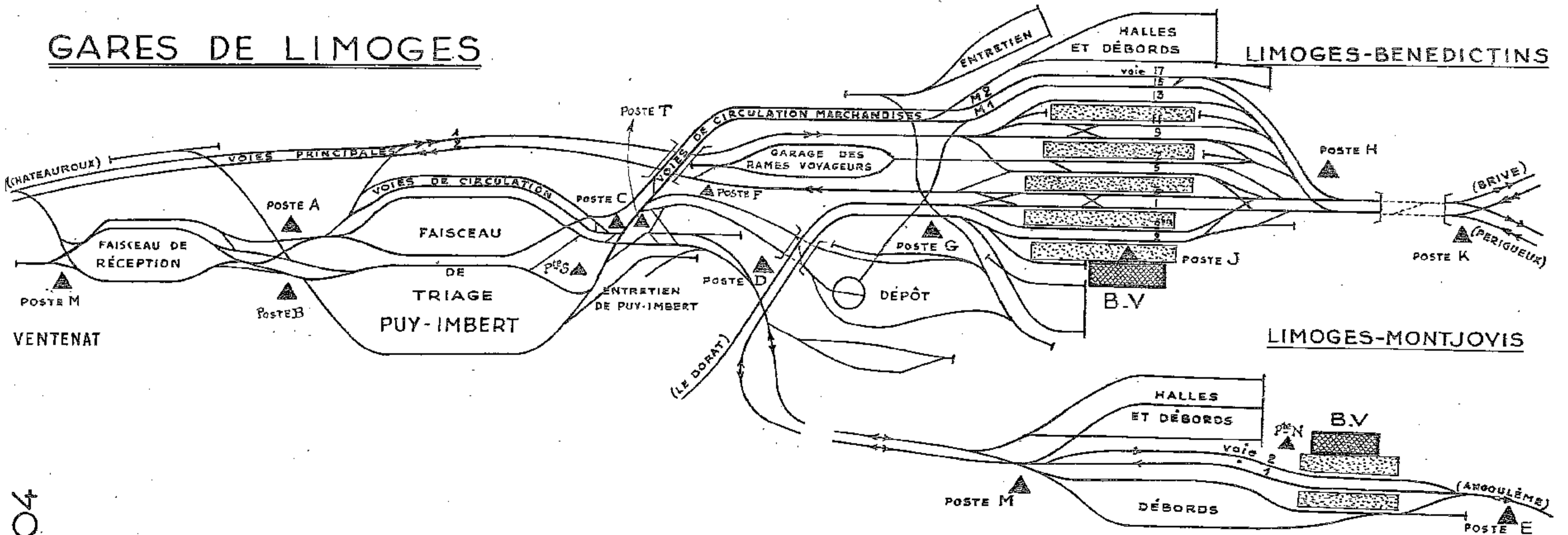

GARE DE TOULOUSE

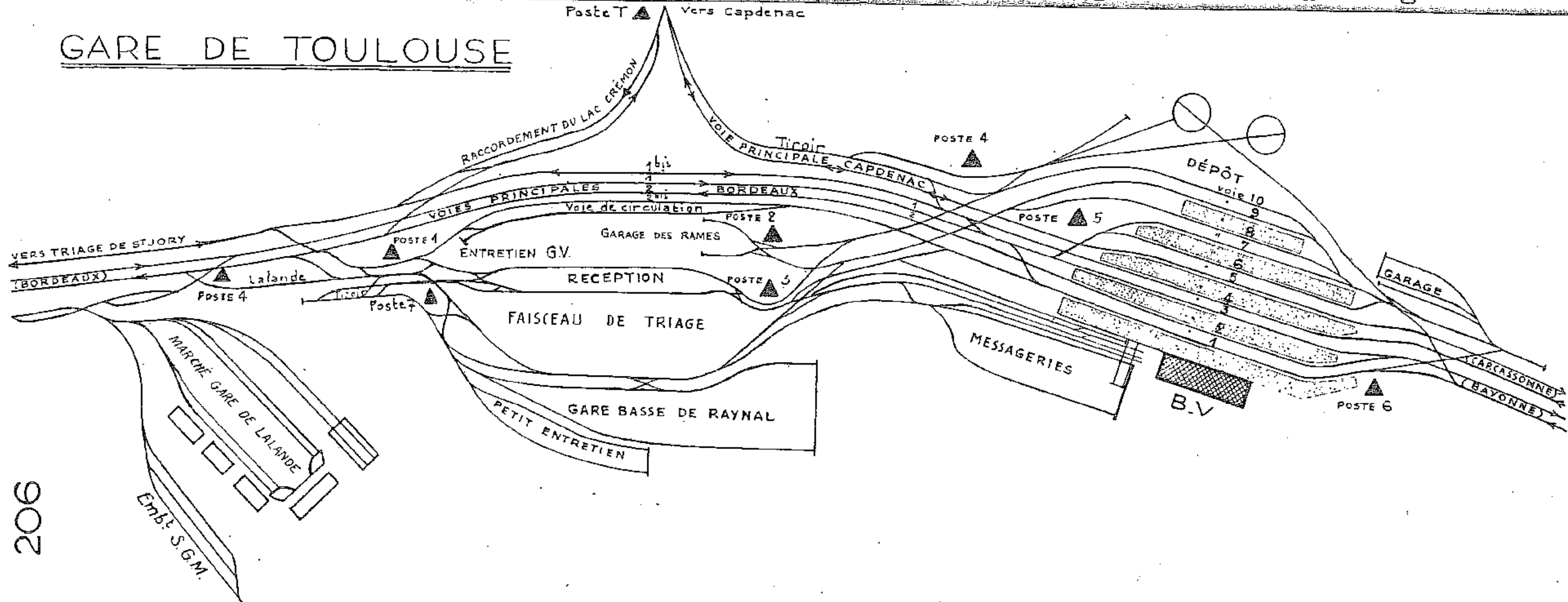

CHARTRES à SAINTES

Section Château-du-Loir à Saumur R.D.

Poste T Vers Capdenac



Raccordement de Saumur R.G.

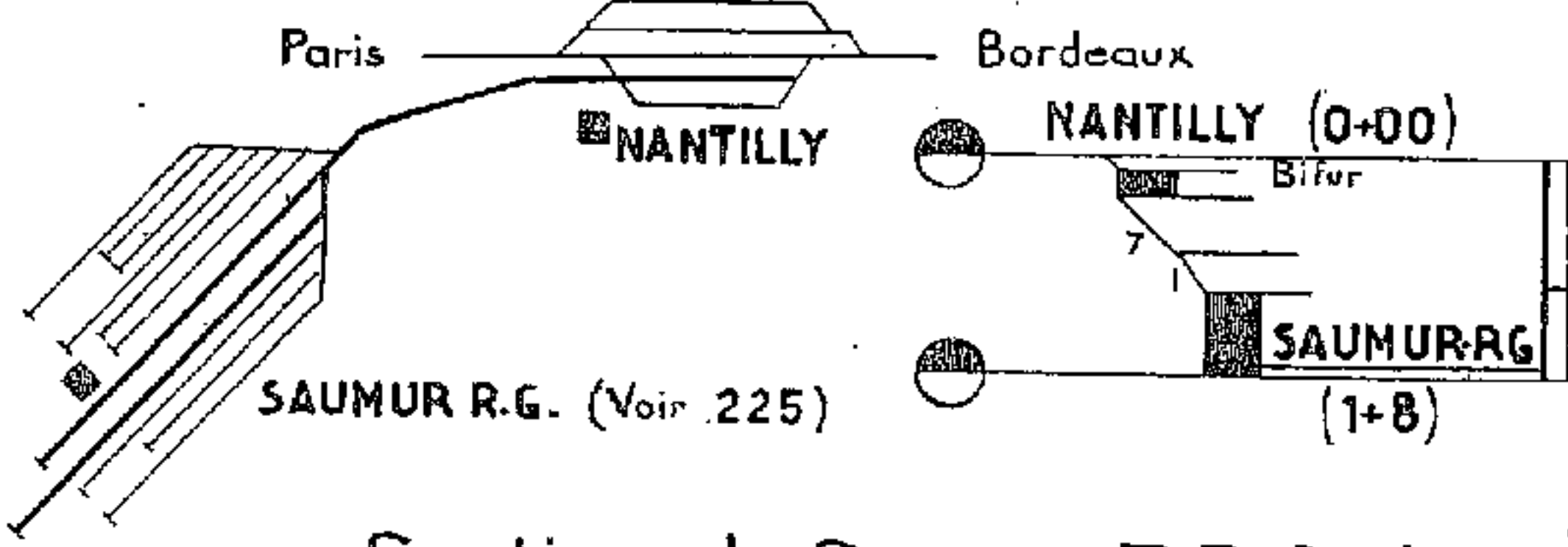

Section de Saumur R.D. à Thouars

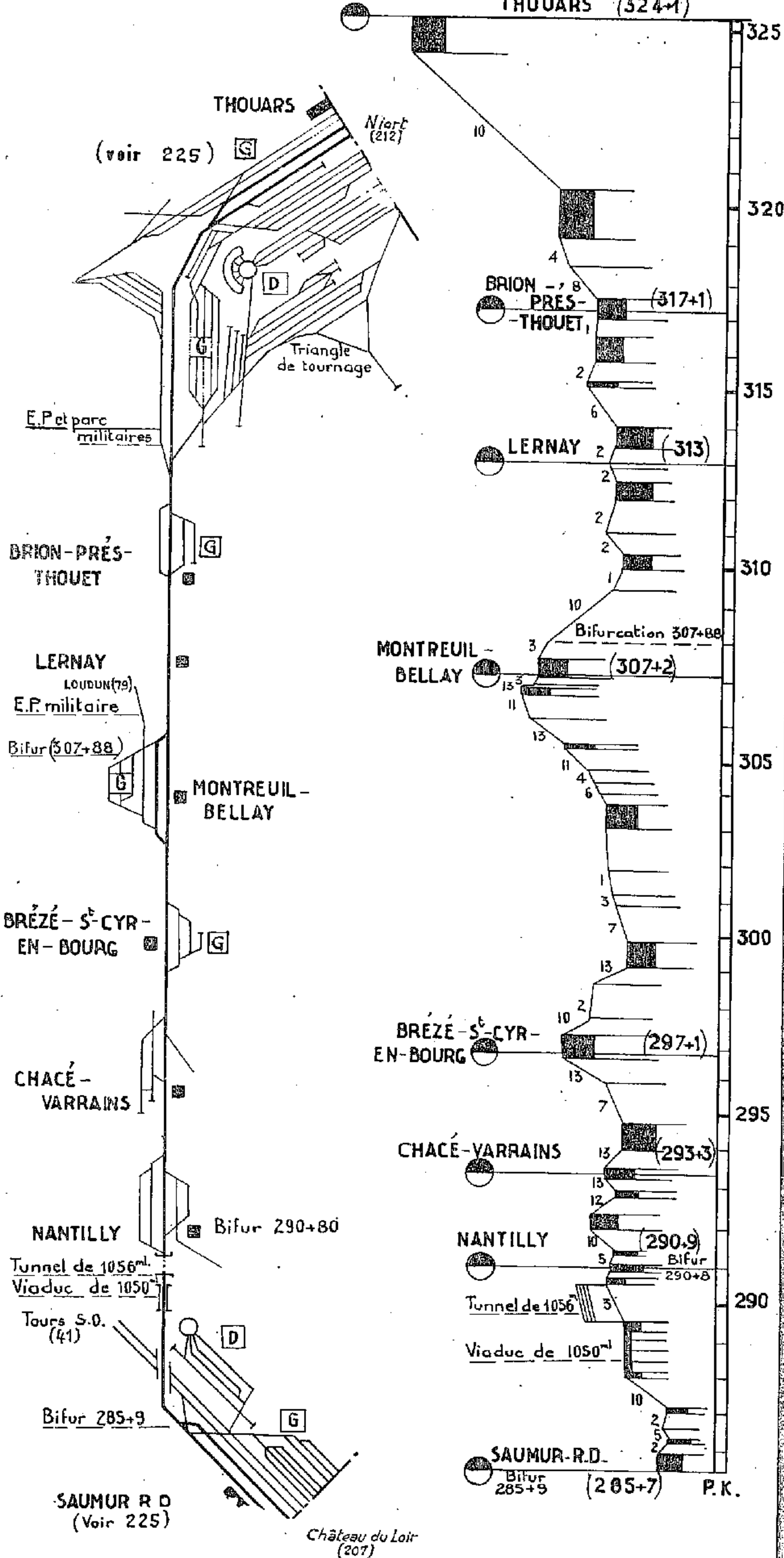

Section Angers-Nantes

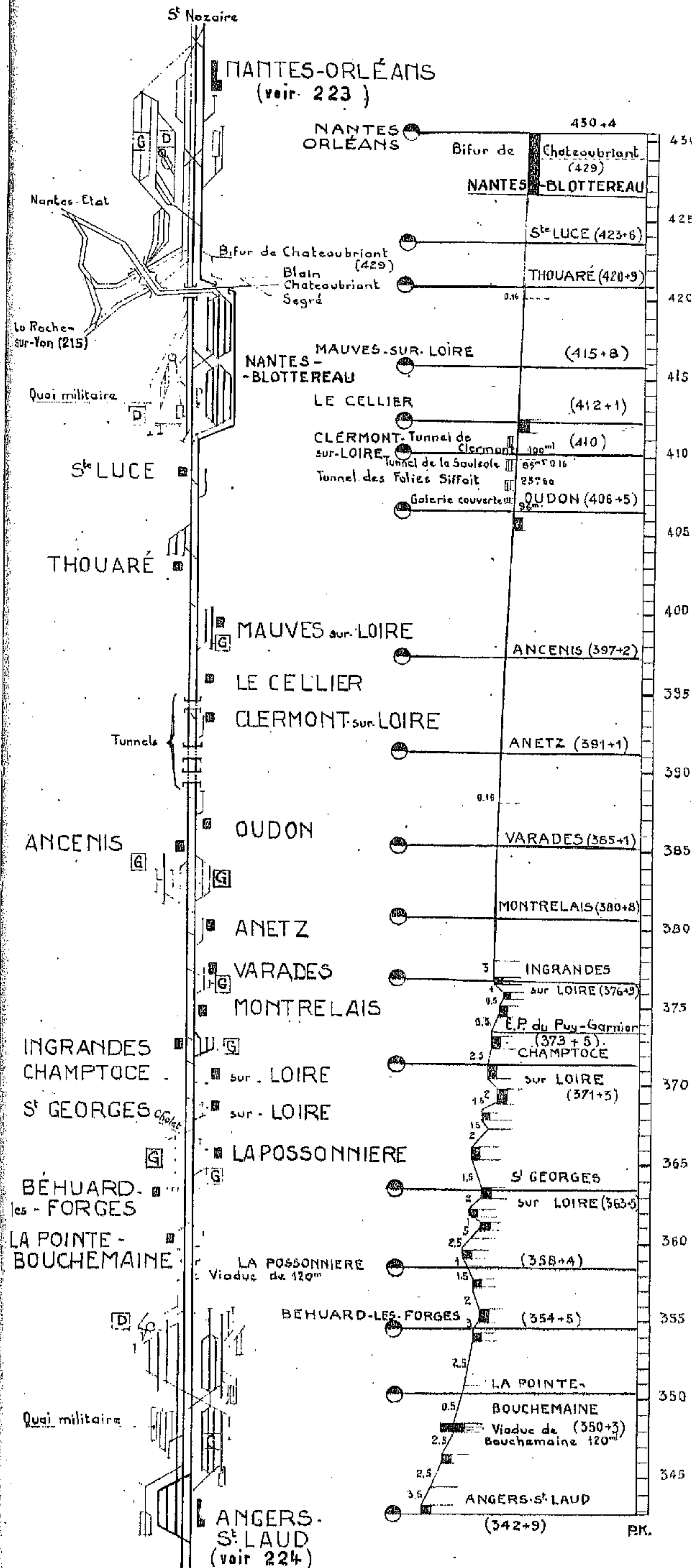

Section Poitiers-Niort

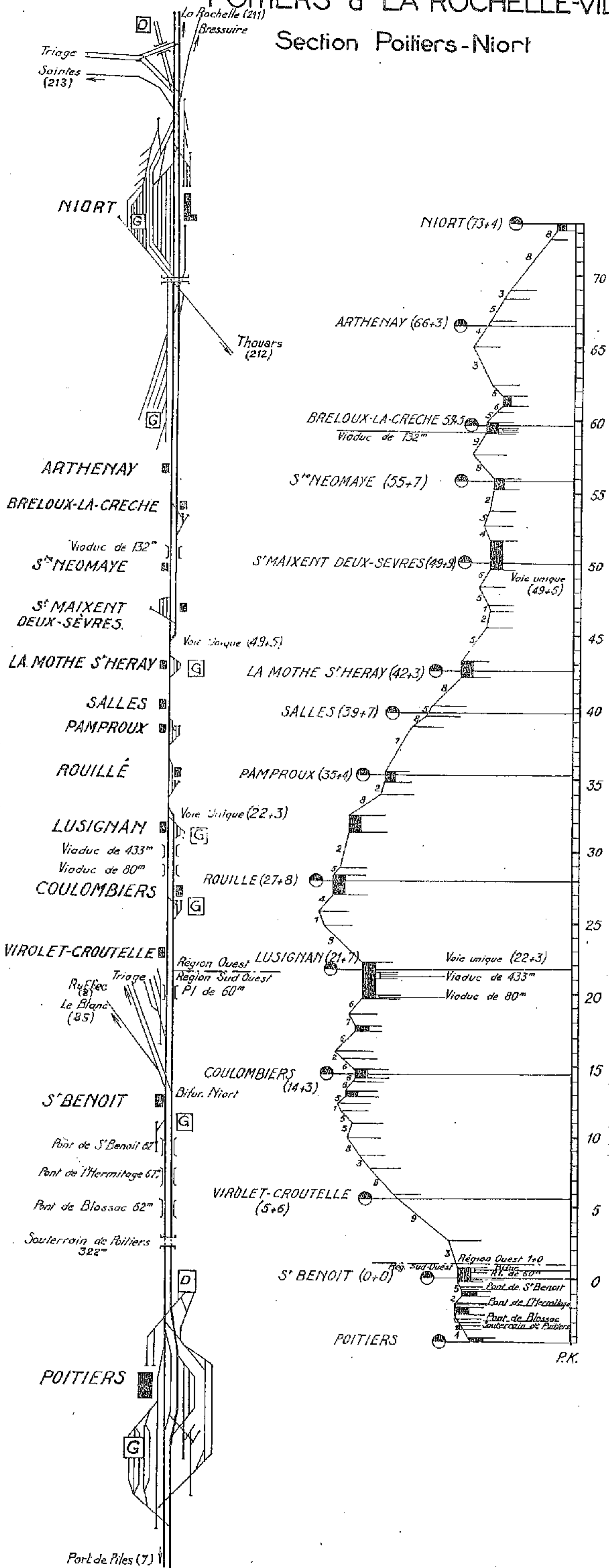

Section Niort la Rochelle-Ville

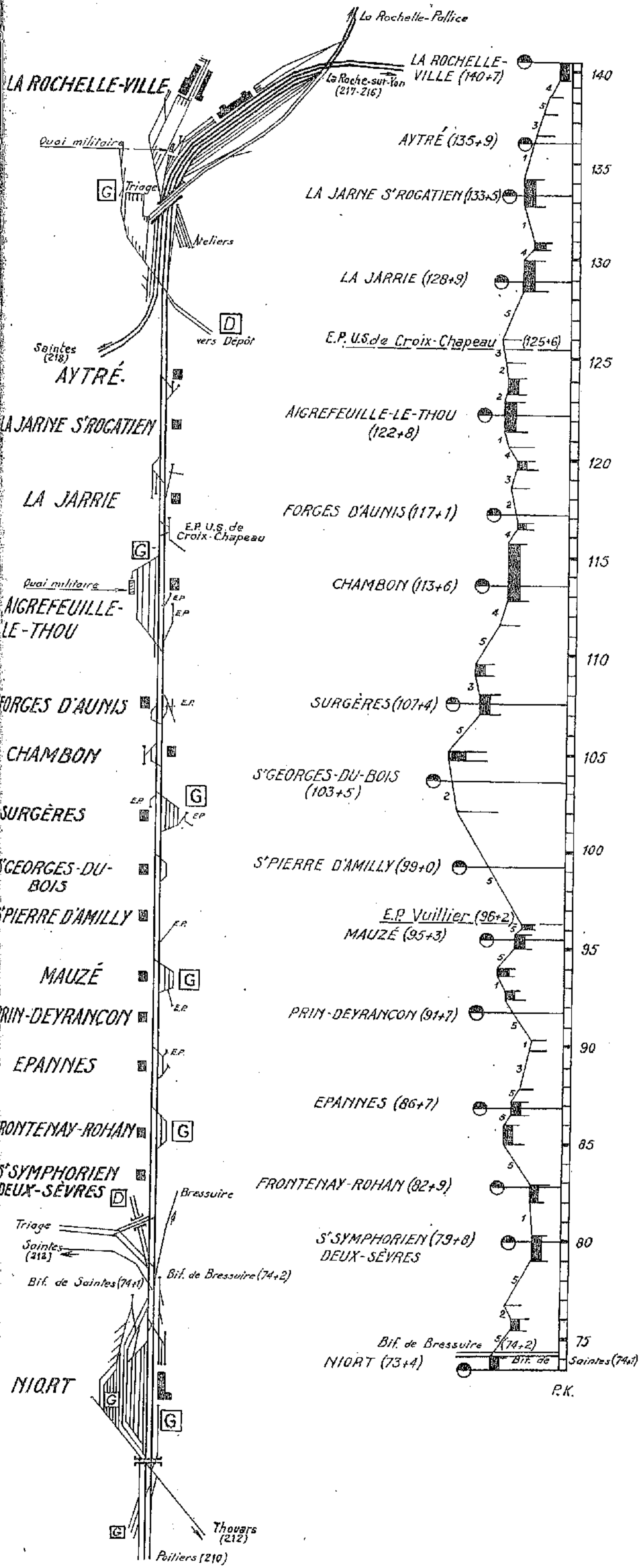

LIGNE de CHARTRES à SAINTES

Section de Thouars à Niort

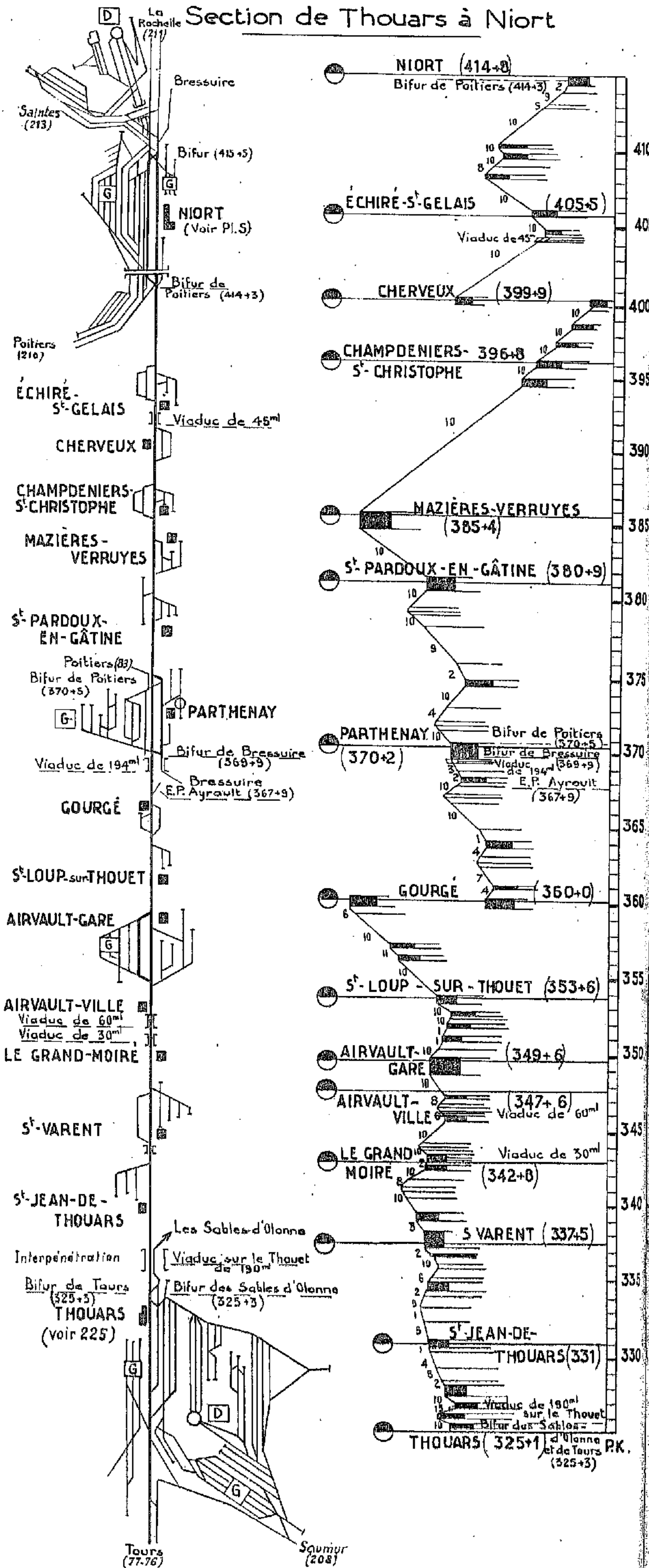

LIGNE de CHARTRES à SAINTES

Section de Niort à Saintes

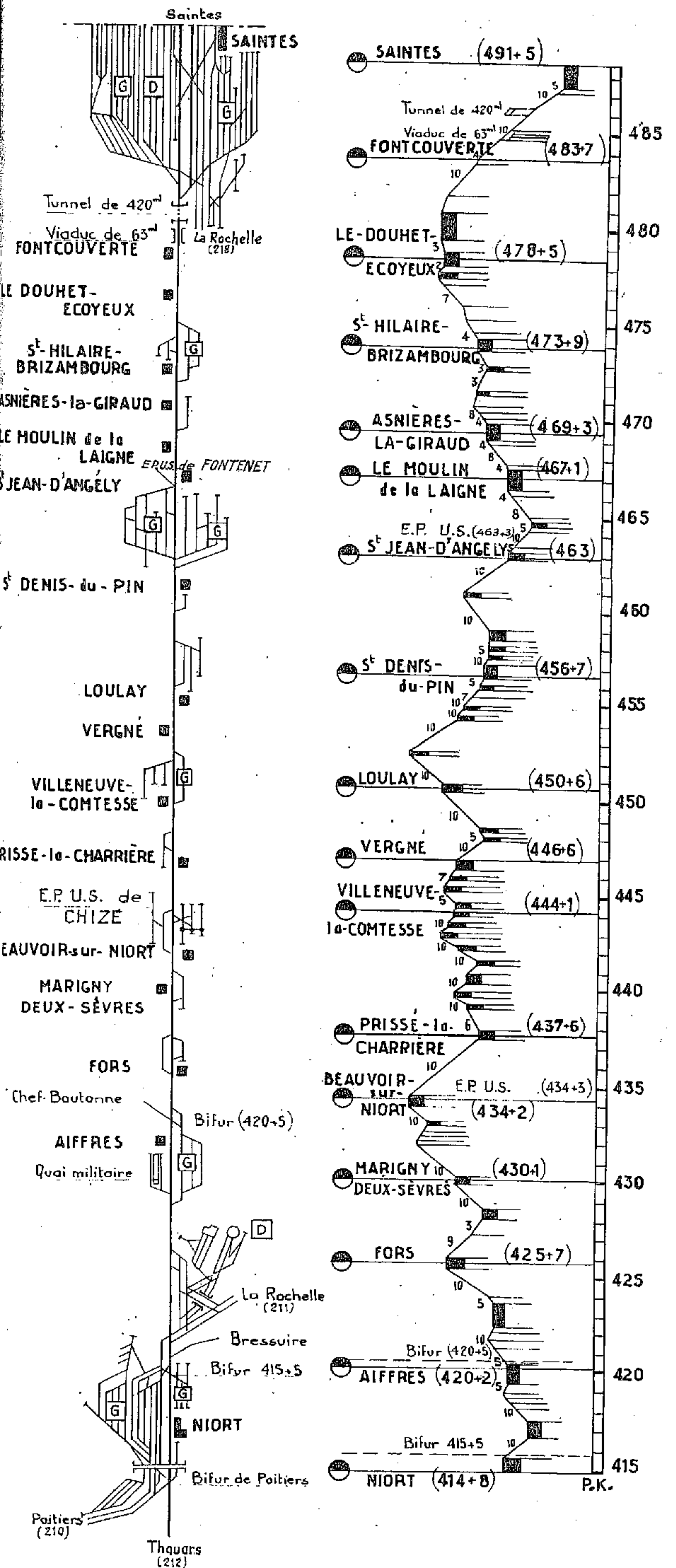

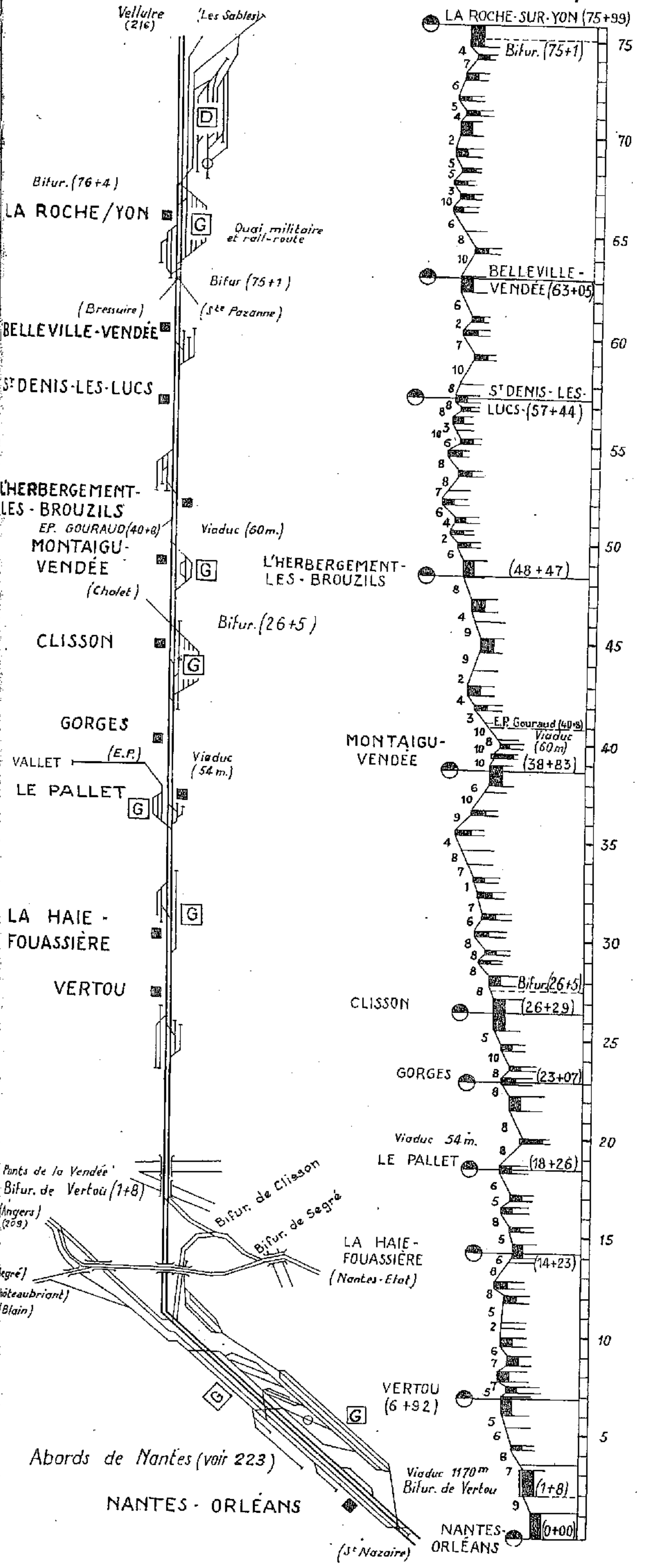
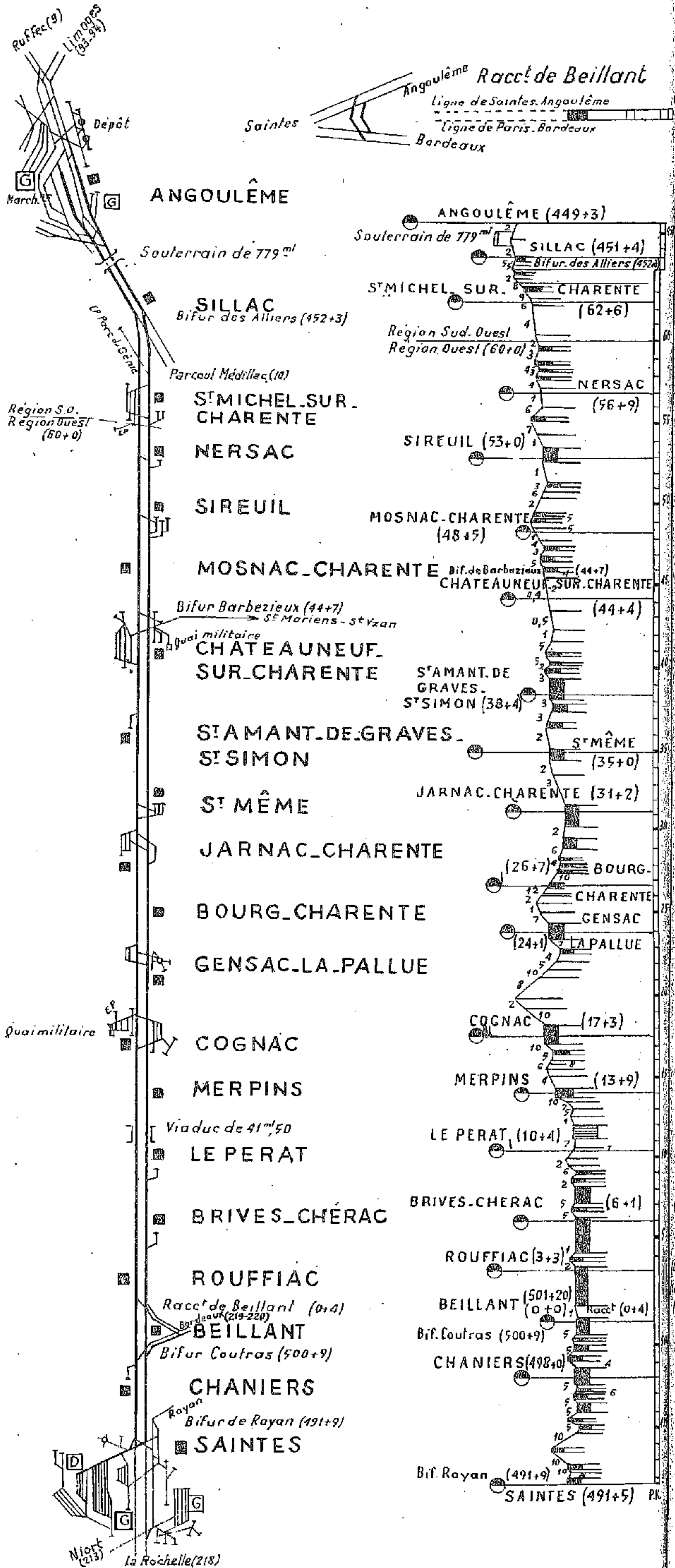

EMBRANCHEMENT du PORT de LUÇON

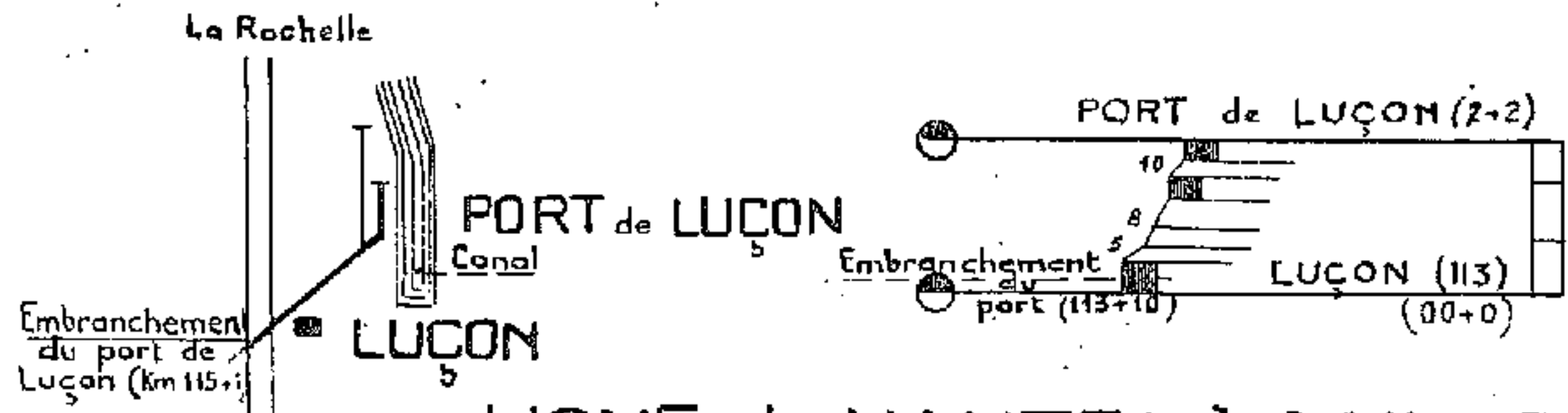

LIGNE de NANTES à SAINTES
Section La Roche-sur-Yon à Velluire

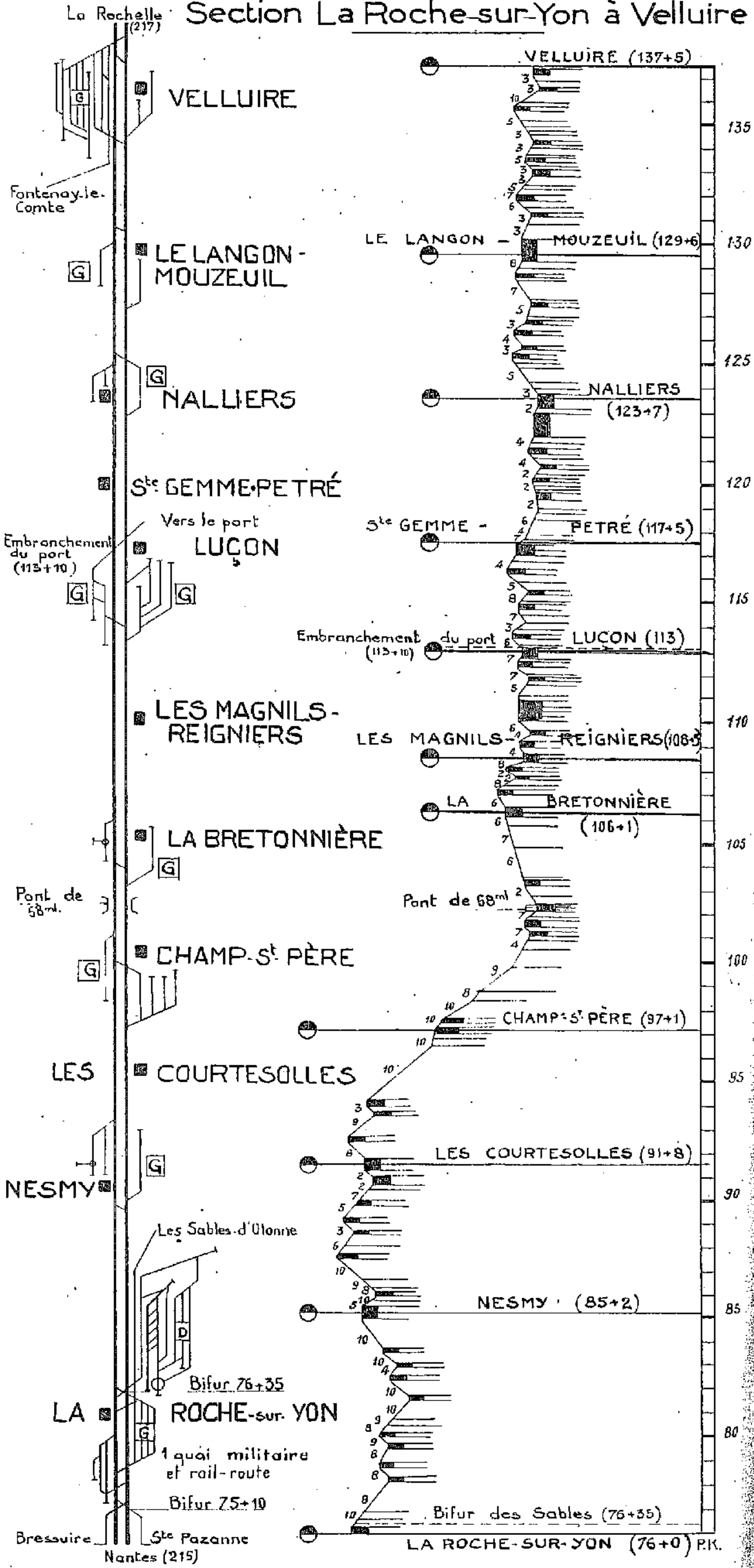

Section Velluire-la Rochelle

Embranchement de la Rochelle à la Rochelle-Pallice

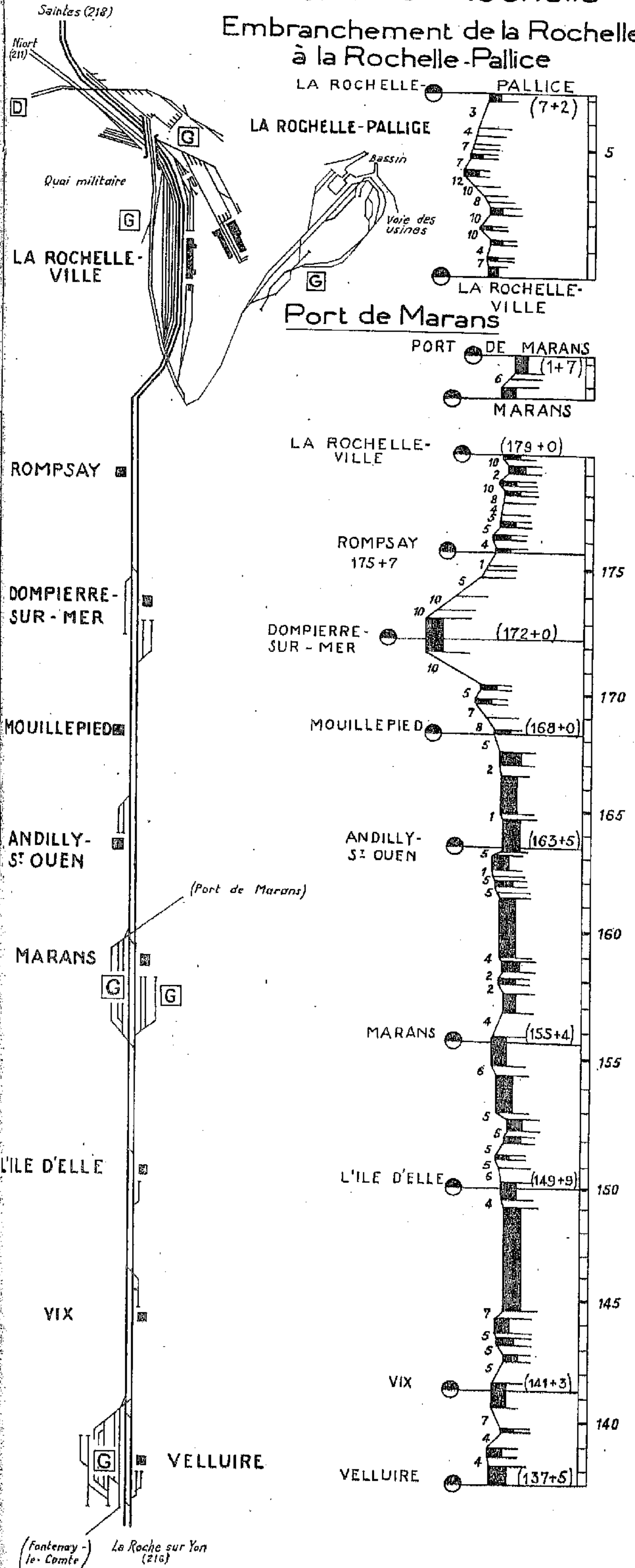

Section la Rochelle-Ville-Saintes

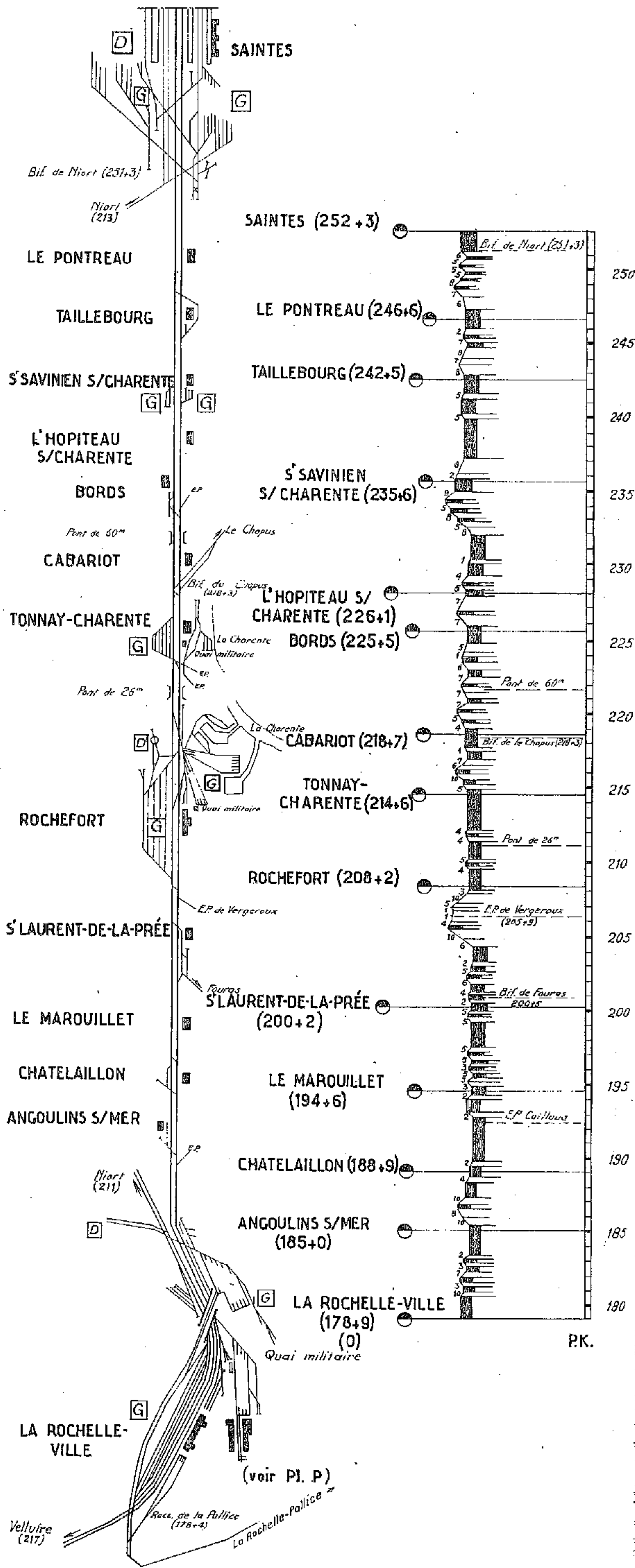

LIGNE de SAINTES-BORDEAUX

Section de Saintes à St Mariens-St Yzan

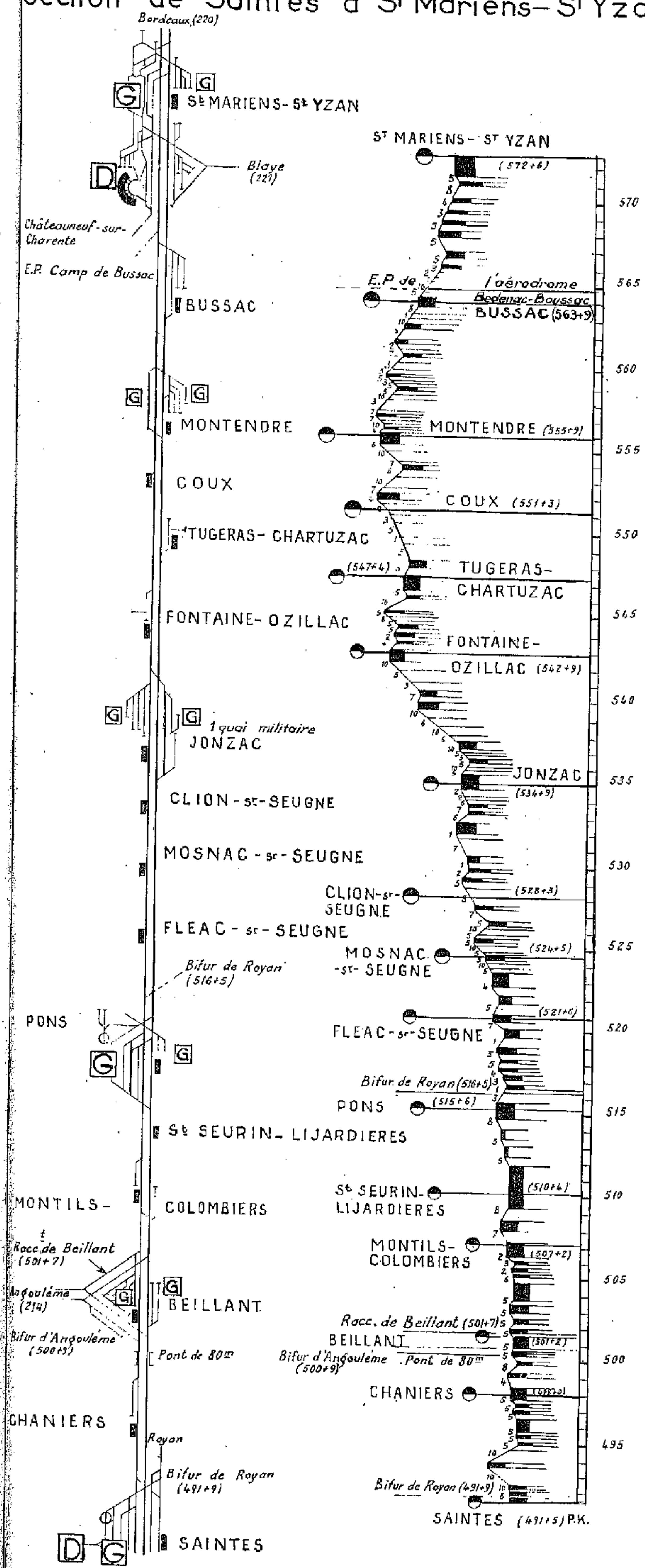

220 LIGNE de SAINTES, BORDEAUX
Section de St Mariens-St Yzan à Bordeaux

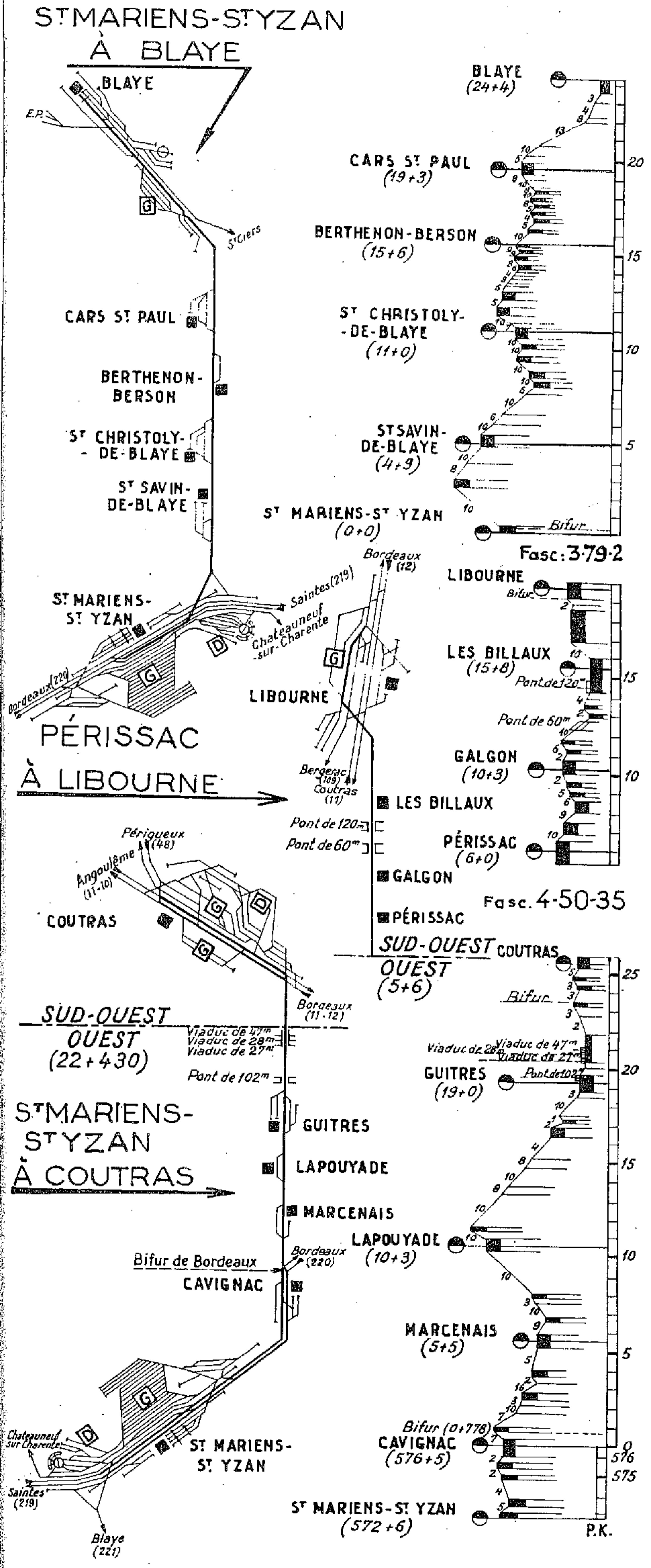
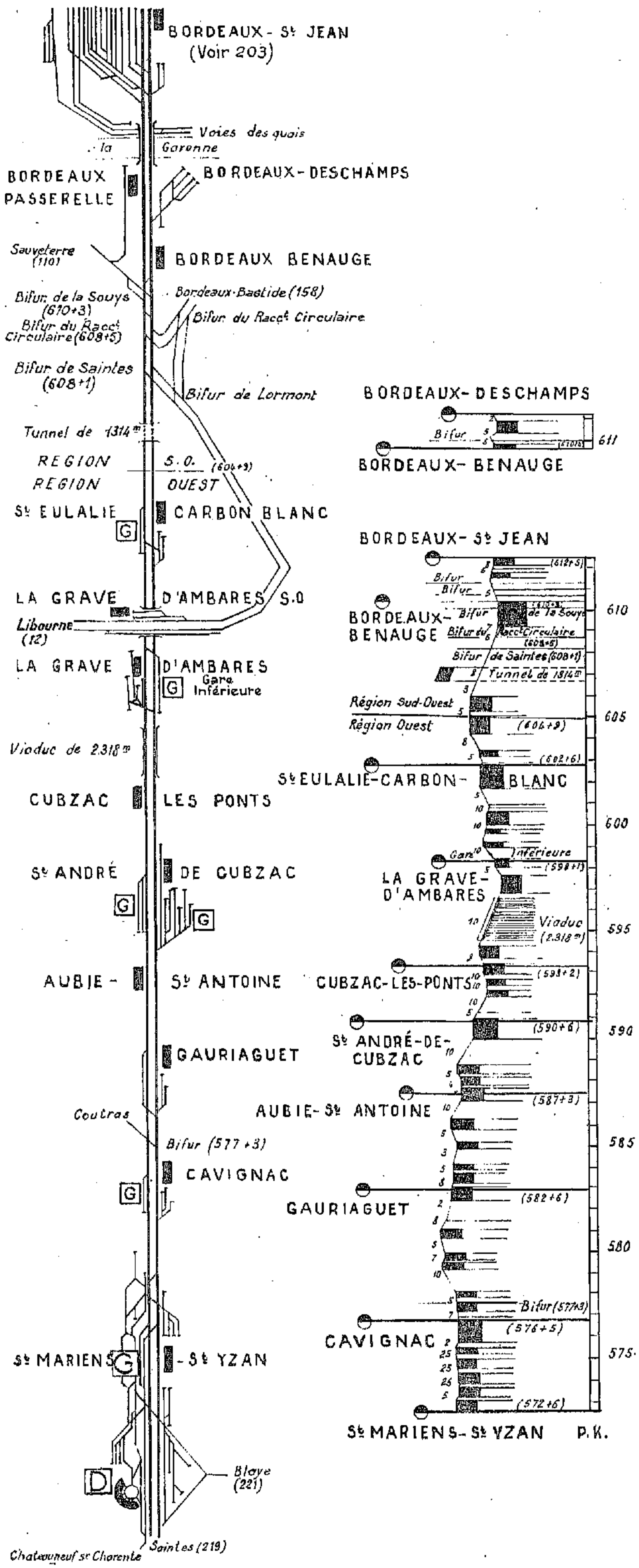

Brest

LAVERRIÈRE

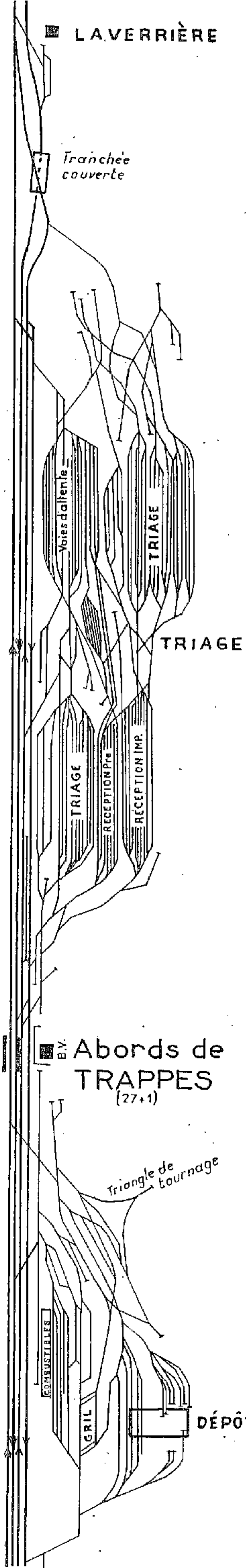

Brest

Bordeaux

Dreux

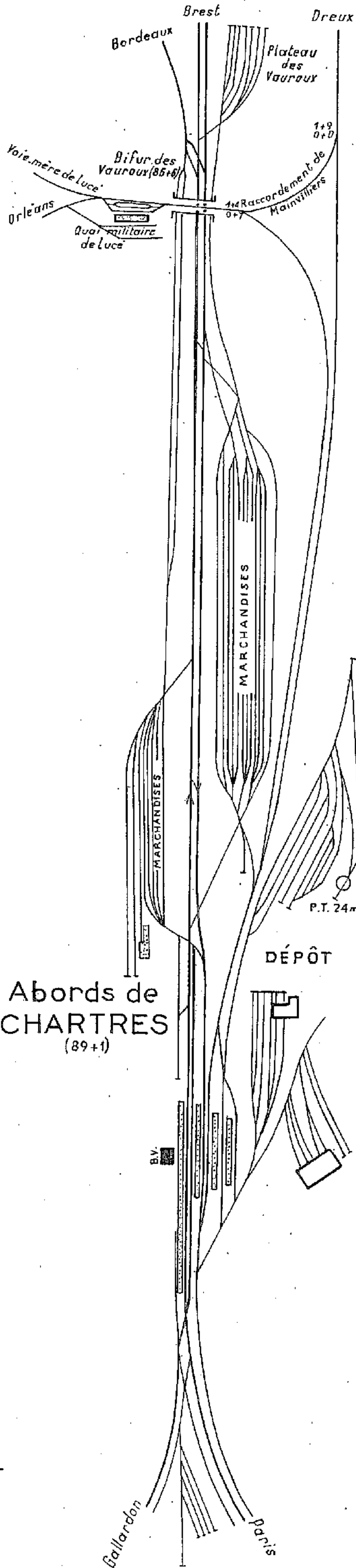

NANTES

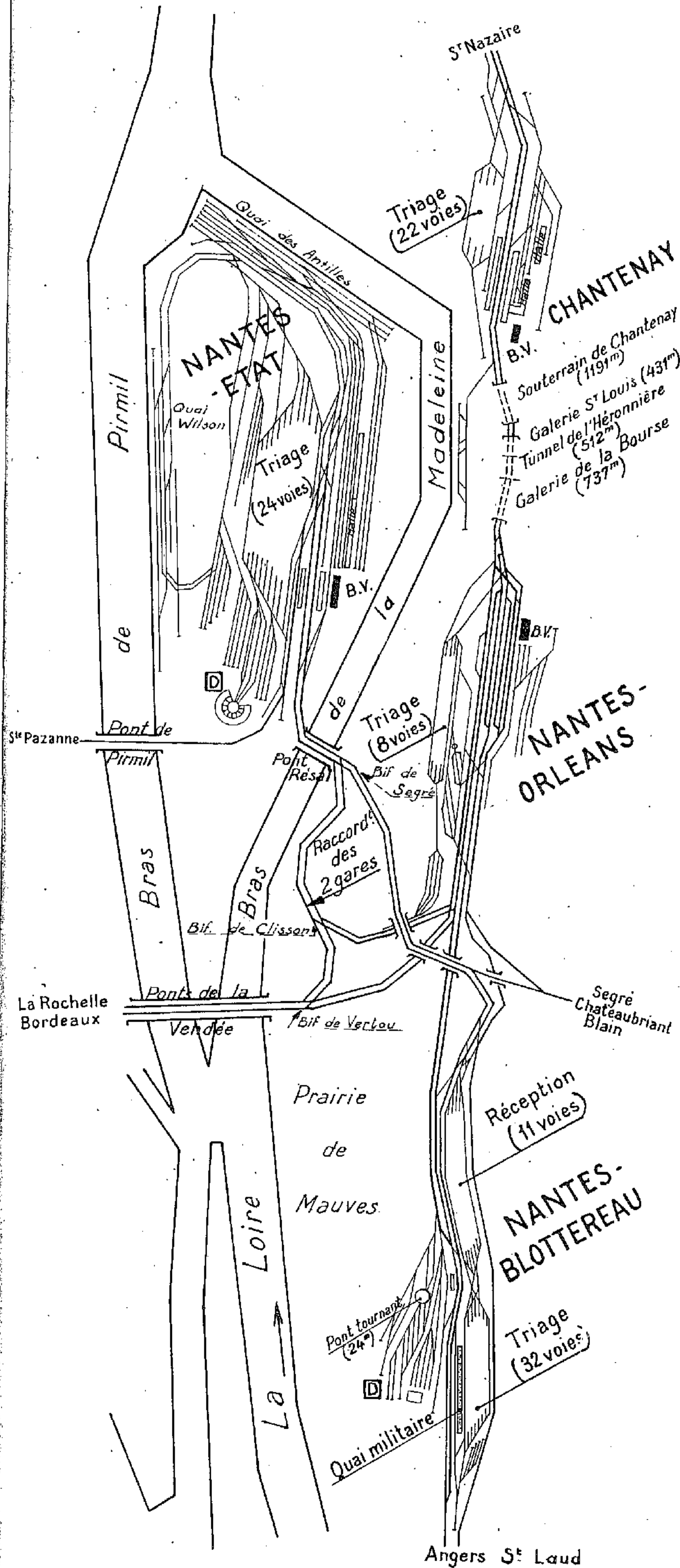

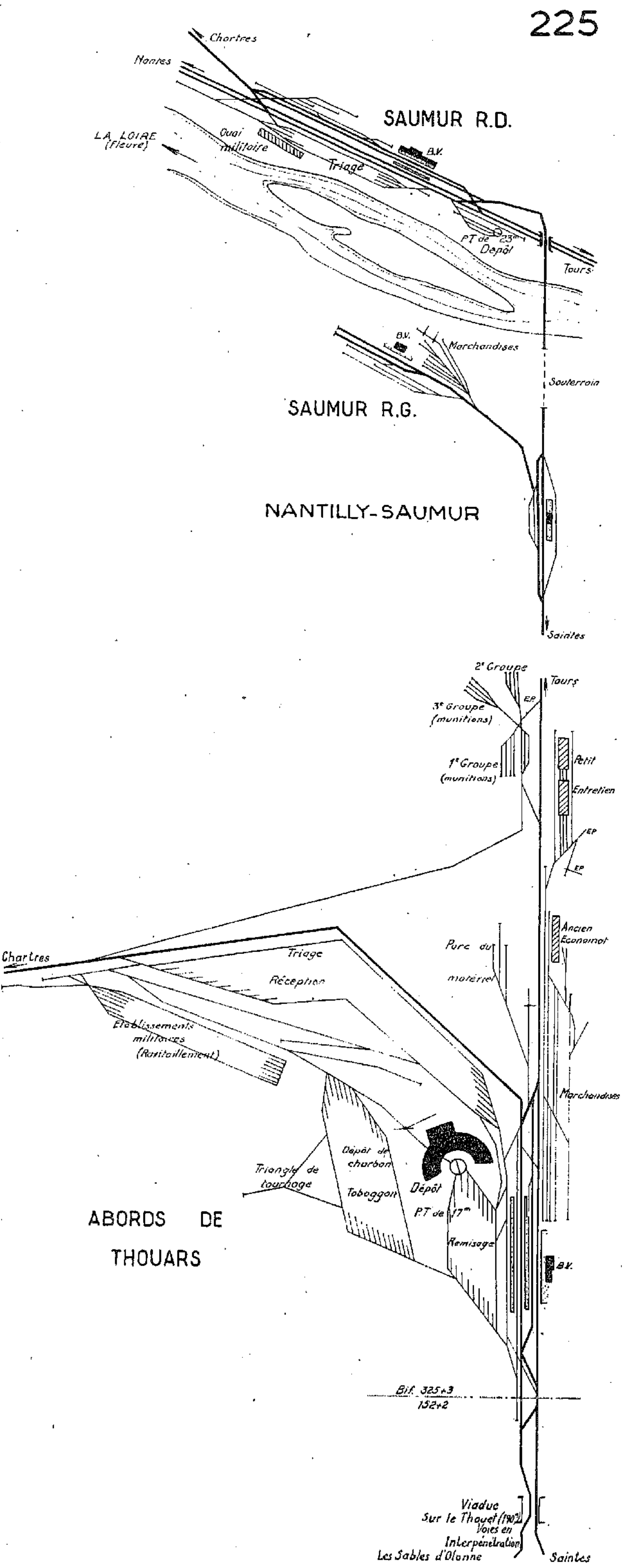
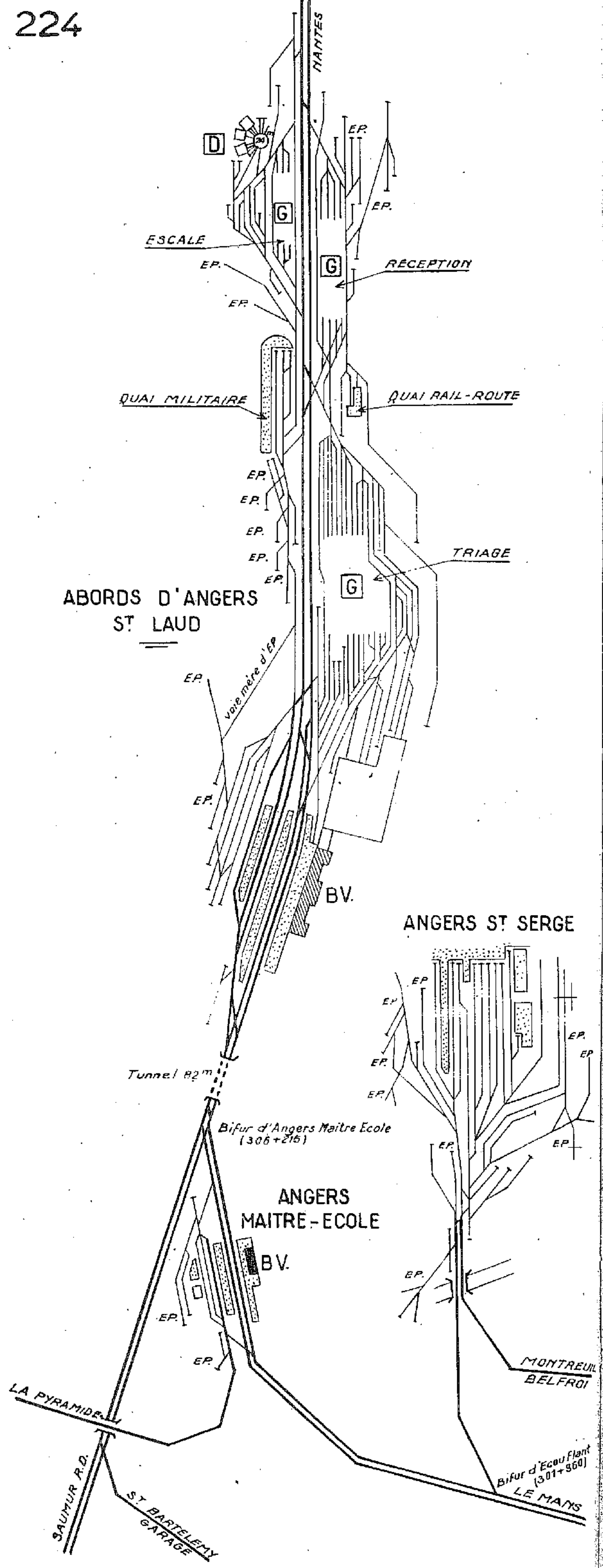

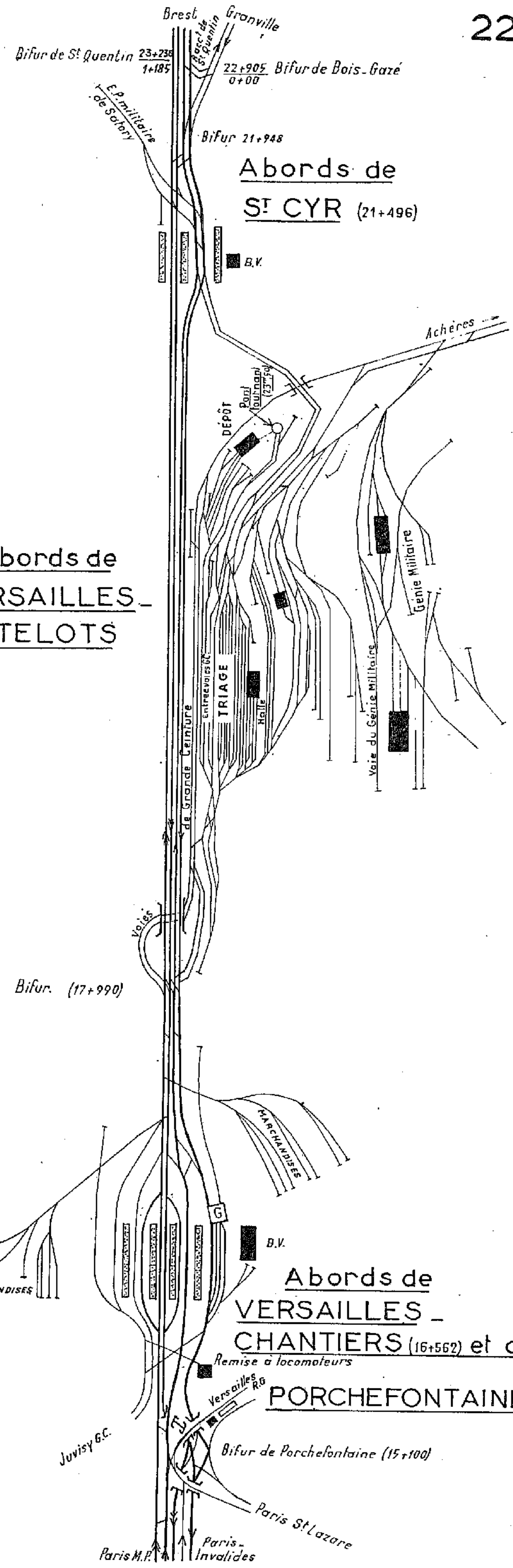
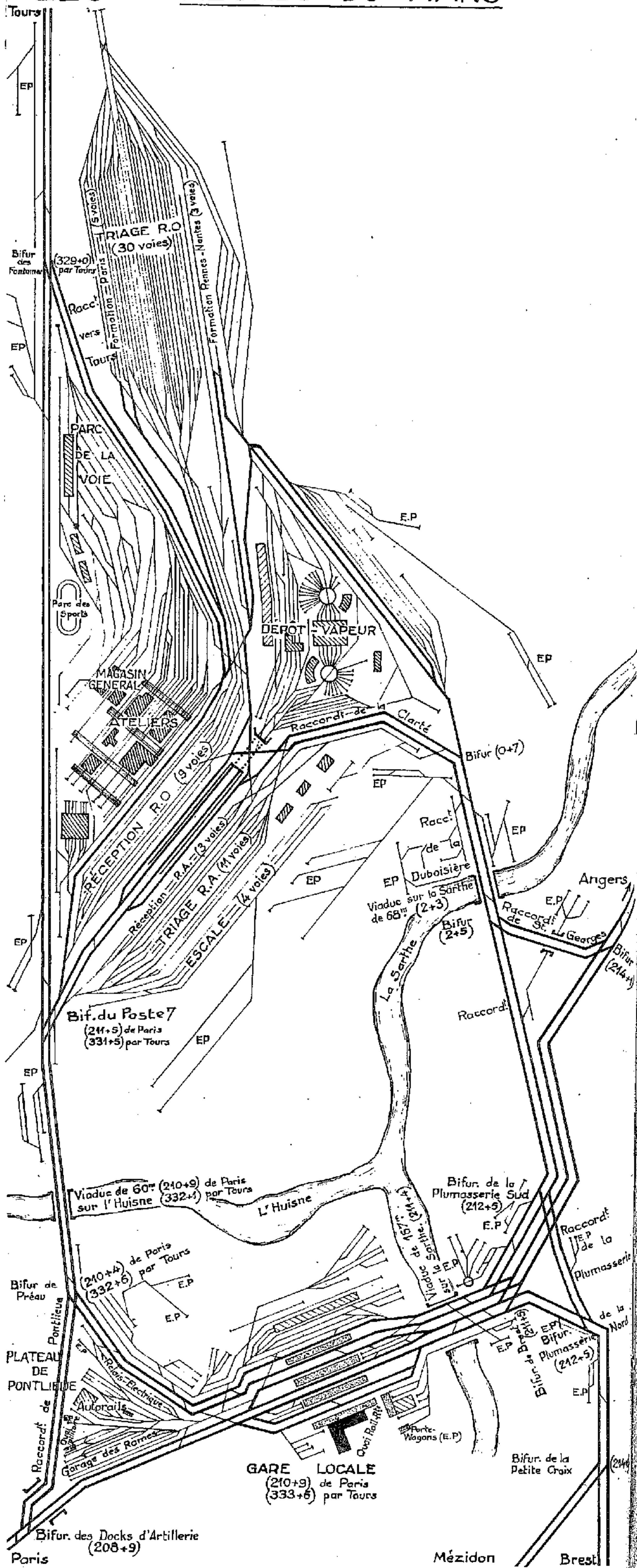

(Versailles)

CLAMART

(Montrouge-Chatillon) A B

VANVES-MALAKOFF

P.S. de 10 m.

Abords de MONTRouGE-CHATILLON

Locations

E.P.

Ceinture

OUEST-CEINTURE

Petit entretien

Petite

P.S. de 10 m.

Locations

E.P.

Voies de Voies de
Formation Départ
et de lavage G.V.

Mar-
chan-
dises

E.P.

Rail-Route

Gril de classement

Rotonde pour 18 machines

Rotonde pour 21 machines

Dépôt

Chantier de combustibles

A (Paris) B

Rail-Route

VAUGIRARD-MARCHANDISES

Pont du

Chateau

MAINE-DÉPART

MAINE-ARRIVÉE

Abords de PARIS - MONT PARNASSE

PARIS- MONT PARNASSE



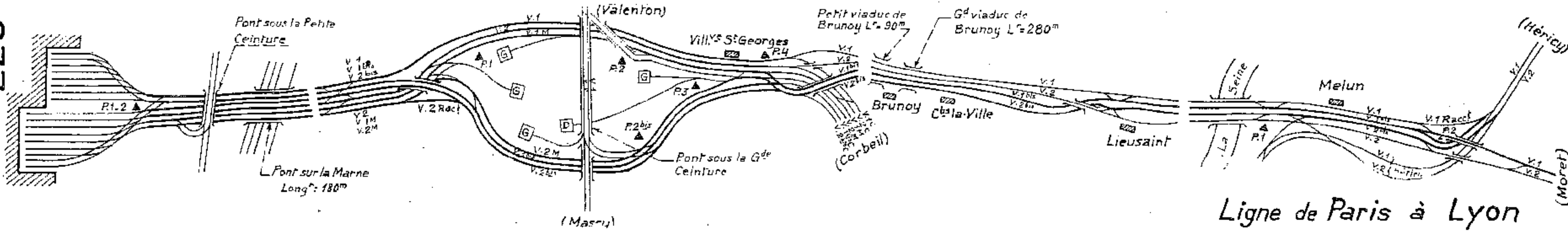

Ligne de Paris à Lyon
 Section de Paris à Melun -
 V.1 et V.2

V.1M et V.2M

V.1^{bis} et V.2^{bis}

V.1^{bis} et V.2^{bis}

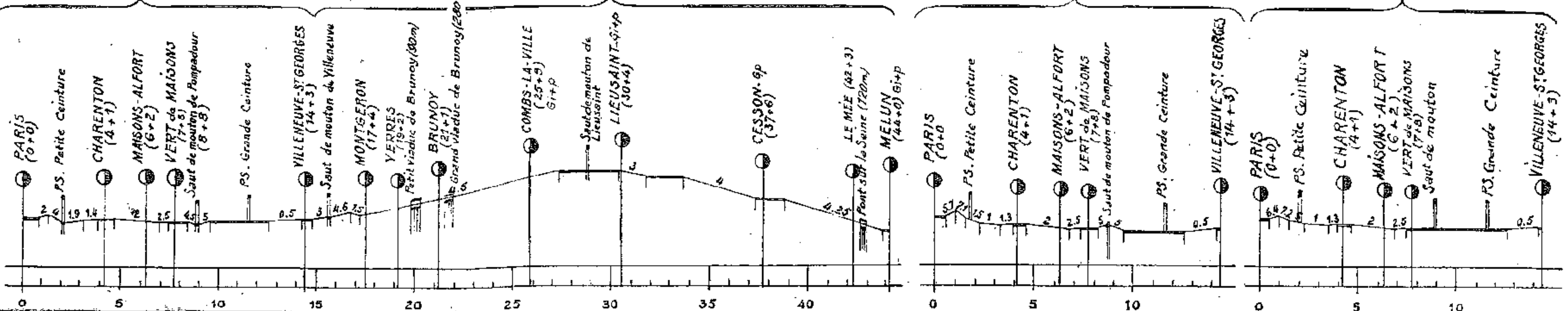

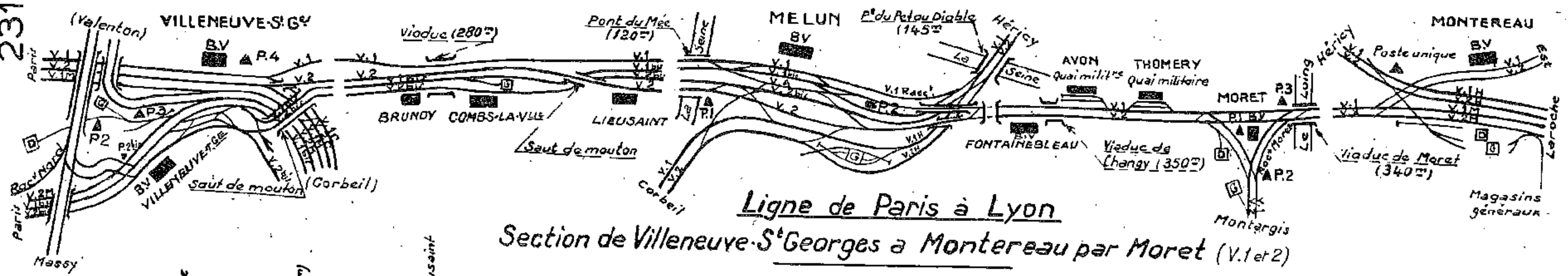

Ligne de Paris à Lyon
Section de Villeneuve-S^tGeorges à Montereau par Moret (V.1 et 2)

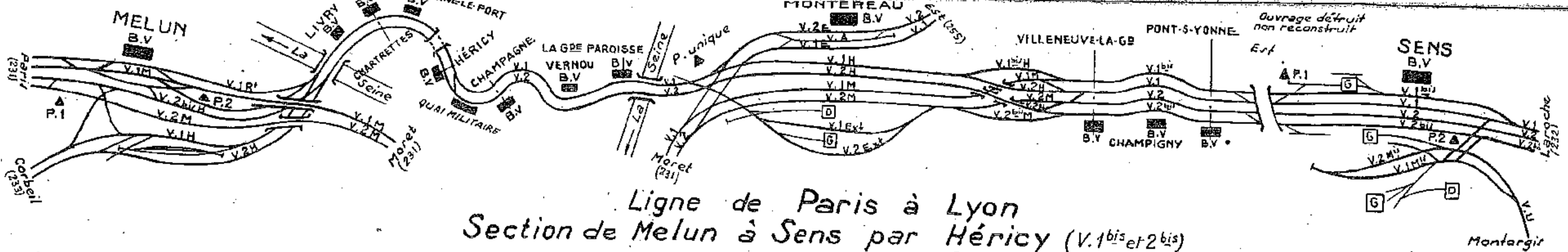
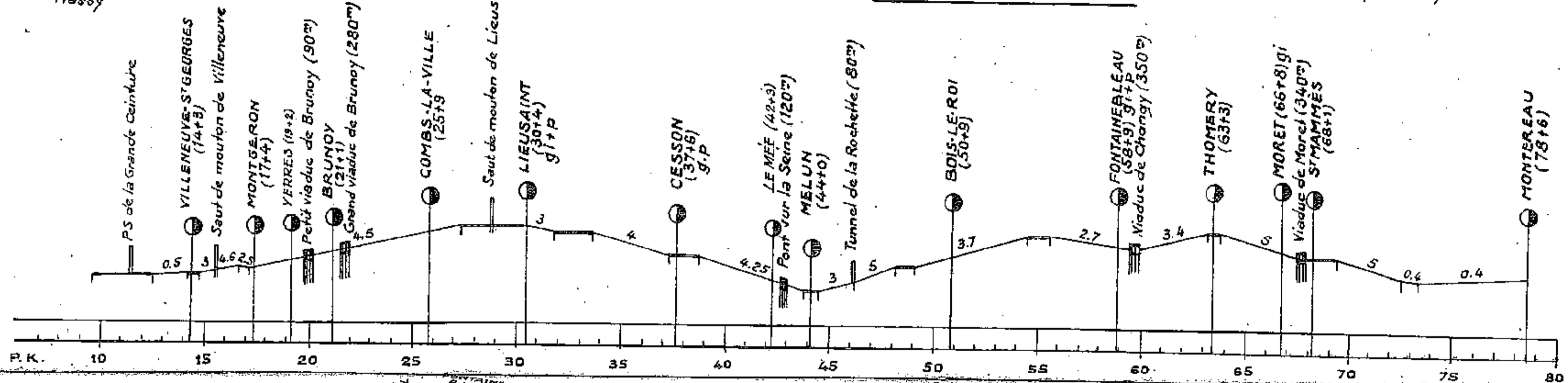

Ligne de Paris à Lyon
Section de Melun à Sens par Héricy (V.1 bis et 2 bis)

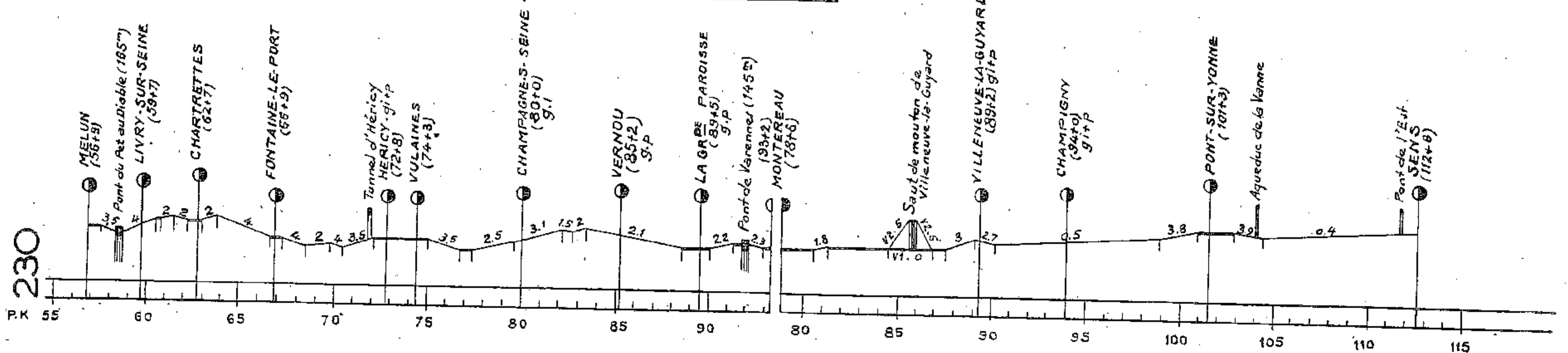

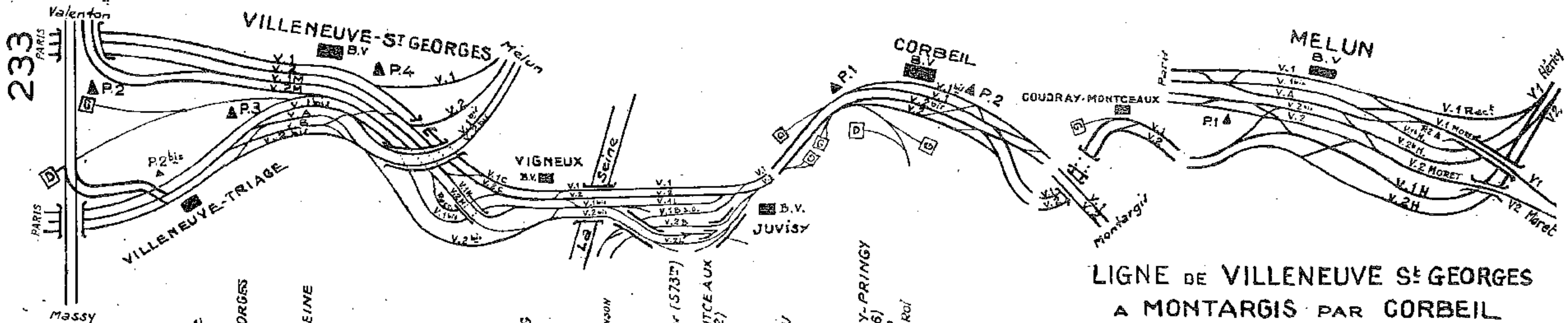

LIGNE DE VILLENEUVE S^t GEORGES
A MONTARGIS PAR CORBEIL
LIGNE DE CORBEIL A MELUN
ET A MONTEREAU

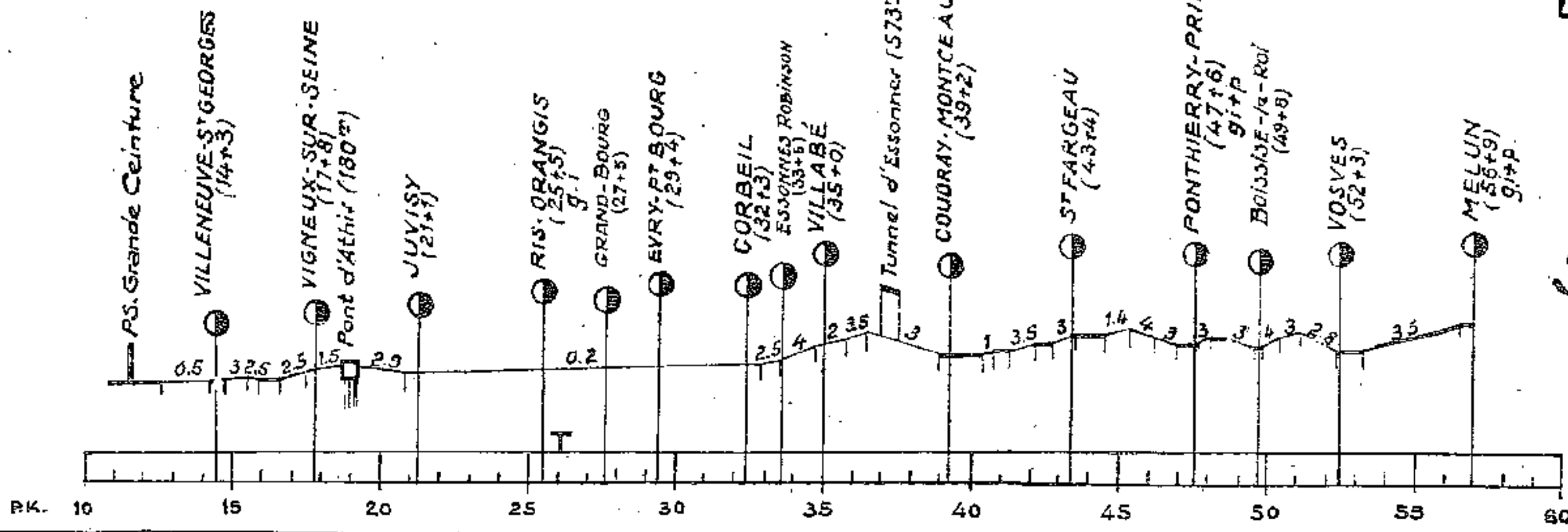

Section de Villeneuve S^t Georges
à Melun par Corbeil

Ligne de Paris à Lyon.
Section de Montereau à Laroche. par V1 et 2

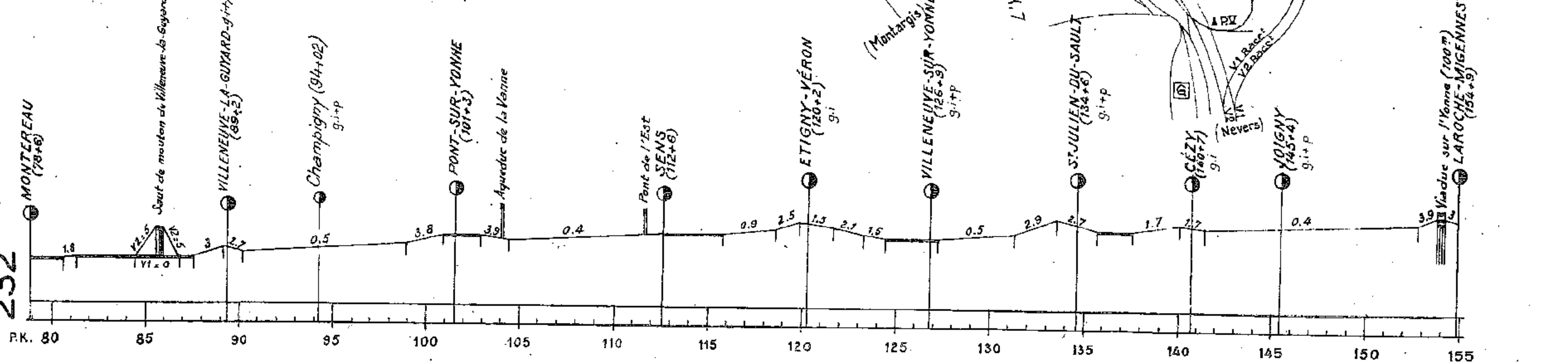
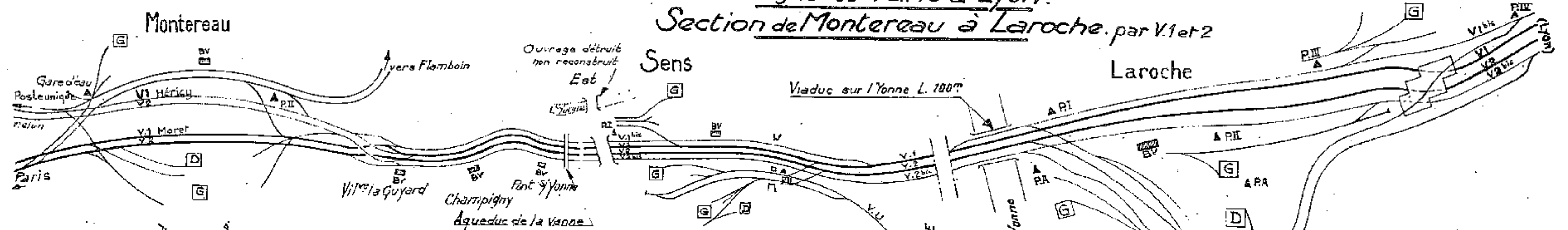

Ligne de Paris à Marseille - Ligne Moret à Roanne
Ligne de Bourron à Malesherbes.

Section de Montereau à Malesherbes - Raccords de Moret et de Filay.

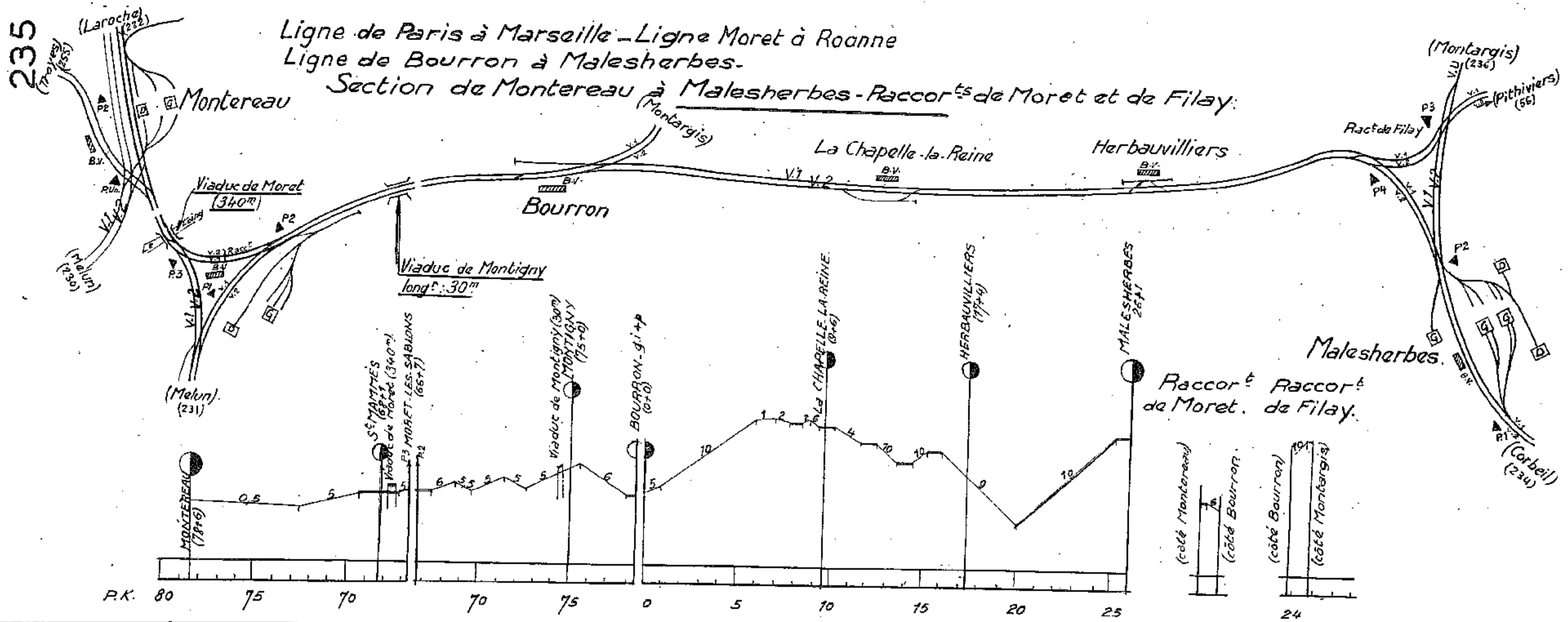

Ligne de Villeneuve St-Georges à Montargis par Corbeil.
Section de Corbeil à Malesherbes.

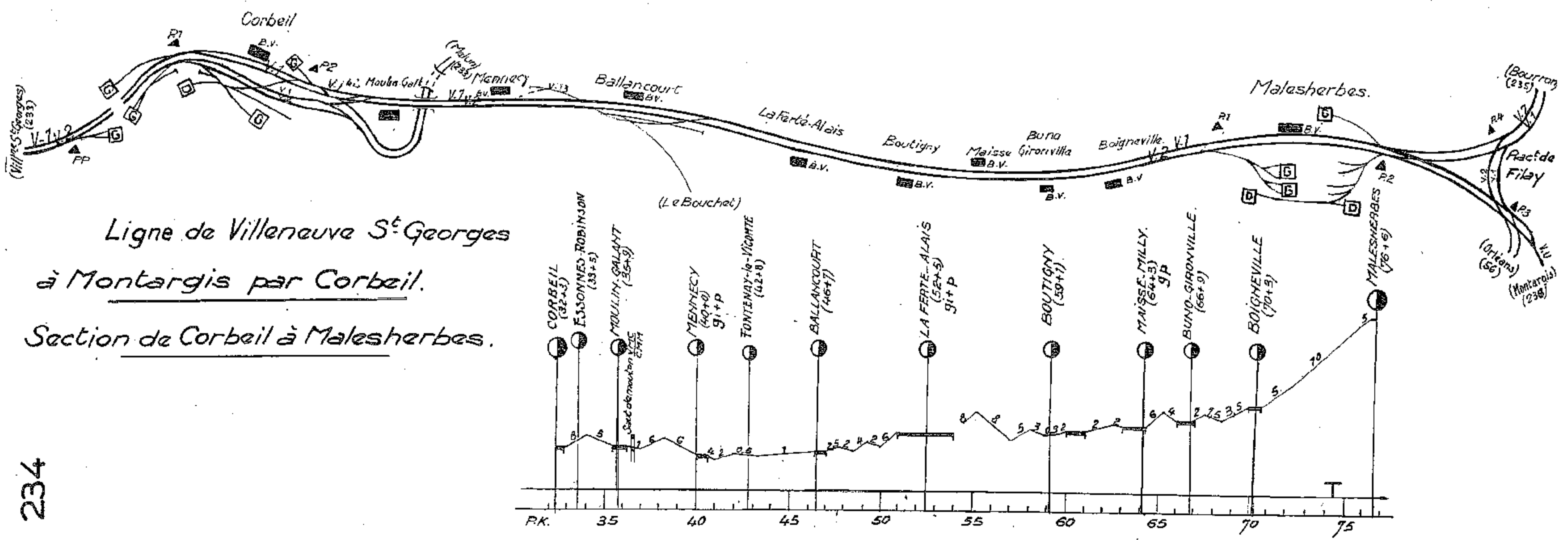

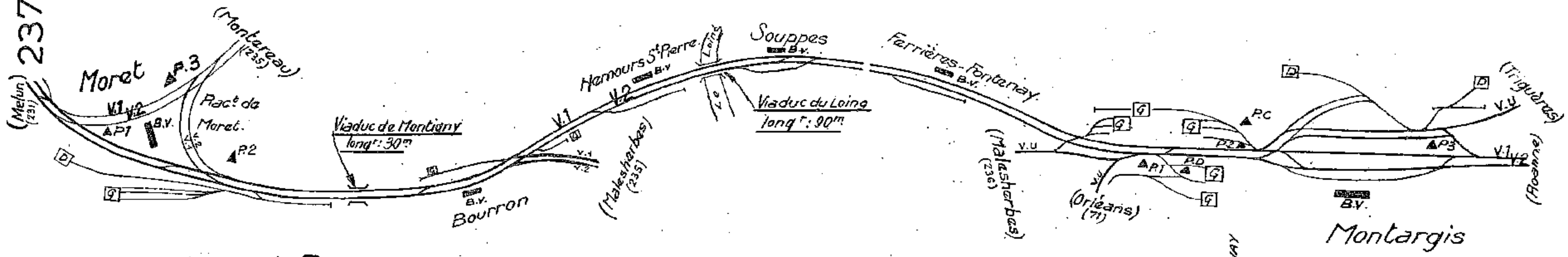

Ligne de Moret à Roanne

Section de Moret à Montargis

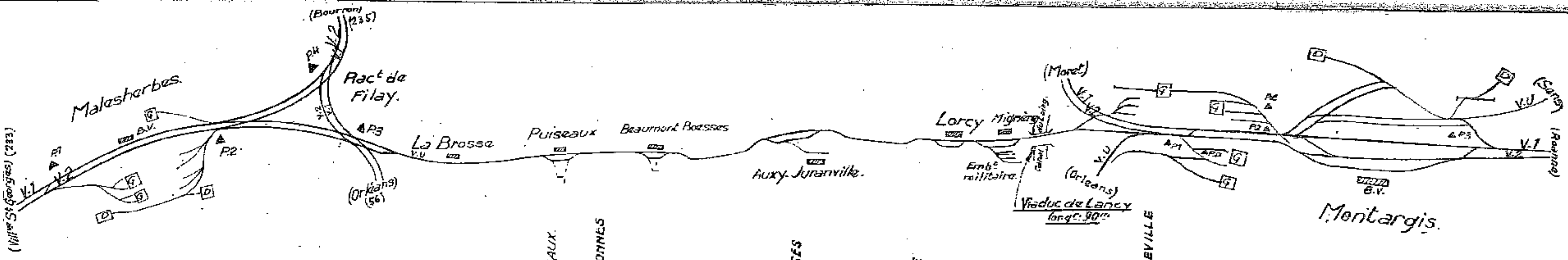
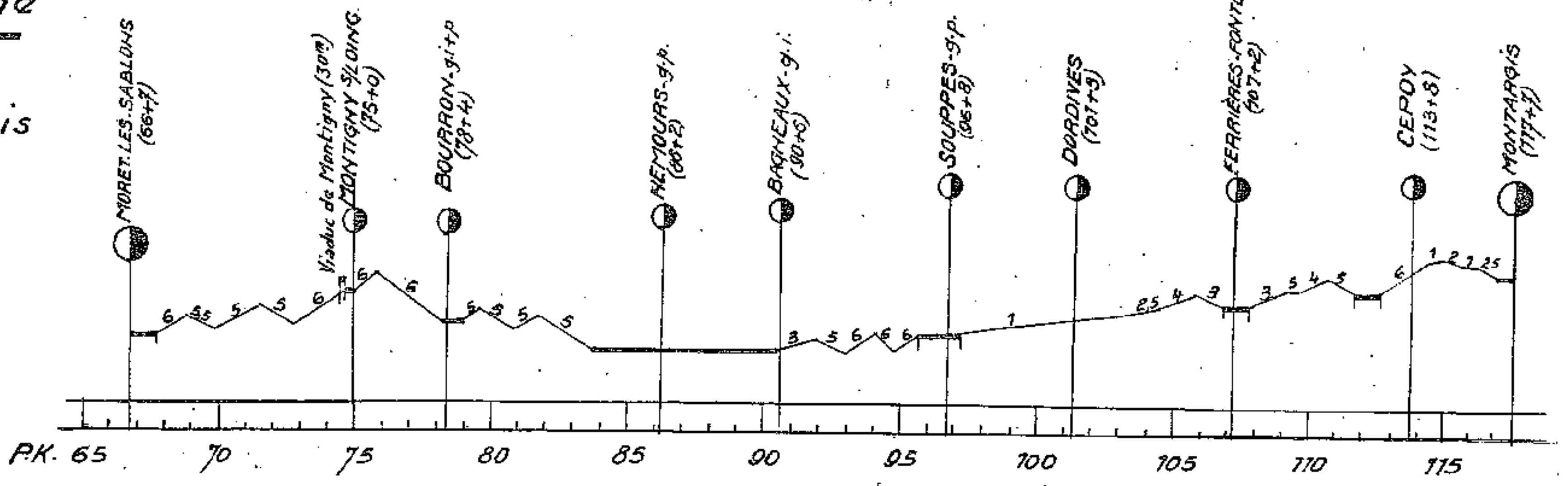

Ligne de Vill^{rs} St Georges à Montargis par Corbeil.

Section de Malesherbes à Montargis

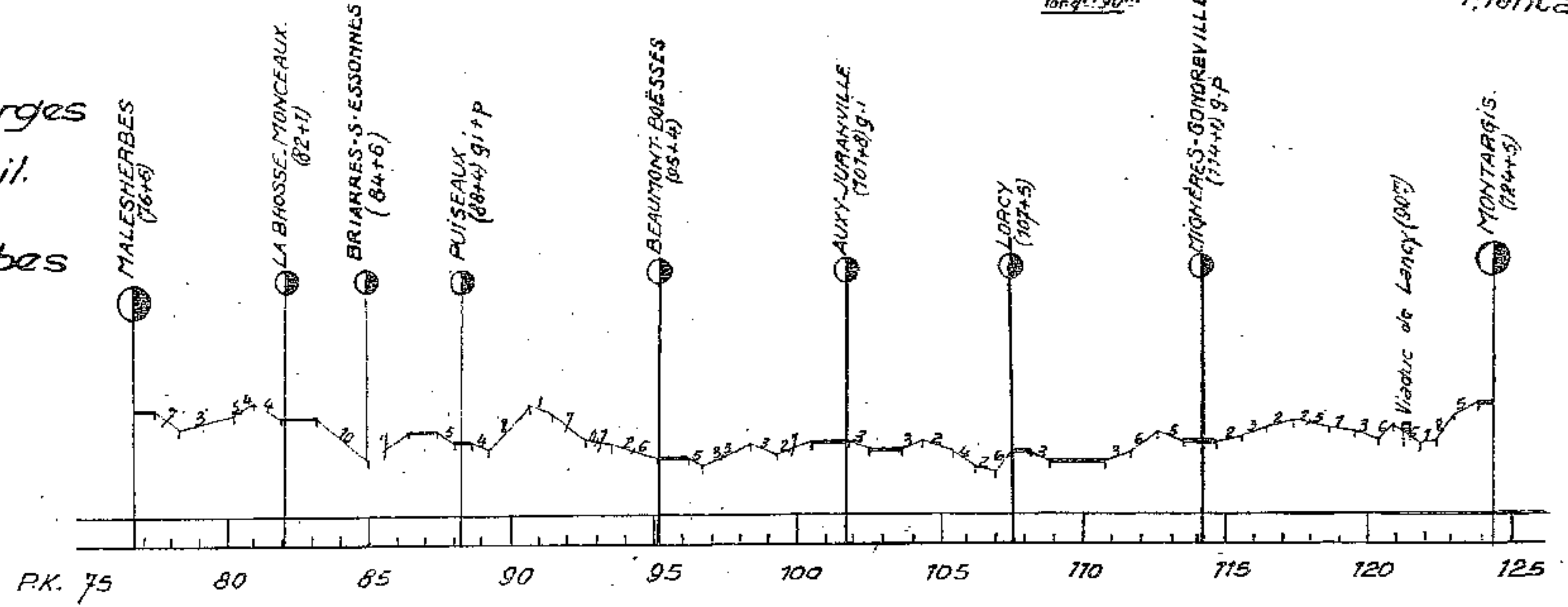

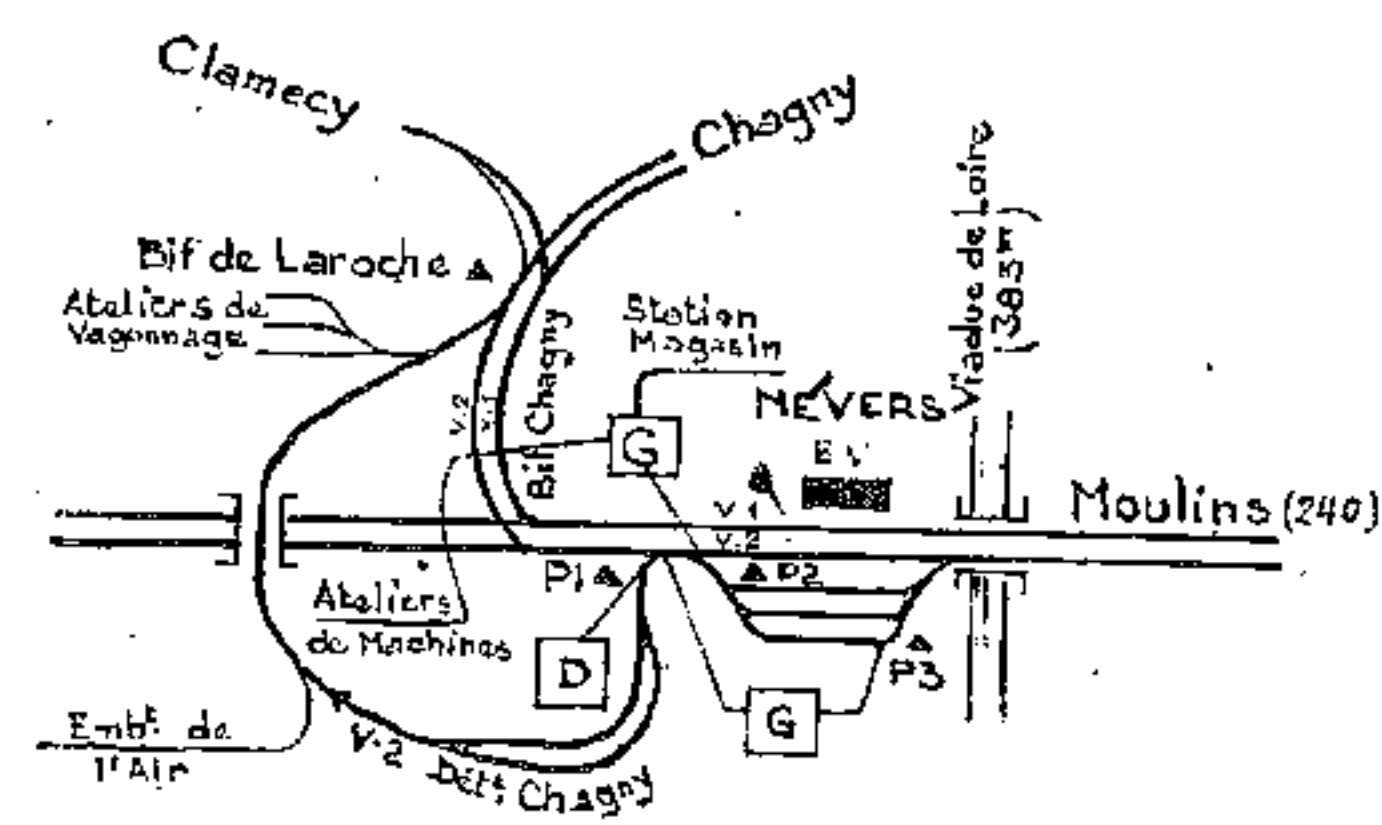
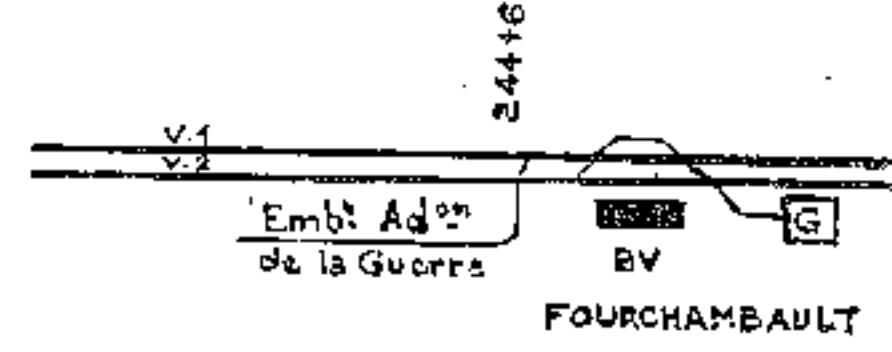
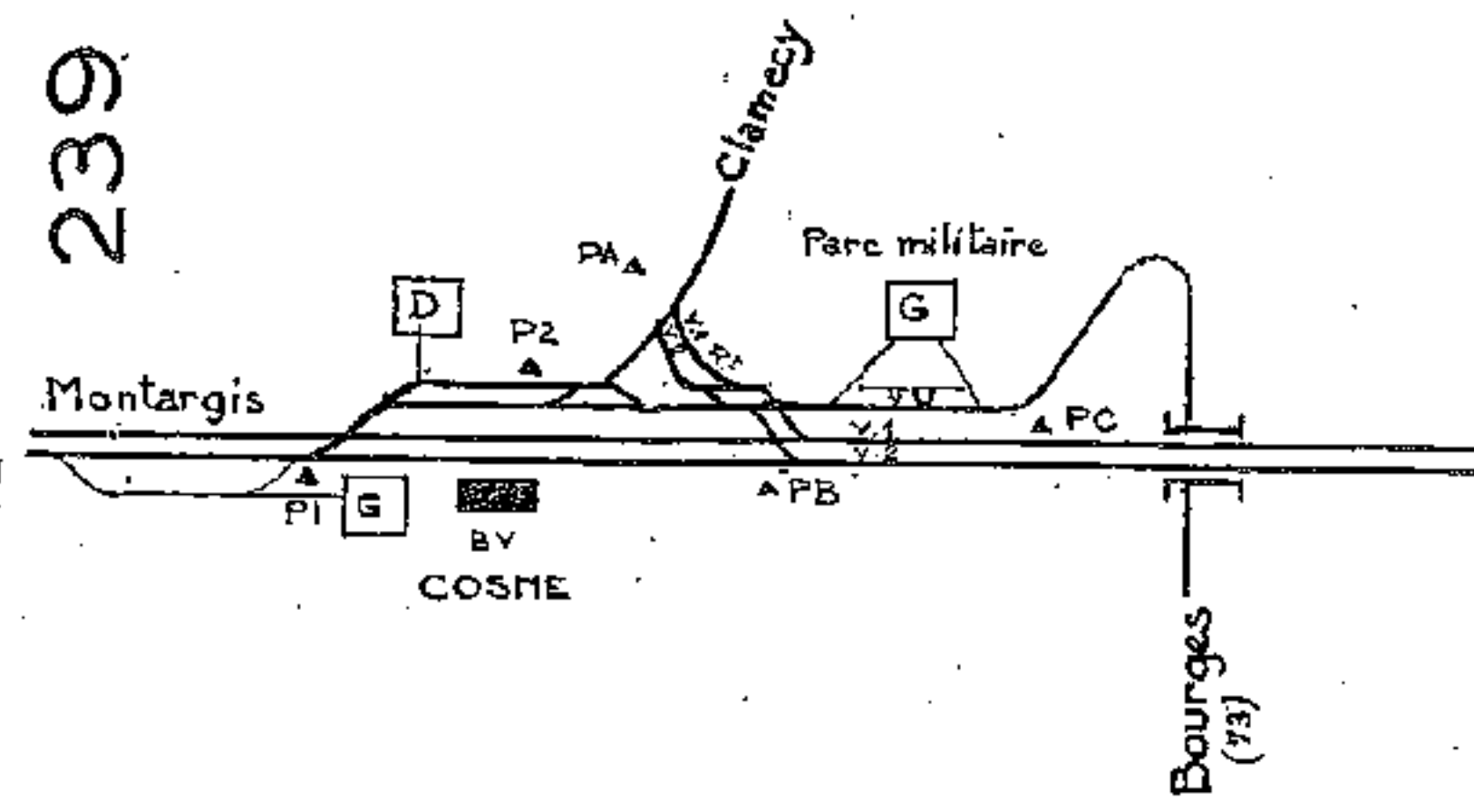

Ligne de PARIS à CLERMONT-FERRAND
Section de COSNE à NEVERS

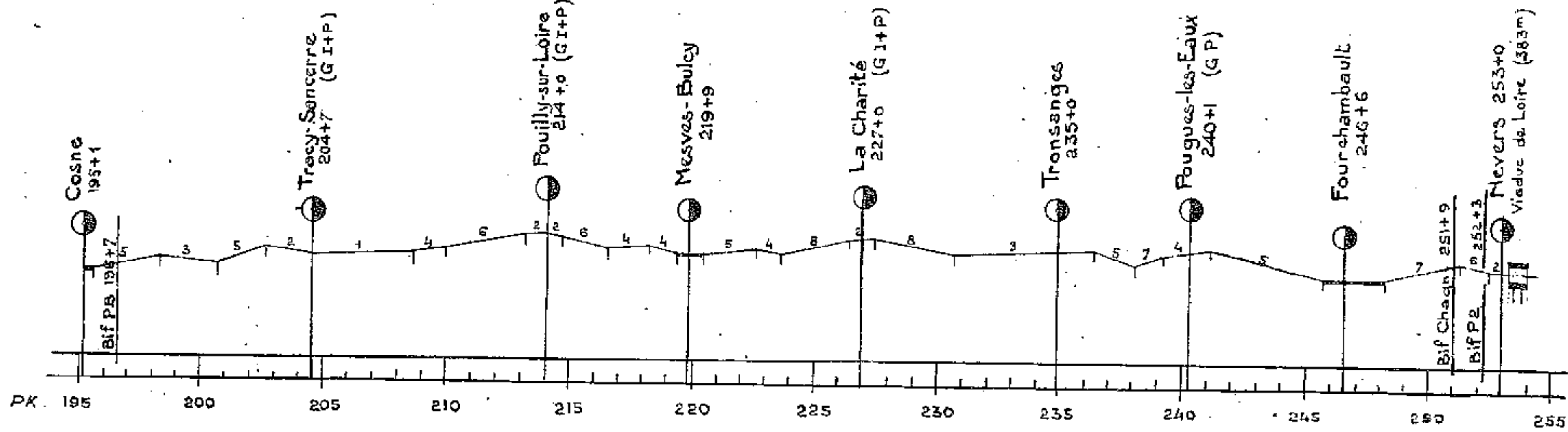

Ligne de Moret à Roanne.
Section de Montargis à Cosne.

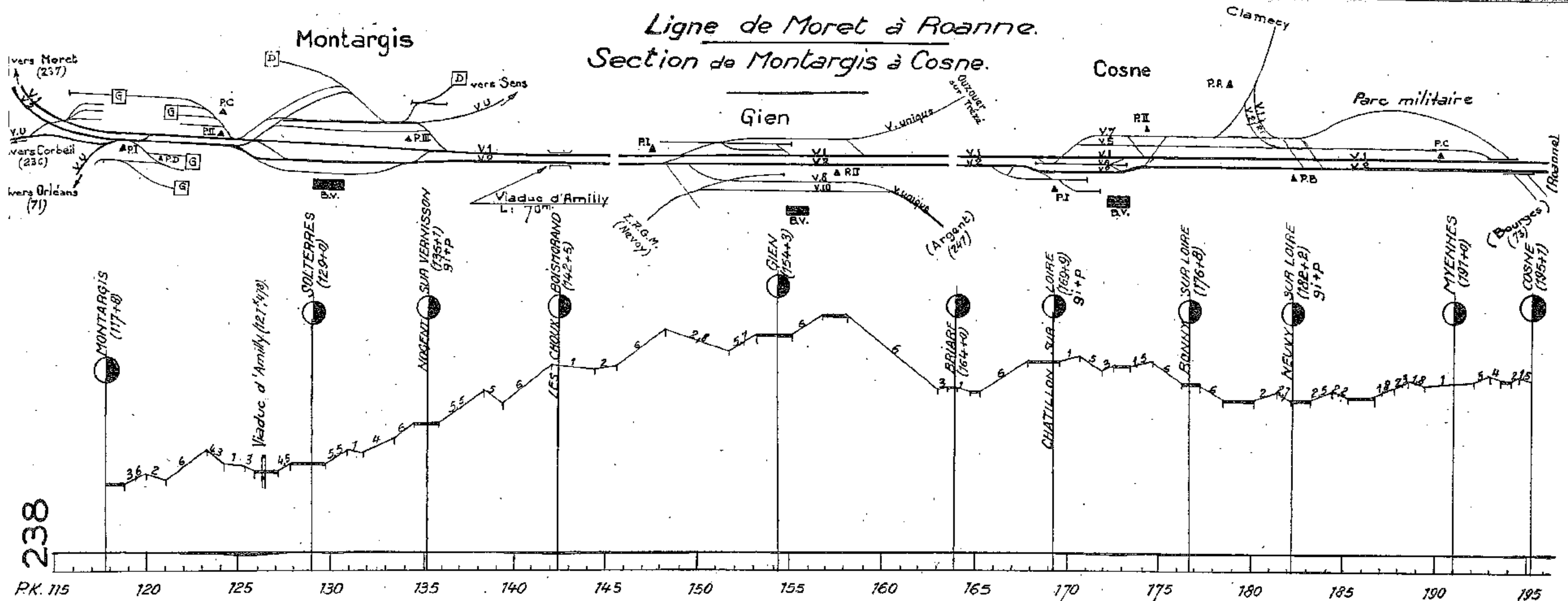

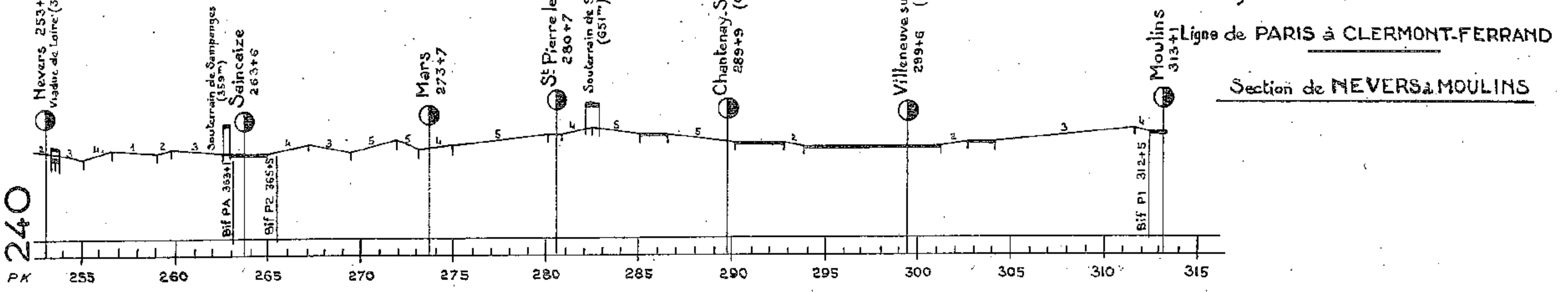
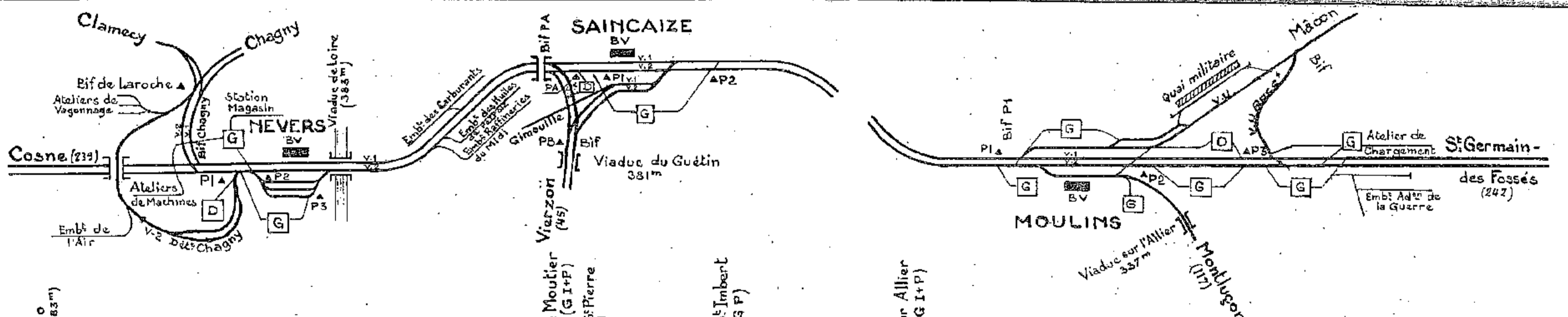
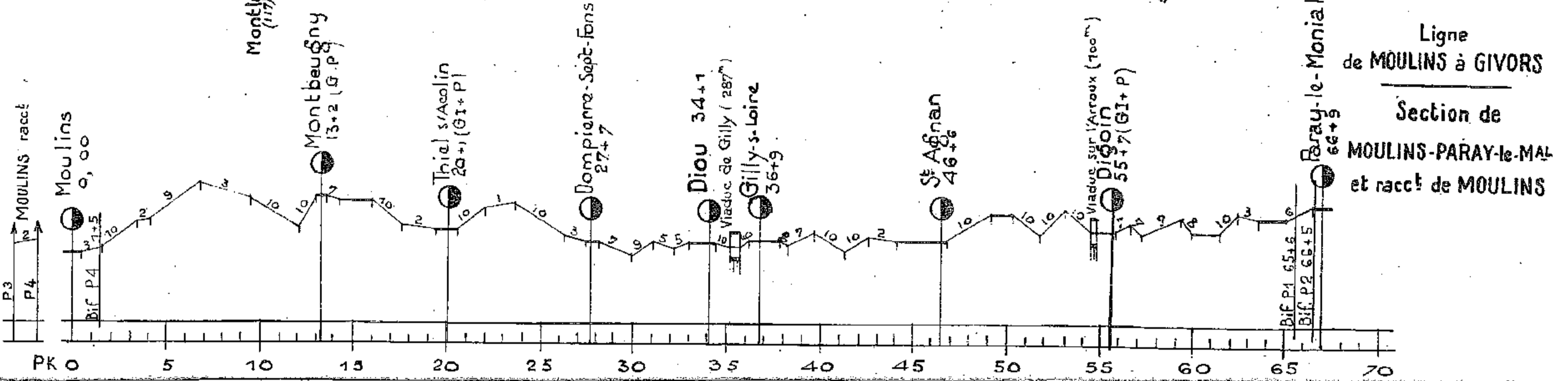
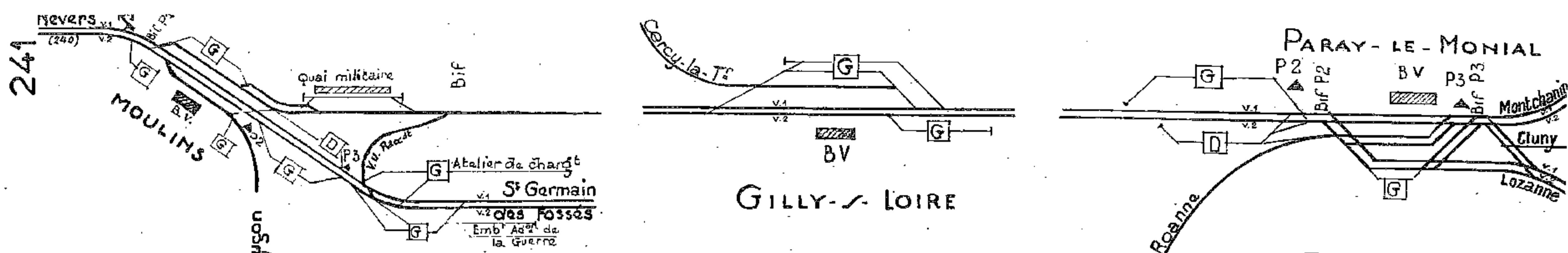

Ligne de S^t GERMAIN à NIMES Section de S^t GERMAIN à RIOM par GANNAT

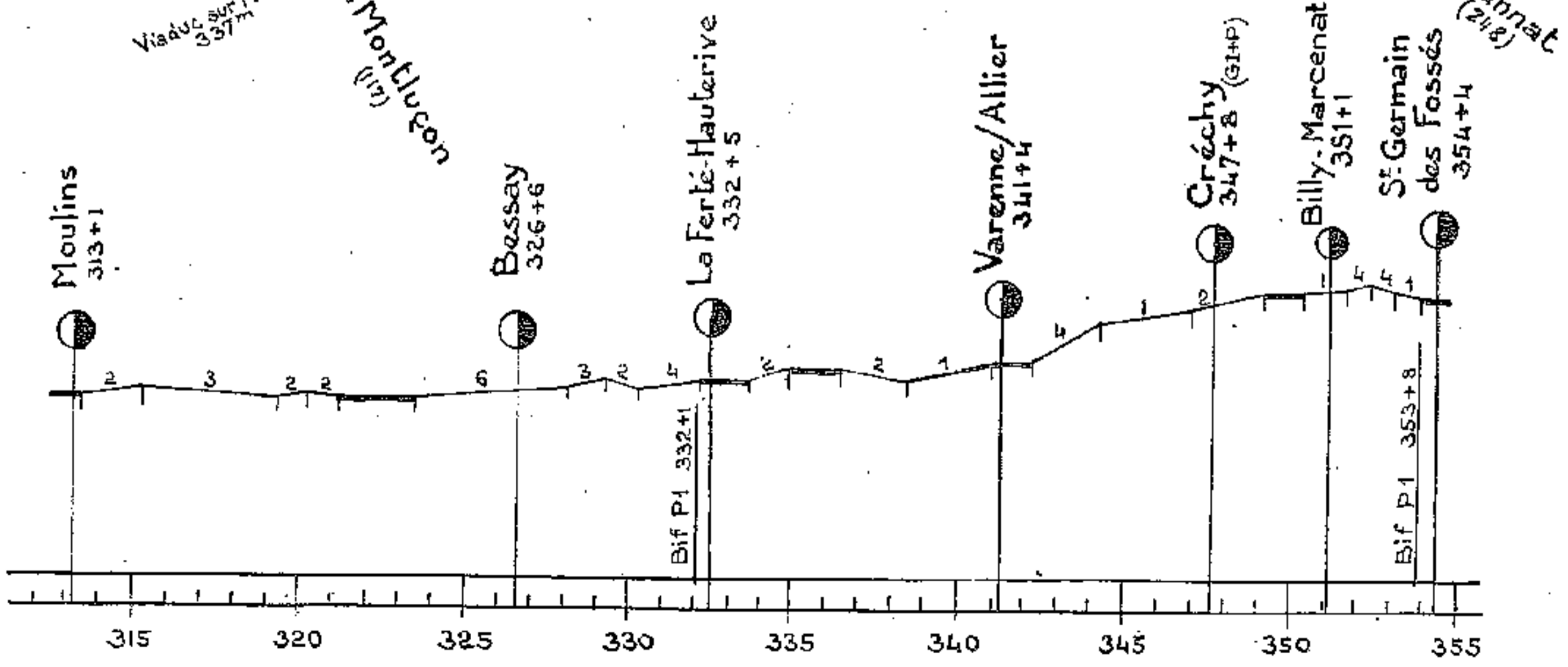
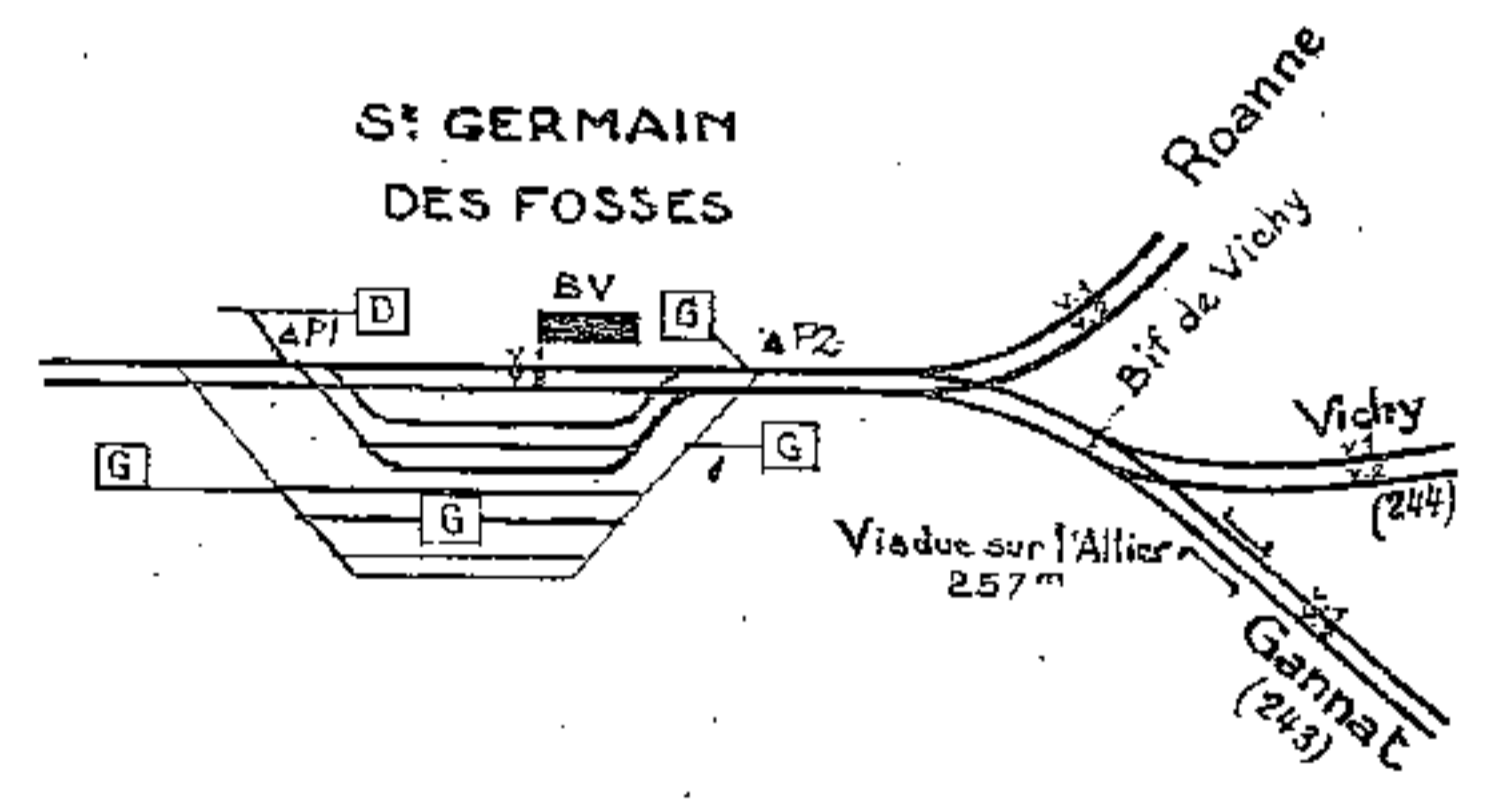
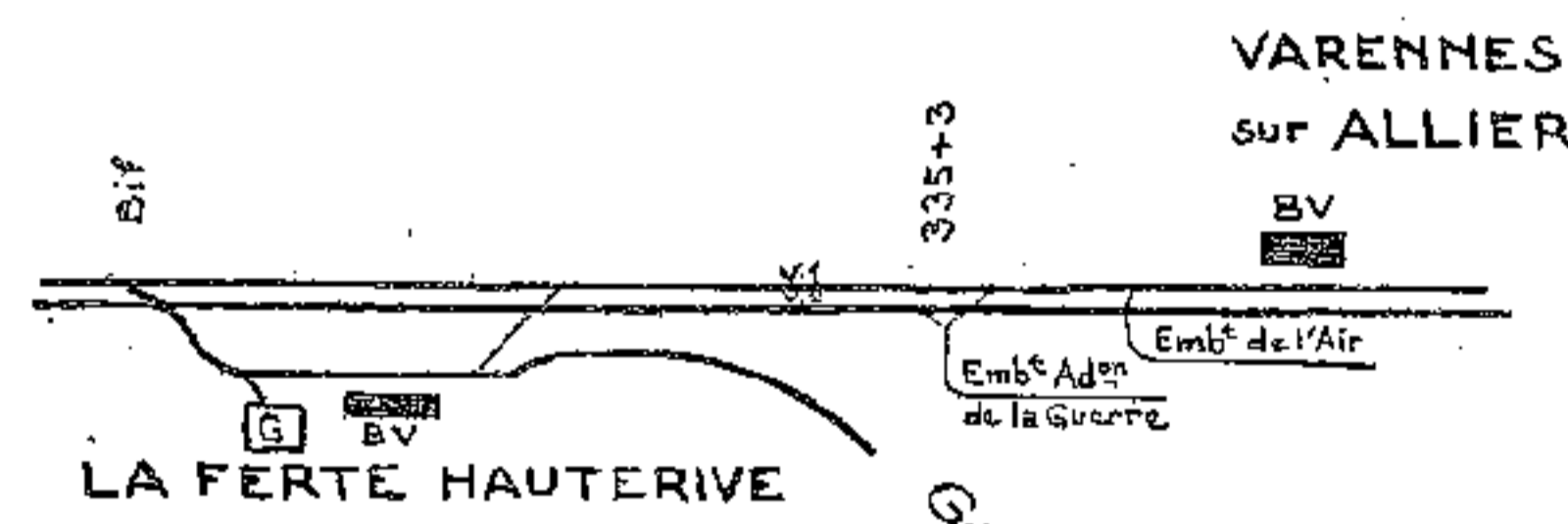
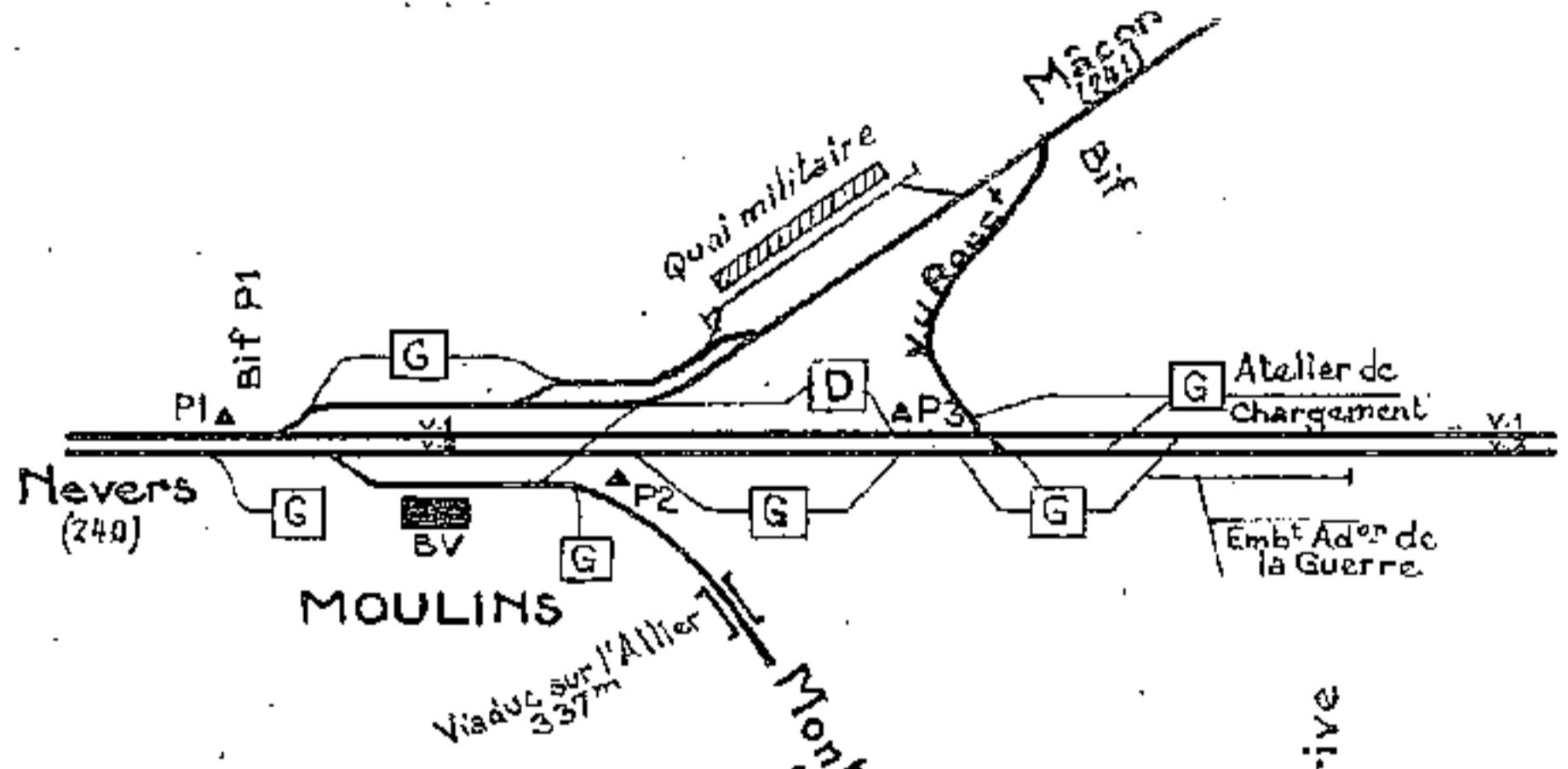
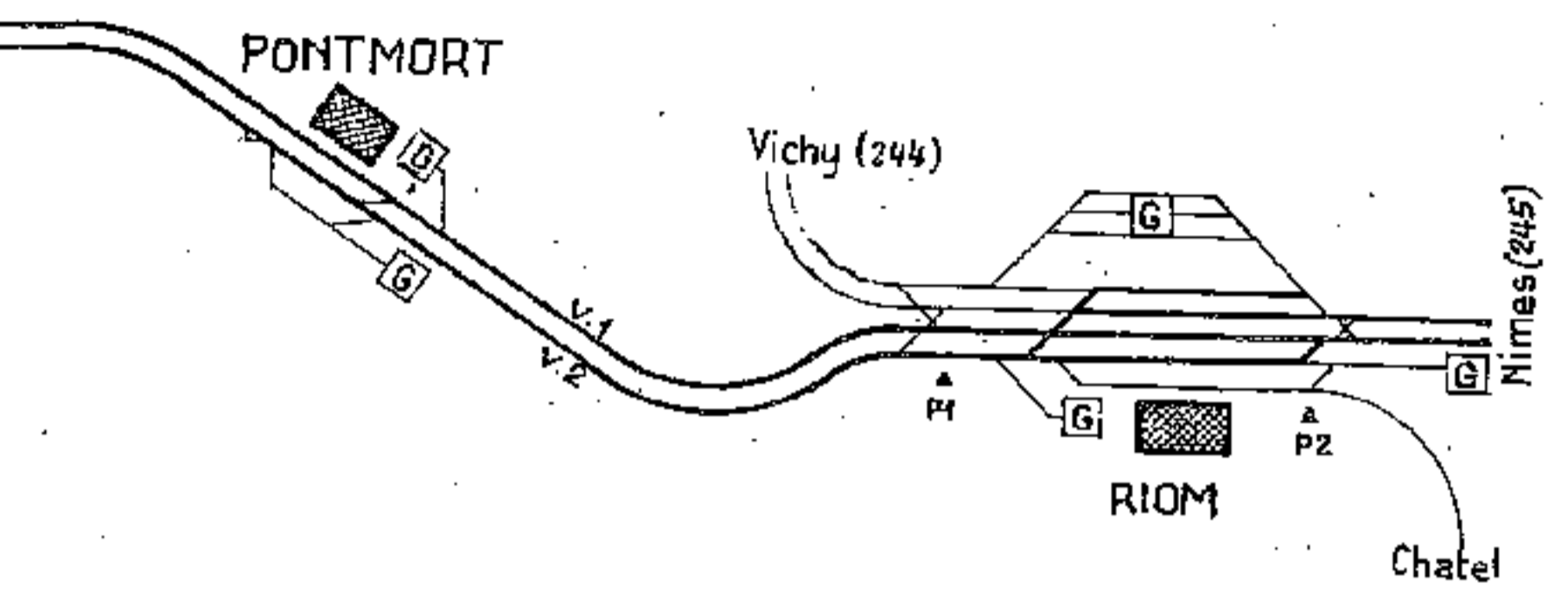
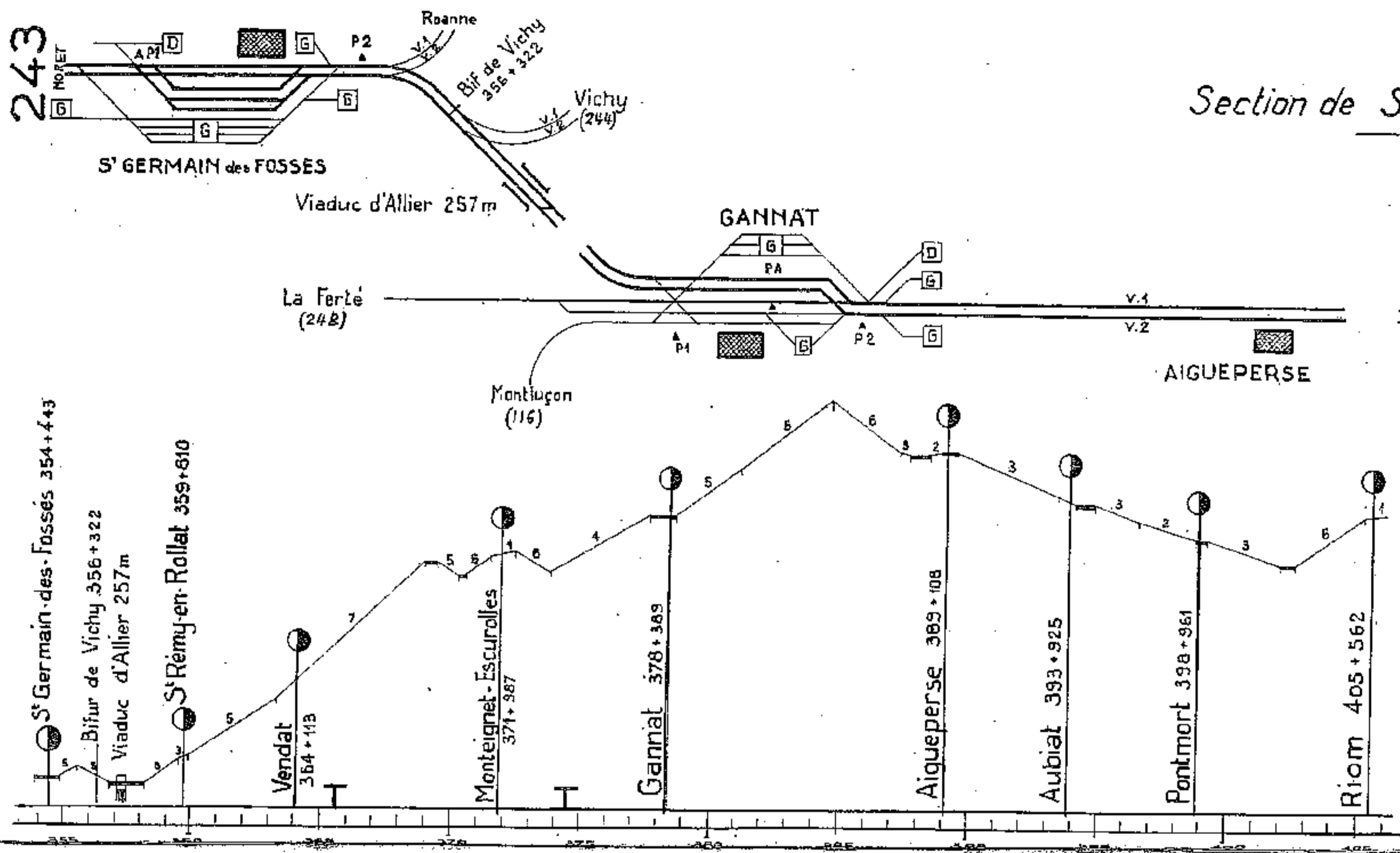

Ligne de PARIS à CLERMONT-FERRAND Section de MOULINS à S^t GERMAIN des FOSSES

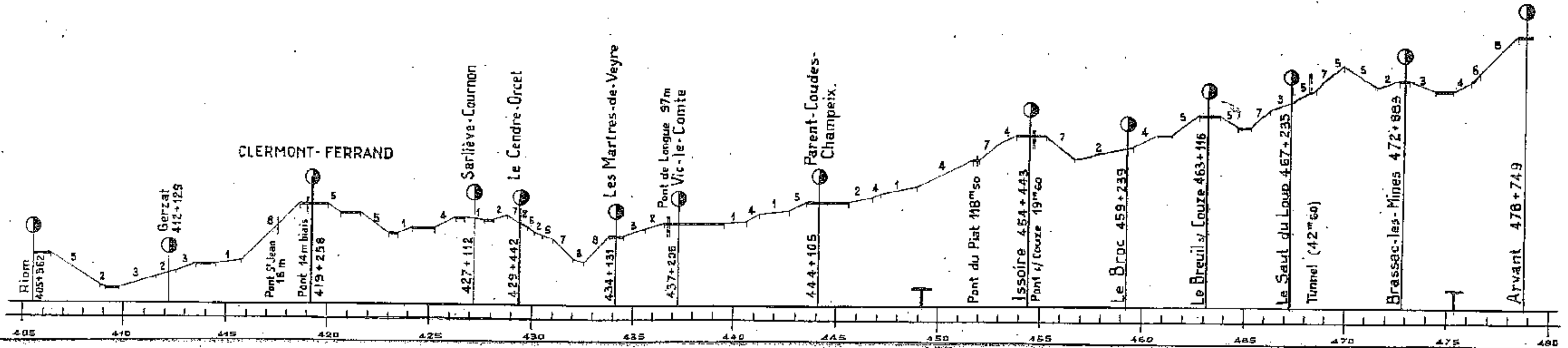
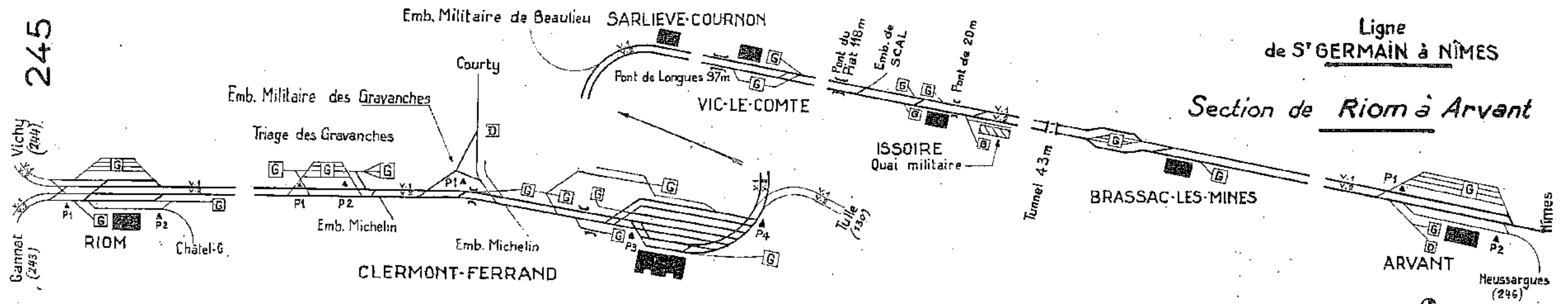

Lignes de S^t GERMAIN à DARSAC

et de VICHY à RIOM

Section de S^t GERMAIN à RIOM

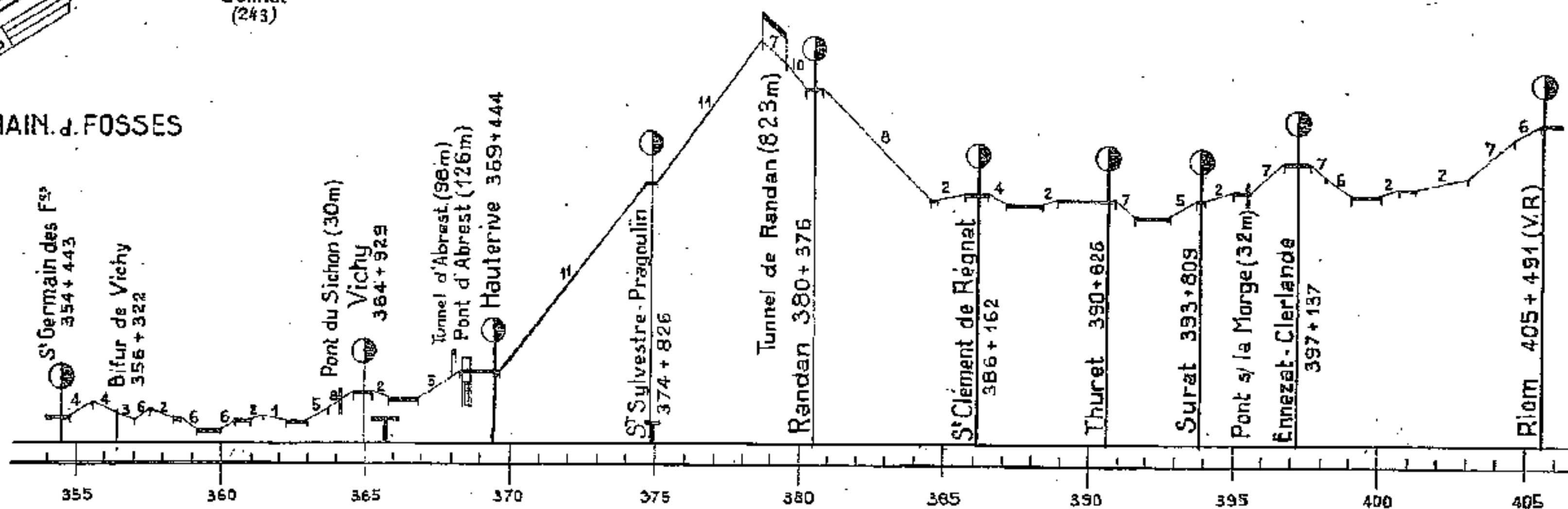
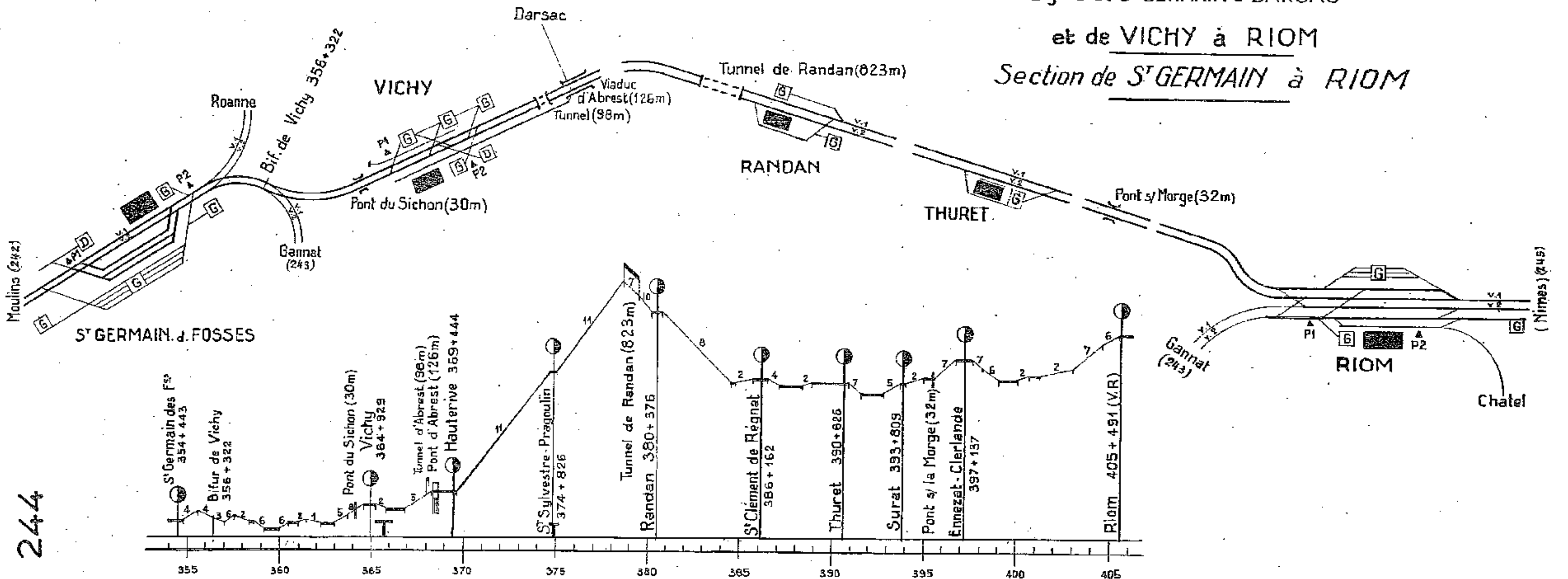

Ligne de Gien à Argent

Section de Gien à Argent

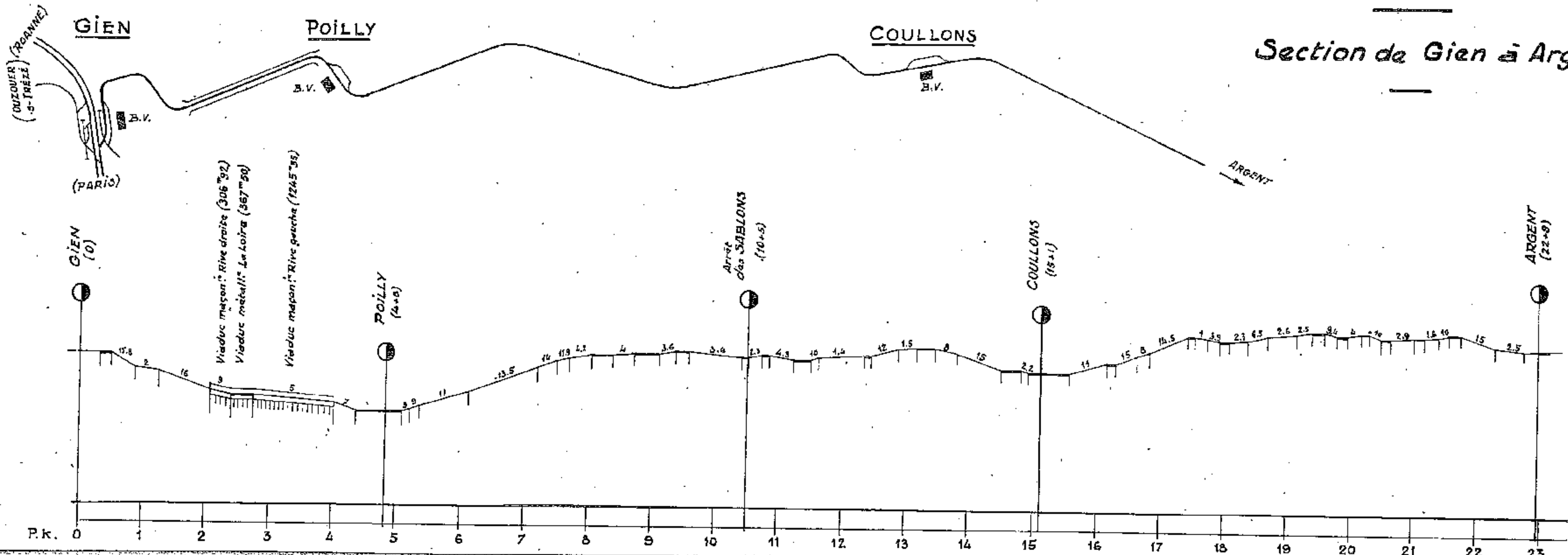

Abords d'Arvant

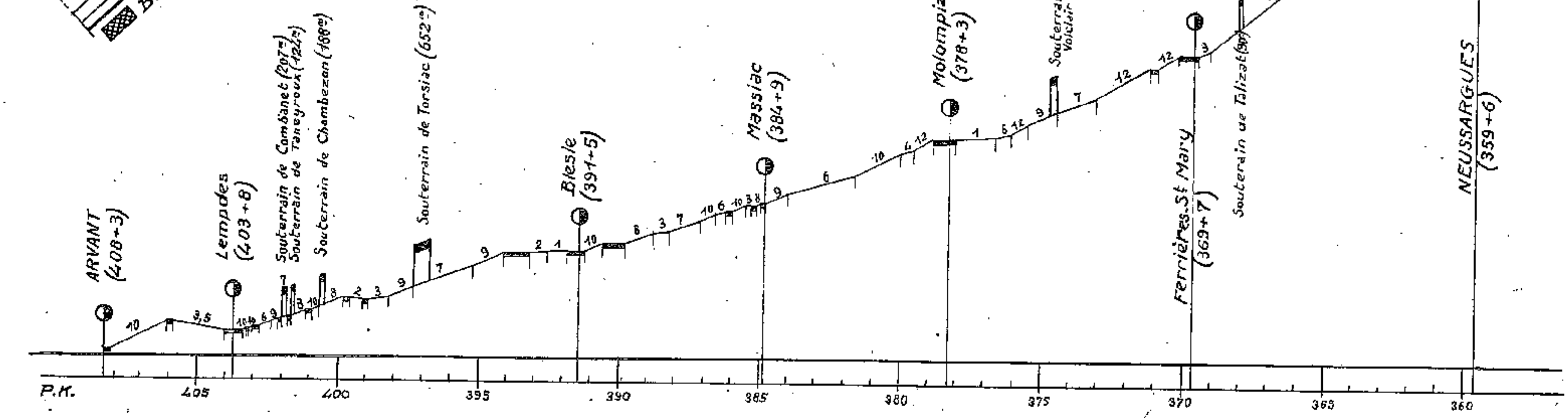
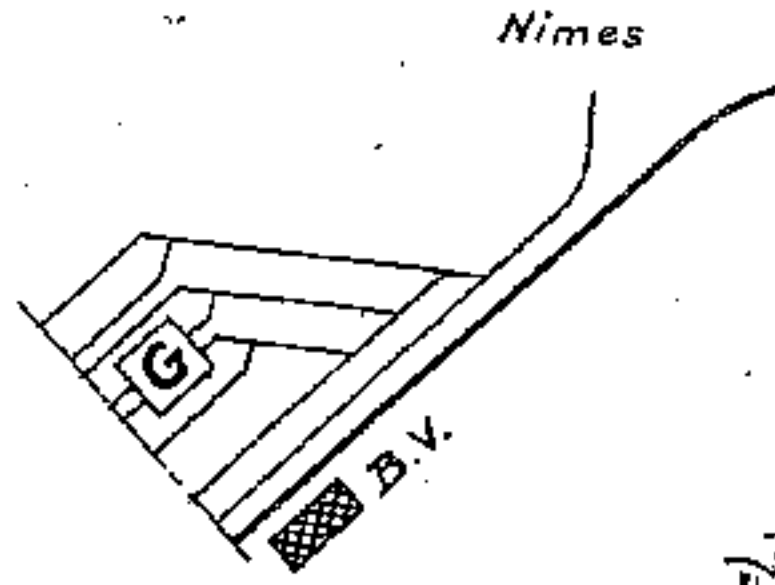

Ligne de BORDEAUX à SÈTE

Section de LEZIGNAN à SÈTE

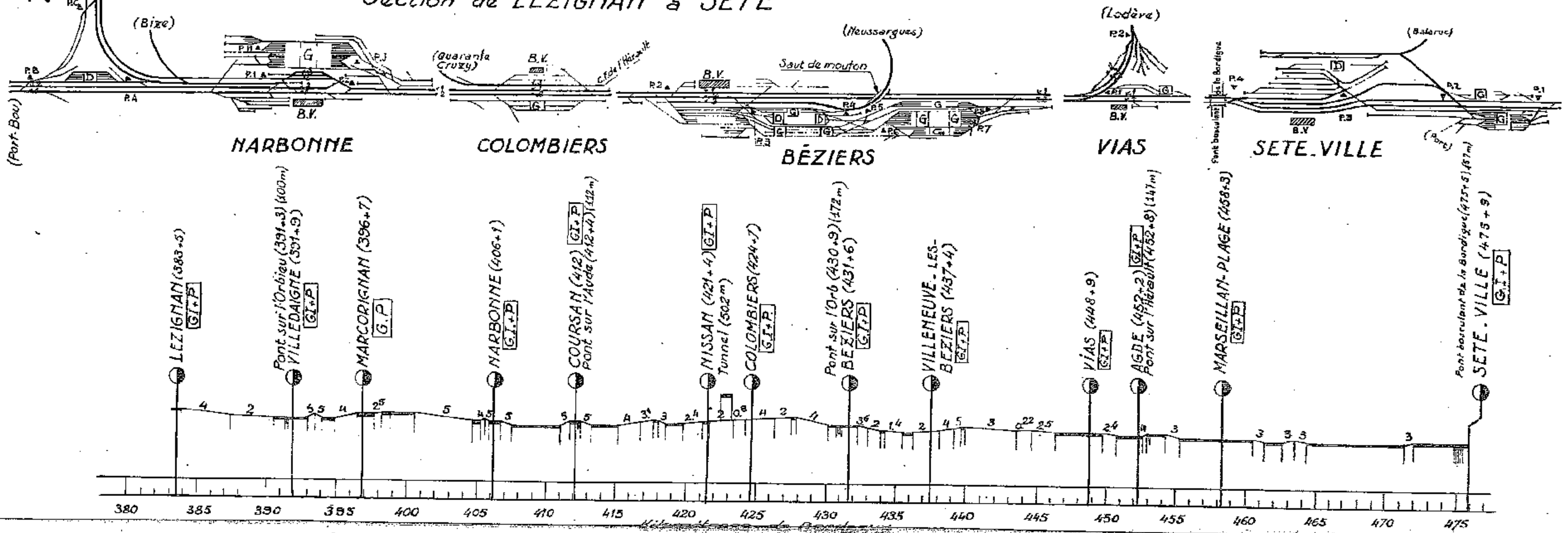

Ligne de LA FERTE-GANNAT

Section de LA FERTE à GANNAT

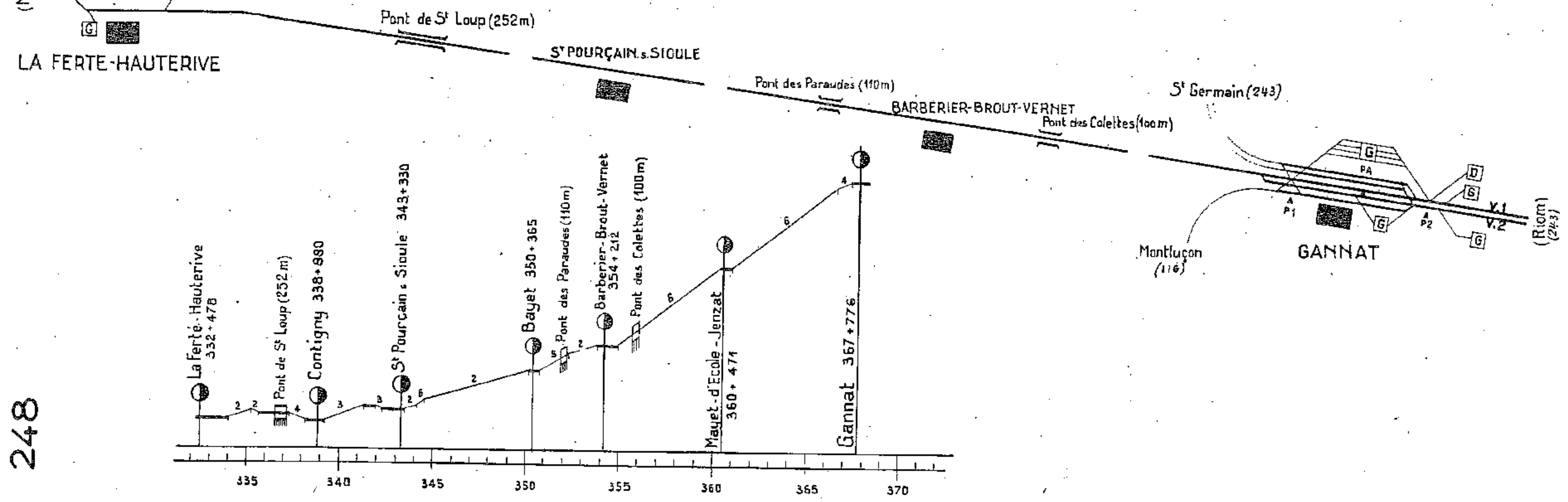

Ligne de CASTRES à BÉDARIEUX

Section de S^t PONS à BÉDARIEUX
(S^t Pons)

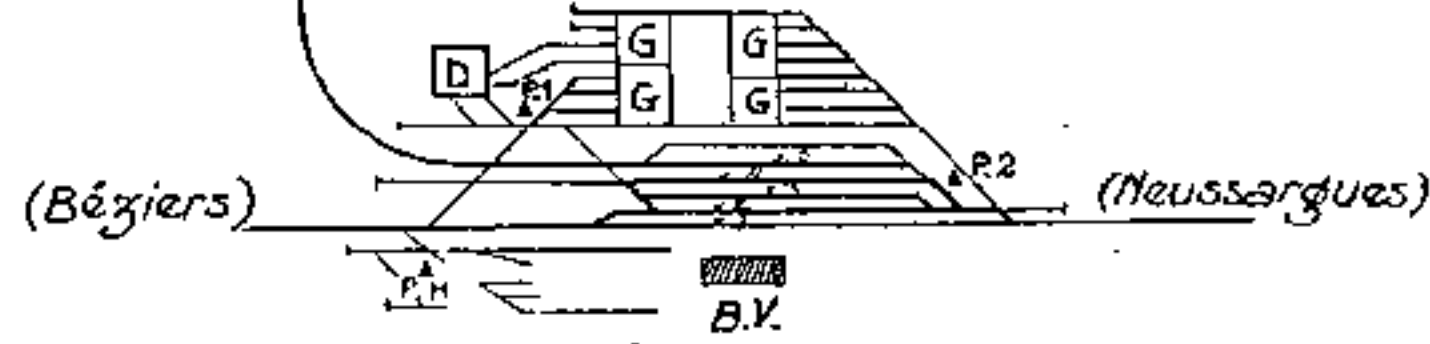

BÉDARIEUX

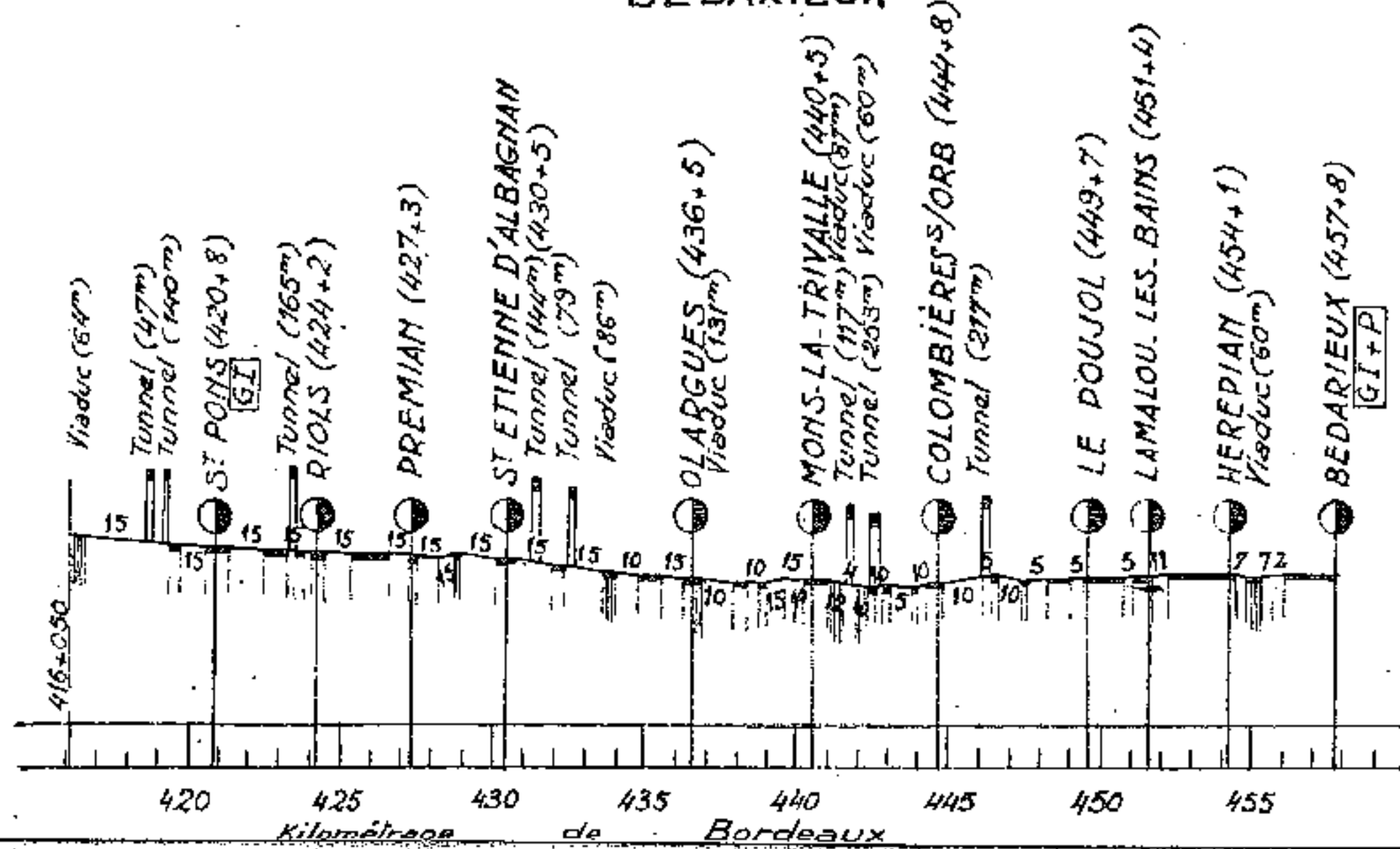

Ligne de TOURNEMIRE-

ROQUEFORT à S^t AFFRIQUE

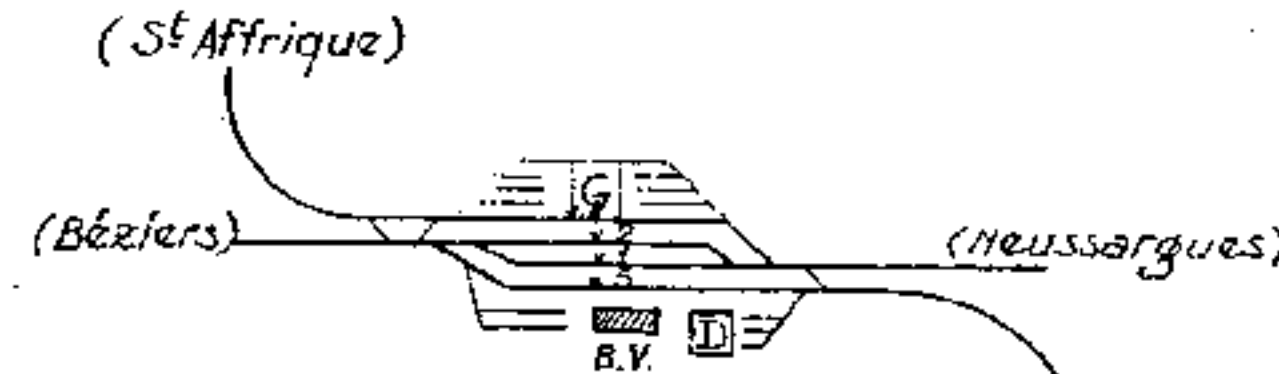

TOURNEMIRE-ROQUEFORT
(Le Vigan)

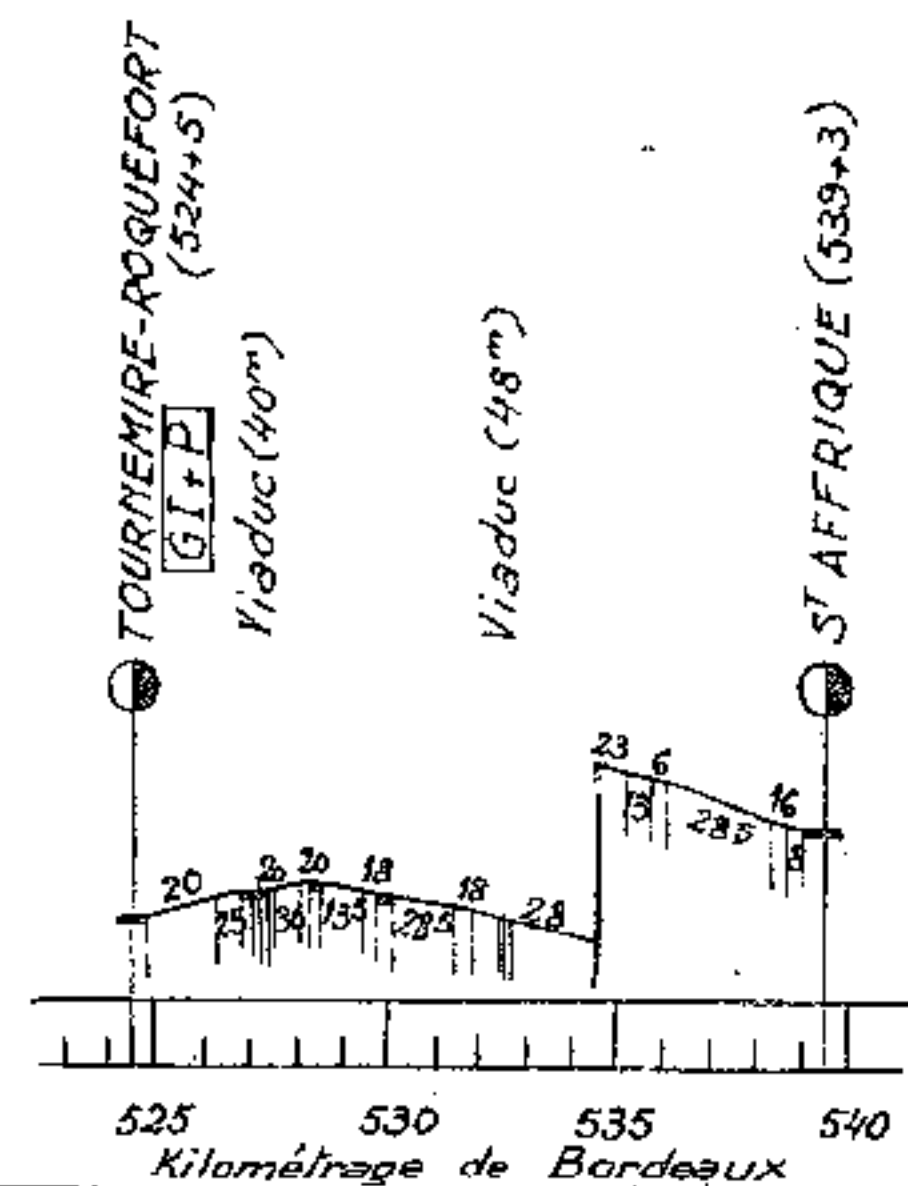

Ligne de LATOUR

à PLAISANCE

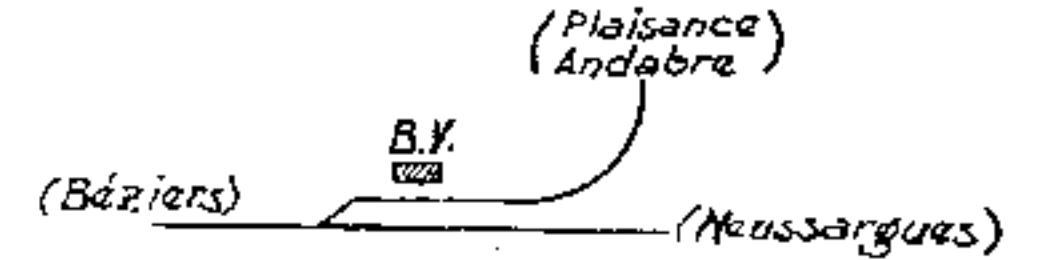

POSTE de LATOUR

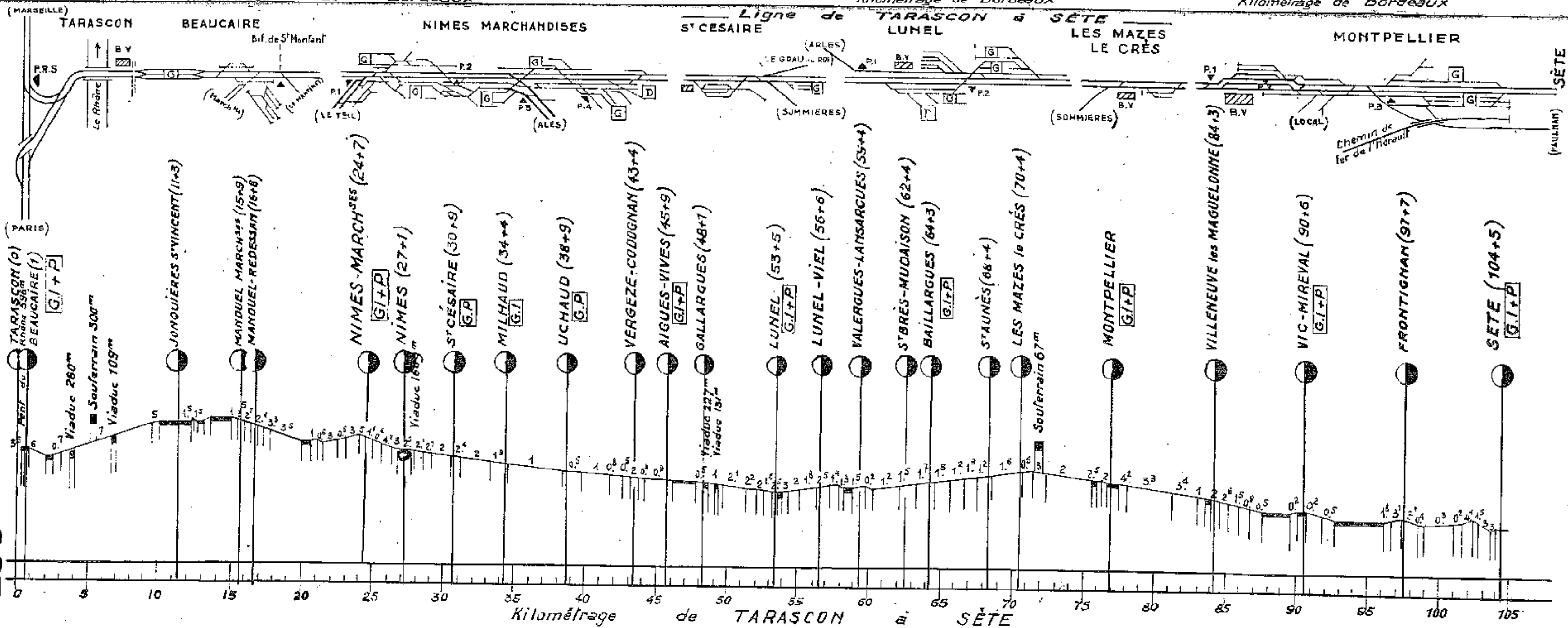
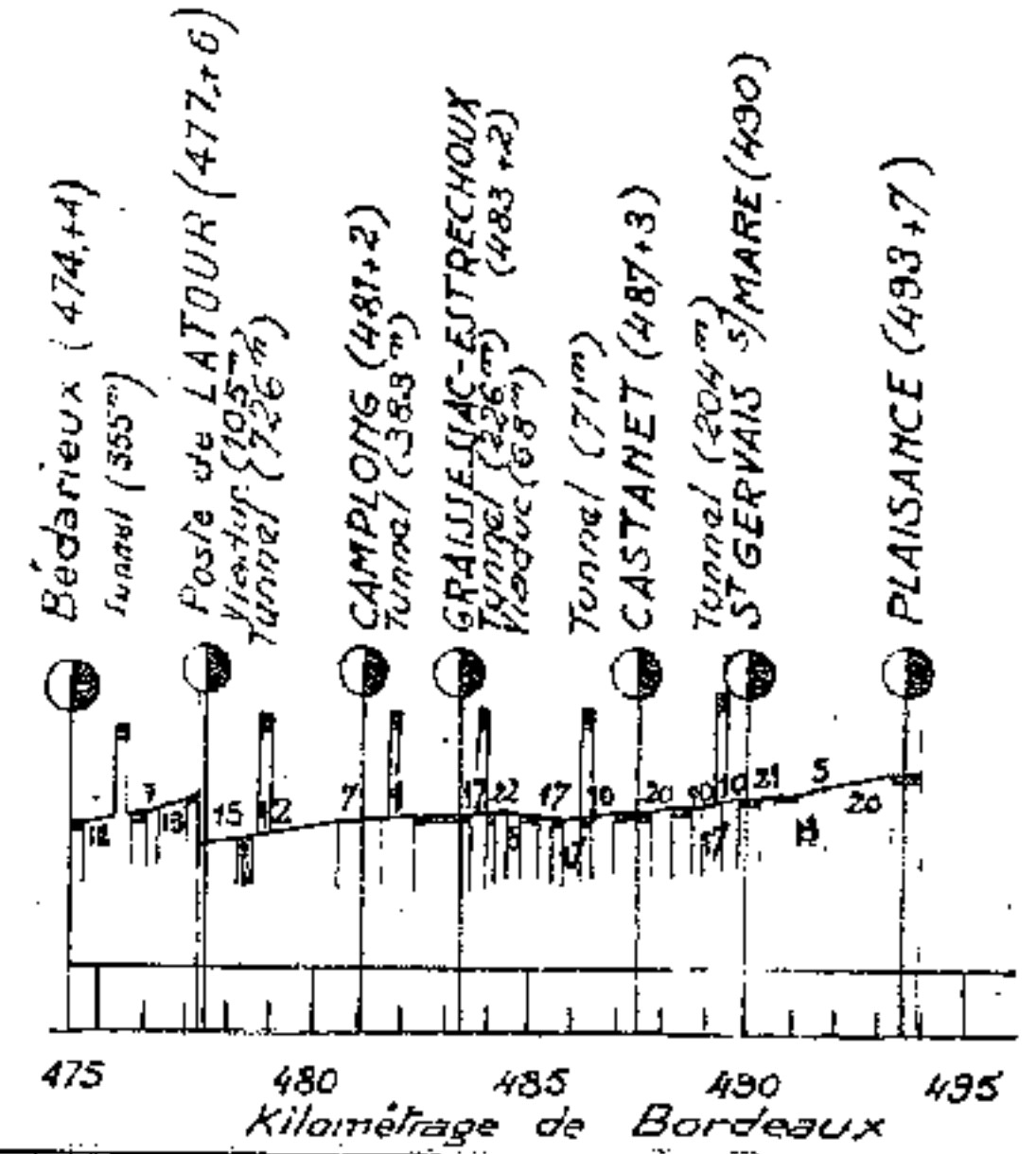

Ligne de LE MONASTIER à LA BASTIDE-S^t LAURENT LES BAINS

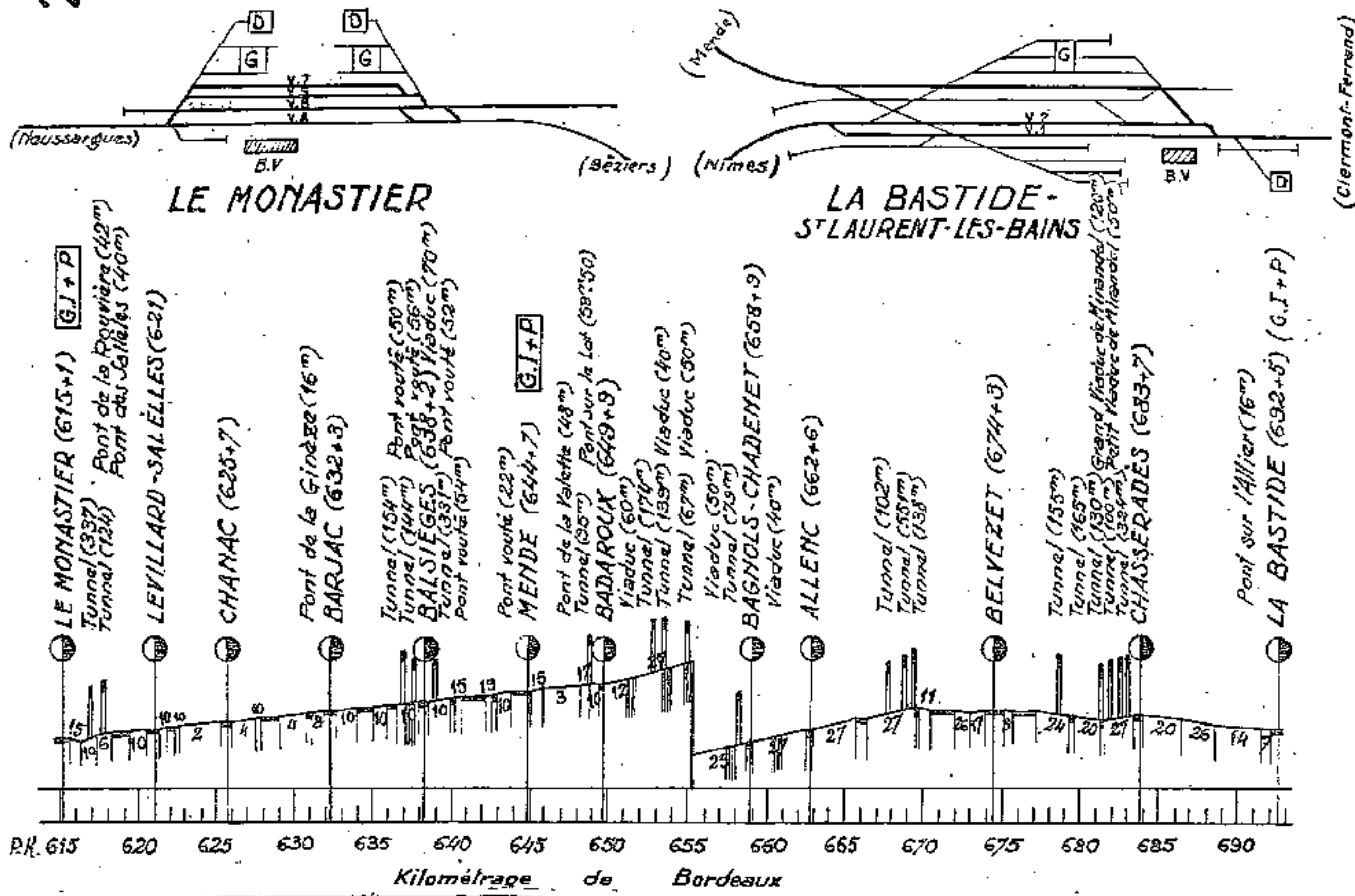

Ligne de SÉVERAC-le-CHATEAU à RODEZ

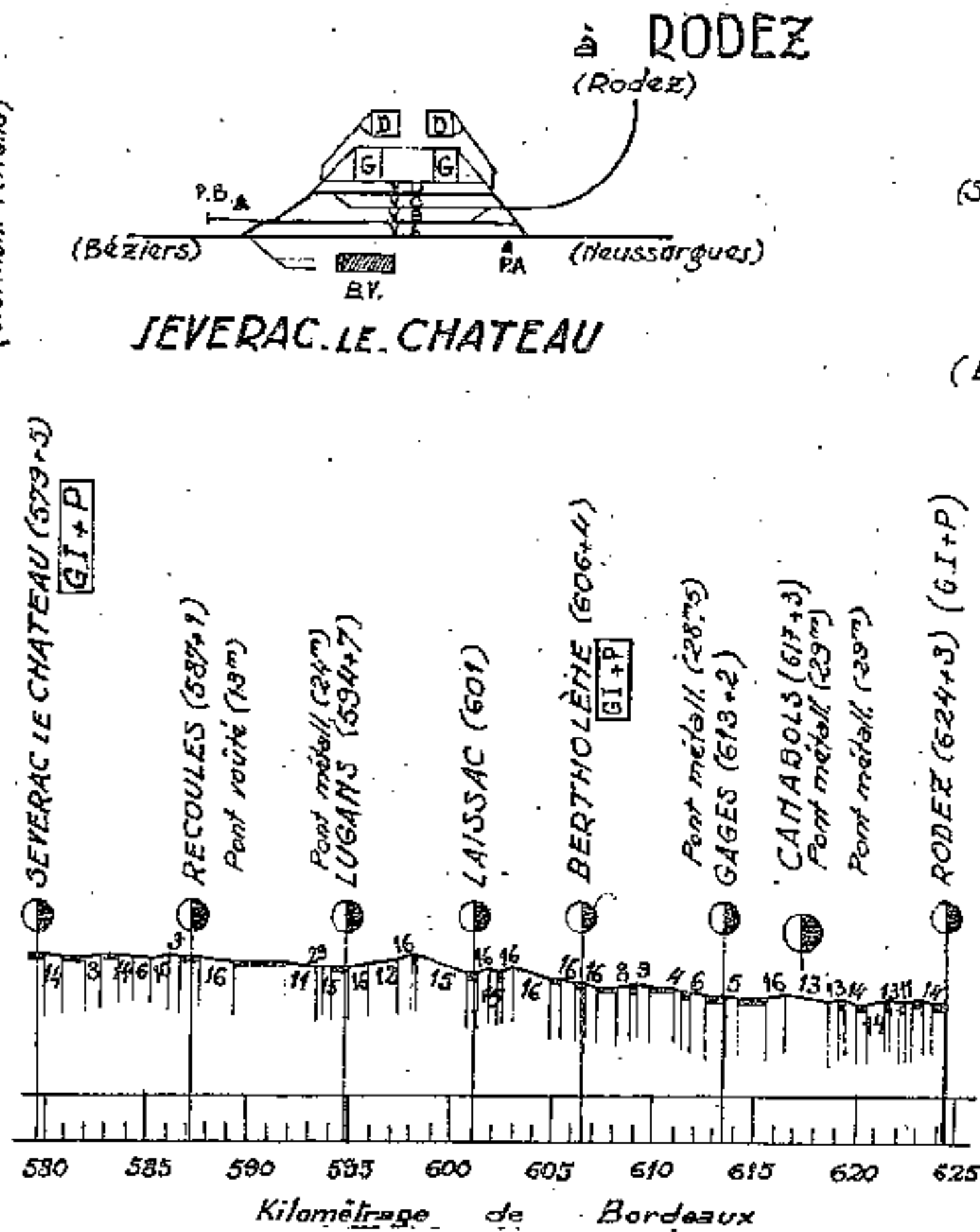

Ligne de BERTHOLÈNE à ESPALION

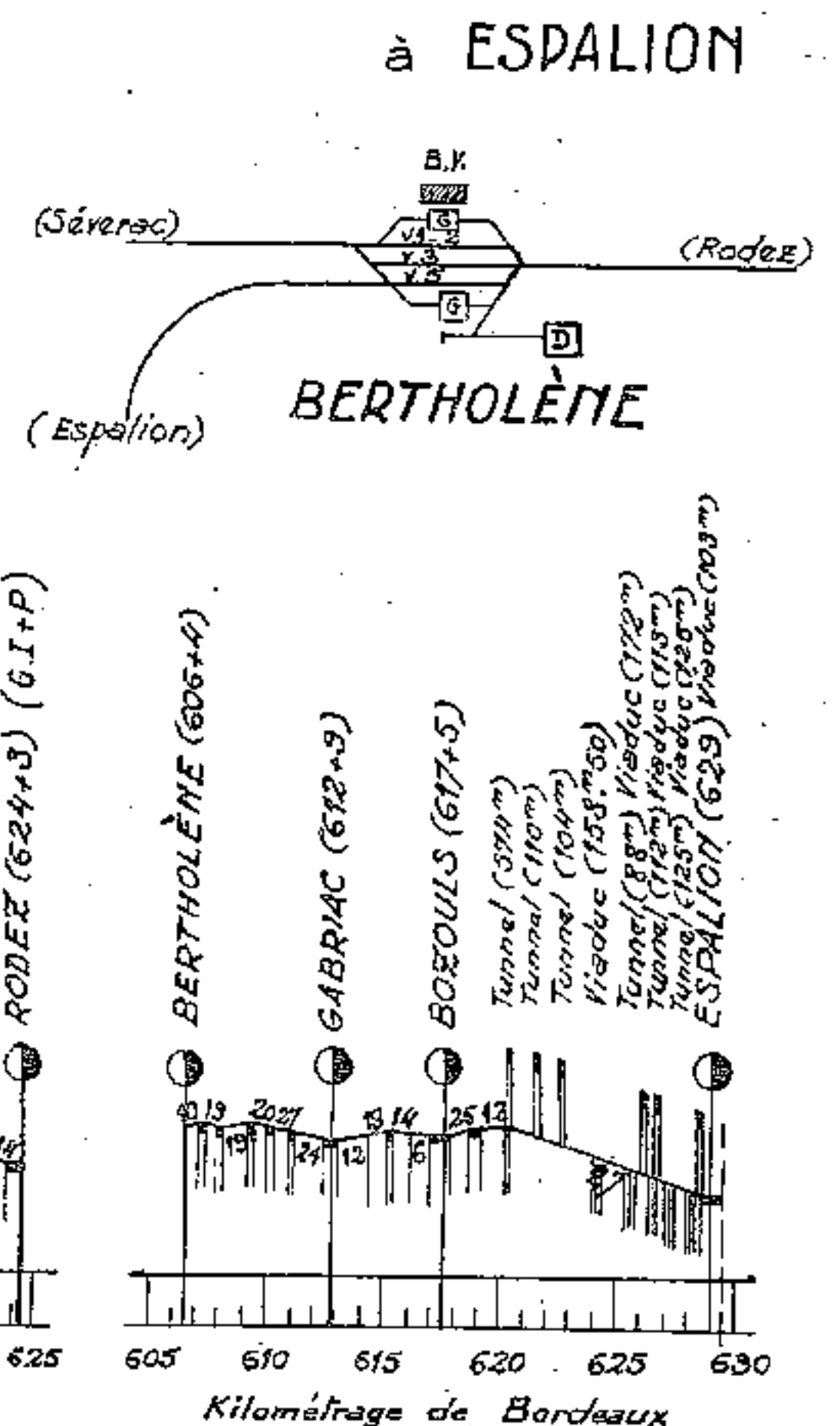

Ligne de FAUGÈRES à PAULHAN et de PAULHAN à MONTPELLIER

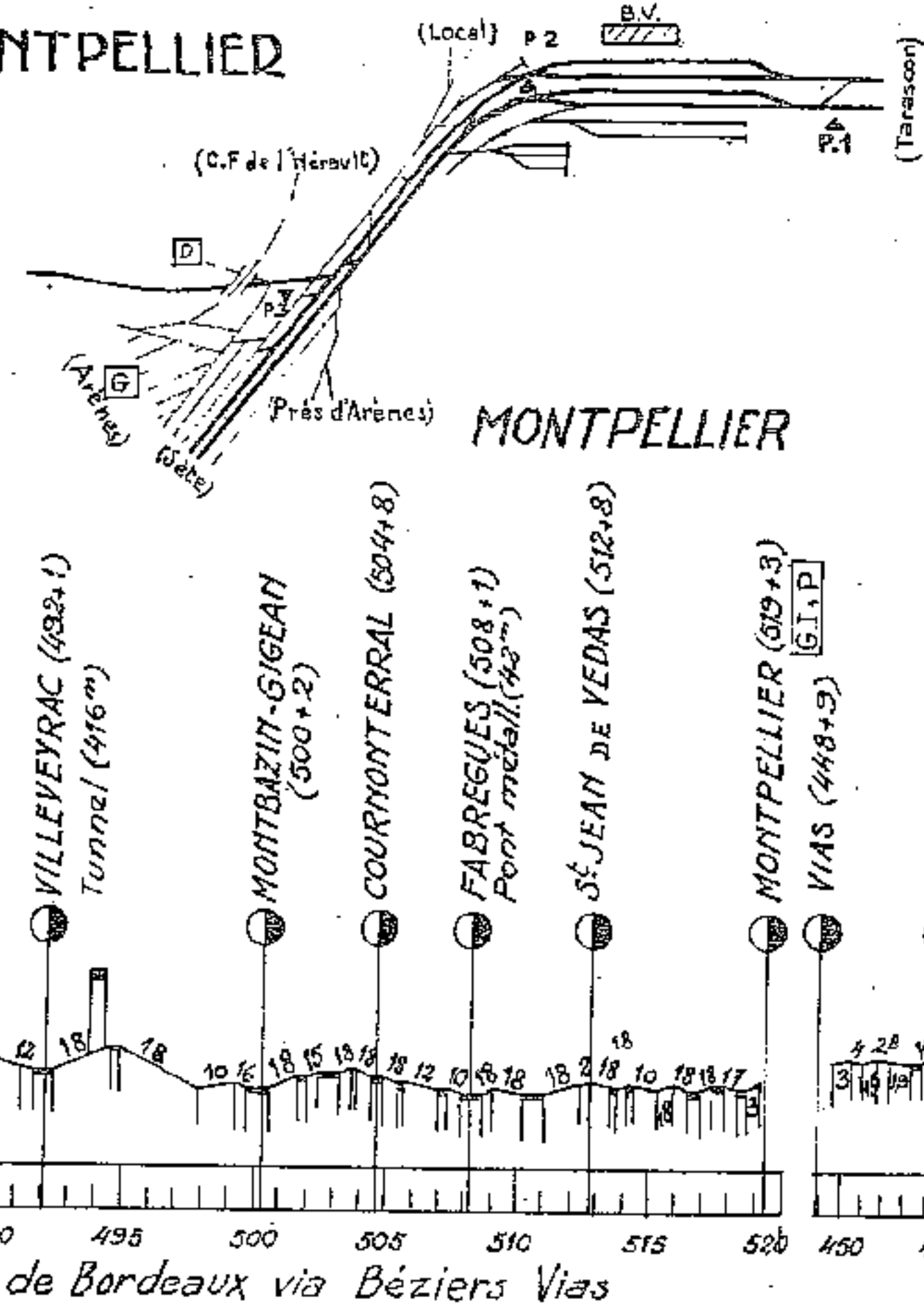
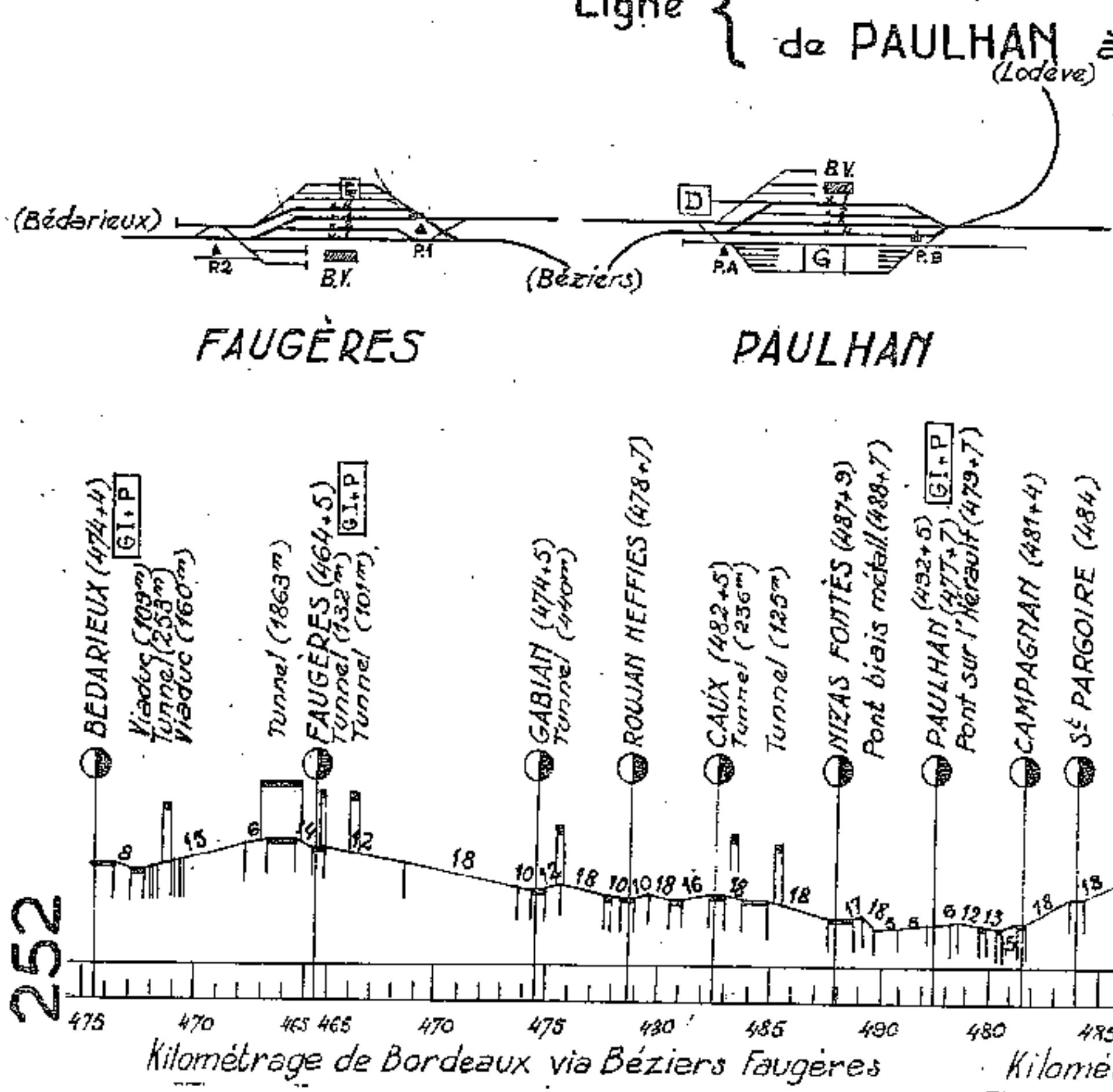

Ligne de VIAS à LODÈVE

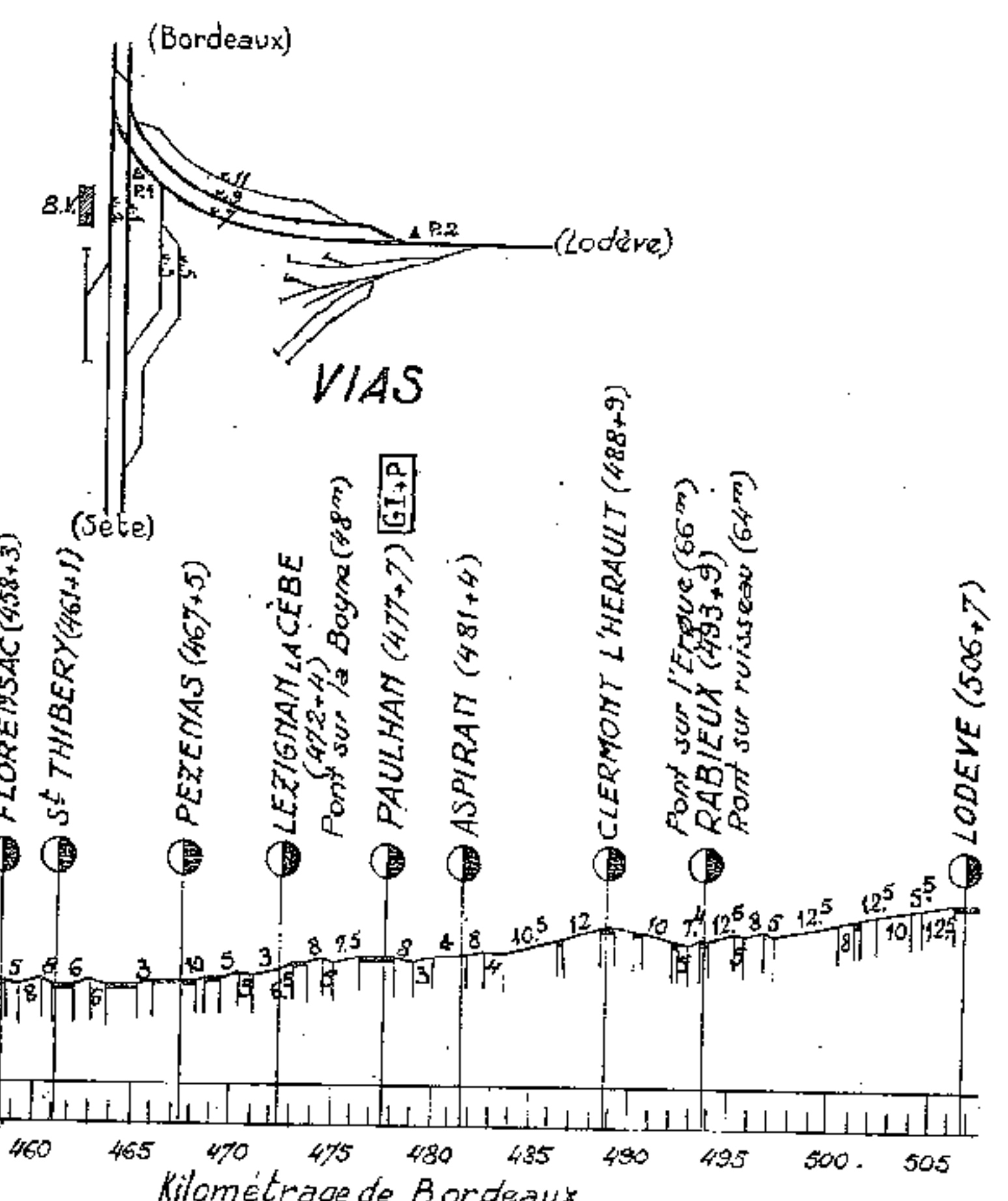

Ligne de FLAMBOIN à MONTEREAU

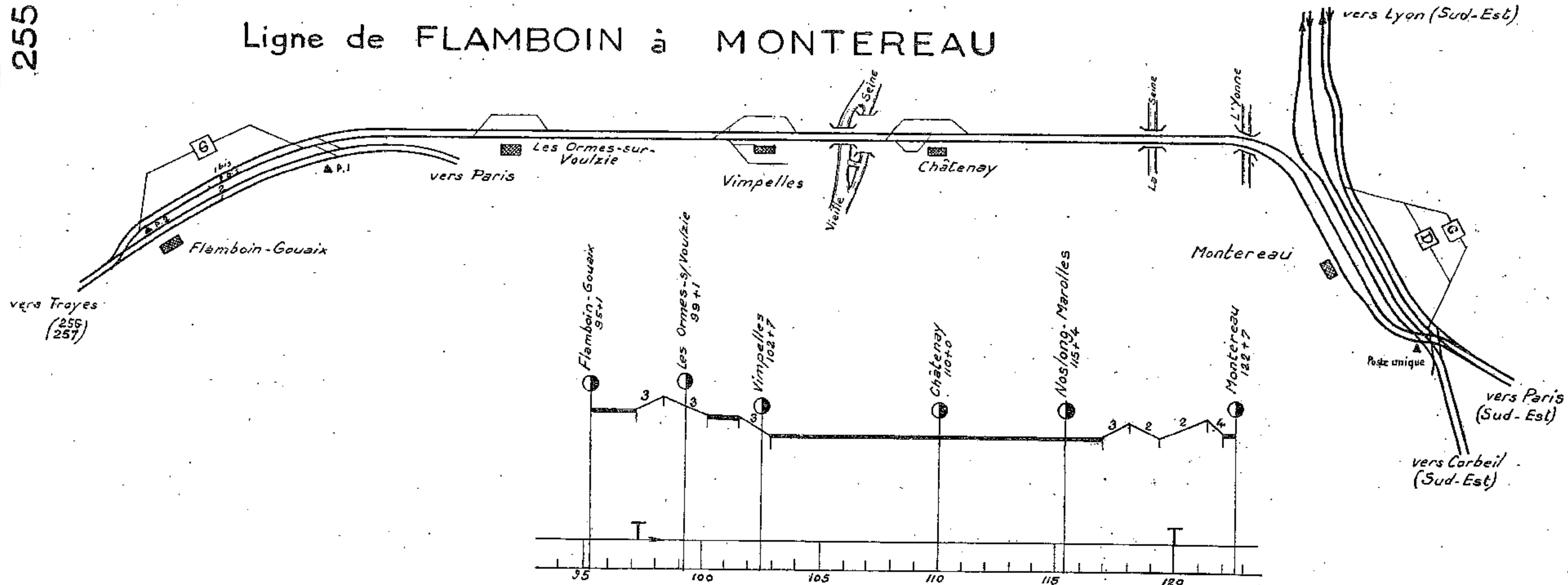

Ligne de PARIS à STRASBOURG (KEHL) Section de Paris à Meaux

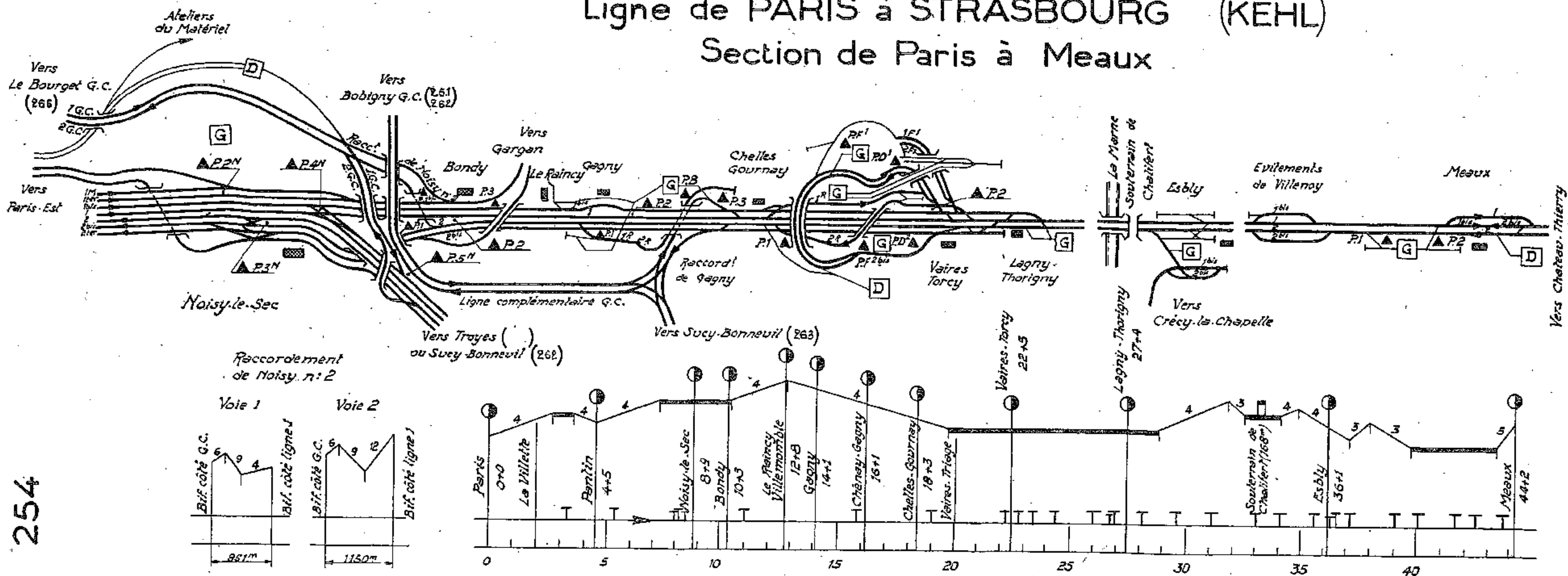

Ligne de PARIS à BAILE Section de Romilly-sur-Seine à Troyes.

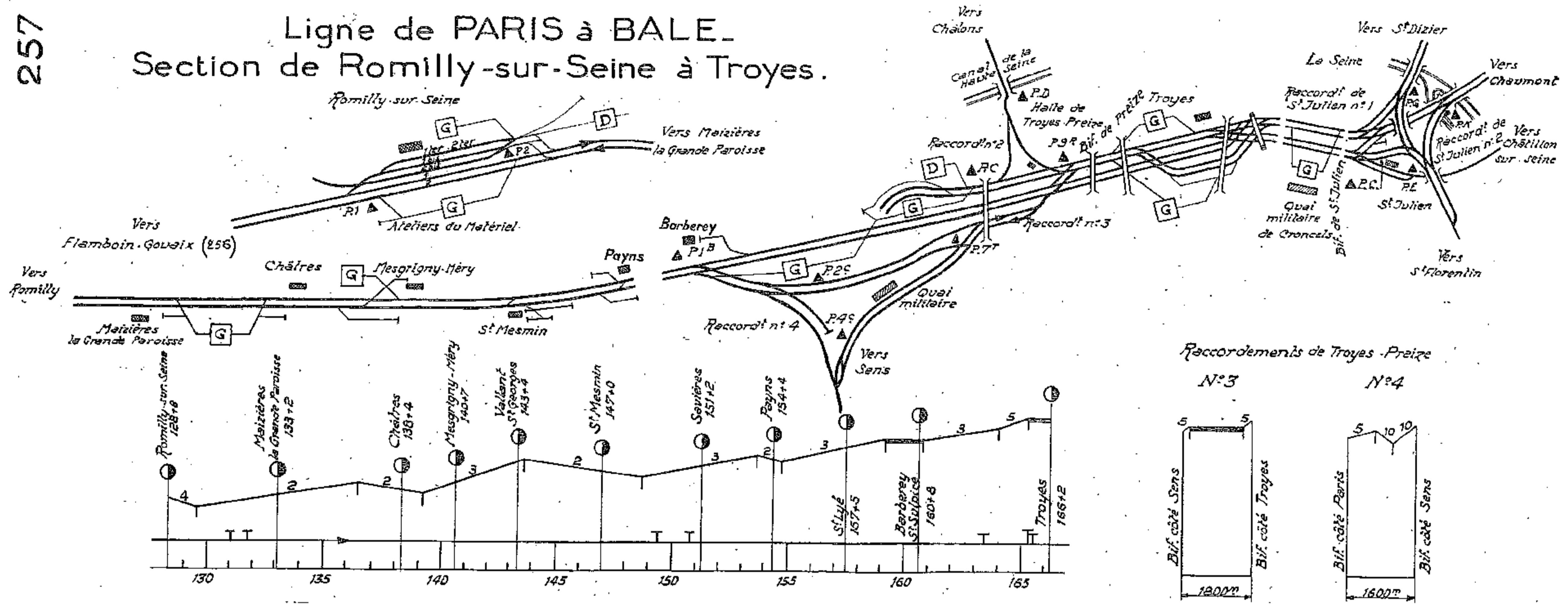

Ligne de PARIS à BAILE - Section de Flamboin-Gouaix à Romilly-sur-Seine.

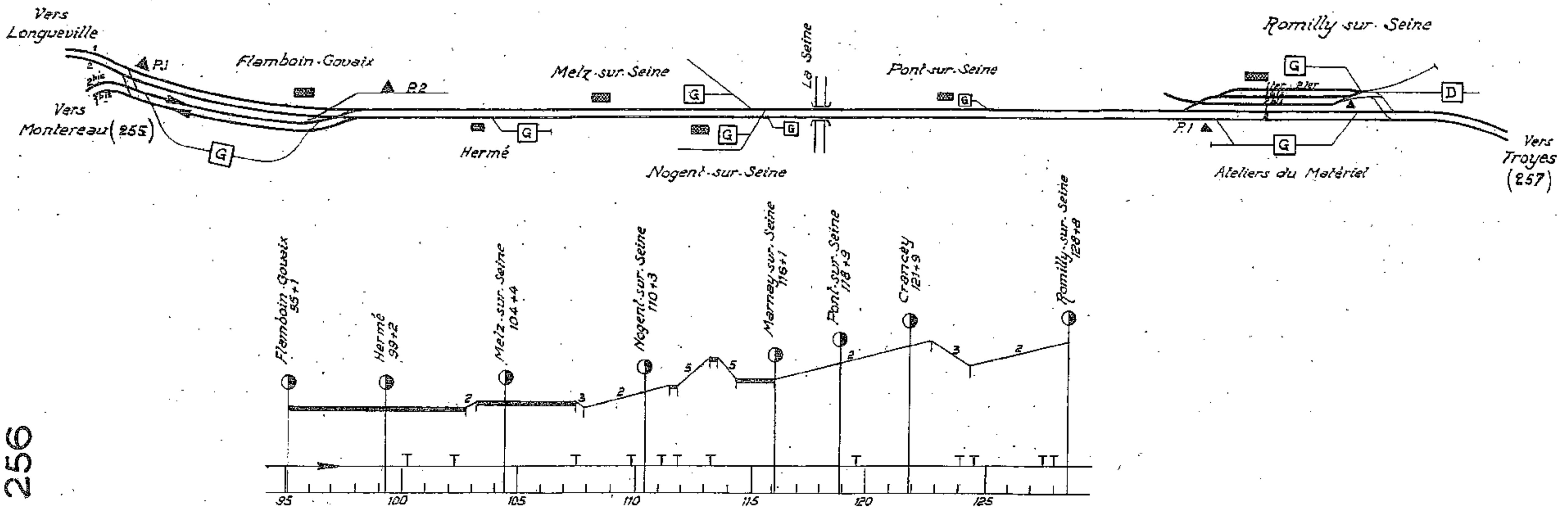

Ligne de PARIS - BASTILLE à VERNEUIL-L'ETANG Section de Sucy-Bonneuil à Verneuil-l'Etang

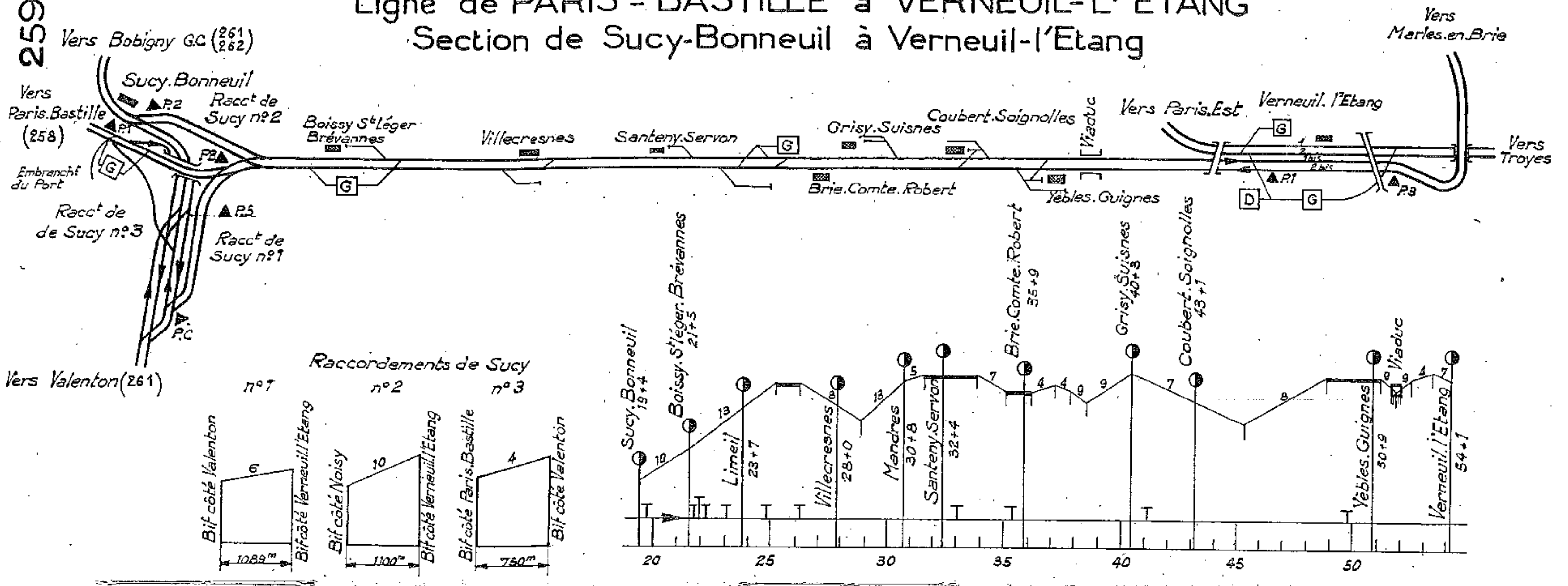

Ligne de PARIS - BASTILLE à VERNEUIL-L'ETANG Section de Paris-Bastille à Sucy - Bonneuil

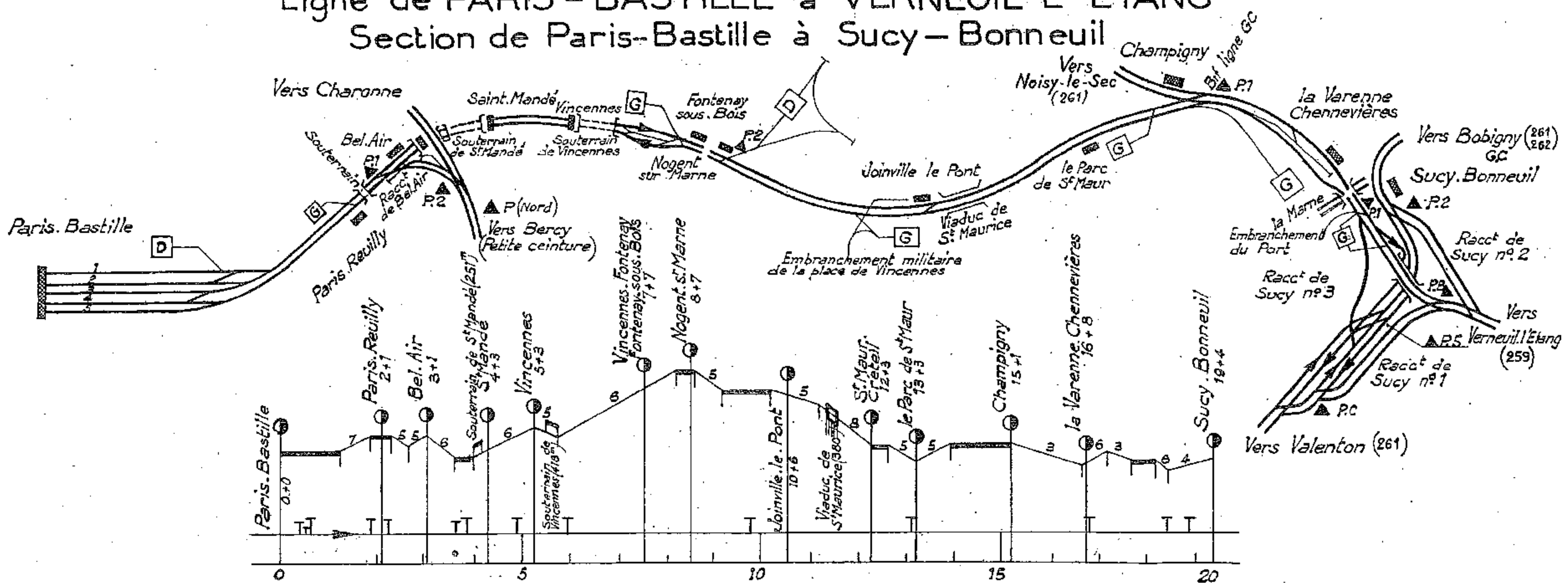

PONT-CARDINET A AUTEUIL-BOULOGNE
AUTEUIL-BOULOGNE A LA RAPÉE-BERCY
PARIS-BATIGNOLLES A LA RAPÉE-BERCY

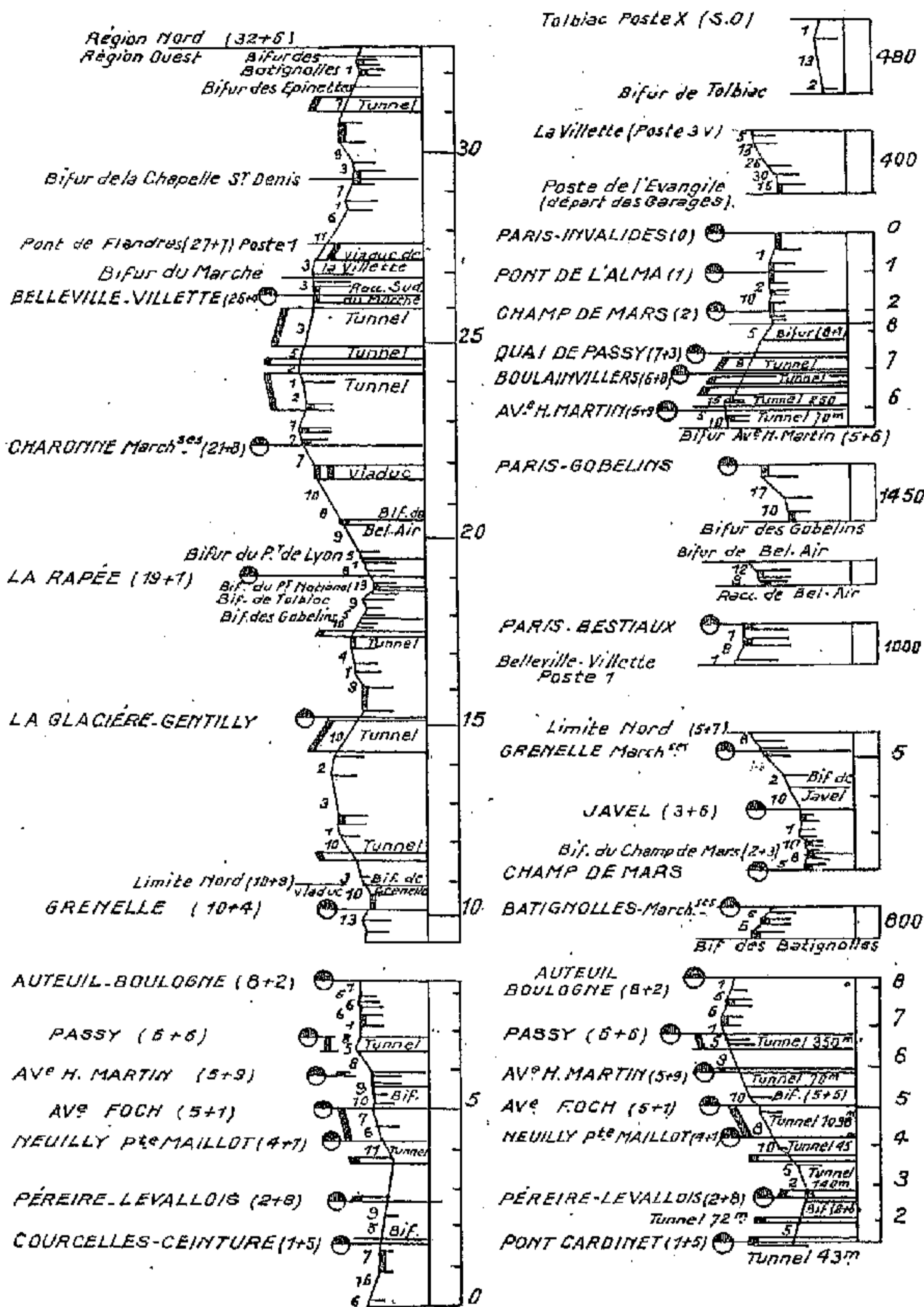

Ligne de GRANDE CEINTURE
Section de Bobigny a Valenton

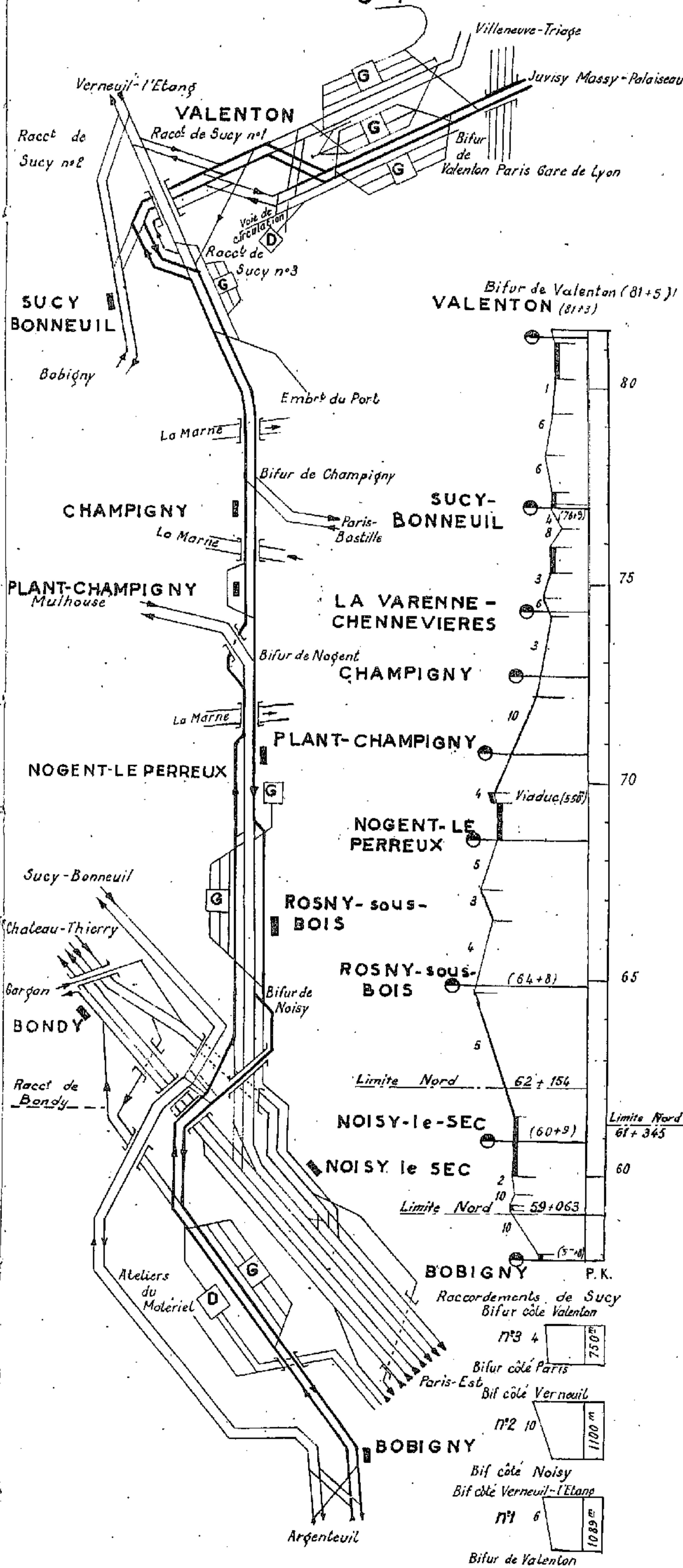

PETITE CEINTURE

Ligne de BOBIGNY à SUCY BONNEUIL

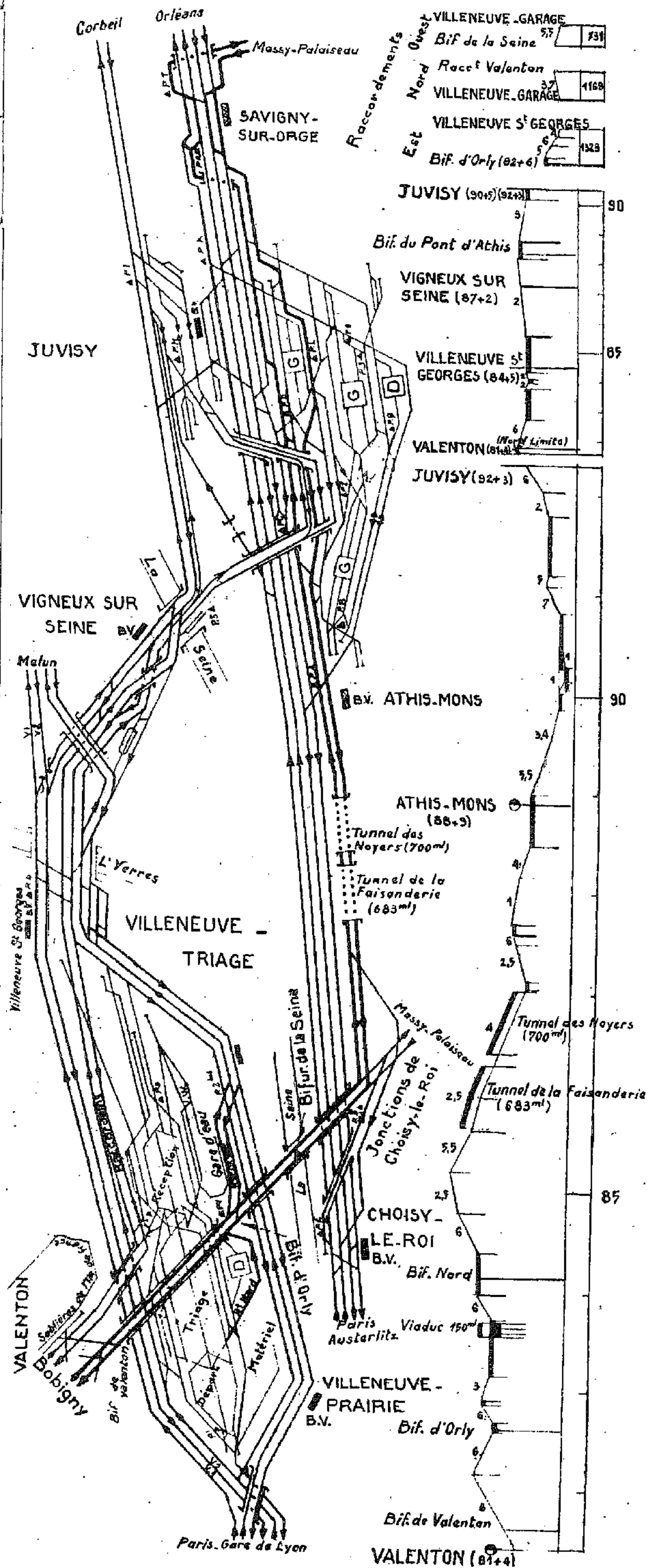
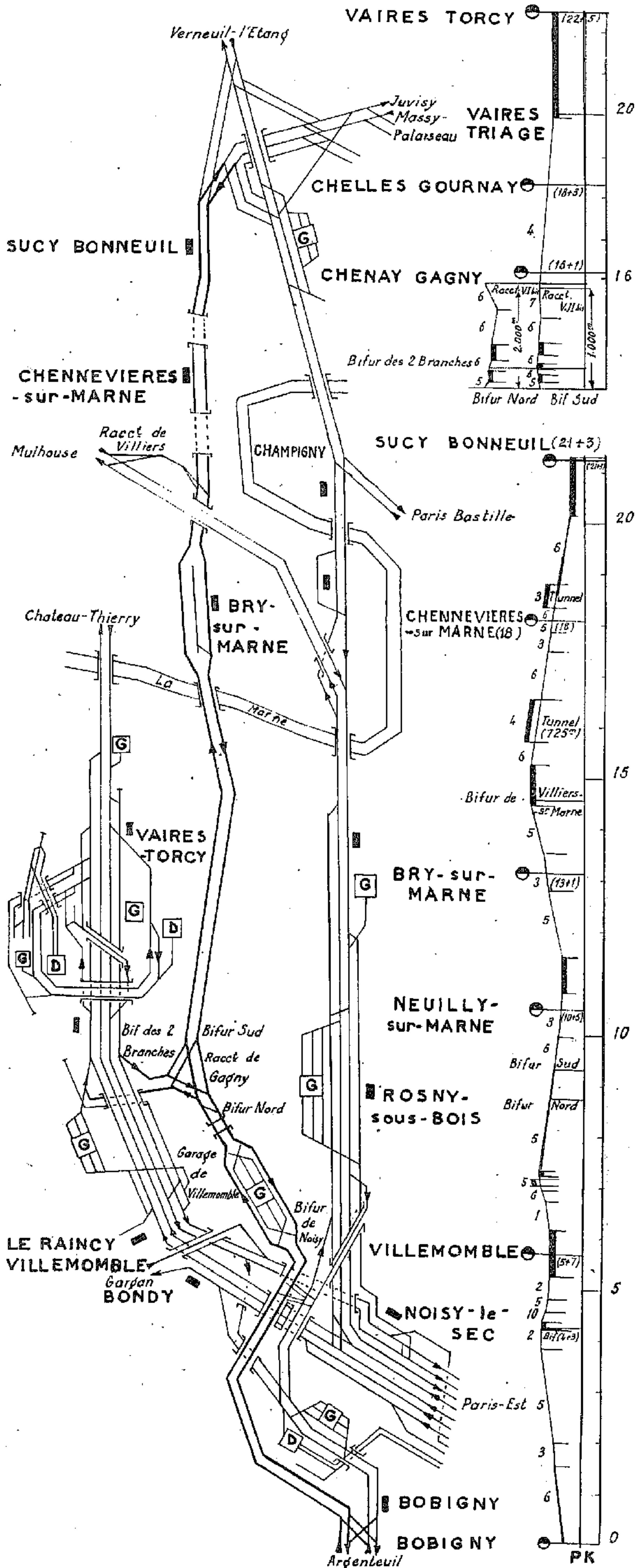

Ligne de GRANDE-CEINTURE Section d'Achères à Bobigny

Noisy-le-Sec

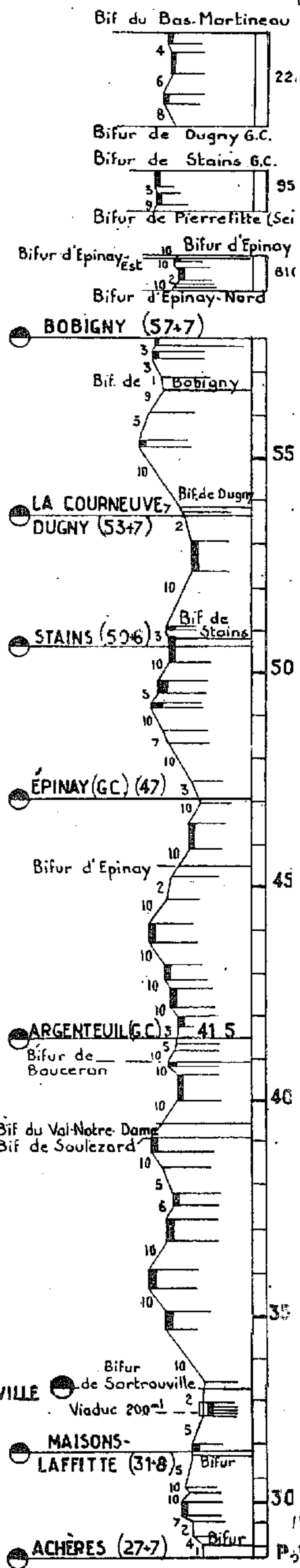
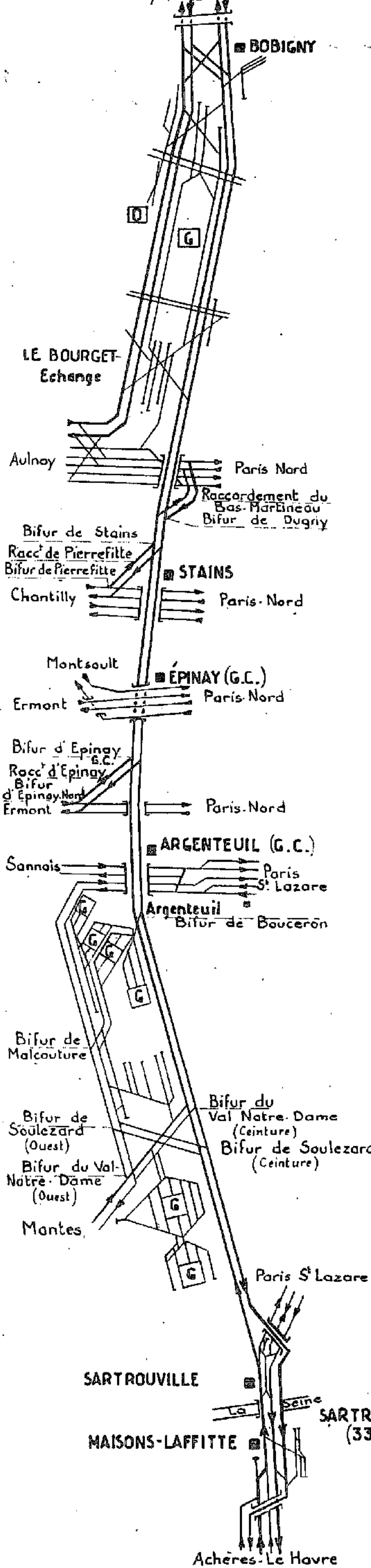

Choisy-Le-Roi à Massy-Palaiseau

De la bifur. de Valenton à la bifur. de Choisy

Telephones fixes d'Alarme sur supports de catenaires tous les 500 m côté impair, (capot peint d'une bande rouge.)

