

AD619497

# APPLICATION OF LITHIUM CHEMICALS FOR AIR REGENERATION OF MANNED SPACECRAFT

R. O. BACH, PhD  
W. W. BOARDMAN, JR., PhD  
J. W. ROBINSON, JR.

LITHIUM CORPORATION OF AMERICA, INC.

COPY _____	OF _____	<i>60</i>
HARD COPY	\$ . 4.00	
MICROFICHE	\$ . 1.00	

*133 P*

JUNE 1965

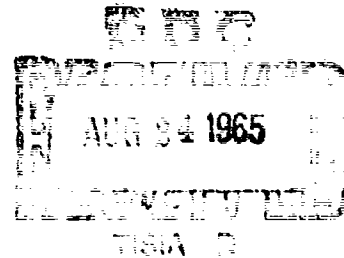

BIOMEDICAL LABORATORY  
AEROSPACE MEDICAL RESEARCH LABORATORIES  
AEROSPACE MEDICAL DIVISION  
AIR FORCE SYSTEMS COMMAND  
WRIGHT-PATTERSON AIR FORCE BASE, OHIO

ARCHIVE COPY

## NOTICES

When US Government drawings, specifications, or other data are used for any purpose other than a definitely related Government procurement operation, the Government thereby incurs no responsibility nor any obligation whatsoever, and the fact that the Government may have formulated, furnished, or in any way supplied the said drawings, specifications, or other data, is not to be regarded by implication or otherwise, as in any manner licensing the holder or any other person or corporation, or conveying any rights or permission to manufacture, use, or sell any patented invention that may in any way be related thereto.

Requests for copies of this report should be directed to either of the addressees listed below, as applicable:

Federal Government agencies and their contractors registered  
with Defense Documentation Center (DDC):

DDC  
Cameron Station  
Alexandria, Virginia 22314

Non-DDC users (stock quantities are available for sale from):

Chief, Input Section  
Clearinghouse for Federal Scientific & Technical Information (CFSTI)  
Sills Building  
5285 Port Royal Road  
Springfield, Virginia 22151

### Change of Address

Organizations and individuals receiving reports via the Aerospace Medical Research Laboratories automatic mailing lists should submit the addressograph plate stamp on the report envelope or refer to the code number when corresponding about change of address or cancellation.

Do not return this copy. Retain or destroy.

**APPLICATION OF LITHIUM CHEMICALS FOR  
AIR REGENERATION OF MANNED SPACECRAFT**

*R. O. BACH, PhD  
W. W. BOARDMAN, JR., PhD  
J. W. ROBINSON, JR.*

Preceding Page Blank

## FOREWORD

This study was initiated by the Biomedical Laboratory of the Aerospace Medical Research Laboratories, Aerospace Medical Division, Wright-Patterson Air Force Base, Ohio. The research was conducted by the Inorganic Products Division of the Research and Development Department of Lithium Corporation of America, Inc., at Bessemer City, North Carolina, under Contract Nr. AF 33(615)-1588, in support of Project No. 6373, "Equipment for Life Support in Aerospace," and Task No. 637302, "Respiratory Support Equipment." Mr. R. O. Bach, PhD, was the principal investigator for Lithium Corporation of America. Mr. W. W. Boardman, PhD, was the project supervisor and was assisted by Mr. J. W. Robinson, Jr., in addition to several chemists of the technical staff of Lithium Corporation of America and Mr. G. E. Cummings, Project Engineer of Atlantic Research Corporation, Alexandria, Virginia.

Mr. Clemens M. Meyer of the Respiratory Equipment Branch was contract monitor for the Aerospace Medical Research Laboratories.

This report is catalogued by Lithium Corporation of America as Research Report No. LCA-564.

This technical report has been reviewed and is approved.

WAYNE H. McCANDLESS  
Technical Director  
Biomedical Laboratory

## ABSTRACT

Lithium Oxide of highly active surface area ( $10\text{m}^2/\text{g}$  or better) has been prepared. This material can absorb up to 1.25 times its weight of carbon dioxide, thus making the most efficient  $\text{CO}_2$  absorber on the basis of its weight. For efficient operation, the molar ratio of water vapor over carbon dioxide in the gaseous atmosphere should be at least unity. At 5 psia of oxygen and 50% relative humidity, the temperature of the gas should be at least  $50^\circ\text{F}$  ( $10^\circ\text{C}$ ) to approach this molar ratio value.

A "passive-dynamic" atmosphere regeneration unit was designed with a small motor blower that circulates the gaseous environment through a cone shaped granular bed of lithium oxide (4-14 mesh). The unit weighs 4-1/2 pounds and has been shown to absorb the daily carbon dioxide output, or more, of one man. The outflowing gas is free of irritating dust due to efficient filters and the gas temperatures are at comfortable levels. The effects of weightlessness, vibration and acceleration on the functioning of the unit, have been considered in its design. An adequate amount of safety of operation also was imparted to the unit. The unit can easily be recharged with fresh lithium oxide granules.

TABLE OF CONTENTS

Section		Page No.
I	Introduction	1
	General Consideration	1
	Solid CO <sub>2</sub> Absorbents	1
	Comparison of Absorption Capacities	2
	Syntheses of Lithium Oxide	2
II	Experimental	8
	Preparation of Lithium Oxide	8
	Testing of Lithium Oxide	16
	Chemical Analyses	24
	Physical Analyses	27
III	Results	29
	The Decomposition of Commercial Lithium Peroxide	29
	The Preparation of High Active Surface Li <sub>2</sub> O	33
	Tests on Granular Beds	42
	The Use of Solid Configurations of Lithium Oxide	82
IV	Engineering, Design and Testing	94
	Design Object	94
	System Selection	94
	Unit Design	95
	Description of Unit	98
	Tests	101
V	Conclusions	113
VI	References	119

TABLES

Table No.		Page No.
I	Data Concerning $\text{Li}_2\text{O}$ Prepared From $\text{Li}_2\text{O}_2$ Directly	31
II	Data Derived From Chemical Analyses	32
III	Principle Data Taken During the Preparation of $\text{Li}_2\text{O}$ Samples	34
IV	Composition of Lithium Oxide Samples Before and After Tests	43
V	Principle Data Obtained From Absorption Tests on Lithium Oxide Samples	44
VI	Composition of Lithium Oxide Samples No. 48 Before and After Tests	49
VII	Principle Data Obtained from Absorption Tests on $\text{Li}_2\text{O}$ , Sample No. 48	50
VIII	Composition of $\text{Li}_2\text{O}$ Samples Before and After Tests	55
IX	Principle Data Obtained from Absorption Tests on $\text{Li}_2\text{O}$ Samples	56
X	Analytical Data on $\text{Li}_2\text{O}$ Sample 118 After Tests	61
XI	Principle Data Obtained from Absorption Tests on $\text{Li}_2\text{O}$ Sample No. 118	62
XII	Analytical Data on $\text{Li}_2\text{O}$ Samples Before and After Tests	69
XIII	Principle Data Obtained from Absorption Tests on $\text{Li}_2\text{O}$ Samples	70
XIV	Analytical Data on $\text{Li}_2\text{O}$ Samples Before and After Tests	79

TABLES (Cont'd.)

Table No.		Page No.
XV	Principle Data Obtained from Absorption Tests on $\text{Li}_2\text{O}$ Samples	80
XVI	Analytical Data on $\text{Li}_2\text{O}$ Pellets Before and After Tests	88
XVII	Principle Data Obtained from Absorption Tests on $\text{Li}_2\text{O}$ Pellets	90
XVIII	Composition of $\text{Li}_2\text{O}$ Samples Before and After Tests	102
XIX	Principle Data Obtained from Absorption Tests on $\text{Li}_2\text{O}$	104



## FIGURES

Figure No.		Page No.
1	Oxygen Pressure of Lithium Peroxide	7
2	Small Decomposition Setup	11
3	Large Decomposition Setup	12
4	Large Decomposition Pot	13
5	Apparatus for Tests at One Atmosphere	18
6	Apparatus for Tests at One-Third Atmosphere	19
7	Apparatus for Tests on the Full Scale Unit	20
8	Oxygen Evolution During $\text{Li}_2\text{O}_2$ Decomposition	29
9	Temperature Profiles of Test No. 4	46
10	Absorption Curve of Run No. 12	47
11	Temperature Profiles of Test No. 18	52
12	Temperature Profiles of Test No. 19	53
13	Temperature Profiles of Test No. 20	54
14	Percentage Conversion vs. Temperature	59
15	Percentage Conversion vs. Vapor Pressure	60
16	Temperature Profiles of Test No. 30	64
17	Temperature Profiles of Test No. 31	65
18	Temperature Profiles of Test No. 32	66
19	Temperature Profiles of Test No. 34	67
20	Temperature Profiles of Test No. 35	68

FIGURES (Cont'd.)

Figure No.		Page No.
21	Peak Temperature vs. Incoming Gas Temperature	72
22	Peak Temperature vs. Ppm H <sub>2</sub> O of Incoming Gas	73
23	Temperature Profiles of Test No. 36	74
24	Temperature Profiles of Test No. 39	75
25	Temperature Profiles of Test No. 40	76
26	Temperature Profiles of Test No. 41	77
27	Temperature Profiles of Test No. 42	83
28	Temperature Profiles of Test No. 43	84
29	Temperature Profiles of Test No. 44	85
30	Temperature Profiles of Test No. 45	86
31	CO <sub>2</sub> Absorber	99
32	Pressure Drop Filters	105
33	Pressure Drop Li <sub>2</sub> O Bed	106
34	Temperature Profiles Unit Test 1	108
35	Temperature Profiles Unit Test 2	109
36	Temperature Profiles Unit Test 3	110
37	Percentage Conversion vs. Mole Ratio	114
38	Mole Ratio vs. Temperature	115

## SECTION I

### INTRODUCTION

#### General Considerations

The present investigation deals with the efficiency of lithium oxide,  $\text{Li}_2\text{O}$ , as an absorber for carbon dioxide,  $\text{CO}_2$ . The specific advantage of lithium oxide would be its capacity on a weight basis which surpasses all known absorbents for carbon dioxide.

The absorption of carbon dioxide by an oxide, such as lithium oxide, is actually an acid-base interaction in the definition of G. N. Lewis (ref. 21). For the purpose of clarity, the term absorption is used throughout this publication with the understanding that the nature of the reaction falls into the category of acid-base interaction.

The removal of carbon dioxide from the atmospheres in sealed environments is necessary to avoid hypercapnia (ref. 14), an excessive accumulation of carbon dioxide in body tissues. The condition of hypercapnia is highly undesirable for its well known effects on the human metabolism.

The composition of the atmosphere of the manned spacecraft was fixed in relation to carbon dioxide: 0.0735 psia. The total pressure was fixed at 5 psia, consisting mainly in oxygen and water vapor. The relative humidity should be 50%, therefore, the partial water vapor pressure will depend entirely on the temperature which can vary between 40 and 120°F. The corresponding partial water vapor pressures fall between .058 psia (40°F) and .849 psia (120°F), or between 3.1 mm of mercury at 4.4°C and 43.9 mm of mercury at 49°C. The ambient at the median temperature of 75°F or 24°C would consist of

	$\text{CO}_2$	3.8 mm of mercury	(0.0735 psia)
	$\text{H}_2\text{O}$	11.2 mm of mercury	(0.216 psia)
	$\text{O}_2$	244 mm of mercury	(4.7115 psia)
Total---		259 mm of mercury	(5 psia)

The concentration of  $\text{CO}_2$  in this atmosphere would be 1.47% by volume. The usual maximum limit of carbon dioxide allowable in spacecraft atmospheres of 14.7 psia is 1% by volume, or 7.5 mm Hg (ref. 17 and 18).

The production of  $\text{CO}_2$  per day is given as 2.4 lbs., or 21.2 cubic feet (at 14.7 psia and 80°F), or 1090 grams or 600 liters (at 760 mm Hg and 26.7°C). The absorption unit specified by the contract should be able to absorb this quantity of  $\text{CO}_2$  with a minimum of weight and volume requirements.

#### Solid $\text{CO}_2$ Absorbents

A fair number of solid absorbers for  $\text{CO}_2$  have been described and have found application in various fields. Among the well known products, the

following merit special mention.

Ascarite, a sodium hydroxide impregnation on an asbestos base.  
Baralyme, a mixture of calcium and barium hydroxides.  
Soda lime, a mixture of sodium and calcium hydroxides.  
Mikohbite, sodium hydroxide on exploded mica.  
Lithium hydroxide, Navy grade L.C.A.

Numerous publications have described the function of these products as CO<sub>2</sub> absorbents. A comparison of these products has been published by S. Marshall (ref. 26). These data stem from a report by R. J. Walker (ref. 34).

A recent publication by G. P. Allen (ref. 2), describes the efficiency of lithium hydroxides, anhydrous and monohydrate, soda lime and others in the "start-up" of an absorbent bed.

#### Comparison of Absorption Capacities

The theoretical absorption capacities of many of the commercially available CO<sub>2</sub> absorbents are not known. In the following Table, these are listed as they are available, together with performance figures.

<u>Sample</u>	<u>Weight of CO<sub>2</sub> Absorbable (gm./gm.)</u>	
	<u>Theoretical</u>	<u>Practical</u>
Baralyme		.14*
Mikohbite		.15*
Soda Lime	.50*	.24*
LiOH	.92	.76*

\* Data (ref. 26).

Lithium oxide has a theoretical capacity of 1.47 g. of CO<sub>2</sub> per g.

The theoretical capacity of Li<sub>2</sub>O is twice that of the practical capacity of LiOH anhydrous, its nearest competitor. This is why the application of Li<sub>2</sub>O is attractive.

#### Synthesis of Lithium Oxide

There are numerous methods of preparation of Li<sub>2</sub>O. In the more recent literature the following merit attention:

##### 1. From Li<sub>2</sub>CO<sub>3</sub>

The thermal decomposition of lithium carbonate has been described by L. Brewer and J. Margrave (ref. 11).

The product was obtained by heating Li<sub>2</sub>CO<sub>3</sub> in a Pt boat at 1000°C.

This method was criticized by Berkowitz-Mattuck (ref. 7). These authors claim that the product obtained by the Brewer-Margrave method contained appreciable quantities of platinum and that it had a grey color.

Another method was described by E. Zintl (ref. 36). Heating under vacuum to 700°C in a Pt boat led to pure oxide.

## 2. From Lithium Hydroxide Monohydrate

A Russian patent, U.S.S.R. No. 146,730, by A. I. Vulikh (ref. 33) in 1962 claims that up to 99% pure Li<sub>2</sub>O could be obtained by a programmed vacuum heating technique:

First, for 2 to 3 hours at 250 to 300°C, then for 5 to 6 hours at 900°C to be terminated by a final heating period at 1000°C.

## 3. From Anhydrous Lithium Hydroxide

Anhydrous lithium hydroxide is heated in a silver-lined boat in a tubular furnace to 675°C; 96% Li<sub>2</sub>O is obtained according to J. Bravo (ref. 10).

## 4. From Lithium Peroxide

Lithium peroxide is easily accessible and numerous methods are available for its synthesis. The literature up to 1961 mentions the following:

- P. Pierron (ref. 29)
- P. Winternitz (ref. 35)
- H. H. Strater (ref. 32)
- A. J. Cohen (ref. 13)
- S. E. Stephanou and J. Kleinberg (ref. 31).

All these methods are based on the interaction of hydrogen peroxide on lithium hydroxide. They differ greatly in the way the water is removed from the mixture, according to the following equation:

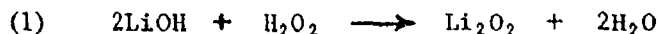

Recently, new methods have become available which were developed in the laboratory of the Lithium Corporation of America. They are the following:

- R. O. Bach (ref. 3)
- R. O. Bach and W. W. Boardman, Jr. (ref. 4)
- W. W. Boardman, Jr. and R. O. Bach (ref. 5).

These are one-step operations with the reactants in stoichiometric proportions; hence, they are very economical. Lithium peroxide is commercially available from Lithium Corporation of America.

The thermal decomposition of lithium peroxide leads to lithium oxide. This reaction has been the object of numerous studies, among which the following have to be mentioned:

P. Pierron (ref. 29) heats lithium peroxide under vacuum in a pyrex tube to 300°C.

Heating in a helium atmosphere to 450°C for six hours is described as a convenient means by S. E. Stephanou and J. Kleinberg (ref. 31) and A. J. Cohen (ref. 13).

This reaction was investigated in greater detail. The dissociation pressure of lithium peroxide would be one means to characterize the system.

M. Blumenthal (ref. 9) measured the oxygen pressure above lithium peroxide at different temperatures by a "dynamic method". He reported one atmosphere of oxygen at 195°C and about 70 mm oxygen pressure at 100°C. However, we have dried the  $\text{Li}_2\text{O}_2$  produced in our laboratories for prolonged periods at temperatures above 100°C in vacuum, without observing any loss of active oxygen. We conclude that this  $\text{Li}_2\text{O}_2$  is more stable than that available to Blumenthal.

In a technical report, M. M. Markowitz and E. W. Desmelyk (ref. 25) of Foote Mineral Company, state: "A number of ambiguities exist, which cast doubt on the validity of (Blumenthal's) data". On page 68 of the same report they say: "It is felt that new determinations of the oxygen vapor pressure of lithium peroxide are in order".

Since no other measurements of the oxygen pressure above lithium peroxide, except those of Blumenthal are extant in the literature, we believe that values derived from recently published thermodynamical data would be of interest at this point. The method of derivation is outlined below:

<u>Compound</u>	<u><math>-\Delta H_f^\circ</math></u>	<u><math>-\Delta F_f^\circ</math></u>
$\text{Li}_2\text{O}$	142.4	133.4 (ref. 23)
$\text{Li}_2\text{O}_2$	151.9	138.1 (ref. 15)

The standard free-energy change at 298°K of oxygen evolution can be arrived at as follows:

$$(2) \quad \Delta F_o = 2\Delta F_{f, \text{Li}_2\text{O}}^\circ - 2\Delta F_{f, \text{Li}_2\text{O}_2}^\circ = 9.4 \text{ Kcal}$$

The factor 2 enters because the reaction must be written as

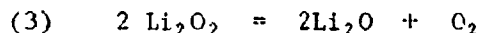

taking into account the evolution of 1 mole of oxygen gas.)

According to van't Hoff's isotherm

$$(4) \quad -\Delta F = RT \ln K_p = RT \ln P_{O_2}$$

$$(5) \quad \log P_{O_2} = \frac{-9400}{4.57 \times 298} = -6.89$$

The enthalpy of oxygen evolution, according to Hess' law, is

$$(6) \quad \Delta H = 2 \Delta H_f^{\circ} \text{Li}_2\text{O} - 2 \Delta H_f^{\circ} \text{Li}_2\text{O}_2 = 19.0 \text{ Kcal}$$

The Clausius-Clapeyron equation allows us to obtain the log p to  $\frac{1}{T}$  relationship from the above data.

$$(7) \quad \frac{d \ln p}{d T} = \frac{-\Delta H}{RT^2}$$

or

$$(8) \quad \frac{\log p_1 - \log p_2}{T_1 - T_2} = \frac{-\Delta H}{4.57 T_1 T_2}$$

The temperature at which p = 1 atmosphere of oxygen can be calculated:

$$(9) \quad \frac{\log 1 - \log P_{298^\circ}}{T_{1 \text{ atm.}} - 298} = \frac{-19,000}{4.57 \times T_{1 \text{ atm.}} \times 298}$$

$$(10) \quad \frac{+ 6.89}{T - 298} = \frac{19,000}{4.57 \times 298 \times T}$$

$$T = 589^\circ\text{K} = 316^\circ\text{C}$$

It has been observed by several authors, among others, K. J. Notz and R. O. Bach (ref. 28), T. V. Rode, T. A. Dobrynina and G. A. Golder (ref. 30), that thermal decomposition of pure  $\text{Li}_2\text{O}_2$  is a fast reaction at around  $350^\circ\text{C}$ . This value is in fair agreement with the value,  $316^\circ\text{C}$ , calculated from equation (10), but is obviously different from Blumenthal's value of  $190^\circ\text{C}$  for oxygen pressure of one atmosphere.

In the adjoined Figure 1, the clausius-Clapeyron curve for  $P_{O_2}$  in the system is shown.

A simple formula representing the oxygen pressures in mm Hg is as follows:

$$(11) \quad \log P_{O_2} = 10.02 - \frac{4200}{T}$$

It must be pointed out that these calculations are based on the assumption that equilibrium does exist. It has been stated above that the system behaves phenomenologically as if it were irreversible. Markowitz and collaborators measured the energy of activation of the decomposition, arriving at the extremely high value of 44,700 cal/mole. Irreversibility is frequently tantamount to an extremely high value of energy of activation. A rough calculation of the pressure equivalent of this energy leads us to values one order of magnitude higher than the ones applied by Markowitz in their attempts to obtain peroxide from oxide by pressure synthesis.

It might be possible, therefore, to convert oxide to peroxide by heating it to 250 to 300°C under an oxygen pressure of 50,000 to 100,000 psia.



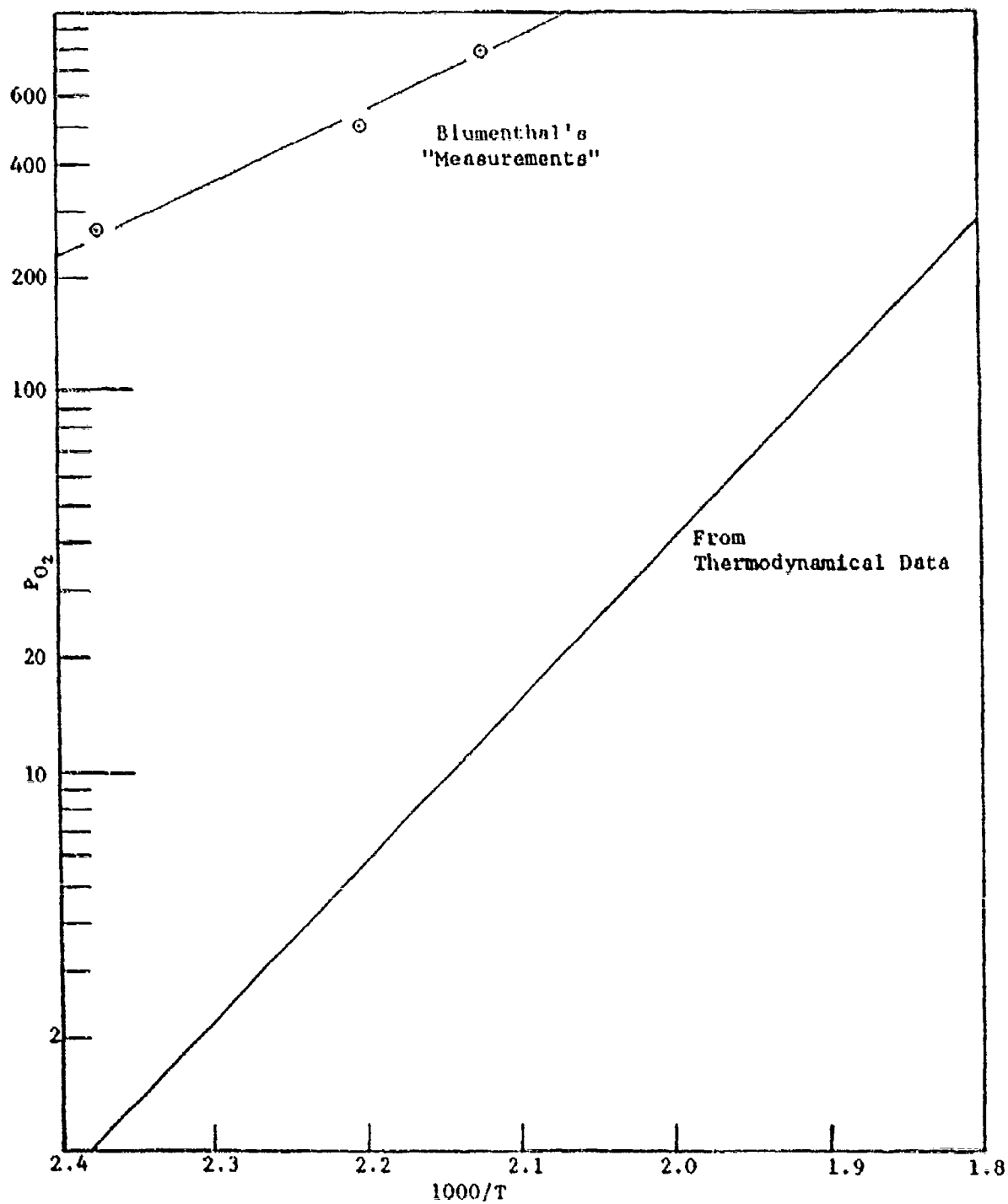

Figure 1 Oxygen Pressure of Lithium Peroxide

## SECTION II

### EXPERIMENTAL

#### Preparation of Lithium Oxide

##### General Considerations

Lithium oxide obtained according to most of the procedures above mentioned is not suitable for atmosphere regeneration. The reaction with  $\text{CO}_2$  and  $\text{H}_2\text{O}$  is extremely limited. The reason for this is that the dense form in which it is obtained will be covered with a layer of carbonate which impedes penetration of  $\text{CO}_2$  into the inside of the lithium oxide particle. In order to obtain an active material, one must expose a large surface area to the gas to be purified. One means to achieve that is to prepare a highly subdivided oxide, a fine powder. This, for obvious reasons, is not feasible because of an extremely high pressure drop observed when gases have to be passed through fine powders.

The other solution is offered by the concept of a highly porous mass, through which the gases can permeate without too large an impediment. This concept was used in the present research.

The outstanding example of the application of this principle is the preparation of anhydrous lithium hydroxide by careful dehydration of lithium hydroxide monohydrate. Not only is the carbon dioxide absorption capacity of the monohydrate very much lower than that of the anhydrous hydroxide, but also the respective active surface measurements show an enormous difference. The molar volume ratio of  $\text{LiOH}$  over  $\text{LiOH}\cdot\text{H}_2\text{O}$  is .59; this is equivalent to 41% void space in the  $\text{LiOH}$  configuration, assuming that the conversion does not affect the dimensions of the original monohydrate structure. "Navy grade  $\text{LiOH}$ " (ref. 22) has an active surface (vide infra) of  $3.3 \text{ m}^2/\text{gram}$ .

The molar volume ratio of lithium oxide over lithium peroxide is .76. This ratio is not very favorable for producing a highly porous, high active surface structure. Additional difficulties arise from the observations of sintering and partial fusion at temperatures not much higher than the one required for thermal decomposition [see Notz and Bach, (ref. 29)]. The impurities causing this reaction, lithium carbonate and hydroxide, are usually present in small amounts of lithium peroxide. At temperatures slightly above  $400^\circ\text{C}$ , this reaction has been observed with considerable concomitant shrinkage and loss of active surface. Furthermore, the connective character of the porous structure might be lost. Therefore, the peroxide used should have a high degree of purity.

Even if this thermal decomposition would be carefully controlled, and thus, the above mentioned deterioration prevented, the final oxide will not have the necessary degree of porosity to allow the location of  $\text{CO}_2$  in the framework of the porous structure, unless unexpected pores are created during carbonation. We conclude this because the product of the molar volume ratio of  $\text{Li}_2\text{CO}_3$  over  $\text{Li}_2\text{O}$ , 2.36, and the molar volume ratio of  $\text{Li}_2\text{O}$  over  $\text{Li}_2\text{O}_2$ , .76, is 1.8 rather than less than 1, as it would have to be for  $\text{CO}_2$  to fit into the framework of the porous structure.

Therefore, it is necessary to prepare a peroxide which already has a structure sufficiently porous and with a high active surface. This can be achieved by removing the volatiles from addition compounds of lithium peroxide and water and hydrogen peroxide. Compounds of this nature have been described in the literature by:

- A. J. Cohen (ref. 13)
- A. Aguzzi (ref. 1)
- S. E. Stephanou and J. Kleinberg (ref. 31)
- S. Z. Makarov and T. A. Dobrynina (ref. 24).

A product having the general formula,  $\text{Li}_2\text{O}_2 \cdot \text{H}_2\text{O}_2 \cdot 2\text{H}_2\text{O}$  is the most common of the described products. Its density has been given as 1.60 g/ml. from calculations. It was measured as 1.69 g/ml. by A. Cohen (ref. 13).

The molar volume ratio of carbonate over this peroxide hydroperoxide dihydrate is .485. Thus by starting with this complex, the final product would have 51.5% void space.

The structural solidity of course would be greatly affected by an excess of volatile component. It is felt that this would occur when the hydroperoxide dihydrate would be subjected to thermal decomposition or "drying" as it will be called henceforth. For this reason, we used an initial material, later found to be very satisfactory, having the following formula:

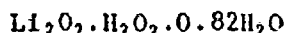

Its formula weight is 95. Assuming a density of 1.6 g/ml., the molar volume is 59 ml. The molar volume ratio of this material over lithium carbonate is 0.60, so the completely carbonated final product would have a 40% void space.

Nevertheless, this might be excessive, and further explorations might yield denser and still very active material. It was not possible to investigate this due to limitations in time and manpower.

The procedure employed in the preparation of active lithium oxide was then

- 1- To synthesize  $\text{Li}_2\text{O}_2 \cdot \text{H}_2\text{O}_2 \cdot 0.82\text{H}_2\text{O}$ . This was achieved by interacting a pentane slurry of commercial lithium peroxide with 70%  $\text{H}_2\text{O}_2$  at temperatures between 0 and +10°C.
- 2- To dry the addition compound thereby removing pentane, water and hydrogen peroxide and thus reclaiming a porous structured lithium peroxide.
- 3- To decompose thermally the peroxide to the oxide.

These steps have to be carried out without permitting sintering or chemical side reactions to occur.

While this has been successful, not all of the variables could be determined in the course of this investigation. It is possible that alternate procedures could be devised.

#### Description of Equipment

1- For the preparation of  $\text{Li}_2\text{O}_2 \cdot \text{H}_2\text{O}_2 \cdot 0.8\text{H}_2\text{O}$ . This reaction was carried out in conventional laboratory equipment: Three-neck glass round-bottom flask, stirrer, funnels, etc.

2- "Drying" of  $\text{Li}_2\text{O}_2 \cdot \text{H}_2\text{O}_2 \cdot 0.8\text{H}_2\text{O}$ . This was done in a vacuum drying oven purchased from National Appliance Company, Model 5850. This oven has a capacity of 1-1/2 cubic feet, and can be heated up to 185°C.

3- Thermal Decomposition of  $\text{Li}_2\text{O}_2$ . In Figure 2 a diagram is shown describing the small scale decomposition furnace used initially to investigate the approximate parameters of this thermal decomposition.

In Figures 3 and 4, the larger size furnace for production of up to 2 pounds of lithium oxide is shown.

#### The Raw Material

Lithium peroxide is a commercial product of Lithium Corporation of America. It has an assay of about 98%  $\text{Li}_2\text{O}_2$ , containing 1.5%  $\text{LiOH}$  and 0.5%  $\text{Li}_2\text{CO}_3$ . Its active oxygen content is between 33.8 and 34.2%. It is produced according to a method described in a pending patent to R. O. Bach and W. W. Boardman, Jr. (ref. 5). It has a light tan color.

#### Conversion of $\text{Li}_2\text{O}_2$ into $\text{Li}_2\text{O}_2 \cdot \text{H}_2\text{O}_2 \cdot \text{H}_2\text{O}$

454 g. Lithium peroxide is suspended in 1-1/2 l. pentane in a 3-neck flask. Vigorous stirring is provided and the slurry is cooled in a dry ice-hexane bath to 0°C.

488 g. 70%  $\text{H}_2\text{O}_2$  is added at a rate at which the temperature remains between 0 and 10°C. This requires between 5 and 10 minutes of time.

The following visual observations can be made:

When about 100-150 g. of hydrogen peroxide are added, the particle turns from tan to a lighter color and agglomerates to larger aggregates where the  $\text{H}_2\text{O}_2$  enters the slurry. This is dispersed by vigorous stirring.

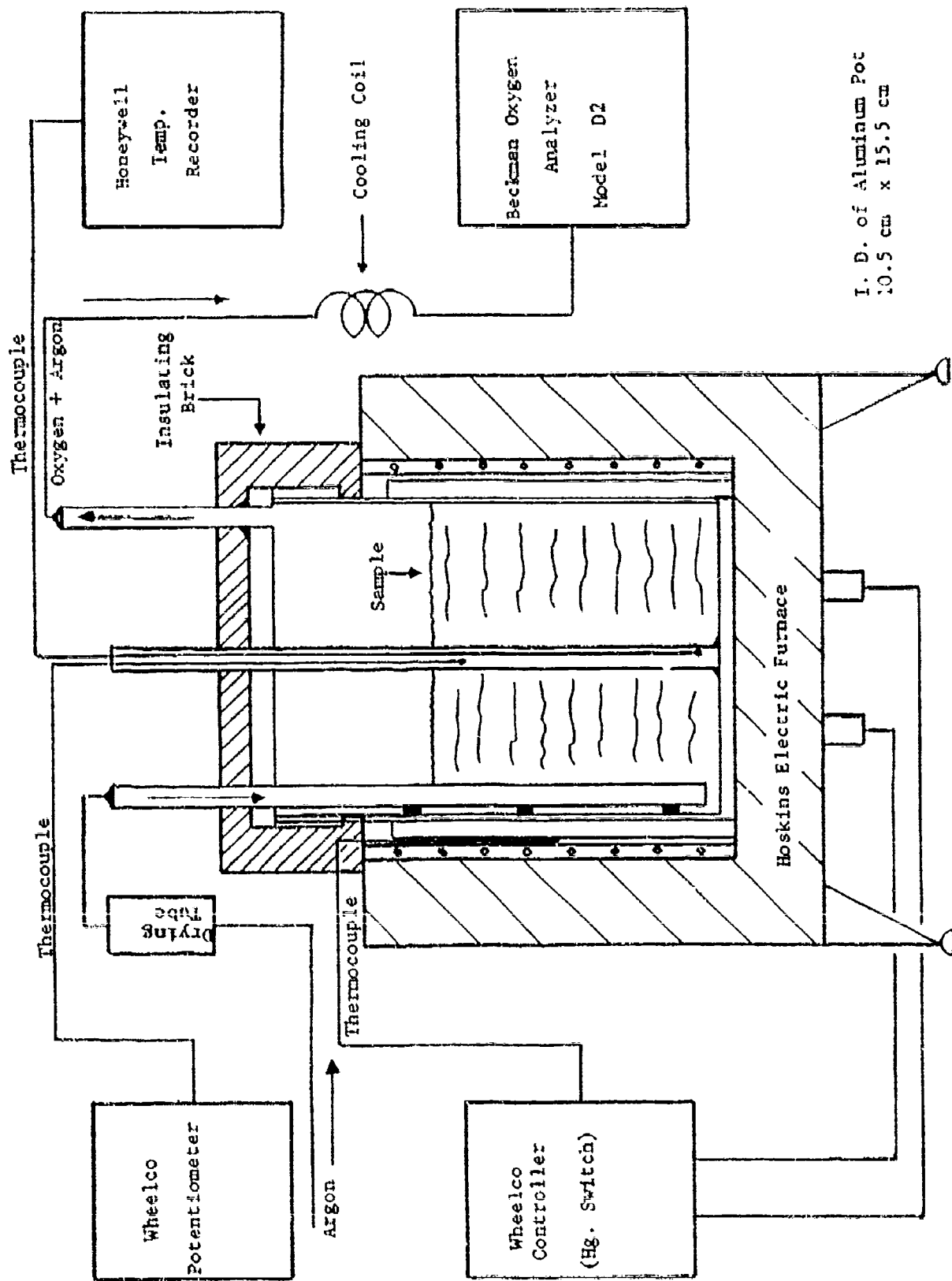

Figure 2 Small Decomposition Set Up

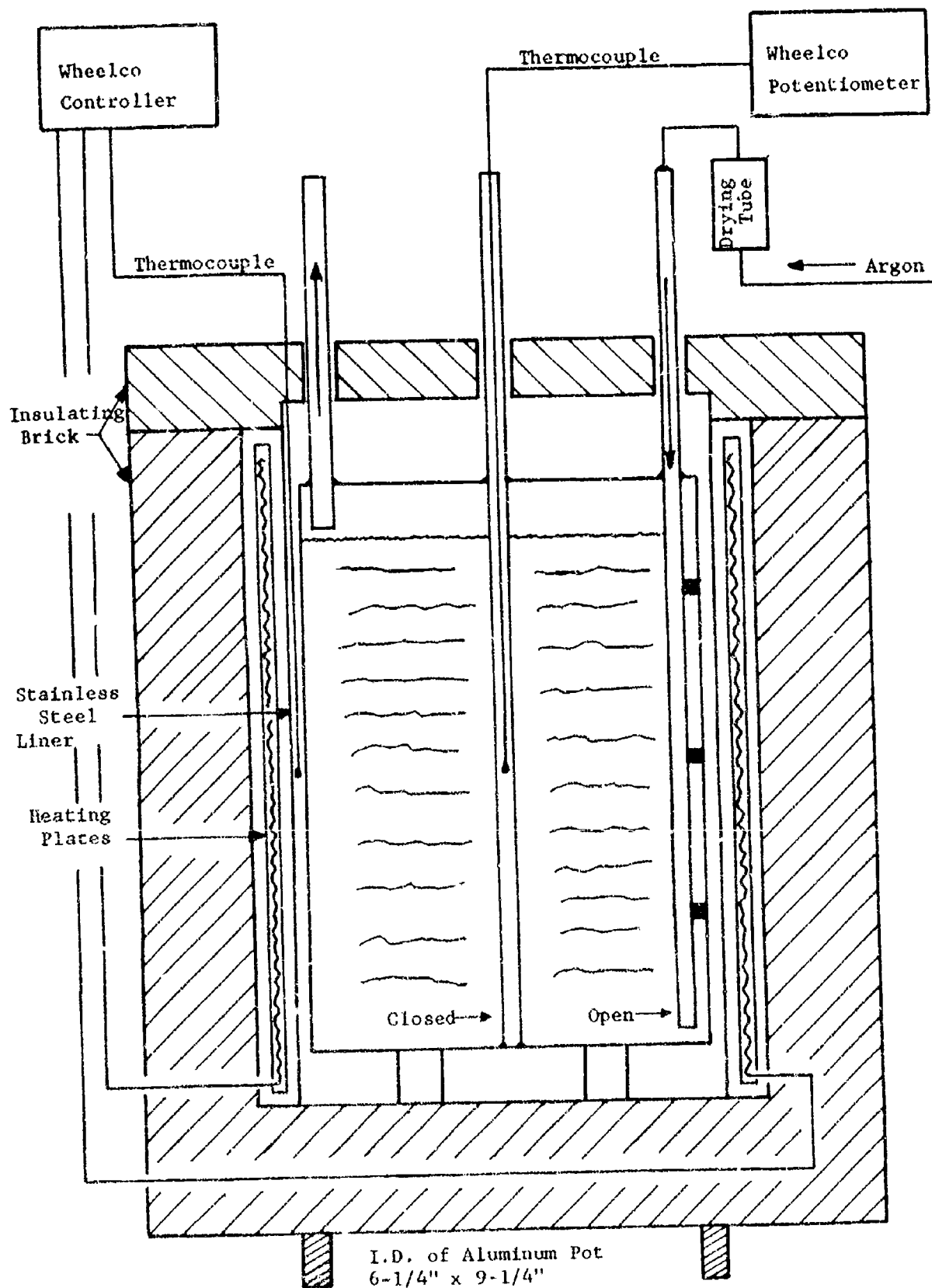

Figure 3 Large Decomposition Set Up

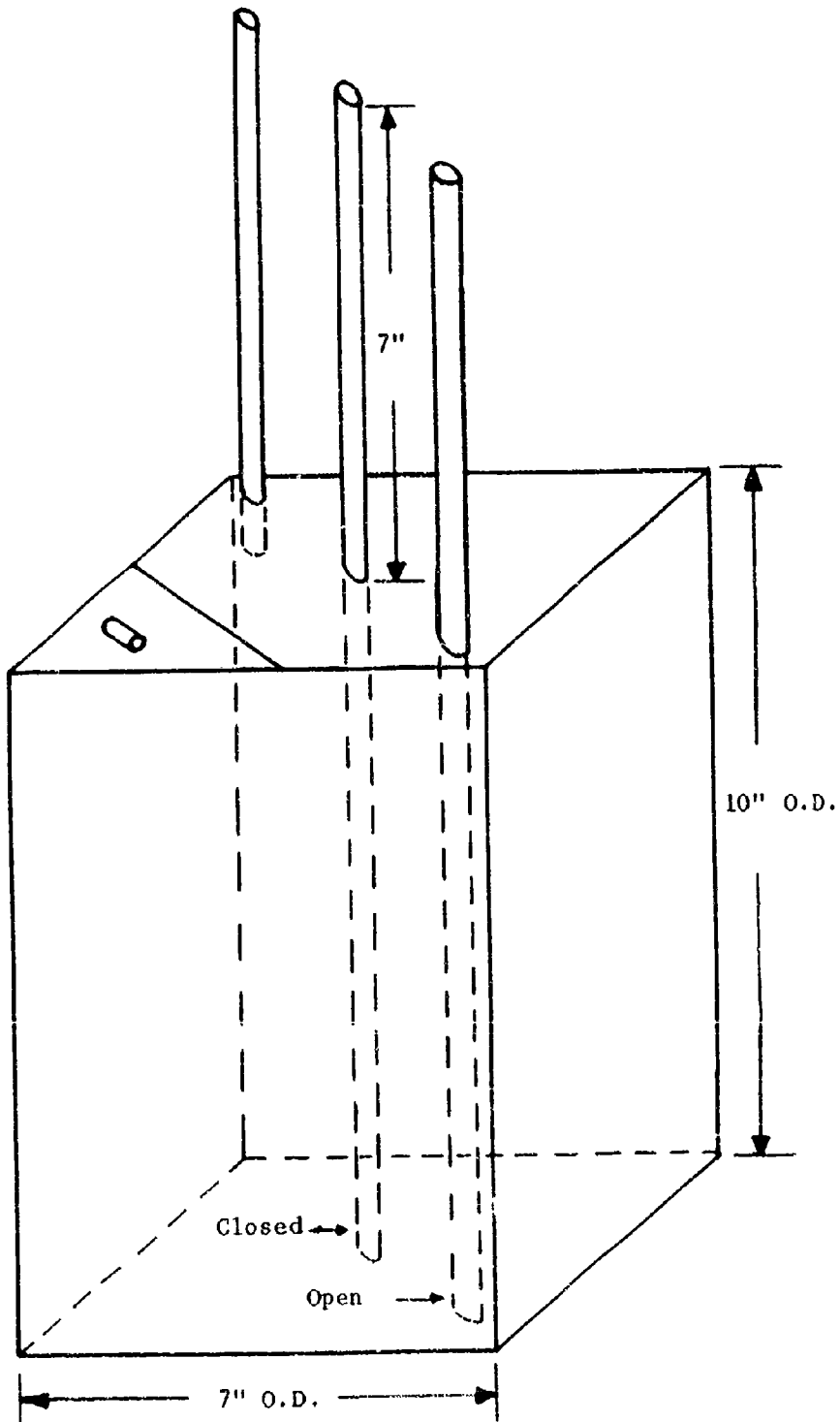

Figure 4 Large Decomposition Pot Made of 3/8" Aluminum Sheet

As the addition progresses, the speed of the stirrer has to be increased in order to avoid consolidation of a large lump of addition compound around the stirrer and the sides of the flask. The lightening of the color continues throughout the addition of the hydrogen peroxide and will end up, if not with a slurry of white solids, with a slurry of much lighter color than the original peroxide.

The slurry is homogeneous.

For a successful further treatment of the product, a particle size should be strived for which will ultimately be the one obtained as lithium oxide. This was determined to be between 4 and 20 mesh. Excessive fines will have to be screened off and will be lost for the process.

With practice, the speed of stirring and the speed of addition can be adjusted in such a way that 75% of the slurry consists in solids of a mesh size of 4 to 14. The undersize, most of which are between 14 and 20 mesh, should not be larger than 25% of the total.

After addition, the mixture is cooled to  $-5$  to  $0^{\circ}\text{C}$ . The cooling bath is removed and most of the pentane is decanted. The pentane-moist solids are placed in a pyrex drying tray and stirred intermittently in order to avoid caking and crust formation resulting from the ensuing endothermic reaction and concomitant evolution of volatiles. Without this stirring it was found that the yield of the right size fraction decreases because the larger chunks could not be subdivided efficiently enough.

After about one hour the temperature of the mass which had risen to about  $60^{\circ}\text{C}$ , begins to decrease. Then, all the pentane has evaporated and the reaction is terminated.

The color should be almost completely white.

The product is sieved and the size fraction 4-14 mesh is retained for further processing.

The most important condition to maintain is that the addition of hydrogen peroxide must be effected at a temperature of 0 to  $10^{\circ}\text{C}$ .

The molar proportions of  $\text{Li}_2\text{O}_2$  to  $\text{H}_2\text{O}_2$  to  $\text{H}_2\text{O}$  in the quantity of reactants was set at 1:1.02:0.825.

A typical product obtained in this step had the following composition:

47.8%	$\text{Li}_2\text{O}_2$
31.6%	$\text{H}_2\text{O}_2$
19.4%	$\text{H}_2\text{O}$
1.2%	$\text{Li}_2\text{CO}_3$ ,

which corresponds to molar ratios of 1:0.9:1.04.



So apparently some hydrogen peroxide is decomposed during the reaction. After screening off the fines from the 4-14 mesh size fraction, the yield was 80%.

This procedure was not investigated with respect to all the parameters. It was repeated frequently and a total of forty pounds of lithium peroxide was converted with entirely consistent results.

#### Preparation of High Active Surface Peroxide

The addition compound described above can be decomposed thermally and lithium peroxide is reclaimed. Unlike the starting material, commercial  $\text{Li}_2\text{O}_2$ , this reclaimed product, obtained on a mesh size of 4-14, has a high active surface area. It is an extremely porous granular material.

The reaction equation is the following:



The molar volume ratio,  $\text{Li}_2\text{O}_2/\text{Li}_2\text{O}_2 \cdot \text{H}_2\text{O}_2 \cdot \text{H}_2\text{O}$ , is .37.

The active surface of the addition compound is about  $1 \text{ m}^2/\text{g}$ , a common value for a granular salt. Upon decomposition, the resulting peroxide has values between 6 and  $8.5 \text{ m}^2/\text{g}$ , exceptionally high values. A seven-fold increase of active surface in this reaction has to be contrasted with approximately a three-fold increase in the thermal decomposition of lithium hydroxide monohydrate. The molar volume ratio,  $\text{LiOH}/\text{LiOH} \cdot \text{H}_2\text{O}$ , for this latter reaction is .59.

The decomposition was carried out by heating the addition compound under a pressure of 7.6 mm of Hg absolute to  $100^\circ\text{C}$  for 16 hours. This was the final "drying" procedure which was settled upon after some initial investigation.

The addition compound is placed in the vacuum drying furnace at room temperature and the temperature is raised from room temperature at a rate which allows the volatile components to be pumped off. This process could be conducted much faster in appropriate installations.

The product is obtained in essentially the same physical form as the raw material, except that the particles are extremely soft.

The analysis of the product shows that it is essentially of the composition of lithium peroxide, whereas, the carbonate and hydroxide impurities are slightly increased over the initial peroxide.

### Thermal Decomposition of Peroxide

The thermal decomposition of the peroxide was carried out in the equipment shown in Figure 2. primarily; Notz and Bach (ref. 28) determined that reaction is fast at around 350°C and found also that carbonate (present in all preparations) will cause partial melting or sintering at a temperature slightly above 400°C. We decided therefore, that the temperature at which the decomposition is carried out must be controlled very carefully.

The rate at which the decomposition is occurring will also depend greatly on the temperature as well. This was investigated. The rates of decomposition of lithium peroxide at different temperatures were investigated by Markowitz and Desmelyk (ref. 25). These results became known after our work on this phase was completed.

The course of the reaction can be followed very closely by monitoring the evolution of oxygen.

### Testing of Lithium Oxide

#### General Considerations

The method (MIL-L-20213A-SHIPS) being used by the U. S. Navy to evaluate the capacity of anhydrous lithium hydroxide employed to control carbon dioxide levels aboard submarines is utilized in the laboratories of Lithium Corporation of America for control of the production of "Absorption Grade Lithium Hydroxide - Anhydrous." In this method, the capacity of the lithium hydroxide as a carbon dioxide absorbent is tested by passing 4% CO<sub>2</sub> in air at about 85% R.H. at 20°C through a specified column of absorbent (3 cm. diameter by 15 cm. depth) at a linear velocity of 500 cm. per minute until the effluent gas from the absorbent registers 2% CO<sub>2</sub> on the monitoring equipment. The monitoring equipment employed in the Lithium Corporation of America laboratories is a relative indication instrument; the output of two thermoconductivity cells are bucked against one another in a typical bridge circuit, the bridge imbalance being read out on a dial meter or on a recorder. Throughout the test, one cell is in contact with a flow of the 4% CO<sub>2</sub> in air while through the other cell flows the effluent gas. The absorption efficiency, grams CO<sub>2</sub> absorbed per gram absorbent, is calculated from the results of carbonate analyses on the lithium hydroxide made before and after the test.

In the present investigation, the same general method has been used, adapted to the special requirements of the atmospheric pressure, relative humidity, and CO<sub>2</sub> partial pressure. The total pressure is set at 5 psia or 0.34 atmospheres. The partial pressure of CO<sub>2</sub> is set at .0735 psia or 0.005 atmospheres. This corresponds to 1.47 vol.% of CO<sub>2</sub>.

Test gas was purchased from the Matheson Company, Inc.: 1.8 to 2.0% CO<sub>2</sub> in dry oxygen. This test gas was saturated with water vapor to the desired degree of relative humidity. This lowered the percentage of CO<sub>2</sub> in varying degrees. The maximum effect is observed at 100% R.H. at 120°F. This would dilute the carbon dioxide concentration from 1.8 to about 1.6%. Thus the testing was performed at slightly higher CO<sub>2</sub> concentrations at one atmosphere.

Several tests were run at 5 psia. The same gases were used and were saturated with water vapor to the desired degree in the same manner. Since the relative humidity is dependent on the temperature and not on the total pressure of the system at any given temperature, the water vapor exerts triple the dilution effect on the gas at one-third atmosphere as at one atmosphere total pressure. Thus under the limiting conditions of 100% R.H. and 120°F the 2% CO<sub>2</sub> becomes 0.9 vol.%.

In order to account for the exact volumes of gas metered into the system, the flow rates were determined before humidification.

The initial testing was performed at one atmosphere pressure. This served to establish the conditions under which lithium oxide can be considered an active carbon dioxide absorbent, this being the main concern of this investigation. The two parameters which change considerably when the total pressure is decreased to 1/3 atmosphere are the linear flow rate of the gas and the amount of water vapor present in the test gas. Both variables were investigated and allowed valid conclusions to be made from the one atmosphere test results. The few tests at 1/3 atmosphere confirmed these conclusions.

#### Description of Equipment

Three block diagrams of the apparatus, Figures 5, 6, and 7 depict the alterations on the absorption equipment found necessary as this investigation moved through the following three major stages:

- 1- Tests at one atmosphere on small research samples of Li<sub>2</sub>O.
- 2- Tests at 1/3 atmosphere on small research samples of Li<sub>2</sub>O.
- 3- Tests at one atmosphere on the full-scale absorption unit.

We shall discuss the equipment in the above order.

- 1- Tests at One Atmosphere on Small Research Samples of Li<sub>2</sub>O.

Although this apparatus as shown in Figure 5 was altered slightly in the course of this investigation according to the experimental necessities it was essentially as shown throughout the tests run on

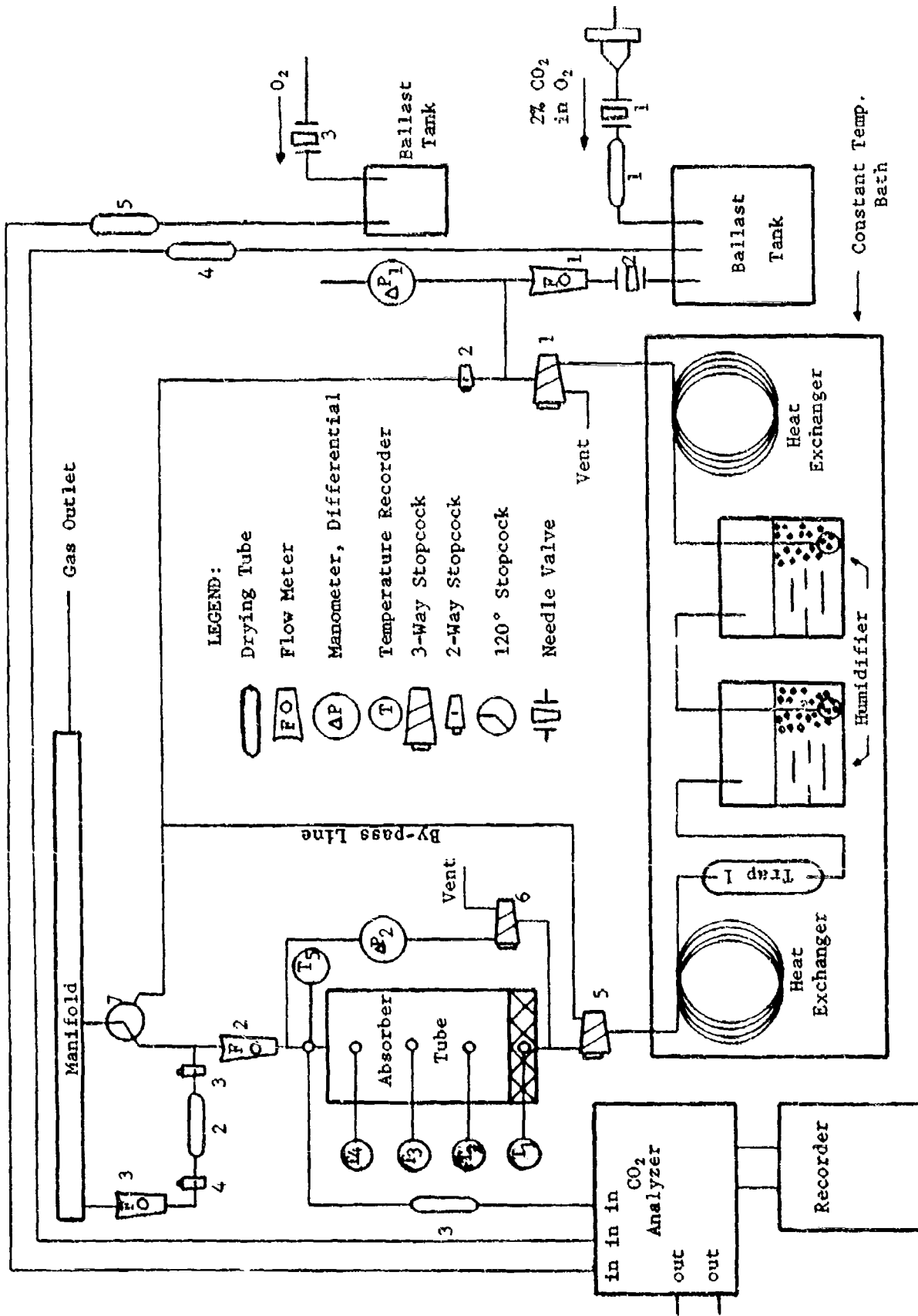

Figure 5 Apparatus for Tests at One Atmosphere Pressure

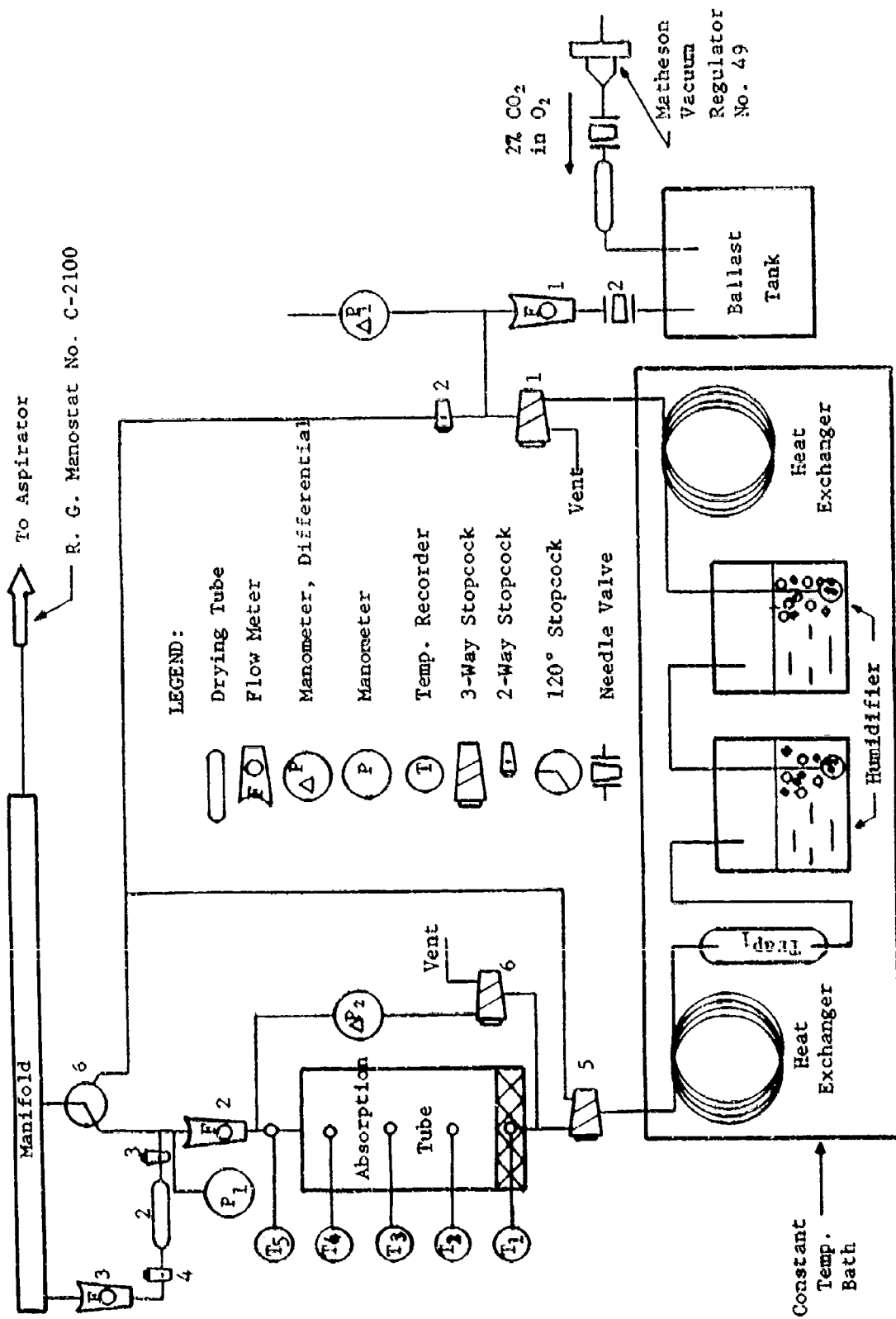

Figure 6 Apparatus for Tests at One-Third Atmosphere Pressure

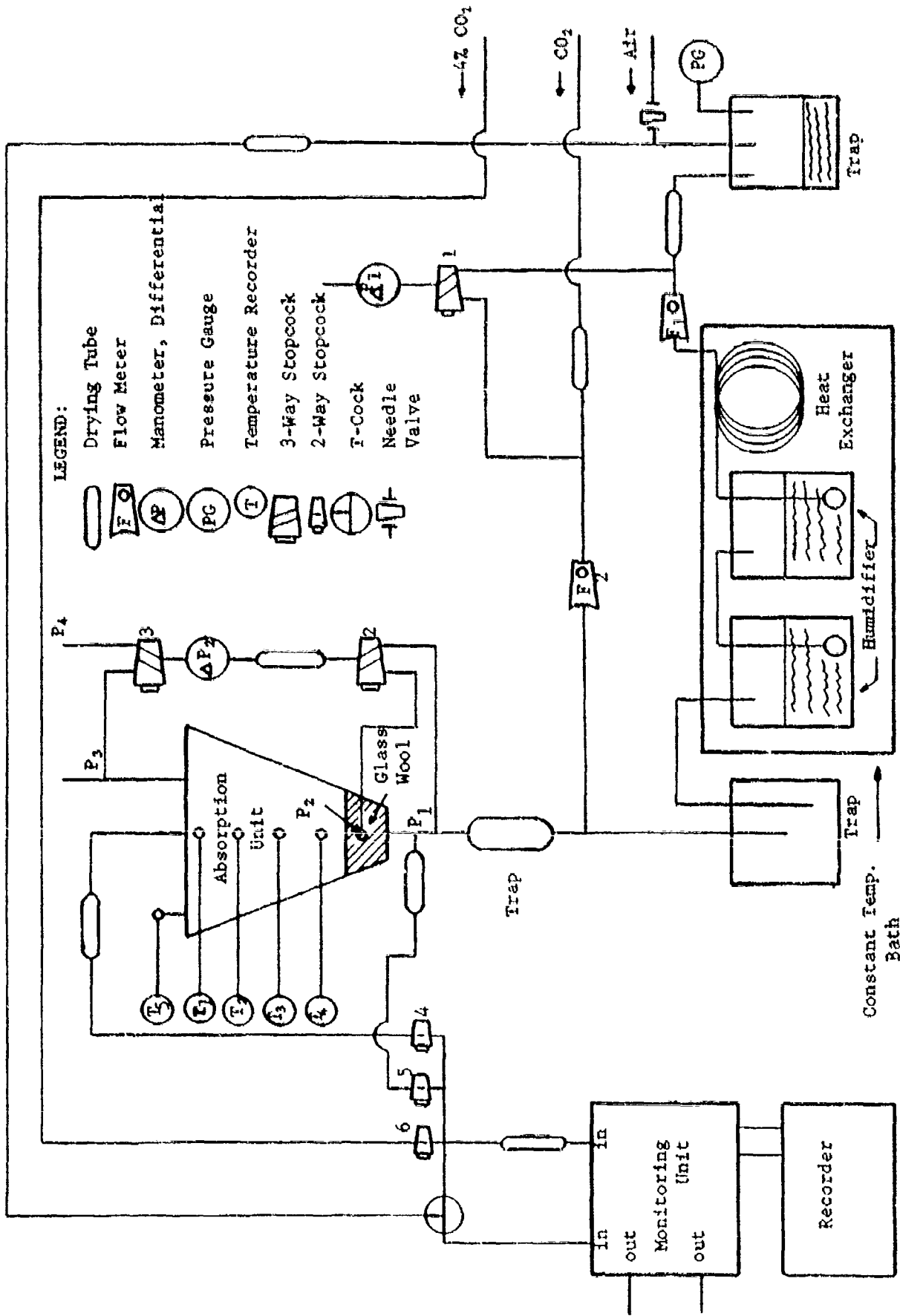

Figure 7 Apparatus for Tests on the Full-Scale Absorption Unit

test-tube amounts of oxide at one atmosphere. The test gas, nominally 2% CO<sub>2</sub> in oxygen, was metered into the system through flow meter, F<sub>1</sub>, the gas pressure being noted on the U-tube mercury manometer, ΔP<sub>1</sub>. The gas was equilibrated to the desired temperature and corresponding humidity by flowing through the heat-exchangers and humidifiers all contained in a constant temperature bath. The equilibrated gas was allowed to flow up through the sample of Li<sub>2</sub>O in the Absorber tube, and the variations of the temperature of the inlet and outlet gas and of various sites in the Li<sub>2</sub>O were monitored continuously on A.P.I.-Temprint Recorders by feeding the output of iron-constantan (1mm. O.D.) thermocouples, T<sub>1</sub>, T<sub>2</sub>, T<sub>3</sub>, T<sub>4</sub> and T<sub>5</sub>\* into the Recorders. The pressure drop across the Absorber and the pressure difference between the gas coming out of the Li<sub>2</sub>O bed and the atmospheric pressure was observed periodically on the dibutyl phthalate U-tube manometer, ΔP<sub>2</sub>. The bulk of the spent gas was permitted to flow through flow meter, F<sub>2</sub>, stopcock - 7 and out through the manifold to the atmosphere. A certain amount of the gas was bypassed to the sample cell of the Gow Mac, Model SC-500. The output signal of the Gow Mac was recorded continuously on a Leeds and Northrup Speedomax-II as percentage CO<sub>2</sub> in the effluent gas stream.

#### Gow Mac SC-500 Operation:

The Gow Mac was a research unit which has been fitted with gas chromatographic thermal conductivity cells. It was zeroed by passing pure dry oxygen through both standard and sample cells at the same pressure and flow rates. The instrument was standardized at the known CO<sub>2</sub> content of the "2%" CO<sub>2</sub> in oxygen gas by allowing the "2%" CO<sub>2</sub> standard gas to flow into the sample cell at the same flow rate at which the oxygen flowed in. Of course, the dry oxygen flow was maintained at the same constant rate through the standard cell.

After standardization, the Gow Mac was then ready to yield reliable percentage CO<sub>2</sub> in the effluent gas as the Gow Mac output was read out on the Leeds and Northrup Speedomax-II.

#### Humidifiers:

The relative humidity of the test gas was controlled at approximately 50% by dispersing the gas through two "humidifiers" containing respectively 600 ml. and 100 ml. of 25 weight percentage of lithium chloride in water.

\* The 1 mm. O.D. Iron-Constantan couple monitoring the effluent gas stream at T<sub>5</sub> was replaced by a very sensitive .005 mm. O.D. Chromel-Constantan couple after test No. 35.

The relative humidity of gases fully equilibrated over 25% lithium chloride solution from 0°C to 50°C are shown in the following table:

Temp. (°C)	Milligrams H <sub>2</sub> O per Liter		RH (Calc'd.)
	over 25% LiCl	over H <sub>2</sub> O	
5	3.6	6.8	53
10	4.9	9.4	52
20	9.0	17.3	52
30	17.0	30.4	56
40	30.2	51.1	59
50	49.5	83.2	59.5

When a known volume of humidified test gas was passed through drying tube No. 1, it was found that the weight gain was 11 ± 1% more than that expected from the above table. This was thought to be due to the entrainment of mist by the gas stream.

### 2- Tests at One-third Atmosphere on Small Research Samples of Li<sub>2</sub>O.

The apparatus employed in the tests at one-third atmosphere on small samples of Li<sub>2</sub>O is outlined in Figure No. 6. This system was essentially the same as that used in tests at one atmosphere, see Figure 3, except that the lines to the Gow Mac were eliminated and several pieces of equipment necessary to the maintaining and regulation of a constant pressure of about one-third of an atmosphere were added.

The fore-pressure in the system was maintained at approximately 55 cm Hg by means of a Matheson Vacuum Regulator No. 49. The pressure in the manifold was maintained at about 25 cm Hg by means of a Roger Gilmont Monostat No. C-2100. The pressure and rate of flow of gas into the system were measured on the differential mercury manometer,  $\Delta P_1$ , and the flow meter, F<sub>1</sub>. The pressure drop across the absorber tube<sup>1</sup> was detected on a differential di-butyl-phthalate manometer,  $\Delta P_2$ , and the quantity of gas leaving the absorber tube was calculated from readings obtained on the absolute mercury manometer, P<sub>1</sub>, and the flowmeter, F<sub>2</sub>.

### 3- Tests at One Atmosphere on the Full-Scale Absorption Unit.

Absorption tests on the full-scale absorption unit were run on the equipment shown schematically in Figure 7. Laboratory compressed air (approximately 60 psig.) was fed into the system through a needle valve\*. The air then took the path shown in the figure. The main flow of about 20 l/min. was monitored on flow meter No. F-1, whereas the

\* The pressure variations in the laboratory air were directly transmitted to the system, so prior to test No. 3, a single stage pressure regulator was installed which eliminated this defect.



pressure at this point was noted on the differential mercury manometer No.  $\Delta P_1$ . The air temperature and humidity were adjusted to known values while flowing through the heat exchanger and humidifiers. The carbon dioxide was introduced into the air stream at about 200 ml./min. at the point indicated. The  $\text{CO}_2$  flow and pressure were monitored on the differential manometer,  $\Delta P_1$ , and flow meter,  $F_2$ . The humidified  $\text{CO}_2$ -air mixture passed up through a spray tower and through a 2-inch diameter extra-course sintered glass disk into the absorption unit containing the lithium oxide. The temperatures at indicated sites within the lithium oxide were monitored continuously on Temprint recorders,  $T_1$ ,  $T_2$ ,  $T_3$ , and  $T_4$ . The 1 mm. O.D. iron-constantan junctions were inserted  $7\frac{1}{2}$  cm. inside the wall of the absorption unit through rubber stoppers. The temperature of the effluent gas was monitored at  $T_5$  by feeding its output of a 0.005 mm. O.D. chromel-constantan couple into a Temprint recorder. The pressure differences between the atmospheric pressure,  $P_4$ , the pressure of effluent gas,  $P_3$ , the fore-pressure to the absorption unit,  $P_1$ , and the pressure immediately inside the small filter of the absorption unit were monitored occasionally throughout each test on the differential mercury manometer,  $\Delta P_2$ . The  $\text{CO}_2$  content of the effluent gas stream was monitored nearly continuously on the Gow Mac, Model 210. The  $\text{CO}_2$  content of the inlet gas stream, on the other hand, was recorded only occasionally during each run. The output of the Gow Mac cells was recorded by connecting a Leeds and Northrup, Speedomax-II Recorder circuit across the meter of the Gow Mac. The Gow Mac was zeroed by adjustment while dry air flowed through both cells and it was standardized when 4%  $\text{CO}_2$ -air mixture flowed through the standard cell.

#### Gow Mac Model 210, Operation:

The Gow Mac (Model 210) is an instrument designed for routine laboratory or plant gas analyses. It is not as sensitive as the Gow Mac, SC-500, however, we discovered that when the signal to the meter was fed into the Leeds and Northrup Recorder, that a full-scale (one millivolt) deflection was obtained when a 2%  $\text{CO}_2$ -air mixture was flowing through the sample cell of the Gow Mac. One other advantage which the Model 210 has over the Model SC-500 is that the former is not sensitive to rather large variations in rate of flow in the range of the flow meters on the instrument panel.

#### Humidifiers:

In test No. 1 and 2, the gas was brought to about 50% R.H. by bubbling through five liters of 25% LiCl solution (distributed in three successive flasks: 3 liters, 1 liter and 1 liter respectively). The humidifiers were not placed in the constant temperature bath, but were allowed to adjust to the room temperature. About 300 ml. of water were placed in the pre-trap to replace the  $\text{H}_2\text{O}$  loss expected during each test.

The humidity of the gas stream was held at about 100% R.H. by the dispersing of gas through about 2 liters of water contained in two flasks as pictured in the figure. The constant temperature bath was held at 25.2°C.

### Chemical Analyses

In order to obtain a general view of the analytical requirements, the following recapitulation of the essential chemical reactions pertaining to this project are given below:

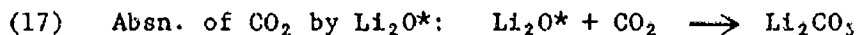
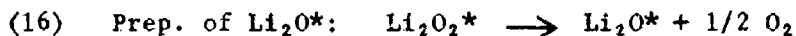
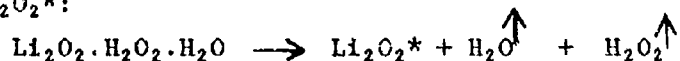
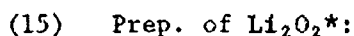
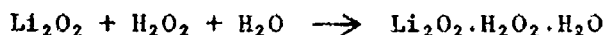
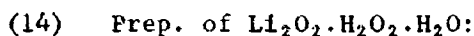
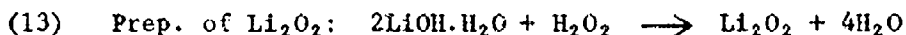

\*  $\text{Li}_2\text{O}_2^*$  designates lithium peroxide of high active surface.  
 $\text{Li}_2\text{O}^*$  designates lithium oxide of high active surface.

The chemical analyses of the principal chemical entities appearing in the above equations resolve into determinations of Total Alkali as  $\text{Li}_2\text{O}$ ,  $\text{Li}_2\text{CO}_3$  and active oxygen (Oa). The contained  $\text{H}_2\text{O}$  was obtained in each case by subtracting the sum of the above three constituents from 100%, since the non-lithium impurities were generally quite negligible.

#### 1- Sampling Procedures:

Ease of obtaining a representative sample of chemicals involved in the above equations decreases with the order in which the equations are listed. No special sampling effort is required in obtaining samples for analysis of  $\text{LiOH}\cdot\text{H}_2\text{O}$ ,  $\text{H}_2\text{O}_2$  or  $\text{Li}_2\text{O}_2$ . However, due to spatial inhomogeneities of constitution the products of equations 14, 15, 16 and 17 were mixed, carefully sampled, and the large sample pulverized and remixed. The procedure followed in all of the small-scale testing of  $\text{CO}_2$  absorption of  $\text{Li}_2\text{O}^*$  was to pulverize the entire final product in the absorption tube, or each separate layer of product which ever was appropriate to the requirements of the test being run. In the large-scale tests the entire product was mixed in a large polyethylene bag, then about 250 grams were carefully sampled and pulverized.

## 2- Analysis for Active Oxygen:

The products of the equations 14 through 17 require an analysis for active oxygen, either as a major constituent or as a possible impurity. The size of the sample employed in each analysis must be determined by the required accuracy. The method employed is outlined as follows:

a. Transfer weighed sample into 100 ml. of water containing 3 ml. of concentrated phosphoric acid, Kolthoff and Belcher (ref. 20) and one drop of 0.025M Ferroin solution. Mix well.

b. Add 8 to 15 ml. of 1 to 1 sulfuric acid, depending on the alkali content of the sample, and titrate rapidly to Ferroin end point with 0.2 N  $\text{KMnO}_4$  with adequate stirring.

c. Calculations:

$$(18) \text{ wt.}\% \text{ O}_a = \frac{(\text{ml. } \text{KMnO}_4) (\text{N of } \text{KMnO}_4) 0.8}{\text{Sample Wt.}}$$

## 3- Analysis for Total Alkali as $\text{Li}_2\text{O}$ and $\text{Li}_2\text{CO}_3$ :

The size of the sample in each analysis was determined by the accuracy required. The following technique was employed:

a. The finely pulverized sample was weighed under dry nitrogen and transferred to a beaker containing about 400 ml. of water and 0.2 ml. of 0.1N NaOH. The solution was blanketed with dry  $\text{N}_2$  or argon and stirred with a teflon-coated magnet until the sample was dissolved or nearly so.

b. If the sample contained over 5%  $\text{O}_a$ , one drop of 0.25N  $\text{OsO}_4$  in 0.1N  $\text{H}_2\text{SO}_4$  was added to decompose the peroxide.

c. 0.5N HCl was added at a rapid dropwise rate until a pH of 9.0 was indicated on a pH meter.

d. At this point, if the sample contained less than about 10%  $\text{Li}_2\text{CO}_3$ , the titration was continued with 0.1N HCl very carefully to a pH of 7.8 to 8.0. If the sample contained more than 10%  $\text{Li}_2\text{CO}_3$ , the titration was continued with 0.5N HCl.

e. The titration was continued carefully to a pH of 3.8 to 4.0, employing either .1N or .5N HCl according to the rule indicated in step d. above.

f. Repeat steps a. through e. omitting only the sample in order to determine the titration blank to pH-8 and pH-4. These blanks will be different for titrations in which osmonium tetroxide is present.

g. Calculations:

$$(19) \quad \text{Total Alkali as wt. \% Li}_2\text{O} = \frac{(M_8 - B_8) - (M_4 - B_4)}{\text{Sample Weight}} \times 1.494$$

where -  $M_8$  represents the millequivalents of HCl to pH-8 for the sample,  
 $B_8$  represents the millequivalents of HCl to pH-8 for the blank,  
 $M_4$  represents the millequivalents of HCl to pH-4 for the sample,  
 and  
 $B_4$  represents the millequivalents of HCl to pH-4 for the blank.

$$(20) \quad \text{wt. \% Li}_2\text{CO}_3 = \frac{2(M_4 - B_4)}{\text{Sample Weight}} \times 3.695$$

or

$$\text{wt. \% CO}_2 = \text{wt. \% Li}_2\text{CO}_3 \times \frac{44}{73.89}$$

4- Experimental Parameters Calculated from the Analytical Results:

Two parameters, wt. CO<sub>2</sub> absorbed and wt. H<sub>2</sub>O absorbed, were derived by difference between the contained weights of CO<sub>2</sub> in the Li<sub>2</sub>O sample before and after passing the humidified 2% CO<sub>2</sub> gas through the sample.

The percentage of Li<sub>2</sub>O converted to Li<sub>2</sub>CO<sub>3</sub> was calculated in two ways as follows:

a. Calculated from the decrease in total alkali as Li<sub>2</sub>O before and after passing humidified 2% CO<sub>2</sub> through the sample of Li<sub>2</sub>O by the equation:

$$(21) \quad \% \text{ Li}_2\text{O converted to Li}_2\text{CO}_3 = \frac{(\text{wt. total alkali as Li}_2\text{O before} - \text{wt. total alkali as Li}_2\text{O after}) \times 100}{\text{wt. Total Alkali as Li}_2\text{O Before}}$$

b. Calculated from the increase in Li<sub>2</sub>CO<sub>3</sub> content by means of the equation:

$$(22) \quad \% \text{ Li}_2\text{O converted to Li}_2\text{CO}_3 = \frac{(\text{wt. Li}_2\text{CO}_3 \text{ after} - \text{wt. Li}_2\text{CO}_3 \text{ before}) 29.88 \times 100}{\text{wt. Total Alkali as Li}_2\text{O before} \times 73.89}$$

The results of calculations from equations (21) and (22) reflect the errors in analytical determination of total alkali and lithium carbonate.

The percentage Li<sub>2</sub>O converted to LiOH was calculated by means of the following procedures:

Case No. 1, if % H<sub>2</sub>O after x 1.66 is greater than Total Alkali as % Li<sub>2</sub>O after, then,

(23) % Li<sub>2</sub>O Converted to LiOH =

$$\frac{\text{wt. of Total Alkali as Li}_2\text{O after} - \text{wt. of H}_2\text{O before} \times 1.66}{\text{wt. Total Alkali as Li}_2\text{O Before}} \times 100$$

or according to

Case No. 2, if % H<sub>2</sub>O after x 1.66 is less than Total Alkali as % Li<sub>2</sub>O After, then,

(24) % Li<sub>2</sub>O Converted to LiOH =

$$\frac{(\text{wt. H}_2\text{O After} - \text{wt. H}_2\text{O Before}) 1.66}{\text{wt. Total Alkali as Li}_2\text{O Before}} \times 100$$

When the carbon dioxide reacts with all of the Li<sub>2</sub>O present in the original sample and part of the LiOH, then, the % Li<sub>2</sub>O converted to LiOH calculated from equation (24), will yield negative values. Here, no LiOH is formed. On the contrary, LiOH present as impurity in the original Li<sub>2</sub>O sample is partially converted to carbonate and the chemically bound water in that LiOH is swept away. Note that the "wt. H<sub>2</sub>O before" can only be present as LiOH.

### Physical Analyses

#### Flow Rate Determinations:

The rates of flow of the various gases employed were determined by readings from Brooks Float Type Rotameters. The variations in reading during one trial were plotted against time and the average reading obtained by integration. The average reading was converted to liters/min. by reference to a set of curves published by the Brooks Rotameter Company. These values were corrected for the density, pressure and temperature pertaining to each gas used at each Rotameter site. However, the flow rate reported in the tables of this report were corrected to the conditions of temperature and pressure of the gas flowing into the absorption column of tests 1 through 41, or those small-scale tests made at about atmospheric pressure. The flow rates for tests 42 through 45 were corrected to the temperature and pressures of the gas coming out of the top of the absorption column.

The total CO<sub>2</sub> flow was calculated by multiplying the density of CO<sub>2</sub> at 760 mm. Hg and 273°K by the total test gas volume in each test corrected to 760 mm and 273°K.

The water transported in the tests 1 through 41 was calculated by multiplying (see Description of Equipment, Humidifiers) the value of liters of gas flowing into the bottom of the absorption column by the grams of water per liter of gas as determined by experiment. The water transported in the tests at 1/3 atmosphere pressure, e.g., tests 42

through 45, was calculated by multiplying the volume of gas at the average of the fore-pressure and the pressure of the gas coming out of the top of the column by the grams of water per liter of gas as determined experimentally.

#### Pressure Measurement:

The types of pressure measurement devices and their sites have already been discussed previously under the Description of Equipment. In both the large and small-scale tests performed at about atmospheric pressure vertical differential, open-end, U-tube manometers were used to measure the difference in pressure between two sites within the test equipment or between such a site and the atmospheric pressure. The manometric fluids employed were either mercury or dibutyl phthalate. In tests at 1/3 atmosphere, these same manometers were employed with the addition of one absolute mercury manometer. In the large scale tests, one dial manometer was employed.

#### Active Surface Determinations:

The active surface (A.S.) of the lithium oxide was determined according to the theory of absorption of Brunauer, Emmet and Teller (ref. 12). This is commonly called the BET method. A slight modification of the technique of Nelson and Eggertsen (ref. 27) was used. The thermal conductivity cell of an Aerograph Model A-90-P Gas Chromatograph was used. The signal was recorded on a Leeds and Northrup Speedomax G with disc chart integrator. The integrator count was standardized with the gas from calibrated loops. The test gas was 25% nitrogen in helium.

### SECTION III

#### RESULTS

##### The Decomposition of Commercial Lithium Peroxide

At the beginning of our efforts it was thought feasible to decompose lithium peroxide as produced commercially. In order to obtain a coarse particle of an adequate mesh size, pelletizing seemed to be the obvious solution. Lithium peroxide cannot be pressed into a compact pellet unless some water is added to it as a binding agent.

After compacting the pellets were dried again under vacuum at around 100°C. They were broken up and screened. The size fraction between 4 and 14 mesh (usually around 67% of the total) was thermally decomposed. In Figure 8, the evolution of oxygen from about a 200 g. batch of peroxide pellet fractures is shown during a decomposition heating.

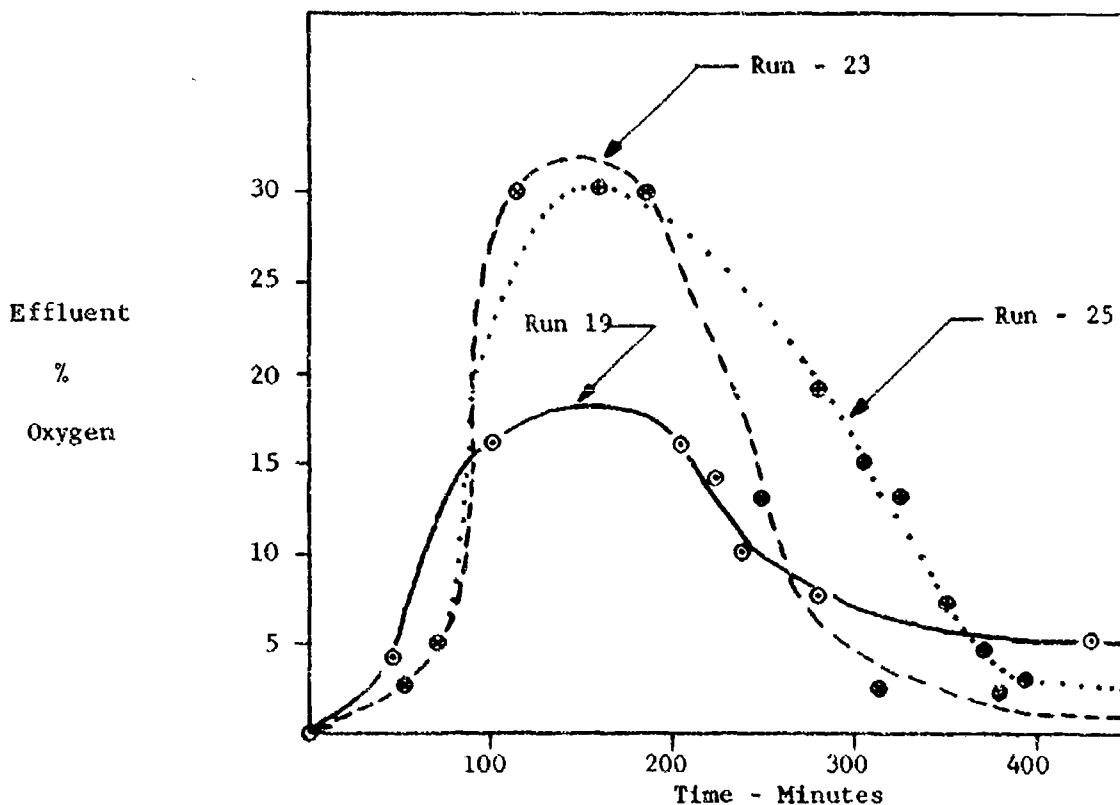

Figure 8 Oxygen Evolution During  $\text{Li}_2\text{O}_2$  Decomposition

It can be stated that a 7-hour heating period is adequate. The decomposition was carried out in the equipment shown in Figure 2.

In the following Table I, these oxide samples are described.

The following observations can be made:

#### Pelletizing Pressure

There is no discernible influence of pelletizing pressure on the density nor active surface in the range of 1000 to 3000 psig.

#### Temperature of Decomposition

The maximal temperature of decomposition seems to be reflected to some degree in the active surface values. The lowest temperature (Sample 15) has the highest active surface and the two highest temperatures have the lowest active surface (Samples 19 and 23). The range of temperatures is somewhat narrow (27°C) and the quantity of runs is insufficient to allow for a definite statement.

#### Density

In general, the density increases with the temperature of decomposition; whereas, the active surface decreases with decreasing values of density.

#### Hydrolysis

When lithium peroxide is moistened, a concentrated solution of LiOH and H<sub>2</sub>O<sub>2</sub> is formed:

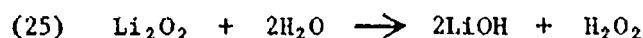

Hydrogen peroxide is not stable in alkaline solutions and decomposes:



Those combined reactions, (25) and (26), can be called hydrolysis.

The following Table II shows the chemical analyses of the samples and the degree of hydrolysis.

The amount of lithium hydroxide generated is appreciable. It is the least in Sample 19 where the water addition for pelletizing was lowest (7.8%) and hydrolysis is highest in Sample 33, where the most water was added (15.4%). There is also a noticeable increase in Li<sub>2</sub>CO<sub>3</sub> due to handling in air in the moist state.



TABLE I  
DATA CONCERNING  $\text{Li}_2\text{O}$  PREPARED FROM  $\text{Li}_2\text{O}_2$  DIRECTLY

Sample No.	Pelletizing Pressure psig	Water Added %	Peroxide* % $\text{Li}_2\text{O}_2$	Density of Dry $\text{Li}_2\text{O}_2$ Pellet g/ml	Maximum Temperature of Decomposition °C	Lithium Oxide % $\text{Li}_2\text{O}$	% Total Alkalinity	Density of $\text{Li}_2\text{O}$ Pellet g/ml	Active Surface $\text{m}^2/\text{g}$
15	3000	13	96.6	1.4	350	90.7	94.5	.94	5.7
19	3000	7.8	97.5	**	371	96.0	97.3	.89	4.8
23	3000	11.2	96.6	1.2	377	87.8	93.7	.78	4.9
25	3000	12.7	96.6	1.3	369	90.7	94.7	.85	5.5
30.1	2000	11.8	97.9	1.65	368	89.9	93.8	.87	5.1
30.2	3000	10.8	97.4	1.71	368	99.3	95.2	.93	5.3
33	1000	15.4	97.4	1.80	360	87.4	93.5	.88	5.4

\* The active surface of commercial lithium peroxide was  $0.5 \text{ m}^2/\text{g}$ .

\*\* Not determined.

TABLE II

## DATA DERIVED FROM CHEMICAL ANALYSES

Sample No.	LITHIUM PEROXIDE			LITHIUM OXIDE			HYDROLYSIS					
	% Li <sub>2</sub> O <sub>2</sub>	% LiOH	% Li <sub>2</sub> CO <sub>3</sub>	Theoretical % Li <sub>2</sub> O	% LiOH	% Li <sub>2</sub> CO <sub>3</sub>	Observed % LiOH	% Li <sub>2</sub> CO <sub>3</sub>	% Oa	increase of LiOH %	Li <sub>2</sub> CO <sub>3</sub> %	
15	96.0	2.0	1.4	94.8	3.1	2.1	90.7	6.1	2.9	5.4	3.0	0.8
19	97.5	1.5	1.0	96.3	2.2	1.5	96.0	2.1	1.9	---	---	0.4
23	96.6	2.0	1.4	94.8	3.1	2.1	87.8	9.4	2.7	0.1	6.3	0.6
25	96.6	2.0	1.4	94.8	3.1	2.1	90.7	6.4	2.8	0.1	3.3	0.7
33	97.4	1.5	1.1	96.0	2.3	1.7	87.3	9.8	2.7	0.2	7.5	1.0

## The Preparation of High Active Surface Li<sub>2</sub>O From High Active Surface Li<sub>2</sub>O<sub>2</sub>

The results of the tests are entered in Table III.

The final procedure of obtaining a grade of oxide, which has a high value of active surface area and also good performance characteristic has been described above. Many runs were made according to this procedure and they are found in Table III, under Sample No. 123-17 through Sample No. 123-24.

Several factors influence the quality of our final product. These can be classified in three categories.

1. Factors in the preparation of Li<sub>2</sub>O<sub>2</sub>·H<sub>2</sub>O<sub>2</sub>·H<sub>2</sub>O.
2. Factors in the drying of Li<sub>2</sub>O<sub>2</sub>·H<sub>2</sub>O<sub>2</sub>·H<sub>2</sub>O for obtaining high surface Li<sub>2</sub>O<sub>2</sub> (h.s. Li<sub>2</sub>O<sub>2</sub>).
3. Thermal decomposition of h.s. Li<sub>2</sub>O<sub>2</sub>.

Under category 1. we list the following:

- a. Temperature of addition.
- b. Quality of Li<sub>2</sub>O<sub>2</sub> used.
- c. Agitation.
- d. Storage time of product.

Concerning category 2., the following:

- a. Temperature of drying.
- b. Gaseous atmosphere (vacuum) when drying.
- c. Speed of drying.

Finally, category 3., the following:

- a. Temperature of furnace operation.
- b. Gaseous environment during the thermal decomposition.

Evidence of many of these factors can be found in the earlier preparations of Li<sub>2</sub>O.

### Hydrolysis (Formation of LiOH)

In many of our preparations, we noted high LiOH contents in the final product. It is possible to convert hydroxide into oxide:

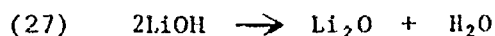

This reaction, however, does not occur in the temperature range of

TABLE III  
PRINCIPLE DATA TAKEN DURING THE PREPARATION OF Li<sub>2</sub>O SAMPLES

Sample No.	Vacuum Drying Temp. °C	Wt. Li <sub>2</sub> O <sub>2</sub> Taken for Decomp. g.	Max. Temp. of Decomp. °C	Wt. After Decomp. g.	Wt. Loss %	4-14 Mesh Bulk Density g/ml	Density of Li <sub>2</sub> O Granule g/ml
36	45	(42.8) <sup>c</sup>	370	20.6	65.6 <sup>a</sup>	.21	.38
38	---	(323) <sup>a</sup>	373	203	62.8 <sup>a</sup>	.19	.36
39	---	(298) <sup>a</sup>	440	136	54.5 <sup>a</sup>	---	---
43	40-45	(174) <sup>c</sup>	433	88	---	.475	.87
45	90	140	390	83	55.0 <sup>a</sup>	.40	.74
48	90	100	357	65.5	67.8 <sup>a</sup>	.15	.27
50	90	106	380	70	68.0 <sup>a</sup>	.47	.86
51	90	119.5	377	76.5	69.4 <sup>a</sup>	.26	.47 (determ., .38)
55	100	373	390	241	67.8 <sup>a</sup>	.31	.56 (determ., .74)
58	100	152.5	368	101.5	74.0 <sup>a</sup>	.22	.40
61	100	253	367	169	61.2 <sup>a</sup>	.23	.42
64	120	390	377	260	61.5 <sup>a</sup>	.33	.60
66	120	394	355	263	ca. 67.0 <sup>a</sup>	.145	.26

TABLE III (Continued)

Active Surface Area		Total Alk. as Li <sub>2</sub> O %	Li <sub>2</sub> CO <sub>3</sub> %	LiOH %	Structure	Remarks
Li <sub>2</sub> O <sub>2</sub>	Li <sub>2</sub> O					
---	11.9	96.0	1.8	5.3	Soft	Pelletized material
---	5.4	83.5	2.9	36.0	Powdery	Not pelletized. Dried for 2 hrs. at 25-200°C in argon.
---	---	68.6	0.6	82.4	Hard	Not pelletized. Dried for 30 mins. at 25-200°C in argon.
---	.26	95.7	2.1	5.8	Hard sintered.	Not pelletized.
---	.57	91.0	2.3	17.9	Mixed hard & soft.	Not pelletized.
---	9.8	95.2	1.7	6.6	Soft, powdery.	Not pelletized.
---	1.4	93.7	2.2	10.8	Somewhat sintered.	Not pelletized.
---	7.4	94.0	2.8	8.6	Mixture hard & soft.	Pelletized material.
---	5.8	92.0	6.0	5.4	Somewhat sintered.	Pelletized material. Decomposed in large furnace.
---	3.8	89.8	3.3	18.2	Quite soft.	Not pelletized, 1/2% SiO <sub>2</sub> added.
---	3.7	93.3	3.7	8	Harder than No.58.	Same as above.
---	2.5	92.3	4.7	7.9	Hard sintered.	Not pelletized. Loaded fine & large particles together.
---	9.5	86.7	3.7	27.5	Soft.	Not pelletized. 1% SiO <sub>2</sub> added; dried before pentane vaporized.

TABLE III (Continued)

Sample No.	Vacuum Drying Temp. °C	Wt. Li <sub>2</sub> O <sub>2</sub> Taken for Decomp. g.	Max. Temp. of Decomp. °C	Wt. After Decomp. g.	Wt. Loss %	4-14 Mesh Bulk Density g/ml	Density of Li <sub>2</sub> O Granule g/ml
118	90	860	354	589	31.5 <sup>b</sup>	.096	.156
123-1	105	1075	348	825	23.3 <sup>b</sup>	.141	---
123-2	105	1075	343	750	30.2 <sup>b</sup>	.153	---
123-3	107	1425	343	925	35.1 <sup>b</sup>	.119	---
123-4	107	1425	354	950	33.3 <sup>b</sup>	.112	.194
123-6	90	1400	343	925	33.9 <sup>b</sup>	.126	---
123-7	109	1319	354	925	29.9 <sup>b</sup>	.096	---
123-8	111	1300	357	925	28.9 <sup>b</sup>	.140	---
123-9	108	725	359	450	37.9 <sup>b</sup>	.161	.280
123-10	111	1400	362	950	32.1 <sup>b</sup>	.142	---
123-11	111	1550	359	1025	33.9 <sup>b</sup>	.140	---
123-12	111	1175	363	894	23.9 <sup>b</sup>	.162	---
123-13	90	1890	335	1300	31.2 <sup>b</sup>	.155	---
123-15	99	1550	340	1075	30.7 <sup>b</sup>	---	---
123-16		1300	357	925	28.8 <sup>b</sup>	.166	---
123-17	113	850	357	575	32.4 <sup>b</sup>	.107	.202

TABLE III (Continued)

Active Surface Area		Total Alk. as Li <sub>2</sub> O %	Li <sub>2</sub> CO <sub>3</sub> %	LiOH %	Structure	Remarks
Li <sub>2</sub> O <sub>2</sub>	m <sup>2</sup> /g Li <sub>2</sub> O					
---	9.9	91.8	3.1	13.3	Very light blocks. Firm.	---
---	4.8	86.3	2.1	30.2	Loose, soft particles.	---
---	4.0	90.7	2.0	18.4	Large, loose particles.	---
---	---	94.9	1.9	7.6	Loose, soft particles.	---
---	7.2	95.2	2.5	6.1	Very light blocks. Firm.	---
---	6.9	95.0	2.8	4.7	Loose particles.	---
---	10.1	93.0	4.3	7.1	Very light blocks. Firm.	---
---	4.9	87.4	2.6	26.5	Loose particles.	---
---	8.3	95.6	2.4	5.1	Very firm blocks.	---
---	6.2	95.9	3.9	0.5	Soft blocks.	---
---	7.4	95.8	3.8	1.0	Firm blocks.	---
---	4.3	91.9	4.3	10.0	Soft particles.	Decomp. pot was a cylinder. This was an attempt to form a cylinder of firm oxide.
---	5.7	91.6	2.5	15.3	Soft particles.	---
---	5.0	93.1	3.0	10.0	More dense and harder particles.	Will not meet specifications.
---	5.5	89.1	3.2	20.1	Loose particles.	---
---	10.0	95.1	3.7	2.8	Firm blocks.	Li <sub>2</sub> O <sub>2</sub> .H <sub>2</sub> O <sub>2</sub> .H <sub>2</sub> O was prepared at -10 to 0°C with slow stirring. Sieved into mesh size 4-14.

TABLE III (Continued)

Sample No.	Vacuum Drying Temp. °C	Wt. $\text{Li}_2\text{O}_2$ Taken for Decomp. g.	Max. Temp. of Decomp. °C	Wt. After Decomp. g.	Wt. Loss %	4-14 Mesh Bulk Density g/ml	Density of $\text{Li}_2\text{O}$ Granule g/ml
123-18	100	1248	360	825	33.9 <sup>b</sup>	.119	.246
123-19	98	1350	360	900	33.3 <sup>b</sup>	.101	.200
123-20	100	1325	360	835	37.0 <sup>b</sup>	.086	.201
123-21*	100	1265	360	850	32.6 <sup>b</sup>	.093	.192
123-22	99	1450	360	950	34.5 <sup>b</sup>	.119	.215
123-23	99	1450	360	950	34.5 <sup>b</sup>	.082	.191
123-24	99	1450	360	950	34.5 <sup>b</sup>	.073	.190

NOTES: a - Referred to initial lithium peroxide addition compound;  
 b - Referred to intermediate lithium peroxide;  
 c - Partially decomposed addition compound.

\* - The active surface of the peroxide hydroperoxide hydrate, first step material of this run, is 0.7 m<sup>2</sup>/gram.

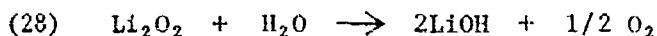

TABLE III (Concluded)

Active Surface Area		Total Alk. as	$\text{Li}_2\text{CO}_3$	$\text{LiOH}$	Structure	Remarks
$\text{Li}_2\text{O}_2$	$\text{Li}_2\text{O}$	$\text{Li}_2\text{O}$ %	%	%		
7.0	9.1	91.4	4.9	9.8	Firm blocks.	Same as 123-17. Except, temp. was -5 to 0°C.
8.2	12.1	92.6	5.0	6.4	Firm blocks.	Ditto. Temp. from -5 to +5°C.
8.5	10.6	93.9	2.7	8.7	Firm blocks.	Ditto. Temp. from -10 to +10°C.
5.9	10.7	92.8	5.0	5.4	Firm blocks.	Ditto.
6.6	10.3	93.5	4.0	6.4	Firm blocks.	Ditto. Temp. -5 to +5°C.
---	10.2	96.6	3.0	0.7	Firm blocks.	Ditto. Temp. 0 to +5°C.
7.1	11.2	95.8	2.5	4.2	Firm blocks.	Ditto.

up to 400°C, but at much higher temperatures out of a melt. It could hardly be expected that such an oxide would have a high active surface, which is necessary for efficient CO<sub>2</sub> absorption.

The reaction of hydrolysis of lithium peroxide



must therefore be considered as irreversible. Anhydrous LiOH is a powerful CO<sub>2</sub> absorber but its capacity is only .96 lb. of CO<sub>2</sub>/lb., whereas the oxide has one of 1.47 lb. of CO<sub>2</sub>/lb., or 153% of that of the hydroxide.

It is well known that the decomposition of peroxidic oxygen is influenced powerfully by the hydroxyl ion concentration and the temperature of the system. The former factor is set in our system: it is a strongly alkaline medium where peroxidic oxygen is not very stable in aqueous media. Therefore, when the lithium peroxide is reacted with the 70% aqueous hydrogen peroxide to form Li<sub>2</sub>O<sub>2</sub>·H<sub>2</sub>O<sub>2</sub>·H<sub>2</sub>O the formation of intermediate aqueous solutions should be avoided.

It has been noted that when the addition is performed at very low temperatures (i.e., -40 to -50°C) the formation of the complex does not occur. An intimate mixture of Li<sub>2</sub>O<sub>2</sub> and frozen 70% H<sub>2</sub>O<sub>2</sub> results.

Subsequently, when this solid is allowed to warm up a sudden exothermic reaction takes place giving a very high temperature rise which will result in loss of active oxygen and concomitant hydrolysis. The high LiOH content of Sample No. 45 and 50 was traced to this condition.

The addition temperature should therefore never fall below -10°C. On the other hand, it should not be allowed to rise above 60°C which is a critical point observed by the investigators earlier. (R. O. Bach and I. M. Paige, unpublished research (ref. 6)). It has been found that solutions of Li<sub>2</sub>O<sub>2</sub>, giving LiOH and H<sub>2</sub>O<sub>2</sub> in the aqueous phase, are relatively stable up to 60°C but lose oxygen very rapidly above this temperature.

We did not conduct extensive studies on the stability of the addition compound or its tendency to hydrolyze on standing, so assumed it to be less stable, either exposed to the room air or stored in air-tight containers, than our lithium peroxide. Usually the time interval between the formation of the addition compound and the initiation of H<sub>2</sub>O and H<sub>2</sub>O<sub>2</sub> removal was somewhere between two and three hours. On one occasion, the addition compound was stored for twelve hours in a refrigerator at 0°C without any evidence of hydrolysis having taken place. A glance at the % LiOH column of Table III should indicate that hydrolysis of lithium peroxide prior to its complete decomposition is one of the major problems in obtaining high purity lithium oxide by this route. However, the existence of oxides

such as Nos. 123-23, 123-10 and 123-11 is evidence that high purity oxides can be obtained.

Early in this investigation, 71 grams of the addition compound was placed in the vacuum oven at 45°C for about twelve hours during which time it became according to analysis,  $\text{Li}_2\text{O}_2 \cdot 0.5\text{H}_2\text{O}_2 \cdot 0.04\text{H}_2\text{O}$ . This was placed in the decomposition furnace and with a slow stream of argon flowing through it, the temperature was programmed from 25° to 200°C within 30 minutes, and then up to a maximum of 370°C. We were encouraged by the results shown in Table III. However, when we tried to eliminate the vacuum drying step completely in producing oxides No. 38 and 39, we found considerable evidence of hydrolytic reaction, these oxides containing 36 and 82% LiOH respectively. Argon flowed through the bed during the entire process in both cases. The reason for the big difference in percentage lithium hydroxide in the product oxide is that the temperature was programmed to rise from 25° to 200°C in two hours in the case of Sample No. 38, whereas, the temperature rose from 25° to 200°C within thirty minutes in the case of Sample 39. The obvious conclusion was reached that a vacuum drying process at or near 100°C was essential for converting large amounts of the lithium peroxide hydroperoxide hydrate to high surface lithium peroxide.

There is the danger in a vacuum drying operation that the water (and hydrogen peroxide) vapors are not carried away fast enough, either due to a fast rise in temperature, or insufficient pumping capacity or a restriction due to small size valves and also due to a combination of these factors. This was the case in several of our sample preparations: No. 66, No. 123-1, No. 123-2, and No. 123-8.

Finally, it must be stated that high surface lithium oxide reacts with water vapor and with carbon dioxide. Therefore, air exposure of the oxide was held to a minimum. For example, transfer from the decomposition pot to polyethylene storage bags was accomplished in a hood through the air. Here the oxide in the pot was kept blanketed with dry nitrogen and the storage bag was purged with dry nitrogen prior and during the transfer. The pulverizing and sieving was done in an argon-filled dry box.

#### Active Surface Area

The temperature of decomposition plays a major role in the formation of an active surface. Lithium peroxide obtained from the "drying" operation has usually an active surface of 5 to 8.5 m<sup>2</sup>/g. It was found that only samples of oxide with active surface values above 9 m<sup>2</sup>/g showed good performance.

The temperature of the furnace was set at 360°C. This temperature, at least on low impurity samples, guaranteed a reasonable rate of decomposition with the result of an active surface of above 10 m<sup>2</sup>/g.

When comparing the influence of temperature on active surface, products of the same impurity content ( $\text{Li}_2\text{CO}_3$  and  $\text{LiOH}$ ) must be chosen.

The following general conclusions can be drawn:

- 1- Less impurity content means higher active surface.
- 2- High firing temperature means low active surface.
- 3- At impurity contents of not more than 5%  $\text{Li}_2\text{CO}_3$  and not more than 6%  $\text{LiOH}$ , temperatures should not be higher than  $360^\circ\text{C}$  to obtain active surface of  $10 \text{ m}^2/\text{g}$  or higher.
- 4- The firing temperatures in excess of  $380^\circ\text{C}$ , always lead to very low active surface values, whereas even with extremely high  $\text{LiOH}$  values medium active surface values can be obtained with low firing temperatures.

Generally speaking, the active surface determinations and the furnacing temperatures recorded are not reliable enough to make really quantitative statements.

#### Tests on Granular Beds

The  $\text{Li}_2\text{O}$  obtained either by direct decomposition of commercial  $\text{Li}_2\text{O}_2$ , or the high active surface material was tested by exposing granular material to a stream of 2%  $\text{CO}_2$  in oxygen. In a few cases, compact solid material and compressed pellets were tested. Relative humidity, temperature and flow rate were varied and the influence of these factors on the conversion of  $\text{Li}_2\text{O}$  to  $\text{Li}_2\text{CO}_3$  were observed. Most of these tests were performed under 1 atmosphere pressure, only a few at 5 psia. Chemical reaction proceeds at high energy levels and the pressure difference of 1 atmosphere to  $1/3$  atmosphere did not significantly influence the direction or rate of these reactions. The results at 1 atmosphere are meaningful, if interpreted correctly. Valid conclusions can be drawn by extrapolation to the condition of  $1/3$  atmosphere.

#### 1- Test at One Atmosphere

The data of the first series of tests at one atmosphere are found in Tables IV and V.

It is evident that absorption efficiency increases with increasing surface areas. Runs 4, 10 and 11 were the first products tested with high active surface areas. High percentages of retention of  $\text{CO}_2$  are combined with good conversions to  $\text{Li}_2\text{CO}_3$ . Of course low flow rates contributed to the success of tests 10 and 11.

The influence of the linear flow rate is clearly shown by the following comparison.

TABLE IV

## COMPOSITION OF LITHIUM OXIDE SAMPLES BEFORE AND AFTER TESTS

Test No.	Sample No.	Sample Wt.		% Li <sub>2</sub> O		% Li <sub>2</sub> CO <sub>3</sub>		% H <sub>2</sub> O		% SiO <sub>2</sub>	
		Before	After	Before	After	Before	After	Before	After	Before	After
3	15	13.5	21	94.5	42.8	2.9	46	2.3	11.2	---	---
5	15	4.35	6.9	94.5	47.8	2.9	39.9	2.6	12.3	---	---
6	19	4.7	5.7	97.9	70.4	1.9	19.7	0.2	9.9	---	---
1	61	21	39.5	93.3	18.9	3.7	74.3	2.5	6.5	0.5	0.3
2	61	3.5	6.1	93.3	36.4	3.7	56.1	2.5	7.2	0.5	0.3
7	61	4.1	6.8	93.3	33.6	3.7	58.2	2.5	7.8	---	---
8	61	5.2	8.7	93.3	27.8	3.7	62	2.5	9.9	---	---
12	61	2.3	5.6	93.3	15.9	3.7	77.3	2.5	6.6	---	---
13	61	3.2	7.0	93.3	13.6	3.7	79.0	2.5	7.2	1.0	0.5
9	43	5	5.9	95.7	86.6	2.0	9	2.2	4.4	---	---
4	66	11	23	86.7	15.7	3.65	72.9	3.6	10.9	---	---
11	48	3.2	8.1	95.2	1.5	1.7	90	3.1	8.5	---	---
10	48	4.4	11.7	95.2	2.6	1.7	83.5	3.1	14.0	---	---

TABLE V  
PRINCIPLE DATA OBTAINED FROM ABSORPTION TESTS<sup>a</sup>  
ON LITHIUM OXIDE SAMPLES

Test No.	Sample No.	Mesh Size	A.S. m <sup>2</sup> /g	Linear		Test Time Min.	Gas Vol. l	Cap. of		Absd. g CO <sub>2</sub>	% CO <sub>2</sub> Absd. of CO <sub>2</sub> In
				Flow Rate l/m	Flow Rate cm/sec			Col. g CO <sub>2</sub>	In g CO <sub>2</sub>		
3	15	4-14	5.7	1.05 0.55	9.0 4.8	283 30	---	18.7	11.3	5.5	49
5 <sup>b</sup>	15	4-14	5.7	0.537	9.8	300	161	6.03	5.73	1.56	27
6	19	8-20	4.8	0.484	4.2	222	108	6.75	4.58	0.61	13
1	61	4-14	3.7	1.00 0.60	8.6 5.2	176 948	---	28.8	26.5	6.4	29
2	61	4-14	3.7	0.94	8.2	145	---	4.81	4.85	1.95	40
7	61	8-20	3.7	0.528	4.6	316	167	5.61	6.00	2.26	33
8	61	4-8	3.7	0.496	4.3	486	241	7.12	8.65	3.09	36
12 <sup>c</sup>	61	4-8	3.7	0.085	.73	1131	97	3.86	3.48	2.5	72
13	61	8-20	3.7	0.078	.67	1455	114	4.43	4.13	3.22	78
9	43	4-8	.3	0.528	4.6	120	633	7.02	2.29	0.25	11
4	66	NC <sup>d</sup>	9.5	0.97	8.3	435	---	13.9	15.2	9.75	64
11	48	8-20	9.8	0.115	1.0	1237	142	4.53	5.13	4.32	84
10	48	8-20	9.8	0.074	.64	3210	239	6.15	8.5	5.76	68

a - Tests all run at room temperature in a test column of 22.2 mm. internal diameter.

b - Smaller diameter tube.

c - Absorption was complete after 997 min.

d - Not classified.

TABLE V (Continued)

In g H <sub>2</sub> O	Absd. g H <sub>2</sub> O	% H <sub>2</sub> O Absd.	% Li <sub>2</sub> O Converted to Li <sub>2</sub> CO <sub>3</sub>		% Li <sub>2</sub> O Conv'd. to LiOH	Mole Ratio H <sub>2</sub> C/CO <sub>2</sub>	% CO <sub>2</sub> in Eff. Gas at End	R.H. %
			ΔLi <sub>2</sub> O	ΔLi <sub>2</sub> CO <sub>3</sub>				
3.46	2.01	58	29	30	26	.75	---	---
2.53	.73	29	20	26	35	1.08	---	68
1.58	.55	35	13	9	20	.84	2.0	64
8.7	2.06	24	62	59	17	.80	---	---
1.63	0.35	22	32	40	17	.82	---	---
2.15	0.427	20	40	40	19	.87	1.2	56
3.10	0.733	24	50	44	26	.87	1.0	56
1.24	0.294	24	66	65	19	.87	2.0	56
1.47	0.425	29	69	73	23	.87	0.8	56
0.81	0.148	18	0	4	5	.86	2.0	56
4.80	1.55	32	62	69	21	.77	---	---
1.75	0.587	33	96	96	-0.3	.83	1.3	54
3.08	1.50	49	93	94	3.8	.88	0.2	56

Test No.	Linear Flow Rate	Average Conversion to $\text{Li}_2\text{CO}_3$	% $\text{CO}_2$ Retained
2	8.2	36	40
7	4.6	40	33
8	4.3	47	36
12	0.73	65	72
13	0.67	71	78

These tests were all performed with the same oxide sample No. 61, a.s.  $3.7 \text{ m}^2/\text{g}$ .

A comparison of tests 4 and 11, different samples but both of high a.s., shows the same trend: decrease of conversion with increase of flow rate.

Mesh size does not seem to influence the yield within the range 4 to 20 mesh.

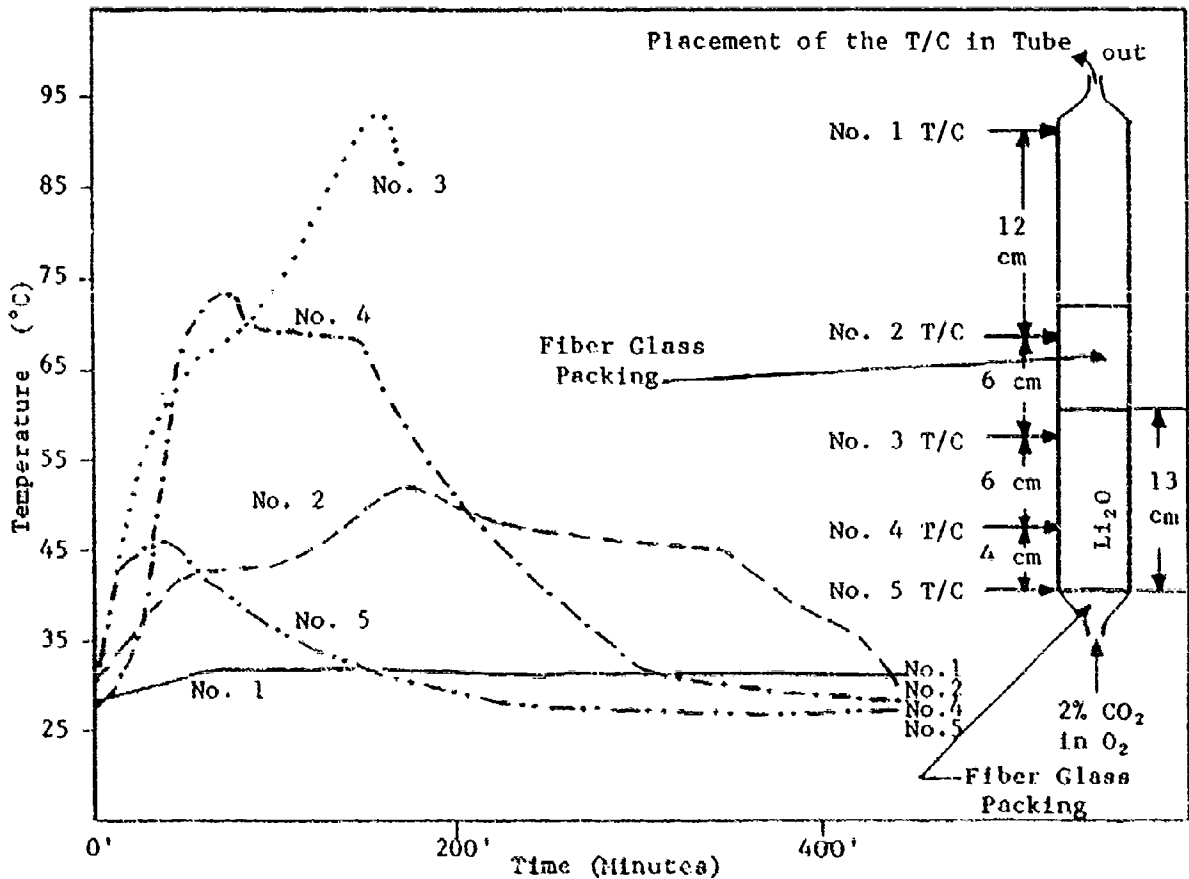

Figure No. 9 Temperature Profile of Test No. 4



In Figure 9 the temperature profile of test No. 4 shows clearly the rate of progress of the reaction. The thermocouples were located at the bottom, in the middle and on top of the column. The gas, being passed upward through the bed, produces a peak temperature 30 minutes after initiation of the test; the peak at the middle of the bed occurs 75 minutes after beginning and the corresponding peak in the top layer is observed at 160 minutes. The temperature of the effluent gas (T.C. No. 2) is a good measure, whether the reaction is still going on; it returns to normal at around 440 minutes and at that point, the reaction was considered concluded.

In Figure 10 corresponding to test run No. 12, a typical recording of CO<sub>2</sub> in the effluent gases is shown.

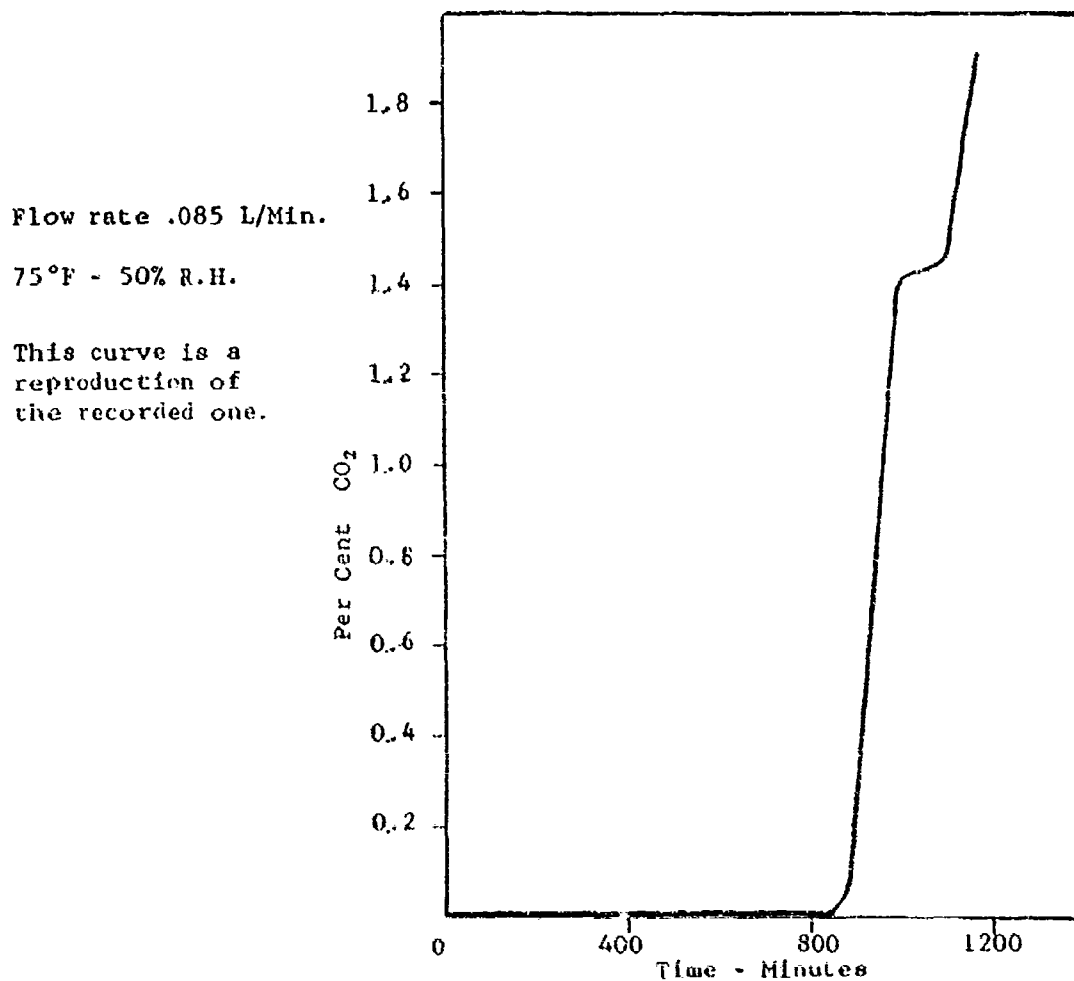

Figure 10 Absorption Curve of Run Number 12

In most cases, enough  $\text{CO}_2$  was passed through the column to completely convert the material to  $\text{Li}_2\text{CO}_3$ , the notable exceptions, referring to the pertinent data listed in Table V, are as follows:

1. Test 9, which illustrates the extreme inefficiency of a highly fired, extremely low surface area  $\text{Li}_2\text{O}$ . Complete breakthrough occurred very fast, absorption of  $\text{CO}_2$  was almost nil.

2. Tests 4, 11 and 10, where slightly less  $\text{CO}_2$  was passed through, but excellent absorption was observed.

The sum of the %  $\text{Li}_2\text{O}$  converted to  $\text{Li}_2\text{CO}_3$  and  $\text{LiOH}$  is near 100% in the case of active oxides. This simply means that practically all the material is accessible to the reacting components in the test gas ( $\text{H}_2\text{O}$  and  $\text{CO}_2$ ). This is the case in tests 4, 11 and 10 (the high a.s. material). All other tests show breakthrough of  $\text{CO}_2$  after very little  $\text{Li}_2\text{O}$  had reacted.

As a result of the data, it is evident that  $\text{Li}_2\text{O}$  reacts first with water, forming  $\text{LiOH}$ . The latter then reacts readily with  $\text{CO}_2$  to form the carbonate.

The military specifications for  $\text{LiOH}$  for absorption purposes places emphasis on the "hardness" of the material. It was assumed that this might be important for lithium oxide as well. In several preparations, we added silicate to the reacting mixtures with the hope that the  $\text{SiO}_2$  content of the final oxide would confer strength and hardness to it. This was not so. In addition, no noticeable effect was observed in the absorption capacity: compare tests 1 and 2 with 7 and 8. The effort was abandoned.

The effect of flow rate on a high active surface lithium oxide is shown in tests 18, 19 and 20. The data are found in Tables VI and VII.

Up to a linear velocity of 8 cm/sec the conversions of  $\text{Li}_2\text{O}$  to  $\text{Li}_2\text{CO}_3$  are quite high, concurrent with a 90% retention of  $\text{CO}_2$ . A slight effect of deterioration is observed at 11 cm/sec, where in the top layer some  $\text{Li}_2\text{O}$  remained unreacted.

The column had three layers of  $\text{Li}_2\text{O}$  separated by plugs of glass wool. Within each layer a thermocouple was imbedded, which monitored the heat of reaction.

TABLE VI

COMPOSITION OF LITHIUM OXIDE SAMPLES NO. 48 BEFORE AND AFTER TESTS

Test No.	Sample Wt. (g)		Total Alk. as $\text{Li}_2\text{O}$ (%)		$\text{Li}_2\text{CO}_3$ (%)		$\text{H}_2\text{O}$ (%)	
	Before	After	Before	After	Before	After	Before	After
18-B	0.71	1.75	95.2	7.0	1.7	83.2	2.5	9.5
18-M	0.85	1.99	95.2	4.0	1.7	90.6	2.5	5.1
18-T	1.19	2.75	95.2	5.4	1.7	88.0	2.5	6.3
18-O	2.75	6.49	95.2	5.4	1.7	87.4	2.5	6.8
19-B	1.01	2.31	95.2	3.7	1.7	92.3	2.5	3.6
19-M	1.37	3.20	95.2	4.5	1.7	91.6	2.5	3.6
19-T	1.43	3.22	95.2	6.9	1.7	87.9	2.5	5.0
19-O	3.81	8.73	95.2	5.2	1.7	90.4	2.5	4.1
20-B	1.8	4.2	95.2	7.7	1.7	83.2	2.5	8.8
20-M	1.72	3.96	95.2	6.4	1.7	89.5	2.5	3.8
20-T	1.68	3.75	95.2	10.0**	1.7	89.3	2.5	0.4
20-O	5.20	11.91	95.2	8.0	1.7	87.2	2.5	4.5

\* Symbols B, M, T and O refer to bottom, middle, top and overall.

\*\* This result is apparently in error.

The temperature profiles of these tests are shown in Figures 11, 12 and 13 which are actual reproductions of recordings.

Exhaustion of the oxide is reflected by a return of the bed temperature to a constant level slightly higher than from the gas inlet temperature. This exhaustion of the layers occurred at different times. Expressed in per cent of total test time, the time required for exhaustion for each layer in three typical tests are listed as follows:

	<u>Test No. 18</u>	<u>No. 19</u>	<u>No. 20</u>
Bottom	55	62	77
Middle	70	89	92
Top	100	100	100

It is seen that with increasing flow rate the end of the reaction is extended timewise. This signifies considerable bypass of  $\text{CO}_2$ . The top layer never reached complete exhaustion.

TABLE VII

PRINCIPLE DATA OBTAINED FROM ABSORPTION TESTS ON  $\text{Li}_2\text{O}$ , SAMPLE NO. 48\*

Test*** No.	Flow Rate l/min.	Linear Flow Rate cm/sec.	Duration of Test min.	Total Gas Passed thru l	$\text{CO}_2$ eq. of $\text{Li}_2\text{O}$ in col. g	$\text{CO}_2$ Passed in g	$\text{CO}_2$ Absorbed g
18-B	0.452	3.9	300	135.6	0.99	3.75	0.86
18-M	0.452	3.9	300	135.6	1.19	3.75	1.06
18-T	0.452	3.9	300	135.6	1.66	3.75	1.43
18-O	0.452	3.9	300	135.6	3.84	3.75	3.35
19-B	0.953	8.2	190	181	1.41	5.02	1.26
19-M	0.953	8.2	190	181	1.91	5.02	1.73
19-T	0.953	8.2	190	181	1.99	5.02	1.67
19-O	0.953	8.2	190	181	5.32	5.02	4.66
20-B	1.29	11.1	203	262	2.51	7.26	2.06
20-M	1.29	11.1	203	262	2.40	7.26	2.09
20-T	1.29	11.1	203	262	2.35	7.26	1.97
20-O	1.29	11.1	203	262	7.26	7.26	6.12

\* Sample No. 48 had the following characteristics: Mesh size, 8-20; Bulk Density, 0.15; Active Surface,  $9.8 \text{ m}^2/\text{g}$ . These tests were run at room temperature. The test gas had a relative humidity of 60%.

\*\* Apparent error in analysis.

\*\*\* Symbols B, T and O designate the bottom, top and overall sample data respectively. Symbol M designates the middle sample.

TABLE VII (Continued)

CO <sub>2</sub> Absorbed %	H <sub>2</sub> O Passed in g	H <sub>2</sub> O Absorbed g	H <sub>2</sub> O Absorbed %	% Li <sub>2</sub> O Converted to Li <sub>2</sub> CO <sub>3</sub>		Li <sub>2</sub> O Converted to LiOH %	Mol. Ratio H <sub>2</sub> O/CO <sub>2</sub>
				Calc. from ΔLi <sub>2</sub> O	Calc. from ΔLi <sub>2</sub> CO <sub>3</sub>		
22.9	1.93	0.15	7.7	81.9	86.5	13.8	---
28.4	1.93	0.08	4.1	90.2	89.5	5.6	---
38.1	1.93	0.14	7.4	86.8	85.8	8.7	---
88.4	1.93	0.37	19.2	87.5	86.1	9.1	1.22
25.0	2.52	0.06	2.3	91.0	89.1	4.7	---
34.5	2.52	0.08	3.2	88.8	90.3	7.9	---
33.3	2.52	0.12	4.9	83.8	83.5	11.8	---
92.8	2.52	0.26	10.5	87.5	87.5	8.5	1.26
28.4	3.52	0.32	9.2	81.2	81.9	14.5	---
28.8	3.52	0.11	3.1	84.5	87.0	11.1	---
27.1	3.52	(-0.03	0)**	76.4	84.1	(-2.8)	---
84.3	3.52	0.40	11.5	80.7	84.3	7.8	1.22

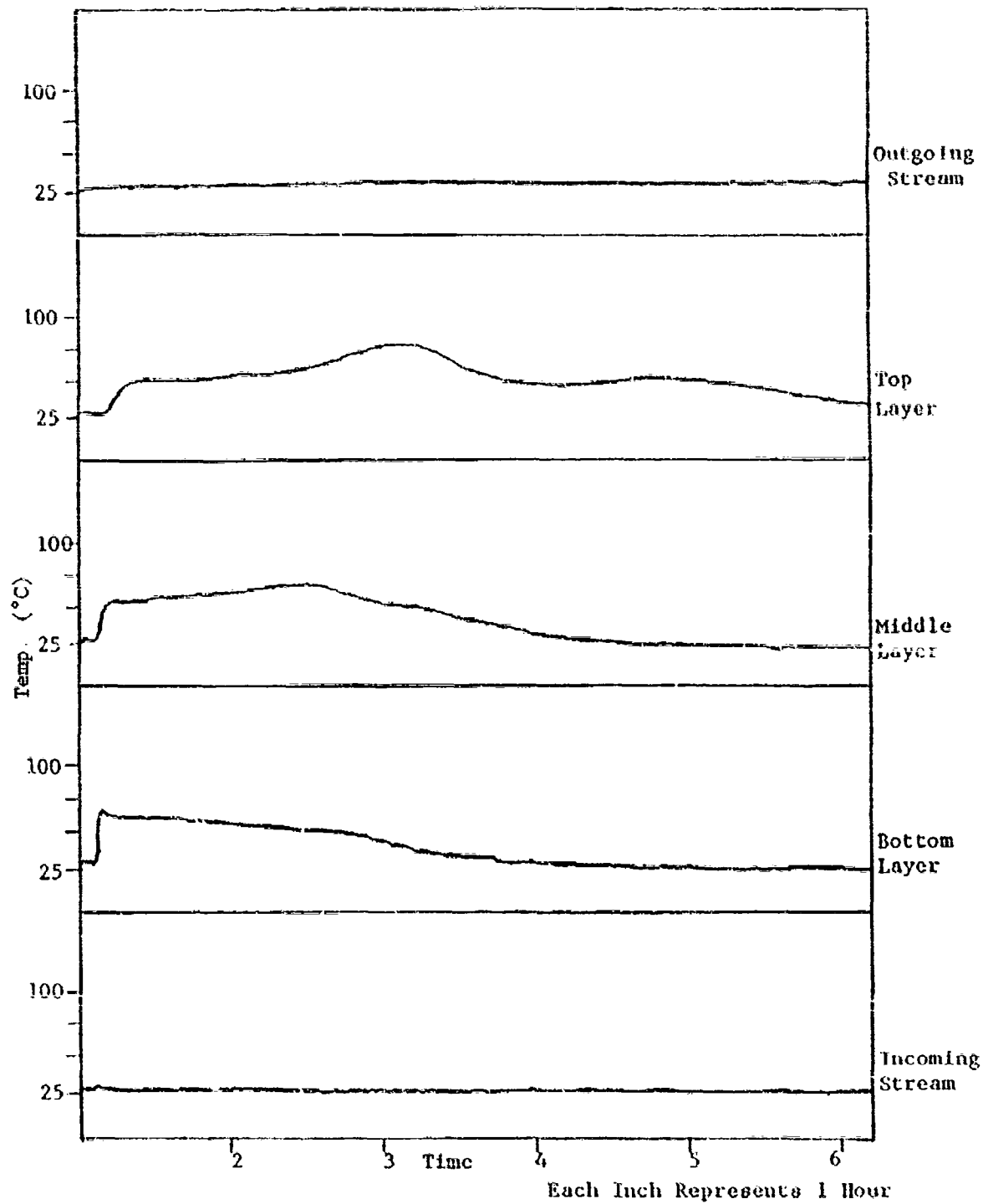

Figure 11 Temperature Profiles Taken at Different Sites During Test No. 18

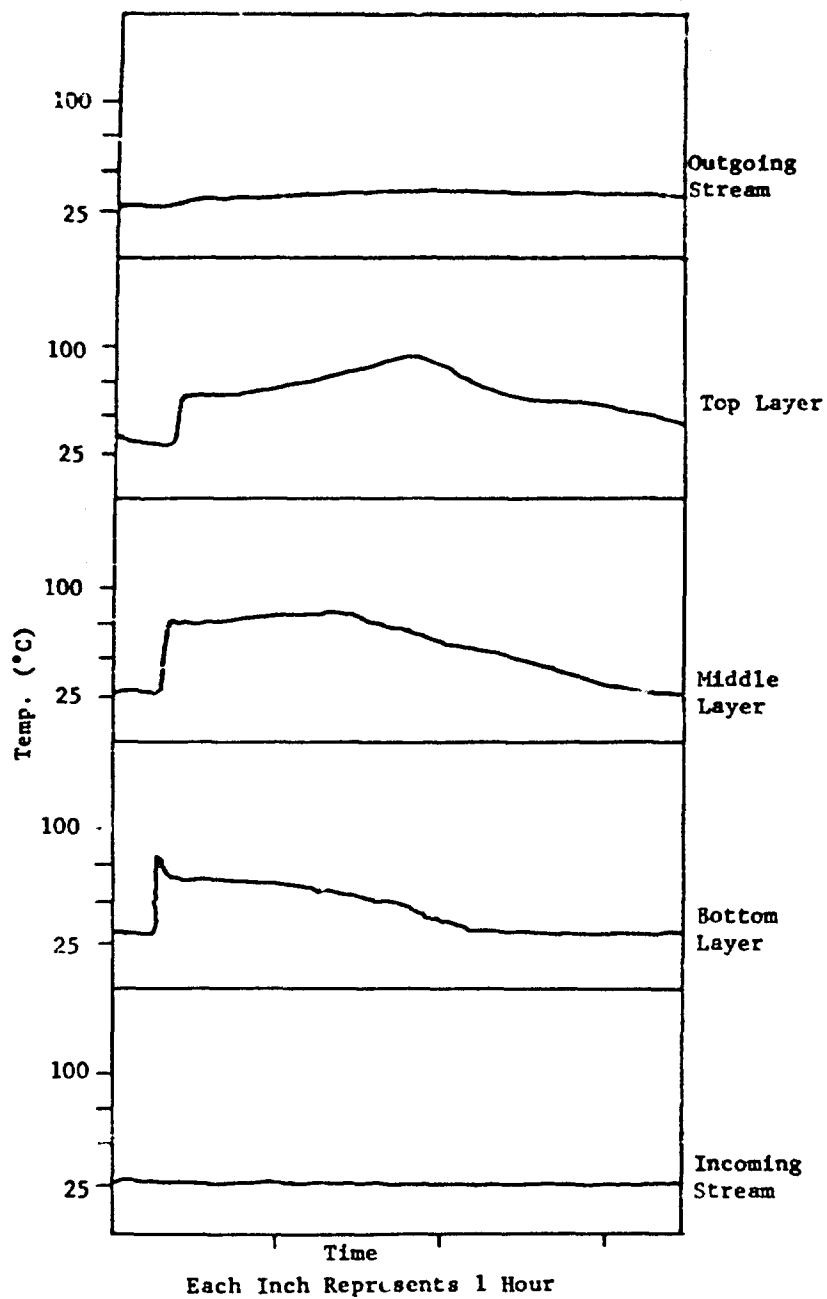
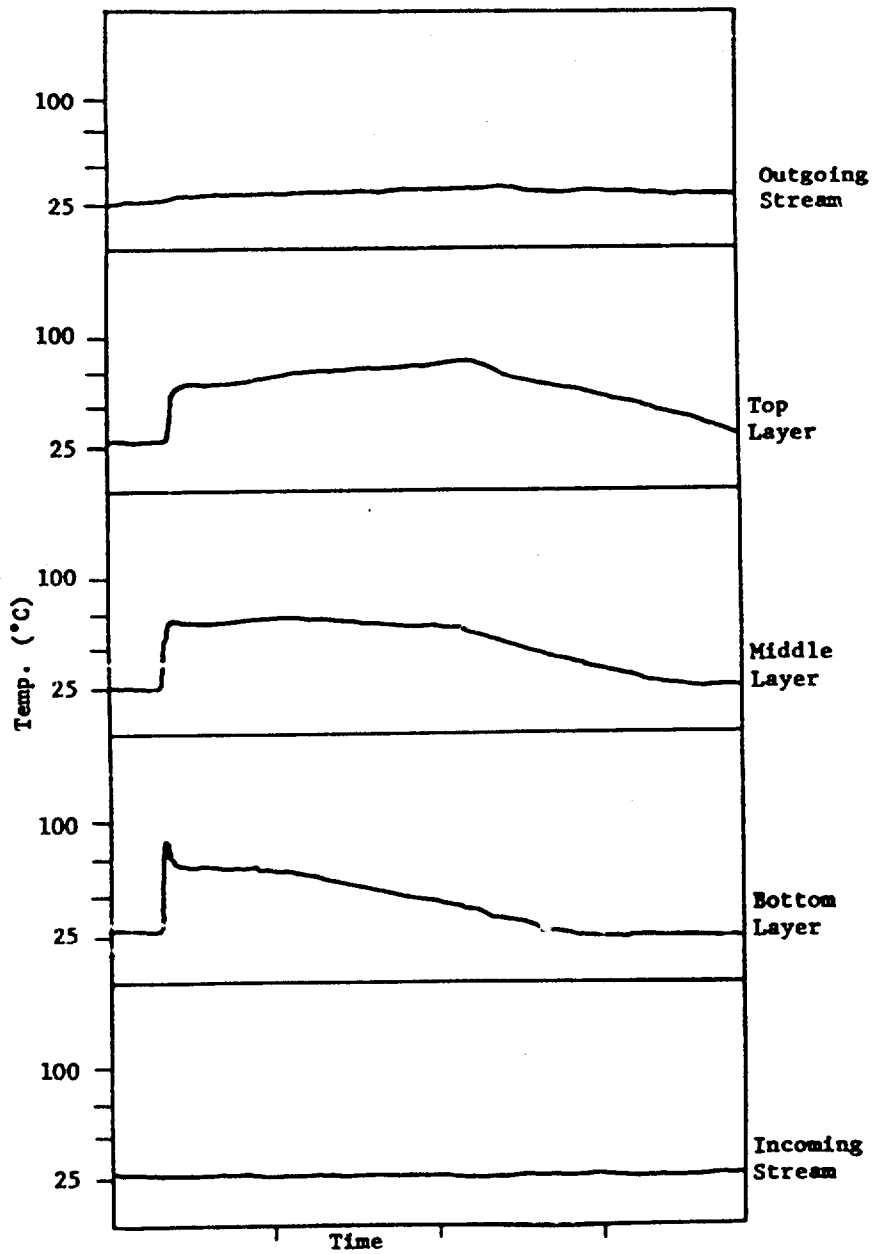

FIGURE 12 Temperature Profiles Taken at Different Sites During Test No. 19



Each Inch Represents One Hour

Figure 13 Temperature Profiles Taken at  
Different Sites During Test  
No. 20



The effect of flow rate is also shown in the level of the initial peak temperatures in the bottom layer (inlet):

Test	Flow Rate l/min.	Temp. °C
18	0.452	66
19	0.953	80
20	1.29	91

The peak temperatures of the top layer (exit) show the cumulative effect of the flow rate:

Test	Flow Rate l/min.	Temp. °C	Occurs at % of Test Time
18	.452	77	40
19	.953	90	45
20	1.29	80	60

The greater the flow rate the later the peak temperature is reached. Furthermore, the peak regions are flattened as the flow rate increases.

In Tables VIII and IX a further illustration of the effect of active surface and flow rate on the conversion of  $\text{Li}_2\text{O}$  to  $\text{Li}_2\text{CO}_3$  is shown.

TABLE VIII

COMPOSITION OF  $\text{Li}_2\text{O}$  SAMPLES BEFORE AND AFTER TESTS

Test No.	Sample No.	Sample Wt.		Total Alk. as % $\text{Li}_2\text{O}$		% $\text{Li}_2\text{CO}_3$		% $\text{H}_2\text{O}$	
		Before	After	Before	After	Before	After	Before	After
21	118	4.46	10.1	91.7	3.2	3.1	93.1	5.0	3.7
23	123-1	2.50	4.40	86.3	22.4	2.1	67.7	11.3	9.6
24	123-9	2.05	3.39	95.6	29.0	2.4	65.6	1.9	8.4
25	123-9	1.22	2.33	95.6	17.8	2.4	76.5	1.9	5.7
26	123-1	1.01	1.88	86.3	15.6	2.1	76.3	11.3	7.9
27	123-4	2.13	4.23	95.2	17.7	2.5	76.2	2.3	6.0

Outstanding is test 21: Sample 118 has an active surface of  $9.9 \text{ m}^2/\text{g}$ , 97.5% of the incoming  $\text{CO}_2$  was retained, whereby over 90% of the  $\text{Li}_2\text{O}$  was converted to the carbonate. A comparison can be made with tests 23 and 24, with samples of lower a.s. and with equal flow rates. These tests showed much lower conversions.

TABLE IX

PRINCIPLE DATA OBTAINED FROM ABSORPTION TESTS\* ON Li<sub>2</sub>O SAMPLES

Test No.	Sample No.	Active Surface m <sup>2</sup> /g	Flow Rate l/min.	Linear Flow Rate cm/sec	Test Time min.	Total Vol. l	CO <sub>2</sub> Capacity of Column g	CO <sub>2</sub> In g	CO <sub>2</sub> Absorbed g
21	118	9.9	1.06	9.1	212	225	6.0	5.65	5.51
23	123-1	4.8	1.07	9.2	163	153	3.17	5.22	1.74
24	123-9	8.3	1.11	9.6	79	87.8	2.87	3.0	1.29
25	123-9	8.3	.25	2.2	157	39.9	1.71	1.37	1.04
26	123-1	4.8	.25	2.2	180	44.7	1.27	1.53	.84
27	123-4	7.2	.54	4.6	180	96.6	2.97	3.29	1.88

\* These tests were run at 25°C and the gas employed had a relative humidity of 59%.  
The mesh size of the oxide samples was 4-16.

TABLE IX (Continued)

CO <sub>2</sub> Absorbed %	H <sub>2</sub> O in g	H <sub>2</sub> O Absorbed g	H <sub>2</sub> O Absorbed %	% Li <sub>2</sub> O Converted to Li <sub>2</sub> CO <sub>3</sub>		% Li <sub>2</sub> O Converted to LiOH	mol. Ratio H <sub>2</sub> O/CO <sub>2</sub>
				ΔLi <sub>2</sub> CO <sub>3</sub>	ΔLi <sub>2</sub> O		
97.5	2.97	.15	5.0	92.3	91.8	-1.2	1.28
33.4	2.1	.14	6.7	54.3	54.9	10.7	.98
43.1	1.2	.25	20.5	49.7	45.0	20.9	.96
75.4	.53	.11	20.6	64.4	60.9	15.7	.93
55.0	.61	.03	5.6	66.2	66.1	6.7	.96
57.3	1.35	.21	15.3	63.1	63.2	17.0	.99

The effect of flow rates is shown by comparing tests 23 and 26 (both on Sample 123-1), where by decreasing the flow the yield rose from 54 to 60%. The same observation holds for Sample 123-9 in tests 24 and 25 whereby decreasing the flow rate from 9.6 cm/sec to 2.2 cm/sec the yield increased from 50 to 64%.

In test 21 we observe a negative value in the column %  $\text{Li}_2\text{O}$  converted to  $\text{LiOH}$ . This means that some of the  $\text{LiOH}$  present originally in the  $\text{Li}_2\text{O}$  was converted to  $\text{Li}_2\text{CO}_3$ . Whenever there is a very high degree of conversion, this can be observed.

Sample No. 118 showed excellent performance and it was decided therefore, to use it to determine the influence of temperature of the gas at 60% relative humidity on the degree of conversion of  $\text{Li}_2\text{O}$  and retention of  $\text{CO}_2$ . The results are shown in Tables X and XI.

The analysis of Sample No. 118 is

Total Alkalinity	91.75%
$\text{Li}_2\text{CO}_3$	3.13%
Water	4.98%

The composition therefore is the following:

$\text{Li}_2\text{O}$	83.45%
$\text{LiOH}$	13.28%
$\text{Li}_2\text{CO}_3$	3.13%

In the preliminary run (test 28) it was found that at about 60% R.H. and at  $5^\circ\text{C}$  ( $41^\circ\text{F}$ ), the absorption of  $\text{CO}_2$  was very low: about 9% of the incoming  $\text{CO}_2$ . Only 11-1/2% of the  $\text{Li}_2\text{O}$  had been converted to the corresponding carbonate. This change in temperature of the incoming gas had a profound effect on the efficiency of the oxide sample 118. The comparison of the results of test 21 (Table IX) with test 28 (Table XI) shows this dramatically.

The temperature change however is not the only factor. As the temperature was changed from  $25^\circ$  (test 21) to  $5^\circ$  (test 28), the mol ratio  $\text{H}_2\text{O}/\text{CO}_2$  of the incoming gases changed from 1.28 to .24. This change is much more relevant than the mere temperature change, as will be shown further on. It should be pointed out that the relative humidity of the test gas was very nearly 100% in both cases.

In the subsequent tests No. 29 through 35, the whole area from  $5^\circ\text{C}$  to  $50^\circ\text{C}$  ( $41^\circ\text{F}$  to  $122^\circ\text{F}$ ) was explored. The overall % conversion figures are plotted in Figure 14 against the temperatures of the incoming gases, in Figure 15 against the absolute water vapor pressures.

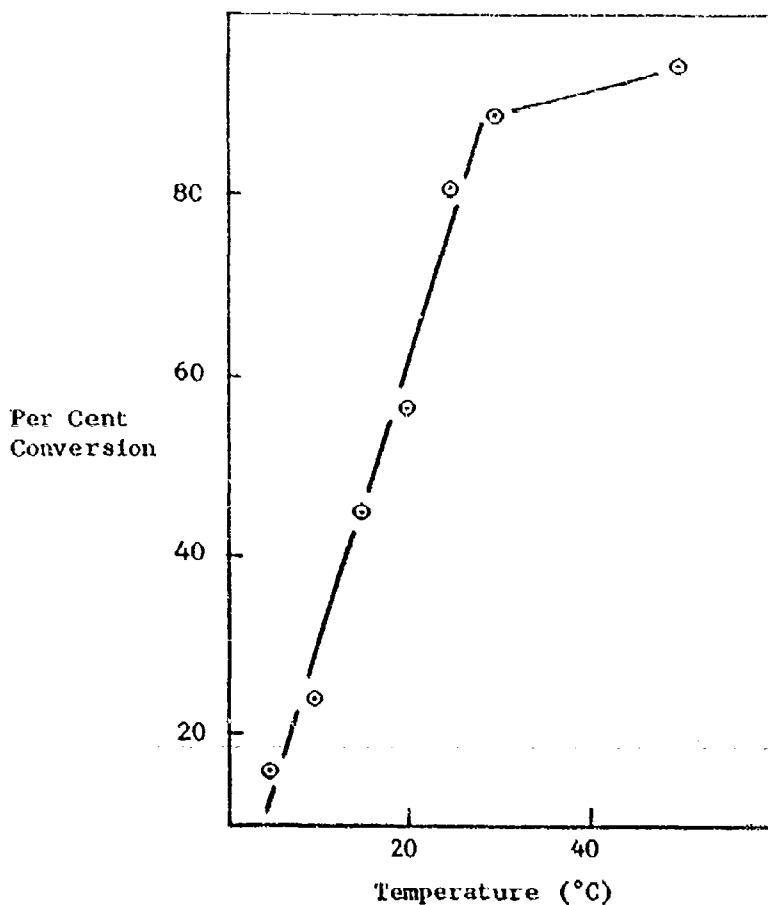

Figure 14 Percentage Conversion vs. Temperature

A steep rise in the conversion is observed up to about 25°C, which at about 60% R.H. is equivalent to about 14 mm of Hg. Our test gas was about 2% CO<sub>2</sub> in oxygen, or approximately 15 mm of Hg. This means that at 25°C, 60% R.H., the mole ratio H<sub>2</sub>O/CO<sub>2</sub> attains the value of 1. From this point on there is still a further increase in conversion as the temperature is increased, but the slope is decreased considerably.

It seems as if the mole ratio is the overriding factor at values lower than unity. The temperature effect becomes noticeable at mole ratios of unity or larger.

The temperature recordings are reproduced in Figures 16 through 20. The peak temperatures of the bottom layer, observed shortly after initiating the gas flow, will reflect the degree of reaction taking place. Heat losses are not very important at this point yet. The relationship of peak temperature and incoming gas temperatures is seen in Figure 21 and the one

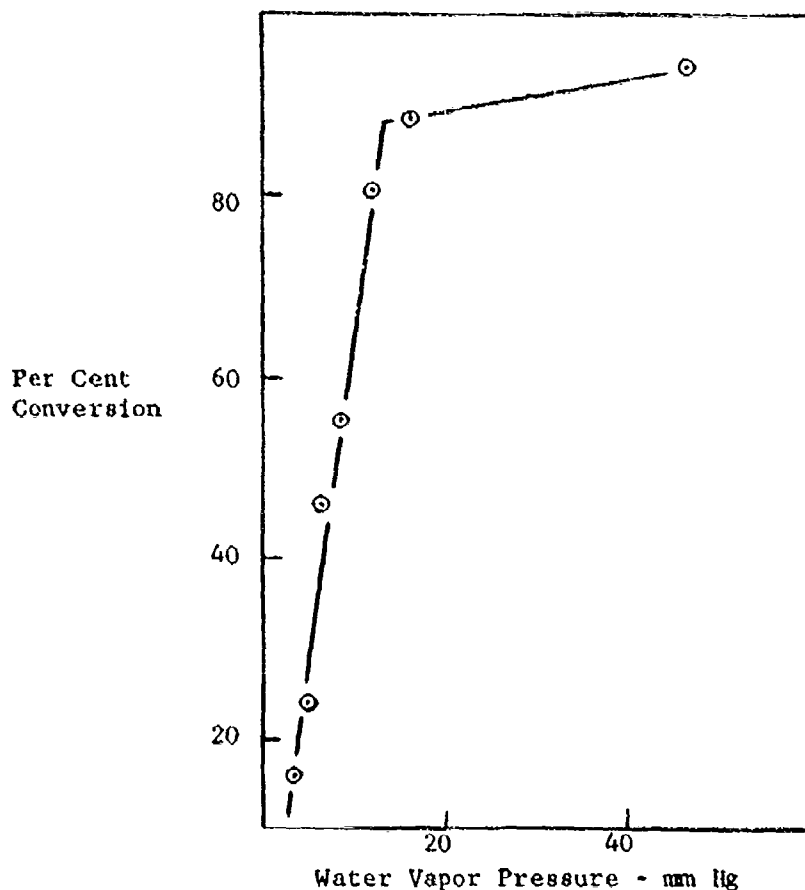

Figure 15 Percentage Conversion vs. Water Vapor Pressure

of peak temperature and water vapor pressure is seen in Figure 22. The latter relationship is linear. This means that the amount of water introduced into the  $\text{Li}_2\text{O}$  bed is directly proportional to the amount of  $\text{CO}_2$  reacting with the  $\text{Li}_2\text{O}$ .

This is equivalent to proving that  $\text{CO}_2$  can react with  $\text{Li}_2\text{O}$  only when water vapor is present. Quantitatively it leads to the conclusion that for complete reaction the mole ratio  $\text{H}_2\text{O}/\text{CO}_2$  in the incoming gases must be at least unity.

Further tests seemed necessary to affirm this conclusion. Tests 36 through 41 were performed with different samples, high and low on active surface area. The results are given in Tables XII and XIII.

TABLE X

ANALYTICAL DATA ON Li<sub>2</sub>O SAMPLE 118 AFTER TESTS

Test* No.	Sample Wt. (g)		Total Alk. as Li <sub>2</sub> O %	Li <sub>2</sub> CO <sub>3</sub> %	H <sub>2</sub> O %
	Before	After	After	After	After
28	2.05	2.51	66.5	24.2	9.1
29-B	0.93	1.29	54.0	34.2	11.6
29-T	1.18	1.45	63.5	26.3	10.0
29-O	2.11	2.74	59.1	30.0	10.9
30-B	1.04	1.63	38.8	44.0	17.0
30-T	1.05	1.40	56.4	30.0	13.4
30-O	2.09	3.03	47.0	37.5	15.4
31-B	1.07	2.04	20.0	69.6	10.2
31-T	1.01	1.64	38.9	46.5	14.5
31-O	2.08	3.68	28.5	59.3	12.1
32-B	1.16	2.35	14.3	78.3	7.2
32-T	1.16	2.04	29.9	57.5	12.6
32-O	2.31	4.39	21.5	68.5	9.7
33-B	1.03	2.28	6.6	89.2	4.1
33-T	1.04	2.21	10.4	83.8	5.7
33-O	2.07	4.48	8.4	86.5	4.9
34-B	1.05	2.41	3.0	92.3	4.6
34-T	1.03	2.32	6.2	89.2	4.5
34-O	2.08	4.74	4.6	90.7	4.6
35-B	1.02	2.47	1.7	92.6	5.5
35-T	1.01	2.34	3.3	91.1	5.5
35-O	2.03	4.81	2.5	91.9	5.5

\* Symbols B, T and O designate the bottom, top and overall sample data respectively.

TABLE XI

PRINCIPLE DATA OBTAINED FROM ABSORPTION TESTS\*  
ON Li<sub>2</sub>O SAMPLE NO. 118

Test No.	Temp. of Gas °C	Test Time Min.	Gas Passed thru l.	CO <sub>2</sub> eq of Li <sub>2</sub> O In Col. g.	CO <sub>2</sub> In g.	CO <sub>2</sub> Absd. g.	CO <sub>2</sub> Absd. %	H <sub>2</sub> O Passed In g.
28	5	90	92	2.76	3.35	0.32	9.6	0.338
29-B	5	121	119	1.25	4.36	0.25	5.6	0.45
29-T	5	121	119	1.59	4.36	0.21	4.7	0.45
29-O	5	121	119	2.83	4.36	0.45	10.3	0.45
30-B	10	115	118	1.40	4.47	0.41	9.1	0.63
30-T	10	115	118	1.41	4.47	0.23	5.1	0.63
30-O	10	115	118	2.81	4.47	0.64	14.2	0.63
31-B	15	125	139	1.44	4.84	0.82	17	0.98
31-T	15	125	139	1.36	4.84	0.43	9.0	0.98
31-O	15	125	139	2.81	4.84	1.26	26.0	0.98
32-B	20	122	131	1.56	4.52	1.07	23.7	1.29
32-T	20	122	131	1.56	4.52	0.68	15.0	1.29
32-O	20	122	131	3.11	4.52	1.75	38.7	1.29
33-B	25	125	139	1.38	4.71	1.19	25.2	1.9
33-T	25	125	139	1.40	4.71	1.08	23.0	1.9
33-O	25	125	139	2.79	4.71	2.27	48.2	1.9
34-B	30	115	130	1.41	4.33	1.31	30.1	2.46
34-T	30	115	130	1.39	4.33	1.21	28.0	2.46
34-O	30	115	130	2.80	4.33	2.52	58.1	2.46
35-B	50	149	167	1.37	5.27	1.34	25.4	9.55
35-T	50	149	167	1.36	5.27	1.25	23.7	9.55
35-O	50	149	167	2.73	5.27	2.59	49.2	9.55

\* Sample mesh size: 4-14; sample active surface: 9.9 m<sup>2</sup>/g.  
 Test gas data: Nominal Relative Humidity, 60%; Flow Rate, 0.99 to 1.13 l/min.  
 Linear Flow Rate, 8.5 to 9.7 cm./sec.



TABLE XI (Continued)

H <sub>2</sub> O Absd. g.	H <sub>2</sub> O Absd. %	% Li <sub>2</sub> O Used		Li <sub>2</sub> O Conv. to LiOH %	Mol. Ratio H <sub>2</sub> O/CO <sub>2</sub>
		Calc. from ΔLi <sub>2</sub> O	Calc. from ΔLi <sub>2</sub> CO <sub>3</sub>		
0.126	37.3	11.4	11.7	11.1	.24
0.103	22.7	18.3	19.6	20.2	---
0.087	19.2	14.6	13.0	13.2	---
0.190	41.9	16.2	15.9	16.6	.25
0.225	35.4	33.8	29.0	39.2	---
0.136	21.4	17.6	16.4	23.5	---
0.361	56.9	25.7	22.7	31.4	.35
0.154	16.0	58.6	56.9	26.4	---
0.181	19.1	31.3	31.8	33.4	---
0.341	35.1	45.3	44.8	29.9	.50
0.111	8.6	68.3	68.8	17.5	---
0.198	15.4	42.6	43.4	31.0	---
0.309	24.0	55.5	56.1	24.3	.70
0.042	2.2	84.1	85.8	6.9	---
0.074	3.9	76.1	76.9	12.7	---
0.116	6.1	80.1	81.3	10.0	.98
0.059	2.4	92.5	92.3	2.5	---
0.053	2.2	84.8	87.0	6.1	---
0.112	4.6	88.7	89.7	4.3	1.39
0.085	0.9	95.4	97.7	-4.3	---
0.079	0.8	91.7	91.7	-0.3	---
0.164	1.7	93.5	94.7	-2.4	4.4

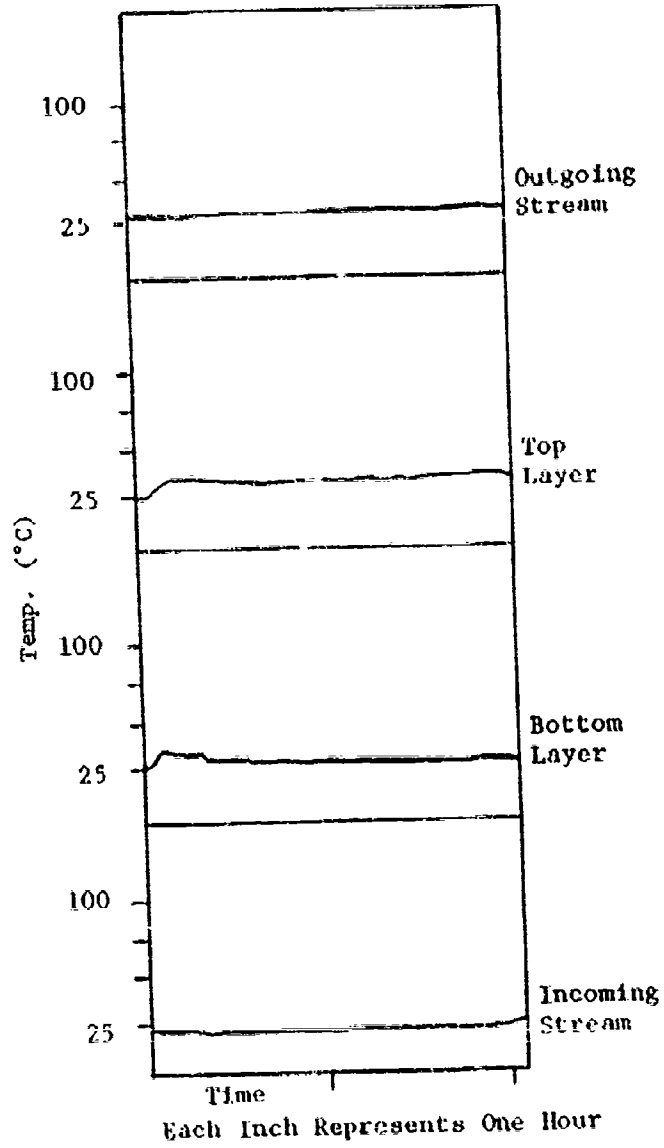

Figure 16 Temperature Profiles Taken at Different Sites During Test No. 30

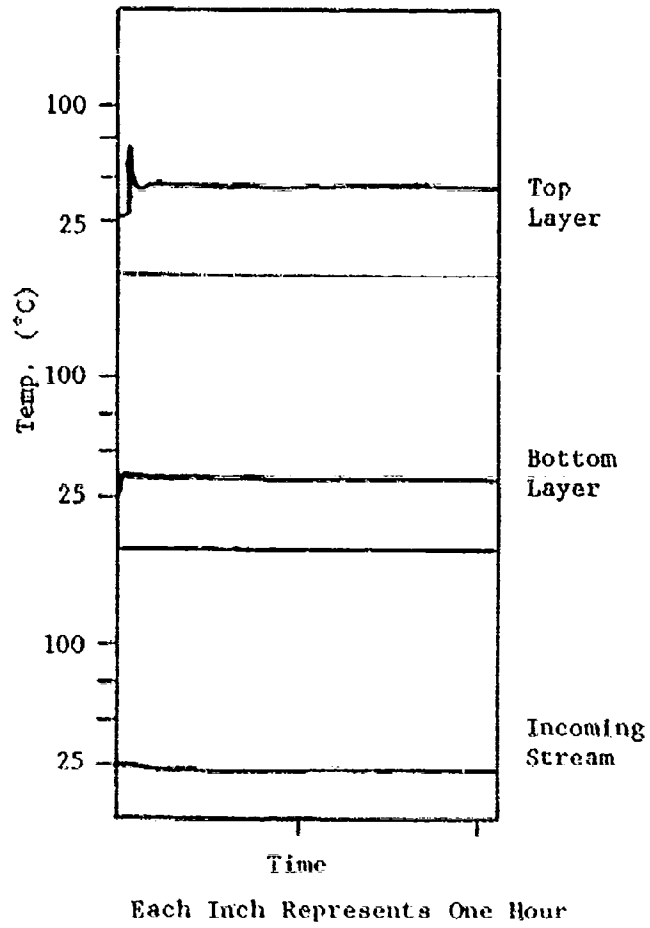

Figure 17 Temperature Profiles Taken at  
Different Sites During Test  
No. 31

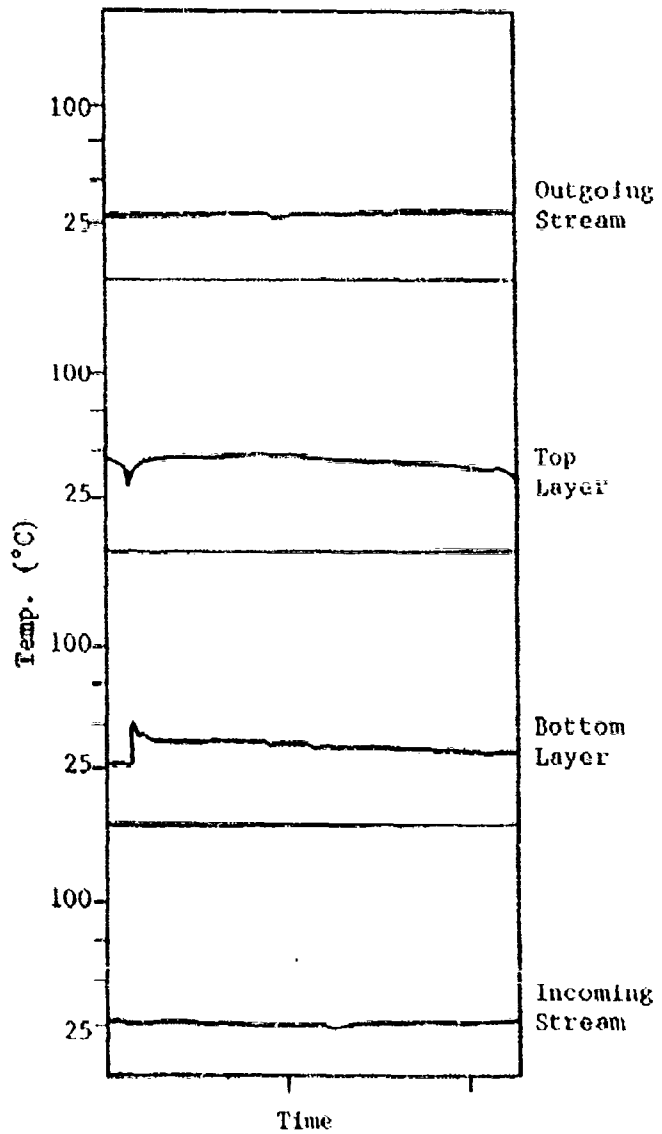

Figure 18

Temperature Profiles Taken at  
 Different Sites During Test  
 No. 32

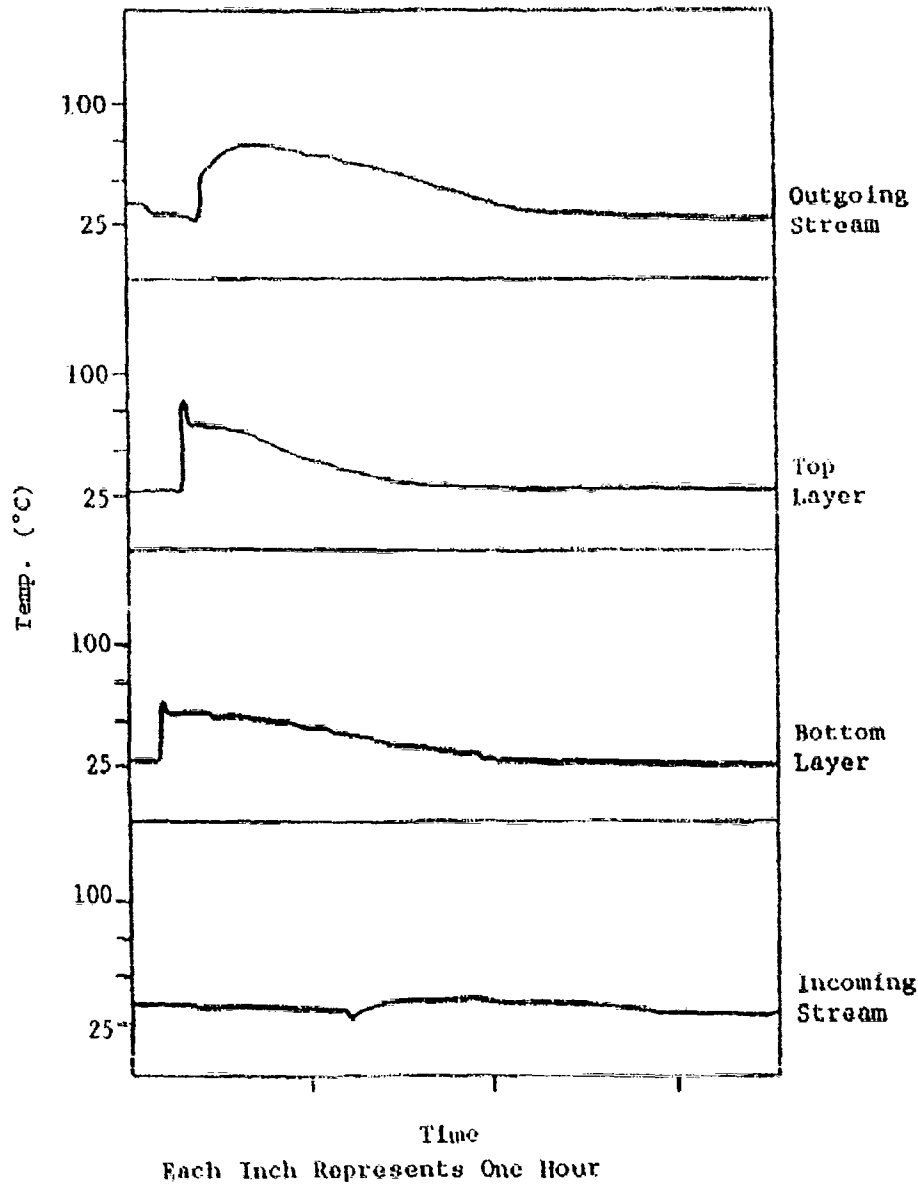
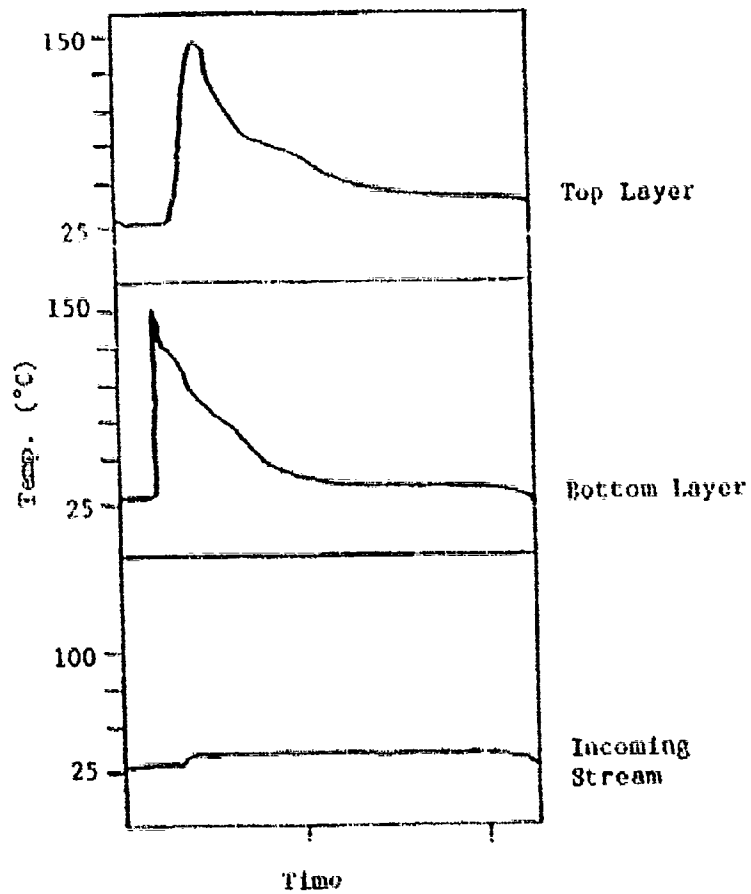

Figure 19 Temperature Profiles Taken at  
 Different Sites During Test  
 No. 34



Each Inch Represents One Hour

Figure 20 Temperature Profiles Taken at  
Different Sites During Test  
No. 35

TABLE XII  
ANALYTICAL DATA ON Li<sub>2</sub>O SAMPLES BEFORE AND AFTER TESTS

Test No.	Li <sub>2</sub> O No.	Sample Wt. (g)		Total Alk. as Li <sub>2</sub> O (%)		Li <sub>2</sub> CO <sub>3</sub> (%)		H <sub>2</sub> O (%)	
		Before	After	Before	After	Before	After	Before	After
36-B	123-16	1.03	2.05	95.1	10.5	3.7	80.0	1.0	9.4
36-F	123-16	1.02	1.87	95.1	19.4	3.7	69.3	1.0	11.1
36-O	123-16	2.05	3.92	95.1	14.7	3.7	74.9	1.0	10.2
37-B	123-24	1.60	3.52	95.8	7.0	2.5	87.4	1.6	5.6
37-F	123-24	1.60	2.95	95.8	29.8	2.5	55.6	1.6	14.5
37-O	123-24	3.20	6.47	95.8	17.4	2.5	72.9	1.6	9.7
38-B	123-23	1.60	3.56	96.6	9.2	3.0	84.4	0.3	6.3
38-F	123-23	1.60	2.93	96.6	28.3	3.0	55.7	0.3	16.1
38-O	123-23	3.20	6.48	96.6	17.8	3.0	71.4	0.3	10.7
39-B	123-24	1.60	3.76	95.8	3.1	2.5	93.1	1.6	3.6
39-F	123-24	1.60	3.62	95.8	7.4	2.5	86.8	1.6	5.7
39-O	123-24	3.20	7.38	95.8	5.2	2.5	90.0	1.6	4.7
40-B	123-24	1.60	3.80	95.8	2.8	2.5	93.5	1.6	3.6
40-F	123-24	1.60	3.32	95.8	17.6	2.5	72.2	1.6	10.2
40-O	123-24	3.20	7.12	95.8	9.7	2.5	83.6	1.6	6.7
41-B	123-24	1.60	3.29	95.8	14.9	2.5	76.7	1.6	8.4
41-F	123-24	1.60	2.59	95.8	40.7	2.5	94.9	1.6	14.3
41-O	123-24	3.20	5.88	95.8	20.3	2.5	62.7	1.6	10.9

TABLE XIII

PRINCIPLE DATA OBTAINED FROM ABSORPTION TESTS ON Li<sub>2</sub>O SAMPLES

Test No.	Sample No.	Bulk Dens. g/cc	Mesh Size	A.S.	Gas Temp. °C	Gas R.H. %	Flow Rate l/min	Linear Flow Rate cm/sec	Test Time Min.	Gas Passed In g.
36-B	123-16	0.166	4-14	5.5	25	60.4	1.07	9.3	173	186
36-T	123-16	0.166	4-14	5.5	25	60.4	1.07	9.3	173	186
36-O	123-16	0.166	4-14	5.5	25	60.4	1.07	9.3	173	186
37-B	123-24	0.073	4-14	11.2	21	58.5	1.12	9.7	117	132
37-T	123-24	0.073	4-14	11.2	21	58.5	1.12	9.7	117	132
37-C	123-24	0.073	4-14	11.2	21	58.5	1.12	9.7	117	132
38-B	123-23	0.082	4-14	10.2	20	58.5	1.13	9.7	142	160
38-T	123-23	0.082	4-14	10.2	20	58.5	1.13	9.7	142	160
38-O	123-23	0.082	4-14	10.2	20	58.5	1.13	9.7	142	160
39-B	123-24	0.073	4-14	11.2	25	59.0	1.23	10.6	129	159
39-T	123-24	0.073	4-14	11.2	25	59.0	1.23	10.6	129	159
39-O	123-24	0.073	4-14	11.2	25	59.0	1.23	10.6	129	159
40-B	123-24	0.073	4-14	11.2	14.8	100	1.16	10.0	136	158
40-T	123-24	0.073	4-14	11.2	14.8	100	1.16	10.0	136	158
40-O	123-24	0.073	4-14	11.2	14.8	100	1.16	10.0	136	158
41-B	123-24	0.073	4-14	11.2	10	100	1.10	9.5	125	137
41-T	123-24	0.073	4-14	11.2	10	100	1.10	9.5	125	137
41-O	123-24	0.073	4-14	11.2	10	100	1.10	9.5	125	137



TABLE XIII (Continued)

CO <sub>2</sub> eq. of Li <sub>2</sub> O In Col. g.	CO <sub>2</sub> Passed		H <sub>2</sub> O Passed		% Li <sub>2</sub> O Used		Li <sub>2</sub> O conv. to LiOH %	Mol. Ratio H <sub>2</sub> O/CO		
	In g.	Absd. %	In g.	Absd. %	Calc. From ΔLi <sub>2</sub> O	Calc. From ΔLi <sub>2</sub> CO <sub>3</sub>				
1.44	6.45	.96	14.8	2.58	.184	7.1	78.3	66.1	20.1	---
1.42	6.45	.75	11.6	2.58	.198	7.7	62.8	52.6	35.7	---
2.86	6.45	1.70	26.4	2.58	.382	14.8	70.5	59.5	27.8	.98
2.25	4.57	1.81	39.5	1.42	.171	12.0	83.9	80.2	13.4	---
2.25	4.57	0.95	20.9	1.42	.404	28.5	42.7	42.3	54.4	---
4.50	4.57	2.76	60.4	1.42	.575	40.5	63.3	61.3	33.9	.76
2.27	5.55	1.76	31.6	1.62	.221	13.6	78.8	77.4	20.7	---
2.27	5.55	0.94	17.0	1.62	.466	28.8	46.5	41.4	53.1	---
4.54	5.55	2.70	48.6	1.62	.687	42.4	64.9	59.4	36.9	.71
2.25	4.95	2.06	41.6	2.16	.116	5.4	92.4	91.5	4.8	---
2.25	4.95	1.84	37.3	2.16	.182	8.4	82.5	81.9	14.7	---
4.50	4.95	3.91	78.9	2.16	.298	13.8	87.5	86.7	9.8	1.06
2.25	5.38	2.09	38.8	2.1	.110	5.2	93.0	92.8	4.3	---
2.25	5.38	1.40	26.1	2.1	.314	15.0	61.9	62.3	35.5	---
4.50	5.38	3.49	64.9	2.1	.424	20.2	77.4	77.5	19.9	.95
2.25	4.95	1.48	29.8	1.33	.250	18.8	68.1	65.6	29.1	---
2.25	4.95	0.67	13.5	1.33	.347	26.1	31.1	29.7	65.5	---
4.50	4.95	2.15	43.3	1.33	.597	44.9	49.6	47.6	47.3	.66

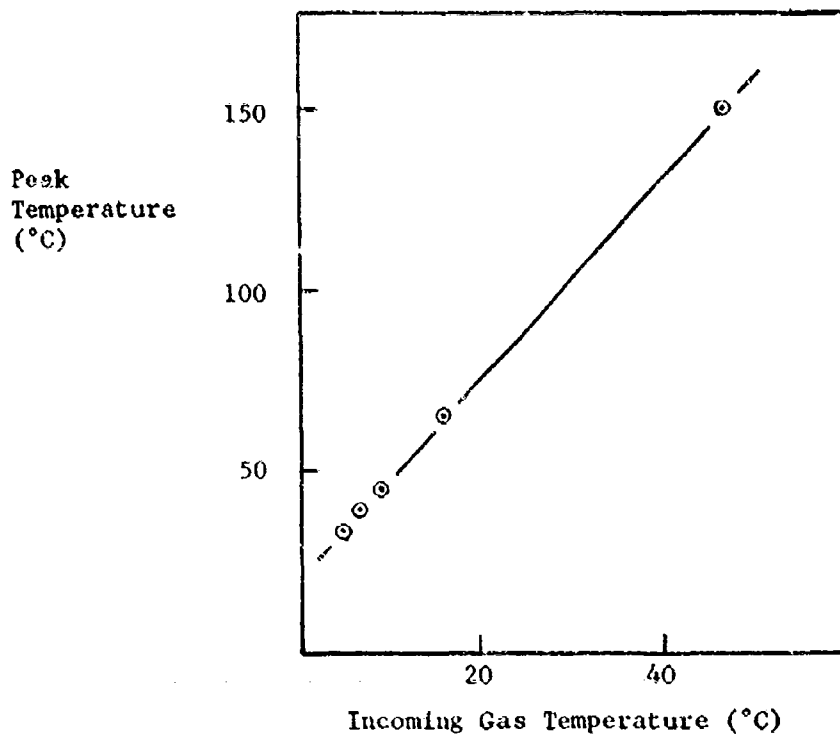

Figure 21 Peak Temperature vs.  
Incoming Gas Temperature

In test 36, a low surface area material ( $5.5 \text{ m}^2/\text{g}$ ) was employed. The yields can be compared with the results of test 39, carried out under equal conditions but with an oxide, which had  $11.2 \text{ m}^2/\text{g}$  of a.s. Yields rose from 70 to 87%. It is interesting to note that a large excess of  $\text{CO}_2$  was passed over the oxide in test 36. This means that even low active surface material can capture appreciable quantities of  $\text{CO}_2$  when enough time is allowed. This surely is not a surprising result: Transport of gas through narrower pores is slowed down, but is definitely taking place.

In tests 28 through 36, a large excess of  $\text{CO}_2$  was employed and the retention % of  $\text{CO}_2$  was relatively low. In tests 37 through 41 only as much  $\text{CO}_2$  containing gas was introduced as would have been necessary to convert 100% of the  $\text{Li}_2\text{O}$  to  $\text{Li}_2\text{CO}_3$ . Consequently the %  $\text{CO}_2$  absorbed was larger and reached 80% in test 39, which represents approximately a room temperature, 50% R.H. condition and can be compared with test 21 and 33.

The results fall into the pattern found in the previous series. If the partial water vapor pressure is plotted versus the yield, as in Figure 15, the points fall directly on the curve established there. This

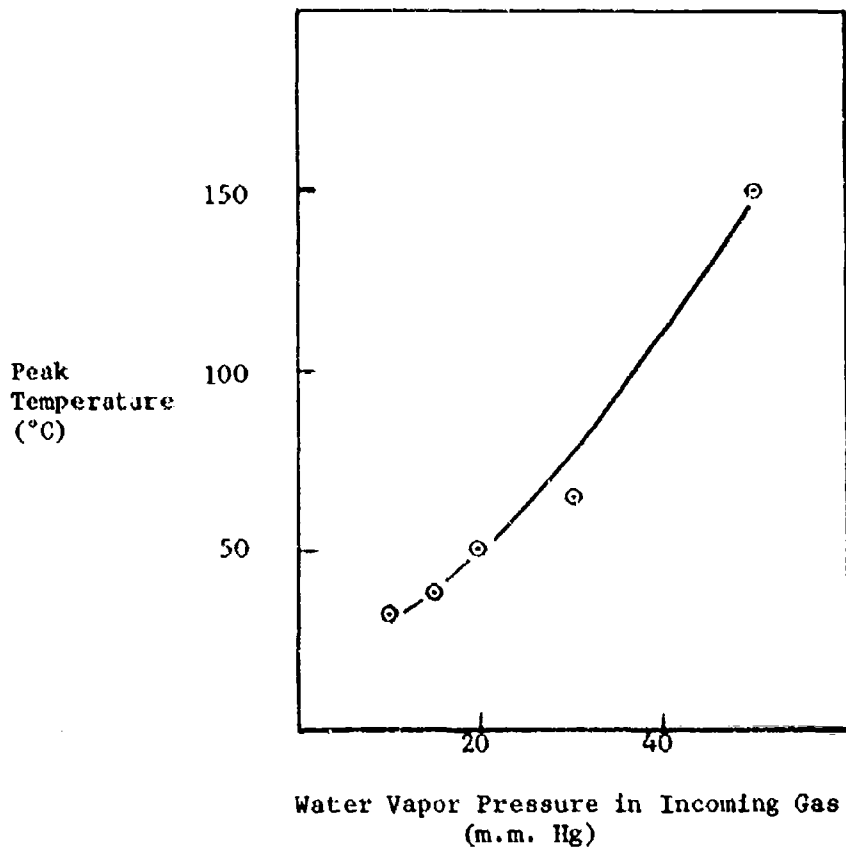

Figure 22 Peak Temperature vs. P<sub>mm</sub> H<sub>2</sub>O of Incoming Gas

of course proves again that at molar ratios H<sub>2</sub>O/CO<sub>2</sub> below unity the partial water vapor pressure is the factor governing the percentage Li<sub>2</sub>O reacted with CO<sub>2</sub>. Qualitatively this is seen in the results of tests 39 and 40, which both employed gases having a molar ratio around unity and gave results slightly above or below 80% in conversion. Test 39 however, was at 25°C and 59% R.H. whereas test 40 was at 14.8°C and 100% R.H. Test 41 (10°C and 100% R.H.) gave results equivalent to results obtained at 20°C and 60% R.H.

The influence of the temperature of the incoming gas alone can be seen from a comparison of tests 38 and 41, employing gas at 25 and 10°C respectively. Both have similar mole ratios H<sub>2</sub>O/CO<sub>2</sub>, but 38 has a yield of over 60% whereas 41 shows a conversion of about 48%.

The temperature profiles of tests 36, 39, 40 and 41 are reproduced from the recordings in Figures 23 through 26. It is seen that the top layers of tests 39, 40 and 41 were still reacting when the test was concluded. Further proof is the large differences in the % Li<sub>2</sub>O used in top and bottom layers.

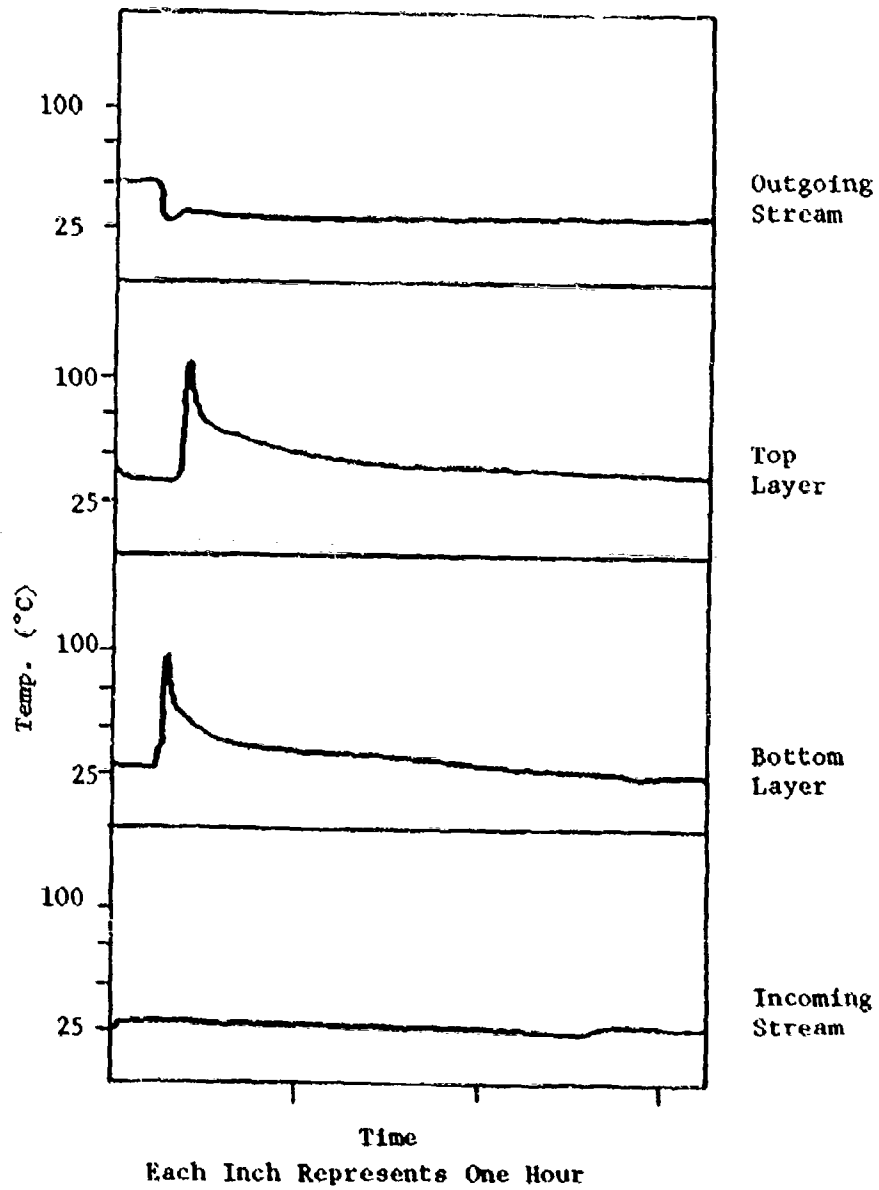

Figure 23      Temperature Profiles Taken at  
 Different Sites During Test  
 No. 36

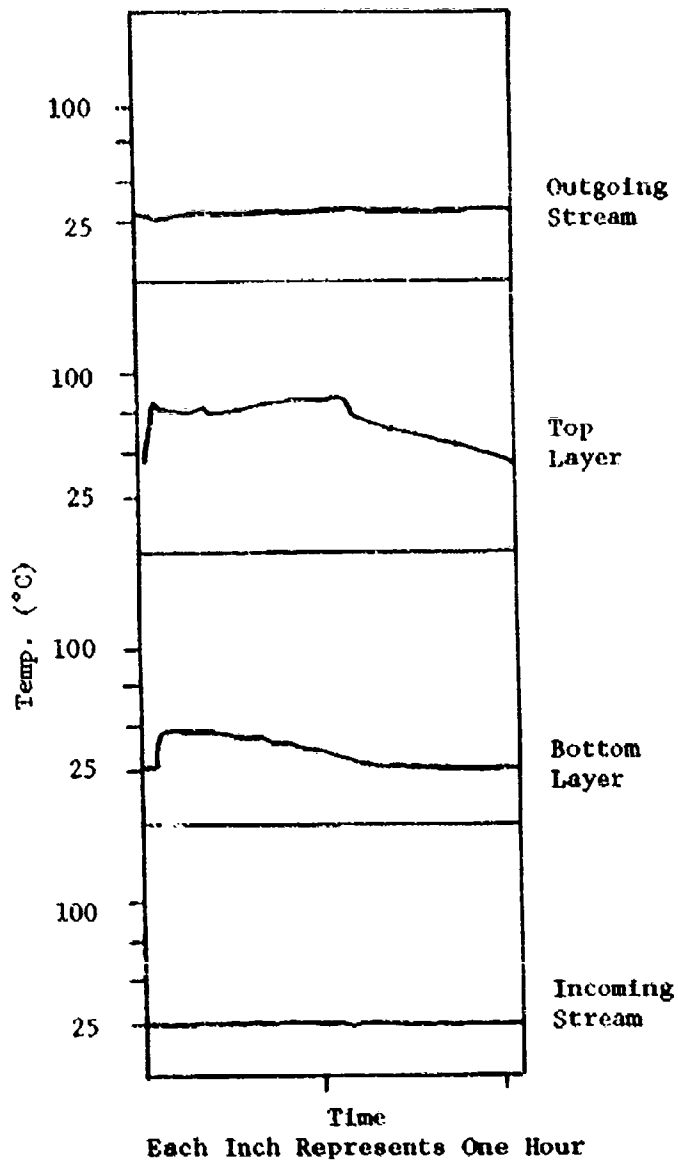

Figure 24 Temperature Profiles Taken At  
Different Sites During Test  
No. 39

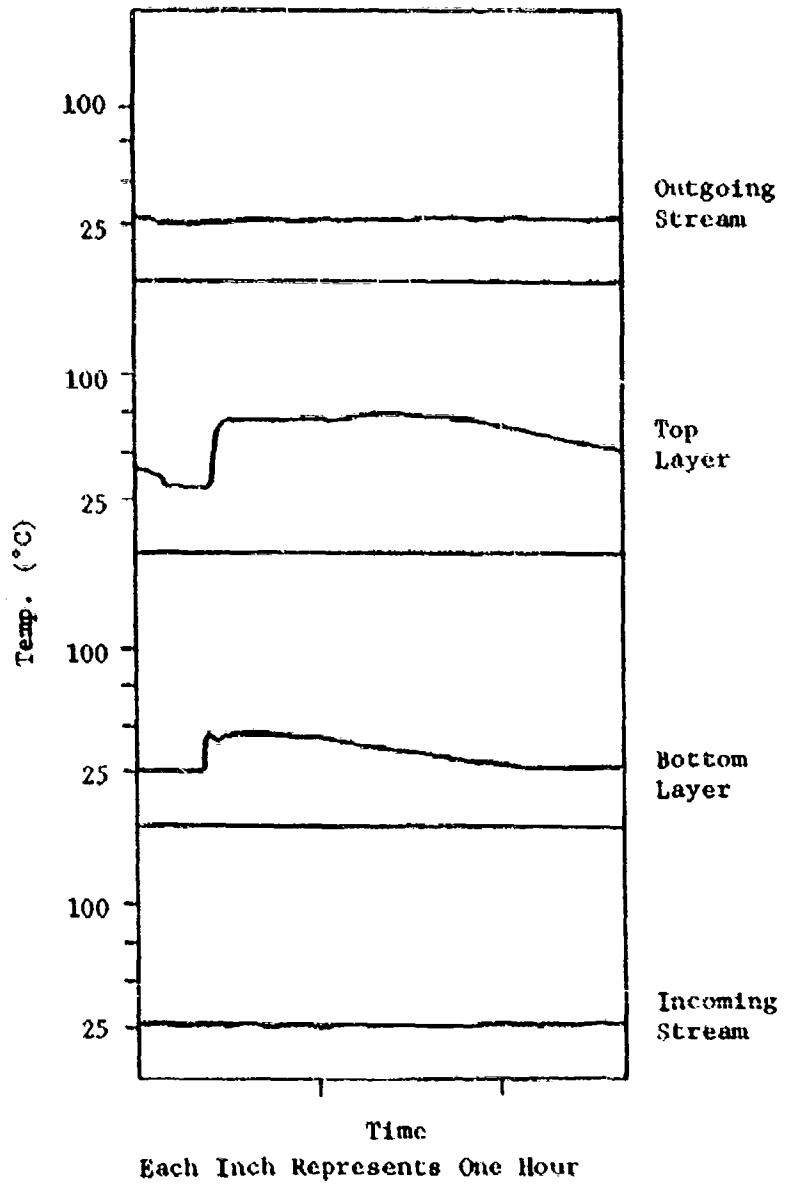

Figure 25 Temperature Profiles Taken At  
 Different Sites During Test  
 No. 40

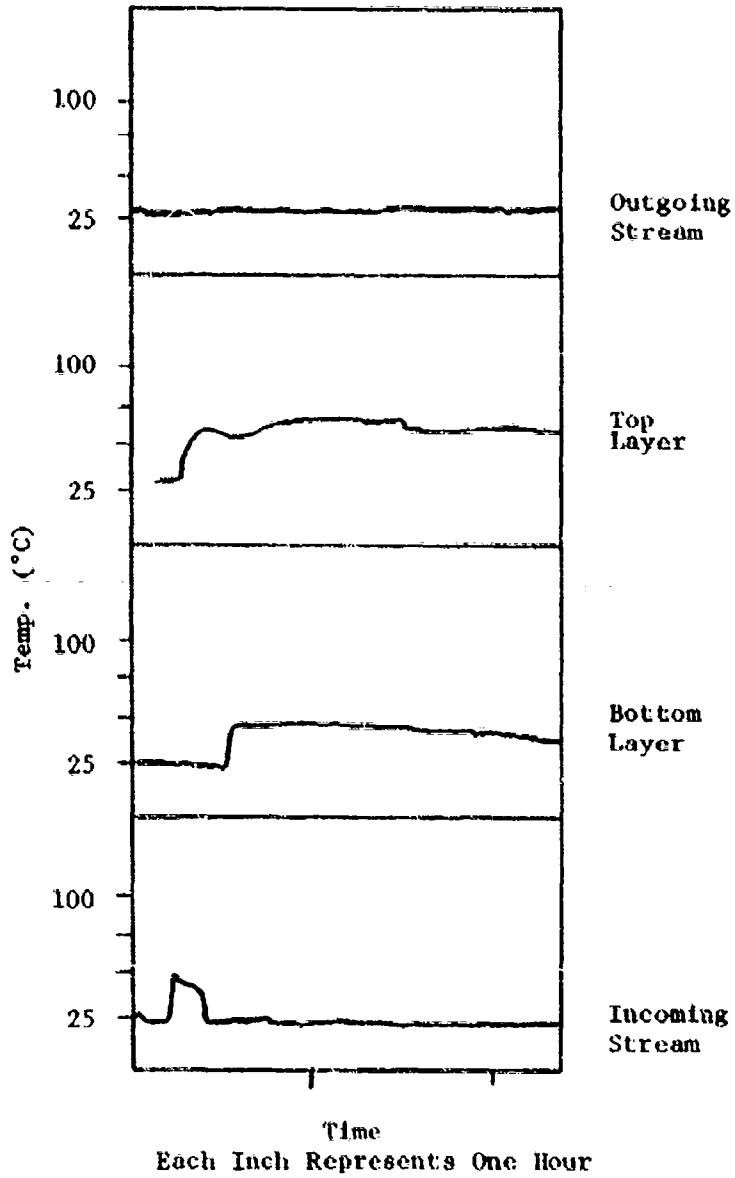

Figure 26      Temperature Profiles Taken At  
 Different Sites During Test  
 No. 41

The bottom layers of both tests 39 and 40 had conversions of over 90% versus 82% and 62% respectively in the top layers. This means that there is still abundant capacity for CO<sub>2</sub> absorption.

The strong influence of partial water vapor pressure is clearly seen in data assembled in the following table:

Test No.	H <sub>2</sub> O mm Hg	Mole Ratio (H <sub>2</sub> O/CO <sub>2</sub> )	CO <sub>2</sub> Absorbed %	H <sub>2</sub> O Absorbed %
41	9.2	.66	43	44.9
38	10.0	.71	48	42.4
37	10.9	.76	60	40.5
40	12.8	.95	64	20.2
39	14.0	1.06	79	13.8

Here one notices that, as the water vapor pressure increases, the CO<sub>2</sub> absorption increases and the H<sub>2</sub>O absorption decreases. The decrease in H<sub>2</sub>O absorption is related to CO<sub>2</sub> absorption in the following manner: as Li<sub>2</sub>O is converted to Li<sub>2</sub>CO<sub>3</sub>, the water originally absorbed is released again. Supporting evidence is seen in the analytical data presented for those tests made on Li<sub>2</sub>O samples separated into two or three layers. In these cases the CO<sub>2</sub> absorbed falls off and the H<sub>2</sub>O retained increases from the bottom to the top layers. This is especially noticeable when the temperature of the incoming gas is low and the relative humidity is high.

## 2- Tests at One-Third Atmosphere

The atmosphere of the manned spacecraft is oxygen at 5 psia. Up to this point all the work was performed under 1 atmosphere pressure. In Tables XIV and XV, the results of four tests under 5 psia pressure (from 226 to 234 mm Hg) are given. The test gas prior to humidification, contained 2% CO<sub>2</sub> and 98% O<sub>2</sub> by volume.

Overall it can be stated that absorption is successful at 1/3 atmosphere. The temperatures of the gas used in these tests were in the range of 10 to 20°C. At 20°C and 76% R.H. (test 42) the bottom layer had a conversion of over 92%. It is seen that in all cases the amount of CO<sub>2</sub> introduced was not equivalent to the theoretical capacity of the column. This is because the Gow Mac Instrument for recording the effluent content in CO<sub>2</sub> could not be used and the amount of gas to be percolated was estimated. Very high conversions were also observed in the bottom layer of test 43 (86.8%).

The active surface area of Sample No. 123-25 was never determined and the remaining part of the sample was mixed with the large bulk quantity prepared for the delivery of the six units. When the results were analyzed, it became clear that Sample 123-25 could not have had the same degree of surface activity.



TABLE XIV

ANALYTICAL DATA ON Li<sub>2</sub>O SAMPLES BEFORE AND AFTER TESTS

Test No.	Li <sub>2</sub> O No.	Sample Wt. (g)		Total Alk. as Li <sub>2</sub> O (%)		Li <sub>2</sub> CO <sub>3</sub> (%)		H <sub>2</sub> O (%)	
		Before	After	Before	After	Before	After	Before	After
42-B	123-24	1.6	3.72	95.8	3.2	2.5	95.0	1.6	3.8
42-T	123-24	1.6	3.34	95.8	12.5	2.5	78.7	1.6	8.8
42-O	123-24	3.2	7.06	95.8	7.6	2.5	86.2	1.6	6.2
43-B	123-24	1.6	3.59	95.8	5.7	2.5	90.3	1.6	4.0
43-T	123-24	1.6	3.2	95.8	19.2	2.5	69.4	1.6	11.4
43-O	123-24	3.2	6.79	95.8	12.0	2.5	80.4	1.6	7.5
44-B	123-25	1.6	3.166	94.1	20.2	4.1	69.3	1.6	10.4
44-T	123-25	1.6	2.65	94.1	37.4	4.1	45.8	1.6	16.7
44-O	123-25	3.2	5.816	94.1	28.0	4.1	58.6	1.6	13.3
45-B	123-25	0.5	1.04	94.1	18.1	4.1	71.5	1.6	10.4
45-T	123-25	0.5	0.94	94.1	26.0	4.1	58.9	1.6	14.9
45-O	123-25	1.0	1.98	94.1	21.8	4.1	65.5	1.6	12.5

TABLE XV

PRINCIPLE DATA OBTAINED FROM ABSORPTION TESTS ON  $Li_2O$  SAMPLES

Test No.	Sample No.	Bulk Dens. g/cc	A.S.	Gas Temp. °C	R.H. of Gas %	Gas Press. mm Hg	Flow Rate l/min	Linear Flow Rate cm/sec	Test Time Min.	Gas Passed In l.
42-B	123-24	0.073	11.2	20	74	234	2.98	25.7	130	388
42-T	123-24	0.073	11.2	20	74	234	2.98	25.7	130	388
42-O	123-24	0.073	11.2	20	74	234	2.98	25.7	130	388
43-B	123-24	0.073	11.2	15.1	38	229	2.86	24.6	123	351
43-T	123-24	0.073	11.2	15.1	38	229	2.86	24.6	123	351
43-O	123-24	0.073	11.2	15.1	38	229	2.86	24.6	123	351
44-B	123-25	0.077	---	10.7	38	228	2.95	25.4	113	333
44-T	123-25	0.077	---	10.7	38	228	2.95	25.4	113	333
44-O	123-25	0.077	---	10.7	38	228	2.95	25.4	113	333
45-B	123-25	0.077	---	14	44	226	0.9	7.8	108	97
45-T	123-25	0.077	---	14	44	226	0.9	7.8	108	97
45-O	123-25	0.077	---	14	44	226	0.9	7.8	108	97

TABLE XV (Continued)

CO <sub>2</sub> eq. of Li <sub>2</sub> O in Col. g.	CO <sub>2</sub> Passed In g.	CO <sub>2</sub> Abad.		H <sub>2</sub> O Passed In g.	H <sub>2</sub> O Abad.		% Li <sub>2</sub> O Used		Li <sub>2</sub> O Conv. to LiOH %	Mol. Ratio H <sub>2</sub> O/CO <sub>2</sub>
		g.	%		g.	%	Calc. from ΔLi <sub>2</sub> O	Calc. from ΔLi <sub>2</sub> CO <sub>3</sub>		
2.25	4.22	2.03	48.2	4.9	0.115	2.4	92.3	90.3	5.0	---
2.25	4.22	1.54	36.5	4.9	0.268	5.5	72.7	68.4	24.6	---
4.50	4.22	3.57	86.7	4.9	0.383	7.8	82.5	79.3	14.8	2.6
2.25	3.8	1.91	50.1	1.78	0.119	6.7	86.8	84.6	10.5	---
2.25	3.8	1.30	34.2	1.78	0.338	19.0	59.9	57.6	36.9	---
4.50	3.8	3.20	84.3	1.78	0.457	25.7	73.4	71.1	23.7	1.14
2.21	3.63	1.27	34.9	1.24	0.304	24.5	57.5	57.3	33.5	---
2.21	3.63	0.68	18.8	1.24	0.417	33.6	34.2	31.0	46.1	---
4.42	3.63	1.95	53.7	1.24	0.721	58.1	45.9	44.1	40.3	.84
0.69	1.04	0.43	41.4	.514	0.099	19.3	60.1	62.2	35.2	---
0.69	1.04	0.32	30.6	.514	0.132	25.7	48.1	45.9	46.8	---
1.38	1.04	0.75	71.9	.514	0.231	44.9	54.1	54.1	40.1	1.21

This is apparent from a comparison of tests 43 and 45 which had very similar conditions of temperature and relative humidity. The results should have been comparable, actually better results should have been obtained in test 45, as the flow rate was decreased to 1/3 the value of test 43. The reverse can be seen and the only explanation is the lower a.s. value of Sample 123-25.

The results of tests 44 and 45 can be considered indicative of a successful operation at 1/3 atmosphere pressure. The low temperatures and low R.H. values combined would lead us to expect much lower conversions than actually obtained. Test 30 (Table XI) corresponds closely to test 44.

Test 30 at 14.7 psia gave a 25% yield.  
Test 44 at 5 psia gave a 46% yield.

Also test 45 can be compared with test 31 (Table XI).

Test 31 at 14.7 psia gave a 45% yield.  
Test 45 at 5 psia gave a 54% yield.

Equal values of relative humidity at 14.7 and at 5 psia are equivalent to a ratio of 1 to 3 in absolute quantities of water vapor transported. This is reflected in the large amounts of water taken up in tests No. 43, 44 and 45. The temperature profile recordings are reproduced in Figures 27 through 30. It is seen that the top layer of tests 42 and 43 had still relatively high temperatures at the conclusion of the test. The extremely high peak temperatures at the very beginning of the runs are primarily due to the large quantity of water initially absorbed which is a strongly exothermic reaction. This shows especially in test 42 where the mole ratio  $H_2O/CO_2$  was 2.8.

The subsequent conversion of  $LiOH$  to  $Li_2CO_3$  is much less exothermic due to the endothermic contribution of water evolution. Therefore, a plateau is observed at much lower temperatures. The temperature effects of Sample 123-25 are much lower which indicated that this sample might have had a much lower active surface area.

#### The Use of Solid Configurations of Lithium Oxide

For a long time it was thought necessary to impart movement to the atmosphere in enclosed spacecrafts for efficient regeneration. It is this condition which is the basic philosophy behind the design of a granular bed of active chemicals through which the atmospheric gases are circulated by force.

D. A. Keating, K. Weiswurm and G. W. Filson (ref. 19) investigated the movement of respired gas in manned space enclosures. The conclusion

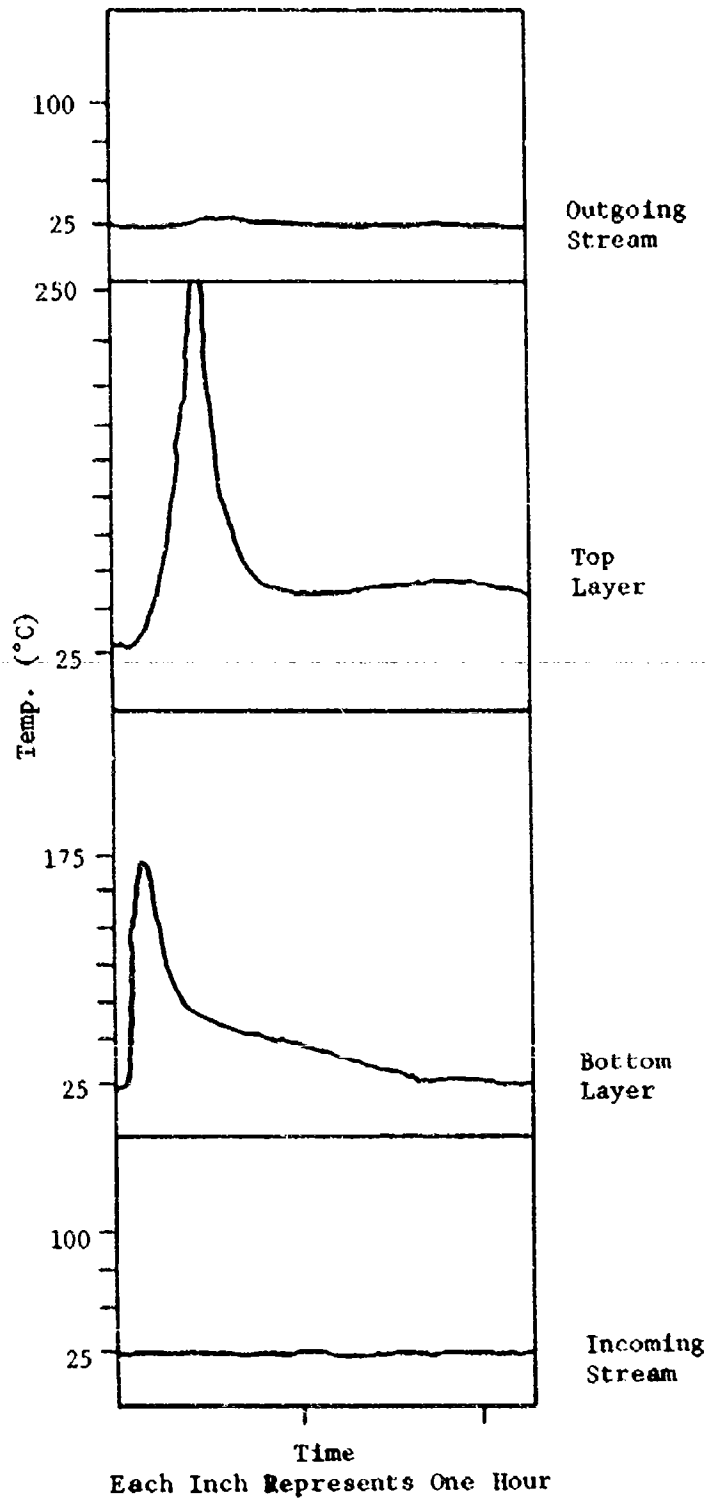

Figure 27 Temperature Profiles Taken At  
 Different Sites During Test  
 No. 42

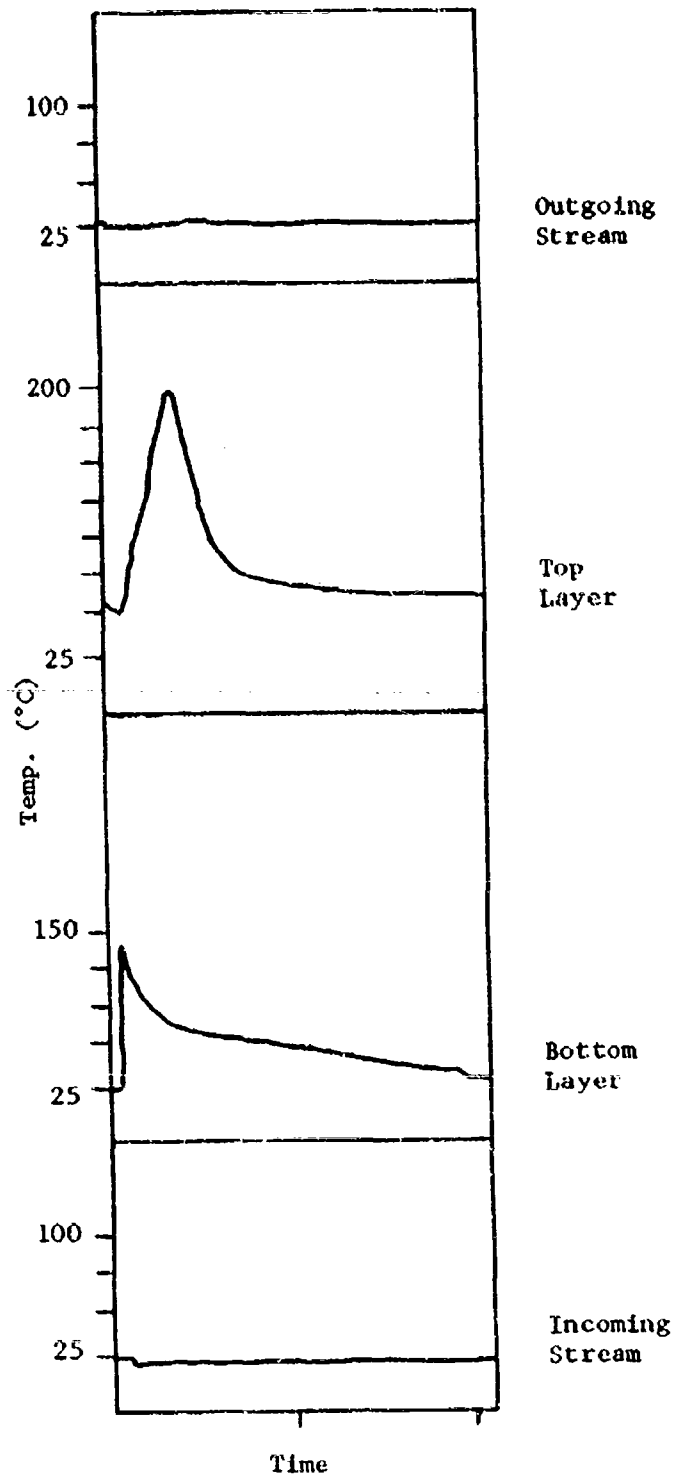

Figure 28 Temperature Profiles Taken At  
 Different Sites During Test  
 No. 43

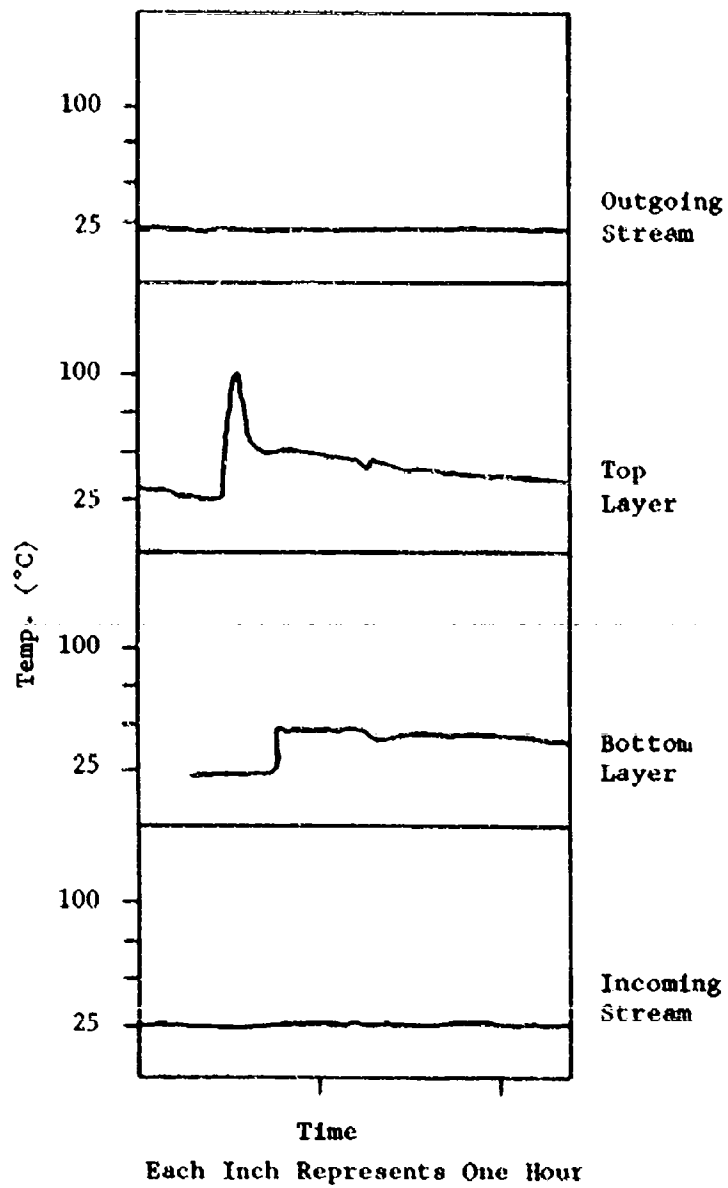

Figure 29 Temperature Profiles Taken  
At Different Sites During  
Test No. 44

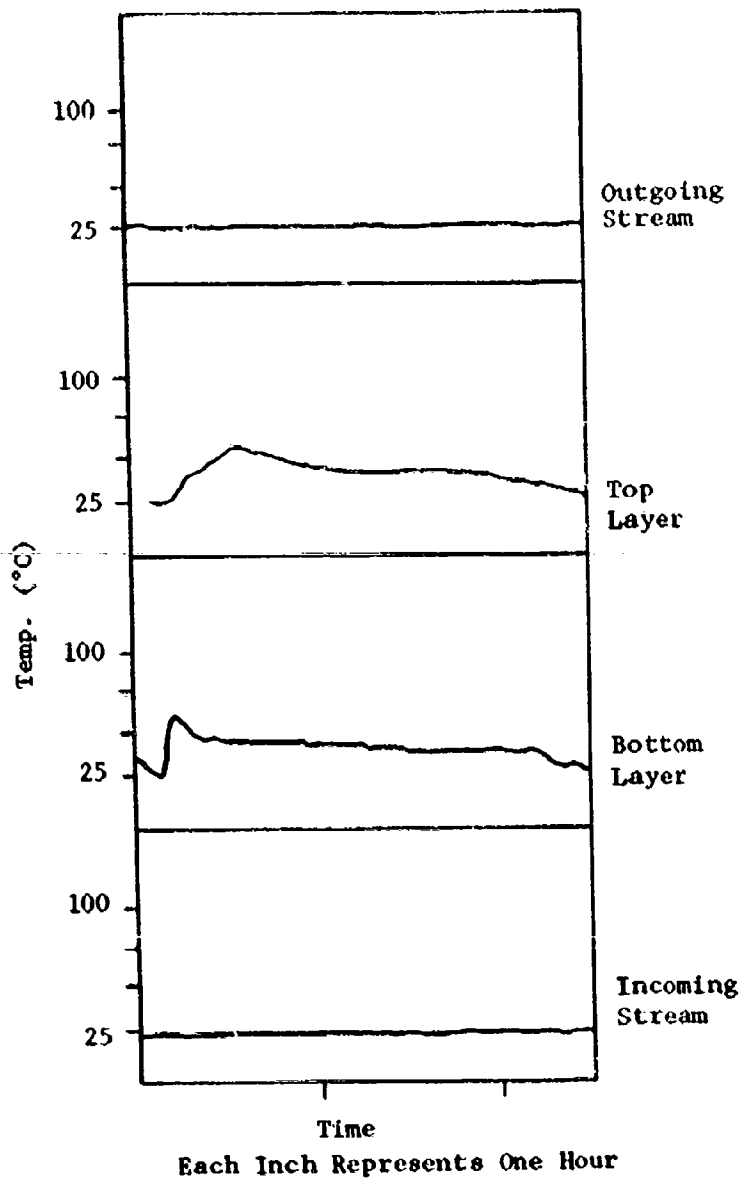

Figure 30 Temperature Profiles Taken  
At Different Sites During  
Test No. 45



of this work is that an astronaut will NOT poison himself (with  $\text{CO}_2$ ) during weightlessness or reduced gravity because of lack of forced atmosphere movement.

Therefore, the concept of passive atmosphere regeneration has become feasible. Preliminary studies on passive carbon dioxide removal were described by D. A. Keating with Baralyme and molecular sieves (ref. 16). In the conclusions it is stated that "passive application.... for manned sealed atmosphere air regeneration systems has been successfully demonstrated".

The awareness of these theoretical and practical data has induced a variation of the present research with the goal to abandon the granular bed concept and to replace it with a configuration amenable to the static method. Honeycombed structures, pellets, blankets, panels, coatings, etc. are all forms more suitable for static than for dynamic air regeneration.

All these latter shapes are only possible if a larger mass can be produced in a coherent form.

The simplest approach is the pellet. In the present research effort, four tests were performed on pelletized material. The results are presented in Tables XVI and XVII.

For test No. 14, a specially prepared material was used. Lithium peroxide (material kept from sample No. 58 prior to thermal decomposition) was compressed at 1500 psig in pellets. 25.22 g. were fired at a maximum temperature of  $369^\circ\text{C}$ . The resulting weight of the oxide pellet was 17.22 g., representing a 31.7% weight loss. The density of the obtained pellet was 0.76 g/cc, the material was very hard. Total alkalinity as  $\text{Li}_2\text{O}$  was 89.6% and the  $\text{LiOH}$  content 19.8%. The Sample No. 62 was assigned to this pellet.

The characteristics of this material led to the conclusion that sintering had taken place and that the A.S. therefore was low.

Tests No. 15 and 16 were made on pellets compressed at 1500 psig from the "fines" collected during the screening out of the 4-14 mesh fraction of the high surface oxides, No. 66 and 48, respectively. Although active surface measurements were not made on the pellets, values for active surface of the original oxide samples No. 66 and 48 had been obtained and were 9.5 and 9.8  $\text{m}^2/\text{g}$ ., respectively (see Table III).

Finally for test No. 17, Sample No. 36 was chosen -- a very high active surface material. Peroxide hydroperoxide hydrate was pelletized at 2000-3000 psig. The pellets were dried at  $45^\circ\text{C}$  under a vacuum of 29". The dried pellets (of  $\text{Li}_2\text{O}_2$ ) were then placed in the furnace and fired

TABLE XVI  
ANALYTICAL DATA ON Li<sub>2</sub>O PELLETS BEFORE AND AFTER TESTS

Test No.	Sample No.	Sample wt.		Total Alk. as Li <sub>2</sub> O		% Li <sub>2</sub> CO <sub>3</sub>		% H <sub>2</sub> O	
		Before	After	Before	After	Before	After	Before	After
14	87	2.71	3.99	89.6	42.7	3.0	41.9	7.4	15.4
15	66	1.47	3.05	86.7	19.1	3.6	63.5	8.6	16.9
16	48	3.36	6.11	95.2	30.6	1.7	52.6	3.1	16.8
17	36	2.08	5.2	96.0	1.8	1.8	92.5	2.0	5.6
22	118	3.59	7.5	91.8	0.6	3.1	95.8	5.0	3.5

at a maximum temperature of 357°C. This material was the lowest density pellet of all pellets utilized in this project.

The diameter of the pellets pressed was 2.56 cm. for Samples 15 and 16, while test No. 14 pellets were slightly smaller because of shrinkage during firing. The interior diameter of the absorption tube was 2.67 cm., thus the pellets fitted rather loosely inside. Each individual pellet was supported on a stainless steel wire mesh screen, separated from the next pellet-screen assembly by a piece of glass tube. The pellets were located at the level of the thermocouple ports. The junction of the thermocouple touched the pellet. This enabled us to observe the very small temperature rises, initiated by the reaction of the pellet. When the latter cooled to the gas temperature, the pellet was considered exhausted. As the reaction progressed from the lower to the upper levels, the corresponding temperature increases and decreases were observed. This is not reported in detail because of the slight variation of this temperature factor. These were small, mainly due to the low flow rates.

It was very rewarding to see that even sintered, hard and dense material (test 14) had still appreciable capacity for absorption. The test was interrupted when absorption had become too slow for practical purposes. The pellets of test 15 absorbed 83% of the incoming  $\text{CO}_2$ , while only 60% of the oxide content was converted to the carbonate. Test 16 was terminated prematurely by mistake. The results would have been as good or better than the ones of No. 15.

Test No. 17 gave exceptionally good results, the pellets being of very high active surface. The flow rate, of course, was rather low in comparison with the granular bed tests. This low flow rate, however, simulates quite appropriately the passive condition.

Common to all three experiments is the fact that absorption slows down. The material is still active but the sites of activity become less accessible. It can be postulated that at first mean free path criteria are responsible for reaction. As the surface layer is converted from oxide to carbonate, the porosity of the honeycombed structure decreases and a capillary diffusion controlled process takes over.

A very interesting observation is the unusually high water retention capability of the pellets, 46 to 100% of the incoming water being retained. In test 15 there is a 46% retention of water when about 60% of  $\text{Li}_2\text{O}$  is converted to carbonate. This, again, proves that the conversion to  $\text{LiOH}$  precedes the absorption of  $\text{CO}_2$ .

Sample No. 118 was obtained in form of large fritted chunks of oxide. The procedure to obtain this was explained above. Almost all the runs from 123-17 on were run according to the same technique and most of them had the fritted texture.

TABLE XVII

PRINCIPLE DATA OBTAINED FROM ABSORPTION TESTS ON  $\text{Li}_2\text{O}$  PELLETS

Test No.	Sample No.	Pellet Density g/cc	A.S. $\text{m}^2/\text{g}$	Flow Rate l/min	Gas Temp. (°C)	R.H. %	Test Time Min.	Gas Passed In l.	$\text{CO}_2$ Abs. Capacity in col. g.	$\text{CO}_2$ in g.
14	62	.76	Not Detd.	.05	24.0	56	945	56.2	3.56	2.03
15	66	.60	"	.036	23.0	54	1330	68.6	1.87	2.48
16	48	.59	"	.062	23.5	54	1315	66.5	4.69	2.41
17	36	.21	11.9	.054	23.7	55	2105	115.9	2.93	4.18
22*	118	.16	9.9	.058	23.2	54	2435	140.1	4.83	4.85

\* Linear Flow Rate, 0.23 cm/sec.

TABLE XVII (Continued)

<u>CO<sub>2</sub> Absd.</u>		<u>H<sub>2</sub>O</u>			<u>% Li<sub>2</sub>O Used</u>		<u>Li<sub>2</sub>O Conv. to LiOH %</u>	<u>Mole Ratio H<sub>2</sub>O/CO<sub>2</sub></u>
<u>g.</u>	<u>%</u>	<u>In g.</u>	<u>Absd. g. %</u>		<u>Calc. from ΔLi<sub>2</sub>O</u>	<u>Calc. From ΔLi<sub>2</sub>CO<sub>3</sub></u>		
.95	47	.72	.42	58	30	26.5	28.6	.88
1.12	45	.85	.39	46	54	60	29.4	.85
1.58	65.5	.82	.92	100	41.5	32	47.8	.82
2.84	68.4	1.46	.25	17.2	95	96.7	1.3	1.22
4.21	86.8	1.74	.08	4.7	98.6	87.2	7.6	.87

Attempts were made to obtain a larger fritted configuration by this technique, but we failed even under very closely controlled conditions. Apparently, the physical parameters play a very important role during thermal decomposition and the variables of rate of heating and temperatures have to be adapted to each width, depth and height parameter. These experiments were made at the close of our contract period and could not be pursued within the time available. There is no doubt that conditions can be found under which larger coherent configurations can be obtained.

A large fritted chunk of Sample 118 was carved into a cylindrical shape 2.4 cm in diameter and 5.5 cm long. For the purpose of test 22, it was encased in a tightly fitting rubber sleeve. The test gas could therefore be pushed through the porous body itself. The results are extremely favorable: almost total retention of CO<sub>2</sub> concomitant with an almost total conversion of Li<sub>2</sub>O to Li<sub>2</sub>CO<sub>3</sub>.

Most revealing are the pressure drop data. This experiment was the first where we actually observed a significant pressure drop. It must be borne in mind that the composition of the cylinder changes from a 91.7% Li<sub>2</sub>O before to a 95.81% Li<sub>2</sub>CO<sub>3</sub> after the test.

The relative pressure drop ( $\Delta p$  per cm column length) shall be expressed in mm Hg per cm length, its symbol being  $\Delta P_r$ . These are:

Start	0.84 mm Hg/cm
End	1.08 mm Hg/cm

Taking into account the calculated void spaces (92.3% before, and 80.8% after), the linear velocities,  $V$ , of the gas through the porous body is as follows:

Start	2.28 cm/sec
End	2.64 cm/sec

Pressure drop and linear velocity are related by the law of Darcy (ref. 3), where the pressure drop is directly proportional to the velocity of flow. This law must be modified for non-newtonian flow condition, such as we experienced in the flow of gas through a solid porous body. Such a modification can be formulated as follows (ref. 8, page 206):

$$(29) \quad \Delta P_r = a \times v^b$$

Of special interest is the power factor  $b$ , which is unity in newtonian flow conditions. For packed beds of granular LiOH,  $b$  has been determined to be 1.72 (ref. 26).

Using the data from test 22, we arrive at the following relationship:

$$(30) \quad \Delta P_r = 0.196 \times v^{1.76}$$

The power factor resembles rather closely the one for granular beds of LiOH.

As long as the linear velocity is large enough to make enough active surface available for CO<sub>2</sub> absorption per unit time, this near static condition is very effective. A cursory examination of these preliminary results shows that there is an ample margin within which a solid configuration could be designed, based solely on a porous lithium oxide body.

More data are necessary to obtain precise design parameters.

## SECTION IV

### ENGINEERING, DESIGN AND TESTING OF REGENERATION UNIT

#### General

The Mechanical Products Division of Atlantic Research Corporation was awarded the contract to develop an air regeneration unit to remove carbon dioxide from a manned sealed atmosphere. This unit is to employ a highly active lithium oxide as an absorbing medium. This chemical was developed by the prime contractor, Lithium Corporation of America, Inc. The hardware development has closely paralleled the research performed at Lithium Corporation of America in finding and producing the most effective form of lithium oxide.

#### Design Object

The goals sought in the design of this unit are dictated both by the anticipated environment of the unit and by the irritating nature of the lithium oxide, when allowed to contaminate the atmosphere.

In order that the unit be suitable for spacecraft use, it must be low in weight, small in size, and have a low power demand. The prototype design must attempt to realize these goals as much as possible. The structural demands imposed by the acceleration and vibrations of space flight must be balanced against excessive weight reduction at the sacrifice of strength. The rather unique conditions imposed by weightlessness must be considered throughout the design.

The operational requirements are such that the unit will successfully remove the carbon dioxide that is generated by one man in one day. In performing this task it must in no way contaminate the atmosphere with lithium oxide dust, lubricant hydrocarbons, or other dangerous or undesirable contaminants. All electrical devices must be capable of operating in essentially 100 per cent oxygen atmosphere with no exposed mechanical switching permitted. The materials must be light weight yet capable of withstanding chemical attack from the lithium oxide and moisture from the atmosphere.

The unit must be capable of unattended operation for a period of 24 hours with the utmost reliability. It is to be designed with the capability of being easily recharged with lithium oxide in a pre-packaged form that can be handled easily in a spacecraft environment.

#### System Selection

At the initiation of this program it was intended to design a unit that would depend on a combination of passive and dynamic gas regeneration.



This policy was subsequently discarded in favor of a marginal dynamic system. The term marginal dynamic system refers to a system that circulates the minimum flow rate of carrier oxygen to pass the carbon dioxide through the unit on a one-pass basis. Ideally this circulation would allow all the carbon dioxide molecules to come in contact with the lithium oxide.

The passive system places full reliance on the circulation set up by a man's breath and on diffusion. This type of circulation has been shown to provide adequate molecular contact between the gas and absorber under weightless conditions. However, a passive system depends on a relatively large surface area of the absorbing chemical that will be in free access to the atmosphere.

A full passive system would be ideally adapted to a chemical that could be formed in a self-supporting structure, such as a honeycomb or wafer configuration. Yet a chemical in granular form would require support by screens and frames in order to present a large surface area.

For the system under consideration, the absorbing chemical is lithium oxide in a granular form of 4-14 mesh. This chemical has high attrition properties and dusts quite easily due to its soft porous structure. This dust is sub-visible in size yet readily apparent when inhaled, as it is highly irritating to the mucous membrane. It immediately became apparent that a highly effective filter system would have to be used in order to contain this dust and prevent it from escaping from the system into the atmosphere. This problem of how to properly filter the system was the prime reason that a dynamic system was selected. A secondary reason was that with a packed bed of lithium oxide, a more compact configuration can be used leading to a smaller overall envelope size and lower weight.

#### Unit Design

After a choice of system type was made, various unit configurations were evaluated from a volume, weight, and gas flow standpoint. Calculations showed that the weight of lithium oxide applied would be 2.26 lbs. with a volume of 488 cu. inches. This volume would more or less establish the major portion of the unit size. Next, it would be necessary to determine the type of blower required to circulate the gas.

A calculation of the minimum flow of oxygen required to circulate the generated rate of carbon dioxide resulted in a carrier flow of 2.93 CFM at ambient temperature and pressure. Since this flow was so low and the anticipated pressure drop through the unit was also low, it permitted the consideration of a small high-speed vane-axial fan. Based on predicted pressure drop, a blower was selected.

As mentioned before it was thought that it would be advantageous if the design of the unit would permit replacing the spent lithium oxide charge with a fresh charge using a pre-packaged cartridge. This would allow rapid replacement without the danger of lithium oxide particles floating about the atmosphere during a transfer. This charge would be packaged in a filter medium and sealed in foil to prevent premature conversion to lithium carbonate in the presence of carbon dioxide. The unit was designed accordingly.

Various configurations were thoroughly evaluated and most discarded for one reason or another. The most promising shapes were the more conventional ones. The criteria for acceptance was that the configuration must be light in weight, small in volume without any one dimension being excessive, structurally strong, adaptable to forced circulation, adaptable to effective filtration, low in pressure drop, and finally, adaptable for cartridge loading. Calculations were made and selection curves prepared to size the various dimensions in order that the resultant shape would contain the required amount of lithium oxide. When the optimum dimensions were selected, a weight calculation was made. If the shape still appeared to have merit, a pressure drop calculation was made and filters were roughly designed.

From the foregoing procedure, the configuration that showed the most attractive features was selected and developed into the final design.

The outcome of the design study was the selection of conical configuration. Basically, the cone is divided into two chambers. One section consists of the lithium oxide bed which occupies the base end of the cone. The other end of the cone is a short plenum chamber at the apex, to which the blower is mounted. The blower blows the gas through the plenum chamber to an inlet filter, through the bed, and back to the atmosphere through the outlet filter at the base of the cone.

Since a unit volume of gas flowing through a conical chamber has an exponentially varying velocity, the exit velocity from the last of the bed is a great deal lower than the inlet velocity. This change in velocity offers a number of attractive advantages.

The velocity of the gas entering the bed is about 60 fpm and falls to about 5 fpm at the exit of the bed under minimum flow conditions (2.93 CFM). Actually, the blower-motor supplied will increase the flow up to 8 CFM. The low exit velocity should result in good scrubbing action as the end portion of the bed will be the last to be converted to lithium carbonate and the low velocity will improve the absorption efficiency.

The inlet filter need not be as effective as the outlet filter as all it must do is contain the lithium with no velocity head against it. This will permit the use of a more porous filter medium that exhibits a low pressure drop. However, the outlet filter must be nearly absolute, filtering down as fine as 5 microns. This type filter has an inherently high pressure drop. The conical configuration provides a low gas

velocity and maximum outlet filter area to reduce the pressure drop and clogging during operation. The inlet filter has a high velocity and small area where both conditions may be tolerated with no detrimental effects due to its function and location.

Tests were conducted to find an effective filtering medium and to gain reliable pressure drop data. A test fixture was built in which a small cylindrical lithium oxide bed was terminated with a filter. The filter could easily be removed. Oxygen was available and metered to the test bed at varying velocities. The filter mediums were evaluated by blowing oxygen through the bed at the highest anticipated velocities and monitoring the outlet by flame ionization technique. Any lithium oxide passing through the filter could readily be detected in this manner. Once the filter mediums were selected, detailed pressure drop data was taken from 1-60 fpm. From this data pressure drop vs. velocity curves were made up for the filter materials.

The pressure drop through the bed of lithium oxide was obtained by a combination of empirical and analytical methods. Lithium-Corporation of America provided test data of the pressure drop through a bed of lithium for oxygen at 14.7 psia. This data was corrected for the reduced pressure at which the system will operate, of 5 psia. Using analytical methods the pressure drop was calculated through a 4-14 mesh bed of randomly packed particles for both 14.7 psia and for 5 psia. The calculated data agreed closely with the test data. From this correlation the calculated reduction in pressure drop was applied to the actual test data for the final curve.

The pressure drop data for the filter media was lowered by the same factor. This procedure may not be verified analytically for filter material, but will be close enough for total system pressure drop used for blower selection. Further test work on filter evaluation is anticipated at 5 psia oxygen to confirm the previous assumption.

The size of the unit was determined on the basis of performance testing results obtained on the final lithium oxide of high active surface characteristics. A most typical test under 5 psia was No. 42 (Table XV). 85% of the incoming carbon dioxide was retained with a conversion of 81.5%  $\text{Li}_2\text{O}$  to  $\text{Li}_2\text{CO}_3$ . The total alkalinity of this material was originally 95.8%  $\text{Li}_2\text{O}$ . Temperature was 20°C (68°F) and the relative humidity 74%. The linear velocity of the gas was 25.7 cm/sec or 50 ft/min.

In order to maintain a very conservative attitude, we assumed that a 76% conversion could firmly be counted on under the actual operation conditions. 2.4 pounds  $\text{CO}_2$  per man-day require theoretically 1.63 pounds of  $\text{Li}_2\text{O}$ . Assuming that the reaction takes place only to 76% of the total, the charge for one man-day of the above mentioned typical material would be

$$\frac{1.63}{.75 \times .958} = 2.26 \text{ Lbs.}$$

Space for this amount has to be provided. Actual charging experiments resulted in a bulk density of 0.128 g/cc. The unit was designed to have an effective loading volume of 8 liters or 488 cubic inches:  $8000 \times 0.128 = 1024$  grams = 2.26 pounds.

The average linear flow rate (at 5 psia) through the bed (170 fpm in, 12 fpm out) is about 50 ft/min. or the same as in test No. 42.

#### Description of Unit

For a description of the unit, reference should be made to the assembly drawing D-40464, which is supplied under separate cover. In Figure 31, a sketch of this unit shows the essential parts.

The unit consists of a filter body, a plenum chamber, a vane-axial blower, filters, and filter retaining ring and screen.

The filter body contains the lithium oxide. It is constructed of 6061-T6 aluminum sheet 0.025 inch thick. At either end of the body is a ring flange (2024-T4 aluminum). These flanges are bonded to the sheet metal by arc-welding in inert gas, tungsten-arc method, and form attachment points for the plenum chamber and the retaining ring and screen assembly. The conical configuration adds inherent strength to this lightweight structure.

The plenum chamber is made of 2024-T aluminum. The plenum provides a transition area from the blower outlet to the inlet filter and prevents a stall condition of the blower. All threaded fasteners are stainless steel of the 300 series and the quarter-turn fasteners are cadmium plated steel. Rather than use adhesives, all parts that had to be joined are tungsten-arc welded under inert gas. This was done to eliminate any out-gassing of an epoxy-based adhesive. The joints are structurally sound and neat in appearance.

All aluminum parts are plated with nickel to a minimum thickness of 0.0003 inches, to protect the aluminum from chemical attack. The plating is of a dull matt finish to prevent undesirable reflection from the unit. This finish is easily scratched and appropriate care should be exercised not to scratch the inside of the filter body. The surface may be cleaned with water and detergents, avoiding abrasive cleaning compounds.

The inlet filter will not normally be removed, but is replaceable if the need should arise.

The outlet filter is expendable and would normally be replaced when the charge is renewed. It is therefore easily removable without

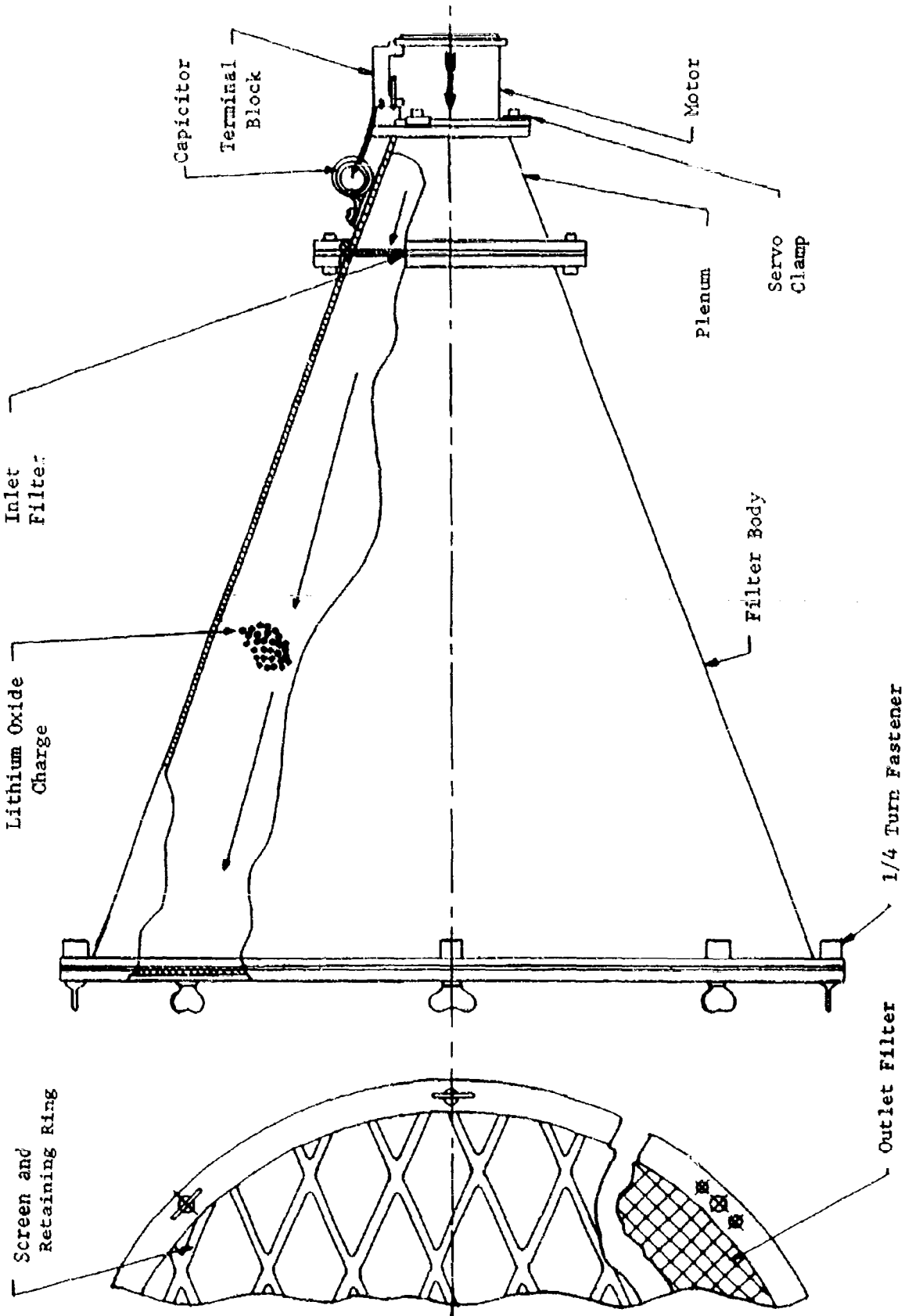

Figure 31 CO<sub>2</sub> Absorber MKI Air Regeneration Unit

the need of tools. To remove the filter, the eight 1/4-turn fasteners are loosened, then the retaining ring and screen assembly are removed which releases the filter and allows replacement of the charge on a bulk loading basis. The retaining ring is made of 2024-T4 aluminum. The screen is made of 3003-H14 expanded aluminum.

The filters used are the same as those furnished on the prototype. The inlet filter is a polypropylene felt of 9 oz./sq. yd. weight. It has a permeability of greater than 150 cfm, as measured by a Frazier Permenometer. The maximum recommended operating temperature is 175°F. The outlet filter is a nylon felt of 18 oz./sq. yd. weight. The permeability is 15-20 cfm and the temperature limit is 250°F.

In the preliminary design report, a blower-motor having 22000 RPM, was used and found to have an appreciable noise level. A noise analysis was performed and it was found that the submitted specifications could be attained. In order to be sure that there would be no inconvenience generated, it was decided finally to supplant this motor by one which was found to have a noise level of 10 decibels less than the previous motor. The blower-motor chosen rates at 11,400 RPM, 400 cps, 115 volts and has a noise level of 65 db at the noisiest location---well within the specifications.

The blower selected is a specially lubricated unit suitable for use in an essentially 100 per cent oxygen atmosphere. The blower was sized to provide in excess of the 2.93 cfm flow required as a calculated minimum.

The minimum flow of carrier oxygen Q is found the following way:

$$(31) \quad Q = \frac{mv}{mf} \quad \text{where } m = \text{CO}_2 \text{ generation rate lb./hr.}$$
$$v = \text{specific vol. cu. ft./lb.}$$
$$mf = \text{mass fraction of CO}_2$$

Specific volume v at 5 psia is 25.8 cu. ft./lb.

$$mf = \frac{0.0735}{5} = 0.0147$$
$$m = 0.1$$
$$Q = 2.93 \text{ CFM}$$

This was done to provide a margin of safety to insure adequate circulation in case the system impedance increased because of filter contamination. The blower moves about 8 cfm of oxygen at 5 psia with clean filters. The power demand is 8 watts.

The lubricant used in the ball bearings of the blower motor is Dow Corning DC-33 silicon grease. Actual test data are not available for establishing the expectant life of the motor operating in oxygen. It is predicted that operating life will be in excess of 1000 hours minimum.

The motors may be stored under normal room conditions for 3 to 4 years. If the blowers are in a sealed dry atmosphere, this storage time may be increased about 50 per cent. This will be the case because each CO<sub>2</sub> absorber is sealed in polyethylene as the lithium oxide will make an excellent desiccant.

A 0.1 mfd hermetically sealed starting capacitor is supplied which should provide satisfactory operation in oxygen. This capacitor is conservatively selected at 600 VDC working voltage and should prove to be extremely reliable.

In the event that the unit should be loaded on a cartridge basis, it should be done as follows. The inlet filter and outlet filter could be dispensed with entirely. This would change the design by eliminating the inlet filter flange and permitting the sheet metal of the filter body to extend to the mounting flange for the blower. The retaining ring and screen assembly would be kept.

The lithium oxide charge would be packaged in a synthetic filter medium with the dimensions of the existing bed. The sides and inlet of the bag would be made of the type filter required at the inlet. The base of the bag would be made of the tight filter medium required to seal the lithium oxide dust within the system. This cartridge could be packaged in vapor-tight, plastic-lined foil to prevent conversion to lithium carbonate.

To load the lithium oxide charge, all that would have to be done is to remove the retaining ring and screen assembly and drop in the cartridge, after removing the foil. Some variation of this concept may be desirable in the future.

The calculated weight of the unit is 2.25 pounds without the lithium oxide charge. Addition of the charge brings the weight up to 4.50 pounds. The unit to charge weight ratio is 1.00.

The unit may be mounted at any attitude for satisfactory operation. A mounting bracket may be attached to the screws holding the plenum to the filter body. In fact, for temporary operation, the unit may be conveniently placed on the floor, resting on the quarter-turn fasteners at the base of the cone.

#### Tests

A prototype of the final design of the unit was subjected to performance tests. It was not possible to test this unit under the actual condition of 5 psia of oxygen as the carrier gas. The actual tests were made with 2% CO<sub>2</sub> in air at 14.7 psia (atmospheric pressure).

TABLE XVIII

COMPOSITION OF Li<sub>2</sub>O SAMPLES BEFORE AND AFTER TESTS

Sample No.	Sample Wt. g		% Li <sub>2</sub> O		% Li <sub>2</sub> CO <sub>3</sub>		% H <sub>2</sub> O	
	Before	After	Before	After	Before	After	Before	After
1 B	1366	2321	93.6	33.8	3.3	55.7	3.1	10.5
2 A	906	1812	94.7	17.7	3.1	71.6	2.2	10.7
3 A	906	1960	94.7	15.0	3.1	79.1	2.2	5.9



## 1- Flow Rate and Pressure Drop

The unit was tested for pressure drops, as well as the single elements composing it.

The filters were tested under varied flow conditions. The results being shown in Figure 32. It is seen that the pressure drop contribution of the outlet filter (100 sq. inches) would be about .01 inches water gauge, or extremely small. For the outlet filter (8.5 sq. inches) the pressure drop would be about .08 inches w.g., taking a flow rate of 3 cu.ft./minute. With a flow rate of 8 cu.ft./minute it would amount to .2 inches water gauge.

The pressure drop data on the lithium oxide bed are presented in Figure 33.

At a flow rate (5 psia) of 8 CFM/minute (flow rate produced by the blower-motor) the pressure drop can be calculated as 1.2 inches water gauge per the total bed (11 inches of length). This would amount to a total pressure drop of the unit of 1.4 inches. Actually, we observed 0.6 inches of dibutylphthalate when the unit was tested under 1 atmosphere pressure with the blower-motor. This is a reasonably good check.

When the flow rate is decreased to 2.93 CFM/minute (the minimum flow requirements), we calculate a total pressure drop of .6 inches water of the total unit. The pressure drop was determined under 1 atmosphere pressure in our actual performance tests. It amounted to about .2 inches, which is quite in accord with the expected value.

The capacity of filtering was tested qualitatively by checking the effluent gases for alkali.

The filter functioned perfectly and we never could detect any alkaline dust.

The filter worked for almost 100 hours. No change in pressure drop could be observed.

Visual inspection of the filter did not reveal any substantial increase in dust.

## 2- Performance

In Tables XVIII & XIX, the results of three tests are given.

Test No. 1 was performed with a low active surface area material and its principal purpose was to check the physical behavior of the unit under flow conditions and the functions of the recording units for CO<sub>2</sub> in the effluent and for the temperatures.

TABLE XIX  
PRINCIPLE DATA OBTAINED FROM ABSORPTION TESTS\* ON Li<sub>2</sub>O

Test No.	Sample	Bulk Dens. g/cc	AS	Duration of Test Hrs.	% RE	Total Cap in CO <sub>2</sub> g.	Added CO <sub>2</sub> g.	Retained CO <sub>2</sub> g.	% CO <sub>2</sub> Retained	% Li <sub>2</sub> O Converted to Li <sub>2</sub> CO <sub>3</sub> Calculated from $\frac{\Delta Li_2CO_3}{\Delta Li_2O}$	Rate of Add. g. CO <sub>2</sub> /hr.	
1	A	.18	Low	45	60	1870	1710	740	43.2	39.4	38.5	38
2	A	.12	High	28	60	1259	1132	757	66.8	60.1	62.6	40.4
3	A	.12	High	30	100	1259	1205	905	75.0	71.9	65.8	40.2

\* Characteristics of the test gas employed in these tests:  
 2% CO<sub>2</sub> in air.  
 20 to 22°C, Atmospheric Pressure.

Approximate linear Flow Rate at Inner Filter: 42 ft./min. (20 cm/sec)  
 at Outer Filter: 3 ft./min. (1.5 cm/sec)

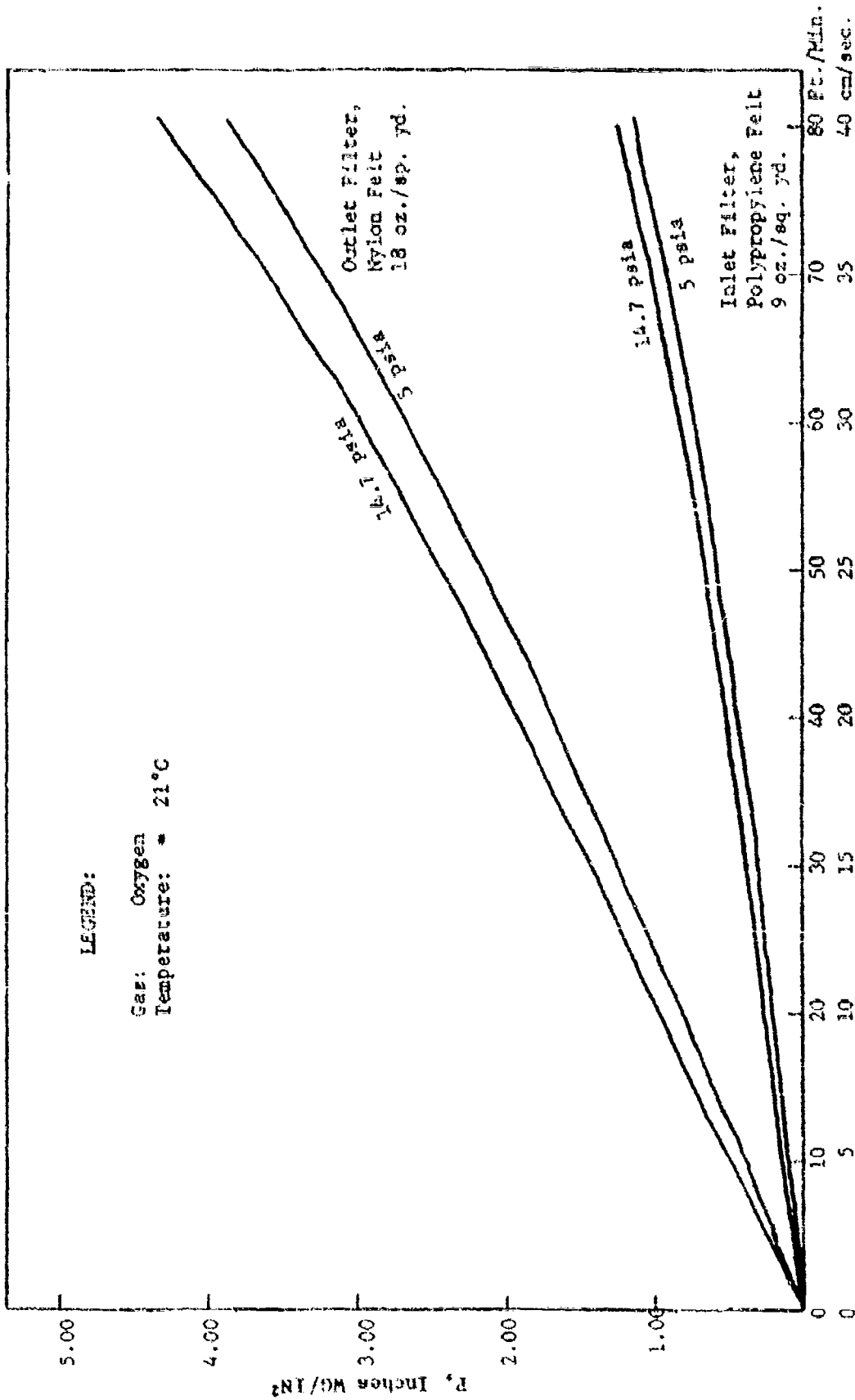

Figure 32 Pressure Drop Per Unit Area of National Filter Media Filters

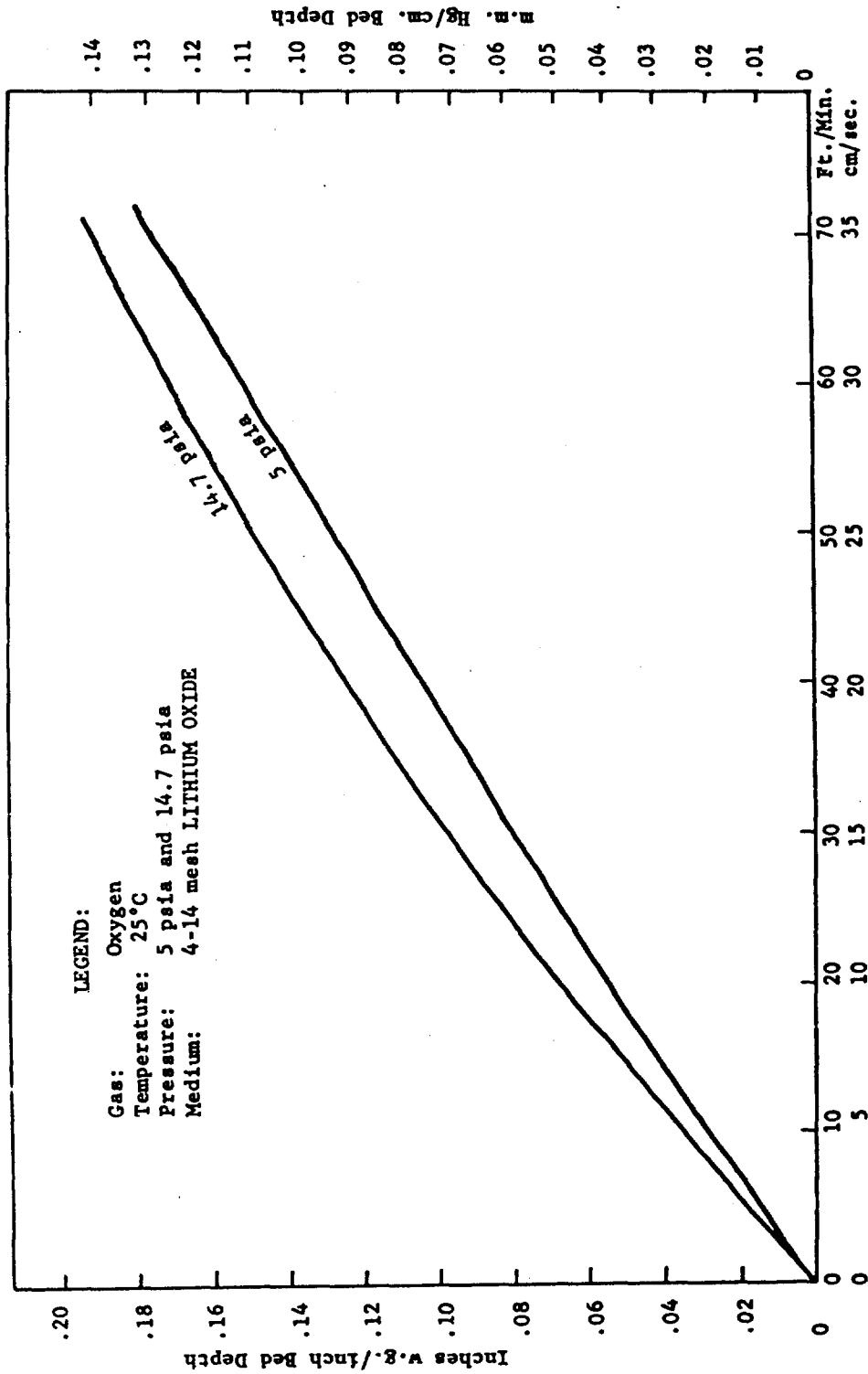

Figure 33 Pressure Drop Per Unit Bed Depth vs. Gas Velocity

The apparatus is block diagrammed in Figure 7.

Sample B, used in tests 2 and 3, is representative of the lithium oxide which was finally charged in the units to be delivered. The charges were exactly 2 pounds (906 grams).

In Figures 34, 35 and 36, the temperature profile during the total absorption time and the CO<sub>2</sub> concentration of the effluent gas are plotted. In test No. 1, we observe a temperature rise, which reaches its peak at 120°C at thermocouple site 2 six hours after the start of the test. There are appreciable differences of temperature between the different sites within the bed. The whole unit shows a symmetrical rise and fall of temperature with time, quite in contrast to the phenomena observed on the small column tests. The thermal behavior of test 2 is quite similar. Site 2 reached a peak of 162°C eight hours after start. This is the consequence of the activity of the material.

In test 1, absorption had virtually ceased when the run was concluded after 45 hours. It is seen that at 28-1/2 hours absorption still took place in test 2, 35% of the incoming CO<sub>2</sub> being absorbed. At this point only 90% of CO<sub>2</sub> had been passed through the unit with respect to the total capacity of the bed, 66.8% of the incoming CO<sub>2</sub> being retained. This test was performed at 60% relative humidity at 1 atmosphere. The mole ratio H<sub>2</sub>O/CO<sub>2</sub> was .76, rather low. If this test would have been performed with 60% relative humidity at 5 psia, the mole ratio would have been above 2. A third test was therefore initiated where 100% relative humidity at atmospheric pressure was applied. The mole ratio was slightly above unity in this case.

The effect of the increased mole ratio is noticeable in the temperature profile and CO<sub>2</sub> absorption recording shown in Figure 36. 2-1/2 hours after start the temperature reaches a peak value of 170°C at the thermocouple site 4, right where the gases enter the bed.

In this experiment, the whole bed acquired an almost uniform temperature throughout the run. Most noteworthy is the fact that at the end of the test of 30 hours duration the unit was still absorbing 70% of the incoming CO<sub>2</sub>. At this point only 75% of the absorption capacity had been exhausted, however, 93% of the theoretically required CO<sub>2</sub> had been passed through.

These tests actually differ quite appreciably from the functioning in the space capsule in two respects:

a. The motor-blower in a test in the space capsule will pass 2 to 3 times the amount of gas through the unit.

b. The mole ratio H<sub>2</sub>O/CO<sub>2</sub> at 50% R.H. at 5 psia will be 3.1 at 25°C, a very much higher value than the one obtainable in bench tests at 1 atmosphere.

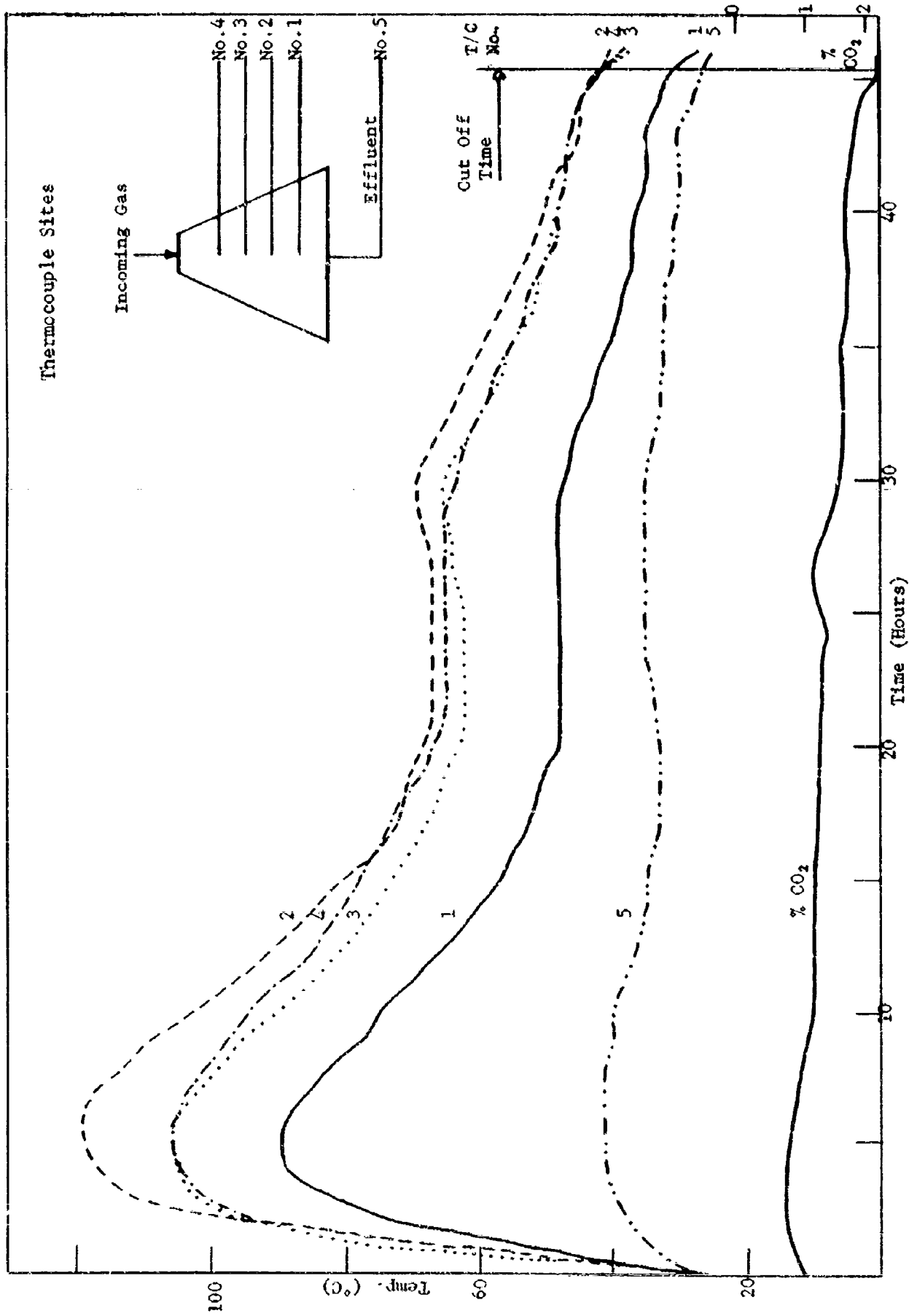

Figure 34 Profiles of Temperature and % CO<sub>2</sub> in Effluent in Test No. 1 of Prototype

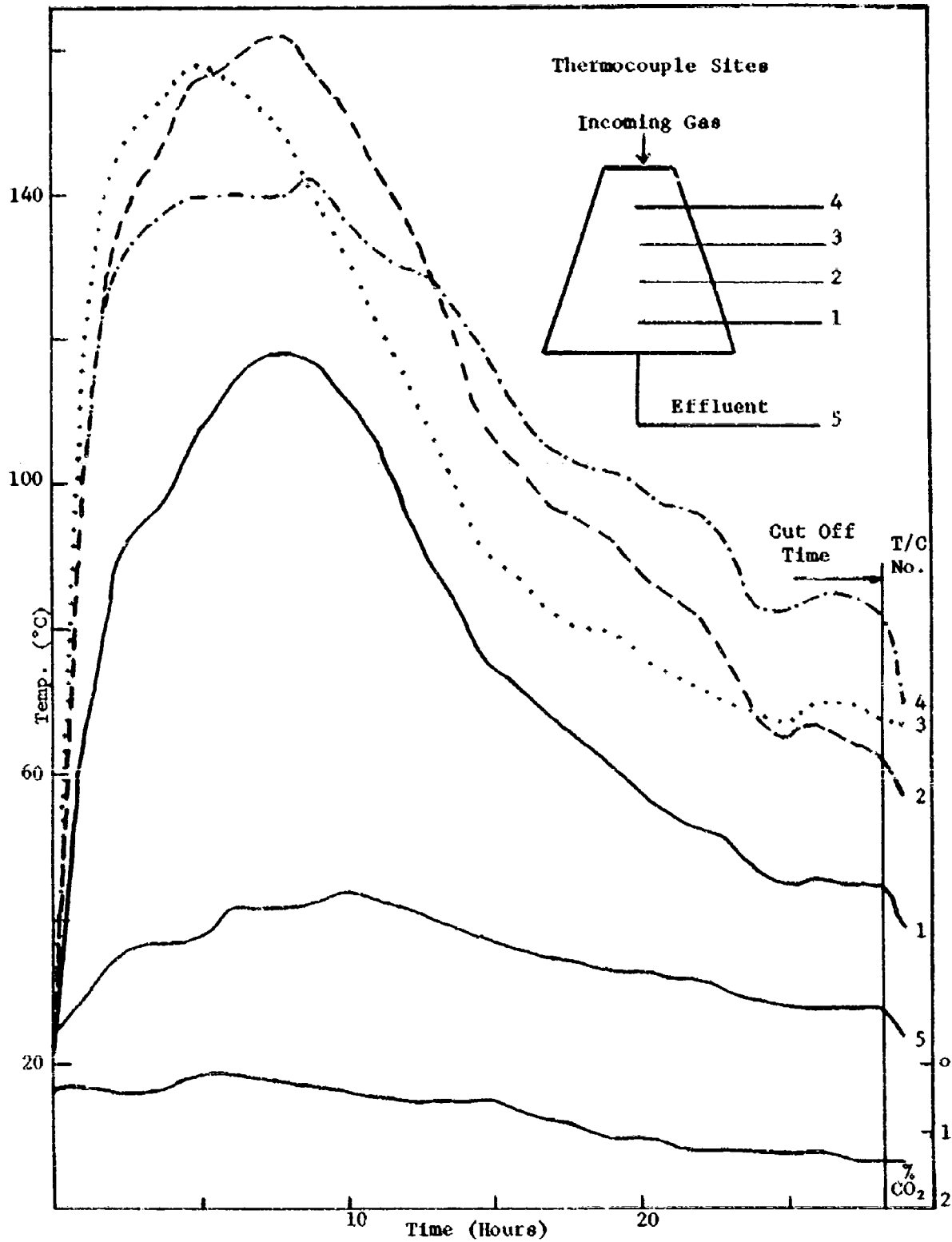

Figure 35 Profiles of Temperature and % CO<sub>2</sub> in Effluent in Test No. 2 of Prototype

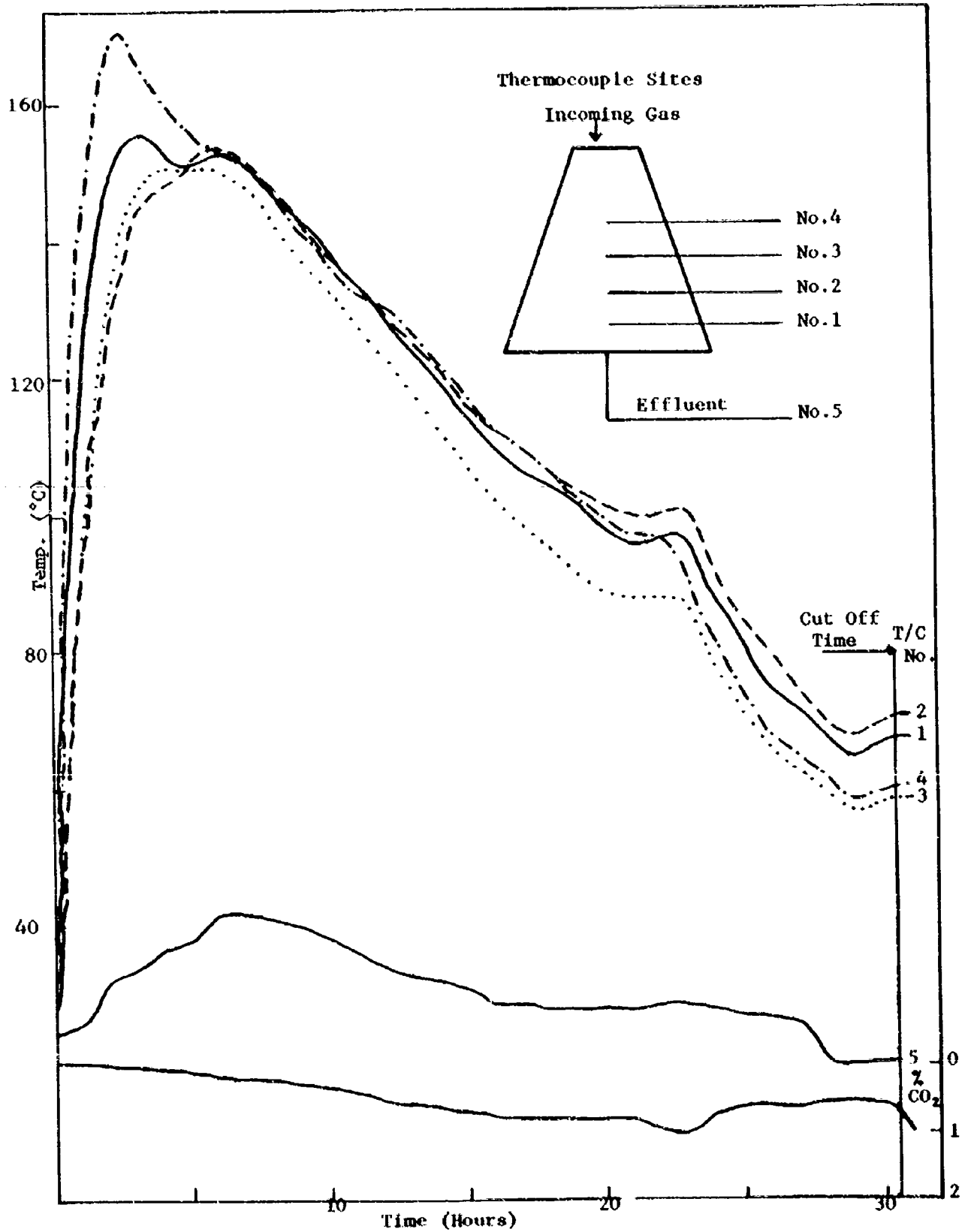

Figure 36 Profiles of Temperature and % CO<sub>2</sub> in Effluent in Test No. 3 of Prototype



Both conditions will, according to our small scale test results, increase the efficiency of the  $\text{Li}_2\text{O}$  bed considerably. It can be predicted that conversions will be close to theoretical. The unit should be able to maintain the atmosphere at the prescribed level up to 30 hours with a charge of 2-1/4 pounds of 93% lithium oxide.

In spite of the very high bed temperatures of up to  $170^\circ\text{C}$ , the effluent gases never reached temperatures above  $44^\circ\text{C}$  ( $111^\circ\text{F}$ ). The average is around  $35^\circ\text{C}$  in test No. 2 and  $33^\circ\text{C}$  in test No. 3. These are temperatures well within the tolerance of a human being, giving only slight discomfort.

In sampling the spent charges, it was discovered that the charge was not homogeneously converted. In test No. 1, seven samples were taken from different sites and showed the following results:

<u>Sample No.</u>	<u>% <math>\text{Li}_2\text{CO}_3</math></u>	<u>% <math>\text{Li}_2\text{O}</math></u>
1	62.7	30.4
2	45.6	41.7
3	43.3	43.7
4	58.0	31.3
5	51.5	36.9
6	70.1	21.9
7	59.0	30.7

In this case, the average of the results was adopted as final values.

For tests 2 and 3, the whole charge was considered a sample and according to accepted analytical practices the analysis of the final reduced sample was accepted as the average.

Prior to sampling, individual samples were taken from different sites and it was observed that considerable caking had taken place in most parts of the bed, but that in many parts, loose particles of the original material were still in existence.

For test No. 2:

<u>Local Sample No.</u>	<u>% <math>\text{Li}_2\text{CO}_3</math></u>	<u>% <math>\text{Li}_2\text{O}</math></u>
1	68.4	20.3
2	93.2	4.0
3	87.6	6.8
4	10.7	86.6

The average analysis, taken from a truly representative sample, is given in Table XVIII.

It is seen that almost completely spent material coexists with virtually unused lithium oxide. All three individual samples taken from test run No. 3 were completely carbonated, while appreciable pockets of oxide rich material still existed, as is shown by the analysis of a representative sample given in Table XVIII.

This bears evidence to defects which were not anticipated:  
Channelling and caking.

Not enough tests could be performed on the final equipment to pin down the causes of these defects. Caking might be a consequence of the relatively high temperatures of the bed during the absorption of  $\text{CO}_2$ . Caking, in turn, might be the cause of some channelling. However, it is clearly seen that in test 3, absorption continues very actively in spite of some caking-channelling, even when the bed was exhausted to about 70% overall.

## SECTION V

### CONCLUSIONS

Lithium oxide was obtained in granular form which showed great avidity to absorb  $\text{CO}_2$  from air when water vapor was present.

The synthesis of this granular form of oxide started with commercial lithium peroxide, which was converted to lithium peroxide peroxyhydrate hydrate. This latter product was reconverted to peroxide by removing water and hydrogen peroxide through a vacuum drying process. The active surface of the reconverted peroxide had increased from values below  $1 \text{ m}^2/\text{g}$  to about  $7 \text{ m}^2/\text{g}$ .

This peroxide was then thermally decomposed to oxide by a carefully controlled furnacing operation. If done at  $360^\circ\text{C} \pm 5^\circ\text{C}$  a highly active, slightly sintered oxide is obtained which can be broken up into a suitable size fraction. This oxide has an active surface area of  $10 \text{ m}^2/\text{g}$  or better, and the individual granule has structural strength.

The material was tested under different conditions of pressure, flow, moisture and temperature. In addition, the influence of size of the granules was investigated.

The results show clearly that retention of  $\text{CO}_2$  can be as high as 90% and that conversion of  $\text{Li}_2\text{O}$  to  $\text{Li}_2\text{CO}_3$  can go almost to completion. The pressure drop through the bed is very small and was therefore not considered as a variable parameter.

Most tests were performed with oxygen at atmospheric pressure, containing 2%  $\text{CO}_2$  by volume. While this is not the actual spacecraft environment, it is sufficiently close to allow valid conclusions.

For tests at atmospheric pressure, the following conclusions can be drawn:

Flow rate of the incoming gases influences the rate of absorption moderately. Very good conversions have been obtained at up to linear flow rates of  $12 \text{ cm}/\text{sec}$ .

The mesh size of the granules is of little consequence within the range of 4 to 20 mesh.

The influence of temperature of the incoming gases by itself is not of great consequence. Generally, it is seen that higher temperatures will increase the conversion of oxide to carbonate.

If the relative humidity is held constant, for instance at 50%, the amount of water vapor present in the gases varies greatly with temperature. It is this variation which influences the conversion powerfully. The mole

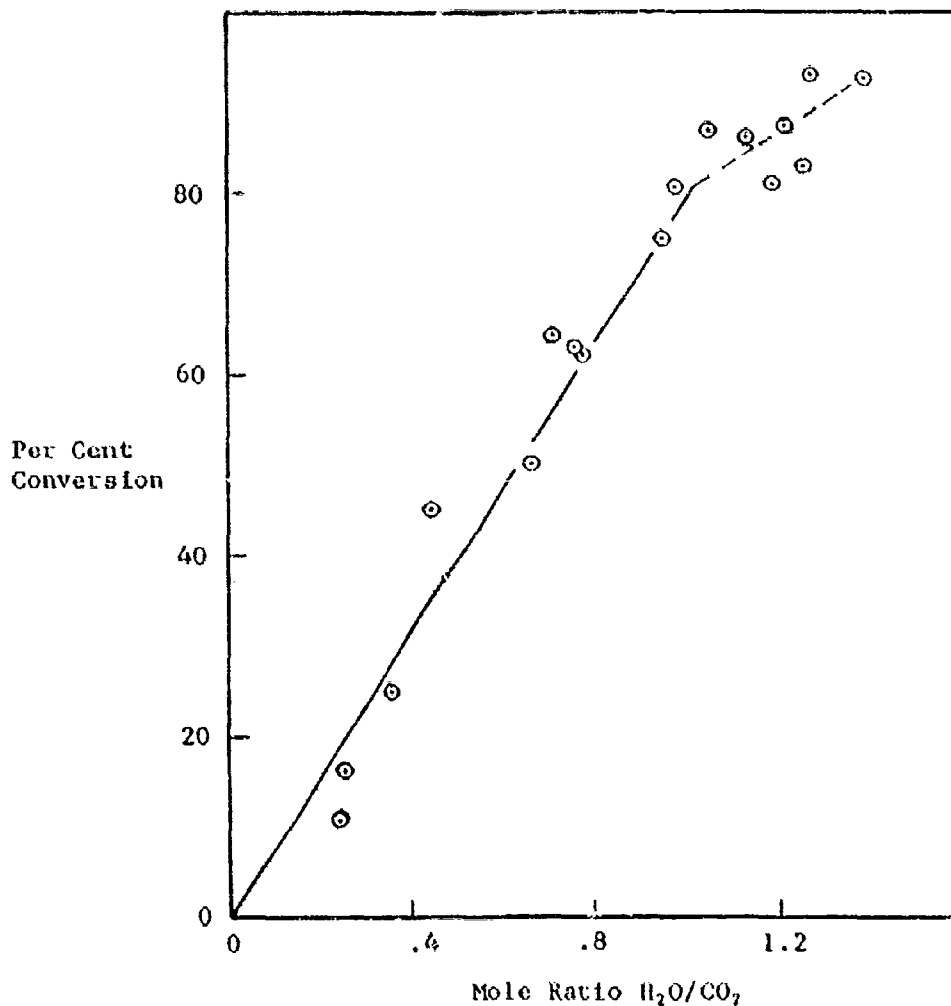

Figure 37 Percentage Conversion Vs. Mole Ratio,  
 $H_2O/CO_2$   
 High Active Surface  
 High Flow Rate

ratio of water vapor over carbon dioxide is related clearly to the per cent conversion. This is shown in Figure 37 for highly active oxides and linear flow rates from 5 to 10 cm/sec. The temperature of the gases varied as widely as from 5°C to 50°C (40°F to 120°F). In order to obtain reasonably good conversions, the mole ratio should be at least unity. This is an expression of the hypothesis that  $CO_2$  absorption is achieved only by  $LiOH$  and not directly by  $Li_2O$ . Another possibility is that while  $LiOH$  might not necessarily be formed, the absorption can only take place by a three-way collision of water vapor, carbon dioxide and lithium oxide.

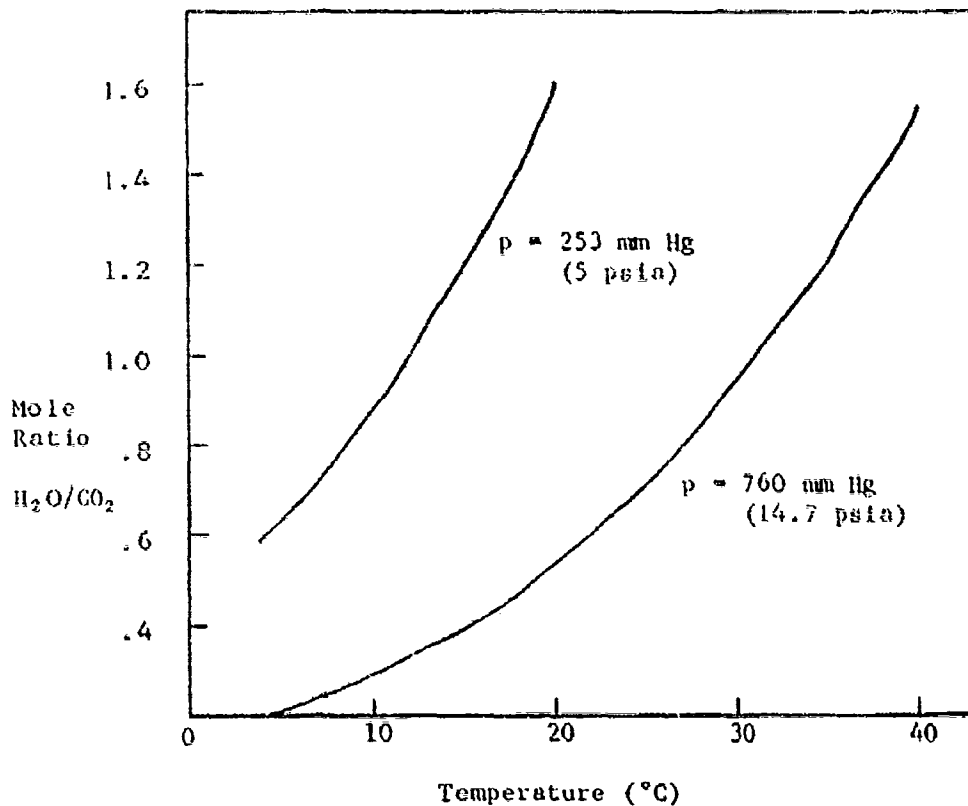

Figure 38 Mole Ratio, H<sub>2</sub>O/CO<sub>2</sub> Vs. Temperature  
2% CO<sub>2</sub> Test Gas  
50% Relative Humidity

A curve is extrapolated through the origin, as seen in Figure 37. This means that in the absence of water vapor, carbon dioxide is not absorbed by Li<sub>2</sub>O.

In Figure 38, the temperature is plotted versus the mole ratio and it is seen that with a 2% CO<sub>2</sub> test gas at 50% relative humidity, unity of the molar ratios is reached at 31°C for atmospheric condition and at 12°C for a 5 psia atmosphere. Below these temperatures, incomplete conversion can be expected.

A rule of thumb was derived from actual performance results:

$$(32) \quad \% \text{ Conversion} = \frac{\% \text{ Relative Humidity} \times ^\circ\text{C}}{20}$$

Applying this rule, the actual conversion is located within a range of  $\pm 5\%$ .

The influence of active surface area is extremely important. At the beginning of our research effort many oxides were tested which had values from 3 to 8 m<sup>2</sup>/gram. While a general rule can be established that the activity increases with increasing surface areas, it cannot be formulated quantitatively with the present data. A quite general statement can be made: good conversions (80%+) can be achieved only with material having an active surface higher than 9 m<sup>2</sup>/gram. This, of course, is conditioned in turn by the parameters discussed above, such as flow rate, pressure, humidity and temperature.

A number of tests under 5 psia of oxygen with approximately 0.1 psia of CO<sub>2</sub> showed in general, that the conclusions drawn from experimental tests at atmospheric pressure are valid. The fact that higher mole ratios of water over carbon dioxide corresponds to the 50% relative humidity condition, will promote excellent conversion. A material having an active surface of 11.2 m<sup>2</sup>/g. gave conversions of about 85% at 38% relative humidity and 15°C. Retention of CO<sub>2</sub> was complete (bottom layer of test 43).

The tests performed on the prototype of the final unit did not deviate essentially from tests made on smaller quantities of Li<sub>2</sub>O. The tests were run with the minimal amount of CO<sub>2</sub> at 2% concentration passed through the bed in 28 to 30 hours. The mole ratios were rather low, just about unity, in test No. 3. At the conclusion of this test, absorption was still very active. Conversion was over 70%. The capacity of the blower-motor is 8 CFM; therefore, under actual conditions 2.7 times the amount of CO<sub>2</sub> will be passed through the bed. Almost complete absorption is to be expected, i.e., the bed will be almost exhausted at the end of the run.

Undoubtedly this will have the effect of altering the atmospheric content of CO<sub>2</sub>: At the beginning it will decrease, as the unit will absorb faster, then the respiratory metabolism will furnish CO<sub>2</sub> into the spacecraft's internal atmosphere. As the absorption becomes slower than the metabolic output of CO<sub>2</sub>, the concentration will rise, to attain the value of 0.0735 psia at the end of a 24-hour cycle. In a large spacecraft, this oscillation will hardly be noticeable but in a very restricted space, it could be quite pronounced. When several persons are located in a spacecraft, multiple units can be allowed to perform in suitably spaced intervals. This will tend to even out the CO<sub>2</sub> concentration oscillations.

It was intended to introduce a satisfactory safety margin into the regeneration unit. The theoretical capacity of Li<sub>2</sub>O (100%) would be 1.63 lb. for one man-day. Our product contains usually 95% Li<sub>2</sub>O, requiring 1.72 lb. for the purpose. We decided finally to create enough space to house 2-1/4 pounds of oxide, thus having the possibility to load 130% of the oxide required. The units were delivered fully loaded. It is expected that the useful work time is 30 hours per unit (97% conversion). Actually, it is sufficient for the unit to work at a 78% conversion level to meet the specification stipulated in the contract.

The total unit will weigh 4-1/2 pounds, half of which consists in active charge. The unit is designed in such a way that it can be recharged with a minimum of inconvenience. Additional charges can be carried aboard, weighing from 1-3/4 to 2-1/4 pounds.

The volume of the total unit is about .53 CF, its specific weight, therefore, 8-1/2 pounds/CF or 1.36 g/cc.

The conditions of weightlessness, vibration and acceleration were considered in the design.

The filters applied to the housing allow operation for at least 100 hours without change. Irritating lithium oxide dust cannot permeate into the breathing atmosphere. Both filters can easily be exchanged, if the unit should be required to operate continuously.

The life time of a motor is estimated to be 2500 hours or 104 days. Thus, a man could live in a spacecraft for one year carrying aboard 3 spare motors, 700 pounds of lithium oxide (86 CF) and two or three spare filters.

A certain amount of caking and channelling was observed in the bed of the regeneration unit. It did not affect the efficiency to a degree which would have made necessary a change in design. It must be stated however, that these phenomena should be studied more in detail before a final design is accepted for use in the actual spacecraft. It could be visualized that the "megaphone shaped" filter unit has to be modified.

While the semistatic or static-dynamic concept of air regeneration has been successful in the past as well as in the present research, the recognition of the principal validity of the concept of purely static regeneration made it expedient to explore the possibility of the use of  $\text{Li}_2\text{O}$  as a static absorbent. A rigid form of good structural properties would be required. When it was observed that some of the batches of  $\text{Li}_2\text{O}$  obtained were slightly fritted, it could be visualized that such a form could be made.

An actual test on a piece of this fritted or sintered material revealed that the gas stream could be forced through it with not too great a pressure drop. Conversion was complete and did not alter the permeability substantially. Several attempts to produce larger pieces met with failure. It was found that the rate of heating and the final temperature depend on the size and configuration of the solid frit.

It is undoubtedly possible to obtain such a material with appropriate design of a special furnace. This could be achieved by determining the variables of rate and temperature. Shapes like a cylindrical tube with the gas inlet through the inner tube and radial permeation through the walls are possible. A simpler design might be plates, either plain or with a corrugated surface. These plates could be placed in a special

holder or could be fastened on the walls of the cabin. Indicating dyestuffs could reveal the degree of conversion when placed within the mass.



## REFERENCES

- (1) Aguzzi, A., "The Dehydration of  $\text{Li}_2\text{O}_2 \cdot \text{H}_2\text{O}_2 \cdot 3\text{H}_2\text{O}$ ", Gazz. chim. ital., 68, 816 (1938).
- (2) Allen, J. P., Carbon Dioxide Management, Part I: Technique for Carbon Dioxide Evaluation, Report FDL TDR 64-67, Part I, AF Flight Dynamics Laboratory, Wright-Patterson Air Force Base, Ohio, June, 1964. (AD 605 287)
- (3) Bach, R. O., "Preparation of Lithium Peroxide", U. S. Patent 3,134,646, Patented May 26, 1964.
- (4) Bach, R. O., and W. W. Boardman, Jr., "Process for Producing Anhydrous Lithium Peroxide by the Use of a Substantially Water-Immiscible Organic Liquid", U. S. Patent 3,147,075, Patented September 1, 1964.
- (5) Bach, R. O., and W. W. Boardman, Jr., "Preparation of Anhydrous Lithium Peroxide", U. S. Patent Application Serial No. 231,865, Filed October 19, 1962.
- (6) Bach, R. O., and I. M. Paige, The Solubility of Lithium Peroxide, Unpublished Research Report, Lithium Corporation of America, Inc., Bessemer City, N. C., 1962.
- (7) Berkowitz - Mattuck, J. B. and A. Buchler, "A Transpiration Study of Lithium Hydroxide", J. Phys. Chem., 67, 1386 (1963).
- (8) Bird, R. B., W. E. Stewart, and E. N. Lightfoot, Notes on Transport Phenomena, John Wiley and Sons, Inc., 1958.
- (9) Blumenthal, M., "Thermal Dissociation of Some Oxides and Peroxides. III. Dissociation of Lithium and Potassium Peroxides", Rodzinski Chem., 12, 110 (1922).
- (10) Bravo, J., "Lithium Hydroxide and Lithium Oxide", in Inorganic Syntheses, Volume VII, J. Kleinberg, editor, McGraw-Hill Book Co., New York, 1963.
- (11) Brewer, L., and J. Margrave, "The Vapor Pressures of Lithium and Sodium Oxides", J. Phys. Chem. 59, 421 (1955).
- (12) Brunauer, S., P. H. Emmett and E. Teller, "Adsorption of Gases in Multimolecular Layers", J. Am. Chem. Soc. 60, 309 (1938).
- (13) Cohen, A. J., "Lithium Hydroperoxide 1-Hydrate", in Inorganic Syntheses, Volume V, T. Moeller, editor, McGraw-Hill Book Co., New York, 1957.

- (14) Dryden, C. E., L. S. Han, E. A. Hitchcock, and R. Zimmerman, Artificial Cabin Atmosphere Systems for High Altitude Aircraft, WADC Technical Report 55-353, Wright Air Development Center, Wright-Patterson Air Force Base, Ohio, November, 1956. (AD 110 490)
- (15) Glassner, A., The Thermochemical Properties of the Oxides, Fluorides, and Chlorides to 2500°K, Report ANL-5107, Argonne National Laboratory, U. S. Atomic Energy Commission, Chicago, Illinois, 1957.
- (16) Keating, D. A., Baralyme and Molecular Sieve Passive Air Regeneration Studies for Manned Sealed Environments, Technical Documentary Report No. MKL-TDR-62-59, Life Support Laboratory, Wright-Patterson Air Force Base, Ohio, May, 1962. (AD 283 845)
- (17) Keating, D. A., Design Parameters for the Engineering of Closed Respiratory Systems, WADC Technical Report 59-766, Wright Air Development Center, Wright-Patterson Air Force Base, Ohio, December, 1959. (AD 241 675)
- (18) Keating, D. A., and R. S. Roundy, Closed Ecology, WADD Technical Report 61-129, Wright Air Development Division, Wright-Patterson Air Force Base, Ohio, March, 1961. (AD 255 976)
- (19) Keating, D. A., K. Weiswurm, and G. W. Filson, "Movement of Respired Gas in Manned Space Enclosures", presented at the meeting of the Aerospace Medical Association, Miami, Florida, May, 1964.
- (20) Kolthoff, I. M., and R. Belcher, Titration Methods, Volume III, Interscience Publishers, Inc., New York, 1957.
- (21) Lewis, G. N., Valence and the Structure of Atoms and Molecules, Reinhold Publishing Corp., New York, 1923.
- (22) Lithium Corporation of America, Inc., Lithium Hydroxide, Data Sheet No. 101A-1261.
- (23) McBride, B. J., S. Heilmel, J. G. Ehlers and S. Gordon, Thermodynamic Properties to 6000°K for 210 Substances Involving the First 18 Elements, No. NASA SP-3001, Lewis Research Center, National Aeronautics and Space Administration, Cleveland, Ohio, 1963.
- (24) Makarov, S. Z., and T. A. Dobrynina, "Systems Containing Hydrogen Peroxide at High Concentration, Communication 11. Characterization of the Solid Phases of the System  $\text{LiOH-H}_2\text{O}_2\text{-H}_2\text{O}$  by Thermal Analysis", Bull. Acad. Sci., U.S.S.R., Div. of Chem. Sci., (Engl. Tr.) 283 (1956).

- (25) Markowitz, M. M., and E. W. Desmelyk, A Study of the Application of Lithium Chemicals to Air Regeneration Techniques in Manned, Sealed Environments, Technical Documentary Report AMRL-TDR-64-1, Aerospace Medical Research Laboratories, Wright-Patterson Air Force Base, Ohio, February, 1964. (AD 435 815)
- (26) Marshall, S., et al, Closed Circuit Respiration/Ventilation System. Phase I, WADD Technical Report 60-33, Wright Air Development Division, Wright-Patterson Air Force Base, Ohio, January, 1960. (AD 236 045)
- (27) Nelson, F. M., and F. T. Eggertsen, "Determination of Surface Area Adsorption Measurements by a Continuous Flow Method", Anal. Chem. **30**, 1387 (1958).
- (28) Notz, K. J., and R. O. Bach, "Concerning a Purported Polymorph of Lithium Peroxide", Chimia **17**, 158 (1963).
- (29) Pierron, P., "Contribution to the Study of the Preparation of the Peroxide and Oxide of Lithium", Bull. soc. chim. France (5), **6**, 235 (1939).
- (30) Rode, T. V., T. A. Dobrynina, and G. A. Golder, "Physicochemical Study of Lithium Peroxide", Bull. Acad. Sci. U.S.S.R., Div. Chem. Sci. (Engl. Tr.), (4) 545 (1955).
- (31) Stephanou, S. E., and J. Kleinberg, "Lithium Peroxide and Lithium Oxide", in Inorganic Syntheses, Volume V, T. Moeller, editor, McGraw-Hill Book Co., New York, 1957.
- (32) Strater, H. H., "Method of Making Lithium Peroxide in Methanol", U. S. Patent No. 2,962,358, November 29, 1960.
- (33) Valikh, A. I., "A Method for the Preparation of Lithium Oxide", U.S.S.R. Patent No. 146,730, April 23, 1962.
- (34) Walker, R. J., Carbon Dioxide Absorbents, File No. C-SS, Anacostia Station, U. S. Naval Research Laboratory, Washington, D. C., May 5, 1941.
- (35) Winternitz, P. F., "Preparation of Anhydrous Lithium Peroxide", U. S. Patent 2,488,485, November 15, 1949.
- (36) Zintl, E., A. Harder, and B. Danth, Z. Electrochem. **40**, 588 (1934).