



MASTERFLEX® L/S® 07528-10

OPERATING MANUAL:

## L/S® DIGITAL PUMP DRIVES

Model Nos.

**07522-20**

**07522-30**

**07551-20**

**07551-30**

**07575-30**

**07575-40**

© 2019 Cole-Parmer Instrument Company. All rights reserved.

**Masterflex** – Reg TM Cole-Parmer Instrument Company.

Trademarks bearing the ® symbol in this publication are registered in the U.S. and in other countries.

# **PUMP FOR LIQUIDS ORIGINAL INSTRUCTIONS**

## SAFETY PRECAUTIONS



**DANGER:** High voltages exist and are accessible. Use extreme caution when servicing internal components.



**WARNINGS:** Tubing breakage may result in fluid being sprayed from pump. Use appropriate measures to protect operator and equipment.

Turn drive off before removing or installing tubing. Fingers or loose clothing could get caught in drive mechanism.



**WARNINGS:** Do not operate the pump drive in a manner not specified in the documentation. Misuse of the pump drive may result in a hazard and may compromise the safety protection built into the pump drive. If the pump drive is damaged, turn it off and not use it until service-trained personnel can check its safety.

**Single-Phase Only. Not to be used with Split-Phase lines.**

The Power switch on the Back Panel is not the main disconnect. Main disconnect is accomplished by disconnecting the detachable power supply cord at the appliance coupler or at the main plug. Ensure the power cord is easily accessible and removable, in the event of an emergency, which requires immediate disconnection.

The operator should check the detachable power supply cord condition. The equipment should not be operated if the power supply cord is cracked or broken. Any obvious damage to the enclosure (from a drop or fall) should be checked by service personnel for loose or damaged parts inside.



**CAUTIONS:** Power must be turned off before connecting the external remote control cable to prevent damage to the drive.

Do not contaminate the lubricant in the container, on the shaft or on the seal with foreign material.

Failure to observe this precaution may result in damage to the seal and premature failure of the seal.

No foreign matter should be allowed under the gasket on the back of the front plate or under the heads of the screws.

Failure to observe this precaution may result in leakage during wash-down of the drive

Do not block the rear panel of the pump drive. The power switch must always be easy to access. The power cord must always be easy to disconnect.

Replace the power cord only with one of the same type and rating. The minimum power ratings are stated on the rear panel.

The power cord set supplied with your pump drive meets the requirements of the country where you purchased the pump drive. If you use the pump drive in another country, you must use a power cord set that meets the requirements of that country.

When using hazardous chemical and biological agents, take all suitable protective measures, such as wearing protective glasses and gloves resistant to the substances used. Follow local and/or national regulations for safe operation and maintenance of the system.

## **SAFETY PRECAUTIONS (continued)**

### **Explanation of Symbols**

### **WARNING: Product Use Limitation**



**CAUTION:** To avoid electrical shock, the power cord protective grounding conductor must be connected to ground. Not for operation in wet locations as defined by EN61010-1.



**CAUTIONS:** Keep fingers away from rotor while pump is in operation. Stop pump before loading or unloading tubing.

To reduce the possibility of tipping, use the stacking clip provided with the unit.



**CAUTION:** Risk of Danger. Consult Operator's manual for nature of hazard and corrective actions.



**CAUTION:** Risk of crushing. Keep fingers away from rotor while pump is in operation. Stop pump before loading or unloading tubing.



**CAUTION:** Hot Surface. Do not touch.



**CAUTION:** Risk of electric shock. Consult Operator's manual for nature of hazard and corrective actions.



This product is not designed for, nor intended for use in patient connected applications; including, but not limited to, medical and dental use, and accordingly has not been submitted for FDA approval.

This product is not designed for, nor intended for use in hazardous duty areas as defined by ATEX or the NEC (National Electrical Code); including, but not limited to use with flammable liquids. Consult the factory for products suitable for these types of applications

# Table of Contents

	<b>Page</b>
<b>Section 1 INTRODUCTION</b> .....	<b>1-1</b>
Application Solutions .....	1-1
General Description .....	1-2
<b>Section 2 INSTALLATION AND SETUP</b> .....	<b>2-1</b>
Before Starting the Drive .....	2-1
Mounting the Pump Head .....	2-2
<b>Section 3 OPERATION</b> .....	<b>3-1</b>
Turning On the Drive .....	3-1
Control Panel .....	3-2
Priming the Pump .....	3-2
Main Menu .....	3-3
Tubing Calibration .....	3-4
Setup Menu .....	3-6
Continuous Mode Screen .....	3-7
Continuous Mode Operation .....	3-8
Time Dispense Mode Screen .....	3-9
Time Dispense Mode Operation .....	3-10
Copy Dispense Mode Screen .....	3-12
Copy Dispense Mode Operation .....	3-13
COPY Setting Screen .....	3-15
COPY Setting Operation .....	3-16
Volume Dispense Mode Screen .....	3-17
Volume Dispense Mode Operation .....	3-18
Remote Control Menu .....	3-20
DB-25 Pin Configuration with Wiring Scheme .....	3-23
31-Pin Configuration with Wiring Scheme .....	3-24
Remote Control Inputs and Outputs .....	3-25
Open Collector Outputs .....	3-26
Anti-Drip Function .....	3-27
Serial Communication Specification .....	3-28
Linkable Instrument Network .....	3-28
Drives .....	3-28
USB .....	3-28

# Table of Contents (continued)

	<b>Page</b>
<b>Section 3 (continued)</b>	
Serial Connections .....	3-29
Serial Data Format .....	3-30
Serial Protocol .....	3-30
Start-Up Sequence .....	3-30
Remote/Local Operation .....	3-31
Command Format .....	3-32
Control Computer Parameter Fields .....	3-33
Pump Drive Status Request .....	3-33
Satellite Response .....	3-34
Error Handling .....	3-34
Satellite Request to Send .....	3-35
Front Panel Switches .....	3-38
ASCII Control Codes Used .....	3-38
<b>Section 4 MAINTENANCE .....</b>	<b>4-1</b>
Replacement Parts and Accessories .....	4-1
Fuse Replacement .....	4-2
Gear Replacement .....	4-3
Shaft Seal Inspection (Stainless Steel and Powder Coated Steel Enclosures Only) .....	4-3
Cleaning .....	4-4
<b>Section 5 TROUBLESHOOTING .....</b>	<b>5-1</b>
Troubleshooting Chart .....	5-1
Error Definitions .....	5-2
<b>Section 6 ACCESSORIES .....</b>	<b>6-1</b>
<b>Section 7 SPECIFICATIONS .....</b>	<b>7-1</b>
<b>Section 8 WARRANTY, PRODUCT RETURN, and TECHNICAL ASSISTANCE ...</b>	<b>8-1</b>
Warranty .....	8-1
Product Return .....	8-2
Technical Assistance .....	8-2

# Figures

	<b>Page</b>
Control Panel .....	3-2
Continuous Mode Screen .....	3-7
Continuous Mode Operation .....	3-8
Time Dispense Mode Screen .....	3-9
Time Dispense Mode Operation .....	3-10
Copy Dispense Mode Screen .....	3-12
Copy Dispense Mode Operation .....	3-13
COPY Setting Screen .....	3-15
COPY Setting Operation .....	3-16
Volume Dispense Mode Screen .....	3-17
Volume Dispense Mode Operation .....	3-18
Remote Control Menu Screen .....	3-20
DB-25 Pin Configuration with Wiring Scheme .....	3-23
31-Pin Configuration with Wiring Scheme .....	3-24
Terminating Open Collector Outputs to a PLC .....	3-26
Anti-Drip Screen .....	3-27
Anti-Drip Degrees Screen .....	3-27
Serial Daisy-Chain Connection .....	3-29
Command Format .....	3-32
Parameter Fields .....	3-33
Fuse Replacement .....	4-2
Motor .....	4-3
Shaft Seal Inspection .....	4-3





# Tables

	<b>Page</b>
Continuous Mode Operation .....	3-22
Dispense Mode Operation .....	3-22
Remote Control Inputs and Outputs .....	3-25
Pump Satellite Commands .....	3-36
Sample Pump Commands and Responses .....	3-37
K command key codes for pump drives .....	3-38
ASCII control codes used .....	3-38



## Section 1 Introduction

The Digital drive controls the speed of MASTERFLEX® Pump Heads to provide flow rates from 0.001 to 3400 mL/min.

Mount up to 2 (600 rpm) or 4 (100 rpm) MASTERFLEX Pump Heads and all MASTERFLEX-compatible Pump Heads.

### Application Solutions

#### Advantages of Peristaltic Pumps:

- Handle abrasive slurries and corrosive fluids with minimal wear. Ideal for titanium dioxide or diatomaceous earth filter aid applications.
- No seals in contact with the medium pumped.
- No valves to clog.
- Inner surfaces are smooth and easy to clean.
- Fluid contacts only the tubing or tube material.
- Suction lift and priming up to 8m water column at sea level.
- Low shearing for handling the most shear sensitive of fluids like latex or fire fighting foam.
- Capable of running dry and pumping fluids with high quantities of entrained air, such as black liquor soap.
- High volumetric efficiency allows operation in metering or dosing applications where high accuracy is required.
- Handle extremely viscous fluids.
- Tubing and tube materials are available that are suitable for food and pharmaceutical use.

## General Description

The MASTERFLEX L/S Digital Peristaltic Pump Drive offers flow rate capacities from 0.001 mL/min to 3400 mL/min using MASTERFLEX Standard, EASY-LOAD® or High-Performance Pump Heads. Even lower flow rates can be achieved with our multichannel and cartridge Pump Heads. Features include a small footprint, plus non-stainless steel drives that are stackable.

The MASTERFLEX digital pump provides a motor speed repeatability of 0.1 percent to maximize productivity in precision liquid dosing, batch dispensing and filling applications. A turndown ratio up to 6000-to-1, bidirectional flow and self-priming capabilities allow for smooth, seamless operation and an extremely broad flow range within one tubing size.

In addition to high accuracy, precision, repeatability and resolution of speed (or flow rate), the MASTERFLEX drive features a multi-language, intuitive, man/machine interface with a four-line graphical LCD display providing direct readout of pump speed (rpm), flow rate (user-selected units), number of dispenses, and menu options.

The easy-to-use keypad eliminates setpoint overshoot and provides easy navigation through menu options that include a number of on-screen programming features.

These drives use high precision, no-maintenance brushless motors for improved reliability. This, combined with its high turndown, superior accuracy, and intuitive interface make the MASTERFLEX drives ideally suited where ultra-precise, repeatable flow control is required. The pump accommodates a variety of product fill volumes and batch dispensing profiles, and fluid only contacts the tubing, providing for contamination-free pumping.

MASTERFLEX pumps are self-priming, can operate dry without damage, are suitable for most chemicals and contain no valves or seals. See *Pump Head* and *Tubing Guides* within this flash drive or on the web.

## Section 2 Installation and Setup

### Before Starting Drive

- The drive should be mounted on a flat horizontal surface, and no more than two (2) Pump Heads should be added for 600 rpm drives or four (4) Pump Heads for 100 rpm drives.
- The ambient air temperature should not exceed 104° F (40° C) and adequate air flow should be provided for.



**CAUTION: Do not block the rear panel of the pump drive. The power switch must always be easy to access. The power cord must always be easy to disconnect.**

- Tubing should be clean and routed so that bend radii are at a minimum four (4) times the tube diameter and as short as possible.



**WARNING: Turn drive off before removing or installing tubing. Fingers or loose clothing could get caught in drive mechanism.**

- Use a tube size of appropriate diameter for the flow rate and viscosity required.
- To maintain the best accuracy of flow rates, re-calibrate tubing regularly. See *Tubing Calibration Section* of this manual.
- For tubing selection and compatibility, see *Tubing Selection Guide* within this flash drive or on the web.
- For Pump Head information, see *Pump Head* datasheets within this flash drive or on the flash drive or on the web.
- When cleaning or performing maintenance, please remove power from the drive.



**CAUTION: The power cord set supplied with your pump drive meets the requirements of the country where you purchased the pump drive. If you use the pump drive in another country, you must use a power cord set that meets the requirements of that country.**



**DANGER: High voltages exist and are accessible. Use extreme caution when servicing internal components.**

## **Mounting the Pump Head**

- Mount Pump Head and load tubing (See *Pump Head* datasheets within this flash drive or on the web). Check to ensure that rollers are clean and free of defects.



***CAUTION: When using hazardous chemical and biological agents, take all suitable protective measures, such as wearing protective glasses and gloves resistant to the substances used. Follow local and/or national regulations for safe operation and maintenance of the system.***

## Section 3 Operation

### Turning On the Drive



**WARNING:** Do not operate the pump drive in a manner not specified in the documentation. Misuse of the pump drive may result in a hazard and may compromise the safety protection built into the pump drive. If the pump drive is damaged, turn it off and not use it until service-trained personnel can check its safety.

1. Plug the power cord into the IEC Connector, located on the rear of the drive. Plug the opposite end of the power cord into an electrical outlet.
2. Flip the power switch located on the rear of the drive.
3. Upon turning on the drive for the first time you will be prompted to select a language. The selected language will be set as the default but can be changed at any time by selecting “LANGUAGE” on the main menu.
4. After selecting your language, the Main Menu will now appear on the LCD screen. (**NOTE:** Each start-up after the initial will revert to the mode of operation screen previously in use.)
5. If the language is accidentally changed and the user would like to reset it to the default language (English), press and hold the UP/DOWN (▲/▼) keys during power up.
6. To restore drive to default settings, press and hold the LEFT/RIGHT (◀/▶) keys during power up.



**CAUTION:** To avoid electrical shock, the power cord protective grounding conductor must be connected to ground. Not for operation in wet locations as defined by EN61010-1.



**CAUTION:** Power must be turned off before connecting the external remote control cable to prevent damage to the drive.





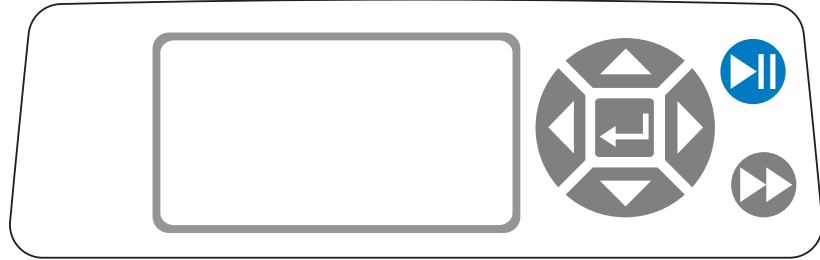

**WARNING:** Tubing breakage may result in fluid being sprayed from pump. Use appropriate measures to protect operator and equipment.

## Control Panel



**Figure 3-1.** Control Panel

- To navigate all menus on the drive use the  directional pad directly to the right of the LCD screen.
- The  (ENTER) key located in the middle of the directional pad is used to enter or select a highlighted field or option. This key is often referred to as the ENTER key in this manual.
- The  (START/STOP) key located at the top right of the control panel is used to start and pause the drive. This key is functional only when in one of the four operating modes: Continuous, Time Dispense, Copy Dispense, or Volume Dispense. This key is often referred to as the START/STOP key in this manual.
- The  (PRIME) key located at the bottom right of the control panel is used to access the prime (fast forward) function. While pressed, this key operates the drive at the maximum allowed speed/flow rate and in the direction shown on the display. When released, the drive returns to its original speed or flow rate.

## Priming the Pump

1. Mount Pump Head to drive.
2. Insert appropriate tubing into Pump Head.
3. Insert tube inlet into supply fluid.
4. Insert supply outlet into desired container.
5. Turn on pump using switch located on the back of the drive.
6. Press and hold the PRIME  key on the drive console to prime the pump. Priming will stop when key is released.



**CAUTION: Keep fingers away from rotor while pump is in operation. Stop pump before loading or unloading tubing.**



## Main Menu

**CONTINUOUS MODE** refer to *Continuous Mode* in this manual.

**TIME DISPENSE MODE** refer to *Time Dispense Mode* in this manual.

**COPY DISPENSE MODE** refer to *Copy Dispense Mode* section in this manual.

**VOLUME DISPENSE MODE** refer to *Volume Dispense Mode* section in this manual.

**REMOTE CONTROL MODE** refer to *Remote Control Mode* section in this manual.

**CUMULATIVE VOLUME:** The drive stores and displays the cumulative volume in units based on flow rate units (see **SETUP MENU** in this section). The Cumulative Volume can also be reset to zero.

**NOTE:** The Cumulative Volume is dependent on the Tubing Size selected. (See **SETUP MENU** in this section.)

**SOUNDS:** An audible “beep” can be enabled to indicate a keypad press, the end of a dispense and/or the end of a batch.

**AUTOSTART:** By default the drive will not restart when power is applied. To enable this feature select **AUTOSTART** and then **ON**. The drive will now restart when power is reapplied.



**DISPLAY CONTRAST:** This display can be adjusted using the **UP/DOWN** (▲/▼) arrows after selecting this menu item.

**LANGUAGE:** After selecting this menu, the user will be able to select one of seven different languages.

**NOTE:** If the language is accidentally changed and the user would like to reset it to the default language (English), press and hold the **UP/DOWN** (▲/▼) keys when power is reapplied.

**DEFAULT SETTINGS:** Selecting this menu item and pressing the **ENTER** key will restore default settings. To restore drive to default settings the user may also press and hold the **LEFT/RIGHT** (◀/▶) keys when power is reapplied.

## Tubing Calibration

1. Mount Pump Head to drive.
2. Insert appropriate tubing into Pump Head.
3. Insert tube inlet into supply fluid.
4. Insert tube outlet into desired container. Container should be a graduated container or a container placed on a scale may be used for increased accuracy.  
  
If using a scale, an acceptable weight to volume conversion for water is 1 gram = 1 mL.
5. Turn on drive using power switch located on the rear of the drive.
6. Go to the Main Menu or Mode Setup Menu by selecting the SETUP icon  and pressing the ENTER key. Use the UP and DOWN keys to highlight TUBING CAL in the Main or Setup Menu and press the ENTER key.
7. Set the drive for the desired flow direction, tube size, and flow rate. Note that these settings are retained and transferred to other mode screens when entering or leaving the TUBING CAL screen.
  - The flow direction is set using the directional keypad to highlight the directional arrow. Pressing ENTER will toggle arrow between CW and CCW.
  - The tube size is set using the directional keypad to highlight the tube size field. Press ENTER and use the UP/DOWN keys to select the tube size. Press ENTER to SAVE the selection and return to TUBING CAL screen.
  - The estimated flow rate is set using the directional keypad to highlight the flow rate field. Press ENTER and use the LEFT/RIGHT keys to select the digit to be changed. Use the UP/DOWN keys to adjust the flow rate value. Press ENTER to SAVE the setting and EXIT field using arrow keys. The drive will adjust this flow rate after calibration is complete.
  - Note that the calibration volume is fixed and cannot be changed.
8. Press and hold the prime key  on the drive console to prime the pump. Priming will stop when key is released.
9. Place a measuring container at the pump outlet. Highlight the START field and press the ENTER key. The drive will run based on the default volume at the estimated flow rate selected.

## Tubing Calibration (continued)

- Upon completion of the calibration run period, the CAL VOLUME field will be highlighted. Press the ENTER key and adjust the CAL VOLUME to the measured quantity. Use the LEFT/RIGHT keys to select digit to be changed, use the UP/DOWN keys to adjust the value, and press ENTER to SAVE setting and EXIT the field.

A lower case “c” should now be displayed when the calibrated tubing size is selected. The volume units will depend on the flow rate units. The flow rate unit mL/min will result in a volume unit of mL; oz/min will result in a volume unit of oz.

### Tubing Calibration Notes

- If the drive is stopped during calibration, empty the container and re-start the procedure.
- Calibration time at maximum allowable flow rate (default max flow rate) is 5-10 seconds and at minimum allowable flow rate (approximately 4% of the maximum flow rate) is 4 minutes. Select the CUSTOM tube size for other tubing sizes or lower flow rates.
- Minimum and maximum flow rates will change after a tubing calibration due to a re-calculation of the vol/rev.
- Optimum results are best obtained after tubing has been broken in by running in pump for at least 10 minutes. Steps 8-10 can be repeated as necessary to optimize the accuracy of the tubing cal.

### CAL RUN TIME FORMULA

$$60 / (\text{flow rate [mL/min]} / \text{cal volume [mL]}) = \text{cal run time (seconds)}$$

### INVALID CAL RUN TIME EXAMPLE

- tube size 13 flow rate range is 0.006 mL/min – 36.0 mL/min
- at flow rate of 1 mL/min, cal run time calculation is as follows:  
 $60 / (1 \text{ mL/min} / 6 \text{ mL}) = 360 \text{ seconds}$   
 360 seconds exceed the max run time of 4 minutes (240 seconds)

## Setup Menu

All four operation mode screens contain a SETUP icon  in the upper right hand that gives quick access to the SETUP menu. The exact options that can be accessed through the SETUP menu will depend on the operating mode currently in use:

1. **Selecting the SETUP Menu:** In any of the four operating modes, use the directional pad and enter key to select the SETUP icon from the mode operation screen.
2. **Navigating the SETUP Menu:** Use the directional pad and the ENTER key to select desired setting.

A breakdown of the setting features common to all modes follows. Other settings are related to the specific operating mode currently in use and can be accessed through the mode operation screen as well.

**Flow Unit:** Select desired flow unit to be displayed.

**Tubing Size:** Size and Maximum Flow Rate are displayed. Select desired tubing size.

**Flow Rate:** Set the flow rate in flow unit listed at the top of the screen. (**NOTE:** To change flow unit, see *Flow Unit* above.) When the entire rate field is highlighted, press ENTER. The digits can be navigated individually using the UP/DOWN arrows; switch between digits using the LEFT/RIGHT arrows. After selecting an optimal flow rate, press ENTER again to validate.

**Tubing Calibration:** See *Tubing Calibration*.

**Pump Direction:** Select the direction of the pump flow.

**Sounds:** Select a beep for keypad, end of dispenses, and batches.

**Remote Control:** See *Remote Control*.

**Keypad Lockout:** Allows for the keypad to be locked and unlocked.

**Cumulative Volume:** View and reset cumulative volume.

**Main Menu:** Return to the Main Menu.



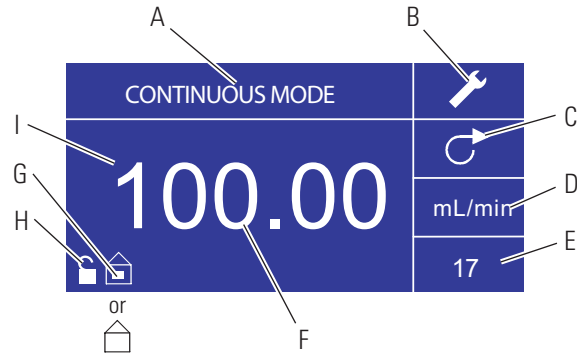

**Exit:** Return to the Mode Operation screen.

## Continuous Mode Screen

**Display Legend:** Below is a screenshot of the screen display for the drive in Continuous Mode. An explanation of the information on the screen follows.



**Figure 3-2.** Continuous Mode Screen

- A. **Mode Display:** Current operating mode in which the drive will operate. Pressing ENTER key when highlighted will cycle through the different operation modes.
- B. **Setup**  : Pressing the ENTER key on this icon goes to the Setup screen. The Setup screen contains most functions that can be accessed from the Continuous Mode operation screen, including: flow units, tubing size, flow rate, pump direction, remote control, and keypad lockout. The Setup screen also provides access to tubing calibration, sounds, cumulative volume and the Main Menu.
- C. **Flow Direction:** Pressing the ENTER key on this icon toggles between clockwise and counterclockwise flow direction.
- D. **Flow Units:** Pressing the ENTER key on this icon goes to the Flow Unit selection screen. **NOTE:** % and rpm are available in Continuous Mode only. When switching to Copy Dispense or Volume Dispense Modes % and rpm units will change to mL/min with values dependent on tubing size selected.
- E. **Tubing Size:** Pressing the ENTER key on this icon goes to the tubing size selection screen.
- F. **Current Flow Rate:** The center digits show the flow rate of the drive in the unit of measure selected and shown to the right (see position D, Figure 3-2).
- G. **Local/Remote**  or  : Pressing the ENTER key on this icon goes to the Remote Control setup screen. This icon indicates whether your drive is in local or remote control mode. If the solid rectangle appears in the center of the figure the drive is set to be operated locally. If the solid rectangle does not appear in the center of the figure the drive is set to be operated by remote control.
- H. **Key Pad Lock**  : Pressing the ENTER key on this icon goes to the Keypad Lockout screen. Locking the keypad will prevent someone from changing the settings on the drive. When locked this icon changes to .

## Continuous Mode Operation

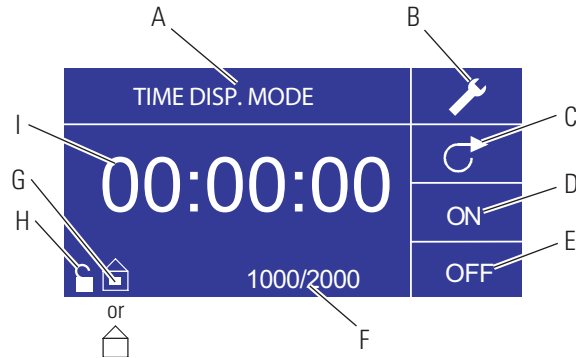

**Figure 3-3.** Continuous Mode Operation





1. **Getting Started:** From the Main Menu, use the ENTER key to select Continuous Mode to enter the Continuous Mode Operation screen.
2. **Calibrating Tubing:** Before operating the pump, insert desired tubing into the Pump Head. For more information, see “*Tubing Calibration*”.
3. **Preparing External Supplies:** Insert tube inlet into supply fluid. Next, insert tube outlet into desired container.
4. **Starting the Drive:** From this operation screen, simply pressing the START/STOP key will start the drive at the speed/flow rate and direction shown. In Continuous Mode the drive will operate at the displayed speed/flow rate and direction continuously.
5. **Stopping the Drive:** To pause or stop the drive, press the START/STOP key in the top right hand corner of the console.
6. **Changing Speed/Flow Rate:** To change the speed/flow rate of the drive, use the directional pad to highlight the numeric field in the center of the display and press the ENTER key. This puts you in a position to change the speed/flow rate of the drive at the farthest digit to the right (tenths, hundredths, thousandths, etc depending on flow unit). Pressing the UP arrow on the directional pad will increase the speed/flow rate by one value and pressing the DOWN arrow will decrease the speed/flow rate by one value. Pressing the ENTER key again will show all the possible digits that can be manipulated for the specific flow unit currently in use; use the LEFT/RIGHT arrows on the directional pad to move between digits and the UP/DOWN arrows to increase or decrease the value, respectively. Once desired speed/flow rate is selected, press ENTER key a final time to set the drive to operate at that speed/flow rate.
7. **Changing Flow Unit:** To change the flow unit of the drive pause the drive using the START/STOP key. Next, use the directional pad to select the Flow Units icon and press the ENTER key. Use the UP/DOWN arrow on the directional pad to select the desired flow unit and press the ENTER key to choose that unit. The drive will now operate in that flow unit. Press the START/STOP key to resume operating the drive.

## Time Dispense Mode Screen

**Display Legend:** Below is a screenshot of the screen display for the drive in Time Dispense Mode. An explanation of the information on the screen follows.



**Figure 3-4.** Time Dispense Mode Screen

- A. **Mode Display:** Current operating mode.
- B. **Setup**  : The Setup screen can be used to select flow units, tubing size, flow rate, tubing calibration, sounds, cumulative volume, and Main Menu. The Setup screen contains some functions that can be accessed from the Time Dispense Mode operation screen, including: pump direction, on/off time, batch count, remote control, and keypad lockout.
- C. **Flow Direction:** Pressing the ENTER key on this icon toggles between clockwise and counterclockwise flow direction.
- D. **Pump ON Time:** When this field is highlighted the drive is ON.  
**NOTE:** The drive will not show 00:00 when switching from ON to OFF Time.
- E. **Pump OFF Time:** When this field is highlighted the drive is OFF.
- F. **Batch Count:** Displays the number of cycles dispensed in the batch.
- G. **Local/Remote**  or  : Pressing the ENTER key on this icon goes to the Remote Control setup screen. This icon indicates whether your drive is in Local or Remote Control mode. If the solid rectangle appears in the center of the figure the drive is set to be operated locally. If the solid rectangle does not appear in the center of the figure the drive is set to be operated by remote control.
- H. **Key Pad Lock**  : Pressing the ENTER key on this icon goes to the Keypad Lockout screen. Locking the keypad will prevent someone from changing the settings on the drive. When locked this icon changes to .
- I. **Time Display:** The center digits show the remaining time of the drive in the ON or OFF Time highlighted on the right of the display (position D or E, Figure 3-4).

## Time Dispense Mode Operation



**Figure 3-5.** Time Dispense Mode Operation

1. **Getting Started:** From the Main Menu, use the enter key to select Time Dispense Mode to enter the Time Dispense Mode Operation screen.
2. **Calibrating Tubing:** Before operating the pump, insert desired tubing into the Pump Head. For more information, see “*Tubing Calibration*”.
3. **Choosing Settings:** Select desired flow unit, tube size, flow rate, pump direction, etc. For more information see “*SETUP Menu.*”
4. **Preparing Tubing:** Insert tube inlet into supply fluid. Next, insert tube outlet into desired container.
5. **Selecting Flow Rate:** Use the directional pad and ENTER key to select the Setup icon. Use the UP/DOWN arrows on the directional pad to select Flow Rate. In the Flow Rate selection screen, press the ENTER key and then use the UP/DOWN arrows on the directional pad to select a desired flow rate. For faster entry, use the LEFT/RIGHT arrows on the directional pad to move between digits and the UP/DOWN arrows to increase or decrease the value, respectively. Press ENTER one more time to validate the selected flow rate. Use the directional pad to select EXIT to return to the Time Dispense Mode Setup Screen.
6. **Setting ON Time:** To set the ON Time, use the directional pad and ENTER key to select the ON field (see position D, Figure 3-4). Doing so will highlight the timer in the center of the screen (see position I, Figure 3-4). Pressing ENTER again, allows the timer to be set using the UP/DOWN arrows. Switch between digits using the LEFT/RIGHT arrows. Having selected an optimal ON Time, press ENTER again to validate. The drive will now run for the time appearing in the center of the screen.



## Time Dispense Mode Operation (continued)



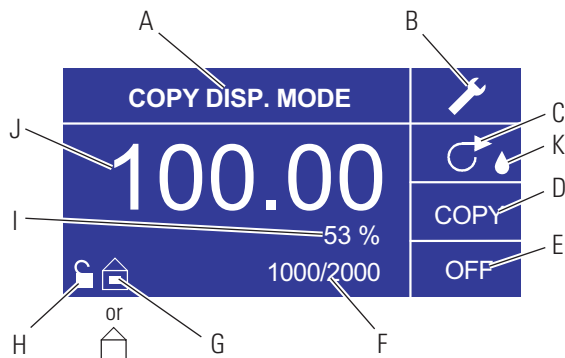

7. **Setting OFF Time:** To set the OFF Time, use the directional pad and ENTER key to select the OFF field (see position E, Figure 3-4). Doing so will highlight the timer in the center of the screen (see position I, Figure 3-4). Pressing ENTER again, allows the timer to be set using the UP/DOWN arrows. Switch between digits using the LEFT/RIGHT arrows. Having selected an optimal OFF Time, press ENTER again to validate. The drive will stop running for the time appearing in the center of the screen. **NOTE:** If the OFF Time is set to 00:00:00, the drive requires a START/STOP **input** from the keypad or the remote I/O Connector to start the next dispense.
8. **Selecting Batch Size:** Before running the drive at the selected ON/OFF Times, select a batch size for the operation. To do so, use the directional pad and the ENTER key to select the BATCH icon (see position F, Figure 3-4). In the Batch Count screen, press the ENTER key and then use the UP/DOWN arrows on the directional pad to select a batch size. Switch between digits using the LEFT/RIGHT arrows. Press ENTER one more time to validate the selected batch size. When set to zero (0) the drive will run for an infinite number of cycles and the  $\infty$  symbol is displayed. Use the directional pad to select EXIT to return to the Time Dispense Operation Screen.
9. **Starting the Drive:** The drive is now set to operate, press the START/STOP **key** in the upper right hand corner to start the drive. The drive can be paused at any time throughout the batch to adjust flow direction, tubing size, flow units, flow rate, etc.
10. **Resetting Batch:** To reset a batch, use the directional pad and the ENTER key to select the BATCH icon (see position F, Figure 3-4). In the Batch Count screen, use directional pad to select RESET and press the ENTER key to reset the batch count, select EXIT to return to the main Time Dispense Mode operation screen.

## Copy Dispense Mode Screen

**Display Legend:** Below is a screenshot of the screen display for the drive in Copy Dispense Mode. An explanation of the information on the screen follows.



**Figure 3-6.** Copy Dispense Mode Screen

- A. **Mode Display:** Current operating mode.
- B. **Setup**  : The Setup screen can be used to select flow units, tubing size, flow rate, tubing calibration, sounds, cumulative volume, and Main Menu. The Setup screen contains some functions that can be accessed from the Time Dispense Mode operation screen, including: pump direction, on/off time, batch count, remote control, and keypad lockout.
- C. **Flow Direction:** Pressing the ENTER key on this icon toggles between clockwise and counterclockwise flow direction.
- D. **Copy Amount Screen:** See *Copy Setting Screen*, Figure 3-8.
- E. **Pump OFF Time:** Highlighted when the drive is OFF.
- F. **Batch Count:** Displays the number of cycles dispensed in the batch.
- G. **Local/Remote**  or  : Pressing the ENTER key on this icon goes to the Remote Control setup screen. This icon indicates whether your drive is in local or remote control mode. If the solid rectangle appears in the center of the figure the drive is set to be operated locally. If the solid rectangle does not appear in the center of the figure the drive is set to be operated by remote control.
- H. **Keypad Lock**  : Pressing the ENTER key on this icon goes to the Keypad Lockout screen. Locking the keypad will prevent someone from changing the settings on the drive. When locked this icon changes to .
- I. **Percentage Completed:** This icon displays the portion of fluid dispensed as a percentage.
- J. **Copy Volume:** Displays the Copy Volume while dispensing or the OFF Time.
- K. **Anti-Drip:** A waterdrop icon present indicates that the Anti-Drip function is on. For further information see Anti-Drip Function page 3-27.

## Copy Dispense Mode Operation

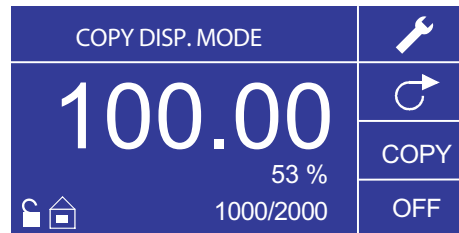

**Figure 3-7.** Copy Dispense Mode Operation

1. **Getting Started:** From the Main Menu, use the ENTER key to select Copy Dispense Mode to enter the Copy Dispense Mode operation screen.
2. **Calibrating Tubing:** Before operating the pump, insert desired tubing into the Pump Head. For more information, see “*Tubing Calibration*”.
3. **Choosing Settings:** Select desired flow unit, tube size, flow rate, pump direction, etc. For more information see “Using the SETUP Menu.”
4. **Preparing Tubing:** Insert tube inlet into supply fluid. Next, insert tube outlet into desired container.
5. **Setting Copy Amount:** See *Copy Setting Operation*.
6. **Setting OFF Time:** Use the directional pad and ENTER key to select OFF on the display to enter the Pump OFF Time. Use the directional pad and ENTER key to set the Pump OFF Time. The timer in the center of the screen will be highlighted, and using the UP/DOWN arrows will increase/decrease the farthest right digit of the time interval. Switch between digits using the LEFT/RIGHT arrows. After selecting an optimal OFF Time, press ENTER again to validate. The drive will now rest for the time appearing in the center of the screen.  
**NOTE:** If the OFF Time is set to 00:00:00, the drive requires a START/STOP **input** from the keypad or the remote I/O Connector to start the next dispense.
7. **Setting Batch Size:** Use the directional pad and ENTER key to select the Batch Count icon from the operation screen (see position F, Figure 3-6). From Batch Count screen use the UP/DOWN arrows to select batch size. Press ENTER to validate batch size. When set to zero (0) the drive will run for an infinite number of cycles and the ∞ symbol is displayed. Select EXIT to return to the Copy Dispense Mode screen.
  - Batch count may be reset from BATCH COUNT screen by selecting RESET.

## Copy Dispense Mode Operation (continued)

8. **Operating Drive:** Press the START/STOP **key** to operate the drive at the settings selected and displayed on the screen. Press again to pause or stop the drive. Drive will automatically stop once batch is complete.
9. **Reset Batch Count:** Use the directional pad and the ENTER key to select the BATCH COUNT icon (see position F, Figure 3-6). In the BATCH COUNT screen, select RESET and press the ENTER key to reset the batch count. Select EXIT to return to the Copy Mode Operation screen.
10. **Maximum Dispense Time:** The specification for the maximum dispense in Copy Mode is over 80+ hours at 600 rpm. Actual maximum volume is dependant on tubing size and flow units selected.

# COPY Setting Screen

**Display Legend:** Below is a screenshot of the screen display for the drive in Copy Setting Mode. An explanation of the information on the screen follows.

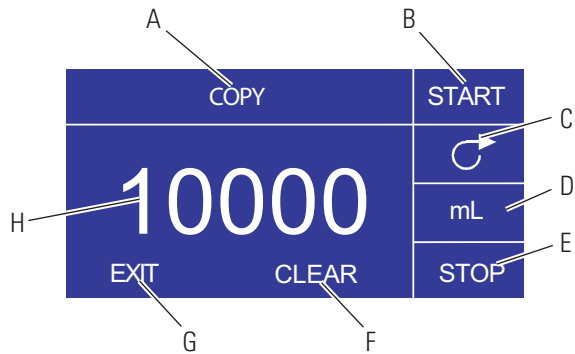

**Figure 3-8.** COPY Setting Screen

- A. **Mode Display:** Current operating mode.
- B. **START:** This icon will start drive allowing for copy volume to be set.
- C. **Flow Direction:** Pressing the ENTER key on this icon toggles between clockwise and counterclockwise flow direction.
- D. **Volume Unit:** This is dependent on the flow rate selected.
- E. **STOP:** This stops the Copy and sets the volume to be dispensed. It is displayed in position H.
- F. **CLEAR:** Selecting this will clear the number displayed on the screen and will allow for a new copy volume to be selected.
- G. **EXIT:** Return to Copy Dispense Mode.
- H. **Volume:** This is the amount that was dispensed during the copy.

## COPY Setting Operation

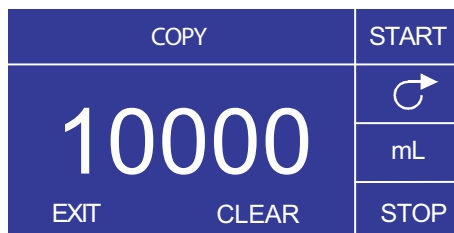

**Figure 3-9.** COPY Setting Operation

1. **Getting Started:** From the COPY DISPENSE MODE Screen select COPY and ENTER.
2. **Clear Volume:** Using the directional Keypad select CLEAR and ENTER.
3. **Establish Copy Volume:** 3 methods are available to the user.
  - a. Place the desired container at the tubing outlet. Press the START/STOP **key** to initiate the dispensing of fluid. When you have reached the desired volume press the START/STOP **key** again. Select EXIT and press ENTER. The drive will store the value of the copy in memory and use that value in the COPY DISPENSE MODE.
  - b. Place the desired container at the tubing outlet. Select the START field on the screen and press the ENTER key to initiate the dispensing of fluid. The drive will now highlight the STOP field on the screen. When you have reached the desired volume press the ENTER key to stop. Select EXIT and press ENTER. The drive will store the value of the copy in memory and use that value in the COPY DISPENSE MODE.
  - c. Place the desired container at the tubing outlet. Close the contacts on the START/STOP **input** to initiate the dispensing of fluid. When you have reached the desired volume, close and release the contacts on the START/STOP **input**. Select EXIT and press ENTER. The drive will store the value of the copy in memory and use that value in the COPY DISPENSE MODE.

**NOTE:** The value displayed as the volume in the COPY SETTING screen and the COPY DISPENSE Mode screen depend on the flow units selected. RPM, and % are invalid. If these units have been selected the drive will display a volume in mL, in the COPY DISPENSE MODE, that is dependent on the tubing size selected.



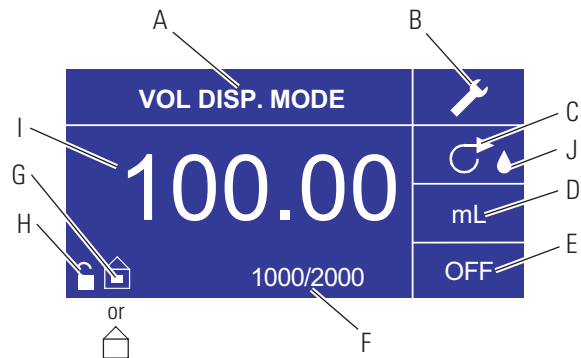

See *TUBING CALIBRATION* to improve the accuracy of this conversion.

## Volume Dispense Mode Screen

**Display Legend:** Below is a screenshot of the screen display for the drive in Volume Dispense Mode. An explanation of the information on the screen follows.



**Figure 3-10.** Volume Dispense Mode Screen

- A. **Mode Display:** Current operating mode.
- B. **Setup**  : The Setup screen can be used to select flow units, tubing size, flow rate, tubing calibration, sounds, cumulative volume, and Main Menu. The Setup screen contains some functions that can be accessed from the Time Dispense Mode operation screen, including: pump direction, on/off time, batch count, remote control, and keypad lockout.
- C. **Flow Direction:** Pressing the ENTER key on this icon toggles between clockwise and counterclockwise flow direction.
- D. **Flow Units:** Select desired flow unit.
- E. **Pump OFF Time:** Highlighted when the drive is OFF.
- F. **Batch Count:** Displays the number of cycles dispensed in the batch.
- G. **Local/Remote**  or  : Pressing the ENTER key on this icon goes to the Remote Control setup screen. This icon tells you whether your drive is in local or remote control mode. If the solid rectangle appears in the center of the figure the drive is set to be operated locally. If the solid rectangle does not appear in the center of the figure the drive is set to be operated by remote control.
- H. **Keypad Lock**  : Pressing the ENTER key on this icon goes to the Keypad Lockout screen. Locking the keypad will prevent someone from changing the settings on the drive. When locked this icon changes to .
- I. **Volume:** Displays the Volume while dispensing or the OFF Time.
- J. **Anti-Drip:** A waterdrop icon present indicates that the Anti-Drip function is on. For further information see Anti-Drip Function page 3-27.

## Volume Dispense Mode Operation

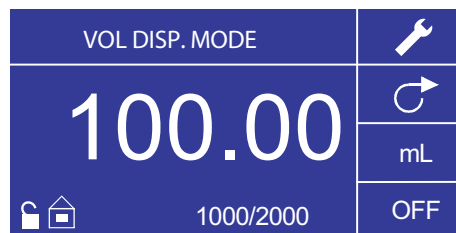

**Figure 3-11.** Volume Dispense Mode Operation

1. **Getting Started:** From the Main Menu, use the ENTER key to select Volume Dispense Mode to enter the Volume Dispense Mode operation screen.
2. **Calibrating Tubing:** Before operating the pump, insert desired tubing into the Pump Head. For more information, see “*Tubing Calibration*”.
3. **Choosing Settings:** Select desired flow unit, tube size, flow rate, pump direction, etc. For more information see “*SETUP Menu.*”
4. **Preparing Tubing:** Insert tube inlet into supply fluid. Next, insert tube outlet into desired container.
5. **Setting Desired Volume:** Using the directional pad highlight the numeric field in the center of the display and press the ENTER key. This puts you in a position to change the fluid volume of the drive at the farthest digit to the right (tenths, hundredths, thousandths, etc., depending on your volume unit). Pressing the UP arrow on the directional pad will increase the volume by one value and pressing the DOWN arrow will decrease the volume by one value. Pressing the ENTER key again will show all the possible digits that can be manipulated for the specific volume unit currently in use; use the LEFT/RIGHT arrows on the directional pad to move between digits and the UP/DOWN arrows to increase or decrease the value, respectively. Once desired volume is selected, press ENTER a final time to set the drive to operate at that volume. Press the START/STOP **key** to resume operating the drive.
6. **Setting Pump OFF Time:** Use the directional pad and ENTER key to select OFF on the display (see position E, Figure 3-10) to enter the OFF TIME. Use the directional pad and ENTER key to set the pump rest time. The timer in the center of the screen will be highlighted, and using the UP/DOWN arrows will increase/decrease the farthest right digit of the time interval. If ENTER is pressed a second time while the timer is highlighted, the digits can be navigated individually using the UP/DOWN arrows; switch between digits using the LEFT/RIGHT arrows. After selecting an optimal OFF time, press ENTER again to validate. The drive will now rest for the time appearing in the center of the screen. **NOTE:** If the OFF Time is set to 00:00:00, the drive requires a START/STOP **input** from the keypad or the remote I/O Connector to start the next dispense.



## Volume Dispense Mode Operation (continued)

7. **Setting Batch Size:** Use the directional pad and ENTER key to select the Batch Count icon from the operation screen (see position F, Figure 3-10). From Batch Count screen use the UP/DOWN arrows to select batch size. Press ENTER to validate batch size. When set to zero (0) the drive will run for an infinite number of cycles and the  $\infty$  symbol is displayed. Select EXIT to return to drive operation screen.
  - Batch count may be reset from the Batch Count screen by selecting RESET.
8. **Operating the Drive:** Press the START/STOP key to operate the drive continuously at the settings selected and displayed on the screen. Press again to pause or stop the drive. Drive will automatically stop once batch is complete.
9. **Reset Batch Count:** Use the directional pad and the ENTER key to select the BATCH COUNT icon (see position F, Figure 3-10). In the BATCH COUNT screen, select RESET and press the ENTER key to reset the batch count. Select EXIT to return to the COPY MODE OPERATION screen.
10. **Maximum Dispense Time:** The specification for the maximum dispense volume in Volume Mode is over 80+ hours at 600 rpm. Actual maximum volume is dependant on tubing size and flow units selected.

## Remote Control Menu

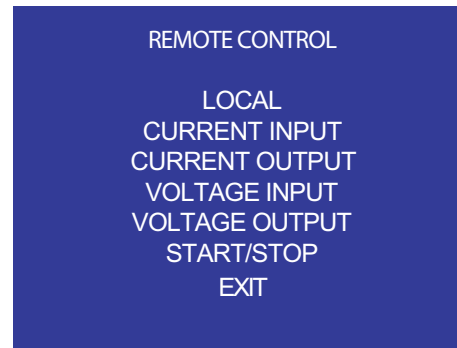

**Figure 3-12.** Remote Control Menu Screen

**NAVIGATION:** From the Main Menu or SETUP Menu select REMOTE CONTROL and ENTER.

**LOCAL:** When this is selected the drive is controlled by the front panel keypad, Start/Stop **Input**, Directional Input or Prime Input.

**CURRENT INPUT:** When this is selected, the drive is in remote control. This allows the user to input a current signal to control the flow. The user has an option to adjust the minimum, maximum and middle set points for current and flow. By default the minimum (MIN) current is set to 4.2 mA and the flow is set to 0. The maximum (MAX) is set to 20 mA and the flow is set to maximum. The middle (MID) is auto calculated for a current and flow that is centered between the MIN and the MAX. The MID can be adjusted if other profiles are needed. The scaling can be inverted if necessary. To confirm CURRENT INPUT MODE is selected, select EXIT after returning to the Remote Control Menu, then select CONTINUOUS PUMP MODE. To deselect Remote Current Input Mode select LOCAL and ENTER.

**NOTE:** When Current Input is selected the drive will not start until the REMOTE CONTROL MODE is exited and CONTINUOUS PUMP MODE is selected.

**CURRENT OUTPUT:** This allows the user to adjust the current output for a given flow. The user has an option to adjust the minimum, maximum and middle setpoints for current and flow. By default the minimum (MIN) flow is set to 0.00 and the current is set to 4.0 mA. The maximum (MAX) is set to maximum flow and the current is set to 20.0 mA. The middle (MID) is auto calculated for a current and flow that is centered between the MIN and the MAX. The MID can be adjusted if other profiles are needed. This allows for a three-point calibration of the current output. The flow is linear between these points. The scaling can be inverted if necessary. **NOTE:** Selecting Current Output will not put user into REMOTE CONTROL MODE. Only selecting VOLTAGE INPUT or CURRENT INPUT will put the user into Remote Control Mode, as indicated by the empty house icon (see position G, Figure 3-2). **NOTE:** The Current Output indicates the Running Command Speed. Use the Motor Running contacts (normally open/closed) to indicate if pump is running.

## Remote Control Menu (continued)

**VOLTAGE INPUT:** When this is selected, the drive is in remote control. This allows the user to input a voltage signal to control the flow. The user has an option to adjust the minimum, maximum and middle setpoints for voltage and flow. By default the minimum (MIN) voltage is set to 00.1 V DC and the flow is set to 00.0. The maximum (MAX) is set to 10.0 V DC and the flow is set to maximum. The middle (MID) is auto-calculated for a voltage and flow that is centered between the MIN and the MAX. The MID can be adjusted if other profiles are needed. The scaling can be inverted, if necessary. To confirm VOLTAGE INPUT MODE is selected, select EXIT after returning to the Remote Control Menu, then select CONTINUOUS PUMP MODE. To deselect Remote Voltage Input Mode select Local and ENTER.

**NOTE:** When Voltage Input is selected the drive will not start until the REMOTE CONTROL MODE is exited and CONTINUOUS PUMP MODE is selected.

**VOLTAGE OUTPUT:** This allows the user to adjust the voltage output for a given flow. The user has an option to adjust the minimum, maximum and middle set points for voltage and flow. By default the minimum (MIN) flow is set to 00.00 and the voltage is set to 00.0V DC. The maximum (MAX) is set to maximum flow and the voltage is set to 10.0V DC. The middle (MID) is auto calculated for a voltage and flow that is centered between the MIN and the MAX. The MID can be adjusted if other profiles are needed. This allows for a three point calibration of the voltage output. The flow is linear between these points. The scaling can be inverted if necessary. **NOTE:** Selecting Voltage Output will not put the user into Remote Control Mode. Only selecting Voltage Input or Current Input will put the user into Remote Control Mode, as indicated by the empty house icon (see position G, Figure 3-2). **NOTE:** The Voltage Output indicates the Running Command Speed. Use the Motor Running contacts (normally open/closed) to indicate if pump is running.

**START/STOP:** The START/STOP **input** can be configured to be OFF (factory default), or ON for the drive to run.

With the OFF selected (factory default), use of the START/STOP **input** is optional. When the START/STOP **input** is open, the drive can still be started using the START/STOP **key**, PRIME key, or PRIME input. In remote modes the drive will also run if there is sufficient current or voltage at the input.

Closing the START/STOP **input** will cause the drive to run until the START/STOP **input** opens or the START/STOP **key** is pressed. In Time dispense, Copy dispense, and Volume dispense mode, only a momentary START/STOP closure is needed to start the drive. If the drive is already running in one of the dispense modes, a momentary START/STOP closure will stop the drive. In SET COPY MODE, the START/STOP **input** functions the same as in CONTINUOUS MODE; closing it will cause the drive to run until it opens.

## Remote Control Menu (continued)

The function of the START/STOP **input** is considerably simplified when the ON is selected. The drive will not run under any condition unless the START/STOP **input** is closed.

**Table 3-1.** Continuous Mode Operation

MENU SETTINGS SETUP OPTIONS		START/STOP INPUT	INTERNAL MODE		mA or V MODE
AUTO START	START/STOP REQUIRED		Drive State When Powered OFF	Drive Response When Powered ON	Drive Running (sufficient level) When Powered OFF  Drive Response when Powered ON (sufficient level present)
OFF	OFF	OPEN	Running	Not running	Not running
OFF	OFF	OPEN	Not running	Not running	Not running
OFF	OFF	CLOSED	Forced run due to S/S CLOSED	Not running	Not running
OFF	ON	OPEN	Forced not running due to S/S OPEN	Not running	Not running
OFF	ON	CLOSED	Forced run due to S/S CLOSED	Not running	Not running
ON	OFF	OPEN	Running	Running	Running
ON	OFF	OPEN	Not running	Not running	Running
ON	OFF	CLOSED	Forced run due to S/S CLOSED	Running	Running
ON	ON	OPEN	Forced not running due to S/S OPEN	Not running	Not running
ON	ON	CLOSED	Forced run due to S/S CLOSED	Running	Running

**NOTE:** In Continuous Mode when using the START/STOP **input** the drive is started with a closed contact and stopped when the contacts are opened.

**Table 3-2.** Dispense Mode Operation

MENU SETTING SETUP OPTIONS		START/STOP INPUT	Drive State When Powered OFF	Drive Response When Powered ON
AUTO START	START/STOP REQUIRED			
OFF	OFF	OPEN	Running	Not running
OFF	OFF	OPEN	Not running	Not running
OFF	OFF	CLOSED*	Forced run due to S/S CLOSED	Not running
OFF	ON	OPEN	Forced not running due to S/S OPEN	Not running
OFF	ON	CLOSED	Forced run due to S/S CLOSED	Not running
ON	OFF	OPEN	Running	Running
ON	OFF	OPEN	Not running	Not running
ON	OFF	CLOSED*	Forced run due to S/S CLOSED	Running
ON	ON	OPEN	Forced not running due to S/S OPEN	Not running
ON	ON	CLOSED	Forced run due to S/S CLOSED	Running

**\* NOTE:** In Dispense Modes and START/STOP MENU SETUP Option OFF the drive will start a dispense with a momentary contact closure and stop with a momentary contact closure during both the dispense period and interval period.

## DB-25 Pin Configuration with Wiring Scheme

## Contact Arrangements

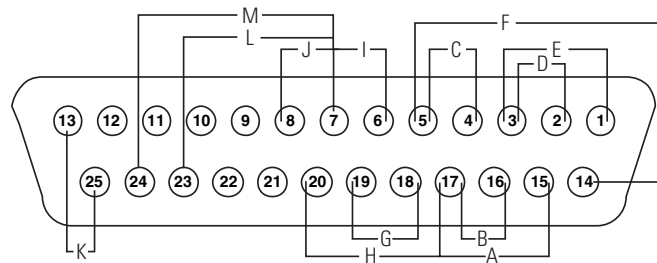

- |                                 |   |
|---------------------------------|---|
| <b>A.</b> START/STOP            | <b>H.</b> PRIME                           |
| <b>B.</b> CW/CCW                | <b>I.</b> MOTOR RUNNING N.O. C(1A @ 24 V) |
| <b>C.</b> OUTPUT 0-20mA; 4-20mA | <b>J.</b> MOTOR RUNNING N.C. (1A @ 24 V)  |
| <b>D.</b> INPUT 0-20mA; 4-20mA  | <b>K.</b> 24V (150mA max.)                |
| <b>E.</b> INPUT 0-10V           | <b>L.</b> General Alarm                   |
| <b>F.</b> OUTPUT 0-10V          | <b>M.</b> Local.Remote Indicator          |
| <b>G.</b> TACH OUTPUT           |   |

**Figure 3-13.** DB-25 Pin Configuration with Wiring Scheme

Pin No. DB-25	Description
1	Speed Control Voltage Input (0-10 V)
2	Speed Control Current Input (0-20 mA)
3	Speed Control Input Ground Return
4	Speed Signal Current Output (0-20 mA)
5	Speed Signal Output Ground Reference
6	(Motor Running N.O. Default) 1A @24 V (Open Collector)
7	Motor Running Ground Return
8	(Motor Running N.C. Default) 1A @24 V (Open Collector)
14	Speed Signal Voltage Output (0-10 V)
15	Remote Start/Stop Input
16	Remote CW/CCW Input
17	Remote Start/Stop, CW/CCW, Prime Grnd Ref.
18	Tach Ground Reference
19	Tach Output (open collector)
20	Remote Prime Input
9	Reserved – Not Used
10	Reserved – Not Used
11	Auxiliary Input (Computer Compatible Drive Only)
12	Auxiliary Input Return (Computer Compatible Drive Only)
21	Auxiliary Output #1 (Computer Compatible Drive Only)
22	Auxiliary Output #2 (Computer Compatible Drive Only)
23	General Alarm (Open Collector)
24	Local.Remote Indicator (Open Collector)
25	Aux 24V+ (150 mA)
13	Aux 24V- (150 mA)

**NOTE:** Pins 5, 13, 17, and 18 are at earth ground, all are suitable for use with START/STOP, PRIME, Direction, Tach, LOCAL/REMOTE, General Alarm Signals and Current and Voltage Outputs.



**CAUTION:** Power must be turned off before connecting the external remote control cable to prevent damage to the drive.

**NOTE:** Open collector outputs in "low impedance" state are at earth ground and when in "high impedance" state are essentially floating. See Open Collector page following.

## 31-Pin Configuration with Wiring Scheme

## Contact Arrangements

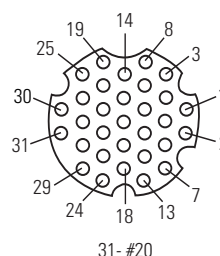

**Figure 3-14.** 31-Pin Configuration with Wiring Scheme

Pin No.	Description
1	Speed Control Voltage Input (0-10 V)
2	Speed Signal Voltage Output (0-10 V)
3	Speed Control Current Input (0-20 mA)
4	Remote Start/Stop Input
5	Speed Control Input Ground Return
6	Remote CW/CCW Input
7	Speed Signal Current Output (0-20 mA)
8	Remote Start/Stop, CW/CCW, Prime Grnd Ref.
9	Speed Signal Output Ground Reference
10	Tach Ground Reference
11	(Motor Running N.O. Default) 1A @24 V (Open Collector)
12	Tach Output (open collector)
13	Motor Running Ground Return
14	Remote Prime Input
15	(Motor Running N.C. Default) 1A @24 V (Open Collector)
16	Reserved – Not Used
17	Reserved – Not Used
18	Reserved – Not Used
19	Reserved – Not Used
20	General Alarm (Open Collector)
21	Reserved – Not Used
22	Local.Remote Indicator (Open Collector)
23	Reserved – Not Used
24	Aux 24V+ (150 mA)
25	Aux 24V- (150 mA)
26	Reserved – Not Used
27	Reserved – Not Used
28	Reserved – Not Used
29	Reserved – Not Used
30	Reserved – Not Used
31	Reserved – Not Used

**NOTE:** Pins 8, 9, 10, and 25 are at earth ground, all are suitable for use with START/STOP, PRIME, Direction, Tach, LOCAL/REMOTE, General Alarm Signals and Current and Voltage Outputs.



**CAUTION:** Power must be turned off before connecting the external remote control cable to prevent damage to the drive.

**NOTE:** Open collector outputs in "low impedance" state are at earth ground and when in "high impedance" state are essentially floating. See Open Collector page following.

# Remote Control Inputs and Outputs

## INPUTS

### Remote CW/CCW, Remote Start/Stop, Remote Prime, & Aux. In:

The remote control inputs work with current sinking outputs (open-collector NPN transistor outputs without passive pull-up resistors) or contact closures to DC common (earth ground). A continuous active low to the Remote Start/Stop **input** causes the drive to run, while a continuous active low to the Remote CW/CCW input causes the drive to run CCW. The motor is brought to a controlled stop before reversing direction. A continuous active low to the Remote Prime input causes the drive to run at full rated speed.

**Table 3-3.** Remote Control Inputs and Outputs

<b>CURRENT CLOSED INPUT</b>	1 mA TYP
<b>VOLTAGE OPEN INPUT</b>	3.2 V TYP
<b>THRESHOLD CURRENT TO ACTIVATE</b>	0.5 mA TYP

### Remote Analog Input:

- 4-20 mA Input: 250 ohms typical input impedance ref. to signal ground. 4 mA, Stop; 20 mA, Full Speed (Default Settings) 10 Bit Resolution
- Overload Capability: 10 V or 40 mA max.
- 0-10 V Input: 10 K ohms typical input impedance ref. to signal ground. 0 V, Stop; 10 V, Full Speed (Default Settings) 10 Bit Resolution

## OUTPUTS

- 4-20 mA Output: 0 to 600 ohms max. load referenced to earth ground. 4 mA, Stop; 20 mA, Full Speed (Default Settings) 10 Bit Resolution
- 0-10 V Output: 1.0 K ohms min. load referenced to earth ground. 0 V, Stop; 10 V, Full Speed (Default Settings) 10 Bit Resolution
- Tach Output: Open Collector, 1.0A @ 28V DC
- Frequency range: 100 to 6000 Hz or 100 to 1000 Hz, 50% Duty Cycle. (10 Hz = 1 pump rpm)
- Logic Outputs: Open Collector, 1.0 A @ 28V DC
- Motor Running Outputs: Normally Open and Normally Closed when drive is running.
- General Alarm Output: Open (High Impedance) when an alarm is displayed.
- Local/Remote Indicator: Open (High Impedance) when in remote control mode (Voltage Input, Current Input, or RS232).

## Open Collector Outputs

Some remote outputs on this drive (Tachometer, Local/Remote, Motor Running and Alarm) are “open collector” type outputs and cannot be wired in the same manner as relay outputs. An open collector output is not isolated and must be configured differently than a relay output. When the open collector output is active, the output is effectively switched to earth ground and if improperly terminated could result in damage to the drive and/or external equipment.

### Recommendation

When connecting to open collector outputs, the output should be connected to a current limiting resistor and then to a positive supply source which is less than 28V DC. Typically this would be connected to a 24V PLC input (see Figure 3-15).

**NOTE: when using the 24V supply on the interface connector, current draw must be limited to 150 mA.**

**NOTE: DO NOT connect 120V supply lines to open collector outputs!**

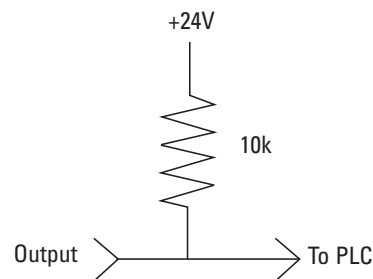

**Figure 3-15.** Terminating Open Collector Outputs to a PLC



## Anti-Drip Function

The same drive offers an Anti-Drip feature. The tendency of fluid to drip after a dispense is dependant on several factors including tubing size, tubing orientation, and the viscosity of the fluid. To minimize this drip the drive will reverse direction after a dispense to draw the fluid back at the end of the tubing.

To access this feature select in either Copy Dispense Mode or Volume Dispense Mode ANTI-DRIP.



**Figure 3-16.** Anti-Drip Screen

If the ANTI-DRIP function is desired, select ON and a second screen will appear which will allow the user to input how many degrees of reverse rotation the drive will perform. Typical values range from 5 to 45 degrees. To exit without changing the current setup select EXIT.

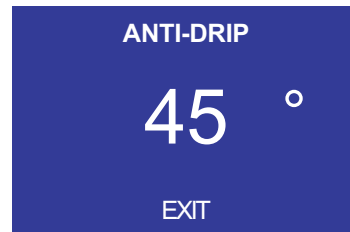

**Figure 3-17.** Anti-Drip Degrees Screen

With the number highlighted press the ENTER key and use the UP and DOWN, and RIGHT and LEFT arrows to change the digits. Press the ENTER key and then select EXIT to save the setting. The drive will now reverse after every dispense.

## Serial Communication Specification

### Linkable Instrument Network

The Linkable Instrument Network is a serial communication system consisting of a control computer with one RS-232C port and one or more satellite units. A satellite unit can be a pump drive, mixer controller, or any future product that conforms to the communications protocol defined in this description. This description describes all the information needed to communicate with a pump drive. Since much of this information applies to other products, the term “satellite unit” will be used as a generic term for all devices compatible with the Linkable Instrument Network. The term “pump drive” will be used when the information applies only to MASTERFLEX Computerized Drives.

### Drives

All communications between the control computer and satellite units is based on a pseudo daisy-chain principle. The transmission line of the control computer will pass through the input and output buffers in each of the satellite units. Each satellite unit will have the ability to turn the buffers on and off to block communications from other units below it in the daisy-chain. The output of the control computer would pass through each of the pump drives without software assistance from the pump drive. All Pump Drives in the daisy-chain must be powered up to enable communications with all drives.

The receive line of the control computer will originate in the transmitter of the last satellite in the chain. It will also be double buffered through each satellite. Each of the pump drives will have the ability to turn off its input receive line and place its own transmitter on the receive line to the control computer.

A third line, the Request To Send (RTS) will be a similarly buffered line. Each satellite will have the ability to set this line to signal the computer its request to send.

The maximum number of satellites is limited to 25 by the Linkable Instrument Network software to minimize communication time. However, up to 89 satellites could be controlled by a single RS-232C port using custom software since satellite units can be assigned any number from 01 to 89.

### USB

Some drives are equipped with a USB Mini Port. The drive supports USB 2.0 through the use of WINLIN software (sold separately). WINLIN can be operated on Windows® XP and Windows® VISTA operating systems. USB needs to be selected within WINLIN in order for the drive to be recognized by the host computer. See the accessories section of this manual for cable information.

**NOTE:** USB is not recommended for long term continuous use due to Windows® operating system issues. For long running applications use RS232 communications.

## Serial Connections

The Digital PWM BLDC Drives communicate with each other and a PC via a standard DB-9 modem cable (Cat. #22050-54). Older satellite units have a dual 6-position modular phone jack labeled “IN” and “OUT”. Pin 1 on both jacks is located towards the top of the drive. The control computer will have a standard DB-25 plug as found on most RS-232C connections. The DB-9 “AT” type connector can also be used with the DB-9 to DB-25 adapter included with the 07550-64 Computer to Pump cable assembly.

### DRIVE DB9 IN

Pin 2 - TXD Transmit signal to computer  
 Pin 3 - RXD Receive signal from computer  
 Pin 5 - GND Ground  
 Pin 8 - RTS Request to send to the computer

### DRIVE DB9 OUT

Pin 2 - RXD Receive signal from next satellite  
 Pin 3 - TXD Transmit signal to next satellite  
 Pin 5 - GND Ground  
 Pin 8 - RTS From next satellite

### DB-25 PLUG ON CONTROL COMPUTER

Pin 2 - Transmitted data to satellite  
 Pin 3 - Received data from satellite  
 Pin 5 - Clear to send—RTS from satellite  
 Pin 7 - Ground

### DB-9 PLUG “AT” type ON CONTROL COMPUTER (DTE) AND SATELLITE

Pin 3 - Transmitted data to satellite  
 Pin 2 - Received data from satellite  
 Pin 8 - Clear to send—RTS from satellite  
 Pin 5 - Ground

### DB-9 SOCKET ON SATELLITE (DCE)

Pin 3 - Receive signal from the computer  
 Pin 2 - Transmit signal to the computer  
 Pin 5 - Ground  
 Pin 8 - Request to send—(RTS) to the computer

The serial lines between units will be passed from unit-to-unit by a hardware buffer on the input, connecting it directly to the output driver through a hardware gate. This way any output only sees one input load. If power is turned off on any pump drive, all drives below it in the daisy-chain cannot communicate.

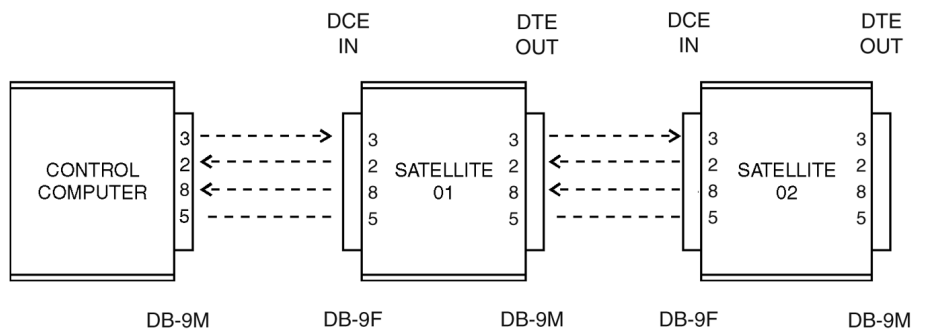

Figure 3-18. Serial Daisy-Chain Connections

## Serial Data Format

The serial data format is full duplex (simultaneously transmit and receive), 1 start bit, 7 data bits, one odd parity bit, and one stop bit at 4800 bits per second. All data transmitted will consist of characters from the standard ASCII character set.

**NOTE:** Odd parity is defined such that the sum of the eight individual bits is an odd number (1, 3, 5 or 7).

## Serial Protocol

All transmissions originate or are requested by the control computer (master). It may issue commands directly and it may request that the satellites report. When asked to report, the satellite would send the data requested. Should a satellite require communication with the computer, it has the ability to operate the request to send (RTS) line. Upon receiving the request, the computer would respond via the serial line (see *Serial Connections* section).

## Start-Up Sequence

*Normal start-up would consist of turning on all the satellite units first and then the control computer.* Each satellite will enable its receive and transmit buffers and activate its RTS line. The control computer would then send the enquire <ENQ> command in response to the active RTS line. Upon receiving the <ENQ> command, all satellites with an active RTS line would disable its receive and transmit buffers to the satellites below it in the daisy-chain. Next the pump drives would respond with one of the following strings depending on its model number and version.

<STX>P?0<CR> = 600 rpm

<STX>P?2<CR> = 100 rpm

The control computer would only see the response from the first satellite in the chain since communications with the others is now blocked. The control computer would then send back <STX> Pnn<CR> with nn being a number starting with 01 for the first satellite and incrementing for each satellite up to 25 maximum. If the pump drive receives the data without errors it will perform the following steps:

1. Deactivate its RTS line and enable the receive buffers to the next satellite.
2. Send an <ACK> to the control computer.
3. Enable the transmit buffer from the next satellite within 100 milliseconds after the last byte has been sent.
4. Put a "P" and the satellite number received in the first 3 positions on the satellite display.

## Start-Up Sequence (continued)

After the control computer receives the <ACK> it will see the RTS from the next satellite and again issue the <ENQ> command. The above process will be repeated until all satellites are numbered.

If a satellite does not receive valid data from the control computer or detects a transmission error, it will send a <NAK>. When the control computer receives the <NAK> it will resend the <STX>Pnn<CR> to the satellite. The Error Handling section describes the maximum retries the control computer will perform.

If a satellite is turned on after all the other satellites have been numbered, it will be numbered the same as described above with the next available number if no commands have been sent to the other satellites. If commands have been issued, the satellite is assigned a temporary number starting with 89 and decrementing for each subsequent satellite. This will cause the satellite to release its RTS so normal communication can proceed. The operator will be alerted to the condition that another satellite has come on-line and needs to be numbered. The operator will then be able to assign the new satellites a number so that they will appear correctly in the system. The control computer will use the following commands to renumber a satellite:

<STX>PooUnn<CR>

The “oo” is the old satellite number and “nn” the new number.

If a satellite is requesting to be numbered and the control computer has already issued 25 satellite numbers, the control computer will assign the satellite the number 89 as described in the preceding paragraph and alert the operator to the situation.

If a satellite is powered down after it has been numbered, it will be treated as a new unit as described above when it is powered up again.

## Remote/Local Operation

Once a satellite is in the remote mode, it can be returned to local mode using the control computer and the “L” command. If the control computer program is no longer running, the satellite can be powered off and then on to return it to local operation. If the “L” command is used, the satellite will retain its assigned number and respond to request commands from the control computer but ignore control commands.

## Command Format

Most commands from the control computer are preceded with the start of text <STX> character (02 hex), a satellite identification letter (P for Pump, M for mixer) and a two digit satellite number (01 through 89). Numbers 00 and 90 through 99 are reserved for special cases. When the same command is to be executed by all pump drives, 99 is sent for the satellite number. Following the command character is the parameter field which varies in size from zero characters to 32 depending on the command. A carriage return <CR>, (0D hex) is used to indicate the end of a command string. (**NOTE:** the exceptions to this computer issued command format are <ENQ>, <ACK> and <NAK>.) See Figure 3-18.

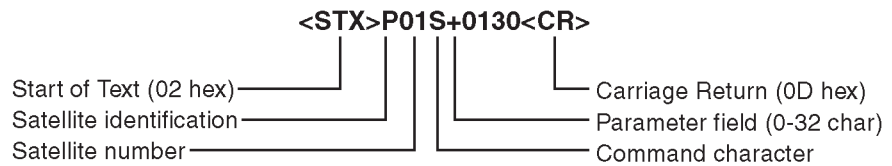

**Figure 3-19.** Command Format

More than one command can be put in a command string as shown following:

<STX>P09S+0500.0V08255.37G <CR>

The above multiple command string example would set the speed at pump satellite 09 to 500.0 rpm, clockwise direction, set 8255.37 revolutions and start the drive. The maximum number of characters allowed in one pump drive string is 38, including <STX>, Pnn and <CR>.

### Command Features

#### 1. INITIALIZING

Before a pump drive can be controlled, it must first be numbered. If any command is issued before this is done, the satellite will not respond.

#### 2. SETTING SPEED

If a SPEED command is issued after the speed has already been set, the new speed will be used. If the pump drive is running and a different direction is sent to the pump, the pump will send back a <NAK>. A “H” command must first be issued before the direction can be reversed.

#### 3. SETTING REVOLUTIONS

When “Revolutions To Go” are set with the “V” command, they are added to the total revolutions to go counter. The maximum this counter can be is 99999.99. If a revolutions to go count is sent to the pump drive which would cause the counter to overflow past 99999.99, the pump drive will not add the value to its revolutions to go counter and will send the control computer a <NAK>. The revolutions to go counter can be set to zero by using the “Z” command, which will also cause the pump to stop if it is running when the “Z” command is received.

## Control Computer Parameter Fields

The parameter field sent by the control computer is variable in length. The control computer will have the option of using leading zeroes, leading spaces, or no padding at all.

For example, if 200 revolutions was to be sent with the “V” command, the following list of parameters would all be accepted by the satellite as valid:

(s = space) 00200.00  
 ss200.00  
 sss200.00  
 ssss200  
 200.00  
 200.0  
 200

### Satellite Data Fields

Any data that a satellite sends to the control computer will have a fixed number of characters which is determined by the command. For example, if the control computer requested the cumulative volume, it would always receive 10 characters representing the cumulative volume (0000000.00 to 9999999.99).

## Pump Drive Status Request

When the control computer requests status from the pump drive (“I” command or <ENQ>), the satellite will respond with the following status information (see Figure 3-20):

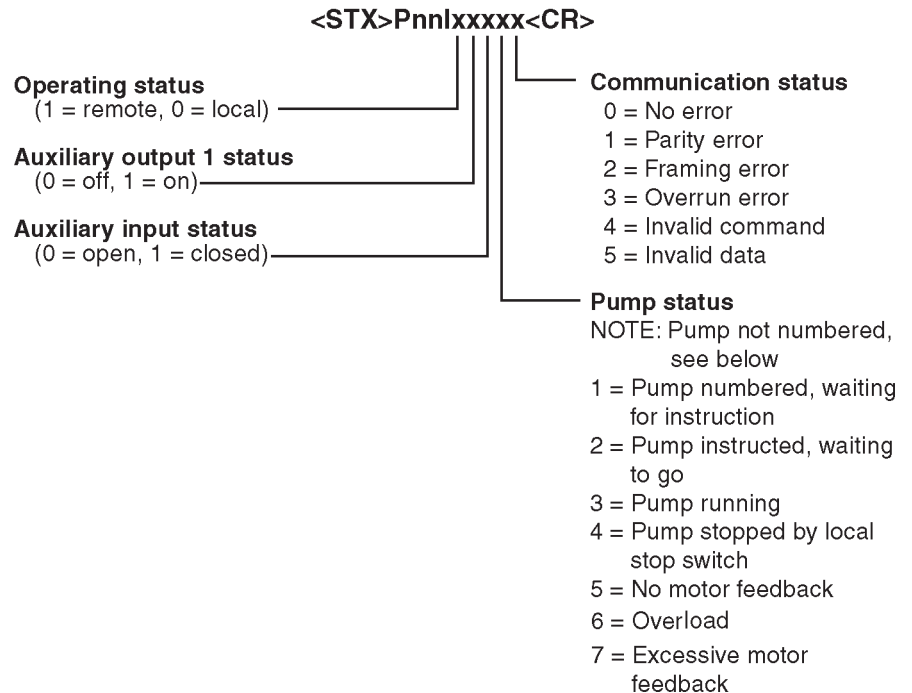

**Figure 3-20.** Parameter Fields

## Pump Drive Status Request (continued)

**NOTE:** “Pump not numbered” is also a pump status, but it is not included in the pump status byte. This condition is handled separately using the P?x (see *Start Up Sequence* section).

When the satellite sends the status information, any status conditions that are latched by the satellite will be cleared by the control computer sending an <ACK>Pnn<CR>. If the satellite receives the “I” command again, it will respond with the same status information.

## Satellite Response

When the pump satellite correctly receives a command, it will send back an <ACK> (06 hex) if it was not an all pumps command (P99). If data has to be sent back to the control copy in response to the command, it will be sent as shown in Table 3-2. If the satellite detected an error while receiving a command, it will respond with a <NAK>.

## Error Handling

Depending on the error code received from the satellite, the control computer would have to take appropriate action to try to eliminate the error condition. Communication errors of type 1, 2 or 3 indicate a hardware type error: noisy communication lines, bad connection, glitches or circuit failure. Communication error codes 4 or 5 could be hardware errors as previously described or software errors caused by incorrect commands or data being sent by the control computer. For hardware type errors the control computer would try sending the same command to see if the problem was only momentary. If an error code is returned four times in a row or if there is no response at all, the control computer would abort trying to send the command and notify the operator of the type of error.

If a satellite does not respond at all, the control computer can assume one of the following:

1. If all other satellites connected after the satellite in question also don't respond, the communication link is broken at that point or the satellite is defective.
2. If all other satellites respond, the unresponding satellite is either turned off, removed from the loop, or defective.



## Satellite Request to Send

When a satellite wants to communicate with the control computer, it will turn on its request to send (RTS) line and then wait for the (ENQ) enquire character (05 hex) from the control computer. The following list shows the possible conditions that would cause the pump drive to activate its RTS line.

1. Auxiliary input status change.
2. Motor error.
3. Stop key pressed at satellite while in the remote mode.
4. Programmed volume was reached.
5. Power up.

The following is the sequence of events for when RTS is activated by a pump drive:

1. Satellite enables RTS line.
2. When control computer detects RTS, it will transmit the (ENQ) enquire command (05 hex) after it completes any communications it may be in the process of performing.
3. When the satellite that has its RTS line enabled receives the <ENQ> it will disable its RS-232C buffers to block the other satellites below it in the daisy-chain from communicating with the control computer. This would give the satellite closest to the control computer the highest priority if more than one satellite enabled its RTS line at the same time.
4. Next the pump drive will send the response from the “I” command as shown in *Pump Drive Status Request* field.
5. If the control computer received the satellite response without any errors (parity, overrun etc.) it will send an acknowledge <ACK>Pnn<CR> which will cause the satellite to release its RTS line and enable the RS-232C buffers allowing the satellites below it in the daisy-chain to communicate. If the control computer detected any error during the transmission it would send the enquire (ENQ) again which would cause the satellite to re-send its response. The control computer will retry a maximum of four times before aborting and reporting the error to the operator.
6. If more than one satellite has its RTS line enabled, the control computer would see only the response from the satellite closest to it. After the closest satellite sent its response and released the RTS line, the control computer would see the RTS of the other satellite and again issue the enquire command which would allow the next satellite with RTS active to respond.

## Satellite Request to Send (continued)

7. If a satellite was responding to an enquire command and another satellite with higher priority also started to respond, cutting off the first responding satellite, the control computer would receive invalid data and get some type of error (parity or framing). This would cause the control computer to resend the enquire, but this time only the higher priority satellite would respond since the communications with the lower satellites is blocked.

**Table 3-4.** Pump Satellite Commands

<b>Command Characters from Control Computer to Pump</b>	<b>Parameter Field</b>
A Request auxiliary input status	none
B Control auxiliary outputs when G command executed	xy, x = aux1, y = aux2, 0 = off, 1 = on
C Request cumulative revolution counter	none
E Request revolutions to go	none
G Go Turn pump on and auxiliary output if preset	none = run for number of revolutions set by V command 0 = continuous run until Halt command
H Halt (turn pump off)	none
I Request status data	none
K Request front panel switch pressed since last K command	none
L Enable local operation	none
O Control auxiliary outputs immediately without affecting drive	xy, x = aux1, y = aux2, 0 = off, 1 = on
R Enable remote operation	none
S Set motor direction and rpm	+xxx.x, -xxx.x, +xxxx, -xxxx + = CW, - = CCW
S Request motor direction and rpm	none
U Change satellite number	nn = new satellite number
V Set number of revolutions to run	xxxxx.xx
Z Zero revolutions to go counter	none
Z Zero cumulative revolutions	0
<CAN> Terminates line of data up to and including STX (used primarily for keyboard input)	none
<ENQ> Enquire which satellite has activated its RTS line	none

## Satellite Request to Send (continued)

**Table 3-5.** Sample Pump Commands and Responses

Control Computer Command String	Pump Drive Response
<STX>PnnA<CR>	<STX>Ax<CR> x: 0=open, 1=closed
<STX>PnnBxy<CR> xy: 0 = off, 1 = on x = aux1, y = aux2	<ACK> or none if P99
<STX>PnnC<CR>	<STX>Cxxxxxx.xx<CR> max revolutions = 9,999,999.99
<STX>PnnE<CR>	<STX>Exxxxx.xx <CR> x : revolutions to go (99,999.99 max) (-xxxx.xx if drive overshoots)
<STX>PnnG<CR>	<ACK> or none if P99
<STX>PnnH<CR>	<ACK> or none if P99
<STX>PnnI<CR>	<STX>PnnIxxxx<CR> (see Pump Drive Status Request section)
<STX>PnnK<CR>	<STX>Kx<CR> (see <i>Front Panel Switches</i> section)
<STX>PnnL<CR>	<ACK> or none if P99
<STX>PnnOxy<CR> xy: 0 = off, 1 = on x = aux1, y = aux2	<ACK> or none if P99
<STX>PnnR<CR>	<ACK> or none if P99
<STX>PnnS+0130<CR> or	<ACK> or none if P99
<STX>PnnS+0130.0<CR>	<ACK> or none if P99
<STX>PnnS<CR>	<STX>S+0432.9<CR>
<STX>PnnUnn<CR> nn = 01, 02, 03...87, 88, 89	<ACK>
<STX>PnnVxxxx.xx<CR> V max = 99999.99	<ACK> or none if P99
<STX>PnnZ<CR>	<ACK> or none if P99
<STX>PnnZ0<CR>	<ACK> or none if P99
<CAN>	<ACK>
<ENQ>	<STX>P?x<CR> (on pump power up) <STX>PnnIxxxx<CR> (see <i>Pump Drive Status Request</i> section)

## Front Panel Switches

The control computer can read the satellite's front panel switches by issuing the "K" command. The satellite will respond with one character indicating the last switch pressed since the last "K" command was acknowledged. If more than one key was pressed, only the last one pressed is indicated. After the control computer receives the satellite's switch status, it must send an <ACK>Pnn<CR> to inform the satellite it can reset the switch status to no key pressed. Table 3-6 following shows the character returned by the "K" command and the corresponding switch for pump units.

**Table 3-6.** K command key codes for pump drives

0 = No key pressed	6 = Dir
1 = Stop/Start	7 = Size
2 = Prime	8 = Flow rate
3 = Mode	9 = Down arrow
4 = Dispense	A = Up arrow
5 = Cal	

## ASCII Control Codes Used

**Table 3-7.** ASCII control codes used

DECIMAL	HEX	CHARACTER	
2	02	STX Start of Text	(CTRL - B)
6	06	ACK Acknowledge	(CTRL - F)
5	05	ENQ Enquire	(CTRL - E)
13	0D	CR Carriage Return	(CTRL - M) (CR)
21	15	NAK Negative Acknowledge	(CTRL - U)
24	18	CAN Cancel	(CTRL - X)

## Replacement Parts and Accessories

### Section 4 Maintenance



**WARNINGS:** *The Power switch on the Back Panel is not the main disconnect. Main disconnect is accomplished by disconnecting the detachable power supply cord at the appliance coupler or at the main plug. Ensure the power cord is easily accessible and removable, in the event of an emergency, which requires immediate disconnection.*

*The operator should check the detachable power supply cord condition. The equipment should not be operated if the power supply cord is cracked or broken. Any obvious damage to the enclosure (from a drop or fall) should be checked by service personnel for loose or damaged parts inside.*



**CAUTIONS:** *Replace the power cord only with one of the same type and rating. The minimum power ratings are stated on the rear panel.*

*The power cord set supplied with your pump drive meets the requirements of the country where you purchased the pump drive. If you use the pump drive in another country, you must use a power cord set that meets the requirements of that country.*

Description	Part Number
Fuse-T3.15A, 5 x 20 mm	77500-25
Gear Service Kit (600)	07553-06
Gear Only (600 rpm)	07553-09
Gear Service Kit (100 rpm)	07553-08
Replacement seal kit (NEMA)*	07575-01
Replacement gear and shaft kit (NEMA)*	07575-02

\*For washdown drives only

# Fuse Replacement

1. Place the power switch in the off position.
2. Disconnect the AC power input line cord from the receptacle.
3. Remove and check the fuse and replace if defective.

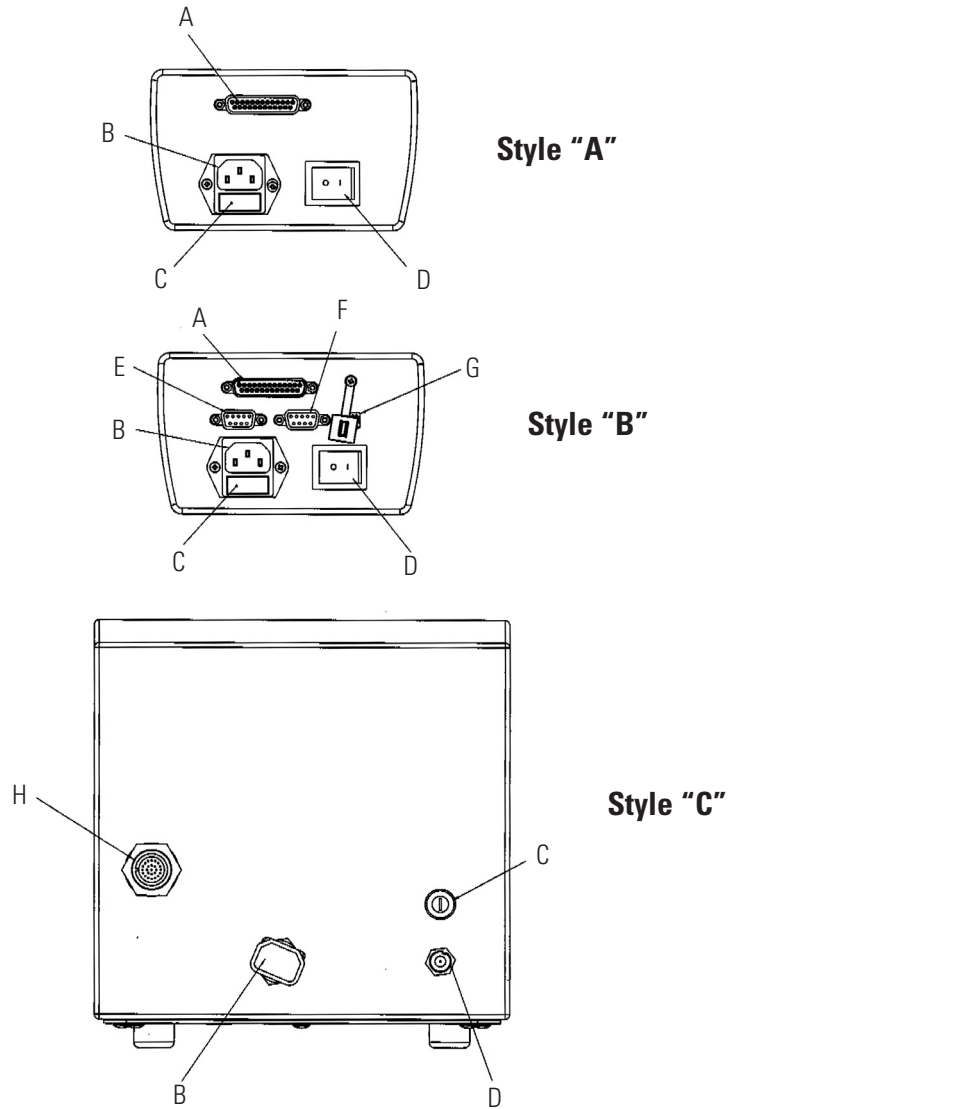

**Figure 4-1.** Fuse Replacement

Item	Description	Item	Description
A	I/O Receptacle DB-25 Pin (Style A and B)	E	RS-232C IN (Style B)
B	IEC Power Entry Module / Line Cord	F	RS-232C OUT (Style B)
C	T3.15A (5 × 20 mm) Fuse – Do Not Substitute	G	USB Port (Style B)
D	Power Switch – All settings are retained in memory	H	I/O Receptacle 31-Pin (Style C)

## Gear Replacement

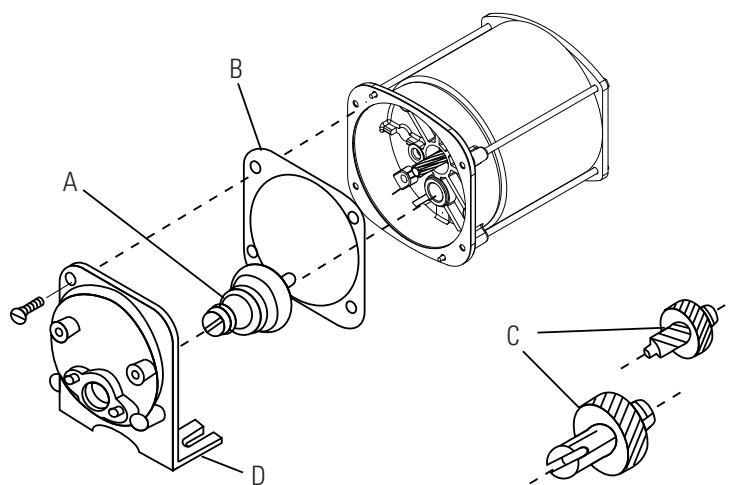

- A.** 6-600 rpm gear assembly (included in service kit 07553-06)
- B.** Gasket
- C.** 1-100 rpm gear set (included in service kit 07553-08)
- D.** Gear Case cover assembly

**Figure 4-2.** Motor

## Shaft Seal Inspection (Stainless Steel and Powder Coated Enclosures Only)

1. Remove any pump(s) attached to the front of the drive. Clean any foreign material from the outside diameter of the drive shaft.
2. Remove the four (4) screws (see Figure 4-3, Item B) that hold the front plate assembly (see Figure 4-3, Item A) to the drive, and pull the front plate assembly off the drive. #8-32 screws may be installed in the pump-mounting holes to provide handles for pulling the plate assembly off. Retain Item B screws for Step 8. **DO NOT** substitute screws.

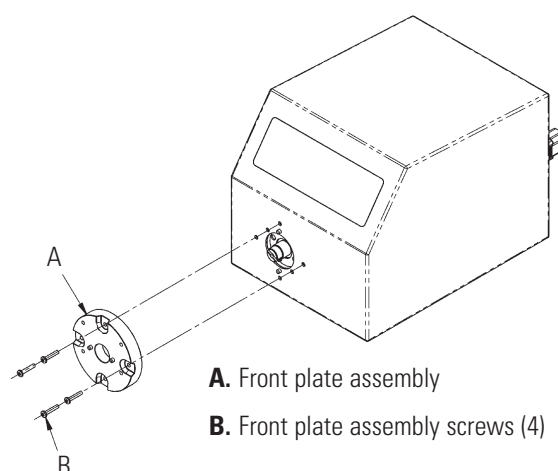

**Figure 4-3.** Shaft Seal Inspection

## Shaft Seal Inspection (continued)

3. Turn the front plate over so that the seal is visible. Wipe the elastomeric seal lips with a clean cloth to remove any grease and foreign material.
4. Inspect the elastomeric seal lips for tears or cuts or missing material. If any of the above mentioned conditions exist, replace the seal assembly using the 07575-01 replacement seal kit.
5. Wipe the exposed part of the drive shaft with a clean cloth. Wipe from the drive outward, to remove all grease and foreign matter.
6. Inspect the shaft surface, in the area touched by the seal. Look for a rough finish, or grooves parallel to the shaft length. If the shaft end is worn or damaged as described above, replace the gear and shaft with the 07575-02 kit. A polished groove, concentric to the outside of the shaft, is not a defect, as long as the groove is no more than 0.002 inches deep.
7. Prior to re-assembly, re-lubricate the shaft and the seal with the food-grade lubricant provided with the unit.



**CAUTION: Do not contaminate the lubricant in the container, on the shaft or on the seal with foreign material.**

**Failure to observe this precaution may result in damage to the seal and premature failure of the seal.**

8. Slide the front plate assembly back over the shaft and onto the locating pins, in the orientation desired. (4 configurations, each 90 degrees of rotation apart, are possible.) Reinstall the four (4) screws, removed in step 2 (see Figure 4-3).



**CAUTION: No foreign matter should be allowed under the gasket on the back of the front plate or under the heads of the screws.**

**Failure to observe this precaution may result in leakage during washdown of the drive.**

## Cleaning

Keep the drive enclosure clean with mild detergents. Do not immerse or use excessive fluid when cleaning.



## Section 5 Troubleshooting

### Troubleshooting Chart

Symptom	Cause	Remedy
Motor does not rotate, Display does not light.	No Power.	1. Check fuse and replace, if necessary.
		2. Check that unit is plugged into a live line.
		3. Check connection of power cord.
		4. Check the line cord for continuity and replace if defective.
		5. Return for servicing.
Motor does not rotate. Display lights.	Defective Remote Control or Setting Error.	1. Place power switch in OFF position.
		2. Check that remote cable connector is fully inserted into the receptacle.
		3. Reapply power.
		4. If motor still does not rotate, select remote control in Main Menu or Setup Menu and verify settings.
		5. Return to Mode screen and verify icon shows  Remote Control Mode.
		6. See <i>Remote Control Mode</i> in this manual for further details.
Drive does not follow Serial or USB Commands	Hardware or Firmware issue.	1. See <i>Remote Control Mode</i> in this manual for further details.
		2. Select "OFF" in START/STOP Menu to run without an input at the I/O Connector cable.
Drive does not follow Serial or USB Commands	Hardware or Firmware issue.	1. Verify cable connection to drive.
		2. COM Port selection error. See <i>WINLIN software</i> . (Hyper terminal not included)

## Error Definitions

### Error #2 Motor Overspeed

---

Description: The drive has exceeded commanded speed value.

---

Error Condition(s): The motor has exceeded the commanded speed value by 20%.

---

Actions: Drive will stop immediately. Verify load is correct and power cycle drive. If error persists consult factory.

---

### Error #3: Instantaneous Over-Current

---

Description: Motor is drawing too much current for a short duration of time.

---

Error Condition(s): The motor current is above 4.0 A peak.

---

Actions: Drive will stop immediately. Verify that pump head is not binding and that the load is not above recommended maximum load. If error persists consult factory.

---

### Error #4: Bad Flash Checksum

---

Description: Run-time checksum (checked at power-on) contains a bad checksum value.

---

Error Condition(s): Checksum is checked at power-on for an invalid value.

---

Actions: Power cycle the drive. If error persists consult factory.

---

### Error #7: Bad EEPROM Checksum (Settings)

---

Description: Bad EEPROM checksum on parameter values and settings, or its data is out of range.

---

Error Condition(s): 1) Checksum value in EEPROM does not match calculated value.

2) Data in EEPROM is out of range.

---

Actions: Error will be cleared after 10 seconds and parameters will be reset to default values. If error persists consult factory.

---

### Error #8: Bad EEPROM Checksum (Factory Cal)

---

Description: Bad EEPROM checksum for Factory Cal

---

Error Condition(s): 1) Checksum value in EEPROM does not match calculated value.

2) Data in EEPROM is out of range.

---

Actions: Error will be cleared after 10 seconds and parameters will be reset to default values. If error persists consult factory.

---

## Error Definitions (continued)

### Error #9: EEPROM Write Verification Error

---

Description:	Data written to EEPROM does not match.
Error Condition(s):	Data values do not match.
Actions:	Error will be cleared after 10 seconds and parameters will be reset. If error persists consult factory.

---

### Error #10: Bus Over Voltage

---

Description:	The measured AC voltage reported by the drive is too high.
Error Condition(s):	The drive voltage is above 260V AC.
Actions:	The pump will stop immediately, check the supply line voltage. If error persists consult factory.

---

### Error #11: Bus Under Voltage

---

Description:	The measured AC voltage reported by the drive is too low.
Error Condition(s):	The drive voltage is below 90V AC.
Actions:	The pump will stop immediately, check the supply line voltage.

---

**NOTE:** This error when displayed during power down is considered normal and proper. If error persists consult factory.

---

### Error #12: Motor Stall / Motor Under Speed

---

Description:	The motor was commanded to run, but has either slowed down significantly or has stopped.
Error Condition(s):	The motor speed is below 95% of the desired speed for too long a period of time.
Actions:	The motor will be commanded to stop. Verify the pump turns freely and is not binding. If error persists consult factory.

---

### Error #14: Ambient Over Temperature

---

Description:	The motor control board is overheating.
Error Condition(s):	The temperature value from motor control board is above given threshold value.
Actions:	The pump will stop immediately. Verify that the ambient air temperature is less than 104° F (40° C). Verify the pump turns freely and that there is no restriction of air flow. If error persists consult factory.

---

## Error Definitions (continued)

---

### Error #15: Motor Feedback Fault

---

Description: Communications to the motor control board is not correct, has disappeared, or some other communications fault.

---

Error Condition(s): No data coming back over the serial port from the motor control board.

---

Actions: The drive will attempt to stop the pump. Power cycle drive. If error persists consult factory.

---

---

### Error #16: Invalid Interrupt or Address

---

Description: Software jumps to an invalid address, invalid interrupt, or other abort/exception (i.e., Data Abort Exception). This may occur due to invalid pointer references, or ram memory corruption, etc.

---

Error Condition(s): These are handled by an Abort Exception/Interrupt within the CPU and should branch out to their respective exception handler functions.

---

Actions: Power cycle the drive to reset error. If error persists consult factory.

---

---

### Error #18: Watchdog Error

---

Description: Program has stopped running as the watch dog has not been updated, i.e., Software Locked up.

---

Error Condition(s): Interrupt triggered when the Watchdog has not been updated.

---

Actions: Power cycle drive to reset error. If error persists consult factory.

---

## Section 6 Accessories

1. Footswitch w/DB-25 male	07523-92
2. Connector DB-25 male	07523-94
3. Cable assembly, DB-25 male connector and 25-ft (7.9m) cable w/stripped wire ends	07523-95
4. Dispensing Wand DB-25 male	07523-97
5. Footswitch (NEMA)*	07575-84
6. Remote control cable (NEMA)*, 25ft (7.62 m)	07575-80
7. Interface Cable DB9M/DB9F	22050-54
8. Cable USB Type A/Type B M/M	22050-60

\*For washdown drives only.



## Section 7 Specifications

### Output

#### Speed:

600 rpm models	0.1 to 600 rpm
100 rpm models	0.02 to 100 rpm

#### Torque output, Maximum:

600 rpm models	180 oz-in (13 kg•cm) 540 oz-in Starting
100 rpm models	360 oz-in (26 kg•cm) 1080 oz-in Starting

#### Speed regulation:

All models	Line $\pm 0.1\%$ F.S. Load $\pm 0.1\%$ F.S. Drift $\pm 0.1\%$ F.S.
------------	--

#### Display:

All models	128 x 64 LCD w/ LED Backlight
------------	-------------------------------

#### Remote outputs:

All models	Voltage speed output (0–10V DC @ 1 k $\Omega$ min)
All models	Current speed output (0–20 mA @ 0–600 $\Omega$ )
Some models	RS-232C
Models w/RS-232C	AUX 1 and 2 OUT (Open Collector 1A @ 28V AC/DC)
600 rpm models	Tach output (100 to 6000 Hz, 50% duty cycle, 10 Hz/rpm)
100 rpm models	Tach output (100 to 1000 Hz, 50% duty cycle, 10 Hz/rpm)
All models	Motor running output (N.O. & N.C. open collector, 1A @ 28V DC)

### **Input**

Supply voltage limits:	
All models	90 to 260 Vrms @ 50/60 Hz (Universal Input) Single Phase Only
Current, max.:	
All models	1.8A @ 115 Vrms, or 1.1A @ 230 Vrms
Remote Inputs:	
All models	STOP/START, CW/CCW, PRIME (Contact closure)
All models	Voltage input (0–10V DC @ 10 k $\Omega$ ), $\pm$ 50V common mode range
All models	Current input (0–20 mA or 4–20mA @ 250 $\Omega$ ), $\pm$ 50V common mode range
Models w/RS-232C	AUX IN (Contact closure)

### **Construction**

Dimensions (L x W x H):	
Models w/plastic enclosure	10.5 in x 8 in x 8 in (267 x 203 x 203 mm)
Models w/stainless steel or powder coated steel enclosure	14.0 in x 9 in x 9.5 in (356 x 229 x 241 mm)
Weight:	
Models w/plastic enclosure	13 lb (5.9 kg)
Models w/stainless steel or powder coated steel enclosure	26 lb (11.8 kg)
Enclosure Rating:	
Models w/plastic enclosure	IP 33 per IEC 60529
Models w/stainless steel or powder coated steel enclosure	IP 66 per IEC 60529/NEMA 4X – indoor use



**Environment**

Temperature, Operating:

All models 0° to 40°C (32° to 104°F)

Temperature, Storage:

All models -25° to 65°C (-13° to 149°F)

Humidity (non-condensing):

Models w/plastic enclosure 10% to 90%

Models w/stainless steel or powder coated steel enclosure 10% to 100%

Altitude:

All models Less than 2000 m

Pollution Degree:

Models w/plastic enclosure Pollution Degree 2  
(Indoor use — lab, office)

Models w/stainless steel or powder coated steel enclosure Pollution Degree 3  
(Indoor use — Sheltered locations)

Chemical Resistance:

Models w/plastic enclosure Exposed material is aluminum, ABS plastic and vinyl

Models w/stainless steel or powder coated steel enclosure Exposed material is 316 enclosure stainless steel, vinyl and powder coated steel

**Compliance:**

Conforms to ANSI/UL Std 61010-1  
Certified to CAN/CSA Std C22.2 No. 61010-1. This product has been tested to the requirements of CAN/CSA-C22.2 No. 61010-1, second edition, including Amendment 1, or a later version of the same standard incorporating the same level of testing requirements.  
(For CE Mark):  
EN61010-1 (EU Low Voltage Directive) and EN61326 (EU EMC Directive)



## Section 8 Warranty, Product Return and Technical Assistance

### Warranty

*Use only MASTERFLEX precision tubing with MASTERFLEX pumps to ensure optimum performance. Use of other tubing may void applicable warranties.*

This product is warranted against defects in material or workmanship, and at the option of the manufacturer or distributor, any defective product will be repaired or replaced at no charge, or the purchase price will be refunded to the purchaser, provided that: (a) the warranty claim is made in writing within the period of time specified on the warranty card, (b) proof of purchase by bill of sale or receipted invoice is submitted concurrently with the claim and shows that the product is within the applicable warranty period, and (c) the purchaser complies with procedures for returns set forth in the general terms and conditions contained in the manufacturer's or distributor's most recent catalog.

This warranty shall not apply to: (a) defects or damage resulting from: (i) misuse of the product, (ii) use of the product in other than its normal and customary manner, (iii) accident or neglect, (iv) improper testing, operation, maintenance, service, repair, installation, or storage, (v) unauthorized alteration or modification, or (b) post-expiration dated materials.

THIS WARRANTY IS THE EXCLUSIVE REMEDY OF THE PURCHASER, AND THE MANUFACTURER AND DISTRIBUTOR DISCLAIM ALL OTHER WARRANTIES, WHETHER EXPRESS, IMPLIED, OR STATUTORY, INCLUDING WITHOUT LIMITATION, WARRANTIES OF MERCHANTABILITY AND FITNESS FOR A PARTICULAR PURPOSE. NO EMPLOYEE, AGENT, OR REPRESENTATIVE OF THE MANUFACTURER OR DISTRIBUTOR IS AUTHORIZED TO BIND THE MANUFACTURER OR DISTRIBUTOR TO ANY OTHER WARRANTY. IN NO EVENT SHALL THE MANUFACTURER OR DISTRIBUTOR BE LIABLE FOR INCIDENTAL, INDIRECT, SPECIAL OR CONSEQUENTIAL DAMAGES.

*The warranty period for this product is two (2) years from date of purchase.*

## **Section 8**

Warranty, Product Return and  
Technical Assistance

### **Product Return**

To limit charges and delays, contact the Manufacturer or authorized seller for authorization and shipping instructions before returning the product, either within or outside of the warranty period. When returning the product, please state the reason for the return. For your protection, pack the product carefully and insure it against possible damage or loss. Any damages resulting from improper packaging are your responsibility.

### **Technical Assistance**

If you have any questions about the use of this product, contact the Manufacturer or authorized seller.



**US & Canada only**

Toll Free 1-800-MASTERFLEX | 1-800-637-3739

**Outside US & Canada**

1-847-549-7600 | 1-847-381-7050

**\*EN809 manufactured by:**

Cole-Parmer Instrument Company  
28W092 Commercial Avenue, Barrington, IL 60010  
techinfo@masterflex.com | [www.masterflex.com](http://www.masterflex.com)