



Response Services User Guide

How to design your Response Service items



Contents

1	Design for mailing effectiveness	5
2	Know your Response Plus audience	6
3	Response Plus design specification	7
3.1	Response Plus Licence numbers	13
3.2	Response Plus Licence Barcodes	14
3.3	Response Plus Address details	16
3.4	Response Plus Window envelopes	18
4	Know your Response Standard audience	19
5	Response Standard design specification	20
5.1	Response Standard Licence number	27
5.2	Response Standard Address details	28
5.3	Response Standard Barcodes	28
5.4	Window envelopes	28
6	Indicia Designs	29
7	Paper & print specifications for Response Services	31
8	Response With Stamps	35
9	Pre-Pay Reply via franking machines	37
10	Admail	38
11	Freepost NAME	39
12	Contact us	40

Response Services User Guide

Introduction

Response Services

Response Services are a simple but powerful tool for your business; they actively encourage businesses, customers and new prospects to respond to you quickly and easily. Use them to great effect for direct mail, magazine inserts, press ads, electoral communications, market research and surveys too.

Response Services are a reply paid service meaning that once you have purchased one of the services below you will only be charged for the items we deliver back to you. You can choose between Response Plus, Response Standard, Response with stamps for Charities and Pre-Pay reply via franking meter machines.

Response Plus

Response Plus is a reply paid, end to end service which can only be used for letters]. You print a licence number and address that we supply on to envelopes; which you then supply to your customers. Response Plus letters can be read easily by our sorting machines and have a lower cost per response than Response Standard.

Business Reply Plus

Choose this service if you prefer the response licence detail to be printed on the top left of the mail item.

Freepost Plus

Choose this service if you prefer the response licence detail to be printed with the return address.

Response Standard

Response Standard is a reply paid, end to end service, which can be used for letter, large letter or parcel responses. You will print a licence number and address that we supply on to envelopes, which you then supply to your customers; or your customers write the licence number and address on parcel items only. This enables us to deliver the mail and invoice you for the responses you receive.

Business Reply Standard

Choose this service if you prefer the response licence detail to be printed on the top left of the mail piece.

Freepost Standard

Freepost Standard only has a pre-printed option (The handwritten option for Letters and Large Letters was withdrawn from 30th March 2015.) You pre-print the envelope with your address and Freepost licence number and then supply the envelopes to your customers. This means that we can deliver the mail and invoice you for the responses you get back. Choose this service if you prefer the response licence detail to be printed with the return address.

Response with stamps

Response with postage stamps has been developed for use by our registered Charity customers. When respondents to a Charity affix a postage stamp in a designated area on a Business Reply or Freepost mail piece we will credit the Charity's account with the cost of the Business Reply or Freepost postage.

Pre-Pay Reply

Pre-Pay Reply enables franking customers to provide pre-paid, pre-franked reply envelopes to their customers to reply to them.

Admail

Admail enables you to print a local or high profile address on your reply items, which when returned by your customers will in fact be delivered to your usual business or other nominated address. You can use Admail with Response Plus, Response Standard and Response with stamps for Charities.

Response Services Agreement

This user guide forms part of your agreement with us for Response Services. The agreement also includes the specific terms for Response Services and our general terms and conditions of business.

1 Design for mailing effectiveness

Whichever Royal Mail Response Service you choose, you need to ensure your reply items meet our design criteria. That's the single best way to ensure that Royal Mail processes your responses speedily and efficiently. You must (other than for Business Reply Plus, Freepost Plus and Pre-Pay Reply) seek our prior approval of each of your pre-printed item designs, to ensure that it meets our design, layout and technical requirements. We also highly recommend that our prior approval is sought for all Business Reply Plus and Freepost Plus designs. These guidelines will help you to get the design of your mail items right every time and avoid them being lost or damaged. You'll be pleased to find there's freedom for you to customise reply items with your own text and graphics, subject to the guidance below. Please note that whichever variant you choose all letter and large letter items should have your 12 alpha character licence number and barcode printed on the mail piece (see sections 3.1, 3.2 and 5.3 for further details).

Response Plus

If you've decided to use Response Plus for your reply items, please follow the guidelines in section 3 and the paper and print specifications in section 7. That way you can be sure that your items are 'machineable' and can be processed automatically by our sorting technology.

Response Standard

If you've decided to use Response Standard for your reply items, please follow the guidelines in section 5. We also recommend you follow the paper and print specs in section 7. That way you can be sure of receiving a reliable and effective service.

Our online design tool

Using our online design tool makes it even easier to produce items meeting our design specifications. You simply enter your licence and address information (as supplied by us), then choose an envelope design style. You can access the design tool at www.royalmail.com/responseservices

If your designs fail to match the guidelines, there is a chance your items may be delayed, lost or damaged. We may apply a 30p surcharge per item for handling each of your items manually, or a monthly charge of £25.00 for all your items on a given licence number.

A choice of design options

Whether you opt for Response Plus or Response Standard for your reply items, you have a choice of two print design options:

- **Business Reply**, which has a highly professional look and feel, ideal for corporate communications.
- **Freepost**, which has a less formal look, often better suited to consumer-focused campaigns.

Further design guidance

Call us on 08457 950950 to get advice or check your mail pieces.

2 Know your Response Plus audience

As long as you follow the essential Response Plus specifications, you're free to customise your envelope or card with text or graphics as you wish. Please note that Response Plus is only suitable for letter format items, which meet the Response Plus specifications outlined in this document.

The essential design specifications for Business Reply Plus and Freepost Plus are identical except for the:

- licence number
- address fonts
- indicia
- barcode

Don't forget that if you decide to produce a Response Plus item the maximum weight is 100g.



Figure 1 - Business Reply Plus DL sample design (not to scale)

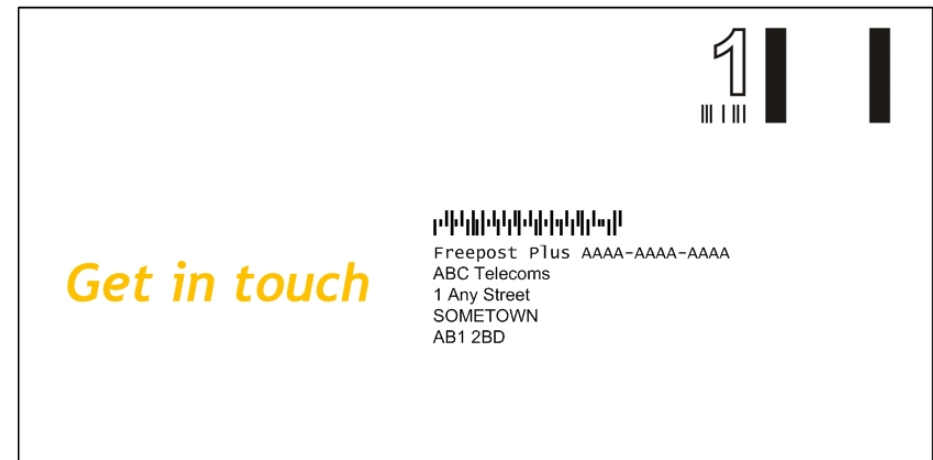

Figure 2 - Freepost Plus DL sample design (not to scale)

3 Response Plus design specification

Make sure your Business Reply Plus envelope or card always follows the essential specifications. This will help us get your reply items back to you with greater efficiency.

The details provided apply to both 1st and 2nd Class designs. Please refer to section 6 for 1st and 2nd Class indicia specifications. Please note – Freepost Plus follows the same layout as Business Reply Plus, except that the licence number moves from upper left to the address block and barcode position changes as shown in the subsequent figures (details can be found in sections 3.1 and 3.2.)

Size

Your letter must be rectangular, with four straight edges and each corner a right angle (90°). The longest edge should be at least 1.4 times the length of the shortest edge.

Orientation

Response Plus mail must always be presented in landscape orientation.

Weight

Your item can have a maximum weight of 100g.

Thickness

The minimum thickness of your envelope is 0.25mm, while its maximum thickness is 5mm.

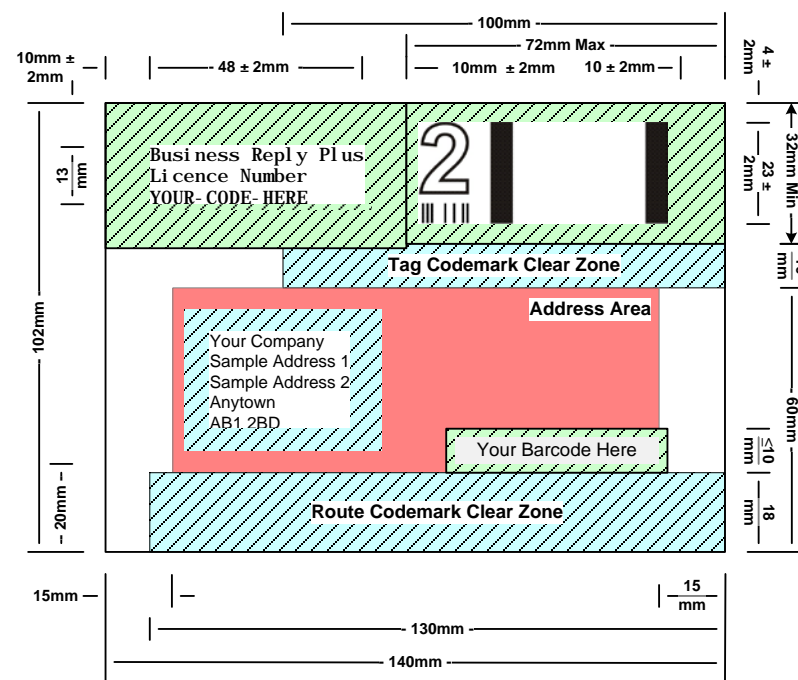

Figure 3 - Business Reply Plus Letter minimum layout specification (not to scale)

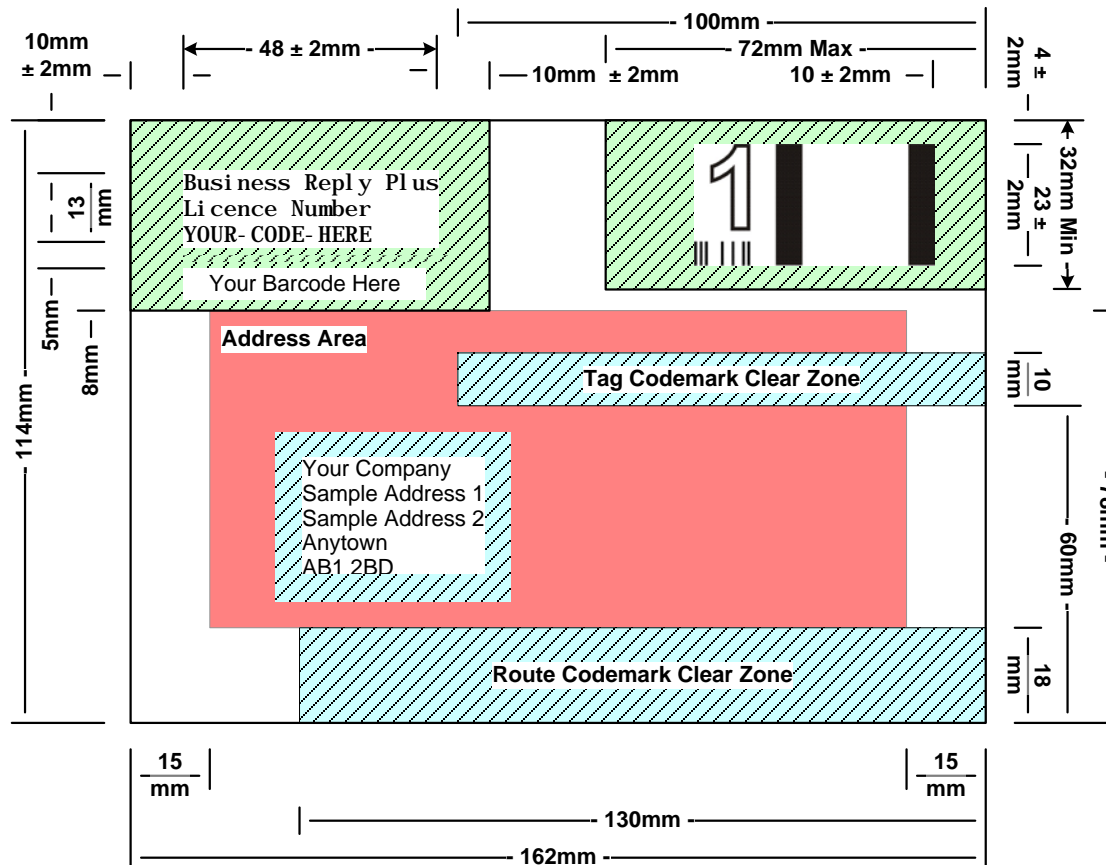

Figure 4 - Business Reply Plus letter C6 layout specification (not to scale)

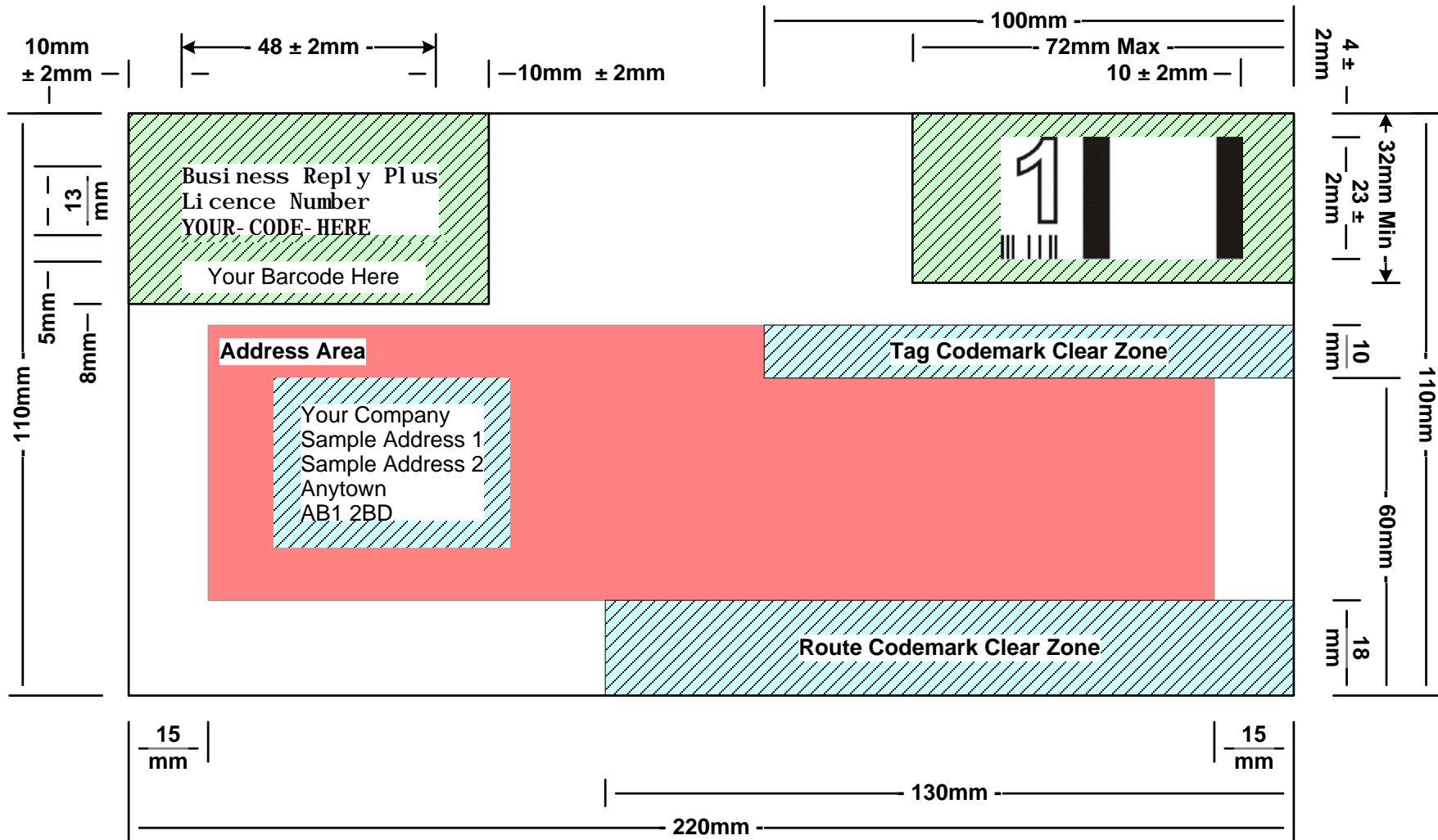

Figure 5 - Business Reply Plus letter DL layout specification (not to scale)

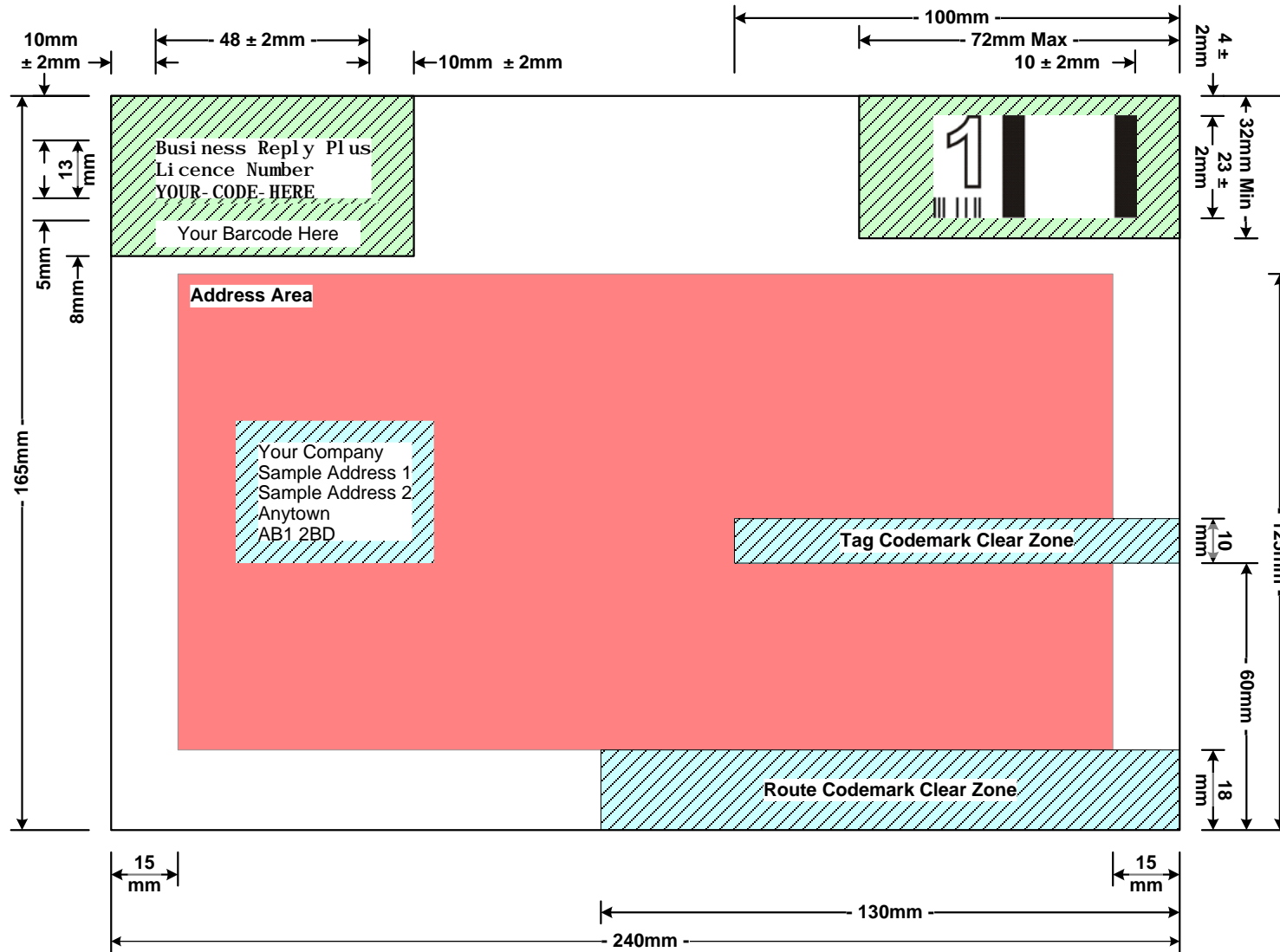

Figure 6 - Business Reply Plus letter maximum layout specification (not to scale)

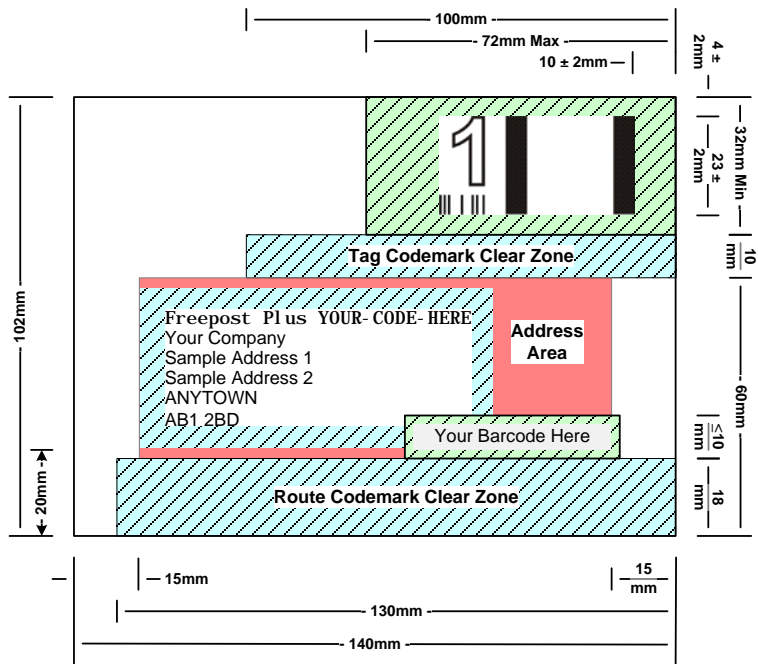

Figure 7 - Freepost Plus letter minimum layout specification (not to scale)

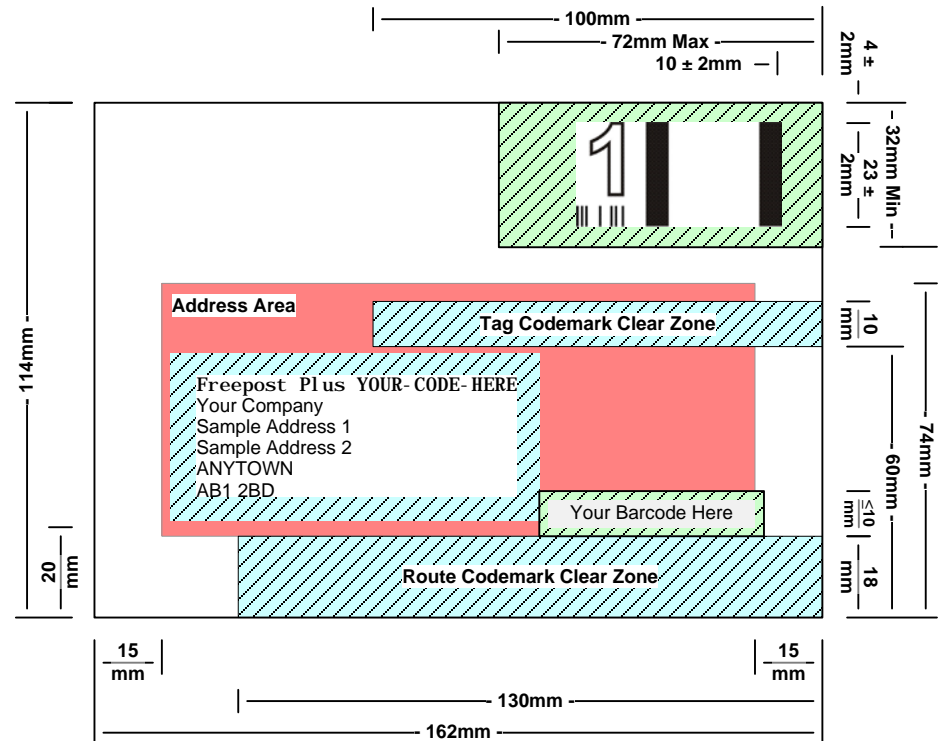

Figure 8 - Freepost Plus letter C6 layout specification (not to scale)

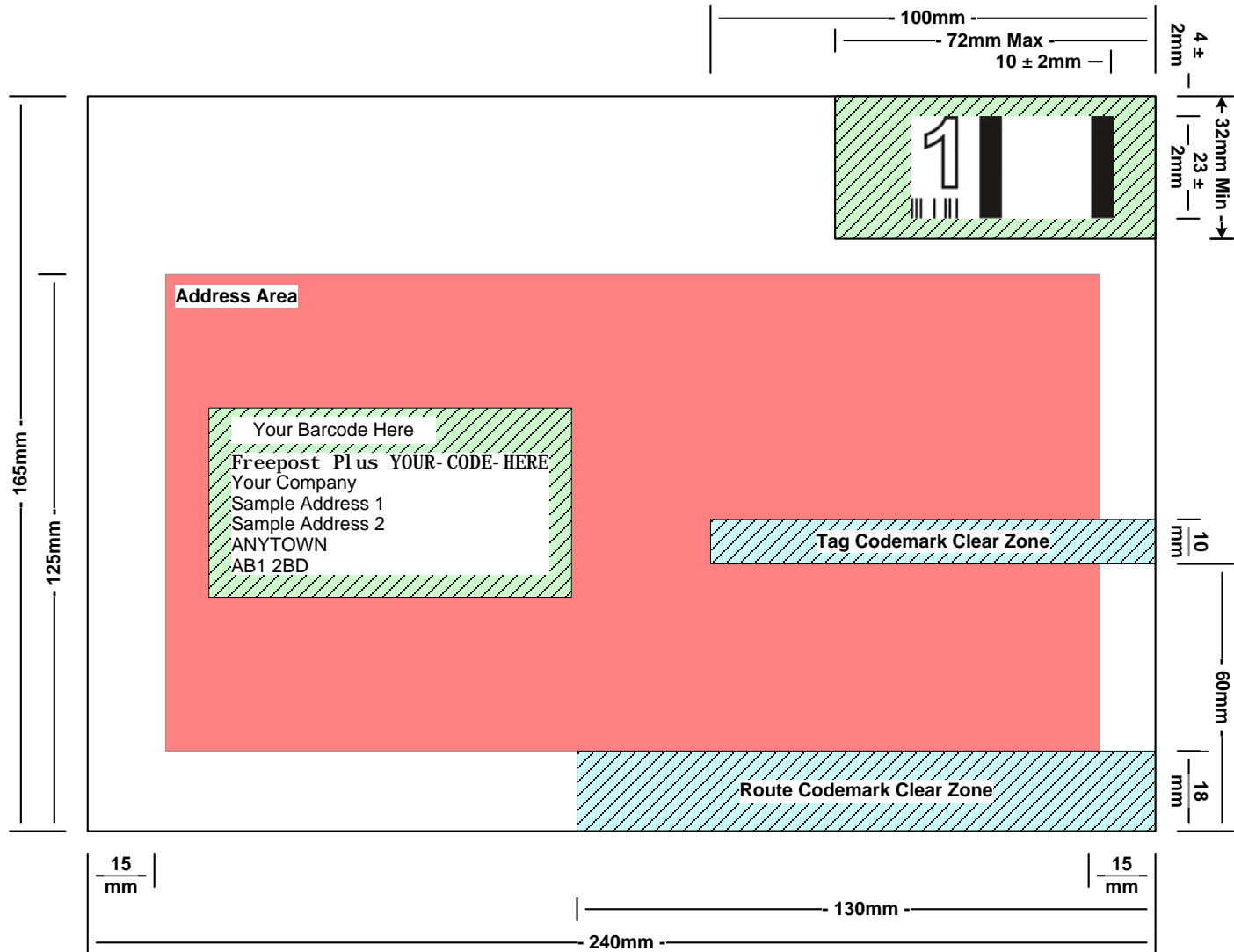

Figure 9 - Freepost Plus letter maximum layout specification (not to scale)

3.1 Response Plus Licence numbers

We will make your licence number available to you in electronic form. If you prefer, you can create the design yourself using the specifications within this document.

- The required print contrast ratio for the licence number printed on envelopes $\geq 50\%$.
- The preferred print colour for the licence number is black.
- Negative contrast is not allowed.

Business Reply Plus style designs

- The licence plate must be positioned at the top left-hand corner of the mail piece item (not contained within a box) and left-hand justified.
- The whole licence plate must be printed in one of the defined fonts in 12pt using 10 characters per 25.4mm (CPI). When printed correctly the characters form into vertical columns as demonstrated by the grid opposite.
- When printed correctly the licence number should be between 35mm-36mm in length.
- Therefore, using the grid as a guide only, the licence plate must be in the following format:

Licence plate format

B	u	s	i	n	e	s	R	e	p	l	y	P	l	u	s
L	i	c	e	n	c	e	N	u	m	b	e	r			
R	R	R	R	-	R	R	R	R	-	R	R	R	R		

- The licence number characters should be printed in upper case and must not be printed using bold or italic fonts.
- The words 'Business Reply Plus' must be in title case.
- The clear zone around the licence plate must be 10mm +/- 2mm above, to the left and to the right; with a clear zone of 5mm below between the plate and the barcode (10mm where there is no barcode).

Freepost Plus style designs

- The first line of the address must bear the words 'Freepost Plus' followed by the licence number. This must be left-hand justified and aligned to the address block. Line spacing must be consistent with that of the address block.
- The licence plate characters must be printed in the defined fonts in 12pt using 10 characters per 25.4mm (CPI). When printed correctly the characters form into vertical columns as demonstrated by the grid below.

- Therefore, using the grid as a guide only, the licence number must be in the following format:

F	r	e	e	p	o	s	t	P	l	u	s	R	R	R	R	-	R	R	R	R	-	R	R	R	R
---	---	---	---	---	---	---	---	---	---	---	---	---	---	---	---	---	---	---	---	---	---	---	---	---	---

- The words 'Freepost Plus' must be in title case.
- When printed correctly the licence number should be between 35mm-36mm in length.
- The licence number characters must be printed in upper case and must not be printed using bold or italic fonts.

Fonts

Always use a font which can be read by our processing machines. Choose one of these defined fonts for your licence number:

OCR B (preferred)

Mnaco
 Let t e r G o t h i c
 L u c i d a C o n s o l e
 L u c i d a S a n s T y p e w r i t e r

Indicia Designs

Business Reply Plus style designs and Freepost Plus style designs must have valid indicia (1st or 2nd Class which complies with the specifications in section 6.)

3.2 Response Plus Licence Barcodes

A Barcode must be included on letter mail pieces.

You can generate your barcode by using our artwork generator tool, which is available from at www.royalmail.com/responseservices.

Your barcode must comply with the following requirements.

Barcode content

The barcode will contain the first 6 digits of the licence number, the service, the format and the delivery speed.

Barcode Properties

- Background Reflectance value of a minimum of 35% is required.
- The reflective difference between the mail piece background and the print reflectance must be a minimum of 30%.
- The barcode must be printed so that it contrasts with the background, typically black bars on a white background, Positive Contrast or Inverse Printing (barcode lighter than the Background) is not permitted.
- A Print Contrast Ratio (PCR) of 40% is required.
- The edges of the barcode must be sharp and clearly defined.

Barcode Alignment and Size

- The skew of each bar in the code must be less than 5°, in either clockwise or anti-clockwise rotation, as illustrated by the angles marked 'Y' in the diagram below. Additionally, the sum of overall code skew and bar skew must be less than 5° in total, as illustrated below. The angle 'X' must be referenced to a line parallel with the longest edge of the mail piece, as shown in the diagram below.

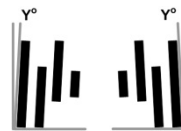

The dimensions for the barcode are:-

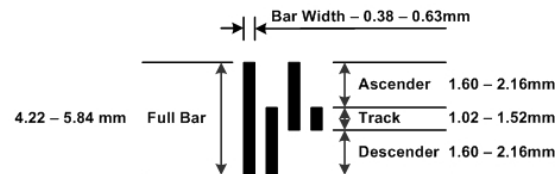

- The barcode pitch must be 20 -24 bars per 25.4mm and must be equally spaced. The recommended bar dimensions are width - 0.54mm, ascender and descender height - 1.9mm, rack bar height - 1.3mm. The recommended pitch is 21.2 bars per inch (25.4mm).
- The track element of the bars must be symmetrical about the centre line of the code +/- 10% of the height of the centre line.

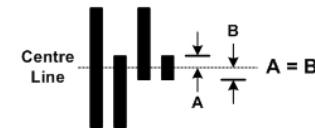

Barcode Positioning

- No other text, graphic, picture, window edge, one piece mailer flap, perforations etc. may appear in the barcode area including its associated clear zone.
- The barcode must not encroach into the clear zones defined below.

The barcode position and clear zone varies dependent upon the product and letter size:-

Business Reply Plus

Minimum Size – The barcode is positioned in the bottom right corner above the Route codemark and 20mm up from the bottom and 15mm in from the right edge + / - 2mm. A clear zone of at least 2mm is required around the barcode.

C6 and larger – The barcode is positioned beneath the Licence Plate, 10mm from the left edge and 5mm beneath the Plate + / - 2mm. A clear zone of at least 2mm is required to the left and right, and below the barcode.

Freepost Plus

Minimum Size & C6 – The barcode is positioned in the bottom right corner above the Route codemark and 20mm up from the bottom and 15mm in from the right edge + / - 2mm. A clear zone of at least 2mm is required around the barcode.

DL and larger – The barcode is positioned in the 2mm above the Licence Plate. A clear zone of at least 2mm is required around the barcode.

3.3 Response Plus Address details

Typography

- The address must be the full and correct geographic address (including postcode) for the place to which the items will be delivered, as defined by the Postal Address File (PAF®). The exception is the Department information which must either:
 - include the PAF® Department, in which case it must fully match that Department held in PAF®
 - exclude the PAF® Department.

Addressee information is restricted to two lines of text above the geographic address. (This may include an alternative 'Department' name that is different to that which appears in PAF® if required.)

- The address must be typed in a landscape format (parallel to the bottom edge).
- The only punctuation and non-alpha-numeric symbols that may be used are those that are included within the Delivery Address as shown in the Postcode Address File.
- All lines of the address must be left-hand justified.
- The address must not be printed using bold or italic fonts.
- The entire Delivery Address should be printed in Title Case with the exception of the Post Town which can either be printed in Title Case or Upper Case, e.g. Milton Keynes or MILTON KEYNES.
- The postcode MUST always be printed in UPPER CASE. It should be the last line of the address and on a line by itself. There should be one or two character spaces between the outward and inward elements.
- The address should be provided as a 'block' of text.
- The content of an address line should not be wrapped on to a second line of text - i.e. London Road must be printed on the same line and not spread over two lines.
- Characters of the same font and point size should be used for each line of the address.
- Character spacing should maintain clear vertical gaps of 0.1mm – 0.4mm between the extremities of adjacent characters.
- Spacing between lines should be uniform – a minimum of 1mm and maximum of 4mm measured from descender to ascender.
- Spacing between words should be < 5mm.
- There should be a maximum of 64 characters (including spaces) per line of the address block.
- There should be no blank lines in the address.
- The address block skew should be no more than 5°.
- The preferred print colour for the address is black.
- Negative contrast is not allowed.
- Print quality should be such that characters are not blurred, smudged, deformed, or incomplete.
- There should be no splashing or ink spatter around the characters.
- Recommended Print Contrast Ratio for addresses printed on envelopes $\geq 50\%$.
- Recommended Print Contrast Ratio for addresses printed on window inserts $\geq 55\%$.
- No other text or information that could be mistaken as a Delivery Address should be included on the face of the mail piece, as this may lead to your items being incorrectly sorted. This includes any areas of an insert which may appear in the window of an envelope if the insert shifts position.

- The gap between the licence plate and address block for Freepost Plus must conform to and be consistent with the spacing in the remainder of the address block. Never have a gap between the licence plate and the first line of the address.

Address placement

You have quite a lot of freedom to choose where you place the address (as outlined in Figure 3 - Figure 9). Just make sure it is at least 15mm from the left edge, 15mm from the right edge and 40mm from the top edge and that you do not impinge on any of the clear zones as outlined below.

Clear zones

Clear zones are zones clear of any markings. They are used by our machines to locate the address on mail items as well as print and read codes. There are four clear zones:

- 18mm from the bottom right-hand corner and 130mm long from the right edge. This is the route code clear zone for Royal Mail codemarking.

- 60mm from the bottom edge, 10mm high, 100mm long and aligned to the right edge.
- 5mm around the address in all directions (this may overlap with either or both of the other two clear zones providing the address remains in the address block area).

Please note – the address block is defined as a rectangle drawn around the outer extremities of the address, including the recipient’s name.

Fonts

Always use an address font which can be read by our processing machines. With Business Reply Plus, you can use any of these fonts:

Arial 10-12 point

Avant Garde 11-15 point

Century School Book 10-11 point

Courier 10-15 point

Courier New 10-15 point

Frankfurt Gothic 10-12 point

Franklin Gothic Book 11-14 point

Geneva 10-14 point

Helvetica 10-14 point

Letter Gothic 12 point *

Lucida Console 12 point *

Lucida Sans Typewriter 12 point *

Mnaco 12 point *

News Gothic MT 10-12 point

OCR B 12 point *

Univers 10-15 point

Verdana 10-12 point

- With Freepost Plus, you can only use one of the five fonts listed with an asterisk printed at 10 characters per 25.4 mm (CPI).
- Our preferred font is OCR B 12 point.

3.4 Response Plus Window envelopes

Window envelopes must follow these guidelines:

- Gloss – the maximum gloss value of the window material is to be 150 when measured at 60° in accordance with ASTM 2457 ‘Standard Test Method for Specular Gloss of Plastic Films’.
- Haze – the window haze should not exceed 75% in accordance with ASTM D1003 ‘Standard Test Method for Haze of Plastic Films’.
- Strength – the window should be robust enough not to become deformed. It should be fixed to the envelope evenly across the surface area it is in contact with.
- The window should not infringe any of the clear zones on the mail piece.
- Windows on mail pieces should only appear on the front of the mail piece (the same side as the address).
- Windows should not take up more than 50% of the surface area of the mail piece.
- There should be no more than two windows on a mail piece.
- Windows should only appear on the front of the envelope.

Where the address is on an insert within a window, the address must be fully visible, with the left, right and bottom edges of the address block at least 2mm away from the window edge. Additionally, there must be a 5mm clear zone around the top, bottom, left and right edges of the address block, which is free from text, graphics or patterning. Note that this means that if the address block is within 5mm of the window edge, then the area of the envelope adjacent to the window must be clear of print graphics or patterning to provide the required 5mm. (The window edge itself is not considered an infringement of the 5mm clear zone.)

These requirements apply at all times, including after the mail item is tapped on any of its four edges to induce maximum insert movement. It’s best to make certain the insert fits snugly within the envelope to prevent excessive movement.

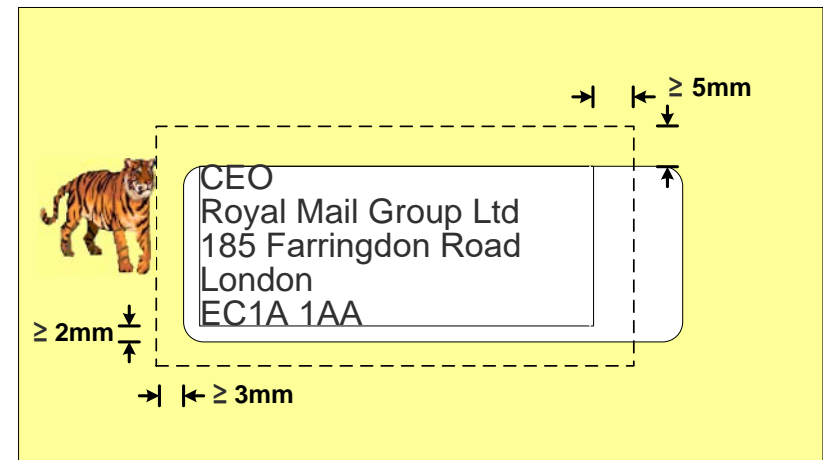

Figure 10 - Window Envelope Clear Zones (not to scale)

4 Know your Response Standard audience

The design of Response Standard items offers you more flexibility than that of Response Plus items because they cannot necessarily be processed by our machines and are subject to a handling charge (please see the Response Services rate card). Within the specifications of this user guide, you're free to customise your Response Standard envelope or card with text or graphics in any way you wish.

With Response Standard you also have the freedom to use all size, weight and dimension formats as defined in section 5. The essential design specifications for Business Reply and Freepost are identical except for the:

- licence number
- indicia
- barcode



Figure 11 – Business Reply Standard DL sample design (not to scale)

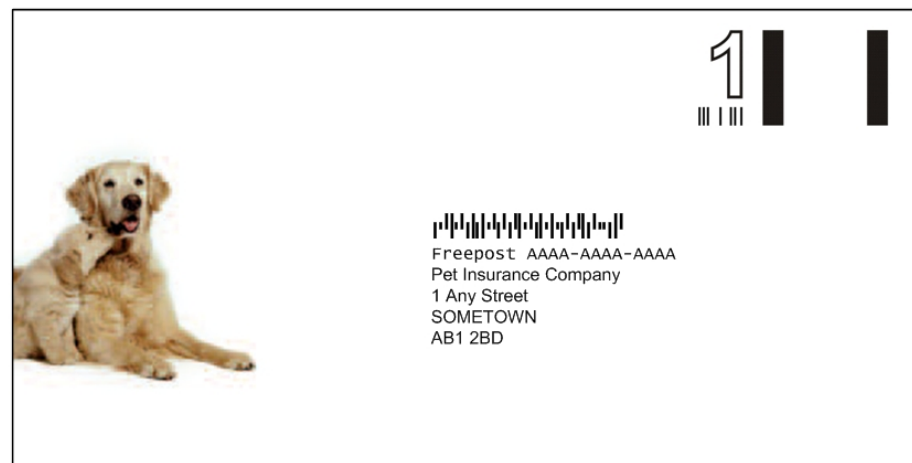

Figure 12 - Freepost Standard DL sample design (not to scale)

5 Response Standard design specification

Make sure your Response Standard envelope or card always follows the essential specifications. This will help us get your reply items back to you with greater efficiency.

The details provided apply to both 1st and 2nd Class designs. Please refer to section 6 for 1st and 2nd Class indicia specifications.

Please note – Freepost follows the same layout as Business Reply, except that the licence number moves from upper left to the address block and barcode position changes as shown in the subsequent figures. (Details can be found in sections 5.1 and 5.2.)

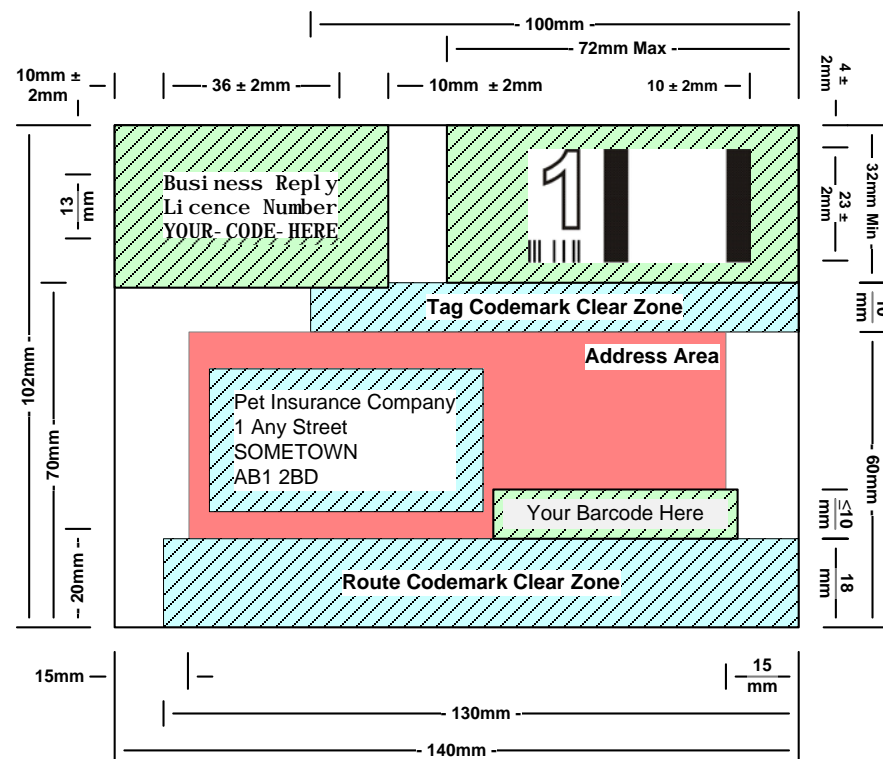

Figure 13 - Business Reply Standard letter minimum layout specification (not to scale)

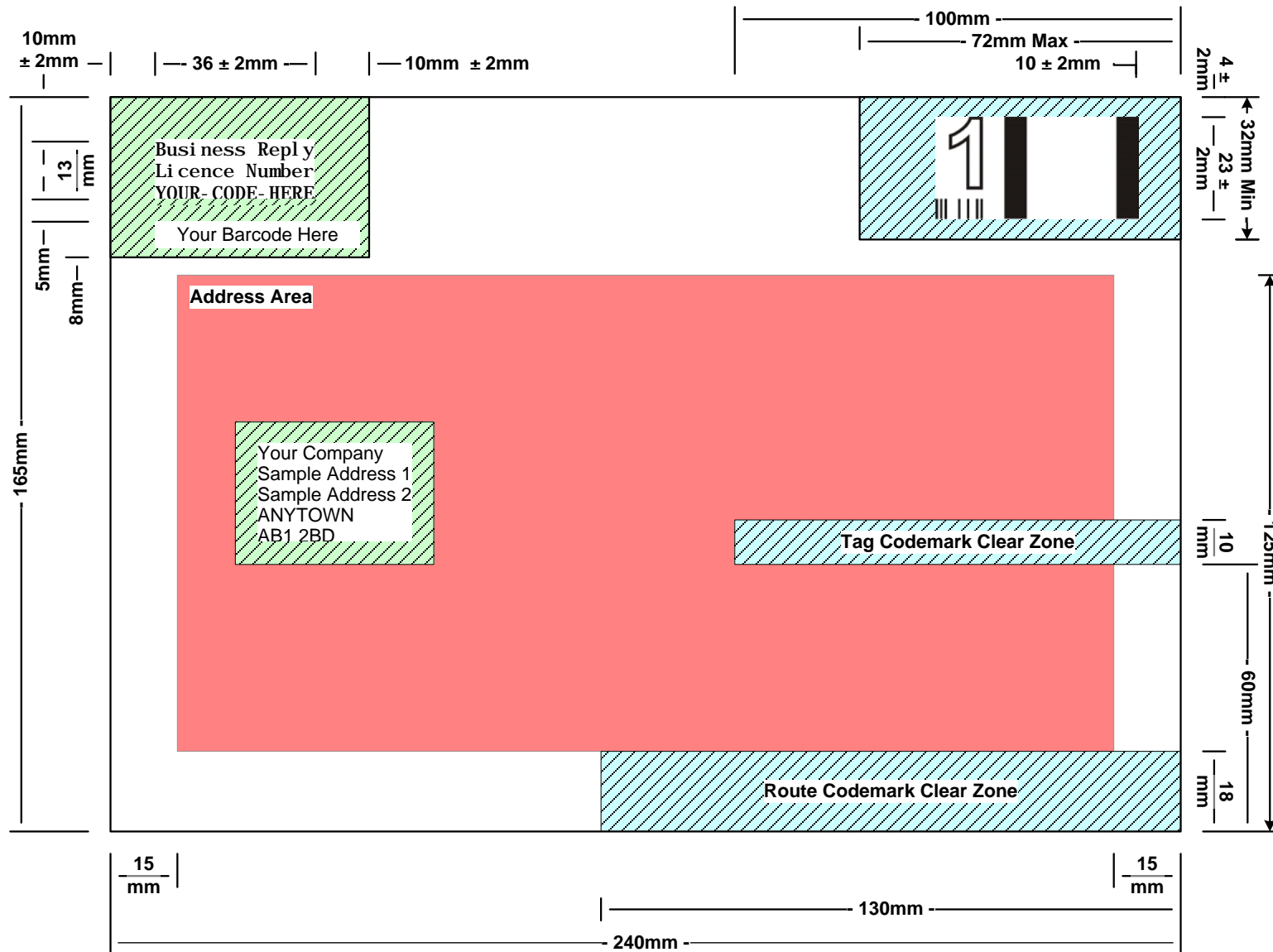

Figure 14 - Business Reply Standard letter maximum layout specification (not to scale)

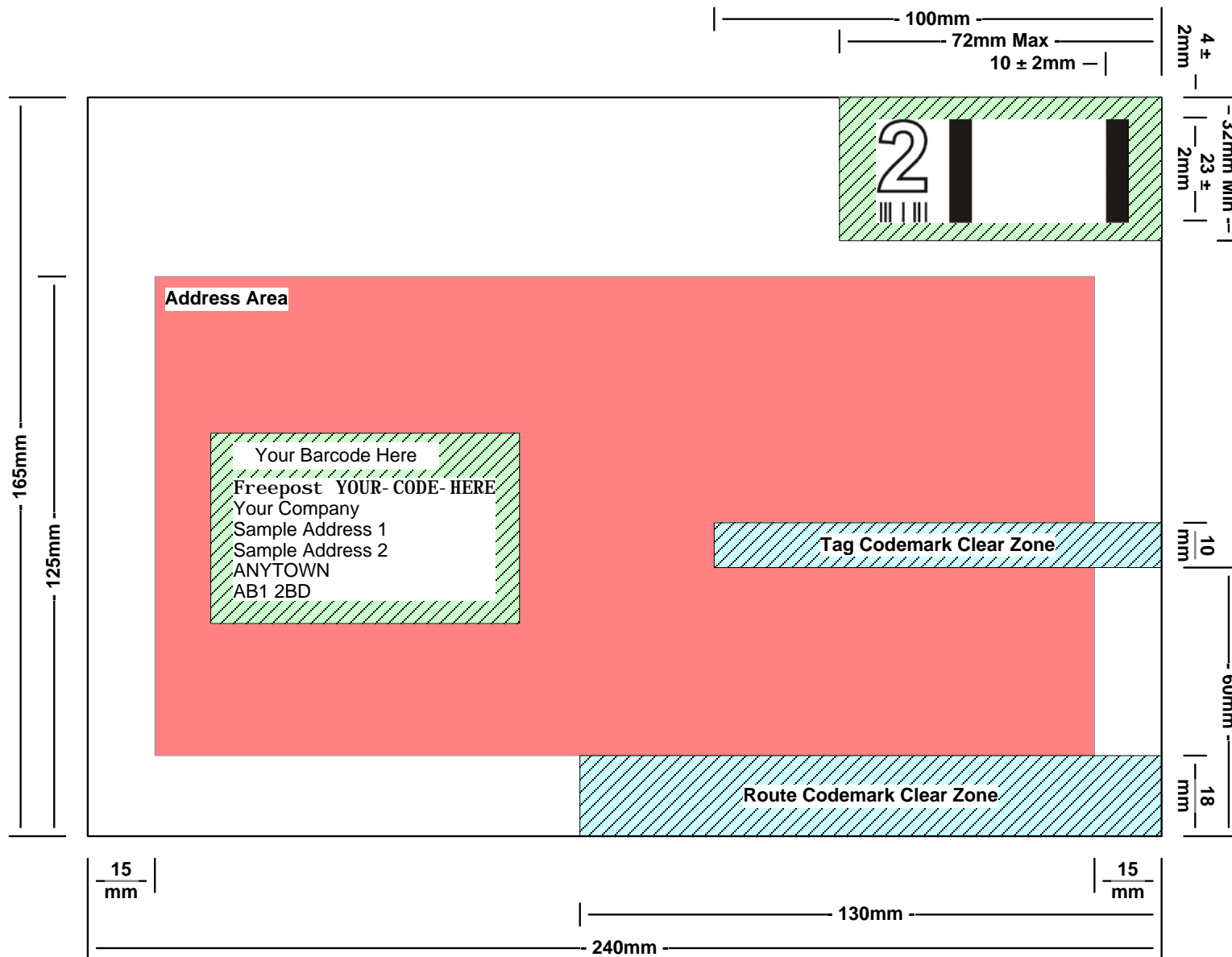

Figure 15 - Freepost Standard letter maximum layout specification (not to scale)

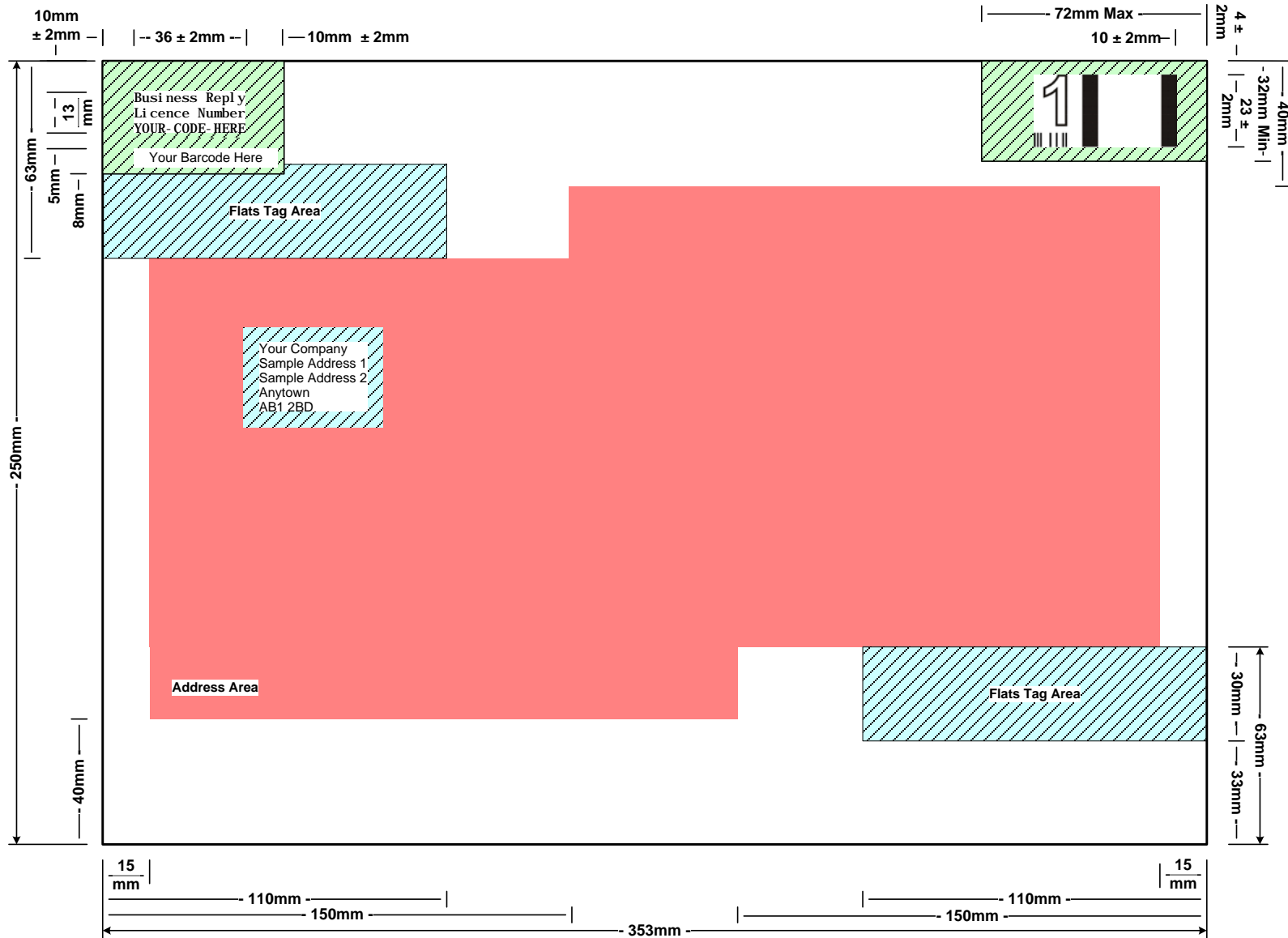

Figure 16 - Business Reply Standard Landscape large letter maximum layout specification (not to scale)

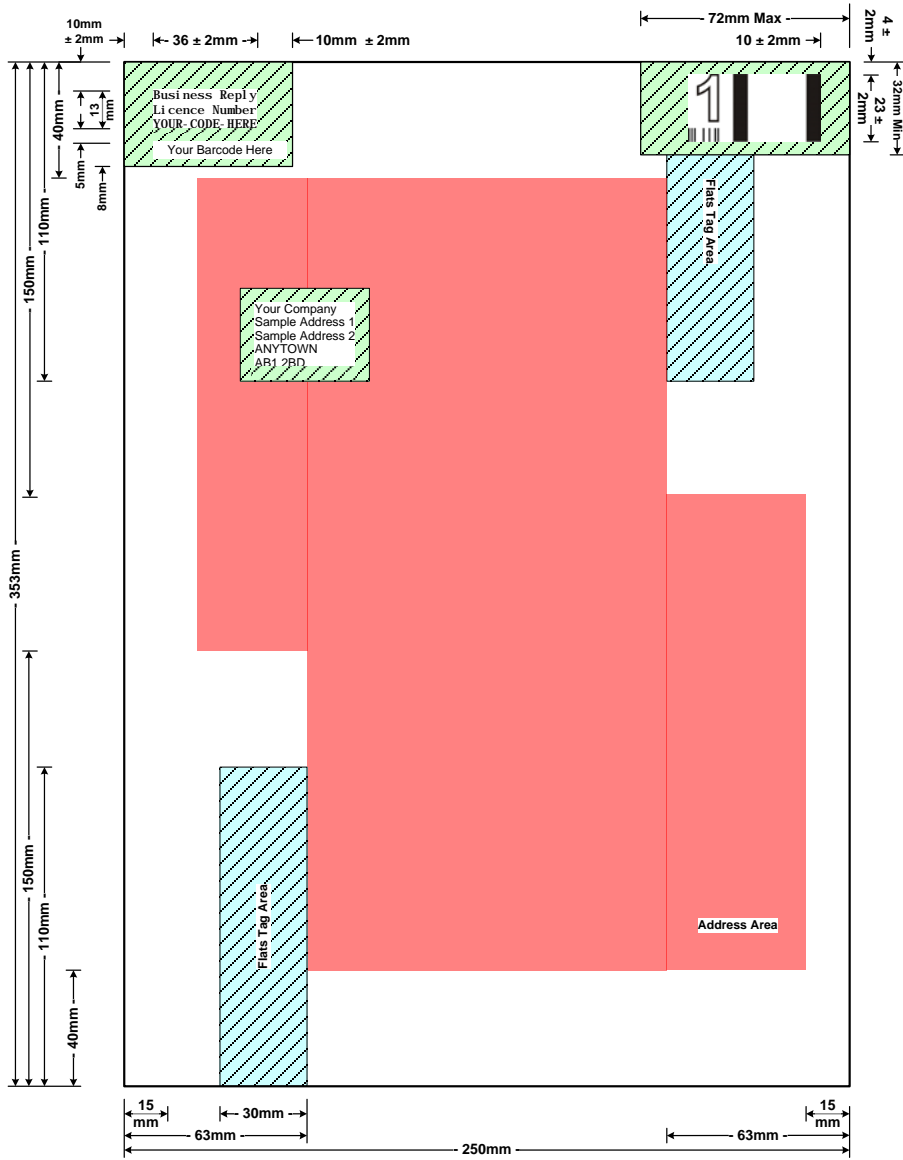

Figure 17 - BR Std Portrait large letter maximum layout (not to scale)

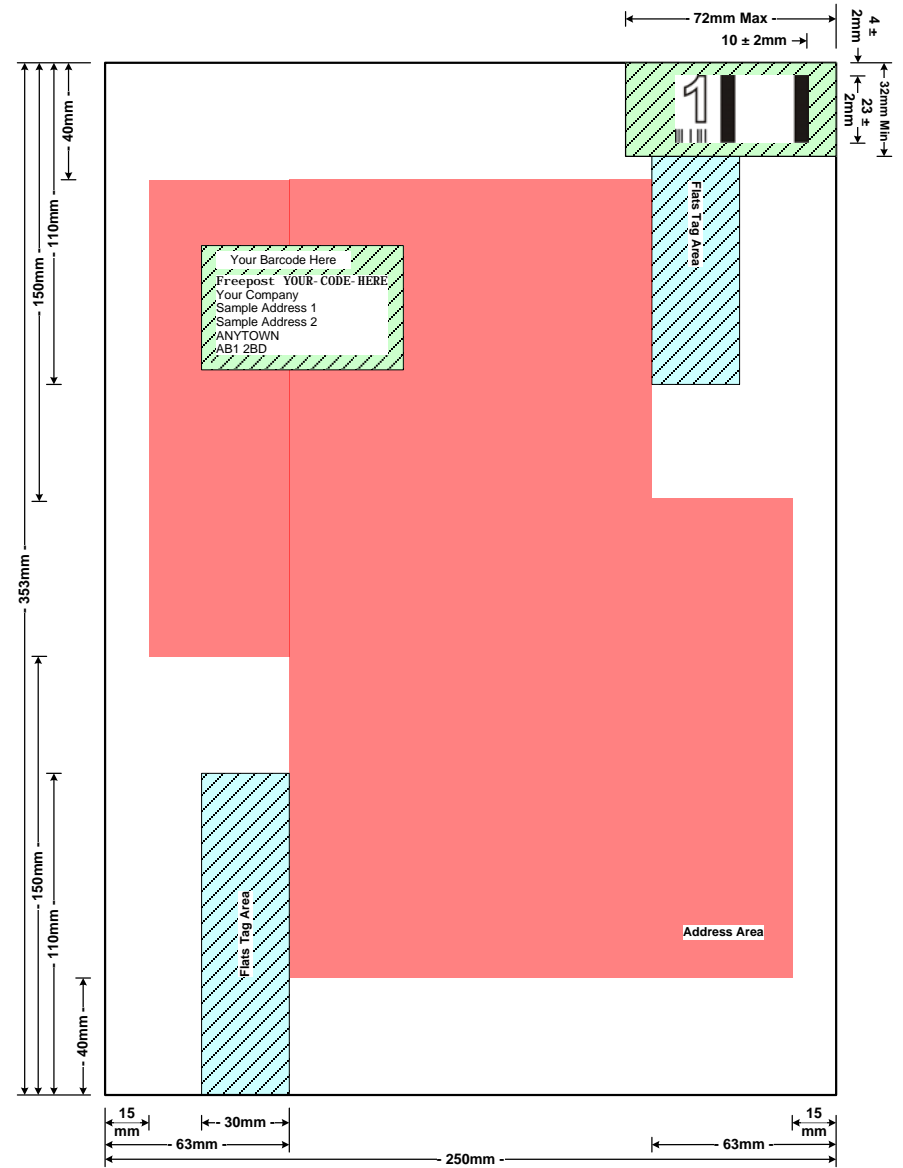

Figure 18 - Freepost Std Portrait large letter maximum layout (not to scale)

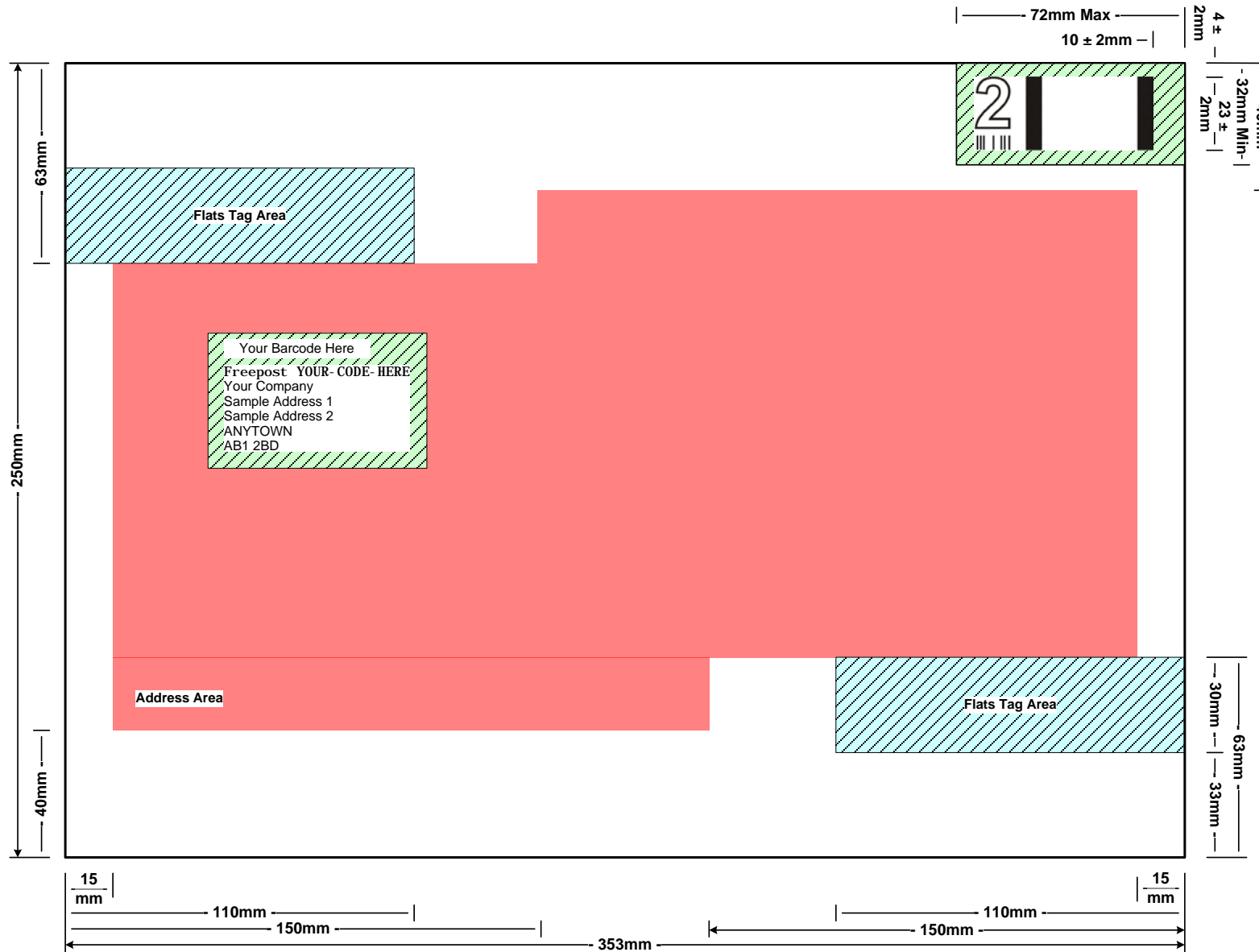

Figure 19 – Freepost Std Landscape large letter maximum layout (not to scale)

Size, weight and dimensions

Size

The minimum size of a mail piece is 140 x 90mm. Please note that the minimum size to allow for the requisite clear zones to fit on the envelope is 140mm x 102mm.

Pre-printed Business Reply and Freepost letters must be rectangular with four straight edges and each corner a right angle (90°). The longest edge should be at least 1.4 times the length of the shortest edge.

Weight

Your item can have a maximum weight of 1kg when it is 2nd Class. The maximum weight limit for 1st Class items is 20kg.

Letter

The minimum thickness of your envelope is 0.25mm. The maximum weight is 100g. The maximum sizes are given below.

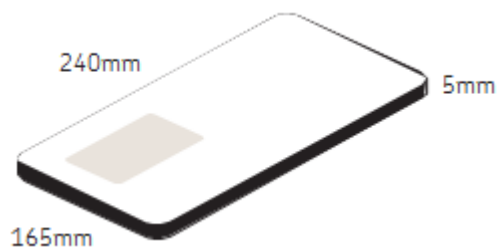

Large letter

Any item that has a dimension exceeding the maximum dimension for a letter and any item weighing more than 100g is a Large Letter.

The maximum weight is 750g.

The maximum sizes are given below. For Response Services the maximum thickness is 25mm*.

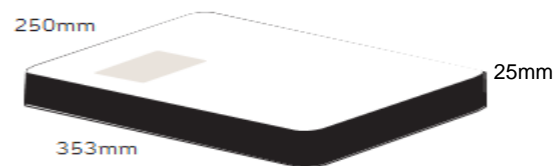

* The maximum thickness change was communicated in the February 2020 and October 2020 terms and conditions communication

Parcel – box

Any item that has a dimension exceeding the maximum dimension for a large letter and any item weighing more than 750g is a Parcel. The maximum sizes are given below.

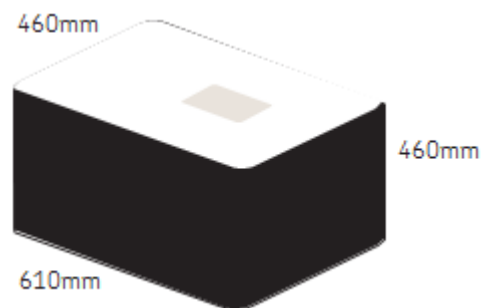

Parcel – tube

Maximum dimensions: length plus twice diameter must not exceed 1,040mm.

Items that are either squarely or rectangularly cuboid in shape are also permitted. All such items at their widest point must still fit within the diameter of the maximum allowable cylindrical dimensions.

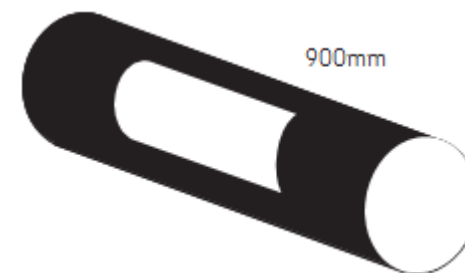

Orientation

Response Services letters must always be presented in landscape orientation, whilst Response Services large letters may be presented in landscape or portrait orientation.

5.1 Response Standard Licence number

We will make your licence number available to you in electronic form. You can create the design yourself if you prefer using the specifications in this document.

Business Reply style designs

- The licence plate must be positioned at the top left-hand corner of the mail piece (NOT contained within a box).
- The whole licence plate must be printed in one of the defined fonts in 12pt using 10 characters per 25.4mm (CPI). When printed correctly the characters form into vertical columns as demonstrated by the grid in the figure below.
- When printed correctly the licence number should be between 35mm-36mm in length.
- Therefore, using the grid as a guide only, the licence plate must be in the format below

B	u	s	i	n	e	s	R	e	p	l	y		
L	i	c	e	n	c	e	N	u	m	b	e	r	
R	R	R	R	-	R	R	R	R	-	R	R	R	R

The words 'Business Reply' should be in title case.

- The licence number characters should be printed in upper case and must not be printed using bold or italic fonts.

The clear zone around the licence plate must be 10mm +/- 2mm above, to the left and to the right; with a clear zone of 5mm below between the plate and the barcode (10mm where there is no barcode).

Freepost Standard style designs

- The first line of the address must bear the words 'Freepost' followed by the licence number. This should be left justified and aligned to the address block. Line spacing should be consistent with that of the address block.
- The licence number characters should be in one of the defined fonts and be printed in 12 point using 10 characters per 25.4mm (CPI) in the following format:

F	r	e	e	p	o	s	t	R	R	R	R	-	R	R	R	R	-	R	R	R	R
---	---	---	---	---	---	---	---	---	---	---	---	---	---	---	---	---	---	---	---	---	---

- The words 'Freepost' should be in title case.
- When printed correctly the licence number should be between 35mm-36mm in length.
- The licence number characters should be printed in upper case and must not be printed using bold or italic fonts.

Fonts

The whole licence plate must be printed in one of the defined fonts. The licence number characters must be printed in upper case font and not in bold or italic. Choose one of these fonts for your licence plate characters:

OCR B (preferred)

Mnaco

Let t e r G o t h i c

Luci d a C o n s o l e

Luci d a S a n s T y p e w r i t e r

Handwritten Licences

Handwritten licences are NOT permissible for Freepost Standard Letters or Large Letters from 30th March 2015.

Indicia Designs

Business Reply style designs and Freepost style designs must have valid indicia (1st or 2nd Class which complies with the specifications in section 6.)

5.2 Response Standard Address details

Typography

We recommend that the address should be the full and correct geographic address (including postcode) for the place to which the items will be delivered as defined by the Postal Address File (PAF®). With the exception of the Department information which must either:

- include the PAF® Department, in which case it must fully match that Department held in PAF®
- or exclude the PAF® Department.

Addressee information is restricted to two lines of text above the geographic address. This may include an alternative 'Department' name that is different to that which appears in PAF® if required.)

- The only punctuation and non-alpha numeric symbols that may be used are those that are included within the Delivery Address as shown in the Postcode Address File.
- All lines of the address must be left-hand justified.
- The entire Delivery Address should be printed in Title Case with the exception of:
 - the Post Town which must be printed in Title Case or Upper Case. e.g. Milton Keynes or MILTON KEYNES
 - the Postcode must always be printed in UPPER CASE.

- Spacing between lines must be uniform – a minimum of 1mm and a maximum of 4mm measured from descender to ascender.

Fonts

You can use any font you want for the address block. We recommend that you use one of the defined fonts in section 3.3. Please do not use script font.

Handwritten addresses

Handwritten addresses are NOT permissible for Letters or Large Letters from 30th March 2015.

5.3 Response Standard Barcodes

Barcodes are required for Letters and Large Letters, but are not required for Freepost Standard parcels. Barcode format, location and printing requirements are the same as those for Response Plus (see section 3.2).

5.4 Window envelopes

When using a window envelope, you must ensure that the address remains clearly visible in the window at all times. It's best to make certain the insert fits snugly within the envelope to prevent excessive movement. See section 3.4 for more detailed guidelines on using window envelopes.

6 Indicia Designs

Contact us and we will send you the indicia in electronic format. You can also download them from royalmail.com/responseplus

However, if you would like to design your own indicia please follow the specification on the following pages.

Position/clear zone

The indicia must be positioned in the top right corner of the mail piece, 4mm +/- 2mm from the top edge, and 10mm +/- 2mm from the right edge. Nothing else must be printed in an area that extends 32mm from the top of the mail piece and 72mm from the right hand edge.

Indicia colour

The indicia colour must be black.

Print quality

The indicia must be printed at a minimum resolution of 300dpi.

Contrast ratio

A value of $\geq 20\%$ must be provided.

Skew

The maximum skew for the whole indicia is +/- 3° from the horizontal axis.

Business Reply Plus and Business Reply Standard style designs

All Business Reply Plus and Business Reply Standard style mail pieces must have valid indicia (1st or 2nd Class) which complies with the following indicia specifications:

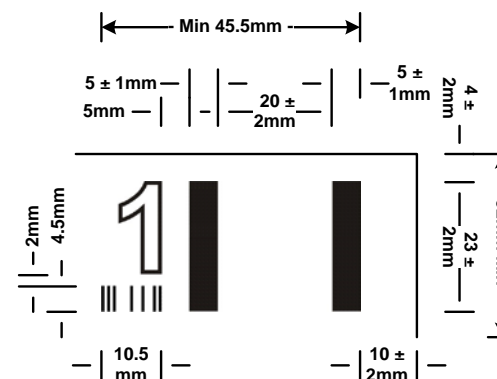

Figure 20 - Business Reply 1st Class indicia dimensions (not to scale)

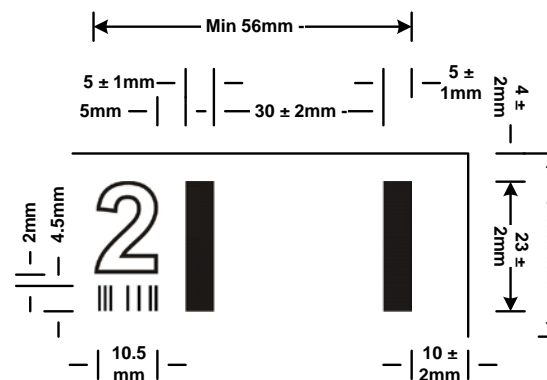

Figure 21 - Business Reply 2nd Class indicia dimensions (not to scale)

Freepost Plus and Freepost Standard style designs

All Freepost Plus and Freepost Standard style mail pieces must have valid indicia (1st or 2nd Class) which complies with the specifications shown in the examples below.

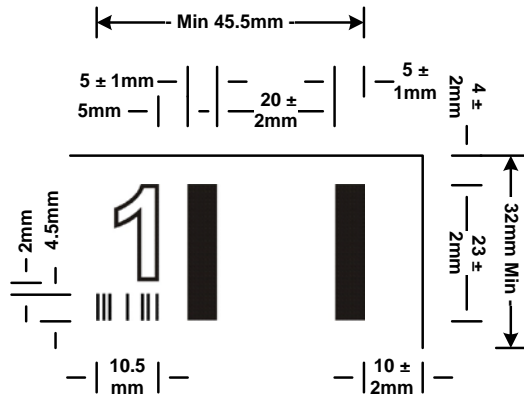

Figure 22 - Freepost 1st Class indicia dimensions (not to scale)

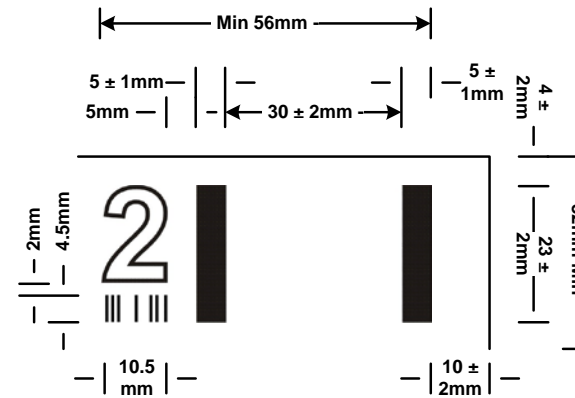

Figure 23 - Freepost 2nd Class indicia dimensions (not to scale)

Please note

The area around the indicia is a designated clear zone. The finder barcode underneath the postage class number relates to the service chosen i.e. Business Reply or Freepost. This barcode is important, as when read by the machine it determines the service to be used. If Business Reply Plus is chosen, the reader will look for the licence number in the top left-hand corner of the envelope. If Freepost Plus is chosen, the reader will look for the licence number in the first line of the address.

7 Paper & print specifications for Response Services

You must use these specifications with Response Plus. We recommend that you also use them with Response Standard (except for printed address labels). If you are using Response Standard and are sending anything other than a letter, we recommend that you follow Royal Mail's packaging guidelines which can be found at www.royalmail.com/packaging

Material

Response Plus items must be paper. You cannot use polythene, plastic or transparent items or envelopes with apertures.

Envelopes should be made of paper with a density no less than 70g per square metre (gsm). Postcards should be made of paper with a density no less than 200gsm and at least 0.25mm thick.

Opacity

The paper on which the address is printed must be more than 85% opaque to prevent any character on the reverse side showing through.

Sealing

The mail piece must be securely sealed on all sides. Only envelopes, postcards and one-piece mailers can be used.

The opening flap may fold to either the back or the front of the mail item. If the flap folds

to the front (address side) of the mail piece, the edge of the flap must not fall within the clear zones.

Opening flaps must be gummed and sealed as far along the edge as possible. All remained edges must be sealed.

There is a maximum tolerance of up to 25mm of the envelope top and where the flaps do not have to be gummed or sealed.

Printed Address Labels

The address may be printed on a label that is applied in the address zone. Where Freepost products are used, the licence and barcode must be printed on the label with the address. Business Reply products must include the Business Reply licence number in the top left corner, and a licence barcode on letters and large letters. Indicias are required on letter and large letter mailpieces. The printing requirements for indicia remain unchanged (see section 6).

Physical label requirements

The physical requirements for the labels are as follows :-

- Labels must be white, rectangular in shape, and have radiused corners.
- The peak peel adhesion strength of the label glue must be $\geq 4\text{N}$ OR fibre tear must be exhibited on separation.
- The label must be securely and evenly applied when presented to Royal Mail.
- The adhesive must not be exposed (including bleed).
- Standard Opacity requirements apply.

Label Content Requirements

The label must be large enough to accommodate the address, the Freepost Licence number and barcode (where Freepost products are used), and their required clear zones. Requirements for the printed content on the labels for Business Reply and Freepost products are as follows.

Labels - Business Reply Standard & Plus

- Normal PAF addressing requirements apply (inc. the skew requirements).
- A clear zone of 5mm is required around the Delivery Address Block. This clear zone may extend onto the envelope provided that a minimum clear zone of 3mm is provided on the label.

Labels - Freepost Standard & Plus

- Normal PAF addressing requirements apply (inc. the skew requirements.)
- The Freepost licence number and barcode is required.
- A clear zone of 5mm is required around the Delivery Address Block and the Freepost Licence. This clear zone may extend onto the envelope to the left, right, and below the label provided that a minimum clear zone of 3mm is provided on the label.
- A clear zone of 3mm is required above the Freepost Barcode, and 2mm clear zone is required to the left and to the right of the Freepost Barcode.

Label Positioning Requirements

When positioned on the mailpiece, the label must not encroach into the standard clear zones :-

- Business Reply Licence Plate clear zones
- Indicia clear zones.
- Border clear zones.
- Codemark clear zones (RS Plus products).

Where the label is to be applied manually, it is strongly recommended that label positioning guides are printed on the mailpiece to indicate where the label must be located and to ensure that the potential for skewing the label is limited.

One-piece mailers

This section defines the specific construction characteristics of one-piece mailers. All other requirements remain as standard.

- The mailer must have at least one fold. Where multiple folds are used, these must be internal to the exterior and meet the gluing requirements specified in this section.
- The reference edge (the edge that is to the bottom of the mailer below the address block) of the mail piece must have only one edge that can be detected. i.e. If multiple folds are required, these must be tucked inside so that there is

only one detectable edge on the reference edge.

- If a flap is present, it may fold either to the back or front of the mail piece. If it folds to the front, it must not interfere with the Codemark clear zones. The flap must be securely sealed and have $\geq 30\text{mm}$ contact on the mail piece. The same rules for glue application apply to the flap as for the edges of the one-piece mailing.
- The paper weight must be $\geq 100\text{gsm}$.
- Where spot-weld glue application is used, the distance between the centres of the spots must not exceed 10mm, and the spot size must be $\geq 5\text{mm}$ in diameter. The maximum distance from the edge of the mail piece for the glue application is $\leq 5\text{mm}$.
- Where continuous weld glue application is used, the maximum distance from the edge of the mail piece for the glue application is $\leq 5\text{mm}$.
- The glue must not run out onto the outside of the mail item or produce protruding mounds on the mail item.
- The glue must be fully cured prior to presentation of the mailing to Royal Mail. The tensile strength of the glue must be $\geq 0.4\text{N}$ and fibre tear must be exhibited on separation.

Porosity

We strongly recommend that the mail piece should have a porosity value of less than 700ml/minute.

Absorbency

15–35gsm of water in one minute.

Reflection

The background reflectivity of the material on which the address is printed must be at least 35% in the red region (600nm) when measured by a spectral reflectometer.

Print Contrast Ratio

The contrast ratio between the background and the address must be at least 50% and at least 55% for window envelopes. The typeface should never be lighter than the background colour.

Paper colour

The best colours to use are white, cream or light buff.

Flexibility

Letters must be flexible along their longest edge. Items must be flexible enough to be capable of being processed in our sorting machines without damage to the machine, the mail piece, or other mail pieces. Each mail piece must therefore be capable of being transported around a pulley with a radius of 140mm with a maximum force of 26 Newtons. Don't enclose inflexible objects such as coins, keys and thick card coupons.

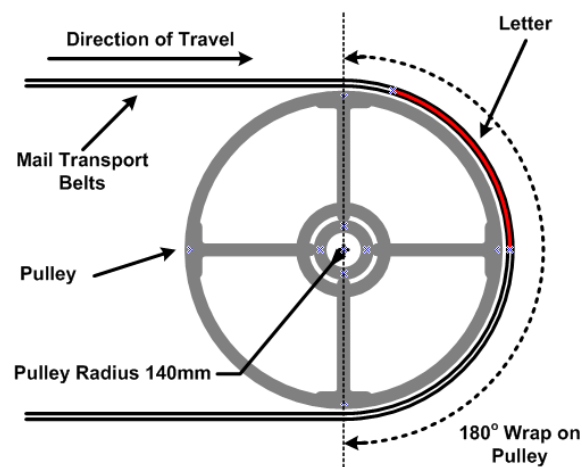

Figure 24 – Flexibility

Things to avoid

The following are typical problems, which can prevent your mail from being processed by an OCR machine:

- Characters with incorrect proportions.

stretched or condensed
large or small

- Poor quality of characters – ones which are poorly printed or defined, either because they have been printed by low quality printers or because the printer needs maintenance (low on toner/ink etc.).



- Characters with poor outlines – fuzzy or blurred, or strokes which are incomplete, broken or smeared.
- Close character spacing – characters which touch adjacent characters, whether on the same line or those from above or below.

ManorRoad or Manor Road
EALING

- Proportionally or unevenly spaced text – characters or words which have too much space between them (more than four character widths or 10mm in size).

M a n o r R o a d

- Over-elaborate typeface styles – italic, inclined, graphic, pseudo-script or handwriting imitations. Typefaces with excessive serifs, which touch or overlap adjacent characters or serifs. Hollow, bold or very heavy fonts. An example of a heavy font might be Arial Black. Generally, sans-serif fonts are preferable to serif fonts.

Script or handwriting

- Poor print contrast – printing white type on a black background or similar, or combinations of colours such as black print on a strong red background.

8 Response With Stamps

Response with postage stamps has been developed for use by our registered Charity customers. When respondents to a Charity affix a postage stamp in a designated area on a Business Reply or Freepost mail piece (as illustrated in Figure 25) we will credit the Charity's account with the cost of the Business Reply or Freepost postage. The postage stamp used by the respondent must be at least the same postage class as the Business Reply or Freepost item being returned.

Product variants and sizes available for Response with Stamps

You must submit example mail pieces to us in order to verify them before you first use Response with Stamps and provide us with the name and address of any 3rd party suppliers that will request a credit to your account on your behalf.

12 alpha character licence numbers with a barcode (on letters and large letters) are mandatory.

Business Reply Standard and Plus can be used for DL letter size and larger only as noted in section 3 of this user guide. Freepost Standard and Plus can be used for

normal minimum and maximum letter sizes as noted in section 5 of this user guide.

Claiming Postage Costs

Charity customers can request a credit to their account for the cost of the Business Reply or Freepost postage by completing a spreadsheet application form available from www.royalmail.com/responseservices and e-mail it to us at charity.response.claims@royalmail.com

Credits will be considered for Business Reply or Freepost items with postage stamps received over the period of each calendar month with a minimum combined value of £100. Charities will be allowed up to 14 days after the end of the relevant calendar month to submit their application for a credit to their account.

The application must contain details of Response postings, including the date the items were received, the volume of items received by class and product type such as Business Reply Standard, Business Reply Plus, Freepost Standard or Freepost Plus.

We will aim to credit your account within 4 weeks of receiving the correctly completed application form, by adding the credit to your

account with us for the Business Reply or Freepost Service used. Any enquiries regarding the credit you have received should be made within 30 days from the date on the credit note. Please make any enquiries in writing to us at charity.response.claims@royalmail.com

To receive a credit to your account you must also post to us the Business Reply or Freepost envelopes with the stamps affixed to enable us to undertake checks. If the numbers received do not correspond with the numbers stated in your application form, we reserve the right to exclude you from the Response with Stamps service.

Please post the envelopes with stamps affixed to us on a weekly basis in bundles of 50 mail pieces. Each weekly posting shall contain all those envelopes received in the previous week. A week is defined as Monday to Saturday. Please post the envelopes to the following address: Finance, Response with stamps, Rowland Hill House, Boythorpe Road, Chesterfield, S49 1HQ.

Envelope designs for affixing postage stamps

Please print the box and text "Please affix postage stamp here to help reduce our costs"

on your Business Reply or Freepost envelope
to the left of the indicia as illustrated in Figure

25.

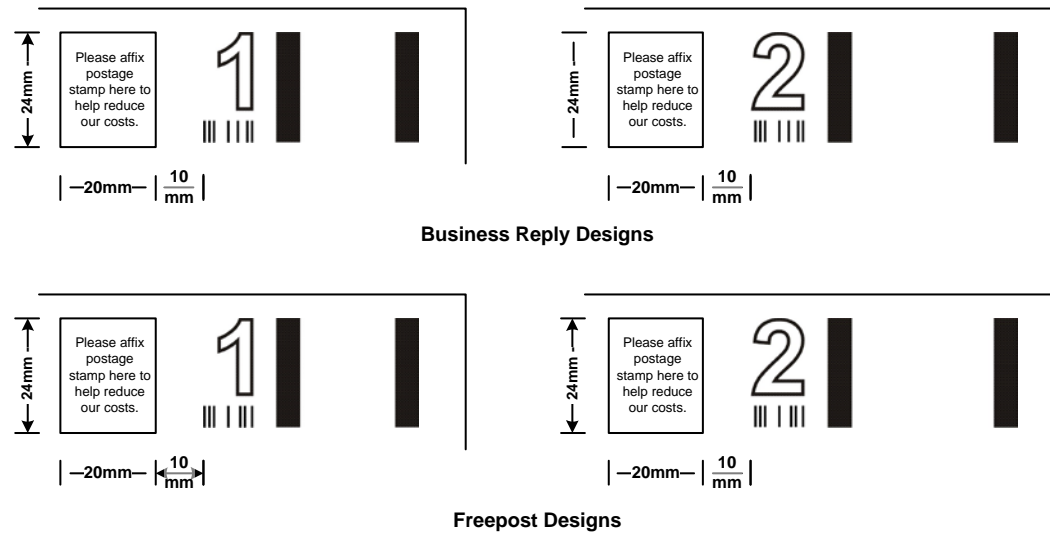

Figure 25 - Response with Stamp indicia (not to scale)

9 Pre-Pay Reply via franking machines

Pre-Pay Reply enables franking customers to provide pre-paid, pre-franked reply envelopes to their final customers.

The Pre-Pay Reply (PPR) product is only available to franking customers using a Mailmark™ franking machine, or who have a franking machine that has been upgraded to Mailmark™ franking technology.

It is available with letters and low weight large letters (0-100g) only.

When using your Mailmark™ franking machine, use the customer interface screen to select the PPR product. This may appear as "PP Reply" (or something similar depending on how your interface screen has been set up). Once the PPR product has been selected your franking machine will print the PPR indicia (as illustrated in Figure 26) on your return addressed envelope (letter, or large letter weighing up to 100g). All PPR reply envelopes printed by a Mailmark™ franking machine must have a valid indicia which includes a Mailmark™ barcode. You will note that the date does not appear in the Visual Service Indicator box on the right hand side of the PPR envelope and the PPR service is indicated under the delivery class (1st Class or 2nd Class) indicator. The correct postage will be deducted from your Mailmark™ franking machine in the normal way.

Once produced by your Mailmark™ franking machine you should place the PPR envelope (folded if required) inside your outbound mail item to be sent to your customer. Your customer can use the PPR envelope to return an item back to you at no cost to them. The PPR envelope can be posted in any Royal Mail post box or Post Office branch. Once posted by your customer, the Pre-Pay Reply mail item will receive the service you selected (1st Class or 2nd Class) and will be delivered back to you.

If you are interested in using our PPR product and you have a Smart franking machine or non-Smart franking machine, please contact your franking machine supplier to find out how to obtain a Mailmark™ franking machine and for more information about the benefits of using one.

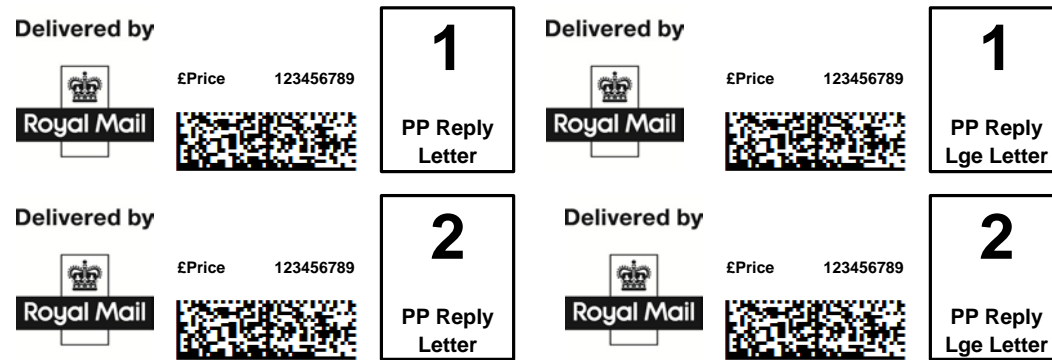

Figure 26 - Pre-Pay Reply (not to scale)

10 Admail

Admail is an add-on service available for use with our Business Reply and Freepost, Standard and Plus variant (excluding Pre-Pay Reply) Response Services products.

Admail enables you to print a local or high profile address on your reply items, which when returned by your customers will in fact be delivered to your usual business or other nominated address.

If you are interested in using our Admail service please contact us and we will provide you with our Admail application form. When completing the application form for Admail you nominate the name and post town you would like on your mail items. We will provide an address in the post town of your choice and deliver the items to an address of your choice.

11 Freepost NAME

Freepost NAME provides an easy to use reply service where the address is a single line containing the word Freepost and a name.

For example, you could choose your company name such as Freepost MARKETREACH.

Instead of a full postal address, your respondent simply writes the Freepost NAME on a blank envelope. or you can provide them with pre-printed mail items featuring your Freepost NAME.

Freepost NAME is available for use with letter, large letter and parcel formats.

We aim to deliver the mail to its destination in 2 working days.

You request a Freepost NAME using the Response Services application and we allocate every Freepost NAME on a first come, first served basis, so as long as your name isn't already in use, it should be fine. Ideally, it will not include geographic information. In some cases, we may need to see proof that you're allowed to use a particular name.

Handwritten Freepost NAME

The respondent writes your Freepost NAME on a blank envelope or parcel and posts in a pillar box or at a Post Office.

Printed Freepost NAME

You provide respondents with a pre-printed envelope containing your Freepost NAME or a label with your Freepost NAME printed on it.

Printed Freepost NAME items must not have other addresses on the front of the mail piece.

Company logos may be printed in the top left corner of the mail piece provided they exclude addresses and other geographic information.

Response Services Indicia and indicia such as printed postage impressions must not be printed on Freepost NAME mail pieces.

Printed Freepost NAMES envelope designs must be submitted for approval before they are used.

The respondent posts the items in a pillar box or at a Post Office

12 Contact us

Visit us at www.royalmail.com/responseservices

Call your local Royal Mail Sales Centre on 08457 950 950 (local rate).

If you are deaf or hard of hearing, we offer a Text phone service on 03456 000606.