

TOPOGRAPHICAL BIBLIOGRAPHY OF
ANCIENT EGYPTIAN HIEROGLYPHIC
TEXTS, RELIEFS, AND PAINTINGS

III. MEMPHIS

Part 1. Abû Rawâsh to Abûsîr

BY

THE LATE BERTHA PORTER

AND

ROSALIND L. B. MOSS

B.Sc. and Hon. D.Litt. (Oxon.), F.S.A.

Assisted by

ETHEL W. BURNEY

SECOND EDITION

REVISED AND AUGMENTED

BY

PH.DR. JAROMÍR MÁLEK



OXFORD
AT THE CLARENDON PRESS

1974

Oxford University Press, Ely House, London W. 1
GLASGOW NEW YORK TORONTO MELBOURNE WELLINGTON
CAPE TOWN IBADAN NAIROBI DAR ES SALAAM LUSAKA ADDIS ABABA
DELHI BOMBAY CALCUTTA MADRAS KARACHI LAHORE DACCA
KUALA LUMPUR SINGAPORE HONG KONG TOKYO

© *Griffith Institute, Ashmolean Museum, Oxford, 1974*

Published on behalf of the Griffith Institute
by the Delegates of the Press

*Printed in Great Britain
at the University Press, Oxford
by Vivian Ridler
Printer to the University*

CONTENTS

Introduction	ix
List of Plans	xiii
List of Sources of Plans	xv
List of Abbreviations. I. Publications	xvii
II. Unpublished sources	xxvi
Note to Readers	xxix

PYRAMID-FIELD OF ABÛ RAWÂSH

I. PYRAMID	I
II. NECROPOLIS	
A. WEST CEMETERIES	
Cemetery F	4
Cemetery M	5
Cemetery H	8
B. SOUTH CEMETERIES	
Cemetery 300	8
Cemetery 400	8
Mastaba 700	8
C. NORTH-WEST CEMETERY (WÂDI QAREN)	9
III. FORT	9
IV. MISCELLANEOUS	9

PYRAMID-FIELD OF GÎZA

I. PYRAMIDS	
A. PYRAMID-COMPLEX OF KHUFU	11
Temple of Isis Mistress-of-the-Pyramid	17
B. PYRAMID-COMPLEX OF KHEPHREN	19
C. PYRAMID-COMPLEX OF MENKAURÉ	26
II. GREAT SPHINX AND SURROUNDING AREA	
A. GREAT SPHINX	35
B. THE SPHINX TEMPLE	38

C. TEMPLE OF ḤAURON-ḤAREMAKHET	39
D. CHAPEL OF TUTHMOSIS I (?)	41
E. RESTHOUSE OF TUT'ANKHAMŪN	41
III. NECROPOLIS	
A. WEST FIELD	
Abu-Bakr Excavation (1953)	47
Abu-Bakr Excavation (1950-1)	48
Abu-Bakr Excavation (1949-50). West part	49
Abu-Bakr Excavation (1952)	52
Cemetery G 1000	52
Cemetery G 1100	55
Cemetery G 1200	56
Cemetery G 1300	61
Abu-Bakr Excavation (1949-50). East part	62
Cemetery G 1400	64
Cemetery G 1500	64
Cemetery G 1600	65
Cemetery G 1900	65
Large Isolated Mastaba G 2000	66
Cemetery G 2000	66
Cemetery G 1200 and Mastaba G 2220	70
Cemetery en Echelon. North part with mastabas G 2300 and 2400	83
Cemetery G 2500	95
Cemetery G 3000	95
Junker Cemetery (West)	100
Steindorff Cemetery	108
Junker Cemetery (East)	118
Cemetery G 4000	122
Cemetery en Echelon. South part	141
Cemetery G 6000	168
Exact provenance unknown	175
B. EAST FIELD	
G 7000X. Tomb of Ḥetepḥeres [I]	179
Cemetery G 7000	182
Rock-cut tombs LG 63-80 and other tombs between them	208
Rock-cut tombs excavated by Service des Antiquités	213
Tombs north of Great Sphinx	214
Exact position and provenance unknown	215

CONTENTS

	vii
C. CEMETERY G I S	216
D. QUARRY CEMETERY WEST OF SECOND PYRAMID	228
E. CENTRAL FIELD	
Old Kingdom tombs	130
LG 100. Sarcophagus-shaped tomb of Khentkaus [I]	288
Saite and later tombs	289
Exact provenance unknown	292
F. MENKAURĒ' CEMETERY	293
G. SOUTH FIELD	
Early Dynastic tombs	294
Late Old Kingdom rock-cut tombs	295
Saite and later tombs	296
IV. MISCELLANEOUS	298
FROM GĪZA TO ZĀWYET EL-'ARYĀN	
	312
PYRAMID-FIELD OF ZĀWYET EL-'ARYĀN	
I. PYRAMIDS	
A. PYRAMID-ENCLOSURE OF NEBKA(?)	312
B. STEP PYRAMID ATTRIBUTED TO KHA'BA	313
II. NECROPOLIS	
CEMETERIES ROUND PYRAMID OF KHA'BA	
Dynasty I Cemetery	313
Dynasty III Cemetery	314
New Kingdom Cemetery	314
ṬAMMŪH	
	314
ABŪ GHURĀB	
SUN-TEMPLE OF NEUSERRĒ'	
	314
PYRAMID-FIELD OF ABŪŞĪR	
I. SUN-TEMPLE	324
II. PYRAMIDS	
A. PYRAMID-COMPLEX OF SAḤURĒ'	326

B. PYRAMID-COMPLEX OF NEUSERRĒꜥ INY	335
C. PYRAMID-COMPLEX OF NEFERIRKARĒꜥ KAKAI	339
D. PYRAMID ATTRIBUTED TO RAꜥNEFEREF	340
III. NECROPOLIS	
A. CEMETERIES NORTH-EAST AND EAST OF PYRAMID OF NEUSERRĒꜥ	
Large Dynasty V Mastabas	340
Dynasty VI and First Intermediate Period Tombs	344
Middle Kingdom tombs	345
Late Burials	348
B. CEMETERY OVER MORTUARY TEMPLE OF NEFERIRKARĒꜥ	348
C. TOMBS IN PLAIN SOUTH-EAST OF PYRAMIDS	348
IV. MISCELLANEOUS	349
FROM ABÛŞÎR TO ŞAQQÂRA	351
ADDENDA	
Gîza, to pp. 40, 61, 69, 108, 113, 125, 151, 176, 296, 299, 311	353
APPENDIXES	
A. Classification of selected scenes in Old Kingdom tombs	355
B. Texts	358
C. Pyramids	360
D. Numbered Gîza tombs and shafts	360
PLANS	after p. 366
INDEXES	
1. Kings	367
2. Private names	369
3. Divinities	376
4. Objects in museums	377
5. Various	391

Munich, Staatl. Sammlung, ÄS. 4290. KAPLONY, *Inscripfen. Suppl. Taf. i* [1047], p. 28; ii, p. 891 [bottom]; BARTA in *Ä.Z.* 92 (1966), Taf. i, ii [2], pp. 1-4.

Two, one with name Beshanka(?) , Dyn. I, in Michaelidis Colln. See KAPLONY, *Inscripfen*, i, p. 203 [iv, 6].

Various

Libation-basins of Baka, and of Harnit, both King's sons, Dyn. IV, in Cairo Mus. 57004, 57013.

Fragment of offering-table (inscribed), quartzite, Dyn. IV, from von Buerkel Colln., in Munich, Staatl. Sammlung, ÄS. 5237. MÜLLER (H. W.) in *Ä.Z.* 91 (1964), Taf. iii [6], p. 132.

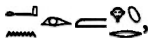
Offering-table of 'Anemho , Divine father of Horus Lord-of-Letopolis, with names of Nektanebos II, granite, in Cairo Mus. 23115. KAMAL, *Tables d'offrandes (Cat. Caire)*, pl. xxvii, pp. 94-5.

Sarcophagus (uninscribed) with palace-façade decoration, Dyn. IV, in Cairo Mus. Ent. 66611. DONADONI ROVERI, *Sarcofagi egizi*, Tav. xxii [2, 3], xxviii [2], p. 124 [B 35].

PYRAMID-FIELD OF GÎZA

Plan III

Plan, POCOCKE, *A Description of the East* (1743), i, pl. xvi [upper] facing p. 41; NORDEN, *Travels in Egypt and Nubia* (1757), i, pl. xliii [upper] before p. 71; *Descr. Ant.* v, pl. 6; PERRING, *Pyramids*, i, two pls. at beginning; VYSE, *Operations*, i, pl. facing p. 1; *L. D.* i. 14; PRISSE, *L'Art ég.* i, 50th pl., 'Plan topographique' (with section); WILKINSON, *Topographical Survey of Thebes* (1830), pl. v; id. *M. and C.* iii. 398 = ed. BIRCH, ii. 360 (No. 462); WHEELER in *Antiquity*, ix (1935), pl. facing p. 188; REISNER, *Giza Necropolis*, i, General Map of the Giza Necropolis; HASSAN, *Giza*, ii, 2nd plan at beginning; iii, 3rd plan at beginning; iv and v, 2nd plan at beginning; vi [3] and vii, 1st plan at end; ABU-BAKR, *Giza*, 1st plan at beginning; FAKHRY, *The Pyramids*, fig. 60; MARAGIOGLIO and RINALDI, *L'Architettura*, vi, Tav. 1; HAY MSS. 29812, 34; BURTON MSS. 25618, 64; WILKINSON MSS. xlV. E.1 [b dentro]; HOSKINS MSS. i. 132. Plan and elevation, GROBERT, *Description des Pyramides de Ghize* [etc.] (1801), 3rd pl. at end; BRUCHET, *Nouvelles recherches sur la Grande Pyramide*, figs. 3, 4.

View of Pyramids and Great Sphinx, SANDYS, *A Relation of a Journey Begun Anno Domini 1610* (1615), pl. on p. 128. Sketch of two Pyramids and Great Sphinx, made in 1821, WILKINSON MSS. xv. 21. Description in 1840, NESTOR L'HÔTE MSS. 20396, 320-2.

Views,¹ mainly of Pyramids, *L. D.* i. 15-20; PARIBENI, *Architettura*, fig. 23; LANGE, *Ägypten. Landschaft*, pl. 24; id. and HIRMER, *Ägypten. Architektur* (1955 and 1957), pls. 26-7; (1967), pls. 25-6; *L'Égypte. Art et civilisation. Sér. 4 bis* (1951), pl. 2; VIOLLET and DORESSÉ, *Egypt*, pl. 50; MONTET, *Lives of the Pharaohs*, fig. on p. 33 [upper]; WESTENDORF, *Das Alte Ägypten*, fig. on p. 42; SOGA, *The Nile*, fig. on pp. 48-9; VON HAGEN, *F. Catherwood*, fig. on pl. facing p. 32 [lower]; HAY MSS. 29812, 27, 58 (= VON HAGEN, op. cit. fig. on pl. facing p. 32 [upper]), 59, 66; WILKINSON MSS. xxviii. 12, 13; HOSKINS MSS. i. 138-9.

Air views,¹ BLAKE in *Discovery*, iii (1922), fig. 3, p. 173; BAIKIE, *A History of Egypt*, i, pl.

¹ Selected references.

viii; id. *Eg. Antiq.* pl. i [lower]; *J.L.N.* Feb. 27, 1932, fig. on p. 311; WHEELER in *Antiquity*, ix (1935), pl. ii facing p. 5; PEET in HAMMERTON, *Universal History of the World*, i, fig. on p. 506; BREASTED, *The Conquest of Civilization*, fig. 1; DRIOTON, *Le Sphinx et les Pyramides de Giza*, pl. vii; FEDDEN, *The Land of Egypt*, fig. 63; DE MONTGON, *L'Égypte*, fig. on p. 19; BENDOW, *Pyramidetidens Egypt*, pl. facing p. 177; EDWARDS, *Pyramids* (1947), pl. i; GRINSELL, *Eg. Pyramids*, pl. vii facing p. 97; FRANKFORT, *Ancient Egyptian Religion*, pl. 31; LAUER, *Le Problème des pyramides d'Égypte*, pl. i facing p. 32; COTTRELL, *The Lost Pharaohs*, pl. 18 facing p. 97; SMITH, *Art . . . Anc. Eg.* pl. 32, p. 59; ALDRED in PIGGOTT, *The Dawn of Civilization*, pl. on p. 110 [24]; GARDINER, *Egypt of the Pharaohs*, pl. v facing p. 82; BRUCHET, *Nouvelles recherches sur la Grande Pyramide*, pl. i.

Vertical air views, CAPART, *Memphis*, pl. on p. xv; GRINSELL, *Eg. Pyramids*, pl. i; RICKE, *Harmachistempel*, frontispiece [upper]; of two Pyramids, BADAWY, *Eg. Architecture*, i, pl. v [b].

I. Pyramids

A. PYRAMID-COMPLEX OF KHUFU

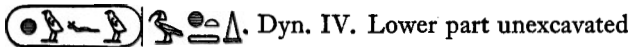

Dyn. IV. Lower part unexcavated

History of exploration, MARAGIOGLIO and RINALDI, *L'Architettura*, iv, pp. 8-11; plan of upper part, Tav. 1 [1].

VALLEY TEMPLE. Beneath village of Nazlet el-Simmân.

LAUER in *Ann. Serv.* xlvi (1947), p. 259; MARAGIOGLIO and RINALDI, *op. cit.* pp. 68-9; GOYON in *B.I.F.A.O.* lxxvii (1969), pp. 63-6, 68, cf. plan and pl. vii [lower].

CAUSEWAY. Destroyed when building village of Nazlet el-Simmân.

LAUER, *op. cit.* pp. 246, 248; MARAGIOGLIO and RINALDI, *op. cit.* pp. 68-9, cf. 170-1 note 52, with plan, Tav. 1 [2]; GOYON, *op. cit.* pp. 49-63, 67, cf. plan and pls. v-vii [upper]. Discernible on most of old plans of Pyramid-field, see p. 10.

Relief-fragments. From upper part, found by Hassan.

Two blocks with *heb-sed* scenes, from south wall; see HASSAN, *Giza*, vi [1], p. 68; JUNKER, *Giza*, vi, p. 9 note 1 [right]; SMITH, *Hist. Eg. Sculpt.* p. 157 note 1; position, see REISNER and SMITH, *Giza Necropolis*, ii, p. 4 (as from walls of Court of Mortuary Temple). (a) Upper part of King with remains of four men behind him; HASSAN, *Giza*, x, pl. vi [A], fig. 4, pp. 21-2; omitting two men, REISNER and SMITH, *op. cit.* fig. 5, p. 4; LAUER in *Ann. Serv.* xlix (1949), pl. i, pp. 113-14. (b) King in *heb-sed* dress seated, large head of King, and columns of text mentioning Pyramid of Khufu; HASSAN, *Giza*, x, pl. vi [B], p. 23 (texts); REISNER and SMITH, *op. cit.* fig. 6, p. 4; LAUER, *op. cit.* pl. ii, pp. 114-15.

Wing of protective bird, and head of hawk, from south wall; HASSAN, *Giza*, x, pl. v [B], fig. 3, p. 21. Legs and wing of vulture holding *ankh*, from north wall; id. *ib.* pl. v [A], fig. 2, p. 20. Two adjoining fragments with torso of King, from north wall; id. *ib.* pl. vii [A], p. 34. Head of hoopoe; id. *ib.* pl. viii [B], fig. 8.

MORTUARY TEMPLE. Completely destroyed except for basalt pavement.

Plans, sections, and reconstructions, MARAGIOGLIO and RINALDI, *L'Architettura*, iv, Tav. 9 [1-5], 10, pp. 60-5, cf. 162-71 notes 45-50. Plans and reconstructions, LAUER in *Ann. Serv.*

xlvi (1947), pl. lxxviii, fig. 17, pp. 246-59; id. *Le Problème des pyramides d'Égypte*, fig. 27, p. 94; HASSAN, *Gîza*, x, fig. 10, pp. 39-42; RICKE, *Bemerkungen zur ägyptischen Baukunst des Alten Reichs*, ii, Abb. 13, cf. pp. 53-60 with Abb. 20-2; SPIEGEL, *Die Phasen der ägyptischen Geistesgeschichte in Saeculum*, i (1950), Taf. i, Abb. 2, pp. 6-7; id. *Hochkultur*, Taf. 10, Abb. 8, pp. 46-8; discussion of plan, LAUER in *Ann. Serv.* xlix (1949), pp. 116-23 with figs. 1-5. Plan with Subsidiary Pyramids and tombs G 7110-7140, REISNER and SMITH, *Giza Necropolis*, ii, fig. 1. Views, LAUER in *Ann. Serv.* xlvi (1947), pl. lxxvii; HASSAN, *Gîza*, x, pls. iii, iv, xv, xvi, pp. 39-42.

Masons' graffito with date, on south wall of entrance corridor. SMITH (W. S.) in *J.N.E.S.* xi (1952), fig. 7 [bottom left], pp. 126-7 [C, 1]; see REISNER, *Giza Necropolis*, i, p. 71 [bottom].

Relief-fragments. Found in area of Subsidiary Pyramids.

From scenes with boats being paddled, REISNER and SMITH, *Giza Necropolis*, ii, fig. 7, p. 5 note 6 [9-12]; with remains of texts, [13, 14, 17]; from scene with man leading ox, [16]; head of man, [15].

Various, found in débris of Causeway, but probably from here. Id. ib. fig. 7, p. 4, and p. 5 note 6 [1-8].

See also blocks from Causeway, supra, p. 11. Blocks re-used at Lisht, see *Bibl.* iv. 79; at Tell Basta, iv. 28.

Khufu statues.

Head with protecting hawk, probably, life-size, fragments, alabaster, found in débris over tomb G 7102 and possibly from here, in Boston Mus. 27.1466. SMITH, *Hist. Eg. Sculp.* pl. 5 [a], p. 20 [4].

Seated statuette, base and front of feet, with cartouche, alabaster, from débris north of Subsidiary Pyramid G I-a, in Boston Mus. unnumbered (Exped. No. 24-12-59). See id. ib. p. 20 [1].

Base with feet of seated statuette, with cartouche, alabaster, from surface débris of tomb G 2391, in Boston Mus. 13.3448. See id. ib. p. 20 [2].

Seated statuette, probably, base and feet, alabaster, found in upper débris of south-west section of East Field, in Boston Mus. 25.1509. Id. ib. fig. 9, p. 20 [3].

Base with remains of cartouche, fragment, found by Schiaparelli, in Turin Mus. Sup. 1884. CURTO, *Gli Scavi*, Tav. i [a], p. 11 [3].

Private and other statues. Old Kingdom.

Ram-statue with names of Khufu, fragment, basalt, presumably from here, in Berlin (East) Mus. 22572. SCHÄFER in *Orientalistische Literaturzeitung*, 29 (1926), Taf. ii, Abb. 1-3, cols. 723-7.

Double-statue, King's *warb*-priest, etc. (name lost), and wife Nefertsopdet(?)  *mitrt*, seated, fragment of lower part. HASSAN, *Gîza*, x, pl. ix, p. 36.

Scribe-statue, bust, red granite. Id. ib. pl. viii [A], p. 36.

Base with right foot, fragment, found by Schiaparelli, in Turin Mus. Sup. 1885. CURTO, op. cit. Tav. i [b], pp. 11-12 [4].

Various.

Mace-head with Horus-name of Khufu, fragment, limestone, from surroundings. HASSAN, *Gîza*, x, pl. x [c], p. 38 [top].

PYRAMID.

Lepsius, IV; Perring and Vyse, 1 of Giza; Reisner, G I; called Great or First Pyramid.

Exterior

View,¹ GREAVES, *Pyramidographia* (1646), 2nd pl. after p. 48; LOOS drawings, pl. 887; GYLLENSKIEPP drawings, pl. 886 (last two reproduced by PETERSON in *Objets*, 3, figs. on pp. 52-3); HAY MSS. 29812, 63; KEIMER in *Egypt Trav. Mag.* No. 17 (Dec. 1955), fig. on p. 18 (taken in 1839 by GOUPIL-FESQUET); TEYNARD, *Égypte et Nubie*, i (1858), pl. 9; BÉCHARD and PALMIERI, *L'Égypte et la Nubie* (1887), pl. xliii (reversed); SEBAH photo. 44; BORCHARDT and RICKE, *Egypt*, pl. 72; VIOLLET and DORESSE, *Egypt*, pl. 51; LAUER, *Observations sur les pyramides*, pl. vii [upper]; HASSAN, *Giza*, x, frontispiece; BRUCHET, *Nouvelles recherches sur la Grande Pyramide*, pl. v [upper]; *Great Museums*, pl. 152; GILBERT, *Méditerranée antique*, fig. 10; Pochan, *L'Énigme de la Grande Pyramide*, 6th pl. after p. 224. Air view, FEDDEN, *The Land of Egypt*, fig. 64; Pochan, op. cit. pl. facing p. 225 (with Second Pyramid).

Elevation and section of interior, LUCAS, *Voyage* (1724), ii, two pls. before p. 129; PERRY, *A View of the Levant* (1743), pl. 25. Plans and sections, MARAGIOGLIO and RINALDI, *L'Architettura*, iv, Tav. 1 [3-5, 12], 2, pp. 10-23, cf. 96-109 notes 2-10.

Interior. BURTON MSS. 25618, 70-3

Section, on plan IV [1]

Plans and sections, POCOCKE, *A Description of the East* (1743), i, pls. xvi [lower], xvii [lower] facing pp. 41, 44; NORDEN, *Travels in Egypt and Nubia* (1757), i, pls. xlviii-li between pp. 74-5, 78-9 (called Second Pyramid); *Descr. Ant.* v, pls. 14 [1-3], 15 [3-8]; DENON, *Voyage dans la Basse et la Haute Égypte* (Paris, 1802), pl. 20 [3-11]; *Hist. exp. Atlas*, pl. 23; PERRING, *Pyramids*, i, pls. i-iv; PRISSE, *L'Art ég.* i, on 3rd pl.; MARAGIOGLIO and RINALDI, op. cit. Tav. 3-8, pp. 22-59, cf. 108-61 notes 11-43; BORCHARDT, *Einiges zur dritten Bauperiode der Grossen Pyramide bei Gise*, passim; cf. id. in *Ä.Z.* xxx (1892), Bl. 4 [lower], pp. 102-6; BURTON MSS. 25618, 65-6 (after NORDEN); HOSKINS MSS. i, 128-9.

Sections, GREAVES, *Pyramidographia* (1646), pl. facing p. 48; SONNINI, *Voyage dans la Haute et Basse Égypte* [etc.] [1799], ii, pl. xxv (detail); DENON, *Egypt delineated*, pl. vi [2]; VYSE, *Operations*, i, pl. facing p. 3; ii, pl. facing p. 158; HOREAU, *Panorama d'Égypte et de Nubie* (1841), p. 9 verso [middle]; PETRIE, *The Pyramids and Temples of Gizeh* (1883), pls. vii [upper], ix; WHEELER in *Antiquity*, ix (1935), figs. 1-4, pp. 162-72; FAKHRY, *The Pyramids*, fig. 68; LANE MSS. 34088, 42; BURTON MSS. 25620, 90-102 verso.

Views of entrance, SANDYS, *A Relation of a Journey Begun Anno Domini 1610* (1615), pl. on p. 130; *Descr. Ant.* v, pl. 14 [4]; DENON, *Voyage dans la Basse et la Haute Égypte* (Paris, 1802), pl. 20 bis [2]; id. *Egypt delineated*, pl. vii [2]; *Hist. exp. Atlas*, pl. 52; HAMILTON, *Remarks on Several Parts of Turkey*. i. *Aegyptiaca* (1809), pl. xix [1]; PERRING, *Pyramids*, i, pl. xiii; VYSE, *Operations*, i, pl. facing p. 236; HOREAU, op. cit. p. 9; PARIBENI, *Architettura*, fig. 25; ROBICHON and VARILLE, *En Égypte* (1937), pl. 22; BRUCHET, *Nouvelles recherches sur la Grande Pyramide*, pl. vi; Pochan, *L'Énigme de la Grande Pyramide*, 3rd pl. after p. 96; of entrance and interior, CAPART, *Memphis*, figs. 50, 55-6; LANE MSS. 34083, 25-6, 34084, 1, 2, 34088, 7-9.

Great Gallery.

Views, *Descr. Ant.* v, pl. 13; HICHENS, *Egypt and its Monuments*, pl. facing p. 10; BADAWY, *Eg. Architecture*, i, pl. vi [b]; SMITH, *Art . . . Anc. Eg.* pl. 27 [A], p. 42; SOGA, *The Nile*, fig. on

¹ Selected references.

p. 63; POCHAN, *op. cit.* 2nd pl. after p. 224; DE CENIVAL, *Living Architecture: Egyptian*, pl. 33 (with passage to 'Queen's Chamber').

Thrust-relieving chambers. 'Chambres de décharge'. Masons' graffiti with names of crews of Khufu.

REISNER, *Mycerinus*, pl. xii [1-93] (copied by ROWE), p. 275 [2].

A 'Campbell's Chamber'

North and south sides, and east and west ends, PERRING, *Pyramids*, i, pl. vii; VYSE, *Operations*, i, pl. facing p. 284 [middle]. Omitting west, LEPSIUS in LENORMANT, *Éclaircissements sur le cercueil du roi memphite Mycérinus* (1839), pl. ii (north, Nos. 22-5, south, Nos. 13-21, east, Nos. 26-8), p. 46. North and south, PRISSE, *L'Art ég.* i, 3rd pl. [lower middle, 1st line]. South, LEPSIUS, *Auswahl*, vii [B]; *L. D.* ii. 1 [a, b].

B 'Lady Arbuthnot's Chamber'

North and south sides, and west end, PERRING, *op. cit.* pl. vi; VYSE, *op. cit.* pl. facing p. 279. North, MASPERO, *Hist. anc.* i, fig. on p. 371 (= *L. D.* ii, 1 [c]). North and west, PRISSE, *op. cit.* 3rd pl. [lower middle, 2nd and 3rd lines]; LEPSIUS, *Auswahl*, vii [A, C, D]; *L. D.* ii. 1 [c, d, e]. North and south, LEPSIUS in LENORMANT, *op. cit.* pl. ii [7-12].

C 'Nelson's Chamber'

West end, PERRING, *op. cit.* pl. v [lower]; VYSE, *op. cit.* pl. facing p. 284 [right end]; LEPSIUS in LENORMANT, *op. cit.* pl. ii [2-6].

D 'Wellington's Chamber'

West end, PERRING, *op. cit.* pl. v [middle]; LEPSIUS in LENORMANT, *op. cit.* pl. ii [1]. East end, PERRING, *op. cit.* pls. v [top], x, xi; part, LEPSIUS, *Auswahl*, vii [E].

Burial chamber. 'King's Chamber'.

View, CAPART, *L'Art ég.* (1909), pl. 5; *id.* *L'Art ég.* i, pl. 20; SAMIVEL and AUDRAIN, *The Glory of Egypt*, pl. 23; MICHALOWSKI, *Art*, fig. 848; POCHAN, *L'Énigme de la Grande Pyramide*, 6th pl. after p. 96.

Sarcophagus (uninscribed), granite. PIAZZI SMYTH, *Life and Work at the Great Pyramid* (1867), i, pl. 1; see DONADONI ROVERI, *Sarcofagi egizi*, p. 104 [A 3]; HAY MSS. 29812, 65.

'Queen's Chamber'. Abandoned burial chamber of second plan (Borchardt).

Plan and sections, PERRING, *op. cit.* pl. viii. View, POCHAN, *op. cit.* 5th pl. after p. 96.

Subterranean chamber. Abandoned part of first plan (Borchardt).

Plan and sections, PERRING, *op. cit.* pl. ix. View, POCHAN, *op. cit.* pl. facing p. 224 [lower].

BOAT-PITS. Five, one of them unexcavated.

Plan V [1]

HASSAN, *Gîza*, vi [1], pp. 40-2; x, p. 38. Plans and sections, MARAGIOGLIO and RINALDI, *L'Architettura*, iv, Tav. 1, 9, 10. Plan showing Boat-pits, ABUBAKR in *Archaeology*, 8 (1955), fig. on p. 97 (after HASSAN); showing Boat-pits Nos. 3-5, HASSAN, *Gîza*, vi [1], fig. 14; x, fig. 10.

View of Boat-pit No. 3 and Subsidiary Pyramids, VIOLETT and DORESSE, *Egypt*, pl. 57; ELSTNER, *Egypt. The Gift of the Nile*, pl. 42. View of boat-pit of North Subsidiary Pyramid, with No. 3, MONTET, *Lives of the Pharaohs*, fig. on p. 33 [lower]; WESTENDORF, *Das Alte*

Ägypten, fig. on p. 44; with Nos. 3 and 5, BRUCHET, *Nouvelles recherches sur la Grande Pyramide*, pl. iii [upper], cf. iii [lower]; ALDRED, *Egypt to the End of the Old Kingdom*, fig. 81; SOGA, *The Nile*, fig. on p. 62 [lower]; MICHALOWSKI, *Art*, fig. 850; with No. 5, *I.L.N.* Feb. 7, 1925, figs. on p. 223.

Boat-pit No. 1. Rectangular. Unexcavated. Covered by outer enclosure wall.

View of roofing blocks, DIMICK in *Archaeology*, 8 (1955), fig. on p. 94.

Boat-pit No. 2. Rectangular, with dismantled wooden boat. Covered by outer enclosure wall.

Account of discovery with plans, views, etc., NOUR and others, *The Cheops Boats*, i, passim. Plans and sections, MARAGIOGLIO and RINALDI, op. cit. iv, Tav. I [6-11], pp. 70-3 [pit 4]. See ČERNÝ in *J.E.A.* 41 (1955), pp. 75-9, cf. figs. 1, 2; LECLANT in *Orientalia*, N.S. 24 (1955), pp. 309-10; 30 (1961), pp. 106-8 [15]; NOUR in *La Revue du Caire*, xxxiii [175] (1955), pp. 37-41.

Views of roofing blocks, interior, and sketch-plan showing position, *Egypt Trav. Mag.* (Special Issue 1954), figs. on p. 65. View of Boat-pit No. 2, and roofing of No. 1, ALDRED, *Egypt to the End of the Old Kingdom*, fig. 83.

Description with views, plans, etc., ABUBAKR and MUSTAFA in *Ricke Festschrift (Beiträge zur ägyptischen Bauforschung und Altertumskunde, 12)*, Taf. 1-9, plans 1-3, figs. 1, 2, 7, pp. 1-6, cf. 12-16.

Views of interior with parts of boat, *I.L.N.* June 19, 1954, figs. on p. 1045; ABOU BAKR in *La Revue du Caire*, xxxiii [175] (1955), figs. 27-30, pp. 32-6; id. in *Archaeology*, 8 (1955), figs. on p. 99; id. in *Egypt Trav. Mag.* No. 53 (Jan. 1959), figs. on pp. 27-9; DIMICK in *Archaeology*, 8 (1955), fig. on p. 95 [upper]; SAINTE FARE GARNOT in *Bulletin de la Société française d'Égyptologie*, No. 17 (1955), figs. 2, 3, pp. 10-12; DESROCHES-NOBLECOURT in *La Revue des arts*, v (1955), figs. 3-6, p. 254; ZIOCK, *Ägypten (Kurt Schroeders Reiseführer)*, pl. facing p. 144 [right]; *Phoenix*, i (1955), figs. 13-15, pp. 21-5; LECLANT in *Orientalia*, N.S. 25 (1956), pls. xlv-xlviii [14-17], pp. 259-61 [16, A]; EDWARDS, *Pyramids* (1961), pl. 13 [A]; FAKHRY, *The Pyramids*, figs. 63-4, pp. 107-9.

View of restored boat and plans and sections, LANDSTRÖM, *Ships of the Pharaohs*, figs. 83-9; view of boat and model, KEATING, *Nubian Twilight*, pls. 27-8, p. 44.

Masons' graffiti of crews of Raꜣzedef, on roofing blocks. ABUBAKR and MUSTAFA, op. cit. figs. 4-6, pp. 8, 12; NOUR in *The Cheops Boats*, i, pl. xi, p. 7; FAKHRY, *The Pyramids*, fig. 62; see NOUR in *La Revue du Caire*, xxxiii [175] (1955), pp. 40-1.

Masons' marks, on south wall of pit. Id. in *The Cheops Boats*, i, fig. 2, p. 7; ABUBAKR and MUSTAFA, op. cit. fig. 3, p. 6.

Boat-pit No. 3.

Plan and description, BURTON MSS. 25619, 16 verso; plan and section, MARAGIOGLIO and RINALDI, op. cit. iv, Tav. 9 [1], pp. 70-1 [pit 2].

Boat-pit No. 4. Plan, id. ib. Tav. 9 [1], pp. 70-1 [pit 1]. View, HASSAN, *Giza*, x, pl. xii.

Intrusive finds. Old Kingdom.

Relief-fragments. With name of Pyramid of Khufu(?), id. ib. pl. vii [B], fig. 7; see vi [1], p. 42 [1]; with *ankh*, see id. ib. p. 42 [3].

Shoulder of large granite statue. Id. ib. x, pl. xi [A], p. 37; see vi [1], p. 42 [4].

Boat-pit No. 5.

Plans and sections, MARAGIOGLIO and RINALDI, op. cit. iv, Tav. 9 [1, 7-12], pp. 70-1 [pit 3]. Views, HASSAN, *Gîza*, x, pls. xiii, xiv.

Intrusive finds.

Fragment of lintel with titles of Her. . . , from a tomb, Old Kingdom. Id. ib. pl. x [A], fig. 9, p. 37; see vi [1], p. 41 [1].

Head of statue of lion, sandstone. Id. ib. x, pl. xi [c], p. 37; see vi [1], p. 41 [2].

THREE SUBSIDIARY PYRAMIDS.**Plan V [1]**

Plans, sections, views of entrances and of casing of Middle Pyramid, PERRING, *Pyramids*, ii, *Pyramids to the E. of Great Pyramid*, pls. i, ii; plans and sections of interior, REISNER, *Giza Necropolis*, i, figs. 63-9, pp. 129-35.

Relief-fragments, found here, but probably from Mortuary Temple, see p. 12.

North Subsidiary Pyramid. Lepsius, V; Perring and Vyse, 7 of Gîza; Reisner, G I-a. With boat-pit at south side.

Plans and sections, MARAGIOGLIO and RINALDI, *L'Architettura*, iv, Tav. 11 [1, 2], 12, pp. 76-85, cf. 176-9 notes 59-64; FAKHRY, *The Pyramids*, fig. 65, p. 112; of interior, REISNER, op. cit. fig. 63, p. 129 [1]; view of entrance, VYSE, *Operations*, ii, pl. facing p. 63 [2]. View of boat-pit, *I.L.N.* March 14, 1925, fig. on p. 433; BAIKIE, *The Glamour of Near East Excavation*, pl. facing p. 80, cf. p. 86; GRINSELL in *Antiquity*, xvii (1943), pl. v, p. 48.

Two fragments of heads of statues, basalt, temp. Khufu, from débris, in Boston Mus. unnumbered (Exped. Nos. 24-12-214, 365). See SMITH, *Hist. Eg. Sculp.* p. 31 [2].

Statue of Akhtihotp, fragment of base, basalt, probably temp. Khufu, from boat-pit, in Boston Mus. unnumbered (Exped. No. 24-11-694). See id. ib. p. 31 [3].

Middle Subsidiary Pyramid. Lepsius, VI; Perring and Vyse, 8 of Gîza; Reisner, G I-b. With boat-pit at south-west corner.

Plans and sections, MARAGIOGLIO and RINALDI, *L'Architettura*, iv, Tav. 11 [1, 2], 13, pp. 84-91, cf. 178-81 notes 65-9; FAKHRY, *The Pyramids*, fig. 66, pp. 112, 115; of interior, REISNER, *Giza Necropolis*, i, fig. 64, p. 130 [2]. View, BURTON MSS. 25619, 14; of entrance, VYSE, *Operations*, ii, pl. facing p. 69 [2]. Boat-pit, see LECLANT in *Orientalia*, n.s. 23 (1954), p. 71 [1, b].

Chapel. Plan, REISNER, op. cit. fig. 120, pp. 211 [1], 248 [top, 1].

Relief-fragments from false-door and walls. Title of Queen, in Boston Mus. 27.1321; SMITH, *Hist. Eg. Sculp.* pl. 38 [b], p. 158 [upper]; REISNER and SMITH, *Giza Necropolis*, ii, fig. 4 [bottom left]. Fragments of offering-list, men bringing offerings and animals, boat being paddled, in Boston Mus. unnumbered; SMITH, op. cit. pl. 38 [a, c], p. 158 [upper]; REISNER and SMITH, op. cit. figs. 2-4, p. 4.

South Subsidiary Pyramid. Lepsius, VII; Perring and Vyse, 9 of Gîza; Reisner, G I-c. Attributed to Henutsen  (wife of Khufu).

Plans and sections, MARAGIOGLIO and RINALDI, *L'Architettura*, iv, Tav. 11 [1, 2], 14, pp. 90-7, cf. 180-3 notes 70-5; VYSE, *Operations*, ii, pl. facing p. 66; FAKHRY, *The Pyramids*,

fig. 67, p. 115; of interior, REISNER, *Giza Necropolis*, i, fig. 65, pp. 130-1 [3]. Small plans, measurements and elevations, sketch of entrance, BURTON MSS. 25619, 15-19. View of entrance, VYSE, op. cit. ii, pl. facing p. 69 [1]. Chapel, see REISNER, op. cit. p. 248 [2].

TEMPLE OF ISIS MISTRESS-OF-THE-PYRAMID

Pyramid-chapel reconstructed during Dyn. XXI

Plan V [2]





HASSAN, *The Sphinx*, pp. 216-21; id. *The Great Sphinx*, pp. 110-18; plan, pl. lii; view, pl. li.

Enlargement of Dyn. XXVI

Block with names of Harbes, his father and mother (see below), exact position unknown. DE ROUGÉ, *Inscr. hiéro.* pl. lxvi [bottom].

Two jambs of Diptahiau , Prophet of Osiris Lord-of-Ra-setau and Ra'zedef, etc., *in situ*, probably seen here. Text of one, PETRIE in SAYCE MSS. 27c [upper]; of another and lintel(?), DE ROUGÉ, *Inscr. hiéro.* pl. lxii [top]; see MARIETTE, *Mastabas*, pp. 564-5 [v]; id. *Notice des principaux monuments . . . à Boulaq* (1864), p. 271 [5].









Room A (of Hassan).

North wall. Harbes , son of Pefteuma'ushu  and Shepenēsi  , temp. Psammetikhos I, kneeling before [Isis suckling Horus]. HASSAN, *The Great Sphinx*, pl. liii, p. 112; see id. *The Sphinx*, p. 221; SMITH, *Art . . . Anc. Eg.* p. 250; BOTHMER, *Eg. Sculp.* pp. 41-2. Upper part of Isis with Horus, in Princeton Univ. Art Mus. Acc. 918; RANKE in *J.N.E.S.* ix (1950), pl. xix, pp. 228-36 (called Dyn. VI).



Hieroglyphic graffiti. Prophets of Isis Mistress-of-the-Pyramid, Khufu, Ra'zedef, Khephren, Menkaurē, etc. Dyn. XXVI.

See WILDUNG, *Die Rolle ägyptischer Könige im Bewusstsein ihrer Nachwelt*, i, in *Münchener ägyptologische Studien*, 17, pp. 177-8, 186-8.



North wall.

Shepensene , son of Pa'heri  and Theri , Abb. xv [1], p. 181. Pashenēsi , son of Haps(?) , Abb. xiv [4], p. 181; HASSAN, *The Great Sphinx*, on pl. liii [right]. Shepensene, son of Pashenēsi and Thesubastepert , Abb. xv [2], p. 181; HASSAN, op. cit. on pl. liii [right]. Titles (no name), Abb. xvi [1], p. 181. Psammethek-nebpehti , son of Irterau  (woman), Abb. xvi [2], p. 181.

East wall.

Pashenēsi, son of Khufuemakhet , with Isis suckling Horus, Abb. xii, pp. 179, 198, 210, 222. Khufuemakhet, son of Pashenēsi and Senebptahiotēs , Abb. xiii, pp. 180, 210, 223. Titles (no name), Abb. xiv [1, 2], p. 180. Pashenēsi, Abb. xiv [3], p. 180. Son of (?) Pa'hemneter, see p. 180.



Original position unknown.

Weḥbrē'nebpehti , son of Psammethek and Taherib , in Cairo Mus. Ent. 38989, Abb. xi [1], pp. 178, 209. Shed. . . , son of Shepensene and Nehau , in Cairo Mus. Ent. 38990, Abb. xi [2], pp. 179, 210.

Room H (of Hassan).

Man with wife and small son, on either side of niche. HASSAN, *The Great Sphinx*, pl. liv, p. 112.

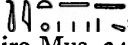
Finds**Dyn. XVIII.**

Donation-stela of Tet-ta , Asiatic, and wife Tanezemt , with Ay before Hathor, year 3, in Cairo Mus. 34187. HARI, *Horemheb et la Reine Moutnedjemet*, fig. 54, pl. xxxi (text), pp. 181-3; text, DARESSY in *Rec. Trav.* xvi (1894), p. 123 [cviii]; SPIEGELBERG, *Rechnungen aus der Zeit Setis I*, p. 36; LACAU, *Stèles du Nouvel Empire (Cat. Caire)*, i, pp. 233-4; HASSAN, *The Great Sphinx*, pp. 101-2 (collated by GRDSELOFF), p. 307; HELCK, *Urk.* iv. 2109-10 [818], cf. *Übersetz.* (1961), p. 402; names and titles, LEGRAIN, *Répertoire généalogique et onomastique du Musée du Caire*, No. 318; see LUR'É in *Epigrafika Vostoka*, v (1951), p. 106 [4].

Dyn. XXI. Blocks and fragments.

Kneeling fan-bearer, and names of Psusennes I, in Cairo Mus. Ent. 4747. MARIETTE, *Mon. div.* pl. 102 [c]; names, DE ROUGÉ, *Inscr. hiéro.* pl. xxxv [bottom] (called Şân); HASSAN, *The Great Sphinx*, p. 299.

Two column-fragments with probably Psusennes I offering wine to Osiris and Isis and adoring Ptaḥ, in Cairo Mus. Ent. 28161. See HASSAN, *The Great Sphinx*, p. 307; *Bull. Inst. Ég.* ii Sér. 8 (1887), Annexe xlv (after p. 368).

Fragment of column with Osiris in relief, in Cairo Mus. Ent. 28162. See ib. Annexe xlv (after p. 368); HASSAN, *The Great Sphinx*, p. 307.

King Amenemōpet before Isis, in Cairo Mus. Ent. 4748. MARIETTE, *Mon. div.* pl. 102 [b]; LEPSIUS in *Ä.Z.* xx (1882), Taf. i [5], p. 106; cartouches, HASSAN, *The Great Sphinx*, p. 299.

Relief with sphinx and cartouches of Amenemōpet, in Edinburgh, Roy. Scot. Mus. 1961. 1069.

Jamb of King Amenemōpet, in Berlin (East) Mus. 7973. LEPSIUS in *Ä.Z.* xx (1882), Taf. i [6], p. 106 (called Mit Rahîna); *Aeg. Inscr.* ii, p. 212; see *Ausf. Verz.* p. 228.

Dyn. XXVI.

'Inventory stela', with text of building Pyramids of Khufu and Henutsen and restoration of Temple and its statues, found by Mariette in 1858, in Cairo Mus. Ent. 2091. HASSAN, *The Great Sphinx*, pls. lv, lvi (text on pedestal), pp. 113-17 with fig. 80; MARIETTE, *Mon. div.* pl. 53; id. *Album du Musée de Boulaq*, pl. 27; MASPERO, *Guide*, fig. 27, pp. 77-8 [174]; id. *Hist. anc.* i, fig. on p. 413; DEVÉRIA squeezes, 6166, i. 1-2; GRDSELOFF MSS. 2.1-3 (photo.); description and text, HASSAN, *The Sphinx*, pp. 222-7; text, DARESSY in *Rec. Trav.* xxx (1908), pp. 1-6; parts of text, DE ROUGÉ, *Recherches sur les monuments* [etc.], pp. 46-7, 49 (repr. in *Bibl. Ég.* xxvi, pp. 45-8); BRUGSCH, *Thes.* 1231 [upper]; part with god Hauron, POSENER in *J.N.E.S.* iv (1945), p. 241 [6].

Monuments of Ḥarbes, son of Peftumaꜥushu and Shepenēsi, temp. Psammetikhos I:

(a) Stela, Ḥarbes and father adore Osiris and Isis, and six lines of text concerning purchase of land, in Cairo Mus. Ent. 28171. See *Bull. Inst. Ég.* ii Sér. 9 (1888), Annexe i (after p. 216); HASSAN, *The Great Sphinx*, p. 307; BOTHMER, *Eg. Sculp.* p. 41.

(b) Offering-table. See id. ib. p. 41 (called Boston Mus.).

(c) Statuette of Shepenēsi seated, lower part, dedicated by Ḥarbes. See id. ib. p. 41 (called Boston Mus.).

(d) Statue of kneeling Harbes, Overseer of the Department, fragment, granite, probably from here, in Brit. Mus. 514. Text, SHARPE, *Eg. Inscr.* 2 Ser. 44 [upper]; see *Guide (Sculpture)*, p. 238 [868]; BOTHMER, op. cit. p. 41.

(e) Statue of Harbes holding naos, probably from here, with E. Button (dealer), Frankfurt-am-Main. See id. ib. p. 41.

B. PYRAMID-COMPLEX OF KHEPHREN



Plan, HÖLSCHER (U.), *Das Grabdenkmal des Königs Chephren*, Bl. ii; with sections, MARAGIOGLIO and RINALDI, *L'Architettura*, v, Tav. 5. Description, BURTON MSS. 25619, 22 verso-24.

VALLEY TEMPLE. 'Granite Temple' or incorrectly 'Sphinx Temple'. Statues, see p. 21.

HÖLSCHER (U.), op. cit. pp. 15-23, 37-49, with views and sections. Account of Mariette's excavations, MARIETTE, *Le Sérapéum de Memphis*, i, pp. 93, 97-9; of von Sieglin Expedition excavations of Valley and Mortuary Temples, HÖLSCHER (U.), op. cit. pp. 1-12; BORCHARDT in *Klio*, ix (1909), pp. 479-83; xi (1911), pp. 261-4. Notes of excavations, finds, etc., ARCH. LACAU MSS./DS. A, Sér. iii.

Plans, PETRIE, *The Pyramids and Temples of Gizeh* (1883), pl. vi; MASPERO, *L'Arch. ég.* (1887), fig. 71; (1907), fig. 75; PARIBENI, *Architettura*, fig. 46; LAUER in *Ann. Serv.* xlvi (1947), fig. 18 [lower], p. 255; RICKE, *Harmachistempel*, on Abb. 2, 3; FAKHRY, *The Pyramids*, fig. 75, pp. 132-5; PRISSE MSS. 20433, 76; BURTON MSS. 25620, 110 [right]; WILKINSON MSS. xiii. 11, 38; SOMERS CLARKE MSS. 8. 17, and R.B. 2. Plans and sections, HÖLSCHER (U.), op. cit. Bl. iii [lower], viii-x, xii; MARAGIOGLIO and RINALDI, op. cit. Tav. 14-16, pp. 76-87, cf. 128-31 notes 35-8. Plan, views of interior, and reconstructions with positions of statues, VIKENTIEV in *Bull. Inst. Ég.* xxxix (1957-8), pls. i, ii, iv-vii, figs. 1, 3, pp. 7-27. Plan and view of interior, PERROT and CHIPIEZ, *Hist. de l'art*, i, figs. 202-3, cf. 204; MURRAY, *Egyptian Temples*, pl. vi [1, 2].

View,¹ BEDFORD, *Photographic Pictures*, No. 15 (part); BÉCHARD and PALMIERI, *L'Égypte et la Nubie* (1887), pl. xlvi (reversed); EBERS, *Aegypten*, i, pl. on p. 173; Eng. ed. pl. facing p. 145; MARIETTE, *Voyage dans la Haute Égypte* (1893), i, pl. 2; PETRIE, *History*, i (1899), fig. 30; (1923), fig. 42 (part); JÉQUIER, *L'Architecture*, i, pls. 3, 4; LAGIER, *L'Égypte monumentale et pittoresque*, pl. 2 [lower]; CAPART, *Memphis*, figs. 7, 59; MORET, *Le Nil et la civilisation égyptienne* (1937), pl. iv [1]; WOLDERING, *Götter*, Abb. 20; SOMERS CLARKE MSS. 19. 6 (photo.). Including interior, TARCHI, *L'Architettura e l'Arte nell'Antico Egitto*, Tav. 3 [lower], 5 [upper]; MORET, *Mystères égyptiens*, pls. xi, xii [left] facing pp. 278, 284; RANKE, *The Art of Ancient Egypt*, and BREASTED, *Geschichte Aegyptens*, 6, 7; PARIBENI, *Architettura*, figs. 45, 47-8; SMITH, *Art . . . Anc. Eg.* pls. 42 [A], 43. View of east façade with entrances, and of interior, MASPERO, *Égypte*, figs. 86-7; HAMANN, *Äg. Kunst*, Abb. 126-9. View of south entrance, LAUER, *Le Problème des pyramides d'Égypte*, pl. ix [2] facing p. 128; of north, RICKE, *Harmachistempel*, Taf. 17 [b].

View¹ of interior, CAPART, *L'Art ég.* (1909), pl. 7; id. *L'Art ég.* i, pl. 22; PETRIE, *The Arts and Crafts of Ancient Egypt*, fig. 81 facing p. 66; id. in WRIGHT, *Twentieth Century Impressions of Egypt*, pl. on p. 129 [upper, 2]; SCHÄFER and ANDRAE, *Kunst* (1925), 204; (1930 and 1942), 213; STEINDORFF, *Kunst*, 113; POULSEN (F.), *Ägyptens Kunst* (1933), fig. 18; SMITH (E. B.), *Egyptian Architecture as Cultural Expression*, pl. xxxiii [3]; LANGE, *Äg. Kunst*, pl. 16; id.

¹ Selected references.

Ägypten. Landschaft, pl. 29; id. and HIRMER, *Ägypten. Architektur* (1955 and 1957), pls. 34–5; (1967), pls. 32–3; DRIOTON, *Le Sphinx et les Pyramides de Giza*, pl. v; GILBERT, *Le Classicisme de l'architecture égyptienne*, figs. 8, 9; id. *Méditerranée antique*, fig. 9; DE WIT, *Oud-Egyptische Kunst*, fig. 12 facing p. 25; FRANKFORT, *Ancient Egyptian Religion*, pl. 27; MURRAY, *Splendour*, pl. xxxiii [1] on p. 129; GIEDION, *The Eternal Present*, ii, figs. 198–9; EDWARDS, *Pyramids* (1961), pl. 15 [b]; ATARASHI, *Egypt*, pl. 6; WESTENDORF, *Das Alte Ägypten*, fig. on p. 46; MICHALOWSKI, *Art*, figs. 61, 854.

Jambes of entrances with remains of text mentioning Hāthor and Bubastis, granite. HÖLSCHER (U.), *Das Grabdenkmal des Königs Chephren*, Abb. 7, 8, cf. Bl. viii, Abb. 5, 6, 21 for positions.

Two blocks with double-crown, from Horus-name of the King, granite, originally above south entrance. RICKE, *Harmachistempel*, Abb. 16, p. 28.

Intrusive blocks. From débris in front of Temple.

Two registers, legs of offering-bringers, and priest with bound Asiatic captive, Dyn. IV–VI. STEINDORFF in HÖLSCHER (U.), op. cit. Abb. 162–3, pp. 110–11; see SMITH, *Hist. Eg. Sculp.* p. 158.

Text of purchase of house from Thenti $\overline{\text{Ⲑ}} \text{ⲓ}$, Scribe, Dyn. V–VI, in Cairo Mus. Ent. 42787 (formerly Ent. 41904). STEINDORFF in HÖLSCHER (U.), op. cit. Abb. 164, pp. 111–12; SETHE, *Ägyptische Inschrift* [etc.] in *Berichte über die Verhandlungen der Königl. Sächsischen Gesellschaft der Wissenschaften zu Leipzig, Phil.-hist. Klasse*, 63 (1911), Taf. v, pp. 135–50; GOEDICKE, *Die privaten Rechtsinschriften aus dem Alten Reich*, Taf. xvi, pp. 149–73; text, SOTTAS, *Étude critique sur un acte de vente immobilière* [etc.], passim; SETHE, *Urk.* i (1933), 157–8 [8 (99)].

Year 1 (probably) of Ramesses II, from ruins of houses. STEINDORFF in HÖLSCHER (U.), op. cit. Abb. 167, p. 114.

Bes and demotic inscription, from ruins of houses. Id. ib. Abb. 168, p. 115.

CAUSEWAY.

HÖLSCHER (U.), *Das Grabdenkmal des Königs Chephren*, pp. 24, 49–50; MARAGIOGLIO and RINALDI, *L'Architettura*, v, pp. 74–7, plan and sections, on Tav. 5. Sections, BURTON MSS. 25620, 113. See BRUGSCH in *Vossischer Zeitung (Königlich privilegierte Berlinische Zeitung)* (Dec. 10, 1880). Views, *I.L.N.* April 6, 1935, figs. on p. 567; HÜRLIMANN in *Atlantis* (Jan. 1936), fig. on p. 27; DRIOTON, *Le Sphinx et les Pyramides de Giza*, pl. vi; GRINSELL, *Eg. Pyramids*, pl. iii facing p. 21; SOGA, *The Nile*, fig. on p. 47 [left]; MICHALOWSKI, *Art*, fig. 858; with Mortuary Temple, HASSAN, *The Great Sphinx*, pl. i.

Block, middle part of body of goddess, found in débris south of tomb G II S, possibly from here, in Hildesheim Mus. 3185. JUNKER, *Gîza*, x, Taf. xvi [a], Abb. 17, pp. 38–40; see id. in *Anzeiger, Wien*, 65 (1928), p. 187 [c].

MORTUARY TEMPLE.

View, CAPART, *Memphis*, fig. 60; SOMERS CLARKE MSS. 10. 1. 10 (photo.).

Account of finding Temple, BELZONI, *Researches*, pp. 260–2. Description with views, plans, and section, HÖLSCHER (U.), *Das Grabdenkmal des Königs Chephren*, pp. 24–30, 50–8, 84, Bl. iii [upper], vi, xviii; with plan, sections, and reconstructions, MARAGIOGLIO and RINALDI, *L'Architettura*, v, pp. 64–73, cf. 118–27 notes 29–33, Tav. 11 [1], 12, 13. Plans, JUNKER, *Gîza*, vi, Abb. 1, pp. 9–10; RICKE, *Bemerkungen zur ägyptischen Baukunst des Alten Reichs*, ii, in *Beiträge zur ägyptischen Bauforschung und Altertumskunde*, 5, Abb. 16 [left],

pp. 47-55; FAKHRY, *The Pyramids*, fig. 76, pp. 135-6; LAUER in *Ann. Serv.* xlvi (1947), fig. 18 [upper], p. 255; BURTON MSS. 25620, 111 [right]; SOMERS CLARKE MSS. R.B.1; of court, RICKE, *Harmachistempel*, Abb. 4. Plan and views, HÖLSCHER (U.) and STEINDORFF in *Ä.Z.* 46 (1909), Taf. i, Abb. 1, 2, pp. 1-12. Reconstruction of court with statues, RICKE, *Bemerkungen* [etc.], Taf. 2, Abb. 17, 19, pp. 47-55, cf. Abb. 20.

Blocks with remains of royal titles, granite. One, HÖLSCHER (U.), *Das Grabdenkmal des Königs Chephren*, Abb. 45, p. 55. RICKE, *Harmachistempel*, Abb. 17 [middle left]; another two, Abb. 17 [top and bottom left], p. 31.

Block with remains of text. PERRING, *Pyramids*, ii, *The 2nd Pyramid*, p. 1; VYSE, *Operations*, i, p. 255 (copied by SALT in 1817).

Mace-heads of Khephren.

(a) Fragment, names, magnesite, in London, Univ. Coll. 11763; PETRIE, *Scarabs and Cylinders* [etc.], pl. viii [4.3 (11)]; id. *Ten Years' Digging in Egypt*, fig. 7, p. 22; MASPERO, *Hist. anc.* i, fig. on p. 442; see PETRIE, *The Pyramids and Temples of Gizeh* (1883), p. 153; GAUTHIER, *Le Livre des Rois d'Égypte*, i, p. 87 [iii]; (b)-(i) eight fragments (five with name), magnesite; six of them, STEINDORFF in HÖLSCHER (U.), op. cit. Abb. 156, pp. 106-7; (j) Horus-name, in Cairo Mus. Ent. 72362. Others, (k) fragment, found near tomb of Khentkaus [I]; HASSAN, *Giza*, iv, pl. vii [E], p. 17 [5]; iii, pl. lvi [3], p. 197 [1]; (l) incomplete, with names, probably from here, in Toronto Mus. 968.241.1; *Rotunda. The Bulletin of the Royal Ontario Museum*, ii [2] (1969), fig. on p. 35 [bottom]; (m) fragment, with names, probably from here, formerly in MacGregor Colln., now in Copenhagen, Ny Carlsberg Glypt. Æ.I.N.1599b; *Sotheby Sale Cat.* (MACGREGOR), June 26-July 6, 1922, pl. xlii [1657, lower left], p. 215 [1657, 3rd obj.]; MOGENSEN in *R.E.A.* i (1927), fig. 1, pp. 227-8; id. *La Collection égyptienne* (1930), pl. ii [A 2c]; PIJOÁN, *Summa Artis*, iii (1945), fig. 82; (n) fragment, with cartouche, probably from here, formerly in MacGregor Colln., now in Copenhagen, Ny Carlsberg Glypt. Æ.I.N.1599a; MOGENSEN in *R.E.A.* i (1927), fig. 2, pp. 227-8; id. *La Collection égyptienne* (1930), pl. ii [A 2b]; see *Sotheby Sale Cat.* (MACGREGOR), June 26-July 6, 1922, p. 215 [1657, 2nd obj.].

Stone vessels.

Diorite fragment with name of King Send, probably from here. See STEINDORFF in HÖLSCHER (U.), op. cit. p. 106; REISNER, *Mycerinus*, p. 102 [6].

Alabaster fragment with incised cartouche of Khephren, in Brit. Mus. 16453. See PETRIE, *The Pyramids and Temples of Gizeh* (1883), p. 153; STEINDORFF in HÖLSCHER (U.), op. cit. pp. 105-6; *Guide, Eg. Colln.* (1930), p. 292; *Guide, 4th to 6th*, p. 15 [3].

Statues from Temples of Khephren

Khephren statues.

Found by Mariette (1860). In Cairo Mus. From well in floor of Long Vestibule of Valley Temple.

See MARIETTE in *Revue Archéologique*, n.s. ii (1860), pp. 19-20; DE ROUGÉ in *Comptes rendus*, iv (1860), pp. 71-2 (letter from Mariette).

King (headless) seated on throne, diorite, No. 9.

BORCHARDT, *Statuen*, i, Bl. 3, pp. 9-10 with fig. and text; HORNEMANN, *Types*, iii, pl. 700. See MASPERO, *Guide*, p. 72 [163]; BORCHARDT in *Ä.Z.* xxxvi (1898), p. 3, text, p. 12.

King (headless) seated, diorite, No. 10.

Id. *Statuen*, i, Bl. 3, pp. 10-11 with fig. and text. See MASPERO, *Guide*, p. 39 [73]; BORCHARDT in *Ä.Z.* xxxvi (1898), p. 3, text, p. 12.

Bubastis and [King], with Nile-god on side of seat, lower part, diorite, Nos. 11, and 1245 (fragment of seat).

No. 11, id. *Statuen*, i, Bl. 3, pp. 11–12 with figs. and text; SCHARFF in *Studi Rosellini*, i, Taf. xxviii [1], p. 306; see BORCHARDT in *Ä.Z.* xxxvi (1898), p. 3, text, p. 12; HASSAN, *The Great Sphinx*, p. 307 [Ent. 27485] ('found in Temple of Isis'); *Bull. Inst. Ég.* ii Sér. 7 (1886), Annexe xxviii [27485] (from 'Temple de Mariette'). No. 1245, BORCHARDT, *Statuen*, iv, Bl. 173, p. 128.

Bust of King seated, diorite, No. 12. Id. ib. i, Bl. 3, p. 13; see id. in *Ä.Z.* xxxvi (1898), p. 3.

King (headless) seated on throne, diorite, No. 13.

Id. *Statuen*, i, Bl. 4, pp. 13–14 with fig. See id. in *Ä.Z.* xxxvi (1898), p. 3; MASPERO, *Guide*, p. 39 [76].

King seated, with hawk perching on back of throne,¹ diorite, No. 14.

BORCHARDT, *Statuen*, i, Bl. 4, pp. 14–16 with fig. and text; id. in *Ä.Z.* xxxvi (1898), Abb. 2, p. 3, details of throne, Abb. 6, 8, text, p. 12; MASPERO, *Guide*, fig. 16, p. 63 [138]; id. and ROEDER, *Führer*, Taf. 1, 2; BRUGSCH in *Ä.Z.* ii (1864), pl. facing p. 59, cf. pp. 58–61; PETRIE, *History*, i (1899), fig. 33; (1923), fig. 45; id. *The Arts and Crafts of Ancient Egypt*, figs. 27–8 facing p. 34; CAPART, *L'Art ég.* (1909), pl. 11; (1911), pl. 108; id. *L'Art ég.* ii, pls. 212–13; id. *Memphis*, figs. 144, 159; VON BISSING, *Denkmäler*, Taf. 10, *Text* to Taf. 10 [1st fig.]; id. *Äg. Kunstgeschichte*, Taf. li [344], lxvi [401]; FECHHEIMER, *Plastik*, Taf. 22–4; TARCHI, *L'Architettura e l'Arte nell'Antico Egitto*, Tav. 9 [lower]; WEIGALL, *Anc. Eg. . . . Art*, 24–6 [upper left]; RICHER, *Le Nu*, fig. 36; DRIOTON, *Le Musée Égyptien* (1939), pl. iv; HAMANN, *Äg. Kunst*, Abb. 1 (frontispiece), 125; PIJOAN, *Summa Artis*, iii (1945), pl. v facing p. 104, fig. 136; STEINDORFF, *Kunst*, 179–80; MURRAY, *Egyptian Sculpture*, pls. viii, ix [1]; RANKE, *The Art of Ancient Egypt*, and BREASTED, *Geschichte Aegyptens*, 52–3; RANKE, *Meisterwerke*, Abb. 8, 9; ALDRED, *O.K. Art*, pls. 15, 16; *Encycl. phot. Caire*, pls. 8–10; EDWARDS, *Pyramids* (1947), pl. 8; (1961), pl. 16; LANGE and HIRMER, *Aegypten. Architektur* (1955 and 1957), pls. 36–9; (1967), pls. 30–1, and iv; WOLF, *Kunst*, Abb. 106–7; WESTENDORF, *Das Alte Ägypten*, figs. on pp. 40–1; MICHALOWSKI, *Art*, figs. 62, 195; MARIETTE, *Album du Musée de Boulaq*, pl. 26; EBERS, *Aegypten*, i, fig. on p. 172; Eng. ed. fig. on p. 150; WARD (J. J.), *Pyramids and Progress*, fig. on p. 34; ROSS, *The Art of Egypt*, pl. on p. 101; POULSEN (F.), *Ägyptens Kunst* (1933), fig. 36, p. 69; MITRY, *Illus. Cat.* No. 138; *Descr. somm.* No. 138 with pl. Upper part of body or head, PETRIE, *The Making of Egypt*, pl. lvi [3]; BORCHARDT, *Works of Art from the Egyptian Museum at Cairo*, pl. 1; DE ROUGÉ, *Album photographique*, pls. 91–2; SCHÄFER and ANDRAE, *Kunst* (1925), Taf. ii facing p. 220; (1930 and 1942), Taf. ii facing p. 230; BOREUX, *L'Art égyptien*, pl. xix; WRESZ., *Atlas*, ii. 52 [Beibild on right]; LANGE, *Äg. Kunst*, pl. 18; SMITH, *Hist. Eg. Sculp.* pl. 5 [c]; id. *Art . . . Anc. Eg.* pl. 40; DRIOTON and SVED, *Art ég.* figs. 11, 12; VANDIER, *Eg. Sculpture*, pl. 4; PRITCHARD, *Anc. Near East*, fig. 377. Hawk, BÉNÉDITE in *Mon. Piot.* xvii (1909), fig. 9, p. 17.

King seated, greywacke, No. 15.

BORCHARDT, *Statuen*, i, Bl. 4, pp. 16–17 with fig. and text; id. in *Ä.Z.* xxxvi (1898), Abb. 1, p. 2, text, p. 11; DE ROUGÉ, *Recherches sur les monuments* [etc.], pl. iv (repr. in *Bibl. Ég.* xxvi, pl. iv); id. *Album photographique*, pls. 93–4; VON BISSING, *Einführung in die Geschichte der Ägyptischen Kunst*, Taf. iii [3]; id. *Äg. Kunstgeschichte*, Taf. li [345]; MASPERO, *Égypte*, fig. 121; HUNGER and LAMER, *Altorientalische Kultur im Bilde*, Abb. 25; MURRAY, *Splendour*, pl. xlviiii [2] on p. 144. Text, MÜLLER (H. W.) in *Ä.Z.* 91 (1964), Abb. 1, p. 131. See MASPERO, *Guide*, p. 79 [179].

¹ Selected references.

Legs of King standing, greywacke, No. 16. BORCHARDT, *Statuen*, i, Bl. 4, p. 17 (with text); see id. in *A.Z.* xxxvi (1898), p. 2, text, p. 11.

King (headless) seated, greywacke, No. 17; adjoining fragment of inscribed base found by Hassan in shaft G of north room of tomb of Kaunesut (see p. 274).

No. 17, id. *Statuen*, i, Bl. 5, pp. 18-9 with fig. and text; id. in *A.Z.* xxxvi (1898), Abb. 7, p. 2, text, pp. 11-12; VANDIER, *Manuel*, iii, pl. iii [1] (from BORCHARDT), p. 557; see MASPERO, *Guide* (1914), p. 67 [168]. Adjoining fragment, HASSAN, *Giza*, ii, pl. xxvi [2, 3], p. 86.

Fragment of shoulder and breast, probably, greywacke, No. 378. See BORCHARDT, *Statuen*, i, p. 199; id. in *A.Z.* xxxvi (1898), p. 2 note 4.

Found by von Sieglin Expedition (1909-10).

Head, fragment, diorite, in Leipzig Mus. Inv. 1945. BORCHARDT in HÖLSCHER (U.), *Das Grabdenkmal des Königs Chephren*, Bl. xvi, Abb. 80-1, p. 92 [1]; FECHHEIMER, *Kleinplastik der Ägypter*, Taf. 8; CAPART, *Documents*, i, pl. 3 [A]; MOGENSEN in *R.E.A.* i (1927), pl. viii [3]; RANKE, *The Art of Ancient Egypt*, and BREASTED, *Geschichte Aegyptens*, 55; SPIEGEL, *Kurzer Führer durch das Ägyptische Museum der Universität Leipzig* (1938), Taf. 1; SMITH, *Hist. Eg. Sculp.* pl. 12 [e], p. 35; BYVANCK, *De Kunst*, pl. xv [52]; STEINDORFF, *A Royal Head*, pl. 11, p. 11 [23]; WOLF, *Die Welt der Ägypter*, Taf. 12; VANDIER, *Manuel*, iii, pl. iii [5] (from SMITH), p. 571; MÜLLER (Dieter) and ETZOLDT, *Ägypten*, front cover.

Head wearing *nemes*, brown stone, in Leipzig Mus. Inv. 1946. BORCHARDT in HÖLSCHER (U.), op. cit. Abb. 82, p. 93 [2]; F.E.R.E. photo. 5944; see VANDIER, *Manuel*, iii, p. 571.

Head wearing Red Crown, fragment, pink limestone, in Leipzig Mus. Inv. 1947. BORCHARDT in HÖLSCHER (U.), op. cit. Abb. 83-4, pp. 93-4 [3]; ABUBAKR, *Untersuchungen über die ägyptischen Kronen*, Taf. 12; see VANDIER, *Manuel*, iii, p. 571.

Heads, fragments, in Leipzig Mus. Inv. 1948, BORCHARDT in HÖLSCHER (U.), op. cit. Abb. 85-6, p. 94 [4]. Inv. 1949, Abb. 87, p. 94 [5]. Inv. 1950, Abb. 88, p. 94 [6]. Inv. 1951, Abb. 89, p. 95 [7]. Inv. 1952, Abb. 90, p. 95 [8]. Inv. 1953 (lost), Abb. 91, p. 95 [9]. Inv. 3775-6, 3778-9, and others.

Fragments, some with remains of texts, alabaster, diorite, and greywacke, in Berlin Mus. 15036-65, 15305-7, 15311-13, 15374-86, 15388 (all West), and 15304, 15387, 19912-13. Nos. 15045, 15047, 15053-4, 15057-8, 15304, 15376-7, 15379-82, 15387, *Aeg. Inschr.* i. p. 2. No. 15048, BORCHARDT in HÖLSCHER (U.), op. cit. Abb. 95, p. 95 [13]; 15052, Abb. 116, p. 99 [34]; 15053, Abb. 128, p. 101 [46]; 15054, Abb. 127, pp. 100-1 [45]; 15311, Abb. 103, p. 97 [21]; 15312, Abb. 124 [left], p. 100 [42]; 15313, Abb. 92, p. 95 [10]; 15379, Abb. 126, p. 100 [44]; 15385, Abb. 154, p. 104 [70]; 15386, Abb. 104, p. 97 [22]; 15387, see p. 97 [25]; 19912, Abb. 111, p. 98 [29]; 19913, Abb. 145, p. 103 [61].

Found by Junker.

In Cairo Museum.

Head wearing *nemes* (damaged), greywacke, found at south-west corner of tomb D. 16, Ent. 49692. JUNKER in *Anzeiger, Wien*, 63 (1926), Taf. ix [b], p. 105; see id. *Giza*, ix, pp. 125-6; SMITH, *Hist. Eg. Sculp.* p. 34 [lower, 1] (called north-west).

In Hildesheim Museum.

Nos. 69, 2694, and unnumbered; see IPPEL and ROEDER, *Denkmäler . . . Hildesheim*, pp. 4, 47.

Fragments, diorite and alabaster, found in shaft of tomb G 5332. See JUNKER, *Giza*, viii, p. 56; id. in *Anzeiger, Wien*, 51 (1914), p. 177 [4]; SMITH, op. cit. p. 34 [9].

Fragments, found in débris of exterior mud-brick chapel of tomb G I S; diorite, see JUNKER, *Gîza*, xi, p. 18; alabaster, with remains of cartouche, Taf. xxii [d (60)], p. 18. Fragments (some inscribed), diorite and alabaster, some re-used, found in débris of tomb G II S; see id. ib. x, pp. 40-1. See id. in *Anzeiger, Wien*, 65 (1928), pp. 185-6 [c].

Found by Reisner.

Fragment of face, alabaster, found in surface débris near shaft G 2370B and in shaft G 2382A, in Boston Mus. 13.3472. SMITH, *Hist. Eg. Sculp.* pl. 12 [c], p. 34 [lower, 4] (with other fragments, some with name).

Mutilated head wearing *nemes*, alabaster, found with last, in Boston Mus. 34.52a,b. See id. ib. p. 34 [lower, 5]; id. *Anc. Eg.* (1942 and 1952), p. 37; (1960), p. 42.

Fragment of beard, and others, several with name, alabaster, probably same statue as next, from area between tombs G 5110 and G 5230. Beard, id. in *W.Z.K.M.* 54 (1957), on fig. 1, p. 186 note 1; see id. *Hist. Eg. Sculp.* p. 34 [8].

Fragments of face, bust, lap, and throne with scenes of Horus and Sēth with *was*-sceptres, from seated statue, alabaster, found in shaft G 5223A and surroundings, G 4833B, and G 7422A, in Boston Mus. 21.951-2. Id. in *W.Z.K.M.* 54 (1957), figs. 1-3, pp. 186-90; No. 21.951, id. *Hist. Eg. Sculp.* pl. 12 [b], p. 34 [lower, 3, 7]; No. 21.952, see p. 34 [upper, 1].

Fragments of several similar statues, see id. ib. 34 [lower, 3].

Head, alabaster, found with fragments with cartouche, from débris at north-east corner of tomb G 5330, in Boston Mus. 21.351. G. A. R[EISNER] in *Boston Mus. Bull.* xix (1921), fig. on p. 62; *Handbook* (1930), fig. on p. 7; RANKE, *The Art of Ancient Egypt*, and BREASTED, *Geschichte Aegyptens*, 54; RAGAI, *L'Art*, pl. 34 [61]; SMITH, *Anc. Eg.* (1942), fig. 17; (1952) fig. 18; (1960), fig. 21; id. *Hist. Eg. Sculp.* pl. 12 [a], p. 34 [lower, 2]; VANDIER in *L'Amour de l'Art*, xxviii, fig. on p. 218; PIRENNE, *Hist. civ.* i, pl. 46 between pp. 148-9; TERRACE in *The Connoisseur*, clxviii (1968), fig. 1, p. 199; MICHALOWSKI, *Art*, fig. 189.

Fragments of seated statues, probably, alabaster, from north of tombs G 5411 and G 5412, in Boston Mus. unnumbered (Exped. Nos. 14-12-57, 58, 63). See SMITH, *Hist. Eg. Sculp.* p. 34 [6].

Fragment, probably, alabaster, found in shaft G 7050B. See id. ib. p. 34 [upper, 3].

Fragment of seat, black granite, found in shaft G 7220A. See id. ib. p. 34 [upper, 2].

Fragment of seat, probably, alabaster, found between tombs G 7220 and G 7230. See id. ib. p. 34 [upper, 4].

Fragments, probably, diorite, found in West Field. See id. ib. p. 34 [upper, 5].

Found by Hassan. See also p. 23.

Fragment of head of statuette, probably, diorite, from north of tomb of Nikaurē (see p. 232). HASSAN, *Gîza*, v, pl. lxix [c], p. 313 [8].

Head, much damaged, diorite, found in a shaft, in Cairo Mus. Ent. 72212. Id. ib. vii, pls. lv, lvi [A], p. 128 [20].

Head, fragment, alabaster, found south of Valley Temple, in Cairo Mus. Ent. 72211 (probably). Id. ib. ix, pl. xlii [D], p. 86 [4, a].

King seated on throne, lower part, diorite, found south of Mortuary Temple, in Cairo Mus. Ent. 72213. See id. ib. vi [3], p. 240 [6].

King standing, lower part, diorite, found on path running along east faces of Valley Temple and the Sphinx Temple, in Cairo Mus. Id. ib. ix, pl. xxxvii [A, B], p. 82 [1]; see *Chron. d'Ég.* xiv (1939), pp. 81, 83 [d].

Base with feet (inscribed), alabaster, found with last. HASSAN, *Gîza*, ix, pl. xiv, p. 39 [upper, 8].

Base of standing statue, diorite, found re-used in Ante-temple of Menkaurē (see p. 27).
Id. ib. iv, pl. xxv [A], p. 55.

Fragment with remains of names, diorite, found with last. Id. ib. pl. xxvii [A], p. 56 [5].

Fragment with cartouche, diorite, found in débris in front of tomb of 'Ankhtef (see p. 275).
Id. ib. v, pl. lxxi [B], p. 318 [39].

Various.

Head, fragment, alabaster, probably from here, formerly in MacGregor Colln., now in Copenhagen, Ny Carlsberg Glypt. Æ.I.N. 1599. *Burlington Fine Arts Club* (1922), pl. iv [right]; *Sotheby Sale Cat.* (MACGREGOR), June 26–July 6, 1922, pl. xlv [1657], p. 215; MOGENSEN in *R.E.A.* i (1927), pl. viii [1, 2], pp. 228–9; id. *La Collection égyptienne* (1930), pl. ii [A 2a]; CAPART, *Documents*, i, pl. 3 [B]; id. *L'Art ég.* ii, pl. 214; PIJOÁN, *Summa Artis*, iii (1945), fig. 134; SMITH, *Hist. Eg. Sculp.* pl. 12 [d], p. 35; ALDRED, *O.K. Art*, pl. 17; MURRAY, *Splendour*, pl. vi on p. 38; KOEFOED-PETERSEN, *Catalogue des statues et statuettes égyptiennes* (1950), pl. 4, p. 8 [2]; id. *Aegyptisk Billedhuggerkunst i Ny Carlsberg Glyptotek* (1938), pl. 5; (1951), pl. 4; id. *Egyptian Sculpture in the Ny Carlsberg Glyptotek* (1951 and 1962), pl. 4; VANDIER, *Eg. Sculpture*, pl. 17; POULSEN, *Äg. Kunst. A. und M.* pl. on p. 49; id. *Ny Carlsberg Glyptothek. Führer durch die Sammlungen* (1969), fig. on p. 8; MICHALOWSKI, *Art*, fig. 192; FRANCESCHI and JOHANSEN, *Et hundrede fire og tyve fotografier*, pl. 8.

Head, fragment, arragonite, probably from here, formerly in MacGregor and Carnarvon Collections, now in New York, M.M.A. 26.7.1392. HAYES, *The Scepter of Egypt*, i, fig. 42, p. 65; see *Sotheby Sale Cat.* (MACGREGOR), June 26–July 6, 1922, p. 215 [1658].

Fragment with remains of Horus-name, alabaster, in Berlin Mus. 1165. *Aeg. Inschr.* i, p. 2; *L. D. Text*, i, p. 126; see *Ausf. Verz.* p. 44.

Fragment of seat, diorite, found in the Sphinx Temple in 1931, in Cairo Mus. Temp. No. 23.12.31.1.

Other statues.

Fragment of Queen's head, and head of female statuette, both alabaster, found by von Sieglin Expedition, former in Leipzig Mus. Inv. 1965, latter lost. BORCHARDT in HÖLSCHER (U.), *Das Grabdenkmal des Königs Chephren*, Abb. 140, 146, pp. 102 [56], 103 [62].

Amūn standing, legs and left arm missing, head mutilated, basalt, New Kingdom, probably from here, in Cairo Mus. 38001. DARESSY, *Statues de divinités (Cat. Caire)*, pl. i, pp. 1–2; BORCHARDT in *Ä.Z.* xxxvi (1898), Abb. 11, p. 15; HORNEMANN, *Types*, i, pl. 146; see MASPERO, *Guide*, p. 182 [673].

PYRAMID.

Lepsius, VIII; Perring and Vyse, 2 of Giza; Reisner, G II; called Second Pyramid.

HÖLSCHER (U.), *Das Grabdenkmal des Königs Chephren*, pp. 31–4, 60–6, with section, Bl. vii, cf. Abb. 52; MARAGIOGLIO and RINALDI, *L'Architettura*, v, pp. 42–63, cf. 98–119 notes 1–27, with plans and sections (including interior), Tav. 5–10 [1–8].

Exterior

Plan and elevation, *Descr. Ant.* v, pl. 16 [1, 2].

View, GREAVES, *Pyramidographia* (1646), fig. on p. 105; PERRING, *Pyramids*, ii, *The 2nd Pyramid*, pls. v, vi; TEYNARD, *Égypte et Nubie*, i (1858), pl. 10; BÉCHARD and PALMIERI, *L'Égypte et la Nubie* (1887), pl. xlvi (reversed); MASPERO, *Hist. anc.* i, fig. on p. 373; PIJOAN, *History of Art*, i, fig. 74 (called Menkaurē); SPIEGEL, *Hochkultur*, Taf. 8; MÜLLER (H. W.), *Ägyptische Kunst*, Abb. 25. View from top of Great Pyramid, VIOLLET and DORESSE, *Egypt*,

pl. 52; WESTENDORF, *Das Alte Ägypten*, fig. on p. 43; BRUCHET, *Nouvelles recherches sur la Grande Pyramide*, pl. iv [upper]; with Mortuary Temple, BORCHARDT and RICKE, *Egypt*, pl. 71; HASSAN, *The Great Sphinx*, pl. iii; EDWARDS, *Pyramids* (1961), pl. 17; LAUER, *Observations sur les pyramides*, pl. vi [upper]. Air view, BUDGE, *Egyptian Tales and Romances*, pl. facing p. 36.

Masons' graffiti on blocks. PETRIE in SAYCE MSS. 28a [upper].

Interior

Section, on plan IV [2]

Account of finding entrance and entering, BELZONI, *Researches*, pp. 262-75. Plans and sections (including sarcophagus), PERRING, *Pyramids*, ii, *The 2nd Pyramid*, pls. i-iv; HOSKINS MSS. i. 123; sections, FORBIN, *Voyage dans le Levant* (1819), last plate [bottom]; VYSE, *Operations*, i, pl. facing p. 5; PETRIE, *The Pyramids and Temples of Gizeh* (1883), pl. vii [middle]; FAKHRY, *The Pyramids*, fig. 77, pp. 137-8; BANKES MSS. ii. B.5; HAY MSS. 29812, 37; BURTON MSS. 25620, 113-14; LANE MSS. 34088, 43. Section and views (including upper entrance), BELZONI, op. cit. pls. 9-12. Views of upper and lower entrances, VYSE, op. cit. pls. facing pp. 169, 185.

Central burial chamber. 'Belzoni's Chamber'

Masons' graffiti on floor blocks. PERRING, *Pyramids*, ii, *The 2nd Pyramid*, pl. iii [8-10].

Sarcophagus (uninscribed), granite. Plans and sections, MARAGIOGLIO and RINALDI, *L'Architettura*, v, Tav. 10 [9-15]; plan, BONOMI MSS. ii. 81; BURTON MSS. 25619, 25 recto; views, HÖLSCHER (U.), *Das Grabdenkmal des Königs Chephren*, Abb. 51, pp. 63-4; see DONADONI ROVERI, *Sarcofagi egizi*, pp. 104-5 [A 5], cf. fig. 13 [b].

BOAT-PITS. Five, with supposed sixth north of Mortuary Temple.

Description with plans and sections, HASSAN, *Gîza*, vi [1], pp. 56-66, figs. 19-22, pl. 1; MARAGIOGLIO and RINALDI, *L'Architettura*, v, pp. 92-5, Tav. 11.

Base with paws of large sphinx, Dyn. IV, from west Boat-pit orientated east-west, south of Mortuary Temple. HASSAN, *The Great Sphinx*, fig. 96a, pp. 162-3; see id. *Gîza*, vi [1], p. 60.

SUBSIDIARY PYRAMID WITH 'SERDAB'. Reisner, G II-a.

Description with plan and section, HÖLSCHER (U.), *Das Grabdenkmal des Königs Chephren*, pp. 34-5, Bl. xiii; MARAGIOGLIO and RINALDI, *L'Architettura*, v, pp. 88-93, cf. 130-1 notes 39-42, Tav. 17 [1-8]; plan and section of interior, REISNER, *Giza Necropolis*, i, fig. 66, pp. 131-2 [4].

Sealing of King's eldest son of his body, etc., and Horus-name of Khephren. STEINDORFF in HÖLSCHER (U.), op. cit. Abb. 157, p. 107.

C. PYRAMID-COMPLEX OF MENKAURĒ'

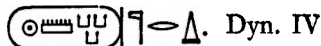

Dyn. IV

Description, BURTON MSS. 25619, 34 verso-38. Plan, MARAGIOGLIO and RINALDI, *L'Architettura*, vi, Tav. 4 [1], pp. 32-5; of upper part, BURTON MSS. 25620, 75, cf. 73; PETRIE, *The Pyramids and Temples of Gizeh* (1883), pl. v. Account of Reisner excavation, BORCHARDT in *Klio*, ix (1909), pp. 483-8; xi (1911), pp. 124-6.

VALLEY TEMPLE.

Ante-temple. Brick-built. Dyn. V or VI

HASSAN, *Giza*, iv, pp. 51-62 (called Valley Temple of Khentkaus [I]); plan, on fig. 1; MARAGIOGLIO and RINALDI, op. cit. on Tav. 10, pp. 72-7, cf. 124-7 notes 35-6; views, HASSAN, op. cit. pls. xxii [A], xxiv [D], xxvi [A], xxviii [A], xxxi.

Finds. Old Kingdom.

Middle part of seated royal statuette, and fragment, schist. Id. ib. pls. xxii [B], xxv [B], pp. 51 [1], 56 [1].

Female head. Id. ib. pl. xxiv [A], p. 52 [25].

Male head. Id. ib. pl. xxx [E], p. 58 [6].

Female seated statuette, lower part, with remains of text. See id. ib. p. 61 [1].

Sphinx, standing, torso, schist. Id. ib. pl. xxvi [B], p. 56 [2]; id. *The Great Sphinx*, fig. 97, p. 164.

Offering-table of Khentkaus [I], re-used. Id. *Giza*, iv, pl. xxvii [C], p. 58 [4].

Valley Temple Proper. Mainly brick-built

Plans and sections, REISNER, *Mycerinus*, pls. viii-x, figs. 18-22, pp. 34-54; MARAGIOGLIO and RINALDI, *L'Architettura*, vi, on Tav. 10, pp. 66-73, 76-9, cf. 120-5, 126-9, notes 33-4, 37-9. Plan, BURTON MSS. 25620, 110 [left]; FAKHRY, *The Pyramids*, fig. 78, pp. 139-40; SOMERS CLARKE MSS. 10.1.11-12 (by REISNER and FISHER). Views, REISNER, op. cit. pls. 24-37; id. in *Boston Mus. Bull.* ix (1911), fig. on p. 16; WHITEHILL, *Museum of Fine Arts Boston. A Centennial History*, i, fig. on p. 255.

Finds.**Menkaurē's statues.**

Nome triad,¹ Hathor Mistress-of-the-Sycamore seated, and King and Hare-nome goddess standing, greywacke, in Boston Mus. 09.200.

REISNER, *Mycerinus*, pls. 38 [a], 39, 40, 46 [c], p. 109 [9]; id. in *Boston Mus. Bull.* ix (1911), figs. on pp. 16-17; *Handbook* (1920), fig. on p. 25; (1930), fig. on p. 10; (1947), fig. on p. 11; (1964), fig. on p. 177 [upper]; SCHÄFER and ANDRAE, *Kunst* (1925), 221 [right]; (1930 and 1942), 231 [right]; KEES, *Ägyptische Kunst*, Abb. 9; *I.L.N.* Jan. 30, 1932, figs. 1, 5, 6 on p. 156; CAPART, *L'Art ég.* ii, pl. 219; DESROCHES-NOBLECOURT, *Le Style égyptien*, pl. xiii; SMITH, *Hist. Eg. Sculp.* pl. 13 [c], p. 38; id. *Anc. Eg.* (1960), fig. 23; MURRAY, *Splendour*, pl. xlix [2] (called Cairo Mus.); SCHARFF in *Studi Rosellini*, i, Taf. xxix [1], p. 307; BOTHMER in *Boston Mus. Bull.* xlviii (1950), figs. 1, 4-10, pp. 11-14, 16-17; SHOUKRY, *Privatgrabstatue*, Abb. 23; HORNEMANN, *Types*, v, pl. 1392; DUNHAM, *Eg. Department*, fig. 22; id. in *Apollo*, xci (Jan. 1970), fig. 5, p. 18; POSENER, SAUNERON and YOYOTTE, *Dict. civ.* fig. on p. 182; POULSEN, *Äg. Kunst. A. und M.* pl. on p. 57; HALL in *Apollo*, lxxxviii (July 1968), fig. 1, pp. 5-6. Upper part, SMITH, *Anc. Eg.* (1942), fig. 20; (1952), fig. 21; id. *Country Life*, fig. 44; Dow in *Archaeology*, i (1948), figs. on p. 137 [top]; STEINDORFF, *A Royal Head*, pl. 12, pp. 11-12 [24]; TERRACE in *Boston Mus. Bull.* lix (1961), fig. 4, p. 41. Head of King, DUNHAM in ib. xli (1943), fig. 7, p. 72. Text of nome-goddess, SETHE, *Urk.* i (1933), 159 [9 (100), c].

¹ Selected references.

Nome triad, King, Ḥathor Mistress-of-the-Sycamore¹ and Theban nome-god standing, greywacke, in Cairo Mus. Ent. 40678.

REISNER, *Mycerinus*, pls. 38 [b], 41–2, 46 [d], p. 109 [10]; MASPERO, *Guide*, fig. 19, p. 68 [149]; id. *Essais*, fig. 4 (called Oxyrhynchite); id. *Eg. Art.*, pl. facing p. 42 [left]; HORNEMANN, *Types*, v, pls. 1371–2; BINDER-HAGELSTANGE, *Ägypten. Ein Reiseführer* (1966), fig. on p. 299. Text of nome-god, SETHE, *Urk.* i (1933), 159 [9 (100), A].

Nome triad,² King, Ḥathor Mistress-of-the-Sycamore¹ and Jackal-nome goddess standing, greywacke, in Cairo Mus. Ent. 40679.

REISNER, *Mycerinus*, pls. 38 [c], 43, 46 [e], p. 109 [11]; MASPERO, *Guide*, fig. 28, p. 79 [180]; *Egyptian Museum* (Cairo, 1949), fig. on p. 8; *Descr. somm.* No. 149, with pl.; MASPERO, *Égypte*, fig. 146; id. *Essais*, fig. 5; id. *Eg. Art.*, pl. facing p. 42 [right]; WEIGALL, *Anc. Eg. . . . Art.*, 29; STEINDORFF, *Kunst*, 181; CAPART, *Memphis*, fig. 213; WHEELER in *Antiquity*, ix (1935), pl. vi; MYRES in HAMMERTON, *Universal History of the World*, i, pl. on p. 479; LANGE, *Äg. Kunst*, pl. 19; LANGE and HIRMER, *Aegypten. Architektur* (1955 and 1957), pl. 47; BOREUX in *Mon. Piot*, xxxix (1943), fig. 5, p. 14; ANTHES, *Meisterwerke ägyptischer Plastik* (1947), Taf. xix; id. *Aegyptische Plastik in Meisterwerken*, Taf. 25; BUSCHOR, *Bildnisstufen*, Abb. 120; EDWARDS, *Pyramids* (1947), pl. 9; (1961), pl. 18; RANKE, *Meisterwerke*, Abb. 18; ALDRED, *O.K. Art.*, pl. 25; id. *Egypt to the End of the Old Kingdom*, fig. 113; SCHARFF in *Studi Rosellini*, i, Taf. xxviii [2], p. 307; DRIOTON and SVED, *Art ég.* fig. 14; WHITE, *Ancient Egypt*, pl. 18 facing p. 73; DONADONI, *Arte Egizia*, fig. 29; ČERNÝ in *Historia de las Religiones*, i (1955), 1st pl. after p. 196; HORNEMANN, *Types*, v, pls. 1390–1; WOLF, *Kunst*, Abb. 110; MICHAŁOWSKI, *Nie tylko piramidy*, pl. 29; id. *Art.*, figs. 63, 208; *Great Museums*, pl. 16. Head of King, HAMANN, *Äg. Kunst*, Abb. 169; LANGE, *Pyramiden*, pl. 53 facing p. 160. Text of nome-goddess, SETHE, *Urk.* i. 159 [9 (100), D].

Nome triad,² King, Ḥathor Mistress-of-the-Sycamore¹ and bat-fetish nome-goddess standing, greywacke, in Cairo Mus. Ent. 46499.

REISNER, *Mycerinus*, pls. 38 [d], 44–5, 46 [a, b], pp. 109–10 [12]; MASPERO, *Essais*, fig. 6; id. *Eg. Art.*, pl. facing p. 46 [upper]; VON BISSING, *Denkmäler, Text*, fig. on p. vi; id. *Äg. Kunstgeschichte*, Taf. lxiii [387], *Text*, i, pp. 80, 157; MURRAY, *Egyptian Sculpture*, pl. x; ROSS, *The Art of Egypt*, pl. on p. 102; CAROTTI, *L'Arte*, fig. 72; CAPART, *L'Art ég.* ii, pl. 218; HAMANN, *Äg. Kunst*, Abb. 132; PIJOÁN, *Summa Artis*, iii (1945), fig. 141; SHOUKRY, *Privatgrabstatue*, Abb. 28, p. 144; SPIEGEL, *Hochkultur*, Taf. 34; PRITCHARD, *Anc. Near East*, fig. 378; LANGE and HIRMER, *Aegypten. Architektur* (1955 and 1957), pl. 46; (1967), pl. 39; HORNEMANN, *Types*, v, pls. 1388–9; ROEDER, *Die ägyptische Götterwelt*, Taf. 19; RIESTERER, *Kunstschätze . . . Kairo*, pl. 5; *Capolavori*, i, No. 10 (1963), fig. on p. 155 [lower right]; Eng. ed. fig. on p. 147 [lower right]; ABBATE, *Arte egizia*, fig. 13; JAMES, *Egyptian Sculptures*, pl. 2; WESTENDORF, *Das Alte Ägypten*, fig. on p. 47; SOGA, *The Nile*, fig. on p. 57 [left]; MICHAŁOWSKI, *Art*, fig. 204; DONADONI, *Egyptian Museum Cairo*, pl. on p. 34, cf. p. 35. Head of King, LOUKIANOFF in *Bull. Inst. Ég.* xv (1932–3), pl. iii [3], p. 91. Text of nome-goddess, SETHE, *Urk.* i (1933), 159 [9 (100), B]. See MASPERO, *Guide*, p. 72 [158].

Nome triad, King, Ḥathor, and nome-god standing, greywacke, middle part in Boston Mus. 11.3147, head of King in Brussels, Mus. Roy. E. 3074.

Boston fragment, REISNER, *Mycerinus*, pl. 46 [f], p. 110 [13]; *Handbook* (1964), fig. on p. 179 [lower]; TERRACE in *Boston Mus. Bull.* lix (1961), figs. 1–3, pp. 41–9; id. in *The Connoisseur*, clxviii (1968), fig. 4, p. 201; GIEDION, *The Eternal Present*, ii, figs. 56–7; WHITEHILL, *Museum of Fine Arts Boston. A Centennial History*, i, fig. on p. 260 [right]; RIEFSTAHL

¹ In all her places.

² Selected references.

and CHAPMAN in *Boston Mus. Bull.* lxxviii (1970), fig. 5, p. 246. Brussels head, CAPART in *Bull. Mus. Roy.* 2 Sér. i (1908), fig. 5, p. 43; id. *Donation d'antiquités égyptiennes* (1911), fig. 5, p. 18; *Bruxelles. Mus. Roy. Département égyptien. Album* (1934), pl. 15; GILBERT in *Bull. Mus. Roy.* 4 Sér. 33 (1961), figs. 2, 3, pp. 49-52; see id. in *Chron. d'Ég.* xxxix (1964), p. 11.

Nome triads, fragments, greywacke. REISNER, *Mycerinus*, pl. 64 [g, h], p. 110 [14, 15].

Double-statue,¹ King and wife (Kha'merernebti [II]) standing, uninscribed, greywacke, in *Boston Mus.* II.1738.

Id. ib. pls. 54-60, p. 110 [17]; id. in *Boston Mus. Bull.* ix (1911), figs. on pp. 18-20; *Handbook* (1915 and 1920), figs. on pp. 17, 19, 20; (1930), figs. on pp. 8, 9; (1947), fig. on p. 10; (1964), fig. on p. 177 [lower]; DELBRÜCK, *Antike Porträts*, Taf. 1; MASPERO, *Essais*, figs. 7-9; id. *Eg. Art*, pls. facing pp. 44, 46 [lower], 48; *Penn. Mus. Journ.* vi (1915), fig. 49 on p. 68; SCHÄFER and ANDRAE, *Kunst* (1925), 221 [left]; (1930 and 1942), 231 [left]; STRÖMBOM, *Egyptens Konst*, fig. 49; POULSEN (F.), *Ægyptens Kunst* (1933), fig. 37; HAYES, *Daily Life in Ancient Egypt in The National Geographic Magazine*, lxxx (1941), fig. on p. 421; CAPART, *L'Art ég.* ii, pl. 220; SMITH, *Anc. Eg.* (1942), fig. 19; (1952), fig. 20; (1960), fig. 22; id. *Art . . . Anc. Eg.* pl. 44 [B]; PIJOÁN, *Summa Artis*, iii (1945), fig. 142; BYVANCK, *De Kunst*, pl. xv [55]; EDWARDS, *Pyramids* (1947), pl. 10; (1961), pl. 19; ALDRED, *O.K. Art*, pls. 26-7; SHOUKRY, *Privatgrabstatue*, Abb. 29, p. 146; VANDIER, *Eg. Sculpture*, pl. 6; DONADONI, *Arte Egizia*, fig. 30; LANGE and HIRMER, *Aegypten. Architektur* (1955 and 1957), pls. 44-5; (1967), pls. 40-1; HORNEMANN, *Types*, v, pl. 1168; WOLF, *Kunst*, Abb. 109; DUNHAM, *Eg. Department*, fig. 21; id. in *Apollo*, xci (Jan. 1970), fig. 4, p. 18; WENIG, *Die Frau*, Abb. 5, p. 46 [5] (called 11.738); POULSEN, *Åg. Kunst. A. und M.* pl. on p. 56; WOLDERING, *Götter*, Abb. 22; TERRACE in *The Connoisseur*, clxviii (1968), pl. 1, pp. 200-1; YOYOTTE, *Treasures of the Pharaohs*, pl. on p. 21; MICHALOWSKI, *Art*, fig. 203. Upper part, MASPERO, *Égypte*, fig. 145 (called New York); WEIGALL, *Anc. Eg. . . . Art*, 30 [upper]; DUNHAM in *Boston Mus. Bull.* xli (1943), fig. 8, p. 72; DE WIT, *Oud-Egyptische Kunst*, fig. 19 facing p. 41; SMITH, *Hist. Eg. Sculp.* pl. 13 [a], p. 38. Hands, BOTHMER in *Boston Mus. Bull.* xlvi (1950), fig. 2, p. 15.

King seated, life-size, fragmentary, alabaster, in *Cairo Mus. Ent.* 40703.

REISNER, *Mycerinus*, pls. 47 [b], 48-9, cf. 47 [a], p. 110 [18]; MITRY, *Illus. Cat.* No. 157; MASPERO, *Égypte*, fig. 144; id. *Essais*, fig. 3; id. *Eg. Art*, pl. facing p. 40; MEIER-GRAEFE, *Pyramide und Tempel*, Taf. 8. Upper part or head, WEIGALL, *Anc. Eg. . . . Art*, 30 [lower]; ENGELBACH in *Ann. Serv.* xxviii (1928), pl. i [1], p. 22; *Boston Mus. Bull.* xxix (1931), fig. on p. 119 [bottom]; *I.L.N.* Jan. 30, 1932, figs. 3, 8, p. 157; PETRIE, *The Making of Egypt*, pl. lvi [4]; LAUER, *Le Problème des pyramides d'Égypte*, pl. ii [2] facing p. 33; LANGE and HIRMER, *Aegypten. Architektur* (1955 and 1957), pl. 43; (1967), pl. 42; GODRON in *Festschrift Struve (Drevnii mir. Sbornik statei.)*, figs. 2, 5, 8, 11, pp. 71-2; id. in *B.I.F.A.O.* lxii (1964), pls. i [B], iii [B], iv [B, E], pp. 59-60; *Capolavori*, i, No. 10 (1963), fig. on p. 158 [upper right]; Eng. ed. fig. on p. 150 [upper right]; WOLF, *Frühe Hochkulturen. Ägypten, Mesopotamien, Ägäis*, Abb. 29. See MASPERO, *Guide*, p. 71 [157].

King seated, lower part, inscribed seat, alabaster, in *Boston Mus.* 09.202.

REISNER, *Mycerinus*, pl. 47 [b, c], cf. 47 [a], p. 111 [19]; DUNHAM, *Eg. Department*, figs. 20 [a], 20 [b] (right side of seat); GARDINER MSS. photo. 28. 61-4 (with back and both sides of seat). Sides of seat, SMITH, *Hist. Eg. Sculp.* fig. 12, p. 37; left, id. *Country Life*, fig. 1; CAPART in *Chron. d'Ég.* xxxii (1957), fig. 74, p. 231 (repr. as *Causeries sur l'art égyptien*, fig. 64); right, A. S[ANBORN] in *Boston Mus. Bull.* xx (1922), fig. on p. 27 [lower]; PIJOÁN, *Summa Artis*, iii

¹ Selected references.

(1945), fig. 17. Back of seat, SCHÄFER, *Principles of Egyptian Art*, pl. 17. Sma-symbols on back and left side of seat, *Sculptures et textes poétiques de l'Égypte* in *Cahiers d'Art*, xxii (1947), figs. on pp. 62-3; on back, EKSCHMITT, *Das Gedächtnis der Völker*, Abb. on p. 111 [upper]. Text beside feet, FISCHER in *J.A.R.C.E.* ii (1963), fig. 2, p. 28.

Two unfinished seated statues, inscribed, lower parts, alabaster. See REISNER, *Mycerinus*, p. 111 [20-1], cf. pl. 47 [a].

Head, alabaster, in Cairo Mus. Ent. 40704.

Id. ib. pls. 50-1, p. 111 [22]; MASPERO, *Essais*, fig. 2; id. *Eg. Art*, pl. facing p. 38 [lower]; *Boston Mus. Bull.* xxix (1931), fig. on p. 119 [top]; VON BISSING, *Äg. Kunstgeschichte*, Taf. lxvi [445], *Text*, i, pp. 83, 163; SMITH (W. S.) in *A. J. A.* xlv (1941), fig. 2, p. 522; id. *Art . . . Anc. Eg.* pl. 42 [B], p. 63; ALDRED, *O.K. Art*, pl. 28; STEINDORFF, *A Royal Head*, pl. 13, p. 12 [25]; SMITH (J. L.), *Tombs, Temples, and Ancient Art*, pl. facing p. 113 [lower]; WOLF, *Kunst*, Abb. 112; LLOYD, *The Art of the Ancient Near East*, fig. 33. Top of head, *I.L.N.* Jan. 30, 1932, fig. 4 on p. 157. See MASPERO, *Guide*, p. 53 [110].

Head, sometimes ascribed to Shepseskaf, alabaster, in Boston Mus. 09.203.

REISNER, *Mycerinus*, pls. 52-3, cf. 47 [a], p. 112 [23]; *Handbook* (1920), fig. on p. 23; (1930), fig. on p. 14; (1947), fig. on p. 15; (1964), fig. on p. 179 [upper right]; ADDISON, *The Boston Museum of Fine Arts* (1910), pl. facing p. 224; REISNER in *Boston Mus. Bull.* ix (1911), fig. on p. 13; DELBRÜCK, *Antike Porträts*, Taf. 2; KEES, *Ägyptische Kunst*, Abb. 11; LUGN, *Konst och Konsthantverk i Egypten*, fig. 33; CAPART, *Propos sur l'art égyptien*, fig. 13; RANKE, *The Art of Ancient Egypt*, and BREASTED, *Geschichte Aegyptens*, 60; SCHÄFER, *Das altägyptische Bildnis*, Taf. 6; SMITH, *Anc. Eg.* (1942), fig. 23; (1952), fig. 24; (1960), fig. 27; BYVANCK, *De Kunst*, pl. xv [53]; ALDRED, *O.K. Art*, pl. 29; id. in PIGGOTT, *The Dawn of Civilization*, fig. on p. 113 [35]; STEINDORFF, *A Royal Head*, pl. 14 [left], pp. 12-13 [26]; SMITH (J. L.), *Tombs, Temples, and Ancient Art*, pl. facing p. 176 [left]; WOLF, *Kunst*, Abb. 111; DUNHAM, *Eg. Department*, fig. 23; MAT'É, *Iskusstvo Drevnego Egipta* (1961), fig. 35; PIRENNE, *Hist. civ.* i, pl. 47 between pp. 148-9; GODRON in *Festschrift Struve (Drevnii mir. Sbornik statei.)*, figs. 3, 6, 9, 12, pp. 71-5; id. in *B.I.F.A.O.* lxii (1964), pls. ii, iii [c], iv [c, f], pp. 59-61; DAUMAS, *Civ. de l'Ég.* pl. 188; TERRACE in *The Connoisseur*, clxviii (1968), fig. 9, p. 203; WOLDERING, *Götter*, Abb. 24.

Fragment of face, alabaster, in Boston Mus. 11.717. REISNER, *Mycerinus*, pl. 64 [b], p. 112 [24].

Inscribed base of seated statue, unfinished, diorite. See id. ib. p. 113 [39], cf. pl. 61 [a, b].

King standing (headless), unfinished, porphyry. Id. ib. pl. 63 [d], p. 113 [40].

Statuette of King standing (headless), ivory, in Boston Mus. 11.280.

REISNER, *Mycerinus*, pl. 63 [g-j], p. 114 [48]; *Handbook* (1964), fig. on p. 179 [upper left]; CAPART, *Documents*, i, pl. 4; id. *L'Art ég.* ii, pl. 217; id. *Memphis*, fig. 243; SMITH, *Anc. Eg.* (1942), fig. 22; (1952), fig. 23; (1960), fig. 25; PIJOÁN, *Summa Artis*, iii (1945), fig. 143; HORNEMANN, *Types*, i, pl. 162.

Fourteen unfinished statuettes of King seated, in various stages of production. For those in Boston Mus., see *Boston Mus. Bull.* xx (1922), p. 26.

(a) Diorite, in Boston Mus. 11.731. REISNER, *Mycerinus*, pl. 62 [a], p. 112 [25]; *Handbook* (1920), fig. on p. 24 [right]; CAPART, *L'Art ég.* ii, pl. 216 [right]; VANDIER, *Manuel*, iii, fig. 4 [1] (from REISNER).

(b) Diorite, in Boston Mus. 11.730. REISNER, op. cit. pl. 62 [b], p. 112 [26]; *Handbook* (1920), fig. on p. 24 [2nd from right]; ANTHES in *Mitt. Kairo*, 10 (1941), Taf. 17 [a] (from REISNER), p. 82; CAPART, *L'Art ég.* ii, pl. 216 [2nd from right]; VANDIER, *Manuel*, iii, fig. 4 [2] (from REISNER); WARD (W. A.), *The Spirit of Ancient Egypt*, pl. xv [A].

(c) Diorite, in Boston Mus. 11.729. REISNER, op. cit. pl. 62 [c], cf. 61 [a, b], p. 112 [27] (called Cairo Mus.); *Handbook* (1920), fig. on p. 24 [3rd from right]; CAPART, *L'Art ég.* ii, pl. 216 [3rd from right]; VANDIER, *Manuel*, iii, fig. 4 [3] (from REISNER).

(d) Diorite, in Cairo Mus. Ent. 41972. REISNER, op. cit. pl. 62 [e], cf. 61 [d], p. 112 [28]; ANTHES, op. cit. Taf. 17 [b] (from REISNER), p. 82; VANDIER, *Manuel*, iii, fig. 4 [5] (from REISNER).

(e) Diorite, in Cairo Mus. Ent. 41974. REISNER, op. cit. pl. 62 [d], cf. 61 [a, b], p. 112 [29]; VANDIER, *Manuel*, iii, fig. 4 [4] (from REISNER); WARD (W. A.), op. cit. pl. xv [B].

(f) Diorite, in Cairo Mus. Ent. 41975. REISNER, op. cit. pl. 62 [i, right], p. 112 [30].

(g) Diorite, in Boston Mus. 11.724. Id. ib. pl. 62 [h, right], cf. 61 [c], p. 112 [31]; *Handbook* (1920), fig. on p. 24 [left]; CAPART, *L'Art ég.* ii, pl. 216 [left].

(h) Diorite, in Boston Mus. 11.733. REISNER, op. cit. pl. 62 [f], cf. 61 [a, b], p. 112 [32]; *Handbook* (1920), fig. on p. 24 [3rd from left]; ANTHES, op. cit. Taf. 17 [c] (from REISNER), p. 82; id. in *Forschungen und Fortschritte*, 24 (1948), Abb. 1 (from REISNER), p. 170; CAPART, *L'Art ég.* ii, pl. 216 [3rd from left]; VANDIER, *Manuel*, iii, fig. 4 [6] (from REISNER); WARD (W. A.), op. cit. pl. xv [c].

(i) Pink limestone, formerly in Boston Mus., now in New York, M.M.A. 37.6.1. REISNER op. cit. pl. 62 [h, left], p. 112 [33]; LANSING in *M.M.A. Bull.* xxxii (1937), fig. 1, pp. 285-6; SCOTT, *Egyptian Statuettes* (1946), fig. 3; HAYES, *The Scepter of Egypt*, i, fig. 43; see *Boston Mus. Bull.* xxxv (1937), p. 73.

(j) Reddish stone, in Boston Mus. 11.725. REISNER, op. cit. pl. 63 [a, right], p. 113 [34]; VANDIER, *Manuel*, iii, fig. 4 [7] (from REISNER).

(k) Diorite, in Boston Mus. 11.732. REISNER, op. cit. pl. 62 [g], cf. 61 [c], p. 113 [35]; *Handbook* (1920), fig. on p. 24 [2nd from left]; CAPART, *L'Art ég.* ii, pl. 216 [2nd from left]; VANDIER, *Manuel*, iii, fig. 4 [8] (from REISNER); *A Survey of Egyptian Sculpture* [&c.] (A Loan Exhibition . . . Durham, N. Carolina, Oct. 16-Nov. 28, 1965), No. 1 with fig.

(l) Diorite, in Cairo Mus. Ent. 41976. REISNER, op. cit. pl. 62 [i, left], p. 113 [36].

(m) Red stone, in Cairo Mus. Ent. 41977. Id. ib. pl. 63 [a, left], cf. 61 [c], p. 113 [37]; VANDIER, *Manuel*, iii, fig. 4 [9] (from REISNER); GILBERT in *Chron. d'Ég.* xxxv (1960), fig. 34, pp. 146-7; see Brussels. 5000 ans, p. 22 [9]; Vienna. 5000 Jahre, No. 13.

(n) Diorite, in Cairo Mus. Ent. 41973. REISNER, op. cit. pl. 63 [c], cf. 61 [a, b], p. 113 [38].

Private statues. Old Kingdom.

Woman standing, grey granite, in Boston Mus. 11.728. REISNER, *Mycerinus*, pl. 63 [k], p. 113 [41].

King's son of his body, Lector-priest of his father (name lost), seated, lower half, diorite. Id. ib. pl. 62 [j], p. 113 [42].

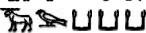
Werkauba  good name Iku, Chief lector-priest, etc., squatting with left knee up, probably Dyn. VI, in Cairo Mus. Ent. 41978. Id. ib. pl. 63 [b, e], cf. 61 [c], pp. 113-14 [43]; VANDIER, *Manuel*, iii, pl. xxi [5], p. 564; SHOUKRY, *Privatgrabstatue*, Abb. 14, p. 69; HORNEMANN, *Types*, ii, pl. 510; see SMITH, *Hist. Eg. Sculp.* p. 87.

Fragments, various materials. REISNER, op. cit. pl. 63 [f], p. 114 [44]; pl. 64 [f, i], p. 114 [46]; see p. 115 [51-2].

VariouS.

Bowl with names of Kings Hetepsekhemui and Ra'neb, and figure of Bubastis, flint, in Cairo Mus. Ent. 41981. REISNER, *Mycerinus*, pl. 70 [c], pp. 102 [I], 179 [I]; NEWBERRY MSS. vi. E.C. 5 (rubbing); see FISCHER in *Artibus Asiae*, xxiv (1961), pp. 46 note 10, 47 note 11.

Bowl of King H̄etepsekhemui, diorite, in Boston Mus. 11.756. REISNER, op. cit. fig. 57 [37] (section and text), pp. 102 [2], 179 [2].

Bowls of Snefru, diorite. Id. ib. fig. 57 [2, 38] (sections and texts), pp. 102 [3, 4], 179 [3, 4].

Wand of Khufu, flint, in Boston Mus. 11.765. Id. ib. pl. 65 [a], cf. 61 [e, f], 65 [b], pp. 36, 233-4; *Handbook* (1920), on fig. on p. 15; (1930, 1935, 1947), on fig. on p. 5 [upper]; see DUNHAM and YOUNG in *J.E.A.* 28 (1942), pp. 57-8; SMITH, *Anc. Eg.* (1960), p. 67.

Protective decree of Pepy II for the Pyramid-town of Menkaurē, mentioning eldest son Nemtiemsaf (later King Merenrē Nemtiemsaf II) and Pyramids of Pepy II and Merenrē I, year of 31st census, fragments, in Boston Mus. 47.1654. REISNER, op. cit. pl. A [1], pp. 280-1 [4]; GOEDICKE, *Königliche Dokumente aus dem Alten Reich*, Abb. 12, pp. 148-54; GARDINER MSS. 29.21 (drawing by W. S. SMITH); text, SETHE, *Urk.* i (1933), 277-8 [29 (169)]; date, SMITH (W. S.) in *J.N.E.S.* xi (1952), fig. 1, p. 113.

Cylinder seal with names of Khephren, silver, in Boston Mus. 11.962. REISNER, op. cit. pls. 64 [1], A [9], pp. 104, 234 [1], 281 [7]; *I.L.N.* Jan. 30, 1932, fig. 9 on pp. 156-7.

Two cylinder seals (one inscribed), steatite and limestone. REISNER, op. cit. pl. 64 [j, k], p. 234 [2, 3].

CAUSEWAY. Sections, BURTON MSS. 25620, 113.

View with Mortuary Temple, SAMIVEL and AUDRAIN, *The Glory of Egypt*, pl. 28. See MARAGIOGLIO and RINALDI, *L'Architettura*, vi, pp. 64-7, cf. 120-1 notes 31-2.

MORTUARY TEMPLE.

Plans and sections, REISNER, *Mycerinus*, pls. i-iii, figs. 1-17, pp. 6-33; MARAGIOGLIO and RINALDI, op. cit. Tav. 8, 9, pp. 48-63, cf. 110-21 notes 23-9. Plan, BURTON MSS. 25620, 111 [left]; LAUER, *Le Problème des pyramides d'Égypte*, fig. 30; id. in *Ann. Serv.* xlvi (1947), fig. 19, p. 256; FAKHRY, *The Pyramids*, fig. 79, pp. 140-1, 145; SOMERS CLARKE MSS. 10.1.6, 13 (by REISNER and FISHER). Reconstructions, RICKE, *Bemerkungen zur ägyptischen Baukunst des Alten Reichs*, ii, in *Beiträge zur ägyptischen Bauforschung und Altertumskunde*, 5, Taf. 1, 3, pp. 28-9.

Views (including interior), REISNER, op. cit. pls. 2-11; before excavation, PETRIE, *Ten Years' Digging in Egypt*, fig. 5; of Temple with Second Pyramid, LANGE and HIRMER, *Aegypten. Architektur* (1955 and 1957), pl. 33; (1967), pl. 34; of interior, SCHARFF in OTTO, *Handbuch der Archäologie*, i, Taf. 61 [2]; LANGE, *Äg. Kunst*, pl. 17; id. *Pyramiden*, pl. 13; of entrance corridor, GIEDION, *The Eternal Present*, ii, fig. 208; outer offering-room, fig. 206; northern corridor, fig. 209.

Masons' marks and graffiti with names of crews of Menkaurē. REISNER, op. cit. pl. xi [i-xvi, xviii-xxxvi] (copied by ROWE), pp. 273-5.

Finds.

Menkaurē statues.

King seated, over life-size, found in fragments, alabaster, in Boston Mus. 09.204 (restored).

REISNER, *Mycerinus*, pls. 12-15, 16 [a], cf. 7 [b, d], 8, p. 108 [1]; *Handbook* (1930), fig. on p. 12; (1947), fig. on p. 13; (1964), fig. on p. 175 [lower]; DUNHAM in *Boston Mus. Bull.* xxxiii (1935), figs. 1-8, pp. 21-5; xli (1943), fig. 6, p. 70; id. *Eg. Department*, fig. 19; id. in *Apollo*, xci (Jan. 1970), fig. 3, p. 18; SMITH, *Anc. Eg.* (1942 and 1952), fig. 21; (1960), fig. 24; id. *Hist. Eg. Sculp.* pl. 13 [b], p. 38; WOLF, *Die Welt der Ägypter*, Taf. 18; GIEDION, *The Eternal Present*, ii, fig. 205; WHITEHILL, *Museum of Fine Arts Boston. A Centennial History*,

i, fig. on p. 261; GARDINER MSS. photo. 28.65. Upper part or head, *Handbook* (1920), fig. on p. 22; REISNER in *Boston Mus. Bull.* ix (1911), fig. on p. 15, cf. pp. 17-18; SMITH (W. S.) in *A. J. A.* xlv (1941), fig. 3, p. 523; PIJOAN, *Summa Artis*, iii (1945), fig. 140; SPIEGEL, *Hochkultur*, Taf. 36; GODRON in *Festschrift Struve (Drevnii mir. Sbornik statei.)*, figs. 1, 4, 7, 10, pp. 71-2; id. in *B.I.F.A.O.* lxii (1964), pls. i [A], iii [A], iv [A, D], pp. 59-60. Hands, BOTHMER in *Boston Mus. Bull.* xlviii (1950), fig. 3, p. 12.

King seated, inscribed, fragments, alabaster (torso in Boston Mus. 11.3146). REISNER, *Mycerinus*, pls. 16 [b-d], 17 [c], cf. 7 [b], 8 [b, c], p. 108 [2].

Small fragments, slate, alabaster, and copper(?). See id. ib. p. 108 [3-7].

Various.

Fragment of wand of Kha'merernebti [I] , flint. REISNER, *Mycerinus*, pl. 19 [a], pp. 18, 233.

Protective decree of Shepseskaf for Pyramid of Menkaurē, year after 1st census, 9 fragments, from débris of portico and outside entrance, in Cairo Mus. Temp. No. 26.2.21.18. Id. ib. pl. 19 [b, d], pp. 278-9 [1, 2]; GOEDICKE, *Königliche Dokumente aus dem Alten Reich*, Abb. 1, pp. 16-21; text, DARESSY in *Ann. Serv.* xiii (1914), pp. 109-11 [1]; SETHE, *Urk.* i (1933), 160 [10 (101)].

Decrees (possibly two) of Merenrē I for Pyramid of Menkaurē, 41 fragments. REISNER, op. cit. pls. 19 [e-i], A [2-5], pp. 279-80 [3]; GOEDICKE, op. cit. Abb. 6, pp. 78-80; text, DARESSY, op. cit. pp. 111-14 [ii, iii]; SETHE, *Urk.* i (1933), 274-6 [28 (168), A-C].

Sealings with names of Menkaurē, Neuserrē, Isesi, Teti, Pepy I. REISNER, op. cit. pl. 17 [a, b], p. 19; id. and SMITH, *Giza Necropolis*, ii, fig. 56, p. 51.

PYRAMID.

Lepsius, IX; Perring and Vyse, 3 of Gîza; Reisner, G III; called Third Pyramid.

Exterior

Plan and elevation of Pyramid, Mortuary Temple, and Causeway, *Descr. Ant.* v, pl. 16 [9, 10]. Views, GREAVES, *Pyramidographia* (1646), fig. on p. 110; PERRING, *Pyramids*, ii, *The 3rd Pyramid*, pl. vii; VYSE, *Operations*, i, pl. facing p. 154; FAKHRY, *The Pyramids*, fig. 83; of Pyramid and Mortuary Temple from Second Pyramid, REISNER, *Mycerinus*, pl. 1; STEINDORFF, *Kunst*, 114; BORCHARDT and RICKE, *Egypt*, pl. 73; CAPART, *Memphis*, fig. 65; *I.L.N.* Jan. 30, 1932, fig. on p. 157 [bottom right]; DUNHAM, *Eg. Department*, fig. 17; LEMAIRE and BALDI, *Atlas biblique*, fig. 64; BRUCHET, *Nouvelles recherches sur la Grande Pyramide*, pl. iv [lower]; with Subsidiary Pyramids, HAMANN, *Äg. Kunst*, Abb. 131; SPIEGEL, *Hochkultur*, Taf. 7 [b]; ŽABA in *Dějiny Afriky*, i, fig. on p. 223.

Restoration-text with cartouches of Menkaurē and date, on north face under entrance, Late Period. See LECLANT in *Orientalia*, n.s. 38 (1969), p. 252 [16, c]; FAKHRY, *The Pyramids* (1969), pp. 257-8; BIETAK in *Archiv für Orientforschung*, xxiii (1970), p. 204.

Masons' graffiti on blocks. REISNER, *Mycerinus*, pl. xii (copied by ROWE), pp. 82-3.

Interior

Section, on plan IV [3]

Plans and sections, PERRING, op. cit. pls. i-iv; VYSE, op. cit. i, pl. facing p. 199; ii, pls. facing pp. 72, 78, 81; MARAGIOGLIO and RINALDI, *L'Architettura*, vi, Tav. 4 [2-8], 5-7, pp. 34-49, cf. 94-111 notes 1-22; BORCHARDT in *Ä.Z.* xxx (1892), Bl. 3 [upper, 1-4], pp. 98-100; FAKHRY, op. cit. fig. 84; sections, BURTON MSS. 25620, 117; PETRIE, *History*, i (1894), fig. 35; (1923), fig. 47.

View of entrance, VYSE, op. cit. ii, pl. facing p. 71; GRINSELL, *Eg. Pyramids*, pl. iv [b] facing p. 26.

Antechamber. Originally burial chamber of first two plans.

View, VYSE, op. cit. ii, pl. facing p. 86; GRINSELL, op. cit. pl. viii facing p. 114.

Fragments of anthropoid coffin with inscribed lid of Menkaurē, wood, Dyn. XXVI, in Brit. Mus. 6647. PERRING, op. cit. pl. vi; VYSE, op. cit. ii, pl. facing p. 94; *Guide, 1st and 2nd*, pl. i, pp. 51-3; *Guide, 1st to 3rd*, pl. i, pp. 36-8; *A Handbook to the Egyptian Mummies* (1938), pl. viii, pp. 21-3; LENORMANT, *Éclaircissement sur le cercueil du roi memphite Mycérinus* (1839), pl. i; L. D. ii. 2 [e]; LEPSIUS, *Auswahl*, vii [bottom right]; EBERS, *Aegypten*, i, fig. on p. 170; Eng. ed. fig. on p. 148; MASPERO, *Hist. anc.* i, fig. on p. 376; BUDGE, *A History of Egypt*, ii, fig. on p. 60; SCHMIDT, *Sarkofager*, fig. 204; text, BIRCH in *Ä.Z.* vii (1869), pp. 49-50; cartouche, PRUDHOE MSS. vi. 156; see SHARPE, *Eg. Antiq.* pp. 32-3.

Burial chamber.

View, VYSE, op. cit. ii, pl. facing p. 83; EBERS, *Aegypten*, i, fig. on p. 171; Eng. ed. fig. on p. 149; GRINSELL, *Eg. Pyramids*, pl. ix facing p. 115; FAKHRY, *The Pyramids*, fig. 86 (from VYSE).

Sarcophagus (uninscribed), palace-façade decoration, basalt, lost at sea off the coast of Spain. PERRING, op. cit. pl. v; VYSE, op. cit. ii, pl. facing p. 84; PRISSE, *L'Art ég.* i, 6th pl. [upper], '*Sarcophages de Menkare et de Ai*'; from PRISSE or PERRING (repr.), PERROT and CHIPIEZ, *Hist. de l'Art*, i, fig. 289; MASPERO, *Hist. anc.* i, fig. on p. 377; MORET, *Le Nil et la civilisation égyptienne* (1937), fig. 41; DONADONI ROVERI, *Sarcofagi egizi*, fig. 14 [b], p. 105 [A 6].

THREE SUBSIDIARY PYRAMIDS.

Plans and sections, REISNER, *Mycerinus*, pls. iv-vii; MARAGIOGLIO and RINALDI, *L'Architettura*, vi, Tav. 11, pp. 80-3, cf. 128-31 notes 40-1; FAKHRY, *The Pyramids*, figs. 80-2. Views (including entrances), VYSE, *Operations*, i, pl. facing p. 183; ii, pls. facing pp. 37 [2, 1], 63 [1]; PERRING, *Pyramids*, ii, *Pyramids to the S. of 3rd Pyramid*, pl. ii; REISNER, op. cit. pls. 73-8, pp. 55-68.

East Subsidiary Pyramid. Lepsius, XII; Perring and Vyse, 5 of Gîza; Reisner, G III-a; sometimes called Fourth Pyramid.

Plan, *Descr. Ant.* v, pl. 16 [11]. Plans and sections, PERRING, op. cit. pl. i [left]; VYSE, op. cit. ii, pl. facing p. 41 [left]; MARAGIOGLIO and RINALDI, op. cit. Tav. 12, pp. 82-9; of interior, REISNER, *Giza Necropolis*, i, fig. 67, p. 132 [5].

Masons' graffiti. REISNER, *Mycerinus*, pl. xi [xxxvii-xli] (copied by ROWE), p. 275; PETRIE in SAYCE MSS. 26.

Finds from Chapel.

Fragments of life-size statue of Queen, alabaster. REISNER, *Mycerinus*, pl. 17 [d], p. 108 [8].

Five model cups of Kai (tomb, with similar cups, see p. 277), alabaster, found under floor, in Boston Mus. 11.691-2, 11.695, 11.714-15. Id. ib. fig. 52 [26-8, 31], pp. 55, 199 [5].

Middle Subsidiary Pyramid. Lepsius, XI; Perring and Vyse, 4 of Gîza; Reisner, G III-b.

Plan and elevation, *Descr. Ant.* v, pl. 16 [12-14]. Plan and sections, PERRING, op. cit. pl. i [middle]; VYSE, op. cit. ii, pl. facing p. 41 [middle]; MARAGIOGLIO and RINALDI, op. cit.

Tav. 13, pp. 88-91, cf. 130-3 notes 42-8; of interior, BORCHARDT in *A.Z.* xxx (1892), Bl. 3 [bottom 1, 2], pp. 100-1; REISNER, *Giza Necropolis*, i, fig. 68, p. 133 [6].

Masons' graffito with name of crew of Menkaurē, on roof of burial chamber. PERRING, op. cit. pl. i [middle bottom]; VYSE, op. cit. ii, p. 48; REISNER, *Mycerinus*, pl. xi [xvii] (from PERRING and VYSE), pp. 63, 274 [13] (called G III-a); NESTOR L'HÔTE MSS. 20396, 118 verso; see BORCHARDT in *A.Z.* xxx (1892), p. 101 note 6.

West Subsidiary Pyramid. Lepsius, X; Perring and Vyse, 6 of Gîza; Reisner, G III-c.

Plans and sections, PERRING, op. cit. pl. i [right]; VYSE, op. cit. ii, pl. facing p. 41 [right]. MARAGIOGLIO and RINALDI, op. cit. Tav. 14, pp. 90-5, cf. 132-3 note 49; of interior, REISNER, *Giza Necropolis*, i, fig. 69, pp. 133-4 [7].

Menkaurē statues. From Valley or Mortuary Temples

Upper part of statuette with hawk head-dress, alabaster, possibly not ancient, in London, Univ. Coll. 16020. PETRIE in *Anc. Eg.* (1923), pl. facing p. 1 and fig. on p. 1; id. *History*, i (1894), fig. 36; (1923), fig. 48; MURRAY, *Egyptian Sculpture*, pl. ix [2]; KRIEGER in *Rev. d'Ég.* xii (1960), fig. 20, pp. 53-5; see REISNER, *Mycerinus*, p. 124 note 14.

Two fragments of alabaster statues, with name, found between tombs G 5110 and G 5230. See SMITH, *Hist. Eg. Sculp.* p. 34 [8].

II. Great Sphinx and surrounding area

Plan VI

Plan, PERROT and CHIPIEZ, *Hist. de l'Art*, i, fig. 204; HASSAN, *The Great Sphinx*, pl. xvi; id. *The Sphinx*, fig. 2 (2nd pl. after p. 28); RICKE, *Harmachistempel*, Abb. 8. Views after excavations, LANGE and HIRMER, *Aegypten. Architektur* (1955 and 1957), pls. 28-31; (1967), pls. 27-9; air view, RICKE, op. cit. frontispiece [lower].

A. THE GREAT SPHINX

Temp. Khephren

Before Caviglia's excavation.

Views, *Descr. Ant.* v, pls. 7-8, 11, 12; DENON, *Egypt delineated*, pl. vii [1]; id. *Voyage dans la Basse et la Haute Égypte* (Paris, 1802), pl. 20 bis [1]; *Hist. exp. Atlas*, pl. 61.

Caviglia's excavation (1816-18). Fragments of beard and uraeus, see p. 37.

Plan, BIRCH in *The Museum of Classical Antiquities*, ii [i] (1852), pl. facing p. 34. Views, VYSE, *Operations*, iii, pl. facing p. 107 (by SALT); EBERS, *Aegypten*, i, fig. on p. 174; Eng. ed. fig. on p. 151 (from VYSE).

Before Baraize's excavation. Including smaller clearances of Mariette (1853) and Maspero and Brugsch (1886).

Description and sketches, BURTON MSS. 25618, 77-81, 25619, 29-32 verso.

View,¹ TEYNARD, *Égypte et Nubie*, i (1858), pl. 8; SEBAH photo. 46; BÉCHARD and PALMIERI, *L'Égypte et la Nubie* (1887), pl. xlix (reversed); EBERS and JUNGHAENDEL, *Aegypten*, pl. vii; MASPERO, *Hist. anc.* i, fig. on p. 249; WARD (J. J.), *Pyramids and Progress*, figs. on

¹ Selected references. See also views of Chapel between forepaws, p. 36.

pp. 38–9; TARCHI, *L'Architettura e l'Arte nell'Antico Egitto*, Tav. 1–3 [upper]; MIETHE, *Unter der Sonne Oberägyptens*, figs. on pp. 232, 235, 237; PETRIE in WRIGHT, *Twentieth Century Impressions of Egypt*, fig. on p. 119; FECHHEIMER, *Plastik*, Taf. 43; WEIGALL, *Anc. Eg. . . . Art*, 26 [upper right and lower], 27 [upper]; BREASTED, *Ancient Times* (1916), fig. 54; (1935), fig. 42; DESROCHES-NOBLECOURT, *Tutankhamen*, fig. 13; BRAY and TRUMP, *A Dictionary of Archaeology*, pl. 27; HAY MSS. 29812, 67–73; HAWKER MSS. ii. 4–5.

Baraize's excavation (1923–36). Fragments of beard, see p. 37.

Views, and various objects, ARCH. LACAU phot. C. i, i bis; views, sketches, and plans, MSS. RC. B. i. 1–54; view, GARDINER MSS. photo. 28.1049. View of head of Sphinx before and after repairs, *I.L.N.* May 1, 1926, figs. on pp. 800–1.

After Baraize's excavation, mostly after Hassan's excavation (1936–7).

View,¹ BRUNNER, *Ägyptische Kunst in Die Kunst dem Volke*, No. 85 (1937), Abb. 54; ERMAN, *L'Égypte des pharaons*, pl. iv [b]; LANGE, *Ägypten. Landschaft*, pl. 27; LAUER, *Le Problème des pyramides d'Égypte*, pl. ix [1]; DRIOTON and SVED, *Art ég.* fig. 13; EDWARDS, *Pyramids* (1961), pl. 15 [a]; GIEDION, *The Eternal Present*, ii, fig. 32; ALDRED, *Egypt to the End of the Old Kingdom*, fig. 85; *Egyptian Mythology*, pl. on p. 20 [lower]. View¹ of front part or head, PIJOAN, *History of Art*, i, fig. 78; FETT, *Mumier og sfinks*, pl. on p. 175; STEINDORFF, *Kunst*, 183; CAPART, *Memphis*, fig. 5; ROBICHON and VARILLE, *En Égypte* (1937), pl. 21; (1955), pl. 24; LEBOVITCH, *Anc. Eg.* fig. 158; FEDDEN, *The Land of Egypt*, fig. 68; KUSCH, *Ägypten im Bild*, Abb. 56–7; GIEDION, op. cit. fig. 33; CASSON, *Ancient Egypt*, fig. on pp. 18, 19; POULSEN, *Äg. Kunst. A. und M.* pl. on p. 45; MONTET, *Lives of the Pharaohs*, fig. on p. 34; SAUNERON, *Nous partons pour l'Égypte*, pl. 1; SOGA, *The Nile*, fig. on p. 46 [upper]; MICHALOWSKI, *Art*, figs. 4, 15a.

View with Valley Temple of Khephren and Great Pyramid, MASPERO, *Hist. anc.* i, fig. on p. 367; FECHHEIMER, *Plastik*, Taf. 1; LANGE, *Ägypten. Landschaft*, pl. 26; SOGA, op. cit. fig. on p. 53.

CHAPEL BETWEEN FOREPAWS. On plan VI.

Plan showing Roman staircase, VYSE, *Operations*, iii, pl. facing p. 110 (by SALT). Plan and sections, *L.D.* i. 30. Reconstruction, BURTON MSS. 25618, 76.

View² of Chapel or front view of Great Sphinx showing Chapel, VYSE, *Operations*, iii, 2nd pl. after p. 110; MASPERO, *L'Arch. ég.* (1887), fig. 179; (1907), fig. 188; id. *Hist. anc.* ii, fig. on p. 293; BORCHARDT, *Über das Alter des Sphinx bei Giseh in Sitzungsber. Berlin* (1897), fig. on p. 753; id. and RICKE, *Egypt*, pls. 68–9; STEINDORFF, *Die Blütezeit des Pharaonenreichs* (1900), Abb. 37; (1926), Abb. 34; id. *Kunst*, 182; *I.L.N.* May 1, 1926, fig. on p. 799; MEIER-GRAEFE, *Pyramide und Tempel*, Taf. 41; WORRINGER, *Ägyptische Kunst*, Abb. 12 (2nd pl. after p. 30); BAIKIE, *A History of Egypt*, pl. ix [right]; id. *Eg. Antiq.* pl. i [upper]; CAPART, *Memphis*, fig. 61; id. *L'Art ég.* ii, pl. 215; PARIBENI, *Architettura*, figs. 49, 50; POULSEN (F.), *Ägyptens Kunst* (1933), fig. 15; VON BISSING, *Äg. Kunstgeschichte*, Taf. Lxxii [419], *Text*, i, pp. 85, 164; CALDWELL, *The Ancient World*, pl. facing p. 37 [lower right]; LEBOVITCH, *Anc. Eg.* fig. 159; DRIOTON, *Le Sphinx et les Pyramides de Giza*, pl. iii; PIJOÁN, *Summa Artis*, iii (1945), figs. 127–8; DE MONTGON, *L'Égypte*, fig. on p. 61; DE WIT, *Oud-Egyptische Kunst*, fig. 13 facing p. 25; FAKHRY, *The Pyramids*, fig. 93; ROEDER, *Volksglaube im Pharaonenreich*, Taf. 5 facing p. 49; SMITH (J. L.), *Tombs, Temples, and Ancient Art*, pl. facing p. 113 [upper];

¹ Selected references. See also below, views of Chapel between forepaws.

² Selected references.

SCHARFF in OTTO, *Handbuch der Archäologie*, i, Taf. 62 [2]; LANE MSS. 34088, 16; SOMERS CLARKE MSS. 19.5 (LEHNERT and LANDROCK photo. 742); GRIFFITH INST. photo. 296A (SEBAH, 46G).

'Dream stela', with double-scene at top, Tuthmosis IV offering to Sphinx, year 1, red granite, at west end. YOUNG, *Hieroglyphics, continued by the Royal Society of Literature*, ii (1828), pl. 80 (from SALT); L.D. iii. 68; VYSE, *Operations*, iii, pl. B facing p. 115 (from SALT, incorrect); HERMANN, *Die ägyptische Königsnovelle*, Taf. i, pp. 5-7; DRIOTON, *Le Sphinx et les Pyramides de Giza*, pl. iv; HASSAN, *The Great Sphinx*, pl. xl, pp. 91-3 (text), cf. 94-5; HAY MSS. 29812, 75-81; DEVÉRIA squeezes, 5365 B; 6170 B, 25-35; ARCH. LACAU phot. C. i bis, 17; GRDSELOFF MSS. 1 (photo.); GARDINER MSS. photo. 28.1050 (reversed); top, LANZONE, *Diz.* pl. CCXXXVII, p. 647; MASPERO, *Hist. anc.* ii, fig. on p. 295; WARD (J. J.), *The Sacred Beetle*, fig. on p. 57; SAMIVEL and AUDRAIN, *The Glory of Egypt*, pl. 24; DESROCHES-NOBLECOURT, *Tutankhamen*, fig. 14; WILKINSON MSS. iv. 74; head of King, L.D. iii. 293 [34], *Text*, i, p. 125; text, HELCK, *Urk.* iv. 1539a-1544 [486], cf. *Übersetz.* (1961), pp. 140-3; SALT drawings, 11-13; ERMAN, *Die Sphinxstele in Sitzungsber. Berlin* (1904), pp. 428-44; incomplete, BRUGSCH in *Ä.Z.* xiv (1876), pp. 89-95.

Stela, Ramesses II with *ka* before Sphinx, found *in situ* at south side, in Louvre, B 18 [N.131a]. VYSE, *Operations*, iii, pl. facing p. 117 (by SALT), cf. p. 110; ARCHIVES phot. E. 657; WILKINSON MSS. iv. 66 A; see BOREUX, *Guide*, i, pp. 62-3; VANDIER, *Guide*, p. 19.

Stela, similar to last, originally at north side, in Louvre, B 19 [N. 131b]. PIANKOFF in *J.E.A.* xviii (1932), fig. on p. 156, cf. pp. 155-8; HASSAN, *The Great Sphinx*, fig. 8, p. 15; ARCHIVES phot. E. 658; WILKINSON MSS. iv. 66 B; see BOREUX, *op. cit.* pp. 62-3; VANDIER, *op. cit.* p. 19.

Caviglia's finds from between forepaws.

Fragments of beard of Great Sphinx.

(a) Cairo Mus. 57119, with reliefs on both faces, kneeling King offering necklace(?), added later (probably New Kingdom), re-discovered by Baraize; SALT in VYSE, *Operations*, iii, 1st pl. after p. 108 [top three] (upper part with head of King now lost); *I.L.N.* May 1, 1926, fig. on p. 801 [bottom left]; RICKE, *Harmachistempel*, Taf. 17 [a], pp. 33-4 with note 53 (called 27119); GRDSELOFF MSS. 3 (photo.); ARCH. LACAU phot. C. i bis, 14; see *Descr. somm.* No. 6031. (b) Cairo Mus. Temp. No. 6.4.49.2 A, B. (c) Brit. Mus. 58; SALT in VYSE, *op. cit.* 1st pl. after p. 108 [bottom]; see SHARPE, *Eg. Antiq.* pp. 1-3 [58]; *Guide (Sculpture)*, p. 7 [21]; *Guide, Eg. Colln.* (1909), p. 199; (1930), p. 294.

Fragment of uraeus of Great Sphinx.

Brit. Mus. 1204; SALT in VYSE, *op. cit.* pl. A [1] facing p. 109; see SHARPE, *op. cit.* p. 3 [443*]; *Guide (Sculpture)*, p. 7 [20]; *Guide, Eg. Colln.* (1909), p. 199; (1930), p. 294.

Various.

Block with cartouches of Ramesses II(?). SALT in VYSE, *op. cit.* pl. A [5] facing p. 109. Sphinx, Ptolemaic, in Brit. Mus. 444*. See LONG, *The Egyptian Antiquities in the British Museum*, i (1846), pp. 221-2 [No. 24]; SHARPE, *op. cit.* p. 137 [No. 444*].

Head of sphinx, Dyn. XXX, in Brit. Mus. 464. See *Guide (Sculpture)*, p. 254 [945].

Statues of lions, Ptolemaic. Brit. Mus. 441, SALT in VYSE, *op. cit.* pl. A [3] facing p. 109; see LONG, *op. cit.* i, pp. 223-4. Brit. Mus. 439, found between front walls of Chapel, id. ib. fig. on p. 223 [No. 50]; see SHARPE, *op. cit.* p. 136 [No. 439]. Brooklyn Mus. 37.1500E (formerly in Abbott and N.Y. Hist. Soc. Collns.), see BONOMI, *Cat. Colln. Abbott*, p. 3 [22]; *N.Y.H.S. Cat.* p. 13 [170].

PROTECTIVE MUD-BRICK WALLS OF TUTHMOSIS IV. Stelae, set up here, see below and p. 42.

HASSAN, *The Great Sphinx*, pp. 5-7, cf. 52; view, fig. 2.

Brick of Tuthmosis IV, in Cairo Mus. Ent. 72371. Id. ib. fig. 4, p. 7.

Votive-stelae of Tuthmosis IV. See HASSAN, *The Great Sphinx*, pp. 95-6.

Found by Hassan.

King offering bread to Buto, id. ib. pl. xli [b]; wine to Seshet, in Cairo Mus. Ent. 72258, id. ib. pl. xliv [a]; see *Descr. somm.* No. 6308; water to Ḥathor Mistress-of-the-Sycamore, HASSAN, op. cit. pl. xliv [b]; water to Ḥathor Mistress-of-Inerty, id. ib. pl. xlv; water to Atum, id. ib. pl. xlvi [a]; bread to Ptaḥ (re-used in building), id. ib. pl. xlvi [b], pp. 37-8; flowers to Termuthis (serpent-headed), in Cairo Mus. Ent. 72257, id. ib. pl. xlvii; BROEKHUIS, *De godin Renenwetet*, pl. 10, p. 39 [59]; see *Descr. somm.* No. 6306.

King and wife Nefertere before Thoth, HASSAN, op. cit. pl. xli [a].

King and wife Nefertere offering incense to Horus-Rē Lord-of-Sakhbu, id. ib. pl. xlii; SAUNERON in *B.I.F.A.O.* lv (1955), fig. 1, p. 63; ointment (?) to Sokari, HASSAN, op. cit. pl. xliii [a]; ointment to Amen-rē, id. ib. pl. xliii [b].

Found by Baraize.

King offering flowers to Isis, in Cairo Mus. Ent. 59460, id. ib. pl. xlvi, pp. 96, 311; ARCH. LACAU phot. C. i bis, 9.

King and wife Nefertere offering water to goddess (name lost), fragmentary, in Cairo Mus. Ent. 59462, HASSAN, op. cit. pl. xlix, pp. 96, 311; ARCH. LACAU phot. C. i bis, 8; wine to Ptaḥ, in Cairo Mus. Ent. 59461, ARCH. LACAU phot. C. i bis, 7; see HASSAN, op. cit. pp. 96, 311.

Found by von Sieglin Expedition.

King offering wine to Amen-rē and Ḥaremakhhet, STEINDORFF in HÖLSCHER (U.), *Das Grabdenkmal des Königs Chephren*, Abb. 160, pp. 108-9.

King and wife Nefertere offering wine to Mut, in Leipzig Mus. Inv. 2429, id. ib. Abb. 161, pp. 109-10; text, HELCK, *Urk.* iv. 1562 [500], cf. *Übersetz.* (1961), p. 151 [500].

Various.

King offering flowers to Rē-Atum, at one time with Eid (dealer in Cairo), see HASSAN, op. cit. p. 96.

King and wife Nefertere offering flowers to Atum, almost certainly from here, in Cairo Mus. Temp. No. 19.4.47.1.

B. THE SPHINX TEMPLE

Temp. Khephren. Regarded as Sun-temple (Anthes¹) or Temple of Ḥaremakhhet (Ricke and Schott)

Excavated by Baraize (1925-32) and Hassan (1935-6)

On plan VI

RICKE, *Harmachistempel*, passim, with plans, sections, and elevations, plans 1, 2, Abb. 3, 5-7, 9-13, 15; HASSAN, *The Great Sphinx*, pp. 25-9, plan, on pl. xvi; id. *The Sphinx*, pp. 28-33, plan, on fig. 2 (2nd pl. after p. 28); MARAGIOGLIO and RINALDI, *L'Architettura*, v,

¹ In Ricke *Festschrift (Beiträge zur ägyptischen Bauforschung und Altertumskunde, 12)*, pp. 47-58.

pp. 134-40, plan and sections, on Tav. 14. Plan, SCHOTT in *Bulletin de la Société française d'Égyptologie*, Nos. 53-4 (1969), fig. 1, pp. 31-5; GRDSELOFF MSS. 10.

Views of Temple and Great Sphinx, DRIOTON, *Le Sphinx et les Pyramides de Giza*, pl. ii; EDWARDS, *Pyramids* (1947), pl. 6 [b]; SCHWEITZER, *Löwe und Sphinx im alten Ägypten*, Abb. 2, p. 34; HASSAN, *The Great Sphinx*, pls. xvii, xviii, xix [B], lvii; id. *The Sphinx*, frontispiece, figs. 1, 3 [B] facing pp. 28, 34; SPIEGEL, *Hochkultur*, Taf. 13 (photo. ABU BAKR); PRITCHARD, *Anc. Near East*, fig. 765; FAKHRY, *The Pyramids*, fig. 92; DE CENIVAL, *Living Architecture: Egyptian*, pl. 36; HELCK, *Geschichte des Alten Ägypten*, Taf. ii [5]; SAUNERON, *Nous partons pour l'Égypte*, pl. 2. View of interior, HASSAN, *The Great Sphinx*, pl. xv; HELCK, op. cit. Taf. i [4]; LECLANT in *Orientalia*, n.s. 38 (1969), pl. xxi [23-4], p. 252 [16, b]; MICHALOWSKI, *Art*, fig. 857. Various views in course of excavation, RICKE, *Harmachistempel*, Taf. 1-16. View of area east of Valley Temple of Khephren and the Sphinx Temple after excavation, HASSAN, *The Great Sphinx*, pl. xxxvii.

Demotic graffito in ink, recording pilgrimage, at west end of passage north of the Sphinx Temple. Id. ib. figs. 37, cf. 95, p. 53; see id. *The Sphinx*, p. 53.



C. TEMPLE OF ḤAURON-ḤAREMAKHET

Plan VI

HASSAN, *The Great Sphinx*, pp. 31-50, with plan, pl. xxiv, cf. xvi; id. *The Sphinx*, pp. 35-42, with plan, fig. 5 facing p. 38; id. *Giza*, ix, pp. 4-5; cf. *Chron. d'Ég.* xiii (1938), pp. 72-3. Views, mainly with Great Sphinx, HASSAN, *The Great Sphinx*, frontispiece, pl. xxviii, fig. 34; BRUCHET, *Nouvelles recherches sur la Grande Pyramide*, pl. v [lower]; GRDSELOFF MSS. 8, 9 (photos.).

I. OUTER HALL. Sethos I.

Sphinx, on east side of entrance doorway. HASSAN, *The Great Sphinx*, fig. 22, p. 36.

Free-standing stela of Para'emḥab , Head of works, etc., son of Pen'anḳet , probably Dyn. XXI, inscribed on all sides except base, *recto*, deceased adoring Atum and Ḥathor (or Ius-ʿas), *verso*, adoring Rē-Ḥarakhti and a goddess, and long hymns to Atum-Khepri, Rē, and Rē-Ḥarakhti-Atum, found *in situ* nearby, in Cairo Mus. Ent. 87823. Id. ib. pls. lxviii, lxix, pp. 268-75 (with text); see id. *The Sphinx*, pp. 157-62; ZAYED in *Rev. d'Ég.* 16 (1964), p. 207.

Doorway. Jambes of Merneptah, thicknesses with Sethos I embraced by Ḥaremakhet and Isis(?); jambes, HASSAN, *The Great Sphinx*, figs. 22, 78, cf. pl. xxix, p. 33; id. *The Sphinx*, fig. 6 (2nd pl. after p. 38), pp. 38-9, 41; thicknesses, id. *The Great Sphinx*, figs. 76-7, pp. 106-7, 246.

Stela of Sethos I, dedicated to Ḥaremakhet, King on foot hunting, with text, and below, 7 lines of text, found *in situ* on pedestal with name of Tuthmosis IV. Id. ib. figs. 74-5, pp. 104-6, cf. fig. 23, p. 263 [No. 80]; id. *The Sphinx*, fig. 42 facing p. 210, cf. pp. 40, 152, 210-12; see id. *Giza*, ix, p. 4 [lower].

II. INNER HALL. Amenophis II.

Doorway. Jambes and lintel of Amenophis II. Id. *The Great Sphinx*, pl. xxv, pp. 36, 46.

'Great Stela', double-scene, Amenophis II offering wine to Sphinx, and below, 27 lines of text about sporting activities of the youthful King. Id. ib. pl. xxxviii, cf. fig. 16, pp. 32,

74-7, 235; id. *The Sphinx*, fig. 38 facing p. 178, cf. pp. 36-7, 177-86; id. in *Ann. Serv.* xxxvii (1937), pls. i, ii, pp. 129-34; VARILLE in *B.I.F.A.O.* xli (1942), pp. 31-8 with pl. (from HASSAN); text, HELCK, *Urk.* iv. 1276-83 [372], cf. *Übersetz.* (1961), pp. 24-8.

Stela-niche, winged solar disk with arms holding cartouche of Tuthmosis IV (erased) at top, double-scene, Amenophis II adoring Sphinx, and below, 14 lines of text, dedicated to Haremakheth, found *in situ* in wall west of 'Great Stela', now destroyed. HASSAN, *The Great Sphinx*, pl. xxxix, pp. 33, 79-83, 235; id. in *Ann. Serv.* xxxviii (1938), pl. ix, pp. 53-61; GRDSELOFF MSS. 24.1 (photo.); text, HELCK, *Urk.* iv. 1283-6 [373], cf. *Übersetz.* (1961), p. 28; see HASSAN, *The Sphinx*, pp. 40, 186-7.

Statue, Tīcā  (wife of Amenophis II), two inscribed fragments of base (one found outside). Id. *The Great Sphinx*, figs. 63-4, pp. 34, 36, 77-8, 240; texts, GRDSELOFF MSS. 25.1-2; see HASSAN, *The Sphinx*, p. 40.

Stela-fragments, double-scene, Tuthmosis IV offering wine to Sphinx. Id. *The Great Sphinx*, fig. 17, p. 34, cf. 35 [bottom], 36.

III AND IV. SUBSIDIARY ROOMS.

Doorways¹. Four jambs and a lintel (3 lines) of Amenophis II; id. ib. pls. xxvi, xxvii, pp. 34, 36, 246. Lintel (3 lines) of Amenophis II, found by Baraize, in Cairo Mus. Ent. 55301; GRDSELOFF MSS. 7 (photo.); ARCH. LACAU phot. C. i bis, 13; see HASSAN, *The Great Sphinx*, p. 311.

V. SOUTH-WEST SUBSIDIARY ROOM.

Doorways. Jambs and thicknesses of Sethos I; id. ib. pl. 1 [A, B], pp. 38, 106, 263.

PROBABLY FROM HERE.

Jamb of Tuthmosis IV, found by Baraize, in Cairo Mus. Ent. 52493. GRDSELOFF MSS. 6 (photo.); ARCH. LACAU phot. C. i bis, 19; see GUNN in *Ann. Serv.* xxix (1929), p. 94.

Jamb of Ramesses III, fragment. HASSAN, *The Great Sphinx*, fig. 79, pp. 109-10.

Foundation deposits

(a) Oval plaque with name of Amenophis II 'beloved of Haremakheth', in Cairo Mus. Ent. 56732, and nine inscribed model jars, Ent. 52483-91, alabaster, found by Baraize 'before Great Sphinx'. Ent. 56732, id. ib. fig. 12, pp. 21, 311; Ent. 52483-91, pl. vi [A], fig. 11, p. 21; GRDSELOFF MSS. 4.1-2 (photos.); presumably these, ARCH. LACAU phot. C. i bis, 1-2; see *Descr. somm.* No. 6141; GUNN in *Ann. Serv.* xxix (1929), p. 94.

(b) Twelve faience plaques with name of Amenophis II 'beloved of Hauron and Haremakheth', six inscribed alabaster vases, and three inscribed pieces of alabaster, probably from here, in Brooklyn Mus. 36.619-21. Eleven plaques, ALBRIGHT in *Bulletin of the American Schools of Oriental Research*, No. 84 (Dec. 1941), figs. 1, 2, pp. 7-10; four, CAPART in *Chron. d'Ég.* xxi (1946), figs. 4, 5, pp. 46-7; see *Syria*, xviii (1937), p. 405; POSENER in *J.N.E.S.* iv (1945), p. 240 [2]; SEELE in ib. iv (1945), pp. 243-4; HASSAN, *The Great Sphinx*, p. 49. Texts of two plaques, HELCK, *Urk.* iv. 1355 [398, 5], cf. *Übersetz.* (1961), p. 56; GARDINER Notebook, 126, p. 40 [lower].

(c) Two model jars, and oval plaque, all with name of Amenophis II, alabaster, and over eighty pottery vases (uninscribed), found by Hassan near wall on west end of passage north of the Sphinx Temple. See HASSAN, *The Great Sphinx*, p. 53; id. *The Sphinx*, pp. 53-4.

¹ See Addenda.

D. CHAPEL OF TUTHMOSIS I (?)

Brick-built

Position, on plan VI

HASSAN, *The Great Sphinx*, p. 67, plan, fig. 60, cf. pl. xvi; id. *The Sphinx*, pp. 61-2, plan, on fig. 2 (2nd pl. after p. 28).

E. RESTHOUSE OF TUT'ANKHAMŪN

Brick-built. South-west of Valley Temple of Khephren

Doorway with cartouches of Tut'ankhamūn and wife 'Ankhesenamūn, 'beloved of Hauron', usurped by Ramesses II, found by Baraize, in Cairo Mus. Ent. 57195. HASSAN, *The Great Sphinx*, fig. 73, pp. 23, 100, 311; cartouches, POSENER in *J.N.E.S.* iv (1945), fig. 1, pp. 240-1 [3]; ARCH. LACAU phot. C. i bis, 10, 23, cf. MSS. RC.B. i, 36; text, HELCK, *Urk.* iv. 2043 [776 a], cf. *Übersetz.* (1961), p. 372; see HASSAN, *The Sphinx*, pp. 203-4, 213.

Fragments of stelae, etc., from here, in Cairo Mus. Temp. No. 27.5.36.1.

Bricks of Amenophis II, and wine-jar sealings, 'Amarna Period, found west of Valley Temple of Khephren. Texts, KAMAL in *Ann. Serv.* x (1910), p. 117.

FINDS FROM SURROUNDINGS OF GREAT SPHINX

From area north of it unless otherwise stated

Old Kingdom finds, from tombs of Central Field, see p. 292.

Statues and statuettes

In chronological order

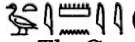
Hetep , Prophet of Sekhmet, son of Sitameny  (mother), scribe-stature, sandstone, Dyn. XII, in Cairo Mus. Ent. 72239. HASSAN, *The Great Sphinx*, pls. xxxiv, xxxv, fig. 51, pp. 60-1; id. *Giza*, ix, pl. xiii, pp. 9, 38 [7] (incomplete text); see id. *The Sphinx*, p. 58.

Statue-fragments, including sphinx with Ramesside cartouche and torso with names of Tuthmosis III on back, found by Baraize. ARCH. LACAU phot. C. i bis, on 6.

King (possibly Amenophis II) standing (lower part missing), in Cairo Mus. Ent. 87821. HASSAN, *The Great Sphinx*, fig. 48, pp. 57-8; see id. *Giza*, ix, p. 9.

'Hiy' seated in palanquin, New Kingdom, in Cairo Mus. Ent. 72240. Id. *The Great Sphinx*, fig. 57, p. 65.

Statue-base of hawk with damaged statuette of donor on front, dedicated by Amenemhab , Commander of the army of Nubians, New Kingdom, found north of Temple of Hauron-Haremakhet. Id. ib. fig. 59, p. 66.

Osiride royal statuette (uninscribed), New Kingdom or later, in Cairo Mus. Ent. 72241; id. ib. pl. xxxiii, p. 52; head of another, found by Baraize, in Cairo Mus. Temp. No. 10.5.30.1; id. ib. pl. xiv [A], p. 23.

Hawk (headless), with cartouche of Psammetikhos I on front of base, dedicated by Harbes , Royal butler, son of Pefteuma'ushu, found by Baraize east of Great Sphinx, in Cairo Mus. Temp. No. 31.12.28.10. ARCH. LACAU phot. C. i bis, 22; see GUNN in *Ann. Serv.* xxix (1929), p. 95 (text).

Psammetikhos II, part, granite, in Berlin (East) Mus. 2275. Text, L. D. iii. 273 [c], *Text*, i, p. 17 [2]; see *Ausf. Verz.* p. 247; HASSAN, *The Great Sphinx*, p. 118 [top].

Sphinx of Apries (headless), painted, found north of the Sphinx Temple, in Cairo Mus. Ent. 72245. Id. ib. fig. 81, pp. 53, 118, 196; see id. *The Sphinx*, pp. 53, 227.

Statue of lion, and another, holding small animal, Late Period, found in Temple of Ḥauron-Ḥaremakhēt. Id. *The Great Sphinx*, pls. xxii, xxiii, p. 33; one, id. *The Sphinx*, fig. 4 facing p. 36, cf. p. 37; see id. *Gîza*, ix, p. 37 [1].

Statues of lions and sphinxes, Late Period. Id. *The Great Sphinx*, fig. 56 [A-C], p. 64.

Sphinxes (headless), Late Period. Two, found by Baraize, ARCH. LACAU phot. C. i bis, 16; another, HASSAN, *The Great Sphinx*, fig. 47 [A], p. 57.

Sphinx, copper, Late Period, found in Temple of Ḥauron-Ḥaremakhēt. Id. ib. fig. 9, p. 36.

Statuettes of hawks and lions, copper, Late Period. Id. ib. fig. 25, p. 37.

Miniature coloured sphinxes (9 complete, 1 with forelegs missing, 1 fragment of head), Ptolemaic, found by Baraize east of Great Sphinx, in Cairo Mus. Ent. 52481a-k. Nine complete, id. ib. pl. xii, p. 23; GRDSELOFF MSS. 5 (photo.); ARCH. LACAU phot. C. i bis, 11; see GUNN in *Ann. Serv.* xxix (1929), p. 96.

Pedusiri and Pasenpkel, base, inscribed in demotic with invocation to Ḥaremakhēt-Shu and Mestasytmis, Roman, found by Baraize east of Great Sphinx, in Cairo Mus. 50041. SPIEGELBERG, *Die demotischen Denkmäler (Cat. Caire)*, iii, Taf. ix, p. 12; see GUNN, op. cit. p. 95 [Ent. 52482, called altar]; HASSAN, *The Great Sphinx*, p. 309.

Statuette of hawk (headless), found by Baraize. ARCH. LACAU phot. C. i bis, 21.

Seated statue with *ankh* in left hand, right hand on knee, lower part, date uncertain. See HASSAN, *Gîza*, ix, p. 38 [5].

Stelae

Sphinx-stelae. Various divinities represented as Sphinx.



Royal.

Tuthmosis IV before Sphinx, with endowment-text concerning Temple, possibly that of Ḥauron-Ḥaremakhēt. HASSAN, *The Great Sphinx*, fig. 187, p. 246; see id. *The Sphinx*, pp. 137-8.

Tutankhamūn with wife 'Ankhesenamūn, upper part, much erased. Id. *The Great Sphinx*, fig. 72, p. 99; see id. *The Sphinx*, p. 203.

Private. New Kingdom unless otherwise stated. In alphabetical order.

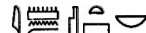
'Aḥmosi, Scribe of Ḥathor Mistress-of-the-Sycamore-of-the-South, son of Wernuro (woman), with winged eye of Horus, in Cairo Mus. Ent. 72278. Id. *The Great Sphinx*, fig. 189, p. 251.

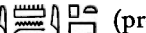

Amenemistneb  Guardian of the Two Great Houses, and Pa. . . , adoring Ḥauron, in Cairo Mus. Ent. 72274. Id. ib. fig. 192, p. 255.

Amenemōpet  (probably son of Amenophis II), stela-niche, two registers, Amenemōpet with offering-bringer before Ḥaremakhēt and Ḥarakhti as Sphinx with statue at front, and with two offering-bringers before Isis, in fragments (Hassan's Stela C). Id. ib. fig. 69, pp. 56, 87-9; id. *The Sphinx*, fig. 41, p. 189.

Amenwahsu  Overseer of scribes of the Lord of the Two Lands, and wife Mutemwia, before Ḥauron-Ḥaremakhēt foremost-of-Setpet as Sphinx with Ptaḥ-Sokari-Osiris beyond, in Cairo Mus. Ent. 72262. Id. *The Great Sphinx*, pl. lxvi, pp. 246, 257-8; see *Descr. somm.* No. 6303.

Benermerut , Overseer of the Two Houses of Silver and Gold, Overseer of all works of the King, etc., adoring Haremakhet, temp. Tuthmosis III, probably from here, formerly in Saint-Ferriol Colln., now in Louvre, C 273 [E.12974]. BOREUX, *Guide*, i, pl. vii, p. 78; MORET in *Revue Égyptologique*, n.s. i (1919), pl. iv [right], pp. 14-16 [iv] (text); HASSAN, *The Great Sphinx*, fig. 93, p. 148; ARCHIVES phot. E.590; F.E.R.E. photo. 17826; sketch with texts, WILKINSON MSS. xx.A.10 [left lower]; text, HELCK, *Urk.* iv. 1372 [411], cf. *Übersetz.* (1961), p. 65 [411]; of top, DEVÉRIA squeezes, 6167.ii.154; see VANDIER, *Guide*, p. 16; *Annuaire des Musées Nationaux* (1928), p. 19.

Hatiay , Vizier, adoring, with Sethos I offering to Sphinx in upper register, in Cairo Mus. Ent. 72269. HASSAN, *The Great Sphinx*, fig. 199, p. 263; id. *The Sphinx*, fig. 36 facing p. 152.

Hernüfer , Overseer of builders of the Lord of the Two Lands, and Meryptah , adoring Rēc-Ḥarakhti-Atum, in Cairo Mus. Ent. 72265. Id. *The Great Sphinx*, fig. 179, p. 238; text, GRDSELOFF MSS. 28 b [lower].



Inḥertmosi  (not represented), Haremakhet as Sphinx, temp. Tuthmosis IV, in Cairo Mus. Ent. 72260. HASSAN, *The Great Sphinx*, fig. 181, p. 244; id. *The Sphinx*, fig. 32 facing p. 136, cf. pp. 136-7.

Iuti , Child of the nursery, adoring Ḥarakhti, with cartouches of Tuthmosis IV and erased figure of King, in Cairo Mus. Ent. 72268. Id. *The Great Sphinx*, fig. 66, p. 81.

Kharuef , Standard-bearer of the company 'Amūn-is-Victorious', adoring Haremakhet, found *in situ* set up in brick wall. Id. *ib.* fig. 94, pp. 64, 149, 256, cf. pl. xxxvi [A, right]; id. *The Sphinx*, fig. 14 facing p. 72, cf. pp. 148-9.

Ma'ca , Herdsman of goats, carrying kid, adoring Hauron, in Cairo Mus. Ent. 72277. Id. *The Great Sphinx*, fig. 194, p. 258; see id. *The Sphinx*, p. 149 (called Inhermes).

May , Chief craftsman in the temple Akh-ra-messe-meriamūn, etc., Rēc-Ḥarakhti as Sphinx, fragment, temp. Ramesses II. Id. *The Great Sphinx*, fig. 5, p. 9; HABACHI in *Chron. d'Ég.* xxix (1954), fig. 29 (from HASSAN), p. 217.

Mentuher , Excellent scribe, and Kamutnakht , Scribe, *recto*, adoring Haremakhet as Sphinx in front of two pyramids drawn in perspective, *verso*, woman, in Cairo Mus. Ent. 72273. HASSAN, *The Great Sphinx*, figs. 53-4, pp. 61-3 [2]; *recto*, id. *The Sphinx*, fig. 12 facing p. 58, cf. pp. 58-60; FAKHRY, *The Pyramids*, fig. 91.



Mer , Excellent scribe, adoring Haremakhet, and 31 ears above, in Cairo Mus. Ent. 72281. HASSAN, *The Great Sphinx*, fig. 31 [5, 10], p. 44 [5, 10]; id. *The Sphinx*, fig. 10.

Mosi, Standard-bearer, Company-leader, and son Nekhtef , adoring Sphinx, and royal statue, with cartouche of Tuthmosis IV, found *in situ* set up in brick wall, in Cairo Mus. Ent. 72266. Id. *The Great Sphinx*, pl. lxxvii, cf. xxxvi [A, left], fig. 62, pp. 64, 261 (as Tuthmosis III); see *Descr. somm.* No. 6305.

Mosi (not represented), with ear above, and another (inscribed), Late Period. WILKINSON MSS. xx.A.10 [right], 10 verso.

Nebamūn, Gold-worker and Sculptor (not represented), with Rēc-Ḥarakhti as Sphinx, in Cairo Mus. Ent. 72283. HASSAN, *The Great Sphinx*, fig. 178, p. 237.

Neḥi , Infantryman, adoring Rēc-Ḥarakhti, Haremakhet and Hauron, in Cairo Mus. Temp. No. 15.5.46.30. Id. *ib.* pl. lxiv, pp. 256-7; text, GRDSELOFF MSS. 28 a [upper].

Nekht-dḥout , Sculptor of the Lord of the Two Lands, and wife 'Anatemḥabt , adoring Hauron-Haremakhet, in Cairo Mus. Ent. 72275. HASSAN, *The Great Sphinx*, fig. 201, p. 265; text, GRDSELOFF MSS. 28 b [upper]; see HASSAN, *The Sphinx*, pp. 153-4.

Paraemḥab adoring Ḥauron-Ḥaremakhet, with cow being milked. Id. *The Great Sphinx*, pl. lxxv, p. 257.



Pentepihu , King's son, Head of bowmen, before Ḥaremakhet, upper part, probably temp. Tuthmosis IV, found near Valley Temple of Khephren. STEINDORFF in HÖLSCHER (U.), *Das Grabdenkmal des Königs Chephren*, Abb. 159, p. 108 [2].

Teku , Mayor of Macti (not represented), with Ḥarakhti as Sphinx, found by Baraize, in Cairo Mus. Ent. 50046. HASSAN, *The Great Sphinx*, pl. ix, pp. 22, 308; ARCH. LACAU phot. C. i bis, on 3-4.

Tha, Scribe, offering to Ḥauron-Rēc-Ḥaremakhet, in Cairo Mus. Ent. 72271. HASSAN, *The Great Sphinx*, fig. 191, pp. 254-5; see id. *The Sphinx*, pp. 147-8.

Tuto , Scribe, fragment. See KAMAL in *Ann. Serv.* x (1910), p. 118.

Tutuia , Scribe of the offering-table of the Lord of the Two Lands, two registers, deceased adoring Atum as Sphinx with double-stature in front of it, and accompanied by relatives, in Cairo Mus. Ent. 72264. HASSAN, *The Great Sphinx*, fig. 197, pp. 261-2; id. *The Sphinx*, fig. 35 (2nd pl. after p. 150), p. 151; text, GRDSELOFF MSS. 27; see *Descr. somm.* No. 6304.

Yukh , Scribe, and wife Sepet , adoring Sphinx, in Cairo Mus. Ent. 72270. HASSAN, *The Great Sphinx*, fig. 196, p. 260; id. *The Sphinx*, fig. 13 facing p. 70, cf. pp. 71 (called No. 12), 151.

Man (probably son of Amenophis II), offering flowers and incense to Ḥaremakhet foremost-of-Setpet and Ḥarakhti as Sphinx, with statue of King at front, incomplete (Hassan's Stela A). Id. *The Great Sphinx*, fig. 67, pp. 56, 84-5, 235; id. *The Sphinx*, fig. 39, p. 188.

Son of Amenophis II offering flowers and duck to Ḥaremakhet and Ḥarakhti as Sphinx with statue of King at front, and Rēc-Ḥarakhti beyond, with 9 lines of text below, in fragments (Hassan's Stela B). Id. *The Great Sphinx*, fig. 68, pp. 56, 85-7, 235, 238, 246; id. *The Sphinx*, fig. 40, pp. 188-9.

Scribe of the works of the Temple of Ptaḥ, adoring Ḥaremakhet as two Sphinxes, in Cairo Mus. Ent. 87076. Id. *The Great Sphinx*, pl. lxxiii, pp. 243-4.

Head of . . . šr of the Temple . . . (name lost), before Ḥaremakhet, in Cairo Mus. Ent. 33974. Remains of text, DARESSY in *Rec. Trav.* xxii (1900), p. 140 [clxx].

Naked child (name illegible) before Sphinx, with cartouche of Amenophis III, found near Valley Temple of Khephren, in Leipzig Mus. Inv. 1667. STEINDORFF in HÖLSCHER (U.), *Das Grabdenkmal des Königs Chephren*, Abb. 158, pp. 107-8 [1].

Man with wife and child (names lost) adoring Sphinx, in Cairo Mus. Ent. 72282. HASSAN, *The Great Sphinx*, fig. 198, p. 262.

Man with wife and sons adoring Ḥarakhti, inscribed, gilded, found in Temple of Ḥauron-Ḥaremakhet, in Cairo Mus. Ent. 72272. Id. ib. fig. 33, p. 46.

Man (no name) adoring Ḥarakhti, in Cairo Mus. Ent. 72279. Id. ib. fig. 172, p. 234.

Man offering and libating before Sphinx, with winged disk above, in Cairo Mus. Ent. 72267. Foreign settler(?), two registers, man adoring Sphinx, and foreign woman adoring before offerings (no text), in Cairo Mus. Ent. 72280. Id. ib. fig. 203, p. 267.

Foreign settler(?), two registers, Sphinx (not on pedestal), and two foreigners adoring (no text). Id. ib. fig. 202, p. 266.

Woman (not represented, name lost), with Ḥaremakhet as Sphinx. Id. ib. fig. 186, p. 245.

Ḥaremakhet as Sphinx, fragment. Id. ib. fig. 184, p. 245.

Ḥarakhti as Sphinx, with winged disk on top, fragment, found by Baraize, in Cairo Mus. Temp. No. 10.5.33.3. Id. ib. pl. x [A], pp. 22, 312.

Ḥarakhti as Sphinx wearing *atef*-crown, with one line of text, Late Period. Id. ib. fig. 182, p. 244.

Ḥarakhti as Sphinx, Late Period. Id. ib. fig. 173, p. 234.

Two uninscribed stelae, Late Period, Ḥarakhti(?) as hawk-headed Sphinx, adored by King on one, other in Cairo Mus. Ent. 72288. Id. ib. figs. 174-5, pp. 235-6.

Rē-Ḥaremakhēt as Sphinx (no name), Late Period. Id. ib. fig. 188, p. 247.

Ḥaremakhēt as Sphinx wearing wig, Late Period, found in débris of tomb No. 11 of Hassan (see p. 215), in Cairo Mus. Ent. 72263. Id. ib. fig. 183, p. 245.

Sphinx and two painted ears. Remains of text in ink, KAMAL in *Ann. Serv.* x (1910), pp. 117-18.

Sphinx and two ears (no text), in Cairo Mus. Ent. 72294. HASSAN, *The Great Sphinx*, fig. 31 [9], p. 44 [9]; id. *The Sphinx*, fig. 11.

Ḥaremakhēt as Sphinx, fragment, found south-west of Valley Temple of Khephren. Id. *Giza*, ix, pl. xliii [B], fig. 36, p. 88 [top].

Sphinx, and ear above on left, found in East Field, in Boston Mus. 27.787.

Various, probably Late Period, in Cairo Mus. Ent. 72276, 72284-7.

Ear-stelae. New Kingdom and later.

Huy , two ears in relief, New Kingdom, found north of Temple of Ḥauron-Ḥaremakhēt, in Cairo Mus. Ent. 72298. Id. *The Great Sphinx*, fig. 30 [1], p. 42 [1]; id. *The Sphinx*, fig. 7.

May , probably temp. Ramesses II, large ear in relief and Ḥarakhti as hawk, in Cairo Mus. Ent. 72293. Id. *The Great Sphinx*, figs. 6, 30 [2], pp. 10, 42 [2]; id. *The Sphinx*, fig. 8.

Stela, ear in relief and two incised hawks, found north of Temple of Ḥauron-Ḥaremakhēt. Id. *The Great Sphinx*, fig. 31 [4], pp. 43-4 [4], 237 [No. 55]; id. *The Sphinx*, fig. 9.



Stela with two incised ears, in Cairo Mus. Ent. 72297. Id. *The Great Sphinx*, figs. 31 [8], 185, pp. 44 [8], 245.

Stela with two ears in relief, and another with many ears incised, found near tombs north of Great Sphinx. Id. ib. fig. 31 [11, 12], p. 44 [11, 12].

Various, in Cairo Mus. Ent. 72296, 72299.

Hawk-stelae. New Kingdom unless otherwise stated.

Amenemḥab  (not represented), dedicated to Ḥauron-Ḥaremakhēt, in Cairo Mus. Ent. 72259. HASSAN, *The Great Sphinx*, fig. 193, p. 256; see id. *The Sphinx*, p. 149.

Nebnyeny , Deputy of Kher-ḥaḥa  (not represented), dedicated to Ḥauron-Ḥaremakhēt, in Cairo Mus. Ent. 72290. Id. *The Great Sphinx*, fig. 190, p. 254; id. *The Sphinx*, fig. 33 facing p. 146.

Two stelae with Ḥarakhti as hawk, incomplete, Late Period, one in Cairo Mus. Ent. 72295. Id. *The Great Sphinx*, figs. 176 (Ent. 72295), 177, p. 236.

Man adoring hawk-god, probably Late Period, found by Baraize, in Cairo Mus. Temp. No. 14.12.34.4.

Two stelae, probably Late Period, in Cairo Mus. Ent. 72291-2.

Various stelae. New Kingdom.



Ramesses II, year 1, upper part, found by Caviglia, in Brit. Mus. 440. *Hiero. Texts*, 9, pls. vii [2], viia [2], p. 13; sketch, YORKE and LEAKE in *Transactions of the Royal Society of Literature of the United Kingdom*, i, Pt. i (1827), pl. viii [23], p. 213 (repr. as *Remarks on some Egyptian Monuments in England*); text, SHARPE, *Eg. Inscr.* 2 Ser. 33 [B]; SEYFFARTH MSS. xi.





9682-4; royal names and titles, GAUTHIER, *Le Livre des Rois d'Égypte*, iii, p. 35 [v]; see *Guide (Sculpture)*, p. 163 [591]; SHARPE, *Eg. Antiq.* p. 63 [440].

Ramesses VI, fragment, with two remaining lines of text, granite, found in 1913, in Cairo Mus. Ent. 44693. See HASSAN, *The Great Sphinx*, pp. 110, 308; id. *The Sphinx*, p. 216.





Stela with 12 remaining lines of text, fragment, re-used in building, in Cairo Mus. Ent. 72300. Id. *The Great Sphinx*, pl. xxxvi [B], p. 64.

Stela-niche of Assistant of the Overseer of workmen of . . . of the Temple of Hauron, with Hauron (destroyed) as mummiform hawk. Id. ib. fig. 200, p. 264; see id. *The Sphinx*, pp. 152-3.

Stela-niche of Nakht  , First King's son of Amūn, Chief *warb*-priest of Amūn, Carrier of the offering-table, son of Kha^c , with kneeling statuette and adoration of Rē, in Cairo Mus. Ent. 2021. VON BISSING, *Denkmäler*, Text to Taf. 65-6 [right fig.]; HASSAN, *The Great Sphinx*, pl. lxii, p. 239; HORNEMANN, *Types*, iii, pl. 633; text, DE ROUGÉ, *Inscr. hiéro.* pl. xliii [lower] (called Saqqâra); see MASPERO, *Guide*, p. 129 [429].

Stela-naos, Nefert(?)   (?), son of Ubastenefert(?)    (?), before Osiris and Isis, found in Temple of Hauron-Haremakhet, in Cairo Mus. Ent. 72256. See HASSAN, *Gîza*, ix, p. 37 [2]; id. *The Great Sphinx*, p. 33; *Descr. somm.* No. 6307.

Khuwiptah, Fanbearer, before solar-bark, in Cairo Mus. Ent. 72261. HASSAN, *The Great Sphinx*, fig. 168, pp. 224-5.

Paia    , Measurer of Sphinx, adoring, and hawk-headed [Har]siēsi facing Shed and goddess Tarauwyna above, in Cairo Mus. Ent. 72289. Id. ib. fig. 195, pp. 259-60; id. *The Sphinx*, fig. 34 facing p. 150; VIKENTIEV in *Bull. Inst. Ég.* xxxvii [1] (1954-5), pl. iii, pp. 293-4; text, GRDSELOFF MSS. 28 a [lower].

Stela, waiting royal chariot, lower part. HASSAN, *The Great Sphinx*, fig. 52, p. 61 [1].



Man adoring (name lost), with text of adoration of Haremakhet (much damaged), found near south wall of Valley Temple of Khephren. Id. *Gîza*, ix, p. 87 [6, a] with fig.

Fragment (inscribed), probably New Kingdom and from here, found near south wall of Valley Temple of Khephren. Id. ib. pl. xlv [A], fig. 37, p. 88 [7, a].

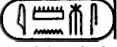
Various

Part of naos of Amenmosi , King's eldest son, General of his father, year 4 of Tuthmosis I 'beloved of Haremakhet', bought 'in Gîza', in Louvre, E.8074. Text, GRÉBAUT in *Rec. Trav.* vii (1886), p. 142; ERMAN, *Ein neues Denkmal von der grossen Sphinx* in *Sitzungsber. Berlin* (1904), pp. 1063-4; SETHE, *Urk.* iv. 91 (36), cf. *Übersetz.* (1914), p. 46; GARDINER Notebook, 71, p. 20 [middle].

Naos of Tuthmosis IV 'beloved of Haremakhet', in Cairo Mus. Ent. 72301. HASSAN, *The Great Sphinx*, fig. 58, p. 65; id. *Gîza*, ix, pl. xii, fig. 14, pp. 37-8 [3].

Naos of Minnakht  , Hereditary prince, Overseer of the Two Granaries, etc., with man before deceased at table on sides, New Kingdom, found north of Great Sphinx. Id. ib. pls. ix-xi, figs. 11-13, pp. 9, 33-5.

Block with cartouches of Tuthmosis IV, found by Baraize, in Cairo Mus. Temp. No. 10.5.33.1. Id. *The Great Sphinx*, pl. viii, pp. 22, 311.

Block (stela-shaped), Asiatic and Nubian tied back to back, Dyn. XVIII, found east of Great Sphinx, in Cairo Mus. Ent. 27438. MASPERO, *Égypte*, fig. 302; GHALIOUNGUI in *Egypt Trav. Mag.* No. 104 (April 1963), fig. 23 (incomplete), p. 21; BECATTI in *Enciclopedia dell'Arte Antica Classica e Orientale*, v, fig. 521, p. 395; see *Bull. Inst. Ég.* ii Sér. 7 (1886), Annexe xxiii.

Sealing of Sethos I. See HASSAN, *The Great Sphinx*, p. 63.

Cornice-block with cartouches of Ramesses II, found by Baraize, in Cairo Mus. Temp. No. 10.5.33.4. Id. ib. fig. 14, pp. 21, 108, 312.

Block from frieze with uraei, New Kingdom. Id. *Giza*, ix, pl. xliii [A], p. 87 [5].

Block with rough figure of archer, found by Baraize, in Cairo Mus. Ent. 50047. Id. *The Great Sphinx*, pl. xi [B], pp. 23, 308.

Block with rough figure of Ptah, found in Temple of Hauron-Haremakhhet. Id. ib. fig. 21, p. 36.

Votive ear (inscribed in ink), fragment. Id. ib. fig. 31 [6], p. 44 [6].

III. Necropolis

Plans of various tombs, BURTON MSS. 25620, 59, 64-5, 67 verso-74, 25621, 4. Plans, sections, elevations, and sketches, of various tombs, WILD MSS. i. A. 1-28; iii. 4-73. Plan of Junker's excavations, JUNKER, *Giza*, xii, plan at beginning; account, KOMORZYNSKI in *Österreichische Lehrerzeitung*, 5 (1951), pp. 5-6.

A. WEST FIELD

Tombs arranged, when possible, according to numbers of Reisner

Plans VII, VIII

Plan, REISNER, *Giza Necropolis*, i, Map of Western Cemetery; JUNKER, *Giza*, i, Abb. 1.

Air views, JUNKER, *Giza*, i, Taf. i; LAMPL, *Cities and Planning in the Ancient Near East*, fig. 80. Views¹ of parts (mainly from Great Pyramid), HAYES, *Daily Life in Ancient Egypt in The National Geographic Magazine*, lxxx (1941), fig. on p. 431; BORCHARDT and RICKE, *Egypt*, pl. 74; JUNKER, *Giza*, i, Taf. iii-vii, xxxi [b]; vii, Taf. i, ii; viii, Taf. i; id. in *J.E.A.* i (1914), pl. xxxix; id. in *Anzeiger, Wien*, 50 (1913), Taf. i; 51 (1914), Taf. i; 63 (1926), Taf. i, vii [a]; id. *Die Kultkammer des Prinzen Kanjnswt im Wiener Kunsthistorischen Museum*, Abb. 1; STEINDORFF, *Kunst*, 116; REISNER, op. cit. pls. 7, 8; id. in *Boston Mus. Bull.* xi (1913), figs. 1, 2, p. 54; xxxiii (1935), fig. 1, p. 70; id. and FISHER in *Ann. Serv.* xiii (1914), pls. i-iii; WOLF in *Der Cicerone*, xx (1928), Abb. on p. 583; SMITH, *Anc. Eg.* (1942 and 1952), fig. 7; (1960), fig. 9; DUNHAM, *Eg. Department*, fig. 15; SCOTT in *M.M.A. Bull.* n.s. vii (Nov. 1948), fig. on p. 95; VON BISSING, *Äg. Kunstgeschichte*, Taf. xlvi [317], *Text*, i, p. 78; VIOLET and DORESSE, *Egypt*, pl. 56; L. D. *Ergänz.* ii; ALDRED, *Egypt to the End of the Old Kingdom*, fig. 98; PIJOÁN, *Summa Artis*, iii (1945), fig. 117; KOMORZYNSKI, *Altägyptens hohe Kunst in Österreich in Wort und Bild*, 31 (1951), Abb. 1, p. 3; id. *Altägypten*, Abb. 1, p. 1; CAPART, *Memphis*, fig. 294 (from JUNKER); SAMIVEL and AUDRAIN, *The Glory of Egypt*, frontispiece; MICHALOWSKI, *Art*, fig. 851; WHITEHILL, *Museum of Fine Arts Boston. A Centennial History*, i, fig. on p. 256.

ABU-BAKR EXCAVATION (1953)

University of Alexandria

Area north and west of tomb LG 19.

Position, on plan VII

MESHA^cEF  Dyn. V-VI.



Brick-built mastaba.

False-door of deceased. Name, LECLANT in *Orientalia*, n.s. 23 (1954), p. 72 [2, a].

¹ Selected references.

TEPASONB . Dyn. V-VI.

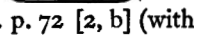
Stone-built mastaba.

False-door of deceased, with among others figure of Amenkaukhufu   , and two offering-stands of deceased, and two of wife. See id. ib. p. 72 [2, b] (with names).

SENU. Dyn. V-VI.

Brick-built mastaba.

Drum of entrance doorway with name of deceased (also in ink on inner part), and panel of false-door with deceased and wife at table. See id. ib. pp. 72-3 [2, c].

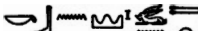
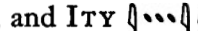
KEBENWENTHET , and ITY . Dyn. V-VI.

Two false-doors. See id. ib. p. 73 [2, d] (with names).

ABU-BAKR EXCAVATION (1950-1)

University of Alexandria

Position, on plan VII

View, LECLANT in *Orientalia*, N.S. 21 (1952), pl. xxxvii [13].

MEHI , Brewer. Late Old Kingdom.

Brick-built mastaba west of tomb LG 20-21.

Statue of deceased seated, in UNESCO building, Paris. Id. ib. pl. xxxviii [14, 15]; p. 241.



LG 19. IPI . Dyn. V or later.

Stone-built mastaba inside brick-built palace-façade enclosure wall.

L. D. *Text*, i, p. 44, with plan. View, with brick construction, probably cage for hyena, LECLANT in *Orientalia*, N.S. 21 (1952), pl. xl [17], p. 241. Sketch of cage, ABOU BAKR in *La Revue du Caire*, xxxiii [175] (1955), pp. 47-8 with fig. View with tomb LG 20-21, SMITH (W. S.) in *A. J. A.* 56 (1952), pl. 2 [B], p. 40.

Lintel of false-door of deceased. L. D. ii. 82 [c].

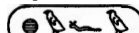
LG 20-21. PERSON , Greatest of the Ten of Upper Egypt, Scribe of the royal documents, Overseer of all works of the King, etc., and IRUKAKHUFU

 , Overseer of the Pyramid-town of Khufu, etc. Probably early Dyn. V.

Wife of Person, Neshut , Royal acquaintance.

Stone-built mastaba inside brick-built palace-façade enclosure wall.

Plan XXIV

L. D. *Text*, i, pp. 44-5; LECLANT in *Orientalia*, N.S. 21 (1952), pp. 240-1 [1]; REISNER, *Giza Necropolis*, i, pp. 217 [23], 311 [h]. Plan and section, L.D. *Text*, i, p. 45. View, LECLANT, op. cit. pl. xxxvi [12].

¹ First four signs of the name in a crenellated enclosure.

Chapel of Person. LG 20.

(1) Upper (partly above doorway), deceased and wife seated, and two registers before them, remains of boats and men netting and bringing fish. Lower, deceased and wife seated, and four registers before them, I, scribes, and men bringing II, garments, III, cloth, IV, hyena.

L. D. *Ergänz.* viii.

(2) Deceased standing.

L. D. ii. 83 [a].

(3) False-door of deceased, (4) deceased and wife, with six registers before them, I-II, daughters squatting, and scribe, III, man censuring and another bringing joint of meat, IV, butchers, V-VI, bringing bull and oryx, (5) uninscribed false-door.

L. D. ii. 83 [b]; names, LIEBLEIN, *Dict.* No. 8.

Serdab of Person. North of Chapel.

Names and titles (showing that three statues of deceased and one of wife were originally here). See LECLANT, *op. cit.* pp. 240 [bottom]-241 [top].

False-door of Irukakhufu. In east face of mastaba. LG 21.

Panel with two men at table, and lower lintel with name and title. L. D. ii. 17 [d]; name and title, L. D. *Text*, i, p. 45.

Serdab of Irukakhufu. Brick-built, in front of false-door.

Scribe-statue, in Cairo Mus. LECLANT, *op. cit.* pl. xxxix [16], pp. 240, 241; SMITH (W. S.) in *A.J.A.* 56 (1952), pl. 3 [A], p. 40; id. *Art . . . Anc. Eg.* pl. 45 [B], p. 67; ABOU BAKR in *La Revue du Caire*, xxxiii [175] (1955), fig. 31, p. 48; SEWELL, *Egypt under the Pharaohs*, pl. 15.

ABU-BAKR EXCAVATION (1949-50). WEST PART

University of Alexandria

Plan XVII

ABU-BAKR, *Giza*, *passim*; plan, 2nd plan at beginning [left]. See LECLANT in *Orientalia*, N.S. 20 (1951), pp. 346-7; SCHWEITZER in *ib.* N.S. 19 (1950), p. 119.

AKHTIHOTP , Greatest of the Ten of Upper Egypt, Inspector of *wab*-priests of the Pyramid of Khufu, Director of members of a phyle, etc. Dyn. VI.

Wife, Hēmtakhti , Royal acquaintance.

Partly stone-built and partly brick-built mastaba.

ABU-BAKR, *Giza*, pp. 1-9 (with texts); plans, sections and elevations, figs. 1, 2, 4; views, pls. i-iii, fig. 3; BADAWY in *ib.* fig. 112, p. 137.

Chapel.

South false-door of deceased. ABU-BAKR, *op. cit.* pl. iv, fig. 5, pp. 4-7.

North false-door of deceased. *Id.* *ib.* pl. v [B], fig. 6, pp. 8-9.

NIHETEPKHNUM , Prophet of Khufu foremost-of-the-*akhet*-Pyramid, Chief of the estate 'Mansion of Khufu', Inspector of *wac**b*-priests, etc. Middle Dyn. V or later.

Wife, Khenti , *mitrt*, etc.

Stone-built mastaba.

ABU-BAKR, *Giza*, pp. 11-25 (with texts); plans, sections and elevations, fig. 7; view, pl. vi.

Chapel.

Entrance doorway. Drum of deceased; id. ib. pl. vii [A], fig. 8, p. 12.

South false-door of deceased and wife, with relatives on outer thicknesses. Id. ib. pls. viii-xiv, figs. 10-12, pp. 14-23.

Lintel and drum of deceased, from north false-doors. Id. ib. pl. xv [B, C], figs. 13, 14, p. 23.

Drum of wife, from north false-doors. Id. ib. pl. xv [A], fig. 15, p. 24.

SEPNI , Chief of the estate 'Mansion of Khufu', *wac**b*-priest of the King's sons, Overseer of the houses of the King's children, etc. End of Dyn. V or later.

Wife (?), Neferihy , Royal acquaintance.

Brick-built mastaba.

ABU-BAKR, *Giza*, pp. 31-7 (with texts); plan and sections, fig. 24 facing p. 32; plans and sections of shafts and burial chambers, figs. 25-6; views, pl. xviii [A]; BADAWY in ib. fig. 111.

Chapel.

Lintel and drum of false-door of Neferihy (third from south, *in situ*). ABU-BAKR, op. cit. pl. xviii [B], figs. 27-8, pp. 33-4.

Drum of false-door of Neferihy. Id. ib. pl. xix [B], fig. 30, p. 34 [2].

Lintel of false-door and block of deceased. Id. ib. pl. xix [A], figs. 29, 31, pp. 34 [1], 35.

Statues

View *in situ* in Chapel, id. ib. pl. xix [C].

Neferihy standing. Id. ib. pl. xxi, p. 36; LECLANT in *Orientalia*, n.s. 20 (1951), pl. xxxix [24], p. 347 [C].

Neferihy (older) seated. ABU-BAKR, op. cit. pl. xxii, pp. 36-7; LECLANT, op. cit. pl. xxxviii [22], p. 347 [C].

Deceased seated. ABU-BAKR, op. cit. pl. xx, pp. 35-6; LECLANT, op. cit. pl. xxxviii [23], p. 347 [C].

NEFERI , Overseer of the *gs-pr* of tomb-makers, King's *wac**b*-priest of the Pyramid of Khufu, Director of a crew of recruits, etc. Middle Dyn. V or later.

Mastaba with rubble core encased in brick walls.

Plan XXIV

ABU-BAKR, *Giza*, pp. 39-67 (with texts); plan and section, figs. 32 [A, B]; of shafts and burial chambers, fig. 34; views, pls. xxiii, xxvi-xxviii; BADAWY in ib. figs. 104, 106, pp. 129-31; id. in *Ann. Serv.* li (1951), fig. 8, p. 12. Title, Overseer of the *gs-pr* of tomb-makers, see FISCHER in *A.Z.* 93 (1966), pp. 65-6 [7].

Chapel.

(1) Niche. (a)–(b) Lintel with offering-text and jambs with deceased and probably his children behind, (c) deceased at table, with offering-bringers and estates below, (d) (unfinished) offering-bringers at bottom, (e) false-door with deceased at back of niche.

ABU-BAKR, op. cit. pls. xxix–xxxiii, figs. 35–40, pp. 48–63; two figures of deceased from (a) and (b), LECLANT in *Orientalia*, N.S. 20 (1951), pls. xxxvi, xxxvii [20–1], p. 347 [a]; names of estates at (c), JACQUET-GORDON, *Domaines*, pp. 315–16 [46G6], Nos. 1–5, cf. figs. 98–9 (after ABU-BAKR).

(2) Remains of wooden false-door, encased in brickwork, from earlier plan of mastaba.

ABU-BAKR, op. cit. pls. xxxiv, xxxv, fig. 41 [A, B], pp. 63–7, cf. pls. xxiv–xxv bis, fig. 33, p. 40; names of estates, JACQUET-GORDON, op. cit. pp. 315–16 [46G6], Nos. 6–9, cf. figs. 98, 100 (after ABU-BAKR).

ABDU , King's *warb*-priest, Overseer of the Great Estate, Scribe of the new settlements of the Great Estate, etc. Dyn. VI.

Wife, Reputka , Prophetess of Hathor and Neith, etc.

Stone-built mastaba.

ABU-BAKR, *Giza*, pp. 69–82 (with texts); plan and sections, fig. 42 facing p. 70 (with elevation); of shafts and burial chambers, figs. 43–5; views, pls. xxxix, xl; LECLANT in *Orientalia*, N.S. 20 (1951), pl. xxxv [19], p. 347 [b].

'Pseudo-mastaba'.

Drum of central false-door in east façade, with name and title of deceased. Text, ABU-BAKR, op. cit. p. 70.

Chapel.**Plan XXIV****I. Pillared hall.**

(1) Doorway. (a)–(b) Lintel, deceased and wife seated, and offering-text, drum with name and titles, jambs, address to visitors and conventional biographical text, (c) and (d) deceased standing.

Id. ib. pls. xxxvi–xxxviii, figs. 46–51, pp. 72–5.

(2) Pillar. (a) Deceased, and bull below, (c) and antelope below, (b) wife with son, and bull below, (d) with daughter, and hyena below.

Id. ib. figs. 56–9, pl. xli [B], pp. 78–80.

(3) Pillar. (a) and (c) Deceased, and bull tethered below, (b) wife with daughter, and ibex below, (d) with son, and two daughters below.

Id. ib. figs. 52–5, pl. xli [A], pp. 76–8.

II. Offering-room.

(4) Left thickness of doorway, deceased leaning on staff, and wife, and three offering-bringers below, in Chicago, Art Inst. 20.266. ALLEN, *A Handbook of the Egyptian Collection* (1923), p. 27 with fig.



(5) Remains of scenes, two groups of butchers, and servant handing lotus-flower to deceased seated. ABU-BAKR, op. cit. figs. 60–1, pp. 80–1.

(6) False-door of deceased, with two offering-stands at back of niche. Id. ib. fig. 62, pp. 81–2.

ABU-BAKR EXCAVATION (1952)

University of Alexandria

Position, on plan VII

SENENU , Washerman of the God, King's *warb*-priest. Dyn. V.Wife, 'Ankherfenezes .View, LECLANT in *Orientalia*, N.S. 22 (1953), pl. xvi [30], p. 94 [2, b].Panel of false-door with deceased and wife at table. Id. ib. pl. xvii [31]; *Jaarbericht Ex Oriente Lux*, No. 13 (1953-4), pl. lxii [upper left], p. 291.Four fragments of slab-stela, [King's daughter of his body seated] before offerings. KAPLONY, *Inscripfien. Suppl.* Taf. 24-6 [1057], pp. 30-1.KATEP , King's *warb*-priest. Dyn. V.Wife, Tepemnefert .North false-door of deceased and wife. Upper part, LECLANT in *Orientalia*, N.S. 22 (1953), pl. xvii [32], p. 94 [2, a].

CEMETERY G 1000

Reisner Excavation. Hearst Expedition of the University of California (1903-5).

Plan X

G 1008. SHEPSEKAF'ANKH , Judge and Strong-of-voice. Dyn. V.

Stone-built mastaba.

REISNER, *Giza Necropolis*, i, p. 252 [12]; name, id. and FISHER in *Ann. Serv.* xiii (1914), p. 244; with title, from lintel, DENNIS in *P.S.B.A.* xxvii (1905), p. 33 [4].

G 1011. Dyn. V.

Stone-built mastaba¹.Plan, REISNER in *Ä.Z.* 48 (1911), fig. 4, p. 113; of chapel, id. *Giza Necropolis*, i, fig. 157. Scribe's writing board with names of Kings, divinities, and estates, etc., wood covered with plaster, from shaft C, in Cairo Mus. Ent. 37734. REISNER in *Ä.Z.* 48 (1911), figs. 1-3, pp. 113-14; names of estates, JACQUET-GORDON, *Domaines*, pp. 259-63 [27G5] (from photo. in Collège de France); see SMITH, *Hist. Eg. Sculp.* pp. 358-9.G 1012. SEDAUG , Overseer of sculptors, King's *warb*-priest, Prophet of Saḥurēc and of the Pyramid of Saḥurēc. Prophet of Rēc in the Sun-temple of Userkaf, etc. Middle Dyn. V to Dyn. VI.

Stone-built mastaba. Excavated by Reisner and Junker.

JUNKER, *Giza*, ix, pp. 107-18; plan, on Abb. 45.

Chapel.

Lintel of entrance doorway with offering-text. Id. ib. Abb. 49, pp. 116-17 [4]; text (incorrect), DENNIS in *P.S.B.A.* xxvii (1905), p. 32 [2].False-door of deceased, in Vienna Mus. Inv. 8014. JUNKER, op. cit. Taf. xvi [b], Abb. 46, pp. 110, 112; see id. in *Anzeiger, Wien*, 64 (1927), pp. 150-1; SMITH, *Hist. Eg. Sculp.* p. 355.Upper part of architrave, two men before deceased and family, in Vienna Mus. Inv. 8520. JUNKER, *Giza*, ix, Abb. 47a, reconstruction, Abb. 47b, pp. 112-14.¹ Lintel of Mesezeru (see infra, p. 178), comes from here.

Block with ancestors (no names), in Vienna Mus. Inv. 8015. Id. ib. Taf. xvi [a], Abb. 48, pp. 114-16.

Libation-basin of deceased, in Vienna Mus. Inv. 8538. Id. ib. Taf. ix [a], Abb. 50, pp. 117-18; see id. in *Anzeiger, Wien*, 64 (1927), p. 151.



Sealing with Horus-name of Neuserre^c, found nearby. Id. *Giza*, vii, Abb. 98, pp. 239-40.

G 1020. MES-SA . Late Dyn. IV or first half of Dyn. V.

Stone-built mastaba.

Plan and sections, REISNER, *Giza Necropolis*, i, figs. 13, 87, 216 [19].

Statues. Found in serdab.

Hetepi , Royal acquaintance (son?), with wife Renpetnefert , seated, in Berkeley Mus. 6.19760. LUTZ, *Statues*, pl. 32, pp. 20-1; Berkeley. *Exhib.* 1966, fig. on p. 55; see SMITH, *Hist. Eg. Sculp.* p. 61 [1].

Deceased standing, in Berkeley Mus. 6.19826. See id. ib. p. 61 [2].

G 1021.

Seated female statuette, second half of Dyn. V or Dyn. VI, in Boston Mus. 21.2603. See id. ib. p. 62.

G 1026. MA , Director of King's *warb*-priests, Inspector of tenants, etc. Dyn. V-VI.

Plan of chapel, REISNER, *Giza Necropolis*, i, fig. 156.

Text on lintel of entrance doorway with dedication of son Khnemu , Inspector of tenants; DENNIS in *P.S.B.A.* xxvii (1905), p. 33 [6].

G 1029. SEKHEMKA , Prophet of Rē^c in the Sun-temple of Neuserre^c, Overseer of the department of tenants of the Great House, Prophet of Khufu, etc. End of Dyn. V or Dyn. VI.

Stone-built mastaba.

Plan XXIV

Plan and sections, REISNER, *Giza Necropolis*, i, figs. 14, 90; plan of chapel, fig. 155, p. 256.

Chapel.

(1)-(2) Five registers before deceased and son Peḥenptaḥ , I, scribes, men pulling papyrus, boat, and men netting fowl, II, boatmen in two boats jousting, ploughing, sowing, and rams treading grain, III, men pulling and binding flax, reaping corn, bringing donkeys, piling up sheaves, IV, men bringing wild animals, and another carrying fish, V, bringing bulls, man carrying bundle of papyrus, ends of IV-V, netting fish.

Men reaping, and quail, SMITH, *Hist. Eg. Sculp.* fig. 73, p. 198. See REISNER, op. cit. pp. 362-3 [2].

(3) Deceased seated before offerings, with two registers of offering-bringers.

(4) Deceased with son Peḥenptaḥ, and three registers of offering-bringers before them. Hands of deceased wrongly drawn, SMITH, op. cit. fig. 112, p. 276.

(5) False-door of deceased, upper lintel with offering-text and deceased and wife seated on left, panel with deceased at table, and men with joints of meat on jambs.

(6) Deceased and wife seated at table, with group of butchers below (unfinished).

G 1032. HETEPID $\frac{\text{𓆎}}{\text{𓆏}} \text{𓆑}$, Inspector of craftsmen of the *warbt*, Overseer of the ten, etc. Dyn. VI.

Wife, Setep $\frac{\text{𓆎}}{\text{𓆏}} \text{𓆑}$.

Offering-table of deceased, presented by son Iunkaf $\frac{\text{𓆎}}{\text{𓆏}} \text{𓆑}$, Overseer of the ten craftsmen of the *warbt*, in Berkeley Mus. 6.19761. LUTZ, *Steles*, pls. 6 [11], 7 [12, 13], 8 [14, 15]; text, SETHE, *Urk.* i (1933), 230 [5 (145), P].

Double-statuette, deceased and wife standing, in Berkeley Mus. 6.19781. LUTZ, *Statues*, pl. 35 [b], pp. 24–5; SMITH, *Hist. Eg. Sculp.* pl. 25 [c], pp. 62–3 [2].

Double-stature, sons, both called Iunkaf, Overseer, and Inspector, of the *warbt*, standing, in Berkeley Mus. 6.19782. LUTZ, *Statues*, pl. 31, p. 20; see SMITH, *op. cit.* p. 62 [1].

G 1036.

1. Scribe-stature, Judge and Royal scribe (no name), reading, late Dyn. V or Dyn. VI, probably from serdab of this tomb, in Berkeley Mus. 6.19765. LUTZ, *Statues*, pl. 25 [b], pp. 16–17; Berkeley. *Exhib.* 1966, fig. on p. 47; see SMITH, *Hist. Eg. Sculp.* p. 63 (description confused with No. 6.19756).

G 1039.

Stone-built mastaba.

REISNER, *Giza Necropolis*, i, p. 276 [4].

Statues. Late Dyn. V or Dyn. VI. See SMITH, *Hist. Eg. Sculp.* p. 63.

Serdab.

Intkaes $\frac{\text{𓆎}}{\text{𓆏}} \text{𓆑}$, Prophetess of Hathor Mistress-of-Dendera, seated, in Berkeley Mus. 6.19773. LUTZ, *Statues*, pls. 26 [b], 27 [a], pp. 17–18; Berkeley. *Exhib.* 1966, fig. on p. 30.

Man seated, in Berkeley Mus. 6.19774. LUTZ, *op. cit.* pl. 19, pp. 12–13 (called G 1214); Berkeley. *Exhib.* 1966, fig. on p. 31.

Corridor.

Statue-group, Mertash $\frac{\text{𓆎}}{\text{𓆏}} \text{𓆑}$, Overseer of the Treasury, etc., wife (?) (upper part only), seated, with son Senenu $\frac{\text{𓆎}}{\text{𓆏}} \text{𓆑}$, Scribe, standing, in Berkeley Mus. 6.19763. LUTZ, *op. cit.* pls. 36–7, pp. 25–6.

Iḥa $\frac{\text{𓆎}}{\text{𓆏}} \text{𓆑}$, Overseer of builders, standing, in Cairo Mus. Ent. 37715.

Man standing, dedicated by Iḥa, in Cairo Mus. Ent. 37721. HORNEMANN, *Types*, i, pl. 132.

Intkaes $\frac{\text{𓆎}}{\text{𓆏}} \text{𓆑}$, Royal acquaintance (woman), standing, in Berkeley Mus. 6.19800. LUTZ, *op. cit.* pl. 29 [b], p. 19; Berkeley. *Exhib.* 1966, fig. on p. 54.

Ipiwēr $\frac{\text{𓆎}}{\text{𓆏}} \text{𓆑}$, Inspector of builders, standing, in Berkeley Mus. 6.19799. LUTZ, *op. cit.* pl. 23 [a], p. 15; Berkeley. *Exhib.* 1966, fig. on p. 40.

Nebtneka $\frac{\text{𓆎}}{\text{𓆏}} \text{𓆑}$, Mistress of the house, etc., standing, in Cairo Mus. Ent. 37718.

Seated statue, black granite, in Berkeley Mus. 6.19809.

G 1040.

Stone-built mastaba.

REISNER, *Giza Necropolis*, i, p. 274 [10].

Seated statue of Teti, Inspector of builders, etc., and standing male and female statues, late Dyn. V or Dyn. VI, in Cairo Mus. Ent. 37720, 37722–3. SMITH, *Hist. Eg. Sculp.* pl. 25 [e], pp. 63–4.

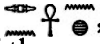
G 1047. NIANKHMIN , Prophet of the Pyramids of Menkauhor and Neuserre, Overseer of the new settlements, etc. Dyn. VI.

Stone-built mastaba.

Plan and section, REISNER, *Giza Necropolis*, i, fig. 15; plan of chapel, fig. 161, pp. 154 [30], 262 [b, 1].

False-door. Name and titles of deceased, DENNIS in *P.S.B.A.* xxvii (1905), p. 33 [7].

G 1061.

Offering-table of Prophetess of Hathor, etc. (unfinished), late Old Kingdom, in Berkeley Mus. 6.19813. LUTZ, *Steles*, pl. 5 [8].

G 1062.

Libation-basin of Henenef , Goldsmith, late Old Kingdom, in Cairo Mus. 57008. KAPLONY in *Mitt. Orientforschung*, xiv (1968), Taf. 10 [18], pp. 203-5 [8].

CEMETERY G 1100

Reisner Excavation. Hearst Expedition of the University of California (1903-5).

Plan X

G 1104. MES-SA . Late Dyn. V.

Brick-built mastaba.

REISNER, *Giza Necropolis*, i, p. 274 [15].

Statue of deceased seated, found in intact serdab, in Cairo Mus. Ent. 37717. See SMITH, *Hist. Eg. Sculp.* p. 64.

G 1105.

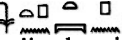

Brick-built mastaba.

REISNER, *Giza Necropolis*, i, p. 274 [17].

Statue of dwarf Petpennesut (?) , standing, late Dyn. V, in Cairo Mus. Ent. 37719. MASPERO, *Le Musée égyptien*, ii, pl. xxix; id. *Égypte*, fig. 149; ENGELBACH in *Ann. Serv.* xxxviii (1938), pl. xxxviii, pp. 285, 699; SMITH, *Hist. Eg. Sculp.* pl. 25 [d], pp. 58, 64; HORNEMANN, *Types*, i, pl. 134; see MASPERO, *Guide*, p. 67 [147]; *Descr. somm.* No. 6310.



G 1109.

REISNER, *Giza Necropolis*, i, p. 210 [38].

Statue-group, man with wife Mertib , seated, and three children (one of them Sitmert , Prophetess of Hathor), late Dyn. IV or early Dyn. V, in Berkeley Mus. 6.19785. LUTZ, *Statues*, pl. 33 [b], p. 22; see SMITH, *Hist. Eg. Sculp.* p. 62.

Mummy-mask, plaster, fragment, late Dyn. IV, from shaft A. See id. ib. pp. 24, 28 [7].

G 1111.

Offering-table of Thenti  and libation-basin of Iyankh , Dyn. V-VI, in Boston Mus. 13.3282-3.

G 1151. KEDNŪFER , Overseer of the department of tenants of the Great House, Prophet of Khufu, Prophet of Rē in the Sun-temple of Neuserre, etc. End of Dyn. V or later.

Wife, Hemtrē .

Plan XXIV

Plan of chapel, REISNER, *Giza Necropolis*, i, fig. 158, cf. 208. Name and titles, DENNIS in *P.S.B.A.* xxvii (1905), p. 34 [10]; cf. REISNER and FISHER in *Ann. Serv.* xiii (1914), p. 245.

I. Passage.

(1)–(2) Deceased with wife, and four registers, I–IV, scribes and men bringing animals (?), harvest-scenes, bringing bulls, ibexes, cranes, and men bringing fowl.

Man beating [donkey] from II, SMITH, *Hist. Eg. Sculp.* fig. 170 [middle], p. 311. Men with bull, and man with two cranes, from III and IV, id. ib. pl. 59 [b], pp. 248–9.

II. Offering-room.

(3) Deceased before offerings, and butchers below.

(4) Deceased and wife with small naked son, and four men below.

(5) False-door, panel, deceased and wife seated.

Finds

Statue-group, man and wife seated, with small son standing, in Berkeley Mus. 6.19806. LUTZ, *Statues*, pl. 33 [a], pp. 21–2; see SMITH, op. cit. p. 64.

G 1152.

Statuette of naked boy standing, wood, from burial chamber, end of Dyn. V or Dyn. VI, in Berkeley Mus. 6.19768. LUTZ, *Statues*, pls. 39, 40, cf. fig. 29 (*in situ*), p. 27; SMITH, *Hist. Eg. Sculp.* pl. 23 [c, d], pp. 59, 90; PIRENNE, *Hist. civ.* i, pl. 99 between pp. 316–17; Berkeley. *Exhib.* 1966, fig. on p. 36; WESTENDORF, *Das Alte Ägypten*, fig. on p. 62.

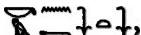

G 1157.

Seated statuette, Dyn. V, in Cairo Mus. See SMITH, op. cit. p. 64.

G 1171. KAEMTHENENT , King's *warb*-priest. Dyn. V–VI.

Entrance doorway. Jamb with deceased and wife (squeezed in later); see SMITH, *Hist. Eg. Sculp.* p. 64.

Finds

Statue of Kapuptah , Supervisor of the police, dedicated by Hehi  (woman), Dyn. V, found in débris, probably from here, in Cairo Mus. Ent. 37716. See id. ib. p. 64; text, FISCHER in *Mitt. Orientforschung*, vii (1960), fig. 2, pp. 301–2.

Head of male statue, Dyn. V–VI, in Boston Mus. 27.1125.

Musical instrument in shape of quail, faience, date uncertain, in Cairo Mus. 69716 HICKMANN, *Instruments de musique (Cat. Caire)*, pl. xlii [B, C], p. 72.

CEMETERY G 1200

Reisner Excavation. Hearst Expedition of the University of California (1903–5).

Plans IX, X

Plan, REISNER, *Giza Necropolis*, i, Map of Cemetery G 1200; views, pls. 9 [b], 10.

G 1201. WEPENNEFERT , King's son, Prophet of Heket, *heka*-priest of Mehyt, etc. Temp. Khufu.

Stone-built mastaba.

REISNER, *Giza Necropolis*, i, pp. 193 [17], 203 [1], 385-7; plans and sections, figs. 104, 216-17, cf. 199; views, pl. 11, cf. 21 [a].

Slab-stela with deceased at table and linen-list, found covered by limestone slab, in Berkeley Mus. 6.19825. Id. ib. pl. 17 [a]; LUTZ, *Steles*, pls. 1 [1], 48; KLEBS, *Reliefs . . . a.R.* Abb. 5, 104; STEINDORFF, *Kunst*, 194; CAPART, *Memphis*, fig. 351; WOLF in BOSSERT, *Geschichte des Kunstgewerbes*, iv, fig. on p. 90 [1]; SMITH, *Hist. Eg. Sculp.* pl. 32 [b], p. 160; id. *Art . . . Anc. Eg.* pl. 39, p. 61; id. in *Archaeology*, 16 (1963), cover, figs. 1, 4, 5 (stela *in situ*), pp. 2-5, 9-13 (plans with position of tomb, figs. 2, 3; detail in 1905 before cleaning, fig. 11, p. 9); WOLDERING, *Ägypten. Die Kunst der Pharaonen*, pl. on p. 66; Berkeley. *Exhib.* 1966, fig. on p. 42; GRIFFITH INST. photos. 308-10; F.E.R.E. photo. 2228; deceased, BAKER, *Furniture in the Ancient World*, pl. ii facing p. 16.

G 1203. KANŪFER , Overseer of commissions, Director of bowmen. Probably temp. Khufu.

Stone-built mastaba.

REISNER, *Giza Necropolis*, i, pp. 389-92; plan and section, fig. 1; of chapel, figs. 94a, 94b, p. 187 [2]; of shaft, fig. 219. Views of chapel, id. ib. pl. 12 [a, b]; id. and FISHER in *Ann. Serv.* xiii (1914), pl. iv [a], pp. 232, 233; SMITH (W. S.) in *Archaeology*, 16 (1963), fig. 6, p. 6.

Masons' graffito (date) on built-in fragment. Id. in *J.N.E.S.* xi (1952), fig. 6 [upper left], p. 127 [2]; see REISNER, op. cit. p. 391 [19].

Slab-stela with deceased at table and linen-list, in fragments. Id. ib. pl. 17 [b]; name and titles, id. and FISHER in *Ann. Serv.* xiii (1914), p. 235.

Reserve-head of wife (?), from shaft A, in Berkeley Mus. 6.19767. REISNER, op. cit. pls. 21 [f] (*in situ*), 22 [a-e]; id. in *Records of the Past*, iv (1905), fig. on p. 140; LUTZ, *Statues*, pl. 38 [a], p. 26; SCHARFF in OTTO, *Handbuch der Archäologie*, i, Taf. 75 [1]; SMITH, *Hist. Eg. Sculp.* pl. 9 [b], p. 26 [21]; Berkeley. *Exhib.* 1966, fig. on p. 29.

G 1204. AKHTIḤOTF. Middle Dyn. V or later.

Plan of chapel, REISNER, *Giza Necropolis*, i, fig. 154. See BAER, *Rank and Title in the Old Kingdom*, p. 52 [9].

G 1205. KHUFUNAKHT , Royal acquaintance. Temp. Khufu.

Stone-built mastaba.

REISNER, *Giza Necropolis*, i, pp. 392-4; plans and sections of chapel and shaft A, figs. 95, 221, p. 188 [3]; views, pls. 12 [c, d], 13 [a, b], 22 [f, g].

Masons' graffito with name of crew of Khufu and date. See id. ib. p. 76 note 2 (called G 1203); SMITH (W. S.) in *J.N.E.S.* xi (1952), p. 125 with note 18.

Slab-stela with deceased at table and linen-list, in Berkeley Mus. 6.19786. REISNER, op. cit. pl. 18 [a]; LUTZ, *Steles*, pl. 2 [3]; F.E.R.E. photo. 2226; name and title, REISNER and FISHER in *Ann. Serv.* xiii (1914), p. 236.

G 1206. IKHETNEB , Inspector of *warb*-priests, etc. Middle Dyn. V or later.

Stone-built mastaba. Chapel without decoration.



REISNER, *Giza Necropolis*, i, p. 218 [29].

Lintel of entrance doorway with name and titles of deceased.

North and west walls of chapel. Graffiti with name and titles of deceased.

Finds

Double-statue, man and wife standing (uninscribed), from serdab, in Berkeley Mus. 6.19775. REISNER in *Records of the Past*, iv (1905), fig. on p. 138; LUTZ, *Statues*, pls. 34, 35 [a], pp. 22-4; Berkeley. *Exhib.* 1966, fig. on p. 41; see SMITH, *Hist. Eg. Sculp.* p. 62.

Offering-table of Senenu , Director of members of a phyle, Prophet of Khufu, etc. (son of deceased), dedicated by son Akhtihotp  , Inspector of boats, Director of a crew of recruits, etc., found in front of serdab, in Berkeley Mus. 6.19752. LUTZ, *Steles*, pl. 3 [4]; Berkeley. *Exhib.* 1966, fig. on p. 52; part of text, SETHE, *Urk.* i (1933), p. 230 [5 (145), N].



G 1207. NŪFER , Royal acquaintance (woman). Temp. Khufu or later.

Stone-built mastaba.

REISNER, *Giza Necropolis*, i, pp. 394-6; plan of chapel and shaft, figs. 99, 222, pp. 113 [7], 190 [11]. Views of chapel with stela *in situ*, id. ib. pl. 13 [c-e]; SMITH (W. S.) in *Archaeology*, 16 (1963), fig. 7, p. 6; REISNER and FISHER in *Ann. Serv.* xiii (1914), pl. iv [b].

Block with masons' graffito with name of Khufu. See id. ib. p. 236.

Slab-stela with deceased at table and linen-list, in Berkeley Mus. 6.19801. REISNER, op. cit. pl. 18 [b]; LUTZ, *Steles*, pl. 2 [2]; Berkeley. *Exhib.* 1966, fig. on pp. 50-1; HASSAN, *Giza*, v, fig. 18, pp. 107-10; F.E.R.E. photo. 2227; name and title, REISNER and FISHER, op. cit. p. 236.

G 1208. AKHTIHOTP  , Prophet of Khufu, Overseer of the Pyramid of Khufu, Overseer of the expedition, etc. Middle Dyn. V or later.

Wife, Mertiotēs.

Plan of chapel, REISNER, *Giza Necropolis*, i, fig. 159.

Entrance doorway. Drum of deceased and wife.

G 1213.

Servant statuettes. Dyn. V or VI. In Berkeley Mus.

Man brewing beer, No. 6.19811. LUTZ, *Statues*, pl. 41 [a], pp. 27-8; Berkeley. *Exhib.* 1966, fig. on p. 45; SMITH, *Hist. Eg. Sculp.* fig. 15 [upper right], pp. 65, 97 [b, 4]; see BREASTED (Jr.), *Eg. Servant Statues*, p. 31 [4].

Woman grinding corn, No. 6.19766. LUTZ, op. cit. pl. 41 [b], p. 28; Berkeley. *Exhib.* 1966, fig. on p. 39; SMITH, op. cit. fig. 15 [upper left], pp. 65, 96.

Woman grinding corn, No. 6.19812. LUTZ, op. cit. pl. 42, pp. 28, 31; Berkeley. *Exhib.* 1966, fig. on p. 43.

G 1214.

Statues. Dyn. V. Found in serdab. In Berkeley Mus.

Kathesu  seated, No. 6.19770. LUTZ, *Statues*, pl. 18, p. 12; Berkeley. *Exhib.* 1966, fig. on p. 53; see SMITH, *Hist. Eg. Sculp.* p. 65 [1214, 1].

Ithetka  (woman), standing, No. 6.19772. LUTZ, op. cit. pls. 28 [b], 29 [a], pp. 18-19; Berkeley. *Exhib.* 1966, fig. on p. 34; see SMITH, op. cit. p. 65 [1214, 2].

G 1221. SHAD (?)  (?), Royal acquaintance. Probably Dyn. V.

Brick-built mastaba.

Plan of chapel, REISNER, *Giza Necropolis*, i, fig. 190, p. 292 [1].

Niche-stela with deceased standing, in Berkeley Mus. 6.19777. LUTZ, *Steles*, pl. 4 [7].

G 1223. KAEM^{CAH} , King's son, Overseer of the phylai of Upper Egypt, Greatest of the Ten of Upper Egypt. Temp. Khufu.

Stone-built mastaba.

REISNER, *Giza Necropolis*, i, pp. 398-403; plan and section, fig. 16; of chapel, fig. 111, p. 203 [2]; of shafts, figs. 33, 225-6, p. 93; views, pls. 14 [b-f], 15 [a], 23 [a, b].

Slab-stela with deceased at table and linen-list, in Cairo Mus. 57128. Id. ib. pl. 19 [a]; name and titles, id. and FISHER in *Ann. Serv.* xiii (1914), p. 236.

G 1225. NEFERTYABT , King's daughter. Middle Dyn. IV.

Stone-built mastaba.

REISNER, *Giza Necropolis*, i, pp. 193 [18], 203 [3], 403-5, cf. figs. 200-1. Plan, BOREUX in *Mon. Piot*, xxxvii (1940), fig. 1 (from W. S. Smith), p. 15; plans and sections of shafts with burial chambers, REISNER, op. cit. figs. 60-1, 229-30; views, pl. 15 [b-f]; of interior, pl. 23 [c, d]; of area between tombs G 1223 and G 1225, id. and FISHER in *Ann. Serv.* xiii (1914), pl. vii [a], pp. 234, 235.

Slab-stela with deceased at table and linen-list, removed by Ballard in 1902, formerly in Sambon and Curtis Collns., now in Louvre, E.15591. SCHÄFER, *Von äg. Kunst* (1919), Taf. 22 [1]; (1922 and 1930), Taf. 10 [1]; (1963), Taf. 11; Eng. ed. *Principles of Egyptian Art*, pl. 19; BOREUX in *R.E.A.* i (1927), pl. ii, pp. 5-14; id. in *Mon. Piot*, xxxvii (1940), pl. i, pp. 13-15; REISNER, op. cit. pl. 19 [b]; VANDIER, *Eg. Sculpture*, pls. 20-1; WOLF, *Die Welt der Ägypter*, Taf. 20 [lower]; POSENER, SAUNERON and YOYOTTE, *Dict. civ.* fig. on p. 45 (left part only); BRUNNER, *Hieroglyphische Chrestomathie*, Taf. 1; HARRIS, *Egyptian Art*, pl. 5; WOLDERING, *Götter*, Taf. vii on p. 61; HASSAN, *Giza*, v, fig. 19, pp. 110-13; see VANDIER, *Guide*, p. 9; id. in *Bulletin des Musées de France*, xi [8] (1946), p. 3.

Statues. Uninscribed, Dyn. VI, found by Ballard. Said to come from here but more likely from a small tomb nearby.

Seated woman, formerly in Sambon Colln. Paris. Galerie Georges Petit. *Catalogue des Objets d'Art* (SAMBON), May 25-8, 1914, 2nd pl. after p. 14 [No. 2] (called Şaqqâra).

Double-statue, man and wife seated, formerly in Sambon and Curtis Collns., now in private possession in France. Id. ib. 1st pl. [No. 1] (called Şaqqâra); FECHHEIMER, *Kleinplastik der Ägypter*, Taf. 12; BOREUX in *Mon. Piot*, xxxvii (1940), fig. 5 (from FECHHEIMER), p. 22; SALMANN in *The Connoisseur*, cxlviii (1961), fig. on p. 120 [lower].

Woman grinding corn, formerly in Sambon and von Bissing Collns. and The Hague, Scheurleer Mus., now in Leyden Mus. F.1934/12.1. Paris. Galerie Georges Petit. *Catalogue des Objets d'Art* (SAMBON), May 25-8, 1914, 1st pl. after p. 8 [No. 3] (called Şaqqâra); COHEN, *Egypte en Voor-Azië*, pl. 4; VON BISSING in *Bulletin van de Vereeniging . . . Antieke Beschaving*, vi [2] (1931), figs. on p. 11, cf. pp. 10-13; id. *Äg. Kunstgeschichte*, Taf. lxvii [405], *Text*, i, pp. 88, 161; Amsterdam. *Tentoonstelling van Antieke Voorwerpen uit Egypte en Voor-Azië*. 3 Oct.-31 Oct. 1931, No. 265 with fig.; WIJNGAARDEN in *Oudheid. Med.* n.r. xvii (1936), fig. 3, p. 10; id. *Meesterwerken der Egyptische Kunst te Leiden* (1938), pl. 18; *Uit de Schatkamers der Oudheid. Jubileumstentoonstelling 1898-1938*. Stedelijk

Museum, Amsterdam. 3 Sept.—16 Oct. 1938, pl. 10, p. 59 [161]; BREASTED (Jr.), *Eg. Servant Statues*, pl. 19 [a], p. 20 [1]; Leyden. *Artefact. 150 Jaar Rijksmuseum van Oudheden 1818—1968*, pl. 33, p. 33.

G 1226.

Head of statuette, Dyn. V or VI. See SMITH, *Hist. Eg. Sculp.* p. 65.

G 1227. SETHIHEKNET , Royal acquaintance (woman). Middle or late Dyn. IV.

Stone-built mastaba.

REISNER, *Giza Necropolis*, i, pp. 191 [14], 407–8; plan and sections of shaft A, figs. 32, 232; views, pls. 16 [a–d], 23 [e].

Slab-stela with deceased at table, linen-list and granaries, in Cairo Mus. 57127. Id. ib. pl. 20 [a]; SMITH (W. S.) in *Ā.Z.* 71 (1935), Taf. iv [upper], p. 135 [27]; name and title, REISNER and FISHER in *Ann. Serv.* xiii (1914), p. 236.

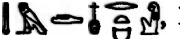
Lintel of Inkaf , Policeman, and wife Medunefert-hemt , late Old Kingdom, found nearby. FISCHER in *Mitt. Orientforschung*, vii (1960), fig. 1, pp. 300–1 with note 5.

G 1231. Not marked on plan.

Nude male statuette (headless), Dyn. V. See SMITH, *Hist. Eg. Sculp.* p. 65.

G 1234. 'ANKH-ḤAF , Judge and Boundary official of the Great House, Overseer of tenants of the Great House, Noble of the King. Late Dyn. V or Dyn. VI.

Plan XXIV

I. Court.

(1) Doorway. (a)–(b) Lintel, jamb, and drum, name and titles, (c) and (d) deceased as fat man with staff, bought 'at Kafr el-Baṭrān' in 1900, in Berlin (East) Mus. 15321 and Strasbourg, Univ. Inst. d'Égyptologie, 1361.

(c) SPIEGELBERG, *Ausgewählte Kunst-Denkmäler der Aegyptischen Sammlung (Strassburg)*, Taf. i [1a]; SCHÄFER, *Ägyptische Kunst in Kunstgeschichte in Bildern*, i, fig. on p. 14 [8]; id. *Von äg. Kunst* (1922 and 1930), Taf. 13 [2]; (1919 and 1963), Taf. 14 [2]; Eng. ed. *Principles of Egyptian Art*, pl. 24; id. and ANDRAE, *Kunst* (1925), 255 [2]; (1930 and 1942), 267 [2]; WOLF, *Kunst*, Abb. 233; upper part, MADSEN in *Ā.Z.* 42 (1905), Abb. 3, p. 68 with note 1; text, *Aeg. Inschr.* i, p. 26; see *Führer* (1961), p. 47.

(d) SPIEGELBERG, *op. cit.* Taf. i [1].

II. Offering-room. Painted decoration (now lost). Recorded in N. de G. Davies paintings, in Boston Mus.

(2) Fragment with male brewer treading pieces of bread in vat.

(3) Remains of netting fowl, with cattle crossing water in lowest register. See SMITH, *Hist. Eg. Sculp.* p. 197.

(4) Seated figure in panther skin.

(5) Feet of deceased.

G 1235. INY , Director of cattle-herdsmen and the pastures. Temp. Khufu.

Stone-built mastaba.

REISNER, *Giza Necropolis*, i, pp. 411-13; plan of chapel, fig. 101, pp. 190-1 [13]; plan and sections of shaft and chamber, figs. 71, 235, p. 163 [2]; views, pls. 16 [e, f], 24 [a, b]. Name and titles, id. and FISHER in *Ann. Serv.* xiii (1914), p. 236.



Slab-stela with deceased at table and linen-list, in Cairo Mus. 57127 bis. REISNER, op. cit. pl. 20 [b]; SMITH (W. S.) in *A.Z.* 71 (1935), Taf. iv [lower], p. 135 [28].

Libation-basin of deceased, found in chapel, in Berkeley Mus. 6.19798. LUTZ, *Steles*, pl. 5 [9]; REISNER, op. cit. fig. 236.

CEMETERY G 1300

Reisner Excavation. Hearst Expedition of the University of California (1903-5).

Plans IX, X

G 1301. MERNESUT  , King's *warb*-priest, Strong-of-voice of the granary of the interior (*hmnw*), Inspector of administrators, etc. Dyn. V.

Wife, Kames  , Overseer of female dancers, etc.

Stone-built mastaba.

See REISNER, *Giza Necropolis*, i, pp. 273 [3], 382 [6].

Chapel. West wall¹. In Detroit, Institute of Arts, 71.292.

False-door with deceased and wife at table on panel, and children and *ka*-servants on jambs.

South of false-door, deceased and wife at table, with offering-list before them.

Finds



Seated statue¹ of deceased, in Cairo Mus. Ent. 37713. See SMITH, *Hist. Eg. Sculp.* p. 65.

Window¹ of deceased, alabaster, in Cairo Mus. Ent. 37728.

G 1309. Dyn. V-VI.



Brick-built mastaba.

Plan of chapel, REISNER, *Giza Necropolis*, i, fig. 170, p. 277 [4].

Offering-table of Werkai  , King's *warb*-priest, etc., alabaster, in Cairo Mus. Ent.

72145.

Ointment-slab (inscribed), alabaster, in Cairo Mus. Ent. 72146.



G 1313. IYZEFA  , Tenant of the Great House, etc. Late Dyn. V or Dyn. VI.

Plan of chapel, REISNER, *Giza Necropolis*, i, fig. 160, p. 262 [a, 1].

G 1314. Second half of Dyn. V.

Architrave with figure of Kha¹kar² repeated nine times. See FISCHER in *Oudheid. Med.* xli (1960), p. 8, cf. fig. 3.

¹ See Addenda.

Double-statue, Kha'karē , Hairdresser of the Great House, with small naked son 'Ankhremens , standing, from serdab, in Berkeley Mus. 6.19780. LUTZ, *Statues*, pl. 22, pp. 14-15; Berkeley. *Exhib.* 1966, fig. on p. 46; see SMITH, *Hist. Eg. Sculp.* pp. 65-6.

G 1351. Dyn. V-VI.

Libation-basin of Shenu (?) , Inspector of *warb*-priests, etc., in Cairo Mus. 57003.

ABU-BAKR EXCAVATION (1949-50). EAST PART

University of Alexandria

Plan X

ABU-BAKR, *Giza*, passim; plan, 2nd plan at the beginning [right]. See LECLANT in *Orientalia*, N.S. 20 (1951), pp. 347-8.

AKHU , Overseer of corn-measurers, Elder of the house. Dyn. V or later.

Wife, Nefert , *mitrt*.

Stone-built mastaba.

ABU-BAKR, *Giza*, pp. 87-90 (with texts); plan and elevation, fig. 71; plans and sections of shafts, fig. 75.

East façade.

South false-door of deceased, with name and title on lintel and drum (*in situ*). Id. ib. pls. xlv, xlvi [A], xlvii, figs. 72A, 72B.

North false-door of deceased and wife. Id. ib. pl. xlvi [B, C], figs. 73A, 73B, 74.

Statues. From serdab behind south false-door,

View *in situ*, id. ib. pls. xlviii, xlix [A], pp. 89-90.

Deceased standing (uninscribed). Id. ib. pls. 1, li; LECLANT in *Orientalia*, N.S. 20 (1951), pl. xliii [29] pp. 347-8 [2].

Wife standing. ABU-BAKR, op. cit. pl. lii; LECLANT, op. cit. pl. xliii [30].

Mastaba C. Dyn. V or later.

Stone-built mastaba, uninscribed.

ABU-BAKR, *Giza*, pp. 91-2; plan, section, and elevation, fig. 76; plans and sections of shafts, fig. 78.

Left of south false-door in east façade, unfinished relief of man and woman embracing (?). Id. ib. pl. liii, fig. 77.

'ANKHU , Judge and Strong-of-voice of the granary. Dyn. V or later.

Rock-cut tomb.

ABU-BAKR, *Giza*, pp. 95-6 (with text); plan and elevations, fig. 82; sections of shafts, fig. 84.

Entrance doorway. Drum with titles of deceased; id. ib. pl. lv, fig. 83.

NIUZAPTAḤ , Overseer of *ka*-servants, Steward, etc. Dyn. V or later.

Wife, Kaemnūhet .

Rock-cut tomb.

ABU-BAKR, *Giza*, pp. 103–20 (with texts); plan and elevations, fig. 90; plans and sections of shafts, fig. 93; view of blocked serdab, pl. lviii [A].



Chapel.

(1) Stela above doorway with deceased standing, and drum with name and titles of deceased.

Id. ib. pl. lvii [A], figs. 91–2.

(2) Deceased with wife and three sons.

Id. ib. fig. 94.

(3) Unfinished palace-façade false-door. (4) Niche with rock-cut statue of man standing. (5) False-door of deceased, with deceased and wife at table on panel. (6) Children squatting before deceased and wife seated, register of offering-bringers below, and niche with three rock-cut standing statues (deceased, wife, and son) at bottom. (7) False-door of deceased, with Nebishet  and woman Teti  at table on panel. (8) Four registers, I (from left), straining beer and filling jars, II, grinding corn and baking cakes, III, kneading dough and heating pots, IV, sifting flour and grinding corn, and niche with two unfinished rock-cut statues at bottom.

Id. ib. figs. 95 [A–E]. (3) Id. ib. pl. lxii [A]. (4) Id. ib. pl. lxii [B]. (5)–(8) Id. ib. pl. lxiii [A]; LECLANT in *Orientalia*, N.S. 20 (1951), pl. xl [25], p. 348 [2, a] (called east wall). (5) and (6) Upper part, ABU-BAKR, op. cit. pl. lxiv. (6) Niche, id. ib. pls. lxi [B], lxiii [B]. (8) I–IV, id. ib. pl. lxv.

(9) Niche with two rock-cut standing statues of deceased.



Id. ib. pl. lxi [A], p. 106; LECLANT in *Orientalia*, N.S. 20 (1951), pl. xli [26], p. 348 [2, a].

Offering-stand (no text), and offering-table of eldest son Raʿwēr , in front of (6). ABU-BAKR, op. cit. pls. lviii [B], lxiii [B], figs. 95 [F, G], p. 116.

Statues. From serdab behind east part of south wall.

Raʿwēr standing. Id. ib. pls. lviii [c] (*in situ*), lix, p. 105; LECLANT in *Orientalia*, N.S. 20 (1951), pl. xlii [28], p. 348 [2, a].

Woman grinding corn. ABU-BAKR, op. cit. pl. lx, p. 106; LECLANT, op. cit. pl. xlii [27], p. 348 [2, a].

NEFERHERENPTAH , Inspector of metal-workers of the *wacht*, Overseer of carpenters, etc.  Dyn. V or later.

Wife, Thentetes , *mitri*.

Rock-cut tomb.

ABU-BAKR, *Giza*, pp. 121–3 (with texts); plan and elevations, fig. 96; plan and sections of shafts, fig. 97.

Entrance doorway. Drum of deceased and wife, id. ib. pl. lxvi [A], fig. 99. Thicknesses with unfinished reliefs of man and woman on both, id. ib. pls. lxvi [B], lxvii [B], pp. 122–3.

East wall, close to the doorway. Unfinished niche with rock-cut statues, man, woman, and child standing (full face sketch); id. ib. pl. lxvii [A], fig. 98; see LECLANT in *Orientalia*, N.S. 20 (1951), p. 348 [2, b].

Rock-cut tomb H. Dyn. V or later.

ABU-BAKR, *Giza*, pp. 125–7; plan and sections, fig. 100; plans and sections of shafts, figs. 102–3.

Rock-cut sarcophagus with palace-façade decoration. Id. *ib.* pl. lxxviii, figs. 101A, 101B; DESROCHES-NOBLECOURT in *Bulletin de la Société française d'Égyptologie*, No. 1 (1949), fig. on p. 9 [lower], cf. p. 14; see LECLANT in *Orientalia*, N.S. 20 (1951), p. 348 [2, c].

CEMETERY G 1400

Reisner Excavation. Hearst Expedition of the University of California (1903-5).

Plan IX



G 1402. Dyn. V.

Brick-built mastaba.

REISNER, *Giza Necropolis*, i, p. 274 [16].

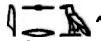
Statues. In Berkeley Mus.

Israni , *mitri* (woman), seated, No. 6.19802. LUTZ, *Statues*, pls. 27 [b], 28 [a], p. 18; see SMITH, *Hist. Eg. Sculp.* p. 66 [1402, 2].

Sabtu  with small son Irukaptah , standing, No. 6.19803. LUTZ, *op. cit.* pl. 30 [b], pp. 19-20; SMITH, *op. cit.* pl. 22 [a], pp. 40, 66 [1402, 1].

G 1452+1453. ZADUWA , Prophet of Khufu, Inspector of *wac*b-priests, etc. Middle Dyn. V or later.

Mastaba with rubble core encased in brick walls.

REISNER, *Giza Necropolis*, i, p. 216 [20].

Two offering-stands with name and titles of deceased, found each side of false-door of chapel. One, in Berkeley Mus. 6.19816, LUTZ, *Steles*, pl. 4 [6]; other, in Cairo Mus. 57002, GRDSELOFF MSS. 13 (photo.).

Offering-table of deceased, in Berkeley Mus. 6.19751. LUTZ, *op. cit.* pl. 3 [5]; Berkeley. *Exhib.* 1966, fig. on p. 49.

G 1457. NEFERTNESUT, Prophet of Khufu, Overseer of the Pyramid-town of Khufu, Overseer of the *wac*bt of the King, etc. Probably Dyn. V.

Mastaba with rubble core encased in brick walls.

Plan and section, REISNER, *Giza Necropolis*, i, fig. 12, p. 210 [37]. View, *id.* in *Boston Mus. Bull.* xxxiii (1935), fig. 2 on p. 70; of chapel with false-door, fig. 3 on p. 71.

Sealings with names of Menkaurē, from shaft A. *Id.* and SMITH, *Giza Necropolis*, ii, fig. 50, pp. 50-1.

G 1461. Position not marked on plan.

Drum of Nūfer , Overseer of scribes of the Pyramid of Khufu, Secretary, Overseer of the Treasury, Dyn. V-VI, found in débris, in Boston Mus. 21.3080. Text, GUNN MSS. iv.A.7 (6 middle); see A. S[ANBORN] in *Boston Mus. Bull.* xx (1922), p. 27; CAPART, *Documents*, ii, p. 23; SMITH, *Hist. Eg. Sculp.* p. 163 note 1.

CEMETERY G 1500

Reisner Excavation. Harvard-Boston Expedition.

G 1501.

Mastaba north of Cemetery G 1200. Position not marked on plan.

Double-statue, Ptahirkh, Steward, and wife Nitankh-hathor, seated, granite, Dyn. V, in Boston Mus. 12.1488. HORNEMANN, *Types*, v, pl. 1186; see SMITH, *Hist. Eg. Sculp.* p. 74.

CEMETERY G 1600

Reisner Excavation. Harvard-Boston Expedition (1931)

Plans IX, XVII

G 1607. IḳAN , Overseer of the House of weaving women, etc. Possibly late Dyn. IV.

Wife, Neferhanesut .

Rock-cut tomb, unfinished.

Plan XXIV

Plan and section, REISNER, *Giza Necropolis*, i, fig. 146, p. 241 [1].

(1) Thickness of doorway, deceased and wife seated, with daughter under chair, in Boston Mus. unnumbered (Exped. No. 32-3-4a).

Wife, SMITH, *Hist. Eg. Sculp.* fig. 151, p. 299.

(2) Deceased with wife seated, and offering-list.

(3) Pair of uninscribed false-doors.

(4) Two pairs of false-doors, with offering-text above.

G 1608. SENENU , Inspector of *ka*-servants. Possibly late Dyn. IV.

Rock-cut tomb.

Plan, REISNER, *Giza Necropolis*, i, fig. 147, p. 241 [3].

Statue of deceased seated, found behind slab covering niche at back of chapel, in Cairo Mus. Ent. 60546. SMITH, *Hist. Eg. Sculp.* pl. 22 [d], pp. 45-6; HORNEMANN, *Types*, iii, pl. 679.

G 1673.

Stone-built mastaba.

REISNER, *Giza Necropolis*, i, p. 275 [3].

Statues. Dyn. V-VI. See SMITH, *Hist. Eg. Sculp.* p. 66.

Man (no name) standing, in Boston Mus. 34.51.

Setymu , scribe-statue, in Cairo Mus. Ent. 60547. HORNEMANN, *Types*, ii, pl. 410.

CEMETERY G 1900

Reisner Excavation. Harvard-Boston Expedition

G 1903.

Mastaba north of Cemetery G 2000. Position not marked on plan.

Statuettes. Found in walled up niche in shaft. Late Dyn. VI.

Seated woman holding child, in Cairo Mus. Ent. 72142. SMITH, *Hist. Eg. Sculp.* pl. 27 [c], pp. 70-1; HORNEMANN, *Types*, v, pl. 1271.

Man seated, in Boston Mus. 39.829. See SMITH, *op. cit.* p. 71.

LARGE ISOLATED MASTABA G 2000

Reisner Excavation. Harvard-Boston Expedition

Plan XI

G 2000. Temp. Khufu or Khephren.

Stone-built mastaba. LG 23.

REISNER, *Giza Necropolis*, i, pp. 414-16; plans and sections, figs. 4, 237 [a], p. 212 [3]; views, pls. 25-6 [a, b]; see L. D. Text, i, p. 46.

Masons' graffito, from south chapel. SMITH (W. S.) in *J.N.E.S.* xi (1952), fig. 5 [top and middle right], p. 126 [B, 3].

Area east of tomb G 2000.

Rough female statuette (headless), Dyn. V-VI, found in débris, in Boston Mus. 06.1879. See SMITH, *Hist. Eg. Sculp.* p. 70.

Scribe's writing-board with names of estates in 10 columns, wood covered with plaster, broken, Dyn. VI, in Boston Mus. 13.4301. See id. ib. p. 359; names, JACQUET-GORDON, *Domaines*, pp. 264-6 [28G5], Nos. 1-24.



Area north of tomb G 2000.

Masons' graffito with date, on loose fragment. SMITH (W. S.) in *J.N.E.S.* xi (1952), fig. 8 [lower left], p. 127 [6].

CEMETERY G 2000¹

Reisner Excavation. Harvard-Boston Expedition (1905-6)

Plan XI

G 2001. THETU  good name KANESUT , Overseer of the Pyramid-town of Khufu, Inspector of *warb*-priests of the Pyramid of Khufu, Royal chamberlain of the Great House, etc. Dyn. V-VI.

Stone-built mastaba.



Plan XXV

Chapel. Plan, REISNER, *Giza Necropolis*, i, fig. 183, p. 286 [2].

- (1) Doorway. (a) and (b) Thicknesses with deceased.
- (2) False-door of Henti , Prophetess of Hathor, etc.
- (3) Address to visitors, including threat to vandals.
- (4) Deceased before offerings, and six offering-bringers below.

Second offering-bringer from left, SMITH, *Hist. Eg. Sculp.* frontispiece (from painting by Norman de G. Davies), pp. 222, 224.

- (5)-(7) At top, men lassoing bull.

(5) Nebt  , Prophetess of Hathor Mistress-of-the-Sycamore, etc., at table, smelling lotus, and offering-bringers (two male and one female) below.

- (6) False-door of Mesni  good name Thetu, Royal chamberlain.

(7) Man and wife Hetep , Prophetess of Hathor Mistress-of-the-Sycamore, etc. (presumably same as at (8)).

¹ All numbers G 2000 as given by FISHER, *The Minor Cemetery at Giza* are to be corrected to G 3000. See Cemetery G 3000, p. 95.

(8) False-door of Wazethotp $\bar{\text{W}} \begin{matrix} \square \\ \bar{\text{W}} \\ \square \end{matrix}$ (called also Hetep and Ipi $\bar{\text{I}} \square \bar{\text{I}}$).

(9) Four registers, oils, offering-bringers, and butchers.

(10) False-door of deceased.

(11) Deceased at table, with offering-list and funerary priests, and six offering-bringers at bottom (one of them Thetu good name Mesni, his eldest son).

(12) False-door of Nebt (same as at (5)).

(13)–(14) Cornice with address to passers-by, and below, architrave with titles of deceased.

(15) and (16) Pillars. Titles and names of deceased.

G 2002. ITETI $\bar{\text{I}} \begin{matrix} \square \\ \bar{\text{I}} \\ \square \end{matrix}$, Supervisor of tenants of the Great House. Dyn. V–VI.
False-door of deceased, in Boston Mus. 06.1888.

G 2004. PTAH-KHENU $\bar{\text{P}} \begin{matrix} \square \\ \bar{\text{P}} \\ \square \end{matrix}$, Supervisor of tenants of the Great House.
Middle Dyn. V.

Stone-built mastaba.

Plan of chapel, REISNER, *Giza Necropolis*, i, fig. 184, p. 286 [3].

Double-statue of deceased and wife standing, in Boston Mus. 06.1876. *Handbook* (1920), fig. on p. 13; O. B[ATES] in *Boston Mus. Bull.* v (1907), fig. on p. 20 [lower]; HORNEMANN, *Types*, v, pl. 1157; TERRACE in *The Connoisseur*, clxviii (1968), pl. 2, p. 199; RIEFSTAHL and CHAPMAN in *Boston Mus. Bull.* lxxviii (1970), fig. 9, p. 254; SMITH, *Anc. Eg.* (1942), fig. 28; (1952), fig. 29; (1960), fig. 32; see id. *Hist. Eg. Sculpt.* p. 69.

G 2009. MOSI $\bar{\text{M}} \begin{matrix} \square \\ \bar{\text{M}} \\ \square \end{matrix}$, Tenant. Middle Dyn. V.

Wife, Sesesekh (?) $\bar{\text{S}} \begin{matrix} \square \\ \bar{\text{S}} \\ \square \end{matrix}$, Prophetess of Hathor in all her places, Tenant.

Offering-tables, both found in chapel, of Khnemu $\bar{\text{K}} \begin{matrix} \square \\ \bar{\text{K}} \\ \square \end{matrix}$, Tenant, in Boston Mus. 06.1884, and Semerka $\bar{\text{S}} \begin{matrix} \square \\ \bar{\text{S}} \\ \square \end{matrix}$, Tenant, in Cairo Mus. Ent. 38674.

Statues. Found in serdab.

View *in situ*, O. B[ATES] in *Boston Mus. Bull.* v (1907), fig. on p. 21 [lower]; SMITH, *Anc. Eg.* (1942), fig. 29; (1952), fig. 30; (1960), fig. 33; id. *Hist. Eg. Sculpt.* pl. 24 [a].

Deceased and wife, double-statue, standing, in Cairo Mus. Ent. 38670. Id. ib. pl. 24 [b], p. 69 [1]; HORNEMANN, *Types*, v, pl. 1153.

Bau $\bar{\text{B}} \begin{matrix} \square \\ \bar{\text{B}} \\ \square \end{matrix}$, Tenant, and wife Baru (?) $\bar{\text{B}} \begin{matrix} \square \\ \bar{\text{B}} \\ \square \end{matrix}$ (?), Prophetess of Neith Opener-of-the-Ways, Tenant, double-statue, seated, in Boston Mus. 06.1885. O. B[ATES], op. cit. fig. on p. 21 [upper left]; SMITH, *Hist. Eg. Sculpt.* pl. 24 [c], p. 69 [2]; HORNEMANN, *Types*, v, pl. 1187.

Nikaukhufu $\bar{\text{N}} \begin{matrix} \square \\ \bar{\text{N}} \\ \square \end{matrix}$, Khuwiptah $\bar{\text{K}} \begin{matrix} \square \\ \bar{\text{K}} \\ \square \end{matrix}$, and Hes $\bar{\text{H}} \begin{matrix} \square \\ \bar{\text{H}} \\ \square \end{matrix}$, all Tenants, statue-group, standing, in Boston Mus. 06.1882. O. B[ATES], op. cit. fig. on p. 21 [upper right]; SMITH, *Hist. Eg. Sculpt.* pl. 24 [e], p. 69 [3]; HORNEMANN, *Types*, v, pl. 1360.

Ptahneperti $\bar{\text{P}} \begin{matrix} \square \\ \bar{\text{P}} \\ \square \end{matrix}$, Craftsman, as naked boy, standing, in Boston Mus. 06.1881. SMITH, *Hist. Eg. Sculpt.* pl. 24 [d], p. 69 [4]; HORNEMANN, *Types*, i, pl. 253.

G 2011. GREF $\bar{\text{G}} \begin{matrix} \square \\ \bar{\text{G}} \\ \square \end{matrix}$, Tenant, Craftsman. Dyn. V–VI.

Father, 'Ankh-haf $\bar{\text{A}} \begin{matrix} \square \\ \bar{\text{A}} \\ \square \end{matrix}$.

Stela in form of tomb-façade, in Cairo Mus. Ent. 38673.

Libation-basin of deceased, dedicated by father, in Boston Mus. 06.1880.

G 2021.

Unfinished false-door, Senüter $\bar{\text{S}} \begin{matrix} \square \\ \bar{\text{S}} \\ \square \end{matrix}$ seated, Dyn. V–VI, in Cairo Mus. Ent. 72136.

G 2032.

Statue of Senenu , Master of the Palace (*dbwt*), *warb*-priest of Rē, etc., seated, granite, end of Dyn. V, Boston Mus. 06.1877, now on loan to Birmingham (Alabama), City Art Mus. Text on left side, FISCHER in *J.A.R.C.E.* ii (1963), p. 25 [lower]. See SMITH, *Hist. Eg. Sculp.* p. 70.

G 2033. IRENRE^c , Judge and Book-keeper, Secretary of judgement. Probably Dyn. VI.

Lower part of false-door and lintel with row of six figures of deceased with texts, mention of Senenu  on left jamb.

Mummy-mask, plaster, from shaft C, in Boston Mus. unnumbered (Exped. No. 37-10-44). See SMITH, *Hist. Eg. Sculp.* p. 28 [9].

G 2035.

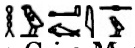
Statue-group, Weḥaṣisu  and wife seated, with small sons Khufusonb and Ity, late Dyn. V or Dyn. VI, in Cairo Mus. Ent. 38671. HORNEMANN, *Types*, vi, pl. 1462; see SMITH, *Hist. Eg. Sculp.* pp. 69-70.

G 2036.



Statue of Kheseḥ , Overseer of the House of *weḥar*-boats, seated, with female figure between feet, late Dyn. V or Dyn. VI, in Cairo Mus. Ent. 38672. HORNEMANN, *Types*, v, pl. 1180; see SMITH, *Hist. Eg. Sculp.* p. 70.

G 2037.

Large male statuette, wood, badly preserved, Dyn. V. See id. ib. p. 59.

G 2037b.

Mummy-mask, plaster, from shaft X (whole body originally covered), probably Dyn. VI, in Boston Mus. 39.828. SMITH, *Anc. Eg.* (1942 and 1952), fig. 36; (1960), fig. 37; SIMPSON in *M.M.A. Bull.* n.s. vii (June 1949), fig. on p. 291 [right]; WILSON, *The Burden of Egypt*, fig. 8 [d]; see SMITH, *Hist. Eg. Sculp.* p. 28 [11].

G 2041. SENENUKA  or KEKI , Overseer of the Pyramid-town of Khufu, Director of King's *warb*-priests, Boundary official of a settlement, etc. Early Dyn. V.

Wife, Iti .

Stone-built mastaba.

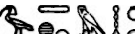

REISNER, *Giza Necropolis*, i, pp. 217 [22], 311 [g]. Name and title, id. and FISHER in *Ann. Serv.* xiii (1914), pp. 247-8.

Chapel.

West wall (the only one decorated). Between two false-doors, offering-list and two registers of offering-bringers and butchers before deceased at table, with daughter Akhtemḥenuti  behind, in Boston Mus. 07.1000.

Omitting false-doors, SMITH, *Hist. Eg. Sculp.* pl. 45 [b], p. 164; TERRACE in *The Connoisseur*, clxviii (1968), fig. 6, pp. 201-2; see SMITH, *Anc. Eg.* (1960), p. 38. North false-door, *Handbook* (1920), fig. on p. 29; GARDINER MSS. photo. 28.269; detail with wife seated, and unfinished figure of Akhtemḥenuti smelling lotus, CAPART, *L'Art ég.* iii, pl. 438.

Débris north of tomb.

False-door¹ of Tefnen , King's *wac*b-priest, Director of corn-measurers, Inspector of administrators of the granary, etc., and wife Pertim , with text of rewarding craftsmen, and family, offering-bringers, and baking and brewing scenes, including grinding corn on quern and in mortar, sifting flour, heating pots, straining beer, on jambs, Dyn. VI, in Cairo Mus. Ent. 56994. BAKIR, *Slavery in Pharaonic Egypt* in *Ann. Serv. Cahier*, No. 18 (1952), pl. i, p. 68; bottom, including two emaciated women grinding, FISCHER in *Artibus Asiae*, xxii [3] (1959), figs. 10, 11, p. 251; woman sifting, id. *Inscriptions from the Coptite Nome* in *Analecta Orientalia*, 40 (1964), fig. 11, p. 74; title, LUCAS and ROWE in *Ann. Serv.* xli (1942), fig. 73, p. 348.

G 2061.

Double-statue, couple (uninscribed), in Cairo Mus. Ent. 72137.

G 2070.

Not marked on plan.

Small head of statuette (much damaged). See SMITH, *Hist. Eg. Sculp.* p. 70.

G 2088.

Servant statuettes. Dyn. IV-V.

Nefertint  (woman) sifting flour, and lower part of woman 'Ankhma's, double-statue, in Cairo Mus. Ent. 72139. Id. ib. fig. 18 [b, right], p. 98 [e, 6]; BREASTED (Jr.), *Eg. Servant Statues*, pl. 29 [a], p. 29 [1]; VANDIER, *Manuel*, iii, pl. xxxix [12] (from BREASTED), p. 566 [xv].

Man cleaning goose. SMITH, op. cit. fig. 18 [c], p. 99 [g, 2]; BREASTED (Jr.), op. cit. pl. 42 [d], p. 43 [top, 2].

Man carrying jars, in Cairo Mus. Ent. 72140. SMITH, op. cit. fig. 18 [b, left], p. 100 [k, 4]; BREASTED (Jr.), op. cit. pl. 50 [c], p. 58 [4]; VANDIER, *Manuel*, iii, pl. xxxix [6] (from BREASTED), p. 566 [xii].

Woman grinding corn, fragmentary. See SMITH, op. cit. p. 96 [a, 15]; BREASTED (Jr.), op. cit. p. 19 [7].

G 2089.

Cylinder jar with name and titles of Kēdnūfer , Inspector of tenants of the Great House, etc., in ink, Dyn. VI (?), from shaft A. REISNER and SMITH, *Giza Necropolis*, ii, pl. 45 [h], fig. 136, p. 102.

G ^{2090?}2091. KAPI . Late Dyn. V or Dyn. VI.

Stone-built mastaba. Scenes in outer part now destroyed. Copied by N. de G. Davies.

Plan XXV

Plan and section of chapel, REISNER, *Giza Necropolis*, i, fig. 182, p. 285 [middle, 1].

I. Passage.

(1)-(2) [Marsh-scene] before deceased and family.

Man plucking bird, SMITH, *Hist. Eg. Sculp.* fig. 184; man with bowl between legs, fig. 212 (both copies of N. de G. DAVIES).

(3) [Presentation of cattle.]

¹ See Addenda.

II. Offering-room.

- (4) At top, furniture, and below, two registers of offering-bringers.
 (5) Deceased in pavilion with offering-bringer, and below, dancers and musicians.
 (6)–(8) At top, man with offerings and offering-list, and architrave with offering-text.
 (6) and (8) False-doors of deceased.
 (7) Palace-façade decoration.
 (9) and (10) On each, four registers, presentation of animals to deceased.
 (11) Pillar. (a) Two registers, family, with two men in each, (b) deceased, (c) wife and two daughters.

G 2092 + 2093. NIMA'ETRĒ'. Dyn. VI.

Stone-built mastaba.

Plan and section of chapel G 2093, REISNER, *Giza Necropolis*, i, fig. 186, p. 287 [2].

Mummy-mask (whole body originally covered), plaster, from shaft A, in Boston Mus. 37.644. Id. in *Boston Mus. Bull.* xxxvi (1938), fig. 7, pp. 27–8; see SMITH, *Hist. Eg. Sculp.* p. 28 [3]; id. *Anc. Eg.* (1942 and 1952) p. 60; (1960), p. 65.

G 2097. ISESIMERNETER  Late Dyn. V or early Dyn. VI.

Hunting scene. Two caracals (wild lynxes); KEIMER in *Ann. Serv.* xlvi (1948), pl. i, fig. 1, pp. 374 with note 2, 375–7. Wild asses; see id. in *Bull. Inst. Ég.* xxx (1947–8), p. 138. Ostrich; id. in *B.I.F.A.O.* lvi (1957), fig. 4, p. 100 with note 1.

G 2099. RARAMU , King's warb-priest of the Great House, etc. Dyn. VI.

Wife, 'Ankhet .

Statues and statuettes.

Deceased and wife standing, in Toledo (Ohio) Mus. 49.4. *The Toledo Museum of Art. Museum News*, n.s. 14 [1] (Spring 1971), *The Art of Egypt*, 1, fig. 11, p. 13.

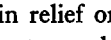
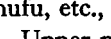
Deceased seated, and in relief on sides of seat, son Kaḥersetef , King's warb-priest, Prophet of Khufu, etc., and daughter Theset , in Toledo (Ohio) Mus. 49.5. Id. ib. fig. 13, p. 13. Upper part, *Guide. The Toledo Museum of Art founded by Edward Drummond Libbey*, fig. on p. 5 [lower].

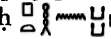
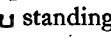
Deceased and Nikaupṭah , standing, with boy Kēdnas  between them, in Cairo Mus. Ent. 72138.

Kaḥersetef with name of Kēdnas on back, formerly in Boston Mus. 39.831, now in Richmond (Virginia) Mus. 49.21. BOTHMER in *Arts in Virginia*, iii [1] (1962), fig. 1, p. 24.



CEMETERY G 2100 AND MASTABA G 2220

Reisner and Junker Excavations. Harvard–Boston (1905–6, 1911–12, 1932–3), and Akademie der Wissenschaften in Wien, Pelizaeus (later Pelizaeus-Museum, Hildesheim), and University of Leipzig Expeditions.

Plan XI

Plan, REISNER, *Giza Necropolis*, i, Map of Cemetery G 2100; view before excavation, pl. 26 [c]. View of Junker excavation, JUNKER, *Giza*, ii, Taf. i [a].

G 2100-I-annexe. MERIB  (also KAPUNESUT, see p. 72), King's son of his body, Greatest of the seers in On, Treasurer of the God in the *ba-neteru*, *bar-neteru*, *neb-rekhyt*, and *dua-tawy* boats, etc. Temp. Menkaurē or Shepseskaf (Reisner) or early Dyn. V (Junker).

Mother, Sedit   , King's daughter of his body, Prophetess of Neith North-of-the-Wall, etc.







Stone-built mastaba. LG 24.

Plan XXIV

JUNKER, *Giza*, ii, pp. 121-35; L. D. *Text*, i, pp. 46-9; REISNER, *Giza Necropolis*, i, pp. 216 [17], 311 [j], 419-21, cf. 67. Plan and sections, L. D. i. 22. View, REISNER, op. cit. pl. 26 [d]; id. and FISHER in *Ann. Serv.* xiii (1914), pl. v [a], p. 236.

Chapel. In Berlin (East) Mus. 1107. Excavated and removed by Lepsius in 1842.

Description with plan, *Ausf. Verz.* pp. 48-50. Plan, L. D. *Text*, i, p. 46; *Aeg. Inschr.* i, p. 88. Synopsis of scenes, JUNKER, *Giza*, iii, pp. 36-7 [18]. Texts, *Aeg. Inschr.* i, pp. 88-100.

(1) Doorway. (a)-(b) Lintel, offering-text with deceased on left, and drum with name and titles, jambs, (a) deceased with son Khufumerneteru       ¹, (b) with son Merib-nezes. (c) Deceased leaning on staff, and three children, including daughter Nensezerkai [I] (tomb G 2101) and son Khufumerneteru, before him. (d) Deceased and small son Merib-nezes, and man handing in list of offerings with offering-bringer before him. (e) Three registers, bull, calf, and oryx.

(a)-(b) L. D. ii. 18; *Aeg. und Vorderasiat. Alterthümer*, Taf. 91; *Ausf. Verz.* Abb. 5; SCHÄFER, *Ägyptische Kunst in Kunstgeschichte in Bildern*, i, fig. on p. 8 [7]; id. and ANDRAE, *Kunst* (1925), 211; (1930) and (1942), 219; PIJOÁN, *Summa Artis*, iii (1945), fig. 149; GRIFFITH INST. photo. 300. (a) and (b) PEET in HAMMERTON, *Universal History of the World*, i, fig. on p. 502 [upper]; heads of deceased, L. D. iii. 288 [4, 5]. (b) HAMANN, *Äg. Kunst*, Abb. 9; BARTA, *Das Selbstzeugnis eines altägyptischen Künstlers*, Taf. xx [33] (from MARBURG INST. photo. 67515). (c) L. D. ii. 22 [a, left]; HAMANN, op. cit. Abb. 123. (d) L. D. ii. 22 [b]; WRESZ., *Atlas*, iii. 67; JUNKER, *Giza*, ii, Abb. 11, p. 129. (e) L. D. ii. 22 [a, right]; bull, PIRENNE, *Hist. civ.* i, pl. 43 between pp. 140-1.

(2) (above doorway) Two registers, deceased in sailing-boat, and in boat being paddled. L. D. ii. 22 [d]; DUEMICHEN, *Flotte*, Taf. xxv [4, 9]; ASSMANN in BORCHARDT, *Das Grabdenkmal des Königs S'ashu-rc*, ii, Abb. 22-3; WRESZ., *Atlas*, iii. 113; lower boat, MÜLLER (H.) in *Mitt. Kairo*, 7 (1937), Abb. 15, p. 75.

(3) Five registers, I-III, estates, IV, men with animals and linen, V, group of butchers, between deceased with mother on left and deceased on right.

L. D. ii. 21. I-III, names of estates, JACQUET-GORDON, *Domaines*, pp. 229-31 [I3G4-5], cf. figs. 35-6. V, HAMANN, *Äg. Kunst*, Abb. 147.

(4) Four registers with offering-bringer in each before deceased, mother, and small son. L. D. ii. 20 [f]; HAMANN, op. cit. Abb. 122; head of deceased, CAPART, *Documents*, ii, pl. 24; id. *L'Art ég.* iii, pl. 440; SMITH, *Hist. Eg. Sculp.* pl. 46 [c], pp. 165, 302; head of mother, L. D. iii. 288 [6].

(5) Deceased seated with three men before him receives accounts of weavers, and two registers below, offering-bringers and butchers.

L. D. ii. 20 [a]; SCHÄFER and ANDRAE, *Kunst* (1925), 212 [left]; (1930 and 1942), 220 [left].

¹ The sign is facing right.

(6) False-door of deceased. (7) Deceased with children, and seven registers of presentation scenes, with scribes, offering-bringers, and men bringing various articles and animals. (8) False-door, with deceased at table and linen-list on panel, above, funerary priests before deceased at table, and on right, four offering-bringers.

L. D. ii. 19; SCHÄFER and ANDRAE, *Kunst* (1925), 212 [right] (1930 and 1942), 220 [right]. Thicknesses of (6) and (8), L. D. ii. 20 [b-e].

(9) Deceased seated receives list of offerings from scribes in two registers, with offerings above, and register of offering-bringers and group of butchers under whole scene.

L. D. ii. 22 [c].

G 2101. NENSEZERKAI [I] , King's daughter, King's adorer, Prophetess of Ḥathor and Khufu. Dyn. V.

Father, Merib called Kapunesut  (tomb G 2100-I-annexe).

Stone-built mastaba.

Plan XXV

JUNKER, *Giza*, ii, pp. 97-121; id. in *Anzeiger, Wien*, xlix (1912), pp. 90-4. Plan and sections, id. *Giza*, ii, Abb. 1-6; vi, on Abb. 78. Plan of chapel, REISNER, *Giza Necropolis*, i, fig. 174 (after JUNKER). Views, JUNKER, *Giza*, ii, Taf. i [b], ii; id. in *Anzeiger, Wien*, xlix (1912), Taf. ii; SCHÄFER, *Ägyptische Kunst in Kunstgeschichte in Bildern*, i, fig. on p. 8 [6] (by JUNKER); CAPART, *L'Art ég.* i, pl. 25; id. *Memphis*, figs. 298, 300; SCHÄFER and ANDRAE, *Kunst* (1925), 210 [lower]; (1930 and 1942), 218 [lower]; VON BISSING, *Äg. Kunstgeschichte*, Taf. lxxiii [436, 436a], *Text*, i, p. 76; ii, p. 107; SCHARFF in OTTO, *Handbuch der Archäologie*, i, Taf. 64 [1].

I. Pillared Hall.

(1)-(2) Architrave with offering-text and deceased at table.

JUNKER, *Giza*, ii, Abb. 7 [upper], pp. 114, 116, 118.

(3) and (4) Pillars. (a) Deceased standing, (b) father, called Kapunesut on (3) and Merib on (4), with deceased as small girl.

Id. ib. Taf. iii [a, b], Abb. 8, p. 118.

II. Offering-room.



(5) Doorway. (a)-(b) Lintel with offering-text and drum with name and titles.

Id. ib. Taf. iv [b], Abb. 7 [lower], p. 118.

(6) and (7) False-doors of deceased.

(6) Id. ib. Taf. iv [a], Abb. 10, p. 121; id. in *Anzeiger, Wien*, xlix (1912), Taf. iii. (7) Id. *Giza*, ii, Taf. iii [c] (upper lintel), Abb. 9, pp. 118, 121.

Found nearby

Lintel with offering-text, and Niptah  called Khuwiptah , Overseer of carpenters of the *is*-chamber of the Royal House, and wife Peseshet , Prophetess of Ḥathor Mistress-of-the-Deserts, etc., seated, late Old Kingdom, in Vienna Mus. Inv. 8550. JUNKER, *Giza*, viii, Taf. xxviii [a], Abb. 91, pp. 174-6.

G 2110. NÜFER , Overseer of scribes of the crews, Director of a crew of recruits, Overseer of the House of Weapons, etc. Temp. Khephren.

Wife, Meresankh, *mitrt*.

Stone-built mastaba.

REISNER, *Giza Necropolis*, i, pp. 201 [3], 422-5; plans and sections of various parts, figs. 109, 205, 240, pp. 201, 375; views, pls. 29, 34 [a].

Masons' graffito with name of deceased, on foundation block. SMITH (W. S.) in *J.N.E.S.* xi (1952), fig. 5 [lower middle right], p. 126 [B, 4].

Chapel. Synopsis of scenes, JUNKER, *Giza*, iii, p. 36 [17].

Present location of fragments of reliefs, see SMITH (W. S.) in *A.Ĵ.A.* xlvi (1942), pp. 509-10; id. *Hist. Eg. Sculp.* p. 163 note 1; BOSTICCO in *Atti dell'Accademia dei Lincei. Rendiconti . . . Scienze morali, storiche e filologiche*, Ser. viii, vol. ix (1954), pp. 104-5.

(1) Doorway. (a) Funerary priests and offering-bringers in three registers before deceased at table, formerly in Prince Napoleon Colln., now in Louvre, B 51 [D 59; E.5599]; (b) four scribes, including Nofru  and Senenuka (tomb G 2041), before deceased, in Boston Mus. 07.1002.

(a) CAPART, *Documents*, ii, pl. 23 [B]; id. *Memphis*, fig. 344; REISNER, *Giza Necropolis*, i, pl. 30 [a]; two upper registers, RICHER, *Le Nu*, fig. 73; texts, PIERRET, *Recueil d'inscriptions inédites du Musée égyptien du Louvre*, ii, in *Études égyptologiques*, viii (1878), pp. 56-7; DEVÉRIA squeezes, 6169, ii. 53; see DE ROUGÉ, *Notice des Monuments* [etc.] (1883), p. 210; BOREUX, *Guide*, i, p. 245; VANDIER, *Guide*, p. 6.

(b) *Handbook* (1920), figs. on pp. 27-8; CAPART, *Documents*, ii, pl. 23 [A]; WRESZ., *Atlas*, iii. 66; REISNER, op. cit. pl. 30 [b]; SMITH, *Anc. Eg.* (1942), fig. 13; (1952) fig. 13 (head of deceased only); (1960), fig. 15; DUNHAM, *Eg. Department*, fig. 121; TERRACE in *The Connoisseur*, clxviii (1968), fig. 7, p. 202; MICHALOWSKI, *Art*, fig. 187 (called Cairo Mus.); upper part of deceased, SMITH (W. S.) in *A.Ĵ.A.* xlv (1941), fig. 7, p. 528; *Handbook* (1964), fig. on p. 175 [upper]; SMITH, *Hist. Eg. Sculp.* pl. 48 [e], p. 163; head of deceased, DUNHAM in *Boston Mus. Bull.* xli (1943), fig. 4, p. 69; deceased and scribes, PIJOÁN, *Summa Artis*, iii (1945), figs. 238-9; scribes, CAPART, *Memphis*, fig. 262; Nofru, SIMPSON and others, *The Literature of Ancient Egypt*, fig. 4; his scribe's equipment, TERRACE, op. cit. fig. 8, p. 203.

(2) Deceased and wife standing (upper part in Boston Mus. 31.780).

REISNER, op. cit. pl. 33. Blocks in Boston, *Boston Mus. Bull.* xxix (1931), fig. on p. 120; SMITH, *Anc. Eg.* (1942 and 1952), fig. 14.

(3) Deceased and wife seated, titles of deceased and remains of name of his wife, and two registers, I, offering-bringers, II, two groups of butchers (blocks with titles and I and II in Copenhagen, Ny Carlsberg Glypt. Æ.I.N. 819).

Deceased and wife, *in situ*, REISNER, op. cit. pl. 32 [a], fig. 241 [left] facing p. 424; part, SMITH, *Hist. Eg. Sculp.* fig. 120. Blocks in Copenhagen, SCHMIDT, *Choix de Monuments Égyptiens* (1910), pl. iii [3], p. 13; MOGENSEN, *La Collection égyptienne* (1930), pl. xciii [A 667], p. 89; KOEFOED-PETERSEN, *Catalogue des bas-reliefs et peintures égyptiens* (1956), pl. xiii, pp. 16 [5], 68; REISNER, op. cit. pl. 32 [b], fig. 241 [middle] facing p. 424; I and II, KLEBS, *Reliefs . . . a.R.* Abb. 99; texts, KOEFOED-PETERSEN, *Recueil des inscriptions hiéroglyphiques* [etc.] in *Bibliotheca Aegyptiaca*, vi, p. 78 [819]; see SCHMIDT, *Den Ægyptiske Samling* (1908), pp. 54-6 [E. 12].

(4) Panel and lintel of false-door, in one piece, with deceased at table, linen-list and granaries, formerly in Prince Napoleon Colln., now in Rome, Museo Barracco, 1.

BARRACCO and HELBIG, *La Collection Barracco* [etc.] (1893), pl. i, *Texte*, p. 11; PIETRANGELI, *Museo Barracco di Sculture Antica. Guida* (1960), Tav. v, pp. 46-7; (1963), Tav. v, pp. 53-4; WEILL, *Les Origines de l'Égypte pharaonique*, i, *La II^e et la III^e dynasties* in *Annales*

du Musée Guimet, xxv (1908), pl. iv (from BARRACCO and HELBIG), pp. 236-42; REISNER, op. cit. pl. 31 [c], fig. 241 [right] facing p. 424; BOSTICCO in *Atti dell'Accademia dei Lincei. Rendiconti . . . Scienze morali, storiche e filologiche*, Ser. viii, Vol. ix (1954), figs. 1-3, pp. 103-21; ALINARI photo. 34760; see PIETRANGELI, op. cit. (1949), pp. 36-7.

(5) Deceased and wife (heads destroyed), and three registers of presentation scenes, I, estates (destroyed), II-III, scribes recording and men bringing animals (II-III in Copenhagen, Ny Carlsberg Glypt. Æ.I.N. 937).

REISNER, op. cit. fig. 242, cf. p. 423 note 1; deceased and wife, *in situ*, pl. 31 [a]. Blocks in Copenhagen, id. ib. pl. 31 [b]; SCHMIDT, *Choix de Monuments Égyptiens* (1910), pl. iv [6]; MOGENSEN, *La Collection égyptienne* (1930), pl. xciv [A 673], p. 90; KOEFOED-PETERSEN, *Catalogue des bas-reliefs et peintures égyptiens* (1956), pl. xiv, pp. 16-17 [6], cf. p. 69; texts, id. *Recueil des inscriptions hiéroglyphiques* [etc.] in *Bibliotheca Aegyptiaca*, vi, p. 77 [937]; see SCHMIDT, *Den Ægyptiske Samling* (1908), pp. 56-8 [E. 13].

Shaft A. Plan and section, REISNER, op. cit. fig. 22.

Reserve-head of deceased, from débris, in Boston Mus. 06.1886. Id. ib. pl. 34 [b-f]; *Handbook* (1920), fig. on p. 26; *Boston Mus. Bull.* iv (1906), cover; O. B[ATES] in ib. v (1907), fig. on p. 20 [upper left]; DELBRÜCK, *Antike Porträts* (1912), Taf. 3; SMITH (W. S.) in *A. J. A.* xlv (1941), fig. 6, p. 527; id. *Anc. Eg.* (1942 and 1952), fig. 12; (1960), fig. 14; id. *Hist. Eg. Sculp.* pl. 48 [d], pp. 27 [22], 303; CAPART, *L'Art ég.* ii, pl. 228; DUNHAM in *Boston Mus. Bull.* xli (1943), fig. 3, p. 69; id. *Eg. Department*, fig. 27 [a]; VANDIER, *Eg. Sculpture*, pl. 18; MONTET, *Eternal Egypt*, pl. 31.

G 2113.

Panel and lintel of false-door, in one piece, unfinished, Thenti, Scribe of the royal documents, with wife . . .kau at table, late Old Kingdom, in Cairo Mus. Ent. 72135.

G 2120. SESHETSEKHENTIU , Chief lector-priest. Middle or late Dyn. IV.

Stone-built mastaba.

REISNER, *Giza Necropolis*, i, pp. 425-30; plans and sections of chapel and shaft A, figs. 243-4, cf. 202; views, pls. 34 [g], 35 [a-d].

Chapel. Unfinished.

Masons' graffito with date, on wall north of false-door. SMITH (W. S.) in *J.N.E.S.* xi (1952), fig. 6 [lower left], p. 127 [3]; see REISNER, op. cit. pp. 76 note 1, 427.

Slab-stela with deceased at table, offering-list, linen-list and granaries, in 14 fragments, probably from here, in Boston Mus. 06.1894. Id. ib. pl. 39 [a].

Drum, fragments with remains of text, red granite, position uncertain. Id. ib. fig. 246.

G 2130. KHENTKA (?) , King's son [of his body], Sole companion. Probably temp. Khufu.

Stone-built mastaba.

Plan XXIV

REISNER, *Giza Necropolis*, i, pp. 430-3, cf. fig. 247; views, pls. 35 [e, f], 36 [a, b, e, f]; id. and FISHER in *Ann. Serv.* xiii (1914), pl. v [b], pp. 236-7.

Masons' graffito with date on casing stone of west face. SMITH (W. S.) in *J.N.E.S.* xi (1952), fig. 6 [upper right], p. 127 [4].

Interior offering-room of south chapel. Plan, REISNER, op. cit. fig. 112, cf. 196, p. 203 [6].

(1) Thickness of doorway with remains of seated figure. Id. ib. fig. 248 [middle left].

(2) Remains of men bringing animals. Id. ib. fig. 248 [bottom].

(3) Remains of false-door with figure of deceased on right jamb and [estate] on right outer thickness. Id. ib. pl. 36 [c, d], fig. 248 [top].

Shaft A. Plan and section, id. ib. fig. 19.

Jar-sealing with Horus-name of Khufu, fragments. Id. ib. fig. 249 [a], p. 433; id. and SMITH, *Giza Necropolis*, ii, fig. 48, p. 50.

G 2132.

False-door of Seniwehemu , King's *warb*-priest, *ka*-servant, etc., Dyn. VI, in Boston Mus. 27.444 (lower part acquired later from a dealer). Lower part, *Chron. d'Ég.* xii (1937), fig. on p. 241; upper part, GARDINER MSS. photo. 28.271; son embraced by mother (?) Nūfer, at back of niche, FISCHER in *J.N.E.S.* xviii (1959), fig. 14 [c], pp. 248-9 with note 39; see *Boston Mus. Bull.* xxv (1927), p. 60; Museum of Fine Arts, Boston. *63rd Annual Report* (1938), p. 41; *Chron. d'Ég.* xiv (1939), p. 158.

ḲEDFY , Overseer of *ka*-servants, etc. End of Dyn. V or later.

Stone-built mastaba.

JUNKER, *Giza*, vi, pp. 80-92; plans and sections, Abb. 21-4; views, Taf. vi, and fig. on p. vii. See id. in *Anzeiger, Wien*, xlix (1912), p. 92.

Statues. From serdab.

Deceased seated (headless), in Vienna Mus. Inv. 7443. Id. *Giza*, vi, Taf. vii, Abb. 25, pp. 90-2.

Remains of female statue. See id. ib. pp. 90, 92.

G 2135. Middle or late Dyn. IV.

Stone-built mastaba south of tomb G 2140. VIIInn of Junker. (There is another G 2135 north of tomb G 2150.)

JUNKER, *Giza*, i, pp. 227-31; plan and section, Abb. 52; view, Taf. xxxvii [a].

Fragment of slab-stela with linen-list, probably from outer face. Id. ib. Taf. xxxvii [b], Abb. 53 [b = upper right].

Sarcophagus (uninscribed), found in fragments in burial chamber, in Hildesheim Mus. 3051. Id. ib. Taf. xi [a], Abb. 5 [lower], p. 56; see DONADONI ROVERI, *Sarcophagi egizi*, p. 122 [B 30].

NŪFER [III] . Late Old Kingdom.

Brick-built mastaba with stone casing.

Plan, JUNKER, *Giza*, vi, on Abb. 26.

Remains of text on north inner jamb of false-door. See id. ib. p. 94.



NIMA'ETRĒ' , Overseer of commissions of the Great House. Late Old Kingdom.

Stone-built mastaba.

JUNKER, *Giza*, vi, pp. 154-5; plan, on Abb. 27.

Double-statue of deceased and wife standing, from serdab, in Cairo Mus. Ent. 43962. Id. ib. Taf. xxiii [b], Abb. 50; see id. in *Anzeiger, Wien*, 50 (1913), p. 184 [b].

G 2136. KAḤIF , Inspector of tenants of the Great House, King's war-priest, Prophet of Horus *mddw* (Khufu), of *mdd-r-nbty* (*nebty*-name of Khufu), and of Khufu, etc. Middle Dyn. VI.

Parents, Maꜥ , Royal scribe, and Khnemt . Wife, Henutsen , Royal acquaintance.

Stone-built mastaba south of tomb G 2140. There is another G 2136 north of tomb G 2150.

Plan XXV

JUNKER, *Giza*, vi, pp. 94-153; id. in *Anzeiger, Wien*, 50 (1913), pp. 163, 175-9; SMITH, *Hist. Eg. Sculpt.* p. 198. Plan, section, and elevation, JUNKER, *Giza*, vi, Abb. 27.

Chapel. Synopsis of scenes, id. ib. iii, pp. 39-40 [27].

(1) Doorway. (a)-(b) Lintel with offering-text, in Vienna Mus. Inv. 8211, and drum with name and titles of deceased; (c) and (d) deceased and wife standing.

(a)-(b) Id. ib. vi, Abb. 28, 29 [middle]. (c) and (d) Id. ib. Abb. 29 [left and right], p. 105.

(2)-(3) Deceased with wife squatting beside him (much destroyed), and five registers, I, lost, II (right to left), rams treading grain, ploughing, netting fish, III, pulling flax, tying up bundles, making ropes, bringing donkey-herd, [boat], IV, corn-reapers with man playing flute, donkeys carrying produce, V, winnowing, donkeys threshing, piling up sheaves.

Id. ib. Taf. x [b], xii-xiv, Abb. 41-3, 45-7, pp. 130-53; id. in *Anzeiger, Wien*, 50 (1913), Taf. vi. Reapers from IV, id. *Zu einigen Reden* [etc.] in *Sitzungsb. Wien*, 221 [5] (1943), Abb. 1, p. 9; two, id. *Giza*, vi, Abb. 44 [6, 10]; with flute-player, HICKMANN, *45 Siècles*, pl. ix; id. *Ägypten*, Abb. 45.

(4) Banquet before deceased and wife at table, and registers of food, guests, and grandchildren as harpists and singer and at small tables.

JUNKER, *Giza*, vi, Abb. 38a, 38b, pp. 121, 124.

(5)-(6) Upper part, deceased at table, with offering-list and eldest son Zednefert (tomb, see infra, p. 77) on right.

Id. ib. Taf. viii [b], Abb. 33, pp. 111-14; disposition of scenes on west wall, Abb. 30.

(5) Lower part, false-door with deceased at table on panel.

Id. ib. Abb. 31, pp. 107, 109.

(6) Lower part, offerings and sons as offering-bringers before deceased seated receiving list from scribe, with butchers below.

Id. ib. Taf. ix, Abb. 34-7, pp. 114-21.

(7) False-door with deceased and mother at tables facing each other on panel, and three registers of ancestors right of it.

Id. ib. Taf. viii [a], x [a], Abb. 32, pp. 109-11, cf. 98-9.

(8) [1st ed. 3] Deceased leaning on staff with small son Zednefert and four registers of men bringing animals and fowl.

Id. ib. Abb. 40, pp. 126-30; id. in *Anzeiger, Wien*, 50 (1913), Taf. vii. Three lower registers, id. *Giza*, vi, Taf. xi.

ZEDNEFERT , Secretary, Tenant. Late Dyn. VI.

Parents, Kaḥif and Ḥenuksen (see tomb G 2136).

Stone-built mastaba between tombs G 2140 and G 2135.

JUNKER, *Giza*, vi, pp. 153-4; plan and sections, on Abb. 27, 48.

Lower part of north false-door. Id. ib. Abb. 49; lintel with remains of text, see pp. 153-4.



G 2140. Late Dyn. IV or Dyn. V.

Stone-built mastaba.

REISNER, *Giza Necropolis*, i, pp. 436-7; plans and sections of chapel and shaft, figs. 254-5, pp. 203 [7], 436-7; view, pl. 38 [a].

Lintel of false-door with unfinished offering-text. Id. ib. pl. 38 [b].

G 2150. KANŪFER , Overseer of commissions, Herdsman of the White Bull, Director of the Palace, etc. Early Dyn. V.

Mother (probably), Meres'ankh , Royal acquaintance (possibly same as wife of Nūfer, tomb G 2110). Wife, Shepsetkau , Prophetess of Ḥathor and Neith, etc.

Stone-built mastaba.

Plan XXV

REISNER, *Giza Necropolis*, i, pp. 437-45, cf. fig. 86; plan of chapel, figs. 123, 265, cf. 206, pp. 214 [6], 311; plans and sections of shaft A, fig. 266; views, pl. 38 [c-e]; some titles, p. 67; JUNKER, *Giza*, vii, p. 161.

North subsidiary niche. In east façade.

Unfinished lintel with titles, on ground in front of tomb. REISNER, op. cit. fig. 263 [lower] facing p. 442, cf. p. 444.

Interior offering-room. Synopsis of scenes, JUNKER, *Giza*, iii, p. 37 [19] (called G 2130).

(1) Doorway. (a) Four *ka*-servants with offerings before [deceased] and son Kas[euza] (tomb, possibly, G 5340) standing, and remains of others behind, right part in Boston Mus. 34.58. (b) Deceased and Meres'ankh standing, left part in Boston Mus. 34.57. (c) Remains of three registers, four men bringing various articles and dwarf carrying monkey. (d) Deceased seated, with scribes handing in list and recording, and men bringing oryx and calf, left part in Boston Mus. 34.58. (e) [Deceased] at table, with man holding ewer and basin before him, right part in Boston Mus. 34.57.

(a) REISNER, op. cit. fig. 264. (b) Id. ib. fig. 263 [upper left]. (c) Id. ib. fig. 263 [upper right]. (d) Id. ib. pl. 39 [b], fig. 262. (e) Id. ib. fig. 261. Boston Mus. 34.57, see SMITH, *Anc. Eg.* (1942 and 1952), p. 34; (1960), p. 38.

(2)-(3) Representations of four sarcophagi (above doorway), in Boston Mus. unnumbered (Exped. No. 32-12-9), three registers of estates and butchers, and offering-list.

REISNER, op. cit. fig. 260 facing p. 440; sarcophagi, see PETRIE in SAYCE MSS. 24d [bottom]; offering-list and names of estates, id. ib. 24d; names of estates, JACQUET-GORDON, *Domaines*, pp. 241-2 [19G5], cf. figs. 48-9 (from REISNER).

(4) Deceased at table. REISNER, op. cit. pl. 40 [b], fig. 259.

(5) False-door of deceased, with offering-bringers left of it. (6) *Ka*-servants before deceased and small son Kaseuza. (7) Remains of false-door.

Id. ib. fig. 257 facing p. 438. (6) Id. ib. pl. 40 [a]; part of figure of deceased, SMITH, *Hist. Eg. Sculpt.* fig. 111, p. 276. Texts, PETRIE in SAYCE MSS. 24a, b.

(8) Deceased and wife with small daughter, block with lower part of wife in Boston Mus. unnumbered (Exped. No. 32-12-42).

REISNER, op. cit. fig. 258; text, PETRIE in SAYCE MSS. 24d.

Shaft B with burial chamber. Plan and section, REISNER, op. cit. fig. 268.

Statue-fragments, alabaster, from débris. See id. ib. p. 445 [bottom].

G 2155. KANENESUT [I] , King's son of his body, *sem*-priest, Director of the Palace, etc. Early Dyn. V.

Wife, Neferhanesut , Royal acquaintance.

Stone-built mastaba.

Plan XXV

JUNKER, *Gîza*, ii, pp. 135-72; id. in *Anzeiger, Wien*, 50 (1913), pp. 163-9; 63 (1926), pp. 70-3; id. *Die Kultkammer des Prinzen Kanjnjswt im Wiener Kunsthistorischen Museum* (quoted here as *Kultkammer*), passim; DEMEL, *Die Reliefs des Kultkammer des Kaninisut* [etc.] in *Jahrbuch der Kunsthistorischen Sammlungen in Wien*, N.F. iii (1929), pp. 5-24; DE ROUGÉ, *Recherches sur les monuments* [etc.], pp. 40-1 (repr. in *Bibl. Ég.* xxvi, pp. 40-1). Plans and sections, JUNKER, *Gîza*, ii, Abb. 12, 13; id. *Kultkammer*, Abb. 4. Synopsis of scenes, id. *Gîza*, iii, p. 37 [21]. Name and titles, LIEBLEIN, *Dict.* No. 2.

I. Exterior vestibule. Brick-built.

Lintel, possibly from here, see chapel of tomb G 2156, p. 79.

II. Interior offering-room. In Vienna, Kunsthistorisches Museum, Inv. 8006.

(1) Doorway. (a) and (b) [1st ed. 2] Deceased at table, with funerary priests before him.

(a) JUNKER, *Gîza*, ii, Abb. 16, pp. 148, 150, 169. (b) Id. ib. Taf. v [a], Abb. 15, pp. 148, 169-70; id. *Kultkammer*, Abb. 5; DEMEL, op. cit. Abb. 1, 2, p. 5.

(2) [1st ed. 1 incorrectly placed] Two narrow registers of offerings, and below, man bringing meat, and two men with oryx.



JUNKER, *Gîza*, ii, Abb. 17, pp. 150, 169. Men and oryx, id. ib. Taf. v [b]; id. *Kultkammer*, Abb. 6; DEMEL, op. cit. Abb. 3, p. 5.

(3)-(4) Two registers, deceased in sailing-boat, (3) in boat being paddled (above doorway), and four registers, I-II, estates, III, men bringing cattle, and two groups of butchers, IV, offering-bringers.

Boats and left part of (4), id. ib. Taf. i, Abb. 7; omitting bottom register, JUNKER in *Anzeiger, Wien*, 50 (1913), Taf. iv. Boats, id. *Gîza*, ii, Taf. ix [a], Abb. 22, pp. 157-8, 169; KLEBS, *Reliefs . . . a.R.* Abb. 86 (from JUNKER); sailing-boat, JUNKER, *Kultkammer*, Abb. 9; *Meisterwerke* (1931), fig. 14; (1958), fig. 4; KOMORZYNSKI, *Erbe*, Abb. 14, 16; deceased and three sailors, in sailing-boat, id. *Altägyptens hohe Kunst in Österreich in Wort und Bild*, 31 (1951), Abb. 6, p. 11; id. *Altägypten*, Abb. 6, p. 13; boat being paddled, JUNKER, *Kultkammer*, Abb. 10; DEMEL, *Äg. Kunst*, Abb. 11. (4) JUNKER, *Gîza*, ii, Abb. 20, pp. 153-7, 169; left four estates in I, id. ib. Taf. ix [b]; id. *Kultkammer*, Abb. 8; names of estates, JACQUET-GORDON, *Domaines*, pp. 247-50 [22G5], cf. figs. 55-6 (from JUNKER); text above sailing-boat, and names of two estates, DE ROUGÉ, *Inscr. hiéro.* pl. lxiii [bottom].

(5) Offering-list, and [deceased] at table.

JUNKER, *Gîza*, ii, Taf. x, Abb. 21, pp. 156, 170-2; DEMEL in *Jahrbuch der Kunsthistorischen Sammlungen in Wien*, N.F. iii (1929), Abb. 6, p. 6.

(6) and (8) Two false-doors with deceased at table on panels, and wife and offering-bringers on sides, (7) [1st ed. 6], architrave with name and titles, below, deceased and wife with sons Ḥarwēr  and Kanenesut [II] (tomb G 2156) and daughter Wazethotp  before them, two registers, I, scribes led by Wehemka (tomb D. 117, see p. 114), II, offering-bringers, and register of offering-bringers under whole scene.

JUNKER, *Giza*, ii, Taf. vi, Abb. 18, pp. 150-2, 169-70; DEMEL, op. cit. Abb. 4, 5; see MARIETTE, *Mastabas*, pp. 565-6 [vii]; id. *Notice des principaux monuments . . . à Boulaq* (1864), p. 271 [7]. (6) and part of (7), KAYSER, *Die Mastaba des Uhemka*, Taf. 19; upper part of (6), JUNKER, *Kultkammer*, Abb. 7; titles from (6), DE ROUGÉ, *Inscr. hiéro.* pl. lxiii [top left]; names and titles of deceased and family from (7), pl. lxxv [upper], lxiii [middle]. (8) KOMORZYNSKI, *Altägyptens hohe Kunst in Österreich in Wort und Bild*, 31 (1951), Abb. 7, p. 12; id. *Altägypten*, Abb. 7, p. 14; id. *Erbe*, Abb. 15.

(9) [1st ed. 7] Deceased and small son Ḥarwēr, and three registers, I-III, scribes handing in list and recording.

JUNKER, *Giza*, ii, Taf. vii, viii, Abb. 19, pp. 152, 169; DEMEL, op. cit. Abb. 8, p. 18; id. *Äg. Kunst*, Abb. 10; KOMORZYNSKI, *Altägyptens hohe Kunst in Österreich in Wort und Bild*, 31 (1951), Abb. 3-5, p. 10; id. *Altägypten*, Abb. 3-5, p. 12; id. *Erbe*, Abb. 10-12; KAYSER, *Die Mastaba des Uhemka*, Taf. 18; WOLF, *Kunst*, Abb. 187; id. *Kulturgeschichte des alten Ägypten*, Abb. 1; POULSEN, *Äg. Kunst. A. und M.* pl. on p. 70; HUSSEIN, *Vom Papyrus zum Codex*, pl. on p. 33 with fig. on p. 11; EKSCMITT, *Das Gedächtnis der Völker*, Abb. on p. 119 [upper]. Deceased and son, JUNKER, *Kultkammer*, Abb. 11; MOHR, *The Mastaba of Hetep-her-akhti in Mededeelingen* [etc.], *Ex Oriente Lux*, No. 5 (1943), fig. 2; STAEHELIN, *Tracht*, Taf. viii [13]; with first two scribes in III, KOMORZYNSKI in *Alte und moderne Kunst*, vii [54-55] (1962), fig. 2, cover, fig. on p. 1, cf. p. 7. III, JUNKER, *Kultkammer*, Abb. 12.

G 2156. KANENESUT [II] , Greatest of the Ten of Upper Egypt, Prophet of Khufu and Ma'et, Secretary of his Lord, etc. Middle Dyn. V.

Parents (see tomb G 2155), Kanenesut [I] and Neferhanesut.

Stone-built mastaba east of tomb G 2155. There is another G 2156 south of G 2220 (see p. 80).

Plan XXV

JUNKER, *Giza*, iii, pp. 145-56; REISNER, *Giza Necropolis*, i, p. 447; plan and sections, JUNKER, *Giza*, iii, Abb. 19; see also plans of tomb G 2155.

Chapel. Synopsis of scenes, JUNKER, *Giza*, iii, p. 35 [11].

(1) Doorway. (a) Drum with name and titles of deceased. (b) and (c) Deceased seated, and before him, son Kanenesut [III] (tomb, probably, see p. 80) censuring and handing lotus flower to him on (b), and offering-bringers on (c).

(a) Id. ib. Abb. 20 [upper]. (b) and (c) Id. ib. Abb. 21, 20 [lower].

(2) Deceased at table, with son Kanenesut [III] and four funerary priests and offering-list before him.

Id. ib. Abb. 22.

Lintel with offering-text, found by Reisner in shaft of tomb G 5080, from above (2) or from exterior vestibule of tomb G 2155. REISNER, op. cit. fig. 270, p. 477 [bottom]; JUNKER, *Giza*, xii, Abb. 17 [lower], pp. 147-9.

Finds

Two sealings of a Lector-priest, from burial chamber, in Hildesheim Mus. 2431, 2502

(latter with Horus-name of Neuserreĕ). See id. *Giza*, iii, p. 150; IPPEL and ROEDER, *Denkmäler . . . Hildesheim*, p. 66; No. 2502, JUNKER, *Giza*, vii, Abb. 99, p. 240; No. 2431, see viii, p. 178.

Offering-table of deceased, found by Reisner in street east of tomb G 2160, probably from here. REISNER, op. cit. fig. 269, p. 447; JUNKER, *Giza*, xii, Abb. 17 [upper], pp. 147-8.

G 2156. REDENES . Dyn. VI.

Mastaba south of tomb G 2220. There is another G 2156 east of G 2155 (see p. 79).

BAER, *Rank and Title in the Old Kingdom*, p. 102 [322].

Possibly KANENESUT [III]. Middle or late Dyn. V.

Stone-built mastaba.

Father (possibly), Kanenesut [II] (tomb G 2156, see p. 79).

Remains of scene, funerary priest kneeling before deceased at table. JUNKER, *Giza*, viii, Abb. 93, pp. 177-8.



G 2175. KHNEMNÜFER. First half of Dyn. V.

Stone-built mastaba.



REISNER, *Giza Necropolis*, i, pp. 268-9 [4], 313.

Relief from chapel, two registers, female dancers, and men bringing animals, in Boston Mus. 12.1512. WRESZ., *Atlas*, iii, 31 [B]; see C. S. F[ISHER] in *Boston Mus. Bull.* xi (1913), p. 22; SMITH, *Anc. Eg.* (1942 and 1952), p. 36; (1960), p. 38; id. *Hist. Eg. Sculp.* p. 191.

G 2178.

Double-statue, Khui , Inspector of builders, etc., and wife Khuit , seated, Dyn. V, from shaft, in Boston Mus. 12.1485. See SMITH, *Hist. Eg. Sculp.* p. 74 [G 2231X].

G 2184. AKHMERUTNESUT , Overseer of the department of tenants of the Great House, King's *warb*-priest, etc. End of Dyn. V or Dyn. VI.

Parents, Kanüfer , Royal acquaintance, and Nuut , Prophetess of Hathor and Neith, etc.

Stone-built mastaba of Kanüfer, re-built by Akhmerutnesut.

Plan XXV

REISNER, *Giza Necropolis*, i, pp. 218 [28], 314 [lower, b], 380-1 [1]; SMITH, *Hist. Eg. Sculp.* pp. 198-9; C. S. F[ISHER] in *Boston Mus. Bull.* xi (1913), pp. 20-2. Title of Akhmerutnesut, BOTHMER in ib. xlvi (1948), fig. 8, p. 35.

Chapel. In Boston Mus. 13.4352. Partly damaged by fire in transit.

I. Exterior court. c of Reisner.

(1) and (3) False-doors of deceased and of Kanüfer and wife, (2) Kanüfer leaning on staff, with wife and small son Akhmerutnesut, and before them, four registers, I-IV, scenes of rendering accounts, (4) Akhmerutnesut hunting with lasso.

WRESZ., *Atlas*, iii, 69 with Textabb. 69 on p. 137. One chief in II, SMITH, op. cit. fig. 187 [right], p. 318; PIRENNE, *Hist. civ.* i, pl. 94 [lower] facing p. 297.

(5) (paintings) Agricultural scene (much damaged), and two hounds pulling down oryx. See SMITH, op. cit. p. 199.

II. Secondary offering-room. b of Reisner.

(6) Doorway. Jambs with offering-text, thicknesses, Kanüfer with his mother, and with wife.

Part, WRESZ., op. cit. on Taf. 69 [left].

(7) False-door (originally doorway to offering-room converted later into serdab).

See SMITH, op. cit. p. 199. Jackal waiting for birth of calf, and man with stick, id. ib. fig. 226c, p. 340; goats browsing on trees, fig. 239, p. 364; man skinning animal hanging from tree, fig. 238, p. 364; deceased spearing fish, with hippopotami attacking crocodile (dragon-fly from here, fig. 194 [top left], p. 319); milking scene, fig. 79; filling granaries, and cattle crossing water with herdsmen in canoe, fig. 229 [left], p. 347; female dancers, figs. 118 [left], 198, pp. 279, 323.

Finds

Statue of Akhmerutnesut seated, found *in situ* in front of false-door at (7), in Boston Mus. 12.1482. REISNER and FISHER in *Ann. Serv.* xiii (1914), pl. vii [b], p. 250 (view *in situ* with libation-basin); *Handbook* (1920), fig. on p. 21; SMITH, op. cit. pl. 22 [c], p. 57; id. *Anc. Eg.* (1942), fig. 33; see id. ib. (1960), p. 54.

G 2185. NEFERSEHEFEN . Late Dyn. V or early Dyn. VI.

False-door, man seated before offerings, with two lines of hieratic text above, fragments, in Boston Mus. 12.1393.

False-door, man, woman, and offering-text, fragments, in Boston Mus. 12.1491, 12.1503.

Statues.

Found in serdab.

Double-statue, two men standing, in Cairo Mus. SMITH, *Hist. Eg. Sculp.* pl. 21 [a], p. 73 [1].

Deceased standing (headless), in Boston Mus. 12.1483. See id. ib. p. 74 [upper, 2] (called 12.1485).

Woman grinding corn, in Boston Mus. 12.1486. BREASTED (Jr.), *Eg. Servant Statues*, pl. 19 [b], p. 20 [3] (called G 2347A); DUNHAM, *Eg. Department*, fig. 118, p. 146; MAZAR and others, *Views of the Biblical World*, i, pl. 138 [lower]; see SMITH, op. cit. p. 74 [upper, 3].

Found in shaft B.

Seated male statuette, in Boston Mus. 37.640. REISNER in *Boston Mus. Bull.* xxxvi (1938), fig. 4, p. 27; see SMITH, op. cit. p. 74 [upper, 4].

G 2188. Dyn. VI.

Re-used block with text concerning burial of dog 'Abutiū , probably from scene of man with dog, Dyn. V-VI, in Cairo Mus. Ent. 67573. REISNER in *Boston Mus. Bull.* xxxiv (1936), pp. 96-8 with figs.; BRUNNER, *Hieroglyphische Chrestomathie*, Taf. 2; FISCHER in *A.Z.* 93 (1966), pp. 57-60 [1] with fig. 2; see BRUNNER in ib. 95 (1969), p. 72.

G 2191. KHNEMU . Middle Dyn. V or later.

BAER, *Rank and Title in the Old Kingdom*, p. 117 [398].

G 2196. IASEN , Tenant, etc. Dyn. V or VI.

Rock-cut tomb.

Plan XXVI

Synopsis of scenes, REISNER, *Giza Necropolis*, i, pp. 365–6 [4], cf. 242 [bottom, 1], 314 [c]; plan and section, fig. 149. See id. and FISHER in *Ann. Serv.* xiii (1914), p. 250.

Chapel.

(1) Doorway. (a)–(b) Lintel, man and woman seated, and offering-text, (c) and (d) deceased standing.

(2) Three registers of presentation scenes before deceased and family, I, two scribes, and men bringing wild animals, including hyena, II–III, men bringing cattle.

Right part of I–III, REISNER in *Boston Mus. Bull.* xxxii (1934), fig. 7, p. 4. See SMITH, *Hist. Eg. Sculp.* pp. 252, 253.

(3) Deceased seated in pavilion receiving lotus-flower, with dog under chair, three registers of attendants behind, and five registers in front of him, I–III, and half of IV, offering-list, IV (half), men cooking, V, offering-bringers and butchers, and VI (under whole scene), dancers, musicians, men filling wine-jars (unfinished).

Dog, REISNER in *Boston Mus. Bull.* xxxiv (1936), fig. on p. 98 [bottom right]. Men with food, from V, and men filling jars, from VI, SMITH, op. cit. pl. 58 [c], pp. 197, 254.

(4) Four funerary priests before deceased at table.

REISNER in *Boston Mus. Bull.* xxxii (1934), fig. 5, p. 4.

(5) Niche with rock-cut standing statue of deceased.

SMITH, op. cit. pl. 57 [b], pp. 55, 189–90.

(6) Deceased at table, and offering-list.

(7) Deceased leaning on staff, and three registers, I, reaping, piling up sheaves, with two subregisters of winnowing, herdsmen drinking, baking, and cattle, II, donkey transporting corn, and cattle, III, rams treading grain, cows giving birth, suckling calf, and being milked.

Deceased and left part of registers, id. ib. pl. 60 [b], p. 247. Boy handing bowl to man, from I, and cow suckling calf, from III, id. ib. figs. 183, 205, pp. 315, 330.

(8) Deceased fowling with split spear from canoe, with man holding birds on right.

REISNER in *Boston Mus. Bull.* xxxiii (1935), fig. 13, p. 76; SMITH, op. cit. pl. 60 [a], pp. 197, 296.

G 2197. PENMERU , King's *warb*-priest, Prophet of Menkaurē, Overseer of *ka*-servants, etc. End of Dyn. V.

Wife, Mertiotēs , *mitrt*, etc.

Stone-built mastaba.

Chapel. See REISNER, *Giza Necropolis*, i, p. 292 [2].

South of door, text of will of deceased in favour of Neferhōtep, 'Brother of the endowment', mentioning bringing offerings from (tomb of) Seshemnūfer [III] (G 5170). REISNER and FISHER in *Ann. Serv.* xiii (1914), pl. xi [a], p. 247; GRDSELOFF in ib. xlii (1943), fig. 3, pp. 39–43; GOEDICKE, *Die privaten Rechtsinschriften aus dem Alten Reich*, Taf. vi, pp. 68–74.

Serdab.

Views, C. S. F[ISHER] in *Boston Mus. Bull.* xi (1913), figs. on pp. 19, 21 [upper]; MORET, *Le Nil et la civilisation égyptienne* (1937), pl. iv [2].

Niche with statue-group, deceased (represented twice), wife, and two small children, standing, in Boston Mus. 12.1484. C. S. F[ISHER], op. cit. fig. on p. 20 [lower]; BOREUX in *Mélanges Maspero*, i [2], pl. iii [2] (from FISHER), p. 812; KOEFOED-PETERSEN, *Et Ægyptisk Billedværk fra Pyramidetiden* in *Fra Nationalmuseets Arbejdsmark* (1941), fig. 3, p. 64; HOYNINGEN-HUENE and STEINDORFF, *Egypt* (1945), fig. on p. 31; SMITH, *Hist. Eg. Sculp.* pl. 21 [d], p. 53; HORNEMANN, *Types*, vi, pl. 1476; incomplete, SMITH, *Anc. Eg.* (1942), fig. 26; (1952), fig. 27; (1960), fig. 29; id. *Country Life*, fig. 34; *Handbook* (1964), fig. on p. 181 [lower]; GARDINER MSS. photo. 28.69.

Triple-statue of deceased standing, found *in situ* beside niche, in Boston Mus. 12.1504. SMITH, *Hist. Eg. Sculp.* pl. 21 [c], p. 53; HORNEMANN, *Types*, v, pl. 1363; see SMITH, *Anc. Eg.* (1942 and 1952), p. 49; (1960), p. 54.

Double-statue of deceased standing, in Cairo Mus. Ent. 43753. BOREUX, op. cit. pl. ii [2], pp. 810, 812 with note 1; SMITH, *Hist. Eg. Sculp.* pl. 21 [b] (called Boston), p. 53; HORNEMANN, *Types*, iv, pl. 1095 (called Nag^c el-Mashâyikh).

G 2220. Late Dyn. IV or early Dyn. V.

Stone-built mastaba.

REISNER, *Giza Necropolis*, i, pp. 216 [18], 450-3; plans and section of chapel and shafts, figs. 275-6, 278; view of burial chamber of shaft B, pl. 42 [a].

East wall of interior chapel, man, wife, and child at north end, and man at south end (unfinished). Id. ib. pl. 41.

CEMETERY EN ECHELON. NORTH PART WITH MASTABAS G 2300 AND 2400

Reisner Excavation. Harvard-Boston Expedition (1911-13)

Plan XII

Plan of part, SMITH (W. S.) in *Boston Mus. Bull.* lvi (1958), fig. 3 on p. 60. View of part, G. A. R[REISNER] in ib. xi (1913), fig. 8, p. 53; id. and FISHER in *Ann. Serv.* xiii (1914), pl. viii, p. 227.

G 2332.

Fragments with part of text of builder under Pepy I, from shaft A, in Boston Mus. 13.4342.

G 2335.

Male statuette, in Boston Mus. 13.3461, and smaller nude male statuette, in Cairo Mus. Ent. 44613, both standing, wood, Dyn. V, from burial chamber of shaft A. See SMITH, *Hist. Eg. Sculp.* p. 59.

G 2336.

Relief-fragment, Khuwiptah  and text, in Boston Mus. 13.4344.

Three female statuettes, wood, Dyn. V-VI, from serdab, in Boston Mus. 13.3463-4, and unnumbered (Expd. No. 12-10-35). See SMITH, *Hist. Eg. Sculp.* pp. 59-60.

False-door of Theneny , Inspector of *ka*-servants, etc., Dyn. VI, found between tombs G 2337 and G 2371, in Boston Mus. 13.4336.

GÎZA—NECROPOLIS

G 2347.

Mummy-mask, plaster, fragment, Dyn. V-VI, from shaft A. See SMITH, *Hist. Eg. Sculp.* p. 28 [10].

G 2347a.

Shaft C.

Two male standing statuettes, wood, Dyn. VI, from burial chamber, in Boston Mus. 37.1320-1. See SMITH, *Hist. Eg. Sculp.* p. 91; REISNER in *Boston Mus. Bull.* xxxvi (1938), p. 30.

Shaft E.

Head of statuette, wood, Dyn. VI, from burial chamber, in Boston Mus. unnumbered (Exped. No. 35-11-16). See SMITH, *op. cit.* p. 92 [2347, 1]; REISNER, *op. cit.* p. 30.

G 2352. HĀGI . End of Dyn. V or later.

Slab-stela, Sethu , Overseer (*mdh*) of the royal scribes, Prophet of Seshet, Greatest of the Ten of Upper Egypt, etc., at table, linen-list and granaries, found in shaft B and probably from another tomb, probably end of Dyn. IV or Dyn. V, in Boston Mus. 13.4341. See SMITH (W. S.) in *J.E.A.* xix (1933), p. 154; REISNER, *Giza Necropolis*, i, p. 333 [7].

G 2353.

Statuettes. Dyn. V. Found in shaft B.

Double-statuette, man with arm round wife's shoulder, standing, damaged, in Boston Mus. 13.3164. SMITH, *Hist. Eg. Sculp.* pl. 25 [f], pp. 42, 57.

Man standing, incomplete, in fragments, in Cairo Mus. Temp. No. 27.1.15.1. See *id. ib.* p. 57.

Shaft G 2357X.

Fragments of wooden statuettes, Dyn. VI, from burial chamber. SMITH, *Hist. Eg. Sculp.* fig. 20 [left], p. 92.

G 2359.

Block with incised masons' graffito with date ('Union of the Two Lands', perhaps Dyn. IV), found under mastaba of Dyn. VI. SMITH (W. S.) in *J.N.E.S.* xi (1952), fig. 6 [lower right], p. 127 [7].

G 2361. MAA , Overseer of barbers. Dyn. VI.

False-door of deceased.

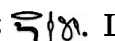

G 2362. RUZ . Dyn. VI.

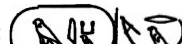
False-door, son Khuwikhnum  before deceased at table on panel.

Architraves, joining at right angle, fragments, (a) name and title of (Senezemib) Mehi, and below, four figures of Ruz, Supervisor of *ka*-servants, Scribe of a phyle, (b) offering-text of Ruz, Judge and Overseer of scribes, with names and small figures of children (including daughter Ikauhormerut  below, in Boston Mus. 13.4334.

G 2366. NIMESTY . Probably Dyn. VI.

BAER, *Rank and Title in the Old Kingdom*, p. 84 [207].

G 2370. SENEZEMIB  good name INTI , Chief Justice and Vizier, King's architect and builder in the Two Houses, etc. Temp. Isesi. (Also owner of tomb LG 10.)

Wife, Thefi , Royal acquaintance.

Stone-built mastaba. LG 27.

Plan XXVI

Plan and sections, L. D. i. 23; REISNER, *Giza Necropolis*, i, fig. 162, cf. 215, pp. 264 [1], 313 [middle, b]; plan, L. D. Text, i, p. 55; MARIETTE, *Mastabas*, pp. 497, 499 [right]. Synopsis of scenes, JUNKER, *Giza*, iii, p. 43 [33]; description of some, BONOMI MSS. Diary, January 31, 1843.

Chapel.

I. Portico with doorway. e of Reisner.

(1) Texts, (a) [1st ed. 1] of son Senezemib Mehi recording tomb-endowment, (b) [1st ed. 2] describing funeral, with scene of transport of sarcophagus in boat below, (c) [1st ed. 8] biographical text of deceased and letter of Isesi, (d) [1st ed. 7] speech of Isesi and his letter. (e) [1st ed. 3] Remains of figures of deceased and son facing him, with marsh-scene below, (f) [1st ed. 6] with herdsmen and cattle crossing water below, (g) [1st ed. 4] deceased spearing fish from canoe, (h) [1st ed. 5] fowling in canoe, with [wife] and son Senezemib Mehi standing before him, and attendants (including Isesibaf) behind, and remains of hippopotamus-hunt on left, (i) and (j) [1st ed. 9, 10] deceased with son Senezemib (Mehi) facing him.

(a) L. D. ii. 76 [c], *Text*, i, p. 56 [x]; text, SETHE, *Urk.* i (1933), pp. 63-5 [42, c].

(b) L. D. ii. 76 [e]; text, SETHE, *Urk.* i (1933), pp. 65-7 [42, d].

(c) L. D. ii. 76 [d], *Text*, i, p. 56 [y]; text, SETHE, *Urk.* i (1933), pp. 59-61 [42, A]; additional four lines (titles and date), see REISNER and FISHER in *Ann. Serv.* xiii (1914), p. 248 [1].

(d) L. D. ii. 76 [f]; text, SETHE, *Urk.* i (1933), pp. 61-3 [42, B]; additional column of text, REISNER and FISHER, op. cit. p. 248 [2].

(e) Cf. L. D. Text, i, p. 56 [c].

(f) L. D. Text, i, p. 56 [d, left].

(g) L. D. *Ergänz.* xvii.

(h) Id. ib. xviii.

(i) L. D. ii. 78 [b, left]; text above son, SETHE, *Urk.* i (1933), p. 67 [43].

(j) L. D. *Ergänz.* xix [right].

Room II. c of Reisner.

(2) [1st ed. 11] Four registers, I (from right), pulling papyrus, carrying bundles, and making papyrus-canoes, II, boatmen jousting, III, three sailing-boats, IV, three rowing-boats.

Id. ib. xx.

(3) [1st ed. 12] Five registers, I-II, deceased carried in palanquin, attendants, and two dogs, III, servants carrying various objects, IV, two standing statues of deceased dragged on sledges, V, three groups of butchers.

L. D. ii. 78 [b, right].

(4)–(5) [1st ed. 13–14] Deceased in papyrus-boat, with son (no name) before him and three others, including Khnementi (tomb G 2374 with shaft G 2385A) behind, right, hippopotamus-hunt and men running (above doorway), left, five registers, **I**, herdsmen preparing food, **II** and **III**, cattle, with bull mounting cow and cow suckling calf, **IV**, making mats, **V**, milking cow.

L. D. ii. 77; names of sons, L. D. *Text*, i, p. 57 note 1.

(6)–(7) [1st ed. 15–16] Five registers of industries (partly above doorway), **I**, destroyed, **II–III**, carpenters, including man sawing, **IV**, vase-makers, **V**, sculptors making two standing statues.

L. D. *Ergänz.* xix [left].

Room III. b of Reisner.

(8) [1st ed. 17, 18] Doorway. (a) and (b) Three registers of estates, all of the same name at (b).

(a) L. D. ii. 76 [b]. Sketch and names, MARIETTE, *Mastabas*, pp. 511–12; names, JACQUET-GORDON, *Domaines*, pp. 293–5 [38G5], Nos. 1–15, cf. figs. 82, 83 [a]. (b) L. D. ii. 76 [a]. Sketch and name, MARIETTE, *Mastabas*, pp. 510–11; name, JACQUET-GORDON, op. cit. pp. 293, 295 [38G5], No. 16, cf. figs. 82, 83 [b].

(9)–(10) [1st ed. 19–20] Seven registers (partly above doorway), **I**, herdsmen with cattle, **II**, scene of rendering accounts, **III–IV**, men bringing animals, **V–VII**, geese, ducks, cattle.

L. D. *Ergänz.* xxiii [c].

(11) [1st ed. 21] Six registers (now destroyed), **I** (from left), pulling flax, **II**, ploughing, sheep treading grain, **III**, reaping, **IV**, donkeys, and tying and filling sacks with sheaves, **V**, transport of corn with donkeys, **VI**, [threshing].

Id. ib. xxii [b].

(12) [1st ed. 22] Six registers, **I–II**, right part of **III**, men bringing baskets of grapes, **III** (from left), men with resonant sticks, treading grapes, **IV**, pressing grapes, filling jars, **V**, cleaning and filling beer-jars, scribes in granary recording, **VI**, heating pots and grinding corn.

Id. ib. xxi. Woman grinding, on extreme right in **VI**, LIEDER squeezes, 1.1.

Room IV. a of Reisner.

(13) [1st ed. 23–4] (a) and (b) Two registers of estates.

(a) LIEDER squeezes, 1.2; sketch and names, MARIETTE, *Mastabas*, pp. 509 (reversed), 513–15; names, JACQUET-GORDON, op. cit. pp. 293, 296–7 [38G5], Nos. 17–26, cf. figs. 82, 83 [c].

(b) LIEDER squeezes, 1.3; sketch and name, MARIETTE, op. cit. pp. 507–8; names, JACQUET-GORDON, op. cit. pp. 293, 297 [38G5], Nos. 27–36, cf. figs. 82, 83 [d].

(14) Funerary priests performing ceremonies (including wiping out footprints) before deceased at table.

See REISNER, *Giza Necropolis*, i, p. 370 [2].

(15) [1st ed. 25] False-door of deceased.

MARIETTE, op. cit. pp. 505–7; upper lintel, LIEDER squeezes, 1.4–6; panel with deceased at table, 1.7; lower lintel, 1.8–10; middle right jamb (MARIETTE FF), 1.11.

V. Pillared Hall. d of Reisner.

(16) [1st ed. 26] Thickness of doorway. Deceased with wife and son Senezemib (Meḥi) facing them.

L. D. ii. 78 [a], *Text*, i, p. 58; deceased and wife, LIEDER squeezes, 1.12 (differs considerably from LEPSIUS).

Sloping shaft. See REISNER, op. cit. p. 152 [12].

Sarcophagus of deceased, granite. DONADONI ROVERI, *Sarcofagi egizi*, Tav. xxxvi [2], pp. 127-8 [B 46]; name inside, G. A. R[REISNER] in *Boston Mus. Bull.* xi (1913), fig. 10, p. 58.

Finds

Face of statue, black granite, late Dyn. V or Dyn. VI, found between tombs G 2372 and G 2373, probably from here, in Boston Mus. 13.3139. See SMITH, *Hist. Eg. Sculp.* p. 85 [bottom].

G 2374 with shaft G 2385A. KHNEMENTI . Early Dyn. VI.

Parents, Senezemib Inti and Thefi (from tomb G 2370).

Stone-built mastaba.

Plan, REISNER, *Giza Necropolis*, i, fig. 165, pp. 267-8 [2], cf. 176, 313 [middle, d]; see id. and SMITH, *Giza Necropolis*, ii, pp. 53-4.

Chapel.

Doorway to Room b (of Reisner), left thickness. Three registers of estates; names, JACQUET-GORDON, *Domaines*, pp. 310-12 [44G6], cf. figs. 94-5.

Block with name of Pyramid of Teti. See REISNER and FISHER in *Ann. Serv.* xiii (1914), p. 249 [top].

Two relief-fragments with butchers, in Boston Mus. 13.3101.

Sloping shaft G 2385A.

Bowl with name of King Teti, diorite. REISNER and SMITH, *Giza Necropolis*, ii, pl. 45 [c], fig. 147 [bottom right], p. 54; see REISNER and FISHER, op. cit. p. 249; REISNER, op. cit. p. 153 [14].

G 2375. AKHETMEHU , Judge and Elder of the Hall, Overseer of the House of Weapons. Temp. Merenrē I or Pepy II.

Stone-built mastaba with exterior brick-built court.

REISNER, *Giza Necropolis*, i, p. 285 [bottom, 1]; SMITH (W. S.) in *Boston Mus. Bull.* lvi (1958), p. 61, position, fig. 3.

Chapel. Two hieroglyphs from lintel, id. *Hist. Eg. Sculp.* pl. 57 [e].

False-door of deceased. See EDEL in *Mitt. Orientforschung*, i (1953), pp. 327-33, text, p. 328.



Shaft A.

Box-sealing of Inspector of embalmers, etc., with Horus-name of Merenrē I or Pepy II. REISNER and SMITH, *Giza Necropolis*, ii, fig. 57, pp. 53-4.

G 2375a. ANKHIRPTAH , Judge and Keeper of Nekhen. Late Dyn. VI.

Stone-built mastaba.

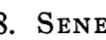
REISNER, *Giza Necropolis*, i, p. 262 [a, 2].

G 2378. SENEZEMIB  good name MEHI , Chief Justice and Vizier, King's architect and builder in the Two Houses, etc. Temp. Unis.

Parents, Senezemib Inti and Thefi (tomb G 2370). Wife, Khentkaus , King's daughter of his body, Prophetess of Hathor . . .

Stone-built mastaba. LG 26.

L. *D. Text*, i, pp. 51-4. Plan and sections of Chapel, L. *D. i.* 23; plan, L. *D. Text*, i, p. 51; MARIETTE, *Mastabas*, pp. 498, 499 [left]; REISNER, *Giza Necropolis*, i, fig. 164, pp. 266-7 [1]. Dimensions of shaft and burial chamber, see id. ib. p. 152 [13]. Synopsis of scenes, JUNKER, *Giza*, iii, p. 44 [34].

Chapel.

I. Forecourt with doorway to Hall. c of Reisner.

(1) (a) [1st ed. 1] (upper part destroyed) Deceased and son with offering-bringers before them, and two registers below, cattle crossing water, with herdsmen in canoes, and men in canoes returning from marshes. (b) [1st ed. 4-5] Upper part, two blocks, men with products of marshes (probably from here) and deceased standing (replaced on wall), lower part, cattle crossing water, with herdsmen in canoes, and men in canoes returning from marshes. (c) and (d) [1st ed. 2, 3] Marsh scenes, (c) deceased in canoe spearing fish, with wife, son Senezemib, and attendants, and man fishing with clap-net on right, with crocodile, hippopotamus, and fish at bottom, (d) fowling, with wife, son, and attendants, and remains of hippopotamus-hunt on left. (e) and (f) [1st ed. 6, 7] Thicknesses, deceased and eldest son Senezemib facing him.

(a) L. *D. Ergänz.* xii [lower]. (b) Id. ib. xi [lower]. (c) Id. ib. xii [upper]. (d) Id. ib. xi [upper]. (e) and (f) Id. ib. xiii.

II. Hall. b of Reisner.

(2) [1st ed. 8] Deceased with son Senezemib, and four registers, I, [man with cranes], II, geese, III-IV, men bringing oryxes.

L. *D. ii.* 74 [b]; head of deceased (removed), L. *D. iii.* 289 [9].

(3) [1st ed. 9] Six registers, I (from right), reaping corn, II, donkeys carrying produce, III, men tying sacks with sheaves, and bringing donkeys, IV, threshing with donkeys, and winnowing, V, bringing offerings and cattle, VI, three groups of butchers.

L. *D. ii.* 73 [left].

(4) [1st ed. 10] Deceased with wife and children Senezemib, Mehi, and Khentkaus.

L. *D. ii.* 73 [right].

(5) [1st ed. 11] Five registers, I [vintage], II (from left), netting fowl and putting birds into cages, III, pulling flax, tying up bundles, [animals treading grain], and ploughing, IV, netting fish, and herdsmen in canoes crossing water, V, officials and offering-bringers with animals.

L. *D. Ergänz.* xiv.

(6) [1st ed. 12] Three registers (from left), I [sculptors], II, weighing metal and blowing, III, two groups of dwarfs making jewellery, and vase-makers.

I, L. *D. Text*, i, fig. on p. 52 [lower]. II and III, L. *D. ii.* 74 [a].

(7) [1st ed. 13] Five registers before deceased seated with wife squatting by his legs, I-III, dancers, clappers, and harpists, flutists, and singers, IV, man handing in list, scene of rendering accounts, scribes, V, men bringing cattle.

Remains of I and II, L. *D. Text*, i, fig. on p. 52 [upper]. III-IV, L. *D. ii.* 74 [c]. Head of wife, and text above, LIEDER squeezes, 2.1. Name of wife, L. *D. Text*, i, p. 51.

III. Inner Hall. a of Reisner.

(8) Doorway. (a) and (b) [1st ed. 14, 15] Two registers of estates.

(a) L. *D. ii.* 74 [d]. Names, L. *D. Text*, i, p. 53 [left]; JACQUET-GORDON, *Domaines*,

pp. 298-300 [39G5], Nos. 1-12, cf. figs. 84, 85 [a]. Sketch, and names of three estates, MARIETTE, *Mastabas*, p. 504. (b) Sketch, and names of three estates, id. ib. pp. 503-4; names of estates, L. D. *Text*, i, p. 53 [right]; JACQUET-GORDON, op. cit. pp. 298-300 [39G5], Nos. 13-24, cf. figs. 84, 85 [b].

(9) [1st ed. 16, 17] Deceased at table, with offerings, [funerary priests], and offering-bringers, before him.

L. D. *Ergänz.* xv.

(10) [1st ed. 19, 20] Deceased at table (removed), with offerings, funerary priests, and offering-bringers, before him.

Id. ib. xvi; deceased, MARIETTE, op. cit. p. 503 [top]; WILKINSON MSS. xiii. 83; text above deceased, LIEDER squeezes, 2.4.

(11) [1st ed. 18] False-door of deceased.

L. D. ii. 75; MARIETTE, op. cit. pp. 500-2; text on right jambs, WILKINSON MSS. xiii. 84 [upper]; inner right jamb, LIEDER squeezes, 2.2; outer right jamb, 2.3; titles of deceased, SETHE, *Urk.* i (1933), p. 68 [44].

Sloping shaft A. Opening out in tomb G 2385. See REISNER, *Giza Necropolis*, i, p. 152 [13].

Statues found at entrance of shaft.

View *in situ*, G. A. R[EISNER] in *Boston Mus. Bull.* xi (1913), fig. 18, p. 62.

Man standing, naked, wood, in Boston Mus. 13.3466. Mainly upper part, id. ib. fig. 19, p. 62; *Handbook* (1920), fig. on p. 11; (1930), fig. on p. 16; (1947), fig. on p. 17; (1964), fig. on p. 183 [lower]; RANKE, *The Art of Ancient Egypt*, and BREASTED, *Geschichte Aegyptens*, 71; SMITH, *Anc. Eg.* (1942), fig. 27; (1952), fig. 28; (1960), fig. 30 (head); id. *Hist. Eg. Sculp.* pl. 23 [a, b] (whole and head), p. 58; CAPART, *L'Art ég.* ii, pl. 257; PIJOÁN, *Summa Artis*, iii (1945), fig. 221; ALDRED, *O.K. Art*, pl. 42; id. *Egypt to the End of the Old Kingdom*, fig. 127 (whole); VANDIER, *Eg. Sculpture*, pl. 39; MALRAUX, *Le Musée imaginaire de la sculpture mondiale*, pl. 41; BEEKMAN, *Hout in alle Tijden*, fig. 7.90, p. 542; WOLF, *Kunst*, Abb. 149; DUNHAM, *Eg. Department*, fig. 28; id. in *Apollo*, xci (Jan. 1970), fig. 8, p. 18; MAT'É, *Iskusstvo Drevnego Egipta* (1961), fig. 48, p. 99; TERRACE in *The Connoisseur*, clxviii (1968), fig. 14, p. 204; WHITEHILL, *Museum of Fine Arts Boston. A Centennial History*, i, fig. on p. 259 [right]. Head, SMITH (W. S.) in *Boston Mus. Bull.* lvi (1958), fig. 4, pp. 61-2; PIRENNE, *Hist. civ.* i, pl. 59 between pp. 180-1.



Man standing, naked, wood, poorly preserved, in Boston Mus. 13.3465. See SMITH, *Hist. Eg. Sculp.* p. 58.

Statuettes found in burial chamber.

Five, bound captives, wood, three in Cairo Mus., two in Boston Mus. 13.3458-9. SMITH, *Hist. Eg. Sculp.* pl. 23 [e, f], p. 58; see id. *Anc. Eg.* (1942 and 1952), p. 50; (1960), p. 56; G. A. R[EISNER] in *Boston Mus. Bull.* xi (1913), p. 62; Boston Mus. 13.3458, HORNEMANN, *Types*, iv, pl. 1023.

G 2379.

Pottery jar with hieratic text, Dyn. VI, from shaft A. REISNER and SMITH, *Giza Necropolis*, ii, fig. 84, p. 70.

G 2381 with shaft G 2382A. MERYRĒ'-MERYPTAḤ'ANKH  good name NEKHEBU , Overseer of all works of the King, King's

architect and builder in the Two Houses, Overseer of the royal commissions of the Pyramid of Pepy I, etc. Temp. Pepy I or Merenrê I.

Father (possibly), Khnmenti (tomb G 2374).

Stone-built mastaba. Almost completely destroyed.

Plan XXVI

REISNER, *Giza Necropolis*, i, p. 266 [4]; sloping shaft with burial chamber, p. 153 [16]. View of court, G. A. R[EISNER] in *Boston Mus. Bull.* xi (1913), fig. 3, p. 53. Names of two dogs, FISCHER in *J.E.A.* 47 (1961), p. 153 [58, 65].

Chapel. See REISNER, *Giza Necropolis*, i, p. 313 [e].

Positions of blocks only approximate, as suggested by Smith (W. S.). Blocks in Boston, see SMITH, *Anc. Eg.* (1942), p. 58; (1952), p. 57; (1960), p. 63.

I. Forecourt.

(1) Biographical text, with deceased seated at bottom, (a) in Cairo Mus. Ent. 44608, (b) in Boston Mus. 13.4331.

(a) GARDINER MSS. photo. 28.277 [middle], 278-85 (with hand-copy by FAULKNER in GARDINER MSS. 29.7A); text, SETHE, *Urk.* i (1933), pp. 215-19 [47 (138)]; from columns 8 and 9, SAINTE FARE GARNOT in *B.I.F.A.O.* xxxvii (1937-8), fig. 2, pp. 63-6, 72 with note 1; see MASPERO, *Guide*, p. 48 [89]; DUNHAM in *J.E.A.* 24 (1938), pp. 1, 3-6 (with text of fragment found in Boston and returned to Cairo).

(b) Id. ib. pls. i [1], ii, pp. 1-3; text, SETHE, *Urk.* i (1933), pp. 219-21 [48 (139)].

(2) Palanquin scene, in Boston Mus. Text, HEERMA VAN VOSS in *Phoenix*, 14 (1968), fig. 49, pp. 129-30.

(3) Deceased with son (name lost), both spearing fish, and wife, in canoe, with brother of deceased and son Pthahsabu , in Boston Mus. 13.4332.

SMITH (W. S.) in *Boston Mus. Bull.* lvi (1958), fig. 2, pp. 58-60; see G. A. R[EISNER] in ib. xi (1913), p. 53; DUNHAM, op. cit. p. 7 [middle].

Doorway to Room II.

(4) and (5) Left of doorway, two registers, I, two lector-priests superimposed on two shrines, and men running with wands, II, men carrying chests, left thickness, deceased and titles, in Boston Mus. 13.4348.

Men running, SMITH, *Hist. Eg. Sculp.* fig. 80, p. 209. Titles from (5), DUNHAM, op. cit. p. 7 [B].

(6) and (7) Right of doorway, three registers of boats, right thickness, deceased and titles, in Boston Mus. 13.4349.

Man in rigging of sailing-boat in upper register, SMITH, op. cit. fig. 164 [left], p. 307. Titles from (7), DUNHAM, op. cit. p. 7 [C].

Probably Doorway to Room III.

(8) Above doorway, series of adjoining blocks, six figures of deceased with name and titles, in Boston Mus. 13.4335.

One block (with text [5] of DUNHAM), G. A. R[EISNER] in *Boston Mus. Bull.* xi (1913), fig. 5, p. 53. Texts on blocks, DUNHAM, op. cit. p. 6 [A] (text of [5] incorrect).

Rooms II or III. Various blocks.

Deceased at table, in Boston Mus. 13.4351. Name and titles, id. ib. p. 7 [D].

Man with calf, and registers with vintage scenes, in Boston Mus. 13.4340, 13.4347. See G. A. R[EISNER] in *Boston Mus. Bull.* xi (1913), p. 57.

Two blocks, procession of animals, and head of Pepy-merytahꜥankh (brother of deceased), both in Boston Mus. 13.4346 a,b. Former, id. ib. fig. 4, p. 53; latter, see DUNHAM, op. cit. p. 7 [middle].

Serdab. Several blocks in Boston Mus.

Two blocks with painted figures of deceased in several registers, in Boston Mus. 13.4339 a,b. CAPART, *Documents*, ii, pl. 31; FISCHER in *J.A.R.C.E.* ii (1963), pl. iii, and frontispiece [upper], p. 21 with note 31.

Block with series of painted figures of deceased, in Cairo Mus. Ent. 44621. Id. ib. pl. ii, p. 21 with note 31.

Finds

Statuettes.

Deceased seated, in Boston Mus. 13.3161. SMITH, *Hist. Eg. Sculp.* pl. 26 [a], p. 84 [1]; WILSON, *The Burden of Egypt*, fig. 8 [c].

Deceased seated, found partly here and partly in tomb G 2370, in Cairo Mus. REISNER and FISHER in *Ann. Serv.* xiii (1914), pl. x [b], pp. 250-1; see SMITH, op. cit. p. 84 [2].

Fragments of two seated statues, in Boston Mus. 13.3150-1. See id. ib. p. 85 [3, 4].

Male head in wig, in Boston Mus. 13.3154. Id. ib. pl. 26 [b, upper left], p. 85 [5]; id. *Anc. Eg.* (1942), fig. 34 [upper left]; G. A. R[EISNER] in *Boston Mus. Bull.* xi (1913), fig. 7 [middle], p. 53.

Male head in wig, in Cairo Mus. Ent. 44421. SMITH, *Hist. Eg. Sculp.* pl. 26 [b, upper right], p. 85 [6]; id. *Anc. Eg.* (1942), fig. 34 [upper right]; G. A. R[EISNER], op. cit. fig. 7 [right], p. 53.

Upper part of male statuette, in Boston Mus. 13.3156. SMITH, *Hist. Eg. Sculp.* pl. 26 [b, lower left], p. 85 [7]; id. *Anc. Eg.* (1942), fig. 34 [lower]; G. A. R[EISNER], op. cit. fig. 7 [left], p. 53.

Base, titles and name of deceased, in Boston Mus. 13.3159. See SMITH, *Hist. Eg. Sculp.* p. 85 [8].

Male head in wig, in Boston Mus. 13.3155. See id. ib. p. 85 [9].

Seated male statuette (lower part destroyed), in Boston Mus. 13.3149. Id. ib. pl. 26 [c], p. 86 [9]; id. *Anc. Eg.* (1960), fig. 36.

Various.

Obelisk of deceased, in Boston Mus. 13.4353. G. A. R[EISNER], op. cit. fig. 6, p. 53.

Offering-table, fragment, diorite, in Boston Mus. 13.3143.

Slab with emplacements for models of Opening-the-Mouth instruments, probably from here, in Boston Mus. 13.3144. See SMITH, *Anc. Eg.* (1942 and 1952), p. 61; (1960), p. 67; NAVILLE, *The Cemeteries of Abydos*, i, p. 3.

Sloping shaft G 2381A. MERYRĒꜥ-MERYPTAHꜥANKH called IMPY  Count, Overseer of works. Temp. Pepy II. Burial chamber found intact.

Father, MeryrĒꜥ-merytahꜥankh good name Nekhebu (tomb G 2381 with shaft G 2382A).

Originally stone-built mastaba. Superstructure destroyed.

Plan and section, REISNER, *Giza Necropolis*, i, fig. 27, pp. 89, 153 [17]. View of opening, id. in *Boston Mus. Bull.* xi (1913), fig. 11, pp. 58-9; of shaft, fig. 12, p. 59; of burial chamber,

with objects *in situ* (including wooden coffin, in Boston Mus. 13.3085), fig. 13, p. 59; SMITH, *Anc. Eg.* fig. 38; of finds, FISHER in *Boston Mus. Bull.* xii (1914), fig. on p. 39; SMITH, *Anc. Eg.* (1942), fig. 39.

Vase with sealing with names of Pepy II. REISNER and SMITH, *Giza Necropolis*, ii, pl. 52 [g], fig. 54, p. 54.

Copper vessels and model tools, etc., in Boston Mus. G. A. R[EISNER] in *Boston Mus. Bull.* xi (1913), figs. 15, 16, cf. 13, p. 59.

Head-rest of Ibebi , alabaster, from coffin, in Boston Mus. 13.2925. See id. ib. p. 59.

Collar, gold and faience, inscribed on end-pieces, from coffin, in Boston Mus. 13.3086. Id. ib. fig. 14, p. 59; *Handbook* (1920), fig. on p. 12; SMITH, *Anc. Eg.* (1942), fig. 37; (1952 and 1960), fig. 39; ALDRED, *Jewels of the Pharaohs*, pl. 19.

Shaft G 2381Y.

Statuette, man carrying jar on head, wood, Dyn. VI. SMITH, *Hist. Eg. Sculp.* fig. 21, pp. 94, 100 [k, 5]; see BREASTED (Jr.), *Eg. Servant Statues*, p. 58 [1].

G 2384.

Fragment with Horus-name of Khufu, and another (inscribed), alabaster, Dyn. VI (?), in Boston Mus. 13.3145 and 3148.

G 2385. Dyn. VI.

Stone-built mastaba. Almost completely destroyed. 'North-eastern Mastaba'.

View, with opening of shaft G 2378A, G. A. R[EISNER] in *Boston Mus. Bull.* xi (1913), fig. 17, p. 59; see id. *Giza Necropolis*, i, p. 268 [3].

G 2387. PEPY-MERYPTAḤANKH. Middle Dyn. VI.



Father (possibly), Khnmenti (tomb G 2374).

Sloping shaft with burial chamber, REISNER, *Giza Necropolis*, i, p. 153 [15].

G 2391. Dyn. VI.

'Tomb of Funerary Priests of Senezemib Family.'

View, G. A. R[EISNER] in *Boston Mus. Bull.* xi (1913), fig. 21, p. 65.

Architrave, offering-text, and four children bringing offerings to Irenakhti  good name Iri , *ka*-servant of (Senezemib) Meḥi (tomb G 2378), Steward, etc., with wife Kasiotes , in Boston Mus. 13.4333. FISCHER, *Dendera*, pl. xxx [b], pp. 60, 219; left part, G. A. R[EISNER], *op. cit.* fig. 22 [upper], p. 65.

Lintel, Meḥi  with son Neferi , and Neferi with children, in Boston Mus. 13.4337. Id. ib. fig. 22 [lower], p. 65.

Block, Neferi with children, and father Meḥi, son of Iri, in Boston Mus. 13.4338.

G 2407.

Statues. Late Dyn. V. Found in débris of shaft D.

Khufukhenui , Inspector of tenants, standing, in Boston Mus. 37.638. REISNER in *Boston Mus. Bull.* xxxvi (1938), fig. 5, pp. 26-7; SHOOLMAN and SLATKIN, *The Enjoyment of Art in America*, pl. 6; see SMITH, *Hist. Eg. Sculp.* p. 75 [2407, 1].

Kaemisit , King's *warb*-priest, Tenant, seated, in Cairo Mus. Ent. 67571. See id. ib. pp. 75-6 [2407, 2]; REISNER, op. cit. pp. 26-7.

G 2415. WERI and wife METI. Late Dyn. V.

Stone-built mastaba.

REISNER, *Giza Necropolis*, i, p. 253 [17]; id. in *Boston Mus. Bull.* xxxvi (1938), p. 27.



Serdab. Statues and statuettes. In Boston Mus.

A. S[ANBORN] in *Boston Mus. Bull.* xx (1922), fig. on p. 25 [upper], cf. p. 26; see SMITH, *Anc. Eg.* (1960), p. 56.

Deceased standing, No. 21.2599. HORNEMANN, *Types*, i, pl. 127; see SMITH, *Hist. Eg. Sculp.* p. 74 [2].

Two, man standing, Nos. 21.2595, 21.2598. See id. ib. p. 74 [3, 1].

Man and woman standing, double-statue, No. 21.2596. See id. ib. p. 75 [5].

Ikhui  and woman Bebi  standing, double-statue, No. 21.2597. See id. ib. pp. 74-5 [4].

Female baker heating pots, No. 21.2600. Id. ib. fig. 15 [lower right], p. 75 [7]; *Handbook* (1964), fig. on p. 181 [upper right]; BREASTED (Jr.), *Eg. Servant Statues*, pl. 28 [b], pp. 27-8 [1]; HORNEMANN, *Types*, iv, pl. 1011; PIRENNE, *Hist. civ.* i, pl. 97 [lower] facing p. 316; HALL in *Apollo*, lxxxviii (July 1968), fig. 2, p. 6; VERCOUTTER in GRIMAL, *Histoire mondiale de la femme. Préhistoire et antiquité*, pl. facing p. 73 [upper right].

Woman grinding corn, No. 21.2601. BREASTED (Jr.), op. cit. pl. 16 [b], p. 18 [3]; HORNEMANN, *Types*, iv, pl. 1031; PRITCHARD, *Anc. Near East*, fig. 149; SMITH, *Country Life*, fig. 35; see id. *Hist. Eg. Sculp.* pp. 75 [6], 96 [a, 9].

Intrusive shaft T. Dyn. VI.

Mummy-mask, plaster, in Cairo Mus. Ent. 45107. Id. ib. pl. 9 [c], p. 27 [2]; see REISNER in *Boston Mus. Bull.* xxxvi (1938), p. 27.

G 2418.

Lintel of *warb*-priest, Inspector of prophets of the Pyramid of Khufu (name lost), in Cairo Mus. Ent. 67574.

Double-statue of man and woman standing, incomplete, late Dyn. V, from shaft U, in Boston Mus. 37.645. Head of woman, REISNER in *Boston Mus. Bull.* xxxvi (1938), fig. 6, p. 26. See SMITH, *Hist. Eg. Sculp.* p. 76 [2418].

G 2420. NEZEMU , Tenant of the Great House, Inspector of *warb*-priests. Late Dyn V.

See REISNER in *Boston Mus. Bull.* xxxvi (1938), p. 26.

Statuettes. Thrown out of serdab, found in shaft D.

Deceased standing, dedicated by son Sonb (?), in Boston Mus. 37.662. See SMITH, *Hist. Eg. Sculp.* p. 75 [2420, 1].

Inti (man) seated, in Boston Mus. 37.641. REISNER, op. cit. fig. 1, p. 26; see SMITH, op. cit. p. 75 [2420, 2].

Deceased (headless) seated, in Boston Mus. 37.642. See id. ib. p. 75 [2420, 3].

Servant cleaning jar, in Cairo Mus. Ent. 67570. Id. ib. fig. 18a, pp. 75 [2420, 4], 97 [c, 5]; BREASTED (Jr.), *Eg. Servant Statues*, pl. 44 [c], p. 47 [5]; MÜLLER (H. W.), *Ägyptische Kunst*, Abb. 51.

G 2422.

Statuette of woman grinding corn, late Dyn. V, from shaft C, in Cairo Mus. Ent. 67572. SMITH, *Hist. Eg. Sculp.* fig. 15 [lower left], pp. 76 [2422], 96 [a, 4]; see BREASTED (Jr.), *Eg. Servant Statues*, p. 18 [2].

G 2423. MEḤU , Judge and Elder of the Hall, Secretary of every secret judgement of the Great Court, Prophet of Ma'et, etc. Dyn. V-VI.

Wife, Khenit .

Stone-built mastaba.

SMITH (W. S.) in *Boston Mus. Bull.* lvi (1958), pp. 60-1; plan showing position, fig. 3.

Relief with upper part of deceased, from scene of spearing fish, from interior chapel, in Boston Mus. 39.833. Id. in Museum of Fine Arts, Boston. *82nd Annual Report* (1957), fig. on p. 38; id. *Anc. Eg.* (1960), frontispiece, p. 63; id. in *Boston Mus. Bull.* lvi (1958), fig. on cover of No. 304, fig. 1 (reconstruction, with other fragments with titles and offering-list), p. 58; Boston Museum. *Calendar of Events* (Feb. 1958), fig. on 3rd page.

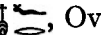
G 2427. MINNŪFER , Overseer of commissions, Inspector of tenants of the Great House. Late Dyn. V.

Block with offering-list. Text, HASSAN, *Giza*, vi [2], pls. lxxv-lxxii [79], p. 135 (called G 2421).

Statues of deceased. Found in serdab.

Standing, formerly in Boston Mus. 37.637, now in Cleveland, Mus. of Art, 48.420. REISNER in *Boston Mus. Bull.* xxxvi (1938), fig. 2, p. 26; WUNDERLICH in *The Bulletin of the Cleveland Museum of Art*, xxxvi (1949), fig. on p. 41 (cover), cf. pp. 43-4; *The Connoisseur*, cxxiv (1949), fig. on p. 120; *The Cleveland Museum of Art. Handbook* (1958), fig. 3; see SMITH, *Hist. Eg. Sculp.* p. 75 [2427, 4].

Standing (headless), in Boston Mus. 37.639. REISNER, op. cit. fig. 3, p. 26; see SMITH, op. cit. p. 75 [2427, 1].

Standing (headless), and lower part of similar statue, both in Boston Mus. unnumbered (Exped. Nos. 36-5-41, 42). See id. ib. 75 [2427, 3, 2].

G 2430. ḤETEPNIPTAḤ , Overseer of tenants of the Great House, Director of the Palace, Secretary of his Lord, etc. Early Dyn. VI.

Wife, Kha'merernebti , Prophetess of Ḥathor in all her places, etc.

Stone-built mastaba. LG 25.

Plan XXVI

Plan and sections, L. D. i. 22. Plan and description, L. D. Text, i, pp. 49-50. Synopsis of scenes, JUNKER, *Giza*, iii, p. 40 [28].

Chapel.

(1) Doorway. (a) and (b) [1st ed. 1, 2] Deceased standing.

L. D. ii. 71 [c].

(2) [1st ed. 3] Bearers of [deceased in palanquin], dogs led by dwarf, and in bottom register, officials and offering-bringers.

L. D. *Ergänz.* x [a].

(3) [1st ed. 4] Deceased seated, with wife squatting by his legs and two children, and three (remaining) registers, bringing donkeys, threshing with cattle and donkeys, female estates, and winnowing, and fragment of scene with deceased, children, and officials, possibly from here.

L. D. ii. 71 [a, a bis]; names of estates, JACQUET-GORDON, *Domaines*, p. 301 [40G5], cf. figs. 86-7.

(4) [1st ed. 5] Deceased with son, and registers of offering-bringers.

L. D. *Ergänz.* x [b].

(5) and (6) [1st ed. 6 and 7] False-door, and four (top destroyed) registers of offering-bringers before deceased with two small sons.

Id. ib. ix. Parts of text of false-door, SETHE, *Urk.* i (1933), pp. 187-8 [27 (118)].

(7) [1st ed. 8] Deceased (head destroyed) at table, with wife and daughter Hēnutsen squatting, [offering-list], funerary priests led by son Kaemthenen , and below, two groups of butchers, and men overthrowing bull.

L. D. ii. 71 [b].

(8) and (9) Pillars (destroyed). Deceased with wife, son, and *ka*-servant respectively, and texts.

L. D. ii. 72 [a, b]. Texts (parts), SETHE, *Urk.* i (1933), pp. 187-8 [27(118)].

G 2450.

Position not marked on plan.

Bust of statuette, probably seated, diorite, Dyn. VI, from shaft B, in Boston Mus. 13.3162. See SMITH, *Hist. Eg. Sculp.* p. 86 [top].

G 2475. SEN^cANKHWĒR , Tenant of the Great House, Flutist, etc. Dyn. VI.

Statuette of deceased seated, in Toronto Mus. 949.42 (from Boston Mus.). NEEDLER in *Bulletin of the Royal Ontario Museum of Archaeology*, No. 18 (March 1952), figs. 4, 5, pp. 9-12; id. in *The Connoisseur*, clxvi (1967), fig. 5 on p. 97.

CEMETERY G 2500

Reisner Excavation. Harvard-Boston Expedition

Plan XI

G 2501.



Head and legs of statuette, Dyn. VI, found in front of mastaba, formerly in Boston Mus. 13.3152-3, head now in New York, M.M.A. 64.66.13. See SMITH, *Hist. Eg. Sculp.* p. 86.

CEMETERY G 3000

'The Minor Cemetery'. Fisher Excavation. The Eckley B. Coxe Jr. Expedition of the University of Pennsylvania (1915)

Plan IX

FISHER, *The Minor Cemetery at Giza*, passim (texts, pp. 134-56, by ROWE); plans and sections, on plans 1-3 (all numbers G 2000 are to be corrected to G 3000).



Lintel of Khaut. . . , Royal acquaintance, and Nefersehetep , King's adorer, etc., Dyn. V-VI, found in débris between tombs G 3003 and 3015, in Philadelphia Mus. E 13540. Text, id. ib. p. 153 [34].



G 3004. KHUFUMERNETERU  , Overseer of the ten of the boat, etc. Dyn. VI.

Brick-built mastaba.

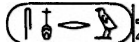
FISHER, *The Minor Cemetery at Giza*, pp. 76-7; plan of shaft B, fig. 63.

False-door with deceased at table on panel. Id. ib. pls. 21, 45; texts, pp. 150-2 [31], cf. fig. 131.

G 3008. SNEFRUḤOTP  , Inspector of *warb*-priests of the Pyramid of Snefru, Greatest of the Ten of Upper Egypt, etc. Dyn. VI.

Wife, Khenut  called Inti , Prophetess of Ḥathor Mistress-of-the-Sycamore and Neith Opener-of-the-Ways, etc.

Stone-built mastaba lined with bricks.

Plan XXVI

FISHER, *The Minor Cemetery at Giza*, pp. 82-6; plan of shaft and sections, figs. 69-71. Synopsis of scenes, JUNKER, *Giza*, iii, p. 41 [30].

Chapel. Unfinished painted decoration (with guiding lines).

Fragment of thickness of entrance doorway, found in shaft C, in Philadelphia Mus. E 13543. FISHER, *op. cit.* pl. 50 [4]; text, p. 154 [35].

(1) Deceased with son before him, and three (remaining) registers of butchers, bringing animals (sketched over estates of earlier plan), and estates (no names). (2) Four registers of harvest before deceased, including treading grain, reaping corn, sifting, and threshing with donkeys.

Id. ib. pl. 53; texts, pp. 157-61, cf. fig. 132.

(3) Deceased at table, and four offering-bringers before him.

Id. ib. pls. 16, 54; texts, pp. 161-2, cf. fig. 133.

(4) Offerings and three registers of offering-bringers, (5) false-door of deceased, (6) three registers of offering-bringers and butchers, (7) false-door of wife (upper lintel, found in chapel of tomb G 3030, in Philadelphia Mus. E 13542).

Id. ib. pl. 55; texts, pp. 163-6, cf. fig. 134; upper lintel of (7), pl. 49 [2]; text, pp. 152-3 [33].

Inscribed fragment of Nūfer , Overseer of the King in all his departments, Dyn. V, found in débris north of tomb G 3008, in Philadelphia Mus. E 13546. Text, id. ib. p. 154 [36].

G 3015. Dyn. VI.

Stone-built mastaba.

FISHER, *The Minor Cemetery at Giza*, p. 96.

Drum of Nūfer , Overseer of scribes of the crews, Director of a crew of recruits, Overseer of the Treasury, etc., re-used in burial chamber A, in Philadelphia Mus. E 13531. Id. ib. pl. 50 [5]; text, p. 147 [23]; see SMITH, *Hist. Eg. Sculp.* p. 163 note 1 (called G 3018); CAPART, *Documents*, ii, p. 23 (called G 2110).

G 3020. SEMERKA , Royal acquaintance, Prophet of Khnem-khufu, etc. Dyn. VI.

Stone-built mastaba.

FISHER, *The Minor Cemetery at Giza*, pp. 96-101; plans and sections, figs. 84, 88-9.

Panel of false-door of deceased, from débris of chapel, in Philadelphia Mus. E 13530.

Id. ib. pl. 50 [1]; text, pp. 146-7 [22].

Lintel, probably of deceased, from shaft B of tomb G 3031, in Philadelphia Mus. E 13536.

Id. ib. pl. 49 [3]; text, p. 148 [28].

G 3033. SABEF , *ka*-servant. Dyn. VI.

Brick-built mastaba with stone débris filling.

FISHER, *The Minor Cemetery at Giza*, pp. 114-20; plans and sections, figs. 107, 109-12.

Lintel and drum (in one piece) of south false-door of deceased, in Philadelphia Mus.

E 13533. Id. ib. pls. 51 [2], 18; text, pp. 147-8 [25].

Panel and drum of deceased, in Cairo Mus. Ent. 60544.

Fragment of false-door with name of daughter Meseht , from débris, in Philadelphia Mus. E 13547. Text, id. ib. p. 155 [38].

G 3035. THENTI , Judge and Scribe. Dyn. VI.

Wife, Nefert , *mitrt*.

Brick-built mastaba with stone débris filling.

FISHER, *The Minor Cemetery at Giza*, pp. 121-3; plan and section of serdab, fig. 114.

North jamb of entrance doorway with five offering-bringers (unfinished). Id. ib. pl. 13 [3].

Drum of false-door of deceased and wife, in Philadelphia Mus. E 13548. Id. ib. pl. 51

[1]; text, p. 149 [29].

G 3050. 'ANKH , *ka*-servant. Dyn. VI.

Wife, Kēdefert , *mitrt*.

Brick-built mastaba with probably stone filling.

FISHER, *The Minor Cemetery at Giza*, p. 133.

Upper part of false-door, with deceased and wife at table on panel, and daughters Khentka

 and Kēdefert on either side, in Philadelphia Mus. E 13537. Id. ib. pl. 51 [3]; text, pp. 149-50 [30].

Lintel of deceased, from débris north of tomb G 3094, in Philadelphia Mus. E 13528; id. ib. pl. 52 [2]; text, p. 145 [20]. Another, in Brussels, Mus. Roy. E. 3269; text, SPELEERS, *Rec. Inscr.* p. 4 [33].

Drum of Nūfer , Royal scribe, Dyn. V-VI, from débris east of tomb G 3071, in Philadelphia Mus. E 13532. FISHER, *op. cit.* pl. 52 [1]; text, p. 147 [24].

G 3082. SENKA , Overseer of washermen. Dyn. VI.

Stone-built mastaba.

FISHER, *The Minor Cemetery at Giza*, pp. 27-8; plans and sections of shafts, figs. 13-15.

Libation-basin of deceased, from débris, in Philadelphia Mus. E 13515. Id. ib. pl. 52 [3]; text, p. 135 [1].

G 3086. RUZ , Prophet of Khufu, Raꜣzedef, and Khephren, *warb*-priest of the King's mother, Supervisor of the police, etc. Dyn. VI.

Parents, Iymerery and Personet (tomb G 3098). Wife, Mest , Royal acquaintance. Brick-built mastaba.

FISHER, *The Minor Cemetery at Giza*, pp. 34-5; section, fig. 24.

Statuette of seated woman (uninscribed), in Philadelphia Mus. E 13521. Id. ib. pl. 43 [I, 2], p. 141 [12].

Libation-basin of deceased and wife, found *in situ* in offering-room, in Cairo Mus. Ent. 46497. Id. ib. pls. 20 (*in situ*), 46 [I], with text, p. 141 [13]; C. S. F[ISHER] in *Penn. Mus. Journ.* viii (1917), fig. 17, p. 50; vi (1915), fig. 56 (*in situ*), p. 76.

Libation-basin of deceased and wife, from serdab, in Philadelphia Mus. E 13522. FISHER, *The Minor Cemetery at Giza*, pl. 46 [2]; text, p. 142 [14].

Pottery offering-stand with incised name of Bebib , *ka*-servant. Id. ib. fig. 25, p. 35.

Panel of false-door of deceased and wife, in Basel, Mus. für Völkerkunde, III. 6197. RÜTIMEYER, *Führer durch das Museum für Völkerkunde Basel, Alt-Ägypten* (1930), fig. 8, pp. 14-15 (called 6419); see id. *Bericht* (1923) in *Verhandlungen der Naturforschenden Gesellschaft in Basel*, xxxv [2], pp. 3-4.

Block with names of deceased and wife, red granite, from floor in passage, in Philadelphia Mus. E 13523. FISHER, *The Minor Cemetery at Giza*, pl. 48 [4]; text, pp. 142-3 [15].

G 3093. MEDEDI , Supervisor of directors of the expedition, etc. Dyn. VI.

Wife, Khnemt , Prophetess of Neith Opener-of-the-Ways, and of Hathor Mistress-of-the-Sycamore, etc.

Mastaba with stone filling lined with bricks.

FISHER, *The Minor Cemetery at Giza*, pp. 49-54; plans and sections, figs. 38-40.

Offering-room.

View of west wall, id. ib. pls. 23-4, cf. 25; *Penn. Mus. Journ.* vi (1915), figs. 54-5, pp. 74-5.

Standing statue of deceased, with large back panel, in Cairo Mus. Ent. 46494. FISHER, op. cit. pl. 44 [1]; text, p. 136 [4].

False-door of wife and deceased, in Cairo Mus. Ent. 46495. Id. ib. pl. 44 [2], with texts, pp. 136-8 [5], cf. fig. 128; C. S. F[ISHER] in *Penn. Mus. Journ.* viii (1917), fig. 15, p. 47.

Male standing statuette (uninscribed), in Philadelphia Mus. E 13516. Id. *The Minor Cemetery at Giza*, pls. 28 (*in situ*), 43 [3], p. 136 [3].

Small added room east of offering-room.



Statuette of Mesyti , Overseer of boat-nets, standing, in Philadelphia Mus. E 13514. Id. ib. pls. 27 (*in situ*), 42, with text, pp. 135-6 [2]; C. S. F[ISHER] in *Penn. Mus. Journ.* viii (1917), fig. 16, p. 47; vi (1915), fig. 53, p. 73; PIJOÁN, *Summa Artis*, iii (1945), fig. 157 (called New York).

G 3094. KHETU , Overseer of the Treasury, etc. Dyn. VI.

Mastaba with stone filling lined with bricks.

FISHER, *The Minor Cemetery at Giza*, pp. 54-6; plan of shaft D, fig. 42.

Drum of deceased, from débris, in Philadelphia Mus. E 13539. Id. ib. pl. 50 [3]; text, p. 154 [37].

Lintel of Khety  (man), Nebeh , *mitrt*, Prophetess of Neith, and Khertka , *mitrt*, Prophetess of Hathor, found in débris north of tomb, in Philadelphia Mus. E 13529. Id. ib. pl. 49 [1]; text, p. 146 [21].

G 3096. NEZSU , Supervisor. Dyn. VI.

Brick-built mastaba.

FISHER, *The Minor Cemetery at Giza*, pp. 57–60; plan and section, figs. 45–7.

Drum of deceased, probably from south false-door, found in débris north of tomb G 3093, in Philadelphia Mus. E 13517. Text, id. ib. pp. 138–9 [7].

G 3097. NEFERHI , King's adorer and Keeper of unguents, etc. Dyn. VI.

Mastaba with stone filling lined with bricks.

FISHER, *The Minor Cemetery at Giza*, pp. 60–3; plans and section of shafts, figs. 48, 50.

Libation-basin of deceased, found *in situ* in front of left north outer niche, in Philadelphia Mus. E 13518. Id. ib. pl. 22 (*in situ*), text, p. 139 [8].

G 3098 with annexe.

Mastaba with stone filling lined with bricks.

FISHER, *The Minor Cemetery at Giza*, pp. 63–7; plan of shaft D, and sections, figs. 51, 53.

(a) IYMERERY , *warb*-priest of the King's mother, Inspector of *warb*-priests, Overseer of the dockyard, etc. Dyn. VI.

Wife, Personet , Royal acquaintance.

Drum of deceased and wife, dedicated by son Ruz (tomb G 3086), from débris, in Philadelphia Mus. E 13527. Id. ib. pl. 50 [6]; text, p. 145 [19].

Pottery offering-stand of deceased, from débris, in Philadelphia Mus. E 13545. Text, id. ib. p. 155 [40].

Libation-basins of Ruz, deceased, and wife (last dedicated by Ruz), first two found *in situ* in front of north and south false-doors, in Philadelphia Mus. E 13524–6. Id. ib. pl. 48 [1, 3, 2]; texts, pp. 143–5 [16–18].

(b) NEFERHETPES-WĒR , King's adorer, etc. Dyn. VI.

Father, Duarēc , King's son of his body.

North-east annexe.

False-door of deceased, in Philadelphia Mus. E 13519. Id. ib. pl. 47 [1]; texts, pp. 139–40 [10], cf. fig. 129.

Libation-basin of deceased, in Philadelphia Mus. E 13520. Id. ib. pl. 47 [2]; text, p. 140 [11].

Fragment with remains of offering-list, from débris north of tomb G 3099, in Philadelphia Mus. E 13538. Id. ib. pl. 50 [2]; text, p. 152 [32].

JUNKER CEMETERY (WEST)

Junker Excavation. Akademie der Wissenschaften in Wien, Pelizaeus-Museum Hildesheim, and University of Leipzig Expedition (1926-7)

Plan XIII [2]

Plans, JUNKER, *Gîza*, v, plan at end; ix, plan iii; xii, plans 1, 2; id. in *Anzeiger, Wien*, 64 (1927), plan after p. 160. Views, id. *Gîza*, v, Taf. i.

IRTY , Recruit, Overseer of draughts-players of the crews, etc. Late Old Kingdom.

Wife, Ishpet , *mitrt.*

Brick-built mastaba.

JUNKER, *Gîza*, v, pp. 156-63; plans and sections, Abb. 46-7; id. in *Anzeiger, Wien*, 64 (1927), Abb. 3, p. 128; views, id. *Gîza*, v, Taf. xiv [b], xvi [b].

South false-door, in corridor of chapel. Id. ib. Taf. xvi [a], Abb. 48, pp. 158-63; texts, id. in *Anzeiger, Wien*, 64 (1927), pp. 146-7. Panel, deceased and wife at table, in Michaelidis Colln. Lower lintel with drum (in one piece), formerly with Blanchard (dealer) in Cairo, then Michaelidis Colln., now in Berlin (West) Mus. 25/66; KAISER, *Äg. Mus. Berlin* (1967), p. 27 [234] with Abb.; see SMITH (W. S.) in REISNER, *The Development of the Egyptian Tomb* [etc.], p. 398.

‘ANKH , *stw*-official. Late Old Kingdom.

Wife, Nefertka , *mitrt.*

Stone-built mastaba with brick-built additions.

JUNKER, *Gîza*, v, pp. 150-4; plan and section, Abb. 43; view, Taf. xiv [a].

Main false-door of chapel, deceased and wife at table on panel, and two registers at back of niche, deceased and wife, with small daughter Nezetpet  by leg of deceased, and man censuring and two offering-bringers below, in Hildesheim Mus. 3086. Id. ib. Taf. xv, Abb. 44-5, pp. 151-4; back of niche, id. in *Anzeiger, Wien*, 64 (1927), Taf. ix, pp. 147-8; daughter, ROEDER, *Die Contax* [etc.] in *Photographie und Forschung* (1936), Abb. vi on p. 222; offering-bringers, KAYSER, *Ägyptisches Kunsthandwerk*, Abb. 170.

IYHERKHERUI , Recruit. Late Old Kingdom.

Brick-built mastaba.

Drum of false-door with name and title. See JUNKER, *Gîza*, v, p. 155; id. in *Anzeiger, Wien*, 64 (1927), p. 152.

S 4399/4507. Late Old Kingdom.

Stone-built mastaba.

JUNKER, *Gîza*, v, pp. 175-8; plan and sections, on Abb. 54a.



Slab set up in middle of east face, deceased, wife, and probably son (no names). Id. ib. Abb. 54b, p. 175.

‘ANKHU , Tutor of the King's sons, Overseer of weavers of the Great House. Late Old Kingdom.

Stone-built mastaba.

JUNKER, *Giza*, v, pp. 128-33; plans and sections, Abb. 33; views, Taf. x.

False-door. Drum with titles of deceased, id. ib. Abb. 34 [lower], p. 130; text, id. in *Anzeiger*, *Wien*, 64 (1927), p. 153; fragment of panel with remains of text (offerings), id. *Giza*, v, Abb. 34 [upper], p. 130.

SONB  (full name  ) , Director of dwarfs in charge of dressing, Tutor of the King's sons, Prophet of Khufu and Ra'zedef, etc. (dwarf). Middle Dyn. VI or later.

Wife, Sentiotes  , Prophetess of Hathor and Neith, etc.

Stone-built mastaba.

Plan XXVII

JUNKER, *Giza*, v, pp. 3-124; id. in *Anzeiger*, *Wien*, 64 (1927), pp. 100-22. Plans and sections, id. *Giza*, v, Abb. 2, 3; id. in *Anzeiger*, *Wien*, 64 (1927), Abb. 1 between pp. 100-1, Abb. 2 facing p. 102. Views, id. *Giza*, v, Taf. ii, iii; id. in *Anzeiger*, *Wien*, 64 (1927), Taf. i; WOLF in *Der Cicerone*, xx (1928), Abb. on p. 585. Plan and views showing domed vault, BADAWY in ABU-BAKR, *Giza*, figs. 113-14, pp. 137, 139.

Chapel.

I. Offering-room.

(1) Doorway. Lintel and drum with name and titles of deceased.

JUNKER, *Giza*, v, Abb. 4a, p. 33.



(2) Offering-table of deceased, of  form, granite.

Id. ib. Taf. vii [b, c], on iv, Abb. 28, pp. 100-4.

(3) False-door of deceased, in Cairo Mus. Ent. 51297. Id. ib. on Taf. iv; MITRY, *Illus. Cat.* No. 6010; synopsis of scenes, JUNKER, *Giza*, iii, pp. 40-1 [29]; see *Descr. somm.* No. 6010.

Upper part, granite. Fragments from panel and lower lintel, JUNKER, *Giza*, v, Abb. 4b, pp. 33-4.

Lower part, limestone.

(a) Three registers, titles of deceased, son 'Ankhma'ra'zedef   censing before deceased seated, and two men bringing haunches.

Id. ib. Abb. 5a, 5b, pp. 36-40.

(b) Titles of deceased, and four registers, **I**, men with linen before deceased standing, **II**, three scribes recording, **III**, two scribes with two workmen receiving rewards, **IV**, three women with rewards.

Id. ib. Taf. v [a] (without titles), Abb. 6-8, pp. 40-6.

(c) Six registers, **I**, deceased with men in boat being paddled, **II**, deceased with men in sailing-boat, **III**, deceased pulling papyrus from boat, **IV-VI**, boats being paddled.

Id. ib. Taf. vi [a], Abb. 14-16, pp. 61-9. **II-III**, id. in *Anzeiger*, *Wien*, 64 (1927), Taf. iv, pp. 117-18. **III**, KEIMER in *Kémi*, ii (1929), pl. iv [3], pp. 95-6 [5] (from JUNKER).

(d) Seven registers, **I-II**, estates, **III**, scribe with two dogs before deceased seated in pavilion, **IV**, scene with herdsmen rendering accounts, **V**, bulls, **VI**, donkeys, **VII**, sheep and goats.

JUNKER, *Gîza*, v, Taf. vi [b], Abb. 17-19, pp. 73-81. V-VII, HAMANN, *Äg. Kunst*, Abb. 56; id. *Tierplastik im Wandel der Zeiten*, Taf. 11. Names of estates from I-II, JACQUET-GORDON, *Domaines*, pp. 304-5 [42G6], cf. figs. 90-1 (from JUNKER).

(e) Three registers, I, deceased carried in palanquin, II, three offering-bringers, III, three attendants.

JUNKER, *Gîza*, v, Abb. 20-1, pp. 83-6. I, id. in *Anzeiger, Wien*, 64 (1927), Taf. v [b], pp. 108, 113.

(f) Four registers, I, three scribes handing in list to deceased seated, II, wife seated receiving lotus-flower from children, III-IV, offering-bringers.

Id. *Gîza*, v, Taf. v [b], Abb. 22-4, pp. 86-92. I-II, id. in *Anzeiger, Wien*, 64 (1927), Taf. v [a], pp. 113-14. Deceased and scribes from I, WATERMANN, *Bilder aus dem Lande des Ptah und Imhotep*, Abb. 29, pp. 60-1.

(g) and (h) Offering-lists.

JUNKER, *Gîza*, v, Abb. 25-6, pp. 92-8. (h) Offering-list for *wah-akh* ritual, id. in *Miscellanea Gregoriana*, fig. on p. 110, cf. pp. 109-15.

II. Small serdab south of false-door.

Stone chest, originally containing wooden statue of deceased, in Hildesheim Mus. 3115. Id. *Gîza*, v, Taf. viii [a-c], pp. 104-5 [2], 121 [5a].

III. Large serdab south of offering-room. Destroyed.

Fragment of base of statue of deceased, inscribed, red granite, with remains of stone chest which contained it, found nearby. Id. ib. Abb. 29 [B], pp. 121-2 [5b].

East Façade.

(4) North false-door of wife.

Id. ib. Abb. 27, pp. 98-100.

IV. Serdab north of false-door of wife.

Statue-group,¹ deceased and wife seated, with son and daughter standing, found in stone chest (see p. 103), in Cairo Mus. Ent. 51280. Id. ib. frontispiece, Taf. ix, Abb. 29 [A], pp. 107-8, 113-14; id. in *Anzeiger, Wien*, 64 (1927), Taf. ii, iii, pp. 107, 120-2; MITRY, *Illus. Cat.* No. 6055; *Egyptian Museum* (Cairo, 1949), fig. on p. 21; FETT, *Mumier og sfinks*, pl. on p. 101; STEINDORFF, *Kunst*, 189; RANKE, *The Art of Ancient Egypt*, and BREASTED, *Geschichte Aegyptens*, 74; SCHARFF in *Antiquity*, xi (1937), pl. ii after p. 176; id. in *J.E.A.* 26 (1940), pl. x [4], pp. 49-50; ENGELBACH in *Ann. Serv.* xxxviii (1938), pl. xxxv, p. 285; LEIBOVITCH, *Anc. Eg.* fig. 60; HAMANN, *Äg. Kunst*, Abb. 141; PIJOÁN, *Summa Artis*, iii (1945), fig. 167; ANTHES, *Meisterwerke ägyptischer Plastik* (1947), Taf. xvii; id. *Aegyptische Plastik in Meisterwerken*, Taf. 22; BYVANCK, *De Kunst*, pl. xix [70]; ALDRED, *O.K. Art*, pl. 53; *Encycl. phot. Caire*, pl. 29; DRIOTON and SVED, *Art. ég.* fig. 28; SHOUKRY, *Privatgrabstatue*, Abb. 37, p. 164; VANDIER, *Eg. Sculpture*, pl. 35; WILSON, *The Burden of Egypt*, fig. 7d; DONADONI, *Arte Egizia*, fig. 38; RIAD, *La Médecine au temps des Pharaons*, fig. 11; WOLF, *Kunst*, Abb. 150; id. in *Der Cicerone*, xx (1928), Abb. on p. 587; DE RACHEWILTZ, *Incontro con l'Arte Egiziana*, Tav. 5; SÄVE-SÖDERBERGH, *Faraoner och människor*, pl. facing p. 33; Eng. ed. *Pharaohs and Mortals*, pl. on p. 48; SENK in *Forschungen und Fortschritte*, 33 (1959), Abb. 3, p. 238; FORMAN (W. and B.) and VILÍMKOVÁ, *Eg. Art*, pl. 35; RIESTERER, *Kunstschätze . . . Kairo*, pl. 10; HARRIS, *Egyptian Art*, fig. 15; WENIG, *Die Frau*, pl. 10; HORNE-

¹ Selected references.

MANN, *Types*, vi, pls. 1463-4; YOYOTTE, *Treasures of the Pharaohs*, pl. on p. 34 (called Ent. 51281); WESTENDORF, *Das Alte Ägypten*, fig. on p. 63; SOGA, *The Nile*, fig. on p. 143 [lower]; MICHALOWSKI, *Art*, fig. 259; TERRACE and FISCHER, *Treasures of the Cairo Museum*, pp. 65-8 with pls. and pl. iii (called Ent. 51281); *Great Museums*, pl. 26; deceased and wife, MONTET, *Lives of the Pharaohs*, pl. on p. 27; see *Descr. somm.* No. 6055.

Stone chest, originally containing statue-group (see p. 102), in Cairo Mus. Ent. 51281. JUNKER, *Giza*, v, Taf. viii [d-f], pp. 104-5 [2].

South shaft.

Sarcophagus (uninscribed), found in fragments, now restored, in Leipzig Mus. Inv. 3695. Id. ib. Taf. vii [a], Abb. 30, pp. 122-4; F.E.R.E. photo. 5943; see DONADONI ROVERI, *Sarcofagi egizi*, pp. 136-7 [B 69].



‘ANKHMA‘RĒC , King's *warb*-priest. Dyn. VI.

Stone-built mastaba.

JUNKER, *Giza*, v, pp. 124-6; plan and sections, Abb. 31.

Two libation-basins (one inscribed), found in front of false-door. Text, id. ib. p. 126; see id. in *Anzeiger, Wien*, 64 (1927), p. 154.

ITHU , King's *warb*-priest. Dyn. VI.

Parents (probably), Iatib , Scribe, and Khaut (?) , *mitrt*. Wife, Intkaes , *mitrt*.

Brick-built mastaba.

JUNKER, *Giza*, v, pp. 134-48; id. in *Anzeiger, Wien*, 64 (1927), pp. 148-9. Plan and sections, id. *Giza*, v, on Abb. 35; views, Taf. xi [a, b], xii.

Chapel.

North false-door of wife. Id. ib. Taf. xi [d], Abb. 36, pp. 137-8, 140-2.

Central false-door of deceased. Id. ib. Abb. 41, pp. 144-5.

South false-door (panel with deceased and wife at table, in Hildesheim Mus. 3113). Id. ib. Taf. xi [c], Abb. 40, pp. 142-4.

Window with name of deceased, opposite serdab, near central false-door. Id. in *Anzeiger, Wien*, 64 (1927), Taf. x [b]; id. *Giza*, v, on Abb. 35, p. 136.

Finds

Double-statue, Iatib and Khaut (?) standing, found in front of south false-door, in Leipzig Mus. Inv. 3694. Id. ib. Taf. xiii, Abb. 42 (base), pp. 146-8; id. in *Anzeiger, Wien*, 64 (1927), Taf. vi, p. 140; upper part, RICHTER in *The Journal of Roman Studies*, xlv (1954), pl. i [2], p. 41 with note 16; GRIFFITH INST. photo. 3212.

SINEKHEN , *stzw*-official, etc. Dyn. VI.

Wife, Ma'kherui , Female steward, etc.

Stone-built mastaba.

JUNKER, *Giza*, v, pp. 182-5; plan and sections, on Abb. 56.

False-door. Drum with name of deceased and wife, found *in situ*; see id. ib. pp. 182, 184; id. in *Anzeiger, Wien*, 64 (1927), pp. 152-3; panel with deceased and wife at table, and lower

lintel with titles (in one piece), fragment, found re-used in shaft S 2503; id. *Gîza*, v, Taf. xix [b], Abb. 57, pp. 184-5; see id. in *Anzeiger, Wien*, 63 (1926), p. 116; 64 (1927), p. 153.

DEMEG , Overseer of the ten of the boat, Overseer of the department of the Great House, etc. Dyn. VI.

Stone-built mastaba.

JUNKER, *Gîza*, v, pp. 185-7; plan, on Abb. 56.

Upper lintel and panel of false-door with deceased at table, in one piece, found north of doorway to chapel. Id. ib. Taf. xix [a], Abb. 58, pp. 186-7; see id. in *Anzeiger, Wien*, 64 (1927), p. 150.

MENISUTIOTNESUT , Elder of the house of the hereditary prince, etc. Late Dyn. VI.

Stone-built mastaba.

JUNKER, *Gîza*, v, pp. 188-92; plan and sections, Abb. 59.

Libation-basin with name and titles of deceased, found in front of false-door, in Vienna Mus. Inv. 8185. Id. ib. Abb. 60, pp. 188-90; see id. in *Anzeiger, Wien*, 64 (1927), pp. 153-4.

S 4248/4321. Late Old Kingdom.

Brick-built mastaba enlarged in stone.

JUNKER, *Gîza*, ix, pp. 214-16; plan and sections, on Abb. 98, cf. Abb. 1 [middle]. View, id. ib. Taf. ii [b]; of shaft S 4248, Taf. iv [c].

Libation-basin, found in front of false-door, in Hildesheim Mus. 3172. Dedication-text of son Ptaḥuser (or Ḥeptuser) , id. ib. p. 215, cf. on Abb. 98; id. in *Anzeiger, Wien*, 64 (1927), p. 154; SETHE, *Urk.* i (1933), 229 [5 (145), L].

MENIB , Prophetess of Ḥathor, etc. Late Old Kingdom.

Mastaba with stone casing.

JUNKER, *Gîza*, ix, pp. 216-18; plan, on Abb. 99; view of shaft, Taf. iv [a].

Upper part of false-door of deceased, found in shaft. See id. ib. p. 218 (with text); id. in *Anzeiger, Wien*, 64 (1927), p. 152 (with text).

KHESEF [II] , Recruit. Dyn. V.

Brick-built mastaba.

JUNKER, *Gîza*, ix, pp. 248-52; plan and sections, Abb. 113-14; view, Taf. xx [b]. Name and title, on fragments of lintel of false-door, see id. ib. pp. 248-9.

NEBTPEZU , *mitrt* (woman). Late Old Kingdom.

Brick-built mastaba.

JUNKER, *Gîza*, ix, pp. 240-4; plan and sections, on Abb. 109, cf. 110 (serdab); view, Taf. xix [a].

Statue of deceased seated, found *in situ* in serdab behind south false-door, in Hildesheim Mus. 3112. Id. ib. Taf. viii [a], Abb. 111 (base), pp. 241-4; id. in *Anzeiger, Wien*, 64 (1927), Taf. viii [a (*in situ*), b], p. 141.

S 4419. Late Old Kingdom.



Brick-built mastaba.



Double-statue of seated couple, found *in situ* at north end of chapel, possibly from here, in Vienna Mus. Inv. 8019. JUNKER in *Anzeiger, Wien*, 64 (1927), Taf. vii, p. 141; KOMORZYN-SKI, *Altägypten*, Abb. 19, p. 41; id. *Altägyptens hohe Kunst in Österreich in Wort und Bild*, 43 (1952), Abb. 3, p. 47; id. *Erbe*, Abb. 24; see JUNKER, *Giza*, ix, pp. 255-6; Vienna. 5000 Jahre, p. 67 [56].

S 4233/4283. Late Old Kingdom.

Stone-built mastaba.

JUNKER, *Giza*, ix, pp. 231-2; plan, on Abb. 103; view, on Taf. xx [a].



Libation-basin, found *in situ*, dedicated by Itiu (?)  (?)  (?), *ka*-servant. Text, id. ib. p. 231; see id. in *Anzeiger, Wien*, 64 (1927), p. 154.

ḤETEPKHNEMT  , Singer of the Great House. Dyn. VI.

Mastaba with stone casing.

JUNKER, *Giza*, ix, pp. 237-8; plan and sections, on Abb. 105; view, on Taf. xx [a].



False-door of deceased (much damaged). Id. ib. Abb. 107; see id. in *Anzeiger, Wien*, 64 (1927), p. 152.

MESHETH  , Inspector of *warb*-priests of the Pyramid of Khufu. Dyn. VI.

Mastaba with stone casing.

JUNKER, *Giza*, ix, pp. 233-6; plan and sections, on Abb. 105; views, on Taf. ii [c], xviii [c].

Lintel with unfinished offering-text, and drum with name and title. Id. ib. Taf. xviii [a], Abb. 106.

KHNEMḤOTP [II]  , Overseer of *ka*-servants, Director of King's *warb*-priests, Prophet of Khufu, etc. Dyn. VI.

Stone-built mastaba.

Plan XXVII

JUNKER, *Giza*, ix, pp. 199-208; plan and sections, on Abb. 91; description of scenes and texts, id. in *Anzeiger, Wien*, 64 (1927), pp. 143-4.

Chapel.

(1) Doorway. (a) Remains of later text; (b) and (c) (much damaged) deceased and wife standing.

(a) Text, id. *Giza*, ix, p. 203. (b) and (c) Id. ib. Abb. 92, pp. 203-4.

(2) Remains of deceased at table, and register of butchers below.

Id. ib. Abb. 94, p. 208.

(3) Deceased and [wife] at tables facing each other, with offerings above, and two groups of butchers below.

Id. ib. Taf. xvi [c], Abb. 93, pp. 204-8.

IIU , Overlord of linen (*ššrw*), etc. Dyn. VI.

Wife, Tepemnefert .

Stone-built mastaba.

JUNKER, *Giza*, ix, pp. 226-31; plan, on Abb. 103.

Lintel of deceased and wife, found in front of central false-door, in Vienna Mus. Inv. 8016. Id. ib. Taf. x [d], Abb. 104, pp. 227-31; see id. in *Anzeiger, Wien*, 64 (1927), p. 152.

SHETUI , King's *warb*-priest, Inspector of scribes of the granary, Overseer of *ka*-servants, etc. End of Dyn. V or Dyn. VI.

Stone-built mastaba.

Plan XXXIV

JUNKER, *Giza*, ix, pp. 184-91; id. in *Anzeiger, Wien*, 64 (1927), pp. 144-6; plan, id. *Giza*, ix, on Abb. 83; view, Taf. xix [d].

Chapel. Much destroyed.

(1) Entrance doorway. (a) Drum with name and titles; (b) and (c) fragments with deceased standing.

(a) Id. ib. Abb. 84 [A], p. 184. (b) and (c) Id. ib. Abb. 84 [B, C], p. 185.

(2) Deceased, and three registers, I, men bringing bulls, II, bringing wild animals, III (much destroyed), female estates kneeling.

Id. ib. Taf. xvii [a], Abb. 86, pp. 186-90; names of estates from III, JACQUET-GORDON, *Domaines*, p. 320 [49G6], cf. figs. 105-6 (from JUNKER).

(3) Panel of false-door, with deceased (twice) at table.

JUNKER, *Giza*, ix, Taf. xvii [b], Abb. 85, pp. 185-6.

Block with upper part of shrine, possibly from scene of transporting statue. Id. ib. Abb. 87, pp. 190-1.

PTAḤSHEPSES [II] , Dyn. VI.

Stone-built mastaba.

JUNKER, *Giza*, ix, p. 191; position, on Abb. 83.

Libation-basin of deceased, in Vienna Mus. Inv. 8554. Id. ib. Abb. 88.



KHESEF [I] , Recruit. Dyn VI.

Originally brick-built mastaba, re-built in stone.

JUNKER, *Giza*, ix, pp. 192-8; plan and sections, on Abb. 89, cf. Abb. 1 [top]; view, Taf. ii [a].

False-door of deceased (much destroyed). Id. ib. Abb. 90, pp. 193-8; see id. in *Anzeiger, Wien*, 64 (1927), pp. 151-2.

INPUḤOTP , Prophet of the shrine of Anubis in Aphroditopolis, Prophet of Saḥurē and Neuserrē, Prophet of Rē in the Sun-temple of Neuserrē, etc. Dyn. VI.

Parents, Ither , Prophet of Neuserrē, etc., and Sabt , Royal acquaintance. Wife, Senezem .

Stone-built mastaba.

JUNKER, *Giza*, ix, pp. 154-69; id. in *Anzeiger, Wien*, 63 (1926), pp. 113-16 [5]; plan, id. *Giza*, ix, on Abb. 70; views, Taf. xiii [b], xiv [c]; names and titles of relatives, pp. 156-8.

North face.

Frieze, with titles. Id. ib. Abb. 72 [bottom], p. 159.

Chapel.

Entrance doorway. Lintel and drum with names and titles of deceased and son Sehi — , Embalmer; id. ib. Abb. 72 [top and middle], pp. 159, 161. Jambs, left, father with mother, right, deceased with wife, and dedication of son Sehi, and on both, two registers of family below; id. ib. Taf. xv [right], Abb. 73. Thicknesses, left, father, mother and family, right, deceased with wife, and below on both, two registers, family and cattle (brought by dwarfs on left); id. ib. Taf. xv [left], Abb. 74-5, pp. 161-8.

Offering-table of deceased, found in front of south false-door, in Hildesheim Mus. 3042. Id. ib. Taf. ix [b], Abb. 76, pp. 168-9.

MENI [I] , Elder of the house. Late Dyn. VI.

Brick-built mastaba.

JUNKER, *Giza*, ix, pp. 140-3, 144-5; id. in *Anzeiger, Wien*, 63 (1926), pp. 108-11 [2]. Plans and sections, id. *Giza*, ix, on Abb. 65-7; id. in *Anzeiger, Wien*, 63 (1926), on Abb. 1, 2; SCHARFF in *Mitt. Kairo*, 8 (1939), pp. 19, 24, Abb. 1 (from JUNKER), 3. Views, JUNKER, *Giza*, ix, Taf. xiv [b, d]; reconstruction, Abb. 3 [upper].

Eight blocks from false-doors of chapel, in Hildesheim Mus. 3053. SCHARFF, op. cit. Taf. 13, 14, pp. 17-33; see JUNKER, *Giza*, ix, pp. 145-8.

MENI [II] , Elder of the house. Late Dyn. VI.

Possibly same as Meni [I].

Wife, Merutnes .

Exact position unknown, perhaps brick-built mastaba S 2530/2531, west of tomb of Meni [I].

Plan and section of tomb S 2530/2531, see references to tomb of Meni [I], above; see JUNKER, *Giza*, ix, pp. 143-4; id. in *Anzeiger, Wien*, 63 (1926), p. 111 [3].

Two false-doors, in Munich, Staatl. Sammlung, Gl. 24.

(a) Panel (Mü 2 of Scharff), deceased with wife receiving offerings from children. Lintel, deceased with wife towed in boat, drum with name of deceased, upper parts of jambs with offering-bringers and women grinding corn (Mü 1, in one piece).

(b) Panel (Mü 4), deceased and wife with children. Lintel (inscribed), drum with name of deceased, upper part of jambs (uninscribed) (Mü 5, in one piece).

SCHARFF in *Mitt. Kairo*, 8 (1939), on Taf. 12, pp. 17-33; Munich. *Äg. Sammlung* (1966), Abb. 14, 15; VON BISSING, *Äg. Kunstgeschichte*, Taf. lviii [366-7], *Text*, i, p. 93 with note 21, ii, p. 63 [14 a] with note 4; id. *Denkmäler*, i, Taf. 15, 16 (without drum and jambs of (b)). Panels of (a) and (b), JUNKER, *Giza*, v, Abb. 38-9, pp. 138-40 (from VON BISSING). Panel of (a), FECHHEIMER, *Plastik* (1914), Taf. 110; (1923), Taf. 120; PIJOÁN, *Summa Artis*, iii (1945), fig. 15; *Schaetze altaegyptischer Kunst. Kunsthalle, Basel, 27 Juni-13 Sept. 1953*, 6th Abb., p. 35 [61]. Lintel of (a), KLEBS, *Reliefs . . . a.R.* Abb. 15 (called 40836); WRESZ., *Atlas*, iii. 115 [B]. Texts (incomplete), SETHE, *Urk.* i (1933), 23 [16, A, B]. See WOLTERS, *Illus. Kat.* (1912), p. 12 [31 a]; id. *Führer* (1928), p. 12 [65]; FURTWÄNGLER, *Beschreibung*, pp. 34-5

[31 a]; MÜLLER (H. W.) in *Mitt. Kairo*, iv (1933), pp. 180-1 with note 4; JUNKER, *Gîza*, ix, pp. 148-50.

Two drums with name of deceased (Mü 3, 6 of Scharff), in Munich, Staatl. Sammlung, Gl. 293-4. SCHARFF, op. cit. Taf. 12, pp. 17-33.

Block from false-door with names of deceased and mother Neferi , perhaps from here, in Munich, Staatl. Sammlung, Gl. 295.



S 4040. Dyn. VI.

Brick-built mastaba.

JUNKER, *Gîza*, ix, pp. 179-81; plan, on Abb. 80, cf. Abb. 81 (serdab).

Two female statuettes, seated, from serdab behind north niche, in Hildesheim Mus. 2975, 3111. No. 3111, id. ib. Taf. viii [d], pp. 180-2; HORNE-MANN, *Types*, iv, pl. 1072. See JUNKER in *Anzeiger, Wien*, 64 (1927), pp. 141-2.

Found near tomb S 4031/4033.

False-door of Inkaf , Overseer of craftsmen, etc., dedicated by son 'Ankh-haf , Inspector of craftsmen, etc., Dyn. VI, in Cairo Mus. JUNKER, *Gîza*, ix, Abb. 78-9, pp. 170-8, position, on Abb. 77; see id. in *Anzeiger, Wien*, 64 (1927), pp. 149-50.

Offering-basin of . . . kek , Tenant. See id. *Gîza*, ix, p. 178, position, on Abb. 77.

SINÜFER , Inspector of tenants of the Great House, etc. Dyn. VI.

Wife, 'Ankh-hathor , Royal acquaintance.

Stone-built mastaba.

JUNKER, *Gîza*, ix, pp. 127-34; id. in *Anzeiger, Wien*, 63 (1926), p. 112 [1]. Plan and section, id. *Gîza*, ix, on Abb. 58; view, Taf. xiii [a].

Chapel.

Entrance doorway. Lintel with offering-text, id. ib. Abb. 60 [A], pp. 131-2; left thickness, deceased and wife standing, id. ib. Abb. 59, pp. 130-1.

North false-door. Lintel with offering-text; id. ib. Abb. 60 [B], pp. 132-3.

South false-door. Lintel with name and title; id. ib. Abb. 60 [C], p. 133.

Serdab.

Double-statue¹, deceased with [probably wife] seated, in Hildesheim Mus. 2973. *In situ*, id. ib. Taf. viii [b], pp. 133-4.

HËBI , Steward, Overseer of *ka*-servants. Dyn. VI.

Stone-cased mastaba.

JUNKER, *Gîza*, ix, pp. 118-21; plan, on Abb. 51.

Libation-basin, dedicated by son Ra'nüfer , in Leipzig Mus. Inv. 3140. Id. ib. Taf. ix [c], Abb. 52; see id. in *Anzeiger, Wien*, 63 (1926), p. 105.

STEINDORFF CEMETERY

Mostly brick-built mastabas. Steindorff Excavation. University of Leipzig and Pelizaeus Expedition (1903-7). Several tombs excavated later by Junker



Plan XIV

¹ See Addenda.

BORCHARDT in *Klio*, v (1905), pp. 411-12. Plan, JUNKER, *Giza*, ix, plan ii; REISNER, *Giza Necropolis*, i, on Map of Western Cemetery; east part, JUNKER, op. cit. on plan i; xii, on plan 3; west part, ix, on plan iii; tombs excavated by Junker, xii, on plan 2.

D. 1.

Head of female statue, Dyn. V-VI, in Leipzig Mus. Inv. 2499.

D. 4. WASHPTAḤ  Inspector of prophets of Ḥathor, etc., and KHENU  Royal acquaintance. Dyn. V-VI.

Upper part of false-door of Khenu, in Hildesheim Mus. 4. See IPPEL and ROEDER, *Denkmäler . . . Hildesheim*, p. 61.

D. 9. RAḤOTP  Dyn. V-VI.

Name from offering-table.

D. 12. KHERIḤĒT  Dyn. V.

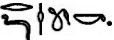
Wife, Ruzka .

Statue-group, deceased with wife and children (originally three), standing, in Hildesheim Mus. 16. HORNEMANN, *Types*, vi, pl. 1483; names, RANKE, *Personennamen*, i, pp. 277 [1], 221 [21]; see IPPEL and ROEDER, op. cit. p. 54.

D. 14. IRKAPTAḤ  Overseer of the Great Estate, etc. Dyn. V-VI.

Lintel of deceased, in Leipzig Mus. Inv. 3128 (lost).

D. 15. KHUFU . . . , King's *warb*-priest. Dyn. V-VI.

Name from drum.

D. 15 B. MERERU  Overseer of the House of weaving women. Dyn. V-VI.

Lintel of deceased, in Leipzig Mus. Inv. 2557.

Relief-fragments, probably from here or tomb D. 37, in Cairo Mus. Ent. 37829, 37831.

D. 19. WERBAURĒ  Overseer of commissions of tenants of the Great House. Dyn. V-VI.

Lintel of deceased, in Hildesheim Mus. 3. See IPPEL and ROEDER, *Denkmäler . . . Hildesheim*, p. 59.

D. 20. TEPEMḤANKH  Overseer of the department of tenants of the Great House,¹ Prophet of Khufu,² etc. Dyn. V-VI.

Drum of deceased, removed by Lepsius, in Berlin Mus. 1138. L. D. ii. 152 [b], *Text*, i, p. 44; text, *Aeg. Inschr.* i, p. 27; see *Ausf. Verz.* p. 58.

False-door, in Pitcairn (Theodore) Collection, Bryn Athyn (Penn.).

Statues and statuettes.

Statue-group, two men (both called TepemḤankh) and woman Autib  standing, in Cairo Mus. Ent. 37826. HORNEMANN, *Types*, v, pl. 1370.

¹ On false-door and drum.

² On false-door.

Man seated (uninscribed), in Hildesheim Mus. 12. SENK in *Archiv für Orientforschung*, ix (1933-4), Abb. 9, p. 311; HORNEMANN, *Types*, iii, pl. 689; see IPPEL and ROEDER, op. cit. p. 48.

Woman grinding corn, in Cairo Mus.

WEMTETKA , Royal acquaintance (woman). Dyn. V-VI.

Stone-built mastaba east of tomb D. 20. Excavated by Junker.

Libation-basin of deceased, found *in situ* in front of north offering-niche, in Vienna Mus. Inv. 8555. JUNKER, *Giza*, ix, Taf. ix [d], Abb. 44, pp. 104-7; see id. in *Anzeiger, Wien*, 63 (1926), p. 104 [bottom].

D. 23. RA^cSHEPSES , King's *warb*-priest. Dyn. V.

Wife, Pepi .

Statue-group, deceased, wife, and small son, standing, in Hildesheim Mus. 17. HORNEMANN, *Types*, v, pl. 1407; KAYSER, *Das Pelizaeus-Museum in Hildesheim* (1966), Abb. 12; see IPPEL and ROEDER, *Denkmäler . . . Hildesheim*, pp. 50, 54.

Libation-basin of Khenut , Royal acquaintance (woman), alabaster, in Leipzig Mus. Inv. 3125.

IBIR . . . , Inspector of *warb*-priests of the Pyramid of Khufu, Secretary. Dyn. VI.

Stone-built mastaba west of tomb G 4000. Excavated by Junker. Position not marked on plan.



False-door of deceased, in Cairo Mus. JUNKER, *Giza*, ix, Abb. 43, pp. 102-4.

D. 29. Dyn. V-VI.

Statuette of woman grinding corn, in Leipzig Mus. Inv. 2567. BREASTED (Jr.), *Eg. Servant Statues*, pl. 18 [b], p. 19 [9]; *Berlin. Ägypten und das Berliner Ägyptische Museum* (1955), Taf. 7; MÜLLER (Dieter) and ETZOLDT, *Ägypten*, Taf. 31; F.E.R.E. photo. 5949.

D. 30. KAU , King's *warb*-priest, Prophet of Khufu, Inspector of *ka*-servants, Carpenter of the Royal House. Dyn. V-VI.

False-door of deceased. Lintel and lower part, in Leipzig Mus. Inv. 2498, 2691 (both lost).

D. 32. MEMI , King's *warb*-priest, and NEFERHERENPTAH , King's *warb*-priest, etc. Dyn. V.

Statues of Memi.

Seated, in Leipzig Mus. Inv. 2560. MÜLLER (Dieter) and ETZOLDT, *Ägypten*, Taf. 28-9; text, SETHE, *Urk.* i (1933), 225 [I (141), A, B]; part (A of SETHE), STEINDORFF in *Ä.Z* 48 (1911), p. 156.

Standing, in Hildesheim Mus. 2. SENK in *Archiv für Orientforschung*, ix (1933-4), Abb. 14, p. 316; HORNEMANN, *Types*, i, pl. 130; *Schaetze altaegyptischer Kunst. Kunsthalle, Basel, 27 Juni-13 Sept. 1953*, 4th Abb., pp. 33-4 [53]; see IPPEL and ROEDER, *Denkmäler . . . Hildesheim*, p. 50.

D. 37. RA^cHERKA , Inspector of scribes,¹ Judge and Overseer of scribes.
Dyn. V.

Wife, Meres^cankh , Royal acquaintance.

Fragments of statuette, woman carrying child, found north of tomb, in Leipzig Mus. Inv. 2446. SMITH, *Hist. Eg. Sculp.* pl. 27 [a, b], p. 58; F.E.R.E. photo. 5947; see BREASTED (Jr.), *Eg. Servant Statues*, p. 97 [Type 1, 1].

Double-statue of deceased and wife standing, probably from here, found by Ballard in 1902, formerly in Curtis Colln., now in Louvre, E. 15592. BOREUX in *Mon. Piot*, xxxvii (1940), pl. ii, pp. 17-25; DESROCHES, *L'Art égyptien au Musée du Louvre* (1941), fig. on 8th p. [lower]; VANDIER, *Manuel*, iii, pl. xlv [6], p. 574; id. and SOUGEZ, *La Sculpture égyptienne au Musée du Louvre*, 3rd pl. [right]; CHARBONNEAUX, *Les Merveilles du Louvre*, i, pl. on p. 40; see VANDIER, *Guide* (1948), pp. 10-11; (1952), p. 11; id. in *Bulletin des Musées de France*, xi [8] (1946), p. 3.

Obelisk (uninscribed), found in front of tomb, in Cairo Mus. 17009. KUENTZ, *Obélisques* (*Cat. Caire*), pl. vi, p. 16.

D. 38.

Reserve-head, Dyn. IV or V, found in 1905, probably from here, in Cairo Mus. Ent. 47838. SMITH, *Hist. Eg. Sculp.* pl. 9 [e], p. 27 [26]; see MASPERO, *Guide*, pp. 50-1 [97A]; NAVILLE, *Les Têtes de pierre* [etc.] in *Mémoire publié à l'occasion du Jubilé de l'Université de Genève* (1909), p. 5.

D. 39/40.² ZASHA , King's *warb*-priest, Prophet of the King's mother.
Dyn. V.

Statues

Deceased seated, in Leipzig Mus. Inv. 2561.

Two, deceased seated, in Cairo Mus. Ent. 37820, 37825. See SMITH, *Hist. Eg. Sculp.* p. 67.

Wife seated, in Cairo Mus. Ent. 37821. HORNEMANN, *Types*, iv, pl. 1043; see SMITH, *op. cit.* p. 67.

Naked boy standing, in Leipzig Mus. Inv. 3028.

Servant statuettes

In Cairo Mus.

Female baker heating pots, Ent. 37822.

Encycl. phot. Caire, pl. 35; HORNEMANN, *Types*, ii, pl. 528; *L'Égypte: Art et Civilisation*, Sér. 57 (1951), pl. 8 [b]; see SMITH, *op. cit.* p. 98 [d, 2].

Butcher, Ent. 37823.

Encycl. phot. Caire, pl. 34; HORNEMANN, *Types*, v, pl. 1337; *L'Égypte: Art et Civilisation*, Sér. 57 (1951), pl. 8 [a]; MICHALOWSKI, *Art*, fig. 224 (called Şaqqâra); see SMITH, *op. cit.* p. 100 [i, 2]; BREASTED (Jr.), *Eg. Servant Statues*, p. 36 [4].

Man roasting goose, Ent. 37824.

HORNEMANN, *Types*, ii, pl. 492; see SMITH, *op. cit.* p. 99 [g, 1]; BREASTED (Jr.), *op. cit.* p. 42 [Type 2, 1].

¹ From double-statue.

² Position of tomb D. 40 in JUNKER, *Giza*, ix, plan iii [bottom left], and Abb. 77, is incorrect. Correct position, id. ib. on plan ii [middle].

In Hildesheim Mus.

Male brewer, No. 18.

HERMANN and SCHWAN, *Äg. Kleinkunst*, fig. on p. 31; BREASTED (Jr.), op. cit. pl. 30 [a], p. 31 [7]; HORNEMANN, *Types*, ii, pl. 350; POSENER, SAUNERON and YOYOTTE, *Dict. civ.* fig. on p. 95; KAYSER, *Die Mastaba des Uhemka*, Taf. 16 [right]; id. *Das Pelizaeus-Museum in Hildesheim* (1966), Abb. 15; see IPPEL and ROEDER, *Denkmäler . . . Hildesheim*, p. 55.

Woman grinding corn, No. 19.

HERMANN and SCHWAN, op. cit. fig. on p. 29; BREASTED (Jr.), op. cit. pl. 18 [a], p. 19 [10]; HORNEMANN, *Types*, iv, pl. 1035; ALDRED in PIGGOTT, *The Dawn of Civilization*, pl. on p. 122 [60]; see IPPEL and ROEDER, op. cit. p. 54.

Woman grinding corn, No. 20.

IPPEL and ROEDER, op. cit. Abb. 11, p. 54; Burg & Co. *Katalog der Ausstellung ägyptischer Kunst*. Berlin, 1929, Taf. iv, p. 6 [7]; BREASTED (Jr.), op. cit. pl. 20 [a], p. 19 [11]; HORNEMANN, *Types*, iv, pl. 1038.

In Leipzig Mus.

Squatting male cook, Inv. 2562.

BREASTED (Jr.), op. cit. pls. 42 [c], 43, p. 45 [Type 3, 2]; HORNEMANN, *Types*, ii, pl. 488; MÜLLER (Dieter) and ETZOLDT, *Ägypten*, Taf. 30; see SMITH, op. cit. p. 100 [h, 2].

Man cleaning jar, Inv. 2563.

BREASTED (Jr.), op. cit. pl. 44 [a], p. 47 [4]; HORNEMANN, *Types*, ii, pl. 509; see SMITH, op. cit. p. 97 [c, 4].

Woman sifting flour, Inv. 2564.

BREASTED (Jr.), op. cit. pl. 25 [c], p. 25 [3]; HORNEMANN, *Types*, iv, pl. 1005.

Female brewer, Inv. 2565.

BREASTED (Jr.), op. cit. pl. 32 [b], p. 33 [2]; HORNEMANN, *Types*, iv, pl. 980.

Man gathering up grain, with five stone granaries, Inv. 2566.

BREASTED (Jr.), op. cit. pl. 9 [a], p. 10 [1]; HORNEMANN, *Types*, ii, pl. 355.

Man leaning over basket full of pots, Inv. 2569.

BREASTED (Jr.), op. cit. pl. 44 [d], p. 47 [1]; HORNEMANN, *Types*, ii, pl. 352.

Woman (?) leaning over vessel, Inv. 2570.

BREASTED (Jr.), op. cit. pl. 41 [b], p. 42 [2]; HORNEMANN, *Types*, ii, pl. 351.

Man bending forward (damaged), Inv. 2571.

BREASTED (Jr.), op. cit. pl. 99, p. 104 [3].

Man leaning over vessel, Inv. 2572.

Id. ib. pl. 41 [a], p. 42 [Type 1, 1]; HORNEMANN, *Types*, iv, pl. 979 (called Inv. 2570).

D. 42. IYNI , Royal acquaintance. Dyn. V-VI.

D. 44. Dyn. V-VI.

Statue of woman, from statue-group, in Leipzig Mus. Inv. 2465.

D. 51. NIMACETPTAH , Inspector of *ka*-servants, Overseer of the ten of the Great Estate, etc. Dyn. V-VI.

Wife, Intkaes .

Lintel, deceased and wife seated, and offering-text, in Hildesheim Mus. 415. ROEDER, *Der Schmuckwert der ägyptischen Hieroglyphen in Buch und Schrift*, ii (1928), Abb. 2 facing p. 84; see IPPEL and ROEDER, *Denkmäler . . . Hildesheim*, p. 59.

Lintel, deceased and wife seated, and children (four men, two women, and three girls) before them, in Hildesheim Mus. 416b.

False-door, panel with deceased at table, jambs with a man, two women, and a girl (names different from those of children), in Hildesheim Mus. 416a. See id. ib. pp. 60-1.

D. 56. Dyn. V-VI.

Two adjoining relief-fragments (one found in tomb D. 70), woman seated and another behind her, in Leipzig Mus. Inv. 3127 (lost).

D. 59. NESUTNÜFER , ka-servant. Dyn. V-VI.

Wife, Sent .

Drum of deceased, in Leipzig Mus. Inv. 3124.

Upper part of false-door¹ of deceased and wife, in Hildesheim Mus. 414. See IPPEL and ROEDER, *Denkmäler . . . Hildesheim*, p. 60, cf. Taf. 14 (part of text with name).

D. 61. IRKAPTAḤ , Inspector of workmen of the *wabḥt* of the Necropolis, etc. Dyn. V-VI.

Wife, Neferḥetpes .

Statue of deceased standing, in Hildesheim Mus. 417. Id. ib. Abb. 8 [right], p. 50; SCHARFF in *J.E.A.* 26 (1940), pl. ix [2], p. 47; KAYSER, *Das Pelizaeus-Museum in Hildesheim* (1966), Abb. 9 [right].

Statue of wife standing, in Hildesheim Mus. 418. Id. ib. Abb. 9 [left]; IPPEL and ROEDER, op. cit. Abb. 8 [left], p. 50.

Two offering-tables of Neferḥetpes, probably from here, in Hildesheim Mus. 1575-6. See id. ib. p. 68.

D. 80/80 A. Dyn. V.

Mastaba-complex with pillared court. LG 22.

L. D. Text, i, pp. 45-6.

Serdab with statues. Sebeḥnef , Inspector of craftsmen, etc.

Deceased seated, in Hildesheim Mus. 419. SENK in *Archiv für Orientforschung*, ix (1933-4), Abb. 10, 13, pp. 314-15; see IPPEL and ROEDER, *Denkmäler . . . Hildesheim*, p. 48; Essen. 5000 Jahre, No. 34.

Maetret  (son of deceased) standing, in Hildesheim Mus. 420. SENK, op. cit. Abb. 15, p. 316; ROEDER in *Forschungen und Fortschritte*, 30 (1956), Abb. 5, p. 243; see IPPEL and ROEDER, op. cit. p. 50.

Thentet , Royal acquaintance (woman), standing.

D. 82. IḤY , Judge and Inspector of tenants of the Great House. Dyn. V-VI.

Standing statuette, uninscribed, Dyn. V-VI, from area between tombs D. 83 and D. 84, in Leipzig Mus. Inv. 2466. HORNEMANN, *Types*, ii, pl. 345.

¹ See Addenda.

D. 100. Dyn. V.

Excavated by Junker.



Sarcophagus (uninscribed), in Vienna Mus. Inv. 8008. JUNKER, *Giza*, i, Taf. xi [b], Abb. 5 [upper], p. 56. See id. in *Anzeiger, Wien*, 63 (1926), p. 68; DONADONI ROVERI, *Sarcofagi egizi*, p. 121 [B 28].

D. 106. Late Dyn. V.

Stone-built mastaba. Excavated by Junker.

JUNKER, *Giza*, ix, pp. 100-2; plan, on Abb. 42.

Statue of squatting man, red granite, found *in situ* in destroyed serdab, in Vienna Mus. Inv. 7442. Id. ib. Taf. vii [b], pp. 100-2 [b]; id. in *Anzeiger, Wien*, xlix (1912), Taf. v [a], p. 98 [b]; Vienna. 5000 Jahre, No. 48 with Abb.

False-door of Washka  called Iri , Inspector of carpenters of the Royal House, Dyn. V-VI, found by Junker *in situ* in area of tombs D. 110 and D. 111, in Cairo Mus. JUNKER, *Giza*, ix, Abb. 40, pp. 96-7.

D. 116. SESHEMU , Overseer of the crew of rowers. Dyn. V-VI.

Wife, Nefert , *mitrt*.

Stone-built mastaba. Excavated by Junker.

JUNKER, *Giza*, ix, pp. 40-7; id. in *Anzeiger, Wien*, 63 (1926), p. 100; plan, id. *Giza*, ix, on Abb. 14.

Panel of false-door with deceased and wife at table, in Hildesheim Mus. 3044. Id. ib. Taf. x [b], Abb. 15, pp. 42-7.





NU (?)  (woman). Dyn. V-VI.

Stone-built mastaba. Excavated by Junker. Cf. text left of doorway of tomb D. 117.

JUNKER, *Giza*, ix, pp. 40-1, 47-50; plan, on Abb. 14.

Fragments of false-doors. Id. ib. Abb. 17, 18.

D. 117. WEHEMKA , Scribe of the archives and of recruits, Steward, etc. Early Dyn. V.

Parents, Iti , Strong-of-voice of the archives, and Zefatsen , Royal acquaintance. Wife, Hetepibes  called Ipi , Royal acquaintance.

Stone-built mastaba. In Hildesheim Mus. 2970.

Plan XXVII

ROEDER, *Die Mastaba des Uhemka im Pelizaeus-Museum zu Hildesheim* (quoted here as *Mastaba*), passim; KAYSER, *Die Mastaba des Uhemka* (quoted here as *Mastaba*), passim. Cf. JUNKER in *Anzeiger, Wien*, 62 (1925), pp. 153-4.

East façade.

(1) Block with name and title of Khenut , Royal acquaintance (woman).

Text, KAYSER, *Mastaba*, p. 41, cf. 22; see ROEDER, *Mastaba*, p. 9 [bottom].

Chapel. Synopsis of scenes, JUNKER, *Giza*, iii, pp. 37-8 [22].

(2) Doorway. (a)-(b) Lintel with offering-text, and drum of deceased and wife, (c) (unfinished) deceased and wife.





(a)-(b) ROEDER, *Mastaba*, Taf. 6, 8; id. *Der Schmuckwert der ägyptischen Hieroglyphen in Buch und Schrift*, ii (1928), Abb. 1 facing p. 84; KAYSER, *Roemer-Pelizaeus-Museum Hildesheim* (1959), Abb. 5; id. *Mastaba*, Taf. 2, 20, p. 41.

(3) Above doorway and upper part, boat paddled, and men bringing cattle, sheep, goats, and donkeys, scribes, chiefs rendering accounts, and men bringing geese, before deceased and wife with children (facing left) and parents (facing right). Lower part, two registers of attendants (including male dwarf) bringing various articles.



Id. *Roemer-Pelizaeus-Museum Hildesheim* (1959), Taf. iii, Abb. 6; id. *Mastaba*, fig. on pp. 36-7, cf. pp. 30-1, 34, 62-70; scribes, etc., before deceased with wife and parents, ROEDER, *Geschäftsbericht des Pelizaeus-Museums* [etc.], 1914-28, 2nd pl.; four women and girl bringing toilet articles, from bottom register, KLEBS, *Reliefs . . . a.R.* Abb. 9, 76 (called Leipzig Mus. 1907); STAEHELIN, *Tracht*, Taf. vii [12].

(4) Two offering-bringers before deceased and wife at table, with offering-list and food-offerings, and two registers below, officials and two groups of butchers.

KAYSER, *Roemer-Pelizaeus-Museum Hildesheim* (1959), Taf. ii; id. *Mastaba*, fig. on p. 32, Taf. 17 [b] (butchers), pp. 29-30, 56-62; group of butchers on right, FISCHER in *Orientalia*, N.S. 29 (1960), fig. 4, pp. 172-4 (from KAYSER).

(5)-(7) At top, funerary priests before deceased and wife at table, and offering-bringers and children on sides, below, (5) and (7), false-doors of deceased and of wife, with family on jambs, (6) upper, daughter Neferthes  with husband Neferhernernti  and small daughter (on left) facing deceased and wife with small son Raçhotp  and daughter Henutsen  (on right side), with three registers of offering-bringers between them, (6) lower, three offering-bringers before deceased and wife at table.

KAYSER, *Roemer-Pelizaeus-Museum Hildesheim* (1959), Taf. i; id. *Mastaba*, fig. on pp. 24-5, details on Taf. 14, 15, 21-2, pp. 26-9, 42-55. (7) and incomplete (6), ROEDER, *Mastaba*, Taf. 9-11; id. *Geschäftsbericht des Pelizaeus-Museums* [etc.], 1914-28, 4th pl. [right]; deceased and wife at (6), KAYSER, *Das Pelizaeus-Museum in Hildesheim* (1966), Abb. 7.



(8) Deceased and wife with small son, followed by grandparents Kaemnefert  and Bebi  with small daughter, and two registers of offering-bringers below.

KAYSER, *Roemer-Pelizaeus-Museum Hildesheim* (1959), Taf. iv; id. *Mastaba*, fig. on p. 33, details of offering-bringers, on Taf. 23-4, pp. 34-5, 70-4; offering-bringers, ROEDER, *Mastaba*, Taf. 12; six of them, from right end of upper register, KLEBS, *Reliefs . . . a.R.* Abb. 18 (called Leipzig Mus. 1911).

D. 200. REDYF  Inspector of corn-measurers of the estates. Dyn. VI.
Stone-built mastaba. Excavated by Junker.

Statue of deceased seated, from serdab, in Vienna Mus. Inv. 8018. JUNKER, *Giza*, ix, Taf. vii [a], Abb. 41 (base), pp. 98-100; id. in *Anzeiger, Wien*, 51 (1914), Taf. xi [right], p. 177; KOMORZYNSKI, *Erbe*, Abb. 23; see id. *Altägyptens hohe Kunst in Österreich in Wort und Bild*, 31 (1951), p. 14; id. *Altägypten*, p. 16; Vienna. 5000 Jahre, p. 66 [52].

D. 201. SENENU  Inspector of the Great House, Secretary of the Toilet-house. Dyn. V-VI.



Son, 'Ankhemthenent  called Ineb , Judge and Inspector of scribes, Secretary of judgement.

Panel of false-door of son and his wife Khenit , in Bryn Athyn (Penn.) Library. PISOAN, *Summa Artis*, iii (1945), fig. 283 (called Dyn. XI).

Statue of man and wife standing (names now illegible), in Leipzig Mus. Inv. 2559. Upper part, MÜLLER (Dieter) and ETZOLDT, *Ägypten*, Taf. 14.

D. 202. NIANKH-KHUFU  Dyn. V-VI.

Name from lintel.

D. 203. NÜFER , Overseer of barbers, etc., and ITISEN , Overseer of the *trw* of the Great Bark. Late Dyn. V or Dyn. VI.

Two false-doors of Nüfer and Itisen. Panel, with both deceased at table, and lintel (in one piece), and drum, in Chicago, Or. Inst. 10812, 10811. Title of Itisen, ERMAN and GRAPOW, *Wörterbuch der ägyptischen Sprache*, v. 353 [7].

Panel of false-door of Overseer of the department, etc. (name lost), in Leipzig Mus. Inv. 2556 (lost).

Found between tombs D. 203 and D. 204. Dyn. V-VI.



Relief-fragment, in Leipzig Mus. Inv. 3147 (lost).

Relief-fragment, Iy , Director of tomb-makers, at table, and offering-bringers, Dyn. V, in Leipzig Mus. Inv. 3120 (lost). Title, FISCHER in *A.Z.* 93 (1966), p. 62 [5].

D. 205. IYNI  Dyn. V-VI.

Wife, Neferkaus .

Double-statue, deceased and wife standing, damaged, in Cairo Mus. Ent. 36271.

D. 207. TY  (also ) Overseer of the *is*-chamber of the *wacb*, Inspector of craftsmen, etc. Dyn. V-VI.

Entrance doorway. Drum with titles of deceased, right thickness with deceased and son Ni'ankhuza .

Fragment of head of female statue, found west of tomb, in Leipzig Mus. Inv. 2445.

D. 208. NEFERIHY , Overseer of washermen and tomb-makers, etc. Dyn. V-VI.

Drum of entrance doorway, names and titles of deceased and son Kai , Inspector of prophets, King's *wacb*-priest, etc.

Statues. View *in situ*, FISCHER in *A.Z.* 93 (1966), Taf. iv [c].

Deceased seated, granite, in Hildesheim Mus. 13. SENK in *Archiv für Orientforschung*, ix (1933-4), Abb. 11, 12, p. 314; MARBURG INST. photo 15031; name and titles, FISCHER, op. cit. Taf. iv [d], fig. 6, pp. 68-9; see IPPEL and ROEDER, *Denkmäler . . . Hildesheim*, p. 48, cf. Taf. 12; SMITH, *Hist. Eg. Sculp.* p. 67.

Deceased as scribe reading, granite, in Leipzig Mus. Inv. 2687. MÜLLER (Dieter) and ETZOLDT, *Ägypten*, Taf. 15; HUSSEIN, *Vom Papyrus zum Codex*, pl. on p. 27; see SMITH, op. cit. p. 67; VANDIER, *Manuel*, iii, p. 571 (called Hildesheim); FISCHER, op. cit. pp. 68-9.

D. 211. HETEP1  King's *wacb*-priest. Dyn. VI.

Block with five figures of deceased (two standing and three seated), in Cairo Mus. 57164.

Block of Hetepti(?) , King's *wacb*-priest, Prophet of Khufu, possibly same as deceased and from here, in Cairo Mus. 57135.

Wooden statuettes.

Deceased seated, in Hildesheim Mus. 1572. IPPEL and ROEDER, *Denkmäler . . . Hildesheim*, Abb. 12, p. 56; CAPART, *Documents*, ii, pl. 20; id. *L'Art ég.* ii, pl. 256; HERMANN and SCHWAN, *Äg. Kleinkunst*, fig. on p. 34; KAYSER, *Die Mastaba des Uhemka*, Taf. 10; upper part, id. *Das Pelizaeus-Museum in Hildesheim* (1966), Abb. 10; see SMITH, *Hist. Eg. Sculp.* p. 59.

Deceased standing, in Hildesheim Mus. 1574.

Man standing, in Leipzig Mus. Inv. 2688 (lost).

Woman standing, probably in Cairo Mus.

D. 213. RUZIB , Prophet of Khufu, King's *warb*-priest, etc. Dyn. V-VI.

Wife, Thentet .

Block with text of deceased, wife, and five children, in Cairo Mus. 57133.

Panel of south false-door of deceased and wife, in Leipzig Mus. Inv. 1607. Name of deceased, RANKE, *Personennamen*, i, p. 221 [13] (called 1601).

D. 215. IMḤŌTEP , Assistant leather-worker, etc. Middle Dyn. V.

Wife, 'Ankh-ḥathor , *mitrt*.

Exact position unknown.

Double-stature, deceased seated and wife standing, in Hildesheim Mus. 1. IPPEL and ROEDER, *Denkmäler . . . Hildesheim*, Abb. 10, p. 50, cf. Taf. 11 (names); ROEDER, *Geschäftsbericht des Pelizaeus Museums* [etc.], 1914-28, 4th pl. [left]; HORNEMANN, *Types*, v, pl. 1181; title of leather-worker, JUNKER, *Weta und das Lederkunsth Handwerk* [etc.] in *Sitzungsb. Wien*, 231 [1] (1957), Taf. i [a, 3], pp. 12-13.

D. 220. THESI , Overseer of craftsmen, etc. Dyn. V-VI.

Stone-built mastaba. Excavated by Steindorff and Junker.

JUNKER, *Giza*, ix, pp. 52-3; position, on Abb. 19.

Panel of false-door, scribe before deceased, wife, and son, probably in Cairo Mus.

Lintel of false-door of deceased and wife, probably from here, in Cairo Mus. 57159.

Lintel of false-door of deceased, in Edinburgh, Roy. Scot. Mus. 1909.483.

Mushroom-shaped stela of deceased with representation of false-door, in Cairo Mus. 57174. VON BISSING, *Äg. Kunstgeschichte*, Taf. xl [287], *Text*, ii, pp. 31, 177 with note 1; text, SETHE, *Urk.* i. 152 [41].

Statuette of seated man (uninscribed), in Leipzig Mus. Inv. 2464.

D. 221. ITI . Probably Dyn. V-VI.

Exact position unknown.

IRI  and SEBANI . Probably Dyn. V-VI.

Exact position unknown.

Lintel of Iri, probably from here, in Cairo Mus. 57156.

Block with Sebani seated, in Leipzig Mus. Inv. 3129 (lost).

False-door of Irenakhti  called Iri, Inspector of *warb*-priests of the Pyramid of Khufu, Boundary official, etc., late Old Kingdom, probably from here, in Vatican Mus. Inv. 351. MARUCCHI, *Di una stela egizia* [etc.] in *Atti della Pontificia Accademia romana*

d'archeologia. II. Dissertazioni, ix (1907), Tav. ii, pp. 34–8 (text); id. *Guide du Musée Égyptien du Vatican* (1927), fig. 8, p. 36; BOTTI and ROMANELLI, *Le Sculture del Museo Gregoriano Egizio*, Tav. lviii [123], p. 76; DIRINGER and REGENSBURGER, *The Alphabet* (1968), ii, pl. 2.7a on p. 43; part of text, FARINA, *Grammatica della Lingua Egiziana Antica* (1910), pp. 174–5 [3]; see MARUCCHI, *Guida del Museo Vaticano di scultura* (1924), p. 283 [217].

JUNKER CEMETERY (EAST)

Junker Excavation. Akademie der Wissenschaften in Wien, Pelizaeus-Museum Hildesheim and University of Leipzig Expedition

Plan XI

Plan, JUNKER, *Giza*, ix, plan i; xii, on plan 3; part, vi, on plan at end. Views, id. ib. ix, Taf. i, xi [a].

NIANKH-HATHOR  ♀, Prophetess of Hathor Mistress-of-the-Deserts, etc. Late Old Kingdom.

Stone-built mastaba.

JUNKER, *Giza*, ix, pp. 91–6; position, on Abb. 34.

South false-door of deceased, in Cairo Mus. Id. ib. Abb. 39, pp. 92–6; name and titles, id. in *Anzeiger, Wien*, 63 (1926), p. 98.

Libation-basin of Nenkheftka  ♀, found nearby, in Vienna Mus. Inv. 7822. Id. *Giza*, ix, Abb. 57, p. 126; see id. in *Anzeiger, Wien*, 51 (1914), p. 165 [8].

SENSEN  ♂, Overseer of the *is*-chamber. Late Old Kingdom.

Wife, Pepi  ♀, Prophetess of Hathor, etc.



Stone-built mastaba.

JUNKER, *Giza*, ix, pp. 83–90; id. in *Anzeiger, Wien*, 63 (1926), p. 99; plan, id. *Giza*, ix, on Abb. 34.

Panel of false-door with deceased and wife at table, in Cairo Mus. Ent. 49694. Id. ib. Taf. x [a], Abb. 36, pp. 85–8.

Lintel of false-door with unfinished figures of children, in Cairo Mus. Id. ib. Abb. 37, pp. 88–90.

MERUKA  ♂, Elder of the Hall, King's *warb*-priest, Prophet of Khufu, etc. Dyn. VI.

Father, Kakherptah  ♂, Elder of the Hall, etc. Wife, Nezetempet  ♀, Royal acquaintance.

Stone-built mastaba.

JUNKER, *Giza*, ix, pp. 70–83; id. in *Anzeiger, Wien*, 63 (1926), pp. 95 [1], 98; plan, id. *Giza*, ix, on Abb. 23; view, Taf. xii [a]; sketch of reconstructed façade, Abb. 28.

Pillared Hall.

Architrave with offering-text and text of building tomb and rewarding craftsmen, and pillars with name and titles. Id. ib. Taf. xii [c], Abb. 30–1, pp. 73–6.

Offering-room.

Lintel of entrance doorway, with offering-text of deceased and father, in Hildesheim Mus. 3049. *Id. ib.* Abb. 32, pp. 76-8.

West wall.

Remains of four registers of offering-bringers, offerings, and butchers before [deceased at table], with offering-list above. *Id. ib.* Taf. xi [c], Abb. 33, pp. 78-83.

Lintel with deceased and wife, probably from north false-door, from Ballard excavation in 1902, formerly Dattari Colln., now in Cleveland, Mus. of Art, 20.1994. *Hôtel Drouot (Paris) Sale Cat.* (LAMBROS and DATTARI), June 1912, pl. xxv [286]; see FISCHER in *Mitt. Orientforschung*, vii (1960), pp. 311-12.

Panel of south false-door, deceased at table, from Ballard excavation, formerly Dattari Colln., now in New Haven (Conn.), Yale Univ. Art Gallery, 1937.214. *Hôtel Drouot (Paris) Sale Cat.* (LAMBROS and DATTARI), June 1912, pl. xxiv [283]; FISCHER, *op. cit.* pl. ii, pp. 310-12 (called 14.19.49).



IUF , Director of tomb-makers, etc. Late Dyn. V or early Dyn. VI.

Wife, Meri , *mitrt*, etc.

Stone-built mastaba.

JUNKER, *Giza*, ix, pp. 67-8, 70; plan, on Abb. 23.

Double-statue, deceased and wife seated, from serdab, in Cairo Mus. Ent. 49691. *Id. ib.* Taf. vii [d] (*in situ*), Abb. 27; *id.* in *Anzeiger, Wien*, 63 (1926), Taf. vii [b], pp. 101-2[2]; HORNEMANN, *Types*, v, pl. 1192; title of deceased, FISCHER in *A.Z.* 93 (1966), fig. 4, p. 62 [4].

NIKAUKHNUM  and NEFERESRIS  = , Royal acquaintance (probably woman). Late Dyn. V or early Dyn. VI.

Stone-built mastaba.

JUNKER, *Giza*, ix, pp. 59-66; *id.* in *Anzeiger, Wien*, 63 (1926), pp. 98-9; plan, *id.* *Giza*, ix, on Abb. 23.

Chapel.

Entrance doorway. Drum of Neferesris, in Cairo Mus., *id. ib.* Taf. xii [b], Abb. 24, p. 60.

Niche. West wall, remains of false-door, *id. ib.* Abb. 25, pp. 63-4; south wall, funerary priests before Nikaukhnum at table, Abb. 26, pp. 64-5.

Serdab.

Statues. View *in situ*, *id. ib.* Taf. vii [c], pp. 65-6.

Man standing (uninscribed), in Leipzig Mus. Inv. 3154. *Id.* in *Anzeiger, Wien*, 63 (1926), Taf. viii [a], p. 101 [1].

Standing couple, in Leipzig Mus. Inv. 3155. *Id. ib.* Taf. viii [b], p. 101 [1]; HORNEMANN, *Types*, v, pl. 1163.

KHENU . Dyn. VI.

Stone-built mastaba.

JUNKER, *Giza*, ix, pp. 54-6, 58-9; *id.* in *Anzeiger, Wien*, 63 (1926), p. 99; plan, *id.* *Giza*, ix, on Abb. 20.

Lintel of north false-door, three sons with offerings and daughter before deceased, in Cairo Mus. *Id. ib.* Taf. x [c], Abb. 21, pp. 55-6, 58-9.

IBINEZEM , Tenant. Dyn. VI.

Stone-built mastaba.

Libation-basin of deceased, found *in situ*, in Hildesheim Mus. 3043. JUNKER, *Giza*, ix, Abb. 22, p. 59, position, Abb. 20, p. 55; see id. in *Anzeiger, Wien*, 63 (1926), p. 100 [top].

Statue of Ibinezem seated, from Ballard excavation in 1902, probably same man and from here, in Cairo Mus. Ent. 35566. See SMITH, *Hist. Eg. Sculp.* p. 68.

NAME UNKNOWN, Companion (*šmr* N.N. of Junker). Dyn. VI.

Stone-built mastaba. Title on fragment of false-door.

JUNKER, *Giza*, ix, pp. 28-31; id. in *Anzeiger, Wien*, 63 (1926), pp. 96, 100; plan and sections, id. *Giza*, ix, on Abb. 9; view, Taf. xi [b].



KHUY , Overseer of tenants of the Great House. Dyn. VI.

Stone-built mastaba.



JUNKER, *Giza*, ix, pp. 33-5; id. in *Anzeiger, Wien*, 63 (1926), p. 100; plan, id. *Giza*, ix, on Abb. 10.

False-door (unfinished), in Cairo Mus. Id. ib. Abb. 11.

Finds from area south of tombs G 2015 and 2015b.

Double-statue, Nepehkau  and wife Wahit  standing, Dyn. VI, in Hildesheim Mus. 2972. HERMANN and SCHWAN, *Ag. Kleinkunst*, fig. on p. 32; HORNEMANN, *Types*, v, pl. 1162; base, JUNKER, *Giza*, ix, Abb. 13, pp. 38-9; see id. in *Anzeiger, Wien*, 63 (1926), pp. 102-3 [3].

Statue, Nepehkau seated, Dyn. VI, found with last, in Hildesheim Mus. 2974. Id. *Giza*, ix, Taf. viii [c], pp. 38-40; see id. in *Anzeiger, Wien*, 63 (1926), pp. 102-3 [3].

Lintel and drum of false-door (in one piece) of Nensezerkai [II]  , *mitrt*, etc., Dyn. V-VI, in Leipzig Mus. Inv. 3131. Id. *Giza*, ix, Abb. 12, pp. 35-7 [c], with position, on Abb. 10; see id. in *Anzeiger, Wien*, 63 (1926), p. 100.

Drum of Demut(?) , Director of embalmers, etc., probably Dyn. VI, in Cairo Mus. See id. *Giza*, ix, pp. 37-8 [d], with position, on Abb. 10; id. in *Anzeiger, Wien*, 63 (1926), p. 100.

S 2411. Dyn. VI.

Stone-built mastaba.

Seated male statuette (uninscribed), in Leipzig Mus. Inv. 3025 (lost). JUNKER, *Giza*, ix, Taf. viii [e], pp. 32-3, with position on Abb. 10; HORNEMANN, *Types*, iii, pl. 723; VANDIER, *Manuel*, iii, pl. xix [5] (from JUNKER), p. 572; see JUNKER in *Anzeiger, Wien*, 63 (1926), p. 103 [4].

NEFEREN , Overseer of corn-measurers, of the store-room, and of female weavers, etc. Dyn. VI.

Wife, Iyti .

Stone-built mastaba.

JUNKER, *Giza*, vi, pp. 198-204; plan and sections, Abb. 73-4; view, Taf. xviii [a, right].

Chapel.

Drum of entrance doorway with titles. Id. ib. Abb. 76 [right upper], p. 198.

Lintel of deceased and wife, removed by Steindorff, in Hildesheim Mus. 5. See IPPEL and ROEDER, *Denkmäler . . . Hildesheim*, p. 59.

Block from false-door, woman and child, in Leipzig Mus. Inv. 3122 (lost).

South false-door, lintel and jambs with offering-texts, deceased with wife, son(?) Zet , and family at bottom, in Leipzig Mus. Inv. 3135 (lost). JUNKER, op. cit. Taf. xvi [b], Abb. 76 [left], pp. 198-200.

North false-door, deceased with son Wēr . Scribe, on panel, and offering-bringers on jambs. Id. ib. Abb. 76 [right lower], pp. 200-1.

WERI , Inspector of *ka*-servants, One belonging to the Great Estate, Scribe of the Treasury, etc. Dyn. VI.

Stone-built mastaba.

JUNKER, *Giza*, vi, pp. 194-8; plan and sections, Abb. 71; view, Taf. xviii [a, left].

Chapel.

Entrance doorway. Drum with name and titles of deceased, see id. ib. p. 196 (text).

West wall. Lintel of south false-door with offering-text, and offering-list and funerary priests before deceased at table right of it. Id. ib. Taf. xviii [b, c], Abb. 72, pp. 196, 198.



KHNEMU , *ka*-servant, One belonging to the Great Estate. Dyn. VI.

Stone-built mastaba.

JUNKER, *Giza*, vi, pp. 190-4; plan and sections, on Abb. 67-8.

West wall of chapel. Partly inscribed south false-door, with deceased on panel, standing; id. ib. Abb. 70 [left], pp. 192-3. Between uninscribed central and partly inscribed north false-door, deceased with wife and parents (names lost) at table, and four sons and two daughters below; id. ib. Taf. xvi [a], Abb. 70 [right], pp. 193-4.

USER , Overseer of *ka*-servants, etc. Late Dyn. V.

Mother, Henutsen  .

Stone-built mastaba.

JUNKER, *Giza*, vi, pp. 186-8; plan, sections, and elevation, on Abb. 67-8.

Entrance doorway. Two lintels with offering-texts and deceased with mother seated on the lower one, and drum with name and titles of deceased. Id. ib. Taf. xvii [a], Abb. 69, pp. 186-8.

Statue of deceased standing (uninscribed), from serdab, in Cairo Mus. Id. ib. Taf. xvii [b, c], p. 188; id. in *Anzeiger, Wien*, xlix (1912), Taf. v [b], p. 98 [d]; see SMITH, *Hist. Eg. Sculp.* p. 72.

SHEPSI , Inspector of builders. Dyn. VI.

Wife, Neferwates    , *mitrt*.

Stone-built mastaba.

JUNKER, *Giza*, vi, pp. 174-80; plan and sections, on Abb. 59, 61.

North false-door. Panel with deceased and wife at table and children in register below, in Vienna Mus. Inv. 8519; id. ib. Taf. xvi [c], Abb. 62, pp. 176-80; Essen. *5000 Jahre*, No. 44 with Abb.; see Vienna. *5000 Jahre*, No. 49.

ḤESY , Director of embalmers of the Great House, Prophet of Duamutf, etc. Dyn. VI.

Wife, Nebtib , Royal acquaintance.

Stone-built mastaba.

JUNKER, *Giza*, vi, pp. 164–8; plan and sections, Abb. 57; view, Taf. xv [a].

Panel of false-door at back of niche in chapel, with deceased and wife at table, in Vienna Mus. Inv. 7448. Id. ib. Taf. xv [b], Abb. 58 [A], p. 166.

Libation-basin of deceased, found in front of false-door, in Vienna Mus. Inv. 7449. Id. ib. Taf. xv [c], Abb. 58 [B], p. 167; Vienna. 5000 Jahre, No. 55 with Abb.

MA'ET-ḤEP  (probably wife of deceased). Dyn. VI.

Stone-built mastaba.

JUNKER, *Giza*, vi, pp. 155–60; position, on Abb. 51; plans and sections, Abb. 52.

Offering-table of Ma'et-Ḥep, found near north false-door. Id. ib. Abb. 53, p. 158.

NEFERIḤI , ka-servant. Dyn. VI.

Stone-built mastaba.

JUNKER, *Giza*, vi, pp. 161–2; position, on Abb. 51; plan, on Abb. 54.

Offering-table of deceased. Id. ib. Abb. 56, p. 162.

CEMETERY G 4000

Reisner and Junker Excavations. Harvard–Boston Expedition (1913–16), and Akademie der Wissenschaften in Wien, Pelizaeus (later Pelizaeus-Museum Hildesheim), and University of Leipzig Expedition. Several tombs excavated earlier by Schiaparelli for the Turin Museum.

Plan XV

Plan, REISNER, *Giza Necropolis*, i, Map of Cemetery G 4000; of Junker's section, JUNKER, *Giza*, i, Abb. 7; iv, Abb. 1. View, REISNER in *Boston Mus. Bull.* xiii (1915), fig. 1, p. 29.

G 4000. ḤEMYUNU , King's son of his body, Chief Justice and Vizier, etc. Temp. Khufu.

Grandfather, probably Snefru. Father, probably Nefermatet.

Stone-built mastaba. D. 60 (Steindorff).

JUNKER, *Giza*, i, pp. 132–62; plan and sections, Abb. 18–22; views (including serdabs), Taf. xv, xvi, xviii [a, b]. General account, SMITH (W. S.) in *A. J. A.* xlvi (1942), pp. 520–30; reliefs of entrance doorway, fig. 10 (from JUNKER).

Masons' graffiti with dates. JUNKER, op. cit. Taf. xxiv, Abb. 24, pp. 157–61.

Interior offering-room. Synopsis of scenes, id. ib. iii, p. 36 [12].

Entrance doorway. Lower part of right jamb with feet of deceased and name and titles, and of thickness with offering-list, in Hildesheim Mus. 2146; id. ib. i, Taf. xvii [a lower, b], Abb. 23 [b, c], pp. 145–8; name and titles on jamb, CAPART, *Documents*, i, pl. 15; id. *Propos sur l'art égyptien*, fig. 43; id. *Memphis*, fig. 259; see IPPEL and ROEDER, *Denkmäler* . . .

Hildesheim, p. 59. Lintel with name and titles, in Hildesheim Mus. 2380; JUNKER, *Giza*, i, Taf. xvii [a upper], Abb. 23 [a], p. 145; see IPPEL and ROEDER, op. cit. p. 59.

Relief-fragments, found by Reisner near south-east corner of mastaba, see SMITH (W. S.), op. cit. pp. 525, 527, 530.

Three, from lintel, in Hildesheim Mus. 4523; id. ib. fig. 16 [top]. Part of head of man, in Boston Mus. 27.1123; id. ib. fig. 13 [upper]. Part of head, probably of deceased, and remains of text, in Boston Mus. 27.296; id. ib. fig. 13 [lower]; id. *Anc. Eg.* (1942), fig. 15; (1952), fig. 16; (1960), fig. 20; id. *Hist. Eg. Sculp.* pl. 48 [c], pp. 22-3; id. in *Archaeology*, 16 (1963), fig. 13, p. 9; STEINDORFF in *A.Z.* 73 (1937), Taf. xi [upper], p. 121; *Handbook* (1947), fig. on p. 9; head, SMITH (W. S.) in *Boston Mus. Bull.* li (1953), fig. 4 [left], p. 23; POSENER, SAUNERON and YOYOTTE, *Dict. civ.* fig. on p. 242 [right]; TERRACE in *The Connoisseur*, clxviii (1968), fig. 5, p. 201. Various, including animals, in Boston Mus. unnumbered; SMITH (W. S.) in *A.J.A.* xlvi (1942), figs. 12, 14, 16 [middle and bottom].

North serdab. Behind north false-door.

Statue¹ of deceased seated, in Hildesheim Mus. 1962. IPPEL and ROEDER, *Denkmäler . . . Hildesheim*, Abb. 7, p. 48; ROEDER in *Forschungen und Fortschritte*, 30 (1956), Abb. 3, p. 241; KAYSER, *Das Pelizaeus-Museum in Hildesheim* (1966), Abb. 13, 14; id. *Die Mastaba des Uhemka*, Taf. 11; JUNKER, *Giza*, i, Taf. xviii [c, d]-xxiii, pp. 153-7; id. in *Anzeiger, Wien*, xlix (1912), Taf. iv, pp. 96-7 [a]; SCHÄFER and ANDRAE, *Kunst* (1925), 225; (1930), 234; (1942), 233; SCHÄFER, *Das altägyptische Bildnis*, Taf. 8; CAPART, *Memphis*, fig. 336; id. *Documents*, ii, pls. 10-12; id. *L'Art ég.* ii, pl. 234; ROSS, *The Art of Egypt*, pl. on p. 104; SCHARFF in *Antiquity*, xi (1937), pl. i facing p. 176; id. in *J.E.A.* 26 (1940), pl. viii [4], p. 46; id. in OTTO, *Handbuch der Archäologie*, i, Taf. 71 [3]; PIJOAN, *Summa Artis*, iii (1945), figs. 131-2, 139; SMITH, *Hist. Eg. Sculp.* pls. 6 [d], 48 [b], p. 22; id. *Art . . . Anc. Eg.* pl. 31 [B], p. 46; ANTHES, *Meisterwerke ägyptischer Plastik* (1947), Taf. vii [a]; id. *Aegyptische Plastik in Meisterwerken*, Taf. 7 [a]; ALDRED, *O.K. Art*, pls. 11, 12; SHOUKRY, *Privatgrabstatue*, Abb. 26, p. 125; SPIEGEL, *Hochkultur*, Taf. 20-1; WOLF, *Kunst*, Abb. 101-2; REUTERSWÄRD, *Studien zur Polychromie der Plastik*, i, *Ägypten*, Taf. i [2]; SENK in *Forschungen und Fortschritte*, 33 (1959), Abb. 4, p. 239; MICHALOWSKI, *Art*, fig. 199; WOLDERING, *Götter*, Abb. 25; POULSEN, *Äg. Kunst. A. und M.* pls. on pp. 52-3; WESTENDORF, *Das Alte Ägypten*, fig. on p. 38; head, RANKE, *The Art of Ancient Egypt*, and BREASTED, *Geschichte Aegyptens*, 59; STEINDORFF in *A.Z.* 73 (1937), Taf. xi [lower], p. 121; KAYSER, *Roemer-Pelizaeus-Museum Hildesheim* (1959), Abb. 7; ALDRED in PIGGOTT, *The Dawn of Civilization*, pl. on p. 112 [28]; LLOYD, *The Art of the Ancient Near East*, fig. 29; detail of hand, RAGAI, *L'Art*, pl. 43 [76], of feet, pl. 44 [77].

G 4121. 'ANKHEMRĒ  Inspector of scribes of the royal documents of the granary. Dyn. V-VI.

Stone-built mastaba. Excavated by Schiaparelli.

CURTO, *Gli Scavi*, pp. 83-5 [B]; BALLERINI, *Notizia*, pp. 63-4 [top] with notes. Plan, CURTO, op. cit. fig. 37 [b].

Chapel.

South wall. Agricultural scene before deceased; texts, id. ib. fig. 35, p. 85 [ii].

West wall. False-door of deceased, with figure of deceased left of it, and false-door of

¹ Selected references.

Kawaꜥb , Scribe of the royal documents of the granary, with remains of offering-bringers and butchers between them; id. ib. fig. 34, pp. 83-5 [i].

G 4140. MERTIOTES , King's daughter of his body. Middle or late Dyn. IV.

Stone-built mastaba.

REISNER, *Giza Necropolis*, i, pp. 201 [4], 460-5; plan and section, fig. 3; view, pl. 46 [a].

Chapel.

Slab-stela with deceased at table, linen-list and granaries, set up in east face of mastaba, in Boston Mus. 12.1510. Id. ib. pls. 46 [b], 57 [a], fig. 280; GARDINER MSS. photo. 28.267; see SMITH, *Anc. Eg.* (1942 and 1952), p. 31; (1960), p. 34.

Shaft A. Plan and section, REISNER, op. cit. fig. 20; views, pl. 46 [c, f].

Reserve-head of deceased, from débris in shaft, in Cairo Mus. Ent. 46217. Id. ib. pls. 52 [b], 46 [d] (*in situ*), p. 462; id. in *Boston Mus. Bull.* xiii (1915), figs. 6, 7 (*in situ*), p. 32; SMITH, *Hist. Eg. Sculp.* pl. 6 [b], pp. 25 [2], 29; id. *Art . . . Anc. Eg.* pl. 36, p. 61; MICHALOWSKI, *Art*, fig. 193; see *Descr. somm.* No. 6003.

Reserve-head of husband, from débris in burial chamber, in Boston Mus. 14.717. REISNER, *Giza Necropolis*, i, pls. 52 [a], 46 [c] (*in situ*), p. 462; id. in *Boston Mus. Bull.* xiii (1915), fig. 5, p. 32; SMITH, *Anc. Eg.* (1942 and 1952), fig. 10; (1960), fig. 13; id. *Hist. Eg. Sculp.* pl. 7 [b], p. 25 [1]; DUNHAM in *Boston Mus. Bull.* xli (1943), fig. 1, pp. 69-70; ALDRED, *O.K. Art*, pl. 18.

Various finds

Head of female statuette, Dyn. V, found in street east of tomb G 4140, but probably not from there, in Boston Mus. 19.1446; see SMITH, *Hist. Eg. Sculp.* p. 71 (Exped. No. 13-11-39). Other statue-fragments, see REISNER, *Giza Necropolis*, i, pp. 464-5.

G 4150. YUNU , King's son, Overseer of the phylai of Upper Egypt, Greatest of the Ten of Upper Egypt. Temp. Khufu.

Stone-built mastaba. Junker, Is.

JUNKER, *Giza*, i, pp. 169-81; plans and sections, Abb. 29, 30; view of shaft, Taf. xxv [b].

Slab-stela with deceased at table, linen-list and granaries, concealed in west wall of chapel, in Hildesheim Mus. 2145. Id. ib. Taf. xxvi (*in situ*), xxvii, Abb. 31, pp. 173-9; id. in *Anzeiger, Wien*, 50 (1913), Taf. iii [b] (*in situ*), cf. iii [a], pp. 155-6; IPPEL and ROEDER, *Denkmäler . . . Hildesheim*, Abb. 13 (*in situ*), 14, p. 60, cf. Taf. 11 (name); ROEDER, *Der Schmuckwert der ägyptischen Hieroglyphen in Buch und Schrift*, ii (1928), Abb. 3 facing p. 84; KAYSER, *Im Reich des Osiris* (1949), Abb. 1, pp. 10, 13; id. *Roemer-Pelizaeus-Museum Hildesheim* (1959), Abb. 4; id. *Die Mastaba des Uhemka*, Taf. 13; id. *Das Pelizaeus-Museum in Hildesheim* (1966), fig. on p. 19; deceased, id. *Ägyptisches Kunsthandwerk*, Abb. 245.

G 4160. Temp. Khufu.

Stone-built mastaba. Junker, In.

JUNKER, *Giza*, i, pp. 162-8; plan, sections, and reconstructed plan of chapel, Abb. 25-6, cf. 9 [top]; view, Taf. xxv [a].

Masons' graffiti. Id. ib. Abb. 28, p. 168 [D].

Male reserve-head, damaged, from débris west of tomb, in Hildesheim Mus. 2158. Id. ib. Taf. xiii [c, d], pp. 167-8 [c]; see id. in *Anzeiger, Wien*, 51 (1914), p. 171; IPPEL and ROEDER, *Denkmäler . . . Hildesheim*, p. 54 (called Hemyunu); SMITH, *Hist. Eg. Sculp.* p. 26 [12].

G 4240. SNEFRUSONB , King's son of his body, *sem*-priest, Boundary official of Dep, etc. Middle Dyn. IV to early Dyn. V.

Stone-built mastaba.

REISNER, *Giza Necropolis*, i, pp. 465-71; CURTO, *Gli Scavi*, pp. 85-90 [c]; BALLERINI, *Notizia*, p. 64 [middle and bottom] with note 3. Views (including shaft), REISNER, op. cit. pls. 47, 48 [a-c]; id. and FISHER in *Ann. Serv.* xiii (1914), pl. vi [b]. Title of deceased, id. ib. p. 242.

Chapel. Plan and section, REISNER, op. cit. fig. 110, pp. 201 [5], 307 [3, c].

West wall. Panel of false-door with deceased at table and offering-list, and lintel (in one piece), in Cairo Mus. Ent. 43292; id. ib. pl. 57 [b], p. 466; CURTO, op. cit. Tav. xxiv [b] (*in situ*), fig. 38; offering-list, HASSAN, *Giza*, vi [2], pls. i-vii [3], pp. 113-14; see MASPERO, *Guide*, p. 32 [65].

Shaft A. Plan and section, REISNER, op. cit. fig. 281; CURTO, op. cit. fig. 36.

Reserve-head of deceased, in Cairo Mus. Ent. 46215. REISNER, op. cit. pl. 53 [a], p. 466; id. in *Boston Mus. Bull.* xiii (1915), fig. 12, p. 32; COTTEVIEILLE-GIRAUDET in *B.I.F.A.O.* xxxiii (1933), pl. xiv [right], p. 151; SMITH, *Hist. Eg. Sculp.* pl. 7 [c], pp. 23, 25 [3]; id. *Art . . . Anc. Eg.* pl. 37, p. 61; SIMPSON in *M.M.A. Bull.* n.s. vii (June 1949), fig. on p. 289 [right]; LANGE and HIRMER, *Aegypten. Architektur* (1955 and 1957), pl. 42; (1967), pl. 38; EDWARDS, *Pyramids* (1961), pl. 3 [a]; see *Descr. somm.* No. 6006.

Reserve-head of wife of deceased(?), found in shaft of tomb G 5020-annexe, with small fragment found here, in Cairo Mus. Ent. 67569. REISNER, *Giza Necropolis*, i, pl. 56 [a], pp. 466, 470; SMITH, *Hist. Eg. Sculp.* pl. 7 [a], p. 26 [10]; see REISNER in *Boston Mus. Bull.* xxxvi (1938), pp. 28, 30.

G 4241. RAḤOTP. Early Dyn. V (Reisner) or end of Dyn. V or later (Baer).

Stone-built mastaba.

BAER, *Rank and Title in the Old Kingdom*, p. 100 [309]; REISNER, *Giza Necropolis*, i, pp. 253-4 [18].

G 4260. Temp. Khufu.

Stone-built mastaba. IIn of Junker.

JUNKER, *Giza*, i, pp. 181-91; plans and section, Abb. 34-5; views, Taf. xxviii; id. in *Anzeiger, Wien*, 50 (1913), Taf. ii, p. 154.

Chapel. Synopsis of scenes, id. *Giza*, iii, p. 36 [13].

Panel of false-door with deceased (name lost) at table, linen-list and granaries, from offering-place in east face of mastaba. Id. ib. i, Taf. xxix [a], Abb. 36, pp. 185-8.

Small relief-fragments¹. Id. ib. Taf. xxx, Abb. 37, pp. 188, 190.

¹ See Addenda.

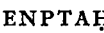
G 4311. NEFERHERENPTAḤ  Judge and Elder of the Hall. Dyn. V.

South wall of chapel. Offering-list; text, HASSAN, *Giza*, vi [2], pls. lxxv-lxxii [78], p. 135.

G 4340. Middle or late Dyn. IV.

Stone-built mastaba.

REISNER, *Giza Necropolis*, i, pp. 201 [6], 471-5; plan and sections of shaft A and burial chamber, fig. 284; views, pls. 48 [d, f], 49 [a, b]; id. and FISHER in *Ann. Serv.* xiii (1914), pl. vi [a]; REISNER in *Boston Mus. Bull.* xiii (1915), fig. 2, p. 29.

Male reserve-head, from débris at bottom of shaft A, in Cairo Mus. Ent. 46218. Id. *Giza Necropolis*, i, pls. 48 [e] (*in situ*), 53 [b]; id. in *Boston Mus. Bull.* xiii (1915), fig. 13, p. 32; COTTEVIEILLE-GIRAUDET in *B.I.F.A.O.* xxxiii (1933), pl. xiv [left], p. 151; LEIBOVITCH, *Anc. Eg.* pl. ix [49]; SMITH, *Hist. Eg. Sculp.* pl. 7 [e], pp. 23, 25 [4], 28; *Encycl. phot. Caire*, pl. 15; SHOUKRY, *Privatgrabstatue*, Abb. 4; Stockholm. 5000 år, No. 19 with fig.; Brussels. 5000 ans, fig. 7, pp. 21-2 [7]; Zürich. 5000 Jahre, Abb. 30, p. 57 [106]; Vienna. 5000 Jahre, No. 11 with Abb.; PIRENNE, *Hist. civ.* i, pl. 48 facing p. 149; PAVLOV, *Egipetskii portret*, pl. 2; MICHALOWSKI, *Art*, fig. 190; ANGIOLETTI and BIGONGIARI, *Testimone in Egitto* (1969), Tav. 14; DONADONI, *Egyptian Museum Cairo*, pl. on p. 36, cf. pp. 35-6; see *Descr. somm.* No. 6004.

G 4350. Middle or late Dyn. IV.

Stone-built mastaba. IIIs of Junker.

JUNKER, *Giza*, i, pp. 194-8; plan and sections, Abb. 39; view, Taf. xxxii [b].

Reserve-head, found at entrance of burial chamber, in Vienna Mus. Inv. 7787. Id. ib. Taf. ix [b] (*in situ*), xii, p. 198 [c]; id. in *Anzeiger, Wien*, 51 (1914), Taf. vii, pp. 171, 173 [1]; *Meisterwerke* (1931), fig. 4; (1958), fig. 6; CAPART in GLANVILLE, *The Legacy of Egypt*, pl. 3 [2]; RANKE, *The Art of Ancient Egypt*, and BREASTED, *Geschichte Aegyptens*, 58; GALASSI, *Tehenu* [etc.], fig. 92, p. 112; PIJOAN, *Summa Artis*, iii (1945), fig. 148; DEMEL, *Ag. Kunst*, Abb. 9; KOMORZYNSKI, *Altägyptens hohe Kunst in Österreich in Wort und Bild*, 43 (1952), Abb. 1, pp. 47-8, cf. 31 (1951), p. 8; id. *Altägypten*, Abb. 17; id. *Erbe*, Abb. 8; DONADONI, *Arte Egizia*, fig. 26; LANGE, *Ägyptische Bildnisse*, Taf. 5; MICHALOWSKI, *Nie tylko piramidy*, pl. 20; id. *Art*, fig. 64 (reversed); see SMITH, *Hist. Eg. Sculp.* p. 26 [13].

G 4351. IMISETKAI , Overseer of the department of tenants of the Great House, Overseer of the Two Houses of Weapons, Prophet of Khufu, etc. 1st Int. Per.

Wife, Khuitbauinu (?)  (?), Prophetess of Hathor Mistress-of-the-Sycamore in all her places, etc.

Stone-built mastaba.

JUNKER, *Giza*, vi, pp. 208-17; plan, Abb. 80. See id. in *Anzeiger, Wien*, 63 (1926), pp. 92-3; 50 (1913), pp. 157, 184 [a].

Chapel.

Entrance doorway. Lintel with offering-text; id. *Giza*, vi, Taf. xix [b upper], Abb. 83 [upper], p. 216. Jambs, column of text with deceased at bottom; id. ib. Abb. 81 [right], 82 [right], p. 214. Thicknesses, left, deceased and wife, right, son censing before deceased; id. ib. Abb. 81 [left], 82 [left], p. 214.

West wall. False-door of deceased, in Leipzig Mus. Inv. 3136 (lost); id. ib. Taf. xix [b lower], Abb. 83 [lower], p. 216.

Serdab. South of Chapel.

Double-statue of deceased and wife standing, in Cairo Mus. Ent. 43960. Id. ib. Taf. xxiii [a], Abb. 84 (base), pp. 216-17; HORNEMANN, *Types*, v, pl. 1143.

G 4360. MERHETEPEF , Judge and Boundary official. Late Dyn. IV or early Dyn. V.

Stone-built mastaba. IIIⁿ of Junker.

JUNKER, *Giza*, i, pp. 198-203; plans and sections, Abb. 40; view, Taf. xxxii [a].



Offering-table of deceased, alabaster, found *in situ* in chapel, in Hildesheim Mus. 3048. Id. ib. Taf. viii [b] (*in situ*), xlii [f], p. 201; id. in *Anzeiger, Wien*, 63 (1926), Taf. ii [a] (*in situ*), p. 66; ROEDER, *Die Mastaba des Uhemka im Pelizaeus-Museum zu Hildesheim*, Taf. 5 (*in situ*).

G 4410. Temp. Userkaf or later.

Stone-built mastaba.









REISNER, *Giza Necropolis*, i, pp. 514-16; views, pl. 71 [b, c]; plan of chapel, fig. 180, p. 283 [3].

Serdab. Adjoining exterior chapel.

Seated statuette of Nishepsnesut , *ka*-servant, Overseer of linen (*ššrw*), and Isitankh , middle Dyn. V or Dyn VI, in Boston Mus. 21.352-3. Id. ib. pl. 71 [d-f]; see SMITH, *Hist. Eg. Sculp.* p. 72.

Shaft A. Plan and section, REISNER, op. cit. fig. 317.

Box-sealing with Horus-name of Userkaf. Id. and SMITH, *Giza Necropolis*, ii, fig. 54, p. 52; REISNER, op. cit. p. 515.

G 4411. SEKHEMKA        , Lector-priest, *sma*-priest of Anubis, Prophet of Horus *km-s*, etc. Middle Dyn. V or later.

Stone-built mastaba. LG 51.

REISNER, *Giza Necropolis*, i, pp. 516-18; L. D. Text, i, pp. 74-6, with plan on p. 74. Plan, views, and sections, L. D. i. 24 [51]. Plan and section of shaft A with burial chamber, REISNER, op. cit. fig. 319; view of east façade, pl. 72 [a].

Chapel.

Doorway to Inner Room. Lintel with offering-text and drum with name and title, and thicknesses, deceased with child, rest destroyed on left, and on right, man handing in list of offerings, and offering-bringers Nishepsnesut and Tetu (tomb G 4420), removed by Lepsius, in Berlin (East) Mus. 1186.



L. D. ii. 89 [b, c]; right thickness, STEINDORFF, *Kunst*, 196; *Führer* (1961), Abb. 13, p. 48; omitting text, SCHÄFER in *Die Antike*, iii (1927), Abb. 16, p. 203; id. *Ägyptische und heutige Kunst*, Abb. 16, p. 17; deceased and son, id. and ANDRAE, *Kunst* (1925), 246; (1930 and 1942), 258; RAGAI, *L'Art*, pl. 76 [146] (called Beni Hasan); SCHÄFER in *Jahrbuch des Deutschen Archäologischen Instituts*, lvii (1942), Abb. 1, p. 161; texts, *Aeg. Inschr.* i, pp. 8-9; see *Ausf. Verz.* p. 54.

Mummy cartonnage, Late Period. L. D. Text, i, figs. on p. 75.

G 4420. TETU  Dyn. V-VI.

Stone-built mastaba.

REISNER, *Giza Necropolis*, i, pp. 197 [30], 502-3; plan and section of shaft A, fig. 307.

Son Neferseshemka    with wife before deceased and wife (no name) at table, at south end of east façade. Id. ib. pl. 64 [h], fig. 308 [upper].

Libation-basin of Neferseshemka, from north exterior chapel. Text, id. ib. fig. 308 [lower].

G 4430. Temp. Khephren or later.

Stone-built mastaba.

REISNER, *Giza Necropolis*, i, pp. 486-8; plan and section, fig. 5; plan of chapel, fig. 106, cf. 207, p. 195 [22]; views of chapel, pl. 60 [c]; id. in *Boston Mus. Bull.* xiii (1915), figs. 3, 4, p. 30.

Shaft A. Plan and section, id. *Giza Necropolis*, i, fig. 23.

Jar-sealings with Horus-name and cartouche of Khephren. Id. ib. pl. 62 [d], fig. 295; id. and SMITH, *Giza Necropolis*, ii, fig. 49, p. 50.

Reserve-head (damaged), clay. See REISNER, op. cit. p. 487; SMITH, *Hist. Eg. Sculp.* p. 26 [11].

G 4440. Middle Dyn. IV to early Dyn. V.

Possibly brother of Snefrusonb (tomb G 4240).

Stone-built mastaba.

REISNER, *Giza Necropolis*, i, pp. 201 [7], 475-9; plan and sections of shaft A, figs. 37, 76, 286.

Reserve-heads. In Boston Mus.

View *in situ* at bottom of shaft A, id. ib. pl. 49 [c]; id. in *Boston Mus. Bull.* xiii (1915), fig. 10, p. 31.

Deceased, No. 14.718, and negroid wife, No. 14.719. Id. *Giza Necropolis*, i, pl. 54; id. in *Boston Mus. Bull.* xiii (1915), figs. 8, 9, pp. 31-2; SMITH (W. S.) in *A. J. A.* xlv (1941), figs. 4, 5, p. 525; id. *Anc. Eg.* (1942 and 1952), figs. 8, 9; (1960), figs. 10, 11; id. *Hist. Eg. Sculp.* pl. 8, pp. 25-6 [5, 6]; ALDRED, *O.K. Art*, pls. 19, 21-2; id. in PIGGOTT, *The Dawn of Civilization*, pls. on p. 112 [30-1]; SPIEGEL, *Hochkultur*, Taf. 24-5; WOLF, *Kunst*, Abb. 103-4; DUNHAM, *Eg. Department*, fig. 27 [c, d]; MONTET, *Eternal Egypt*, pls. 29, 32-3. No. 14.718, SMITH (J. L.), *Tombs, Temples, and Ancient Art*, pl. facing p. 161 [right]; POULSEN, *Åg. Kunst. A. und M.* pls. on pp. 46-7. No. 14.719, *Anc. Eg.* (1916), 1st pl. after p. 48; CAPART, *Memphis*, fig. 334; id. *L'Art ég.* ii, pl. 229; id. in GLANVILLE, *The Legacy of Egypt*, pl. 3 [3]; DUNHAM in *Boston Mus. Bull.* xli (1943), fig. 2, p. 70; id. in *Apollo*, xci (Jan. 1970), fig. 7, p. 18; PIJOÁN, *Summa Artis*, iii (1945), fig. 147; HOYNINGEN-HUENE and STEINDORFF, *Egypt* (1945), fig. on p. 29; SIMPSON in *M.M.A. Bull.* n.s. vii (June 1949), fig. on p. 290 [right]; SAINTE FARE GARNOT, *L'Égypte*, fig. on p. 78 [bottom]; VANDIER, *Eg. Sculpture*, pl. 19; BRUNNER in *Forschungen und Fortschritte*, 28 (1954), Abb. 2 [left], p. 332; POSENER, SAUNERON and YOYOTTE, *Dict. civ.* fig. on p. 275 [lower left]; LLOYD, *The Art of the Ancient Near East*, fig. 31; TERRACE in *Boston Mus. Bull.* lix (1961), fig. 6, p. 45; id. in *The Connoisseur*, clxviii (1968), fig. 3, pp. 199-200; WOLDERING, *Götter*, Abb. 26; WHITEHILL, *Museum of Fine Arts Boston. A Centennial History*, i, fig. on p. 265 [left].

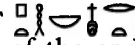
G 4442. PTAḤNEBNEFERT , Steward, Scribe of (a) the granary, (b) the Treasury, (c) a phyle of the endowment of Meḥi (probably Senezemib, tomb G 2378). Dyn. VI or later.

Stone-built mastaba.

JUNKER, *Giza*, vi, pp. 226–8 (called Meḥi); id. in *Anzeiger, Wien*, 63 (1926), pp. 91–2. Lintel with offering-text of deceased, from débris. Id. *Giza*, vi, Abb. 91.

MEDUNŪFER , *ka*-servant. Dyn. VI.

Superstructure destroyed.

False-door and offering-table of deceased, in Leipzig Mus. Inv. 3138, 729 (both lost). JUNKER, *Giza*, vi, Abb. 85–6, pp. 217–20.

G 4461. KAPUPTAḤ , Royal acquaintance of the Great House. Dyn. V.

Wife, Ipep , *mitrt*.

Stone-built mastaba.

JUNKER, *Giza*, vi, pp. 220–6; plan and sections, Abb. 87; views, Taf. xx. See id. in *Anzeiger, Wien*, 63 (1926), p. 87.

Chapel.

Entrance doorway. Drum with name and title; id. *Giza*, vi, Abb. 88 [B], p. 221.

West wall. Offering-list between two uninscribed false-doors; id. ib. Abb. 88 [A], pp. 222–3.

Serdab.

Double-statue of deceased and wife standing, from débris outside, in Vienna Mus. Inv. 7444. Id. ib. Taf. xxii, Abb. 90 (base), pp. 224–6; DEMEL, *Äg. Kunst*, Abb. 15; KOMORZYNSKI, *Altägyptens hohe Kunst in Österreich in Wort und Bild*, xxxi (1951), Abb. 9; id. *Altägypten*, Abb. 9; id. *Erbe*, Abb. 18; see JUNKER in *Anzeiger, Wien*, xlix (1912), p. 98 [c]; Vienna. 5000 Jahre, p. 65 [45].



Main shaft. S 2047 of Junker.

Sealing with Horus-name of Neuserrē^c. See JUNKER, *Giza*, vi, p. 224.

G 4513. NEFERIḤY. Dyn. VI.

Stone-built mastaba.

BAER, *Rank and Title in the Old Kingdom*, pp. 90–1 [257]. Plan of chapel, REISNER, *Giza Necropolis*, i, fig. 185, pp. 286–7 [1].

G 4520. KHUFU^cANKH  , Tenant of the Great House, Overseer of singers of the Great House, Overseer of flutists, etc. Temp. Userkaf (Reisner and Smith) or late Dyn. V (Baer).

Parents, Iaunesut  and Iupu , both Tenants. Wife, Zefatka , Royal acquaintance.

Stone-built mastaba.

REISNER, *Giza Necropolis*, i, pp. 215-16 [16], 503-7, cf. fig. 204; views, pls. 65 [a], 66 [a], 67 [a, b]. See id. in *Boston Mus. Bull.* xiii (1915), p. 31.

Vestibule. b of Reisner.

Libation-basin of deceased, found in front of small false-door of deceased and family, in Boston Mus. 47.1634. Id. *Giza Necropolis*, i, pl. 66 [d], p. 505.

Offering-room. a of Reisner.

False-door of deceased, presented by the King, in Boston Mus. 21.3081. Id. ib. pls. 65 [b], 66 [c], pp. 504-5; HICKMANN, *45 Siècles*, pl. lxxvii; GARDINER MSS. photo. 28.268; text of inner part, GARDINER Notebook, 126, near end; see SMITH, *Anc. Eg.* (1942 and 1952), p. 36; (1960), pp. 38, 41.

Offering-table of deceased and wife, found in front of false-door. REISNER, *Giza Necropolis*, i, pl. 66 [b], p. 505.

Shaft A. Plan and section, id. ib. fig. 309; views, pl. 66 [e, f].

Head-rest (uninscribed), alabaster, found in coffin, in Boston Mus. 21.2790. Id. ib. pl. 69 [d], fig. 310, p. 506; see SMITH, *Anc. Eg.* (1942 and 1952), p. 60; (1960), p. 65.

Box-sealing with Horus-name of Userkaf. REISNER and SMITH, *Giza Necropolis*, ii, fig. 54, p. 52; see REISNER, *Giza Necropolis*, i, p. 507.







Finds

Statue-group, deceased (headless) and wife seated with small son Menkaurē-ankh, dedicated by son, from débris of Chapel. Id. ib. pl. 67 [c], p. 507; see SMITH, *Hist. Eg. Sculp.* p. 71.

G 4522.

Objects found in débris. Late Dyn. V.

Statuettes. See REISNER, *Giza Necropolis*, i, pp. 507-8.

Double-statuette of Kap   , Tenant, etc., and wife Hy   , standing, in Boston Mus. 21.2602. Id. ib. pl. 67 [d]; see SMITH, *Hist. Eg. Sculp.* p. 72 [4522, 1].

Male torso, a head and a female head, found east of tomb G 4520, REISNER, op. cit. pl. 67 [e]; see SMITH, op. cit. p. 72 [4522, 4]. Legs and inscribed fragments of seat, see id. ib. p. 72 [4522, 2 and 3].

Various.

Fragment of lintel of Nishepsesnesut. See REISNER, op. cit. p. 507 [bottom].

G 4530.

Standing male statuette, Dyn. VI, from débris and street east of tomb G 4620, in Boston Mus. 21.2604. See SMITH, *Hist. Eg. Sculp.* p. 71.

G 4540. Middle or late Dyn. IV.

Stone-built mastaba.

REISNER, *Giza Necropolis*, i, pp. 193 [19], 479-81; plan and sections of shaft A and burial chamber, figs. 38, 288; views, pls. 49 [d, f], 50 [a-c].

Female reserve-head, from shaft A, in Boston Mus. 21.328. Id. ib. pls. 49 [e] (*in situ*), 55 [a]; id. in *Boston Mus. Bull.* xiii (1915), fig. 11, pp. 31, 32; *Handbook* (1935), fig. on p. 7; (1947), fig. on p. 8; (1964), fig. on p. 173 [upper right]; SMITH, *Anc. Eg.* (1942 and 1952), fig. 11; (1960), fig. 12; id. *Hist. Eg. Sculp.* pl. 7 [d], pp. 26 [7], 28; PIJOÁN, *Summa Artis*, iii (1945), fig. 146; ALDRED, *O.K. Art*, pl. 20; MALRAUX, *Le Musée imaginaire de la sculpture mondiale*, pl. 35; SPIEGEL, *Hochkultur*, Taf. 26-7; BRUNNER in *Forschungen und Fortschritte*, 28 (1954), Abb. 2 [right], p. 332; DUNHAM, *Eg. Department*, fig. 27 [b]; MONTET, *Eternal Egypt*, pl. 30; TERRACE in *The Connoisseur*, clxviii (1968), fig. 2, pp. 199-200.

G 4560. Middle or late Dyn. IV.

Stone-built mastaba. Vn of Junker.

JUNKER, *Giza*, i, pp. 208-11; view, Taf. xxxiv [a]; plan and sections, Abb. 46, cf. 9 [middle].

Female reserve-head, from burial chamber, in Cairo Mus. Ent. 44974. Id. ib. Taf. xiv [a, b], pp. 210-11 [D]; id. in *Anzeiger, Wien*, 51 (1914), pp. 171, 174 [3]; id. in *J.E.A.* i (1914), pl. xl [3], p. 253; see SMITH, *Hist. Eg. Sculp.* p. 26 [14].

G 4561. KAEM'ANKH Inspector of administrators of the Treasury, King's *warb*-priest, Inspector of prophets, etc. Dyn. VI.

Wife, Theset , Prophetess of Hathor Mistress-of-the-Sycamore in all her places, and of Neith Opener-of-the-Ways, etc.

Stone-built mastaba.

Plan XXVI

JUNKER, *Giza*, iv, passim; id. in *Anzeiger, Wien*, 63 (1926), pp. 76-86. Plan and sections, id. *Giza*, iv, Abb. 3, 4. View of chapel, id. ib. Taf. i [b]. Synopsis of scenes, id. ib. iii, pp. 44-5 [35].

North and south faces.

(1)-(2), (3)-(4) Frieze with name and titles of deceased.

Id. ib. iv, Abb. 2, on Taf. i [a], p. 17; id. in *Anzeiger, Wien*, 63 (1926), on Taf. iv [a].

I. Passage.

(5) Doorway. (a)-(b) Lintel, deceased seated and offering-text, (c) and (d) deceased standing.

(a)-(b) Id. *Giza*, iv, on Taf. i [a], Abb. 5 [upper], pp. 17-18. (c) and (d) Id. ib. Abb. 5 [lower], p. 18.

(6) (a)-(b) Architrave with nine figures of deceased.

Id. ib. Abb. 10 [B], pp. 18, 20.

(7) At top, five servants preparing chair and bed, and two others. Below, four registers before deceased and wife seated, I, son Khuwiwēr  with scribe and officials squatting, II, harpists, flutists, and singers, III, games of *mehen* (snake-game) and *senet* (draughts), latter played with deceased, IV, female dancers and clappers.

Top, id. ib. Abb. 10 [A], pp. 40-3; below, Abb. 9, pp. 35-40. Harpist and singer from right end, and flutist and singer from left end of II, HICKMANN, *45 Siècles*, pls. v, vi. Man and *mehen*-game from left end of III, id. in *Bull. Inst. Ég.* xxxvi (1953-4), pl. ii, pp. 495-6 note 4.

(8) False-door of wife.

JUNKER, *Giza*, iv, Abb. 11, p. 43.

II. Hall.

(9) Lector-priest with another man and offering-list at top, and three registers before deceased at table, I, six funerary priests performing ceremonies (including wiping out footprints), II, offering-bringers, III, two groups of butchers.

Id. ib. Abb. 7, on Taf. i [b] (left part), pp. 21-7.

(10) [1st ed. 3] Deceased with son Khuwîwēr in canoe spearing fish in papyrus-swamp, followed by an attendant and three men with fish, with hovering birds above, and hippopotamus and cattle below.

Id. ib. Abb. 8, pp. 27-35; id. in *Anzeiger, Wien*, 63 (1926), Taf. iv [b].

(11) False-door of deceased.

Id. *Gîza*, iv, Abb. 6, pp. 20-1.

Burial chamber. Painted decoration.

Sarcophagus with offering-text in ink. Id. ib. on Taf. ii; id. in *Anzeiger, Wien*, 63 (1926), on Taf. v [a], p. 81; see DONADONI ROVERI, *Sarcofagi egizi*, p. 137 [B 71].

(12) Three registers with offering-bringer in each, bringing calves, antelope, and bulls. JUNKER, *Gîza*, iv, Taf. xii [upper], pp. 95-6.

(13) Offering-list, with funerary priests right of it and below, and offering-bringers on both sides.

Id. ib. Taf. xvi, pp. 87-92.

(14) Funerary priest and five registers, I-IV, food-offerings, V, three groups of butchers.

Id. ib. Taf. xvii, pp. 92-5.

(15) [1st ed. 4-5] Four registers (from right), I, servant preparing bed, with another bed and furniture, II, seven oil-vases, III, female clappers and dancers, IV, harpists, flutists, and singers.

Id. ib. Taf. xiv, xv, pp. 85-7. I-III, id. in *Anzeiger, Wien*, 63 (1926), Taf. vi [b]. Servant preparing bed, POSENER, SAUNERON and YOYOTTE, *Dict. civ. fig.* on p. 17 [upper].

(16) Three registers, I-II, herdsmen preparing food, III, provisions.

JUNKER, *Gîza*, iv, Taf. xiii, p. 85. Man shaping loaves, from I, VANDIER in *Kémi*, xvii (1964), fig. 3, p. 30 (from JUNKER).

(17) Two registers (from right), I, tending cattle, including milking, II, issuing seed, ploughing, reaping corn.

JUNKER, *Gîza*, iv, Taf. xii [lower], pp. 81-5.

(18) [part, 1st ed. 6] Three registers, I, deceased fowling with split spear from canoe in papyrus-swamp, and three storehouses, with lists of parts of boats, furniture and tools, garments, and II and III, granaries.

Id. ib. Taf. ix-xi, cf. ii, pp. 67-81. Storehouses, id. in *Anzeiger, Wien*, 63 (1926), Taf. vi [a]; WOLF, *Kunst*, Abb. 220.

(19) Five registers (from right), I, two men leading calves, II, two freight-boats transporting cattle, III, cooking meat, roasting and plucking goose, cutting up meat, IV, straining beer, shaping loaves, heating pots, V, sealing beer-jars, and women grinding corn and heating pots.

JUNKER, *Gîza*, iv, Taf. vi, viii, pp. 55-6, 65-7. I and II, DAVIES (Nina) and GARDINER, *Ancient Egyptian Paintings*, pl. iii.

(20) [1st ed. 7] Three registers (from right), **I**, three sailing-boats, with man leading calf above first and second, **II**, geese, ducks and pigeons, **III**, granaries on sledges and vases.

JUNKER, *Giza*, iv, Taf. iii-v, vii, pp. 51-65. Right part, WOLF in *Der Cicerone*, xx (1928), Abb. on p. 582; of **I** and **II**, JUNKER in *Anzeiger, Wien*, 63 (1926), Taf. v [b]. First sailing-boat in **I**, DAVIES (Nina) and GARDINER, op. cit. pl. ii. First and fourth bird in **II**, DAVIES (Nina) in *J.E.A.* 32 (1946), pl. i (frontispiece).

G 4611. NIUTY , Secretary of the Toilet-house, Keeper of oils of the Great House, Boundary official of (the district) 'Star of Horus Foremost of Heaven', etc. End of Dyn. V or later.

Stone-built mastaba. LG 50.

Plan XXVI

L. D. *Text*, i, p. 73, with plan; cf. REISNER, *Giza Necropolis*, i, figs. 210-11. Synopsis of scenes, JUNKER, *Giza*, iii, p. 39 [26].

Chapel.

(1) Entrance doorway. (a)-(b) Lintel with offering-text and deceased standing. Drum with name and titles, in New Haven (Conn.), Yale Univ. Art. Gallery, 1937.132.

L. D. ii. 89 [a], *Text*, i, p. 73. Drum, FISCHER in *Mitt. Orientforschung*, vii (1960), Taf. iii [b], pp. 314-15.

(2)-(3) Three registers, man handing in list, and bulls, oryxes, and ibex brought to deceased leaning on staff, and wife and child.

L. D. *Ergänz.* xxx.

(4)-(6) Between two false-doors (right uninscribed), funerary priests, men with joint of meat and birds, and butchers before deceased at table, with [offering-list] above.

Id. ib. xxxi.

(7) Deceased seated receiving lotus-flower from man and offering-bringer with bird.

Id. ib. x [c].

G 4620. KANŪFER , Scribe of the royal documents. Dyn. V.

Stone-built mastaba.

REISNER, *Giza Necropolis*, i, pp. 197 [29], 508-9; plan and section of shaft A, fig. 311; views, pl. 68 [a, b].

Name and title of deceased on east façade. Id. ib. pl. 67 [f], p. 508.

G 4630. MEDUNŪFER , Chief lector-priest, Scribe of divine books, *sm*-priest of Anubis, etc. Dyn. V.

Wife, Nubka , Royal acquaintance.

Stone-built mastaba. Partly excavated by Schiaparelli.

REISNER, *Giza Necropolis*, i, pp. 491-5; CURTO, *Gli Scavi*, pp. 78-83 [A]; BALLERINI, *Notizia*, pp. 61-2 with notes 2-4. Plan and section of shaft A and burial chamber, REISNER, op. cit. fig. 298; views, pl. 61 [a-e].

Chapel. Plan, id. ib. fig. 107, p. 195 [25]; CURTO, op. cit. fig. 29; BALLERINI, op. cit. fig. on p. 46 [lower].

South false-door, with son 'Ankhiris before deceased and wife on panel, dedicated by 'Ankhiris, in Cairo Mus. 57123. CURTO, op. cit. Tav. xxiii [left], xxv, fig. 32, pp. 78-81

(called 57321); CAIRO, CENTRE OF DOCUMENTATION photo. S.A., 2653 [left]; text (part), SETHE, *Urk.* i (1933), p. 229 [5 (145), M] (called 57321); see REISNER, op. cit. p. 492.

North false-door of 'Ankhiris $\text{𓆎} \text{𓆏}$, *khet*-priest of W̄er and Thentet-cattle, etc., dedicated by son Medunūfer, in Cairo Mus. 57189. CURTO, op. cit. Tav. xxiii [right], fig. 33, pp. 82-3; CAIRO, CENTRE OF DOCUMENTATION photo. S.A., 2653 [right]; see REISNER, op. cit. p. 492.

G 4631. NENSEZERKAI $\text{𓆎} \text{𓆏} \text{𓆎} \text{𓆏}$, Prophetess of Hathor and Neith, etc. Dyn. V.
Brick-built mastaba.

REISNER, *Giza Necropolis*, i, pp. 495-9; plans and sections of shafts A-C, figs. 300-3.

Chapel.

False-door of deceased, with name and titles of 'Ankhiris (also in tomb G 4630) on right jamb. Id. ib. pls. 61 [f], 62 [a], p. 495.

Shaft B.

Sealing with Horus-name of Userkaf. Id. ib. pl. 64 [e], p. 498; id. and SMITH, *Giza Necropolis*, ii, fig. 53, pp. 51-2.

G 4640. Middle or late Dyn. IV.

Stone-built mastaba.

REISNER, *Giza Necropolis*, i, pp. 201 [8], 481-4; plan and section of shaft A, fig. 290; views, pl. 50 [d, f].

Male reserve-head, from shaft A, in Cairo Mus. Ent. 46216. Id. ib. pls. 50 [e] (*in situ*), 55 [b]; id. in *Boston Mus. Bull.* xiii (1915), fig. 14, pp. 31, 32; LEIBOVITCH, *Anc. Eg.* pl. ix [50]; SMITH, *Hist. Eg. Sculp.* pl. 7 [f], pp. 23, 26 [8]; LANGE and HIRMER, *Aegypten. Architektur* (1955 and 1957), pls. 40-1; (1967), pls. 36-7; *Capolavori*, i, No. 10 (1963), fig. on p. 156 [left]; Eng. ed. fig. on p. 148 [left]; WESTENDORF, *Das Alte Ägypten*, fig. on p. 48; *Great Museums*, pl. 36; see *Descr. somm.* No. 6005.

G 4646. ITY $\text{𓆎} \text{𓆏}$, Overseer of the department of tenants of the Great House, Companion of the house, etc. Late Dyn. VI.

Stone-built mastaba.

JUNKER, *Giza*, vi, pp. 230-1; plan and sections, Abb. 92.

False-door of deceased, from east face, in Vienna Mus. Inv. 8536a-d. Id. ib. Abb. 93; i, Taf. xxxv [b left].

G 4650. IABTET $\text{𓆎} \text{𓆏}$, King's daughter of his body. Middle or late Dyn. IV.

Stone-built mastaba. VIs of Junker.



JUNKER, *Giza*, i, pp. 216-27; plan and sections, Abb. 50; plan, id. in *Anzeiger, Wien*, 51 (1914), Abb. 3, pp. 144-6 [a], 158-9[2].

Chapel. Synopsis of scenes, id. *Giza*, iii, p. 36 [14].

False-door of deceased, set up by Kai (tomb G 4651), early to middle Dyn. V, and pilaster with estates and offering-bringers on east and north faces in front of it. Id. ib. i, Taf. xxxv, xxxvi, Abb. 51, pp. 220-6; names and titles, SETHE, *Urk.* i (1933), 155 [4 (95)]; names of estates, JACQUET-GORDON, *Domaines*, pp. 203-6 [1G4], cf. fig. 12 (from JUNKER).

Burial chamber.

Reserve-head of deceased, found at entrance, in Hildesheim Mus. 2384. JUNKER, *Giza*, i, Taf. xiii [a, b], pp. 226-7 [c]; id. in *Anzeiger, Wien*, 51 (1914), Taf. viii [upper], pp. 173-4 [2]; id. in *J.E.A.* i (1914), pl. xl [4], p. 253; SIMPSON in *M.M.A. Bull.* n.s. vii (June 1949), fig. on p. 290 [left]; KAYSER, *Die Mastaba des Uhemka*, Taf. 12; see SMITH, *Hist. Eg. Sculpt.* p. 26 [15]; IPPEL and ROEDER, *Denkmäler . . . Hildesheim*, p. 54.

G 465I. KAPUNESUT  called KAI , Overseer of *ka*-servants, Overseer of the houses of the King's children, Judge and Scribe of the crews, etc. Early to middle Dyn. V.

Wife, Khuitka , Royal acquaintance.

Stone-built mastaba.

Plan XXXIII

JUNKER, *Giza*, iii, pp. 123-45; id. in *Anzeiger, Wien*, 51 (1914), pp. 156-8 [1]. Plans and sections, id. *Giza*, iii, Abb. 12, 13.

Chapel. Synopsis of scenes, id. ib. p. 35 [10].

(1) Doorway. (a)-(b) Lintel with offering-text, and drum with name and titles, jambs with deceased and wife. (c) and (d) Deceased and wife seated, and deceased seated with children.

(a)-(b) Id. ib. Taf. vii [a], Abb. 14, pp. 134, 136. (c) and (d) Id. ib. Taf. viii, Abb. 15, p. 136.

(2) Offering-list, and deceased at table below.

Id. ib. Abb. 17, pp. 140-1.



(3)-(5) Deceased and wife with son between two false-doors of deceased, with offering-scenes above doors.

Id. ib. Abb. 16, pp. 136-40. (5) Id. in *Anzeiger, Wien*, 51 (1914), Taf. iii; id. *Giza*, iii, on Taf. vii [b].

(6) Four registers, I-III, bringing animals, IV, butchers.

Id. ib. Abb. 18, p. 140; III-IV, on Taf. vii [b]; ibex from II, Abb. 7 [5].

Finds

Drum of 'Ankhmaḥor  called Inkhi , Judge and Elder of the Hall, Dyn. V-VI, found re-used to cover shaft¹ east of tomb. Id. ib. vii, Taf. xxvii [a, top], Abb. 56, p. 143 [4]; see id. in *Anzeiger, Wien*, 63 (1926), p. 90 [top].

G 4660. Middle or late Dyn. IV.

Stone-built mastaba.

JUNKER, *Giza*, i, pp. 213-16; plan and section, Abb. 49.

Reserve-head, badly weathered, found by Reisner east of tomb G 4560, possibly from here, probably in Cairo Mus. Temp. No. 19.11.24.5. See SMITH, *Hist. Eg. Sculpt.* p. 26 [17].

G 4710. SETHU , Director of the Palace, Secretary of the Toilet-house, Master of the largesse in the Mansion of Life, etc. Dyn. V.

Wife, Nubḥotp , Prophetess of Ḥathor North-of-the-Wall, etc.

Stone-built mastaba. LG 49.

Plan XXVII

¹ With lintel of Khufusonb [II], see p. 153.

REISNER, *Giza Necropolis*, i, pp. 521-4. Plan and section, *L. D. Text*, i, p. 72. Plan of chapel, REISNER, op. cit. fig. 117, p. 208 [25]; plan and section of shaft A, fig. 324; views, pls. 72 [f], 73 [a-c]. Name, MARIETTE, *Mastabas*, pp. 518-19.

Chapel. Partly removed by Lepsius.

(1) Entrance doorway. (a)-(b) Lintel with offering-text and drum with name and titles. (c) and (d) Deceased at table, and offering-bringer at (c) and funerary priest at (d) before him.

L. D. ii. 86 [b]. Lower parts of (c) and (d), REISNER, op. cit. pl. 74 [c, d], p. 523.

(2) False-door, with deceased, wife and family. (3) Deceased and presentation scene before him, four registers of scribes, offering-bringers and estates (no names).

L. D. ii. 87. Thicknesses of (2), *L. D. Ergänz.* xxvii [b]; upper lintel, in Berlin Mus. 1149, text, *Aeg. Inschr.* i, p. 29; see *Ausf. Verz.* p. 59; panel with deceased at table, formerly in N.Y. Hist. Soc. Colln., now in Brooklyn Mus. 37.34E, REISNER, op. cit. pl. 74 [b]; see *N.Y.H.S. Cat.* p. 25 [383]; SMITH (W. S.) in *A. J. A.* xlvi (1942), p. 509; upper part of upper right jamb and left thickness (top figure), in Berlin Mus. 1125-6, texts, *Aeg. Inschr.* i, p. 29; see *Ausf. Verz.* p. 59; central part of left thickness, in Berlin Mus. 1127, see *Ausf. Verz.* p. 59. (3) Registers, REISNER, op. cit. pl. 75 [a, b], p. 523.

G 4712. NIMA^ⲚETHAP, Seer of Horus and Sēth, *wrt hts* (woman). Probably first half of Dyn. V.

Stone-built mastaba.

REISNER, *Giza Necropolis*, i, p. 253 [15].

G 4714. NEFERHETPES , King's daughter of his body. Probably first half of Dyn. V.

Stone-built mastaba. LG 48.

REISNER, *Giza Necropolis*, i, p. 253 [16]; *L. D. Text*, i, p. 72, with plan.

Drum of entrance doorway with name and title. *L. D.* ii. 82 [c].

G 4715.

Sealing with names of Saḥurē(?) and Neuserrē, from shaft B. REISNER and SMITH, *Giza Necropolis*, ii, fig. 54, pp. 52-3.

G 4721. Probably end of Dyn. V.

Stone-built mastaba.

REISNER, *Giza Necropolis*, i, pp. 263 [6], 512.



Box-sealing with Horus-name of Isesi(?), from shaft A. Id. and SMITH, *Giza Necropolis*, ii, fig. 57, p. 53; see REISNER, op. cit. p. 499.

Lower part of double-statulette, granite, found in débris between tombs G 4720 and G 4721 (Exped. No. 14-2-15). See SMITH, *Hist. Eg. Sculp.* p. 72.

G 4733. Late Dyn. V or Dyn. VI.

Ointment-slab, alabaster, in Boston Mus. 24.599.

Box-sealing with names of Isesi, from shaft E. REISNER and SMITH, *Giza Necropolis*, ii, fig. 57, p. 53; see REISNER, *Giza Necropolis*, i, p. 499.

False-door of Nīrankhnemti  called Ny , Overseer of the expedition, Director of King's *warb*-priests of the Pyramid of Khufu, etc., Dyn. VI, found re-used west of tomb G 4840, in Stockholm Mus. MM. 11406. JUNKER, *Giza*, vi, Abb. 101, pp. 239-40; see id. in *Anzeiger, Wien*, 51 (1914), pp. 163-4 [2].

G 4750. AKHI , Overseer of all works of the King, Overseer of the Two Treasuries, Overseer of the royal granaries, etc. Temp. Menkaurē.

Stone-built mastaba. VIIs of Junker.

JUNKER, *Giza*, i, pp. 234-42; views, Taf. xxxviii; plan and sections, Abb. 55. See id. in *Anzeiger, Wien*, 51 (1914), pp. 146-7 [b], 164 [4].

Chapel. Relief-fragments. See id. *Giza*, i, pp. 236-41; iii, p. 36 [15].

Fragments of lintel, some in Vienna Mus. Inv. 7801, 8542. Id. ib. i, Taf. xxxix [a], Abb. 57 [1]; with two fragments adding new title, found by Reisner in shaft G 4734A, now in Boston Mus. unnumbered (Exped. No. 14-2-13), SMITH (W. S.) in *A. J. A.* xlvi (1942), fig. 15, pp. 530-1.



Birds, in Vienna Mus. Inv. 8541. JUNKER, *Giza*, i, Taf. xxxix [c], Abb. 57 [4]; see Vienna. 5000 Jahre, p. 59 [16].

Various, from scene with offering-bringers before deceased and daughter. JUNKER, *Giza*, i, Abb. 56 (2 left is in Vienna Mus. Inv. 8545), 57 [2, 3, 5-10].

Inscribed fragment, probably from here, found near tomb G 4811+4812, in Turin Mus. Sup. 1870. CURTO, *Gli Scavi*, Tav. xxvi [d], fig. 30 [c], pp. 77 [ii], 93-4; SMITH, op. cit. p. 531.



Serdab. Fragment of statue-group; JUNKER, *Giza*, i, Taf. xxxix [b], p. 236.

Finds from area east of tomb G 4760.

False-door of Nīrankhpēpy  good name Irenakhti  called Iri , Inspector of physicians of the Great House, Eye physician of the Great House, He who has command over Selkis, etc., late Old Kingdom, re-used to cover shaft S 2065, in Vienna Mus. Inv. 8009. JUNKER in *A. Z.* 63 (1928), Taf. ii, pp. 53-68; GHALIUNGUI in *Egypt Trav. Mag.* No. 108 (1963), fig. 4, p. 25; see JUNKER, *Giza*, vi, p. 80; id. in *Anzeiger, Wien*, 63 (1926), p. 90.

Lintel of Master of the house of the Great House, Secretary (name lost), fragment, late Old Kingdom. Id. *Giza*, vi, Abb. 20, p. 80.

G 4761. NŪFER [I] , Prophet of Horus *mddw* (Khufu), *mdd-r-nbty* (*nebty*-name of Khufu), and Khufu, Overseer of *ka*-servants, etc. End of Dyn. V or Dyn. VI.

Parents (probably), Kakhent  and Thetit , both Royal acquaintances. Wife, Hetepmatet , Royal acquaintance.

Stone-built mastaba.

Plan XXVIII

JUNKER, *Giza*, vi, pp. 26-74; id. in *Anzeiger, Wien*, xlix (1912), pp. 94-6; 63 (1926), p. 90. Plan and sections, id. *Giza*, vi, Abb. 3; views, Taf. i [a], v [b].

Chapel. Synopsis of scenes, id. ib. iii, p. 39 [25].

(1) Entrance doorway. (a)-(b) Drum with name and titles; (c) and (d) deceased seated receiving lists from two men at (c), and from son Setka (tomb, see p. 160) and Iḥa  at (d).

(a)–(b) Id. ib. vi, Abb. 4, p. 36. (c) and (d) Id. ib. Abb. 5, pp. 36, 38.

(2) Six registers (from left), I, ploughing and fishing with small nets, II, making ropes, tying bundles, and pulling flax, III, reaping corn, IV, netting fowl, V, donkeys carrying produce, and men piling up sheaves, VI, sowing, and sheep treading in grain. (3)–(4) Four registers before deceased with son Setka, I, three sailing-boats, and above, man carrying oar and another with calf, II, man with cranes, geese and ducks, III, men bringing cattle, IV, men bringing oryxes, ibex and hyena.

(2)–(4) Id. ib. Abb. 14. (2) Id. ib. Abb. 17, pp. 66–73; man from III, Abb. 44 [7]; V and VI, Taf. iv. (3)–(4) Id. ib. Abb. 15, 16, pp. 59–66; crane and goose from II, and men with oryx and man with hyena from IV, Taf. ii [d, e, a, c], p. 35 [1, 3–5].

(5) Food-offerings, and offering-bringer and man handing lotus-flower to deceased with wife seated, and below, two registers, flutists, harpists, and singers, and female dancers and clappers.

Id. ib. Abb. 13, pp. 56–9.

(6) Food-offerings and two groups of butchers. (7) and (9) False-doors of deceased, with men censuring and offering-bringers on panels and jambs. (8) Offering-list above deceased at table and registers of food-offerings. (10) Parents at table, food-offerings, and men bringing bull and calf below. (6)–(10) Frieze-text (name and titles) along top of wall.

Id. ib. Abb. 6–12, Taf. i [b], iii, v [a], pp. 38–56; man with calf from (10), Taf. ii [b], p. 35 [2].

Finds

False-door of Iḥa, Judge and Overseer of scribes, Inspector of *wab*-priests of the Pyramid of Khufu, etc., early Dyn. VI, found in fragments in Chapel, in Vienna Mus. Inv. 7445. Id. ib. Taf. xix [a], Abb. 18, 18a, pp. 74–7.

G 4811+4812. ḲANKHIRPTAḲ  Overseer of the *wabt*, Overseer of craftsmen of the Great House, Overseer of works of the King. Late Dyn. V or Dyn. VI.

Stone-built mastaba. Excavated by Schiaparelli.

Plan XXVIII

REISNER, *Giza Necropolis*, i, pp. 269–70 [5]; CURTO, *Gli Scavi*, pp. 74–7 [L]; BALLERINI, *Notizia*, pp. 58 [middle]–59 [middle]. Plan, CURTO, op. cit. fig. 28.

Chapel of ḲankhirptaḲ. G 4811. Decoration unfinished (preliminary sketches).

(1) Six women standing. Four, id. ib. Tav. xvii [b].

(2) Deceased and wife.

(3) Three registers of offering-bringers, and remains of text. Text, id. ib. fig. 30 [b].

(4) Deceased seated.

(5) False-door of deceased. Id. ib. fig. 31, pp. 76–7 [i].

G 4813. Late Dyn. V or Dyn. VI.

Rough mummy-mask, plaster, from shaft A, in Boston Mus. unnumbered (Exped. No. 15–11–64). See SMITH, *Hist. Eg. Sculpt.* p. 28 [6].

G 4817.

Upper part of seated male statue, late Dyn. V, found in débris of shaft A, in Boston Mus. 30.830. Id. ib. pl. 22 [b], p. 56; see id. *Anc. Eg.* (1942 and 1952), p. 50; (1960), p. 56.

G 4840. WONSHET , King's daughter of his body, Prophetess of Neith North-of-the-Wall and of Hathor Mistress-of-the-Sycamore. Middle or late Dyn. IV.

Stone-built mastaba. VIIIss of Junker.

JUNKER, *Giza*, i, pp. 249-55; id. in *Anzeiger, Wien*, 51 (1914), p. 163 [1]. Plan and sections, id. *Giza*, i, Abb. 62.

Fragment of slab-stela of deceased, probably from South chapel, found by Reisner in tomb G 4832. REISNER, *Giza Necropolis*, i, fig. 306, p. 500.

North chapel.

False-door, with deceased and family, including daughters Thenteti (tomb, see below) and Wehemnefert (tomb, see below), estates and offering-bringers, in Hildesheim Mus. 2971. JUNKER, *Giza*, i, Taf. xl [b], Abb. 63, pp. 250-5; ROEDER, *Geschäftsbericht des Pelizaeus-Museums* [etc.] 1914-28, 3rd pl.; id. *Die Mastaba des Uhemka im Pelizaeus-Museum zu Hildesheim*, Taf. 4; names of estates, JACQUET-GORDON, *Domaines*, pp. 211-12 [5G4], cf. figs. 18 (false-door incorrectly placed in South chapel), 19 (both from JUNKER).

S 984. Dyn. V.

Brick-built mastaba.

JUNKER, *Giza*, vii, pp. 17-24; plan, Abb. 6; views, Taf. v, vi [6].

Female reserve-head, clay, in Cairo Mus. Id. ib. i, Taf. xiv [c, d], xl [a], p. 256; id. in *Anzeiger, Wien*, 51 (1914), Taf. viii [lower], pp. 171, 174 [4]; PAVLOV, *Skulpturnyi portret v drevnem Egipte*, 5th pl. at end (from JUNKER); see REISNER, *Giza Necropolis*, i, p. 500; SMITH, *Hist. Eg. Sculp.* p. 26 [16].

NISU , Inspector of *ka*-servants, etc. Late Old Kingdom.

Brick-built mastaba.

JUNKER, *Giza*, vi, pp. 237-8; plan, Abb. 99.

Libation-basin of deceased, found in front of north false-door, in Vienna Mus. Inv. 8556. Id. ib. Abb. 100, p. 238.

THENTET , (called THENTETI in tomb G 4840), King's daughter. Late Dyn. IV or Dyn. V.

Mother, Wonshet (tomb G 4840).

Probably east of tomb G 4840. Excavated by Schiaparelli.

False-door of deceased, in Turin Mus. Sup. 1842. CURTO, *Gli Scavi*, Tav. xvi, fig. 17 [upper], p. 61 [D]; see BALLERINI, *Notizia*, p. 55 [top].

Fragment of lintel with deceased seated, in Turin Mus. Sup. 1862. CURTO, op. cit. fig. 17 [lower], p. 61.

Relief-fragment, in Turin Mus. Sup. 1861.

WEHEMNEFERT , King's daughter. Late Dyn. IV or Dyn. V.

Mother, Wonshet (tomb G 4840).

Probably east of tomb G 4840. Excavated by Schiaparelli.

False-door of deceased, with family, officials, estates, and offering-bringers on jambs, in Turin Mus. Sup. 1840. CURTO, *Gli Scavi*, Tav. xvii [a] (*in situ*), xviii, fig. 20; FARINA, *II Regio Museo* (1938), pl. on p. 40 [right]; titles of deceased, BALLERINI, *Notizia*, p. 55 [middle and bottom]; names of estates, JACQUET-GORDON, *Domaines*, p. 213 [6G4].

Uninscribed offering-table, found with last, in Turin Mus. Sup. 1841. See CURTO, op. cit. p. 66 [E, ii].

WERKAI , Royal acquaintance. Dyn. V-VI.

Stone-built mastaba.

JUNKER, *Giza*, vi, pp. 241-2; id. in *Anzeiger, Wien*, 63 (1926), p. 91.

Plan and section, id. *Giza*, vi, Abb. 102; view, Taf. xxiv [a].

South false-door, with family of deceased on outer jambs. Id. ib. Taf. xxiv [b], Abb. 103.

KHEPETHET  (or KHETHEPET), Elder of the house, Overseer of the store-room. Dyn. VI.

Wife, Ketketi .

JUNKER, *Giza*, vi, pp. 231-2; id. in *Anzeiger, Wien*, 63 (1926), p. 89.

Libation-basin of deceased, dedicated by wife, in Leipzig Mus. Inv. 3133 (lost). Id. *Giza*, vi, Abb. 94; name, RANKE, *Personennamen*, i, p. 269 [8].

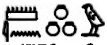
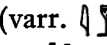
MINU  (varr. , etc.), King's *warb*-priest, Prophet of Horus *mḏdw* (Khufu), *mḏd-r-nbty* (*nebty*-name of Khufu), *hrwry-nb* (Golden Horus name of Khufu), Khufu, etc. Dyn. VI.

Stone-built, mastaba.

JUNKER, *Giza*, vi, pp. 232-7; id. in *Anzeiger, Wien*, 63 (1926), p. 88 (with name and titles). Plan and section, id. *Giza*, vi, on Abb. 95.

Chapel.

Entrance doorway. Lintel with offering-text and deceased seated, in Vienna Mus. Inv. 8518; id. ib. Abb. 96, pp. 234-5.

West wall. North false-door of deceased; id. ib. Taf. xxiii [c], Abb. 97, p. 235. Offering-list, south of last, in Vienna Mus. Inv. 8533a-b; id. ib. Abb. 98, pp. 235, 237.

PTAḤWĒR , Overseer of craftsmen. Late Old Kingdom.

Wife, Wazethotp .

Stone-built mastaba.

JUNKER, *Giza*, vi, pp. 242, 244; id. in *Anzeiger, Wien*, 63 (1926), p. 89. Plan, id. *Giza*, vi, on Abb. 95.

Lintel with offering-text and deceased and wife at table. Text, id. ib. p. 242.

KĒDNAS [I]  (Nisuked of Junker), Tenant, King's *warb*-priest, Prophet of Horus *mḏdw* (Khufu) and Khufu. 1st Int. Per.

Wife, Abdet .

JUNKER, *Giza*, vi, pp. 244-8; id. in *Anzeiger, Wien*, 63 (1926), p. 88 (called Denekh-seked). Plan, id. *Giza*, vi, on Abb. 95.

South false-door of deceased and family, with deceased in relief at back of niche, in Cairo Mus. Ent. 49693, upper lintel in Leipzig Mus. Inv. 3132. Id. ib. Taf. xxiii [d], Abb. 104-5, pp. 244, 247.

Block with dedication of son Merykhufu  , Tenant of the Great House, original position unknown, in Vienna Mus. Inv. 8548. Id. ib. Abb. 106, pp. 247-8.

G 4860. NAME UNKNOWN, Scribe of divine books, Lector-priest. Middle or late Dyn. IV.

Stone-built mastaba. VIIIn of Junker.

JUNKER, *Giza*, i, pp. 242-8; plan and sections, Abb. 58.

Slab-stela with deceased (head destroyed) at table, linen-list and granaries, found *in situ* near south end of east face, in Vienna Mus. Inv. 4750. Id. ib. Taf. viii [a], Abb. 59, pp. 242-6.

CEMETERY EN ECHELON. SOUTH PART

Reisner and Junker Excavations. Harvard-Boston Expedition (1913-16), and Akademie der Wissenschaften in Wien, Pelizaeus (later Pelizaeus-Museum) and University of Leipzig Expedition. Several tombs excavated earlier by Schiaparelli for the Turin Museum and by Steindorff for the Ernst von Sieglin Expedition (1909).

Plan XVI

Plan of Junker excavations, JUNKER, *Giza*, iii, Abb. 1; vii, plan at end; viii, plan at end, Abb. 1; xii, plan 4; id. in *Anzeiger, Wien*, 51 (1914), Abb. 2, cf. 1, pp. 141-4.

G 4911. 'ANKHTEF , King's *warb*-priest, Prophet of Khufu, etc. Dyn. V-VI.

Wife, Zefat .

Mastaba excavated by Schiaparelli.

CURTO, *Gli Scavi*, p. 74 [1].

False-door of deceased and wife, in Turin Mus. Sup. 1846. Id. ib. Tav. xix, fig. 24; see BALLERINI, *Notizia*, p. 58 [top].

G 4920. THENTI , Director of the Palace, Secretary of the Toilet-house, Chief of *bat*, etc. Early Dyn. V or later.

Wife, Nefertkau , Royal acquaintance.

Stone-built mastaba. LG 47.

Plan XXVIII

L. D. *Text*, i, pp. 71-2, with plan of Chapel, p. 71; REISNER, *Giza Necropolis*, i, pp. 214 [10], 312 [n].

Chapel. Synopsis of scenes, JUNKER, *Giza*, iii, pp. 38-9 [24].

(1) Doorway. (a) and (b) [1st ed. 1, 2] Deceased at table, with remains of offering-text.

L. D. ii. 31 [c, d].

(2) [1st ed. 3] Three registers, **I**, [estates before deceased seated], **II**, estates, **III**, men bringing animals, including cow suckling calf.

Id. ib. 31 [a]; names of estates, JACQUET-GORDON, *Domaines*, pp. 253-4 [24G5], cf. figs. 59, 60 (from LEPSIUS).

(3) [1st ed. 4] Deceased with attendants and members of household in two registers before and behind him.

L. D. ii. 31 [b].

(4) and (6) [1st ed. 5 and 6] False-doors, with Iasen  and men with fowl left of (4), and funerary priests right of (6). (5) Four registers, **I**, scribes handing in lists and recording before deceased, **II-IV**, men bringing animals and various articles.

Id. ib. 30.

(7) Deceased at table, with two registers below, **I**, offering-bringers, **II**, two groups of butchers.

L. D. *Ergänz.* xxvi [b].

G 4940. SESHEMNŪFER [I] , Royal chamberlain, One belonging to the estate 'Mansion of Ḥar-kheper (Raʿzedef)', Prophet of Ḥequet, Judge and Boundary official, etc. Temp. Saḥurē or Neferirkarē.

Wife, Amenzefas , Royal acquaintance.

Stone-built mastaba. LG 45.

Plan XXVIII

L. D. *Text*, i, p. 71, with plan. Plan of Chapel, REISNER, *Giza Necropolis*, i, fig. 124, cf. 89, 197, pp. 214 [9], 311 [d]. Synopsis of scenes, JUNKER, *Giza*, iii, p. 33 [1]; names and titles, p. 9 [1].

Chapel.

(1) (upper part unfinished) Two registers, men bringing antelope, and butchers.

See REISNER, op. cit. pp. 321 [29], 328 [10].

(2) [1st ed. 1]. Offering-list, and four registers, **I**, two sailing-boats carrying deceased, with man blowing trumpet in prow of first boat, two men running above, and [two rowing-boats] (partly above doorway), **II-III**, 'Brothers of the endowment' and offering-bringers, **IV**, estates.

L. D. ii. 28; see REISNER, op. cit. p. 325 [3]. Sailing-boat on right in **I**, DUEMICHEN, *Flotte*, xxv [6]. Seven offering-bringers from **II**, and names of seven *ka*-servants from **III**, NESTOR L'HÔTE MSS. 20396, 317 verso [lower], 318 [top]. Names of estates, JACQUET-GORDON, *Domaines*, pp. 239-40 [18G5], cf. figs. 46-7 (from LEPSIUS).

(3) [1st ed. 2] Deceased seated, with two attendants behind.

L. D. ii. 29[b]; NESTOR L'HÔTE MSS. 20396, 317 [left].

(4)-(6) [1st ed. 3-4] Deceased and wife with children, including Peḥenptaḥ (tomb G 5280) and Raʿwēr (tomb, probably, G 5270), between two false-doors of deceased with attendants on sides.

L. D. ii. 27. Omitting lower part, NESTOR L'HÔTE MSS. 20406, 'Tombeau du temps de Kheops', A, G (squeezes), 20396, 317 verso [upper]. Four sons in front of deceased, SMITH, *Hist. Eg. Sculp.* pl. 50 [a], pp. 165, 299. Deformed servant-girl, on right of (6), id. ib. fig. 176 [right], pp. 313-14; MORSE in BROTHWELL and SANDISON, *Diseases in Antiquity*, fig. 4 [A], p. 263. Inner thicknesses of (6) with four offering-bringers, L. D. ii. 29 [c, d].

(7) [1st ed. 5] Deceased and wife with small son before them.

Id. ib. 29 [a]; NESTOR L'HÔTE MSS. 20396, 317 [right]. Heads of deceased and wife, and titles above, SMITH, *op. cit.* pl. 50 [b], p. 165.

Shaft B.

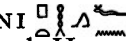

Male reserve-head, intrusive, Dyn. IV-V, in Boston Mus. 21.329. REISNER, *op. cit.* pl. 56 [b]; SMITH, *op. cit.* pl. 9 [a], p. 26 [9].

G 4941. PTAHIUFNI , Tenant of the Pyramid of Pepy I, Carpenter of the Great Dockyard, Honoured by Ḥarzedef, etc. Dyn. VI.

Stone-built mastaba.

JUNKER, *Giza*, vii, pp. 24-8, with plan on Abb. 4; id. in *Anzeiger, Wien*, 63 (1926), p. 89 note 1.

Upper part of false-door of deceased, found in fragments, in Leipzig Mus. Inv. 3134 (lost). Id. *Giza*, vii, Taf. vi [b, c], Abb. 8; id. in *Studi Rosellini*, ii, Taf. xiii, Abb. 1, p. 134.



ḤETEPI  , Inspector of tenants of the Great House, etc. Dyn. VI.

Stone-built mastaba.

JUNKER, *Giza*, vii, pp. 14-17; plan, on Abb. 4.



Lintel of entrance doorway or false-door, with offering-text, found on ground, in Vienna Mus. Inv. 8535a-b. Id. ib. Abb. 5.



Remains of texts of false-door. See id. ib. p. 16.

ḤETEPI  , Inspector of tenants of the Great House, Secretary, etc. Dyn. VI.

Position uncertain, perhaps north of last tomb.

False-door of deceased, in Turin Mus. Sup. 1847. CURTO, *Gli Scavi*, Tav. xx, xxi, fig. 21, pp. 67-9 [F]; see BALLERINI, *Notizia*, p. 67 note 2.

Fragments of false-door, Dyn. V-VI, found south-east of tomb G 4960. [Mert]iotes   (woman) smelling lotus, in Hildesheim Mus. 2404; JUNKER, *Giza*, vii, Taf. iv [d], Abb. 3, p. 12, cf. Taf. iii [a], Abb. 2; see IPPEL and ROEDER, *Denkmäler . . . Hildesheim*, p. 59.

G 4970. NESUTNŪFER   , Overseer of strongholds of the Heliopolitan-East nome, Leader of the land of the Thinite and Aphroditopolite nomes, Prophet of the statue (of Khephren), etc. Early or middle Dyn. V.

Wife, Khentetka   called Khent  , Prophetess of Ḥathor and Neith, etc.

Stone-built mastaba.





Plan XXVIII

JUNKER, *Giza*, iii, pp. 163-87; id. in *Anzeiger, Wien*, 50 (1913), pp. 169-75. Plans, sections, and elevation, id. *Giza*, iii, Abb. 25-6.

Chapel. Synopsis of scenes, id. ib. p. 35 [9]; hieroglyphic signs, Taf. vi [1-6, 8, 9].

(1) Doorway. (a)-(b) Drum with name and titles; (c) deceased seated (unfinished); (d) five registers of oils.

(a)-(b) Id. ib. Abb. 31 [a], p. 166. (c) See id. ib. p. 166. (d) Id. ib. Abb. 31 [c].

(2)-(3) Two registers of boats with deceased being rowed and paddled (above doorway) and four registers of sons (including Kawez'ankh    , Boundary official of a frontier district), daughters, and offering-bringers before deceased and wife with small son.

Id. ib. Taf. x, xi [a], Abb. 28-9, pp. 170, 172, 184-5; see id. in *Anzeiger, Wien*, 50 (1913), pp. 173-4.

(4) Offering-list, funerary priests before deceased at table, and two groups of butchers (copied from tomb G 5150, (4)).

Id. *Gîza*, iii, Abb. 9b, pp. 71, 76, 170, 184-5; funerary priests, MÜLLER (H.) in *Mitt. Kairo*, 7 (1937), Abb. 16 (from JUNKER), p. 78; see JUNKER in *Anzeiger, Wien*, 50 (1913), p. 174.

(5)-(7) [part, 1st ed. 1] Two false-doors of deceased, with offering-bringers and attendants (including Nubians and dwarfs) on sides, and between them, deceased and wife with small son, and five registers of scribes, estates, and men bringing animals.

Id. *Gîza*, iii, Abb. 27, pp. 183-4; scribe from II and two dwarfs beside (7), Taf. v; offering-stands on thicknesses of (7), Abb. 31 [b]. Two dwarfs, id. ib. v, Abb. 1 [1, 2], pp. 8, 10. Names of estates, JACQUET-GORDON, *Domaines*, pp. 255-6 [25G5], cf. figs. 61-2 (from JUNKER). See JUNKER in *Anzeiger, Wien*, 50 (1913), p. 172.

(8) [1st ed. 2] Deceased and wife seated, with offerings, scribe handing in list, and libation-scene before them, and register of offering-bringers below.



Id. *Gîza*, iii, Taf. xi [b], Abb. 30, pp. 170, 185; id. in *Anzeiger, Wien*, 50 (1913), Taf. v, pp. 171-2; CAPART, *Memphis*, fig. 299. Detail of dress of man from libation-scene, JUNKER, *Gîza*, iii, Taf. vi [7].

Serdab behind south false-door.

Statue of deceased seated, in Hildesheim Mus. 2143. Id. ib. Taf. xiv [a], Abb. 32 [A] (text), pp. 185-7; id. in *Anzeiger, Wien*, 50 (1913), Taf. x [left], p. 184 [c]; IPPEL and ROEDER, *Denkmäler . . . Hildesheim*, Abb. 6, p. 48; HORNEMANN, *Types*, iii, pl. 690.

Serdab behind north false-door.

Statue of wife seated, with small son Ruzu , in Vienna Mus. Inv. 7507. JUNKER, *Gîza*, iii, Taf. xiv [b], Abb. 32 [B] (text), pp. 185-7; id. in *Anzeiger, Wien*, 50 (1913), Taf. x [right], pp. 184-5 [c]; DEMEL, *Äg. Kunst*, Abb. 14; KOMORZYNSKI, *Altägyptens hohe Kunst in Österreich in Wort und Bild*, 31 (1951), Abb. 8, p. 13; id. in *Österreichische Lehrerzeitung*, 5 (1951), fig. on p. 24; id. *Altägypten*, Abb. 8, p. 15; id. *Erbe*, Abb. 17; HORNEMANN, *Types*, v, pl. 1290; Zürich. *5000 Jahre*, Abb. 27, p. 59 [116]; Vienna. *5000 Jahre*, No. 44 with Abb.

IRENRĒꜥ , King's *warb*-priest, Overseer of *ka*-servants of the endowment of Kanenesut, Inspector of prophets (west part), and his eldest son 'ANKH-EMRĒꜥ  (east part). Late Dyn. V or early Dyn. VI.

Father of Irenrēꜥ, Kanenesut [probably III] , Royal acquaintance (tomb, probably, see p. 80).

Stone-built mastaba.

JUNKER, *Gîza*, iii, pp. 146, 148, 156-63; plan and sections, on Abb. 23; view, Taf. ix [a]; see id. in *Anzeiger, Wien*, 63 (1926), pp. 69-70.

Remains of frieze-text from north façade with name and titles. Id. *Gîza*, iii, Abb. 24 [a].

Chapel.

Entrance doorway. Thicknesses with deceased and dedication of son; id. ib. Abb. 24 [b, c].

False-doors of deceased. Id. ib. Abb. 24 [d, e].

Shaft S 2147.

False-door of Heknu , fragments, found re-used. CAIRO, CENTRE OF DOCUMENTATION photo. S.R., Box 149, 2293; see JUNKER, *Giza*, iii, pp. 146, 162.

G 5030. Late Dyn. IV or Dyn. V.

Stone-built mastaba. LG 46.

Interior offering-room. Decoration unfinished.

L. D. *Text*, i, p. 71, with plan; REISNER, *Giza Necropolis*, i, p. 215 [15].

Between unscribed false-doors, deceased, wife and child, with two remaining registers, estates, and men bringing cattle. L. D. *Ergänz.* xxix [a]; names of estates, JACQUET-GORDON, *Domaines*, pp. 237-8 [1764-5], cf. figs. 44-5 (from LEPSIUS).

G 5032. REDENES , King's *warb*-priest, Scribe. Dyn. VI.

Wife, Mertiotes .

False-door, deceased *en face* at back of niche, with threat to vandals on right outer jamb, in Boston Mus. 21.961. A. S[ANBORN] in *Boston Mus. Bull.* xx (1922), fig. on p. 27 [upper left]; WRESZ., *Atlas*, iii, 21; BRUNNER, *Hieroglyphische Chrestomathie*, Taf. 3; GARDINER MSS. photo. 28.270 [left]; central part, SMITH, *Hist. Eg. Sculp.* pl. 57 [c], pp. 190, 324-5; deceased *en face*, SÄVE-SÖDERBERGH, *Egyptisk Egenart*, fig. 30 [A]; text (part), SETHE, *Urk.* i (1933), 226 [3 (143)]; see SMITH, *Anc. Eg.* (1942), p. 58; (1952), p. 57; (1960), p. 63.

BASHEPSES , Inspector of the Great House, Secretary of the King in the Great House, etc. Dyn. V-VI.

Close to tomb G 5032 or possibly same tomb.

CURTO, *Gli Scavi*, pp. 55-8 [B] (called G 5032); plan and sections, figs. 11 [B], 14. Plan and titles, BALLERINI, *Notizia*, on fig. on p. 53 [top], cf. pp. 53, 54 [top and middle].

Chapel.

Lintel of entrance doorway with offering-text and titles (other than on false-door), name destroyed. CURTO, *op. cit.* fig. 16 [b], pp. 55-6 [a].

False-door of deceased. Id. *ib.* fig. 18, pp. 56-7 [c].

G 5040. KAEMKED , King's *warb*-priest, etc. Late Dyn. V or Dyn. VI.

CURTO, *Gli Scavi*, pp. 51-5; plan, on fig. 11; details, sections, and sketches, figs. 14, 15; views, Tav. xiv. Plan and titles, BALLERINI, *Notizia*, on fig. on p. 53 [top], cf. p. 53.

Lintel of entrance doorway with figures of deceased and wife (no name) seated. CURTO, *op. cit.* fig. 16 [a], pp. 51-2.

Mummy-mask, plaster, fragments, from shaft C. See SMITH, *Hist. Eg. Sculp.* p. 28 [8].

SNEFRUNÜFER , Inspector of singers of the Great House, Overseer of entertainment, etc. End of Dyn. V or Dyn. VI.

Stone-built mastaba.

JUNKER, *Giza*, vii, pp. 32-6, 38-9; plan and sections, Abb. 11; view, Taf. ix [a].



Chapel.

Lintel of doorway with offering-text and drum with name, in Vienna Mus. Inv. 7498, 7504. Id. *ib.* Taf. ix [b, c], Abb. 12, pp. 33-4.

Serdab.

Nude standing statue of deceased, in Vienna Mus. Inv. 7506. Id. ib. Taf. x, Abb. 13 (base), 14, pp. 38-9; id. in *Anzeiger, Wien*, 50 (1913), Taf. xi [left] (*in situ*), xi [right], pp. 185-6 [d]; *Meisterwerke* (1931), fig. 7 [right]; (1958), fig. 8; LANGE, *Äg. Kunst*, pl. 23; DEMEL, *Äg. Kunst*, Abb. 12; KOMORZYNSKI, *Altägyptens hohe Kunst in Österreich in Wort und Bild*, 31 (1951), Abb. 13, p. 14; id. *Altägypten*, Abb. 13, p. 16; id. *Erbe*, Abb. 22; HICKMANN, *Ägypten*, Abb. 115; id. *Le Métier du musicien in Cahiers d'Histoire Égyptienne*, vi (1954), fig. 2, p. 260; WOLF, *Kunst*, Abb. 123; Vienna. 5000 Jahre, No. 32 with Abb.; see SMITH, *Hist. Eg. Sculp.* p. 73.

G 5080. SESHEMNÜFER [II] , Overseer of scribes of the royal documents, Overseer of all works of the King, etc. Temp. Neuserrēc.

Mother, Mertiotēs , Royal acquaintance. Wife, Hēnutsen .

Stone-built mastaba.

Plan XXVIII

REISNER, *Giza Necropolis*, i, pp. 214-15 [11], 311 [lower, c]; names and titles, JUNKER, *Giza*, iii, p. 9 [2].

Chapel. Synopsis of scenes, id. ib. p. 33 [2]; plan, JACQUET-GORDON, *Domaines*, fig. 50.

(1) Doorway. (a) Upper part destroyed, below, remains of boat being paddled, bottom register, two men bringing oryx. (b) Man bringing calves.

(a) See REISNER, op. cit. pp. 321 [30], 325 [2]. (b) SMITH, *Hist. Eg. Sculp.* pl. 47 [a], p. 165.

(2) Four registers before deceased, I, scribes, and II-IV, men bringing wild animals, cattle, and fowl.

Man carrying cages of birds, from IV, id. ib. fig. 234. Man with goose, from IV, BRUNNER-TRAUT in *Mitt. Kairo*, 15 (1957), Taf. iv [1], pp. 21, 23.

(3) Deceased in pavilion receiving lotus-flower from his son, with offering-bringers and family, and female dancers and clappers with harpist and singer in bottom register.

Deceased, SMITH, op. cit. fig. 141 [right], p. 287. Two dancers, harpist, and singer, HICKMANN, *45 Siècles*, pl. viii; id. in *Ann. Serv.* liv (1957), pl. x, p. 227. See REISNER, op. cit. p. 330 [2].

(4) Mother standing.

See id. ib. p. 344 [9].

(5) and (7) Inscribed false-doors.

(6) Deceased and wife at table, with children, and two groups of butchers below.

See id. ib. p. 328 [9].

(8) Four sons of deceased.

See id. ib. p. 344 [9].

(9) Four registers, I-II, III (left part), estates, III (right part) and IV, offering-bringers and attendants.

Man carrying gazelle in III, and man carrying calf in IV, SMITH, op. cit. figs. 235 [left], 236 [left]. Names of estates, JACQUET-GORDON, op. cit. pp. 243-4 [20G5], cf. figs. 50-1.

Relief-fragment with upper part of deceased, perhaps from here, in Boston Mus. 34.1466.

Serdab. With chambers for statues.

JUNKER, *Giza*, iii, pp. 187-92, with plan, sections, and reconstruction, Abb. 33-4; id. in *Anzeiger, Wien*, 50 (1913), pp. 160-1 [a], with plan on Taf. facing p. 162 [upper].

(10)-(13) False-doors with representations of bolts (inscribed).

Berlin (East) Mus. 21600; STRÖMBOM, *Egyptens Konst*, fig. 32; KOENIGSBERGER, *Die Konstruktion der ägyptischen Tür*, Taf. vii [1], p. 41; HERMANN in *Miscellanea Gregoriana*, fig. 2, p. 93.

Hildesheim Mus. 1540 (name in top left corner lost); see IPPEL and ROEDER, *Denkmäler . . .*

Hildesheim, p. 60, cf. Taf. 11 [b] (name).

Tübingen, Äg. Inst. der Univ. Inv. 4 (cut across top).

Leipzig Mus. Inv. 2555 (lost); HÖLSCHER (U.), *Das Grabdenkmal des Königs Chephren*, Abb. 10; F.E.R.E. photo. 5948.

(14) Offerings, in Leipzig Mus. Inv. 2579 (lost).

JUNKER, *Giza*, iii, Abb. 35, p. 188; *Kurzer Führer durch das Ägyptische Museum der Universität Leipzig* (1938), Taf. 2, p. 15.

Statues of deceased

Standing (headless), found in fragments in serdab, in Leipzig Mus. Inv. 2580 (lost).

JUNKER, *Giza*, iii, Taf. xiv [c], p. 192.

Scribe-statue, black granite, in Boston Mus. 34.53, and painted limestone head, in Boston Mus. unnumbered (Exped. No. 33-2-96), both found in shaft B. See SMITH, *Hist. Eg. Sculp.* p. 52.

Fragments, two alabaster and one black granite, found east of tomb. See id. *ib.* p. 52.

Head, red granite, found in shaft G 2191B, in Boston Mus. 12.1487. C. S. F[ISHER] in *Boston Mus. Bull.* xi (1913), fig. on p. 20 [upper] (*in situ*); *Handbook* (1930), fig. on p. 15; (1947), fig. on p. 16; (1964), fig. on p. 181 [upper left]; A. S[ANBORN] in *Boston Mus. Bull.* xxiii (1925), fig. on p. 72 [lower]; RANKE, *The Art of Ancient Egypt*, and BREASTED, *Geschichte Aegyptens*, 61; SMITH, *Anc. Eg.* (1942), fig. 25; (1952), fig. 26; (1960), fig. 28; id. *Hist. Eg. Sculp.* pl. 20 [a, b], p. 52; PIJOÁN, *Summa Artis*, iii (1945), fig. 144; ALDRED, *O.K. Art*, pl. 34. Fragments of knee and shoulder, found east of tomb, see SMITH, *Hist. Eg. Sculp.* p. 52.

Shaft B.

Sarcophagus of deceased, with lid, red granite, in Cairo Mus. Ent. 60541. DONADONI ROVERI, *Sarcofagi egizi*, Tav. xix [2], pp. 126-7 [B 43].

Inscribed wand of deceased, in Cairo Mus. Ent. 60545.

Slab with offering-list, in Cairo Mus. Ent. 60543. Text, HASSAN, *Giza*, vi [2], pls. lxxv-lxxii [71], p. 133.

Sealing with Horus-name of Shepseskaf, and another with bound captives. REISNER and SMITH, *Giza Necropolis*, ii, on figs. 50-1, p. 51.

Shaft C.

Fragment with incised masons' graffito with date, found in débris. SMITH (W. S.) in *J.N.E.S.* xi (1952), fig. 8 [lower middle], p. 127 [5].

Various finds

False-door of Sethu  (possibly son of deceased), with family on jambs, perhaps from here, in Cairo Mus. Ent. 60542.

False-door of Neferi , Overseer of the department of tenants of the Great House, etc., from east of tombs G 5080 and G 4990, lower part in Boston Mus. 12.1498, 12.1515.



G 5110. DUAENRĒ . (Vizier of MenkaurĒ.) Temp. Khephren to MenkaurĒ.

Parents, Khephren and Meres'ankh [III].

Stone-built mastaba. LG 44.

Plan XXVII

L. D. Text, i, p. 70; REISNER, *Giza Necropolis*, i, pp. 69, 146 [2], 247.

Fragment with incised masons' graffito with names of Perneb  and Iufi , both Overseers of the ten, from débris. SMITH (W. S.) in *J.N.E.S.* xi (1952), fig. 8 [upper left], p. 126 [B, 5].

Chapel.

Plan, REISNER, op. cit. fig. 152, pp. 218 [31], 248 [middle 1], 311 [lower a], 318 [24]. Synopsis of scenes, JUNKER, *Giza*, iii, p. 36 [16].

Relief-fragment with head of deceased, in Boston Mus. 34.1465.

(1) Doorway. (a) and (b) Deceased seated with attendants behind him, remains of offering-text, and scribe and butchers at (b).

See REISNER, op. cit. pp. 318 [24], 328 [8].

(2) (unfinished) Deceased, and men bringing offerings and animals.

Gazelle and ibex, SMITH, *Hist. Eg. Sculp.* pl. 58 [b], pp. 164, 245, 247-9.

(3) Deceased, and offerings and butchers.

Butcher, id. ib. fig. 185 [lower left]; goose as offering, fig. 192.

(4) (unfinished) Deceased with son, and bringing cattle.

(5) Deceased, and offerings and men bringing animals.

Bringing ibex, and dog, id. ib. pls. 58 [d], 59 [a].

Shaft A. See REISNER, op. cit. p. 167 [13].

Sarcophagus with lid (uninscribed), red granite, found by Schiaparelli, in Turin Mus. Sup. 1838-9. CURTO, *Gli Scavi*, Tav. xxii, figs. 25-6, pp. 72-3 [H]; DONADONI ROVERI, *Sarcofagi egizi*, Tav. xvi [2], p. 117 [B 20]; see BALLERINI, *Notizia*, p. 57 [middle].

KHENTKAUS , Prophetess of Hathor Mistress-of-Dendera, etc. Dyn. VI.

Father (probably), Isu , Overseer of the expedition.

Stone-built mastaba.

Plan XXXIV

JUNKER, *Giza*, vii, pp. 68-85, 88; plans and sections, on Abb. 28; CURTO, *Gli Scavi*, on fig. 11. View, JUNKER, op. cit. on Taf. xv [b].

Room II.

(1) Doorway. (a) Drum with name and titles; (b) remains of seated couple.

Id. ib. Abb. 30a, 30b.

(2) Two (remaining) registers before [deceased], I, attendants with various articles, and in left part, female dwarf before [seated couple] (possibly parents) with attendants beyond, II, men bringing animals (including hyena).

Id. ib. Taf. xvi [a], Abb. 31, pp. 72-6.

Room III.

(3) Offering-list, [funerary priests], offering-bringers, estates, and [butchers] before three people with small boy.

Id. ib. Taf. xvi [b], Abb. 32, 33b (fragment from here), pp. 76-85; see BALLERINI, *Notizia*, p. 54 [bottom]; names of estates, JACQUET-GORDON, *Domaines*, p. 317 [47G6], cf. figs. 101-2 (from JUNKER).



False-door of deceased, with dedication of Isu on jamb, removed by Schiaparelli, in Turin Mus. Sup. 1848. CURTO, op. cit. Tav. xv, fig. 19, pp. 58-61 [c]; see BALLERINI, *Notizia*, p. 54 [bottom].

THENA , Prophet of Ḥathor. End of Dyn. V or early Dyn. VI.

Stone-built mastaba.

JUNKER, *Giza*, vii, pp. 85-8; plans and sections, on Abb. 28.

Statue of deceased standing, from upper niche of west shaft (S 833), in Cairo Mus. Ent. 45106. Id. ib. Taf. xvii [b, c], Abb. 34 (base), pp. 87-8, cf. Taf. xvii [a] (*in situ* with two wooden ant-eaten statues).

G 5150. SESHETHOTP  called HETI , King's son of his body, Overseer of all works of the King, Greatest of the Ten of Upper Egypt, etc. Early Dyn. V.

Wife, Mertiotes , Prophetess of Neith and Ḥathor, etc.

Stone-built mastaba. LG 36.

Plan XXVIII

L. D. *Text*, i, pp. 63-5 (with plan); JUNKER, *Giza*, ii, pp. 172-95; plan and sections, Abb. 23; section, iii, Abb. 3 [top]; views, ii, Taf. xi, xii.

East face.

False-door at north end. Fragment of lintel, id. ib. Abb. 24 [b], pp. 175-6.

Chapel. Synopsis of scenes, id. ib. iii, p. 38 [23].

(1) Doorway. (a)-(b) Lintel. (c) [1st ed. 1] (much destroyed) Deceased and wife seated, and small son. (d) [1st ed. 2] Deceased at table, with daughter behind him and two funerary priests before him. (e) Three registers, each with two offering-bringers.

(a)-(b) Fragment with deceased seated; id. ib. ii, Abb. 24 [a], p. 174. (c) L. D. ii. 25 [lower left]; JUNKER, *Giza*, ii, Abb. 26, p. 181. (d) L. D. ii. 25 [upper right]; JUNKER, *Giza*, ii, Abb. 25, p. 181. (e) L. D. ii. 25 [lower middle]; JUNKER, *Giza*, ii, Abb. 27.

(2) [1st ed. 4] (above doorway) Men paddling boat with deceased (upper part destroyed).

L. D. ii. 24 [middle]; JUNKER, *Giza*, ii, Abb. 32; WILKINSON MSS. xiii. 88-9 [bottom right].

(3) [1st ed. 5] Deceased with wife and small son, and presentation scene in four registers (upper two much destroyed), men bringing various articles, animals and fowl, and two groups of butchers.

L. D. ii. 24 [right]; JUNKER, *Giza*, ii, Abb. 31, pp. 181, 184.

(4) [1st ed. 6] Funerary priests before deceased at table, offering-list above, and two groups of butchers below.

L. D. ii. 25 [lower right]; JUNKER, *Giza*, ii, Abb. 33, p. 184; iii, Abb. 9a.

(5) and (7) [1st ed. 7, 8] Two false-doors of deceased, with offering-bringers (including Nubian and man carrying young hyena) on sides, and between them, (6) four registers (top lost) of presentation scene before deceased and children, with scribes recording, estates, and men bringing animals.

L. D. ii. 23; JUNKER, *Giza*, ii, Taf. xv, xvi [b], Abb. 28, p. 184. Incomplete, WILKINSON MSS. xiii. 84 [lower], 85 [upper right], 92. Names of children and text of estates, L. D. Text, i, p. 64; names of estates, JACQUET-GORDON, *Domaines*, pp. 251-2 [23G5], cf. figs. 57-8 (from JUNKER).

(8) [1st ed. 9] Deceased and wife seated, with small son, receiving list of offerings, and offering-bringers below.

L. D. ii. 25 [upper left]; JUNKER, *Giza*, ii, Taf. xvi [a], Abb. 29, p. 184; part, WILKINSON MSS. xiii. 85 [upper left]; Neferirtes , Dentist, GHALIUNGUI in *Egypt Trav. Mag.* No. 108 (1963), fig. 1, p. 22 (from LEPSIUS).

(9) [1st ed. 3] Deceased and wife seated, with children, and men bringing oryx and bull below.

L. D. ii. 24 [left]; JUNKER, *Giza*, ii, Abb. 30, pp. 184-5; incomplete, WILKINSON MSS. xiii. 88 [bottom].

North-west shaft.

Rectangular coffin with palace-façade decoration, wood, in Cairo Mus. Ent. 49695. JUNKER, *Giza*, ii, Taf. xiv [b, c], pp. 178-9; id. in *Anzeiger, Wien*, 63 (1926), Taf. iii [b], p. 75; DONADONI ROVERI, *Sarcofagi egizi*, Tav. xi, xiii, p. 155 [C 10]; see GAUTHIER in *Ann. Serv.* xxx (1930), p. 175 [a].

Statues

Vizier (name lost) and wife standing (heads damaged), possibly parents of deceased, found partly in serdab and partly in shaft, in Vienna Mus. Inv. 7788. JUNKER, *Giza*, ii, Taf. xiii, xiv [a], Abb. 34, pp. 180-1 [2], 188-93; id. in *Anzeiger, Wien*, 51 (1914), Taf. x (part), pp. 177-8 [5]; KOMORZYNSKI, *Altägyptens hohe Kunst in Österreich in Wort und Bild*, 31 (1951), Abb. 16, p. 14; id. *Altägypten*, Abb. 16, p. 16; id. *Erbe*, Abb. 28; see SMITH, *Hist. Eg. Sculp.* p. 54.

Torso of man standing, found east of tomb. See JUNKER, *Giza*, ii, pp. 179-80.



Various

Fragments of small false-door of Henkit , Prophetess of Hathor, late Old Kingdom, found between tombs G 5150 and G 5340. Id. ib. vii, Abb. 106, p. 251.

THENTI . Dyn. V.

Stone-built mastaba.

JUNKER, *Giza*, vii, pp. 90-2; plans and sections, Abb. 36-7; view, Taf. xviii [a].

Two cylinder-seals with names of owners 'Ankhmersu  and Zau  and of deceased, limestone, found in débris, probably from shafts, in Cairo Mus. Ent. 60485-6. Id. in *Mélanges Maspero*, i [1], pp. 267-71 with pl.; see id. *Giza*, vii, p. 90.

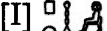
PTAḤSHEPSES [I] , Inspector of *ka*-servants. Late Dyn. V.

Wife, Redenes , Royal acquaintance.

Stone-built mastaba.

JUNKER, *Giza*, vii, pp. 92-113 (Shepsesptah), with plan, on Abb. 38; see id. in *Anzeiger, Wien*, 50 (1913), pp. 182-4; SMITH, *Hist. Eg. Sculp.* pp. 72-3.

Statues

In order of JUNKER, *Giza*, vii, pp. 93-4, 103-4.

East serdab. S 2 of Junker.

Deceased standing (headless), in Vienna Mus. Inv. 7503. Id. ib. Taf. xxi [b], Abb. 40 [lower] (base), pp. 104-5.

Deceased and wife standing (headless), in Vienna Mus. Inv. 7501. Id. ib. Taf. xxi [a], Abb. 40 [upper] (base), pp. 94-100, 104-5.

Upper part of statue-group and remains of another statue. See id. ib. p. 94.

West serdab. S 1 of Junker. View *in situ*, id. ib. Taf. xix; id. in *Anzeiger, Wien*, 50 (1913), Taf. ix; CAPART, *L'Art ég.* i, pl. 30; id. *Memphis*, fig. 326 (both from JUNKER).

Man standing, in Vienna Mus. Inv. 7499. JUNKER, *Giza*, vii, Taf. xxii [a], pp. 104-5; KOMORZYNSKI, *Altägyptens hohe Kunst in Österreich in Wort und Bild*, 31 (1951), Abb. 14, p. 14; id. *Altägypten*, Abb. 14, p. 16; id. *Erbe*, Abb. 26; see Vienna. *5000 Jahre*, p. 67 [54].

Man standing, in Cairo Mus. Ent. 43963. JUNKER, *Giza*, vii, Taf. xx [a, 2nd from right].

Man standing (with feet together), in Vienna Mus. Inv. 7508. Id. ib. Taf. xxi [c], p. 105 [2]; KOMORZYNSKI in *Österreich in Wort und Bild*, 31 (1951), Abb. 15, p. 14; id. *Altägypten*, Abb. 15, p. 16; id. *Erbe*, Abb. 27.

Male double-statue, standing, in Hildesheim Mus. 2144. JUNKER, *Giza*, vii, Taf. xxii [b], pp. 96-100; see IPPEL and ROEDER, *Denkmäler . . . Hildesheim*, p. 54.

Male double-statue, standing, in Cairo Mus. Ent. 43961. JUNKER, *Giza*, vii, Taf. xx [a left], pp. 96-100; BOREUX in *Mélanges Maspero*, i [2], pl. ii [1], p. 810; HORNE-MANN, *Types*, iv, pl. 1093.

Squatting scribe¹ reading, in Hildesheim Mus. 2141. JUNKER, *Giza*, vii, Taf. xx [b, 2nd from right], pp. 100-2, 105-8.

Squatting scribe, in Cairo Mus. Ent. 43966. Id. ib. Taf. xx [a middle, b 2nd from left], pp. 100-3, 105-7; HORNE-MANN, *Types*, ii, pl. 418.

Woman standing, in Cairo Mus. Ent. 43964. JUNKER, *Giza*, vii, Taf. xx [a right]; HORNE-MANN, *Types*, iv, pl. 833.

Male baker heating pots, in Hildesheim Mus. 2140. Id. *Giza*, vii, Taf. xx [b left], xxii [c], p. 111; HERMANN and SCHWAN, *Ag. Kleinkunst*, fig. on p. 30; BREASTED (Jr.), *Eg. Servant Statues*, pl. 28 [a], p. 28 [3]; KAYSER, *Im Reich des Osiris* (1949), Abb. 4, p. 13; id. *Roemer-Pelisaeus-Museum Hildesheim* (1959), Abb. 3; id. *Das Pelisaeus-Museum in Hildesheim* (1966), Abb. 16; id. *Die Mastaba des Uhemka*, Taf. 16 [a]; HORNE-MANN, *Types*, ii, pl. 527; ADRIAN, *So wurde Brot aus Halm und Glut* (2nd ed.), Abb. 57; see IPPEL and ROEDER, *Denkmäler . . . Hildesheim*, p. 55.

Squatting man Iyshema  (headless) wiping out jar, damaged, in Hildesheim Mus. 2142. JUNKER, *Giza*, vii, Taf. xxii [d], pp. 111-13; BREASTED (Jr.), op. cit. pl. 44 [b], p. 47 [6]; see IPPEL and ROEDER, op. cit. p. 55.

Model vat (from statuette of brewer). See JUNKER, *Giza*, vii, p. 94.

¹ See Addenda.

Woman grinding corn, in Vienna Mus. Inv. 7500. Id. ib. Taf. xx [b right], p. 110; KOMORZYNSKI, *Altägyptens hohe Kunst in Österreich in Wort und Bild*, 43 (1952), Abb. 2, p. 47; id. *Altägypten*, Abb. 18, p. 41; id. *Erbe*, Abb. 9; Vienna. 5000 Jahre, No. 30 with Abb. Statuette. See JUNKER, *Gîza*, vii, p. 94.

Found outside mastaba.

Squatting scribe (headless) reading, found south-west of mastaba but probably not from here, in Vienna Mus. Inv. 7789. JUNKER, *Gîza*, vii, Taf. xxiii, pp. 108-10; see id. in *Anzeiger, Wien*, 51 (1914), p. 176 [2].

S 344/346. Dyn. V-VI.

Stone-built mastaba. Almost completely destroyed.

Mummy mask (whole body originally covered), plaster, from burial chamber connected with shafts S 345 and 346, in Vienna Mus. Inv. 8568. JUNKER, *Gîza*, vii, Taf. xxiv, pp. 113-16, with position on Abb. 38; id. in *Anzeiger, Wien*, 51 (1914), Taf. v, p. 170; see SMITH, *Hist. Eg. Sculp.* p. 28 [12].

S 466/467. Dyn. V-VI.

Stone-built mastaba.

Head of deceased enclosed in plaster (whole body originally covered), from shaft S 466, in Vienna Mus. Inv. 7800. JUNKER, *Gîza*, vii, Taf. xxv, pp. 116-17, with position on Abb. 38; id. in *Anzeiger, Wien*, 51 (1914), Taf. vi [lower], p. 170; id. in *J.E.A.* i (1914), pl. xl [1], p. 253; BRUNNER in *Forschungen und Fortschritte*, 28 (1954), Abb. 1 [right], p. 331; see SMITH, *Hist. Eg. Sculp.* p. 28 [13].

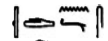
ḲEDNAS [II]  (Nisūḳed of Junker), Overseer of the department of tenants of the Great House, Overseer of the ten of the Great House, Prophet of Khufu, etc. Dyn. VI.

Stone-built mastaba.

JUNKER, *Gîza*, vii, pp. 133-8; plans and sections, Abb. 49.

Chapel.

Entrance doorway. Thicknesses, right, eldest son Sabi  censing before deceased, left, deceased, in Vienna Mus. Inv. 7509-10; id. ib. Abb. 51, p. 136; right, Taf. xxvii [c].

False-door of deceased. Id. ib. Taf. xxviii [b], Abb. 50 [lower], pp. 133-4.



Lintel with offering-text, from entrance doorway or false-door, in Vienna Mus. Inv. 7511. Id. ib. Taf. xxviii [a], Abb. 50 [upper], pp. 134-6.

S 359. Dyn. V-VI.

Stone-built mastaba.

JUNKER, *Gîza*, vii, pp. 138-40; plan and sections, Abb. 52.

Entrance doorway. Right thickness, son censing before deceased, in Hildesheim Mus. 2389. Id. ib. Taf. xxviii [c], Abb. 53; see IPPEL and ROEDER, *Denkmäler . . . Hildesheim*, p. 59.

KHUFUSONB [I]   Prophet of *md-d-r-nbty* (*nebty*-name of Khufu),

Secretary of his Lord, Overseer of the royal harîm, etc. End of Dyn. V or later.

Stone-built mastaba.

JUNKER, *Gîza*, vii, pp. 117-26; plans and sections, Abb. 43-4; view, Taf. xxvi [a].

Chapel.

Entrance doorway. Lower part of left thickness with deceased and wife seated; id. ib. Abb. 45, p. 123. Lintel with offering-text, found in shaft of tomb G 5170, in Hildesheim Mus. 3050; id. ib. Abb. 46, p. 124; see id. in *Anzeiger, Wien*, 63 (1926), p. 91 [1].



Shaft S 353. View, id. *Giza*, vii, Taf. xxvi [b].

Statue of deceased, life-size, wood, almost completely destroyed, found near sarcophagus. See id. ib. pp. 125-6.

SESHETHOTP [II] , Prophet. Late Old Kingdom.

Stone-built mastaba.

Sketch showing offering-room with remains of false-door, JUNKER, *Giza*, vii, Abb. 55, pp. 141-3.

KHUFUSONB [II]  || , Prophet of Horus *mddw* (Khufu) and of Khufu, Overseer of commissions of tenants of the Great House, etc. Dyn. VI.

Father (possibly), Khufusonb [I] (tomb, see p. 152).



Stone-built mastaba.



JUNKER, *Giza*, vii, pp. 126-33; plan, on Abb. 38; view, on Taf. xxix [a].

Chapel.

Entrance doorway. Lintel, found re-used to cover shaft¹ east of tomb G 4651, in Vienna Mus. Inv. 8521; id. ib. Taf. xxvii [a middle and bottom], Abb. 47 [a], pp. 128-9; see id. in *Anzeiger, Wien*, 51 (1914), p. 165 [upper]. Left outer jamb, remains of text concerning building tomb; id. *Giza*, vii, Taf. xxvii [b right], Abb. 48b, pp. 130, 132. Right thickness, son Hemakhti  censuring before deceased, in Hildesheim Mus. 2387; id. ib. Abb. 48a [left], p. 130; see IPPEL and ROEDER, *Denkmäler . . . Hildesheim*, p. 59, cf. Taf. 11 [b] (name). Left thickness, remains of deceased; JUNKER, *Giza*, vii, Taf. xxvii [b left], Abb. 48a [right], pp. 130-1.

Lintel of false-door of deceased. Id. ib. Abb. 47 [b], pp. 129-30.

G 5170. SESHEMNÜFER [III]  , King's son of his body, Chief Justice and Vizier, etc. Temp. Iseis (early).

Parents, Seshemnüfer [II] and Henutsen (tomb G 5080). Wife, Hetepheres  , King's daughter, Prophetess of Hathor Mistress-of-the-Sycamore and Neith Opener-of-the-Ways, etc.

Stone-built mastaba. Excavated by Steindorff in 1908.

Plan XXIX

JUNKER, *Giza*, iii, pp. 192-214, with plans and sections, Abb. 36-8, 38a, cf. x, Abb. 14 [bottom]; id. in *Anzeiger, Wien*, 51 (1914), pp. 148-9 (called Seshemnüfer II); 63 (1926), pp. 73-4 (called Seshemnüfer II). Names and titles, id. *Giza*, iii, pp. 9-10 [3]. Position, GRDSELOFF in *Ann. Serv.* xlii (1943), fig. 4, p. 40.

Jambs of Seshemnüfer, with offering-bringers on thicknesses, possibly from here, in Cairo Mus. 57151-2.

With drum of 'Ankhamathor, see p. 135.

Interior offering-room. In Tübingen, Äg. Inst. der Univ. Inv. 3.

Synopsis of scenes, JUNKER, *Giza*, iii, p. 33 [3]. Sketch-plan, PETRIE in SAYCE MSS. 19a. Names and titles of deceased, etc., DE ROUGÉ, *Inscr. hiéro.* pl. lxiv [lower]. See SMITH, *Hist. Eg. Sculp.* p. 362.

(1) Offering-list above doorway, and four registers before deceased leaning on staff with small son Seshemnūfer, I, scribes, II, men bringing wild animals, III, bringing cattle, IV, bringing fowl.

Omitting offering-list, JUNKER, *Giza*, iii, Taf. iii, Abb. 8b, pp. 203, 213-14. Oxen from III, and first man with goose from IV, both with ancient corrections, BRUNNER-TRAUT in *Mitt. Kairo*, 15 (1957), Taf. ii, iii, Abb. 1, 2, pp. 18-23. Texts of deceased and men with animals, etc., including name of son (now destroyed), PETRIE in SAYCE MSS. 20b, c.

(2) Deceased seated, receiving lotus-flower from son Seshemnūfer, with seven registers before him, offerings, offering-bringers, sons, with female clappers and dancers and male harpists in bottom register.

JUNKER, *Giza*, iii, Taf. ii, pp. 202-3, 213; BRUNNER, *Eine ägyptische Grabkammer* [etc.] in *Attempto (Nachrichten . . . der Tübinger Univ.)*, 3 (1954), fig. on p. 35; BRUNNER-TRAUT, *Tübingens Schätze aus dem Alten Ägypten in Tübinger Blätter*, 46 (1959), fig. on p. 47. Texts, of deceased, offering-bringers, and musicians, PETRIE in SAYCE MSS. 20d. See SMITH, op. cit. p. 289 note 1 (called G 5180).

(3) False-door of deceased, with mother left of it, (4) deceased and wife at tables with offering-list above and two groups of butchers below, (5) false-door of deceased, with four registers of relatives right of it.

JUNKER, *Giza*, iii, Taf. i, pp. 202, 213. (3)-(4) VASSALLI MSS. 7. Heads of deceased and wife at (4), GRIFFITH INST. photo. 301. Texts of (3), PETRIE in SAYCE MSS. 19b [right]; of mother, 19b [left]; above deceased and wife, and offering-list (right end now destroyed), 19c; of (5), including upper lintel (now missing), and of relatives, 19d. See MARIETTE, *Mastabas*, pp. 566-7; id. *Notice des principaux monuments . . . à Boulaq* (1864), p. 272 [8].

(6) Four registers of estates.

JUNKER, *Giza*, iii, Taf. iv, pp. 203-4, 209-10. Names of estates, JACQUET-GORDON, *Domaines*, pp. 270-4 [30G5], cf. figs. 67-8 (from JUNKER); VASSALLI MSS. 9 [right]; PETRIE in SAYCE MSS. 20a.

South shaft. View, JUNKER in *Anzeiger, Wien*, 63 (1926), Taf. iii [a], p. 74.

Canopic-jars with hieroglyphic signs in ink. Id. *Giza*, iii, Taf. xii [a], p. 214; id. in *Anzeiger, Wien*, 63 (1926), p. 74.

False-door of Iḥu , Royal chamberlain, fragments, Dyn. VI, found thrown away in shaft, perhaps from one of tombs south of here, in Hildesheim Mus. 3046. Id. *Giza*, vii, Abb. 107, pp. 251-3 [4] (called 2403); see id. in *Anzeiger, Wien*, 63 (1926), p. 91 [2].

S 576. Dyn. V-VI.

Stone-built mastaba.

JUNKER, *Giza*, vii, pp. 146-9; plan, on Abb. 59.

False-door of Nūfer [II], Steward, etc., with text of building tomb, rewarding craftsmen, and threat to vandals, re-used to cover shaft S 576, in Hildesheim Mus. 2403. Id. ib. Taf. xxix [b], Abb. 60; text, SETHE, *Urk.* i (1933), pp. 225-6 [2 (142)]; see IPPEL and ROEDER, *Denkmäler . . . Hildesheim*, p. 61; JUNKER in *Anzeiger, Wien*, 51 (1914), p. 165 [7].

G 5190.

Relief-fragments, two women and two columns of text, Dyn. VI, in Boston Mus. 13.4343.

Sealings with Horus-name of Menkaurē, from shaft A. REISNER and SMITH, *Giza Necropolis*, ii, fig. 50, p. 51.

G 5210.  King's war-priest, Prophet of Khufu, Steward of Kawaḥb, [Hetep]heres [II] and Meresankh [III], etc. Temp. Khufu to end of Dyn. IV or early Dyn. V.

Stone-built mastaba. LG 43.

Plan XXVIII

L. D. *Text*, i, pp. 69–70; MARIETTE, *Mastabas*, pp. 517 [1], 519–21; REISNER, *Giza Necropolis*, i, p. 312 [1]. Plan, L. D. *Text*, i, p. 70; of chapel, REISNER, op. cit. fig. 177, pp. 281–2 [2]. View, L. D. ii. 26 [bottom]; MASPERO, *Hist. anc.* i, fig. on p. 248; PRISSE, *L'Art ég. Texte*, fig. on p. 216.

East face.

(1) Frieze. From north, (a)–(c) three blocks with titles of deceased, with offering-text of deceased on inner face of (c).

L. D. ii. 26 [a, b, c, c bis], *Text*, i, p. 70; MARIETTE, op. cit. p. 520 [middle and bottom], cf. p. 521; SHARPE, *Eg. Inscr.* 2 Ser. 48, ll. 1–3; BURTON, *Excerpta hiero.* pl. xxvii [1, 3]; BURTON MSS. 25621, 56 [right], 135, 136 [1, 3]; 25619, 45 [upper]; NESTOR L'HÔTE MSS. 20396, 309 verso; WILKINSON MSS. xvii. F. h [A]; xiii. 45. Cartouche of Khufu, PRUDHON MSS. vi. 144. Inner face of (c), BRUGSCH, *Monumens*, xiv [2].

(2) North false-door of deceased.

Lintel with offering-text, L. D. ii. 26 [e]; MARIETTE, op. cit. p. 520 [top] (reversed); SHARPE, op. cit. 41, ll. 23–4 (reversed, text only); NESTOR L'HÔTE MSS. 20396, 309 [lower]; WILKINSON MSS. xiii. 44 [bottom]; xvii. F. h [B]; LIEDER squeezes, 3. 1, 2.

Chapel.

(3) Lower register, men with linen, singer, harpist, and flutists, and men bringing animals. See REISNER, op. cit. p. 330 [3].

(4) [1st ed. 1] False-door of deceased.

Upper part, L. D. ii. 26[d]; MARIETTE, op. cit. p. 519; BURTON MSS. 25621, 56 [left]; NESTOR L'HÔTE MSS. 20396, 309 [upper]; panel, WILKINSON MSS. xiii. 44 [middle]; xvii. F. h [C]; LIEDER squeezes, 3. 3; upper lintel, 3. 4.

G 5221,

Part of lintel of Memi , Royal chamberlain of the Great House, etc., Dyn. V–VI, in Boston Mus. 21.959.

G 5230. BABAF  (sometimes called Khnembaf), Hereditary prince, Companion, Overseer of all works of the King, etc. (Probably Vizier of Shepseskaf.) End of Dyn. IV to early Dyn. V.

Father (probably), Duaenrē (tomb G 5110).

Stone-built mastaba. LG 40.

L. D. *Text*, i, pp. 66–9; JUNKER, *Giza*, vii, pp. 151–5. Plan, section, and elevation, BURTON MSS. 25619, 46. Plan and sections, REISNER, *Giza Necropolis*, i, fig. 153, p. 248 [bottom, 1];

L. D. i. 24 (with view), *Text*, i, figs. on pp. 67–8. Plan and section of north chapel, JUNKER, op. cit. Abb. 63; cf. MARIETTE, *Mastabas*, fig. on p. 517 [upper].

Sarcophagus with palace-façade decoration, red granite, possibly from here, in Cairo Mus. Ent. 48853. DONADONI ROVERI, *Sarcofagi egizi*, Tav. xxix [2], pp. 120–1 [B 26]; see MASPERO, *Guide*, p. 27 [36]; REISNER, op. cit. p. 168 [1].

Statues of deceased

For those in Boston Mus., see SMITH, *Anc. Eg.* (1942 and 1952), p. 49; (1960), p. 53.

Black granite.

Scribe-statue, writing, in Boston Mus. 21.931. A. S[ANBORN] in *Boston Mus. Bull.* xx (1922), fig. on p. 26; SMITH, *Hist. Eg. Sculp.* pl. 19 [a], p. 50; ALDRED, *O.K. Art*, pl. 43; HORNEMANN, *Types*, ii, pl. 413; VANDIER, *Eg. Sculpture*, pl. 30; WHITE, *Ancient Egypt*, pl. 24 facing p. 87; GROLLENBERG, *Atlas de la Bible*, fig. 202; text, JUNKER, *Gîza*, vii, Abb. 65; see *Boston Mus. Bull.* xix (1921), p. 62.

Lower part of standing statue, from north-west of serdabs. JUNKER, op. cit. Taf. xxxiii [a], Abb. 64 [right upper], 66, pp. 154 [No. 3], 156–7 [α]; see id. in *Anzeiger, Wien*, 51 (1914), p. 177 [3].

Lower part of seated statue, from north-west of serdabs, in Vienna Mus. Inv. 8567. Id. *Gîza*, vii, Taf. xxxiii [b, c], Abb. 64 [right lower], pp. 154 [No. 2], 157 [β]; see id. in *Anzeiger, Wien*, 51 (1914), p. 177 [3].

Life-size seated statue (inscribed), small standing statuette, and three small seated statuettes, all in fragments, in Boston Mus. unnumbered. See SMITH, *Hist. Eg. Sculp.* p. 50.

Red granite.

Head, probably of deceased, found in shaft G 4813C, formerly in Boston Mus. 21.932, now in New York, M.M.A. 64.66.3. SMITH, *Hist. Eg. Sculp.* pl. 20 [c], pp. 52–3; FISCHER in *M.M.A. Bull.* n.s. xxiii (Oct. 1964), fig. on p. 65.

Small head wearing full wig, in Boston Mus. 21.950. See SMITH, op. cit. p. 50; id. *Anc. Eg.* (1942 and 1952), p. 49; (1960), p. 53.

Male double-statue, standing, in fragments, with names of deceased on base, in Boston Mus. unnumbered (Exped. Nos. 14–11–84, 89, 117, 118, 14–12–27). See id. *Hist. Eg. Sculp.* p. 50.

Male double-statuettes, seated, in fragments. See id. *ib.* p. 50.

Three seated statuettes, in fragments, in Boston Mus. unnumbered. See id. *ib.* p. 50.

Alabaster.

Standing, from débris of tomb north-west of serdabs, in Vienna Mus. Inv. 7785. JUNKER, *Gîza*, vii, Taf. xxx, xxxi, Abb. 64 [left], pp. 152, 154 [No. 1], 155–6 [a]; id. in *Anzeiger, Wien*, 51 (1914), Taf. xi [left] (*in situ*), p. 177 [3]; *Meisterwerke* (1931), fig. 7 [left]; DEMEL, *Äg. Kunst*, Abb. 13; KOMORZYNSKI, *Altägyptens hohe Kunst in Österreich in Wort und Bild*, 31 (1951), Abb. 10, p. 14; id. *Altägypten*, Abb. 10, p. 16; id. *Erbe*, Abb. 19; Vienna. 5000 Jahre, No. 33 with Abb.

Standing, reconstructed from fragments, in Boston Mus. 24.603. DUNHAM in *Boston Mus. Bull.* xxxvii (1939), figs. on p. 118; id. *Eg. Department*, fig. 115; SMITH, *Hist. Eg. Sculp.* pl. 19 [b middle and right], p. 51 [top]; see id. *Anc. Eg.* (1942 and 1952), p. 49; (1960), p. 53; REISNER, *Gîza Necropolis*, i, p. 509.

Head, from north of serdabs, in Vienna Mus. Inv. 7786. JUNKER, *Gîza*, vii, Taf. xxxii, pp. 154, 156 [b]; KOMORZYNSKI in *Österreich in Wort und Bild*, 31 (1951), Abb. 11 [upper],

p. 13; id. *Altägypten*, Abb. 11, p. 15; id. *Erbe*, Abb. 20; see JUNKER in *Anzeiger, Wien*, 51 (1914), p. 177 [3]; Vienna. 5000 Jahre, p. 63 [34]. Other fragments, possibly from same statue, were also found.

Head wearing short wig, found near tomb G 4830, in Boston Mus. unnumbered. SMITH, *Hist. Eg. Sculp.* pl. 19 [b bottom left], p. 51 [near top]; see DUNHAM in *Boston Mus. Bull.* xxxvii (1939), p. 117.

Fragments of standing statuette, in Boston Mus. unnumbered. SMITH, op. cit. pl. 19 [b top left], p. 51 [near top].

Fragments of seated statuette, inscribed. See id. ib. p. 51 [middle].

Other statue-fragments. See id. ib. p. 51 [middle].

Limestone.

Four, standing (headless), all formerly in Boston Mus. 21.953-6, Nos. 21.954, 956 now in New York, M.M.A. 64.66.2, 1. Id. ib. pl. 19 [c], p. 50; GILBERT in *Chron. d'Ég.* xxix (1954), fig. 22, p. 206; see *Boston Mus. Bull.* xix (1921), p. 62. Statues in New York, FISCHER in *M.M.A. Bull.* n.s. xxiii (Oct. 1964), fig. on p. 64; id. in *Apollo*, lxxxii (1965), figs. 2, 3 on pp. 170-1; see *Gazette des Beaux-Arts*, lxxv (1965), Supp. Feb. 1965, p. 27 [123].

Two similar statues (headless), in Boston Mus. 34.235, 34.1461. See SMITH, *Hist. Eg. Sculp.* p. 50.

Bases of three similar statues, inscribed fragment from another, and inscribed base, found in débris east of tomb G 2370. See id. ib. p. 50 with note 2.

NAME UNCERTAIN, Director of scribes of the granary, etc. Late Dyn. V or Dyn. VI.

Exact position unknown, probably north of tomb G 5220 and east of G 5230. Excavated by Schiaparelli.

False-door of deceased. CURTO, *Gli Scavi*, fig. 30 [a], pp. 69-70 [G, i]; see BALLERINI, *Notizia*, p. 56 and note 2.

BEBIB $\text{J} \text{J} \text{v}$, Judge and Boundary official, Belonging to the foremost seat, Overseer of scribes, etc. Late Dyn. V or Dyn. VI.

Exact position unknown, probably north of tomb G 5220 and east of G 5230. Excavated by Schiaparelli.

See CURTO, *Gli Scavi*, p. 69 [G]; titles, BALLERINI, *Notizia*, p. 56 [lower].

Lintel with offering-text of deceased, in Turin Mus. Sup. 1864. CURTO, op. cit. fig. 23 [upper], pp. 71-2 [a].

Drum with name and titles. Id. ib. fig. 23 [lower left], p. 72 [b].

G 5232.

Lintel of 'Yetty', Dyn. IV-V, in Boston Mus. 21.957.

G 5245.

Not marked on plan.

Head of male statuette, Old Kingdom, from shaft A, in Boston Mus. 34.55. See *Boston Mus. Bull.* xxxii (1934), p. 38.

G 5270. RA^cWĒR [I] , Scribe of the royal documents in the presence, etc. Middle Dyn. V.

Parents (probably), Seshemntüfer [I] and Amenzefas (tomb G 4940).

Stone-built mastaba.

JUNKER, *Giza*, iii, pp. 217-23; id. in *Anzeiger, Wien*, 50 (1913), pp. 161-2 [b], 182. Plan of Chapel, id. ib. Taf. facing p. 162 [lower]. Plans and sections, id. *Giza*, iii, Abb. 3 [middle], 40-1. Synopsis of scenes, id. ib. p. 33 [4].

Chapel.

Thicknesses of entrance doorway. Remains of deceased and men bringing animals; id. ib. Abb. 42 [b, c], pp. 220, 222.

Serdab. Outside mastaba, south of doorway to Chapel.

Exterior. Frieze-text mentioning *ḥwt-ks*, with name and titles of deceased, in Cairo Mus. Ent. 43965. Id. ib. Taf. xiii [a], Abb. 11, 42 [a], p. 222; see MORET in *A.Z.* 52 (1914), pp. 88-9 (corrected by JUNKER, *Giza*, iii, pp. 119-22); MASPERO, *Guide*, p. 30 [60] (called Neuserre).

Statue-base of deceased (inscribed), in Vienna Mus. Inv. 8544. JUNKER, *Giza*, iii, Taf. xiv [d], Abb. 43 [lower left], pp. 217, 222.

Finds

Offering-table of son Seshemntüfer , Judge and Overseer of scribes, found in front of south niche in east face of mastaba. Id. ib. Abb. 43 [lower right], p. 223.

Libation-basin of Kaemib , Greatest of the Ten of Upper Egypt, Overseer of the phylai of Upper Egypt, Overseer of commissions of cedar, etc., late Old Kingdom, from north-east of tomb, in Hildesheim Mus. 2406. Id. ib. vii, Taf. xxix [c], Abb. 62, pp. 150-1; see IPPEL and ROEDER, *Denkmäler . . . Hildesheim*, p. 68.

G 5280. PEḤENPTAḤ , Scribe of the royal documents, etc. Middle Dyn. V.

Parents, Seshemntüfer [I] and Amenzefas (tomb G 4940).

Stone-built mastaba.

REISNER, *Giza Necropolis*, i, p. 251 [2], cf. fig. 209. Name and titles, JUNKER, *Giza*, iii, p. 10 [6].

Statues. From serdab. See SMITH, *Hist. Eg. Sculp.* p. 54 [top].

Deceased standing, in Cairo Mus. Ent. 44609. REISNER and FISHER in *Ann. Serv.* xiii (1914), pl. x [a], p. 250; HORNEMANN, *Types*, ii, pl. 344; upper part, DRIOTON and SVED, *Art ég.* fig. 18.

Double-statue, deceased and mother standing (headless), in Vienna Mus. Inv. 7502. Texts on base, JUNKER, *Giza*, iii, Abb. 43 [upper], p. 223.

Seated triad, woman between two men (headless), in Boston Mus. 13.4330.

Head and feet of statuette, Dyn. VI, found in débris, in Boston Mus. 13.3157. SMITH, op. cit. pl. 26 [b lower right].

G 5290. ḤETEPNIPTAḤ. Middle Dyn. V or later.

BAER, *Rank and Title in the Old Kingdom*, p. 107 [355].

G 5330. IHY , Overseer of the Great Court, Overseer of commissions in the whole country, *iun-kenmut*-priest, etc. Dyn. VI.

Stone-built mastaba. LG 41.

L. D. *Text*, i, p. 69; REISNER, *Giza Necropolis*, i, p. 263 [4].

West wall of chapel. False-door of deceased; L. D. ii. 88 [a], *Text*, i, p. 69.

Obelisks of deceased. One, from left of false-door, removed by Lepsius, in Berlin (East Mus. 1146; L. D. ii. 88 [b], *Text*, i, p. 69; SCHÄFER and ANDRAE, *Kunst* (1925), 259 [6]; (1930 and 1942), 269 [6]; text, *Aeg. Inschr.* i, p. 67; see *Ausf. Verz.* p. 66. Another, in Boston Mus. 21.958; A. S[ANBORN] in *Boston Mus. Bull.* xx (1922), fig. on p. 27 [upper right]; GARDINER MSS. photo. 28.270 [right].

G 5332. Dyn. V-VI.

Stone-built mastaba. Probably LG 39.

JUNKER, *Giza*, viii, pp. 53-60; plan, on Abb. 19.

Shaft. S 796 of Junker. Plans and sections, id. ib. Abb. 20a, 20b; views, Taf. x.

Masons' graffiti with dates. Id. ib. Abb. 21, pp. 58-9; see id. in *Anzeiger, Wien*, 51 (1914), pp. 154-5 [c].

Head of statue, granite, in Cairo Mus. See id. *Giza*, viii, p. 56; id. in *Anzeiger, Wien*, 51 (1914), p. 177 [4].

G 5340. KASEUZA , Overseer of commissions, Director of interpreters, Herdsman of the White Bull, etc. Middle Dyn. V.

Parents (possibly), Kanüfer and Shepsetkau (tomb G 2150).

Stone-built mastaba. LG 37.

Plan XXVIII

JUNKER, *Giza*, vii, pp. 158-84; L. D. *Text*, i, p. 65; cf. MARIETTE, *Mastabas*, fig. on p. 517 [lower]. Plan and sections, JUNKER, op. cit. Abb. 67-8; plan, L. D. *Text*, i, fig. on p. 65. View, JUNKER, op. cit. Taf. xxxiv [a].

Chapel. Synopsis of scenes, id. ib. iii, p. 37 [20].

(1) Funerary priests before deceased at table, and offering-list above.

L. D. ii. 85 [a]; JUNKER, *Giza*, vii, Abb. 70, pp. 166-9.

(2) False-door of deceased, with offering-text on upper lintel and three registers of offering-bringers on right jamb.

L. D. ii. 85 [b]; JUNKER, *Giza*, vii, Taf. xxxv [a left], Abb. 69 [left], pp. 163-4; lintel, BRUGSCH, *Monumens*, pl. xiv [6]; BURTON MSS. 25621, 55 [upper]; painted text above lintel, see JUNKER, op. cit. p. 164.

(3)-(4) Imitation of false-door, and uninscribed false-door, with three registers of offering-bringers right of it.

L. D. *Ergänz.* xxvii [a]; JUNKER, *Giza*, vii, Taf. xxxiv [b], xxxv [a right], Abb. 69 [right], pp. 164-6.

(5) Deceased seated receiving lotus-flower, registers with offerings, harpist, singer, and flutist, and under whole scene, female dancers and clappers.

L. D. *Ergänz.* xxviii [d], *Text*, i, fig. on p. 66; JUNKER, *Giza*, vii, Taf. xxxv [b], Abb. 71, pp. 169-78.

KHUFUDINEFANKH , Overseer of the department of tenants of the Great House, etc. Dyn. V-VI.

Brick-built mastaba.

JUNKER, *Gîza*, viii, pp. 50-3; plan, on Abb. 19.

West wall of chapel. Lower part of false-door of deceased; id. ib. Taf. ix, Abb. 18.

Shaft S 820. Dyn. V-VI.

Near tomb G 5340. Position not marked on plan.

Mummy-mask, plaster. JUNKER, *Gîza*, viii, Taf. v [c], p. 27; id. in *J.E.A.* i (1914), pl. xl [2], p. 253; see id. in *Anzeiger, Wien*, 51 (1914), p. 170; SMITH, *Hist. Eg. Sculp.* p. 28 [14].

G 5350. Dyn. V-VI.

Stone-built mastaba.

JUNKER, *Gîza*, vii, pp. 184-8 (S 846/847); plans and sections, Abb. 76-7; cf. MARIETTE, *Mastabas*, fig. on p. 517 [lower].

Ointment-slab, with names in ink, alabaster, from shaft S 846, in Hildesheim Mus. 2432. JUNKER, op. cit. Abb. 79, pp. 186-7 (called 2437); see IPPEL and ROEDER, *Denkmäler . . . Hildesheim*, p. 68.

Ointment-slab, with names incised, alabaster, found nearby. JUNKER, op. cit. Abb. 80, p. 187.

KANÛFER , Judge and Boundary official, Overseer of scribes. Late Old Kingdom.



Stone-built mastaba.

JUNKER, *Gîza*, vii, pp. 189-92; plan, on Abb. 76.

False-door of deceased. Id. ib. Abb. 81, p. 190.

Left part of lintel with deceased standing, in Vienna Mus. Inv. 8526. Id. ib. Abb. 82, pp. 190, 192; Vienna. 5000 Jahre, No. 21 with Abb.

Fragment of jamb of Nüfer [IV], from shaft of tomb east of tomb of Kanûfer. See JUNKER, *Gîza*, vii, p. 192.

SETKA , Judge and Overseer of scribes of the secret judgement of the Great Court, Director of scribes of the members of the Great Jury, etc., and his son ПТАННОТ , Judge and Overseer of scribes, Secretary of the secret judgement of the Great Court, etc. Dyn. VI.

Parents of Setka, Nüfer [I] and Hetepmatet (tomb G 4761).

Stone-built mastaba-complex.

Plan XXVII

JUNKER, *Gîza*, vii, pp. 192-228; id. in *Anzeiger, Wien*, 51 (1914), pp. 149-50 [2], 159-60 [3]. Plan and sections, id. *Gîza*, vii, Abb. 83-4; id. in *Anzeiger, Wien*, 51 (1914), Abb. 5. Titles, id. *Gîza*, vii, pp. 198, 201.

I. **Offering-room of Setka.** Synopsis of scenes, id. ib. iii, p. 41 [30a].

(1) False-door of deceased.

Id. ib. vii, Abb. 85, pp. 202-7.

(2) Deceased at table (twice), with Pthahhotp and funerary priests before him, offering-list and offerings above, two groups of butchers below.

Id. ib. Taf. xxxvi [a], Abb. 87, pp. 210-19.

(3) False-door of deceased.

Id. ib. Abb. 86, on Taf. xxxvi [b left], pp. 207-10.

(4) Offerings, and three registers of offering-bringers and men bringing animals.

Id. ib. Taf. xxxvi [b right], Abb. 88, pp. 219-22.

II. Offering-room of Pthahhotp.

(5) False-door of deceased, fragments in Cairo Mus. Temp. Nos. 11.5.14.2, 3, 5, 6.

Id. ib. Abb. 89, pp. 222-4; CAIRO, CENTRE OF DOCUMENTATION photo. S.R., Box 149, 685.

North shaft. S 890 of Junker.

Rectangular coffin of Setka, wood, in Cairo Mus. Ent. 49696. JUNKER, *Giza*, vii, Abb. 90a, pp. 224-7, cf. Taf. xxxvii [a]; see DONADONI ROVERI, *Sarcofagi egizi*, p. 156 [C 12].

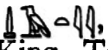
G 5370. ZATY  Greatest of the Ten of Upper Egypt, Overseer of all works of the King. Temp. Neferirkarē or later.

Stone-built mastaba. LG 31.

Plan XXIX

JUNKER, *Giza*, vii, pp. 230-41; L. D. Text, i, p. 60, with plan; REISNER, *Giza Necropolis*, i, pp. 251 [3], 312 [q]; MARIETTE, *Mastabas*, p. 518 [14]. Plan and sections, JUNKER, op. cit. Abb. 94. Section, id. ib. iii, Abb. 3 [bottom].

Chapel.

(1) (a)-(b) Architrave with offering-text.

L. D. ii. 86 [a]; JUNKER, *Giza*, vii, Abb. 95, pp. 230-1.

(2) False-door of deceased.

Text on drum and lintel, id. ib. p. 231.

Five registers, boat, butchers, female and male offering-bringers, son before deceased and wife, perhaps from thickness of a false-door, and lintel with deceased and four lines of text, found in shaft G 2337X, in Boston Mus. 27.445-6.



See *Boston Mus. Bull.* xxv (1927), p. 60.

Shaft. West of Chapel.

Wooden chest with sealings of Lector-priests of Sahurē and Neferirkarē. JUNKER, *Giza*, vii, Taf. xxxviii [b] (*in situ*), xxxix, Abb. 96a, 96b, 97, pp. 231-41; see id. in *Anzeiger, Wien*, 51 (1914), p. 156. Two with Horus-name of Sahurē (= Taf. xxxix [middle left and middle right]), in Vienna Mus. Inv. 7916, 7918.

S 696/703. Dyn. V-VI.



Stone-built mastaba.

False-door of Senezemib  called Inti  Scribe of the royal documents in the presence, Inspector of ka-servants, fragments, Dyn. VI or later, thrown down shaft S 703, in Vienna Mus. Inv. 8527. JUNKER, *Giza*, vii, Taf. xl [b], Abb. 104, pp. 246-9, with position on Abb. 100; see id. in *Anzeiger, Wien*, 51 (1914), pp. 162-3 with note 1.

KHENIT  ♀, Prophetess of Hathor, etc. Temp. Isesi.

Stone-built mastaba.

JUNKER, *Gîza*, vii, pp. 241-6; id. in *Anzeiger, Wien*, 51 (1914), p. 164 [3]. Plan, id. *Gîza*, vii, Abb. 100.

Fragment, probably of lintel of entrance doorway, son Isesibaf   Lector-priest (also in tomb G 2370), and [daughter] before deceased seated. Id. ib. Abb. 102, p. 245; see id. in *Anzeiger, Wien*, 64 (1927), p. 153.

West wall. False-door of deceased, with list of oils on jambs, in Vienna Mus. Inv. 8007; id. *Gîza*, vii, Taf. xl [a], Abb. 101.

S 677/817. Late Old Kingdom.

Stone-built mastaba.

JUNKER, *Gîza*, viii, pp. 38-44; plan, on Abb. 11.

Fragments re-used or thrown away in shafts.

Block, heads of man and wife and part of offering-list, re-used to cover shaft S 735. Id. ib. Abb. 13, pp. 42-3.

Unfinished lintel of Overseer of commissions of the Great House, re-used with last. Id. ib. Abb. 14, pp. 43-4.

Block, heads of man and wife, re-used to cover shaft S 738a, in Vienna Mus. Inv. 8531. Id. ib. Abb. 15, p. 44.

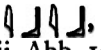
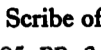
False-door of Ibib   Scribe of the royal documents, upper part, from débris in shaft S 817. Id. ib. vii, Abb. 105, pp. 249-51.

S 676/707. Dyn. V-VI.

Stone-built mastaba.

Wooden statuettes of female offering-bringer and two cooks, decayed, from north serdab. See JUNKER, *Gîza*, viii, pp. 45-6, cf. 44, with position on Abb. 11; id. in *Anzeiger, Wien*, 51 (1914), p. 179 (called shaft S 684). Similar statuettes originally also in south serdab.

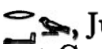
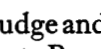
G 5470. RA'WĒR [II]   Judge and Boundary official, Secretary of the secret judgement of the Great Court, Prophet of Maet, etc. Late Dyn. V.

Stone-built mastaba. LG 32.

Plan XXVIII

L. D. *Text*, i, pp. 60-1, with plan on p. 60; JUNKER, *Gîza*, iii, pp. 223-35; titles, p. 10 [5]; plan and sections, Abb. 44.

Chapel. Now much destroyed. Synopsis of scenes, id. ib. p. 34 [5].

(1) Originally five registers before deceased, I, destroyed, II, scribe handing in list, donkeys threshing, and men bringing donkeys to be loaded, III-IV, men bringing wild animals and cattle, V, man with cranes, geese, etc.

L. D. *Ergänz.* xxv, *Text*, i, p. 61 [lower]; JUNKER, op. cit. Abb. 48, pp. 231-4.

(2) Deceased seated in pavilion, and registers of offerings and offering-bringers, with harpist, flutist, singers, and two groups of butchers below.

L. D. *Ergänz.* xxvi [a], *Text*, i, p. 61 [upper].

(3)-(5) [1st ed. 3-4] Deceased at table, with offerings and funerary priests before him (including wiping out footprints), false-door of deceased, and deceased standing, with three registers, offering-bringers and three groups of butchers.

L. D. ii. 84; JUNKER, op. cit. Abb. 46, pp. 228-31. (4) WILKINSON MSS. xiii. 85 [lower]; text of lintel, MARIETTE, *Mastabas*, pp. 517-18 [12]; left outer jamb, BRUGSCH, *Monumens*, pl. xiv [lower left].

Serdab.

Masons' graffiti with dates. JUNKER, *Giza*, viii, Abb. 12, pp. 38-40.

Burial chamber.

Sealing with cartouche of Zadkarē (Isesi). Id. ib. iii, Abb. 45 [7], pp. 13, 226; see id. in *Anzeiger, Wien*, 51 (1914), p. 156.

S 679/705.

Clay statuettes of captives with hieratic execration-texts in ink, found in inscribed pottery jar, late Old Kingdom, not necessarily originally from here. JUNKER, *Giza*, viii, Taf. vi [b], vii, Abb. 8-10, pp. 30-8, with position, on Abb. 7; see iii, p. 226, cf. Abb. 45 [3] (jar); id. in *Anzeiger, Wien*, 51 (1914), p. 175.

NIKHET , [Overseer of scribes, Tenant], etc. Late Old Kingdom.

Stone-built mastaba.

JUNKER, *Giza*, viii, pp. 28-9; plan, on Abb. 5, 7.

Lower part of false-door of deceased. Name and titles, id. ib. p. 28.

Shaft S 492. Dyn. VI.

Mummy-mask, plaster, in Hildesheim Mus. 2386. JUNKER, *Giza*, viii, Taf. v [b], pp. 26-7; id. in *Anzeiger, Wien*, 51 (1914), Taf. vi [upper], p. 170 (called S 493); KAYSER, *Die Mastaba des Uhemka*, Taf. 9; BRUNNER in *Forschungen und Fortschritte*, 28 (1954), Abb. 1 [left], p. 331; see SMITH, *Hist. Eg. Sculp.* p. 28 [15].

LG 33. SEKHEM'ANKHUPTAH (?), *ka*-servant and Scribe of a phyle of the endowment of Senezemib (with titles [Overseer of all works of] the King, Overseer of scribes of the royal documents). Dyn. VI.

Stone-built mastaba. S 660/661 of Junker.

JUNKER, *Giza*, viii, pp. 154-7; plan, on Abb. 77.

Fragment of architrave, names and titles with three figures of deceased below. L. D. *Text*, i, fig. on p. 62 [upper]; JUNKER, op. cit. Abb. 78 (from LEPSIUS), pp. 155-7.

G 5480. HETI , Judge and Overseer of scribes, etc. Late Dyn. V or Dyn. VI.

Mother (probably), Meres'ankh  (on statue of Khenut, see p. 164).

Stone-built mastaba. LG 29.

Plan XXVIII

JUNKER, *Giza*, viii, pp. 11-12; plan and sections, Abb. 3; view, Taf. vi [a]. See L. D. *Text*, i, p. 59.

Chapel. Synopsis of scenes, JUNKER, *Giza*, iii, p. 34 [6].

(1) Deceased and family (no names). See id. ib. viii, p. 22.

(2) Funerary priests before deceased at table, and offering-list.

Texts, id. ib. pp. 20-1.

(3) [1st ed. p. 36 as Sethu, 1] Three registers of officials and estates before deceased.

See id. ib. p. 21 (with names of estates). Names of estates, L. D. *Text*, i, p. 59; JACQUET-GORDON, *Domaines*, pp. 302-3 [41G5-6], cf. figs. 88-9 (from JUNKER).

Serdab. Statues. See SMITH, *Hist. Eg. Sculp.* p. 73.



Squatting scribe writing (uninscribed), in Hildesheim Mus. 2407. JUNKER, *Giza*, viii, Taf. iii, pp. 12-16 [1]; id. in *Anzeiger, Wien*, 51 (1914), Taf. ix, p. 176 [c]; IPPEL and ROEDER, *Denkmäler . . . Hildesheim*, Taf. 1, Abb. 9, p. 50; ROEDER, *Geschäftsbericht des Pelizaeus-Museums* [etc.], 1914-28, 6th pl.; Burg & Co. *Katalog der Ausstellung ägyptischer Kunst*. Berlin, 1929, Taf. iii, p. 5 [1]; CAPART, *Memphis*, fig. 272; KAYSER, *Im Reich des Osiris* (1949), Abb. 3, p. 15; id. *Roemer-Pelizaeus-Museum Hildesheim* (1959), Abb. 8; id. *Das Pelizaeus-Museum in Hildesheim* (1966), Abb. 11; HORNEMANN, *Types*, ii, pl. 414; ROEDER in *Forschungen und Fortschritte*, 30 (1956), Abb. 6, p. 244.

Deceased seated (headless), probably in Cairo Mus. JUNKER, *Giza*, viii, Taf. iv [a], Abb. 4 [right] (base), pp. 16-18 [2] (called Vienna Mus.); see id. in *Anzeiger, Wien*, 51 (1914), pp. 175-6 [a].



Base and feet of deceased standing. Id. *Giza*, viii, Abb. 4 [upper left], p. 18 [3].

Deceased (headless) with sister Khenut  standing, formerly in Cairo Mus. Temp. No. 11.5.14.10, now in Cambridge, Fitzwilliam Mus. E. 42.1926. Id. ib. Taf. iv [b], Abb. 4 [lower left] (base), pp. 18-20 [4]; see id. in *Anzeiger, Wien*, 51 (1914), p. 176 [b].

Shaft S 590.

Incomplete lintel, father Weses  and mother Itiut  at table on right, [Seshemu] on left, and eight children between, Dyn. V-VI, re-used to cover shaft, in Vienna Mus. Inv. 7793. JUNKER, *Giza*, viii, Taf. v [a], Abb. 6, pp. 23-6, with position, on Abb. 5.

G 5482.

Fragment with names of Pthahiufti , King's *wac*b-priest, Inspector of *ka*-servants, etc., and wife Hemtrē , Dyn. V-VI, probably from here. See JUNKER, *Giza*, viii, p. 22 (with text).

G 5520. S^cANKHENPTAḤ . Late Dyn. V or Dyn. VI.

Stone-built mastaba. LG 28.

L. D. *Text*, i, pp. 58-9; REISNER, *Giza Necropolis*, i, pp. 264-5 [2]. Plan, id. ib. fig. 163; of chapel, L. D. i. 23, *Text*, i, fig. on p. 58.

Remains of cranes, etc., brought to deceased and wife, with sculptors making standing statue and carpenter beyond, in End Room (d of Reisner) of chapel. L. D. *Text*, i, fig. on p. 59.

LG 38.¹ KHNEMḤOTP , Overseer of the department of tenants of the Great House, Companion of the house, etc. Dyn. VI.

Stone-built mastaba.

Plan XXIX

¹ The equation of LG 38 with G 5550 on Map of Western Cemetery in REISNER, *Giza Necropolis*, i, is incorrect.

JUNKER, *Giza*, viii, pp. 60-5; *L. D. Text*, i, p. 65. Plan, JUNKER, op. cit. on Abb. 25.

Chapel.

(1) Entrance doorway. (a)-(b) Fragments of lintel of Master of the house of the Great House, Overseer of commissions, etc. (name lost), probably from here. (c) Lower part of deceased and wife.

(a)-(b) Id. ib. Taf. xxviii [b], Abb. 28, pp. 63-5. (c) Id. ib. Abb. 26, p. 62.



(2) Lower part of false-door of deceased.

L. D. ii. 88 [c], *Text*, i, p. 65; JUNKER, op. cit. Abb. 27 (from LEPSIUS), pp. 62-3. Text on fragments of lintel, id. ib. p. 62.

IPU. Dyn. VI or later.

Stone-built mastaba.

JUNKER, *Giza*, viii, p. 66; plan, on Abb. 25; remains of inscribed wooden coffin, see p. 66.

G 5550.¹ NÜFER  good name IDU [I] , Chief Justice and Vizier, etc. Early Dyn. VI.

Wife, Hemtrēc , Prophetess of Neith Opener-of-the-Ways.

Stone-built mastaba.

JUNKER, *Giza*, viii, pp. 66-90; id. in *Anzeiger, Wien*, 51 (1914), pp. 153-4 [b], 160-1 [1]. Plan, id. *Giza*, viii, on Abb. 25; views, Taf. xi; names and titles, pp. 69-73.

Chapel. Fragments in Hildesheim Museum, see IPPEL and ROEDER, *Denkmäler... Hildesheim*, pp. 59, 62.

Right thickness of doorway, deceased, in Cairo Mus. Ent. 44972. JUNKER, *Giza*, viii, Taf. xiii [c], Abb. 31, pp. 73-4.

Architrave from above doorway, five figures of deceased, in Hildesheim Mus. 2396-7. Id. ib. Taf. xv [a, b], Abb. 38, pp. 88-9.

South wall. Deceased and wife at table, with [sons], official and offerings before them, and dwarf carrying monkey under chair, in Hildesheim Mus. 2390. Id. ib. Taf. xiv [a], xv [c left], Abb. 35, 37 [left], pp. 82-4.

West wall. Fragments of false-door of deceased, in Hildesheim Mus. 2391-5, lower part of right outer jamb, in Cairo Mus. Temp. No. 11.5.14.8. Id. ib. Taf. xii, xiii [a, b], Abb. 32-4, pp. 74-81.

North wall. Remains of offerings, offering-bringers and butchers before [deceased and wife at table], in Hildesheim Mus. 2398-2400. Id. ib. Taf. xiv [b], xv [c right], xxviii [c], Abb. 36, 37 [right], pp. 84-8.

Sloping shaft. Plan and sections, id. ib. Abb. 30.

Sarcophagus of deceased, inscribed in ink. See id. ib. pp. 89-90 (text); DONADONI ROVERI, *Sarcofagi egizi*, pp. 135-6 [B 66].

IDU [II] , Inspector of scribes of the royal documents, Royal chamberlain of the Great House, Overseer of the House of Cedar, etc. Dyn. VI.

Superstructure completely destroyed.

¹ The equation of LG 38 with G 5550 on Map of Western Cemetery in REISNER, *Giza Necropolis*, i, is incorrect.

JUNKER, *Gîza*, viii, pp. 90-107; position, on Abb. 25; plan and section of serdab, Abb. 39; titles of deceased, p. 91.

Serdab. Wooden statuettes. Arranged in order of Junker.

View *in situ* (much damaged), id. ib. Taf. xvi, pp. 91-3. See id. in *Anzeiger, Wien*, 51 (1914), pp. 178-9.

Man standing, and double-statue of man and wife.

Two women grinding corn, in Hildesheim Mus. 2521. Id. *Gîza*, viii, Taf. xvii [c]; BREASTED (Jr.), *Eg. Servant Statues*, pl. 21 [a], p. 22 [top, 2].

Dough-kneader (?).

Baker. JUNKER, *Gîza*, viii, Taf. xvii [d].

Upper part of brewer, in Hildesheim Mus. 2520 (with limestone jars and baskets, 2522-4). See BREASTED (Jr.), op. cit. p. 106 [B, 1] (called Idu [I]); IPPEL and ROEDER, *Denkmäler . . . Hildesheim*, p. 56.



Servant carrying supplies. JUNKER, *Gîza*, viii, Taf. xvii [e].

Women carrying baskets on heads. See BREASTED (Jr.), op. cit. p. 60 [2].

Boats. JUNKER, *Gîza*, viii, Taf. xvii [a, b], pp. 93-6.

Burial chamber.

Rectangular coffin of deceased with titles, offering-text, and offering-list, wood, in Hildesheim Mus. 2511. Id. ib. Taf. xviii, Abb. 40-6, pp. 96-106; id. in *Anzeiger, Wien*, 51 (1914), Taf. iv, pp. 166-7 [a]; IPPEL and ROEDER, *Denkmäler . . . Hildesheim*, Abb. 17, pp. 66, 68; DONADONI ROVERI, *Sarcophagi egizi*, Tav. xxxviii, xxxix, pp. 157-8 [c 14]; KAYSER, *Die Mastaba des Uhemka*, Taf. 8; inserted piece of wood, id. *Ägyptisches Kunsthandwerk*, Abb. 244; see JUNKER in *J.E.A.* i (1914), p. 251.

G 5560. KAKHERPTAḤ  good name FETEKTA  Overseer of the Memphite and Letopolite nomes, Overseer of the new settlements of the Pyramid of Isesi, Inspector of *wac*b-priests of the Pyramid of Khufu, etc. Early Dyn. VI.

Stone-built mastaba. LG 35.

JUNKER, *Gîza*, viii, pp. 108-22; id. in *Anzeiger, Wien*, 51 (1914), p. 161 [2]; L. D. *Text*, i, pp. 62-3. Plan, JUNKER, *Gîza*, viii, Abb. 47; titles of deceased, pp. 111-12.

Façade.

Blocks with frieze-text, with deceased seated at end. L. D. ii. 78 [d], *Text*, i, p. 62; JUNKER, *Gîza*, viii, Abb. 50 (from LEPSIUS), and Taf. xix, Abb. 51-2, p. 112.

Entrance doorway of Chapel.

Lintel with name and titles of deceased; L. D. *Text*, i, p. 62; text (corrected), JUNKER, *Gîza*, viii, p. 113. Thicknesses, left, remains of lower part of deceased and titles, see id. ib. pp. 113-14; right, remains of upper part of deceased, Abb. 53 [upper], p. 114.

Offering-room.

Fragment of upper lintel of south false-door of deceased. *Text*, id. ib. p. 115.

Lower part of north false-door, probably of wife. L. D. *Text*, i, fig. on p. 63 [upper]; JUNKER, *Gîza*, viii, Abb. 49 (from LEPSIUS), p. 108.



Relief-fragments, offering-bringers and offerings. Id. ib. Abb. 53 [lower], p. 114 (with text of another block with titles).

Block with upper part of deceased throwing stick, from fowling scene, removed by Lepsius, in Berlin (East) Mus. 1137. *L. D. Text*, i, fig. on p. 62 [lower]; JUNKER, op. cit. Abb. 54 (from LEPSIUS), pp. 115-16; text, *Aeg. Inschr.* i, p. 20; see *Ausf. Verz.* p. 57.

Sloping shaft. Plan and section, JUNKER, *Giza*, viii, Abb. 48.

Lower part of false-door with four figures of deceased, in east façade, near entrance of shaft. Id. ib. Abb. 55, p. 116.

East wall of burial chamber. Offering-list before deceased at table, painted. Id. ib. Taf. xxi, Abb. 56, pp. 117-21; id. in *Anzeiger, Wien*, 51 (1914), Taf. ii, p. 153 [a]; text, SETHE, *Urk.* i (1933), p. 186 [26 (117)].

ANKHUZA  good name ITHI , Royal chamberlain, Judge and Overseer of scribes, Scribe of the royal documents in the presence, etc. Dyn. VI.

Wife, Meruka , Royal acquaintance.

Stone-built mastaba.

JUNKER, *Giza*, viii, pp. 122-39; id. in *Anzeiger, Wien*, 51 (1914), pp. 161-2 [3]. Plan, id. *Giza*, viii, Abb. 57; titles of deceased and relatives, pp. 122-4.

Entrance doorway to Outer Room.

Left thickness, two female estates and remains of two others, offering-list, and remains of conventional biographical text, in Vienna Mus. Inv. 8540. Id. ib. Taf. xxiii [a], Abb. 61, pp. 130-4; names of estates, JACQUET-GORDON, *Domaines*, pp. 318-19 [48G6], cf. figs. 103-4 (from JUNKER).

Lintel, deceased with wife and children at left end, in Vienna Mus. Inv. 8524a-b. JUNKER, *Giza*, viii, Taf. xxii [a], Abb. 59, pp. 124, 126.



Block with name and title of deceased and threat to vandals, probably from here, in Vienna Mus. Inv. 8537. Id. ib. Taf. xxiii [b], Abb. 62, pp. 134-5; see id. in *Anzeiger, Wien*, 51 (1914), p. 165 [7].

Inner Room.

False-door of deceased with left part of upper lintel, in Vienna Mus. Inv. 7791, 8534. Id. *Giza*, viii, Taf. xxii [b], Abb. 58, 60, pp. 126, 128-30.

Shaft S 670.

Panel of false-door of Theset , Prophetess of Hathor, etc., from debris, in Vienna Mus. Inv. 8525. Id. ib. Taf. xxiii [c], Abb. 64, pp. 136-8.

Shaft S 687. IRENAKHTI  called IRI , Noble of the King, Companion of the house, etc. Late Dyn. VI or 1st Int. Per.

Superstructure completely destroyed.

JUNKER, *Giza*, viii, pp. 151-3; plan and section, Abb. 73.

Fragments of wooden coffin of deceased with remains of offering-text. Id. ib. Abb. 74-5; see DONADONI ROVERI, *Sarcofagi egizi*, p. 158 [C 15].

Shaft S 693. MERIB  Noble of the King, Companion of the house, etc. Late Dyn. VI or 1st Int. Per.

Superstructure completely destroyed.

JUNKER, *Giza*, viii, pp. 140-151; id. in *Anzeiger, Wien*, 51 (1914), pp. 167-8 [b].

Rectangular outer coffin with offering-text, wood. Id. *Gîza*, viii, Abb. 66-8, pp. 140-3; see DONADONI ROVERI, *Sarcofagi egizi*, pp. 159-60 [C 18].

Rectangular inner coffin with offering-text outside and offering-list inside, wood. JUNKER, *Gîza*, viii, Taf. xxiv, Abb. 69-72, pp. 143-51; id. in *J.E.A.* i (1914), fig. 1, p. 251; see DONADONI ROVERI, op. cit. pp. 160-1 [C 19].

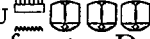
LG 30.¹ MENḤEBU , Secretary of craftsmen, Prophet of Horus *mdzw* (Khufu) and Khufu, etc. Dyn. VI.

Stone-built mastaba.

JUNKER, *Gîza*, viii, pp. 159-65; plan and reconstruction, on Abb. 83-4.

Pillared offering-room. Earlier stage of mastaba.

West wall, north end. Remains of false-door of deceased; texts, id. ib. p. 162.

East face of annexe.

Lower part of north false-door of deceased, *in situ*. Id. ib. Taf. xxvi, Abb. 85, pp. 162-4.

South false-door of deceased, found lying in front of tomb. Remains of text, id. ib. p. 164, cf. 162.

Thicknesses of entrance doorway. Remains of deceased and offerings-bringers below; L. D. *Ergänz.* xxiv; see *Text*, i, pp. 59-60.

Finds



Block with fat man with staff, from débris south of tomb. JUNKER, *Gîza*, viii, Abb. 82, p. 158.

Shaft S 700.

Superstructure completely destroyed.

JUNKER, *Gîza*, viii, pp. 166-72; plan, on Abb. 83.

Found thrown away in shaft. Id. in *Anzeiger, Wien*, 51 (1914), p. 162 [4].

Right thickness of doorway, Nisuptah  good name Nisu , Scribe of the royal documents of the Great House in the presence, with son Khnmenti , Noble of the King, before him, early Dyn. VI, in Cairo Mus. Ent. 44973. Id. *Gîza*, viii, Taf. xxvii [b], Abb. 89, p. 172.

False-door of Nisuptah (same as above), in Hildesheim Mus. 2388. Id. ib. Taf. xxvii [a], Abb. 88, pp. 168-71; IPPEL and ROEDER, *Denkmäler . . . Hildesheim*, Abb. 15, p. 61, cf. Taf. 11 [b] (name and title); LUGN, *Ausgewählte Denkmäler aus ägyptischen Sammlungen in Schweden*, Abb. 1 facing p. 14.

Fragment of lintel with offering-text (name lost), found near shafts S 638, 639.² *Text*, JUNKER, *Gîza*, viii, p. 166.

CEMETERY G 6000

Reisner Excavation. Harvard-Boston Expedition (1925-6).

Plan XIII [1]

¹ Only the annexe seems to have been marked LG 30.

² JUNKER, *Gîza*, viii, plan at end [bottom right] incorrectly 689 instead of 639.

G 6010. NEFERBAUPTAH , Steward of the Great Estate, Prophet of Khufu, Saḥurē, Neferirkarē, and Neuserre, etc. Middle to end of Dyn. V.

Parents, Iymery and Nikauḥathor (tomb G 6020). Wife, Khenut , Royal acquaintance.

Stone-built mastaba. LG 15.

Plan XXIX

L. D. Text, i, pp. 34–8, with plan and sections, on p. 34, and L. D. i. 21; REISNER, *Giza Necropolis*, i, pp. 217 [27], 290–1 [3], 314 [top, b]; plan of chapel, fig. 188; MARIETTE, *Mastabas*, on fig. on p. 490 [lower]. Plan of Rooms III and IV, NESTOR L'HÔTE MSS. 20396, 315 verso. Synopsis of scenes, JUNKER, *Giza*, iii, pp. 42–3 [32].

Room II. I of Junker.

(1)–(2) Deceased on right, and three registers, I, unfinished, II (from left), men bringing [donkeys] to be loaded, and handing in list, III, donkeys carrying produce, and men piling up sheaves.

Lower part of deceased, and II and III, L. D. ii. 56 [a]. Deceased and right end of registers, REISNER in *Boston Mus. Bull.* xxxvii (1939), fig. 6 [left], p. 35.

(3)–(4) Deceased seated on right, and three registers, I, scribes, scene of rendering accounts, and deceased on pleasure-cruise in canoe, II, scribes, and two groups of men ploughing and others hacking ground, III, issuing seed, and rams treading grain.

L. D. ii. 56 [a bis]. Incomplete, WILKINSON MSS. xiii. 22–4. Rendering accounts, with scribes, from I, and deceased with titles, DEVÉRIA squeezes, 5370 C, 5371 E; LIEDER squeezes, 4. 1. Left end of I–III, REISNER in *Boston Mus. Bull.* xxxvii (1939), fig. 6 [right], p. 35. III, LIEDER squeezes, 4. 2.

Room III. II of Junker.

(5)–(6) Architrave with name and titles, removed by Lepsius, in Berlin (East) Mus. 1114 (part).

L. D. ii. 55 [upper]; MARIETTE, *Mastabas*, fig. on p. 491 [bottom]; ANTHES in *Berliner Museen*, lvii (1936), on Abb. 2 on p. 49; NESTOR L'HÔTE MSS. 20396, 314 [middle]; text, *Aeg. Inschr.* i, p. 6 [i]; see *Ausf. Verz.* p. 54.

(7) and (8) [1st ed. 7–12]. Pillars, with grandfather Shepseskaf(ankh at (7) (a), father at (8) (a), and deceased elsewhere, with name and titles above, removed by Lepsius, in Berlin (East) Mus. 1114 (part).

L. D. ii. 55 [lower]; MARIETTE, op. cit. figs. on pp. 492, 493 [upper]; ANTHES, op. cit. on Abb. 2 on p. 49; NESTOR L'HÔTE MSS. 20396, 307, 315; text, *Aeg. Inschr.* i, pp. 6–7 [ii]; text at (8) (b), SHARPE, *Eg. Inschr.* 2 Ser. 38, ll. 39–42; see *Ausf. Verz.* p. 54.

Room IV. III of Junker.

(9) [1st ed. 13–19] Doorway. (a)–(b) Lintel, and below, (c) man standing, (d) father and deceased. (e) and (f) Deceased and wife seated, with *ka*-servants censuring and bringing bird at (e), and with small son at (f). (g) Drum with names and titles of deceased and father.

(a)–(d), (g) L. D. ii. 56 [b]; BRUGSCH, *Monumens*, pl. xv; NESTOR L'HÔTE MSS. 20396, 314 [bottom], 316 verso. (a)–(b) DEVÉRIA squeezes, 5368 D; LIEDER squeezes, 4. 3; text, GARDINER Notebook, 61, pp. 12–13. (a)–(b), (d), (f), (g), WILKINSON MSS. xiii. 19–21

[left and right upper]. (a)-(b), (e)-(g), *MARIETTE, Mastabas*, fig. on p. 495. (c) and (d) *Id. ib.* figs. on pp. 493 [lower], 494 [upper]; titles, *LIEDER* squeezes, 4. 4-6. Heads of deceased and father at (d), *L. D. iii.* 289 [7, 8]. (e) and (f) *L. D. ii.* 57 [a]. (e) and (g), and titles of (f), *NESTOR L'HÔTE MSS.* 20396, 314 verso. *Ka*-servant censuring, and titles at (e), *LIEDER* squeezes, 4. 7-8. Titles of deceased at (f), *id. ib.* 4. 9. (g) *DEVÉRIA* squeezes, 5367 B; *LIEDER* squeezes, 4. 10.

(10) [1st ed. 20-1] Men with cattle (above doorway), deceased and wife, and four registers, **I**, men led by eldest son *Neferseshemtaḥ*, **II-III**, bringing oryxes and cattle, **IV**, bringing various articles.

L. D. ii. 58 [a]. Deceased, wife, son, and two men, *NESTOR L'HÔTE MSS.* 20396, 316 [lower].

(11) [1st ed. 22] Deceased seated receiving lotus-flower, with registers of offerings and offering-bringers before him.

L. D. ii. 57 [b]; titles, *WILKINSON MSS.* xiii. 21 [right lower]; *GARDINER Notebook*, 61, pp. 9 [lower], 11 [top].

(12) [1st ed. 23] Between false-doors, deceased at table, with offering-list, offerings, offering-bringers and six funerary priests before him, and on left and right ends of wall, four registers of offering-bringers.

L. D. ii. 58 [b]. Offering-list, *DEVÉRIA* squeezes, 5369 A.

(13) [1st ed. 24] Deceased and son *Neferseshemtaḥ*, with four registers before them, scribe and men bringing bulls.

L. D. ii. 57 [c]. Upper part (bulls omitted), *MARIETTE*, *op. cit.* fig. on p. 494 [bottom]; *NESTOR L'HÔTE MSS.* 20396, 316 [upper].

G 6012.

Mummy-mask, plaster, fragment, found east of tomb, in *Boston Mus.* unnumbered (Exped. No. 25-11-75). See *SMITH, Hist. Eg. Sculp.* p. 28 [5].

G 6014.

Mummy-mask, plaster, from shaft A, in *Boston Mus.* unnumbered (Exped. No. 25-11-115). See *id. ib.* p. 28 [4].

G 6020. *IYMERY* , Prophet of *Khufu*, Steward of the Great Estate, Scribe of the archives, etc. Temp. *Neuserrē* or later.

Father, *Shepseskaf* (tomb G 6040). Wife, *Nikauḥathor* , Royal acquaintance, etc.

Stone-built mastaba. *LG* 16. 'Tomb of Trades.'

Plan XXIX

L. D. Text, i, pp. 38-42, with plan, sections and view, on p. 38, and *L. D. i.* 21; *REISNER, Giza Necropolis*, i, pp. 289-90 [2], 314 [top, a]; *NESTOR L'HÔTE MSS.* 20396, 337. Some scenes, *WILKINSON* squeezes, Box 28. 1-23. Plan, *MARIETTE, Mastabas*, on fig. on p. 490 [lower]; *NESTOR L'HÔTE MSS.* 20396, 308 [middle]; *BURTON MSS.* 25619, 43 [lower]. Some titles, *CHAMP., Not. descr.* ii. 482 [middle]. Synopsis of scenes, *JUNKER, Giza*, iii, pp. 41-2 [31]; *REISNER, op. cit.* pp. 363-5 [3].

Room I. c of Reisner.

(1) [1st ed. 1-3] Doorway. (a) [Deceased?] in sailing-boat, with scene above destroyed. (b) Father in sailing-boat, with man carrying oar and another bringing calf above. (c) Drum with name and titles of deceased and father.

(a) *L. D. Ergänzt.* iv [a]; text, SHARPE, *Eg. Inscr.* 2 Ser. 39, l. 8. (b) *L. D. Ergänzt.* iii [c]. (c) *L. D. Text*, i, p. 40; BURTON MSS. 25619, 47 [bottom].

(2) [1st ed. 4-5] Deceased with [son Neferbaupṭah (tomb G 6010)], and four registers, I (partly above doorway), scribes handing in list and recording, II-IV, men bringing animals.

L. D. ii. 49 [a]. Omitting pair of bulls, oryx, and ibex in III and IV, NESTOR L'HÔTE MSS. 20406, 'Tombeau de Imeri III', 3 squeezes, 'Tombeau de Imeri I', 1 squeeze. First two scribes from I, WILKINSON MSS. vii. 67 [upper right]. Scribe with pens in hair from I, HAY MSS. 29821, 92.

(3) [1st ed. 6] Five registers of industries, I (from right), two coffins, and carpenters making beds, II, shrine on sledge, carpenters sawing, making door-bolt, etc., III, metal-workers, including weighing, [blowing], and beating, IV (damaged), sculptor and leather-workers, V, list of oils, men filling jars, pressing and selling oil.

L. D. ii. 49 [b]. Omitting right halves of IV and V, CHAMP., *Mon.* ccccxii [1], ccccxii [2]. I-III, NESTOR L'HÔTE MSS. 20406, 'Tombeau de Imeri IV', 2 squeezes; BURTON MSS. 25621, 26-9; WILKINSON MSS. ii. 5 [lower]; vii. 42-3 [middle], 66 [upper]-67 [upper left]; xiii. 41 [lower]-42. Two carpenters and overseer, from I, WILKINSON, *M. and C.* ii. 42 (No. 89) = ed. BIRCH, i. 306 (No. 108). Men beating copper, from III, PETRIE in *Anc. Eg.* (1915), fig. 12 (from LEPSIUS), p. 14.

(4) [1st ed. 7-8] Father leaning on staff, with deceased behind him, and four registers, I-IV, men bringing cattle, oryxes, and cranes, with two registers above doorway, hyena and gazelles, and men with oxen.

L. D. ii. 50 [b]. Omitting registers above doorway, REISNER in *Boston Mus. Bull.* xxxvii (1939), fig. 4, p. 35. Omitting oryxes and cranes, NESTOR L'HÔTE MSS. 20406, 'Tombeau de Imeri IV', 3 squeezes, 'Tombeau de Imeri V', 1 squeeze. Father and deceased, WILKINSON MSS. iii. 17 verso A [right]; vii. 42 [lower left]; xiii. 43; PRUDHOE MSS. vi. 142-3. III-IV, BURTON MSS. 25621, 30. First man with oryx in III, WILKINSON MSS. vii. 66 [lower left]. Names and titles of deceased and father, SHARPE, *Eg. Inscr.* 2 Ser. 39, ll. 1-7; BURTON MSS. 25621, 23; of father, WILKINSON MSS. xiii. 18 [left]; of deceased, VYSE, *Operations*, ii, p. 7.

(5) [1st ed. 9] Four registers, I-II, deceased followed by son Neferbaupṭah and two others, and brother before father carried in palanquin, with attendants, and dog, III, furniture, two scribes and men with various articles, IV, estates.

L. D. ii. 50 [a]; NESTOR L'HÔTE MSS. 20406, 'Tombeau de Imeri III', 1 squeeze, 'Tombeau de Imeri II', 3 squeezes. Two attendants from II, and estates from IV, DEVÉRIA squeezes, 5382 A, B, C; WILKINSON MSS. vi. 219 (some estates); vii. 69 [bottom left]. Two scribes from III, id. ib. vii. 69 [bottom middle]. Estates, BURTON MSS. 25621, 31, 32. Cartouches from names of estates, WILKINSON MSS. xli. 41 [middle right]. Names of estates, SHARPE, *Eg. Inscr.* 2 Ser. 39, ll. 9-18; JACQUET-GORDON, *Domaines*, pp. 275-7 [31G5], cf. figs. 69, 70 (from LEPSIUS) (called Brit. Mus.).

Room II. b of Reisner.

(6) [1st ed. 10-11] Above doorway, three registers, men pulling papyrus and carrying

bundles of papyrus, and deceased fowling from canoe, right of doorway, three registers, men paddling boat and men with oxen.

L. D. *Ergänz.* v. Boat, WILKINSON MSS. ii. 5 [top right].

(7) [1st ed. 12-13] Five registers (from right), **I**, herdsmen drinking, roasting and plucking geese, baking cakes, kneading dough, making mats, and an overseer and cow, **II**, men bringing bulls, **III**, **IV-V** (right part), cattle, including milking, suckling calves and calving scene, **IV-V** (left part), remains of rowing-boats.

L. D. *Ergänz.* vii. Cooking in **I**, WILKINSON MSS. iii. 17 verso B. Man baking cakes, SMITH, *Hist. Eg. Sculp.* fig. 196b, p. 322. Cow in **I**, and another suckling calf, from **IV**, HAY MSS. 29821, 99, 98. Third bull in **II**, cow suckling calf, from **IV**, and cow calving, from **V**, WILKINSON MSS. ii. 5 B [bottom row]. Bull, from **III**, WILKINSON MSS. vii. 66 [lower middle]. **V**, NESTOR L'HÔTE MSS. 20406, 'Tombeau de Imeri III', 1 squeeze; HAY MSS. 29821, 94. Cow calving, from **V**, CHAMP., *Mon.* ccccxii [4]; ROSELLINI, *Mon. Civ.* xxvii [1]; BURTON MSS. 25621, 16, 19, 20.

(8) [1st ed. 14-15] On right, deceased seated smelling lotus, with dog sleeping beneath chair, offerings and three *ka*-servants in front of him, and five registers on left, **I-II**, two groups of butchers in each, **III**, cooking, **IV**, male dancers in couples and clappers, **V** (under whole scene), harpists, flutists, singers, male dancers and female clappers, and four groups eating and drinking.

L. D. ii. 52. Incomplete, WILKINSON MSS. ii. 5 B [upper]; iii. 17 verso A [left]; vii. 66 [lower right], 67 [lower], 68 [upper], 69 [top and middle], 70 [lower and upper right], 71 [lower left]; xiii. 14, 15 [left], 17 [lower]. Dog, and harpists below, HICKMANN in *Bull. Inst. Ég.* xxxv (1952-3), pl. i, fig. 9, p. 323. Two *ka*-servants bringing food, WILKINSON *M. and C.* ii. 399 (No. 283) = ed. BIRCH, ii. 43 (No. 307). Melon from heap of offerings, SMITH, *Hist. Eg. Sculp.* fig. 206 [lower], p. 330. Various vases, CHAMP., *Mon.* ccccxii [4], ccccxix [bottom]; ROSELLINI, *Mon. Civ.* lxi [5-17]. Butcher with blood dripping from knife, from **II**, SMITH, op. cit. fig. 99, pp. 223 note 1, 272. Group of butchers, from **II**, and cooking, from **III**, BURTON MSS. 25621, 39, 44 [upper]. **III**, WILKINSON, *M. and C.* ii. 388 (No. 278) = ed. BIRCH, ii. 35 (No. 302); CHAMP., *Mon.* ccccxiii [2]; ROSELLINI, *Mon. Civ.* lxxxiv [3]. **IV**, CHAMP., *Mon.* ccccxiv [1, 2]; ROSELLINI, *Mon. Civ.* c [1-5]; BURTON MSS. 25621, 40-3; SMITH, op. cit. fig. 75, pp. 196-7; omitting man on extreme left, WILKINSON, *M. and C.* ii. 337 (No. 240, lower) = ed. BIRCH, i. 507 (No. 265, lower); couples dancing, NESTOR L'HÔTE MSS. 20406, 'Tombeau de Imeri IV', 1 squeeze; texts, GARDINER Notebook, 61, p. 9 [upper]. Musicians, and four clappers with one of dancers in **V**, WILKINSON, *M. and C.* ii. 233 (No. 184), 336 (No. 239) = ed. BIRCH, i. 437 (No. 209), 506 (No. 264); BURTON MSS. 25621, 37, 38; NESTOR L'HÔTE MSS. 20406, 'Tombeau de Imeri III', 1 squeeze. Musicians in **V**, HICKMANN, *45 Siècles*, pls. xii, xiii; omitting harpist on right, CHAMP., *Mon.* ccccxviii [4], ccccx [1]; left harpist (incomplete), SMITH, op. cit. fig. 127 [b], p. 285; flutists with singers, and one singer from group of harpists, ROSELLINI, *Mon. Civ.* xcvi [6]; HICKMANN in *Ä.Z.* 83 (1958), Taf. xi [b], p. 123 note 1; id. in *Bull. Inst. Ég.* xxxvi (1953-4), pl. i, p. 490; id. *Musicologie pharaonique*, pl. i, p. 149; flutist in lower sub-register, id. *Ägypten*, Abb. 85. Three clappers and one dancer, ROSELLINI, *Mon. Civ.* xciv [2, upper right]. Four groups eating and drinking, CHAMP., *Mon.* ccccx [4]; ROSELLINI, *Mon. Civ.* lxxxiv [2]; WILKINSON, *M. and C.* ii. 401 (No. 285) = ed. BIRCH, ii. 44 (No. 309).

(9) [1st ed. 16-17]. Five registers, **I**, scaring birds, **II**, men picking grapes and figs (above doorway), **III**, men treading grapes, **IV**, pressing grapes, **V**, filling jars.

L. D. ii. 53 [b]. **II**, WILKINSON, *M. and C.* ii. 146 (No. 132) = ed. BIRCH, i. 379 (No. 152).

II-IV, LANE MSS. 34088, 15. **II-V**, WILKINSON MSS. ii. 4 [lower]. Picking grapes from **II**, and **III-IV**, CHAMP., *Mon.* ccccxii [2, 3], ccclxxxix [2] (called Beni Hasan); ROSELLINI, *Mon. Civ.* xxxviii [1], xxxvii [3]; BURTON MSS. 25621, 51, 54. **III-IV**, WILKINSON, *M. and C.* ii, pl. x, figs. 2, 3 facing p. 152. **IV**, CAILLIAUD, *Arts et métiers*, pl. 6 [2]; WILKINSON MSS. ii. 30 verso, fig. 2. **V**, CHAMP., *Mon.* ccccxiii [1]; ROSELLINI, *Mon. Civ.* xxxviii [4]; WILKINSON, *M. and C.* ii. 157 (No. 143) = ed. BIRCH, i. 387 (No. 163).

(10) [1st ed. 18-19]. Deceased seated, two registers behind him (above doorway), scribes and scene of rendering accounts, and issuing seed, and five registers before him, **I** (from right), reaping corn, binding sheaves, and scribe recording, an overseer, man bringing donkeys to be loaded, and man with list, **III**, donkeys carrying produce, men piling up sheaves, and scribe recording, **IV**, two groups of men ploughing, **V** (under whole scene), men hacking ground, and rams treading grain.

L. D. ii. 51. Upper register above doorway, ROSELLINI, *Mon. Civ.* cxxiv [2]; CHAMP., *Mon.* ccclxiii [4] (two men on left omitted); NESTOR L'HÔTE MSS. 20406, 'Tombeau de Imeri IV', 1 squeeze. Piling up sheaves, from **III**, *Descr. Ant.* v, pl. 17 [13]. **IV-V**, BURTON MSS. 25621, 44 [lower]-50. Group on left, from **IV**, CAILLIAUD, *Arts et métiers*, pl. 31 [2]; *Descr. Ant.* v, pl. 17 [16]; LANE MSS. 34088, 14. **V** (omitting men on left), CHAMP., *Mon.* ccccxiii [3]; ROSELLINI, *Mon. Civ.* xxxii [1]; NESTOR L'HÔTE MSS. op. cit. 1 squeeze. Various details, WILKINSON MSS. vii. 68 [bottom], 70 [upper left]; xiii. 17 [upper].

(11) [1st ed. 20-1] Four registers before deceased leaning on staff, **I** (from right), netting fowl, and men taking birds out of cages, **II**, netting and men bringing fish, **III**, building papyrus-canoes, with men making ropes, **IV**, boatmen jousting.

L. D. *Ergänz.* vi. **III-IV** (omitting boat on right in **III**), BURTON MSS. 25621, 33-6; LANE MSS. 34088, 13. **IV**, CHAMP., *Mon.* ccccxiii bis [bottom right] (called 'Koûm-el-Ahmar'), ccccxiv [3]; ROSELLINI, *Mon. Civ.* cvi [4], civ [9]; WILKINSON, *M. and C.* ii. 441 (No. 313) = ed. BIRCH, ii. 74 (No. 341); WILKINSON MSS. ii. 5 [upper left]; NESTOR L'HÔTE MSS. 20406 'Tombeau de Imeri I', 1 squeeze; probably DEVÉRIA squeezes, 6169, ii. 57-8 (tracing). Man fallen from boat in **IV**, SMITH, *Hist. Eg. Sculp.* fig. 166 [bottom right], p. 309.

Room III. a of Reisner. Plan with diagram of scenes, CHAMP., *Not. descr.* ii. 477.

(12) [1st ed. 22-3] Two daughters and sister Usertka (wife of Iti, tomb G 6030) above doorway, and four registers before deceased with wife, **I**, son Neferbaptaḥ and scribes, **II**, men bringing wild animals, **III**, bringing oxen, **IV**, bringing fowl, taking birds out of cage, and man with yoke bringing young animals.

L. D. ii. 54, cf. *Ergänz.* iii [b]; NESTOR L'HÔTE MSS. 20406, 'Tombeau de Imeri V', 4 squeezes. Omitting daughters and sister above doorway, JUNKER, *Giza*, iii, Abb. 8a. **III-IV**, BURTON MSS. 25621, 52, 53. **IV**, CHAMP., *Mon.* ccccxii [3], ccccxiii [4], ccccx [2]; ROSELLINI, *Mon. Civ.* lxxxiv [5, 6, 1], lxxxii [10]; WILKINSON MSS. iii. 17 verso F [right]; vii. 72-3 [upper]; first man holding goose, BRUNNER-TRAUT in *Mitt. Kairo*, 15 (1957), Taf. iv [2], p. 21; man with yoke, *Descr. Ant.* v, pl. 17 [12]; WILKINSON, *M. and C.* iii. 8 (No. 319) = ed. BIRCH, ii. 82 (No. 347). Texts (incomplete), CHAMP., *Not. descr.* ii. 477-8, Nos. 1-10, 11 (ascribed to 13) by mistake on sketch-plan). Texts of son and deceased, WILKINSON MSS. xiii. 16 [lower].

(13) [1st ed. 24] Father seated in pavilion, and seven registers before him, **I-III**, offerings, **IV**, offering-bringers, **V**, deceased as eldest son holding out lotus-flower to his father, offerings and *ka*-servant, **VI**, children of deceased, including Neferbaptaḥ, **VII** (under whole scene), female clappers, male dancers, and singer and harpist.

L. D. ii. 53 [a]; REISNER in *Boston Mus. Bull.* xxxvii (1939), fig. 5, p. 35; NESTOR L'HÔTE MSS. 20406, 'Tombeau de Imeri V', 3 squeezes; incomplete, WILKINSON MSS. iii. 17 verso F [left]; vii. 43 [middle right], 71 [right], 72 [lower]. Two men carrying tray with food, from IV, CHAMP., *Mon.* ccccki [1]; ROSELLINI, *Mon. Civ.* lxxxvii [1]. VI, and two dancers with harpist and singer from VII, HICKMANN in *Bull. Inst. Ég.* xxxv (1952-3), pl. v, fig. 10, p. 323; id. 45 *Siècles*, pl. xiv; id. in *Egypt Trav. Mag.* No. 30 (Feb. 1957), fig. 6, p. 9. VII, CHAMP., *Mon.* ccccx [5]; ROSELLINI, *Mon. Civ.* xciv [lower]. Texts (almost complete), CHAMP., *Not. descr.* ii. 478-9, Nos. 12-17. Titles of father, VYSE, *Operations*, ii, p. 8; BURTON MSS. 25619, 44 [upper]; WILKINSON MSS. xiii. 16 [upper].

(14) [1st ed. 25] Deceased at table, with offering-list above, funerary priests before him, and two groups of butchers below. (15) False-door. (16) [1st ed. 26] Four registers of offering-bringers.

L. D. *Ergänz.* iv [b, c] (omitting false-door); NESTOR L'HÔTE MSS. 20406, 'Tombeau de Imeri V', several squeezes. Offering-list, WILKINSON MSS. vii. 74. Texts, BURTON MSS. 25621, 24.

(17) [1st ed. 27] Four registers of offering-bringers.

L. D. *Ergänz.* iii [a].

G 6030. ITI $\bar{\text{I}}$ $\bar{\text{I}}$, Overseer of singing in the Great House, Prophet of Rē^c and Ḥathor in the Sun-temple of Neferirkarē^c, Prophet of Neferirkarē^c, Saḥurē^c, and Neuserre^c, etc. Middle Dyn. V.

Wife, Usertka $\bar{\text{I}}$ $\bar{\text{I}}$ $\bar{\text{I}}$, Royal acquaintance (daughter of Shepseskaf^cankh, tomb G 6040).

Stone-built mastaba. LG 17.

Plan XXIX

L. D. *Text*, i, pp. 42-4, with plan and sections on p. 38, and L. D. i. 21. Plan, MARIETTE, *Mastabas*, on fig. on p. 490 [lower]. Titles of deceased(?), DE ROUGÉ, *Inscr. hiéro.* lxii [bottom]. See WILKINSON MSS. xli. 41 [middle left]; NESTOR L'HÔTE MSS. 20406, 'Tombeau de Ata' (fragments of squeezes).

Chapel.

(1) [1st ed. 1-3] Doorway. (a)-(c) Thicknesses with deceased and wife, and drum with name and titles of deceased.

L. D. ii. 59 [b]; texts, SETHE, *Urk.* i. 45 [28, b]; of (a) and (c), NESTOR L'HÔTE MSS. 20396, 308 [bottom].

(2) [1st ed. 4-5] False-door of deceased.

Lintel with offering-text and deceased at table, L. D. ii. 59 [a]; CHAMP., *Not. descr.* ii. 480 [bottom]; BURTON, *Excerpta hiero.* pl. xxvii [5]; BURTON MSS. 25621, 55 [middle], 136 [5]; WILKINSON MSS. vii. 42-3 [top]; xiii. 44 [top]; NESTOR L'HÔTE MSS. 20396, 307 verso; part of text, SETHE, *Urk.* i. 45 [28, a]; bottom line, WILKINSON, *M. and C.* iii. 280 (No. 381, 1) = ed. BIRCH, ii. 274 (No. 420, 1).

G 6037. Dyn. V-VI.

Stone-built mastaba. Much destroyed. Partly excavated by Schiaparelli and Junker.

Plan XXXIV

Chapel.

CURTO, *Gli Scavi*, pp. 91-2 [A]; BALLERINI, *Notizia*, p. 47 [2]. Plan with sketches of

scenes, CURTO, *op. cit.* fig. 37 [a]. Synopsis of scenes, JUNKER in *Anzeiger, Wien*, 63 (1926), p. 104.

(1) Deceased and wife facing a man and a woman, with son Nikauptah  between them.

(2) Deceased and wife with small daughter, and offering-list.
Offering-list, CURTO, *op. cit.* fig. 39 [a], pp. 91 [bottom]–92.

(3) Deceased with wife and small son.

(4) Deceased and wife seated, with son holding goose before them.

G 6040. SHEPSESKAFANKH  ♀, Steward, etc. Temp. Neferirkarē.
Stone-built mastaba. LG 18.

Plan XXVII

L. D. Text, i, p. 44; REISNER, *Giza Necropolis*, i, pp. 217 [26], 289 [1]. View, *id.* in *Boston Mus. Bull.* xxxvii (1939), fig. 1, p. 30. Sketch of north face, MARIETTE, *Mastabas*, fig. on p. 495 [lower].

Funeral ramp.

Two round-topped stelae, found *in situ* on either side. REISNER in *Boston Mus. Bull.* xxxvii (1939), fig. 3, p. 30; *id.* in *Studies presented to F. Ll. Griffith*, pl. 51 [a], pp. 328–9; east stela, pl. 51 [b].

I. Exterior room.

(1) False-door with lintel.

(2) Doorway. (a)–(b) Lintel with drum.

II. Interior room. Converted into serdab.

(3) Unfinished scene.

(4) Two priests before deceased seated in pavilion.

Deceased, SMITH, *Hist. Eg. Sculp.* fig. 141 [left], p. 292; priest on left, fig. 139 [left lower].

(5) Unfinished scene (in preliminary sketch) with offerings.

REISNER in *Boston Mus. Bull.* xxxvii (1939), fig. 2, p. 30.

Finds

Seated female statuette (damaged), in Boston Mus. unnumbered (Exped. Nos. 25–12–26, 47). See SMITH, *op. cit.* p. 73 [middle].

G 6042.

Double-statuette, man and wife (headless), standing, late Dyn. V, in Boston Mus. 27.1122. See SMITH, *Hist. Eg. Sculp.* p. 73.

EXACT PROVENANCE UNKNOWN

(a) Ballard Excavation (1902)

Cemeteries G 1000–1400, and parts of Steindorff and Junker Cemeteries

See SMITH, *Hist. Eg. Sculp.* pp. 67–8; BOREUX in *R.E.A.* i (1927), p. 11 note 4.

Statues and statuettes.

Dersenez , Scribe of the granary, Steward, Dyn. V.

(a) With wife Nefertka , seated, double-stature, red granite, formerly in von Bissing Colln., now¹ in Berlin (West) Mus. 23720. VON BISSING, *Denkmäler*, Taf. 4; id. *Äg. Kunstgeschichte*, Taf. lxii [381], *Text*, i, pp. 80, 87; ANTHES in *Berliner Museen*, lv (1934), Abb. 1, 2, pp. 90-1; CAROTTI, *L'Arte*, fig. 39; SCHARFF in *J.E.A.* xxvi (1940), pl. x [2], p. 48; SCHÄFER and ANDRAE, *Kunst* (1942), 238 [right]; HORNE-MANN, *Types*, v, pl. 1185; WOLF, *Kunst*, Abb. 118.

(b) Scribe-stature, red granite, in Berlin (East) Mus. 15701. ANTHES in *Berliner Museen*, lv (1934), Abb. 3, p. 92; *Führer* (1961), Abb. 11, p. 48; VON BISSING, *Denkmäler*, Taf. 7; BONNET, *Ägyptisches Schrifttum*, Abb. 13, p. 15; FECHHEIMER, *Plastik*, Taf. 25-7; SCHÄFER and ANDRAE, *Kunst* (1925), 223; (1930) 233; (1942) 238 [left]; STRÖMBOM, *Egyptens Konst*, fig. 44, p. 61; RANKE, *The Art of Ancient Egypt*, and BREASTED, *Geschichte Aegyptens*, 64; PIJOÁN, *Summa Artis*, iii (1945), figs. 184-5; BYVANCK, *De Kunst*, pl. xvii [63]; *Sculptures et textes poétiques de l'Égypte in Cahiers d'Art*, xxii (1947), fig. on p. 59; HORNE-MANN, *Types*, ii, pl. 427; VANDIER, *Eg. Sculpture*, pl. 5; WOLF, *Die Stellung der ägyptischen Kunst* [etc.], Taf. iii [a]; id. *Kunst*, Abb. 117; LANGE, *Pyramiden*, pl. 74 after p. 184; id. *Ägyptische Bildnisse*, Taf. 11; FIRCHOW, *Ägyptische Plastik*, pl. 2; EKSCHEMITT, *Das Gedächtnis der Völker*, Abb. on p. 112 [upper]; see RANKE in *Ä.Z.* 75 (1939), p. 89 note 4; SMITH, *Hist. Eg. Sculp.* p. 68.

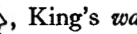
Imsu , King's *wab*-priest, and wife Wact , *mitri*, standing, double-stature, dedicated by Sebknakht, Dyn. V-VI, in Munich, Staatl. Sammlung, Gl. 25. Munich, *Äg. Sammlung* (1966), Abb. 23; VON BISSING, *Denkmäler*, Taf. 6; PIJOÁN, *Summa Artis*, iii (1945), fig. 224 (called Berlin); MICHALOWSKI, *Art*, fig. 219 (called Berlin); MARBURG INST. photo. 626153; see WOLTERS, *Illus. Kat.* (1912), p. 11 [28a]; id. *Führer*, p. 12 [64]; FURTWÄNGLER, *Beschreibung der Glyptothek Königs Ludwigs I zu München* (1916), p. 31 [N. 28a]; SMITH, op. cit. p. 68.

Nüfer , Dyn. V-VI, in Cairo Mus.

(a) Ent. 35563, seated; HORNE-MANN, *Types*, iii, pl. 697; see SMITH, op. cit. p. 68. (b) Ent. 35564, standing; HORNE-MANN, *Types*, i, pl. 135; see SMITH, op. cit. p. 68. (c) Ent. 35565, with wife, standing; id. ib. pl. 26 [d]; HORNE-MANN, *Types*, v, pl. 1148; see MASPERO, *Guide*, p. 74 [167].

Man standing, Dyn. V, in Cairo Mus. Ent. 35567. See SMITH, op. cit. p. 68.

Lintels.

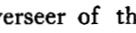
Nenseper , Overseer of the department, etc., and wife Hathorneferiu , probably Dyn. V, formerly in Dattari Colln., now in Cleveland, Mus. of Art, 20.1993. *Hôtel Drouot (Paris) Sale Cat.* (LAMBROS and DATTARI), June 1912, pl. xxiv [284].

Neferi , Scribe of a phyle of the Pyramid of Khufu, fragment, Dyn. V-VI, formerly in Dattari Colln., now in Cleveland, Mus. of Art, 20.1992. Id. ib. pl. xxiv [285].

(b) Schiaparelli Excavation (1903). In Turin Museum



Double-stature in niche, man and woman (both headless) standing, uninscribed, Dyn. IV-V, Sup. 1875. CURTO, *Gli Scavi*, Tav. xxxii [a], p. 97 [17]; MARBURG INST. photo. 68762; see FARINA, *Il Regio Museo* (1931), p. 9 [3]; (1938), p. 9.





Face of female statue, red granite, Dyn. IV, Sup. 1880. CURTO, op. cit. Tav. xxxiii [a], pp. 97-8 [18].









¹ See Addenda.

Fragments of alabaster statues, Dyn. IV, Sup. 1879. See id. ib. p. 98 [20].

Fragments (no names) from lintels, Sup. 1857, 1867, 1866, 1863. Id. ib. Tav. xxx [a], xxix [c], xxix [a], xxvii [a], pp. 94-5 [5, 6, 9, 12]. Sup. 1863, see BALLERINI, *Notizia*, p. 65 note 1.

Lintel of false-door of Isi  — , Dyn. IV, Sup. 1858. CURTO, op. cit. Tav. xxix [b], p. 94 [8].

Panel of false-door, Kai  , King's *warb*-priest, etc., with wife Neferseshem   , at table, Dyn. VI, Sup. 1850. Id. ib. Tav. xxvii [b], p. 96 [14].

Fragments of drums of false-doors of Ni'ankhnekhbet        , Inspector of *ka*-servants, Dyn. IV, Sup. 1868-9. Id. ib. Tav. xxviii [b], pp. 95-6 [13].



Panel of false-door, Mery (woman) at table, Sup. 1256.

Two blocks with remains of funerary priests (including wiping out footprints), offering-bringers, and butchers, Sup. 1855-6. Id. ib. Tav. xxvi [a, b], p. 93 [1, 2].





Block, netting fish, perhaps from same tomb as last blocks, Sup. 1854. Id. ib. Tav. xxvi [c], p. 93 [3].



Block, man bringing goose, Sup. 1867. Id. ib. Tav. xxxi [a], p. 94 [7].

Fragment of biographical text of [Prophet of] *md̄d-r-nbty* (*nebty*-name of Khufu), Dyn. IV-V, Sup. 1853. Id. ib. Tav. xxviii [a], p. 96 [15]; text, SETHE, *Urk.* i (1933), 154 [3 (94)].

Libation-basin of Mereru   , Overseer of the store-room, Elder of the house of the Great Estate, etc., Dyn. VI, Sup. 1873. Text, CURTO, op. cit. fig. 39 [b], pp. 96-7 [16].

(c) Steindorff Excavation (1903-6). Late Old Kingdom

False-door of Hab   and wife Mertiotet, with dedication of son Keki   , Elder of the house, in Leipzig Mus. Inv. 3121 (lost). Dedicatory text, SETHE, *Urk.* i (1933), 230 [5 (145), Q].

Libation-basin of Ini   , Overseer of the ten, in Hildesheim Mus. 6. See IPPEL and ROEDER, *Denkmäler . . . Hildesheim*, p. 68.

Statuette of man kneading dough, in Munich, Staatl. Sammlung, ÄS. 4862. Zürich. *5000 Jahre*, Abb. 34, p. 60 [125]; Essen. *5000 Jahre*, No. 43 with Abb.; Munich. *Äg. Sammlung* (1966), Abb. 17; WOLDERING, *Götter*, fig. on p. 227 [Kat. 37]; see MÜLLER (H. W.) in *Münchener Jahrb.* 3 Ser. xiv (1963), p. 216.

























Statuette of man standing, wood, in Leipzig Mus. Inv. 1493.

(d) Reisner Excavation

Hearst Expedition of the University of California (1903-5). Cemeteries G 1000-1400.

In Berkeley Museum.

Statues and statuettes. Dyn. V-VI.

Paten                  , *warb*-priest, with daughter Nebt-tai        in relief on back pillar, 6.19690. LUTZ, *Statues*, pls. 20-1, pp. 13-14; Berkeley. *Exhib.* 1966, fig. on p. 38.

Man standing, painted, broken, 6.19692. Id. ib. fig. on p. 48.

Scribe-statue, man writing, 6.19756. LUTZ, op. cit. pls. 24 [b], 25 [a], p. 16.



Woman standing, upper part, 6.19822. Id. ib. pl. 30 [a], p. 19.



Male head, 6.19808. Id. ib. pl. 26 [a], p. 17.

Two, man standing, wood (possibly from Nag' el-Deir), 6.15989-90. Id. ib. pls. 38 [b], 24 [a], pp. 26-7, 16.

Various. Dyn. V-VI.

False-door of Iy  (woman), Tenant of the Pyramid of Pepy I, etc., 6.19830. Id. *Steles*, pl. 9 [17].

Block with Imasahur  , *ka*-servant, etc., bringing linen, 6.19829. Id. ib. pl. 9 [16].

Offering-table of Mesezer , Inspector of builders, etc., (wife Mernefertnesut , *mitri*), dedicated by son Keki , 6.19821. Id. ib. pl. 6 [10]; dedicatory text, DENNIS in *P.S.B.A.* xxvii (1905), p. 34 [8] (incorrect); SETHE, *Urk.* i (1933), p. 230 [5 (145) 0].

In Cairo Museum. Dyn. V-VI.

Statuette, name in ink (effaced), Ent. 37714.

Libation-basin of Kai , Elder of the house, No. 57006.

From unidentified tombs. Dyn. V-VI. Copies by James T. Dennis in 1903-4.

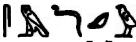
Lintel¹ of Mesezeru , Keeper of the magazine of gold, etc. Text, DENNIS in *P.S.B.A.* xxvii (1905), p. 32 [3].

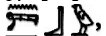
False-door of Nebu , with names of children below. Text, id. ib. p. 34 [11].

False-door of Nefert-hotp , (woman). Text, id. ib. p. 33 [5].

False-door of Ptah-hotp , Judge and Boundary official, etc. Text, id. ib. p. 34 [9].

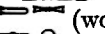
False-door of Theset , (woman). Text, id. ib. p. 32 [1].

Harvard-Boston Expedition.

Double-stature of man and wife seated, upper part, Dyn. V, in Boston Mus. 12.1507-8. See SMITH, *Hist. Eg. Sculpt.* p. 74.

False-door of Kakhent , *ka*-servant, Old Kingdom, in Boston Mus. 12.1520.

(e) Fisher Excavation (1915). Cemetery G 3000

Libation-basin of Neferse . . . , Inspector of *warb*-priests, Dyn. V-VI, from surface débris, in Philadelphia Mus. E 13544. FISHER, *The Minor Cemetery at Giza*, pl. 47 [3]; text, p. 155 [39].

(f) Junker Excavation. Old Kingdom

False-door of King's *warb*-priest, Secretary, Tenant (unfinished, name unknown). JUNKER, *Giza*, vii, Abb. 57, pp. 143-4.

Slab-stela(?) of Hatnufér , late Old Kingdom, from offering-place of brick-built mastaba. Id. ib. viii, Abb. 92, pp. 176-7.

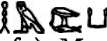
Lintel of Hamkai , Prophet of Horus *mddw* (Khufu), Khufu, and *hrwy-nb* (Golden Horus name of Khufu), Master of the house of the Great House, etc., Dyn. VI, in Vienna Mus. Inv. 8532. Id. ib. vii, Abb. 108, pp. 253-4; see id. in *Anzeiger, Wien*, 51 (1914), p. 165 [top] (called Ham).

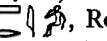

Lintel of Sheri , Royal acquaintance, fragments, found in a shaft. Id. *Giza*, ix, Abb. 117, pp. 257-8; see id. in *Anzeiger, Wien*, 64 (1927), p. 152.

¹ From tomb G 1011 (see supra, p. 52). FISCHER in *Bulletin of the Detroit Institute of Arts*, 51 (1972), fig. 9, note 25 on p. 80.

Fragment of re-used lintel of [Judge and] Overseer of scribes, [Overseer] of the Memphite and Letopolite nomes, etc., late Dyn. V. Id. *Giza*, viii, Abb. 90, p. 173.

Fragments of slab-stelae, [deceased] at table, offering-list, and linen-list. Id. ib. i, Taf. xxix [b], Abb. 53 [a, c], pp. 258-9.

Blocks, in Hildesheim Mus. 2401, 2405, 2671, 2692. See IPPEL and ROEDER, *Denkmäler . . . Hildesheim*, pp. 59, 60. No. 2405, JUNKER, *Giza*, viii, Abb. 22a, p. 59. No. 2671, see id. ib. p. 178.

Mirror of Merut  , Prophetess of Hathor, etc., copper, Dyn. V-VI, found at bottom of a shaft, in Hildesheim Mus. 2455. Id. ib. vii, Taf. xiii [b], p. 62.

(g) Abu-Bakr Excavation

False-door of Ika , with estate at bottom of left jamb, end of Dyn. VI or later, from mastaba north of Cemetery G 1200. Name of estate, JACQUET-GORDON, *Domaines*, p. 321 [5066], cf. fig. 107.

Block with part of biographical text, probably Dyn V. GOEDICKE in *J.E.A.* 45 (1959), pl. ii, fig. 1, pp. 8-11.

Statuettes with execration-texts, Old Kingdom. See POSENER in *Mitt. Kairo*, 16 (1958), p. 252 note 3.

B. EAST FIELD

Plan XVIII

Plan, REISNER, *Giza Necropolis*, i, Map of Cemetery G 7000; of area east of Subsidiary Pyramids, id. in *A.Z.* 64 (1929), p. 97. View, id. *Giza Necropolis*, i, pl. 6; id. in *Boston Mus. Bull.* xxvi (1928), fig. on p. 76; id. in *A.Z.* 64 (1929), Taf. ii [1]; DUNHAM, *Eg. Department*, fig. 16; CAPART, *Memphis*, fig. 49; *I.L.N.* Feb. 7, 1925, on fig. on p. 223 [upper]; DANIEL, *The First Civilizations*, pl. 19.

G 7000X. TOMB OF HETEPHERES [I]¹

Temp. Khufu

Husband, Snefru. Son, Khufu.

No superstructure. Re-burial, transferred from unidentified tomb probably at Dahshûr. Reiner Excavation. Harvard-Boston Expedition (1925-7).

REISNER and SMITH, *Giza Necropolis*, ii (quoted here as REISNER and SMITH); REISNER, *Hetep-Heres* [etc.] in *Boston Mus. Bull.* Supp. (May 1927); SMITH (W. S.) in ib. li (1953), pp. 23-30.

Plans and sections, REISNER and SMITH, figs. 12-15, 21-2. Views of exterior, id. ib. pls. 1, 2; REISNER in *Boston Mus. Bull.* Supp. (May 1927), figs. on pp. 6, 7; EDWARDS, *Pyramids* (1961), pl. 13 [b]; with burial chamber, *I.L.N.* March 12, 1927, figs. on pp. 436-7. View of burial chamber, REISNER and SMITH, pl. 4 [a]; DOW in *Archaeology*, i (1948), fig. on p. 137 [middle]; ELLIS in *Egypt Trav. Mag.* No. 31 (March 1957), fig. 1, p. 7; SMITH (W. S.) in *Boston Mus. Bull.* li (1953), fig. 3, p. 30; *I.L.N.* May 8, 1954, fig. 2, p. 764. Interior (from painting by J. L. SMITH), REISNER in *Boston Mus. Bull.* Supp. (May 1927), fig. on p. 11; KARNAGHAN in *Art and Archaeology*, xxxi (1931), fig. on p. 257 [lower]; DUNHAM, *Eg. Department*, fig. 33. View of objects *in situ* in central part, REISNER in *Boston Mus. Bull.* xxvi

¹ Daughter of the God of his body, Mother of the King of Upper and Lower Egypt, *khet*-priestess of Horus, etc.

(1928), fig. on p. 84; *I.L.N.* Nov. 24, 1928, fig. on p. 959 [bottom]; DUNHAM, op. cit. fig. 34; COTTRELL, *The Lost Pharaohs*, pl. 21 facing p. 113. Plan of burial chamber with objects *in situ*, REISNER and SMITH, fig. 19. Reconstruction with objects, id. ib. fig. 20; SMITH (W. S.) in *Boston Mus. Bull.* li (1953), fig. 1, p. 23; *I.L.N.* May 8, 1954, fig. 1, p. 764.

Furniture, etc.

View of restored bed, head-rest, armchair with papyrus-flower decoration, and bed canopy,¹ in Cairo Mus. REISNER in *Boston Mus. Bull.* xxx (1932), fig. on p. 55; ZIPPERT in *Archiv für Orientforschung*, viii (1932-3), Abb. 6, pp. 155-6; Dow in *Archaeology*, i (1948), fig. on p. 137 [bottom]; COTTRELL, *The Lost Pharaohs*, pl. 23 facing p. 128; ALDRED in SINGER, *A History of Technology*, i, figs. 502-3, pp. 698-9; SMITH, *Art . . . Anc. Eg.* pl. 30 [A], pp. 49-53; MONTET, *Lives of the Pharaohs*, pl. on p. 25; YOYOTTE, *Treasures of the Pharaohs*, pl. on p. 22 (without headrest). Reproductions in Boston Mus.; HAYES, *Daily Life in Ancient Egypt* in *The National Geographic Magazine*, lxxx (1941), fig. on p. 433 [lower]; SMITH, *Anc. Eg.* fig. 40; BEEKMAN, *Hout in alle Tijden*, fig. 7.67, p. 513; WHITEHILL, *Museum of Fine Arts Boston. A Centennial History*, i, fig. on p. 272.

Bed canopy² (inscribed), gold covered, presented by Snefru, in Cairo Mus. Ent. 57711 (restored).

REISNER and SMITH, pls. 5-10, figs. 23-7, pp. 23-5, cf. pl. 3 [c], fig. 17, p. 14; REISNER in *Boston Mus. Bull.* xxx (1932), pp. 56-60 with figs.; id. in *I.L.N.* May 7, 1932, pp. 767-9 with figs.; see *Descr. somm.* No. 6199. Reconstruction and right thickness, *I.L.N.* March 26, 1927, figs. 1, 4, p. 539. Hieroglyphs from right thickness, *Antiquity*, i (1927), pl. i facing p. 216; ROWE in *I.L.N.* April 9, 1932, fig. 2, p. 536; SMITH, *Hist. Eg. Sculp.* pl. 37, pp. 144, 328; id. *Country Life*, figs. 14, 21, 40 (from Boston reproduction); id. *Art . . . Anc. Eg.* pl. 34, p. 50; GALASSI in *La Critica d'Arte*, n.s. ii (1955), fig. 249, p. 313; BAKER, *Furniture in the Ancient World*, fig. 33, cf. 34 (from Boston reproduction).

Bed² with inlaid footboard, gold covered, in Cairo Mus. Ent. 53261 (restored).

REISNER and SMITH, pls. 25-6, fig. 33, pp. 32-3, cf. pl. 31; *I.L.N.* Aug. 24, 1929, figs. on p. 345; see *Descr. somm.* No. 6162. Restored, REISNER in *Boston Mus. Bull.* xxvii (1929), figs. 8, 9, pp. 88-9; MICHALOWSKI, *Art*, fig. 807 (with head-rest). Inlay design, SMITH, *Hist. Eg. Sculp.* fig. 57 [lower]. Gold casing of legs, *I.L.N.* March 26, 1927, fig. on p. 538 [bottom right]. Reproduction in Boston, KAYSER, *Ägyptisches Kunsthandwerk*, Abb. 265 (with head-rest).

Curtain box³ (inscribed), gold covered, faience inlaid, presented by Snefru, with King seated on north end, and names and winged disk on south end, in Cairo Mus. Ent. 72030 (restored).

REISNER and SMITH, pls. 7 [b], 11-13, figs. 28-9, pp. 23, 25-7; REISNER in *I.L.N.* Nov. 18, 1939, figs. on pp. 757-8; see *Descr. somm.* No. 6330. Restored, ELLIS in *Egypt Trav. Mag.* No. 31 (March 1957), fig. 4, p. 9; BAKER, op. cit. fig. 35; SMITH (W. S.) in *Boston Mus. Bull.* li (1953), fig. 2, p. 30; GRDSELOFF MSS. 42 (photos.). North end, REISNER in *Boston Mus. Bull.* Supp. (May 1927), fig. on p. 19; *I.L.N.* March 26, 1927, fig. 3, p. 539; DUNHAM, *Eg. Department*, fig. 38; King, SMITH, *Hist. Eg. Sculp.* fig. 54 [middle]. South end, id. *Country Life*, fig. 41 (from Boston reproduction); winged disk, id. *Hist. Eg. Sculp.* fig. 204 [right top].

¹ As separate items, see below.

Reproduction in Boston Mus. See also above.

² Reproduction in Boston Mus.

Armchair¹ with papyrus-flower decoration, gold covered, in Cairo Mus. Ent. 53263 (restored).

REISNER and SMITH, pls. 14 [b, c]–16, fig. 31, pp. 28–9; *I.L.N.* Aug. 24, 1929, figs. on p. 344 [top and middle right] (including view *in situ*); see *Descr. somm.* No. 6161. Restored, REISNER in *Boston Mus. Bull.* xxvii (1929), figs. 1–3, pp. 84–5; ROSS, *The Art of Egypt*, pl. on p. 117 [5]; KEES, *Ägypten* (OTTO, *Handbuch der Altertumswissenschaft*, iii, Pt. 1, vol. iii, *Kulturgeschichte des Alten Orients*, 1), Taf. 24; LEBOVITCH, *Anc. Eg.* fig. 124; DRIOTON, *Le Musée Égyptien* (1939), pl. vi; MITRY, *Illus. Cat.* No. 6161; ELLIS in *Egypt Trav. Mag.* No. 31 (March 1957), fig. 5, p. 10; MICHALOWSKI, *Art*, fig. 808. Reproduction in Boston, KAYSER, *Ägyptisches Kunsthandwerk*, Abb. 2.

Armchair with inlays of Neith-standards on both faces of back, with hawk standing on palm column on arms (wood perished), gold covered, in Cairo Mus.²

REISNER and SMITH, pls. 17–24, fig. 32 (reconstruction), pp. 29–32; SMITH (W. S.) in *Boston Mus. Bull.* li (1953), fig. 7 (reconstruction), p. 30; id. *Hist. Eg. Sculp.* figs. 58–9 (inlay design); *I.L.N.* May 8, 1954, figs. 3, 4 (reconstruction), 6, pp. 764–5.

Gold fragments with deceased seated smelling lotus, probably from lid of small box, in Cairo Mus.²

REISNER and SMITH, pl. 14 [a], fig. 30, p. 29; SMITH, *Hist. Eg. Sculp.* fig. 55, p. 145.

Palanquin³ (inscribed on back), gold covered, in Cairo Mus. Ent. 52372 (restored).

REISNER and SMITH, pls. 27–9, cf. pls. 31, 32 [b], fig. 34, pp. 33–4; *I.L.N.* Nov. 24, 1928, figs. on pp. 958 [bottom right], 959 [top left]; see *Descr. somm.* No. 6041. *In situ*, DUNHAM, *Eg. Department*, fig. 35. Restored, and text, REISNER in *Boston Mus. Bull.* xxvi (1928), figs. on p. 85; ROSS, *The Art of Egypt*, pls. on pp. 116–17 [1–4]; BREASTED, *Ancient Times* (1935), figs. 47–8. Restored, SCHÄFER and ANDRAE, *Kunst* (1930 and 1942), 268 [upper] (from REISNER); CAPART, *Memphis*, fig. 251; KEES, *Ägypten* (OTTO, *Handbuch der Altertumswissenschaft*, iii, Pt. 1, vol. iii, *Kulturgeschichte des Alten Orients*, 1), Taf. 23; LEBOVITCH, *Anc. Eg.* fig. 125; DE WIT, *Oud-Egyptische Kunst*, fig. 44 facing p. 80; BAKER, *Furniture in the Ancient World*, fig. 38. Text, WHEELER in *Antiquity*, ix (1935), pl. v; ELLIS in *Egypt Trav. Mag.* No. 31 (March 1957), fig. 7 (horizontal text only) on p. 11; SMITH, *Art . . . Anc. Eg.* pl. 30 [B], pp. 49–51; *Boston Mus. Bull.* liii (1955), figs. on p. 68 (part of vertical text). Determinative of name, SMITH, *Hist. Eg. Sculp.* fig. 54 [right]. Reproduction in Boston, SMITH, *Anc. Eg.* (1942 and 1952), fig. 41; WILSON, *The Burden of Egypt*, fig. 6a; WHITE, *Ancient Egypt*, pl. 16 facing p. 72; KAYSER, *Ägyptisches Kunsthandwerk*, Abb. 249.

Remains of tubular leather case containing two long staves covered with gold ribbed casing (one restored, in Cairo Mus. Ent. 89619a, with silver fragments, Ent. 89619b), and wooden stick with inlaid Min-emblem decoration, in Cairo Mus.²

REISNER and SMITH, pl. 33, fig. 46, pp. 45–7.

Chest with inlaid lid with text and Min-emblem decoration, gold covered, in Cairo Mus.²

REISNER and SMITH, pl. 35, figs. 38–40, pp. 36–40, cf. pls. 32 [a], 33 [a]. Reconstruction of lid, SMITH (W. S.) in *Boston Mus. Bull.* li (1953), fig. 8, p. 30; *I.L.N.* May 8, 1954, fig. 5, p. 765. Inlay design, SMITH, *Hist. Eg. Sculp.* fig. 56.

¹ Reproduction in Boston Mus. See also p. 180.

² Numbers of unrestored objects on p. 182.

³ Reproduction in Boston Mus.

Original contents of chest (see supra, p. 181).

(a) Box (wood almost completely perished, now restored) with eight alabaster ointment-jars (inscribed) in stand, and copper toilet-spoon, in Cairo Mus. Ent. 52373a-h (jars), i (spoon), j (box).

REISNER and SMITH, pl. 34 [a, c], fig. 41, pp. 42, 93-4; see *Descr. somm.* No. 6046. Restored, REISNER in *Boston Mus. Bull.* xxvi (1928), fig. on p. 86 [upper]; *I.L.N.* March 26, 1927, fig. on p. 538 [middle left]; Nov. 24, 1928, fig. on p. 958 [bottom left].

(b) Box (inscribed), gold covered, containing silver bracelets with butterfly design, in Cairo Mus. Ent. 53265 (restored box), 53266-81, fragments of two¹ bracelets and inlays, in Boston Mus. 47.1699-1701.

REISNER and SMITH, pls. 36-9 [c], fig. 44, pp. 43-4. View *in situ*, *Antiquity*, i (1927), pl. ii facing p. 218; DUNHAM, *Eg. Department*, fig. 37. Restored box with bracelets, REISNER in *Boston Mus. Bull.* xxvii (1929), figs. 4-7, pp. 86-7; *I.L.N.* Aug. 24, 1929, figs. on p. 344 [bottom] (including *in situ*); bracelets, BREASTED, *Ancient Times* (1935), fig. 49; COTTRELL, *The Lost Pharaohs*, pl. 22; see *Descr. somm.* Nos. 6163-4; design, KEIMER in *Ann. Serv.* xxxiv (1934), pl. xv [7], pp. 194-5; SMITH, *Hist. Eg. Sculp.* fig. 57 [upper]. Fragments of bracelets and inlays in Boston, id. in *Boston Mus. Bull.* li (1953), fig. 6 [lower], p. 27; ALDRED, *Jewels of the Pharaohs*, pl. 3; inlays, SMITH, *Country Life*, fig. 20 [lower].

(c) Head-rest,² wood, covered with gold and silver (uninscribed), in Cairo Mus. Ent. 53262 (restored).

REISNER and SMITH, pl. 39 [a, b], fig. 43, pp. 42-3; *I.L.N.* Aug. 24, 1929, fig. on p. 344 [middle left]; see *Descr. somm.* No. 6160.

Unrestored. In Cairo Mus.

Temp. Nos. 22.2.60.1 (gold ribbed bars, etc.), 2 (gold foils and faience), 3 (gold and faience, including four hawks), 4, 5 (Min-emblems, etc.), 6 (lid of chest?), 7 (inlays from chest and armchair), 8 (flower-patterns), 9 (gold sheets), 10 (chest and armchair remains), 11 (foil from portrait of deceased), 12 (various); 18.4.47.5.

Other finds.

Sarcophagus (uninscribed), alabaster, in Cairo Mus. Ent. 51899. REISNER and SMITH, pls. 4 [b], 43 [d], p. 16; REISNER in *Boston Mus. Bull.* xxvi (1928), figs. on p. 77; *I.L.N.* March 26, 1927, fig. on p. 537; DONADONI ROVERI, *Sarcofagi egizi*, Tav. xvii [1], xxi [1], pp. 111-12 [B 9]; see *Descr. somm.* No. 6025.

Canopic-box (uninscribed), alabaster, found in blocked niche in west wall, in Cairo Mus. Ent. 52452. REISNER and SMITH, pl. 44, pp. 21-2, cf. fig. 22; REISNER in *Boston Mus. Bull.* xxvi (1928), figs. on pp. 79-80; see *Descr. somm.* No. 6047.

Sealings with names of Khufu. REISNER and SMITH, fig. 47, pl. 43 [c], pp. 48-9.

CEMETERY G 7000

Reisner Excavation. Harvard-Boston Expedition (1924-31)

Plan XVIII

G 7050. Probably NEFERTKAU  (woman). Temp. Khephren.

Father, Snefru.

Stone-built mastaba. No inscriptions found.

¹ In Boston Mus. also reproduction of a bracelet.

² Reproduction in Boston Mus. See also p. 180.

REISNER, *Giza Necropolis*, i, pp. 28, 60, 73, 308 [middle, e], 381 [bottom, 2]; plan and section, fig. 10. View, id. in *A.Z.* 64 (1929), on Taf. ii [2] facing p. 98.

G 7060. NEFERMA'ET , King's son, Hereditary prince, Overlord of Nekheb, etc. (Vizier of Khephren.) Temp. Khufu to Khephren.

Mother, Nefertkau (tomb, probably, G 7050).

Stone-built mastaba. LG 57.

Plan XXVII

L. *D. Text*, i, pp. 82-3; MARIETTE, *Mastabas*, pp. 530-1 [12]; REISNER, *Giza Necropolis*, i, pp. 60, 116 [28]. Plan of chapel, id. ib. fig. 119, pp. 209 [31], 309 [e], 381 [bottom, 3]; L. *D. Text*, i, fig. on p. 82. View, REISNER in *A.Z.* 64 (1929), on Taf. ii [2] facing p. 98.

Chapel. Synopsis of scenes, JUNKER, *Giza*, iii, p. 45 [36].

(1) Four registers before [deceased and wife], I, [scribes], II-III, men bringing animals, IV, cranes.

L. *D.* ii. 17 [b]. III-IV, WILKINSON MSS. iv. 32 [left]. Man dragging oryx, from III, JUNKER, op. cit. Abb. 7 [3] (reversed).

(2) [Deceased seated before offerings], with dog under chair, and register of female clappers at bottom.

L. *D.* ii. 17 [c]. Dog, WILKINSON MSS. xiii. 41 [top right].

(3) Deceased with wife (name lost). (4) False-door. (5) Deceased with son Snefrukha'ef (tomb G 7070).

L. *D.* ii. 17 [a]. (4) WILKINSON MSS. xiii. 88 [upper].

G 7070. SNEFRUKHA'EF  , Treasurer of the King of Lower Egypt, Herdsman of Apis, etc. Middle Dyn. IV to early Dyn. V.

Father, Neferma'et (tomb G 7060).

Stone-built mastaba. LG 56.

Plan XXIX

L. *D. Text*, i, p. 82; MARIETTE, *Mastabas*, pp. 530 [11], 532-4; REISNER, *Giza Necropolis*, i, pp. 60, 116 [29], 209 [32], 309 [g], 381 [4]. Plan, section, and elevation, PRISSE, *L'Art ég.* i, 5th pl. [top], 'Nécropole de Memphis'; L. *D.* i. 25. Plan of chapel, L. *D. Text*, i, fig. on p. 82; cf. MARIETTE, op. cit. fig. on p. 531. View, REISNER in *A.Z.* 64 (1929), on Taf. ii [2] facing p. 98.

Chapel. Synopsis of scenes, JUNKER, *Giza*, iii, p. 45 [37].

(1) Doorway. (a)-(b) Lintel with offering-text and genealogy, found in front of doorway. (c) [1st ed. 1] Deceased followed by son. (d) Similar to (c), with another small son before him.

(a)-(b) REISNER in *A.Z.* 64 (1929), Taf. iii [3]. (c) L. *D.* ii. 16 [upper]; sketch (son omitted), MARIETTE, op. cit. fig. on p. 534. (c) and (d) See REISNER, *Giza Necropolis*, i, p. 316 [7].

(2) False-door of deceased.

L. D. ii. 16 [lower]; MARIETTE, op. cit. fig. on p. 533; PRISSE, op. cit. 5th pl. [middle]; lintel, DE ROUGÉ, *Inscr. hiéro.* pl. lxiv [upper]; REISNER in *A.Z.* 64 (1929), Taf. iii [4]; NESTOR L'HÔTE MSS. 20396, 310; WILKINSON MSS. iii. 17 verso E [upper]; xiii. 86 [middle].

Shaft B.

Sarcophagus (uninscribed), in Cairo Mus. Ent. 54936. DONADONI ROVERI, *Sarcofagi egizi*, Tav. xviii [1], p. 125 [B 38].

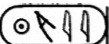
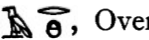
G 7101. MERYRĒ'NŪFER¹  good name KĀR , Overseer of the Pyramid-towns of Khufu and Menkaurē, Inspector of *warb*-priests of the Pyramid of Khephren, Tenant of the Pyramid of Pepy I, etc. Temp. Pepy I or later.

Wife, Gefi , Prophetess of Ḥathor, etc.

Stone-built mastaba.

Plan XXX

To be published by DUNHAM and SIMPSON.

REISNER in *Boston Mus. Bull.* xxiii (1925), pp. 13-14; id. *Giza Necropolis*, i, p. 314 [h]. Texts of I-III with sketch-plan, ČERNÝ Notebook, 122, pp. 5 verso-11. View, *I.L.N.* March 14, 1925, fig. on p. 432 [lower right].

I. Staircase Passage.

(1) Deceased at table.

(2) Deceased, with fish from remains of marsh-scene in front of him. Relief-fragments with deceased and son Idu (tomb, probably, G 7102) hunting, and cat seizing bird, in Boston Mus. 27.1130, 27.1440.

(3) Upper part of scene, deceased at table, in Boston Mus. 27.1134.

SMITH, *Anc. Eg.* (1942), fig. 32; (1952), fig. 33.

II. Court.

(4) Three registers, I, deceased at table before offerings, offering-list, and (above doorway) seven funerary priests, II, coffin carried to purification-tent (*ibw*), funerary priests and female mourner, bound oxen, III (from right), men carrying coffin, and dragging boat with shrine with coffin and mourners to embalming-house (*warbt*), and ceremonies inside.

Omitting scene above doorway, LÜDDECKENS in *Mitt. Kairo*, 11 (1943), Taf. 9-12, pp. 19-21, cf. 5-6. Priests above doorway, see REISNER, *Giza Necropolis*, i, p. 370 [3]. Offering-list in I, HASSAN, *Giza*, vi [2], pls. lxxx-lxxxviii [87], pp. 137-8. II and III, SMITH, *Hist. Eg. Sculp.* fig. 84a, pp. 211, 319; GRDSELOFF, *Das ägyptische Reinigungszelt*, Abb. 8 (from SMITH). Purification-tent, in II, id. ib. Abb. 2; HASSAN, *Giza*, iv, fig. 36; RICKE, *Bemerkungen zur ägyptischen Baukunst* [etc.], ii, in *Beiträge zur ägyptischen Bauforschung*, 5, Abb. 39. Priest and mourner, in II, SMITH, op. cit. fig. 224 [left], p. 340; GRDSELOFF in *Ann. Serv.* xxxix (1939), fig. 18 (from SMITH), p. 399. Bound ox (upper), in II, SMITH, op. cit. fig. 193 [left]. Mourners in boat, in III, see WERBROUCK, *Pleureuses*, p. 15.

(5) [1st ed. 1] Deceased at table and wife standing behind, and two registers of funerary priests performing ceremonies.

REISNER in *Boston Mus. Bull.* xxiii (1925), fig. on p. 26 [top], cf. p. 28. See id. *Giza Necropolis*, i, p. 370 [4].

¹ Textual evidence also permits Meryrē'nūfer Kār to be son of Idu (tomb G 7102).

III. Hall.

View, *I.L.N.* March 14, 1925, fig. on p. 432 [upper left]; BAIKIE, *The Glamour of Near East Excavation*, pl. facing p. 88; id. *Eg. Antiq.* pl. ii [lower]; KARNAGHAN in *Art and Archaeology*, xxxi (1931), fig. on p. 259 [lower] (painting by J. L. SMITH).

(6) [part, 1st ed. 2-4] (a)-(c) Architrave with titles and deceased seated at both ends; (a), (b), (c), (h) name and titles and deceased seated at bottom; (d), (e), (f), (g) deceased standing.

(7) Deceased with dogs under chair, and two sisters below.

Upper part, REISNER in *Boston Mus. Bull.* xxxiv (1936), fig. on p. 98 [upper right].

(8) Deceased carried in palanquin, with attendants and men carrying various articles, and titles above doorway.

See id. *Giza Necropolis*, i, p. 368 [12].

(9) Niche with five statues of deceased and one of son Idu, with titles of deceased above.

Omitting two statues of deceased, *I.L.N.* March 14, 1925, fig. on p. 432 [upper right].

IV. Offering-room.

(10) Doorway. (a)-(b) [1st ed. 5-6] Lintel with offering-text, and jambs with deceased seated; (c) and (d) deceased as lector-priest; (e)-(f) (above doorway) two cooking-scenes; (e) offering-list, and two registers of funerary priests and butchers; (f) three registers, butchers and offering-bringers.

(a) and (b) REISNER in *Boston Mus. Bull.* xxiii (1925), fig. on p. 26 [middle].

(11) Offering-list, and offerings before deceased.

(12) Deceased and wife at table, offering-list, and offerings.

Deceased with ointment-jar, SMITH, *Hist. Eg. Sculp.* fig. 132, p. 286.

(13) False-door, and left of it, offerings with offering-bringers below, right of it, deceased with offerings above.

Finds

Relief-fragment with five rowers, in Boston Mus. 27.1129.

Cylinder seal, in Cairo Mus. Ent. 51902.

G 7102. Idu , Tenant of the Pyramid of Pepy I, Overseer of scribes of the *meret*, Inspector of *warb*-priests of the Pyramids of Khufu and Khephren, etc. Temp. Pepy I or later.

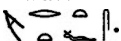
Parents (possibly), Meryrēnūfer Ḳar and Gefi (tomb G 7101).¹ Wife, Mertiotēs .

Stone-built mastaba.

Plan XXX

To be published by DUNHAM and SIMPSON.

REISNER in *Boston Mus. Bull.* xxiii (1925), pp. 14, 28. Texts with sketch-plan, ČERNÝ Notebook, 121, pp. 22 verso-28; 122, pp. 1-5.

Chapel.

(1) Doorway. (a)-(b) [1st ed. 1-2] Conventional biographical text, and below, lintel with

¹ Textual evidence also permits Meryrēnūfer Ḳar to be son of Idu.

long offering-text and deceased standing, and drum with name and titles; (c) deceased standing with son Ɣar; (d) deceased standing, and address to *warb*-priests entering; (e)–(f) lintel, shrine with coffin on sledge, dragged by oxen, leaving embalming-house (*warbt*) (in part on right jamb); (e) four registers, I, men carrying coffin to embalming-house, II, offerings and purification-tent (*ibw*), III, shrine in boat, IV, men with coffin; (f) [part, 1st ed. 3] five registers, I–II, male mourners, III–IV, female mourners, V, house of deceased.

(a)–(b) REISNER in *Boston Mus. Bull.* xxiii (1925), fig. on p. 27 [upper]; text, SETHE, *Urk.* i. 204 [40 (131)]. (c), (d) Upper part, LÜDDECKENS in *Mitt. Kairo*, 11 (1943), on Taf. 5. Inner doorway, id. ib. Taf. 1–8, pp. 16–17, 25, cf. Abb. 7 [left]; SMITH, *Hist. Eg. Sculp.* fig. 84b, p. 211; GRDSELOFF, *Das ägyptische Reinigungszelt*, Abb. 9 (from SMITH); incomplete, GRDSELOFF MSS. 12.1–6 (photos.). (e) I–II, *I.L.N.* Feb. 7, 1925, fig. on p. 222 [upper left]; II, GRDSELOFF, *Das ägyptische Reinigungszelt*, Abb. 3 (from SMITH), p. 10; HASSAN, *Gîza*, iv, fig. 37; RICKE, *Bemerkungen zur ägyptischen Baukunst* [etc.], ii, in *Beiträge zur ägyptischen Bauforschung*, 5, Abb. 40. Embalming-house, and I–IV at (f), WERBROUCK, *Pleureuses*, fig. 1, p. 16. Embalming-house and I–II at (f), REISNER in *Boston Mus. Bull.* xxiii (1925), fig. on p. 26 [bottom]. (f) I–IV, MÜLLER (H.) in *Mitt. Kairo*, 7 (1937), Abb. 49, p. 111; II–III, *I.L.N.* Feb. 7, 1925, fig. on p. 222 [upper right]; mourners, from I, WERBROUCK, op. cit. figs. 61, 76–7, 89, 90, and fig. on p. 160 [bottom right]; from II, figs. 88, 154–5; from III, figs. 79, 86, 160, cf. fig. on p. 160; from IV, figs. 75, 78, 87, 91, 157, cf. figs. on p. 160.

(2) Deceased at table, and small figure of wife holding his leg, with offering-list above and offering-bringers below.

Omitting offering-bringers, *I.L.N.* Feb. 7, 1925, fig. on p. 222 [lower left]. Wife, SMITH, *Hist. Eg. Sculp.* fig. 146 [upper middle]. Offering-list, HASSAN, *Gîza*, vi [2], pls. lxxxix–lxxxviii [88], p. 138.

(3) [1st ed. 4] (a) and (b) List of oils; (c) false-door with bust of deceased below.

Plan and section, REISNER, *Gîza Necropolis*, i, fig. 214. (c) Id. in *Boston Mus. Bull.* xxiii (1925), fig. on p. 13; *I.L.N.* Feb. 7, 1925, fig. on p. 222 [lower right]; BAIKIE, *Eg. Antiq.* pl. ii [upper]; SMITH, op. cit. pl. 57 [a], pp. 38–9; SHOUKRY, *Privatgrabstatue*, Abb. 79; HICKMANN in *Ann. Serv.* liv (1957), pl. ii, p. 213; DAUMAS, *Civ. de l'Ég.* pl. 143; SOGA, *The Nile*, fig. on p. 71.

(4) Deceased at table, and three registers, offerings, offering-bringers, and three groups of butchers.

(5) Deceased seated in palanquin (with sculptor's alterations), and seven registers, I, games, II, dancers and clappers, III, playing draughts and snake-game, IV, harpists, flutist, and singer, V–VI, filling beer-jars, baking, etc., VII, estates (no names).

Deceased and I–V, HICKMANN in *Ann. Serv.* liv (1957), pls. iii–ix, xi, xii, figs. 1, 2, 10, pp. 213–34. Deceased and I, SMITH, op. cit. figs. 96, 82. I–II, TOUNY and WENIG, *Der Sport im Alten Ägypten*, Taf. 41. II–V, HICKMANN, *45 Siècles*, pls. i, ii. III–V, id. in *Archiv Orientalní*, xx (1952), pl. xlvi, p. 451; id. in *Bull. Inst. Ég.* xxxiv (1951–2), figs. 2, 3, pp. 235, 239; id. *Musicologie pharaonique*, figs. 2, 3 on pp. 104–5; id. *Ägypten*, Abb. 60. See REISNER, *Gîza Necropolis*, i, p. 368 [11].

(6) Four registers, men in boats returning from marshes with animals.

(7) Niche with five rock-cut statues of deceased and one (on left) of son Ɣar, all with names and titles.

Three, HICKMANN in *Ann. Serv.* liv (1957), pl. i, p. 213.

G 7110+7120. KAWAḲB  J, King's eldest son of his body,¹ Hereditary prince, Chief lector-priest,¹ etc., and wife HETEPHERES [II] (later, wife of King Raʿzedef). Temp. Khufu.

Parents of KawaḲb, Khufu and Mertiotes [I] (eldest son). Father of Heteperes [II], Khufu.

Stone-built twin-mastaba. See also tomb G 7350.

REISNER, *Giza Necropolis*, i, pp. 115 [1, 2], 118 [1], 125 [5, 7], 151, 307 [bottom a, b]; plan and section, fig. 6.

Masons' graffito with crew-name, on east face. SMITH (W. S.) in *J.N.E.S.* xi (1952), fig. 5 [bottom left], p. 126 [B, 2].

G 7110. Heteperes [II]

Chapel.

Fragment with title of Mertiotes [I]. Id. ib. fig. 3 [lower], pp. 124-5 note 16; REISNER and SMITH, *Giza Necropolis*, ii, fig. 8b, p. 6.

G 7120. KawaḲb

Chapel. Plan, REISNER, op. cit. fig. 113, p. 205 [8].

False-door of Mertiotes [I] (Mariette's 'Stela of Queen Mertiotes'), probably from here, removed and present location unknown. Text, DE ROUGÉ, *Inscr. hiéro.* pl. lxii [middle]; SMITH (W. S.), op. cit. fig. 3 [upper], p. 124; REISNER and SMITH, *Giza Necropolis*, ii, fig. 8a, p. 6 (both from DE ROUGÉ); some titles, DE ROUGÉ, *Recherches sur les monuments* [etc.], pp. 36-7 (repr. in *Bibl. Ég.* xxvi); see MARIETTE, *Mastabas*, p. 565 [vi]; id. *Notice des principaux monuments . . . à Boulaq* (1864), p. 271 [6].

Relief-fragments.

Remains of deceased facing mother, from façade south of entrance doorway. REISNER and SMITH, *Giza Necropolis*, ii, fig. 9, p. 6; SMITH (W. S.), op. cit. fig. 2, p. 124 note 16.

Deceased (?) in boat returning from fowling, with heron and ducks, in Boston Mus. 34.59. REISNER in *Boston Mus. Bull.* xxxii (1934), fig. 3, p. 4; SMITH, *Anc. Eg.* (1942), fig. 16; (1952), fig. 17; (1960), fig. 19; id. *Hist. Eg. Sculp.* fig. 62, pp. 167, 279; id. *Country Life*, fig. 11; id. in *A. J. A.* xlvi (1942), fig. 11 [upper left], p. 525.

Bringing cattle. Id. ib. fig. 11 [two top right], p. 525.

Making mats, in Boston Mus. unnumbered (Exped. No. 24-12-1126). Id. ib. fig. 11 [middle right], p. 525.

Statues. Fragments of between ten and twenty pieces.

Deceased as squatting scribe, lower part, red granite, in Boston Mus. 27.1127. Id. *Hist. Eg. Sculp.* pl. 10 [b], p. 30 [1] (called diorite); see id. *Anc. Eg.* (1942 and 1952), p. 45; (1960), p. 46.

Deceased as squatting scribe holding scroll with offering-list, lower part, black granite, in Boston Mus. unnumbered (Exped. No. 34-4-1). Id. *Hist. Eg. Sculp.* pl. 10 [a], p. 30 [2]; REISNER in *Boston Mus. Bull.* xxxiii (1935), fig. 9, p. 75; see xxxvi (1938), p. 30.

¹ From tomb G 7530 + 7540.



Sloping shaft G 7120A. See id. *Giza Necropolis*, i, pp. 115 [1], 151 [1], 162 [1], 166 [1].

Sarcophagus of deceased, red granite, damaged, in Cairo Mus. Ent. 54937. DONADONI ROVERI, *Sarcophagi egizi*, Tav. xviii [2], p. 113 [B 12].

G 7112.

Superstructure completely destroyed.

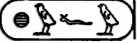
Box-sealing with Horus-name of Neuserrē, found in shaft A. REISNER and SMITH, *Giza Necropolis*, ii, fig. 52, p. 53.

G 7130+7140. KHUFUKHAᶜEF [I] , King's son of his body, Chief Justice and Vizier¹ (probably of Khufu), etc., and wife NEFERTKAU . Temp. Khufu to end of Dyn. IV.

Parents of Khufukhaᶜef [I], Khufu and probably Hēnutsen.

Stone-built twin-mastaba.

G 7130. Nefertkau. Shaft G 7130B, see p. 190

Chapel and shaft G 7130A. REISNER, *Giza Necropolis*, i, pp. 115 [10], 120 [10], 205 [12], 308 [1].

Relief-fragment with head of man, perhaps from Chapel, found in Temple of Isis (see p. 17), in Boston Mus. 34.60. APPEL, *Skin Beauty and Health*, fig. 2, p. 11. See SMITH, *Anc. Eg.* (1942 and 1952), p. 36; (1960), p. 38.

G 7140. Khufukhaᶜef [I]

Masons' graffito with date. Id. in *J.N.E.S.* xi (1952), fig. 7 [bottom right], p. 127 [8].

Chapel. Altered by Ptolemaic cuttings.

Plan XXX

Plans and sections, REISNER, op. cit. figs. 114, 194, pp. 206 [14], 308 [j]. Synopsis of scenes, JUNKER, *Giza*, iii, p. 46 [40]. Texts with plan, DARESSY in *Ann. Serv.* xvi (1916), pp. 257-67 (often incorrect); ČERNÝ Notebook, 121, pp. 1-10. See MARIETTE, *Mastabas*, pp. 562-4; id. *Notice des principaux monuments . . . à Boulaq* (1864), pp. 270-1 [4].

I. Hall. b of Reisner.

(1) [1st ed. 1-2] Doorway. (a) and (b) Offering-texts with large figures of Anubis-jackals. [DARESSY, 258] Jackal at (b), SMITH, *Hist. Eg. Sculpt.* fig. 104 [1].

(2) [1st ed. 3] Deceased preceded by mother, and three registers behind, scribes, officials, [ka-servants].

[DARESSY, 258-9] REISNER in *Boston Mus. Bull.* xxxii (1934), fig. 9, p. 12; STAEHELIN, *Tracht*, Taf. xvi [24]. Deceased and mother, JUNKER in *Anzeiger, Wien*, 90 (1953), pl. facing p. 174, cf. pp. 171-5; id. *Giza*, xii, Abb. 11; SMITH, op. cit. pl. 44 [b]. Sistrum-ornament on costume of deceased, id. ib. fig. 191 [middle], p. 317. Text of mother, DE ROUGÉ, *Inscr. hiéro.* pl. lxi [middle right].

(3) [1st ed. 4] Deceased with small son, and three registers behind, two sons squatting and scribes.

¹ On statue Cairo Mus. 46.

[DARESSY, 259] SMITH, op. cit. pl. 43 [b], p. 304. Names of sons, DE ROUGÉ, op. cit. pl. lxi [lower middle left].

II. Inner Hall. a of Reisner.

(4) [1st ed. 5-7] Doorway. (a) Drum with name and titles; (b) deceased seated, with wife behind, receiving accounts from two sons, and lists of linen and oils; (c) deceased seated, with small daughter behind, receiving accounts from two sons, and lists of animals and fowl.

(a) [DARESSY, 261] Text, DE ROUGÉ, op. cit. pls. lx [middle], lxi [3rd line from top]. (b) [DARESSY, 260] Titles of deceased, id. ib. pl. lxi [lower right]. (c) [DARESSY, 261] Titles of deceased, id. ib. pl. lxi [lower left]. (b) and (c) See REISNER, *Giza Necropolis*, i, p. 318 [23].

(5) [1st ed. 8] Deceased seated, with daughter standing behind, and four registers, I, vessels, II, presenting linen (with boxes behind) and oils, III, presenting oils, IV, presenting garments.

[DARESSY, 262-3] Part of figure of deceased, and man in IV, SMITH, *Hist. Eg. Sculp.* pl. 42 [c], p. 161. Daughter, id. ib. fig. 152. Two men with linen, from II, id. in *Ä.Z.* 71 (1935), fig. 2, p. 140. Two men holding garment, from IV, id. in *J.E.A.* xix (1933), fig. 1, p. 155. Stand with vases, PETRIE, *A Season in Egypt*, pl. xxv [top middle], pp. 32-3 [49].

(6) [1st ed. 9] Deceased at table, with two registers of funerary priests, and offering-list above.

[DARESSY, 263] Deceased (incomplete), SMITH, *Hist. Eg. Sculp.* fig. 142. Priests, REISNER in *Boston Mus. Bull.* xxxii (1934), fig. 4, p. 7. Text above deceased, DE ROUGÉ, *Inscr. hiéro.* pl. lxi [upper middle left].

(7) [1st ed. 10] Four registers, estates with animals on leash.

[DARESSY, 264] REISNER in *Boston Mus. Bull.* xxxii (1934), on fig. 2, p. 4. Names, DE ROUGÉ, op. cit. pl. lx [lower first four]; JACQUET-GORDON, *Domaines*, pp. 207-8 [2G4], Nos. 6-9, cf. figs. 14 (from REISNER), 15.

(8) [1st ed. 11] False-door of deceased, with doorway to later burial chamber cut through middle of it. (a) and (b) Five registers of offering-bringers on each; (c) and (d) offering-stands; (e) panel with deceased at table, and offering-list, lintel and drum with texts.

[DARESSY, 264-5] Left part, REISNER in *Boston Mus. Bull.* xxxii (1934), on fig. 2, p. 4. Man pouring water, in III at (a), SMITH, *Hist. Eg. Sculp.* fig. 174c. Offering-stand, PETRIE, *A Season in Egypt*, pl. xxv [left], p. 32 [48].

(9) [1st ed. 12] Deceased and wife, and five registers, I, estates bringing fowl, II, scribes, III, censuring, bringing garment, etc., IV, bringing food, V, bringing fowl and animals.

[DARESSY, 265-7] Omitting top register, REISNER in *Boston Mus. Bull.* xxxii (1934), figs. 6a, 6b, p. 10. Deceased and wife, DONADONI, *Arte Egizia*, fig. 43 (called Boston); GILBERT in *Chron. d'Ég.* xxxi (1956), fig. 6, p. 230. Upper part of figures, SMITH, *Hist. Eg. Sculp.* pl. 43 [a], fig. 109, p. 275; id. *Art. . . Anc. Eg.* pl. 35, p. 61; ALDRED, *O.K. Art.* pl. 37; id. *Jewels of the Pharaohs*, pl. 15; id. in PIGGOTT, *The Dawn of Civilization*, pl. on page 113 [33]; JUNKER, *Giza*, xii, Abb. 12; GALASSI in *La Critica d'Arte*, n.s. ii (1955), fig. 252, p. 313; DRIOTON and DU BOURGUET, *Les Pharaons à la conquête de l'art*, pl. 14 [lower]; WOLDERING, *Götter*, fig. on p. 229 [Kat. 44] (called Boston Mus.); WESTENDORF, *Das Alte Ägypten*, fig. on p. 49; SOGA, *The Nile*, fig. on p. 56 [right]. Names of estates in I, JACQUET-GORDON, *Domaines*, pp. 207-8 [2G4], Nos. 1-5, cf. figs. 14 (from REISNER), 15; estates Nos. 2-5 (of JACQUET-GORDON), DE ROUGÉ, *Inscr. hiéro.* pl. lx [lower last four]. Two men bringing garment, from III, SMITH (W. S.) in *J.E.A.* xix (1933), fig. 2, p. 155. Man carrying calf, from V, id. *Hist. Eg. Sculp.* fig. 235 [right], p. 362.

(10) [1st ed. 13] Deceased leaning on staff, with wife facing him.

[DARESSY, 267] REISNER in *Boston Mus. Bull.* xxxii (1934), fig. 1, p. 12; KARNAGHAN in *Art and Archaeology*, xxxi (1931), fig. on p. 258 [upper] (from painting by J. L. SMITH); DONADONI, *Arte Egizia*, fig. 44 (called Boston); JUNKER, *Giza*, xii, Abb. 13, p. 139. Upper part of figure of deceased, SMITH, *Art . . . Anc. Eg.* pl. 38, p. 61; id. in *Archaeology*, 16 (1963), fig. 9, pp. 8-9, cf. fig. 14.

Shaft G 7130B. With two rooms and burial chamber. Altered by Ptolemaic cuttings.

Sarcophagus, red granite, fragments. See REISNER, *Giza Necropolis*, i, pp. 115 [9], 118 [9], 121, 167 [5].

Statues.

Deceased (headless) seated, with feet missing, diorite, found in Temple of Isis (see p. 17), in Cairo Mus. 46, and adjoining fragment of base with name, found by Reisner, in Boston Mus. unnumbered (Exped. No. 24-12-962). REISNER and SMITH, *Giza Necropolis*, ii, fig. 11, p. 10. Cairo Mus. 46, BORCHARDT in *A.Z.* xxxvi (1898) Abb. 10, p. 14; id. *Statuen*, i, Bl. 12, p. 42; see MASPERO, *Guide*, p. 39 [74]; SMITH, *Hist. Eg. Sculp.* p. 31 [4].

Min^cankh, Royal acquaintance, seated, lower part, Dyn. V, from shaft G 7130X. See id. ib. p. 76.

G 7142.

False-door, Nubka  (woman) at table, Dyn. V-VI, in Boston Mus. 27.1131.

Lintel, Kameni , at table, and offering-text, probably Dyn. V, in Boston Mus. 27.1132. GARDINER MSS. photo. 28.401 [upper left].

G 7150. KHUFUKHA^cEF [II]  Greatest of the Ten of Upper Egypt, Belonging to the foremost seat, Secretary of his Lord. Temp. Neuserr^c.

Stone-built mastaba.

Plan XXX

West face.

Name and titles of deceased. CAPART, *L'Art ég.* i, on pl. 26; PETRIE in SAYCE MSS. 17a [top].

Pillared Exterior Room. REISNER, *Giza Necropolis*, i, p. 313 [bottom, d].

(1) Doorway. (a)-(b) Lintel with offering-text; (c) and (d) deceased and wife.

(a)-(b) Titles of deceased, DE ROUGÉ, *Inscr. hiéro.* pl. lxi [2nd line].

(2) Destroyed scene above doorway, and eight registers, netting fowl and fish, boats, harvest, granaries, etc.

(3) Deceased, and five registers, butchers, bringing animals, dancers receiving gifts, and estates.

Dancers, see SMITH, *Hist. Eg. Sculp.* p. 198. Names of estates, JACQUET-GORDON, *Domaines*, p. 278 [32G5], figs. 71-2.

(4) Deceased and wife at table, and five registers, offerings and funerary priests, two registers of offering-bringers, and two of butchers.

(5) Palace-façade decoration.

See REISNER, *op. cit.* p. 382 [h, i].

(6) False-door of deceased.

(7) Four registers of offering-bringers, cooks, and jewellers.

See SMITH, *op. cit.* p. 198.

(8) Pillar. Deceased, on all faces.

(9) Architrave. (a)-(b) Row of figures of deceased with titles.

G 7152. SEKHEM^cANKHPTAH , Chief Justice and Vizier, etc.
Late Dyn. V or Dyn. VI.

Stone-built mastaba.

Plan XXIX

Chapel. Right of doorway, false-door of Buntüfer , King's daughter of his body.

View of doorway with two seated statues, LAMBRINO, *L'Égypte*, fig. on p. 39; MICHALOWSKI, *Art*, fig. 852. Texts, ČERNÝ Notebook, 122, pp. 12 verso-15 (with sketch-plan). See SMITH, *Hist. Eg. Sculp.* p. 200 [top]; REISNER, *Giza Necropolis*, i, pp. 210 [39], 312 [v].

(1) False-door of deceased with conventional biographical text on the rear wall of niche.

(2) Deceased, and four registers of presentation of animals and fowl.

(3) Originally two registers, with men tending cattle at bottom.

(4) Deceased with wife and daughter, and two registers of harvest.

G 7210+7220. HĀRZEDEF , King's son of his body, Count, Keeper of Nekhen, etc., and his wife. Temp. Khufu to late Dyn. IV.

Parents, Khufu and probably Mertiotet [I].

Stone-built twin-mastaba.

REISNER, *Giza Necropolis*, i, pp. 115 [3, 4], 118 [3, 4], 121, 125 [1, 6], 129, 149, 205 [9], 308 [upper, d], cf. fig. 195; JUNKER in *Studi Rosellini*, ii, pp. 136-40.

Masons' graffiti with name of crew of Khufu, on east face. SMITH (W. S.) in *J.N.E.S.* xi (1952), fig. 5 [middle left], p. 126 [B, 1].

G 7220. Hārzedef

West wall. False-door of deceased; name and titles on drum, BRUNNER-TRAUT in *A.Z.* 76 (1940), p. 7; offering-bringers on jambs, see REISNER, *op. cit.* p. 327 [c, 2]. Offering-bringers south of false-door, see *id. ib.* p. 344 [1].

Shaft G 7220A. With two rooms.

Sarcophagus (unfinished) of Hārzedef, red granite, in Cairo Mus. Ent. 54938. CURTO, *Gli Scavi*, Tav. xxxi [b], fig. 27 [a], p. 73; DONADONI ROVERI, *Sarcophagi egizi*, Tav. xvi [1], p. 112 [B 10] (called 6193); see *Descr. somm.* No. 6193 (name not given).

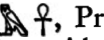
G 7211. KAEM^cANKH , Prophet of Rē^c in the Sun-temple of Menkauhor, Prophet of the Pyramid of Menkauhor, Inspector of administrators of the Treasury, etc. Late Dyn. V or Dyn. VI.

Stone-built mastaba.

Plan XXX

- (1) and (3) Offering-bringers. (2) False-door of deceased. (4) Cattle crossing water.
(5) Procession of estates.



False-door of Kha , Overseer of craftsmen, Noble of the King, Adorer of H̄arzedef, etc., Dyn. VI, found here, in Boston Mus. unnumbered (Exped. No. 25-1-319), now on permanent loan to Providence, Rhode Island School of Design. GOEDICKE in *Ann. Serv.* lv (1958), pl. i, pp. 35-55.

G 7244-6. Dyn. V.

Composite stone-built mastaba.

G 7244

Chapel. Khuentah , Keeper of the legs of the Great House.

Mother, Intkaes . Wife, Khenut .

Plan XXX

Plan, REISNER, *Giza Necropolis*, i, fig. 181, p. 285 [top, 2].



(1) Entrance doorway. (a)-(b) Unfinished lintel.

(2) and (4) False-doors of deceased.

(3) Offering-list with deceased at table. List, HASSAN, *Giza*, vi [2], pls. lxxv-lxxxii [77], p. 135.

(5) Pillar. (a) Mother; (b) and (c) deceased; (d) wife.

G 7248.

False-door of Mesthu , ka-servant, and wife Nubhotp , Dyn. V-VI, from shaft A, in Boston Mus. 27.1117.

G 7249. MENIB . Dyn. IV-V.

Stone-built mastaba.

REISNER, *Giza Necropolis*, i, p. 311 [i].

West wall. Between two false-doors, offering-list with deceased at table and funerary priests, right end of wall, deceased standing.

Box-sealing with Horus-name of Neuserre, from shaft A. REISNER and SMITH, *Giza Necropolis*, ii, fig. 54, p. 53.

G 7330+7340. Middle or late Dyn. IV.

Stone-built twin-mastaba.

Plan and section, REISNER, *Giza Necropolis*, i, fig. 17, p. 206 [16].

Sarcophagus (uninscribed) with panther-skin in relief on lid, and palace-façade decoration, from shaft of G 7340, in Cairo Mus. Ent. 54934. LEIBOVITCH, *Anc. Eg.* fig. 46; lid, GAUTHIER in *Ann. Serv.* xxx (1930), pl. iii, p. 177; DONADONI ROVERI, *Sarcofagi egizi*, Tav. xxiii [2], xxiv, xl, p. 123 [B 33] (called 6170); palace-façade decoration on one end, LANGE and HIRMER, *Ägypten. Architektur* (1967), pl. v; FORMAN (W. and B.) and VILÍMKOVÁ, *Eg. Art.*, pl. 9; see *Descr. somm.* No. 6170.

G 7350. HETEPHERES [II] (?). End of Dyn. IV.

Husbands, Kawaḥb (tomb G 7120) and later King Ratzedef.

Stone-built mastaba. See also tomb G 7110.

REISNER, *Giza Necropolis*, i, p. 207 [20], cf. fig. 85; plan of interior chapel, fig. 116.

Masons' graffito with date. SMITH (W.S.) in *J.N.E.S.* xi (1952), fig. 7 [top left], p. 127 [10]; see REISNER, op. cit. p. 73 note 2.

Block with heads of Hetepheres [II] (?) and Meresankh [III] (?), in Cairo Mus. Ent. 54939. SMITH, *Hist. Eg. Sculp.* pl. 45 [a], pp. 164-5, 302; see *Descr. somm.* No. 6172.

Shaft A.

Sarcophagus, red granite. REISNER, op. cit. pp. 116 [22], 118 [21], cf. 149.

G 7391. ITETI $\text{I} \text{ḫ} \text{t} \text{t} \text{y}$, Inspector of *warb*-priests of the Pyramid of Khephren, Inspector of the Great House, etc. Late Dyn. V.

Wife, Sentankh $\text{I} \text{ḫ} \text{t} \text{t} \text{y} \text{ḫ} \text{t}$, Royal acquaintance.

Stone-built mastaba.

Plan XXX

CURTO, *Gli Scavi*, pp. 34-46; BALLERINI, *Notizia*, pp. 47-50; REISNER, *Giza Necropolis*, i, p. 312 [u]. Plans and sections, CURTO, op. cit. figs. 4, 5; BALLERINI, op. cit. fig. on p. 46 [upper]. Views, CURTO, op. cit. Tav. iv-vi [a]; titles and family, p. 45.

East face.

(1) False-door of deceased, with family and offering-bringers on jambs, in Turin Mus. Sup. 1843.

Id. ib. Tav. vii, fig. 7, pp. 39-41, cf. Tav. v.

(2) (a) and (b) Painted row of geese, in Turin Mus. Sup. 1851-2.

Id. ib. Tav. viii [a, b], pp. 41-2.

Chapel. Id. ib. pp. 35-9.

(3) Doorway. (a) and (b) Offering-bringers; (c) and (d) sons; (e) deceased and wife seated; (f) deceased, and sons as funerary priests before him; (g) drum with name and titles.

Disposition and texts, id. ib. fig. 6.

(4) Remains of marsh-scene with hippopotami (above doorway), and boats. (5) Deceased seated, and offering-list. (6) False-door of deceased. (7) Deceased with wife and small daughter, and three registers, offering-bringers, family and *ka*-servants, butchers.

Disposition and texts, id. ib. fig. 8. (7) Deceased and wife, id. ib. Tav. vi [b]; wife, SMITH, *Hist. Eg. Sculp.* fig. 150 [lower left], p. 297.

(8) Deceased before offerings, and two registers below, family and offering-bringers.

Disposition and texts, CURTO, op. cit. fig. 9. Two offering-bringers, SMITH, op. cit. fig. 186, p. 316.

Finds

Head and lower part of seated statue of deceased, in Turin Mus. Sup. 1876. CURTO, op. cit. Tav. ix-xi, pp. 42-5; id. in *Aegyptus*, xxviii (1948), pp. 199-212 with pl.; see FARINA, *Il Regio Museo*, p. 11; SMITH, op. cit. pp. 56-7; BALLERINI, op. cit. p. 52 note 1.

KA I , Royal acquaintance. Dyn. V-VI.

Stone-built mastaba east of tomb G 739I. Position not marked on plan.

CURTO, *Gli Scavi*, pp. 46-50 [B]; BALLERINI, *Notizia*, p. 49 note 2, p. 51 note 1. Plan, CURTO, op. cit. fig. 10.

Chapel.

False-door of deceased, with family and offering-bringers on jambs, and offering-stands at bottom, in Turin Mus. Sup. 1844. Id. ib. Tav. xii, fig. 12, pp. 46-8.

Smaller false-door of deceased, with family on jambs, in Turin Mus. Sup. 1845. Id. ib. Tav. xiii, fig. 13, pp. 49-50.

G 7410+7420. MERES'ANKH [II]  ♀, King's daughter of his body, King's wife, etc., and probably HARBAF , King's son. Temp. Khufu to early Dyn. V.

Parents of Meres'ankh [II], Khufu and probably Mertioties [I]. Father of Harbaf, probably Khufu.

Stone-built twin-mastaba.

REISNER, *Giza Necropolis*, i, pp. 115 [7, 8], 121, 125 [2, 3], 205 [11], 308 [g, h].

G 7410. Meres'ankh [II]

Chapel.

Relief-fragments, deceased punted in boat, and part of papyrus and bird's wing from marsh-scene, in Boston Mus. 33.720. SMITH (W. S.) in *A. J. A.* xlvi (1942), fig. 11 [lower left], p. 525; id. *Hist. Eg. Sculp.* fig. 63, p. 291.

Shaft G 7410B. With two rooms.

Plan and section of recess, REISNER, op. cit. fig. 74, p. 166 [3].

Sarcophagus of Meres'ankh [II], with Anubis-jackal on lid and offering-lists on ends, red granite, in Boston Mus. 27.441. DONADONI ROVERI, *Sarcofagi egizi*, Tav. xxx, xxxi, p. 116 [B 18]; lid and side, D. D[UNHAM] in *Boston Mus. Bull.* xxv (1927), figs. on p. 97; text on lid, SETHE, *Urk.* i (1933), 156 [6 (97)]; see SMITH (W. S.) in *J. E. A.* xix (1933), p. 152.

G 7420. Probably Harbaf

Chapel.

Relief-fragments with estates, in Boston Mus. Names, JACQUET-GORDON, *Domaines*, p. 210 [4G4].

Shaft G 7420A. Plan and section, REISNER, op. cit. fig. 21, pp. 166-7 [4].

Sarcophagus of Harbaf, red granite, probably from here, in Cairo Mus. 1788. BORCHARDT, *Denkmäler*, ii, Bl. 111, pp. 206-7; SCHMIDT, *Sarkofager*, fig. 211; DONADONI ROVERI, *Sarcofagi egizi*, Tav. xxvi [1], pp. 112-13 [B 11]; text, DE ROUGÉ, *Inscr. hiéro.* pl. lxvi [upper middle]; see MARIETTE, *Notice des principaux monuments . . . à Boulaq* (1864), pp. 272-3 [11]; (1874), p. 93 [6]; MASPERO, *Guide*, p. 28 [42]; REISNER, op. cit. p. 168 [2].

Shaft G 7420B.

Small nude female statuette, wood, Dyn. VI, intrusive. See SMITH, *Hist. Eg. Sculp.* p. 92.

G 7411. KAEMTHENENT  Dyn. V.

Stone-built mastaba.

Wife, Hathornufer 

Plan XXX

Chapel.

(1) (a) and (b) Deceased with son. (2) Deceased seated, and dancers below. (3) Two registers, an offering-bringer in each. (4) False-door of wife.

(5) Two registers, two men in each.

Man censeng, from II, SMITH, *Hist. Eg. Sculp.* fig. 185 [lower right], p. 316.

(6) Two remaining registers of harvest-scenes, including reaping, donkeys, piling up sheaves, etc.

See id. ib. p. 310.

G 7430+7440. MINKHAC'EF , King's son of his body, Chief Justice and Vizier (of Khephren), etc. Temp. Khufu to Khephren.

Parents, Khufu and possibly Henutsen.

Stone-built twin-mastaba. G 7430 is LG 61.

Plans and sections, REISNER, *Giza Necropolis*, i, fig. 7, p. 205 [13]; of south chapel G 7440, fig. 115, pp. 206-7 [17]. Titles, SMITH (W. S.) in *J.E.A.* xix (1933), p. 150.

G 7430

North subsidiary niche.

Remains of text with date. Id. in *J.N.E.S.* xi (1952), fig. 4 [top], p. 126 [A, 3].

Chapel. L. D. *Text*, i, p. 85, with sketch-plan.

Drum of entrance doorway with name and titles. L. D. ii. 82 [d].

Fragment of lintel with offering-text and titles of deceased, in sunk relief, possibly from here. SMITH, *Hist. Eg. Sculp.* pl. 46 [a], p. 251.

Relief-fragment, part of squatting man with leash, probably from hunting-scene, in Boston Mus. unnumbered. Id. in *A.J.A.* xlvi (1942), fig. 11 [bottom right], p. 525; id. *Hist. Eg. Sculp.* fig. 65, p. 167.

Shaft G 7430A. With two rooms. REISNER, *op. cit.* pp. 115 [15], 118 [15], 121, 167 [6].

Sarcophagus of deceased with palace-façade decoration and offering-list, red granite, in Cairo Mus. Ent. 48852. SMITH (W. S.) in *J.E.A.* xix (1933), pls. xxi-xxiv, pp. 150-9; DONADONI ROVERI, *Sarcofagi egizi*, Tav. xxxii, xxxiii, pp. 117-19 [B 21]; see MASPERO, *Guide*, p. 25 [32].

G 7450.

Fragment with remains of incised date ('Union of the Two Lands'), from débris. SMITH (W. S.) in *J.N.E.S.* xi (1952), fig. 8 [upper middle], p. 128 [13].

G 7491.

Mummy-mask, plaster, from burial chamber of shaft B, in Cairo Mus. Ent. 54942. Id. *Hist. Eg. Sculp.* pl. 9 [f], p. 27 [1].

G 7510. 'ANKH-ḤAF . (Vizier of Khephren.) Temp. Khephren.

Parents, Snefru and a minor Queen. Wife, Hetepheres (eldest daughter of Hetepheres [I] (tomb G 7000X) and Snefru).

Stone-built mastaba. No burial place for wife.

Plan XXXI

Plan and section, REISNER, *Giza Necropolis*, i, fig. 8, p. 41. Plan of chapel, DUNHAM in *Boston Mus. Bull.* xxxvii (1939), fig. on p. 43.

I. Exterior Room. d of Reisner.

Bust¹ (of deceased), in Boston Mus. 27.442. SCHÄFER and ANDRAE, *Kunst* (1942), Taf. iv facing p. 234; DUNHAM in *The Art Quarterly*, ii (1939), pl. on p. 279, cf. pp. 285-6; id. in *Boston Mus. Bull.* xxxvii (1939), figs. on pp. 41-2, 44-6; xli (1943), fig. on p. 10, and fig. 5, p. 71; id. *Eg. Department*, frontispiece (fig. 26); id. in *Apollo*, xci (Jan. 1970), fig. 6, p. 18; CAPART in *Chron. d'Ég.* xiv (1939), pp. 237-44 with fig.; id. *L'Art ég.* ii, pls. 230-2; SMITH (W. S.) in *A. J. A.* xlv (1941), fig. 1, p. 522; id. *Anc. Eg.* (1942), fig. 18; (1952), fig. 19; (1960), fig. 17; id. *Hist. Eg. Sculp.* pls. 14, 15 [a], pp. 38-9; id. *Art . . . Anc. Eg.* pl. 44 [A], pp. 62-3; GALASSI, *Tehenu* [etc.], figs. 94-5; *J. E. A.* 29 (1943), pl. i; SEGALL in *Baltimore. Journal of the Walters Art Gallery*, ix (1946), fig. 5, pp. 56-7; BUSCHOR, *Bildnistufen*, Abb. 121; *Handbook* (1947), fig. on p. 7; (1964), fig. on p. 169; RANKE, *Meisterwerke*, Abb. 10, 11; ALDRED, *O. K. Art*, pls. 23-4; SHOUKRY, *Privatgrabstatue*, Abb. 6; WILSON, *The Burden of Egypt*, fig. 8b; LANGE, *Pyramiden*, pl. 12; id. and HIRMER, *Aegypten. Architektur* (1955 and 1957), pl. 21; (1967), pl. 24; SAINTE FARE GARNOT, *L'Égypte*, fig. on p. 78 [top]; SPIEGEL, *Hochkultur*, Taf. 22-3; BRUNNER in *Forschungen und Fortschritte*, 28 (1954), Abb. 3, p. 332; SMITH (J. L.), *Tombs, Temples, and Ancient Art*, pl. facing p. 161 [left] (painting); SHOOLMAN and SLATKIN, *The Enjoyment of Art in America*, pl. 9; WOLDERING, *Ägypten. Die Kunst der Pharaonen*, pl. on p. 81; id. *Götter*, Abb. 27; POULSEN, *Äg. Kunst. A. und M.* pl. on p. 2; WESTENDORF, *Das Alte Ägypten*, fig. on p. 39; MICHALOWSKI, *Art*, fig. 191. Head, BYVANCK, *De Kunst*, pl. xvi [58]; LLOYD, *The Art of the Ancient Near East*, fig. 30; TERRACE in *Boston Mus. Bull.* lix (1961), fig. 8, p. 48; id. in *The Connoisseur*, clxviii (1968), fig. 11, p. 204; ALDRED in PIGGOTT, *The Dawn of Civilization*, pl. on p. 113 [32]; MONTET, *Eternal Egypt*, pl. 34.

II. Interior Offering-room. a of Reisner.

Plan, REISNER, op. cit. fig. 122, pp. 212 [4], 308 [1, b].

Fragment with masons' graffito with date, from débris. SMITH (W. S.) in *J. N. E. S.* xi (1952), fig. 8 [lower right], p. 128 [12].

Relief-fragments with name and titles of wife. REISNER and SMITH, *Giza Necropolis*, ii, fig. 10, p. 11.

(1) Relief-fragment with head of ibex(?), probably from here, in Boston Mus. 30.836.

SMITH, *Hist. Eg. Sculp.* pl. 40 [c], p. 160.



(2) Relief-fragments. Estates, in Boston Mus. 34.1468, 30.838, 30.837; id. ib. pl. 40 [a, d, e], p. 160; names, JACQUET-GORDON, *Domaines*, p. 209 [364]. Child behind deceased, and men with clasped hands, still *in situ*; SMITH, op. cit. pl. 40 [b], fig. 139 [right], p. 288.

Shaft X.

Fragment of scribe-stature, with remains of text, diorite. See SMITH, *Hist. Eg. Sculp.* p. 76.

¹ Selected references.

G 7524.

Four canopic-jars of Haremakheth , son of Hedebiru  (woman), Dyn. XXVI, from shaft A, in Boston Mus. 29.1133-6.

G 7530+7540. MERESANKH [III] , King's daughter of his body, etc. Temp. Khufu to Shepseskaf.

Parents, Kawa'b (tomb G 7120) and Hetepheres [II] (tombs G 7110, 7350). Husband, Khephren.

Stone-built twin-mastaba. Some relief-fragments in Boston Mus.

Complete, DUNHAM and SIMPSON, *The Tomb of Mersyankh III*, in preparation. See REISNER, *Giza Necropolis*, i, p. 207 [18].

Masons' graffiti with dates and name of mother. SMITH (W. S.) in *J.N.E.S.* xi (1952), fig. 7 [upper and middle right], p. 127 [9]; see REISNER, op. cit. p. 73.

G 7530

Chapel. Rock-cut, under north part of east face of mastaba. Decoration unfinished.

Plan XXX

REISNER, *The Tomb of Meresankh* [etc.] in *Boston Mus. Bull.* xxv (1927), pp. 64-79 with figs. (quoted here as REISNER). Plan and section, id. *Giza Necropolis*, i, fig. 131, cf. 203, pp. 225-6 [8], 310 [e]. Synopsis of scenes, JUNKER, *Giza*, iii, pp. 46-7 [41]. Texts and description with sketch-plan, ČERNÝ Notebook, 121, pp. 11-22.

Room I. a of Reisner.

(1) Doorway. (a)-(b) Lintel with name and titles; (a) and (b) texts giving dates of death and funeral (probably temp. Shepseskaf); (c) and (d) offering-texts with large figures of Anubis-jackals, and deceased with two female attendants behind at each, and before her Khemtnu (tomb G 5210) handing in accounts of craftsmen at (c), and two men bringing oryx and hyena at (d); (e) drum with name and titles.

Views from outside, REISNER, figs. 1, 16; (a)-(b) fig. 18, p. 74; texts on jambs, SETHE, *Urk.* i (1933), 156-7 [7 (98) A, B]; SMITH (W. S.) in *J.N.E.S.* xi (1952), fig. 4 [bottom], p. 126 [A, 1]. (c) REISNER, fig. 17; deceased, SMITH, *Hist. Eg. Sculpt.* fig. 133; text of Khemtnu, SETHE, *Urk.* i (1933), 157 [7 (98), C]. (d) Man with oryx, SMITH, op. cit. pl. 47 [b], p. 167. (c) and (d) See REISNER, *Giza Necropolis*, i, p. 317 [11].

(2) Five registers, I-II, two boats in each, III, sculptors carving and painting statues, men dragging statues, IV, men making sarcophagus, shrine, and false-door, V, men with blow-pipes melting gold and making palanquin.

REISNER, figs. 11, 12, pp. 78-9. Inkaf , Sculptor, with painter, from III, SMITH, op. cit. fig. 232, p. 351. See REISNER, *Giza Necropolis*, i, pp. 350-1 [1], 367 [2].

(3) Upper part, deceased seated holding lotus-flower in each hand, and three registers of officials, offering-bringers, and butchers, lower part, continued from (2), Raḥay  painting statue, two servants making bed under canopy, and two sub-registers, men and women with furniture and various objects in each (also monkey and female dwarf), bottom, three niches with scribe-statues of six funerary priests (no texts).

REISNER, fig. 13, pp. 68, 70. Painter, SMITH, op. cit. fig. 233, p. 351. Making bed, id. ib. fig. 67. See REISNER, *Giza Necropolis*, i, pp. 348 [3], 351 [top]. Statues, see SMITH, op. cit. pp. 43-4.

(4) False-door, with deceased at table on panel, and Khemtnu left of it.

Lion-seat of deceased, SMITH, op. cit. fig. 13 [left], p. 291.

(5) Deceased, with offering-text on architrave above.

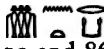
(6) Mother with small girl kneeling behind her, followed by deceased with small son Khenterka  holding lotus-flower and hoopoe, and Nebemakhet (son of deceased, tombs LG 12 and 86) followed by three small children (no names).

REISNER, fig. 5, pp. 66-7; GALASSI, *Tehenu* [etc.], fig. 99; *I.L.N.* July 9, 1927, fig. 4, p. 69. Upper part, SMITH, op. cit. pl. 44 [a, c], pp. 163, 250, 279; of mother and deceased, REISNER, fig. 7. Mother with deceased and Khenterka, HÖLSCHER (W.), *Libyer und Ägypter*, Abb. 2, p. 28; WENIG, *Die Frau*, pl. 9 (colour). Upper part of mother, GALASSI in *La Critica d'Arte*, n.s. ii (1955), fig. 253 (called 263), p. 313. Omitting mother, id. ib. fig. 251, p. 313; REISNER, fig. 6. Deceased with Khenterka, STAEBELIN, *Tracht*, Taf. x [16].

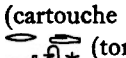
(7) and (8) Pillars. Deceased facing inwards, with small sons Neuserrē^c-ankh  (cartouche and ^cankh added later, tomb of Neuserrē^c, see p. 234) at (7), and Dua(en)rē^c  (tomb G 5110) at (8). Architraves with offering-text and name and titles.

REISNER, on figs. 3, 4, and on p. 63 (cover), cf. p. 73; *I.L.N.* July 9, 1927, on figs. 1-3, p. 69; CAPART, *Memphis*, on fig. 323; SHOUKRY, *Privatgrabstatue*, on Abb. 76; SMITH, *Art . . . Anc. Eg.* on pl. 46 [B], p. 63; ATARASHI, *Egypt*, pl. 7; MÜLLER (H. W.), *Ägyptische Kunst*, on Abb. 30.

(9) Father with staff facing left, deceased and mother in boat pulling papyrus, and four registers, I, estates, II, netting fowl, with two sub-registers, mat-making, and putting birds in cage, and plucking, III, men bringing fowl and cattle, IV, boats with boatmen jousting and sheep treading grain.

REISNER, fig. 8, cf. 2; SMITH, *Art . . . Anc. Eg.* pl. 46 [A], p. 61; id. in *Archaeology*, 16 (1963), fig. 8, p. 8; see REISNER, *Giza Necropolis*, i, p. 349 [3]. Father, REISNER, fig. 9, p. 64; SMITH, *Hist. Eg. Sculp.* fig. 110, pp. 276, 304; ALDRED in PIGGOTT, *The Dawn of Civilization*, pl. on p. 114 [38]. Deceased and mother in boat, REISNER, fig. 10, p. 66; DUNHAM in *Boston Mus. Bull.* xxxvii (1939), fig. 3, p. 63; SMITH, op. cit. fig. 64; ALDRED in PIGGOTT, op. cit. pl. on p. 115 [39]; SMITH (J. L.), *Tombs, Temples, and Ancient Art*, pl. facing p. 144 (painting); Boston, Mass. *In Tribute to Suzanne E. Chapman*, pl. on 28th p. [upper]. Left part of I-III, SMITH, *Hist. Eg. Sculp.* pl. 49 [a], p. 170; of I-II, MÜLLER (H. W.), *Ägyptische Kunst*, Abb. 31 [upper]. Names of estates in I, JACQUET-GORDON, *Domaines*, pp. 222-3 [10G4], cf. figs. 29, 30. Boats in IV, see REISNER, *Giza Necropolis*, i, p. 357 [lower]. Agriculture in IV, see id. ib. p. 358 [1].

Room II. b of Reisner.

(10) Two registers, I, deceased with offering-list, and two sub-registers, funerary priests and offering-bringers, II, scribes before Khemtnu, and scene of rendering accounts.

See id. ib. p. 371; SMITH, op. cit. p. 172.

(11) (a) False-door; (b) and (c) rock-cut statues of deceased with mother; (d) and (e) palace-façade stelae. Offering-text at top of wall.

(a)-(c) REISNER, fig. 19, p. 68; SHOUKRY, *Privatgrabstatue*, Abb. 77. See SMITH, op. cit. p. 43.

(12) Unpainted reliefs. Deceased seated holding lotus-flower, and four registers, I and II, musicians, singers, dancers, and offering-bringers, III, bringing food, IV, cooking and wine-cellar scene.

Right half, REISNER, fig. 15, p. 70. Man tending fire, and cook, from IV, SMITH, op. cit. figs. 188, 182b, pp. 315, 318. See REISNER, *Giza Necropolis*, i, p. 348 [4].

(13) Three unfinished registers (in outline), men carrying sacks, winnowing (?), filling granary.

See id. ib. p. 358 [1].

(14) Pillar. Khemtnu-nezes with accounts before deceased.

REISNER, fig. 14.

Room III. c of Reisner.

(15) Niche with ten rock-cut statues (from left, 3 daughters, 4 of deceased, 3 of mother).

See references under (7) and (8). Two younger daughters, SMITH, op. cit. pl. 16 [d], p. 43. Statues of deceased and eldest daughter, SMITH (J. L.), *Tombs, Temples, and Ancient Art*, pl. facing p. 145; KARNAGHAN in *Art and Archaeology*, xxxi (1931), fig. on p. 256 (from painting by J. L. SMITH).

Shaft G 7530A.

Sarcophagus presented to deceased by mother, palace-façade decoration, black granite, in Cairo Mus. Ent. 54935. REISNER, fig. 20; DONADONI ROVERI, *Sarcophagi egizi*, Tav. xxviii [1], p. 119 [B 22]; see REISNER, *Giza Necropolis*, i, p. 116 [21]; *Descr. somm.* No. 6171.

G 7540

Chapel.

North wall. Four women attendants and dwarf from destroyed scene.

North subsidiary niche. Left of entrance doorway to Chapel G 7530.

Remains of text with dates. SMITH (W. S.) in *J.N.E.S.* xi (1952), fig. 4 [middle], p. 126 [A, 2]; ČERNÝ Notebook, 121, p. 22 [bottom].

Statues. In Boston Museum

Mother and deceased standing, found in débris, No. 30.1456. DUNHAM in *Boston Mus. Bull.* xxxiv (1936), pp. 3-5 with figs.; id. *Eg. Department*, fig. 25; BOREUX in *Mon. Piot*, xxxvii (1940), fig. 8, p. 24; COTT in *Worcester Art Museum Annual*, i (1935-6), fig. 3, p. 18; CAPART, *L'Art ég.* ii, pl. 259; SMITH, *Hist. Eg. Sculp.* pl. 16 [c], p. 42; ALDRED, *O.K. Art*, pl. 31; HORNE MANN, *Types*, v, pl. 1223; WOLF, *Kunst*, Abb. 115; WENIG, *Die Frau*, pl. 8; see SMITH, *Anc. Eg.* (1942 and 1952), p. 45; (1960), p. 51.

Deceased standing, dedicated by son Nebemakhet, fragments, found in débris, No. 30.1457. See id. *Hist. Eg. Sculp.* p. 42.

Head of deceased from statue-group, found in débris of shaft O of tomb G 7521, No. 30.1461. Id. ib. fig. 14c, p. 42.

Servant statuettes. See id. *Anc. Eg.* (1942 and 1952), p. 45; (1960), p. 51.

Squatting woman (headless) sifting flour, No. 30.1458. Id. *Hist. Eg. Sculp.* fig. 14a [right], pp. 44, 98 [e, 1]; BREASTED (Jr.), *Eg. Servant Statues*, pl. 25 [b], p. 25 [1]; HORNE MANN, *Types*, iv, pl. 998.

Butcher (headless), No. 30.1462. SMITH, *Hist. Eg. Sculp.* fig. 14b, pp. 44, 100 [i, 1]; BREASTED (Jr.), op. cit. pl. 32 [d], p. 35 [1].

Female brewer (headless), unnumbered (Exped. No. 27-5-6). SMITH, *Hist. Eg. Sculp.* fig. 14a [left], pp. 44, 96 [b, 1]; BREASTED (Jr.), op. cit. pl. 29 [b], p. 30 [2].

G 7550. DUAENḤOR , King's son of his body, Companion of his father. Temp. Khufu to Menkaurē.

Parents, probably Kawab (tomb G 7120) and Ḥetepḥeres [II] (tombs G 7110, 7350).

Stone-built mastaba. LG 58.

Plan XXIX

Plan and sections, REISNER, *Giza Necropolis*, i, figs. 11, 88.

Chapel. Plan, id. ib. fig. 118, pp. 208 [27], 309; L. D. *Text*, i, pp. 83-4, with plan.

(1) Deceased and family.

L. D. ii. 82 [b].

(2) Table scene. (3) At bottom, butchers (much destroyed).

See REISNER, op. cit. p. 328 [4].

(4) [1st ed. 2] False-door of deceased.

Upper part, L. D. ii. 82 [a].

G 7560. Middle or late Dyn. IV.

Stone-built mastaba.

Plan XXIX

REISNER, *Giza Necropolis*, i, p. 210 [35].

Chapel.

(1) Part of two (remaining) registers, men carrying birds in cages, from destroyed marsh-scene, and six figures below.

Man carrying gazelle (1st figure on right), and man carrying bird-trapping equipment (4th figure from right), in bottom register, SMITH, *Hist. Eg. Sculp.* figs. 236 [right], 178 [right], pp. 362, 314.

(2) Two (remaining) registers, men bringing animals, and carrying papyrus-plants.

(3) False-door, with two offering-bringers on right.



Shaft B. See REISNER, op. cit. p. 116 [32]; id. in *Boston Mus. Bull.* xxxvi (1938), p. 30.

Male reserve-head, in New York, M.M.A. 48.156. SIMPSON in *M.M.A. Bull.* n.s. vii (June 1949), figs. on pp. 287-8, 291 [lower]; see SMITH, *Hist. Eg. Sculp.* p. 27 [23].

Female reserve-head, in Boston Mus. 37.643. See id. ib. p. 27 [24].

G 7632.

Statuette of Imḥōtep son of Khreduankh, seated, bronze, Late Period, in Boston Mus. 27.984. See ROEDER, *Ägyptische Bronzefiguren*, p. 14 [7, c].

G 7650. AKHTIḤOTP , Prophet of Khufu, Sole companion, Director of the Palace, etc., and wife MERTIOTES , King's daughter of his body, Prophetess of Khufu, Ḥathor, and Neith, etc. Temp. Khufu to Khephren.

Parents of Mertiotes, probably Khufu and Mertiotes [I].

Stone-built mastaba.

Plan XXXI

Plan and section, REISNER, *Giza Necropolis*, i, fig. 9, pp. 212 [5], 308 [d, 1, c].

Masons' graffiti with dates. SMITH (W. S.) in *J.N.E.S.* xi (1952), fig. 7 [middle left], pp. 127-8 [11]; see REISNER, op. cit. p. 73 note 1.

Interior offering-room. a of Reisner.

(1) Doorway. (a) and (b) Deceased with attendants; (c) and (d) [deceased and wife]. (c) and (d) See id. ib. p. 316 [6].

(2) Fragments. With head of wife, in Boston Mus. 37.2620; SMITH, *Hist. Eg. Sculp.* pl. 41 [a], pp. 161, 301; id. *Anc. Eg.* (1952), fig. 15; part, id. in *Archaeology*, 16 (1963), fig. 12, p. 9. Remains of netting fish and bringing fish and fowl; id. *Hist. Eg. Sculp.* fig. 66, p. 167.

(3) Deceased with child.

(4) Block from false-door with figure of deceased, in Rome, Museo Barracco, 3.

Id. ib. pl. 42 [b], pp. 161, 301; BARRACCO and HELBIG, *La Collection Barracco*, n.s. (1907), pl. ii; STRÖMBOM, *Egyptens Konst*, fig. 62; ALINARI photo. 34761; part, PIRENNE, *Hist. civ.* i, pl. 68 facing p. 209; see PIETRANGELI, *Museo Barracco di Sculture Antica. Guida* (1949), p. 33; (1960), p. 46; (1963), p. 53.

(5) Woman seated, butchers, and deceased with daughters.

Butchers, SMITH, *Hist. Eg. Sculp.* pl. 41 [c], p. 160; see REISNER, op. cit. p. 328 [1]. Block with two daughters, formerly in MacGregor Colln., now in Fundação Calouste Gulbenkian, Lisbon, Inv. 159; SMITH, *Hist. Eg. Sculp.* pl. 41 [b], pp. 160-1; *Sotheby Sale Cat.* (MACGREGOR), June 26-July 6, 1922, pl. xlvii [1567]; British Museum. *Ancient Egyptian Sculpture lent by C. S. Gulbenkian, Esq.* (1937), pl. xviii, pp. 9-10; *Egyptian Sculpture from the Gulbenkian Collection* (Washington, 1949), fig. on p. 37, cf. p. 17 [1]; see *Burlington Fine Arts Club* (1922), p. 109 [B].

(6) False-door of wife.

Hand incorrectly drawn from south side, SMITH, *Hist. Eg. Sculp.* fig. 115, p. 278.

(7) Three registers (destroyed) with part of two offering-bringers remaining at top.

See REISNER, *Giza Necropolis*, i, pp. 327 [f, 1], 344 [3].

(8) Deceased, with remains of four registers, **I**, two men bringing garment, **II**, two men with oryx, **III-IV**, destroyed.

SMITH, *Hist. Eg. Sculp.* pl. 42 [a], fig. 168. **I**, id. in *J.E.A.* xix (1933), fig. 3, p. 155.

Shaft C. See REISNER, op. cit. pp. 118 [18], 167 [7], 212 [5].

Sarcophagus, with palace-façade decoration, red granite, in Brooklyn Mus. 48.110.

Reserve-head (much damaged), found between tombs G 7650 and 7660, in Boston Mus. unnumbered (Exped. No. 27-4-1219). See SMITH, *Hist. Eg. Sculp.* p. 27 [25].

G 7652.

Shaft A.

Coffin, wood, Ptolemaic, in Boston Mus. 29.1860.

Fragment of lintel of an Overseer of the Memphite and Letopolite nomes, Overseer of the new settlements of the Pyramid of Isesi, etc. (name lost), late Dyn. V. FISCHER, *Dendera*, fig. 3, p. 10 note 47.

G 7660. KAEMSEKHEM , King's son, Director of the Palace, etc. Late Dyn. IV.

Parents, Kawa'b (tomb G 7120) and Hetepheres [II] (tombs G 7110, 7350).

Stone-built mastaba. LG 59.

L. D. *Text*, i, p. 84; REISNER, *Giza Necropolis*, i, p. 208 [28].

Interior offering-room.

Id. ib. p. 309 [I, a]. Plan, L. D. *Text*, i, on p. 84. Synopsis of scenes, JUNKER, *Giza*, iii, pp. 45-6 [39].

(1) Doorway. (a) and (b) Deceased and wife at table (much destroyed).

See REISNER, *op. cit.* p. 318 [I6].

(2) Five registers, I-III (nearly destroyed), offering-bringers, IV, butchers, V (destroyed).

See id. ib. p. 328 [2].

(3) [1st ed. 1] Three registers of estates led by scribe in each (only remains in I and III) before deceased and wife.

L. D. ii. 32 [left], *Text*, i, p. 84. Names of estates, JACQUET-GORDON, *Domaines*, pp. 216-18 [8G4], *cf.* figs. 24-5.

(4) [1st ed. 2] Four registers, I, [deceased] in boat being paddled, II, women carrying various objects, III-IV, butchers, IV, destroyed.

L. D. ii. 32 [right].

Shaft B. With two rooms. See REISNER, *op. cit.* pp. 116 [25], 119 [25], 121.



Sarcophagus of deceased, red granite, in Cairo Mus. 1789. BORCHARDT, *Denkmäler*, ii, Bl. 111, p. 208; SCHMIDT, *Sarkofager*, fig. 210; DONADONI ROVERI, *Sarcofagi egizi*, Tav. xxvi [2], p. 113 [B 13]; name and title, DE ROUGÉ, *Inscr. hiéro.* pl. lxxvi [lower middle]; see MARIETTE, *Notice des principaux monuments . . . à Boulaq* (1864), p. 273 [12]; (1874), p. 93 [7]; MASPERO, *Guide*, p. 29 [46].

G 7663.



Box-sealing with names of Saḥurēc. REISNER and SMITH, *Giza Necropolis*, ii, fig. 55, p. 52.

G 7671. Ointment-slab (inscribed), alabaster, in Boston Mus. 31.796.

G 7690. Relief-fragment of Iui , Old Kingdom, in Boston Mus. 30.206.

ITISEN  , Overseer of *ka*-servants. Dyn. V.

Entrance doorway. Lintel with offering-text.

IBY  , Judge and Scribe, etc. Dyn. V.



Entrance doorway. Drum of deceased, left thickness, deceased with wife and two sons, right thickness, Wepwautbaſ  with wife and son.

SIENSNEFRU , Director of the *is*-chamber, etc. Dyn. V.

Entrance doorway. Lintel of deceased.

G 7711a. KHNEMZEDEF , King's son, Greatest of the Ten of Upper Egypt, Overseer of works of the King. Dyn. V-VI.

Drum of entrance doorway with name and titles. GAUTHIER in *Ann. Serv.* xxii (1922), p. 207.

MERYKHUFU  , King's son of his body, Hereditary prince, etc.
Dyn. V-VI.

North of tomb G 7711a. Position not marked on plan.

Two pillars with names and titles, red granite. Texts, id. ib. pp. 205-7; see SMITH, *Hist. Eg. Sculp.* p. 52.

Head of statue, red granite, found by Tewfik Boulas in the neighbourhood in 1923, in Cairo Mus. Ent. 47776. Id. ib. pl. 20 [d], p. 52; see *Descr. somm.* No. 6001.

G 7715.

Statuettes. Dyn. VI. In Cairo Mus.

Dwarf with jars, Ent. 72144. SMITH, *Hist. Eg. Sculp.* pl. 28 [b], p. 100 [k, 3]; BREASTED (Jr.), *Eg. Servant Statues*, pl. 50 [b], p. 58 [3].

Man feeding dog, Ent. 72143. SMITH, op. cit. pl. 28 [d], p. 101 [m, 3]; BREASTED (Jr.), op. cit. pl. 94 [e], p. 101 [vi, 1].

G 7721. KAKHERPTAH , Supervisor of the police, etc. Dyn. V.

Rock-cut tomb.



Plan and texts from pillars, drums, and false-doors, PETRIE in SAYCE MSS. 17b. View showing rock-cut statues, CAPART, *Memphis*, fig. 320.

G 7750. Middle or late Dyn. IV.

Stone-built mastaba.

REISNER, *Giza Necropolis*, i, p. 209 [30]; plan and section of burial chamber of shaft B, fig. 59.

Entrance doorway. Left thickness with deceased; SMITH, *Hist. Eg. Sculp.* fig. 113, p. 164. Right thickness with deceased and wife; see id. ib. pp. 248, 249.



False-doors of Inti , Prophetess of Hathor Mistress-of-the-Sycamore, etc., and of Tebash , Overseer of builders, with wife Merut , *mitri*, Old Kingdom, from débris east of tomb G 7753, in Boston Mus. 31.781-2. See *Boston Mus. Bull.* xxix (1931), p. 120.

G 7757.

Anthropoid sarcophagus of Kheperre^c , basalt, Ptolemaic, from shaft A, room X, in Boston Mus. 30.834. Lid, D. D [UNHAM] in *Boston Mus. Bull.* xxx (1932), fig. on p. 90; BUHL, *Sarcophagi*, fig. 4, pp. 27-8 [B, a 1], with titles on pl. i.

G 7760. MINZEDEF , King's son of his body, Hereditary prince, Treasurer of the King of Lower Egypt, etc. Temp. Khufu to Menkaur^c.

Parents (possibly), Kawab (tomb G 7120) and Hetepheres [II] (tombs G 7110, 7350).

Wife, Khufu'ankh  .

Stone-built mastaba. LG 60.

Plan XXXI

L. D. *Text*, i, pp. 84-5; REISNER, *Giza Necropolis*, p. 209 [29]. Plan, L. D. i. 26 [middle]; PRISSE, *L'Art ég.* i, 5th pl. [bottom middle], 'Nécropole de Memphis'.

Chapel. Sketch-plan, *L. D. Text*, i, fig. on p. 85. Synopsis of scenes, JUNKER, *Gîza*, iii, p. 45 [38].

(1) Deceased (head damaged) and wife seated.

L. D. ii. 33 [a].

(2) Remains of two registers of estates. (3) [1st ed. 2] False-door of deceased, palace-façade decoration, and thicknesses with estates.

(2) *L. D.* ii. 33 [b, left]. (3) *Id. ib.* 33 [b, middle] (with detail of decoration, *id. ib.* i. 26 [left and right]); PRISSE, *op. cit.* 5th pl. [bottom left and right] (with section); thicknesses, *L. D.* ii. 33 [c, d]. See REISNER, *op. cit.* p. 382 [f, 1]. Names of estates, JACQUET-GORDON, *Domaines*, pp. 214-15 [7G4], cf. figs. 21-3 (from LEPSIUS).

(4) [1st ed. 3] (much destroyed) Presentation-scene, with men bringing fowl and animals, and butchers, before deceased and wife with small son.

L. D. ii 33 [b, right].

Shaft B. With two rooms. See REISNER, *op. cit.* pp. 116 [26], 121, 167 [9].

Sarcophagus of deceased, red granite, formerly in Boston Mus., now in New York, M.M.A. 54.80. SCOTT in *M.M.A. Bull.* N.S. xv (Nov. 1956), fig. on p. 80 [5], cf. pp. 79, 82.

G 7772.

Two rough seated statuettes, Dyn. V, larger one in Cairo Mus. Ent. 72141, the other in Boston Mus. 39.832. SMITH, *Hist. Eg. Sculp.* pl. 25 [a, b], pp. 76-7.

G 7788.

Clay plaques of captives with hieratic execration texts, Dyn. XVIII, from débris, in Boston Mus. POSENER in *Mitt. Kairo*, 16 (1958), Taf. xxvi, xxvii, pp. 252-70.

G 7792.

Statue of Osiris, upper part, schist, Dyn. XXVI, from débris in shaft, in Boston Mus. 29.1131. DUNHAM in *Boston Mus. Bull.* xxix (1931), fig. on p. 26; see SMITH, *Anc. Eg.* (1942 and 1952), p. 156; (1960), p. 176.



G 7803. Probably Dyn. V-VI.



Rock-cut tomb.

Masons' graffiti with dates on walls, *id.* in *J.N.E.S.* xi (1952), fig. 8 [upper right], p. 128 [14].

G 7809.

Upper part of male statuette, probably seated, Dyn V, found outside shaft A, in Boston Mus. 27.1323. See SMITH, *Hist. Eg. Sculp.* p. 76.

False-door of Reti  , Overseer of *ka*-servants, granite, Dyn. V, from shaft D, in Boston Mus. 27.1128.

G 7810. ZATY   , King's son of his body, Overseer of the expedition. End of Dyn. IV or early Dyn. V.

Mother (possibly), Meres'ankh [II] (tomb G 7410).

Stone-built mastaba. Excavated by Service des Antiquités in 1923.

REISNER, *Giza Necropolis*, i, pp. 209 [34], 309, 382; shafts, pp. 116 [31], 119 [31]. Name and titles, GAUTHIER in *Rec. Trav.* xl (1923), p. 194 [14].

Chapel.

South wall. Table scene.

West wall. South of false-door, three registers of offering-bringers; see REISNER, *op. cit.* pp. 327 [g, 1], 344 [5]. False-door with deceased and wife at tables; see *id. ib.* p. 335 [1]. North of false-door, presentation scene, with butchers below; see *id. ib.* p. 328 [6].

WERIRNI , Hereditary prince, Herdsman of Apis, etc. Probably Dyn. V.

Between tombs G 7810 and 7820.

Sarcophagus with palace-façade decoration and panther-skin in relief on lid, red granite, in Cairo Mus. Ent. 48078. GAUTHIER in *Ann. Serv.* xxx (1930), pl. i, pp. 178-9 (text), cf. 174-5; DONADONI ROVERI, *Sarcofagi egizi*, Tav. xxix [1], pp. 122-3 [B 32]; CAPART, *Memphis*, fig. 316; see *Descr. somm.* No. 6007; LACAU in *Comptes rendus* (1924), p. 298.

G 7814. KA^cAPER , Overseer of the Two Treasuries, Overseer of works, etc. Dyn. V-VI.

Rock-cut tomb.

Plan, REISNER, *Giza Necropolis*, i, fig. 144, pp. 237-8 [2].

Doorway. Lintel with offering-text, and drum with name and titles, PETRIE in SAYCE MSS. 21b [bottom and top].

Beside doorway, deceased and wife. Text, *id. ib.* 21b [middle].

G 7815. HEPENNEBTI , Prophetess of Hathor and Neith, etc. Dyn. V-VI.

Rock-cut tomb.

REISNER, *Giza Necropolis*, i, p. 242 [middle, 1]; name, RANKE, *Personennamen*, i, p. 425 [30].

G 7820. IYNEFER . . . and wife NEFERTKAU. End of Dyn. IV or early Dyn. V.

Mother of Nefertkau (possibly), Meres^cankh [II] (tomb G 7410).

Stone-built mastaba.

REISNER, *Giza Necropolis*, i, pp. 60, 116 [30], 209 [33].

Block with estate, probably from here, in Chicago, Nat. Hist. Mus. A. 31706. Name of estate, JACQUET-GORDON, *Domaines*, p. 291 [36G5].

G 7821. NEFERSESHEMPTAH , Steward of the Great Estate, etc. Dyn. V-VI.

Rock-cut tomb. REISNER, *Giza Necropolis*, i, p. 240 [1].

G 7822. MESU , Director of vine-dressers, etc. Dyn. V-VI.

Rock-cut tomb. *Id. ib.* p. 241 [4].

G 7836. NEBTYHERKAUS , Prophetess of Hathor Mistress-of-the-Sycamore, etc. Dyn. V.

Rock-cut tomb.

REISNER, *Giza Necropolis*, i, p. 243 [top, 3].

Offering-list on rock-cut architrave of west wall. HASSAN, *Giza*, vi [2], pls. lxx-lxxii [76], p. 134.

G 7837+7843. 'ANKHMA'RĒ' . Probably first half of Dyn. V.

Rock-cut tomb, enlarged by cutting into older tomb.

Plan XXXI

REISNER, *Giza Necropolis*, i, pp. 238-9 [7], 314 [d].

Room I. G 7837, a of Reisner.

(1) Doorway. (a) and (b) Deceased seated with biographical text above, and four offering-bringers at (a), and six men at (b); (c) and (d) biographical text continued; (e) scribe-statue in niche; (f) two registers of men.

See id. ib. p. 319 [28].

(2) Deceased, and four registers, netting fowl and fish, bringing animals, and estates, with five rock-cut statues in niches.

Names of estates, JACQUET-GORDON, *Domaines*, pp. 290-1 [35G5], figs. 78-9.

(3) Deceased at table with offering-list, and three rock-cut scribe-statues below. (4) Blank niches, and standing rock-cut statue below.

(5) Deceased followed by fan-bearer, and four registers, men leading animals, offerings, and two registers of men dragging statues, and men at bottom. Four rock-cut scribe-statues below. (6) Deceased carried in palanquin, with dwarf leading dog under it, two registers of attendants before and behind, and in register below, scribes and officials. Two rock-cut scribe-statues below.

Statues at (5) and (6), SMITH, *Hist. Eg. Sculpt.* pl. 57 [d], pp. 55, 189. (6) See REISNER, op. cit. p. 368 [4]; dwarf and dog, id. in *Boston Mus. Bull.* xxxiv (1936), fig. on p. 98 [lower left].

Room II. G 7843, b of Reisner.

(7) Three registers, men with furniture, including armchair, and making bed, men with draughts-board, with musicians and singers, and men and dwarf with various articles, dog, and monkey.

See id. *Giza Necropolis*, i, pp. 351-2.

(8) False-door (uninscribed), man with offerings on both sides (much damaged).

G 7851. WERMERU. End of Dyn. V or Dyn. VI.

Rock-cut tomb.

See BAER, *Rank and Title in the Old Kingdom*, pp. 67-8 [116].

G 7911.

Head of statuette of boy, Dyn. V-VI, from shaft U, in Boston Mus. 31.779. See SMITH, *Hist. Eg. Sculpt.* p. 76.



G 7946. NEFU  Inspector of administrators of the Treasury, etc. Dyn. V-VI.

Wife, Khnemt-sethu , *mitrt*, etc.



Statuettes. Thrown down shaft. See SMITH, *Hist. Eg. Sculp.* p. 76.

Deceased seated, formerly in Boston Mus. 31.778, now in Kansas City, William Rockhill Nelson Gallery of Art, 48.47. *The William Rockhill Nelson Collection* (1949), fig. on p. 12 [lower]; Kansas City. *Handbook of the Collections* (1959), fig. on p. 17 [left].

Double-statue of deceased and wife standing, in Boston Mus. 31.777.

Thenti  , Inspector of administrators of the Treasury. (a) As standing naked youth, in Cairo Mus. Ent. 57019; HORNEMANN, *Types*, i, pl. 124; BAUMGARTEL in *J.A.R.C.E.* vii (1968), pls. x [20], xi [21-2], p. 13. (b) Scribe-statue, black granite, in Boston Mus. 31.776; HORNEMANN, *Types*, ii, pl. 405 (called diorite).

G 7948. RA'KHA'EF'ANKH   , Companion of the Great House, Inspector of *wab*-priests of the Pyramid of Khephren, etc. Dyn. V or later.

Wife, Nikahor  , Prophetess of Hathor Mistress-of-the-Sycamore and Mistress-of-Dendera, and of Neith Opener-of-the-Ways, etc.

Rock-cut tomb. LG 75. 'Tomb of Numbers'.



Plan XXXI

L. D. *Text*, i, pp. 91-4 (with plan); MARIETTE, *Mastabas*, pp. 540 [7], 567-71 (from papers of NESTOR L'HÔTE); REISNER, *Giza Necropolis*, i, pp. 238 [4], 314 [e]. Synopsis of scenes, JUNKER, *Giza*, iii, p. 47 [42]. Titles, etc., BURTON MSS. 25621, 67, 67 verso [left].

Chapel.

(1) [1st ed. 1-3] Doorway. (a)-(b) Fragment of lintel, probably from here, in Durham Univ. Gulbenkian Mus. 2153; drum with name and titles, removed by Lepsius, in Berlin (East) Mus. 1150; (c) and (d) deceased with two children, and names and titles.

Drum and (c)-(d) L. D. ii. 8 [a, b], *Text*, i, p. 91; MARIETTE, op. cit. fig. on p. 568 (incomplete); NESTOR L'HÔTE MSS. 20396, 331; WILKINSON MSS. iv. 49 [top], 50-1 [upper]; vii. 41 [right]. Names of children, MARIETTE, op. cit. p. 567 [H], 571 [lower]. Text of drum, BURTON, *Excerpta hiero.* pl. xxvii [4]; *Aeg. Inscr.* i. p. 27; BURTON MSS. 25621, 55 [bottom], 136 [4]; see *Ausf. Verz.* p. 58. Two small sons from (c), SMITH, *Hist. Eg. Sculp.* pl. 46 [b], p. 299.



(2) [1st ed. 4-5] Servant with sunshade before deceased with 'his brother of his endowment' Iteti  , Inspector of *wab*-priests of the Pyramid of Khephren, and six registers (from left), I (much destroyed), boats, II, piling up sheaves, donkey carrying produce, threshing with donkeys, heaping corn, sifting, and stela of the Harvest-goddess, III, son handing in list, scribes and chiefs rendering accounts, binding sheaves, deceased with dog watching men reaping corn, IV, scribes, chiefs rendering accounts, netting fowl, bringing fish, V-VI, bringing cattle, goats, donkeys, sheep (all with numbers above), netting fish.

L. D. ii. 9, *Text*, i, p. 92; WILKINSON MSS. iv. 32 [right]-40; xiii. 5. Deceased with Iteti and servant, MARIETTE, op. cit. fig. on p. 570; NESTOR L'HÔTE MSS. 20396, 333; BURTON MSS. 25621, 139. Names of two sons, WILKINSON MSS. xl. 115 [right]. Donkeys from II, EBERS, *Aegypten*, i, fig. on p. 155 [middle]; Eng. ed. fig. on p. 133 [middle]. III, deceased watching reapers (incomplete), id. ib. i, fig. on p. 156 [top]; Eng. ed. fig. on p. 134

[top]; reaper, SMITH, op. cit. fig. 175 [left]. Scribes, chief, and men reaping, from III-IV, BURTON MSS. 25621, 65, 66, 66 verso, 81. Left half of III-VI, CAPART, *Memphis*, fig. 201. V and VI, animals and fishing, WILKINSON, *M. and C.* ii. 20 (No. 81), 2 Ser. i. 130 (No. 441) = ed. BIRCH, i. 291 (No. 100); ii. 447 (No. 484). Animals before deceased, CAILLIAUD, *Voyage à Méroé* [etc.], ii, pl. lxxiii [2]. Donkeys and goats before deceased, id. *Arts et métiers*, pl. 38 [1]. Numbers and sketches of animals, BURTON MSS. 25621, 64. Netting fish, in V-VI, id. ib. 141; EBERS, *Aegypten*, i, fig. on p. 156 [middle]; Eng. ed. fig. on p. 134 [middle]. Numbers, HALL in *J.E.A.* ii (1915), pl. xvi, p. 138 (letter from SALT in 1822).

(3) [1st ed. 6] Deceased and wife at table, with daughter squatting under chair, and six registers before them, children, offering-bringers, butchers, geese, etc.

L. D. ii. 10 [b]; NESTOR L'HÔTE MSS. 20396, 332; BURTON MSS. 25621, 67 verso [right]; WILKINSON MSS. iv. 42-5; incomplete, MARIETTE, op. cit. p. 569. Name of daughter, WILKINSON MSS. xl. 115 [right]. Names of children in top register, MARIETTE, op. cit. fig. on p. 567 [A]; two names, L. D. *Text*, i, p. 92.

(4)-(5) [1st ed. 7-8, 14-15]. Deceased with son, and two registers above niche, men bringing hyena, and sons as scribes. Niche with rock-cut standing statue of deceased, (a) three registers of estates, (b) remains of estates. (6) [1st ed. 9, 16, 17] False-door with deceased and wife at table on panel. (7) [1st ed. 10] False-door of deceased. (8)-(11) [1st ed. 11-12] False-doors, (8) wife, with deceased at table on panel, (9) wife, (10) Ḥerimeru , Royal acquaintance, and wife Ishpet , (11) Ishpet.

(4)-(7) L. D. ii. 11; sketches, omitting (7), BURTON MSS. 25621, 61, 62, 65 verso; names of two sons and wife, MARIETTE, op. cit. p. 571 [upper]. (4)-(11) WILKINSON MSS. iv. 41, 46-8 [top], 49 [lower]; xiii. 6-9. (5) (a) L. D. ii. 8 [c]; WILKINSON MSS. iv. 48 [lower]; names, JACQUET-GORDON, *Domaines*, pp. 257-8 [26G5], cf. figs. 63-4 (from LEPSIUS); three names, WILKINSON MSS. xl. 115 [right]; (b) L. D. *Text*, i, p. 93 [right]. (6) Remains of text on thicknesses, id. ib. p. 93 [left]. (8)-(11) L. D. ii. 10 [a], *Text*, i, pp. 93-4; names, MARIETTE, op. cit. p. 540; sketch, BURTON MSS. 25621, 57, 63; name of deceased and Ishpet, PRUDHOE MSS. vi. 150. (11) L. D. *Ergänz.* xxviii [a].

(12) [1st ed. 13] (a) and (b) Remains of marsh-scene.

L. D. *Ergänz.* xxviii [b, c]. (b) WILKINSON MSS. iv. 51 [lower].

ROCK-CUT TOMBS LG 63-80 AND OTHER TOMBS BETWEEN THEM

Plan XVIII

Plan, L. D. *Text*, i, fig. on p. 86.

LG 63. KAEMNEFERT , Director of King's hairdressers, Director of the Palace, Keeper of the diadem, etc. Dyn. V-VI.

Plan XXXI

L. D. *Text*, i, p. 87, with plan. Synopsis of scenes, JUNKER, *Giza*, iii, p. 48 [43].

Chapel.

(1) Thickness of entrance doorway. Upper part of deceased and wife (no name).

L. D. ii. 91 [b]. *Text*, MARIETTE, *Mastabas*, p. 542 [lower left].

(2) Deceased leaning on staff, with attendants behind him, and four registers, I, scribes, and men bringing donkeys, II, piling up sheaves, donkeys carrying produce, III, ploughing, IV, sowing and sheep treading grain.

L. D. *Ergänz.* xxxii [lower]. Omitting deceased, WILKINSON MSS. iv. 52-3 [upper]. Two men with donkey, in II on left, DENON, *Voyage dans la Basse et la Haute Égypte* (Paris, 1802), pl. 97 [D]; *Hist. exp. Atlas*, pl. 116 [D]. IV, omitting man on extreme right, WILKINSON, *M. and C.* 2 Ser. i. 38 [No. 421] = ed. BIRCH, ii. 390 [No. 464].

(3) Deceased and wife (no names) with small son Kaemnefert, and three registers, men handing in list and bringing cattle and cranes.

L. D. ii. 91 [c], *Text*, i, p. 87; WILKINSON MSS. iv. 58-9; xiii. 50. Name and title of son, MARIETTE, *op. cit.* p. 542 [lower right].

(4) Four rock-cut standing statues.

L. D. *Text*, i, on fig. on p. 88.

(5) [1st ed. 4] Hetetu , Inspector of *ka*-servants, presenting lotus to deceased with wife seated, and registers of offerings, with [dancers] and clappers below.

L. D. *Ergänz.* xxii [a]; WILKINSON MSS. iv. 56-7. Hetetu, *id. ib.* xiii. 51 [upper].

(6)-(7) [1st ed. 5-6] Three registers, I and III, men bringing animals, II, two groups of butchers, and above doorway, herdsman tending cows.

L. D. *Ergänz.* xxxii [upper]; WILKINSON MSS. iv. 52-3 [bottom], 54-5. Two butchers, in II on left, DENON, *op. cit.* 97 [B]; *Hist. exp. Atlas*, pl. 116 [B].

LG 64. NESEMNAU , Inspector of physicians of the Great House, Secretary, King's *warb*-priest, etc. Middle Dyn. V or Dyn. VI.

Wife, Iti , Royal acquaintance.

Plan XXXI

L. D. *Text*, i, pp. 87-8 (with plan); plan, REISNER, *Giza Necropolis*, i, fig. 151, p. 243 [bottom, 3]. Synopsis of scenes, JUNKER, *Giza*, iii, p. 48 [44].

Chapel.

(1) Offering-list before deceased at table, and three registers of offering-bringers, offerings, and butchers.

L. D. ii. 92 [e]. Omitting deceased, DEVÉRIA squeezes, 5366 A. Physician with *hes*-vase in top register, MÜLLER (H.) in *Mitt. Kairo*, 7 (1937), Abb. 4, p. 65. Text at top, WILKINSON MSS. xiii. 52.

(2) False-door of deceased, with offering-bringers on thicknesses.

L. D. *Ergänz.* xxxiii [left and right].

(3) Deceased and wife at table, and remains of register of offering-bringers below.

L. D. *Ergänz.* xxxiii [middle]. Omitting offering-bringers, MARIETTE, *Mastabas*, p. 542 [upper]. Text, WILKINSON MSS. xiii. 51 [lower].

(4) Deceased and wife.

L. D. ii. 92 [d].

LG 65. NAME UNCERTAIN , Elder of the house, etc. Dyn. V-VI.

L. D. *Text*, i, p. 88, with plan.

Drum of entrance doorway with name and titles. L. D. ii. 92 [a].

Three mutilated rock-cut statues against south wall.

LG 66. Dyn. V-VI.

Deceased and wife on thicknesses of doorway. Name and title of wife, *L. D. Text*, i, p. 88.

IAUPTAH . Dyn. V-VI.

Tomb near LG 66. Exact position unknown.

Drum. Text, PETRIE in SAYCE MSS. 21c [middle].

LG 67. WA^c , Eye physician, etc. Dyn. V-VI.

L. D. Text, i, p. 89, with plan.

Drum of entrance doorway with name and titles of deceased [and wife]. *L. D.* ii. 93 [a].

NAME UNCERTAIN. Dyn. V-VI.

Tomb between LG 67 and 68. Exact position unknown.

False-door, deceased and wife at table on panel, and offering-text on lintel. Texts, PETRIE in SAYCE MSS. 21c [bottom].

Three rock-cut statues in niche.

LG 68. ITETI , King's *warb*-priest, Inspector of *warb*-priests and Overseer of *ka*-servants of the King's mother, etc. Dyn. V-VI.

REISNER, *Giza Necropolis*, i, p. 243 [upper, 1]; *L. D. Text*, i, p. 89, with plan. Name, MARIETTE, *Mastabas*, p. 541 [10].

Doorway to south-east burial chamber (d of Lepsius). Above doorway, man before man with wife at table (much destroyed); *L. D.* ii. 92 [c]; names, *L. D. Text*, i, p. 89.

Doorway to south-west room (B of Lepsius). Thicknesses with deceased on each, drum with name and titles; *L. D.* ii. 92 [b]; right thickness and drum, WILKINSON MSS. xiii. 53 [upper].

'TOMB WITH THREE PILLARS.' Dyn. V-VI.

Between tombs LG 68 and 69. Exact position unknown.

Architrave-text. PETRIE in SAYCE MSS. 21c [top].



THENTI , Director of the dining hall of the Great House, Overseer of *ka*-servants, etc. Dyn. V-VI.

East of tomb LG 68. Exact position unknown.

See SMITH, *Hist. Eg. Sculp.* p. 189.

False-door of deceased. Texts, PETRIE in SAYCE MSS. 21d [bottom].

Small false-door of Intkaes. Remains of text, id. ib. 21d [top].

Text above niche with rock-cut statues, mentioning Intkaes  (mother?) and Ak-hotp  (father?). Id. ib. 21d [middle].

SOKARIHOTP , Prophet of Khufu, etc. Dyn. V-VI.

Tomb below LG 69.

False-door with deceased and wife at table on panel, and offering-list on lintel. Remains of text on panel, lintels, and jambs, PETRIE in SAYCE MSS. 21a [upper].

Remains of text beside door. Id. ib. 21a [lower].

LG 69. KAY , King's *warb*-priest and Elder of the Hall of the Pyramid of Khufu. Dyn. V-VI.

Wife, Henutsen .

Plan XXXI

L. *D. Text*, i, pp. 89-90; plan, p. 89 [bottom].

(1) Fragment with name of wife. L. *D. ii.* 34 [a].

(2) Remains of deceased and wife, with titles above. L. *D. ii.* 34 [b]; WILKINSON MSS. xiii. 53 [lower].

LG 70. MERIB . Dyn. VI.

Thickness of entrance doorway. Remains of deceased, and name; L. *D. Text*, i, p. 90.

'KAZEDED', King's son of his body. Dyn. V.

Near tomb No. 6 of Service des Antiquités according to Reisner.

See REISNER, *Giza Necropolis*, i, p. 243 [middle]; SMITH, *Hist. Eg. Sculpt.* p. 189 with note 1, p. 190.

LG 71. Dyn. V-VI.

Unscribed pillared tomb with several rock-cut statues in niches.

Plan and sections, L. *D. i.* 26; REISNER, *Giza Necropolis*, i, fig. 139, pp. 233-4 [bottom].

LG 72. NEBU , Director of tomb-makers, Greatest of the craftsmen of the King. Dyn. V-VI.

L. *D. Text*, i, p. 90, with plan.

Drum of entrance doorway with name and titles. L. *D. ii.* 93 [b]; titles, FISCHER in *A.Z.* 93 (1966), pp. 63-5 with fig. 5 (from LEPSIUS).

LG 73. DENDENU , Overseer of scribes of the crews, Scribe of the royal documents, Overseer of herds, etc. Dyn. V-VI.

Wife, Neferhetpes .

L. *D. Text*, i, pp. 90-1; plan, fig. on p. 90 [lower].

Entrance doorway.

Jambs with deceased and small son on each, lintel with offering-text, and drum with name and title. L. *D. ii.* 93 [e], *Text*, i, p. 90; drum, LIEDER squeezes, 6. 1-4; titles of deceased on right jamb, 6. 5.

Thicknesses, deceased with wife and small son on each. L. *D. ii.* 93 [d]; text of left thickness, LIEDER squeezes, 6. 6, 7; of right (incomplete), 6. 8.

LG 74. DENDENU , Overseer of scribes of the crews. Dyn. V-VI.

Entrance doorway. Drum with name and title; L. *D. ii.* 93 [c]; MARIETTE, *Mastabas*, p. 541 [middle].

Vestibule. Probably in front of entrance doorway.

North wall. Remains of offering-text and titles, id. ib. p. 541 [bottom].

NAME UNKNOWN, Overseer of the Two Treasuries, etc. Dyn. V-VI.

Near tomb G 7948, probably north of it. Exact position unknown. Sanded up in time of Mariette.

Remains of text of drum of entrance doorway; MARIETTE, *Mastabas*, pp. 540-1 [8].



LG 76. KHUFUḤOTP  , Overseer of all works of the King, etc. Dyn. V or later.

Wife, Ḥenutsen , Prophetess of Ḥathor, etc.

L. D. *Text*, i, p. 94, with plan; MARIETTE, *Mastabas*, p. 539 [5], with plan; REISNER, *Giza Necropolis*, i, pp. 234-5 [2].

Entrance doorway.

Lintel with offering-text, left jamb with dedication-text of son, and right thickness with deceased and wife. L. D. ii. 34 [c], cf. sketch, *Text*, i, p. 94; lintel and jamb, WILKINSON MSS. vii. 41 [middle]; lintel and text of thickness, MARIETTE, op. cit. p. 539; name and title from lintel, CHAMP., *Not. descr.* ii. 481 [top], 482 [bottom]; title from lintel, PRUDHOE MSS. vi. 151 [upper]; text of jamb, SETHE, *Urk.* i (1933), 9 [6].

LG 77. THENTI  , Secretary of the King's *wabt*, Overseer of the *gs-pr* of the Necropolis, etc. Dyn. V-VI.

L. D. *Text*, i, p. 95, with plan, cf. L. D. i. 26. Plan, REISNER, *Giza Necropolis*, i, fig. 143, p. 237 [1]; MARIETTE, *Mastabas*, p. 538.

Outer Room. a of Reisner.

Entrance doorway. Left jamb with dedication of son Ptahiuṭni (?) , and drum, L. D. ii. 34 [d], *Text*, i, p. 95; MARIETTE, op. cit. p. 538 [A]; WILKINSON MSS. vii. 41 [left and top]; text of jamb, SETHE, *Urk.* i (1933), 8 [5].

West wall. Doorway to Inner Room; lintel with offering-text and drum with name and titles, L. D. ii. 34 [e]; MARIETTE, op. cit. p. 538 [B]; BRUGSCH, *Monumens*, xiv [5]; WILKINSON MSS. vii. 40 [middle] (probably).

LG 78. PERSONB , *ka*-servant, Steward. Middle Dyn. V or Dyn. VI.

Wife, Ḥetepḥernefert , Royal acquaintance.

Plan XXXI

Description with plan, L. D. *Text*, i, p. 95; MARIETTE, *Mastabas*, pp. 536-7.

I. North Room.

(1)-(2) Architrave with remains of offering-text. L. D. ii. 34 [f].

II. South Room. Rock-cut statues in niches in south wall.

(3) Wife and small child. L. D. ii. 94 [c, left], *Text*, i, p. 95.

(4) and (5) Pillar. Deceased with small daughter.

L. D. ii. 94 [c, right]. Title of deceased, MARIETTE, op. cit. p. 537.

LG 79. NEFERSEFEKH-PTAḤ  , King's *wabt*-priest, Prophet of Ḥathor. Dyn. V-VI.

Wife, Abdut , *mitrt*.

L. D. *Text*, i, p. 96 (with plan); REISNER, *Giza Necropolis*, p. 239 [13].

Outer Room.

West wall. Deceased with wife and children between statue-niche and doorway, and offering-text above doorway; L. D. ii. 94 [e], *Text*, i, p. 96.

LG 80. IPI  Inspector of manicurists of the Great House, etc. Dyn. V.

L. D. *Text*, i, p. 96 (with plan); MARIETTE, *Mastabas*, p. 536; REISNER, *Giza Necropolis*, i, p. 235 [3].

Drum of entrance doorway with name and titles. L. D. ii. 82 [f]; MARIETTE, *op. cit.* p. 536; PRUDHOE MSS. vi. 151 [lower]; DEVÉRIA squeezes, 5385 G.

ROCK-CUT TOMBS EXCAVATED BY SERVICE DES ANTIQUITÉS

(1932-4)

Plan XVIII



FAKHRY, *Sept tombeaux à l'est de la Grande Pyramide de Guizeh*, *passim*. View, *id. ib.* pl. i.

1. 'ANKHWEZES  Inspector of *warb*-priests. Dyn. V or later.

FAKHRY, *op. cit.* pp. 4-7; plan and sections, pl. ii.

Entrance doorway. Drum with name and title of deceased; *id. ib.* fig. 1.

Side-room.

False-door of Nikauhor  Overseer of the 'Pyramid' () of Shepseskaf, Inspector of *warb*-priests, etc. *Id. ib.* fig. 2.

2. TUA  Overseer of *ka*-servants, etc. Dyn. V or later.

FAKHRY, *op. cit.* p. 8; plan and section, pl. iii.

Entrance doorway. Drum with name and title of deceased; *id. ib.* fig. 3.

4. KHNEMHOTP  Overseer of the royal sealed documents (a) of the Great House, (b) of the *meret*, (c) of the land, etc. Dyn. V or later.

FAKHRY, *op. cit.* pp. 11-16; plan and sections, pl. iv.

Entrance doorway. *Id. ib.* pl. vii.

Lintel with offering-text, and drum with name and title of deceased. *Id. ib.* fig. 5, p. 12.

Jambs, deceased standing, with small son on left, and 'Ankhwezes, Judge and Scribe, on right. *Id. ib.* figs. 6, 7, pp. 12-16.

5. NEFERT  Inspector of craftsmen, etc. Dyn. V or later.

FAKHRY, *op. cit.* pp. 17-18; plan and sections, pl. vi.

False-door of deceased in west wall. Remains of text, *id. ib.* p. 17.

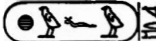
6. MERYKHUFU  Prophet of Khephren and Menkaurē, Inspector of *warb*-priests of the King's mother, etc. Dyn. V or later.

Father, Zat .

FAKHRY, *op. cit.* pp. 19-25; plan and sections, pl. vi.

Outer Room. View of north-west wall with false-doors, *id. ib.* pl. viii.

Entrance doorway. Lintel with offering-text; *id. ib.* fig. 10. Drum with titles and name; *id. ib.* fig. 11. Left jamb, text claiming that tomb was built by Menkaurē, threat to vandals, and mention of rewarding craftsmen; *id. ib.* fig. 12.

Originally four false-doors (three remaining, of deceased, father, and uninscribed). Id. ib. figs. 14-16.

Architrave above false-doors with name and titles. Id. ib. fig. 13.

7. KANENEB , Judge and Elder of the Hall, Master of the largesse of *rekhyt*, Inspector of masters of the largesse, etc. Dyn. V or later.

FAKHRY, op. cit. pp. 26-7; REISNER, *Giza Necropolis*, i, pp. 240-1 [2] (called No. 2).

Entrance doorway. Lintel and drum with name and titles of deceased on each; FAKHRY, op. cit. figs. 17, 18.

TOMBS NORTH OF GREAT SPHINX

Mostly unfinished

Plans VI, XVIII

Plan, MARIETTE, *Mastabas*, on fig. on p. 551; HASSAN, *The Great Sphinx*, on pl. xvi, pp. 55-6. See id. *Giza*, ix, pp. 5-6, 11-31.

KAWEHEM , Overseer of the four, five, and ten of the boat, Elder (?) of the expedition, etc. Dyn. V-VI.

Stone-built mastaba. Much destroyed, now inaccessible.

HASSAN, *Giza*, ix, pp. 13-15 (with texts), with plan at end; id. *The Great Sphinx*, p. 60; id. *The Sphinx*, p. 57.

Doorway. Left jamb, remains of text of building tomb and rewarding craftsmen; id. *Giza*, ix, pl. ii, fig. 1. Thicknesses, deceased, and name and titles; id. ib. pls. iii, iv, figs. 2, 3.

NO. 4 (HASSAN). AKHRĒC , King's eldest son of his body. Dyn. V-VI.

Rock-cut tomb. Re-used in New Kingdom.

HASSAN, *Giza*, ix, pp. 5 [bottom], 17-19, with plan at end; id. *The Great Sphinx*, pp. 56-7; id. *The Sphinx*, pp. 55-6.

Outer Room.

Doorway. Left of it, . . . mut  kneeling adoring Ḥarakhti as Sphinx, right of it, Amen-rēc, both New Kingdom; id. *Giza*, ix, pl. v [B], figs. 5, 6; id. *The Great Sphinx*, figs. 44-5, pp. 56-7. Drum, name and title of Akhrēc; id. *Giza*, ix, pl. v [A], fig. 4. Left thickness, two figures of Amen-rēc (much damaged), New Kingdom; see id. ib. p. 18 [bottom].

Statuettes.

Lower part of seated man, Dyn. V-VI, from serdab. Id. *The Great Sphinx*, fig. 49, p. 59; see id. *Giza*, ix, p. 12 note 3 [a].

Female head, black granite, Old Kingdom, found in front of tomb. Id. *The Great Sphinx*, fig. 47 [B], p. 57; see id. *Giza*, ix, p. 12 note 3 [b].

INKAF , Prophet of Sahurēc, Inspector of prophets of Ḥathor, Overseer of the store-room of the King's repast, etc. Dyn. V.

Rock-cut tomb.

HASSAN, *Giza*, ix, pp. 6 [top], 21-6 (with texts), and plan at end.

Chapel.

Portico. Architrave and columns with name and titles; id. *ib.* pls. vi, vii [A], fig. 7.

Entrance doorway. Lintel with offering-text; id. *ib.* pl. viii, pp. 23-4; see id. *The Great Sphinx*, p. 59 [bottom]. Drum with name and titles; id. *Giza*, ix, pl. vii [B], fig. 8.

Finds

Statue-base, part with foot of deceased, found thrown out of tomb. See id. *The Great Sphinx*, p. 64; id. *The Sphinx*, p. 61.

NO. 9 (HASSAN). Old Kingdom.

Rock-cut tomb. Position uncertain.

HASSAN, *Giza*, ix, p. 27.

Offering-table on pedestal, *in situ*, in front of tomb. Id. *ib.* on pl. i, pp. 12, 27; id. *The Great Sphinx*, fig. 50, pp. 56, 59.

NO. 11 (HASSAN). Old Kingdom.

Rock-cut tomb. Re-used in New Kingdom.

HASSAN, *Giza*, ix, pp. 29-31, with plan at end.

Outer Room.

Doorway. Right thickness, man offering to sphinx with *atef*-crown, New Kingdom; id. *ib.* fig. 9.

West wall. Above niche, sphinx with stela between forepaws, two men adoring, and pyramid(?) in foreground, New Kingdom; id. *ib.* fig. 10.

Almost certainly from these tombs

Statuette of man seated, pink granite, Old Kingdom, found near Great Sphinx. Id. *The Great Sphinx*, fig. 55, p. 63; see id. *Giza*, ix, pp. 12 note 3 [c], 38 [6].

EXACT POSITION AND PROVENANCE UNKNOWN**(a) Rock-cut tombs excavated by Schiaparelli (1903)**

NEFERKA , King's *wab*-priest, Master of the largesse of *rekhyt*, etc. Late Dyn. IV or later.

Wife, Thentet , Royal acquaintance.

CURTO, *Gli Scavi*, pp. 13-31; BALLERINI, *Notizia*, p. 45 [middle and bottom].

Façade.

Right of entrance doorway, deceased with small figure of wife, five registers of bringing animals, offering-bringers, and butchers, and false-door of deceased and wife, with offering-list on lintel and relatives on jambs and right of it. CURTO, *op. cit.* Tav. ii, fig. 22; id. in *A.Z.* 94 (1967), Taf. i, p. 16.

ITHER , Royal acquaintance, Inspector of recruits, Steward. Dyn. V-VI.

Wife, Pernefert , Prophetess of Neith, etc.

CURTO, *Gli Scavi*, pp. 31-3; BALLERINI, *Notizia*, pp. 65-6 note 1.



Upper part of false-door, deceased at table on panel, and wife seated right of it, in Turin Mus. Sup. 1849. CURTO, *op. cit.* Tav. iii.

Lintel (broken) and inscribed block of deceased, probably from here, in Turin Mus. Sup. 1865, 1865 bis. Id. ib. Tav. xxx [b, c], p. 95 [10, 11].

(b) Various

Reserve-head, Dyn. IV, found by Tewfik Boulas in 1923, in Cairo Mus. Ent. 37832. SMITH, *Hist. Eg. Sculp.* pl. 9 [d], p. 27 [27].

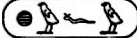
Relief-fragment with head of King's daughter of his body, Prophetess of Khufu, etc., Old Kingdom, in Boston Mus. 30.831.

Sarcophagus of Khufu'ankh  ♀ , Treasurer of the King of Lower Egypt, Herdsman of Apis, Keeper of the whole Pe, etc., with palace-façade decoration, red granite, Dyn. IV-V, found south-east of Great Pyramid, in Cairo Mus. 1790. BORCHARDT, *Denkmäler*, ii, Bl. 112, pp. 209-12; id. *Works of Art from the Egyptian Museum at Cairo*, 49; PERROT and CHIPIEZ, *Hist. de l'Art*, i, figs. 123-4; BRUGSCH, *Thes.* 1412, cf. 234-5 [C] (text from lid, called Şaqqāra); MASPERO, *L'Arch. ég.* (1887), fig. 22; (1907), fig. 23; id. *Égypte*, fig. 42; id. and ROEDER, *Führer*, Taf. 11; GRÉBAUT, *Le Musée Égyptien*, i, pl. xxi, pp. 18-19 (text); SCHÄFER, *Ägyptische Kunst in Kunstgeschichte in Bildern*, i, p. 31 [3]; id. and ANDRAE, *Kunst* (1925), 256 [lower] (from GRÉBAUT); SCHMIDT, *Sarkofager*, figs. 212-13 (same side on both); QUIBELL (A.A.), *Egyptian History and Art*, pl. iii; EMERY in *Ann. Serv.* xlv (1947), pl. xvii [a], p. 150; DONADONI ROVERI, *Sarcofagi egizi*, Tav. xxvii [1], pp. 114-15 [B 15]. Text on one side, DE ROUGÉ, *Inscr. hiéro.* pl. iv [middle]. Some titles, id. *Recherches sur les monuments* [etc.], p. 51 (repr. in *Bibl. Ég.* xxvi, pp. 50-1). See MARIETTE, *Lettre à M. de Rougé* in *Comptes rendus*, ii (1858), pp. 116-18; id. *Notice des principaux monuments . . . à Boulaq* (1874), pp. 366-7 [970]; MASPERO, *Guide*, p. 28 [44].

C. CEMETERY G I S

Temp. Menkaurē (Junker) or earlier (Reisner) with later mastabas in between.

Plan XIX [1]

Plans, JUNKER, *Gîza*, xii, plans 5, 6; west part, x, plans 1, 2; east part, xi, plan at end; Dyn. IV mastabas, x, Abb. 5; cf. MARIETTE, *Mastabas*, fig. on p. 525.

View of east part from top of Great Pyramid, CAPART, *Memphis*, fig. 48; REISNER, *Giza Necropolis*, i, pl. 3 [b]; of west part from top of Second Pyramid, pl. 2 [b].

G I S. Temp. Menkaurē.

Stone-built mastaba. I of Junker.

JUNKER, *Gîza*, x, pp. 12-18; id. in *Anzeiger, Wien*, 65 (1928), pp. 153-6. Plan and section, id. *Gîza*, x, on Abb. 7, cf. 14 [1]; view, Taf. ii [a].

Sarcophagus (uninscribed), granite, from burial chamber, in Hildesheim Mus. 3176. *In situ*, id. ib. Taf. x [c], with plan and section, on Abb. 7, p. 16; id. in *Anzeiger, Wien*, 65 (1928), Taf. iii [b], p. 155; see DONADONI ROVERI, *Sarcofagi egizi*, p. 121 [B 27].

ITHEF , [Inspector of] book-keepers. Dyn. VI.

Stone-built mastaba.

JUNKER, *Gîza*, x, pp. 92-105; id. in *Anzeiger, Wien*, 65 (1928), pp. 179-81. Plan and sections, id. *Gîza*, x, Abb. 37, cf. 4; view of shafts, Taf. ix [c, d].

Lintel of entrance doorway with deceased and [wife] seated, fragments. Id. ib. Taf. xix [d], Abb. 38, pp. 95-6; see id. in *Anzeiger, Wien*, 65 (1928), p. 179.

Statues

Statue-group, probably deceased and wife, seated, with two small children standing (un-inscribed), from large west serdab against tomb G I S, in Vienna Mus. Inv. 8410. Id. *Giza*, x, Taf. xiii [c, d], pp. 98-9; id. in *Anzeiger, Wien*, 65 (1928), Taf. viii [a], p. 180; Vienna. 5000 Jahre, No. 53 with Abb.

Head of male statue, from south shaft (S 9), probably in Cairo Mus. JUNKER, *Giza*, x, Taf. xv [a, b], pp. 99-100 [1]; id. in *Anzeiger, Wien*, 65 (1928), Taf. ix [a], p. 181.

Male head from double-statue, red granite, from shaft S 42 north of tomb, probably in Cairo Mus. Id. *Giza*, x, Taf. xv [c, d], pp. 99-101 [2]; id. in *Anzeiger, Wien*, 65 (1928), Taf. ix [b], p. 181 note 1.

Fragments, alabaster, from south of tomb. Id. *Giza*, x, Taf. xxii [d (56, 59)], pp. 18, 99-101 [3, 4].

Arm of seated statue, black granite. Id. ib. Taf. xv [e], pp. 99, 101-2 [6] (with other fragments).

KHNEMNÜFER . Sole companion, Keeper of the diadem, Inspector of King's hairdressers, etc. Dyn. VI.

Partly stone-built and partly brick-built mastaba.

JUNKER, *Giza*, x, pp. 110-11; plans and sections, on Abb. 40-1.

Sarcophagus with name and titles of deceased in ink, from shaft (S 46). Text, id. ib. p. 111; id. in *Anzeiger, Wien*, 65 (1928), p. 189 [top]; see DONADONI ROVERI, *Sarcophagi egizi*, p. 136 [B 68].

NUNÜTER . Dyn. VI.

Stone-built mastaba.

Wife, Henutsen , *mitri*.

JUNKER, *Giza*, x, pp. 113-36; id. in *Anzeiger, Wien*, 65 (1928), pp. 174-8. Plan and sections, id. *Giza*, x, Abb. 43. Names of deceased and wife, id. ib. pp. 116-17.

Chapel. Synopsis of scenes, id. ib. iii, p. 54 [60].

West wall (south of false-door), in Vienna Mus. Inv. 8028. Remains of offering-list, and two registers, I, deceased at table (with monkey under chair), with son Nunüter-nezes before him, two groups of butchers, and funerary priest, II, wife and daughter feasting, female clappers and dancers (with female dwarf).

Id. ib. x, Taf. xviii, Abb. 44-6, pp. 117-36; id. in *Anzeiger, Wien*, 65 (1928), Taf. vi, vii; F.E.R.E. photos. 12227, 15233. Group of dancers (incomplete) with dwarf, in II, HICKMANN, *45 Siècles*, pl. xv [A]; id. in *Egypt Trav. Mag.* No. 30 (Feb. 1957), fig. 4, p. 8. Dancer and dwarf imitating her, JUNKER, *Giza*, v, Abb. 1 [11], p. 11.

S 39/40. Dyn. VI.

Superstructure destroyed.

JUNKER, *Giza*, x, pp. 137-9; plan, on Abb. 47.

Head and torso of female statue, from statue-group, thrown away in shaft S 39. Id. ib. Taf. xv [g, h].

NI'ANKH-HATHOR [II] , *mîtrt* (woman). Dyn. VI.

Stone-built mastaba. Superstructure destroyed.

JUNKER, *Gîza*, x, pp. 139-40; plan, Abb. 48.

Libation-basin of deceased, found *in situ* in front of false-door. Id. ib. Taf. v [d], Abb. 49; text, id. in *Anzeiger, Wien*, 65 (1928), p. 189 [middle].

ISU  and MESHEDU , both *ka*-servants. Dyn. VI.

Brick-built mastaba lined with stone.

JUNKER, *Gîza*, x, pp. 140-3; plan and section, Abb. 50, cf. 4; views, Taf. vi [c, d].

Two drums of Isu and one of Meshedu. See id. ib. pp. 141-2; id. in *Anzeiger, Wien*, 65 (1928), p. 188.

G II S. KAEMNEFERT , Royal chamberlain. Temp. Menkaurêc.

Stone-built mastaba. III of Junker.

JUNKER, *Gîza*, x, pp. 18-38; id. in *Anzeiger, Wien*, 65 (1928), pp. 156-62. Plan and sections, id. *Gîza*, x, Abb. 8, 10, cf. 14 [III]. Plan of chapel, id. in *Anzeiger, Wien*, 65 (1928), Abb. 1. Views, id. *Gîza*, x, Taf. ii [b], iii [a, b]; id. in *Anzeiger, Wien*, 65 (1928), Taf. ii.

Chapel. See id. *Gîza*, iii, p. 54 [57].

Blocks from walls with attendants bringing various articles, and remains of deceased in sailing-boat. Id. ib. x, Taf. xvi [b, c (right)], Abb. 12, pp. 27-30.

Two inscribed fragments. Id. ib. Taf. xvi [c (left)], Abb. 13, p. 30.

South shaft. S 66 of Junker. Views, id. ib. Taf. viii [a, b].

Sarcophagus with name and titles of deceased and palace-façade decoration, red granite, in Hildesheim Mus. 3177. Id. ib. Taf. x [a, b], Abb. 15, 16, pp. 33-6; id. in *Anzeiger, Wien*, 65 (1928), Taf. iii [a], pp. 161-2; MARBURG INST. photo. 15037; see DONADONI ROVERI, *Sarcofagi egizi*, p. 120 [B 25].

Finds

Torso of nude statue, probably of deceased, basalt, found north of exterior chapel, in Hildesheim Mus. 3184. JUNKER, *Gîza*, x, Taf. xiii [a, b], pp. 37-8; id. in *Anzeiger, Wien*, 65 (1928), Taf. viii [b], p. 184 [a].

IYMERY [I] , King's *warb*-priest, Inspector of scribes (a) of the royal documents of the Treasury, (b) of the royal linen (*ššrw*), (c) of the royal light cloth (*ššp*), etc. Dyn. VI.

Stone-built mastaba.

JUNKER, *Gîza*, x, pp. 143-7; plan and sections, Abb. 52.

Offering-table of deceased, with offering-list, alabaster, in Cairo Mus. Ent. 53151. Id. ib. Taf. xxii [a], Abb. 53, pp. 145-7; id. in *Anzeiger, Wien*, 65 (1928), Taf. x [a], pp. 189-91 [a]; *I.L.N.* April 6, 1929, fig. 1, p. 584.

Drum of Nebty . . . , Royal acquaintance (woman), late Old Kingdom, built into floor of later mastaba east of last tomb. JUNKER, *Gîza*, x, Abb. 54, p. 148; see id. in *Anzeiger, Wien*, 65 (1928), p. 188.

G III S. KHUFUZEDEF , King's son, Master of the [royal] largesse. Temp. Menkaurêc.

Stone-built mastaba. IV of Junker.

JUNKER, *Gîza*, x, pp. 42-64; id. in *Anzeiger, Wien*, 65 (1928), pp. 162-6. Plans and sections, id. *Gîza*, x, Abb. 20-3, cf. 14 [IV]; reconstruction of entrance façade, Abb. 24. Plan of chapel, id. in *Anzeiger, Wien*, 65 (1928), Abb. 2. Views, id. *Gîza*, x, Taf. iii [c, d], iv [a, b]; id. in *Anzeiger, Wien*, 65 (1928), Taf. iv.

Chapel. Synopsis of scenes, id. *Gîza*, iii, p. 54 [58].

South wall. Deceased at table with two funerary priests before him, and remains of offering-list above. Id. ib. x, Taf. xvii [a], Abb. 25, pp. 52-6.

Fragments of estates before deceased (from east wall), and of offering-bringers, etc. Id. ib. Taf. xvii [b, c], Abb. 26-7, pp. 56-61; name of estate, JACQUET-GORDON, *Domaines*, pp. 236-7 [16G4-5], cf. figs. 42-3 (from JUNKER).

Shaft.

Sarcophagus with name and title of deceased and palace-façade decoration, red granite, in Cairo Mus. Ent. 53149. JUNKER, *Gîza*, x, Taf. xi, xii [a], Abb. 28-9, pp. 62-3; id. in *Anzeiger, Wien*, 65 (1928), Taf. v [a], p. 166; *I.L.N.* April 6, 1929, fig. 6, p. 585; DONADONI ROVERI, *Sarcofagi egizi*, Tav. xx [2], xxiii [3], pp. 113-14 [B 14]; see *Descr. somm.* No. 6156.

S 94/160. NAME UNKNOWN. Iymery [II] of Junker. Dyn. VI.

Stone-built mastaba.

JUNKER, *Gîza*, x, pp. 153-4; id. in *Anzeiger, Wien*, 65 (1928), p. 187 [b]; plans and sections, id. *Gîza*, x, Abb. 1, 2, and on Abb. 55.

Remains of text on false-door, mentioning son Iymery (probably I, tomb, see p. 218), and of scenes with clappers and dancers. See id. ib. p. 153.

G IV S. NI'ANKHRÊc [I]  [♀]. Temp. Menkaurêc.

Stone-built mastaba. LG 52.

JUNKER, *Gîza*, x, pp. 156-61; id. in *Anzeiger, Wien*, 65 (1928), pp. 167-70; *L. D. Text*, i, p. 76; MARIETTE, *Mastabas*, pp. 527-8 [7]. Plan, sections, and reconstruction, JUNKER, *Gîza*, x, Abb. 58-60, cf. 3. Plan of chapel, MARIETTE, op. cit. fig. on p. 527 [middle]. View of south shaft, JUNKER, *Gîza*, x, Taf. ix [a]; of burial chamber of north shaft (with uninscribed sarcophagus), Taf. xii [b]; id. in *Anzeiger, Wien*, 65 (1928), Taf. v [b], p. 169.

Statue of man standing, lower part, black granite (?), from débris of serdab. Id. *Gîza*, x, Taf. xv [f], p. 159.

S 127/129. Dyn. VI.

Stone-built mastaba.

JUNKER, *Gîza*, x, pp. 162-9; plans and sections, Abb. 62-3.

Offering-list with funerary priests, fragments, probably from west wall of chapel, in Hildesheim Mus. 3257. Id. ib. Abb. 64; see id. in *Anzeiger, Wien*, 65 (1928), pp. 186-7 [a].

S 125/157. Dyn. VI.

Stone-built mastaba.

JUNKER, *Gîza*, x, pp. 169-74; plans and sections, Abb. 65.

Shaft S 125. View with sarcophagus, id. ib. Taf. xii [d].

Ointment-slab (inscribed), alabaster. Id. ib. Taf. xxii [c, middle], Abb. 66, p. 172 [6]; id. in *Anzeiger, Wien*, 65 (1928), Taf. x [b, middle], p. 191 [b].

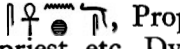
NISUSANKH , Prophet of Khufu, Director of members of a phyle, King's *wab*-priest, etc. Dyn. VI.

Wife, Khenut , *ka*-servant, etc.

Stone-built mastaba.

JUNKER, *Gîza*, x, pp. 175-82; plans and sections, on Abb. 67; names and titles, p. 177; id. in *Anzeiger, Wien*, 65 (1928), pp. 187-8.

North and south false-doors of deceased and wife. Id. *Gîza*, x, Taf. xix [a, b], Abb. 68-9, pp. 177-81.

NISUḤENU , *ka*-servant, Keeper of the dockyard. Dyn. VI.

Wife, Ni^cankh-ḥathor, *mitrt*.

Partly brick-built and partly stone-built mastaba.

JUNKER, *Gîza*, x, pp. 182-4; plans and sections, on Abb. 67.

Panel of false-door, deceased and wife at table, found in pieces in shaft S 139, in Hildesheim Mus. 3235. Id. ib. Taf. xix [c], Abb. 70; names and titles, id. in *Anzeiger, Wien*, 65 (1928), p. 188.

G VI S. Temp. Menkaurē^c.

Stone-built mastaba. VII of Junker.

JUNKER, *Gîza*, x, pp. 67-83; plan, on Abb. 33, cf. 14 [VII]; views, Taf. iv [c, d].

Masons' graffiti with name of crew of Menkaurē^c and dates, mostly on blocks of north face. Id. ib. Taf. xx, Abb. 34-5, pp. 69-81; Nos. 1, 2, id. in *Anzeiger, Wien*, 66 (1929), Taf. iv [a], p. 82 [top]; *I.L.N.* April 6, 1929, fig. 8, p. 585; date of No. 1, JUNKER, *Gîza*, viii, Abb. 22b, p. 59.

North shaft. S 108 of Junker. View, id. ib. x, Taf. viii [c].

Sarcophagus (uninscribed), red granite, damaged by tomb-robbers, now restored, in Vienna Mus. Inv. 8027. Id. ib. Taf. x [d] (as found), on Abb. 33, pp. 81-2; see Vienna. 5000 *Jahre*, No. 18 (called Mastaba I); DONADONI ROVERI, *Sarcofagi egizi*, p. 122 [B 31].

G VII S. Temp. Menkaurē^c.

Stone-built mastaba. VIII of Junker.

JUNKER, *Gîza*, x, pp. 83-90; id. in *Anzeiger, Wien*, 66 (1929), pp. 86-8. Plan, id. *Gîza*, x, Abb. 36; views, Taf. v [a, b]; of south burial chamber with sarcophagus, Taf. xii [c].

Fragments of statues, including two female heads (originally from other tombs), alabaster, probably in Cairo Mus. Id. ib. Taf. xiv, pp. 88-90; see id. in *Anzeiger, Wien*, 66 (1929), pp. 138-40.

G VIII S. SEKHEMKA , Judge and Boundary official, *iun-kenmut*-priest, Prophet of Ma'et, etc. End of Dyn. V or later.

Stone-built mastaba. IX of Junker.

Plan XXXI

JUNKER, *Giza*, xi, pp. 1-48; id. in *Anzeiger, Wien*, 66 (1929), pp. 89-97. Plans and sections, id. *Giza*, xi, Abb. 1, 3, 4; view, Taf. ii [d]; of north chapel, Taf. ii [c].

South Chapel. Synopsis of scenes, id. ib. iii, p. 54 [59].

Views, id. ib. xi, Taf. ii [a, b], iii [a, b]; id. in *Anzeiger, Wien*, 66 (1929), Taf. v [a].

I. Entrance Room.

(1) and (2) Remains of offering-bringers.

Id. *Giza*, xi, Abb. 29, 30, pp. 46-8.

II. Offering-room. Reconstruction of original positions by Junker.

(3) and (4) [9, 8 of Junker] Doorway. Thicknesses with three registers of offering-bringers on each.

Id. ib. Taf. v [c, upper], Abb. 26, 28, pp. 41-6.

(5) [7b of Junker] Probably similar to (6).

(6) [7a of Junker] Food, and registers of offering-bringers below.

Id. ib. Taf. iv [e], Abb. 21, pp. 37-40.

(7) and (8) [6, 5 of Junker] Deceased seated, with small son Kaemnefert and offering-bringers at (8), and butchers at (7).

Id. ib. Abb. 19, 20, pp. 33-6; fragment with food-offerings, probably from here, Abb. 22-5, Taf. iv [f], v [b], v [c, lower], pp. 40-1.

(9) and (10) [4b, a of Junker] Deceased with small son , and register of offering-bringers below.

Id. ib. Taf. iv [c, d], Abb. 17, 18, pp. 30-3. Man helping peasant woman with basket, from (9), id. in *Anzeiger, Wien*, 66 (1929), Abb. 1, p. 93.

(11) and (12) [3, 2 of Junker] Originally four registers (top destroyed), I-III, offering-bringers, IV, table with offerings, with funerary priest, offering-bringers, and butchers at (11), and with three funerary priests and food-offerings at (12).

Id. *Giza*, xi, Taf. iv [a, b], Abb. 13, 14, pp. 19-30; butchers, id. in *Anzeiger, Wien*, 66 (1929), Abb. 2, p. 94.

(13) [1 of Junker] (destroyed) Fragment with figure of deceased; id. *Giza*, xi, Abb. 12, pp. 18-19.

South sloping shaft.

Plan and sections, id. ib. Abb. 6, cf. x, Abb. 14 [IX]; view, xi, Taf. iii [d].



Sarcophagus (uninscribed), granite, in Hildesheim Mus. 3178, with fragments of inner limestone sarcophagus. Id. ib. Taf. iii [c], Abb. 7, pp. 10-12; id. in *Anzeiger, Wien*, 66 (1929), Taf. v [b], pp. 96-7; see DONADONI ROVERI, *Sarcofagi egizi*, p. 136 [B 67].

Finds

Statue of deceased seated (inscribed), lower part, found in Forecourt, in Hildesheim Mus.

3262. JUNKER, *Gîza*, xi, Taf. v [a], Abb. 11 (base), p. 17; name and titles, id. in *Anzeiger, Wien*, 66 (1929), p. 90.

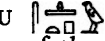
Fragment of pottery jar with ink text mentioning 'House of Isesi', from débris. Id. *Gîza*, xi, Taf. v [e], Abb. 10, pp. 15-17; see id. in *Anzeiger, Wien*, 66 (1929), p. 85.

SEHOTPU  good name TEPY , Judge and Overseer of scribes, Director of the Broad Hall, Secretary of judgement, etc. End of Dyn. V or early Dyn. VI.

Father (probably), Seshemnûfer [IV] (tomb LG 53).

Stone-built mastaba.

Plan XXXI

JUNKER, *Gîza*, xi, pp. 48-66; id. in *Anzeiger, Wien*, 66 (1929), pp. 130-3. Plans and sections, id. *Gîza*, xi, Abb. 31, on 32; view, Taf. vi [a].

Chapel.

(1) (a) and (b) Jambs with offering-text.

Id. ib. Abb. 34, on Taf. vi [b], p. 58.

(2) [Deceased seated] (not carved), and remains of registers of bulls, with son Khenu  and man leading dog with monkey on its back in bottom register.

Id. ib. Abb. 36, pp. 63-6; bottom register, Taf. vii [a]. Man with dog and monkey, id. in *Anzeiger, Wien*, 66 (1929), Abb. 6, p. 132.

(3) Deceased at table, with dog under chair, and three registers with food, offering-bringers, and man with calf.

Id. *Gîza*, xi, Abb. 35, pp. 58-63. Deceased with dog, id. ib. Taf. vi [c]; *I.L.N.* April 6, 1929, fig. 4, p. 584.

(4) False-door of deceased.

JUNKER, *Gîza*, xi, on Taf. vi [b], Abb. 33, pp. 54-8.

HENENI , Judge and Overseer of scribes, Boundary official of a frontier-district, Overseer of the gates in the Two Houses, etc. Dyn. VI.

Stone-built mastaba.

JUNKER, *Gîza*, xi, pp. 66-73; id. in *Anzeiger, Wien*, 66 (1929), pp. 133-4. Plans and sections, id. *Gîza*, xi, Abb. 37, on 32.

False-door of deceased, in Hildesheim Mus. 3179. Id. ib. Taf. vii [c], Abb. 40, pp. 69-73; KAYSER, *Das Pelizaeus-Museum in Hildesheim* (1966), Abb. 6; titles, JUNKER in *Anzeiger, Wien*, 66 (1929), pp. 133-4.

G IX S. Temp. Menkaurêc.

Stone-built mastaba. X of Junker.

JUNKER, *Gîza*, xi, pp. 74-7; id. in *Anzeiger, Wien*, 66 (1929), pp. 88-9. Plan and sections, id. *Gîza*, xi, Abb. 41; view of south burial chamber, Taf. vii [b].

Name of Inti  (woman), Old Kingdom, on block of east face, belonging to later burial. Id. ib. Taf. vii [d], Abb. 42, pp. 74-5; see id. in *Anzeiger, Wien*, 66 (1929), p. 89.

KHENUT , Royal acquaintance (woman). Dyn. VI.

Stone-built mastaba.

JUNKER, *Gîza*, xi, pp. 77-9; id. in *Anzeiger, Wien*, 66 (1929), p. 140. Plan and section, id. *Gîza*, xi, Abb. 43.

Head and lower part with inscribed base of seated statue of deceased. Id. ib. Taf. viii [c, d], Abb. 44 (base), pp. 78-9; see id. in *Anzeiger, Wien*, 66 (1929), p. 140.

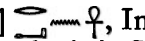
LG 55. NĪCANKHRĒC [II] , Inspector of physicians of the Great House, Prophet of Heka, Horus who is in Shenwet (?), and Anubis foremost-of-Sepa, etc. Late Dyn. V or early Dyn. VI.

Stone-built mastaba.

JUNKER, *Giza*, xi, pp. 79-91; L. D. *Text*, i, pp. 81-2, with sketch of position. Plan and section, JUNKER, op. cit. Abb. 45; view, Taf. ix [a].

False-door of deceased (now destroyed). L. D. ii. 91 [a], sketch, *Text*, i, p. 81; JUNKER, op. cit. Abb. 47 (from LEPSIUS), pp. 85-7; some titles, DE ROUGÉ, *Inscr. hiéro.* pl. lxxvi [top]; see MARIETTE, *Notice des principaux monuments . . . à Boulaq* (1864), p. 272 [9],

Statue of deceased squatting, from serdab, in Cairo Mus. Ent. 53150. JUNKER, op. cit. Taf. x, ix [b] (*in situ*), Abb. 48 (base), pp. 87-91; id. in *Anzeiger, Wien*, 66 (1929), Taf. ix, x, pp. 134-7; *I.L.N.* April 6, 1929, fig. 3, p. 584; ENGELBACH in *Ann. Serv.* xxxviii (1938), pl. xxxvii [1], p. 285; SCHARFF in *J.E.A.* xxvi (1940), pl. ix [3], p. 49; CAPART, *L'Art ég.* ii, pl. 248; ALDRED, *O.K. Art*, pl. 49; DRIOTON and SVED, *Art ég.* fig. 25; SHOUKRY, *Privatgrabstatue*, Abb. 15; RIAD, *La Médecine au temps des Pharaons*, fig. 22; WOLF, *Kunst*, Abb. 148; HORNEMANN, *Types*, ii, pl. 507; JONCKHEERE, *Les Médecins de l'Égypte pharaonique*, fig. 13; FECHT, *Vom Wandel des Menschenbildes in der ägyptischen Rundplastik*, Taf. 7; LANGE and HIRMER, *Ägypten. Architektur* (1967), pl. 78; *Great Museums*, pl. 27; ANGIOLETTI and BIGONGIARI, *Testimone in Egitto* (1969), Tav. 8; DONADONI, *Egyptian Museum Cairo*, pl. on p. 51 [upper], cf. p. 50; see *Descr. somm.* No. 6138.

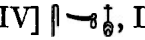
LG 53. SESHEMNÜFER [IV] , Director of the Two Seats in the Mansion of Life, Secretary of all secret commands of the King, Chief of *bat*, etc. End of Dyn. V or Dyn. VI.

Stone-built mastaba.

Plan XXXII

JUNKER, *Giza*, xi, pp. 94-6, 100-19, 126-31, 137-241; id. in *Anzeiger, Wien*, 66 (1929), pp. 100-6, 109-13, 115-22, 125-6, 137-8; L. D. *Text*, i, pp. 77-9. Plans and sections, JUNKER, *Giza*, xi, on Abb. 49, 50; L. D. i. on 25, *Text*, i, fig. on p. 77 [upper]; REISNER, *Giza Necropolis*, i, fig. 189 [left], p. 271 [upper]. Names and titles, JUNKER, *Giza*, iii, p. 10 [7]; view, xi, Taf. xi [b].

Chapel. Synopsis of scenes, id. ib. iii, pp. 34-5 [7].

Fragment with remains of cartouche of . . .kaf, in Berlin (West) Mus. 1318. L. D. *Text*, i, p. 78 with note 1.

I. Forecourt.

View, JUNKER, *Giza*, xi, Taf. xii [b]; restored, showing statues at (1) and (2) and obelisks, Taf. xi [a]; id. in *Anzeiger, Wien*, 66 (1929), Taf. vi [a]; VON BISSING, *Äg. Kunstgeschichte*, Taf. xxxix [290]; RANKE, *The Art of Ancient Egypt*, and BREASTED, *Geschichte Aegyptens*, 4 (caption incorrect); HOYNINGEN-HUENE and STEINDORFF, *Egypt* (1945), fig. on p. 39 (caption incorrect); LECLANT and RACCAH, *Dans les pas des Pharaons*, pl. 9; SIEGNER, *Ägypten. Ein Bildwerk*, pl. 137; ŽABA in *Dějiny Afriky*, i, pl. facing p. 224; SOGA, *The Nile*, fig. on p. 62 [upper right]. Reconstruction, JUNKER, *Giza*, xi, Taf. i; id. in *Anzeiger, Wien*, 66 (1929), Abb. 3 facing p. 100.

Six small obelisks, one of them *in situ* beside (2). View of four, id. *Gíza*, xi, Taf. xiv [b, c], pp. 110-11.

(1) and (2) Seated statues of deceased (inscribed).

Id. ib. Taf. xiii [c, d], Abb. 51a, pp. 109-10; see id. in *Anzeiger, Wien*, 66 (1929), pp. 137-8. (2) *I.L.N.* April 6, 1929, fig. 2, p. 584.

(3) and (4) Remains of registers with offering-bringers before [deceased], and calves ferried in canoes.

JUNKER, *Gíza*, xi, Taf. xviii [a, b], Abb. 61-2, pp. 142-9; see id. in *Anzeiger, Wien*, 66 (1929), pp. 116-17.

(5) Bottom of scene, [deceased and son] in canoes [spearing fish], accompanied by family, and small angling scene, crocodile and hippopotami, and frogs on branch below.

Id. *Gíza*, xi, Taf. xvi [c, d], Abb. 60, pp. 140-2.

II. Vestibule.

(6) [1st ed. 5] Three remaining registers, hunting antelopes with lasso in desert, and bringing cattle.

Id. ib. Taf. xvii, Abb. 63, pp. 150-7; part, id. in *Anzeiger, Wien*, 66 (1929), Taf. vii [a], Abb. 5, pp. 117-20 [A].

(7) [Deceased], and before him in bottom register, remains of men netting fish.

Id. *Gíza*, xi, Abb. 66, pp. 168-70.

(8) [1st ed. 6] Bottom register, baking and brewing, including (from left) grinding corn in mortar and on quern, sifting flour, heating pots, testing bread with stick, pouring dough into pots, sealing beer-jars.

Id. ib. Taf. xviii [c], Abb. 64, pp. 157-65. Texts, id. in *Anzeiger, Wien*, 66 (1929), pp. 120-1 [B].

(9) [1st ed. 7] Men with linen in register at bottom (much destroyed), and block with man in register above, before [deceased].

Id. *Gíza*, xi, Abb. 65, pp. 165-8. Texts, id. in *Anzeiger, Wien*, 66 (1929), pp. 121-2 [C].

III. Court.

(10) Uninscribed palace-façade false-door (a of Lepsius).

Id. *Gíza*, xi, Taf. xiii [b], Abb. 51, pp. 105-7; view of Court with (10), Taf. xii [c], xiii [a]; id. in *Anzeiger, Wien*, 66 (1929), Taf. vi [b]; *I.L.N.* April 6, 1929, fig. 5, p. 585.

IV. Pillared Hall. Doorway to Room I of Seshemnûfer-theti, see p. 227.

(11) (1st ed. 8] At bottom, two men bringing antelopes to [deceased].

JUNKER, *Gíza*, xi, Taf. xxii [a], Abb. 68, pp. 170-2. Texts, id. in *Anzeiger, Wien*, 66 (1929), p. 113.

(12) At bottom, remains of fishing scene. See id. *Gíza*, xi, p. 170.

(13) At bottom, remains of cattle crossing water, with hippopotami and crocodile.

Id. ib. Abb. 67, p. 170.

V. Outer Hall. A of Lepsius and Junker.

(14) [1st ed. 9-13] Doorway. (a)-(b) Right part of lintel with offering-text and titles, and drum with name and titles; (a) and (b) lower part of deceased and wife (?), with Seshemnûfer-theti (tomb, see p. 227) facing them (later); (c) deceased, with probably Seshemnûfer-theti before him; (d) lower part of deceased, and remains of biographical text in

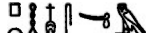
front of him; (e) and (f) deceased with sons Neferseshemtah  and Ptaḥhotp (tomb, see p. 228) at (f), and son and Seḥotpu (tomb, probably, see p. 222) at (e), and Theti (later) before deceased at both (e) and (f).

(a)–(b) Lintel, id. ib. Taf. xxii [c], Abb. 70 [upper], pp. 172–4, cf. Abb. 69; some titles, id. in *Anzeiger, Wien*, 66 (1929), p. 110 [top]. Drum, L. D. ii. 79 [middle]; JUNKER, *Giza*, xi, Abb. 70 [lower], p. 174, cf. Abb. 69. (a) and (b) Id. ib. Taf. xix [a, b], Abb. 72a, 72b, pp. 178–81, cf. Abb. 69; name of Seshemnūfer-theti, L. D. Text, i, p. 77 [middle]. (c) JUNKER, *Giza*, xi, Abb. 71 [left], pp. 176–8, cf. Abb. 69. (d) Id. ib. Abb. 71 [right], pp. 174–6, cf. Abb. 69; text, id. in *Anzeiger, Wien*, 66 (1929), p. 110 [middle]; SETHE, *Urk.* i (1933), 178 [22 (113)]. (e) and (f) L. D. ii. 79 [left and right]; JUNKER, *Giza*, xi, Taf. xix [c, d], Abb. 73a, 73b, pp. 181–6.

(15) [1st ed. 14] Two bottom registers, estates, removed by Lepsius, in Berlin Mus. 1128. L. D. ii. 80 [b], Text, i, pp. 77–8 with fig.; JUNKER, *Giza*, xi, Taf. xx [a], Abb. 76, pp. 196–202; *Aeg. und Vorderasiat. Alterthümer*, Taf. 4 [middle]; GRIFFITH INST. photo. 302 [middle]. Texts, *Aeg. Inschr.* i, pp. 10–11. Names of estates, JACQUET-GORDON, *Domaines*, pp. 306–9 [43G6], cf. figs. 92–3 (from LEPSIUS). See *Ausf. Verz.* p. 55.

(16) [1st ed. 17] Two remaining bottom registers of harvest, including (from left) sifting, winnowing, heaping corn, tying sack with sheaves, bringing donkey, and donkeys threshing, removed by Lepsius, in Berlin (East) Mus. 1129.

L. D. ii. 80 [a], Text, i, pp. 77–8 with fig.; JUNKER, *Giza*, xi, Taf. xx [b], xxi [a–c], Abb. 75, pp. 186–96; WRESZ., *Atlas*, i. 382 [B]; *Aeg. und Vorderasiat. Alterthümer*, Taf. 4 [bottom]; GRIFFITH INST. photo. 302 [bottom]; MÜLLER (W.) in *Forschungen und Berichte. Staatliche Museen zu Berlin*, 5 (1962), Abb. 1, p. 93. Lower register, men dragging donkey, CAPART, *Memphis*, fig. 366 (called Khnemḥotp); SMITH, *Hist. Eg. Sculp.* fig. 95 [3] (with guiding lines), p. 247. Group of donkeys, ROSS, *The Art of Egypt*, pl. on p. 114 [I]; LANGE, *Lebensbilder aus der Pharaonenzeit*, Abb. 18; PIRENNE, *Hist. civ.* i, pl. 53 [lower] facing p. 164. Texts, *Aeg. Inschr.* i, p. 12. See *Ausf. Verz.* p. 55; *Führer* (1961), p. 43.

(17) [1st ed. 16] Three (remaining) registers of flax and corn harvest before deceased, including binding sheaves, reaping corn, donkeys carrying produce, and men piling up sheaves. Right part of registers, in Hildesheim Mus. 3191, rest destroyed.

L. D. ii. 80 [c, right]; JUNKER, *Giza*, xi, Abb. 74b (from LEPSIUS), pp. 186–96. Hildesheim Mus. 3191, id. ib. Taf. xxi [d], Abb. 74a; KAYSER, *Das Pelizaeus-Museum in Hildesheim* (1966), Abb. 8; man reaping, from II, and laden donkey, from III, MICHALOWSKI, *Art*, figs. 258, 260; men with sheaves and two laden donkeys, from III, KAYSER, *Die Mastaba des Uhemka*, Taf. 17 [a]; Essen. 5000 Jahre, No. 46 with Abb.; WOLDERING, *Götter*, fig. on p. 230 [Kat. 47]; part, KAYSER, *Göttliche Tiere*, fig. on p. 21.

(18) [1st ed. 15] Remaining bottom register, four offering-bringers.

L. D. ii. 80 [c, left]; JUNKER, *Giza*, xi, Abb. 77, pp. 202–3.

VI. Inner Hall. B and D. 2 of Lepsius and B and E of Junker.

(19) [1st ed. 18–19] (a) and (b) Three registers, men bringing animals. Block with man and bull from (b), in Hildesheim Mus. 3194.

Id. ib. Abb. 78–9, Taf. xx [d], pp. 203–7; L. D. ii. 80 [d, e], Text, i, p. 78.

(20) Remaining bottom register, officials and offering-bringer, led by Seḥotpu.

L. D. *Ergänz.* xxiii [b], Text, i, pp. 78 [bottom], 79; JUNKER, *Giza*, xi, Abb. 81 (from LEPSIUS), pp. 211–12.

(21) Remains of men bringing bull and young gazelle.

Id. ib. Taf. xxii [b], Abb. 82, pp. 212-14.

(22) [1st ed. 25] Offering-scenes before statue of deceased in his presence. Block with statue of deceased and remains of offering-scenes, in Hildesheim Mus. 3190.

Id. ib. Taf. xxii [d], xxiii [a, b], Abb. 89, 90, cf. 88, pp. 222-9; see id. in *Anzeiger, Wien*, 66 (1929), pp. 106, 111-12. Hildesheim Mus. 3190, id. in *Anzeiger, Wien*, 87 (1950), Taf. i, pp. 402-3; WOLF, *Kunst*, Abb. 162.

(23) [1st ed. 21] Bottom register, Sehotpu, two officials, and man with bull, removed by Lepsius, in Berlin Mus. 1130, and remains of register above, bringing cattle.

L. D. *Ergänz.* xxiii [a]; JUNKER, *Gîza*, xi, Abb. 80 (from LEPSIUS), pp. 207-11. Berlin Mus. 1130, id. ib. Taf. xx [c]; *Aeg. und Vorderasiat. Alterthümer*, Taf. 4 [top]; GRIFFITH INST. photo. 302 [top]. Texts, *Aeg. Inschr.* i, p. 10. See *Ausf. Verz.* p. 54.

VII. Offering-room. C of Lepsius and Junker.

(24) At bottom, remains of butchers.

JUNKER, *Gîza*, xi, Taf. xxiii [c, d], Abb. 84, p. 219.

(25) [1st ed. 22] Fragments of *kheker*-frieze and offering-list from top, and remains of offering-bringers at bottom.

Id. ib. Abb. 85-7, Taf. xxiii [e], pp. 219-22. Four names of offering-bringers, id. in *Anzeiger, Wien*, 66 (1929), p. 111.

(26) [1st ed. 23] False-door of deceased, with conventional biographical text at back of niche (now probably destroyed).

L. D. ii. 81; JUNKER, *Gîza*, xi, Abb. 83 (from LEPSIUS), pp. 214-16. Upper part, MARIETTE, *Mastabas*, pp. 529-30 (sketch and text); WILKINSON MSS. xiii. 89 [upper]. Text at back of niche, SETHÉ, *Urk.* i (1933), 57 [39]. See MARIETTE, *Notice des principaux monuments . . . à Boulaq* (1864), p. 272 [10].

Blocks. Original position uncertain.

Putting birds into cages, from scene of netting fowl, in Hildesheim Mus. 3193. JUNKER, *Gîza*, xi, Taf. xxiv [a], Abb. 91, pp. 233-5.

Bringing hyenas (two fragments, smaller in Hildesheim Mus. 3270). Id. ib. Abb. 92, pp. 235-7.

Goats, in two registers, in Hildesheim Mus. 3192. Id. ib. Taf. xxiv [b], Abb. 93, pp. 237-8.

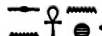
Remains of standing figure of Sien'ankh . Id. ib. Abb. 94, pp. 238-40.

Fragment of lintel with remains of offering-text. Id. ib. Abb. 95, pp. 240-1.



Sloping shaft. Opening in Court III.

Plan and sections, JUNKER, *Gîza*, xi, Abb. 52; view with uninscribed sarcophagus, Taf. xv [a], pp. 111-14; id. in *Anzeiger, Wien*, 66 (1929), Taf. viii [a], pp. 125-6; *J.L.N.* April 6, 1929, fig. 7, p. 585.

East wall. Painted offering-list; JUNKER, *Gîza*, xi, Taf. xvi [a], Abb. 53, pp. 114-16.

Finds

Base of seated statue of [Neferseshemtah] good name Sheshi , probably son of deceased, from débris. Id. ib. Abb. 111, pp. 270-1; see id. in *Anzeiger, Wien*, 66 (1929), pp. 140 [bottom], 141.

SESHEMNŪFER-THETI  called THETI , Chief of *bat*, Sole companion, Director of the Two Seats, etc. Dyn. VI.

Stone-built mastaba.

Plan XXXII

JUNKER, *Giza*, xi, pp. 96-7, 119-22, 131-6, 241-58; id. in *Anzeiger, Wien*, 66 (1929), pp. 106-9, 113-15, 127-8. Plans and section, id. *Giza*, xi, on Abb. 49, 50; of sloping shaft and burial chamber with uninscribed sarcophagus, Abb. 56, pp. 119-22; views of shaft and chamber, Taf. xiv [d, e], xv [c]; id. in *Anzeiger, Wien*, 66 (1929), Taf. vii [b], viii [b]. Synopsis of scenes, id. *Giza*, iii, p. 35 [8].

Room I. A of Junker. Entered from Pillared Hall IV of LG 53, see p. 224.

Three fragments, perhaps from doorway, titles on two, and deceased standing on one. Id. ib. xi, Abb. 102a, 102b, 103, Taf. xxv [c], pp. 257-8.

Fragment, probably from south wall, deceased carried in palanquin, and dwarf with dog and monkey on leash. Id. ib. Taf. xxv [a], Abb. 100, pp. 249-55; id. in *Anzeiger, Wien*, 66 (1929), Abb. 4, pp. 113-14.

Room III. C of Junker.

Fragment with offering-bringers, perhaps from north wall. Id. *Giza*, xi, Taf. xxv [b], Abb. 101, pp. 255-7.

Fragments from north and south walls. *Kheker*-frieze, offering-list, deceased seated, offering-bringers, etc.; id. ib. Abb. 97a-c, 98, cf. Abb. 96 (reconstruction of north wall), pp. 242-7.

False-door of deceased (restored from fragments). Id. ib. xii, Abb. 15, 16, pp. 143-7.

Room IV. E of Junker.

Bottom of scene on west wall, offering-scenes before two statues in presence of deceased and son(?). Id. ib. xi, Taf. xxiv [c], Abb. 99, pp. 247, 249.

Position uncertain.

Block with six estates, possibly from here, now lying in tomb LG 53. Names, JACQUET-GORDON, *Domaines*, pp. 313-14 [45G6], cf. figs. 96-7.

LG 54. HETEPHERES , Prophetess of Neith, etc. Dyn. VI.

Stone-built mastaba.

Plan XXXII

JUNKER, *Giza*, xi, pp. 97-8, 122-4, 136-7, 258-63; id. in *Anzeiger, Wien*, 66 (1929), pp. 109, 126-7; L. D. *Text*, i, pp. 79-81. Plans and sections, JUNKER, *Giza*, xi, on Abb. 49; L. D. i. on 25, *Text*, i, fig. on p. 77 [upper]; REISNER, *Giza Necropolis*, i, fig. 189 [right], p. 271 [upper].

Chapel. Painted decoration.

(1) Fragment with two offering-bringers, and food above.

JUNKER, *Giza*, xi, Abb. 105a, pp. 261-3.

(2) [1st ed. 1] Offering-bringer before deceased at table.

L. D. ii. 90 [left]; JUNKER, *Giza*, xi, Abb. 105 (from LEPSIUS), pp. 260-1.

(3) [1st ed. 2] False-door of deceased (upper lintel now missing).

L. D. ii. 90 [right], *Text*, i, p. 79; JUNKER, *Gîza*, xi, Taf. xxvi [a], Abb. 104, pp. 258, 260.

Intrusive burials.

Anthropoid coffins, wood, Late Period. L. D. *Text*, i, fig. on p. 80, cf. pp. 80-1; SCHMIDT, *Sarkofager*, figs. 1196-8 (from LEPSIUS).

Sloping shaft. Opening north of tomb of Seshemnûfer-theti (see p. 227).

Plan and sections, JUNKER, *Gîza*, xi, Abb. 57, pp. 122-4; views, Taf. xii [a], xv [d] (with uninscribed sarcophagus).

Ointment-slab with five (remaining) names of oils, alabaster, fragment. Id. ib. Abb. 58 [upper], p. 124.

PTAḤHOTP , Physician of the Great House, Inspector of *ka*-servants, Hereditary prince, etc. Dyn. VI.

Father, Seshemnûfer [IV] (tomb LG 53).

Stone-built mastaba.

JUNKER, *Gîza*, xi, pp. 98-100, 124-5, 137, 263-8; id. in *Anzeiger, Wien*, 66 (1929), pp. 128-30. Plan, id. *Gîza*, xi, on Abb. 49; plan and sections of burial chamber with uninscribed sarcophagus, Abb. 59. View of tomb, id. ib. Taf. xii [d]; id. in *Anzeiger, Wien*, 66 (1929), Taf. i [b]; of burial chamber, id. *Gîza*, xi, Taf. xv [b].

Chapel.

Fragment with lower part of deceased seated, from left of doorway, and with titles, from lintel. Id. ib. Abb. 106, pp. 263-4.

Two blocks with remains of biographical text. Id. ib. Abb. 107, pp. 264-5.

Lower part of false-door of deceased. Id. ib. Taf. xxvi [c], Abb. 108, pp. 265-8.

THETUT , Royal acquaintance (woman). Dyn. VI.

Stone-built mastaba.

JUNKER, *Gîza*, xi, pp. 268-9; id. in *Anzeiger, Wien*, 66 (1929), p. 134. Plan, id. *Gîza*, xi, on Abb. 49.

False-door of deceased, in Hildesheim Mus. 3180. Id. ib. Taf. xxvi [b], Abb. 109; see id. in *Anzeiger, Wien*, 66 (1929), p. 134.

False-door of Seshemnûfer (no title), lower part, found nearby. Id. *Gîza*, xi, Taf. xxvi [d], Abb. 110, p. 270.

D. QUARRY CEMETERY WEST OF SECOND PYRAMID

Rock-cut tombs in the face formed by cutting down the rock for pyramid-platform. Mostly unfinished.



Plan XIX [2]

Plan, *Descr. Ant.* v, pl. 16 [1]; L. D. i. on 14; HÖLSCHER (U.), *Das Grabdenkmal des Königs Chephren*, on Bl. ii.

IMA , Royal chamberlain, Herdsman of *rekhyt*, Secretary of all commands of the King, etc. Dyn. V-VI.

Lintel of false-door; PETRIE in SAYCE MSS. 28b [lower].

Remains of scene with men leading oxen.

LG 10. SENEZEMIB  good name INTI . Temp. Isesi. (Also owner of tomb G 2370.)

Plan, L. D. *Text*, i, p. 30.

Entrance doorway. Lintel with offering-text; L. D. ii. 78 [c], *Text*, i, p. 30 [10]; MARIETTE, *Mastabas*, p. 523 [upper]; WILKINSON MSS. xiii. 81 [upper].

LG 11. NAME LOST, Prophetess of Hathor, etc. Dyn. V-VI.

L. D. *Text*, i, p. 30.

False-door. Text on left jamb, PETRIE in SAYCE MSS. 28c.

Smaller false-door. Remains of text, id. ib. 28c.

LG 12. NEBEMAKHET . Temp. Khephren to Menkaure or a little later. (Also owner of tomb LG 86.)

'Tomb of Palm-tree Beams'.

Plan, L. D. *Text*, i, fig. on p. 31 [right], cf. pp. 30-2; MARIETTE, *Mastabas*, fig. on p. 524, cf. pp. 523-4; REISNER, *Giza Necropolis*, i, fig. 129, p. 224 [5]; plan and sections, *Descr. Ant.* v, pl. 16 [3-5, position, 1c]. Section, BURTON MSS. 25619, 24.



Entrance doorway. Lintel with remains of offering-text, right jamb with [deceased and brother]; L. D. *Text*, i, fig. on p. 31 [left]; HÖLSCHER (U.), *Das Grabdenkmal des Königs Chephren*, Abb. 20, p. 34; lintel, MARIETTE, op. cit. fig. on p. 523 [lower]; WILKINSON MSS. xiii. 80 [lower]; PETRIE in SAYCE MSS. 28 b [upper] (called LG 13).

LG 13. NAME LOST, Sole companion. Dyn. V-VI.

Drum and right jamb with remains of text. MARIETTE, *Mastabas*, p. 524; WILKINSON MSS. xiii. 80 [upper]; PETRIE in SAYCE MSS. 17a [bottom]; see L. D. *Text*, i, p. 32 [13].

Tomb of Washptah, and another with statue of Neferseshemtah, Dyn. IV-V, discovered by Service des Antiquités in 1965-6. See FAKHRY, *The Pyramids* (1969), p. 256.

Graffiti. Temp. Ramesses II. Position, on plan XIX [2].

(a) May , Overseer of works in Akh-ra'messe-meriamun, etc., son of Bekenamun , Overseer of works, with Pameniu , Head of sculptors. (b) May.

Views, HÖLSCHER (U.), *Das Grabdenkmal des Königs Chephren*, Abb. 53-4; HABACHI in *Chron. d'Ég.* xxix (1954), figs. 25-6, pp. 212-13. Texts, PERRING, *Pyramids*, ii, *The 2nd Pyramid*, p. 5, cf. pl. vii; VYSE, *Operations*, i, p. 160, cf. pl. facing p. 159; L. D. iii. 142 [i, k]; BRUGSCH, *Thes.* 1243 [v, a-c]; CHAMP., *Not. descr.* ii. 482 [top]; SAUNERON in *B.I.F.A.O.* liii (1953), pp. 57-8, cf. fig. 1; BURTON MSS. 25619, 24; 25620, 73 verso; 25618, 61 and 63; 25621, 136 [2]; WILKINSON MSS. iv. 72; xiii. 81 [lower]; GARDINER Notebook, 61, p. 10 [middle and bottom]. (a) View, Pochan, *L'Énigme de la Grande Pyramide*, 3rd pl. after p. 244 [lower]; GARDINER MSS. photo. 28.1051; text, BURTON, *Excerpta hiero.* pl. xxvii [2]; LANE MSS. 34088, 10. (b) Text, *Descr. Ant.* v, pl. 14 [15]; L. D. *Text*, i, p. 32; NESTOR L'HÔTE MSS. 20396, 334; PETRIE in SAYCE MSS. 17a [middle]; BONOMI MSS. Diary, May 15, 1827.

E. CENTRAL FIELD

Plans of parts, HASSAN, *Gîza*, i, frontispiece; ii, 1st plan at beginning; iii, first two plans at beginning; iv and v, 1st plan at beginning; vi [3] and vii, 2nd plan at end; ix, general plan.

Views, LANGE and HIRMER, *Aegypten. Architektur* (1955 and 1957), pl. 32; (1967), pl. 35; YOYOTTE, *Treasures of the Pharaohs*, pl. on p. 19.

OLD KINGDOM TOMBS

Mostly Hassan Excavation. Cairo University (1929-37)

Key plan XX. Plans XXI-XXIII

ḤAR . . . , Hereditary prince, King's eldest son. Probably late Dyn. IV.

Rock-cut tomb, near tomb LG 86. Not marked on plan.

Plan, MARIETTE, *Mastabas*, p. 549 [middle, z]. Drum with remains of titles and name; id. ib. p. 550 [top and middle].

LG 86. NEBEMAKHET , King's son of his body, Chief Justice and Vizier, etc. Temp. Khephren to Menkaurē or a little later. (Also owner of tomb LG 12.)

Parents, Khephren and Meresankh [III] (tomb G 7530+7540). Wife, Nubhotp , Prophetess of Ḥathor Mistress-of-the-Sycamore in all her places, etc.

Rock-cut tomb.

Position, on plan XXI, B-2. Plan XXXII

L. D. *Text*, i, pp. 102-4; HASSAN, *Gîza*, iv, pp. 125-50 (with texts). Plan, L. D. *Text*, i, p. 102; REISNER, *Gîza Necropolis*, i, fig. 140, pp. 236 [1], 247-8; cf. MARIETTE, *Mastabas*, plan on p. 549 [middle, a]. Plan and section, HASSAN, op. cit. figs. 71-2, cf. 103-5 (shafts). Synopsis of scenes, JUNKER, *Gîza*, iii, pp. 49-50 [47]. Name of wife, MARIETTE, op. cit. p. 549.

Room I.

(1) Entrance doorway. Fragments of lintel and drum with name and titles, found in débris and replaced.

HASSAN, op. cit. figs. 73-4, pl. xxxvi [A].

(2) Above doorway, remains of scene with herdsmen, and goats browsing.

Id. ib. fig. 75.

(3) [1st ed. 1-2] [Deceased and sister Shepsetkau , King's daughter of his body], and five registers, I, scribes, men putting birds into cages, and netting fowl, II (now lost), ploughing, and goats treading grain, III, netting fowl, with man presenting bird to an overseer, IV (now much destroyed), boats, V (destroyed), bringing cattle.



L. D. ii. 12 [a], *Text*, i, p. 103; HASSAN, op. cit. fig. 76. I-III, WILKINSON MSS. iv. 69. Men with geese, and fowling with clap-net, BURTON MSS. 25621, 75 verso-76. Boat in IV, DUEMICHEN, *Flotte*, xxv [2]. Titles of deceased, DE ROUGÉ, *Recherches sur les monuments* [etc.], p. 57 (repr. in *Bibl. Ég.* xxvi, pp. 55-6).

(4) [1st ed. 3-4] Deceased fowling from canoe (lower part of scene and left part of III-V destroyed by cutting niche), and five registers, I, men bringing fish, and cutting out roes,

II, bringing fowl and young animals in boxes (including hare, hedgehog, gazelles), and gazelle and young one, **III**, men carrying bundles of papyrus, and building papyrus-canoes, **IV**, cattle crossing water, and herdsman in canoe, **V** (now destroyed), estates.

L. *D.* ii. 12 [b]; HASSAN, op. cit. pl. xxxvii, fig. 77 (from LEPSIUS); WILKINSON MSS. iv. 66 D [right], 67. Stern of canoe of deceased, BURTON MSS. 25619, 44 [lower]. **I-V**, WILKINSON squeezes, Box 28. 25-38. **I-IV**, NESTOR L'HÔTE MSS. 20406, 'Tombeau du temps de Kheops', B, E, F (squeezes). **I**, WILKINSON, *M. and C.* iii. 56-7 (Nos. 344-5) = ed. BIRCH, ii. 118-19 (Nos. 373-4); cutting out roes for preparing botargo, see KEIMER in *Bull. Inst. Ég.* xxi (1938-9), p. 222 [4] with pl. iv [1] (from LEPSIUS); VANDIER in *Kémi*, xvii (1964), pp. 31-3 with fig. 4 (from LEPSIUS). **II**, WILKINSON MSS. ii. 29 verso [left upper]; omitting man with hedgehog, BURTON MSS. 25621, 72, 73; right half, WILKINSON, *M. and C.* iii. 9 (No. 320) = ed. BIRCH, ii. 83 (No. 348); gazelles and men with young gazelles, *Descr. Ant.* v, pl. 17 [9]; HAY MSS. 29821, 95. **III-IV**, BONOMI MSS. ii. 41. **III**, *Descr. Ant.* v, pl. 18 [7]; DUEMICHEN, *Flotte*, xxv [1, left]. Three bulls, from **IV**, *Descr. Ant.* v, pl. 18 [4] (reversed). Raft with decoy bird, from **IV**, id. ib. pl. 18 [5]; DUEMICHEN, *Flotte*, xxv [1, right]. **V** (partly reversed, incomplete), *Descr. Ant.* v, pl. 18 [8]; names of estates, MARIETTE, *Mastabas*, p. 549 [bottom]; JACQUET-GORDON, *Domaines*, pp. 227-8 [12G4-5], Nos. 3-8, cf. figs. 33-4 (from LEPSIUS).

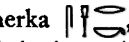
Room II.

(5) [1st ed. 5-10] Doorway. (a) Semerka , Painter, and Inkaf , with text above. (b) Two bottom registers, men bringing animals, including hyena. (c) (much destroyed) Men overthrowing bull, and [geese] below. (d) (now destroyed) Offerings, butchers, and male dancers. (e) Above doorway, deceased with sister Shepsetkau and probably brother Duaenrê (tomb G 5110) before mother (upper part only). (f) Three registers, **I**, two men and coffin on bier under canopy, **II-III**, attendants bringing various objects.

(a) L. *D.* ii. 12 [c]; HASSAN, op. cit. fig. 78. Text, SETHE, *Urk.* i (1933), 16 [12]; SMITH, *Hist. Eg. Sculp.* p. 352. (b) L. *D.* ii. 14 [c]; HASSAN, op. cit. pl. xxxvi [B], fig. 80; WILKINSON squeezes, Box 28. 39-46. Reversed, and omitting hyena, probably, *Descr. Ant.* v, pl. 18 [9]. (c) L. *D.* ii. 14 [b]; HASSAN, op. cit. fig. 79; BURTON MSS. 25621, 74. Omitting geese, *Descr. Ant.* v, pl. 18 [6]; LANZONE, *Dix.* Tav. ccvi. (d)-(f) L. *D.* ii. 14 [a], *Text*, i, p. 104; HASSAN, op. cit. pl. xxxviii, fig. 81 [left]. (f) **I**, *Descr. Ant.* v, pl. 47 [3]; LANZONE, *Dix.* Tav. ccv, pp. 534-5; BURTON MSS. 25621, 70; corrected drawing of headrest (not bull's head), BORCHARDT in *A.Z.* 35 (1897), p. 168. **III**, *Descr. Ant.* v, pl. 18 [1].

(6) [1st ed. 11-12] Deceased and wife, with two baboons, and five registers of industries, **I**, jewellers, **II**, man painting naos, filling and sealing wine-jars, and in right half of **I-II**, pressing grapes, **III**, vase-makers, sculptors, carpenters, **IV**, melting and beating metal, **V**, making metal vases, and weighing.

L. *D.* ii. 13; HASSAN, op. cit. fig. 81 [right]. Text above deceased and wife, and two men, from **III**, WILKINSON MSS. xvii. F. on f. Baboon, BURTON MSS. 25621, 84. **I-II**, WILKINSON MSS. iv. 68; right part, BURTON MSS. 25621, 82; filling and sealing, and wine-press, *Descr. Ant.* v, pls. 17 [15], 18 [2]. **IV**, BURTON MSS. 25621, 87; men blowing furnace, WILKINSON MSS. xiii. 63 [lower right]; beating metal, *Descr. Ant.* v, pl. 17 [5].

(7) [1st ed. 13-14] (much destroyed by cutting window) Five registers, bringing jewelry and various objects, for rewarding workmen, to [deceased and wife] with attendants behind.

L. *D.* *Ergänz.* xxxiv [a]; HASSAN, op. cit. fig. 82. Incomplete, JUNKER, *Giza*, v, Abb. 11 (from LEPSIUS), pp. 51-2. Men with collars, and box with collars, *Descr. Ant.* v, pl. 18 [3].

(8) Completely destroyed. Various fragments found in débris, including brother Neuserre^c  (tomb, see p. 234) and two estates; HASSAN, op. cit. figs. 83-102, pl. ix [B]; v, pl. lxix [E], p. 314 [12]; names of estates, JACQUET-GORDON, *Domaines*, pp. 227-8 [1264-5], Nos. 9, 10, cf. fig. 33.

Finds. Old Kingdom

Found in Room II.

Statue-group, three squatting men (middle one Iskha , ka-servant), lower part. HASSAN, *Gîza*, iv, pl. xxxix [A], p. 148 [1].

Statue-base (inscribed), fragment. See id. ib. p. 148 [2].

Female torso. Id. ib. pl. xxxix [C], p. 148 [4].

Various statue-fragments. See id. ib. p. 148 [3, 5-6], with pl. xxxix [B].

Found nearby.

Head of male statue, black granite, thrown down an unfinished shaft. Id. ib. ix, pls. xl [D], xli, p. 86 [2]; see *Chron. d'Ég.* xiv (1939), p. 83 [ii].

Two blocks, man with two attendants, and hyena. HASSAN, op. cit. v, pl. lxviii [A, B], p. 313 [6, 7].

Block, man censing before [deceased]. Id. ib. ix, pl. xlvi, fig. 40, pp. 89-90 (text).

LG 87. NIKAURĒ^c , King's eldest son of his body, Chief Justice and Vizier (probably of Menkaure^c), etc. Temp. Khephren to end of Dyn. IV.

Parents, Khephren and Personet (tomb LG 88). Wife, Nikanebti , Prophetess of Hathor Mistress-of-the-Sycamore in all her places, and of Neith, etc.

Rock-cut tomb.

Position, on plan XXI, B/C-2. Plan XXXI

Plans and sections, L. D. i. 28, *Text*, i, fig. on p. 105, cf. pp. 104-6; REISNER, *Giza Necropolis*, i, fig. 125 [lower], pp. 221 [1], 310 [a], cf. 152 [2]; plan, MARIETTE, *Mastabas*, on plan on p. 547. Synopsis of scenes, JUNKER, *Gîza*, iii, pp. 48-9 [45].

Room II. b of Reisner.

(1) Deceased, holding lotus, seated in pavilion with offerings and harpist, flutist, and singers.

L. D. *Ergänz.* xxxv [lower], *Text*, i, p. 105; see REISNER, op. cit. p. 348 [1].

(2) [1st ed. 2-3] Deceased at table, offering-list before him, and offering-bringers and [butchers] below.

L. D. *Ergänz.* xxxv [upper]. Deceased and text above, WILKINSON MSS. xiii. 62 [right].

(3) [1st ed. 4-5] Five registers of presentation scenes before deceased and wife, I, II, V, scribes, and men bringing bulls, donkey, and hyena, III, IV, estates.

L. D. ii. 15 [b]. Names of estates, JACQUET-GORDON, *Domaines*, pp. 219-21 [964], Nos. 1-12, cf. figs. 26, 27 (from LEPSIUS).

Room III. y of Reisner.

(4) [1st ed. 6] Will concerning estates, in favour of wife and children, dated 'Year of 12th census'.

L. D. ii. 15 [a, left and middle], *Text*, i, p. 106; BURTON MSS. 25619, 47 [top, and middle right]; WILKINSON MSS. xiii. 63 [upper left]. Text of will, SETHE, *Urk.* i (1933), 16-17 [13];

GOEDICKE, *Die privaten Rechtsinschriften aus dem Alten Reich*, Taf. iii, pp. 21-30. Names of estates, JACQUET-GORDON, op. cit. pp. 219, 221 [9G4], Nos. 13-16, cf. figs. 26, 28 (from SETHE).

(5) [1st ed. 7] Names and titles of deceased and wife.

L. D. ii. 15 [a, right]; MARIETTE, *Mastabas*, p. 549 [top]; CHAMP., *Not. descr.* ii. 480 [top]; BURTON MSS. 25619, 47 [middle left]; WILKINSON MSS. xiii. 63 [upper right].

Finds

Fragments of lid of rock-cut sarcophagus with ritual-scene of Ḥarkhebi , Prophet of Ptolemy III Euergetes I and IV Philopator, etc., son of Ḥarkhebi, from side-chamber of shaft 790 (of Hassan), north of tomb. See HASSAN, *Giza*, v, pp. 313-14 [9] (with text).

LG 88. PER[SONET] , King's wife, King's daughter of his body, etc. Temp. Khephren.

Husband, Khephren.



Rock-cut tomb.

Position, on plan XXI, C-2

Plan and section, L. D. i. 28, *Text*, i, on fig. on p. 105, cf. pp. 107-8; REISNER, *Giza Necropolis*, i, fig. 125 [upper], pp. 225 [7], 310 [g], cf. 152 [3]; plan, NESTOR L'HÔTE MSS. 20396, 313 [upper]; MARIETTE, *Mastabas*, on plan on p. 547.

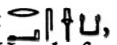
South pillar, east face. Titles of deceased, L. D. ii. 152 [c], *Text*, i, p. 108; MARIETTE, *Mastabas*, p. 550 [lower left]; NESTOR L'HÔTE MSS. 20396, 313 [lower left]; WILKINSON MSS. xiii. 62 [left]; incomplete, CHAMP., *Not. descr.* ii. 480 [middle].

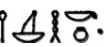
LG 89. SEKHEMKARĒ , King's eldest son of his body, Chief Justice and Vizier (probably of Userkaf and Saḥurē), etc. Temp. Khephren to early Dyn. V.

Parents, Khephren and Ḥeknuḥezet . Wife, Khufu . . . et .

Royal acquaintance.

Rock-cut tomb.

Position, on plan XXI, C-2. Plan XXXII

L. D. *Text*, i, pp. 108-11; MARIETTE, *Mastabas*, pp. 546-7 [a]; HASSAN, *Giza*, iv, pp. 103-23 (with texts); *Chron. d'Ég.* ix (1934), p. 72 [2]. Plan, L. D. *Text*, i, on fig. on p. 108; HASSAN, op. cit. fig. 53, cf. 66-70 (shafts); REISNER, *Giza Necropolis*, i, fig. 128, pp. 223-4 [4], 310 [c]; MARIETTE, op. cit. on plan on p. 547 [a]. Synopsis of scenes, JUNKER, *Giza*, iii, p. 49 [46].

Room I.

(1) Entrance doorway (much damaged). (a) and (b) Deceased standing; (c) [1st ed. 1] drum with name and titles; (d) remains of offering-bringers; (e) remains of deceased and wife(?) seated; (f) [1st ed. 2] row of vases, and three remaining registers, goat grazing, netting fowl, and men putting birds into cages; (g) [1st ed. 3] four remaining registers, boat-building, men drilling(?), and scenes with granaries and women sifting grain.

(a)–(c) HASSAN, op. cit. pl. xxxiii, fig. 54. (c) L. D. ii. 41 [c]; WILKINSON MSS. xiii. 59 [right]. (d) HASSAN, op. cit. fig. 56. (e) Id. ib. fig. 55. (f) and (g) L. D. *Ergänz.* xxxvi; HASSAN, op. cit. fig. 57.

(2) [1st ed. 4] (lower part destroyed) Remains of two registers of boats before deceased and mother seated.

L. D. *Ergänz.* xxxvii; HASSAN, op. cit. fig. 61; deceased and mother, L. D. ii. 42 [b].

(3) [1st ed. 10] Deceased and wife seated, and three remaining registers of presentation scenes before them, I, four sons squatting, and estates, II, men bringing birds and taking them out of cage, and two scenes of netting fowl, III (right half), remains of netting fish.

L. D. ii. 42 [a], *Text*, i, p. 109 (sketch); HASSAN, op. cit. fig. 58. Part, WILKINSON MSS. xiii. 60, 61 [upper]. Names of estates, JACQUET-GORDON, *Domaines*, pp. 224–6 [1164–5], cf. figs. 31, 32 (from LEPSIUS); names of four (incorrect), MARIETTE, *Mastabas*, p. 547.

(4) Partition wall (completely destroyed). Blocks with remains of birds, butterfly, and men felling trees; HASSAN, op. cit. figs. 59, 60.

Room II.

(5) [1st ed. 5–6] Offering-list with name and title above.

L. D. ii. 42 [c], *Text*, i, fig. on p. 111 [upper]; HASSAN, op. cit. fig. 63.

(6) [1st ed. 9] Deceased and mother seated before pavilion, with offerings and offering-bringers before them, and dancers below the whole scene.

L. D. ii. 41 [b]; HASSAN, op. cit. fig. 62.

(7) [1st ed. 7–8] Palace-façade false-door, and above doorway, titles with names of Khephren, Menkaurê, Shepseskaf, Userkaf, and Sahurê.

L. D. ii. 41 [a], *Text*, i, pp. 109–10; HASSAN, op. cit. pl. xxxiv, fig. 64. Titles, DE ROUGÉ, *Recherches sur les monuments* [etc.], p. 77 (repr. in *Bibl. Ég.* xxvi, p. 74); SHARPE, *Eg. Inscr.* 2 Ser. 38, ll. 31–5; SETHE, *Urk.* i (1933), 166 [15 (106)]; WILKINSON MSS. xiii. 61 [lower]. Four cartouches, DEVÉRIA squeezes, 5385F.

Finds

New Year's bottle, faience, Late Period. HASSAN, op. cit. fig. 65, p. 120 [1].

NEUSERRÊ , King's son of his body, Chief lector-priest of his father, Treasurer of the King of Lower Egypt, etc. Middle to end of Dyn. IV.

Parents, Khephren and Meresankh [III] (tomb G 7530+7540). Not mentioned here. Rock-cut tomb. Unfinished.

Position, on plan XXI, C-1

HASSAN, *Giza*, iv, pp. 185–8 (with texts); plan, fig. 131, cf. 134 (shaft); REISNER, *Giza Necropolis*, i, fig. 137, pp. 231–2 [14].

Entrance doorway. Left thickness with deceased and [son], and drum with name and titles; HASSAN, op. cit. pl. xl, figs. 132–3.

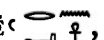
NIANKHRÊ , King's son, Secretary of the Toilet-house, Overseer of all works of the King, etc. Probably Dyn. V.

Rock-cut tomb.

Position, on plan XXI, D-1/2

HASSAN, *Giza*, iv, pp. 151-8 (with texts); plan and elevation of façade, figs. 106-7; plan and section of shaft, fig. 112. Plan, REISNER, *Giza Necropolis*, i, fig. 150, p. 243 [bottom, 1].

Entrance doorway. Lintel and drum with name and titles. HASSAN, op. cit. pl. xli, figs. 108-9.

Finds

Relief-fragment, lower part of deceased(?). Id. ib. pl. xlili [A], p. 152 [1].

Double-statue, men standing, lower part, basalt. Id. ib. pl. xlili [B], p. 152 [3].

Head of male statue, basalt, from débris of shaft south of tomb, in Cairo Mus. Ent. 87815, id. ib. pl. xlii, p. 152 [6]; arm of same statue, from burial chamber of deceased, see p. 158 [6].

Niche with three seated statues, north of tomb LG 90. Position, on plan XXI, D-1.

View, CASSAS, *Voyage pittoresque de la Syrie*, iii, pl. 92, cf. 88; position, MARIETTE, *Mastabas*, p. 546 [b], with plans on pp. 544-5.

LG 90. DEBHEN , Overlord of Nekheb, Secretary of the Toilet-house, Master of the largesse in the Mansion of Life, etc. Temp. Menkaurē.^c

Rock-cut tomb. 'Tomb of Hammed es-Samaan.'

Position, on plan XXI, E-1. Plan XXXII

L. D. Text, i, pp. 111-12; HASSAN, *Giza*, iv, pp. 159-84 (with texts); NESTOR L'HÔTE MSS. 20396, 335; cf. MARIETTE, *Mastabas*, p. 546 [top, a]; *Rev. d'Ég.* i (1933), p. 299. Plan and sections or elevation, L. D. i. 27; HASSAN, op. cit. figs. 113, 120; CASSAS, *Voyage pittoresque de la Syrie*, iii, pl. 87; *Descr. Ant.* v, pl. 16 [6-8]; REISNER, *Giza Necropolis*, i, fig. 126, pp. 221 [2], 310 [b]. Plan L. D. Text, i, fig. on p. 111 [lower]; NESTOR L'HÔTE MSS. 20396, 312 [lower]. Plan and sections of burial chamber, HASSAN, op. cit. fig. 129; of another shaft, fig. 130. Synopsis of scenes, JUNKER, *Giza*, iii, p. 50 [48]. Views, CASSAS, op. cit. pls. 88-9, 91; BURTON MSS. 25621, 77.

Room I.

(1) Entrance doorway. (a)-(b) [1st ed. 1-2] Lintel with offering-text; (c) [1st ed. 3] drum with name and titles; (d) [1st ed. 5, incorrectly placed] deceased with small son, and two attendants and dog behind; (e) [1st ed. 4, incorrectly placed] deceased with small daughter, and two attendants and monkey behind.

(a)-(c) L. D. ii. 37 [a]; HASSAN, op. cit. pl. xlvi, figs. 114-15. (a)-(b) Lintel, BRUSGCH, *Monumens*, pl. xiv [3]; NESTOR L'HÔTE MSS. 20396, 311 [upper]; BURTON MSS. 25621, 88; WILKINSON MSS. iv. 22; xiii. 55. (d) L. D. ii. 36 [a]; HASSAN, op. cit. fig. 117. Dog, with text, BURTON MSS. 25621, 78 verso [lower], 92 verso [middle left], 93 verso. (e) L. D. ii. 36 [b]; HASSAN, op. cit. fig. 116; NESTOR L'HÔTE MSS. 20396, 311 [lower]. Deceased, and titles, WILKINSON MSS. xiii. 56. Monkey, BURTON MSS. 25621, 78 verso [upper], 92 verso [middle left], 93 verso; WILKINSON squeezes, Box 29. 73.

(2) [1st ed. 8-9] Niche with thirteen rock-cut statues (now destroyed), and above, text of building tomb by Menkaurē.^c

Statues, L. D. i. on 27. Text, L. D. ii. 37 [b]; HASSAN, op. cit. pl. xlvi, fig. 118; SETHE, *Urk.* i (1933), 18-21 [14]; cf. WILKINSON MSS. xiii. 59 [left].

(3) [1st ed. 6] Deceased seated, with monkey under chair, and five registers before him, **I-III**, offerings, **IV**, harpists, singers, and flutists, **V**, female dancers and clappers with female dwarf.

L. D. ii. 36 [c]; HASSAN, op. cit. pl. xlix, fig. 119 [left]; NESTOR L'HÔTE MSS. 20396, 312 [upper]; HAY MSS. 29821, 87; WILKINSON squeezes, Box 29. 74-97. Deceased and titles, BRUGSCH, *Monumens*, pl. xiv [4]; upper part, WILKINSON MSS. xiii. 57 [lower]. Deceased, with monkey and two dancers, *Descr. Ant.* v, pl. 47 [4]; monkey, LIEDER squeezes, 8. 1, 2. **IV**, HICKMANN, *45 Siècles*, pls. iii, iv; harpists and singer, id. in *Bull. Inst. Ég.* xxxv (1952-3), pl. iii, pp. 320-1 with fig. 12; id. *Ägypten*, Abb. 2; harpists, WILKINSON MSS. xiii. 57 [upper]; harpist and singer, BURTON MSS. 25621, 79 [right lower]; harpist, LANE MSS. 34088, 11. Dancer, two clappers, and dwarf, in **V**, BURTON MSS. 25621, 79 [upper]; dancer and clapper with dwarf, *Descr. Ant.* v, pl. 17 [2, 3]; dancer and clapper, LANE MSS. 34088, 11.

(4) [1st ed. 7] Name and titles of deceased.

L. D. *Text*, i, p. 112; HASSAN, op. cit. fig. 119 [right].

Room II.

(5) [1st ed. 10-11] Funerary priests performing ceremonies, and offering-list, with butchers below, and eight registers on right, **I-II**, dragging statues on sledges, **III-IV**, offerings, **V**, funerary priests performing ceremonies, **VI**, cattle, **VII**, offering-bringers ascending ramp towards statue of deceased in shrine on sledge on top of tomb, **VIII**, female dancers and clappers, bottom register (**IX**) below both parts, bringing fowl and animals (including young hyena), and on right, row of various objects.

HASSAN, op. cit. pl. I, fig. 122, cf. 40, p. 84; omitting **I-IV**, L. D. ii. 35; WILKINSON squeezes, Box 29. 98-138. Priests and offering-list, BURTON MSS. 25621, 85, 89. Offering-list, HASSAN, *Giza*, vi [2], pls. ix-xvi [11], p. 116; DUEMICHEN, *Das Grabpalast des Patuamenap*, i, Taf. xviii-xxvi [c]; DEVÉRIA squeezes, 5383D. Butchers, EBERS, *Aegypten*, i, fig. on p. 155 [top]; Eng. ed. fig. on p. 133 [top]; WILKINSON MSS. xiii. 58 [lower]; one group, BURTON MSS. 25621, 25. **V-VII**, SMITH, *Hist. Eg. Sculp.* pl. 47 [c], pp. 166-7, 171, 346; see REISNER, *Giza Necropolis*, i, pp. 358-9. Tomb, in **VII**, CHAMP., *Not. descr.* ii. 481 [lower]. Dancer and clapper, from **VIII**, BURTON MSS. 25621, 80, 92 verso [top right]; dancer, *Descr. Ant.* v, pl. 17 [4]. **IX**, BURTON MSS. 25621, 78; man carrying hyena, two men with ibex and oryx, and man carrying goose, *Descr. Ant.* v, pl. 18 [10]; man leading bull, WILKINSON MSS. xiii. 58 [upper].

(6) Palace-façade false-door with remains of name and titles of deceased on left jambs.

HASSAN, *Giza*, iv, fig. 128.

(7) (completely destroyed) Fragments, mostly with remains of titles; id. ib. figs. 123-7.

(8) [1st ed. 12] At bottom, remains of marsh-scene, fish and hippopotamus.

L. D. *Ergänz.* xxxiv [b]; HASSAN, *Giza*, iv, fig. 121; hippopotamus, BURTON MSS. 25621, 79 [left lower]; LIEDER squeezes, 8. 6, 7. Hippopotamus-hunt in marshes, possibly from here, HAY MSS. 29821, 86.

Finds

Fragments of statues of deceased. HASSAN, *Giza*, iv, pls. li, lii [B-D], p. 162 [1-5, 7-10].

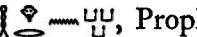
LG 91. NIKAUHOR  Prophet of Ma'et, Overseer of scribes of the land, Belonging to the foremost seat. Middle Dyn. V or later.

Stone-built mastaba.

Position, on plan XXI, E-1

L. *D. Text*, i, p. 113; HASSAN, *Giza*, iv, pp. 189-95 (with texts). Plan, L. *D. Text*, i, fig. on p. 113; HASSAN, op. cit. fig. 135, cf. 142 (sloping shaft).

Inner Room.

North wall. Offering-bringers at bottom; id. ib. pl. liii [A], fig. 136.

South wall. Remains of offering-bringers at bottom, and fragments found in débris; id. ib. pl. liii [B, C], figs. 137-9.

West wall. Lower part of false-door of deceased; L. *D.* ii. 94 [d]; HASSAN, op. cit. pl. liv, figs. 140-1.

LG 92. YUNMIN , King's eldest son of his body, Chief Justice and Vizier (of Menkauré), etc. End of Dyn. IV.

Wife, Kha^cmerernebti .

Partly rock-cut and partly stone-built mastaba.

Position, on plan XXII, E-1/2

L. *D. Text*, i, p. 113; HASSAN, *Giza*, vii, pp. 13-20; *Chron. d'Ég.* xi (1936), pp. 373-4. Plan and sections, L. *D.* i. 29; REISNER, *Giza Necropolis*, i, fig. 127, pp. 221 [3], 224; HASSAN, op. cit. figs. 8, 9; of shafts, figs. 11-16; MARIETTE, *Mastabas*, fig. on p. 543 [bottom, c], cf. pp. 544, 545 [c].

Entrance doorway. Lintel with offering-text, and drum with name and titles; L. *D.* ii. 34 [g]; HASSAN, op. cit. pl. xvi [A, B], fig. 10; lintel, MARIETTE, op. cit. pp. 547-8 [b] (not b of plan on p. 547); ends omitted, BRUGSCH, *Monumens*, pl. xiv [1]; drum, with titles from lintel, de ROUGÉ, *Inscr. hiéro.* pl. lxx [bottom].

Two fragments, deceased with staff, seated, alabaster. HASSAN, op. cit. pl. xvi [C], p. 18 [1].

KHUIENPTAH , King's *warb*-priest, Elder of the Hall, etc. End of Dyn. V or later.

Wife, Minut  (also .

Stone-built mastaba.

Position, on plan XXII, F-2

HASSAN, *Giza*, vii, pp. 35-41; plans and sections (including shafts), figs. 26, 26 bis, 32-4.

Chapel.

Entrance doorway. Lintel with offering-text (found re-used, now replaced), and drum with name and titles; id. ib. pl. xxiv [A, B], fig. 27. Thicknesses, deceased and wife; id. ib. pl. xxiv [C, D], figs. 28-9.

North false-door. Lintel with offering-text, and deceased and wife seated, with daughter behind; id. ib. pl. xxv [A], fig. 30.

South false-door. Lintel with offering-text, and deceased and wife seated; id. ib. pl. xxv [B], fig. 31.

NAME UNKNOWN Old Kingdom.

Rock-cut tomb. Re-used as burial-place of ibises in Late Period.

Position, on plan XXII, F-2

HASSAN, *Giza*, vii, pp. 43-4; plans and section, figs. 35-6.

Thoth on casing of west wall of chapel, Late Period. Id. ib. pl. xxvi [A].

HEKNIKHNUM , Overseer of the deserts, Overseer of the Road of Horus, Overseer of the expedition, etc. Middle Dyn. V or later.

Stone-built mastaba.

Position, on plan XXII, G-2

HASSAN, *Giza*, vii, pp. 49-52; plan, fig. 41; view showing small uninscribed obelisk *in situ*, pl. xxviii [A]. Plan and section of shaft, id. ib. fig. 39.

Sarcophagus of deceased, from burial chamber. Id. ib. pl. xxviii [B], figs. 40, 42; text of east side, id. ib. v, p. 61; see DONADONI ROVERI, *Sarcofagi egizi*, p. 134 [B 63].

MEMI , Inspector of prophets of Hathor, King's *warb*-priest of the Palace (*dbt*), Inspector of singers, etc. Dyn. V or later.

Rock-cut tomb.

Position, on plan XXII, G-2

HASSAN, *Giza*, vii, pp. 45-8; plan, fig. 37.

Entrance doorway. Lintel with offering-text, drum with name and titles, and jambs with remains of deceased; id. ib. pl. xxvii, fig. 38.

ITY , Master of the Great House, etc. Probably Dyn. V or later.

Stone-built mastaba.

Position, on plan XXII, G-2

HASSAN, *Giza*, vii, pp. 53-4; plan, fig. 44; plan and section of shaft, fig. 43.

Circular offering-table of deceased, alabaster, set into floor of chapel. Id. ib. pl. xxix [A]; v, fig. 35.

NEFERḤŌTEP , Elder of the Hall of the Pyramid of Menkaurē. Middle Dyn. V or later.

Stone-built mastaba.

Position, on plan XXII, G-2

HASSAN, *Giza*, vii, pp. 55-6; plan, fig. 47; shafts, figs. 45-6.

Circular offering-table of deceased, alabaster, set into floor in front of destroyed false-door. Id. ib. pl. xxix [B, C]; v, fig. 34.

SESHEMNŪFER  good name IFI , Judge and Overseer of scribes, Judge and Boundary official, *iun-kenmut*-priest, etc. Dyn. VI.

Rock-cut tomb.

Position, on plan XXII, G-2. Plan XXXV

HASSAN, *Giza*, vii, pp. 57-63; *Chron. d'Ég.* xi (1936), p. 375. Plan, HASSAN, op. cit. fig. 48. Name and two titles, possibly from here, DE ROUGÉ, *Inscr. hiéro.* pl. lxx [lower middle].

Niche in rock-cut façade.

(1) (a)–(b) Lintel with offering-text; (a) and (b) jambs with name and titles; (c) and (d) deceased at table; (e) false-door of deceased.

(a)–(b) and (e), HASSAN, op. cit. pls. xxx, xxxi [B], fig. 49; *I.L.N.* May 2, 1936, fig. on p. 765 [middle right]. (c) and (d) HASSAN, op. cit. pl. xxxi [A, C], figs. 50–1.

Burial chamber. Plan and section, id. ib. fig. 52b, cf. 52a; view of opening of shaft, *I.L.N.* May 2, 1936, fig. on p. 765 [middle].

(2) Remains of three painted registers of offerings and text above.

HASSAN, op. cit. pl. xxxii, fig. 53.

NAME UNKNOWN.

Rock-cut tomb. Uninscribed.

Position, on plan XXII, G–1

False-door of Hemyunu , Royal chamberlain of the Great House, Lector-priest, etc., Dyn. VI or later, found nearby. HASSAN, *Giza*, vii, pl. lviii bis, p. 127 [16].

BABAF  (Khnembaef of Hassan), King's son, Hereditary prince, Assistant of Duau, etc. Middle to end of Dyn. IV or early Dyn. V.

Father, Khephren.

Stone-built mastaba with rock-cut substructure.

Position, on plan XXII, E/F–3

HASSAN, *Giza*, vii, pp. 7–11; *Chron. d'Ég.* ix (1934), p. 72 [5]. Plans and section, HASSAN, op. cit. figs. 4, 7; plan and section of burial chamber with sarcophagus, fig. 6. View of façade, id. ib. pl. vii; *I.L.N.* May 2, 1936, figs. on p. 765 [top right and bottom right]; of burial chamber, HASSAN, op. cit. pl. ix [A]; cf. v, pl. i [B]. See id. ib. vi [2], p. 9.

Statues.

Deceased seated, grey granite, lower part, found near uninscribed false-door in façade. HASSAN, *Giza*, vii, pl. viii.

Deceased seated, red granite, lower part, found near tomb LG 100. Id. ib. pl. xv, fig. 5.

NAME UNKNOWN. End of Dyn. IV.

Stone-built mastaba with rock-cut substructure. 'Mastaba of Daughter of Khephren'.

Position, on plan XXII, F–2

HASSAN, *Giza*, vii, pp. 1–5; *Chron. d'Ég.* xi (1936), p. 374. Plan, section, and elevation, HASSAN, op. cit. figs. 1, 2.

Burial chamber.

Id. ib. pp. 4–5, with plan and section, fig. 3; vi [2], pp. 7–8. View, id. ib. vii, pl. ii [C]; v, pl. i [A]; *I.L.N.* April 11, 1936, fig. on p. 639 [left, middle and bottom].

Female reserve-head. HASSAN, op. cit. vii, pls. iii, iv [A], pp. 4–5; *I.L.N.* April 11, 1936, figs. on p. 639 [right, middle and bottom]; WATERMANN, *Bilder aus dem Lande des Ptah und Imhotep*, Abb. 7, pp. 28–9; see SMITH, *Hist. Eg. Sculpt.* p. 27 [28].

NAME UNKNOWN. Dyn. V-VI.

Stone-built mastaba.

Position, on plan XXII, F-3

HASSAN, *Giza*, vii, pp. 91-4; plans and sections, figs. 81-8.

Two male and one female standing statuette, from serdab, in Cairo Mus. Ent. 87801-3. Id. ib. pl. xlii, pp. 91, 93 [1-3]. Ent. 87801 (No. 1 of Hassan), GHALIOUNGUI in *B.I.F.A.O.* lxii (1964), pl. viii [A], p. 64.

NEKHETKA , King's *warb*-priest, Prophet of Sahurē, Inspector of scribes of the granary, etc. Middle Dyn. V or later.

Wife, Hetepheres , Prophetess of Hathor, etc.

Stone-built mastaba.

Position, on plan XXII, F-3. Plan XXXIII

HASSAN, *Giza*, vii, pp. 21-33; plan, fig. 17; plans and sections of shafts, figs. 24-5.

Lintel with offering-text (name lost), fragment. Id. ib. pl. xxi [B], fig. 23.

Offering-room.

- (1) Thickness of doorway (unfinished). Deceased and wife; id. ib. pl. xviii, fig. 18.
- (2) Deceased leaning on staff, and five registers of men bringing animals (partly above doorway). Id. ib. pls. xx, xxi [A] (upside down), fig. 22.
- (3) Deceased and wife seated before offerings and offering-bringers, with harpists, flutist, and singers below. Id. ib. pl. xvii [C], fig. 21.
- (4) Two false-doors of deceased, with deceased at table between them, and remains of offering-list at top. Id. ib. pl. xix, fig. 20.
- (5) Five registers, offering-bringers (damaged) and two groups of butchers. Id. ib. pl. xvii [D], fig. 19.

IRSEKHU , Treasurer of the God in the two boats, Overseer of the expedition, Overseer of tutors of the King's children of his body, etc. Possibly late Dyn. IV.

Rock-cut tomb.

Position, on plan XXII, H-3

HASSAN, *Giza*, vii, pp. 65-71; plans and sections, figs. 54, 57-9, 61-4. View, *I.L.N.* May 2, 1936, fig. on p. 765 [top left].

Pillared Hall.

Entrance doorway. Lintel with offering-text and drum with name and titles; HASSAN, op. cit. pls. xxxiii [A], xxxiv [A], fig. 55.

West wall. Unfinished figure of deceased and small son; id. ib. pl. xxxiii [B].

Offering-room.

South false-door of deceased with remains of text. Id. ib. pl. xxxiv [B], fig. 56.

Shaft. 1644 of Hassan.

Sarcophagus of deceased. Id. ib. pl. xxxv, fig. 60; text, v, pp. 60-1; see DONADONI ROVERI, *Sarcofagi egizi*, p. 135 [B 64].

RA'KHUF , Greatest of the Ten of Upper Egypt, Overseer of the Pyramid of Khephren, Prophet of Khephren, etc. Dyn. V or later.

Stone-built mastaba.

Position, on plan XXI, B-3/4

HASSAN, *Giza*, vii, pp. 95-9; plans and sections, figs. 90, 92-5.

North false-door of deceased. Id. ib. pl. xliii, figs. 89, 91.

RA'ḤOTP , King's son, Hereditary prince, Overseer of the Broad Hall, etc. Middle Dyn. V or later.

Stone-built mastaba with rock-cut substructure.

Position, on plan XXI, B-3/4

HASSAN, *Giza*, vii, pp. 81-4; plans and section, figs. 71, 73.

Entrance doorway. Lintel with remains of offering-text and drum with name and titles; id. ib. pl. xli, fig. 72.

Lintel, probably from here, in Cairo Mus. Temp. No. 2.2.21.16.

Block-statue of Menkau , Lector-priest, Middle Kingdom, from débris north-west of doorway, in Cairo Mus. Ent. 72242. Id. ib. pl. lvi bis, p. 126 [12] (with texts); MÜLLER (H. W.), *Ein Kopf von einem frühen Würfelhocker* [etc.] in *Festgabe für Dr. Walter Will* (1966), Taf. vi [1], p. 141 note 28; see BOTHMER in *Brooklyn Museum Annual*, ii-iii (1960-2), p. 31 [xvii].

ḤETEPI , Greatest of the Ten of Upper Egypt, Overseer of scribes of the royal sealed documents, Overseer of scribes of the land, etc. End of Dyn. V or later.

Stone-built mastaba.

Position, on plan XXI, B/C-3

HASSAN, *Giza*, vii, pp. 101-5; plans and section, figs. 97, 102.

Shaft. 1546 of Hassan. Plan and section, id. ib. fig. 96.

Sarcophagus of deceased, with palace-façade decoration, and offering-list on inner east side. Id. ib. pl. xlv [A], 98-101; west side, v, fig. 7, pp. 62-3 (all outer texts); id. *The Great Sphinx*, fig. 91, p. 146; offering-list, id. *Giza*, vi [2], pls. lxxiii-lxxx [80], p. 136; see DONADONI ROVERI, *Sarcofagi egizi*, pp. 133-4 [B 61].

Statuette of deceased(?), upper part, in Cairo Mus. Ent. 72220. HASSAN, *Giza*, vii, pl. xlv [A], p. 103; HORNE MANN, *Types*, iv, pl. 1139.

Finds











Drum of Nūfer, Prophet of Khephren, Dyn. V-VI, found south of tomb. HASSAN, *Giza*, vii, pl. lvii [A], p. 126 [13].



NI...ETRE' , King's son, Chief lector-priest, etc. Middle Dyn. V or later.

Stone-built mastaba with rock-cut substructure.

Position, on plan XXI, B/C-4

HASSAN, *Giza*, vii, pp. 73-9; plans, section, and elevation, figs. 65-6, 70.

Entrance doorway. Thicknesses, deceased and son Thenti      , Overseer of the Palace, before him, with Ikau      behind them on the left one. Id. ib. pls. xxxvi, xxxvii, figs. 67-8. Drum with name and title; id. ib. fig. 69.

LG 94. RA^cWĒR [III]   , Judge and Boundary official, *iun-kenmut*-priest, Overseer of all works of the King, etc. Late Dyn. IV or Dyn. V (Reisner) or Dyn. VI (Baer).

Stone-built mastaba with rock-cut substructure.

Position, on plan XXII, E/F-4

HASSAN, *Giza*, v, pp. 293-7; L. D. *Text*, i, p. 115 (with sketch-plan); REISNER, *Giza Necropolis*, i, p. 152 [5]. Plan, HASSAN, op. cit. fig. 154.

Chapel.

False-door of deceased. L. D. ii. 95 [e]; HASSAN, op. cit. pl. lviii [A], fig. 155; fragment of lintel, pl. lix [A], fig. 156.

Fragments of lintel and jamb with titles, probably from entrance doorway. Id. ib. pls. lviii [B], lix [B], figs. 157-8.

Sloping shaft. Excavated by Baraize.

Outer room. Painted decoration.

Offering-list, offerings, and offering-bringers on east and south walls. See id. ib. pp. 296-7.

Inner room.

Sarcophagus (uninscribed), with palace-façade decoration, in Cairo Mus. Ent. 51950. BALCZ in *Mitt. Kairo*, i (1930), Taf. xvii, p. 55; VON BISSING, *Äg. Kunstgeschichte*, Taf. lxxviii [409], *Text*, i, p. 79; ii, p. 56; MITRY, *Illus. Cat.* No. 6039; LANGE and HIRMER, *Aegypten. Architektur* (1955 and 1957), pl. 49; (1967), pl. 43 (called No. 519); PIRENNE, *Hist. civ.* i, pl. 40 facing p. 125 (called Menkaurêc); *Capolavori*, i, No. 10 (1963), fig. on p. 164 [upper left]; Eng. ed. fig. on p. 156 [upper left]; ABBATE, *Arte egizia*, fig. 29; DAUMAS, *Civ. de l'Ég.* pl. 24; WESTENDORF, *Das Alte Ägypten*, fig. on p. 51; DONADONI ROVERI, *Sarcophagi egizi*, Tav. xxiii [1], xxvii [2], pp. 125-6 [B 40]; DONADONI, *Egyptian Museum Cairo*, pl. on p. 59; MARBURG INST. photo. 86493; see *Descr. somm.* No. 6039.

Tombs between LG 94 and LG 100, excavated by Service des Antiquités in 1942-6. Dyn. V-VI.

(a) KHA^cKAUPTAḤ.

False-door of deceased. See *The Egyptian Education Bureau London. The Bulletin* (May 1947), p. 102 [a].

(b) KHA^cBAUPTAḤ            .

Statue of man standing (uninscribed), from chapel. Ib. fig. 54 [left], p. 102 [b]; *La Revue du Caire*, xxxiii [175] (1955), fig. 32.

Relief-fragment with upper part of Kha^cbauptaḤ, Overseer of manicurists of the Great House, possibly from here, in Bremen, Übersee-Mus. CAIRO, CENTRE OF DOCUMENTATION photo. S.R., Box 173, 12907 [right].

Ointment-slab of deceased (inscribed). See *The Egyptian Education Bureau London. The Bulletin* (May 1947), p. 102 [b].

(c) SHEPSIPUPTAḤ.

False-door of deceased. See *ib.* pp. 102-3 [c].

(d) UNINSCRIBED.

Statue of man standing (uninscribed). *Ib.* fig. 54 [right], p. 103.

YUNRĒꜥ , Eldest son of his body of Khephren, the King of Lower and Upper Egypt, Chief lector-priest of his father, Overseer of all works, etc. End of Dyn. IV.

Rock-cut tomb.

Position, on plan XXI, B-5

HASSAN, *Giza*, vi [3], pp. 31-4; plan, fig. 25, cf. 27 (shaft); REISNER, *Giza Necropolis*, i, fig. 145, p. 238 [3].

Male rock-cut statues, in niches in courtyard. HASSAN, *op. cit.* pls. xvii [A], xviii, p. 33.

Entrance doorway. Lintel with remains of text, and drum with name and titles; *id. ib.* pl. xvii [B], fig. 26.

Head of female statuette, found nearby, in Cairo Mus. Ent. 87813. See *id. ib.* p. 240 [5].

KASEUZA , Keeper of the diadem in the place of the King (?), Foremost of the Keepers of ornaments of dancers, Scribe of the royal linen (*ššrw*), etc. Dyn. V or later.

Rock-cut tomb.

Position, on plan XXI, B-5

HASSAN, *Giza*, vi [3], pp. 187-95; plan, fig. 187.

Chapel.

Entrance doorway. Lintel with remains of offering-text, drum with name and titles, and upper part of jambs with remains of biographical text; *id. ib.* pl. lxxxii, fig. 188. Left thicknesses, outer, [deceased], inner, remains of vintage scenes, including picking and treading grapes and filling wine-jars; *id. ib.* fig. 189. Right thickness, outer, deceased (much destroyed); *id. ib.* fig. 190.

South wall (west part). Six registers, cooking scenes, including plucking and cleaning goose and shaping loaves, and [butchers]; *id. ib.* pl. lxxxii [A], fig. 191.

West wall. False-door, deceased at table and butchers on left, and offering-list on right; *id. ib.* pl. lxxxiii, fig. 192; offering-list, vi [2], pls. xli-xlvi [45], pp. 125-6 (called north wall).

East wall. Deceased with small son standing; *id. ib.* vi [3], pl. lxxxii [B], p. 193.

Shaft. Plan and section, *id. ib.* fig. 193.

Block, deceased at table, with three funerary priests before him, and offering-list above, found leaning against north wall of chamber. *Id. ib.* pls. lxxxiv, lxxxv, pp. 194-5; offering-list, vi [2], pls. xli-xlvi [46], pp. 125-6.

HEMTRĒꜥ , King's eldest daughter of his body, Prophetess of Hathor, etc. Middle to end of Dyn. IV or Dyn. V.

Father, probably Khephren.

Rock-cut tomb with minor additions of masonry.

Position, on plan XXI, B-5. Plan, XXXV

HASSAN, *Gîza*, vi [3], pp. 43-65; plans, sections, and elevation, figs. 34-5, 47-9. Plan, REISNER, *Giza Necropolis*, i, fig. 134, pp. 228-9 [11].

Room I.

(1) Entrance doorway. (a)-(b) Lintel with offering-text, and drum with name and titles; (c) and (d) estates, and men bringing bulls.

(a)-(b) HASSAN, op. cit. pl. xxiii [A, B], fig. 36. (c) and (d) Id. ib. pl. xxiv, figs. 37-8; names of estates, JACQUET-GORDON, *Domaines*, pp. 232-3 [14G4-5], figs. 37-9 (from HASSAN).

(2)-(4) Pillars, deceased with children and offering-bringers, including Senebuka (tomb, see below). Only preliminary sketch at (2) (a).

HASSAN, op. cit., pls. xxvi-xxix, figs. 39-45.

Room II.

(5) Doorway. (a)-(b) Lintel with offering-text.

Id. ib. pl. xxiii [c], fig. 46.

Finds

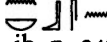
Upper part of false-door of Nebsen  Sole companion, Royal chamberlain, Dyn. V-VI, found in Passage. Texts, id. ib. p. 246 [14].

SENEBUKA  Steward, Overseer of *ka*-servants, etc. Early Dyn. V.

Rock-cut tomb with additions of masonry.

Position, on plan XXI, B-5

HASSAN, *Gîza*, vi [3], pp. 67-9; plans and sections, figs. 50, 52-6.

Entrance doorway. Lintel with offering-text, and drum with name and titles; id. ib. pl. xxx [A], fig. 51.

KADUA  Prophet of Khephren, Horus *wšr-ib* (Khephren), *nbty-wšr-m* (*nbty*-name of Khephren), Elder of the Hall of the Pyramid of Khephren, etc. Temp. Neuserre^c or later.

Wife, Neferres  Royal acquaintance.

Stone-built mastaba.

Position, on plans XXI, XXIII, B-5/6

HASSAN, *Gîza*, vi [3], pp. 93-110; plans and sections, figs. 77, 84-94. Synopsis of scenes, JUNKER, *Gîza*, iii, pp. 53-4 [56].

Passage.

Entrance doorway. Left thickness with name and titles of deceased; HASSAN, op. cit. pl. xxxviii [B], fig. 78.

False-door of Hemu (tomb, probably, see p. 245). Translation of texts, see id. ib. pp. 96-7; titles, p. 94.

Offering-room.

Doorway. Lintel with offering-text, and drum with name and titles; id. ib. pls. xxxviii [A], xxxix [B], fig. 79. Left outer thickness, deceased with wife, and sons (including Hemu) and *ka*-servant in two registers below; id. ib. pl. xl [B]. Left inner thickness, remains of deceased with small daughter; id. ib. pl. xxxviii [c].

East wall. Deceased seated, and five registers of offerings, offering-bringers, butchers, harpists, flutists, and singers, and male dancers and female clappers (much destroyed).

Id. ib. pls. xxxix [A], xlvii-1, fig. 83; flutists and singer and harpist on right, HICKMANN, *45 Siècles*, pls. x, xi; upper sub-register of flutists and singers, id. in BLUME, *Die Musik in Geschichte und Gegenwart*, Abb. 12, col. 320; harpist and singer on right, HICKMANN, *Ägypten*, Abb. 3 (called Seshemnūfer); harpist, id. in *Bull. Inst. Ég.* xxxv (1952-3), pl. iv, fig. 11, p. 323.

South wall. Deceased, and seven registers of fowl and men bringing animals (including hyena).

HASSAN, op. cit. pl. xlvi, fig. 82.

West wall. Two false-doors of deceased, and between them, offering-list, and funerary priests before deceased at table (including man wiping out footprints).

Id. ib. pls. xxxix [C], xl [A], xlii-xlv, fig. 81; offering-list, vi [2], pls. xlix-lvi [58], p. 129.

North wall. Remains of deceased spearing fish, cow giving birth, and herdsmen cooking, including men drinking, roasting goose, shaping cakes, and making mats.

Id. ib. vi [3], pl. xli, fig. 80.

Blocks, exact position uncertain, Hemu and wife Nubhotp , Prophetess of Hathor, etc., standing, in Cairo Mus. Temp. No. 19.6.46.7, and five fragments of jamb of deceased; texts, id. ib. p. 110.

Serdab.

Statue of deceased standing, in Cairo Mus. Ent. 72218. Id. ib. pls. li, lii, p. 106; KIELLAND, *Geometry in Egyptian Art*, fig. 18.

HĒMU , Prophet of Neuserre, and of Re in the Sun-temples of Neuserre and Menkauhor, etc. End of Dyn. V or later.

Father (probably), Kadua (tomb, see p. 244). Wife, Nubhotp (from block found in tomb of Kadua).

Stone-built mastaba.

Position, on plan XXIII, B-6

HASSAN, *Giza*, vi [3], pp. 81-91; plans and sections, figs. 63 (called 36), 71-6.

Corridor.

Entrance doorway. Lintel with offering-text; id. ib. pl. xxxiv [A], fig. 65. Drum with name and titles; id. ib. pl. xxxiv [B], fig. 64. Thicknesses, deceased with son and daughter, and female estate leading bull below; id. ib. pls. xxxv, xxxvi [B], figs. 66-7; names of estates, JACQUET-GORDON, *Domaines*, p. 292 [37G5], figs. 80-1 (from HASSAN).

North false-door of deceased (upper part damaged); HASSAN, op. cit. pl. xxxvii [B], fig. 68.

South false-door of Shepseskafankh  , Steward, Overseer of ka-servants, etc.; id. ib. pl. xxxvii [A], fig. 69.

Offering-room.

West wall (damaged in upper part). False-door of deceased, left of it, man bringing oryx, gazelle, and bulls, right of it, offering-list and offerings; id. ib. pl. xxxvi [A, C], fig. 70; offering-list, vi [2], pls. lvii-lxiv [65], p. 131.

ANKHEMSAF , Overseer of officials (*šrw*), Judge and Elder of the Hall, Judge and Keeper of Nekhen who judges rightly, etc. End of Dyn. V or later.

Wife, Sesheshet , Prophetess of Hathor Mistress-of-the-Sycamore, and of Neith, etc.

Stone-built mastaba.

Position, on plans XXI, XXIII, B-5/6

HASSAN, *Giza*, vi [3], pp. 147-53; plans, and section of shaft, figs. 141, 148.

Chapel.

Entrance doorway. Lintel with offering-text, drum with name and title, and jambs with remains of address to passers-by; id. ib. pls. lxiii, lxiv [A], figs. 142-3. Thicknesses, deceased with small son; id. ib. pls. lxiv [B, C], figs. 144-5.

North false-door of deceased. Id. ib. pl. lxv [A], figs. 146, 146 a.

Between false-doors, remains of deceased seated. Id. ib. pl. lxv [B], fig. 147.

TETI , Royal acquaintance (man). Dyn. V.

Rock-cut tomb.

Position, on plan XXIII, B-6

HASSAN, *Giza*, vi [3], pp. 213-16; plans and section, figs. 211, 213.

False-door with remains of text (no name). Id. ib. fig. 212.

Offering-table of deceased, of  form, found in front of false-door. Id. ib. pl. lxxxix [B], pp. 215-16 (texts); v, fig. 32, p. 184.

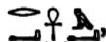
ANKHMA'RĒC , King's eldest son of his body, Chief Justice and Vizier (of Menkaurēc), Treasurer of his father the King of Lower Egypt, etc. End of Dyn. IV.

Rock-cut tomb.

Position, on plan XXI, B/C-5

HASSAN, *Giza*, vi [3], pp. 35-41; plans, sections, and elevation, figs. 28-9, 31-3. Plan, REISNER, *Giza Necropolis*, i, fig. 136, pp. 230-1 [13].

Entrance doorway. Drum with name and titles; HASSAN, op. cit. fig. 30.

Double-stature of Shepsesnesut , Inspector, etc., and Nefert-ius  (wife), seated (both headless), found in débris. Id. ib. pls. xix, xx, pp. 39-40.

SEKHEMKA , Overseer of the expedition, Treasurer of the God in the boat, etc. End of Dyn. IV or later.

Stone-built mastaba with rock-cut chapel.

Position, on plan XXIII, B/C-6

HASSAN, *Giza*, vi [3], pp. 143-6; plans and section, figs. 138, 140.

Entrance doorway. Lintel with remains of offering-text, and panel with deceased at table and children; id. ib. pl. lxii, fig. 139.

NIKAUḤATHOR , Royal acquaintance (woman). Dyn. V.

Stone-built mastaba.

Position, on plan XXIII, B-6

HASSAN, *Giza*, vi [3], pp. 173-85; plans and sections, figs. 166, 173-86.

Corridor.

Block with names of Khephren. Id. ib. pl. lxxiii [A], p. 173.

Offering-room.

Doorway. Remains of right thickness with man bringing oxen; id. ib. fig. 167.

East wall, left part. Remains of row of male and female figures (probably children of deceased); id. ib. fig. 171.

South wall. Remains of seated man and woman; id. ib. fig. 172.



West wall. False-door of deceased, and right of it, remains of deceased at table, and offering-list; id. ib. figs. 169-70.

North wall. Two registers, netting fish, fishermen in canoe, and two boats rowed; id. ib. pl. lxxiii [D], fig. 168.



Servant statuettes



From brick-built serdab. Numbers are those of Cairo Museum



View *in situ*, id. ib. v, pl. x [A], p. 48; vi [3], pl. lxxiii [B, C]; after cleaning, v, pl. x [B].

Henutsen  (woman) grinding corn, Ent. 72234; id. ib. vi [3], pl. lxxiv, pp. 177-8; ...pahert  (woman) sifting flour, Ent. 87820; pl. lxxv, p. 178; Ni'ankhisi

 cleaning goose, Ent. 72232; pl. lxxvi [B, D], pp. 178-9; Remensekhemka(?)

 cooking, Ent. 72230; pl. lxxvii, p. 179; Hererem(?)  cleaning jars, Ent. 72229; pl. lxxvi [A, C], p. 179; woman heating pots, Ent. 72227; pl. lxxviii, p. 180;

Werdi(?)  brewing, Ent. 72231; pl. lxxix [C-E], p. 180; Inpusheshi  dyeing(?), Ent. 72233; pl. lxxix [A, B], pp. 180-1; Nima'et'hat'hor  (woman) kneading, Ent. 72228; pl. lxxx, p. 181.

RUZKA  , Prophet of Khephren, Inspector of *warb*-priests, etc. Early Dyn. V.

Stone-built mastaba.

Position, on plan XXIII, B-6

HASSAN, *Giza*, vi [3], pp. 125-32; plans and sections, figs. 105 (on p. 118, called fig. 116), 120-4.

South false-door of deceased with family (including son Inkaf , Sculptor of the *warbt*). Id. ib. pl. lvi, figs. 117 (upper lintel, re-used), 118.

North false-door of Inkaf, with wife Wenherakhet  and children, and offering-list on jambs. Id. ib. pl. lvii [B], fig. 119; offering-list, vi [2], pls. xxxiii-xl [43], p. 125.

NI'ANKH-KHNUM , Overseer of commissions of the Great House, Inspector of Nubians, King's adorer and Keeper of gold, etc. Dyn. VI.

Wife, Nubhotp , Royal acquaintance.

Stone-built mastaba.

Position, on plan XXIII, B-6

HASSAN, *Giza*, vi [3], pp. 133-42; plans and sections, figs. 125, 132-7.

Entrance doorway. Lintel and jambs with remains of names and titles; id. ib. pl. lviii, fig. 126. Thicknesses, deceased (head destroyed) with son, and four men below; id. ib. pl. lix, figs. 127-8.

North and south false-doors of deceased, with family on jambs. Id. ib. pl. lx [D], fig. 129, and pl. lx [A-C], fig. 130.

Between false-doors, deceased at table, with funerary priests before him, and deceased seated with three registers, offerings, fowl, offering-bringers, butchers, and dwarf with cattle. Id. ib. pl. lxi, fig. 131.

Two blocks with remains of titles. Text, id. ib. p. 140.

KAKAI^cANKH  . Dyn. V.

Stone-built mastaba.

Position, on plan XXIII, B-6

HASSAN, *Giza*, vi [3], pp. 111-16; plans and sections, figs. 96, 102-3.

Circular offering-table of deceased, with offering-list, usurped by Inkaf and placed in front of his false-door (see p. 247). Id. ib. pl. lvii [A], p. 131; v, pl. xi, p. 187; offering-list, vi [2], pls. xxxiii-xl [41], p. 124.

Offering-room.

Doorway. Block with name, probably from lintel; id. ib. vi [3], pl. liii [B], p. 111. Left thickness, remains of man bringing ox; id. ib. fig. 95.

East wall. [Man and woman with child], men bringing various articles, and bringing cattle; id. ib. pl. liv [B], figs. 97-8.

West wall. Remains of offering-list, and offerings, men bringing fowl, and butchers; id. ib. pl. liii [A, C, D], figs. 100-1.

North wall. [Deceased and wife seated facing each other], and below, male dancers and female clappers; id. ib. pl. liv [A], fig. 99.

INKAF , Prophet of Khephren, Inspector of *warc*-priests, etc. Middle Dyn. V or later.

Stone-built mastaba.



Position, on plan XXIII, B-6

HASSAN, *Giza*, vi [3], pp. 117-24; plans and sections, figs. 116 (on p. 126), 108-15.

Entrance doorway. Lintel with name and titles; id. ib. pl. lv [A], fig. 104. Thicknesses, upper part of deceased and name and titles; id. ib. figs. 106-7.

Double-statue of two men standing, found in serdab. Id. ib. pl. lv [B], p. 120.

Block with offering-list, found in burial chamber, in Cairo Mus. Ent. 72254. Offering-list, id. ib. vi [2], pls. xxxiii-xl [44], p. 125.

NEFERKHUU , Greatest of the Ten of Upper Egypt, Overseer of the Pyramid of Khephren, and KA^cAPER , Greatest of the Ten of Upper Egypt, Overseer of the Pyramid of Khephren, He who judges rightly in the Great Court, etc. Dyn. V-VI.

Wife of Neferkhuu, Nis^cankh-hathor , Royal acquaintance.

Stone-built mastaba.

Position, on plan XXIII, C-6

HASSAN, *Giza*, vi [3], pp. 155-62; plans and sections, figs. 149, 153-6.

South chapel. Neferkhuu.

Entrance doorway. Drum of deceased and Seshemnūfer $\text{𓅓} \text{𓅓} \text{𓅓}$, Overseer of the Pyramid of Khephren, Director of King's *warb*-priests, etc.; id. ib. pl. lxvi [A], fig. 151.

False-door of Seshemnūfer, found in corridor. Id. ib. pl. lxvii, fig. 152.

False-door of deceased, in offering-room. Id. ib. pl. lxviii, pp. 160-1.

North chapel. Kaaper.

False-door of deceased. Id. ib. pl. lxvi [B], fig. 150.

NAME UNKNOWN (man). Dyn. V-VI.

Stone-built mastaba.

Position, on plan XXIII, C-6/7

HASSAN, *Giza*, vi [3], pp. 229-33; plan, fig. 229.

Entrance doorway. Jambs with deceased, thicknesses with deceased and family. Id. ib. pls. xcvi, xcvi, figs. 228, 230-2.

SEHEMNŪFER $\text{𓅓} \text{𓅓}$, Royal chamberlain, Judge and Boundary official, *iun-kenmut*-priest, etc. Middle Dyn. V or later.

Stone-built mastaba.

Position, on plan XXIII, B-6/7

HASSAN, *Giza*, vi [3], pp. 201-6; plans and sections, figs. 199, 204-5.

Offering-room.

Doorway. Thicknesses, remains of legs of deceased with probably son; id. ib. pl. lxxxvi [B, C], fig. 200.

North wall. Traces of a scene; id. ib. fig. 201.

West wall. Two false-doors of deceased; id. ib. pls. lxxxvii (north), lxxxviii, fig. 202; VASSALLI MSS. 8. Right of north false-door, remains of butchers; HASSAN, op. cit. fig. 203.

REKHETRE $\text{𓅓} \text{𓅓}$, King's daughter of his body, King's wife, etc. Late Dyn. IV or Dyn. V.

Father, Khephren.

Stone-built mastaba with rock-cut chapel.

Position, on plan XXIII, B-6/7

HASSAN, *Giza*, vi [3], pp. 3-8. Plans and elevation, id. ib. figs. 1, 2; plan, REISNER, *Giza Necropolis*, i, fig. 133, pp. 227-8 [10], 220.

Interior part of chapel.



Drum with name and titles. HASSAN, op. cit. pl. i [A], fig. 3.

North false-door of deceased with remains of text. Id. ib. fig. 4.

Finds

Fragment with incised figure of woman seated, alabaster, from burial chamber. Id. ib. pl. [B, E], p. 7 [6].

Inscribed fragment, diorite, possibly from offering-table, found in chapel. Id. ib. pl. ii [G], p. 8 [lower, 2].



SESHEMNŪFER  called IFI , Scribe of the royal documents in the presence. Dyn. VI.







Rock-cut tomb.

Position, on plan XXIII, B-7

HASSAN, *Giza*, vi [3], pp. 217-24; plans and sections, figs. 214, 221-3.

Entrance doorway. Defaced lintel, and drum with offering text; id. ib. fig. 215, pl. xc [A]. Thicknesses, son(?) Iḳri  before deceased, and remains of offering-bringers below; id. ib. pl. xc [B, C], figs. 216-17.

False-doors (from south). Nefert  called Ini  (probably wife), id. ib. pl. xci [B], fig. 218; Iḳri, pl. xci [A], fig. 219; deceased, pl. xcii, fig. 220.

IRENAKHTI , also called IRENPTAḤ  and IRI , Supervisor of prophets of the Pyramid of Khephren, Inspector of prophets of the Pyramid of Menkaurē, Judge and Boundary official, etc.; KAEMNEFERT , Overseer of *ka*-servants of the endowment (of Rekhetrē, tomb, see p. 249), Elder of the dockyard; KAKAI'ANKH  , Elder of the dockyard, etc. Dyn. VI.

Stone-built mastaba-complex.

Position, on plan XXIII, B/C-7

HASSAN, *Giza*, vi [3], pp. 9-29; plans and sections, figs. 5, 12, 13, 21-4.

South part. Irenakhti.

Entrance doorway. Lintel with six figures of deceased; id. ib. pl. iii [A], fig. 6. Drum with name (Irenptaḥ) and titles; id. ib. pl. iii [D], fig. 7.

False-door of deceased. Id. ib. pls. iii [C], ix [C], figs. 8, 9.

South wall. Offering-bringers before [deceased leaning on staff and seated] at table; id. ib. pl. iv [A, B], fig. 10.



North wall. Deceased at table with children, and offering-bringers below; id. ib. pl. v [A], fig. 11.

Inscribed relief-fragments, from shaft 1379. Id. ib. pls. iv [C], v [B-D], p. 17.

Corridor. Kaemnefert.

Entrance doorway. Thicknesses, deceased censng before Rekhetrē smelling lotus, with offering-bringers below; id. ib. pl. vi, figs. 14, 15.

South false-door of deceased, with offering-list on jambs. Id. ib. pl. vii, fig. 16; offering-list, vi [2], pls. ix-xvi [13], pp. 116-17.

North false-door of Sokarishepses  . Id. ib. vi [3], pl. viii, fig. 17.

Base with feet of male statue, from serdab. Id. ib. pl. xv [A], p. 23.

North part. Kakai'ankh.

False-door of deceased. Id. ib. pl. ix [B], fig. 18.

Blocks with names and titles of a daughter of Khephren, Kaemnefert, and [Kakai'ankh]. Id. ib. figs. 19, 20, pls. ix [A], iii [B].

Serdab of Kakai'ankh. Statues.

Two male standing statues. Id. ib. pls. x-xiii, pp. 27-8 [2, 3].

Scribe-statue, in Cairo Mus. Ent. 72222. Id. ib. pl. xiv, p. 27 [1]; see Vienna. 5000 Jahre, p. 59 [14].

Lower parts of one female and two male (seated and standing) statues. HASSAN, op. cit. pls. xv [B, D], xvi, p. 28 [1-3].

Statuette of female baker heating pots, lower part. Id. ib. pls. xv [C], xcix [A], pp. 28 [4], 240 [3].

SMACANKH , Scribe of the expedition, Judge and Inspector of scribes, Overseer of *ka*-servants, etc. Dyn. VI.

Stone-built mastaba.

Position, on plan XXIII, B-7

HASSAN, *Giza*, vi [3], pp. 163-71; plans and sections, figs. 158, 162-5.

Corridor.

Entrance doorway. Drum with remains of name and titles; id. ib. fig. 157. Thicknesses with deceased and son standing; id. ib. pl. lxix [B, D], figs. 159-60.

North false-door of deceased. Id. ib. pl. lxix [C], pp. 165-6.

South false-door of deceased, fitted into doorway to offering-room. Translation of texts, id. ib. p. 166.

Offering-list, and deceased at table with funerary priests and butchers before him, between false-doors. Id. ib. pl. lxix [A], p. 167.

Offering-room.

West wall. Two false-doors, and between them, son before man (names lost) at table, with butchers below; id. ib. pls. lxxi, lxxii, fig. 161.

South wall. Deceased standing, in loose blocks; id. ib. pl. lxx, p. 168.

KAR , Overseer of scribes, Judge and Inspector of book-keepers, Secretary of commissions of the divine offerings, etc. End of Dyn. V or later.

Stone-built mastaba.

Position, on plan XXIII, C-7

HASSAN, *Giza*, vi [3], pp. 207-11; plans and sections, figs. 206, 208-10.

False-door of deceased. Id. ib. pl. lxxxix [A], fig. 207.

Head of male statuette, from débris south of tomb. Id. ib. vii, pl. lv bis [A], p. 126 [10].

NAME UNKNOWN. Dyn. V or later.

Stone-built mastaba.

Position, on plan XXIII, C-6

HASSAN, *Giza*, vi [3], pp. 225-8; plans and sections, figs. 224-7.

Two seated male statuettes, from serdab. Id. ib. pls. xciii, xciv, pp. 225, 227.

SEKHENTIUKA , Royal acquaintance. Dyn. V or later.

Wife, Nitankh-sheret , Royal acquaintance.

Stone-built mastaba.

Position, on plan XXIII, C-6

HASSAN, *Giza*, iv, pp. 197-201; plans and sections, figs. 143, 149-50.

Entrance doorway. Fragments of left part of lintel, deceased and wife seated, found re-used; id. ib. pl. lv [A], fig. 144.

Pillar. East and west faces, deceased; north and south faces, two registers, deceased, and below, wife on north, and man and woman on south; id. ib. figs. 145-8.

False-door of deceased and wife, fragmentary, probably from here, in Frankfurt-am-Main, Liebieghaus.

Statuette of woman grinding corn (incomplete), from serdab. Id. ib. pl. lv [B, C], p. 199 [bottom].

IMANEIT , King's *wab*-priest, etc. Dyn. V or later.

Stone-built mastaba.

Position, on plan XXIII, C-6

HASSAN, *Giza*, iv, pp. 203-7; plans and sections, figs. 151, 153-9.

Entrance doorway. Lintel with remains of offering-text; id. ib. pl. lvi, fig. 152.

Male statuette, upper part, black granite, from shaft 1695. Id. ib. pl. lvii [A], p. 206.

ITISEN , Greatest of the Ten of Upper Egypt, Director of scribes in the Great Broad Hall, Prophet of Ma'et, etc. Middle Dyn. V or later.

Wife, Nima'ethap , Royal acquaintance.

Partly rock-cut and partly stone-built mastaba.

Position, on plan XXIII, D-6. Plan XXXII

HASSAN, *Giza*, v, pp. 261-78; plans and sections, figs. 118, 136-9.

Pillared offering-room.

(1) Doorway. (a)-(b) Lintel with offering-text, and drum with name and titles; (c) and (d) deceased with wife and children.

(a)-(b) Id. ib. pl. xxxiii [A], fig. 119; drum, pl. xxxiii [B], fig. 120. (c) and (d) Id. ib. pl. xxxiv, figs. 121a, b.

(2) Five registers, I-II, deceased carried in palanquin, and attendants, III, men carrying various objects, IV, men leading dogs and baboon, V, officials. (3) Above doorway, men netting fowl. (4) Deceased spearing fish from canoe, and five registers, I, sailing-boats, II-IV, herdsmen cooking, and tending cattle, V, boatmen jousting.

(2)-(4) Id. ib. fig. 123 [middle and right]. (2) Id. ib. pls. xxxv, xxxvi [left], fig. 122. (3) Id. ib. on pls. xxxvi, xxxvii, 1st coloured pl. after pl. li, fig. 124. (4) Id. ib. pls. xxxvii, xxxviii.

(5) Remains of offerings and offering-bringers. See id. ib. p. 270.

(6) False-door of deceased, with offering-bringers on left, and offering-list and offerings on right. (7) Uninscribed painted palace-façade decoration. (8) False-door, with deceased on jambs, and offering-bringers and funerary priest on left, and offering-list on right.

(6)-(8) Id. ib. fig. 126. (6) Id. ib. pls. xlv-xlvii, 4th coloured pl. after pl. li; offering-list, vi [2], pls. xxv-xxxii [32], p. 122. (7) Id. ib. v, pl. xlv, 2nd coloured pl. after pl. li. (8) Id. ib. pls. xlii, xliiii; offering-list, vi [2], pls. xxv-xxxii [33], p. 122.

(9) Five registers, I-III, offerings, IV, butchers, V, and five narrow registers on right, bringing animals.

Id. ib. v, pl. xxxix, fig. 123 [left].

(10) Deceased at table, and five registers, I-III, offerings, IV, offering-bringers, V, four groups of butchers.

Id. ib. pls. xl, xli, 3rd coloured pl. after pl. li, fig. 125.



(11)-(14) Pillars. All faces, deceased.



Id. ib. pls. xlvi-li, figs. 128-35.





Architrave above pillars. Both faces, offering-text.



Id. ib. fig. 127.

Various finds. Late Old Kingdom

Lintel of Nas  , Prophet of Anubis, of Wepwaut, of the Souls of Nekhen, etc. Text, id. ib. p. 276 [upper].

Lintel of . . . nezib  , Judge and Elder of the Hall, Greatest of the Ten of the Great Court and the Mansion of Life, etc. Text, id. ib. p. 276 [lower].

NEFERHERENPTAH    small name FEFI , King's *warb*-priest, Prophet of Khephren and Menkaurē, etc. Dyn. V or later.

Wife, Sitmert  , Royal acquaintance.

Stone-built mastaba.

Position, on plan XXIII, D-6

HASSAN, *Giza*, v, pp. 279-87; plans and sections, figs. 140, 143-50.

Entrance doorway. Lintel with offering-text; id. ib. pl. lii [A], fig. 141.



Doorway to inner offering-room. Lintel with offering-text; id. ib. pl. lii [c], fig. 142.



Statues. From serdab. In Cairo Mus.

View *in situ*, id. ib. pl. lii [B], p. 282.

Deceased standing, Ent. 87804. Id. ib. pl. liii [A], pp. 282-3; GHALIOUNGUI in *B.I.F.A.O.* lxii (1964), pl. vi [B], p. 64.

Wife standing, Ent. 87806. HASSAN, *op. cit.* pl. liv, p. 283; GHALIOUNGUI, *op. cit.* pl. vi [A], p. 63.

Son Itisen  , Butcher of the slaughterhouse of the Great House, seated Ent. 87805. HASSAN, *op. cit.* pl. liii [B], p. 284; GHALIOUNGUI, *op. cit.* pl. vii, pp. 63-4.

Daughter Mertiotēs    seated, Ent. 87807. HASSAN, *op. cit.* pl. lv, pp. 283-4.



SUF , Hairdresser of the Great House, Keeper of the diadem, Secretary of the Toilet-house, etc. Dyn. V or later.



Wife, Nezetempet  , Royal acquaintance.

Rock-cut tomb.

Position, on plan XXIII, D-6

HASSAN, *Giza*, v, pp. 257-60; plans and section, figs. 115, 117.

Entrance doorway. Lintel, offering-text with dedication of grandson Neferiru  ; id. ib. pl. xxxii, fig. 116.

Libation-basin of Mosi  , Dyn. V-VI, found north of tomb. Id. ib. vi [3], pl. cxvii [E], p. 245 [8].



NAME UNKNOWN. Dyn. V-VI.

Rock-cut tomb. Re-used in Late Period.

Position, on plan XXIII, D-6

HASSAN, *Giza*, v, pp. 307-12; plans and sections, figs. 166-9; views, pls. lxv, lxvi.

Entrance doorway. Thickness with remains of two registers of men bringing animals and fowl, and offering-bringers; see id. ib. p. 307.

Anthropoid sarcophagi of Ḥarsīēsi , son of Tak'as  (woman), and of Ēsimekhebi(?)  (woman), Late Period. Id. ib. pls. lxiii [A, B], lxiv, p. 309 (with texts).

MES-SA , Sole companion, Secretary of the Toilet-house, Master of the largesse in the Mansion of Life, etc. Middle Dyn. V.

Rock-cut tomb.

Position, on plan XXIII, D-6/7

HASSAN, *Giza*, v, pp. 289-92; plan, fig. 151; probably this, *L. D. Text*, i, pp. 116-18 with sketch-plans.

Entrance doorway. Lintel with offering-text and deceased, wife and son Khuwīwēr (tomb LG 95); HASSAN, op. cit. pl. lvii [A], fig. 152. Drum with name and titles; id. ib. pl. lvii [B], fig. 153.

Statue of son Khuwīwēr, upper part, probably from serdab, found by Lepsius, in Berlin Mus. 1113. Text, *Aeg. Inschr.* i, p. 16; part, *L. D. Text*, i, p. 116; see *Ausf. Verz.* p. 56.

LG 95. KHUWIWĒR , Prophet of Rē^c in the Sun-temple of Neferīkarē^c, Prophet of Menkaurē^c and Osiris, etc. End of Dyn. V.

Father, Mes-sa (tomb, see above). Wife, Ḥenutsen , Prophetess of Ḥathor, etc.

Rock-cut tomb. Façade cased with masonry.

Position, on plan XXIII, D-7. Plan XXXV

HASSAN, *Giza*, v, pp. 237-56 (with texts); *L. D. Text*, i, pp. 115-16. Plan, HASSAN, op. cit. fig. 99; of chapel, *L. D. Text*, i, p. 115; with sections, *L. D.* i. 29; plan and sections of shafts, HASSAN, op. cit. figs. 112-13. Synopsis of scenes, JUNKER, *Giza*, iii, pp. 50-1 [49].

I. Vestibule.

(1) Entrance doorway. Drum of father and deceased, from débris; HASSAN, op. cit. pl. xxvi [A], fig. 100.

(2) and (3) Conventional biographical text.

L. D. ii. 43 [c, d]; HASSAN, op. cit. figs. 101a, 101b; text, SETHE, *Urk.* i (1933), 46-8 [29]; titles, DE ROUGÉ, *Recherches sur les monuments* [etc.], pp. 85-6 (repr. in *Bibl. Ég.* xxvi, pp. 82-3).

II. Offering-room.

(4) Doorway. (a)-(b) Lintel with offering-text; (a) and (b) jambs, deceased with wife; (c) drum with name and titles; (d) and (e) deceased standing.

(a)-(c) *L. D.* ii. 43 [b]; HASSAN, op. cit. pl. xxvi [B], fig. 102; omitting jambs, WILKINSON MSS. xiii. 46. (d) *L. D. Ergänz.* xxxix [d]; HASSAN, op. cit. fig. 103a. (e) Id. ib. fig. 103b; text, *L. D. Text*, i, p. 115.

(5) Five registers, **I**, deceased with wife at each end, and children seated in between, **II**, harvest scenes, including reaping, binding sheaves, transporting corn and threshing with donkeys, and three registers either side of doorway, on left, **III**, rowing and sailing-boats, **IV**, netting fowl and fish, **V**, officials, on right, **III**, ploughing, **IV**, deceased in palanquin on pair of donkeys, and attendants, **V**, deceased fowling with split spear from canoe.

L. *D.* ii. 43 [a]; HASSAN, op. cit. fig. 104. Left, **III**, one sailing and two rowing-boats, MASPERO, *L'Arch. ég.* (1887), fig. 124; (1907), fig. 129; EBERS, *Aegypten*, i, fig. on p. 156 [bottom]; Eng. ed. fig. on p. 134 [bottom]; upper rowing-boat (reversed), and sailing-boats, DUEMICHEN, *Flotte*, xxv [11, 7]. Right, **IV**, EBERS, op. cit. fig. on p. 155 [bottom]; Eng. ed. fig. on p. 133 [bottom]; deceased, WILKINSON, *M. and C.* ed. BIRCH, i. 237 (No. 70); **V**, DUEMICHEN, *Flotte*, xxv [3].

(6) Five registers (much damaged), **I**, [offerings], **II**, harpists, **III**, men bringing offerings, **IV**, male dancers and clappers, **V**, female estates (no names).

L. *D.* *Ergänz.* xxxviii [left]; HASSAN, op. cit. fig. 105.

(7) Deceased seated, and six registers before him, **I** (lower part only), men, **II**, **III**, and right part of **IV**, bringing cattle and handing in list, **IV**, and **V** (left part), men bringing various articles, **V** (right part), butchers, **VI**, [estates].

L. *D.* *Ergänz.* xxxviii [right]; HASSAN, op. cit. fig. 106.

(8) and (9) Niches with rock-cut standing statues of deceased.

L. *D.* i. 29; ii. 44 [a, left and right]; HASSAN, op. cit. pl. xxvii, fig. 107; sketch, WILKINSON MSS. xiii. 47.

(10) (a) and (b) Offering-lists, with butchers and offering-bringers below (much destroyed at (b)). Two last entries in rows 3 and 4 of offering-list at (b), removed by Lepsius, in Berlin Mus. 1136. (c) False-door, with deceased (twice) at table on panel.

(a) L. *D.* ii. 44 [b]; HASSAN, op. cit. figs. 109-10, pl. xxviii [B]; WILKINSON MSS. xiii. 48.

(b) L. *D.* ii. 44 [c]; HASSAN, op. cit. fig. 111, pl. xxviii [A]. Text of fragment in Berlin Mus. 1136, *Aeg. Inschr.* i, p. 16; see *Ausf. Verz.* p. 56. (a) and (b) Offering-lists, DUEMICHEN, *Der Grabpalast des Patuamenap*, i, Taf. xviii-xxvi [f]; HASSAN, op. cit. vi [2], pls. clviii-clxxxiii [154], pp. 154-5, and pls. xxv-xxxii [35], pp. 122-3. (c) L. *D.* ii. 44 [a, middle]; HASSAN, op. cit. v, fig. 108.

Statues. Originally in serdabs

Deceased seated, lower part, greywacke, found in débris. Id. ib. pl. xxix, p. 253.

Deceased seated, lower part, black granite, found in south serdab. Id. ib. pls. xxx, xxx bis [A, B], p. 253.

Male bust, found in shaft 973, in Cairo Mus. Ent. 72221. Id. ib. pl. xxxi, p. 254; LANGE and HIRMER, *Aegypten. Architektur*, pl. 79; KEES, *Das alte Ägypten* (1955), Abb. 41; (1958), Abb. 50; Eng. ed. *Ancient Egypt* (1961), pl. 23 [b]; DONADONI, *Egyptian Museum Cairo*, pl. on p. 52.

Base (inscribed) of statue of deceased. HASSAN, op. cit. i, pl. xlvi [5], p. 72 [3].

Various



False-door of Weḥa , Royal chamberlain, Overseer of butlers, etc., end of Dyn. VI or later, found in fragments in shaft 973, in Cairo Mus. Ent. 72253. Id. ib. v, pl. xxx bis [c], fig. 114, pp. 255-6.

Tomb I. Dyn. V or VI.

Rock-cut tomb. Re-used in Late Period.

Position, on plan XXIII, E-6

HASSAN, *Giza*, iii, pp. 223-8; plans and sections, figs. 194, 196-8.

Anthropoid coffin of Pashenihet , son of Kheperheref  and Thebet , wood, Late Period. Id. ib. pl. lxiii [left], fig. 195 (text), pp. 223, 225-6.

S^cANKHUWI , King's *warb*-priest, etc. Middle Dyn. V or later.

Rock-cut tomb.

Position, on plan XXIII, E-6

HASSAN, *Giza*, iii, pp. 219-22; plans and sections, figs. 191-3.

Drum of entrance doorway with name and titles. Id. ib. fig. 190.

BUNŪFER , King's wife, King's daughter of his body, Prophetess of *nbty-špsš'* (*nbty*-name of Shepseskaf), Thasepef, etc. End of Dyn. IV to Dyn. V.

Father, Shepseskaf (GRDSELOFF). Husband, Thamphthis (GRDSELOFF) or Shepseskaf (HASSAN).

Rock-cut tomb.

Position, on plan XXIII, E-6. Plan XXXIII

HASSAN, *Giza*, iii, pp. 176-99 (with texts); plans and sections, figs. 146, 160-6; plan, REISNER, *Giza Necropolis*, i, fig. 135, p. 230 [12]. See GRDSELOFF in *Ann. Serv.* xlii (1943), pp. 66-9.

Chapel. Synopsis of scenes, JUNKER, *Giza*, iii, p. 53 [55].

(1)-(9) Doorways to inner offering-room. (a)-(b) Lintels with offering-text, drums with name and titles. (1) (b) Vintage (?); (c) sealing jars and pressing grapes. (2) (a) and (d) Estates leading animals; (b) man with [gazelle], and others bringing fowl; (c) offerings, [men bringing various objects]. (3) (a) Baking and brewing, including man treading pieces of bread in vat; (c) men with vases. (4) and (5) Deceased standing. (6)-(9) Name and titles of deceased.

(1)-(3) Outer doorways, and (4)-(5), HASSAN, *Giza*, iii, fig. 147a. (1) (a)-(b) Lintel, id. ib. pl. lvi [1]; (c) fig. 148, pl. lvi [2]. (2) (a)-(b) Id. ib. pl. liv; (c) fig. 151; (d) fig. 147b [left]; names of estates on (a) and (d), JACQUET-GORDON, *Domaines*, pp. 234-5 [1564-5], cf. figs. 40-1 (from HASSAN) (b on fig. 40 incorrect). (3) (a)-(b) HASSAN, op. cit. pl. lviii; (c) fig. 153. (4) Id. ib. pl. lv. (5) Id. ib. pl. lviii [lower, left]. (6)-(9) Id. ib. figs. 149, 150, 147b [right], 152.

(10) Secondary entrance doorway. (a)-(b) Lintel with remains of offering-text, and drum with name and titles. Id. ib. figs. 158-9.

Blocks, one of them with herdsmen feeding oxen, found in chapel. Id. ib. figs. 154-6.

Sloping passage. Plan and section, id. ib. fig. 157.

View of uninscribed sarcophagus, id. ib. pl. lvii.

Tomb H. NAME UNKNOWN (woman). Middle Dyn. V or later.

Rock-cut tomb.

Position, on plan XXIII, E-6

HASSAN, *Giza*, iii, pp. 166-75 (with texts); plans and section, figs. 142, 145.

Entrance doorway. Right thickness, [deceased seated], with daughter and officials (including Kairis , Overseer of the Pyramid-town of Khephren), and offering-bringers below; id. ib. pl. iii, fig. 143. Left thickness, similar scene, with butchers below; id. ib. fig. 144.

RENPETNŪFER , King's *warb*-priest, Prophet of the King's mother (probably Khentkaus [I]). Dyn. V or later.

Rock-cut tomb.

Position, on plan XXIII, E-6

HASSAN, *Giza*, iii, pp. 160-5; plans and sections, figs. 134, 138-41.

Entrance doorway. Lintel with remains of offering-text, and drum with name and titles; id. ib. figs. 133, 135. Right thickness, [deceased and wife], left thickness, [deceased]; id. ib. figs. 136-7.

PERNEB , Steward, etc. Dyn. V or later.

Rock-cut tomb.

Position, on plan XXIII, E-6

HASSAN, *Giza*, iii, pp. 157-9; plans and section, figs. 131-2.

Drum of entrance doorway with name and titles. Id. ib. fig. 130.

THESTI , *ka*-servant, etc. Dyn. V.

Rock-cut tomb.

Position, on plan XXIII, E-7

HASSAN, *Giza*, iii, pp. 148-56 (with texts); plans and section, figs. 126, 129.

Chapel.

West wall. Two false-doors of deceased, with family on jambs, and between them, niche with two rock-cut male statues, and lintel with offering-text above. Id. ib. pls. xlviiii-1, fig. 127.

North wall with niche. Statuette of deceased seated, black granite, originally here, found in débris, in Cairo Mus. Temp. No. 8.5.43.4; id. ib. pl. li [upper], p. 150.

East wall. Remains of deceased with family; id. ib. fig. 128.

ANKH-HAF  called KAR , Overseer of the Two Treasuries, Overseer of the Two Houses of Gold, Greatest of the *best*, etc. Dyn. VI.

Partly rock-cut and partly stone-built tomb.

Position, on plan XXIII, E-7

HASSAN, *Giza*, iii, pp. 130-47 (with texts); GAUTHIER in *Rev. d'Ég.* i (1933), p. 299; *Chron. d'Ég.* ix (1934), pp. 72-3 [III]; plan, HASSAN, op. cit. figs. 106, 113.

Hall.

False-door, panel with deceased at table and son Nis'ankhakhti (tomb, see below) censuring. Id. ib. pl. xl, fig. 114.

Offering-room.

Doorway. Lintel with offering-text, and jambs with name and titles; id. ib. fig. 115.

Sloping shaft. Plan, section, and view, id. ib. figs. 116-17.

Ointment-slab (inscribed), alabaster, in Cairo Mus. Ent. 72303. Id. ib. pl. xlvii [3], p. 140 [3, a].

Shaft 626. Plan and section, id. ib. fig. 120.



Ointment-slab (inscribed), alabaster, in Cairo Mus. Temp. No. 10.5.43.16. Id. ib. pl. xliii [middle], p. 145 [1].

Shaft 637. Plan and section, id. ib. fig. 125.

Head of male statuette. Id. ib. pl. xlvii [2], p. 147.

Found nearby

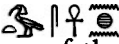
Unfinished male statuette, from débris east of tomb. Id. ib. vi [3], pl. xcix [B], p. 240 [4].

NIS'ANKHAKHTI  called **ITHI** , Overseer of the Two Treasuries, Overseer of the Two Houses of Gold, Greatest of the *best*, etc. Dyn. VI.

Father, 'Ankh-ḥaf (see preceding tomb).

Rock-cut tomb.

Position, on plan XXIII, E-7

HASSAN, *Gîza*, iii, pp. 119-29 (with texts); plans and sections, figs. 106, 110-13.

East chapel.

Entrance doorway. Lintel with five figures of deceased on left, and four of father facing them on right; id. ib. fig. 107. Drum with names and titles of deceased and [father]; id. ib. fig. 108.

North false-door of deceased, with son 'Ankh , Elder of the physicians of the Great House, censuring before deceased on panel. Id. ib. pls. xxxviii, xxxix, figs. 109, 109 bis.

MEDUNŪFER , Physician of the Great House, Director of eye physicians of the Great House, Assistant of Duau, etc. Middle Dyn. V or later.

Rock-cut tomb.

Position, on plan XXIII, E-6/7

HASSAN, *Gîza*, iii, pp. 115-18; plans, section, and view of façade, figs. 103, 105.

Entrance doorway. Lintel with offering-text, dedicated by nephew Senmereri ; id. ib. pl. xxxvii, fig. 104.

LG 99. NŪFER , Director of the Palace, Director of King's hairdressers, Prophet of Khephren, etc. Middle Dyn. V or later.

Wife, Nubirt .

Rock-cut tomb with masonry façade.

Position, on plan XXIII, E-6. Plan XXXIV

HASSAN, *Giza*, iii, pp. 200-18 (with texts); *L. D. Text*, i, p. 121; plans and sections, HASSAN, op. cit. figs. 167, 177, 179-81; plan, *L. D.* i. 31.

Embalming-house (wꜣbt). In court. Brick-built.

See HASSAN, op. cit. iv, p. 85, with plan fig. 41.

Chapel.

I. Outer offering-room.

(1) Entrance doorway. (a) Deceased with wife and son (badly damaged); (b)-(c) drum with name and titles; (b) and (c) three fragments, deceased and son Nikaukhnun; (d) and (e) deceased, with wife and son respectively.

(a) *Id. ib.* iii, fig. 168. (b) and (c) Jambs, *id. ib.* fig. 169 [A-C]. (b)-(c) Drum, and (d), (e), *L. D.* ii. 95 [F], *Text*, i, p. 121; HASSAN, op. cit. iii, pl. lix, figs. 170-2.

(2) False-door of deceased (in fragments), with panel in form of palace-façade.

Id. ib. pl. lx [1], fig. 173.

II. Inner offering-room with niche.

(3)-(5) Remains of scenes, including dancers, men dragging sledges with chests, and geese at (5).

Id. ib. figs. 174-6.

III. Long corridor. Approached by secondary entrance doorway.

(6) Funerary priests in front of [deceased at table].

Id. ib. fig. 178.

Loose blocks

Remains of texts and scenes, *id. ib.* pp. 216-18.

Nos. 1-8 (of Hassan). Various, including deceased at table and offering-bringers. *Id. ib.* figs. 169 [lower five], 182-4.

No. 9. Fragment of jamb of son Nikaukhnun . *Id. ib.* pl. lxi [upper], fig. 185.

No. 10. Block with name of Nisu-uset , Overseer of the Treasury, red granite. *Id. ib.* pl. lx [5], fig. 186; *L. D. Text*, i, p. 127 [bottom right].

Nos. 11-13. Bringing cattle and fowl. HASSAN, op. cit. iii, figs. 187-9.

SEDHOTP , King's *wꜣrb*-priest of the Great House. Dyn. V.

Rock-cut tomb.

Position, on plan XXIII, D/E-6/7

HASSAN, *Giza*, iii, pp. 108-14; plans and sections, figs. 96-102.

South wall of west offering-room. Niche with rock-cut statues of man and wife; *id. ib.* pl. xxxi, p. 108.

Statue of deceased standing, found in serdab, in Cairo Mus. Ent. 87799. *Id. ib.* pls. xxxii, xxxiii, p. 110 (with text).

Two statuettes of women grinding corn, found between this tomb and that of Medunifer (see p. 258), presumably from here, one in Cairo Mus. Ent. 87819. *Id. ib.* pls. xxxiv-xxxvi, p. 111.

LG 96. KAMENI , Chief of the King. Dyn. V.

Wife, Ḥaterkau .

Rock-cut tomb.

Position, on plan XXIII, D/E-7

HASSAN, *Giza*, iii, pp. 98-107, with plans and sections, figs. 87, 92-5; L. D. Text, i, pp. 119-20, with plan.

South entrance. Lintel with remains of offering-text (much damaged); HASSAN, op. cit. fig. 88; L. D. ii. 40 [a]. Thicknesses, deceased, with sons(?) on the left one, and with men leading bulls on the right one. HASSAN, op. cit. figs. 89, 90.

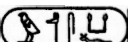
West wall. Two false-doors of deceased and wife, and between them, deceased and wife with son Userkaḥankh  and daughter. Id. ib. pl. xxix, fig. 91; L. D. ii. 40 [b].

SHEPSESAKHTI , Inspector of prophets of the King's mother, etc. Probably Dyn. VI.

Wife, Iti .

Stone-built mastaba.

Position, on plan XXIII, E-7

HASSAN, *Giza*, iii, pp. 93-7 (with texts); plans and sections, figs. 83, 85-6.

North false-door of deceased, with family on jambs. Id. ib. pl. xxviii, fig. 84.

SESHEMU , Overseer of the department, Secretary of the royal harīm, etc. Dyn. VI.

Wife, Thetut , Prophetess of Ḥathor in all her places, and of Neith, etc.

Stone-built mastaba.

Position, on plan XXIII, E-7

HASSAN, *Giza*, iii, pp. 78-92 (with texts); plans and sections, figs. 68, 71-3, 76-81.

North chapel.

False-door of deceased, with conventional biographical text on right jamb. Id. ib. pl. xxv, fig. 69.

False-door of wife. Id. ib. pl. xxvii [2], fig. 70.

Tomb F. Dyn. V-VI.

Rock-cut tomb.

Position, on plan XXIII, D/E-7

See HASSAN, *Giza*, iii, pp. 72-7; plans and section of shaft, figs. 65-6.

Lintel of a Prophet of the Pyramid of Isesi, fragment, end of Dyn. V or Dyn. VI. Id. ib. v, pl. lxix [D], p. 315 [13]; see iii, p. 74 [shaft 742].

Statuette of Meresḥankh , Prophetess of Ḥathor Mistress-of-the-Sycamore, etc., standing, late Old Kingdom, from south of tomb, in Cairo Mus. Ent. 87797. Id. ib. vi [3], pls. xcvi [A] (*in situ*), xcvi, p. 239 [1].

Tomb G. Dyn. V-VI.

Rock-cut tomb.

Position, on plan XXIII, D-7

HASSAN, *Giza*, iii, pp. 76-7. Sketch-plan, *L. D. Text*, i, p. 119 [upper left]. Plans and section of shaft, HASSAN, *op. cit.* figs. 65, 67.

Masons' graffiti. *L. D. Text*, i, p. 119 [upper right], pp. 118-19; see LEPSIUS, *Die alt-ägyptische Elle und ihre Eintheilung* (repr. from *Abhandlungen der Königl. Akademie der Wissenschaften zu Berlin*, 1865), pp. 11-12.

Tomb E. Dyn. V-VI.

Partly rock-cut and partly stone-built mastaba.

Position, on plan XXIII, E-7

HASSAN, *Giza*, iii, pp. 50-2; plans and section, figs. 44-5.

Rock-cut statues in north wall of chapel. One group, *id. ib.* pl. xx.

KHENU , Inspector of *ka*-servants, Prophet of Menkaurē, Steward, etc. Dyn. VI.

Wife, Iufenankh , Prophetess of Hathor.

Stone-built mastaba.

Position, on plan XXIII, B-7

HASSAN, *Giza*, ii, pp. 159-68; plans and sections, figs. 188, 197-201.

Chapel.

Entrance doorway. Lintel with offering-text, and drum with name and titles, both found in débris. *Id. ib.* pls. lvi [2], lvii [2], figs. 189-90.

North false-door of deceased, in fragments. *Id. ib.* pls. lvii [1], lviii, figs. 192-3.



Lower part of south false-door of deceased. *Id. ib.* pl. lix, figs. 194-5.

Fragment of lintel with offering-text of deceased, probably common to both false-doors. *Id. ib.* pl. lvi [1], fig. 191.

South wall. Deceased at table, with offering-list and two registers before him, offering-bringers and funerary priests. *Id. ib.* pl. lx, fig. 196; offering-list, vi [2], pls. lvii-lxiv [66], p. 131.

Various



Lintel of Kanebef , Inspector of *ka*-servants, in fragments, Dyn. V-VI, found west of tomb.¹ *Id. ib.* v, pl. lxx [E], p. 316 [24].

REMENUKA  called IMI , Inspector of prophets and *warb*-priests of Menkaurē, Herdsman of Thentet-cattle, etc. Dyn. VI.

Stone-built mastaba.

Position, on plan XXIII, C-7. Plan XXXIV

HASSAN, *Giza*, ii, pp. 169-78; plans and section, figs. 202, 209. Reconstruction of position of architraves, FISCHER, *Dendera*, fig. 44, pp. 218-19.

(1) (a)-(b) Architrave with text of building tomb and rewarding craftsmen, and fragment of architrave with figures of deceased, Shepsipuptah , Overseer of tenants of the Great House, and woman Ifimery .

HASSAN, *op. cit.* pl. lxi [2], figs. 206, 210.

¹ Probably this tomb is meant by Hassan, and not tomb of Khenu, p. 279.

(2) Niche. (a) and (b) Remains of deceased, with sons as offering-bringers below;
(c) lower part of false-door of deceased, with lintel with offering-text.

(a) and (b) Id. ib. figs. 203-4, on pl. lxii. (c) Id. ib. pls. lxi [1], lxii, figs. 205, 207-8.

Finds

Male standing statue, in fragments, Dyn. V, found west of last tomb, and in shaft 856 of tomb south of tomb of Kaaper (see below). Id. ib. v, pl. lxxv, p. 318 [38] with note 1.

KAHERSETEF , Overseer of *ka*-servants of the King's wife (probably Rekhetrê), Inspector of cooling of the Great House, Overseer of Per-nu of the Great House, etc. Dyn. V or early Dyn. VI.

Stone-built mastaba with rock-cut chapel.

Position, on plan XXIII, C-7

HASSAN, *Giza*, vi [3], pp. 73-9; plans and sections, figs. 57, 61-2.

Hall.

Entrance doorway. Lintel with offering-text; id. ib. pl. xxx [B], fig. 58.

Niche in east wall. Four rock-cut statues (two of deceased, and wife with child), and granite statuette of deceased, found *in situ*, in Cairo Mus. Ent. 87798; id. ib. pl. xxxi, p. 76; granite statuette, pl. xxxii, p. 77.

Offering-room.

Doorway. Lintel with offering-text; id. ib. pl. xxxiii [A], fig. 59.

South false-door of deceased. Id. ib. pl. xxxiii [B], fig. 60.

Finds. Late Old Kingdom

From west of tomb unless otherwise stated.

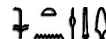
False-door of Wezmedunesutima(?) , Overseer of commands (of the King), fragment. Id. ib. vii, pl. liii [c], p. 125 [4].

Double-statuette of man and wife standing, and male seated statuette, both much damaged. Id. ib. pl. liii [A, B], p. 125 [1, 3].

Head of female statuette, thrown away in shaft. Id. ib. pl. liii [D], p. 125 [2].

Male standing statuette, upper part, found at entrance. Id. ib. pl. liv bis [c], p. 125 [8].

NAME UNKNOWN. Dyn. V-VI.

Rock-cut tomb. Unfinished.

Position, on plan XXIII, C-7/8

HASSAN, *Giza*, v, pp. 303-6; plans and sections, figs. 161-5.

Statuette of man standing, from passage. Id. ib. pl. lxii, p. 303.

KAAPER , Overseer of officials (*srw*), Overseer of the expedition, Overseer of the granary, etc. Probably late Dyn. V.

Rock-cut tomb.

Position, on plan XXIII, C-8

HASSAN, *Giza*, ii, pp. 155-8; plans and sections, figs. 184, 186-7.

Rock-cut lintel of entrance doorway with offering-text. Id. ib. fig. 185.

Female bust, probably from seated statue, from shaft nearby. Id. ib. v, pl. lxxiv, p. 318 [37].

MASTABA-COMPLEX OF KAEMNEFERT FAMILY. Middle Dyn. V or later.

Partly rock-cut and partly stone-built.

Position, on plan XXIII, B/C-8. Plan XXXIV

HASSAN, *Giza*, ii, pp. 104-38; id. in *Anc. Eg.* (1930), p. 24; plan, id. *Giza*, ii, fig. 112; plans and sections of shafts, figs. 161-8. Synopsis of scenes, JUNKER, *Giza*, iii, pp. 52-3 [52].

South tomb. KAEMNEFERT  (father), Sole companion, Director of the Palace, Chief of *bat*, etc.

Elevation, HASSAN, *Giza*, ii, fig. 115.

(1) Entrance doorway. (a)-(b) Part of drum with remains of titles, found in débris; jambs with remains of name and titles; (c) and (d) lower parts, deceased, with offering-bringers at (c), and family at (d).

(a)-(b) Drum, see id. ib. p. 108; jambs, pl. xxxiii, figs. 113A, 113B. (c) and (d) Id. ib. fig. 114.

(2) Doorway. (a)-(b) Lintel with offering-text, and drum with name and titles; (a) and (b) jambs, remains of deceased; (c) and (d) remains of deceased with family and offering-bringers.

Id. ib. pls. xxxiv, xxxv [3], xxxvi [1, 2], figs. 116-18.

North tomb. KAEMNEFERT (son), Royal chamberlain, etc.

Elevation, id. ib. fig. 119.

Vestibule. A of Hassan.

(3) Remains of two registers, netting fish, and papyrus-canoe scene.

Id. ib. fig. 120; block with boatmen jousting, fig. 121.

(4) Between two destroyed false-doors, remains of butchers.

Id. ib. fig. 122; blocks with milking tethered cow, cattle crossing water, female dancers, offering-bringers, butchers, figs. 123-7.

(5) Above apertures of serdabs, two registers of bringing cattle and female estates (no names).

Id. ib. fig. 128.

Passage. B of Hassan.

(6) Doorway. Fragments of jambs with three columns of titles.

Id. ib. figs. 129-34.

(7) Four registers, I, destroyed, II, butchers, III, bringing animals, IV, female estates.

Id. ib. pls. xl-xlii, figs. 135-7; names of estates in IV, JACQUET-GORDON, *Domaines*, pp. 281-6 [34G5], Nos. 1-32, cf. figs. 76-7 (from HASSAN).

(8) Similar to (7), now in loose blocks.

HASSAN, *Gîza*, ii, figs. 138, 147 (joins fig. 138 [upper left]); names of estates, JACQUET-GORDON, op. cit. pp. 281-3, 286-9 [34G5], Nos. 33-64, cf. figs. 76-7 (from HASSAN).

Offering-room. D of Hassan.

(9) Doorway. Remains of names and titles on drum and jambs.

HASSAN, *Gîza*, ii, fig. 139.

(10) and (11) Loose blocks, deceased at table and offering-list, estates (no names), etc.

Id. ib. figs. 142-5.

(12) Remains of man standing.

Id. ib. fig. 141.

(13) Herdsmen with cattle crossing water, and hippopotamus-hunt.

Id. ib. fig. 140.

Exact position unknown.

Twelve relief-fragments, bringing cattle, offering-bringers, netting fowl, butchers, boatmen jousting, man leading dog, fragment of legal text, titles. Id. ib. figs. 148-59, pl. xliii [2], pp. 130-3 [2-13].

Débris in shafts 162 and 213.

Offering-tables (some inscribed), alabaster, fragments (one with offering-bringers and dôm-palm). See id. ib. pp. 136 [6, 7], 137 (with texts).

East tomb. NAME UNKNOWN, Scribe of petitions, Overseer of the House of *wehat*-boats, Steward of Shey, etc.

(14) Entrance doorway. Fragments of lintel with offering-text.

Id. ib. pl. xliv, fig. 160.

Finds from Mastaba-complex

Head of statue (of Kaemnefert, son), sandstone, from north serdab of North tomb. Id. ib. pls. xxxvii-xxxix, pp. 118-19; *I.L.N.* June 20, 1931, fig. on p. 1061 [bottom middle]; LEBOVITCH, *Anc. Eg.* fig. on p. 67 [bottom].

Small sphinx, bronze, Late Period, from offering-room of North tomb. HASSAN, *Gîza*, ii, pl. xliii [3, 4], pp. 129-30 [3].

Block with remains of text, found nearby. Id. ib. ix, pl. xlvii [A, B], p. 90 [e].

Block with text of will endowing tomb near Second Pyramid, possibly from here, in Cairo Mus. 1432 (wrongly as 1452 in 1st ed.). BORCHARDT, *Denkmäler*, i, Bl. 28, pp. 112-13 (with text). Text, DE ROUGÉ, *Inscr. hiéro.* pl. i; MORET in *Rec. Trav.* xxix (1907), pp. 75-91; BRUGSCH, *Thes.* 1210-12; SETHE, *Urk.* i (1933), 11-15 [10]; GOEDICKE, *Die privaten Rechtsinschriften aus dem Alten Reich*, Taf. v, pp. 44-67; cf. EDEL in *A.Z.* 92 (1966), pp. 96-9; see MASPERO, *Guide*, pp. 38-9 [72].

Tomb of shaft 294. Dyn. V-VI.

Stone-built mastaba.

Position, on plan XXIII, C-8

HASSAN, *Gîza*, ii, pp. 139-50; id. in *Anc. Eg.* (1930), p. 24; *Chron. d'Ég.* vii (1932), pp. 70-2; plan, HASSAN, *Gîza*, ii, fig. 170.

Shaft 294. Plan and section, id. ib. fig. 171.

Gold diadem and necklace, found in sarcophagus, in Cairo Mus. Id. ib. pls. li, lii [2], cf. xlix, l, p. 149 [I, 3]; *I.L.N.* Feb. 21, 1931, figs. on pp. 294-5, 297 [upper]; ALDRED, *Jewels of the Pharaohs*, pls. 4, 5.

Inscribed fragment, found in débris in shaft. See HASSAN, *Giza*, ii, p. 141 [3] (text).

Shaft 294 bis. Plan and section, id. ib. fig. 176.

Torso of female statue, from débris. Id. ib. pl. liv [2, 3], p. 150 [1].

ZEFANESUT . Middle Dyn. V.

Stone-built mastaba.

Position, on plan XXIII, C-8

HASSAN, *Giza*, i, pp. 63-5; id. in *Anc. Eg.* (1930), p. 24; plans and sections, id. *Giza*, i, figs. 115, 117-18, on frontispiece; view, pl. xliii.

Entrance doorway to passage. Right jamb(?) with deceased seated; id. ib. fig. 116.

North wall of pillared chapel. Niche with two rock-cut statues; see id. ib. p. 65.

Seated male statuette. Id. ib. pl. xlv [2], p. 65.

RA^cWĒR , Overseer of linen (*ššrw*) of the endowment, *ka*-servant, Teacher of the royal singers, etc. Dyn. VI.



Stone-built mastaba.

Position, on plan XXIII, C-8

HASSAN, *Giza*, i, pp. 66-8; plans and sections, figs. 119, 123-4, on frontispiece.

Three false-doors of deceased in east façade, with 'Ankhtef (tomb, see p. 275) on jambs of two of them. Id. ib. pl. xlv [1], figs. 120-2, pp. 66-8 (texts).

RA^cWĒR , Sole companion, Boundary official of Dep, Prophet of Buto in Pe and Dep, King's hairdresser, etc. Temp. Neferirkarē^c or a little later.

Parents, Itisen  and Hetepheres .

Stone-built mastaba.

Position, on plan XXIII, C/D-8/9. Plan XXXIII

HASSAN, *Giza*, i, pp. 1-61; id. in *Anc. Eg.* (1930), pp. 23-4; id. in *Chron. d'Ég.* vi (1931), pp. 271-2; plans and section, id. *Giza*, i, on frontispiece, figs. 2, 4, 6, 10-12, 14, 15, 17-20, 22-4; view of rock-cut chamber, pl. xxxi. Synopsis of scenes, JUNKER, *Giza*, iii, p. 52 [51].

Chapel.

(1) Entrance doorway. (a) Architrave (originally on columns) with offering-text; (b)-(c) lintel and jambs with name and titles, and names and titles on either side of doorway (damaged).

HASSAN, *Giza*, i, pls. i, ii, fig. 1, pp. 4, 6.

I. Vestibule.

(2) Doorway. (a) and (b) Remains of titles.

Id. ib. pl. iii [1, 2], p. 7 [top].

(3) Remains of flax-harvest, transport with donkeys, papyrus-boats.

Id. ib. pl. iii [3], p. 7.

(4) (a) Deceased seated with mother before him; (b) two women facing each other; (c) two men.

Id. ib. pl. iv, fig. 5, pp. 7-8.

II. Offering-hall. View, id. ib. pl. v.

(5) Doorway. (a) and (b) Destroyed texts. See id. ib. pp. 9-10.

(6) Six fragments of scenes with estates and offering-bringers (removed).

Id. ib. pls. vi, vii, viii [2], fig. 7, pp. 11-12 [A-F]; names of estates, JACQUET-GORDON, *Domaines*, pp. 267-9 [29G5], Nos. 1-13, cf. figs. 65 (from HASSAN) and 66 (position on wall).

(7) Triple-statue of deceased standing, quartzite, found *in situ*, now in Cairo Mus. Ent. 66615.

HASSAN, *Gîza*, i, pls. viii [1], ix, pp. 12-13; HORNEMANN, *Types*, v, pl. 1364; see *Descr. somm.* No. 6266.

III. East passage. View of uninscribed false-door and serdabs, HASSAN, *Gîza*, i, pl. xv.

(8) Doorway. (a) Lower part of deceased and wife(?); (b) name of deceased.

(a) Id. ib. pl. xi [1], p. 13. (b) See id. ib. p. 13.

(9) Deceased seated with offering-bringers and butchers.

See id. ib. p. 13.

IV. Chamber for offerings (?).

(10) Doorway. Probably from here, block with offerings, lotus-flower column, and titles.

Id. ib. pl. xi [2].

(11) Remains of biographical text.

Id. ib. pl. xii, p. 15; text, SETHE, *Urk.* i (1933), 233-4 [8 (148)].

Niche. N. 7 of Hassan.

(12) Standing statue of deceased in niche, in one piece (damaged).

HASSAN, *Gîza*, i, pl. xiii, p. 16.

V. Central court. View, id. ib. pl. xvi.

Fragment from roof, imitating palm-trunk beams. Id. ib. pl. xvii [1], p. 17.

(13) Doorway. Fragment of jamb with names of deceased; id. ib. pl. xiv [1], p. 17.

Principal serdab. S. 12 of Hassan.

(14) Doorway. (a) and (b) Remains of titles.

See id. ib. p. 17 [bottom].

(15) Two figures of deceased facing each other, titles.

Id. ib. pl. xvii [2], p. 18 [top].

(16) Standing statue of deceased in niche, in one piece (upper part destroyed).

Id. ib. pl. xix, p. 19.

Serdab. S. 13 of Hassan.

(17) Doorway. Blocks with name and titles; id. ib. pl. xx, pp. 19-20 [top].

VI. Open court. View of altar, id. ib. pl. xxv [2].

Fragments of scenes with deceased seated and standing, and remains of titles. See id. ib. p. 21.

(18) and (19) Pillars. On all faces, deceased.

One, id. ib. pl. xxv [1], p. 21.

(20) Along the wall, name and titles of deceased. Id. ib. fig. 16.

Niche. N. 9 of Hassan.

(21) Remains of scene with butchers. See id. ib. p. 22 [top].

VII. Brick chamber with niche. N. 14 of Hassan.

(22) Alabaster niche-stela with deceased, in Cairo Mus. Ent. 66626.

Id. ib. pls. xxvii, xxviii, cf. xxvi, pp. 24, 26; DONADONI, *Egyptian Museum Cairo*, pl. on p. 58, cf. p. 56; LANGE and HIRMER, *Ägypten. Architektur* (1967), pl. 50; upper part, id. ib. (1955 and 1957), pl. 52; ATARASHI, *Egypt*, pl. 77; see *Descr. somm.* No. 6267.

VIII. Chamber.

(23) Doorway. Door-socket with titles, *in situ*; HASSAN, *Giza*, i, pl. xxxvii [1], p. 27.

Serdab. S. 16 of Hassan.

(24) Fragment of threshing with donkeys. Id. ib. fig. 21.

Niche. N. 19 of Hassan.

(25) Statue of deceased in niche, in one piece. See id. ib. p. 27.

IX. Court.

(26) Fragment of scene, Shepseskafankh  , Inspector of *ka*-servants, censuring, and remains of offering-bringers.

Id. ib. pl. xxix, p. 27.

X. Hall.

(27) Doorway. Remains of names and titles; see id. ib. p. 30.

XI. Offering-room.

(28) Altar, deceased and titles, alabaster.

Id. ib. pl. xxxii, fig. 25.

Blocks with reliefs and texts.

Various, including donkey, boatmen jousting, picking grapes, scribes, offering-bringers, and names and titles. Id. ib. pls. xxxiii, xxxiv, xxxv [3], xxxvi, xxxvii [2-8], fig. 26, pp. 32-6 [1-26]; fragment No. 26, cf. JACQUET-GORDON, *Domaines*, p. 269, No. 6.

Name and title of deceased, from shaft 322 of an uninscribed tomb. See HASSAN, *Giza*, ii, p. 74 [1].

Remains of titles of deceased, in Cairo Mus. 1675. See BORCHARDT, *Denkmäler*, ii, p. 130 (text).

Upper part of man holding stick, found east of tomb. HASSAN, *Giza*, ix, pl. xlvii [E], p. 90 [G].

Statues

Found by Hassan. See also supra, (7), (12), (16) and (25).

Statue-group of deceased, parents, and son Ra'wēr and daughter Hētephēres, all standing. Deceased (headless, with hand of child round right leg), in Kansas City, William Rockhill Nelson Gallery of Art, 38. 11; father (headless), in Brooklyn Mus. 37. 365; head of deceased or father, in Cairo Mus. 287; mother (headless), in Worcester (Mass.) Art Mus. 1934.48; statues of children seen with dealer in Paris, and one later with dealer in New York. COONEY in *J.E.A.* 31 (1945), pl. i (statues), pp. 54-6; inscribed base, HASSAN, *Giza*, i, pl. xxx [1], p. 29; Cairo Mus. 287, see BORCHARDT, *Statuen*, i, pp. 177-8, cf. 178 note 1. Deceased, *The*

William Rockhill Nelson Collection (1940), fig. 3; (1949), fig. on p. 13; Kansas City. *Handbook of the Collections* (1959), fig. on p. 17 [right]; POULSEN, *Ag. Kunst. A. und M.* pl. on p. 62. Father, COONEY in *Brooklyn Museum Quarterly*, 24 (1937), fig. on p. 191 [left], cf. pp. 190-6; RIEFSTAHL, *Patterned Textiles in Pharaonic Egypt*, fig. 5, p. 8. Mother, COONEY in *Brooklyn Museum Quarterly*, 24 (1937), fig. on p. 191 [right], cf. pp. 190-6; CAPART, *Limites*, pl. iv [1], p. 43; COTT in *Worcester Art Museum Annual*, i (1935-6), fig. 1, p. 17; *Worcester Art Museum. News Bulletin and Calendar*, xi [1] (1945), fig. on p. 2; SMITH, *Hist. Eg. Sculp.* pl. 16 [a], pp. 42-3; RANKE, *Meisterwerke*, pl. 63; ALDRED, *O.K. Art*, pl. 36; VANDIER, *Eg. Sculpture*, pl. 25; GIEDION, *The Eternal Present*, ii, fig. 58; WOLF, *Kunst*, Abb. 124; POSENER, SAUNERON and YOYOTTE, *Dict. civ.* fig. on p. 116; MILKOVICH in *Archaeology*, 16 (1963), fig. on p. 155 [right]; DRIOTON and DU BOURGUET, *Les Pharaons à la conquête de l'art*, pl. 30; POULSEN, op. cit. pl. on p. 63; Worcester Art Museum. *Art through Fifty Centuries* (1948), fig. 3; HALL in *Apollo*, lxxxviii (July 1968), fig. 5, p. 6; MICHALOWSKI, *Art*, fig. 209; *Apollo*, xciv (Dec. 1971), fig. 4, p. 433.

Triple-statue of man standing, from shafts 145 of tomb of Mersu'ankh (see p. 269) and 151 of neighbouring tomb, in Cairo Mus. Ent. 66616. HASSAN, *Gîza*, i, pl. xxii, pp. 20, 21, 114; BOREUX in *Mélanges Maspero*, i [2], pl. iii [4], p. 812; SHOUKRY, *Privatgrabstatue*, Abb. 33, p. 152 [bottom, 3] (note 9 incorrect); HORNEMANN, *Types*, v, pl. 1361; Louisiana (E. Zealand, Denmark). *5000 Ars Aegyptisk Kunst*. 1. April-27. Maj, 1962, No. 65 with fig.; MICHALOWSKI, *Art*, fig. 220; see Vienna. *5000 Jahre*, No. 28; *Descr. somm.* No. 6265.

Torso of triad, in two adjoining fragments, red granite, found in shafts 35 of neighbouring tomb and 294 (tomb, see p. 264). HASSAN, *Gîza*, ii, pl. xlv [1], p. 141 [2]; i, pl. xlvi [4], p. 72 [2].

Man standing, from shafts 145 of tomb of Mersu'ankh (see p. 269) and 151 of neighbouring tomb, in Cairo Mus. Ent. 66622. Id. ib. pl. xxi, pp. 20-1, 114; HORNEMANN, *Types*, i, pl. 125; see *Descr. somm.* No. 6266.

Woman seated, from Offering-hall. HASSAN, *Gîza*, i, pl. xxxix [1], p. 36 [2].

Deceased seated (headless) from serdab S. 14 of Hassan. Id. ib. pl. xxiii [2], p. 22.

Bust, basalt, from neighbouring shaft. *I.L.N.* June 20, 1931, fig. on p. 1061 [top middle]; see *Chron. d'Ég.* vii (1932), p. 75 [bottom].

Male bust. HASSAN, *Gîza*, i, pl. xxxviii [3].

Male head, black granite, from niche N. 13 of Hassan. Id. ib. pl. xxxviii [2], p. 24.

Head of large male statue (much damaged), from west of serdab S. 12 of Hassan. Id. ib. pl. xxxviii [1], p. 36 [1].

Face of male statue, fragment, from serdab S. 14 of Hassan, in Cairo Mus. Ent. 66625. Id. ib. pl. xxiv, p. 22; LANGE, *Ag. Kunst*, pl. 21; id. and HIRMER, *Aegypten. Architektur* (1955 and 1957), pl. 53; (1967), pl. 51; SPIEGEL, *Hochkultur*, Taf. 37 [b]; DRIOTON and HASSIA, *Temples and Treasures of Egypt* in *Art et style* (1954), pl. 24; GILBERT in *Chron. d'Ég.* xxxv (1960), figs. 36-7, pp. 150-3; see *Descr. somm.* No. 6265; Brussels. *5000 ans*, Addenda, No. 14 B; Vienna. *5000 Jahre*, No. 27.

Torso of man, alabaster, found in front of niche N. 2 of Hassan, and head, found in shaft 130 (head, probably in Cairo Mus. Ent. 87816). HASSAN, *Gîza*, i, pl. x, p. 10.

Torso of male statue, from serdab S. 14 of Hassan. Id. ib. pl. xxiii [1], p. 24 [top].

Man standing, lower part, from serdab S. 13 of Hassan. Id. ib. pl. xxiii [3], p. 20.

Two seated statues of deceased, fragments, from serdab S. 5 of Hassan. Id. ib. pl. xiv [2, 3], p. 16.

Bases of statues of deceased, from serdabs S. 17, 19, 20 of Hassan. Id. ib. pls. xxxix [5], xxx [2, 3], pp. 27, 29.

Deceased seated, three fragments, found in shafts 35 and 322. Id. ib. pl. xlvi [2], p. 71 [1] (called shafts 35 and 161); see ii, p. 74 [2].

Head of statuette. Id. ib. i, pl. xlvi [3], p. 72 [2].

Base with foot of deceased, fragment, granite, found near tomb of Kēdnas (see p. 276). Id. ib. v, pl. lxxi [c], pp. 316-17 [30].

Statue-fragments. Id. ib. i, pls. xxxix [2-4], xl, xli, pp. 36-8 [3-50].

In Cairo Museum since 1886.

Deceased seated, Nos. 197-9, 216-17. See BORCHARDT, *Statuen*, i, pp. 134-5, 144-5 (with texts); texts of Nos. 199 and 217, DE ROUGÉ, *Inscr. hiéro.* pls. lxx [upper middle], vi [right].

Man standing, statuette, ivory (found at feet of No. 198), No. 815. BORCHARDT, *Statuen*, iii, Bl. 151, p. 109.

Deceased seated (headless), No. 200. Id. ib. i, Bl. 42, p. 136 (with text).

Deceased seated, fragments, Nos. 365-7. See id. ib. pp. 192-3 (texts).

Torso of standing statue(?), No. 280. See id. ib. p. 175.

Base with foot, fragment, possibly from here, No. 318. See id. ib. p. 185.

Statue-fragments, Nos. 1162, 1164. See id. ib. iv, p. 86 (remains of texts).

Various finds

Stela with biographical text (with incident of *ams*-staff), found in serdab S. 12 of Hassan, in Cairo Mus. Ent. 66682. HASSAN, *Giza*, i, pl. xviii, fig. 13, pp. 18-19 (translation); text, SETHE, *Urk.* i (1933), 232 [7 (147)].

Fragments of niche-stela with deceased, alabaster. HASSAN, *Giza*, i, fig. 9, p. 13.

Fragments, title and name of deceased, and remains of deceased, alabaster, both found in Valley Temple of Menkaurē, in Boston Mus. 11.716. REISNER, *Mycerinus*, pls. A [7], 46 [g], pp. 37 [Jan. 1-7], 38 [Feb. 18-23].

NEFERWENT , Inspector of tenants of the Great House, Overseer of the department of tenants of the Great House. Dyn. V.

Stone-built mastaba.

Position, on plan XXIII, C-8/9

HASSAN, *Giza*, i, pp. 68-71; plan, on fig. 119 and frontispiece; plans and sections of shafts, figs. 126-7.

False-door of deceased, found lying in front of recess in east façade. Id. ib. pl. xliv [3], fig. 125.

MERSUANKH , Overseer of the young men in the endowment of Companion Račwēr, Overseer of all his (Račwēr's) properties in and outside the endowment, etc. End of Dyn. V.

Mother, Ruzsaus , Overseer of the House of weaving women in (the endowment).

Stone-built mastaba.

Position, on plan XXIII, C-8

HASSAN, *Giza*, i, pp. 104-17 (with texts); plan, fig. 177, on frontispiece; plans and sections of shafts, figs. 186-7.

Chapel.

Entrance doorway. Lintel with three figures of deceased and jambs with name and titles; id. ib. pl. lxxvii, figs. 178–9. Thicknesses with deceased standing; id. ib. figs. 180–1.

West wall. South false-door of deceased, with family on jambs, and three offering-tables and one libation-basin of deceased in front of it; id. ib. pls. lxxviii, lxxix [2–4], fig. 182, pp. 106, 110–11; text of false-door, SETHE, *Urk.* i (1933), 234 [9 (149)].

North false-door of mother, dedicated by deceased. HASSAN, *Giza*, i, pl. lxxix [1], fig. 184; text, SETHE, *Urk.* i (1933), 229 [5 (145), 1].

North wall. On wall of upper serdab, offering-list and sons as funerary priests before deceased at table; HASSAN, *Giza*, i, fig. 185; offering-list, vi [2], pls. xxv–xxxii [34], p. 122. Above opening of lower serdab, offering-text; id. ib. i, fig. 183.

Statues and statuettes**Lower serdab.**

Triple-stature of deceased (two seated and one standing), in Cairo Mus. Ent. 66618. Id. ib. pl. lxx, pp. 114–15; BOREUX in *Mélanges Maspero*, i [2], pl. iii [5], p. 811 note 5; LEBOVITCH, *Anc. Eg.* pl. ix [48], p. 75; KOEFOED-PETERSEN, *Et ægyptisk Billedværk fra Pyramidetiden in Fra Nationalmuseets Arbejdsmark* (1941), fig. 4, p. 64; SHOUKRY, *Privatgrabstatue*, Abb. 34, p. 154; HORNEMANN, *Types*, v, pl. 1366.

Female brewer, in Cairo Mus. Ent. 66624. HASSAN, *Giza*, i, pl. lxxi, p. 115; *Encycl. phot. Caire*, pl. 38; RIESTERER, *Kunstschätze . . . Kairo*, pl. 11 (called Şaqqāra); HORNEMANN, *Types*, iv, pl. 983; LANGE and HIRMER, *Ägypten. Architektur* (1967), pl. vii (called Şaqqāra); WENIG, *Die Frau*, pl. 15 [lower]; *Great Museums*, pl. 22.

Upper serdab. View, HASSAN, *Giza*, i, pl. lxxvii [top].

Double-stature of deceased standing, in Cairo Mus. Ent. 66620. Id. ib. pl. lxxii, p. 115; BOREUX, *op. cit.* pl. iii [1], pp. 812–13; SCHARFF in *J.E.A.* 26 (1940), pl. x [3], p. 48; HORNEMANN, *Types*, iv, pl. 1097.

Double-stature of man and woman standing, in Cairo Mus. Ent. 66619. HASSAN, *Giza*, i, pl. lxxiii, pp. 115–16; HORNEMANN, *Types*, v, pl. 1146.

Triple-stature of deceased and two daughters standing, in Cairo Mus. Ent. 66617. HASSAN, *Giza*, i, pl. lxxiv, p. 116; HORNEMANN, *Types*, v, pl. 1385.

Shaft 145.

Statue of man standing, in Cairo Mus. Ent. 66621. HASSAN, *Giza*, i, pl. lxxvi, pp. 114, 116–17.

Shaft 151 of neighbouring mastaba.

Fragments of double-stature of deceased and Ḥathorwēr  (woman) standing. Id. ib. pl. lxxv, p. 117.

MERUKA  Steward of the *sem*-priest and of the Director of the kilt (Raṯwēr?), etc. Middle Dyn. V or later.

Stone-built mastaba.

Position, on plan XXIII, B/C–9

HASSAN, *Giza*, i, pp. 62–3; plan, fig. 114, on frontispiece; plan and section of shaft, fig. 114A.

Fragments of false-doors of deceased, found in shaft. Id. ib. pl. xlii [2–4], p. 63 (texts).

Tomb of shaft 35. Dyn. V-VI.

Stone-built mastaba.

Position, on plan XXIII, C-9

HASSAN, *Giza*, i, pp. 71-2; plans and section, figs. 128-9, on frontispiece.

Statuette of baker, fragments, from shaft 36. Id. ib. pl. xlvi [1], p. 72.

KAKHERNESUT , Manicurist, *ka*-servant of the endowment of Sole companion Ra'wēr, etc. Dyn. V.

Stone-built mastaba.

Position, on plan XXIII, C-9

HASSAN, *Giza*, ii, pp. 65-71; plans and sections, figs. 62, 66-75.

Chapel.

Entrance doorway. Lintel with offering-text of deceased, in fragments; id. ib. pl. xxi [1], fig. 63.

South false-door of Khuenptah , with children on jambs, in north half of west wall. Id. ib. figs. 64-5.

Serdab.

Statuette of Khuenptah, Supervisor of *ka*-servants, seated. Id. ib. pl. xxi [2, 3], pp. 68-9.

DAG , King's *wab*-priest, Overseer of *ka*-servants, Prophet of Khnem-khufu, etc. Dyn. VI.



Wife, Theteti , King's sole adorer, etc.

Stone-built mastaba.

Position, on plan XXIII, C-9

HASSAN, *Giza*, ii, pp. 46-64; *Chron. d'Ég.* vii (1932), p. 72 [3]; plans and sections, HASSAN, op. cit. figs. 42 (with elevation), 43, 53-61.

Pillared hall.

Four false-doors, from north, (a) Isitankh , Inspector of *ka*-servants, etc., (b) uninscribed, (c) Zefakhnum , Overseer of *ka*-servants, etc., (d) wife. Id. ib. pls. xv [1], xvi, figs. 44-50.

South offering-room.

Lintel above false-doors, with offering-text of deceased. Id. ib. figs. 51-2.



Offering-table of Niḥap  (woman), found in débris. Id. ib. pl. xvii, pp. 58-9.

Statues. Dyn. VI. Found east of tomb

Double-stature of man and wife standing, in Cairo Mus. Temp. No. 8.5.43.1. Id. ib. pl. xviii [1], p. 59 [1]; *I.L.N.* June 20, 1931, fig. on p. 1061 [bottom right].

Two, woman standing, and man seated, latter in Cairo Mus. Temp. No. 8.5.43.3. HASSAN, op. cit. pls. xviii [2, 3], xix, pp. 59-60 [II, III].

Perneb , Elder of the house, standing, in Cairo Mus. Temp. No. 8.5.43.2. Id. ib. pl. xx, pp. 60-1 [IV].

SEKHEM^cANKHPTAḥ  called SEKHEMPTAḥ, Director of the dining hall, Inspector of *ka*-servants, Prophet of Menkaurē^c, etc., and NISU-USERT , Director of the dining hall, etc. Dyn. VI.

Wife of Sekhem^cankhptah, Khenut , Royal acquaintance. Wife of Nisu-usert, Meresihi , same title.

Stone-built mastaba.

Position, on plan XXIII, C-9

HASSAN, *Giza*, ii, pp. 32-45; plans and sections, figs. 31, 40-1.

Chapel.



Entrance doorway. Fragment of lintel with offering-text, drum with name and titles of Sekhemptah, thicknesses, right, Sekhemptah and wife, left, Nisu-usert and wife. Id. ib. pl. ix, figs. 32-4.



South wall. Offering-list, and butchers and offering-bringers below. Id. ib. pl. xiii, fig. 39; offering-list, vi [2], pls. xlix-lvii [56], p. 128.

West wall. Architrave with five remaining figures of relatives, and below, three false-doors, from north, (a) Sekhem^cankhptah, (b) Nisu-usert and wife, with offering-bringers on jambs, (c) Ni^cankhrē^c , Overseer of the gangs, etc., and wife. Id. ib. ii, pls. x-xii, figs. 35-8, pp. 37-43 (translations).

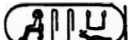
Finds

Statue of Nisu-usert seated. Id. ib. pl. xiv, p. 45; *I.L.N.* June 20, 1931, fig. on p. 1061 [middle].

SHEPSES^cKAF^cANKH  , Overlord of Nekheb, Prophet of Khephren, Magician of Selkis of the Great House, etc. End of Dyn. V to middle Dyn. VI.

Parents, Wa^czedef , Scribe of the granary, etc., and Neferhetpes , Royal acquaintance. Wife, S^cankhet , same title.

Stone-built mastaba.

Position, on plan XXIII, C-9. Plan XXXIV

HASSAN, *Giza*, ii, pp. 15-31; plans and sections, figs. 15 (with elevation), 16, 28-30.

Chapel. Re-used later.

- (1) Entrance doorway. (a)-(b) Lintel with offering-text, incomplete; id. ib. fig. 17.
- (2) Offering-list (much damaged), deceased at two tables with offerings, with son wiping out footprints, and below, offering-bringers and butchers. Id. ib. fig. 27, on pl. viii.
- (3) Four registers of children of deceased. Id. ib. fig. 26.
- (4) False-door of deceased. Id. ib. fig. 25, cf. pl. viii, fig. 24.
- (5) Deceased and wife with children. Id. ib. pls. v-vii, fig. 23.
- (6) False-door of deceased. Id. ib. fig. 22, cf. 21.
- (7) Parents of deceased with children, and register of girls below. Id. ib. fig. 20.
- (8) and (9) False-door of Shepseskaf^cankh called Seska , and man and son standing. Id. ib. fig. 19, cf. 18.

WETETH-ḤOTP , Royal acquaintance (man). Late Dyn. IV or Dyn. V.
Stone-built mastaba. Entrance doorway blocked by protective wall built round Great Sphinx.

Position, on plan XXIII, B/C-9/10

HASSAN, *Giza*, ii, pp. 1-4; *Chron. d'Ég.* vii (1932), p. 72 [2]; plans and sections, HASSAN, op. cit. figs. 1-4; name on drum of doorway, p. 1.

Male seated statues. From serdab. In Cairo Mus.

Temp. No. 19.6.46.11. Id. ib. pl. i, p. 4 [1]; *I.L.N.* June 20, 1931, fig. on p. 1061 [top left].

Ent. 87809. HASSAN, op. cit. pl. ii [3, 4], p. 4 [3].

Ent. 87810. Id. ib. pl. ii [1, 2], p. 4 [2]; GHALIOUNGUI in *B.I.F.A.O.* lxii (1964), pl. viii [B, right], p. 65.

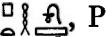
WASHPTAḤ , Prophet of Ptah, SOKAḤI, and Khufu, Overseer of craftsmen of the *wabḥt*, etc. End of Dyn. IV or early Dyn. V.

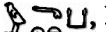
Wife, Wemetka , Prophetess of Ḥathor, etc.

Rock-cut tomb.

Position, on plan XXIII, C-9. Plan XXXIII

HASSAN, *Giza*, ii, pp. 5-14; plans and section, figs. 6, 14; view of façade, fig. 5.

Chapel.

(1) Doorway. (a)-(b) Lintel, name and titles of Kha^cmerernebti [II] (tomb, see below) and offering-text of deceased, drum with name and titles; (a) (much destroyed) name and titles, and remains of deceased; (b) name and titles, and deceased with small son; (c) deceased with wife and children, and [men bringing oryxes] below; (d) deceased seated with two sons, and two registers of men bringing bulls below.

(a)-(b) Id. ib. pl. iv, figs. 7-10, 13. (c) Id. ib. fig. 12. (d) Id. ib. fig. 11.

KHA^cMERERNEBTI [II] , King's eldest daughter of his body, King's wife, Seer of Horus and Sēth, etc. Middle to end of Dyn. IV.

Parents, Khephren and Kha^cmerernebti [I]. Husband, Menkaurē.

Rock-cut tomb. Excavated by Galarza in 1907. 'Galarza Tomb'.

Position, on plan XXIII, C-9/10

DARESSY in *Ann. Serv.* x (1910), pp. 41-9; cf. *Chron. d'Ég.* vii (1932), p. 73 [5]; EDEL in *Mitt. Orientforschung*, ii (1954), pp. 183-7. Plan, DARESSY, op. cit. p. 42; REISNER, *Giza Necropolis*, i, fig. 142, pp. 152 [4], 236 [bottom], 237.

Pillared Outer Hall. South part. B of Daressy.

Niche, with rock-cut statue of deceased standing, in face of pillar. See DARESSY, op. cit. p. 43 [top].

Doorway to Inner Hall. G of Daressy.

Exterior. Lintel with names and titles of Kha^cmerernebti [I], King's mother, and of deceased, her eldest daughter, in Cairo Mus., and right jamb with remains of conventional biographical text and mention of rewarding craftsmen. Texts, id. ib. p. 46; KAMAL in

Ann. Serv. x (1910), p. 119 [middle upper]; SETHE, *Urk.* i (1933), 155-6 [5 (96), A, B]. Reconstruction of text on jamb, EDEL in *Mitt. Orientforschung*, i (1953), pp. 333-6.

Interior. Left jamb, remains of name and titles. Text, DARESSY, op. cit. p. 46; KAMAL, op. cit. p. 119 [middle lower].

Statues

From north part of Pillared Outer Hall. C of Daressy.

Deceased seated, twice life-size, from north-east corner, in Cairo Mus. Ent. 48856. Texts, DARESSY, op. cit. p. 44; KAMAL, op. cit. p. 118; see SMITH, *Hist. Eg. Sculp.* pp. 41-2.

Sekhemrê(??) , King's eldest son of his body, Hereditary prince, seated, from niche in north-west corner. DARESSY, op. cit. pl. ii, p. 44 (text); text, KAMAL, op. cit. pp. 118-19.

From serdab (?), south of Pillared Outer Hall.



Woman seated (uninscribed), and double-statue of [Khu]enrê (tomb, MQ 1, see p. 293) and Kha^{mer}ernebti (probably deceased) seated. See DARESSY, p. 43 (with text).

Woman in cloak (headless), in Cairo Mus. Ent. 48828. Id. ib. pl. i, p. 43; HEUZEY in *Gazette des Beaux-Arts*, 6 Pér. xvi (1936), fig. 2, p. 23; DITTMANN in *Mitt. Kairo*, 8 (1939), pls. 24, 25 [a], pp. 165-70; HORNEMANN, *Types*, i, pl. 21; WOLF, *Kunst*, Abb. 108; see MASPERO, *Guide*, p. 80 [200]; SMITH, *Hist. Eg. Sculp.* p. 41.

Woman seated (no texts). See DARESSY, op. cit. p. 43.

From sloping passage. J of Daressy.

Statue of man kneading dough (headless). See id. ib. p. 48; BREASTED (Jr.), *Eg. Servant Statues*, p. 26 [1].

KAUNESUT  , Director of the Palace, Keeper of the diadem, Director of hairdressers, Prophet of Nekhbet and Buto, etc. Late Dyn. IV or Dyn. V.



Wife, Wertka  , Prophetess of Hathor, etc.

Rock-cut tomb with stone casing.

Position, on plan XXIII, C-10

HASSAN, *Gîza*, ii, pp. 75-86; plans and section, figs. 82, 91; remains of embalming-house (*warbt*) in front of tomb, see iv, p. 85.



East façade. View, id. ib. ii, pl. xxiii; elevation, fig. 81.

North niche. Right thickness, with deceased, wife, and son standing, and false-door, with deceased with wife on panel, and with small son Shepseskaf^{ankh}   on jamb. Id. ib. pls. xxiv [1], xxv, figs. 84-6.

South offering-room.

Doorway. Drum with name and titles, left thickness, man before deceased facing in, and two registers of offering-bringers beyond, right thickness, deceased with small son facing in; id. ib. pls. xxiv [2], xxvi [1], figs. 87-9.

West wall. Fragment of lintel of false-door with remains of offering-text; id. ib. fig. 90.

IUNES  , King's adorer, Prophetess of Hathor. Late Old Kingdom.

Exact position unknown. West or south-west of Valley Temple of Khephren.

False-door of deceased. Upper part, found by Galarza; text, KAMAL in *Ann. Serv.* ix (1908), p. 90; see x (1910), p. 116. Lower part, found by Hassan south-east of Valley Temple of Khephren; HASSAN, *Giza*, ix, pl. xxxix, fig. 35, p. 84 [2].

NARY , Royal acquaintance. Dyn. V-VI.

Wife, Nefert , Royal acquaintance.

Stone-built mastaba.

Position, on plan XXIII, C/D-7

HASSAN, *Giza*, v, pp. 299-302; plans and section, figs. 159-60.

Statues. Found on platform in front of tomb.

Double-statue of deceased (headless) and wife seated. Id. ib. pl. lxi, p. 301, cf. pl. lx [A].

Imhôtep , Scribe of the crews, etc., seated, in Cairo Mus. Ent. 87812. Id. ib. pl. lx [B], pp. 301-2; GHALIOUNGUI in *B.I.F.A.O.* lxii (1964), pl. v [B], p. 63.

‘ANKHTEF , Inspector of *ka*-servants, Overseer of linen (*ššrw*), etc. Dyn. VI.

Wife, ‘Ankhnes . . . .

Stone-built mastaba.

Position, on plan XXIII, C-7. Plan XXXV

HASSAN, *Giza*, v, pp. 225-35; plans and sections, figs. 84, 93-8.

I. Vestibule.

(1) False-door of deceased, with family on jambs, and left of it, ‘Ankh-haf , Inspector of scribes of the crews, etc., with wife and son below.

Id. ib. pl. xxi, figs. 85-6.

II. Offering-room.

(2) Doorway. (a)-(b) Lintel with remains of names and titles.

Id. ib. pl. xxii [A], fig. 87.

(3) Niche with false-door. (a)-(b) Lintel with remains of offering-text, jambs, deceased and wife, with offerings at (a) and butchers at (b) below; (c) offering-list; (d) offering-bringers; (e) false-door of deceased.

Id. ib. pl. xxii [B], figs. 88-92.

Statues

From serdab behind uninscribed false-door

View of false-doors used as roofing, and statues *in situ*, id. ib. pl. xxiii, p. 232.

Deceased seated, in Cairo Mus. Ent. 87808. Id. ib. pl. xxiv, pp. 232-3; GHALIOUNGUI in *B.I.F.A.O.* lxii (1964), pl. viii [B, left], p. 65.

Woman grinding corn, in Cairo Mus. Ent. 87818. HASSAN, *op. cit.* pl. xxv, p. 233; LANGE and HIRMER, *Aegypten. Architektur* (1955 and 1957), pl. 57; (1967), pl. 63; MONTET, *Lives of the Pharaohs*, fig. on p. 41.

Various

Relief-fragment, head of man with *sekhem*-sceptre, Dyn. V-VI, found nearby. HASSAN, *op. cit.* pl. lxxvi [B], p. 318 [41].

NEFERNEMTUT , Royal acquaintance (woman). Probably Dyn. V.

Rock-cut tomb.

Position, on plan XXIII, D-7

HASSAN, *Giza*, v, pp. 195-201 (with texts); plans and sections, figs. 36, 38-40.

Entrance doorway. Drum with name and titles; id. ib. fig. 37.

Standing female statuette, and damaged statuette of naked woman, both from shaft 1003, in Cairo Mus. Ent. 72219 bis and 72219. Id. ib. pl. xii [B, C], pp. 199-200; see VANDIER, *Manuel*, iii, p. 565.

LG 98. Old Kingdom.

Rock-cut tomb.

Exact position unknown, approximately plan XXIII, D/E-8

Sarcophagus (uninscribed) with palace-façade decoration, red granite, from north shaft, with Masarra (dealer) in time of Lepsius. L. D. i. 30, *Text*, i, p. 121; WILD MSS. iii. 38-9; see DONADONI ROVERI, *Sarcofagi egizi*, p. 125 [B 39].

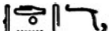
KEDNAS , Overseer of cattle-stalls, etc. Dyn. V-VI.

Wife, Henutes .

Partly rock-cut and partly stone-built tomb.

Position, on plan XXIII, C/D-7

HASSAN, *Giza*, v, pp. 203-11; plans and sections, figs. 41, 44-65.

Lintel of entrance doorway with offering-text, and drum with name and title. Id. ib. pl. xiii, fig. 42.

Finds

False-door of Raçhotp , Prophet, etc., Dyn. V-VI, found re-used with later burial. Id. ib. pl. xv [B], fig. 43.

Seated male statuette, quartzite. Id. ib. pls. xiv, xv [A], p. 205.

Base and feet of statuette (text illegible), found nearby. Id. ib. pl. lxxii [A], p. 317 [31].

KADEBHEN , Sealer of the best provisions of the King of Lower Egypt, Overseer of the treasury of the two boat-crews, Inspector of scribes of the Treasury, etc. Dyn. VI.

Stone-built mastaba.

Position, on plan XXIII, C-7. Plan XXXV

HASSAN, *Giza*, v, pp. 213-23; plans and sections, figs. 66, 73-83.

East façade.

(1) False-door of deceased.

Id. ib. pls. xvi, xvii, figs. 67-8.

Offering-room.

(2) (lower part only) Two registers of baking bread and brewing, including grinding corn in mortar, shaping loaves, straining beer, filling beer-jars, kneading dough, and heating pots.

Id. ib. pl. xx, fig. 72.

(3) Remains of four registers of men bringing cattle.

Id. ib. pl. xviii [A], fig. 69.

(4) False-door of deceased, with man and wife on right (upper part lost), and funerary priests before man at table on left (much destroyed).

Id. ib. pls. xviii [B], xix, figs. 70-1.

Various

Lintel with titles and name of deceased, from débris outside tomb. Text, id. ib. p. 223.

RA KHA ʿEF ʿANKH , Keeper of the diadem, Director of King's hair-dressers, etc. Dyn. V-VI.

Rock-cut tomb. Excavated by Mariette (1860) and Service des Antiquités (probably 1923-4).

Position, on plan XXIII, C/D-8. Plan XXXIV

Plan, HASSAN, *Giza*, ii, iv, v, on plans at beginning; ix, on general plan; VASSALLI MSS. 4. Synopsis of scenes, JUNKER, *Giza*, iii, p. 52 [50a].



I. Pillared Hall.

East, south, and west walls. Rock-cut statues.

II. Offering-room.

(1) Doorway. (a)-(b) Lintel with offering-text, drum with name and titles, jambs with deceased; (c) and (d) deceased and remains of five registers, offering-bringers and men bringing animals.

VASSALLI MSS. 5, 6. Texts with name and titles, DE ROUGÉ, *Inscr. hiéro.* pl. lx [upper].

KAI  , King's son of his body, Treasurer of the God in the boat, Overseer of the Residence (*hnw*). Early or middle Dyn. V.

Mother, Khen. . . , King's daughter.

Rock-cut tomb with additions of masonry and mud-brick.

Position, on plan XXIII, D/E-7/8

HASSAN, *Giza*, iii, pp. 29-40 (with texts); plans and sections, figs. 29, 36-7; views, pls. xii, xiii, xv.

Exterior building. Embalming-house (*wabt*) according to Hassan. Brick-built.

Plan, id. ib. iv, fig. 42, pp. 85-6.

Doorway. Fragment of right jamb with upper part of deceased, and remains of right thickness, deceased, and name of mother. Id. ib. iii, pls. xiv [1, 2], xvi [2], figs. 31-3.

Inner offering-room.

Doorway. Drum with name and title, fragments of jambs with offering-text, and right thickness with remains of three registers of offering-bringers; id. ib. pls. xvi [1], xvii, figs. 34-5.

Finds

Three model cups with name of deceased, alabaster. Id. ib. pl. xiv [3], fig. 30.

Back of head of male statue, sandstone, found in uninscribed tomb, probably from here. See id. ib. p. 49 [1].

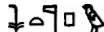
NESUTPUNŪTER . Temp. Raʿzedef to Saḥurēꜥ.

Excavated by Service des Antiquités (1923-4).

Position, on plan XXIII, D-8

Plan, JACQUET-GORDON, *Domaines*, fig. 52; HASSAN, *Gīza*, ii, iv, v, on plans at beginning; ix, on general plan. Synopsis of scenes, JUNKER, *Gīza*, iii, p. 51 [50]. See REISNER, *Gīza Necropolis*, i, p. 314 [lower, a]; JUNKER, *Gīza*, xii, p. 2.

Outer Room.

Doorway. Lintel with titles of deceased connected with Raʿzedef, Khephren, Menkaurēꜥ, Shepseskaf, Userkaf, and Saḥurēꜥ; text, GAUTHIER in *Ann. Serv.* xxv (1925), p. 180; SETHE, *Urk.* i (1933), 166 [16 (107)].

Pillared Hall.

East wall. South part, bringing cattle and wild animals, and estates; remaining names of estates, JACQUET-GORDON, *op. cit.* pp. 245-6 [2165], Nos. 6-17, cf. figs. 52, 54. North part, deceased with son watching ploughing and rams treading grain.

South wall. Musicians, singers, and dancers, and below, offering-bringers, with openings of serdab.

West wall. Left of doorway, deceased with wife and son, and estates; names of estates, JACQUET-GORDON, *op. cit.* Nos. 1-5, cf. figs. 52-3. Right of doorway, butchers.

North wall. Tending cattle, and below, deceased fowling from canoe and herdsmen with cattle crossing water, with openings of serdab.

Offering-room.

Doorway. Large figures of Anubis-jackals with offering-text on thicknesses.

Finds

Fragment of lintel with offering-text, Dyn. V-VI, found nearby. HASSAN, *Gīza*, v, pl. lxx [D], p. 316 [25].

THERERU , Inspector of *ka*-servants, Overseer of linen (*ššrw*). Dyn. VI.

Stone-built mastaba.

Position, on plan XXIII, D-8

HASSAN, *Gīza*, iii, pp. 23-5 (with text); plans and sections, figs. 23-5.

False-door of deceased in east façade, with man censuring before [deceased and wife] on panel. *Id. ib.* pl. x, fig. 22.

Tomb C. Dyn. V-VI.

Brick-built mastaba.

Position, on plan XXIII, D-8

HASSAN, *Gīza*, iii, pp. 26-8; plans and sections, figs. 26-8.

Two unfinished standing male statuettes, from débris. *Id. ib.* pl. xi [1], p. 26.

MERʿANKHEF , King's *warb*-priest, Prophet of Khufu, Steward, etc. Dyn. VI.

Wife, Neferhetpes , *ka*-servant, etc.

Rock-cut tomb.

Position, on plan XXIII, D-8

HASSAN, *Giza*, iii, pp. 14-22 (with texts); plans and sections, figs. 14 (with elevation of façade), 18-21.

East façade.

Two false-doors of deceased and wife, with remains probably of address to visitors and text of rewarding craftsmen on jambs of one of them, and between them, doorway to chapel, with lintel with remains of offering-text, drum and jambs with names and titles, and son before deceased and wife on thicknesses, and above doorway, niche with rock-cut standing male statue. Id. ib. pls. vi, vii, ix, figs. 15-17.

Offering-room.

West wall. Right of doorway, rock-cut standing male statue (unfinished). See id. ib. p. 20 [bottom].

Finds

Seated statuette of man, in two pieces. Id. ib. pl. viii, p. 21.

KHUTA , Prophet of Menkaurê, Inspector of young men of the Great Estate, Master of wood, etc. Middle Dyn. V or later.

Wife, Neferhanesut .



Rock-cut tomb with small additions of masonry.

Position, on plan XXIII, E-8

HASSAN, *Giza*, iii, pp. 41-6 (with texts); plans and sections, figs. 38 (with elevation of west wall of offering-room), 40-1.

Entrance doorway. Drum with name and titles, two lintels with offering-text, and panel with daughter and offering-bringers before deceased and wife at table. Id. ib. pls. xviii, xix [1], fig. 39.

Upper part of male statuette, from débris. Id. ib. pl. xix [2], p. 45 [1].



SEHEMNÛFER  , Royal acquaintance (woman). Dyn. V-VI.

Stone-built mastaba.

Position, on plan XXIII, E-7

HASSAN, *Giza*, iii, pp. 236-9 (with text); plans and section, figs. 211, 213.



False-door, with Neterwêr , ka-servant, before deceased seated, on panel. Id. ib. fig. 212.

KHENT  , Director of the dining hall, etc. End of Dyn. V or later.

Stone-built mastaba.

Position, on plan XXIII, E-7

HASSAN, *Giza*, vi [3], pp. 197-200 (with texts); plans and sections, figs. 194, 196-8.

North false-door of deceased, with relatives (including son Kakai'ankh  ) on jambs. Id. ib. pl. lxxxvi [A], fig. 195.

KHENU  . Dyn. V-VI.

Stone-built mastaba.

Position, on plan XXIII, E-8

HASSAN, *Giza*, iii, pp. 53-6 (with texts); plans and sections, figs. 47, 49, 50.

East façade. South false-door of deceased, with remains of texts, and north false-door (uninscribed), with remains of man before deceased(?) on panel; id. ib. figs. 46, 48.

IRERU , Overseer of the store-room of the King's repast, King's *warb*-priest, etc. End of Dyn. V or Dyn. VI.

Wife, Kaemhemt .

Stone-built mastaba.

Position, on plan XXIII, E-8

HASSAN, *Giza*, iii, pp. 57-71 (with texts); plans and sections, figs. 51, 59-64.

West Chapel.

Entrance doorway. Drum with name and title of deceased, jambs with remains of name and titles of son Wetka , thicknesses with [deceased and wife] and two registers of offering-bringers below; id. ib. pl. xxi, figs. 53-5.

Two false-doors of deceased (south one in a niche). Id. ib. pls. xxiii, xxiv, figs. 56, 58, cf. 52.

Between false-doors, offering-list, four funerary priests before deceased at table, and below, scribe, dwarf leading bull, and butchers. Id. ib. pl. xxii, fig. 57; offering-list, vi [2], pls. xxv-xxxii [36], p. 123.

Fragments of lintel of deceased, found by Reisner in Valley Temple of Menkaurē. REISNER, *Mycerinus*, pls. 64 [d, e] (caption incorrect), A [8], p. 281 [6].

DERSEMAT , Royal chamberlain. Dyn. V-VI.

Rock-cut tomb, partly cased with masonry.

Position, on plan XXIII, E-8

HASSAN, *Giza*, iii, pp. 7-13 (with texts); plan with elevation of façade, fig. 6; plan and section of a shaft, fig. 7.

Shaft 538. Plan and section, id. ib. fig. 8.

Ointment-slab, with offering-text and deceased seated, in fragments, alabaster. Id. ib. pl. iii [1], p. 10 [1].

Statuette of man seated, in Cairo Mus. Ent. 87811. Id. ib. pl. v, p. 11 [4]; GHALIOUNGUI in *B.I.F.A.O.* lxii (1964), pl. v [A], p. 63.

WASHPTAḤ , Royal chamberlain, Judge and Boundary official, Prophet of Ma'et, etc. Late Dyn. V or Dyn. VI.

Stone-built mastaba.

Position, on plan XXIII, E-8

HASSAN, *Giza*, iii, pp. 1-6 (with texts); plans and section, figs. 1, 4.

False-door of deceased, lower part, in west wall of chapel. Id. ib. pl. i, figs. 2, 3.

ZADI , Overseer of *ka*-servants. Dyn. V.

Rock-cut tomb.

Position, on plan XXIII, D-9

HASSAN, *Giza*, i, pp. 86-9; plans and sections, figs. 147, 149-51, on frontispiece; view of entrance doorway, pl. lii.

Chapel. Rock-cut statues in niches; id. ib. pls. liii, liv, p. 86.

West wall. Upper part of north false-door of deceased; id. ib. fig. 148.

NEFERTNESUT , Inspector of tenants of the Great House, etc. Dyn. V.

Wife, Nisuhenu , Royal acquaintance.

Stone-built mastaba.

Position, on plan XXIII, C/D-9/10

HASSAN, *Giza*, ii, pp. 87-95; plans and sections, figs. 92, 95-100.

North false-door from east façade, deceased with wife at table on panel, family on jambs, in Cairo Mus. Temp. No. 19.6.46.4. Id. ib. pl. xxvii, figs. 93-4.



KEDNAS , Scribe of the four divisions of craftsmen, etc. Dyn. V.

Rock-cut tomb with additions of masonry.

Position, on plan XXIII, D-10

HASSAN, *Giza*, ii, pp. 96-103; plans and sections, figs. 101, 107-11.

Chapel.



Four false-doors. Lower parts of second and fourth from north, with family on jambs; id. ib. figs. 102-3. Two panels of false-doors, man and wife (uninscribed), and Thenti , Inspector of craftsmen, etc., with wife Meres'ankh , at table, latter in Cairo Mus. Temp. No. 19.6.46.3; id. ib. pls. xxx, xxxi [1], figs. 104-5. Fragment of left end of lintel, man before a couple seated; id. ib. pl. xxxi [2], fig. 106.

Serdab.

Statue of deceased standing (headless). Id. ib. pl. xxix [3, 4], p. 99 (text).

Shaft 366 bis.

Statuette (headless) of male baker, from débris. Id. ib. pl. xxix [1, 2], p. 103.

WPEMNEFERT  called WEP , Secretary of the Toilet-house, Boundary official of Dep, Master of the largesse in the Mansion of Life, etc. Middle to late Dyn. V.

Wife, Meres'ankh , King's daughter.

Rock-cut tomb with additions of masonry.

Position, on plan XXIII, E-9. Plan XXXIV

HASSAN, *Giza*, ii, pp. 179-201; *Chron. d'Ég.* vii (1932), pp. 74-5 [III]; plans and sections, HASSAN, op. cit. figs. 211, 220-1; elevation of façade, fig. 212. Synopsis of scenes, JUNKER, *Giza*, iii, p. 53 [53].

I. Vestibule.

(1) Entrance doorway. (a)-(b) Lintel with offering-text.

HASSAN, op. cit. pl. lxiv [upper], fig. 213.

II. Serdab. Female statues, probably of Meresankh. See also p. 285.

View *in situ*, id. ib. pl. lxiv [lower]. First four, see *Descr. somm.* Nos. 6315-18.

Standing, with left foot advanced, in Cairo Mus. Ent. 72214. HASSAN, op. cit. pl. lxv, p. 182; *I.L.N.* June 20, 1931, fig. on p. 1061 [bottom left]; SHOUKRY, *Privatgrabstatue*, Abb. 17, p. 73.

Standing, with left foot advanced, in Cairo Mus. Ent. 72215. HASSAN, op. cit. pl. lxvi, p. 183.

Standing, in Cairo Mus. Ent. 72216. Id. ib. pl. lxvii, pp. 183-4; *I.L.N.* June 20, 1931, fig. on p. 1061 [top right].

Standing, in Cairo Mus. Ent. 72217. HASSAN, op. cit. pl. lxviii, pp. 184-5; *I.L.N.* June 20, 1931, fig. on p. 1061 [bottom near left]; DRIOTON and SVED, *Art ég.* fig. 19.

Seated, two fragments, red granite (head from here, lower part from débris of Vestibule I). HASSAN, op. cit. pl. lxix [1, 2], pp. 181, 185.

III. Offering-room. Wepemnefert.

(2) Doorway. (a)-(b) Lintel with offering-text, drum with name and titles, and jambs, son before deceased and wife.

Id. ib. pls. lxx, lxxi [1], fig. 214.



(3) and (4) False-doors of deceased, with only lintels with offering-text preserved.

Id. ib. pl. lxxi [2, 3], figs. 215-16.

IV. Offering-room. Son Ibi , Lector-priest, Scribe of divine books, etc.

(5) Doorway. (a)-(b) Lintel with offering-text, and drum with name and titles.

Id. ib. pls. lxxii, lxxiii, figs. 217-18.



(6) Wepemnefert and son Ibi, text of will in favour of Ibi, concerning north shaft (374 of Hassan) and offering-room, dated 'Year of Union of the Two Lands', with witnesses including a Physician, Eye physician, Tomb-maker, Raḥay , Painter, Khenu , Sculptor, and four registers of crafts, I, metal-workers, including beating metal, pouring molten metal into mould, and men with blowpipes, and straining beer, II, two men polishing sarcophagus, sculptor making a standing and a seated statue, and brewing, including man cleaning jar and another filling beer-jars, III, carpenter making oar, men polishing door, and baking, IV, two pairs of dwarfs making jewelry, and baking-scenes, including women grinding corn, kneading dough, and heating pots.

Id. ib. pls. lxxiv-lxxvi, fig. 219; omitting registers, GOEDICKE, *Die privaten Rechtsinschriften aus dem Alten Reich*, Taf. iv, pp. 31-43. Physician and Eye physician, see GALIUNGHİ in *Egypt Trav. Mag.* No. 109 (Sept. 1963), p. 15, cf. fig. 18 (from HASSAN). Raḥay and Khenu, see SMITH, *Hist. Eg. Sculp.* pp. 351-2. Tomb-maker, see FISCHER in *Ä.Z.* 93 (1966), pp. 60-1 [2].

Shaft 374.

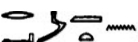
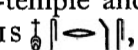
False-door with remains of texts, found in débris. HASSAN, op. cit. fig. 222.

NIMACETRĒC , Overseer of singing in the Great House, Prophet of RēC in the Sun-temple and *warb*-priest of the Pyramid of NeuserrēC, etc., and NEFERESRIS , Overseer of dancers of the King, Overseer of the ladies of the harīm of the King, King's sole adorer, etc. (woman). Late Dyn. V.

Wife of Nima'etret, Hetepheres , called Khenut , Prophetess of Ḥathor and Neith, etc.

Partly rock-cut and partly stone-built tomb.

Position, on plan XXIII, E-9. Plan XXXIII

HASSAN, *Giza*, ii, pp. 202–25; KAMAL in *Ann. Serv.* x (1910), pp. 119–21; plans and sections, HASSAN, op. cit. figs. 224, 249–51; elevation of façade, fig. 223.

I. Offering-room. Nima^cetrē.

(1) Doorway. (a)–(b) Lintel with offering-text, jambs with address to lector-priests and visitors, mentioning building tomb and rewarding craftsmen; (c) much destroyed, similar to (d); (d) deceased with wife and son, and below, estate, and text concerning bringing offerings from chapel of Kha^cmerernebti [II].

(a)–(b) Id. ib. pls. lxxvii [3], lxxx [2], fig. 231. Completed text on jambs, EDEL in *Mitt. Kairo*, 13 (1944), p. 77, cf. 74–8. (c) and (d) HASSAN, op. cit. pl. lxxxii [1], figs. 232–3; names of estates, JACQUET-GORDON, *Domaines*, pp. 279–80 [33G5], Nos. 1, 2, cf. figs. 73, 75 (from HASSAN). (d) Estate and reconstruction of text, GRDSELOFF in *Ann. Serv.* xlii (1943), fig. 5, p. 52.

(2) Left part, I, netting fowl, II (destroyed), netting fish, lower registers destroyed. Central part, text concerning building tomb and rewarding craftsmen (much destroyed), and deceased carried in palanquin. Right part, four registers before deceased under sunshade, I, boatmen jousting, II (much destroyed), bringing cattle, and offering-bringers, III, reaping corn, IV, estates.

HASSAN, op. cit. fig. 240; titles of deceased under sunshade, PETRIE in SAYCE MSS. 23 [bottom right]; text of building tomb, 15 [bottom], 23 [bottom left]; names of estates, JACQUET-GORDON, op. cit. pp. 279–80 [33G5], Nos. 3–11, cf. figs. 73–4 (from HASSAN); deceased greeted by servant, with reconstruction of text, GRDSELOFF, op. cit. fig. 6, pp. 56–7 [3].

(3) Deceased at table, with offering-list before him.

HASSAN, op. cit. fig. 239; offering-list, vi [2], pls. lvii–lxiv [70], p. 133.

(4) (destroyed) Deceased at table. (5) Composite false-door of deceased (cornice and lintel with offering-text above palace-façade flanked by two small false-doors), with offerings above. (6) Remains of four registers of offering-bringers.

Id. ib. ii, pl. lxxxiii, figs. 237–8; some texts, KAMAL, op. cit. p. 121 [upper]; PETRIE in SAYCE MSS. 15 [upper middle left], 23 [top].

(7) (much destroyed) [Deceased and wife], and marsh-scene, with birds hovering, papyrus-canoes, and cattle about to cross water.

HASSAN, *Giza*, ii, fig. 236. Text (now destroyed), KAMAL, op. cit. p. 121 [lower].

(8) Pillar. Deceased and son with name and titles.

HASSAN, *Giza*, ii, pl. lxxxii [2], fig. 235.

(9) Pillar. Remains of titles.

PETRIE in SAYCE MSS. 15 [lower middle], 23 [upper middle].

(8)–(9) Architrave with name and titles of deceased.

HASSAN, *Giza*, ii, fig. 234.

Blocks with remains of texts and scenes. Id. ib. figs. 241–8, pp. 221–4 [1–8].

II. Serdab.

Head of male statue and feet of female statue. See KAMAL, op. cit. p. 120.

Fragment of seated man from double-statue, found nearby. HASSAN, *Giza*, ii, pl. lxxxii, pp. 217–18.

East façade.

(10) False-door of Hetepheres called Khenut.

Id. ib. pls. lxxvii [2], lxxx [1], figs. 229-30.

III. Offering-room. Neferesris.

(11) Doorway. (a)-(b) Lintel with offering-text; (c) and (d) deceased standing and text of building tomb by Nimaetret.



Id. ib. pl. lxxvii [1], lxxviii, figs. 225-6.

(12) False-door, with deceased on either side. Id. ib. pl. lxxix, figs. 227-8.

Finds

Offering-table with remains of text, alabaster; see KAMAL, *op. cit.* p. 120 (with text). Similar fragments, see HASSAN, *Giza*, ii, p. 224 [1, 2].

AKHTIḤOTP , Overseer of scribes of the Pyramid of Khufu, Inspector of scribes of the Treasury, Overseer of *ka*-servants of the King's mother, etc. Early Dyn. V to early Dyn. VI.

Parents (probably), Kanüfer , Royal acquaintance, and Peseshet , Overseer of physicians, *ka*-servant, etc. Wife, Nikauhatḥor , *ka*-servant of the King's mother.

Partly rock-cut and partly stone-built tomb.

Position, on plan XXIII, D-9

HASSAN, *Giza*, i, pp. 73-86; plans and sections, figs. 130, 141, 145-6, on frontispiece.

Façade. Elevation, id. ib. fig. 131.

False-door of wife. Id. ib. fig. 144.

Outer Room. A of Hassan.

Entrance doorway. Lintel with offering-text, drum with name and titles, and thicknesses, deceased seated with child; id. ib. pl. xlvii, figs. 132-5.

Pillar. On all faces, deceased with child, and below, offering-bringers, bringing animals, or butchers; id. ib. pls. xlvi, xlv, figs. 137-40.



Architrave with offering-text and offering-list. Id. ib. fig. 136; offering-list, vi [2], pls. ix-xvi [14], p. 117.

Inner Room. B of Hassan.

False-door of deceased. Id. ib. i, pl. 1, fig. 142.

False-door of mother. Id. ib. pl. li [1], fig. 143; see GHALIUNGUI in *Egypt Trav. Mag.* No. 108 (August 1963), p. 28, cf. fig. 9 (from HASSAN).

Palace-façade decoration, right of false-doors. HASSAN, *Giza*, i, pl. li [2].

IMBY  , Overseer of *ka*-servants of the King's mother, Overseer of the department of tenants of the Great House, etc. End of Dyn. V or later.

Wife, Nefert , Royal acquaintance.

Partly rock-cut and partly stone-built tomb.

Position, on plan XXIII, D/E-9

HASSAN, *Giza*, i, pp. 91-5; plans and sections, figs. 154, 159-60, on frontispiece.

Entrance doorway. Lintel with offering-text, and drum with name and titles; id. ib. pl. lvi [2, 1], figs. 155-6.

False-doors of deceased and of wife. Id. ib. pl. lvi [3], figs. 157-8.

Seated statue of deceased, from serdab. Id. ib. pl. lvii, pp. 93, 95 (text).

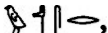
USER , Overseer of *ka*-servants, Steward, etc. Middle Dyn. V or later.

Stone-built mastaba.

Position, on plan XXIII, D/E-9

HASSAN, *Giza*, i, pp. 95-7; plans and sections, figs. 161, 164-5, on frontispiece; view, pl. lviii.

Entrance doorway. Lintel with offering-text and drum with name and titles; id. ib. figs. 162-3.

IY , Steward, etc. End of Dyn. V or later.

Wife, Heknu .



Stone-built mastaba.

Position, on plan XXIII, E-9

HASSAN, *Giza*, i, pp. 101-4; plans and section, figs. 171, 176, on frontispiece.

Entrance doorway. Lintel with offering-text of deceased, dedicated by wife; id. ib. fig. 172, cf. pl. lxvi; part of text, SETHE, *Urk.* i (1933), 227 [5 (145), c, upper].

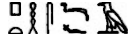
False-door of deceased, dedicated by wife. HASSAN, op. cit. figs. 173-5; dedication, SETHE, *Urk.* i (1933), 227 [5 (145), c, lower].

PTAḤSEZEFA  called FEFI , Overseer of *ka*-servants, etc. Middle Dyn. V or later.

Wife, Hetepheres , Royal acquaintance.

Partly rock-cut and partly stone-built tomb.

Position, on plan XXIII, D/E-9

HASSAN, *Giza*, i, pp. 97-101; plans, fig. 166, on frontispiece.

Chapel.



Entrance doorway. Fragments of lintel with offering-text, and drum with name and titles; id. ib. pl. lix [1], figs. 167-8.

South false-door, with deceased and wife on panel, and child on each side of panel. Id. ib. pl. lx, fig. 169.

Shaft. Plan and section, id. ib. fig. 170.

Sarcophagus of deceased, with palace-façade decoration, in Cairo Mus. Ent. 66681. Id. ib. pls. lxi-lxv, pp. 100-1; DONADONI ROVERI, *Sarcofagi egizi*, Tav. xxv, p. 128 [B 47]; part of text, SETHE, *Urk.* i (1933), 228 [5 (145), D]; HASSAN, *Giza*, v, p. 61.

Fragments of female statuette, found here, but possibly of Meres'tankh from tomb of Wepemnefert (see p. 282). Id. ib. i, pl. lix [2], pp. 100-1; ii, pl. lxix [3], p. 181.

ḤESI , Overseer of the department of tenants of the Great House, etc., and
 NI'ANKH-ḤATHOR , Royal acquaintance (possibly wife). Dyn. V.

Stone-built mastaba.

Position, on plan XXIII, E-10

HASSAN, *Giza*, iii, pp. 245-56 (with texts); plans and sections, figs. 218, 223-7.

Chapel.

Entrance doorway. Lintel with offering-text of Ḥesi, dedicated by son Duarē (tomb, probably, see p. 287), and drum with name and title of Ḥesi. Id. ib. pl. lxxviii, figs. 219-20.

South false-door of Ḥesi, with sons on jambs. Id. ib. pl. lxxix [1], fig. 221.

North false-door of Ni'ankh-Ḥathor, with daughters on jambs. Id. ib. pl. lxxix [2], fig. 222.

Finds

Head of life-size male statue, from shaft 492, in Cairo Mus. Ent. 87817. Id. ib. pl. lxx, p. 253.

Crude nude statuettes, male (with text in ink), and female (uninscribed), from débris, in Cairo Mus. Ent. 72225-6. Id. ib. pl. lxxi [2], p. 256; see VANDIER, *Manuel*, iii, p. 565.

KAUSERT , King's adorer, Prophetess of Neith. Dyn. V.

Mother, Nefernemtut (tomb, probably, see p. 276).

Partly rock-cut and partly stone-built tomb.

Position, on plan XXIII, D-10

HASSAN, *Giza*, ix, pp. 43-7 (with texts); *Chron. d'Ég.* xiv (1939), p. 80 [1]. View, HASSAN, op. cit. pl. xv [A].

Entrance doorway to courtyard. Drum of deceased and mother, from débris; id. ib. pl. xv [B], fig. 15.

South false-door of deceased, in façade. Drum with name and title, and right outer jamb with remains of deceased; id. ib. pls. xvi, xvii [C], fig. 16.

Doorway to chapel. Lintel with offering-text, and drum with name and title; id. ib. pl. xvii [A, B], fig. 17.

KAḤERSETEF , [King's] warb-priest. Dyn. V.

Brick-built mastaba.

Position, on plan XXIII, D-10

HASSAN, *Giza*, ix, pp. 71-2; view, pl. xxviii [A].

Façade. Lower part of south false-door with deceased on jambs; id. ib. pl. xxviii [B], fig. 30.

Fragment of jamb with remains of text, found north-east of tomb. Id. ib. pl. xliv [B], fig. 38, p. 88 [b].

NEFERḤŌTEP , Overseer of ka-servants, Secretary of his Lord, etc. Dyn. V.

Wife, 'Ankhkaus , Prophetess of Ḥathor and Neith, *mitrt*, etc.

Stone-built mastaba.

Position, on plan XXIII, D-10

HASSAN, *Giza*, ix, pp. 63-70 (with texts).

Chapel.

Doorway. Remains of inscribed lintel, drum of deceased mentioning funerary endowment of Kha^cmerernebti [II], and jambs and thicknesses with deceased; id. ib. pl. xxv, figs. 25-7.

Four false-doors of deceased (a-d from south). (a) and (b) See id. ib. p. 66 [1, 2]; (c) pl. xxvi [middle], figs. 28a, 28b; (d) with double-scene of wife at table on panel; pl. xxvi [right], figs. 29a, 29b.

Offering-list (upper part lost) between false-doors (b) and (c), with deceased and wife at table, and children. Id. ib. pls. xxvi [left], xxvii, pp. 69-70; vi [2], pls. xlix-lvi [64], p. 131.

Finds. Old Kingdom

Head of male statuette, damaged, found south-east of tomb. Id. ib. ix, pl. xlii [B], p. 86 [4, b].

Libation-basin (inscribed, no name), found south-west of tomb. Id. ib. pl. xlix [B], p. 91 [8] with note 1.

Lower part of false-door (inscribed, no name), unfinished, found south-east of tomb. Id. ib. pl. xlvi, fig. 41, p. 90 [i].

NEST-THEMAT , Overseer of the department of the Great House, etc. Dyn. V.

Wife, Nubka .

Partly rock-cut and partly stone-built tomb.

Position, on plan XXIII, D/E-10

HASSAN, *Giza*, ix, pp. 75-7; *Chron. d'Ég.* xiv (1939), pp. 80-1 [2].

Doorway. Lintel with offering-text and deceased and wife seated. HASSAN, op. cit. pl. xxxi [A], fig. 32.

Architrave with offering-text. Id. ib. pl. xxxi [B], fig. 33.

Niche in west wall. Statue with rock-cut body, and head and legs added; id. ib. pl. xxxi [C], pp. 76-7.

Fragment of panel of false-door, found north-east of tomb. Id. ib. pl. xlv, fig. 39, p. 89 [C].

NAME UNKNOWN, Inspector of craftsmen of the *warbt*. Dyn. V.

Stone-built mastaba.

Position, on plan XXIII, E-10

HASSAN, *Giza*, ix, pp. 73-4.

Lintel with offering-text, fragment, from débris. Id. ib. pl. xxx [C], fig. 31, p. 74 [4].

Statue-group, four men seated on bench, with remains of text. Id. ib. pl. xxix, p. 73 [1].

Statue-fragments (hands), alabaster. Id. ib. pl. xxx [A, B], p. 74 [2, 3].

DUARĒ^c , Prophet of Menkaurē^c, Lector-priest, Master of the house of tenants of the Great House, etc. Dyn. V.

Parents (probably), Hesi and Ni^cankh-ḥathor (tomb, see p. 286).

Stone-built mastaba.

Position, on plan XXIII, E-10

HASSAN, *Giza*, ix, pp. 59-62 (with texts).

Entrance doorway. Thicknesses, right, two men (one of them son Irenakhti ) left, [deceased], and a man below. Id. ib. pl. xxiii, p. 60.

False-door of deceased. Id. ib. pl. xxiv, figs. 24a, 24b.

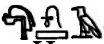
WASHDUAU , Eye physician of the Great House, Inspector of physicians of the Great House, Prophet of Duau, etc. Dyn. V.

Stone-built mastaba.

Position, on plan XXIII, E-10

HASSAN, *Giza*, ix, pp. 49-55 (with texts); *Chron. d'Ég.* xiv (1939), p. 81 [6].

Chapel.



Entrance doorway. Lintel with offering-text; HASSAN, op. cit. pl. xviii, fig. 18. Left jamb with remains of name and titles, and left thickness, deceased with [daughter], [man] bringing bull below; id. ib. pl. xix, figs. 19, 20.

North false-door, with deceased at table on panel. Id. ib. pl. xx [A], figs. 21a, 21b.

South false-door of deceased with remains of texts. Id. ib. pl. xx [B], fig. 22.

Offering-list at top of west wall, with deceased at table and funerary priests before him (including wiping out footprints). Id. ib. pl. xxi, fig. 23; offering-list, vi [2], pls. xlix-lvi [63], p. 130.

Finds

Double-statue, Duaukhuf , Inspector of physicians, etc., and woman Khetrē , standing, lower part, Dyn. V, found nearby. Id. ib. ix, pl. xxii [A], pp. 54-5.

LG 100. SARCOPHAGUS-SHAPED TOMB OF

KHENTKAUS [I]¹ 

End of Dyn. IV or early Dyn. V

Position, on plan XX

HASSAN, *Giza*, iv, pp. 1-3, 13-26, 32-4; L. D. Text, i, pp. 121-2 (with sketch-plan); JUNKER in *Mitt. Kairo*, iii (1932), pp. 123-49, with view, Abb. 1 (from LEPSIUS); *Chron. d'Ég.* viii (1933), pp. 86-92. Plan, HASSAN, op. cit. on fig. 1, cf. 32; L. D. i. 31 (with view); plans and sections, MARAGIOGLIO and RINALDI, *L'Architettura*, vi, Tav. 18-21, pp. 168-95. Views, HASSAN, op. cit. pls. i-iv, xiii, xiv [A]; id. *The Great Sphinx*, fig. 1, p. 4; *I.L.N.* March 5, 1932, figs. on pp. 334-5; ZIPPERT in *Archiv für Orientforschung*, viii (1932-3), Abb. 5 (from *I.L.N.*), pp. 154-5.

Valley Temple (according to Hassan), see Ante-temple of Valley Temple of Menkaurē, supra, p. 27.

CHAPEL.



Entrance doorway. Jambs with name and titles of deceased, red granite; HASSAN, *Giza*, iv, pls. v, vi, fig. 2, pp. 16-17; *I.L.N.* March 12, 1932, figs. on p. 393.

Remains of north false-door of deceased, red granite, in inner room. HASSAN, op. cit. pl. viii, p. 24.

¹ Mother of the two Kings of Upper and Lower Egypt, Daughter of the God, etc.

Relief-fragments, including scribes, offering-bringers, flutist, and texts. Id. ib. figs. 3-30, pp. 18-23 [1-32].

Finds.

Vase-lid of Zaa   , fragment, alabaster. Id. ib. pl. vii [F], p. 17 [7].

BOAT-PIT.

Plan and sections, id. ib. fig. 31, p. 33; see vi [I], pp. 68-9.

'PYRAMID-TOWN'.

Id. ib. iv, pp. 35-50; *Chron. d'Ég.* ix (1934), pp. 70-1 [I]; views, HASSAN, *Giza*, iv, pls. xvi [H], xix [E].

Finds.

Female bust (headless), granite. Id. ib. pl. ix [A], p. 37 [22].

Torso of male standing statuette. Id. ib. pl. xviii [E], p. 46 [11].

Fragments of panel and lintel of false-door. Id. ib. pl. xvii [H], p. 43 [19].

SAITE AND LATER TOMBS





Mainly near the Causeway of Khephren and Great Sphinx

LG 81. Dyn. XXVI.

Position, on plan III

L. D. *Text*, i, pp. 96-7, with plan, sections, and view, L. D. i. 27; MARIETTE, *Mastabas*, pp. 531-2 [13], with sketch of column and plan.

South, west, and north walls of main room, deceased and wife watching [netting fish], men bringing fish and fowl, [butchers], etc. L. D. iii. 278.

LG 83. 'AḤMOSI , Commander of the army, and his mother Queen NEKHTUBASTERAU    (wife of Amasis). Dyn. XXVI.



Position, on plan III

Sarcophagi.

'Aḥmosi, anthropoid, black granite, formerly in Leuchtenberg Colln., now in Leningrad, State Hermitage Mus. 766. MARIETTE, *Mastabas*, pp. 554-61 (sketches and text); LECLANT in *Festschrift Struve (Drevnii mir. Sbornik statei.)*, figs. 17 (from LEPSIUS), 18 (left side), p. 108 [e]; *Putevoditel' po zalam Otdela Vostoka* (1939), fig. facing p. 25, cf. p. 29 [74]; WILKINSON, MSS. iii. 17 verso, E [lower]; xvii. F.d. 20, a, b; id. squeezes, Box 28. 47-72. Foot, head, right and left sides, L. D. iii. 276 [f, g, h], *Text*, i, p. 100. Right side, LANZONE, *Diz.* Tav. clxxxvii. Text on lid, L. D. *Text*, i, p. 99 [upper]; beginning, LIEBLEIN, *Die aegyptischen Denkmäler* [etc.] (1873), Taf. ii [10], p. 12; names, id. *Dict.* No. 2552. See GOLÉNISCHEFF, *Inventaire de la collection égyptienne* (1891), pp. 94-6; GUBCHEVSKY, *The Hermitage Museum. A Short Guide* (1955), p. 50.

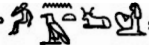
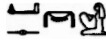
Nekhtubasterau, anthropoid, black granite, formerly in Leuchtenberg Colln., now in Leningrad, State Hermitage Mus. 767. Text on lid, and line of text below edge, L. D. *Text*, i, p. 98; WILKINSON MSS. xvii. C 2, d, e verso; text on lid, MARIETTE, *Mastabas*, p. 553 [2]; LIEBLEIN, *Die aegyptischen Denkmäler* [etc.] (1873), Taf. ii [11], pp. 12-13. See GOLÉNISCHEFF, op. cit. pp. 96-7; *Putevoditel' po zalam Otdela Vostoka* (1939), p. 29 [73].

Tashentihet , daughter of Desnub . Text on lid, *L. D. Text*, i, p. 99 [bottom]; MARIETTE, *Mastabas*, p. 553 [1]; DARESSY in *Ann. Serv.* iv (1903), p. 109 [8] (lid in court of Cairo School of Medicine at that time); parts, LIEDER squeezes, 9. 1-3; name, WILKINSON MSS. xl. 115 [left].

LG 84. PAKAP  good name WEHEBRĒ-EMAKHET , Overseer of scribes of the King's repast, etc. Dyn. XXVI.

Entirely destroyed. 'Campbell's Tomb'.

Position, on plan III

VYSE, *Operations*, i, pp. 216-18, 232-3; ii, pp. 131-44; *L. D. Text*, i, pp. 100-1.

Plan and sections, PERRING, *Pyramids*, iii, pl. xix [1-5]; VYSE, op. cit. ii, pls. facing pp. 131, 132; plan, WILKINSON MSS. xxi. A. 8; views of exterior and interior, PERRING, op. cit. iii, pl. xx; VYSE, op. cit. i, pls. facing pp. 175, 216.

Substructure.

Line of text round walls, PERRING, op. cit. iii, pl. xix [9-12]; VYSE, op. cit. ii, pl. facing p. 134 (position varies in different copies); *L. D.* iii. 277 [f].



Vaulted tomb.



North and south exterior walls, horizontal line of text. *L. D.* iii. 277 [d, e].



Outer sarcophagus. Line of text at foot end, PERRING, op. cit. iii, pl. xix [8]; VYSE, op. cit. ii, 2nd pl. after p. 132 [8]; i, p. 217. Line of text on lower surface of lid, PERRING, op. cit. iii, pl. xix [6]; VYSE, op. cit. ii, 2nd pl. after p. 132 [6].

Inner sarcophagus of deceased, anthropoid, basalt, in Brit. Mus. 1384. *Guide (Sculpture)*, pl. xxxi, p. 230 [827]; *A Handbook to the Egyptian Mummies* (1938), pl. xxix, p. 67; detail, *Egyptian Mythology*, fig. on p. 105. Lid, PERRING, op. cit. iii, pl. xix [7]; VYSE, op. cit. ii, 2nd pl. after p. 132 [7]; text, *L. D.* iii. 277 [b]; NESTOR L'HÔTE MSS. 20396, 329. See BUHL, *Sarcophagi*, p. 25 [A, 6], with title, pl. i.



Subsidiary burial chambers. Anthropoid sarcophagi.

X (of Perring). Ptaḥhotp , Overseer of the Treasury, son of Ḥarenpates-nakht  (mother), basalt, temp. Darius I. Lid with Chapter 72 of Book of the Dead, formerly in Cook Colln., now in Oxford, Ashmolean Mus. 1947.295; *Ashmolean Museum Report* (1947), pl. i, p. 15; BUHL, op. cit. fig. 82, p. 140 [K, 1], with title, pl. ix; text, *L. D.* iii. 277 [c], *Text*, i, p. 101 (names); DEVÉRIA squeezes, 5384, E. See MENGEDOHT, *Catalogue of the Egyptian Antiquities . . . Collection of Sir Herbert Cook* [etc.] (1924), pp. 16-17 [39]; DE MEULENAERE in *Bibliotheca Orientalis*, xvii (1960), p. 33 [K, 1].

Y (of Perring). Es-isut , war-priest of the Temples of Memphis, etc., son of 'Aḥmosi , Prophet of Buto, and Tasaenankh , granite, Dyn XXVII, in Brit. Mus. 30. PERRING, op. cit. iii, pls. xxi, xxii; VYSE, op. cit. ii, pls. facing pp. 136, 140, 142, 144; *Guide, Eg. Colln.* (1909), pl. xviii; (1930), fig. 127; SCHMIDT, *Sarkofager*, fig. 1193; BUHL, op. cit. fig. 84, p. 147; WILLIAMS rubbings, ii. 2. 1-18. See SHARPE, *Eg. Antiq.* pp. 97-9; *Guide (Sculpture)*, p. 229 [825]; *A Handbook to the Egyptian Mummies* (1938), p. 66. Texts, SHARPE, *Eg. Inscr.* 1 Ser. 74-7.

Es-isut, war-priest of the Temples of Memphis, Prophet of Imḥōtep son of Ptaḥ, etc., son of Pashenihet , Prophet of Buto, and Wazetemḥēt , basalt, part, Dyn. XXVII, in Brit. Mus. 525. Text on lid, SHARPE, *Eg. Inscr.* 2 Ser. 30 [right]; PIEHL,

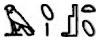
Inscriptions hiéroglyphiques recueillies en Égypte, 3 Sér. xliii-xliiii [A]. See SHARPE, *Eg. Antiq.* p. 106 [525].

LG 97. ḤARSIĒSI  and ḤARWOZ , both *wnrw*-priests. Dyn. XXVI.
Mother, Tentamūn . Names and titles from ushabtis.

Exact position unknown, approximately plan XXIII, D-6

Fragments of two sarcophagi. Texts, L. *D. Text*, i, p. 120 [lower].



THAIḤARPATA , Commander of the army. Dyn. XXX or early Ptolemaic.

Mother, Tashentihet .

Exact position unknown

Bottom of wooden coffin, in Uppsala, Victoriamus. 156. Texts from Book of the Dead, DARESSY in *Ann. Serv.* iii (1902), pp. 158-9.

PEDUBASTE , Commander of the army, Prophet of Bubastis, etc. Dyn. XXVI.

Parents, Ḥor  and Zehō .

Discovered by Salt in 1820, called 'Temple of Osiris', seen by Wilkinson in 1821, removed shortly afterwards.

Position, on plan VI

See MARIETTE, *Le Sérapéum de Memphis*, i, p. 94 [upper]. Position, BIRCH in *The Museum of Classical Antiquities*, ii [i] (1852), on plan facing p. 34 [F]; MARIETTE, *Mastabas*, on fig. on p. 551 [top, near A]; WILKINSON, *Topographical Survey of Thebes* (1830), on pl. v; id. *M. and C.* iii. on 398 [F] = ed. BIRCH, ii. on 360 (No. 462) [F].

Entrance doorway. Lintel with double-scene of deceased before Osiris, jambs, six columns of text with deceased in long robe at bottom; WILKINSON MSS. iv. 28-9, 30 [left]; xv. 35; xxviii. 11.

PTAḤARDAIS , Royal acquaintance. Dyn. XXVI.

Seen by Wilkinson in 1821.

Position, on plan VI. Plan XXXV

Plan, WILKINSON MSS. iv. 30 [lower right]; position, BIRCH in *The Museum of Classical Antiquities*, ii [i] (1852), on plan facing p. 34 [E, middle]; cf. MARIETTE, *Mastabas*, on fig. on p. 551 [top, middle].

Columned Court.



(1) *Ka*-servants bringing animals and offerings. (2) (upper part destroyed) Man before deceased seated. (3) Ends of four vertical lines of text.

WILKINSON MSS. iv. 30 [right], 31.

EXACT PROVENANCE UNKNOWN

Old Kingdom. Found by Hassan near Valley Temple of Khephren unless otherwise stated

Statues and statuettes.

Dedi  , Royal acquaintance, lower part, black granite, found by Baraize east of Great Sphinx, in Cairo Mus. Temp. No. 31.12.28.11. See GUNN in *Ann. Serv.* xxix (1929), p. 92.

Sole companion, King's *warb*-priest (name lost), seated, lower part, granite. HASSAN, *Gîza*, ix, pl. xxxv [B], p. 81 [9, d].

Scribe-statue, granite, found in shaft 350 (of Hassan, position unknown), in Cairo Mus. Temp. No. 8.5.43.5. See *Chron. d'Ég.* vii (1932), p. 75 [bottom].

Man standing, in Cairo Mus. Ent. 87800.

Torso of male statuette, alabaster, found on path running along east faces of Valley Temple of Khephren and Temple of Sphinx. HASSAN, *Gîza*, ix, pl. xxxvii [C], p. 82 [2, a].

Two women standing, double-statue, with remains of text. Id. ib. pl. xlii [A], p. 86 [3] (text).

Man seated, sandstone, found in west part of Central Field in 1935-6. Id. ib. vii, pl. lvi [B], p. 128 [22].

Man seated, in Cairo Mus. Id. ib. ix, pl. xl [A-C], p. 85; see *Chron. d'Ég.* xiv (1939), p. 83 [e].

Head of male statuette, from shaft 3099 (of Hassan, position unknown). HASSAN, *Gîza*, vi [3], pl. xcvi [B], p. 239 [2].

Fragment of face, alabaster, and head of female statuette, much damaged, limestone. Id. ib. ix, pls. xxxiv [B], xxxv [A], p. 81 [9, a, c].

Head of female statuette, damaged, alabaster. See id. ib. p. 81 [9, b].



Right half of torso of male statuette, sandstone. Id. ib. pl. xxxv [c], p. 81 [9, e].



Hand of statue, alabaster, and upper part of female statuette, sandstone. Id. ib. pl. xlii [E, c], pp. 86-7 [4, d, c].



Torso and lower part of male statuette. Id. ib. i, pl. lxxvii [1].



Head, in Cairo Mus. Ent. 87814.

False-doors.



Impy  , Regulator of a phyle, Chief of an estate of the Pyramid of Khephren, fragment, late Old Kingdom or 1st Int. Per., found by von Sieglin Expedition. STEINDORFF in HÖLSCHER (U.), *Das Grabdenkmal des Königs Chephren*, Abb. 165, pp. 112-14 [3].

Istai  , Overseer of hunters, etc., bottom part, late Old Kingdom, seen by Wilkinson in Valley Temple of Khephren in 1856, not *in situ*. WILKINSON MSS. xiii. 13, with sketch showing position, 12.

Ninekhbet  , Inspector of tenants of the Pyramid of Khephren, late Old Kingdom, in Cairo Mus. Temp. No. 19.6.46.5.

Wazi  , late Old Kingdom, found in *sebakh* east of Great Sphinx. Text, KAMAL in *Ann. Serv.* ix (1908), p. 88 [iii].

Panel, damaged, with Niaptah  , Scribe, and wife Demezkaus  , at table, found by von Sieglin Expedition. STEINDORFF in HÖLSCHER (U.), op. cit. Abb. 166, p. 114 [4].

Sezem  , Prophet of the Pyramid of Khephren, found by Baraize near Great Sphinx. ARCH. LACAU phot. C. i bis, 12.

Libation-basins.

Kaemnefert , Judge and Overseer of scribes, Prophet of Matet, son of Kaemnefert, alabaster. HASSAN, *Giza*, ix, pl. xxxviii, fig. 34, pp. 83-4 [I] (text).

Nubheset  (woman) with son Ptaḥshepses, found 'in front of false-door above shaft 89' (of Hassan, position unknown), in Cairo Mus. Temp. No. 19.6.46.1.

Ti , Inspector of tenants of the Great House, Boundary official, etc., 'found near mastaba of Sankhuka'. Id. ib. v, pl. lxxix [c], p. 317 [36] (text).

Usert , ka-servant, in Cairo Mus. Temp. No. 19.6.46.2.

Fragment (inscribed). Id. ib. ix, pl. xxxiv [A], p. 81 [6] (text).

Various.

Block with head of man, and another with remains of text. Id. ib. pl. xlvi [D, C], p. 90 [h, f].

Block from thickness of doorway, part of scene with funerary priest before [deceased], found in wooden case north of Temple of Ḥauron-Ḥaremakhēt. Id. *The Great Sphinx*, fig. 32, p. 45; see id. *The Sphinx*, pp. 47-8.

Block with man, and two others, named Ḥetepi and Weri, below, in Cairo Mus. Temp. No. 27.6.46.1.

Block with woman and three children, in Cairo Mus. Ent. 87824.

Ointment-slab, alabaster, found in shaft 4092 (of Hassan, position unknown), in Cairo Mus. Temp. No. 15.5.46.27.



F. MENKAURĒ^c CEMETERY

Tombs now sanded up

Position, on plan III

See REISNER, *Mycerinus*, p. 9 [lower].

LG 93. SETHU , Inspector of *wab*-priests and tenants, Elder of the Hall, etc. Dyn. V-VI.

Wives, Pepi  and Khentut .

Rock-cut tomb.

L. D. Text, i, p. 114, with plan.

North Room. A of Lepsius.

West and south walls. False-door with deceased at table on panel, and deceased with Pepi and family, including son Menkaurē^c-ankh (tomb, possibly, MQ 3); L. D. ii. 38 [b, c].

South Room. B of Lepsius.

West wall, north of false-door. Deceased with Khentut; L. D. ii. 38 [a].

MQ 1. KHUENRĒ^c , King's eldest son of his body, Sole companion of his father. Temp. Menkaurē^c.

Parents, Menkaurē^c and Kha^cmerernebti [II].

Rock-cut tomb.

Plan XXXV

Plan, REISNER, *Giza Necropolis*, i, fig. 132, pp. 152 [8], 226-7 [9], 310 [f]. See id. and FISHER in *Ann. Serv.* xiii (1914), p. 251.

Hall. a of Reisner.

(1) Deceased with scribe Ptahhotp before him and attendants behind, and five registers of industries, **I-II**, boat-building, **III**, vase-makers, men polishing sarcophagus, sculptors making and painting statues, **IV**, rope-making and metal-workers, **V**, carpenters.

I-III, SMITH, *Hist. Eg. Sculp.* pl. 49[b], fig. 175 [right], p. 169. See REISNER, op. cit. p. 351 [3].

(2) Mother seated, with deceased as naked boy holding hoopoe before her, and female attendants behind, and six registers, **I-IV**, cooking, **V**, musicians and singers, **VI** (under whole scene, unfinished), female dancers.

Deceased before mother, id. in *Boston Mus. Bull.* xxxii (1934), fig. 10, p. 12; SMITH, op. cit. fig. 153, pp. 291, 299. See REISNER, *Giza Necropolis*, i, pp. 347-8 [2].

Finds

√ Scribe-statuette (no text), from débris of Hall, in Boston Mus. 13.3140. C. S. F[ISHER] in *Boston Mus. Bull.* xii (1914), fig. on p. 40 [lower]; *Handbook* (1930 and 1935), fig. on p. 13; (1947), fig. on p. 14; RANKE, *The Art of Ancient Egypt*, and BREASTED, *Geschichte Aegyptens*, 62; SMITH, *Anc. Eg.* (1942), fig. 24; (1952), fig. 25; (1960), fig. 26; id. *Hist. Eg. Sculp.* pl. 10 [c], pp. 31, 40-1; CAPART, *Pour faire aimer l'art égyptien*, fig. 16; ALDRED, *O.K. Art*, pl. 30; SPIEGEL, *Hochkultur*, Taf. 43 [a]; WOLF, *Kunst*, Abb. 114; DUNHAM, *Eg. Department*, fig. 24; TERRACE in *The Connoisseur*, clxviii (1968), fig. 10, pp. 203-4; SIMPSON and others, *The Literature of Ancient Egypt*, fig. 2.

MQ 2. SEREHU , Secretary and Overseer of the jury of the Pyramid of Menkaurē, etc. Dyn. V-VI.

Rock-cut tomb.

See SMITH, *Hist. Eg. Sculp.* pp. 244-5, 247. Views showing lintel of doorway with offering-text, REISNER and FISHER in *Ann. Serv.* xiii (1914), pl. xii, p. 251; SCHARFF in OTTO, *Handbuch der Archäologie*, i, Taf. 64 [2], p. 489.

Probably MQ 3. MENKAURĒC-ANKH  and ANKHNEBEF , Inspector of rowers of the bark, Prophet of Menkaurē, etc. Dyn. V-VI.

Parents of Menkaurēc-ankh, possibly Sethu and Pepi (tomb LG 93).

G. SOUTH FIELD

On plan III

PETRIE in *Egypt Exploration Fund. Archaeological Report 1906-1907*, pp. 27-8.

EARLY DYNASTIC TOMBS

South section of the Field

Brick-built mastaba of Dyn. II or III.

'Covington's Tomb'. Excavated by Covington (1902-3) and Petrie (1906-7).

COVINGTON in *Ann. Serv.* vi (1905), pp. 193-218, with plans and section; PETRIE, *Gizeh and Rifeh*, pp. 7-8 [16-18], with plan, pl. vii.

Fragment of painted offering-list, possibly from here. See SMITH, *Hist. Eg. Sculp.* p. 141.

Tomb of Dyn. II, covered by mastaba of Dyn. XXVI.

Exact position uncertain, east of 'Covington's Tomb'. Excavated by Petrie (1906-7).

PETRIE, *Gizeh and Rifeh*, p. 7 [14, 15].

Jar-sealings with Horus-name Ninüter, in Manchester Mus. 4295, 4297-9, and in Brussels, Mus. Roy. E. 2481. Id. ib. pl. v E [bottom]; see KAPLONY, *Inschriften*, i, pp. 151-2; ii, notes 883, 885-90.

LATE OLD KINGDOM ROCK-CUT TOMBS

In ridge facing east

Plan, PETRIE, *Gizeh and Rifeh*, pl. vii c, pp. 8-9.

NEFERHERENPTAḤ , Treasurer of the royal granary. Dyn. V-VI.

Wife, Nefert .

Rock-cut tomb.

Entrance doorway. Lintel of deceased and family, with text of rewarding Pepi , Workman of the Necropolis, and drum with offering-text of deceased, in Manchester Mus. 4612, 4617; id. ib. on pl. vii A.

AKHIB , Overseer of the store-room of the King's repast, etc. Dyn. V-VI.

Rock-cut tomb.

Entrance doorway. Drum with name and titles of deceased, in Cambridge, Fitzwilliam Mus. E. 37.1907; id. ib. on pl. vii A.

PERNIANKH , Rower of the bark, Administrator of the Treasury, etc. Dyn. V-VI.

Rock-cut tomb.

Entrance doorway. Drum with offering-text of deceased, in Philadelphia Mus. E 15990; id. ib. on pl. vii A.

REDENPTAḤ , Companion of the Great House, Overseer of physicians, etc. Dyn. V-VI.

Wife, Iymeryt .

Rock-cut tomb.



Two false-doors. Lintel with offering-text of deceased and drum with name of wife, in Cairo Mus. 57177, lintel with text concerning acquisition of these pieces and drum with name and title of deceased, in Liverpool, City Mus. 4.9.07.6-7 (lost); id. ib. on pl. vii A.

THENTI , Overseer of linen (*ššrw*) of the Pyramids of Khufu and Khephren, etc. Dyn. V-VI.

Two false-doors of deceased. Texts, KAMAL in *Ann. Serv.* ix (1908), pp. 86-7 [ii].

Various late Old Kingdom finds

Statuette of Hinfifer , Tomb-maker, standing, in Manchester Mus. 4171. PETRIE *Gizeh and Rifeh*, pl. vii B [top right]; HORNE-MANN, *Types*, i, pl. 126; FISCHER in *A.Z.* 93 (1966), Taf. iv [a, b]. pp. 61-2 [3].



Offering-tables. Hefepfrēc , King's *wab*-priest, in Philadelphia Mus. E 2923, Seshemnūfer , Scribe of the granary (destroyed). PETRIE, op. cit. pls. vii B [bottom right], vii D [top].

Libation-basin of Nezem , Inspector of builders, etc., in Manchester Mus. 4355. Id. ib. pl. vii D [middle].

SAITE AND LATER TOMBS¹

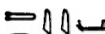
South section of the Field

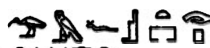
THERY , Overseer of the police, etc. Dyn. XXVI.

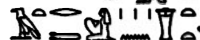
Parents, Gemefēsikap  and Tadehor . Wives, Tadehor and Taremtenubaste .

Stone-built mastaba. Excavated by Petrie (1907), re-opened by Abu-Bakr (1945-6).

Plan XXXV

PETRIE, *Gizeh and Rifeh*, pp. 28-9; plan, pl. xxxvii. See SCHWEITZER in *Orientalia*, N.S. 19 (1950), p. 118; YOYOTTE in *Rev. d'Ég.* 9 (1952), pp. 149-50 [52] with note 5. View, PETRIE, op. cit. pl. xxxii [upper right].

Relief-fragments,² probably from here, in Bristol Mus. H 1902 (head), 2738-9.

I. South Hall.

(1) Two harpists and singers, and man offering. Id. ib. pl. xxxvi A [upper]; HICKMANN, *45 Siècles*, pl. vii.

(2) Deceased and wife (no text) seated. PETRIE, op. cit. pl. xxxvi C [right].

(3) Two registers, deceased adoring and standing with staff. Id. ib. pl. xxxvi G [middle right].

II. Central Hall.

(4) Three registers, weighing soul with monster below, deceased adoring Geb, and adoring Hathor-cow in bark. Id. ib. pls. xxxvi G [middle left], xxxii [lower right].

(5) Three registers, deceased before Sokari-bark, adoring Osiris, and adoring Isis. Id. ib. pl. xxxvi G [right].

III. West Hall.

(6) Wife Ta(de)hor. Id. ib. pl. xxxvi G [left].

(7) and (8) Guardians with text of Book of Gates, and above at (8), Nephthys kneeling before [mummy on couch]. Id. ib. pls. xxxvi F, xxxvi E, xxxvi A [lower left].

(9) Anubis tending mummy, with Isis and Nephthys, and guardians of the underworld below. Id. ib. pl. xxxvi D.

IV. East Hall. Parts,² formerly in Brooklyn Mus. 34.1220.

(10) and (11) Thery (grandfather of deceased), and his mother Tashepenneit . Id. ib. pl. xxxiii [middle].

¹ Ushabtis only were found in Saite tombs LG 101 of Hor , *wnw*-priest, and LG 102 of Uzahor

 called Psammethek-sisekhmet , Royal Herald. See L. D. Text, i, pp. 122-5.

² See Addenda.

(12) Ḥathor embracing mummy. Id. ib. pl. xxxiii [left].

(13) Anubis embracing mummy. Id. ib. pls. xxxii [lower left], xxxiii [right].

(14) Two Anubis-jackals, below, sons Psammethék, Overseer of the police, born of Taremtenubaste, and Gemefēsikap, born of Tadeḥor, offering to deceased at table. Id. ib. pls. xxxvi B [top], xxxvi.

(15) Deceased adoring Thoth and six ram-headed gods. Id. ib. pl. xxxv.

(16) Deceased with eldest son Psammethék before his father.

Id. ib. pl. xxxiv.

V. North Hall.

(17) Deceased adoring *zad*-pillar. Id. ib. pl. xxxvi B [lower right].

(18) Deceased adoring Osiris-Onnophris with feather-headed Maet. Id. ib. pls. xxxvi B [lower left], xxxii [upper left], xxxvi A [lower right].

(19) Osiris between two goddesses. Id. ib. pl. xxxvi c [left].

NIWEḤEBRĒꜥ  Ⓞ. Dyn. XXVI.

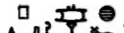
Father, Pedeteukhef(?) .

Rock-cut tomb.

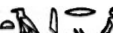

Sarcophagus of deceased. Text, KAMAL in *Ann. Serv.* ix (1908), pp. 85-6 [i].



Rock-cut tombs of PEDĒSI  and of TAIRI . Dyn. XXVI.

Near tomb of Thery (see p. 296). Excavated by Abu-Bakr for Service des Antiquités (1945-6).



Wooden painted coffins. See SCHWEITZER in *Orientalia*, n.s. 19 (1950), p. 119.

Various finds

Stela, Haremakhet , son of Pedēsi  and Tashenpashai , adoring, fragment, Ptolemaic, in Boston Mus. 07.548. PETRIE, *Gizeh and Rifeh*, pl. xxvii N[3].

Stela, Esdḥout(?) , son of Psammethék and Irterau , adoring Osiris and Isis, Ptolemaic, in Brussels, Mus. Roy. E.4288. Id. ib. pl. xxvii N [4]; text, SPELEERS, *Rec. inscr.* p. 94 [352].

Blocks with demotic graffiti, Roman, of Pedusiri, son of Pedeharsemtu, of 'Ahkh-ḥap and others, in Manchester Mus. 4622, 4618, and of Pato and others, in Cairo Mus., PETRIE, op. cit. pl. xxxvii A [upper left], p. 29 [81].

Coffins of Amenrekhes , daughter of Zeho  (planks from head and foot, in Munich, Staatl. Sammlung, ÄS.1625), and unnamed, Dyn. XXVI or later. Id. ib. pls. xxxi [lower], xxxi A [lower], xxxviii B [top left], xxxi B [lower], xxxvii A [top right], p. 29 [80]; SCHMIDT, *Sarkofager*, figs. 1304-10, 1312 (from PETRIE); see PETRIE, *The Funeral Furniture of Egypt*, p. 24 [545].

Canopic-jars of Imḥōtep, Dyn. XXX, in Edinburgh, Roy. Scot. Mus. 1907.713.1. Id. *Gizeh and Rifeh*, pl. xxxi A [upper], p. 29; *Guide to the Collection of Egyptian Antiquities* (1920), pl. vii [lower], p. 28.

IV. *Miscellaneous*

(a) Tombs and larger groups of finds

Old Kingdom.

‘ANKHWEZES , Book-keeper of the Great House, King's *warb*-priest, Prophet of Menkaurē, etc. Dyn. V or VI.

Wife, Tepemnefert .

Possibly from here.

Double-statue of deceased and wife seated, in Louvre, E.25368, and offering-table of deceased, wife, and Nīankhnesut , long sides, two boats carrying deceased on each, short sides, offerings, in Louvre, E.25369. VANDIER in *Rev. d'Ég.* xi (1957), pls. 9–11, figs. 1, 2, pp. 145–55; id. in *La Revue du Louvre*, xvii (1967), figs. 1, 2, p. 302; E.25368, id. *Manuel*, iii, pl. xxvii [5], p. 574; E.25369, id. ib. ii, fig. 308 [upper]. See id. *Guide* (1952), p. 9 [top]; *Vingt ans d'acquisitions au Musée du Louvre, 1947–1967*, p. 20 [Cat. 70].

ḤETEPT , Prophetess of Ḥathor, Tenant, etc. Dyn. V–VI.

Unfinished. Removed by Menas-Expedition about 1909, probably from West Field.

False-door, deceased at table on panel, parents (no names) on jambs, in Frankfurt-am-Main, Liebieghaus, 722. See *Städtische Galerie. Kurzes Verzeichnis der Bildwerke* (1930), p. 90.

Parts of false-door, drum with short offering-list, lintel with titles, and blocks from jambs with offering-bringers, in Berlin (East) Mus. 15416–18 (No. 15418 not found). Texts, *Aeg. Inschr.* i, p. 17; No. 15416, see *Führer* (1961), p. 46.

Block with three female offering-bringers, in Berlin (East) Mus. 15419. Names, *Aeg. Inschr.* i, p. 17.

Part of wall with reliefs on two faces, (a) deceased with daughter(?) on pleasure cruise in canoe in papyrus thicket (birds and butterfly sketched only), (b) two daughters(?), in Berlin (East) Mus. 15420. (a) SCHÄFER and ANDRAE, *Kunst* (1925), 238 [1]; (1930 and 1942), 250 [1]; WRESZ., *Atlas*, i, 376; canoe, SCHÄFER, *Von äg. Kunst* (1919), Taf. 16 [2]; (1922 and 1930), Taf. 15 [2]; (1963), Taf. 20 [1]; Eng. ed. *Principles of Egyptian Art*, pl. 34; HAMANN, *Äg. Kunst*, Abb. 152; *Sculptures et textes poétiques de l'Égypte* in *Cahiers d'Art*, xxii (1947), fig. on p. 64; PIRENNE, *Hist. civ.* i, inside cover i. Texts, *Aeg. Inschr.* i, p. 18; see *Führer* (1961), p. 45.

Part of wall with reliefs on two faces, (a) deceased seated, with probably daughter Ḥetept behind (sketched only), watching men pulling flax and tying up bundles, (b) female weavers with rewards, in Berlin (East) Mus. 15421. (a) Without daughter on left, SCHÄFER and ANDRAE, *Kunst* (1925), 238 [2]; (1930 and 1942), 250 [2]; KLEBS, *Reliefs . . . a.R.* Abb. 40; (b) JUNKER, *Gīza*, v, Abb. 12, pp. 52–3. Texts, *Aeg. Inschr.* i, pp. 18–19; see *Führer* (1961), p. 45.

IYNEFERT , Judge and Inspector of scribes, Overseer of the Pyramid of Menkaurē, Scribe of the treasury of the estate 'Mansion of Menkaurē', etc. Dyn. V or VI.

Wife, Mertiotēs , Royal acquaintance.

Probably from Menkaurē Cemetery.

Chapel. In Karlsruhe Mus. H. 532.

WIEDEMANN and PÖRTNER, *Aegyptische Grabreliefs aus der Grossherzoglichen Alterthümer-Sammlung zu Karlsruhe*, pp. 1-31 (with texts), pls. i-vi.

Doorway. Lintel of wife and deceased, thicknesses with deceased and offering-bringers below. Id. ib. pl. i.

False-door of deceased, deceased and wife on either side, with children and *ka*-servants below. Id. ib. pl. ii.

Funerary priests before deceased at table, with offering-list above, and men bringing animals below. Id. ib. pl. iii.

Deceased fowling from boat with many rowers, hippopotamus-hunt, and on right, two registers, cattle, and deceased in boat in swamp, and three registers, netting fowl and fish, with men bringing birds and fish, and ploughing and rams treading grain, with shepherd's song, all watched by large figure of deceased leaning on staff on right, and below all scenes, two registers of brewing, baking bread, and roasting goose and cooking meat. Id. ib. pls. iv-vi. See Addenda.

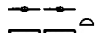
False-door of Mertiotēs, with daughters Hētephēres and Seshsheshet  on jambs, possibly from this tomb, in Brit. Mus. 1228. *Hiero. Texts*, i, pl. 8 [right]; ⁱ², pl. xiii [2], p. 13; see *Guide (Sculpture)*, p. 4 [7].



MEMI-SABU , Steward, etc. Late Dyn. V or early Dyn. VI.

Probably from north edge of West Field.

Double-stature, deceased with arm round wife's shoulder, standing, in New York, M.M.A. 48.111. SCOTT in *M.M.A. Bull.* n.s. vii (Nov. 1948), fig. on p. 96, cf. pp. 95-8; ALDRED, *O.K. Art*, pl. 32; id. *The Egyptians*, pl. 14; id. in PIGGOTT, *The Dawn of Civilization*, pl. on p. 116 [42]; DAUMAS, *Civ. de l'Ég.* pl. 44; HORNE-MANN, *Types*, v, pl. 1147; WOLDERING, *Götter*, fig. on p. 221 [Kat. 21]; ZANDEE, *De schatten van Egypte*, fig. 43; upper part, FISCHER in *Apollo*, lxxxii (1965), fig. 6 on p. 173.

Statue of wife (unnamed, but with name of Sabu) seated, formerly in Stern (Louis) Colln., now in Philadelphia, Mus. of Art, 63.181.257. SCOTT, op. cit. fig. on p. 99, cf. pp. 99-100; *Man in the Ancient World* (Exhib. New York, Queens College, Flushing, Feb. 10-March 7, 1958), pl. 90; *Gazette des Beaux-Arts*, lxxv (1965), Supp. Feb. 1965, fig. on p. 26 [121].

NEFERENKHUFU , Inspector of young men of the Great House, Director of a crew of recruits, Inspector of boats, etc. Dyn. V.

Mother (?), Sethtet . Wife, Isi , King's adorer.

Probably from West Field.

Upper part of false-door, with deceased and wife on panel, formerly in von Bissing Colln. and The Hague, Scheurleer Mus., now in Leyden Mus. F. 1939/2.1. FISCHER in *Oudheid. Med.* xli (1960), pl. xv [a], pp. 1-4, cf. fig. 1.

Panel of false-door, deceased and mother (?) at table, in Vienna Mus. Inv. 7446. KOMORZYNSKI in *W.Z.K.M.* 54 (1957), pl. facing p. 104, cf. pp. 101-8; Vienna. 5000 Jahre, No. 19 with Abb.; see FISCHER, op. cit. p. 6.

Statue of deceased standing (head probably from another statue), formerly in von Bissing Colln. and The Hague, Scheurleer Mus. S. 967, now in Leyden Mus. F. 1938/7.4. VAN OS in *Oudheid. Med.* n.r. xxxvi (1955), fig. 20, p. 81; FISCHER, op. cit. pl. xv [b, c], fig. 2 (text), pp. 4-6.

NIKAUINPU  Dyn. V-VI.

Wife, Hemtrēc , Royal acquaintance.

Allegedly from West Field.

Statuettes

In Chicago, Or. Inst.

View, BREASTED, *A Beginning and a Program in A. J. S. L.* xxxviii (1921-2), fig. 45 (repr. in *Chic. O. I. C.* No. 1); CAPART, *Memphis*, fig. 217; id. *Propos sur l'art égyptien*, fig. 47; id. *Le Paysage et les scènes de genre* [etc.], fig. 28 (all from BREASTED); ENGBERG, *The Dawn of Civilization*, fig. on p. 97. See VON BISSING, *Äg. Kunstgeschichte, Text*, i, p. 88 with note 19; *Handbook* (1941), p. 19; SMITH, *Hist. Eg. Sculp.* pp. 96-102.

Deceased and wife standing, No. 10618. ENGBERG, op. cit. fig. on p. 94; PIJOÁN, *Summa Artis*, iii (1945), figs. 227-8; HORNEMANN, *Types*, v, pl. 1158; STAHELIN, *Tracht*, Taf. ii [2].

Deceased and wife standing, No. 10619. HORNEMANN, *Types*, v, pl. 1159.

Deceased standing, No. 10620. Id. ib. i, pl. 128.

Deceased seated, No. 10621.

Servant statuettes

In Chicago, Or. Inst.

Nebtempet  (woman) grinding corn, No. 10622. PIJOÁN, op. cit. figs. 231-2; BREASTED (Jr.), *Eg. Servant Statues*, pl. 15 [a], p. 18 [5]; HORNEMANN, *Types*, iv, pl. 1039. See SMITH, op. cit. p. 96 [a, 12].

Semert (woman) sifting flour, No. 10623. BREASTED (Jr.), op. cit. pl. 26 [a], pp. 25-6 [5]; HORNEMANN, *Types*, iv, pl. 1003. See SMITH, op. cit. p. 98 [e, 4].

Minkhaef  moulding cakes, No. 10624. BREASTED (Jr.), op. cit. pl. 26 [b], p. 26 [2]; HORNEMANN, *Types*, ii, pl. 551. See SMITH, op. cit. p. 98 [f, 3].

Butcher slaughtering calf, No. 10625. BREASTED (Jr.), op. cit. pl. 34 [b], p. 36 [3]. See SMITH, op. cit. p. 100 [i, 4].

Butcher slaughtering ox, No. 10626. BREASTED (Jr.), op. cit. pl. 32 [a], pp. 35-6 [2]; SMITH, op. cit. pl. 28 [e], p. 100 [i, 3]; HORNEMANN, *Types*, v, pl. 1336.

Dwarf carrying bag, No. 10627. BREASTED (Jr.), op. cit. pl. 50 [a], p. 58 [upper 2]; HORNEMANN, *Types*, i, pl. 19. See SMITH, op. cit. p. 100 [k, 2].

Male potter squatting, No. 10628, with three jars, No. 10645. BREASTED, *Ancient Times* (1935), fig. 53; CAPART, *Limites*, pl. v [1], p. 45; id. *L'Art ég.* ii, pl. 266; id. *Le Paysage et les scènes de genre* [etc.], fig. 29; ENGBERG, *The Dawn of Civilization*, fig. on p. 136; PIJOÁN, *Summa Artis*, iii (1945), figs. 229-30; KELSO and THORLEY in *The Biblical Archaeologist*, viii (1945), fig. 1, p. 81; SMITH, op. cit. pl. 28 [g], p. 100 [j, 1]; BREASTED (Jr.), op. cit. pl. 45 [b], pp. 49-50 [2, 1]; ALDRED, *O.K. Art*, pl. 57; id. in PIGGOTT, *The Dawn of Civilization*, pl. on p. 122 [61]; VANDIER, *Eg. Sculpture*, pl. 37; WILSON, *The Burden of Egypt*, fig. 7a; WOLF, *Kunst*, Abb. 133; HORNEMANN, *Types*, iii, pl. 657; FISCHER in *Artibus Asiae*, xxii (1959), fig. 12, p. 251; WOLDERING, *Ägypten. Die Kunst der Pharaonen*, pl. on p. 79; id. *Götter*, fig. on p. 227 [Kat. 38]; JAMES in *Expedition. The Bulletin of the University Museum of the University of Pennsylvania*, 5 (1962), fig. 15, p. 41.

Khenu cooking food in basin, No. 10629. BREASTED (Jr.), op. cit. pl. 42 [a, b], p. 44 [1]; HORNEMANN, *Types*, ii, pl. 489. See SMITH, op. cit. p. 100 [h, 1].

Man sealing jar, No. 10630. BREASTED (Jr.), op. cit. pl. 14 [a], p. 16 [Type 2, 1]; HORNEMANN, *Types*, ii, pl. 490. See SMITH, op. cit. p. 97 [c, 6].

Man with blowpipe, No. 10631. BREASTED (Jr.), op. cit. pl. 45 [a], p. 50 [Type 3, 1]; SMITH, op. cit. pl. 28 [a], p. 100 [j, 2]; HORNE-MANN, *Types*, ii, pl. 530.

Two men squatting opposite each other (one figure missing), and squatting man (perhaps adjoining), No. 10632. BREASTED (Jr.), op. cit. pl. 98 [b], p. 105 [4].

Woman sifting flour from rectangular sieve, No. 10633. Id. ib. pl. 25 [a], p. 25 [4]; HORNE-MANN, *Types*, iv, pl. 1004. See SMITH, op. cit. p. 98 [e, 5].

Man tending cakes, No. 10634. BREASTED (Jr.), op. cit. pl. 26 [c], p. 28 [2]; HORNE-MANN, *Types*, ii, pl. 491. See SMITH, op. cit. p. 98 [upper, 6].

Female brewer, No. 10635. BREASTED (Jr.), op. cit. pl. 31 [b], pp. 32-3 [Type 3, 1]; SMITH, op. cit. pl. 28 [f], p. 97 [upper, 7]; BOTHMER in *Archaeology*, 2 (1949), fig. on p. 165; HORNE-MANN, *Types*, iv, pl. 982.

Man storing grain (or drummer?), No. 10636, with six granaries and base (inscribed), No. 10643. BREASTED (Jr.), op. cit. pl. 9 [b], pp. 11-12; SMITH, op. cit. pl. 27 [e, right], p. 101 [l, 4]; ENGBERG, *The Dawn of Civilization*, on fig. on p. 95 [upper]; HORNE-MANN, *Types*, ii, pl. 356. Granaries and base, BREASTED (Jr.), op. cit. pl. 8, p. 11 [bottom].

Squatting woman pouring grain on grinder, No. 10637. Id. ib. pl. 16 [a], p. 17 [Type 1, 1]; SMITH, op. cit. pl. 28 [c], p. 96 [a, 14]; HORNE-MANN, *Types*, iv, pl. 1022.

Woman grinding corn, No. 10638. BREASTED (Jr.), op. cit. pl. 17 [a], p. 19 [6]; HORNE-MANN, *Types*, iv, pl. 1037. See SMITH, op. cit. p. 96 [a, 13].



Boy and girl playing, No. 10639. ENGBERG, op. cit. fig. on p. 96; WRESZ., *Atlas*, iii, Text-abb. 106, 4, p. 244; ROEDER in *Oudheid. Med.* N.R. xx (1939), Abb. 13, 14, pp. 16-17; SCHÄFER in *Jahrbuch des Deutschen archäologischen Instituts*, lvii (1942), Abb. 7, p. 172; id. and ANDRAE, *Kunst* (1942), 241 [1]; CAPART, *Le Paysage et les scènes de genre* [etc.], fig. 30; SMITH, op. cit. pl. 27 [f], p. 101 [m, 1]; BREASTED (Jr.), op. cit. pl. 86, pp. 90-1 [1]; ALDRED, *O.K. Art*, pl. 56; HORNE-MANN, *Types*, v, pl. 1297; WOLF, *Kunst*, Abb. 134; PIRENNE, *Hist. civ.* i, pl. 100 facing p. 317.

Musicians, Nos. 10640-2. SMITH, op. cit. pl. 27 [e, except right], p. 101 [l, 1-3]; ENGBERG, *The Dawn of Civilization*, on fig. on p. 95 [upper]. Female harpist, No. 10640; BREASTED (Jr.), op. cit. pl. 80 [b], p. 87 [3]; HORNE-MANN, *Types*, iv, pl. 999; PIRENNE, *Hist. civ.* i, pl. 98 between pp. 316-17. Dwarf playing harp, No. 10641; BREASTED (Jr.), op. cit. pl. 81 [b], p. 87 [2]; HORNE-MANN, *Types*, ii, pl. 381. Female harpist, No. 10642; BREASTED (Jr.), op. cit. pl. 81 [a], pp. 86-7 [1]; HORNE-MANN, *Types*, iv, pl. 1000.

Chopping block, No. 10644.

In New York, M.M.A.

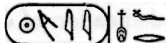
Squatting woman nursing two children, No. 26.7.1405 (from Carnarvon Colln.). *Burlington Fine Arts Club* (1922), pl. xiii [lower left], p. 76 [18]; SMITH, op. cit. pl. 27 [d], pp. 101 [m, 2], 71; HORNE-MANN, *Types*, v, pl. 1429. See HORNBLOWER in *J.E.A.* xv (1929), p. 43; BREASTED (Jr.), op. cit. p. 97 [Type 2, 1] with note 34.

PEPYNŪFER  or MERYRĒ'NŪFER  good name K̄AR , Count, Overseer of the *g's-pr*, etc. Temp. Pepy I or later.

Possibly from here.



Wife, Behenu  King's sole adorer.







Doorway. Drum and jambs with name and titles of deceased, thicknesses, deceased with name and titles above, right of doorway, deceased and wife, in Brit. Mus. 1319 A, B. *Hiero. Texts*, i, pls. 35-6; i², pl. xxxiii [1, 2], pp. 34-5.

False-door of deceased, in Brit. Mus. 1341. *Hiero. Texts*, i, pl. 34 [right]; i², pl. xxxii [2], p. 34; *Guide (Sculpture)*, pl. ii, p. 23 [75]; *Guide, Eg. Colln.* (1930), fig. 161, p. 301.

False-door of deceased, in Brit. Mus. 1342. *Hiero. Texts*, i, pl. 34 [left]; i², pl. xxxii [1], pp. 33-4; see *Guide (Sculpture)*, p. 23 [76].



False-door of wife, in Brit. Mus. 1330. *Hiero. Texts*, i, pl. 37 [right]; i², pl. xxxiv [1], pp. 35-6; see *Guide (Sculpture)*, p. 27 [88].

SONB , Inspector of , etc. Dyn. V-VI.



Wife, Henutsen   , Royal acquaintance. Son (probably), Ka'aper  , Inspector of .

Blocks re-used in village Nazlet el-Batrân in time of Lepsius.

Lintel with offering-text of deceased and wife. L. D. ii. 94 [a], *Text*, i, p. 126.





Lintel and block of Ka'aper and wife Renpetnefert {  , *mitrt.* L. D. ii. 95 [c], *Text*, i, p. 126.

Various.

Panel of false-door, deceased and wife seated, with Ka'aper and Reshuterkai   (woman) before them offering, formerly in Mimaut, Pourtalès, and Amherst Collns. Text and sketch, CRUM in GARDINER Notebook, 66, p. 16; see DUBOIS, *Description des Antiquités Égyptiennes . . . Collection Mimaut* (1837), No. 440; id. *Description des Antiques . . . Pourtalès-Gorgier* (1841), No. 45; *Vente de la Galerie Pourtalès. Catalogue des objets d'art* (Febr. 6, 1865), No. 45; *Sotheby Sale Cat.* (AMHERST), June 13-17, 1921, No. 189.

Corner-block, (a) Sonb, King's *warb*-priest, dressed in panther's skin, (b) Henutsen, Royal acquaintance, possibly from here, in Cairo Mus. 1740. BORCHARDT, *Denkmäler*, ii, Bl. 96, p. 166; DEVÉRIA squeezes, 6170A, 25.

THETHI , (a) Overseer, (b) Secretary, and (c) Director of members of a phyle, of the Pyramid of Khephren, etc. Dyn. V or VI.

Parents, Ramu   and Thentet , both Royal acquaintances. Wife, Debit  , Prophetess of Hathor and Neith foremost of the Temple of Khephren.

Probably from east part of Central Field.

Plan XXXV

BIRCH in *Archaeologia*, xxix (1842), pp. 111-26. Plan, id. ib. pl. xiii [bottom]; WILKINSON MSS. iv. 61 [bottom]. View, BIRCH, op. cit. pl. xiii [top]. Pieces in Brit. Mus. (formerly Salt Colln.), see *Sotheby Sale Cat.* (SALT), June 29-July 8, 1835, Nos. 1261-2, part of 1268 (repr. ATHANASI, *A Brief Account*); SHARPE, *Eg. Antiq.* pp. 23, 24.

Chapel.

(1) False-door of parents, parts of inner jambs, panel, and lower lintel, in Brit. Mus. 528, left outer jamb with dedication of deceased, in Brit. Mus. 157 C.

Complete, *Hiero. Texts*, i, pls. 5 [right], 17 [left]; i², pls. viii [1], xvi, pp. 7, 16; WILKINSON MSS. iv. 26 [middle and right], 27; jamb, xxiii. 181 [right]; see *Guide (Sculpture)*, pp. 8-9 [26] (with text of 157 C), 16 [47]. Brit. Mus. 528, panel, WILLIAMS rubbings, iv. 114. Brit. Mus. 157 C, LEPSIUS, *Auswahl*, Taf. viii [D]; text, SETHE, *Urk.* i. 15 [11].

(2) and (3) Two false-doors of deceased and wife, parts in Brit. Mus. 157 A-B.

Complete, WILKINSON MSS. iv. 26 [left], 60 [top and middle], 61-5. Sketch of (2), BIRCH, op. cit. pl. xiii [middle]; (3) pl. xiv. Parts in Brit. Mus., *Hiero. Texts*, i, pls. 6, 7; i²,

pls. vi, vii, pp. 6-7; names and titles, LIEBLEIN, *Dict.* Nos. 10, 11; (2) LEPSIUS, *Auswahl*, Taf. viii [B, C] (incomplete, but with outer thicknesses, now missing); WARD (J. J.), *Pyramids and Progress*, fig. on p. 36; see *Guide (Sculpture)*, p. 8 [25]; (3) LEPSIUS, *Auswahl*, Taf. viii [A] (incomplete); KING and HALL, *Egypt and Western Asia*, pl. facing p. 86; PIJOAN, *History of Art*, i, pl. v facing p. 44; GIEDION, *The Eternal Present*, ii, fig. 83.

(4) Lintel of false-door (?) of deceased, WILKINSON MSS. iv. 60 [bottom].

WASHKA , Overseer of the store-room of the Sun-temple of Userkaf.
Dyn. V.

Wife, Zefatsen , Prophetess of Hathor.

Probably from here.

False-door of deceased, with deceased and wife at table on panel, and family on jambs, in Brit. Mus. 1156 A, and offering-table, with five kneeling sons before deceased and wife at table, in Brit. Mus. 1156 B. *Hiero. Texts*, i, pls. 22-3; i², pl. xxvii, pp. 27-8; BUDGE, *The Mummy* (1925), figs. on pp. 434, 439. No. 1156 A, see *Guide (Sculpture)*, p. 20 [63].

NAME UNKNOWN. Dyn. V-VI. Possibly from here.

Blocks in Brit. Mus. Bought in 1898. *Hiero. Texts*, i², pls. xxiii, xxiv, pp. 23-5, cf. fig. 2; see *Guide (Sculpture)*, p. 19 [54-9].

Front wall. Two registers, offering-bringers and butchers, Nos. 1270 B (front), 869, 1270 A (front), 865. Butchers (Nos. 1270 A, 865), FISCHER in *Orientalia*, n.s. 29 (1960), pls. xlvi, xlvi, pp. 181-3 [2]. Nos. 865, 869, *Hiero. Texts*, vi, pls. 13, 15.

Side wall. Deceased and wife (no texts), and offering-bringers below, Nos. 1270 B (side), 864, 1270 A (side), 1270 C. No. 864, id. ib. pl. 13.

Doorway. Thicknesses, bringing animals (including hyena) and offerings, and butchers, Nos. 867-8. Id. ib. pl. 14.

Block with funerary priests before deceased at table, No. 866. Id. ib. pl. 13.

New Kingdom.



PTAḤMAY , Head of gold-workers of Temple of the Aten. Temp. Amenophis IV.

Wife, Ty , Lady of the house.

At Nazlet el-Baṭrān, destroyed in 1873.

Blocks in Cairo Mus. Names and titles, LIEBLEIN, *Dict.* No. 2016.

Remains of three registers, I (destroyed), II, musicians before deceased and wife seated, III, deceased supervising man making naos, Temp. No. 14.6.24.2. BULLE, *Der schöne Mensch im Altertum* (1898), Taf. 15 [right]; (1912), Taf. 23 [right]; HICKMANN in *Ann. Serv.* xlix (1949), fig. 16, p. 441; MASPERO, *Égypte*, fig. 373; see id. *Guide*, p. 165 [563]; id. and ROEDER, *Führer*, p. 47 [370].

Deceased with wife accompanied by Maḥuy  with wife Hes  at table, Temp. No. 3.7.24.12. STEINDORFF, *Kunst*, 245; GRIFFITH INST. photo. 307; deceased with wife, FORMAN (W. and B.) and VILÍMKOVÁ, *Eg. Art*, pl. 75; see MASPERO, *Guide*, pp. 179-80 [651 A].

Four registers of preparing food and wine, with girl dancer, Temp. No. 5.7.24.18. Dancer, BRUNNER-TRAUT, *Der Tanz im alten Ägypten*, Abb. 34; see MASPERO, *Guide*, p. 181 [662]; id. and ROEDER, *Führer*, p. 50 [380].

KHA'EMWĒSET , Master of the royal wig. Dyn. XIX.

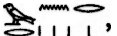
Wife, Wernuro , Lady of the house.

Tomb found by Vassalli 'at Kafr el-Baṭrân' about 1870.

MASPERO, *Histoire ancienne des peuples de l'Orient* (4th ed. 1886), p. 255 note 2; id. *Hist. anc.* ii, p. 426 note 1 (as son of Ramesses II in error).

Blocks.

In Cairo Mus. Temp. No. 12.6.24.20. See MASPERO, *Guide du visiteur au Musée de Boulaq* (1883), pp. 427-9 [6050, 6053-4, 6056]. Names and titles, LIEBLEIN, *Dict.* Nos. 2019, 2021.

[6053] Three registers of funerary scenes (including breaking jars, mourners, and sarco-phagus dragged by oxen). WERBROUCK, *Pleureuses*, pl. xxxiv, pp. 82-3; breaking jars, BORCHARDT in *A.Z.* 64 (1929), Taf. i [4], p. 15.

[6050, 6056] Tree-goddess scene (arms only) with deceased and wife drinking in presence of their *bas*.

[6054] Rest of funerary procession with priests and wife before mummy embraced by Anubis.

(b) Statues

Old Kingdom.

Imakhufu  and wife seated, double-statue, from excavations of the Service des Antiquités, in Cairo Mus. Ent. 48076. HORNE MANN, *Types*, v, pls. 1190-1.

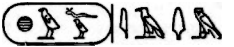
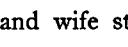
Imakhufu  and wife standing, with son S'ankhnek  seated between them, statue-group, Dyn. V or VI, possibly from here, formerly in Gualino Colln., now in Turin Mus. Sup. 17135. VENTURI, *La Collection Gualino*, pl. lii; FARINA, *Il Regio Museo* (1938), fig. on p. 42 [lower], cf. p. 12; SCAMUZZI, *Un gruppo statuario* [etc.] in *Bollettino della Società Piemontese di Archeologia e di Belle Arti*, n.s. ii (1948), pp. 3-9 with figs.; F.E.R.E. photo. 18019.

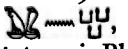
Nikaunebti , Prophetess of Ḥathor, seated, Dyn. V. in Cairo Mus. 82. BORCHARDT, *Statuen*, i, Bl. 19, p. 66.

Man as scribe, and wife squatting beside him, double-statue, red granite, found at Moslem Cemetery at Nazlet el-Simmân, in Cairo Mus. Ent. 89171. HORNE MANN, *Types*, v, pl. 1178.

Man standing (headless), Dyn. V, found by Caviglia, in Brit. Mus. 35. LONG, *The Egyptian Antiquities in the British Museum*, ii (1846), fig. on p. 18; see SHARPE, *Eg. Antiq.* p. 85 [35]; *Guide (Sculpture)*, pp. 11-12 [34].

Naked boy standing, wood, Dyn. V, in Cairo Mus. 128. BORCHARDT, *Statuen*, i, Bl. 29, pp. 96-7; PERROT and CHAPIEZ, *Hist. de l'Art*, i, fig. 442; WEIGALL, *Anc. Eg. . . . Art*, 34 [lower]; HORNE MANN, *Types*, ii, pl. 343.

Man with short kilt, and another with long kilt, both standing, wood, Dyn. VI, in Marseilles, Mus. d'archéologie, 217, 218. *Château Borély. Les Trésors d'art* [etc.] (1963), pls. 2, 1; (1970), 4th and 5th plates. No. 217, CAPART, *Recueil de Monuments Égyptiens*, ii, pl. iv. No. 218, BENOIT, *Le Château Borély. Musée archéologique de Marseille*, fig. on p. 51 [left]. See MASPERO, *Catalogue du Musée Égyptien de Marseille*, pp. 12-13 [17, 18].

Head of rock-cut male statue, from rock-cut tomb, in Berlin Mus. 14109. See *Ausf. Verz.* p. 70.

Head of statue, painted, Dyn. IV-V, probably from here, in Stockholm Mus. MM. 10224.

Head of statue, diorite, Dyn. IV. See *Christie Sale Cat.* (March 2, 1937), No. 23.

Head of statue, black granite, Dyn. V-VI, from Reisner excavation (Harvard-Boston Expedition), in Boston Mus. 34-54. See *Boston Mus. Bull.* xxxii (1934), p. 38.

Head of statue, red granite, possibly Dyn. IV, in Los Angeles, County Mus. 47.8.6. BREASTED (Jr.) in *Bulletin of the Art Division. Los Angeles County Museum*, i [2] (1947), fig. 2, p. 4.

Head of male statue, red granite. *Christie Sale Cat.* (April 14, 1970), No. 117 with plate.

Reserve-head, probably Dyn. V, possibly from here, in London, Univ. Coll. Mus. 15988.

PETRIE in *Anc. Eg.* (1914), fig. on p. 125; see SMITH, *Hist. Eg. Sculp.* p. 27 [31].

Reserve-head, in Cairo Mus. Ent. 89611.

Middle Kingdom.



Female bust, probably from statue-group, granite, allegedly from here, in Oxford, Ashmolean Mus. 1872.86. See CHESTER, *Catalogue of the Egyptian Antiquities in the Ashmolean Museum, Oxford* (1881), p. 2 [27].

Upper part of standing(?) female statue, in Cairo Mus. 523. See BORCHARDT, *Statuen*, ii, p. 80.

New Kingdom to Ptolemaic.

Amenophis III seated between [Nekhbet] and Buto, statue-group, black granite, in Cairo Mus. Ent. 39507. HORNEMANN, *Types*, v, pl. 1399.

Statue-base of Ēsinefert  (presumably wife of Ramesses II), in Cairo Mus. Ent. 25772. See HASSAN, *The Great Sphinx*, p. 306.

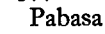
Pabasa , Head of bowmen, son of Khay , and wife Tawertemhab , kneeling in front of Ḥathor-cow, statue-group, New Kingdom, formerly in Anastasi Colln., now in Leyden Mus. B.261 [Inv. AST]. BOESER, *Beschreibung der aegyptischen Sammlung* [etc.], v, Taf. xiii [31] (called A.261); LEEMANS, *Aegyptische Monumenten . . . Leyden*, i, pl. xxii [261]; HORNEMANN, *Types*, v, pls. 1433-4; WILKINSON MSS. xxix. 2 (giving provenance). See LEEMANS, *Description . . . du Musée d'antiquités des Pays-Bas à Leide* (1840), pp. 26-7 [261]; BOESER, *Catalogus van het Rijksmuseum van Oudheden te Leiden*, p. 54 [8].

Esbanebbed  Great Chief of the Ma, kneeling, holding two pots, headless, glassy faience, Dyn. XXII, formerly Abbott and N.Y. Hist. Soc. Collns., now in Brooklyn Mus. 37.344E. *Brief Guide to the Department of Ancient Art* (1970), pl. on p. 63, cf. p. 62; YOYOTTE in *Mélanges Maspero*, i [4] (1961), pl. iii, pp. 127 [30], 141; COONEY, *Glass Sculpture in Ancient Egypt* in *Journal of Glass Studies*, ii (1960), fig. 24, pp. 33-4; RIEFSTAHL, *Ancient Egyptian Glass and Glazes in the Brooklyn Museum* (1968), fig. 57, p. 106; see *N.Y.H.S. Cat.* p. 6 [85].

Head with inscribed back-pillar, schist, Dyn. XXVI, in Royal-Athena Galleries (New York dealer). EISENBERG, *A Catalog of Egyptian and other Near Eastern Antiquities*, No. 42 (1962), No. 9 with fig.; *Egyptian . . . Antiquities (Royal-Athena Galleries)*, Parke-Bernet Galleries, *Sale Cat.* (April 29-30, 1964), p. 30 [147] with fig.

Head of man, dark brown stone, Dyn. XXVI, formerly in The Hague, Scheurleer Mus. SCHEURLEER, *Catalogus eener verzameling* [etc.] (1909), pl. ii [37], pp. 59-60.

Lower part of seated statue of Imḥōtep, with papyrus on lap, dedicated by man (name lost), Dyn. XXVI or later, formerly in N.Y. Hist. Soc. Colln., now in Brooklyn Mus. 37.1356E. See *N.Y.H.S. Cat.* p. 9 [134].

Sphinx, Late Period, in Cairo Mus. 1188. BORCHARDT, *Statuen*, iv, Bl. 167, p. 93.

Sphinx, Ptolemaic, in Royal-Athena Galleries (New York dealer). EISENBERG, *A Catalog of Late Egyptian and Coptic Sculptures* (1960), pl. 14, p. 18 [25].

(c) False-doors. Old Kingdom. In alphabetical order

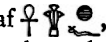
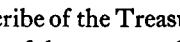
‘Ankh-haf , Scribe of the Treasury, etc., with wife Nefertsezemt , upper part of false-door, drum of doorway, and various other blocks, Dyn. IV or later, formerly in Salt Colln., now in Brit. Mus. 527 A, B, 529–30, 532–5. *Hiero. Texts*, i², pl. xv, pp. 14–16; see *Guide (Sculpture)*, p. 15 [45A–H]. Nos. 527, 529, 530, 535. *Hiero. Texts*, i, pl. 18. No. 527 A, panel, WILLIAMS rubbings, iv. 59.

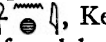
‘Ankhi , Keeper of the diadem, Inspector of King’s hairdressers, etc., late Old Kingdom, found by Abu-Bakr, in Bremen, Übersee-Mus. B. 4547. CAIRO, CENTRE OF DOCUMENTATION photo. S.R., Box 173, 12908.

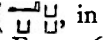
Hakau , in two pieces, from Reisner excavation (Harvard-Boston Expedition), in Cairo Mus. Ent. 44634.

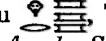
Herimeru , Treasurer of the God in the boat, panel, in Heidelberg, Äg. Inst. 28. OTTO (E.), *Aus der Sammlung des Ägyptologischen Institutes der Universität Heidelberg* (1964), Abb. 10, p. 91; MARBURG INST. photo. 620979.

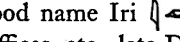

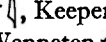
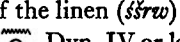
Irenakhti , good name Iri , Lector-priest, Secretary of the Toilet-house, Director of all divine offices, etc., late Dyn. V or VI, in Minneapolis, Inst. of Arts, 52. 22. *Archaeology*, 6 (1953), fig. on p. 185 [right]; *Bulletin. The Minneapolis Institute of Arts*, xlii (1953), pp. 45–53 with figs.

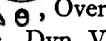
Iufi , Keeper of the linen (*šrw*) of the Royal House, Director of vine-dressers, etc., with wife Wenneten , Dyn. IV or later, formerly in Salt Colln., now in Brit. Mus. 130. *Hiero. Texts*, i, pl. 14; i², pl. xiv, p. 14; WILLIAMS rubbings, iii. 39, 40. Texts, GARDINER Notebook, 54, p. 15 [upper]. See *Sotheby Sale Cat.* (SALT), June 29–July 8, 1835, No. 1264 (repr. ATHANASI, *A Brief Account*); *Guide (Sculpture)*, p. 15 [44].

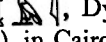
Kar , Overseer of the Pyramid-town of Khufu, Inspector of prophets, Sole companion, etc., Dyn. V–VI, in Munich, Staatl. Sammlung, Gl. 98. See WOLTERS, *Illus. Kat.* (1912), p. 12 [31b]; id. *Führer* (1928), p. 12 [66].

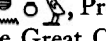

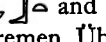
Khai , Dyn. V (?), in two pieces, from Reisner excavation (Harvard-Boston Expedition), in Cairo Mus. Ent. 44633.

Khenu , Prophet of Menkaurē, Inspector of tenants, One who sets right the judgement of the Great Court, etc., Dyn. IV or later, probably from here, in Brit. Mus. 1272. *Hiero. Texts*, i, pl. 8 [left]; i², pl. ix [1], p. 9; see *Guide (Sculpture)*, p. 10 [31].

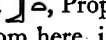

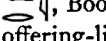
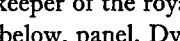
Neft  and Merut  (both women), late Old Kingdom, found by Abu-Bakr, in Bremen, Übersee-Mus. B. 4548. CAIRO, CENTRE OF DOCUMENTATION photos. S.R., Box 173, 12906, 12907 [left].

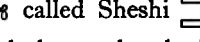
Neft , Prophetess of Hathor, late Old Kingdom or 1st Int. Per., bought in Cairo, possibly from here, in Cambridge (Mass.), Harvard Univ. Semitic Mus. 2357.

Neferi , Book-keeper of the royal documents, etc., and wife Mer(t)min , at table, with offering-list below, panel, Dyn. V, in Cairo Mus. 1653. BORCHARDT, *Denkmäler*, ii, Bl. 86, p. 114; text, DARESSY in *Rec. Trav.* xiv (1893), p. 165 [liii].

Neferseshemkhufu , called Sheshi , Inspector of King’s *wab*-priests, Scribe of the royal documents, with deceased and wife Khentetka  at tables

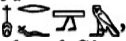
on panel, Dyn. IV or later, probably from here, in Brit. Mus. 1282. *Hiero. Texts*, i, pl. 15 [right]; i², pl. xi [1], p. 11; *Guide, Eg. Colln.* (1909), pl. iii, p. 68; (1930), fig. 39; *Wall Decorations of Egyptian Tombs*, fig. 2, p. 4; see *Guide (Sculpture)*, pp. 6-7 [18].

Nefershemem  *ka*-servant, and (wife) Merer  *mitrt*, panel, Dyn. IV, found near house at Nazlet el-Simmân, in Cairo Mus. Ent. 45972.

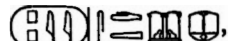

Nefery  *Regulator of a phyle of the Pyramid of Shepseskaf, late Old Kingdom, fragment, formerly in Meux Colln. Text, BUDGE, Some Account . . . Collection . . . Meux, p. 97 [41].*

Niꜥankhnekhbet  *ka*-servant, etc., with wife, at table, panel, in Cairo Mus. 1682; see BORCHARDT, *Denkmäler*, ii, p. 133; HASSAN, *The Great Sphinx*, p. 307 [Ent. 28173]. Fragment of drum of same man, in Cairo Mus. 1700, see BORCHARDT, *op. cit.* p. 143.

[Ni]ḥesedpepy  Sole companion, Overseer of scribes, Dyn. VI, possibly from here, in Brit. Mus. 112. SHARPE, *Eg. Inscr.* 1 Ser. 14; *Hiero. Texts*, i, pl. 41 [left]; i², pl. xxxvi [3], p. 39; WILLIAMS rubbings, iv. 119; WILKINSON MSS. xxii. 21, 21 verso [upper left]; see SHARPE, *Eg. Antiq.* p. 17; *Guide (Sculpture)*, p. 27 [89].

Nubkaus  True prophetess of Ḥathor, fragment, seen 'at Kafr el-Haram' in 1881. WILBOUR MSS. 2D, 33; see WILBOUR, *Travels in Egypt*, p. 22 (probably this).

Raꜥnūfer, Scribe of the royal documents, lintel and drum, Dyn. V(?), probably from here, in Brit. Mus. 1011. *Hiero. Texts*, i², pl. xx [2], p. 19; see *Guide (Sculpture)*, p. 27 [87].

Senenu  Inspector of the store-room of the Sun-temple of Neuserrē, etc., with wife Thentetes  and family, middle Dyn. V or later, possibly from here, in Brit. Mus. 1136. *Hiero. Texts*, i, pl. 27; i², pl. xx [3], pp. 19-20; *Wall Decorations of Egyptian Tombs*, fig. 3; *Guide (Sculpture)*, pl. iv facing p. 25.

Serefka  King's *wab*-priest, Secretary, Tenant of the Great House, etc., Dyn. VI, in Cairo Mus. 1521. See BORCHARDT, *Denkmäler*, i, p. 222 (text); MARIETTE, *Mastabas*, p. 562 [iii]; *id. Notice des principaux monuments . . . à Boulaq* (1864), p. 270 [3].

Wep  *imy-hnt*, Master of the largesse in the Mansion of Life, Lector-priest, etc., Dyn. III-IV (Werbrouck) or later, possibly from here. Left outer and right inner jambs, deceased, in Cairo Mus.; WERBROUCK in *Bull. Mus. Roy.* 3 Sér. xv (1943), figs. 20-1, pp. 29, 31. Right outer jamb with deceased and thickness with offering-bringers, in Brussels, Mus. Roy. E. 2160 (from Philip Colln.), *id. ib.* figs. 16-19, pp. 27-9; *Hôtel Drouot (Paris) Sale Cat.* (PHILIP), April 10-12, 1905, No. 96 with pl.; jamb, *Bruxelles. Mus. Roy. Département égyptien. Album* (1934), pl. 1; CAPART, *Les Antiquités égyptiennes* [etc.] (1905), fig. 4; text, SPELEERS, *Rec. inscr.* p. 6 [43]. Panel, deceased at table, formerly in Meux and Hearst Collns., now in Glasgow, Burrell Colln. 13.184; BUDGE, *Some Account . . . Collection . . . Meux*, pl. vii, pp. 97-8 [42]; titles, WERBROUCK, *op. cit.* p. 31; see *Sotheby Sale Cat.* (HEARST), July 11-12, 1939, No. 31.

Weri  Overseer of officials (*šrw*), etc., late Old Kingdom or 1st Int. Per., in Oxford, Ashmolean Mus. 1885.504. Text, WIEDEMANN in *Rec. Trav.* xvii (1895), p. 1 [1]; GARDINER Notebook, 68, p. 4.

Inspector of *wab*-priests of the Pyramid of Khephren (name lost), at table on *recto* of panel, and similar scene on *verso*, Dyn. IV, in Cairo Mus. 1727. BORCHARDT, *Denkmäler*, ii, Bl. 93, pp. 157-8; see HASSAN, *The Great Sphinx*, p. 307 [Ent. 28166].

Supervisor . . . of the Pyramid of Khephren (name lost), formerly in Meux Colln. Text, BUDGE, *Some Account . . . Collection . . . Meux*, p. 97 [40].

Fragment (no name), in Boston Mus. 12.1490.

(d) Stelae. Middle Kingdom to Late Period. In chronological order

Nakht with family, Dyn. XII, 'from Pyramids', in Cairo Mus. Ent. 20430-1. See HASSAN, *The Great Sphinx*, p. 305.

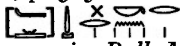
Hezerkenro(?)  (Negro), fragment, Dyn. XVIII-XIX, in Brussels, Mus. Roy. E.2385. CAPART in *Bull. Mus. Roy. 2 Sér.* xii (1913), fig. 4, p. 63. Text, SPELEERS, *Rec. inscr.* p. 39 [146].

Ptahmosi, Real royal scribe, Overseer of grain(?) of the Lord of the Two Lands, adoring, with Opening-the-Mouth ceremony below, Dyn. XIX, found near Pyramids, formerly in Salt Colln., now in Brit. Mus. 160. See *Guide (Sculpture)*, p. 178 [642].



Donation stela, year 6 of Ramesses III(?), found at Nazlet el-Batrân, in Cairo Mus. Ent. 66612.

Pedusiri, son of Pedeamûn and Takheru , adoring Osiris and Isis, Late Period. LUCAS, *Voyage*, ii (1724), pl. facing p. 130; MONTFAUCON, *L'Antiquité expliquée*, Supplement, ii (1724), 1st pl. after pl. li [1] (from LUCAS).

Stela with hawk at top and demotic text, Roman, in Cairo Mus. 50031. SPIEGELBERG, *Die demotischen Denkmäler (Cat. Caire)*, iii, Taf. iv [right], p. 6.

Cippus, Horus on the crocodiles, Roman, in Cairo Mus. 9423. DARESSY, *Textes et dessins magiques (Cat. Caire)*, pl. x, pp. 33-4.

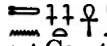
(e) Lintels, drums, blocks, etc.**Old Kingdom.**

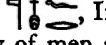
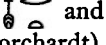

Lintel of 'Ankhemthenet , Judge and Supervisor of police, One who sets right the judgement of the Great Court, etc., with wife Nebt , Dyn. VI, possibly from West Field, in Cairo Mus. Temp. No. 6.4.49.1. FISCHER in *Mitteil. Orientforschung*, vii (1960), fig. 3, pp. 302, 304 with note 8.

Block of Neferhabwër(?) , 'with cartouche of Khephren', in Cairo Mus. Ent. 25776. See HASSAN, *The Great Sphinx*, p. 306.

Jamb, three registers, Neternüfer , Inspector of officials (*šrw*), with wife Neferten-nesut  and daughter, row of men and women, grinding corn and heating pots, Dyn. IV (Borchardt) or later, in Cairo Mus. 1451. BORCHARDT, *Denkmäler*, i, Bl. 34, p. 137. Text (incomplete), LIEBLEIN, *Dict.* No. 1368; DE ROUGÉ, *Inscr. hiéro.*, pl. iv [bottom].

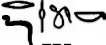
Block with Neternüfer (same man as above), Dyn. IV or later, in Cairo Mus. 1529. See BORCHARDT, *op. cit.* p. 228.

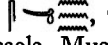
Drum and lintel of Ruzka , Prophet and Inspector of *wa'b*-priests, of the Pyramid of Khephren, etc., Dyn. IV or later, probably from here, in Brit. Mus. 1268-9. *Hiero. Texts*, i, pl. 20 [lower]; i², pl. viii [4, 3], p. 8; see *Guide (Sculpture)*, pp. 7-8 [22-3]; *Guide, Eg. Colln.* (1930), p. 292.

Block of Seshemu , Overseer of the store-room, etc., and wife Semut , Dyn. V-VI, in Brussels, Mus. Roy. E.759. Text, SPELEERS, *Rec. inscr.* p. 6 [42] (called Dyn. III-IV).

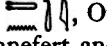
Lintel with text of will of Thenti , Overseer of commissions, Director of the Two Canals, etc., in favour of wife Tepemnefert and Kaemnefert, 'Brother of the endowment', Dyn. VI, in Cairo Mus. 57139. Text, MORET in *Comptes rendus* (1914), p. 541, cf. 538-46; SETHE, *Urk.* i (1933), 163-5 [12 (103)]; GOEDICKE, *Die privaten Rechtsinschriften aus dem Alten Reich*, Taf. xiii, pp. 122-30.

Block with Thethi , Royal acquaintance (woman), possibly from here, in Brit. Mus. 1161. *Hiero. Texts*, i, pl. 29 [right]; i², pl. iv [2], pp. 4-5; see *Guide (Sculpture)*, p. 19 [60].

Two similar blocks with four registers of people, dedicated by son Weta , from south Giza in 1892, in Cairo Mus. 1479, 1480. Texts, BORCHARDT, *Denkmäler*, i, pp. 166-7. Dedication on No. 1479, SETHE, *Urk.* i (1933), 228 [5 (145), H].

Lintel of Prophetess of Hathor Mistress-of-Dendera and Neith in all their places, etc., fragment, Dyn. IV-V, from Reisner excavation. FISCHER, *Dendera*, fig. 5, p. 24 [3] with note 98.

Block with titles, Dyn. V, possibly from here, in Brit. Mus. 992. *Hiero. Texts*, i, pl. 21 [39]; i², pl. xxv [2], p. 26; see *Guide (Sculpture)*, p. 12 [39].

Fragments with remains of offering-text and titles, probably from Petrie excavation in 1907, in Brussels, Mus. Roy. E.5267, 4605. Texts, SPELEERS, *Rec. inscr.* pp. 4 [37], 7 [47].

Thicknesses, three registers of men bringing animals, Dyn. IV(?), in Cairo Mus. 1538-9. BORCHARDT, *Denkmäler*, i, Bl. 51, pp. 242-3. No. 1538, GRIFFITH INST. photo. 305.

Three registers, men cutting out roes of fish, bringing fish, and netting fowl, formerly in von Bissing Colln., now in Munich, Staatl. Sammlung, Gl. 115. WOLTERS in *Münchner Jahrb.* (1913), Abb. 2, p. 159; Munich. *Äg. Sammlung* (1966), Abb. 22.

Three registers, boat-building, female dancers and boys at games (including one wearing mask), donkeys transporting produce, men reaping corn, and netting fish, Dyn. V, possibly from here, in Brit. Mus. 994. CAPART in *B.I.F.A.O.* xxx (1930), pp. 73-5 with pl.; *Hiero. Texts*, vi, pl. 17; i², pl. xxv [3], p. 26; WRESZ., *Atlas*, iii. 27, cf. Textabb. 95, I on p. 200; SMITH, *Hist. Eg. Sculp.* fig. 83, p. 211; DRIOTON in *L'Amour de l'Art*, xxviii, fig. on p. 200; see JONCKHEERE, *La Circoncision des anciens Égyptiens in Centaurus*, i [3] (1951), p. 234 with note 68 (called 944 in error); *Guide (Sculpture)*, p. 22 [72].

Three groups of blocks, deceased seated, butchers, with men reaping corn and binding sheaves below, and herdsmen with cattle crossing canal, Dyn. V, in Dresden, Albertinum, ZV. 1748-50. ZV. 1749-50, WRESZ., *Atlas*, i. 393-4 (called Şaqqâra), cf. iii. 38 [B]; RANKE, *The Art of Ancient Egypt*, and BREASTED, *Geschichte Aegyptens*, 194-5; PIJOÁN, *Summa Artis*, iii (1945), figs. 198-200. ZV. 1750, LARSEN, *En Egyptisk Aeventyrare*, fig. on p. 15; see *Führer* (1900), p. 219 [5-7]; (1903), p. 227 [5-7]; *Guide to the Royal Collections of Dresden* (1902), p. 239 [5-7]; HERRMANN, *Verzeichnis*, p. 11 [1-3].



Offering-bringers, Dyn. VI, probably from here, in Brit. Mus. 993. *Hiero. Texts*, i², pl. xxxiii [3], p. 35; see *Guide (Sculpture)*, p. 12 [37].

Man standing, in Cairo Mus. Ent. 19762. See HASSAN, *The Great Sphinx*, p. 305.

Head of man, formerly in Amherst Colln. See *Sotheby Sale Cat.* (AMHERST), June 13-17, 1921, No. 185.

Blocks re-used in village Nazlet el-Batrân in time of Lepsius

Drum and fragment of jamb of Isti , Steward. L. D. ii. 95 [b, d], *Text*, i, p. 127.

Block with Sethy  at [table] and wife Nefertheshathor  standing behind. L. D. *Text*, i, p. 127.

Lintel of Thenet , Overseer of dates. L. D. ii. 95 [a], *Text*, iii, p. 127.

Lintel of Thentet (woman). L. D. ii. 94 [b], *Text*, i, p. 127 (with another block).

Fragment of lintel of Inspector of scribes of the Treasury, etc. L. D. *Text*, i, p. 127 [top].

Fragment of inscribed lintel with dedication text of Weta . Id. ib. p. 127 [middle right].

New Kingdom.

Two fragments of jamb of Ramesses II, re-used in Nazlet el-Baṭrân in time of Lepsius. *L. D. Text*, i, p. 127.

Jamb of Khaemwëset (son of Ramesses II), granite, re-used in Nazlet el-Baṭrân in time of Lepsius. *Id. ib.* p. 126 [bottom].

Block with cartouches of Ramesses III, formerly in Salt Colln., now in Brit. Mus. 442. See *Guide (Sculpture)*, p. 198 [718].

Fragment of column of Ramesses IV, re-used in brick building south of Subsidiary Pyramids of Menkaurē. *Text*, MASPERO in *A.Z.* xix (1881), p. 116 [xvii b]; PETRIE in SAYCE MSS. 28 a [lower].

Saite.

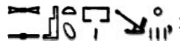
Jamb of Weḥibrē, son of Ḥapwas  and Thesēsipert  in Florence Mus. 2603. *Text*, BEREND, *Principaux monuments du Musée égyptien de Florence* (1882), p. 97; SCHIAPARELLI, *Museo archeologico di Firenze. Antichità egizie*, i (1887), pp. 378-9 [1641]; names, LIEBLEIN, *Dict. No.* 1155, cf. *Suppl.* p. 979; see MIGLIARINI, *Indication succincte des monuments égyptiens du Musée de Florence* (1859), p. 28.

Block with head of a king holding sistrum, formerly in Salt Colln., now in Brit. Mus. 595. See *Guide (Sculpture)*, p. 240 [880].



Block of Ptaḥmosi, Overseer of all work on the monuments of the King, etc., probably Saite, built into Moslem tomb in time of Lepsius. *Text*, *L. D. Text*, i, p. 126 [8].

(f) Libation-basins. Old Kingdom





Henu , Dyn. III-IV (Speleers) or later, in Brussels, Mus. Roy. E.949. *Text*, SPELEERS, *Rec. inscr.* p. 4 [38].

Intkaes , Prophetess of Ḥaṭhor, Dyn. VI, in Brit. Mus. 1175. *Hiero. Texts*, i, pl. 44 [93]; i², pl. xxxiii [4], p. 35; see *Guide (Sculpture)*, p. 28 [93].

Khertenkhenut , (woman), Dyn. VI, in Brit. Mus. 1176. *Hiero. Texts*, i, pl. 44 [94]; i², pl. xxxix [3], p. 42; BUDGE, *The Mummy* (1925), fig. on p. 433; see *Guide (Sculpture)*, p. 28 [94].



Nitankhnemti , Inspector of officials (*srw*), dedicated by Nikarē , Supervisor of officials (*srw*), with dealer at Gîza in 1907. *Text*, SETHE, *Urk.* i (1933), 165 [13 (104)].

Nubḥotp , Royal acquaintance, from 'Pyramids 1860', in Cairo Mus. 1361. See BORCHARDT, *Denkmäler*, i, p. 28.

Libation-basin dedicated by Senezemib , Judge and Keeper of Nekhen, Elder of the Hall, to parents Unnūfer  and Iadmet  and uncle Peḥernūfer , found by Covington, in Cairo Mus. 57007. KAPLONY in *Mitt. Orientforschung*, xiv (1968), Taf. 10 [17], pp. 202-3 [7].

(g) Offering-tables

Ḥepiu , probably New Kingdom, in Cairo Mus. 23074. KAMAL, *Tables d'Offrandes (Cat. Caire)*, pl. xvi [upper], p. 62.



Ḥaṭhorardais , daughter of Nesut-ḥeteptau , Dyn. XXVI, in Cairo Mus. 23039. *Id. ib.* pl. xv, p. 31.



(h) Sarcophagi

Old Kingdom.

Weta , Tenant and Secretary of the Pyramid of Menkaurē, Leather-worker, etc., late Old Kingdom, from south Giza in 1892, in Cairo Mus. 1787. BORCHARDT, *Denkmäler*, ii, Bl. 110, pp. 205-6 with plan; DONADONI ROVERI, *Sarcophagi egizi*, Tav. xxxvi [1], pp. 132-3 [B 60]; SCHMIDT, *Sarkofager*, fig. 209; text, DARESSY in *Rec. Trav.* xiv (1893), p. 165 [liv]; SETHE, *Urk.* i (1933), 22 [15]; titles, JUNKER, *Weta und das Lederkunsthandwerk* [etc.] in *Sitzungsb. Wien*, 231 [1] (1957), pp. 5-33, cf. Taf. i [a, 1-2; b, right]; DE RICCI MSS. D. 62, 33; see HASSAN, *The Great Sphinx*, p. 308 [Ent. 30189]; MASPERO, *Guide*, p. 30 [59].

Saite.

Ḥor , Treasurer of the King of Lower Egypt, Prophet, etc., son of Unnūfer and Taremtenubaste , grey granite, in Louvre, D 10 [N. 346]. Texts, WILKINSON MSS. ii. 38 verso-39; GOODWIN MSS. 31279, fol. 37-8 [14]; see BOREUX, *Guide*, i, pp. 113-14; VANDIER, *Guide*, p. 24.

Lid of sarcophagus of Ḥor , Commander-in-chief of His Majesty, etc., son of Takhou  (woman). Text, L. D. iii. 277 [a], *Text*, i, p. 126.

(i) Various. In chronological order

Bowl with name of Snefru, and another with Horus-name of Khufu, diorite, fragments, in London, Univ. Coll. 11756, 11758. PETRIE, *Scarabs and Cylinders* [etc.], pl. viii [3.9 (3), 4.2 (1)]; see id. *The Pyramids and Temples of Gizeh* (1883), p. 153 [bottom].

Plummet with name of Khufu, limestone, in London, Univ. Coll. 11761. Id. *Scarabs and Cylinders*, pl. viii [4.2 (7)].

Cylinder-seal with name of Pyramid of Khufu, basalt, in London, Univ. Coll. 11099. Id. *ib.* pl. viii [4.2 (5)].

Shrine of Igeg, limestone, Dyn. V, in Brooks Colln. *Ancient Art in American Private Collections*. The Fogg Art Mus. of Harvard University (1954), pl. ii, p. 17 [3].

Obelisk of Khuu , Overseer of interpreters, etc., Dyn. V, possibly from here, formerly in Sams Colln., now in Brit. Mus. 199. *Hiero. Texts*, i, pl. 21 [67]; i², pl. xxv [1], p. 25; see *Guide (Sculpture)*, p. 21 [67].

Statuettes¹ with execration texts, clay, Old Kingdom, found by Reisner, in Cairo Mus. Ent. 88146 A-D. See POSENER in *Mitt. Kairo*, 16 (1958), p. 252 note 3.

Jug dedicated to Amen-rē, bronze, Dyn. XVIII-XIX, formerly in Farman Colln., now in New York, M.M.A. 04.2.350. WILBOUR MSS. 2 B, 194 [bottom].

Panels from casket, four with offering-bringer (one incomplete), two with lotus (one incomplete), and one with text, ivory, probably from Saite tomb, formerly in MacGregor Colln., in Fundação Calouste Gulbenkian, Lisbon, Inv. 164. British Museum, *Ancient Egyptian Sculpture lent by C. S. Gulbenkian, Esq.* (1937), pl. xxxi, pp. 15-16; *Egyptian Sculpture from the Gulbenkian Collection* (Washington, 1949), fig. on p. 67, cf. p. 31 [25]; complete panels, CAPART, *Propos sur l'art égyptien*, fig. 89; id. *Lectures on Egyptian Art*, fig. 89; id. *L'Art ég.* iv, pl. 785; KLEBS, *Die Reliefs und Malereien des neuen Reiches*, i, Abb. 82 (from CAPART); offering-bringers, CAPART, *L'Art et la parure féminine* in *Annales de la Société d'Archéologie de Bruxelles*, xxi [3 and 4] (1907), pl. iii; offering-bringer carrying lotus-flowers, MASPERO, *Égypte*, fig. 130; BARNETT in SINGER [etc.], *A History of Technology*, i, fig. 463, p. 670; leading calf, MASPERO, *Hist. anc.* i, fig. on p. 412, cf. p. 413 note 2; one carrying

¹ See Addenda.

lotus-flowers and one with goose, CAPART, *L'Art ég.* (1911), pl. 191; *Sotheby Sale Cat.* (MACGREGOR), June 26–July 6, 1922, pl. xxi [697], p. 91; two last with lotus-panel and text, *Burlington Fine Arts Club* (1922), pl. IV; see VON BISSING in *Sphinx*, xi (1908), p. 198.

Sistrum-handle with text of Bubastis, faience, Dyn. XXVI or later, formerly in Abbott and N.Y. Hist. Soc. Collns., now in Brooklyn Mus. 37.1697E. See *N.Y.H.S. Cat.* p. 21 [315].

Vase of Nektanebos II, blue faience, in Cairo Mus. Ent. 53866. Cartouche, HASSAN, *The Great Sphinx*, p. 309.

FROM GÎZA TO ZÂWYET EL-'ARYÂN

MASTABA OF DYN. I.

Brick-built, with subsidiary burials on all four sides. Found by Barsanti, excavated by Daressy (1904).

DARESSY in *Ann. Serv.* vi (1905), pp. 99–106, with plan and section, fig. 1; PETRIE, *Gizeh and Rifeh*, pp. 2–3, with plan, pl. vi.

Jar-sealings with name of Zet. One, in Manchester Mus. 4300, id. ib. on pl. iii A. See DARESSY, op. cit. p. 103; KAPLONY, *Inscripfen*, i, p. 84 [B]; ii, notes 416–18.

PYRAMID-FIELD OF ZÂWYET EL-'ARYÂN

Plan, L. D. i. 32 (inset).

I. Pyramids

A. PYRAMID-ENCLOSURE OF NEBKA(?) (4U).

Dyn. IV. Unfinished

Valley Temple, Causeway and Mortuary Temple, if ever existed, unexcavated

PYRAMID. Lepsius, XIII; called 'Unfinished Pyramid'. Almost no superstructure.







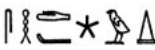

L. D. *Text*, i, p. 128, with sketch-plan; BARSANTI in *Ann. Serv.* vii (1906), pp. 260–86, with plans and sections (including red granite sarcophagus), figs. 1–10, views, pls. i–iii; viii (1907), pp. 201–7, with plans and section, figs. 11–13; xii (1912), pp. 57–9, 62, with views, pls. i–iii; MARAGIOGLIO and RINALDI, *L'Architettura*, vi, pp. 16–29, with plans and sections, on Tav. 2, 3 (including sarcophagus).

Plan and sections, REISNER, *The Development of the Egyptian Tomb* [etc.], fig. 71 (based on BARSANTI), pp. 151, 153, 357; LAUER, *Le Problème des pyramides d'Égypte*, fig. 17 (from REISNER), pp. 76–7; see id. *La Pyramide à degrés*, iii, p. 54 [3].

Views. Open trench and shaft, CAPART, *L'Art ég.* (1909), pls. 1, 2; id. *L'Art ég.* i, pls. 5, 6; id. *Memphis*, figs. 18–24, pp. 19–25; MASPERO, *Égypte*, figs. 78–9; VON BISSING, *Äg. Kunstgeschichte*, Taf. xxvi [215–18], *Text*, ii, pp. 35–6; FAKHRY, *The Pyramids*, figs. 28–9 (from CAPART and BARSANTI), pp. 53–8; LAUER in *Rev. d'Ég.* 14 (1962), pl. i, pp. 21–36, cf. fig. 2 (plan and sections from REISNER); WILKINSON MSS. xxviii. 13 verso, 14. Open trench, LAGIER, *L'Égypte monumentale et pittoresque*, pl. 4 (from CAPART); CAPART, *Propos sur l'art égyptien*, fig. 148; PEET in HAMMERTON, *Universal History of the World*, i, fig. on p. 491 [bottom] (from CAPART); LAUER, *Le Problème des pyramides d'Égypte*, pl. xii [2] facing p. 145 (from CAPART); SAMIVEL and AUDRAIN, *The Glory of Egypt*, pl. 27; PIJOÁN, *Summa Artis*, iii

APPENDIXES

C. PYRAMIDS

		<i>Lepsius</i> ¹	<i>Perring and Vyse</i> ²	<i>Reisner</i>	<i>Page</i>
ABÛ RAWĀSH					
Raʿzedef 	Dyn. IV	II			1
Subsidiary Pyramid		III			1
GĪZA					
Khufu 	Dyn. IV	IV	1	G I	13
North Subsidiary Pyramid		V	7	G I-a	16
Middle		VI	8	G I-b	16
South		VII	9	G I-c	16
Khephren 	Dyn. IV	VIII	2	G II	25
Subsidiary Pyramid				G II-a	26
Menkaurē 	Dyn. IV	IX	3	G III	33
East Subsidiary Pyramid		XII	5	G III-a	34
Middle		XI	4	G III-b	34
West		X	6	G III-c	35
ZĀWYET EL-ʿARYĀN					
Nebka(?)	Dyn. IV	XIII			312
Khaʿba (attributed)	Dyn. III	XIV			313
ABÛŠĪR					
Saḥurē 	Dyn. V	XVIII			334
Subsidiary Pyramid					335
Neuserrē 	Dyn. V	XX			338
Subsidiary Pyramid					339
Neferirkarē 	Dyn. V	XXI			340
Raʿneferef (attributed) 	Dyn. V	XXVI			340

D. NUMBERED GĪZA TOMBS AND SHAFTS

Only those in the letterpress. Main references in Roman type. Concordances with Reisner's numbers given whenever possible.

(a) *Reisner*³

West and East Fields

Numbers followed by capital letters are those of shafts

No.	Page	No.	Page	No.	Page
G 1008	52	G 1040	54	G 1157	56
G 1011	52	G 1047	55	G 1171	56
G 1012	52	G 1061	55	G 1201	57
G 1020	53	G 1062	55	G 1203	57
G 1021	53	G 1104	55	G 1204	57
G 1026	53	G 1105	55	G 1205	57
G 1029	53	G 1109	55	G 1206	57
G 1032	54	G 1111	55	G 1207	58
G 1036	54	G 1151	56	G 1208	58
G 1039	54	G 1152	56	G 1213	58

¹ Pyramid XVI is unexcavated (see p. 319), XV and XVII are the Sun-temples of Neuserrē (see p. 315) and Userkaf (see p. 324), XIX is the tomb of Ptahshepses (see p. 340).

² Numbering of the Giza pyramids.

³ All numbers G 2000 of FISCHER, *The Minor Cemetery at Giza*, should be G 3000.

No.	Page	No.	Page	No.	Page
G 1214	58	G 2150	77	G 2427	94
G 1221	59	G 2155	78, 79	G 2430	94
G 1223	59, 59	G 2156 (east of G		G 2450	95
G 1225	59	2155)	78, 79	G 2475	95
G 1226	60	G 2156 (south of G		G 2501	95
G 1227	60	2220)	80	G 3003	96
G 1231	60	G 2160	80	G 3004	96
G 1234	60	G 2175	80	G 3008	96
G 1235	61	G 2178	80	G 3015	96, 96
G 1301	61	G 2180	see G 4990	G 3020	97
G 1309	61	G 2184	80	G 3030	96
G 1313	61	G 2185	81	G 3031	97
G 1314	61	G 2188	81	G 3033	97
G 1351	62	G 2191	81, 147	G 3035	97
G 1402	64	G 2196	82	G 3050	97
G 1452+		G 2197	82	G 3071	97
1453	64	G 2200	see G 5080	G 3082	97
G 1457	64	G 2220	83	G 3086	98
G 1461	64	G 2231X	see G 2178	G 3093	98, 99
G 1501	64	G 2300	see G 5190	G 3094	97, 98
G 1607	65	G 2320	see G 5280	G 3096	99
G 1608	65	G 2332	83	G 3097	99
G 1673	65	G 2335	83	G 3098	99
G 1903	65	G 2336	83	G 3099	99
G 2000	66	G 2337	83, 161	G 4000	122
G 2001	66	G 2340	see G 5480	G 4121	123
G 2002	67	G 2342	see G 5520	G 4140	124
G 2004	67	G 2347	84	G 4150	124
G 2009	67	G 2347a	84	G 4160	124
G 2011	67	G 2350	see G 5290	G 4240	125
G 2015	120	G 2352	84	G 4241	125
G 2015b	120	G 2353	84	G 4260	125
G 2021	67	G 2357X	84	G 4311	126
G 2032	68	G 2359	84	G 4340	126
G 2033	68	G 2361	84	G 4350	126
G 2035	68	G 2362	84	G 4351	126
G 2036	68	G 2366	85	G 4360	127
G 2037	68	G 2370	24, 85, 91,	G 4410	127
G 2037b	68		157	G 4411	127
G 2041	68	G 2371	83	G 4420	128
G 2061	69	G 2372	87	G 4430	128
G 2070	69	G 2373	87	G 4440	128
G 2088	69	G 2374	87	G 4442	129
G 2089	69	G 2375	87	G 4461	129
G 2091	69	G 2375a	87	G 4513	129
G 2092+		G 2378	87, 92	G 4520	129, 130
2093	70	G 2379	89	G 4522	130
G 2097	70	G 2381	89	G 4530	130
G 2099	70	G 2381A	91	G 4540	130
G 2100-I-annexe		G 2381Y	92	G 4560	131, 135
71		G 2382A	24, 89	G 4561	131
G 2100-II-annexe		G 2384	92	G 4611	133
see G 2101		G 2385	89, 92	G 4620	130, 133
G 2101	72	G 2385A	87	G 4630	133
G 2110	72	G 2387	92	G 4631	134
G 2113	74	G 2391	12, 92	G 4640	134
G 2120	74	G 2407	92	G 4646	134
G 2130	74	G 2415	93	G 4650	134
G 2132	75	G 2418	93	G 4651	135, 153
G 2135	75	G 2420	93	G 4660	135
G 2136	76	G 2422	94	G 4710	135
G 2140	77	G 2423	94	G 4712	136

No.	Page	No.	Page	No.	Page
G 4714	136	G 5370	161	G 7391	193
G 4715	136	G 5411+		G 7410+	
G 4720	136	5412	24	7420	194
G 4721	136	G 5470	162	G 7411	195
G 4733	136	G 5480	163	G 7422A	24
G 4734A	137	G 5482	164	G 7430+	
G 4750	137	G 5520	164	7440	195
G 4761	137	G 5550	165	G 7450	195
G 4770	see G 2135	G 5552	see G 2359	G 7491	195
G 4811+		G 5560	166	G 7510	196
4812	137, 138	G 5561	see G 2381Y and G 2357X	G 7521O	199
G 4813	138, 156	G 5562	see G 2347	G 7524	197
G 4817	139	G 5564A	see G 2347aC	G 7530+	
G 4830	157	G 5564C	see G 2347aE	7540	197
G 4832	139	G 6010	169	G 7550	200
G 4833B	24	G 6012	170	G 7560	200
G 4840	137, 139	G 6014	170	G 7632	200
G 4860	141	G 6020	170	G 7650	200
G 4870	see G 2155	G 6030	174	G 7652	201
G 4911	141	G 6037	174	G 7660	201, 201
G 4920	141	G 6040	175	G 7663	202
G 4940	142	G 6042	175	G 7671	202
G 4941	143	G 7000X	179	G 7690	202
G 4960	143	G 7050	24, 182	G 7711a	202
G 4970	143	G 7060	183	G 7715	203
G 4990	148	G 7070	183	G 7721	203
G 5020-annexe		G 7101	184	G 7750	203
125		G 7102	12, 185	G 7753	203
G 5030	145	G 7110+		G 7757	203
G 5032	145	7120	12, 187	G 7760	203
G 5040	145	G 7112	188	G 7772	204
G 5080	79, 146	G 7130+		G 7788	204
G 5110	24, 35, 148	7140	12, 188	G 7792	204
G 5150	144, 149	G 7142	190	G 7803	204
G 5170	153, 153	G 7150	190	G 7809	204
G 5190	155	G 7152	191	G 7810	204
G 5210	155	G 7210+		G 7814	205
G 5221	155	7220	24, 24, 191	G 7815	205
G 5223A	24	G 7211	191	G 7820	205
G 5230	24, 35, 155	G 7230	24	G 7821	205
G 5232	157	G 7244-6	192	G 7822	205
G 5245	157	G 7248	192	G 7836	206
G 5270	158	G 7249	192	G 7837+	
G 5280	158	G 7330+		7843	206
G 5290	158	7340	192	G 7851	206
G 5330	24, 159	G 7350	193	G 7911	206
G 5332	23, 159			G 7946	207
G 5340	150, 159			G 7948	207
G 5350	160				

Cemetery G I S

Reisner No.	Junker No.	Page
G I S	I	24, 216
G II S	III	20, 24, 218
G III S	IV	219
G IV S		219
G VI S	VII	220
G VII S	VIII	220
G VIII S	IX	221
G IX S	X	222

Menkauré Cemetery

No.	Page
MQ 1	293
MQ 2	294
MQ 3	294

(b) *Lepsius*¹

No.	Page	No.	Page	No.	Page
LG 10	229	LG 41	see G 5330	LG 73	211
LG 11	229	LG 43	see G 5210	LG 74	211
LG 12	229	LG 44	see G 5110	LG 75	see G 7948
LG 13	229	LG 45	see G 4940	LG 76	212
LG 15	see G 6010	LG 46	see G 5030	LG 77	212
LG 16	see G 6020	LG 47	see G 4920	LG 78	212
LG 17	see G 6030	LG 48	see G 4714	LG 79	212
LG 18	see G 6040	LG 49	see G 4710	LG 80	213
LG 19	47, 48	LG 50	see G 4611	LG 81	289
LG 20-21	48, 48	LG 51	see G 4411	LG 83	289
LG 22	see D. 80/80A	LG 52	see G IV S	LG 84	290
LG 23	see G 2000	LG 53	223, 227	LG 86	230
LG 24	see G 2100-I-annexe	LG 54	227	LG 87	232
LG 25	see G 2430	LG 55	223	LG 88	233
LG 26	see G 2378	LG 56	see G 7070	LG 89	233
LG 27	see G 2370	LG 57	see G 7060	LG 90	235
LG 28	see G 5520	LG 58	see G 7550	LG 91	236
LG 29	see G 5480	LG 59	see G 7660	LG 92	237
LG 30 ²	168	LG 60	see G 7760	LG 93	293
LG 31	see G 5370	LG 61	see G 7430	LG 94	242
LG 32	see G 5470	LG 63	208	LG 95	254
LG 33	163	LG 64	209	LG 96	260
LG 35	see G 5560	LG 65	209	LG 97	291
LG 36	see G 5150	LG 66	210	LG 98	276
LG 37	see G 5340 ³	LG 67	210	LG 99	258
LG 38	164	LG 68	210	LG 100	239, 288
LG 39	see G 5332 (probably)	LG 69	211	LG 101	296 note 1
LG 40	see G 5230	LG 70	211	LG 102	296 note 1
		LG 71	211		
		LG 72	211		

(c) *Junker*⁴

No.	Page	No.	Page	No.	Page
S 9 (shaft)	217	S 638 (shaft)	168	S 820 (shaft)	160
S 39/40	217	S 639 (shaft)	168	S 833 (shaft)	149
S 42 (shaft)	217	S 660/661	see LG 33	S 846/847	see G 5350
S 46 (shaft)	217	S 670 (shaft)	167	S 890 (shaft)	161
S 66 (shaft)	218	S 676/707	162	S 984	139
S 94/160	219	S 677/817 (with shafts S 735, 738a, 817)	162	S 2047 (shaft)	129
S 108 (shaft)	220	S 679/705	163	S 2065 (shaft)	137
S 125/157	220	S 687 (shaft)	167	S 2147 (shaft)	145
S 127/129	219	S 693 (shaft)	167	S 2411	120
S 139 (shaft)	220	S 696/703	161	S 2503 (shaft)	104
S 344/346	152	S 700 (shaft)	168	S 2530/2531	107, 107
S 345 (shaft)	152	S 703 (shaft)	see S 696/703	S 4031/4033	108
S 353 (shaft)	153	S 735 (shaft)	see S 677/817	S 4040	108
S 359	152	S 738a (shaft)	see S 677/817	S 4233/4283	105
S 466/467	152	S 796 (shaft)	159	S 4248/4321	104
S 492 (shaft)	163	S 817	see S 677/817	S 4390/4507	100
S 576	154			S 4419	105
S 590 (shaft)	164				

¹ For LG 1-9, see Pyramids IV-XII of Lepsius, Appendix C. Tombs LG 14, 34, 42, 62, 82, 85, 103-6 have been omitted.

² Annexe of tomb of Menhebu.

³ On plan L.D.i.14 both G 5340 and 5350.

⁴ For some tombs of Cemetery G I S see *supra*, Section (a).

APPENDIXES

No.

In	<i>see</i> G 4160
Is	<i>see</i> G 4150
IIn	<i>see</i> G 4260
IIIn	<i>see</i> G 4360
IIIs	<i>see</i> G 4350
Vn	<i>see</i> G 4560
VIIs	<i>see</i> G 4650
VIIIs	<i>see</i> G 4750
VIIInn	<i>see</i> G 2135
VIIIIn	<i>see</i> G 4860
VIIIss	<i>see</i> G 4840

(d) Steindorff

<i>No.</i>	<i>Page</i>	<i>No.</i>	<i>Page</i>	<i>No.</i>	<i>Page</i>
D. 1	109	D. 39/40	111	D. 111	114
D. 4	109	D. 42	112	D. 116	114
D. 9	109	D. 44	112	D. 117	114
D. 12	109	D. 51	112	D. 200	115
D. 14	109	D. 56	113	D. 201	115
D. 15	109	D. 59	113	D. 202	116
D. 15 B	109	D. 60	<i>see</i> G 4000	D. 203	116
D. 16	23	D. 61	113	D. 204	116
D. 19	109	D. 70	113	D. 205	116
D. 20	109	D. 80/80A	113	D. 207	116
D. 23	110	D. 82	113	D. 208	116
D. 29	110	D. 83	113	D. 211	116
D. 30	110	D. 84	113	D. 213	117
D. 32	110	D. 100	114	D. 215	117
D. 37	109, 111	D. 106	114	D. 220	117
D. 38	111	D. 110	114	D. 221	117

(e) Hassan

East Field		Central Field	
<i>Tomb No.</i>	<i>Page</i>	<i>Tomb</i>	<i>Page</i>
4	214	C	278
9	215	E	261
11	45, 215	F	260
		G	260
		H	257
		I	256

Shafts

<i>No.</i>	<i>Page</i>	<i>No.</i>	<i>Page</i>	<i>No.</i>	<i>Page</i>
35	268, 269, 271	322	267, 269	973	255, 255
36	271	350	292	1003	276
89	293	366 bis	281	1379	250
130	268	374	282, 282	1546	241
145	268, 268, 270	492	286	1644	240
151	268, 268, 270	538	280	1695	252
162	264	626	258	3099	292
213	264	637	258	4092	293
294	264, 268	790	233		
294 bis	265	856	262		

(f) *Abu-Bakr*

<i>Tomb</i>	<i>Page</i>
C	62
H	63

(g) *Various*

	<i>Page</i>
Campbell's Tomb	<i>see</i> LG 84
Covington's Tomb	294
Daughter of Khephren, Mastaba of	239
Funerary Priests of Senzemib Family, Tomb of	<i>see</i> G 2391
Galarza Tomb	273
Hammed es-Samaan, Tomb of	<i>see</i> LG 90
'Mother (?) of Khephren', Tomb of the, <i>see</i> Galarza Tomb	
North-eastern Mastaba	<i>see</i> G 2385
Numbers, Tomb of	<i>see</i> G 7948
Palm-tree Beams, Tomb of	<i>see</i> LG 12
Temple of Osiris	291
Three pillars, Tomb with	210
Trades, Tomb of	<i>see</i> G 6020

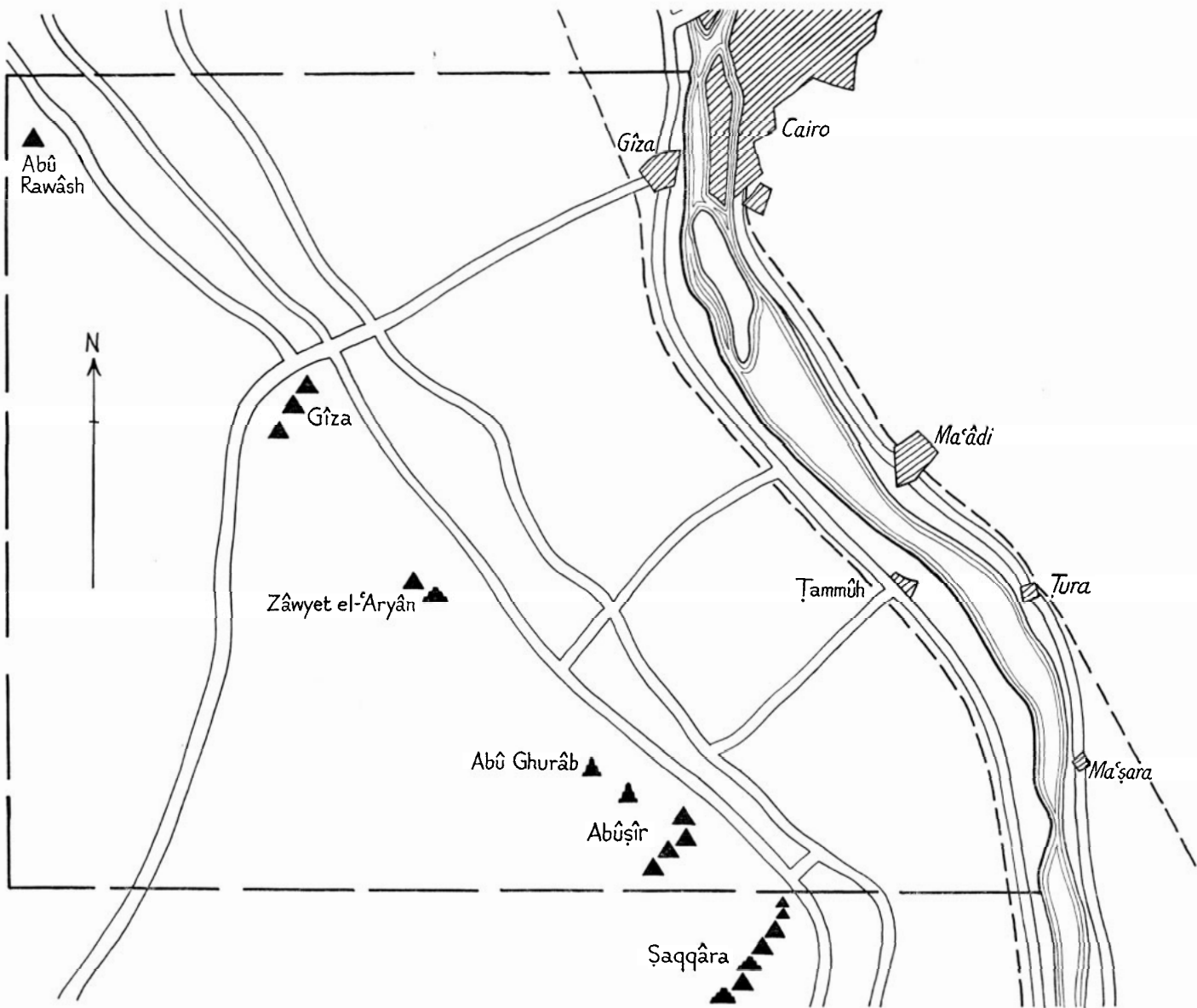

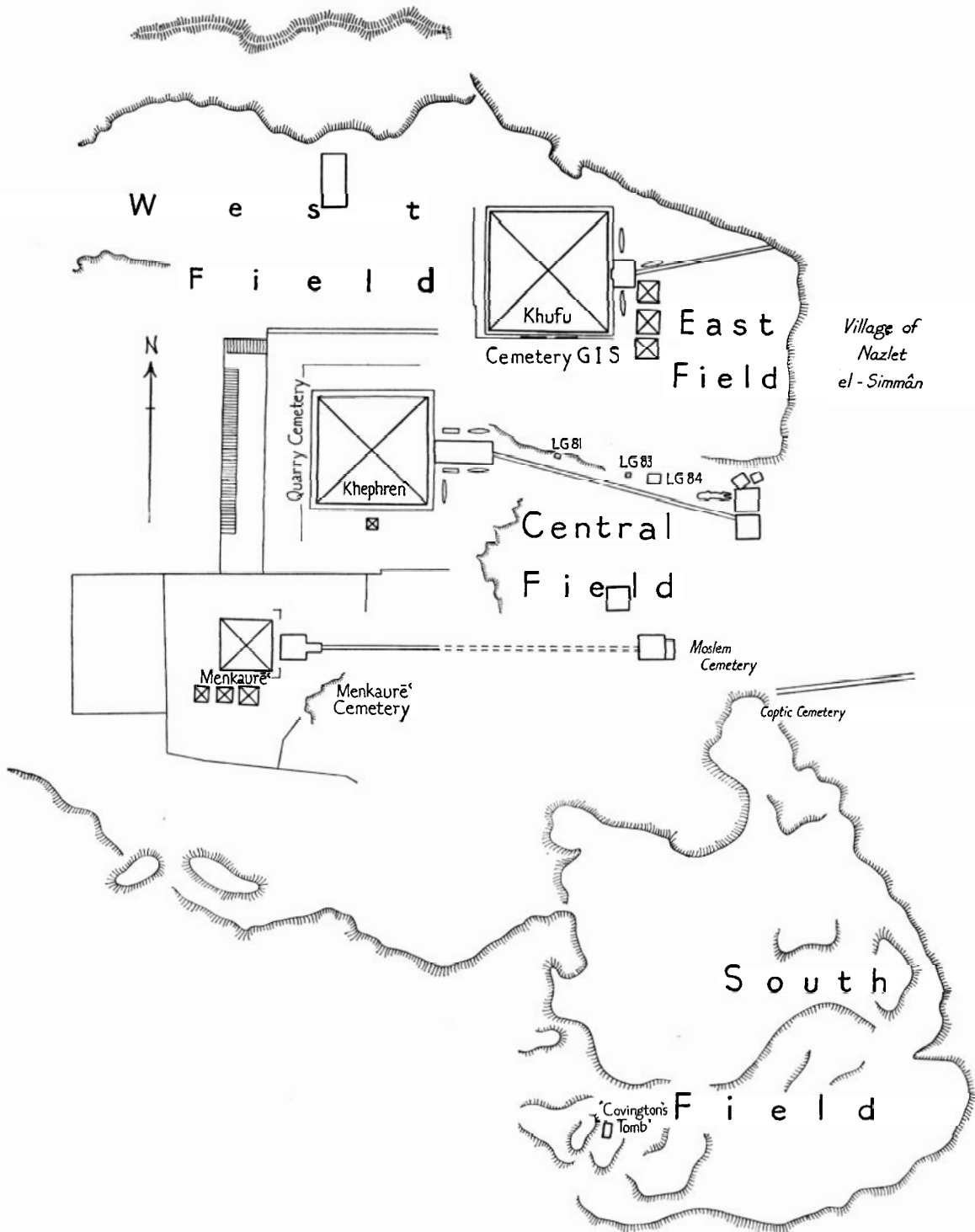

III. Giza. General plan. See p. 10.

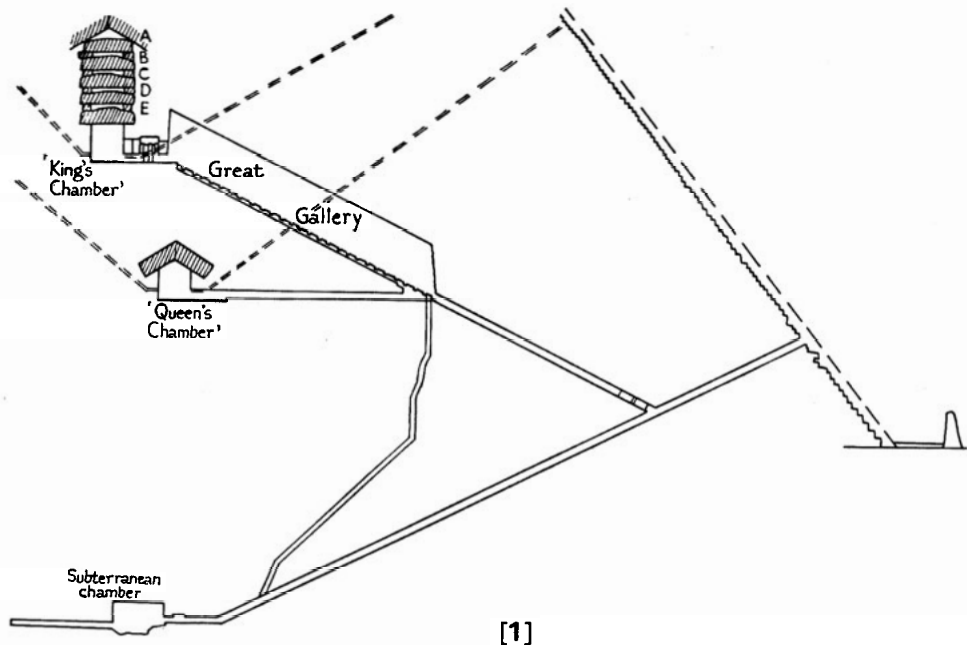

[1]

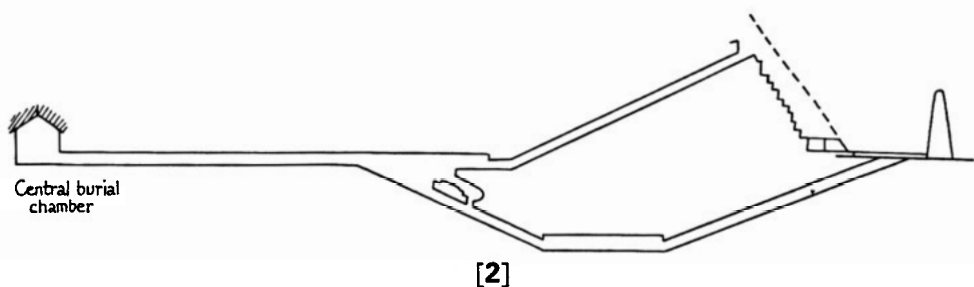

[2]

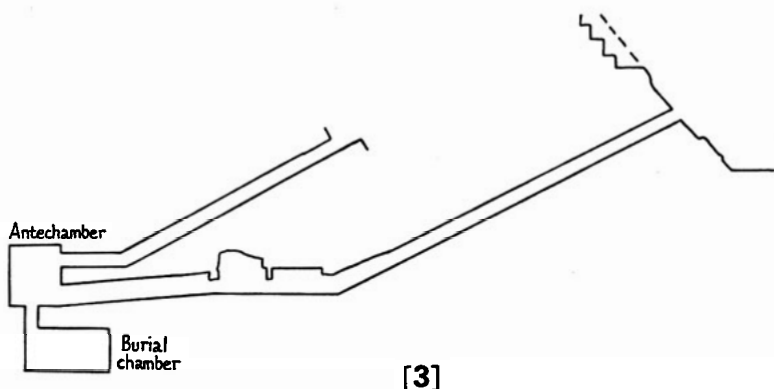

[3]

IV. Giza. Sections (north-south) of Pyramids.

1. Khufu. *See p. 13.*
2. Khephren. *See p. 26.*
3. Menkaure^c. *See p. 33.*

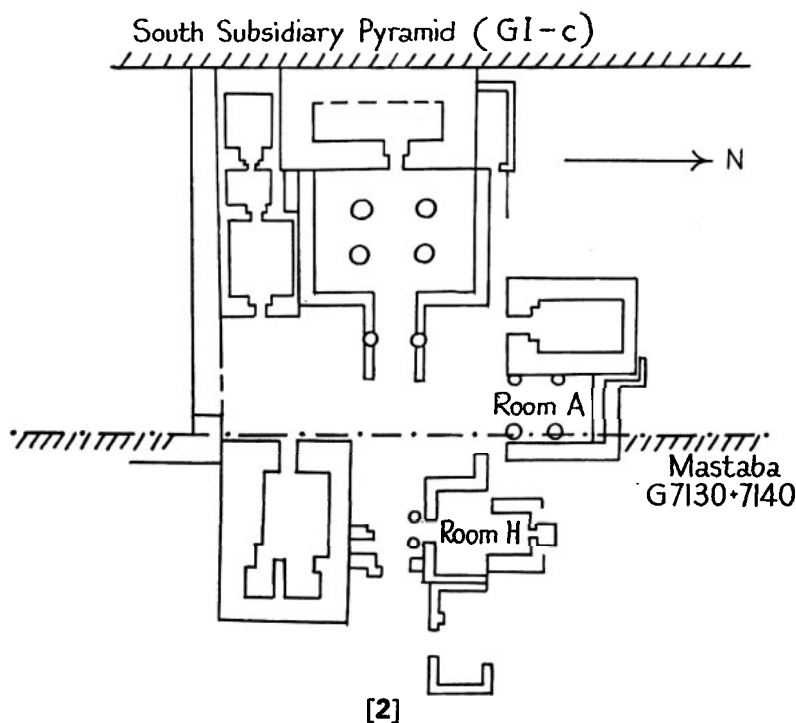
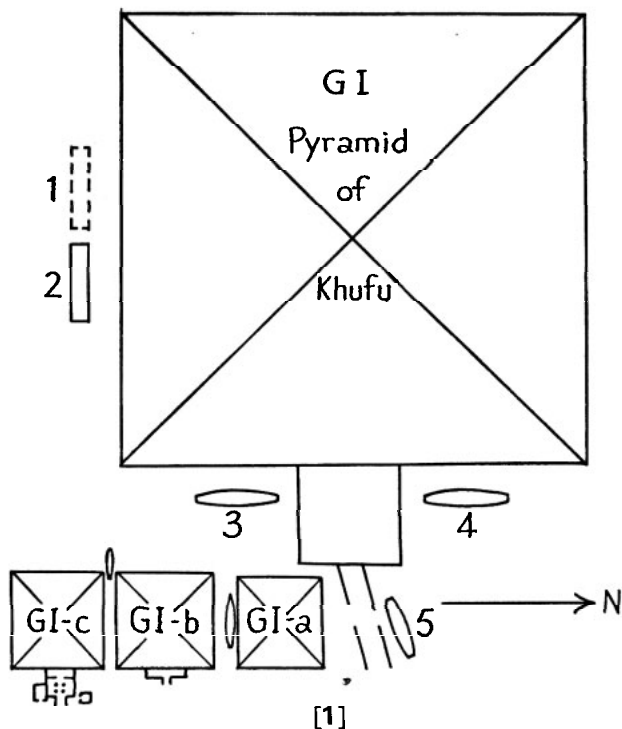

V. Giza.

1. Subsidiary Pyramids and Boat-pits of Khufu. See plan III, p. 14.
2. Temple of Isis Mistress-of-the-Pyramid. See plan XVIII, p. 17.

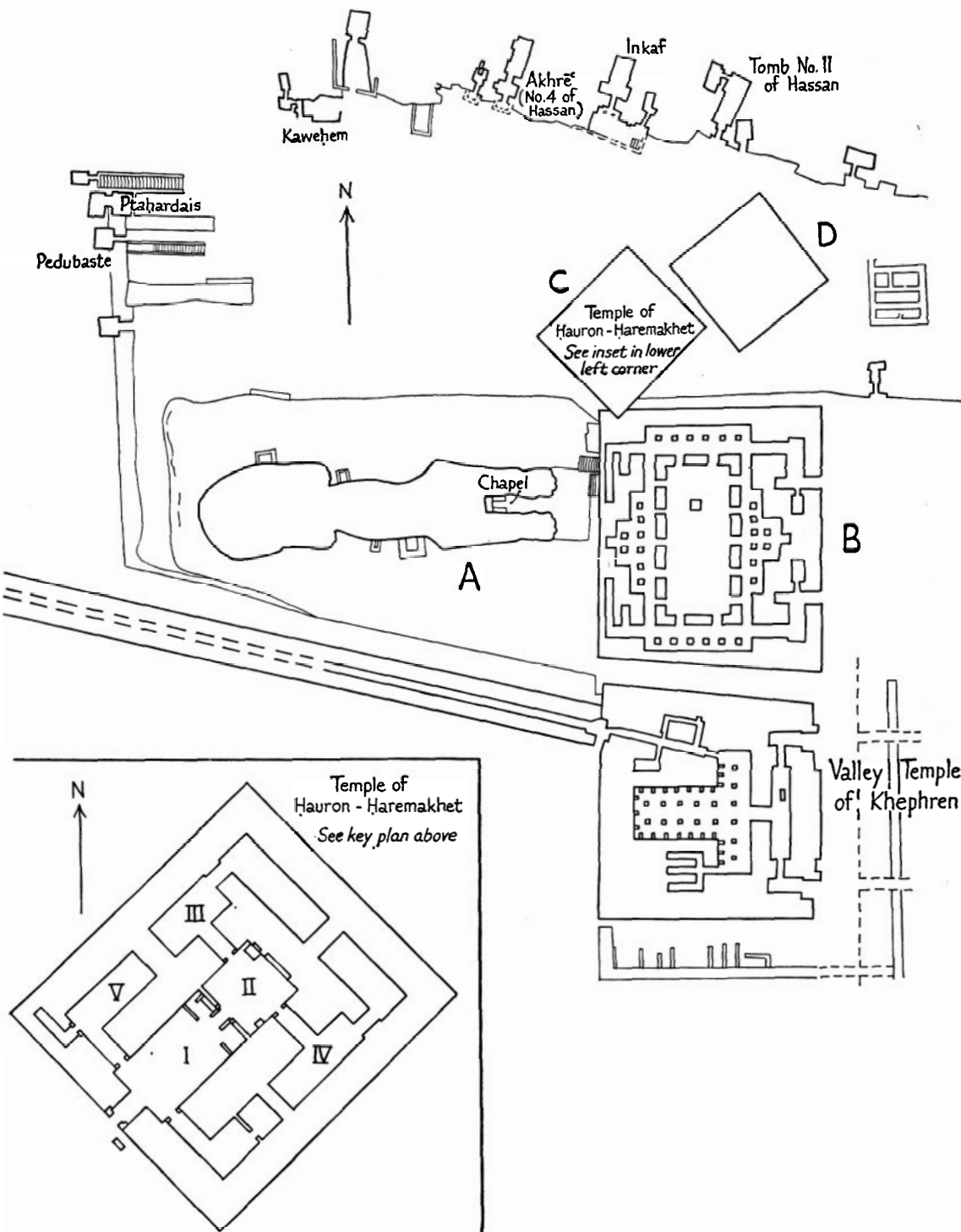

VI. Giza. Great Sphinx and surrounding area, including tombs north of Great Sphinx and Saite tombs.
See plan III, pp. 35, 214 and 291.

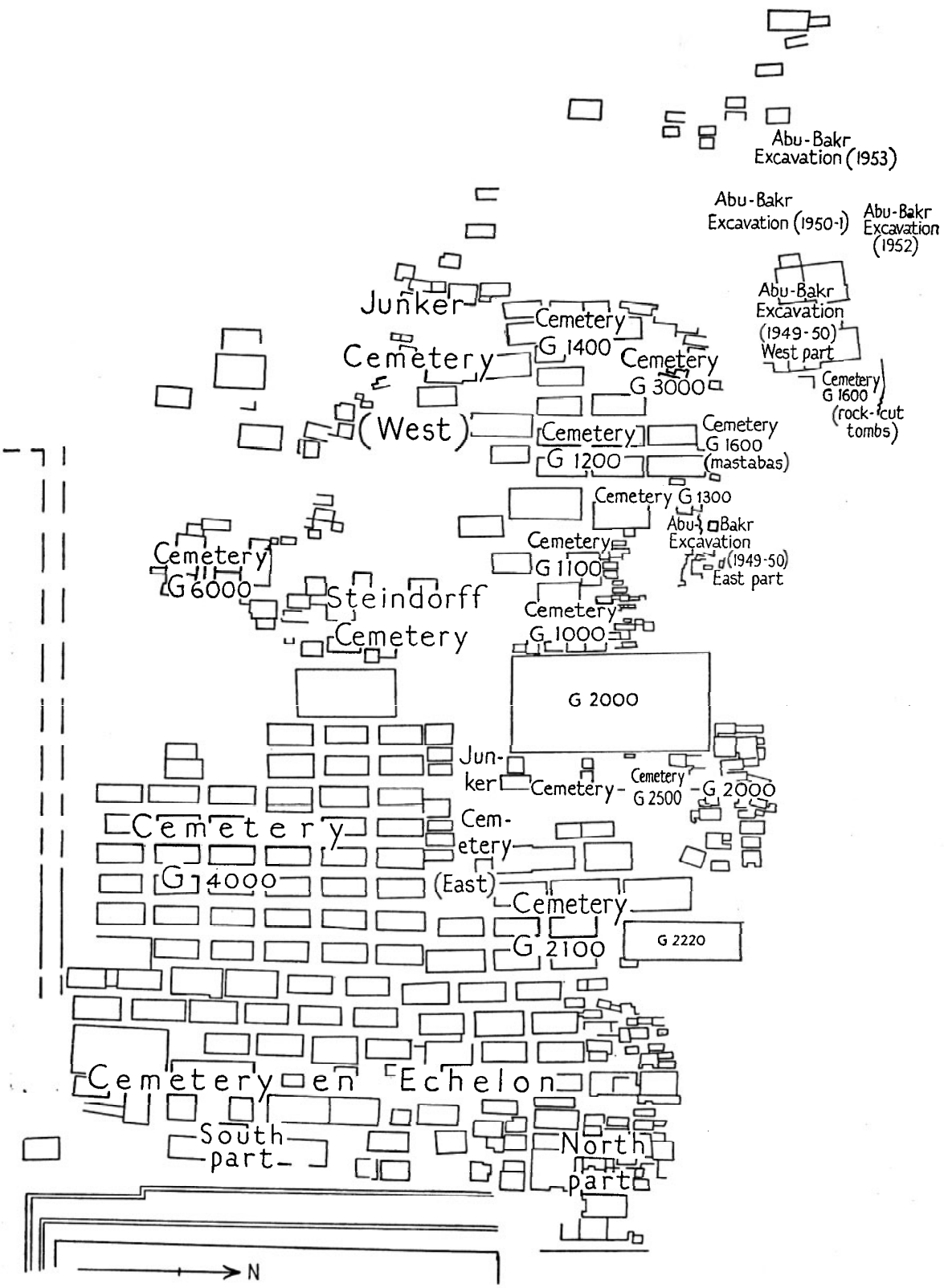

VII. Giza. West Field. General plan. See plan III and key plan VIII, p. 47.

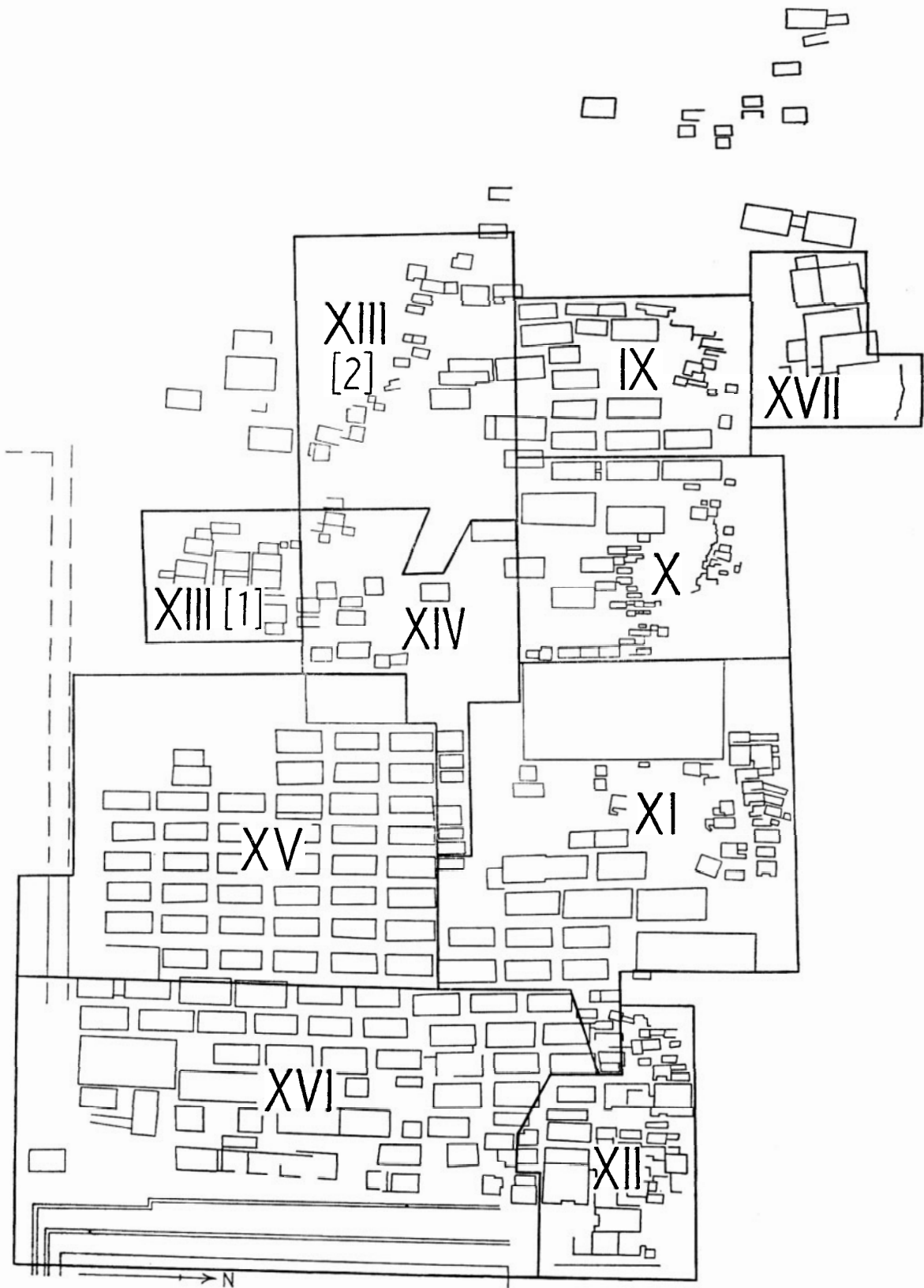

VIII. Giza. West Field. Key plan. See general plan VII. Numbers are those of detailed plans of cemeteries.

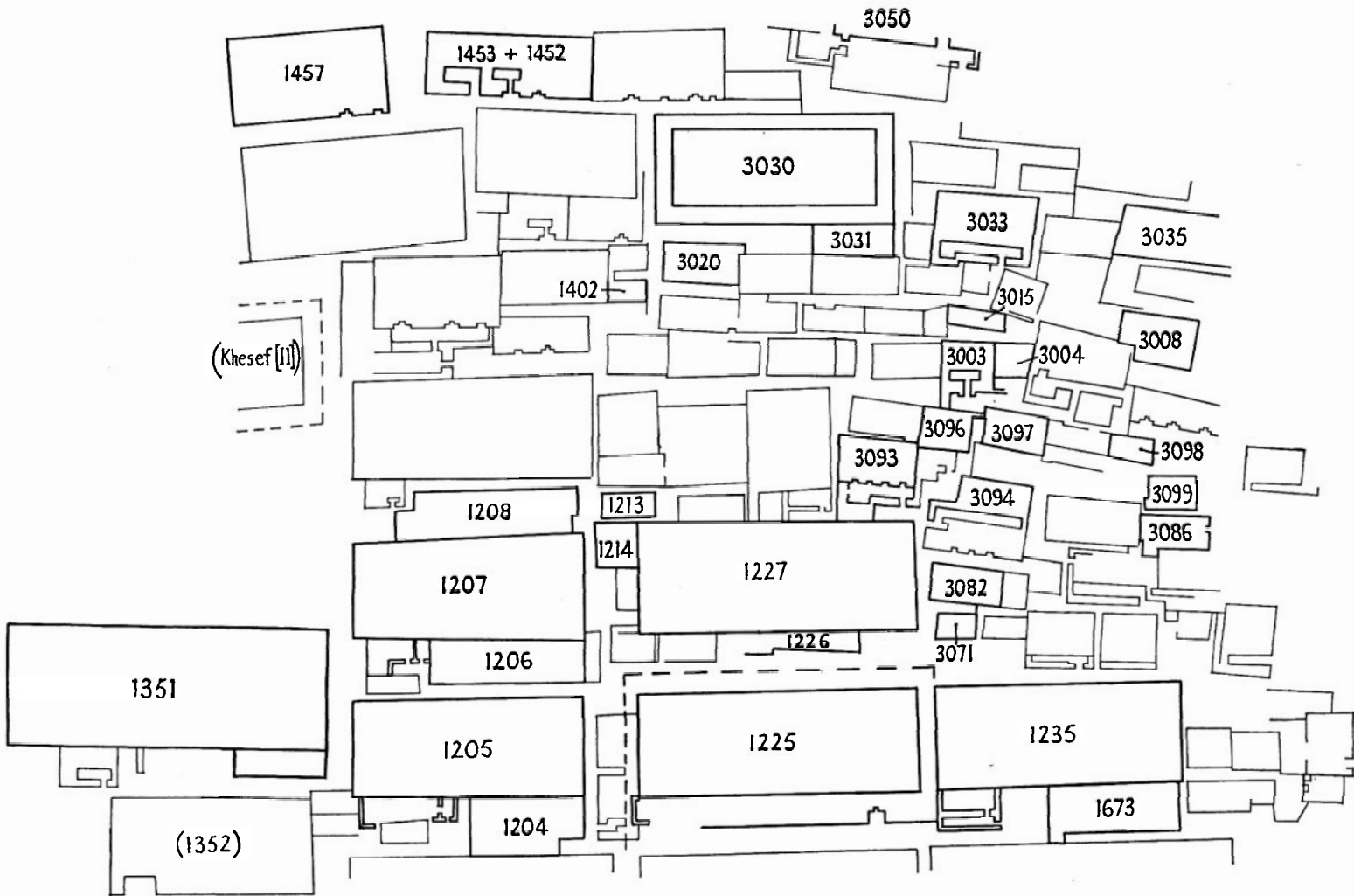

IX. Giza. Cemeteries G 1200, 1400, 3000, and mastabas of Cemetery G 1600.
See plan VII, pp. 56, 64, 95, and 65.

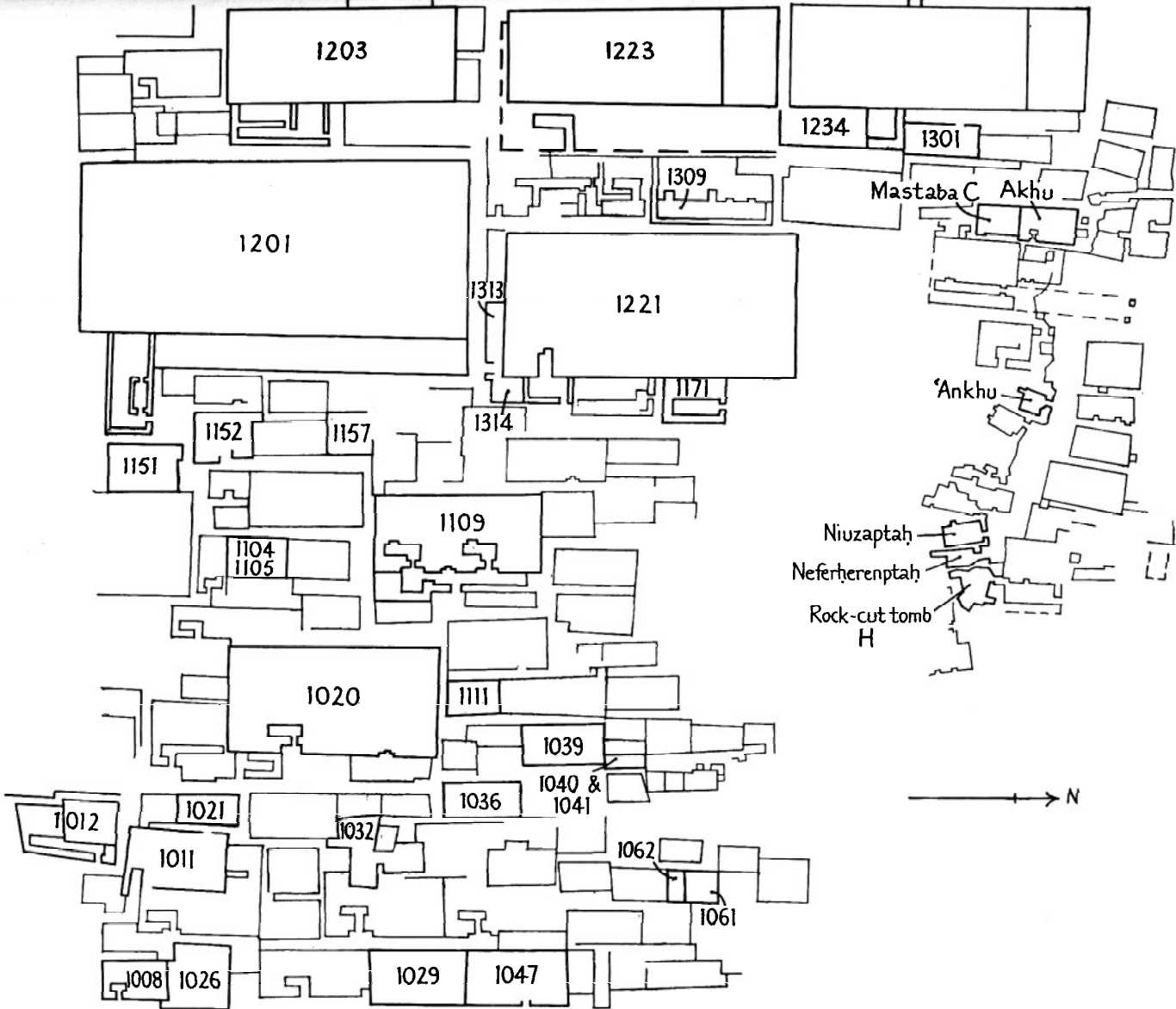

(2000)

X. Giza. Cemeteries G 1000, 1100, 1200 and 1300, and east part of Abu-Bakr Excavation (1949-50).
See plan VII, pp. 52, 55, 56, 61 and 62.

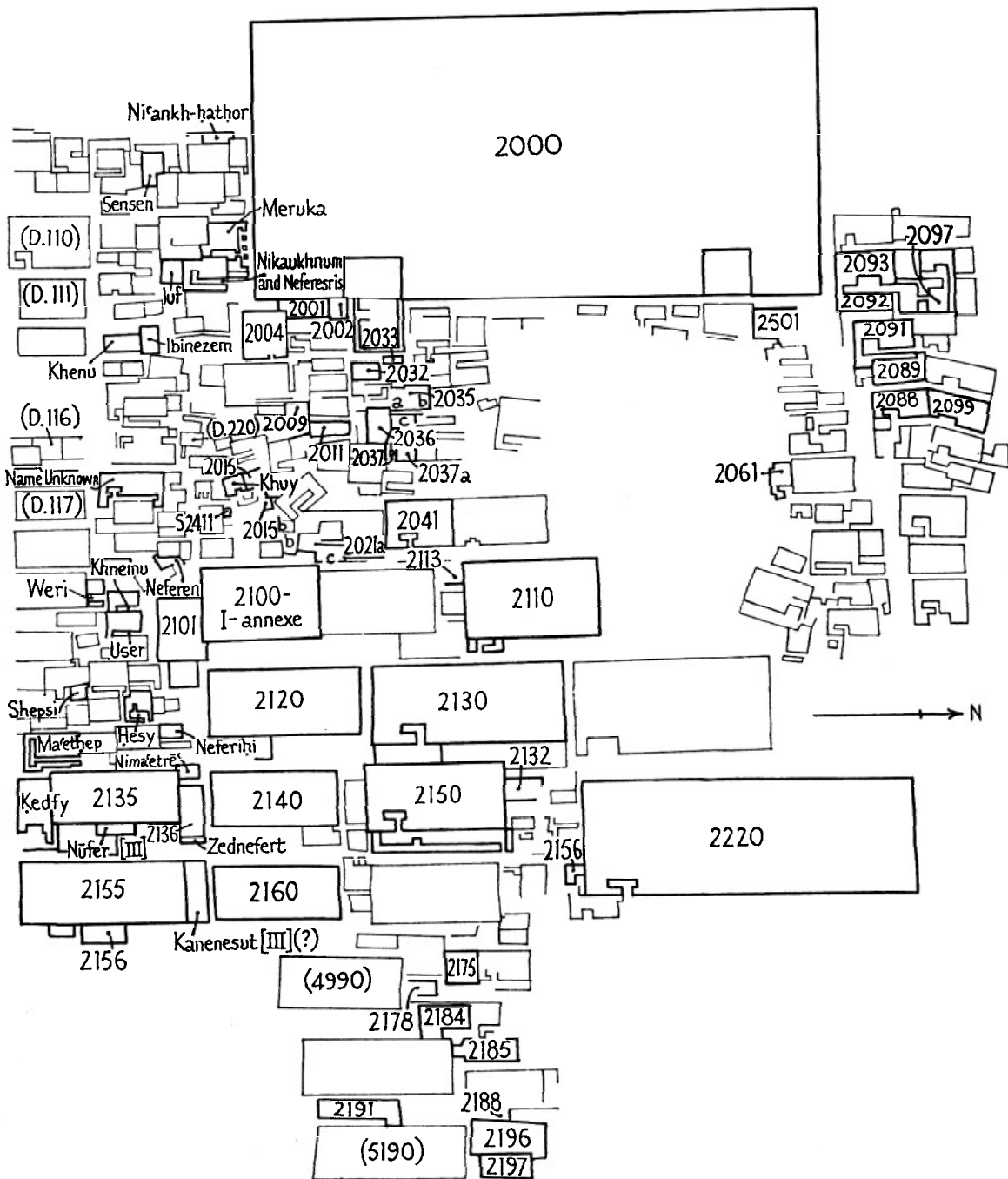

XI. Giza. Cemeteries G 2000, 2100 and 2500, and Junker Cemetery (East).
 See plan VII, pp. 66, 70, 95, and 118.

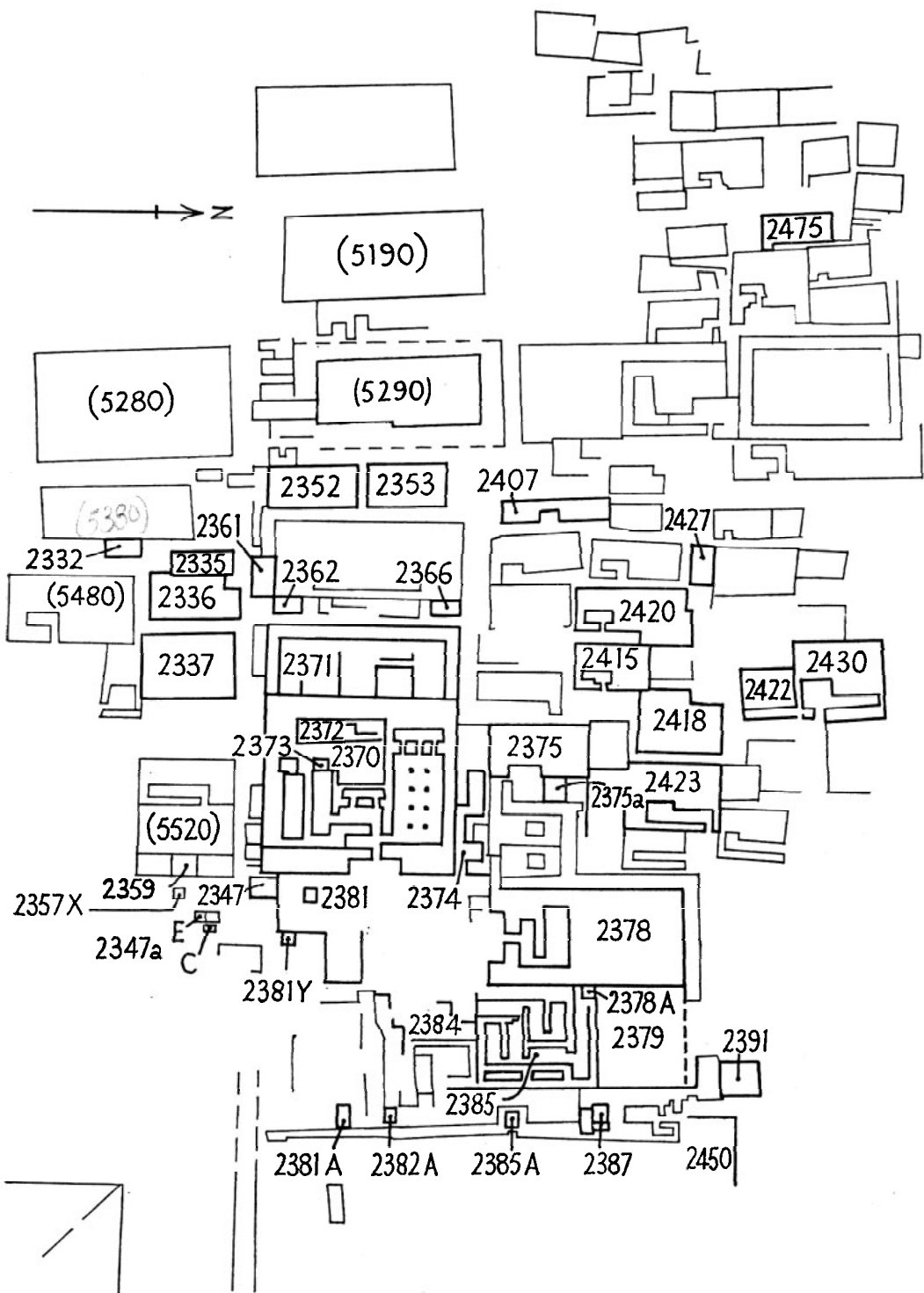

XII. Giza. Cemetery en Echelon, north part. See plan VII, p. 83.

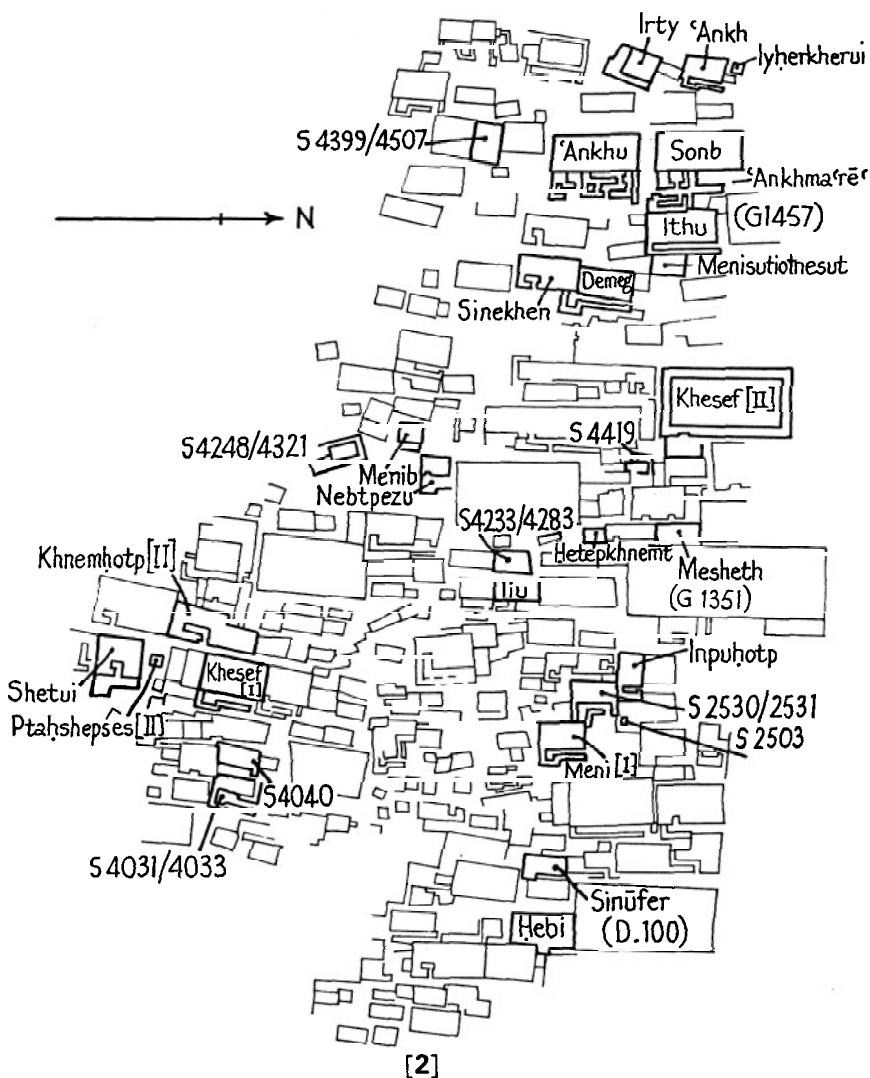
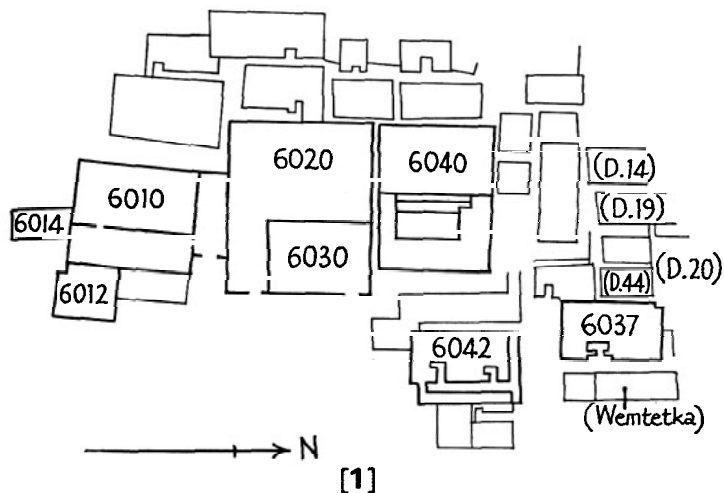

XIII. Giza.

1. Cemetery G 6000. See plan VII, p. 168.

2. Junker Cemetery (West). See plan VII, p. 100.

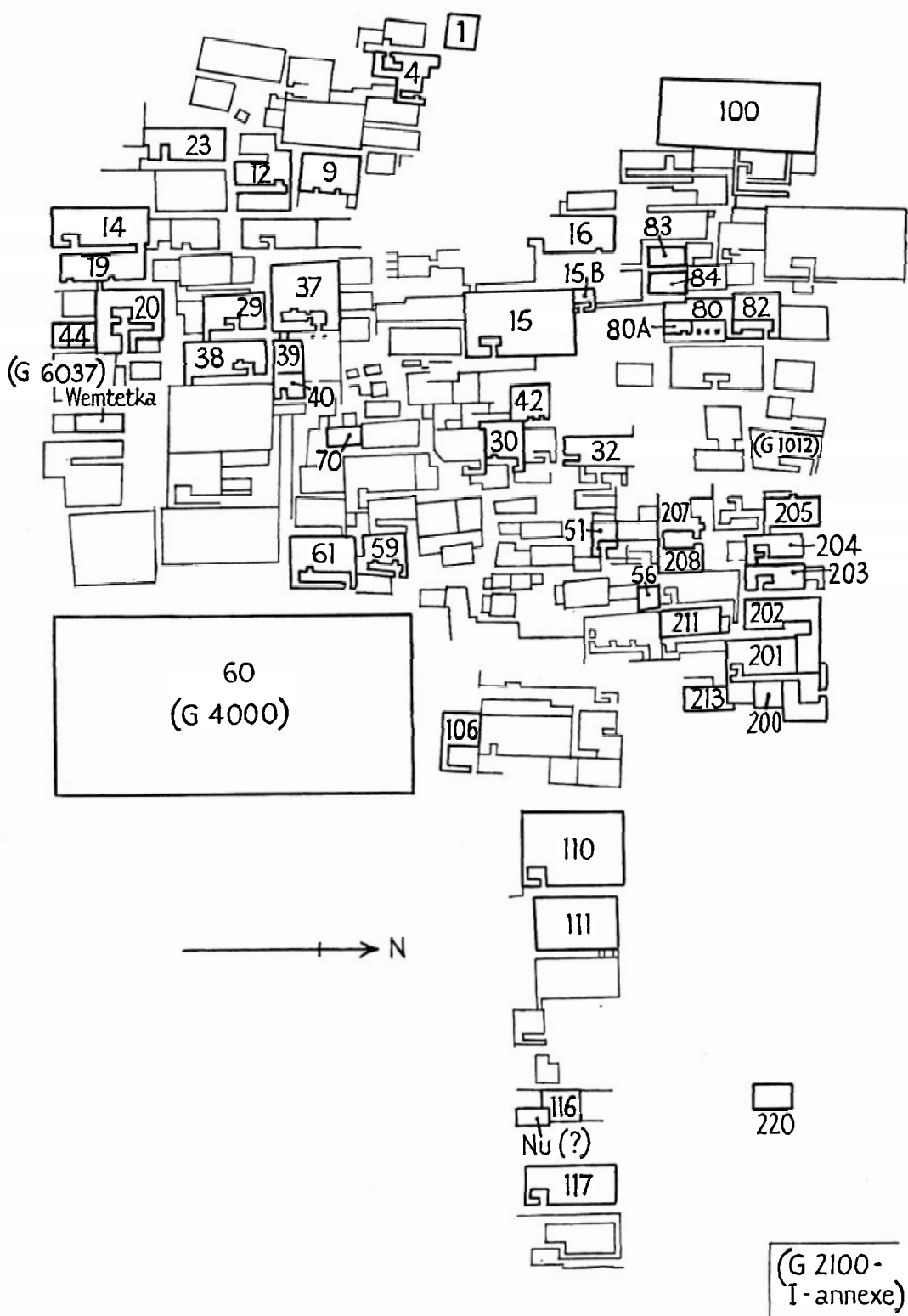

XIV. Giza. Steindorff Cemetery. See plan VII, p. 108. All tomb numbers are preceded by D.

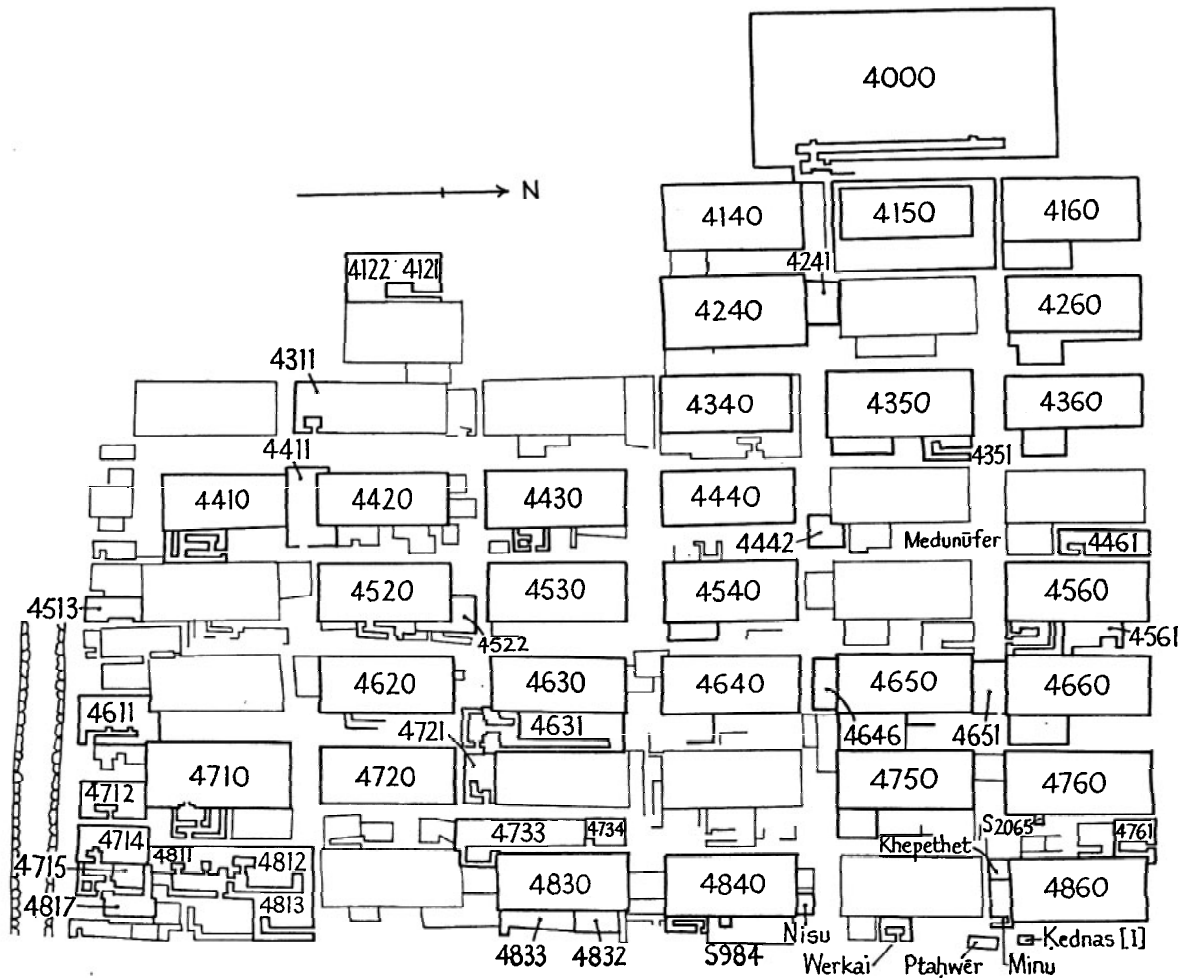

XV. Giza. Cemetery G 4000. See plan VII, p. 122.

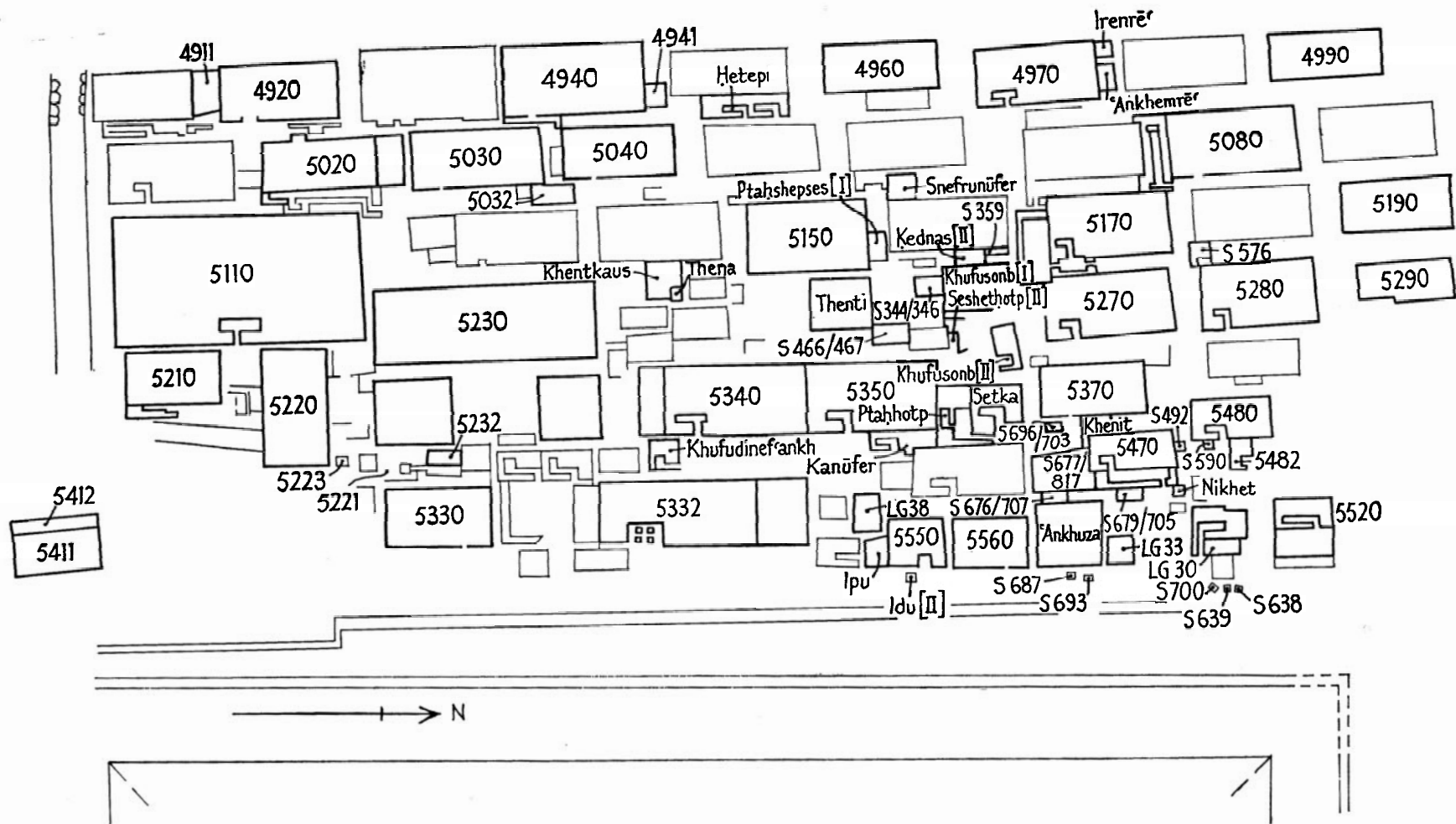

XVI. Giza. Cemetery en Echelon, south part. See plan VII, p. 141.

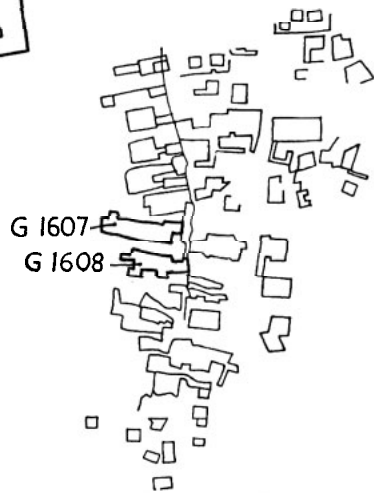
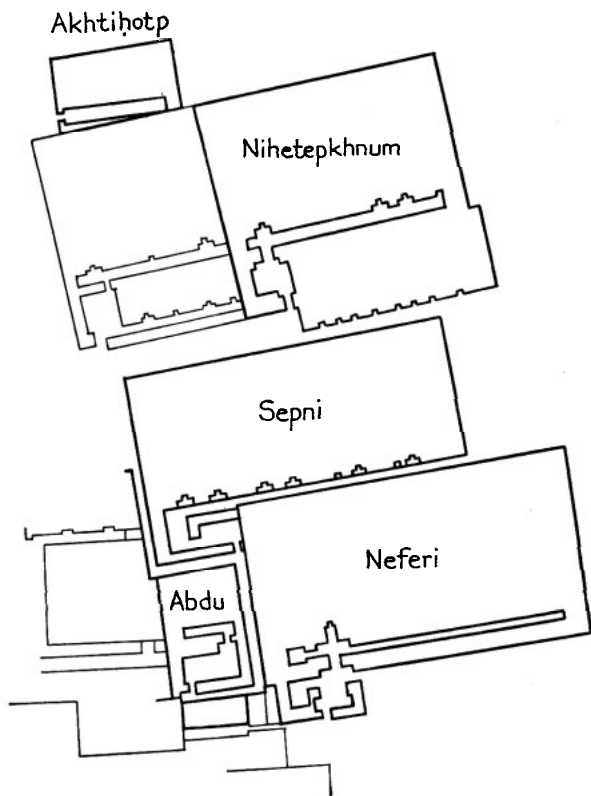
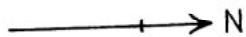
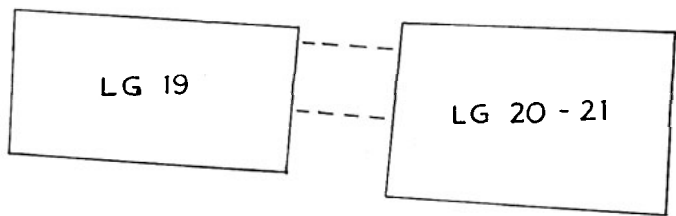

XVII. Giza. West part of Abu-Bakr Excavation (1949-50) and rock-cut tombs of Cemetery G 1600.
See plan VII, pp. 49 and 65.

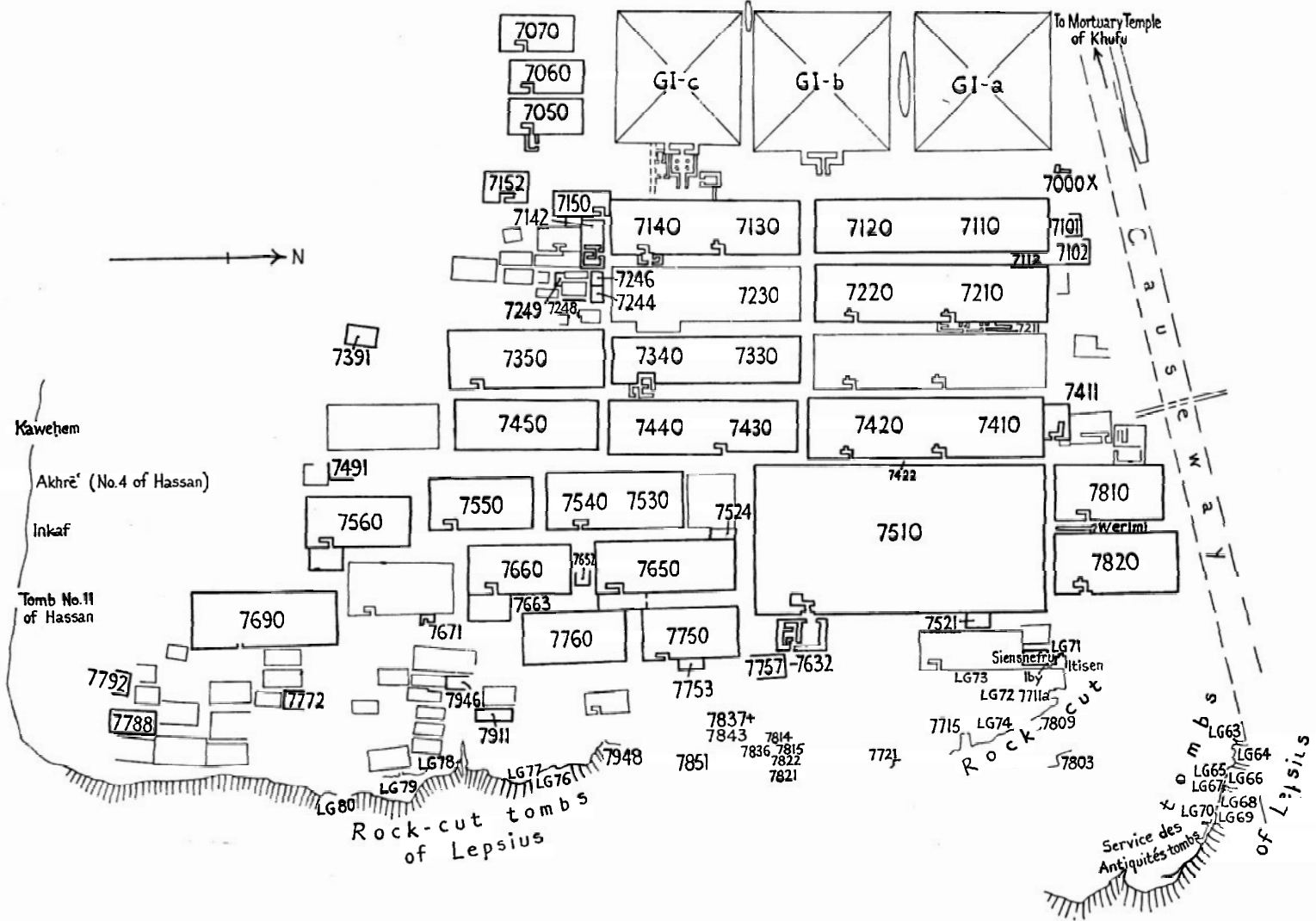

XVIII. Giza. East Field. See plan III, p. 179.

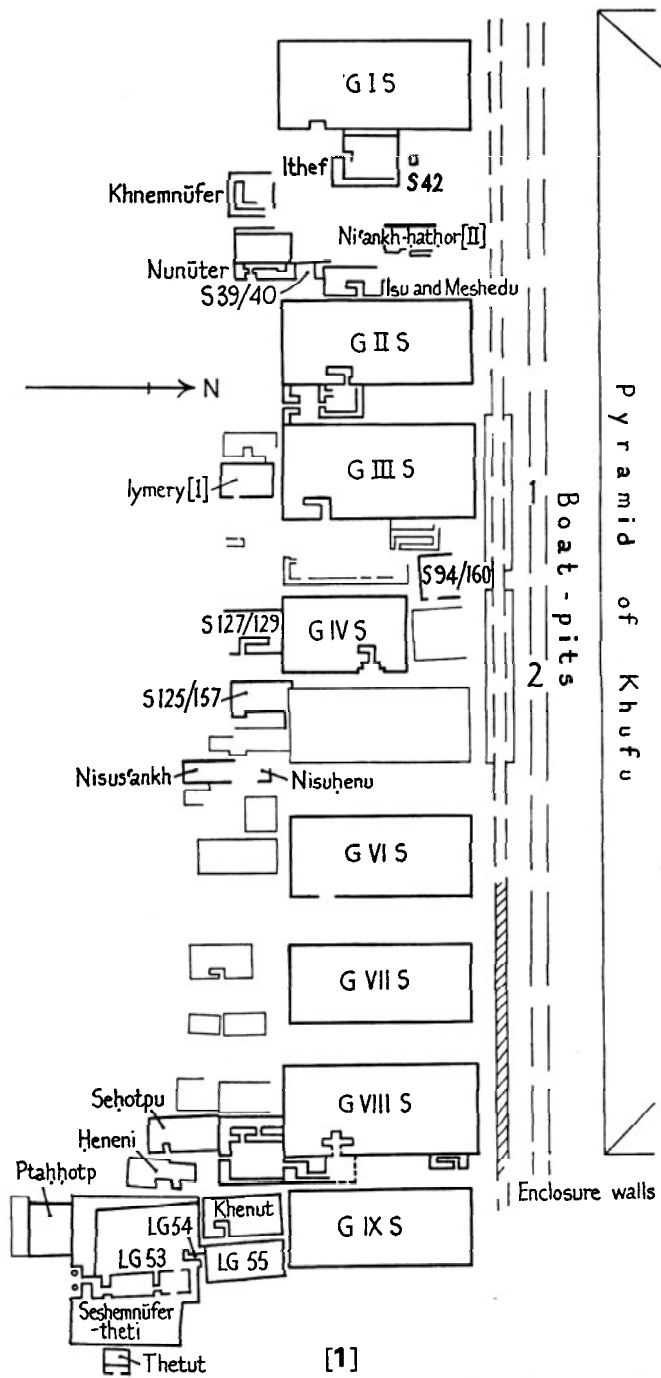

[1]

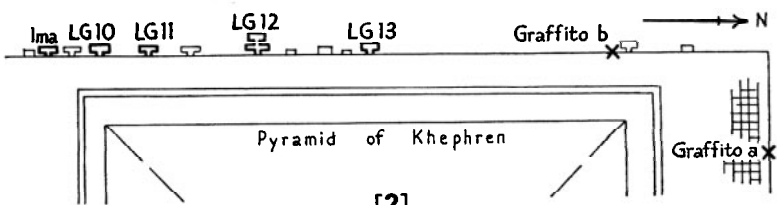

[2]

XIX. Giza.

1. Cemetery G I S. See plan III, p. 216.

2. Quarry Cemetery west of Second Pyramid. See plan III, p. 228.

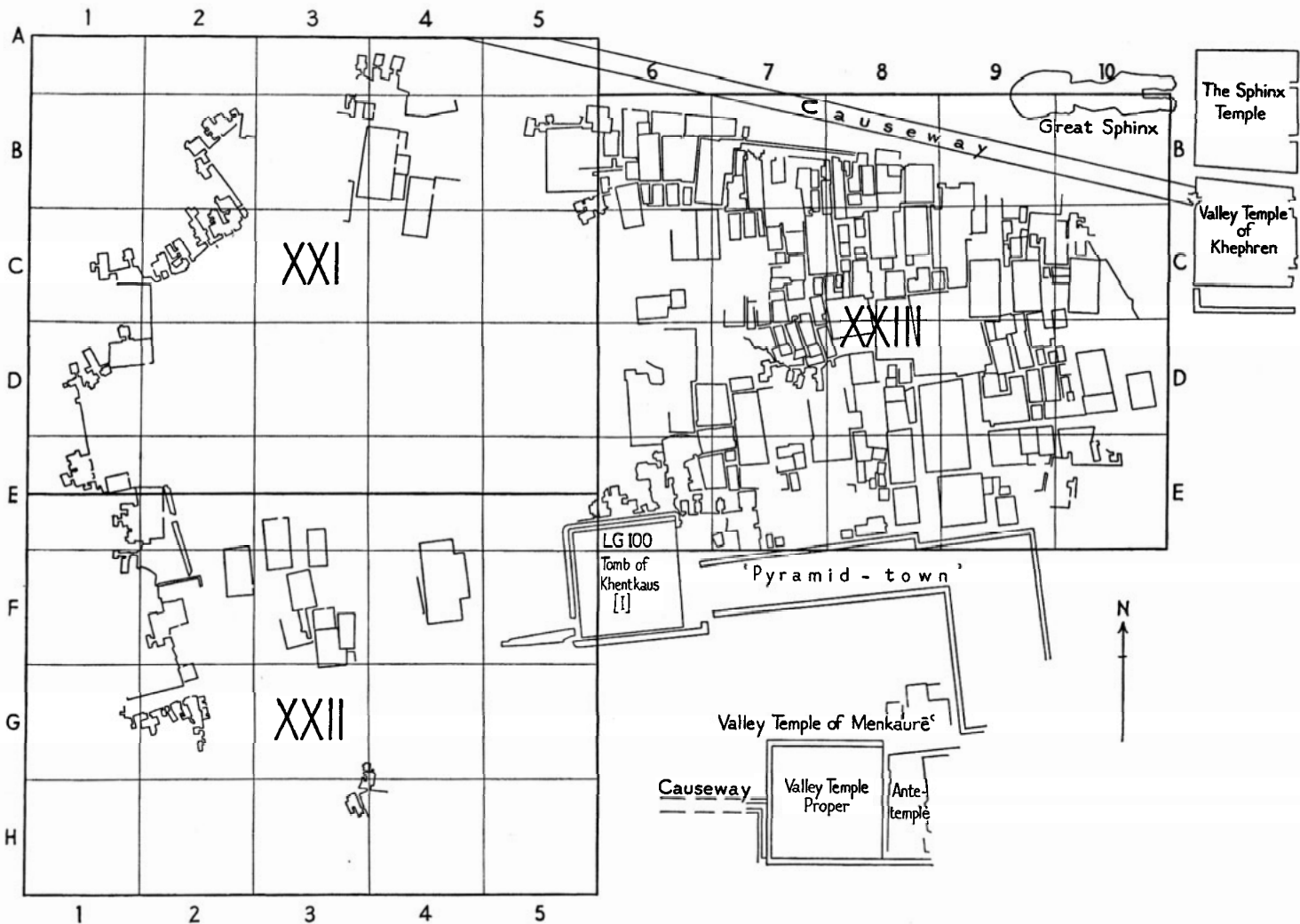

XX. Giza. Central Field. Key plan. See plan III, p. 230.

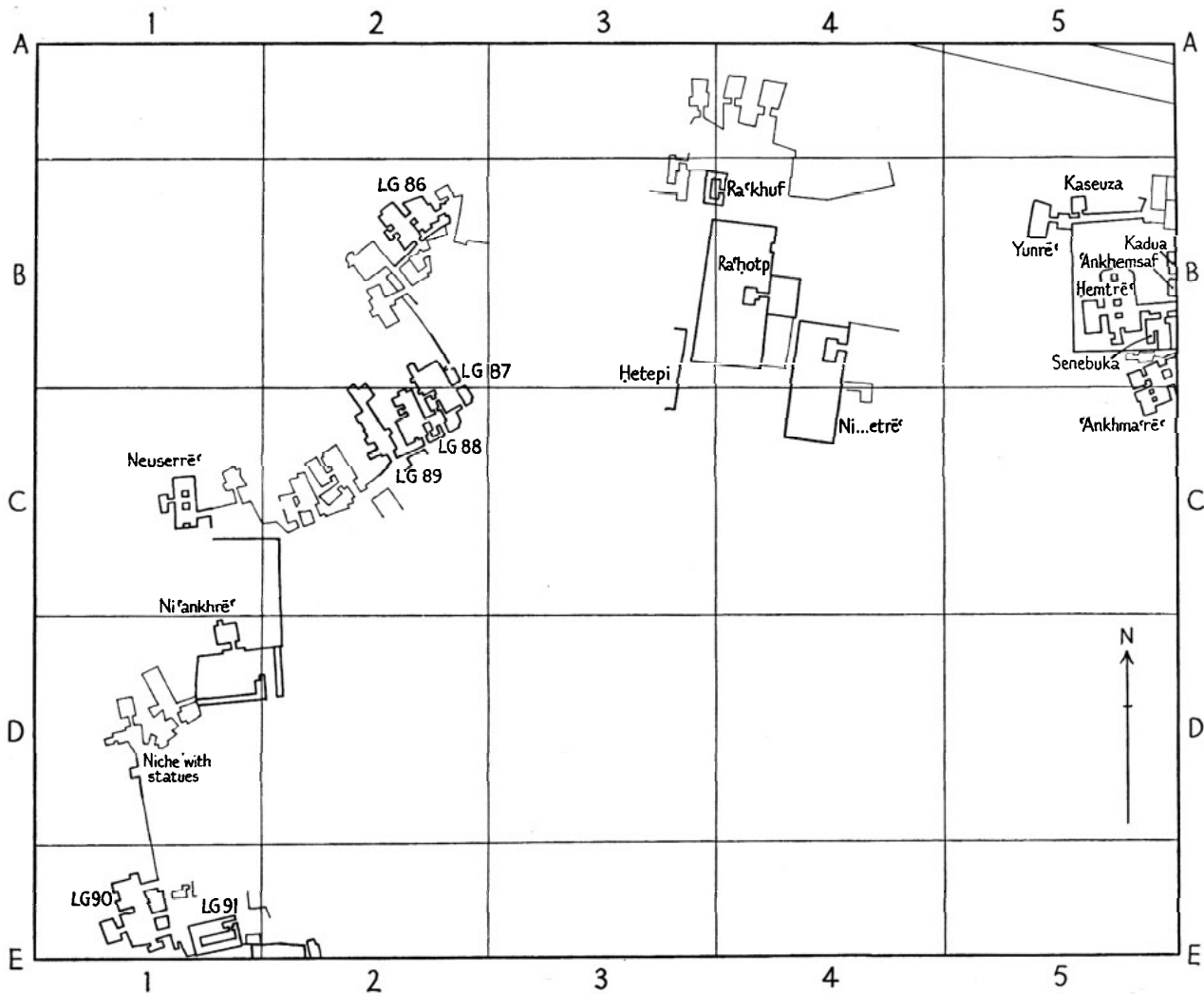

XXI. Giza. Central Field. Plan showing positions of tombs. See plan XX.

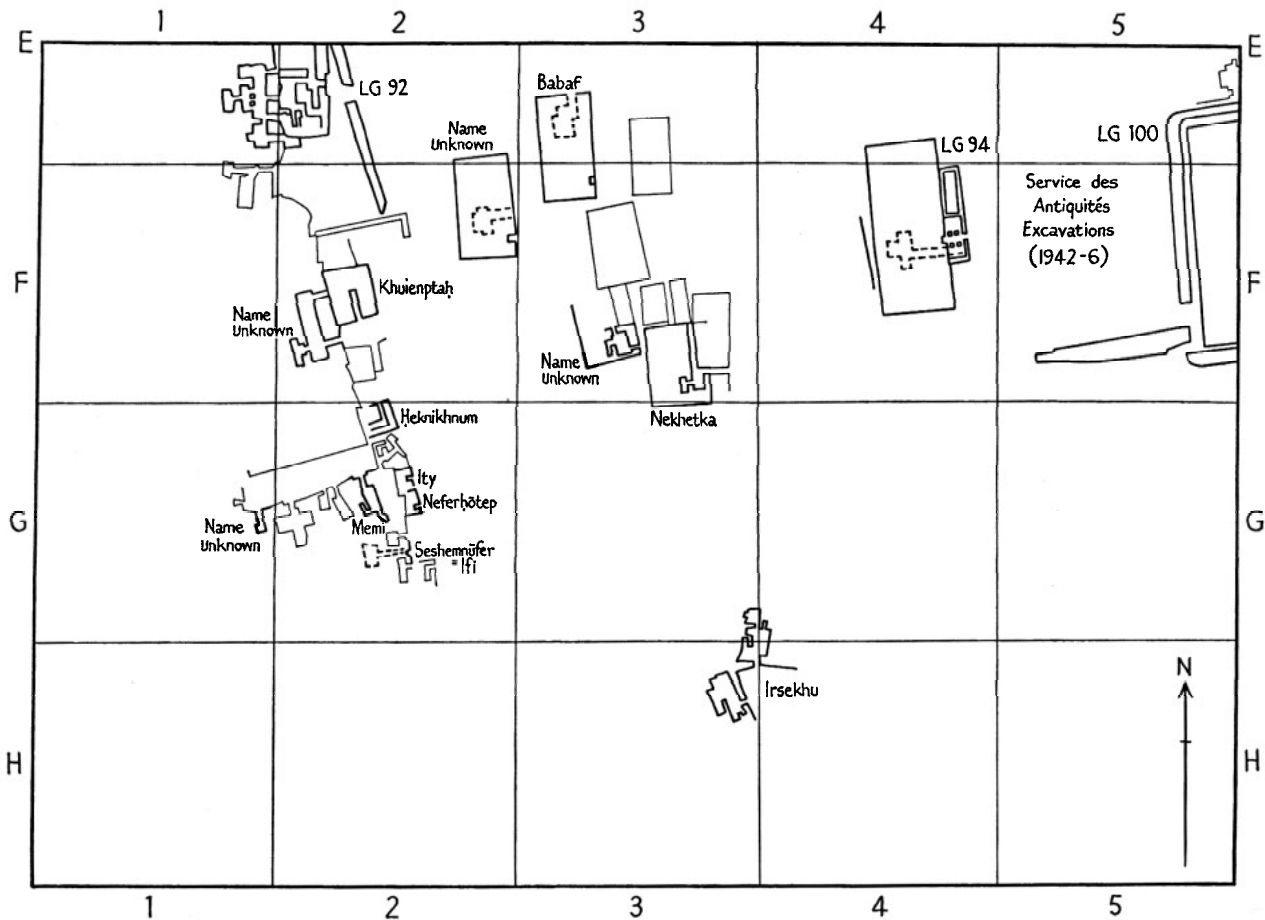

XXII. Giza. Central Field. Plan showing positions of tombs. See plan XX.

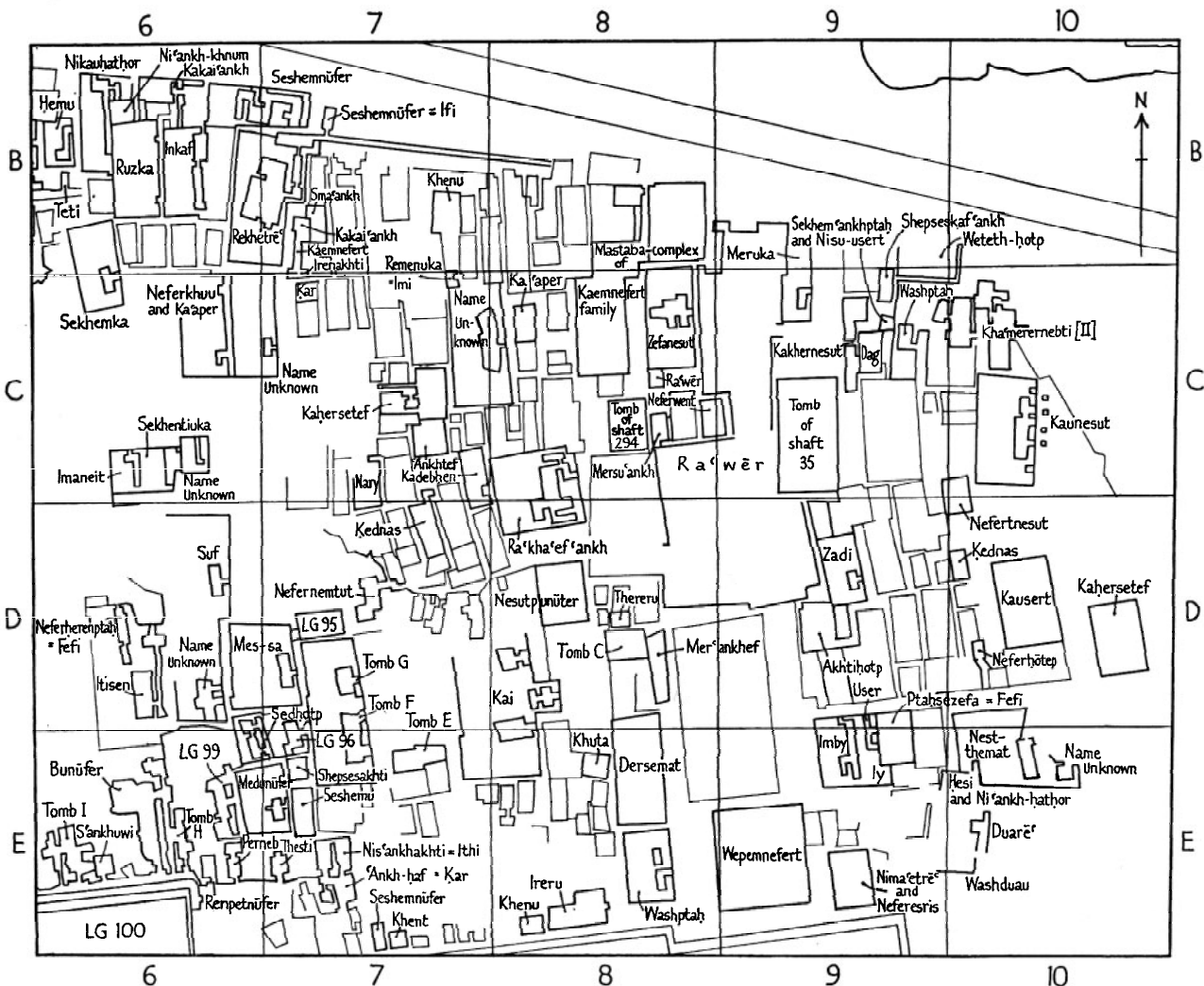

XXIII. Giza. Central Field. Plan showing positions of tombs. See plan XX.

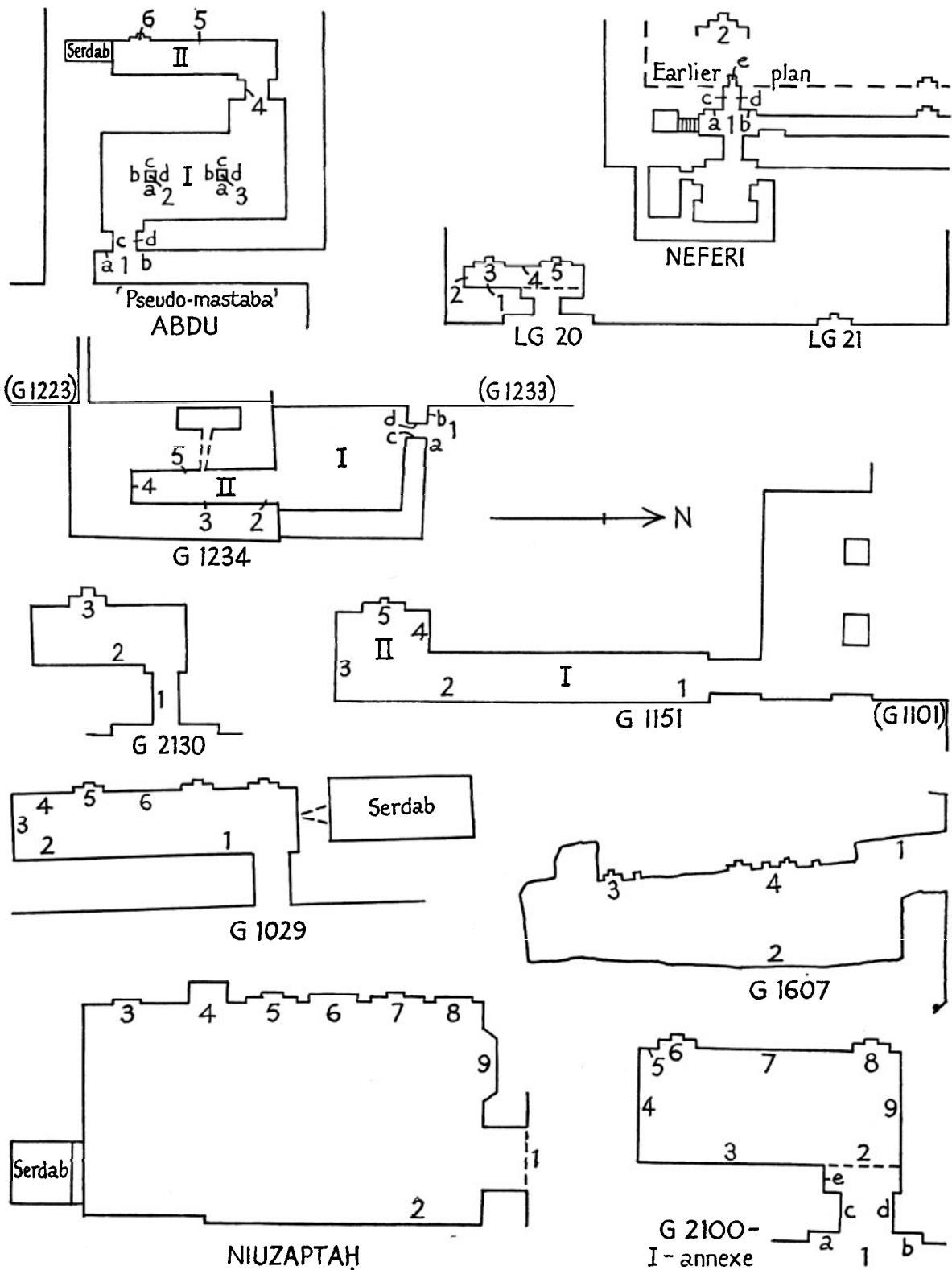

XXIV. Giza. Plans of tombs.

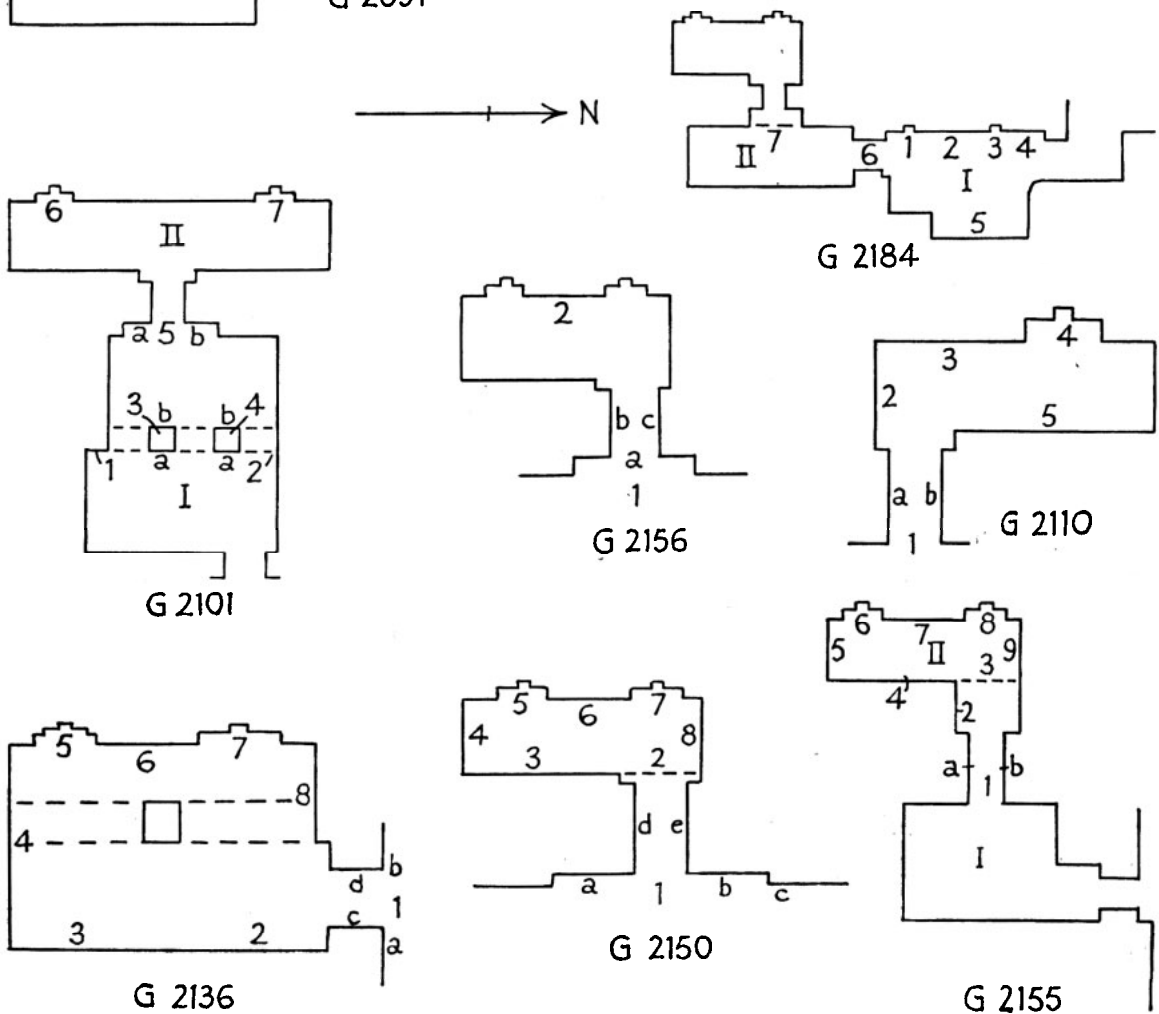
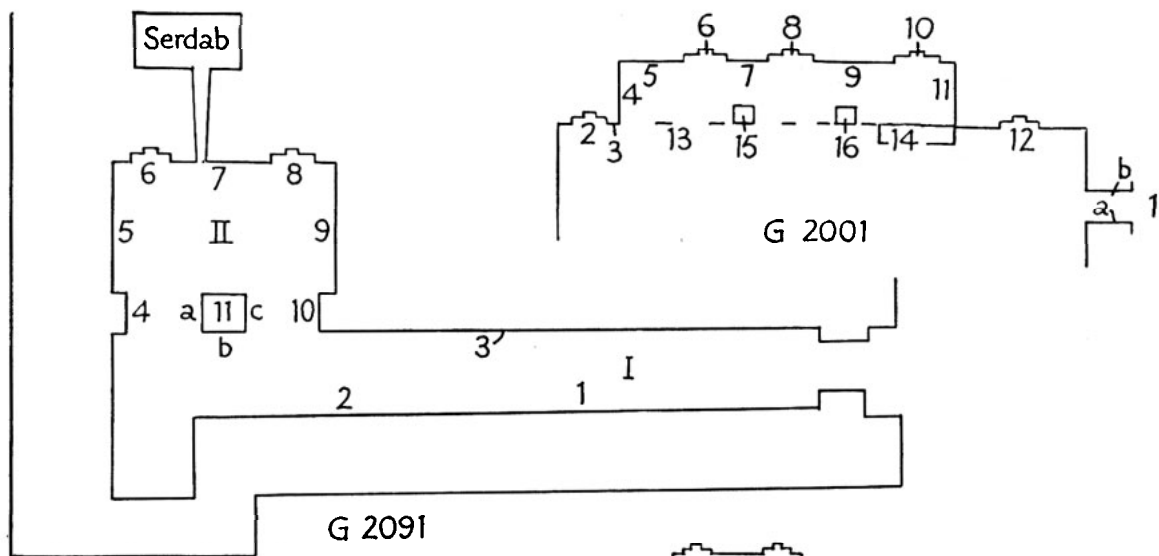

XXV. Giza. Plans of tombs.

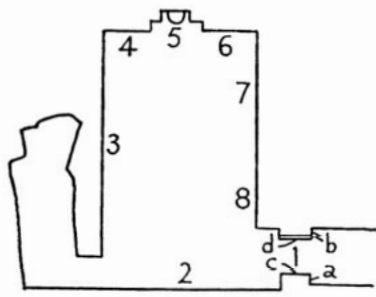

G 2196

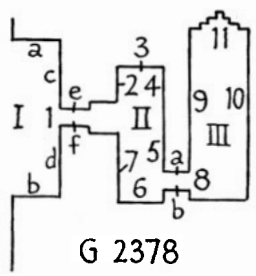

G 2378

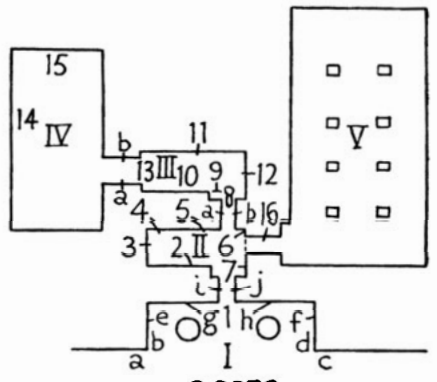

G 2370

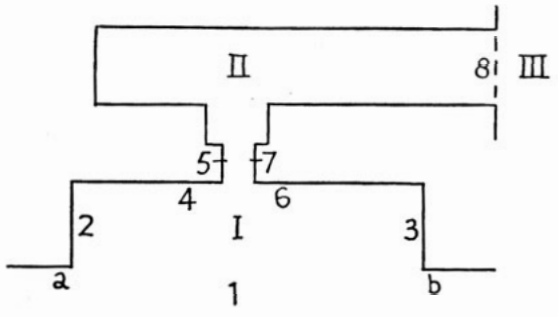

G 2381
(reconstruction)

→ Z

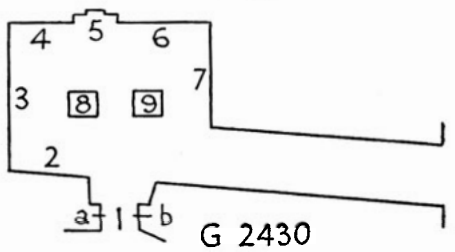

G 2430

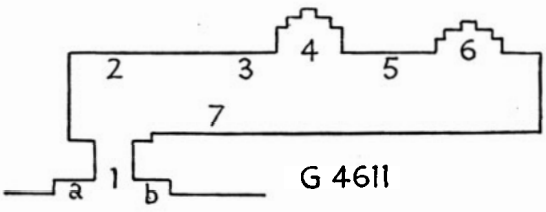

G 4611

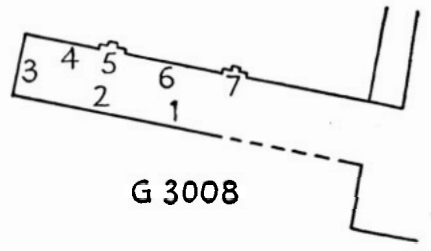

G 3008

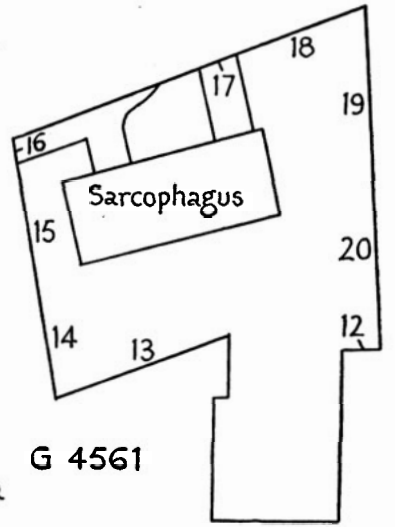
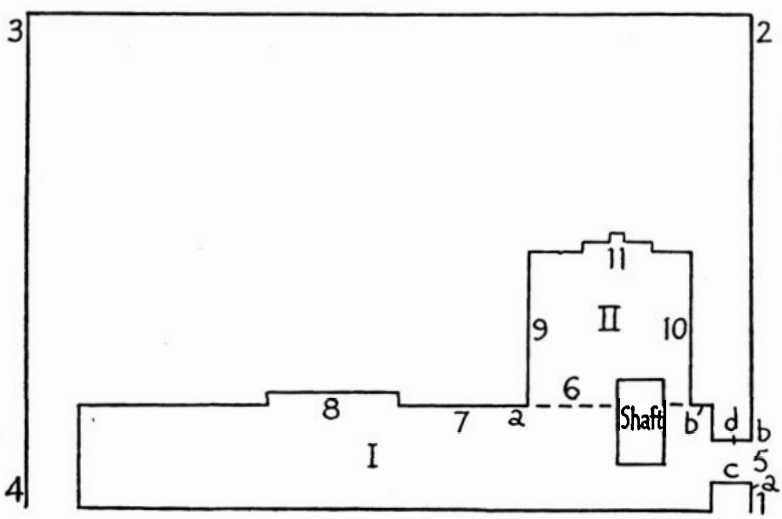

G 4561

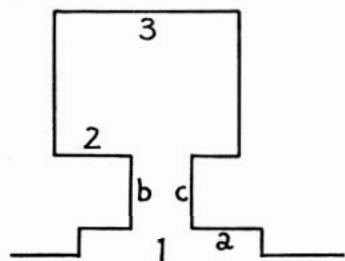

KHNEMHOTP [II]

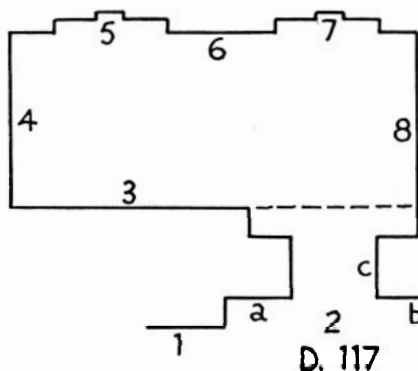

D. 117

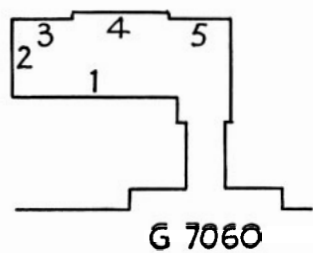

G 7060

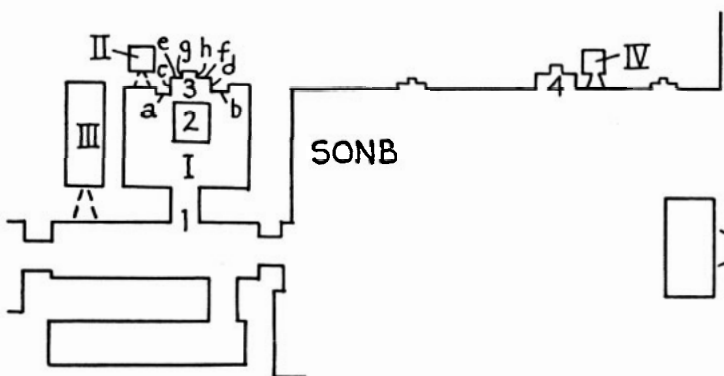

SONB

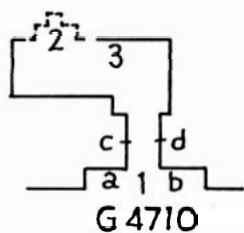

G 4710

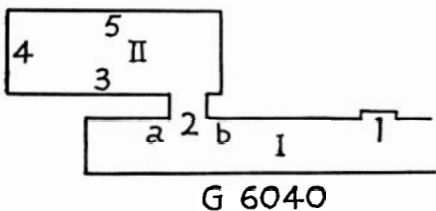

G 6040

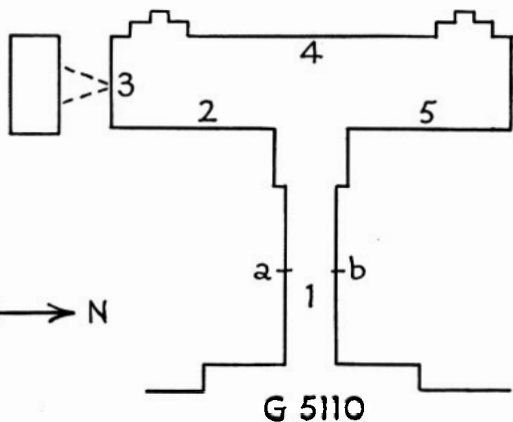

G 5110

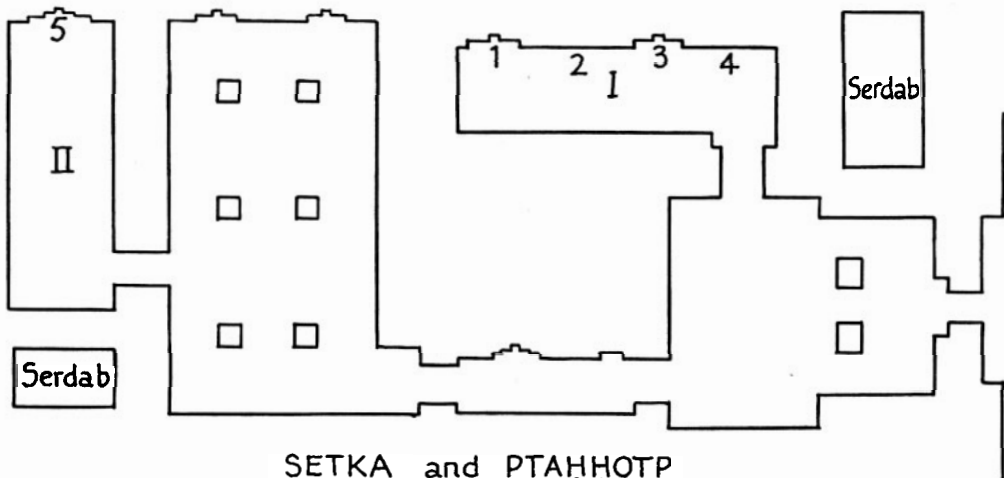

SETKA and PTAHOTP

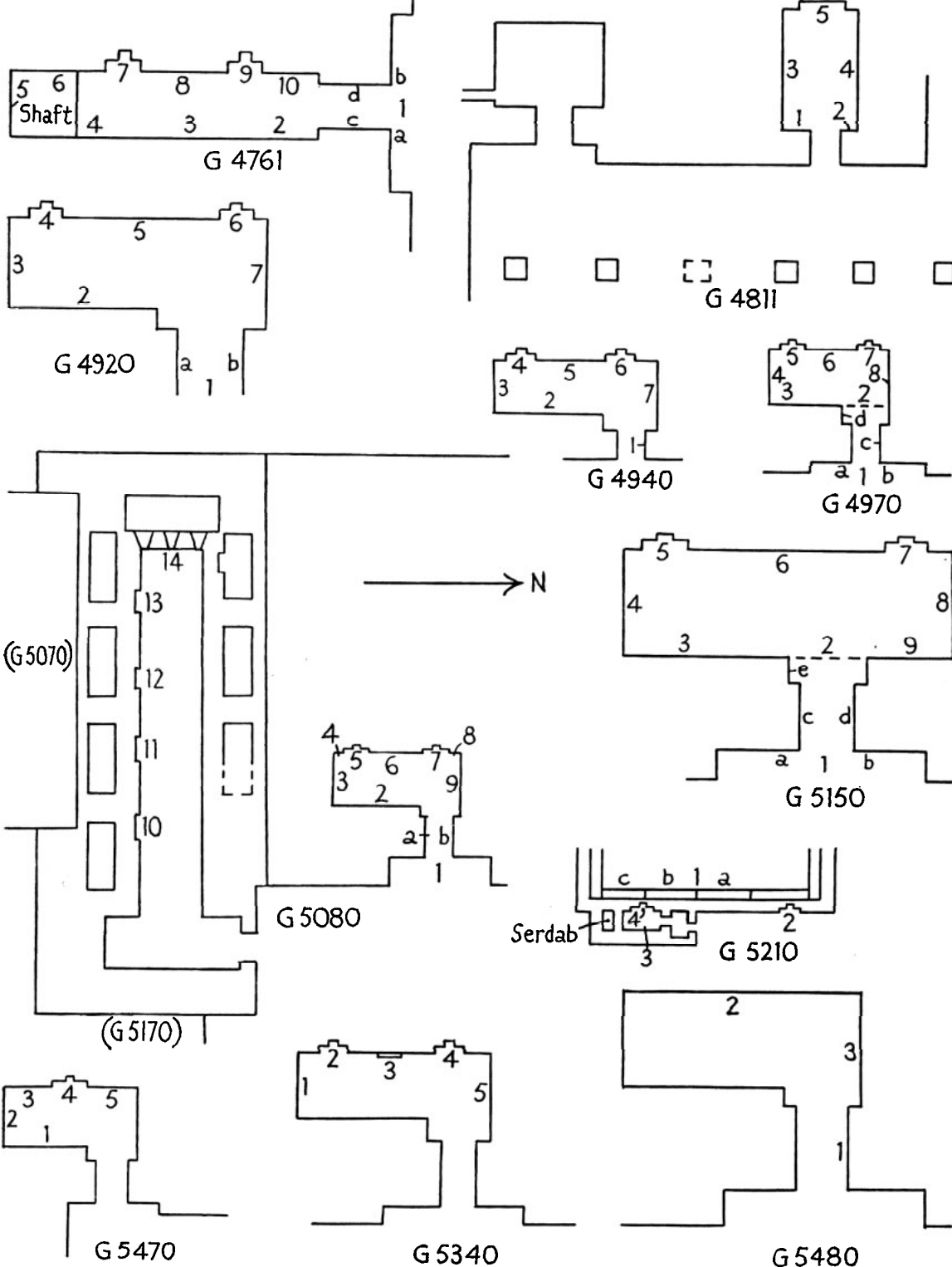

XXVIII. Giza. Plans of tombs.

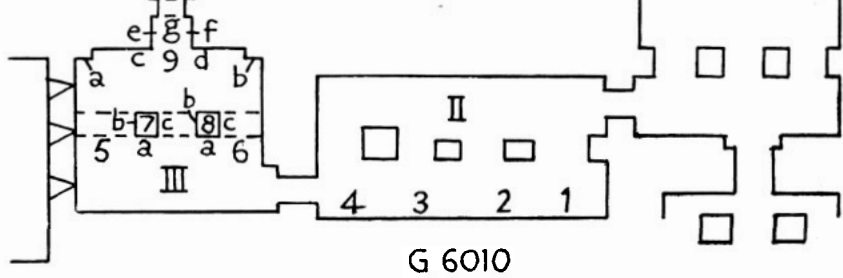
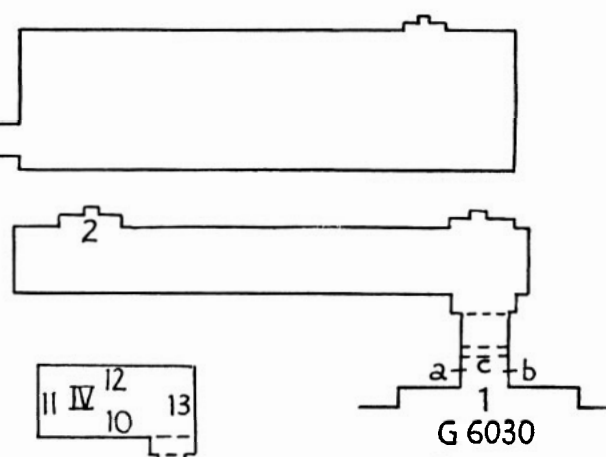
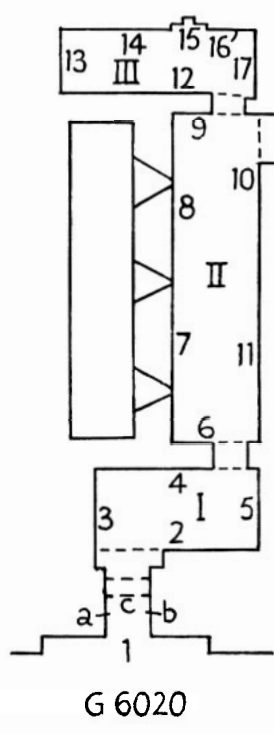
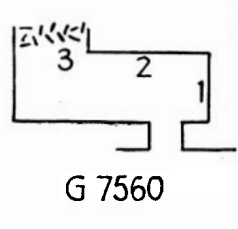
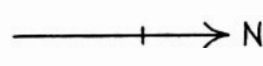
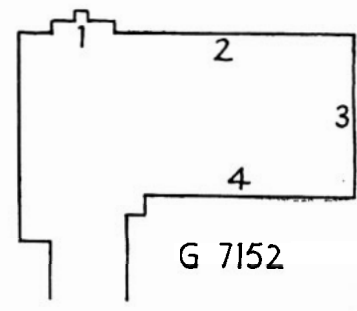
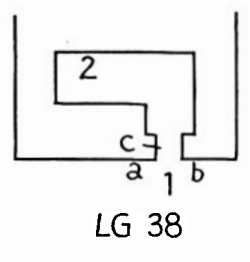
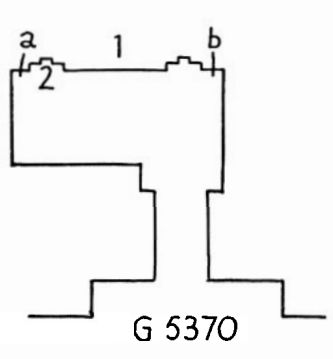
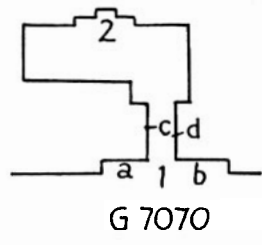
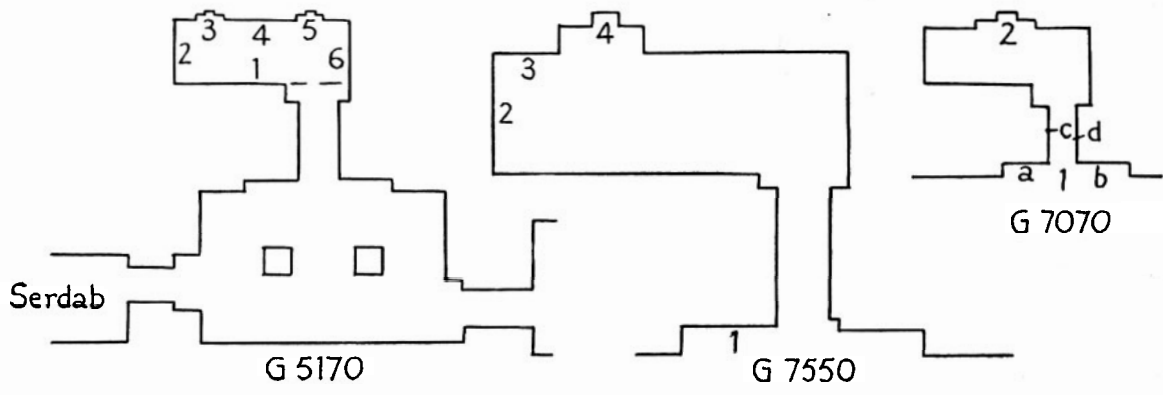

XXIX. Giza. Plans of tombs.

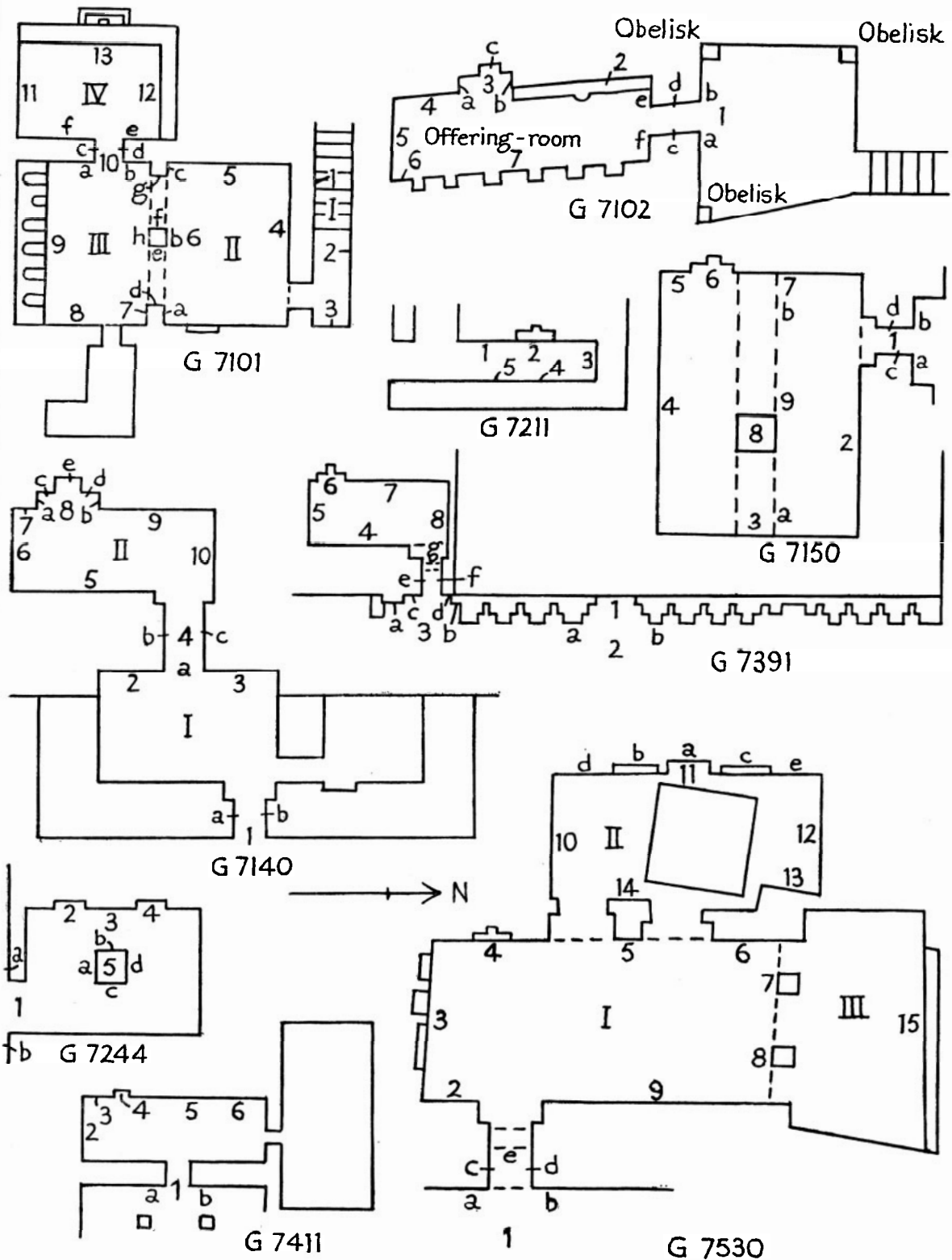

XXX. Giza. Plans of tombs.

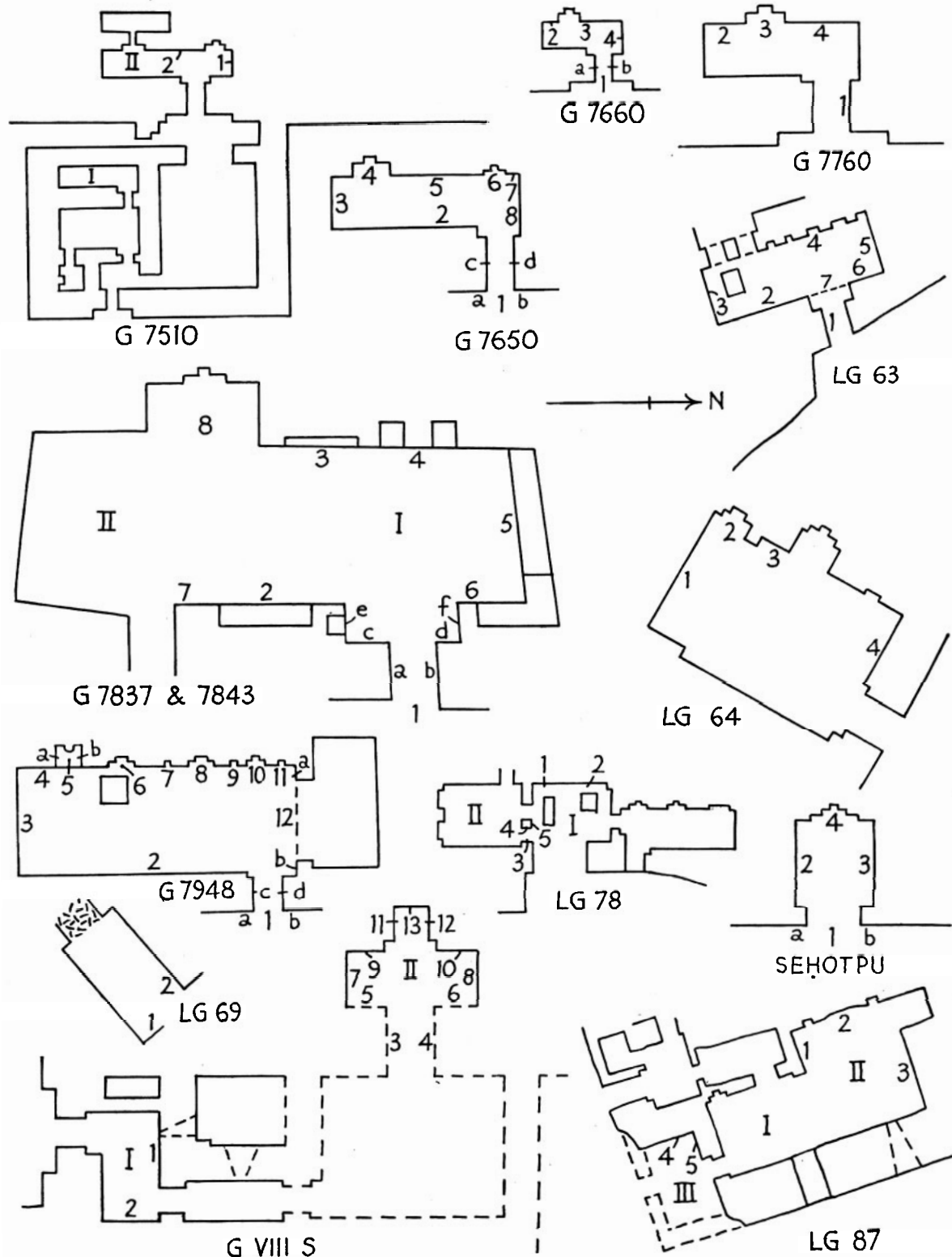

XXXI. Giza. Plans of tombs.

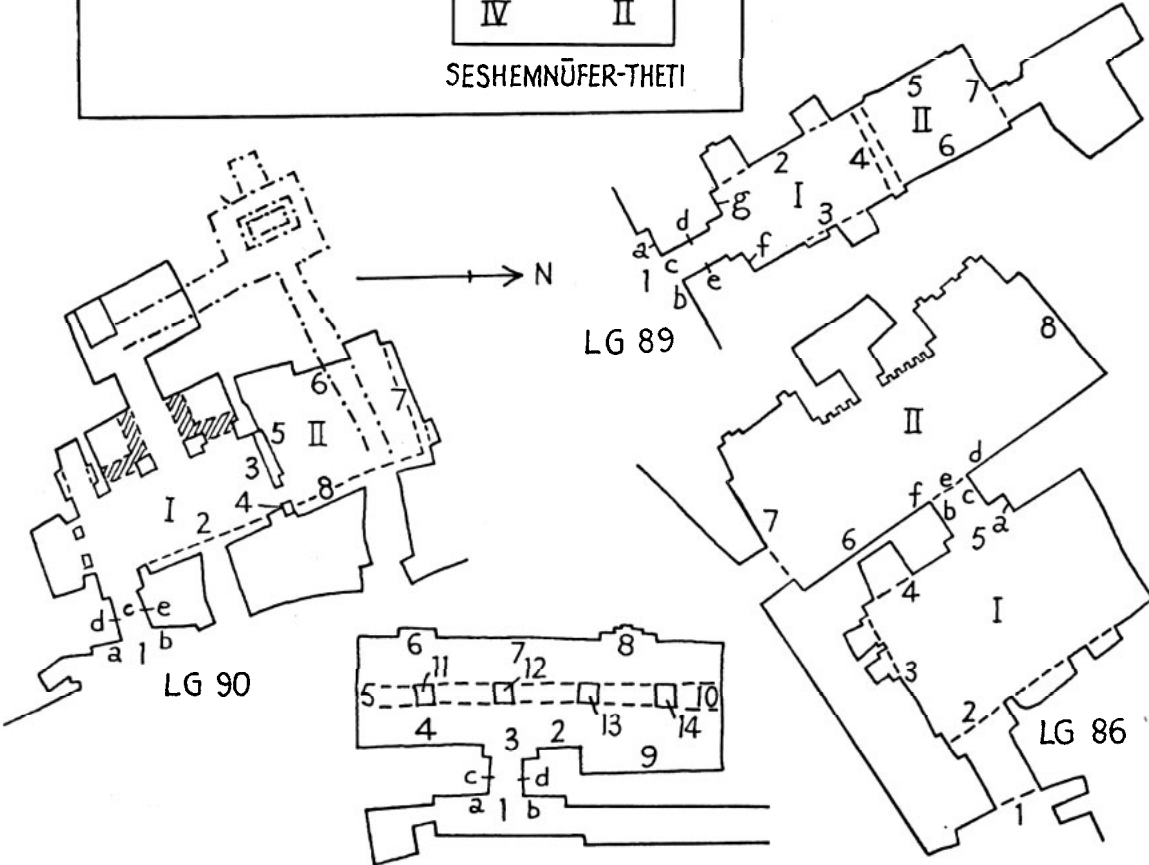
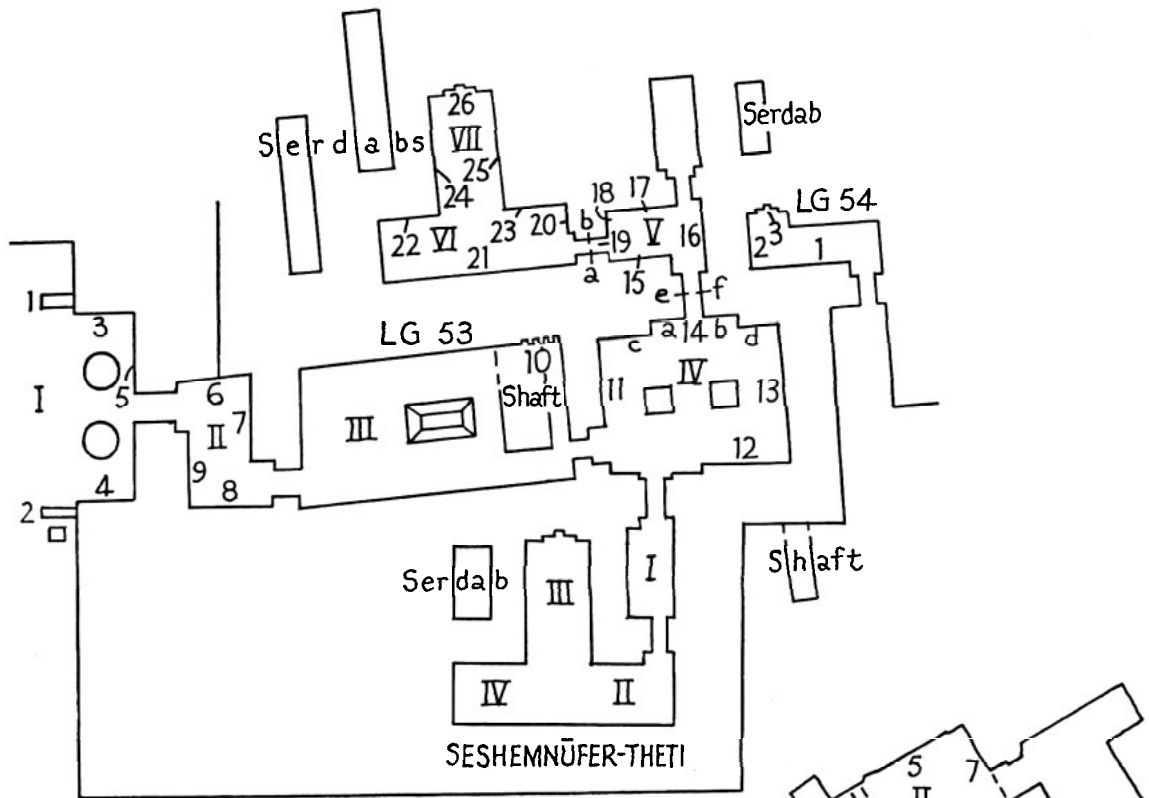

ITISEN
XXXII. Giza. Plans of tombs.

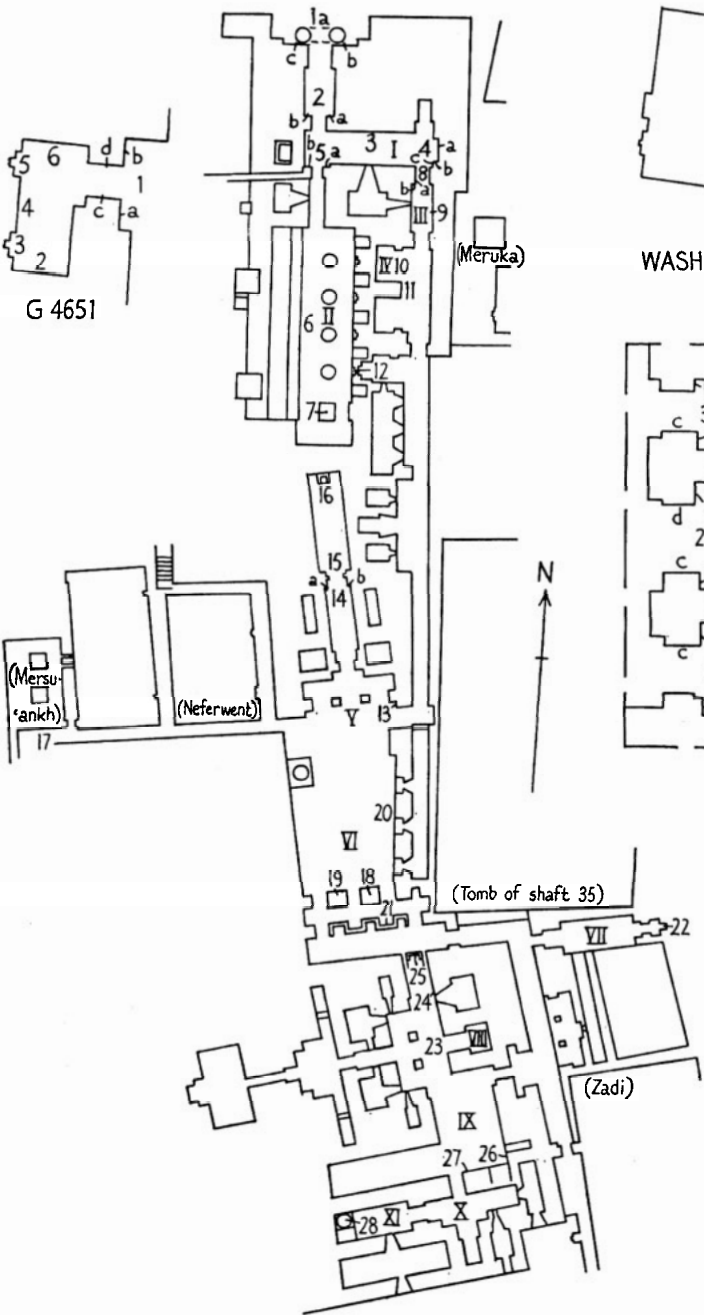

RA'WĒR

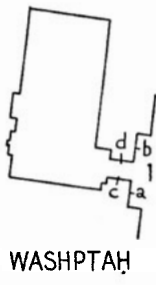

WASHPTAH

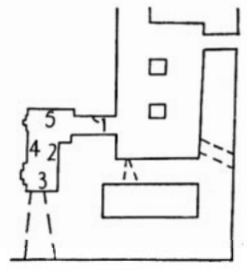

NEKHETKA

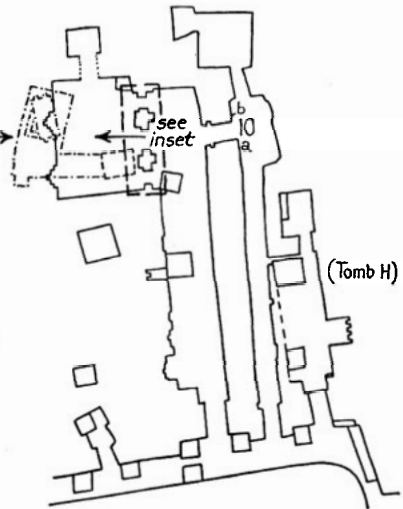
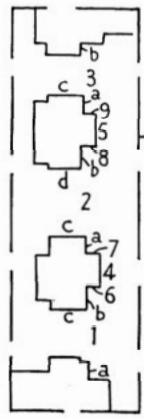

BUNÜFER

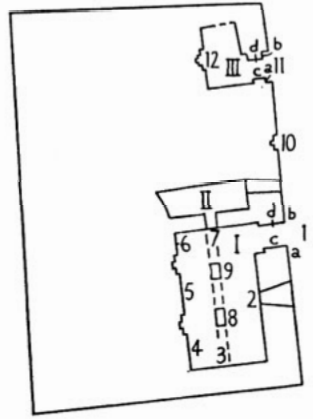

NIMA'ETRĒ

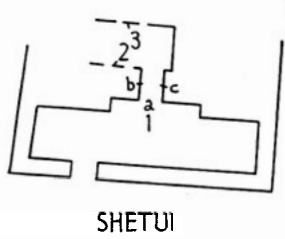

SHETUI

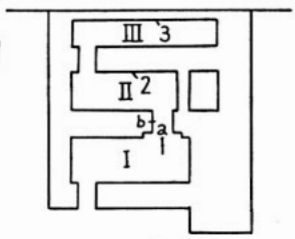

KHENTKAUS



G 6037

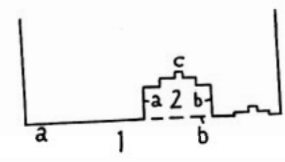

REMENUKA = IMI

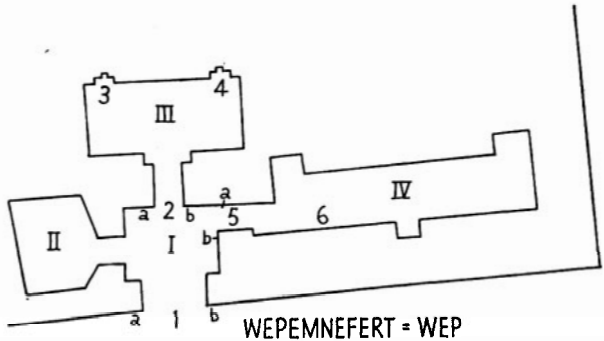

WEPENNEFERT = WEP

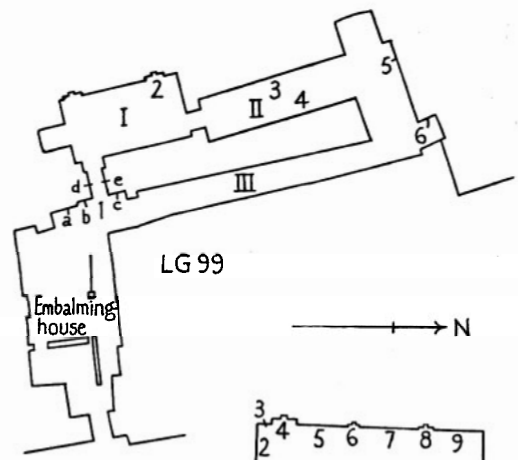

LG 99

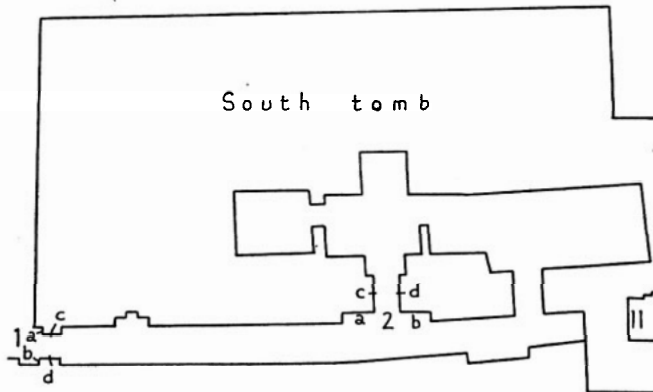
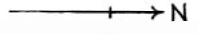

South tomb

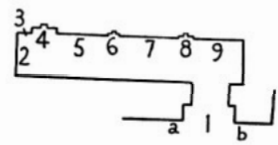

SHEPSEKAF = ANKH

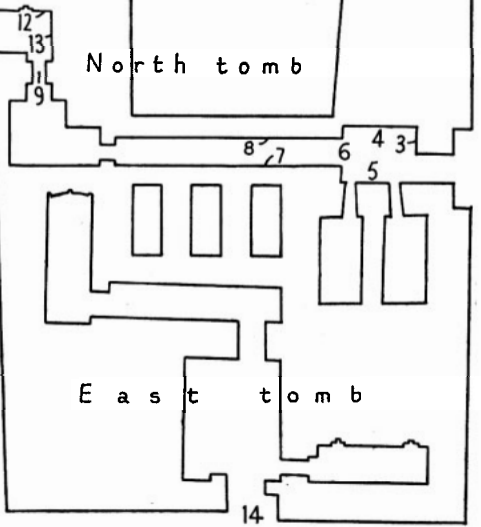

North tomb

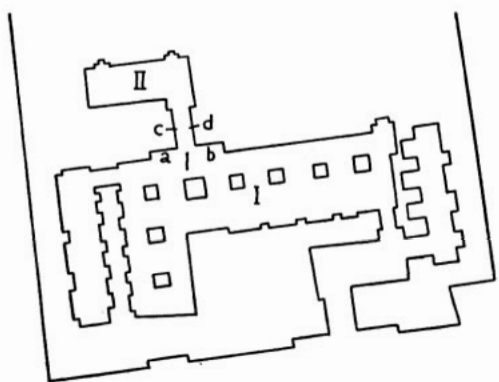

RA = KHA = EF = ANKH

MASTABA-COMPLEX OF KAEMNEFERT FAMILY

XXXIV. Giza. Plans of tombs.

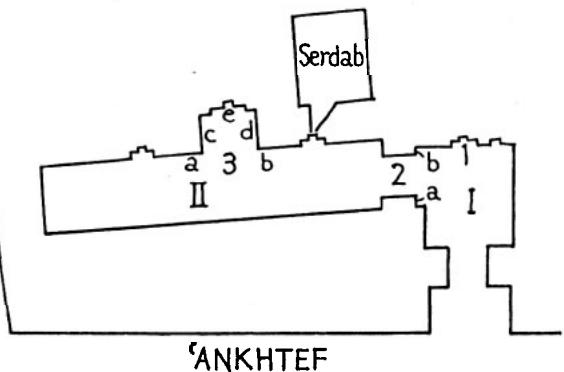
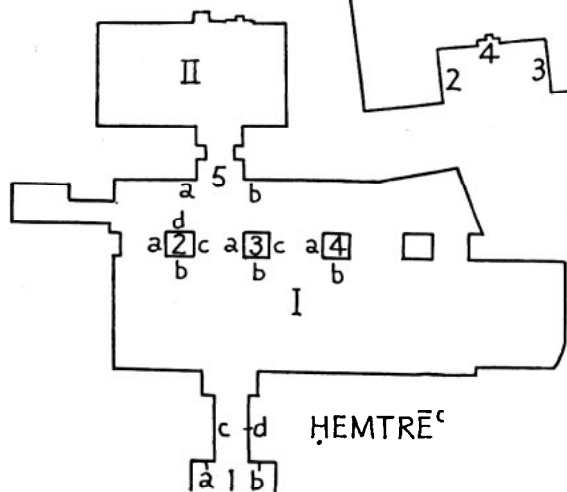
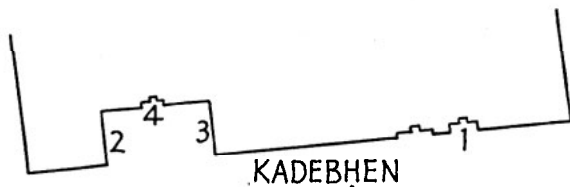
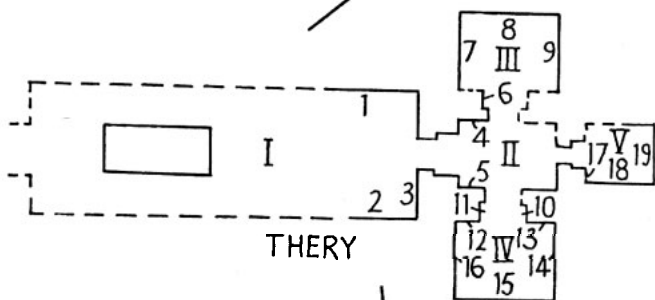
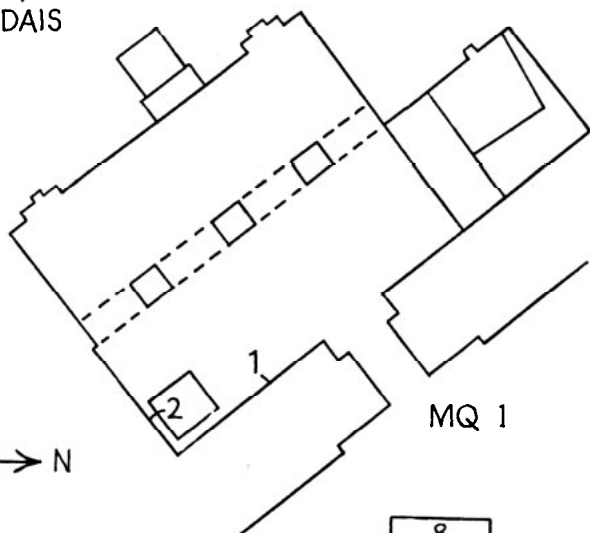
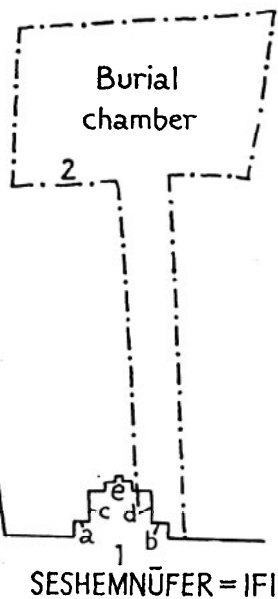
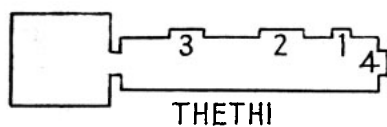
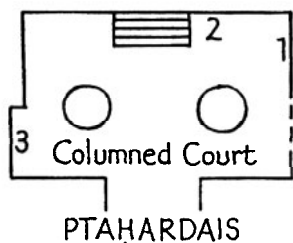
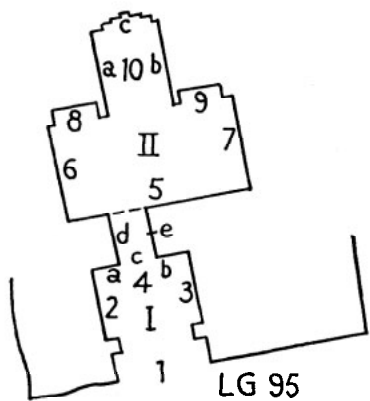

XXXV. Giza. Plans of tombs.