

AIBA TECHNICAL & COMPETITION RULES

Effective as of September 20, 2021

AIBA reserves the right to amend these rules as required.

Table of Contents

COMPLIANCE WITH THE RULES.....	4
DEFINITIONS.....	5
RULES FOR COMPETITION MANAGEMENT	9
RULE 1. AOB COMPETITION GUIDELINES.....	9
RULE 2. CLASSIFICATION.....	11
RULE 3. DURATION AND NUMBER OF ROUNDS	13
RULE 4. MEMBERSHIP AND ATHLETE ELIGIBILITY	13
RULE 5. COMPETITION REGISTRATION	21
RULE 6. SPORT ENTRIES CHECK.....	23
RULE 7. OFFICIAL DRAW	24
RULE 8. SEEDING PROCEDURE	25
RULE 9. DRAW COMMISSIONER PROTOCOL	27
RULE 10. ATHLETE MEDICAL EXAMINATION.....	30
RULE 11. DAILY WEIGH-IN.....	31
RULE 12. FIELD OF PLAY (FOP)	33
RULE 13. AIBA ANTI-DOPING AND MEDICAL RULES	35
RULE 14. TEAM OFFICIALS	36
RULE 15. AIBA WORLD RANKING	39
RULE 16. RESULT PROTOCOL.....	41
RULE 17. AIBA DATABASE.....	42
RULES FOR SCORING	43
RULE 18. AIBA SCORING SYSTEM.....	43
RULE 19. DECISIONS.....	45
RULE 20. BOUT REVIEW	49
RULE 21. FOULS	53
RULE 22. LOW BLOW	55
RULE 23. CAUTION, WARNING, DISQUALIFICATION.....	56
RULE 24. KNOCKDOWN.....	56
RULES FOR COMPETITION OFFICIALS.....	59
RULE 25. APPOINTMENT PROCEDURE	59
RULE 26. TECHNICAL DELEGATE.....	61
RULE 27. INTERNATIONAL TECHNICAL OFFICIALS (ITOS).....	62
RULE 28. DEPUTY TECHNICAL DELEGATE	61
RULE 29. REFEREE AND JUDGE EVALUATOR	61
RULE 30. RINGSIDE DOCTORS.....	62
RULE 31. AIBA CUT TECHNICIAN	63
RULE 32. EQUIPMENT MANAGER.....	64
RULE 33. REFEREE AND JUDGE COORDINATOR.....	65
RULE 34. DRAW COMMISSIONER	65
RULE 35. OBSERVER.....	65
RULE 36. NATIONAL TECHNICAL OFFICIALS	66

RULE 37. TIMEKEEPER AND GONG OPERATOR	66
RULE 38. ANNOUNCER.....	67
RULE 39. REFEREES AND JUDGES	67
RULE 40. LOC COMPETITION MANAGER	71
RULES FOR COMPETITION EQUIPMENT AND UNIFORMS	72
RULE 41. COMPETITION EQUIPMENT	72
RULE 42. RING.....	72
RULE 43. RINGSIDE ACCESSORIES.....	75
RULE 44. GLOVES.....	75
RULE 45. HEADGUARD.....	77
RULE 46. BANDAGES, PROFESSIONAL HANDWRAPS AND BANDAX HANDWRAPS	78
RULE 47. BOXING SENSORS.....	79
RULE 48. ATHLETE COMPETITION UNIFORM AND EQUIPMENT	79
RULE 49. OFFICIALS' COMPETITION UNIFORM	83
APPENDICES	84
APPENDIX 1: CHANGE OF SPORT NATIONALITY PROCEDURE	85
APPENDIX 4: AIBA CODE OF CONDUCT	91
APPENDIX 6: ANTI-DOPING CONSENT FORM	95
APPENDIX 8: CHANGE OF SPORT APPLICATION FORM	98
APPENDIX 14: UNIFORM DIAGRAMME.....	105
APPENDIX 1: CHANGE OF SPORT NATIONALITY PROCEDURE	85
APPENDIX 2: CHANGE OF SPORT NATIONALITY APPLICATION FORM.....	86
APPENDIX 3: SEEDING DIAGRAMMES.....	87
APPENDIX 4: AIBA CODE OF CONDUCT.....	91
APPENDIX 5: MEDICAL CERTIFICATE TEMPLATE.....	92
APPENDIX 6: ANTI-DOPING CONSENT FORM	95
APPENDIX 7: DECLARATION OF NON-PREGNANCY	96
APPENDIX 8: CHANGE OF SPORT APPLICATION FORM.....	98
APPENDIX 9: GRADUATED RETURN TO BOXING PROGRAMME	99
APPENDIX 10: BOUT REVIEW REQUEST FORM	100
APPENDIX 11: COMPETITION VENUE REQUIREMENTS	102
APPENDIX 12: GLOVE SPECIFICATIONS.....	103
APPENDIX 13: HEADGUARD SPECIFICATIONS.....	104
APPENDIX 14: UNIFORM DIAGRAMME	105

COMPLIANCE WITH THE RULES

These AIBA Technical and Competition Rules apply to all AIBA's AOB Competitions and are the only AIBA Technical and Competition Rules worldwide that AIBA National Federations and members of the AIBA boxing community must follow and respect in all of their boxing Competitions in accordance to the Competition level. No National Federation may develop its own Technical and Competition Rules that are contradictory to these rules. However National Federations, for National Competitions, may alter these rules to reflect National laws or regulations, as long as, the alteration does not diminish the rules, especially with regards to medical and safety requirements.

DEFINITIONS

“**AIBA**” means the International Boxing Association;

“**AIBA Anti-Doping Rules**” means the rules published by AIBA in relation to the anti-doping standards required to be observed prior, during, and after AOB Competitions;

“**AIBA Certification Course**” means the certification programme and examination that allows a member of a National Federation to be recognised as an AIBA star-level coach, Referee and Judge, International Technical Official, or a Technical Delegate (formerly known as Supervisor);

“**AIBA Cut Technician**” means the person who is appointed by AIBA as ITO to oversee the work of and advise the Teams’ Cut Technicians;

“**AIBA Database**” means the AIBA’s online system for storing profiles and results, maintaining registration for Competitions and AIBA Certification Courses, and any other additional functions as required by AIBA;

“**AIBA HQ (AIBA HQ)**” means the head office of AIBA;

“**AIBA Official Equipment Licensee**” means the contracted licensee of AIBA who is approved to produce the equipment for use in all AOB Competitions;

“**AIBA Rules**” means the AIBA Technical and Competition Rules, AIBA Code of Ethics, AIBA Disciplinary Code, AIBA Regulations, AIBA Anti-Doping Rules, AIBA Medical Rules and any other rules that are developed by AIBA to govern AOB Competitions and its participants;

“**AIBA Scoring System**” means the AIBA-approved electronic system that conducts the official draw, the electronic draw of Referees and Judges, records decisions of all Judges, and produces official scoring documents of the Bouts;

“**AIBA Technical and Competition Rules**” means the sport-specific and Competition-related rules that govern all AOB Competitions.

“**AOB**” means AIBA Open Boxing;

“**AOB Competition**” means any boxing Competitions regulated by AIBA Rules;

“**Bout**” means the boxing contest between two Boxers;

“**Bout Review**” means the process during which the result of the Bout is being re-assessed.

“**Boxer**” means any athlete registered by an AIBA National Federation;

“**Closed Competition**” means a Competition which Boxers can attend only after qualifying in a qualifying Competition;

“**Competition**” means a series of Bouts;

“**Competition Official**” means any person appointed or certified to act as a Technical Delegate, an International Technical Official, a Referee and Judge, or any appointed position in AIBA Competitions;

“**Competition Venue**” means the area where Competition takes place;

“**Confederation**” means an AIBA’s continental office;

“Continental Multi-Sport Games” means the multi-sport event of the respective continent;

“Daily Weigh-In” means the daily process of checking registered Boxers with document check, medical check and weigh-in before the Boxers’ Bouts of the day;

“Deputy Technical Delegate” means the person who manages all issues related to each Bout;

“Disciplinary Code” means AIBA’s code that governs disciplinary matters applicable to AIBA, each Confederation, each National Federation and its member, and any Competition Official or Team Delegation member;

“Elite” pertains to any Boxer 19 years of age or older competing at a national, international or professional level.

“Field of Play (FOP)” means the Competition area which extends from all 4 sides of the ring and which only Competition Officials, Boxers, and Seconds can enter;

“Gloves” means the equipment that is worn on the hands to protect them during a Bout;

“Headguards” means the equipment that is worn on the head to protect it during a Bout;

“Host National Federation” means the National Federation of the country in which the Competition is staged, and which is responsible for organising the Competition and all additional events necessary for the Competition to take place (ex. Official Draw, etc.);

“Individual Physical Contact Sport” means any of the following sports in any of their forms: Aikido, Cage Fighting, Judo, Ju-jitsu, Karate, Kendo, Kickboxing, K-1, Kung Fu, Muay Thai, MMA, Sambo, Savate, Sumo, Taekwondo, Wrestling, Wushu and such other sports as may be deemed by AIBA to be an individual physical contact sport;

“International Technical Official (ITO)” Means a Competition official who has passed an AIBA Certification Course and can be appointed to work at AOB Competitions. In Multi-sport Games, such as, but not limited to, Olympic Games, “ITO” also refers to a Referee and Judge.

“Judge” means the person who allocates points during a Bout according to AIBA Technical and Competition Rules based on Boxers’ performance;

“Local Organising Committee (LOC)” means a body, whether emanating from the Host National Federation or otherwise (with or without legal personality), responsible for the preparation and staging of the Competition and all additional events necessary for the Competition to take place (ex. Official Draw, etc.);

“Medical Bout Report” means the form that is filled out by the Ringside Doctor after the Bout to report any medical-related activities that took place during the Bout;

“AIBA Medical Rules” means the rules published by AIBA in relation to the medical standards required to be observed prior, during, and after AOB Competitions;

“National Federation” means an AIBA Member Federation who is recognised by AIBA as legal entity who governs the sport of boxing in the AIBA Member Federation’s country;

“National Competition” means a Competition organised and sanctioned by a National Federation;

“Official Draw” means the procedure for drawing the Boxers to decide the Bout schedules in each Weight Category for the entire Competition;

“Open Competition” means a Competition which Boxers can attend without having to attend a qualifying Competition;

“Referee and Judge Draw (R&J Draw)” means the procedure for drawing the Referees and Judges for every Bout;

“Referee” means the person who ensures that the Boxers follow the AIBA Rules during their Bouts in the ring;

“Referee and Judge (R&J)” means a person who works as a Referee and Judge during Competitions;

“Results Management Authority” means the organisation that is responsible, in accordance with WADA Code, for the management of the results of anti-doping testing (or other evidence of a potential anti-doping rule violation) and hearings.

“Sample Collection Authority” means the organisation that is responsible for the collection of anti-doping samples in compliance with the requirements of the International Standard for Testing and Investigations.

“Seconds” means the Team Delegation members who can work in their Boxer’s corner of the ring;

“Seeding” means the system to ensure that the Competition may have a better-balanced level of difficulty by keeping the best Boxers from facing off in the preliminaries of the Competition;

“Sport Entries Check” means the process before the Official Draw to check and validate the Team Delegation registration and all related documents and equipment;

“Sport Nationality” means the nationality under which a Boxer chooses to compete in AOB Competitions;

“Technical Delegate” means the person who is responsible for ensuring that the AOB Competition follows the AIBA Rules.

“Technical Meeting” means a meeting between the Technical Delegate and the Team Officials, where the Technical Delegate presents Competition details and other relevant content;

“Team Delegation” means the members of an AIBA National Federation who are registered for and who attend the Competition and include Boxers, Coaches, a Doctor, a Cut Technician, a Physiotherapist a Team Manager, and any other staff recognised by AIBA;

“Team Officials” means the members of the Team Delegation, except the Boxers;

“Testing Authority” The organisation that has authorised a particular Sample collection, whether (1) an Anti-Doping Organisation (such as, the International Olympic Committee or other Major Event Organisation, WADA, an International Federation, or a National Anti-Doping Organisation); or (2) another organisation conducting anti-doping testing pursuant to the authority of and in accordance with the rules of the Anti-Doping Organisation (such as, a National Federation that is a member of an International Federation);

“Training Venue” means a designated area where Boxers and their Team Officials can train throughout the Competition;

“Warm-up Area” means the designated area where Boxers and their Team Officials can prepare for the Bout prior to the Bout.

Throughout this document, metric units of length – centimetres (cm) and metres (m) – are used.

RULES FOR COMPETITION MANAGEMENT

RULE 1. AOB COMPETITION GUIDELINES

- 1.1. AOB Competitions can be owned by AIBA, sanctioned by AIBA, or affiliated with AIBA.
- 1.1.1. An AIBA-owned Competition is overseen by AIBA HQ.
- 1.1.2. An AIBA-sanctioned Competition is overseen by the governing body of the Competition and AIBA HQ provides counsel in the planning and operational stages.
- 1.1.3. An AIBA-affiliated Competition follows AIBA Rules but does not involve AIBA HQ.
- 1.2. Results of AIBA-owned and AIBA-sanctioned Elite Men's and Women's Competitions are used for the computation of the AIBA World Ranking.
- 1.3. The following table describes all AOB Competitions:

Governing Body	Competitions	Classification	
IOC	<ul style="list-style-type: none"> – Olympic Games – Youth Olympic Games 	World	AIBA-sanctioned
AIBA	<ul style="list-style-type: none"> – Elite World Boxing Championships (men and women) – Youth World Boxing Championships (men and women) – AOB Olympic Qualifying Events (men and women) 	World	AIBA-owned
AIBA Confederations	<ul style="list-style-type: none"> – Elite Continental Championships (men and women) – Youth Continental Championships (men and women) – Youth / Elite Continental Championships that act as a qualifier for AIBA-owned events (men and women) – Youth Olympic Qualifying Events (men and women) 	Continental	AIBA-sanctioned
Organisers of the Multi-sport Events	<ul style="list-style-type: none"> – Continental Multi-sport Events (European Games, Asian Games, Pan American Games, Pacific Games, All-Africa Games) – Non-Continental Multi-sport Events (Commonwealth Games) 	Continental	AIBA-sanctioned

AIBA Confederations	<ul style="list-style-type: none"> – Under 22 Continental Championships (men and women) – Junior Continental Championships (boys and girls) – Under 14 Continental Championships (boys and girls) 	Continental	AIBA-affiliated
AIBA National Federations	<ul style="list-style-type: none"> – National Championships (Elite and Youth men and women) 	National	AIBA-affiliated

1.4. Organisational Rules

	National	Continental	World
Participants	A National Competition involves the National Elite and Youth Boxers.	<p>A Continental Competition can involve any of the AIBA National Federations of the same continent and has to include a minimum of three different National Federations.</p> <p>In the case of Non-Continental Multi-sport Events, these Competitions can involve any of the AIBA National Federations in the world.</p>	A World Competition can involve any AIBA National Federation.
Technical Delegate Appointment	<p>Appointed by:</p> <p>National Federation for its National Competitions</p>	<p>Appointed by:</p> <p>Confederation for Continental Championships</p> <p>AIBA for Multi-sport events and Youth / Elite Continental Championships qualifying for World events</p>	<p>Appointed by:</p> <p>AIBA for both AIBA events and Multi-sport events</p>
ITOs appointments	<p>Appointed by:</p> <p>National Federation for its National Competitions</p>	<p>Appointed by:</p> <p>Confederation for Continental Championships</p> <p>AIBA for Multi-sport events and Youth / Elite Continental Championships qualifying for World events</p>	<p>Appointed by:</p> <p>AIBA for both AIBA events and Multi-sport events</p>
R&Js Appointments	National Federation defines if R&Js have to be appointed or if	<p>Appointed by:</p> <p>Confederation for Continental Championships</p>	<p>Appointed by:</p> <p>AIBA for both AIBA events and Multi-sport events</p>

	each team brings its own R&J.	AIBA for Multi-sport events and Youth / Elite Continental Championships qualifying for World events	
Minimum R&Js Level	National certification	U-22, U-14, Junior: AIBA Certified 1-Star R&Js Youth: AIBA Certified 2-Star R&Js Elite and any qualifying event for World event: AIBA Certified 3-Star R&Js European Games, Asian Games, Pan American Games, Commonwealth Games: AIBA Certified 3-Star R&Js Pacific Games, All-Africa Games: AIBA Certified 2-Star R&Js	AIBA Certified 3-Star R&Js
Coordination and follow-up of the preparation	National Federation is responsible for overseeing the preparations of its Competition.	Confederation is responsible for following-up on preparations and coordinating with the LOC for Continental Championships AIBA for Multi-sport events and Youth / Elite Continental Championships qualifying for World events	AIBA is responsible for World Championships and IOC for Olympic and Youth Olympic Games.
Reporting		Confederation is responsible for reporting the main facts and results of the Competition to AIBA.	

RULE 2. CLASSIFICATION

2.1. Age Classification

- 2.1.1. The age of a Boxer is determined using his/her year of birth.
- 2.1.2. Men and Women Boxers between the ages of 19 to 40 are categorised as Elite Boxers.
- 2.1.3. Men and Women Boxers between the ages of 17 to 18 are categorised as Youth Boxers.
- 2.1.4. Boys and Girls Boxers between the ages of 15 to 16 are categorised as Junior Boxers.

2.1.5. In all Competitions related to Junior and school-age boys and girls, as well as, in all other younger age categories, the age range of the participating Boxers must not be more than 2 years.

2.2. Weight Classification

ELITE AND YOUTH MEN BOXERS							
AIBA				OLYMPIC			
#	Weight Category	over Kg	to Kg	#	Weight Category	over Kg	to Kg
1	Minimumweight	46	48	1	Flyweight	48	52
2	Flyweight	48	51	2	Featherweight	52	57
3	Bantamweight	51	54	3	Lightweight	57	63
4	Featherweight	54	57	4	Welterweight	63	69
5	Lightweight	57	60	5	Middleweight	69	75
6	Light Welterweight	60	63.5	6	Light Heavyweight	75	81
7	Welterweight	63.5	67	7	Heavyweight	81	91
8	Light Middleweight	67	71	8	Super Heavyweight	91	-
9	Middleweight	71	75				
10	Light Heavyweight	75	80				
11	Cruiserweight	80	86				
12	Heavyweight	86	92				
13	Super Heavyweight	92	-				

ELITE AND YOUTH WOMEN BOXERS							
AIBA				OLYMPIC			
#	Weight Category	over Kg	to Kg	#	Weight Category	Over Kg	to Kg
1	Minimumweight	45	48	1	Flyweight	48	51
2	Light Flyweight	48	50	2	Featherweight	54	57
3	Flyweight	50	52	3	Lightweight	57	60
4	Bantamweight	52	54	4	Welterweight	64	69
5	Featherweight	54	57	5	Middleweight	69	75
6	Lightweight	57	60				
7	Light Welterweight	60	63				
8	Welterweight	63	66				
9	Light Middleweight	66	70				
10	Middleweight	70	75				
11	Light Heavyweight	75	81				
12	Heavyweight	81	-				

Junior Boys and Girls Boxers			
#	Weight Category	over Kg	to Kg
1	Pin	44	46
2	Light Fly	46	48
3	Fly	48	50
4	Light Bantam	50	52
5	Bantam	52	54
6	Feather	54	57
7	Light	57	60
8	Light Welter	60	63
9	Welter	63	66
10	Light Middle	66	70
11	Middle	70	75
12	Light Heavy	75	80
13	Heavy	80	-

RULE 3. DURATION AND NUMBER OF ROUNDS

- 3.1. In all AOB Elite and Youth Men's and Women's Competitions, the Bouts must consist of three (3) rounds of three (3) minutes each.
- 3.2. In all AOB Junior Boys' and Girls' Competitions, the Bouts must consist of three (3) rounds of two (2) minutes each.
- 3.3. For all above listed Competitions, the rest time between rounds is one (1) minute.

RULE 4. MEMBERSHIP AND ATHLETE ELIGIBILITY

- 4.1. Membership
 - 4.1.1. All Boxers, Team Officials, ITOs, R&Js, AIBA National Federation staff and management must be members of or licensed and/or authorised by their National Federation, Confederation and AIBA to participate in AOB Competitions, unless AIBA otherwise consents.
- 4.2. Athlete Eligibility
 - 4.2.1. AIBA has the right to make a final decision regarding a Boxer's eligibility.
 - 4.2.2. Each National Federation is responsible for ensuring that its Boxers meet all the requirements of Rule 4 of these rules.
 - 4.2.3. Sport Nationality Eligibility
 - .2.3.1. Boxers must be of the same nationality as the National Federation which has registered them.

- 4.2.3.2. A Boxer who is a national of two or more countries at the same time may represent either one of them, as the Boxer may elect. However, after having represented one country in an AIBA-owned or AIBA-sanctioned Competition, a Boxer may not represent another country unless he/she meets the conditions laid out in Rule 4 of these rules.
- 4.2.3.3. A Boxer elects his nationality when he becomes an Elite Boxer.
- 4.2.3.4. If a complaint on the eligibility of a Boxer is received during any AOB Competition, the Technical Delegate must immediately report the case to the AIBA HQ. If an ineligibility case is proved, the Technical Delegate must immediately disqualify the Boxer and inform the Boxer's National Federation.
 - 4.2.3.4.1. Under no circumstance will there be a redraw, if an ineligibility case is proved after the Official Draw.
 - 4.2.3.4.2. If an ineligibility case is proved after the competition begins, and the ineligible Boxer competes (and wins), only the last defeated boxer can re-enter the competition.
- 4.2.3.5. For all disputes on eligibility taking place prior to or after an AOB Competition, the final decision on determining the nationality lies with the AIBA Executive Committee. If it is believed that nationality rules have been violated, the matter is submitted to the AIBA Disciplinary Commission for review and sanctions may be imposed on the Boxer and/or his/her National Federation.
- 4.2.3.6. Sport Nationality shall be confirmed by the Boxer's passport issued by the represented country. When the nationality is questioned, AIBA has the right to request the following documents:
 - 4.2.3.6.1. Birth Certificate;
 - 4.2.3.6.2. Citizenship Identity Papers;
 - 4.2.3.6.3. Nationality Identity Document;
 - 4.2.3.6.4. Confirmation Letter from the NOC.
- 4.2.3.7. Change of Sport Nationality
 - 4.2.3.7.1. Change of Sport Nationality applies to a Boxer who has more than one nationality or acquired a new nationality, and who would like to change his/her Sport Nationality.
 - 4.2.3.7.2. Change of Sport Nationality rules follow the Olympic Charter, Bye-law to Rule 41.

- 4.2.3.7.3. A Boxer who has represented one country in any AIBA-owned or AIBA-sanctioned Competition and who wishes to represent another country of which he/she holds the nationality may represent his new country provided that at least three (3) years have passed since the Boxer last represented his former country in an AIBA-owned or AIBA-sanctioned competition.
- 4.2.3.7.4. A Boxer who has represented one country in any AIBA-owned or AIBA-sanctioned Competition and who wishes to represent another country nationality of which he/she acquired through naturalisation may represent his/her new country provided that at least three (3) years have passed since the Boxer last represented his/her former country.
- 4.2.3.7.5. In case that the two National Federations concerned agree, they may request AIBA Executive Committee Board to shorten the period.
- 4.2.3.7.6. A Boxer can only change the federation of origin once and may not change to a third federation.
- 4.2.3.7.7. To start the procedure to change the Sport Nationality of a Boxer, AIBA HQ needs to receive the documents mentioned in Appendix 1 of these rules.
- 4.2.3.7.8. Refugee status
- 4.2.3.7.8.1. Boxers who are recognised as refugees or beneficiaries of international protection according to the United Nation High Commissioner for Refugees (UNHCR) agency and who have high Competition results may be entered in AIBA-owned and AIBA-sanctioned Competitions, except Multi-sport Events, under the AIBA flag based on prior approval from the AIBA Executive Committee.
- 4.2.3.7.8.2. In all other Competitions, such as but not limited to Multi-sport Events and National Competitions, eligibility criteria is be defined by the bodies owning the respective event.

4.2.4. Eligibility on Sport-related Issues

4.2.4.1. Participation in Individual Physical Contact Sport other than Boxing

4.2.4.1.1. An athlete who has competed at an amateur or professional level in any Individual Physical Contact Sport other than Boxing is eligible to compete in an AOB or National Competition, at an appropriate level, under the following conditions:

4.2.4.1.1.1. National Federation of the athlete shall complete the Application Form in Appendix 8 of these rules and an AIBA Medical Certificate in Appendix 5 of these rules and submit both documents to AIBA HQ for acceptance and registration.

4.2.4.1.1.2. The registration will be reviewed and potentially approved by AIBA in consultation with the AIBA Technical & Competition Rules Commission.

4.2.4.1.1.3. The athlete shall be eligible to participate once the National Federation receives a written confirmation of approval from AIBA.

4.2.4.1.1.3.1. Any athlete registered as a Boxer by a National Federation under Rule 4.2.4.1.1. above shall not participate in any other Individual Physical Contact Sport once approved by AIBA.

4.2.5. Eligibility on Medical-related Issues

4.2.5.1. All allowed disabilities and prohibited conditions are outlined in the AIBA Medical Rules.

4.2.5.2. Boxers are not allowed to enter any AOB Competition with the following conditions:

4.2.5.2.1. Boxers wearing a dressing on a cut, wound abrasion, laceration or blood swelling (on the scalp or face including the nose and ears).

4.2.5.2.1.1. If a Boxer has an abrasion or a laceration, no dressing other than non-petroleum skin-protective jelly, Collodion, Thrombin Solution,

Micro Fibrillar Collagen, Gelfoam, Surgicel, and Adrenaline 1/1000 or Steri-Strip may be used.

4.2.5.2.1.2. The decision is made by the doctor during the medical examination at the Daily Weigh-in.

4.2.5.2.2. A Boxer must be clean-shaved before all Medical Examinations and each Bout.

4.2.5.2.2.1. Beards and moustaches are not allowed.

4.2.5.2.3. No body piercing and no body accessories are permitted to be worn during a Bout.

4.2.5.2.4. Implanted electrical devices are allowed if approved by the surgeon/physician who implanted the device.

4.2.5.2.4.1. A copy of the original consent from the surgeon/physician who implanted the device should be presented at the Sport Entries Check.

4.2.5.2.5. A Boxer is only allowed to wear soft contact lenses. All other contact lenses are prohibited.

4.2.5.2.5.1. If the concerned Boxer loses contact lenses, the following rules apply:

4.2.5.2.5.1.1. The Boxer accepts to continue to box and the Bout continues;

4.2.5.2.5.1.2. The Boxer does not accept to continue to box without contact lenses, the Referee terminates the Bout, and the opponent is declared the winner by ABD.

4.2.5.2.6. Boxer's laser eye surgery is accepted if accompanied by a letter from the practitioner who carried out the surgery attesting that it is safe to box.

4.2.5.2.6.1. A copy of the original consent from the practitioner should be presented at the Sport Entries Check.

4.2.5.2.7. A Boxer with epilepsy regardless of whether the Boxer is on or off medication can compete if he/she provides a letter from his/her neurologist attesting that it is safe to box.

- 4.2.5.2.7.1. A copy of the original consent from the neurologist should be presented at the Sport Entries Check.
- 4.2.5.2.8. A Boxer wearing braces, including braces on both upper and lower sets of teeth, can box if he/she is wearing a fitted gumshield and can provide a letter from his or her orthodontist attesting that it is safe to box.
- 4.2.5.2.8.1. For Boxers with braces on both upper and lower sets of teeth wearing a gumshield for the upper set of teeth is sufficient.
- 4.2.5.2.8.2. A copy of the original consent from the orthodontist should be presented at the Sport Entries Check.
- 4.2.5.2.9. A Boxer must possess a thumb, an index finger, and either a ring or a middle finger, on each hand to be allowed to compete.
- 4.2.5.2.10 Boxers are allowed to use Kinesiology taping; but it can only be applied from waist down, and to the back of the body.
- 4.2.5.3. Medical Certification following Probation Periods
- 4.2.5.3.1. Before resuming boxing after any period of rest as prescribed in Rule 4.2.5.5. of these rules, a Boxer must be certified as "fit to box" by a doctor to be able to take part in AOB Competitions.
- 4.2.5.4. Knockout (KO) and Referee Stops Contest (RSC)
- 4.2.5.4.1. When the result of the Bout is KO or RSC, the Ringside Doctor must fill out and sign a Medical Bout Report.
- 4.2.5.4.1.1. The Ringside Doctor delivers the Medical Bout Report to the Technical Delegate with a recommendation on how many rest days are prescribed and/or the protective sanitary measures to be taken.
- 4.2.5.4.1.2. The Ringside Doctor must send a copy of the report to the AIBA HQ and the AIBA HQ uploads the document in the AIBA Database and sends it to the National Federation concerned.
- 4.2.5.5. Protective Sanitary Measures and Suspension Periods

- 4.2.5.5.1. A suspension period is a period of time in which a Boxer is not allowed to train, spar or box in competition. Suspension Periods are enforced to protect the Boxer's own health.
- 4.2.5.5.2. All Boxers who have received a suspension period must be examined by a doctor before returning to boxing and must have completed an accepted internationally recognised return to play protocol.
- 4.2.5.5.3. The AIBA Medical Commission has created a programme aligned with the international return to play protocol, called Graduated Return to Boxing Programme "GRTP" (Appendix 9 of these rules) with detailed steps and timeline that must be followed after a suspension period.
- 4.2.5.5.4. Single Occurrence of KO or RSC (with or without a loss of consciousness)
 - 4.2.5.5.4.1. If a Boxer suffers a KO as a result of a blow(s) to the head (KO-H) or has a diagnosis of concussion, the Boxer is suspended for 30 days following this period, the Boxer must follow approved GRTP protocols.
 - 4.2.5.5.4.2. If the result of a Bout is RSC because the Boxer has received heavy blows to the head (RSC-H) and the Ringside Doctor makes a diagnosis of concussion, the Boxer is suspended for 30 days, following this period they must follow approved GRTP protocols.
 - 4.2.5.5.4.3. If the result of the Bout is RSC because the Boxer has received heavy blows to the head (RSC-H) and the Boxer is not diagnosed with concussion, then the Boxer does not require a suspension period, although the Ringside Doctor may give a suspension if they feel it is appropriate.
- 4.2.5.5.5. Double Occurrence of KO or RSC
 - 4.2.5.5.5.1. - If during a period of three months a Boxer twice loses a Bout due to KO or RSC due to a

head blow (KO-H or RSC-H) (with or without loss of consciousness) or has a diagnosis of concussion, then the Boxer may not take part in Boxing or sparring for a minimum period of 30 days after the second occurrence. The Boxer must follow approved GRTP protocols.

4.2.5.5.2. If the result of a Bout is RSC because the Boxer has received heavy blows to the head (RSC-H) and the Boxer is not diagnosed with concussion, then the Boxer does not require a suspension period, although the Ringside Doctor may give a suspension if they feel it is appropriate.

4.2.5.5.6. Triple Occurrence of Knockout or RSC

4.2.5.5.6.1. If during a period of 12 months the Boxer suffers three KOs (with or without loss of consciousness) or three RSCs due to the Boxer having received heavy blows to the head (KO-H or RSC-H) and the Boxer is diagnosed with concussion, then the Boxer may not take part in Boxing or sparring for a period of one year after the third occurrence.

4.2.5.5.6.2. Any combination of KO or RSC (due to head injuries) that equals three under these circumstances qualifies for a one-year suspension. The Boxer must follow approved GRTP protocols.

4.2.5.5.6.3. Any Boxer who has a medical restriction must not train or spar during the suspension period.

4.2.5.5.7. All protective measures must also apply if a KO and/or concussion occur during training or anywhere else. The Coach is responsible for reporting to the National Federation.

4.2.5.5.8. If one Boxer is knocked out as a result of a head blow after “break” or “stop” and is counted up to “ten” (10), the

win by disqualification does not permit this Boxer to continue boxing in the Competition.

4.2.5.5.9. Boxers returning from protective sanitary measures must receive written clearance from their national medical commission and inform the AIBA HQ before returning to box. AIBA HQ then upload the document to the Boxers' profiles in the AIBA Database.

4.2.5.5.9.1. If the National Federation does not have any national medical commission, a neurologist or sports medicine specialist must provide the clearance.

4.2.5.5.10. In the case of body blows, the rest period or the protective sanitary measures are at the discretion of the Ringside Doctor, following the Post-Bout Medical Examination.

RULE 5. COMPETITION REGISTRATION

- 5.1. Boxers must comply with Rule 2 and 4 of these rules (Classification, Membership and Eligibility) to register for an AOB Competition.
- 5.2. In AOB Competitions, only one Boxer per Weight Category per country is allowed to compete.
- 5.3. When registering for any AOB Competition, all Boxers and Team Officials must provide a clear and legible copy of their current passport, a national identification document or a refugee identification document.
- 5.4. In all AOB Competitions, except for National Competitions, Boxers and Team Officials' registration is done in two mandatory phases:
 - 5.4.1. Registration in the AIBA Database
 - 5.4.1.1. This does not apply to Multi-sport Games
 - 5.4.2. Validation of the registration at the Sport Entries Check.
- 5.5. AIBA Database
 - 5.5.1. Boxers and Team Officials can be registered in the AIBA Database only by their respective National Federations.
 - 5.5.2. Each AIBA Database profile has to have the following documents:
 - 5.5.2.1. A clear and legible copy of the current passport, a national identification document or a refugee identification document.;

- 5.5.2.2. Signed Anti-doping Consent Form (Appendix 6 of these rules) for Boxers only;
- 5.5.2.3. Completed, signed, and stamped copy of the AIBA Medical Certificate (Appendix 5 of these rules) for Boxers only;
- 5.5.2.4. Signed Declaration of Non-Pregnancy (Appendix 7 of these rules) for Women Boxers only;
- 5.5.3. AIBA National Federations are responsible for ensuring that Boxers' and Team Officials' profiles are correct and up-to-date.
- 5.6. Submission of the Anti-Doping Consent Form
 - 5.6.1. To participate in an AOB Competition, Boxers must have a signed Anti-Doping Consent Form uploaded to their AIBA Database profile.
 - 5.6.1.1. For Boxers who are 18 (eighteen) years-old or older, the Anti-Doping Consent Form has to be signed by the Boxer
 - 5.6.1.2. For Boxers who are under 18 (eighteen) years-old, the Anti-Doping Consent Form has to be signed by the Boxer and by at least one of the Boxer's parents/legal guardians.
- 5.7. Submission of the Medical Certificate
 - 5.7.1. In all AIBA-owned and AIBA-sanctioned Competitions, a Boxer's AIBA Medical Certificate issued within the previous three (3) months must be presented at the Sport Entries Check.
 - 5.7.2. In all AIBA-affiliated Competitions, a Boxer's AIBA Medical Certificate issued within the previous one year must be checked.
 - 5.7.3. In order for a Medical Certificate to be valid, the examination must have been completed (i) by a qualified Doctor, (ii) no later than the period defined for submission of medical certificate, (iii) the record of the examination must contain clear and legible results for all test areas, and (iv) has to be signed, and stamped by the doctor after the doctor finishes performing a medical check on the Boxer.
 - 5.7.3.1. A copy of the annual original laboratory documentation for Hepatitis B, Hepatitis C, and HIV tests must be presented together with the Medical Certificate.
 - 5.7.3.2. A copy of these documents has to be uploaded to the Boxer's profile in the AIBA Database.
- 5.8. Submission of the Declaration of Non-Pregnancy
 - 5.8.1. To participate in an AOB Competition, Women must have a signed Declaration of Non-Pregnancy uploaded to their AIBA Database profile.

- 5.8.1.1. For women Boxers who are 18 (eighteen) years-old or older, the Declaration of Non-pregnancy has to be signed by the Boxer.
- 5.8.1.2. For women Boxers who are under 18 (eighteen) years-old, the Declaration of Non-pregnancy has to be signed by the Boxer and by at least one of her parents/legal guardians.
- 5.9. Submission of an AIBA Boxer's Record Book
 - 5.9.1. In all AOB Competitions, a Boxer's AIBA Boxer's Record Book has to be presented and validated at the Sport Entries Check for the Boxer to be eligible to participate in the Competition.
 - 5.9.2. The AIBA Boxer's Record Book must be duly completed, including the medical section, and must be signed and stamped by the Secretary General or Executive Director of the Boxer's National Federation.

RULE 6. SPORT ENTRIES CHECK

- 6.1. A Sport Entries Check is mandatory for all AOB Competitions, except for National Competitions.
- 6.2. All Team Delegations must attend the Sport Entries Check Meeting to confirm their registered Boxers and team officials.
- 6.3. The Sport Entries Check should take place two days before the first Competition day and always before the Official Draw. In exceptional circumstances, the Technical Delegate may decide to extend the meeting due to delayed arrivals.
- 6.4. The Team Manager and the Team Doctor of each Team Delegation must attend this meeting. If they are not available, then the Head Coach must replace them.
- 6.5. To confirm the team registration, the below listed documents must be presented:
 - 6.5.1. Copy of passport or national identification document of each Boxer;
 - 6.5.2. AIBA Boxer's Record book of each Boxer;
 - 6.5.3. AIBA Medical certificate issued within the previous 3 months of each Boxer and accompanied by a copy of the annual original laboratory documentation for Hepatitis B, Hepatitis C, and HIV tests;
 - 6.5.4. Boxers' uniforms;
 - 6.5.5. Boxers' equipment;
 - 6.5.6. Any other document or item as requested in the Team's Delegation Handbook
 - 6.5.7. Any additional document or item as requested by the Technical Delegate
- 6.6. The Sport Entries Check Meeting is comprised of several stations with ITOs. The Technical Delegate appoints two ITOs to each station, taking into consideration that one Doctor must be present at each of them.

- 6.7. ITOs verify the provided registration documents and confirm the final entries through the signature of the Sport Entries Form.
- 6.8. No changes are accepted once the Form has been signed off by both the ITOs and the Team Representative(s).
- 6.9. Failure to attend the Sport Entries Meeting results in the cancellation of the registration of the Team Delegation
- 6.10. Failure to provide one or several documents results in the cancellation of the registration of the concerned Boxer(s).
- 6.11. Substitution of Boxers at Sport Entries Check meeting
 - 6.11.1. In Open Competitions, it is permissible to substitute a Boxer during the Sport Entries Check meeting, as long as, the substitute Boxer was registered through the AIBA Database in a different weight category or as a reserve Boxer.
 - 6.11.2. In Closed Competitions (where a qualification is required to participate), it is not permissible to substitute any Boxer at the Sport Entries Check Meeting.

RULE 7. OFFICIAL DRAW

- 7.1. The Official Draw has to take place after the completion of the Sport Entries Check Meeting. It must be completed no less than three (3) hours prior to the first Bout on the first Competition day.
- 7.2. At least one Team Official of each participating Delegation has to attend the Official Draw.
- 7.3. An AIBA Scoring System is to be used for the Official Draw in all AOB Competitions and should be operated by the AIBA Scoring System operator.
- 7.4. In case the AIBA Scoring System is not working, a manual system may be used.
- 7.5. In any case, until the last Weight Category draw is completed, if there is any error caused by the AIBA Scoring System or the AIBA Scoring System Operator, the Technical Delegate has the right to order that Weight Category draw to be re-done.
- 7.6. The Technical Delegate has to ensure, where applicable, that no Boxer can box twice in the Competition before all other Boxers of the same Weight Category have boxed at least once.
- 7.7. Competition Schedule
 - 7.7.1. In AIBA-owned and AIBA-sanctioned Competitions, the Bouts should be arranged, if possible, in the order of weights from lowest weight categories to highest.
 - 7.7.1.1. In arranging the schedule of the Semi-Finals and Finals of these Competitions, requests from the Local Organising Committee may

be accommodated by the Technical Delegate, as long as, the results of the Official Draw are not called into question.

7.7.1.2. At the request of the Host Broadcaster, and in agreement with the Technical Delegate, the Bout schedule of a given day can be amended, so that Boxers from the same nationality box consecutively within the same Session- even if they were originally planned in two different sessions – if the following requirements are met:

7.7.1.3. The new Bout schedule has to be communicated to the Teams at least one day before the scheduled Bout; and

7.7.1.4. In case one Bout is moved from a Session to another session, the Bout of the next direct opponent shall be moved as well to the same session.

7.8. Boxers must respect a minimum rest period of twelve (12 hours) between two (2) Bouts.

7.9. The Official Draw has to respect the Seeding Procedure as per Rule 8 of these rules and be in accordance with AIBA World Ranking procedure as per Rule 15 of these rules.

RULE 8. SEEDING PROCEDURE

8.1. In the following AOB Elite Competitions, a certain number of Boxers shall be seeded by the Seeding Commission, based on the Boxers' AIBA World Ranking and past performances at the:

8.1.1. Olympic Games

8.1.2. AIBA World Championships

8.1.3. Confederation Championships

8.1.4. Continental Multi-sport Games

8.2. Seeding Commission

8.2.1. A Seeding Commission must be formed no later than one (1) month prior to each above-mentioned Competition by the AIBA President based on the recommendations of the AIBA Technical & Competition Rules Commission Chairman.

8.2.2. The Seeding Commission is formed by the Technical & Competition Rules Commission and operates when required. A total of three (3) members are part of the Seeding Commission.

8.2.3. For each Competition where seeding should be applied the Seeding Commission reviews the up to date AIBA World Ranking and the Boxers' past performances in order to decide which Boxers are eligible to be seeded.

8.2.4. The Process is as follows:

8.2.4.1. AIBA HQ sends the entry list to the Seeding Commission

8.2.4.2. The Seeding Commission works on the seeding and sends the final seeding back to AIBA HQ not later than 10 days prior to the Official Draw

8.2.4.3. AIBA HQ sends the final seeding to the AIBA Scoring System operators no later than 5 days prior to the Official Draw.

8.3. Seeding Criteria

8.3.1. To prepare the seeding for the Official Draw, the AIBA Seeding Commission must follow the rationale laid out in Rule 8.3 of these rules. A Boxer who does not meet these criteria does not get seeded.

8.3.2. To be seeded Boxers must be ranked in the AIBA World Ranking

8.3.3. Additionally, Boxers must meet one of the criteria below:

8.3.3.1. Be within the Quarterfinalists of the last edition of the AIBA Elite World Boxing Championships.

8.3.3.2. Be within the Quarterfinalists of the last edition of the Elite Confederation Championships.

8.3.3.3. Be within the top 8 of the individual ranking of the last completed WSB Season.

8.4. Seeding Procedure during the Official Draw

8.4.1. The number of seeds at the Official Draw are as follows:

Number of entries in the weight Category	Number of seeded Boxers
≤ 3	0
4 to 8	Up to 2
9 to 16	Up to 4
Over 17	Up to 8

8.4.2. Depending on the number of seeds, seeded entries are placed as detailed in Appendix 3 of these rules and as described hereafter.

8.4.2.1. Up to two (2) seeded Boxers:

8.4.2.1.1. Seeds 1 and 2 should be placed respectively at the top and the bottom of the draw.

8.4.2.1.2. The remaining places are filled with non-seeded Boxers randomly drawn by the AIBA Scoring System.

8.4.2.2. Up to four (4) seeded Boxers:

8.4.2.2.1. Seeds 1 and 2 should be placed respectively at the top and the bottom of the draw.

- 8.4.2.2.2. Seeds 3 and 4 should be drawn to potentially face seeds 1 and seeds 2 in the Semi-finals.
 - 8.4.2.2.3. The remaining places are filled with non-seeded Boxers randomly drawn by the AIBA Scoring System.
 - 8.4.2.3. Up to eight (8) seeded Boxers:
 - 8.4.2.3.1. Seeds 1 and 2 should be placed respectively at the top and the bottom of the draw.
 - 8.4.2.3.2. Seeds 3 and 4 should be drawn to potentially face seeds 1 and seeds 2 in the Semi-finals.
 - 8.4.2.3.3. Seeds 5,6,7 and 8 shall be drawn to potentially Box seeds 1,2,3 and 4 in the Quarter-finals.
 - 8.4.2.3.4. The remaining places are filled with non-seeded Boxers randomly drawn by the AIBA Scoring System.
 - 8.4.3. The number of byes must be defined and placed as follows:
 - 8.4.3.1. When the number of Boxers is 4, 8, 16, 32, 64, 128 or any higher power of 2, they meet in pairs (e.g. Diagram 1 in Appendix 3 of these rules).
 - 8.4.3.2. When the number of Boxers is a power of 2, there are byes in the first round of the Bouts. The number of byes is equal to the difference between the next higher power of 2 and the number of Boxers (e.g. with 17 Boxers, there are $32 - 17 = 15$ byes).

RULE 9. DRAW COMMISSIONER PROTOCOL

9.1. First Day of the Competition

- 9.1.1. Upon arriving to the Competition, the Draw Commissioner receives a list of all R&Js taking part in the tournament, produced by the AIBA Scoring System. This list is to be used as reference throughout the Competition.

9.2. Prior to start of a Boxing Session

- 9.2.1. During the Daily Technical Delegate Meeting, the Draw Commissioner informs Technical Delegate of any names to be withdrawn from the R&J pool for the Sessions of the current day. The Technical Delegate sends an Official Communication, using the template provided by the AIBA Scoring System, to the AIBA Scoring System operator with clear instructions of which names have to be withdrawn from the day's R&J pool. If no names are to be withdrawn and no filters are to be used during the R&J Draw for the given day, no action is required.

- 9.2.1.1. R&Js can be withdrawn from the R&J pool for a Session based on the evaluations and recommendations of the R&J Evaluators.
- 9.2.1.2. Filters used for the R&J Draw must abide by the rules of neutrality of the AIBA Technical and Competition Rules.
- 9.2.1.3. Additional filters can only be used for the R&J Draw when an R&J is from a country that is in major current conflict with the country(ies) of one or both of the competing Boxers in the given Bout.
- 9.2.2. The deadline for the Official Communication to be sent to the AIBA Scoring System operator is one and a half hours (1h30m) before the start of the first Session of the day. The communication can be hand-written and delivered in person at the Competition Venue, as well as, electronically.
- 9.2.3. One and a half hours (1h30m) before the start of the first Session of the day, the AIBA Scoring System operator inputs all requested filters and withdrawals and then draws the R&Js for that Session.
 - 9.2.3.1. The date and time of the R&J Draw is protooled into the AIBA Scoring System, assuring no second draw can take place.
 - 9.2.3.2. The AIBA Scoring System operator then produces the R&J draw sheet for the Session and gives it to the Draw Commissioner in the Field of Play.
- 9.2.4. For all consequent Sessions of the day, 15 minutes after the end of the previous Session, the AIBA Scoring System operator inputs all requested filters and withdrawals, that were stipulated in the morning in the Official Communication as per Rule 9.2 of these rules, and then draws the R&Js for that Session.
 - 9.2.4.1. The date and time of the R&J Draw will be protooled into the AIBA Scoring System, assuring no second draw will take place.
 - 9.2.4.2. The AIBA Scoring System operator will then produce the R&J draw sheet for the Session and gives it to the Draw Commissioner in the Field of Play.
- 9.2.5. No later than thirty (30) minutes prior to the start of each session, the Draw Commissioner must hand in the R&J Draw Sheet (with any extraordinary change requests, as per Rule 9.3 of these rules, or in the case where no Judge is drawn by the AIBA Scoring System and signed by the Technical Delegate) to the AIBA Scoring System operator.

- 9.2.5.1. If no change requests are made, the Draw Commissioner must hand in the overall R&J draw sheet signed by the Technical Delegate to the AIBA Scoring System operator.
- 9.2.5.2. If the Draw Commissioner needs to make any changes or manual entries that involves his/her nation, this needs to be brought to the attention of the Technical Delegate and the Deputy Technical delegate for a final approval.
- 9.2.6. The duty of a Draw Commissioner is to ensure that the morning Official Communication to the AIBA Scoring System operator contains all the necessary filter and withdrawal requests, so that the computerised R&J draw is made with as much input as possible, and with the objective of not having to request any changes once the draw has been made.
- 9.2.7. From the moment the Draw Commissioner receives the R&J draw sheet and starts reviewing it, he or she must remain in the Field of Play, until he or she returns the R&J draw sheet, that is signed off by the Technical Delegate, to the AIBA Scoring System operator.
- 9.2.8. The Technical Delegate must be present in the Field of Play to approve and sign off the R&J draw sheet after it is reviewed by the Draw Commissioner.
 - 9.2.8.1. From the moment the Technical Delegate receives the R&J draw sheet for review, approval and signature, and until the document is returned to the Draw Commissioner and then the AIBA Scoring System operator, the Technical Delegate may not leave the Field of Play.
- 9.2.9. All change requests must abide by the rules of neutrality stated in the AIBA Technical and Competition Rules.
- 9.2.10. Once the R&J Draw Sheet is returned to the AIBA Scoring System operator, with or without change requests, the AIBA Scoring System operator prints four updated R&J per Bout draw sheets for the upcoming Session.
 - 9.2.10.1. The AIBA Scoring System operator hands all copies, Bout per Bout to the R&J Coordinator who:
 - 9.2.10.1.1. Hands one copy to the announcer at ringside.
 - 9.2.10.1.2. Hands a copy to each of the R&J Evaluators.
 - 9.2.10.1.3. Keeps one copy in order to properly call the R&Js taking part in the upcoming Bout.
- 9.3. After the start of a Boxing Session
 - 9.3.1. The Draw Commissioner can only request changes to the R&J Draw after the start of the Boxing Session if:

- 9.3.1.1. Unforeseen individual problems occur to an R&J, such as illness, injury or external emergencies.
- 9.3.1.2. An unexpected “no show” from an R&J for the Bout where the R&J is assigned.
- 9.3.1.3. A CLEAR identification of wrongdoing as per AIBA’s Code of Ethics is recognised during the said Session.
- 9.3.1.4. A CLEAR identification of a safety hazard for the R&J or the Boxer is recognised during the said Session.
- 9.3.2. When a change request is made after the “Start of Session”, the request should be made through an Official Communication, using the template provided by the AIBA Scoring System, signed by the Technical Delegate, and detailing each individual substitution (Bout number, name and number of the substituted R&J; name and number of the new R&J). The Official Communication must also include the reason why the substitution was made.
- 9.3.3. If a selected Judge cannot continue judging during a bout due to illness, the procedures as per Rule 9.3.2. of these rules will be followed. The total score will be calculated as if no replacements took place.

RULE 10. ATHLETE MEDICAL EXAMINATION

- 10.1. Within 3 months before all AIBA-owned and AIBA-sanctioned Competitions, Boxers must pass a medical examination with the NF Registered Medical/Ringside doctor to receive their completed, signed, and stamped AIBA Medical Certificate.
- 10.2. Within 1 year before all AIBA-affiliated Competitions, Boxers must pass a medical examination with the NF Registered Medical/Ringside doctor to receive their completed, signed, and stamped AIBA Medical Certificate.
- 10.3. Pre-bout medical examination
 - 10.3.1. Pre-bout medical examination must be on the same day as the Bout and takes place during the Daily Weigh-In.
 - 10.3.2. The Technical Delegate decides the starting time of the pre-bout medical examination and must communicate the starting time to the LOC, Team Delegations and Competition Officials.
 - 10.3.3. Ringside Doctors are assigned by the Technical Delegate to work at the pre-bout medical examination.
 - 10.3.3.1. The Chairperson of the Ringside Doctors may select Local or Team Doctors to assist with the pre-bout medical examinations.

10.3.3.1.1. Local and Team Doctors must be qualified doctors and must provide a legible copy of his/her current passport (no other proof of identity is accepted) and medical credentials.

10.3.4. A Boxer must be examined by the doctor and has to be confirmed “fit to compete” before being able to weigh-in.

10.4. In AOB Competitions, gender tests may be conducted.

10.5. Post-bout medical examinations are conducted as per AIBA Medical Rules.

10.6. Additional medical examinations may be conducted as per AIBA Medical Rules.

RULE 11. DAILY WEIGH-IN

11.1. During the Boxer’s first Daily Weigh-In of the Competition, both the minimum and the maximum weight limits are controlled.

11.1.1. Boxer’s weight must not exceed the maximum of the Boxer’s Weight Category nor be below the minimum of the Boxer’s Weight Category.

11.2. The weight registered at the Sport Entries Check decides the Boxer’s Weight Category for the entire Competition.

11.3. At the consequent Daily Weigh-Ins, only the maximum weight limit is controlled, not the minimum weight limit.

11.3.1. If a Boxer exceeds the maximum weight limit at the Daily Weigh-In, that Boxer is not allowed to continue competing as per Rule 19.11.2. of these rules.

11.4. A Boxer is allowed to be present at the official scales only once.

11.5. The weight is the one shown on the scale, the body being naked except for a swimming suit or underwear. When necessary, the Boxer may take off the underwear.

11.6. There is a zero tolerance on any overweight than the chosen Weight Category.

11.7. The Weigh-In must be conducted by Competition Officials appointed by the Technical Delegate.

11.8. The Weigh-In must be conducted by Competition Officials of the same gender as the Boxers.

11.9. Electronic scales must be used for both Test scales and Daily Weigh-In scales, and have to be of the same brand and model, calibrated daily and not moved after calibration.

11.10. Test scales must be available at the Weigh-In area and each Team Hotel.

11.11. The time from the end of the Daily Weigh-In to the start of the first Bout of the Competition days must not be less than 3 hours.

11.11.1. The Technical Delegate reserves the right to relax this condition if unavoidable circumstances occur and after consultation with the Chairperson of the Ringside Doctors.

11.12. The LOC of a mixed Competition, where both Men and Women Boxers compete, must arrange distinct areas for the Medical Examination and the Daily Weigh-In, so these activities can be carried out separately for Men and Women Boxers.

RULE 12. FIELD OF PLAY (FOP)

12.1. FOP Set Up – One ring

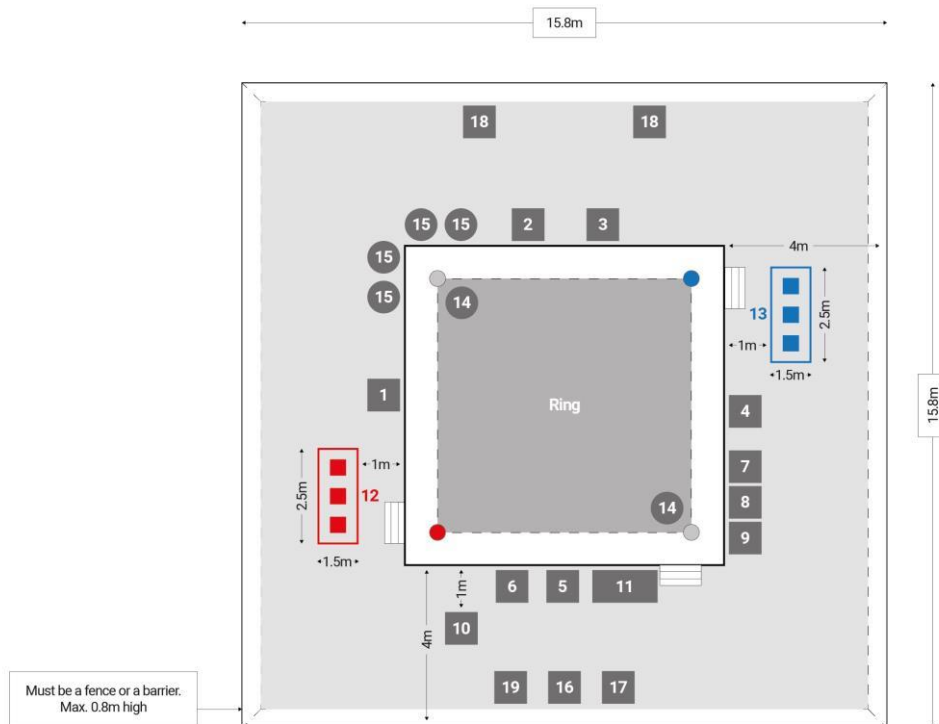

- | | |
|-----------------------------|---------------------------------|
| 1 Judge 1 | 10 AIBA Scoring System Operator |
| 2 Judge 2 | 11 Ringside Doctor's Table |
| 3 Judge 3 | 12 Red Corner Seating Area |
| 4 Judge 4 | 13 Blue Corner Seating Area |
| 5 Judge 5 | 14 Neutral Corners |
| 6 Deputy Technical Delegate | 15 Photographers |
| 7 Official Announcer | 16 Technical Delegate |
| 8 Timekeeper | 17 Draw Commissioner |
| 9 Gong Operator | 18 R&J Evaluator |
| | 19 Observer |

Positions of R&J Coordinator and Standby R&Js will depend on the FOP. The Technical Delegate will define these positions during the FOP check.

The Graphics Operator must be placed outside of the FOP.

12.2. FOP Set Up – Two rings

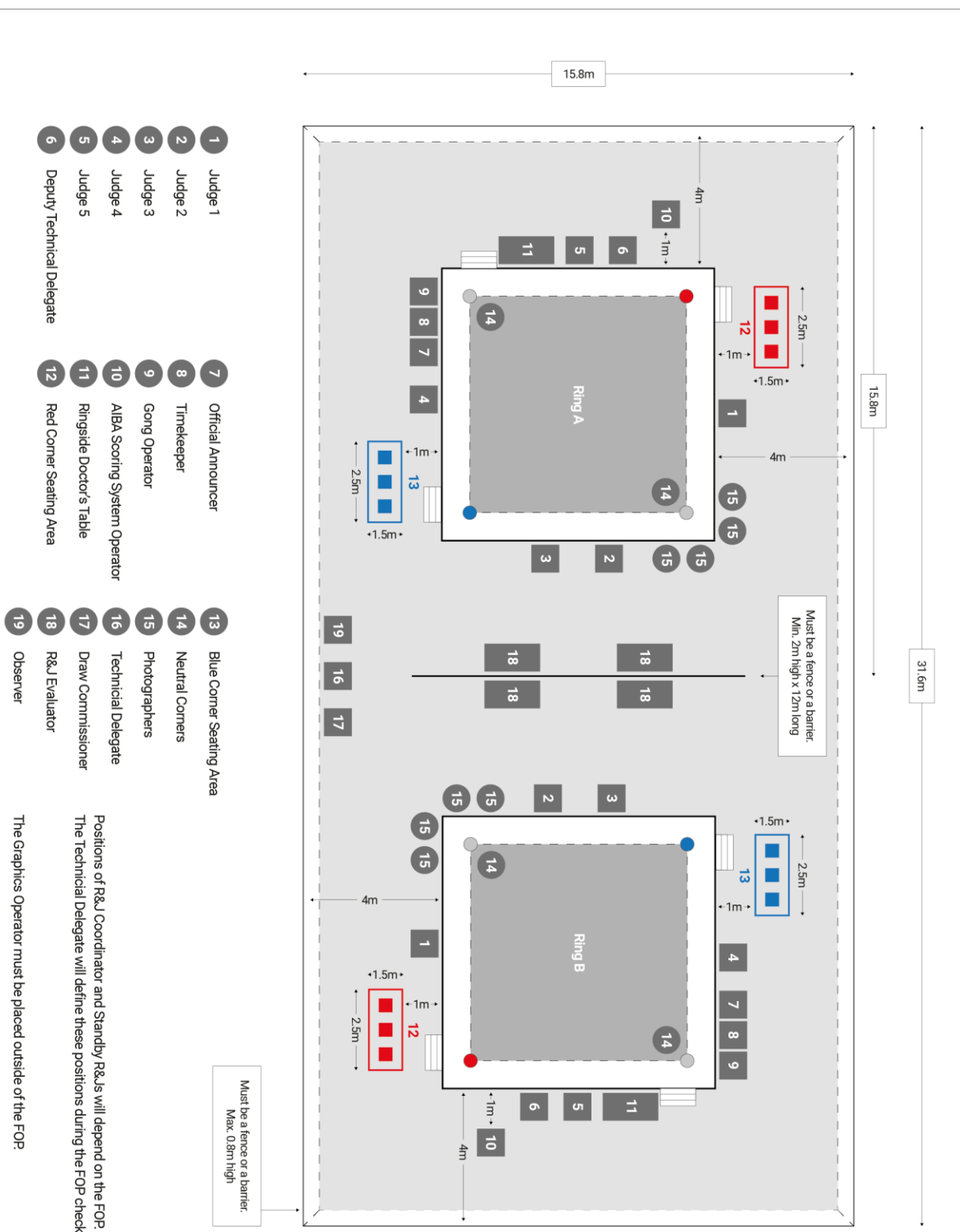

12.3. ITO Positions in and around the FOP

- 12.3.1. The R&J Coordinator(s) chair(s) must be placed in the same area as the stand-by R&Js chairs.
- 12.3.2. The Equipment Managers' table must be located near Boxers' entrance to the FOP.
- 12.3.3. The Record Book Managers must be seated at a table located nearby the Boxers' exit from the FOP.

12.4. Media Guidelines

- 12.4.1. If a platform for TV cameras is required during a Competition, its length and width have to be 1 m each. Its height is determined jointly by the AIBA HQ and the Competition Manager, subject to the Technical Delegate's approval.
- 12.4.2. A maximum of two (2) TV camera operators can mount the ring apron during and between Bouts, but only one (1) can enter the ring and only for the announcement of the Bout decision.
- 12.4.3. Each camera operator may have one assistant at the maximum, and this assistant must remain on the floor.
- 12.4.4. No more than four (4) photographers may be positioned at ringside during Competition. They are to remain in a marked area of 1.5 m from the neutral corner towards Judge 1 and Judge 2.
- 12.4.5. Microphones may only be attached to the backside of the pads in the neutral corners.

RULE 13. AIBA ANTI-DOPING AND MEDICAL RULES

- 13.1. All AOB Competitions must adhere to the AIBA Anti-Doping Rules and the AIBA Medical Rules.
- 13.2. In all AOB Competitions, anti-doping tests must be conducted.
 - 13.2.1. The test distribution plan needs to be requested to the AIBA HQ.
- 13.3. At the end of a Competition, the LOC is responsible for uploading all Doping Control Forms (DCF) into ADAMS (Anti-Doping Administration & Management System), under a new mission order. All physical records of anti-doping tests, including DCFs and Chain of Custody forms, must then be sent to the AIBA HQ, via mail, within forty-eight (48) hours after the end of a Competition.

13.4. Authority overview:

Event	Sample Collection Authority	Testing Authority	Results Management Authority
AOB Event	AIBA decides	AIBA	AIBA
WSB Event	AIBA decides	AIBA	AIBA
Confederation Event	Local Organising Committee decides	AIBA	AIBA
Multi-sport Event	Multi-sport Event Organising Committee decides	Multi-sport Event Organising Committee	NADO/ Multi-sport Event Organising Committee & AIBA
International Event not organized by AIBA	Local Organising Committee decides	AIBA	AIBA

RULE 14. TEAM OFFICIALS

14.1. Team Cut Technician

14.1.1. Eligibility

14.1.1.1. A Team Cut Technician must be AIBA certified to be part of a team delegation.

14.1.1.2. A Team Cut Technician is there to assist a Boxer's preparation and may accompany a Boxer to the ring. A Team Cut Technician is mostly needed in Competitions that are required to use professional handwraps and no headguards. However, they may work in any type of event.

14.1.2. The duties of the Team Cut Technician

14.1.2.1. A Team Cut Technician is responsible for using their skills and knowledge to ensure injury prevention of a Boxer.

14.1.2.2. Examples of a Team Cut Technician's duties in the following areas;

14.1.2.2.1. Hand wrapping

14.1.2.2.2. Facial area treatment prior and during a Bout to help prevent injuries

14.1.2.2.3. Treatment of cuts, swelling and nosebleeds during and after a bout

14.2. Seconds

14.2.1. Eligibility

14.2.1.1. Only AIBA-certified Coaches and AIBA-certified Team Cut Technicians can work as Seconds in all AOB Competitions, unless due to exceptional circumstances AIBA allows otherwise.

14.2.1.2. Any Coach active in professional boxing shall be allowed to be a Coach and/or Second in AIBA Competitions once the Coach has been certified by AIBA as a registered Coach. Reciprocally, an AIBA certified Coach may be active in professional boxing.

14.2.1.3. Each Boxer is entitled to be accompanied to the ring by up to three (3) Seconds. However, only two (2) Seconds may mount the apron of the ring and only one (1) may enter the ring.

14.2.1.3.1. In any Elite AOB Competition, one (1) Second position must be filled by a Team Cut Technician, otherwise the Boxer can only be accompanied to the ring by two (2) Seconds. An AIBA Team Cut Technician must always be accompanied by an AIBA-certified Coach.

14.2.2. The duties of the Seconds

14.2.2.1. Seconds must leave the ring and the apron prior to the start of each round, and must remove seats, towels, buckets, etc., from the platform of the ring.

14.2.2.2. Seconds must have a towel for the Boxer during the Bout. A Second may indicate retirement of the Boxer by throwing the towel into the ring when this Boxer is considered to be unfit or unable to continue boxing, except when the Referee is in the course of counting.

14.2.2.3. Seconds can only use the transparent bottled water provided by the Organizing Committee. In the case of a cut, the Seconds can use non-petroleum skin-protective jelly, Collodion, Thrombin Solution, Micro Fibrillar Collagen, Gelfoam, Surgicel and Adrenaline 1/1000. Ice bags, Enswell and Swabs are permissible.

14.2.2.4. Seconds may not administer any drugs aside from the approved ones during the Bout.

14.2.2.5. Seconds may use a bag with maximum dimensions of 30 cm x 20 cm x 20 cm.

14.2.3. Prohibited activities

- 14.2.3.1. Seconds are not permitted to stand up and/or to encourage or incite spectators by words or signs during the progress of a round. Seconds are not allowed to touch the ring during the Bout, yell, cause a scandal or disturb the Competition.
- 14.2.3.2. Seconds' seating area must be 1 metre away from the ring corner within a 1.5 m x 2.5 m designated area.
- 14.2.3.3. Seconds are not permitted to walk off Second's designated area with disagreed actions against the Referee.
- 14.2.3.4. Seconds are not permitted to throw any item into the ring to demonstrate a disagreement or to kick any chair or water bottle or to take any other action that may be deemed as unsportsmanlike behaviour.
- 14.2.3.5. The use of any communication device is not permitted in the FOP such as but not limited to mobile telephones, walkie-talkies, smart phones, headsets, shortwave radios, etc.
- 14.2.3.6. Under no circumstance are Seconds allowed to administrate supplemental oxygen or any type of inhaler to a Boxer during a Bout.
- 14.2.3.7. Seconds are not permitted to yell at/argue with any Official on the FOP during or after the Bout.

14.2.4. Sanctions

- 14.2.4.1. For a 1st violation on any of above prohibited activities, a Second receives a caution.
- 14.2.4.2. For a 2nd violation on any of above prohibited activities, a Second receives a warning and be placed just outside of the FOP area but be allowed to remain the Competition Venue.
- 14.2.4.3. For a 3rd violation on any of the above prohibited activities, a Second is removed by the Technical Delegate for the rest of the day.
- 14.2.4.4. If a Second is removed for a second time, that Second is completely suspended from the Competition.

RULE 15. AIBA WORLD RANKING

- 15.1. AIBA World Ranking points for each Boxer are accumulated over a two (2) year “rolling” period.
- 15.2. AIBA World Ranking points are awarded for each Competition and maintained in full for four (4) Competitions.
- 15.3. From the 5th Competition onwards (up to a maximum of 7 Competitions), any AIBA World Ranking point awarded are decreased by 25% per Competition.
- 15.4. The Official AIBA World Ranking is issued after each Competition counting into the ranking system.
- 15.5. Every Boxer participating in AIBA-owned and AIBA-sanctioned Elite Competitions, except for AOB Olympic Qualifying Events for the Olympic Games and the Youth Olympic Games, is ranked within the Competition and gains points depending on final result and position.
- 15.6. For Men, AIBA World Ranking points are allocated for the following listed Competitions:
- 15.6.1. Olympic Games
 - 15.6.2. World Championships
 - 15.6.3. Continental Multi-Sport Games
 - 15.6.3.1. All-Africa Games
 - 15.6.3.2. Asian Games
 - 15.6.3.3. European Games
 - 15.6.3.4. Pan American Games
 - 15.6.4. Confederation Championships
- 15.7. Men’s ranking points allocation table

Ranking Competitions	Ranking points to earn for reaching the following place									
	1 st	2 nd	3 rd	4 th	5 th	6 th	7 th	8 th	9 th	10 th
Olympic Games	1300	900	750	750	600	550	500	450	100	100
World Championships	1200	800	650	650	500	450	400	350	100	90
Continental Multi-Sport Games	700	500	350	350	250	200	150	100	50	10
Confederation Championships	500	400	300	300	200	150	100	50	20	0

15.7.1.1. The above-listed ranking points are adjusted for the Continental Championships based on the number of Boxers in each Weight Category as follows:

15.7.1.1.1. 7 Boxers or less: 50% deduction from above-listed points

15.7.1.1.2. 8 to 11 Boxers:30% deduction from above-listed points

15.7.1.1.3. 12 Boxers or more: No deduction

15.8. For Women, AIBA World Ranking points are allocated for the following listed Competitions:

15.8.1. Olympic Games

15.8.2. World Championships

15.8.3. Continental Multi-Sport Games

15.8.3.1. All-Africa Games

15.8.3.2. Asian Games

15.8.3.3. European Games

15.8.3.4. Pan American Games

15.8.4. Confederation Championships

15.9. Women's ranking points allocation table

Ranking Competitions	Ranking points awarded for reaching the following place				
	1st	2nd	3rd	4th	5th
Olympic Games	1300	900	750	750	600
World Championships	1200	800	650	650	500
Continental Multi-Sport Games	700	500	350	350	250
Confederation Championships	500	400	300	300	200

15.9.1.1. The above-listed ranking points are adjusted for the Continental Championships based on the number of Boxers in each Weight Category as follows:

15.9.1.1.1. 7 Boxers or less: 50% deduction from above listed points

15.9.1.1.2. 8 to 11 Boxers:30% deduction from above listed points

15.9.1.1.3. 12 Boxers or more: No deduction

15.10.A Boxer disqualified for a violation of the AIBA Disciplinary Code including for anti-doping issues is not awarded with any ranking point.

15.11. Extra criteria (Men and Women)

- 15.11.1. Any Boxer who changes Weight Category is awarded 75% of all points granted in the previous Weight Category.
- 15.11.2. Two (2) Boxers with the same amount of points are firstly ranked by the number of Competitions in which they participated.
- 15.11.3. If two (2) Boxers have the same number of points gained in the same number of Competitions, they are ranked through the best result in the highest ranked Competition as follows:
 - 15.11.3.1. World Championships
 - 15.11.3.2. Olympic Games
 - 15.11.3.3. Confederation Championships
 - 15.11.3.4. Youth World Championships

RULE 16. RESULT PROTOCOL

16.1. In AOB Competitions, Boxers' results are classified as follows:

Result	Rank	Competition Stages
1	1	Gold
2	2	Silver
3	3	Loser vs Gold in Semi-Final (SF)
3	4	Loser vs Silver in Semi-Final (SF)
5	5	Loser vs Gold in Quarter-Final (QF)
5	6	Loser vs Silver in Quarter-Final (QF)
5	7	Loser in QF vs Loser to Gold in SF
5	8	Loser in QF vs Loser to Silver in SF
9	9	Loser vs Gold in Round of 16
9	10	Loser vs Silver in Round of 16

16.2. In an AOB Competition where box-off Bout for the third (3rd) place is organised between the two (2) losers of the semi-finals, the Boxers result must be classified as follows:

Result	Rank	Competition Stages
1	1	Gold

2	2	Silver
3	3	Winner of the Box-off Bout for the third (3 rd) place
4	4	Loser of the Box-off Bout for the third (3 rd) place
5	5	Loser vs Gold in Quarter-Final (QF)
5	6	Loser vs Silver in Quarter-Final (QF)
5	7	Loser in Quarter-Finals (QF) vs the Boxer ranked third (3 rd)
5	8	Loser in Quarter-Finals (QF) vs the Boxer ranked fourth (4 th)
9	9	Loser vs Gold in Round of 16
9	10	Loser vs Silver in Round of 16

16.3. In an AOB Competition where box-off Bout for the fifth (5th) places are organised between the four (4) losers of the quarter-finals, the Boxer's result must be classified as follows:

Result	Rank	Competition Stages
1	1	Gold
2	2	Silver
3	3	Loser vs Gold in Semi-Final (SF)
3	4	Loser vs Silver in Semi-Final (SF)
5	5	Two (2) Winners of the Box-off Bout are ranked at the fifth (5 th) place
7	7	Two (2) Losers of the Box-off Bout are ranked at the seventh (7 th) place
9	9	Loser vs Gold in Round of 16
9	10	Loser vs Silver in Round of 16

16.4. In all other cases, Rule 19 of these rules applies.

RULE 17. AIBA DATABASE

17.1. The AIBA HQ Office maintains records of AIBA certified R&Js and ITOs. Certification, participation, evaluation and personal information is stored on the AIBA Database.

17.2. Each AIBA 3-Star R&J and ITO receives a username and password to access his/her profile to view and edit personal information. All other officials must ask their respective National Federation to maintain their AIBA Database profile.

RULES FOR SCORING

RULE 18. AIBA SCORING SYSTEM

- 18.1. The AIBA Scoring System must be used in all Bouts and must be operated by the AIBA Scoring System operator.
- 18.2. The AIBA Scoring System is based on a “Ten Point Must-System”.
- 18.3. In all Bouts of AOB Competitions, the five (5) Judges for each Bout are allocated a position around the ring in accordance with the electronic draw by the AIBA Scoring System.
- 18.4. At the end of each round, each Judge determines the winning Boxer of that round by awarding a score of ten (10) points and by awarding nine (9) or less points (seven (7) is the minimum score) to the losing Boxer, depending on the judgment as to the degree to which the opponent lost the round. Every round must have a declared winner.
 - 18.4.1. At the end of each round, the scores awarded and the Judge who awarded each score is identified on a public display, but not visible to the Referee and Judges in the Field of Play.
- 18.5. The scores of all five (5) Judges shall be counted in determining the winning Boxer.
- 18.6. The Judges have to push the button on the scoring pad within fifteen (15) seconds. These scores are transmitted directly to a computer system managed by the Deputy Technical Delegate, and no alterations or additions are made to these scores after the initial transmission. The announcement of the scores by the Announcer and on the live TV broadcast are made immediately at the end of the Bout, after the approval of the scores by the Deputy Technical Delegate.
 - 18.6.1. At the end of the Bout, but only after the winner of the Bout is announced, the precise scores awarded and the Judge who awarded each score is identified on a public display. This public display also indicates the total score by each Judge for each Boxer for the entire Bout (including any deduction due to warnings).
- 18.7. In case the total scores awarded by each Judge, including any deduction, are equal at the end of the Bout, the decision is determined as per Rule 19.3 of these rules.
- 18.8. In any case, the Judges’ scores of all the rounds must not be disclosed or displayed until the winner of the Bout is announced.
- 18.9. The Deputy Technical Delegate informs the Announcer of the official results.
- 18.10. If the AIBA Scoring System becomes defective during a Bout, the Referee collects all 5 Judges’ score cards with the names of the Judges and gives them to the Deputy Technical Delegate.
- 18.11. Each Judge independently judges the merits of the two (2) Boxers using the AIBA Scoring System based on the following criteria:
 - 18.11.1. Number of quality blows on target area;

18.11.2. Domination of the Bout by technical and tactical superiority;

- 18.11.3. Competitiveness;
- 18.12. The Judges must apply the following criteria to score each round:
 - 18.12.1. 10 vs. 9 – Close round;
 - 18.12.2. 10 vs. 8 – Clear winner;
 - 18.12.3. 10 vs. 7 – Total dominance;
- 18.13. Results Management
 - 18.13.1. At the conclusion of each Bout and each Session, the results recorded in the AIBA Scoring System must be printed and handed to the Technical Delegate.
 - 18.13.2. In all AIBA-owned and AIBA-sanctioned Competitions, at the end of each Session, AIBA Scoring System Operator forwards the Session Results to AIBA HQ.
 - 18.13.3. In all AOB Competitions, after the final Session of the Competition, the AIBA Scoring System Operator forwards all Competition documents to AIBA HQ.

RULE 19. DECISIONS

- 19.1. Win on points – WP
 - 19.1.1. At the end of a Bout, each Judge determines a winner based on the Boxer's total scores of the Bout. The winner is determined by either unanimous or split decision.
 - 19.1.2. The Judges score the round for each Boxer up to the time of the termination of the Bout, and the Boxer who is ahead on points is declared the winner of the Bout on points in accordance with the AIBA Scoring System. The round in which the Bout is stopped is scored, even if it is a partial round.
 - 19.1.2.1. Cases where Rule 19.1.2. of these rules applies:
 - 19.1.2.1.1. If an injury caused by an unintentional foul occurs during any round and as a result the contest is stopped by the Referee;
 - 19.1.2.1.2. In case both Boxers are injured at the same time and as a result the contest is stopped by the Referee;
 - 19.1.2.1.3. In case the Bout is terminated by the Referee due to an event that is out of the Boxer's or Referee's control, such as the destruction of the ring, failure of the lighting supply, forces of nature and other similar unforeseen conditions, and only if the event mentioned occurs after the end of the first round.

- 19.2. The AIBA Scoring System appoints the winner by a unanimous or split decision as follows:
- 19.2.1. Unanimous decision by points: the five (5) Judges appoint the same winner, or
 - 19.2.2. Split decision by points:
 - 19.2.2.1. Three (3) Judges appoint one (1) Boxer as the winner and the other two (2) Judges either appoint the other Boxer as a winner or a draw; or
 - 19.2.2.2. Four (4) Judges appoint one (1) Boxer as the winner and the other Judge either appoints the other Boxer as a winner or a draw.
- 19.3. Tiebreak - In the event that the total scores awarded by each Judge, including any deduction, are equal at the end of the Bout, the Judge(s) with equal scores are requested to nominate which Boxer is the winner of the Bout in their opinion in the following cases:
- 19.3.1. One (1) Judge has even scores, and the total scores of the other four (4) judges are evenly split; or
 - 19.3.2. Two (2) Judges have even scores and the other three (3) judges do not score unanimously; or
 - 19.3.3. Three (3) or more Judges have even scores.
- 19.4. There is no "Technical Draw".
- 19.5. Abandon ("ABD"). If a Boxer retires voluntarily or if the Coach throws the towel into the ring or appears on the apron, however not while the Referee is counting, the opponent is declared the winner of the Bout by Abandon.
- 19.6. Win by Referee Stops Contest ("RSC")
RSC-H : Stoppages due to punches to the head
RSC-B : Stoppages due to punches to the body
- 19.6.1. If a Boxer fails to resume boxing immediately after the rest period between rounds, the opponent is declared the winner of the Bout by RSC.
 - 19.6.2. If a Boxer, in the Referee's opinion, is being outclassed or is receiving excessive punishment or hard blows, the Bout is stopped and the opponent is declared the winner of the Bout by RSC.
 - 19.6.3. If a Boxer is unfit to continue and fails to resume boxing after a Knockdown, the opponent is declared the winner of the Bout by RSC.
 - 19.6.4. If a Boxer does not recover after ninety (90) seconds, as per Rule 22, the opponent is declared the winner of the Bout by RSC.
 - 19.6.5. In the case of a Boxer being punched out of the ring by a legal blow, the Boxer must be allowed thirty (30) seconds to come back into the ring, after the eight (8) count, without the help of anyone. In case the Boxer is not able to come back within the above-mentioned timeframe, such Boxer is deemed to have lost the Bout by RSC.

- 19.6.6. The Ringside Doctor has the option to advise the Referee to terminate a Bout if a Boxer receives too much punishment. The opponent is declared the winner of the Bout by RSC.
- 19.7. Win by Referee Stops Contest-Injury (“RSC-I”)
- 19.7.1. If a Boxer, in the opinion of the Referee, is unfit to continue because of a sustained or increased injury from correct punches, the Bout is stopped and the opponent is declared the winner of the Bout by RSC-I.
- 19.7.2. If a Boxer, in the opinion of the Referee, becomes incapable of continuing to compete because of an injury not sustained from punches, the Bout is stopped and the opponent is declared the winner of the Bout by RSC-I.
- 19.8. Win by Disqualification – DSQ
- 19.8.1. If a Boxer is disqualified for any reason, the opponent is declared the winner of the Bout by DSQ.
- 19.8.1.1. If the Boxer who won by DSQ is declared unfit to compete in the next round of the same Competition due to that foul or any other reason, then Rule 19.11.2. applies.
- 19.8.2. If the Referee, at his/her discretion, determines that an intentional foul caused an injury to a Boxer and that the fouled and injured Boxer cannot continue because of the injury sustained from this intentional foul, the offending Boxer is disqualified and the injured Boxer is declared the winner of the Bout by DSQ.
- 19.8.3. The third warning in the whole Bout automatically disqualifies the Boxer and the opponent is declared the winner of the Bout by DSQ.
- 19.8.4. In the case a Double Disqualification (BDSQ) occurs, including Walkovers, both Boxers lose the Bout by BDSQ.
- 19.8.5. If a Boxer is disqualified for Unsportsmanlike Behaviour (such as assaulting or acting aggressively towards a Referee, Judge, Technical Delegate, Team Official, or other), the opponent is declared the winner of the Bout by Disqualification for Unsportsmanlike Behaviour (DQB). The disqualified Boxer is subject to sanctions determined by the AIBA Disciplinary Commission in accordance with the AIBA Disciplinary Code.
- 19.8.6. If the Boxer has been disqualified due to misconduct or unsportsmanlike behaviour, it has to be brought to the attention of the AIBA Disciplinary Commission by the Technical Delegate within twenty-four (24) hours of the end of the respective Bout.

- 19.8.7. A Boxer disqualified by DSQ will not be awarded a medal, a quota place if the Competition is a qualifying event, or AIBA World Ranking points related to the Bout.

- 19.8.8. A Boxer disqualified for behaviour by DQB will not be awarded a quota place if the Competition is a qualifying event, a medal or AIBA World Ranking points related to the Bout.
- 19.8.9. If both Boxers do not box competitively in the ring, both shall be disqualified by BDSQ. In this case, both Boxers will not be awarded quota places if the Competition is a qualifying event, medals or AIBA World Ranking points related to the Bout.
- 19.8.10. If a Boxer is disqualified in the semi-finals or finals, the Boxer's medal will not be reallocated and his Competition ranking will be annulled. In this case, the next best ranked Boxer will not be moved up the Competition ranking.
- 19.9. Win by Knockout – KO
Knockout due to blows to the head: KO-H
Knockout due to blows to the body: KO-B
- 19.9.1. If a Boxer is knocked down and fails to resume boxing before that Boxer is counted up to ten (10), the opponent will be declared the winner of the Bout by KO.
- 19.9.2. In the case of an emergency and the Referee summons the Ringside Doctor in the ring before the Boxer is counted up to ten (10), the opponent will be declared the winner of the Bout by KO.
- 19.10. Both Boxers are disqualified or KO
- 19.10.1. If both Boxers are disqualified or KO at any stage of the Competition before a semifinal, the opponent in the next round will win by walkover.
- 19.10.2. In case of double disqualification during a final, they will not be eligible to receive a medal.
- 19.10.3. In the case a Double KO (DKO) occurs, both Boxers will lose the Bout by DKO.
- 19.10.4. If a DKO occurs during a final, Rule 19.1.2. of these rules applies.
- 19.11. Win by Walkover – WO
- 19.11.1. If a Boxer is present in the ring fully attired and ready to box and the opposing Boxer fails to appear in the ring after being announced and a maximum period of one (1) minute has elapsed after the bell has been sounded, the Referee will declare the present Boxer to be the winner by WO.
- 19.11.2. If a Boxer fails the Medical Examination or Daily Weigh-In, his/her opponent will win by Walkover.
- 19.11.3. If the Technical Delegate knows in advance that a Boxer will not be present, he/she must cancel the procedure mentioned in Rule 19.11.1. of these rules, and the result must be officially announced.
- 19.11.4. No medal will be awarded to a Boxer who has not boxed at least once within the entire Competition period.
- 19.12. There is no "No Contest" decision

19.13. If a Bout cannot take place

19.13.1. If a Bout cannot take place because both Boxers cannot compete, at any stage of Competition before the semifinals, the opponent in the next round will win by walkover.

19.13.2. If a semifinal Bout cannot take place:

19.13.2.1. If both Boxers failed the weigh-in or did not show, both will be disqualified from the semifinal and will not be eligible for receiving a medal

19.13.2.2. If both Boxers were not allowed to compete by medical decision or force majeure, both Boxers will receive a bronze medal in addition to the loser of the other semifinal bout

19.13.3. If a final Bout cannot take place

19.13.3.1. If both Boxers failed the weigh-in or did not show, both will be disqualified from the final and will not be eligible for receiving a medal

19.13.3.2. If both Boxers were not allowed to compete by medical decision or force majeure, both Boxers will receive a silver medal, the two Boxers will be ranked second.

19.13.4. If both semifinal Bouts cannot take place, four Boxers will be ranked third.

19.14. Extraordinary Rescheduling

19.14.1. The Bout may be terminated by the Referee due to an event that is out of the Boxer's or the Referee's control, such as the destruction of the ring, failure of the lighting supply, forces of nature and other similar unforeseen conditions. In such circumstances, if it occurs before the end of the first round, the Bout will be terminated and will then have to be rescheduled by the Technical Delegate, preferably within the same day.

RULE 20. BOUT REVIEW

20.1. Implementation of the Bout Review

20.1.1. The Bout Review Rule will be in effect from July 2021 at the following Competitions:

20.1.1.1. Only AIBA-owned and AIBA-Sanctioned elite and youth events, that is, Elite and Youth World championships, Elite and Youth Continental Championships.

20.2. Composition of the Bout Review Jury

- 20.2.1. The Bout Review Jury shall be comprised of the Observer, the Referee Evaluator and the Judge Evaluator, all from the ring in which the Bout in question took place.
- 20.2.2. The Bout Review Technician, or an AIBA HQ/ LOC staff trained in operating the Bout Review hardware and software, assists the Bout Review Jury with the Review, preparing the relevant footage, from the official video equipment used for the Competition, for the Jury to review.

20.3. Bout Review Equipment

- 20.3.1. Only equipment provided by an AIBA Official Equipment Licensee can be used for Bout Review. or AIBA approved LOC equipment

20.4. Lodging a Bout Review to protest a decision.

- 20.4.1. The Second and the Boxer shall leave the Field of Play by the normal route in an orderly fashion.
- 20.4.2. Upon leaving the Field of Play, and within 15 minutes of the bout decision, the Team Manager/Second shall make their way to the Equipment Manager's table and inform the Equipment Manager that the team wishes to protest the result of the Bout. The Equipment Manager shall give the Team Manager/Second the Bout Review form (Appendix 10 of these rules).
- 20.4.3. The Bout Review forms will be available at the Equipment Manager's table and collected only by the Team Manager / Second designated or confirmed at the sports entry check.
- 20.4.4. The Team Manger/Second shall complete (in English) and submit the Bout Review form, signing to agree that the team's National Federation will be invoiced for the fee at the end of the Competition as per Rule 20.8 of these rules.
- 20.4.5. The form shall be submitted to the Equipment Manager no later than thirty (30) minutes after advising the Equipment Manager of their intent to protest the result.
- 20.4.6. The Equipment Manager must record both the exact time when the Team Manager/Second notifies their intent to protest the decision and the time of submission of the form onto the Bout Review Form. The Equipment Manager keeps the original form and gives a copy to the Team Manager/Second. The times will be checked against the result of the bout recorded in the AIBA Scoring System by AIBA's Scoring System Operator.
- 20.4.7. At the end of the Session, the Equipment Manager shall pass all Bout Review forms from that Session to the Technical Delegate.

- 20.4.8. The AIBA Scoring System Operator will email scans of all Bout Review forms to AIBA Sport Department by email at the end of each day of the Competition.
- 20.4.9. The AIBA Scoring System Operator will record all Bout Review requests in the AIBA Scoring System.
- 20.4.10. If the Technical Delegate determines, after consulting the Bout Review Jury, that the protest should be allowed to proceed, the Bout in question will be reviewed by the Jury using the Bout Review equipment at the end of that Session, if possible, or at the end of the final Session of the day. This will be at the Technical Delegate's discretion.
- 20.4.11. The Technical Delegate will determine whether the protest will be accepted, or not, after consulting with the Bout Review Jury and will only notify the Team Manager/Second who is the designee appointed at the sports entry check. An email will be sent to inform both parties of the decision based on the AIBA Technical and Competition Rules and those consultations.
- 20.4.12. The analysis will take place in the Bout Review office if one is available, or in another suitably equipped lockable space within the venue.
- 20.4.13. Bout Reviews will be conducted in the order that the Bouts took place during the day. The Bout review will be considered lodged regardless of whether it is accepted by the jury or withdrawn by the team.
- 20.4.14. If the Technical Delegate believes that the decision of the Judges or the Referee has been taken in contravention of the AIBA rules, the Technical Delegate can lodge a Bout Review by following Rule 20.4. of these rules.
- 20.5. Bout Review Acceptance Criteria
- 20.5.1. The Team Manager/Second can lodge a protest against any decision awarded on points (5-0; 4-1; 3-2). No protest can be made against a win by ABD, RSC, RSC-I, DSQ, KO-H, KO-B or WO
- 20.5.1.1. In the case of a protest relating to the scoring of a Bout, the protest must be made specific to the decision of the Bout, i.e., citing which round or rounds are being disputed, on the Bout Review form.
- 20.5.2. In the case of a protest claiming that an AIBA Technical Rule was violated by the Referee, the protest should clearly indicate which AIBA rule(s) has/have been breached, in which round(s) the breach is alleged to have taken place, and how the breach(es) affected the final result, on the Bout Review form, as follows:
- 20.5.2.1. Procedures not followed by the Referee, as outlined in the AIBA Technical and Competition Rules.
- 20.5.2.2. Foul ruled as a legal action by the Referee.
- 20.5.2.3. Legal action ruled as a foul by the Referee.
- 20.6. The Bout Review Decision

- 20.6.1. In the event of a protest against the scoring of a Bout, using the Bout Review, the Bout Review Jury will determine the winner of the protested Bout using all three (3) scoring criteria (as below) and taking into account the issue(s) raised by the protest:
 - 20.6.1.1. Number of quality blows on target area;
 - 20.6.1.2. Domination of the Bout by technical and tactical superiority;
 - 20.6.1.3. Competitiveness.
 - 20.6.2. In the case of a protest claiming that an AIBA Technical and Competition Rule was violated by the Referee, the Bout Review Jury will determine the winner of the protested Bout by reviewing the Bout and finding:
 - 20.6.2.1. A clear violation of a rule which warrants the reversal of the decision.
 - 20.6.2.2. An incorrect decision which affected the result of the Bout i.e. not only that an error was made, but that it changed the outcome of the Bout.
 - 20.6.3. After the review of the Bout, the Observer and Referee/Judge Evaluators will make a decision regarding the Bout Review request. They will communicate this decision to the Technical Delegate and AIBA Scoring System Operator who, in turn, will document it in the AIBA Scoring System.
 - 20.6.4. Both teams will be notified in writing, by the Technical Delegate, of the Bout Review Jury's decision, and the rationale behind it, immediately after the Review has been completed. That decision must be unanimous and will be final.
- 20.7. Bout Review after finals
- 20.7.1. In order to mitigate delays caused by Bout Reviews lodged during the final Session(s) of the Competition, and considering that the Bout Review Jury has to be readily available after such a protest is lodged, designated ITOs should be available to take over the Bout Review Jury's work near the ring and allow the Bout Review Jury to review the Bout while boxing continues.
 - 20.7.2. The medal ceremony will not be conducted until a decision of the Bout Review Jury has been rendered.
- 20.8. Number of Bout Reviews
- 20.8.1. Each team will be allowed up to three (3) failed Bout Reviews per Competition
 - 20.8.1.1. Once a team reaches three (3) failed Bout Reviews it will not be allowed to lodge any further protests during that Competition.
 - 20.8.2. Equipment Manager will update the National Federation protest list to ensure that no National Federation goes over its allotted number of Bout Reviews.
 - 20.8.3. When a team lodges a Bout Review, and the original decision is overturned, it will retain that Bout Review for possible use later in the Competition.

- 20.8.4. When a team lodges a Bout Review and the original decision is upheld, the team will lose one (1) of its three (3) Bout Reviews.

RULE 21. FOULS

21.1. Types of Fouls

21.1.1. Hitting

- 21.1.1.1. Below the belt (low blow), with the head, shoulder, forearm or elbow
- 21.1.1.2. With an open glove, the inside of the glove, wrist or side of the hand
- 21.1.1.3. The back of the opponent, especially on the back of the neck or head
- 21.1.1.4. With a kidney punch
- 21.1.1.5. With a pivot blow / backhand punch

21.1.2. Holding

- 21.1.2.1. Holding and hitting
- 21.1.2.2. Locking the opponent's arm or head, or pushing an arm underneath the arm of the opponent

21.1.3. Tripping

21.1.4. Kicking

21.1.5. Butting

21.1.6. Strangling

21.1.7. Pulling

21.1.8. Biting

21.1.9. Faking / simulating

21.1.10. Pushing

- 21.1.10.1. Opponent's face with an arm or an elbow
- 21.1.10.2. The head of the opponent back over the ropes;

21.1.11. Attacking whilst holding the ropes or making any unfair use of the ropes;

21.1.12. Lying on, wrestling and throwing in the clinch;

21.1.13. Attacking an opponent who is down or who is in the act of rising;

21.1.14. Ducking below the belt of the opponent;

21.1.15. Completely passive defense by means of double cover and intentionally falling, running, or turning the back to avoid a blow;

21.1.16. Speaking;

- 21.1.17. Not stepping back when ordered to break;
- 21.1.18. Attempting to strike opponent immediately after the Referee has ordered “break” and before taking a step back;
- 21.1.19. Assaulting or behaving in an aggressive manner towards a Referee at any time;
- 21.1.20. Gumshield falling out
 - 21.1.20.1. Spitting out the gumshield intentionally without receiving a correct punch will cause the Boxer to receive a mandatory warning;
 - 21.1.20.2. If the gumshield falls out after the Boxer has received a correct punch, and if this happens for the third time, the Boxer will receive a mandatory warning;
- 21.1.21. Keeping the advanced hand straight in order to obstruct the opponent’s vision.

RULE 22. LOW BLOW

- 22.1. After a low blow, if the offended Boxer does not complain and the low blow was not hard and intentional, the Referee must signal the foul without interrupting the Bout.
- 22.2. After a low blow, if the offended Boxer complains about the severity of the low blow, the Referee will have two (2) options:
 - 22.2.1. The offending Boxer will be immediately disqualified if it is an intentional and hard blow.
 - 22.2.2. Start an eight (8) count.
- 22.3. After the eight (8) count, the Referee will have (2) options:
 - 22.3.1. The Boxer is fit to continue: the Referee may give a warning to the offender, if the Referee considers it as necessary, and the Bout will continue.
 - 22.3.2. The Boxer is unfit to continue: the Referee will give a certain amount of time to the Boxer to try to recover with a maximum of up to one (1) minute and a half.
- 22.4. After above mentioned timeframe, the Referee will have two (2) options:
 - 22.4.1. The Boxer is fit to continue: the Referee may give a warning to the offender and the Bout will continue.
 - 22.4.2. The Boxer is unfit to continue: the opponent will be declared the winner of the Bout by RSC-I.

RULE 23. CAUTION, WARNING, DISQUALIFICATION

- 23.1. A Boxer who does not obey the instructions of the Referee, who acts against the rules of boxing, who boxes in any unsportsmanlike manner, or who commits fouls, will, at the discretion of the Referee, be cautioned, warned or disqualified. If a Referee intends to warn a Boxer, the Referee must say “stop” and demonstrate the infringement. The Referee must then indicate to the Boxer and then to the Deputy Technical Delegate.
- 23.2. If a Boxer receives a Referee’s warning, the Deputy Technical Delegate will record the warning and inform the AIBA Scoring System Operator who, in turn, will record the warning in the AIBA Scoring System. Each warning will reduce the total score of the offending Boxer by one (1) point per Judge. The third warning in a Bout will automatically disqualify the Boxer.
- 23.3. If a Boxer receives a headbutt or any other serious illegal blow which does not cause an injury or a cut, the Referee will give a Warning to the offending Boxer, deducting one (1) point per Judge or may disqualify the offending Boxer if actions deemed sufficiently serious to warrant a disqualification.
- 23.4. If a Boxer receives a headbutt or any other illegal blow which causes an injury or a cut, the Referee must disqualify the offending Boxer.
- 23.5. If the Referee has any reason to believe that a foul has been committed which the Referee has not seen, the Referee may consult the Judges.
- 23.6. If an irregularity is found in the Boxer’s bandages after the Bout which, in the Referee’s opinion, gave an advantage to the Boxer, this Boxer must be immediately disqualified.
- 23.7. The Technical Delegate has the right to caution, to remove from the Field of Play, and to remove the accreditation of a Second who has infringed the AIBA Technical and Competition Rules.
- 23.8. If a Boxer is guilty of a serious and deliberate offence that is contrary to the spirit of sportsmanship, the Technical Delegate, the Referee and ITOs have the right to recommend to the Executive Committee Bureau to put the case to the Disciplinary Commission for possible sanctions.

RULE 24. KNOCKDOWN

- 24.1. A Boxer is considered to be knocked down due to a legal blow if:
 - 24.1.1. The Boxer touches the floor with any part of the body other than the Boxer’s feet as the result of a blow or series of blows.
 - 24.1.2. The Boxer hangs helplessly on the ropes as the result of a blow or series of blows.

- 24.1.3. The Boxer is outside or partly outside the ropes as the result of a blow or series of blows.
- 24.1.4. Following a hard punch, the Boxer has not fallen and is not lying on the ropes, but is in a semi-conscious state and cannot, in Referee's opinion, continue the Bout.
- 24.2. Counts following a Knockdown
 - 24.2.1. In the case of a Knockdown, the Referee must say "stop" and then begin an Eight Count – count from one (1) to eight (8) – if the Boxer is fit to continue; and count from one (1) to ten (10) if the Boxer is unfit to continue.
 - 24.2.2. The Referee counts with intervals of one (1) second between the numbers and indicates each second with the hand so that the Boxer who has been knocked down may be aware of the count.
 - 24.2.3. Before the number "one" is counted, an interval of one (1) second must have elapsed from the time when the Boxer is knocked down, and the time of announcing "one".
- 24.3. Responsibilities of the Opponent
 - 24.3.1. If a Boxer is knocked down, the Boxer's opponent must at once go to the neutral corner as designated by the Referee and remain there until the Referee allows the Boxer to leave. If the opponent does not respect this, the Referee must suspend the count until the opponent complies with the command.
- 24.4. Mandatory Eight Counts
 - 24.4.1. When a Boxer is knocked down as the result of a blow, the Bout must not continue until the Referee has reached a mandatory count of eight (8), even if the Boxer is ready to continue before then or the round has come to a close.
- 24.5. Both Boxers Knocked Down
 - 24.5.1. If both Boxers are knocked down at the same time, the count is continued, as long as, one of them is still knocked down.
- 24.6. Compulsory Count Limits
 - 24.6.1. A maximum of three (3) Eight Counts are given in one (1) round;
 - 24.6.2. In Men Elite AOB Competitions, no limit of the amount of Eight Counts apply in one Bout;
 - 24.6.3. In Women, Youth and Junior AOB Competitions, a maximum of four (4) Eight Counts apply in one Bout.
 - 24.6.4. Eight Counts due to an illegal blow, are not considered in this amount.
- 24.7. Boxer Knocked Out of the Ring
 - 24.7.1. In the case of a Boxer being punched out of the ring by a legal blow, the Boxer must be allowed thirty (30) seconds to come back into the ring, after the Eight Count, without the help of anyone. In case the Boxer is not able to come back

within the above-mentioned timeframe, such Boxer is deemed to have lost the Bout by RSC.

24.8. Knockout

24.8.1. After the Referee has said “ten”, the Bout ends and must be decided as KO. The Referee may stop the count if in his/her opinion the Boxer is in immediate need of medical attention.

24.9. Boxer Knocked Down at the End of a Round

24.9.1. In the case of a Boxer being knocked down at the end of any round, the Referee must continue to count until the Boxer is no longer knocked down irrespective of the end of the round.

24.9.2. Should the Referee count up to ten (10), such Boxer is deemed to have lost the Bout by KO. The gong does not save the Boxer.

24.10. Second Knockdown without a Further Punch

24.10.1. If a Boxer is knocked down as the result of a punch and the Bout is continued after the count of eight (8) has been reached, but the Boxer falls again without having received a further punch, the Referee may continue the count from the count of eight (8) up to the count of ten (10).

RULES FOR COMPETITION OFFICIALS

RULE 25. APPOINTMENT PROCEDURE

- 25.1. The Officials' nomination criteria and appointment process depends on the category of the AOB Competition.
- 25.2. All Officials nominated and appointed to AOB Competitions should follow Rule 25 of these rules.
- 25.3. AIBA-owned and AIBA-sanctioned Competitions (World, IOC & Multi-sport)
 - 25.3.1. Technical Delegate: The AIBA Technical & Rules Commission task force composed of at least 3 members (Chair or Vice-Chair + 2 members) appoints the Technical Delegate and informs the AIBA HQ.
 - 25.3.2. ITO: The AIBA Technical & Rules Commission task force composed of at least 3 members (Chair or Vice-Chair + 2 members) appoints the ITO candidates and informs the AIBA HQ.
 - 25.3.2.1. Ringside Doctor appointments should have the AIBA Medical Commission's input
 - 25.3.2.2. R&J Evaluator & Observer appointments should have the AIBA R&J Commission's input
 - 25.3.3. R&J: The AIBA R&J Commission task force composed of at least 3 members (Chair or Vice-Chair + 2 members) appoints the list of R&Js and informs the AIBA HQ.
 - 25.3.4. Criteria used for official's appointment
 - 25.3.4.1. Qualification
 - 25.3.4.2. Nationality
 - 25.3.4.3. Geographic location
 - 25.3.4.4. Performance and/or certification date (for newly certified officials)
 - 25.3.4.5. Rotation
 - 25.3.5. Admin Process
 - 25.3.5.1. All letters of communication for appointments should come from the AIBA HQ
 - 25.3.5.2. Appointment letters will be signed by the respective AIBA Commission Chairpersons.
 - 25.3.5.3. To keep track of communication with regards to events, all emails regarding appointments of officials should be sent to the AIBA HQ (Sport Department) from the Commissions within a set deadline.

The Sport Department will collect all inputs and appointments from respective Commissions.

- 25.4. AIBA-sanctioned and AIBA-affiliated Competitions (Continental, except for Multi-sport and National)
 - 25.4.1. Technical Delegate: The Confederation Competition Commission task force composed of at least 3 members (Chair or Vice-Chair + 2 members) appoints the Technical Delegate and informs the Confederation HQ.
 - 25.4.2. ITO: The Confederation Competition Commission task force composed of at least 3 members (Chair or Vice-Chair + 2 members) appoints the ITO candidates and informs the Confederation HQ.
 - 25.4.2.1. Ringside Doctor appointments should have the Confederation Medical Commission Chairperson's input
 - 25.4.2.2. R&J Evaluator appointments should have the Confederation R&J Commission Chairperson's input
 - 25.4.3. R&J: The Confederation R&J Commission task force composed of at least 3 members (Chair or Vice-Chair + 2 members) appoints the list of R&Js and informs the Confederation HQ.
 - 25.4.4. Criteria used for official's appointment
 - 25.4.4.1. Qualification
 - 25.4.4.2. Nationality
 - 25.4.4.3. Geographic location
 - 25.4.4.4. Performance and/or certification date (for newly certified officials)
 - 25.4.4.5. Rotation
 - 25.4.5. Admin Process
 - 25.4.5.1. Prior to the Confederation Commission nominating and approving the appointments of officials, a request to the AIBA HQ for the latest certified officials is required to ensure eligible candidates are considered. The same eligibility check is required when National Federations nominate their own R&Js.
 - 25.4.5.2. After each event, the Confederation Commission is required to report evaluations of R&Js and ITOs to the AIBA HQ.
 - 25.4.5.3. All letters of communication for appointments should come from the Confederation HQ
 - 25.4.5.3.1. Including for AIBA-affiliated Continental Competitions;
 - 25.4.5.3.2. Including any neutral R&J or ITO proposed by AIBA;
 - 25.4.5.3.3. Appointment letters will be signed by the respective Confederation Commission Chairperson.

RULE 26. TECHNICAL DELEGATE

26.1. Qualification and Eligibility

- 26.1.1. To be appointed for an AOB Competition, the Technical Delegate must have successfully passed the AIBA Technical Delegate Certification Course or the AOB Technical Delegate Certification Course.
- 26.1.2. To be a Technical Delegate at an AOB Competition, a person cannot be an active Coach, Referee, Judge, Team Manager and/or Boxer, nor should have ever been sanctioned with an over six (6) month suspension.
- 26.1.3. The Technical Delegate may not be a national of the country where the AOB Competition takes place.
- 26.1.4. The Technical Delegate must respect and sign the AIBA Code of Conduct (Appendix 4 of these rules) and upload it to his/her AIBA Database profile.

26.2. Duties

- 26.2.1. Prior to the start of an AOB Competition, the Technical Delegate is responsible for conducting a Technical Meeting with Team Officials.
- 26.2.2. Prior to the start and throughout an AOB Competition, the Technical Delegate is responsible for ensuring that the FOP and the athletes' and officials' areas are functioning as per the AIBA Technical and Competition Rules.
- 26.2.3. A Session does not commence without the presence of the Technical Delegate.
 - 26.2.3.1. In the event that the Technical Delegate is not present, a qualified designee will assume the role of the Technical Delegate.
- 26.2.4. During an AOB Competition, the Technical Delegate will be responsible for overseeing all Bout decisions.
- 26.2.5. The Technical Delegate will review the scores and obtain feedback from the Referee and Judge Evaluators regarding the performance of the Referees and Judges.
 - 26.2.5.1. The Technical Delegate will immediately suspend a Referee and/or Judge for the rest of the Competition day for any wrongdoing. Once the Competition is completed, the Technical Delegate will discuss any further recommendation to the Disciplinary Commission regarding sanctioning the Referee and Judge.
- 26.2.6. In AOB Competitions, the Technical Delegate will evaluate ITOs based on the criteria developed by the AIBA Technical & Competition Rules Commission

- and the AIBA HQ, and will forward the results to the AIBA HQ and the AIBA Technical & Competition Rules Commission.
- 26.2.7. If an International Technical Official or National Technical Official appointed for a Bout is absent, the Technical Delegate will appoint a replacement from the Officials present at the Competition.
 - 26.2.8. If a Bout cannot be held due to a force majeure, the Technical Delegate may order to stop the Bout until it can be satisfactorily resumed.
 - 26.2.9. The Technical Delegate may not work in Bouts involving Boxers from the country where the Technical Delegate was born or resides.
 - 26.2.10. During an AOB Competition, the appointed Technical Delegate will be responsible for cautioning, warning and/or removing accreditation of persons who display improper behaviour.
 - 26.2.11. The detailed duties of the Technical Delegate are listed in the AIBA Technical Officials' Regulations.

RULE 27. INTERNATIONAL TECHNICAL OFFICIALS (ITOS)

27.1. Qualification and Eligibility

- 27.1.1. To work in AOB Competitions, an ITO has to successfully pass the AIBA ITO Certification Course.
- 27.1.2. To be appointed as an ITO at an AOB Competition, a person cannot be an active Coach, Referee, Judge, Team Manager and/or Boxer, nor should have ever been sanctioned with an over six (6) month suspension.
- 27.1.3. ITO positions include the following roles:
 - 27.1.3.1. Deputy Technical Delegate
 - 27.1.3.2. Draw Commissioner
 - 27.1.3.3. Ringside Doctor
 - 27.1.3.4. AIBA Cut Technician
 - 27.1.3.5. Referee and Judge Evaluator
 - 27.1.3.6. Referee and Judge Coordinator
 - 27.1.3.7. Observer
 - 27.1.3.8. Equipment Manager
- 27.1.4. In an AOB Competition, there can be no more than two ITOs of the same nationality. These ITOs from the same nationality cannot be assigned in the same Bout.
- 27.1.5. An ITO may not work in Bouts involving Boxers from the country where the ITO was either born or resides.

- 27.1.6. Every ITO must respect and sign the AIBA Code of Conduct (Appendix 4 of these rules) and upload it to his/her AIBA Database profile.
- 27.1.7. The detailed duties of the ITOs are listed in the AIBA Technical Officials' Regulations.

RULE 28. DEPUTY TECHNICAL DELEGATE

28.1. Qualification and Eligibility

- 28.1.1. To be appointed for an AOB Competition, the Deputy Technical Delegate must have successfully passed the AIBA Technical Delegate Certification Course or the AOB Technical Delegate Certification Course.

28.2. In an AOB Competition, the Deputy Technical Delegate may not be a national of the country where the Competition is taking place and must hold a different nationality than the appointed Technical Delegate.

28.3. Appointment

- 28.3.1. AIBA will appoint a minimum of two (2) Deputy Technical Delegates for any AOB Competition that uses two (2) rings.
- 28.3.2. AIBA will appoint a minimum of one (1) Deputy Technical Delegate for any AOB Competition that uses one (1) ring.

28.4. Duties

- 28.4.1. In an AOB Competition, the Deputy Technical Delegate will be responsible for all Competition aspects of the Bout with the same duties as the appointed Technical Delegate.

RULE 29. REFEREE AND JUDGE EVALUATOR

29.1. Qualification and Eligibility

- 29.1.1. To be appointed for an AOB Competition, the Referee and Judge Evaluator has to be a former 3-Star R&J and has to have passed the AIBA ITO Certification Course and an additional AIBA Certification Course specifically designed for R&J Evaluators/Observer.

29.2. Appointment

- 29.2.1. AIBA will appoint three (3) Evaluators for one ring Competitions or five (5) Evaluators for two ring Competitions.

29.3. Duties

- 29.3.1. Attend daily Technical Delegate meetings to provide post-bout feedback and analysis

- 29.3.2. Evaluate the performance of the Referees or Judges
- 29.3.3. Judge Evaluators should score each round for comparison with the Judges scores
- 29.3.4. Fill out Database Evaluation form
- 29.3.5. Conduct the daily R&J Meeting before the first Session, and before the second Session if required

RULE 30. RINGSIDE DOCTORS

30.1. Qualification and Eligibility

- 30.1.1. For all AIBA-owned, AIBA-sanctioned and AIBA-affiliated Competitions (except National classification events), only AIBA Certified Ringside Doctors are permitted to serve as Ringside Doctors.
- 30.1.2. In emergency situations during an AOB Competition where appointed AIBA Ringside Doctors are not able to perform their duties, the appointed Technical Delegate can appoint a Local or a Team Doctor to work at ring side.

30.2. Attendance in Competition

- 30.2.1. Ringside Doctors must be present one hour before the first Bout and until they check the Boxers at the end of the last Bout.
- 30.2.2. Ringside Doctors have to wear surgical gloves during the Bout.

30.3. Number of Ringside Doctors

- 30.3.1. In an AOB Competition where one (1) ring is used, a minimum of three (3) AIBA Ringside Doctors are appointed. However, there must not be more than two (2) Ringside Doctors at the ringside.
- 30.3.2. In an AOB Competition where two (2) rings are used, a minimum of five (5) Ringside Doctors are appointed. However, there must not be more than two (2) Ringside Doctors at the ringside of each ring.

30.4. Duties

- 30.4.1. A Ringside Doctor has to ensure that the AOB Competition follows the AIBA Medical Rules.
- 30.4.2. A Ringside Doctor performs Medical Examinations at all Daily Weigh-Ins.
- 30.4.3. During a Bout, a Ringside Doctor may be called by the Referee to express an opinion regarding the competing Boxer's condition.
 - 30.4.3.1. At the discretion of the Ringside Doctor, he or she can treat a Boxer's injury (cut or nosebleed, etc.) up to a maximum of 1 minute during a Bout.
- 30.4.4. Ringside Doctors provide support for anti-doping related matters.

- 30.4.5. Before the start of an AOB Competition, appointed Ringside Doctors carry out Medical Examinations for appointed Referees and Judges.
- 30.4.6. Prior to the start of each Session, a Ringside Doctor must:
 - 30.4.6.1. Check for the presence of oxygen and stretcher, other recovery equipment, evacuation equipment, and evacuation route;
 - 30.4.6.2. Check that one ambulance is present for each ring
 - 30.4.6.3. Confirm that a hospital has been designated to take care of injured Boxers, Team Officials, and other persons taking part in the Competition
- 30.4.7. At least one Ringside Doctor must be at ringside for the entire duration of the Bout;
- 30.4.8. Ringside Doctors must inform the Technical Delegate to stop the Bout if a competing Boxer appears unable to continue.
- 30.4.9. Procedure after KO or RSC
 - 30.4.9.1. Unconscious Boxer - If a Boxer is rendered unconscious, only the Referee and the Ringside Doctor can remain in the ring. Only the Ringside Doctor can request additional help.
 - 30.4.9.2. In case a Boxer is unconscious for more than one (1) minute, this Boxer must be transported to the nearest hospital (if possible to the neurosurgery department) for further evaluation. Any Boxer with a concussion may be referred to the hospital by the Ringside Doctor.
 - 30.4.9.3. In the case of a Knockout without unconsciousness or in the case of Referee Stops Contest, the Boxer must be examined by a Doctor immediately afterwards in the locker room to determine the nature of the injury and the need of a further medical observation and/or hospitalization.
 - 30.4.9.4. Ringside Doctors may recommend treatment for injured Boxers.
 - 30.4.9.5. Ringside Doctors decides if a Boxer is “fit to box”.
 - 30.4.9.6. Ringside Doctors must fill out the Medical Bout Report in the case a restriction period and/or protective sanitary measures have been ordered for the Boxer.

RULE 31. AIBA CUT TECHNICIAN

31.1. Qualification and Eligibility

- 31.1.1. AIBA Cut Technicians must have passed the AIBA Cut Technician Certification Course.
- 31.2. Appointment
 - 31.2.1. AIBA will appoint one (1) AIBA Cut Technician for one-ring Competitions and two (2) for two-ring Competitions.
- 31.3. Duties
 - 31.3.1. When appointed to Elite AOB Competitions, the AIBA Cut Technician controls the handwraps prepared by the Coaches and intervenes only if these do not comply with these Rules.
 - 31.3.2. He oversees the work of the Teams' Cut Technician at the corner and provides advice to the Seconds if necessary.
 - 31.3.3. The AIBA Cut Technician can conduct Handwraps workshops, seminars or courses for Coaches.

RULE 32. EQUIPMENT MANAGER

- 32.1. Qualification and Eligibility
 - 32.1.1. Must have passed the AIBA ITO Certification Course.
- 32.2. Appointment
 - 32.2.1. AIBA will appoint two (2) Equipment managers for each AIBA-owned and AIBA-sanctioned Competition.
- 32.3. Duties
 - 32.3.1. Ensure that all Boxer's equipment, equipment distribution and handling align with AIBA Technical and Competition rules
 - 32.3.2. Responsible for all Boxer's Competition related equipment and its distribution
 - 32.3.3. Manage the volunteers in charge of escorting the Boxers, running gloves, bandages, headguard and equipment storage
 - 32.3.4. Inspect all Boxer's and their equipment prior to entering the FOP
 - 32.3.5. Inspect all coaches and Seconds to ensure proper clothing is used
 - 32.3.6. Ensure that only eligible Seconds who also possess valid accreditation enter the FOP.
 - 32.3.7. Manage the Bout Review request forms by providing the forms to Team Officials upon their request. Keep record of Bout Review requests and deliver all submitted forms to the Technical Delegate after the end of each Session.

RULE 33. REFEREE AND JUDGE COORDINATOR

33.1. Qualification and Eligibility

33.1.1. Must have passed the AIBA ITO Certification Course.

33.2. Appointment

33.2.1. AIBA will appoint two (2) R&J Coordinators for one-ring or three (3) R&J Coordinators for two-ring AIBA-owned and AIBA-sanctioned Competitions.

33.3. Duties

33.3.1. Collect R&J draw from the AIBA Scoring System operator.

33.3.2. Use R&J draw sheet to lead the Referee and Judges from the R&J lounge to a designated area around the FOP.

33.3.3. Inform the R&Js to enter the FOP and ensure each are in their correct positions.

33.3.4. Distribute R&J Draw sheets to the Announcer, R&J evaluators and TD

33.3.5. Ensure R&Js exit the FOP in an orderly fashion

RULE 34. DRAW COMMISSIONER

34.1. Qualification and Eligibility

34.1.1. Must have passed the AIBA ITO Certification Course.

34.2. Appointment

34.2.1. AIBA will appoint one (1) Draw Commissioner for one-ring Competitions and up to two (2) for two-ring Competitions.

34.3. Duties

34.3.1. Follow the Draw Commissioner Protocol as per Rule 9 of these rules.

34.3.2. Review the list of R&Js appointed to the Competition.

34.3.3. Provide all filters to the Technical delegate prior to the computerized R&J draw. Filters should comply with neutrality rules specified in these rules.

34.3.4. Ensure the R&J draw aligns with the rules of neutrality.

34.3.5. After the R&J draw, change requests can only be made under extraordinary circumstances and should abide by the Draw Commissioner Protocol.

RULE 35. OBSERVER

35.1. Qualification and Eligibility

- 35.1.1. Experienced AIBA ITO (Referee and Judge Evaluator) who has passed the AIBA ITO Certification Course and an additional AIBA Certification Course specifically designed for Referee & Judge Evaluators/Observer.
- 35.2. Appointment
 - 35.2.1. AIBA will appoint one (1) Observer for any AIBA-Owned or AIBA-Sanctioned event (World, IOC & Multi-sport).
- 35.3. Duties
 - 35.3.1. Observe the scores of the Judges, as well as, the Evaluators
 - 35.3.2. Enter Judge's scores after each round (if not automated) and evaluate against the evaluators' scores into the AIBA Database
 - 35.3.3. Compare Judge's scores with Evaluators score in each round and make appropriate deductions against each judge (if not automated).
 - 35.3.4. Be a member of the Protest Jury
 - 35.3.5. Record all protests and outcomes using the AIBA Database
 - 35.3.6. Evaluate performance of R&J Evaluator
 - 35.3.7. Back up Evaluator if any national neutrality conflicts arise

RULE 36. NATIONAL TECHNICAL OFFICIALS

- 36.1. Host National Federation nominates qualified persons as National Technical Officials ("NTO's") for the following positions:
 - 36.1.1. Timekeeper (use of an AIBA 1-star Referee and Judge for this position is strongly recommended)
 - 36.1.2. Gong Operator
 - 36.1.3. Record Book Manager
 - 36.1.4. Assistant Referee and Judge Coordinator
 - 36.1.5. Assistant Equipment Manager
- 36.2. Every NTO must respect and sign the AIBA Code of Conduct (Appendix 4 of these rules).

RULE 37. TIMEKEEPER AND GONG OPERATOR

- 37.1. The duties of the Timekeeper & Gong Operator can be performed by one person; however, at AIBA-owned and AIBA sanctioned Competitions, it is recommended to have two persons to perform these duties to ensure consistent quality control.
- 37.2. Duties

- 37.2.1. Regulate the number and duration of the rounds and the intervals between the rounds. The intervals between the rounds must be of one (1) minute.
- 37.2.2. The Timekeeper & Gong Operator must start and end each round by striking the gong.
- 37.2.3. Ten (10) seconds before the end of each round, the Timekeeper & Gong Operator will signal the approaching end of the round.
- 37.2.4. The Timekeeper & Gong Operator must regulate all periods of time and counts by a watch or clock but will only stop the clock when instructed by the Referee with the command “time” resuming after the Referee gives the command “box”.
- 37.2.5. Following a Knockdown, the Timekeeper & Gong Operator will give the sound signal to the Referee indicating the elapsing seconds while the Referee is counting.
- 37.2.6. If, at the end of a round, a Boxer is knocked down and the Referee is in the course of counting, the gong indicating the end of the round will not be sounded. The gong will be sounded only when the Referee gives the command “box” indicating the continuation of the Bout.
- 37.2.7. The Timekeeper & Gong Operator will regulate the time when a low blow or Loss of Consciousness occurs and if a Boxer falls out of the ring.

RULE 38. ANNOUNCER

38.1. Duties

- 38.1.1. Before the Bout, the Announcer will announce the Bout number, weight category, name and country of each Boxer, as well as, the name and country of each Referee and Judge.
- 38.1.2. The Announcer must announce the round number after the start of each round.
- 38.1.3. Ten (10) seconds before the start of each round, the Announcer must clear the ring by ordering “Seconds out”, except for the first round.
- 38.1.4. The Announcer must reveal the final results and the winner of the Bout after having received the final results from the Deputy Technical Delegate.

RULE 39. REFEREES AND JUDGES

- 39.1. All AIBA certified Referees and Judges have to abide by the most recent AIBA Technical & Competition Rules and AIBA Referee and Judge Regulations.
- 39.2. AIBA R&J Certification Courses are organised only by AIBA.

- 39.3. In all AIBA-affiliated Competitions, except for National Championships, the Referees and Judges must be AIBA-certified.
- 39.4. In all AIBA-owned and AIBA-sanctioned Competitions, the Referees and Judges should be appointed as follows:
- 39.4.1. To ensure neutrality, the Referee and Judges for each Bout will be selected by the AIBA Scoring System and approved by the Draw Commissioner and the Technical Delegate.
 - 39.4.2. Each Referee and Judge must be an AIBA certified Referee and Judge.
 - 39.4.3. Each Referee and Judge must be of a different country and National Federation from one another, as well as, from any of the Boxers taking part in the Bout.
 - 39.4.4. Each Referee and Judge must not be a national or resident of any country which is a dominion, colony or dependency of the country of any of the Boxers taking part in the Bout.
 - 39.4.5. In case of a change in nationality, such Referee and Judge must not officiate in any Bout in which a Boxer of the Referee and Judge's former nationality is taking part.
 - 39.4.6. In case it is impossible for the Draw Commissioner to comply with the above directives, the Technical Delegate, along with the Deputy Technical Delegate must approve the final selection.
- 39.5. Referees and Judges have to respect and sign the AIBA Code of Conduct (Appendix 4 of these rules).
- 39.6. Disciplinary Action
- 39.6.1. A decision on suspension related to Referees' or Judges' poor performances in a Competition can be proposed by the Referee and Judge Evaluator(s) to the Technical Delegate and the Technical Delegate, in turn, would inform the AIBA Scoring System Operator of the R&J name(s) that need to be withdrawn from a Session.
 - 39.6.2. A decision of suspension related to Referees' or Judges' ethics must be made by the Disciplinary Commission.
- 39.7. In all AOB Competitions, each Bout must be controlled by a Referee, who will officiate in the ring but will not score the Bout. For AOB Competitions the Referees shall be drawn by the AIBA Scoring System and confirmed by the Draw Commissioner and the Technical Delegate.
- 39.8. Duties of the Referee
- 39.8.1. To be primarily concerned for the health of both Boxers throughout the Bout.
 - 39.8.2. To see that all rules and fair play are strictly observed.

- 39.8.3. To maintain control of the contest at all stages.
- 39.8.4. To prevent a weak Boxer from receiving undue and unnecessary punishment.
- 39.8.5. To use four (4) words of command:
 - 39.8.5.1. “Stop” when ordering the Boxers to stop boxing;
 - 39.8.5.2. “Box” when ordering the Boxers to continue boxing;
 - 39.8.5.3. “Break” when breaking a clinch;
 - 39.8.5.4. “Time” when ordering the Timekeeper & Gong Operator to stop the time, and to order the Boxers to stop boxing.
- 39.8.6. To indicate to a Boxer any infringement of the AIBA Technical & Competition Rules using suitable explanatory signs, verbal commands and/or gestures.
- 39.8.7. The Referee may touch with the hand a Boxer to stop and to break the Bout, or to separate the Boxers.
- 39.8.8. The Referee must not indicate the winner by raising a Boxer’s hand or otherwise, until the announcement has been made. When the winner of a Bout is announced, the Referee must be positioned in the middle of the ring holding one hand of each Boxer and raise the hand of the winning Boxer while facing the main TV camera.
- 39.8.9. When a Referee terminates a Bout for any reason, this Referee must first inform the Deputy Technical Delegate of the decision and the reason why the Bout was stopped. The Deputy Technical Delegate should inform the Referee if the decision is clearly against the AIBA Technical & Competition Rules.
- 39.8.10. The Referee may consult the Ringside Doctor regarding the competing Boxer’s condition.
- 39.8.11. When the Referee calls the Ringside Doctor to the ring to examine a Boxer, only the Referee and the Ringside Doctor will be present in the ring or on the apron; however, the Ringside Doctor may request someone to help him/her.
- 39.8.12. If an injury occurs the Referee will follow the steps set out below:
 - 39.8.12.1. Ask the non-injured Boxer to go to the neutral corner;
 - 39.8.12.2. Ask the Ringside Doctor if the injured Boxer is fit to continue. If the Ringside Doctor informs the Referee that the Boxer is fit to continue, then the Referee may decide to continue the Bout;
 - 39.8.12.3. If the Ringside Doctor informs the Referee that the Boxer is not fit to continue, then the Referee may decide to terminate the Bout. If the Referee did not see the cause of injury the Referee will request the opinion of each of the five (5) Judges to see whether all or a majority have seen a foul or a correct blow and the Referee will then make one of the following decisions:

- 39.8.12.3.1. Where all or a majority of the Judges have seen a correct blow – Rule 19.7.1. of these rules applies;
 - 39.8.12.3.2. Where all or a majority of the Judges have seen an intentional foul – Rule 19.9.2. of these rules applies;
 - 39.8.12.3.3. Where all or a majority of the Judges have seen an unintentional foul – Rule 19.1.2. of these rules applies;
 - 39.8.13. To terminate a contest at any stage if this Referee considers it to be one-sided.
 - 39.8.14. To terminate a contest at any stage if one of the Boxers has received an injury which the Referee decides the Boxer should not continue.
 - 39.8.15. To terminate a contest at any stage if this Referee considers the Boxers inactive and not competitive. In such a case, the Referee may disqualify one or both Boxers.
 - 39.8.16. To caution a Boxer or administer a warning to a Boxer against fouls or for any other reason in the interest of fair play, or to ensure compliance with these rules.
 - 39.8.17. To disqualify a Boxer who fails to comply immediately with the Referee's command, or behaves towards the Referee in an offensive or aggressive manner at any time
 - 39.8.18. With or without previous warning, to disqualify a Boxer for committing a serious foul;
 - 39.8.19. To interpret these rules insofar as they are applicable or relevant to the Bout or to decide and take action on any circumstance of the Bout which is not covered by these rules.
 - 39.8.20. Right to check the Boxer
 - 39.8.20.1. Once a Boxer has entered the ring, the Referee has to ensure that the Boxer is wearing an appropriate uniform and equipment as per the AIBA Technical & Competition Rules.
 - 39.8.20.2. At the end of the Bout, the Referee has to ensure that the Boxer has appropriate bandages as per the AIBA Technical & Competition Rules.
 - 39.8.20.3. In the case of a Boxer's glove becoming undone during a Bout, the Referee will stop the Bout to have the issue rectified.
 - 39.8.21. The Referee will check that the positions of the Judges and of the Ringside Doctor(s) are correct before the start of the Bout.
 - 39.8.22. The Referee starts the Bout only after the authorisation of the Deputy Technical Delegate.
- 39.9. Duties of the Judge

- 39.9.1. To follow the scoring process and regulations as per AIBA Technical and Competition Rules
- 39.9.2. To score independently the merit of the Boxers during each round of the assigned Bout.
- 39.9.3. To not speak or give any sign to a Boxer or to another Judge or to anyone else before, during and after the Bout.
- 39.9.4. To not leave his/her seat until the results have been announced to the public.

RULE 40. LOC COMPETITION MANAGER

- 40.1. In all AIBA-owned and AIBA-sanctioned Competitions, the Local Organising Committee has to appoint a dedicated LOC Competition Manager.
- 40.2. The LOC Competition Manager is responsible for ensuring that the Competition is organised according to the AIBA Technical & Competition Rules, and for following the instructions and guidance of the Technical Delegate and AIBA HQ.
- 40.3. The LOC Competition Manager has to ensure that the Competition follows the competition venue requirements as per Appendix 11 of these rules.

RULES FOR COMPETITION EQUIPMENT AND UNIFORMS

RULE 41. COMPETITION EQUIPMENT

- 41.1. In all AIBA-owned and AIBA-sanctioned Competitions, equipment, outlined in the Rule 41.3. of these rules, must be provided by an AIBA Official Equipment Licensees, unless exceptionally agreed by AIBA.
- 41.2. In all AIBA-owned and AIBA-sanctioned Competitions, gloves, headguards, and bandages manufactured by one of the AIBA Official Equipment Licensees shall be provided by AIBA via the Local Organising Committee and shall be verified by the Technical Delegate.
- 41.3. FOP Equipment
 - 41.3.1. Ring
 - 41.3.2. Ring Accessories
 - 41.3.3. Gloves
 - 41.3.4. Glove Tape
 - 41.3.5. Headguard
 - 41.3.6. Bandage/Professional Handwraps
- 41.4. Warm-up Area and Training Venue Equipment
 - 41.4.1. Ring
 - 41.4.2. Floor ring
 - 41.4.3. Punching bags and frames
 - 41.4.4. Training gloves (16 oz or more)
 - 41.4.5. Headguards

RULE 42. RING

- 42.1. In all AOB Competitions, only rings manufactured by one of the AIBA Official Equipment Licensees can be used.
- 42.2. Ring Specifications
 - 42.2.1. In all AOB Competitions, the ring must measure 6.10 m inside the ropes on all four (4) sides.
 - 42.2.2. The size of the apron must extend for 85 cm outside the line of the ropes on each side, including additional canvas necessary to tighten and secure it.
 - 42.2.3. The ring must have the dimensions in accordance with the Manufacturer Guidelines: AIBA Official Ring.

42.2.3.1. For the total height of the poles, distance between the ropes, and the width of the rope strips, a margin of 2 cm is accepted.

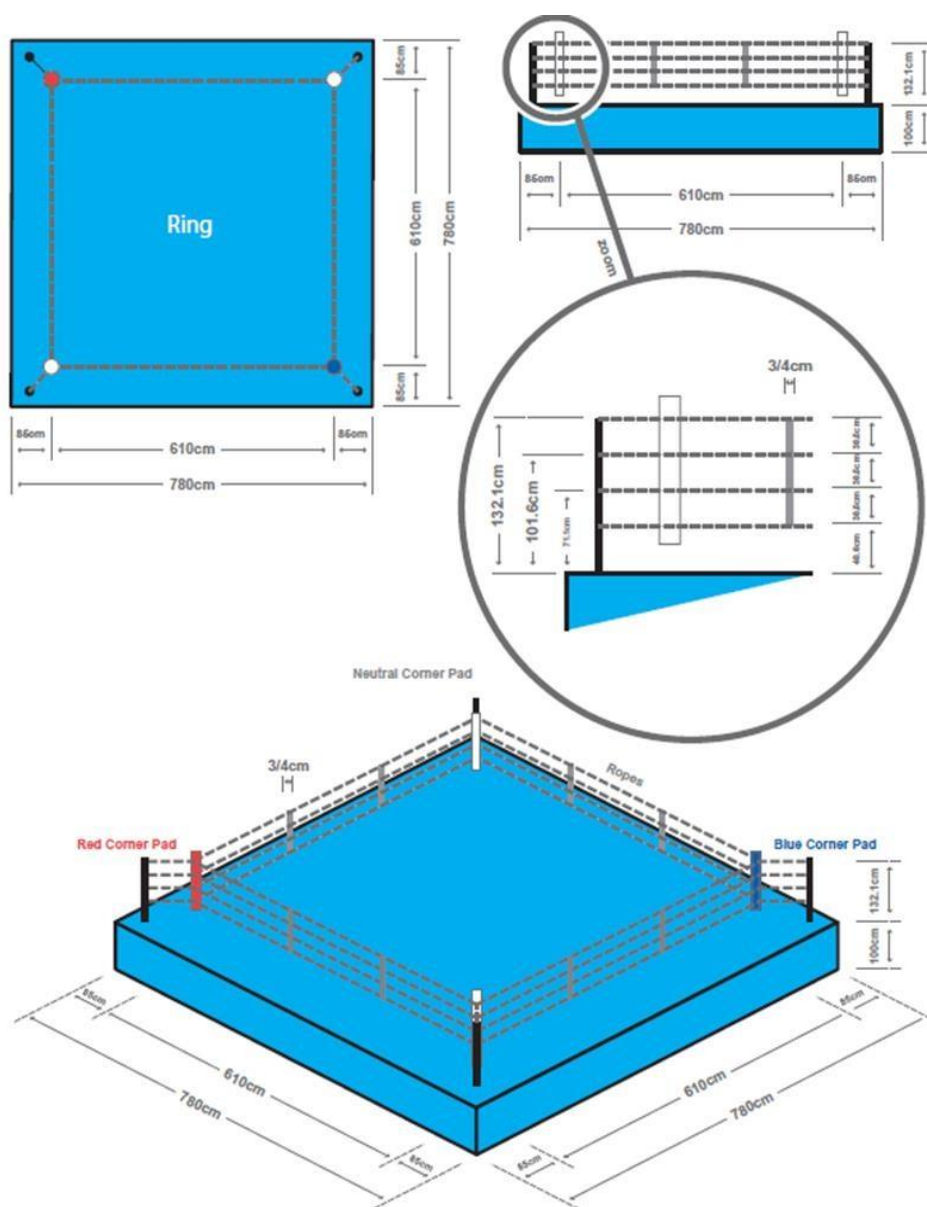

42.2.4. Platform and Corner Pads

42.2.4.1. The platform must be safely constructed, levelled and free from any obstructing projection. It must be fitted with four (4) corner posts with four (4) corner pads in order to prevent injury to the Boxers. The corner pads must be arranged facing towards the Technical Delegate as follows:

- 42.2.4.1.1. In the near left side corner – red
- 42.2.4.1.2. In the far-left side corner – white
- 42.2.4.1.3. In the far-right side corner – blue

- 42.2.4.1.4. In the near right side corner – white.
- 42.2.4.2. The platform must be 100 cm from the ground.
- 42.2.4.3. The length and the width of the ring platform must be 7.80m x 7.80m.
- 42.2.5. Surface of the Ring Floor
 - 42.2.5.1. The floor must be covered with felt, rubber or other suitably approved material that is soft quality and elasticity. It must not be less than 1.5 cm and no more than 2.0 cm.
- 42.2.6. Canvas
 - 42.2.6.1. The canvas must cover the entire platform and must be made of non-slippery material.
 - 42.2.6.2. The canvas must be blue, pantone 299, unless otherwise approved by AIBA.
- 42.2.7. Ropes
 - 42.2.7.1. The ropes must be covered by a thick padding.
 - 42.2.7.2. The ring must include four (4) separate ropes on each side of the corner posts. They must be 4cm-thick, without considering the cover.
 - 42.2.7.3. The heights of the four (4) ropes must be 40 cm, 70 cm, 100 cm, and 130 cm from the canvas.
 - 42.2.7.4. Rope separator specifications
 - 42.2.7.4.1. The four (4) ropes must be joined on each side of the ring, at equal intervals, by two (2) pieces of material (close to the texture of the canvas) 3 to 4 cm wide. The two (2) pieces must not slide along the rope.
 - 42.2.7.5. The tension of each section of the top two ropes must be tight. The tension of bottom two must not be too tight. However, in any case, the Referee and/or the Technical Delegate have the right to ask the LOC to adjust the tension if necessary.
- 42.2.8. Stairs
 - 42.2.8.1. The ring must be provided with three (3) sets of stairs, with each one having three (3) steps.
 - 42.2.8.2. Two (2) sets of stairs at the opposite corners for the use of the Boxers and Seconds, and one (1) set of stairs in the neutral corner for the use of the Referee and of the Ringside Doctor.

RULE 43. RINGSIDE ACCESSORIES

43.1. The following ringside accessories are required for all Bouts and must be provided by the organisers no later than two (2) days before the start time of the Competition per ring:

- 43.1.1. Gong.
- 43.1.2. Two (2) plastic receptacles which can be used for spitting.
- 43.1.3. Chairs and tables for the Technical Delegate and Deputy Technical Delegates (in AOB Competitions), Ringside Doctors, Timekeeper & Gong Operator, Official Announcer, TV Graphics Operator and Judges.
- 43.1.4. The tables for the Judges must be standardized for all AIBA Competitions
 - 43.1.4.1. Form – Square
 - 43.1.4.2. Width – 70 cm x 70 cm
 - 43.1.4.3. Height – 80 cm
 - 43.1.4.4. Drape Colour – a solid colour that matches the branding of the Competition, otherwise – white.
- 43.1.5. One (1) electronic stopwatch which complies with the requirements of the AIBA Scoring System and one manual stopwatch as a backup.
- 43.1.6. One (1) AIBA Scoring System.
- 43.1.7. One (1) microphone connected to the loudspeaker system.
- 43.1.8. First-aid supplies as required in accordance with the AIBA Medical Rules.
- 43.1.9. A non-transparent small plastic bag placed in the two neutral corners outside of the ring.
- 43.1.10. Three (3) chairs for the Seconds in each corner with clearly indicated area borders.
- 43.1.11. One (1) stretcher.
- 43.1.12. Mops or towels for cleaning the ring.

RULE 44. GLOVES

- 44.1. Boxers must wear red or blue gloves, as per the respective Boxer's corner.
- 44.2. Boxers must put on their gloves before entering the ring.
- 44.3. Gloves must be taken off immediately after the Bout is over and before the decision is announced.
- 44.4. The padding of the gloves must not be displaced or broken.
- 44.5. Only clean and serviceable gloves must be used. All Gloves must be cleaned using 10% Sodium Hypochlorite before they are used again.

44.6. In AOB Elite and Youth Men's Competitions:

44.6.1. Ten (10) oz gloves must be used for the Minimum Weight (46-48kg) category to the Welterweight (67kg) category.

44.6.2. Twelve (12) oz gloves must be used for the Light Middleweight (71kg) category to Super Heavyweight (92+ kg) category.

44.7. In AOB Elite and Youth Women's Competitions:

44.7.1. Ten (10) oz gloves must be used in all weight categories

44.8. Glove Specifications

44.8.1. Gloves must weigh 284 grams (approx. 10 oz) and 340 grams (approx. 12 oz), with a tolerance of 5% up or downwards, of which the leather portion must not weigh more than half of the total weight, and the padding portion not less than half of the total weight. The margin of 5% would also apply downwards and upwards, respectively.

44.8.2. Only gloves with Velcro closing systems will be approved for all AOB Competitions.

44.8.3. In all AOB Competitions, the glove closure system shall be covered by glove tape with a maximum of one layer around the wrist part of the gloves to avoid any cut or laceration for the opponent.

44.8.3.1. The glove tape must be procured from an AIBA Official Equipment Licensee.

44.8.3.2. The glove tape must be 5 cm wide.

44.8.4. The leather portion of the gloves must be made of high-quality material such as:

44.8.4.1. Cowhide leather

44.8.4.2. Grade A leather

44.8.4.3. Others of equivalent quality subject to AIBA's approval.

44.8.5. The thumb must be fixed to the main body of the gloves by the top part and with a maximum gap of ten (10) millimeters.

44.8.6. The Competition identification or the manufacturer logo may be printed and may be displayed at the following positioning and measurements:

44.8.6.1. Maximum 50 cm² on the front top part of each glove.

44.8.7. The official manufacturer's logo may be printed and may be displayed at the following positioning and measurements:

44.8.7.1. Maximum 24 cm² on the thumb of each glove.

44.8.8. Any other form of advertising is prohibited such as and non-limited to figurative logo, design mark, script and manufacturer name, etc.

- 44.8.9. The AIBA mark must be placed on the internal part of the gloves.
- 44.8.10. Detailed glove specifications can be found in Appendix 12 of these rules.

RULE 45. HEADGUARD

- 45.1. In AOB Elite Men's Competitions, headguards are not allowed.
 - 45.1.1. If a Boxer is not wearing headguards and has hair that reaches below the neckline, a hair net or any other item must be worn to control the hair.
 - 45.1.1.1. The Seconds have to ensure that the hair is secured appropriately.
- 45.2. In all AOB Competitions, except Elite Competitions, a Boxer must wear a red or a blue headguard, as per the respective Boxer's corner.
- 45.3. Long hair should not limit a Boxer's vision and should be appropriately tied.
- 45.4. There is no restriction on hair length.
- 45.5. A Boxer must put on a headguard only after entering the ring.
- 45.6. A headguard must be taken off immediately after the Bout is over and before the decision is announced. Hair net or any other item worn to control the hair can be kept.
- 45.7. All headguards must be cleaned using 10% Sodium Hypochlorite before they are used again.
- 45.8. Headguard Specifications
 - 45.8.1. A headguard must weigh a maximum of 450 grams (approx. 16 oz).
 - 45.8.2. In AOB Competitions, headguards should come in 4 mandatory sizes (S=Small, M=Medium, L=Large, XL Extra Large).
 - 45.8.3. Only a headguard with Velcro closing systems is approved for all AOB Competitions.
 - 45.8.4. The measurements of the headguard must respect the dimension as described in Appendix 13 of these rules.
 - 45.8.5. The padding of the headguards must respect a minimum thickness of 2-3 cm.
 - 45.8.6. The leather portion of the headguard must be made of high-quality leather such as:
 - 45.8.6.1. Cowhide leather
 - 45.8.6.2. Grade A leather
 - 45.8.6.3. Others of equivalent quality subject to AIBA's approval.
 - 45.8.7. The Competition identification or the manufacturer logo may be printed and may be displayed at the following positioning and measurements:
 - 45.8.7.1. Maximum 50 cm² on the front part of the headguard.

- 45.8.8. The official manufacturer's logo may be printed and may be displayed at the following positioning and measurements:
 - 45.8.8.1. Maximum 40 cm² on the back part of the headguard.
- 45.8.9. Any other form of advertising is prohibited such as and non-limited to figurative logo, design mark, script, manufacturer name, etc.
- 45.8.10. The AIBA mark must be placed on the inside part of the headguard.
- 45.8.11. Detailed headguard specifications can be found in in Appendix 13 of these rules.

RULE 46. BANDAGES, PROFESSIONAL HANDWRAPS AND BANDAX HANDWRAPS

46.1. Use of Bandages

- 46.1.1. In AOB Competitions, except for Elite Competitions, Velcro bandages shall be used.
- 46.1.2. The bandages are distributed at the equipment table by the Equipment Manager.
- 46.1.3. The bandages of each Boxer must be checked and marked by the Equipment Manager at the equipment check table.
- 46.1.4. Bandages must not be longer than 4.5 m (14.76 feet), and not shorter than 2.5 m (8.2 feet). Bandages must be 5.7 cm (2 ¼ inches) wide.
- 46.1.5. Bandages must be made of stretchy cotton material with a Velcro closure.
- 46.1.6. The use of any substance on the bandages is prohibited.

46.2. Use of Professional Handwraps

- 46.2.1. In AOB Elite Competitions and any other event as decided by AIBA, the use of professional handwraps or Bandax wraps (i.e : 46.3) shall be mandatory.
- 46.2.2. The materials provided for professional handwraps for each Boxer shall be as follows:
 - 46.2.2.1. Gauze Bandage: 2 rolls of 5 cm x 15 m Gauze (1 roll of gauze for each hand)
 - 46.2.2.2. 2 rolls of 5 cm x 10 m Gauze (1 roll to create a knuckle pad for each hand)
 - 46.2.2.3. Zinc Oxide Tape: 2 rolls of 2.5 cm x 13 m
 - 46.2.2.4. 1 roll of 1.25 cm x 13 m for between the fingers
- 46.2.3. All equipment shall be clearly branded, and packaging will include specifications and relevant instructions.

46.2.4. In AOB Elite Competitions, a Boxer shall apply the provided gauze bandages and tape on his hands as he likes, provided that the knuckles of his hand are not covered by the Zinc Oxide Tape.

46.2.5. The use of any substance or object on the Gauze and/or Zinc Oxide Tape is prohibited.

46.3 Use of Bandax Technology Handwraps

46.3.1. Bandax Technology Handwraps may be used in any AOB competitions.

46.3.1.1. One pair of Bandax Handwraps shall only be used for a maximum of six official bouts.

RULE 47. BOXING SENSORS

47.1. In all AIBA-owned and AIBA-sanctioned Competitions, boxing sensors manufactured by the AIBA Official Data provider/partner shall be allowed to be worn in order to gather Competition and boxing data/metrics.

47.2. Sensors shall be inserted either in the Competition gloves or on the bandages depending on the official gloves brand used during the Competition.

RULE 48. ATHLETE COMPETITION UNIFORM AND EQUIPMENT

48.1. In all AOB Competitions, a Boxer has to wear a uniform that complies with Rule 48 of these rules and the Manufacturer Guidelines: AIBA Official Boxers' Uniform.

48.2. The Technical Delegate of the Competition or a Technical Official who was given authority of a Technical Delegate determines the uniforms permitted in the FOP in accordance with the AIBA Technical and Competition Rules.

48.3. Vests, shorts/skirts, and robes

48.3.1. Men and Boy Boxers have to wear a vest and shorts.

48.3.2. Women and Girl Boxers have to wear a vest and either shorts or a skirt.

48.3.3. The length of the shorts must not be shorter than mid-thigh, cannot cover the knee and must not be worn above the belt line.

48.3.4. The vest and shorts/skirt can be in the Boxer's respective national colours or in red or blue colour according to the Boxer's respective corner allocation.

48.3.5. Elite Boxers may wear a robe over his/her uniform on the way to the ring, and the robe can be in the Boxer's respective national colours or in red or blue colour according to the Boxer's respective corner allocation.

48.3.5.1. The robe must be of the same material as the uniform.

48.3.6. For the avoidance of doubt, if the uniform and/or robe is in red or blue colour, a solid red or blue colour has to be used and must be one of the following:

48.3.6.1. Red: Pantone 185, 199 or 485

- 48.3.6.2. Blue: Pantone 286, 293 or 661
- 48.3.7. A Boxer is not be allowed to have tape, in any form, on his/her uniform.
- 48.3.8. The belt line must be clearly identified by a contrasting colour to the shorts/skirt and vest and must be 6-10cm wide.
 - 48.3.8.1. The belt line is an imaginary line from the navel to the top of the hips and must not cover the navel.
- 48.4. Footwear and socks
 - 48.4.1. A Boxer must box in boxing appropriate footwear, such as shoes or light boots (without spikes or heels).
 - 48.4.2. A Boxer may wear socks, but they must not be higher than the knee.
- 48.5. Gumshield
 - 48.5.1. A Boxer must wear a gumshield during every Bout.
 - 48.5.2. No red or partially red-coloured gumshield may be worn.
 - 48.5.3. A Boxer should never use a borrowed gumshield.
 - 48.5.4. The gumshield has to fit exactly and comfortably.
- 48.6. Cup and Breast protectors
 - 48.6.1. Men and Boy Boxers must wear a cup protector during a Bout and may additionally wear a jock-strap.
 - 48.6.1.1. The cup protector must not cover any part of the target area.
 - 48.6.1.2. The cup protector must have no metal parts except if there is a fastening at the back of the Boxer.
 - 48.6.2. Women and Girl Boxers may use a breast protector and/or a cup protector during a Bout.
 - 48.6.2.1. The breast protector should be confined to the natural contours of the breast, so as not to provide extra protection to surrounding structures. It may not shield any target area of the body, including the breastbone.
 - 48.6.2.2. The breast and cup protectors must have no metal parts except if there is a fastening at the back of the Boxer.
- 48.7. Hijab
 - 48.7.1. Women and Girl Boxers may wear a black sport form-fitting Hijab
 - 48.7.1.1. The Hijab can include the following elements:
 - 48.7.1.1.1. Long-sleeved form fitting shirt under the Competition vest;
 - 48.7.1.1.2. Full-length form fitting tights under the Competition shorts or skirt;
 - 48.7.1.1.3. Sport Hijab scarf.

- 48.7.1.2. The use of Hijab in the Field of Play shall not interfere with the view of the referee and judges, or potentially cause any injuries or cuts, or give any unfair competitive advantages.
 - 48.7.1.3. No identification of the Member Association, and no further elements such as marks, insignia, statements or slogans shall be displayed on the Hijab, tights or sleeves.
 - 48.7.1.4. The hijab outfit has to be presented and approved during the Sport Entries Check.
- 48.8. There shall not be any demonstrations, symbols or patterns containing political, religious and racial propaganda, and of items on the WADA prohibited substance list, and messages against AIBA Code of Ethics visible on the Boxer's body or apparel including uniform, footwear, socks, permanent or temporary tattoo on the body, etc.
- 48.9. A uniform diagramme can be found in Appendix 14 of these rules.
- 48.10. Identification Specifications
- 48.10.1. In all AIBA-sanctioned Multi-sport competitions, Team Delegations have to follow identification specifications of the Multi-sport LOC.
 - 48.10.2. National Flag
 - 48.10.2.1. The flag of the country of the National Federation may be displayed only once on the vest, once on the robe, and once on the shorts and/or skirt.
 - 48.10.2.2. The flag must not contain any manufacturer's identification, sponsor advertising, design features or other elements.
 - 48.10.2.3. The flag may be printed, embroidered or sewn on as a badge.
 - 48.10.2.4. There are no restrictions on the shape of the flag, but the following measurements and positioning on the item must be observed:
 - 48.10.2.4.1. Vest and robe: Maximum 50 cm², front of the vest and robe, over the heart
 - 48.10.2.4.2. Shorts/skirt: Maximum 50 cm², front of left leg.
 - 48.10.3. Manufacturer's Logo
 - 48.10.3.1. The manufacturer's identification may be displayed only once on each of the following:
 - 48.10.3.1.1. Vest
 - 48.10.3.1.2. Robe
 - 48.10.3.1.3. Shorts and/or skirt
 - 48.10.3.1.4. Each sock
 - 48.10.3.1.5. Each item of footwear
 - 48.10.3.1.6. Each item of protective equipment

- 48.10.3.1.7. Second's bag
- 48.10.3.2. The manufacturer's identification may be printed, embroidered or sewn on to the vest, robe, shorts/skirt, socks and footwear and must not interfere with the other elements identifying the National Federation (e.g. flag).
- 48.10.3.3. The following quantities, positioning and measurements must be observed:
 - 48.10.3.3.1. Vest and robe: Maximum 30 cm², front of the vest and robe, at heart level and on the opposite side of the National Flag;
 - 48.10.3.3.2. Shorts/skirt: Maximum 30 cm², front of the right leg;
 - 48.10.3.3.3. Socks: Maximum 10 cm² per sock;
 - 48.10.3.3.4. Footwear: as generally used on products sold through retail trade during the period of 6 months prior to the AOB Competition;
 - 48.10.3.3.5. Protective equipment: Maximum 6 cm² per item;
 - 48.10.3.3.6. Bag: no greater than 10% of the surface area of the item, to a maximum size of 60 cm²;
- 48.10.4. Olympic National Abbreviation of the National Federation (ONANF)
 - 48.10.4.1. The ONANF is the Olympic Abbreviation of the National Federation's Country name, therefore, consisting of 3 capital letters.
 - 48.10.4.2. It may be displayed only once on the back of the vest and robe.
 - 48.10.4.3. The letters must not exceed 10 cm in height and 20 cm in length.
 - 48.10.4.4. The letters must be in a contrasting colour to the colour(s) of the vest and robe. For a better legibility, they may be affixed to a neutral-coloured patch or surrounded by a border or shadow outline.
 - 48.10.4.5. The letters may be printed, embroidered or sewn on as a badge.
 - 48.10.4.6. The ONANF must not interfere with the other elements of the uniform that identify the Boxer (e.g. Boxer's name).
- 48.10.5. Boxer's Name:
 - 48.10.5.1. Each Boxer may be identified by means of the surname on the back of the vest.
 - 48.10.5.2. The name must be identical to that indicated in the passport.
 - 48.10.5.3. The name must be positioned on the upper part of the back of the vest under the ONANF.

- 48.10.5.4. The letters must not exceed 5 cm in height and 20 cm in width.
- 48.10.5.5. The letters must be in a contrasting colour to the colour(s) of the vest. For a better legibility, they may be affixed to a neutral coloured patch or surrounded by a border or shadow outline.
- 48.10.5.6. The letters may be printed, embroidered or sewn on as a badge.
- 48.10.5.7. The letters must not interfere with the other elements of the uniform that identify the Boxer (e.g. ONANF).
- 48.10.5.8. The name may not contain any manufacturer identification, sponsor advertising, design features or any other elements.
- 48.10.6. National Federation's Sponsors Advertising
 - 48.10.6.1. All forms of advertising for sponsors or third parties, of political, religious or personal statements or other prohibited class such as alcohol (exception for beer and wine), tobacco, casino, gambling and betting are prohibited on all kit items inside the Competition Venue.
 - 48.10.6.2. The National Federation's sponsor advertising may be printed, embroidered or sewn on to the vest and must not interfere with the other elements identifying the National Federation (e.g. the flag). The following quantities, positioning and measurements must be observed:
 - 48.10.6.2.1. Vest: Maximum 150 cm² once on the front of the vest below the chest level area

RULE 49. OFFICIALS' COMPETITION UNIFORM

- 49.1. Referees and Judges must wear only the official AIBA attire for Referees and Judges.
 - 49.1.1. White, short-sleeve, button-down collared shirt (long-sleeve acceptable in exceptional cases)
 - 49.1.2. Black bow tie
 - 49.1.3. AIBA R&J badge affixed upon the left side (over the heart) of the shirt
 - 49.1.4. Black trousers (no denim)
 - 49.1.5. Black sport shoes with no heels
- 49.2. Referees may use surgical gloves when officiating.
- 49.3. Technical Delegates and ITOs must dress in strict business attire, unless provided with an AIBA-approved uniform.

APPENDICES

APPENDIX 1: CHANGE OF SPORT NATIONALITY PROCEDURE

To start the process to change the Sport Nationality of a Boxer, AIBA HQ needs to receive from the Boxer's New National Federation the mandatory documents listed below:

Document 1 – Official request for changing Sport Nationality. The document can be found in Appendix 2 of these rules.

Document 2 – Copy of the Boxer's original passport, corresponding to the nationality waived by the Boxer

Document 3 – Copy of the Boxers' new passport, corresponding to the country of the Boxers' new National Federation

Document 4 – New National Federation confirmation letter agreeing with the change of sport nationality

Document 5 – Former Federation confirmation letter agreeing with the change of sport nationality.

APPENDIX 2: CHANGE OF SPORT NATIONALITY APPLICATION FORM



Change of Sport Nationality - Application Form

Boxer (to be filled by the Boxer's New Federation of Origin and signed by the Boxer)

_____	_____	Photo				
<i>Last Name</i>	<i>First Name</i>					
_____	_____					
<i>Date of Birth DD/MM/YEAR</i>	<i>Place of Birth</i>					
_____	_____	<table border="1"> <tr> <td colspan="2" style="text-align: center;"><i>Gender</i></td> </tr> <tr> <td style="text-align: center;">Woman</td> <td style="text-align: center;">Man</td> </tr> </table>	<i>Gender</i>		Woman	Man
<i>Gender</i>						
Woman	Man					
<i>New Sport Nationality</i>	<i>Passport N° New National Federation</i>					
_____	_____					
<i>Previous Sport Nationality</i>	<i>Passport N° National Federation of Origin</i>					
Date and competition the Boxer last represented his Federation of origin						
_____	_____	_____				
<i>Place</i>	<i>Date</i>	<i>Boxer's signature</i>				

To be filled by the Boxers' New National Federation

_____	Approved  Not Approved* (to be filled by AIBA HQ)
<i>Name of the National Federation</i>	
_____	_____
<i>Name of the NF President</i>	<i>Seal and Signature of NF President</i>

To be filled by the Boxer's National Federation of Origin

_____	Approved  Not Approved* (to be filled by AIBA HQ)
<i>Name of the National Federation</i>	
_____	_____
<i>Name of the NF President</i>	<i>Seal and Signature of NF President</i>

To be filled by AIBA

_____	Change of Sport Nationality approved  Change of Sport Nationality Not Approved (to be filled by AIBA HQ)
<i>Change of Sport Nationality will take effect on</i>	
_____	_____
<i>Place and Date</i>	<i>AIBA Executive Director Signature</i>
_____	_____

APPENDIX 3: SEEDING DIAGRAMMES

Diagramme 1



Diagramme 2



Diagramme 3 (top part)

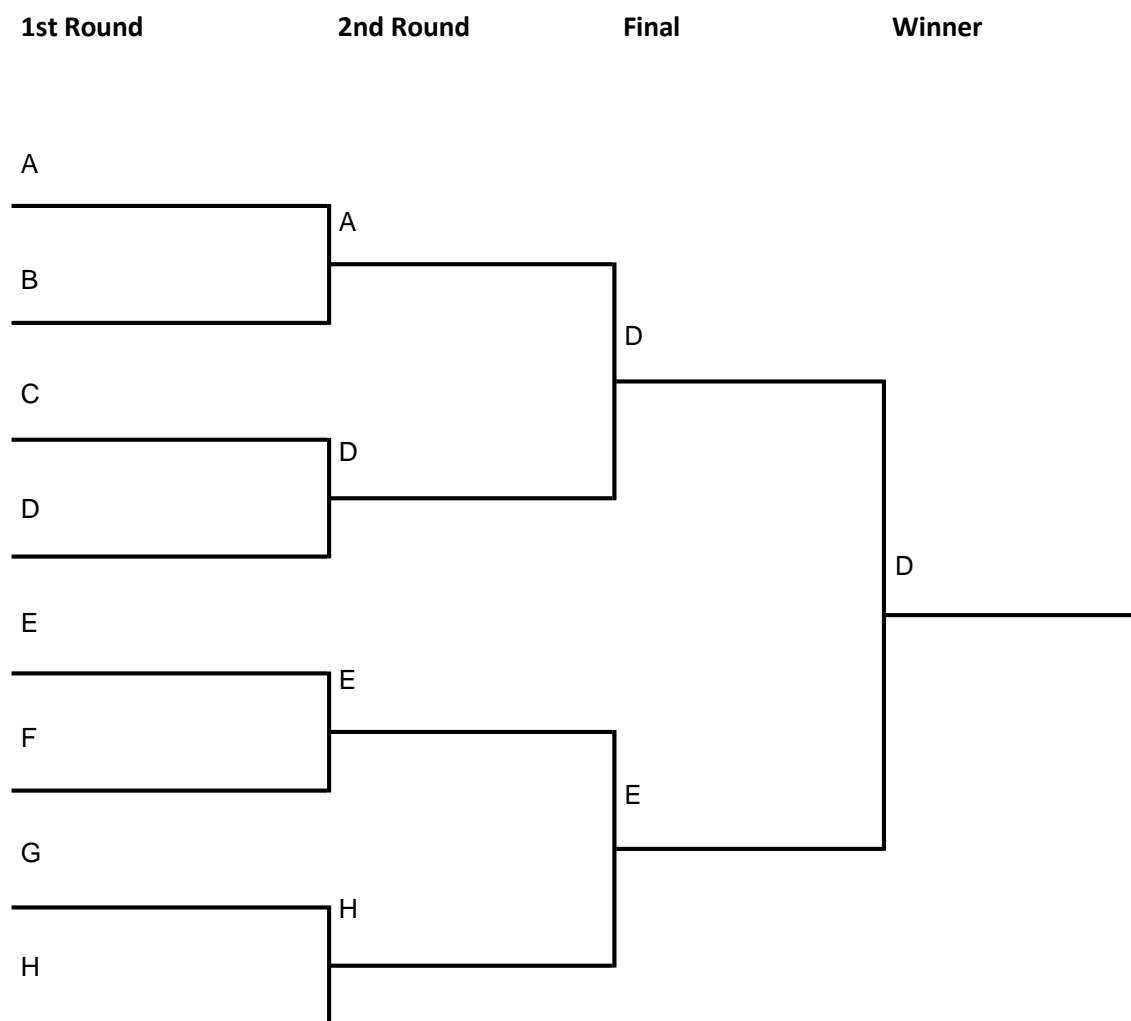

Diagramme 3 (bottom part)

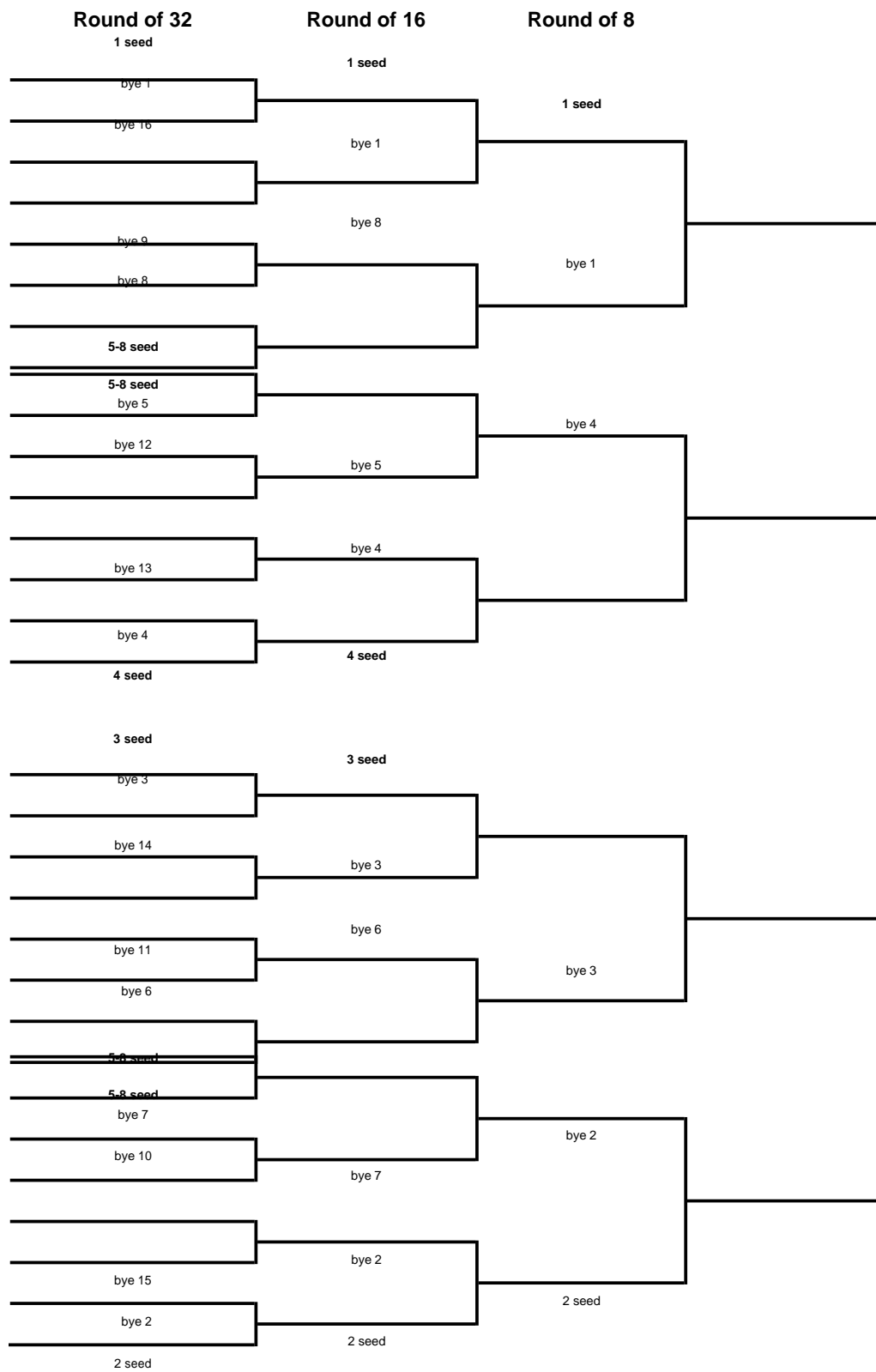

APPENDIX 4: AIBA CODE OF CONDUCT

The International Boxing Association (AIBA) hereby requests your agreement to the following “Code of Conduct”, which will apply for as long as you are officiating as a Competition Official in any AIBA Competition:

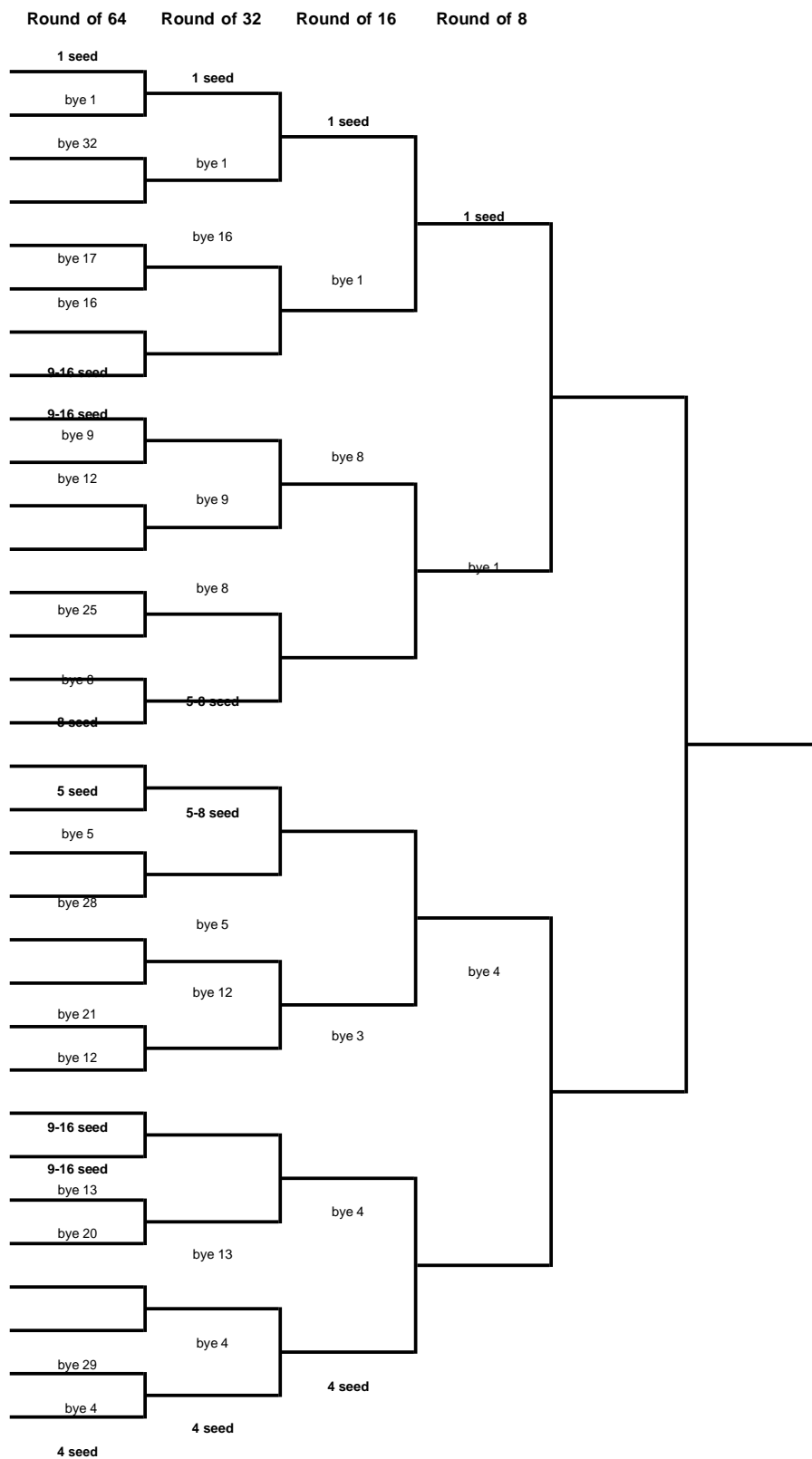
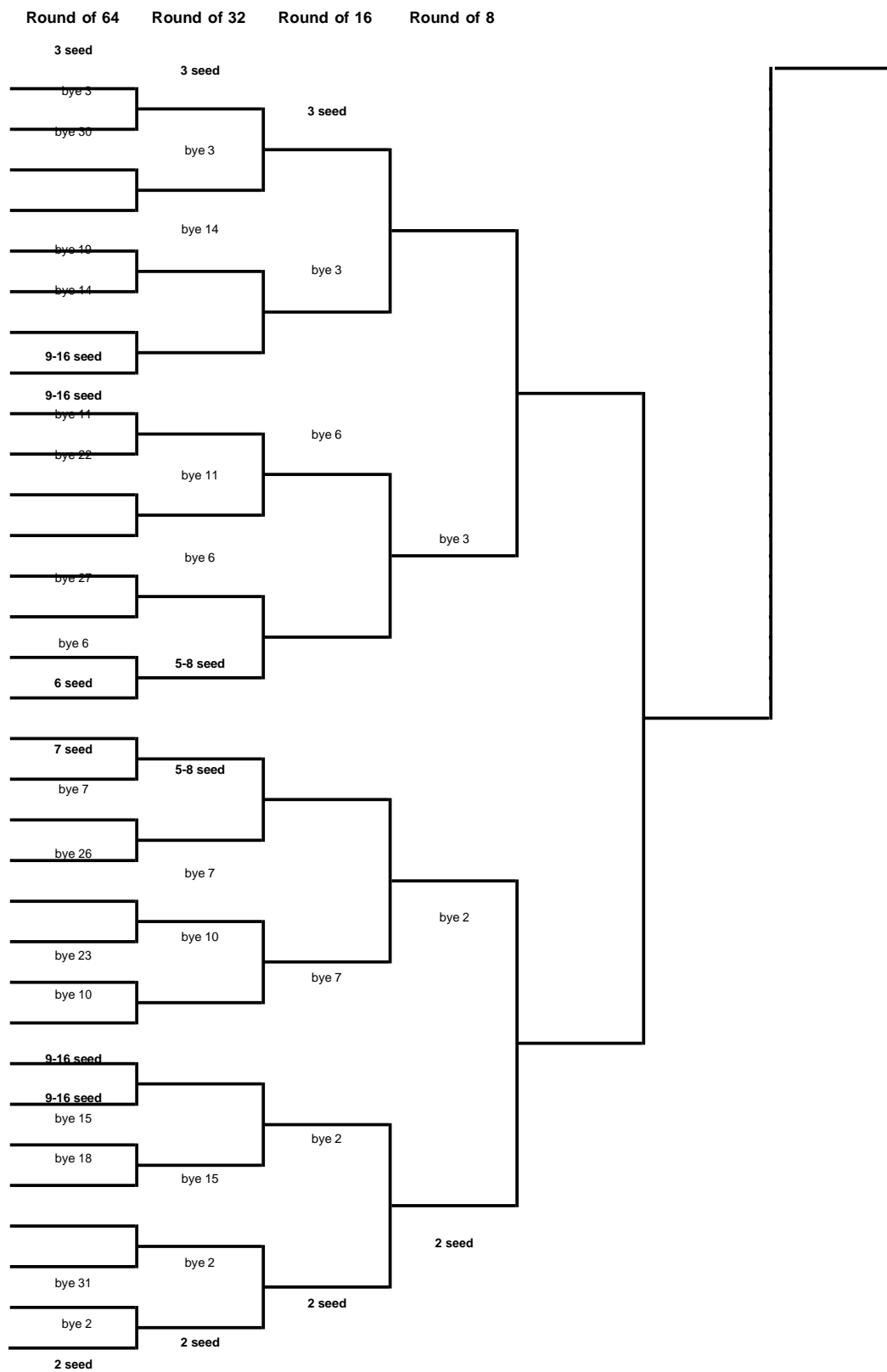
DIGNITY

- Code 1: I shall not be under the influence of alcohol while officiating or participating in any AIBA Competition, including all related meetings and weigh-ins.
- Code 2: I shall not smoke in the Competition Venue.
- Code 3: I shall not conduct myself in any manner that may bring the sport of boxing and/or AIBA into disrepute.

INTEGRITY

- Code 4: I shall not collude or collaborate with any party by violating any Rule (as applicable).
- Code 5: I shall not socialize with or become intimate with Boxers and/or Coaches and Seconds and/or other team delegation members, or enter into any relationship or take any action that casts doubt on my impartiality as a Competition Official. In the event that I believe any relationship may cause a perception of bias I shall declare the relationship in advance to AIBA HQ for consideration in appointments.
- Code 6: I shall at all times conduct myself in a professional and ethical manner, giving due regard to the Technical Delegate.
- Code 7: I shall not, directly or indirectly, solicit, accept or offer any form of remuneration or commission, nor any concealed benefit, service or gift of any nature that could be considered as a bribe or undue influence, connected with anyone related to any Competition in which I participate. I confirm that any approaches or offers made in this regard shall be reported immediately to a relevant person.
- Code 8: Only official souvenirs as approved by AIBA HQ may be given or accepted, as a mark of respect or appreciation for my contribution.

CONFIDENTIALITY

- Code 9: When performing my duties as a Competition Official, I shall not communicate with anybody about any Competition related issue within the Competition Venue and/or any other location for the entire period of the Competition and after, especially to persons from my own country such as National Federation members, Executive Committee members, media and the public. I shall not comment about any Competition related issues on social media.
- Code 10: I shall treat any information I may receive from AIBA or learn in the course of my duties as a Competition Official as confidential and will not inform others including but not limited to those involved in National Federation team delegations.

RESPONSIBILITY

- Code 11: I shall be on time for all Competitions assigned to me.
- Code 12: I shall be available to attend any Competition Official's meetings on or before the Competition day.
- Code 13: I shall fulfil all duties assigned to me by the Technical Delegate.
- Code 14: I shall not use or carry any electronic communication device, including but not limited to a mobile phone, a laptop and a tablet computer inside the Competition Venue.
- Code 15: I shall maintain a good physical condition, personal hygiene and a professional appearance at all times when performing my duties as a Competition Official.
- Code 16: I shall not criticize or attempt to explain calls or decisions made by other Competition Official, unless where requested by the Technical Delegate to do so.
- Code 17: I shall respect all AIBA Rules.

I agree to be bound by this Code of Conduct and acknowledge that any infringement of this Code of Conduct may be referred to the AIBA Disciplinary Commission / AIBA Executive Committee and could lead to disciplinary investigation and sanction against me.

DATE: _____

NAME: _____ SIGNATURE: _____

APPENDIX 5: MEDICAL CERTIFICATE TEMPLATE

Athlete

NAME:	_____
DATE OF BIRTH:	_____
SIGNATURE:	_____ DATE: _____

Doctor

NAME:	_____
TITLE/POSITION:	_____
ADDRESS:	_____
SIGNATURE:	_____ DATE: _____
STAMP	_____
COMMENTS:	_____

Fit to Box

Not Fit to Box

QUESTION FOR ATHLETE: IF YES, EXPLAIN

1. Is a Doctor currently treating you for anything?

2. Have you ever been unconscious or had a concussion?

3. Have you been hit hard in the head in the last 6 weeks?

4. Have you had any headache in the last 2 weeks?

5. Do you have any problem with bleeding?

6. Do you have a history of hepatitis B or hepatitis C or HIV infection?

7. Does any disease run in your family? Sudden unexpected deaths?

8. Have you had any surgery?

9. Have you ever had to stay in a hospital?

10. Do you have any medical condition?

MEDICAL CERTIFICATE		ABNORMALITIES		
If Athlete had a Concussion in the past year, please certify that:	Medical Examination following rest period after Concussion was normal Athlete Fit To Box	Normal	Abnormal	
General Medical Exam	List abnormalities not covered in specific system exams below:			
Mental Status/ Psychological	Brief survey	Normal	Abnormal	
Head	Cranial nerves, eyes, pupil size and reactivity, Fundi, vision by chart (record)	Normal	Abnormal	
	Mouth, teeth, throat	Normal	Abnormal	
	Ears	Normal	Abnormal	
	Temporomandibular joint	Normal	Abnormal	
Neck	Cervical spine, lymph nodes	Normal	Abnormal	
Chest	Breath sounds, rib tenderness on compression	Normal	Abnormal	
Cardio Vascular System	Pulse/blood pressure (record)	Normal	Abnormal	
	Heart examination: sounds, murmurs, heaves, size, rhythm	Normal	Abnormal	
Orthopaedic System	Upper limb: shoulder, wrist, hand, fingers	Normal	Abnormal	
	Lower limb: foot, ankle, knee, hip	Normal	Abnormal	
Neurological System	Reflexes	Normal	Abnormal	
	Verbal Responses	Normal	Abnormal	
	Motor responses and balance	Normal	Abnormal	
Allergies	(record)	Yes	No	
	Type of reaction (record)			
Medications used	Name and dosage (record)	Yes	No	

Any TUE Submitted?

No

Yes (If yes, please explain)

APPENDIX 6: ANTI-DOPING CONSENT FORM

CONSENT FORM

As a member of [National Federation] and/or a participant in an event authorized or recognized by [National Federation or International Federation], I hereby declare as follows:

I acknowledge that I am bound by, and confirm that I shall comply with, all of the provisions of AIBA Anti-Doping Rules (as amended from time to time) and the *International Standards* issued by the World Anti-Doping Agency and published on its website.

I acknowledge the authority of AIBA [and its member National Federations and/or National Anti-Doping Organizations] under the AIBA Anti-Doping Rules to enforce, to manage results under, and to impose sanctions in accordance with, the AIBA Anti-Doping Rules.

I also acknowledge and agree that any dispute arising out of a decision made pursuant to the AIBA Anti-Doping Rules, after exhaustion of the process expressly provided for in the AIBA Anti-Doping Rules, may be appealed exclusively as provided in Article 13 of the AIBA Anti-Doping Rules to an appellate body for final and binding arbitration, which in the case of International-Level Athletes is the Court of Arbitration for Sport (CAS).

I acknowledge and agree that the decisions of the arbitral appellate body referenced above shall be final and enforceable, and that I will not bring any claim, arbitration, lawsuit or litigation in any other court or tribunal.

I have read and understand the present declaration.

Date

Print Name (Last Name, First Name)

Date of Birth (Day/Month/Year)

Signature (If minor, signature legal guardian)

APPENDIX 7: DECLARATION OF NON-PREGNANCY

1. Declaration of Non-Pregnancy for Women Boxers aged eighteen (18) and older

Date: _____

Place: _____

National Federation: _____

Passport details of the Boxer: _____

Passport issued by: _____

Date of birth of the Boxer: _____

I, _____, (*insert name of the Boxer*) declare that I am not pregnant.

I understand the seriousness of this statement and accept full responsibility for it. In the case that this declaration is subsequently shown to be inaccurate or untrue and I suffer any related injury or damage during the Competition, I on behalf of myself, my heirs, executors and administrators, waive and release any and all claims for damages I may have against AIBA (including its officials and employees), the organisers of the Competition (including the Local Organising Committee and/or the Host Federation) and the Competition Venue owners for such injury or damage.

Signature of the Boxer

2. Declaration of Non-Pregnancy for Girls Boxers aged Under eighteen (18)

Date: _____
Place: _____
National Federation: _____
Passport details of the Boxer: _____
Passport Issued by: _____
Date of birth of the Boxer: _____
Passport details of the parent/legal guardian: _____
Passport issued by: _____

I, _____, one of the parent / legal guardian of
_____, (*insert name of the Boxer*) declare, on her behalf, that she is
not pregnant.

I understand the seriousness of this statement and accept full responsibility for it. In the case that this
declaration is subsequently shown to be inaccurate or untrue and
_____, (*insert name of the Boxer*) suffers any related injury or damage
during the Competition, I on behalf of _____, (*insert name of the Boxer*),

her heirs, executors and administrators, waive and release any and all claims for damages she may
have against AIBA (including its officials and employees), the organisers of the Competition (including
the Local Organising Committee and the Host Federation) and the Competition Venue owners for such
injury or damage.

Signature of the Parent / Legal Guardian: _____

Acknowledged by

Signature of the Boxer _____

APPENDIX 8: CHANGE OF SPORT APPLICATION FORM

NF ACCEPTANCE NOTICE FOR INDIVIDUAL PHYSICAL CONTACT SPORT ATHLETES

TO: International Boxing Association (AIBA)
FROM: _____
(Name of National Federation)
DATE: _____

Dear Sirs,

We hereby inform AIBA that the following athlete from _____ (name of sport) wishes to participate in the sport of boxing and cease his/her involvement in the former sport. Our National Federation has reviewed this athlete and decided to accept him/her as one of our Boxers.

Athlete's Full Name: _____

Athlete's Desired Weight Category: _____

Athlete's Desired Weight Category Classification: _____

Athlete's Gender: _____

Athlete's Passport Details: _____

We understand the below AIBA Technical and Competition Rules related to this issue and will wait to receive written confirmation of approval from AIBA before the athlete is eligible to participate in AOB Competitions.

4.2.4.1.1. An athlete who has competed at an amateur or professional level in any Individual Physical Contact Sport other than Boxing is eligible to compete in an AOB or National Competition, at an appropriate level, under the following conditions:

4.2.4.1.1.1. National Federation shall complete the Application Form in Appendix 8 and the AIBA Medical Certificate and submit both documents to AIBA HQ for acceptance and registration.

4.2.4.1.1.2. The registration will be reviewed and potentially approved by AIBA in consultation with the AIBA Technical & Competition Rules Commission.

4.2.4.1.1.3. The athlete shall be eligible to participate once the National Federation receives a written confirmation of approval from AIBA.

4.2.4.1.1.3.1. Any athlete registered as a Boxer by a National Federation under Rule 4.2.4.1.1. above shall not participate in any other Individual Physical Contact Sport once approved by AIBA.

Signature of President or Chairman of National Federation

APPENDIX 9: GRADUATED RETURN TO BOXING

G RTP for a 30-day suspension period:

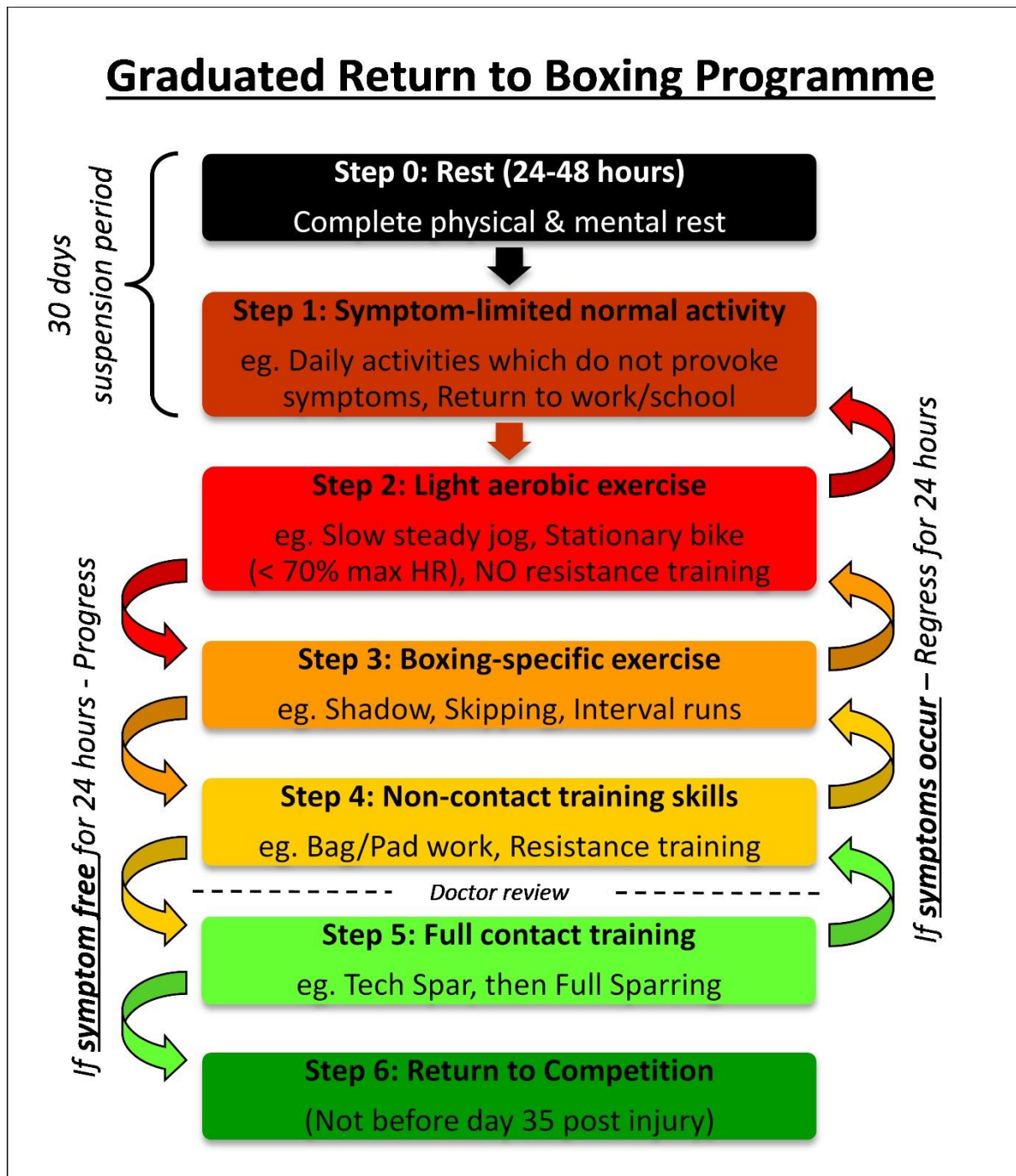

* Same steps are followed for longer suspension periods, except for Step 0 – 1, which would be extended to the medical restriction prescribed by the Ringside Doctor.

APPENDIX 10: BOUT REVIEW REQUEST FORM

AIBA Bout Review Request Form

COMPETITION INFORMATION

Competition Name:

City and Country:

Today's Date:

Session Number:

Bout Number:

Time Bout Review Request (15 minutes after bout decision):

Weight Category:

Men/Women:

DELEGATION REQUESTING BOUT REVIEW

Boxer's Full Name:

NOC Code:

Team Manager/Second's Full Name:

Email:

Phone number:

Opponent's Full Name:

NOC Code:

Signature:

By signing this document, I understand my national delegation will be invoiced \$1,000 USD if the original decision is upheld after the Bout Review. If the decision is overturned, the Bout Review fee will be waived and will retain a Bout Review for possible use later in the tournament. Once the Bout Review form is signed and submitted to the Equipment Manager, the Bout Review process cannot be withdrawn.

PROTEST DETAILS

Judge's Decision

- Which round(s) are being disputed?

Referee's Decision

- Which criteria effected the result of the bout (check one)
 - Proper Procedure not followed
 - Foul ruled as a legal action
 - Legal action ruled as a foul

- Which rule(s) were breached?

- In which round was the breach made?

2nd page to be filled out by AIBA Officials only

Equipment Manager

Full Name:

Signature:

Date received:

Exact time received:

30 minutes after collection of form

DECISIONS

Original Bout Decision:

Specific finding(s) of the Bout Review Jury:

Final Decision of the Bout Review Jury:

Uphold original decision

Overtake original decision

Juror 1: _____

Signature: _____

Juror 2: _____

Signature: _____

Juror 3:

Signature:

COMMUNICATION CHECK LIST

Decision communicated to the AIBA Scoring System operator

Decision communicated to the Protesting Delegation

Decision communicated to the opponent of the Protesting Delegation

Technical Delegate

Full Name:

Signature:

Date received:

Exact time received:

APPENDIX 11: COMPETITION VENUE REQUIREMENTS

- 1.1. Required Venue Facilities:
 - 1.1.1. Lounge for Referees and Judges
 - 1.1.2. Lounge for International Technical Officials
 - 1.1.3. Meeting Room for ITOs and Referees and Judges
 - 1.1.4. Boxers' Locker Rooms
 - 1.1.5. Anti-Doping Rooms
 - 1.1.6. Medical Room (Doctor's Room)
 - 1.1.7. Boxers' Warm-Up Areas
 - 1.1.8. Storage for Boxing Equipment
 - 1.1.9. Offices for AIBA, Local Organising Committee, Technical Delegate
 - 1.1.10. Media/Press Room, Interview/Press Conference Room, Mixed Zone in accordance with the AIBA Media/Press Guidelines
 - 1.1.11. VIP Lounge

APPENDIX 12: GLOVE SPECIFICATIONS

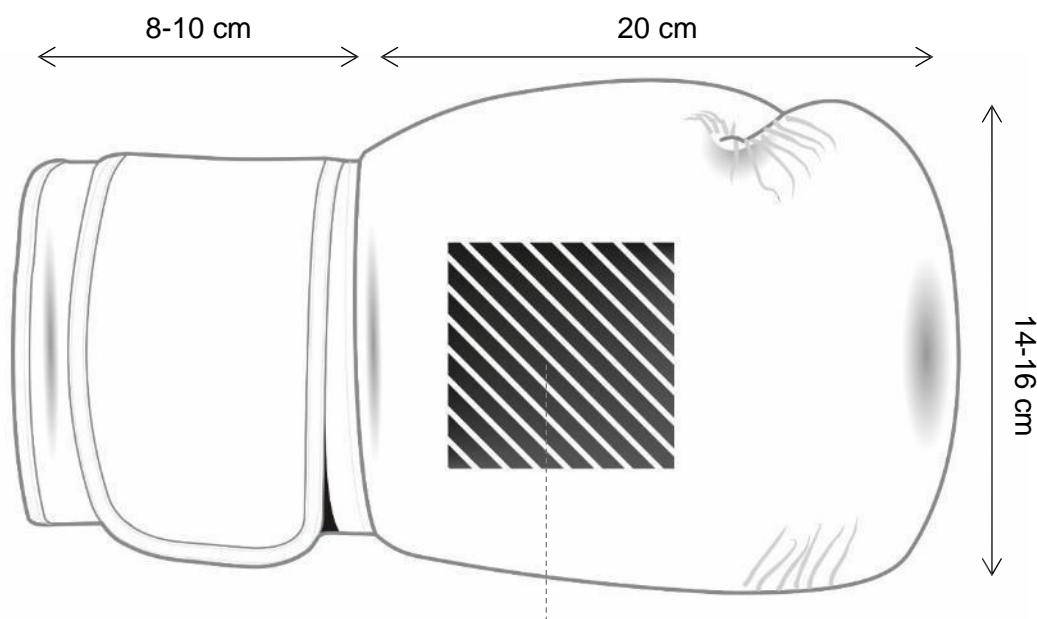

**Competition Identification or
Manufacturer's Logo**

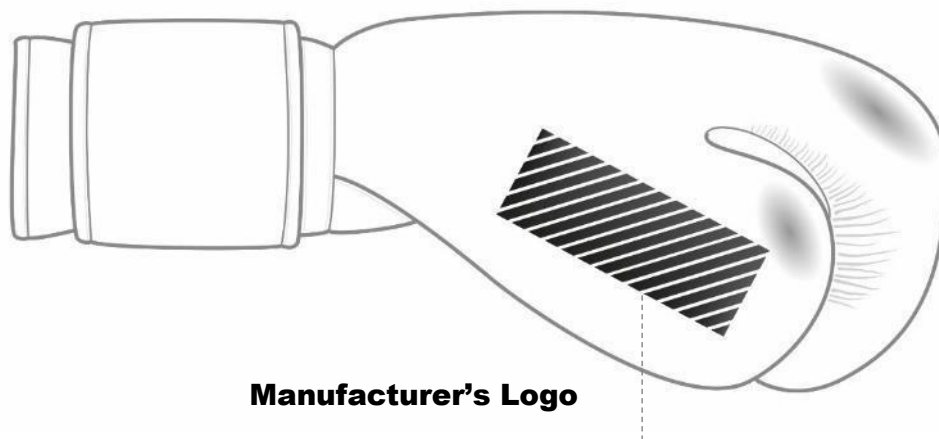
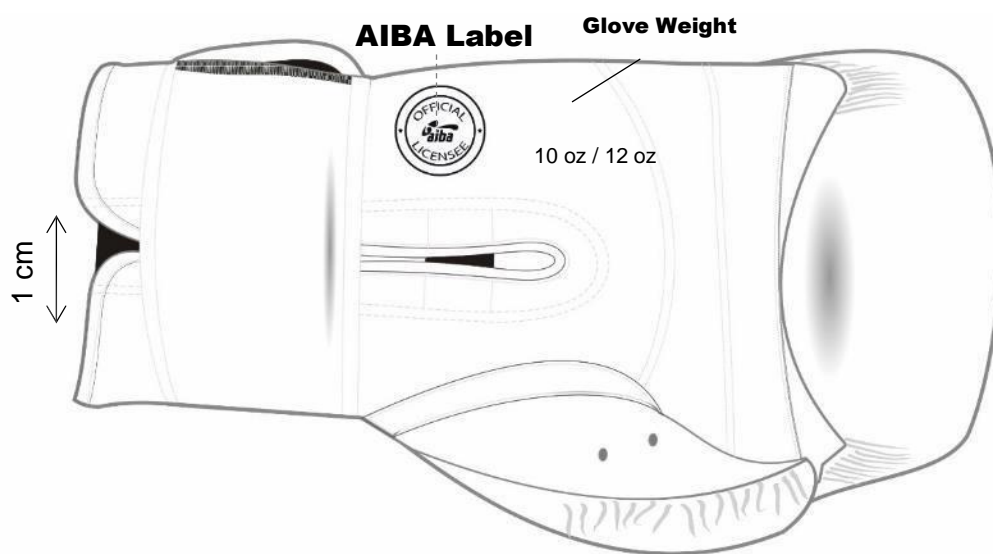

Max. 24 cm²

(Must fit in a 3 cm x 8 cm rectangle)

APPENDIX 13: HEADGUARD SPECIFICATIONS

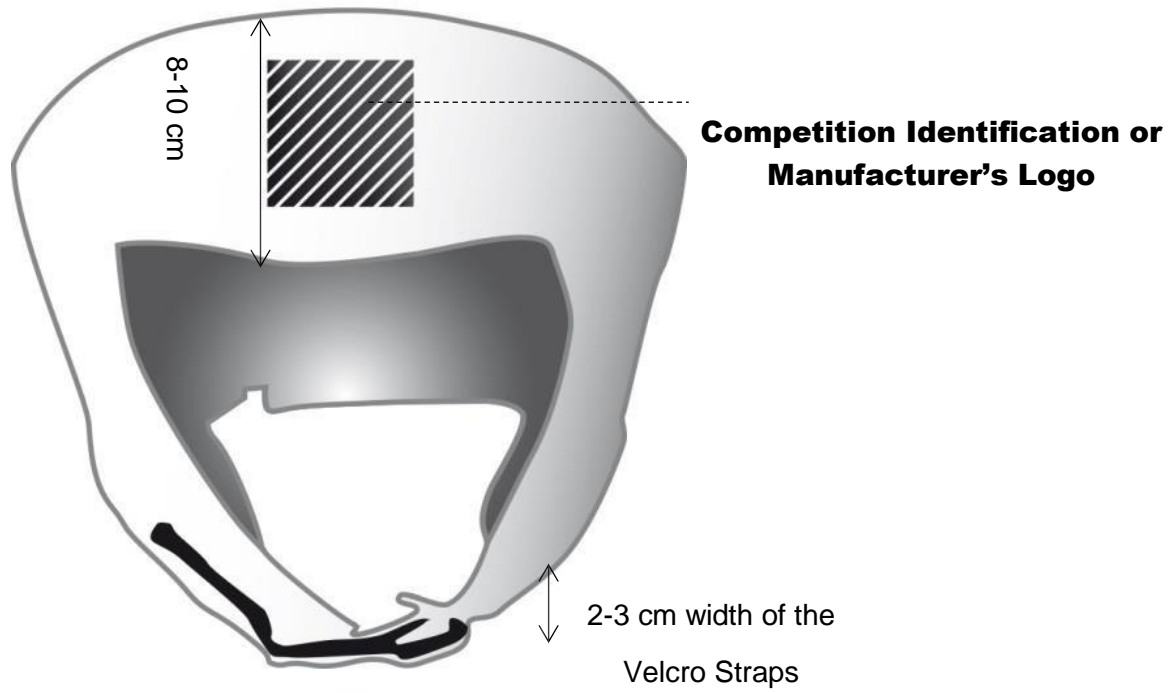

Manufacturer's Logo

Max. 40 cm²

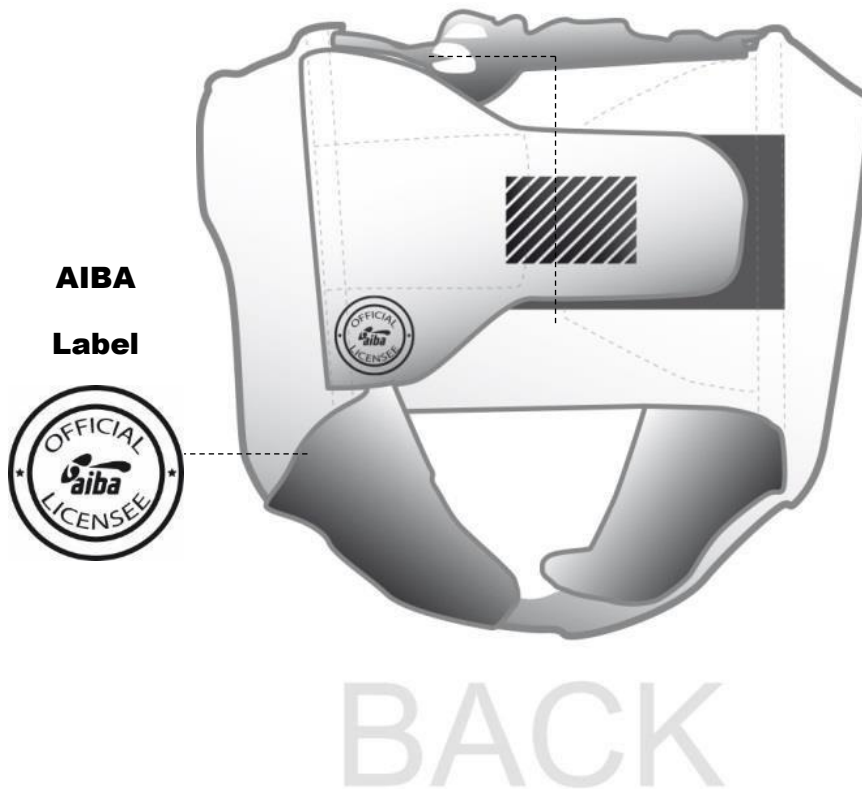

**APPENDIX 14: UNIFORM
DIAGRAMME**

**Olympic National
Federation's Abbreviation**

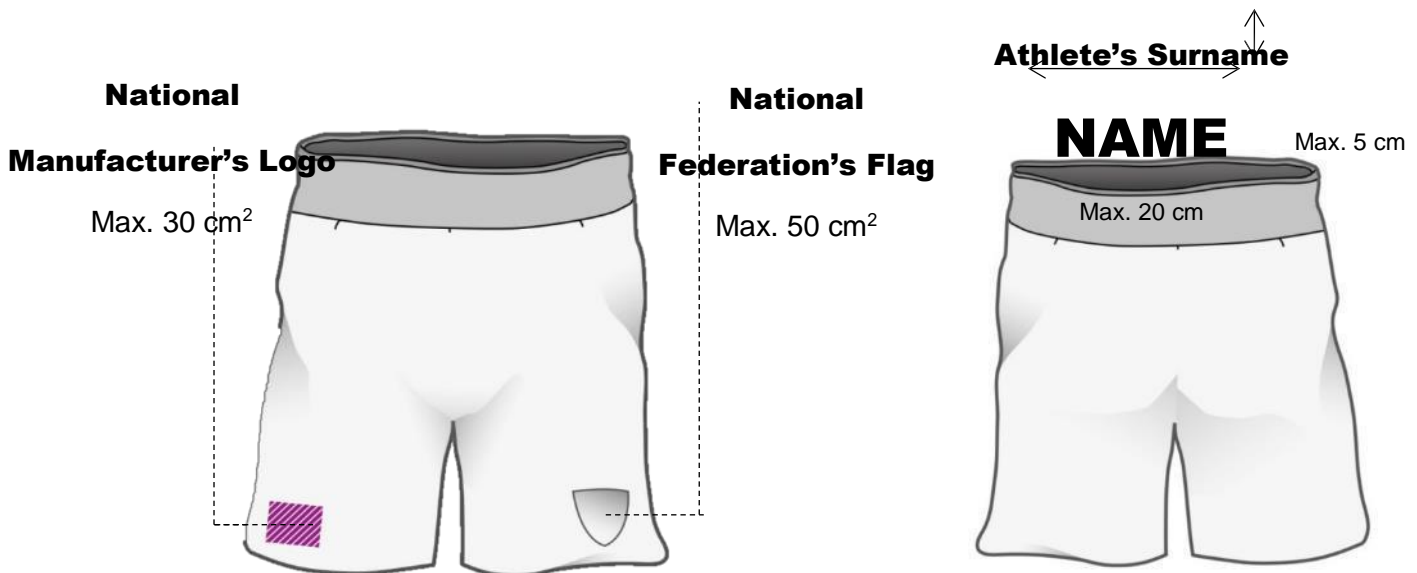
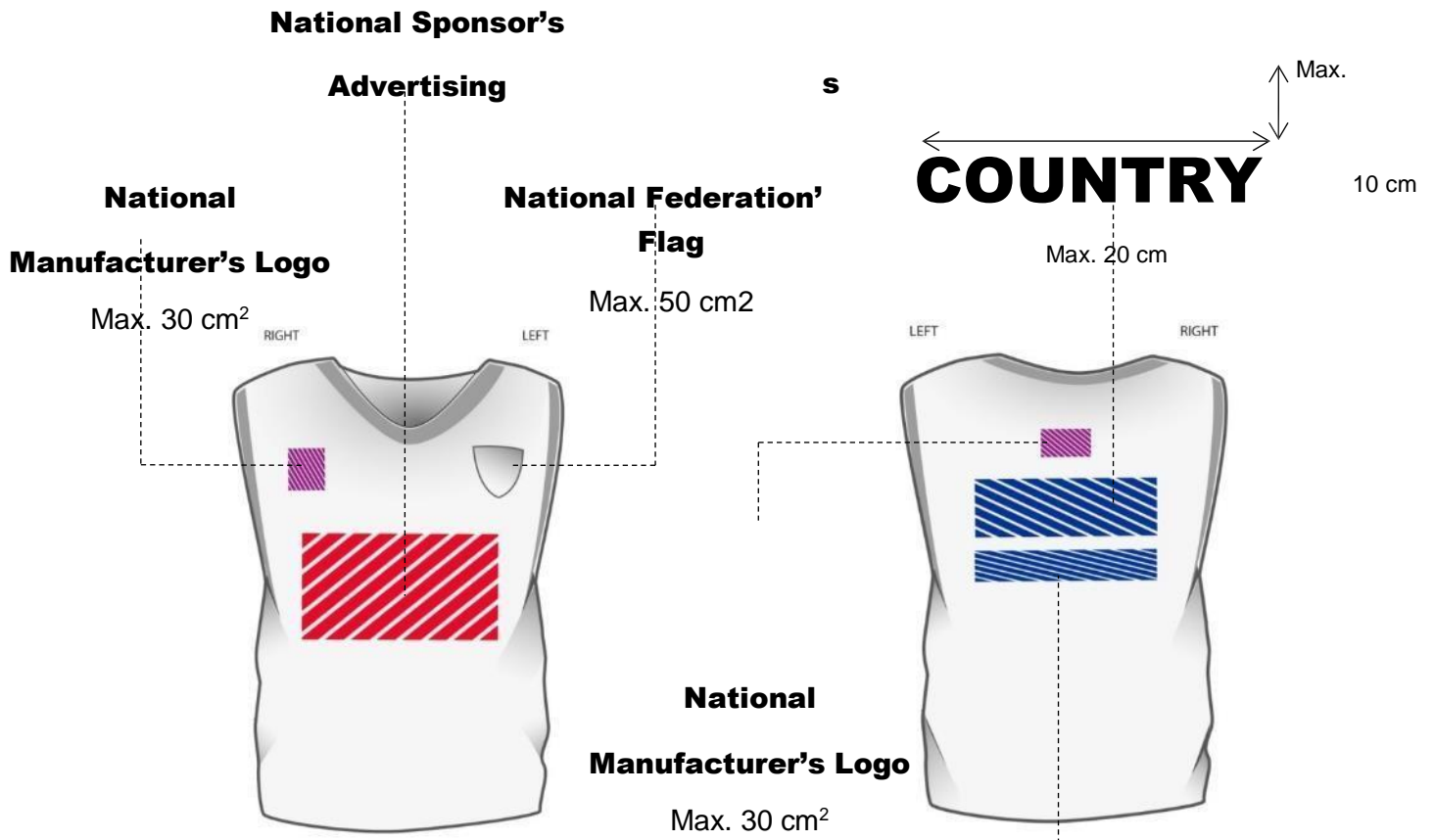

FRONT

BACK

FRONT

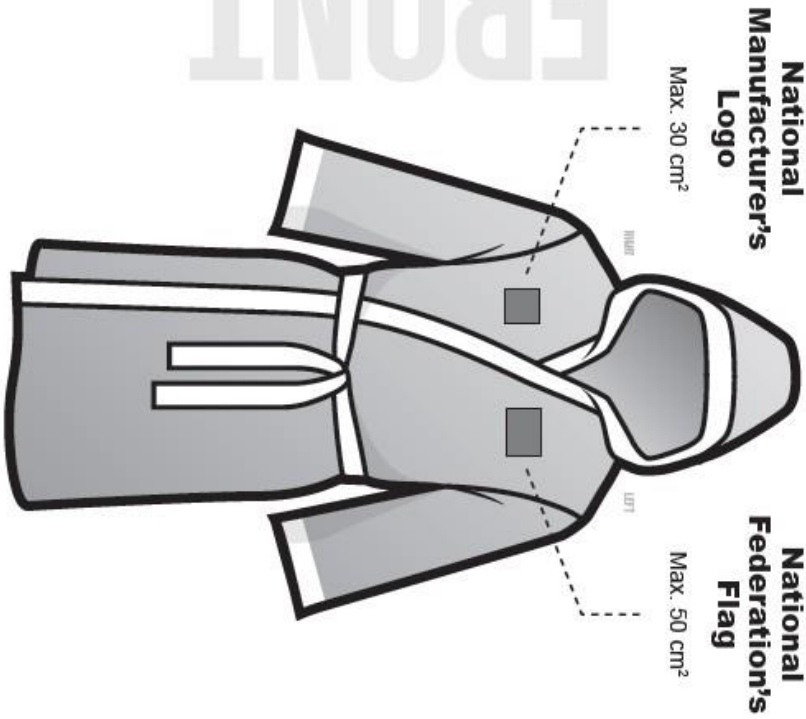

Olympic National Federation's Abbreviation

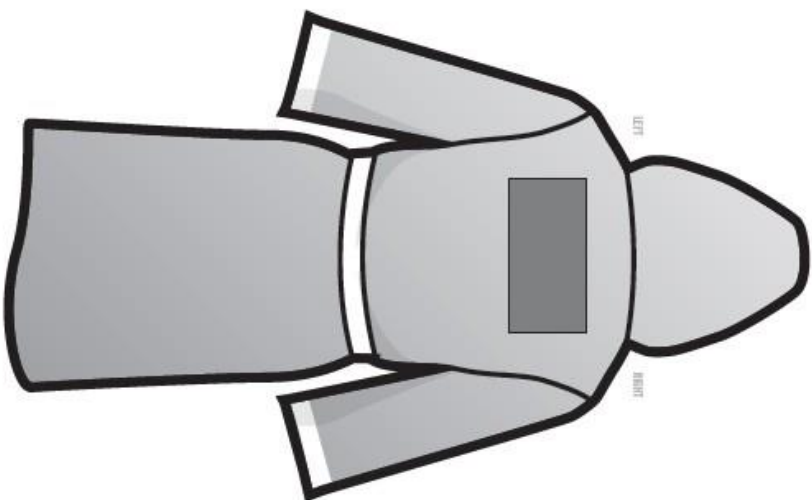
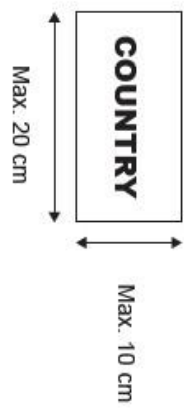

BACK

END