

Beehive Fence™ Construction Manual

A step by step guide to building a protective beehive fence™ to deter crop-raiding elephants from small scale farm land

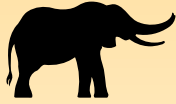

Written and Illustrated by Dr Lucy E. King
Human-Elephant Co-Existence Program, Save the Elephants

www.elephantsandbees.com

Front cover images: (1) Elephant family peacefully foraging in Samburu National Reserve, Kenya; (2) Elephant-Friendly Honey™ harvested from a Beehive Fence™ in Taita-Taveta, Tsavo, Kenya; (3) Beehive Fence™ of Langstroth beehives protecting a maize field in Sagalla community, next to Tsavo East National Park.

Photo credits: The Elephants and Bees Project

Editorial Contributions: E. Brennan, N. Raja, M. Baker, B. Stievater, C. de Wolff

With special thanks to our corporate & charitable donors who support our projects



Copyright © Dr Lucy E. King
Fourth Edition 2019
All rights reserved

Published by
The Elephants and Bees Project
Human-Elephant Co-Existence Program
Save the Elephants
P.O. Box 54667
Nairobi 00200, Kenya
Project website: www.elephantsandbees.com
Email: lucy@savetheelephants.org

Contents **Page 1**

1. Introduction	2
Save the Elephants organisation	3
Elephant behaviour and human-elephant conflict	4-5
2. Beehives	6
Traditional, Kenyan top bar or Langstroth hives	7
Beehive fences using traditional hives	8
Beehive fences using KTBH beehive fences	9
Beehive fences using Langstroth hives	10
Using “dummy hives” with Langstroth beehive fence	11
Step-by step construction of KTBH hives	12-15
3. Building a Beehive Fence	16
Constructing a beehive fence	17-18
Using <i>Commiphora</i> posts for a living fence	19
Common issues and maintenance tips	20
Bees protecting trees from elephants	21
4. Beekeeping	22
Introduction to beekeeping	23
Encouraging colonisation	24
Maintaining and managing occupied hives	25-26
Honey harvesting and processing	27-28
5. Pests and Parasites	29
Honey badgers	30
Wax moths	31
Ants and hive beetles	32
6. Record Keeping & Resources	33
Hive occupation records	34
Elephant movement records	35
Predicted conditions for success	36
The science and research behind the manual	37
Introduction to the HEC Co-Existence Toolbox	38
Helpful websites and resources	39
Author and acknowledgements	40



Chapter One

Introduction

Save the Elephants, African Elephants and African Honey Bees

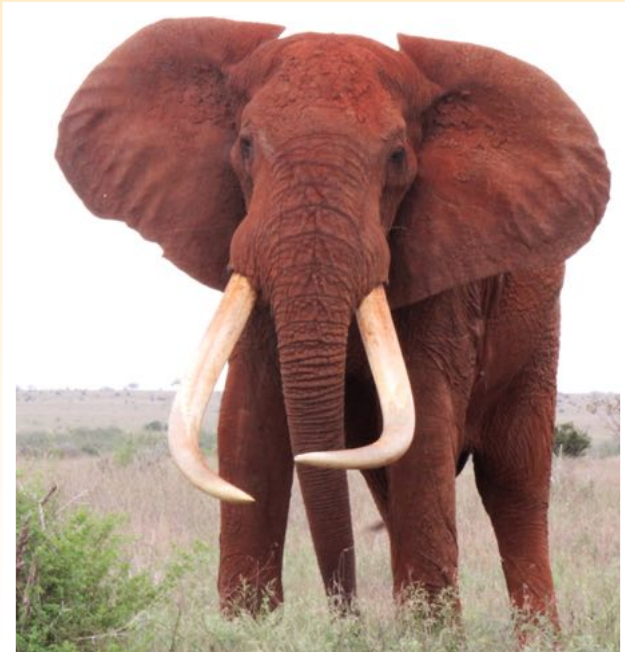



Save the Elephants' Mission

To secure a future for elephants and sustain the beauty and ecological integrity of the places they live, to promote man's delight in their intelligence and the diversity of their world, and to develop a tolerant relationship between the two species.

Four Pillars: Research, Protection, Grassroots, Education

The Save The Elephants charity was founded in 1993 by Dr. Iain Douglas-Hamilton, OBE, who made a pioneering study of elephant behaviour in the late '60s in Lake Manyara National Park, Tanzania, and has been at the forefront of elephant research and conservation continent-wide ever since. Explorers, conservationists and elephant scientists serve as fellow trustees and advisors to the board.

Save The Elephants' programs focus on research, education, grass-roots conservation, monitoring and protection and includes projects across the four regions of Africa. Research projects range from investigations into the dynamics of elephant society at a molecular level through to ranging behaviour of savannah and forest elephants using cutting-edge GPS collars. We are at the forefront of technological developments designed to track and analyse elephant movements, providing vital information for land-use management plans aimed at reducing conflict with humans and allowing elephants continued access to vital parts of their range.

Save The Elephants works closely with government and non-governmental organisations, universities and research institutions to ensure the long-term conservation of elephants in Africa. STE manages the the Elephant Crisis Fund to provide emergency response funding to high-impact partners across Africa and Asia to battle the ivory crisis in a three-pronged approach of anti-poaching, anti-trafficking and demand-reduction. The ECF has funded more than 255 projects in 36 countries as of July 2019. We are involved in surveys to establish population trends and risk mapping, providing critical information used by CITES and the IUCN to assess the conservation status of the African elephant. We recognise the need to reconcile elephants with their human neighbours and our Elephants and Bees Project is core to our mission to investigate innovative and cost-effective methods to reduce conflict as well as exploring the cultural relationships between people and elephants.

Please see www.savetheelephants.org for more details on STE's overall organisation's program.



Elephant Behaviour and Human-Elephant Conflict

Elephants in Kenya are not confined to national parks and reserves and hence interactions with farmers, particularly crop raiding, pose serious social, political, economic and conservation problems in Kenya as it does in many other parts of Africa. Accordingly, research efforts are now focused on finding effective, appropriate farmer-managed deterrents especially in 'conflict' zones where large electric fences are neither feasible nor affordable. This Beehive Fence Construction Manual is the output of collaborative research by The Elephants and Bees Project at Save the Elephants, in partnership with Oxford University and Disney's Animal Kingdom investigating the use of bees as a natural deterrent for crop raiding elephants.

Elephants avoid Bees



Building on traditional Kenyan folklore, playback research conducted with elephants in Samburu and Buffalo Springs National Reserves in Kenya have demonstrated that elephants will run from the sound of disturbed honey bees. Additionally, when they do run away,

the elephants also emit a unique low frequency "bee alarm rumble" vocalization which warns neighbouring elephants to retreat as well. These behavioural discoveries have revealed that elephants appear to retain a negative memory about honey bees which 'scares' them away from an area. Anecdotes from pastoralists and local people tell us that elephants can be stung around the eyes, the trunk and behind the thinner skin of the ears which must be painful enough to make them wary of future encounters with these insects.

With assistance from The Elephants and Bees Project, rural farmers are using this knowledge to protect their fields from crop raiding elephants. They are building beehive fences of strong posts round their farms on which they hang beehives at regular 20 meter spaces.

Trial beehive fences have now been built around dozens of farms in Kenya and 18 other countries in Africa and Asia. This research has involved monitoring the effect of the beehive fences on deterring crop-raiding elephants as well as understanding how farmers adapt to the new technology. Beehive fences have been proven to be highly successful in stopping elephants from entering farms and crop raiding. When cared for properly, the bees can produce a large amount of honey that can be sold for a significant increase in household income. Beehive Fence farmers are benefiting from this "Elephant-Friendly Honey™" and awareness and tolerance for elephants is slowly increasing. This manual is intended to encourage farmers and wildlife managers across Africa to manage human-elephant conflict in an innovative, sustainable and beneficial way.



Elephant-Friendly Honey™ is a healthy and valuable product of the beehive fence which enhances livelihoods and family income.

Elephants and people competing for space

The African elephant is perhaps the most iconic land mammal on the continent. Catastrophic poaching in the 1970's and 80's saw their populations plummet to a mere fraction of pre 1970's numbers. An effective international ivory trade ban implemented by CITES in 1989, combined with improved wildlife management strategies, has resulted in rising elephant numbers, particularly in East and Southern Africa. However, these elephants are increasingly discovering their historic range is increasingly settled by people. With landscape-level developments and huge agricultural expansion blocking historic migratory routes, incidence of human elephant conflict is on the rise. Elephants tend to crop-raid at night time, and farmers are often left with no choice but to shout, throw stones or bang iron sheets to try to scare them away. This confrontation leads to heightened aggression and some elephants may charge and attack, often leading to terrible injuries or deaths of both people and elephants.



Natural migration

Elephants are herbivores and have no reason to attack man unless in self-defence. Family groups travel with the young protected and guided by the older females and matriarch. Teenage bulls leave their families and join up with older bull elephants where they learn how to find seasonal water and food. As these elephants migrate through the landscape looking for food and water they often take advantage of nutritious crops. Keeping key migration corridors clear of farms and development will reduce the chance of conflict incidents.



The loss of key individual elephants

Unfortunately both people and elephants are sometimes killed due to conflict over resources. Wounded elephants can go wild with pain which can be very dangerous to anyone in their path. Fatal wounds resulting in the death of an elephant is not only illegal, and should be avoided at all costs, but also causes stress within the family. There is evidence that elephants who have lost a family member due to conflict or culling may become more aggressive to humans in the future.

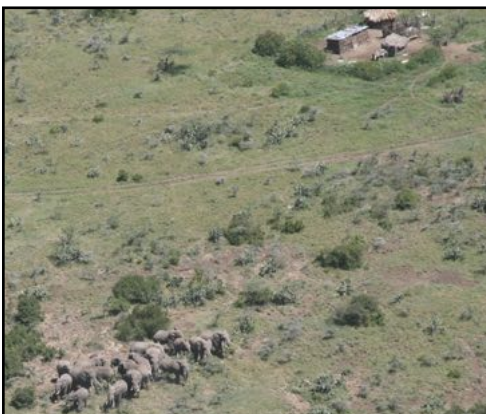

Barriers to conflict

It is best to stop elephants from entering a farm as once they are inside and feasting on crops it can be difficult to chase them away safely. Farm barriers include wooden fences, thorn brush, hedges, chilli oil covered ropes, cow bells and stone walls. Electric fences can be good deterrents but are often much too expensive. Usually a combination of barriers and deterrents is a good idea. In this manual we describe how to construct beehive fence around individual farms but it is important to try combining multiple elephant deterrents.



Chapter Two

Beehives

Traditional hives, Kenyan top bar hives, Langstroth hives and dummy hives in the beehive fence



Traditional, KTBH or Langstroth Hives?

Beehive fences can be made with any type of beehive. If you already own or are using beehives on your farm it is very cheap and easy to convert your existing beekeeping project into a protective beehive fence. Strip bark hives, log hives, basket hives and professional timber can be hung from posts to create a beehive fence. Essential to all hives is some kind of shade to keep the bees cool but other than this feel free to adapt the resources you have. Below, the table summarises suggestions for the use of three types of beehives and enables you to make your own decision on which hives to use.

	Traditional Log Hives	Kenyan Top Bar Hives (KTBH)	Langstroth Beehives
Cost	Much cheaper, free if made from hollowed out tree trunks. Often present in communities and simply need to be moved into a fence structure to deter crop raiding elephants.	More expensive to make as materials like plywood, cedar top bars, nails and varnish need to be bought. Expect to pay roughly \$35 per hive.	Most expensive type of hive and usually bought from a beekeeping company. Expect to pay roughly \$60 for a full beehive.
Construction	Simple covers need to be made to close off the entrances to the hive leaving just a few small gaps for the bees to enter.	Construction requires some basic carpentry skills and tools. If our design is followed one man can make 3 hives in a day. "Dummy hives" can be used to increase fence length.	Intricate and complex and requires a skill carpenter to construct. A super box is stacked above the brood chamber. "Dummy hives" can increase fence length.
Harvesting ease	Not so easy to harvest as access to the hive is only from one direction. Highly disturbing to the bees so bee stings and hive abandonment is common after harvesting.	Easy to harvest as one top bar is lifted out and harvested at a time. Honey comb comes out in natural, attractive curved shapes that match the shape of the beehive. Usually the comb is cut off the top bar.	Very easy to harvest. Honey can be extracted from the honeycomb which can be then returned to the superbox. Once a hive is strong, frequent honey harvesting is possible.
Honey quality and quantity	Honey from traditional hives tends to be mixed with brood which can attract a lower price. Heavy smoke used to calm the bees can cause a smokey flavour to the honey which reduces value. Due to their size most log hives harvesting is usually around 5-7kgs.	Honey is pure and brood-free as you only harvest honey from the honey chamber. Less smoke makes sure the honey tastes natural and can fetch a top price at market if well filtered. The larger honey chamber of KTBH can yield 5-15kg per harvest.	Honey is pure without brood and, if correctly extracted, is free of wax. Minimal smoke use means truly top-quality honey selling at a premium rate. Full hives can weigh as much as 40kgs and honey harvests can be as much as 10-12kgs per superbox.
Effectiveness against elephants	Effective against elephants. See King <i>et al.</i> , (2009) for trial results.	Effective against elephants. See King, (2010) for trial results.	Effective against elephants. See King <i>et al.</i> , (2017) for trial results.

Beehive Fences using Traditional Hives

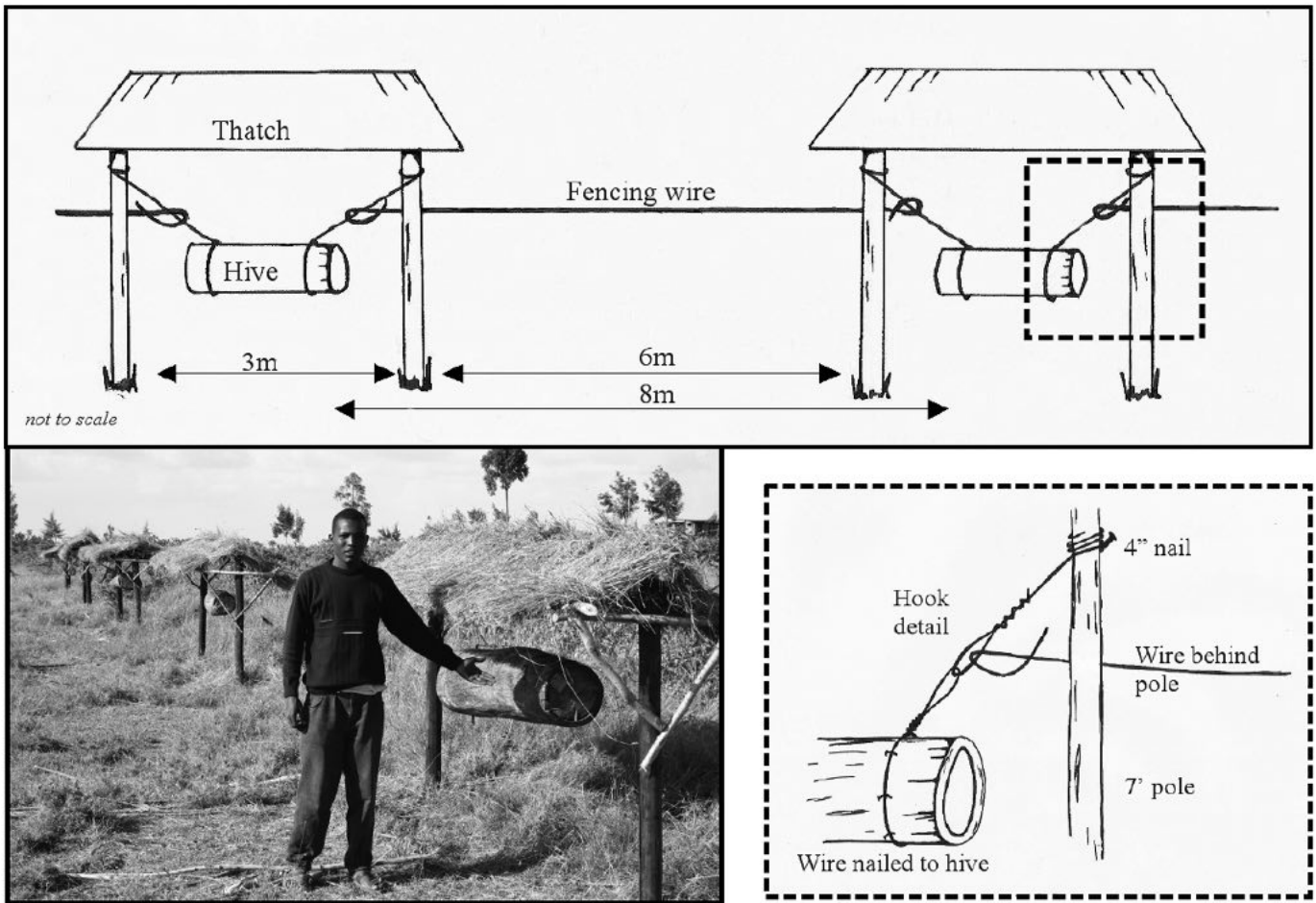

The First Beehive Fence in Laikipia, Northern Kenya

Following the scientific demonstration of elephant's fear of African honeybees, the Beehive Fence concept was designed and first trialled in Laikipia in 2007. Traditional log beehives were hung between wooden posts under small roofs made of thatched sticks and grass. Some of the log hives were bought from Tharaka, Meru at a cost of US\$4-6 per hive and others were found in the local area and moved into the beehive fence at no cost.

As detailed above, posts in this trial were spaced 6m apart allowing the hives to be spaced 8m apart. The beehives were able to swing freely, suspended by tightly secured fencing wire to the top of the posts. Each hive was interlinked to the next with strong fencing wire that hooks into the hanging wire of each beehive.

An intruding elephant trying to enter the farm will avoid the solid structures and be channelled between them. As the elephant tries to push through the wire it causes the attached beehives to swing violently, disturbing and releasing the bees to irritate or sting the elephant.

This style of beehive fence is ideal if you already own traditional log beehives as the cost of construction will be minimal. You may want to adopt a simpler roofing style as illustrated further on in this manual. Our latest research has shown that beehives can be placed 10m apart and still be effective so do try this to get a longer fence line.

(Refer to King *et al.*, 2009 for details of this study)

Beehive Fences with Kenyan Top Bar Hives

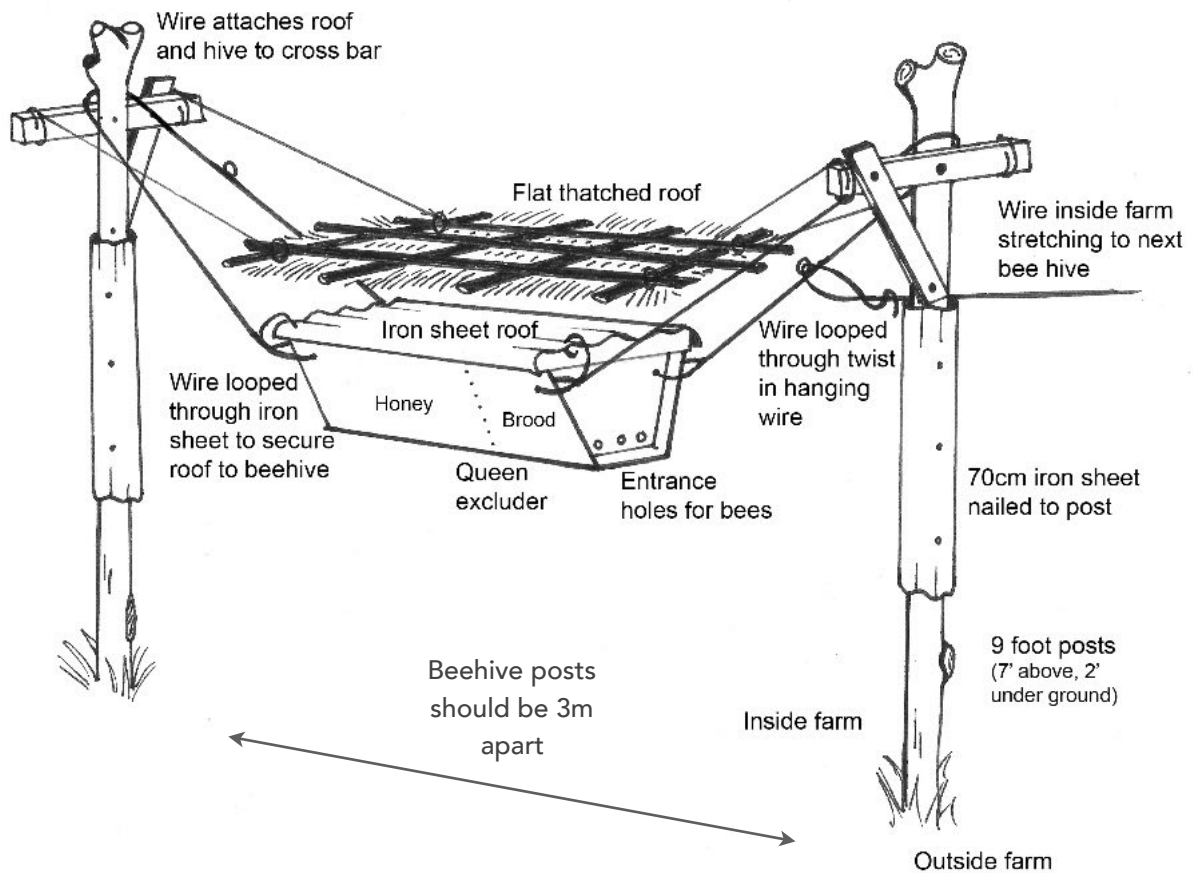

Kenyan Top Bar Hives and the next stage of Beehive Fence Design - the bee hut.

Three 80cm long Kenyan Top Bar Hives can be constructed out of one 8'x4' 9mm piece of plywood using our design (p11-15). This KTBH design (adapted from Jones, 1999) incorporates a vertical queen excluder made of coffee wire to keep the brood separate from the honey chamber to ease harvesting and to increase the value of the honey.

The rain-proof roof is made from an iron sheet and is protected from the sun by a flat-thatched roof. The hive is hung by drilling small holes in the side walls and feeding through strong plain wire. This is looped around the top of the posts placed 3m apart.

An elephant attempting to enter the farm will instinctively try to pass between the beehives. This pressure on the wire will cause the beehives to swing, aggravating the bees and causing them to swarm out.

(Refer to King, 2010, for KTBH trial results)



Beehive Fences using Langstroth Hives



Langstroth beehive design

Langstroth beehives are made of rectangular or square boxes that fit neatly one on top of the other. The larger brood chamber on the bottom contains a set of frames containing a thin foundation strip of beeswax that is held in place with fine strips of wire. Once the bees have occupied the brood chamber, and built up the foundation combs with beeswax and brood, a second 'super' box should be placed on top. In between the two boxes lies a queen excluder wire mesh that lies as a horizontal sheet over the top of the brood chamber combs. This prevents the queen from travelling up into the super box which allows the worker bees to fill the super box with pure wax comb and honey stores. This is the section that you harvest for honey leaving the brood chamber alone.



A super on top of a queen excluder and brood box, held in place with a wire

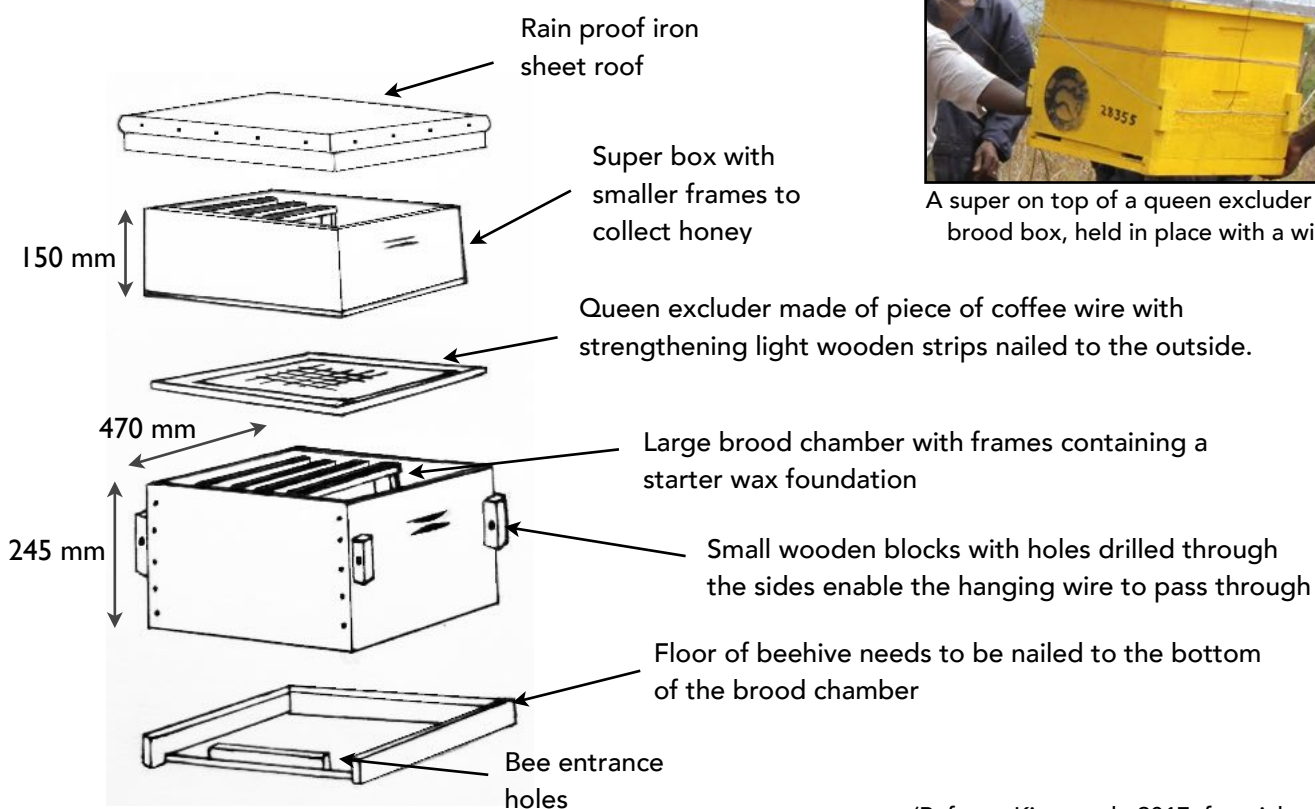

(Refer to King et al., 2017, for trial results)

Using "Dummy Hives" in the Beehive Fence

The beehive fence design requires hanging a beehive every 10 meters to create a strong barrier to raiding elephants. If you spread the beehives further apart than 10 meters, the wire is difficult to connect tightly and the barrier becomes less effective. To protect the boundary of 1 acre of farm land you therefore need 24 beehives, quite expensive and demanding in terms of occupancy rates for the density of bees in semi-arid areas. We have successfully tried installing "dummy hives" every second beehive and can recommend this design if you have few beehives or a big farm boundary that needs protection. We recommend 8'x4' 9mm plywood sheets for cutting out dummies in the silhouette of a beehive. Shapes reflecting either KTBH or Langstroth are possible and our designs for cutting dummy hives are included below.

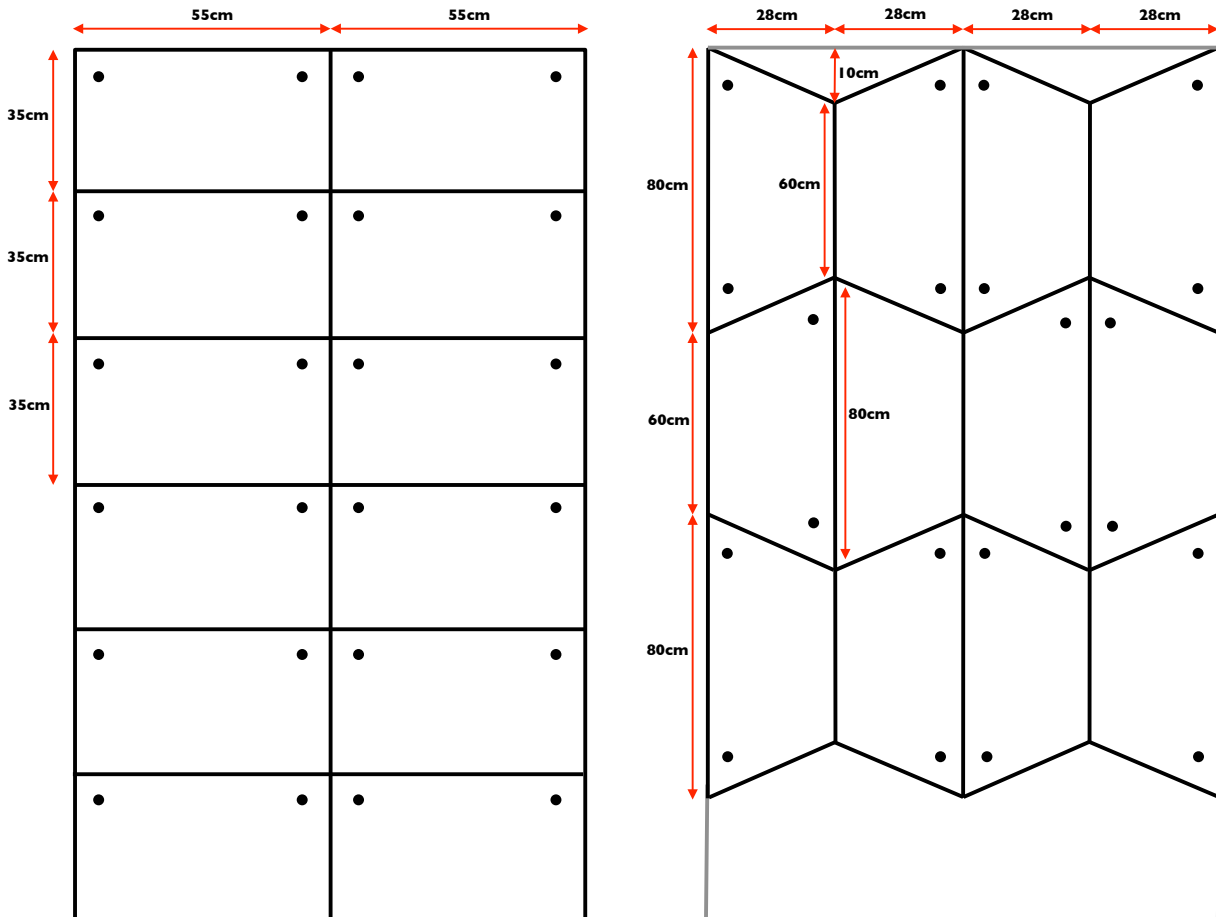

A 240m beehive fence consisting of 12 beehives and 12 "dummy" beehives can protect 1 acre of farm land. 12 beehives are much more realistic for full occupations and beekeeping than 24 beehives.



Step by Step Construction of KTBH hives

Construction of the beehive fences using Kenyan Top Bar Hives is easy and following these simple steps will help ensure that your beehive fence is constructed correctly with an optimum chance of occupation by bees.

1. Wood panel preparations



The following design shows the sizes of each plywood panel that is needed to build a KTBH hive. Standard 9mm plywood usually comes in 2.4m x 1.2m sheets and you will find that three 80cm long beehives can be made from one sheet. Follow the design below to cut out each side of the beehive. 3/4 inch planed wood can also be used to make top bar beehives so long as it is not too heavy to hang. The length and width of each beehive can be made to suit your budgets and resources but don't make them too heavy. Plywood can warp and bend in heavy rain or humid environments so consider using planed wood in high rainfall areas.

Cutting out 3 Beehives on 9mm Plywood Sheets (2.4m x 1.2m)

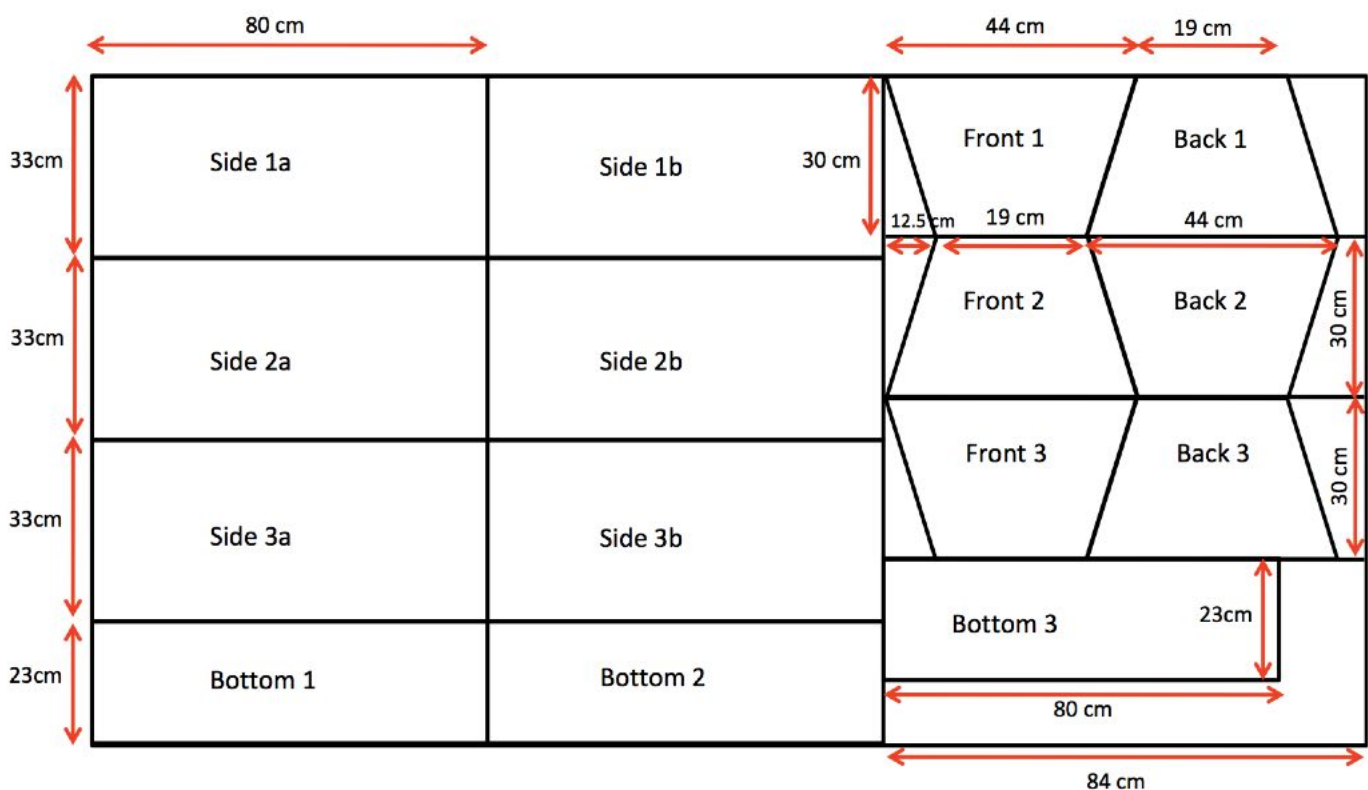

Top Tip: Draw all pieces of the design onto the plywood sheet like a jigsaw before starting to cut. This ensures you get the most value out of each sheet. Keep all cut offs as they will help you later for internal parts.

2. Construction of KTBH beehive



Before you glue and nail the pieces of together, sand down the edges to ensure a smooth surface and to prevent getting splinters while you work. Using simple wood glue to seal the pieces together will help prevent ants and insects from crawling into the hive. Once glued, nail the pieces of the beehive together using plenty of one inch nails.

For the front end of the hive, nail the front piece 2cm back into the hive leaving a small lip at the front. This gives the bees a place to rest at the entrance to their hive.

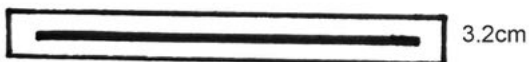
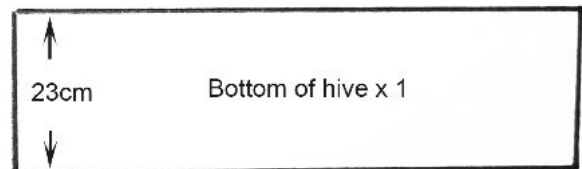
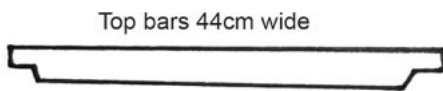
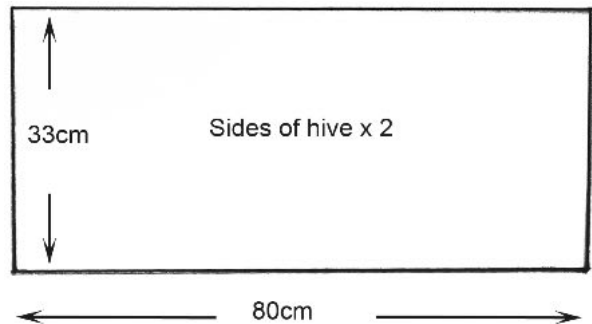
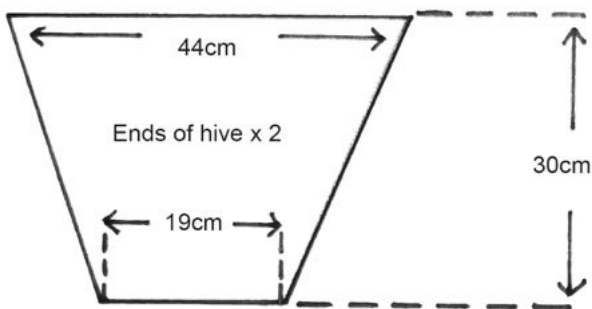

The 44cm long top bars should be cut from strips of natural wood, cedar or grevaria are both good choices. The only critical measurement is that the top bars must be 3.2m wide. Either grooves or points can be carved to encourage the bees to lay down wax.



This beehive design is adopted and adapted from Jones (1999) "Beekeeping as a business" by the International Bee Research Association.

Top Tip: Rub a small amount of bees wax along each of the top bars to help attract bees to the hive and to show them where to start laying their foundation comb.

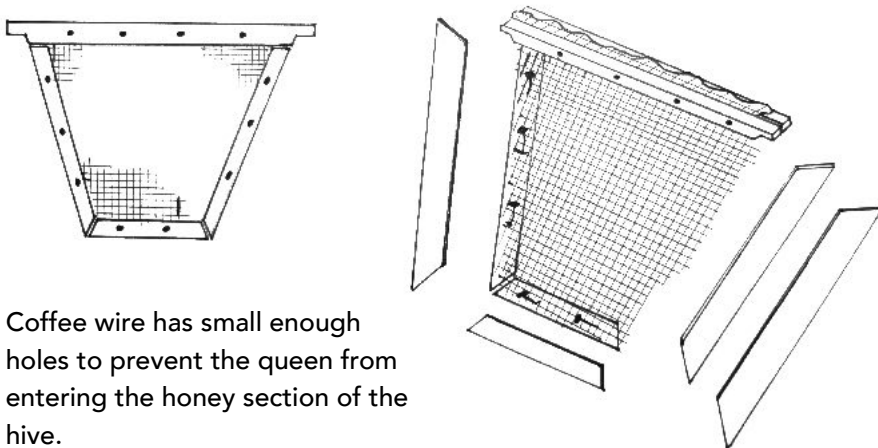

Coffee wire has small enough holes to prevent the queen from entering the honey section of the hive.

3. Queen excluder

Saw one top bar in half (long ways) and nail a piece of coffee wire in between the two halves. Using small strips of leftover plywood, fashion the remaining structure of the queen excluder to fit the inside of the tapered beehive. The coffee wire should be tightly nailed between the wooden strips and should fit snugly inside the beehive.

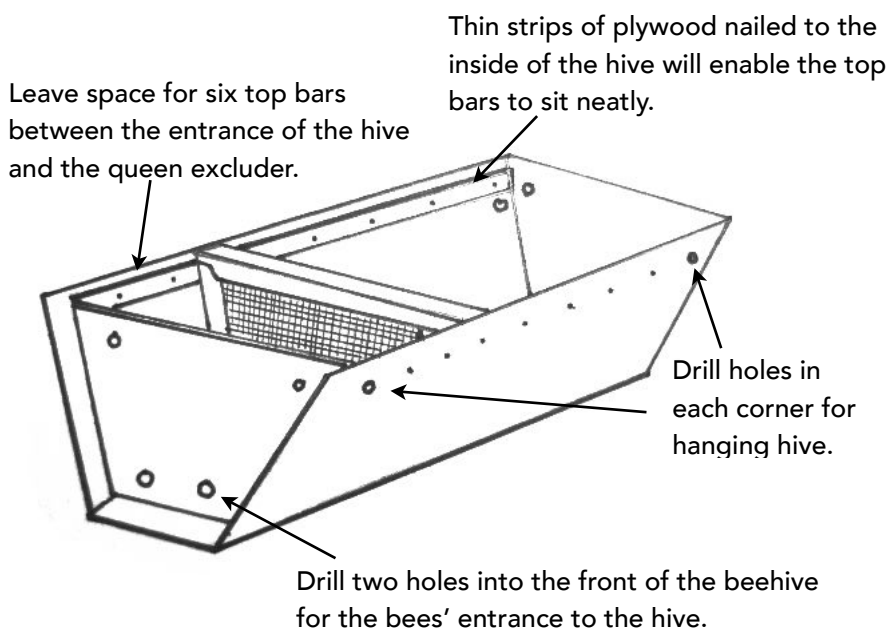

4. Fitting the queen excluder

The queen excluder should be held in place six top bars back from the entrance of the hive. Thin strips of left over plywood should be nailed lengthways down the side of the hive leaving a 3.2cm gap for the queen excluder to slide into place. Ideally the queen excluder should be removable but you may need a small nail to hold it in securely in place. The long strips of wood will become a ledge enabling the top bars to sit neatly inside the hive.



Top Tip: At this stage its a good idea to varnish the outside of the beehives with a non-insecticide based varnish or bright white or yellow paint to protect the hives from degrading in the sun. If you use a varnish ensure it has a polyurethrene base as this is non-poisonous to the bees. The inside must not be painted or varnished.

5. Top bars and roof



The top bars are the only part of the beehive that have to be measured accurately. The bars need to be exactly 3.2cm wide - the proven distance apart that bees like to make their comb. This includes a small gap that the bees leave for passing between combs so they can store honey and feed their brood. You may find it worth the investment to get these thin strips of top bars cut with an industrial machine saw. If you don't manage to cut the top bars exactly to 3.2cm the bees tend to build the honeycombs over the join of the top bars. This isn't a disaster, it just means that you'll find it harder to harvest honey as several top bars will get 'stuck together'.

The top bars should fit tightly together across the top of the beehive.

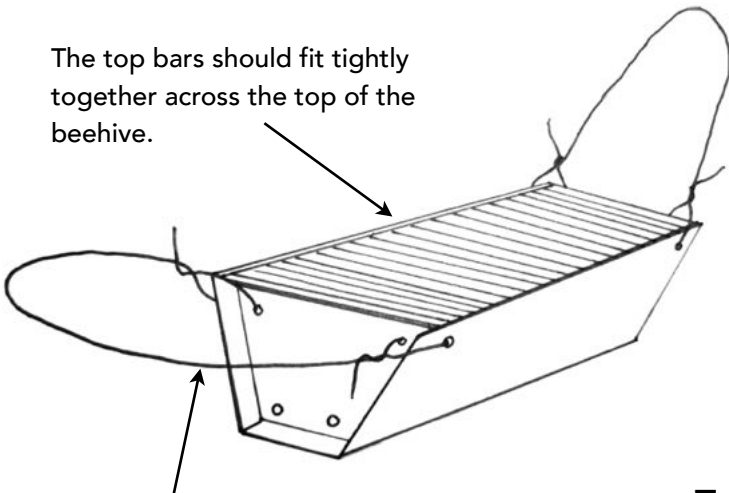

Strong wire should be looped through drilled holes ready for hanging.

6. Sealing the hive

Fitting the top bars into the hive should create a sealed chamber beneath. This be helpful during harvesting as bees will only be able to fly out of the gap made by a removed top bar. If you have spare wood you can cut and place a flat piece over the top of the bars to create a 'lid' which will help keep the hive cooler under the metal roof and keep bugs out of the hive.

7. The roof

A waterproof roof is essential to keep the bees dry. Corrugated iron sheets are ideal for this as the water flows off the roof and away from the hive. You need to make the roof wider and longer than the hive so that the hive is totally protected from the rain. If you buy 3x1m iron sheets you can roof 4.5 beehives if you cut each roof sheet into 1m x 65cm strips.

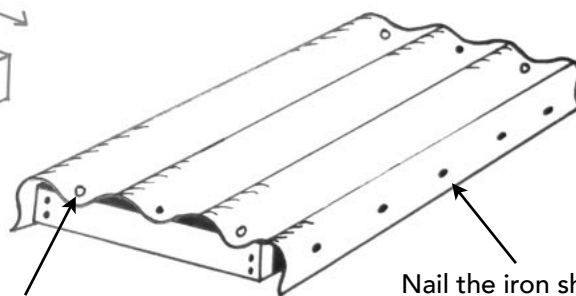
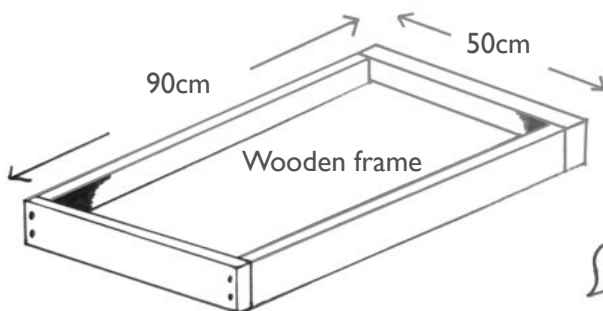

Holes for attaching to hive with ends of hanging wire.

Nail the iron sheets firmly to the sides and top of the wooden frame.

Top Tip: Drill two holes into the front of the iron sheet to allow the ends of the hanging wire to loop through and tie the roof to the beehive. This stops the roof flying off in strong winds and helps stop honey badgers from breaking into the hive. Hammering a 4-inch nail through the iron sheet creates a perfect sized hole.



Chapter Three

Building a Beehive Fence

Step-by-step building process, live *Commiphora* posts, maintenance tips, and using bees to protect trees



Constructing the Beehive Fence

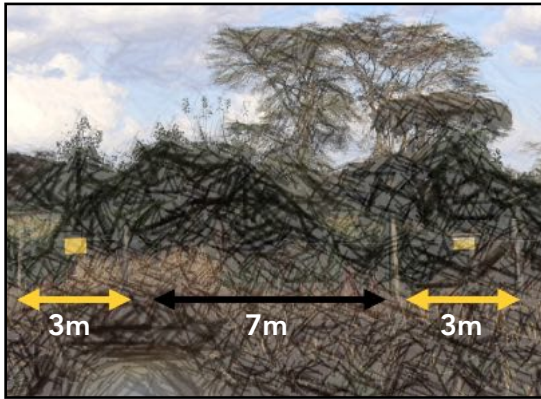

1. Measuring field for posts

Posts should be planted in a 3m-7m-3m-7m arrangement with beehives and dummy hives hung alternatively between the posts 3m apart. Strong plain wire will be used for connecting each unit 7m apart. You should construct your beehive fence at the outer perimeter of your farm to ensure maximum visibility to approaching elephants. There is some evidence they recognise the shape of beehives and will avoid them on sight. Leave any other fence barriers you have in place with the beehive fence as the first barrier line to elephants.



2. Treating wooden posts

Wooden posts used to hang beehives should ideally be 8 or 9 foot long. A termite-resistant fencing pole should be ideally used. If you use 'normal' wood they will need to be treated with an insecticide and left to dry before planting. Used engine oil is a good bee-friendly alternative. Nearby trees should not be felled to make posts as this is essential bee forage. Some *Commiphora* tree species will re-grow to create a live bio-fence to hang your beehives. Do not paint oil on or hammer nails into live posts.



3. Digging holes

Post holes should be dug to approximately 2.5 feet. A simple measure for this is the length of your arm from finger tip to armpit. It helps to hammer in stones around the base of the post and to tightly pack the soil when erecting the posts. Weak or unstable posts will fall over in heavy rain or when the hive is very heavy with honey. This is a crucial step for constructing a strong and stable fence as shallow holes will bring big issues later on.



4. Hanging the hives

Once the posts are firmly embedded in the ground you should hammer in a strong 4 inch nail at the side and near the top of each post. If you are using live posts, try to use natural notches or branch forks on the posts to hang the hives. The hive should be hung at chest height for ease of harvesting, maximum visibility for approaching elephants, and to be out of reach of honey badgers. See our honey badger deterrent section for more ideas for effective deterrents.



5. Thatching shade roofs for the beehives

If left in the sun the hive will overheat and the bees will become aggressive and leave. A simple thatched grass or stick roof is an easy solution to keep the hive cool. It is also another swinging element to the beehive fence that further disturbs elephants trying to enter the farm. A lattice frame made out of sticks creates a strong base for the thatched shade. You should sandwich plenty of grass between two lattice work frames and use small twists of binding wire to hold the structure together. A strong, thick shade will last much longer than a thin one. Painted plywood rectangles are a good alternative (below).



6. Wiring together the beehive fence

The thatched shade should hang freely a foot above the hive for clear air circulation. Hang the shade by attaching binding wire to each corner and loop this around the post. This makes it easy to lift the shade off for honey harvesting or if it drops over time. Each beehive and dummy hive in the fence should be interlinked to the next using pieces of strong plain wire. This interlinking wire should be attached to a loop made in the wire hanging the beehive and must be on the inside of the fence so the beehives will swing should an elephant try to enter. The wire should be chest-height so livestock can safely pass underneath.

The author standing next to a section of beehive fence constructed before the planting season in the community of Sagalla, just outside of Tsavo East National Park, Kenya.



Top Tip: Paint numbers onto the beehives after they have been hung on the fence line. Numbers help to keep accurate records of occupation and honey harvesting events and are a deterrent to potential thieves.

Using *Commiphora* Posts for a Living Fence



Live Posts - Bio-fence to hang beehives

Certain *Commiphora* tree species can be cut for posts and, if given a day or two to rest after cutting, can be replanted as both a post and as a tree. Once the roots have started to regrow, shoots and leaves will start to grow providing natural shade for the beehives. The roots will help to keep the post strong for supporting the beehives and will create a living "bio-fence" that should require very little maintenance and even provide food for your bees at certain times of year. *Commiphora* species also provide good gums and resins for bees.



Cutting and preparing the posts

The ideal height for a *Commiphora* post is 9ft (2.75m) though the width can be different depending on if you'll be hanging a beehive or a dummy hive. It's better not to cut down larger trees than necessary, so try to select the right size before beginning to cut. Posts for dummy hives with a diameter of 8-10cm are sufficient. Posts for beehives should have a base diameter of 12-15cm to support a full hive weighing up to 40kg! Small branches can be left on to encourage the tree to regrow. Cut posts should be stored upright in the shade of a tree before replanting, ideally for not longer than 3-4 days.



Planting the posts

To ensure the post is stable at the base, you should dig a hole 2.5ft deep. This should leave ~7ft of post above the ground which is the ideal amount to securely hang a beehive. Leave 2 inches of loose soil at the bottom to allow the roots to take hold. Once the post has been 'planted', refill the remaining space and use your digger to firm up the soil around the post. You can put a few rocks between the post and the edge of the hole to help support it while it starts to regrow. Do not hammer nails or paint with oil as this will kill the tree.



Post replacement

Unfortunately, sometimes posts will fail to regrow and eventually die. This may happen due to termites, because the tree was unhealthy or because it was left for too long before re-planting. If you notice a post turning brown or the bark beginning to crack then you'll need to replace it. If you need to replace a post for an occupied hive you can dig a hole adjacent to the existing post during the day and then transfer the hive over during the evening while in your beesuit. Dead posts can be used to make great fertiliser!

Common Issues & Maintenance Tips



Post maintenance & low beehives

As beehives get heavy with honey or if there has been heavy rainfall, the posts can start to lean inwards and can suddenly snap if weak. If the beehive gets too low it also becomes vulnerable to predators such as honey badgers who can reach up and grab the hive. Posts should either be replaced or dug back into the soil using stones for extra support. If all else fails, consider connecting a 3rd post along the top to keep the two upright posts apart. If the hive falls, lift it up immediately to stop ants and pests accessing the honey inside and to help stop the bees from absconding.



Wiring smart

If you have to move, take down or adjust a beehive in the fence it can be tricky to remove the wiring suspending the hive. Before hanging, you can create wire loops at each corner of the hive that the main hanging wire can be attached to. This will make moving, re-hanging and adjusting the hives a lot easier. In strong wind, it's possible that the shade roofs can be blown upside-down or knock on the beehive. To prevent this, attach a small piece of wire at each corner of the shade and to the wire loops on the hive. Alternatively, create 4 small loops in the wire hanging the hive and fix the shade on this way.



Water & feeding of bees in dry season

As the dry season approaches the bees will come under stress as their natural sources of water and nectar dry up. You must provide clean water to help the bees survive the dry season. If you see any signs of agitation or swarming behaviour you should start feeding the bees with a 1:1 sugar water solution to keep them in your hive. These bottles should be hung in a nearby tree at least 10m from the hive to make it safe and easy for you to re-fill without disturbing the hive. One cup of water every few days should make sure your bees survive the dry season. Remember to put a few sticks in the bottle so any bees that fall in the bottle can climb out!



Damaged shades

If your shades become damaged and allow too much direct sunlight through then the hive will become overheated and the bees may leave. If you are using plywood shades you will find that a few seasons of heavy rain and hot sun will degrade them. Strong thatched shades will last longer than plywood. It is important not to wait too long before thatching and replacing your damaged shades as this may undo a lot of your hard work! It may be difficult to replace a shade on an occupied hive so this can be done at night.

Bees Protecting Trees from Elephants

Several colleagues are also using beehives to protect certain trees from elephant damage. In South Africa Elephants Alive are successfully using beehives of *Apis mellifera scutellata* bees hung on branches of Marula Trees to reduce the likelihood of elephants breaking the branches (refer to Cook et al. 2018).



Photo: Robin Cook



Photo: Mike Kendrick



Visit www.elephantsalive.org for more information



Photo: Tamsin Lotter

Hives can either be hung from hooks embedded into the woodwork OR on platforms that enable easier access to the hives for cleaning and harvesting.



Photo: Steeve Ngama

Hanging beehives around the trunk of particularly precious trees could be one way to reduce bark stripping or trees being pushed over until the tree has grown large enough to withstand elephant damage.



In Gabon researchers in The Gamba have shown that highly active beehives filled with *Apis mellifera adansonii* bees can be hung up to reduce forest elephants *Loxodonta africana cyclotis* from damaging fruit trees (refer to Ngama et al., 2016).



Chapter Four

Beekeeping

Beekeeping introduction, hive management, honey harvesting and honey processing



Introduction to Beekeeping

Once your hives are constructed and installed you will want wild bee colonies to colonise them swiftly. Following occupation, you'll need to manage your hives properly so that the bees don't abscond and so you have the best chance of harvesting honey. Collectively this is known as beekeeping.

Key terms

Brood: Honeybee eggs and larvae that are raised in brood comb.

Brood nest: The area of a colony in which brood is reared.

Capped comb: Full honeycomb where bees have sealed the cells of honey with a white wax cap.

Colony: Family unit of bees comprising a queen, up to a few hundred drones, and up to 50,000 worker bees.

Drone: Male bees in a colony, raised from unfertilized eggs.

Hive tool: Simple instrument used to open hives, remove frames and to scrape off excess propolis or wax.

Pollen: Powdery substance collected by bees from flower stamen and stored or used to feed the brood.

Nectar: A sweet liquid secreted by the flowers of plants used by bees to make honey.

Propolis: A resin-like substance made by bees from collecting gums & resins from trees and used as glue within the beehive. It has antiseptic properties.

Queen: The leader of the colony. She lays all the eggs and releases pheromones to direct the workers and drones.

Queen cell: A special, elongated cell in which a larvae is fed royal jelly so that it develops into a new queen.

Royal Jelly: A nutritious milky substance produced by worker bees from water and pollen used to rear a new queen.

Worker: Female honeybees that carry out most of the functions in a beehive. Workers do not mate and do not lay eggs.

Colony overview



Worker bees do all the work in the hive – rearing larvae, building wax honeycomb, guarding and cleaning hive, tending the queen, receiving nectar from other workers returning from the field, converting nectar and storing it as honey, storing pollen, and even ventilating the hive to control temperature and humidity. Young worker bees begin life as 'nurse bees' who feed and rear the brood. They then progress into 'field bees' who go out to forage for nectar, pollen, water, and propolis. Older worker bees will become 'guard bees' and defend the hive from pests and predators or 'scout bees' who will search for potential new beehives.

The queen bee is the only fully developed female and leaves the hive only once or twice in her life to mate with drones. She produces many different pheromones to attract worker bees and direct them to their various functions within the hive. A colony without a queen cannot operate properly.

Drone bees (males) are raised from unfertilized eggs. Their only function is to mate with the virgin queen, who stores the semen for the rest of her life and uses it to lay brood. She is able to lay either drone (unfertilized) or worker (fertilized) eggs, depending on the needs of the colony.



Encouraging Colonisation

Diverse vegetation

Ideally the area surrounding your farm has diverse wild vegetation to give bees enough resources to build strong, healthy hives. Ensuring large trees, particularly Acacia species, are present will be a big help to the productivity of your bees. Different plants flower at different times of year, so a wide variety of species will help make pollen and nectar resources available for the bees for as much of the year as possible. Certain crop types including moringa, sunflowers and cassava are highly attractive sources of forage whereas single crop types will be less attractive to bees.



Attractants

Attractants will encourage swarms of bees to colonise your hives. The best attractant is beeswax - a frame with a fresh foundation wax is ideal. Propolis is also attractive to bees and can be rubbed around the hive entrance. Lemongrass or lemongrass oil is highly attractive to bees and can also be rubbed at the entrance. Honey itself is NOT a good attractant and will only attract pests like ants. A hive that already had bees will colonise more quickly than a new one. Bright hives (painted yellow or white like flowers) help attract bees.



Clean hives

Maintaining clean hives is also crucial - bees are very clean themselves and want a clean home. They will not move into a hive that is dirty or has become inhabited by wasps, spiders, moths, lizards or even some snakes so be sure to check unoccupied hives at least once per month for cleaning and to remove any unwanted guests. Prune (but do not clear) grass and vegetation under the hives to minimise access to pests.



Providing water

All living things need water and honeybees are no exception. Bees will fly up to 3km from their hive to search and forage for water. It is used for many essential functions in the hive including honey production, brood rearing, production of royal jelly and even to control the temperature and humidity of the hive during the dry season. When scout bees are out searching for a new home they will take note of any water sources in the area. If there are no natural water sources in the area then providing a container filled with clean water will encourage wild swarms to occupy your hives.



Maintaining and Managing Occupied Hives

African Honeybees can be very aggressive and give you a painful sting. They are most aggressive during the daytime so all beekeeping that occurs around houses or farmsteads should be carried out in the evening hours to avoid conflict with children and livestock on the farm. Avoid opening occupied beehives if it is raining or windy.

Opening a beehive to add a superbox or harvest honey will disturb the bees and trigger them to attack. There are a few important precautions to take to ensure you aren't stung and can complete your beekeeping session with as little impact on the bees as possible.



Protective clothing

You must make sure to cover all exposed skin. Wearing a beesuit is ideal as they are designed to prevent bees from stinging through the material. Wear long clothes underneath, gumboots, beekeeping gloves and a baseball cap on to keep your face clear. You will need a work light for beekeeping after dark. Bees react very aggressively to white light so use a red light if possible as bees cannot see this colour. Try not to wear any perfume or aftershave before approaching a hive - they will attack!



Smoking the hive

Smoke masks alarm pheromones produced by disturbed bees so will decrease their aggression while beekeeping. A smoker can be bought from any beekeeping supply shop but you can also make your own. It is helpful to apply a few puffs of smoke before you removed the hive roof and as you lift each frame out. Good smoking materials include wood shavings, small sticks and compact dry grass. Make sure you don't over-smoke the bees or direct a lit flame towards the hive.



Slowly, but surely

Opening a beehive and becoming surrounded by angry, buzzing bees can be quite intimidating at first. Be assured that your beekeeping clothing will prevent bees from getting in or stinging you. Work slowly, remove one frame at a time and don't forget to use your smoker if the bees start become aggressive. If you are stung, remain calm and slowly walk away from the hive if necessary. Sudden movements and loud noise will only attract more bees. You can use your smoker to mask the alarm pheromone on the sting.



Avoid crushing bees

As you lift out honey comb frames to check the colony for pests, parasites, and for honey production be very careful as you handle the bees. Its easy to crush bees by accident and not only is this not good but the smell will also anger the other bees and cause more aggression. Try to find a soft brush or bunch of leaves to gently brush the bees back into the hive before removing any frames. A short but firm tap of the frame on the hive should knock the bees back into the hive.

Ph

Checking your hives

The most important part of beekeeping is regularly checking on the health and progress of your bee colonies. By looking at the colony size, behaviour, honeycomb, brood, honey and pollen stores over time you will learn to understand what is happening in the colony and what action you can take to help the colony grow, remain strong, produce lots of honey and be effective at deterring crop raiding elephants. If you do need to take action, inspections will help show you how effective your intervention has been. You should be looking to answer questions such as:

- How is the brood developing in the different stages (eggs, larvae, capped cells)?
- Are the cells filled with honey and pollen?
- Are there any pests or diseases affecting the hive?
- How busy is the hive entrance?
- Are there many bees coming and going from the field?
- Are there guard bees protecting the entrance to the hive?
- Are the bees using the water source that you have provided?



The Brood Box

If you have Langstroth beehives, you need to wait for the brood box to fill with a healthy bee colony before you add the superbox. This can take anywhere between 2 weeks and 4 months depending on conditions. If you need to remove frames it is important that they are returned in the same order. It is important not to add the superbox too soon as this will create a large empty space of which pests may take advantage. Once there are 5-6 frames of honeycomb with active bees, brood and some honey stored you can add the meshed queen excluder and super box that will become the honey production area.



The Superbox

After the queen excluder and superbox are added, worker bees will start moving up to expand the colony's stores with more honeycomb, honey and small amounts of pollen. Only worker bees are small enough to pass through the queen excluder into the superbox so honey produced here will be pure and free of brood. The brood box should NOT be harvested for honey so that the queen is left as undisturbed as possible. This area is the factory producing new bees and it's essential that the colony remains strong for repeat harvesting and effective elephant deterrence.



Small Colonies

Small colonies will focus on brood rearing to build up the population of the hive. As the colony grows, the number of worker bees needed for brood production and maintenance will decrease. They will be released from these duties to now forage for water, nectar, pollen and propolis. Do not expect a honey harvest from a small colony. Instead, be patient and ensure they have the right conditions to survive the dry seasons and grow when forage is abundant. If managed correctly, a small colony can grow into a large, strong one and produce lots of honey in future seasons.

Honey Harvesting and Processing

Honey harvesting can be the most exciting part of beekeeping and is an extra financial reward for all your hard work maintaining your fence and caring for your bees! Harvesting at the right times and in the right way ensures you will receive the maximum amount of honey while causing minimal disruption to your bees. Honey production is greatest when there are abundant flowering plants, so harvesting towards the end of this vegetation bloom should give you a good yield while still leaving plenty of stored honey in the brood chamber. Honey should not be harvesting during the dry season or from the brood chamber at all. This will cause substantial stress to your bees and likely lead to them absconding.

Honey harvesting

Start by applying a few puffs of smoke into the entrance and under the lid at to mask any alarm pheromones. Next, check the amount of honey present in each frame. As a general rule, only frames with complete honeycomb containing at least 75% capped honey should be harvested. Frames containing small combs or large amounts of uncapped honey or empty cells should be left and checked again the following season. Full, capped frames should be taken out using your hive tool and brushed with your bee brush to remove any bees. Frames should be put into a bucket and covered with a mosquito net or cloth to keep away bees and bugs.

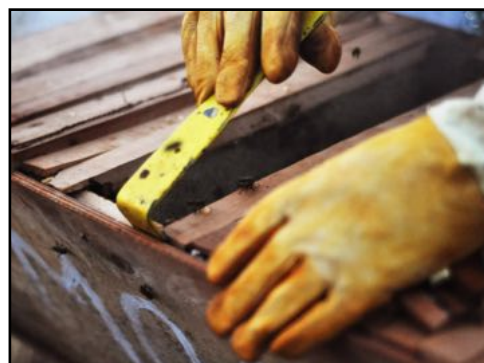

Honey processing - KTBH or Traditional

Harvesting from the honey chamber of a KTBH or traditional beehive will provide you with sheets of pure wax comb filled with nothing but delicious honey. The cut honeycomb should be smashed and filtered through a fine mesh material into a bucket. Either leave the honeycomb overnight to drain or squeeze the comb to release the honey. Leftover wax is a valuable resource that can be made into beeswax products or new foundation wax strips.



Candles and lip balms

Here are two quick recipes to make use of any spare beeswax:

Beeswax Candle - Ingredients required: Beeswax, Candle Wick, Mold, Cooking Oil

1. Gently melt the beeswax in a pan or double boiler.
2. Coat the mold with a layer of cooking oil, cut the wick and dip it in the melted beeswax.
3. Secure the wick at the bottom of the mold and pour in the melted beeswax.
4. Allow to fully cool for ~5 hours before use. Any shape mould can be used.



Lip Balm - Ingredients required: 200g Olive Oil, 50g Beeswax, 50g Coconut Oil, 20g Honey, 10ml Vanilla Essence. Makes 300ml of Lip Balm (20 x 15ml tins)

1. Gently melt the beeswax in a pan or double boiler.
2. Add the olive and coconut oils and stir just until the wax re-melts then remove from the heat.
3. Add the honey and vanilla. Mix just until it starts to thicken and all the ingredients are thoroughly combined.
4. Pour into tins or containers while still liquid and allow to cool before sealing. You can gently re-melt the mixture if it solidifies before you've finished pouring!

Processing Honey from Langstroth Hives

Processing honey harvested from Langstroth hives can produce pure, wax-free honey, though it does require extra resources and time. If you do have a spinning centrifuge facility or the option to buy one, we highly recommend processing your honey in this way. For the full process you will need:

- A sealed room
- Hand centrifuge
- Metal or plastic trays
- Decapping tool
- 2-3 buckets
- Cooker to sterilise jars
- Set of sieves or muslin cloth
- Plastic spatula or scraper
- Honey jars and lids

1. Before you start, ensure that all equipment and work surfaces are fully clean and dried with no water droplets. Bring a pan of water to the boil and put in your jars and lids to make sure they are clean and sanitary so honey can be stored safely. Ideally place these jars onto trays into a kitchen cooker to sterilise the jars above 100C.

2. Start by holding the frames one at a time above a metal catching tray and removing the wax cell caps using your decapping tool or even a fork. Keep all wax cappings as a resource to make candles and lip balms.

3. Once fully decapped, load the frames into the centrifuge and spin rapidly. Turn the frames a few times to ensure all honey is removed from both sides. Keep the empty frames with honeycomb to replace any removed for harvesting. You can also put a new superbox on a brood hive with old honey comb frames (assuming no disease).

4. After all frames have been spun, open the tap at the bottom of the centrifuge to pour the honey carefully through the first sieve and into a bucket below. Use your spatula to scrape all excess honey from the sides.

5. Wearing gloves or at least thoroughly cleaned hands, hand-squeeze decapped wax and any broken honeycomb to extract the honey from here. Keep this beeswax to sell or make candles and lip balms if you have access to

6. Gently pour the honey through each subsequent sieve and cloth to filter out all wax particles until you are left with pure, clear honey!

7. Pour the filtered honey into the clean, dry jars and secure the lid tightly. Add labels and decoration.

8. Make sure to thoroughly clean and rinse all your equipment once you are finished as leftover drops or traces of honey will attract ants and bees.

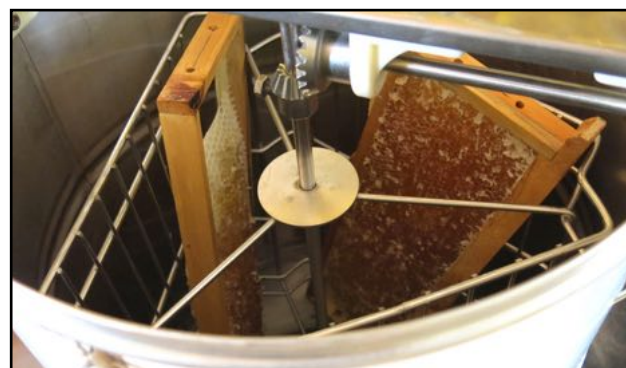

Elephant Friendly Honey

Honey harvested from beehive fences has been coined as 'Elephant-Friendly Honey'. The elephants are deterred from entering farms during their natural foraging activities ensuring that farmers are less disturbed by elephants and, we hope, will become more tolerant of elephants walking near their farmland. Simple labels can be made for honey jars to advertise the unique source of the honey and this will attract interest and support for more beehive fence projects. Keep a record of how many kilos of honey is taken from each hive.



Chapter Five

Pests and Parasites

Honey badgers, wax moth, ants, hive beetles and prevention & management



Honey Badgers



Honey Badgers are very special animals. They are nocturnal (active at night) and are mostly solitary but do occasionally hunt in pairs. Besides honey, they feed on several animals including rodents, birds, lizards, insects, rats, mice, scorpions and they hunt and eat very venomous snakes like cobras, puff adders and mambas. They are famous for being fearless and will stand up to lions and elephants! Tourists love seeing honey badgers in the wild and they are famous for their bravery.

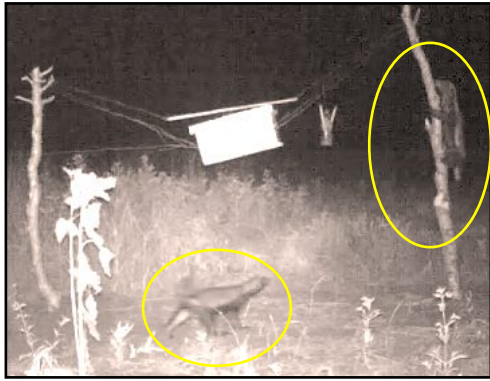

Honey Badgers & Beehive Fences

Honey badgers are a particular risk to beehives hung in a beehive fence as the posts offer an easy access route to the hive as they can easily grip onto wood. Rather than killing these rare, important animals, ensure your hives are protected with strong deterrents that will keep your honey safe year after year. Plan to either a) stop the honey badger climbing the post or b) stop the honey badger ripping open the beehive once it reaches the hive. If you have the budget, you may choose to add more than one deterrent.



Iron Sheet Deterrents

This is a method we have used for many years and is relatively cheap and easy. We suggest you buy a 3m iron sheet (approx \$8) and cut 70cm strips from it (roughly 8 pieces per iron sheet) to wrap around the posts. If you have live *Commiphora* posts don't nail the iron sheet onto the live post, use wire woven tightly through small holes in the iron sheet to hold the iron sheet onto the post. This system works if your posts remain upright as the honey badger can't get his claws into the metal. Sometimes we find these metal sheets house pests like spiders can suffocate live posts.



Nzumu's Cage Deterrent

This innovative metal cage was designed by our project officer in Kenya and it stops the honey badger from landing on the hive and ripping open the metal roof. The spikes are pretty nasty to walk on, but they are static so would not actively harm the honey badger. To make these, buy a large 1.2m x 2.4m grid wire mesh sheet from a hardware store that are typically used for construction and cut it in half. Bend the corners over to make a cage and cut out the corners to neatly attach the sides together. Leave gaps to slot the cage over the hanging wire. Approximate cost per deterrent of \$4.



Metal Cone Deterrent

As honey badgers can easily climb up the wooden posts we have experimented with attaching a metal cone umbrella to the posts with some success. The advantage of this is that it doesn't suffocate live posts like iron sheets nor do they harbour any pests. The idea works well if the cone is secured central on the posts but if it leans to one side or is not wide enough, the honey badgers can climb over. We also found these are tricky to attach at the top, we welded small attachment pieces of metal to the top but the cost of manufacture started to become prohibitive.

Wax Moths

After the Honey Badger, Wax Moth are the biggest threat to your honeybee colonies. They can affect the wax within the beehives and can destroy that hard-earned honeycomb in little time if left unchecked. Wax moths can enter hives at night when the bees are less active and lay their eggs, particularly in joins and crevices that the bees may struggle to reach. Once the moth larvae hatch they begin feeding on wax, pollen, hive debris and brood, tunnelling their way through the honeycomb as they eat. They leave behind an extremely sticky web and lots of waste - conditions that often lead the bees to consume their honey and leave the hive. As always, prevention is better than the cure, and there are a few ways you can help prevent wax moth infestations.



Entrance reducers

Wax moths are more easily able to enter a beehive through larger gaps. Strong honeybee colonies will naturally fill the gap at the entrance to the hive with propolis specifically to keep pests out. However, this can take several months with a newly occupied colony that first needs to become established and build honeycomb. You can help prevent wax moth infestations during this critical stage of development by fitting a small piece of wood or a tight-fitting stick in the entrance to reduce the size of the 'door'. Other gaps that a wax moth may use to enter the hive should be filled in the same way.



Checking hives & keeping strong colonies

Strong and healthy honeybee colonies will fare much better when attempting to fight off potential wax moth invaders. Hives should be checked at least every month for pests (wax moth, honey beetles etc.) and for the levels of wax comb and honey. Frames infested with wax moth should be removed and any evidence on the body of the hive should be scraped off and removed. During the dry season the bees will slowly consume their honey stores to ensure their survival until the next rainy season. You can assist here by providing a solution of 1:1 sugar and water to keep up the strength and resilience of the colony during this time. Don't forget to put in sticks so the bees don't drown!



Cleaning hives after an infestation

Unfortunately wax moth invasions do sometimes cause a colony to leave. However, it should also be noted that once a colony decides to abscond they will stop fighting off any wax moths. Without regular checks it is difficult to know if the bees left due to a wax moth infestation or another reason. If you have an empty hive containing wax moth a thorough clean is critical.

Any evidence of wax moth or infested comb on the frames, lid, or hive body should be scraped off and burned or fed to your chickens. Boiling water should then be used to clean all the frames, hive and lid before being left to dry in the sun for 24 hours. Only then should the hive be reassembled, re-waxed and hung in its position in the fence.



Ants and Hive Beetles



Ants and Grease

Ants are a common pest that the beehive fence farmer should not forget to consider. Left unchecked, they are capable of attacking the hive over the period of several nights, leaving the colony weak and unable to protect themselves. Colonies that have been under siege from ants over multiple nights will be more aggressive during the day. Ants are most interested in consuming the brood within the colony and will most likely carry out their raids during the evening hours when bees are less aggressive. Ensure that the wires connecting the hive and the shade to the posts are greased in the middle. Ants are unable to walk over grease as their legs will get stuck and thus prevent them reaching the hive.



Hive Beetle

Hive Beetles are another common pest to be aware of. There are two common types - the Small and Large Hive Beetle. Both types can feed on just about everything within the hive - honey, wax, brood, pollen and even food regurgitated from guard bees. Similar to wax moth, they will lay their eggs in hard-to-reach places within the hive. Heavy infestations cause the hive to become 'slimed out' forcing the colony to abscond.

Any Hive Beetles found during an inspection should be removed and killed to prevent them from reentering the hive. Entrance reducers can be used to make it more difficult for the beetle to get inside. Similarly, any cracks or openings (except for the entrance) should be filled with sticks or spare pieces of wood. Grease will also help restrict access. Strong colonies will be able to fight off most potential invaders but small colonies or those weakened during the dry season may be vulnerable.



Long grass

It is sensible to keep some vegetation under your beehives as cleared ground absorbs a lot of radiation from the sun and may cause your hives to overheat. However, long grass or other vegetation that has grown tall enough to reach your hives will provide a means of access for several types of unwanted insect pest. You should regularly cut back this vegetation to prevent this from happening. Once again, if you have a particularly aggressive colony this should be done during the evening hours while wearing your beesuit.



Chapter Six

Record Keeping & Resources

Beehive records, elephant visit records and
conditions for success



Hive Occupation Records

The table below should help you to design your own record sheets for monitoring activity around your beehive fence. Keep a record of every event including colony occupations, abandonment events, new occupations, harvesting events, visits by elephants or honey badgers etc. This system will help you identify sections of the beehive fence which are vulnerable to predation, drought, disturbance and which sections are providing you with the best honey harvests.

Beehive (farmer initials)	Hang date	Occupied date	Abandoned date & reason	Event	Event	Event	Event
HN1 (example)	6.2.2014	18.4.2014	12.10.14 (left due to drought)	Occupied 8.1.2015	1.12.2015 Harvested 6kgs honey	3.2.2016 Visit by elephants but no break through	etc
HN2	6.2.2014	9.4.2014		1 Post replaced 15.4.14	7.7.15 harvested 4kgs	harvested 7.1.17 8kgs	etc
HN3	6.2.2014	etc					

A Beehive Fence in action...

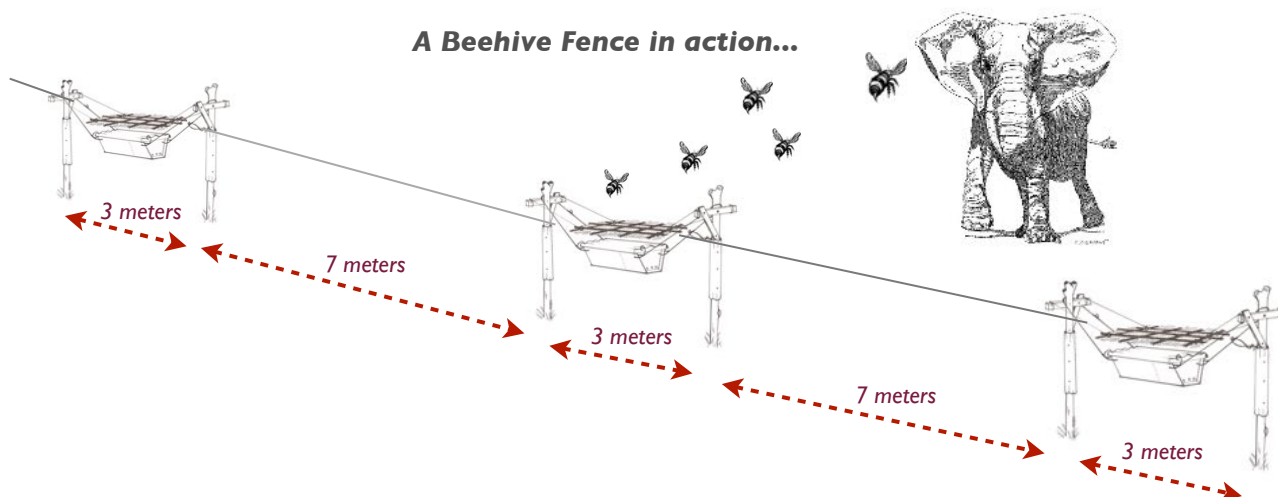

Top Tips to increase hive occupation in your Beehive Fence

- Plant flowering plants or crops around your beehive fence to provide nectar and pollen for the bees. Do not cut down any indigenous flowering plants as well fed bees will provide you with lots of honey. Sunflowers are ideal plants as, if pressed, they can also provide you with sunflower oil for cooking.
- Rub beeswax onto the middle of your KTBH top bars to help the bees find the hive and to start building wax along the top bars. Rubbing propolis around the hive entrance may also attract passing bees.
- When providing water for the bees, make sure you place stones or sturdy branches in the water as bees will drown in deep water. Replace any stagnant or green water as it can poison the bees.
- If thatching grass is in short supply, use multiple sticks to form a dense stick roof - keeping the bees cool is absolutely essential or they will become aggressive and will eventually swarm and leave the hive.
- Cut down any long grasses or branches that overhang or touch the beehives, these will provide bridges for honey badgers or ants to crawl into the hive or for pirate wasps to attack the bees.



Elephant Movement Records

Elephants will continue to visit beehive fence protected farms, most probably due to a memory of available crops from previous years. Most farmers sleep in their farm next to their crops building up to harvest season and its likely that farmers with new beehive fences will continue to sleep in the farm to check that the system is working. If possible, farmers should try to resist scaring away the elephants as they approach the farm. Trust the beehive fences to stop the approaching group. Try to watch the behaviour of the elephants, how do they move around the fence? Are they approaching the wire or trying to push through between hives? If its too dark to see clearly, make a note of the footprints the next morning. I highly recommend keeping a record and notes of this behaviour for the first few seasons using a beehive fence. Patterns of behaviour may emerge including particularly aggressive movements that may lead to an individual trying to break through the fence. The ideal situation is to avoid direct conflict with elephants to

reduce the risk of either you or the elephants coming to harm. If you manage to reduce direct action (stone throwing, firecrackers, shouting etc) to a minimum it will mean the elephants will become less habituated to these more direct action attempts and they should respond and run away should you need to resort to these tactics later in the season. Additionally, keeping a record of where elephants have approached the beehive fence (or attempted to enter) will help to focus multiple deterrent tactics in that area of your farm. You may want to try covering the linking wire with chilli oil or hang cow bells to help warn you when an elephant is trying to break through.

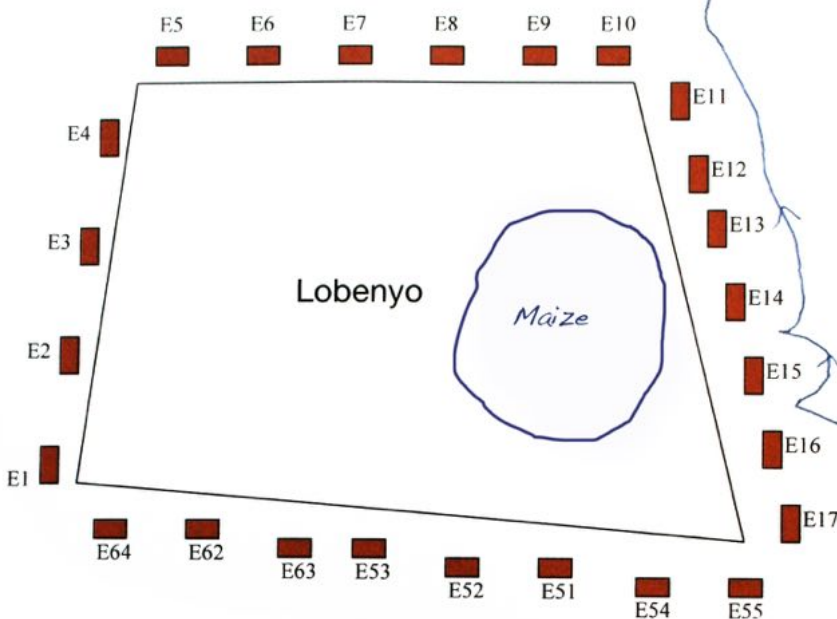



This monitoring sheet example of farmer Lobenyo's farm shows the location and number of each beehive in his fence. The elephants approached his farm at one corner and attempted to enter twice between hives E16, E15 and E14 before walking along the fence and then finally giving up and heading to the river instead. By drawing on the movements of these bulls we can learn a lot about how the elephants approach the beehive fences and whether the beehive fence deterrent is working. Keep a note of the date, time and number of elephants in the approaching group.

Date	12-1-10
Time of Incident	Night
No. of Elephants	3 bulls
Enter Farm?	No



Predicted Conditions for Success

The table below summarises the predicted conditions for success of beehive fences when deploying beehive fences in Kenya as an elephant deterrent in locations where the African savannah elephant *Loxodonta africana* resides alongside farmland. In our experience, the greatest chances of success may be found where (1) a farmer lives below 2,500m, (2) owns his own beehives, (3) places them in a circular position around his 1-3 acre farm, and (4) uses Langstroth beehives.

Higher Success 	Lower Success 
<p>Lower Altitudes</p> <ul style="list-style-type: none"> • Between 400m – 2000m above sea level where <i>A. m. scutellata</i> typically lives should be most effective. • Coastal regions 0 - 400m where <i>A. m. litorea</i> lives is also known to be an aggressive honey bee so results should be comparable. • Warmer conditions at night keep bees active and capable of swarming out of the hive when disturbed. 	<p>Higher Altitudes</p> <ul style="list-style-type: none"> • Above 2,500m lives <i>A.m.monticola</i>, which is a less aggressive honey bee and might have less affect when swarming out and disturbing elephants. • Cooler conditions means bees are less active at night when most crop-raiding occurs. • Snow or icy conditions may result in inactivity or semi-dormancy of bees where valuable honey stores are consumed to keep them warm and alive.
<p>Farmer/Individual Owned Beehives</p> <ul style="list-style-type: none"> • Will maintain fences due to personal financial incentive of selling and using honey and wax. • More likely to want to learn new beekeeping techniques and skills. • Vigilant on a daily basis for theft or elephant movements around bee fences. 	<p>Community/Group Owned Beehives</p> <ul style="list-style-type: none"> • Confusion over who is responsible for maintaining each hive or each section of the beehive fence. • Lack of incentive for harvesting honey if proceeds are divided amongst many. • Less accountability for stolen honey or beehives. • Employment of hive technician recommended.
<p>Small Circular Beehive Fences</p> <ul style="list-style-type: none"> • Fully encloses each farm preventing elephants from walking around the 'end of the line' to enter the farm. 1-3 acres is an ideal size. • Leave a 'gap' around the house or access area to prevent accidental disturbance of the hives during the day. Add dummy hives/lights to gap. • Enables elephants to pass between farms on their natural migration routes. 	<p>Long Straight Lines of Beehive Fences</p> <ul style="list-style-type: none"> • Applicable for communally run farms sitting side by side, but the farms at either end of the line will get crop raided more than the central farms. • Once inside a farm they can then have access to all the other farms 'behind' the beehive fence deterrent. • Extended beehive fences may have problems with maintenance as several farmers will need to co-operate to look after each section of the fence. Better to build a small circular beehive fence inside each farm.
<p>Langstroth or KTBH (with queen excluder)</p> <ul style="list-style-type: none"> • Swing well between posts. • Waterproof against rain with metal roof on. • Brood chamber keeps queen and brood separate from honey chamber making harvesting easier and the honey more valuable as brood is not mixed with honey. • Easy to maintain and check on hive health • More expensive to make but income from honey should justify initial expense. 	<p>Traditional Log Beehives</p> <ul style="list-style-type: none"> • Often already available locally so can be easily transferred to beehive fences <i>but</i> if not available means cutting down large valuable trees to make hives. • Brood and honey chambers are mixed so harvesting can result in destroying the combs and the bees will swarm and leave. You can nail a circular piece of coffee wire inside the hive to act as a basic queen excluder. • Difficult access to honey can mean use of excessive smoke and lower quality honey due to smoky flavour.

The Science and Research behind this Manual

All our research papers and construction manuals can be downloaded for free from our project website www.elephantsandbees.com

1. King, L., Serem, E., Russo, L (2018) Minimal effect of honey beehive fences on native bee diversity and abundance at the farm scale during the dry season in southern Kenya. *Apidologie*. DOI: 10.1007/s13592-018-0608-9
2. King, L., Oldenburg, C., and Cookson, L. (2018) 12 Tools to Live in Harmony with Elephants. Human-Elephant Co-Existence Program, Save the Elephants, Nairobi, Kenya.
3. King, L., Pardo, M., Weerathunga, S., Kumara, T.V., Jayasena, N., Soltis, J. and de Silva, S. (2018) Wild Sri Lankan elephants retreat from the sound of disturbed Asian honey bees. *Current Biology* 28, R51–R65, Jan 22.
4. Cook, R.M., Parrini, F., King, L., Witkowski, E.T.F. and Henley, M.D. (2018) African honeybees as a mitigation method for elephant impact on trees. *Biological Conservation*, 217: 329-336.
5. Cook, R.M., Henley, M.D., and King, L. (2018) Elephants, Bees and Trees Project Manual. Produced by Elephants Alive, South Africa.
6. King, L., Lala, F., Nzumu, H., Mwambingu, E. & Douglas-Hamilton, I. (2017) Beehive fences as a multi-dimensional conflict mitigation tool for farmers co-existing with elephants. *Conservation Biology*, p1-10.
7. King, L. & Raja, N. (2016) Busy and buzzing on the frontline of human-elephant conflict. *SWARA Magazine*. June p40-43.
8. Ngama S., Korte L., Bindelle J., Vermeulen C., Poulsen J.R. (2016) How Bees Deter Elephants: Beehive Trials with Forest Elephants (*Loxodonta africana cyclotis*) in Gabon. *PLoS ONE* 11(5): e0155690. doi:10.1371/journal.pone.0155690
9. King, L. (2015) Using honey bees to save elephants. *Biological Sciences Review*. September. P16-22.
10. Soltis, J., King, L.E., Douglas-Hamilton, I., Vollrath, F. and Savage, A. (2014) African Elephant Alarm Calls Distinguish between threats from Humans and Bees. *PLoS One* 9(2): e89403. doi:10.1371/journal.pone.0089403.
11. King, L.E. (2013) Elephants and Bees. Could honey bees be effective for Asia's crop-raiding elephants? *Sanctuary Asia Magazine*, India. October 2013.
12. King, L.E., Douglas-Hamilton, I, Vollrath, F. (2011) Beehive fences as effective deterrents for crop-raiding elephants: field trials in northern Kenya. *African Journal of Ecology*. 49: 431-439.
13. King, L.E. (2010) The interaction between the African elephant (*Loxodonta africana africana*) and the African honey bee (*Apis mellifera scutellata*) and its potential application as an elephant deterrent. DPhil thesis. University of Oxford, UK.
14. King, L.E., Soltis, J., Douglas-Hamilton, I., Savage, A. & Vollrath, F. (2010) Bee threat elicits alarm call in African Elephants. *PLoS One* 5(4), e10346. doi:10.1371/ journal.pone.0010346.
15. King, L.E., Lawrence, A., Douglas-Hamilton, I. & Vollrath, F. (2009) Beehive fence deters crop-raiding elephants. *African Journal of Ecology* 47, 131–137.
16. King, L. (2009) Bees help Protect Crops From Damage by Elephants in Kenya. *Bee Craft*. September P9-11.
17. King, L.E., Douglas-Hamilton, I. & Vollrath, F. (2007) African elephants run from the sound of disturbed bees. *Current Biology* 17, R832–R833.
18. Vollrath, F. & Douglas-Hamilton, I. (2002) African bees to control African elephants. *Naturwissenschaften* 89, 508–511.

Human-Elephant Co-Existence ToolBox

King, L., Oldenburg, C., and Cookson, L. (2018) 12 Tools to Live in Harmony with Elephants. Human-Elephant Co-Existence Program, Save the Elephants, Nairobi, Kenya.

12 Tools to Live in Harmony with Elephants



A toolbox of deterrent methods for small scale rural farmers to reduce elephant crop-raiding, improve yields and enhance quality of life



Produced by Save the Elephants' Human-Elephant Co-Existence Program
Written by Dr Lucy King, Cara Oldenburg & Letitia Cookson
Illustrations by Letitia Cookson



Welcome to Save the Elephants' Human-Elephant Co-Existence ToolBox.

Welcome to our illustrated booklet of tested tools that can help rural farmers in Africa and Asia live more peacefully with elephants.

The first five pages illustrate some of the simplest tools for small budgets, through to three more integrated deterrent concepts that require some financial input, finishing with three ideas for active fencing that are a little more expensive to implement. Finally, we recommend an "Intelligent Farm" that combines thoughtful land use planning (to avoid blocking elephant corridors) with non-palatable crop selection. Combining or rotating various mitigation tools can help to keep elephants safely at bay without them becoming habituated. Additionally some methods can also boost your crop yield and income generating potential.

Elephants and people have lived together for thousands of years. With innovation, imagination and compassion we should all be able to share the same landscape and resources for many years to come.

Dr Lucy King, DPhil
Head of Human-Elephant Co-Existence Program
Elephants and Bees Project Leader
Save the Elephants, P.O.Box 54667, Nairobi 00200, Kenya





For other ideas on how to live in harmony with elephants, download our HEC ToolBox Booklet at

www.elephantsandbees.com



Helpful Websites and Extra Resources:

Elephants and Bees Project - www.elephantsandbees.com

Save the Elephants - www.savetheelephants.org

Honey Care Africa - www.honeycareafrika.org

Natural Beekeeping Forum - www.biobees.com

Bees for Development - www.beesfordevelopment.org

Resources for African Beekeeping - www.apiconsult.com

International Bee Research Association - www.ibra.com

African Elephant Specialist Group - www.afesg.com

Elephant Pepper - www.elephantpepper.org

Elephants Alive - www.elephantsalive.org

Eco-Exist - www.ecoexistproject.org

Download all scientific papers and additional manuals from
www.elephantsandbees.com



Dr Lucy E. King has been researching the use of bees as a natural elephant deterrent since 2006 and has published her findings in numerous scientific journals. Her research has won her The St Andrews Prize for the Environment 2013, The Future for Nature Award 2013, and The 2011 Thesis Award from UNEP/CMS for her Doctor of Philosophy in Zoology thesis conferred by the University of Oxford in 2010. Previously, she completed an MSc in Biology, Integrative Bioscience, from Balliol College, Oxford (2006) and gained a First Class BSc degree in Zoology from Bristol University (1999). She was brought up in Somalia, Lesotho and Kenya and now lives in Nairobi leading further research into the use of bees as an elephant deterrent both in Kenya and further afield. Contact: lucy@savetheelephants.org.

Author's note - Beehive fence community

If you have been inspired by this beehive fence construction manual and plan to initiate a project around your farm I would encourage you to contact us and share your experiences and outputs. Any anecdotes or suggested improvements of the design of the beehive fences will help future farmers wanting to try the idea. By combining data and success rates from different beehive fence protected farms we can work towards improving the concept year after year. Please email us at lucy@savetheelephants.org and we will be happy to offer any advice on your plans.



Acknowledgements

I thank the Office of the President of Kenya and Kenya Wildlife Service for permission to conduct this research in Kenya. I am grateful for the significant contributions to the science behind this manual from my colleagues Dr Iain Douglas-Hamilton, Professor Fritz Vollrath, Dr Joseph Soltis, Dr Anne Savage, Dr Anna Lawrence, Onesmas Kahindi, Lucas Lepuiyapui, Wilson Lelukumani, Hesron Nzumu, Emmanuel Mwambingu, Esther Serem, Gloria Mugo, Kennedy Lenuiya, Abi Johnson, Robin Cook and Kylie Butler. We are grateful for the co-operation and hospitality shown by all the communities of Ex-Erok, Chumviyere, Etorro and Sagalla. Corporate/charitable funding for this research gratefully received from ESRC/NERC, Disney's Conservation Fund, Disney's Reverse the Decline Fund, The Rufford Foundation, Future for Nature, St Andrews Prize for the Environment, Bella Matata, VSNi, The James Ford Bell Foundation, Appropriate Development Consultancy Ltd, The Kileva Foundation, Balliol College Oxford, Elephant Action League, Ernest Kleinwort Charitable Trust, Artypopyart, Deciem, Karis Foundation, Glassybaby White Light Fund, Wildlife Conservation Network, and Save the Elephants.



Field Notes:

18 horizontal grey bars for writing field notes.



Beehive Fence Construction Manual

Copyright © Dr Lucy E. King

Fourth Edition 2019

All rights reserved

Published by

The Elephants and Bees Project

Human-Elephant Co-Existence Program

Save the Elephants

P.O. Box 54667

Nairobi 00200

Kenya

Project website: www.elephantsandbees.com

Email: lucy@savetheelephants.org