

THE ENGLISH NOUN PHRASE  
IN ITS SENTENTIAL ASPECT

Vol. 1

by

Steven Paul Abney

B.A., Indiana University  
(1983)

SUBMITTED IN PARTIAL FULFILLMENT  
OF THE REQUIREMENTS OF THE  
DEGREE OF

DOCTOR OF PHILOSOPHY  
IN LINGUISTICS

at the

MASSACHUSETTS INSTITUTE OF TECHNOLOGY

June 1987

© Steven Paul Abney, 1987

The author hereby grants to M.I.T. permission to reproduce and to distribute copies of this thesis document in whole or in part.

Signature of Author

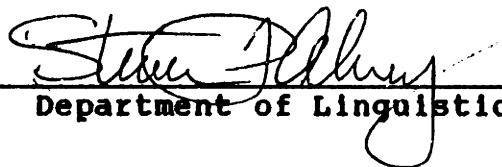

Department of Linguistics and Philosophy  
8 May 1987

Certified by

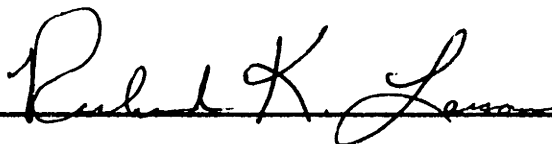

Richard Larson  
Thesis Supervisor

Accepted by

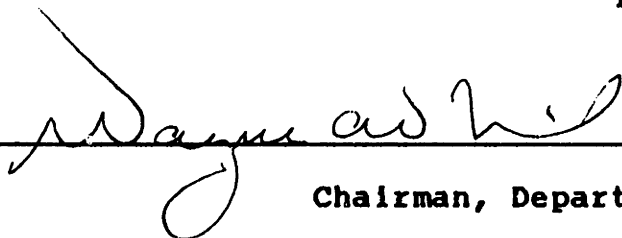

Wayne O'Neil  
Chairman, Departmental Committee

Vol. 1  
MASSACHUSETTS INSTITUTE  
OF TECHNOLOGY

JUN 26 1987

LIBRARIES



The English Noun Phrase  
In Its Sentential Aspect

by

Steven Paul Abney

Submitted to the Department of Linguistics and Philosophy  
on 8 May 1987, in partial fulfillment of the  
requirements for the Degree of Doctor of Philosophy  
in Linguistics

ABSTRACT

This dissertation is a defense of the hypothesis that the noun phrase is headed by a functional element (i.e., "non-lexical" category) D, identified with the determiner. In this way, the structure of the noun phrase parallels that of the sentence, which is headed by Infl(ection), under assumptions now standard within the Government-Binding (GB) framework.

The central empirical problem addressed is the question of the proper analysis of the so-called "Poss-ing" gerund in English. This construction possesses simultaneously many properties of sentences, and many properties of noun phrases. The problem of capturing this dual aspect of the Poss-ing construction is heightened by current restrictive views of X-bar theory, which, in particular, rule out the obvious structure for Poss-ing, [<sub>NP</sub> NP VP<sub>ing</sub>], by virtue of its exocentricity.

Consideration of languages in which nouns, even the most basic concrete nouns, show agreement (AGR) with their possessors, points to an analysis of the noun phrase as headed by an element similar to Infl, which provides a position for AGR; I call this Infl-like element "D". D and Infl belong to the class of non-lexical categories, which I prefer to call functional categories. The analysis in which D heads the noun phrase I call the "DP-analysis".

Importing the DP-analysis into English yields an immediate solution for the problem of the Poss-ing gerund: Poss-ing gerunds (and by extension, noun phrases generally) have a more sentence-like structure than hitherto thought, namely, [DP DP's D VP<sub>ing</sub>]. (In non-gerundive noun phrases, "VP" is replaced by a projection of N. This projection of N, despite being a maximal X-bar projection, corresponds to N-bar in the standard analysis.)

Current trends in the treatment of minor categories -- so-called "non-lexical" categories -- lead us to a similar conclusion. Until recently, minor categories like complementizers and modals had been treated as syncategorematic. Under current assumptions, however, they participate fully in the X-bar schema. In this way, two simplifications are achieved simultaneously: we eliminate syncategorematic elements, and we acquire an endocentric analysis of the sentence, which had been exceptional in being the only exocentric major category. To make these results fully general, we are led to treat the remaining syncategorematic elements -- in particular, determiners in noun phrases and degree words in adjective phrases -- as heads of full phrases. The analogy with complementizers and modals indicates that determiners and degree words should head noun phrases and adjective phrases, respectively. In other words, determiners are lexical instantiations of "D" in the same way that modals are lexical instantiations of Infl.

However, despite the conceptual links, the question of the existence of a functional head of the noun phrase (the DP-analysis), and the question of the place of the determiner, are independent questions, and I treat them separately: Chapters One through Three are concerned predominately with the former question, Chapter Four with the latter.

Chapter One provides a brief introduction. In Chapter Two I present the DP-analysis, motivating it by examining languages with agreement between noun and possessor. I also discuss issues raised by the DP-analysis, with emphasis on the parallelism between noun phrase and sentence hypothesized under the DP-analysis. In particular, I treat the question of PRO in the noun phrase; and I show that the numerous differences between sentence and noun phrase do not invalidate the parallelism of structure proposed under the DP-analysis. In Chapter Three I apply the analysis to the three gerundive constructions, Acc-ing, Poss-ing, and Ing-of. Finally, in Chapter Four, I turn to the question of whether the determiner is the lexical instantiation of D, the functional head of the noun phrase.

Thesis Supervisor: Dr. Richard K. Larson  
Title: Assistant Professor of Linguistics

## Acknowledgements

I would like to acknowledge, first of all, my debt to my many teachers and mentors these last four years: to my thesis advisor, Rich Larson, for his guidance in matters syntactic and semantic, as well as for sound advice in the mechanics of thesis-writing. To the other members of my committee: Noam Chomsky, Ken Hale, and Richie Kayne. To Jim Higginbotham, with whom I have worked closely since coming to MIT; unfortunately for me, he is in Pisa this semester. Thanks also to Jay Keyser, both for guidance in linguistics and encouragement in my computational interests; and to Morris Halle, for encouragement and direction, and for keeping me aware of the beauties of phonology.

Though none of my work in parsing has found its way into this thesis, nonetheless a very important part of my intellectual development as a graduate student has been in the area of computation. I am especially indebted to Sam Epstein, my mentor at Bell Communications Research, for providing me with a golden opportunity to develop my ideas in parsing, and for his indispensable guidance and encouragement. At MIT, thanks to Bob Berwick, for much help and direction; to Carl Hewitt, for the opportunity to work with the Apiary Project; to Gul Agha, for endless support and advice; to Jennifer Cole, who I had the good fortune to collaborate with in the summer and fall of 1985, in work on parsing; to Tom Reinhart, my Lisp guru; and to Beth Levin, for her guidance during the summer I worked for the Lexicon Project.

I would like to thank the others with whom I worked at Bellcore: (alphabetically) George Collier, Stu Feldman, Mike Lesk, Maria Slowiaczek, Don Walker. I would also like to thank Don Hindle, Mitch Marcus, and Richard Sproat, of AT&T Bell Laboratories; and Bob Ingria of Bolt, Beranek, & Newman.

In psycholinguistics, special thanks to Merrill Garrett and Janet Fodor.

My studies at MIT were partially funded by a Mellon Graduate Fellowship in the Humanities; I gratefully acknowledge their support.

Among fellow students, present and past, the eight with whom I have been together since 1983 will always be very special to me. I consider myself very lucky to have worked together with these people; I only wish it weren't over so soon. They are: Hyon-Sook Choe, Jennifer Cole, John Lumsden, Doug Saddy, Ur Shlonsky, Michele Sigler, Carol Tenny, Loren Trigo. Still a member of the group i. spirit -- though he left us for warm and sunny Palo Alto -- is Steve Neale. There are also two unofficial members of our class who have been very important to me: Betsy Ritter and Kyoko Masunaga. Among my other colleagues, I would especially like to mention Diana Archangeli (and husband Dante), Mark Baker, Andy Barss, Ed Barton, Maggie Browning, Viviane Deprez, Naoki Fukui, Alicja Gorecka, Mohamed Guerssel, Ewa Higgins, Kyle Johnson, Mike Kashket, Mary Laughren, Juliette Levin, Anne Lobeck, Dinette Massam, Katie McCreight, Janis Melvold, Janet Nicol, Tova Rapoport, Malka Rappaport, Marc Ryser, Gabe Segal, Kelly Sloan, Peggy Speas, Tim Stowell, Catherine Womack.

Thanks to the staff in the Linguistics department, especially Maggie Carracino and Nancy Peters.

For my sanity and emotional well-being, I owe a great debt to Carol Tenny and her parents -- as well as to Mushka and Freddy the Weasel; to Marc and Ilana Amrani-Cohen, and boss-man Edan; to my family; to Betsy Ritter; and to the incomparable Capitol Theatre in Arlington. My deepest debt, however, is to my wife Nina, for encouraging, cajoling, for love. It is to her that this work is dedicated.

To Nina

# **Contents in Brief**

## **I. Introduction**

- 1. A Puzzle and Its Solution**
- 2. Overview**

## **II. Noun Phrase and Sentence**

- 1. General Similarities**
- 2. Infl in the Noun Phrase**
- 3. The DP-Analysis**
- 4. PRO in the Noun Phrase**
- 5. Differences Between Noun Phrase and Sentence**

## **III. Gerunds**

- 1. Introduction**
- 2. Noun Phrase Aspects of Poss-ing**
- 3. Sentential Aspects of Poss-ing**
- 4. Analyses I: Finding the Scams**
- 5. Analyses II: The Morphological Angle**
- 6. Conclusion: Syntactic Affixation**

## **IV. Lexical determiners**

- 1. Determiner As Head**
- 2. The Adjective Phrase**
- 3. The Position of Prenominal Adjectives**
- 4. Conclusion**



# Table of Contents

<b>I. Introduction</b>	<b>14</b>
1. A Puzzle and Its Solution . . . . .	14
1.1 The Puzzle	14
1.2 An Apparently Unrelated Fact	17
1.3 The Solution	21
1.4 The Identity of X	23
1.5 Sentence and Noun Phrase	25
2. Overview . . . . .	28
<b>II. Noun Phrase and Sentence</b>	<b>30</b>
1. General Similarities . . . . .	30
2. Infl in the Noun Phrase . . . . .	37
2.1 Yup'ik	39
2.2 Mayan	42
2.3 Hungarian	44
2.4 Digression: Comp in the Noun Phrase	46
2.5 Turkish	49
3. The DP-Analysis . . . . .	54
3.1 Concepts and Terminology	54
a. "Inflectional" Elements	54
b. C-Projection and S-Projection	57
c. "D" vs. "Det"	58
d. Syntactic Features	60
3.2 Functional Selection	63
3.3 Two Notions of Command	68
3.4 Det as Head	71
3.5 The Position of 'g	78
a. Morphological Case Affix	78
b. Determiner	79
c. Postposition: N Case-Assigns	79
d. Postposition: AGR Case-Assigns	81
3.6 Appendix: Selection of DP	85

4. PRO in the Noun Phrase . . . . .	89
4.1 <u>PRO</u> book	89
4.2 $\emptyset$ -Theory	92
a. Derived Nominals	92
b. Rationale Clauses	93
4.3 Control Theory	97
4.4 Binding Theory	97
4.5 Arguments Against PRO in the Noun Phrase	101
a. <u>Yesterday's Destruction</u>	101
b. Obligatoriness of Control	103
5. Differences Between Noun Phrase and Sentence . .	107
5.1 Predication in the Noun Phrase	107
5.2 Catalog of Differences	115
a. A Preliminary: Process vs. Result	115
b. Obligatoriness of Subject	121
c. Pleonastics	122
d. Case	122
e. Restrictions on Passive	123
f. Psych Nouns	125
g. Raising	129
h. Exceptional Case Marking	129
i. Small Clauses	131
j. Ditransitivity	131
k. Object Control	134
l. <u>Tough</u> Constructions	135
m. <u>John's breaking his leg</u>	139
n. Pseudo-Passive	142
o. Particles, Particle Movement	143
p. Resultative Secondary Predicates	143
q. Object Pleonastics	145
r. Concealed Questions	146
s. Indirect Questions	146
t. Complementizer Deletion	147
5.3 Appendix: Reducing the Differences	149

**III. Gerunds** 165

---

1. Introduction . . . . .	165
1.1 The Range of Gerund Constructions	167
1.2 Reuland's Analysis of Acc-ing	168
2. Noun Phrase Aspects of Poss-ing . . . . .	171
2.1 External Evidence	171
a. Distribution	171
b. Agreement	175
c. Long-Distance Binding	175

2.2	Internal Evidence	176
	a. Subject	176
	b. Specificity	178
	c. Pied Piping	179
	d. Scope	179
	e. Sentential Adverbs	180
3.	Sentential Aspects of Poss-ing . . . . .	182
3.1	VP in Poss-ing	182
3.2	PRO in the Gerund	183
3.3	"N-bar" Deletion	188
4.	Analyses I: Finding the Seams . . . . .	190
4.1	Schachter	190
4.2	Horn	192
4.3	The D-VP Analysis	193
	a. <u>-ing</u> as Functional Head	193
	b. Turkish Again	196
	c. <u>'s</u> and Determiners	197
4.4	The D-IP Analysis	199
	a. Determiners	201
	b. The Position of <u>-ing</u>	201
	c. Spanish <u>El</u> + Infinitive	202
	d. Scope of <u>Not</u>	203
	e. <u>'s</u> as $\emptyset$ -Assigner	205
5.	Analyses II: The Morphological Angle . . . . .	210
5.1	Jackendoff	210
	a. The Deverbal Rule Schema	210
	b. The History of the English Gerund	211
	c. Ing-of	214
5.2	Pesetsky/Lebeaux	217
5.3	Baker	219
6.	Conclusion: Syntactic Affixation . . . . .	222
6.1	A Final Analysis	222
	a. The "Scope" of <u>-Ing</u>	222
	b. Acc-ing	225
	c. Poss-ing	228
	d. The Site of -Ing	231
	e. Lowering -Ing	238
	f. Appendix: VP- and NP-Deletion	244
6.2	Affixes in the Syntax	248
	a. The "New Morphology"	248
	b. Turkish Gerunds and the Mirror Principle	249
	c. Generalizing the Mirror Principle	251

6.3	Verbal and Adjectival Passive	253
	a. Distribution	254
	b. Internal Evidence	257
	c. A Digression On Case Absorption	258
	d. More Internal Evidence	262

#### IV. Lexical determiners 265

1.	Determiner As Head . . . . .	268
1.1	Arguments for the Standard Analysis	268
	a. Selectional Restrictions	268
	b. Determiners and Possessors	270
	c. Hungarian	272
1.2	Sundry Evidence for Det as Head	277
	a. Dets That Cannot Stand Alone	277
	b. Dets That Can Stand Alone	278
	c. Pronouns	281
	d. Dets as Functional Elements	285
	e. Head-to-Head Movement	285
1.3	The Range of Specifiers	287
	a. Two Bars vs. Three Bars	287
	b. Noun Phrase Specifiers	290
	c. Pseudo-Partitive	295
2.	The Adjective Phrase . . . . .	298
2.1	Deg as Head	298
2.2	Adjective, Adverb, and Quantifier	301
2.3	The "Subject" of Deg	304
2.4	Extent Clauses	312
2.5	Two Specifiers in the Adjective Phrase	315
2.6	Overview of Structures	320
3.	The Position of Prenominal Adjectives . . . . .	322
3.1	Two Hypotheses	322
3.2	Adjective as Head of NP	323
	a. <u>Too Big a House</u>	323
	b. Complements	326
	c. <u>Mere</u> and <u>Utter</u>	328
	d. Semantics	328
	e. Comparatives	331
	f. Determination of Noun Phrase Type	333
	g. Idioms	334
3.3	Two More Hypotheses	335
	a. AP vs. DegP	335
	b. Quantifiers	338
	c. Problems	341

<b>4. Conclusion</b>	<b>351</b>
<b>Bibliography</b>	<b>355</b>

# Chapter One

## Introduction

### 1 A Puzzle and Its Solution

#### 1.1 The Puzzle

One of the most perplexing structures in English is the so-called "Poss-ing" gerundive construction. An example is:

(1)  
John's building a spaceship

What makes this construction so perplexing is that it seems to be neither fish nor fowl, so to speak. On the one hand, it is obviously a sentence; but on the other hand, it is obviously a noun phrase.

Considered with regard to its external distribution, the Poss-ing gerundive behaves exactly like a noun phrase. It appears in noun-phrase positions -- and particularly, in noun-phrase positions from which sentences are excluded, such as subject position under Subject-Aux Inversion, embedded subject position, or object of preposition:

(2)

- a. \*did [that John built a spaceship] upset you?  
 did [John] upset you?  
 did [John's building a spaceship] upset you?
- b. \*I wondered if [that John built a spaceship] had upset you  
 I wondered if [John] had upset you  
 I wondered if [John's building a spaceship] had upset you
- c. \*I told you about [that John built a spaceship]  
 I told you about [John]  
 I told you about [John's building a spaceship]

Likewise, the "subject" of the gerundive -- i.e., John's -- behaves like the "subject" of a noun phrase (the possessor), not the subject of a sentence. This is most evident in the fact that it receives genitive case, not nominative case:

(3)

- [John] destroyed the spaceship  
 [John's] destruction of the spaceship  
 [John's] destroying the spaceship

It is clear that externally, and with respect to the subject, the gerundive is a noun phrase. We have this piece of structure, then:

(4)

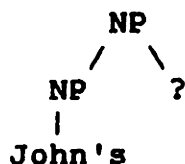

On the other hand, it is equally clear that the remainder of the gerundive, i.e., building a spaceship, constitutes a VP. -ing is a fully productive verbal affix: any verb can appear in the gerundive construction. In this way it differs from clear cases of derived nouns, which are quite sporadic in

their productivity, in English -- we have destruction, for example, but not \*debunktion; referral, but not \*interral. More importantly, there is quite a long list of processes and constructions which appear in the verb phrase, but not in the noun phrase, including case assignment to the object, raising, Exceptional Case Marking (Raising to Object), double objects, particles and particle movement, and numerous others. All of these constructions are to be found in the gerundive:

(5)

- a. \*John's destruction the spaceship  
John destroyed the spaceship  
John's destroying the spaceship
- b. \*John's appearance to be dead  
John appeared to be dead  
John's appearing to be dead
- c. \*John's belief Bill to be Caesar Augustus  
John believed Bill to be Caesar Augustus  
John's believing Bill to be Caesar Augustus
- d. \*John's gift/rental (of) Mary (of) a Fiat  
John gave/rented Mary a Fiat  
John's giving/renting Mary a Fiat
- e. \*John's explanation (away) of the problem (away)  
John explained (away) the problem (away)  
John's explaining (away) the problem (away)

This gives us another piece of the structure:

(6)

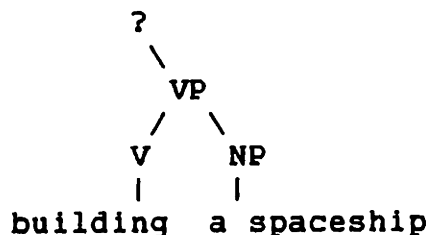

The puzzle is how to fit these two pieces together -- (4) and (6) -- without doing violence to the principles which



constrain phrase structure. The obvious way of putting them together, as in (7), does not satisfy this criterion:

(7)

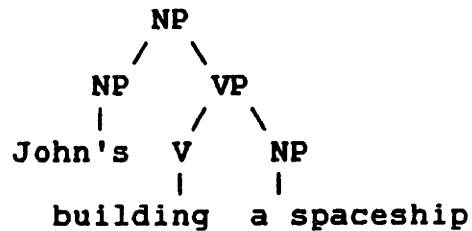

The structure (7) violates widely-assumed conditions on phrase structure, in that the highest NP lacks a head. VP cannot be the missing head, because it does not have the same syntactic category as NP. If (7) is not the correct structure, what is? To date, no fully satisfactory solution has been given.

It is my goal in the present work to solve the puzzle of the Poss-ing gerundive construction, and more generally, to defend the novel analysis of noun phrase structure upon which my solution depends, the so-called "DP-analysis". With flagrant disregard for the principles of good mystery writing, then, I sketch out my solution here in the introduction. The rest of the thesis is a denouement, in which I work out the details.

## 1.2 An Apparently Unrelated Fact

There are a large number of languages in which an overt agreement element appears in the noun phrase. Consider, for example, this paradigm from Hungarian (from Szabolcsi 1987):

(8)

az en kalap-om  
 the I:NOM hat-1sg  
 "my hat"

a te kalap-od  
 the you:NOM hat-2sg  
 "your hat"

a Peter kalap-ja  
 the Peter:NOM hat-3sg  
 "Peter's hat"

Kalap- is a simple noun, not a verbal form -- it could be replaced in this paradigm by any noun at all. Yet kalap- agrees with its possessor, marking its person and number with an agreement marker (AGR). The possessor, in turn, bears nominative case, as does the subject of the sentence. It is generally assumed (in the Government-Binding paradigm, which I implicitly adopt throughout) that nominative case in the sentence is assigned under government by AGR; hence the co-occurrence of agreement and nominative case. The minimal assumption is that nominative case in the noun phrase in Hungarian is also assigned under government by AGR. As in the sentence, the subject of the noun phrase (i.e., the possessor) and AGR are mutually dependent. A nominative possessor can only appear when AGR is present, and AGR only appears when there is a possessor (though that possessor may at times be non-overt).

In the sentence, AGR is assumed to occupy an Inflectional position outside the maximal syntactic projection of V. The obvious hypothesis concerning AGR in the noun phrase is that it occupies a similar Inflectional position; i.e., that the

structure of noun phrase and sentence are parallel in Hungarian:

(9)

Sentence:

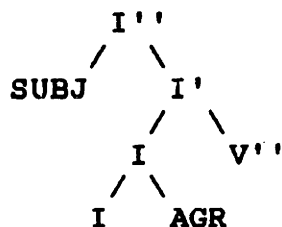

Noun Phrase:

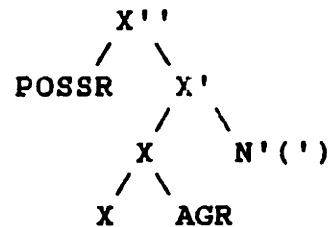

It is not clear what the category X is, beyond saying it is a nominal inflectional category. We cannot say it is Infl, as we would then be unable to distinguish Sentence and Noun Phrase as syntactic categories; but it is more like Infl than anything else.

A batch of questions arise immediately: What is the category X? Is the projection of N which is sister to X maximal? If so, what consequences does that have for the relation between noun and possessor? What consequences does the contemplated structure have for binding theory, predication, and  $\theta$ -theory with respect to the possessor? What consequences does it have for extraction from the noun phrase?

Instead of facing this phalanx of questions, it may seem preferable to suppose that AGR in the noun phrase does not appear in the same sort of position, structurally, as AGR in the sentence. An alternative is that AGR is simply adjoined to  $N^0$ :

(10)

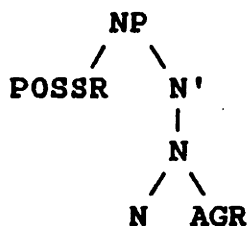

But there are questions that this hypothesis raises as well. Why does AGR coindex only with the possessor, and never with e.g. an object noun phrase? Why do AGR in the noun phrase and in the sentence occupy different positions? This latter question is made especially pointed by the fact that the form of sentential AGR and nominal AGR are frequently very similar. In Central Alaskan Yup'ik, for example, they are identical:<sup>1</sup>

(11)

kiputaa- $\emptyset$	"he bought it"
kiputaa-t	"they (dual) bought it"
kiputaa-k	"they (plural) bought it"
kuiga- $\emptyset$	"his river"
kuiga-t	"their (dual) river"
kuiga-k	"their (plural) river"

Also, AGR in the sentence and AGR in the noun phrase frequently assign the same case: Nominative, in Hungarian; ergative, in Yup'ik or Mayan.

Clearly, the structure given in (9) for the noun phrase in Hungarian and similar languages is the minimal hypothesis, and if the questions it raises can be satisfactorily answered  
-----

1. Yup'ik data drawn from Reed et al. (1977).

-- as I believe they can -- it is eminently preferable to the alternatives.

### 1.3 The Solution

The relevance of the structure of the Hungarian noun phrase to the puzzle of the English gerund becomes clear (if it is not clear already) when we examine the Turkish gerund. Languages which possess a gerundive construction of the Poss-ing type are very rare; in fact, English and Turkish are the only two I have found. Turkish differs from English in that it also happens to be a language with overt AGR in the noun phrase:<sup>2</sup>

(12)

el  
"the/a hand"

sen-in el-in  
you-GEN hand-2sg  
"your hand"

on-un el-i  
he-GEN hand-3sg  
"his hand"

Similar arguments as were forwarded concerning Hungarian lead us to the conclusion that the noun phrase in Turkish is headed by an inflectional element, which hosts AGR, as in (9). The only difference between Turkish and Hungarian is that the nominal AGR in Turkish assigns genitive case, not nominative case.

-----

2. Turkish data drawn from Underhill (1976).

The Turkish gerund is constructed by adding -diğ to a verb stem:

(13)

Halil'-in kedi-ye yemek-Ø ver-me-diğ-i  
 Halil-GEN cat-DAT food-ACC give-NEG-ING-3sg  
 "Halil's not giving food to the cat"

As in English, the Turkish gerund behaves like a noun phrase in its distribution, and in showing genitive case on the subject. On the other hand -- again as in English -- kediyeye yemek vermediği clearly constitutes a verb phrase. Nouns do not take accusative complements in Turkish, for example, any more than in English.

But if we analyze the noun phrase in Turkish as in (9), an extraordinarily simple account for the gerund falls into our lap: under analysis (9), the noun phrase and sentence involve inflectional elements taking projections of N and V, respectively. The exceptionality of the gerund consists therein, that the nominal inflectional element exceptionally takes VP as a complement, instead of a projection of N. (14a) gives the structure of a non-gerundive noun phrase in Turkish, (14b) that of a gerund:

(14)

a.

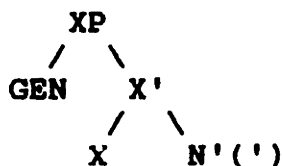

b.

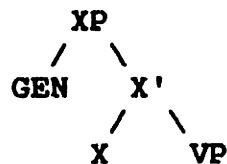

The source of the gerund construction, under this analysis, is a selectional quirk of X -- in the gerundive, X exceptionally takes a verbal rather than nominal complement.

In English, we need only suppose that there is an empty nominal AGR assigning Genitive case, exactly corresponding to the nominal AGR we see overtly in Turkish. With that, we can import into English the analysis we just sketched for gerunds in Turkish, giving us a remarkably simple and principled solution for the puzzle of the gerund. The pieces fit together this way:

(15)

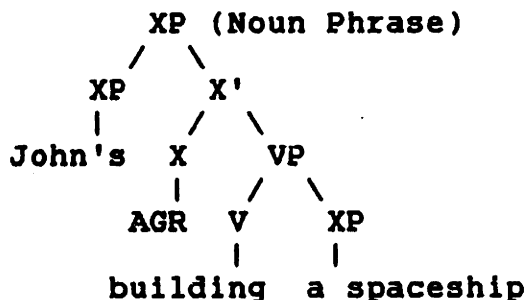

#### 1.4 The Identity of X

The most important loose end in my solution is the identity of the category X. One answer would be that it is a new, previously unrecognized category; it is simply the noun-phrase correlate of Infl, and the only member of category X is the invisible AGR which assigns genitive case. One might

object that it would be impossible for a language learner to learn of the existence of X, if there is never any overt word of that category. For this reason, we would have to assume that X as the category of the noun phrase is supplied by Universal Grammar, and not learned.

If the absence of overt members of category X does not necessarily render the hypothesis of the existence of X untenable, it would nonetheless be much preferable if we could identify a class of lexical elements of category X. The lexical class of category Infl is the class of modals. The question is then, What is the noun-phrase equivalent of the modal? And the only real candidate, as far as I can see, is the determiner. There is some a priori plausibility to taking Determiner to be our mystery category. It is generally assumed that every word projects a phrasal node. If there is a DetP, though, under standard assumptions about the structure of the noun phrase, it never contains any material except the determiner. Where are the complements and specifiers of the determiner? If we assume that X = Determiner, we kill two birds with one stone: we provide category X with lexical instantiations, and we provide determiners with specifiers (the possessor) and complements (a projection of N):<sup>3</sup>

-----

3. I have been somewhat misleading in (16), in that every is the sole determiner which co-occurs with a possessor. All other determiners are ill-formed in this context: e.g. \*John's the book. I discuss this in some detail in Chapter Four.



(16)

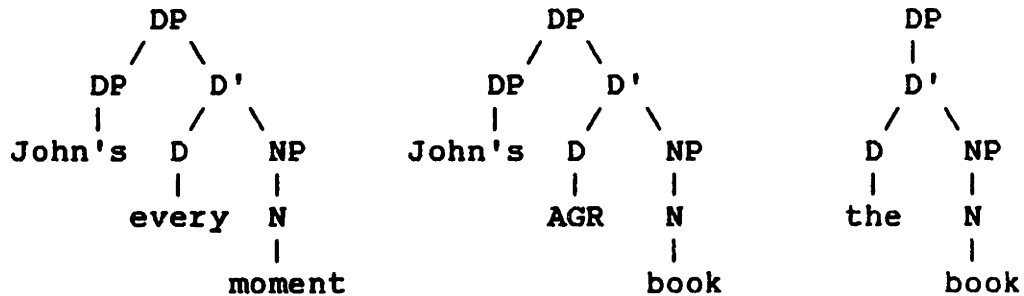

On the basis of this speculation, I will use "D" to denote the mystery category X throughout, and I will call the hypothesis that there is an Inflectional head of the noun phrase, the "DP-analysis".

It is important to note, though, that there are really two questions here, that turn out to be partially independent: (1) Is there an Inflectional head of the noun phrase? and (2) If there is an inflectional head of the noun phrase, is the determiner its lexical instantiation? In the first part of the thesis, though I use the symbol "D" to denote the mystery category X, I am for the most part only concerned with the first question. In Chapter Four, I turn to the second question: whether in fact Determiner = D.

### 1.5 Sentence and Noun Phrase

The solution I have proposed is, in effect, to assign a more sentence-like structure to the English noun phrase than is commonly assumed. This is attractive for conceptual reasons, in addition to the empirical advantages it provides. Verb versus noun is the most fundamental opposition in grammar, and it is appealing to be able to assign the phrases

built on them -- sentence and noun phrase, respectively -- parallel structure.

Similarities between noun phrase and sentence are a recurrent theme in grammatical study. Sentence and noun phrase play a distinguished role in many aspects of grammar: they were the two cyclic nodes, for instance, in earlier versions of transformational grammar; they are also the two categories which freely contain subjects.

On the other hand, there are very substantial differences in noun-phrase and sentence structure, which cannot be ignored. A recurring theme of the thesis is noun-phrase/sentence similarities and differences. I compare noun-phrase/sentence structure in a general way, briefly, for completeness' sake. I am chiefly concerned, however, with a single sentential aspect of the noun phrase: the existence of an inflectional head of the noun phrase.

Finally, while we are on the topic of noun-phrase/sentence parallels, it is perhaps relevant to note that the puzzle of how to put the two pieces of the Poss-ing gerund together is actually the same problem as led to the IP analysis of the sentence. In earlier generative grammar, the node S stood out as an exception to a restrictive version of X-bar theory that requires all phrases to be headed. The solution proposed for fitting the pieces of the sentence together was to raise the status of a minor category, modal, to head of the sentence, and to postulate an entirely abstract

head in sentences which lacked modals. I have simply imported this solution into the noun phrase, to solve the puzzle of the gerund.

## 2 Overview

The organization of the thesis is as follows. Chapter Two is titled "Noun Phrase and Sentence". I begin with a general discussion of parallels that have been seen between sentence and noun phrase, historically, and parallels in their structure within current theory. In section 2, I focus on the question of Infl and AGR in the noun phrase, presenting a survey of languages in which nouns show agreement with their possessors. After considering the evidence for an inflectional head of the noun phrase, I consider how this proposal should be spelled out, in section 3. In section 4, I discuss an issue raised in a new form by the Infl-in-NP analysis, which is of particular relevance to noun-phrase/sentence parallelism: the question of PRO in the noun phrase. Finally, in section 5, I treat some of the differences between noun phrase and sentence.

Chapter Three is devoted to the English gerund. I present in detail the evidence which shows that it is accurate to characterize the gerund as a creature which is half noun phrase, half verb phrase. I discuss previous attempts to solve this riddle, and incorporate aspects of several of these analyses -- especially that of Jackendoff (1977) -- into my own solution. An idea that plays a central role in my solution is that phonologically dependent affixes can behave as independent words, syntactically. Here I rely especially on Baker (1985b).

In Chapter Four, I turn to the question whether determiners are the lexical elements that occupy the D position. I argue that a major motivation for assuming so is that it provides us with enough positions in a "Two-Bar" X-bar theory to account for the quite complex range of distinctions to be found in the structure of the noun phrase specifier. Again, I rely heavily on Jackendoff (1977). I also discuss the adjective phrase at some length, arguing for parallel analyses of adjective phrase and noun phrase.

## Chapter Two

### Noun Phrase and Sentence

#### 1 General Similarities

The similarities between noun phrase and sentence have received much attention in Generative Grammar. In this section, I will consider a few of those similarities in a general way.

Lees 1960, the first doctoral dissertation to come from MIT in linguistics, considered the similarities between sentences and noun phrases. He noted, first, that sentences and noun phrases are similar in their external distribution. Both sentence and noun phrase occur as subject or direct object; both sentence and noun phrase undergo Passive:

(17)

- a. John surprised me.  
That John came surprised me.
- b. I know John.  
I know that John came.
- c. John was known t by many linguists.  
That John came was known t by many linguists.

For this reason, Lees assumed that embedded sentences were dominated by an NP node. For him, nominalization included not

only derived nominal and gerund, but all categories with sentence-like internal semantics, which appear in an argument position. This was a common view in early generative grammar. At least in some contexts, embedded sentences were dominated by noun phrases; sometimes including noun heads, which were deleted before surface structure.

Of course, because two phrases share the same distribution, and are subject to the same transformations, does not mean that they are necessarily the same category. An obvious alternative is that the processes which treat NP and S-bar the same are stated so as to operate on a class of categories, of which NP and S-bar are members. This is the current view: NP and S-bar are the arguments.

NP and S are not only distinguished in being arguments, they were also distinguished as being the two cyclic nodes, in earlier generative grammar. That NP and S should be so distinguished is not surprising. Noun and verb are the two most basic categories; they play a central role in every language. NP and S are their "maximal projections", in an intuitive sense (which I will make precise below). This does not explain why NP and S have precisely the properties they have, but it does lead us to expect them to play a special role in the grammar.

Another way that sentences behave rather like noun phrases is in participating in binding relations. Consider the following examples:

(18)

- a. [that words are meaningless]<sub>i</sub> refutes itself<sub>i</sub>
- b. \*[that words are meaningless]<sub>i</sub> refutes it<sub>i</sub>  
[that John is dead]<sub>i</sub> means that he doesn't know it<sub>i</sub>
- c. \*it<sub>i</sub> proves that Bill thinks [that words are meaningful]<sub>i</sub>

(18) illustrates sentences participating in binding relations that are subject to the binding conditions. (18a), (b), and (c) illustrate binding conditions A, B, and C, respectively.

Lees also noted that certain noun phrases -- namely, derived nominals -- were similar to sentences in their internal structure, and he accounted for these similarities by deriving the noun phrases transformationally from sentences. The internal similarities between sentence and noun phrase will be of much more concern for us than the similarities in their distribution. The most important reason for deriving noun phrases from sentences was to account for the near-synonymy in pairs like the following:

(19)

- a. [Nero's destruction of Rome] dismayed the Senate.
- b. [That Nero destroyed Rome] dismayed the Senate.

No account was given of the interpretation of either sentences or noun phrases, but it was considered that simplex sentences were the domain of interpretation. Hence, to account for the synonymy of the noun phrase in (19a) and the sentential subject of (19b), it was necessary to derive them both from the same simplex sentence, viz., Nero destroyed Rome. The relevant part of the interpretation of simplex sentences is represented in the current theory by  $\theta$ -grids; by assuming



destroy and destruction have the same  $\theta$ -grid, we can dispense with the transformational account of (19).

Sentences and noun phrases are also similar with respect to processes like control and binding. The basic binding facts are the same in sentence and noun phrase:

(20)

John<sub>i</sub> portrayed himself<sub>i</sub>  
John<sub>i</sub>'s portrayal of himself<sub>i</sub>

\*himself<sub>i</sub> portrayed John<sub>i</sub>/him<sub>i</sub>  
\*his own<sub>i</sub> portrayal of John<sub>i</sub>/him<sub>i</sub>

John recommended for [himself<sub>i</sub> to portray himself<sub>i</sub>]  
John recommended [his own<sub>i</sub> portrayal of himself<sub>i</sub>]

\*John recommended for [himself<sub>i</sub> to portray him<sub>i</sub>]  
\*John recommended [his own<sub>i</sub> portrayal of him<sub>i</sub>]

Control facts are also similar in noun phrase and sentence. Adjunct clauses can only be controlled by the subject, not the object:

(21)

- a. John criticized Bill<sub>j</sub> after his<sub>j</sub> talk.
- b. John's criticism of Bill<sub>j</sub> after his<sub>j</sub> talk.
- c. \*John criticized Bill<sub>j</sub> after PRO<sub>j</sub> talking.
- d. \*John's criticism of Bill<sub>j</sub> after PRO<sub>j</sub> talking.

(Both (c) and (d) are fine where John controls PRO.)

When Chomsky introduced a non-transformational account of the thematic similarities between sentence and noun phrase (Chomsky 1970), he also considered the fact that a structural subject-object distinction was necessary in the noun phrase as well as sentence, and introduced the node N-bar -- and X-bar-theory -- precisely for this reason. If we define c-command

as follows:  $\alpha$  c-commands  $\beta$  if neither dominates the other, and the first (branching) node dominating  $\alpha$  dominates  $\beta$ ; then with the introduction of N-bar, the noun phrase and sentence are similar enough in structure to account for the facts of (20) and (21). The "subjects" of both noun phrase and sentence assymmetrically c-command the objects, allowing us to capture the assymetry in binding and control facts.

A point on which sentence and noun phrase remain dissimilar, under Chomsky's account -- which has become the standard account -- is Case- and  $\theta$ -assignment to the subject. In the noun phrase, the head's "external"  $\theta$ -role is assigned internal to its maximal projection. In the sentence, the verb's external  $\theta$ -role is assigned externally. To distinguish internal and external  $\theta$ -assignment, then, it seems we must again use the relation c-command with the first-branching-node definition. Actually, we cannot say first branching node, but first node: otherwise, we would incorrectly characterize the  $\theta$ -role assigned to John in John's graduation (for example) as an internal  $\theta$ -role. If (lack of) c-command by the head is the relation which defines external  $\theta$ -assignment, we must characterize the relation between the node which assigns the external  $\theta$ -role and the recipient of that role as something different. Namely, VP does not c-command the subject of the sentence. The relation between VP and the subject is one of m-command ("m" for "maximal"; the term is from Chomsky (1986a)):  $\alpha$  m-commands  $\beta$  iff neither dominates the other and the first maximal projection dominating  $\alpha$  dominates  $\beta$ . (Of

course, the relation is actually tighter than simply m-command, namely government. Government is a special case of m-command.)

The other point of dissimilarity between sentence and noun phrase is Case-assignment to the subject. In recent work, Chomsky (1986b) assumes that the Case-assigner of the subject of the noun phrase is the noun head. The Case-assigner of the subject of the sentence, on the other hand, is not the verb, but AGR in Infl. In either case, the relation between the Case-assigner and the subject is again one of m-command, not c-command.

I will return to the c-command/m-command distinction in section 3.3. I will argue that the distinction is only necessary because the structural positions standardly assigned to subject of noun phrase and subject of sentence are not sufficiently parallel to account for the similarities in their behavior in a simpler manner. What is of greater interest at the moment, however, is Case-assignment to the subject of the noun phrase. There is evidence that, if taking the noun to be the assigner of genitive case is not obviously inadequate in English, it is not adequate as a universal solution. Namely, there are numerous languages in which Case-assignment to the subject of the noun phrase is much more similar to Case-assignment to the subject of the sentence, than it is in English. This will lead us to a different structure for the noun phrase in these other languages, a structure which is much more similar to the structure of the sentence. The

question which then arises is whether this other structure -- the DP-analysis -- is adequate as a universal characterization of noun phrase structure, if the standard analysis is not. I will show that it is adequate -- in fact, highly desirable -- for English.

## 2 Infl in the Noun Phrase

There are numerous languages in which the noun phrase is much more like the sentence than it is in English, in that the noun phrase in these languages has one or both of the following properties: (1) a possessed noun agrees with its subject in the same way that the verb agrees with its subject, and (2) the possessor receives the same case as the subject of the sentence, rather than a special genitive case.

Schematically:

(22)  
[NP NP<sub>1</sub>-nom/erg N-agr<sub>1</sub> ... ]

Both of these phenomena point to the existence of an AGR in the noun phrase: we see it overtly, and we see its effects in the case assigned to the possessor. If there is an AGR, then the minimal assumption is that there is an Infl-like position which it occupies. If not, we must find an explanation for why AGR occupies different positions in the sentence and noun phrase.

The only alternative to postulating a noun-phrase Infl which suggests itself is that AGR is adjoined to N<sup>0</sup>:

(23)

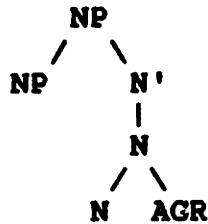

Not only is this less desirable a priori, because it makes it more difficult to account for the constraints on the positions in which AGR appears, but it is also empirically inadequate. Namely, it is reasonable to suppose that the configuration illustrated in (23), with "V" substituted for "N", is the structure of object agreement markers: subject agreement markers are generated in Infl, object agreement markers in the verb. If NP lacks an Infl-like position, we predict that it will only have object agreement markers. In fact, in Yup'ik, nouns have both subject and "object" agreement markers.<sup>4</sup> Thus the hypothesis under which (23) illustrates the only position for AGR in the noun phrase is empirically inadequate, and we are forced to assume an Infl-like position in the noun phrase.

Let us begin, then, by considering the facts from Yup'ik in more detail.

-----

4. The "object" agreement is not agreement with an actual object; I have called it "object" agreement because it is morphologically identical to object agreement in the sentence. See immediately below, section 2.1.

## 2.1 Yup'ik

Yup'ik, a Central Alaskan Eskimo language, provides a textbook example of a language with AGR in the noun phrase. Nouns -- even concrete nouns -- agree with their possessors. The agreement they show is the same agreement morpheme which is found on the verb, sharing even the same suppletions. Furthermore, the subject of the noun phrase takes ergative case, the case of subjects of transitive verbs:<sup>5</sup>

(24)

angute-m kiputa-a-Ø  
 man-ERG buy-OM-SM  
 "the man bought it"

angute-t kiputa-a-t "the men (pl.) bought it"  
 angute-k kiputa-a-k "the men (du.) bought it"

angute-m kuiga-Ø  
 man-ERG river-SM  
 "the man's river"

angute-t kuiga-t "the men's (pl.) river"  
 angute-k kuiga-k "the men's (du.) river"

The parallelism in agreement and Case-assignment is immediately accounted for if we assume parallel structures:

-----

5. "SM" abbreviates "subject agreement marker; "OM" abbreviates "object agreement marker".

(25)

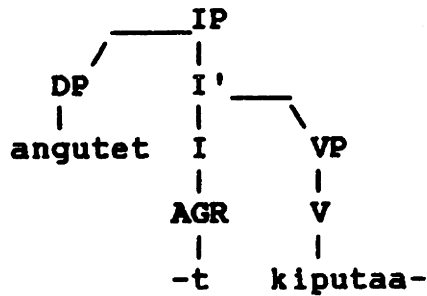

(26)

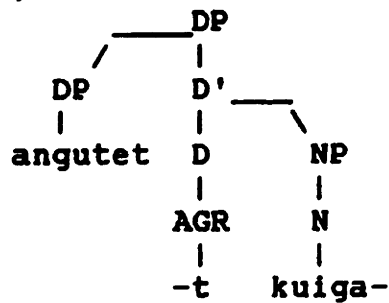

The lexical head, kiputaa- or kuiga-, raises to join to AGR, possibly at PF.

On the other hand, there is a difference between the two structures. Namely, the verb s agreeing with two arguments, whereas the noun has only one argument. This might suggest that the alternative to the DP-analysis illustrated in (23) is in fact correct. Suppose that a given head can only agree with one argument (at d-structure; head-raising may create elements containing multiple agreement markers after d-structure):

(27)

At d-structure, a head can bear at most one AGR element

We could argue that Infl is necessary in the sentence because the verb has two arguments, and two AGR's, but it can only bear one of the AGR's itself: hence the necessity of an Infl



to bear the other AGR. The noun, on the other hand, has only one AGR; thus no noun-phrase Infl is necessary:

(28)

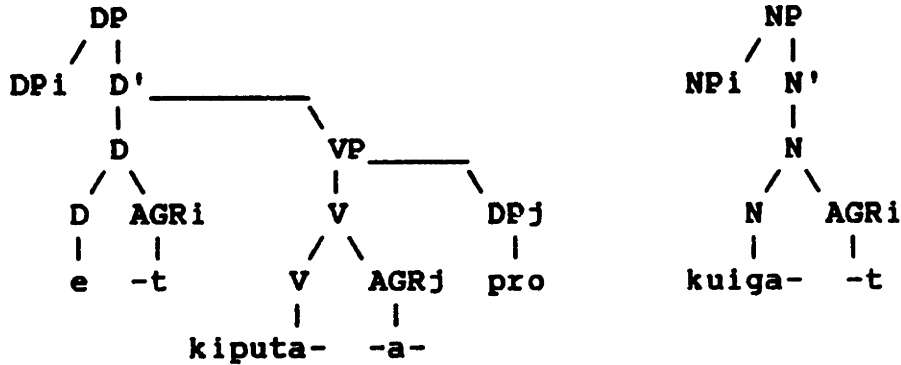

But under this analysis, it is curious that possessed nouns pattern morphologically with transitive verbs, rather than intransitive verbs. Unpossessed nouns pattern with intransitive verbs:

(29)

yurartuq- $\emptyset$  "(s)he dances"  
 yurartu-t "they (pl.) dance"  
 yurartu-k "they (du.) dance"

arnaq- $\emptyset$  "a woman"  
 arna-t "women (pl.)"  
 arna-k "women (du.)"

Despite the fact that unpossessed nouns have no argument, they bear an "agreement" marker, which encodes their own referential features (specifically, number). Morphologically, this "agreement" marker is identical to that on the verb. Let us assume that it is in fact the same element, AGR. To now we have made the implicit assumption that AGR is licensed (loosely speaking) by bearing an agreement relation to an argument. We now need to qualify that assumption:

(30)

AGR is licensed either (A) by bearing the Agreement relation to an argument, or (B) by affixing to the (semantic) head of an argument

Reconsider possessed nouns now. Possessed nouns also show "own" agreement, and this agreement corresponds to object agreement in the verb:

(31)

angute-t kiputa-a-t "the men (pl.) bought it"  
 angute-t kiputa-i-t "the men (pl.) bought them (pl.)"  
 angute-k kiputa-k-t "the men (pl.) bought them (du.)"<sup>6</sup>

angute-t kuig-a-t "the men's (pl.) river"  
 angute-t kuig-i-t "the men's (pl.) rivers (pl.)"  
 angute-t kuig-k-t "the men's (pl.) rivers (du.)"

Thus the original structure given for the noun phrase in (26) should be revised, not to (28), but to the following:

(32)

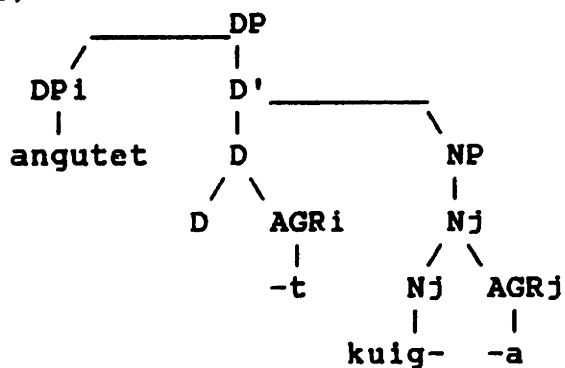

## 2.2 Mayan

A similar paradigm is found in Mayan. I illustrate with data from Tzutujil, drawn from Dayley 1985.

-----

6. -k-t suppletes to -qket.

Tzutujil lacks case marking, but its agreement follows an ergative/absolutive pattern, in that the subject agreement marker for intransitive verbs is identical to the object agreement marker for transitive verbs. For example,

(33)			
x-oq-wari	aspect-1pOM-sleep		'we slept'
x-ix-wari	-2pOM-		'you (pl.) slept'
x-ee-wari	-3pOM-		'they slept'
x-ix-qa-kunaaaj	aspect-2pOM-1pSM-cure		'we cured you (pl.)'
x-∅-e-kunaaaj	-3sOM-2pSM-		'you (pl.) cured him'
x-ee-ki-kuunaaaj	-3pOM-3pSM-		'they cured them'

In the Mayan literature, the "ergative" agreement markers (which I have labelled "SM") are called Type A, and the "absolutive" markers ("OM") Type B. The full paradigm is:

(34)		
B (abs/OM)	A (erg/SM)	
in-	nuu-	
at-	aa-	
∅-	ruu-	
oq-	qa-	
ix-	ee-	
ee-	kee-	

(Ki- is an alternant of kee-.)

Nouns agree with their possessors, and the agreement marker they take is the "ergative" marker (SM):

(35)		
qa-tza7n	'our nose'	
ee-tza7n	'your (pl.) nose'	
kee-tza7n	'their nose'	

As in Yup'ik, we can characterize the Type A AGR as AGR associated with a functional category -- I or D -- and the

Type B AGR as AGR associated with lexical categories.

Tzutujil differs from Yup'ik only in that Tzutujil does not use Type B AGR as "own" AGR on the noun.

### 2.3 Hungarian

In Hungarian as well, similar facts are to be found. Hungarian differs from the other languages we have examined in that it is nominative-accusative, rather than ergative-absolutive. The relevant paradigm in Hungarian is the following (from Szabolcsi 1984, cf. Szabolcsi 1981, 1987):

- (36)
- |       |          |                |                |
|-------|----------|----------------|----------------|
| az    | en       | vendeg-e-m     |                |
| the   | I-nom    | guest-possd-1s | 'my guest'     |
| a     | te       | vendeg-e-d     |                |
| the   | you-nom  | guest-possd-2s | 'your guest'   |
| (a)   | Mari     | vendeg-e-∅     |                |
| (the) | Mary-nom | guest-possd-3s | 'Mary's guest' |

Again, the possessor shows the case of the subject of the sentence -- nominative, in this case, rather than ergative -- and the head noun agrees with the possessor. This agreement is morphologically identical to the verb's subject agreement. On the basis of these examples, in fact, Szabolcsi argues that there is an Infl node in the noun phrase. She argues that Infl is specified either for the feature Tense or for the feature Possessed;<sup>7</sup> the former when it appears in the

-----

7. Horrocks & Stavrou (1985) argue for the same analysis, and the same two features, for modern Greek. Szabolcsi and Horrocks & Stavrou have arrived at the same analysis, apparently independently. (Nouns do not agree with their

sentence, and the latter when it appears in the noun phrase. Her Infl[+Tense] corresponds to our Infl, and her Infl[+Poss] corresponds to our D.

It may cause some concern that the definite article precedes the possessor in (36). If the determiner marks the position of noun-phrase Infl, as we speculated in the introduction, then the possessor in (36) appears in the one place it should not appear. In particular, if a nominal Infl selects NP, and the determiner marks the position of Infl, there are four possible word orders, as follows:

(37)

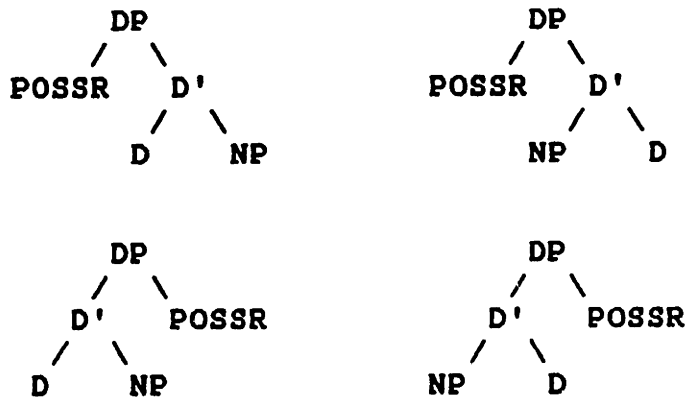

The two orders that are excluded are those in which the Possessor appears between determiner and noun, exactly as in (36).

Szabolcsi notes that az is eccentric in its position, however. All other determiners appear where we would expect them:

-----  
 possessors in Modern Greek; Horrocks & Stavrou were concerned with accounting for extraction from noun phrase in Greek. I will discuss some of their facts shortly.)

(38)

Peter minden kalapja	"Peter's every hat"
Peter ezen kalapja	"Peter's this hat"
Peter melyik kalapja	"Peter's which hat"

Szabolcsi argues that az, unlike the other determiners, is not a noun-phrase Infl, but a noun-phrase Complementizer: she argues that the noun phrase in Hungarian parallels the sentence in structure not only in possessing an Inflectional head, but also in possessing a nominal Complementizer projection beyond that.

I will not consider this extension of the basic idea of noun-phrase/sentence parallelism in any detail, but I would like to briefly examine the facts. Since there are also facts from Greek which bear on the question, I will devote a separate section to it. The question of the position of lexical determiners in Hungarian I take up again in section IV-1.1.c.

#### 2.4 Digression: Comp in the Noun Phrase

Szabolcsi points out that there is a second kind of possessor in Hungarian, which takes dative case and precedes az:

(39)

Peter-nek a kalapja	
Peter-DAT the hat	
"Peter's hat"	

This possessor differs from the nominative possessor in that it can be freely extracted, whereas the nominative possessor

cannot be extracted at all. Szabolcsi argues that the difference between the two possessors is that the nominative possessor is the specifier of a noun-phrase Infl, whereas the dative possessor is the specifier of a noun-phrase Comp. The dative possessor can be extracted, and still properly govern its trace, whereas the trace of the nominative possessor is too deep inside the noun phrase to be properly governed from outside.

Horrocks & Stavrou (1985) also argue for a Comp "escape hatch" in modern Greek, though not on the basis of a dative possessor. Horrocks & Stavrou note that many extractions from noun phrase that are ungrammatical in English are good in Greek:

(40)

pyon<sub>i</sub> akuses [t<sub>i</sub> fimi [t<sub>i</sub> oti [apelisan t<sub>i</sub>]]]]  
 who hear-2s the story that dismiss-3p

\*who did you hear [the story [that they dismissed t]]

[to kokino]<sub>i</sub> mu ipes pos aghorases [t<sub>i</sub> to forema t<sub>i</sub>]]  
 the red me-dat said-2s how bought-2s the dress

\*the red you told me that you bought the t dress

He correlates this with the fact that there is a "topic" position in the noun phrase in Greek:

(41)

a. to vivlio [tu Chomsky]  
 the book [the-gen Chomsky]  
 "Chomsky's book"

to endhiaferon [ya to arthro afto]  
 the interest [in the article this]  
 "the interest in this article"

to forema [to kokino]  
 the dress [the red]  
 "the red dress"

b. [[tu Chomsky]<sub>i</sub> [to vivlio t<sub>i</sub>]]  
 "Chomsky's book"

[[ya to arthro afto]<sub>i</sub> [to endhiaron t<sub>i</sub>]]  
 "the interest in this article"

[[to kokino]<sub>i</sub> [to forema t<sub>i</sub>]]  
 "the red dress"

He claims that this topic position is the specifier of a noun-phrase Comp (K), which also serves as an escape hatch for extraction out of noun phrase in Greek:

(42)

[to kokino]<sub>i</sub> mu ipes pos aghorases [kp t<sub>i</sub> [DP to forema t<sub>i</sub>]]

If Horrocks & Stavrou's and Szabolcsi's claim that there is a noun-phrase Comp can be verified -- and the evidence, at least on the cursory examination we have given it, seems to indicate so -- it constitutes a strong case that the noun phrase and sentence are parallel in possessing functional heads, and bolsters the more modest proposal which I wish to defend, namely, that there is a noun-phrase equivalent of Infl.



## 2.5 Turkish

Turkish also shows an agreement element on possessed nouns, even on concrete nouns. Consider the following examples (from Underhill (1976)):

(43)

- a. el  
"the/a hand"
- b. (sen-in) el-in  
you-GEN hand-2s  
"your hand"
- c. (on-un) el-i  
he-GEN hand-3s  
"his hand"

In Turkish, the possessor has genitive case, not nominative or ergative. Also, the agreement paradigm differs from that found on matrix verbs. The paradigms are:

(44)

Verbal:	Nominal:
1s -(y)Im	1s -Im
2s -sIn	2s -In
3s (-Dİr)	3s -(s)I(n)
1p -(y)İz	1p -İmİz
2p -sİnİz	2p -İnİz
3p (-Dİr)(lEr)	3p -lErİ(n)

(The capitalized vowels are specified only [ $\pm$ H]); their other features are filled in by a process of vowel harmony. The capitalized "D" is a dental stop unspecified for voicing.)

If nominal AGR differs from verbal AGR in Turkish in its morphological form, and in the Case it assigns, it nonetheless behaves like a true AGR in that it licenses pro-drop. (In

fact, though we have not mentioned it to now, the nominal and verbal AGR's in all the languages we have discussed to now license pro-drop. This is not a necessary property of AGR, but it is a typical property, cross-linguistically.) Kornfilt (1984) shows carefully that the noun phrases in Turkish that can be pro-dropped are all and only those whose features are marked by either nominal or verbal AGR: i.e., subject of the sentence, possessor, and object of certain postpositions.<sup>8</sup> Though other arguments can be dropped, they cannot be dropped freely, but only under restrictive discourse conditions. Kornfilt argues that pro-drop is not involved in such cases.

Kornfilt also shows that nominal AGR assigns genitive case. For example, the two are mutually dependent: a noun phrase cannot bear genitive case unless it agrees with a nominal AGR, and if there is any overt noun phrase which agrees with a nominal AGR, it must bear genitive Case:

-----

8. These postpositional phrases have the surface syntactic appearance of noun phrases and possibly are to be analyzed as such: e.g. masa-nın alt-ı table-GEN under-3s "under the table".

(45)

- a. pasta-nın bir parça-sı  
cake-GEN a piece-3s  
"a piece of cake"
- b. pasta-dan bir parça  
cake-ABL a piece  
"a piece of cake"
- c. \*pasta-nın bir parça
- d. \*pasta-dan/∅ bir parça-sı

Turkish also has English-type gerunds. In fact, all subordinate clauses are gerundive. There are two types, known in the literature as "verbal noun" and "nominalization". The verbal noun involves the affix -mE/-mEk; the nominalization involves the affix -DIğ (non-future) or -(y)EcEğ (future). There is a difference in meaning, which Underhill characterizes as "action" (verbal noun) vs. "fact" (nominalization). Their syntax is virtually the same, though: the nominalizing morpheme is attached to the verb stem, after which nominal suffixes -- nominal AGR, case markers -- can be attached. The complements and adjuncts the nominalized verb takes are identical to those which it takes as a matrix verb, with the exception that the subject appears in genitive case, not nominative case. Examples:

(46)

- a. i. Halil her dakika iş-im-e kariş-ir  
 Halil every minute business-1s-DAT interfere-3s  
 "Halil constantly interferes in my business"
- ii. Halil'-in her dakika iş-im-e kariş-ma-sı  
 Halil-GEN every minute business-1s-DAT interfere-ING-3s  
 "Halil's constantly interfering in my business"
- b. Halil'-in gel-diğ-in-i bil-iyor-um  
 Halil-GEN come-ING-3s-ACC know-PROG-1s  
 "I know that Halil is coming"
- c. Kedi-ye yemek-ø ver-me-diğ-iniz doğru mu?  
 cat-DAT food-ACC give-NEG-ING-2p true Q  
 "Is it true that you did not give food to the cat?"

In (46c), for example, the verb give assigns the same array of cases it assigns in matrix sentences; there are no underived nouns which take a comparable array of arguments. Kornfilt argues that AGR is the head of these embedded sentences: that their structure is exactly parallel to that of the non-embedded versions. She argues further that the structure extends to possessive noun phrases: they, too, are headed by the AGR which appears on the possessed noun and assigns genitive case to the possessor. She claims that possessive noun phrases and sentences are both IP. Under Kornfilt's account, then, non-possessive noun phrases differ in syntactic category from possessive noun phrase, the former being NP, the latter IP. This problem can be eliminated by assuming exactly what we have argued to now: sentence and noun phrase are both headed by inflectional elements, Infl in the sentence, D in the noun phrase. The difference between possessed and non-possessed noun phrases is the presence or absence of AGR, not a difference of syntactic category.

The Turkish facts are especially interesting for two reasons: they show that, at least in some languages, there is an AGR in the noun phrase which assigns Genitive case, pointing the way toward an analysis in which there is a similar, but abstract, AGR in English noun phrases; and secondly, the Poss-ing type of gerund appears to be rare cross-linguistically, but Turkish shows that it is not simply a quirk of English. I will have a great deal more to say about the Poss-ing gerund in the Chapter III; in III-4.3.b. and 6.2.b. I return briefly to Turkish gerunds.

### 3 The DP-Analysis

#### 3.1 Concepts and Terminology

I have presented the essence of the position which I will defend in the rest of this thesis: that the noun phrase is headed by an Infl-like category in many languages, including English, and probably universally. I would like to spell out my hypothesis carefully here, and define my terminology.

##### 3.1.a. "Inflectional" Elements

First, I have spoken of an "Infl-like" node, or an "inflectional element" in the noun phrase, without defining precisely what I mean. I consider the node Infl to be typical of a class of elements, that I have elsewhere called functional elements, in contrast with thematic elements.<sup>9</sup> They are typically called "non-lexical categories"; I resist this designation because I assume that complementizers and modals, etc., have lexical entries like any other word. The two uncontroversial functional elements are Complementizer and Inflection.

The primary property of functional elements is this: they select a unique complement, which is not plausibly either an argument or an adjunct of the functional element. C selects IP, and I selects VP. C and I do not take typical arguments

-----

9. Abney (1986).

(noun phrases, prepositional phrases, subordinate clauses), not even as an option. C and I do not take multiple arguments, but only one IP, or one VP, respectively. And semantically, at least on an intuitive level, C and I contrast with N, V, A, etc., in that they do not describe a distinct object from that described by their complement. In That John hit the ball, for instance, the VP hit the ball (intuitively) describes an act of hitting, the IP John hit the ball describes an act of hitting, and the CP that John hit the ball also describes an act of hitting. This intuition is a major motivation for the continuing debate over whether V is not actually the head of the sentence. In the "passing on" of the descriptive content of their complements, functional heads contrast with thematic heads. The noun phrase the ball describes a ball; when that noun phrase is the complement of a verb, as in hit the ball, the VP emphatically does not describe a ball, but an action; in this case, an act of hitting.

We see, then, that the relation between a functional element and its complement, and the relation between a thematic element and its complement, contrast starkly. I assume that there are syntactic relations between all heads and their complements or adjuncts, by which those complements and adjuncts are licensed -- a minimal condition on a well-formed syntactic structure is that every node be licensed by some such relation. These relations divide into two classes: thematic relations, on the one hand, including at least  $\theta$ -

assignment and the relation by which adjuncts are licensed (there is no consensus about what precisely that relation is); and functional selection, or f-selection, on the other hand. The syntactic relation between a functional element and its complement is f-selection. F-selection corresponds semantically to the "passing on" of the descriptive content of the complement. The relation between a non-functional element and its complement is a thematic relation; for this reason, I call non-functional elements "thematic" elements. I distinguish functional elements from thematic elements by means of the syntactic category feature [+F]. Functional elements are [+F], thematic elements are [-F].

There are a large number of properties that typify the functional elements, in contrast with the thematic elements, and justify our treatment of them as a natural class. I will discuss these properties in the next section. I would like to point out here that these additional properties do not define the class of functional elements; functional elements are defined as those elements which possess the feature [+F]. There are atypical functional elements, just as there are atypical elements within virtually every grammatical category. This does not call into question the existence of the classes, it only means that in some cases, it is difficult to decide how to classify a particular item.



### 3.1.b. C-Projection and S-Projection

The distinction between f-selection and thematic relations allows us to capture the intuition that the verb is the head of the sentence, without supposing literally that  $S = VP$ . Let us distinguish two notions of projection, which we may call c-projection ("category projection", i.e., "syntactic" projection) and s-projection ("semantic" projection). (These designations are of course modelled on Pesetsky's (1982) "c-selection" and "s-selection".) A node's c-projection is its syntactic projection in the usual sense: the maximal c-projection of  $V$  is  $VP$ ,  $I$   $IP$ , and  $C$   $CP$ . A node's s-projection path is the path of nodes along which its descriptive content is "passed along". The maximal s-projection of  $V$  is  $CP$ , via  $IP$ ; likewise the maximal s-projection of  $I$  is  $CP$ , and the maximal s-projection of  $C$  is  $CP$ . Formally:

(47)

- $\beta$  is an s-projection of  $\alpha$  iff
- a.  $\beta = \alpha$ , or
  - b.  $\beta$  is a c-projection of an s-projection of  $\alpha$ , or
  - c.  $\beta$  f-selects an s-projection of  $\alpha$

To illustrate graphically, the c-projection set of the lower  $V$  is circled in (48a), and its s-projection set is circled in (48b):

(48)

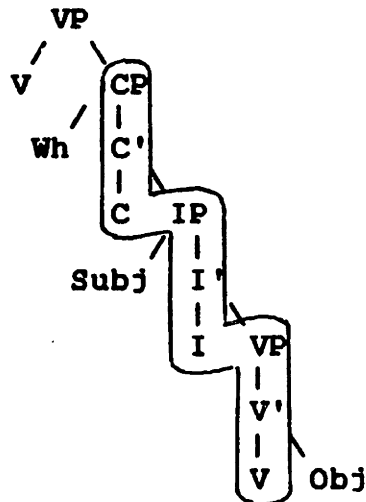
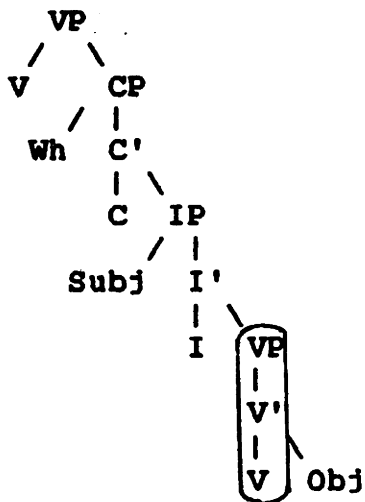

## 3.1.c. "D" vs. "Det"

Returning to the noun phrase, what it means to propose an "Infl-like" node as head is that there is a functional element, a [+F] category, which heads the noun phrase. I have designated this category D, and will continue to do so, but I must stress that the existence of a functional head of the noun phrase, and the question whether the determiner is the head of the noun phrase, are two separate questions. Except in a handful of passages, I will be concerned only with the former question -- whether there is a functional head of the noun phrase -- in this chapter and the next. In Chapter Four I turn to the second question: whether or not determiners are lexical items of category D, the way modals are items of category I.

It is easy to conflate the two issues. The Infl node is the site of both lexical "Infl's" -- i.e., modals -- and of AGR. This correspondence is not necessary, however. An

account in which there were no independent morphemes of syntactic category Infl would not be incoherent. As it happens, there is some evidence that modals are of category Infl: they are in contrastive distribution with overt AGR (i.e., only when a modal is present do finite verbs fail to mark agreement with the subject); they are in contrastive distribution with infinitival to (which is itself in contrastive distribution with AGR, overt or non-overt). It is an open question whether similar evidence can be produced to support the claim that lexical determiners occupy the same position as AGR in the noun phrase (assuming there is an AGR in the noun phrase).

For the purposes of the next two chapters, then, the designation "D" is entirely arbitrary; it is a hypothetical syntactic category which is [+F], but distinguished from Infl and Comp in that it belongs to the nominal system, not the verbal system: i.e., D is [+N,+F], whereas Infl and Comp are [-N,+F]. D is the site of AGR in the noun phrase. By "Determiner", on the other hand, I mean the lexical determiners, leaving open the question whether in fact D = Determiner. "Det" is synonymous with "Determiner".

A few more notes on terminology: under the DP-analysis, the noun phrase is DP, not NP. DP is subject to the Case Filter and  $\emptyset$ -Criterion; DP undergoes Passive and Wh-Movement, leaving behind DP-traces. When I write "NP", I mean the maximal (c-)projection of N. NP under the DP-analysis corresponds to N-bar in the standard analysis. I never use

"NP" simply as an abbreviation for "noun phrase" in a pretheoretic sense. When I wish to refer to the noun phrase, without presupposing an analysis, I always write out "noun phrase": this refers to DP, under the DP-analysis, and NP, under the standard analysis.

### 3.1.d. Syntactic Features

I would like to conclude this section by spelling out my assumptions about the feature composition of syntactic categories in a little more detail.

Anticipating conclusions of later chapters, let us take the noun-verb distinction to be the most fundamental categorial distinction; adjectives clearly group with nouns in English (though not in all languages); prepositions less clearly group with verbs, but probably so. Adhering to standard notation, the feature that captures the noun-verb dichotomy is thus [±N]. I am not persuaded that adjectives and verbs have something in common that nouns and prepositions lack, however, in the way that they are grouped by the feature [±V]. Certainly the adjective-verb vs. noun-preposition dichotomy is in no way on a par with the noun vs. verb or functional vs. thematic dichotomies. There are two major motivations for having the feature [±V]: (1) to predict that there are four major syntactic categories, when taken in conjunction with [±N], and (2) to permit a treatment of passive participles as unspecified for [±V].

As concerns the second point, in section III-6.3 I argue for a very different view of passive participles, which replaces any need for considering passive participles to be verb-adjective hybrids, unspecified for [+V].

As concerns the first point, there are in fact clearly many more syntactic categories than N, V, A, and P in English. We can also add at least Q, Adv, Det, Infl, Comp, Conj. And A and P are not so major that they appear in all languages. Some languages lack English-type adjectives, or nearly so (Swahili is a famous example). Other languages appear to lack a separate class of adpositions, using nouns instead (the Mayan languages, for instance).

Further, there are two distinct categories, with very different syntactic properties, which meet notional criteria of adjective-hood (i.e., they typically denote physical attributes, emotional states, etc.). In some languages, "adjectives" (in the notional sense) are syntactically very similar to -- even a subcategory of -- verbs; in other languages they behave syntactically like nouns. Many languages have both syntactic types, with a preponderance of one or the other.<sup>10</sup> It appears, then, that there are at least two syntactic categories that are notionally adjectives, one essentially nominal ([+N]), as in English, and one essentially verbal ([-N]). If so, and if both syntactic types of

-----

10. See Dixon (1982) for a detailed notional characterization of "adjective" and a survey of language types with regard to the syntactic expression of "adjective" notions.

adjective constitute major categories, then we have five major categories, not four.

These are my reasons for being skeptical of the standard [+N+V] category tetrachotomy. I do not claim that I have proven in this brief discussion that there is no feature [+V]; nonetheless, I do not adopt it. I do assume nouns are distinguished from adjectives, and prepositions are distinguished from verbs, but I do not assume that these two distinctions necessarily have anything in common.

I assume two major features, [+F], [+N], which define four major classes of syntactic categories.<sup>11</sup> I also assume that there are minor features that distinguish subclasses of syntactic categories, but I will not argue here for a particular set of minor features. Unless a given minor feature cuts across major syntactic-category classes, the question of the identity of the minor features is not very interesting. (A candidate for a minor feature which cuts across major syntactic-category classes is that which distinguishes nouns and adjectives. In section IV-3, I examine the possibility that this feature also distinguishes between main verbs and auxiliaries: i.e., that N:A::V:Aux.)

-----

11. I do not assume that categories are necessarily defined by their feature compositions. I assume that features define classes of categories, but I leave open the question whether it is possible for two categories to have all feature specifications in common, yet remain distinct categories.

The four major classes of syntactic categories are as follows:

(49)	[-F]	[+F]
	[-N] V, Aux, P(?)	I, C
	[+N] N, A, Q, Adv	D

These classes appear not to be exhaustive. For example, conjunctions like and, or, appear to be [+F], but unspecified for [+N]: they appear equally freely in both nominal and verbal systems. Likewise, P seems to straddle the line between functional and thematic elements; one might wish to treat it as unspecified for [+F].

### 3.2 Functional Selection

In this section, I would like to consider the properties of functional categories in more detail.

The distinction between thematic and functional categories is a very venerable one. Aristotle, in his Poetics, makes a major category cut between complementizers, conjunctions, etc., on the one hand, and nouns, verbs, and adjectives, on the other. The traditional Japanese grammarian, Akira Suzuki, in his Genryo Yonsyu-Ron ("On Four Parts of Speech": 1824), distinguishes four syntactic categories: noun, verb, adjective, and particles (case

markers, auxiliary verbs, etc.). The first three are si, the last, zi.<sup>12</sup>

The distinction between functional and thematic elements is also important in psychology. Children acquire functional elements later than thematic elements. Also, in certain aphasias, the ability to process functional elements is lost, while the ability to use and understand thematic elements survives.

There are a number of properties that characterize functional elements, in contradistinction to thematic elements. Like all major grammatical distinctions, there is a substantial gray area between thematic and functional elements; there are thematic elements with some properties of functional elements, and vice versa, and some items that are very difficult to categorize at all. This does not nullify the distinction, however. And even though none of the following properties are critical for classification as a functional element, that does not mean that it is false or naive to ascribe these properties to the class of functional elements. The properties which characterize functional elements, then, are:

1. Functional elements constitute closed lexical classes.
2. Functional elements are generally phonologically and morphologically dependent. They are generally

-----  
 12. My source on Suzuki is Makino (1968).



stressless, often clitics or affixes, and sometimes even phonologically null.

3. Functional elements permit only one complement, which is in general not an argument. The arguments are CP, PP, and (I claim) DP. Functional elements select IP, VP, NP.
4. Functional elements are usually inseparable from their complement.
5. Functional elements lack what I will call "descriptive content". Their semantic contribution is second-order, regulating or contributing to the interpretation of their complement. They mark grammatical or relational features, rather than picking out a class of objects.

The final characteristic, concerning the semantics of functional elements, is in some sense the crucial characteristic. It is the property consistently chosen by traditional grammarians to characterize functional elements. Aristotle defines functional elements simply as "words without meaning", in contrast to thematic elements, "words with meaning". For Suzuki, the first property of a si (thematic element) is that "it denotes something"; the first property of a zi is that "it denotes nothing; it only attaches 'voice of heart' to si" (quoted in Makino (1968:12)).

"Descriptive content" -- what functional elements lack -- is a phrase's link to the world. If someone utters the word

"ball", and there is a ball in view, the default assumption is that that ball is being described by the utterance. This is the sense in which the noun ball has descriptive content. Verbs also have descriptive content in this sense. For instance, if John hits Bill, and the word "hit" is uttered, it is clear what action is being described. On the other hand, with the utterance of a functional element -- say, the modal will, or the complementizer if -- it is not possible to pick out some bit of the world in the same way. Words with immediacy and concreteness are those with descriptive content; they are the words that survive when language is reduced to bare bones, as when one is attempting to communicate with a non-speaker of one's language.

More formally, thematic elements are roughly those which denote a predicate of type  $\langle e, t \rangle$  (i.e., functions from entities to truth values: first-order predicates). This is uncontroversial with regard to common nouns. Verbs, however, are not usually considered to be exclusively single-place predicates. Under most accounts, there are at least transitive verbs of type  $\langle e, \langle e, t \rangle \rangle$ , in addition to intransitives.<sup>13</sup> My characterization of thematic elements as those with  $\langle e, t \rangle$  denotations can be maintained, though, if we

-----

13. On the other hand, predicates of type  $\langle e, \langle e, t \rangle \rangle$  (and  $\langle e, \langle e, \langle e, t \rangle \rangle \rangle$ , etc.) are first-order predicates, in contrast with e.g. determiners, which are of type  $\langle \langle e, t \rangle, \langle \langle e, t \rangle, t \rangle \rangle$ : i.e., which take predicates as arguments. If one finds objectionable the extension of Davidson's ideas I present immediately below in the text, thematic and functional elements can still be distinguished as first-order vs. second-order predicates.

adopt a somewhat extreme form of Davidson's event semantics. Let us assume that, as in my informal discussion, verbs are single-place predicates over events.<sup>14</sup> Hit, for example, does not denote  $\lambda x, y(x \text{ hit } y)$ , nor even  $\lambda e, x, y(e \text{ is/was an event of } x \text{ hitting } y)$  (as Higginbotham (1986b) assumes), but rather  $\lambda e(e \text{ is/was an event of hitting})$ . For thematic elements, then, this view involves a complete divorcing of semantic arguments and syntactic arguments. No syntactic argument of a verb is a semantic argument of it. Syntactic arguments (e.g., agent, patient) are related to the verb via  $\theta$ -roles -- functions from events to objects. For example, the VP hit a boy would have the denotation  $\lambda e(e \text{ is/was an event of hitting } \& \exists x[\text{boy}(x) \& \text{Patient}(e)=x])$ . I take  $\theta$ -assignment to be a 3-place syntactic relation, holding among a  $\theta$ -assigner, a  $\theta$ -receiver, and a  $\theta$ -role. In general, the denotation of any phrase-marker of the form [<sub>a</sub> b c], where  $\text{Theta}(b, c, \theta)$ , is  $\lambda e([\text{b}](e) \& \theta(e)=[\text{c}])$ .<sup>15</sup>

In contrast to thematic elements, functional elements take predicates as arguments: they are functors. Following Higginbotham (1985), we may assume that Infl is an existential quantifier over predicates of events. The denotation of an I-bar [I VP] is true iff  $\exists e([\text{VP}](e))$ . In similar fashion,

-----

14. In a very broad sense of "event", which means something closer to "situation" than "event" in the usual sense. In particular, I assume that stative verbs and the like denote events, in the intended sense of "event".
15. There are a number of matters I am glossing over. I give a formal, and much more detailed, account in Abney (in preparation).

determiners take two predicates as arguments; the characterization of determiners (specifically, quantificational determiners) as relations between sets is from Barwise and Cooper (1981), cf. Higginbotham & May (1980). The denotation of the noun phrase the boy, for instance, is  $\lambda X[\lambda Y(\text{boy}'(y))=Y(\text{boy}'(y))]$ , if  $|\varphi(\text{boy}'(y))|=1$ , undefined otherwise.

### 3.3 Two Notions of Command

Before I turn to a preliminary consideration of the "second half" of the DP hypothesis -- i.e., that determiners occupy the position of D -- I would like to discuss one advantage that accrues to the DP hypothesis simpliciter. The DP-analysis allows us to re-unify the notion of c-command. For most purposes, the definition of c-command which is required is one in which the c-domain of a node is the first maximal category which dominates that node. But with respect to binding in the noun phrase, a simplified version of Reinhart's (1978) original "branching node" definition is necessary. Consider the noun phrases of (50).

(50)

- a. [ $\alpha$  picture of himself]
- b. The city's [ $\alpha$  destruction t ]
- c. His [ $\alpha$  picture of himself]
- d. Its [ $\alpha$  destruction t ]
- e. \*Himself's [ $\alpha$  picture of himself]
- f. \*Himself's [ $\alpha$  destruction t]

If we assume the "maximal category" definition of c-command, and assume that  $\alpha$  is not maximal, the subject and object

positions mutually c-command. So we would expect that (a), John's picture of himself, would violate Condition C of the binding theory, as the r-expression John is c-commanded and bound by himself. Similarly, his picture of himself should violate Condition B, and (e) and (f) should arguably be good, with each anaphor binding the other. For this reason, Chomsky 1986a adopts two command relations: c-command, with the "branching node" definition, and m-command, with the "maximal category" definition. We can avoid this duplication of relations by supposing, as in the DP-analysis, that  $\alpha$  is in fact maximal. Then a noun's complement would fail to m-command its subject, as desired.

It is conceptually disagreeable to have one general notion of command -- m-command -- and another special notion of command for binding theory, solely to be able to account for binding in the noun phrase. But matters are in fact worse than this. Consider again these adjunct control examples from section 1:

(51)

- a. John criticized Bill<sub>j</sub> after his<sub>j</sub> talk  
John's criticism of Bill<sub>j</sub> after his<sub>j</sub> talk
- b. \*John criticized Bill<sub>j</sub> after PRO<sub>j</sub> talking  
\*John's criticism of Bill<sub>j</sub> after PRO<sub>j</sub> talking

We can account for this paradigm if we assume that the after adjunct is attached high enough that the coindexed elements, Bill and his, or Bill and PRO, do not c-command each other. This does not prevent the pronoun from taking Bill as antecedent, but it does block control of PRO by Bill (51b).

Control of PRO is possible only when the antecedent c-commands PRO.

Under the standard analysis, this entails that c-command, not m-command, is the requisite notion of command, inasmuch as we can attach the after adjunct no higher than daughter of NP, in which case the only node intervening between Bill and PRO is N-bar.

This is problematic because it would predict that it would be impossible for a direct object of a verb to control an adjunct within VP. In the structure (52), NP does not c-command IP; hence control should be blocked:

(52)

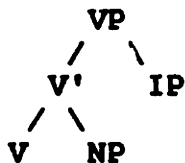

But there is reason to believe that control is in fact not blocked in this configuration. Consider the following examples:

(53)

- a.  $I_i$  gave the gun to Mugsy $_j$  PRO $_i$  to get rid of it
- b.  $I_i$  gave the gun to Mugsy $_j$  PRO $_j$  to get rid of it
- c. \* $I_i$  gave the gun to Mugsy $_j$  PRO $_i$  to get rid of
- d.  $I_i$  gave the gun to Mugsy $_j$  PRO $_j$  to get rid of

We can account for this paradigm by assuming there must be mutual c-command between the controller and the adjunct. When there is no operator, the adjunct can attach either under IP (53a) or under VP (53b), with corresponding differences in the

identity of the controller. When the object position is bound by an empty operator, on the other hand, there must be mutual c-command between the adjunct and the antecedent of the empty operator, viz., the gun. Hence, only the VP attachment is available, and (53c) is ungrammatical.

If the adjunct is under VP, however, it is still an adjunct, and for that reason cannot be under V-bar. Thus we are brought to the conclusion that (53b) and (53d) have the structure shown in (52), with control between the object and the adjunct. This conclusion runs directly counter to the hypothesis that the subject-object asymmetry in control in the noun phrase (51) is to be accounted for by attaching the adjunct outside N-bar. It is perfectly compatible with the DP-analysis, however, where the uniform definition of command is in terms of maximal projections, and "N-bar", but not V-bar, is a maximal projection.

### 3.4 Det as Head

In this section, I would like to consider, in a preliminary way, the hypothesis that the determiner is the lexical instantiation of D.

The primary motivation for putting determiners in the position of D is to allow us to maintain a general, restrictive version of X-bar theory. First, it is widely assumed (in GB circles) that phrase structure rules should be

entirely eliminated. If we eliminate the phrase structure rule (54):

(54)  
 NP --> {  $\begin{matrix} \text{NP} \\ \text{Det} \end{matrix} \}$  N-bar

we must explain what constrains the determiner to appear in the position it occupies, i.e., under the standard analysis:

(55)

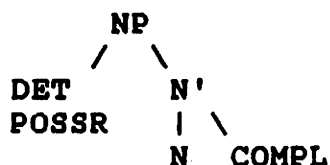

In current GB-theory, an account for the distribution of some element  $\alpha$  generally takes the following form:  $\alpha$  appears only where it is licensed. It is licensed minimally by some semantically-interpreted relation it bears to some other element --  $\theta$ -assignment is the quintessential such licensing relation. Additional relations may impose additional restrictions.

There is apparently a selectional relation between the determiner and noun, that provides a likely candidate for the licensing relation that determines the distribution of determiners. Determiners only occur in noun phrases,<sup>16</sup> and nouns often require a determiner (e.g., singular count nouns).

-----

16. With some exceptions. That, for instance, also occurs in AP's: that big. But it is sufficient here that there exist determiners, such as the, every, which only appear in noun phrases.



The question is then the nature of the relation between determiner and noun. We might assume that N selects Det (alternatively, DetP):

(56)

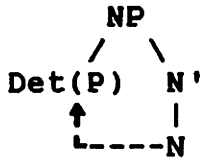

The only real models we have for such a relation are the relation between I and its subject, or that between C and its subject (following Fassi Fehri (1980), Chomsky (1986a), in assuming that fronted wh-elements occupy Spec of C). However, N clearly does not  $\theta$ -assign Det(P), nor is there any likely source for a movement which lands Det(P) in Spec of N. If determiners were "subjects" of N, we would expect e.g. that paw to be interpreted as if it were \*that's paw. But determiners are neither arguments nor adjuncts.

Another possibility is that Det(P) modifies N, and selection is imposed via this modification relation (i.e., Det(P) is only capable of modifying N's):

(57)

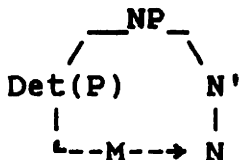

This would put Det(P) on a par with adjective phrases. Determiners differ from adjectives in important ways, however. Adjectives, even in prenominal position, clearly head full

phrases, as is evident from the fact that they take their own specifiers:

(58)  
a [<sub>AP</sub> nearly as devastating] attack

DetP never contains any material except Det. Corresponding to this, AP's appear in positions other than the prenominal position: postnominally, as complement of be, seem, etc., as heads of small clauses. Some Det's never appear outside of the noun phrase -- e.g. the, a -- and others, when they stand alone, behave exactly like noun phrases:

(59)  
[<sub>DetP</sub> that] was a nice idea  
I would like [<sub>DetP</sub> some]  
John thought about [<sub>DetP</sub> those]

This last fact suggests that DetP in fact is the noun phrase. This leads us to a third hypothesis, that Det selects a projection of N, not vice versa:

(60)

```

      DetP
     /  \
    Det  --> NP
           |
           N
  
```

In this case, there is a ready model for the relation between Det and NP, namely, f-selection. Det has all the properties of a functional element. It constitutes a closed lexical class, it is often phonologically weak, and inseparable from its "complement" (e.g., the and a), and it lacks "descriptive content". If Det belongs to the same class of elements as

Comp and Infl -- as it certainly appears to -- the minimal assumption is that it is licensed by the same relation, viz., f-selection.<sup>17</sup> The analysis (60) allows us to account for the licensing of Det without inventing a new kind of relation; the licensing of Det generalizes with that of Infl and Comp.

There are further X-bar theoretic considerations that make the Det-as-head analysis attractive. First, D is no longer defective with respect to X-bar-theory, but projects a phrasal node, and takes a complement, like other categories. This is in keeping with the analysis of I and C which has emerged in recent years (see Chomsky 1981, Stowell 1981, Chomsky 1986a), in which I and C are taken to participate fully in the X-bar system. In fact, the Det-as-head analysis is almost forced if we wish to suppose generally that "non-lexical" categories are not defective with respect to X-bar theory.

Another X-bar theoretic advantage of the Det-as-head analysis is that determiner and possessor no longer appear in the same position. There is a tendency in current views of X-bar theory toward the position that there are  $x^0$  positions, on the one hand, and  $x^{\max}$  positions, on the other, and the two

-----

17. I am being a little sloppy here in my use of the word "license". Technically, Det is not licensed by NP under the analysis (60); rather, NP is licensed by Det. Det is licensed by being the head of DetP, which is now the noun phrase, and licensed in the ways that we have always assumed noun phrases are licensed. Det is "licensed" by f-selection only in the sense that the analysis (60) provides a place for Det in the network of licensing relations.

are completely disjoint. In the formulation of the X-bar-schema given in Stowell 1981, the Spec position (like complement positions) can only be filled with maximal projections, not  $X^0$ 's. An  $X^0$  cannot fill an  $X^{\max}$ -position, and vice versa. This separation of  $X^0$  and  $X^{\max}$  positions is preserved and strengthened in Chomsky's recent work: an  $X^{\max}$  can substitute only into an  $X^{\max}$  position, and an  $X^{\max}$  can adjoin only to an  $X^{\max}$ , mutatis mutandis for  $X^0$ . The Det-as-head analysis allows us to adopt this strong version of the X-bar schema, without confronting us with the embarrassing question of why DetP never contains any material except Det.

With regard to complements and specifiers, we now have a very symmetric system. Only functional categories (i.e., C, I, D) freely have (overt) subjects:<sup>18</sup> \*[<sub>IP</sub> (John) [<sub>VP</sub> was Bill seen]], \*[<sub>DP</sub> (John's) [<sub>NP</sub> Bill ('s) picture]] -- if we assume that only functional categories can host AGR, this fact is immediately accounted for. All and only subject positions are landing sites for movement, where substitution is involved: [<sub>CP</sub> who [<sub>IP</sub> Bill saw t]], [<sub>IP</sub> Bill [<sub>VP</sub> was seen t]], [<sub>DP</sub> the city's [<sub>NP</sub> destruction t]].

Another factor which makes a parallel syntactic treatment of Det and Infl attractive is their semantic similarity. The function of the determiner is to specify the reference of a  
-----

18. The qualification "freely" is meant to exclude cases where ECM into, say, Spec of AP or Spec of PP (under Stowell's (1981, 1982) account of small clauses) permits subjects to (exceptionally) appear in these categories.

noun phrase. The noun provides a predicate, and the determiner picks out a particular member of that predicate's extension. The same function is performed in the verbal system by tense, or Inflection. The VP provides a predicate, that is, a class of events, and tense locates a particular event in time. In Higginbotham's terms, Infl binds the VP's event place, in the same way that the Determiner binds the open place in NP.

Though the idea that the Determiner is the head of the noun phrase seems rather odd at first, the conceptual considerations I have just sketched make it seem a very natural, even necessary development of current views of phrase structure. I will discuss the Det-as-head analysis in more detail in Chapter Four. I have introduced it here because I will occasionally make reference to it in the remainder of this chapter, and in the next.

As a bibliographic note, I would also like to point out that the Det-as-head analysis, and the analysis in which there is an Inflectional (i.e., functional) head of the noun phrase, are also not so odd that others have not thought of it before me. When I first began exploring the possibility, I thought it quite novel, but I have since discovered comparable proposals in Brame 1981, 1982, Hale 1980, Hellan 1986, Horrocks & Stavrou 1985, Hudson 1984, Kornfilt 1984, Kuroda 1986, Reuland 1985, Szabolcsi 1981, 1984. For the most part, these authors appear to be unaware of each other's work.

The determiner as head of the noun phrase is also, of course, a very well-established tenet in the Montagovian semantic tradition (Montague 1974), and receives particular attention in the Generalized Quantifier proposal of Barwise & Cooper 1981, cf. Higginbotham & May 1980.

### 3.5 The Position of 's

In this section, I would like to consider how Case is assigned to the possessor under the DP-analysis. It is generally assumed that the 's is involved in Case-assignment to the possessor. But what precisely is the position of 's, and what is its relation to the possessor?

#### 3.5.a. Morphological Case Affix

One possibility that can be immediately eliminated is that 's is a morphological case-marking. As is well-known, 's cliticizes to the entire subject noun phrase; it does not appear simply as an affix on the head:<sup>19,20</sup>

- 
19. If words like mine, your, are suppletive from I's (or me's), you's, then cliticization of 's feeds morphological processes. This is not problematic.
  20. The text examples are not perfectly well-formed. Later, in a different context, I mark them as marginal. I think they are sufficiently good, though, to illustrate the claim that 's is not simply a case affix which attaches to the head of the noun phrase.

(61)

- a. [a cousin of mine]'s house  
 b. [the man in the store]'s sudden disappearance

## 3.5.b. Determiner

Another possibility (suggested to me by Richard Larson) is that 's in fact occupies the determiner position: i.e., that the structure is the following:

(62)

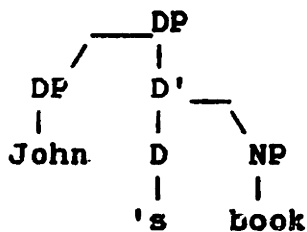

's appears only pre-nominally in noun phrases (DP's) because it is in fact a D. The non-co-occurrence of possessors and determiners is not problematic, because possessors do co-occur with a determiner, namely 's. Case-assignment to the possessor is parallel to Case-assignment in the sentence: 's corresponds to AGR in assigning Case to its subject. Possessors fail to co-occur with other determiners, because other determiners are unable to assign Case.

## 3.5.c. Postposition: N Case-Assigns

A third possibility is that 's is a postpositional Case-marker. Let us assume Chomsky's 1986b characterization of Case-assignment in the noun phrase. He assumes the standard analysis of the noun phrase, in which the noun is head. 's is

not present at d-structure. It is also not the assigner of Case to the possessor. Rather, the noun assigns genitive case to the possessor.<sup>21</sup> Genitive case, in contrast to nominative and accusative case, is an inherent case, and is assigned at d-structure. However, even though it is assigned at d-structure, it must be "realized" at s-structure; this is the purpose of 's-insertion. 's is the "realization" of genitive case.

This analysis is not readily transplantable into the DP-analysis structure. It is crucial for Chomsky that the noun govern the position in which 's appears: this is a consequence of his Uniformity Condition on inherent Case-assignment, by which he intends to account for the lack of raising in the noun phrase (among other things). In the DP-analysis, though, the noun does not govern the position of the possessor. This problem might be gotten around by introducing a notion of s-government, which differs from government only in that the elements which a node  $\alpha$  can s-govern belong to the domain of its ( $\alpha$ 's) maximal s-projection, rather than that of its maximal c-projection. Unless it can be shown that

-----

21. To account for genitive case assignment in the Poss-ing gerund, Chomsky assumes VP can assign genitive case when it heads a noun phrase. This is highly problematic. We have already discussed how making VP the head of the Poss-ing gerund violates X-bar theory, strictly interpreted. Further unanswered questions are why VP is the only Case-assigner which is a maximal projection, and why VP doesn't assign genitive case in other places, such as to the subject of infinitives. The DP-analysis permits a much less ad hoc account of gerunds, as we have seen, and as will be spelled out in detail in the next chapter.



s-government plays some independent role in the grammar, however, an analysis which did not require it would be preferable.

Quite apart from the DP-analysis, an objection to Chomsky's analysis is that it does not explain why 's only appears with possessors. If 's is the realization of genitive Case, it is explicable why it can only appear in the context of genitive case assignment, but this would still permit 's appearing post-nominally (\*destruction the city's) or in AP's.

On the other hand, if 's can only be inserted under government by N, it is difficult to explain why it can appear in gerunds: John's baking the cake. (As mentioned in footnote 21, Chomsky assumes that VP exceptionally assigns genitive case here; this move seems to me to be entirely ad hoc.)

#### 3.5.d. Postposition: AGR Case-Assigns

Alternatively, we could take 's to be a postposition marking genitive Case assigned by AGR, not N:

(63)

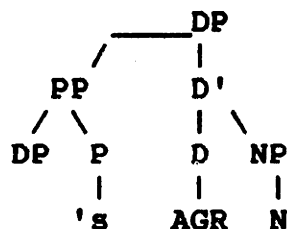

An apparent problem for the postpositional analysis is that the determiner never actually appears, but is always empty when there is a possessor. This would seem to make the

postpositional analysis and the DP-analysis incompatible. One possibility is that the disappearance of the determiner is actually an instance of a more general process of determiner elision. If this is the case, it turns this apparent liability into an advantage. Under an analysis in which determiner and possessor occupy the same position, there is no determiner at all, not even a deleted one, making it difficult to explain why possessed noun phrases have a definite interpretation. Under the elision analysis, we can assume that the determiner that has been deleted is definite.

Evidence for other cases of determiner elision is not hard to find. In English, consider the noun phrases:

(64)

- a. [a hundred] nights  
\*[hundred] nights
- b. \*those [a hundred] nights  
those [Ø hundred] nights

A is required before hundred unless a determiner proceeds, when it is elided.

A similar process is found in Papago:<sup>22</sup>

(65)

- a. g 'a'al  
the children
- b. g ha-je'g  
the 3p-mother  
"their mother"

-----  
22. Data from K. Hale (p.c.). Cf. Hale et al (1977).

- |                                                                                           |                                                                           |
|-------------------------------------------------------------------------------------------|---------------------------------------------------------------------------|
| c. *g [g 'a'al] ha-je'ë<br>the the children 3p-mother                                     | c.' *'am [g miisa] weco<br>the the table underneath                       |
| d. g t ha-je'ë ... [g 'a'al]<br>the 3p-mother ... the children<br>"the children's mother" | d.' 'am t weco [g miisa]<br>the underneath the table<br>"under the table" |
| e. g [∅ 'a'al] ha-je'ë<br>the children 3p-mother<br>"the children's mother"               | e.' 'am [∅ miisa] weco<br>the table underneath<br>"under the table"       |

Two consecutive determiners, as in (65c,c'), are ungrammatical. Either the possessor can be extraposed, as in (65d,d') (other material in the sentence can intervene between the noun phrase and the extraposed possessor), or the inner possessor's determiner can be elided. Evidence that the bracketting in (65e') is as shown, and not ['am miisa] weco is that 'am is a special locative determiner that only occurs with "postpositions" like weco: \*'am miisa is ill-formed.

One piece of evidence weighing against the elision analysis is that relative clauses are licensed by the, but are prohibited with possessors: the book that I read, \*John's book that I read. If there is an elided the with the possessor, -- i.e., if the structure is actually John's the book that I read prior to PF -- this is unexpected.

An alternative to the elision analysis is that there is a co-occurrence restriction in English which prevents nominal AGR from occupying a D node which is already occupied by a lexical determiner. Then overt possessors cannot co-occur with determiners, because the possessors would not receive Case.

A final question is whether the genitive marker 's is present at d-structure, or inserted after d-structure. If it is present at d-structure, we must tread lightly vis-a-vis passive in the noun phrase. Object of postposition is generally assumed not to be a valid landing site for movement; if we take 's to be a postposition, this would apparently be incompatible with noun-phrase passive. We can avoid this problem by taking 's to be equivalent to a case-marker in languages that overtly mark case. For concreteness, let us assume case-markers differ from "true" adpositions in that the phrase headed by the case-marker is like a noun phrase with respect to  $\theta$ -assignment. Case-markers are functional elements that inherit the descriptive content -- and the referential index -- of their complement, whereas "true" adpositions are thematic elements that  $\theta$ - and Case-assign their complements. I will denote case-markers as "K", in contrast with "true" adpositions, i.e., "P". Further, let us suppose that an argument must be a maximal s-projection. This means that a DP is an argument when it is not the complement of a K, but DP is not an argument when it is the complement of K. Thus, assigning a  $\theta$ -role to XP but not to the DP "buried" inside it does not violate the  $\theta$ -criterion. Finally, case-markers bear the case features of the argument they head; these case features must be licensed by and coincide with the Case actually assigned to the argument. If [DP 's] is a KP, we can generate it as complement of a noun, receiving the internal  $\theta$ -role assigned by that noun, and raise it to Spec of D to receive genitive Case from AGR: in other words, the

characterization of K I have just given permits us to treat 's as a postpositional K, without forcing us to abandon the idea of passive in the noun phrase.

It seems, then, that coherent accounts can given whether we take 's to be present at d-structure or inserted in the course of the derivation. For conceptual reasons, I prefer a theory in which d-structure can be "read off" of s-structure; hence a theory which eschews insertion operations. For this reason, I prefer the analysis in which 's is present at d-structure -- though it will not be crucial for anything I have to say in what follows.

There is also little evidence clearly favoring the 's-as-case-marker analysis over the 's-as-determiner analysis of section 3.5.b., or vice versa. I prefer the 's-as-case-marker analysis for two reasons: (1) historically, 's was a case morpheme; synchronically, analyzing it as a case marker is more intuitive than analyzing it as a determiner; and (2) the 's-as-determiner analysis does not generalize to languages like Hungarian, where possessors and lexical determiners (i.e., ACP and lexical determiners) do co-occur; the 's-as-case-marker analysis does generalize to these languages.

### 3.6 Appendix: Selection of DP

An obvious objection to the DP-analysis is that unlike C and I, D does not appear to be selected by a matrix head; but as is well-known, selectional restrictions are imposed on N.

This would argue against D as the head of the noun phrase. But note, first, that the kinds of selectional restrictions imposed on nouns are purely semantic, and not structural in the way the restrictions imposed on C and I have been argued to be. Namely, the kinds of selectional restriction imposed on object noun phrases are also imposed on subject noun phrases. Restriction to animate nouns is one such example, as illustrated in the classic sentences (66):

(66)

- a. i. Sincerity frightens John
- ii. \*John frightens sincerity
- b. i. \*Sincerity fears John
- ii. John fears sincerity

The subject, however, is not governed by the verb, which imposes the restriction. Thus, though it is unexplained why verbs do not select for determiners, this is actually a general problem: verbs do not select for any part of the noun phrase in the way they select for C and I.

In regard to the selection of determiners, there is a very interesting paradigm from Navaho that merits consideration. There is a small class of Navaho verbs which select for semantic categories typically assigned to the determiner, as illustrated in (67), (68). (Perfective stem given. All Navaho examples drawn from Young & Morgan 1971.)

(67)

- a. hi "to kill one thing"  
tseed "to kill two or more things"
- b. ghod "to run, of one being"  
chaa' "to run, of two beings"  
jee' "to run, of three or more beings"
- c. han "to throw one thing"  
tl'iid "to throw two or more things"

(68)

- a. 'aad "to lose, toss, a flat, flexible object"  
deel "to lose, toss, a slender, flexible object"  
ne' "to lose, toss, a round or bulky object"
- b. tsooz "to handle a flat, flexible object"  
la "to handle a slender, flexible object"  
'a "to handle a round or bulky object"  
tlee' "to handle mushy matter"  
ta "to handle a slender, stiff object"
- c. keez "to fall, of a slender, stiff object"  
heezh "to fall, flow, of mushy matter"  
ts'id "to fall, of a hard object"  
tlizh "to fall, of an animate object"

The distinctions made in (68) are distinctions often encoded in determiners, i.e., in class markers such as are found in many East African languages.

What is most striking is that, unlike the semantic selectional restrictions found in English, these restrictions are imposed only on the object. There are no transitive verbs in Navaho which select for the number of their subject in this fashion.

There are two facts that make this paradigm only a curiosity, however. First, though the selected argument is always a sole argument, it is probably not always an underlying object: run, for instance, is not a typical

unaccusative meaning. Secondly, and more importantly, Navaho does not actually mark any of these distinctions -- object class or number -- in its determiner. Despite this, though, I think that the Navaho paradigm does show that selection of determiner is not a possibility excluded by Universal Grammar.



## 4 PRO in the Noun Phrase

A question on which the DP-analysis bears is whether there can be a PRO subject of the noun phrase. The DP-analysis involves making the noun phrase sentence-like in such a way as to "make room" for a PRO subject. Certain curiosities about noun phrase behavior, which indicate it is as if there was a PRO in the noun phrase, have long been noted. In this section, I review and expand on these facts.

Under the standard analysis, PRO in the noun phrase is not a possibility, without significantly altering certain assumptions about PRO: if the noun phrase is the maximal projection of N, its subject position is always governed by N, hence PRO is always excluded.

On the other hand, the DP-analysis permits PRO in the subject position of the noun phrase. In particular, since D is not a lexical category, we expect it not to be a governor; hence its subject position may be ungoverned (depending on whether there is an external governor, and whether DP is a barrier to government). In principle, then, there may be a PRO in the subject position of DP.

### 4.1 PRO book

The standard analysis appears to make the right predictions for examples like \*(the) PRO book, as observed by Aoun & Sportiche (1981). I wanted (the) book cannot mean

either "I wanted my book", or "I wanted someone's book". This indicates that there is neither a controlled nor arbitrary PRO possessor present.

However, there is an explanation for the non-occurrence of PRO, independent of the non-governability of PRO. It is very likely that the "possessor"  $\theta$ -role is not assigned by the noun. Possession is possible with every concrete noun, not varying from item to item as  $\theta$ -roles do. It has been claimed by some that 's is the assigner of the possessor  $\theta$ -role. I would like to state it slightly differently: the possessor  $\theta$ -role is assigned by D, but only when 's is present. This comes to the same thing if 's is a D: we claim that 's is the only determiner that assigns the possessor  $\theta$ -role. If 's is a case-marker, we can suppose that there is a unique empty D which AGR is able to occupy; this empty D is the assigner of the possessor  $\theta$ -role.

If this story is correct, PRO book violates the  $\theta$ -Criterion: there is no role for PRO, as there is no 's.<sup>23</sup> On

-----

23. Under the account in which 's is a case-marker, we are forced to take the somewhat curious position that the empty D that assigns the possessor  $\theta$ -role (call it " $D_e$ ") cannot appear without AGR. If  $D_e$  satisfies count nouns' need for a determiner, and if it could appear without AGR, we would expect it to be able to assign the possessor role to PRO in \*[PRO  $D_e$  book]. Note that it is not sufficient simply to say that  $D_e$  is a governor, independently of whether it has an AGR or not. If  $D_e$  can appear without AGR, we would predict that \*[ $D_e$  book], without a PRO, is well-formed: the count noun book has an acceptable determiner. If we claimed that \*[ $D_e$  book] is bad because  $D_e$  obligatorily assigns a  $\theta$ -role, but there is nothing available in \*[ $D_e$  book] to assign it to, then we run into problems with examples of noun-phrase passive like the

the other hand, if 's does appear, there is either an AGR with it, or it is itself equivalent to AGR (on the 's-as-determiner story) in being a Case-assigner. Thus PRO's book is also ill-formed, in this case because PRO is governed by AGR.

An apparent weakness in this account is a problem with one of my assumptions, namely, that  $D_{AGR}$  is the assigner of the possessive  $\theta$ -role. There are apparent recipients of the possessive  $\theta$ -role which appear as complements of N, as in the social security number of your spouse, cf. your spouse's social security number. If the possessive  $\theta$ -role is assigned by D, how can it show up inside NP? I would like to suggest that the of involved in these examples is a true preposition which assigns the possessive  $\theta$ -role. In other words,  $D_{AGR}$  assigns the possessive  $\theta$ -role, but it is not the only word which does so.  $D_{AGR}$  and of are unable to co-occur for the same reason that two verbal adjuncts which assign the same  $\theta$ -role cannot co-occur: \*your spouse's social security number of the big lout is equivalent to \*the ship was destroyed by an Exocet missile with that fiendish weapon. Of your spouse in the social security number of your spouse is thus distinct from of your spouse in the deception of your spouse. The former is a PP, the latter a KP. The former is a  $\theta$ -assigner, the latter not. The distinction is underlined in the fact

-----  
city's  $D_e$  destruction, where we would like to say that  $D_e$  Case-assigns, but crucially does not  $\theta$ -assign, the city.

that the  $\theta$ -assigner imposes special restrictions on its objects which are not imposed by the case marker. Consider:<sup>24</sup>

(69)

- a. the battle-cry of the Visigoths  
\*the battle-cry of John
- b. the elimination of the Visigoths  
the elimination of John

## 4.2 $\theta$ -theory

### 4.2.a. Derived Nominals

The first argument that there is in some cases a PRO subject of DP comes from  $\theta$ -theory. The  $\theta$ -Criterion, in its simplest form, predicts a recipient for the external  $\theta$ -role in action nominalizations like the destruction of the city, and in fact an agent is understood. Ceteris paribus, we would expect the agent to be syntactically realized:

(70)

[<sub>DP</sub> PRO the [<sub>NP</sub> destruction of the city]]  
 $\swarrow$   
 $\theta$

We can assume that NP assigns the external  $\theta$ -role of destruction to PRO via predication.<sup>25</sup> For cases such as Caesar's [<sub>D</sub> AGR] [<sub>NP</sub> destruction of the city], I wish to make  
 -----

24. Whatever this restriction is, it is not phonological (i.e., "no monosyllables"), as it might seem at first: OK the battle-cry of fools.

25. Counter Williams (1981), I assume that predication is possible in the noun phrase, precisely because I assume, counter Williams, that there is a maximal-category predicate (NP) within the noun phrase. More on predication below, section 5.1.

a similar claim: Caesar is Case-assigned by  $D_{AGR}$ , but it is  $\theta$ -assigned by NP. The empty D in the possessive construction assigns the possessor  $\theta$ -role optionally, I assume. If the possessor receives a  $\theta$ -role from N (either externally, as in Caesar's destruction of Carthage, or via an internal trace, as in the city's destruction t),  $D_{AGR}$  does not assign the possessor  $\theta$ -role, and the subject receives only one  $\theta$ -role, as desired.

#### 4.2.b. Rationale Clauses

Roeper 1984 presents evidence that "implicit agents" behave as if they are syntactically present, which supports the claim that implicit agents are indeed present as PRO.

Consider:

(71)

- a. the PRO destruction of the city [PRO to prove a point]
- b. \*the city's destruction [PRO to prove a point]

(72)

- a. the PRO review of the book [PRO to prove a point]
  - b. \*the book's review [PRO to prove a point]
- (Roeper 1984, exx. 103,104)

Roeper argues that the rationale clause is licensed only if the Agent role is syntactically realized. In the (a) sentences, the first PRO receives the Agent role, licensing the rationale clause. In the (b) sentences, on the other hand, the passivized object fills the subject position, excluding PRO. Hence the Agent is not realized, and the rationale clause is not licensed.

We cannot say simply that there must be an Agent in the matrix clause, and it must control the subject of the rationale clause. First, there are rationale clauses even where no control is involved:

(73)

Jesus died that we might live  
John cleaned off the table for Mary to have room to work

Let us assume that rationale clauses are licensed by a relation  $R$  between the matrix and subordinate situations, where the interpretation of  $R(\alpha, \beta)$  is "the purpose of  $\alpha$  is  $\beta$ ". Where the subject of the rationale clause is PRO, though,  $R$  is subject to a condition on control. Where the matrix situation is an action (as opposed to a state), there must be an agent, and it must control the lower PRO. Where the matrix situation is stative, on the other hand, this is not the case:

(74)

Roses<sub>i</sub> are thorny PRO to protect them<sub>i</sub> from gardeners

Not only is there no agent, but the sole argument, roses, also does not control PRO: if we claimed that roses controlled PRO, then we would have a Principle B violation between PRO and them.

In these cases, as observed by Lasnik (1984), it does not appear that PRO has an arbitrary interpretation. Rather, the controller appears to be the matrix situation. Thus (74) means that the fact of roses being thorny protects them from gardeners.

It is not necessary that the situation be the controller in statives, however. Consider:

(75)

Sharks are streamlined PRO to cut through the water better

Here sharks is the controller; situations (in particular, that of sharks being streamlined) cannot cut through water.

The proper generalization appears to be this: with a matrix action (= a [-stative] situation), there must be an agent, and it must control the rationale clause. With a matrix state (= a [+stative] situation), any argument, including the situation itself, may be the controller.

This predicts, contrary to Roeper, that rationale clauses should in fact be possible with middles, if middles can be made [+stative]. This can be accomplished by making the matrix sentence generic:

(76)

Continents sink PRO to replenish the earth's supply of magma

The distinction between this example and Roeper's ungrammatical \*the boat sank to prove a point (Roeper 1984 ex.3a) is that the matrix sentence in Roeper's example describes an individual event, hence is [-stative]; and thus an agent is required.

Finally, Roeper notes that in contrast to passive in nominals and middles, passive in the sentence does not nullify rationale-clause licensing:

(77)

The boat was sunk to collect the insurance

Roeper argues that the Agent role is in fact syntactically realized, on the passive morphology. Baker, Johnson, and Roberts 1985 propose that the passive morpheme -en behaves like a subject clitic. Alternatively, we can analyze this implicit argument as a PRO as well, if we adopt a "bi-clausal" analysis of passive, roughly:

(78)

the boat was [PRO<sub>i</sub> -en [vp sink t]] [PRO<sub>i</sub> to collect the insurance]

↑                                  ← Ag                                                                                  |

---

The matrix PRO (or the -en, under the Baker, Johnson, & Roberts proposal) bears the agent role, and licenses the rationale clause. In nominals and middles, the morphology is absent, hence the embedded passive "clause" with its PRO is absent, the Agent role cannot be assigned, and the rationale clause is not licensed:

(79)

\*[the boat] 's D [NP destruction t] [to collect the insurance]

↑

---

The long and short of this discussion is that, when restricted to [-stative] cases, Roeper's original observation still holds: rationale clauses require a syntactically-realized controlling agent argument to be licensed. PRO provides such a controller in the nominal, though not in the "passive" nominal, where PRO is displaced by the fronted object.



### 4.3 Control Theory

A second argument that has been forwarded in favor of a PRO in subject of the noun phrase is provided by control theory. Consider:

(80)  
Any attempt [PRO to leave]  
The desire [PRO to succeed]

In the first example, the attempter is necessarily the same as the leaver, and mutatis mutandis for the second example. This is explained if we assume that a configuration of obligatory control is involved, and that there is a PRO subject of attempt (desire).

A problem is that similar facts arise even where control cannot be involved. For example, in an attempted escape, the attempter is necessarily the escaper, but we would not wish to say there is a control relation between two PRO subjects. Apparently, there is a purely semantic "control" phenomenon, following from the meaning of attempt.

### 4.4 Binding theory

Binding theory also provides arguments for the existence of PRO in the noun phrase. The simplest examples are the following:

(81)

- a. [pictures of themselves] bother the men
- b. [criticism of oneself] is necessary in moderation

The anaphors themselves, oneself, lack overt antecedents.

Principle A insists that a local antecedent exist; therefore, it must be non-overt. A PRO subject of noun phrase is by far the most likely candidate.

There is an alternative explanation one might suggest for (81a). Consider:

(82)

- a. [pictures of each other] were given t to the men
- d. I gave [pictures of each other] to the men

Suppose that the men c-commands each other in (82b).

Principle A is satisfied in the normal way, even without a PRO in pictures of each other. If we assume that binding theory is applied to a configuration in which noun phrases are (at least optionally) reconstructed into their d-structure positions, (82a) is grammatical because it is identical to (82b) at the relevant level of representation. In like manner, we might explain the grammaticality of (81a) by assuming that the d-structure is in fact (83):

(83)

e bother the men [pictures of each other]

This explanation does not extend to (81b), however; thus (81b) remains as evidence for a noun-phrase PRO.

Parallel to (81b) are examples like

(84)  
 \*PRO<sub>i</sub> criticism of them<sub>i</sub>

where the criticiser(s) cannot be them. This can be accounted for as a Principle B violation, if there is a PRO subject of criticism.

Further examples are due to Ross (1967):

(85)  
 a. PRO<sub>i</sub> the realization that he<sub>i</sub> has broken the law  
 b. PRO<sub>j</sub>,\*<sub>i</sub> the realization that John<sub>i</sub> has broken the law

In (85a), the realizer can be he. In (85b), on the other hand, the realizer cannot be John, but must be someone else. This is explicable as a Principle C violation, assuming there is a PRO present.

It is also possible to construct violations of Strong Crossover, though the judgments are rather subtle. Consider the following two discourses:

(86)  
 John won in small claims court.  
 The judge believed PRO<sub>i</sub> the assertion that Bill cheated him<sub>i</sub>.

(87)  
 I can't remember who it was who won in small claims court.  
 Who<sub>i</sub> did the judge believe PRO<sub>j</sub>,\*<sub>i</sub> the assertion that Bill cheated t?

In (86), it is possible that John is speaking for himself: that he is the asserter. In (87), it does not seem that the speaker can be assuming that the asserter and the cheated were the same person, whose identity is under question. (There is a mild CNPC violation in (87), making it

less than fully grammatical, but that is irrelevant to the point under discussion.)

Again, consider these examples from Chomsky 1986b:

(88)

- a. They<sub>i</sub> heard [stories about each other<sub>i</sub>]
- b. They<sub>i</sub> heard [(PRO) stories about them<sub>i</sub>]
- c. They<sub>i</sub> told [stories about each other<sub>i</sub>]
- d. \*They<sub>i</sub> told [(PRO) stories about them<sub>i</sub>]

Assuming Chomsky's binding theory, the judgements are as would be expected, except for the (b) sentence, They told stories about them. Since the whole sentence is the governing category for them, we would expect a violation of Condition B, just as in (d). On the other hand, if PRO optionally appears in the noun phrase, the noun phrase becomes the governing category. Thus, sentence (b) becomes acceptable, where PRO is not coindexed with them. And in fact, the only interpretation available is one in which they heard someone else's stories about them. In sentence (d), on the other hand, the PRO must be coindexed with the subject, hence with them, because of the meaning of tell. Thus (d) cannot be saved by allowing the optional PRO to appear.

This argument is actually not consistent with an earlier argument, at least on the face of it. It is crucial to the argument from paradigm (88) that PRO be optional. If PRO is optional, however, then we lose our earlier explanation of why they cannot be the criticisers in criticism of them. I will not pursue the issue here, beyond suggesting that it may be relevant that criticism is a derived nominal, while story is

not. Perhaps PRO is required with criticism, to receive the external  $\theta$ -role, but not with story, because story is not deverbal, hence lacks a  $\theta$ -grid. Story can acquire an external  $\theta$ -role by a kind of back-formation process, treating it as if it were deverbal. This process is presumably optional, and somewhat marginal.

#### 4.5 Arguments Against PRO in the Noun Phrase

##### 4.5.a. Yesterday's Destruction

Williams 1985 presents several arguments against having PRO in the noun phrase. One argument is that, in the noun phrase, temporal adjuncts can fill the subject position, under certain circumstances. When they do so, they presumably displace PRO, yet rationale clauses are still licensed, indicating that the licensing of rationale clauses is not evidence for the presence of PRO after all:

(89)

yesterday's D<sub>AGR</sub> destruction of the ship [to collect the insurance]

I would like to claim that PRO is in fact present in (89): that the structure is:

(90)

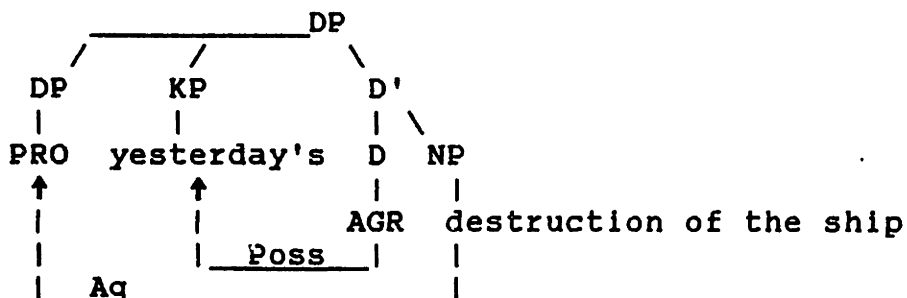

Let us suppose that PRO only "counts" as governed when it participates in some relation with a governor. In (90),  $D_{AGR}$  Case-assigns and  $\theta$ -assigns yesterday, but it has no relation to PRO, hence does not govern PRO.<sup>26</sup> In this, (90) crucially differs from (91):

(91)

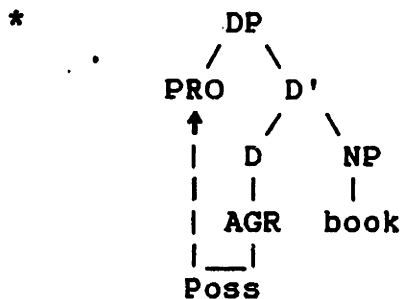

In (91), PRO is  $\theta$ -assigned by  $D_{AGR}$ , hence governed. In (90), PRO has no relation to  $D_{AGR}$ . PRO is  $\theta$ -assigned by NP, receiving the external  $\theta$ -role of destruction, and of course PRO requires no Case. NP does not qualify as a governor,

-----

26. I assume that yesterday receives the possessor  $\theta$ -role from  $D_{AGR}$ . (90) is interpreted as "the destruction belonging to yesterday", "the destruction of yesterday". This highly abstract sense of possession appears to be well within the range of associations that qualify as "possession"; the range of relations qualifying as "possession" is notoriously broad.

being a maximal projection: else PRO would be governed by VP in infinitives, as well.

#### 4.5.b. Obligatoriness of Control

The major argument against having a PRO in the noun phrase is that the "PRO" in the noun phrase differs from sentential PRO in its properties as a controllee. PRO in the sentence must usually be controlled; otherwise it must be arb. PRO in the noun phrase, on the other hand, may be both non-controlled and non-arbitrary (i.e., non-generic). Consider these examples from Williams 1985:

(92)

- a. The leaves<sub>i</sub> should not be bothered while PRO<sub>i</sub> dessicating.
- b. The leaves<sub>i</sub> should not be bothered during PRO<sub>i</sub> dessication.

(93)

- a. \*You should not bother the leaves<sub>i</sub> while PRO<sub>i</sub> dessicating.
- b. You should not bother the leaves<sub>i</sub> during PRO<sub>i</sub> dessication.

The PRO of the gerund must be coreferential with the surface-structure subject. This provides strong evidence that it in fact exists. The "PRO" of the noun phrase, on the other hand, is not subject to this restriction. It does not require an antecedent at all:

(94)

You<sub>i</sub> should not enter the chamber during PRO<sub>j</sub> detoxification of the samples.

(vs. \*You<sub>i</sub> should not enter the chamber while PRO<sub>j</sub> detoxifying the samples.)

If there were actually a PRO in the noun phrase, one would expect it to behave like PRO in the sentence. Since PRO in the sentence cannot take a "discourse" antecedent, this suggests that "PRO" in the noun phrase either does not exist, or is not PRO.

Wasow and Roeper 1972 also note the obligatoriness of control into sentences, but not into noun phrases. They compare different kinds of gerunds. Consider:

(95)

- a. I<sub>i</sub> detest PRO<sub>j</sub> loud singing<sub>N</sub>
- b. \*I<sub>i</sub> detest PRO<sub>j</sub> singing<sub>V</sub> loudly

(96)

- a. John<sub>i</sub> enjoyed PRO<sub>j</sub> a reading<sub>N</sub> of The Bald Soprano
- b. \*John<sub>i</sub> enjoyed PRO<sub>j</sub> reading<sub>V</sub> The Bald Soprano

(97)

- a. PRO<sub>j</sub> sightings<sub>N</sub> of UFO's make Mary<sub>i</sub> nervous
- b. \*PRO<sub>j</sub> sighting<sub>V</sub> UFO's makes Mary<sub>i</sub> nervous

(98)

- a. PRO<sub>j</sub> the killing<sub>N</sub> of his dog upset John<sub>i</sub>
- b. \*PRO<sub>j</sub> killing<sub>V</sub> his dog upset John<sub>i</sub>

All the verbal gerunds are good with coreference. The nouns vary: (a) is bad, the others are relatively acceptable.

One possible explanation for these facts is the following. It is proposed in Williams 1981 that control is



not a direct relation between an antecedent and PRO, but is actually a relation between an antecedent and the clause of which PRO is subject, and only indirectly a relation between antecedent and PRO. This would permit us to make a distinction between PRO in the noun phrase and PRO in sentences, if we suppose that sentences are subject to control, but noun phrases are not. The apparent difference between PRO in sentences and PRO in noun phrases with regard to obligatoriness of control is actually a difference in the ability of the phrase containing PRO to be controlled.

A distinction in control properties depending on the nature of the phrase of which PRO is subject seems to me very reasonable. We must be careful in how we spell it out, though. Anticipating results of Chapter Three, I assume that "PRO-ing" and "Ing-of" gerunds are not distinct in syntactic category; both are noun phrases. But they are distinct in their control properties, as we saw above: PRO-ing patterning with infinitives, and Ing-of patterning with noun phrases. This is a ticklish problem, to which I return in section III-3.2. For now, it must remain outstanding.

In conclusion, the DP-analysis provides "room" for a PRO in the noun phrase, and there is evidence that such a PRO exists. At present, the evidence is somewhat mixed, because of the differences in control properties of noun-phrase PRO and sentence PRO, but if the proposal proves defensible that these differences trace to differences in the phrase containing PRO, rather than to PRO itself, the major

disadvantage of postulating a PRO in the noun phrase will have been removed.

## 5 Differences Between Noun Phrase and Sentence

The theme of this chapter has been the similarities between noun phrase and sentence, particularly those noun-phrase/sentence similarities which provide evidence for the parallelism of noun-phrase and sentence structure postulated under the DP-analysis. However, there are also substantial differences between noun phrase and sentence. This leads to understandable skepticism of the DP-analysis, which could well appear susceptible to the charge that it is motivated by a handful of similarities, only at the expense of ignoring a much larger body of differences. In this section, I defend the DP-analysis against this accusation. I present a long list of sentence/noun-phrase dissimilarities, to show that none of them seriously challenge the DP-analysis. The majority clearly are concerned only with the relation between the noun and its complements, the remainder arguably so.

Before I catalog these differences, though, I consider one alleged difference that clearly does concern the structure of the noun phrase specifier, not its complements: namely, the alleged lack of predication in the noun phrase.

### 5.1 Predication in the Noun Phrase

It has been claimed that there is no predication in the noun phrase. Williams (1981) and Rothstein (1983) claim that N-bar does not predicate of an external argument, as it is a

non-maximal category, and only maximal categories are syntactic predicates. Consider the following examples:

(99)

- a. I consider John [a good lawyer]
- b. I saw [John's lawyer]

(a) involves a small clause, in which a good lawyer is the predicate, and John is the subject. This small clause corresponds in meaning to the full clause John is a good lawyer, in which a good lawyer is likewise predicated of John. Now consider (99b). If there were predication between the N-bar lawyer and the "subject" John, we would expect the sense "John is a lawyer". But (99b) does not presuppose that John is a lawyer, rather that there is someone who is a lawyer, with whom John is associated, probably as client. That (99b) does not have a reading in which John is the lawyer is attributed to a lack of predication between N-bar and possessor.

These facts appear in quite a different light, however, if we take seriously the idea that verbs denote situations. If verbs denote situations, the "predication" involved in (99a) is clearly different from predication between a VP and its subject, as in John left. In John left, the VP denotes an event of leaving, and its subject is identified with some role defined by that event: in this case, the leaver. In I consider [John a good lawyer], on the other hand, the

predicational noun phrase denotes a lawyer,<sup>27</sup> and the subject is identified with the lawyer, not with some role defined relative to a lawyer.

To bring home the point, let us consider the examples

(100):

(100)

Caesar destroyed the city  
Caesar's destruction of the city

Modifying assumptions of Higginbotham (1985), let us take the denotation of the VP destroy the city to be the one-place predicate (101):<sup>28</sup>

(101)

$\lambda e \exists x [\exists y: \text{CITY}(y)] (\text{DESTROY}_0(e) \ \& \ R_1(x, e) \ \& \ R_2(y, e))$

where  $\text{DESTROY}_0$  is a one-place predicate true of exactly the acts of destruction,  $R_1$  is an Agent relation, and  $R_2$  is a Patient relation. The relation between this predicate and the denotation of the subject, Caesar, is not one of semantic predication, rather, Caesar fills one of the roles associated

-----

27. Or some platonic ideal of a lawyer, an abstract "essential lawyer". For the sake of concreteness, let us assume, with Montague, that individuals are sets of properties (or functions from properties to possible worlds, if we take intensionality into account). Then the predicational noun phrase a lawyer can be taken to denote the set containing only the property of being a lawyer: an "archi-individual". The predicate "is identified with" of the next phrase in the text should then be understood as "includes".
28. Or, to be consistent with the previous footnote, we could take it to denote the singleton set containing the property corresponding to this predicate.

with  $\text{DESTROY}_0$ , namely  $R_1$  of (101). More precisely,  $\lambda x(x=\text{Caesar})$  is added as a restriction on one of the existential quantifiers: assuming that  $\text{Infl}$  serves to existentially bind the lambda-abstracted variable  $e$  of (101), the denotation of the IP Caesar destroyed the city is the following:

(102)  
 $\exists e[\exists x:x=\text{Caesar}][\exists y:\text{CITY}(y)](\text{DESTROY}_0(e) \ \& \ R_1(x,e) \ \& \ R_2(y,e))$

I would like to argue that the semantics for destruction is exactly parallel. Recall that the syntactic structure I assume for Caesar's destruction of the city is:

(103)

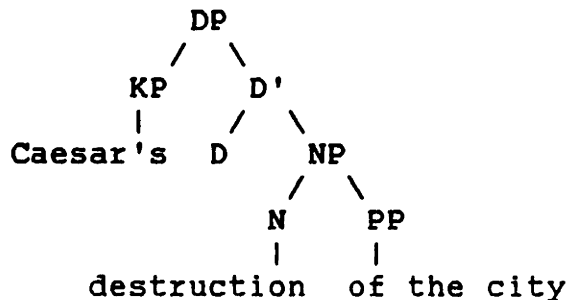

The NP destruction of the city, I claim, is semantically identical to the verb phrase destroy the city. Its translation is (101). In DP, the variable  $e$  is bound by D, in the same way that  $\text{Infl}$  binds the  $e$ -position in VP, and there is a syntactic relation of Predication between the maximal projection NP and its subject, Caesar, which is interpreted just like the syntactic relation of Predication between VP and its subject: namely, not as semantic predication, but as the "filling" of an argument-slot by restricting a variable:

(104)

$$\exists e[\exists x:x=Caesar][\exists y:CITY(y)](DESTROY_0(e) \ \& \ R_1(x,e) \ \& \ R_2(y,e))$$

If this account is correct, then there is in fact predication within the noun phrase; and the relation between John and a lawyer in I consider John a lawyer is not predication at all, but identification.<sup>29</sup> If predication were involved in small clauses headed by noun phrases, we would expect e.g. I consider [sc John [pp an expression of grief]] to be synonymous with I consider [ip John to have [vp expressed grief]], but of course it is not.

I should add, though, that I do not wish to imply that NP always predicates of the subject of DP. I have already stated explicitly that I take the possessive  $\theta$ -role to be assigned by D, not to be an external  $\theta$ -role of NP assigned via predication. Thus John's expression of grief and John's puzzled expression differ in the way John acquires a  $\theta$ -role: there is syntactic predication by NP in the former, but not in the latter.

Two more arguments Rothstein (1983) gives against predication in the noun phrase are (1) the optionality of the subject in the noun phrase, and (2) the lack of pleonastics in the noun phrase. The paradigm (105) is illustrative:

-----

29. More precisely, the denotation of John is taken to include (be a superset of) the denotation of a lawyer, where the denotation of John is the set of John's properties, and the denotation of a lawyer is the set containing the sole property lawyer-hood. Cf. footnote (27).

(105)

- a. \*destroyed the city  
the destruction of the city
- b. it is likely that John will leave  
\*its likelihood that John will leave

The generalization is not quite noun phrase vs. sentence, however, at least not if Poss-ing gerunds are noun phrases, as is widely accepted, and as I argue in the next chapter.

Pleonastics are permitted in both Acc-ing and Poss-ing gerunds:<sup>30</sup>

(106)

- a. I approve of [there being a literacy exam for political  
candidates]  
I was worried about [it being too obvious that Charlie was  
lying]
- b. I was worried about [its being too obvious that Charlie was  
lying]

The subject of gerunds is also obligatory. If it is not overt, there must be a PRO present, as illustrated by the contrast (107) from Williams 1985, cited earlier:

-----

30. Poss-ing with there is ill-formed, but it is generally agreed that this is due to extraneous factors. This is especially likely in light of the well-formedness of the there example in (106a); perhaps it has to do with the fact that there bears an "inherent case" in its adverbial function, which clashes with genitive case: cf.:

(i)

- a. yesterday's party
- b. \*then's party  
\*now's party  
\*here's party  
\*there's party



(107)

- a. #The leaves should not be disturbed while PRO dessicating
- b. The leaves should not be disturbed during dessication

(Whether there is a PRO in (107b) is immaterial here. What is important is that the obligatorily agent-controlled reading of the adjunct in (107a) indicates that a PRO is indeed present.)

In short, in some noun phrases (namely, gerunds), the subject is obligatory, and pleonastics are allowed. These are precisely the noun phrases in which a VP appears in place of an NP, under the analysis of gerunds I sketched in the introduction.

Under the DP-analysis, then, the generalization is that VP requires a subject to predicate of; whereas NP is capable of predicating of a subject, but does not require a subject. PRO is obligatory only where predication is obligatory, and pleonastics are permitted only where predication is obligatory. This commits us to a weaker position than Rothstein's: namely, that syntactic predicates do not always require subjects, only verbal syntactic predicates do. This revision of Rothstein's claim seems reasonable, especially in light of the fact that with regard to other forms of argument-taking -- e.g., internal  $\theta$ -assignment -- verbs demand their arguments to be syntactically present in a way that nouns do not. The only nouns whose arguments are not freely deletable are derived nominals -- and if Lebeaux' (1986) claims are correct, derived nominals are not nouns at LF, but verbs. They are certainly atypical nouns on anyone's account. We may

claim, then, that syntactic arguments of verbs, both  $\theta$ -arguments and predication arguments, are obligatory, while those of nouns are in general optional.

## 5.2 Catalog of Differences

In this section I give a fairly exhaustive list of the constructions found in the sentence which are not found in the noun phrase. Many of these facts are old observations; some, as far as I know, have not been noted previously in the literature. The purpose of presenting this catalog of differences is to show that they do not call into question the parallelism between noun phrase and sentence structure postulated under the DP-analysis. The DP-analysis postulates similar specifier structures for noun phrase and sentence; most of the differences listed here have clearly to do with noun complement structure, as it contrasts with verb complement structure. I do not attempt to give detailed analyses of all these constructions, however; doing so would be a thesis in itself. I only wish to show that the fact of these differences is not problematic for the DP-analysis.

### 5.2.a. A Preliminary: Process vs. Result

In examining the differences between sentence and noun phrase, we will have frequent cause to compare derived nominals with the verbs from which they derive. In doing so, it is crucial to make a distinction which is too frequently not made in the literature on derived nominals, namely, between "process" nominals and "result" nominals. Process nominals denote actions/events, and result nominals denote

objects.<sup>31</sup> Consistently, the  $\theta$ -grid of the verb is preserved only in process nominals, not result nominals. Result nominals may have PP complements that appear to correspond to arguments of the verb, but they are never obligatory, and frequently show other indications of being modifiers, not arguments. This is most clearly seen with derived nominals that have both result and process readings, such as examination:

(108)

- a. [examination of the students] will take several hours  
\*[examination] will take several hours
- b. \*[the examination of the students] was printed on pink paper  
[the examination] was printed on pink paper

Examination in (108a) denotes an action, whereas examination in (108b) denotes a concrete object. (Though the object is ill-formed with the result nominal here, this is not always the case:

(109)

- a. [a reconstruction of the events] will take a long time  
\*[a reconstruction] will take a long time
- b. [John's reconstruction of a 17th-century French village] was destroyed in the fire (adapted from Anderson (1979))  
[John's reconstruction] was destroyed in the fire

It is not always a trivial task to determine whether one is dealing with a process nominal or a result nominal in a  
-----

31. "Result nominal" is something of a misnomer, in that result nominals do not always denote the result of the action of the verb -- though that is often the case. Following Grimshaw (1986), I use the term in an extended sense, to cover all nominals that denote objects (concrete or abstract) instead of events.

given example. There are a number of diagnostics that are helpful, if not foolproof. These are collected in Grimshaw 1986:

1. Process nominals do not pluralize. Thus, the clipping of the grass is a process nominal, but in the plural, the clippings, it can only be a result nominal.
2. Process nominals do not occur with demonstrative determiners. Thus, ?that examination of the students occurred a week ago is distinctly odd, whereas that examination is twenty pages long is fine.
3. Result nominals often require a determiner. Consider: \*examination was ten pages long, but ✓examination of the students took ten hours.
4. Process nominals do not occur with of NP's. The adjunct of NP's only has a concrete-possession reading, which is incompatible with events: \*the discovery of the vaccine's occurred at an opportune moment; cf. the vaccine's discovery occurred at an opportune moment.

The distinction between process and result nominals is made clearly in Anderson and Grimshaw, but it is much more often completely ignored, with the result that many of the arguments in the literature concerning derived nominals are compromised. Two examples occur especially frequently: \*John's belief to be intelligent is repeatedly cited as an illustration that there is no raising in the noun phrase, and

\*John's gift of Mary (of) a book is cited to show that there is no dative shift in the noun phrase. Neither of these examples quite illustrate the intended point, however. Both belief and gift are result nominals, not process nominals. Belief does not preserve the argument structure of the verb:

(110)

John believed the story  
\*John's belief of the story

And gift obviously denotes the object given; it cannot denote the act of giving:

(111)

\*[John's gift of a Rembrandt to the Fogg] took place yesterday

What confuses matters somewhat is that belief and gift do take arguments that appear to correspond to verbal arguments:

(112)

a. the belief that John was intelligent  
b. the gift of a book to Mary

These arguments in fact fall under a nominal paradigm, however. Result nominals fail to preserve the  $\theta$ -grid of the verb from which they were derived, but they may take modifiers like those of similar concrete nouns (this is one factor which contributes to difficulty at times in distinguishing process and result nominals). Belief patterns with non-derived nouns like theory:

(113)

the belief that John was intelligent  
 the theory that John was intelligent

Gift's arguments pattern with two different sets of non-derived nouns. The gift of a book has the argument-structure of nouns like tribute, honorarium:

(114)

a gift of a book  
 an honorarium of a gold-inlaid plaque  
 a yearly tribute of a horse

A gift to Mary has the argument-structure of non-derived nouns like present, letter:

(115)

a gift to Mary  
 a present to Mary  
 a letter to Mary

In short, one must be careful to distinguish between arguments that pattern with nominal paradigms, and those inherited from root verbs. Only process nominals -- nominals that denote events -- preserve the  $\theta$ -grid of the root verb.

Two closing notes: first, Belief and gift are typical of a large class of derived nouns which have only result readings, namely, zero-derived nouns. Often, zero-derived nouns do not take modifiers which even appear to correspond to verbal direct objects:

(116)

- \*a hit of the ball
- \*John's kick of the dog
- \*the slap of the little brat
- \*Mary's fright of Bill

Even when zero-derived nouns take of-complements, they consistently meet diagnostics for being result, not process, nominals:

(117)

- a. John's fear of water
  - John's fear
  - John's fears of failure
- b. a smear of paint
  - a smear
  - several smears of paint

It is also usually clear that the nominal does not denote an action, but an object -- though especially with nouns of mental state, it is all but impossible to distinguish between the "action" denoted by the verb, and the mental state denoted by the result nominal. For example, it is difficult to distinguish between the "action" of fearing something, and the mental state of fear.<sup>32</sup>

Second, derived nominals in -ing often behave differently from other derived nominals. The two most salient differences -----

32. As pointed out to me by R. Kayne, there is at least one apparently zero-derived nominal which denotes an action, and otherwise appears to be a process nominal, namely, capture. I submit, however, that capture is analyzed as a "cranberry" word, derived affixally from the stem \*capt, from which are also derived captor, captive. Capture thus actually patterns with failure, seizure, not with zero-derived nominals (which are almost always Anglo-Saxon).



are that nominals in -ing never allow passive, and they do allow particles:

(118)

- a. the bombing of the city  
the destruction of the city  
  
\*the city's bombing  
the city's destruction
- b. the explaining away of the problem  
\*the explanation away of the problem

Because of these facts, zero-derived nominals and nominals in -ing are best avoided in making generalizations about the relation between derived nominals and the verbs they derive from. The best nominals to study are affixally derived -- usually latinate -- and clearly denote actions, not objects.

With this in mind, I turn to an examination of the differences between noun phrase and sentence.

### 5.2.b. Obligatoriness of Subject

The subject is obligatory in the sentence, but not in the noun phrase:

(119)

- \*destroyed the city
- destruction of the city

## 5.2.c. Pleonastics

When there is no genuine subject in the sentence, a pleonastic subject is inserted. This option is not available in the noun phrase:

(120)

- a. there arrived a man
- \*there's arrival of a man
- b. it was proven that the earth is round
- \*its proof that the earth is round

These two facts do clearly concern the specifier of the noun phrase, not the complement. But it appears that a reasonable account can be given under the DP-analysis, as sketched at the end of the previous section; I have nothing to add to my discussion there.

## 5.2.d. Case

Nouns do not Case-assign their objects, hence they may not appear with bare-noun-phrase complements, unlike their verbal counterparts:

(121)

- a. Caesar destroyed the city
- b. \*Caesar's destruction the city

It is usually claimed that (b) is a well-formed d-structure, and that it is "saved" by a rule of of-insertion, which

applies to yield the well-formed s-structure Caesar's destruction of the city. Alternatively, we may take of to be a Case-marker (K), rather as we argued for 's. Probably we should distinguish the Case marked by 's and the Case marked by of: I will call the former "genitive" and the latter "partitive", though with the caveat that what I mean by "partitive" is precisely "the Case marked by of"; "genitive1" and "genitive2" would perhaps be better, in being more neutral, but they would be harder to keep straight. The noun assigns partitive Case; D<sub>AGR</sub> assigns genitive Case. A KP generated in the object position of a noun can be headed by either a partitive or genitive case-marker; the Case it is actually assigned must agree with the Case marked, however, which requires it to raise to a position of genitive Case assignment if it shows genitive marking.

#### 5.2.e. Restrictions on Passive

There is a noun-phrase equivalent of passive, as we have noted. There are additional restrictions on this movement, however, beyond those found in the sentence. Consider the following examples, adapted from examples noted by Mona Anderson (1979):<sup>33</sup>

-----

33. It is not entirely clear that knowledge is a process nominal. Because of its Anglo-Saxon origins, and its similarity to clear result nominals like fear, it is arguable that \*algebra's knowledge is out: because knowledge is a result nominal. This would make of algebra a PP-modifier, not a direct object, of knowledge. A similar argument cannot be brought against contemplation, however, so the paradigm stands.

(122)

- a. I know algebra  
Algebra is known by many people
- I contemplated the day's events  
The day's events should be contemplated before sleeping
- b. knowledge of algebra  
\*algebra's knowledge
- contemplation of recent events  
\*recent events' contemplation

The account given by Anderson -- the only account given to date -- is that what is involved is an "Affectedness Constraint" on subcategorization frames, whereby only nouns denoting actions which "affect" the denotata of the nouns' objects can be subcategorized for a bare-noun-phrase object. Non-"affective" nouns can be subcategorized only for genuine (i.e., d-structure) of-PP's. Since only bare noun phrases, and not PP's, can undergo passive, passive can only occur with "affective" nouns. If this account is correct, it locates the difference in the complement structure of nouns.

It is not entirely clear that the Affectedness Constraint really constitutes a difference between noun phrase and sentence. There are, after all, verbs which do not permit passive: resemble, weigh, cost. It is interesting that none of the nominalizations of these verbs take objects:

(123)

- a. John weighed 180 pounds
  - \*180 pounds were weighed by John
  - \*John's weighing/weight of 180 pounds
- b. John resembles his father
  - \*his father is resembled by John
  - \*John's resembling/resemblance of his father
- c. That book costs \$20.00
  - \*\$20.00 are cost by that book
  - \*That book's costing/cost of \$20.00

I would like to suggest that the objects of weigh, etc., are not direct objects, but measure adjuncts which have to some extent been made into arguments, at least in that they are obligatory. We can either suppose that they differ from "true" arguments thematically or Case-theoretically: let us call them simply "oblique" arguments, without deciding whether "oblique" is to be defined as "bearer of oblique  $\theta$ -role" or "bearer of oblique Case". The generalization then is that oblique arguments cannot be passivized, and objects of nominals cannot correspond to oblique arguments of verbs.

#### 5.2.f. Psych Nouns

A class of derived nominals which consistently fail to take objects are the "psych" nouns:

(124)

- a. Mary frightened John
- Mary amused John
- Mary angered John
- Mary bored John
- Mary liked John
- Mary hated John
  
- b. \*Mary's fright of John
- \*Mary's amusement of John
- \*Mary's anger of John
- \*Mary's boredom of John
- \*Mary's like of John
- \*Mary's hate of John

The reason, however, is obviously that all the examples in (124b) are result nominals. All but two are zero-derived, and the affixal examples, amusement and boredom, clearly refer to mental states, not acts: amusement cannot refer to the act of amusing someone, and boredom cannot refer to the act of boring someone. The question is then why no process psych nominals exist. If any class of nouns is to fail to have process nominalizations, we would expect it to be nouns of mental state, inasmuch as their thematic structure is so very unlike the canonical Agent-Patient structure. In fact, if we consider -ing nominals, the examples of (124) divide into a hierarchy of well-formedness when an of object is present; roughly, the verbs with the greatest element of causation are most grammatical:

(125)

- c. Mary's frightening of John
- Mary's angering of John
- ?\*Mary's amusing of John
- ?\*Mary's boring of John
- \*Mary's liking of John
- \*Mary's hating of John

And if we consider examples like tempt or realize, that have two readings -- one causative, one stative -- we find only the causative reading in the process nominal:

(126)

- a. I can tell that cake is tempting John
- the devil tempted Jesus
- b. \*the cake's temptation of John
- the devil's temptation of Jesus

(127)

- a. John realized his mistake
- John realized his fondest dreams
- b. \*John's realization of his mistake
- John's realization of his fondest dreams

In short, it appears that process nominals can only be built on verb meanings that include an element of agentivity, not on purely stative verb meanings. Purely stative verb meanings yield stative nominals, which are uniformly result nominals.

Possibly, this generalization subsumes the Affectedness Constraint. Consider an example like fear of cats. Fear is obviously a result nominal, so we must take of cats to be a PP modifier that expresses, as it were, the "content" or "subject matter" of the mental state of fear. This presents the possibility of analyzing knowledge of language in the same way: knowledge is a result nominal, and of language is a PP

modifier specifying the "content" or "subject matter" of the mental state of knowing. Thus \*language's knowledge is out because language is not an argument, but a modifier, of knowledge, hence cannot passivize; mutatis mutandis for \*the proposal's contemplation. The "object" of knowledge or contemplation is freely deletable, which is consistent with their being result nominals:<sup>34</sup>

(128)

- a. [knowledge of language] makes man man  
[knowledge] makes man man
- b. he's busy with [contemplation of the proposal]  
he's busy with [contemplation]

At any rate, it seems clear that the question hinges on differences in the thematic structures of nouns and verbs, and is not relevant to the question of the structure of the noun phrase specifier.

-----

34. However, knowledge and contemplation do seem to differ when they are definite:

- (i)
  - a. [the knowledge of his impending doom] frightened him  
[the knowledge] frightened him
  - b. [the contemplation of his impending doom] frightened him  
\* [the contemplation] frightened him

There is also a contrast with the passivization facts if we use pronouns instead of full noun phrases, as pointed out to me by R. Kayne: ??its contemplation (i.e., of his impending doom), \*its knowledge. A more systematic investigation is called for.



## 5.2.g. Raising

Raising (i.e., Raising to Subject) is possible in the sentence, but not in the noun phrase.

(129)

- a. John appeared to have left  
John was believed to be intelligent  
John was likely to win
- b. \*John's appearance to have left  
\*John's belief to be intelligent  
\*John's likelihood to win

I will discuss these facts together with those in the next two paragraphs.

## 5.2.h. Exceptional Case Marking

Exceptional Case Marking (Raising to Object) is found in the sentence, but not in the noun phrase:

(130)

- a. I believed John to be intelligent  
I expected John to win
- b. \*My belief John to be intelligent  
\*My expectation/expectancy John to win

An alternative way to Case-mark objects of nouns is via of-insertion, but this course is also unavailable for the noun phrases of (130b):

(131)

- \*My belief of John to be intelligent
- \*My expectation of John to win

It should be pointed out that \*my belief of John and \*my expectation of John are also ill-formed, contra ✓I believe

John, √I expected John. Likewise \*John's belief t, etc., corresponding to \*John's belief to be intelligent, though √John was believed. This suggests that whatever is wrong with e.g. \*John's belief to be intelligent is the same thing as is wrong with the simpler \*John's belief t, and has nothing to do with raising. A ready suggestion is that the ill-formedness of \*John's belief t has the same source as the ill-formedness of \*algebra's knowledge t. We could claim that John in I believe John is not an argument, but an oblique adjunct. (Actually, we must group belief with weight, not knowledge: \*Bill's weight of the package, \*Bill's belief of John, √Bill's knowledge of algebra.) However, this would not explain why \*John's belief to be intelligent is ill-formed: whatever prevents oblique noun phrases from passivizing (Case clash, perhaps) should not prevent the argument John in John to be intelligent from moving to Spec of D and receiving genitive Case.

The proper generalization, I believe, is that nouns cannot take reduced clause complements, but only full CP complements. If nouns are incapable of licensing bare-IP complements, then the noun would be incapable of governing the subject of the lower clause, hence incapable of Case-assigning it, accounting for the lack of ECM. Likewise, a raised subject would be incapable of governing its trace, which would thus violate the ECP.

I will postpone discussion of why nouns should be incapable of taking reduced-clause complements until I have

presented the numerous other noun-phrase/sentence differences that fall under the same generalization. Note, though, that if the difference is in the subcategorization/selectional properties of nouns and verbs, as I claim, then we do not need to assume differences in the landing sites of A-movement -- i.e., the structure of the specifier -- of noun phrases and sentences.

### 5.2.i. Small Clauses

Another reduced clause which nouns do not take are small clauses -- though the unavailability of raising and Exceptional Case Marking are sufficient in themselves to preclude any well-formed small clause structure in the noun phrase:

(132)

- a. I believe John a fool  
I expect John in my office
- b. \*my belief John a fool  
\*my expectation John in my office
- c. \*my belief of John a fool  
\*my expectation of John in my office

(133)

- a. John was believed a fool  
John was expected in my office
- b. \*John's belief a fool  
\*John's expectation in my office

### 5.2.j. Ditransitivity

There are no ditransitive nouns (Dative Shift):

(134)

- a. I gave Bill a book  
     I rented Bill a car  
     I fed the cat dinner
- b. \*the rental of Bill (of) a car
- c. \*the giving of Bill (of) a book  
     \*the renting of Bill (of) a car  
     \*the feeding of the cat (of) dinner

(Gift is a result nominal; thus the ill-formedness of the frequently-cited \*the gift of Bill (of) a car is out for entirely extraneous reasons. Rental does not appear to suffer from this shortcoming: cf. my rental of the car took place a full year ago.)

This fact fits in with both generalizations I have put forward to now: the inability of nouns to assign "partitive" Case (i.e., of) to arguments that receive oblique Case in the VP, and the inability of nouns to take reduced clause complements. The lack of ditransitives falls under the latter generalization if we adopt an analysis in which double-object verbs take a "small clause" complement. Several such analyses have been proposed, including those of Kayne (1984a), Larson (1986). The lack of ditransitives falls under the prohibition against oblique arguments if we assume one of the two arguments is oblique. If we consider the contrast \*the feeding of the cat dinner, ✓the feeding of the cat, it seems to indicate that the Theme is the oblique argument (it also appears to indicate that "oblique" should be defined in terms of Case-assignment, not  $\theta$ -assignment, inasmuch as there are many examples with non-oblique Theme arguments: e.g., the

selling of the car.) On the other hand, the following alternation indicates that it is the Goal argument which is oblique:

(135)

- a. i. I presented the award to John
- ii. I presented John with the award
- b. i. my presentation of the award to John
- ii. \*my presentation (of) John with the award

The Theme is embedded in a PP in (135.b.ii), hence could not be the offending argument.

One possibility is to assume that feed has two distinct  $\theta$ -grids: in feed the cat, the cat receives the Patient  $\theta$ -role, and in feed the cat dinner, the cat receives the Goal  $\theta$ -role. Then taking "oblique" to mean "Goal" would give the right results. Another possibility is to follow Kayne (1984a) in extending the small-clause analysis of ditransitives to present [John with the award].

Another example which possibly belongs here is the contrast:

(136)

- a. I believe the story
- I believe John
- b. ??my belief of the story
- \*my belief of John

my belief of the story is not very good, but it is clearly better than when the sentence with the goal argument is nominalized.

## 5.2.k. Object Control

Object control constructions do not appear in the noun phrase:

(137)

- a. I persuaded John to leave  
I instructed John to leave
- b. \*my persuasion of John to leave  
\*my instruction of John to leave

(Other commonly-cited examples, like \*my command of John to leave, \*my order of John to leave, are trivially ungrammatical by virtue of involving zero-derived result nominals.)

One possibility is that these examples fall under the prohibition against oblique arguments, assuming that John is oblique:<sup>35</sup> It is true that examples like my persuasion of John are grammatical, but we might argue that persuasion, like feed, is ambiguous between two frames, one which is a simple action verb, taking a direct object (Patient), and no object control, and the second which takes an oblique Goal argument, and object control.

-----

35. One is tempted to cite \*my instruction to John to leave here, but that example is actually irrelevant, being clearly a result nominal patterning with my command to John to leave, etc. Cf. \*I instructed to John to leave.

(138)

- a. I persuaded John<sub>pt</sub>  
I persuaded John<sub>Goal</sub> to leave
- I coerced John<sub>pt</sub>  
I coerced John<sub>Goal</sub> to leave
- b. my persuasion of John<sub>pt</sub>  
\*my persuasion of John<sub>Goal</sub> to leave
- my coercion of John<sub>pt</sub>  
\*my coercion of John<sub>Goal</sub> to leave

It is rather difficult to detect much difference in the meanings of these pairs, however, vis-a-vis the role of John. An alternative is to appeal to the prohibition against small clauses, and analyze the examples of (138b) as:

(139)

- my persuasion of John  
\*my persuasion [<sub>sc</sub> of John [<sub>cp</sub> PRO to leave]]
- my coercion of John  
\*my coercion [<sub>sc</sub> of John [<sub>cp</sub> PRO to leave]]

### 5.2.1. Tough Constructions

Tough constructions are not available in the noun phrase:

(140)

- a. John is tough to please  
Bill is easy to offend  
Mary is pleasant to look at
- b. \*John's toughness to please  
\*Bill's easiness to offend  
\*Mary's pleasantness to look at

It is possible to assimilate these examples either to the examples involving oblique arguments, or to the examples involving semi-clauses. Let us consider the former alternative first.

It has been argued that there is a non-overt benefactive argument in tough constructions which controls the infinitival clause, corresponding to an overt for-controller, as in John is tough for Bill, [PRO<sub>i</sub> to please]<sub>i</sub>, it is tough for Bill, [PRO<sub>i</sub> to please John]<sub>i</sub>. If this is correct, we have the following structure, where e is the non-overt controller of PRO:

(141)  
John<sub>j</sub> is tough e<sub>i</sub> [OP<sub>j</sub> PRO<sub>i</sub> to please t<sub>j</sub>]

If e is syntactically present, it is reasonable to consider it an oblique argument, as it is a for adjunct when it appears overtly, i.e., a "benefactive" or "ethical dative" adjunct.

A second possibility is that tough constructions are actually unaccusative; in particular, that John is not  $\theta$ -assigned by tough, but is the subject of a small clause complement of tough:

(142)  
e is tough [<sub>sc</sub> John<sub>i</sub> [OP<sub>i</sub> PRO to please t<sub>i</sub>]]

There is some direct evidence in favor of this structure. First, there is the fact that we do have sentences like it is tough to please John, that seem to indicate that the subject position of tough is not a  $\theta$ -position. Further, recall the sentences (143):



(143)

- a.  $I_1$  gave the gun to Mugsy<sub>j</sub> PRO<sub>i,j</sub> to get rid of it  
 b.  $I_1$  gave the gun to Mugsy<sub>j</sub> OP PRO\*<sub>i,j</sub> to get rid of t

On the basis of these sentences, we argued that a clause must be in a relation of mutual c-command with the antecedents of both an empty operator in its specifier, and PRO, if its subject is PRO. The PRO<sub>i</sub> reading is ruled out in (143b) because, if the adjunct clause attaches to IP, the antecedent of OP does not c-command OP, and if the adjunct clause attaches to VP, the adjunct clause does not c-command the antecedent of PRO. On the PRO<sub>j</sub> reading, if the adjunct clause attaches to VP, both the antecedent of OP and the antecedent of PRO c-command the adjunct clause, and the adjunct clause c-commands both of them, thus the structure is well-formed.

If this analysis is correct, and if the infinitival clause is a complement of tough in John is tough to please, as indicated by the fact that it is selected by tough (cf. e.g. \*John is necessary to please, to see that the infinitival clause indeed subcategorizes the predicate), then the infinitival clause is attached under VP, and John must also originate under VP.

If we adopt Belletti & Rizzi's (1986) proposal that psych verbs are actually double-object unaccusatives -- i.e., that John feared Mary derives from e feared Mary John -- we not only have a precedent for the analysis of tough movement proposed here, but it also seems possible to defend a very strong thematic restriction on the position of arguments at d-

structure, namely, that arguments are external at d-structure iff they bear an "actor" or "agent"  $\theta$ -role -- crucially, not an "experiencer"  $\theta$ -role. ("Agent" alone appears to be too strong for cases of simple intransitives like sneeze, where the subject is an actor, but arguably not an agent.)

There is actually a third possibility: that tough nominalizations are excluded on both counts, oblique arguments and small clauses. Suppose that there is an empty controller of PRO, and that John originates as subject of a small clause:

(144)

John<sub>j</sub> is tough e<sub>i</sub> [<sub>SC</sub> t<sub>j</sub> [<sub>OP<sub>j</sub></sub> PRO<sub>i</sub> to please t<sub>j</sub>]]

The one fly in the ointment for all these alternatives is the example Mary is pretty to look at. Unlike Mary is pleasant to look at, there is no impersonal version, \*it is pretty to look at Mary, and pretty takes no for-phrase: \*Mary is pretty for John to look at. My only suggestion is that Mary is pretty to look at is formed on analogy with sentences built on synonyms of pretty, all of which otherwise fit at least halfway into the tough-construction paradigm (the lack of for adjuncts requires explanation, though):

(145)

- a. the sun streaming in is beautiful to look at  
 the sun streaming in is lovely to look at  
 ?the sun streaming in is gorgeous to behold  
 the sun streaming in is breathtaking to behold  
 the sun streaming in is pleasant to look at  
 the sun streaming in is nice to look at
- b. it is beautiful to see the sun streaming in  
 it is lovely to see the sun streaming in  
 ?it is gorgeous to see the sun streaming in  
 it is breathtaking to see the sun streaming in  
 it is pleasant to see the sun streaming in  
 it is nice to see the sun streaming in

5.2.m. John's breaking his leg

One curious difference between sentence and noun phrase is the possibilities of interpretation in the following pair:

(146)

- a. John's breaking his leg  
 b. John's breaking of his leg

(a) can describe a situation in which John unintentionally breaks his leg (the "Experiencer" reading); in (b), on the other hand, the strongly preferred reading is that in which John intentionally breaks his leg (the "Agent" reading).

(This is not precisely a difference between sentence and noun phrase, but rather one between VP and NP -- at least under my assumptions about the structure of gerunds.)

It is possible to ascribe the semantic ambiguity of (146a) to a syntactic ambiguity. Break can be either an action verb or an experiencer verb. Under the agentive reading, let us suppose that break is a simple transitive, but under the experiencer reading, let us suppose that break is a

double-object unaccusative. Under the latter reading, John is non-agentive because it is underlyingly not a subject, but an object. The contrasting d-structures are:

(147)

- |                                |               |
|--------------------------------|---------------|
| a. John broke his leg          | (agentive)    |
| b. <u>e</u> broke John his leg | (experiencer) |

(b) is parallel to the ditransitive structure of give. As with give, the second object (the "displaced" direct object) cannot be easily passivized: ??The book was given John, likewise, his leg was broken only has the agentive reading, where someone intentionally broke John's leg.

We can then subsume the unavailability of the experiencer reading in the nominal under either the prohibition against obliques or the prohibition against small clauses, as with ditransitives. (It would fall under the prohibition against small clauses if we extended Kayne's or Larson's small-clause analysis of ditransitives to the structure of (147b).)

Striking confirmation for this account comes from West Flemish. In many Germanic languages, there is an "ethical dative" that can be used with verbs of acquisition and deprivation. In English it is found only with verbs of acquisition, as in I'm going to get myself a new TV. In German, it is also found with verbs of deprivation:

(148)

dem Kind ist sein Fahrrad geklaut worden  
 the child-DAT is his bike-NOM stolen become  
 "the child's bike was stolen"

As in English, the direct object becomes the subject. In West Flemish, however, the "ethical dative" can become the subject, as discussed by Liliane Haegeman (1986):

(149)

Jan is zenen velo gepakt  
 Jan-NOM is his bike stolen  
 "Jan's bike was stolen"

Haegeman applies a battery of tests which show unambiguously that Jan is the subject, not a topic, in (149): it agrees with the verb, it can be replaced with a subject clitic, etc. This example differs from John broke his arm, under the analysis I am proposing, only in that it is passive, and not ergative. Haegeman also gives "transitive ergative" examples:

(150)

- a. Jan is zenen oarm gebroken  
 Jan is his arm broken  
 "Jan broke his arm"
- b. Jan is zenen inkel verstukt  
 Jan is his ankle sprained  
 "Jan sprained his ankle"
- c. Jan is zenen boek vergeten  
 Jan is his book forgotten  
 "Jan forgot his book"

Haegeman argues that these are unaccusatives, not intransitives, because the auxiliary is to be, not to have.<sup>36</sup>

-----  
 36. A question which Haegeman does not address is the fact that these ergatives are apparently identical to the structures she called passives earlier. The passives

As such, they exactly match the structure I propose for John broke his arm, and provide striking cross-linguistic evidence supporting that analysis.

### 5.2.n. Pseudo-Passive

Pseudo-passive is not available in the noun phrase:

(151)

- a. The dispute was settled  
A sum was settled on
- b. The dispute's settlement  
\*A sum's settlement on

Under usual assumptions, the availability of pseudopassive depends on the possibility of reanalysis between verb and preposition. This is then a third difference between nouns and verbs: nouns do not take oblique objects, do not take reduced clause complements, and do not reanalyze with prepositions. We can make this third prohibition more general if we follow Baker (1985b) in taking the "reanalysis" of pseudopassive to be in fact preposition incorporation. In general, it is not possible to incorporate into nouns, but only into verbs. Pseudopassive is only a special case.

-----  
differ from German and Dutch passives in that the past participle of the passive auxiliary (to become) is absent. I assume that this has brought about an accidental similarity between passive and ergative structures. At any rate, it is clear that the examples of (150) are ergatives -- especially because of example (150c): there is no possible source for it as a passive. The only candidate would be the nonsensical \*Someone forgot John his book.

Whichever analysis we choose, it seems clear that what is at stake is the relation between the noun and preposition, hence our analysis of specifier structure is not affected.

### 5.2.o. Particles, Particle Movement

Neither particles nor particle movement are permitted in noun phrases:

(152)

- a. he explained/defined away the problem  
 he explained/defined the problem away
- he separated out the impurities  
 he separated the impurities out
- b. \*his explanation/definition away of the problem  
 \*his explanation/definition of the problem away  
 (cf. ✓his explanation/definition of the problem)
- \*his separation out of the impurities  
 \*his separation of the impurities out  
 (cf. ✓his separation of the component media)

If we follow Kayne (1984b) and Gueron (1985) in analyzing particle constructions as small clauses, this fact, too, falls under the prohibition against reduced clause complements of nouns.

### 5.2.p. Resultative Secondary Predicates

Resultative secondary predicates are not permitted in the noun phrase:<sup>37</sup>

-----

37. I have had to illustrate with gerundive forms because I have been unable to find any verbs which take resultative clauses, and yield nominals that take arguments. Almost no Latin verbs take resultative predicates, and almost

(153)

- a. We painted the house red  
We hammered the metal flat  
We shot him dead
- b. Our painting the house red  
Our hammering the metal flat  
Our shooting him dead
- c. \*Our painting of the house red  
\*Our hammering of the metal flat  
\*Our shooting of him dead

If we adopt a small-clause analysis of ditransitives, it would be natural to distinguish resultative from depictive secondary predicates by treating resultatives as small clause complements, and depictives as simple adjuncts:

(154)

we painted [<sub>SC</sub> the house red]  
Mary painted John [<sub>AP</sub> nude]

This would account for the contrasts between resultative and depictive secondary predicates: resultatives predicate only of objects, never subjects,<sup>38</sup> and resultatives apparently

-----  
no Anglo-Saxon verbs (which are also for the most part zero-derived) yield nominals that take arguments:

(1)

- a. \*We injected him dead  
\*We contused him senseless  
\*We extruded the metal round
- b. \*Our paint of the house  
\*Our hammer of the metal  
\*Our shot of the escapee

38. Consider for instance the contrast (1):



subcategorize the matrix verb: only a restricted class of verbs take resultative secondary predicates. Depictives, on the other hand, can predicate of subjects as well as objects, and appear much more freely, with nearly any verb. (154)

would be no more difficult to interpret than ditransitives under a small clause analysis. It would differ from ditransitives, in fact, only in having an understood "come to be" instead of "come to have" in the small clause. We gave [John a book] would be interpreted roughly as "we were the agents of an act of giving, whose causandum was that John should come to have a book", and we painted [the house red] would be roughly "we were the agents of an act of painting, whose causandum was that the house should come to be red".

#### 5.2.q. Object Pleonastics

Pleonastics do not appear exclusively in subject position. There are some object pleonastics in English, and they are plentiful in other languages, such as German. They do not appear in the noun phrase, however:

-----

(i)

John drank himself<sub>i</sub> silly<sub>i</sub>

\*John<sub>i</sub> drank whisky silly<sub>i</sub>

(155)

- a. I hate it when it snows on my French toast  
 I lose it whenever she looks at me that way  
 I can't believe it that you've never listened to Twisted  
 Sister
- b. \*my hatred of it when it snows on my French toast  
 \*my loss of it whenever she looks at me that way  
 \*my disbelief of it that that you've never listened to  
 Twisted Sister

## 5.2.r. Concealed Questions

Concealed questions are not available in the noun phrase:

(156)

- a. I considered your offer  
 I considered sabotage
- I knew the facts  
 I knew the time
- b. my consideration of your offer  
 \*my consideration of sabotage
- my knowledge of the facts  
 \*my knowledge of the time

## 5.2.s. Indirect Questions

Over a broad range, indirect questions are unavailable in  
 the noun phrase:

(157)

- a. I know who came  
 I recollect who came  
 I determined who came  
 I remember who came
- b. \*my knowledge who came  
 \*my recollection who came  
 \*my determination who came  
 \*my remembrance who came

These are all good when of is inserted:

(158)

my knowledge of who came  
 my recollection of who came  
 my determination of who came  
 my remembrance of who came

## 5.2.t. Complementizer Deletion

The complementizers that and for can be deleted in the sentence, after bridge verbs, but not in the noun phrase:

(159)

a. I know Bill came  
 I believe Bill came  
 I remember Bill came

I'd prefer Bill to do it

b. \*my knowledge Bill came  
 \*my belief Bill came  
 \*my remembrance Bill came

\*my preference Bill to do it

c. my knowledge that Bill came  
 my belief that Bill came  
 my remembrance that Bill came

my preference for Bill to do it

These last four sets of facts (object pleonastics, concealed questions, indirect questions, that-deletion) I have no analysis of. I only note that the phenomena clearly concern only the complement of the noun, not its specifier.

In conclusion, I have shown -- in rather more detail than was probably necessary -- that the many differences between sentences and noun phrases are differences in the complements permitted by nouns and verbs. Three major generalizations are these: verbs, but not nouns, allow oblique arguments; verbs,

but not nouns, take reduced clause complements; and verbs, but not nouns, can be incorporated into. These differences do not weigh against the DP-analysis, in that the parallelism between noun phrase and sentence structure envisioned under the DP-analysis centers on the structure of their specifiers, not their complements; also because these differences are for the most part selectional, not structural.

### 5.3 Appendix: Reducing the Differences

In this section, I would like to indulge in some frankly speculative theorizing, the aim of which is to reduce the three major differences between noun and verb identified in the previous section to one overarching difference.

These are the cases we wish to account for:<sup>39</sup>

(160)

- a. \*John's appearance to have left
- b. \*the appearance of John to have left
- c. \*my expectation of John in my office
- d. \*my rental of Bill a car  
my rental of the car
- \*my feeding of the cat dinner  
my feeding of the cat
- e. the presentation of the award to John  
\*the presentation of John with the award

-----

39. There are six other cases we have examined, but which do not appear to fall under our "three generalizations", hence which are ignored in (160); namely, obligatoriness of subject, (subject) pleonastics, object pleonastics, concealed questions, embedded questions, and that-deletion.

- f. \*my persuasion of John to leave  
my persuasion of John
- g. \*John's toughness to please
- h. \*John's breaking of his leg (under Experiencer reading)
- i. \*a sum's settlement on
- j. \*the explanation away of the problem  
\*the explanation of the problem away
- k. \*the shooting of John dead
- l. \*my amusement of the children

Let us set aside (i) for the moment, and consider the remaining cases, which fall under the prohibition against (direct) oblique arguments and the prohibition against reduced clauses. It seems that the cases potentially explicable under the prohibition against oblique arguments is a proper subset of the cases explicable under the prohibition against reduced clauses. All cases receive at least a potential account under the prohibition against reduced clauses, but several do not appear to involve oblique arguments; i.e., (a), (b), (c), (j), (k) and (l). To substantiate this claim, we must verify that there are no cases of single oblique arguments (i.e., not in a ditransitive construction, or a construction otherwise analyzable as a small clause) which are prohibited in the noun phrase. The examples that readily spring to mind are also bad in the sentence, hence are irrelevant:

(161)

\*the rental of BillGoal  
 but: \*I rented BillGoal

\*the presentation of BillGoal  
 but: \*we presented BillGoal

In fact, there are cases that we have already noticed where what is apparently a Goal argument is good precisely when it occurs alone:

(162)

\*the feeding of the cat dinner  
 the feeding of the cat

\*my persuasion of Bill to leave  
 my persuasion of Bill

\*my instruction of Bill to clean up  
 my instruction of Bill (in the finer points of hygiene)

A few problematic cases do exist. First, we have already noted the contrast it weighs 100 lbs., \*its weighing of 100 lbs.. In this case, though, it appears that we are dealing with a constraint above and beyond the prohibition against oblique arguments. Namely, 100 lbs. cannot passivize in the sentence, whereas the oblique arguments we have been concerned with otherwise do passivize: \*100 lbs. was weighed by the book, John was rented a car. A second problematic case is \*my promising of John, cf. ✓I promised John, ?John was promised. This does seem to be a genuine counterexample. But since it is the only one I have found, I will assume there is some complicating factor I have not discovered. At worst, we could appeal to the prohibition against oblique arguments for this individual case, even if we reduce it to the prohibition against small clauses in all other cases.

Let us begin with ditransitives. It is the Goal argument which receives the verb's accusative case: it is the Goal argument, for instance, which must appear adjacent to the verb, and it is the Goal argument which passivizes:

(163)

I gave John a book  
\*I gave a book John

John was given a book  
\*a book was given John (in American English)

Something special must be said about the way the second argument, the Theme, receives Case. Baker (1985b) suggests that it does not receive Case, but is identified (hence passes the Case filter) by incorporating into the verb at LF. I would like to suggest a modification of this account. Let us adopt a small-clause analysis of the double-object construction. Further, let us suppose that there is an abstract  $X^0$  head of the small clause, as required by a strict interpretation of X-bar theory:

(164)

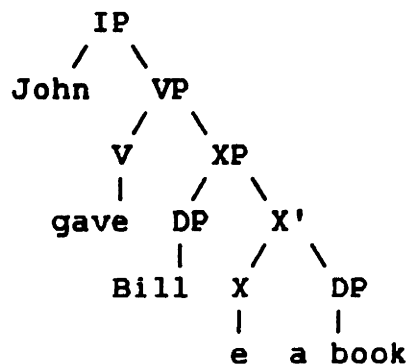

Let us suppose that there is a special constraint on such an empty head, namely, that it must be identified by incorporating into the verb. So it is not the second object



which incorporates into the verb- but the empty head taking the second object as its complement.

It is not clear what syntactic category to assign X to. I assume that the second object is licensed by being  $\theta$ -assigned and Case-assigned by X; this makes X appear to be a preposition, and the construction in question to be an "applicative", if Baker (1985b) is right in analyzing applicatives as cases of preposition-incorporation. On the other hand, the small clause parallel suggests treating X as an Infl. Another possibility would be that it is a verb. We might treat X as a "proto-verb" that corresponds to the "have" part of the meaning of give, and assigns the two  $\theta$ -roles associated with that part of the meaning of give, namely, the Goal (Possessor) and Theme roles. The verb give is actually the combination V+X, and does not correspond to a unique syntactic node until after incorporation has occurred at LF. This explains the obligatoriness of incorporation: X alone is not a word, and if it did not incorporate, it could not be assigned its lexical properties, which it possesses only by virtue of being a part of the word give.

This third alternative is indistinguishable for practical purposes from the account presented in Larson (1987a). Larson assumes verb-raising, rather than "proto-verb" incorporation,

but otherwise his structure is identical to that of (164), with "V" substituted for "X":<sup>40</sup>

(165)

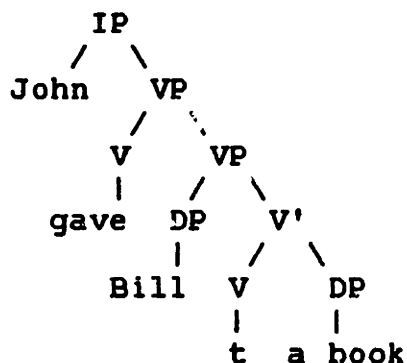

Larson defends this analysis (in part) by appealing to a large range of tests, summed up in Barss & Lasnik (1986), that show that the inner (indirect) object is actually higher in the structure than the outer (direct) object. The "small-clause" structure is one of the few conceivable analyses for the double-object construction that has the property that the inner object asymmetrically commands the outer object.

Larson prefers a verb-raising analysis over an incorporation analysis, in order to avoid the pitfalls of "lexical decomposition"; he does not wish to repeat the mistakes of the generative semanticists in decomposing give into cause to come to have. However, the "proto-verb" approach I am proposing is subtly, but fundamentally,

-----

40. Larson also assumes NP's instead of DP's; I am glossing over that difference for consistency's sake. Another wrinkle to Larson's analysis which is not important for my purposes is that he assumes the underlying structure is actually John [<sub>v</sub> e] a book gave (to) Bill, and "passive" applies in the lower VP (as well as verb-raising out of the lower VP) to yield the surface order.

different from lexical decomposition. The basic problem with the lexical-decomposition approach is that it cannot account for the idiosyncratic properties of give that are not contributed by any of its components, cause, come-to, or have. My view is that verb meanings are arranged in an inheritance lattice, such that individual verbs indeed possess idiosyncratic properties, but the properties they share with all other verbs of their class need not be stated individually for each verb, but once for the class-object that represents the entire verb class.<sup>41</sup> Agentive verbs, for instance, all inherit from a class-object that possesses two or three  $\theta$ -roles: Agent, Instrument, and Patient. Motion verbs inherit from a class-object that possesses the roles Theme, Source, Goal. It is these class-objects which I mean when I say "proto-verb". The agentive-verb class-object is the proto-verb with roughly the content of "cause"; the motion-verb class-object is the proto-verb with roughly the content of "go". It is important to understand that these "proto-verbs" or "archi-verbs" are not the actual verbs cause and go. Rather, it is convenient to designate them as "cause" and "go" because the agentive-verb class-object and the motion-verb class-object are present in "purest" form in the verbs cause and go, respectively: cause and go appear to inherit from the single classes CAUSE (agentive class) and GO (motion class),

-----

41. Inheritance lattices have been extremely well studied in the artificial intelligence literature; they are as basic to knowledge representation as constituent structure is to syntax. Reasonable starting points for the interested reader are Winston (1984), Chapter 8; Fahlman (1979b,a).

respectively. The verbs cause and go are distinct from the classes CAUSE and GO, however, and do have some idiosyncratic properties they do not inherit from those classes.

A verb may instantiate more than one class. Different verbs instantiating the same classes may map the roles provided by those classes differently. For example, one verb inheriting from both the Agentive class and the Motion class may map the Agent and Theme roles onto the same position (fly, for instance), while another may map Patient and Theme roles onto the same position (throw, for instance). Further, an individual verb can have idiosyncratic properties, which it does not inherit from any class. An individual verb may also override properties provided by a class object. Fly, for instance, inherits from CAUSE (arguably), but it overrides the Patient role in the  $\theta$ -grid it inherits from CAUSE, keeping only Agent and Instrument roles (he flew with a hang-glider). In short, viewing "proto-verbs" as verb class-objects avoids the problems of lexical decomposition as usually conceived. We can view give as containing the parts (inheriting from the classes) CAUSE, COME-TO, GO, without implying that give has only the properties provided by these parts. This disarms Larson's major motivation for adopting a verb-raising analysis in preference to an incorporation analysis like that of (164).

The analysis (164) is also reminiscent of Chomsky's 1955 analysis of small clauses. Chomsky suggested that the matrix verb and the small-clause predicate form a complex predicate,

and the small-clause predicate is subsequently extraposed, to yield the surface word order:

(166)

- a. I consider-intelligent John ==>  
 b. I consider John intelligent

In the current framework, this would probably be revised so that (b) is s-structure, and (a) is not d-structure, but LF: i.e., intelligent incorporates into consider. The analysis (164) differs from this hypothetical revision of Chomsky's analysis only in that it is not intelligent, but an abstract element selecting intelligent, which incorporates into consider:

(167)

I [v consider [x e]] [xp John [x' [x t ] intelligent]]

There is actually something of an inaccuracy in (167), in that, under the analysis I have proposed, the verb consider is actually the V complex which includes X: X is part of the lexical entry of consider. In other words, it is only at LF that there is a unique node corresponding to the word consider. Thus verbs which take small clause complements select those complements in the strongest possible sense: the head of the complement is actually a part of the verb's lexical entry.

Notice that, whatever the category of X, adopting the analysis (164) in effect generalizes the unavailability of the double-object construction in noun phrases with the

impossibility of incorporating into nouns, which we had used to account for the lack of pseudo-passive ((i) of (160)). The account (164) also generalizes to (c), (e), (f), (g), (h), (k), and (l) of (160), under the analyses illustrated in (168):

(168)

- c. \*expectation [ $\chi_P$  of John  $X_e$  [ $\text{pp}$  in my office]]
- e. \*presentation [ $\chi_P$  of John  $X_e$  [ $\text{pp}$  with the award]]
- f. \*persuasion [ $\chi_P$  of John  $X_e$  [ $\text{CP}$  PRO to leave]]
- g. \*John's<sub>i</sub> toughness [ $\chi_P$   $\underline{t}_i$   $X_e$  [ $\text{CP}$  OP<sub>j</sub> PRO to please  $\underline{t}_j$ ]]
- h. \*John's<sub>i</sub> breaking [ $\chi_P$   $\underline{t}_i$   $X_e$  [ $\text{pp}$  of his leg]]
- k. \*shooting [ $\chi_P$  of John  $X_e$  [ $\text{AP}$  dead]]
- l. \*my<sub>i</sub> amusement [ $\chi_P$   $\underline{t}_i$   $X_e$  [ $\text{pp}$  of the children]]

A note about (h) and (l): these differ from the others in that I have placed the of on the second object, not the first object. This is because these two cases derive from double-object unaccusative verbs, under the analysis I am assuming. Leaving the first object in its d-structure position or leaving the of off the second argument does not improve matters:

(169)

- \*the breaking of John his leg
- \*the breaking his leg (put John in an awful fix)
- \*the amusement of John the children
- \*John's amusement the children

(John's breaking his leg is grammatical, but deceptive: it is clearly a Poss-ing gerund, not an Ing-of gerund. Only the Ing-of gerund is relevant to the question at hand.)

The remaining cases are (a), (b), and (j) of (160): raising, infinitival ECM, and particles. (a) and (b) differ from the examples of (168) in that they involve "S-bar deletion" infinitives, not small clauses. I would like to claim that these complements are not IP's, but CP's. They generalize with the examples of (168) in that the empty complementizer is incorporated into the matrix head, in order to be identified. The structure is thus:

(170)  
 [v consider [c e]] [CP [c t̄] [IP John to VP]]  
 ↑—————|

I assume that it is the empty complementizer which assigns accusative case to the lower subject, John, much in the way that X' assigns Case to the second object in double-object constructions.

Raising and infinitival ECM are ungrammatical in the noun phrase, under this account, because they, too, involve incorporation into the matrix head, which is illegal when that head is a noun.

It is tempting to assume that the failure of complementizer deletion in noun phrases is also due to the requirement that the empty complementizer be identified by incorporating into the matrix verb. This is not obviously possible, however. If we took that course, we would be unable to distinguish ECM and control constructions:

(171)

I'd prefer+C<sub>i</sub> [CP [C t<sub>i</sub>] [IP John to do it]]I expected+C<sub>i</sub> [CP [C t<sub>i</sub>] [IP John to do it]]

Possibly there is a way of resolving this quandary, and bringing the lack of complementizer deletion in the noun phrase under the prohibition against incorporation as well; but I leave it as an open question.

The final case is (160j), the lack of particles in the noun phrase. Kayne (1984b) argues that particle constructions are also to be analyzed as small clausal, where the particle is a "little verb":

(172)

I looked [pp the information [p' up]]

It would be natural to assume that the version I looked up the information is derived by incorporating up. Kayne gives a number of arguments against this hypothesis, however. For instance, pronouns are permitted in the "particle-moved" construction, but not when the particle is adjacent to the verb:

(173)

I looked [it up]

\*I looked-up it

This is unexpected if look up is a complex verb, as verbs can certainly take pronominal objects: I sought it.

Another argument is that particles allow modifiers, whereas parts of compound verbs do not:



(174)

I looked it right up  
\*I right-up-ended the chair

Another argument is that "sentential subjects" can appear with preposed particles, but not postposed particles:

(175)

a. I pointed out that John had left  
b. \*I pointed [that John had left] out

Kayne generalizes the ill-formedness of (175b) with the ill-formedness of sentential subjects of embedded clauses. He analyzes (175a) as involving extraposition of the sentential subject. If we moved the particle leftward to derive (175a), on the other hand, that John had left would still be an embedded sentential subject: the subject of the trace of out. Thus we would incorrectly predict (175a) to be ill-formed. Kayne argues that the examples with "preposed" particles are uniformly derived by extraposing the subject of the particle -- obligatorily, with sentential subjects; optionally, with noun-phrase subjects.

I will follow Kayne in assuming that "preposed" particle constructions are derived by extraposition of the subject of the particle. I assume, though, that the particle does incorporate at LF, accounting for the unavailability of particle constructions in noun phrases.

An unsolved problem for this analysis is why particles are good with -ing nominals, but not with other derived nominals:

(176)

- a.i. the explaining away of the problem
- ii. \*the explanation away of the problem
- b.i. ?all the gyrating away they do (makes tops susceptible to idiosyncratic types of structural damage)
- ii. \*all the gyration away ...

(176b) shows that it is not Case- or  $\theta$ -assignment to the object that makes (176.a.ii) bad: the same contrast is to be found where an intransitive verb is involved.

One possible solution is that -ing nominals exceptionally permit incorporation. This is clearly wrong, though, because -ing nominals do not permit incorporation in any of the other cases we have discussed:

(177)

- \*the expecting of John to leave
- \*the giving of John a book
- \*the being tough to please
- etc.

Another possibility is that -ing nominals with particles are in fact V+particle compound verbs, in contrast to verbs appearing with particles in the sentence. This would explain why the "base" form of these nominals is bad: \*the looking of the information up.<sup>42</sup> Most of Kayne's tests ruling out a

-----

42. As Kayne points out, this example can also be ruled out by a prohibition against PP's in subject position. He cites contrasts such as (i) to illustrate that this prohibition can force rightward movement of the subject, when it is a PP:

(i)

- John teamed up with Bill
- \*John teamed with Bill up

V+particle complex verb in the sentence are not helpful in the noun phrase, because they involve other small clauses in addition to the particle; these would be independently ruled out by the prohibition on small clauses in the noun phrase. The two tests that can be applied to -ing nominals give conflicting results: (178a) is ill-formed, indicating that looking up is not a complex noun, but (178b) is also ill-formed, indicating that up is not an independent word.

(178)

- a. \*the looking up of it
- b. \*the looking right up of the information

I leave this as an open question.

To sum up the results of this section: given the analyses illustrated in (164) and (170), a significant range of the constructions which are prohibited in the noun phrase can be unified under a single generalization, namely, a prohibition against incorporation into nouns.

-----

- They stocked up on foodstuffs
- \*They stocked on foodstuffs up



## Chapter Three

### The Gerund

#### 1 Introduction

In English, the construction in which the noun phrase looks most like a sentence is the gerund, where by "gerund" we mean the class of structures headed by verb+ing.<sup>43</sup> The gerund -- particularly the so-called "Poss-ing" construction -- has long been a puzzle. Unlike the sentence-like noun phrases we have examined in other languages, the English Poss-ing construction is not simply a noun phrase with sentential properties, but has a decidedly griffon-like structure. Its "forequarters" (i.e., its external distribution and its subject) are that of a noun phrase, while its "hindquarters" (its complement structure) are that of a verb phrase.

The gerund is of great interest in evaluating the DP-analysis, inasmuch as, if the DP-analysis is correct, it

-----

43. In traditional usage, the term gerund usually refers to the noun in -ing, not to the construction headed by such a noun (see e.g. Poutsma (1923)). Current usage is frequently more lax, applying the term gerund both to the noun in -ing and to the noun phrase headed (in a pre-theoretic sense) by N<sub>ing</sub>. I follow the more liberal usage here.

provides a simple and general structure for the gerund, which appears otherwise so exceptional. Under the DP-analysis, we can take the Poss-ing construction to involve D taking a VP-complement, instead of an NP complement. In this way, we account for the properties of the Poss-ing construction, while maintaining a strict version of X-bar theory.

There is a respectable transformational literature on the gerund, including Lees 1960, Rosenbaum 1967, Ross 1967, 1973, Emonds 1970, Wasow and Roeper 1972, Stockwell, Schachter, and Partee 1973, Thompson 1973, Horn 1975, Williams 1975, Schachter 1976, Reuland 1983, Baker 1985c. In the earlier work, it was assumed that all gerunds were sentence transforms. The "lexicalist hypothesis" of Chomsky 1970 paved the way for a non-sentential treatment of Poss-ing; and he argued explicitly for a non-sentential treatment of gerunds like the calling of the roll. Emonds 1970 claimed that Poss-ing gerunds were never dominated by S at any level of derivation; this position was apparently not widely adopted until the mid-seventies, however. Horn (1975) and Schachter (1976) both argue for this position; Schachter's analysis appears to have become standard (it is adopted, for example, in Chomsky 1981).<sup>44</sup>

-----

44. Horn and Schachter appear to come independently to the conclusion that Poss-ing is a noun phrase at all levels. Both claim the non-transformational analysis as an innovation, and neither includes the other in his bibliography.

The paradigmatic sentence -- tensed S with that complementizer -- and the paradigmatic noun phrase -- a simple concrete noun phrase like the rock -- have very distinct properties both internally and externally, i.e., with regard both to their structure and distribution. As Ross 1973 points out, though, there is a range of structures possessing both sentence and noun-phrase properties. Ross argued that these constructions form a continuum, of which tensed S and concrete noun phrase are the endpoints: in order of increasing "nouniness", tensed S, indirect question, infinitive, Acc-ing, Poss-ing, action nominal ("Ing-of"), derived nominal, concrete noun. Under more common assumptions, there is a cut between sentence and noun phrase, and exceptional properties of atypical constructions must be accounted for in some other way. The generally accepted cut, at least since Reuland 1983, is between Acc-ing (the most noun-phrase-like sentence) and Poss-ing (the most sentence-like noun phrase).

### 1.1 The Range of Gerund Constructions

There are a number of distinct structures in which the gerund appears. In this section, I would like to survey them. In coming sections, I will focus more narrowly on the Poss-ing construction.

Discriminating at a fairly fine grain, we can distinguish at least these uses of V+ing:

1. Present Participle
  - a. After progressive be
  - b. As pre- or post-nominal modifier

- c. In adjunct clause (sometimes with nominative or accusative subject)
2. (Argumental) "Acc-ing"
  3. "PRO-ing"
  4. "Poss-ing"
  5. "Ing-of"

Traditionally, (1) is distinguished from (2)-(5), the former being named the Participle, the latter, the Gerund. I will not be much concerned about the participle. (2)-(4) are distinguished from (5) in that (5), Ing-of, appears to involve a simple deverbal noun, and lacks the verbal characteristics to be found in the other cases. (2) Acc-ing and (4) Poss-ing are distinguished chiefly in the Case which is assigned to the subject of the gerund: Accusative in Acc-ing, Genitive in Poss-ing. PRO-ing differs from Poss-ing and Acc-ing in lacking an overt subject. It is an open question whether the structure of PRO-ing is actually the same as that of Poss-ing, Acc-ing, or may have either structure depending on context. Less likely, though not to be ruled out a priori, is that PRO-ing has a structure distinct from that of either Acc-ing or Poss-ing.

Eliminating the participle, then, and assuming provisionally that PRO-ing collapses with either Acc-ing, Poss-ing, or both, we have three basic types of gerund construction: Poss-ing, Acc-ing, and Ing-of.

## 1.2 Reuland's Analysis of Acc-ing

The most thorough recent analysis of the Acc-ing construction is that of Reuland (1983). I adopt his



characterization of Acc-ing at face value, for the time being, to provide a backdrop against which to compare the properties of Poss-ing, which is my chief concern. I offer a new analysis of Acc-ing in section 6.

These are the most important characteristics of the Acc-ing construction:

1. The subject receives accusative case:  
"We approve of him studying linguistics"
2. The subject alternates with PRO:  
"We approve of PRO studying linguistics"
3. The Acc-ing clause must appear in a Case-marked position.
4. The subject takes scope within the Acc-ing clause:  
"I counted on no one coming" vs. "I counted on no one to come"
5. No overt complementizer, no overt wh in Comp.
6. No raising from subject:  
"\*John was hated having to leave so soon"
7. Wh-movement from subject permitted:  
"Who did you approve of t studying linguistics"
8. Anaphors permitted in subject position:  
"We anticipated each other winning his race"
9. Acc-ing can be selected for.

Reuland accounts for these facts by proposing that the Acc-ing construction is a CP with an empty Complementizer, selecting an IP headed by -ing. -ing is a nominal element (when Acc-ing is an argument), and requires Case. It "shares" that Case with its subject.<sup>45</sup> -Ing lowers onto the verb via affix-hopping, or "Rule R" of Chomsky 1981. If it lowers in the syntax, no Case can be assigned to the subject, the subject position is ungoverned, and PRO appears. If it does

-----

45. Though the morphological case which appears on the subject of Acc-ing may differ from the abstract Case assigned to the Acc-ing phrase as a whole: as for instance when the Acc-ing construction appears in subject position, receiving nominative Case, but assigning accusative Case to its own subject. Reuland offers no explanation for this discrepancy.

not lower until PF, PRO is excluded, and the subject receives accusative Case. -Ing does not count as a Subject (in the binding theory of Chomsky 1981) for the subject, by stipulation. A matrix verb can govern IP and its head -ing across an empty complementizer, but not the subject of -ing, as -ing counts as a closer governor. For this reason, the ECP is violated if raising is attempted from the subject position, or if one attempts to raise the subject out of the Acc-ing clause by QR. Wh-movement out of Acc-ing is permitted, on the other hand, because it can use the empty Comp as an intermediate landing site; this option is not available to A-movement and QR.

## 2 Noun Phrase Aspects of Poss-ing

As the first order of business, I would like to review the evidence which leads us to the conclusion that Poss-ing gerunds are noun phrases, while Acc-ing gerunds are sentences.

### 2.1 External evidence

#### 2.1.a. Distribution

The first class of evidence indicating that Poss-ing is a noun phrase and not a sentence, is its external distribution. There are a number of positions from which sentences are excluded; Poss-ing does appear in these positions. These positions include (a) object of preposition, (b) subject of a sentence where Subject-Auxiliary Inversion has applied, (c) subject of an embedded sentence, (d) subject of a sentence following a sentence-initial adverb, (e) topic position,<sup>46</sup> (f)

-----

46. As Horn (1975) notes, topicalization of a clause is possible, curiously, if it originates as a sentential subject:

- (i) \*That John died we believed \_\_\_  
 (ii) That John died we believed \_\_\_ to be horrible

This is especially curious since the putative source is ungrammatical:

- (iii) \*We believed that John died to be horrible

Descriptively, when a sentential subject leaves its d-structure position, it can either move leftward and leave an empty category, or it can move rightward and leave an

cleft position:

(179)

- a. I learned about John's weakness for stogies  
 I learned about John's smoking stogies  
 I learned about John smoking stogies  
 \*I learned about that John smoke(s) stogies  
 \*I learned about (for John) to smoke stogies
- b. Does John's weakness for stogies bother you  
 Would John's smoking stogies bother you  
 ?Would John smoking stogies bother you  
 \*Does that John smokes stogies bother you  
 \*Would (for John) to smoke stogies bother you
- c. I believe that John's weakness for stogies bothers you  
 I believe that John's smoking stogies would bother you  
 ?I believe that John smoking stogies would bother you  
 \*I believe that that John smokes stogies bothers you  
 \*I believe that (for John) to smoke stogies would bother you
- d. Perhaps John's weakness for stogies bothers you  
 Perhaps John's smoking stogies would bother you  
 Perhaps John smoking stogies would bother you  
 ??Perhaps that John smokes stogies bothers you  
 ??Perhaps (for John) to smoke stogies would bother you

-----  
 overt pleonastic. If it is unable to leave a pleonastic, it is also unable to move leftward and leave an empty category. In this regard, consider cases where an object pleonastic is possible:

- (iv) We were sure of it that John would win  
 ?That John would win we were sure of \_\_\_
- (v) You can count on it that John will win  
 ?That John will win you can count on \_\_\_
- (vi) I said it first that John would win  
 ?That John would win I said first \_\_\_

The generalization breaks down with examples like the following:

- (vii) We resented it that John was given the prize  
 \*That John was given the prize we resented \_\_\_
- (viii) I hate it when it snows on my French toast  
 \*When it snows on my French toast I hate \_\_\_

- e. John's weakness for stogies I can't abide  
 John's smoking stogies I can't abide  
 ?John smoking stogies I can't abide  
 \*That John smokes stogies I can't believe  
 \*For John to smoke stogies I won't permit
- f. It's John's weakness for stogies that I can't abide  
 It's John's smoking stogies that I can't abide  
 It's John smoking stogies that I can't abide  
 \*It's that John smokes stogies that I can't believe  
 \*It's for John to smoke stogies that I won't permit

Acc-ing gerunds present the least serious violation. On the basis of this evidence alone, in fact, one can make a case for including Acc-ing with Poss-ing as a noun phrase. The degraded status of Acc-ing in (b)-(f) might be ascribed to some problem with accusative Case assignment in these contexts, or simply to the generally slightly marginal status of Acc-ing. In section 6 I will offer an analysis which predicts that Acc-ing has the distribution of a noun phrase, but no other noun phrase properties. Until then, I leave the behavior of Acc-ing in the paradigm (179) as an anomaly.

At any rate, the contrast between simple noun phrase and Poss-ing, on the one hand, and infinitives and tensed clauses, on the other, illustrates the point at hand: that Poss-ing has the distribution of a noun phrase, not that of a sentence.

Another irregularity is the behavior of indirect questions, which pattern like noun phrases in some contexts:

(180)

- a. I heard about what you did
- b. the knowledge (\*of) that John came  
the knowledge \*(of) who John saw

Two possibilities are (1) that indirect questions in these contexts share something of the structure of headless relatives, which are arguably noun phrases, or (2) that there is a [+wh] AGR in Comp that licenses wh-words in Spec of C, and this AGR supplies CP with certain nominal features.<sup>47</sup> I will not pursue the issue here.

There is one noun phrase position in which gerunds do not appear, namely, subject of noun phrase: \*stagnating's evils (Cf. √stagnation's evils.) This is due to other factors,  
-----

47. Possibly, the AGR in Comp acquires these nominal features in turn from the wh-word it agrees with -- or we could take the more traditional line that wh-words occupy Comp. It might be objected that not all wh-words are noun phrases, but the Case requirement remains:

(i)

I heard about what you did  
I heard about why you did it

the knowledge \*(of) what you did  
the knowledge \*(of) why you did it

We can follow Larson (1985), however, in taking wh-words like why, how, to be noun phrases that perform adverbial functions, on a par with "bare-NP adverbs" like yesterday, last year. We would need to assume that the "inherent Case" these words possess, under Larson's analysis, is not passed on to the CP they appear in, a plausible assumption. Note that with true PP's as wh-phrases, indirect questions do not show the same properties:

(ii)

\*I heard about in what way you did it  
\*the knowledge (of) in what way you did it

though. Note that -ing forms do not make good possessors even when they are clearly nouns:

(181)

\*[the singing]'s affect on them was heartwarming  
\*[the rioting]'s polarization of the country

### 2.1.b. Agreement

The Poss-ing gerund also differs from sentences in that it "bears agreement": i.e., conjoined gerunds trigger plural agreement on the verb, whereas with conjoined sentential subjects, the verb shows default singular agreement: (182). (Again, note that Acc-ing patterns with sentences, not Poss-ing.)

(182)

- a. That John came and that Mary left bothers/\*bother me
- b. John coming (so often) and Mary leaving (so often) bothers/\*bother me
- c. John's coming and Mary's leaving \*bothers/bother me

We can account for this fact if we assume, as is natural, that AGR can coindex with nominal elements, but not with sentences. An "unbound" AGR shows default singular agreement.<sup>48</sup>

### 2.1.c. Long-distance Binding

Finally, Acc-ing and Poss-ing gerunds show differences with regard to long-distance binding of their subjects: such  
-----

48. Alternatively, sentences, but not noun phrases, are forced to topicalize out of subject position (see Koster (1978), Stowell (1981)), and the trace left behind always has default number features.

binding is possible in noun phrases, and in Poss-ing gerunds, but not in Acc-ing gerunds:

(183)

a. they thought that each other's giving up the ship was forgivable

?\*they thought that each other giving up the ship was forgivable

b. they thought that each other's desertion was forgivable

c. ?\*they thought that for each other to desert would be forgivable

(cf. ?they thought that for John to desert would be forgivable)

## 2.2 Internal evidence

In this section, I turn to the aspects of the internal structure of Poss-ing that indicate that it is a noun phrase.

### 2.2.a. Subject

With regard to their internal structure, gerunds look like noun phrases because of the properties of their subject. First, unlike subjects of sentences, subjects of gerunds bear genitive Case.

Secondly, as noted by Horn (1975) and Reuland (1983), there are certain semantic restrictions on the subject of Poss-ing which makes it look like any other genitive noun-phrase specifier. In particular, inanimate subjects make poor possessors:



(184)

- a. ??the refrigerator's door  
John's door
- b. ?we were very upset at the refrigerator's tipping over  
we were very upset at the refrigerator tipping over
- c. \*we were very upset at our idea's being unfairly  
criticized  
we were very upset at our idea being unfairly criticized

Likewise, idiom chunks are not very happy in the  
possessor:

(185)

- a. \*I was irked at advantage's being taken of John's situation
- b. \*The outcome justified much's being made of Calvin's  
foresight

The evidence of (184) must be taken with a grain of salt,  
however. There are perfectly good Poss-ing gerunds where the  
possessor is not animate and concrete:

(186)

We would prefer its not raining just now

We might also cite the classic example, the city's  
destruction. Possibly, the contrast in (185b) amounts to no  
more than a (weak) stylistic tendency to prefer Acc-ing over  
Poss-ing when the subject is non-pronominal (as noted, for  
example, by Poutsma (1923)).

Thirdly, the Poss-ing genitive behaves like a possessor  
in the requirement that it be head-final:<sup>49</sup>

-----

49. Examples like those I have starred here are frequently  
produced in conversation, and it is arguable that they are  
not ungrammatical, but only bad style. Whatever the  
status of the deviance of (187a-b), though, it is their

(187)

- a. ?a friend of mine's new house
- \*a friend of the little boy's new bicycle
- \*the man responsible's briefcase
- \*the man who left early's briefcase

I was upset at ...

- b. \*a friend of mine's leaving early
- \*a friend of the little boy's leaving early
- \*the man responsible's leaving early
- \*the man who came late's leaving early

I was upset at ...

- c. a friend of mine leaving early
- a friend of the little boy leaving early
- the man responsible leaving early
- the man who came late leaving early

### 2.2.b. Specificity

Further, extraction from gerunds shows specificity effects. In this gerunds contrast minimally with Acc-ing constructions. Consider:

(188)

- a. We remember him describing Rome
- b. We remember his describing Rome
- c. the city that we remember him describing t
- d. \*the city that we remember his describing t

The ungrammaticality of (d) can be accounted for by assimilating it to specificity effects in extraction from noun phrases:

-----  
 contrast with the perfectly acceptable (187c) that is relevant for the point at hand.



(191)

- a. John disapproves of everyone's taking a day off (✓ wide)  
     John disapproves of everyone taking a day off (\* wide)
- b. John disapproves of everyone's happiness (✓ wide)
- c. John prefers everyone to take a day off (\* wide)

This is explained if (1) QR cannot cross a barrier nor move Comp-to-Comp, and (2) Acc-ing gerunds have a CP-IP structure with an empty complementizer. On the assumption that the subject of the noun phrase is embedded under only one maximal projection (DP) and not two (CP and IP), it is free to move out.

### 2.2.e. Sentential Adverbials

Finally, it is usually assumed (in particular, by Williams (1975), Jackendoff (1977), and Reuland (1983)) that sentential adverbials are not very good in Poss-ing gerunds, but that they are good in sentences, including Acc-ing gerunds:

(192)

- a. John probably being a spy, Bill thought it wise to avoid  
     him (Reuland 1983)  
     ?\*John's probably being a spy made Bill think it wise to  
     avoid him
- b. John fortunately knowing the answer, I didn't fail the  
     test  
     ?\*John's fortunately knowing the answer kept me from  
     failing

This paradigm is called somewhat into question, however, by the fact that Acc-ing does not take sentence adverbials when it is in argument position:

(193)

- a. \*I was worried about John probably being a spy
- b. \*I was grateful for John fortunately knowing the answer

Factivity probably contributes to the ill-formedness of

(193a): note that I was worried about John being a spy

involves the presupposition that John is a spy; this would be incompatible with an adverb like probably. This does not account for the ungrammaticality of (193b), however. Whatever the condition that prevents sentence adverbials from appearing in Acc-ing gerunds in argument position may well also exclude them from Poss-ing gerunds, which must always appear in argument position. I leave this as an unresolved question.

### 3 Sentential Aspects of Poss-ing

In the previous section, I summarized the evidence that has been collected over the years that makes it quite clear that Poss-ing gerunds are noun phrases, whereas Acc-ing gerunds are sentential.

#### 3.1 VP in Poss-ing

If Poss-ing gerunds are noun phrases, though, there is clearly a VP embedded in them. The "head" of the gerund -- i.e., the V+ing -- (a) Case-assigns its complement, (b) takes adverbs rather than adjectives, (c) takes auxiliaries, (d) takes double object complements, etc., etc. (For a complete catalog of the constructions that are found in the complement of verbs, including Poss-ing gerunds, but not in the complement of nouns, see section II-5.) In all these ways, it behaves like a true verb, and not a noun:

(194)

- a. John's discovering a thesis-writing algorithm  
\*John's discovery a thesis-writing algorithm
- b. Horace's carefully describing the bank vault to Max  
\*Horace's carefully description of the bank vault to Max
- c. Guineve's having presented a golden cup to Bertrand  
\*Guineve's have(ing) presentation of a golden cup to Bertrand
- d. Ilana's giving Marc a kiss in public  
\*Ilana's gift of Marc of a kiss in public

These facts indicate that there is a VP embedded within Poss-ing, that the structure is [NP NP's ... VP].

## 3.2 PRO in the Gerund

There is a bit of complicating evidence. There are ways in which the genitive noun phrase does not behave like a typical genitive. In particular, the subject of the gerund, like the subject of the sentence, but unlike the subject of the noun phrase, is obligatory -- as we discussed in II-4.5.b. As discussed at length by Wasow & Roeper, Poss-ing differs from Ing-of in that Poss-ing -- or more accurately, "PRO-ing", since there is no sign of genitive case -- shows obligatory control (Wasow & Roeper (1972) exx. 3-5.):

(195)

- a.i. I detest loud singing
  - ii. I detest singing loudly
- b.i. John enjoyed a reading of The Bald Soprano
  - ii. John enjoyed reading The Bald Soprano
- c.i. The killing of his dog upset John
  - ii. Killing his dog upset John

In the (ii) sentences, the agent of the gerund is necessarily understood to be either the subject of the sentence; or the object, in the psych-verb constructions (i.e., "I" in (a), "John" in (b) and (c)). This is the usual pattern for control of infinitives, as well: I would prefer to sing loudly, To kill his dog would upset John. In the (i) examples, on the other hand, the nominal need not be understood as controlled. This seems to indicate that there is necessarily a PRO subject in the (ii) examples, but necessarily none in the (i) examples.

There are two sets of apparent counterexamples to the claim that PRO is obligatory in the PRO-ing examples. First are examples like Shooting deer is fun/illegal. Wasow & Roeper argue that these involve a deleted one -- in current terms, PRO<sub>arb</sub>. Supporting their analysis, we may observe that examples of this sort are only possible in generic contexts, and in general correspond to PRO<sub>arb</sub> contexts for infinitives. It has been suggested that such cases actually involve control by an implicit benefactive argument: Shooting deer is fun for X/illegal for X. If so, these examples generalize with the next set of apparently problematic examples.

The second class of apparent counterexamples involve PRO-ing constructions as subjects of passives, such as Seceding from the Union was considered. Wasow & Roeper argue that the controller is the implicit agent of the passive; this seems quite reasonable, especially in light of recent work into the syntactic activeness of such implicit arguments.

Baker (1985c) notes that, not only are PRO-ing gerunds obligatorily controlled, but they require pleonastic subjects, when no external  $\theta$ -role is assigned:

(196)

I am disappointed by ...

a. its/\*the/\* $\emptyset$  raining all day

b. its/\*the being certain that she'll quit

c. \*its/the certainty that she'll quit

(Baker 1985c ex. 21.)



Baker also cites examples like \*I enjoyed PRO rendition of the aria as evidence that PRO is not only not required in non-gerundive noun phrases, it is not allowed. Such examples must be considered with caution, though. They crucially assume that subjects of noun phrases occupy the same position as determiners. This is called somewhat into question by examples such as there's no PRO fixing this boat now, where a determiner and PRO co-occur. (As Quirk et al. (1985) point out, the presentational context is one place in which gerunds productively appear with determiners. Jespersen cites similar examples.) Be that as it may, it is clear that controlled PRO is excluded from non-gerundive noun phrases.

Baker explains the obligatoriness of PRO and pleonastics in gerunds by appealing to Rothstein's Rule of Predicate-Linking. Rothstein (1983) argues that verb phrases are predicates, and are thus subject to a syntactic requirement that they have a subject. N-bar, on the other hand, is not a predicate, and thus does not require (and apparently also does not license) PRO or pleonastics.

In section II-4.5.b., I adopted a modified version of this hypothesis, namely, that VP, but not NP, is a predicate that requires a subject. VP is found in both Acc-ing and Poss-ing; hence the requirement that PRO or an overt subject appear when VP has an external  $\theta$ -role, and a pleonastic, when it does not. Contrary to Rothstein, I assumed that NP can, but need not, license a PRO. The fact that PRO is not

obligatory correlates with the fact that control is not obligatory with Ing-of.

There is a residual problem which this does not solve, however. Consider the examples (197), where the context is a discussion about one's children:

(197)

- a. It's the constant bickering at each other that bothers me most
- b. \*It's bickering at each other that bothers me most

In (197a), we have an Ing-of in a control environment, and the anaphor each other seems to require a PRO antecedent. Control is not required, however, as indicated by the well-formedness of the example. If control had been required, the antecedent me would have made PRO singular, thus an unsuitable antecedent for each other. Just such a situation is illustrated in (197b), with a PRO-ing construction.

If this argument is correct, it indicates that it is not simply the presence of PRO that determines whether a phrase must be controlled, but also the type of phrase involved. The generalization we made earlier was that control is mediated by the phrase containing PRO, and that sentences, but not noun phrases, require control. This hypothesis is incompatible with analyzing Poss-ing as a noun phrase. If PRO-ing can at least optionally be an empty-subject version of Poss-ing, and control of Poss-ing is not obligatory, inasmuch as Poss-ing is a noun phrase, then we would expect examples like (197b) to be

grammatical. Poss-ing should pattern with Ing-of with respect to obligatoriness of control.

One option is to assume that Poss-ing never exists with a PRO subject. We might suppose, for instance, that the only determiner that selects VP, and thus heads a Poss-ing type construction, is [+AGR], and excludes PRO by being a governor. This does not seem to conform to the facts, however. There are a few [-AGR] determiners that appear in Poss-ing constructions -- we have seen there's [no fixing this boat] now, for example. Also, there are positions in which only Poss-ing, and not Acc-ing, can appear:

(198)

a. the Administration defended North's siphoning funds to the Khmer Rouge

\*the Administration defended North siphoning funds to the Khmer Rouge

b. the Administration deplored North's getting caught at it

\*the Administration deplored North getting caught at it

In these contexts, it is still possible to find PRO-ing examples, indicating that these PRO-ing examples must correspond to Poss-ing structures; as expected, we do have obligatory control:<sup>50</sup>

-----

50. A fact that calls this paradigm somewhat into question is that there are verbs under which neither Poss-ing nor Acc-ing appears, yet PRO-ing does appear. These include avoid, cherish, deny, and possibly enjoy and detest. This weakens the claim that, because Acc-ing structures are ill-formed in these contexts, by process of elimination the examples of (199) must necessarily involve Poss-ing structures.

(199)

- a. the Administration defended siphoning funds to the Khmer Rouge
- b. the Administration deplored getting caught at it

I do not have a solution to this residual problem. I believe the most likely line is to argue that the Poss-ing construction indeed always has an overt subject, and all examples of PRO-ing have the structure of Acc-ing. Under this hypothesis, an explanation remains to be found for the examples of (199) and examples like there's [no fixing this boat] now (cf. e.g. footnote 50). A second possibility is that the obligatoriness of control is in some way tied to the obligatoriness of PRO: when PRO appears as the subject of NP, it is only optionally controlled, because it is an "optional PRO".

### 3.3 "N-bar" Deletion

A second way in which the possessor in gerunds differs from that in non-gerundive noun phrases is its ability to support a deleted complement. "N-bar" deletion is possible with concrete noun phrases, but not with gerunds:

(200)

- I was surprised by John's eagerness, and by Mary's, too.
- \*I was surprised by John's pitching in, and by Mary's, too.

This property is not unique to gerunds, though, but is also possessed by derived nominals:

(201)

\*I was surprised by John's discovery of an answer, and by  
Mary's, too.

It appears to depend only on the fact that these nominals denote situations, rather than objects. (The cut is between situations and objects, not between concrete and abstract, as indicated by the well-formedness of similar sentences where an abstract object is involved: I was surprised by John's idea, and by Mary's, too.)

I return to this issue in section 6.1.f.

## 4 Analyses I: Finding the Seams

Several proposals have been made in the literature as to the proper analysis of Poss-ing. In this section I would like to discuss each of them, as well as some that have not previously been proposed.

### 4.1 Schachter

Schachter (1976) argues for this structure:

(202)

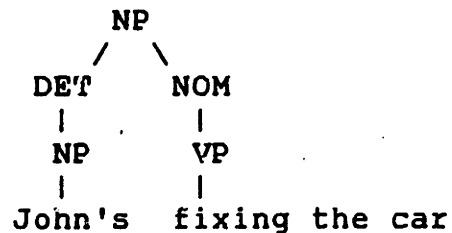

Chomsky (1981) adopts much the same structure, though he omits the "DET" and "NOM" nodes, and generates VP and the possessive NP directly under the topmost NP node.

Schachter assumes that auxiliaries are generated inside VP, but modals are generated external to VP, explaining the absence of modals in gerunds:<sup>51</sup>

-----

51. Actually, Schachter notes that, given his assumptions about phrase-structure, there is no principled way of excluding the rule NOM --> Aux VP (in place of NOM --> VP). Thus the lack of modals is correctly captured in his rules, but is not actually explained.

(203)

\*Frederick's must(ing) depart

\*Alan's can(ning) burn toy soldiers

Schachter's and Chomsky's analyses are problematic under current views concerning X-bar structure. There are two problems with Schachter's structure, assuming VP is the head of NOM, and ultimately of NP: how can a maximal category head another category, and how can a head differ in syntactic category from the phrase it heads: i.e., how can a verbal category head a nominal category? On the other hand, if VP is not the head of NP, then NP is unheaded, and we still have a violation of X-bar-theory.

Also, to account for the appearance of genitive Case in the gerund, it is assumed that genitive Case is assigned to the structural position [NP,NP]. All other Cases are assigned by lexical Case assigners, though. It would be much preferable to assimilate genitive Case to the others in this respect.<sup>52</sup> In Knowledge of Language, Chomsky takes the noun to be the genitive Case-assigner, but this leaves the presence of genitive Case in the gerund a mystery, since there is no noun present.<sup>53</sup>

-----

52. Certainly, there appear to be instances of Case-assignment without Case-assigners; in adjectival absolutes, for example: our fearless leader sick, we all pitched in to help. Here a "default" Case appears, which is, in English, objective or "common" Case. Genitive Case assignment has little in common with such constructions.

53. Chomsky claims that VP is the genitive Case-assigner in gerunds. The mystery is then why VP is the sole phrasal Case-assigner (all other Cases are assigned by X<sup>0</sup>'s) and

On the positive side, Chomsky gets some mileage from the fact that no noun head is present in the gerund. Specifically, he argues that PRO is possible in the gerund, but not in non-gerundive noun phrases, because in non-gerundive noun phrases, the noun governs the specifier position, precluding PRO; but in gerunds, there is no lexical head, and PRO is permitted.

#### 4.2 Horn

Horn (1975) proposes:

(204)

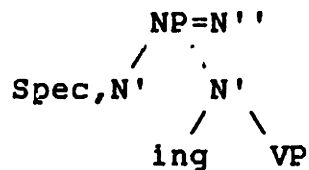

Under Horn's analysis (as well as under Schachter's), the availability of PRO is predicted: though -ing is a noun, it is also an affix, and presumably does not qualify as a "lexical category"; hence it does not preclude PRO in its government-domain.

The two problems with Schachter's analysis -- incompatibility with current X-bar theory, assignment of genitive Case -- receive natural solutions under Horn's analysis. X-bar theory is observed: the head of NP is an N;

-----  
 why VP assigns genitive Case only when it appears inside the noun phrase.



VP is a complement of that N, not the head of the gerund. Since -ing appears at PF merged with the verb, we can account for the intuition that the verb is the head. The presence of genitive Case can be ascribed to the noun -ing, under assumptions like Chomsky's, viz., that nouns are assigners of genitive Case.

### 4.3 The D-VP Analysis

#### 4.3.a. -ing as Functional Head

A reason for being uneasy with Horn's analysis is that -ing is not a typical noun. Nouns are not normally affixes. Nouns do not normally select VP's. Nouns do not normally have obligatory complements.

A related problem is why determiners cannot generally fill the specifier position of -ing, especially since a possessor is permitted. Also, if -ing is a noun, why are adjectives, PP modifiers, relative clauses, etc. excluded? The lack of adjectives, etc. might suggest treating -ing as a pronoun, but if it is a pronoun, why does it permit a possessor?

The fact that -ing shows up as a verbal affix, and displaces modals, makes it appear a priori to be an Infl. In fact, if we accept Reuland's arguments, -ing is precisely a garden-variety Infl in the Acc-ing construction. Unfortunately, if it were an Infl in the Poss-ing

construction, Poss-ing should behave like a sentence, not a noun phrase.

Given the framework developed in Chapter II, we can take -ing in Poss-ing to be "Inflectional" in the sense of being a functional element; one which is like Infl, moreover, in selecting VP. We can assume that it differs from -ing in Acc-ing in that it possesses the feature [+N] rather than [-N]. This idea is attractive, in that it postulates minimal variance between the -ing of Acc-ing, Poss-ing, and Ing-of, yet still accounts for the substantial differences in their behavior. The -ing of the Ing-of construction, we may assume, is like the Poss-ing -ing in being [+N]. It differs from Poss-ing -ing in that it selects  $V^0$ , not VP: it is not an affix with an independent syntactic domain.

By changing [-N] to [+N] in the lexical entry of Acc-ing -ing, we in effect create a Determiner ([+F,+N]) not a Noun ([-F,+N]), under the feature decomposition of syntactic categories which we proposed earlier. Thus if we take seriously the ways in which Horn's -ing behaves like a functional element, rather than a lexical element, we are led to recast his structure as a DP structure:

(205)

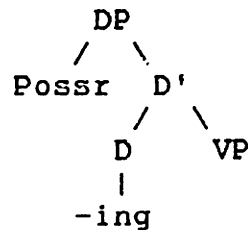

The unavailability of determiners and adjectives follows from the fact that they are not licensed by D, but by N. The fact that -ing is an affix, and obligatorily selects a non-argument complement, are typical properties of functional elements.

This analysis preserves solutions provided by Horn's analysis for the problems in Schachter's analysis. First, the VP is not the head of the noun phrase: the Determiner is. The intuition that V is the "head" of the phrase is preserved, if we assume that D functionally-selects VP. Namely, if D functionally-selects VP, then it inherits its descriptive content from VP, and becomes an s-projection of V. But since D c-projects the noun phrase (i.e., DP), X-bar-theory is not violated. What is involved is merely the substitution of one maximal category, VP, for another, NP.

Second, genitive Case in the gerund is accounted for, given our earlier hypothesis that AGR in the Determiner assigns genitive Case -- we need only assume the AGR which assigns genitive Case can co-occur with -ing.

The availability of PRO is also predicted, given that -ing is a functional element, thus not a governor for PRO.

## 4.3.b. Turkish Again

The D-VP analysis is also rendered particularly attractive because it exactly parallels Kornfilt's (1984) analysis of gerunds in Turkish. Recall that there is an overt AGR which assigns genitive Case in Turkish noun phrases, and thus strong evidence for the existence of a D node. The gerund construction, as in English, is a mixed construction: externally, and as concerns the subject, it behaves like a noun phrase, while internally, it behaves like a VP:

(206)

- a. Halil'-in her dakika iş-im-e karış-ma-sı  
 Halil-GEN every minute business-1s-DAT interfere-ING-3s  
 "Halil's constantly interfering in my business"
- b. Halil'-in gel-diğ-in-i bil-iyor-um  
 Halil-GEN come-ING-3s-ACC know-PROG-1s  
 "I know that Halil is coming"
- c. Kedi-ye yemek-Ø ver-me-diğ-iniz doğru mu?  
 cat-DAT food-ACC give-NEG-ING-2p true Q  
 "Is it true that you did not give food to the cat?"

The verb takes all its usual complements and modifiers: except for the morphology on the verb, the phrase including the verb and its complements is indistinguishable from any other verb phrase. On the other hand, the AGR is nominal AGR, and assigns genitive Case rather than nominative Case; also, the phrase as a whole is assigned Case like any non-gerundive noun phrase.<sup>54</sup> Clearly, the structure of the Turkish gerund is

-----

54. The absence of a case-marker in (206c) is not indicative of failure of case-assignment. The accusative case-marker is often omitted, even with non-gerundive noun phrases.

precisely what the D-VP analysis proposes for English Poss-ing:

(207)

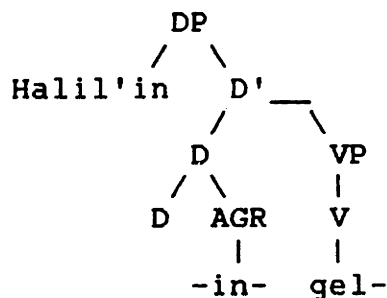

(What is less clear is precisely where -diq attaches, and where the case marker belongs. For this reason, I have omitted them from the diagram. I will return to this question below.)

#### 4.3.c. 's and Determiners

An (apparent) problem for the D-VP analysis is that there are a few cases of lexical determiners co-occurring with -ing. Jespersen (1909-49:vol.V,p.96) cites the following examples (the first of them is also cited by Jackendoff (1977) and Schachter (1976); similar examples are noted in Ross (1973)):

(208)

- a. There is [no enjoying life] without thee
- b. [This telling tales out of school] has got to stop
- c. The judgement of heaven for [my wicked leaving my father's  
house]
- d. Between rheumatism and [constant handling the rod and gun]

(Jespersen ascribes (c) to Defoe; (d) to Kingsley.)

The appearance of determiners in Poss-ing class gerunds was apparently much freer until early in this century.

Poutsma (1923) cites numerous examples from Dickens:

(209)

- a. [The having to fight with that boisterous wind] took off his attention. (Chimes, I)
- b. [the being cheerful and fresh for the first moment,] and then [the being weighed down by the stale and dismal oppression of remembrance.] (David Copperfield, Ch.IV, 30a)
- c. I am not disposed to maintain that [the being born in a workhouse] is in itself the most fortunate and enviable circumstance that can possibly befall a human being. (Oliver Twist, Ch.I, 19)

Poutsma cites further such examples from Dickens, Fielding, Samuel Butler, Hume, Thackeray, Jane Austen, Scott, Shakespeare, and several others.

(208c) and (208d) are the most disturbing, because they include adjectives. This suggests a structure in which the VP is inside of N-bar. It is difficult to know how to evaluate them, however, as they are definitely ungrammatical in the modern idiom. (208a), on the other hand, illustrates a construction that is quite productive to the present.

Consider:

(210)

There's no fixing it now  
There's no turning back the clock

Gerunds with this are also fairly acceptable (as noted also by Jackendoff):

(211)

?This telling tales out of school has to stop

?This mixing business and pleasure is going to catch up with  
you

Neither of these examples are overwhelming. The construction of (210) is clearly a fixed phrase. No cannot take gerunds in other contexts: \*I would recommend no stuffing ballot boxes this time, \*John thought no teasing his dog could bother the general. And the examples of (211) are really not very good, and to the extent that they are acceptable, the construction has the flavor of examples like This "Why, Mommy?" every time I tell you to do something has got to stop, where what follows this is disquotational -- one can even imagine having a silent gesture after this.

#### 4.4 The D-IP Analysis

A variation on the D-VP analysis is what we might call the "D-IP" analysis:

(212)

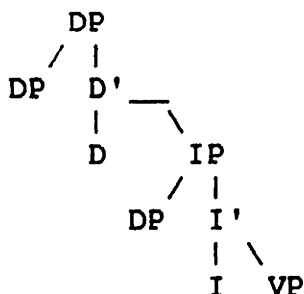

John 's PRO -ing hit the ball

Under this analysis, 's and -ing occupy two distinct functional-element positions. The complement of D is basically Infl, but it is "nominalized" by the -ing, to some

extent. Its syntactic category is Infl, but it has certain lexical features which make it sufficiently nominal in character that D can select it. In effect, this analysis involves the embedding of a PRO-ing structure under a noun-phrase specifier.

I argued for the D-IP analysis in Abney (1986); it was originally suggested to me by Richard Larson. Larson's suggestion was that [PRO V<sub>ing</sub> ...] denotes a property which is possessed by the subject (see below, section 4.5.e.). In his view, 's is a rough semantic equivalent of the verb have.

The D-IP analysis is required if we are to take 's to be a determiner (an analysis which I considered earlier, in section II-3.5.b., but did not adopt). In particular, supposing that 's occupies the determiner position raises a conflict with the supposition that -ing is in the determiner position. Possibly both share the determiner position: we might suppose that 's is a spell-out of AGR, and that in the same way AGR in the sentence can co-occur with e.g. Tense, 's can co-occur with an inflectional element, viz., -ing.

But this raises the question why 's cannot co-occur with e.g. the, if it can co-occur with -ing: why is \*John's [D the] book bad, where John's [D -ing] leave early is not? This is not a problem under the D-IP analysis.

There are considerations that make the D-IP analysis seem plausible, at least initially.



#### 4.4.a. Determiners

First, if one found unsatisfying the way I explained away the apparent cases of determiners in gerunds, or if one wishes to assign a structure to the archaic sentences cited by Jespersen, the D-IP analysis makes room for a full range of determiners. The fact that determiners do not generally appear with gerunds might be explained along lines suggested by Schachter -- to wit, that gerunds are like proper nouns in taking only a restricted set of determiners -- or by supposing that only certain determiners are "satisfied" with the nominal character of the gerundive IP, and most determiners require true NP's.

#### 4.4.b. The Position of -ing

A conceptual problem with the D-VP analysis, as well as Horn's analysis, is the position of -ing. Under the D-VP analysis, we must assume an -ing lowering rule, to get the right word order; but lowering rules raise certain problems with regard to the proper government of the trace of movement. If we assume the verb raises to -ing, on the other hand, we are unable to derive gerunds like:

(213)

John's hurriedly [<sub>D</sub> put-ting] [<sub>VP</sub> t out the fire]

Hurriedly appears outside of VP, in a position where it cannot be licensed.<sup>55</sup>

Under the D-IP analysis, on the other hand, we may assume V raises to -ing, and still have a position available for hurriedly -- the same position it occupies in the finite clause (214b):

(214)

- a. John's [<sub>IP</sub> PRO hurriedly [<sub>I</sub> put-ting] [<sub>VP</sub> t out the fire]]  
 b. [<sub>IP</sub> John hurriedly [<sub>I</sub> put-AGR] [<sub>VP</sub> t out the fire]]

Counterbalancing this argument to some extent is the fact that the D-IP analysis makes room for sentence adverbials, as well; however, as we noted above, these adverbials are generally considered ungrammatical in gerunds. On the other hand, I expressed some question as to whether they were actually excluded from gerunds; if we decide that they are not, there is no problem for the D-IP analysis.

#### 4.4.c. Spanish El + Infinitive

In Spanish, we find the definite article taking both infinitives, which are the equivalent of gerunds in English, and que clauses (examples from Plann (1981)):

-----

55. Though the possibility that hurriedly originates in the VP and is moved to its observed position cannot be dismissed.

(215)  
 [el [lamentar la perdida de las elecciones]] es inutil  
 the lament the loss of the elections is futile  
 "lamenting the loss in the elections is futile"

[el [que tu vengas]] no es importante  
 the that you come not is important  
 "it is not important that you are coming"

The fact that el takes a clause in Spanish lends credence to the claim that determiners can take clausal complements.

#### 4.4.d. Scope of Not

There is also evidence from scope phenomena which seems to support the D-IP analysis over the D-VP analysis and Horn's analysis. In the sentence, it is preferred for not in Infl to take wide scope over the subject of the sentence. Consider the sentence:

(216)  
 [IP Everyone [I didn't] come]

Both readings,  $\neg\forall x(x \text{ came})$  and  $\forall x\neg(x \text{ came})$ , are possible, but the former is preferred. We may assume that both scope relations are possible because the two operators mutually c-command, and that the negation operator has wide scope preferentially because it is "more prominent", being the head of the constituent.

Now consider the Poss-ing gerund:

(217)  
Everyone's not coming

Here, the narrow scope reading for not is actually excluded: the only interpretation is "the fact that  $\forall x \neg (x \text{ came})$ ". This is expected under the D-IP analysis. Assuming the scope of not to be IP, everyone is outside its scope:

(218)  
[DP everyone 's [IP PRO [I not -ing] come]]

Under the D-VP analysis, on the other hand, we would expect the scopal relations to be the same as in the sentence -- assuming that not appears in D in the gerund in the same way it appears in I in the sentence:

(219)  
[DP everyone [D 's not -ing] come]

The crucial contrast, though, is between Acc-ing and Poss-ing gerunds. Under the D-IP analysis, we would expect that they would differ: Acc-ing should behave exactly like the sentence. Unfortunately, the judgements are very subtle, but it does seem that giving not wide scope is better in the Acc-ing construction:

- (220)
- a. ?I was irked at [everyone not coming], but at least George and Maria were there.
  - b. ?\*I was irked at [everyone's not coming], but at least George and Maria were there.

Oddly enough, (220a) seems slightly better with stress on everyone. Also, in the context of (220b), the wide-scope

reading for not is not so bad as it is out of context. And here as well, stress on everyone causes considerable improvement. In sum, it seems that robust judgements are not to be had concerning scope-assignment to not, but to the extent that they go as I have indicated, they provide support for the D-IP analysis.

#### 4.4.e. 's as $\theta$ -Assigner

In Abney (1986), it was assumed that 's uniformly assigned a  $\theta$ -role to its subject, accounting in this way for the lack of raising and pleonastics in the noun phrase. The gerund differs from non-gerundive noun phrases in that raising is possible:

(221)

- a. [John's being likely t to win] will only spur Bill on
- b. [John's being certain t to win] will make Bill give up
- c. [John's appearing/seeming t to want us to leave him alone]  
miffed Muffy

The D-IP analysis allows one to preserve the assumption that 's is a  $\theta$ -assigner, in that it makes room for a PRO antecedent of the NP-trace, without assuming that John moved into a  $\theta$ -position. The problem which arises now is getting the proper interpretation with regard to the role of John in the situation denoted by the IP. In Abney (1986), I presented an account which also solved a problem which arises generally in analyses in which A-movement in the noun phrase is rejected (Grimshaw (1986) presents such an analysis): this problem is the construal of possessors which appear to receive a  $\theta$ -role

other than Possessor from the noun, namely, in derived nominals like Caesar's destruction of the city, the city's destruction.

The account I gave in Abney (1986), in a nutshell, is as follows.<sup>56</sup> First, consider a phrase like John's honesty, which denotes an attribute. Presumably, this does involve simple possession, and not A-movement.<sup>57</sup> Yet there is entailment that, if John's honesty succeeds in denoting something (i.e., if we are not dealing with a sentence like John's honesty is non-existent, in which John's honesty fails to denote), then honest(John). If John possesses the attribute of honesty (where we assume the interpretation of honesty to be the property  $\lambda x[\text{honest}(x)]$ ) then John is honest. This is what I called the Possessional Entailment.

(222)

Possessional Entailment:

Where  $\alpha$  is an entity, and  $\beta$  is an attribute,  $\text{Poss}(\alpha, \beta) \rightarrow \beta(\alpha)$

Now we can get the proper construal of e.g. John in John's leaving by claiming that the interpretation of [<sub>IP</sub> PRO leaving] is  $\lambda x[\exists e[e \text{ is a leaving} \ \& \ \text{Agent}(x, e)]]$ , PRO in effect providing the variable of abstraction for the property.

Predicating this attribute of John is to say that John left.

-----

56. The central idea, of possession of a property, is due to Richard Larson.

57. Though an analysis in which all deadjectival nouns were "unaccusative" would not be inconceivable.

A similar account can be given for derived nominals by claiming that they also denote properties: namely, that when the noun destruction is formed from the verb destroy, the interpretation of destruction is a property formed by abstracting over one of the two  $\theta$ -positions of destroy, i.e., either  $\lambda x[\exists e[\text{destruction}(e) \ \& \ \text{Agent}(x,e)]]$  or  $\lambda x[\exists e[\text{destruction}(e) \ \& \ \text{Patient}(x,e)]]$ .

Though there may be something to this account, as it stands, it seems to be a complex fix for an unnecessarily complex analysis. It would perhaps be necessary if other evidence supported the claim that the subject position of Poss-ing is a  $\theta$ -position. We would expect, for instance, that pleonastics and idiom chunks be disallowed in this position (as they are in non-gerundive noun phrases). Idiom chunks are indeed not very good:

(223)

- a. Advantage was taken of John's situation  
 (I was irked at) advantage being taken of John's situation  
 ??(I was irked at) advantage's being taken of John's  
 situation
- b. The bull was taken by the horns  
 (I approve of) the bull being taken by the horns in this  
 matter  
 ??(I approve of) the bull's being taken by the horns in this  
 matter
- c. Much was made of Calvin's foresight  
 (The slim margin by which global thermonuclear warfare was  
 averted justified) much being made of Calvin's foresight  
 \*(The slim margin by which global thermonuclear warfare was  
 averted justified) much's being made of Calvin's foresight

But pleonastics are rather good. Judgments are somewhat mixed, but there is a clear contrast between pleonastics with gerunds and pleonastics with non-gerundive noun phrases (Baker (1985c) gives a gerund with its being likely as fully grammatical):

(224)

- a. ?(I'm happy about) its being likely that John will finish soon  
 ??(I was surprised at) its seeming that John might not win
- b. \*its likelihood that John would win  
 \*its appearance that John would win  
cf.: the likelihood that John would win

The ill-formedness of the examples with idiom chunks we can ascribe to the independent condition on possessors that they be animate. Non-animate, even non-concrete possessors are acceptable, with some degradation. This degradation is most severe, we may assume, with noun phrases like idiom chunks that do not denote anything at all. In fact, the examples of (223) do seem to vary in acceptability according to the extent



to which they can be interpreted as metaphoric, rather than out-and-out non-referential. We can account for the marginality of the pleonastic examples of (224) in like fashion. This is my intuition, for instance, about the difference between the example with be likely and that with seem: it is forced to be understood as referential. With be likely, it can be fairly easily construed as denoting the proposition John will win, and propositions can be likely. With seem, on the other hand, even if we construe it as the proposition that John might not win, we cannot speak of propositions seeming, hence the additional ill-formedness of the example: we are forced to recognize it as truly non-referential.<sup>58</sup>

In sum, none of the arguments for the D-IP analysis are particularly strong, and the relative well-formedness of the examples with pleonastics is rather persuasive evidence against it. Thus I reject it, and with it, the proposition that 's is a  $\theta$ -assigning head of DP.

-----

58. Burzio's examples (i) are relevant here.

- (i)  
it was likely, without PRO being obvious, that S  
 \*it seemed, without being obvious, that S

A possible interpretation of the contrast in (i) is that it as subject of be likely occupies a  $\theta$ -position, hence can control a PRO. It as subject of seem, on the other hand, cannot control, indicating that it is a true pleonastic (thanks to N. Chomsky for reminding me of these examples).

## 5 Analyses II: The Morpho-logical Angle

There is another approach to the problem of gerund structure, exemplified by the analyses of Jackendoff, Lebeaux, and Baker. In this view, the question of gerund structure is a question of the interaction of morphology and syntax: it is a question of the behavior of phonologically dependent morphemes that, at some level, behave like independent morphemes, syntactically.

### 5.1 Jackendoff

#### 5.1.a. The Deverbal Rule Schema

Jackendoff (1977) recognizes that gerunds are problematic for a restrictive X-bar schema. The assumption that gerunds involve a noun phrase headed by a verb violates his Uniform Three-Level Hypothesis (that every category  $X^0$  projects to  $X^3$ , and every  $X^3$  is headed by an  $X^0$ ). He subsumes gerunds, along with five other structures, under a single exceptional rule schema, the Deverbalizing Rule Schema:

(225)  
 $X^i \rightarrow af - v^i$

His structure for Poss-ing gerunds results from instantiating this schema with  $X=N$ ,  $i=2$ , and  $af=\underline{-ing}$ :

(226)

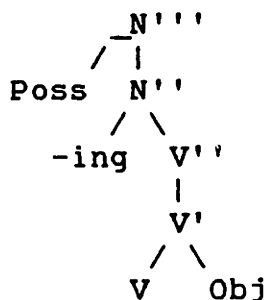

-ing subsequently lowers to V, yielding the correct surface form.

In this way, he accounts for the presence of a genitive (which is regularly a N''' specifier), the presence of VP (V'' for him: V''' is S), and the absence of a nominative subject, modals, and sentence adverbials, which are all daughters of V'''.

#### 5.1.b. The History of the English Gerund

As Jackendoff points out, this view permits a straightforward account of the history of the construction. Apparently the oldest form of the gerund is a simple deverbal noun, such as building, writing. Jackendoff speculates that the historical development of the gerund involved a raising of the attachment site of the nominalizing affix, from (227) (where X=N and i=0) to (226) (X=N, i=2):

(227)

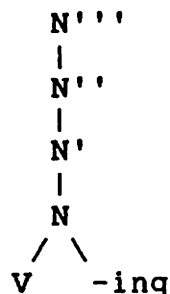

Emonds (1973) and Poutsma (1923) give chronologies for the development of the gerund that support Jackendoff's claims. Emonds 1973 is a study of gerunds in Chaucer, with the intent to demonstrate that the Poss-ing construction is not used by Chaucer, but only the Ing-of construction. He gives a list of criteria for distinguishing the Poss-ing and Ing-of constructions, and applies these criteria to all the examples of V+ing in Chaucer's "The Parson's Tale". Virtually all examples are either clearly Ing-of, or do not show clear indications of their status. There are only a handful of examples which appear to be Poss-ing or PRO-ing; these Emonds attempts to explain away, with more or less success. Even if he does not show Poss-ing to be non-existent in Chaucer, he does demonstrate that it is very rare, much more so than in current usage.

Poutsma gives a much more general chronology of the development of the gerund. This is his account, in brief: The gerund ending was originally -unq; that of the participle, -end(e) (-ind(e) in Southern dialects). As with modern German nominals in -unq, or Dutch nominals in -ing, the Old English gerund in -unq had only nominal characteristics, and none of

the mixed quality of present-day Poss-ing. The gerund and participle endings collapsed in the development of Middle English. Poutsma reconstructs the course of change as loss of the dental stop in the participle ending, followed by free variation between a dental and velar point of articulation for the nasal. By the fourteenth century, both endings were -ing, except in some Northern dialects, where distinct endings had been preserved at least to the time of Poutsma's writing: -an(d) for the participle, -in(q) for the gerund. The collapse of participle and gerund paved the way for the "mixing" of the verbal properties of the participle and the nominal properties of the gerund. The beginnings of the "mixed" gerund occurred in the mid fifteenth century. First, gerunds began appearing with particles (previously, according to Poutsma, particles were found with gerunds only as prefixes, not as separate words):

(228)

- a. the making up of the seide evidencez (Paston Let. No. 43, ca. 1444)
- b. smytynge of of hese feteris ("smiting off of his fetters", Paston Let. No. 144, ca. 1464)

Examples of gerunds taking a direct object begin to appear in the late fifteenth century. Finally, it is only much later (the end of the sixteenth century) that gerunds begin to appear with aspect and voice distinctions. Until that time, active gerunds are used in a passive sense (this usage is frequent even in Shakespeare, and survives to the present day in constructions like to be worth seeing (synonymous with to be worth being seen)).

This chronology accords well with Jackendoff's claim that the development of the gerund involved attaching -ing at an ever higher point in the expansion of NP. The only glitch appears to be accounting for the stage at which auxiliaries are not generated, but particles and bare-noun-phrase direct objects are. This would seem to indicate application of the Deverbalizing Rule Schema at the X' level -- Jackendoff generates auxiliaries under V''. However, adjectives and specifiers like many, three, are generated outside N', predicting that at the stage in which auxiliaries were not generated, adjectives were permitted, which is highly unlikely -- though I do not have data one way or the other.

### 5.1.c. Ing-of

A third possible instantiation of the Deverbalizing Rule Schema with X=N and af=-ing, which Jackendoff does not discuss, is the following, where i=1:

(229)

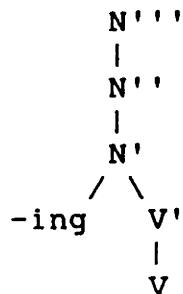

In Jackendoff's system, such a construction would have the following properties: it would have the distribution of a noun phrase, it would have both N''' and N'' specifiers -- i.e., possessors, determiners, quantifiers, and adjectives; it would

have both non-restrictive and restrictive relative clauses, but objects would not be marked with of, but would be bare noun phrases. It would lack modals, auxiliaries, all adverbials, but would have verbal subcategorizations, including particles, Case-marked noun phrases, double objects, etc.

There is a construction which has some, but not all, of these properties: namely, the "Ing-of" construction:

(230)

John's fixing of the car  
the looking up of the information

This construction appears to involve a simple deverbal noun, like derived nominals. In particular, it lacks the primary characteristic of a verbal construction, viz., Case-marking of the direct object. However, it differs in important ways from other derived nominals, which point to a more verbal character. Firstly, it permits particles, as we have seen -- though it does not permit particle movement: \*the looking of the information up. It is also like a verb and unlike a derived nominal in that it does not permit passive without passive morphology:

(231)

- a. Their carefully rebuilding the city  
 Their careful rebuilding of the city  
 Their careful reconstruction of the city

\*The city's carefully rebuilding t\*The city's careful rebuilding t

The city's careful reconstruction

Thirdly, it patterns with Poss-ing rather than derived nominals in not permitting temporal subjects (examples from Emonds (1973):

(232)

- a. Their renewing our contract this year  
 Their renewing of our contract this year  
 Their renewal of our contract

- b. \*This year's renewing our contract  
 \*This year's renewing of our contract  
 This year's renewal of our contract

On the other hand, determiners and relative clauses<sup>59</sup> are permitted, and modals and auxiliaries are excluded:

-----

59. Restrictive relative clauses are often not as good as one might like. This seems to have to do with the fact that these items denote situations; it is a property they share with derived nominals:

- (i) ?the sinking of a ship that bothered me the most was when the Lusitanic went down
- (ii) ?the destruction of a city that bothered me the most was when they bombed Dresden



(233)

- a. [the counting of the votes that took the longest] was in the 4th district
- b. \*the having fixed of the car

In short, the properties of the Ing-of construction are not precisely what Jackendoff would predict, assuming the structure (229), but they are close enough to merit further investigation.

## 5.2 Pesetsky/Lebeaux

A structure similar to that of (229) has been proposed by Lebeaux (1986). Lebeaux, following Pesetsky (1985), argues that there is LF-movement of affixes, and that the verbal properties of the Ing-of construction can be accounted for by assuming LF-raising of -ing to N-bar.

Pesetsky argues for using LF-raising of affixes to account for a number of "paradoxes" in morphology. Most of his examples involve a stem with both a prefix and a suffix, where the phonology indicates that the prefix is attached after the suffix, whereas the syntax or semantics indicates that the suffix is attached after the prefix. For instance, consider the form un-happi-er. -er attaches only to monosyllabic stems, or disyllabic stems with especially light second syllables: \*direct-er, \*complex-er.<sup>60</sup> This indicates -----

60. Though I am not entirely convinced that the combination of light first syllable, stressed second syllable, and semi-vowel third syllable allows -er even where the first syllable is not a prefix. I have been unable to find

that, for the phonology, the analysis must be [un [happy er]]. However, the meaning is not "not more happy", but "more not happy", indicating that, for the semantics, the analysis must be [[un happy] er]. Pesetsky solves this puzzle by satisfying the phonology at s-structure, and the semantics at LF: he raises -er at LF, so that it has narrow scope at s-structure, and broad scope at LF:

(234)

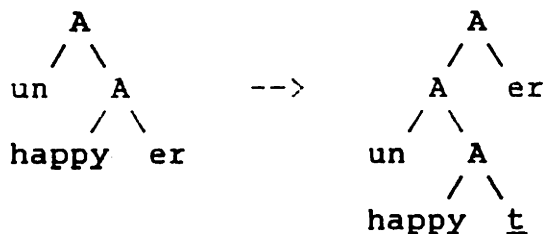

Lebeaux (1986) suggests using this device to account for the verbal properties of the Ing-of construction. He suggests that the V+ing noun in e.g. the singing of the song has many verbal properties because, at LF, it is a verb:

-----  
 existing words of this form, but the neologism corrodey (< corrode + -y, "disgusting") sounds quite happy with -er: This is corrodier than anything my mom's ever made me do before. This does not bear on the other paradoxes which Pesetsky has collected, however.

(235)

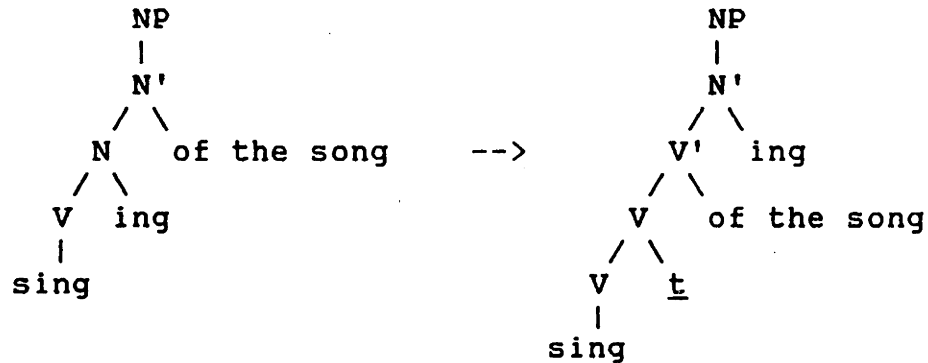

(Note that syntactic-feature percolation reapplies at LF, with the result that some of the category labels change between s-structure and LF. In particular, morphological traces do not possess syntactic category features, so the former complement ( $\{v \text{ sing}\}$ ) becomes the new head, as far as percolation of syntactic-category features is concerned.)

The similarity to the analysis I suggested to fill out the Jackendovian paradigm is striking. It is attractive to attempt to account for (part of) Ross' range of noun-phrase-like vs. sentence-like constructions by postulating differences in the scope of the nominalizing affix -ing. In lexicalized forms like building, it takes scope over  $N^0$ ; in Ing-of, it takes scope over N-bar; in Poss-ing, it takes scope over NP; and in Acc-ing, it takes scope beyond the projections of N, heading its own, independent, syntactic projection.

### 5.3 Baker

Baker (1985c) argues that the difference between Poss-ing and Ing-of gerunds is a matter of scope of -ing. He takes the Poss-ing construction to be a case of "syntactic affixation",

on a par with noun-incorporation, in contrast to Ing-of, which involves lexical affixation of -ing. More precisely, he assumes that Poss-ing gerunds have d-structures exemplified by (236), and s-structures like (237):

(236)

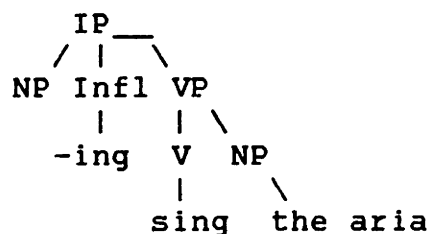

(237)

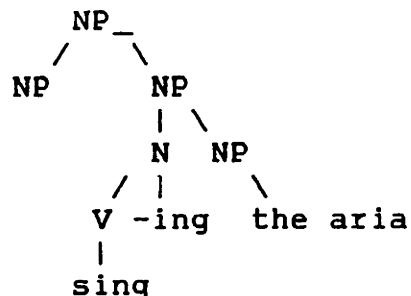

-ing has lowered to affix itself to sing; it is the head of the new complex lexical item [[sing] ing]. Following Pesetsky (1985), Baker assumes that projection conventions "reapply" at s-structure, with the effect that the nodes formerly labelled "V" and "VP" are relabelled "N" and "NP". The former Infl disappears without leaving a trace, and -ing becomes (remains?) head of the former IP, which is accordingly relabelled "NP". Baker ascribes the sentence-like properties of gerunds to the fact that they are sentences at d-structure, and their noun-phrase-like properties to the fact that they are noun phrases at s-structure and beyond.

There are a number of details which Baker does not iron out. First, Baker considers -ing to be the head of IP at d-structure; this would indicate that -ing is of syntactic category I, however, not N. The alternative is to assume an empty Infl at d-structure which disappears at s-structure. Secondly, there is a paradox concerning the timing of affix-movement and Case-marking. For the complements of sing, Baker requires Case-marking to apply before affix-movement, inasmuch as after affix-movement, the Case-assigner sing has become the non-Case-assigning noun singing. On the other hand, the gerund as a whole behaves like a noun phrase for the purposes of Case-assignment: it is not Case-resistant; it in fact requires Case. This requires Case-assignment to apply sometime after affix-movement, when the gerund has become a noun phrase. In this case, an empty Infl will not help, however. IP cannot become NP until after affix-movement has occurred, but by then it is too late to Case-mark the complement(s) of sing. Thus to make Baker's account coherent, we must assume that the gerund is a noun phrase at all levels. Case-assignment precedes affix-movement, and affix-movement precedes PF, and probably s-structure.

## 6 Conclusion: Syntactic Affixation

### 6.1 A Final Analysis

#### 6.1.a. The "Scope" of -Ing

The analysis of gerunds I would like to defend is very close to that of Jackendoff, except that I will generalize my analysis to Ing-of, and I adopt a DP structure for the noun phrase. The essence of the analysis is this: the differences in the structures of the various types of gerund in English reduce to differences in the "scope" of the nominalizer -ing. -Ing has the same basic properties in all three gerund structures -- Acc-ing, Poss-ing, Ing-of -- namely, it takes a verbal projection, and converts it into a nominal category. The three types of gerund differ only with regard to the point on the s-projection path of V that the conversion to a nominal category occurs: at  $V^0$ , at VP, or at IP.

Most of the properties of Acc-ing, Poss-ing, and Ing-of fall out correctly if we interpret "take scope over" as meaning "be sister of", creating the following structures (at s-structure):

(238)

a. Acc-ing:

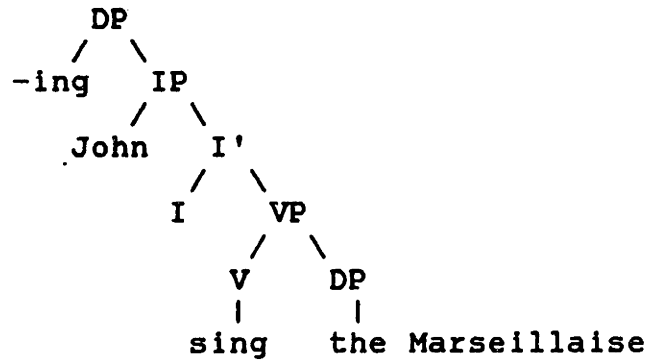

"John singing the Marseillaise"

b. Poss-ing:

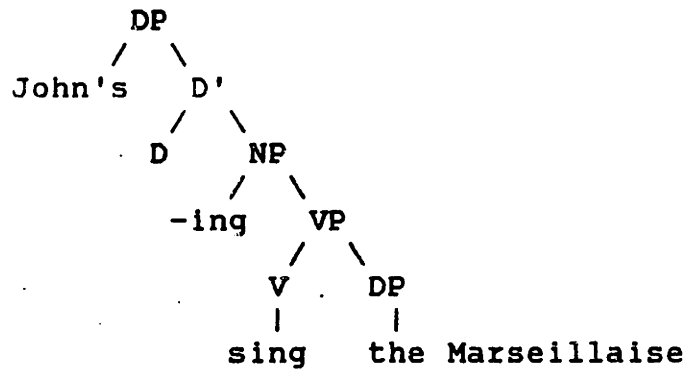

"John's singing the Marseillaise"

c. Ing-of:

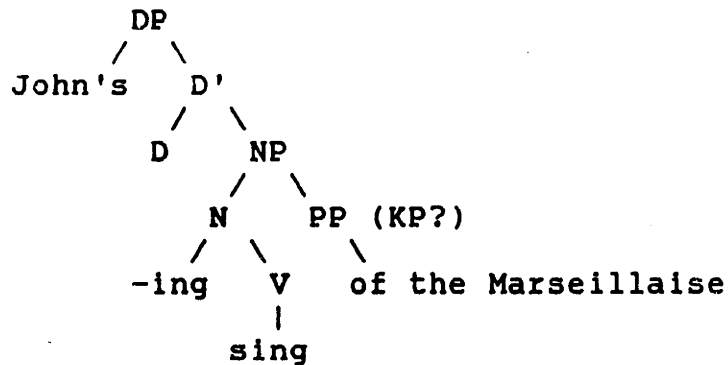

"John's singing of the Marseillaise"

I have taken -ing to adjoin to a (s-)projection of V, projecting its own nominal features to the category resulting from the adjunction, after the manner of morphological affixation (despite the fact that the adjunction is in the

syntax). If we assume that -ing can only adjoin to a maximal projection when it adjoins in the syntax, then, under the DP-analysis, we correctly predict three possible adjunction sites for -ing, viz., those of (238): adjunction to  $V^0$  (i.e., adjunction in the morphology), adjunction to VP, adjunction to IP.<sup>61</sup> For sake of preciseness, let us assume that -ing has the feature [+N]. Assuming V, VP have the features [-F,-N], adjoining -ing overrides the [-N] value, creating categories of type [-F,+N], i.e., N, NP. Assuming IP has the features [+F,-N], adjoining -ing produces a [+F,+N] category: i.e., DP.<sup>62</sup>

I should make very clear that I assume that -ing "affixes" to a verbal projection, "converting" it directly into a nominal projection, without projecting any structure of its own. For example, in the Acc-ing construction, I assume that -ing affixes to IP and converts it into DP. -ing is not a D; it simply substitutes its [+N] feature into the IP matrix, producing a DP. There is no  $D^0$  and no D-bar. If -ing were a D projecting DP in accordance with X-bar theory, we would expect it to take a subject, or to license other  
-----

61. A fourth possibility would be adjunction to CP. Preliminarily, we may follow Chomsky (1986a) in assuming that adjunction to CP is excluded by (as yet obscure) universal principles. The structure [<sub>CP</sub> C [<sub>DP</sub> -ing [<sub>IP</sub> ... ]]] is excluded because the selection properties of C are violated.
62. I am assuming, as I have since I.1.2, that N and V are distinguished by their value for the single feature [+N]. Under more standard assumptions about their feature composition, we would have to assume that -ing has the features [+N,-V].



dependents, such as locative PP's; but it does not. I spell out the mechanisms of this "affixation to XP" in section 6.1.e.

#### 6.1.b. Acc-ing

The only noun-phrase property of Acc-ing, if its structure is as given in (238a), is its external distribution. All the properties of the subject, including the Case it receives, and all the properties of the verb phrase contained within Acc-ing, are the same as are found in the sentence. This differs from Reuland's account -- which we have assumed to now -- in that it predicts a noun-phrase-like distribution for Acc-ing. Reuland ascribed no noun-phrase properties to Acc-ing at all. The predictions made by assigning Acc-ing the structure in (238a) seem to accord better with the facts. As we noted in discussing the external properties of Poss-ing (section 2.1 above), the distribution of Acc-ing is more like that of Poss-ing than we would expect if Acc-ing were a CP plain and simple. Acc-ing is somewhat marginal in most noun-phrase positions from which sentences are excluded, but not as bad as we would expect under Reuland's analysis (cf. the examples of section 2.1.a.).

In addition to its distribution, we identified (in 2.1) two other ways in which Poss-ing had the external behavior of a noun phrase, but Acc-ing did not. If we are now to assume, contrary to our earlier assumptions, that Acc-ing is a noun phrase at its outermost level, these ways that Acc-ing differs



as an accessible SUBJECT for anaphors within Acc-ing, accounting for the difference in long-distance binding properties between Acc-ing and noun phrases that do bear Phi-features, including Poss-ing.<sup>64</sup>

Thus, all the external evidence distinguishing Poss-ing as noun phrase but Acc-ing as sentence can readily be accounted for under hypothesis (238), under which both are noun phrases externally. They continue to differ with regard to the expected behavior of their subjects (cf. 2.2.a.): the subject of Poss-ing behaves like the subject of a noun phrase, but the subject of Acc-ing behaves like the subject of a sentence.

The assignment of accusative Case to the subject of Acc-ing bears a bit of discussion. I will part ways with Reuland, and assume not that accusative Case is assigned from outside, and transferred by -ing to the subject, but that there is an AGR present. I assume there is a nominal AGR in Poss-ing, assigning genitive Case, and a verbal AGR in Acc-ing, assigning common Case or nominative Case (nominative Case is usually only assigned in absolutive constructions, such as Mary was wasting her time on John, [he being a confirmed bachelor]). I take the (possibility of the) presence of AGR

-----

64. In the binding theory of Chomsky (1986b), the difference is one of the availability of a BT-compatible indexing. AGR does not count as a "potential binder" for anaphors in Poss-ing because of the "i-within-i" condition; AGR does count as a potential binder for anaphors in Acc-ing, because it does not coindex with Acc-ing. See Chomsky (1986b:173-174).

in Infl to be the default case, not the exception. The one place where it is not possible to have AGR in Infl is in the infinitive. In the infinitive, we may assume that it is the presence of to in Infl which precludes AGR.

### 6.1.c. Poss-ing

The analysis of Poss-ing presented in (238b) varies only slightly from the D-VP analysis examined earlier, and most explanations of properties of Poss-ing given under the D-VP analysis carry over into the current analysis. Poss-ing has the distribution of a noun phrase because it is in fact a noun phrase (DP). With regard to agreement and long-distance binding when Poss-ing fills subject position, we have just noted that Poss-ing differs from Acc-ing in possessing a D position, hence, Phi-features.<sup>65</sup> The subject receives genitive Case from D<sub>AGR</sub>. I assume that there is a non-overt AGR in D assigning genitive Case, and that 's is a postpositional case-marker (K). If sentence adverbials are licensed by the presence of an Infl, then we predict they will be found in Acc-ing but not Poss-ing; this seems to be correct, though, as we noted earlier (§2.2.e.), there is some unclarity in how to interpret the facts.

We also observed that quantifier subjects of Acc-ing strongly prefer narrow scope interpretation, whereas

-----

65. Recall that Acc-ing is a DP, but there is no D<sup>0</sup> -- -ing converts IP directly into DP. See section 6.1.e. for an account of the mechanisms involved.

quantifier subjects of Poss-ing strongly prefer wide scope interpretation. If quantifiers need to adjoin to IP to take scope, the inability of quantifiers to take narrow scope in Poss-ing, and their ability to do so in Acc-ing, is immediately accounted for, under the current analysis: there is an IP in Acc-ing, but not in Poss-ing.<sup>66</sup> What we have not yet explained is why quantifier subjects in Acc-ing resist wide scope interpretation, whereas corresponding subjects in e.g. infinitival complements are amenable to either scope:

(240)

- a. John disapproves of everyone taking a day off (\* wide)  
 b. John wanted every girl in the chorus line to be his wife (✓ wide)

I would like to suggest that there is a stronger relation between (bridge) verbs and their sentential complements than simply  $\theta$ -assignment, and that this relation is possible only between verbs and other verbal projections (i.e., IP, CP): hence, the fact that Acc-ing is a DP at the highest level explains its inability to "clause-merge" with the matrix verb. We can explain the inability of quantifiers in Acc-ing to take matrix scope by claiming that the lack of "clause-merging" creates a barrier to quantifier climbing.

Finally, we noted two other ways in which Acc-ing and Poss-ing are differentiated: Poss-ing shows "specificity"

-----

66. Fiengo & Higginbotham (1980) argue that quantifiers can also adjoin to N-bar (NP, under the DP-analysis). This does not affect the question at hand, as long as quantifiers cannot adjoin to DP (NP, under the standard analysis).

effects, and permits pied piping; Acc-ing does not. There is no standard account of the mechanism which permits pied piping. I would like to suggest that it involves the percolation of a wh-feature along non-verbal projections. The wh-feature of a wh-PP can percolate to a licensing (i.e.,  $\emptyset$ -marking) noun, at least in some cases, but never to a licensing verb (at least in English):

(241)

- a. my mother, [a picture of whom] you saw t  
 b. \*my mother, [examine whom] I thought the doctor never would t

Assuming the subject is licensed by the functional head containing AGR -- Infl in Acc-ing, D in Poss-ing -- the ability or inability of the wh-feature to percolate to the phrase as a whole is correctly predicted under the current analysis. Infl is a verbal category, thus percolation of the subject wh-feature, and pied piping of the Acc-ing phrase, are prohibited; D is a nominal category, hence pied piping of DP is permitted:

(242)

- \*the man [who flirting with your wife] you took such exception to  
 the man [whose flirting with your wife] you took such exception to

Concerning "specificity" effects: If we localize the source of this effect in the presence of a D node, it follows straightforwardly from the current analysis that Poss-ing, but not Acc-ing, will show specificity effects. The current analysis makes it more difficult to give a subjacency-based account for the distinction in question (i.e., the city which I remember him describing t vs. \*the city which I remember his

describing t). There is no concensus on the proper way to treat specificity effects, but it has been frequently observed that, even among non-gerundive noun phrases, the degree to which a noun phrase node is a "barrier" to extraction corresponds to the degree to which that noun phrase is interpreted as referential. If this intuition can be developed into a satisfactory formal account, it will plausibly cut properly between Poss-ing constructions -- which possess Phi-features, and are to that extent referential -- and Acc-ing constructions, which lack a D node.

As a closing note, recall that the primary problem with the D-VP analysis was explaining the co-occurrence of -ing and either AGR/'s or lexical determiners, in the D position. Since -ing is not generated in the D position under the current analysis, this is no longer a problem.

#### 6.1.d. The Site of -Ing

The question I would like to address in this section is precisely what licenses the configuration (243a) or (243b):

(243)



This appears to be adjunction of -ing to IP or VP, except that adjunction does not change category labels. I have described this configuration as "affixation" to a maximal projection. It is similar to affixation in that the features of the top

node are determined by combining the features of the affix (-ing) and the features of the "stem" (IP,VP). In particular, DP and NP inherit the feature [+N] from the affix, and the feature [+F] from the "stem". This is similar to the way that e.g. destruction inherits some features (e.g. syntactic category) from the affix -tion, and other features (e.g.  $\emptyset$ -grid) from the stem destroy.

Before I can spell out precisely what I mean by "affixation to a maximal projection", I must lay some groundwork. First, I would like to present a certain interpretation of X-bar theory which, though non-standard, is extensionally indistinguishable from the standard interpretation of X-bar theory. Let us begin by considering the tree (244):

(244)

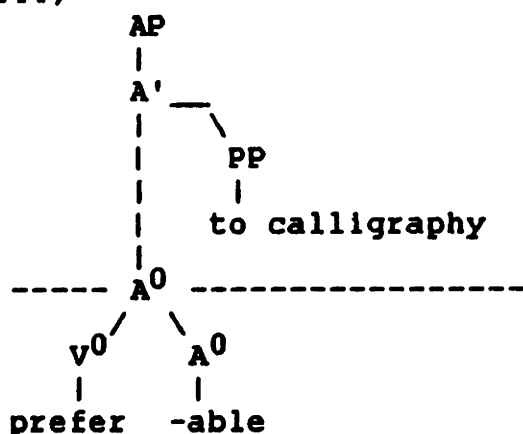

As it is usually conceived, there are two quite separate trees here: above the line is the syntax, to which X-bar theory applies, and below the line is morphology, to which quite different well-formedness principles apply. It is only a coincidence that one node,  $A^0$ , belongs to both trees. On the



other hand, the distinction between syntax and morphology is being blurred more and more in recent work, such as that of Baker, in which parts of words play important, independent syntactic roles. If we simply "erase the line" between syntax and morphology, however, and assign to phrases structures like (244), including both "syntactic" and "morphological" nodes, X-bar theory must be revised. Otherwise, for instance, X-bar theory would be violated by a subtree like (245):

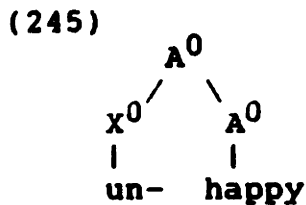

Under standard morphological assumptions, un- is the head of the higher  $A^0$ ; if so, however,  $A^0$  does not agree in syntactic category with its head, but with the complement of its head, violating X-bar theory. Further, the lower  $A^0$  is not a head, yet it is also not a maximal projection, again violating X-bar theory.

There is an obvious reinterpretation of X-bar theory that avoids these problems. Let us take X-bar theory to be a set of well-formedness principles which apply to subtrees of depth one:

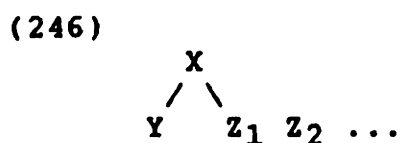

X-bar theory states that, in such a subtree:

(247)

- i. there is a head of X, let it be Y
- ii. where  $\underline{n}$  is the bar-level of X,  $\underline{n} > 0$  and the bar-level of Y is  $\underline{n}$  or  $\underline{n}-1$
- iii. X and Y have the same specifications for all inheritable features, including syntactic category
- iv. all non-heads  $Z_1$  are maximal projections

Let us suppose that every subtree must be licensed with respect to a set of configurational principles. To now, we have assumed that the only configurational principle-set is X-bar theory. If we extend phrase markers to include both syntactic and morphological nodes, however, we must include a second set of configurational principles: the principles governing affixation and compounding. They say, roughly, that in the subtree (246):

(248)

- i. there is a head of X, let it be Y
- ii. there is exactly one non-head, Z
- iii. X, Y, and Z all have X-bar level 0
- iv. for all features for which Y is specified, X and Y have identical feature-specifications
- v. for all features for which Y is not specified, but Z is specified, X and Z have identical feature-specifications

Every subtree must be licensed either by the syntactic conditions (247) (i.e., X-bar theory), or by the principles governing affixation and compounding (248). If we include the statement (249) (immediately following), what we have said so far is not a revision, but simply an alternative formalization of the standard view: a theory that does not have distinct syntactic and morphological structures, but does include (249), is extensionally indistinguishable from the current theory, with distinct syntactic and morphological structures:

(249)

A subtree must be licensed by X-bar theory if its head has X-bar level  $\underline{n} > 0$ ; otherwise, it may be licensed either by X-bar theory or by the principles governing morphological configurations.

This is true because we can still draw a line between the morphology and the syntax, as in (244). In every path from root to leaf, there will be a unique node below which all subtrees are licensed by the morphological conditions (248), and above which all subtrees are licensed by the syntactic conditions (247). This is guaranteed by the fact that all nodes must be  $X^0$ 's, for a subtree to be licensed by the morphological conditions, but any subtree licensed by the syntactic conditions will have at least one node of X-bar level greater than 0, namely, the root. Thus, in ascending a path from leaf to root, it is possible to switch from using the morphological conditions to license subtrees to using the syntactic conditions, but it is not possible to switch back.

Given this alternative formalization of conditions on structural configurations as background, the revision I would like to propose is simply this: in the morphological conditions, I would like to revise the clause (248iii), which reads "X, Y, and Z have X-bar level 0", to (248iii'):

(248)

iii'. if Y has X-bar level 0, then Z has X-bar level 0

Given (249), this revision will have no effect: if Y has X-bar level greater than 0, the subtree will be subject to X-bar theory, not to the morphological principles. If Y has X-bar

level equal to 0, then X has X-bar level 0 by inheritance, and Z has X-bar level 0 by the revised clause (248iii'). Finally, we may assume that X-bar levels less than 0 are universally prohibited.

The revision (249) will have no effect, that is, unless there are elements which are unspecified for X-bar level. It is possible to have elements unspecified for X-bar level if we treat X-bar level as a multi-valued feature, on a par with syntactic category or person, number, and gender. For instance, "N<sup>0</sup>" would be a shorthand for "[-F,+N,0Bar]". I would like to countenance the possibility that there are elements that are not specified for the feature [nBar], in the same way that there are elements like un- which are not specified for the features [+F,+N]. In particular, I would like to assume that -ing is such an affix. Consider then the configuration (250):<sup>67</sup>

-----

67. To be more precise, I should not represent "ing" as a separate node, but as an abbreviation for a phonological representation. Switching to a postfix feature representation for clarity, the tree should actually be:

(1)

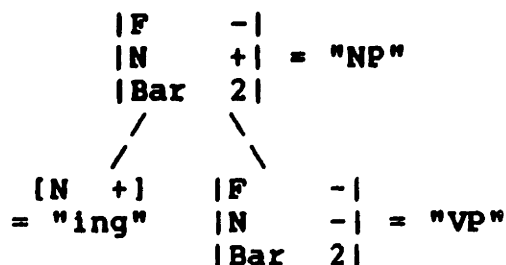

(250)

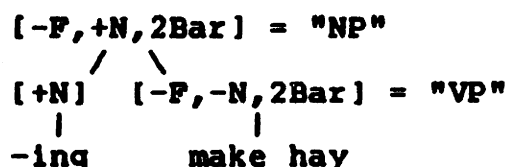

Since -ing does not have a X-bar level which is greater than 0 (inasmuch as it has no X-bar level at all), (249) permits us to license (250) by X-bar theory (247) or by the morphological conditions (248). If we try to license it by X-bar theory, we fail, inasmuch as the head does not have an X-bar level which is equal to or one less than that of the maximal projection. (In particular, the head has no X-bar level at all.) If we try to license (250) by the morphological conditions, though, everything is in order: the root node inherits its syntactic features from -ing; and since -ing is unspecified for X-bar level, the root node inherits its X-bar level from the complement of -ing.

I must emphasize that with regard to elements specified for X-bar level, the assumptions I have presented here are extensionally equivalent to -- i.e., a "notational variant" of -- standard assumptions. The assumptions presented here differ extensionally from standard assumptions only in the constraints they place on elements unspecified for bar level -- under standard assumptions, such elements do not exist. The entire extent of my revision of the theory is to say "let us suppose elements unspecified for bar-level exist". I have presented a notational variant of the standard theory, and made the minimal modification which permits elements

unspecified for bar level to exist. The resulting theory, without any additional assumptions, predicts a certain behavior for elements unspecified for X-bar level; this behavior is precisely the behavior of -ing.

#### 6.1.e. Lowering -ing

One outstanding question is whether the structures of (238) are representations at d-structure, s-structure, or LF. Lebeaux needed to assume that movement of -ing in Ing-of constructions (under his analysis) occurred at LF, because if -ing were adjoined higher than  $V^0$  at s-structure, then the verb should Case-assign the direct object (for instance), but this is of course characteristic of Poss-ing, not Ing-of. As concerns Case-assignment, we would wish to say that the representations of (238) are s-structure representations: the direct object receives Case in (a) and (b), but not in (c).

For this reason, we should take the representations of (238) to be s-structure representations. This creates the problem, though, that V and -ing form a morphological unit, at least at PF. It would seem that we are forced to assume either that -ing lowers onto the verb at PF, or that Case-marking is done before s-structure, and the verb raises to -ing by s-structure. Horn, Jackendoff, and Baker adopt the former course. This requires some comment, because there are problems which lowering movements raise for the ECP; these problems have led to lowering movements being generally disfavored. Affix-hopping ("Rule R" of Chomsky 1981), for

instance, has been replaced by verb-raising in Chomsky's more recent work. Under lowering movements, the trace of movement is not c-commanded by the moved element, hence the trace cannot escape the ECP by means of being antecedent-governed by the moved element.

On the other hand, there are empirical difficulties facing the assumption that all movements are raising movements, particularly as concerns affix-hopping. In French, there is clear evidence for raising of the verb into Infl.<sup>68</sup> Tensed verbs -- verbs which have merged with the AGR which originates in Infl -- precede negative adverbs, but infinitival forms -- where there has been no merging with AGR -- follow negative adverbs:

(251)

- a. je ne sais pas  
     \*je ne pas sais
- b. \*ne savoir pas  
     ne pas savoir

This receives a ready explanation if the verb raises into Infl to merge with AGR (and fails to do so when no AGR is present), and items like pas appear between Infl and VP.

In English, however, no similar evidence has been discovered, and the evidence in fact appears to point in the opposite direction. In most registers, adverbs can appear  
 -----

68. The argument presented here is originally due to Emonds.

between infinitival to and VP, indicating that adverbs do appear between Infl and VP in English, as in French:

(252)  
to thoroughly read the article

If the verb raises to Infl to merge with AGR, we would predict that (253) is grammatical, when it is in fact ungrammatical:<sup>69</sup>

(253)  
\*John read thoroughly [<sub>v</sub> t] the article

This appears to indicate that in English, unlike in French, AGR lowers to the verb, rather than the verb raising to AGR. Thus, the fact that the present analysis and those of Horn etc. involve lowering of affixes cannot be taken to weigh against them. We can preserve the ECP by assuming one of the following: (1) -ing leaves no trace, (2) the trace of -ing is not subject to the ECP, or (3) the lowering of -ing occurs in PF, where the ECP does not apply. The third option, lowering at PF, is least problematic. If one wishes to take either of the first two courses -- lowering in the syntax -- a caveat is in order. Assuming that -ing lowers to V between d-structure and s-structure means that the representations of (238) are in fact d-structure representations, not s-structures. The s-structures and LF's must be identical to (238) in relevant respects, though. In particular, to account for Case-

-----

69. Note that Case-adjacency is not a problem: the trace of the verb, not the verb itself, is the Case-assigner: this must be so, as the verb itself no longer governs the direct object.



assignment properties, lowering -ing cannot be allowed to convert the V into an N in Poss-ing and Acc-ing: we must assume that syntactic categories, once set at d-structure, cannot be changed at s-structure (though if we follow Lebeaux in taking the -ing of Ing-of to raise at LF, we must allow labels to change between s-structure and LF). Also, if we lower -ing without leaving a trace, we cannot allow the structure created by -ing to be destroyed by the movement of -ing. For instance, we must assume that the LF of the Poss-ing construction is:

(254)

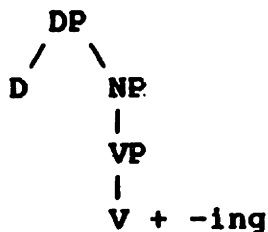

Otherwise the selectional properties of D would not be satisfied at LF.

An alternative to both lowering of -ing and pre-s-structure Case-assignment is this:<sup>70</sup> let us assume that the -ing which affixes to VP or IP is not the overt morphological affix, but a separate, abstract element; let us write it "ING". The structure of e.g. Poss-ing is:

-----

70. This analysis was suggested to me by N. Chomsky.

(255)

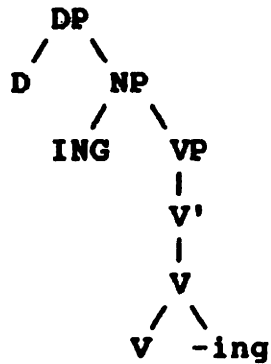

$V_{ing}$  raises at LF as a normal case of abstract head-raising, yielding the LF:

(256)

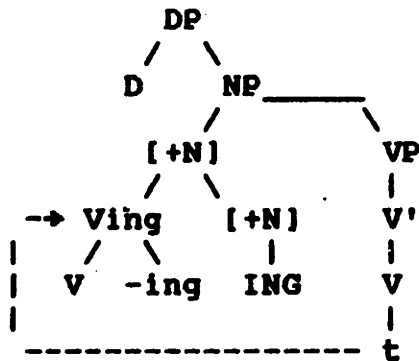

At LF, we may assume, morphological selectional requirements of ING guarantee that the verb has the -ing affix. The s-structure and LF of Acc-ing are, similarly, (257):

(257)

ss:

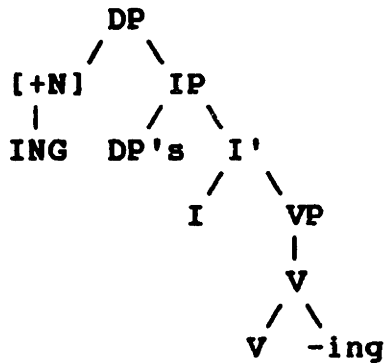

LF:

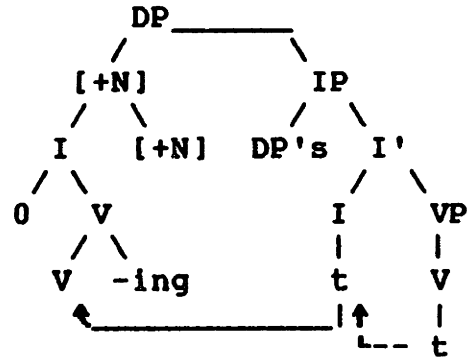

An alternative to head raising is the percolation of some feature distinguishing -ing -- say, [+ing], for lack of anything more inspired -- to the s-structure complement of ING. Note that this would require that Infl in Acc-ing "inherits" the feature [+ing] from its VP complement.

Note that under either version of the "ING" analysis, it is still necessary to license ING by the morphological conditions (248), not by X-bar theory. ING is not an independent syntactic head which projects a full X-bar projection. First, unless we permit ING to be specified only for [+N], and inherit its specifications for the feature [+F] from its complement, we cannot assume the same item ING in all gerunds -- Acc-ing, Poss-ing and Ing-of. Secondly, if ING projected a full set of X-bar projections, we would expect much more structure in Acc-ing and Poss-ing gerunds than we find. For instance, we would expect to find adjectives in Poss-ing, and possessors in Acc-ing:

(258)

\*

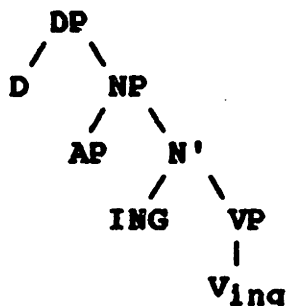

\*

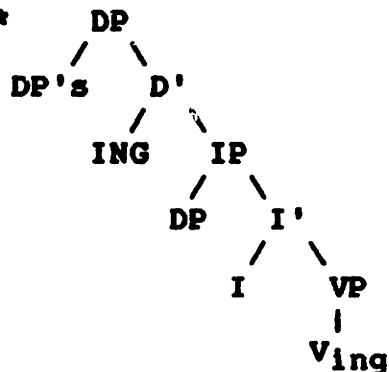

In conclusion, if we assume a separate, abstract item ING, we can assume LF-raising of  $V_{ing}$ , rather than PF-lowering of -ing. We must take ING to have precisely the characteristics we assigned to -ing in the previous section, and the conditions (247), (248), and (249) of that section continue to be necessary.

#### 6.1.f. Appendix: VP- and NP-Deletion

One of the unexpected ways that Poss-ing and Ing-of differ is in their ability to participate in "N-bar Deletion" -- which we must rename "NP-Deletion", under the DP-analysis. Consider:

(259)

- a. \*John's fixing the sink was suprising, and Bill's [e] was  
more so
- b. John's fixing of the sink was skillful, and Bill's [e] was  
more so

Under the current analysis, both involve the deletion of an NP under identity with a preceding NP. Why then is there a difference in grammaticality?

The first thing to notice is that John's fixing of the sink is actually ambiguous: it can either mean the manner in which John fixed the sink ("Act" reading), or the fact that John fixed the sink ("Fact" reading). Only under the Act reading is NP-Deletion possible:

(260)

- a. John's fixing of the sink was skillful, but Bill's [e] was
- b. \*John's fixing of the sink was surprising, and Bill's [e] <sup>more so</sup> was even more so

The explanation of the contrast in (259) is that (259a) involves a Fact reading, while (259b) involves an Act reading. Poss-ing differs from Ing-of in that the Act reading is not available:

(261)

- a. \*John's fixing the sink was skillful
- b. John's fixing the sink was surprising

Acc-ing also does not admit of an Act reading, and is not subject to NP-Deletion:

(262)

- a. \*John fixing the sink was skillful
- b. John fixing the sink was surprising
- \*John fixing the sink was surprising, and Bill [e] was more so

In Acc-ing there is of course the additional factor that there is no NP present, only a VP. This raises the question, though, why VP-Deletion cannot apply in (262b). VP-Deletion, unlike NP-Deletion, does apply to constructions with a Fact reading:

(263)

That John fixed the sink was surprising, but that Bill did [e]  
was more so

In fact, VP-Deletion applies only too constructions with Fact readings, simply because there are no VP's with Act readings. We can explain the failure of VP-Deletion to apply to Acc-ing by hypothesizing that the domains in which NP-Deletion and VP-Deletion apply are mutually exclusive: NP-Deletion always applies within DP, VP-Deletion always applies in IP's that are not within DP.<sup>71</sup> Thus the Acc-ing construction is in the domain of NP-Deletion, not VP-Deletion. But even if we generalize NP-Deletion to apply to either NP or VP indiscriminately (but again, within DP), it still will not apply in Acc-ing, because Acc-ing does not have an Act reading.

This account of the application of NP-Deletion reduces to three postulates, then:

(264)

- A. NP-Deletion applies only within DP
- B. NP-Deletion applies only in constructions with an Act  
reading
- C. A construction has an Act reading only if it contains an  
N<sup>0</sup>

Poss-ing and Acc-ing differ crucially from Ing-of in lacking N<sup>0</sup>, hence an Act reading.

-----

71. Of course, "not within DP" is not precise enough. We should say, "IP's that are not on an s-projection path which terminates in a DP". This distinguishes between the IP in Acc-ing and IP's in the complement of a noun. The latter are within a DP, but not on an s-projection path terminating in a DP.

Notice that derived nominals are like Ing-of in being ambiguous between Act and Fact readings. As predicted, they permit NP-Deletion only under the Act reading:

(265)

- a. Caesar's destruction of his fleet was thorough  
Caesar's destruction of his fleet was thorough, but  
Antony's [e] was more so
- b. Caesar's destruction of his fleet was quite unexpected  
\*Caesar's destruction of his fleet was quite unexpected,  
and Antony's [e] was even more so

Suppose we adopt Lebeaux' claim that Ing-of and derived nominals are distinguished from other nominals in that the affix (-ing, -tion, etc.) can raise at LF, creating a VP where an NP had been at surface structure (translating, now, into the DP-analysis):

(266)

SS:

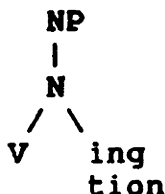

LF:

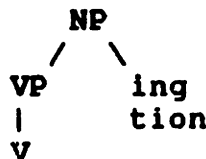

If the affix raises, we have a Fact reading; if it does not, we have an Act reading. Then we can put forward the complement of (264):

(267)

- A. VP-Deletion applies only within IP not in DP
- B. VP-Deletion applies only in constructions with a Fact reading
- C. A construction has a Fact reading only if it contains a V<sup>0</sup>

## 6.2 Affixes in the Syntax

This analysis, in which we analyze the various gerunds as involving affixation of -ing to maximal categories, accounts for the facts extremely well. A natural question, then, is the place this process has in the grammar more generally. Is -ing unique in behaving in this manner? How does the process of "affixation in the syntax" relate to other structures, particularly those created by functional heads?

### 6.2.a. The "New Morphology"

The idea of having affixes occupy syntactic positions independent of their roots is not a new idea by any means: cf. the classic analysis of Affix-Hopping in Chomsky 1955. But it is an idea that has come to play a central role in the "new morphology" developed in works such as Selkirk (1982), Fabb (1984), Sproat (1985), and especially Baker (1985b).

Baker (1985a) shows that the syntactic effects of morphemes are calculated in the same order as those morphemes are affixed to the root. In Baker 1985b, he gives an explanation for this observation, for a certain subset of cases, by proposing that the root of a complex verb actually be generated in a lower clause. The fact that the effects of the outer affix are felt later is simply a result of the cycle (loosely speaking).



An example is Baker's treatment of causative. The causative morpheme is generated in the matrix clause, and the verb root is generated downstairs, subsequently raising to the causative morpheme:

(268)

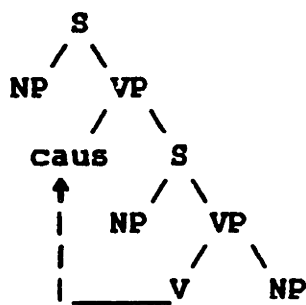

#### 6.2.b. Turkish Gerunds and the Mirror Principle

We see a Mirror Principle of a slightly different sort operating in Turkish. Recall that we had left a few loose ends in our discussion of Turkish gerunds in section 4.3.a., namely, the location of some of the affixes, such as the case marker. Consider a fairly complex example:

(269)

Herkes ben-im istakoz-a bayıl-diğ-im-i bil-iyor  
 everyone me-GEN lobster-ACC adore-NOM-1s-ACC know-PROG/3s  
 "everyone knows I adore lobster"  
 (lit., "everyone knows of my adoring lobster")

The skeleton of the structure of the gerund is:

(270)

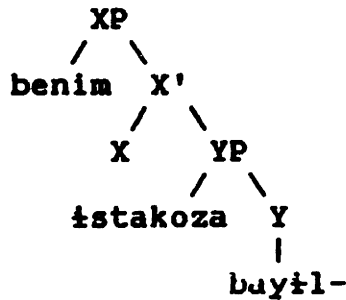

XP receives Accusative case under government from outside; this suggests that the case marker -I should be adjoined to XP (or it is a functional head selecting XP). Benim receives genitive case, as argued, from the nominal AGR -Im-, hence -Im- must govern benim. The obvious site for -Im-, then, is X; since -Im- is nominal AGR, presumably X=D. D selects NP, on the one hand; but the complements of Y are typical verb complements, not noun complements (istakoza is dative here, but accusative objects, etc., can also appear in gerunds). This suggests that Y=V, and -diq- affixes to YP, converting it to an NP. This leaves the bare verb stem in the lowest position. The complete structure is:

(271)

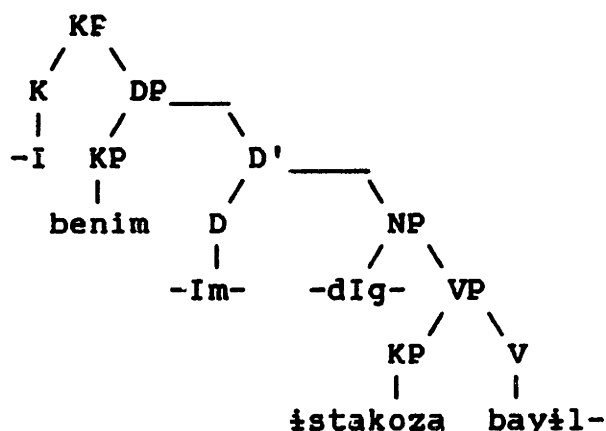

A kind of Mirror Principle is observed, in that, if we place the affixes in the syntactic positions which they behave as if they occupied -- as we have done in (271) -- the resulting hierarchy of affixes exactly mirrors the observed morphological hierarchy, with the highest affixes syntactically being outermost, morphologically. This is the same kind of syntactic-morphological correspondence as we observed in Baker's analysis of causatives.<sup>72</sup>

### 6.2.c. Generalizing the Mirror Principle

It is tempting to try to generalize the type of syntactic account which successfully yields the Mirror Principle effect

-----

72. Though I should hasten to make clear that the "kind of Mirror Principle" observed in Turkish is not the same Mirror Principle that Baker proposed. Baker cast his Mirror Principle in terms of order of application of morphological and syntactic processes: the order of application of the morphological processes brought on by affixes mirrors the order of application of the syntactic processes brought on by those affixes. In Baker's analysis of causative, but not in his analyses of many other morpho-syntactic processes, the order that syntactic processes occur is also mirrored in the hierarchy of positions morphemes occupy syntactically.

in the case of causatives and gerunds to all the cases discussed in Baker 1985a. A strong hypothesis would be that all affixes occupy independent syntactic positions, in a hierarchy corresponding to the order of their morphological occurrence.<sup>73</sup> This hypothesis has a certain attractiveness to it. The acquisition of gerund structures under the current analysis would be somewhat less of a mystery if it were the default case that affixes take phrasal scope. I will not attempt to seriously evaluate the hypothesis here, though. I only note an a priori difficulty in defending it. Namely, certain of the grammatical-function changing affixes which Baker (1985a) discusses have effects which would be difficult to ascribe to the presence of a syntactic affix. I have in mind particularly reflexive/reciprocal affixes. It is difficult to see how the presence of recipr in (272) would bring about the syntactic effect that is apparently required, viz., that DP1 and DP2 are marked as coreferential, DP2 is externalized, and DP1 suppressed (not allowed to be overt):<sup>74</sup>

-----

73. Even if this hypothesis could be established, it would still be necessary to demonstrate that the order in which syntactic processes apply which are brought on by the morphemes mirrors the syntactic hierarchy of the morphemes.

74. These are the effects expressed by Baker's grammatical-function changing rule

(1) NP1 VERB NP2 ... --> NP2 VERB -- ...  
       subj       obj                   subj       obj  
                                          (NP2 = NP1)

(Baker 1985a:393, ex. 44)

(272)

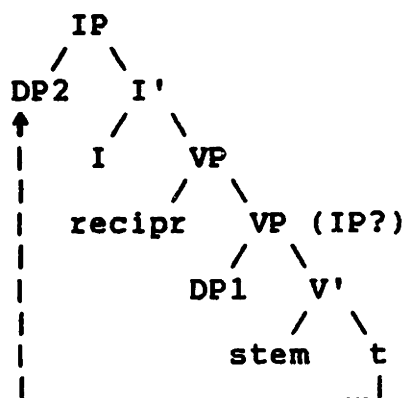

The nature of the effects of the reflexive/reciprocal morpheme seem to require that they be expressed as operations on lexical argument structure properties, not on syntactic structure.

### 6.3 Verbal and Adjectival Passive

It is reasonable to expect that other verbal affixes would behave like -ing in taking varying scope. A possibility that deserves mention, but which I will not pursue here, is that participial -ing derives adjectival categories from verbal categories in the way gerundive -ing derives nominal categories from verbal categories. Arguably, participles usually involve affixation of -ing to VP (or IP), but there are some words in -ing that function like pure adjectives -- e.g. seething, glowing mentioned earlier. These involve affixation of adjectival -ing to  $v^0$ .

A possibility I would like to pursue here is that the passive morpheme -en behaves like -ing in affixing in either the morphology or the syntax. In particular, I would like to

explore the possibility that the difference between verbal and adjectival passives is a matter of scope of -en, rather than a matter of category, as commonly assumed. I propose the following analysis for verbal (273a) and adjectival (273b) passives:

(273)

a.

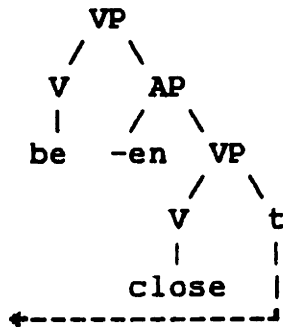

b.

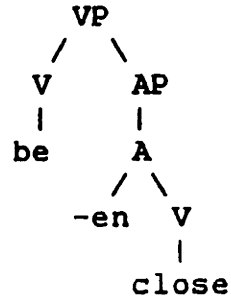

### 6.3.a. Distribution

The chief difference between this analysis and the standard analysis is that verbal passive phrases are analyzed as VPs, externally, in the standard analysis, but as APs, in this analysis. There are indications that the present analysis is more adequate.

First, verbal passive does not have the distribution of a typical VP. Anywhere a verbal passive can appear, an AP can appear; this is not true of tensed and infinitival VPs:

(274)

- a. the door was [closed]  
the door was [red]
- b. the door [closed in Bill's face on that fateful day] (has  
long since rotted away)  
the door [full of bulletholes]
- c. [closed in 1973], the plant has never reopened  
[first fashionable in 1967], the miniskirt has become a  
permanent part of American life

(275)

- a. John [came]  
\*John [busy]
- b. I watched John [leave]  
\*I watched John [tipsy]

On the other hand, as has often been pointed out, there are a few contexts in which APs, including adjectival passives, appear, but verbal passives do not. Such cases, in which verbal passives do not have the distribution of APs, constitute prima facie counterevidence to the present analysis. The primary such context is the complement of the verbs seem, remain, look, sound, and a few others:

(276)

- a. \*the door remained closed by the wind  
the door remained full of bulletholes
- b. \*the door looks closed by the wind  
?the door looks full of bulletholes  
the door looks red

One way to dismiss this evidence would be to claim that the constraint illustrated in (276) is not VP versus AP, but active versus stative: as Levin & Rapaport (1985) note, there are some adjectival passives that are excluded in this context, apparently because they are not stative: \*the books

remained unsent to the factory. However, even clearly stative verbal passives are not good: \*John remains known by everyone (cf. John remains known to everyone). Another possibility is that the failure of verbal passives to appear under remain, etc. can be associated with the failure of active participles to appear in this context:

(277)

\*John's tribute to Bill remained glowing through the years  
\*John remained seething at Bill

cf.:

John's tribute to Bill remained heartfelt through the years  
John remained angry at Bill

What is interesting about participles like glowing and seething is that they are clearly adjectives, having undergone semantic drift: cf. \*John seethed at Bill, ??John's tribute to Bill glowed. I will assume that an account for the examples of (276) can be given along these lines, hence that they do not constitute counterevidence to the present analysis.

It has also been claimed that verbal passives are excluded from prenominal adjective position, but here it is much more difficult to test. To be sure one is dealing with a verbal passive, and not an adjectival passive, it is usually necessary to include some sort of adjunct like a by-phrase; but phrases containing post-head material are excluded from prenominal position on independent grounds.

In short, the distributional evidence is mixed, but appears to favor an analysis in which both adjectival and verbal passives are APs.



## 6.3.b. Internal Evidence

Adjectival and verbal passives are more clearly differentiated by their internal structure. Here the standard analysis and the present analysis are in agreement: verbal passives have the internal structure of VPs; adjectival passives have the internal structure of APs.

The first point is the semantics of the two constructions. Verbal passives frequently denote actions; adjectival passives always denote properties. We have already seen this as a difference between gerunds where -ing affixes in the morphology (e.g. John's writing: on one reading, at least, it denotes an object, not an action) and where -ing affixes in the syntax (e.g., John's writing the letter: only denotes an action).

Secondly, verbal passives can assign Case, whereas adjectival passives cannot. Of course, this cannot be demonstrated with the simplest examples, as the case assigned to the direct object is "absorbed" in passivization, but this can be demonstrated with verbs that take double objects:

(278)

- a. %A book was [sent John]  
     John was [sent a book]
- b. \*The book remained [unsent John!]  
     \*John remained [unsent a book]

This is straightforwardly accounted for under the current analysis, inasmuch as verbs can assign Case, but adjectives

cannot (in English). In (278a), the object is adjacent to a verb at s-structure, but not in (278b):

(279)

- a. [<sub>AP</sub> -en [<sub>vp</sub> [<sub>v</sub> send] a book]]
- b. [<sub>AP</sub> [<sub>A</sub> [<sub>v</sub> send] -en] a book]

### 6.3.c. A Digression On Case Absorption

This raises the question, however, of what the mechanism of Case absorption is. If we assume that the passive morpheme "absorbs" the verb's Accusative case, we are forced to generate -en adjoined to  $V^0$ : if it is adjoined to VP, it is too high to absorb the Accusative case assigned to the direct object.

An alternative is to assume that Accusative case is not absorbed, but remains unassigned for some other reason. We might follow Rothstein (1983), for example, in supposing that the motivation for NP-movement in passive is not to provide Case for the object, but rather so that the highest VP can satisfy the requirements of Predication: (280) is bad because VP1 is a predicate which lacks a subject.

(280)

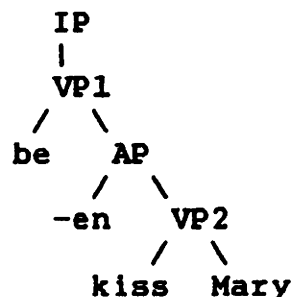

A number of questions arise: why can VP1's predication requirements not be satisfied by a pleonastic? Why does VP2 not require a subject? The most distressing question, however, arises from consideration of passive constructions as postnominal modifiers. Consider sentence (281a) with possible structures (281b.i.,ii.):

(281)

- a. \*[the boy kissed the girl] is John
- b. i. the boy [AP -en [VP PRO kiss the girl]]  
 ii. the boy [AP OP<sub>i</sub> [AP -en [VP t<sub>i</sub> kiss the girl]]]

We might argue that (281b.i.) is out because PRO is not high enough to construe with the boy. This could be solved by using an operator, as in (281b.ii.), parallel to the structure the man OP t to fix the sink. Then we might claim that the problem is the ECP: the subject trace is not properly governed. This is not defensible, however, because we would presumably assign an exactly parallel structure to the active participle construction: the boy OP -ing t kiss the girl, which is good.

Another alternative for the problem of Case absorption is that we adopt for -en the analysis suggested at the end of our

discussion of -ing-lowering vs. verb-raising: namely, that there are two -en elements, one abstract, which we can write "EN", and one concrete. The structure of a verbal passive is actually:

(282)

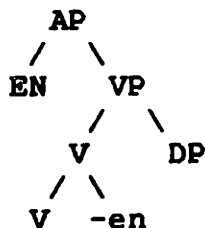

$V_{en}$  raises to EN at LF to satisfy EN's morphological selectional requirement that it be affixed to a  $v^0$ .

This opens the possibility that EN and -en divide the properties of the "passive morpheme" between them. In particular, suppose that EN has adjectival syntactic features, while -en has "Case-absorption" properties.<sup>75</sup> -en is in the right position to make the Case-absorption aspect of passivization felt, while EN is in the right position to permit verbal passive to contain a full VP.

We must be careful how this is spelled out, though. We must distinguish between the assignment of Accusative case, and the assignment of the "second Case" in double object constructions. We must have an account under which the former is absorbed by -en, but the latter is not. A likely

-----

75. Assigning Case-absorption properties to -en is reminiscent of the way that it is the trace of verb-movement, not the moved verb, which retains the Case-assignment properties of the verb that moves.

hypothesis is the following. The ability to assign Accusative Case is a property specific to certain lexical items, which -en can negate -- suppose, for concreteness, that Accusative-Case-assigning verbs have a feature [+A], and -en possesses the feature [-A], which overrides the stem's specification for [ $\alpha$ A] in the usual way. The ability to assign the "second Case" of double-object constructions, on the other hand, depends only on syntactic category (let us assume). If a head can license a second object by  $\theta$ -assignment, then it need only have the syntactic category V in order to Case-assign that object. The trace of -en has the feature [-A], but is not specified for syntactic category. The complex verb, V+-en, inherits the feature [-A] from -en, but since -en is unspecified for syntactic category, the complex verb inherits the category V from the stem. Hence, the  $V_{en}$  complex does not assign Accusative case, but it does assign the second-object Case (if it takes a second object).

This is only a sketch of an account. There are many questions left unanswered, such as why the "second-object Case" is apparently assigned to the first object in e.g. (a book was) given John, and why the "second-object Case" is unavailable when there is only one object. If the hypothesis is to be defended that the verbal passive/adjectival passive distinction is to be accounted to a difference in the scope of -en, the details must be worked out. I leave that for future investigation, however.

## 6.3.d. More Internal Evidence

Returning to the main line of discussion, a third way verbal and adjectival passives differ is that raising is possible with verbal passives, but not with adjectival passives:

(283)

- a. John was [known to be a genius]
- b. \*John was [unknown to be a genius]

This plausibly also follows from the fact that the head is a verb in (283a), but an adjective in (283b). Arguably, adjectives, like nouns, do not accept reduced-clause complements -- this was argued for nouns in section II-5. I follow Levin & Rappaport (1985) in assuming that raising adjectives like likely, possible are exceptional, and that the non-raising adjectives like obvious are the norm.

Fourthly, idiom chunks can be the subjects of verbal passives, but not of adjectival passives:

(284)

- a. Advantage was [taken t of the new computers]  
     Tabs were [kept t on Jane Fonda]
- b. \*Advantage remains [untaken t of the new computers]  
     \*Tabs remain [kept t on Jane Fonda]

This is explicable on the assumption that the parts of an idiom must be sisters. This is satisfied in (284a), but not in (284b), as a more detailed examination of the structure makes clear:

(285)

- a. [AP -en [vp [v keep] tabs]]
- b. \*[AP [A [v keep] -en] tabs]

Under more standard assumptions, this account of the absence of raising and idiom chunks in adjectival passives is not available. The assumption by which these facts are accounted for in the standard analysis (e.g., in Levin & Rappaport 1985) is that adjectival passive differs from verbal passive in being required to assign an external  $\theta$ -role. This  $\theta$ -assignment explanation is also available under the present analysis. I do not know of any evidence on which to base a decision between these two possible explanations.

There are a handful of other properties that are less clearcut in their implications, but suggest that the head of a verbal passive is a verb, but the head of an adjectival passive is an adjective. Agentive by-phrases, for example, are much happier in verbal passives than in adjectival passives:

(286)

- a. the door was [closed by the janitor]
- b. \*the door remained [closed by the janitor]

Also, too and similar degree words are more acceptable with adjectival passives than with verbal passives: this would fall out from the current analysis if we assume they are specifiers of adjectives, but not of verbs:<sup>76</sup>

-----

76. This assumption runs counter to assumptions I will explore in Chapter IV, viz., that degree words in AP are heads like determiners in noun phrases.

(287)

- a. \*the gravestone was [too damaged by the vandals last night  
to read]  
\*[<sub>AP</sub> EN [<sub>VP</sub> too [<sub>V</sub> damaged] by the vandals to read]]
- b. the gravestone remained [too damaged to read]  
[<sub>AP</sub> too [<sub>A</sub> [<sub>V</sub> damaged] EN] to read]

In sum, it is at least plausible that the difference between adjectival and verbal passives is to be accounted to a difference in the scope of -en, along the lines of my account of the differences among the three major classes of gerunds. If so, this supports my account of gerund structure, by showing that the mechanisms I postulated for gerunds have a more general validity.

My account of gerunds supports the DP-analysis, in turn, in that the prediction of the existence of precisely three types of gerund relies crucially on an analysis of Poss-ing in which it is headed by D, and D selects a nominal maximal projection.



## Chapter Four

### Lexical Determiners

We have been concerned to now primarily with the question whether there is an AGR occupying a functional (i.e., Infl-like) head position in the noun phrase. I believe the evidence of section II-2 from languages that have overt AGR in the noun phrase, and the evidence provided by the gerund, presented in the previous chapter, constitute a very strong case for adopting the position that the noun phrase is in fact a "DP", where "D" is a nominal functional element, the noun-phrase equivalent of Infl. Now, in the same way that Modal is the class of independent (i.e., non-affixal) words of category I, and Complementizer is the class of independent words of category C, we would expect there to be a class of independent words of category D, and the natural candidate is the class of Determiners -- the choice of the designation "D" was of course based on the tenuous hypothesis that Determiners are the noun-phrase equivalents of Modals. The question I would like to address in this chapter is whether this hypothesis is true: Are determiners of category D? Do determiners head the noun phrase?

In the first section, I discuss the evidence which bears directly on the question whether determiners head the noun phrase. First, I discuss evidence from Hungarian which shows that the strongest piece of evidence in favor of the standard analysis, namely, the fact that determiners and possessors are in contrastive distribution in English, does not in fact decide between the two analyses. I then discuss positive evidence for the Det-as-head analysis. One piece of evidence is that, when determiners stand alone, they continue to behave precisely like noun phrases, which is unexpected unless the phrase they project is in fact a "noun phrase". I argue that pronouns are in fact "intransitive" determiners. However, the most convincing reason for adopting the Det-as-head analysis is that the standard analysis simply does not provide enough distinct positions to accommodate the range of elements which appear before the noun in the noun phrase. Jackendoff (1977) assumed three bar-levels in the noun phrase, and he fully exploited them; the Det-as-head analysis provides the required extra specifier positions under a two-bar X-bar theory.

There are five major categories which fit my pre-theoretic characterization of "functional elements": complementizers, modals, determiners, pronouns, and degree words.<sup>77</sup> If complementizers, modals, determiners, and

-----  
77. There is actually a fifth, namely, conjunctions. Conjunctions have a number of unusual properties, and I will not attempt a treatment of their syntax.

Adpositions meet some of the criteria of functional elements, though not others (for example, adpositions

pronouns head larger phrases -- CP, IP, DP, and DP, respectively -- we would expect degree words to do the same. In section 2, I argue that this is in fact the case: that adjective phrases are in fact DegP's. This is almost unavoidable under the Det-as-head analysis, given the high degree of similarity in English between adjective phrase and noun phrase. I show that the DegP analysis permits an elegant account of the very rich specifier structure of the English adjective phrase.

In section 3, I return to a question of the internal structure of the noun phrase which I had slighted in section 1, namely, the position of descriptive adjectives. I argue that prenominal descriptive adjectives are the nominal equivalent of auxiliaries in the verb phrase, and as such are syntactic heads of the noun phrase they appear in. This accounts for a large range of differences in the behavior of pre- and post-nominal adjective phrases.

-----  
 freely appear in compounds; other functional elements are uniformly excluded from compounds). Earlier I briefly discussed the possibility that adpositions divide between true adpositions (P), which are thematic elements, and case-markers (K), which are functional elements, and do not assign  $\theta$ -roles to their complements.

## **1 Determiner As Head**

In this section, I consider the evidence which bears directly on the Det-as-head hypothesis. First, I consider evidence in favor of treating N as the syntactic head of the noun phrase, arguing that it does not in fact support the standard analysis over the Det-as-head analysis. In the second subsection, I present a handful of direct evidence in favor of the Det-as-head hypothesis. And in subsection three, I show how the Det-as-head analysis accommodates the range of specifiers found in the noun phrase, the wealth of which is something of an embarrassment for the standard analysis, inasmuch as the standard analysis only provides one specifier position for all these elements.

### **1.1 Arguments for the Standard Analysis**

#### **1.1.a. Selectional Restrictions**

There are two major arguments in favor of the standard analysis. First, it is the noun head which determines whether the noun phrase meets selectional restrictions imposed on it. Selectional restrictions are notoriously bad criteria for syntactic headship, however. Consider for example:

(288)

a large number of her friends admire a large number of her  
 #a large number of her virtues admire a large number of her  
virtues  
friends

If selectional restrictions determined syntactic headship, we would be forced to take friends and virtues to be the syntactic heads of a large number of her friends and a large number of her virtues in (288). This is, in fact, the position Chomsky took in Chomsky (1970): he considered a large number of to be a "predeterminer", which precedes the determiner her in Spec of N-bar. This hypothesis has since been generally abandoned as indefensible. For instance, of her friends is not a constituent in the "predeterminer" analysis, yet there is a good deal of evidence that it is a constituent in fact. It can be extracted, for instance:

(289)

Of her friends, [a large number t] admire her virtues

Selectional restrictions only require that we give an account of the way that the noun is the semantic head of the noun phrase. We have already provided such an account under the Det-as-head analysis. In section II-5.1 we assumed that NP provides a predicate over individuals, and that the determiner is a functor which relates that predicate to the predicate denoted by the rest of the sentence. Consider a simple case like the man admires sincerity. If we abbreviate the predicate  $\lambda x[x \text{ admires sincerity}]$  as F, the selectional restriction it imposes on its subject is this:  $F(x) \rightarrow \text{animate}(x)$ . The NP man translates as  $\lambda x[\text{man}(x)]$ . The binds

the variable position in this predicate; the translation of the DP the man is  $\lambda x[\text{man}(x)]$ . It is a tautology that  $\text{man}(\lambda x[\text{man}(x)])$ , hence it follows that  $\text{animate}(\lambda x[\text{man}(x)])$ , and we have accounted for the satisfaction of the selectional restriction imposed by the predicate  $\lambda x[x \text{ admires sincerity}]$ . Similar demonstrations can be given for other determiners, though I will not give them here.

### 1.1.b. Determiners and Possessors

The second major argument in favor of the standard analysis is that lexical determiners are in contrastive distribution with possessors:<sup>78</sup>

(290)  
\*John('s) the/that/some book

Under the standard analysis, possessors and determiners occupy the same structural position, hence they cannot co-occur.

In contrast, under the Det-as-head hypothesis, we must say something extra to account for the complementarity of possessors and determiners. We must adopt some constraint along the lines of (291):

-----

78. An exception to which I will return is every: John's every book.

(291)

AGR in D does not co-occur with lexical determiners

Assuming that possessors only appear when there is an AGR in D (which assigns genitive case), the inability of AGR to co-occur with lexical determiners explains the inability of possessors to co-occur with lexical determiners.

Because the Det-as-head analysis requires the added constraint (291), the standard analysis would appear to be minimal.

In defense of the Det-as-head hypothesis, consider first that (291) does not in fact involve introducing a new mechanism into the grammar. We already assume a constraint of the form " $\alpha$  does not co-occur with AGR"; namely, for  $\alpha$  = infinitival to. To, unlike modals, precludes AGR. Further, I will show that in Hungarian, unlike in English, determiners and possessors do co-occur. Determiners appear in precisely the position we would expect if they occupy the position of D. This leads us to conclude that determiners occupy the D position in Hungarian. For the sake of cross-linguistic generality, we would like the same to be true in English. Under the Det-as-head analysis, the difference between English and Hungarian is only whether the constraint (291) applies or not. Under the standard analysis, on the other hand, English and Hungarian have radically different noun-phrase structure. Thus the Det-as-head analysis is in fact the minimal hypothesis.

## 1.1.c. Hungarian

In English, there is at least one counterexample to the generalization that determiners do not co-occur with possessors, namely, every, as in John's every wish. If we assume that determiners appear in Spec of D, we would probably take John's every wish to involve an exceptional categorization of every as a quantificational adjective, parallel to John's many wishes. But then the problem is to explain why we do not have \*the every wish, \*an every wish, \*this every wish. (\*Each every wish, \*some every wish, etc., are presumably out for semantic reasons.) The only noun-phrase specifier that every co-occurs with is the possessor. This would seem to indicate that the possessor does not appear in the same position as lexical determiners, despite appearances.

We might ignore John's every wish as an anomaly, an idiom on a par with in as much as or the be all and end all. However, in Hungarian, the literal translation of John's every wish, John's each apple, John's which book are all grammatical, as Szabolcsi (1987) points out:

(292)

	minden		
	ezen/azon		
Peter	valamennyi		kalapja
	mindket		
	semelyik		
	melyik		



	every		
	this/that		
"Peter's	each		hat"
	both		
	neither		
	which		

This makes it clear that we cannot take determiners to be in Spec of D, in Hungarian.

The determiners of (292) appear precisely in the position of D:

(293)

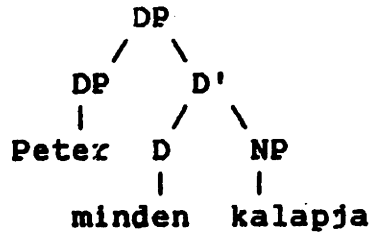

A problem for this hypothesis is that D has two realizations in (293): there is the determiner minden, but there is also the inflectional ending -ja on the noun. A comparable situation in the sentence would be if there was a modal, yet the verb continued to agree with the subject. AGR does co-occur with modals, as indicated by the fact that the subject continues to receive nominative case; it is only that AGR cannot be overt when modals are present. Admittedly, if AGR were overt, we would expect it to appear on the modal, not on the verb.

Below (section 3.3.c), I argue that there are affixal degs/determiners in English (and other languages) which appear on the noun, and raise to D at LF. I argue that "doubly-

filled" D's are prohibited at s-structure, but not at LF. If this hypothesis is correct, it provides an explanation for the structure (293). In (293), we must assume that there is an AGR in D at s-structure, to assign Case to the subject. Assume that a prohibition against doubly-filled D's holds in Hungarian,<sup>79</sup> but it applies at PF in Hungarian. This would permit -ja to occupy D at s-structure and Case-assign Peter, then lower onto the noun before PF.

The claim that determiners appear in the position of D in Hungarian is corroborated by the fact that Hungarian, unlike English, appears to have an equivalent of Comp in the noun phrase, as well as an equivalent of Infl. There are two ways of expressing the possessor in Hungarian: either in the nominative case, as we have seen, or in the Dative case:

(294)

Peter-nek a kalapja  
 Peter-DAT the hat  
 "Peter's hat"

Szabolcsi argues that the Dative possessor occupies the subject position of a noun-phrase equivalent of Comp, which she calls "Komp" (K).<sup>80</sup> She shows clearly that noun phrases like that of (294) form a constituent (they can undergo focus movement as a constituent, for instance). The dative

-----

79. Though we would not necessarily wish to assume it holds in all languages.

80. Horrocks & Stavrou (1985) make a similar claim for Greek.

possessor differs from the nominative possessor in that it can be extracted, whereas the nominative possessor cannot:

(295)

- a. Peter-nek lattam [t a kalapja-t]  
 Peter-DAT I-saw the hat-ACC  
 "Peter's hat I saw"
- b. \*Peter- $\emptyset$  lattam [a t kalapja-t]  
 Peter-NOM I-saw the hat-ACC

Szabolcsi ascribes this asymmetry to the ECP, claiming that the nominative position cannot be properly governed from outside the noun phrase, but the dative position can.

In the same way that Hungarian has determiners of category D, there is also one determiner that is arguably of category K, namely, the definite article a(z). Precisely as we would predict, a(z) appears after dative possessors, but before nominative possessors:

(296)

- a. Peter-nek a kalapja  
 Peter-DAT the hat
- b. a Peter- $\emptyset$  kalapja  
 the Peter-NOM hat

(That the determiner in (296b) belongs with the matrix noun phrase, and not with Peter, is shown by the fact that in the majority dialect (from which the examples of (296) are drawn), determiners are unable to co-occur with proper nouns: \*a Peter. In all dialects, determiners are unable to co-occur with pronouns (e.g., \*a te "the you"), yet determiners are found in structures like (296) even when the possessor is a

pronoun: a te kalapja "your hat", indicating clearly that a belongs with kalapja, not with te.)

The two types of determiner can also co-occur:<sup>81</sup>

(297)  
a Peter minden kalapja  
"Peter's every hat"

To the extent that it is correct to postulate the structure [KP DAT K [DP NOM D [NP N ]]] for Hungarian noun phrases, there seems to be little choice but to place az in the K position, as both the specifier of K and the specifier of D are spoken for by the two types of possessor.

In conclusion, Hungarian provides rather striking evidence that determiners head DP and even KP, at least as an option provided by UG. In the ideal case, determiners would have the same syntactic behavior in all languages. The minimal assumption is thus that determiners head DP in English; the burden of proof is on those who would wish to make determiners heads of noun phrases in Hungarian, but specifiers of noun phrases in English.

-----

81. Though they cannot be adjacent in PF: \*a minden kalapja. Szabolcsi argues for a PF rule deleting az when it appears string-adjacent to another determiner.

## 1.2 Sundry Evidence For Det As Head

Having disarmed certain arguments against the Det-as-head analysis, I turn in this section to positive evidence for the Det-as-head analysis.

### 1.2.a. Dets That Cannot Stand Alone

First, there are determiners like the which absolutely require following noun-phrase material, and which cannot appear alone, in any capacity. There are few words that so strongly require accompaniment as the and a. In the cases where such words are to be found, their inability to stand alone is encoded as the obligatory selection of a complement. Examples are complementizers like if, which select a sentence; prepositions like of, which select a noun phrase; and conjunctions like and, which select a range of complements, but must appear with some complement. We can account for the co-occurrence requirements imposed by the without introducing new mechanisms into the grammar, if we assume the obligatorily selects an NP complement (hence that it heads the noun phrase (DP)).<sup>82</sup>

-----

82. There are a few problematic examples, such as the [up to a year] that it takes students to complete this requirement or %John runs the [better] of the two, where the appears to take a PP and AdvP, respectively. However these examples are to be explained, I do not believe they call into serious doubt the point being made in the text.

## 1.2.b. Dets That Can Stand Alone

On the other hand, there are other determiners which can stand alone, such as that: [that man], [that] was silly. In this case, too, the standard analysis predicts something slightly different from what we actually find. Under the standard analysis, the position of the determiner is similar to that of an adjective, in that both are prenominal, non-head maximal categories:

(298)



AP can appear outside of the noun phrase, and when it does so, it has its own distinct behavior; it does not behave like a noun phrase:

(299)

- a. he seems [AP nice]  
 \*he seems [NP a fool]  
 \*he seems [NP the fool]
- b. \*[AP nice] just walked in  
 [NP the/a fool] just walked in

Under the standard analysis (i.e., (298)), we would expect DetP to do likewise: when it appears outside the noun phrase, we would expect it to behave differently from the noun phrase,

just as AP does. In fact, however, a DetP standing alone behaves exactly like a noun phrase:<sup>83</sup>

(300)

- a. \*he seems [the fool]  
     \*he seems [that]
- b. [the fool] just walked in  
     [that] just walked in

DetP behaves exactly like a noun phrase.<sup>84</sup> The simplest explanation is that it is a noun phrase:

(301)

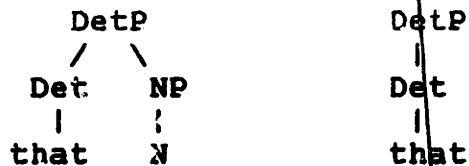

There is, of course, an alternative analysis for these structures, one involving an empty noun head:

-----

83. Of course, there are many complexities that the toy paradigm (300) does not take into account, but I take the point to be clear enough that a more thorough discussion is unwarranted.
84. Actually, there is at least one way that pronouns like that (if they are indeed pronouns) do not behave like noun phrases: they cannot be possessors: \*that's paws. This is not true of personal pronouns: ✓its paws.

(302)

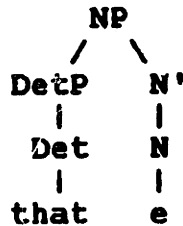

There is some justification for such a structure in "N-bar" gapping constructions, inasmuch as, in "N-bar" gapping constructions, a noun complement is "left behind", even though the head noun has disappeared:

(303)

There were some proofs of Fermat's Theorem in John's new book, and [several of the Law of Diminishing Returns], as well.

When several takes an of-complement, the interpretation is partitive: several of the problems. In (303), if of the Law of Diminishing Returns is a complement of several, its interpretation ("proofs of the Law of Diminishing Returns") is inexplicable. We are led to postulate an empty head noun whose content is supplied by proofs.

The evidence for an empty noun head is rather weaker in "N-bar" deletion constructions -- in fact, several recent analyses (e.g. Napoli (1986), Lobeck (1985), Chao (1987)) postulate no empty head, but treat determiners in these constructions as pronominal. The assumption that there is an empty noun is especially questionable for the demonstratives, which function pronominally in virtually every language, regardless of the existence of a "N-bar" deletion construction in that language.



Whether or not there are noun phrases with empty heads, if we admit of any noun phrases consisting solely of determiners, without the support of an empty noun head, we are led to adopt the Det-as-head analysis.

### 1.2.c. Pronouns

The case for an empty noun head is weakest in the case of personal pronouns. In this section, I argue that pronouns are of the syntactic category Det.<sup>85</sup> If so, they provide a yet stronger example of noun phrases consisting solely of, hence headed by, determiners.

It is generally assumed that pronouns are nouns. If this is the case, however, it is mysterious why pronouns do not appear with any noun specifiers: determiners, possessors, adjectives, quantifiers, measure phrases, are all prohibited:

(304)

\*[the she that I talked to] was nice  
 \*[my she] has always been good to me  
 \*[dependable them] are hard to find  
 \*[many they] make housecalls  
 \*[two dozen us] signed the petition

This distinguishes pronouns sharply from e.g. proper nouns, which, though they most commonly appear without specifiers, can productively appear with specifiers in the meaning of "someone named N" or "someone resembling N":

-----

85. The resemblance between determiner and pronoun is not a new observation. It is noted, for instance, by Emonds (1985), who proposes to treat pronouns as noun phrases containing only specifiers.

(305)

[the Mary that I talked to] was nice  
 [my Santa Claus] has always been good to me  
 [dependable Marilyn Monroes] are hard to find  
 [many Doctor Welbys] make yacht-calls  
 [two dozen John Smiths] signed the hotel register

If pronouns were nouns, we would expect them to do likewise, appearing in usual noun positions with a minor meaning shift. We could expect \*the she that I talked to to mean "the female that I talked to", for instance.

Further, as Postal (1966) observes, there are situations in which personal pronouns also behave like determiners:

(306)

I Claudius/\*idiot  
 we tradesmen/\*idiots  
 you \*sailor/Idiot  
 you idiots/sailors  
 \*he tradesman/idiot  
 \*they sailors/idiots

There are idiosyncratic gaps, admittedly.<sup>86</sup> It is not clear that I Claudius is restrictive, or if it is only good as an appositive. It is not clear why the deprecatory usage is bad in the first person (it is good in German: ich Idiot), or why the non-deprecatory usage is bad in the second person singular. The lack of third person forms is arguably due to demonstratives being suppletive in the paradigm: those tradesmen, those idiots.

-----

86. It has been argued that the examples of (306) are merely appositives. If this is correct, the paradigm (306) fails to provide evidence for the categorial identification of pronouns with determiners, but the other arguments I present remain unaffected.

Another property pronouns and determiners have in common is that both appear to be the basic site of the grammatical features of noun phrases, such as person, number, and gender; the so-called "Phi" features. In particular, in many languages, determiners show the most distinctions in their inflections, more so than adjectives, and much more so than nouns. In German, for instance, determiners display a full paradigm of person, number, and gender marking, whereas nouns are marked, for the most part, only for number.<sup>87</sup> And like determiners, German pronouns mark a full range of inflectional distinctions. In English and French, pronouns are the only items which still mark case. If the determiner position is the actual site of the noun phrase's grammatical features (and in particular does not simply agree with the noun, after the manner of a modifier), this indicates that the determiner is the head of the noun phrase.

(Recall that some of the arguments we have already made rely on the assumption that D is the site of a noun phrase's referential features. In section III-6.1, our accounts for many of the differences between Poss-ing and Acc-ing were based on the presence of a D node in Poss-ing as the site of person, number, and gender features. If Determiner is the lexical category which is the locus for these features, then

-----

87. In a few cases, dative is marked on nouns -- in the dative plural regularly, in the dative singular of some nouns (obsolescent) -- and genitive is marked on masculine and neuter nouns.

we are led to suppose that D = Determiner, hence that Determiner heads the noun phrase.)

More generally, pronouns are clearly functional elements. They belong to a closed lexical class, and though they refer, they do not describe: they do not provide a predicate over individuals, but merely mark grammatical features.

If we account for the similarities between determiners and pronouns by assigning them to the same lexical category (namely, D), and if we assume that both are accordingly heads of their phrases, the structure of illustrative noun phrases containing pronouns and those containing determiners is as follows:

(307)

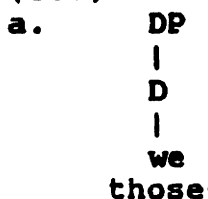

"we (are ready)"  
 "(I like) those"

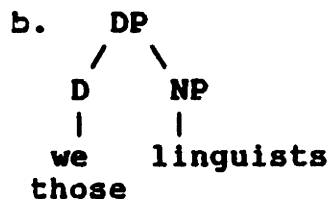

"we linguists"  
 "those linguists"

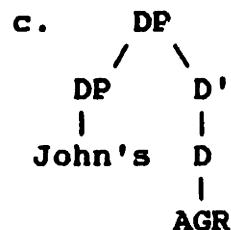

"(that is) John's"

In conclusion, the Det-as-head analysis allows us to account for the similarities between determiners and pronouns, and generate them in the same position, without being forced to generate all pronouns with empty noun heads.

### 1.2.d. Dets As Functional Elements

Thirdly, the fact that determiners have the properties of functional elements like complementizers and modals suggests that they should receive a parallel syntactic treatment. Determiners are closed-class elements. They lack "descriptive content" (i.e., they do not provide predicates over individuals -- if Barwise & Cooper (1981) are right, they are predicates over predicates; at any rate, they are quantificational rather than predicational). They are often stressless: in many languages, they are clitics (French, Hebrew, Classical Greek) or affixes (Norwegian, Soninke).<sup>88</sup>

### 1.2.e. Head-To-Head Movement

Finally, another piece of evidence is supplied by head-to-head movement. Consider examples like the following:

(308)

a. au < a + le

b. everyone < every + one

If we assume that these morphological mergers are made possible by head-movement, we must assume that determiners are -----

88. One way determiners differ from other functional elements is that determiners sometimes appear without a complement -- if pronouns are in fact determiners, as I have suggested. Possibly, though, the appearance of functional elements as "intransitives", in a pronominal usage, constitutes a systematic exception to the otherwise general requirement that they take an obligatory complement. It has been argued (Napoli (1986), e.g.; cf. Lobeck (1985), Chao (1987)) that Sluicing and VP-Deletion are instances of Complementizers and Infs, respectively, being used "intransitively", as pronouns.

the heads of noun phrases. Otherwise, the ECP will be violated, at least in (308b): the moved head does not c-command, hence does not govern, its trace, under the standard analysis (309a), but does, under the Det-as-head analysis (309b):

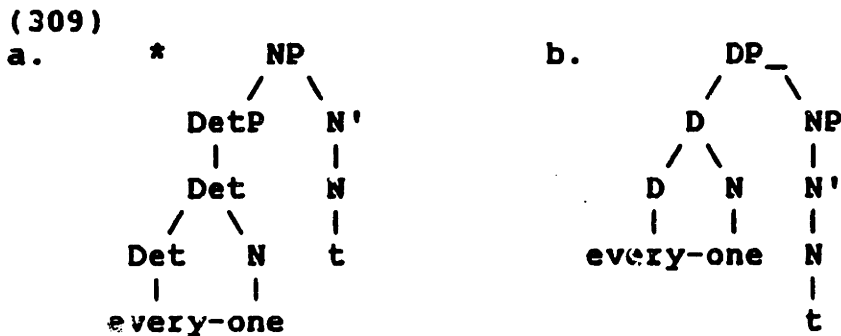

There is some evidence which supports the analysis (309b).<sup>89</sup> Most adjectives cannot stand alone when they appear postnominally:

- (310)
- \*a man clever
  - \*a person good

Systematic exceptions are observed with everyone, someone, everything, something:

-----

89. As pointed out to me by R. Kayne (p.c.).

(311)

someone clever  
 someone good

something clever  
 something good

?everyone clever  
 ?everyone good

?everything clever  
 everything good

This is explained under the analysis (309b). The structure of the examples of (311) is as in (312):<sup>90</sup>

(312)

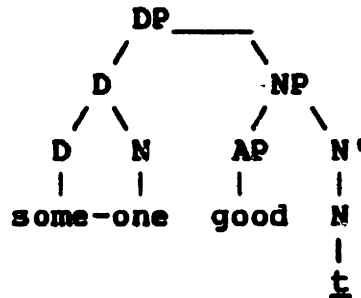

### 1.3 The Range of Specifiers

#### 1.3.a. Two Bars vs. Three Bars

What is perhaps the most persuasive motivation for assuming determiners head noun phrases, however, is somewhat indirect and theory-internal. The version of X-bar theory which is implicitly adopted in most current work (and explicitly argued for in Stowell 1981) is quite restrictive. The standard analysis fails to conform to it. If the standard  
 -----

90. Residual questions, for which I have no answers, are: Why does the morphological combination of e.g. some and one yield someone and not one-some, on the pattern of girl-chaser < chase girls, in-grown < grow in? and, Why is this an exception to the general rule that functional elements never appear in morphologically complex words, in any language? (With respect to determiners, cf. the well-known examples New-York lover vs. \*The-Bronx lover.)

analysis is modified to conform to the letter (if not the spirit) of X-bar theory, it is still inadequate to account for the full range of English nominal specifiers. If we assume that determiners head the noun phrase, on the other hand, we conform to X-bar theory, strictly interpreted; and we are able to account for the full range of English specifiers.

To be specific, I take the most widely accepted version of X-bar theory to include these two clauses:

(313)

- A. All non-head nodes are maximal projections, and
- B. Two-bar projections are maximal projections, for all categories (what we might call the "Uniform Two-Level Hypothesis", to adapt a term from Jackendoff 1977)

What I mean by the "standard analysis" of the structure of the noun phrase is the structure (314):

(314)

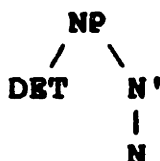

Interpreted strictly, the X-bar requirement (313-A), that non-head nodes be maximal projections, rules out the structure (314), inasmuch as DET is a non-head which is not a maximal projection. To preserve X-bar theory, we must modify the standard structure for the noun phrase to:



(315)

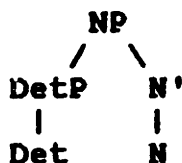

But the structure (315) is made highly suspect by the fact that DetP (under this analysis) never contains any material except Det. It is difficult to motivate a phrasal node XP where there is no member of the class X which ever takes specifiers or complements. If it means anything to be a phrasal node, it is that the node in question dominates more than one word, at least potentially. This is the sense in which the standard analysis can be made to conform to the letter, but not the spirit, of X-bar theory.

The property (313-B) of X-bar theory -- the Uniform Two-Level Hypothesis -- raises unsolved problems under the standard analysis of noun phrase structure, in that the standard analysis simply does not provide enough distinct positions to accommodate the full range of nominal specifiers. The most recent, and most thorough, study of the phrase structure of the noun phrase (and related categories, particularly AP) is Jackendoff 1977. Jackendoff showed that the specifier systems of nouns and adjectives, far from being sparse and uninteresting, circumscribe a highly-articulated range of structural distinctions. Jackendoff assumed there were three bar-levels in all categories, and made full use of the range of distinctions that hypothesis afforded, in his analysis of noun-phrase specifiers. The problem of accounting

for this range of distinctions under a two-bar hypothesis has not previously been addressed.

### 1.3.b. Noun Phrase Specifiers

Let us consider the range of specifiers in the noun phrase. Determiners and possessors, we have already considered -- they alone exhaust the single specifier position provided under the standard analysis. Descriptive adjectives co-occur with determiners and possessives prenominally. It is not clear that they are specifiers, however; they are usually considered to be adjoined to N-bar. I will return in section 3 to the question of the position of prenominal adjectives in the noun phrase.

Between determiners/possessors and descriptive adjectives, we find a range of elements. There are quantifier phrases, as in the [many] good men, the [little] soggy rice we had. There are also four distinct constructions which, according to Jackendoff (1977), involve a noun phrase in this position: measure phrase, semi-numeral, numeral, and group noun. These are illustrated in the following:

(316)

- a. [two parts] steel (measure phrase)  
 [one half] garbage
- b. [two dozen] roses (semi-numerals)  
 [a million] stars
- c. [three] men (numerals)  
 [six] eggs
- d. [a group of] men (group nouns)  
 [a bunch of] mistakes

To accommodate these elements, Jackendoff assumes a second, lower specifier position in the noun phrase:

(317)

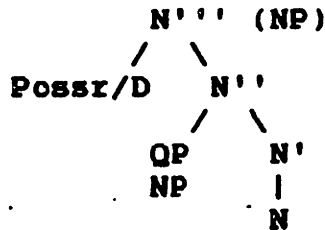

It is sometimes difficult to show that the noun phrases of (316) actually appear in this lower position, because they vary in their ability to appear with an overt higher determiner. There appears to be a constraint ruling out two determiners in a row, making good examples illustrating the structure (317) difficult to find. Jackendoff (1977) and Selkirk (1977) note the contrast in number agreement between examples like that three weeks and those three weeks, attributing it to attachment of that:

(318)

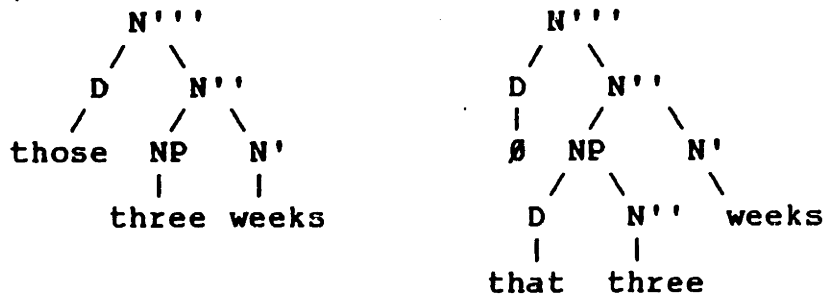

Examples which clearly show semi-numerals (and quantifiers) to be full phrases appearing below the position of the determiner, are the following (Selkirk and Jackendoff overlook examples of this sort):

(319)

- a. the [nearly a dozen] men who fell  
     the [precisely a thousand] paper birds we folded
- b. the [nearly as many] men who didn't fall .

If we wish to preserve the standard analysis, we must assume that these QP's and NP's do not occupy a lower spec position. One possibility would be that they are simply a species of prenominal adjective. There are a number of ways that they differ from descriptive adjectives, though, that render this hypothesis untenable. First, though Q's are in fact a variety of adjective, the noun phrases are clearly noun phrases, not adjectives. If they pattern with descriptive adjectives, it is not at all clear why we cannot have descriptive noun phrases here, such as (320):

(320)

\*the [nearly a doctor] medical student

Further, though there are ordering restrictions on descriptive adjectives that are not syntactic (Dixon (1982), for example, identifies seven semantic classes of descriptive adjective, and argues that the preferred order of prenominal adjectives is determined by their membership in these classes), these semantic ordering restrictions are generally very weak, and are often violated for the sake of emphasis. The requirement that QP and NP precede descriptive adjectives cannot be so readily violated:

(321)

a fancy new car  
a NEW fancy car

the many honest men  
\*the HONEST many men

Third, descriptive adjectives can be iterated (even within semantic classes) -- this is of course one of the original motivations for generating them adjoined to NOM (N-bar). Quantifiers and measure noun phrases cannot be iterated:

(322)

a large, round, red, smooth ball  
\*the few six men

I submit that the inability to iterate quantifier/measure phrases is that they receive a  $\theta$ -role from the noun, whereas descriptive adjectives are simply predicated of the noun, and

hence can be iterated ad libitum. In particular, I take plural and mass nouns to translate as:

(323)  $[N]x \ \& \ \text{Meas}_N(d,x)$

where  $\text{Meas}_N(d,x)$  iff  $f(d) = f(x)$ , under a measure  $f$  (possibly, one of many) determined by the meaning of  $N$ . For example, the translation of two cups rice is:

(324)  $\text{rice}(x) \ \& \ \text{Meas}_{\text{rice}}(\text{two-cups},x)$

where rice is true of arbitrary quantities of rice, and at least one possible measure for rice is  $f$  such that  $f(d) = f(x)$  iff  $\underline{d}$  and  $\underline{x}$  are equi-voluminous.

Under this account, measure phrases differ from descriptive adjectives in that measure phrases are genuine arguments of the head noun.

I conclude, with Jackendoff, that it is necessary to have two distinct specifier positions within the noun phrase, one for possessors/external arguments, and one for quantifier phrases/measure phrases. Jackendoff assumed three bar levels, in order to accommodate both specifier positions. (325) illustrates how the DP-analysis makes room for the extra position under a Two-Bar X-bar theory:

(325)

Jackendoff:

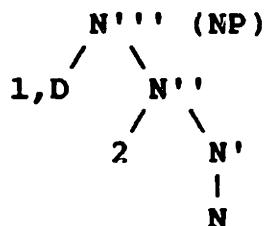

DP:

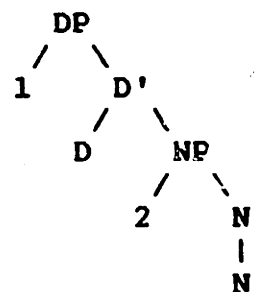

My analysis is not merely a translation of Jackendoff's analysis into a Two-Bar DP-analysis, however. It is an advance over Jackendoff's analysis in that there is no need for phrase-structure rules, not even the fairly general schema which Jackendoff assumes. We have already seen in detail how the subject of D is licensed via an interaction of Case and  $\theta$ -theory. If I am correct, the lower specifier is also licensed by  $\theta$ -theory. The elements which can appear in this position are precisely those which satisfy the Measure  $\theta$ -role. I assume that the Measure role is left-directional, hence the requirement that its recipients appear in specifier position, not complement position, and I assume that measure phrases are not Case-assigned by the noun, but have their own "inherent" Case.

### 1.3.c. Pseudo-Partitive

Finally, there is one point on which I take issue with Jackendoff's analysis. Namely, following Selkirk (1977), Jackendoff assumes that group nouns (see (316d)) also occupy the lower specifier position in the noun phrase (Spec of NP, under the DP-analysis):

(326)

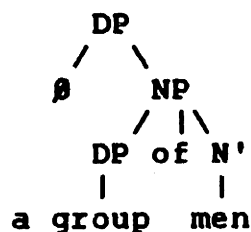

I am reluctant to adopt this analysis, because it requires one to assume a dangling of which does not take a complement. The major (though not the only) evidence which Selkirk adduces for this construction -- which she calls the pseudo-partitive -- is that the of N' of the pseudo-partitive is not extractable, whereas the of DP of the superficially-similar partitive construction is extractable:

(327)

- a. [a number of men] like anchovies (PSEUDO-PARTITIVE)  
 \*[of men], [a number t] like anchovies  
 \*[a number t] were killed [of men who like anchovies]
- b. [a number of the men] like anchovies (PARTITIVE)  
 [of the men], [a number t] like anchovies  
 [a number t] were killed [of the men who like anchovies]

Jackendoff, adapting Selkirk's analysis, explains these facts by treating partitives as involving a simple noun phrase with a PP complement, and assigning pseudo-partitives the structure (326). The of-phrase cannot be extracted in pseudo-partitives, very simply, because it is not a constituent.

I claim that partitives and pseudo-partitives have the same structure: [DP D [NP N [PP of DP]]]. The differences in extractability can be accounted for by non-structural differences in the of-PP's. In particular, let us suppose that the noun phrase under of in partitives is referential



(i.e., the men in a number of the men), but the noun phrase under of in pseudo-partitives is predicational (i.e., men in a number of men). The former is assigned a  $\theta$ -role, but the latter is not. Instead, it is on a par with predicational of DP in examples like:

(328)

- a. a monster of a machine  
a fool of a lawyer  
a little slip of a girl
- b. a coat of wool  
a coat of red

None of these of PP's can be extracted either:

(329)

- a. \*[of a machine], it was [a monster t]  
\*[of a lawyer], he was [a fool t]  
\*[of a girl], she was [a little slip t]  
  
\*[a monster t] was delivered [of a machine]  
\*[that fool t] showed up [of a lawyer]  
\*[a little slip t] came in [of a girl]
- b. \*[of wool], I have [a coat t]  
\*[of red], I have [a coat t]  
  
\*[a coat t] is warm [of wool]  
\*[a coat t] was lost [of red]

Possibly, if no  $\theta$ -role is assigned to these PP's (as I claim), the ECP is violated if they are extracted. The same explanation extends to the non-extractability of the PP in pseudo-partitives (327a).

In this way, we can give an account for the properties of the pseudo-partitive without assuming a dangling of as in Selkirk and Jackendoff's analysis.

## 2 The Adjective Phrase

In this section, I examine the adjective phrase, and a final category of functional element, namely, Degree words. As Jackendoff (1977) notes, the adjective phrase has a specifier system that parallels that of the noun phrase in many ways, and rivals it in richness. I show that analyzing the adjective phrase as a projection of Deg allows us to accommodate the variety of adjectival specifiers under a two-bar X-bar theory.

### 2.1 Deg as Head

A corollary of analyzing noun phrases as DetP's is that determiners are found only in noun phrases. This corollary appears to be falsified by AP's such as:

(330)

	this big
(It was)	that big
	all red

In fact, these are arguably not determiners, but rather elements that are ambiguous between determiners and Degree elements (Deg), such as:

(331)  
 so big  
 as big  
 too big  
 how big  
 big enough

Nonetheless, if we adopt an analysis in which determiners are the head of noun phrases, we must either analyze Deg's as the head of adjective phrases, or explain why they differ from Det's. I will take the former course here, and consider the consequences of analyzing adjective phrases as DegP's.

An immediate problem is that not only adjectives, strictly speaking, can appear with degree words, but other categories as well:

- (332)
- |                                                                                       |       |
|---------------------------------------------------------------------------------------|-------|
| a. too many<br>as much<br>few enough                                                  | (Q)   |
| b. too quickly<br>as hungrily<br>passionately enough                                  | (Adv) |
| c. far down the road<br>long after dark                                               | (P)   |
| d. ?as under the weather as anyone I have ever seen<br>too off the wall for my tastes | (P)   |

(332c) and (d) can be eliminated fairly easily as irrelevant.

(332d) arguably involves an exocentric compound functioning as an adjective: i.e., [<sub>A</sub> under-the-weather], [<sub>A</sub> off-the-wall].

First, only a restricted set of idiomatic PPs shows this

behavior; cf. \*John was as in the running as any other

candidate. Second, the degree word does not modify the head

preposition, but the entire phrase, in contrast to the examples of (332c). Consider:

(333)

- a. (they went) far down  
long after (, they discovered the truth)
- b. \*(the poor boy was) so under  
\*(he was) too off

Concerning the examples of (332c), observe that these "degree words" differ from the degree words of (332a-b) in being able to take other degree words:

(334)

- a. \*as too sick  
\*too as happy
- b. as far down the road  
too long after dark

The "degree words" in PP's are not Deg's, but QP's, such as are illustrated in (332a). QP's appear not only in the specifier of PP ([as far] down the road), but also of AP, as in [as much] too big; furthermore, far and long are not limited to appearing in PP's: [far] too permissive, [long] overdue. I discuss the position of QP's shortly. (Jackendoff (1977) also classifies the PP-specifiers of (334) as QP's, noting that they alternate with noun-phrase measure phrases, as is typical for QP's: [six miles] down the road, cf. [six inches] too big.)

## 2.2 Adjective, Adverb, and Quantifier

As for the remaining two examples of non-adjectives taking degree words -- quantifiers and adverbs -- I claim that these are in fact subclasses of adjectives. For concreteness, I distinguish them from adjectives proper by using the features Q and Adv: quantifiers are [+Q,-Adv], adverbs are [-Q,+Adv], and adjectives proper are [-Q,-Adv]. Quantifiers differ from adjectives proper primarily in their semantics, in supporting the partitive construction, and functioning as pronouns. Adjectives take on at least the latter two properties in the comparative and superlative: the older (of the two), the oldest (of the men). Adverbs differ from adjectives primarily in taking an -ly suffix and modifying verbs instead of nouns. With regard to their internal structure, adjective phrases and adverb phrases are virtually identical, as has been frequently noted, e.g., by Bowers (1975a). Both adjectives and adverbs take the same degree words, including comparative and superlative forms, and both are modified by adverbs (e.g., sufficiently quick, sufficiently quickly). Many adverbs do not even differ from the corresponding adjective by taking -ly; and -ly is always lacking in the comparative and superlative of adverbs. If we follow Larson (1987b) in taking -ly to be a "Case-assigner" for adjective phrases, then the internal structure of adjective phrases and adverb phrases is indeed identical, as both are the same category. Let us follow Larson in assuming that adjective phrases, like noun phrases, require Case.

Adjective phrases acquire Case by agreeing with Case-marked noun phrases. Certain nouns and adjectives are lexically marked with a feature [+C] which, Larson assumes, Case-marks the phrase which bears it.<sup>91</sup> These are the "bare-NP" and "bare-AP" adverbs, like I left [yesterday], he runs [fast].<sup>92</sup> Larson assumes that -ly is a prepositional adjective Case-marker. We may take it to be a suffix like -ing that affixes to an adjective phrase, and provides it with the "intrinsic Case" feature [+C]:

(335)

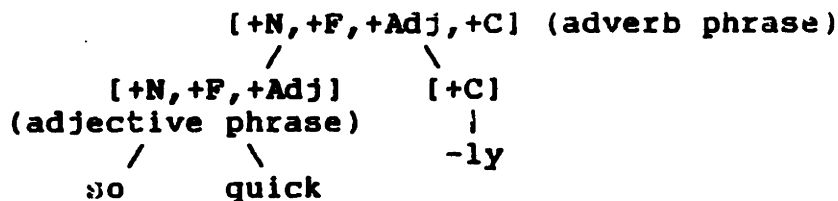

If this is correct, we can dispense with the [Adv] feature, replacing it with the intrinsic-Case feature [C], which also distinguishes "bare-NP adverb" nouns from other nouns.

As we proceed, the fact that adjective phrase, quantifier phrases, and adverb phrases are identical in internal structure will become abundantly clear. I conclude that they are subvarieties of the same syntactic category, [+N,+Adj].

-----

91. Larson gives the feature as [+F], not [+C]. I have altered his notation to avoid confusion with the functional-element feature [F].

92. See Larson (1985).

One piece of evidence weighing against the DegP analysis is that certain adjectives resist all degree words. For example:

(336)

everyone here [<sub>AP</sub> tested for drugs] has come up negative

\*as tested for drugs as anyone else

\*too tested for drugs for there to be any chance of error

\*more tested for drugs than me

\*so tested for drugs that I think I'm going to scream

If adjective phrases are consistently DegP's, there must be an empty Deg even in cases such as these. The appearance of an empty Deg is not disturbing -- I assume an empty Deg in all adjective phrases consisting just of an adjective, just as I assume an empty D in all noun phrases without an overt determiner. What requires explanation is why an overt Deg can never appear with these adjectives.

Adjectives which resist degree words appear to be rather consistently participles, particularly past participles as in (336). Perhaps their inability to appear with degree words generalizes with the inability of gerunds to appear with determiners: \*the singing the song. Unfortunately, however, the analysis of adjectival passives I gave in section III-6.3 groups adjectival passives with Ing-of gerunds, not Poss-ing gerunds; Ing-of gerunds do appear with determiners: the singing of the song. I leave this as an unsolved problem.

One final question raised by the proposal that adjective phrases are uniformly DegP's is that, unlike noun phrases, adjective phrases usually appear without a Deg. This is

probably semantically motivated, though, and does not reflect any difference in syntax. The two types of noun phrase with which adjectives have the most in common frequently appear without determiners: namely, mass/plural noun phrases ("gradable" noun phrases, i.e., noun phrases that, like adjectives, take measure phrases), and predicate nominals (which uniformly lack determiners in many languages, e.g., most Indo-European languages, and sporadically lack determiners in English).

Henceforth, I assume that adjective phrase, quantifier phrase, and adverb phrase are all actually DegP's. Deg selects AP[<sub>+Adv</sub>,<sub>+Q</sub>], in the same way Det (D) selects NP. In referring to adjective phrases, I will follow the same conventions as with noun phrases: "adjective phrase" is used in its pre-theoretic sense; it refers to AP under the standard analysis, DegP under the DegP-analysis. "AP" denotes different nodes under the standard analysis and under the DegP-analysis. "AP" under the DegP analysis corresponds roughly to A-bar under the standard analysis. "DegP" corresponds to AP (QP, AdvP) under the standard analysis.

### 2.3 The "Subject" of Deg

If noun phrase and adjective phrase are similar in being headed by a functional category, it is fair to ask if they are similar in taking subjects. There are a number of phrases which can appear in Spec of Deg, quantifier phrases and noun-phrase measure phrases for instance:



(337)

- a. [DegP [DegP[+Q] much] too [AP good]]  
 [far] too permissive  
 (he was) [little] -er kind (than before)
- b. [DegP [DP six miles] too [AP far]]  
 [a little] -er kind  
 [ten times] as fast

Another class of phrases that appear in this position, which Jackendoff does not take note of, are AdvP's:<sup>93</sup>

(338)

- [quite] as nice  
 [entirely] too naive  
 [nearly] so friendly

To be precise, the structures I propose are these:

-----

93. There are also a few cases where adjectives appear to take adjective phrases or PP's as measure phrases:

(1)

- a. [close [to a year]] overdue  
 [nigh [on a year]] long  
 [less [than an inch]] too wide  
 [more [than a mile]] off the mark
- b. [up to a year] overdue  
 [under an inch] long  
 [over a mile] long

One open question is whether the proper bracketting is not in fact e.g. close to [a year overdue], less than [an inch too wide], over [a mile long], despite the fact that prepositions do not usually take adjectival complements: \*close to [overdue], \*less than [too wide]. I will not attempt a proper analysis of these examples.

(339)

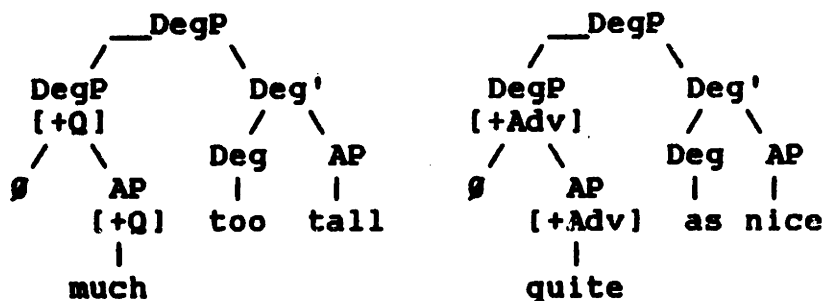

Degree words in quantifier and adverb phrases behave identically, as predicted:

(340)

- a. **much too little**  
     **ten times as many**  
     **precisely as few**
- b. **much too quickly**  
     **ten times as passionately**  
     **precisely as densely**

Also, it is worth noting that this is the same range of elements which appears in the specifier of P:

(341)

- a. **much to his liking**  
     **far down the road**  
     **little to the point**
- b. **six miles down the road**  
     **ten times around the track**  
     **ten years after graduation**
- c. **precisely in the middle**  
     **nearly off the chart**  
     **practically at the end**

I follow Jackendoff in taking these phrases to be in the specifier of P:

(342)

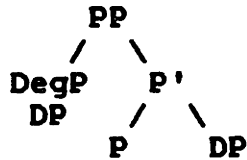

The specifier phrases of (337) and (338) are obviously not subjects of the same type as the subject of the sentence or subject of the noun phrase: there is no Case-assigning AGR, for instance. When they are noun phrases, they are noun phrases which are "intrinsically" Case-marked; they can often appear as adjuncts in the VP:

(343)

they ran [six miles]  
 they ran around the track [ten times]

I assume that they are  $\theta$ -marked, however, in the same way that measure phrases in the noun phrase are  $\theta$ -marked. The case for  $\theta$ -marking of measure phrases within the adjective phrase is in fact somewhat clearer than in the noun phrase. Measure phrases in the adjective phrase alternate with postposed PP's:

(344)

- a. [much] too good  
too good [by far]
- b. [much] too slow  
too slow [by an order of magnitude]

They can also be extracted out of the adjective phrase, unlike e.g. adverbs:<sup>94</sup>

(345)

- ?[how many inches] is the door [t wider than before]  
[how many miles] is the course [t long]
- \*[how sufficiently] is the door [t wider than before]

Let us consider first the simpler case of measure phrases with positive adjectives:

(346)

[six feet] tall

I take the semantics of adjectives to be similar to that of mass nouns: tall denotes a certain quantity of tallness, in the way that rice denotes a certain quantity of rice. This corresponds with the approach to verb meanings espoused earlier, in section II-5.1, where a verb like destroy was taken to have the same denotation as its nominalization destruction. The two differ only syntactically, not semantically. In the same way, here I take the adjective tall and its nominalization tallness to denote the same thing: a certain quantity of abstract stuff. Or more precisely, the

-----

94. Though admittedly rather sporadically. Also, specifiers of too cannot be very easily extracted: \*[how many inches] is he [t too tall to serve on a sub].

DegP tall denotes a certain quantity of tallness; the adjective tall is a predicate over individual quantities of tallness. On this view, then, verbs, nouns, and adjectives are all first-order predicates, i.e., predicates over individuals. They differ only in the kind of individual that makes up their denotation. Verbs are predicates over situations, nouns are predicates over objects, and adjectives are predicates over attributes. The union of situations, objects, and attributes is the universal set of individuals.

The adjective tall translates as:

(347)

$\text{tall}(e) \ \& \ \text{Meas}(m,e) \ \& \ \text{Theme}(x,e)$

Meas and Theme are both  $\theta$ -roles. As with mass nouns,  $\text{Meas}(m,e)$  iff  $f(e)=f(m)$ , for the relevant measure function  $f$ .<sup>95</sup>

A phrase where these  $\theta$ -roles have been assigned, e.g.

John is six feet tall, translates as:

-----

95. To be more precise, Meas and Theme are actually classes of  $\theta$ -roles (as argued by e.g. Marantz (1981)), or rather, functions from words to individual  $\theta$ -roles. We should write, more properly,  $\text{Meas}_{\text{tall}}(m,e)$  iff  $f_{\text{tall}}(e)=f_{\text{tall}}(m)$ . Given this refinement, we can account for the semantic ill-formedness of e.g. #six feet intelligent: the measure function of intelligence is undefined for the measurement six feet, i.e.,  $f_{\text{intelligent}}(\text{six-feet})$  is undefined. Different words may have the same measure function. For example,  $f_{\text{tall}}=f_{\text{wide}}$ ; hence the well-formedness of e.g. John is as tall as Bill is wide. But  $f_{\text{tall}} \neq f_{\text{intelligent}}$ , hence the ill-formedness of #John is as tall as Bill is intelligent.

(348)

tall(e) &amp; Meas(six-feet,e) &amp; Theme(John,e)

i.e., John possesses a tallness which is equi-metric with six feet.

Too suppresses the adjective's Measure role, and adds one of its own. John is six inches too tall translates as:

(349)

tall(e) &amp; Theme(John,e) &amp; Too(six-inches,e,^tall)

where  $\text{Too}(m,e,F)$  iff the measure of e equals s concatenate m, where s is the maximal satisfactory measure for the attribute F. That is, John's tallness exceeds the maximal satisfactory tallness by six inches.

This sketch has not been intended as a serious semantic account. Rather, it is a cursory examination of the relation between measures and attributes to illustrate that Meas has as good a claim to  $\theta$ -role status as any other relation.

If six inches is  $\theta$ -marked by too in six inches too tall, though, it still is not quite a "true" subject. As noted, there is no indication of agreement between too and the measure phrase. Also, Spec of Deg is not a valid landing site for movement. That is, there are no examples like:

(350)

Your symptoms are [rubella('s) indicative t]  
cf.: indicative of rubella

Syntactically, I believe this is mostly an accidental gap, though there are semantic motivations. Syntactically, the AGR

we find in the English noun phrase seems to be a rather marked element. There are few languages with true overt noun phrase subjects. They are non-existent in Romance languages. Even other Germanic languages have much stronger restrictions on the elements that can appear in subject of noun phrase: in German, for instance, it is more or less restricted to proper names. Since noun-phrase-like adjective phrases are marked in themselves (they are lacking in many languages), it is not surprising that their internal structure lacks the more marked aspects of noun-phrase internal structure.

On the semantic/thematic side, the markedness of subjects in adjective phrase is surely amplified by the fact that adjectives are uniformly non-agentive in their  $\theta$ -structure. Possibly, adjectives are uniformly unaccusative; as suggested, for instance, by the fact that the external arguments of adjectives can systematically appear as internal arguments when the adjectives are nominalized: the happiness of Bill, cf. \*the destruction of Caesar Agent.<sup>96</sup> If such an analysis can be defended, the lack of a subject position in adjective phrases would correlate with the fact that it would never be needed -- except for "passives" like \*rubella indicative, \*your proposal supportive.

-----

96. On the other hand, -ing nominalizations of (non-unaccusative) intransitive verbs have the same property: the crying of the baby, the shooting of the hunters.

## 2.4 Extent Clauses

Degree words license various types of extent clauses:

(351)

so big that I couldn't see over it  
as big as John said/as a house  
too big to use  
-er big than the other one was/than the other one

These clauses are not permitted when the degree word is absent:

(352)

\*big that I couldn't see over it  
 %big as John said  
 \*big to use  
 \*big than the other one was

Further, the various types of clause are specific to one degree word. Even if a degree word is present, if it is the wrong degree word, the clause is not permitted:

(353)

\*too big that I couldn't see over it  
 \*as big than the other one was  
 \*bigger to use

These facts clearly illustrate that the extent clauses are licensed by particular degree words.

As has been frequently noted, the relation between degree words and the clauses they license is very similar to the relation between a definite article and relative clause. The definite article often appears to be licensed by the relative clause:



(354)

- a. \*the Paris  
the Paris that I love
- b. \*the book of John's  
the book of John's that I read

There are clearly differences between this case and that of extent clauses, however. First, in the examples just given, it is the relative clause which licenses the article, not vice versa. Relative clauses can appear with other determiners, and even when no determiner appears:

(355)

- a book that I read
- that book that I read
- books that I read

On the other hand, relative clauses are prohibited with possessors:

(356)

- \*John's book that I read
- \*my book that I lost

We can claim that the difference between relative clause and extent clause is only that the relative clause is less specific to a particular determiner. It can be licensed by a range of determiners, including the empty determiners that appear with mass and plural nouns. But it is not licensed by [D AGR].

As Jackendoff points out, the paradigm (354) is also somewhat misleading in that it is not only a relative clause which permits the determiner to appear, but any restrictive modifier:

(357)  
 the Paris of the Thirties  
 the book of John's on the table

In response, note that there are a core of cases where this is not true:<sup>97</sup>

(358)  
the up to a year that it has taken people to complete this requirement  
\*this up to a year that it has taken ...  
\*your up to a year that it takes you to complete such projects

In conclusion, it does seem that there is a special relation between determiner and relative clause, which parallels the relation between degree word and extent clause. This supports the hypothesis that the two occupy parallel structural positions.

An advantage of the DegP analysis emerges when we consider the question of how the relation between degree word and extent clause is expressed structurally. It is most economical to generate the extent clause as a sister of the degree word which licenses it; this permits us to express the co-occurrence restrictions between degree word and extent clause as normal complement selection. The account adopted by e.g. Selkirk (1970) is to generate the extent clause adjacent to the degree word and extrapose it to the end of the adjective phrase: e.g. [as as a house] big --> [as] big [as a house]. Likewise for relative clauses: [the that I read] book

-----

97. Admittedly, this is a very curious construction whose syntax is not at all clear. It appears to involve the exceptional selection of a PP by the determiner.

--> [the] book [that I read]. The DegP analysis opens another possibility: we can generate the extent clause as sister to the degree word in its surface position:

(359)

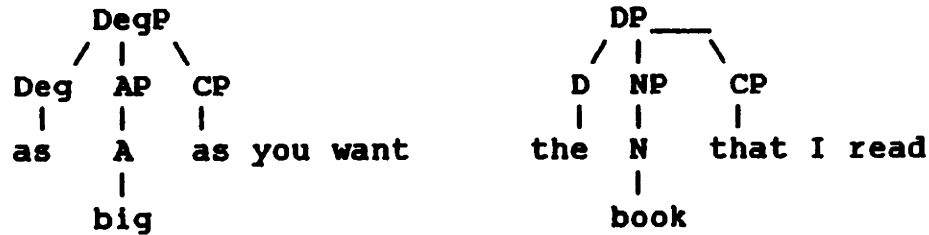

In this way, the DegP analysis allows us to preserve the selectional relation between degree word and extent clause, without assuming systematic, obligatory displacement of extent clauses from their d-structure position.

In fairness, though, we must observe that this analysis does not eliminate all cases of extent clause extraposition. Extent-clause extraposition is necessary even under the DegP analysis for examples like (360):

(360)

- a. a [more beautiful] woman [than I'd ever seen]
- b. [as much] too much [as last time]

## 2.5 Two Specifiers in the Adjective Phrase

If we could show that there are two distinct specifier positions in the adjective phrase, as in the noun phrase, that would constitute supportive evidence for the DegP analysis, inasmuch as the DegP analysis, but not the standard analysis, provides a specifier position both under DegP and under AP.

Consider for example adjectives with adverbs, but without degree words, as in:

(361)  
 [thoroughly] befuddled  
 [hopelessly] lost  
 [entirely] dark  
 [understandably] distressed  
 [obviously] content

Is the structure that of (362a) or (362b)?

(362)

a.

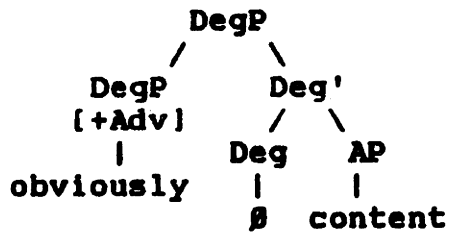

b.

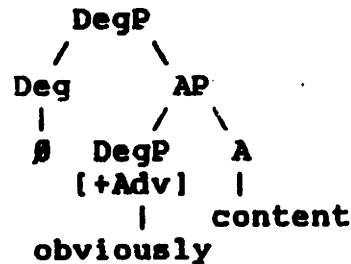

It is difficult to find clear cases of degree words co-occurring with following adverbs, where the structure is clearly that of (362b). Usually, it is at least arguable that the degree word has scope over the adverb, not the adjective:

(363)

- a. [so thoroughly] befuddled
- b. [too obviously] content
- c. [so heavily] favored to win

Consider for instance the contrast:

(364)

he was too content to get up  
 #he was too obviously content to get up

(cf. he was too obviously content for us to have the heart to disturb him)

Likewise, adjectival passives, as we have seen, do not accept degree words: \*so favored to win, indicating that the structure of (363c) is as given there.

In other cases, the unavailability of degree words seems to be traceable to the adverb involved:

(365)

\*too entirely mixed-up  
 cf.: too mixed-up  
       entirely mixed-up  
       \*too entirely

\*so always right  
 cf.: so right  
       always right  
       \*so always

But since the adverb contributes to the meaning of the AP even under (362b), this does not seem to constitute decisive evidence in favor of (362a).

The question extends to the other two categories appearing in Spec of Deg, viz., measure noun phrase and quantifier phrase. We have, for instance:<sup>98</sup>

-----

98. (366b) is somewhat misleading, in that alike and different are the only adjectives which take non-comparative, non-superlative quantifiers.

(366)

- a. [two miles] long  
    [three years] old
- b. [much] alike  
    [little] different

Here there are clear meaning differences: two miles is clearly dependent on too in two miles too long, but on long in two miles long. On the other hand, if there is an empty Deg in two miles long, with the interpretation "positive degree", the difference in interpretation can be accounted for without assuming a difference in syntactic attachment.

With the measure phrases, a preceding degree word is impossible:

(367)

- a. \*too [two miles] long  
    \*as [three years] old
- b. \*too [miles] long  
    \*as [years] old

The (a) examples are arguably semantically ill-formed, being "doubly specified". Even without a numeral in the noun phrase, though, the examples are still bad, as the (b) examples show.<sup>99</sup>

-----

99. The only exceptions are examples that are arguably adjective compounds, such as eons-old: as eons-old as the cities of Babylon. Eons-old is different from e.g. years old in that it can appear inside a noun phrase, despite being plural:

- (1)
- an eons-old statue
- \*a years old statue

The import of the discussion so far is that it is difficult to find clearcut examples deciding one way or the other. However, I believe the example (368) does give clear indication that the lower specifier position is necessary:

(368)

If it's already needlessly long, it won't hurt to make it [six inches more needlessly long], will it?

In this case, needlessly is clearly within the scope of more, yet more modifies long, not needlessly.

I conclude that the adjective, as well as Deg, takes adverb, quantifier, and measure-noun-phrase specifiers. The full structure of the adjective phrase (excluding complements) is then:

(369)

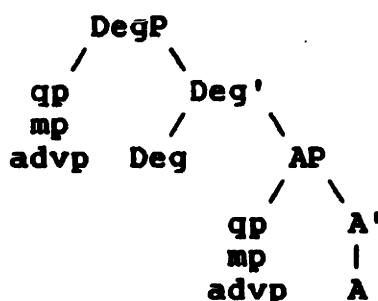

where "qp", "mp", and "advp" are abbreviations for "DegP[+Q]", "DP[+measure]", and "DegP[+Adv]", respectively.

-----  
 cf.: six years old  
 \*a six years old boy  
 a six-year-old boy

## 2.6 Overview of Structures

To sum up these last two sections, I give in (369) the full range of specifier structures which Jackendoff argues for (1977:81, 165-166):

(370)

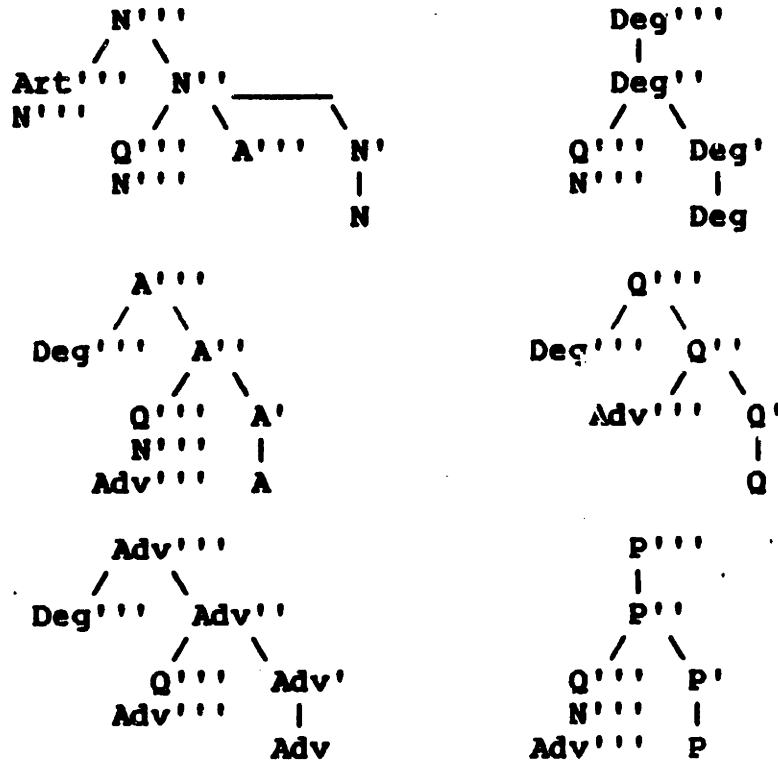

(I have added the Adv''' under Q''. I believe Jackendoff omitted it only because he had not introduced the category Q in the chapter in which he discussed adverbs. Clearly there are adverbs in QP: sufficiently many, exceedingly few.)

Under the DP and DegP analysis, the structures of (370) translate into those of (371) (again, recall that "np", "qp", and "advp" abbreviate "DP[+measure]", "DegP[+Q]", and "DegP[+Adv]", respectively):



(371)

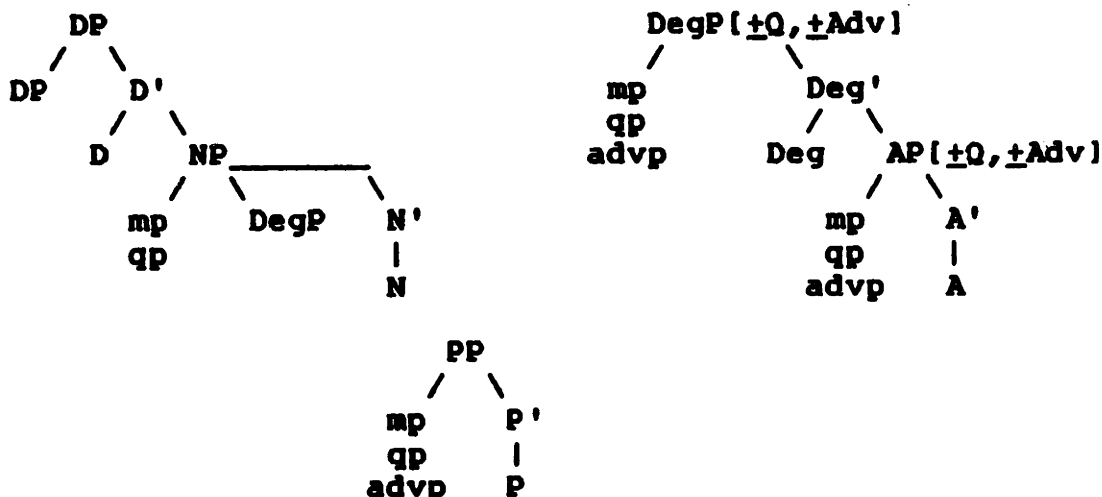

(These structures differ in empirical predictions from Jackendoff in that they conflate adjective phrase, adverb phrase, and quantifier phrase all as DegP, and predict that there should be measure-phrase, quantifier-phrase, and adverb-phrase specifiers in all three. Adverb phrases are attested in all three, but measure phrases are not attested in adverb phrases or quantifier phrases, and quantifier phrases are not attested in quantifier phrases. The lack of quantifier phrases in quantifier phrases is not surprising -- there are only two adjectives (different, alike) that take quantifier phrases, and only one adverb (differently). The lack of measure phrases I leave unaccounted for.)

In conclusion, the DP/DegP analysis is quite adequate to capture the full range of English specifier structures; in fact, it makes room in a two-bar X-bar theory for the distinctions which Jackendoff needed three bars to make.

### 3 The Position of Prenominal Adjectives

#### 3.1 Two Hypotheses

Having considered the internal structure of the adjective phrase, I would like to return to a question we postponed in section 1, namely, the place of prenominal adjective phrases within the noun phrase.

Jackendoff assumed prenominal adjective phrases were sisters of N'. Translating into the DP-analysis:

(372)

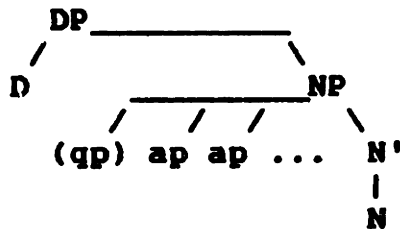

There are two problems with this analysis: (1) it espouses an arbitrary number of specifiers of N, and (2) it does not capture the scope relations between the "specifiers" of N. This is most clear with syncategorematic adjectives. Consider the example an alleged 600-lb. canary. If alleged, 600-lb., and [N: canary] are all sisters, we would expect the operation by which their meanings are combined to be associative and commutative. Obviously, though, an alleged 600-lb. canary is not the same thing as a 600-lb. alleged canary: the latter weighs 600 lbs., while the former might not.

A second (and much older) hypothesis is that prenominal adjective phrases are adjoined to a nominal projection, presumably N-bar:

(373)

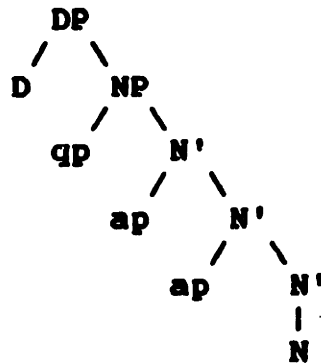

A problem with this analysis is that it espouses adjunction in the base, and furthermore, adjunction to a non-maximal category. An embarrassing question is why there are no elements adjoined to any other single-bar projection at d-structure: not to V', P', A', I', C', etc.

A problem for both of these hypotheses is that there is a range of evidence which suggests that prenominal adjectives are in some sense heads of the noun phrases in which they appear. I present this evidence in the next section.

### 3.2 Adjective as Head of NP

#### 3.2.a. Too Big a House

There is one set of examples in which it appears we have no choice but to take adjectives as heads of noun phrases:

(374)  
 [too big] a house  
 [yea long] a fish  
 [how old] a man  
 [too smart] a raccoon

Examples like this are not discussed by Jackendoff, though they are discussed at length by Bresnan (1973). What sets these examples apart is that the noun phrase appears to be a complement of the adjective. In some dialects (including my own), there can be an interposed of:

(375)  
 too big of a house  
 as nice of a man  
 how long of a board

This suggests a structure like:

(376)

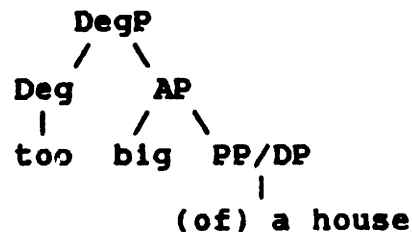

The only alternative appears to be to take too big to be some sort of specifier of a house, possibly:

(377)

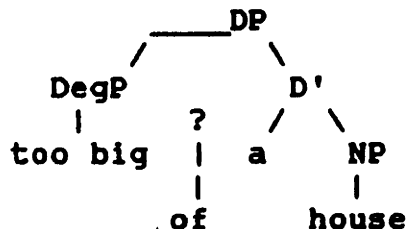

This leaves of dangling, though, without a satisfactory attachment site.

What is remarkable about the structure (376) is that, despite being headed by an adjective, the phrase as a whole behaves like a noun phrase, not like an adjective phrase:

(378)

- a. I live in [too big (of) a house]
- b. I live in a mansion [too big to clean]  
\*I live in a mansion [too big of a house]

This indicates that it is possible for an adjective to project a phrase which is interpreted like a noun phrase -- but only when it takes a noun phrase complement: \*I live in [too big]. An explanation ready at hand is that the relation between big and a house in too big (of) a house is f-selection, and that the adjective inherits certain nominal features from the noun phrase it f-selects. This hypothesis explains two additional facts: (1) Adjectives are not Case-markers, yet the noun phrase appears without a preposition in too big a house. If the noun phrase is f-selected, it is not an argument, hence does not require Case. (2) The noun phrase complement must be predicative, not referential, and it cannot be extracted:<sup>100</sup>

(379)

- a. \*I live in [too big that house]
- b. \*[which house] do you live in [too big (of) t]  
\*[a house], I live in [too big (of) t]

This indicates, again, that the noun phrase is not an argument; f-selected complements are in general not arguments.

-----

100. The interpretation of (379a) would be "I live in that house, which is too big".

In sum, examples like too big (of) a house indicate that devices are necessary which permit adjectives to head phrases that behave like, and are interpreted like, noun phrases. The independent need for such devices opens the way for an analysis of prenominal adjectives in which they head the noun phrase they appear in. In the next subsections, I consider evidence that suggests that some such analysis is the right analysis. Most of the facts I consider involve differences in the behavior of prenominal and postnominal adjectives. If both are simply syntactic and semantic modifiers of the head noun, differing only in which side of the noun they appear on, these differences are not expected.

### 3.2.b. Complements

Prenominal adjectives differ from postnominal adjectives in that prenominal adjectives may not have complements, whereas postnominal adjectives must have complements:

(380)

- a. the [proud] man  
\*the [proud of his son] man
- b. \*the man [proud]  
the man [proud of his son]

(There are exceptions to the requirement that postnominal adjectives have complements. First, it is sufficient to have conjoined adjectives postnominally: a man bruised and battered. Second, it is sometimes sufficient to have a specifier for the adjective: a fish this big, a steak just right. Third, there are a handful of adjectives which can

appear postnominally without complements: a man [alone], the man [responsible], six dollars [even], the example [following], etc. Fourth, indefinite pronouns permit postnominal adjectives without complements (as noted by Smith (1961)): someone [bold], something [terrible], etc. -- though if our analysis in section 1.2.d. is correct, these last examples only appear to involve postnominal adjectives, and actually involve prenominal adjectives where the noun has been raised to D.)

If prenominal adjectives f-select NP as complement, the lack of the adjectives' usual complements is explained:

(381)

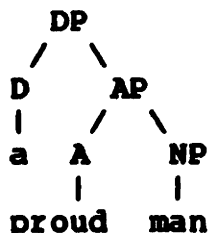

An analogy that is suggestive is that of auxiliary verbs. It is sometimes supposed that auxiliary verbs are verbs that take VP's and project VP's. A verb like have can take e.g. a noun phrase when it appears as a main verb, but not when it appears as an auxiliary; in the same way, we might suppose, adjectives cannot take their usual complements when they appear as "auxiliary nouns". We have already noted the very close syntactic similarity between A and N. Plausibly, adjectives are "defective" nouns; let us suppose that they lack only one feature, say [+substantive], to be nouns. If prenominal adjectives are like auxiliary verbs, and take an NP

complement, it is conceivable that they inherit their complement's [+substantive] specification, and hence project a category that is featurally indistinct from an NP.<sup>101</sup>

### 3.2.c. Mere and Utter

There are certain adjectives, such as mere and utter, that appear only in prenominal position, never in postnominal or predicative position:

(382)

the utter indignity	cf.:	the big ball
*the indignity is utter		the ball is big
*the indignity, utter and unrelenting		the ball, big and round

We could say that these adjectives are exceptional only in obligatorily f-selecting an NP complement.

### 3.2.d. Semantics

Something must be said about the semantics of adjectives when they f-select noun phrase complements. We have assumed that adjectives denote attributes, yet obviously a big house (or too big a house) does not denote a quantity of bigness, but rather a house. Obviously, big has different semantic

-----

101. Actually, "featurally indistinct" is probably too strong. It appears that prenominal adjectives do appear with degree words, as we will discuss below. If degree words take prenominal adjectives as complements, and prenominal adjectives are featurally indistinct from NP's, we would expect degree words to take NP's as complements, which is of course false. Therefore, we must consider prenominal adjectives and NP's distinct. Determiners are not sensitive to the distinction, but degree words are.



values depending on whether it f-selects a noun phrase or not. Let us suppose that there is a general function Aux converting adjective meanings to "auxiliary noun" meanings; as a first approximation:

$$(383) \quad \text{Aux}(F) = \lambda e, G[\exists a(F(a, e) \ \& \ G(e))]$$

For example, the translation of [ $\lambda$ , black [NP cat]]] will be:

$$(384) \quad \begin{aligned} & \text{Aux}(\text{black}')[\text{cat}'] \\ &= (\lambda e, G[\exists a(\text{black}'(a, e) \ \& \ G(e))]) [\text{cat}'] \\ &= \lambda e\{\exists a(\text{black}'(a, e) \ \& \ \text{cat}'(e))\} \end{aligned}$$

where  $\text{black}'(a, e)$  iff  $\text{black}'_0(a) \ \& \ \text{Theme}(e, a)$ .

If the function Aux seems just a ploy for making adjectives fit semantically into an unwonted syntactic frame, there is a class of adjectives -- the syncategorematic adjectives -- which in their basic meaning must take NP as argument. A standard example is alleged. The meaning of the adjective alleged is derived from the meaning of the verb allege in a manner something along the following lines:

$$(385) \quad \text{alleged}' = \lambda x, F[\exists e, y[\text{allege}'(e, \hat{(Fx)}, y)]]$$

where  $\text{allege}'(e, P, x)$  iff  $\text{allege}_0(e) \ \& \ \text{Theme}(P, e) \ \& \ \text{Agent}(x, e)$ ; i.e., e is a situation of x alleging that P. The translation of alleged Communist is:

(386)

$$\lambda x[\exists e, y[\text{allege}'(e, \wedge(\text{Communist}'(x)), y)]]$$

It is sometimes possible for syncategorematic adjectives to appear in positions other than prenominal position; i.e., without an NP complement. In these cases, we may take the adjective to be "intransitivized" by supplying the object from context. That is, the intransitivized reading for alleged is:

(387)

$$\lambda x[\exists e, y[\text{allege}'(e, \wedge(Fx), y)]]$$

where the predicate F is supplied from context. Thus the translation of a Communist, alleged but not proven is:

(388)

$$\lambda Y[Y \cap \lambda Gx \neq \emptyset], \text{ where}$$

$$G = \lambda x[\text{Communist}'(x) \ \& \ \text{alleged}'(x) \ \& \ \neg\text{proven}'(x)]$$

$$= \lambda x[\text{Communist}'(x) \ \& \ \exists e, y[\text{allege}'(e, \wedge(Fx), y)] \ \& \ \dots]$$

where context determines that  $F = \text{Communist}'$ .

This accounts for the difference in meaning between a Communist, alleged but not proven, and an alleged Communist, but not a proven Communist. The former denotes a Communist, but the latter may fail to denote a Communist, as predicted by the translations we have assigned to these noun phrases, (386) and (388), respectively. This indicates that, for the syncategorematic adjectives, prenominal and postnominal adjectives differ precisely in whether they take the NP as an argument or not.

If there is a class of adjectives which take NP's as complements in a non-vacuous manner -- the syncategorematic

adjectives -- then the semantic "type-raising" function Aux becomes rather less suspicious, in that it is not simply a warping of the semantics of adjectives to make them fit an unintuitive syntax, but rather the (optional) assimilation of one class of adjectives to the semantic structure of another, independent class, so that both may appear in the same syntactic structure.

### 3.2.e. Comparatives

Another difference between pre- and post-nominal adjectives is illustrated in the following contrast, discussed at length by Bresnan (1973):

(389)

- a. #I have never known [a [taller] man than my mother]
- b. I have never known [a man [taller] than my mother]

Bresnan assumes that the identity of the deleted phrase in the than-clause is determined by the phrase to which the than-clause is adjoined at s-structure. In (389a), the clause adjoined to is a taller man, hence the reconstructed than-clause is than my mother is [a X tall man]. In (389b), on the other hand, the than clause is adjoined to taller, and the reconstructed clause is than my mother is [X tall].

If it is the s-structure position of the than clause which determines its content, however, it is difficult to account for sentences like:

(390)  
 [a taller man] arrived [than Bill]

In this case, than Bill is presumably adjoined to the sentence a taller man arrived. Reconstruction of the than-clause yields the nonsensical than Bill (was) [an X tall man arrived]. This indicates that the than clause must be reconstructed at LF, after the than-clause itself has been restored to its pre-s-structure position in the noun phrase. If the than-clause can be restored to the position of one of its traces before having its internal structure reconstructed, however, we should be able to move than my mother in (389a) back into the AP from which it came, before we reconstruct it:

(391)  
 a [taller [than my mother]] man ==>  
 a [taller [than my mother is X tall]] man

Thus Bresnan would incorrectly predict that #a taller man than my mother does have a non-anomalous interpretation.

Under the analysis in which adjectives take NP-complements, on the other hand, the explanation is straightforward: at all levels of representation, -er has scope over tall man in (389a), but only over tall in (389b); it is the scope of -er, not the attachment of than S, that determines how the than clause is to be reconstructed.

(392)

- a. a -er [<sub>AP</sub> tall [<sub>NP</sub> man]] than my mother  
 b. a man -er [<sub>AP</sub> tall] than my mother

It is the scope of -er, not the attachment of the than-clause, that determines how the than-clause is to be reconstructed.

### 3.2.f. Determination of Noun Phrase Type

A prenominal adjective can determine the type of the noun phrase in a way that postnominal adjectives cannot. There is a contrast between "predicative" (the term used by Bresnan (1973)) and non-predicative noun phrases. Certain contexts select for one or the other. Bresnan uses the object position of know, for instance, when it is not embedded under a modal or negative, as a context that selects non-predicative noun phrases: I've known [many dogs], ??I've known [a dog like Fido]. Under a negative or modal, both are permitted: I've never known [many dogs], I've never known [a dog like Fido].

Now consider:

(393)

- a. I've never known [a [smarter] dog than Fido]  
 ??I've known [a [smarter] dog than Fido]  
 b. I've never known [a dog [smarter than Fido]]  
 I've known [a dog [smarter than Fido]]

Noun phrases with prenominal comparatives count as "predicative" in the desired sense, hence are barred from complement position of non-negative know, but noun phrases with postnominal comparatives are permitted in this position. (Noun phrases with pre-determiner AP's behave like noun

phrases with prenominal adjectives: I've never known [as smart] (of) a dog as Fido, ??I've known as smart (of) a dog as Fido.)

It appears that the predicative nature of the comparative adjective "percolates" to the enclosing noun phrase from prenominal position, but not from postnominal position. Determining the features of the enclosing phrase is a property typical of heads.

### 3.2.g. Idioms

For completeness' sake, I will mention a final difference between pre- and postnominal adjectives, though I have no explanation for it. Certain adjectives in idiomatic usages are excluded from prenominal position:

(394)

- a. \*a [thrown] party  
cf.: √a [thrown] ball
- b. a party [thrown on Saturday]  
the party planned and the party [thrown] were two very different parties

If this does not provide evidence for the adjective-as-head analysis, it does emphasize the point that there are substantial differences between pre- and post-nominal adjectives.

### 3.3 Two More Hypotheses

#### 3.3.a. AP vs. DegP

If we adopt the hypothesis that prenominal adjectives f-select NP complements, there are two major variants to choose between, differing as to whether a prenominal adjective phrase is a DegP or a bare AP:

(395)

a.

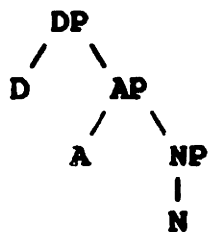

b.

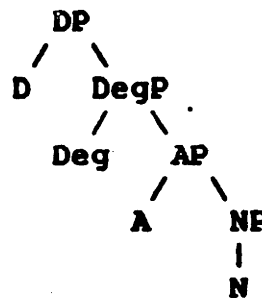

(395a) seems a priori preferable, for the following reason.

We have assumed that D necessarily selects a [-F] category, in order to explain the ill-formedness of e.g. \*the each boy:

[<sub>DP</sub> each boy] is a [+F] category, hence not a legitimate

complement for the. (Note that the problem is not semantic:

the word-for-word translation of \*the each boy is grammatical

in Hungarian.) If this is correct, it rules out the structure

(395b): DegP is a [+F] category. In fact, if prenominal

adjectives inherit the feature [+subst] from their NP

complements, the AP's in (395) are featurally indistinct from

NP's, and the DegP in (395b) is featurally indistinct from DP.

This appears to be corroborated by examples like the following:

(396)

- a. \*a [too tall] man  
 \*a [so big] fish

Cf.:

- b. a man [too tall to be a submariner]  
 a fish [so big]

The non-appearance of Deg's does not entail the elimination of the Spec of AP, however. And in fact, we find e.g. adverbs in prenominal AP:

(397)

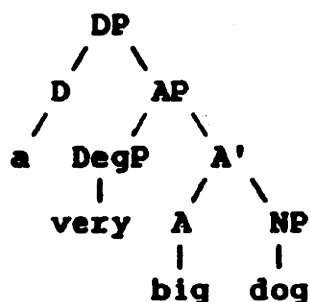

More subtle, yet more striking, evidence against (395b) and in favor of (395a) is provided by the fact that all  $\theta$ -marked specifiers of degree words are excluded in prenominal position:

(398)

- \*a [[six millimeter(s)] too narrow] lens  
 \*your [[six gram(s)] too heavy] counterbalance  
 \*a [[six time(s)] as effective] medication  
 \*a [[several second(s)] quicker] time

Cf.:

- six millimeters too narrow  
 six grams too heavy  
 six times as effective  
 several seconds quicker

This is not the result of a general prohibition against measure phrases buried inside prenominal adjective phrases.



If the measure phrase is more deeply buried, the examples improve (even though they become more difficult to process):

(399)

?their [[six millimeters] too narrowly] ground lens  
 ?your [[six grams] too heavily] weighted counterbalance  
 ?a [[six times] as effectively] administered medication

Further, if the measure phrase is not in the specifier of the degree word, but in the specifier of the adjective itself, it is acceptable:<sup>102</sup>

(400)

a [[six inch] long] pencil  
 a [[six millimeter] wide] lens  
 a [[several month] long] hiatus

This otherwise mysterious array of facts is predicted under the analysis (395a). The examples of (398) are ungrammatical because there is no Deg allowed, hence no Spec of Deg for measure phrases to occupy. In contrast, the  
 -----

102. Admittedly, when the measure phrases are plural, their acceptability degrades substantially:

(i)

\*a six inches long pencil  
 \*a six millimeters wide lens  
 etc.

By the same token, singular measure phrases are not very good in predicate ap's:

(ii)

\*the pencil is [six inch long]  
 \*the lens is [six millimeter wide]  
 etc.

I have no explanation.

examples of (399) and (400) have the analyses (401), which are well-formed:

(401)

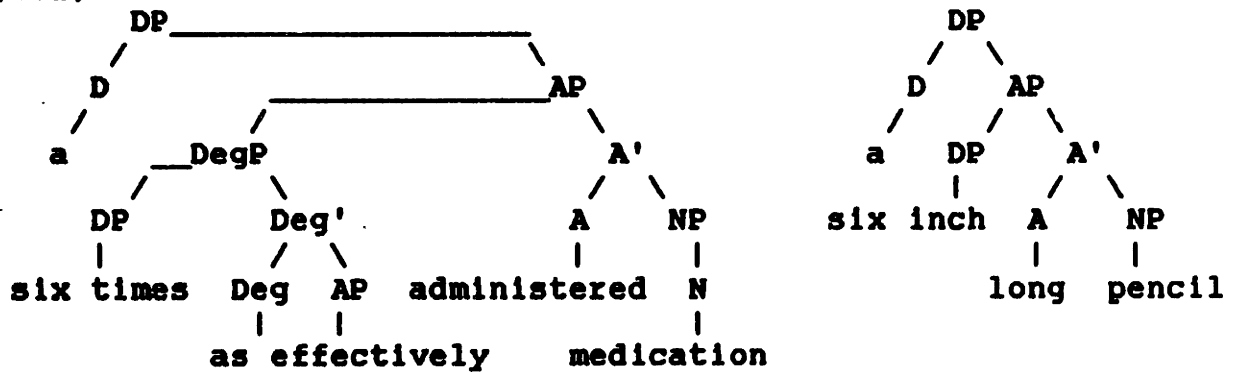

The facts of (398)-(400) not only support (395a) over (395b), they also support (395a) over the other two possible analyses of prenominal adjective attachment discussed at the beginning of this section. As far as I can see, the only analysis that can account naturally for (398)-(400) is (395a).

### 3.3.b. Quantifiers

If we adopt the analysis (395a), we must reconsider the position of quantifiers. If quantifier phrases appear in Spec of N, and prenominal adjectives take NP as complement, we predict that quantifiers are grammatical following adjectives, but ungrammatical preceding adjectives:

(402)

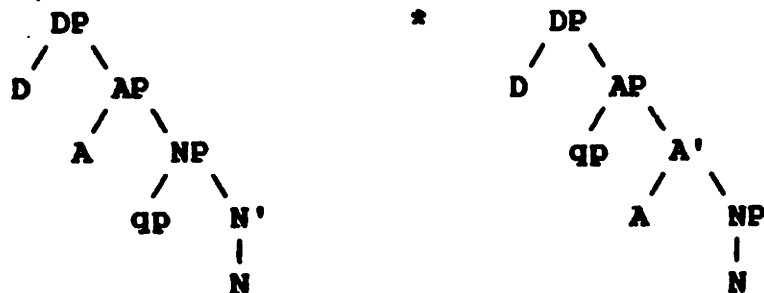

Of course, just the opposite is in fact the case.

The alternative is to revise our earlier analysis, and assume that quantifiers, like descriptive adjectives, appear on the path that leads from DP to N:

(403)

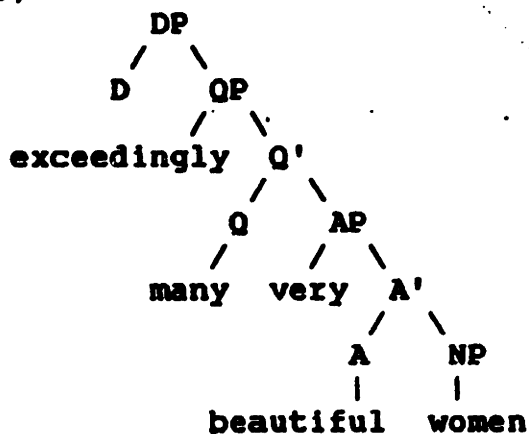

There is some evidence in favor of this analysis. In particular, there is evidence that comparative and superlative adjectives are quantifiers. We have already seen evidence that comparatives and superlatives take an NP complement; therefore, we have positive evidence that at least some quantifiers take NP complements.

This is the evidence that comparative and superlative adjectives are quantifiers: (1) comparatives and superlatives must precede all descriptive adjectives:

(404)

a big fancy car	the big fancy car
*a big fancier car	*the big fanciest car
a fancier big car	the fanciest big car

(2) comparatives and superlatives license partitives, and missing noun heads:

(405)

[the better (of the two)] will win  
[the best (of all)] will win

This is otherwise a property solely of determiners and quantifiers:<sup>103</sup>

(406)

[each (of the men)] will win  
[several (of the men)] will win  
[many (of the men)] will win  
[few (of the men)] will win

\*[the many good (of the men)] will win  
\*[an old (of the men)] will win  
\*[beautiful (of the women)] will win

The analysis (403) provides us with a simple characterization of the elements that license missing noun heads and partitive. We can say that there is a unique empty noun which takes the partitive of-phrase as an optional  
-----

103. There are of course the examples like the poor, but these are quite restricted in English: they are possible only when they fit the template "the  $A_{p1}$ ". Cf.: \*a poor is among us, \*poor are always among us, \*the old poor are always among us, etc.

complement,  $N_e$ . Determiners and quantifiers select  $N_e$ , but descriptive adjectives do not. Under this account, there is a hierarchy of selectional properties:

(407)

D: selects NP, AP,  $NP_e$ , QP

Q: selects NP, AP,  $NP_e$

A: selects NP, AP

Given these lexical selection properties, we correctly predict a large part of the range of internal noun phrase structures.

### 3.3.c. Problems

The analysis I have argued for -- (395a) supplemented with (403) -- appears to account most successfully for the broadest range of data, of the four analyses I have considered in this section. However, there are a couple of difficult residual problems. One is that we are left with no specifiers within NP. I consider this problem minor, for two reasons: (1) if adjectives correspond to auxiliaries, and NP corresponds to VP, then the absence of specifiers of NP corresponds to the absence of obvious candidates for Spec of VP. (2) the lack of Spec of NP might seem to undermine one of our arguments on behalf of Det-as-head presented in section 1 -- that there are too many specifiers in the noun phrase for the standard analysis to accommodate. But we have only eliminated Spec of N by adopting an even more radical version of the Det-as-head analysis, one in which adjectives are heads of noun phrases as well. Further, even if we have no Spec of

N, we do still have specifiers of complements of D: namely, when QP or AP are complements of D.

A more serious problem is that we are left with no analysis for examples like the following:

(408)  
 the [nearly as many] men who didn't make it  
 a [nearly as devastating] attack

These examples suggest that the ill-formedness of examples like \*a too beautiful woman is the result of a surface constraint against adjacent D's and Deg's, not the result of a structural constraint against DegP complements of D.

I will suggest a possible approach to this problem, though I must note from the outset that my solution is not fully satisfactory.

A first observation is that Deg's vary widely in their ability to appear in structures like (408). In my judgment, the best examples are with -er and -est (or more and most) as degree words -- these are good even without an intervening adverb. With an intervening adverb, as is rather good, and too sometimes; other Degs, such as so, that, are never good:

(409)

\*(I have never before encountered) a [nearly so virulent] strain  
 \*(I have never before seen) a [quite that beautiful] woman

Cf.:

√(I have never before encountered) a strain [nearly so virulent]  
 √(I have never before seen) a woman [quite that beautiful]

Let us begin with -er and -est. As mentioned, these Deg's appear consistently under determiners, even without an intervening adverb:

(410)

the better man  
 the best man

There are even examples that seem to show that -er and -est appear under Deg's:

(411)

- a. he does it [the best (of all)]
- b. he ran [the quicker of the two]
- c. [the quicker you run], the quicker I'll catch you
- d. [the better to eat you with]

All of these phrases function as adverbs, not arguments. For this reason, their structure would appear to be e.g.:

(412)

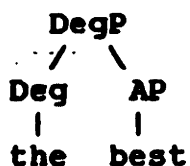

i.e., the, like that, can function both as a Det and as a Deg. I do not adopt this analysis, however, because of the fact that partitive of is licensed in these structures (see

(411a,b)). I have assumed that partitive of is licensed only by  $N_e$ ; this requires the structure (413) for the examples (411):

(413)

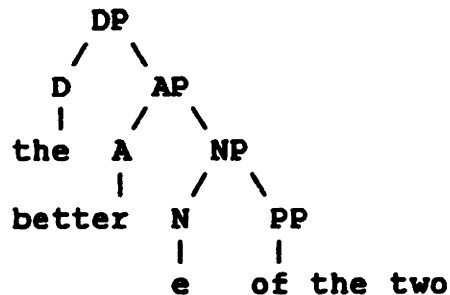

We can take these to be "bare-NP adverbs", as Larson (1985) christens examples like yesterday. The proper semantics are obtained by allowing  $N_e$  to range over adverb meanings: manners, speeds, etc.

The ability of -er and -est to co-occur with determiners seems clearly to be related to the fact that they are affixes. It is rather reminiscent of cases of doubled determiners in languages like Norwegian and Soninke that have affixal determiners. In Norwegian, doubled determiners are not normally grammatical; but doubling does occur when the second determiner is the definite affix -en:<sup>104</sup>

-----

104. Data from Hellan (1986).



(414)

\*denne hver sko  
 this each shoe

denne sko-en  
 this shoe-the

Similarly, in Soninke (a Mande language of Mali), doubled determiners are permitted when the second determiner is the affixal definite determiner:<sup>105</sup>

(415)

ke samage-n  
 this snake-the

These examples suggest that there is a constraint against doubly-filled Det's at s-structure, but not at LF. The affixal determiner can raise at LF, yielding e.g.:

(416)

{DP [D denne -en<sub>i</sub>] [NP [N sko-t<sub>i</sub>]]}

A similar process is necessary in English if we are to assume that the determiner is the site of "Phi-features", as I suggested earlier; hence that the plural morpheme must raise into a (possibly filled) Det at LF.

Let us return to comparatives and superlatives now. We can assign the following well-formed LF to comparatives and superlatives under determiners:

-----

105. Data from my own field work, conducted in 1982-83.

(417)  
 [DP [D a -er<sub>1</sub>] [AP pretty-t<sub>1</sub> [NP girl]]]

If this is correct, it implies that examples like \*as prettiest<sup>106</sup> are not ungrammatical because there are two Deg's -- -er should be able to raise into a filled Deg in the same way it raises into a filled Det -- but rather for semantic reasons; presumably for the same reasons that examples like \*very so pretty are out.

The structure (417) is not available for Deg's other than -er and -est because other Deg's must be base-generated in the Deg/Det position, not affixed to adjectives.

However, more and most behave just like -er and -est with respect to their ability to appear under determiners:

(418)  
 a more beautiful woman  
 the most beautiful woman

One possibility is that these are simply quantifiers in Spec of A, the comparative and superlative of much. As has long been puzzled over, though (Bresnan (1973), Jackendoff (1977)), this leaves unexplained why much in the positive degree is ill-formed in these examples: \*a much beautiful woman.

I would like to suggest that more and most are exactly like -er and -est in every respect, except that they are not  
 -----

106. The intended reading is not "as much prettier" -- where as takes scope over -er, not pretty -- but rather something like "as pretty, which is to say, the prettiest".

phonological affixes. In particular, I suggest that they are syntactic affixes, much like -ing. They affix to AP, and raise into Deg/Det at LF; in this way they escape the s-structure prohibition on doubly-filled D:

(419)

SS:

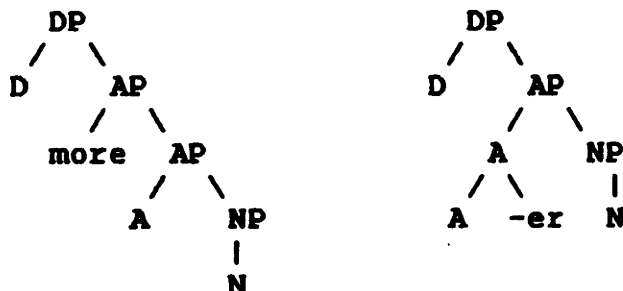

LF: [DP [D a more<sub>i</sub>] [AP t<sub>i</sub> [AP beautiful woman]]]

The subtree [AP more AP] is licensed by morphological conditions, not by X-bar theory. More is not adjoined to AP; rather it is the head of [AP more AP] in the same way that -er is the head of [A A -er]. Hence, more occupies an A-position, not an A-bar position, and its raising into Deg/Det is proper movement.

In short, I propose that there are certain elements -- more and most -- which are not phonologically affixes, but nonetheless behave syntactically like affixes.

Possibly, a similar analysis can be applied to problematic cases like a nearly as devastating attack. As I noted, only certain Deg's can appear in these structures, and then only sporadically and with large variances in speaker judgments. There also appear to be idiosyncratic PF constraints on the process. In addition to the prohibition

against string-adjacent Det's and Deg's, there is a prohibition against mono-syllabic adjectives in this construction: \*a nearly as long interview vs. ?a nearly as lengthy interview. These facts suggest that whatever process is involved, it is rather marked. A reasonable hypothesis is that Deg's other than more and most are sporadically reanalyzed as syntactic affixes, as more and most have done completely. As is fairly susceptible to this reanalysis, too somewhat less so, and so and that not at all.

Some tenuous support for this hypothesis is supplied by examples like his too-eager grin, where too actually appears adjacent to a determiner, but there is a strong intuition that it forms a compound with eager, in some sense. Under the present hypothesis, it "compounds" with eager in that it is a syntactic affix on the AP headed by eager.

A final stumbling-block is the fact that not only adjectives and quantifiers, but also measure nouns, fit into the paradigm of a nearly as devastating attack. Consider:

(420)

\*the [a dozen] men who came  
 the [nearly a dozen] men who came

In this case, there are two courses open to us. We might assume that a reanalyzes as an affix on dozen. Alternatively, it may be that a dozen is in fact an NP, not a DP. Perlmutter (1970) argues that a is not a determiner, but a reduced form of the numeral one. Whether his analysis is correct or not, there are certain advantages that accrue to taking a to have

some analysis other than as a determiner. There is a class of phrases of the form a A\* NP that are set apart from argumental noun phrases in a number of ways. Examples are:

(421)  
 too big [a house]  
 a monster of [a problem]  
 two of [a kind]

Semantically, these phrases are predicates, not arguments.

The examples of (421) are interpreted (very roughly) as:

(422)  
 too-big'(x) & house'(x)  
 monster'(x) & problem'(x)  
 two'(X) & of-a-kind'(X)

In particular, the a-phrases do not introduce a separate variable ranging over objects, but are simply predicates which are applied to the variable introduced by the matrix phrase.

Correspondingly, these phrases can never be extracted:

(423)  
 \*[a house], that's too big of \_\_\_  
 \*[a problem], that's a monster of \_\_\_  
 \*[a kind], they're two of \_\_\_  
 \*only too big (of) \_\_\_ was available [(of) a house]  
 \*a monster (of) \_\_\_ came up [(of) a problem]  
 \*two (of) \_\_\_ were there [(of) a kind]

Both of these facts would be explained if the a-phrases in question were NP's, not DP's. NP's are predicates, not arguments; NP's cannot be extraposed like DP's. If this is correct, we can take nearly a dozen in the nearly a dozen men who came to be an NP, not a DP.

An added benefit is that singular and plural dozen differ markedly less under this analysis than under most analyses.

Consider the paradigm:

(424)  
 a dozen men  
 dozens of men (Pseudo-partitive)  
 dozens of the men (Partitive)

Under the current analysis, the structures are:

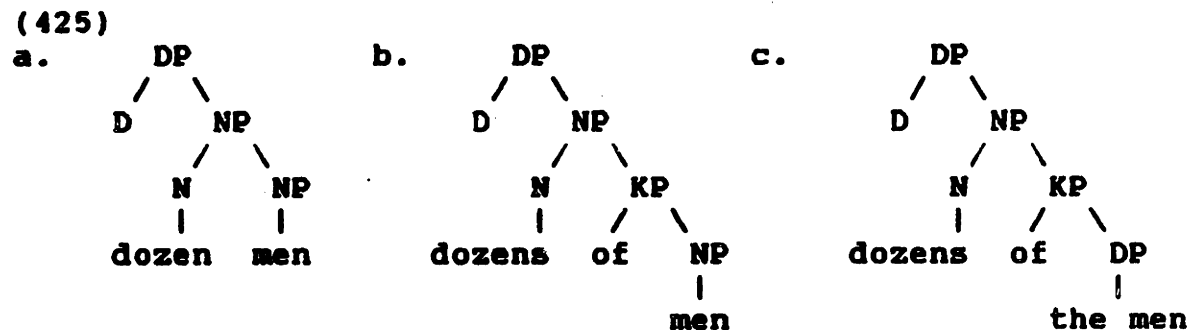

Dozen differs from dozens only in that it f-selects an NP rather than a KP. Dozens f-selects either an argumental KP (one containing a DP) or a predicative KP (one containing an NP: recall that pseudo-partitives (i.e., (425b)) cannot be extracted, which would be explained if they are NP's, not DP's: several t were asked [of \* $\theta$ /the questions concerning electromagnetism]).

In its current state, this solution to the problems which face the Adj-as-head analysis is based on somewhat scanty evidence, and to that extent speculative. I must leave refinements, or a new and more adequate solution, to future research.

#### 4 Conclusion

To sum up, the Det-as-head analysis is thoroughly defensible, and has a number of advantages over the standard analysis. The chief motivation for adopting the Det-as-head analysis is conceptual, however. The DP-analysis permits us to preserve the same restrictive characterization of X-bar theory which motivates the IP-analysis of the sentence, and the Det-as-head analysis involves assigning determiners an analysis which parallels current analyses of other functional elements, such as complementizers and modals. Further, the Det-as-head analysis provides "room" for the full range of specifiers found in the noun phrase.

Support for this analysis of determiners is derived from examination of the adjective phrase. In English, noun phrase and adjective phrase have a great deal in common, including the existence of degree elements as adjective-phrase correlates of determiners in the noun phrase. I argue that degree elements are exactly parallel to determiners, and accordingly head the "adjective phrase" (DegP). This provides two distinct specifier positions in the adjective phrase, in addition to the position of the degree word, and I argue that, as in the noun phrase, all positions are exploited.

More generally, I argue that there are two major dichotomies of syntactic categories: functional elements [+F] vs. thematic elements [-F], and nominal elements [+N] vs.

verbal elements [-N]. I have given lengthy characterizations of the distinction between functional and thematic elements; the most important structural differences are that functional elements do not possess a distinct index from that of their complement, and that functional-element positions are sites for AGR, hence functional categories, but not thematic categories, freely take overt subjects.

The functional/thematic and nominal/verbal dichotomies are extremely robust, much more so than the alleged dichotomy between [+V] elements (V,A) and [-V] elements (N,P). For this reason, I challenge the traditional four "major categories" (N,V,A,P); also because the notional category "adjective" does not correspond to a single category with a stable syntactic characterization, but rather to two distinct categories, one a subcategory of verbs, the other a subcategory of nouns (the latter being predominate in English).

My discussion of the feature composition of syntactic categories is spread throughout the thesis. I would like to sum up here. I recognize (at least) five features: +F, +N, +Adj, +Q, +C. +F and +N are the major features. +Adj distinguishes nouns from (nominal-type) adjectives; presumably we should also use it to distinguish verbs from verbal-type adjectives.<sup>107</sup> +C distinguishes "inherently Case-marked"

-----

107. Another possibility is to distinguish nouns and nominal-type adjectives by a feature +Aux, which we would also use to distinguish verbs and auxiliaries. I have not taken that position here, because I have claimed that only prenominal adjectives pattern with auxiliaries.



elements: i.e., adverbs, including "bare-NP" adverbs, bare-adjective adverbs, and adverbs in -ly. It is relevant only for [-F,+N] categories. +Q distinguishes quantificational and descriptive adjectives. It is relevant only for [-F,+N,+Adj] categories.

The complete set of distinctions for the features +F, +N, and +Adj is the following:

(426)		-Adj		+Adj	
	-N		+N	-N	+N
-F	V,P		N	--	A,Q,Adv
+F	I,C		D,K	--	Deg

It is not clear where P belongs. Perhaps languages differ as to whether P is [-N] or [+N] (I am thinking particularly of languages like Mayan where P's are very similar to nouns).

It is not clear what feature distinguishes I from C and D from K, but, presumably, it is the same feature in both cases.

Possibly, there are [-F,-N,+Adj] elements in other languages: i.e., verbal-type adjectives. It is not clear that there are [+F,-N,+Adj] elements in any language.

To repeat, the central claim embodied in the distribution of categories (426) is that there are two major dichotomies, functional vs. thematic elements and nominal vs. verbal elements, and that functional elements occupy a uniform structural position in both nominal and verbal systems. The

thrust of the present work is that the nominal system is not defective, but possesses a functional element D, on a par with the functional elements I and C of the verbal system.

## Bibliography

- Abney S. (1984) "Comp", ms., MIT.
- Abney S. (1985) "Some Topics Relevant to Subcategorization", Generals paper, MIT.
- Abney S. (1986) "Functional Elements and Licensing", paper presented to GLOW 1986, Gerona, Spain.
- Abney S. (in preparation) "A Semantics for GB", ms., MIT, Cambridge MA.
- Amritavalli R. (1980) "Expressing Cross-Categorial Selectional Correspondences: An Alternative to the X-bar Syntax Approach", Linguistic Analysis 6.3.
- Anderson M. (1979) Noun Phrase Structure, Doctoral dissertation, University of Connecticut, Storrs CT.
- Anderson M. (1984) "Prenominal Genitive NPs", The Linguistic Review 3:1-24.
- Aoun J. (1985) A Grammar of Anaphora, Linguistic Inquiry Monograph No. 11, MIT Press, Cambridge MA.
- Aoun J. & D. Sportiche (1981) "On the Formal Theory of Government", The Linguistic Review 2:211-236.
- Aristotle, The Poetics, published 1939, with a translation by W. Hamilton Fyfe, Loeb Classical Library, Harvard University Press, Cambridge MA.
- Aronoff M. (1976) Word Formation in Generative Grammar, Linguistic Inquiry Monograph No. 1, MIT Press, Cambridge MA.
- Bach E. (1968) "The noun phrase", in E. Bach & R.T. Harms, eds., Universals of Linguistic Theory, Holt, Rinehart, and Winston, New York.
- Baker M. (1985a) "The Mirror Principle and Morphological Explanation", Linguistic Inquiry 16.3.

- Baker M. (1985b) Incorporation: A Theory of Grammatical Function Changing, Doctoral dissertation, MIT, Cambridge MA.
- Baker M. (1985c) "Syntactic Affixation and English Gerunds", in Cobler et al., eds., Proceedings of the West Coast Conference of Formal Linguistics, Stanford University, Palo Alto, CA.
- Baker M., K. Johnson, & I. Roberts (1985) "Explicit Passive Arguments", talk presented at MIT, Cambridge MA.
- Barss A. & H. Lasnik (1986) "A Note on Anaphora and Double Objects", Linguistic Inquiry 17:347-354.
- Barwise J. and R. Cooper (1981) "Generalized Quantifiers and Natural Language", Linguistics and Philosophy 4:159-219.
- Belletti A. (1986) "Unaccusatives as Case Assigners", Lexicon Project Working Papers #8, Center for Cognitive Science, MIT, Cambridge MA.
- Belletti A. & L. Rizzi (1986) "Psych-Verbs and  $\theta$ -theory", ms., MIT (both), Scuole Normale Superiore di Pisa (Belletti), and Universite de Geneve (Rizzi).
- Bolinger D. (1972) Degree Words, Mouton, The Hague.
- Bowers J.S. (1975a) "Adjectives and Adverbs in English", Foundations of Language 13.4.
- Bowers J.S. (1975b) "Some Adjectival Nominalizations in English", Lingua 37:341-361.
- Brame M. (1981) "The General Theory of Binding and Fusion", Linguistic Analysis 7.3.
- Brame M. (1982) "The Head-Selector Theory of Lexical Specifications and the Nonexistence of Coarse Categories", Linguistic Analysis 8.4.
- Bresnan J. (1973) "Syntax of the Comparative Clause Construction in English", Linguistic Inquiry 5.4.
- Chao W. (1987) On Ellipsis, Doctoral dissertation, University of Massachusetts, Amherst MA.
- Chomsky N. (1955) The Logical Structure of Linguistic Theory, published 1975, The University of Chicago Press, Chicago.
- Chomsky N. (1970) "Remarks on Nominalization", in R. Jacobs & P. Rosenbaum, eds., Readings in English Transformational Grammar, Ginn, Waltham MA.

- Chomsky N. (1977) "On WH-Movement", in P. Culicover, T. Wasow, & A. Akmajian, eds., Formal Syntax, Academic Press, New York.
- Chomsky N. (1981) Lectures on Government and Binding, Foris Publications, Dordrecht, Holland.
- Chomsky N. (1986a) Barriers, Linguistic Inquiry Monograph No.13, MIT Press, Cambridge MA.
- Chomsky N. (1986b) Knowledge of Language, Praeger Publications, New York.
- Davidson D. (1980) Essays on Actions and Events, Clarendon Press, Oxford.
- Dayley (1985) A Tzutujil Grammar, University of California Press, Berkeley and Los Angeles.
- Dixon R.M.W. (1982) Where Have All the Adjectives Gone?, Mouton, Amsterdam.
- Emonds J. (1970) Root and Structure Preserving Transformations, Doctoral dissertation, MIT, Cambridge, MA.
- Emonds J. (1971) "Derived Nominals, Gerunds, and Participles in Chaucer's English", in B. Kachrun, ed., Issues in Linguistics, University of Illinois Press.
- Emonds J. (1985) A Unified Theory of Syntactic Categories, Foris, Dordrecht, Holland.
- Fabb N. (1984) Syntactic Affixation, Doctoral dissertation, MIT, Cambridge MA.
- Fahlman, S. (1979a) NETL: A System for Representing and Using Real-World Knowledge, MIT Press.
- Fahlman, S. (1979b) "Representing and Using Real-World Knowledge", Artificial Intelligence: An MIT Perspective, Vol 1, pp. 451-470.
- Fassi Fehri (1980) "Some Complement Phenomena in Arabic, Lexical Grammar, the Complementizer Phrase Hypothesis and the Non-Accessibility Condition", ms., University of Rabat.
- Fiengo R. & J. Higginbotham (1981) "Opacity in NP", Linguistic Analysis 7.4.
- Fiva T. (1984) "NP-Internal Chains in Norwegian", Nordic Journal of Linguistics 8:25-47.

- Grimshaw J. (1986) "Nouns, Arguments and Adjuncts", ms., Brandeis University, Waltham MA.
- Gruber J. (1965) Studies in Lexical Relations, Doctoral dissertation, MIT, Cambridge MA.
- Gueron J. (1985) "Clause Union and the Verb-Particle Construction in English", ms., Universite de Paris VIII.
- Haegeman, L. (1986) "Passivization in Flemish Dialects", ms., University of Geneva.
- Hale K. (1980) class at LSA Summer Institute, Albuquerque NM, cited in G. Lamontagne & L. Travis (1986) "The Case Filter and the ECP", ms., McGill University, Montreal.
- Hale K., L.M. Jeanne, & P. Platero (1977) papago in P. Culicover, T. Wasow, & A. Akmajian, eds., Formal Syntax, Academic Press, New York.
- Hellan L. (1986) "The Headedness of NPs in Norwegian", Chapter 4 of P. Muysken & H. van Riemsijk, eds., Features and Projections, Foris Publications, Dordrecht, Holland.
- Higginbotham J. (1983) "Linguistic Relations", ms., MIT, Cambridge, MA.
- Higginbotham J. (1983) "Logical Form, Binding, and Nominals", Linguistic Inquiry 14.3.
- Higginbotham J. (1985) "On Semantics", Linguistic Inquiry 16.4.
- Higginbotham J. (1986a) "Elucidation of Meaning", ms., MIT.
- Higginbotham J. (1986b) "A Systematization", ms., MIT.
- Higginbotham J. & R. May (1980) "Questions, quantifiers and crossing", The Linguistic Review 1:41-80.
- Horn G. (1975) "On the Nonsentential Nature of the Poss-Ing Construction", Linguistic Analysis 1.4.
- Horrocks G. & M. Stavrou (1985) "Bounding Theory and Greek Syntax; Evidence for Wh-movement in NP", ms., St. John's College, Cambridge.
- Hudson R.A. (1976) Arguments for a Non-transformational Grammar, The University of Chicago Press, Chicago.
- Hudson R.A. (1984) Word Grammar, Basil Blackwell, Oxford.
- Jackendoff R. (1968) "Quantifiers in English", Foundations of Language 4.4:422-442.

- Jackendoff R. (1977) X-bar Syntax: A Study of Phrase Structure, Linguistic Inquiry Monograph No. 2, MIT Press, Cambridge MA.
- Jespersen O. (1909-1949) A Modern English Grammar, George Allen & Unwin, London.
- Kayne R. (1984a) "Unambiguous Paths", Chapter 7 of Connectedness and Binary Branching, Foris Publications, Dordrecht, The Netherlands.
- Kayne R.S. (1984b) "Principles of Particle Constructions", Chapter 5 of J. Gueron, H.-G. Obenauer, & J.-Y. Pollock, eds., Levels of Syntactic Representation II, Foris Publications, Dordrecht, Holland.
- Kayne R.S. (1985) "L'Accord du Participe Passe en Francais et en Italien", Modeles Linguistiques 7.1.
- Klein E. (to appear) "Comparatives", in A. von Stechow & D. Wunderlich, eds., Handbook of Semantics, Athenaeum Verlag.
- Kornfilt J. (1984) Case Marking, Agreement, and Empty Categories in Turkish, Doctoral dissertation, Harvard, Cambridge MA.
- Koster J. (1978) "Why Subject Sentences Don't Exist", in S.J. Keyser, ed., Recent Transformational Studies in European Languages, MIT Press, Cambridge MA.
- Kuroda S.-Y. (1986) "Whether you agree or not", ms., University of California at San Diego, San Diego CA.
- Larson R.K. (1985) "Bare-NP Adverbs", Linguistic Inquiry 16.4.
- Larson R.K. (1987a) "On the Double Object Construction", ms., MIT, Cambridge MA.
- Larson R.K. (1987b) "'Missing Prepositions' and the Analysis of English Free Relative Clauses", Linguistic Inquiry 18.2.
- Lasnik H. (1984) "Random Thoughts on Implicit Arguments", ms., University of Connecticut, Storrs CT.
- Lasnik H. & J. Kupin (1977) "A restrictive theory of transformational grammar", Theoretical Linguistics 4.3.
- Lasnik H. & M. Saito (1984) "On the Nature of Proper Government", Linguistic Inquiry 15.2.
- Lebeaux D. (1986) "The Interpretation of Derived Nominals", CLS 22, Part 1.

- Lees R.B. (1960) The Grammar of English Nominalizations,  
Doctoral dissertation, MIT, Cambridge MA.
- Levin B. & M. Rappaport (1985) "The Formation of Adjectival  
Passives", Lexicon Project Working Papers #2, The Center  
for Cognitive Science, MIT, Cambridge MA.
- Lieber R. (1980) On the Organization of the Lexicon, Doctoral  
dissertation, MIT, Cambridge MA.
- Lieber R. (1983) "Argument Linking and Compounds in English",  
Linguistic Inquiry 14:251-285.
- Loback A. (1985) Syntactic Constraints on VP Ellipsis,  
Doctoral dissertation, University of Washington.
- Marantz A. (1984) On the Nature of Grammatical Relations,  
Linguistic Inquiry Monograph No. 10, MIT Press, Cambridge  
MA.
- Makino S. (1968) Some Aspects of Japanese Nominalizations,  
Tokai University Press, Tokyo.
- Milner J.-C. (1982) "Les genitifs adnominaux en français", in  
Ordres et raisons de langue, Editions du Seuil, Paris.
- Montague R. (1974) Formal Philosophy: Selected Papers of  
Richard Montague, R.H. Thomason, ed., Yale University  
Press, New Haven CT.
- Napoli D.J. (1985) "Verb phrase deletion in English: a base-  
generated analysis", J. Linguistics 21:281-319.
- Perlmutter D. (1970) "On the Article in English", in M.  
Bierwisch & K.E. Heidolph, eds., Progress in Linguistics,  
Mouton, The Hague.
- Pesetsky D. (1982) Paths and Categories, Doctoral  
dissertation, MIT, Cambridge, MA.
- Pesetsky D. (1985) "Morphology and Logical Form", Linguistic  
Inquiry 16.2.
- Plann S. (1981) "The Two el + infinitive Constructions in  
Spanish", Linguistic Analysis 7.3.
- Postal P.M. (1966) "On So-Called 'Pronouns' in English", in D.  
Reibel & S. Schane, eds. (1969) Modern Studies in  
English, Prentice-Hall, Englewood Cliffs, NJ.
- Postal P.M. (1974) On Raising, MIT Press, Cambridge MA.
- Poutsma H. (1923) The Infinitive, the Gerund and the  
Participles of the English Verb, P. Noordhoff, Groningen.



- Quirk R., S. Greenbaum, G. Leech, & J. Svartvik (1985) A Comprehensive Grammar of the English Language, Longman, New York.
- Rappaport M. (1982a) "On the Nature of Derived Nominals", ms., MIT, Cambridge MA.
- Rappaport M. (1982b) "Derived Nominals and the Theory of Lexical Categories", ms., MIT, Cambridge MA.
- Reed I. et al. (1977) Yup'ik Eskimo Grammar, University of Alaska.
- Reinhart T. (1978) "Syntactic Domains for Semantic Rules", in F. Guenther & S.J. Schmidt, eds., Formal Semantics and Pragmatics for Natural Languages, Reidel, Dordrecht, Holland.
- Reuland E. (1983) "Governing -ing", Linguistic Inquiry 14.1.
- Reuland E. (1985) "A Feature System for the Set of Categorial Heads", ms., Rijksuniversiteit Groningen.
- Ritter E. (1986) "Genitive NPs in Hebrew: A Functor Analysis", Generals Paper, MIT, Cambridge MA.
- Ritter E. & A. Szabolcsi (1985) "Let's Take the That-t Effect Seriously", ms., MIT.
- Roeper T. (1984) "Implicit Arguments and the Projection Principle", ms., University of Massachusetts, Amherst MA.
- Rosenbaum P. (1967) The Grammar of English Predicate Complement Constructions, The MIT Press, Cambridge, MA.
- Ross J. (1967) Constraints on Variables in Syntax, Doctoral dissertation, MIT, Cambridge MA.
- Ross J. (1973) "Nouniness", in O. Fujimura, ed., Three Dimensions of Linguistic Theory, TEC Company, Tokyo, Japan.
- Rothstein S. (1983) The Syntactic Forms of Predication, Doctoral dissertation, MIT, Cambridge MA.
- Schachter P. (1976) "A Nontransformational Account of Gerundive Nominals in English", Linguistic Inquiry 7.2.
- Selkirk E. (1970) "On the Determiner Systems of Noun Phrase and Adjective Phrase", ms., MIT, Cambridge MA.
- Selkirk E. (1977) "Some Remarks on Noun Phrase Structure", in P. Culicover, T. Wasow, & A. Akmajian, eds., Formal Syntax, Academic Press, New York.

- Selkirk, E. (1982) The Syntax of Words, Linguistic Inquiry Monograph No. 7, MIT Press, Cambridge MA.
- Siegel D. (1974) Topics in English Morphology, Doctoral dissertation, MIT, Cambridge MA.
- Smith C. (1961) "A class of complex modifiers in English", Language 37.3, pp.342-365.
- Sportiche D. (1983) Structural Invariance and Symmetry in Syntax, Doctoral dissertation, MIT, Cambridge MA.
- Sproat R. (1985) On Deriving the Lexicon, doctoral dissertation, MIT, Cambridge MA.
- Stockwell R., P. Schachter, & E. Partee (1973) The Major Syntactic Structures of English, Holt, Rinehart, and Winston, NY.
- Stowell T. (1981) Origins of Phrase Structure, Doctoral dissertation, MIT, Cambridge MA.
- Stowell T. (1983) "Subjects Across Categories", The Linguistic Review 2:285-312.
- Szabolcsi A. (1981) "The Possessive Construction in Hungarian: A Configurational Category in a Non-Configurational Language", Acta Linguistica Academiae Scientiarum Hungaricae 31:261-289.
- Szabolcsi A. (1984) "The possessor that ran away from home", The Linguistic Review 3:89-102.
- Szabolcsi A. (1987) "Functional Categories in the Noun Phrase," to appear in Kenesei, ed., Approaches to Hungarian, Vol.2, Szeged.
- Thompson S. (1973) "On Subjectless Gerunds in English", Foundations of Language 9:374-383.
- Underhill R. (1976) Turkish Grammar, MIT Press, Cambridge MA.
- Vendler Z. (1967) Adjectives and Nominalizations, Mouton, The Hague.
- Vergnaud J.-R. (1974) French Relative Clauses, Doctoral dissertation, MIT, Cambridge MA.
- Wasow T. & T. Roeper (1972) "On the Subject of Gerunds", Foundations of Language 8.1.
- Wik B. (1973) English Nominalizations in -ing, Acta Universitatis Upsaliensis, Studia Anglistica Upsaliensia #12, Uppsala.

- Williams E. (1975) "Small Clauses in English", in J. Kimball, ed., Syntax and Semantics, Vol. 4, Academic Press, NY.
- Williams E. (1980) "Predication", Linguistic Inquiry 11:203-238.
- Williams E. (1982) "The NP-Cycle", Linguistic Inquiry 13.2.
- Williams E. (1985) "PRO and Subject of NP", Natural Language and Linguistic Theory 3:297-315.
- Winston P. (1984) Artificial Intelligence, Addison-Wesley, Reading MA.
- Young R. & W. Morgan (1971) The Navaho Language, Deseret Book Company.