



**Basic
Highway
Plan
Reading**

Basic Highway Plan Reading

Basic Highway Plan Reading

Reproduction of any or all portions of this Manual is prohibited without the written consent of the Georgia Department of Transportation.



developed in conjunction with



Revised October 1, 2020

Table of Contents

List of Figures	vi
Forward	ix
A Note on Safety	x
Nuts and Bolts of the Course	xi
Chapter 1	
Beginning to Read Plans	1
General Information.....	1
Requirements and Specifications	1
What Part of The Contract Applies?.....	1
In Case of A Discrepancy, Certain Parts of The Contract Govern Over Others.....	1
Sheet Order.....	1
Errors or Omissions.....	2
Cover Sheet.....	2
Description.....	4
Project Location Sketch	5
Layout View	5
Sheet Identification	6
Plans Revised and Plans Completed	8
Scale.....	8
Project Length.....	10
Cover Sheet Questions	10
Design Data	10
Chapter 2	
Index and Revision Summary Sheet	11
Index	11
Revision Summary Sheet.....	11
Chapter 3	
Typical Sections	13
Introduction to Typical Sections.....	13
Horizontal Distance	14
Chapter 4	
Summary & Detailed Estimate Quantities	15
Summary of Quantities	15

(Continued on page ii)

Drainage Summary	15
Detailed Estimate.....	16
Chapter 5	
Views.....	19
Introduction to Views	19
Longitudinal Cross Section.....	19
Cross Section	20
Profile View.....	20
Chapter 6	
Stationing, Symbols, And Abbreviations	23
Stationing.....	23
Half Stations.....	24
Station Equations (Equalities).....	26
Determining of The Project Length.....	27
Symbols and Abbreviations	
Introduction to Symbols	28
Introduction to Plan Abbreviations	28
Conventional and Right of Way (ROW) Symbols.....	29
Utility Symbols	
Water Mains	30
Gas Mains and Petroleum Product Pipe Lines	31
Sanitary Sewer and Steam Lines	32
Electrical Power	33
Telephone and Telegraph.....	34
Television/ and Microwave Cable.....	35
Utility Abbreviations and Railroad	36
Chapter 7	
Plan and Profile Sheets	37
Plan View.....	37
Horizontal Alignment.....	39
Superelevation.....	41
Bearings	42

(Continued on page iii)

Profile View (Vertical Alignment)	45
Elevations.....	46
Grade.....	47
Vertical Curves and Grade Point.....	48
Paving Limits.....	49
Construction Limits	50
Fencing	50
Guard Rail.....	50
Right of Way Markers	50
Chapter 8	
Drainage	53
Pipe Culverts.....	53
Box Culverts	54
Plan View	57
Wing Walls	58
Bridges.....	60
Bents	62
Utility Accommodations.....	64
Chapter 9	
Utilities	67
Chapter 10	
Signing, Pavement Markings, Signals, Highway Lighting, Landscaping	69
Traffic Signals	69
Lighting.	69
Landscaping.....	69
Chapter 11	
Maintenance of Traffic, Sequence of Operations, and Staging	71
Chapter 12	
Erosion, Sedimentation, And Pollution Control Plans (ESPCP)	73
Introduction to Erosion Control	73
When Are ESPCP Necessary?	73
What Is Included in the ESPCP?	74

(Continued on page iv)

Contractor Responsibilities.....	74
Examples from the Plans	75
Chapter 13	
Cross Sections	
Introduction to Cross Sections	77
Earthwork	77
Grade	80
Slopes	80
Slope Stakes.....	81
Chapter 14	
Standards & Details	
Introduction to Standards & Details.....	85
Intersection Details	85
Chapter 15	
Right of Way	
Introduction	87
Right of Way Terms and Definitions.....	88
Right of Way Plan Sheets	91
Questions for Appendices	95
Appendix A: Definitions.....	97
Appendix B: Abbreviations	107
Answers to Chapter Questions	
Chapter 1	117
Chapter 2	117
Chapter 3	117
Chapter 4	117
Chapter 5	117
Chapter 6	118
Chapter 7	118
Chapter 8	120
Chapter 9	120
Chapter 10	121
Chapter 11	121
Chapter 12	121
Chapter 13	121

Chapter 14	121
Chapter 15	121
Appendices	121
Index	123

List of Figures

Chapter 1

Figure 1-1. Plan View of Project	4
Figure 1-2. Description of Project.	4
Figure 1-3. Location Sketch	5
Figure 1-4. Plan View of a Project	5
Figure 1-5. Standard Identification Box.	6
Figure 1-6. Cover Sheet note and legality.....	6
Figure 1-7. Cover Sheet Box for signatures and titles of those responsible for the plans	7
Figure 1-8. Cover Sheet Plans Revised box.....	8
Figure 1-9. Civil Engineer’s Scale and Architect’s Scale.	9
Figure 1-10. Detail of the Civil Engineer’s Scale.	9
Figure 1-11. Bar Scale from Plan Sheet 60.....	9
Figure 1-12. Length of Project.....	10
Figure 1-13. Cover Sheet Design Data.	10

Chapter 2

Figure 2-1. Index.	11
Figure 2-2. Revision Summary Sheet.	12

Chapter 3

Figure 3-1. Typical Roadway Section.	13
Figure 3-2. Required Pavement	14
Figure 3-3. Horizontal Distance compared with Slope Distance	14

Chapter 4

Figure 4-1. Summary of Quantities.	15
Figure 4-2. Drainage Summary.	16
Figure 4-3. Detailed Estimate.	17

Chapter 5

Figure 5-1. Plan View.....	19
Figure 5-2. Side and Rear Elevations	19
Figure 5-3. Longitudinal Cross Section and Standard Cross Section	19
Figure 5-4. Views of a Boat for Question 5-1.....	20
Figure 5-5. Profile View: Sectioning of a Pencil	21
Figure 5-6. Sections Views of a Pencil.....	21

Chapter 6

Figure 6.1 How to Think about Stations.....23
Figure 6-2. Stationing Example Illustrating Halfway.....24
Figure 6-3. Plan Sheet Stationing. 25
Figure 6-4. Station Equality..... 26
Figure 6-5. Stationing Exercise27
Figure 6-6. Symbols for Proposed and Existing Right-of-Way 28
Figure 6-7. Conventional and Right-of-Way (ROW) Symbols 29
Figure 6-8. Water and Non Potable Water Mains or Lines.....30
Figure 6-9. Gas Mains and Petroleum Product Pipe Lines31
Figure 6-10. Sanitary Sewer and Steam Lines.....32
Figure 6-11. Electrical Power 33
Figure 6-12. Telephone and Telegraph.....34
Figure 6-13. Television and Microwave Cables35
Figure 6-14. Utility Symbol Abbreviations and Railroad Symbols.....36

Chapter 7

Figure 7-1. Plan View of a Roadway.....37
Figure 7-2. North-South Arrow. 38
Figure 7-3. Types of Curves 40
Figure 7-4. Spiral Curve 41
Figure 7-5. Compass Bearing. 42
Figure 7-6. Bearing Question. 43
Figure 7-7. Profile Grade Lines 46
Figure 7-8. Positive and Negative Grades.47
Figure 7-9. Vertical Curves and P.V.I.'s48
Figure 7-10. Grade Points.....48
Figure 7-11. Symbols for Proposed (Left) and Existing (Right) ROW.50

Chapter 8

Figure 8-1. Drainage Table from Sheet 198.53
Figure 8-2. Box Culvert Sections 54
Figure 8-3. Culverts with Multiple Barrels.....55
Figure 8-4. Longitudinal Section of a Box Culvert.56
Figure 8-5. Plan View of a Box Culvert57

Figure 8-6. Skewed View of a Box Culvert.....	57
Figure 8-7. Partial Plan View of Wing Wall.....	58
Figure 8-8. Wing Wall Section.	58
Figure 8-9. Box Culvert on 60 degree skew	59
Figure 8-10. Partial Plan Showing Angles of Wings and Barrel.	59
Figure 8-11. Plan and Elevation Views of a Bridge	60
Figure 8-12. End Bent Elevations.....	62
Figure 8-13. Cross Section of Bridge.	64
Figure 8-14. End Bent Elevation and Section.....	65
Chapter 12	
Figure 12-1. Erosion, Sediment & Pollution Control Plan	73
Figure 12-2. Stage 1 BMP Plan Sheet: Location Details.....	74
Chapter 13	
Figure 13-1. Typical terrain for a Two-Lane Roadway	77
Figure 13-2. Examples of Cut and Fill Cross Sections	78
Figure 13-3. Typical Cross Section.	78
Figure 13-4. Typical Cross Section along Centerline.....	79
Figure 13-5. Typical Cross Section and Cross Section of the Original Ground, along Centerline.	79
Figure 13-6. Volume of Cut.	79
Figure 13-7. Views of Slopes in Cross Section	80
Figure 13-8. Slope Cross Section.	81
Figure 13-9. Slope Stake Positioning	82
Figure 13-10: Station Numbering on Slope Stake.	83
Figure 13-11. Offset Distance on Slope Stake.....	83
Chapters 14	
Figure 14-1. Ramp Identification by Letter	85
Chapters 15	
Figure 15-1. Right of Way Plan Sheet: Cover Sheets 1 and 2.	91
Figure 15-2. Right of Way Plans Sheet 1.	93
Figure 15-3. Right of Way Plan Sheet 3, Parcel 4.	93
Figure 15-4. Parcel Required Right of Way.	94

Forward

This Plan Reading Course is to present a step-by-step procedure on how to read, interpret, and relate to a standard set of roadway plans; to help identify and interpret symbols used in a standard set of plans; and to help develop the necessary skills to interpret a set of plans in non-technical terms to laypersons (property owners and others). Along with this manual you will use plan sheets and standards that specifically relate to a project. The plan sheets/standards included have been reduced to half their original size so they can be handled more easily.

A partnership of Transportation entities, The Georgia Partnership for Transportation Quality (GPTQ), works together to improve the quality of the nation's highways and as one of the initiatives, the GPTQ Steering Committee created a team from public and private sector organizations to jointly focus on the improvement of highway construction plans. The team determined that quality improvements were attainable by developing a Plan Presentation Guide to assist designers in the presentation of the work to be accomplished and thereby making plans more efficient for the user. This guide can be found on the Georgia DOT Web Pages for further information.

Since it is our intent to provide you, the student, with a "well rounded" exposure to highway construction plans, you may be asked to look at a plan sheet from a particular project. Please be sure that you are looking at the correct set of plans for the text that you are reading and the questions you may be asked to answer.

A Note on Safety

As an employee of the Georgia Department of Transportation, it is your responsibility to direct your concern to one goal, which is to provide the traveling public with the best and safest roadway system that can be constructed.

With this goal constantly in mind, it is the responsibility of each DOT employee to observe, suggest, and act to achieve a safe system of roadways throughout the State. Regardless of a specific assigned duty, it is the responsibility of all the employees of the Georgia Department of Transportation to call to his/her supervisor's attention any item, whether in design or construction, which appears to be an obvious hazard to the motoring public.

Safety is our business and will remain the primary factor in designing and constructing highways.

Nuts and Bolts of the Course

This is a self-instructional study course. The subject matter is arranged so that you the student may work at your own speed. Each part of the course builds on the information that has preceded it and prepares for information to follow. Most of the parts present new information. Some parts review important concepts that have been introduced to you earlier in the program and apply these concepts in new ways.

The idea behind this method is for you to read and study the information, actively participate by writing or checking off answers to questions, then find out immediately if you are correct. This method reinforces what you have read and enables you to retain what you have learned for a longer period of time. The retention of information from a self-instructional study course should be far greater than from a lecture or textbook.

To get the most from this course, start at the beginning. Read each section as it comes; preparing you for the next section. You will find questions within each section. By answering these questions, you will be able to retain what you have just read longer than by lecture or discussion.

The answers to these questions appear at the end of the text.

Chapter 1: Beginning to Read Plans

GENERAL INFORMATION

REQUIREMENTS AND SPECIFICATIONS

A requirement occurring in one of the parts of a Georgia DOT contract is as binding as though occurring in all. The Specifications, Supplemental Specifications, Plans, Special Provisions, and all supplementary documents are all part of the contract.

WHAT PART OF THE CONTRACT APPLIES?

In case of a discrepancy, certain parts of the contract govern over others. The governing order will be as follows:

1. Special Provisions
2. Project Plans including Special Plan Details
3. Supplemental Specifications
4. Standard Plans including Standard Construction Details
5. Standard Specifications

Calculated dimensions will govern over scaled dimensions.

The Contractor shall take no advantage of any apparent error or omissions in the Plans or Specifications. In the event the Contractor discovers such an error or omission, he shall immediately notify the Engineer. The Engineer will then make such corrections and interpretations as may be deemed necessary for fulfilling the intent of the Plans or Specifications.

SHEET ORDER

When the plans for a contract are completed, the sheets are normally placed in a specific order. (The following list is used as a general guide and is sometimes changed to better fit an individual project).

- 01-Cover
- 02-Index (it may be shown on the Cover Sheet, if it's a smaller project with few sheets)
- 03-Revision Summary Sheet
- 04-General Notes
- 05-Typical Sections
- 06-Summary of Quantities (Roadway and Signing & Marking)
- 07- Quantities Required by Amendment Drawing
- 08-Quantities Required on Construction Drawing
- 10-Traffic Diagram Drawings
- 11- Construction Layout Drawing /Stakeout Drawing
- 12-Corridor Location map or Aerial Photo Mosaics (on new location)

- 13- Mainline Roadway, Crossroad, Side Street, Frontage Road and Ramp Plan Drawings (plan & profile may be on same drawings)
- 15- Mainline Roadway Profile Drawing
- 16- Crossroad, Side Street, Frontage Road, and Ramp Profile Drawing
- 17- Driveway Profile Drawing
- 18- Special Grading Drawings (Sediment/Detention Basins, Parking Lots, etc...)
- 19- Construction Staging Plan Drawings and Staging Cross-Section Drawings
- 20- Construction Staging Details (Detours, Haul Roads, Drainage, etc...)
- 21- Drainage Map
- 22- Drainage Profiles
- 23- Cross-Sections
- 24- Utility Plans
- 25- Lighting Plans and Details
- 26- Signing and Marking Plans and Details
- 27- Signal Plans
- 28- ATMS/ITS Plans
- 29- Landscaping Plans and Details
- 30- Mitigation Plans (wetland, stream, etc...)
- 31- Retaining Wall Envelopes
- 32- Retaining Wall Plans
- 33- Noise Barrier Envelopes
- 34- Noise Barrier Plans
- 35- Bridge Plans
- 36- Bridge Culvert Plans
- 37- Miscellaneous Structural Plans (Buildings, tollbooths, ice canopies, etc...)
- 38- Special Construction Details (Project Specific - ADA, Special Design Drainage Structures, Post-Construction Stormwater BMPs, etc...)
- 39- Special Design Box Culverts
- 40- Construction Details
- 41- Georgia Standards
- 44- UTILITY RELOCATION PLANS – Water/Sewer, Electric, Gas, Communications, Cable
- 50- Erosion Control Plans – Cover Drawing
- 51- Erosion Control Plans – Erosion, Sedimentation and Pollution Control General Notes Drawing
- 52- Erosion Control Plans – Erosion Control Legend and Uniform Code Drawing
- 53- Erosion Control Plans – Drainage Area Map
- 54- Erosion Control Plans – Construction Best Management Practices (BMP) Location Details
- 55- Erosion Control Plans – Erosion Control Watershed Map and Site Monitoring Location
- 56- Erosion Control Plans – Construction Standards and Details (for Erosion Control only)
- 60- Right of Way Plans

ERRORS OR OMISSIONS

The Contractor is not supposed to take advantage of any apparent error or omission in the plans or specifications.

In the event such errors or omissions are discovered, the Engineer will then make such corrections and interpretations, as may be determined necessary for the fulfillment of the intent of the Plans and Specifications.

Cover Sheet

The front sheet of a set of plans is called the **COVER SHEET**. The information shown on it is

- Project name
- Project number
- Project identification number (P.I. No.)

- County
- Congressional district
- Standard note directing attention to the Georgia DOT Standard Specification Book
- Project location sketch
- Box containing revisions
- Project limits (shown in large scale)
- Box containing the length of the project
- Federal Route Number (if applicable)
- State Route Number (if applicable)
- Signature Boxes for those responsible for the Design of the Plans
- Signature Box for the Chief Engineer or Responsible Official
- Date the Plans were completed
- Professional Engineer's Stamp

If room is available, the following is included:

- Legend of Items used in the Plans
- Sheet Layout Diagram
- An Index, if the project is small enough

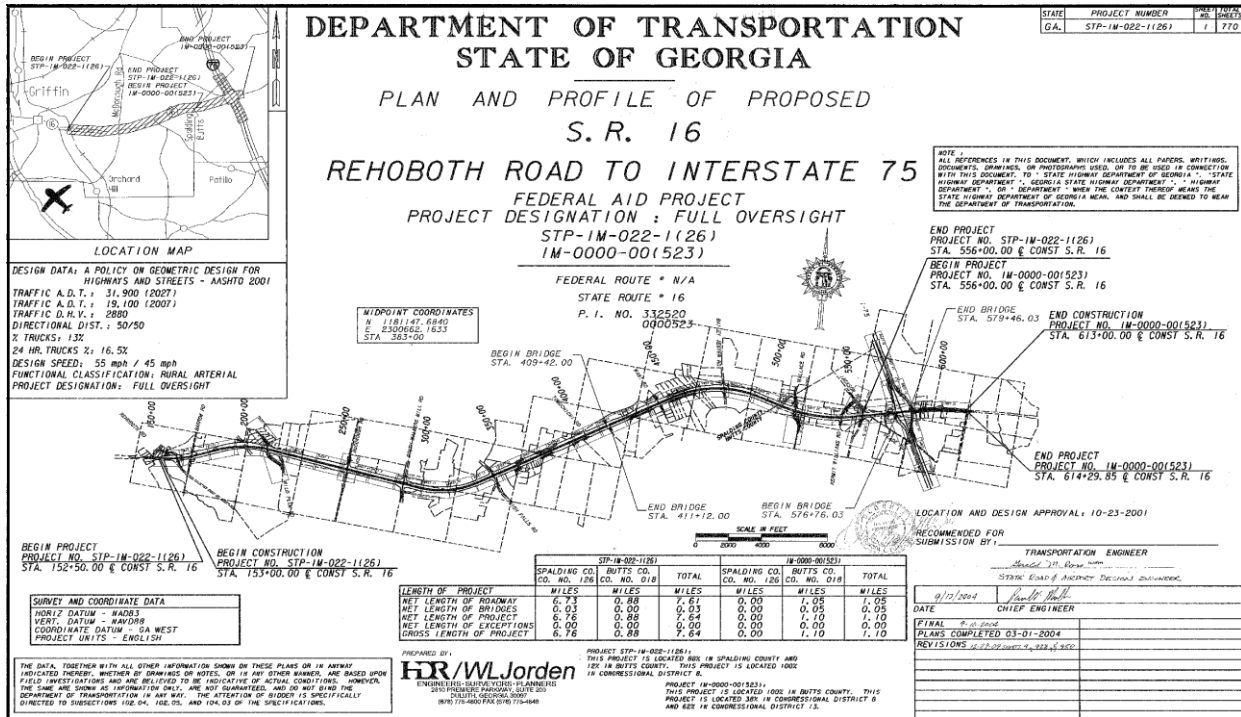

Figure 1-1. Plan View of Project

Turn to the **COVER SHEET**, Construction Plan Sheet 1 and see how many of the above features you can identify on your own.

Please answer the following questions:

- 1-1 What gives you the basic description of the project?
- 1-2 What gives you the beginning and ending project limits?

DESCRIPTION

Looking at your set of plans you should have found this description.

**PLAN AND PROFILE OF PROPOSED
S. R. 16
REBOTH ROAD TO INTERSTATE 75**

Figure 1-2. Description of Project.

You will note that the proposed project is for construction of SR 16 in Spalding and Butts Counties.

The next thing to be noted is the Project Identification Number (P.I. No.) The project Program Identification Number is 332520.

This project also has a second P.I. No. (0000523) for the interstate bridge widening project. Not all projects will have multiple PIs. This plan set only covers P.I. No. 332520.

The project number for P.I. No. 332520 is STP-IM-022-1(26) and the project number for P.I. No. 0000523 is IM-0000-001 (523). Questions in this text only refer to P.I. No. 332520 which is project number STP-IM-022-1(26).

Lastly, note that this project has does not have a Federal Route Number, only a State Route Number of 16.

PROJECT LOCATION SKETCH

In the upper left corner of the Cover Sheet is a Location Sketch, which shows the general geographical area of the project. This map shows the approximate limits of the project. An example is shown at the right in Figure 1-3.

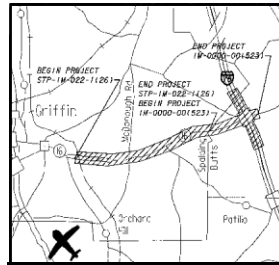

Figure 1-3. Location

LAYOUT VIEW

In the center and under the title of the Cover Sheet is a **LAYOUT VIEW**. This view shows the beginning station and the ending station of the project.

Figure 1-4 above is a “Plan View” of the project. You will be exposed to a **PLAN VIEW** in another section of this manual. If you were flying over this project in an airplane and looking down, the **PLAN VIEW** is what you would see.

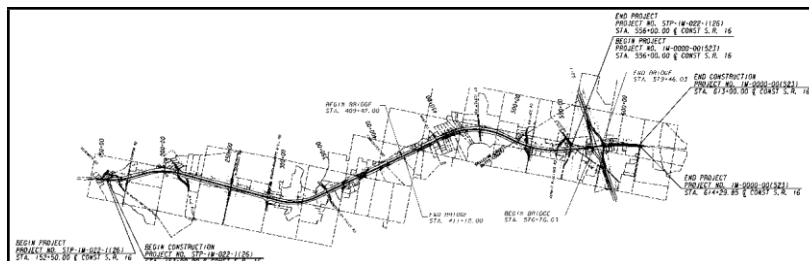

Figure 1-4. Plan View of a Project

SHEET IDENTIFICATION

Now look in the upper right corner of the Cover Sheet and see the box like the one shown below. Each sheet in a set of plans has a similar box for standard identification for each sheet of a set of plans for a given project. The box lists the project number of the Plan Sheet being looked at, the number of the Plan Sheet, and the total number of sheets in the plans.

STATE	PROJECT NUMBER	SHEET NO.	TOTAL SHEETS
GA.	STP-IM-022-1(26)	1	770

Figure 1-5. Standard Identification Box.

On the Cover Sheet, there is included a statement referring to the Department's responsibility about the work.

THE DATA, TOGETHER WITH ALL OTHER INFORMATION SHOWN ON THESE PLANS OR IN ANYWAY INDICATED THEREBY, WHETHER BY DRAWINGS OR NOTES, OR IN ANY OTHER MANNER, ARE BASED UPON FIELD INVESTIGATIONS AND ARE BELIEVED TO BE INDICATIVE OF ACTUAL CONDITIONS. HOWEVER, THE SAME ARE SHOWN AS INFORMATION ONLY, ARE NOT GUARANTEED, AND DO NOT BIND THE DEPARTMENT OF TRANSPORTATION IN ANY WAY. THE ATTENTION OF BIDDER IS SPECIFICALLY DIRECTED TO SUBSECTIONS 102.04, 102.05, AND 104.03 OF THE SPECIFICATIONS.

Figure 1-6. Cover Sheet note and legality.

Other notes may be found that call attention to the legality of the data shown on the plans. Although not found on the sample construction plans cover sheet, the following signatures and titles of those responsible for the preparation and approval of the plans under the authority of the State Highway Engineer are often found on plans.

PREPARED BY: DATE

RECOMMENDED FOR SUBMISSION BY: DATE

TRANSPORTATION ENGINEER

SUBMITTED BY: DATE

RECOMMENDED FOR APPROVAL DATE

DISTRICT ENGINEER DATE

APPROVED DATE

CHIEF ENGINEER DATE

Figure 1-7. Cover Sheet Box for signatures and titles of those responsible for the plans.

Please answer the questions concerning the **COVERSHEET**:

- 1-3** What Standard Specifications shows the Georgia Department of Transportation’s responsibility concerning the quantities on these plans?
- 1-4** Where is the location of the project found?
- 1-5** What does the Layout view show?

PLANS REVISED AND PLANS COMPLETED

A box is provided on the cover sheet to list each time the plans have been revised. A date is placed in the box for each of these occurrences. Above this box you will also find a place for a date to be placed when the plans were completed. Note that these plans show one revision, 12-29-04.

FINAL 9-10-2004	
PLANS COMPLETED 03-01-2004	
REVISIONS 12-29-04 SHEETS 4, 422, & 450	

Figure 1-8. Cover Sheet Plans Revised box.

SCALE

Roadway and structure plans are drawn to scale in order that they might be presented on easy-to-use sheets.

Roadway plans are normally drawn with an engineer’s scale while structure plans use both engineer’s and architect’s scales.

A civil engineer's scale has divisions of 10, 20, 30, 40, 50 and 60 to the inch.

An architect's (or mechanical engineer's) scale expresses scale as fraction of an inch to one foot. Sample scales would be $1/4'' = 1$ foot, $3/8'' = 1$ foot, $1/8'' = 1$ foot, or similar.

The engineer's scale is one that expresses "scale" as 1 inch = 10 feet; 1 inch = 20 feet, 1 inch = 30 feet, 1 inch = 40 feet, 1 inch = 50 feet, 1 inch = 60 feet, or some multiple of these numbers. It is usually 1 foot long and may be triangular or flat.

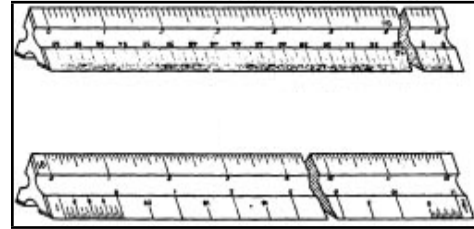

Figure 1-9. Civil engineer's scale (above top) and architect's scale (above bottom).

The scales are divided into decimal parts of an inch such as 1/10th inch, 1/20th inch, etc.

The triangular, or six-scale scale, has scales with 10, 20, 30, 40, 50, and 60 divisions to the inch. In the next drawing, each division equals 1-foot - in the $1'' = 10'$ scale, there are 10 divisions to the inch. Each division can be treated in multiples of 10 as well, for example, $1'' = 100'$, $1'' = 1000'$, etc.

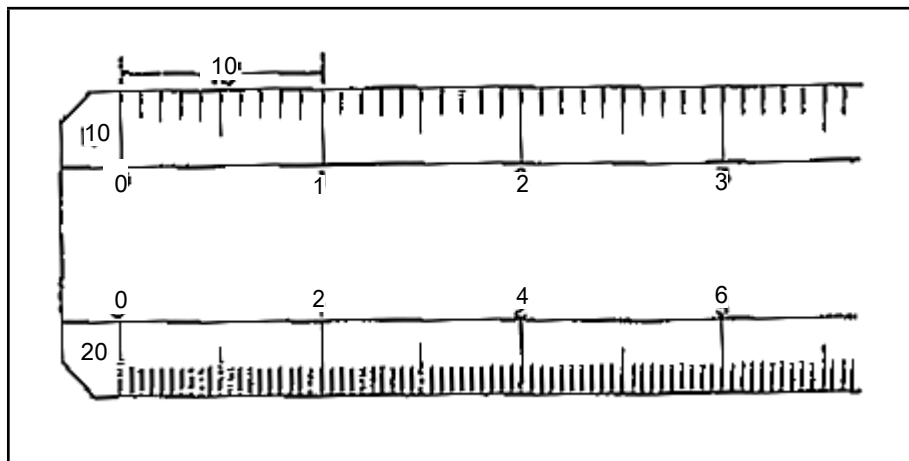

Figure 1-10. Detail of the Engineer's Scale.

The scale on which the Cover Sheet was plotted is shown graphically above the Length of Project Box. The cover sheet for this plan set is $1'' = 2000'$. Plan sheets, however, are plotted on various scales depending on the need for detail, etc., and are notated as such on the respective plan sheets. Turn to Sheet No. 60 and note the scale. A bar scale is shown and stated in feet.

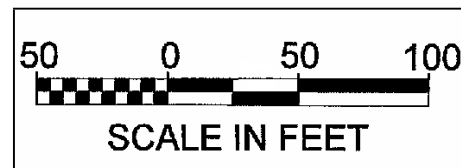

Figure 1-11. Bar Scale from Plan Sheet 60.

IF ANY EXERCISE IN THIS MANUAL CALLS FOR MEASUREMENTS, YOU MUST REMEMBER THESE ARE HALF-SIZE PLAN SHEETS AND YOU WILL HAVE TO DOUBLE THE LENGTH.

PROJECT LENGTH

A Length of Project box is shown on the Cover Sheet noting the length of the project, bridges and exceptions, when applicable.

	STP-IM-022-1(26)			IM-0000-00(523)		
	SPALDING CO.	BUTTS CO.	TOTAL	SPALDING CO.	BUTTS CO.	TOTAL
	CO. NO. 126	CO. NO. 018		CO. NO. 126	CO. NO. 018	
	MILES	MILES	MILES	MILES	MILES	MILES
LENGTH OF PROJECT						
NET LENGTH OF ROADWAY	6.73	0.88	7.61	0.00	1.05	1.05
NET LENGTH OF BRIDGES	0.03	0.00	0.03	0.00	0.05	0.05
NET LENGTH OF PROJECT	6.76	0.88	7.64	0.00	1.10	1.10
NET LENGTH OF EXCEPTIONS	0.00	0.00	0.00	0.00	0.00	0.00
GROSS LENGTH OF PROJECT	6.76	0.88	7.64	0.00	1.10	1.10

Figure 1-12. Length of Project.

Please answer the questions concerning the **COVERSHEET**:

- 1-6 What is the total gross length for this project?
- 1-7 What type of scale are roadway plans normally drawn with?

DESIGN DATA

In the design of a highway, traffic data is used to determine the number of lanes and the depth of paving. This data is shown on the Cover Sheet as well.

DESIGN DATA: A POLICY ON GEOMETRIC DESIGN FOR HIGHWAYS AND STREETS	
TRAFFIC A.D.T.:	31,900 (2027)
TRAFFIC A.D.T.:	19,100 (2007)
TRAFFIC D.H.V.:	2880
DIRECTIONAL DIST.:	50/50
% TRUCKS:	13%
24 HR. TRUCKS %:	16.5%
SPEED DESIGN:	55 mph / 45 mph
FUNCTIONAL CLASSIFICATION:	RURAL ARTERIAL
PROJECT DESIGNATION:	FULL OVERSIGHT

Figure 1-13. Cover Sheet Design Data.

Chapter 2: Index and Revision Summary Sheet

INDEX

An index is required for each set of construction plans to help the user in identifying what sheets are in the set of plans. The index can be included on the cover sheet on smaller projects with few sheets, but normally it will be included as a separate sheet directly following the cover sheet.

The index sheet includes a description of each plan sheet with each corresponding sheet number. A listing of all the Georgia DOT standards and construction drawings relating to that particular project, are also shown along with the corresponding standard number, the most recent revision date of the standard, and the sheet number.

An area is usually available on the sheet for later additions or deletions of sheets and the total number of all sheets are shown.

REVISION SUMMARY SHEET

At times after the final set of plans have been drawn up, it will be necessary to revise (change) the design for a portion of the plans. A Revision Summary Sheet is used for the purpose of keeping a record of those revisions. For this reason, a revision summary sheet is a required element of a set of construction plans.

<i>I N D E X</i>		
<i>SHEET NO.</i>	<i>DWG. NO.</i>	<i>DESCRIPTION</i>
<i>1</i>	<i>1-01</i>	<i>COVER SHEET</i>
<i>2 - 3</i>	<i>2-01 - 2-02</i>	<i>INDEX SHEETS</i>
<i>4</i>	<i>3-01</i>	<i>REVISION SUMMARY SHEET</i>
<i>5</i>	<i>4-01</i>	<i>GENERAL NOTES</i>
<i>6 - 17</i>	<i>5-01 - 5-12</i>	<i>TYPICAL SECTION SHEETS</i>
<i>18 - 50</i>	<i>6-01 - 6-33</i>	<i>SUMMARY OF QUANTITIES</i>
<i>51 - 56</i>	<i>9-01 - 9-06</i>	<i>DETAILED ESTIMATE SHEETS</i>
<i>57 - 59</i>	<i>10-01 - 10-03</i>	<i>TRAFFIC DIAGRAM SHEETS</i>
<i>60 - 90</i>	<i>13-01 - 13-31</i>	<i>MAINLINE CONSTRUCTION PLAN SHEETS</i>
<i>91 - 105</i>	<i>14-01 - 14-15</i>	<i>SIDESTREET CONSTRUCTION PLAN SHEETS</i>
<i>106 - 121</i>	<i>15-01 - 15-16</i>	<i>MAINLINE PROFILE SHEETS</i>
<i>122 - 141</i>	<i>16-01 - 16-20</i>	<i>SIDESTREET PROFILE SHEETS</i>
<i>142 - 153</i>	<i>17-01 - 17-12</i>	<i>DRIVEWAYS PROFILE SHEETS</i>
<i>154 - 197</i>	<i>19-01 - 19-44</i>	<i>STAGING PLAN SHEETS</i>
<i>198 - 200</i>	<i>21-01 - 21-03</i>	<i>DRAINAGE AREA MAP</i>
<i>201 - 226</i>	<i>22-01 - 22-26</i>	<i>DRAINAGE PROFILES</i>
<i>227 - 416</i>	<i>23-01 - 23-190</i>	<i>CROSS SECTIONS</i>
<i>417</i>	<i>24-00</i>	<i>UTILITY LEGEND</i>
<i>418 - 463</i>	<i>24-01 - 24-46</i>	<i>UTILITY PLANS</i>
<i>464 - 473A</i>		<i>LIGHTING PLANS AND DETAILS</i>
<i>474 - 522</i>	<i>26-01 - 26-49</i>	<i>SIGNING AND MARKING PLANS AND DETAILS</i>
<i>523 - 526</i>	<i>27-01 - 27-04</i>	<i>SIGNAL PLANS</i>
<i>527 - 557</i>		<i>BRIDGE PLANS AND BRIDGE STANDARDS</i>

Figure 2-1. Index Sheet.

The Revision Summary Sheet consists of three columns (in addition to the normal project information in the title blocks). The first column is for the date on which the revision was made; the second column is for the plan sheet number; and the third column contains a description of the revision, described in enough detail to quickly understand the nature of the revision. The Revision Summary Sheet will typically follow directly behind the Index Sheet or the Cover Sheet.

Please identify the question as True or False:

- 2-1 True False An Index is required for each set of Construction Plans.
- 2-2 True False A Revision Summary Sheet is part of the contract.
- 2-3 True False A listing of all Standards and Construction Drawings are included in the index.

DATE	REVISED SHEET NO.	REVISION
12-29-04	422 & 450	RELOCATED UTILITY LINE ADDED

Figure 2-2. Revision Summary Sheet.

Chapter 3: Typical Sections

INTRODUCTION TO TYPICAL SECTIONS

The typical section is a picture, with dimensions, of how the cross-sectional view of the roadway would appear after the construction is completed. A cross section is how the view of the road would look if cut from side to side. Figure 3-1 shows an idealized roadway typical section with the various elements identified.

The left side of Figure 3-1 below illustrates how the roadway is to be constructed in a fill area. The right side of this typical section illustrates how the roadway is to be constructed in a cut area (the road will be below existing grade). We will talk in more detail about “cut” and “fill” later. However, the right and left sides of the Typical Section are interchangeable.

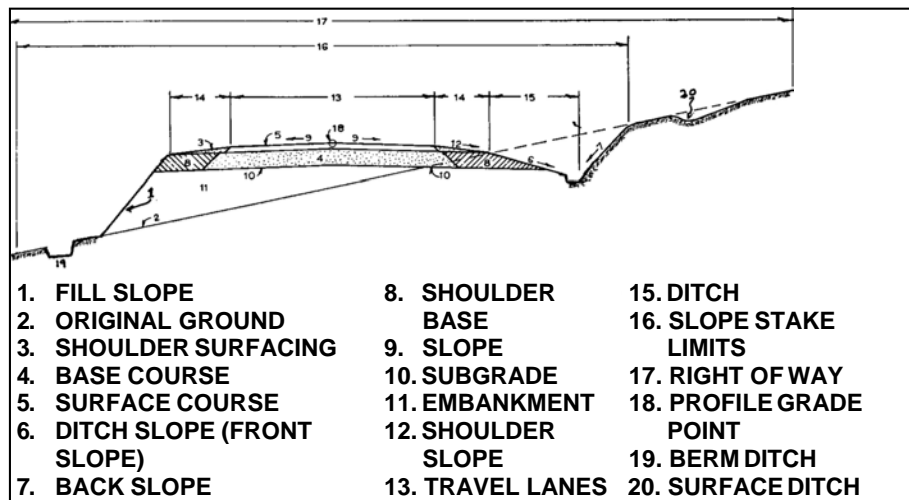

Figure 3-1. Typical Roadway Section.

Look at Construction Plan Sheet #7 and find some of the significant features you should know about this Typical Section:

1. This is a dual-lane roadway with a median.
2. The travel lanes for each side of the roadway are 24 ft. wide.
3. There is a 6'6" paved shoulder on the outside of each roadway and a two foot paved shoulder on the inside (median) side of each roadway.
4. The profile grade point is at the construction centerline (C_L CONST).
5. The location where the typical section is to be used is shown.
6. Paving requirements are also spelled out under the Normal Tangent Section. Refer to Figure 3-2 on the following page for a detail of “REQUIRED PAVEMENT” from Sheet 7.

REQUIRED PAVEMENT	
A	ASPHALTIC CONCRETE, 12.5 mm SUPERPAVE (165 lb/yd ²), DESIGN LEVEL A
B	ASPHALTIC CONCRETE, 12.5 mm SUPERPAVE (165 lb/yd ²), DESIGN LEVEL B
C	ASPHALTIC CONCRETE, 19 mm SUPERPAVE (220 lb/yd ²), DESIGN LEVEL A
D	ASPHALTIC CONCRETE, 19 mm SUPERPAVE (220 lb/yd ²), DESIGN LEVEL B
E	
F	
G	
H	ASPHALTIC CONCRETE, 25 mm SUPERPAVE (660 lb/yd ²), DESIGN LEVEL A
I	ASPHALTIC CONCRETE, 19 mm SUPERPAVE (330 lb/yd ²), DESIGN LEVEL A
J	
K	PORTLAND CEMENT CONCRETE PAVEMENT, CLASS 3, 12"
L	CONCRETE MEDIAN, DOWELED, 6"
M	6" GRADED AGGREGATE BASE
N	CONCRETE CURB AND GUTTER, 8" X 30", TP 2
O	14" GRADED AGGREGATE BASE
P	12" GRADED AGGREGATE BASE
Q	CONCRETE CURB AND GUTTER, 8" X 30", TP 7
R	CONCRETE MEDIAN PAVING, 4"
S	CONCRETE SIDEWALK, 4"
T	LONGITUDINAL CONSTRUCTION JOINT WITH TIE BARS. SEE GA. STD. 5046-H FOR DETAILS.
U	5/8" TIE BARS, SPACED 18 INCH CENTER TO CENTER
V	REMOVE EXISTING PAVEMENT

Figure 3-2. Required Pavement

HORIZONTAL DISTANCE

The dimensions given for Typical Sections are Horizontal dimensions. This means that the distances are not measured along the slopes of the roadway. For example, the distance from the profile grade of the left lane of the Typical Section to the edge of the pavement is written as 24'. The distance measured along the 1/4" per foot slope would be slightly longer than 24'. Figure 3-3 exaggerates that difference. All the dimensions shown by level lines are Horizontal Distances. Explanations of Slopes will be discussed later in this book.

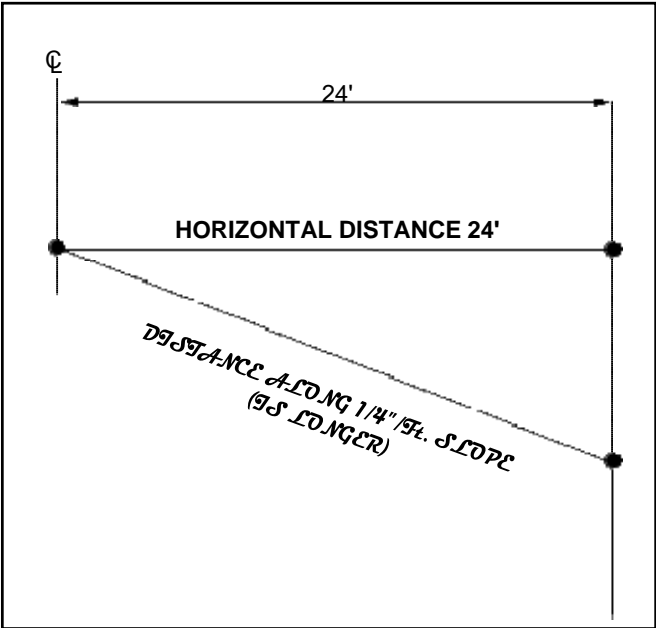

Figure 3-3. Horizontal Distance compared with Slope Distance.

Use Construction Plan Sheet 7, Tangent Section (Section 3), and answer these questions:

- 3-1 What is the total thickness of the Asphaltic Concrete?
- 3-2 What is the material used under the Asphaltic Concrete?
- 3-3 How wide is the outside unpaved shoulder?
- 3-4 What is the slope required on the outside paved shoulder?
- 3-5 How many lanes make up the normal section for each side of this roadway?
- 3-6 How wide is the median ditch?

Chapter 4: Summary & Detailed Estimate Quantities

SUMMARY OF QUANTITIES

The Summary of Quantities Construction Plan Sheets show all the items of construction that are indicated on the Plan and Profile Sheets. The items are normally lumped together into like categories and then the categories are placed in boxes on the sheet with their representative quantities. An exception to this is if it's stated that an item is included in the cost of another item. Another exception would be on a small bridge replacement project where quantities are small and pay items are very limited. In this case, the quantities are placed on the Detailed Estimate only.

Turn to the Summary of Quantities for Sheets 12 through 19. The Summary of Quantity notes the location, size, etc., where the item is required.

FIELD ENGINEER'S OFFICE - TYPE 1 TOTAL: 1400 LF <small>NOTE: REFER TO SPECIAL PROVISIONS CONTAINING FIELD ENGINEER'S OFFICE</small>	CONCRETE CURB & GUTTER 8" x 36" TYPE 1, GA STD 9032-B TOTAL: 780 LF	CONCRETE MEDIAN, 4 IN TOTAL: 240 SF	RIGHT-OF-WAY BARRIERS TOTAL: 178 EACH	PROJECT NUMBER STA. 153+00-155+25
TRAFFIC CONTROL TOTAL: 1 LUMP SUM	WATER QUALITY MONITORING AND SAMPLING TOTAL: 2 EACH	ROCK EMBANKMENT TOTAL: 4400 CF <small>NOTE: TO BE USED FROM STA. 14+00 TO STA. 14+50 AS SHOWN ON THE PROFILES</small>	WOVEN WIRE FENCE TOTAL: 2790 LF	GLONHD REINFORCEMENT, TPB 200#75 - 88#75 SF 840 200#25 - 355#25 SF 1780 400#25 - 402#75 SF 3530 400#75 - 490#25 SF 1610 TOTAL: 4600
WATER QUALITY INSPECTIONS TOTAL: 30 WS	AGGREGATE SURFACE COURSE TOTAL: 8000 TONS	CLASS B CONCRETE, BASE OR PAVT WIDENING TOTAL: 80 CF	PRECAST CONCRETE MEDIAN BARRIER, METHOD 3 TOTAL: 1580 LF	BEI/FP CONC APPROACH SLAB TOTAL: 310 SF
CONTRACTOR CERTIFIED CROSS SECTIONS TOTAL: 8 300 SF	TRAFFIC DETECTION LOOP SYSTEM, VOL. 205-037.5 TOTAL: 1 LUMP SUM	CONDUIT, NOMINAL, TP 3, 2 IN TOTAL: 1010 LF	FILL 1 INCL. WOVEN WIRE TOTAL: 2000 LF	GROOVED CONCRETE TOTAL: 310 SF
STRAIN POLE, TP 4 TOTAL: 8 EACH	TRAFFIC SIGNAL INSTALLATION NO. 1: 1 LUMP SUM NO. 2: 1 LUMP SUM	PAVEMENT MARKERS (EACH) REFLECTIVE WHITE: 500 SOLID WHITE: 1000 SOLID YELLOW: 1000 SOLID RED: 500	THERMOPLASTIC STRIPE DESCRIPTION QUANTITY (LBS) UNIT THERMOPLASTIC: 4000 WHITE: 4000 YELLOW: 4000 <small>NOTE: ALL THERMOPLASTIC STRIPES TO BE INSTALLED PER SPEC.</small>	TRAFFIC SIGNAL DESCRIPTION UNIT QUANTITY THERMOPLASTIC: 4000 2" SOLID WHITE: 1000 4" SOLID WHITE: 2000 5" SOLID WHITE: 600 5" SOLID YELLOW: 600
HR/W/Jordan CONSULTING ENGINEERS 1000 W. BROADWAY, SUITE 1000 ATLANTA, GA 30309 PHONE: 404.525.1234 FAX: 404.525.1235 WWW: HRWJORDAN.COM		REVISIONS DATE: REVISIONS: DATE: REVISIONS:	GEORGIA DEPARTMENT OF TRANSPORTATION SUMMARY OF QUANTITIES PROJECT NO. 153+00-155+25 SPALDING COUNTY DATE: 01/20/20 Dwg. NO. 4-02	

Figure 4-1. Summary of Quantities.

Using Construction Plan Sheets number 18-30, answer these questions:

- 4-1 How many tons of aggregate surface course is required?
- 4-2 How many total linear feet of woven wire field fence is needed?
- 4-3 Between Sta. 153+00 and 159+25, how many feet of guard rail are required?
- 4-4 How much concrete and steel reinforcing bar are required at structure 23, Sta. 233+20?

DRAINAGE SUMMARY

A numerical drainage summary is used in most project plans. This part of the summary is usually on its own sheet in a set of Plans and follows after the Summary of Quantities Plan Sheet. Storm drain pipe, drainage structures, culverts, etc., that are to be placed on the project are listed in a chart format with the quantities needed and then consecutively numbered. The numbers correspond with the numbers on the Plan View Plan Sheets and the Drainage Cross Section sheets so that project personnel are able to cross-reference them from one view to another. Sheet 30 provides an example of drainage quantities, and box culvert information is found on Sheet 21.

DETAILED ESTIMATE					
ITEM NO.	DESCRIPTION	UNITS	STP-IM-022-1(26)	IM-0000-00(523)	TOTAL
			QUANTITY	QUANTITY	QUANTITY
	--ROADWAY--				
150-1000	TRAFFIC CONTROL - PROJECT NO. STP-IM-022-1(26)	LS	LUMP		LUMP
150-1000	TRAFFIC CONTROL - PROJECT NO. IM-0000-00(523)	LS		LUMP	LUMP
150-5000	TRAFFIC CONTROL, TEMPORARY SAND LOADED ATTENUATOR MODULE	EA		50	50
153-1300	FIELD ENGINEERS OFFICE TP 3	EA	1		1
201-1500	CLEARING & GRUBBING - PROJECT NO. STP-IM-022-1(26)	LS	LUMP		LUMP
201-1500	CLEARING & GRUBBING - PROJECT NO. IM-0000-00(523)	LS		LUMP	LUMP
205-0001	UNCLASS EXCAV	CY	985000	87800	1072800
205-0300	CONTRACTOR CERTIFIED CROSS SECTIONS	MI	8	2	10
207-0203	FOUND BK FILL MATL TP II	CY	2100	500	2600
208-0200	ROCK EMBANKMENT	CY	4400		4400
310-1101	GR AGGR BASE CRS. INCL. MATL	TN	270300	71600	341900
318-3000	AGGREGATE SURFACE COURSE	TN	8000	2000	10000
402-3121	RECYCLED ASPH CONC 25 MM SUPERPAVE, GP 1 OR 2, INCL BITUM MATL & H LIME	TN	113800	13100	126900
402-3130	RECYCLED ASPH CONC 12.5 MM SUPERPAVE, GP 2 ONLY, INCL BITUM MATL & H LIME	TN	37100	5100	42200
402-3190	RECYCLED ASPH CONC 19 MM SUPERPAVE, GP 1 OR 2, INCL BITUM MATL & H LIME	TN	47400	14100	61500
413-1000	BITUM TACK COAT	GAL	54600	6900	61500
433-1000	REINF CONC APPROACH SLAB	SY	310		310
433-1100	REINF CONC APPROACH SLAB, INCL CURB	SY		530	530
436-1000	ASPHALTIC CONCRETE CURB, 5 IN	LF	31100	12800	43900
436-0028	PLAIN PC CONC PCMT, CL 3 CONC, 12" THICK	SY		45900	45900
441-0016	DRIVEWAY CONCRETE, 8 IN TK	SY		3600	3600
441-0104	CONC SIDEWALK, 4 IN	SY		650	650
441-0301	CONC SPILLWAY, TP 1	EA	14	2	16
441-0302	CONC SPILLWAY, TP 2	EA	7	3	10
441-0740	CONCRETE MEDIAN, 4 IN	SY	250	4400	4650
441-0748	CONCRETE MEDIAN, 8 IN	SY		860	860
441-8022	CONC CURB & GUTTER, 8 IN X 30 IN, TP 2	LF		1100	1100
441-8740	CONC CURB & GUTTER, 8 IN X 30 IN, TP 7	LF	760	8400	9160
444-1000	SAWED JOINTS IN EXIST PAVEMENT - PCC	LF	480	400	880
466-2012	INDENTATION RUMBLE STRIPS - GROUND-IN-PLACE (CONTINUOUS)	GLM		3	3
466-2015	INDENTATION RUMBLE STRIPS - GROUND-IN-PLACE (SKIP)	GLM	16	2	18
487-1010	GEOGRID REINFORCEMENT, TP B	SY	6900		6900
500-0100	GROOVED CONCRETE	SY	310	530	840
500-3101	CLASS A CONCRETE	CY	1300	230	1530
500-3200	CLASS B CONCRETE	CY	8	3	11
500-3959	CLASS C CONCRETE, BASE OR PVMT WIDENING	CY	80	20	100
511-1000	BAR REINF STEEL	LB	172200	31600	203800
613-8008	REM PORTIONS OF EXISTING CLVT, INCL WINGWALLS & PARAPETS, STA. 192+24.09	LS	LUMP		LUMP
613-8008	REM PORTIONS OF EXISTING CLVT, INCL WINGWALLS & PARAPETS, STA. 233+20.41	LS	LUMP		LUMP
613-8008	REM PORTIONS OF EXISTING CLVT, INCL WINGWALLS & PARAPETS, STA. 251+32.82	LS	LUMP		LUMP
613-8008	REM PORTIONS OF EXISTING CLVT, INCL WINGWALLS & PARAPETS, STA. 261+39.44	LS	LUMP		LUMP
613-8008	REM PORTIONS OF EXISTING CLVT, INCL WINGWALLS & PARAPETS, STA. 300+22.73	LS	LUMP		LUMP
613-8008	REM PORTIONS OF EXISTING CLVT, INCL WINGWALLS & PARAPETS, STA. 355+39.11	LS	LUMP		LUMP
613-8008	REM PORTIONS OF EXISTING CLVT, INCL WINGWALLS & PARAPETS, STA. 403+40.14	LS	LUMP		LUMP
613-8008	REM PORTIONS OF EXISTING CLVT, INCL WINGWALLS & PARAPETS, STA. 462+56.97	LS	LUMP		LUMP
613-8008	REM PORTIONS OF EXISTING CLVT, INCL WINGWALLS & PARAPETS, STA. 505+96.18	LS	LUMP		LUMP
613-8008	REM PORTIONS OF EXISTING CLVT, INCL WINGWALLS & PARAPETS, STA. 531+15.86	LS	LUMP		LUMP
613-8008	REM PORTIONS OF EXISTING CLVT, INCL WINGWALLS & PARAPETS, STA. 40+84.84	LS	LUMP		LUMP
613-8008	REM PORTIONS OF EXISTING CLVT, INCL WINGWALLS & PARAPETS, STA. 427+06.28	LS	LUMP		LUMP
822-1033	PRECAST CONCRETE MEDIAN BARRIER, METHOD 3	LF	1600	1800	2900
832-8003	CHANGEABLE MESSAGE SIGN, PORTABLE, TYPE 3	EA		4	4
834-1200	RIGHT OF WAY MARKER	EA	180	87	267
841-1100	GUARDRAIL, TP T	LF	150	1300	1450
841-1200	GUARDRAIL, TP W	LF	28400	11000	39400
841-8001	GUARDRAIL ANCHORAGE, TP 1	EA	18	11	27
841-8012	GUARDRAIL ANCHORAGE, TP 12	EA	61	13	74
843-0010	FIELD FENCE, WOVEN WIRE	LF	3400	1300	4700
843-4000	WOVEN WIRE FENCE	LF	38000	5300	43300
843-9000	GATE, FIELD FENCE, STA. 465+80.00	EA	1		1
847-8200	TRAFFIC DETECTION LOOP SYSTEM, NO - 255-0373	LS	LUMP		LUMP
	--DRAINAGE--				
550-1150	STORM DRAIN PIPE, 15 IN, H 1-10	LF		19	19
550-1151	STORM DRAIN PIPE, 15 IN, H 10-15	LF		37	37
550-1180	STORM DRAIN PIPE, 18 IN, H 1-10	LF	7400	910	8310
550-1240	STORM DRAIN PIPE, 24 IN, H 1-10	LF	850	140	780
550-1241	STORM DRAIN PIPE, 24 IN, H 10-15	LF	93		93
550-1300	STORM DRAIN PIPE, 30 IN, H 1-10	LF	200		200
550-1350	STORM DRAIN PIPE, 36 IN, H 1-10	LF	92		92
550-1352	STORM DRAIN PIPE, 36 IN, H 15-20	LF	260		260
550-1353	STORM DRAIN PIPE, 36 IN, H 20-25	LF	270		270
550-1355	STORM DRAIN PIPE, 36 IN, H 30-35	LF	67		67
550-1420	STORM DRAIN PIPE, 42 IN, H 1-10	LF	34	250	284
550-1422	STORM DRAIN PIPE, 42 IN, H 15-20	LF	48		48
550-1483	STORM DRAIN PIPE, 48 IN, H 20-25	LF	150	180	330
550-2180	SIDE DRAIN PIPE, 18 IN, H 1-10	LF	1200	610	1810

Figure 4-3. Detailed Estimate.

Using the Detailed Construction Plan Sheets number 51-53, answer the questions. Remember that this project covered two P.I. Nos. 332520 and 0000523. Questions for this text only cover P.I. No. 332520, which is project number STP-IM-022-1(26). The detailed estimate shows both projects.

4-5 How many right of way markers are required for this project?

4-6 How many linear feet of 18" Storm Drain Pipe is set up for this project?

Chapter 5: Views

INTRODUCTION TO VIEWS

Before going any further, you need to know more about the different viewing angles from which various things are shown in a set of plans. A view is the way you look at or “see” the different items that are shown on a set of plans.

A view may show something observed from the inside or from the outside. These views are drawn to give you clear and complete pictures of how the fence, pipe, ditch, or culvert, etc., should be built or placed. To get the information you need, you must be able to look at the view and “see” what is being pictured. You need to know from which angle the item is shown. To help you “see” the different views, a chair will be used as the object pictured because of its familiarity to the reader.

The views here show this chair in the same way that the “real” views show things more appropriate to road and structure building.

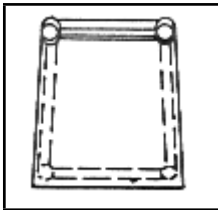

Figure 5-1.
Plan View

A Plan View is a view from directly above the object. A top view looking down on a chair is pictured. Dotted lines show parts of the chair you would not see because the seat would hide the legs and crosspieces and you would not see them.

Now look at the set of plans you were given with this material. The first sheet, cover sheet, shows a Plan View of the entire project. If you were flying in an airplane over this project and looked down, the plan view is what you would see.

The next set of views shows the elevation or height of the chair from the side and rear. The view might also be shown from the other side or from the front.

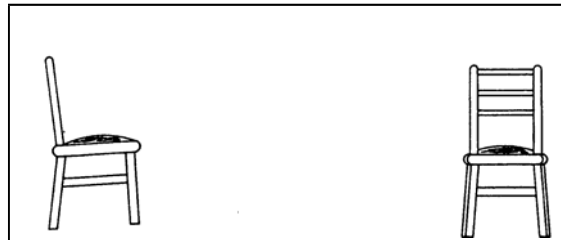

Figure 5-2. Side and Rear Elevations

LONGITUDINAL CROSS SECTION

As you face the side of the chair, a section has been “sliced” away. You see the inside of the seat from the side. Also note the inside of the crosspieces at the top and bottom of the chair.



**Figure 5-3. Longitudinal Cross Section (Left),
Standard Cross Section (Right).**

CROSS SECTION

As you face the front of the chair, a section has been “sliced” away. Here the chair was sliced across the seat. You see the layers of the cushion and seat inside the seat. The rest of the chair, shown by dotted lines, is behind the point where the “slice” was made.

PROFILE VIEW

A Profile View is a lot like a longitudinal cross section of the roadway. Rather than left to right, the profile view shows the “hills and valleys” of the roadway running along the centerline of the road. It is how the road would look if you were actually riding on the surface of the road. (Profile view will be further discussed in another chapter, where you will see example images using the profile view.)

5-1 Below is a drawing of an old boat. Five of the six views mentioned previously are shown on it. Write the name of the view above each drawing.





<p>1. _____</p>  <p>Hint- from the top</p>	<p>2. _____</p>  <p>Hint- A section has been sliced away, cross the boat</p>	<ul style="list-style-type: none"> • CROSS SECTION • LONGITUDINAL CROSS SECTION • PLAN • REAR ELEVATION • SIDE ELEVATION
<p>3. _____</p>  <p>Hint- A section has been sliced away, longways</p>	<p>4. _____</p>  <p>Hint- You're looking at it from the side</p>	
<p>5. _____</p>  <p>Hint- Rear View</p>		

Figure 5-4. Views of a Boat for Question 5-1.

If you missed any of the names of the views, be sure you correct them. Make sure that you understand your corrections. When you are reading plans, you will not be required to name the views. However, you should know what the names mean so that when looking at a plan, you will know whether you are seeing the item from the rear (rear elevation), from the inside (cross-section), etc. This will help you “see” the item better.

Of course, the actual views on a set of plans also give dimensions, materials used in construction, and many other construction details.

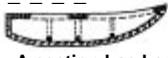
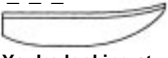
The ELEVATIONS generally show the items from the OUTSIDE. These views are usually very clear drawings, almost like a picture.

The CROSS-SECTIONS always show an inside view - something has been “sliced” away to show you how the inside part should be. These slices may be made at any point and would be compared to cutting an apple into two parts with a knife. The next pages show you how you can sometimes tell where the section is or where the “cut” was made.

Suppose, for example, sections of a pencil were used to show the inside materials at different places along the length. See how this is shown in Figure 5-5. The lines between the letters A-A, B-B, and C-C show where the section is taken. These arrows on the ends of the lines show which way you’re looking toward when you look at the section.

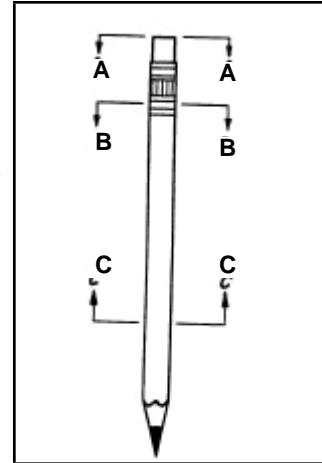

Figure 5-5. Profile View: Sectioning of a Pencil.

The sections are labeled, A-A, B-B, and C-C, etc., to correspond with the letters on the overall diagram, will always be close by as shown here:

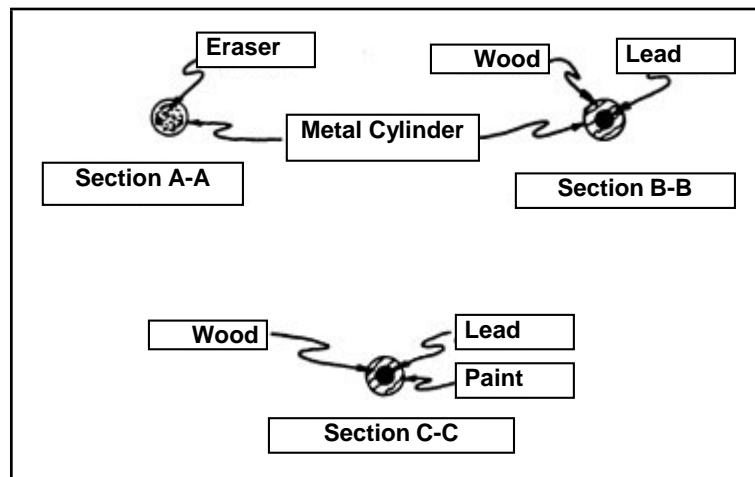

Figure 5-6. Sections Views of a Pencil.

Using the drawing of the pencil Figure 5-6, answer the questions:

- 5-2 Consider the eraser end the “back” of the pencil and the pointed end the “front”. Is section A-A looking toward the back or the front of the pencil?
- 5-3 What direction are you looking toward in Section B-B?

5-4 What direction are you looking toward in Section C-C?

5-5 In Section C-C, what material is shown in the center of the pencil?

5-6 What material surrounds the lead?

5-7 Is the lead in front of or behind the eraser in Section C-C?

Chapter 6: Stationing, Symbols and Abbreviations

STATIONING

Stationing is fundamental to highway plans. A station is the horizontal measurement along the Construction Survey Line of a project. Distances are measured and points are identified on plans with reference to station numbers. One hundred feet is equivalent to one station. Highway stationing might be compared with a rope having knots at 100-foot intervals. The beginning end of the rope would be 0, the first knot at 100 feet would be Station Number 1 and would be written as 1+00. The second station number would be 2 (which is 200 feet from the beginning) and would be written as 2+00, and so on.

Station numbers usually increase from the beginning of the project to the end of the project with the convention of South to North or from West to East. The beginning station of a project can be assumed or referenced to a previous project. If assumed, it generally starts with 10+00 or 100+00. If there was a project for this road in the past, the beginning station number may be much higher than the previous example.

Two types of centerline are used. A survey centerline is used to denote the existing alignment, and a construction centerline is used to denote the proposed alignment. In this text, a reference to centerline generally indicates construction line unless the survey centerline is shown and specifically referenced.

The length of the project in feet may be arrived at by subtracting the beginning station from the ending station and multiplying by one hundred.

For instance, if a project begins at station 650 (written 650+00) and ends at station 920 (written 920+00), the length is $(920-650) \times 100 = 27,000$ feet. This can easily be converted to miles by dividing by 5280 feet per mile.

Think of stations in this way (refer to Figure 6.1).

Just as 12 inches make one foot, 100 feet make one station. It is 100 feet from Station 1+00 to Station 2+00 or Sta. 493 to Sta. 494, etc.

Answer the question:

6-1 How many feet make up a station?

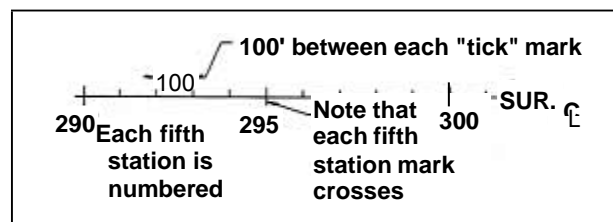

Figure 6.1 How to Think about Stations.

HALF STATIONS

A half station is 50 feet and is located halfway between stations. It is written as +50 after the station number. Figure 6-2 shows you how station numbers and half stations are written. Any point between two stations is shown in this same manner.

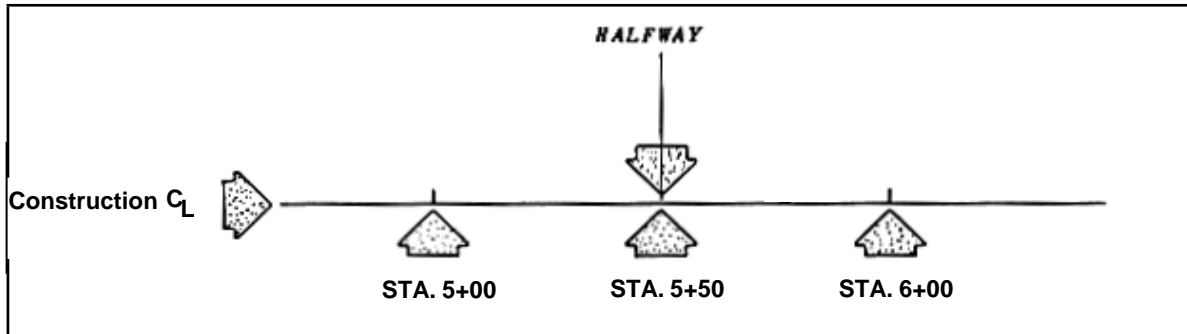

Figure 6-2. Stationing Example Illustrating Halfway.

For example, two feet forward of station 500+00 is written as 500+02. Numbers less than 10 are indicated as 01, 02, 03, etc. Ninety nine feet ahead of station 500+00 is written as 500+99. Of course, 100 feet ahead of STA. 500+00 is STA. 501+00.

In other words, to show that a point is exactly on a station write it as +00.

To find the distance between any two stations (Except where station equations or equalities are involved) simply subtract the lower station from the higher one, ignoring the plus sign. You will get the answer in feet.

Example

To find the distance from Station 20+60 to Station 12+80, you can write the numbers without the + sign like this:	$\begin{array}{r} 2060 \\ - 1280 \\ \hline 780 \end{array}$
---	---

It is 780 feet from Station 20+60 to Station 12+80.

To check:

From Station 12+80 to 13+00	20
From 13+00 to 20+00 (7 stations)	700
From 20+00 to 20+60	$\begin{array}{r} + 60 \\ \hline 780 \end{array}$

Please calculate the following:

- 6-2 The distance from Station 14+10 to 15+00 is _____ feet
- 6-3 The distance from Station 80+10 to 85+20 is _____ feet
- 6-4 The distance between Station 48+76.2 and Station 51+24.8 is _____ feet.

On the Plan Sheets, the Station Numbers are usually written along the Construction Centerline. Stationing is sometimes along a baseline, or along one lane of a multiple lane highway. On a project, AHEAD means in the direction in which Station Numbers increase (usually toward the END of a project) BACK means in the direction in which Station Numbers decrease (usually towards the BEGINNING of the project).

Ahead is sometimes abbreviated FWD (for FORWARD), and BACK is abbreviated BK.

On a plan sheet, stationing would be similar to that shown above on Figure 6-3

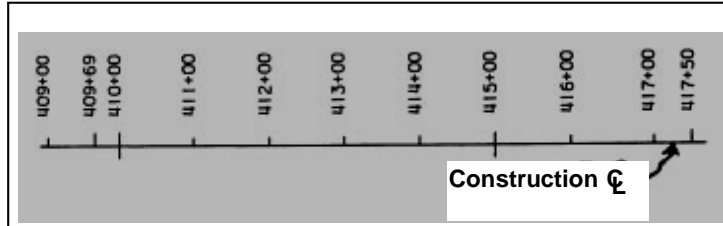

Figure 6-3. Plan Sheet Stationing.

Please answer the following questions based on this figure:

- 6-5 How far is it from Station 410+00 to Station 411+00? _____ feet
- 6-6 How far is it from Station 409+00 to Station 409+69? _____ feet
- 6-7 How far is it from Station 410+30.17 to Station 412+89.29? _____ feet
- 6-8 What is the Station Number of a point on Survey C/L 50 feet AHEAD of Station 412+00?
- 6-9 What is the Station Number of a point 50 feet BACK of Station 412+00?
- 6-10 What is the distance between Station 411+50 and Station 412+50? _____ feet

Generally, station numbers progress (increase) from WEST to EAST or from SOUTH to NORTH. Since highways curve and change direction, the above statement is not always true on any one segment of the road.

Just remember that when you say AHEAD you mean toward a higher or “up” station. When you say BACK, you mean toward a lower or “down” station.

STATION EQUATIONS (EQUALITIES)

Sometimes it is necessary to relate a system of stationing to another system as the connection between two projects or to account for an increase or decrease in the project's length due to a change in horizontal alignment.

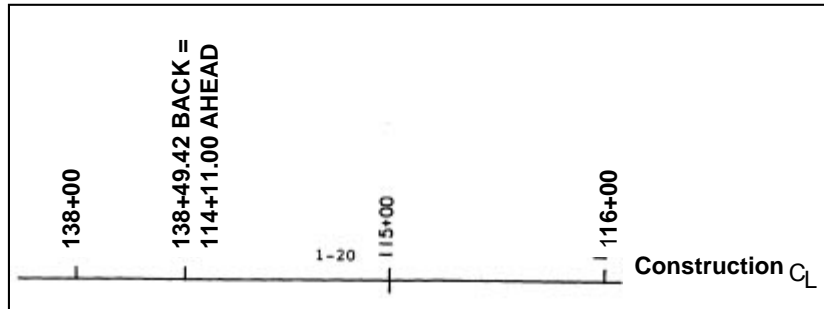

Figure 6-4. Station Equality.

Equalities are written to describe a point on a Construction C_L where the station numbers of one system change to the station numbers of another system.

Here is one equality:

Station 138+49.42 BACK = Station 114+11.00 AHEAD as shown in Figure 6-4.

The first number is the stationing that is ending. The next number is the beginning station number.

Please answer the following questions:

- 6-11** If you are walking along the reading the station numbers written on the stakes and these numbers are getting larger as you go, there is a good chance that you are walking toward what direction?
- 6-12** If this station equation is given:
Station 550+00 BACK = 2+00 AHEAD
- What is the Station Number of a point 50 feet BACK of the equation?
 - What is the Station Number of a point 50 feet AHEAD of the equation?

Any point pertaining to a project may be located on the ground and on the plans by its Station and the number of feet LT/RT (LEFT or RIGHT) of the Construction C_L (centerline). Left and Right of the Construction Line C_L is orientated to increasing stationing (facing ahead). Note that Left and Right are often abbreviated as LT and RT.

Refer to the following sketch and answer the questions:

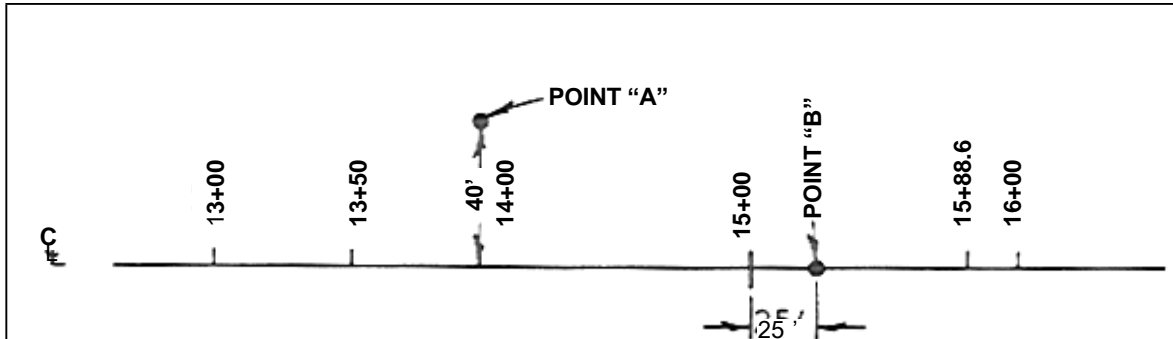

Figure 6-5. Stationing Exercise

- 6-13 What is the station location of point A on the previous sketch?
- 6-14 What is the station location of point B on the previous sketch?
- 6-15 Station numbers generally increase toward the _____ or _____.
- 6-16 How far (in feet) is Sta. 15+88.60 from Sta. 15+00?
- 6-17 Is Sta. 13+00 ahead of or back of Sta. 14+00?
- 6-18 How far is it from Sta. 13+50 to Sta. 16+00?
- 6-19 What station is 100 ft. AHEAD of Sta. 1142+40 BK = STA. 1+00 AHD (AHEAD)?
- 6-20 What station is 100 ft. BACK of a point at which the equation in question number 6-19 is given?

DETERMINING OF THE PROJECT LENGTH

If there are NO STATION EQUALITIES on the project, you can subtract the beginning station from the ending station and have the length of the project.

This project ends at station	701+50.00
This project begins at station	<u>409+69.00</u>
Equals the length of the project	291+81.00

Always remember that this length, 291+81.00 (or 291+80 X 100 ft/station) is the length of the project only if no equalities occur between the beginning and the end of the project. To determine the mileage in a project, you divide the feet in the project by 5280 ft. (the number of feet in a mile). In this case you would divide 29,181.00 by 5280 and you would get 5.526 miles.

INTRODUCTION TO SYMBOLS

A legend of symbols and abbreviations is not included in the plans. However, certain symbols and abbreviations are common to a set of highway plans. For example, see Figure 6-6.



Figure 6-6. Symbols for Proposed (Left) and Existing (Right) ROW Markers.

Refer to pages 28-35 for excerpts from the Department's Manual of Guidance (MOG) which define the symbols used by the Georgia Department of Transportation. You should become familiar with the location of the MOG's used by your unit.

Introduction to Plan Abbreviations

It is often necessary to abbreviate words on plan sheets. Some standard abbreviations are:

Ahd/FWD = Ahead

Beg = Begin

Emb = Embankment

Hwy = Highway

Pd = Pond

R/W = Right-of-Way

If you run across an abbreviation you don't understand, turn to Appendix B: Abbreviations in this book.

Find the abbreviation/symbol:

6-21 The symbol below is:



6-22 UC is an abbreviation for:

6-23 SNG is an abbreviation for:

CONVENTIONAL SYMBOLS

State or County Line
 City Limit Line
 Property Line
 Survey or Base Line

Right of Way Line

Existing
 Required
 Limit of Access
 R/W & Limit of Access
 R/W Marker

Fence
 Railroads
 Power Line
 Telephone Line
 Power Poles
 Telephone or Telegraph Poles

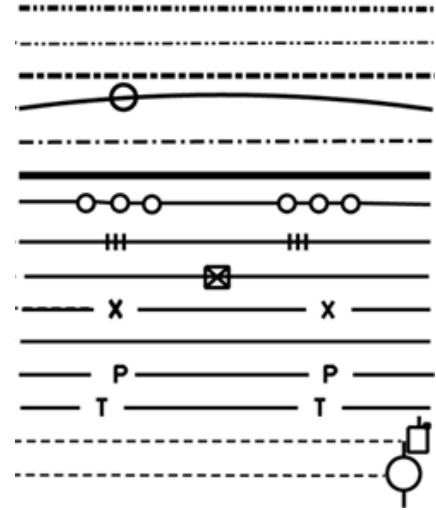

RIGHT OF WAY (ROW) SYMBOLS

Begin Limit of Access

End Limit of Access

Limit of Access

R/W and Limit of Access

Property and Existing R/W Line

Required R/W Line

Construction Limits
 C = Cut
 F = Full

Easement For Constr & Maintenance Of Slopes (Permanent)

Easement For Constr Of Slopes (Temporary)

Easement For Const Of Drives (Temporary)

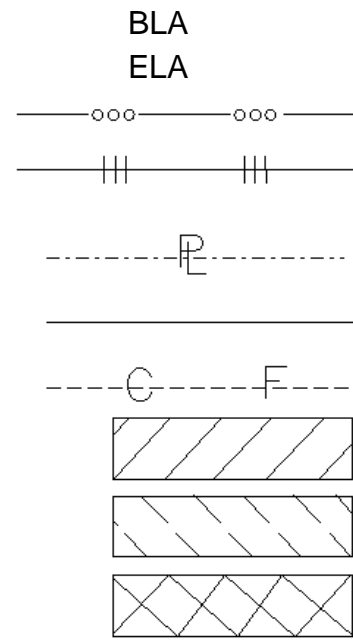

Figure 6-7. Conventional and Right of Way (ROW) Symbols

UTILITY SYMBOLS

WATER MAINS

Existing	----- W ----- size ----- W -----
To Be Removed	--- X --- W --- X --- size --- X --- W --- X ---
Proposed	----- W ----- size ----- W -----
Temporary	----- TW ----- size ----- TW -----

Meters	--- W --- □ WW ---	--- W --- □ WW ---
Casings	--- SIZE W ---	--- SIZE W ---
Fire Hydrant	--- W --- ∪ FH	--- W --- ∪ FH
Valves	--- ∩ WW ---	--- ∩ WW ---

NON POTABLE WATER MAINS OR LINES

Existing	----- NW ----- size ----- NW -----
To Be Removed	--- X --- NW --- X --- size --- X --- NW ---
Proposed	----- NW ----- size ----- NW -----
Temporary	----- TNW ----- size ----- TNW -----

• Symbols used only in special cases as Rest Areas, etc.

Figure 6-8. Water and Non Potable Water Mains or Lines.

GAS MAINS

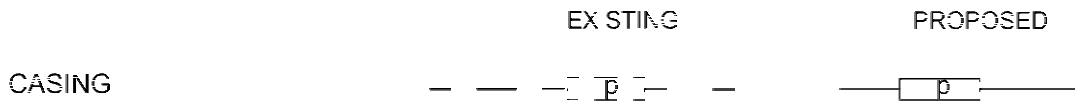
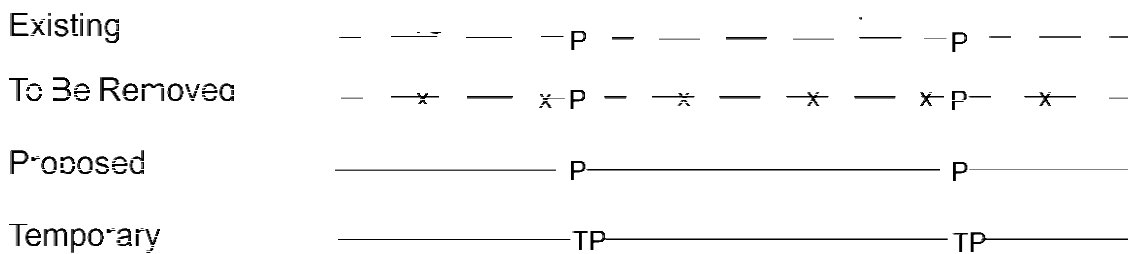
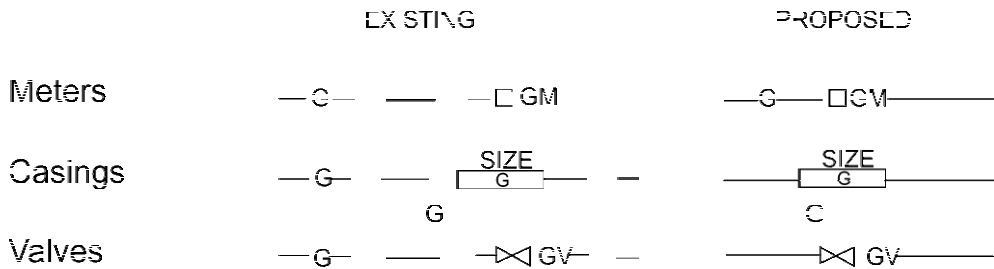
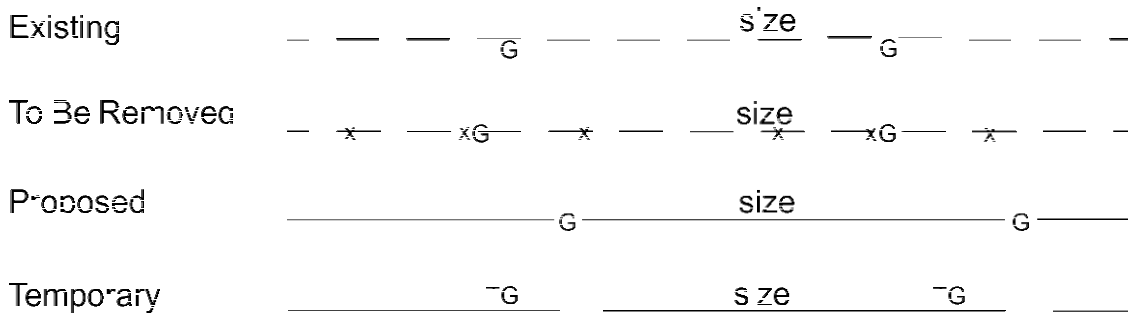
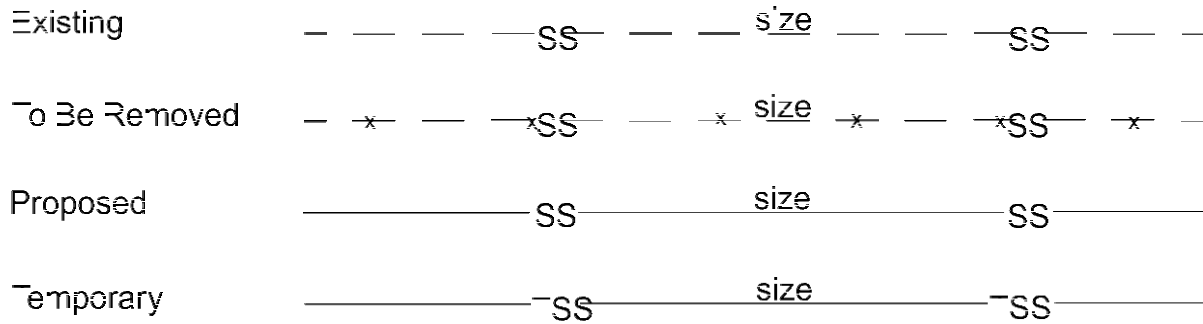

Figure 6-9. Gas Mains and Petroleum Product Pipe Lines.

SANITARY SEWER
SANITARY SEWER



EXISTING

PROPOSED

MANHOLES



STEAM LINES

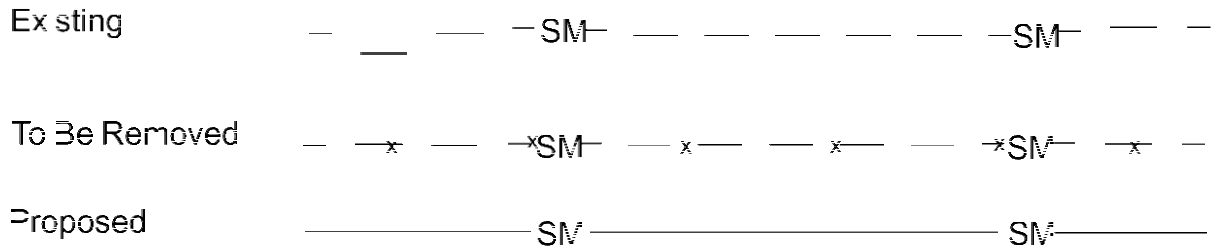
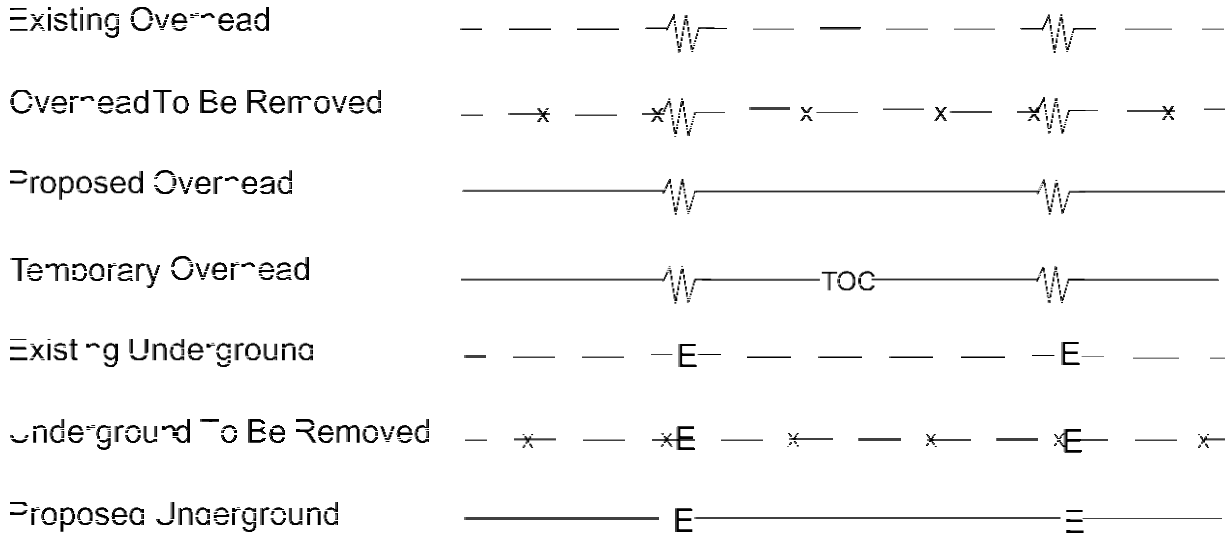

Figure 6-10. Sanitary Sewer and Steam Lines.

ELECTRICAL POWER



	EXISTING	PROPOSED	TEMPORARY
Poles			
Guys			
Transformers			

NOTE For Overhead Wire Crossings give the elevation of the overhead clearances and plot the elevation of the overhead clearances in the profile also

Figure 6-11. Electrical Power.

TELEPHONE AND TELEGRAPH

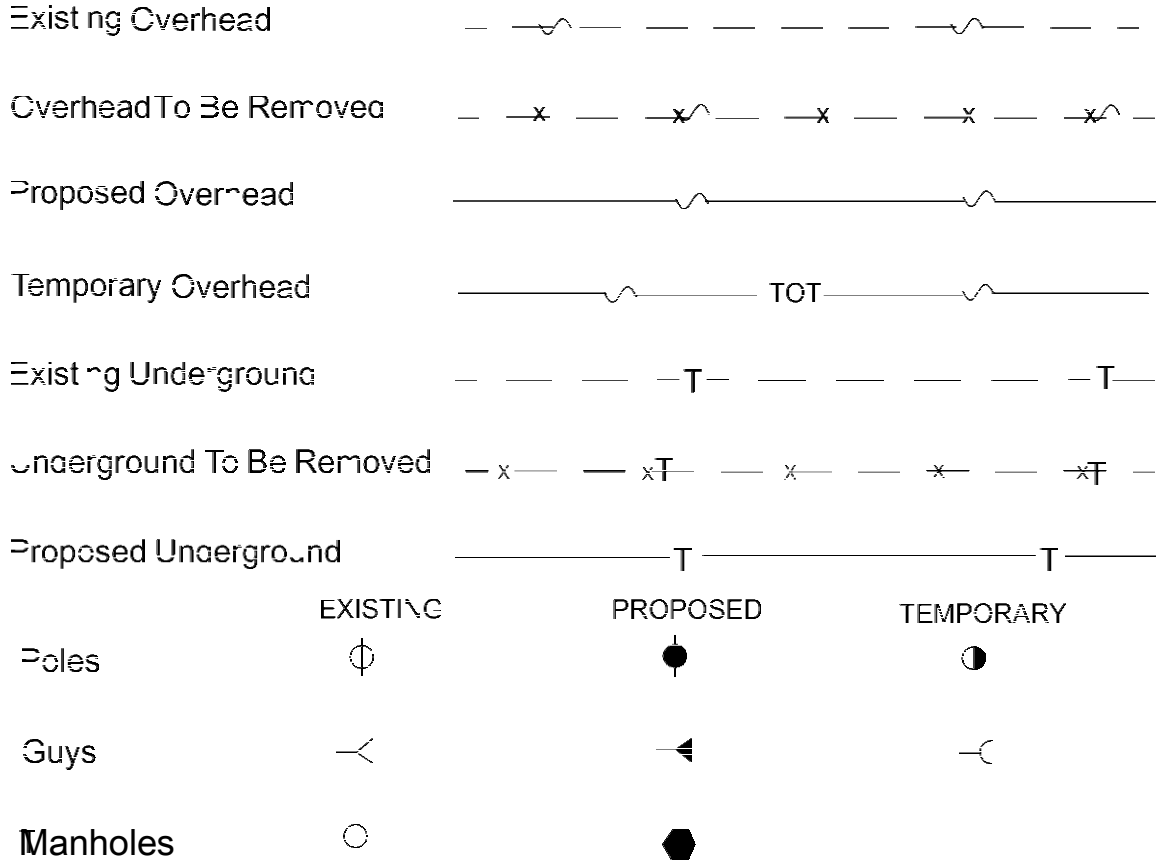

NOTE: For Overhead Wire Crossings give the elevation of the overhead clearances and plot the elevation of the overhead clearances in the profile also.

Figure 6-12. Telephone and Telegraph.

TELEVISION CABLE

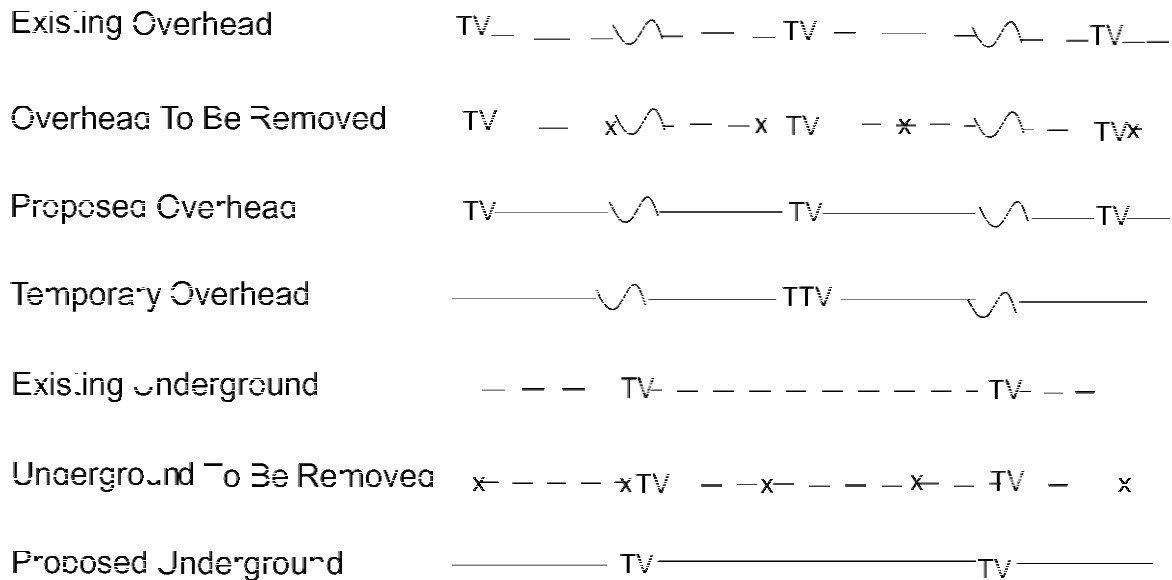

NOTE: For Overhead Wire Crossings give the elevation of the overhead clearances and plot the elevation of the overhead clearances in the profile also.

Microwave Cable

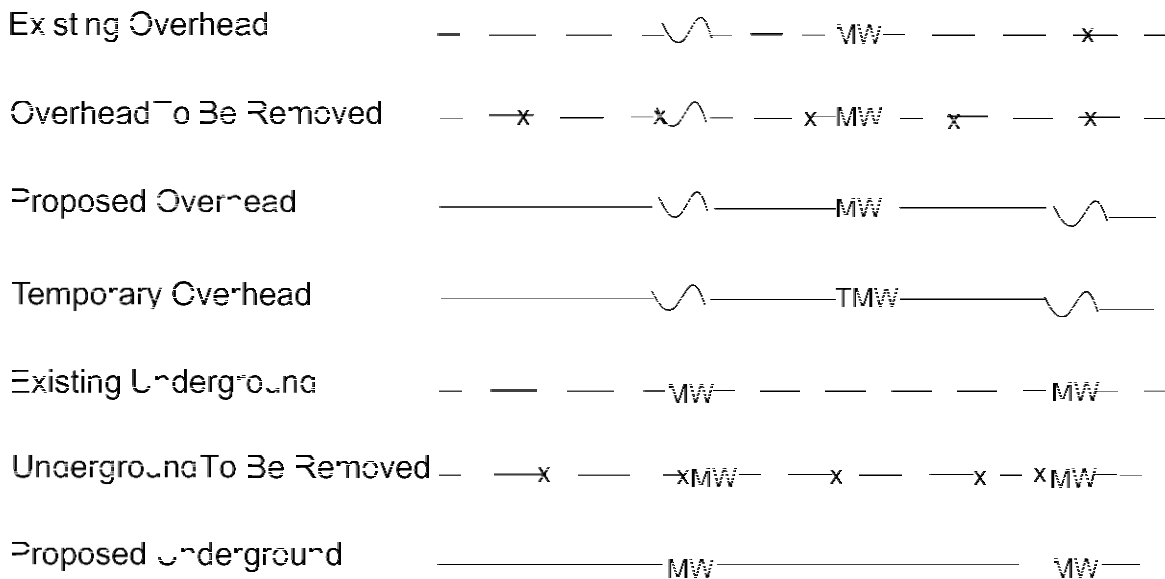

Figure 6-13. Television and Microwave Cables.

UTILITY SYMBOL ABBREVIATIONS

Plantation Pipe Line	PPL-
Southern Natural Gas	SNG-
Colonial Pipe Line	- CPL-
Overhead Cable	OC-
Underground Cable	- UC-
Southern Bell Overhead	- SBO-
Southern Bell Underground	- SBU-
American Tel. & Tel. Overhead	ATTO-
American Tel. & Tel. Underground	ATTU-
Western Union Overhead	WUO-
Western Union Underground	WUU-

RAILROAD

Railroad Tracks	
Railroad Milepost	
Railroad Crossing Sign	
Railroad Cross Sign & Signal	
Automatic Flashing Signal (R.R. x-ing)	
Automatic Gate { R.R. Crossing Draw Bridge or Parking Lot	
Automatic Gate with Flashing Signal	

Figure 6-14. Utility Symbol Abbreviations and Railroad Symbols.

Chapter 7: Plan and Profile Sheets

Introduction to Plan and Profile Sheets

Roadway Plan Sheets depict details of the project's horizontal alignment. They may be presented in conjunction with the corresponding profile on the lower half of the sheet called a Plan/Profile Sheet, or the Profile Plan Sheets will be a separate sheet from the Plan Sheet.

Existing features and roadway design elements such as pavement and shoulder widths, medians, curbs, drainage elements, tapers, turning provisions, and intersecting roadways are shown on these sheets. All horizontal geometry is depicted and labeled to fully define the design intent. Separate Plan Sheets may be required for details, which cannot be adequately shown on the Roadway Plan Sheets.

Both separate Plan & Profile Sheets and combinations Plan/Profile Sheets give a view of the entire project. They both begin with the lowest station number and the beginning of the project and show the entire roadway ahead to the end of the project.

PLAN VIEW

Remember that a PLAN VIEW shows the roadway as if you were flying over the project and were looking down. Turn to Construction Plan Sheet 60. On this Plan Sheet, the PAVEMENT LINES (edges of the pavement) are shown.

You can also see the SURVEY LINE running from the left of the sheet "AHEAD" to the right of the sheet, then continuing on the Construction Plan Sheet 61. Above Construction C_L , on the Plan Sheet, is considered left of the Survey Line.

Below the survey C_L is considered right of the Survey Line. Either case will be as though you were standing on the Survey Line facing ahead.

Remember throughout this course and when speaking of plans that LEFT refers to LEFT of the Construction Line

C_L and RIGHT refers to the Right of the Construction Line C_L , relative to increasing stationing as, shown in the previous drawing, not the left and right side of the Plan Sheet.

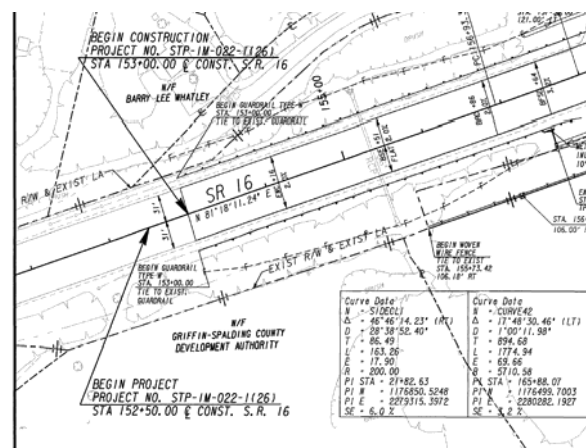

Figure 7-1. Plan View of a Roadway.

On all construction plans and right of way plans, there is an arrow-like symbol with the point indicating North. The north arrow will be orientated on the plans to north (not necessarily to the top of the page) and will indicate the basis of north. Figure 7.2 shows a north arrow referenced to magnetic north and one referenced to the Georgia

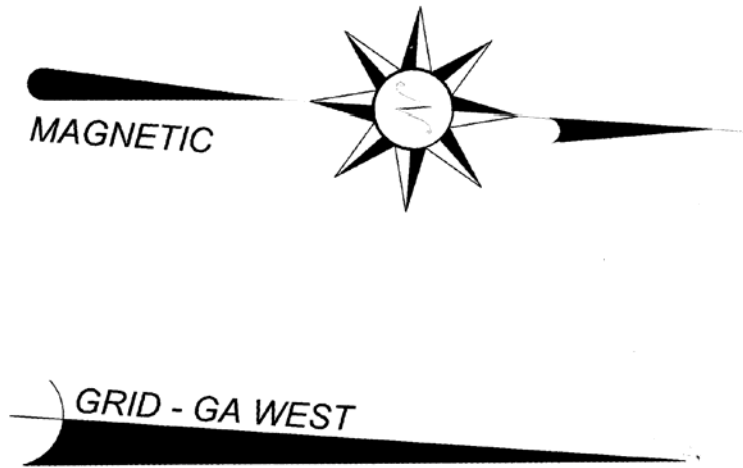

Figure 7-2. North-South Arrow.

State Plane Coordinate System West Zone.

The direction of all control and boundary lines is in reference to this North arrow.

The direction of a Construction Line as you are advancing in stationing, as expressed by a bearing, defines the relationship between the direction of the survey line and a North line. It is customary to orient drawings so that the North direction is to the TOP of the plan. However, since plans for a complete highway project can seldom be confined to a single sheet, and must be a series of sheets, it is an accepted practice to make the plans so as to extend from left to right without regard to the North direction. Look again at Construction Plan Sheet 61 and see the NORTH ARROW at the top right corner of the sheet. Remember that Station Numbers usually increase from SOUTH to NORTH.

Circle the correct answer:

- 7-1 There is an arrow-like symbol with the point indicating (north / south) on all construction plans.
- 7-2 (Roadway Plan Sheets / Drainage Cross Section Sheets) depict details of the project's horizontal alignment.
- 7-3 Below the Centerline is considered (left / right) of the survey line.

HORIZONTAL ALIGNMENT

Horizontal Alignment consists of tangents (straight sections of road) and curves and is shown on the Plan View. Plan views are shown on the construction and right of way plan sheets. Construction Plan Sheet 60 shows the Horizontal Alignment. Construction Plan Sheet 106 shows the Vertical Alignment or Profile View of the same section of roadway. (Vertical Alignment will be discussed more later).

- Point on Curve: A point on a curved segment of roadway
- Superelevation: Elevating the outside edge of pavement; this compensates for centrifugal force in a curved segment of roadway.
- Delta Angle: The angle that intersects between the forward and back angle.
- Superelevation Rate: Percent slope required on a pavement surface in a curve segment of roadway
- Superelevation Runoff: The distance of the transition area where the road goes from a normal crown to full superelevation.
- Tangent Distance: The distance measured from the P.C. (point of curve) or P.T. (point of tangent) to the P.I. (point of intersection)
- Length of Curve: The distance measured along the curve from the P.C. (point of curve) to P.T. (point of tangent)
- Degree of Curve: Angle to express how quickly a curve turns.
- Tangent: A straight segment of roadway
- Point of intersection: The point where 2 tangents intersect
- Curve: Segment of roadway joining two tangent segments
- Point of curvature: Beginning of a horizontal curve
- Point of Tangent: The end of a curve.

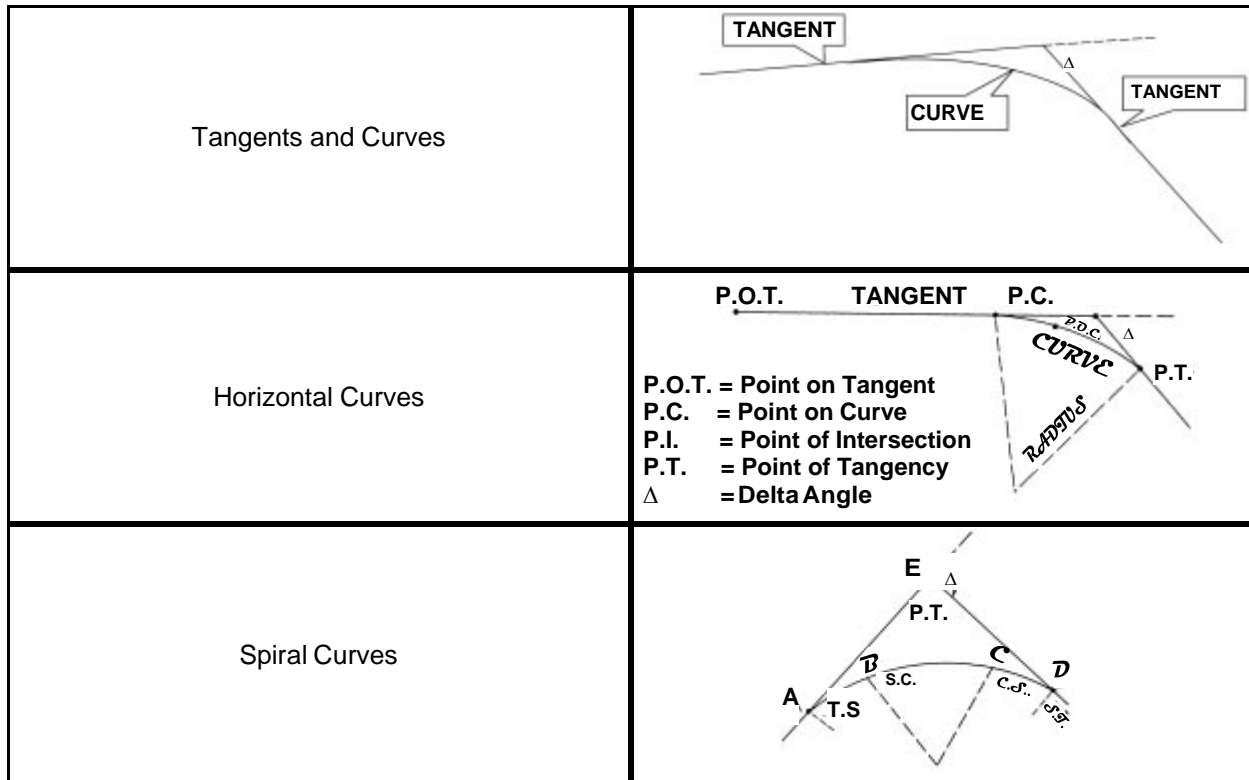

Figure 7-3. Types of Curves

True or False

7-4 True False A tangent is an arc or segment of a circle joining two lines.

7-5 True False A circular curve is an arc or segment of a circle joining two tangents.

Turn to Construction Plan Sheet 60 and see the CURVE DATA in the lower middle part of the sheet. Locate curve KC46.

P.I. = 17+81.45

Point of Intersection (The place where two tangents intersect.)

D = 14° - 59' - 59.99"

Degree of Curve

T = 329.03'

Tangent Distance (P.T. to P.I. & P.I. to P.T.)

L = 543.22'

Length of Curve (P.C. to P.T.)

SE = 6%

Superelevation Rate (the amount the road needs to be elevated on the surface of a curve in order to overcome the centrifugal force that acts on a motor vehicle.)

Turn to Construction Plan Sheet 60 and answer the questions:

7-6 At what station does the project begin? _____

7-7 What do we call the sheets that give horizontal alignment information? _____

Turn to Construction Plan Sheets 60 and 61 and answer the questions:

7-8 What is the station number of the P.C. for curve 42? _____

7-9 What is the degree of curve for this curve? _____

SPIRAL CURVES (Transition Curves) are introduced for the purpose of connecting a tangent with a circular curve in such a manner that the change of direction and elevation from one to the other takes place gradually. A spiral is a curve in which the degree of curve increases directly with the length of curve measured from the point where the curve leaves the tangent. The degree of curve is zero at the tangent and at the point at which the spiral meets the circular, it is equal to the degree of circular curve.

Spiral curves are always used in railroad work, but are seldom used in new construction highway work.

Figure 7-4 shows the following significant spiral curve stations.

TS—Tangent to spiral station

SC—Spiral to curve station

CS—Curve to spiral station

ST—Spiral to tangent station

Δ —Deflection angle for the curve system

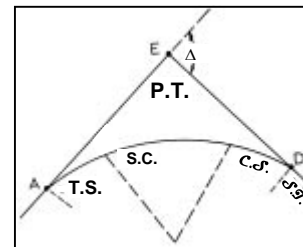

Figure 7-4. Spiral Curve.

SUPERELEVATION

Superelevation of Curves - “superelevate” may be defined as the rotating of the roadway CROSS SECTION in such a manner as to overcome the centrifugal force that acts on the motor vehicle while it is traversing curved sections.

In other words, when you are in a curve, your car tends to be thrown to the outside of the curve. So, in order to overcome centrifugal force, it will be readily seen that the normal roadway cross section will have to be “tilted” to the superelevated cross section. This tilting is accomplished by means of rotating the cross section about the inner edge of the pavement for divided highways so that the inner edge retains its normal grade but the centerline grade is varied. On two (2) lane pavements, the tilting is accomplished by means of rotating the section about the centerline axis.

The distance required for accomplishing the transition from a NORMAL to SUPERELEVATED SECTION is called a “transitional runoff” (t) and is a function of the design speed, degree of curvature, and the rate of superelevation. Transitional runoff is between the beginning of superelevation and the beginning of full superelevation.

Turn to Sheet 690 (Standard 9028C) and look at the methods for obtaining superelevation for 2 lane pavements and divided highways.

SUPERELEVATION ABBREVIATIONS

ENC	end normal crown
BSE	begin superelevation
BRC	begin reverse crown
BFSE	begin full superelevation
EFSE	end full superelevation
ERC	end reverse crown
ESE	end superelevation
BNC	begin normal curve

BEARINGS

A bearing is a method used to express direction. Bearings are used on a set of plans to indicate the magnetic direction of the Construction Line C_L and the magnetic direction of survey lines and property lines.

Bearings may be referenced to true north, magnetic north or grid north (state plane grid).

Angular measurement is referenced to a circle, and the circle can be broken into more precise measurements of minutes and seconds. There are 360 degrees in a full circle. There are 60 minutes for each degree and 60 seconds in each minute. When shown as a compass circle, the circle is divided at North, East, West, and South points into four sections of 90° each. The four 90° sections are called QUADRANTS and designated: Northeast (N.E.), Northwest (NW), Southeast (SE) and Southwest (SW). This is illustrated by Figure 7-5.

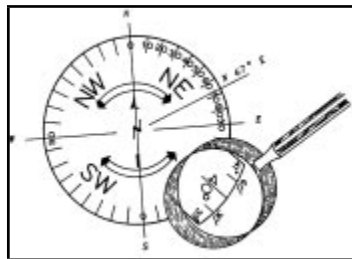

Figure 7-5. Compass Bearing.

All Bearings on the plans must be definitely described as to direction, degrees, minutes, and seconds. It is not sufficient to describe a line or bearing simply as Northeast or Southwest. The bearing must be described as so many degrees, minutes, and seconds in the direction in which the line is progressing. The accuracy of calculations is dependent on exact measurements of distances and bearings. A bearing might be written as N $65^\circ 15' 30''$ E.

Bearings are the angular measurements of a line running East or West of due North; and East or West of due South. Highway bearings do not go beyond $89^\circ 59' 59''$, which is read as 89 degrees, 59 minutes, 59 seconds. After the aforementioned bearing, they are either due East or due West, or in another quadrant.

Answer the questions:

- 7-10** Bearings on plans have to be described by _____, _____, _____, and _____.
- 7-11** There are _____ degrees in a full circle.
- 7-12** In a compass circle, the four 90° sections called _____.
- 7-13** A bearing is used to express _____.

Turn to Construction Plan Sheet No. 60 and note that the bearing on the Construction Centerline is N 81° 18' 11.24" E in reference to the North Arrow. This means the line is running 81 degrees, 18 minutes, and 11.24 seconds east of North/South line.

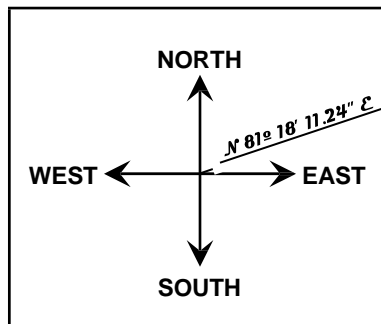

Figure 7-6. Bearing Question

Answer the questions using Construction Plan Sheet 61.

- 7-14** What is the bearing of the Construction Centerline after curve 42? _____
- 7-15** What angle does this bearing make with the North direction? _____
- 7-16** Match the definitions with the words in the columns:

COLUMN A

1. The point where two tangents intersect
2. A point on a curved segment of roadway
3. The point at the beginning of a tangent section of roadway coming to a curve
4. Segment of roadway joining two tangent segments
5. The distance measured from the P.C. (point of curve) or P.T. (point of tangent) to the P.I. (point of intersection)
6. The distance measured along the curve from the P.C. to P.T.
7. The distance of the transition area where the road goes from a normal crown to full superelevation
8. The rotating pavement surface slope to compensate for centrifugal force in a curved segment of roadway
9. The angle that intersects between the forward and back angle
10. The beginning of a curved segment of roadway coming from a tangent.
11. The arc between two tangents, measured in degrees
12. A point on a tangent (straight) segment of roadway
13. A straight segment of roadway
14. Percent slope required on a pavement surface in a curve segment of roadway

COLUMN B

- A. Point on Curve
- B. Superelevation
- C. Point of curve
- D. Delta Angle
- E. Superelevation Rate
- F. Superelevation Runoff
- G. Tangent
- H. Length of Curve
- I. Degree of Curve
- J. Point on Tangent
- K. Point of Intersection
- L. Tangent Distance
- M. Curve
- N. Point of tangent

PROFILE VIEW (VERTICAL ALIGNMENT)

Now turn to Construction Plan Sheet 106. Look at the profile shown on the sheet. The next few pages in this book are about the PROFILE VIEW or VERTICAL ALIGNMENT.

A profile is like a longitudinal (length-wise) cross section of the roadway; rather than the left to right width of the roadway. The profile shows vertical alignment along the roadway at the centerline, survey line, construction centerline, or another point. The cut or fill on the point shown on the profile does not necessarily mean that the cut or fill will be the same at this or at any other point on the cross section. For instance, the left side of the roadway might be in a cut section while the right side might be in a fill section.

Please note that on your reduced plan sheets, in the PLAN VIEW, scale is $\frac{1}{2}'' = 50'$ ($1'' = 100'$) in the PROFILE VIEW - VERTICAL ALIGNMENT scale is $\frac{1}{2}'' = 10'$ ($1'' = 20'$). Keep this difference in mind when you look at the VERTICAL ALIGNMENT sections of the Plan Sheets.

On the Profile View, a heavy dark solid line usually shows the proposed Profile Grade Line. It is a regular and smooth line, just as the top of the roadway will be when finished being built. Look at the Profile Grade Line in the bottom section of Construction Plan Sheet No. 106. The Original Ground Line is usually shown by a dashed line and is very irregular since the original ground is irregular (or bumpy) before construction begins.

The primary purpose of the profile (grid) Profile Sheet is to show the relationship between the proposed Profile Grade and the Original Ground Line.

Circle the correct answers:

- 7-17 Another name for profile view is (vertical alignment / horizontal alignment).
- 7-18 A profile can show the vertical alignment along the roadway at the (centerline / cross-over).
- 7-19 The cut or fill on the profile (does / does not) always mean that the cut or fill will be the same on each side of the roadway.
- 7-20 The proposed profile grade line is usually shown as a (solid / dashed line).

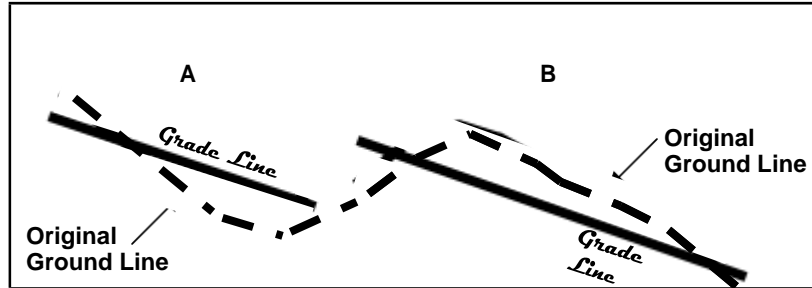

Figure 7-7. Profile Grade Lines.

Please refer to Figure 7-7 above and answer the questions:

7-21 In sketch A above, is the area beneath the Grade Line a cut or a fill area?

7-22 Does sketch B, above, show a cut or a fill area?

ELEVATIONS

Elevations are given in feet above a datum. A datum is a reference surface such as sea level. These are numbers shown on the right and left edge of the Profile Sheet. Looking at Construction Plan Sheet No. 106, look at the station numbers at the bottom of the page. On each side of the gridline that is drawn from the station number are two elevation numbers. On the left side of each line is the existing grade elevation at that station number and on the right side of the line is the proposed grade elevation at that station. Note that these numbers are elevations (in feet) ABOVE sea level.

The surveyors set reference points of known elevations so that they measure differences in elevations (vertical distances). Sometimes, markers will be set in trees or in structures and their elevations determined and recorded.

These markers are called BENCH MARKS(BM) and are shown by Numbers (BM #1, BM#2, etc.) These Bench Marks may be listed on the Plan's Profile Sheets.

GRADE

Grade is the slope of the roadway. It is expressed as a percentage of the horizontal distance.

That is, a +3% grade means a RISE of 3 feet per 100 feet of horizontal distance.

The grade is considered to be + (positive) or - (negative) depending upon whether it rises or falls as you proceed along the GRADE LINE in the direction of increasing stations.

Circle the correct answers:

7-23 Elevations are given in (feet / yards).

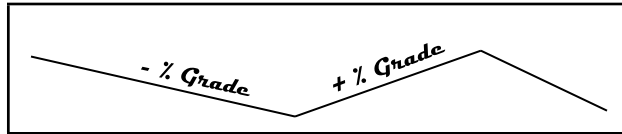

Figure 7-8. Positive and Negative Grades.

7-24 The elevation numbers are shown on the (bottom / left & right) edge of the Profile Sheet.

7-25 Reference point markers of known elevations are called (ground points / bench marks)

7-26 (Grade / Elevation) is the slope of the roadway with a vertical rise and fall.

Look at Construction Plan Sheet 106 at the PROFILE VIEW and answer the questions:

7-27 What is the existing elevation at Sta. 170+00? _____

7-28 What is the proposed elevation at Sta. 170+00? _____

VERTICAL CURVES

When a road goes over a hill or mountain, it must curve over the top, (crest), or down in a valley (sag). These are VERTICAL (up and down) CURVES and are shown on the PROFILE SHEETS. They differ from horizontal curves in two ways.

1. They are parabolic and not circular curves.
2. They define neither vertical and nor horizontal alignment.

A small triangle at the intersection of the tangents shows the P.V.I. or Point of Vertical Intersection. These P.V.I.s

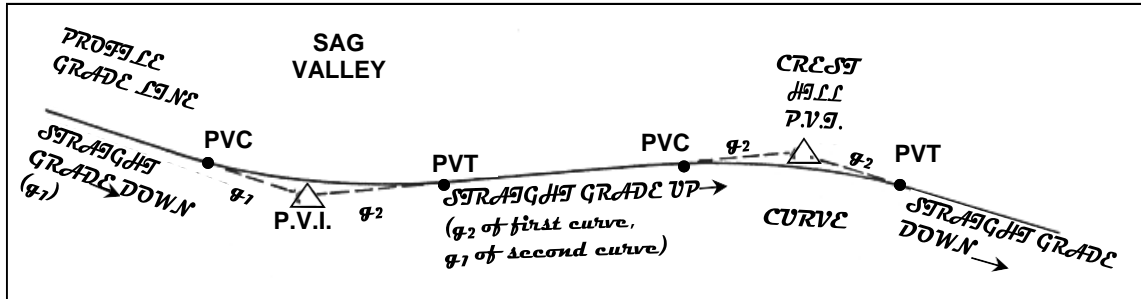

Figure 7-9. Vertical Curves and P.V.I.s.

are similar to the P.I.s (Point of Intersection) for horizontal curves. Look at the P.V.I.s in Figure 7-9, and notice that the P.V.I.s are NEVER on the actual grade. They will be either above or below grade.

The beginning point of the curve is the PVC (Point of Vertical Curve), and the end of the curve is the PVT (Point of Vertical Tangent). The length between the PVC and PVT is the length of vertical curve (LVC). Almost always, the PVC to P.V.I. and P.V.I. to PVT is 1/2 of the LVC. The grade into the P.V.I. is g_1 , and the grade out of the P.V.I. is g_2 . A negative grade is downhill.

GRADE POINT

The Grade Point is a point where the profile grade line (proposed roadway surface) crosses the original ground line. Refer to Figure 7-10 below.

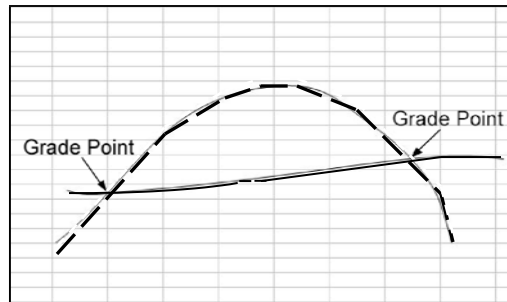

Figure 7-10. Grade Points.

Fill in the blanks:

- 7-29 A vertical curve over a hill is referred to as a _____.
- 7-30 A vertical curve that goes in a valley is referred to as a _____.
- 7-31 The Point of Vertical Intersection is shown by a _____ at the intersection of the tangents.
- 7-32 The _____ is a point where the profile grade line crosses the original ground line.

Using Construction Plan Sheet No. 106, answer the questions:

- 7-33 What is the P.V.I. elevation at Sta. 171+00? _____
- 7-34 Is the elevation above or below the construction profile? _____
- 7-35 What is the percent of grade from Sta. 171+00 forward? _____

Using Construction Plan Sheet No. 111, answer the questions:

- 7-36 Is this vertical curve between Stations. 302+50 and 315+50 a sag or a crest? _____
- 7-37 Where are the PVC, PVT and the P.V.I. Stations? _____
- 7-38 What is the length of this vertical curve? _____

PAVING LIMITS

Paving limits are the LENGTH AND WIDTH of the roadway to be paved. Look at Construction Plan Sheet 13. Typical sections for the crossroads are shown. Note that a different cross section is used for tangent and super elevated sections.

Using Construction Plan Sheet 13, answer the questions:

- 7-39 What are the tangent section paving limits for the following crossroads?
 - a. Jackson RD _____
 - b. Glad RD _____
- 7-40 What are the paving widths? _____

Construction Limits

The Construction Limits of grading represent either the toe of the fill or limits of the cut slopes or lateral ditches, berm ditches or surface ditches showing where the limits of the construction should be. These limits of grading are usually shown as dashed lines on the plans. Looking at Construction Plan Sheet 60, left of the survey line at Station 155+00, you will notice that the letters “F” are part of that dashed line. This indicates that in this area, the limits will be in a fill section of the terrain. At Station 159+00, left and right of the centerline a dashed line is shown with the letter “C.” This indicates that in this area, the limits will be in a cut section of the terrain. It is possible to have cut on one side of the centerline and fill on the other.

FENCING

Fencing is used to physically delineate the right of way of a controlled/limited access roadway or to replace fence that is along the right of way and personal property. A separate “Fencing Plan” may be included in a set of plans if the amount of fence warrants it. In most plans, fencing is pictured on the construction plans, as any other construction item would be, however, the quantities and locations are listed on the Quantity & Summary Sheets of the plans.

GUARD RAIL

Turn to Construction Plan Sheet 676 of your set of sample plans and note the details for Guard Rail location under the various conditions. Please note that this one sheet covers only a few of many different conditions. Look at Construction Plan Sheet 77 near the bridge. The beginning, end and type of guard rail locations are shown. The Summary of Quantities would also show this information.

RIGHT OF WAY MARKERS

Right of Way (ROW) Markers are used to physically mark the limits of the land, property, etc. that was acquired for highway purposes on the ground. Normally right of way markers are placed where there is a break in the right of way such as a PC or PT.



Figure 7-11. Symbols for Proposed (Left) and Existing (Right) ROW Markers.

Refer to Figure 7-11 for the symbols for proposed and existing Right of Way Markers.

In addition to the symbol used, the locations are flagged with a station number and the distance from the construction centerline.

Fill in the blanks:

- 7-41** Plan Sheets and Profile Sheets contain a horizontal alignment, vertical alignment and a _____ and _____ of construction items of the work to be done on the project.
- 7-42** The _____ are the length and width of the roadway to be paved.
- 7-43** The _____ of grading are shown as dashed lines on a set of plans.
- 7-44** Fencing is either pictured on a plan sheet of its own or pictured on the regular _____.
- 7-45** Guardrail quantities are found on the _____ of _____ Plan Sheet.
- 7-46** Right of Way Markers mark the ground showing the limits of the land acquired for _____ purposes.

Using Construction Plan Sheet 92, answer the following questions:

- 7-47** How many Right of Way Markers are proposed on the right side of the project from Sta. 31+35.06 to 37+25? _____
- 7-48** What is the distance from the survey line to the Right of Way Marker on the right side of Station 33+00? _____

Chapter 8: Drainage

INTRODUCTION TO DRAINAGE

Project drainage is accomplished by means of ditches, pipe culverts, box culverts, bridges and minor drainage structures such as drop inlets, junction boxes, man-holes, spring boxes, endwalls, etc. The amount of water to be drained determines the type of drainage structure(s) to be built.

Although the terms of culvert and bridge are sometimes used interchangeably, they are different structures.

- A culvert is a structure not classified as a bridge that provides an opening under a roadway - usually for water drainage. Standard Specifications 101.21 defines a culvert as any structure under the roadway with a clear opening of 20 feet or less.
- A bridge is a structure having a length of over a twenty foot span that is erected over a roadway, stream, railroad, depression, or combination of these.

Each drainage structure is pictured in the Plan Sheets (Refer to Figure 8-1 at right). Also included in plans will be a cross section view of each of the drainage structures to be installed.

CULVERT NO.	STATION	SKEW	SIZE	DRAINAGE AREA	Q ₅₀	RECEIVING STREAM
4	170+05.55	65.08	30'	25.59 ACRE	31.39	BUCK CREEK
5	171+06.18	95.43	30'	24.92 ACRE	30.92	BUCK CREEK
7	184+40.13	57.51	36'	40.95 ACRE	60.63	BUCK CREEK
10	192+24.02	83.05	5' x 4'	0.106 MI. ²	171.34	BUCK CREEK
13	200+87.78	116.26	36'	19.19 ACRE	31.29	BUCK CREEK
15	207+20.56	91.23	24'	15.35 ACRE	22.52	BUCK CREEK
23	233+20.24	51.78	6' x 5'	0.137 MI. ²	200.61	BUCK CREEK
28A	16+75	90	36'	22.04 MI. ²	32.92	BUCK CREEK
29	20+95	106.66	24'	5.51 MI. ²	10.63	BUCK CREEK
30	261+32.61	93.00	7' x 7'	0.401 MI. ²	384.36	BUCK CREEK
35	281+39.61	102.05	6' x 4'	0.166 MI. ²	224.56	BUCK CREEK
38	300+22.27	78.12	6' x 6'	0.241 MI. ²	281.76	BUCK CREEK
45	317+88.00	116.07	42'	38.40 ACRE	59.09	BUCK CREEK
49	331+17.50	114.32	30'	26.23 ACRE	36.46	BUCK CREEK
51	335+75.95	108.21	24'	18.55 ACRE	30.54	BUCK CREEK

Figure 8-1. Drainage Table from Sheet 198.

PIPE CULVERTS

Several examples of pipe culverts are found on Sheet 62. Look near station 192+50. An 18" slope drain (SD) pipe culvert is used to drain a portion of the median and incorporates a median drop inlet. The pipe flows to a flared end section at the outfall (left side of road). Note also the profile view. This structure is identified as 10A. Construction Plan Sheet 214, median drain profiles, shows pipe profiles.

At station 192+29.09 a 5'x4' box culvert is shown. It is identified as structure 10. A portion of the existing culvert will be removed and rebuilt to accommodate the road widening. Construction Plan Sheet 202, Drainage Profiles, shows the culvert profile.

On Construction Plan Sheet No. 198, Drainage Map Plan Sheets, note the culvert details. Station location, skew angle, size, drainage area, Q₅₀ (water flow rate) and receiving stream are shown.

Circle the correct answers:

- 8-1 Drainage structures (are / are not) pictured in the Plan /Profile Plan Sheet
- 8-2 A culvert (is / is not) classified as a bridge.
- 8-3 A bridge is a structure having a span length (over / under) 20 feet.

Box Culverts

You need to know the names of the different box culvert parts. Examine the following diagrams very carefully.

You should be aware of the fact that culverts can be built with more than one barrel also.

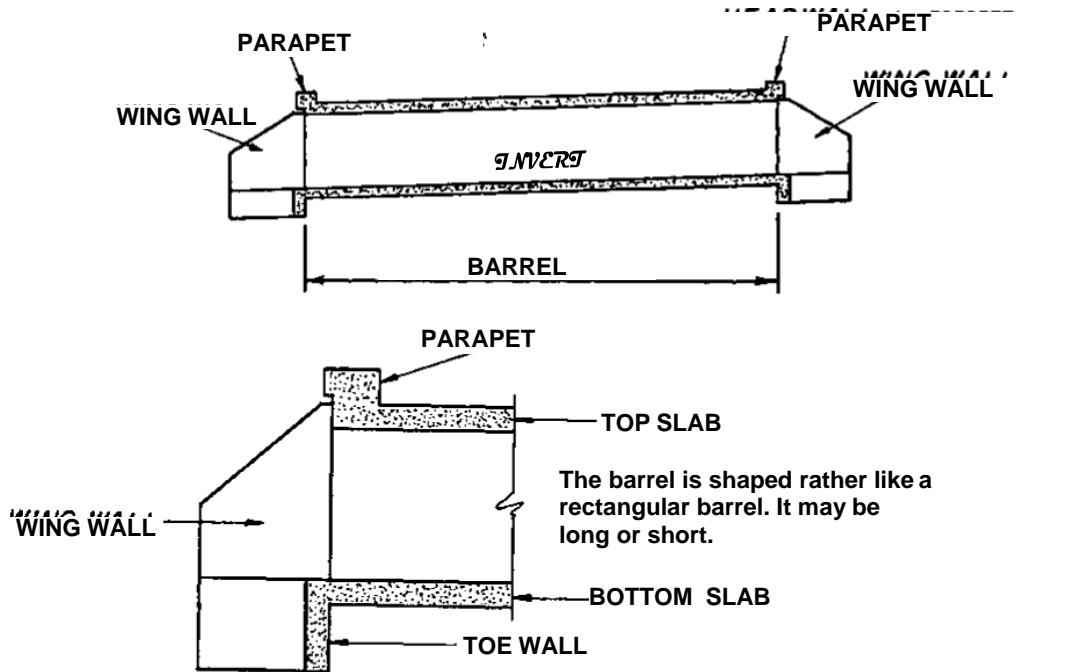

LONGITUDINAL CROSS SECTION

The "BARREL" has these parts

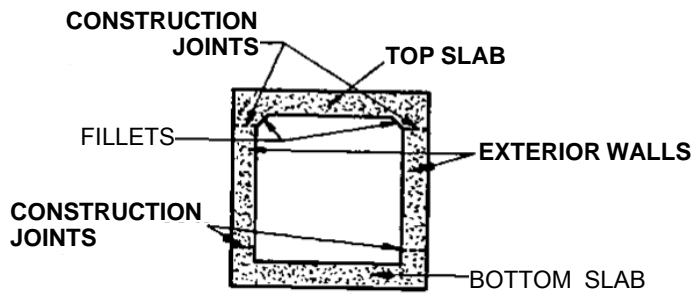

CROSS SECTION

The dimensions are measured like this:

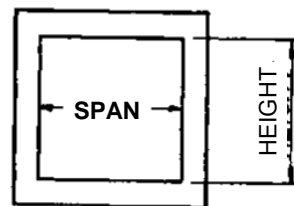

Note: A 7'x5' Box Culvert means the SPAN is 7' and the HEIGHT is 5'. The span is always the first dimension shown.

Figure 8-2. Box Culvert Sections.

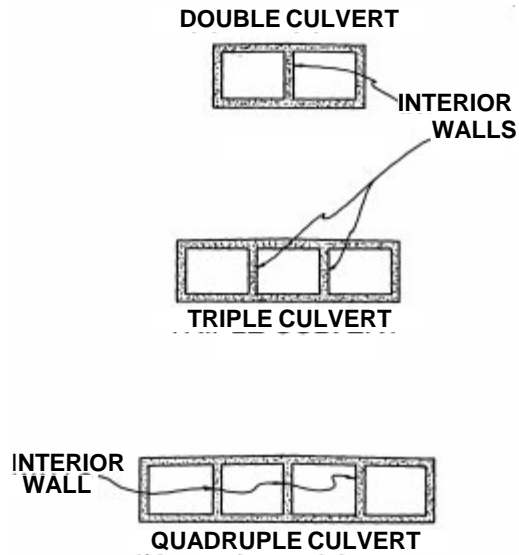

Figure 8-3. Culverts with Multiple Barrels.

Using the previous drawings, answer the questions:

- 8-4 What are the three MAJOR parts of a box culvert? _____

- 8-5 What “hangs down” below the bottom slab at each end of the barrel? _____
- 8-6 The barrel walls become _____ walls at each end of the barrel.
- 8-7 Is the horizontal or vertical distance considered to be the box culvert SPAN? _____
- 8-8 Is the horizontal or vertical distance considered to be the box culvert HEIGHT? _____
- 8-9 What is the SPAN and HEIGHT of each barrel of a DOUBLE 10’ X 8’ Box Culvert?
 _____ and _____

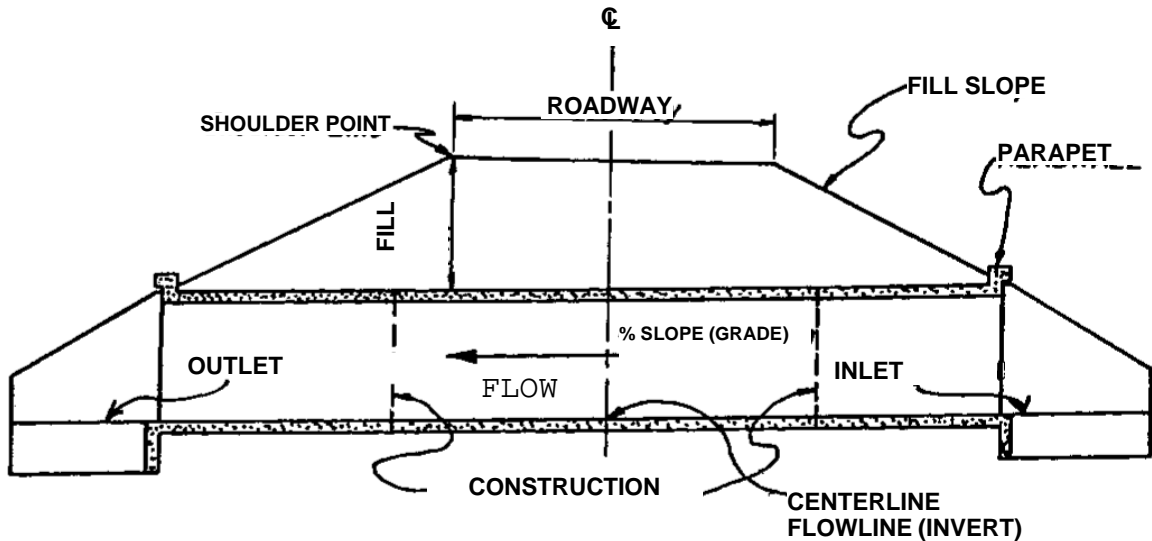

Figure 8-4. Longitudinal Section of a Box Culvert.

Notice these things particularly about the above. Shown above is a longitudinal section of a box culvert:

- a. The INLET and OUTLET ends - water goes in the INLET and flows to the OUTLET end of a culvert. The INLET end is always HIGHER than the OUTLET end.
- b. The CENTERLINE FLOWLINE - is the elevation of the top of the bottom slab at the centerline of the roadway. Also known as INVERT.
- c. The PERCENT OF SLOPE for the culvert BARREL - this is shown in the longitudinal section on the drainage cross section sheet. It is established from elevations set for the inlet and outlet elevations.
- d. The SLOPE OF THE FILL - is controlled by the height of fill from the shoulder line to the toe of the slope - see typical sections.
- e. The CONSTRUCTION JOINTS - show where one concrete pour may end, and another may begin.

PLAN VIEW

Look at the PLAN VIEW shown below for the box culvert. Wing Walls and Parapet are not shown. This plan view shows the culvert from the top. See the centerline of the roadway? Notice that the culvert is on a line perpendicular to the roadway centerline. This culvert is said to be on a 90 degree SKEW.

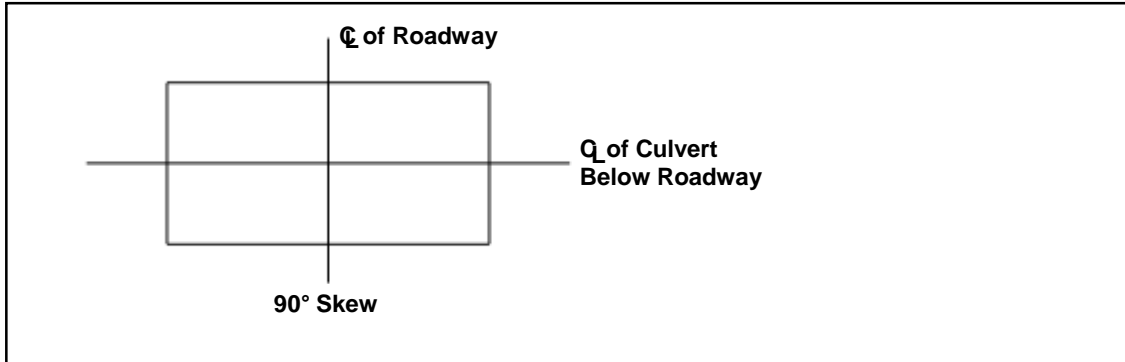

Figure 8-5. Plan View of a Box Culvert

This SKEW ANGLE is the angle that the centerline of the culvert makes with the centerline of the roadway as measured in a clockwise or counterclockwise direction from the centerline of the roadway looking ahead. Look at the next drawing of a 45 degree skew condition.

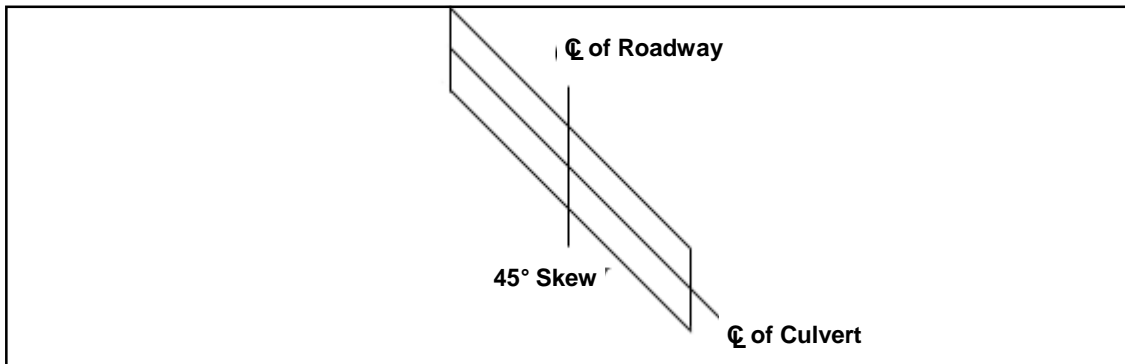

Figure 8-6. Skew View of a Box Culvert.

Using the preceding drawings of a culvert, answer the questions and/or choose the right answer:

- 8-10** The end of the culvert that the water goes **IN** is called the _____ end. This is the (higher / lower) end.
- 8-11** The culvert slopes **DOWN** to the _____ end.

- 8-12 A place at which one concrete pour may end and join another concrete pour is called the _____.
- 8-13 The toe of the fill slope meets the back of the _____.
- 8-14 A skew angle is the angle formed by what two lines?
_____ and _____

Using Construction Plan Sheets 62, 198 and 202 for culvert structure 10, answer the questions:

- 8-15 What is the SKEW ANGLE of the CULVERT as shown on the plans at Station 192+24.02?

- 8-16 Does water flow from left to right, or from right to left in this culvert?
_____ to _____
- 8-17 What is the inlet elevation? _____
- 8-18 What is the outlet elevation? _____
- 8-19 What is the % grade of the **new** portion of the culvert? _____
What is the % grade of the **old** portion of the culvert? _____

WING WALLS

The barrel of the culvert is the portion of the structure that conveys the water. Wing walls are on both ends of the barrel.

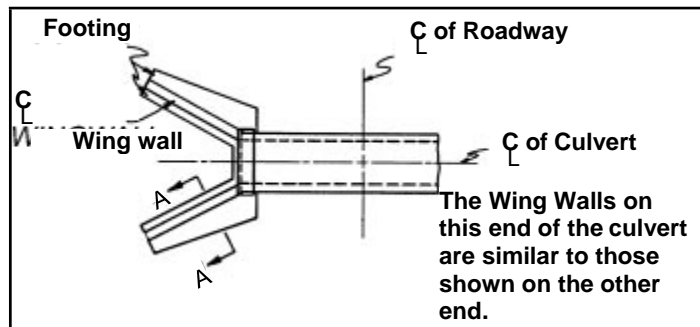

Figure 8-7. Part Plan View of Wing Wall

The purpose of wing walls is to keep the earth "fill" above the culvert from spilling into the stream bed. At right is a section of the wing wall on the previous drawing of a culvert.

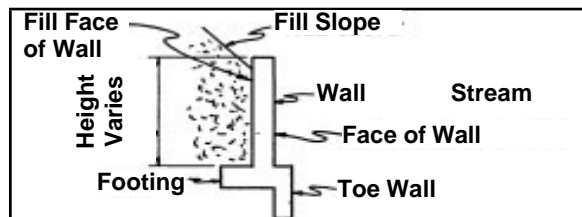

Figure 8-8. Wing Wall Section.

Wing walls are extensions of the barrel walls that flare out away from the stream. Figure 8-9 shows a box culvert on a 60-degree skew. Notice how one wing is shorter than the other.

Notice that the length of each wing is such that the fill slope, as indicated by the arrowed lines, proceeds down the slope from the shoulder line of the roadway.

Therefore, the wing lengths will vary from culvert to culvert - depending upon the height of the culvert, the slope of the fill, and skew of the culvert. Turn to Standard 2328 on Sheet 655 of your example plans. Plan views for different skew angles are shown. Notice the lengths of Wing M and Wing N. These varying wing lengths are examples of short and long wings.

The angles that the wings make with the barrel are illustrated in the part plan shown below. Note that the wings are parallel to lines that cut in half (bisect) the interior corner angles of the culvert.

This procedure is the normal or standard method of establishing the direction of the wings. There are special occasions (not very often) when the wings are not placed as shown in the "Part Plan" (Figure 8-10) above.

Circle the correct answers:

8-20 The purpose of a wing wall is to keep the earth (fill / cut) from entering the stream.

8-21 Wing wall wings (are / are not) different lengths if the culvert is built on a skew.



Figure 8-8. Part Plan of Box Culvert on 60 degree Skew.



Figure 8-9. Box Culvert on 60 degree skew.

BRIDGES

A bridge is constructed over a roadway, stream, or railroad, or a combination of these. Refer to Figure 8-11 below for two views of a three span bridge over a roadway. Look this structure over carefully.

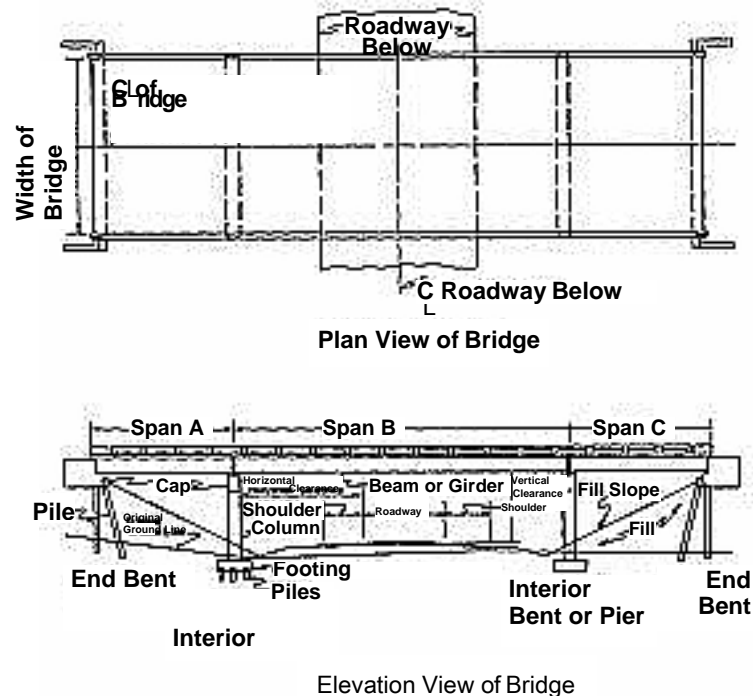

Figure 8-11. Plan and Elevation Views of a Bridge

Notice these things particularly on the views of the bridge:

1. Look at SPANS A, B, and C - These Spans make up the riding surface of the bridge and consist of a reinforced concrete deck (slab) supported on steel or concrete BEAMS or GIRDERS that is supported on the end by BENTS.
2. BEAMS OR GIRDERS - These are placed lengthwise along the bridge (parallel to the Centerline of the Bridge as shown in the PLAN VIEW) with each end resting on the BENT CAP. They can be made of steel or concrete. They directly support the roadway slab.
3. BENT - considered to be composed of the BENT CAP, COLUMN, FOOTING, AND THE PILES, beneath the footing or the Bent Cap and the Pile supporting the cap (in some instances, there are no columns or footings such as a stream crossing, this is known as a pile bent).
4. BENT CAPS - These are constructed of reinforced concrete and are supported either by means of concrete or steel PILES or reinforced concrete columns. End Bents normally use Piles.

5. **FOOTINGS** - These support the Columns and are constructed of reinforced concrete. Footings are supported either on Piles or firm soil. Footings are not seen once the bridge has been constructed since they will be covered with earth.
6. **PILES** - Piles are used when there is no firm material available to support a footing. Steel piles are used in areas where rock is found; concrete piles are also used in areas where steel piles would corrode easily such as in coastal areas.
7. **SUPERSTRUCTURE OF A BRIDGE** - This is the part of the bridge that is above the top of the bent caps.
8. **SUBSTRUCTURE OF A BRIDGE** - This is the part of the bridge that is below the top of the Bent Caps.
9. **FILL** - This is the earth that was required to be placed on top of the existing ground to provide the foundation for the roadway.
10. **FILL SLOPE** - This is the slope of the earth which has been placed on existing ground. Fill slope is normally 2:1 for bridges over highways and streams.
11. **CUT SLOPE** - The slope beneath a bridge can also be a cut slope. This would be the case where the bridge is to be built on an existing roadway and the earth below the bridge must be removed to provide for the roadway below.

BENTS

The following are views of the most common types of Interior and End Bents that you will find in structure plans. The views show what you would see if you cut a section across a bridge between bents.

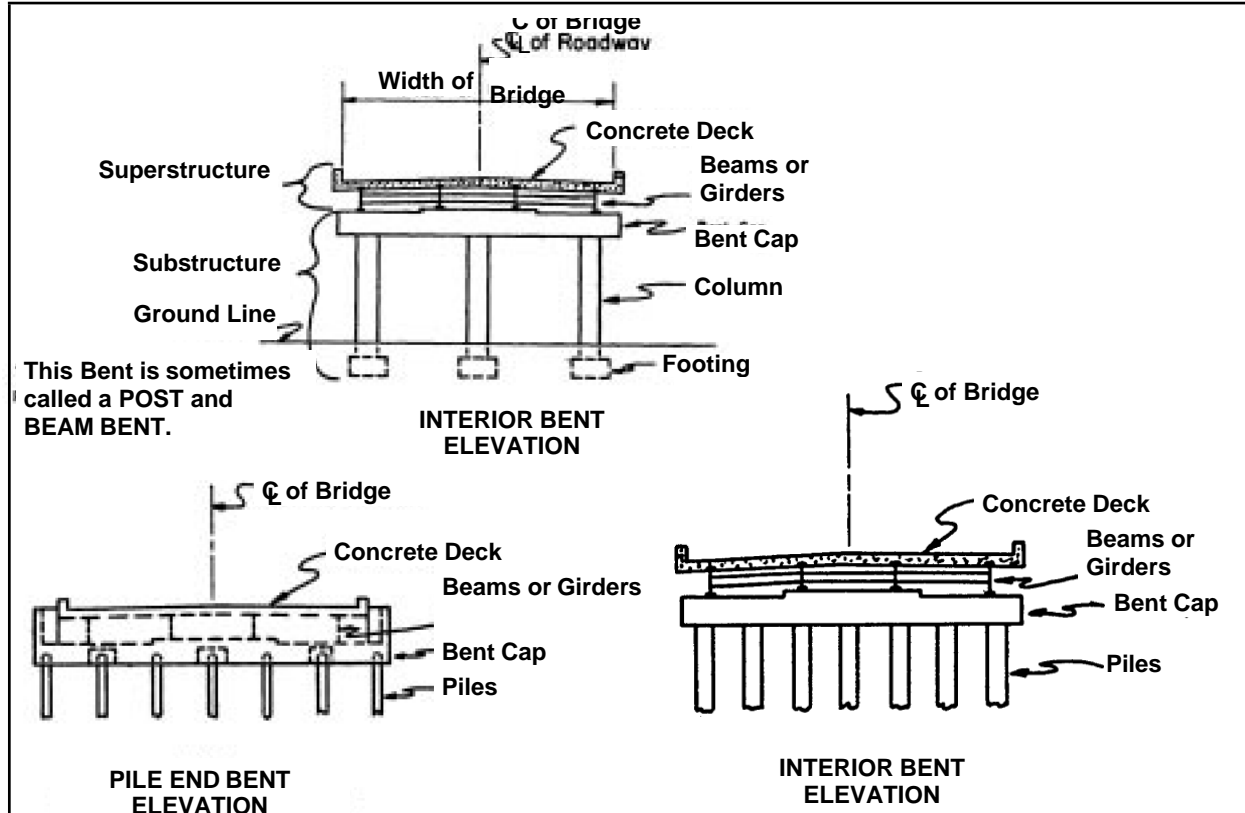

Figure 8-12. End Bent Elevations.

Turn to Construction Plan Sheet 535. This bridge is a bridge widening. The existing bridge is being constructed for the widening. The elevation, left bridge, shows the new pile foundation. The elevation, bent 3 right bridge shows angle iron supports being added.

Using the previous drawings and information, answer the questions:

- 8-22** The two main parts of a bridge are _____ and _____. (Hint - Above & Below Bent Cap)
- 8-23** The supporting members that hold up (directly support) the roadway slab and the traffic on this slab are _____ or _____.
- 8-24** The supporting members in Question 8-23 are supported at each end by a _____ or _____.
- 8-25** The portion of the bridge that supports the Superstructure is called the _____.
- 8-26** Depending on the ground, Bent Footings may be supported in two ways. These are _____ or _____.
- 8-27** What are the two types of piles normally used? _____ and _____
- 8-28** What two materials are beams or girders made of? _____ or _____

UTILITY ACCOMMODATIONS

Often it is necessary for UTILITIES such as water lines, gas lines, telephone lines, power lines and others to cross the roadway spanned by a bridge. The cross section below shows how utilities are supported below a bridge slab.

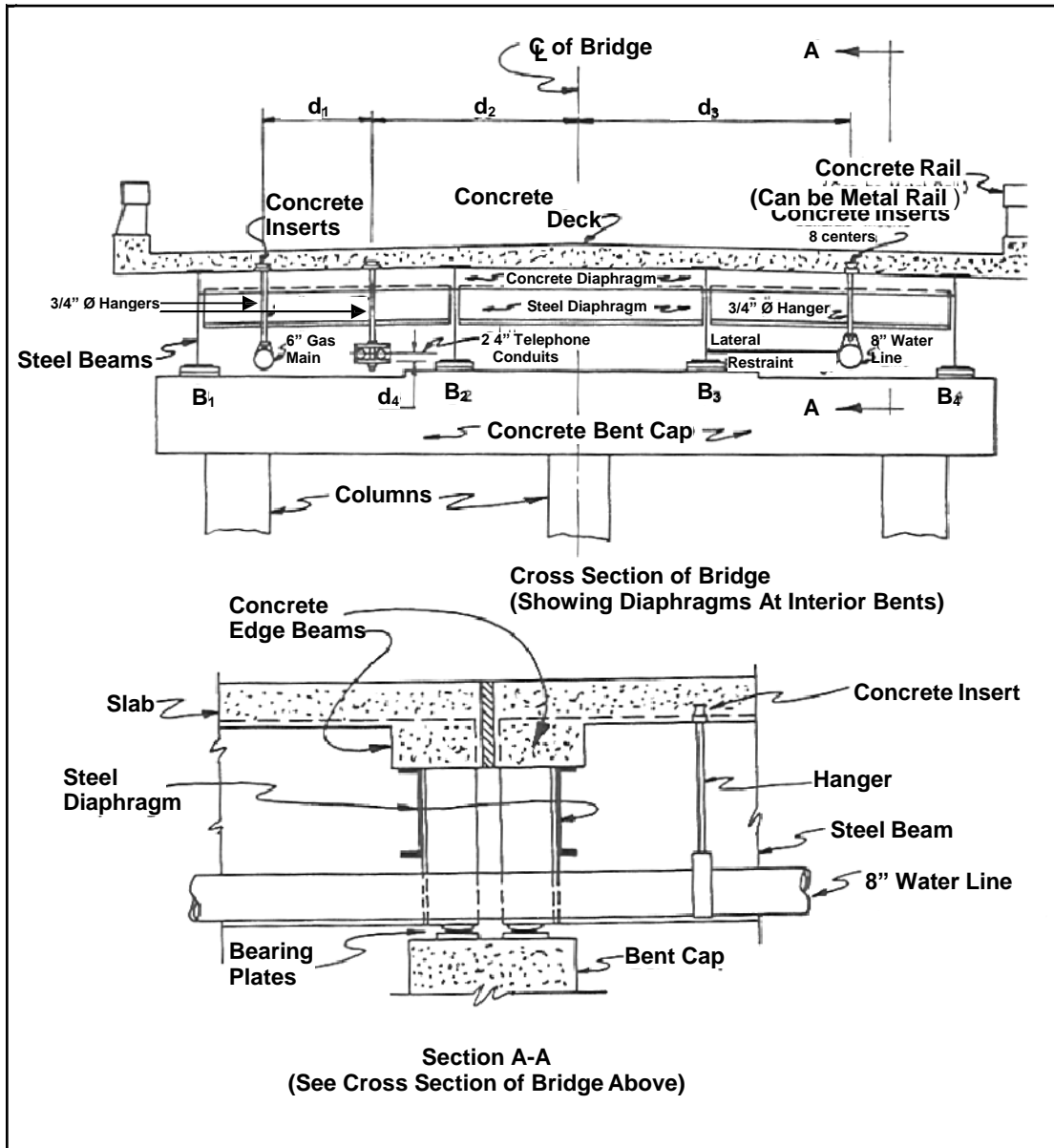

Figure 8-13. Cross Section of Bridge.

Notice the following things shown on the preceding drawing of a cross section of a bridge. Remember that you are looking at a cross sectional side view of Section A-A.

1. The concrete inserts are placed in the slab when the concrete is poured. The $\frac{3}{4}$ " hangers are then screwed into the bottom of the insert when the utility is put in place.
2. The utilities are normally placed inside the exterior beams and above the bottom of the beam so they cannot be readily seen by anyone passing under the bridge in a vehicle.
3. The utilities must clear the steel diaphragm. At times the diaphragm may have to be adjusted up or down to permit the utility to be placed on the bridge.
4. The lines or conduits are normally located by the dimensions d1, d2, d3, and d4 as shown.

Using the previous bridge cross sections, answer the questions:

8-29 What three utilities are shown in the cross-section?

8-30 How many and what size telephone conduits are shown? _____

Utility details are more difficult at the end of a bridge. The view below is one looking at the beginning or the ending end of a bridge which shows the end wall that pipes and conduits must pass through. The bottom section is a profile view at the end bent.

Examine each diagram carefully.

Figure 8-14. End Bent Elevation and Section

Notice the following things shown on the previous End Elevation drawing:

1. The end wall that the utilities must pass through is a reinforced concrete wall that is poured at the same time as the concrete slab is poured.
2. Note the pipe sleeves that are cast in the end wall for the pipes to pass through. Also, see the opening that is left for the telephone conduits.

Chapter 9: Utility Plans

Utility plans are used primarily to facilitate coordination between the construction contractor and utility companies having facilities in the roadway corridor. (The DOT is not involved in the relocation of utilities unless it is done under a Force Account). These plans show the contractor the approximate locations of existing, relocated, and proposed new utilities aiding the designer and contractor in identifying and/or avoiding conflicts or damage to facilities. Information is typically obtained from either field survey data and/or the affected utility owner.

Construction Plan Sheet 419 is an example utility plan. Note the gas lines shown before Station 180+00. One gas line is being relocated, and the other remains in the original location. Also note the Colonial Pipeline dig notification requirement.

Please identify the following statement as True or False.

9-1 True False Utility plans show the exact location of the utilities of the project.

Plans are also prepared consisting of signs and pavement markings. These plans are normally in the same general format as the roadway plans.

All permanent roadway signs and pavement markings are placed on the plans as they are supposed to appear upon completion of the project. See Construction Plan Sheet No. 474 for an example of this.

Chapter 10: Signing and Pavement Markings, Signals, Highway Lighting & Landscaping

All required pavement markings are depicted on the plans including the color, width, and spacing, etc. Call-outs may be provided to identify the type of each line on Plan Sheet. All required arrows and hatching in accordance with Department Standards are included. Each arrow may not be labeled but at least one note referencing the applicable standard is included on each sheet.

A summary of the quantities for any overhead signs typically follow the sign/pavement marking plans. For post mounted signs, a summary is included with the normal Summary of Quantities Plan Sheets discussed previously in Chapter 4. It lists the location, installation number, sign codes, etc. for each sign.

TRAFFIC SIGNALS

The signalization plans will show the complete site layout, equipment details, electrical circuitry, signal phasing, and other relevant data for the installation of traffic signal(s). A separate plan sheet(s) for each intersection requiring signalization will be provided. A summary table of items needed for each of intersection will be included showing the name of the item, the method of payment and the quantity to be used for each of the installation(s).

See Construction Plan Sheet 523 for a sample of an installation.

LIGHTING

Highway lighting plans are required when a project involves lighting improvements. The lighting plans are to provide a comprehensive set of construction details, electrical circuit tabulations, pole data summaries, conduit descriptions, service point locations, luminaire type and intensity, foundations and details, and all other specific data relevant to the construction of all lighting related features and components.

If the project consists of high mast lighting towers, it is also required that a soil survey and foundation design is done.

LANDSCAPING

Projects which require landscaping may require a separate set of plans, at the Department's direction. These plans may be included in the roadway contract or as a stand-alone set of plans.

The following information is usually provided in landscape plans:

1. An overall Site Plan and an area map depicting the roadway corridor in relation to the surrounding environment

2. A Planting Plan
3. A Planting Plan Detail
4. An Irrigation Plan

Circle the correct answers:

- 10-1** Sign and Pavement Marking Plans (are /are not) normally in the same format as roadway plans.
- 10-2** Plans (do / do not) indicate the color, width and/or spacing of the pavement markings.
- 10-3** Traffic Signal Plans (do / do not) have a summary of items needed for each intersection.
- 10-4** Lighting Plans (are / are not) required when the project involves extensive lighting improvements.
- 10-5** List two (2) things that are to be included in a set of Landscape Plans.
1. _____
 2. _____

Using Construction Plan Sheet 474, answer the following questions:

- 10-6** What size skip stripe is to be placed on the right side of the project centerline from Station 153+00 to 165+00?
- _____
- 10-7** What size and color stop bar is to be placed on Rehoboth Road?
- _____

The Traffic Control Plan consists of the plans and specifications developed for each individual construction project, supplemented by such detailed plans as required by the contract. The Traffic Control Plan complements the Traffic Control Specifications and the Manual of Uniform Traffic Control Devices (MUTCD).

Chapter 11: Maintenance of Traffic, Sequence of Operations, and Staging

Special attention is given to constructability, traffic handling, detours, restrictions to traffic, hours of closure/lane loss, and responsibility of the contractor. Signing and markings for the Traffic Control Plans are included for projects such as off-site detours and projects of unusual complexity. Routine projects do not necessarily identify specific signs, markings, and other devices ordinarily required by the Specifications and Standard Drawings.

Preliminarily, specific Traffic Control Plan sheets for each stage of construction using information from the plan sheets and intersection and interchange layout sheets are prepared. For each construction stage, plans show the roadway areas and major drainage structure to be constructed, along with traffic flow patterns, including lane widths, for the stage. Indicate on the plan areas of temporary pavement, locations of temporary barriers, and any temporary drainage structures.

Also included on these plan sheets is a narrative of the sequence of construction and of the handling of traffic for each stage. Where necessary, cross sections of the stage indicating the area to be constructed along with the area to be used to maintain traffic are included, showing any areas of temporary pavement and any temporary barriers.

If an on-site detour is required, detour plans with cross sections and signing are usually included showing detour centerline/baseline with curve and alignment data, detour profile, pavement edges, pavement width, construction limits of the detour, required right-of-way and easements, temporary drainage, and temporary barriers if necessary. If a road closing and an off-site detour is required, there will be a plan showing a layout of the local roads with the road closure points and the detour route.

Please answer the following true/false questions:

- | | | |
|-------------|------------|---|
| 11-1 | True False | Traffic Control Plans are general and are used from project to project. |
| 11-2 | True False | Detours are not given any attention in a set of Traffic Control Plans. |
| 11-3 | True False | Cross sections of each construction stage are always included in the plans. |

Chapter 12: Erosion, Sedimentation, and Pollution Control Plans (ESPCP)

INTRODUCTION

Steep embankments, ditches, or other exposed surfaces adjacent to a roadway require some means to be taken to keep exposed soil from eroding away by the action of wind, water, and freezing and thawing action of the weather. Depending upon the need, erosion control measures such as grassing, silt fence, paved ditches, straw mulch, silt gates, baled straw, and other devices such as bituminous treated glass fiber, soil reinforcing mats, etc. may be used.

In creating the **Erosion, Sedimentation and Pollution Control Plans (ESPCP)**, references such as the most recent Department's Uniform Code System For Soil Erosion And Sediment Control Design Guidelines (Section 161 of the Department Specifications), the Department's Manual On Drainage Design For Highways, the Department's Standard Specifications Construction of Roads and Bridges, the Department's Construction Details, and the Georgia State Soil And Water Conservation Commission Manual For Erosion And Sediment Control in Georgia, to name a few, may be used in preparing the Erosion, Sedimentation and Pollution Control Plans (ESPCP) and/or package.

WHEN ARE ESPCP NECESSARY?

If the total project disturbs less than one (1) acres only a set of BMP (Best Management Practices) Location Details are prepared and included in the project construction plans. BMP's are either structural or vegetative. Structural measures are structures that control erosion such as rip-rap or paved ditches. Vegetative measures are methods such as grassing, sod or soil matting.

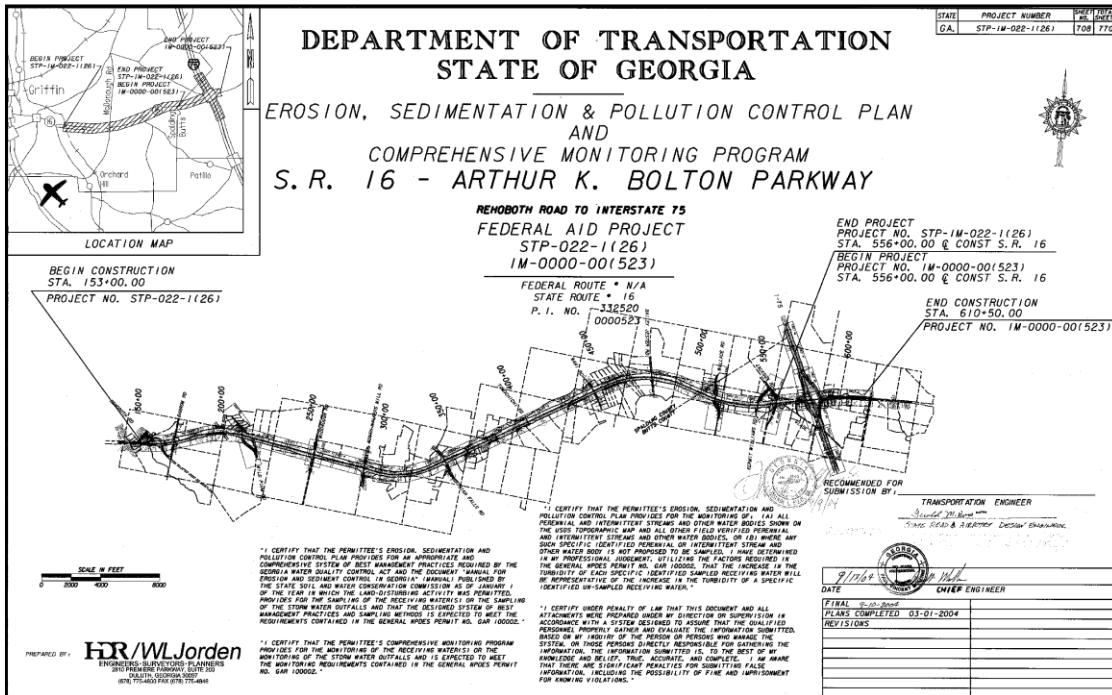

Figure 12-1. Erosion, Sediment & Pollution Control Plan

If the total project disturbs 1 acre or more, there will be a standalone erosion control package. This package will be placed at the back of a set of final construction plans.

WHAT IS INCLUDED IN THE ESPCP?

Included in ESPCP standalone package you should find the following sheets:

- Cover Sheet (Construction Type)
- General Note Sheet
- Drainage Area Map
- BMP Plan Sheets (Best Management Practices)
- Comprehensive Monitoring Program General Note Sheet
- Topographical Sheet
- Erosion Control Item Construction Details and Standards
- NOI (Notice of Intent)

The **BMP Plan Sheets** (Figure 12-2, below) contain the recommended types and locations for permanent and temporary erosion control items. The types of temporary items that should be shown on the plans include silt control gates, sediment basins, temporary slope drains and sediment barriers, or any other items deemed necessary and designated as “Temporary Erosion Control” on the uniform code sheets. Any staging to be done on the project must also be included in these sheets.

The sheets are designed with the same scale and matchlines as the construction plans.

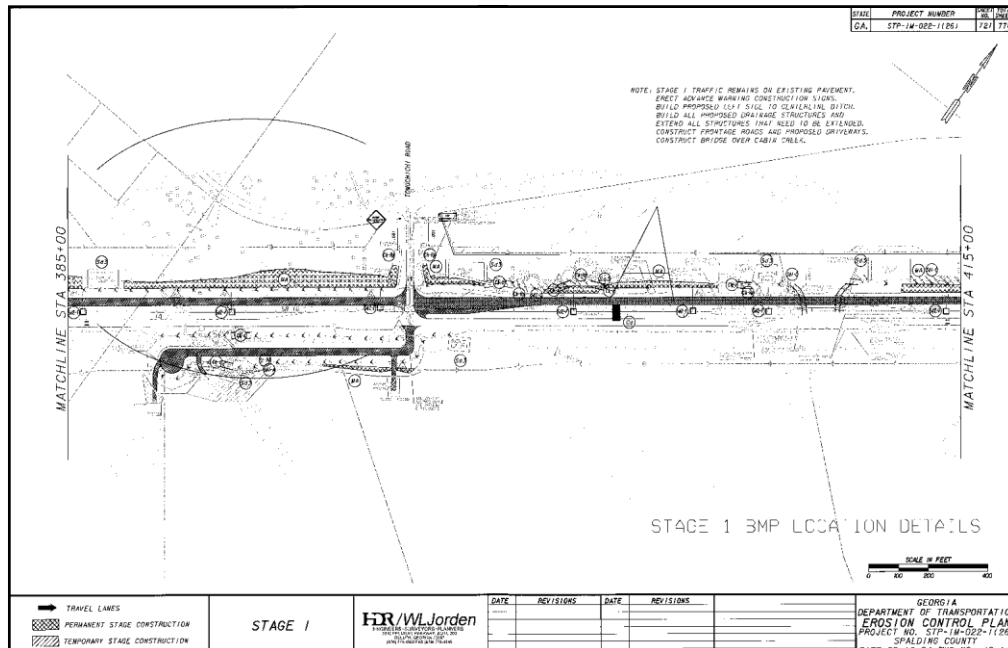

Figure 12-2. Stage 1 BMP Plan Sheet: Location Details.

CONTRACTOR RESPONSIBILITIES

The Department of Transportation provides all these plans; however, if there are any changes to the staging, the contractor is responsible for revising the plans. In addition, the contractor is responsible for the ESPCP for borrow pits, haul roads, and waste pits.

EXAMPLES

Berm ditches may require concrete ditch paving as erosion control measures. The limits and quantities are noted in the Summary of Quantities.

Erosion control measures are identified by standard symbols. Measures shown on Construction Plan Sheet 721 include Co (construction exit), Sd3 (temporary sediment basin), and Ch (channel stabilization). These measures are considered structural BMPs. All measures required for the project are found in the construction details.

Circle the correct answers:

- 12-1** If a total project is (greater / less) than one (1) acres a set of Erosion Control Plans will be included in a separate package and attached to the back of the project plans.
- 12-2** The Department of Transportation has to develop and submit erosion control plans according to Specification Section (161 / 611)
- 12-3** Name three (3) erosion control measures that can be used on a project.
1. _____
 2. _____
 3. _____

Chapter 13: Cross Sections

INTRODUCTION TO CROSS SECTIONS

Cross Sections depict the existing ground conditions, including all man-made features, as sections perpendicular to the construction centerline or baseline. The proposed cross-sectional outline of the new roadway with all its elements is also shown on the cross sections. Standard Cross Section Plan Sheets are used for showing the roadway cross sections. The recommended scale is $1'' = 100'$ or $1'' = 200'$. If the entire cross section cannot be shown on one sheet, the sheets may be turned horizontally or more sheets with appropriate match lines shown are used.

Existing ground lines are shown with a dashed line. A note of the existing ground line elevation at the profile grade line (PGL) just below the ground line is shown. The surface and subgrade of the existing construction such as pavements, curbs, and sidewalks are shown also with a dashed line. If present, the limits of unsuitable material are shown. The station number of the section is normally shown in heavy numbers to the right of or below the cross section.

The proposed roadway template is shown with a solid line. The proposed profile grade elevation is vertically shown just above the profile grade line. If there are any special ditches, the elevations are normally included as well. Any and all station equations are shown, even if a cross section may not be plotted at that point.

Roadway Cross Section Plan sheets are usually lined up in a similar way to the list below:

1. Mainline
2. Cross Streets
3. Side Streets
4. Ramps
5. Major Driveways

EARTHWORK

Figure 13-1 is an illustration of typical terrain upon which a two-lane roadway is shown. The illustration can only be a general picture, but it does convey a third dimension-depth, which a plan view cannot show. Within the illustration, you can see one item of construction that is changing from station to station and that item is earthwork (cubic yards of dirt).



Figure 13-1. Typical terrain for a Two-Lane Roadway

Because earthwork is usually a costly item in highway construction, it must be accounted for in the estimate prepared for the project. Since it would be extremely difficult to measure the exact amount of earthwork in a project, the designer resorts to approximation. This is accomplished by using the Cross Section Plan Sheets.

Remember that the cross section shows what you would see if the highway were cut at right angles to the centerline.

See the next illustration with examples of cross sections taken in cut and in fill:

The cross section is not always all cut or all fill as shown previously; it may also be part cut and part fill. Many factors are considered before combining a typical section of the roadway with a cross section of the ground.

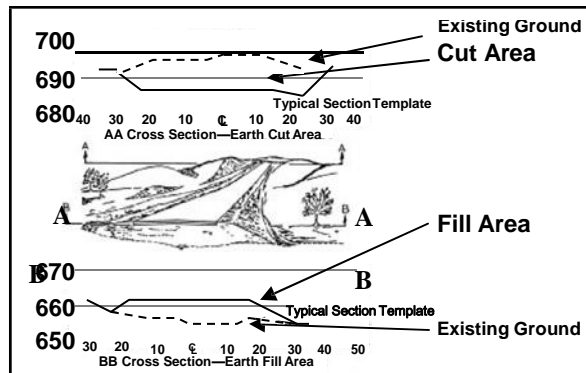

Figure 13-2. Examples of Cut and Fill Cross Sections

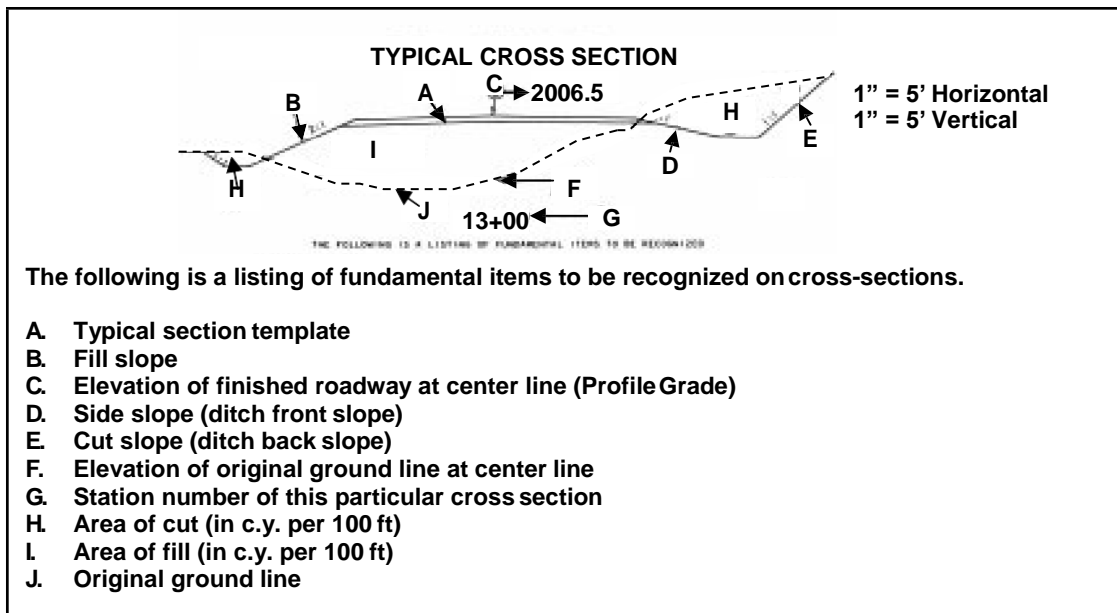

Figure 13-3. Typical Cross Section.

The typical section represents an end view of the pavement necessary to carry the type and volume of traffic established in the highway design.

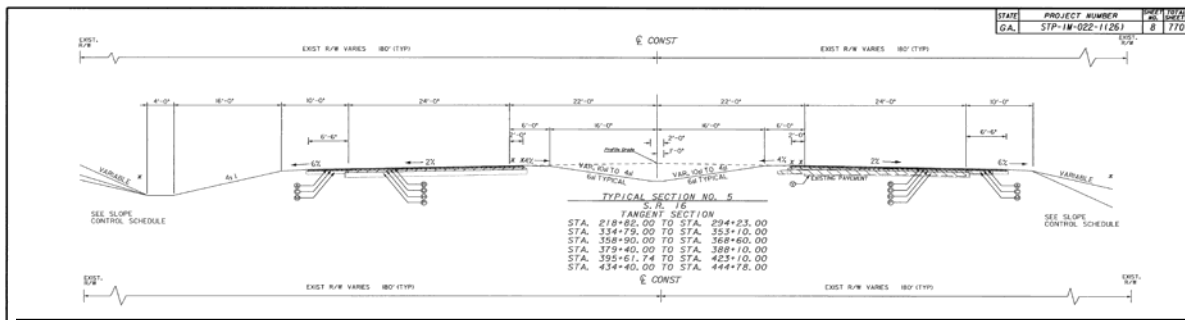

Figure 13-4. Typical Cross Section along Centerline.

The cross section of the original ground is distinctive for every location along the centerline.

By combining the typical section and the cross section of the original ground, a determination is made of the area of cut, fill, or both.

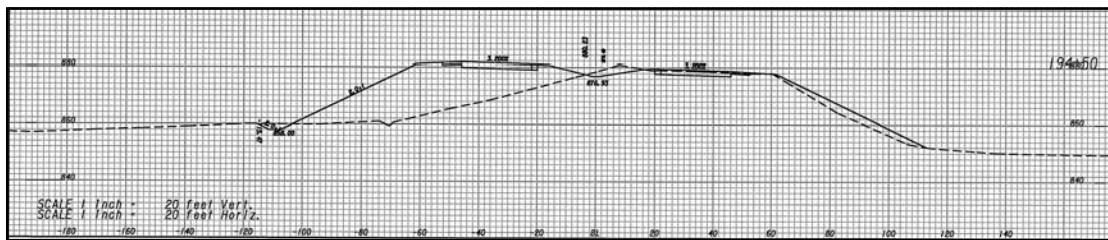

Figure 13-5. Cross Section at Station 194+50.

The drawing on Figure 13-6 shows how depth (100 ft.) is multiplied by an averaging of end areas to give a “volume” answer. The vertical point of reference for a typical section at a particular location along the roadway is called the profile grade.

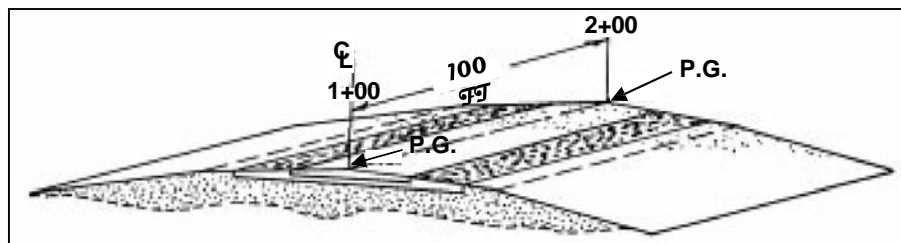

Figure 13-6. Volume of Cut.

On projects where the amount of dirt is over a set amount by the Department, the earthwork is paid for as a Cubic Yard item and not Lump Sum. The District Earthwork Coordinator will verify the cubic yard amount of earthwork at the beginning of each project. Project personnel will pay up to 95% of the verified quantity of earthwork per the Standard Specifications until final dressing, etc. is complete.

Upon completion of the final dressing, project personnel should submit to the District Earthwork Coordinator a list of all areas where the contractor deviated from the plan template with approval of the Department. This form is the “Earthwork Template Exceptions List”. In the case that the project was built without any exceptions, project personnel should send a letter stating such to the District Earthwork Coordinator as well.

GRADE

Look at Construction Plan Sheet 236, a Cross Section Plan Sheet, and note that the profile grade elevation (top elevation) listed for 196+00 is 880.82. The lower elevation is the finished grade for the ditch. The smaller elevation just below and right of the profile grade elevation is the existing grade. Turn to Construction Plan Sheet 106 and verify the elevations at Sta. 196+00. Now turn to Construction Plan Sheet 8 for the typical section and compare the required grading template to the plotted cross section. Note that the profile grade is at the center of the median.

SLOPES

Slopes are usually referred to as “cut slopes” (back slopes), “fill slopes” and “side slopes” (front slopes). A cut slope is that portion of the roadway between the side drainage ditch and the top of the cut. A fill slope is that portion of roadway between the shoulder point of the roadway and the toe of the fill. The side slope is that portion of the roadway between the shoulder point and the adjacent drainage ditch. These slopes are measured as a ratio of horizontal distance (from and to edge of pavement) versus each foot of decrease or increase in elevation (height).

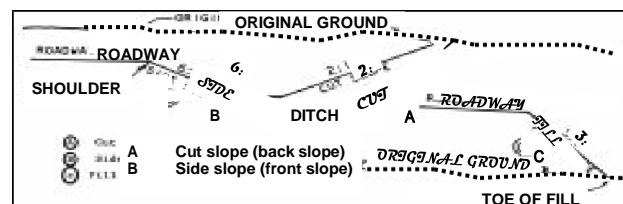

Figure 13-7. Views of Slopes in Cross Section

Figure 13-7 shows some views of the various slopes used on cross sections.

A 2:1 slope means that for every 2 feet of horizontal distance, the elevation (or vertical distance) increases (cut section) or decreases (fill section) 1 foot, depending on the type of slope shown on the previous drawing.

Using Cross Section Construction Plan Sheet No. 236, look at Sta. 194+50. Notice that the left side slopes shown here is a 2:1 slope which is a “fill slope”. Look now at Construction Plan Sheet 8 - Typical Section - and notice that a fill slope over 10 feet will have a 2:1 slope and that guardrail will be required in this section because of the depth of fill.

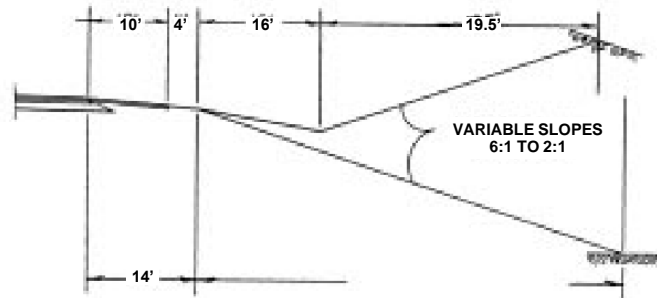

Figure 13-8. Slope Cross Section.

SLOPE STAKES

The following information is a general guide only. Information on these stakes varies with various contractors, surveyors, and districts. Stakes contain information that tells the Contractor how much “cut” or “fill” is required from the point of the stake to the ditch line (or shoulder point) of the roadway, depending on whether the stake is in a cut or in a fill section.

Slope stakes are placed at the point of intersection of the cut or fill slope and the natural ground line.

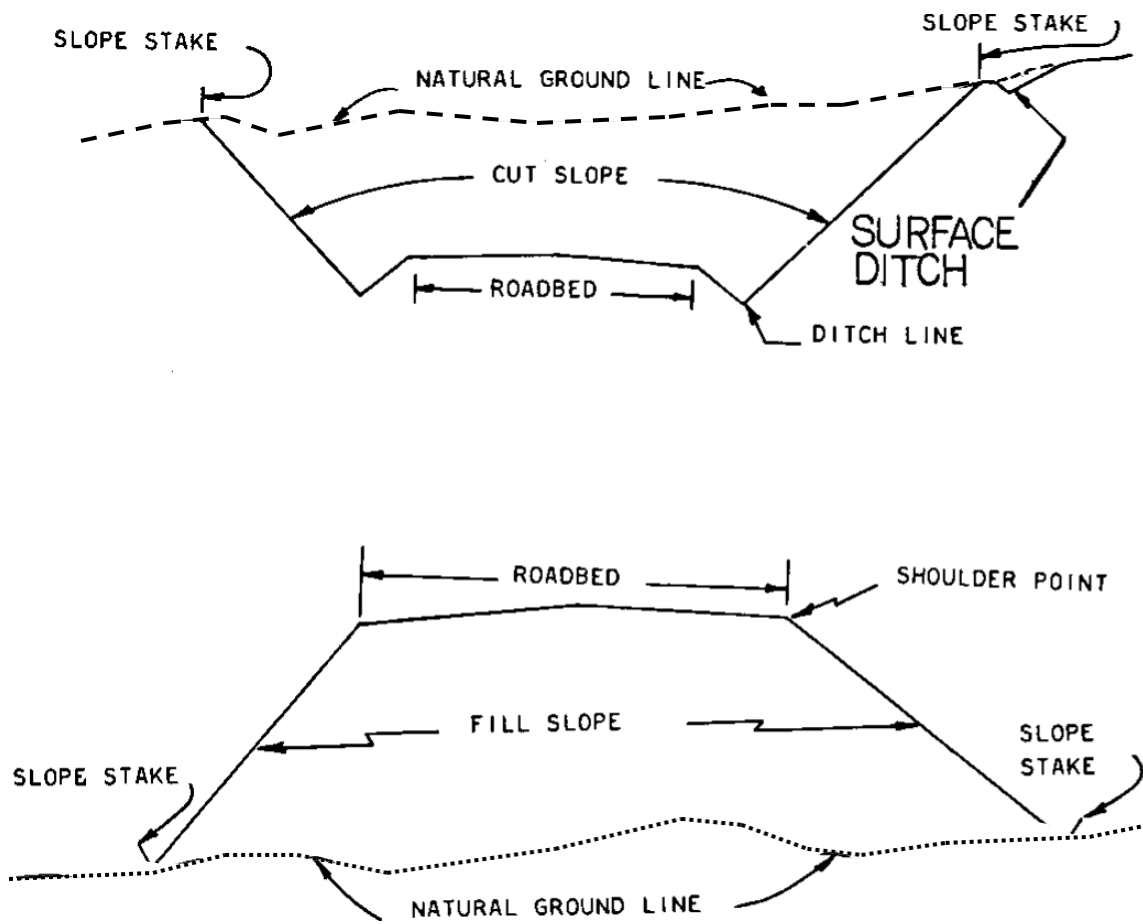

Figure 13-9. Slope Stake Positioning

The following information may be shown on the side of the slope stake facing the roadway (this would be the front of the stake). Refer to Figure 13-10 below.

1. Indicates cut (C) or fill (F)
2. The amount of cut (to the bottom of the ditch) or the amount of fill (to the shoulder point).
3. The distance from the stake to the centerline of the roadway or some other reference line.
4. The rate of slope (such as 2:1)
5. The rate of super elevation (only required when roadway is in a curve section).



Figure 13-10: Station Numbering on Slope Stake.

The station number is shown on the side of the stake away from the roadway or back of the stake. Refer the right side of Figure 13-10 above.

Often, slope stakes are offset in order to allow the Contractor to perform his work without destroying the slope stakes. In this case, information should be shown in the same manner as the in-place slope stake except that the following additional information should be shown encircled on the front of the offset stake.

- The distance from the offset stake location to the slope stake location.
- The change in elevation between the slope stake location and the offset location as indicated by a + or a - depending on whether the offset stake location is higher + or lower - than the slope stake location.

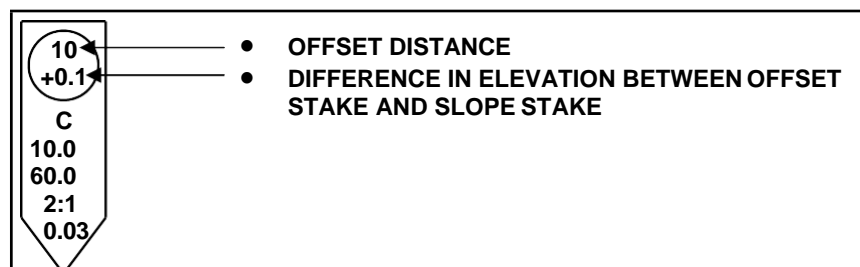

Figure 13-11. Offset Distance on Slope Stake.

Please identify the following statements as True or False:

- 13-1 True False Roadway cross sections depict existing ground only.
- 13-2 True False Existing ground lines are shown as solid lines on roadway cross sections
- 13-3 True False The proposed roadway template is not shown on the roadway cross sections

Circle the correct answers:

- 13-4 Cross sections show what you would see if the highway were cut at a right angle to the (centerline / station).
- 13-5 Cross sections of the original ground (is / is not) distinctive for every location along the center line.
- 13-6 Top elevation listed on the cross sections (is / is not) the original ground line.
- 13-7 Cut slopes (are / are not) usually referred to as back slopes.
- 13-8 Slope stakes (do / do not) contain information that tells the contractor how much “cut” or “fill” is required for a certain part of the roadway.

Chapter 14: Standards & Details

INTRODUCTION TO STANDARDS AND DETAILS

“Georgia Construction Standard Drawings” or Standards are generalized construction drawings that are applicable to most construction projects. Think of Standards as drawings of the normal way the Department of Transportation wants something built or to be done.

“Georgia Construction Detail Drawings” or Details are a more specific and specialized way that the Department wants something built. It will usually be something that is not as common a way of doing something on most construction projects.

“Georgia Special Construction Details” are drawings that are specific and specialized to that project only.

Turn to the Index Sheet and note that Construction Plan Sheets 566-631 are Construction Details and Sheets 632-707 are Construction Standards and are to be used on the job. Two of these Standard Drawings, Construction Plan Sheet No. 690 (9028C Superelevation) and Construction Plan Sheet No. 694 (9031S Median Drop Inlet), are included as examples.

INTERSECTION DETAILS

Intersection details are larger scale views showing detailed information that could not be shown clearly on a smaller scale normal Plan Sheet.

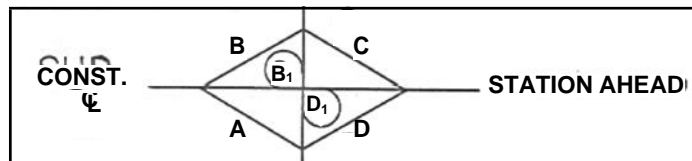

Figure 14-1. Ramp Identification by Letter.

Each ramp in an interchange is identified by a letter designation. These are usually assigned as shown in Figure 14-1.

Interior ramps or loops are designated with a Subscript A1, A2, etc. or as Loop A, Loop B, etc. At this particular interchange, Ramps A & B were constructed under a previous contract and would be shown by a dashed line, indicating existing conditions.

4-1 Match the Columns

Column A

- A. Georgia Construction Standard Drawings
- B. Georgia Construction Detail Drawings
- C. Georgia Special Construction Details

Column B

- 1. Project specific construction drawings
- 2. Generally used construction drawings
- 3. Not the common way on all projects

Chapter 15: Right of Way

INTRODUCTION

In order to construct any highway, the Right of Way Office must be successful in securing the needed land for right of way purposes. The Right of Way Office personnel, in most instances, are the first official contact that the property owner will have with the Department. It is imperative that they also be competent in highway plan reading so that the plans can properly be interpreted for a highway project to the property owner.

The property owner, above anyone else, is most vitally concerned as to how a proposed highway will affect his own property. The Right of Way specialist will be required to answer questions concerning the plans in addition to the general questions concerning the right of way acquisition procedure. On the initial contact with the property owner, it is of prime importance to properly interpret the highway plans for the owner as well as explain other phases of the right of way acquisition procedure.

Many times the owner will ask questions regarding ingress (enter in) and egress (exit from) of a proposed highway; how cuts and fills will affect his property; and how his residence or business will be affected by the highway project. The farmer is particularly interested in such matters as how his fields and pastures will be divided by a proposed highway; how his woodland will be affected; how the access to water will be affected; and the appropriation and relocation of fencing.

Farmers will also ask questions regarding the movement and protection of livestock; how the construction schedule of the project will affect his planting, growing, and harvesting seasons; and many other questions such as the appropriation of farm outbuildings and his access to the proposed highway facility. These are only a few of the questions that a Right of Way Specialist may be asked by a property owner, and the importance of highway plan reading cannot be stressed too much. If a Right of Way Specialist is hesitant about answering questions regarding the plans, due to his lack of knowledge, the property owner is apt to become defensive and the Specialist will have a difficult time in acquiring the property.

In Urban areas, the Right of Way Specialist should be particularly careful in noting the “cuts” and “fills” as indicated on the plans. Major “cuts” and “fills” can affect locations as to where driveways can be reconnected. It is entirely possible that the depth of a cut or the height of a fill could eliminate a driveway from being reconnected even though the project has no limited or control of access.

Urban property owners are particularly interested in such matters as to the appropriation of landscaping, how close a roadway is to a dwelling or business, driveway reconnections, and parking on a proposed street. Property owners may have more questions regarding highway construction. In many instances, a property owner will move a residence or commercial building, which is located within the right of way limits of a highway project to a new location.

For these reasons, it is imperative that the Right of Way Specialist properly and accurately interprets the plans and read slope stakes. Highway plan reading is of vital importance to employees of all sections of the Right of Way Office and all employees should take full advantage of this Plan Reading Course.

RIGHT OF WAY TERMS AND DEFINITIONS

ABANDONMENT - the act of the cessation of use of a right of way with no intention to reclaim or use the right of way again for highway purposes.

ACQUISITION OR TAKING - the acquiring of a property in its entirety or a portion thereof, for highway purposes.

ABUTTING LAND OWNERS - the owners whose land adjoin or abut the land spoken of.

BORROW PIT - an area or pit from which suitable material from sources outside the project limits is excavated and generally used for embankments.

CATTLE PASS - an opening under the roadway, which allows the movement of livestock from one side of the road to another. Cattle passes consist of a pipe or box culvert or a provision made under a structure to allow the movement of livestock from one side of the roadway to another.

CHANNEL CHANGE - a man-made change or diversion in the natural flow of water or man-made change in the channel of a ditch, stream, creek, or river.

CONDEMNED PROPERTY - power of eminent domain (Stoppage).

CONSTRUCTION EASEMENT - an easement that extends to the farthest limits of construction, beyond the right of way limits as shown on the plans.

CONSTRUCTION LIMITS - the limits shown on the plans by symbols which designates the limits of construction.

CONTROL OF ACCESS - the condition whereby the Transportation Department controls the right of property owners or occupants of abutting property to enter or leave a highway.

CUL-DE-SAC - a street or road which is open to traffic at one end only with a special provision for turning around at the other end.

DEED OF EASEMENT - an instrument by which a right is acquired by the Department to use or control property for highway purposes.

DRAINAGE EASEMENT - an instrument or easement granting the Department the necessary property beyond the right of way limits as shown on the plans to provide for the proper drainage of a highway.

EGRESS - the act of leaving.

ENCROACHMENT - the use of highway right of way for an indefinite term with or without permission of the Transportation Department. Encroachments usually involve man-made obstruction either above or below the highway.

FEE SIMPLE TITLE - absolute ownership of property including also the unlimited right to control same for any purpose whatsoever.

IMPROVEMENT DESIGNATIONS - designations or symbols shown on the plans which identify specific improvements or items of real or personal property.

INGRESS - the act of entering.

LIMITED ACCESS - ingress and egress to a highway is at points designated by the Department of Transportation.

OWNERSHIP - the legal right of possession of real or personal property. Ownership of property designated on the plans is shown by the owner's name appearing in print on the plans.

PARCEL NUMBER - the number designated on the plans generally enclosed by a circle, which designates a parcel or tract of land.

PARTIAL CONTROL OF ACCESS - similar to Limited Access in that the Department of Transportation will give preference to through traffic. Access connection may be provided with selected public roads. There may be grade crossings and some private driveway connections allowed at designated locations.

PARTIAL TAKE - the acquiring of a portion of a property for highway purposes.

PERMANENT EASEMENT - an easement in perpetuity that gives the Department the right to utilize property for an unlimited time.

PERSONAL PROPERTY - the right or interest in personal things which are moveable or transferable from one place to another.

PROPERTY LINE - the boundaries or limits outlining the ownership of a tract or parcel of land.

REAL PROPERTY - the rights and interests in land and those items or things of a permanent nature affixed to the land and generally whatever is growing upon the land.

REQUIRED RIGHT OF WAY BOUNDARY OR LIMITS - the limits or boundaries as shown on the plans which show how much property is to be acquired for right of way in order to properly construct the highway.

RIGHT OF ACCESS - the right of ingress (entering into) or egress (leaving from) to a highway from abutting property.

RIGHT OF WAY - this is a term denoting land, interest therein, or property which is acquired for highway purposes.

RIGHT OF WAY MONUMENT - a marker, usually concrete, placed on the ground that shows or indicates the limits of the right of way.

RIGHT OF WAY PLANS - are plans which contain all necessary information for the acquisition of right of way as found on design plans with the addition of any additional information that may be helpful in the acquisition of right of way.

SIGHT DISTANCE - the length of roadway visible to the driver of a vehicle at any given point on the roadway when the view is unobstructed. That area or property designated on the plans to be acquired for sight distance purposes in order to grant the driver of a vehicle an unobstructed view.

SYMBOLS - a conventional sign used in writing or printing which relates or represents quantities, items, or things.

TEMPORARY EASEMENT - an easement granted to the Transportation Department on a temporary basis usually for a specified time and specified purpose.

THE LOCATION OF MONUMENTS AND TIES IN RELATION TO PROPERTY LINES - those locations designated on the plans by distance from and/or reference to a point on the survey line which designates the location of a property line intersecting a right of way boundary or which designates the location of a right of way monument on the right of way boundary.

TOTAL TAKE - the acquiring of a property in its entirety for highway purposes.

UTILITY - physical plants and operating facilities which provide public or private utilities consisting mainly of communication lines, electric power lines, gas lines, water mains, sewer mains, and other pipe lines, and the supporting structures for these facilities.

WASTE PIT - an area or location in which excess or unsuitable material obtained during construction is deposited.

RIGHT OF WAY PLAN SHEETS

Right of Way Plans are a separate set of plans from the construction Plans. In going through this section of the manual, you will find yourself being referenced to a sample set of a Right of Way Plans. You will find those sheets at the back of your sample pack of Plan Sheets that you received when you began this manual.

In your set of plans, you will find two (2) Cover Sheets for “Proposed Right of Way SR 16—Arthur K. Bolton Parkway.” Notice the Sheet Number differences for the Cover Sheet. The Right of Way information begins on Cover Sheet Number 1 and finishes on Sheet number 2. The construction plans had one coversheet. Similar to construction plans, a revision summary sheet is also included (Sheet 3).

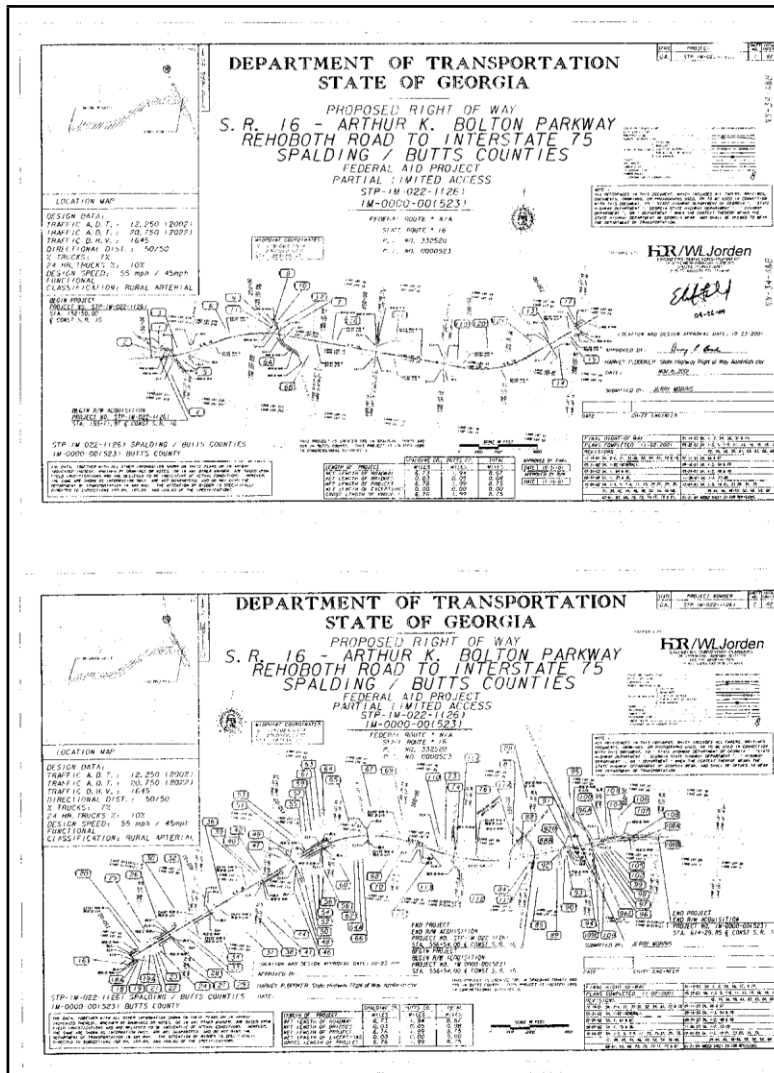

Figure 15-1. Right of Way Plan Sheet: Cover Sheets 1 and 2.

While there are similarities between a Construction Cover Sheet (page 4) and a Right of Way Cover Sheet, there are also differences.

A. Similarities

1. Title of Description - "SR16—Arthur K. Bolton Parkway" in Spalding and Butts counties. It is a federal-aid project, but the project involved partial limited access and is not on a Federal route. The interstate improvements are on I-75.
2. Project Number - you will notice that the Right of Way Sheets included in your sample pack of plans is STP-IM022-1(26) and IM-0000-00(523), the same as the construction plans. Between the time the Right of Way plans are developed, in the Preconstruction phase of a project, and the time the project reaches the Construction phase, slight changes may be made, such as an administrative or funding source change. This could cause a change in the Project Number.
3. Location Sketch - both Cover Sheets have a location sketch on them.
4. Sheet Identification Block - both have blocks in the upper right corner showing the project number, the sheet number, and the total number of sheets. This set of Right of Way plans has 82 sheets compared with the 770 sheets in the construction plans.
5. Scale & Length of Project - both have a Scale Box & a Length Box. Sometimes the Gross length of Construction plans may be different than the Right of Way Length. It is likely that a difference is the distance needed to tie into the existing construction where the right of way was already purchased and the new construction.
6. Miscellaneous - both sets of cover sheets have information attesting to their legal status and the basis on which they are developed.

B. Differences

1. Property Owners - instead of an Index, the Right of Way Cover Sheet shows adjoining parcels and a number identifying the parcel (rectangular boxes with numbers).
2. Plan View - the Plan View shows the project in the relationship to the affected property lines rather than the topographical landmarks of a Construction Cover Sheet.
3. Conventional Symbols - notice, particularly, the block in the upper right side. You should pay close attention to the slight variations among the various types of lines. Refer to Figure 15-2 for an example of a Conventional Symbol block.

The letters P & L written on the line identifies property lines. Usually a property line is a thin solid line broken by a single dash. Notice that the symbol for existing Right of Way is the same as that for a property line, but without the P.L. This applies to the Right of Way Plans. On Construction Plans, existing Right of Way is shown by long, broken thin lines. Look at Construction Right of Way Plan Sheet 61, near Station 175+00, either to the right or left for an example of this.

Using Right of Way Plan Sheet 31, answer the questions:

- 15-2** Locate the property of Frank Chen, Parcel 37. At what station point and offset does the property line between Chen and Holcomb intersect the required right of way?

Property information that details the right of way taking is either shown on the same plan sheet on which the property is shown, or on a separate plan sheet. The property being taken will be described by a point, offset/distance, station/bearing and alignment. The point reference is shown on the right of way plan sheet. The offset/distance is the offset from centerline, and the distance is to the next right of way point. The station/bearing is the station of the point, and the bearing is to the next right of way point. The alignment indicates what construction centerline is being used (mainline or side road). Using Figure 15-4 from KC25004 to KC25005 is 48.252

feet at a bearing of N 88° 34' 56.99" E. Point KC25004 is 38.630 feet left of Rehoboth Road at Station 10+75.

Similar information is also given for required drive easements, temporary easements, construction easements, and limited access.

***** PARCEL 1 REQ'D R/W KC25002 *****			
PNT	OFFSET/ DIST	STATION/ BEARING	ALIGNMENT
KC25004	38.630 L	10+75.00	REHOBOTH RD.
	48.252	N 88°34'56.99" E	
KC25005	60.000 L	11+20.00	REHOBOTH RD.
ARC LENGTH = 77.483			
CHORD BEAR = S 73°33'26.47" E			
LNTH CHORD = 77.296			
RADIUS = 321.972			
DEGREE = 17° 47' 42"			
KC25010	60.000 L	12+11.92	REHOBOTH RD.
	34.802	S 11°38'36.81" W	
PL1197	25.219 L	12+10.56	REHOBOTH RD.
	127.692	N 64°36'01.01" W	
KC25004	38.630 L	10+75.00	REHOBOTH RD.
	= 2610.10	SF	
	= 0.060	ACRES	
REMAINDER	= +/- 0.677	ACRES	

Figure 15-4. Parcel Required Right of Way.

On this project, there are a number of

construction and/or drive easements. An easement is giving permission to temporarily use a part of someone's private property to perform an act of construction for a set amount of time.

By looking at the Right of Way Plan Sheets, you can identify most of the locations at a glance. They are marked with diagonal shadings. To see one of these locations, look at Right of Way Plan Sheet Number 3 at Parcel Number 3.

Using Right of Way Plan Sheet 31 and 32 (data on Parcel No. 37) to answer the questions:

- 15-3** How much right of way is required on Frank Chen's property (Parcel No. 37)?

- 15-4** How many feet of limited access is required for the same property?

Questions for Appendices

1 Based on the information in the **Definitions** section beginning on page 91, match the columns.

COLUMN A

- A. Plan View
- B. Slope Stake
- C. Culvert
- D. Bearing
- E. Station Equation

COLUMN B

- 1. A stake that contains information that tells the contractor how much “cut” or “fill” is required from the point of the stake to the ditch line (or shoulder point) of the roadway.
- 2. A two dimensional view (length and width) from directly above the object or project.
- 3. A structure not classified as a bridge which provides an opening under a roadway - usually for water drainage
- 4. A point on the centerline where the station numbers of one system change to the station numbers of another system
- 5. A method used to express direction. The angle and direction, which the line makes with respect to a North-South line

2 Based on the information in the **Abbreviations** section beginning on page 103, match the columns.

COLUMN A

- A. HWY
- B. FES
- C. PRIV
- D. NBL
- E. BLA
- F. MP

COLUMN B

- 1. Begin Limited Access
- 2. Highway
- 3. Flared end section
- 4. Private
- 5. Milepost
- 6. Northbound lane

Appendix A: Definitions

A

ABANDONMENT - the act of the cessation (stoppage) of use of a right-of-way with no intentions to reclaim or use the right of way again for highway purposes.

ABUTTING LAND OWNERS - the owners whose land adjoin (abut) the land spoken of.

ACCELERATION LANE - a connecting lane leading from a ramp to a freeway and designed to enable the motorist to merge into freeway traffic.

ACQUISITION OR TAKING - the acquiring of a property in its entirety, or a portion thereof, for highway purposes.

ACRE -a measure of land area 1.e. 160 square rods; 4,840 square yards; 43,560 square feet.

ALIGNMENT - SEE "Horizontal Alignment" and Vertical Alignment".

ANGLE - the figure formed by the intersection of two straight lines.

ARC -a segment of a circle.

AREA DATA SHEETS - sheets in a set of plans which show the areas of the property to be appropriated and the remaining areas shown in acreage or square feet or portions thereof.

AZIMUTH -the angle between true meridian (North) through an observer and the line of sight to an object. In surveying, the azimuth is measured clockwise from the North.

B

BACKFILL - material used to replace (or act of replacing) material used during the construction of a project.

BACKSLOPE - that portion of roadway between the side drainage ditch and the top of the cut - usually measured as a ratio of horizontal distance versus each foot of increase of elevation i.e. 4 to 1 slope.

BALANCE STATIONS - stations between which excavated earth material approximately equals the amount of embankment material required.

BARREL - the part of a culvert that water flows through.

BASE COURSE - a part of the pavement structure between the surface course and the subgrade.

BEAM - member spanning from bent to bent along the bridge with its end resting on a cap or a bent - made of steel or concrete.

BEARING - a method used to express direction. The bearing of a line is the angle and direction, which the line makes with respect to a North-south line.

BENCH MARKS (B.M.) - a point of known elevation, usually a mark of some durable material such as a stone, a concrete post, or a bronze plate to serve as a reference point in running a line of levels for the determination of the elevation.

BENT CAP - a part of a bridge - constructed of reinforced concrete and supported either by means of columns or piles.

BERM DITCH - any open water course constructed for the collection and handling of surface drainage.

BORROW - suitable material from sources outside the project limits used primarily for embankments.

BORROW PIT - an area or pit from which suitable material from sources outside the project limits is excavated. This material is generally used for embankments.

BOUNDARY - that which fixes or indicates a limit or extent to a parcel of land.

BOX CULVERT - (see culvert)

BRIDGE - a structure having a length of over a twenty feet span, erected over a roadway, stream, railroad, depression, or combination of these. Multiple lines of pipe culvert regardless of their length are not considered a bridge.

C

CATCH BASIN - a minor drainage structure

CATTLE PASS - an opening under the roadway which allows the movement of livestock from one side of the road to another. A cattle pass consists of a pipe or box culvert or a provision made under a structure to allow the movement of livestock from one side of the roadway to another.

CENTERLINE - the longitudinal mid-point of all contiguous travel lanes. Surveyed stations are normally on the centerline if the roadway is two lanes.

CHANNEL CHANGE - a man-made change or diversion in the natural flow of water or man-made change in the channel of a ditch, stream, creek, or river.

CIRCULAR CURVE - an arc or segment of a circle joining two tangents (straight lines)

CLEARING - the work done by the contractor to remove and dispose of all trees, stumps, brush, trash, buildings, fence, signs, etc. within the limits of the total project.

COARSE AGGREGATE BASE COURSE - crushed stone used as a part of the roadway base to support pavement.

COMMUNICATION LINE - a utility.

CONDEMNED PROPERTY - property which has been acquired for highway purposes by the exercise of the right or power of eminent domain (stoppage).

CONSTRUCTION EASEMENT - an easement that extends to the furthest limits of construction, beyond the right of way limits as shown on the plans.

CONSTRUCTION ITEMS - work to be done on a project i.e. paving limits, grading, structures, etc.

CONSTRUCTION JOINT - the place where one concrete pour ends, and another begins.

CONSTRUCTION LIMITS - the limits shown on the plans by symbols which designate the limits of construction.

CONTRACT - an agreement between two or more persons or parties to build a section of roadway or structure.

CONTROL OF ACCESS - the condition whereby the Transportation Department controls the right of property owners or occupants of abutting property to enter or leave a highway.

CONVENTIONAL SIGNS - symbols used by the designer to convey a meaning to whoever is reading a set of plans.

CROSS SECTIONS - a view of an object where the object has been "sliced away" - produced by a vertical plane cutting through the roadway at right angles to the centerline showing the profile of existing and proposed earth.

CROWN SLOPE - the slope on the top surface of a roadway.

CUL-DE-SAC - a street or road which is open to traffic at one end only with a special provision for turning around at the other end.

CULVERT - a structure not classified as a bridge which provides an opening under a roadway - usually for water drainage.

CURVE - an arc (segment of a circle) joining two tangents.

CUT - a term used to describe an excavation or removal of earth.

D

DATUM PLANE - an assumed plane of reference above or below which elevations are measured. Sea level is often used as the datum plane.

DEED OF EASEMENT - an instrument by which a right is acquired by the Department to use or control property for highway purposes.

DEFLECTION - a change in the horizontal direction of a line, the magnitude of which is expressed in degrees.

DEGREE - a unit of angular measurement - a degree represents 1/360th part of a circle.

DELTA ANGLE - it is the angle formed by the intersection of the forward and back tangent; represented by the symbol: Δ

DIAPHRAGM - steel or concrete members found on the bridge that are wed (joined) to connect beams or girders together for the purpose of distribution loads to all supporting members. Diaphragms are normally placed perpendicular to the beams of the bridge.

DITCH SLOPE - see Side Slope

DRAINAGE EASEMENT - an instrument or easement granting the Department the necessary property beyond the right of way limits as shown on the plans to provide for the proper drainage of a highway.

DITCH - an open water course constructed for the collection and handling of surface drainage.

E

EARTHWORK - amount of cut and fill earth to be worked with between any two specific stations (measured in cubic yards of earth).

EASEMENT - a property right to use or control the real property of another person.

EGRESS - the act of leaving.

ELEVATION - the height above or below the average level of the sea or other datum plane.

EMBANKMENT - a wall of material, such as dirt, to raise the height of a roadway - or where a "cut" section has been made through an undulating (up and down) surface.

EMINENT DOMAIN - the government's acquiring private property for public use by virtue of the superior dominion of the government over all lands within its jurisdiction.

ENCROACHMENT - the use of highway right of way for an indefinite term with or without permission of the Transportation Department. Encroachments usually involve man-made obstruction either above or below the highway.

END BENT - that part of a bridge, on either end, that supports the beams.

ENDWALL - a minor drainage structure.

EQUALITY - see Station Equation.

F

FEDERAL HIGHWAY ADMINISTRATION - the office within the Department of Transportation in the U.S. Government which reviews, recommends, and approves the details concerning Federal participation on our highway system.

FEE SIMPLE TITLE - absolute ownership of property including also the unlimited right to control same for any purpose whatsoever.

FENCE - an item, usually made of barbed wire, chain link, or woven wire, to keep animals off a controlled access roadway.

FILL - use of suitable material (usually earth or gravel) to equalize or raise topography to a certain elevation; to build up with fill; to fill low ground with sand, gravel, or earth, etc.

FILL SLOPE - that portion of a roadway between the outside of the shoulder and the toe of the slope.

FINISHED GRADE LINE - proposed elevations along the finished surface of the roadway.

FLARED END SECTION - an end treatment that is part of a minor drainage structure.

FOOTING - that part of a bridge that supports the column and is usually constructed of reinforced concrete.

FRONT ELEVATION - a view from the front side of an object.

G

GUARDRAIL - a protective barrier placed between travel lanes of the roadway and a safety hazard (such as high fill, bridge piers, etc.).

H

HANGER - usually located below a bridge to hold a water line, gas line, or telephone line.

HEADWALL - that part of a culvert that retains fill.

HORIZONTAL ALIGNMENT - a series of tangent and curves on the "Plan View" which show the direction of the road.

HORIZONTAL DISTANCE - a measurement on a Typical Section from the Centerline of a roadway to the edge of the pavement - the slope is not taken into consideration in a horizontal distance - all horizontal measurements are level lines.

I

IMPROVEMENT DESIGNATIONS - designations or symbols shown on the plans which identify specific improvements or items of real or personal property.

INDEX OF SHEETS - a brief summary of each sheet or series of sheets in a set of plans.

INGRESS - the act of entering.

INLET END OF A CULVERT - the end that the water enters.

INSERT - an item embedded in the concrete of a structure. A hanger screwed into an insert to hold water lines, gas line, or telephone conduit.

INTERIOR BENT - that part of a bridge that supports the beam and is not at either end of the bridge.

INTERSECTION - a place where two roads join at a common point.

INTERSECTION DETAILS - sheets on a set of plans showing a larger scale view of detailed information of proposed intersection in a particular project.

J

JUNCTION BOX - a minor drainage structure.

L

LIMITED ACCESS - Ingress and egress to a highway is at points designated by the Department of Transportation.

LOCATION MAP - a small map found on the Cover Sheet which shows the location of the project. (The beginning and ending of the project).

LONGITUDINAL CROSS SECTION - a view of the side of an object that has been “sliced away”.

M

MANHOLE - a minor drainage structure.

MEDIAN - the center section of a divided highway which separates the traffic lanes in one direction from the traffic lanes in the opposite direction.

MEDIAN EDGE OF PAVEMENT - on a dual lane road, the inside pavement edge or line.

MILE - 5,280 feet.

MINOR DRAINAGE STRUCTURE - an inlet, junction box, manhole, spring box, catch basin, endwall, flared end section, etc.

N

NATURAL GROUND LINE - see “Original Ground Line”.

NORTH ARROW - on all construction and right of way plans, there is an arrow-like symbol with the point indicating North. The direction of all control and boundary lines are in reference to this North-South arrow.

O

OFFSET SLOPE STAKE - sometime, in order to allow the contractor to perform his work without destroying the slope stake, slope stakes are placed farther back from the Centerline of the roadway.

ORIGINAL GROUND LINE - shows how the land was before construction began.

OUTLET END OF A CULVERT - the end of a culvert that the water flows from.

OWNERSHIP - the legal right of possession of real or personal property. Ownership of property designated on the plans is shown by the owner's name appearing in print on the plans.

P

PARCEL NUMBER - the number designated on the plans generally enclosed by a circle which designates a parcel or tract of land.

PART PLAN - a plan view of an item when only a part of the item is shown.

PARTIAL CONTROL OF ACCESS - similar to Limited Access in that the Department of Transportation will give preference to through traffic. Access connection may be provided with selected public roads. There may be grade crossings and some private driveway connections allowed at designated locations.

PARTIAL TAKE - the acquiring of a portion of a property for highway purposes.

PAVEMENT LINES - the edge of the pavement on a roadway.

PAVEMENT SCHEDULE - a statement showing the type and thickness of pavement to be used in a Typical Section.

PAVING LIMITS - the total length and width to be paved on any portion of a project.

PERMANENT EASEMENT - an easement in perpetuity that gives the Department the right to utilize property for an unlimited time.

PERPENDICULAR - a line at right angles to a given line or plane.

PERSONAL PROPERTY - the right or interest in personal things which are movable or transferable from one place to another.

PILES - used in construction of a bridge when subsoil is not firm enough to support a footing of a bridge bent; materials may be wood, steel, or concrete.

PLAN SHEET - a sheet in a set of plans showing the "Plan View" of a part of a particular project.

PLAN VIEW - a two dimensional view (length and width) from directly above the object or project.

PROFILE GRADE - a longitudinal length of the roadway showing the "up and down" (rise and fall) of the roadway.

PROFILE GRADE LINE - the trace of a vertical plane intersecting the top surface of the proposed roadway (wearing surface) usually along the longitudinal centerline of the roadbed.

PROFILE VIEW - a side (longitudinal) view of an object (roadway) showing an elevation of the original ground line and an exaggerated elevation of the proposed roadway.

PROPERTY LINES - the boundaries or limits outlining the ownership of a tract or parcel of land.

R

REAL PROPERTY - the rights and interests in land and those items or things of a permanent nature affixed to the land and generally whatever is growing upon the land.

REAR ELEVATION - a view from the back side of an object.

RETAINING WALL - a vertical wall constructed for the purpose of supporting fill in areas of limited right of way.

RIGHT OF ACCESS - the right of ingress (entering in) or egress (leaving from) to a highway from abutting property.

RIGHT OF WAY - This is a term denoting land, interest therein, or property which is acquired for highway purposes.

REQUIRED RIGHT OF WAY BOUNDARY OR LIMITS - the limits or boundaries as shown on the plans which show how much property is to be acquired for right of way in order to properly construct the highway.

RIGHT OF WAY MONUMENT - a marker, usually concrete, placed on the ground that shows or indicates the limits of the right of way.

RIGHT OF WAY PLANS - are plans which contain all necessary information for the acquisition of right of way as found on design plans with the addition of any additional information that may be helpful in the acquisition of right of way.

S

SCALE - the measurement (length) used on a set of plans to represent a larger measurement. For instance, 1" in a set of plans may mean (or equal) 100'.

SHOULDER - the portion of roadway adjacent to the traveled surface for accommodation of stopped vehicles for emergency use, and for lateral (side) support of base and surface courses.

SHRINKAGE - when earth is taken from its original position and placed in a fill area, it is compacted. Shrinkage takes place due to the decrease in volume from the earth's being compacted.

SIGHT DISTANCE - the length of roadway visible to the driver of a vehicle at any given point on the roadway when the view is unobstructed.

SIDE ELEVATION - a view from the right or left of an object.

SIDE SLOPE - that portion of the roadway between the shoulder point and the adjacent drainage ditch.

SIGHT DISTANCE - the length of roadway visible to the driver of a vehicle at any given point on the roadway when the view is unobstructed.

SKEW ANGLE - the angle that a pipe, culvert, bridge, or other structure makes with the centerline of the roadway as measured in a clockwise direction from the centerline.

SLOPE - a ratio of horizontal distance versus each foot of decrease or increase in elevation.

SLOPE STAKE - a stake that contains information that tells the contractor how much “cut” or “fill” is required from the point of the stake to the ditch line (or shoulder point) of the roadway.

SPAN - a portion of a bridge made up of the bridge slab and beams that cross over the roadway or stream below. The span is supported on each end by bents. A culvert span is that portion of the top slab between the walls of a barrel.

SPRING BOX - a minor drainage structure.

STANDARD DRAWINGS - a group of plan sheets for the construction of various items in a project.

STANDARD SPECIFICATIONS - a book published by the Georgia Department of Transportation which gives various standards for different items.

STATION - the horizontal measurement along the survey line of a project from West to East or South to North. Stations are measured in 100-foot intervals. When used as a location, a station is a designated point on the project.

STATION AND OFFSETT - those locations designated on the plans by distance from and/or reference to a point on the survey line which designates the location of a property line intersecting a right of way boundary or which designates the location of a right of way monument on the right of way boundary.

STATION EQUATION - a point on the centerline where the station numbers of one system change to the station numbers of another system.

STRUCTURE - consists of a bridge, culvert, or retaining wall.

SUBGRADE - the top surface of a roadbed that is prepared as a foundation for the pavement structure.

SUBSTRUCTURE OF A BRIDGE - that part of the bridge that is below the top of the bent cap.

SUMMARY OF QUANTITIES - a plan sheet which shows the total amounts of all items included in a particular contract.

SUPERELEVATION - that amount of elevation required on the surface of a curve in order to overcome the centrifugal force that acts on a motor vehicle. The difference in elevation between the edges of a traffic lane applied where curves in the roadway alignment are used.

SUPERSTRUCTURE OF A BRIDGE - that part of the bridge that is above the top of the bent cap.

SURFACE COURSE - the top layer of the pavement structure.

SURVEY LINE - a line established by surveying to mark the location of a highway as the boundaries of property.

SYMBOLS - a conventional sign used in writing or printing which relates or represents quantities, items, or things.

T

TANGENT - any straight section of the roadway (alignment). A tangent to a curve is a line that touches the curve at one point and is also at right angles to the radius at the point of contact with the curve.

TEMPORARY EASEMENT - an easement granted to the Transportation Department on a temporary basis usually for a specified time and specified purpose. A right to use the land during construction which, upon completion, the land reverts back to the owner.

TOTAL TAKE - the acquiring of a property in its entirety for highway purposes.

TRAVEL LANES - lanes in which vehicles move.

TYPICAL SECTION - a cross sectional view of a roadway showing how the roadway would appear after the roadway is completed.

U

UTILITY - physical plants and operating facilities which provide public or private utilities consisting mainly of communication lines, electric power lines, gas lines, water mains, sewer mains, and other pipe lines, and the supporting structures for these facilities.

V

VERTICAL - perpendicular to the plane of the horizon or to a primary axis.

VERTICAL ALIGNMENT - see "Profile View".

VERTICAL CURVE - a parabolic curve drawn tangent to intersecting grade lines to provide a smooth transition from one grade to another.

VIEW - the way you look at or "see" the different items that are shown in a set of plans.

W

WASTE - that portion of excavated material from a project that is not used in the construction of the project.

WASTE AREA - an area or location in which excess or unsuitable material obtained during construction is deposited.

WASTE PIT - area or location in which excess or unsuitable material obtained during construction is deposited.

WINGWALL - a part of a culvert that extends at an angle to keep earth from spilling into the stream bed.

Appendix B: Abbreviations

A

Aban - abandoned

Ac - acre

ADT - average daily traffic

Ahd or Ah - ahead

Asph - asphalt

Ave - avenue

Az - azimuth

B

Bd - board

Beg - begin

BFSE - begin full superelevation

Bk - back

BLA - Begin Limited Access

BLK - block

Blvd. - boulevard

BM - bench mark

Bn - beacon

BNC - begin normal curve

Br - bridge, branch

BRC - begin reverse crown

Brg - bearing

BSE - begin superelevation

BST - bituminous surface treatment

BW - barbed wire

C

C/A - control of access

CB - catch basin

Cem - cemetery

CH - courthouse

Ch - church

C/L - centerline

CM - corrugated metal

CMP - corrugated metal pipe

Co - county

Comb - combination

Conc - concrete

Const - construction

Coord - coordinate

Cor - corner

Cr - creek

CY - cubic yards

D

D - dwelling, degree of curve

DI - drop inlet

Dist - district

Div - division

Dr - drive

E

E - east

EFSE - end full superelevation

ELA - End Limited Access

Elev - elevation

EMB - embankment

ENC - end normal crown

ERC - end reverse crown

ESE - end superelevation

EXCAV - excavation

Expwy - expressway

Ext - extension

F

F - frame, face of curb

Fd - ford

FES - flared end section

FL - focal length

For - forest

FR - frame

Ft - fort

Fwy - freeway

Fy - ferry

G

GABC - graded aggregate base course

Gals - gallons

G - garage, gutter

GI - grated inlet

Gr - gravel

H

Hyd - hydrant

Hdqtrs - headquarters

Horiz - horizontal

Hosp - hospital

H Tr - house trailer

Hwy - highway

I

ID - inside diameter

Ind - Indian

IP - iron pin

J

JB - junction box.

Junc - junction

L

L - lake, line, location, lane

Lbs - pounds

Ldg - landing

LF - linear feet

LH - lighthouse

LS - lump sum

Lt - light, left

M

M - masonry

Max - maximum

Med - median

MH - manhole

Mi - mile

Mil - military

Min - minimum

Mon - monument

MP - milepost

MPOC - (midpoint) point on curve

Mt, mts - mountain, mountains

N

N - North

Nat - national

NBL - northbound lane

No - number

O

Obs - observation

OH - outside toilet, outhouse

Orch - orchard

P

P - property line

Pav't - pavement

PC - point of curve

Pd - pond

PG - profile grade point

PGL - profile grade line

PH - powerhouse

PI - point of intersection of tangents (curve)

PIS - point of intersection of tangents (spiral)

Pk - peak

Pkwy - parkway

PL - property line

Plan - planimetry

PO - post office

POC - point on curve

MPOC - point on curve (midpoint)

POS - point on spiral

POST - point on sub-tangent

PP - power pole

PRC - point of reverse curve

Priv - private

Prop - proposed

PT - point of tangent

Pt - point

PVC - point of vertical curvature

PVI - point of vertical intersection

PVT - point of vertical tangency

R

R - river

RC - reinforced concrete

RCBC - reinforced concrete box culvert

Rd - road

Rem - remove

Res - reservation, reservoir

RR - railroad

Rt - right

R/W - right of way

S

S - sewer, shack, shed, South, storm, strand

SBL - southbound lane

Sch - school

SE - super elevation

Spr - spring

Sq Yds - square yards

SR - secondary road

SS - sanitary sewer

St - street

Sta - station

Stk - stock

SY or Sq Yds - square yards

T

TBM - temporary bench mark

TC - terra cotta

TCP - terra cotta pipe

Tel - telephone, telegraph

Temp - temporary

Topo - topography

TP - telephone pole

Trans - transmission

U

UC - under construction

UG - underground

UNCL - unclassified

V

V - valve

VA - vertical angle

VC - vertical curve, vitreous slay

Vert - vertical

VPT - vertical photo tie

W

W - water, well, well house, West

WL - water level

WM - water main

WW - waterworks, woven wire

Answers to Chapter Questions

CHAPTER 1

- 1-1. The name of the project: SR 16 from Rehoboth RD to I75.
- 1-2. The project limits, begin and ending project stations.
- 1-3. 102.04, 102.05, 1.4.03
- 1-4. Project location map
- 1-5. Beginning and ending station of the project
- 1-6. 8.74 miles
- 1-7. Engineer's

CHAPTER 2

- 2-1. true
- 2-2. false, part of the construction plans
- 2-3. true

CHAPTER 3

- 3-1. 9.5" or 237.5 mm
- 3-2. graded aggregate base
- 3-3. 3'6" or 3.5'
- 3-4. 6 percent
- 3-5. 2
- 3-6. varies 2' to 32' (1'0" to 16'0" x 2 = 2' to 32')

CHAPTER 4

- 4-1. 8000, Sheet 19
- 4-2. 3308, Sheet 19
- 4-3. 625 LT to 450 RT = 1075 FT total
- 4-4. 128 yd³, 16,619 lbs. Sheet 21.
- 4-5. 180
- 4-6. 7400 linear feet

CHAPTER 5

- 5-1.
 - 1.plan
 - 2.cross section
 - 3.longitudinal cross section
 - 4.side elevation
 - 5.rear elevation
- 5-2. front
- 5-3. front
- 5-4. back
- 5-5. lead
- 5-6. wood
- 5-7. front

CHAPTER 6

- 6-1. 100 feet
- 6-2. 90 feet
- 6-3. 510 feet
- 6-4. 248.6
- 6-5. 100
- 6-6. 69
- 6-7. 259.12
- 6-8. 412+50
- 6-9. 411+50
- 6-10. 100
- 6-11. East or North
- 6-12. a) 549+50; b) 2+50
- 6-13. 14+00
- 6-14. 15+25
- 6-15. north or east
- 6-16. 88.6
- 6-17. back of
- 6-18. 250 feet
- 6-19. 2+00
- 6-20. 1141+40
- 6-21. proposed pole
- 6-22. underground cable
- 6-23. Southern Natural Gas

CHAPTER 7

- 7-1. north
- 7-2. roadway plan sheets
- 7-3. right
- 7-4. false
- 7-5. true
- 7-6. 152+50 [STP-IM-022-1(26)]
- 7-7. plan sheets
- 7-8. 156+93.39
- 7-9. $1^{\circ} 00' 11.98''$
- 7-10. direction, degrees, minutes, seconds
- 7-11. 360
- 7-12. quadrants
- 7-13. direction
- 7-14. N $63^{\circ} 29' 40.78''$ E
- 7-15. $63^{\circ} 29' 40.78''$

7-16.

1. K
2. A
3. N
4. M
5. L
6. H
7. F
8. B
9. D
10. C
11. I
12. J
13. G
14. E

7-17. vertical alignment

7-18. Centerline

7-19. Does not

7-20. Solid

7-21. Fill

7-22. Cut

7-23. Feet

7-24. left & right

7-25. Bench mark

7-26. Grade

7-27. 893.81

7-28. 894.46

7-29. Crest

7-30. Sag

7-31. triangle

7-32. Grade point

7-33. 892.90

7-34. Below

7-35. -0.67%

7-36. Sag

7-37. $PVC = 302+50$, $PVT = 315+50$, $PVI = 309+00$

7-38. 1300 feet

7-39. A) Jackson RD $23+02$ to $26+50 = 348'$

B) Glade RD $21+11$ to $21+50 = 39'$

7-40. Variable, existing to 12'

7-41. Picture and description

7-42. Paving limits

7-43. Construction limits

7-44. Construction plans

7-45. Summary of quantities

7-46. Highway

7-47. 7

7-48. 50 feet

CHAPTER 8

- 8-1. are
- 8-2. is not
- 8-3. over
- 8-4. wing wall, barrel, headwall (parapet)
- 8-5. toe wall
- 8-6. wing
- 8-7. horizontal
- 8-8. vertical
- 8-9. span=10 feet; height= 8 feet
- 8-10. inlet higher
- 8-11. outlet
- 8-12. construction joints
- 8-13. headwall (parapet)
- 8-14. centerline of culvert, centerline of roadway
- 8-15. 83.05 degrees
- 8-16. left; right
- 8-17. 836.64
- 8-18. 833.64
- 8-19. 0.77% 1.44%
- 8-20. fill
- 8-21. are
- 8-22. superstructure, substructure
- 8-23. beams or girders
- 8-24. bent, bent cap
- 8-25. substructure
- 8-26. piles or earth
- 8-27. steel; concrete
- 8-28. steel; concrete
- 8-29. gas; telephone; water
- 8-30. 2, 4"

CHAPTER 9

- 9-1. false, approximate location

CHAPTER 10

- 10-1. are
- 10-2. do
- 10-3. do
- 10-4. are
- 10-5. Site Plan; Planting Plan; Planting Plan Detail; Irrigation Plan
- 10-6. 5 inch skip white
- 10-7. 24inch white

CHAPTER 11

- 11-1. false
- 11-2. false
- 11-3. false

CHAPTER 12

- 12-1. greater
- 12-2. 161
- 12-3. 1) grassing; 2) silt fence; 3) straw mulch or
1) silt gates; 2) baled straw; 3) soil reinforcing mats

CHAPTER 13

- 13-1. false
- 13-2. false, dashed
- 13-3. false, template is shown
- 13-4. centerline
- 13-5. is
- 13-6. is not
- 13-7. are
- 13-8. do

CHAPTER 14

- 14-1. A-2; B-3; C-1

CHAPTER 15

- 15-1. 211
- 15-2. KC 20026; STA 394+27.05, 197.643 RT
- 15-3. 0.097 AC
- 15-4. 1295.11 FT

APPENDICES

- 1.A-2; B-1; C-3; D-5; E-4
- 2.A-2; B-3; C-4; D-6; E-1; F-5

Index

A

Abbreviations 23, 28, 36, 42, 95, 109

 Superelevation abbreviations 42

Alignment

 Horizontal 26, 37-39, 41, 48, 51, 97, 101

 Vertical 45, 48, 51, 97, 106, 121

B

Bearings 42,

Bents 60-62, 64, 105

Box culverts 54

Bridges 10, 53, 60-61, 73

C

Construction limits 29, 50, 71, 88, 99, 121

Cover/coversheet 1-12, 19, 91, 92-93, 102

Cross section 2, 13, 16, 19-20, 38, 41, 45, 49, 53, 56, 64-65, 67, 71, 72, 79-81, 84, 99, 102, 106

Culvert 19, 51-59, 97, -99, 101, 103, 105, 107, 122

Curves 39-41, 48, 101, 105

D

Design data 10

Detailed estimate 1, 15-17

Drainage 2, 37-38, 53, 56, 71, 73-74, 80, 88, 95, 97-102, 105

Drainage summary 15-16

E

Earthwork 2, 77, 79-80, 100

Elevations 19, 21, 46-47, 56, 62, 77, 80, 99, 101

Equalities 24, 26-27

Erosion 2, 73-75

Errors 2

F

Fencing 50-51, 87

G

Grade 13-14, 45-49, 56, 58, 77-80, 89, 101, 103, 106, 114, 121

Grade point 13, 48, 114, 121

Guard rail 15, 50

H

Highway lighting 69

Horizontal distance 14, 47, 80, 97, 101, 105

I

Index sheet 11-12, 85

Intersection details 85, 101

L

Land lots 93

Landscaping 69, 87

Layout view 5, 8

Lighting 2, 69-70

Longitudinal cross section 19-20, 54, 102

M

Markings 69-71

O

Omissions 1-2

P

Pavement markings see Markings

Paving limits 49, 99, 103

Pipe culverts 53

Pollution 73

Project length 10, 27

Project location sketch 3, 5

R

Revision summary sheet 1, 11-12, 91

Right of way 13, 29, 37-39, 50-51, 87-94, 97, 99, 100, 102, 104-105, 115

S

Scale 3, 8, 10, 45, 74, 77, 85, 92, 101, 104

Sedimentation 75

Signing 1-2, 69, 71

Slope stakes 82-84, 87, 103

Station equations (equalities) 24, 26, 77

Stationing 23-26, 37-38

Summary of quantities 1, 15, 50, 69, 75, 105

Superelevation 39-42, 44, 85, 105, 109, 111

Symbols 23, 28-29, 30, 36, 50, 75, 88-89, 92, 99, 101, 106

T

Telephone and Telegraph symbols 34

Traffic signals 69

Typical section 1, 13-14, 49, 56, 78-81, 101, 103, 106

U

Utility accommodations 64

Utility plans 2, 67

Utility symbols 30

V

Vertical alignment 45, 48, 51, 97, 106, 121

Vertical curves 48

Views 19-21, 39, 59, 60, 62, 80, 85

W

Water mains 30, 90, 106

Wing walls 58-59