

**AIRCRAFT ACCIDENT REPORT 1/2010**

---

**Air Accidents Investigation Branch**

---

**Department for Transport**

---

**Report on the accident to  
Boeing 777-236ER, G-YMMM,  
at London Heathrow Airport  
on 17 January 2008**

---

This investigation was carried out in accordance with  
*The Civil Aviation (Investigation of Air Accidents and Incidents) Regulations 1996*

The sole objective of the investigation of an accident or incident under these Regulations shall be the prevention of accidents and incidents. It shall not be the purpose of such an investigation to apportion blame or liability.

© *Crown Copyright 2010*

Published with the permission of the Department for Transport (Air Accidents Investigation Branch).

This report contains facts which have been determined up to the time of publication. This information is published to inform the aviation industry and the public of the general circumstances of accidents and serious incidents.

Extracts may be published without specific permission providing that the source is duly acknowledged.

Published 9 February 2010

**Printed in the United Kingdom for the Air Accidents Investigation Branch**

**Department for Transport  
Air Accidents Investigation Branch  
Farnborough House  
Berkshire Copse Road  
Aldershot  
Hampshire GU11 2HH**

January 2010

*The Right Honourable Lord Adonis  
Secretary of State for Transport*

Dear Secretary of State

I have the honour to submit the report by Mr P A Sleight and Mr R D G Carter, Inspectors of Air Accidents, on the circumstances of the accident to Boeing 777-236ER, registration G-YMMM at London Heathrow Airport on 17 January 2008.

Yours sincerely

**David King**  
Chief Inspector of Air Accidents



## Contents

<b>Synopsis.....</b>	<b>1</b>
<b>1 Factual Information .....</b>	<b>4</b>
1.1 History of the flight.....	4
1.1.1 Previous flights .....	6
1.2 Injuries to persons .....	7
1.3 Damage to aircraft.....	7
1.4 Other damage .....	7
1.5 Personnel information.....	7
1.5.1 Commander.....	7
1.5.2 Senior co-pilot (Operating).....	8
1.5.3 Co-pilot (Cruise).....	8
1.5.4 Crew rest.....	8
1.6 Aircraft information .....	9
1.6.1 General.....	9
1.6.2 ‘AIRSPEED LOW’ and stall warning.....	9
1.6.3 Autoflight.....	10
1.6.3.1 Autopilot .....	10
1.6.3.2 Autothrottle (A/T).....	10
1.6.4 Electrical.....	11
1.6.4.1 Electrical Load Management System (ELMS).....	11
1.6.5 Cabin.....	12
1.6.5.1 Layout .....	12
1.6.5.2 Cabin lighting.....	13
1.6.5.3 Emergency lighting.....	14
1.6.5.4 Seats .....	14
1.6.6 Engine fire protection and detection .....	16
1.6.7 Flying controls .....	16
1.6.7.1 Flaps.....	16
1.6.8 Fuel System.....	16
1.6.8.1 Fuel temperature measurement.....	22
1.6.8.2 Fuel spar valve control and indication.....	23
1.6.8.3 Fuel quantity .....	24
1.6.9 Engine.....	25
1.6.9.1 Engine control.....	25

---

1.6.10	APU .....	26
1.6.10.1	APU fuel system .....	26
1.6.10.2	APU control .....	27
1.6.11	Hydraulics.....	27
1.6.12	Ram Air Turbine (RAT).....	27
1.6.13	Landing gear .....	27
1.6.14	Oxygen.....	29
1.6.14.1	Crew oxygen system.....	29
1.6.14.2	Passenger oxygen system.....	29
1.6.15	Structure.....	30
1.6.15.1	Fuselage .....	30
1.6.15.2	Wings .....	30
1.6.15.3	Engine nacelle attachment .....	30
1.6.16	Air temperature measurement.....	31
1.6.16.1	Total Air Temperature (TAT).....	31
1.6.16.2	Static Air Temperature (SAT) .....	31
1.6.17	Central Maintenance Computer .....	31
1.6.18	Aircraft maintenance history .....	32
1.7	Meteorological information .....	33
1.7.1	Beijing.....	33
1.7.2	En route.....	33
1.7.3	Heathrow.....	34
1.8	Aids to navigation.....	35
1.9	Communications .....	35
1.10	Aerodrome information.....	35
1.11	Flight Recorders.....	37
1.11.1	Introduction .....	37
1.11.2	Recorded Data - Beijing to London.....	39
1.11.3	Engine oil recorded data .....	44
1.11.4	DFDR and QAR system recording requirements .....	52
1.11.5	Data mining.....	52
1.12	Wreckage, impact information and aircraft examination.....	53
1.12.1	Accident site .....	53
1.12.2	Ground marks .....	53
1.12.3	Initial examination .....	56
1.12.3.1	Circuit breakers.....	56
1.12.3.2	Cockpit switch positions .....	56

1.12.3.3	Landing gear examination.....	57
1.12.3.4	Oxygen leakage.....	62
1.12.3.5	Aircraft structural examination.....	63
1.12.3.6	Engine pylons.....	63
1.12.3.7	Cabin.....	64
1.12.3.8	Fuel quantity.....	68
1.12.3.9	Left and right wing wiring damage.....	69
1.12.3.10	Engines.....	69
1.12.3.11	Fuel system.....	70
1.12.3.12	Fuel vent system.....	73
1.12.3.13	Fuel system valves.....	73
1.12.3.14	Auxiliary Power Unit.....	73
1.12.3.15	Ram Air Turbine.....	73
1.12.4	Detailed Examination.....	74
1.12.4.1	Engine.....	74
1.12.4.2	Aircraft fuel system.....	77
1.12.4.3	Electrical system.....	84
1.12.4.4	Auxiliary Power Unit Controller (APUC).....	84
1.13	Medical information.....	84
1.14	Fire.....	85
1.15	Survival Aspects.....	85
1.15.1	Evacuation.....	85
1.15.2	Airport Fire Service.....	86
1.16	Tests and Research.....	86
1.16.1	Effect of flap selection.....	86
1.16.2	Fuel.....	87
1.16.2.1	Fuel samples.....	87
1.16.2.2	Review of documentation for fuel loaded onto G-YMMM at Beijing.....	87
1.16.3	High Intensity Radiated Field (HIRF) and Electro-Magnetic Interference (EMI).....	88
1.16.4	Engine fuel system.....	88
1.16.4.1	Engine System Test Facility (STF) testing.....	88
1.16.4.2	Full-scale engine testing (L12).....	90
1.16.5	Fuel System Testing.....	93
1.16.5.1	Introduction.....	93
1.16.5.2	Full-scale aircraft tests.....	93

---

1.16.5.3	Boeing subscale fuel icing tests .....	94
1.16.5.4	Boeing large-scale icing tests.....	95
1.16.5.5	Observations .....	101
1.16.5.6	Fluid modelling.....	110
1.16.5.7	Thermal modelling.....	111
1.16.6	Ice formation in B777 fuel tanks .....	112
1.16.7	Aeration testing.....	114
1.16.8	Evacuation Alarm .....	115
1.16.9	Crashworthiness modelling.....	115
1.16.9.1	Crashworthiness certification requirements.....	115
1.16.9.2	Crashworthiness modelling.....	115
1.16.10	Structure metallurgical tests.....	116
1.16.11	Cabin lighting tests .....	116
1.16.11.1	Fluorescent tubes .....	116
1.16.11.2	Exit light signs .....	117
1.17	Organisational and management information.....	117
1.18	Additional information.....	117
1.18.1	Aviation turbine fuel .....	117
1.18.1.1	Types of aviation turbine fuel .....	117
1.18.1.2	Water in aviation turbine fuel.....	118
1.18.1.3	Estimated water content of fuel on G-YMMM.....	119
1.18.1.4	Formation of ice in fuel.....	119
1.18.1.5	Generation of ice in testing .....	120
1.18.1.6	Fuel waxing.....	121
1.18.1.7	Entrapped air in aviation fuel.....	122
1.18.2	Other relevant events .....	122
1.18.2.1	Incident to Boeing 777-200ER (N862DA).....	122
1.18.2.2	Accident to USAF B52D .....	123
1.18.3	Literature.....	124
1.18.4	Fuel Heaters .....	125
1.18.5	Fuel System Icing Inhibitor (FSII).....	125
1.18.6	Regulatory information.....	126
1.18.6.1	Introduction.....	126
1.18.6.2	Aircraft fuel system.....	126
1.18.6.3	Engine fuel system.....	128
1.18.7	The operator's policy on fuel sumping .....	129
1.18.8	Ultrasonic water detectors .....	129



1.18.9	Evacuation checklist .....	130
1.18.10	B777-200LR modified drag brace design.....	131
1.18.11	Safety actions taken .....	132
1.18.11.1	Video monitor attachment bracket .....	132
1.18.11.2	Spar valve.....	133
1.18.11.3	Fuel Flow Restriction.....	133
1.19	Useful or effective investigation techniques.....	136
1.19.1	Data mining.....	136
<b>2</b>	<b>Analysis.....</b>	<b>138</b>
2.1	Conduct of the flight .....	138
2.2	Evacuation.....	141
2.3	Aircraft examination .....	142
2.3.1	Auxiliary Power Unit.....	142
2.3.2	Cross-feed valves .....	142
2.3.3	Spar valves .....	142
2.3.4	Left engine HP fuel shutoff valve circuit breaker.....	144
2.3.5	Right suction feed check valve .....	144
2.3.6	Loose fuel scavenge union.....	145
2.3.7	Foreign Object Debris (FOD).....	145
2.4	High Intensity Radiated Field (HIRF) and Electro-Magnetic Interference (EMI).....	145
2.5	Fuel quality .....	146
2.6	Fuel waxing.....	146
2.7	Water management.....	147
2.7.1	Centre fuel tank water content .....	147
2.7.2	Fuel sumping.....	148
2.7.3	Water scavenge .....	148
2.8	Fuel flow restriction .....	149
2.8.1	Engine controls .....	150
2.8.2	Fuel system tests .....	150
2.8.3	Engine testing .....	152
2.8.4	Data mining analysis.....	152
2.8.5	The engine rollbacks.....	154
2.8.6	Other engine/airframe combinations .....	157
2.9	Anti-ice additives in aviation fuel.....	157
2.10	Future industry activity .....	158

2.11	Certification.....	159
2.12	Recorders .....	159
2.13	Crashworthiness .....	160
2.13.1	The fuel tank rupture.....	160
2.13.2	Cabin issues .....	163
<b>3</b>	<b>Conclusions .....</b>	<b>166</b>
(a)	Findings.....	166
(b)	Causal factors.....	176
<b>4</b>	<b>Safety Recommendations.....</b>	<b>177</b>

## Appendices

**App A** - Temperature Conversion Chart

**App B** - Evacuation Check List

**App C** - Fuel Sampling

**App D** - HIRF/EMI of Spar Valve and Control System

**App E** - Gear Pump Cavitation

**App F** - Data Mining

**App G** - Constraints and Limitations of the Fuel Rig Test Procedures

**App H** - Relevant Certification Requirements - Landing Gear

**App I** - Relevant Certification Requirements - Passenger Seats

**App J** - Manufacturer's Analysis of the Accident Landing Gear Breakaway Sequence

**App K** - Crashworthiness Analysis by Cranfield Impact Centre (CIC)

## GLOSSARY OF ABBREVIATIONS USED IN THIS REPORT

°C	Degrees Centigrade	CMM	Component Maintenance Manual
°F	Degrees Fahrenheit	CPU	Central Processing Units
°M	Degrees Magnetic	CRI	Certification Review Item
A/T	Autothrottle	CS	Certification Specification
AAIB	Air Accidents Investigation Branch	CSD	Cabin Service Director
aal	above airfield level	CVR	Cockpit Voice Recorder
AC	alternating current	CW	Continuous Wave
ACARS	Aircraft Communication and Automatic Reporting System	dB	decibel
ACMF	Aircraft Condition Monitoring Function	DC	direct current
AD	Airworthiness Directive	DEF STAN	Defence Standard
ADIRU	Air Data and Inertial Reference Unit	DFDR	Digital Flight Data Recorder
AFM	Aircraft Flight Manual	E&E	Electrical and Electronic
AFS	Airport Fire Service	EASA	European Aviation Safety Agency
agl	above ground level	ECS	Environmental Control System
AIMS	Airplane Information Management System	EEC	Electronic Engine Control
AIR	Aerospace Information Report	EHM	Engine Health Monitoring
amsl	above mean sea level	EICAS	Engine Indication and Crew Alerting System
AoA	Angle of Attack	ELMS	Electrical Load Management System
AOHE	Air/Oil Heat Exchanger	EMI	Electronic Magnetic Interference
APM	Aircraft Performance Monitoring	EPR	Engine Pressure Ratio
APU	Auxiliary Power Unit	FAA	Federal Aviation Administration
APUC	Auxiliary Power Unit Controller	FAME	Fatty Acid Methyl Ester
ARINC	Air Radio Incorporated	FAR	Federal Aviation Requirement
ARP	Aerospace Recommended Practice	FCDC	Flight Control direct current
ASTM	American Society for Testing and Materials	FE	Finite Element
ASU	Aerial Support Unit	FFFP	Film-Forming FlouroProtein
ATC	Air Traffic Control	FL	Flight Level
ATIS	Automatic Terminal Information Service	FMC	Flight Management Computer
ATP	Acceptance Test Procedure	FMS	Flight Management System
BA	British Airways	FMU	Fuel Metering Unit
BS	British Standards	FMV	Fuel Metering Valve
CAS	Computed Air Speed	FOD	Foreign Object Debris
CB	Circuit Breaker	FOHE	Fuel/Oil Heat Exchanger
CCM	Cabin Crew Member	fpm	feet per minute
CDU	Control Display Unit	FQIS	Fuel Quantity Indication System
CG	Centre of Gravity	FQPU	Fuel Quantity Processor Unit
CIC	Cranfield Impact Centre	FSII	Fuel System Icing Inhibitor
cm	centimetre	ft	feet
CMC	Central Maintenance Computer	FTPP	Fuel Temperature Predication Program
		g	gravity
		HIRF	High Intensity Radio Frequency
		HP	High Pressure
		Hz	Hertz
		IDG	Integrated Drive Generator

## GLOSSARY OF ABBREVIATIONS USED IN THIS REPORT (cont)

IFE	In-Flight Entertainment	ppm	parts per million
IiC	Investigator in Charge	PSA	Power Supply Assembly
ILS	Instrument Landing System	psi	pounds per square inch
inHg	inches of mercury	psid	pounds per square inch differential
IP	Intermediate Pressure		
JAA	Joint Aviation Authorities	psig	pounds per square inch gauge
JAR	Joint Airworthiness Requirement	PSU	Passenger Service Unit
kg	Kilogram	QAR	Quick Access Recorder
kHz	Kilohertz	R ENG	Right Engine
km	Kilometre	RAT	Ram Air Turbine
kt	knot	RF	Radio Frequency
L ENG	Left Engine	rpm	Revolutions per minute
lb	pound	RTCA	Radio Technical Commission for Aeronautics
lbf	Pound force		
LDA	Landing Distance Available	SAE	Society of Automotive Engineers
LIC	Loop In Control	SAT	Static Air Temperature
LP	Low Pressure	SB	Service Bulletin
m	metre	SOV	Shut Off Valve
mb	millibar	SqW	Square Wave
MBC	Microbiological Contamination	STF	Systems Test Facility
MCP	Mode Control Panel	TAT	Total Air Temperature
MEP	Main Engine Pump	TRA	Throttle resolver angle
MHz	Megahertz	TRU	Transformer Rectifier Unit
ml	millilitre	US Gal	US Gallon
MLG	Main Landing Gear	USAF	US Air Force
mm	millimetre	UTC	Co-ordinated Universal Time
MOD	Ministry of Defence	VDC	Volts direct current
NACA	National Advisory Committee for Aeronautics	VHF	Very High Frequency
NLG	Nose Landing Gear	VNAV	Vertical Navigation
nm	nautical mile	VS	Vertical speed
NORM	Normal	VSV	Variable Stator Vane
NPRM	Notice of Proposed Rule Making	WEU	Warning Electronics Unit
NTSB	National Transportation Safety Board	WFP	Fuel Flow
		WFP30	Fuel flow divided by burner pressure
NVM	Non-Volatile Memory		
OAT	Outside Air Temperature		
OEM	Original Equipment Manufacturer		
OJ	Override/Jettison		
OPAS	Overhead panel ARINC 629 System		
P30	Burner Pressure		
PA	Passenger Announcement		
PCMCIA	Personal Computer Memory Card International Association		
PMG	Permanent Magnet Generator		
pph	pounds per hour		

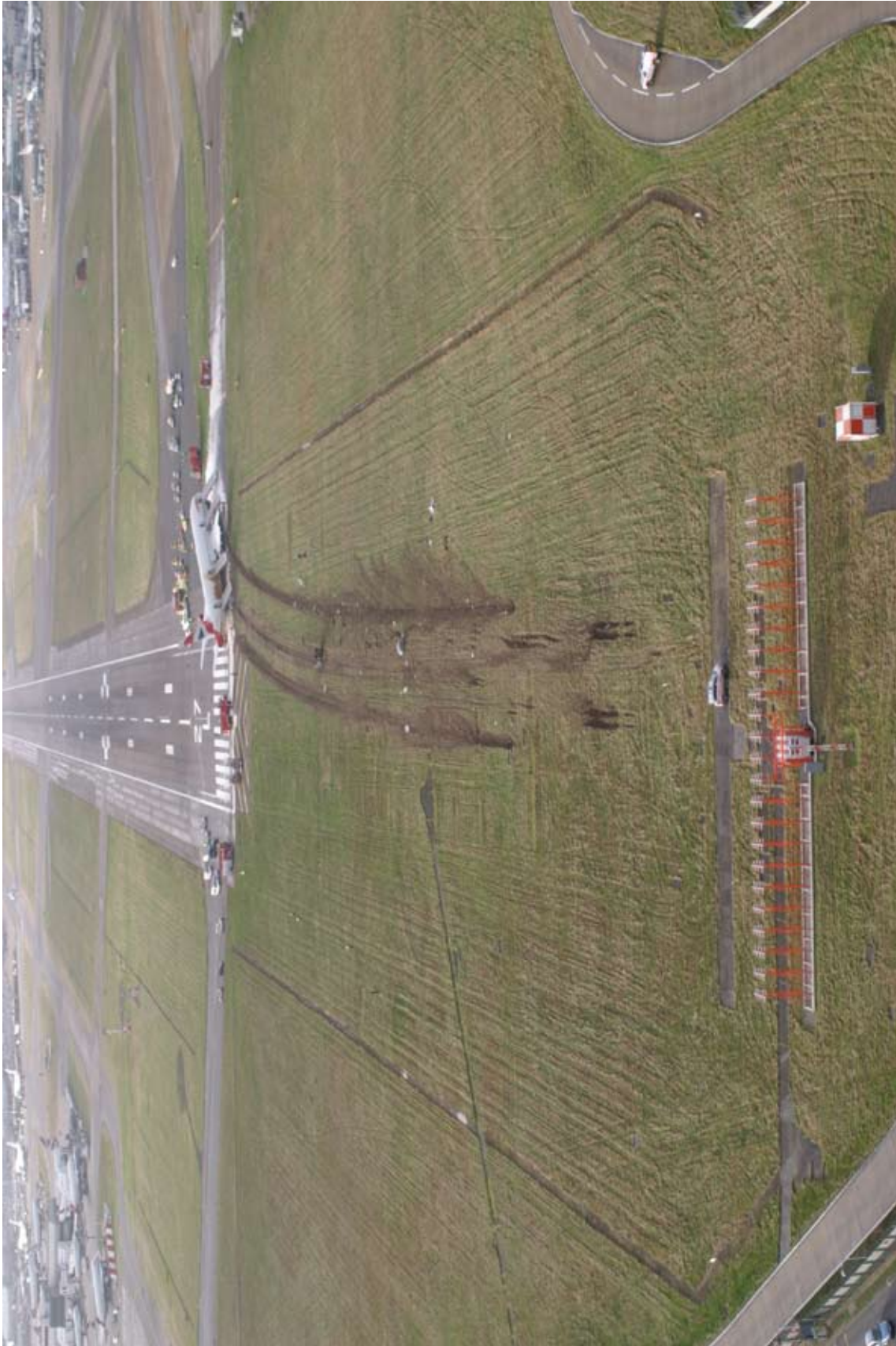

**Figure 1**

*Photograph courtesy of:  
Metropolitan Police ASU*

G-YMMM at Runway 27L undershoot shortly after the accident



---

**Air Accidents Investigation Branch****Aircraft Accident Report No: 1/2010 (EW/C2008/01/01)**

Registered Owner and Operator	British Airways PLC
Aircraft Type	Boeing 777-236ER
Serial No	30314
Nationality	British
Registration	G-YMMM
Place of Accident	London Heathrow Airport
Date and Time	17 January 2008 at 1242 hrs All times in this report are UTC

**Synopsis**

The Air Accidents Investigation Branch (AAIB) was notified at 1251 hrs on 17 January 2008 of an accident involving a Boeing 777-236ER aircraft registration G-YMMM at London Heathrow Airport. The investigation commenced immediately and the AAIB team consisted of:

Mr R Tydeman	Investigator-in-Charge January 2008 – October 2008
Mr R D G Carter	Investigator-in-Charge from November 2008
Mr P A Sleight	Engineering – Deputy IiC & Lead Engineer
Ms A Evans	Engineering – Chair Crashworthiness Group
Mr B D McDermid	Engineering – Chair Fuel and Fuel System Group
Mr S W Moss	Engineering – Chair Powerplant Group
Mr R Parkinson	Engineering – Chair Aircraft Group
Mr M W Ford	Flight Data Recorders – Chair Data Group
Mr A Severs	Operations – Lead Operations
Mr P E B Taylor	Operations – Chair Evacuation Group

In accordance with established international arrangements, the National Transportation Safety Board (NTSB) of the USA, representing the State of Design and Manufacture of the aircraft, appointed an Accredited Representative and was supported by a team which included additional investigators from the NTSB, the Federal Aviation Administration (FAA) and Boeing; Rolls-Royce, the engine manufacturer, also participated fully in the

investigation. The operator co-operated with the investigation and provided expertise as required. The Civil Aviation Authority (CAA) and the European Aviation Safety Agency (EASA) were kept informed of developments.

On 28 November 2008, a Boeing 777-200ER suffered an in-flight engine rollback; an investigation by the NTSB was initiated with Mr P A Sleight, from the AAIB, assigned as the UK accredited representative.

Prior to this Final Report the AAIB published an Initial Report, on 18 January 2008, a subsequent update on 23 January 2008, Special Bulletins on 18 February 2008 and 12 May 2008, and Interim Reports on 4 September 2008 and 12 March 2009.

Eighteen Safety Recommendations have been made.

Whilst on approach to London (Heathrow) from Beijing, China, at 720 feet agl, the right engine of G-YMMM ceased responding to autothrottle commands for increased power and instead the power reduced to 1.03 Engine Pressure Ratio (EPR). Seven seconds later the left engine power reduced to 1.02 EPR. This reduction led to a loss of airspeed and the aircraft touching down some 330 m short of the paved surface of Runway 27L at London Heathrow. The investigation identified that the reduction in thrust was due to restricted fuel flow to both engines.

It was determined that this restriction occurred on the right engine at its Fuel Oil Heat Exchanger (FOHE). For the left engine, the investigation concluded that the restriction most likely occurred at its FOHE. However, due to limitations in available recorded data, it was not possible totally to eliminate the possibility of a restriction elsewhere in the fuel system, although the testing and data mining activity carried out for this investigation suggested that this was very unlikely. Further, the likelihood of a separate restriction mechanism occurring within seven seconds of that for the right engine was determined to be very low.

The investigation identified the following probable causal factors that led to the fuel flow restrictions:

- 1) Accreted ice from within the fuel system<sup>1</sup> released, causing a restriction to the engine fuel flow at the face of the FOHE, on both of the engines.
- 2) Ice had formed within the fuel system, from water that occurred naturally in the fuel, whilst the aircraft operated with low fuel flows over a long period and the localised fuel temperatures were in an area described as the 'sticky range'.

---

<sup>1</sup> For this report 'fuel system' refers to the aircraft and engine fuel system upstream of the FOHE.



- 3) The FOHE, although compliant with the applicable certification requirements, was shown to be susceptible to restriction when presented with soft ice in a high concentration, with a fuel temperature that is below  $-10^{\circ}\text{C}$  and a fuel flow above flight idle.
- 4) Certification requirements, with which the aircraft and engine fuel systems had to comply, did not take account of this phenomenon as the risk was unrecognised at that time.

# 1 Factual Information

## 1.1 History of the flight

G-YMMM was on a scheduled return flight from Beijing, China, to London (Heathrow) with a flight crew consisting of a commander and two co-pilots; the additional co-pilot enabled the crew to take in-flight rest.

There had been no reported defects with G-YMMM during the outboard flight from London (Heathrow) to Beijing, China. The flight plan for the return sector, produced by the aircraft's operator, required an initial climb to 10,400 m (FL341) with a descent to 9,600 m (FL315) because of predicted 'Extreme Cold' at POLHO (a waypoint that lies on the border between China and Mongolia). Having checked the flight plan and the weather in more detail the crew agreed on a total fuel load for the flight of 79,000 kg.

The startup, taxi, takeoff at 0209 hrs and the departure were all uneventful. During the climb, Air Traffic Control (ATC) requested that G-YMMM climb to an initial cruise altitude of 10,600 m (FL348). The crew accepted this altitude and, due to the predicted low temperatures, briefed that they would monitor the fuel temperature en route. The initial climb to altitude was completed using the autopilot set in the Vertical Navigation (VNAV) mode. Approximately 350 nm north of Moscow the aircraft climbed to FL380; this step climb was carried out using the Vertical Speed (VS) mode of the autoflight system. Another climb was then carried out whilst the aircraft was over Sweden, this time to FL400, and again this was completed in VS mode. During the flight the crew monitored the fuel temperature displayed on the Engine Indication and Crew Alerting System (EICAS) and noted that the minimum indicated fuel temperature en route was  $-34^{\circ}\text{C}$ . At no time did the low fuel temperature warning annunciate.

The flight continued uneventfully until the later stages of the approach into Heathrow. The commander was flying at this time and during the descent, from FL400, the aircraft entered the hold at Lambourne at FL110; it remained in the hold for approximately five minutes, during which it descended to FL90. The aircraft was radar vectored for an Instrument Landing System (ILS) approach to Runway 27L at Heathrow and subsequently stabilised on the ILS with the autopilot and autothrottle engaged. At 1,000 ft aal, and 83 seconds before touchdown, the aircraft was fully configured for the landing, with the landing gear down and FLAP 30 selected.

At approximately 800 ft aal the co-pilot took control of the aircraft, in accordance with the briefed procedure. The landing was to be under manual control and the co-pilot intended to disconnect the autopilot at 600 ft aal. Shortly after the co-pilot had assumed control, the autothrottles commanded an increase in thrust from both engines. The engines initially responded but, at a height of about 720 ft, 57 seconds before touchdown, the thrust of the right engine reduced. Some seven seconds later, the thrust reduced on the left engine to a similar level. The engines did not shut down and both engines continued to produce thrust above flight idle, but less than the commanded thrust. At this time, and 48 seconds before touchdown, the co-pilot noted that the thrust lever positions had begun to 'split'.

On passing 500 ft agl there was an automatic call of the Radio Altimeter height, at this time Heathrow Tower gave the aircraft a landing clearance, which the crew acknowledged. Some 34 seconds before touchdown, at 430 ft agl, the commander announced that the approach was stable, to which the co-pilot responded "JUST". Seven seconds later, the co-pilot noticed that the airspeed was reducing below the expected approach speed of 135 kt. On the Cockpit Voice Recorder (CVR) the flight crew were heard to comment that the engines were at idle power and they attempted to identify what was causing the loss of thrust. The engines failed to respond to further demands for increased thrust from the autothrottle and manual movement of the thrust levers to fully forward. The airspeed reduced as the autopilot attempted to maintain the ILS glide slope.

When the airspeed reached 115 kt the 'AIRSPEED LOW' warning was annunciated, along with a master caution aural warning. The airspeed stabilised for a short period, so in an attempt to reduce drag the commander retracted the flaps from FLAP 30 to FLAP 25. In addition, he moved what he believed to be an engine starter/ignition switch on the overhead panel. The airspeed continued to reduce and by 200 ft it had decreased to about 108 kt.

Ten seconds before touchdown the stick shaker operated, indicating that the aircraft was nearing a stall and in response the co-pilot pushed the control column forward. This caused the autopilot to disconnect as well as reducing the aircraft's nose-high pitch attitude. In the last few seconds before impact, the commander attempted to start the APU and on realising that a crash was imminent he transmitted a 'MAYDAY' call.

As the aircraft approached the ground the co-pilot pulled back on the control column, but the aircraft struck the ground in the grass undershoot for 27L approximately 330 m short of the paved runway surface and 110 m inside the airfield perimeter fence.

During the impact and short ground roll the nose landing gear (NLG) and both the main landing gears (MLG) collapsed. The right MLG separated from the aircraft but the left MLG remained attached. The aircraft came to rest on the paved surface in the undershoot area of Runway 27L. The commander attempted to initiate an evacuation by making an evacuation call, which he believed was on the cabin Passenger Announcement (PA) system but which he inadvertently transmitted on the Heathrow Tower frequency. During this period the co-pilot started the actions from his evacuation checklist. Heathrow Tower advised the commander that his call had been on the tower frequency so the commander repeated the evacuation call over the aircraft's PA system before completing his evacuation checklist. The flight crew then left the flight deck and exited the aircraft via the escape slides at Doors 1L and 1R.

The cabin crew supervised the emergency evacuation of the cabin and all occupants left the aircraft via the slides, all of which operated correctly. One passenger was seriously injured, having suffered a broken leg, as a result of detached items from the right MLG penetrating the fuselage.

Heathrow Tower initiated their accident plan, with a crash message sent at 1242:22 hrs and fire crews were on scene 1 minute and 43 seconds later. The evacuation was completed shortly after the arrival of the fire vehicles.

After the aircraft came to rest there was a significant fuel leak from the engines and an oxygen leak from the disrupted passenger oxygen bottles, but there was no fire. Fuel continued to leak from the engine fuel pipes until the spar valves were manually closed.

#### 1.1.1 Previous flights

In the days prior to the accident flight G-YMMM had operated a return scheduled flight from London Heathrow to Shanghai that departed on 14 January 2008. The outbound flight was 11 hours in duration and the 13 hour return flight arrived back into Heathrow at 1652 hrs on 15 January 2008.

Routine maintenance on the aircraft, completed overnight, included a daily check and a drain of the fuel tank sumps to check for water contamination. The aircraft then departed Heathrow for Beijing on the afternoon of 16 January 2008 and after 10 hours arrived at Beijing at 0009 hrs on 17 January 2008.

**1.2 Injuries to persons**

Injuries	Crew	Passengers	Others
Fatal	0	0	0
Serious	0	1	0
Minor/none	16	135	0

**1.3 Damage to aircraft**

The aircraft was damaged beyond economic repair.

**1.4 Other damage**

The main surface damage to the undershoot area of Runway 27L was where the main landing gears and the engines impacted the ground. A number of approach lights and a small near-field monitor aerial were destroyed and two large inspection pit concrete covers were damaged.

**1.5 Personnel information****1.5.1 Commander**

Male	aged 43 years	
Licence:	Airline Transport Pilot's Licence	
Aircraft ratings:	L1011, DC10, B777	
Licence Proficiency Check and Instrument Rating:	Valid to 31 October 2008	
Operator's Proficiency Check:	Valid to 6 April 2008	
Line Check:	Valid to 30 April 2008	
Medical Certificate:	Class 1, valid to 14 January 2009	
Limitations:	None	
Flying Experience:	Total all types	12,700 hours
	Total on type	8,450 hours
	Last 90 days	85 hours
	Last 28 days	52 hours
	Last 24 hours	10 hours

## 1.5.2 Senior co-pilot (Operating)

Male	aged 41 years	
Licence:	Airline Transport Pilot's Licence	
Aircraft ratings:	B737, B777	
Licence Proficiency Check and Instrument Rating:	Valid to 31 October 2008	
Operator's Proficiency Check:	Valid to 31 October 2008	
Line Check:	Valid to 31 May 2008	
Medical Certificate:	Class 1, valid to 31 July 2008	
Limitations:	None	
Flying Experience:	Total all types	9,000 hours
	Total on type	7,000 hours
	Last 90 days	214 hours
	Last 28 days	87 hours
	Last 24 hours	10 hours

## 1.5.3 Co-pilot (Cruise)

Male	aged 35 years	
Licence:	Airline Transport Pilot's Licence	
Aircraft ratings:	AVRO RJ, BAe146, B737, B777	
Licence Proficiency Check and Instrument Rating:	Valid to 31 Aug 08	
Operator's Proficiency Check:	Valid to 29 Feb 08	
Line Check:	Valid to 30 September 2008	
Medical Certificate:	Class 1, valid to 9 March 2008	
Limitations:	None	
Flying Experience:	Total all types	5,000 hours
	Total on type	1,120 hours
	Last 90 days	254 hours
	Last 28 days	91 hours
	Last 24 hours	10 hours

## 1.5.4 Crew rest

The crew operated a flight from London Heathrow to Beijing on 14 January 2008. They rested in Beijing for approximately 44 hours and during the accident flight each of the crew took approximately three hours rest, in the aircraft's crew rest area.

## 1.6 Aircraft information

### 1.6.1 General

Manufacturer	Boeing Company
Type	Boeing 777-236ER
Aircraft serial number	30314
Year of manufacture	2001
Number and type of engines	2 Rolls-Royce RB211 Trent 895-17 turbofan engines
Total airframe hours	28,675 hours 3,957 cycles
Certificate of registration	UK registered on 31 May 2001
Certificate of airworthiness	Certificate of Airworthiness issued in the Large Aeroplane category by the UK Civil Aviation Authority on 31 May 2007 expiring on 30 May 2008
Minimum operating OAT	-75°C above FL320

#### *Weight and Balance*

The aircraft's takeoff weight was approximately 254,300 kg which included a fuel load of 79,000 kg. The centre of gravity (CG) at the takeoff weight was at 30.1% of the Mean Aerodynamic Chord (MAC) and at 29.2% of MAC at zero fuel weight, within limits for the flight. The investigation confirmed that the weights and loading of the aircraft were consistent with the aircraft load sheet.

### 1.6.2 'AIRSPEED LOW' and stall warning

On the Boeing 777 the minimum manoeuvre margin for the aircraft is displayed as an amber band on the Primary Flight Display (PFD) airspeed tape. This indicates a speed margin above the stick shaker speed and below the minimum manoeuvre speed. When the aircraft's airspeed reduces below the minimum manoeuvre speed, and by an additional 30% of this margin, an amber caution message, 'AIRSPEED LOW', is displayed on EICAS. In addition the master caution lights illuminate and an aural warning sounds.

The stall warning system on the Boeing 777 operates when the aircraft's computed angle of attack (AoA) is too high and warns the flight crew that the aircraft is about to enter or has entered a stall. The AoA at which the warning occurs is calculated within the Warning Electronic Unit (WEU), which uses inputs from various aircraft systems, including the Air Data Inertial Reference Unit (ADIRU). When the aircraft's actual AoA equals or exceeds the calculated stall warning AoA, the stick shakers attached to the control columns operate.

The estimated weight of the aircraft during the approach into Heathrow was 186,372 kg (410,880 lb) and the calculated stall speeds:

At FLAP 30: 104 Kt (the stick shaker operates at 108 kt)

At FLAP 25: 106 Kt (the stick shaker operates at 110 kt)

### 1.6.3 Autoflight

#### 1.6.3.1 Autopilot

The autopilot is engaged by operation of pushbutton switches on the Mode Control Panel (MCP). Once engaged the autopilot can control the aircraft in various modes selected on the MCP. The autopilot will disengage if the flight crew override an autopilot command through the use of the rudder pedals or control column. The autopilot has several pitch modes, including Vertical Navigation (VNAV) and Vertical Speed (VS).

In VNAV mode, the autothrottle sets the engine thrust to achieve maximum climb thrust. The autopilot then uses elevator commands to control the airspeed to the VNAV target speed set in the Flight Management Computer (FMC).

In VS mode the autothrottle modulates the engine thrust to maintain the speed set on the MCP. The autopilot uses elevator commands to control the aircraft's vertical speed to the vertical speed/flight path angle set on the MCP.

#### 1.6.3.2 Autothrottle (A/T)

The autothrottle commands the thrust levers to achieve an engine thrust setting, or a selected airspeed. The A/T is armed by the operation of two toggle switches and engaged by the operation of a pushbutton switch on the MCP.

The autothrottle has various protections to prevent 'overstressing' of the engine. Included in these protections is 'TRA<sup>1</sup> Dot', which limits the autothrottle rate of change when engine thrust is lagging behind the autothrottle command. This is to prevent a sudden increase in engine thrust that could lead to an engine overspeed.

The autothrottle can be overridden by the flight crew applying a manual input to the thrust levers. However, the A/T does not disconnect when the thrust levers are manually overridden.

---

<sup>1</sup> Throttle Resolver Angle



#### 1.6.4 Electrical

The electrical power system on the Boeing 777 is controlled by the Electrical Load Management System (ELMS) and operates as two independent networks, left and right.

The 115 volt AC power for each network comes from its respective engine Integrated-Drive Generator (IDG). In addition the Auxiliary Power Unit (APU) generator and external power connections are also sources of AC power for either main network busbar.

The 28 volt DC power for the two networks is delivered through Transformer Rectifier Units (TRU) that provide 28 volt DC power from the available AC power. In addition, batteries provide power to the hot battery busbar and APU battery busbar.

Backup generators operate when the engines are running. They supply power to the backup converter so that if a main AC busbar loses power, the converter supplies power to the related transfer busbar. In flight, if electrical power is not available on the left and right transfer buses, the Ram-Air Turbine (RAT) deploys and its generator supplies electrical power.

The aft fuel cross-feed valve is powered from the 28 volt DC 'captain flight instrument' busbar and the forward fuel cross-feed valve is powered from the left main DC busbar. The 28 volt DC 'captain flight instrument' busbar is powered from TRU Centre 1, which in turn is supplied by the left 115 volt AC transfer busbar, or the hot battery busbar.

##### 1.6.4.1 Electrical Load Management System (ELMS)

The ELMS distributes, monitors and protects the aircraft electrical power. It also supplies control logic for some of the aircraft systems. Within the ELMS are a number of Central Processing Units (CPUs) which contain 'Fault Logs' that record equipment failures and circuit faults for the current and the last 64 flight legs.

## 1.6.5 Cabin

## 1.6.5.1 Layout

G-YMMM had a 4-class cabin layout with, from the front, First Class, Club Class, Business Economy, and Traveller sections. The First Class section contained 13 seats which were forward facing but angled away from the fore-aft direction. In the Club Class section there were 48 seats which were alternately forward and aft facing pod-style seats. There were 48 Business Economy and 127 Traveller seats (including 3 crew rest seats), which were traditional-style seats with an in-flight entertainment video monitor and tray table located in the seat back.

The aircraft was equipped with eight Type A exits each with door mounted escape slides, four on each side of the aircraft. Doors 1L and 1R were located forward of the First Class cabin section, Doors 2L and 2R were forward of the Club Class cabin, Doors 3L and 3R were located between the Business Economy and the Traveller sections, and Door 4L and 4R were located aft of the Traveller section.

The cabin crew seats were attached to either the seat tracks, the walls of the lavatories, galleys, or partitions, and were forward or aft facing. The seat structure had a seat pan which folded down and a spring, with a damper, causing the seat pan to fold up when there was no weight applied. The seats were fitted with an 'inertia reel' seat belt and shoulder harness.

A small flight deck crew rest area was located on the main deck just forward of Door 2R and an overhead cabin crew rest area was located above the main cabin with access via stairs near Door 3R.

The location of the doors and cabin layout is shown in Figure 2.

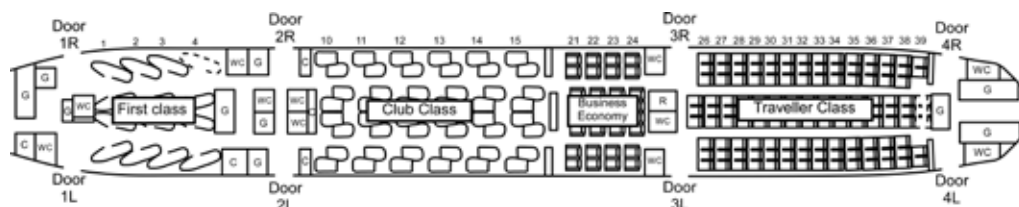

**Figure 2**

G-YMMM cabin layout

The B777 is fitted with Passenger Service Units (PSU) located above the passenger seats; there are different types of PSU, including those for the provision of oxygen in the event of a loss of cabin pressure (see paragraph 1.6.14). The PSUs attach to rails with four latches, which also form the hinges. There is a door latch actuator which is permanently magnetised and, in the event of a depressurisation, is electrically signalled to disengage and allow the panel to drop and release the oxygen masks from their stowage.

#### 1.6.5.2 Cabin lighting

Passenger cabin illumination on the B777-200 is provided by indirect ceiling lighting, night lights and sidewall lights.

The indirect ceiling lights are located on top of the outboard overhead stowage bins, below the ceiling panels, and are hidden from view by a valence panel. Each light assembly comprises a fluorescent tube with a ballast resistor to regulate the electrical power, located within a lightweight fixture which is then attached to the top of the overhead bin. The fluorescent tubes are filled with a gas containing low-pressure mercury vapour, which may represent a hazard if broken. The lights are set at an angle so that they overlap, thus preventing any shadows on the ceiling. The continuous layout of the lighting results in the fixtures bridging any joins between adjacent overhead bins.

The night lights are attached to the indirect ceiling light fixture located near the passenger entry doors and are incandescent, bayonet-style lamps. The sidewall lights are located, behind a lens cover, between the outboard PSUs and the sidewall panels.

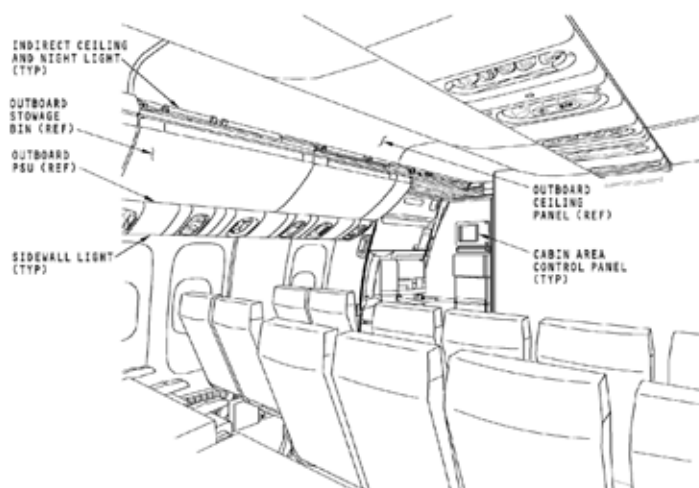

**Figure 3**

Passenger cabin

### 1.6.5.3 Emergency lighting

Emergency lights provide illumination when normal power sources are not available. They aid evacuation by identifying the routes to, and the location of, the emergency exits. There were a number of different emergency lights in the main passenger cabin area of G-YMMM: comprising area lights, floor proximity lights and exit lights.

The exit lights illuminate the 'EXIT' signs above each door and identify the location of the exit in the event of an emergency evacuation (Figure 4). The exit signs are on lowered ceiling panels adjacent to all the doors and in the cross aisles beside each door.

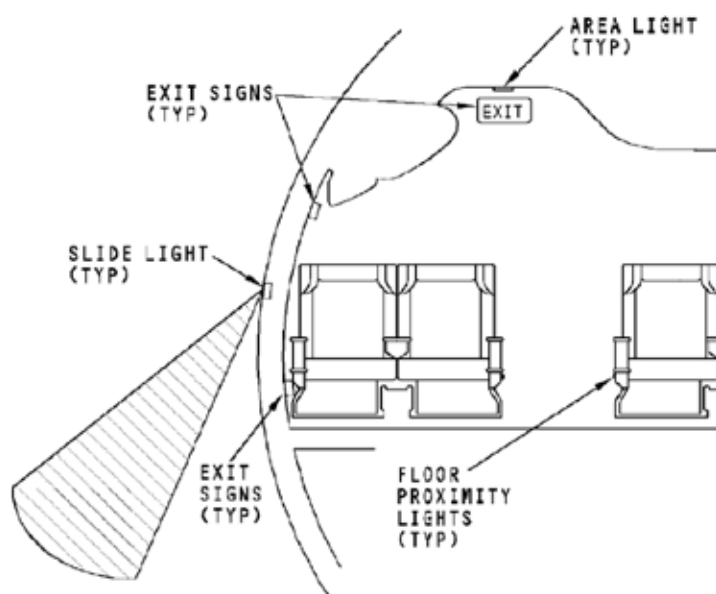

**Figure 4**

#### Door exit signs

The exit light comprises a fixture with twelve incandescent bulbs over which there is a lens cover that is simply compressed for removal and access to the bulbs. The lens cover is designed to be secured at six locations; the two pins (one at each end) and four 'clips' (two each on the top and bottom of the sign) which are protrusions on the lenses that snap into recesses in the housing.

### 1.6.5.4 Seats

The Business Economy seat fitted to the operator's B777 is a Recaro seat Model 4400, series 630. It has a video monitor located in the seat back, which is retained by means of a spring clip that engages into a detent on a support bracket attached to the back of the seat (Figure 5).

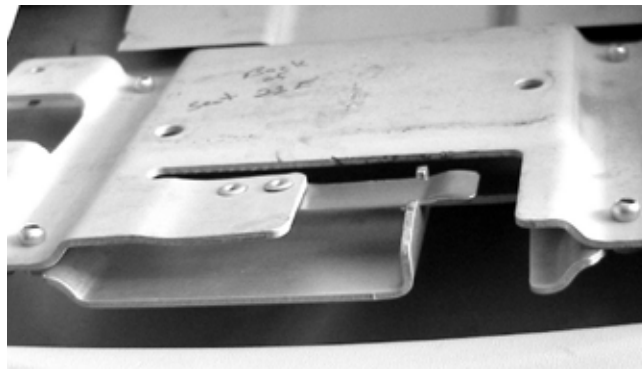
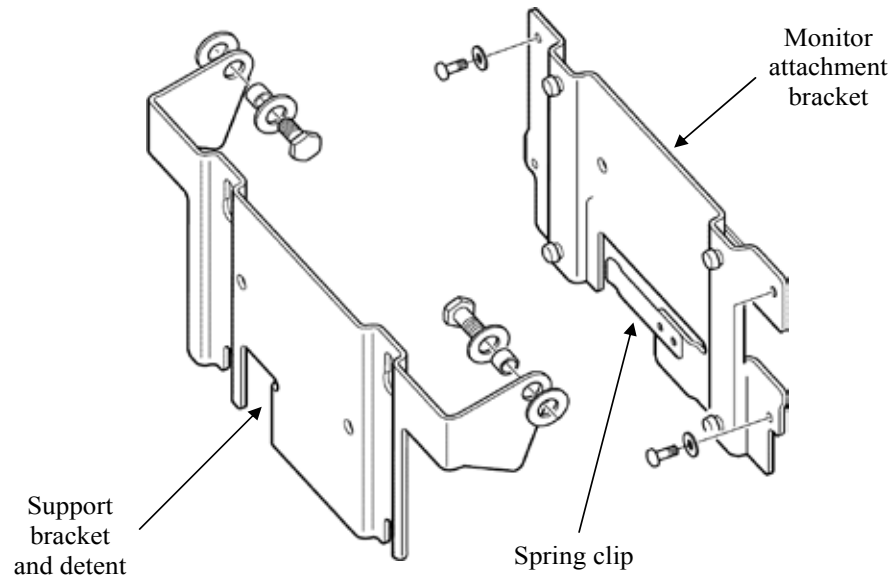

**Figure 5**

View showing spring clip engaged in support bracket detent

Studs on the attachment bracket engage into holes in the support bracket and the monitor can slide up to allow the spring clip to engage into the support bracket detent. There is no visible means to determine correct engagement of the studs or the spring clip, as all the fixings are designed to be hidden from view.

The Recaro Seat Model 4400 is also fitted to other aircraft types (B747 and B767) flown by this operator and on A330 and A340 aircraft with other operators.

### 1.6.6 Engine fire protection and detection

The aircraft has two engine fire extinguishers, each with cartridges which, when fired, can supply extinguishant to either engine. However, only one bottle can supply one engine at any one time. The extinguishers are operated by the pulling and twisting of the fire handles in the flight deck.

### 1.6.7 Flying controls

The Boeing 777 primary flight control system uses fly-by-wire flying controls consisting of ailerons, flaperons, elevators, movable horizontal stabiliser, rudder and spoilers.

#### 1.6.7.1 Flaps

The Boeing 777 has trailing edge flaps, leading edge slats and Krueger flap high lift devices controlled via a flap lever in the flight deck. The flap lever has detent positions set at UP, 1, 5, 15, 20, 25, and 30.

### 1.6.8 Fuel System

The fuel on the Boeing 777-200ER is stored in three fuel tanks: a centre tank, a left main tank and a right main tank (see Figure 6). The centre tank contains two override / jettison pumps (OJ) and each main fuel tank contains two boost pumps, identified as forward and aft. Each of the pump inlets is protected by a ¼ inch mesh screen and the pumps are equipped with a check valve fitted in the discharge port, to prevent fuel in the fuel feed manifold flowing back through the pump. A pressure switch, mounted between the pump's impeller and check valve, monitors the fuel pressure and triggers an advisory warning in the flight deck if the pressure rise across the pump drops below a value, of between 4 and 7 psi.

#### *Fuel feed manifold*

The fuel feed manifold runs across the aircraft and connects to the engine fuel feed lines. The manifold is split between the left and right system by two cross-feed valves, identified as forward and aft. When these valves are closed, and the centre tank is the source of the fuel, the left OJ feeds the left engine and the right OJ feeds the right engine. The fuel from the left and right main tanks supply their respective engines during main tank feed. Spar valves in the fuel manifold provide a means of shutting off the fuel supply to the engines.

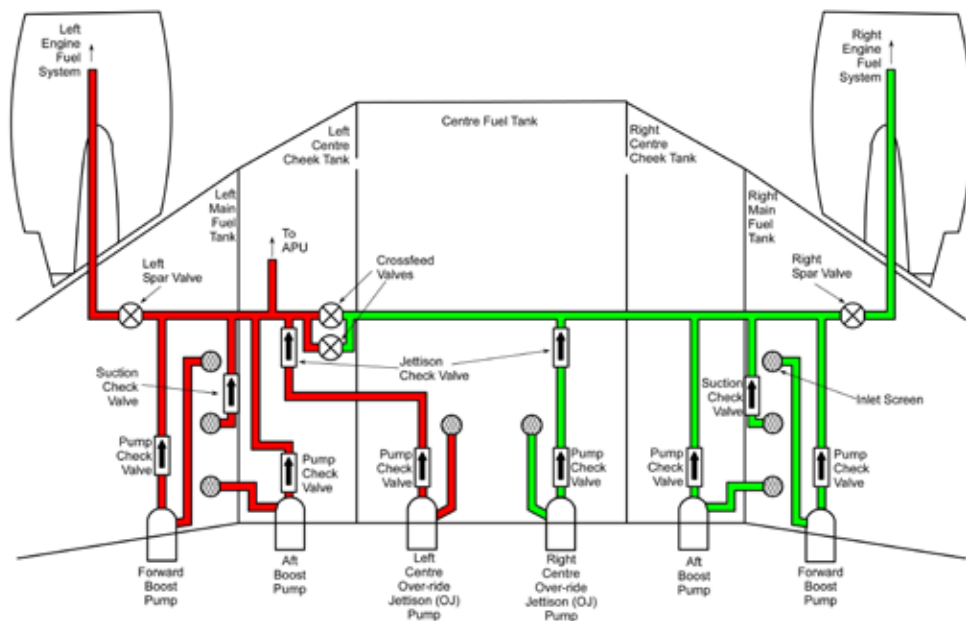

**Figure 6**

Simplified diagram of the airframe fuel system

### *Water scavenge*

To prevent large amounts of ‘free water’ building up in the fuel tanks, the aircraft is fitted with a water scavenge system that uses jet pumps operated by motive flow from the OJ and boost pumps. One jet pump is located in each main tank and there are two in the centre tank. In the main fuel tanks the jet pumps draw fluid from the lowest sections of each tank and inject it close to the inlet of each aft boost pump. In the centre tank, fluid is drawn from the lowest section of the tank and injected close to the OJ inlets.

### *Centre tank fuel scavenge*

The aircraft is equipped with a centre tank fuel scavenge system, which increases the amount of useable fuel in this tank. The system uses jet pumps, provided with motive flow from the boost pumps, to draw fuel from the lowest part of the centre tank and feed it into both main fuel tanks. A float valve mounted in the centre tank turns on the motive flow when the centre tank contents are below 15,800 kg. Float valves mounted in each of the main fuel tanks prevent fuel scavenge when the contents of these tanks are above 12,500 kg.

### *Fuel tank vent system*

Each tank is vented to atmosphere through channels in the roof of the fuel tanks, which are connected to surge tanks mounted outboard of each of the main tanks. The surge tanks are vented to atmosphere through a flame arrestor and a scoop mounted on the lower surface of each wing. Should the flame arrestor or scoop become blocked, a pressure relief valve will operate and prevent the tanks from becoming over, or under, pressurised.

### *Fuel delivery*

If fuel is loaded into the centre tank, the normal operation is to select all OJ and boost pumps ON at the start of the flight. As the OJs operate at a higher delivery pressure than the boost pumps the centre tank will empty first. During this period the boost pumps will provide fuel flow for their internal cooling and lubrication and supply motive flow to the jet pumps. When the centre tank is nearly empty, the pressure in the fuel feed manifold reduces and the main tank boost pump check valves open, supplying fuel into the manifold. The flight crew then manually switch OFF the OJ pumps. In the event of low pressure from both the boost pumps in a main tank, the suction feed bypass check valve opens and fuel, via an inlet screen, is drawn from the main fuel tank by the engine Low Pressure (LP) pump.

### *Engine low pressure stage of the Main Engine pump (Figure 7)*

The airframe fuel system supplies fuel to the LP engine-driven pump, which forms part of the Main Engine Pump (MEP). This raises the fuel pressure (and fuel temperature slightly) and pumps the fuel through a Fuel/Oil Heat Exchanger (FOHE).

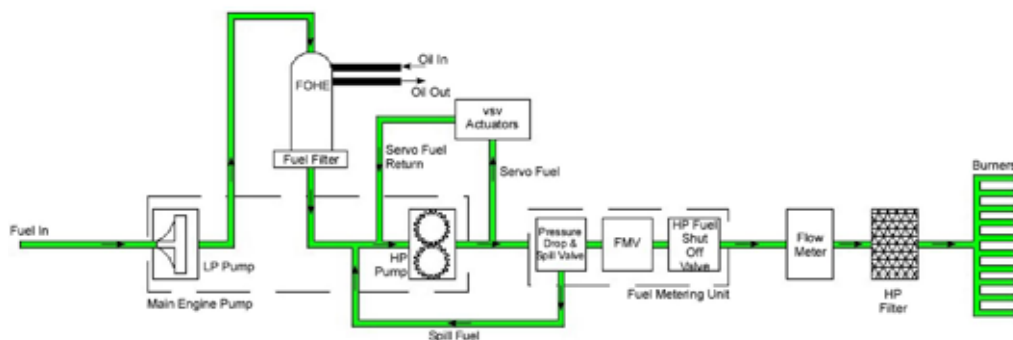

**Figure 7**

Simplified diagram of the engine fuel system



*Fuel Oil Heat Exchanger (Figure 8)*

The FOHE serves the dual purpose of cooling the engine oil and raising the temperature of the fuel so that ice does not affect the downstream components, including the LP filter and the Fuel Metering Unit (FMU). The FOHE is a hybrid cross-flow / counter-flow design and it includes a matrix of fine tubes. The fuel enters the top of the FOHE and passes through the tubes; the hot oil enters the FOHE main body and passes around the fuel tubes.

The temperature of the fuel after it has passed through the FOHE is considerably above its entry temperature. The FOHE matrix consists of over 1,000 small tubes that are crimped at various locations along their length to improve thermal transfer efficiency. The crimps at the inlet of the tubes are to a slightly smaller diameter than the remainder of the crimps to prevent small debris becoming lodged in the matrix. The tubes protrude by approximately 4 mm from the matrix top plate, which separates the fuel from the oil, and therefore extend into the fuel in the inlet chamber.

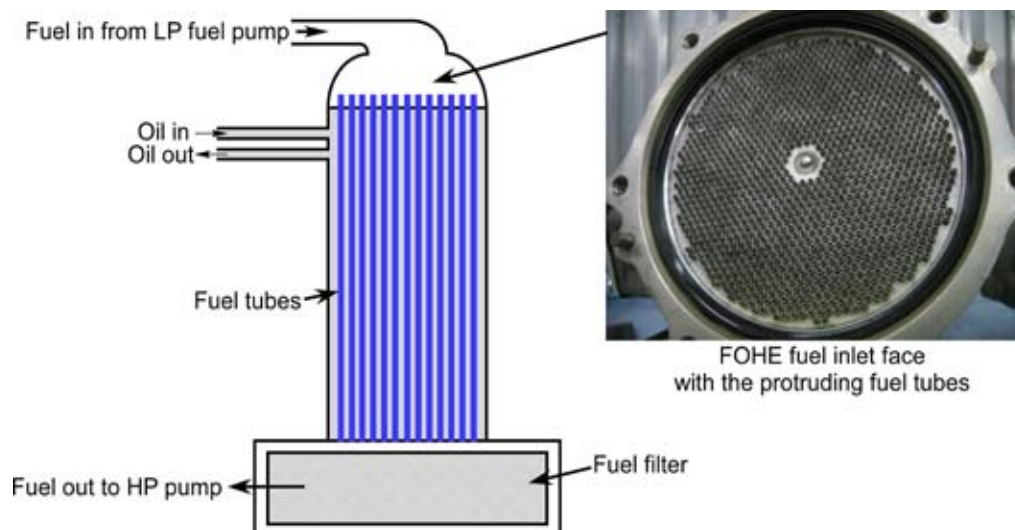
**Figure 8****Fuel Oil Heat Exchanger (FOHE)**

In the event that the oil becomes too viscous during engine start in cold conditions, the FOHE incorporates an oil pressure relief valve to bypass oil away from part of the matrix to reduce the time taken to heat the oil to operating temperatures. Under certain conditions the fuel flow may not be sufficient to keep the oil temperature within limits and therefore cooling is augmented by an Air Oil Heat Exchanger (AOHE), controlled by the Electronic Engine Control (EEC).

### *Low Pressure Fuel Filter*

The LP filter is mounted directly below and downstream of the FOHE. It has a bypass that will operate should the fuel flow through the filter become restricted. When the LP filter begins to become restricted a differential pressure builds up across the filter and when this reaches a predetermined limit it operates a switch which then provides an indication to the flight crew of an impending filter blockage by displaying the message 'ENG FUEL FILTER L(R)' on the EICAS. The LP filter differential pressure switch operates before the bypass of the filter operates.

### *Engine High Pressure stage of the Main Engine Pump*

After the LP filter, the fuel travels to the High Pressure (HP) pump of the MEP where its pressure is again raised, to the values needed for injection through the fuel spray nozzles in the combustion chamber.

### *Main Engine Pump (MEP) (Figure 9)*

The MEP comprises a centrifugal LP stage and a gear-type HP stage (Figure 9). Both stages are housed in a single unit, although LP fuel is passed to the FOHE/LP filter unit before being fed back to the HP stage. The pump is driven from the HP spool of the engine through the accessory gearbox. There are four phosphor-bronze plain bearings which mount the two gears of the HP stage and these are coated with a dry-film lubricant, although the fuel itself is the primary lubricant.

### *Fuel Metering Unit*

The HP fuel is ported into the Fuel Metering Unit (FMU). The FMU contains a Fuel Metering Valve (FMV), which regulates the fuel flow to match a thrust demand and is commanded from the EEC. The FMU is attached to the MEP case but is a separate unit. It contains three torque motors, which direct servo fuel to regulate fuel for metering, overspeed protection and fuel shutoff; movement of the torque motors is controlled by the EEC. The FMV position is measured by a resolver, which feeds back this information to the EEC. Changes in pressure drop are caused by FMV position variations, so the FMU contains a pressure drop and spill valve to maintain a constant pressure drop across the fuel metering valve and spills excess fuel back to the HP pump inlet.

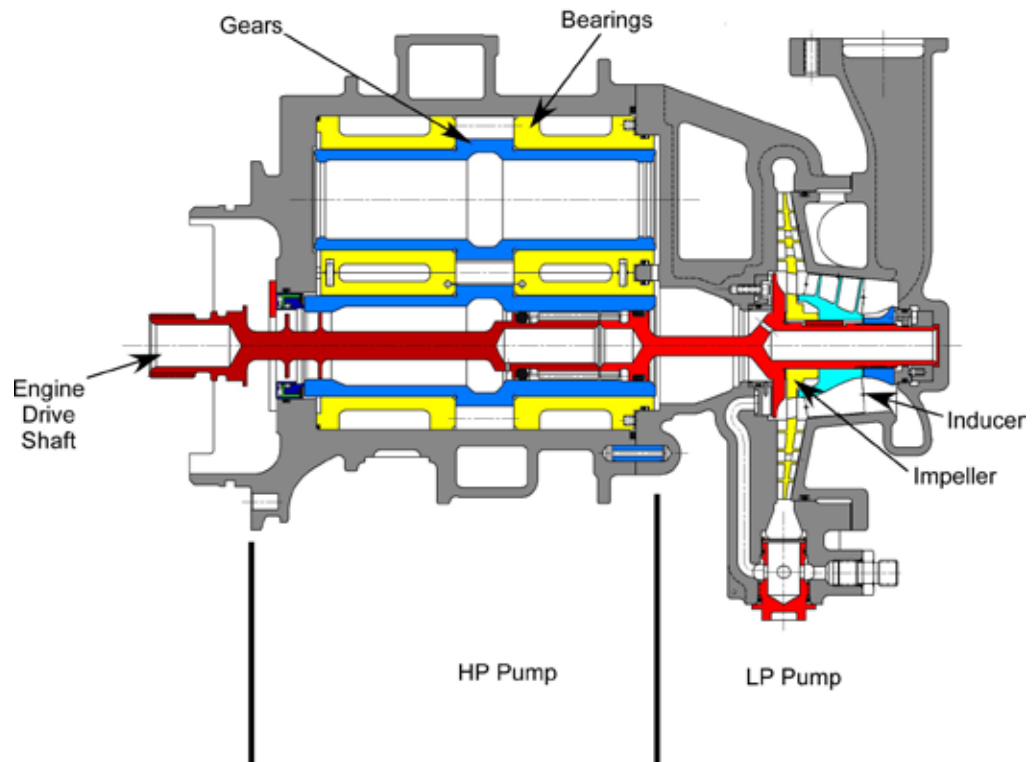

**Figure 9**

**Main Engine Pump (MEP)**

*High-pressure fuel shutoff*

To shut off the high-pressure fuel supply to the engine, the ‘pressure raising and shutoff’ valve in the FMU closes when the related engine run/cutoff switch is operated to CUTOFF, or the fire switch on that engine is pulled.

*Engine burners and fuel flow meter*

The fuel from the FMU is routed to the burners via a flowmeter and a coarse HP strainer. The ELDEC flowmeters are mass-flow (as opposed to volumetric) measuring devices and include a vane which is spun by the flow and sends an analogue signal to the EEC. The latter calculates the fuel mass flow and provides this information for display on the cockpit instrumentation. To prevent constant fluctuations of the displayed fuel flow, a time constant is introduced to ‘slug’ the changes and it is this conditioned signal which is recorded on the Digital Flight Data Recorder (DFDR).

#### 1.6.8.1 Fuel temperature measurement

The fuel temperature indication system has a temperature probe located between ribs 9 and 10 in the left main tank. The probe is situated approximately 12.6 inches above the lower wing skin and is located 40 inches outboard of the aft boost pump inlet. The fuel in the left wing tank can be slightly colder than the right wing tank. This is because the right fuel tank contains two hydraulic fluid/fuel heat exchangers, which are used to cool the hydraulic fluid, whereas the left wing has only one.

Fuel temperature is displayed in white on the primary EICAS. The EICAS low temperature warning trigger automatically defaults to the freezing limit of Jet A, unless another temperature, such as the freezing point of Jet A-1, has been set in the Flight Management Computer (FMC) Control Display Unit (CDU). Once the fuel temperature reaches 3°C above the fuel freezing temperature (-37°C for Jet A and -44°C for Jet A-1) the fuel temperature indication turns amber and the FUEL TEMP LOW advisory message is displayed on the EICAS.

On long flights the temperature of the fuel in the main wing tanks will tend towards the temperature of the boundary layer around the wing, which can be up to 3°C lower than Total Air Temperature (TAT). Whilst the cheek tanks of the centre tank are situated in the wings, and are affected by aerodynamic cooling, the majority of the centre tank fuel is sandwiched between the cabin and the air conditioning packs. Consequently the fuel in the centre tank is considerably warmer than the fuel in the main tanks.

The aircraft manufacturer had previously undertaken tests on a B777-200, which has the same wing fuel system as the B777-200ER, to determine the effectiveness of the fuel temperature probe. During the test three racks of thermocouples, mounted vertically in the tank, were fitted along the span of the left main fuel tank. The test established that there is a temperature gradient along the wing span with the coldest fuel inboard and the warmest fuel outboard. This gradient occurs because the wing surface to fuel volume ratio results in the fuel in the outer sections of the wing cooling at a greater rate than the fuel in the inboard sections of the wing. However, a consequence of the wing dihedral and flexing in flight is that the cold fuel migrates towards the inboard sections of the wing. A comparison of the test data with the actual fuel probe temperatures revealed that there is a close correlation between the temperature of the fuel measured by the probe and that measured by the rack of thermocouples mounted adjacent to the probe.

### 1.6.8.2 Fuel spar valve control and indication

The spar valves are manually selected and electrically operated by the use of either the engine fuel control switches in normal operation or by the fire switches in the event of an engine fire. The operation of the engine fuel control switches, through a spar valve control relay, electrically commands the spar valve actuator to OPEN or CLOSE. The operation of the fire switch directly commands the spar valve actuator to CLOSE and isolates power to the spar valve control relay CLOSE coil.

The control wiring for the spar valve is fed via various connectors in the aircraft. In three locations the connectors contain wiring for both the OPEN and CLOSE command signals for both left and right spar valves. The signal wiring, from the engine fuel control switches to the spar valve control relay, routes through two common connectors D4017 and D4417, both located in the electrical bay. The fire switch signal wiring and the engine fuel control switch wiring to the relays both route through connector D1325 located in the cabin roof area.

In addition, connector D1304 for the right spar valve and D1313 for the left spar valve have OPEN and CLOSE signal wiring routed through them. Both of these connectors are located in a panel in the forward cabin roof area.

The wiring to the spar valves is routed along the wing rear spar in two separate looms. The valve OPEN signal wire, fire CLOSE signal wire and position indication wiring route in a loom that runs in the raceway located above the main landing gear attachment fitting. The engine fuel control switch CLOSE signal wire is routed in a separate loom that is lower down on the rear spar and routes initially outboard toward the engine strut, before routing back along the rear spar and into the spar valve connector.

The power supply to operate the spar valves is 28 V DC from the fuel Shut Off Valve (SOV) bus. This bus is normally supplied by the 28 V DC hot battery bus, however in the event of a loss of power from the aircraft's battery, there is an independent spar valve battery. This spar valve battery has its own charger and any failures are indicated by a status message on EICAS.

In 2002 Boeing issued a Service Bulletin (SB) 777-28-0025 to add additional wiring such that power was available to the engine fuel control relay following the operation of the engine fire switches. This modification was introduced to prevent the situation in which an open circuit of the CLOSE wire from the fire switch would prevent the spar valve from closing if the fire switches were

operated prior to the engine fuel control switches. This SB had not been incorporated on G-YMMM at the time of the accident.

In 2005 the FAA mandated the SB via airworthiness directive AD 2005-13-20 requiring the installation of the modified wiring by July 2010.

#### *Spar valve position indication*

The 'fuel synoptic' page on EICAS indicates the position of the spar valve. In addition the fuel management maintenance page gives the command signal and actual position status indication for the valves.

The Overhead Panel ARINC 629 System (OPAS) monitors the position of the spar valve and the commands from the spar valve control relay. If there is a discrepancy between the spar valve control relay position and the spar valve actual position, then OPAS sends a fault message to AIMS to display a status message 'FUEL SPAR VALVE L(R)'. If the spar valve is in transit for more than 10 seconds an advisory message is indicated on EICAS.

The DFDR gives the spar valve position indication taken from AIMS based on signal information from OPAS. The DFDR gives four indications, OPEN, CLOSED, INVALID and FAILED. The FAILED indication shows on the DFDR if the valve is not in either the OPEN or CLOSE position for more than 5 seconds.

#### 1.6.8.3 Fuel quantity

A Fuel Quantity Processor Unit (FQPU) receives signals from tank units and densitometers in the fuel tanks and uses these to calculate the fuel quantity in the each of the three fuel tanks. The FQPU then sends data to EICAS for the display of fuel quantity to the flight crew.

Each tank unit measures the fuel height at its location, through the use of an ultrasonic transmitter/receiver. The FQPU commands each tank unit's ultrasonic transmitter to send out a sonic pulse, the time for the pulse to be reflected from the fuel surface and return to the receiver directly relates to the fuel height in the tank.

The densitometers use a vibrating cylinder; the frequency of vibration is proportional to the fuel density.

Each tank has measuring sticks at various locations so that the fuel quantity can be manually checked on the ground. The sticks use a magnetic float which

surrounds the measuring stick housing and rests on the fuel surface. When the measuring stick is moved from within its housing, the end of the stick 'catches' at the position of the magnetic float. The stick has graduations which give a direct reading of the height of fuel in the tank at that location. Fuel quantity in the tank can then be calculated using conversion tables, with reference to the aircraft's pitch and roll attitude, fuel density and the fuel heights measured at each of the stick locations. These were used to establish the fuel quantity onboard the aircraft following the accident see para 1.12.3.8.

#### *Fuel on board G-YMMM*

G-YMMM was refuelled with 71,400 kg of Jet A-1 at Heathrow approximately 1 hour 30 minutes prior to engine start for the outbound flight to Beijing. The Quick Access Recorder (QAR) recorded the fuel temperature in the left tank at 1130 hrs, 47 minutes prior to the start of the refuel, as 3°C. The aircraft landed at Beijing with 4,100 kg in the right main, 4,000 kg in the left main and 0 kg in the centre fuel tank. The temperature of the fuel in the left tank was recorded as 10°C on departing Heathrow and -20°C on arrival at Beijing. At Beijing the aircraft was refuelled with 71,401 kg of Jet A-1, at a temperature of 5°C, 30 minutes before the engines were started for the return flight to Heathrow. The total fuel load at the start of the return leg was recorded on the DFDR as 79,000 kg, with 28,900 kg in each of the main fuel tanks and 21,200 kg in the centre fuel tank. The temperature of the fuel in the left main tank at engine start was recorded as -2°C.

### 1.6.9 Engine

The Rolls-Royce RB211 Trent 800 series engine is a version of the Trent engine specifically engineered for the Boeing 777. Different versions of the Trent power other aircraft and the basic design is derived from the three-spool RB211 engine which has operated since the 1970s.

The three spools are termed Low Pressure (LP), Intermediate Pressure (IP) and High Pressure (HP): their speeds of rotation are respectively notated N1, N2 and N3. The accessories such as fuel, oil and hydraulic pumps are driven from the HP spool.

#### 1.6.9.1 Engine control

Engine control is performed by a digital Electronic Engine Control unit (EEC). Its primary function is to control operation of the Fuel Metering Unit (FMU), based on power demands from the thrust levers and from information, including

speeds, temperatures and pressures, received from sensors on the engine. However, in addition to direct control of fuel flow, the EEC also controls items such as the Variable Stator Vanes (VSV), bleed valve positions and the Air-Oil Heat Exchanger (AOHE) activity.

The EEC has two independent but identical lanes, one of which will be in control whilst the other is on standby: the EEC associated with each engine is also independent from that on the other engine and they do not communicate with each other. The EEC is programmed using bespoke software which may be periodically updated by the manufacturer: both EECs on G-YMMM were to software standard B6.1. During certification, the EEC was tested for resistance to Radio Frequency (RF) interference and Electro-Magnetic Radiation.

The EEC also logs fault codes registered during engine operation. In addition to the code itself, other engine parameters pertaining at the moment of registering are also recorded as a 'snapshot'. Additional parameters, such as FMV position (commanded and actual) are recorded continuously on the QAR, together with the current EEC Loop in Control (LIC). There are many control loops, depending on phase of operation, and the LIC may also change when various fault conditions are detected. The most relevant to this investigation are LIC 14 (WFP30) which is entered following a 'surge detect', and LIC 17 (Absolute Maximum Fuel Flow) which is entered when the EEC commands the FMV to open fully to obtain maximum fuel flow. During normal operations the EEC enters several different control loops, and spends most of the time in LIC 4 (EPR), as the EEC matches power demands from thrust lever or autothrottle inputs.

#### 1.6.10 APU

##### 1.6.10.1 APU fuel system

The APU is supplied with fuel from the left engine fuel feed manifold. When the APU switch in the flight deck is switched to ON the APU air inlet door is commanded open. If there is no pressure in the left fuel manifold, the APU DC pump operates, otherwise it remains off. At 7% revolutions per minute (rpm), the APU fuel shutoff solenoid opens and the APU continues to accelerate with the fuel flow controlled by the APU Controller (APUC) via a fuel metering valve.

In the event of a left engine flame out in flight, due to a lack of fuel pressure in the left fuel manifold, the APU DC fuel pump can be used to pump fuel into the manifold through the APU isolation valve.



#### 1.6.10.2 APU control

To start the APU normally requires the manual operation of the APU start switch. However, the Boeing 777 APU has an auto start function, the logic of which is provided by the ELMS to the APUC. The start sequence is initiated if the RAT is deployed following the loss of electrical power on the transfer buses, whilst the aircraft is in the air mode. Once the auto start has initiated it takes over 60 seconds for the APU to start and reach the required speed for its generator to provide electrical power to the electrical network. During an APU auto start the cockpit switch remains in the OFF position.

#### 1.6.11 Hydraulics

The Boeing 777 has three main hydraulic systems: left, right and centre. The hydraulic fluid is cooled using the aircraft's fuel, with heat exchangers located in both the main fuel tanks. The left main fuel tank contains one heat exchanger for the left hydraulic system, the right main fuel tank contains two heat exchangers: one for the right and one for the centre hydraulic system.

#### 1.6.12 Ram Air Turbine (RAT)

The Ram Air Turbine (RAT) can provide hydraulic and electrical power in the event of an emergency. It is located on the right side of the aircraft in a fairing to the rear of the landing gear bay and will deploy automatically if it detects a loss of all three hydraulic systems in flight. It will also deploy if the ELMS detects a loss of electrical power on the transfer bus for more than 15 seconds with the aircraft in the air. The RAT can also be deployed manually from the flight deck.

#### 1.6.13 Landing gear

The B777-200 has a conventional tricycle gear configuration, with a nose landing gear and two main landing gears.

The Nose Landing Gear (NLG) comprises a conventional two-wheel landing gear attached to a gas-oil shock strut with an inner cylinder moving within the fixed outer cylinder. A drag brace assembly holds the NLG outer cylinder in the extended or retracted position and a lock link assembly moves to the over-centre position to lock the drag brace in either position. There are four primary support points: two drag brace trunnion fittings and two outer cylinder trunnion fittings about which the gear rotates to retract or extend.

The Main Landing Gear (MLG) consists of two six wheel tri-tandem main gears as shown Figure 10:

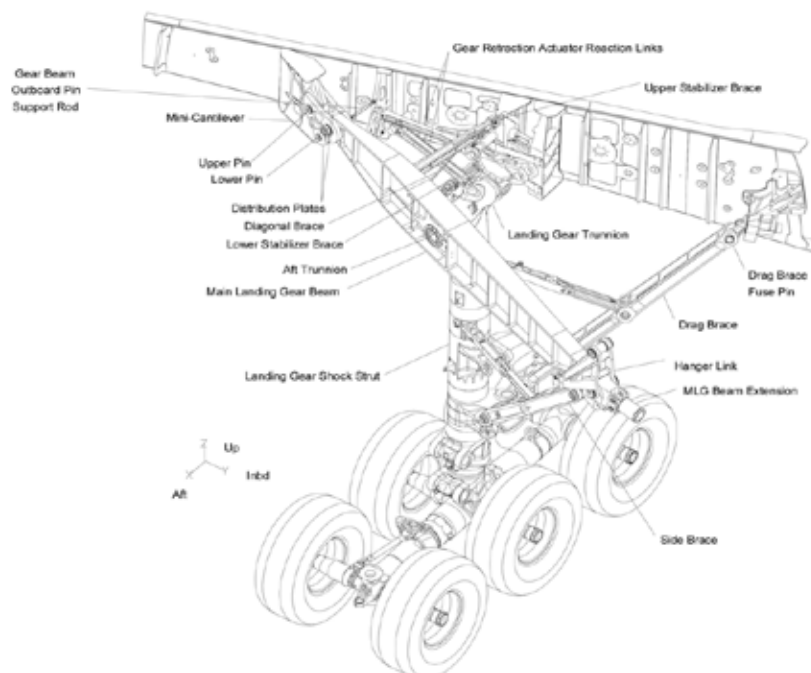

**Figure 10**

#### MLG general arrangement

It comprises a shock strut, at the top of which is the MLG trunnion; at the lower end is a truck beam with three axles and six wheels. The truck beam rotates in pitch about a pivot at the base of the shock strut and a truck position actuator tilts the truck when the aircraft is airborne. A drag brace and a side brace hold each gear in the extended position and give support to the MLG. Lock links hold the drag brace and side brace in the extended position, which in turn locks the MLG.

The MLG structural support is provided by the rear wing spar and a gear beam linked to the main fuselage. The gear beam attaches at its outboard end to the rear wing spar via a 'mini-cantilever' beam and at its inboard end to the main fuselage structure via a hanger link. There are four primary support points: the forward and aft trunnions, a drag brace upper spindle attachment and a side brace upper spindle attachment. The drag and side struts each carry a portion of the drag and side loads. The forward trunnion and the drag brace fitting are attached to the rear spar; the aft trunnion and the side brace are attached to the gear beam.

The aft trunnion fits inside a spherical bearing within the gear beam and the forward trunnion fits inside a plain bearing within the lower support housing, known as the 'H block'. There is also an upper support housing.

The MLG is designed to separate under overload conditions via a series of strength-controlled fuse pins at critical attachment points (Figure 11). The fuse pins are designed to control the breakaway sequence to prevent rupture of the fuel tanks.

There are two fuse pins in the attachment, or 'distribution plate', between the gear beam and the mini-cantilever beam, six fuse pins in the forward trunnion housing (four in the lower housing (H block) and two in the upper housing), and one fuse pin in the drag brace fitting. There is also a fuse pin in the actuator retraction link.

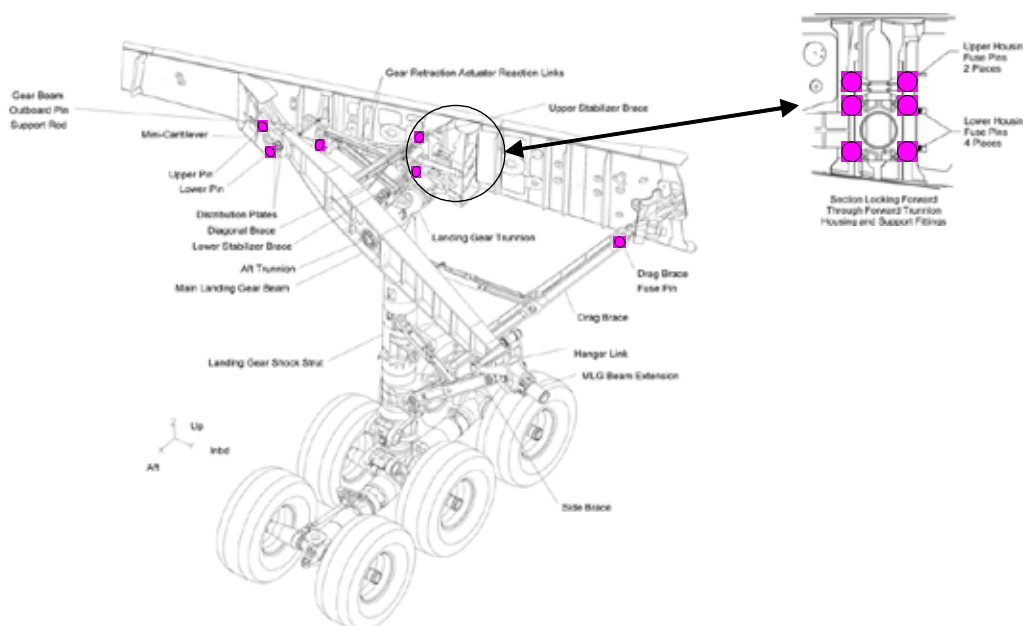

**Figure 11**

MLG fuse pin location

#### 1.6.14 Oxygen

##### 1.6.14.1 Crew oxygen system

The crew oxygen masks are supplied with gaseous oxygen from cylinders located to the left of the nose landing gear support structure and inside the electrical bay.

##### 1.6.14.2 Passenger oxygen system

Passenger oxygen is supplied via masks that drop from overhead passenger service units. Pulling the mask operates a valve in the PSU to open the supply of oxygen to the passenger.

The oxygen is provided by 13 gaseous oxygen cylinders located in the right forward side wall of the aft cargo hold. Each cylinder holds 3,150 litres of oxygen pressurised to 1,850 psi.

#### 1.6.15 Structure

##### 1.6.15.1 Fuselage

The B777-200 fuselage is a semi-monocoque structure with reinforcement provided by frames and stringers. There is also a keel beam located at the underside of the fuselage which, in addition to providing structural reinforcement, also provides protection to the underside of the centre fuel tank in the event of an emergency landing.

##### 1.6.15.2 Wings

The primary wing structure on the B777-200 is formed by the wing box, which comprises the front and rear spars together with the upper and lower wing skins reinforced with stringers. The wing box is in turn joined to the main fuselage structure via terminal fittings. Internal to the wing box are fore/aft ribs which serve as further strengthening elements. A back-up fitting, known as the 'hockey stick', is located at the junction between the terminal fitting and the rear spar. The main landing gear drag brace is joined to the rear face of the rear spar web, the terminal fitting and the back-up fitting. Attached to the innermost rib (rib 2) is a further back-up fitting which again attaches through the rear spar web to the main landing gear drag brace fitting. The wing box also forms part of the centre fuel tank and the wing fuel tanks (see paragraph 1.6.8)

##### 1.6.15.3 Engine nacelle attachment

The B777-200 engine nacelle and pylon assemblies are attached to the wing by four fuse pins (Figure 12). The fuse pins are designed to fail in the event of abnormal loads being applied to the nacelle, such as during an emergency landing, in order to preserve the wing structure and allow the engine assembly to separate cleanly.

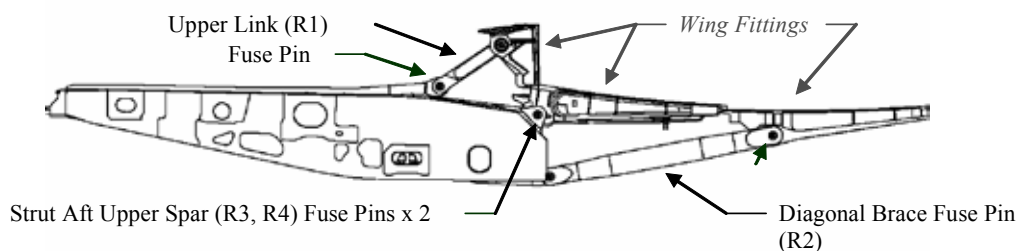

**Figure 12**

Engine pylon fuse pin locations

1.6.16 Air temperature measurement

1.6.16.1 Total Air Temperature (TAT)

The total air temperature (TAT) is a measure of the air temperature at the point the air is brought to rest relative to the aircraft's forward motion ('stagnation point'). It is always higher than the static air temperature (SAT) when the aircraft is in flight.

The Boeing 777 has two TAT probes, one located on each side of the nose section of the aircraft just below the rear-most cockpit window.

1.6.16.2 Static Air Temperature (SAT)

The Air Data Inertial Reference System calculates the SAT from the temperature provided by the TAT probes, Computed Air Speed (CAS) and Mach number.

1.6.17 Central Maintenance Computer

The Central Maintenance Computer (CMC) collects and stores information from the majority of the aircraft systems. It can store fault histories as well as monitor and conduct tests on the various systems. The fault history contains details of warnings, cautions and maintenance messages.

The CMC only has volatile memory; disconnection of the main aircraft battery clears any stored information. At regular intervals, during flight, the CMC transmits any recorded fault messages, via the Aircraft Communication and Automatic Reporting System (ACARS), to the operator's ground station.

## 1.6.18 Aircraft maintenance history

Following the inbound flight from Shanghai on 15 January 2008, G-YMMM was moved to the aircraft operator's maintenance base at Heathrow. Overnight, two ad-hoc maintenance actions and a routine Daily Check were completed. The ad-hoc items were in response to Technical Log entries for the replenishment of the crew oxygen system and the updating of the Flight Management System (FMS) navigation database. The Daily Check was performed prior to the aircraft's departure to Beijing on the morning of 16 January 2008 and included a fuel sump drain. Whilst the aircraft was at the maintenance base on the night of 15/16 January 2008 the APU was run, with fuel being drawn from the left main fuel tank.

The following are the dates on which the last scheduled maintenance checks had been carried out in accordance with the operator's approved maintenance schedule:

<b>Scheduled Check</b>	<b>Date maintenance check last completed on G-YMMM</b>	<b>Schedule</b>
Weekly	14 January 2008	Weekly or 100 hours
2A	14 December 2007	105 days or 400 cycles
4A	14 December 2007	210 days or 800 cycles
B	10 June 2007	400 days or 2,000 cycles or 6,000 hours
C	10 June 2007	750 days or 4,000 cycles or 12,000 hours
2C	10 June 2005	1,500 days or 8,000 cycles or 24,000 hours

During the 2C maintenance check, which was completed during May and June 2005, all three fuel tanks were drained, purged and entered for inspection in accordance with the manufacturer's Maintenance Manual. This was the last recorded maintenance activity within the fuel tanks on G-YMMM prior to the accident flight.

The flight to Beijing from London Heathrow on 16 January 2008 was without incident and no defects were recorded in the technical log following the flight.

During the accident flight the following CMC messages were received by the aircraft operator via the ACARS in-flight communication system.

Date	Time	Code	Message	Reason
17/01/2008	0600	2610231	Engine fire detection card (left)	Fire Loop 2 (left engine) is shorted
17/01/2008	0155	3457425	Autopilot Flight Director Computer (left), Autopilot Flight Director Computer (centre), Autopilot Flight Director Computer (right)	Paravirtual Display (F/O) has no output on ARINC 429 bus
17/01/2008	0157	7386291	Electronic Engine Controller (EEC) (L ENG)	LP (N1) Turbine Speed Probe 2 (L Eng, Ch B) signal is failed

## 1.7 Meteorological information

The Met office provided an aftercast of the weather situation using archived charts and data from for 17th January 2008.

### 1.7.1 Beijing

The Beijing departure Automatic Terminal Information Service (ATIS) for 17 January 2008 reported a surface wind from 090° at 3 m/s (approx 6 kt) with 5 km visibility, a temperature of -7°C, a dew point of -16°C and a QNH of 1039 mb. The short term forecast was for little change other than temporary reductions in the visibility to 3,500 m in light showers of snow.

### 1.7.2 En route

The aircraft had climbed out of Beijing to an initial cruise altitude of FL348 before flying toward Siberia. Estimated temperatures at FL348 were around -65°C, giving the aircraft an estimated TAT of -37°C. The upper winds at this altitude were from the west at around 20 kt.

Shortly after crossing the Ural mountains, the aircraft climbed to FL380. At the time the aircraft passed through the area between the Urals and Eastern Scandinavia, there was a region of particularly cold upper winds, with temperatures en route as low as  $-74^{\circ}\text{C}$ .

The Met office described the temperature conditions in this area as “unusually low compared to the average but not exceptional.” This was based on a statistical analysis of a data set of the mean January temperatures recorded in this area between 1992 and 2007. The average temperature was  $-61^{\circ}\text{C}$ . Temperatures in the range of  $-56.25^{\circ}\text{C}$  and  $-65.75^{\circ}\text{C}$  were within one ‘standard deviation’ and those in the range  $-46.5^{\circ}\text{C}$  and  $-75.5^{\circ}\text{C}$  were within three standard deviations. The recorded SAT of  $-73^{\circ}\text{C}$  on G-YMMM was toward the lower end of three standard deviations from the mean, but was not as low as the lowest recorded mean temperature in this area (Figure 13).

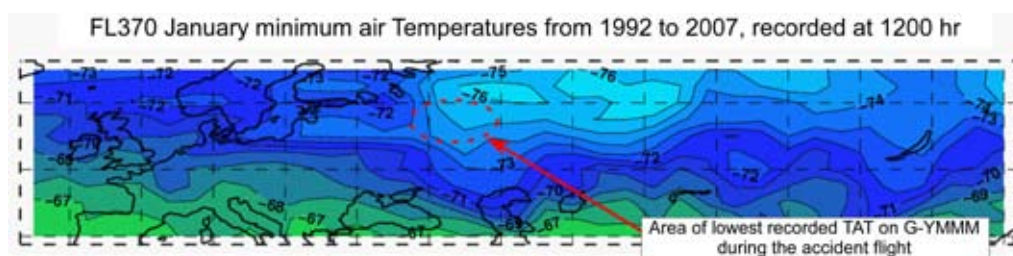

**Figure 13**

Met office minimum recorded air temperatures

### 1.7.3 Heathrow

The synoptic situation had a low pressure system over Rockall, associated with an occlusion in the vicinity of London and aligned north to south along the Greenwich meridian. At the time of the accident this occlusion was to the east of Heathrow, although layers of lower cloud had yet to clear the airport. The aircraft was likely to have flown through layered cloud whilst descending between 26,000 and 14,000 ft, with further bands of cloud between 4,000 and 800 ft. The 2,000ft wind was from 250°M at 33 kt.

The Heathrow weather was mild at the time of the accident. The arrival ATIS at 1240 hrs on 17 January 2008 was ‘C’ and reported a wind from 200° at 10 kt, with a visibility of over 10 km, scattered cloud at 800 ft and broken cloud at 1,000 ft. The surface temperature was  $10^{\circ}\text{C}$  with a dew point of  $8^{\circ}\text{C}$ . There was a warning of moderate icing in the vicinity of the Bovingdon beacon (approximately 15 nm north of Heathrow) at FL090.



**1.8 Aids to navigation**

Not applicable to this investigation.

**1.9 Communications**

The aircraft was operating under call sign 'Speedbird 38'. All communications on the VHF, ACARS and PA systems were satisfactory.

Recordings of the VHF transmissions between the aircraft and London Heathrow were made available to the investigation.

**1.10 Aerodrome information**

London Heathrow Airport is located 15 miles west of London and has two parallel main runways running east-west.

Runway 27L is approved for Category 3 ILS autolands and has a Landing Distance Available (LDA) of 3,660 m, is 50 m wide and has a threshold elevation of 77 ft amsl. The runway surface is of grooved asphalt construction and there is a short asphalt marked undershoot that is 27 m in length. The remaining undershoot area for 27L is mainly grass, about 370 m in length to the ILS antenna structure and then a further 70 m to a perimeter fence. To the east of the perimeter fence is the airfield perimeter road, and the A30 Great West Road main trunk road. (Figure 14)

Runway 27L is equipped with a high intensity approach lighting system, threshold lights, touchdown zone lighting, centreline lighting and runway edge lighting.

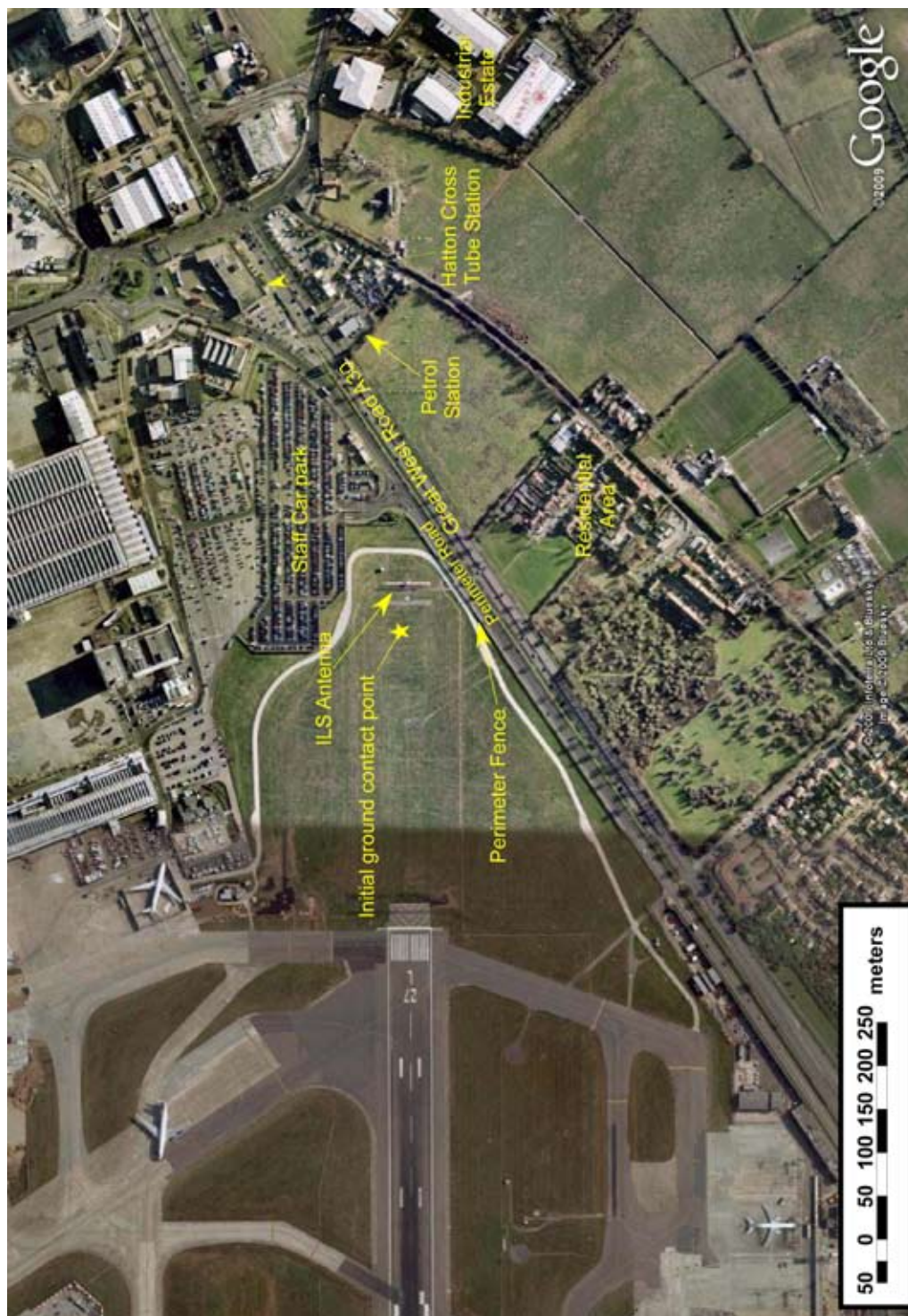

**Figure 14**  
Heathrow area of accident

## 1.11 Flight Recorders

### 1.11.1 Introduction

In accordance with regulatory requirements, the aircraft was equipped with a 25-hour duration Flight Data Recorder (DFDR)<sup>2</sup> and a 120 minute Cockpit Voice Recorder (CVR)<sup>3</sup>. The aircraft was also equipped with a Quick Access Recorder (QAR)<sup>4</sup>, which recorded data into a removable solid state memory card. These were all successfully replayed.

The DFDR provided a complete record<sup>5</sup> of both the accident flight and the preceding flight, London to Beijing, which was operated on 16 January 2008. The DFDR also contained the latter stages of the flight from Shanghai to London, which arrived on 15 January 2008. The CVR record covered the time period between 1041 hrs and 1242 hr: from about 80 minutes prior to the start of the descent to Heathrow until the aircraft's initial impact.

The QAR record<sup>6</sup> contained the outbound sector and the accident flight. However, the accident flight record ended about 45<sup>7</sup> seconds prior to the initial impact and did not include the final seconds of the approach and touchdown. The QAR, unlike the DFDR, recorded the position of both engine FMVs and the recording included the initial onset of a fuel flow reduction to both engines and the subsequent FMV movements.

A comprehensive range of parameters was available from the DFDR and QAR, with just over 1,400 parameters recorded. Salient parameters from the DFDR and QAR included:

- Fuel temperature within the left main fuel tank (recorded by the DFDR at a rate of once every 64 seconds and by the QAR at a rate of once every four seconds). Temperature was recorded by both DFDR and QAR to a resolution of 1°C.

---

2 Honeywell manufactured Solid State Flight Data Recorder, part number 980-4700-042, serial no 6147.

3 Honeywell manufactured Solid State Cockpit Voice Recorder, part number 980-6022-001, serial no 3807.

4 Penny and Giles manufactured PCMCIA QAR, part number D52000-63000, serial no 927008-002.

5 During normal operation, DFDR recording commences at first engine start and ceases after last engine shutdown.

6 In normal operation, QAR recording would commence just prior to first engine start and cease shortly after last engine shutdown. QAR recording was also activated, although not on every occasion, when only the APU was operating.

7 The loss of the 45 seconds of QAR data was later accounted for. Data is processed by the Aircraft Condition Monitoring Function (ACMF) before being sent to the QAR for recording. Analysis of the ACMF software, in conjunction with ground tests, identified that data was buffered within the ACMF for about 45 seconds before being sent to the QAR for recording. Data within the ACMF buffer could not be recovered as electrical power from the aircraft battery, used to maintain the contents of the buffer, was removed shortly after the accident.

- Fuel flow delivered to both engines (recorded by both the DFDR and QAR at a rate of once every second). A smoothing filter was applied to the parameter prior to recording. Unless specified, all fuel flows are referenced in their filtered state.
- Demanded and selected FMV position for both engines (recorded by the QAR once per second).
- Spar valve positions (recorded by the DFDR once per second).
- Forward and aft fuel cross-feed valve positions (recorded by the DFDR once every four seconds and by the QAR at a rate of once every second).
- Fuel pump low pressure warnings from all six pumps; two centre fuel tank override / jettison fuel pumps and the left and right main fuel tank forward and aft boost pumps (each low pressure warning recorded by the DFDR once every four seconds).
- Left and right engine fuel cutoff valves (recorded by the DFDR once per second).
- Fuel quantity within the centre, left main and right main fuel tanks (recorded by the DFDR at a rate of once every 64 seconds and by the QAR once every four seconds).
- Fuel Quantity Indication System (FQIS) water detection system. Three detectors, one in the centre fuel tank and one in each of the left and right main fuel tanks (indications recorded by the DFDR once every 64 seconds).
- Left and right engine oil pressure and oil temperature (recorded by the DFDR at a rate of once every 64 seconds and by the QAR once every two seconds).

### 1.11.2 Recorded Data - Beijing to London (Figures 15 to 21)

#### *Pre-flight, taxi and takeoff*

The DFDR record of the flight from Beijing to London (Heathrow) commenced at 0155 hrs, as the aircraft was pushed back from the stand and the right engine started. The left engine was then started before the APU was shut down. The APU did not operate for the remainder of the flight. Total flight duration was 10 hours 33 minutes.

As the DFDR record commenced, an active status message was recorded from the FQIS water detector located in the centre fuel tank (Figure 15). The status message remained active for five consecutive samples of that parameter: a total of five minutes and twenty seconds. After the pushback, the park brake was applied and the aircraft remained stationary for about three and a half minutes before taxiing. As the aircraft taxied, the levels of aircraft vibration increased. The water detector message remained active for a further 100 to 160 seconds before extinguishing; the exact time could not be confirmed due to the long period between successive samples of the parameter. There were no further indications from the centre tank water detector. There were no indications from the left and right fuel tank water detectors during the flight.

Whilst taxiing, the TAT was  $-6^{\circ}\text{C}$ , and the fuel temperature, measured in the left main fuel tank, was  $-2^{\circ}\text{C}$ . The aircraft took off at 0209 hrs. The total fuel quantity at takeoff was 78,700 kg, with 28,900 kg in both the left and right main tanks and 20,900 kg in the centre tank. The recorded aircraft gross weight was 254,755 kg. Both autopilot and autothrottle were engaged. Engine fuel flow during the takeoff phase peaked at 24,176 pounds per hour (pph) for the left engine and 23,334 pph for the right engine, with both engines being fed with fuel from the centre tank.

#### *Initial Climb*

The aircraft climbed to a pressure altitude of 10,590 m (34,750 ft), where, at 0232 hrs, it levelled off into the cruise portion of the flight (average fuel flow during the climb had been 15,000 pph for each engine). Engine thrust was reduced, stabilising at a fuel flow of about 8,000 pph to both engines. TAT had reduced to  $-25^{\circ}\text{C}$ , with the fuel temperature remaining at  $-2^{\circ}\text{C}$ .

### *Cruise*

At 0436 hrs, about two hours into the cruise, TAT had reduced to  $-32^{\circ}\text{C}$  and the left main tank fuel temperature had progressively reduced to about  $-22^{\circ}\text{C}$ . At this point the engines fuel feed supply switched from the centre tank to their respective left and right main fuel tanks, as designed; the total fuel quantity was 58,500 kg, with fuel being distributed 28,900 kg, 800 kg and 28,800 kg across the left, centre and right fuel tanks respectively.

During the next three and a half hours, fuel temperature reduced further from  $-22^{\circ}\text{C}$  to  $-32^{\circ}\text{C}$ , in line with reductions in TAT (See Figure 16 and Figure 17).

### *Step climb*

At 0842 hrs the aircraft made the first of two cruise step climbs, climbing from 10,590 m (34,750 ft) to 11,610 m (38,100 ft). The step climb was managed using the vertical speed (VS) mode of the autopilot, with the vertical speed set at 400 fpm. The peak fuel flow during the step climb was 8,688 pph for the left engine and 8,512 pph for the right engine. Prior to the second step climb, the aircraft made a minor flight level change to FL380 as it crossed international air traffic control boundaries; there was no significant change in engine fuel flow during this manoeuvre.

### *Lowest temperatures*

At 0930 hrs, fuel temperature reduced to its lowest recorded value of  $-34^{\circ}\text{C}$ . It remained there for about 80 minutes, during which the lowest value of TAT was recorded at  $-45^{\circ}\text{C}$ .

### *Fuel scavenge*

At 0948 hrs, as the left and right main fuel tank quantities approached 12,200 kg, automatic scavenging of the remaining fuel within the centre fuel tank to the main fuel tanks commenced, as designed. Over a period of about half an hour the centre tank quantity indication reduced from 800 kg to zero, indicating that complete fuel scavenge took place.

### *TAT rise and step climb*

Just over two hours from touchdown the TAT started to rise, in response to the increasing SAT, and this was followed by an associated rise in fuel temperature.

About twenty minutes later, the aircraft made its second and final step climb from FL380 to FL400. This was also completed using the VS mode of the autopilot, but with a higher vertical speed of 600 fpm set. During this climb the peak fuel flow was 8,896 pph for the left engine and 8,704 pph for the right engine. These were the highest fuel flows while on the main fuel tanks in the cruise. Average cruise fuel flow while on the main tanks had been 6,900 pph for the left engine and 6,800 pph for the right engine. For the entire nine and a half hour cruise, which included about the first two hours on the centre tank, average fuel flow was 7,100 pph to the left engine and 7,000 pph to the right, with maximum cruise fuel flow on the centre tank being 9,153 pph.

### *Descent*

At 1202 hrs the aircraft started its descent (Figures 18 and 19). The aircraft levelled at FL110, to enter the hold at Lambourne; it remained in the hold for about five minutes, during which it descended to FL90. During the first six minutes of the descent, the autothrottle reduced the engine thrust, with fuel flows not exceeding 1,250 pph. The oil temperature during this period was about 95°C. This was followed by two fuel flow peaks of up to 4,900 pph as the aircraft briefly levelled before entering the hold. Fuel flow then increased to about 5,500 pph. The aircraft was radar vectored for an ILS approach to Runway 27L and subsequently stabilised on the ILS with the autopilot and autothrottle systems engaged. At a height of about 1,200 ft, the aircraft was fully configured for landing and FLAP 30 was selected. By this time the fuel temperature had risen to -22°C. From the top of descent to the time of being fully configured for landing, fuel flow had not exceeded 7,300 pph for either engine.

### *Approach*

As the flaps reached the 30° position the airspeed had reduced to the target approach speed of 135 kt and the autothrottle commanded additional thrust to stabilise the airspeed (Figure 20, Point A). In response to variations in the wind velocity and associated airspeed changes, there followed a series of four, almost cyclic, thrust commands by the autothrottle (Figure 20, Point B). It was during the fourth acceleration, and as additional thrust was being commanded, that the right engine, followed some seven seconds later by the left engine, experienced a reduction in fuel flow (Figure 20, Point C). The right engine fuel flow reduction occurred at a height of about 720 ft and the left engine at about 620 ft. Just prior to the reduction in right engine fuel flow, about 2.5 nm from the runway, the flight crew were visual with the runway and the co-pilot became pilot flying (Figure 21).

Of the four thrust commands it was the second that resulted in the highest delivery of fuel flow, reaching a peak of 12,288 pph for the left engine and 12,032 pph for the right (Figure 20, Point D). These peaks occurred about 26 seconds prior to the reduction in fuel flow to the right engine. Peak fuel flows during the first and third thrust commands were lower, at about 9,500 pph and 9,000 pph respectively.

During the fourth thrust increase, the right engine fuel flow had increased to 8,300 pph before gradually reducing. The recorded EPR then started to diverge from the commanded EPR and the right engine FMV opened fully (Figure 20, Point E). Some seven seconds later, the left engine fuel flow, which had increased to 11,056 pph, also started to reduce and the left engine FMV also moved to its fully open position (Figure 20, Point F). The QAR record ended shortly after.

Fuel temperature at the time of the fuel reduction to both engines was  $-22^{\circ}\text{C}$ . Since commencing the descent, TAT had risen by  $43^{\circ}\text{C}$  and was now  $11^{\circ}\text{C}$ .

As the left engine fuel flow had decreased, a slight stagger in the position of the thrust levers occurred, with the left lever leading the right. It was at this time, at a height of about 590 ft and about 48 seconds prior to impact with the ground, that the flight crew started to become aware of an anomaly, with the co-pilot noticing the split in the thrust lever positions. The thrust lever stagger occurred as a result of the autothrottle system entering an alternate mode, termed 'TRA dot', which is described in detail in section 1.6.3.2.

Several seconds later, the thrust levers were then realigned as the autothrottle continued to advance both levers towards the maximum thrust position. A few seconds later the automatic 500 ft Radio Altimeter callout occurred.

About 34 seconds prior to touchdown, at a height of about 430 ft and airspeed of 133 kt, the commander announced "STABLE" and the co-pilot replied "JUST". Some seven seconds later the co-pilot stated "WHAT'S HAPPENED TO THE SPEED.....YEAH BUT LOOK.....WHAT'S GOING ON". They then referred to the engines being at idle power and then retarded and advanced the thrust levers. The aircraft was now about 20 seconds from touchdown.

Following the reduction in fuel flow, the left engine fuel flow stabilised at about 5,000 pph and the right at about 6,000 pph, with the engines continuing to produce thrust above flight idle. The autothrottle and the flight crew commanded full thrust. Shortly after the thrust levers had been placed



fully forward, the flight crew briefly retarded the thrust levers, to a position corresponding to a thrust level above that which was being delivered, before placing them fully forward again, where they remained. There was no increase in thrust from either engine. The actual engine fuel flows continued to remain significantly below that which was being commanded.

### *Impact*

Following the reduction in thrust, the autopilot attempted to maintain the aircraft on the ILS glideslope. As the airspeed started to decay the autopilot compensated by commanding a progressively nose-high pitch attitude. By about 240 ft the airspeed had reduced to 115 kt, at which point there was a master caution aural warning, indicative of the 'AIRSPEED LOW' warning. This speed was now some 20 kt below the target approach speed, at which time the commander selected FLAP 25. At 200 ft, airspeed had reached 108 kt and the stick shaker started to activate as the aircraft neared the stall. Shortly afterwards the co-pilot made a nose-down pitch control input which reduced the aircraft pitch attitude and automatically disconnected the autopilot. At this time the commander made a 'MAYDAY' call. The aircraft remained near to the stall and three seconds later it impacted the ground at a descent rate of about 1,400 fpm (~25 ft/s) and a recorded peak normal load of 2.9g; the time was 1242:09 hrs. The aircraft bounced and then slid along the ground, during which time the DFDR and CVR records ceased due to a loss of electrical power.

### *Other relevant observations during the flight*

Data indicated that throughout the flight, the fuel cross-feed valves were closed and the fuel spar valves and engine shutoff valves were open. There was no activation of a low pressure warning from the fuel boost pumps or impending blockage warning for either engine fuel filter.

At approximately six seconds before impact, DFDR data indicated that the APU start switch had been moved from the APU OFF to APU ON position. At the same time, the APU fuel shutoff valve opened. In the remaining seconds of DFDR data, the APU rpm indication remained at zero and the APU inlet door indicated it was not in the open position. There was also no indication that the APU was providing electrical power to the aircraft. At no time during this period, or the entire flight, did the RAT indicate that it had been unlocked.

### 1.11.3 Engine oil recorded data

The engine oil temperature, which is sensed at the scavenge outlet, takes some time to register variations but experience has shown that the oil pressure sensor, which is sensitive to changes in viscosity due to temperature changes, is quicker to react.

During early analysis of the G-YMMM recorded data, attempts were made to interpret the oil temperature parameters but this was hampered by the fact that the DFDR records oil temperature and pressure only at intervals of 64 seconds. The QAR samples at a faster rate - every two seconds - but, because of data buffering, QAR data was lost immediately after the left engine rolled back. It was concluded that no meaningful trend of oil temperature for either engine could be discerned.

The data was examined with respect to oil pressure. This showed that both the left and right engines' oil pressure generally follow each other until the start of the final acceleration, which resulted in first the right and then the left engines rolling back. The left engine oil pressure rose, as expected, as the engine accelerated: the right engine pressure, however, started to decrease, even though the engine was also accelerating prior to its rollback. Whilst, this observation, on the right engine, was based on only a few data points, it can be inferred that this was due to an oil temperature increase at, or close to, the start of the final acceleration. However, the loss of QAR data so close to the left engine rollback meant that it was not possible to draw a similar conclusion for the left engine. (Figure 20)

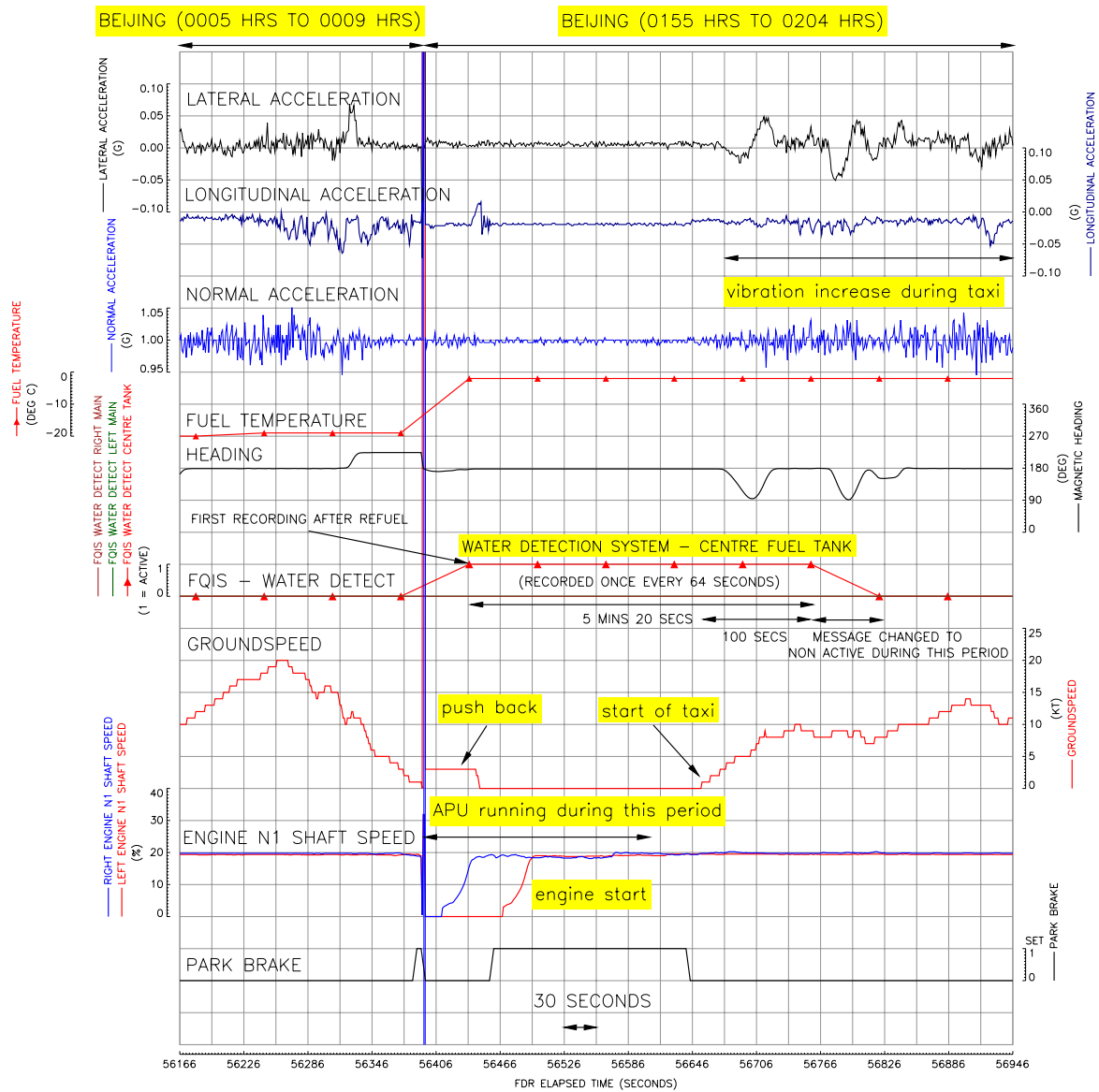

Figure 15

Taxi out at Beijing

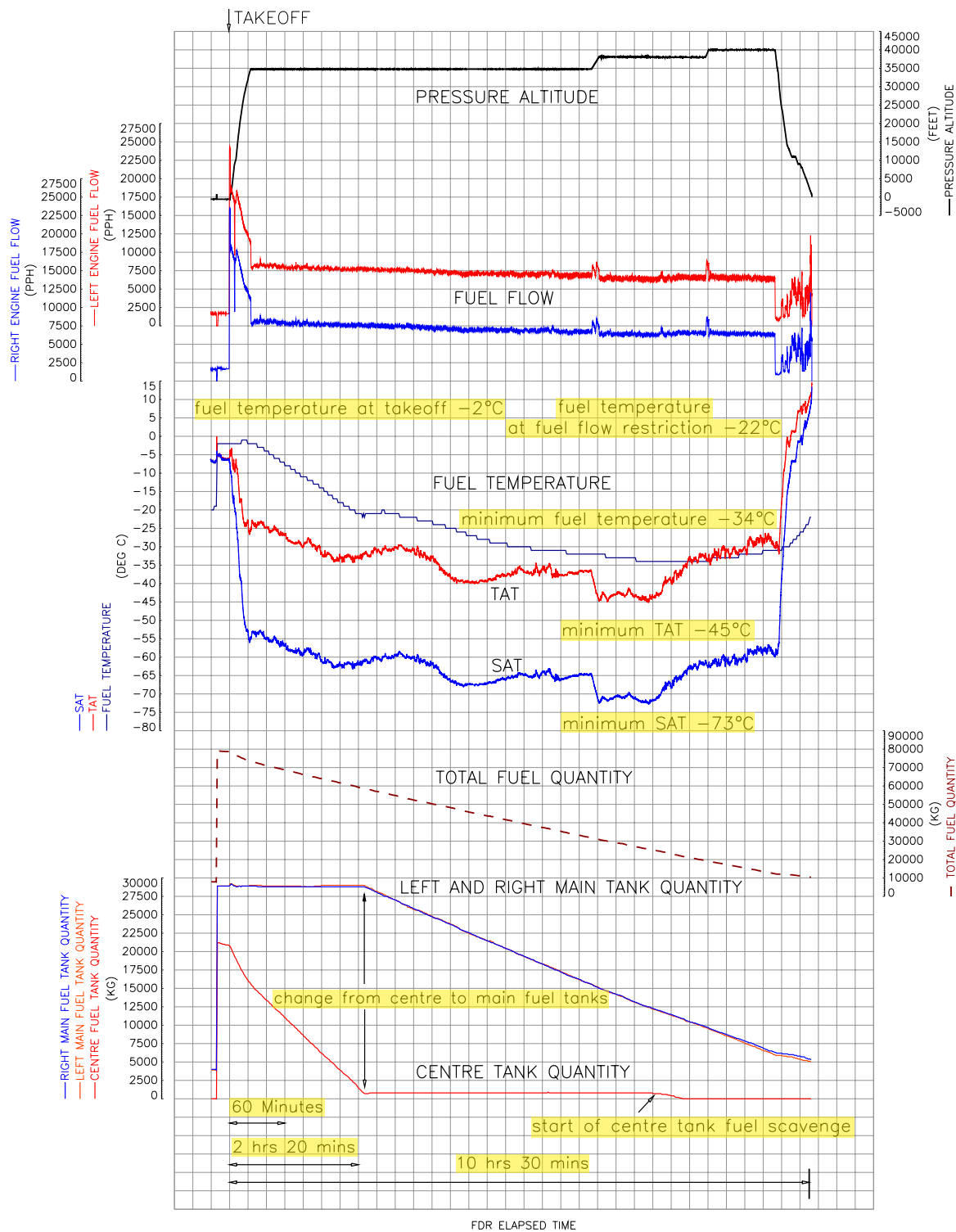
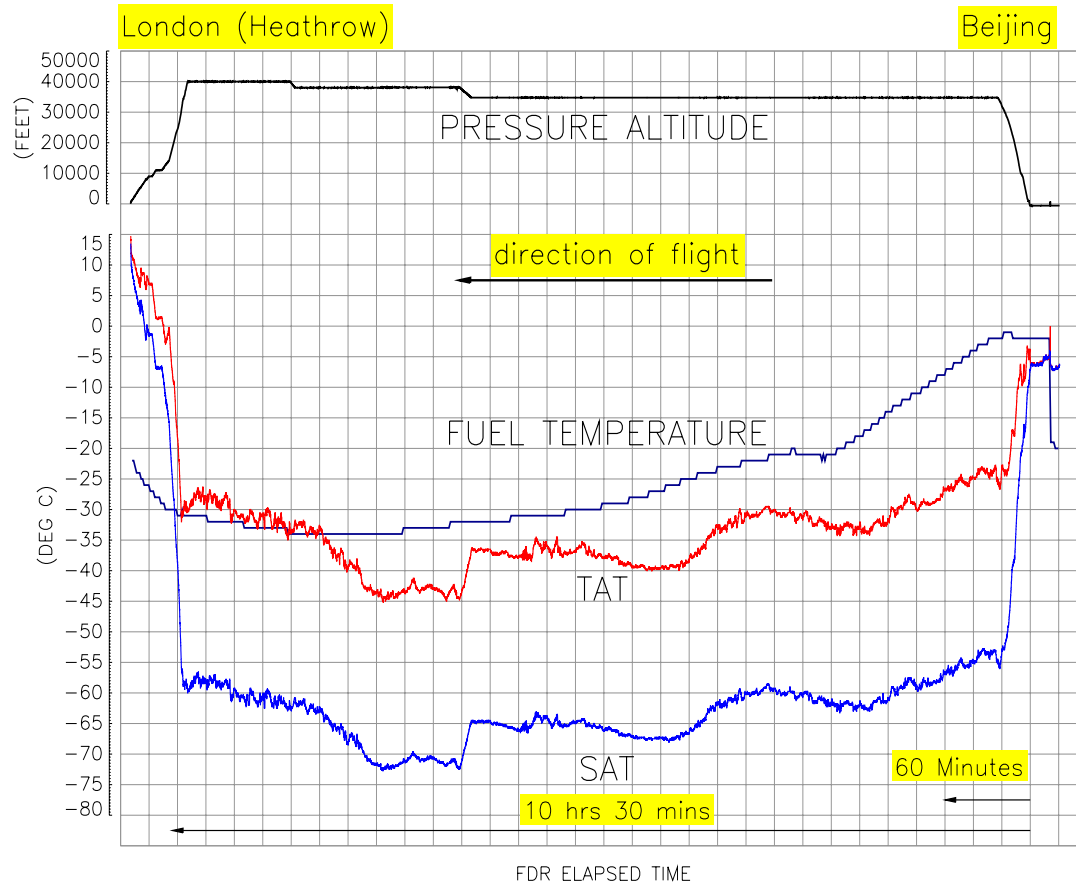

Figure 16

Temperatures - Beijing to London (Heathrow)



© 2008 Google - Map data  
Image NASA  
© 2008 DMapas; © 2008 Europa Technologies;  
© 2008 Tele Atlas

Figure 17

Flight Track and Temperatures - Beijing to London

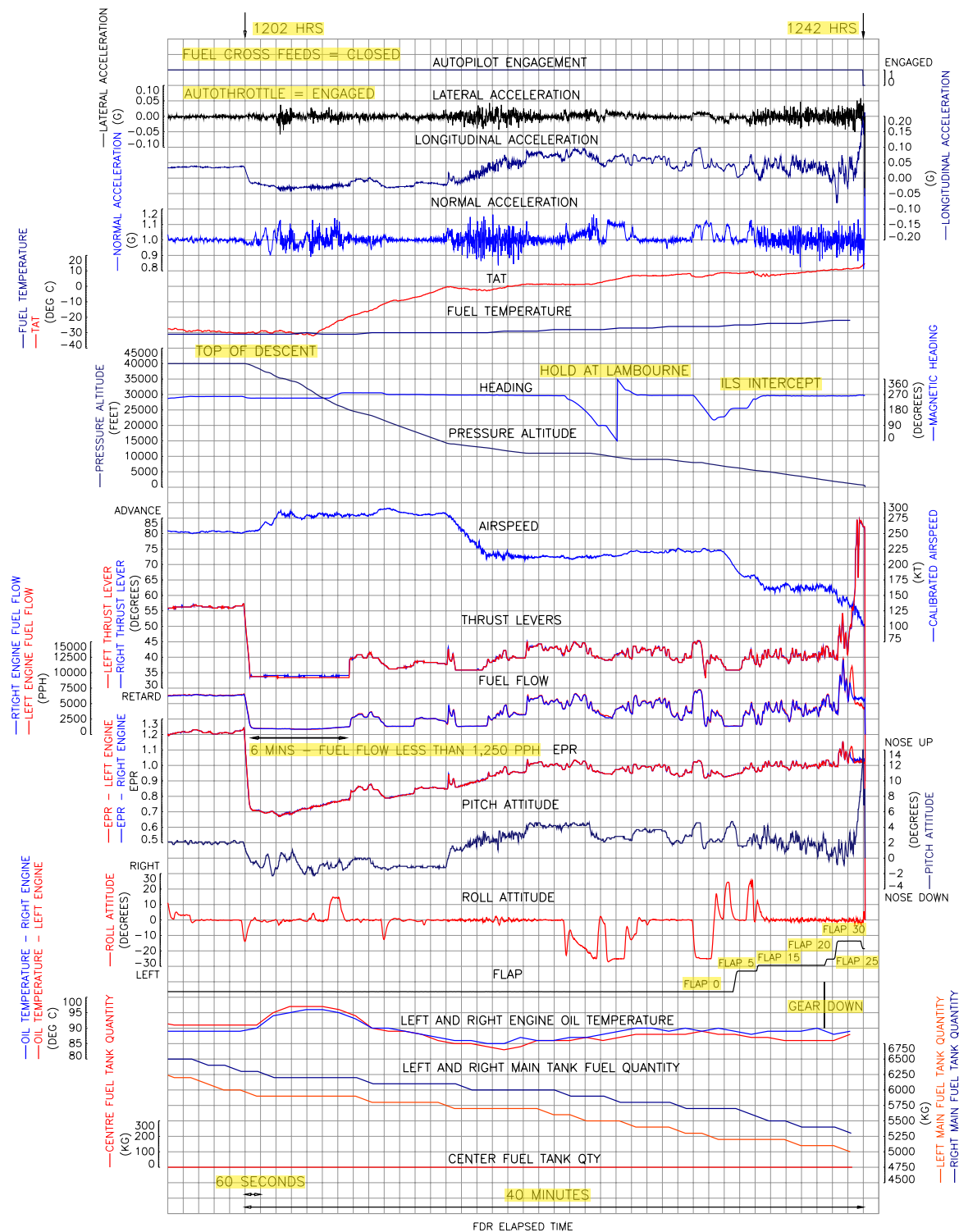

Figure 18

Salient Parameters - Top of Descent to London



Figure 19

Flight Track - Top of Descent to London

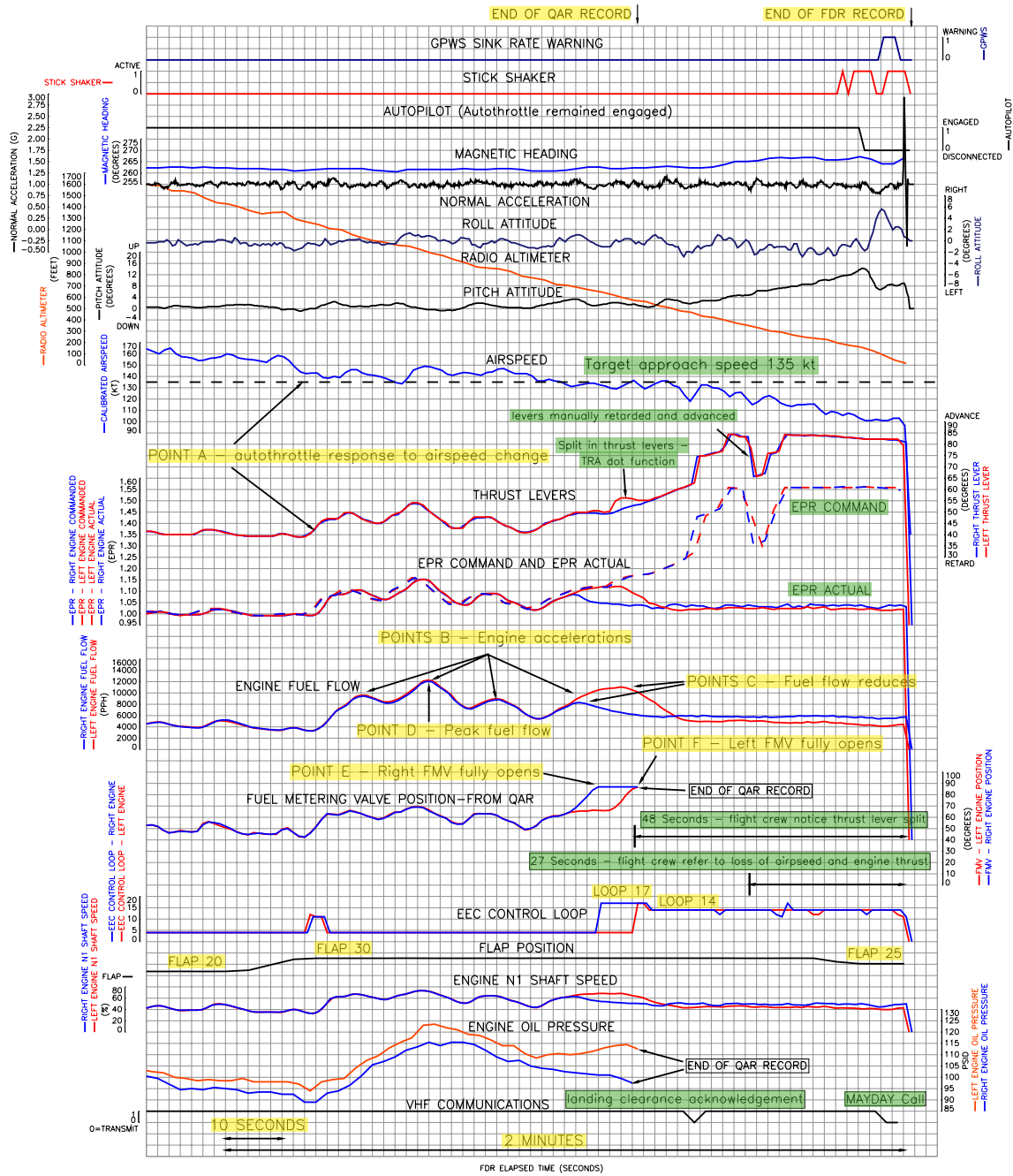
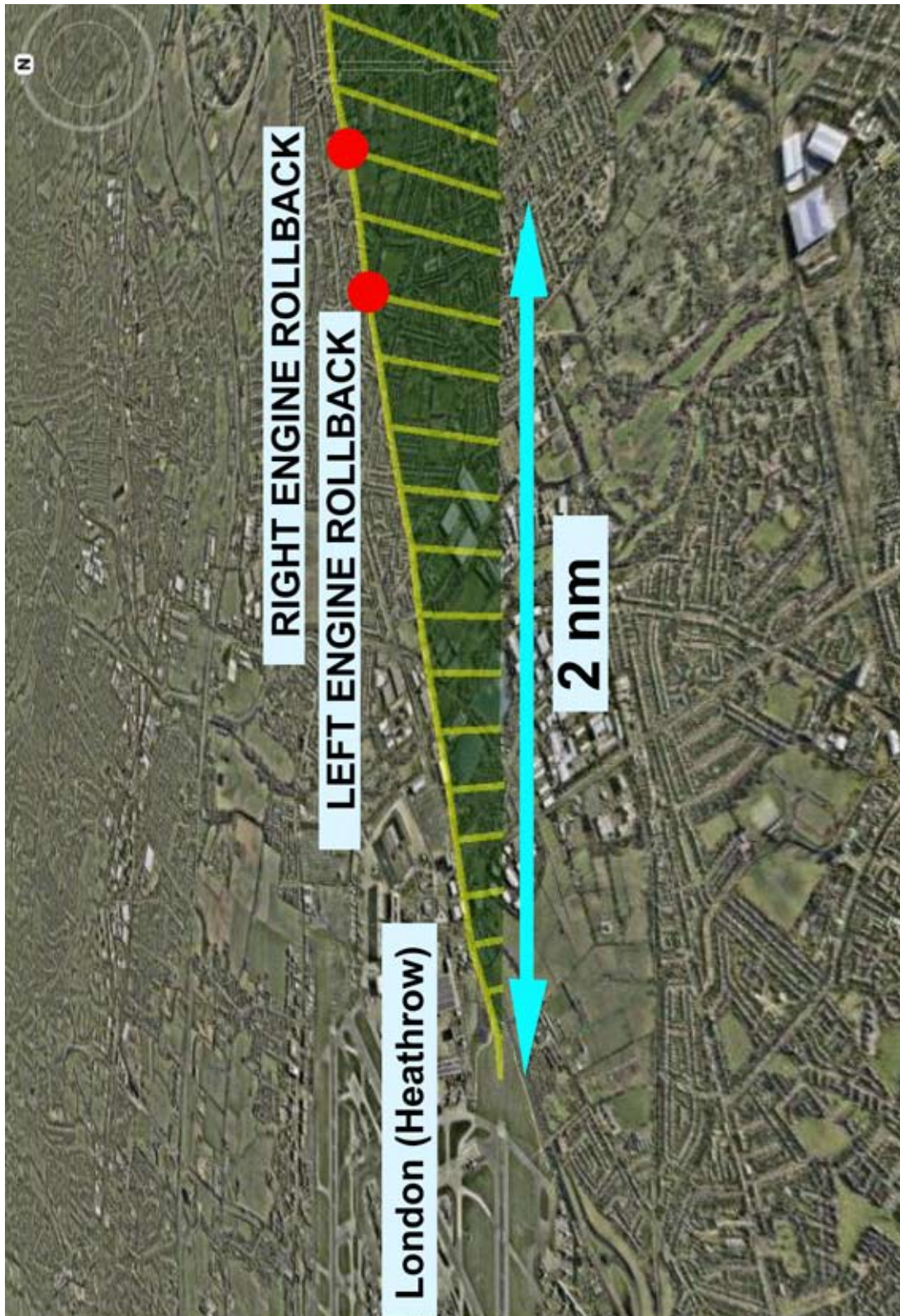

Figure 20

Final minutes of approach





© 2009 Infoterra Ltd & Bluesky; © 2009 Europa Technologies; © 2009 Tele Atlas; Image © 2009 Bluesky

Figure 21

Flight Track – Final approach

#### 1.11.4 DFDR and QAR system recording requirements

At the time of the accident, the DFDR system fitted to G-YMMM was compliant with both European regulation Joint Airworthiness Requirements (JAR) OPS 1.715 and US regulation Federal Aviation Requirements (FAR) 121.343. JAR OPS 1.715 has since been superseded by EC OPS 1.715, and the recording requirements for the engines are '*Propulsive thrust/power on each engine and cockpit thrust/power lever position if applicable*'. FAR 121.343 requirements are similar. Parameters from the system that directly controls the flow of fuel into the engines, such as the fuel metering valves, are not required by either regulation; the DFDR system equipped to G-YMMM did not record the position of the FMVs.

G-YMMM was also equipped with an ACMF system. The ACMF is a centralised system designed for the purpose of providing Engine Health Monitoring (EHM) and Aircraft Performance Monitoring (APM). It also records flight data onto a QAR, which is widely used for flight data monitoring, incident investigation and maintenance purposes. DFDR certification requirements do not apply to QAR and ACMF type systems. The QAR is not required to be accident protected and there is no requirement governing the use of buffering or the recording of certain parameters. Unlike the DFDR system, the ACMF may also be readily modified by the operator to suit its operational requirements.

The ACMF uses buffers so that analysis may be performed on data that occurred both before and after an event has been detected. This feature is commonly used within the EHM and APM functions. The aircraft manufacturer also used a similar feature within the QAR start logic, where data was recorded with a time offset so that engine pre-start information could be captured. At the time of the accident, the QAR recording delay was about 45 seconds. Through an ACMF software update, this delay was later minimised on the remainder of the operator's B777 fleet with no adverse affect on the ACMF or QAR operation.

#### 1.11.5 Data mining

A team of statisticians from QinetiQ, together with specialists from the aircraft and engine manufacturer, the operator and the AAIB, conducted a review of data from the accident flight and from other data sources.

The principles of data mining are explained in 1.19.1. Results of the data mining activity are detailed in Appendix F and a full analysis of these results can be found in section 2.8.4.

## 1.12 Wreckage, impact information and aircraft examination

### 1.12.1 Accident site

The accident site was a flat grass area situated between the airfield's internal perimeter road and the eastern end of Runway 27L. Located within this grass area were items of airfield furniture such as approach lights. Also in this area, either side of the extended runway centreline, were two large rectangular cable inspection pits. The southern pit was approximately 94 m from the aircraft's initial impact point and the northern pit was approximately 210 m from that point. At the time of the accident the ground was very soft due to an extended period of rainfall.

### 1.12.2 Ground marks

The initial impact of the aircraft was approximately 110 m inside the airfield's perimeter fence. The first ground marks (Figure 22) were made by the rearmost wheels, followed by all the main wheels as the trucks tilted forward, at which time the maximum vertical acceleration spike of 2.9g was recorded on the DFDR. The touchdown into soft soil produced impact gouges with a depth of up to 0.45 m from the right gear and 0.36 m from the left gear. There was also a mark from the contact with the rear fuselage as the aircraft continued forward.

The aircraft then rebounded and briefly became airborne again. On the second impact, approximately 53 m from the first impact, the ground marks indicated that the right MLG had moved inboard. There were also marks from contact by the engine nacelles and the NLG, which immediately collapsed. As the weight of the aircraft transferred onto the engine nacelles, the engine cowlings and engine accessories were damaged and the engines dug into the ground.

Also shown in Figure 23 is the final position of the main section of right MLG and the front section of the truck beam, with its two wheels.

Approximately 40 m beyond its initial contact, the left engine struck the concrete cover of the southern inspection pit, which caused severe disruption to the front and lower engine area and the failure of the majority of its fan blades.

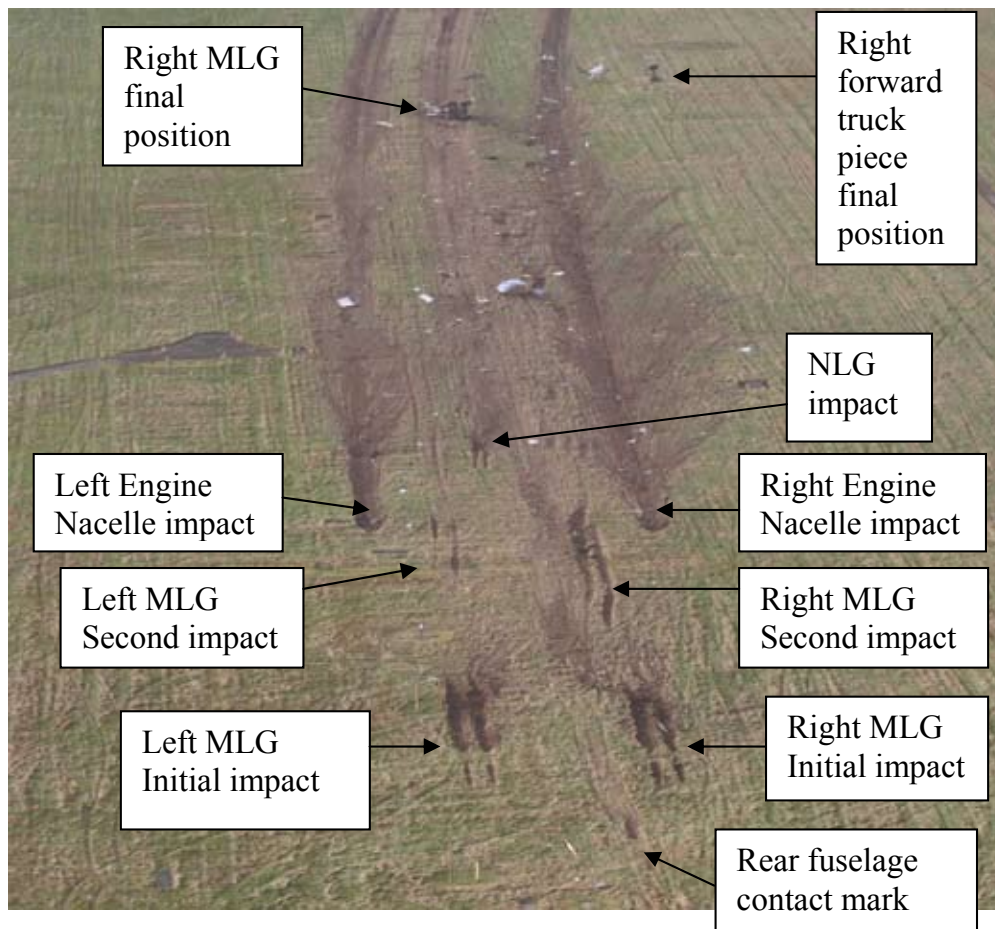

*Photograph courtesy of:  
Metropolitan Police ASU*

**Figure 22**

Initial impact ground marks

During the ground slide both the engines scooped up soft soil, which increased the aircraft's retardation. Approximately 152 m after its initial contact the right engine struck the thick concrete cover of the northern inspection pit.

This caused damage to the lower part of the engine and assisted the deviation of the aircraft's ground slide to the right.

The aircraft came to rest on the tarmac area just to the north of the threshold of Runway 27L, approximately 372 m from the first impact point.

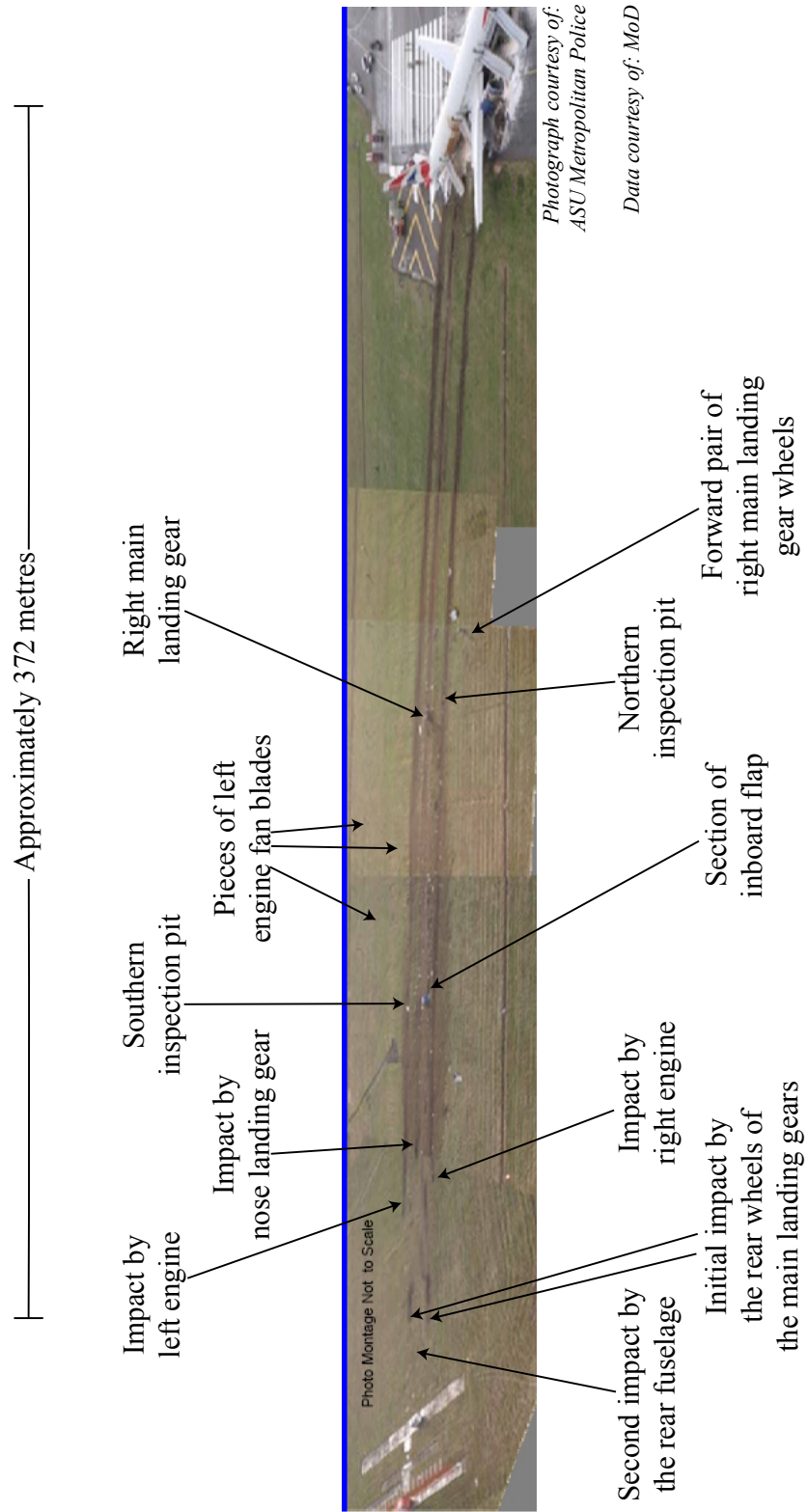

**Figure 23**

Ground impact marks and wreckage trail

### 1.12.3 Initial examination

Immediately following the accident, and to make the aircraft safe, the AFS assisted by engineers from the operator accessed the aircraft. The aircraft battery was disconnected, and in the flight deck the Battery switch and the APU switch were moved from ON to OFF.

#### 1.12.3.1 Circuit breakers

During the accident several circuit breakers had 'tripped'. The significant breakers related to the fuel or engine systems that were found in a tripped condition were:

Circuit breaker B4 'L engine fuel valve' – protects the power supply circuit to the engine fuel shutoff valve on the engine's fuel metering unit.

Circuit breaker A18 'L engine fuel spar valve' – protects the power supply circuit to the left spar valve.

#### 1.12.3.2 Cockpit switch positions

Following the accident the following switch positions were noted in the flight deck:

*Fire switches* - The fire switches for the APU and both engines had been 'pulled' and twisted to trigger the fire extinguishers.

*APU and Electrical panel* - The Battery and APU switches were initially ON; the fire service moved these to OFF shortly after the accident. The engine generator switches were ON and the Bus Tie switches were in AUTO.

*Fuel panel* - The main engine fuel feed pumps were ON, the centre OJ pump switches were OFF. The cross-feed valve switches were in the OPEN position.

*Engine overhead panel* - Both the left and right EEC mode pushbuttons were selected to NORM. The left and right engine start switches were in NORM.

*Engine fuel control switches* - Both engine fuel control switches were in CUTOFF.

*Engine thrust levers* - Both engine thrust levers were in the full thrust position.

*Flaps* - FLAP 25 selected.

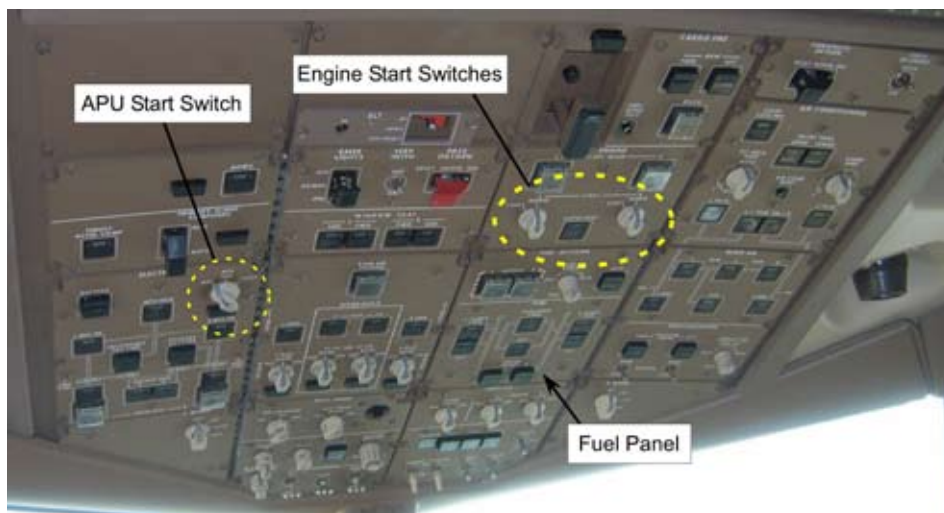

**Figure 24**

Overhead panel shortly after the accident

#### 1.12.3.3 Landing gear examination

The aircraft structure and landing gear were subjected to an initial examination on-site following the accident and a more detailed examination after the aircraft had been recovered.

The nose landing gear had separated from the aircraft; damage to its attachments were consistent with both a high vertical load and side load to the left.

The left MLG had partially separated due to overload but remained attached to the fuselage by the drag and side braces. During the initial impact the gear beam outboard end fuse pin had fractured, which allowed the gear beam to rotate upwards. The trunnion housing fuse pins then also fractured, allowing the forward trunnion to move upwards. The significant vertical load had also resulted in a piece of top wing skin being removed. There were witness marks on the aft trunnion outer bearing race, consistent with the aft trunnion then having been pulled out. The attachment of the inboard end of the gear beam was damaged but remained intact; the drag strut fuse pin had 'crankshafted' in a direction indicating that a load had been applied in tension but this had also remained intact.

The truck beam had evidence of damage due to over-travel in the truck pitch-up direction. There was no visible damage to the shock strut or centre axle

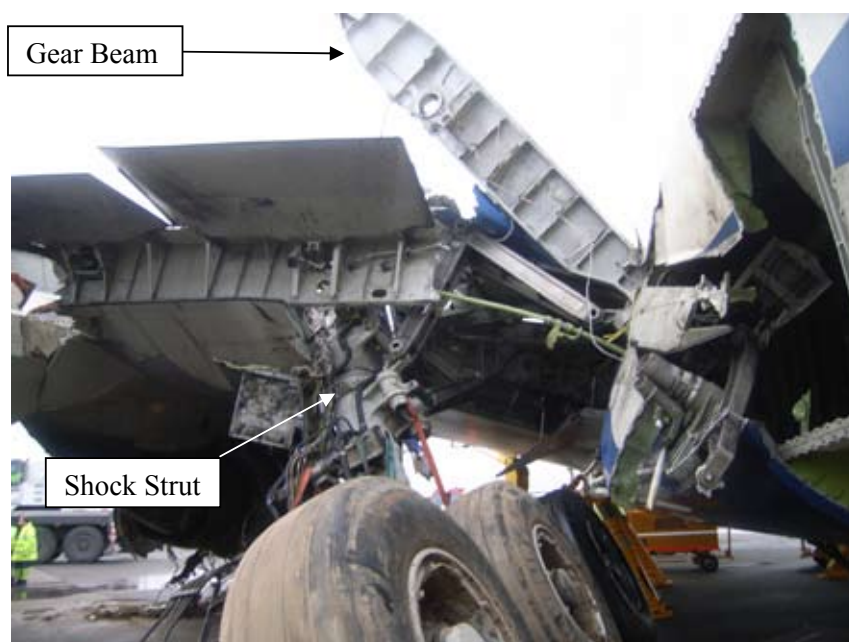

**Figure 25**

#### Left Main Landing Gear

During the initial impact the fuse pins in the right MLG gear beam outboard end fractured, which allowed it to rotate upwards in the same manner that had occurred on the left MLG. The lower housing (H block) fuse pins had then also fractured and witness marks on the lower housing support indicated that the H block, together with the forward trunnion, had been pulled aft and down.

There was no evidence of any ‘crank-shafting’ or damage to the drag brace fuse pin. Witness marks on the upper surface of the truck beam indicated an over-travel in both the truck pitch-up and pitch-down directions.

During the subsequent ground slide the right MLG had separated from the aircraft, rupturing the rear wing spar web. The drag brace support fitting, together with portions of the rear spar web, rear terminal fitting and the internal back-up fitting remained attached to the right main landing gear around the drag brace fitting. Examination of the fracture surfaces indicated an overload in the aft direction.



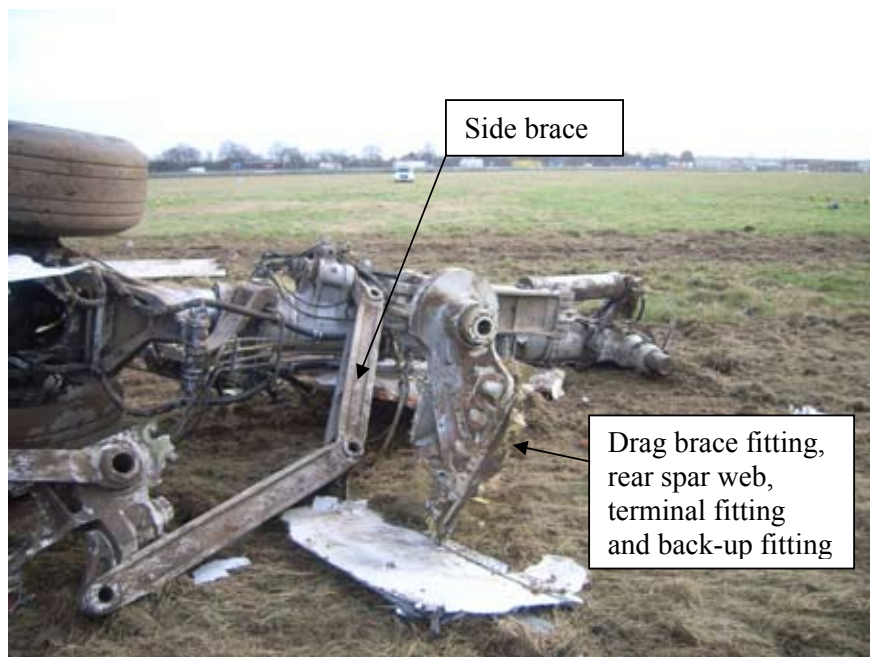

**Figure 26**

Right Main Landing Gear with rear spar web



**Figure 27**

Right Main Landing Gear with embedded portion of right horizontal stabiliser leading edge

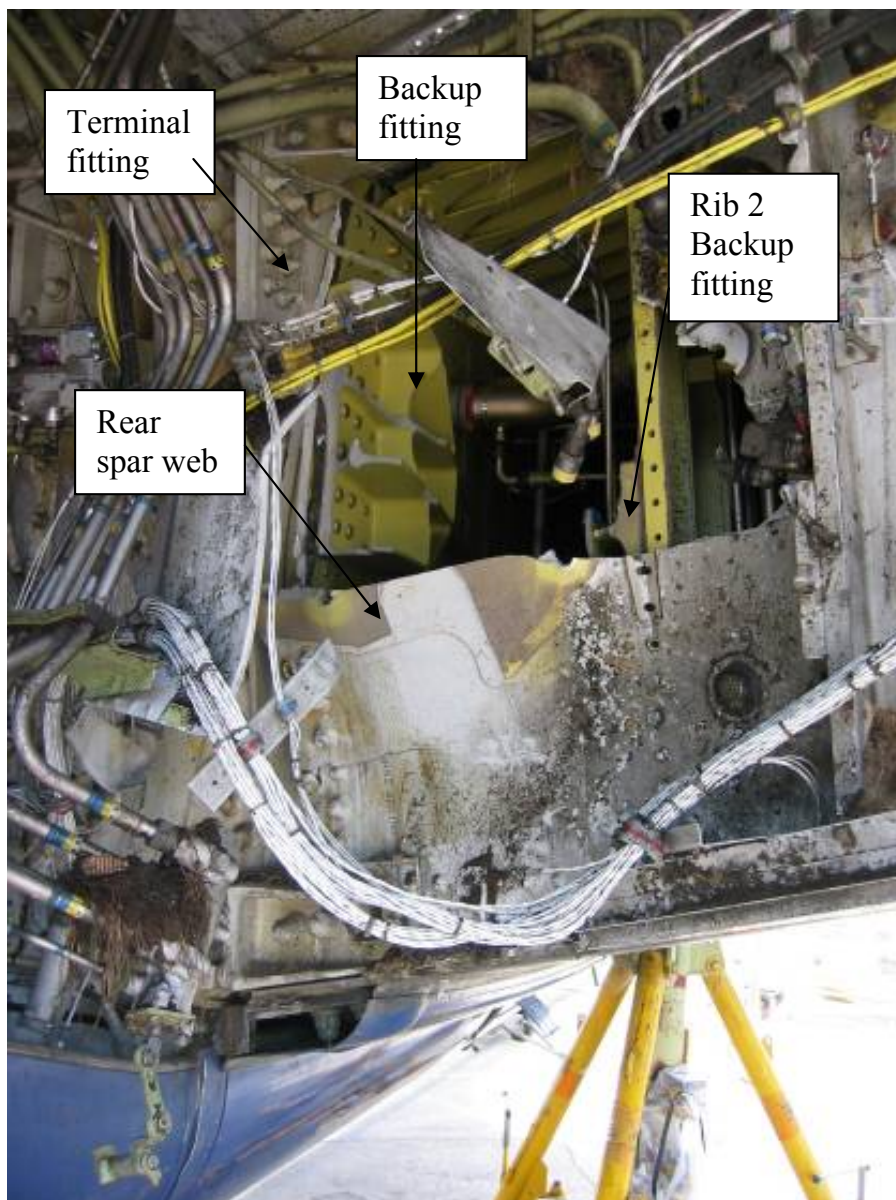

**Figure 28**

Right rear spar showing missing drag brace attachment point and centre fuel tank structure

Additionally, during the separation, the remaining section of the right MLG had impacted the fuselage, damaging the wing-to-body fairing and penetrating the rear cargo hold. This impact had caused damage to and leakage from, the passenger oxygen cylinders, located in the rear cargo hold.

This section of MLG had then become airborne and impacted the right horizontal stabiliser as the aircraft continued to slide. This was confirmed by the presence of an embedded portion of horizontal stabiliser leading edge material.

The two front wheels of the right MLG, together with the forward section of the truck beam ahead of the centre axle became detached and impacted the right side of the fuselage.



**Figure 29**

View showing damage to right fuselage aft of the MLG bay.  
(Dotted lines indicate impact marks from the rear two wheels of the truck beam)

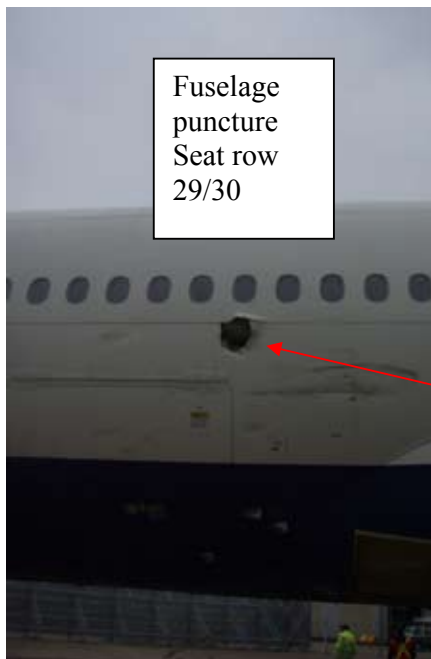

**Figure 30**

Right side of fuselage showing damage at seat rows 29/30



**Figure 31**

Forward portion of truck beam and two wheels

#### 1.12.3.4 Oxygen leakage

The impact and penetration of the forward right side of the rear cargo bay by the right landing gear tore one of the oxygen cylinders from the cabin oxygen supply manifold, rupturing the manifold pipe (Figure 32). This allowed all the remaining cabin oxygen cylinders to vent to atmosphere.



**Figure 32**

Disrupted passenger oxygen bottles in the rear cargo hold

### 1.12.3.5 Aircraft structural examination

The right MLG forward truck beam and its wheels had punctured the right side of the fuselage adjacent to seat rows 29-30, at the height of the seat armrest (Figures 33 and 34). This had breached the fuselage outer skin, insulation blankets and the cabin lining panel. The sidewall lining had been pushed into the cabin, resulting in the injury to the passenger seated in 30K and the failure of the outboard spreader bar extension of seat 29K.



**Figure 33**

Cabin damage at rows 29/30

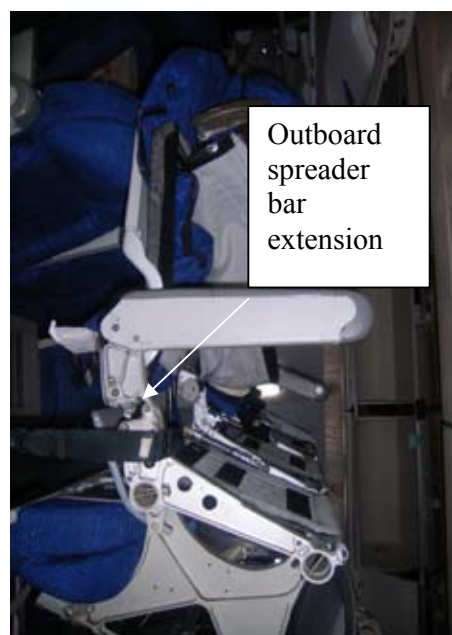

**Figure 34**

Damage to seat 29K  
(outboard spreader bar  
extension fractured)

There was no damage to the keel structure in the centre fuselage section in the area of the centre fuel tank. The main deck floor structure and cargo stanchions were inspected in the forward and aft cargo compartments; there was no evidence of damage.

### 1.12.3.6 Engine pylons

The pylon attachments upper link (R1) fuse pins on both right and left engines were intact but showed evidence of 'crankshafting' which indicated a compressive overload.

### 1.12.3.7 Cabin

Inspection of the cabin, including the seat structure, floor fitting and seat tracks revealed no visible damage, other than at rows 29/30. There was no visible damage to the cabin crew seats, apart from deformation of the seat pan on the forward facing seat adjacent to Door 4L. The cabin crew inertia reel seat belts were checked and functioned correctly.

Oxygen masks had deployed from their PSUs at 13 locations; of these, ten were missing the PSU door covers and the nylon hinges having fractured. On the remaining three units the door covers had remained attached and hinged from the latches.

There were significant amounts of glass debris in the forward area of the Traveller cabin section, which was more extensive on the left side of the cabin in the region of Door 3L (Figures 35 to 37). The glass debris extended as far forward as Door 2L and 2R, and as far aft as seat row 31, with highest concentrations in the areas between rows 21 and 29.

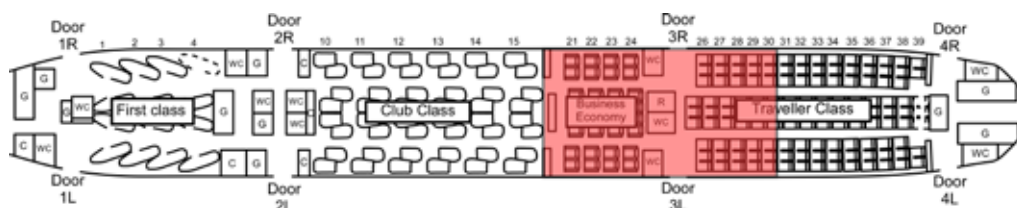
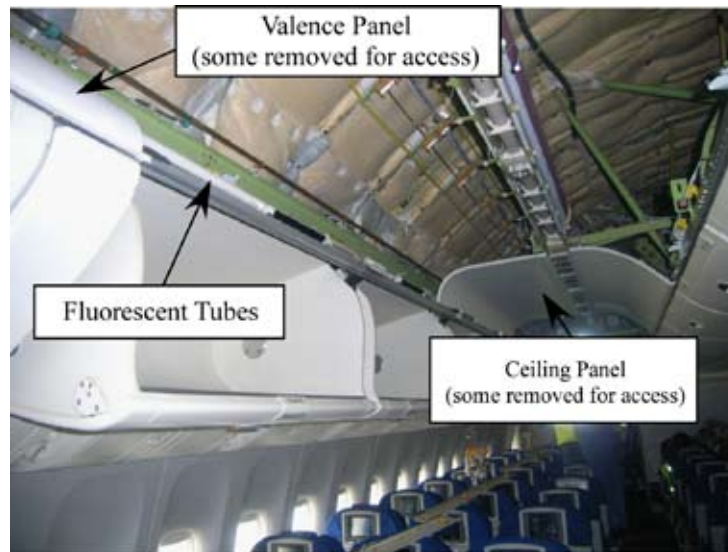

**Figure 35**

Cabin layout showing location of glass debris

Inspection of the ceiling lights above the overhead storage bins in this area, and aft, indicated that some of the fluorescent tubes were missing and some had become dislodged from their fixtures.

A further, detailed examination showed that on the right side there were eight fluorescent tubes missing. Of these, five had separated from the fixtures but were intact and were lodged above the overhead bins behind the valence panels. Three fluorescent tubes had broken. On the left side there were ten fluorescent tubes missing; five tubes had separated but were intact and five had broken. Three of the fixtures were damaged but the tube retaining end fittings were still functional. The gap between the ceiling panel and the valence panel contained numerous fragments from the fluorescent tubes.



**Figure 36**

Overhead lighting, showing loose fluorescent tubes



**Figure 37**

Debris on the floor from fluorescent tubes in area of Door 3L

The exit signs light lenses were found to have detached from Door 3L and 3R (Figure 38) and it was evident that any misalignment of the plastic door mouldings resulted in difficulty in engaging all four of the mounting clips.



**Figure 38**

View showing Door 3R with the exit light lens cover missing

In the Business Economy section, nine of the 32 seat back video monitors had separated; of these, eight remained suspended by their electrical harness but one had separated completely and was found on the cabin floor (Figure 39).

Further examination revealed that by exerting a downward force by hand, it was possible to detach one of the monitors which otherwise appeared to be correctly located. The spring clip attachments were found to be loose, allowing movement of the clip and preventing correct engagement in the detent.





**Figure 39**

Business Economy section showing video monitors detached from the seat backs



**Figure 40**

Video monitor attachment fittings

Six footrest stowage areas were found open in Club Class, and several under-seat life jacket stowage compartments on Business Economy seats and Traveller seats were also open. Further enquiries indicated that the life jackets had been removed from their stowages following the accident and prior to the detailed examination of the cabin by AAIB.

Detailed examination of the areas above the cabin, including the supporting structure for the centre and outboard overhead bins, galley complexes and lavatories revealed no evidence of significant damage.

#### 1.12.3.8 Fuel quantity

After the accident fuel was seen to leak out of the ruptured engine fuel pipes until the spar valves were closed.

DFDR data showed that, at the time of the accident, the total fuel in the aircraft was 10,500 kg, with 5,100 kg in the left main tank and 5,400 kg in the right main tank. From photographs taken as the aircraft crossed the airfield perimeter fence, and pitch data obtained from the DFDR, the manufacturer assessed from the frost pattern on the lower wing surface that the fuel quantity, and its distribution, in the main tanks at the end of the flight was consistent with the fuel load recorded on the DFDR.

The contents of the main fuel tanks were checked on 18 January 2008, after the spar valves had been closed, using the aircraft fuel measuring sticks. After taking into account the aircraft attitude, it was established that there was approximately 3,750 kg of fuel in the aircraft, with 2,240 kg in the left main tank and 1,510 kg in the right main tank. A comparison of the contents recorded on the DFDR and that established from the measuring sticks, indicated that following the accident approximately 6,750 kg of fuel had leaked out of the fractured engine fuel pipes.

At the accident site the aircraft was lifted to allow jacks to be installed at the 'wing to body' fairings. During this lift the left wing was raised higher than the right wing and the aircraft remained in this attitude for some time. The aircraft was subsequently positioned in a level attitude which was maintained during the move from the runway to the maintenance area, where the fuel contents were again checked using the aircraft fuel measuring sticks. It was established that there was about 3,562 kg of fuel in the aircraft with 596 kg in the left main tank and 2,976 kg in the right main tank. As there was no evidence of any fuel leakage after the spar valves had been closed, it is believed that approximately 1,500 kg of fuel transferred from the left to the right wing when the left wing was raised during the initial lifting of the aircraft at the accident site.

Following the taking of the fuel samples, approximately 3,600 kg of useable fuel was recovered from the main fuel tanks into a clean bowser using a defueling adaptor mounted in each of the main tank aft boost pump housings. The unusable fuel in the main tanks was drained from the bottom of the fuel tanks. Approximately 2,000 kg of fluid, which consisted mostly of the fire fighting medium, was drained out of the centre tank.

#### 1.12.3.9 Left and right wing wiring damage

As a result of the landing gear failure, the wiring looms in the raceway to the top of the rear spar and above the main landing attachment fitting had been severed; wiring in the proximity of the landing gear attachment fittings had suffered various levels of damage. This wiring damage was evident on both sides of the aircraft. These looms included wiring to the left and right fuel spar valves, main fuel tank boost pumps and fuel quantity indication.

Examination of the wiring damage was consistent with it being sustained during the accident, either from the disruption from the main landing gear separation or from the ground slide. There was no evidence of a pre-existing failure of the wiring on the aircraft.

#### 1.12.3.10 Engines

Both engines had remained attached to the aircraft but had suffered heavy damage to their undersides and cowlings caused by the ground slide. The left engine had lost its accessory gearbox (later recovered from the debris trail) and the right engine gearbox only remained attached by some of its pipework. Fuel was seen to be flowing at a considerable rate from a fracture in the pipe connected to the LP pump inlet of the right engine. Both spar valves were closed manually to stop this leak.

Both engines had ingested considerable quantities of earth and debris which had damaged the fan blades: the left engine was more badly damaged in this respect, having lost approximately 50% of the span of each blade as the engine had struck a concrete drain during the ground slide. However, both engines showed signs of rotation, albeit under relatively low power and subsequent inspection of aerial photographs showed that both had thrown characteristic 'plumes' of earth sideways during the ground slide.

The wiring on the underside of the engines, including that connected to the engine fuel valves contained in the FMU, had suffered significant damage during the ground slide.

There were no signs of fire or non-containment of either engine nor any damage which could not be explained by the impact.

Both LP fuel filters were removed and sent to the engine manufacturer for examination. As part of this procedure, the filter housings were drained and any fluid collected for analysis. The left engine filter housing contained 15 ml of fuel and the right yielded about 100 to 250 ml of fuel.

#### 1.12.3.11 Fuel system

##### *Visual inspection*

The AAIB and the aircraft manufacturer carried out a visual inspection of the aircraft fuel tanks, the fuel system components and the fuel tank vent system, prior to the pressure and suction tests. The main components in the fuel delivery system were subsequently removed from the aircraft and returned to the manufacturer for further inspection and testing under AAIB supervision. The AAIB also removed the fuel delivery system from the left and right wings, and the left side of the centre tank. The left system was reassembled at the AAIB facility at Farnborough and the right system was used in the manufacturer's fuel test rig. The fuel tanks were clean and correctly constructed with no evidence of any damage beyond that which occurred during the impact. All the water drain holes were found to be clear and the check valves in the baffle ribs operated correctly. With the exception of the points listed below, the visual inspection established that all the components, pipes, seals and flexible hoses were in a serviceable condition.

##### *Left main wing tank, rib 8/9*

The union for the centre tank fuel scavenge discharge pipe located in the roof of the left main fuel tank, at rib 8/9, was found to be fully unwound from the threaded portion of the pipe.

##### *Foreign objects*

Five foreign objects were discovered in the fuel system:

A red plastic scraper approximately 11.5 cm long x 2.2 cm wide was found adjacent to the right tank suction intake. The scraper was identified as a tool used by the aircraft manufacturers tank closure personnel.

In the area of the left main tank water scavenge pump inlet:

A piece of black plastic tape (3M 226HD) approximately 52 mm x 50 mm (2 inch tape). The tape had a number of circular marks similar in size and layout to the holes on the water scavenge pump inlet. It was likely that the tape was left in the tank during the construction of the aircraft.

A piece of brown paper the same shape and size as the black plastic tape. The paper had two circular marks similar to those on the plastic tape and is believed to be the adhesive backing for this piece of tape.

A piece of yellow plastic approximately 10 mm x 12 mm. The plastic was similar in appearance to electrical cable identity tape.

A small piece of fabric/paper was found in the inlet gate/guillotine valve of the right centre OJ pump.

The significance of these items is discussed in sections 2.3.6 and 2.3.7.

#### *Borescope inspection*

An internal borescope inspection of the fuel delivery system was carried out on 26 and 28 January 2008 using a 30 ft probe. The probe was inserted at several points along the fuel delivery manifold between the left and right engine fuel disconnect pipes. There was no evidence of an obstruction in any of the pipes, collapsed hoses or internal damage to the spar and cross-feed valves.

#### *Pressure tests*

The integrity of the aircraft fuel delivery system between the aircraft fuel pump check valves and the engine strut disconnect was checked, using compressed air and nitrogen, at pressures up to 60 psi, which is 5 psi above the design pressure of 55 psi. The aim of the test was to check the integrity of the pipes (tubes) and to establish if there were any leaks across any of the valves in the system, including the spar and cross-feed valves.

When the air/nitrogen supply was removed the system maintained the pressure for periods in excess of five minutes at pressures up to 55 psi. When the pressure

was increased above 55 psi some of the thermal relief ports in the valves started to open and allowed the internal pressure to dissipate.

The pressure test proved the system integrity up to the design pressure of 55 psi. The test also established that in ambient conditions none of the thermal relief ports in the spar valves operated below the maximum system pressure of 55 psi.

*Suction tests.*

Suction tests were carried out to check the integrity of the fuel delivery system between the engine strut disconnect and the inlet pipes to the aircraft fuel pumps. This test required the removal of the aircraft fuel pumps and their associated check valves and bungs to be fitted to the engine feed suction by-pass inlets and the check valve ports.

In the first test a vacuum of 12.5 inch Hg (6.1 psi) was applied at the left engine fuel disconnect connection with the right engine fuel disconnect connection blanked off. There was no audible detection of a leak in the aircraft fuel delivery system. The suction pump was then disconnected and after five minutes the vacuum had fallen to 10 inch Hg. Given the difficulty in sealing the aircraft it was inevitable that there would be some leakage; however there was no evidence of a gross leak. The blank on the engine disconnect was removed and the test repeated using the spar and cross-feed valves to seal the pipes. The suction pump was then fitted to the right engine and the test repeated.

In the second test a suction pump was connected to each of the engine fuel disconnect pipes and a vacuum of approximately 22 inch Hg (11 psi) was applied. There was no audible evidence of any air leaks into the fuel delivery system. Because of the arrangement of the suction pumps it was not possible to disconnect the suction pump and time the decay in the vacuum.

A suction test of the aircraft pump inlets was carried out by fitting the defuel tool to each of the pump housings in turn. The pump inlet screens were removed and a blank was fitted into the bell mouths. A suction pump was connected to the defuel tool and a vacuum of 26 inch Hg (13 psi) was applied. There was no audible detection of a leak in any of the pump inlet pipes. The suction was removed and after five minutes there was no appreciable drop in the vacuum in any of the inlet pipes.

The suction tests indicated that at ambient conditions there were no leaks across any part of the fuel delivery system.

#### 1.12.3.12 Fuel vent system

The fuel tank vent system pressure relief valves for both the left and right main tanks were found in the 'set' position, indicating that there had not been an excessive differential between the vent system and the ambient air. Both pressure relief valves were tested and found to operate to the manufacturer's specification. The vent system scoops and flame arrestors were visually inspected, no blockage was found nor was there any distortion that would have indicated a transient blockage.

#### 1.12.3.13 Fuel system valves

Both the left and right spar valves were found in the fully OPEN position after the accident and were manually moved to CLOSED to stop the fuel leakage from the engine. The operation of the valves was smooth and the fuel leakage stopped shortly after their operation. An examination carried out several days later established that the actuator drive arms for both valves were intact.

The forward cross-feed valve was found in the CLOSED position, the aft cross-feed valve was found in the OPEN position with no damage to the actuator or actuating arms.

The refuel and defuel valves were all in the CLOSED position.

#### 1.12.3.14 Auxiliary Power Unit

The APU air inlet door was found in the OPEN position and the APU fuel shutoff valve was also OPEN. The APU isolation valve was in the CLOSED position. The APU switch in the flight deck was also found in the ON position, but the APU had not started.

#### 1.12.3.15 Ram Air Turbine

The Ram Air Turbine (RAT) had not deployed before the initial impact, however subsequent examination indicated that the RAT had partially deployed during the ground slide. The damage to the surrounding area from the right main landing gear separation had caused its attachment fittings to become damaged such that the RAT dropped out of its locked position when the aircraft came to rest.

## 1.12.4 Detailed Examination

## 1.12.4.1 Engine

*Electronic Engine Controller (EEC)*

The left and right EECs were removed from the engines and despatched to their manufacturer for downloading of their fault history. It was found that both EECs had logged fault conditions after rollback:

- Fault code 855 – ‘absolute maximum fuel flow power limiting’
- Fault code 861 – ‘surge detected’
- Fault code 854 – ‘WFP30 maximum power limiting’

The right engine had logged all three of the codes in the order given, the left engine had logged code 861 followed by 854.

The logic generating the codes is as follows:

- Fault code 855 will be set when the EEC has been demanding maximum fuel flow (ie operating on LIC 17) for more than 2 seconds.
- Fault code 861 will be set following detection of a rapid drop in P30 ‘burner pressure’. A combination of rate of change and a threshold level trigger the ‘surge detect’ message and both engines logged this code at least 3 times (the maximum the EEC can store). Fault code 861 will also trigger a change of LIC to loop 14, which is designed to prevent over fuelling of the engine during a surge recovery.
- Fault code 854 is set when the engine has been operating on LIC 14 for more than 30 seconds and is a direct consequence of the multiple ‘surge detect’ messages.

Analysis of the recorded data showed that the left engine did not log fault code 855 because the change of LIC to 14 occurred before the FMV had been commanded fully open for 2 seconds.



Full function testing of the EECs required erasing the flight software loaded onto them and replacing with test software. When all parties to the investigation were satisfied that the flight software was not an issue, both were subjected to a full Production Acceptance Test. Both units passed with no anomalies recorded.

#### *Main Engine Pump (MEP)*

The MEPs, still bolted to their respective FMUs, were despatched to the engine manufacturer for a strip examination under AAIB supervision.

After draining any residual fluids, the pumps were separated from the FMUs and dismantling commenced. The only abnormality found on the LP stages of either FMU was the presence of small fragments from a blue plastic item on the left unit. This was later identified as a piece of a plastic snubber which had detached from an airframe fuel system check valve. Other remnants of this item were also recovered from the left FOHE inlet and reflected a known minor problem for which a modification existed. These plastic fragments caused no impairment to the operation of the LP pump or the FOHE. It was established that they must have been collected whilst the engine and its FOHE were fitted to a different aircraft, since no check valve on G-YMMM was found to be lacking a snubber and no check valves had been replaced.

Strip of the HP gear pump did not reveal any mechanical discrepancies other than some unusual marks on the delivery sides of both pumps which the manufacturer described as being indicative of 'cavitation' (Figure 41). The marks comprised slight, but distinct, erosion of the dry film lubricant on the bearings and also of the outlet ports: they appeared fresh and bright.

Advice from the pump manufacturer was that these marks, at this location, were highly unusual. However, local cavitation erosion was to be expected at various known positions, mainly associated with the inlet side of the pump; the marks were hardly ever seen at the outlet ports. A series of tests had been carried out originally to certify the pump. Part of the tests involved running a pump at very low inlet pressures for several minutes. When the unit was stripped, marks were present which were almost identical to those which had been found on the pumps from G-YMMM. (Appendix E 'Explanation of Cavitation'.)

Apart from the marks, which would have had no effect on pump operation, no other abnormalities were found in either MEP from G-YMMM.

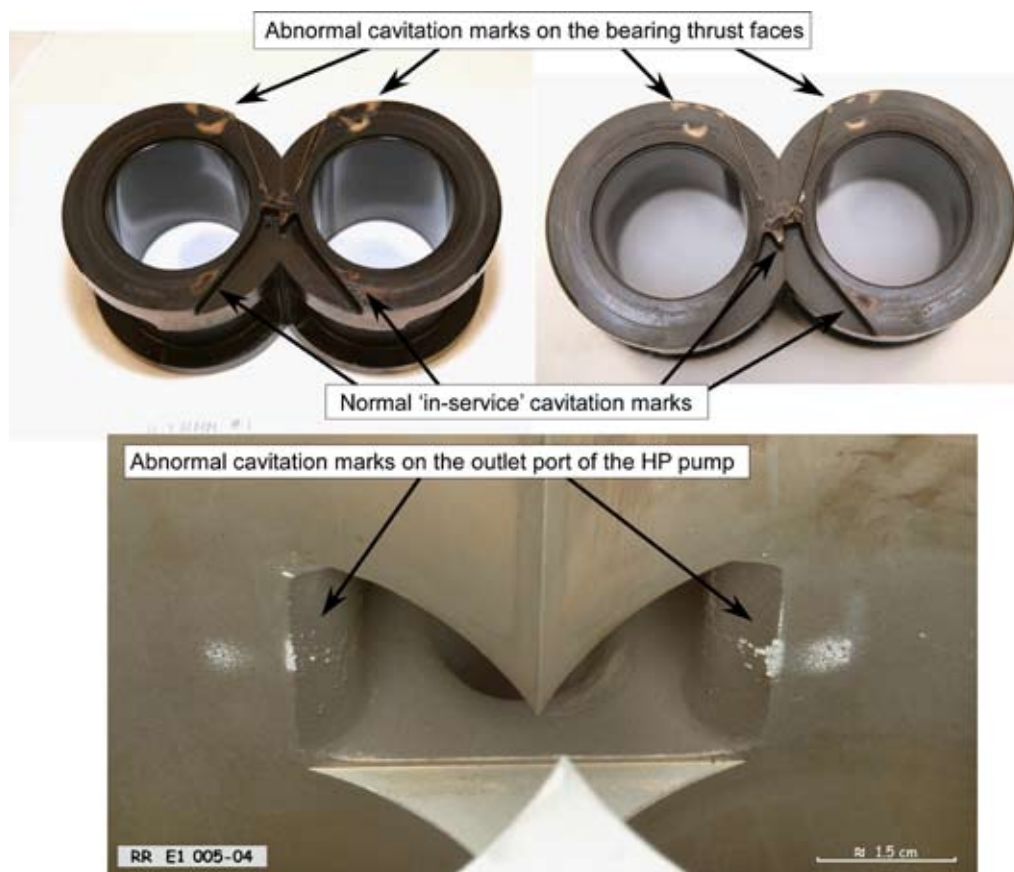

**Figure 41**

Cavitation markings on the HP pumps from G-YMMM

#### *Fuel Oil Heat Exchanger (FOHE)*

The FOHEs were stripped and examined. Small debris were found in the inlet chamber, comprising fragments of an 'O' ring and pieces of the blue plastic check valve snubber which had also been found in the LP pump inlet stage. None of this debris was considered to have impaired normal operation of the FOHE.

The internal fuel tubes were examined for any signs of blockage and none was found. The oil by-pass valves were inspected and found to be serviceable.

#### *LP fuel filters*

The LP fuel filter is situated immediately below the FOHE. The fuel from the FOHE enters the filter bowl and flows radially inwards through the paper-type filter element before exiting to the HP pump. Both filters were removed and sent to the engine manufacturer for examination under AAIB supervision.

The left engine filter was subjected to the standard test for contamination which is firstly to examine it visually for signs of gross contamination. None was found and therefore it was placed in an ultrasonic cleaning bath of filtered petroleum spirit and agitated for 10 minutes. Any debris was filtered out, collected and examined under a microscope. The contamination was considered to be typical of that found in filters with similar in-service time.

It was decided that the right engine filter, after visual examination, should be sent to its manufacturer for flow testing and other tests. Both the visual examination and the testing concluded that the filter was 'clean', consistent with its low operating time of 412 hours, and met the requirements for a new unit.

#### *Fuel Metering Unit*

After their separation from the MEPs, the FMUs were sent to their manufacturer for strip inspection, again under AAIB supervision. Due to impact damage, both units were assessed as unsuitable for function testing and it was noted that they both had evidence of ingress of fire fighting media. However, it appeared that both were in good condition, considering the severity of the impact. This was confirmed as the strip examination commenced with no abnormalities apparent, either electrical or mechanical. X-rays were used to examine the servo valve latched positions, which were all in the normal RUN condition.

Examination of both units showed no pre-impact defects or anomalies which would have prevented normal operation.

#### *Flow meters, VSV controllers, VSV actuators, burners, pipework*

These items were all subjected to testing or strip examination as appropriate. No pre-impact abnormalities were found with any of the items.

#### 1.12.4.2 Aircraft fuel system

##### *Fuel Quantity Processor Unit*

The FQPU was removed from the aircraft and sent to the manufacturer for download of its internal memory and testing. The memory contained several faults, the first of which was logged on the last flight leg of the aircraft (the accident flight) at a time of 1242:51. This fault was a record of a failure of the left inboard fuel quantity wire harness. There is a correlation time of about 30 seconds, so the actual time of the fault correlates with, and identifies, the time of the aircraft's ground slide, and was related to wiring damage sustained by the

landing gear. The additional recorded faults all occurred after the initial impact and were also related to damage being sustained to the aircraft. The bench test of the FQPU was satisfactory.

#### *Fuel temperature probe*

The fuel temperature probe was tested by the Original Equipment Manufacturer (OEM) in accordance with their test schedule over a temperature range of +60°C to -60°C. The probe met the manufacturer's specifications.

#### *Aircraft fuel pumps*

The aircraft boost and OJ pumps, which had all run for 26,675 hours since new, and the pump housing assemblies, were all inspected and tested by the OEM under the supervision of the AAIB. The pump housing assemblies and pressure switches were tested in accordance with the Component Maintenance Manual (CMM)<sup>8</sup> and met all the required specifications.

#### *Aircraft boost pumps*

The boost pump consists of an axial flow inducer and two centrifugal impellers installed, rear faces together, on one end of the shaft assembly. A paddle-type re-prime impeller is installed on the other end of the shaft. The boost pumps were tested in accordance with the CMM<sup>9</sup> and met all the required specifications.

Inspection of the boost pumps revealed cavitation erosion on the re-prime pump stator and discoloration of the surface treatment on the re-prime impeller, which was assessed to have been caused by cavitation erosion. A comparison of this damage was carried out against boost pumps removed from another of the operator's aircraft, G-YMML (Figure 42). All the boost pumps from both aircraft, which had a similar service history, displayed the same cavitation damage to the re-prime stator and impeller. The pump manufacturer demonstrated that this type of damage was normal for pumps of this age.

#### *Aircraft override jettison pumps*

The construction of the OJ pump is similar to the boost pump, with the exception that it has a single centrifugal impeller. The OJ pumps were tested in accordance with the CMM<sup>10</sup>.

---

8 CMM 28-20-47 Rev 5.

9 CMM 28-20-42 Rev 8.

10 CMM 28-20-44 Rev 5 and PAT 568-SD-29331-000 issue 11.

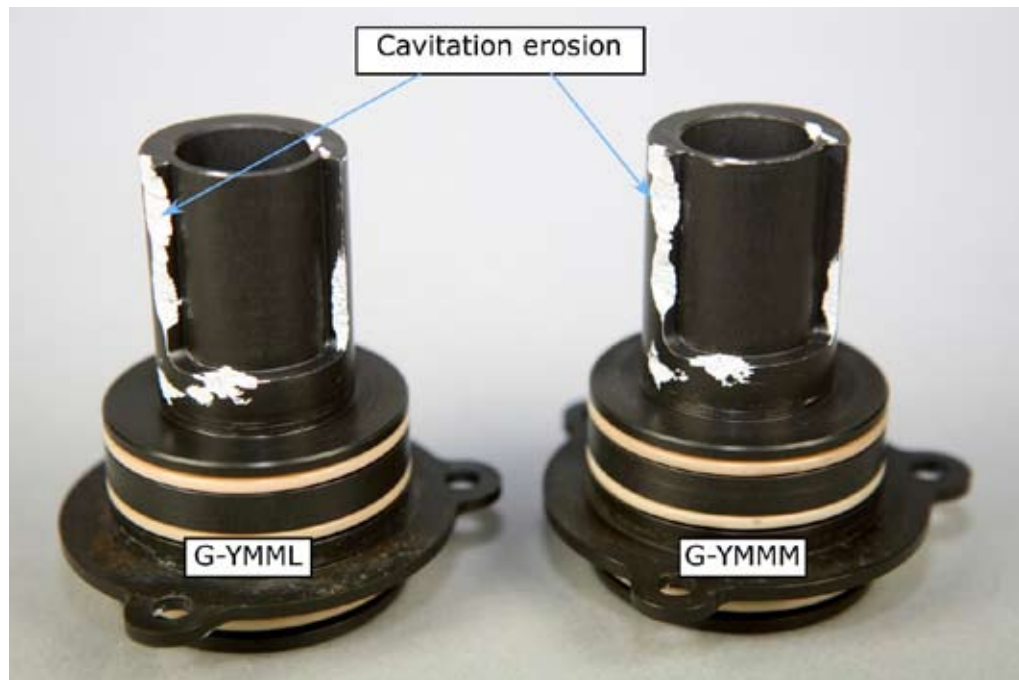

**Figure 42**

Cavitation wear marks on the re-prime pump stator

Inspection of the OJ pumps revealed signs of cavitation erosion to the webs in the main pump housing and discoloration of the surface treatment on the axial flow inducer, which was also assessed to have been caused by cavitation erosion. This light erosion, which the manufacturer considered to be normal, is expected because the OJ pumps are normally left switched on until the pump low fuel pressure switches activate. The operator's engineers also commented that they often heard the OJ pumps cavitating when they transferred fuel out of the centre tank.

#### *Boost and OJ fuel pump low pressure switches*

The low fuel pressure switches, fitted to the boost and OJ fuel pumps, use a diaphragm-type sensing element that acts against a spring and operates a microswitch that sends a position signal to the ELMS. The microswitch operates when the fuel pressure rises to 7 psig and returns to its original state when the fuel pressure drops below 4 psig.

All the pressure switches were examined and tested in accordance with the CMM<sup>11</sup> and met all the required specifications.

<sup>11</sup> CMM 28-42-02 Rev 1.

*Suction feed and jettison check valves*

The suction feed and jettison check valves were all removed from the aircraft, inspected and tested against the specifications detailed in the aircraft maintenance manual. With the exception of the right suction feed check valve all the valves were found to operate correctly.

When the right suction feed check valve (serial number 0705) was manually opened it would not spring back to the closed position, but instead would remain at the position to which it was moved. A visual inspection indicated that this defect was probably due to insufficient clearance between the base of the valve, where it rotates about the shaft, and the sides of the lug in which the base of the valve sits.

*Spar valve and cross-feed valve examination*

The spar valves, cross-feed valves and their actuators were tested against the equipment specifications detailed in the Acceptance Test Procedures (ATP)<sup>12, 13</sup>. The valves and actuators were then stripped down and subjected to a detailed examination.

DFDR data during the accident flight showed the cross-feed valves in the CLOSED position and the spar valves in the OPEN position throughout. In addition, all the valve electrical actuators passed the ATP and were assessed as being in a good condition. It was established that on all the actuators the position indicator pin (pin 3) would only supply 28 volts once the actuator had moved to its limit of travel. This was confirmed by applying a 28 volt supply to the actuator when it was in an intermediate position and ensuring that there was an open circuit (0 volt) on the position indicator pin (pin 3) (Figure 43). In addition to the tests detailed in the ATP, two further tests were carried out on the actuators.

The integrity of the actuator casings was established by pressurising the inside of the casings, with nitrogen, to 14 psig. Using a fluid leak detector, no leaks could be detected from any of the actuator casings.

A test was carried out to ensure that the actuators would move to the CLOSED position if electrical power was applied simultaneously to the OPEN and CLOSED inputs. All the actuators moved to the fully CLOSED position when electrical power was simultaneously applied to both inputs.

---

12 Valves ITT Acceptance Test Procedures E850-125334D-1 Rev D.

13 Electrical actuators ITT Acceptance Test Procedures E850-MA20A1001.

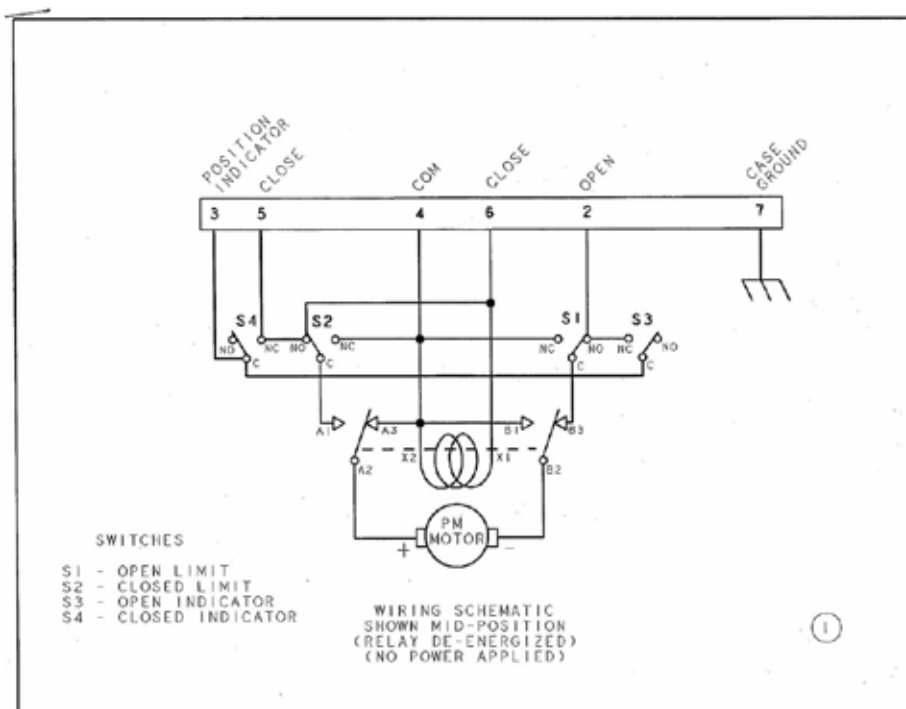

Figure 43

Courtesy of:  
ITT Aerospace Controls Division

#### Actuator electrical schematic

With the exception of the forward cross-feed valve, all the valves passed the ATP and were assessed as being in good condition. The forward cross-feed valve did not fully achieve the requirements for the two thermal relief valves identified as First and Second port. However, it was assessed that the slightly early operation of one thermal relief valve and the delayed operation of the second would not have played any part in this accident.

#### *Spar valve control wiring*

The control system wiring was subjected to detailed examination. This included the common connectors through which control signals for the left and right spar valves ran. The connectors (identified as D1325, D4017, D4417, D1313 and D1304) were initially checked for internal shorting; none was found. They were then carefully disconnected and inspected; there was no indication of damage, contamination or of shorting between the pins. A terminal strip located in the forward avionics compartment, through which the wiring for the spar valves and the engine HP fuel shutoff valves pass, was inspected and was found to be installed correctly with no signs of damage, moisture contamination or degradation. All the wires into the terminal strip were secure and there was no degradation to the wiring in this area.

All the wiring examinations were satisfactory, except for the damaged wiring at the rear spar of both wings that had resulted from the separation of the left and right main landing gears. The wiring from the fire switches that signal the spar valves to CLOSE had been severed; the spar valve OPEN signal wires and the spar valve position indication wires were also damaged. In some cases the wiring had been severed such that the screen of the wire was in contact with the conductor.

The left spar valve CLOSE signal wire from the spar valve control relay had some chafing damage to the conductor, such that the screen was shorting to the conductor. The right spar valve CLOSE signal wire from the spar valve control relay was continuous and had little damage. These wires were routed in a different loom that had not been disrupted by the separation of the landing gear.

#### *Spar valve battery and charger*

The spar valve battery and charger were tested and found to operate satisfactorily.

#### *Spar valve control relay*

Both the left and right fuel system control relays were found in the position which would command the spar valves to move to the OPEN position. These relays were examined by the aircraft manufacturer and were found to be serviceable.

#### *Water Scavenge systems*

The nozzles from all the water scavenge jet pumps were removed and examined on 2 February 2008 and the following discrepancies were noted.

When the nozzle from the right main scavenge jet pump was removed from its housing half a teaspoon of a 'jelly-like' substance, later identified in a laboratory as "water", was found in the housing. It is not known if this water was originally lodged in the nozzle and was pulled through the flap valve into the housing, or whether the water had been introduced into the housing during a previous maintenance activity. The water was tested for microbiological contamination and the quantity of contamination was assessed as negligible.



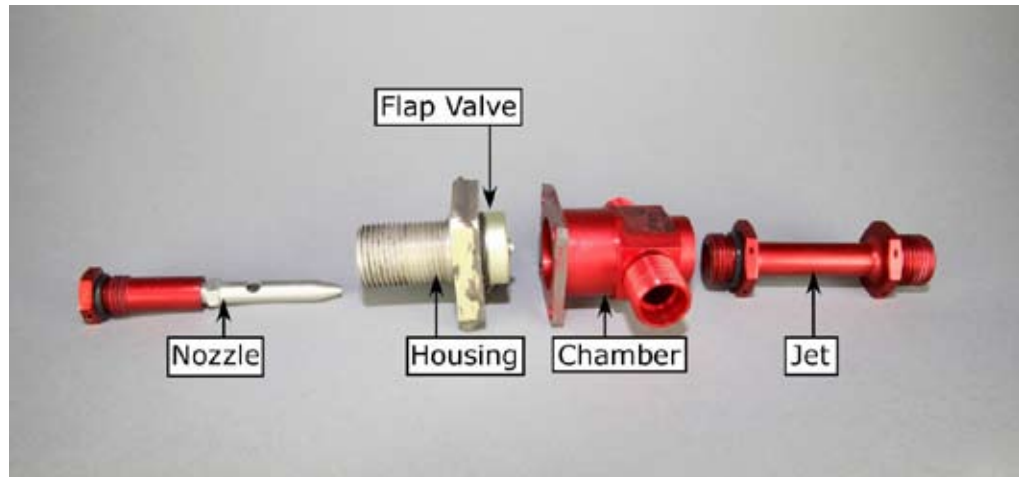

**Figure 44**

Water scavenge jet pump breakdown

A 6 mm plastic disc (chad) was found in the chamber of the right main scavenge jet pump, which was large enough to block one of the ports in the nozzle, Figure 45. A flake of paint was found trapped in the pipe between the scavenge inlet and the chamber (Figure 45). From a swab taken from the inside of the chamber, it was established that there was a moderate amount of microbiological contamination on the internal surfaces of the chamber.



**Figure 45**

Plastic chad in right main water scavenge jet pump nozzle and paint lodged in jet pump inlet.

#### 1.12.4.3 Electrical system

The ELMS unit processor cards were taken to the manufacturer where, under AAIB supervision they were examined, the memory downloaded and the cards tested.

The processor cards within each of the ELMS Central Processing Units (CPUs) were removed and the 'Fault Log' information retrieved. There were two equipment faults recorded during the last flight leg and these were 'LEFT FORWARD BOOST PUMP' and 'ENGINE 2R SQUIB – FIRE EXTINGUISHER' and one relay fault which was 'APU DC FUEL PUMP'. There were a number of relay faults logged on the last flight leg that had been recorded on all the previous flight legs. The information recorded within the 'Fault Logs' do not have an aircraft time associated with the fault.

All the processor cards passed a post production test, with no fault found.

#### 1.12.4.4 Auxiliary Power Unit Controller (APUC)

The APUC was sent to the unit's manufacturer and, under the supervision of the NTSB, was examined, the memory data downloaded and the unit tested.

The last twelve blocks of memory data were incomplete in that there was no date/time data, the flight phase was 0, the flight leg was 0 and the APU was not running. Analysis of this data showed that these faults occurred during or after the ground impact sequence. The last recorded fault with complete data was on 11 January 2008 which occurred during APU start-up.

A functional test of the unit found it to be serviceable.

### 1.13 Medical information

There was one serious injury: a passenger seated in seat 30K sustained a fracture of his right leg. Thirty-four of the passengers reported minor injuries, principally to their neck or back. These passengers were seated throughout the aircraft cabin.

Twelve of the 13 cabin crew members (CCMs) suffered minor injuries, again, principally to their back or neck. Of these, eight reported that they were still suffering various degrees of discomfort 18 months later. Amongst the 12 injured CCMs, seven, at Doors 1 Left (1L), 2 Left (2L), 2 Right (2R), and 3 Right (3R), reported that the shoulder straps of their harnesses did not

restrain them during the accident and another, at Door 4 Left (4L) was not restrained by the lap straps. The seats affected included those at forward and aft facing positions. Five of the CCMs reported that they were aware of being thrown laterally, from side to side, even when the seat harness held firm.

The three flight crew reported that they were not injured.

#### **1.14 Fire**

There was no fire.

#### **1.15 Survival Aspects**

##### **1.15.1 Evacuation**

The cabin crew had not been alerted to the emergency prior to landing. In the initial impact some oxygen masks dropped down from the PSUs, a number of overhead lockers opened and cabin crew observed a dust/mist in the area of the Business Economy seats at rows 21 to 24, and Doors 3L and 3R. As the aircraft came to a halt some passengers rose from their seats and made their way towards nearby exits. Immediately, the cabin crew shouted instructions for the passengers to “sit down, stay in your seats”. After a short wait, the evacuation alarm sounded in the cabin, along with a flashing red light at each cabin crew station. Some of the CCMs reported that the alarm sounded ‘faint’ and the CCM at Door 3R did not hear the alarm. The commander then made a passenger announcement, advising the passengers “this is the Captain, this is an emergency, evacuate, evacuate” and the cabin crew then initiated the evacuation.

Doors 1L, 2L, 1R, 2R and 4L, were each crewed by two CCMs, the other three doors were attended by a single CCM. From a witness’ photographic evidence the doors began to open at around 1242:51. The cabin crew instructed passengers to wait until the escape slides were fully inflated. Once each slide had fully inflated, the cabin crew moved to their ‘assist’ positions at the side of the exit and instructed passengers to jump, helping them where necessary. Passengers began emerging onto the slides at around 1243:07. The CCMs at Door 2L decided that the debris at the bottom of that escape slide appeared hazardous, so they blocked that exit and directed passengers to Doors 1L and 2R.

The passenger in seat 30K, who had sustained a serious injury, was assisted by a neighbouring passenger who subsequently accompanied him down the slide.

After confirming with nearby colleagues that nobody remained on board, the cabin crew evacuated down the escape slides at their exits. A further photograph from the same witness, taken at around 1245:11 hrs showed the right side of the aircraft with empty evacuation slides.

The lack of fire and of significant damage within the cabin enabled a smooth evacuation to be carried out; subsequent comments made by the passengers were that the evacuation had been conducted efficiently and with clear instructions from the cabin crew.

Some of the passengers took personal items of luggage with them before exiting via the escape slides. One passenger, who had already evacuated the aircraft, climbed up the Door 4L escape slide to re-enter the cabin, and retrieve his personal belongings, and then exited the aircraft once more.

#### 1.15.2 Airport Fire Service

Air Traffic Control (ATC) had alerted the Airport Fire Service (AFS) and the first vehicle arrived at the aircraft at 1244:13 hrs. At 1255 hrs members of the AFS entered the cabin and confirmed that all the passengers and crew had evacuated. There was no fire, but fuel was seen leaking from the engines, and oxygen was heard to be leaking from the disrupted passenger oxygen cylinders. This created a significant fire risk and the AFS deployed foam and water media, in stages. As the right centre fuel tank had been ruptured, the AFS pumped foam directly into the opening to reduce any risk of fire from any residual fuel in the tank. In total 300,000 litres of water and 17,000 litres of Film-Forming FluoroProtein (FFFP) foam were used.

### 1.16 Tests and Research

#### 1.16.1 Effect of flap selection

The aircraft manufacturer carried out an analysis of the final approach of G-YMMM's accident flight to establish the effect of selecting FLAP 25 at around 240 ft agl. The analysis concluded that, had the crew left the flaps at FLAP 30, the aircraft would have touched down about 51 m (168 ft) short of the actual touchdown on the accident flight, still within the airfield boundary.

## 1.16.2 Fuel

### 1.16.2.1 Fuel samples

Following the accident, 66 fuel samples were taken from the aircraft, and engines, and a number of these samples were tested by QinetiQ and another independent laboratory.

The first fuel samples were taken within two hours of the accident from the fuel leaking out of the fractured engine fuel pipes. Samples from the engine fuel filters and the right main tank sump drain were taken the following day, before the aircraft had been placed in a level attitude. After the aircraft had been levelled and the fuel had time to settle, samples were taken from all three fuel tank sump drains. The remainder of the fuel samples were taken during the detailed examination and testing of the fuel system, after the aircraft had been moved to the maintenance area.

Approximately 2,000 kg of fluid was drained out of the centre tank after the accident. Analysis of this fluid showed that it consisted of a mixture of aviation fuel, water, fire fighting foam and aircraft hydraulic fluid. This gross contamination meant that it was not possible to determine the condition of the fuel in the centre tank prior to the accident.

An explanation of the testing conducted on these samples and the results are detailed in Appendix C.

The fuel samples from G-YMMM complied fully with the specifications for Jet A-1. The sampled fuel had a fuel freeze temperature of -57°C and water content of between 35 and 40 parts per million (ppm). The samples were clear of any microbial growth and did not contain any anti-icing additives such as Fuel System Icing Inhibitor (FSII) nor was there any evidence of contamination by 'Bio fuel'.

### 1.16.2.2 Review of documentation for fuel loaded onto G-YMMM at Beijing

It was reported in the AAIB Interim Report, dated 4 September 2008, that 71,401 kg of No 3 Jet Fuel (People's Republic of China) had been loaded onto G-YMMM at Beijing prior to the start of the accident flight. Since receiving this initial information the AAIB was provided with further documentation indicating that the fuel was Jet A-1, which had originated in South Korea and was shipped to Tianjin, China, before being transferred to the airport bulk fuel storage facility at Beijing.

The investigation was provided with a number of documents including the refinery test certificates, airport storage tank records, hydrant records and refuelling vehicle records. The Korean test certificate indicated that the fuel was compliant with Check List Issue 22, which ensures that the fuel meets the requirements of Defence Standard 91-91 and ASTM D1655. Quality assurance checks undertaken at various points on its journey to the aircraft showed no evidence of significant contamination of the fuel. Moreover, the properties of the fuel recorded in the refuelling receipt and quality assurance certificates were consistent with the test results for the fuel samples taken from G-YMMM after the accident.

### 1.16.3 High Intensity Radiated Field (HIRF) and Electro-Magnetic Interference (EMI)

The aircraft fuel control system, and in particular the parts associated with control of the spar valve, was tested under laboratory conditions. The equipment tested included the wiring, relays, switches and spar valves to establish whether a source of HIRF/EMI could induce enough energy to give an uncommanded closure of the spar valve.

Several different radiated fields were applied to the system in the laboratory (a full list of the radiated fields applied are listed in Appendix D). These were up to power levels well in excess of those that would be present within an aircraft environment or emitted from portable electronic devices. There was no uncommanded movement of the spar valve during these tests, nor was there a change in any control relay state.

During initial certification, the EEC and the engine control system was tested to the HIRF/EMI requirements as defined in Radio Technical Commission for Aeronautics (RTCA)/DO-160, '*Environmental Conditions and Test Procedures for Airborne Equipment*'. The EEC was tested satisfactorily to level A<sup>14</sup> requirements.

### 1.16.4 Engine fuel system

#### 1.16.4.1 Engine System Test Facility (STF) testing

The Rolls-Royce System Test Facility (STF) is a hydro-mechanical rig which uses engine components and an electric motor to simulate engine rotation in order to drive the fuel pump. The primary objective of these tests was

---

<sup>14</sup> FAA Advisory Circular AC 20-158 'The Certification Of Aircraft Electrical And Electronic Systems For Operation In The High-Intensity Radiated Fields (HIRF) Environment' has more information on the certification levels of testing required. Level 'A' is applied for each electrical and electronic system that performs a function whose failure would prevent the continued safe flight and landing of the rotorcraft/airplane.

to confirm the response of the EEC, the FMU and the MEP, under certain conditions, including restricted fuel flow. The following slave engine components, which were of a comparable build standard to those fitted to the engines on G-YMMM, used on the STF were: EEC, MEP, FOHE, FMU and fuel flowmeters.

The speed of the electric motor is calculated from an algorithm to replicate the response of HP spool rotation and another algorithm is used to simulate the burner pressure (P30) sensed by the EEC.

For the purposes of this series of tests, it was necessary to introduce a manually-operated valve into the line upstream of the fuel pump, to simulate a restriction in the fuel supply. The rig had many additional tappings to record pressures throughout the system and the behaviour of the EEC and the FMV were closely monitored and recorded. However, the limitations incurred by the need to 'synthesise' values of burner pressure and the rotation of the HP spool, meant that there would always be discrepancies between the precise reaction of the whole system and a full engine test.

The first phase of STF testing used the manually-operated valve to apply a restriction upstream of the LP pump and between the LP pump and the FOHE. The restriction was sized to give a steady state fuel flow of about 5,000 pph (about the value recorded after the event engines had rolled back) and was initially applied at a fixed EPR value of 1.1, again representative of the maximum power achieved on the final acceleration cycle. Although this showed that control loop changes, fault codes and P30/fuel flow oscillations similar to the event were generated, the 'slew' rate of the FMV was slower than that recorded on the QAR. The procedure was therefore modified to start with the STF 'engine' at a low EPR setting, introduce a restriction and accelerate the engine through the restriction. The FMV slew rate then closely matched the event, but there appeared to be some variability in the timing of the control loop changes and setting of the fault codes.

#### *EEC Loop In Control (LIC) 14 (Surge Detect) observations*

The change to EEC LIC 14 (WFP30) is essentially dictated by the rate of change of P30 but is influenced by other parameters affecting engine condition and is more sensitive when the FMV is fully open. The testing demonstrated that very small changes in P30 fluctuations can cause variability in the timing of when the surge detect message is set, and the subsequent switching to LIC 14.

*STF results*

The test results indicated that with a given restriction at the LP pump or the FOHE, the FMV moves fully open during the first of the four accelerations seen at the end of the accident flight. A restriction further upstream from the LP pump allowed for more accelerations to be achieved before the system responded and commanded the FMV fully open. The STF results also suggested that throttling the flow upstream of the LP pump was more representative of the event data than the test which introduced the restriction between the LP pump and the FOHE. However, to investigate this more thoroughly, and because of the limitations of the STF described below, it was clear that only a full engine test would accurately replicate the conditions.

The STF tests showed that the amplitude of the P30 oscillations sometimes fell well below the levels recorded on the event QAR. This was determined to be due to the limitations of the STF, which derived P30 but could not simulate dynamic combustion chamber response during the rollback condition. Although further tests were conducted using the STF, it confirmed that investigation of the behaviour of P30 and fuel flow oscillations during the 'steady state' running with reduced flow would be better conducted using an actual engine on a test bed.

#### 1.16.4.2 Full-scale engine testing (L12)

Testing of an engine with restricted fuel flow was accomplished at Rolls-Royce Derby using a development Trent 895 engine serial number L12 (hereinafter referred to as 'the L12 tests').

The engine was installed in the test bed and a remotely-operated valve was used to apply a restriction. A by-pass was also fitted to ensure that fuel would be available to run the engine, at least at ground idle rpm, should control of the motorised valve be lost.

*First phase – restriction by manually operated valve*

The first engine runs followed approximately the method used on the STF, whereby the engine was run at 1.1 EPR and the restriction slowly introduced until the fuel flow fell away to a steady rate of about 5,000 pph. The response of the EEC, FMV and the fuel pressures at points around the fuel system were recorded. These showed that, following a sudden collapse of HP pump inlet pressure as the restriction increased, the fuel flow and EPR fell rapidly. Both parameters remained constant but with low-order oscillations which



also affected the P30 (burner pressure) in a corresponding manner. In order to preserve the HP pump integrity, running in this condition was limited to 60 seconds before the restriction was removed: the engine recovered rapidly as this was done.

As with the STF testing, it was found that the FMV slew rate did not match the event data and it was necessary to maintain the restriction at a fixed flow rate and accelerate the engine from an idle condition 'through' the restriction, attempting to replicate the rate at which the thrust levers had moved during the event. However, the testing did produce a good match with respect to system response and fault codes set.

#### *Second phase – fixed restriction*

A second series of test runs were therefore conducted, using a fixed restriction sized to result in a maximum fuel flow rate of about 5,000-6,000 pph (ie in the range of the final values achieved by both engines during the accident flight).

Again, this technique matched the FMV slew rate during the event and showed similar characteristics whereby the acceleration was initially normal but followed by a sudden 'roll-off' of fuel flow down to the value at which the restriction had been set. There was still some variability with the setting of some of the fault codes and control loop switching which were known to have occurred during the event - sometimes there was a close match and sometimes codes or switching did not occur in the right sequence or, indeed, at all. As with the STF testing, the engine testing demonstrated that very small changes in the P30 fluctuations from run to run can cause the timing of the setting of the surge detect message (861) to vary.

Detailed analysis of the parameters during the L12 tests showed that the fuel flow delivered to the burners, recorded by the engine flowmeter, exceeded the fuel delivered upstream of the restriction (measured by the 'rig' flowmeter) during the engine accelerations; it became the same when the flow had rolled off to the stable low value. Calculations later showed that the engine had been using fuel from the pipework between the restrictor valve and the HP pump until this was exhausted, thus delaying the onset of HP pump cavitation and the associated 'roll-off' effect.

*Third Phase – fixed restriction with orifice plates*

The third phase of testing was to investigate locating the restriction upstream of the LP pump and between the LP pump and the FOHE. However, the use of a remotely operated valve meant that several metres of flexible pipe had to be used between components which would otherwise have been closer together. In the previous tests, it was suspected that the volume of fuel contained in pipework had effects, both in the time taken for the restriction to affect engine performance and the nature of the fuel flow fluctuations after the engine had rolled back. Therefore, it was decided that the restriction would be simulated with the use of an orifice plate which could be introduced adjacent to the component being investigated. Thus, an FOHE restriction could be placed adjacent to the FOHE fuel inlet and an LP pump restriction could be simulated immediately upstream of the pump. Subsequently, restrictions were placed at locations upstream of the LP pump inlet, representing restrictions at positions deeper into the aircraft fuel system. The distances, measured from the engine/airframe interface by the mounting pylon were 25, 45 and 70 feet. The restrictors themselves were simple metal plates with orifices drilled in them, sized to pass roughly the same flow rate as that recorded after the rollbacks.

The overall purpose of the third testing phase was to replicate, as closely as possible, the engine parameters seen on the accident flight. At the same time, having now proved that the engine could draw on fuel contained in pipework before rolling back, an ‘autothrottle’ was incorporated, programmed to duplicate the aircraft’s autothrottle demands and rates during the final three acceleration/deceleration cycles before the fourth acceleration, which caused the rollback. The intention was to test the hypothesis that a restriction which existed prior to the final accelerations might not have affected the engine until the fourth acceleration if sufficient volume of fuel existed downstream of the restriction.

The first test involved placing the restriction immediately upstream of the FOHE. As it was known that the engine would almost certainly rollback during the first acceleration attempt, only the fourth accident acceleration was attempted: the rollback occurred as predicted. Testing was also conducted with the restriction at the LP pump inlet, with the rollback also occurring as predicted during the fourth acceleration.

Following the tests, the HP pumps from both the STF and the L12 engine were inspected and found to have cavitation damage in the same location as that on the pumps removed from the engines on G-YMMM. The damage was

more severe and consistent with the length of time the test pumps operated in a restricted fuel flow condition.

#### *L12 test observations*

The testing subsequently showed that, with the restriction placed between 25 and 45 ft from the interface, the engine was able to perform normally during the first three accelerations but rolled back on the fourth, as recorded data from the accident showed. Most of the parameters being compared to the accident data also matched closely, including FMV slew rate, P30 and fuel flow oscillations. The timing of the triggering of the control loop changes and the setting of fault codes remained variable, as had been observed throughout the testing. Comparison of the test rig and engine flowmeters showed that fuel was being used from the pipework and was being partially replenished during the first three acceleration/deceleration cycles.

However, it was clear that the testing differed from the conditions which existed at the time of the accident as it did not use cold or weathered<sup>15</sup> fuel, forward airspeed could not be simulated and the pipes used to simulate the aircraft fuel system were of necessity flexible.

### 1.16.5 Fuel System Testing

#### 1.16.5.1 Introduction

A programme of subscale and large-scale fuel system icing tests were undertaken at Boeing's Kent Fuels Laboratory and North Boeing Field Propulsion Laboratory, with the involvement of the AAIB and other parties to the investigation. Consideration was also given to undertaking full-scale aircraft tests.

#### 1.16.5.2 Full-scale aircraft tests

The intention of the full-scale aircraft tests was to replicate the aircraft installation and the environment during the accident flight. The options considered included flight testing and the full-scale testing of a Boeing 777 in a climatic chamber.

Flight testing initially appeared to be the most obvious choice as the aircraft systems could be tested in their normal operating environment; however, there were a number of significant disadvantages. It would not be possible to

---

<sup>15</sup> Weathered fuel is described in section 1.18.1.7.

control the external environment and, as the conditions for fuel icing were not fully known, it was possible that fuel system icing might not occur during any of the test flights. Moreover, it was estimated that the fuel flow restrictions seen on the accident flight would require the equivalent of approximately 95% of the cross-sectional area of a fuel system component to be blocked with ice. A lesser amount of ice would have little effect on the fuel pressure and, therefore, the build up of ice would not be detected by pressure transducers. It was also not possible to use cameras as cold fuel containing suspended water, and ice, is very cloudy.

The McKinley climatic chamber at Eglin Airforce Base in Florida was identified as a suitable facility in which to conduct full-scale testing of a Boeing 777. The facility would have allowed the aircraft to be exposed to the TAT experienced during the accident flight and one of the engines could have been run at cruise power for one hour at the fuel flow experienced during the accident flight. However, it would still not have been possible to reproduce all the engine and environmental factors and there would have been difficulties in detecting the formation of ice.

#### 1.16.5.3 Boeing subscale fuel icing tests

The Boeing Advanced Technology Development Organization undertook a series of subscale icing tests, commonly referred to as 'beaker tests', to support the investigation by providing a basic understanding of the potential forms of ice accumulation, blockage and the conditions conducive to fuel icing. The tests were carried out in a transparent environmental chamber which had a capacity of six litres and could be cooled down to  $-40^{\circ}\text{C}$ . The test chamber could also be supplied with fuel from a 190 litre conditioning tank where the fuel could be cooled and conditioned with water.

During these tests, observations were made on the formation and mobility of ice produced by a number of different methods. It was also possible to observe the nucleation and growth of ice crystals on a number of representative fuel system components. From the observations it appeared that ice would more readily stick to its surroundings, and other ice crystals, when the fuel temperature was between  $-5^{\circ}\text{C}$  and  $-20^{\circ}\text{C}$ . Below  $-20^{\circ}\text{C}$  the ice crystals appeared to have a more crystalline appearance and did not readily adhere to their surroundings or other ice crystals.

#### 1.16.5.4 Boeing large-scale icing tests

Large-scale icing tests were undertaken at the Boeing Propulsion Laboratory at North Boeing Field. These tests were conducted in four phases, with each phase building on the knowledge and experience gained in the previous phases. The phases were: initial, snowball, accretion and environmental testing. In addition the fuel rig was used to investigate the effect of icing of the boost pump check valves, centre tank fuel scavenge system and the effect of air being drawn into the fuel delivery system through the centre tank feed.

##### *Fuel test rig*

The fuel test rig was developed throughout the investigation and components were added, or removed, to suit the requirements of individual tests. The basic set-up consisted of a storage tank containing 3,520 litre (930 US Gal) of Jet A aviation fuel, which could be cooled down to  $-40^{\circ}\text{C}$ . All the components in the aircraft fuel system from the boost pump inlet screen to the FOHE and engine-driven LP pump were used on the rig. Whilst the rigid pipes, and their couplings, used during the early phases were not standard to the Boeing 777, the rig did incorporate the flexible fuel feed pipes removed from G-YMMM. A photograph of the layout of the fuel test rig at the end of the investigation is at Figure 46.

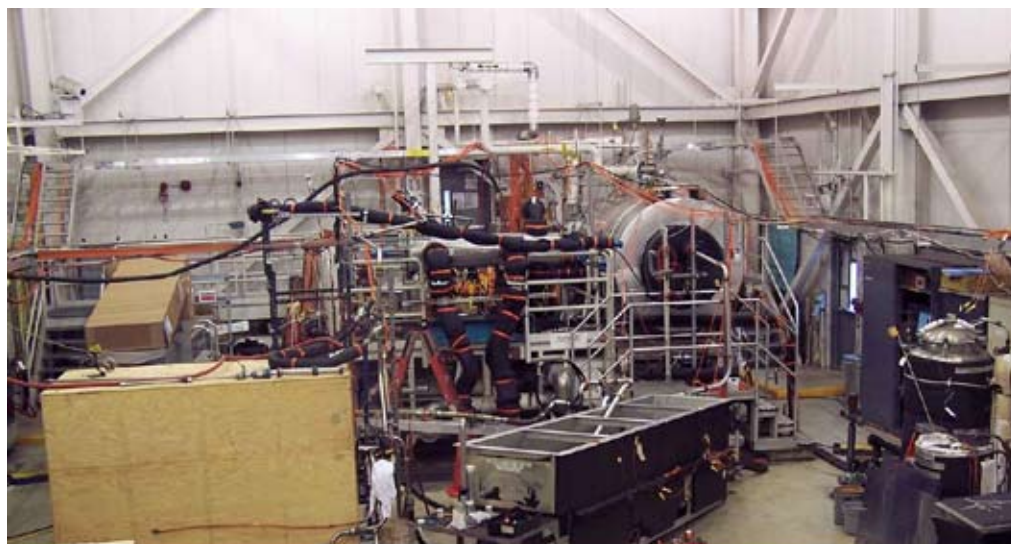

**Figure 46**

Fuel test rig at the end of the investigation

The fuel in the tank was drawn through a ¼ inch mesh inlet screen to the boost pump; it then passed through a number of components before returning to the tank via an external heat exchanger. The MEP was installed downstream of the spar valve and was driven by an electrical, variable-speed motor. As the cavitation damage in the HP pump could only have been caused by a restriction upstream of this pump, the HP side of the MEP was not incorporated into the test rig. The FOHE was mounted approximately five feet above the MEP at an angle of 45°, representing its orientation on the engine. Hot oil was supplied to the FOHE from a separate oil reservoir. A hand-operated gate valve controlled the fuel flow through the system. Water and ice could be introduced through one of three ports: one allowed water and ice to be introduced into a pan under the inlet screen, the second allowed it to be injected directly into the inlet pipe upstream of the boost pump and the third allowed water or ice to be injected directly into the fuel stream. The rig was equipped with a number of temperature and pressure sensors with the data captured automatically by a data acquisition system. The rig also incorporated a number of viewing windows which allowed visual observations to be made of the inlet screen and the fuel flowing through the pipes. A schematic of the general layout of the fuel rig is at Figure 47.

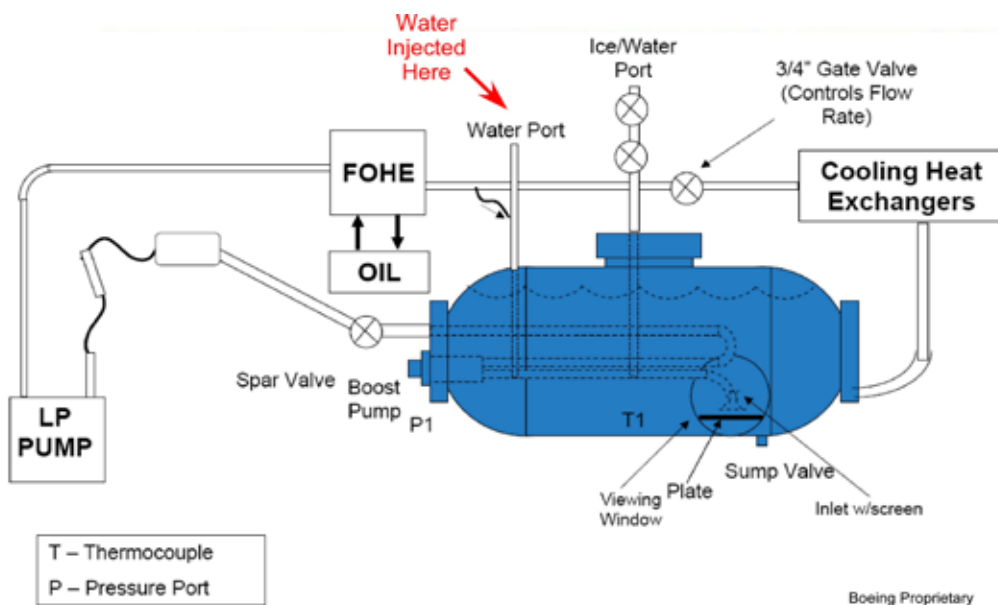

**Figure 47**

Schematic of the fuel test rig

A constraint of the basic rig was that the geometry and length of the pipe runs were not identical to the aircraft configuration.

### *Environmental test rig*

In order to make the rig more representative of the aircraft installation, and the environment in which the fuel system operated during the accident flight, it was modified to include the majority of the right fuel system feed pipes, from the boost pump inlet to the MEP, that had been removed from G-YMMM. These pipes were arranged so that their gradients were representative of the attitude of the aircraft in cruise. An environmental tank, filled with cold fuel, was used to simulate the environment surrounding the fuel feed pipes in the main fuel tank. An insulated box was built around those fuel pipes which pass through the centre 'cheek' tanks and dry ice was used to control the temperature in this area. The pipes located along the top of the strut (engine pylon) were exposed to the ambient conditions of the building in which the fuel rig was located; thermal modelling by the aircraft manufacturer indicated that this would approximate the temperature in this area during the cruise. A schematic of the environmental test rig is at Figure 48 and a photograph of the environmental test tank is at Figure 49.

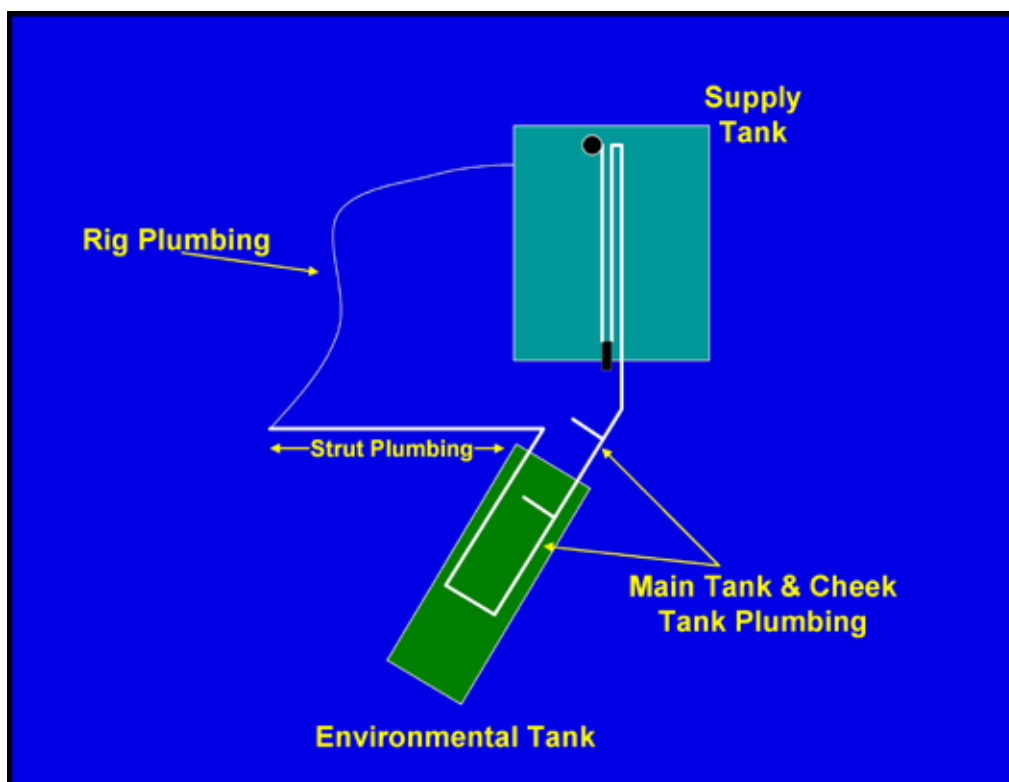

**Figure 48**

Schematic of the environmental test rig

The environmental tank was also equipped with a main fuel tank water scavange system, which was used to observe the effect of the formation of ice on the boost pump inlet screen and inlet pipe.

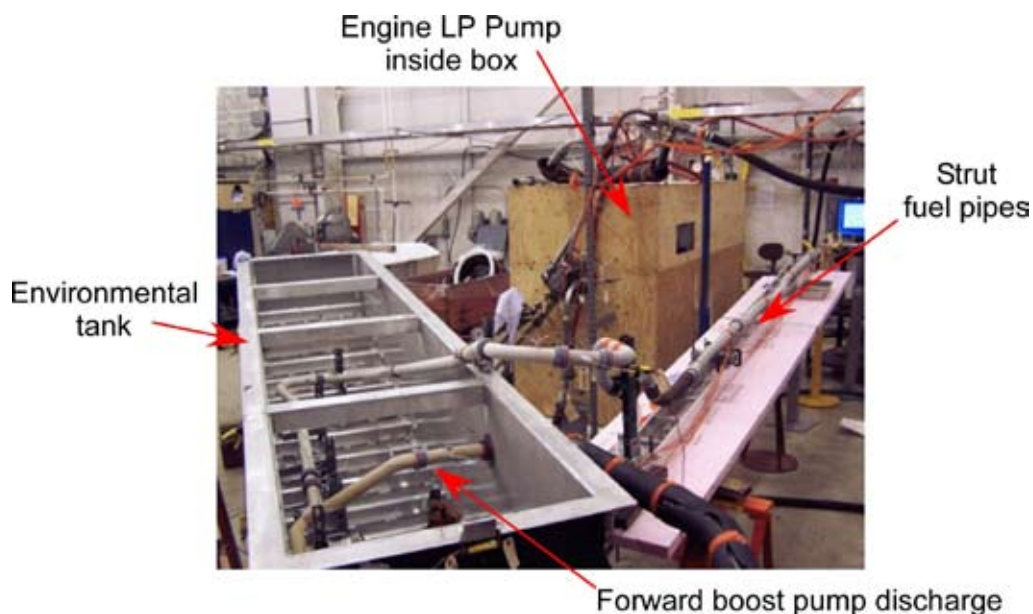

**Figure 49**

Environmental test tank

#### *Measuring water concentration*

The water concentration in the fuel was determined by the Karl Fischer test ASTM D6304. This procedure used the chemical reaction between water and iodine with sulphur dioxide to determine the total amount of water in the fuel sample – dissolved, entrained and free water. The repeatability of the test was such that with a water concentration of 100 ppm there was a 95% chance that the test would show a result between 76 and 124 ppm. However, ‘repeatability’ is defined as the difference between successive results obtained by the same operator with the same apparatus under constant operating conditions on an identical test sample. Therefore any deviation from these conditions was likely to result in poorer repeatability. The procedure was also dependent on the samples being thoroughly mixed and the rapid separation of the water from the fuel could be a further source of error.



### *Initial testing*

The initial testing was undertaken at fuel temperatures down to -34°C and flow rates of 6,000 and 3,000 pph. On some of the tests hot oil at a temperature of either 85°C or 95°C was supplied to the FOHE. Water was introduced into the fuel system by injecting it into either the pan under the boost pump inlet screen, or into the boost pump inlet. The pressure drop across each component was then monitored for evidence of a build up of ice. At the end of the tests the system was dismantled and inspected for the presence of ice.

### *'Snowball' testing*

'Snowball' testing investigated the effect of ice releasing and travelling through the fuel system as a concentration of ice crystals, a 'snowball'. The LP pump was operated during these tests to provide a fuel pressure at the inlet of the FOHE of at least 200 psig and hot oil, between 75°C and 95°C was fed into the FOHE. The 'snowball' was generated by injecting a measured amount of water into the boost pump inlet. The cold fuel would quickly turn the water into ice crystals and the flow rate and pressure differential across the components was monitored as the ice moved through the fuel system. The concentration of the ice crystals could be varied by adjusting the fuel flow during the period that the water was injected into the system. The fuel flow would then be increased to the desired level. During these tests the fuel temperature, fuel flow, water volume and concentration were all varied.

Two types of tests were carried out: constant flow and dynamic. In the constant flow tests the gate valve was not moved after the desired flow rate had been set. In dynamic testing the gate valve was completely opened when the pressure drop across the FOHE began to rise as a result of the ice crystals blocking the fuel tubes. This action simulated the response of the fuel metering valve on the accident flight.

In order to see how ice accumulated on the face of the FOHE, Boeing manufactured an end cap with a clear window that could be fitted in place of the production cap which normally fits on the top of the heat exchanger. This modification had limited success, as the visibility would quickly reduce when the ice crystals reached the FOHE.

### *Accretion testing*

The accretion testing investigated the accumulation of ice within the fuel system over a long duration and the conditions required to shed the build up of ice. Because of the difficulty in maintaining the required concentration of water in the fuel, the rig was modified such that a 30 cm square acrylic box was fitted around the boost pump inlet screen; metered water was then sprayed directly into the fuel within the box. To prevent ice blocking the end of the nozzle it was mounted within a shroud pressurised with nitrogen which prevented the nozzle from coming into contact with the cold fuel.

### *Environmental testing*

The environmental testing was a continuation of the accretion testing using the fuel pipes removed from G-YMMM mounted in a similar environment to that experienced during the accident flight. The accumulation tests were run at flow rates of 3,000 and 6,000 pph and fuel temperatures of +5°C, -20°C and -34°C. The tests simulated centre tank feed and main tank feed through the forward and aft boost pump housings. A target water concentration of 90 ppm (as defined in ARP 1401) was selected for all the tests. The shedding tests were conducted either by increasing the fuel flow, which would increase the shear force on the accreted ice and free it from the inside of the fuel pipes, or by maintaining the fuel flow and increasing the temperature around the outside of the strut pipes. This test simulated the temperature increase in the strut area as a result of an increase in TAT during the later stages of the accident flight.

The general procedure during the accumulation tests was to run at the desired conditions, with sampling of the fuel every 30 minutes. At the end of the test period the system was quickly dismantled and the pipes inspected both visually and with a video scope. The ice in each section of pipe was allowed to melt into a container and the quantity of fuel and water released from the ice was measured.

For the shedding tests, ice was allowed to accumulate within the fuel system using the boost pump to maintain the flow at 6,000 pph, using fuel conditioned with approximately 90 ppm of water and maintained at a temperature of -20°C, which was near the fuel temperature at which the rollbacks occurred on G-YMMM and N862DA (refer to 1.18.2.1). At the end of this phase the cold FOHE<sup>16</sup> and LP pump were taken out of by-pass and either fuel flow or the strut temperature was increased and the pressure drop across the FOHE was monitored for evidence of

---

<sup>16</sup> A cold FOHE does not have any hot oil flowing through it and was used in the tests as a strainer to 'catch' any released ice.

a build up of ice. The test was stopped and the system dismantled and examined if, after three minutes, there was no appreciable increase in the pressure drop across the FOHE.

#### 1.16.5.5 Observations

##### *Restriction in the aircraft fuel feed system*

During the testing, a restriction at the fuel boost pump inlet screen was achieved on six occasions sufficient to restrict the flow: on one occasion the force on the ice distorted the inlet screen. These restrictions appeared to have occurred as a result of the method by which water was introduced into the fuel to maintain the required concentration; consequently these restrictions were considered to be an artefact of the test set-up. The restrictions were all characterised by a drop in the fuel pressure, sufficient to generate the boost pump low fuel pressure warning, and a reduction in the electrical current draw of the boost pump.

The only occasion when it appeared that there might be a sufficient quantity of ice to block a pipe occurred when approx 6 litres of water had been injected into the boost pump inlet over a period of 7 hours. During this period the flow rate was maintained at 6,000 pph and the water content varied between 100 and 150 ppm. On dismantling the system a large ball of soft ice was found just down stream of the spar valve on a coupling that is not used on the aircraft (Figure 50). Despite the presence of the ice, no pressure drop was detected across this section of tube whilst the fuel was flowing at 6,000 pph.

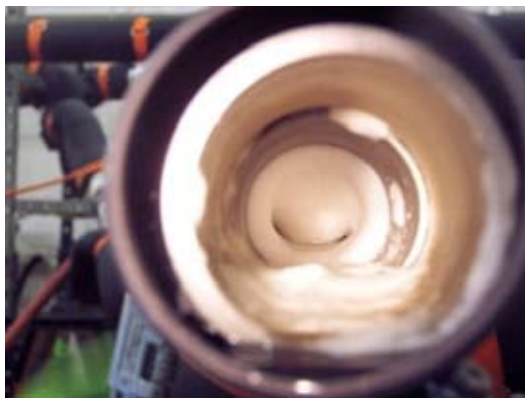

**Figure 50**

Ball of soft ice found in pipework in the fuel test rig assembled from steel components that are not used on the Boeing 777

It should be noted that the coupling used on the rig was manufactured from steel and had a different pipe interface than the aluminium Wiggins couplings

used on the aircraft. The test was repeated using a Wiggins coupling with no evidence of a significant build-up of ice in the pipe. However, it is not known if the different test results were due to the coupling or the apparent random nature of the formation of ice experienced during the initial accumulation tests.

#### *Boost pump check valve*

On a number of occasions small quantities of ice formed on the springs and the rear face of the boost pump check valve. Consideration was given to the possibility that over a number of flights this ice might melt and refreeze and form an ice chip which would either restrict the movement of the valve, or move into the fuel feed manifold and cause a restriction in the fuel delivery system.

To explore this theory, a number of tests were carried out using dyed water that had been frozen in a check valve housing (Figure 51). In one test, compressed air was applied to the valve which started to open when the pressure was approximately 3 to 4 psi. On another test, with the housing fitted to the rig, it was possible to achieve a flow of 28,000 pph. At the end of these tests the ice chip was still located in the housing.



**Figure 51**

Dyed ice in check valve housing

X-rays were also taken to determine the position of the valve at various flow rates, which established that at 6,000 pph the valve was open  $1.8^\circ$  and at 12,000 pph it was open  $5.1^\circ$ . It was also established from the x-rays that the distance the valve opened when the housing contained the maximum size ice chip, and was subject to air pressure at 3 to 4 psi, was sufficient to allow a flow rate of at least 18,000 pph.

### *Flow restriction from blocks of ice*

Tests were undertaken to establish if it was possible for pieces of ice to cause a restriction in the fuel delivery system. Such ice might have formed in the fuel tanks and been drawn into the boost pump inlet, or might have formed from water that had collected in the downstream side of the boost pump check valve housings. However, large pieces of ice could not pass through the ¼ inch mesh on the inlet screen. Nevertheless, with the screen removed, blocks of ice were fed into the boost pump inlet and it was observed that these were then broken by the action of the pump and passed into the manifold as small ice particles.

Coloured ice was manufactured in a freezer, using the check valve housing as a mould, and positioned in front of the spar valve and close to the inlet of the LP pump in a way that could have caused a restriction to the fuel flow. At the end of the test there was evidence of some erosion of the coloured ice and some build up of white ice from crystals suspended in the fuel. When the ice was melted the total water content of the chip at the end of the tests was found to be less than the amount of water used to initially form the ice chip. However, there was no restriction to the fuel flow or detectable pressure rise across the block of ice.

### *Icing of centre tank fuel scavenge system*

Tests were carried out to establish if it was possible for a high concentration of water in the centre tank to be scavenged into the main fuel tanks at the flow rates and environmental conditions experienced during the accident flight. The tests established that, with a centre tank fuel temperature of +5°C and a scavenge motive flow temperature (fuel in main tank) of -20°C, ice would form in the jet pump and block the induced flow from the centre tank when the water concentration reached 10%. With a motive flow of -34°C the induced flow ceased when the water concentration was 3.2%. However, it was difficult to maintain a homogenous mix during this test and it is likely that, due to the technique used, the water concentration at the time the jet pump became blocked with ice was probably greater than 3.2%.

### *Restriction at the FOHE*

During the 'snowball' tests, with the fuel flow set at 6,000 pph, it took approximately 40 seconds for the water introduced at the boost pump inlet to reach the face of the FOHE. As the water flowed through the fuel system it turned into ice crystals and under certain conditions these crystals would collect on the face of the FOHE, restricting the fuel flow (Figure 52). However, during

all of the testing the fuel flow never fell below that required by an engine at flight idle. Moreover, the restriction could always be cleared by reducing the fuel flow to idle, which resulted in a change in the equilibrium between the cold fuel and hot oil in the heat exchanger, such that the ice melted on the inlet face of the FOHE, sufficient to restore the demanded fuel flow.



**Figure 52**

Ice collected on the face of the FOHE

The testing investigated the effect of fuel temperature, fuel flow, quantity of water and the concentration of the snowball. The following observations were made:

- Fuel temperature and fuel flow had a large affect on the quantity of ice required to restrict the fuel flow at the FOHE.
- Variation of the FOHE oil temperature between 75°C and 95°C made a small difference to the amount of water required to restrict the FOHE.
- As little as 25 ml of water, when introduced into the fuel at an extremely high concentration<sup>17</sup>, can form sufficient ice to restrict the fuel flow through the FOHE.
- It was not possible to restrict the fuel flow through the FOHE when the temperature of the fuel in the main tank was above -15°C at a fuel flow of 6,000 pph and -10°C at a fuel flow of 12,000 pph.
- Smaller amounts of water caused a temporary restriction which quickly cleared as the ice melted, whereas the restriction persisted when larger quantities of water were used. However, this restriction could always be cleared by reducing the fuel flow to idle.

<sup>17</sup> The water concentrations in the fuel, when the water was introduced in the manner used in these tests, were of the order of 100 times the concentration levels specified in the certification requirements.

*Ice accumulation tests*

The results from the ice accumulation tests undertaken on the basic fuel rig proved to be inconsistent, with poor repeatability. However, there was a significant improvement in the repeatability when the tests were run on the environmental test rig where the following observations were made:

- When warm fuel (at a temperature of 5°C) was fed from the centre tank, a thin layer of ice formed around the inside of the fuel feed pipes that pass through the main fuel tank (fuel at a temperature of -20°C). During these tests the warm fuel had a water concentration of between 200 and 600 ppm.
- Ice formed around the inside of all the fuel feed pipes from the boost pump discharge port to the front of the strut when fuel flowed for 3 hours at temperatures of -12°C and -20°C. The thickness of the ice was similar (1 to 2 mm) at both temperatures; however at -12°C the build up of ice was more consistent and visually there appeared to be more ice throughout the system.
- Very little ice formed on the inside of the fuel feed pipes when the fuel temperature was at -34°C.
- There was less repeatability in the amount of ice found in the fuel pipes at the end of the accumulation runs when the duration was increased from 3 to 6 hours. Several tests were carried out, using the same batch of fuel, at a fuel temperature of -20°C with quite different results. The amount of ice within the system ranged from very little ice to a build up of approximately 6 mm along the bottom of the pipe and 1 to 2 mm around the circumference of the pipe (Figure 53). However, it is possible that on some of the runs ice might have been released before the end of the test.
- When the fuel temperature was cooled from -12°C to -33°C, over a 7 hour period, at a similar rate to the accident flight, the amount of ice found in the fuel pipes was consistent with the findings after the 3 hour run at a fuel temperature of -12°C.
- The ice was soft and easy to move and there appeared to be no difference in the properties of the ice that accumulated at any of the cold test temperatures. However, in the test when the fuel temperature was cooled from -12°C to -33°C, the surface of the ice took on a 'pebbly' appearance.



**Figure 53**

Ice in the flexible hose located at the rear of the strut

- Examination of the melted ice showed that it consisted of a mixture of water and fuel. The quantity of water in the ice deposited along the inside of the fuel pipes in the strut area was greater than the amount found necessary, in previous tests, to restrict the FOHE.
- On two occasions approximately 90 ml of water was recovered from the ice that had accumulated in pipes in the strut area. On another occasion approximately 170 ml of water was recovered from this area; however, the possibility that this sample had been contaminated after the test could not be excluded.

#### *Ice release tests – cold FOHE*

Tests were carried out using the environmental test rig to establish whether increasing the flow rate would release sufficient ice, that had accumulated on the inside of the fuel pipes, to cause a restriction at the face of a FOHE. However, because of the limitations of the test rig, and the apparent ‘random’ process by which ice formed, it was not possible to fully replicate the conditions just prior to the engine rollback on G-YMMM.

The first phase of each test was to accumulate ice within the fuel system using a boost pump to maintain the fuel flow at 6,000 pph, with the fuel conditioned with approximately 90 ppm of water and maintained at a temperature of -20°C. This was the approximate fuel temperature at which the rollbacks occurred on G-YMMM. It should be noted that it was not possible to establish visually how much ice had accumulated at the end of this phase, without compromising the release test. After the accumulation phase, the fuel flow returning from the end of the strut was diverted through a cold FOHE and the fuel flow was increased.



In the first test, ice was allowed to accumulate for 3 hours before the fuel flow was increased to 10,000 pph for 3 minutes; during this test no pressure drop was detected across the FOHE. On examining the fuel system no ice was found on the face of the cold FOHE and the amount of ice found on the inside of the fuel pipes was similar to the amount found during the previous accumulation tests undertaken at similar conditions.

In order to increase the flow rate above 10,000 pph it was necessary to fit an engine LP pump into the flow path. Under normal operation the LP pump increases the fuel pressure from around 30 to 200 psig, which is sufficient to provide a flow rate of approximately 30,000 pph with the control valve fully open.

During the next two tests, ice was allowed to accumulate for 6 hours before the fuel flow was diverted to the LP pump and cold FOHE. The fuel flow was increased by progressively opening the control valve during which, on both tests, the pressure drop across the FOHE increased and the LP pump outlet pressure reduced. In the first of these tests, as the control valve was gradually moved fully open, the pressure drop across the FOHE began to increase when the fuel flow was between 6,000 and 10,000 pph, indicating that ice had released and started to form a restriction at the FOHE. The fuel flow became restricted to 14,500 pph before decreasing to 11,000 pph, with a corresponding pressure drop of 165 psid across the FOHE.

During the next test, the pressure drop across the FOHE also began to increase when the flow rate was between 6,000 and 10,000 pph. The fuel flow became restricted to 10,000 pph before decreasing to 6,000 pph, with a pressure drop of 195 psid across the FOHE. Whilst the pressure drop across the FOHE, in both cases, was evidence of the cold FOHE being restricted by ice, the reduction in the boost pump and LP pump outlet pressures, and a reduction in the current drawn by the boost pump, were indications that the fuel flow through the system was also restricted by ice collecting on the boost pump inlet screen.

Following these tests, 35 ml and 55 ml of water was collected from the ice that melted from the face of the FOHE. From a visual inspection of the inside of the fuel pipes, it appeared that in the penultimate test the ice was released from the strut area, whereas in the final test ice released from all of the fuel pipes.

*Ice release tests – hot FOHE*

Two further ice release tests were carried out with a fuel temperature of -18°C and hot oil at 85°C flowing through the FOHE. A clear cap was fitted to the FOHE in order to monitor its face visually.

In the first test there was only a small rise in the pressure drop across the FOHE as the fuel flow was increased above 6,000 pph. However, with the control valve fully open the fuel flow peaked at 14,900 pph before falling back to around 11,000 pph. The drop in the current drawn by the boost pump, and a reduction in the boost pump outlet pressure, indicated that the fuel flow was probably restricted as a result of ice forming on the boost pump inlet screen.

After removing the bypass loop it was possible to observe the ice entering the FOHE for approximately 15 seconds before the fuel became too cloudy to make visual observations. The size of the ice varied from small flakes up to a piece approximately 21 mm x 15 mm. The appearance and thickness of the ice was consistent with it having been shed from the inside walls of the fuel pipes. On making contact with the face of the FOHE, the smaller pieces of ice would ‘instantly’ melt, whereas it took several seconds for the larger pieces of ice to disappear. Some of the ice was still intact after three seconds but, as the fuel turned cloudy, it was not possible to establish if this ice would melt or grow.

The second test was run at the same conditions as the first and used the same batch of fuel. In this test the pressure drop across the FOHE began to increase when the fuel flow was at 10,000 pph. The fuel flow peaked at 19,000 pph, with the control valve fully open, and a corresponding pressure drop across the FOHE of 105 psid. Over the following two minutes the fuel flow decreased to 17,000 pph with an increase in the pressure drop across the FOHE to 125 psid. There were no indications that the fuel flow was restricted by icing of the inlet screen and very little ice was found in any of the fuel pipes at the end of the test.

This last test demonstrated the principle that ice can accumulate and release from the inside of the fuel feed pipes in a sufficient quantity to restrict the fuel flow through a hot FOHE. However, the level of restriction during this test was less than that experienced on the accident flight.

*Ice release test – effect of temperature in the strut*

Ice was allowed to accumulate for 6 hours at a fuel flow of 6,000 pph and a temperature of -20°C. At the end of this period, hot air was blown into a box surrounding the strut pipes to increase the temperature from approximately 15°C to 38°C. Whilst the frost on the outside of the strut pipes remained intact, the pressure drop across a cold FOHE slowly increased from 20 to 75 psid. After a further hour the fuel flow was increased, but despite the control valve being moved to the fully open position the fuel flow peaked briefly at 10,000 pph before dropping back to 8,000 pph with a corresponding increase in the pressure drop across the FOHE of 170 psid. This was indicative of a restriction at the FOHE.

An inspection of the fuel pipes revealed that, whilst there was no ice in the rigid pipes in the strut, there was some ice in the flexible pipe in the strut and a large amount of ice throughout the rest of the fuel system. Approximately 35 ml of water was collected from the ice on the face of the FOHE.

*Refuelling at Beijing*

A test was run to simulate refuelling the aircraft at Beijing when fuel at a temperature of 5°C was added to fuel tanks containing fuel at a temperature of -20°C.

During the test a fresh batch of fuel at 10°C was added to fuel at a temperature of -22°C in the environmental tank at a ratio of 1/1. The boost pump was run for 25 minutes to provide pump cooling and motive flow for the water scavenge pump. Whilst a few ice crystals were observed floating in the fuel, there was no build up of ice either in the tank or on the boost pump inlet screen or inlet pipe.

*Effect of water scavenge system*

A test was carried out to determine the effect of the operation of the water scavenge system on the formation of ice.

The environmental fuel tank was filled with fuel at a temperature of -20°C and conditioned with water at a concentration of 70 ppm. The water scavenge system was then operated for 1.5 hours when the fuel temperature had warmed to -5°C. There was no evidence of any build up of ice in the fuel tank, boost pump inlet screen or inlet pipe.

### *Water concentration*

During the environmental tests the amount of water sprayed into the fuel was closely monitored to try and maintain the concentration at 90 ppm. Frequent fuel samples were taken throughout the tests and the water concentration was established by running at least two Karl Fischer tests on each sample. The results indicated that the water concentration in the fuel flowing through the test section of the rig varied between 45 to 150 ppm. The discrepancy between the metered and measured water content might be explained by ice collecting, and being released from the supply tank and the pipes being tested. However, it was also observed, from the results of several Karl Fischer tests carried out on the same sample of fuel, that the measured water concentration varied by up to 60 ppm.

### *Constraints and limitations*

A summary of the constraints and limitations of the fuel system test procedures used during the investigation are listed at Appendix G.

#### 1.16.5.6 Fluid modelling

A computer simulation model of the aircraft fuel tank venting and engine fuel feed system was developed using a commercial software package called 'Flowmaster'. The model was based on component performance characteristics supplied by the manufacturer, and measurements taken directly from the aircraft and the reconstructed left engine fuel feed system from G-YMMM. The model was further refined and validated by using the aircraft manufacturer's flight test data and information obtained from the fuel system testing undertaken as part of this investigation.

A number of simulations were run using the conditions experienced during the latter stages of the accident flight and it was concluded that:

The aircraft vent system was unlikely to have contributed to the reduction in the fuel flow to the engines.

The boost pumps and the engine-driven LP pump were capable of supplying sufficient fuel to meet the demand from the engines without cavitating during the flight.

The fuel flow from each boost pump was dependent on the pump's performance characteristic, which differs slightly between individual pumps, and the head

of pressure at the pump inlet. This head of pressure was slightly different for the forward and aft boost pumps and changed with the pitch of the aircraft. It is therefore possible that during the flight the forward and aft boost pumps were not providing an equal amount of fuel to their respective engines. Given the number of variables it was not possible to calculate the proportion of fuel provided by each pump at the different phases of the accident flight. However, this factor was taken into account during the fuel system tests undertaken by the aircraft manufacturer on their fuel test rig.

#### 1.16.5.7 Thermal modelling

##### *Fuel Temperature Prediction Program (FTPP)*

The aircraft manufacturer produced a Fuel Temperature Prediction Program (FTPP) to be used by operators of the Boeing 777 during flight planning. The program predicts the fuel temperature based on the intended flight profile and the expected air temperatures, and is accurate enough for operators to predict the in-flight fuel temperature. This allows the operator to alter the flight plan should the predicted fuel temperature be close to the fuel freeze temperature.

The FTTP was run for the G-YMMM accident flight conditions and was compared to the DFDR fuel temperature. There was a very close correlation between the FTTP and the measured fuel temperature.

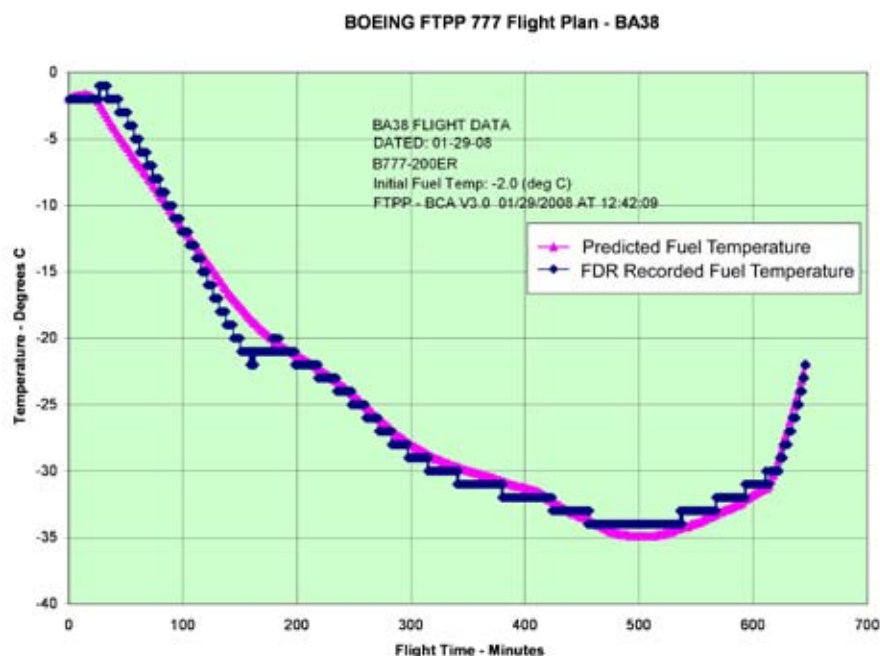

### *Centre tank*

The aircraft manufacturer produced a prediction of the centre tank fuel temperature based on the various parameters recorded on the DFDR and QAR. This revealed that the centre tank fuel temperature could have dropped below freezing about 4.5 hours into the flight and remained below this temperature for a further 4.5 hours. This occurred after the fuel supply to the engines had switched from the centre tanks to the main fuel tanks, but was prior to and whilst the centre tank fuel scavenge took place. In addition the model gave a prediction on the temperature in the centre wing cheek tank. The results of the model are shown in Figure 55.

### *Fuel temperatures in the pipe*

Boeing's flight test data gathered during initial certification allowed for an approximation of the fuel temperature throughout the fuel delivery system. This revealed that the lowest fuel temperature was close to the boost pump inlet within the main fuel tank, and that the fuel rose in temperature by about 2°C across the boost pump. The model did show some changes in the fuel temperature at the wall of the fuel pipes under low fuel flow conditions and was thought to be related to a possible laminar flow. At high flows there was little temperature difference across the pipe cross section.

The fuel temperature rise across the LP fuel pump was estimated by the engine manufacturer to be about 6°C at 6,000 pph, reducing to about 3°C at 12,000 pph.

### *Temperatures external to the pipe*

Using flight test data and standard thermodynamic flow calculations, the aircraft manufacturer produced a prediction of the environmental temperatures through which the fuel pipework was routed. Most significant was the temperature in the strut area, where it was estimated that this could be up to 56°C higher than TAT.

#### 1.16.6 Ice formation in B777 fuel tanks

Following the defueling and draining of G-YMMM's main fuel tanks, some fluid remained trapped between the stringers adjacent to Rib 8. Approximately 0.6 litre of fluid was removed, by syringe, from each main fuel tank and stored in a clean glass jar. The fluid settled into two distinct layers and was analysed by QinetiQ who confirmed that the 0.6 litre sample from the left wing included 0.2 to 0.25 litre of water and the sample from the right wing 0.1 litre of water.

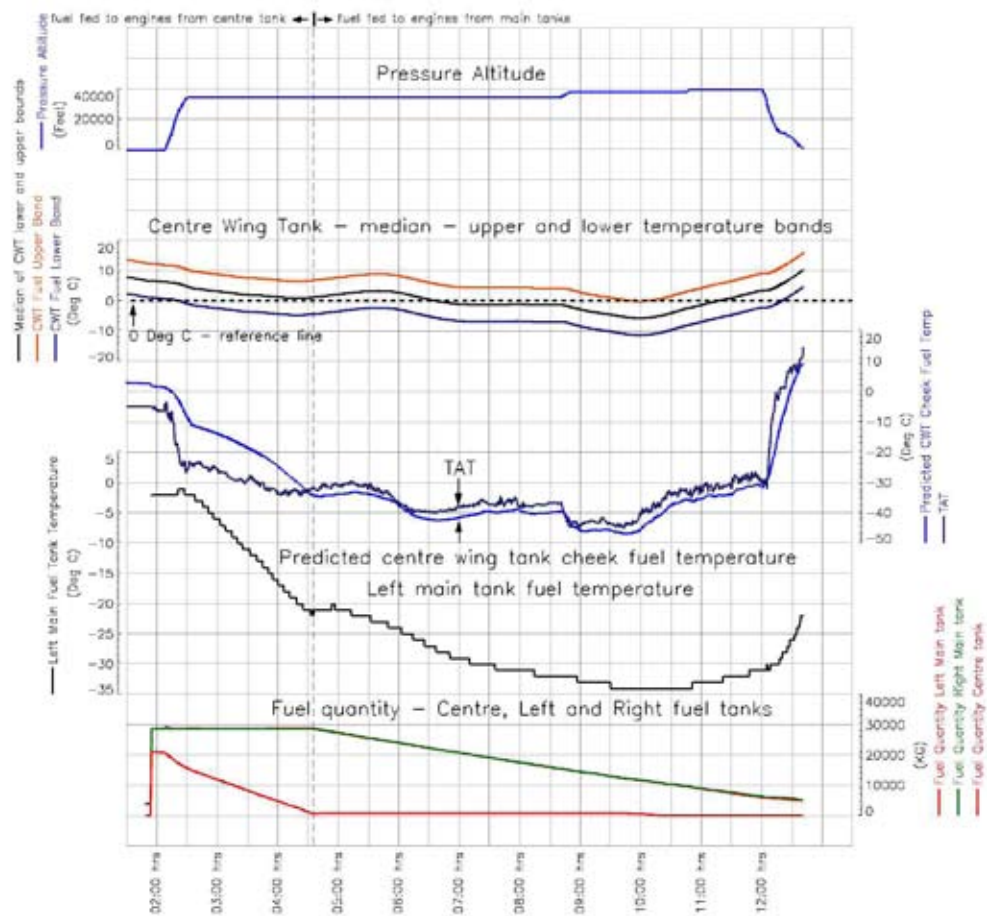

**Figure 55**

### Fuel temperature predictions

To establish if the quantities of free water found in the dead space in the fuel tanks on G-YMMM were normal, two of the operator's other Boeing 777s were inspected after arriving from Beijing on 21 February 2008 and 17 March 2008. Access was gained to the main fuel tanks within 3 hours of the aircraft landing and while the fuel temperature was still below 0°C. On both occasions small amounts of ice were found adjacent to Rib 8, around the edge of the stringers in front of the forward boost pump inlet. The largest piece of ice, on both aircraft, had built up around the inboard of the tank hatch and measured approximately 14 cm x 11 cm x 3.5 cm. This ice was firmly attached to the bottom of the fuel tank. There was no evidence of ice or slush in the rear part of the tank; however there were small pockets of water in a number of locations along Rib 8. It is estimated that the total amount of ice and water was about 0.5 litres. From the distribution of the ice and water, it would appear that water collects and ice forms mainly forward of the front boost pump inlet where there are no water drain holes in the stringers.

### 1.16.7 Aeration testing

To investigate the possibility that the fuel had become aerated, a series of tests were conducted both at the engine manufacturers STF and on the aircraft manufacturer's fuel system test rig.

The STF tests were conducted specifically to investigate the behaviour of the fuel and engine control system to aerated fuel flow. Since there was no precedent for such testing, a system was devised in which air was injected into the LP pump inlet under pressure at varying flow rates and at different engine power settings.

As air was introduced into the fuel, the LP pump showed some degradation in its pressure rise capability. There were also fluctuations in the recorded LP pump outlet pressure and a drop in the HP pump inlet pressure. It was observed that the pressure and fuel flow fluctuations were cyclic with amplitudes well in excess of those seen on the G-YMMM accident flight. The FMV responded to these fluctuations, but it did not move fully open, and it followed the cyclic pressure response from the pump. This FMV response was unlike that seen on the accident flight or during the fuel flow restriction tests. During the test the cyclic pressure fluctuations from the pumps were audible within the test cell.

Analysis of the fuel system showed that there was a possibility that air could be induced into the fuel system when two out of the three check valves (two boost pump check valves and the suction check valve) were blocked and the third had a restricted fuel flow. In this configuration, the suction from the engine low pressure fuel pump would be strong enough to open both the jettison isolation check valve and the centre tank OJ pump check valve, allowing air to be drawn into the fuel manifold from the empty centre fuel tank.

To test this scenario the aircraft manufacturer's fuel rig was configured so that a ball valve represented a restricted boost pump check valve and an extra fuel line was added, which incorporated an aircraft jettison check valve and an override jettison pump check valve with the end of the fuel line open to atmosphere. Runs were then carried out with un-weathered fuel and also fuel weathered<sup>18</sup> to the equivalent of an aircraft at 39,000 ft.

The results of these tests confirmed that, with a restricted check valve, air could be drawn into the fuel feed system from the centre tank. The recorded pressure fluctuations were cyclic in nature and similar to those experienced during the earlier STF aeration runs.

---

<sup>18</sup> Weathered fuel is described in section 1.18.1.7.



It was concluded that the system response and the recorded unstable pressure and fuel flow fluctuations, with aerated fuel, were fundamentally different to that of the accident flight.

#### 1.16.8 Evacuation Alarm

As a result of reports from the cabin crew that the evacuation alarm was 'faint', the evacuation alarm system was tested throughout the aircraft. It was found to be operating at all doors except Door 1L. The evacuation alarm reset button at the Door 1L crew station was found to be stuck in the RESET position, thereby silencing the alarm at that location. It is not known when this switch became stuck.

With the evacuation alarm sounding, the noise levels were recorded at each station. The ambient noise level was about 40 dB; this increased to between 80-85 dB with the alarm sounding and was consistent at all stations. Similar noise levels were recorded on another Boeing 777 with the same evacuation alarm system.

The evacuation alarm system is optional on the Boeing 777 and therefore there are no minimum performance specifications regarding the noise level of the alarm. British Standard BS EN ISO 7731, which sets requirements for evacuation alarms in public and work places, specifies a minimum signal noise level of 65 dB and a minimum of 15 dB above ambient noise. The evacuation alarm noise levels measured on G-YMMM met this standard.

#### 1.16.9 Crashworthiness modelling

##### 1.16.9.1 Crashworthiness certification requirements

Details of the relevant crashworthiness certification requirements applicable to the Boeing 777-200 aircraft are detailed in Appendix H and Appendix I.

##### 1.16.9.2 Crashworthiness modelling

A study was carried out by Cranfield Impact Centre (CIC) to simulate the impact in order to investigate the failure of the right MLG. A Finite Element (FE) model of the aircraft, based on data from the manufacturer, was combined with a FE model of the accident site. For this structural impact analysis LS-DYNA software was used for its capability to predict the dynamic behaviour of non-linear materials under transient loads and varying boundary conditions.

The FE model for the landing gear and its attachment to the aircraft model was derived from engineering data supplied by the manufacturer and supplemented by additional data from other sources. The model of the accident site was created from a detailed site survey, which included soil properties measured at the impact area. The aircraft and ground models were combined to predict the dynamic behaviour of the aircraft during the impact and the aircraft model was projected at the ground at the velocity and attitude derived from the recorded data. More detail on the analysis by CIC, and the results, are contained in Appendix K.

In addition to a simulation of the accident conditions, a number of test cases were also run to investigate the factors in the impact; these included the impact surface (soft soil and hard ground) and yaw/roll angle at impact. A 'normal' landing case was also simulated using data supplied by the manufacturer to validate the model. The nature of the surface was found to have a significant effect on the outcome of the simulation.

#### 1.16.10 Structure metallurgical tests

Material samples were taken from the right rear spar terminal fitting, rear spar web, both the drag brace backup fittings and the rib 2 backup fitting. They were subjected to a metallurgical examination by the manufacturer; all were found to be satisfactory.

#### 1.16.11 Cabin lighting tests

##### 1.16.11.1 Fluorescent tubes

A number of light fixtures were removed from G-YMMM for further examination and testing. Varying degrees of damage were noted, which was consistent with flexure and shock sustained in the impact.

Testing was carried out by the aircraft manufacturer to investigate the effect on the fluorescent tubes and their fixtures of the flexing of the overhead bin structure that was likely to have taken place during the impact. This showed that the tubes were retained in their holders and did not fracture under downward flexing within a relative bin motion of 2°. However, they did eventually fracture at a downward flexure of between 7° and 7.5°, when the tube contacted a rubber cushion at the midpoint of the fixture. Upward flexing resulted in the deformation of the fixture, with the tube remaining intact.

It was also observed that a combination of a download and a longitudinal pull on the end fitting could result in the release of an intact tube. Bending of both

end fittings outward could also result in the release of the tube, with no axial force applied. During the testing it was not possible to initiate release of a tube from a fixture which had straight end fittings; the tube would always fracture prior to release.

#### 1.16.11.2 Exit light signs

Testing was carried out by the aircraft manufacturer to investigate the separation of the lens cover. When all six attachment points were engaged a 7 lbf pull was required on the face of the lens to dislodge it. However, this reduced to around 1.5 lbf, or lower, if the pins were not fully engaged. It was also noted that with the sign housing installed in a production over-door panel, it was not possible to engage the lens fully at all six location points, partly because the surrounding panel interfered with full seating of the lens and partly because the required force to engage the retention devices could no longer be applied.

### 1.17 **Organisational and management information**

Not applicable to this investigation.

### 1.18 **Additional information**

#### 1.18.1 Aviation turbine fuel

##### 1.18.1.1 Types of aviation turbine fuel

Aviation turbine fuel is composed of a mixture of different hydrocarbon molecules and, depending on the mix of the different hydrocarbons, the properties of the fuel can vary between batches. Therefore aviation turbine fuel is manufactured to a specification that defines 30 properties that the fuel must meet, which includes the methods to be used to test the fuel.

The two predominant aviation turbine fuels used in civil aviation are Jet A-1 and Jet A. Jet A-1 is produced to the UK specification DEF STAN 91-91 and the USA specification ATSM D1655. Jet A is mainly used in North America and is also produced to the USA specification ATSM D1655. These fuels are comparable in performance terms but have a different maximum freezing point; this is -47°C for Jet A-1 and -40°C for Jet A.

Batches of aviation fuels contain differing blends of hydrocarbon molecules and therefore their performance, and freezing point, also differ. Consequently the fuel is manufactured to exceed the minimum / maximum specification and

it is normal for parameters such as the freezing point to exceed the specification of  $-47^{\circ}\text{C}$  for Jet A-1. This was evident from the fuel samples taken from the accident aircraft where tests established that the maximum freezing point of the fuel was  $-57^{\circ}\text{C}$ .

#### 1.18.1.2 Water in aviation turbine fuel

Water is always present, to some extent, in aircraft fuel systems and may be introduced during refuelling or by condensation from moist air which has entered the fuel tanks through the tank vent system. The latter effect is greatest when a cold soaked aircraft descends into a warm moist air mass. The water in the fuel can take one of three forms: dissolved, entrained (suspended) or free water.

*Dissolved water:* Dissolved water occurs when a molecule of water attaches itself to a hydrocarbon molecule; the amount of water dissolved in fuel is a function of humidity, temperature and the chemical constitution of the fuel. As a general guide the dissolved water content of aviation turbine fuel in parts per million (ppm) is approximately numerically equal to the temperature of the fuel in degrees Fahrenheit. When warm fuel is cooled the dissolved water is released and takes the form of either entrained or free water.

*Entrained (suspended) water:* Entrained water is water that is suspended in the fuel as tiny droplets and may not be visible to the naked eye in concentrations below 30 ppm. At higher concentrations entrained water will give the fuel a cloudy or hazy appearance, depending upon the size and number of water droplets. Entrained water can be formed by the release of dissolved water as the fuel cools, by violently agitating water and fuel together, or if there is a surfactant in the fuel.

A surfactant acts to stabilise small water droplets so that they do not form large water droplets that would settle out on the bottom of the tank. The maximum amount of surfactant allowed in aviation turbine fuel is not directly specified in the fuel specification but is controlled by water separation testing as part of fuel delivery requirements.

Agitation can occur during refuelling, mixing of the water scavenge outlet with the bulk fuel, or as the fuel and water pass through the aircraft fuel pumps. Entrained water will settle out of the fuel, but the rate is dependent on the droplet size, the density of the fuel and the

amount of fuel agitation. As a general rule, under static conditions, entrained water is considered to settle at a rate of about one foot per hour; however it is unlikely that on an in-service aircraft all the entrained water would have the opportunity to settle out of the fuel.

*Free water:* Free water is the water which is neither dissolved nor entrained and, as it has a higher density than the fuel, it takes the form of droplets, or puddles of water lying on the bottom of the fuel tanks. Free water can also be found in the fuel filters and stagnation points within the fuel delivery system.

#### 1.18.1.3 Estimated water content of fuel on G-YMMM

Based on the temperature of the fuel, it was estimated that the fuel loaded at Beijing would have contained up to 3 litre (40 ppm) of dissolved water and a maximum of 2 litre (30 ppm) of undissolved water (entrained or free). In addition, it was estimated that a maximum of 0.14 litre of water could have been drawn in through the fuel tank vent system during the flight to Heathrow. This water would have been evenly spread throughout the fuel and would have been in addition to any water remaining in the fuel system from previous flights. These quantities of water are considered normal for aviation turbine fuel.

#### 1.18.1.4 Formation of ice in fuel

As water cools it freezes and forms ice as follows:

*Dissolved water:* Any water that is still dissolved in the fuel at low temperatures will not form ice because the water molecules are still chemically bonded to the fuel. Dust particles in the fuel could provide a nucleation point for the formation of water droplets that could then form ice. However, at low fuel temperatures the concentration of dissolved water is very low and therefore the amount of ice formed by this mechanism would be small.

*Free water:* Free water forms ice as it is cooled below its freezing point and within the aircraft fuel tanks the cooling mechanism is the effect of the TAT on the lower wing skin; it is the water closest to the wing skin which freezes first. From the examination of two other B777 aircraft, by the AAIB, it appeared that, in the main fuel tanks, ice forms around the rivets, access panels and structure adjacent to Rib 8 and it was very difficult to release some of this ice from the bottom of the tank. For the ice to release it is necessary to increase

the temperature of either the fuel or the lower wing skin above the melting point of the ice.

At the point, in the accident flight, when the engines did not respond to the demand for an increase in power, the fuel temperature was  $-22^{\circ}\text{C}$  and the TAT was  $12^{\circ}\text{C}$ . Photographs of G-YMMM taken as it crossed the airfield perimeter show the inboard sections of the lower wings skins, which form the main fuel tanks, covered in frost which indicates that the wing skin was very cold; therefore, there was no release mechanism for any ice that may have formed on the bottom of the fuel tank.

*Entrained (suspended) water:* Entrained water in fuel will freeze and form ice crystals, which turn the fuel cloudy. Because the density of the ice crystals is approximately the same as the fuel, the crystals will generally stay in suspension and drift within the fuel until they make contact with a cold surface. Due to impurities in the water the ice crystals will not start to form in the fuel until the temperature has reduced to around  $-1^{\circ}\text{C}$  to  $-3^{\circ}\text{C}$ . As the temperature is further reduced it reaches the 'Critical Icing Temperature' which is considered to occur between  $-9^{\circ}\text{C}$  and  $-11^{\circ}\text{C}$ . The 'Critical Icing Temperature', is the temperature at which the ice crystals start to stick to their surroundings. As the temperature is further reduced to  $-18^{\circ}\text{C}$ , the ice crystals start to adhere to each other so that they become larger, with the risk of blocking small orifices.

The temperature range over which ice crystals in fuel adhere to surfaces, and each other, is sometimes called the 'sticky range'. From observations made during the sub-scale testing, the investigation defined the 'sticky range' as being between  $-5^{\circ}\text{C}$  and  $-20^{\circ}\text{C}$ .

#### 1.18.1.5 Generation of ice in testing

When water freezes it can form a number of different ice crystal structures, which determine the physical properties of the ice. During this investigation very hard, dense ice was found in the bottom of the aircraft main fuel tanks and occasionally, during the testing, a thin layer of what appeared to be rime ice formed around the outlet of the boost pump check valve housings. However, for the most part, during the icing tests, the ice which formed within the fuel system pipes was very soft and could be easily moved around. Temperature variations did not appear to affect the type of ice that was formed. When the ice was melted it was found to contain a mixture of fuel and water.

To overcome the difficulties in maintaining the water concentration in cold fuel, the aircraft manufacturer fitted an acrylic box around the boost pump inlet and introduced a mixture of warm fuel and water into the cold fuel, through an atomising nozzle. Nitrogen was then blown across the nozzle to prevent the water freezing and blocking the holes. This produced ice crystals which had formed from a high concentration of entrained water, which would then adhere to the inside of the pipes. During the accident flight, the ice crystals would have formed from a lower concentration of entrained water. Some of this entrained water would already be present in the fuel and some would have formed as dissolved water was released as the fuel cooled. These processes may produce varying sizes of water droplet which, with the different concentrations and agitation of the fuel, might influence the properties of the ice crystals and the ice which subsequently formed on the inside of the fuel feed pipes.

In the testing of the FOHE, on the fuel rig, the ice crystals were formed by injecting a mixture of water, at very high concentrations, and fuel directly into the boost pump inlet. These ice crystals would then travel at the same velocity as the fuel through the fuel system and collect on the face of the FOHE, causing a restriction of the fuel flow. However, it is not known if the properties of the ice generated in this manner are the same as the properties of the ice which might release from the inside of the fuel feed pipes. It is also not known if ice released from the inside of the fuel pipes travels through the system at the same velocity as the fuel.

#### 1.18.1.6 Fuel waxing

As fuel is cooled beyond its freezing point it is the long straight chain (heavier) hydrocarbons which first form wax crystals. These wax crystals have a similar density to liquid fuel and, therefore, remain suspended in the fuel. This mixture of fuel and wax crystals can normally be pumped by the aircraft boost pumps into the fuel system until the fuel temperature reaches its 'pour point', which is much colder than the fuel freezing point.

Previous testing by the aircraft manufacturer has established that there is a vertical thermal gradient (stratification) in fuel tanks and other research has established that it is the fuel adjacent to the lower wing skin which will wax first and form a layer that lines the bottom of the tank. This layer of wax then acts as an insulator which serves to reduce the rate of cooling of the bulk fuel. However, in flight there are a number of factors which tend to equalise the vertical temperature gradient of the fuel in the tank. These include fuel sloshing and circulation of the fuel as a result of the flow into the boost pumps, action

of the water scavenge systems and migration of the cold fuel from the outer to inner sections of the wing tanks.

In previous testing undertaken by the aircraft manufacturer on a B777-200, which has the same wing fuel system as the B777-200ER, it was established that during feed from the centre fuel tank, stratification of the fuel in the main fuel tanks occurred as TAT reduced. During the test, ten thermocouples mounted vertically in the tank close to the fuel temperature probe recorded the temperature as varying from -17°C at the bottom of the tank to -3°C near the top of the tank. When the boost pump was turned ON, so that the flow was sufficient to provide the motive flow for the water scavenge system and internal pump cooling, the stratification diminished and the vertical temperature variation adjacent to the temperature probe reduced to around 3°C.

#### 1.18.1.7 Entrapped air in aviation fuel

Jet fuel contains dissolved air and the amount depends on the temperature of the fuel and the altitude. As the airplane climbs to cruising altitude, and the ambient pressure decreases, air is liberated from the fuel as bubbles that rise to the surface. As the flight progresses the rate of effervescence decreases as the fuel comes into equilibrium with the atmospheric and fuel temperature conditions. This condition is called fuel weathering. Since the accident flight was in descent, fuel was in a weathered condition and the liberation of entrapped air was not considered to be an issue.

#### 1.18.2 Other relevant events

##### 1.18.2.1 Incident to Boeing 777-200ER (N862DA)

On 26 November 2008, a Boeing 777-200ER powered by Rolls-Royce Trent 800 engines, registered N862DA was being operated from Pudong International Airport, Shanghai, People's Republic of China to Atlanta-Hartsfield International Airport, Atlanta, Georgia, USA. Whilst in cruise at FL390, the right engine suffered an uncommanded reduction in engine power.

Subsequent examination of the right engine HP pump revealed the presence of severe cavitation damage, in a similar location to, but worse than, that found on the HP pumps removed from G-YMMM. Data from the DFDR revealed an increase in the combined scavenge oil temperature and a reduction in the oil pressure following a step climb from flight level FL350 to FL370. The step climb occurred approximately 9.5 hours into the 13.5 hour flight and the fuel flow was increased from about 6,900 pph to around 10,900 pph to accomplish



the climb. The engine power reduction occurred 55 minutes after the step climb and during a small increase in power commanded by the autothrottle. The fuel flow to the right engine was restricted to approximately 5,000 pph. The power reduction persisted for 23 minutes despite several autothrottle commands for increased thrust.

The engine thrust levers were retarded to idle as the aircraft descended to a lower altitude. During this descent the engine recovered, the fuel flow returned to that demanded and the oil temperature reduced.

The fuel temperature at the time of the rollback was -22°C, which was the lowest fuel temperature experienced during the flight.

Preliminary conclusions issued by the NTSB in their recommendations document SB-09-11 issued on 11 March 2009, were that the FOHE on the right engine had become restricted with ice, thus reducing the fuel flow and causing the engine to rollback. This resulted in the increased oil temperature as the cooling efficiency of the oil by the fuel had been compromised. Once the engine had been commanded to idle fuel flow during the descent, the oil temperature dropped and the fuel flow was restored. This led to the conclusion that the restriction was temporary and that it had been cleared through the reduction of engine power to idle.

#### 1.18.2.2 Accident to USAF B52D

On 11 February 1958 a Boeing B52D crashed in South Dakota, USA. During a go-around engines 1, 2 and 5 had an uncommanded reduction in engine power. During the subsequent approach, power was gradually lost from all the engines, despite the selection of full thrust.

The aircraft struck the ground some 3,500 ft short of the runway threshold fatally injuring three of the crew. Despite a significant post-crash fire, ice was discovered within the aircraft fuel system.

A subsequent inquiry attributed the engine power loss to icing of the engine fuel pump screens, causing a restricted fuel flow to the engines. Contributory factors were excess water/ice in the fuel tanks and no bypass on the fuel pump screen.

### 1.18.3 Literature

Since the early 1950s considerable research has been carried out on the issue of fuel system icing by various organisations, resulting in several substantial reports. Some of this literature is freely available; some reports are proprietary or have government, military or export constraints.

This early research established that it is possible for ice to form from dissolved water, alone, in aviation turbine fuel and this can then block filters and small orifices. A number of different types of ice were observed, and described as being 'slush ice' and 'soft white ice', which when melted contained between 10% and 30% water. During this period the United States Air Force (USAF) undertook research into the formation of ice in fuel and observed that not all the water droplets form ice crystals, but some of the water remains as supercooled droplets. The research concluded that the type of ice is dependent on a number of factors including the rate of cooling, water droplet size and the agitation of the fuel. It was also noted that the variation in fuel composition between batches of fuel affects the concentration and size of the water droplets and the amount of subsequent icing.

Two documents produced by the Society of Automotive Engineers (SAE) detail succinctly the issue and findings of this research at that time and advises the aerospace industry on suggested procedures to test aircraft fuel systems and components for icing.

The SAE initially produced Aerospace Information Report (AIR) 790 in 1964; this was intended to provide information on ice formation in aircraft fuel systems.

With regard to testing AIR 790 states:

*'Test set-ups should represent actual aircraft conditions as closely as practicable. The component or system installation should be representative of that in the aircraft in configuration and location relative to aircraft features which might influence the performance...'*

With regard to conditioning of the fuel it states:

*'fuel conditioning and water content control can be accomplished in a number of ways...Common water injection methods are by atomising water over the surface of the fuel and by simply feeding water into the suction side of a circulation pump. The test fuel should be kept agitated by circulation to keep undissolved water in suspension and uniformly distributed throughout the system...'*

*'Single pass tests, where conditioned fuel is passed through the test system once is preferred, however the quantity of conditioned fuel required for a simulated mission of a large transport, cargo or tanker aircraft can be prohibitive for most facilities. In this case, delivery systems which return fuel from the test system outlet to the conditioned fuel supply are commonly used...'*

A second SAE document, Aerospace Recommended Practice (ARP) 1401, recommends test procedures for aircraft fuel systems. It provides a recommendation on the preparation of the fuel for these tests to achieve a water saturation, by continually injecting water into the fuel via an atomising nozzle, of at least 90 ppm.

#### 1.18.4 Fuel Heaters

Fuel heaters were initially introduced on the first generation of jet aircraft to prevent fuel icing. These generally utilised bleed air from the engines to heat the fuel through a heat exchanger, and were usually located on the spar or in the engine pylon area.

Following generations of aircraft used the engine's oil as the heating medium as the engine size and heat exchanger design had reached a point at which the oil could heat the fuel adequately to prevent icing on the sensitive components downstream. It is now common for large turbofans to be fitted with an FOHE at the engine for this purpose. However, smaller turbofan engines, such as those on business jets, do not have the heat capacity in their FOHEs to warm the fuel adequately; consequently they use FSII as an alternative means of preventing icing.

#### 1.18.5 Fuel System Icing Inhibitor (FSII)

Fuel System Icing Inhibitor (FSII) is a fuel additive that, when used in concentrations of 0.10% to 0.15% by volume, can prevent the formation of

water ice down to a temperature of  $-40^{\circ}\text{C}$ . FSII is only effective on undissolved water (entrained and free) and, as it is approximately 500 times more soluble in water than fuel, it will migrate into the undissolved water and lower its freezing point. The mixture of water and FSII has a similar density to water and will be consumed by the engines or removed during routine draining of the fuel tank sumps.

FSII is not commonly used in large public transport aircraft and was not detected in the fuel samples taken from G-YMMM. However, aviation turbine fuel containing FSII has been used on aircraft flown by the Royal Air Force, US Air Force and other military forces for about 50 years. The additive was introduced following the accident to the Boeing B52 when engine fuel filter icing led to restricted fuel flow and subsequent engine rollbacks and flame outs. FSII is also in use as an alternative to fuel heaters on many small civilian jet aircraft. The additive is approved for use on the Boeing 777 and the FAA has provided information on its use in aircraft through Advisory Circular 20-29B.

#### 1.18.6 Regulatory information

##### 1.18.6.1 Introduction

The Boeing 777-200 was certified by the Federal Aviation Authority (FAA) in April 1995 based on the requirements of Part 25 of the Federal Aviation Regulations (up to amendment 25-8). The Joint Aviation Authorities (JAA) validation was based on JAR 25 (change 13).

##### 1.18.6.2 Aircraft fuel system

The aircraft fuel system was certificated in accordance with the FAR, Part 25, Chapter 25.951 to Chapter 25.999. These regulations state:

*'Each fuel system must be constructed ...to ensure a flow of fuel.... for proper engine..... functioning under each likely operating condition'*

*'Each fuel system for a turbine engine must be capable of sustained operation throughout its flow and pressure range with fuel initially saturated with water at  $80^{\circ}\text{F}$  and having 0.75cc of free water per gallon (200 ppm) added and cooled to the most critical condition for icing likely to be encountered in operation.'*

Acceptable methods of compliance with the FAA regulations include:

Drawing and schematic review undertaken with an inspection of the aircraft or mock-up

System description

Ground and flight functional demonstrations

Ground and flight performance tests

Supporting analysis

Compliance can also be achieved by similarity where the component, or system, has previously demonstrated compliance with an industry standard; the previous approval is applicable to this application; and there has been satisfactory service experience on a previously approved existing design.

Full-scale testing for ice accumulation is very difficult on large aircraft fuel systems; therefore Boeing, like other aircraft manufacturers, have used a combination of industry knowledge, individual component testing and in-service experience on other aircraft models which have a similar fuel system.

The Boeing 777 aircraft fuel system is similar to the fuel system on the Boeing 757 and 767 and utilises many of the components used on these aircraft. The design of the fuel pipes are used on a large range of aircraft and some of the components, such as the boost pump inlet screens, were first used on the Boeing 707. Consequently a large number of components used on the Boeing 777 were certificated on the basis of similarity.

Some of the components such as the boost pump, its check valve, housing and pressure switches were unique to the Boeing 777 and were, therefore, subject to component-level testing for compliance. During testing of the boost pump there was evidence of a fuel flow restriction below -12.2°C, but it was concluded that the restriction was probably caused by ice forming on the boost pump inlet screen that had been used on the test rig.

Whilst full scale testing of the performance of the aircraft fuel system was carried out during the ground and flight tests, these tests did not include any fuel contamination or fuel icing tests.

### 1.18.6.3 Engine fuel system

The Rolls-Royce RB211-Trent 895-17 was initially certified by the CAA in June 1999 to JAR-E<sup>19</sup> Change 8, which was found to provide a level of safety equivalent to that provided by FAA FAR 33, Amendment 33-15.

Certification testing was conducted on all the engine fuel system components, including the FOHE, to satisfy the requirements of JAR-E-670. The requirement dealt with the satisfactory performance of the components with set levels of both solid and water contamination of the fuel. For the latter case:

*'The contaminated fuel should consist of fuel initially saturated with water at a fuel/water temperature of 27°C into which a further 0.2 ml of free water per litre of fuel has been evenly dispersed.'*

In addition:

*'The test should be conducted with the contaminated mixture cooled to the most critical condition for icing likely to be encountered in operation.'*

Tests were undertaken in which the fuel was cooled to +8°C and water was introduced into the bulk fuel supply using air blast atomising spray guns with the nozzle placed just under the surface. The fuel was then cooled to the required temperature at a rate of 10°C per hour (approximately the rate of cooling in the aircraft tanks) and the test commenced, having checked the water concentration.

The fuel and oil flow rates were then set, as was the oil temperature, and the test was deemed to start when the FOHE inlet temperature fell below 0°C. A large number of test points were recorded, representing taxi, takeoff, climb, cruise and descent, followed by further takeoff flows to simulate a go-around condition. The fuel flowing through the FOHE was directed to a catcher tank and was not recirculated, thus it was a 'one-pass' test and avoided the difficulty in maintaining fuel temperature and water concentration when fuel is circulated back to the supply tank.

During testing there was one occasion, at the start of a test, in which there was a small unexpected increase in pressure differential across the FOHE. This did not result in a restriction of the fuel flow, but was thought at the time probably to be due to the release of ice that had accumulated in the test rig. A repeat of the test was satisfactory.

<sup>19</sup> JAR-E has been superseded by EASA CS-E.

The conclusion of the tests was that there was no significant drop in pressure across the FOHE, other than a small but distinct increase due to the increased viscosity of fuel at very cold temperatures (-42°C). Although, the water concentrations specified in the JAR equated to approximately 260 ppm, the quantity of water used in the test was in concentrations closer to 600 ppm.

#### 1.18.7 The operator's policy on fuel sumping

Prior to the accident the operator had initiated a review of the effectiveness of their sumping programme, which was carried out during routine Daily and Transit checks. The review indicated that the drain valves could freeze and, when the fuel was cold, the flow of fluid through the drains could be very slow. During the review, a number of aircraft were checked in a warm hangar where any ice in the fuel tanks would have melted and migrated to the drains. G-YMMM was sumped in this manner on 14 December 2007.

The review established that while the free water does freeze, and could occasionally block the tank drains, there was no evidence of any significant quantities of free water having accumulated in any of the operator's 43 Boeing 777 aircraft.

#### 1.18.8 Ultrasonic water detectors

Ultrasonic water detectors are fitted in each of the fuel tanks and provide an indication on the fuel management maintenance page and the DFDR when the detectors have been activated for more than 60 seconds, the Air/Ground discrete is set at Ground and the aircraft is not being refuelled (refuel panel door is closed). Should there be a fault in the water detection system then a message will be stored in the CMC. There were no recent water detection faults recorded in the CMC for G-YMMM.

The water message on the fuel management maintenance page is not activated in flight and the operator informed the AAIB that there is no requirement for either their flight crew or engineers to check if the message has been activated. Nevertheless, a number of their engineers did routinely check for this message during the Daily and Transit checks.

The water detector units are immersed in the fuel and calculate the time that it takes for a signal to travel from the transducer and be reflected back from an integral end cap to the detector. If water is present in the fuel then the signal will be reflected from the fuel/water interface and the transit time for the signal will be shorter. If the actual transit time is different from the predicted time then the detector assumes that water is present and a message is generated.

However, ice and air bubbles in the fuel also affect the transit time and might be sufficient to trigger the water detection signal. The minimum amount of water required to cover the end cap and trigger the message is 7 US Gallons (32 litres) in the main tanks and 138 US Gallons (697 litres) in the centre tanks.

The aircraft manufacturer had previously raised the issue of the number of nuisance centre tank water messages generated on aircraft operating from their flight line. The messages would typically occur after refuelling and clear after a short taxi run, or after fuel was pumped and/or re-circulated within the tank. Consequently, the detector manufacturer undertook a laboratory test where they concluded that the message was probably generated by an air bubble becoming trapped on the face of the transducer, which would then clear after a small amount of turbulence in the fuel. They also concluded that the air bubble was more likely to become trapped on the face of the centre tank detectors than the main tank detectors which, due to the wing dihedral, were mounted at an angle which would help the air bubble to escape.

Following the accident to G-YMMM the aircraft operator carried out a survey between 17 January 2008 and 13 February 2008, during the transit check, to establish the frequency of nuisance water in fuel messages. The survey established that during this period the message had been activated on 15 aircraft on 40 occasions. The arisings per tank were: Right 6, Left 13, and Centre 21. On visually checking the fuel samples taken from the tank drains, small quantities of water were only found on three occasions, none of which was sufficient to trigger the water in fuel message.

#### 1.18.9 Evacuation checklist

The evacuation checklist for the Boeing 777, issued by Boeing, shows operation of the fuel control switches to cutoff prior to operation of the fire handles. This sequence allows for both CLOSE paths to the spar valve to be exploited and increases the likelihood that the spar valves close before electrical power to the spar valves is isolated. However, on aircraft that have not incorporated SB-777-28-0025, there is only a single CLOSE path if the fire handle is operated first.

The operator's evacuation checklist, for which Boeing had raised no technical objection, required the commander ('*Captain*') to operate the fuel control switches whilst the co-pilot ('*First Officer*') operated the fire handles, this was in order to reduce the time required to action the checklist. These actions



were carried out independently, with no measure in place to ensure the correct sequencing. The evacuation drill was on a placard mounted on the face of the control column boss (Figure 56).



**Figure 56**

Evacuation check list on G-YMMM control column

#### 1.18.10 B777-200LR modified drag brace design

The B777-200LR has provision for auxiliary fuel tanks located under the cabin floor, behind the MLG bay. A rotational stop tab and a local change in cross-sectional area were added to the landing gear drag brace, which, in the event of sufficient displacement of the gear towards the fuselage, would result in the fracture of the drag brace before any fuselage contact and therefore facilitate gear breakaway due to the vertical overload condition. In an emergency landing the design is such that vertical and/or drag overloads transmitted to the landing

gear would cause the drag brace to fail prior to the forward trunnion separation from the rear spar. This minimises the likelihood of the landing gear rotating inboard toward the auxiliary fuel tanks. This altered breakaway sequence causes the gear to separate away from the fuselage and the failure mode is not likely to cause damage to, and thus leakage from, the auxiliary fuel tank or any part of the fuel system.

#### 1.18.11 Safety actions taken

The following details the safety actions that have taken place either as a result of AAIB recommendations made in previous reports or examination findings.

##### 1.18.11.1 Video monitor attachment bracket

As a result of the detailed post-accident examination by the seat manufacturer of the video monitor attachments, wear in the spring clip and its associated fixings was identified as the cause for the release of the monitor. The seat manufacturer issued a Service Bulletin (SB) No 440-25MB059 in February 2009, applicable to seat model 4400 as fitted to the B747-400, B777 and B767-300 with this operator. The SB recommended the replacement of the spring clip and accessory rivets on the monitor attachment bracket and introduced an additional 'holding plate'. The materials for both the spring steel clip and the rivets holding the clip in place have been upgraded. The timescale of compliance with the SB was that it should be performed at the earliest opportunity and it was further recommended that inspections be made every time the monitor is removed or installed.

The SB is actioned by the operator at their seat overhaul workshop whenever these seats are sent to them, either for scheduled maintenance periods or for rectification work. They amended their task manual to include the inspections and briefed the teams on the importance of the inspection.

The original SB was only applicable to this operator. Revision 3 of this SB was issued in September 2009 as a Mandatory Service Bulletin and widening its applicability to all 4400 seat models. The seat manufacturer has reviewed the video monitor attachments on other seat models and concluded that they are not affected.

### 1.18.11.2 Spar valve

In the AAIB Special Bulletin S1/2008 published on 18 February 2008, the following Safety Recommendation was made:

**Safety Recommendation 2008-009**

Boeing should notify all Boeing 777 operators of the necessity to operate the fuel control switch to CUTOFF prior to operation of the fire handle, for both the fire drill and the evacuation drill, and ensure that all versions of its checklists, including electronic and placarded versions of the drill, are consistent with this procedure.

Boeing accepted this recommendation. On 15 February 2008 Boeing issued a Multi Operator Message, advising operators to ensure that '*evacuation and engine fire checklists specify that the fuel control switches are placed in the cutoff position prior to the operation of the fire handles*'. This advice only related to those aircraft that have not had Boeing SB 777-28-0025 incorporated. Boeing also recommended that operators review their engine fire and evacuation checklists (Quick Reference Handbook, Electronic and Placard) to ensure consistency with this advice.

The operator subsequently amended their checklist in February 2008 and they have incorporated Boeing SB 777-28-0025 on all their Boeing 777 aircraft.

### 1.18.11.3 Fuel Flow Restriction

In September 2008, the AAIB issued the first Interim Report. At that time the investigation had demonstrated that the fuel flow to both engines was restricted and that this was most probably due to ice within the fuel feed system. The exact mechanism in which the ice caused the restriction was still unknown but it was determined that the risk of recurrence needed to be addressed in the short term whilst the investigation continued and therefore the following Safety Recommendation was made on 15 September 2008:

**Safety Recommendation 2008-047**

It is recommended that the Federal Aviation Administration and the European Aviation Safety Agency, in conjunction with Boeing and Rolls-Royce, introduce interim measures for the Boeing 777, powered by Trent 800 engines, to reduce the risk of ice formed from water in aviation turbine fuel causing a restriction in the fuel feed system.

In response to this recommendation the aircraft manufacturer issued an amendment to the Aircraft Flight Manual (AFM) introducing the following procedures:

A recirculation procedure during refuelling if the fuel temperature is below 0°C.

An in flight procedure, when the fuel temperature is below -10°C, requiring the application of maximum climb thrust for at least 10 seconds, within 3 hours of top of descent.

In addition, an engine response non-normal procedure was added to provide a procedure should the engine fail to respond to a thrust application. The procedure called for the thrust levers to be set to idle for 30 seconds, after which each engine thrust lever is moved to max thrust to ensure the restriction has cleared.

The FAA issued Airworthiness Directive (AD) 2008-19-04 which mandated the above revision of the Boeing 777 AFM. The EASA also issued AD US-2008-19-04.

In March 2009 an amendment was made to the AFM to require the application of maximum climb thrust 2 hours prior to top of descent. The FAA issued AD 2009-05-11 which superseded AD 2008-19-04, to mandate the amendment to the AFM. The EASA also issued AD US-2009-05-11 which superseded their previous AD US-2008-19-04.

The following Safety Recommendation was also made on 15 September 2008:

**Safety Recommendation 2008-048**

It is recommended that the Federal Aviation Administration and the European Aviation Safety Agency should take immediate action to consider the implications of the findings of this investigation on other certificated airframe / engine combinations.

In Interim Report 2, issued on 12 March 2009, the following additional Safety Recommendations were made with regard to fuel flow restrictions to the engine:

**Safety Recommendation 2009-028**

It is recommended that Boeing and Rolls-Royce jointly review the aircraft and engine fuel system design for the Boeing 777, powered by Rolls-Royce Trent 800 engines, to develop changes which prevent ice from causing a restriction to the fuel flow at the fuel oil heat exchanger.

In response to Safety Recommendation 2009-028 Boeing and Rolls-Royce stated that:

“Boeing and Rolls-Royce have accepted the above recommendation. To mitigate the potential for a future fuel system ice accumulation and release event, to cause a blockage at the inlet to the FOHE, Rolls-Royce have developed a modification to the FOHE. The modification will improve the FOHE’s capability in the event of a fuel system ice release event.”

Rolls-Royce issued SB 79-AG257 on 24 June 2009 and Boeing issued SB 777-72A0030 on 10 July 2009. These SBs introduced a modification to the FOHE by redesigning its face such that the fuel heat transfer tubes are now flush with the end plate and the inlet crimps have been removed. This redesign has been shown, in testing, to be able to withstand soft ice that is being released from within the fuel system at fuel temperatures down to at least -44°C.

To ensure that changes as a result of Safety Recommendation 2009-028 were introduced onto in-service aircraft in a timely manner the following Safety Recommendation was made on 12 March 2009:

**Safety Recommendation 2009-029**

It is recommended that the Federal Aviation Administration and the European Aviation Safety Agency consider mandating design changes that are introduced as a result of recommendation 2009-028, developed to prevent ice from causing a restriction to the fuel flow at the fuel oil heat exchanger on Boeing 777 aircraft powered by Rolls-Royce Trent 800 engines.

In response to this Safety Recommendation the EASA issued an Airworthiness Directive (AD) 2009-0142 on 13 July 2009 which mandates the modification detailed in Rolls-Royce SB 79-AG257 and Boeing SB 777-A0030; the AD requires operators to comply within 6,000 flying hours of 10 July 2009 or by 1 January 2011 whichever is soonest. In addition the FAA issued Notice of Proposed Rule Making (NPRM) 2009-NE-25-AD.

Rolls-Royce has also pro-actively issued Service Bulletins to modify the FOHE fitted to the Trent 500 and Trent 700 engines. The EASA has issued an Airworthiness Directive (AD) 2009-0257, which mandates these Service Bulletins.

## **1.19 Useful or effective investigation techniques**

### **1.19.1 Data mining**

Data mining in itself is not a new development, but its application to aircraft accident investigation is relatively new to accident investigators. Data mining has roots in three fundamental areas, classical statistics, artificial intelligence and machine learning. These techniques can then be used together, or in isolation, to analyse large amounts of data to identify unusual patterns or previously hidden trends. The techniques themselves have been developed and applied over a number of years in both science and business.

The intent of the data mining activity for this investigation was to identify any parameters or a combination of parameters that were unique to the accident flight. Initial analysis of the accident flight identified that certain features were unusual or unique when compared to a small number of flights having operated on the same route and under similar atmospheric conditions. However, it was difficult to place a statistical significance on these findings alone due to the small sample size. Analysis of a much larger data set was required, and this was best supported by tools specifically designed for the purpose of data mining. A team was formed of statisticians from QinetiQ, together with specialists from the aircraft and engine manufacturer, the operator and the AAIB.

The process of data mining is well documented, from the initial stages of cleaning the data, selection of analysis techniques and final processing. When applied to flight data, the process is similar to that for other data types. An initial 600 flights were selected from the 13,500 available; this was termed the 'training set' and consisted of the accident flight and a selection of aircraft that had operated the same route, as well as some different routes. Of the total parameters, about 350 were selected from the various aircraft systems. The

training set was then used to develop algorithms and identify potential problems with the data, before analysis of the larger data set took place. Several issues were identified with the quality of the QAR data. The most significant was that a small number of flights demonstrated sections of data where parameters changed instantaneously to a value that exceeded the practicable limits of the parameter. It was unclear if the erroneous data was a result of a defect in the QAR or the ACMF. To ensure that these random parameter excursions did not impair the analysis, parameter filtering was rigorously tested and applied.

In addition to parameters being analysed throughout an entire flight, it was also necessary to divide a flight into phases, including takeoff, cruise, descent and final approach. This aided comparative analysis of the accident flight during each phase and assisted in the final identification of unusual and unique features. Although an aircraft-generated flight phase parameter was available from the QAR, it was found that an algorithm run retrospectively by the ground-based analysis systems produced more accurate results.

Once the initial testing had taken place, the algorithms and analysis were then applied to the 13,500 flights. Later in the investigation, a specification was also produced that enabled other airlines to contribute QAR data results to the investigation. The provision of QAR data is a sensitive one and this development meant that airlines were able to provide a summary of results, rather than the QAR data itself.

The data mining process was largely complementary to the laboratory testing that had been ongoing during the course of the investigation, with features identified from the data mining being incorporated into laboratory tests and similarly, laboratory results being applied to the data analysis.

## 2 Analysis

This investigation benefited from having an aircraft that remained relatively intact, all the persons on board survived, there were many witnesses to the accident and data was available from several sources. However, it was not possible to determine the most likely cause without an extensive test and research programme. Early in the investigation it became apparent that the reason for the rollbacks of both engines had been due to a restriction of the fuel flow, but the lack of physical evidence, apart from cavitation marks on the HP pumps, made the determination of the cause particularly challenging. Nevertheless, the investigation was able to determine that the most likely cause was ice that had accreted in the fuel system during the flight, which had then been released and formed a restriction at the face of the FOHE.

The rollbacks occurred on both engines at a late stage of the approach into Heathrow's Runway 27L, which made it inevitable that the aircraft would touchdown short of its intended landing point. Despite the resulting impact, G-YMMM remained substantially intact, and fortuitously there was no post-crash fire and only one serious injury. The analysis also assesses the crashworthiness and survivability aspects of this accident.

### 2.1 Conduct of the flight

#### *Flight crew qualification*

The flight crew were properly qualified and experienced in their respective roles to operate the flight and, at the time of the accident, they had completed just over 12 hours of duty, which was within their allowable duty time and they were suitably rested.

#### *Preparation*

The crew had conducted a pre-flight briefing and they were aware that the flight would take the aircraft through an area of unusually cold air, but that this was within the limitations of the aircraft. Whilst airborne, they monitored the fuel temperature, which remained within the aircraft's limitations and at no point cooled to a level that would have required crew action.

#### *The step climbs*

For reasons of passenger comfort, the flight crew had conducted the two cruise step climbs in the VS (vertical speed) mode of the autopilot, which was an



acceptable and commonly used mode for step climbs on a lightly-loaded aircraft. The rationale is that in VS mode the autothrottle does not need to command the engines to accelerate to full climb power, but instead a lower power setting is used to achieve the programmed climb at a set vertical speed. This means that there is no harsh acceleration that would disturb the passengers and the cabin noise levels remain low.

As a result of using VS mode, the fuel flows through the engine were significantly lower than if a corresponding VNAV (vertical navigation mode) climb had been used. This is significant in the later discussion of fuel system icing.

### *Final approach*

The right engine ceased responding to autothrottle demands 57 seconds before the touchdown and within seconds the crew became aware that there was a problem with the engine thrust control of both engines. This presented the flight crew with a situation that was highly unusual, for which no specific training existed.

The rollback event occurred whilst the aircraft was close to the ground, leaving the crew very little time to react. The commander did make a 'MAYDAY' call during this period but he was not able, in the time available, to brief the cabin crew about the emergency or issue a 'brace brace' command.

### *Actions of the co-pilot*

The co-pilot initially believed he had disconnected the autopilot at the intended height on the approach in order to carry out a manual landing on Runway 27L. However, as the aircraft descended through 600 ft he became aware of a problem with the engines, indicated by a split in the thrust lever positions. It is likely that, in attempting to understand the sudden and unprecedented problem with which he was presented he was distracted and thus omitted to disconnect the autopilot at this point.

Engine power had now reduced to a level at which the aircraft was losing airspeed and it started to descend below the glideslope. As the autopilot had remained engaged it attempted to maintain the ILS glide path by increasing the aircraft's pitch attitude. This led to a further gradual reduction of airspeed, the initial 'AIRSPEED LOW' master caution and the eventual triggering of the stall warning stick shaker. It was at this stage the co-pilot promptly pushed the control column forward, leading to the disconnect of the autopilot as overriding force

was applied to the column to avoid the stall. However, the aircraft was now only 150 ft above the ground and a landing short of the runway surface was inevitable. At this point there was insufficient height available for the aircraft to develop the airspeed needed for a landing flare, to reduce the high rate of descent.

#### *Actions of the commander*

The commander, on realising that he was unable to obtain any additional thrust from the engines, attempted to reduce the drag of the aircraft by reducing the flap setting. However, the aircraft was now so close to the ground that there was little time for the beneficial affects of this action to take effect.

The action of reducing the flap setting was prompt and resulted in a reduction of the aerodynamic drag, with a minimal effect on the aircraft stall speed; it moved the point of initial ground contact about 50 m towards the runway threshold. Had the flaps remained at FLAP 30, the touchdown would have been just before the ILS antenna, but still within the airfield boundary. The effects of contact with the ILS antenna are unknown but such contact would probably have led to more substantial structural damage to the aircraft.

#### *Assessment of flight crew actions - summary*

From the available evidence, it is apparent that the flight crew's preparation and conduct of the flight preceding the engine rollbacks was orderly, and in accordance with the operating company's standard operating procedures.

On the final approach to land the flight crew were presented with an operational situation, a double-engine rollback at a low height, which was unprecedented. Most importantly at this point, when the stick shaker was alerting them to an impending stall, they kept the aircraft flying and under control so that, at impact, it was wings level and at a moderate pitch attitude. The reduction in flap setting did allow the aircraft to clear the ILS aerial array and, given more height, it would have been more effective.

In analysing the flight crew's actions during final approach, the first indication of a problem was the thrust lever split. The flight crew did not, at this time, realise that this was associated with the ensuing engine rollback; slight splits in the thrust lever positions are common and manually moving the thrust levers back into alignment is a normal response. The flight crew became fully aware of the problem some 30 seconds before touchdown and at this point the subsequent high rate of descent at impact was inevitable.

The crew's attention was on monitoring the approach and the external environment and, while the autopilot remained engaged, the crew's focus was on the developing situation with falling engine thrust and reducing airspeed, and their subsequent attempts to restore power.

In the very limited time available after identification of the problem, the flight crew clearly prioritised their actions and thus did make the 'MAYDAY' call, although they were not able to make the 'brace brace' call. The initial use of the VHF radio rather than PA system for the cabin evacuation call had no effect on the accident outcome.

## **2.2 Evacuation**

The cabin crew initiated the passenger evacuation on hearing the evacuation alarm. The alarm was reported as being 'faint', however later tests revealed it to be satisfactory, except at Door 1L. The alarm was an optional fit and did not have any noise level specification; it did, however, meet the requirements of BS EN ISO 7731 for workplace evacuation alarms. The available evidence indicates that the evacuation was conducted in an efficient manner, with all the slides deploying and all the passengers and crew being able to evacuate the aircraft in a timely manner.

The evacuation benefitted from the lack of a post-crash fire and the fact that the cabin and aircraft structure remained largely intact. There was, however, a significant risk of fire from the fuel leaks and the oxygen leak from the passenger oxygen system. The AFS were prompt in their arrival at the aircraft and reduced the fire risk through their actions.

A higher proportion of CCMs (92%) than passengers (26%) reported suffering injury, whereas the flight crew did not report any injury. This suggests that the cabin crew may have been less protected from injury than the other occupants in the aircraft. There was no time for the flight crew to warn those in the cabin to "brace" and assume the brace position.

Some of the CCMs who suffered injuries also reported that their harnesses did not restrain them, particularly commenting that the inertia reel shoulder straps did not lock. Five CCMs mentioned that they were aware of being thrown laterally from side to side. This seemed to be irrespective of whether the inertia reel on the shoulder straps did or did not lock. However, the correct operation of the inertia reel locking mechanism on the harnesses at each CCM's seat was confirmed after the accident.

## 2.3 Aircraft examination

A comprehensive examination of the aircraft systems revealed no pre-existing defects with the electrical systems, hydraulics, autoflight systems, navigation systems or the flying controls. Examination of the engines indicated no evidence of a mechanical defect, a bird strike or core engine icing and there was adequate fuel on board on the aircraft.

### 2.3.1 Auxiliary Power Unit

Photographs taken of the aircraft during the ground slide show that the APU inlet door was open, which would have occurred had an APU start been initiated. Examination of the aircraft and the DFDR data showed the RAT had not deployed, which would occur during an automatic start of the APU. This is consistent with the commander's statement that he attempted an APU start during the latter stages of the approach.

### 2.3.2 Cross-feed valves

Following the accident the cross-feed valves were found with the aft valve in CLOSED and the forward valve in OPEN. The cross-feed switches in the flight deck were found in the OPEN position, although the flight crew do not recall operating these. The DFDR showed both valves to be CLOSED throughout the flight, indicating that the forward valve was manually commanded OPEN following the loss of AC power to the DFDR at impact. The loss of AC power would explain why only the forward cross-feed valve opened and the aft valve remained closed. The forward valve was powered from the DC battery bus whereas the aft valve was powered from the transfer bus which was supplied from the AC system. Therefore, the operation of the cross-feed valve switches occurred following the loss of AC power, but prior to the battery being disconnected.

### 2.3.3 Spar valves

On examination, both spar valves were found to be OPEN, which allowed fuel to leak from the fractured engine fuel pipes. This was despite the fire handles having been pulled by the flight crew.

The spar valves are designed to shut off the fuel supply to the engines following the operation of the fuel control switches or after operation of the fire handles in the cockpit. Each valve has two separate electrical wire paths which can be used to supply power to shut the valve; the first is via a run/cutoff relay, controlled by the fuel control switches, the other is directly from the fire handles.

The wiring on G-YMMM was as originally designed and manufactured, such that when the fire handle was operated, it isolated the power supply to the run/cutoff relay. When tested, the run/cutoff relays for the left and right engines were still in the valve OPEN position, despite the fuel control switches being set to cutoff. The fire handles had also been pulled and the engine fire bottles had fired. Therefore, the fire handles had been operated prior to the fuel control switches.

The left spar valve circuit breaker (CB) had tripped as a result of damage to the wiring to the valve caused by the left main landing gear being forced upward through the wiring raceway. Consequently, there was no means of electrically closing the left spar valve. Damage was also evident to the right spar valve wiring, although the CB remained set.

Examination and tests of the wiring identified that, in the case of the right engine, the valve CLOSE wire from the spar valve control relay was still capable of providing an adequate control signal to the valve. This would have allowed the valve to move to CLOSE had the fuel switch been operated before the fire handle.

Boeing had issued a Service Bulletin (SB 777-28-0025) which recommended the splicing together of the wires for the fuel control switches and the fire handles to avoid the need to sequence their operation. An FAA airworthiness directive (2005-13-20) requires this SB to be completed by July 2010; however, this had not yet been incorporated on G-YMMM. Had it been incorporated, then the right spar valve should have closed when the fuel control switch was operated.

The evacuation checklist for the Boeing 777, issued by Boeing, shows operation of the fuel control switches to cutoff prior to operation of the fire handles. This sequence allows for both CLOSE paths to the spar valve to be exploited and increases the likelihood that the spar valves close before electrical power to the spar valves is isolated. However, if the fire handle is operated first, then only a single path is available.

The operator's evacuation checklist, to which Boeing had raised no technical objection, required the commander to operate the fuel control switches whilst the co-pilot operated the fire handles, this was in order to reduce the time required to action the checklist. These actions were carried out independently, with no measure in place to ensure the correct sequencing.

An evacuation checklist with the division of independent tasks between the crew leaves a possibility that the fire handles could be operated before the fuel control switches which, with fire handle to spar valve wire damage, could leave the engine fuel spar shut-off valves in an OPEN position. This occurred in this accident, and resulted in the loss of 6,750 kg of fuel from the aircraft. This was not causal to the accident but could have had serious consequences in the event of a fire during the evacuation. As a result Safety Recommendation 2008-009 was made on 18 February 2008.

#### 2.3.4 Left engine HP fuel shutoff valve circuit breaker

The CB for the left engine HP fuel shutoff valve was found tripped, this was due to disruption of the wiring on the underside of the engine which occurred during the ground slide. The recorded data showed that the HP fuel shutoff valve was OPEN throughout the flight and was not a factor in this accident.

#### 2.3.5 Right suction feed check valve

During the examination of the fuel system it was discovered that the right suction feed check valve would not move to the closed position, under spring pressure, after it had been manually opened.

Had this valve been open in flight then, during centre tank feed, fuel would have flowed into the right main fuel tank; at this stage of the flight the aircraft would be in the climb and the main fuel tank would have been full. Any additional fuel entering the main tank would have leaked overboard through the vent system. However, the fuel tank contents, as recorded on the DFDR and QAR, were consistent with the fuel consumed by each engine and there is no evidence that fuel had leaked out of, or across, the vent system. This indicates that the suction feed check valve was closed during the early stages of the flight when the centre tank was supplying fuel to the engines. The fuel system is designed so that in the event of a failure of the forward and aft boost pumps, the engine can draw fuel from the main fuel tank through the suction check valve. Therefore, the check valve being stuck open in flight would not have compromised the fuel flow to the right engine at the time of the rollback.

#### *Fuel transfer following the accident*

Following the movement of the aircraft from the accident site it was discovered that approximately 1,500 kg of fuel had transferred from the left to the right main fuel tank. This could only have occurred if a cross-feed

valve, and either the suction check valve or one of the check valves in the boost pumps were open. Given the discovery of the sticking suction check valve it is most likely that it was the drop in pressure as a result of fuel leaking out of the fractured engine fuel pipes and open spar valves that opened both suction check valves and allowed fuel to siphon out of the main fuel tanks. Once the spar valves were closed, in order to stop the fuel leaking out of the aircraft, it is likely that the right suction check valve remained in the open position. This would have allowed fuel to transfer from the left to right tank, through the open cross-feed valve, when the left wing was raised higher than the right during its movement from the accident site.

#### 2.3.6 Loose fuel scavenge union

The union on the left centre tank fuel scavenge discharge pipe was found to be fully unwound from the threaded portion of the pipe. It is possible that scavenge fuel could have leaked into the main tank through this coupling prior to fuel scavenge. However, there is no evidence from the aircraft fuel quantity indicators that there was early transfer of fuel between the centre and left main tanks which suggests that any leak would have been small and insignificant.

#### 2.3.7 Foreign Object Debris (FOD)

Five loose articles were discovered in the fuel tanks, which otherwise were clean. It was likely that the plastic scraper had been in the aircraft since the aircraft was constructed and as it was trapped beneath the right tank suction inlet, it would not have compromised the fuel feed from this tank. The two pieces of plastic tape and the brown backing paper might have compromised the left main tank water scavenge system; however there is no evidence that this contributed to the accident. Likewise, it was assessed that the small piece of fabric/paper in the guillotine valve of the right OJ pump would have had no effect on the fuel flow from the centre tank.

#### 2.4 **High Intensity Radiated Field (HIRF) and Electro-Magnetic Interference (EMI)**

Tests were conducted on the effects of HIRF and EMI on the fuel control system, in particular that associated with the spar valve and its control. These tests were carried out up to power levels well in excess of published standards and no anomalous behaviour was experienced. Indeed, the DFDR did not record any change in the state of the spar valve position from OPEN at any time during the flight, once the valves had been opened for engine start in Beijing.

The EECs were originally tested, during certification, to power levels in excess of those that would have affected other more sensitive aircraft systems. A full review of the engine control and fuel systems, as well as the available data from the accident flight, showed that the system responses were not as a result of any external interference or from HIRF or EMI. Had there been HIRF or EMI on the accident flight it would have been evident on other, more sensitive, aircraft systems such as electrical, navigation or communication systems. None of these systems exhibited any anomalous behaviour on the accident flight and there was no interference heard on the CVR or apparent in the recorded parameters in the available data.

There was therefore no evidence that HIRF or EMI were factors in this accident.

## **2.5 Fuel quality**

Extensive testing of the fuel samples could identify nothing unusual about the fuel, which complied fully with the specifications for Jet A-1. Moreover, there was no evidence of contamination and no components were detected that would not normally be found in aviation turbine fuel. FSII was not detected in any of the samples tested.

Water will always be present in aviation turbine fuel. At 35 to 40 ppm the total water content measured in the fuel samples taken from G-YMMM was similar to that in the samples taken from another B777, G-YMMN. The small quantity of water droplets found in the engine fuel filter housings was also similar. The quantity of free water found in the main fuel tanks on G-YMMM, after the accident, was also similar to the quantity of free water found in the tanks of two other aircraft which had flown a similar route.

In summary, there was no evidence of excessive or unusual amounts of water in either the fuel or the fuel tanks on G-YMMM.

## **2.6 Fuel waxing**

The freezing point of aviation turbine fuel is established by cooling the fuel until wax has formed and then warming the fuel until the last crystal of wax is seen to disappear. The freezing point of the fuel sampled from G-YMMM was measured using both an automatic and a manual test. Neither test could detect any wax crystals in the fuel at temperatures warmer than  $-57^{\circ}\text{C}$ .

The Boeing 777 has a fuel temperature probe located in the inboard section



of the left main tank. The aircraft manufacturer previously undertook tests to establish the effectiveness of the fuel temperature probe by fitting a number of racks of thermocouples along the inside of the main fuel tanks. The tests established that the coldest fuel in the main fuel tanks is at the inboard section. The tests also established that there was a close correlation between the temperature of the fuel measured by the temperature probe and the rack of thermocouples mounted adjacent to the probe. On the accident flight, the temperature probe measured the minimum fuel temperature as  $-34^{\circ}\text{C}$ .

On long flights the temperature of the fuel in the main wing tanks will tend towards the temperature of the boundary layer around the wing, which can be up to  $3^{\circ}\text{C}$  lower than TAT. On the accident flight the minimum TAT was  $-45^{\circ}\text{C}$ .

Therefore, the data indicates that the fuel did not reach a low enough temperature to cause the fuel to wax during the accident flight

## 2.7 Water management

Inspection of the aircraft fuel tanks, after the accident, and testing of the fuel samples did not reveal any evidence of there having been excess water in the fuel system during the accident flight. Had a large quantity of free water been present in the main fuel tanks at the start of the accident flight, then the temperature of the fuel would have caused it to freeze before the main fuel tanks started to supply fuel to the engines. Such ice is difficult to break up and tends to stick to the bottom of the fuel tanks. If it did break away, then large pieces of ice would not have been able to pass through the  $\frac{1}{4}$  inch mesh on the boost pump inlets, nor would it have been able to block the inlet screens sufficiently to restrict the flow to the engines. There was also no damage to any of the inlet screens, which would have been an indication that the boost pumps had tried to draw large pieces of ice into the pump inlet.

### 2.7.1 Centre fuel tank water content

The location and shape of the centre tank meant that it could potentially hold a large quantity of water that might not have frozen during the accident flight. However, contamination of the centre tank with fire fighting medium, after the accident, meant that it was not possible to establish how much water was in the centre tank at the end of the flight.

From the DFDR it was established that on the flight to Beijing the water detector for the centre tank activated at first engine start and remained active for 9.5 minutes before clearing whilst the aircraft was still taxiing. This message is

for maintenance purposes and is not indicated to the flight crew. On the return flight to Heathrow the centre tank water detector activated at first engine start and remained active for 5.5 minutes before clearing as the aircraft taxied for takeoff. As the water detection messages cleared whilst the aircraft was taxiing, these were determined to have been 'nuisance' messages, most probably caused by an air bubble becoming trapped on the face of the centre tank water detector transducer whilst the aircraft was being refuelled.

Any excess water in the centre tank would either have been pumped to the engines during centre tank feed or, once the main fuel tanks started to supply fuel to the engines, would have been transferred to the main fuel tanks through the centre tank fuel scavenge system. There is, however, no evidence that either engine consumed a large quantity of water at any stage during the flight.

It is conceivable that water from the centre tank could have formed ice on the inside of the fuel feed pipes which pass through the main tanks and centre-cheek tank ullage. Testing has demonstrated that with the fuel temperatures experienced during the accident flight, the fuel scavenge jet pump would freeze if the water concentration exceeded 10% and would have led to an incomplete fuel scavenge; there was complete centre tank fuel scavenge. Lesser amounts of water would be transferred to the outer section of the main fuel tank where it would form ice crystals that might migrate through the tank baffles to the boost pump inlets. However, there was no evidence of excessive amounts of water in the main fuel tanks at the end of the flight.

### 2.7.2 Fuel sumping

The aircraft operator sumped its aircraft at the highest practicable frequency and whilst this would not remove ice from the fuel tanks, neither the operator nor the manufacturer was aware of any occasions when large quantities of water had been found in the fuel tanks of the operator's Boeing 777 aircraft.

### 2.7.3 Water scavenge

In each fuel tank the inlet for the water scavenge jet pump is mounted close to the floor of the tank and it is probable that, had a large quantity of water accumulated in the main fuel tanks, it would have frozen and blocked the inlet to the water scavenge system. The inspection of the aircraft fuel system also identified four items of FOD that might have affected the efficiency of the left and right main fuel tank water scavenge systems. The circular marks on the plastic tape, and its backing paper, showed that at some point since the aircraft was constructed these items had partially blocked the right main water

scavenge inlet. It is also possible that the plastic 'chad' and the flake of paint might have compromised the left main water scavenge system.

However, the primary purpose of the water scavenge system is to prevent the growth of Micro Biological Contamination (MBC) by keeping the amount of free water in the fuel tanks to a minimum. A build up of free water would have frozen and the ice would have stuck firmly to the bottom of the fuel tanks. However, there was no evidence of MBC or excessive amounts of water in the main fuel tanks at the end of the flight.

## 2.8 Fuel flow restriction

The DFDR data showed that, following the rollback of the engines on approach, the fuel flow reduced to 5,000 pph on the left engine and 6,000 pph on the right, whereas the expected fuel flow with the FMV in the fully open position (from QAR data) should have been in excess of 38,000 pph. This indicates that the fuel flow was being restricted, and this restriction continued after the initial engine rollback and through to the ground impact.

Both engine HP pumps exhibited cavitation marks on the pressure outlet ports and from testing and in-service experience it is concluded that these marks were fresh. Therefore, this damage most probably occurred on this flight and was caused by a restricted fuel flow leading to low inlet pressure at the HP pump.

The aircraft boost pumps that were supplying fuel from the main fuel tanks to the engine at the time of engine rollback, did not indicate a low pressure at any time during the flight. Subsequent tests of the indication system found it to be serviceable. Therefore, the restriction was downstream of the boost pump low pressure switches and upstream of the HP pump inlet.

Had both boost pumps and suction feed check valves become restricted, then a low pressure in the fuel manifold would have led to air being drawn from the centre tank, via the jettison and override pump check valves. However, testing showed that aeration causes a different response from the engine to that seen during the event. Furthermore, if a restriction occurred in the fuel manifold, between the centre tank feed and the point at which the boost pump feed lines connect into the manifold, there would have been adequate fuel supply from the boost pumps downstream, or from the suction feed bypass. Thus, the restriction must have been downstream of the connection of the forward boost pump feed line to the fuel manifold.

Examination of the fuel system did not reveal any physical restriction in the fuel system and the spar valves remained open throughout the flight.

### 2.8.1 Engine controls

The possibility of the fuel flow reduction and engine rollback being due to an engine control failure was explored in depth during the investigation.

The data from the aircraft, and the subsequent tests on the STF, indicated that the system response, and in particular that from the EEC, were all as a result of a fuel flow restriction. The recorded FMV movement, on the QAR, was consistent with the EEC commanding the FMV to operate to its full open position due to reducing fuel flow against the calculated demand. A full open FMV would have allowed full fuel flow had there not been an upstream restriction. Also, the data clearly shows the FMV responding correctly to commands from the EEC as it entered the various control loops needed to protect the engine.

Despite the generation of fault code 861 'Surge Detected' on the EECs of both engines, neither engine had experienced a surge. A surge results in a distinctive combination of engine parameter anomalies, particularly rising exhaust gas temperatures, and this behaviour was not observed in the recorded data.

It was therefore concluded, from the data and testing, that the engine control system was not contributory to the restriction to the fuel flow and subsequent engine rollbacks; it was responding, as expected, to the fuel flow restriction.

### 2.8.2 Fuel system tests

#### *FOHE restriction*

The extensive fuel system and laboratory tests established that, under certain conditions, it was possible to partially block the FOHE and restrict the fuel flow to the engine HP fuel pump. These restrictions were achieved by injecting water directly into the boost pump inlet, leading to a high water concentration<sup>1</sup> in the fuel. As the water moved through the fuel system it formed ice crystals, which subsequently blocked the ends of a majority of the tubes in the FOHE matrix. It was established that under certain circumstances 25 ml of water, when introduced into the fuel flow in this manner, could form sufficient ice to restrict the fuel flow through the FOHE.

---

<sup>1</sup> The water concentrations in the fuel, when the water was introduced in the manner used in these tests, were of the order of 100 times the concentration levels specified in the certification requirements.

However, this restriction could always be cleared by reducing the fuel flow, which changed the equilibrium between the cold fuel and hot oil in the heat exchanger, such that the ice melted on the inlet face of the FOHE sufficient to restore the original fuel flow. Variation of the FOHE oil temperature made a small difference to the amount of water required to restrict the FOHE, whereas variations in fuel temperature and fuel flow had a larger affect. It was concluded that it was not possible to restrict the fuel flow through the FOHE when the temperature of the fuel in the main tank was above  $-15^{\circ}\text{C}$  (at a fuel flow of 6,000 pph) and  $-10^{\circ}\text{C}$  (at a fuel flow of 12,000 pph). Moreover, when restricted, the fuel flow never dropped below that required by the engine for operation at flight idle.

#### *Inlet screens*

During the testing, blockage of the fuel boost pump inlet screen was achieved on six occasions sufficient to restrict the flow. The restrictions occurred during the testing and were believed to be an artefact of the test set-up. As mentioned previously, the data from the accident flight indicated that the boost pump low pressure switches did not trigger throughout the flight and, therefore, icing of the inlet screens is unlikely to have caused the particular fuel flow restrictions experienced on G-YMMM. Indeed, had there been a restriction of all three inlet screens in each tank, then it is more likely that the fuel would become aerated due to the suction force of the LP pump opening the jettison and centre tank override jettison check valves and drawing air in from the empty centre fuel tank. It was demonstrated that aeration of the fuel would lead to an engine response unlike that seen in the data from G-YMMM.

#### *Fuel system ice accumulation*

The later system tests demonstrated that, with normal concentrations of dissolved and entrained water present in aviation turbine fuel, ice can form around the inside of the fuel feed pipes. The accumulation of ice appeared to be dependent on the velocity of the fuel, and the fuel and environmental temperatures. The testing established that in certain environmental conditions ice can accumulate in the fuel system when the fuel is at a temperature between  $+5^{\circ}\text{C}$  and  $-20^{\circ}\text{C}$ , with ice appearing to accumulate at a lower rate at  $-20^{\circ}\text{C}$ . Whilst very little ice accumulates at  $-35^{\circ}\text{C}$ , ice which has accumulated at warmer temperatures will stay attached to the pipe walls as the temperature is reduced to  $-35^{\circ}\text{C}$  with no apparent change in its properties. These results are consistent with the earlier laboratory tests undertaken by the aircraft manufacturer, as well as previous research on the formation of ice in aircraft fuel systems. This work identified that

there is a 'sticky range' between approximately  $-5^{\circ}\text{C}$  and  $-20^{\circ}\text{C}$ , where ice will adhere to its surroundings with ice being at its most 'sticky' at around  $-12^{\circ}\text{C}$ .

The tests carried out in the environmental fuel test rig then demonstrated that increasing the fuel flow can result in the release of a quantity of ice sufficient to restrict the fuel flow through the FOHE. An increase in the TAT, which occurs when the aircraft descends, results in an increase in the temperature in the strut, which the tests proved could also cause ice to be released from the fuel pipes in the strut area.

It was also evident, from all the fuel rig testing, that ice can move through the fuel feed system and under very low flow conditions might collect in areas such as the fuel pipes in the strut, which form a low point when the aircraft is in its normal cruise attitude, and the LP pump inlet. It was observed during these tests that, apart from the inlet screens and the FOHE, restrictions to the fuel flow did not occur in any of the other fuel system components nor were any features identified in the fuel system which would cause a large enough concentration of ice to accumulate and cause a restriction.

### 2.8.3 Engine testing

The tests by the engine manufacturer showed that to achieve the accident flight response from the engine control system to the fuel flow reduction it was necessary to have a restriction at the face of the FOHE or LP pump just prior to or during the final acceleration of the engines on the approach. If the restriction occurred on the face of the FOHE or the LP pump inlet prior to the final series of accelerations, the rollback would have occurred earlier and most likely during the first acceleration. These tests also demonstrated that the further upstream a restriction was placed from the HP pump the more acceleration/deceleration cycles could be completed following the introduction of the restriction, before the engine rolled back. Testing also showed that a restriction on the face of the FOHE on G-YMMM could not have been from a gradual accretion of ice, but more likely from an 'avalanche' or 'snowball' of ice.

### 2.8.4 Data mining analysis

The data mining group's activity in support of this investigation was innovative, substantial and sought to understand whether the G-YMMM accident flight had unusual or even unique features compared to other Boeing 777 flights. This activity was also to understand further the reason why the engine rollbacks occurred on the G-YMMM accident flight, and the later N862DA incident flight, and not the other thousands of flights.

### *Fuel temperature in flight*

The accident flight's minimum fuel temperature of  $-34^{\circ}\text{C}$  was identified as being unusual, although testing has shown that most ice accumulates on the inside of fuel feed pipes at temperatures between  $-5^{\circ}\text{C}$  and  $-20^{\circ}\text{C}$ . The rate that ice accumulates will reduce as the temperature drops further toward the minimum experienced in flight. Therefore, the minimum fuel temperature experienced on the accident flight is not considered a causal factor, however it did contribute to the low fuel temperature of  $-22^{\circ}\text{C}$  on approach.

### *Fuel temperature at takeoff*

A relatively small percentage of flights had taken off with fuel temperatures below  $0^{\circ}\text{C}$ . Testing has shown that adding warm fuel to cold fuel, as would have occurred during the accident flight refuelling at Beijing, or taking off with fuel below  $0^{\circ}\text{C}$ , would have had little or no bearing on whether ice was later formed on the inside of fuel feed pipes. Analysis of flights found that it was not unusual for aircraft to takeoff with fuel above  $0^{\circ}\text{C}$  only to see the fuel temperatures reduce below  $0^{\circ}\text{C}$  when in the cruise, as seen on the N862DA incident flight.

### *Engine fuel flow*

The accident flight had operated for over eight hours in the cruise, at an average fuel flow of about 7,000 pph. During the same period, fuel temperatures had remained below  $-20^{\circ}\text{C}$  and, due to the use of the VS mode for the step climbs, fuel flows had not exceeded 8,897 pph. Testing has shown that at similar temperatures and flow rates, ice can be formed within the fuel feed pipes. Testing has also demonstrated that ice may be released from the fuel feed pipes at higher levels of fuel flow, similar to those attained during the final stages of the approach when the maximum fuel flow reached 12,288 pph.

### *Unique features*

Analysis of 175,000 flights identified that the accident flight was unique among 35,000 Rolls-Royce powered flights in having a combination of the lowest cruise fuel flow, combined with the highest fuel flow during approach while at the lowest temperature on approach. Just two flights from 142,000 Pratt and Whitney powered aircraft flights had these features. However, analysis of the N862DA incident and subsequent data mining identified that this flight was not unique with respect to its combination of fuel temperature and fuel flows, although only a relatively small percentage (0.3%) of flights shared the same features.

It is not fully understood why other Rolls-Royce powered Boeing 777 flights that had similar features to the G-YMMM accident flight, and perhaps more so the N862DA incident flight, did not experience similar fuel restrictions. Testing does offer some explanation, with the observation of ‘randomness’ in the formation of ice, indicative that there may also be a variance in the quantity of ice generated during similar flights. Similarly, differences between the G-YMMM accident flight and N862DA incident flight, with one experiencing a more rapid onset and the other a more progressive restriction, indicate that factors other than flow rate and temperature may affect the release of ice from within fuel feed pipes. The properties of ice generated within an aircraft, rather than a laboratory environment, may also have different characteristics.

#### *Detection of an incipient fuel flow restriction*

Although other flights having similar levels of fuel restriction to G-YMMM and N862DA were not discovered, it cannot be ruled out that other aircraft experienced a lower level of fuel flow restriction that went undetected. A search of previous EEC Control Loop 17 occurrences, and an FMV position algorithm, did not identify any flights that had suffered a ‘gross’ mismatch in commanded and actual fuel flow. However, when the incident flight of N862DA was analysed, the FMV position and expected fuel flow algorithm did not detect a mismatch until several minutes after the restriction had first started to occur. The EEC Control Loop 17 also activated some minutes later. Testing has shown that ice on the inlet face of the FOHE will clear when the commanded fuel flow is reduced to idle thrust.

#### 2.8.5 The engine rollbacks

The extensive testing enabled the investigation to determine the most likely sequence of events which led to the eventual loss of thrust on both the left and right engine during the approach to Runway 27L.

#### *Ice accumulation during centre tank feed*

The tests demonstrated that with relatively low fuel flow, ice can start to form on the inside of the fuel pipes. On G-YMMM this ice probably started to form on the fuel feed pipes that pass through the main fuel tank, whilst the centre tank was supplying fuel to the engines. The fuel temperature of the centre tank fuel would have been above 0°C, and therefore above the freezing temperature of water. However, this fuel flowed through pipes that pass through the cold fuel in the main fuel tank as the fuel temperature was dropped from -2°C to -21°C.



*Ice accumulation during main tank feed*

When the main fuel tanks started to supply fuel to the engines, the temperature of the fuel in the main tanks was approximately  $-22^{\circ}\text{C}$  and continued to reduce over the next five hours to a temperature of  $-34^{\circ}\text{C}$ . During this period the rate that ice accumulated in the pipes, located within the main fuel tanks, would have reduced as the fuel temperature moved out of the 'sticky range'. Although the minimum fuel temperature on G-YMMM was low, it was not unusual. Moreover, testing and research has demonstrated that at this low temperature ice will not accumulate on the inside of the pipes and therefore the low fuel temperature of  $-34^{\circ}\text{C}$  experienced on the accident flight is not considered to be a factor in this accident.

It is possible that the temperature in the strut area may have led to increased ice accretion in the pipes in this section, as the fuel temperature at the walls of the pipes may have increased into the 'sticky range'. Towards the end of the flight, the rate that ice accumulated in the fuel feed pipes would change as the TAT and the fuel temperature increased.

*Release of accumulated ice on approach*

It is considered that, in the later stages of the approach, the engine accelerations, and perhaps a combination of other factors such as turbulence, aircraft pitch changes and an increase in the strut temperature, could have contributed to a sudden release of soft ice in the fuel feed system for both engines.

*The fuel flow restriction*

This ice would have travelled through the fuel feed pipes, where it could have formed a restriction. The testing has shown the FOHE to be capable of restriction when presented with soft ice released from the fuel system in high concentration and when the main fuel tank temperature is below  $-10^{\circ}\text{C}$ . Also, the tests have demonstrated that sufficient ice can accumulate within the Boeing 777 fuel system, which when released can form a restriction at the face of the FOHE.

The fuel flow restrictions seen on G-YMMM could not have occurred at the FOHE until the final of the four accelerations. Engine oil pressure data recorded from the right engine indicate that its FOHE did become restricted during the final acceleration as the cooling efficiency of the heat exchanger was compromised, as was seen on the event to N862DA. As the left engine rollback occurred 7 seconds after the right engine, there was not enough

recorded data for the left engine oil temperature or pressure to establish if a restriction occurred at its FOHE. However, it was established that there was no restriction at the FOHE prior to the fourth acceleration. It is for this reason, that for the left engine, the investigation has not been able totally to eliminate the possibility that a restriction formed elsewhere in the fuel system, although the testing and research carried out for this investigation was unable to demonstrate such a restriction.

#### *Other possible restriction locations*

Throughout the extensive testing it has not been possible to identify any features elsewhere in the fuel system which would have caused a large enough concentration of ice to accumulate and cause a restriction. This is despite analysis of the data from the L12 engine testing indicating that a restriction 25 ft or more from the aircraft-to-engine strut interface more closely matched the accident flight data than a restriction at the FOHE or LP pump. Possible reasons for this discrepancy could be that the engine tests were carried out using warm, un-weathered fuel and fixed 'restrictor' plates. Also, the engine test was not able to consider the dynamics of ice moving through the system, or possible changes in the porosity of the ice as it becomes compressed onto the face of the FOHE.

#### *Simultaneous engine rollbacks*

The investigation considered the possibility that the rollback on each engine occurred for a different reason. The fuel feed systems on each side of the aircraft are almost identical and were exposed to the same fuel, environmental factors and motion of the aircraft. Moreover, there was a high level of repeatability during the tests to restrict the fuel flow through the FOHE and some consistency in the ice accumulation and release tests undertaken on the environmental rig. Therefore the scenario that ice accumulated within the fuel feed system and subsequently released and restricted the fuel flow through the FOHE is consistent with the rollback on both engines occurring almost simultaneously.

The investigation, including the data mining activity of over 175,000 flights, only demonstrated two engine rollbacks (G-YMMM right engine and N862DA) which were positively identified as consistent with ice releasing from the fuel system and forming a restriction at the FOHE. No other mechanism was identified throughout the testing that would have caused a restricted fuel flow elsewhere in the fuel system and the subsequent engine

control response on the accident flight. These occurrences are thus very rare and therefore, although the data for the left engine ceased before it was possible to determine with certainty that its FOHE had become restricted, the likelihood of a separate restriction mechanism occurring within seven seconds of that for the right engine is very low.

#### *Safety Recommendations and safety action*

As a result of these conclusions Safety Recommendations 2009-028 and 2009-029 were made on 12 March 2009. (refer to para 1.18.11.3)

In June 2008, following the findings of the initial FOHE restriction tests at Boeing, Rolls-Royce began to redesign the FOHE as a product improvement. In July 2009 Rolls-Royce had produced a modified FOHE for the Trent 800 engines. The modification involved changing the fuel inlet face of the FOHE; the fuel tube inlet crimps were removed and the fuel tubes were made flush with the inlet face. Testing has shown that the new FOHE is resilient to soft ice, in high concentration, at fuel temperatures down to at least -44°C; this is the fuel temperature that generates a fuel temperature warning on aircraft fuelled with Jet A-1. This modification has since been mandated by the regulatory authorities.

#### 2.8.6 Other engine/airframe combinations

Throughout the investigation all of the testing and research into the causes of this accident were conducted on the Boeing 777 / Trent 800 aircraft engine combination, and it is unknown whether other aircraft / engine combinations that have already been certificated might also be vulnerable to this previously unforeseen threat. Safety Recommendation 2008-048 was made to the regulatory authorities on 15 September 2008 to address this (refer to para 1.18.11.3).

### 2.9 **Anti-ice additives in aviation fuel**

Ice in aviation turbine fuel is an industry-wide problem. The military, and some business jet operators, have used anti-icing additives in aviation turbine fuel as a means of preventing ice from forming within the aircraft and engine fuel systems. The widespread use of such additives would reduce the risk from ice in fuel. However, its introduction worldwide would not only require changes to the infrastructure and ground fuel handling systems, but it could also lead to increased aircraft maintenance. Moreover, unlike the Boeing 777, not all aircraft are currently cleared to use existing anti-icing additives.

Despite the difficulties, the use of an anti-icing additive could significantly reduce, or even eliminate, ice formation in aviation turbine fuel. Therefore, to clarify the current issues the following Safety Recommendation was made on 12 March 2009:

It is recommended that the Federal Aviation Administration and the European Aviation Safety Agency conduct a study into the feasibility of expanding the use of anti-ice additives in aviation turbine fuel on civil aircraft.

**Safety Recommendation 2009-030**

## 2.10 Future industry activity

The formation of ice in fuel systems from dissolved and entrained water in aviation turbine fuel is well documented and is largely based on observations and conclusions made during research projects undertaken in the 1950s. However, little is known about the properties of ice formed in aviation turbine fuel and, during the extensive testing undertaken on the fuel test rig during this investigation, there was 'randomness' in the formation of ice, with poor repeatability between batches of fuel with similar compositions.

The investigation has established that the risk from fuel system icing is complex and is dependent on a number of interactions that are not fully understood. Much of the current industry guidance is based on research undertaken over 50 years ago and since that time civil aircraft have become larger, fly for longer periods and incorporate new technology and materials. In order to improve guidelines for the design and testing of aircraft fuel systems it will be necessary for the aviation industry, led by the regulatory authorities, to undertake a number of co-ordinated research projects. The first step would be to understand how ice forms in aviation turbine fuel and the properties of this ice. Therefore the following Safety Recommendation was made on 12 March 2009:

It is recommended that the Federal Aviation Administration and the European Aviation Safety Agency jointly conduct research into ice formation in aviation turbine fuels.

**Safety Recommendation 2009-031**

Research is also required to establish how ice accumulates in a fuel system and to establish the factors that may cause it to be released in a sufficient concentration to restrict the fuel flow. The results of this research can then be used to further develop the industry guidance on fuel system design, materials, and the development of test procedures for aircraft fuel systems. Therefore the following Safety Recommendation was made on 12 March 2009:

It is recommended that the Federal Aviation Administration and the European Aviation Safety Agency jointly conduct research into ice accumulation and subsequent release mechanisms within aircraft and engine fuel systems.

**Safety Recommendation 2009-032**

## 2.11 Certification

The Boeing 777 was certificated in 1995 as meeting both the FAA FARs and the JAA JARs in force at the time. These required that an aircraft and engine fuel system must be capable of sustained operation throughout its flow and pressure range, and at low temperatures, with a prescribed concentration of water. However, the requirements, which remain current, do not appear to address the scenarios identified during this investigation, such as the sudden release of accrued ice, which could lead to a restricted fuel flow. Therefore the following Safety Recommendation was made on 15 September 2008:

It is recommended that the Federal Aviation Administration and the European Aviation Safety Agency review the current certification requirements to ensure that aircraft and engine fuel systems are tolerant to the potential build up and sudden release of ice in the fuel feed system.

**Safety Recommendation 2008-049**

## 2.12 Recorders

Testing has shown that ice generated within a fuel system may restrict the flow of fuel to the engine such that commanded thrust cannot be achieved. There are a number of other scenarios in which commanded thrust may not result in the appropriate delivery of fuel to the engine. However, there is no current requirement to record parameters which control the delivery of fuel to the engines, such as the position of the FMV. On G-YMMM, the DFDR did record the LIC, although this parameter does not reflect the dynamic nature of the FMV nor its immediate position. In this accident (and the incident to N862DA), the availability of the FMV positional information was invaluable in being able to determine that the engine control system was functioning correctly and that a fuel restriction had occurred, but there is no requirement that this be recorded on the crash-protected DFDR.

The required DFDR parameters for commercial air transport aircraft are provided in ICAO Annex 6 Part 1. This Annex is currently subject to amendment to include a wider range of recorded information than is currently prescribed. This enhanced list of DFDR parameters has already been adopted and implemented by the FAA but not yet by EASA.

As well as 'power on each engine', the proposed change to the Annex details a number of examples of 'additional engine parameters' to be recorded, including 'fuel cutoff lever position'. For future fuel-flow related investigations it is important that the operational position of the engine fuel metering devices be known. Thus it would be appropriate that this information be required by regulation to be recorded by a DFDR. Therefore:

It is recommended that the European Aviation Safety Agency introduce a requirement to record, on a DFDR, the operational position of each engine fuel metering device where practicable.  
**Safety Recommendation 2009-091**

Furthermore:

It is recommended that the Federal Aviation Administration introduce a requirement to record, on a DFDR, the operational position of each engine fuel metering device where practicable.  
**Safety Recommendation 2009-092**

The QAR is recognised, by accident investigators and aircraft manufacturers, as providing a valuable source of additional information. Unlike the DFDR there is no legislative requirement governing the buffering of data prior to recording. On many occasions, buffering has not been an issue, although during this accident, had the fuel restriction occurred just a few seconds later, the accompanying FMV data from the QAR would not have been available. By means of a software update to the ACMF, by the operator, the degree of data buffering of QAR data on its Boeing 777 aircraft has been greatly reduced. Other Boeing 777 operators have not implemented these changes and therefore:

It is recommended that Boeing minimise the amount of buffering of data, prior to its being recorded on a QAR, on all Boeing 777 aircraft. **Recommendation 2009-093**

## 2.13 Crashworthiness

### 2.13.1 The fuel tank rupture

Both main landing gears partially separated at the initial impact, which occurred with a vertical rate of descent of 25 ft/s immediately before impact. It was determined from the ground marks at the second impact, the main landing gear legs were by then unable to sustain vertical load and the aircraft contacted the ground on its engine nacelles and its nose landing gear, which immediately collapsed.

The separation of the left gear attachments followed the design breakaway sequence, leaving the fuel tanks intact except for a small gap between the upper wing skin and the rear spar. The gear remained with the aircraft as it continued to slide along the ground. Analysis of the sequence of failures indicated a very heavy vertical impact, with the fracture of all six fuse pins in the upper and lower housings of the forward trunnion. The drag brace fuse pin showed some evidence of 'crankshafting' but did not fracture.

The right gear showed a similar initial breakaway sequence following the fracture of the outboard end of the gear beam attachment; however only the four fuse pins in the lower housing for the forward trunnion failed, leaving the two upper housing pins intact. The forward trunnion was then forced down and aft. The ground marks at the second impact indicated that the right MLG had been displaced inboard during the initial impact.

As the aircraft continued the ground slide the right MLG moved aft allowing the shock strut to contact the truck beam. This resulted in the separation of the forward portion of the truck beam together with two wheels. This piece then struck the right side of the fuselage causing damage within the cabin and leading to the passenger injury. As the remainder of the gear assembly continued to move aft the inboard wheels contacted the fuselage behind the MLG bay. The rear spar web, together with the back-up fitting and terminal fittings, ruptured and this caused the right MLG to separate. This became airborne and struck the right horizontal stabiliser before coming to rest.

The possibility of the landing gear being displaced inboard was considered in the certification of the B777-200LR, as this variant has a fuel tank located aft of the main landing gear bay. As a result, the manufacturer introduced a rotational tab, and reduced the cross-sectional area, on the drag brace to protect the additional fuel tank in the event of an overload condition. On G-YMMM this area contained the passenger oxygen bottles, which were disrupted by the MLG during the ground slide; this could have contributed to a post-impact fire.

The fuel tank rupture represents a significant hazard in a survivable accident. The following Safety Recommendation is therefore made:

It is recommended that Boeing apply the modified design of the B777-200LR main landing gear drag brace, or an equivalent measure, to prevent fuel tank rupture, on future Boeing 777 models and continuing production of existing models of the type.

**Safety Recommendation 2009-094**

The rupture of the rear spar resulted in a breach in the centre fuel tank. Based on the knowledge at the time, the design breakaway scenario was accepted when the aircraft was certificated and found to be in compliance with the requirements.

The current CS 25.721 (a) requirements state that:

*'...The overloads must be assumed to act in the upward and aft directions in combination with side loads acting inboard and outboard. In the absence of a more rational analysis, the side loads must be assumed to be up to 20% of the vertical load or 20% of the drag load, whichever is greater...'*

Although, as part of the B777-200 certification, this criteria was met as part of the EASA Certification Review Item (CRI) there is no such requirement in the FARs.

The following Safety Recommendation is therefore made:

It is recommended that the Federal Aviation Administration amend their requirements for landing gear emergency loading conditions to include combinations of side loads.

**Safety Recommendation 2009-095**

The analysis by Cranfield Impact Centre (CIC) also showed very different failures resulting from landing on soft ground as opposed to a hard runway surface. In the soft ground accident simulation, the results showed that only one of the fuse pins failed. A delayed build-up of shear forces in the pins (when compared to impact with hard ground) prevented most of them from reaching their failure loads. This delaying action allowed the fuse pins to continue transferring loads into the rear spars and resulted in distortion in the region of the drag brace attachment.

It was concluded that the difference in outcome in the simulation from that of the accident was due to the soil characteristics in the model being different to those of the soil at the accident site. Had the soil strength in the model been greater, it is probable that more fuse pins would have failed and the rear spar distortions would have been less. However, the analysis did indicate that landing gear interaction with soft ground can substantially modify the breakaway sequence.



Dynamic FE modelling is a novel and complex task. The analysis carried out by CIC had a number of limitations and ultimately did not correctly reproduce the accident outcome. Further research is required in order to fully understand the effects of soft ground on the landing gear breakaway and the dynamics of the fuse pin loading.

The current requirements do not explicitly differentiate between landings on different types of surfaces and the resulting dynamics. Emergency landings may be performed onto soft surfaces either outside the airfield boundary, or beside the runway itself. Therefore it is important to consider different type of surfaces in the landing gear design requirements.

The following Safety Recommendation is therefore made:

It is recommended that the Federal Aviation Administration, in conjunction with the European Aviation Safety Agency review the requirements for landing gear failures to include the effects of landing on different types of surface.

**Safety Recommendation 2009-096**

#### 2.13.2 Cabin issues

There were a number of cabin safety issues that were identified during the investigation. These included the separation of the 'EXIT' light lenses from two emergency exits, broken glass fragments from fluorescent tubes, and the release of the in-flight entertainment monitors in the back of the Business Economy seats.

##### *Exit door lenses*

The detachment of the EXIT sign lenses at doors 3L and 3R could have hampered the identification of exits had the ambient light level been low during the evacuation. The design of the lenses had no positive retention method and so it was possible for the lens covers to readily detach, especially as demonstrated during the testing if the fit of the surrounding trim was less than ideal. However, there were additional aids to passengers to identify the exits, such as area and floor proximity lights. It is also accepted that the bulbs for the sign would still be lit, albeit without an 'EXIT' identification.

*Fluorescent tubes*

The glass fragments noted in the area of Door 3L were from the indirect ceiling light fluorescent tubes. Passenger reports stated that there was a 'fog' and particles in the air at the time of the impact.

Testing indicated that it was possible to break the tubes if sufficient flexure was applied to the light fixtures, and tubes could be released if the end fittings were slightly distorted. It was evident from the cabin examination that some tubes were released intact, and retained within the valance, while others were released, perhaps already broken, and travelled forward in the impact before hitting the floor primarily in the area of Door 3L.

The release of the fluorescent tube pieces and the presence of the glass fragments on the floor increased the risk of injury to the passengers both in the impact and during the evacuation. Once released it was possible for the tubes to escape from behind the valance. The presence of a restraint, such as a lens cover, could prevent escape of the tubes and any broken glass from entering the aisles.

The following Safety Recommendation is therefore made:

It is recommended that the Federal Aviation Administration require that Boeing modify the design, for the Boeing 777, of the indirect ceiling light assemblies, their associated attachments, and their immediate surroundings to ensure that the fluorescent tubes, or their fragments, will be retained in a survivable impact.

**Safety Recommendation 2009-097**

The light fixture meets the regulatory requirements for emergency landing loads; however, the manufacturer's qualification testing is performed in a static test rig with loads applied to the light fixture itself, not as installed in the aircraft, i.e. allowing for the movement and flexing of the overhead bin structure. This does not represent a realistic condition and therefore the following Safety Recommendation is made:

It is recommended that the Federal Aviation Administration and the European Aviation Safety Agency, review the qualification testing requirements applied by manufacturers to cabin fittings, to allow for dynamic flexing of fuselage and cabin structure.

**Safety Recommendation 2009-098**

*Video monitors*

During the subsequent detailed examination it was found that nine of the 32 Business Economy class seat back video monitors had detached from their attachment brackets. The examinations showed that there was wear in the support detent and spring clip which had resulted in the monitors not being attached securely with resultant release during impact. The nature of the fasteners, which were designed to be hidden from view, is such that it is difficult to check whether the monitor is correctly secured. The release of video monitors represents a potential hazard to occupants, both from the possibility of head injury in the impact and as an obstruction in the subsequent evacuation. The relevant airworthiness requirements require all '*items of mass*' to be retained.

The seat manufacturer has issued a Mandatory Service Bulletin (SB 4400-25MB059 Revision 3), applicable to the model 4400 seat, which recommends replacement of the spring clip and accessory rivets of the monitor attachment bracket. Compliance with the SB is recommended at the earliest opportunity.

In view of the number of seats affected and the hazard represented by the release of a video monitor, the following Safety Recommendations are therefore made:

It is recommended that the European Aviation Safety Agency mandate MSB4400-25MB059 Revision 3 to require the inspection and replacement of the video monitor fittings on the Recaro seat model 4400.

**Safety Recommendation 2009-100**

### 3 Conclusions

#### (a) Findings

##### *Conduct of the flight*

1. The crew were properly licensed and rested to conduct the flight.
2. The aircraft had been loaded with 71,401 Kg of Jet A-1 fuel at Beijing and the total fuel load at the start of the accident flight was 79,000 kg. This was sufficient fuel to complete the flight.
3. The left main fuel tank temperature at takeoff was -2°C, this was not unique and data mining revealed that a small percentage of B777 flights had a fuel temperature below 0°C at takeoff.
4. During the flight from Beijing the fuel temperature reached a minimum of -34°C and the minimum TAT reached was -45°C. These temperatures experienced during the flight were unusual but were within the operating envelope of the aircraft and were not unique.
5. During the flight two step climbs were completed in VS mode which required relatively low fuel flows and contributed to low average fuel flows for the flight.
6. Data mining showed that the accident flight was unique amongst 175,000 flights as having a low cruise fuel flow and a high fuel flow during approach while at a low fuel temperature.
7. The flight from Beijing had been uneventful until the final approach to Runway 27L at London Heathrow.
8. The co-pilot took control of the aircraft from the commander at 800 ft in accordance with the operator's procedures.
9. At 720 ft agl the right engine suffered an uncommanded reduction in engine power to 1.03 EPR and seven seconds later the left engine suffered an uncommanded reduction in engine power to 1.02 EPR.
10. The right engine fuel flow reduced to 6,000 pph and the left engine fuel flow reduced to 5,000 pph, levels above those required by an engine at flight idle.

11. Both the left and right engine FMVs moved to full open and the EECs entered LIC 17, with no effect on the fuel flow.
12. Data mining did not reveal any flight, other than the G-YMMM accident flight and the N862DA incident flight, that had indicated an EEC LIC 17 or had a genuine FMV position versus fuel flow mismatch.
13. The fuel temperature at the time of the engine rollback was -22°C. This was also the fuel temperature at which the rollback occurred on the N862DA incident flight.
14. The flight crew became aware of a possible problem with the thrust 48 seconds before touchdown.
15. The co-pilot intended to disconnect the autopilot at 600 ft but became distracted by the engine rollback, so the autopilot remained engaged.
16. The loss of engine power led to a reduction in airspeed as the autopilot attempted to follow the ILS glideslope, leading to a nose-high pitch attitude.
17. Thirty-four seconds before touchdown the flight crew became concerned about the reduction in airspeed below the target approach speed and attempted manually to increase engine thrust to compensate; there was no response from the engines.
18. At 240 ft agl the commander retracted the flap from FLAP 30 to FLAP 25 which increased the distance to touchdown by about 50 metres; if left at FLAP 30 the touchdown would have still been within the airfield boundary.
19. At 200 ft agl the stick shaker activated and as a touchdown short of the runway was inevitable the commander transmitted a 'MAYDAY' call three seconds before touchdown.
20. At the operation of the stick-shaker, the co-pilot pushed forward on the control column and the autopilot disconnected.
21. The aircraft struck the ground within the airfield boundary at a recorded normal peak load of 2.9g, and a descent rate of about 1400 fpm (~25 ft/s), at 1242:09 hrs, 330 m short of Runway 27L and slid 372 m before coming to rest.

22. During the latter stages of the approach the commander attempted to start the APU, but the start sequence was not completed.
23. The landing gear attachments were disrupted during the initial impact, the left MLG collapsed and the right MLG separated from the aircraft.
24. The nose landing gear collapsed and the lower side of the aircraft and engines were severely disrupted during the ground slide.

*Evacuation and survivability*

25. There was insufficient time for the flight crew to brief the cabin crew or issue a 'brace brace' command.
26. The evacuation alarm was perceived by the cabin crew as sounding 'faint' in the cabin.
27. The evacuation alarm was later found to operate satisfactorily, except at Door 1L which was silenced due to a stuck reset switch.
28. There is no minimum performance specification for the evacuation alarm as it is an optional fit to the aircraft. However, sound level checks met BS EN ISO 7731.
29. The commander initially announced his evacuation call over the VHF radio, but when ATC informed him of this, the call was repeated over the cabin PA system.
30. The cabin crew initiated the evacuation, all the escape slides deployed satisfactorily and all the passengers evacuated the aircraft.
31. The passenger in seat 30K suffered a broken leg as items from the right MLG penetrated the fuselage during the ground slide.
32. 34 passengers and 12 cabin crew suffered minor injuries, mainly to the back and neck.
33. The evacuation was conducted efficiently with clear instructions from the cabin crew.
34. Some passengers attempted to retrieve personal items during the evacuation.

35. There was no fire; however there was a significant fuel leak and an oxygen leak from disrupted passenger oxygen bottles. The AFS were on site within 2 minutes of the initial touchdown.
36. The operator's evacuation check list split the actions between the commander and co-pilot and was on a placard on the control column. The commander operated the engine run/cutoff switch and the co-pilot the engine fire switches. The engine fire switches were operated first.
37. The evacuation check list from the aircraft manufacturer required the operation of the engine run/cutoff switch to CUTOFF prior to pulling the fire switch.
38. The spar valves remained OPEN following the accident despite the operation of the fire switches and engine run/cutoff switch to CUTOFF. This allowed 6,750 kg of fuel to leak out of the engines until the valves were manually closed.
39. The spar valves remained OPEN due to the wiring damage caused by the separation of the MLGs, which also caused the left spar valve circuit breaker to trip.
40. The wiring to the right spar valve from the engine run/cutoff switch remained intact. Pulling the fire handle isolated the run/cutoff relay and removed the ability of the run/cutoff switch signal to CLOSE the spar valve.
41. SB 777-28-0025 introduced a means of shutting the spar valve from the engine run/cutoff switches, even if the fire switch has been pulled. This SB had not been embodied on G-YMMM.

#### *Crashworthiness - cabin*

42. Exit sign lenses at Doors 3L and 3R detached during the accident due to the lack of positive retention.
43. Glass fragments from the indirect ceiling fluorescent tubes were found on the cabin floor.
44. The light fittings met the regulatory requirements for emergency landing loads, but these requirements did not allow for flexing of the surrounding structure.
45. Nine of the 32 Business economy video monitors detached from the seat backs, in the impact, due to wear of the support detent and spring.

---

*Crashworthiness – structure*

46. Both MLGs partially separated at initial impact with a vertical descent rate of 25 ft/s.
47. The left MLG attachments separated as designed.
48. On the right side a section of rear spar web ruptured during the detachment of the right MLG and thus left a large breach in the right wing rear spar and centre fuel tank.
49. The right MLG had moved aft, causing the shock strut to contact the truck beam leading to the separation of the forward truck beam and two front wheels.
50. Two of the right MLG inboard wheels contacted the fuselage behind the MLG bay, disrupting the RAT and the passenger oxygen bottles, leading to an oxygen leak.
51. Simulation of the accident showed different behaviour depending on the type of impact surface.
52. Certification requirements for landing gear design do not specify differing impact surfaces.

*Aircraft examination*

53. The aircraft had been adequately maintained and had a valid certificate of airworthiness.
54. There were no recorded technical defects with the aircraft, prior to departure from Beijing, that would have contributed to the accident.
55. The left engine fuel valve circuit breaker had tripped due to the wiring disruption to the underside of the engine during the ground slide.
56. The Ram Air Turbine had not deployed prior to the initial impact.
57. The forward cross-feed valve was found OPEN and the switches for the cross-feed valves on the overhead fuel panel were also in OPEN.
58. The operation of the forward cross-feed valve was after the power had been lost to the DFDR during the accident ground slide. Prior to this point it was CLOSED.



- 
59. The loose fuel scavenge union in the left fuel tank was not a factor in this accident.
  60. The manufacturing debris found in the fuel tanks was not a factor in this accident.
  61. The right suction check valve was found to stick OPEN, but was not a factor in this accident.
  62. There was no evidence that HIRF or EMI were factors in this accident.
  63. There were no pre-existing defects with the engines and the engine control systems operated correctly.

#### *Fuel*

64. There was 10,500 kg of fuel remaining on the aircraft at the time of the engine rollback, 5,100 kg in the left main fuel tank and 5,400 kg in the right main fuel tank.
65. The fuel onboard G-YMMM was consistent with Jet A-1 and met the Defence Standard 91-91 and ASTM D1655.
66. The fuel sampled from G-YMMM contained 35 to 40 ppm of water, which was similar to that found on other aircraft that had flown similar routes.
67. The fuel had not, at any time during the flight, cooled to a temperature at which it would suffer from fuel waxing.
68. The operator had the highest practicable frequency of fuel sumping for the Boeing 777. The frequency and efficiency of the fuel tank sumping was not a factor in this accident. The aircraft had been last sumped on the 15 January 2008.
69. The centre tank water detection messages, recorded during taxi in Beijing, were most likely 'nuisance' messages.
70. The centre tank fuel scavenge system was not a factor in this accident.
71. The water scavenge system was not a factor in this accident.

*Recorded data*

72. The DFDR did not record FMV position; however it was recorded on the non-protected QAR.
73. The QAR buffer caused the loss of 45 seconds of data prior to the accident.

*Restriction to fuel flow*

74. The FMV positions and the recorded fuel flows showed that both engines had suffered restrictions in the fuel delivery system to the engine.
75. The left and right HP pumps had signs of fresh cavitation, indicating that the restriction was recent and upstream of the pump.
76. The aircraft fuel boost pump had not indicated a low pressure during the flight.
77. Testing and analysis of the engine response has shown that aeration of the fuel had not occurred.
78. The restriction was downstream of the forward boost pump connection into the fuel manifold and upstream of the HP pump.
79. There was no remaining evidence of a physical restriction in the fuel system.
80. The fuel spar valves had remained open throughout the flight and there was no indication of an uncommanded movement of a spar valve, either recorded or reported by the flight crew.

*Engine testing*

81. Engine tests and analysis suggested that a restriction could have been in place prior to the final series of four acceleration/deceleration cycles, during the approach, if the restriction was sited 25 feet or more from the strut interface.
82. The engine tests used fixed restrictor plates, warm, unweathered fuel and did not consider the dynamics or properties of ice in the system.
83. It was concluded that the restriction most probably occurred at the face of the FOHE just prior to the final acceleration cycle.

*Fuel system testing*

84. Ice can form within the fuel system feed pipes with normal concentrations of dissolved and entrained water present in aviation turbine fuel.
85. Ice can form on the inside of fuel pipes when warm fuel at a temperature of +5°C flows through cold pipes.
86. There is a 'sticky range' between -5°C and -20°C, when ice crystals in aviation fuel are most likely to adhere to their surroundings.
87. The ice is most 'sticky' at -12°C.
88. Ice does not appear to stick to the inside of the fuel pipes when the fuel temperature is at -35°C or below.
89. Ice that accumulated in the fuel system, during testing, was always soft and mobile.
90. The properties of the ice generated during testing may not be the same as the properties of the ice generated in flight.
91. Increasing the fuel flow can cause accreted ice to be released from the walls of the fuel pipes.
92. Ice released from within the fuel pipes could form a restriction at the face of the FOHE.
93. Tests demonstrated that water when injected into a cold fuel flow at concentrations of the order of 100 times more than certification requirements could form a restriction at the face of the FOHE.
94. Sufficient ice can accumulate in the Boeing 777 fuel system, which, when released, could form a restriction on the face of the FOHE.
95. It was not possible to restrict the fuel flow through the FOHE when fuel temperature in the main tank was warmer than: -15°C at a flow of 6,000 pph, and -10°C at a flow of 10,000 pph.
96. Reducing the fuel flow to idle always cleared any ice restriction on the face of the FOHE and therefore restored full fuel flow capability.
97. The FOHE was the only component in the fuel system that could be demonstrated to collect sufficient ice to cause the fuel restrictions observed during the accident flight.

98. The minimum fuel temperature of  $-34^{\circ}\text{C}$  was not critical to the formation of ice in the fuel system.
99. A temperature below  $0^{\circ}\text{C}$  at takeoff has little effect on ice accumulation compared to during flight.
100. FSII is a means of preventing ice formation in fuel systems.
101. Research from the 1950s identified the problem of ice formation in fuel systems from dissolved or entrained water, but did not identify the scenario of accumulated ice release and subsequent restriction to fuel flow.
102. There are no published guidelines on environmental conditions or fuel rig size required to accomplish tests on the susceptibility of a fuel system to ice.
103. Current certification requirements do not address the scenario of ice accumulation and release within fuel systems.

#### *The engine rollbacks*

104. Ice probably began to accumulate in the fuel feed pipes whilst the warm centre tank fuel flowed through cold fuel pipes that pass through the main fuel tank at the start of the flight.
105. Ice would have continued to accumulate in the fuel feed pipes as the fuel was later fed from the main fuel tanks, but the rate of ice accumulation reduced as the fuel temperature dropped from  $-20^{\circ}\text{C}$  down to its minimum temperature of  $-34^{\circ}\text{C}$ .
106. The rate of accumulation of ice in the fuel pipes in the strut area may have been greater due to the warmer environment, whilst the localised fuel temperature was in the 'sticky range'.
107. Ice accumulation rates changed as the fuel temperature and TAT rose toward the end of the flight.
108. During the later stages of approach, the accumulated ice in the fuel system was probably released due to the final set of engine accelerations and possibly a combination of turbulence, aircraft pitch changes and an increase in strut temperature.

109. The ice would have travelled through the fuel feed system and formed a restriction on the face of the FOHE sufficient to cause the subsequent engine rollbacks.
110. The recorded drop in oil pressure on the right engine, which occurred close to the start of the final acceleration, was consistent with a restriction of the fuel flow at the face of its FOHE.
111. The recorded oil pressure data for the left engine ceased before it could provide any meaningful data for a positive determination of a restriction at its FOHE.
112. For the left engine, the investigation concluded that the restriction most likely occurred at its FOHE. However, due to limitations in available recorded data, it was not possible totally to eliminate the possibility of a restriction elsewhere in the fuel system, although the testing and data mining activity carried out for this investigation suggested that this was very unlikely.
113. For the left engine, the likelihood of a separate restriction mechanism occurring within seven seconds of that for the right engine is very low.
114. In response to AAIB Safety Recommendation 2008-047, Boeing introduced operational changes to mitigate the risk from fuel icing in the B777 powered by Trent 800 engines.
115. In response to the findings of this investigation Rolls-Royce developed a modified version of the FOHE and this was approved, and mandated, by the EASA.

**(b) Causal factors**

Whilst on approach to London (Heathrow) from Beijing, China, at 720 feet agl, the right engine of G-YMMM ceased responding to autothrottle commands for increased power and instead the power reduced to 1.03 Engine Pressure Ratio (EPR). Seven seconds later the left engine power reduced to 1.02 EPR. This reduction led to a loss of airspeed and the aircraft touching down some 330 m short of the paved surface of Runway 27L at London Heathrow. The investigation identified that the reduction in thrust was due to restricted fuel flow to both engines.

It was determined that this restriction occurred on the right engine at its FOHE. For the left engine, the investigation concluded that the restriction most likely occurred at its FOHE. However, due to limitations in available recorded data, it was not possible totally to eliminate the possibility of a restriction elsewhere in the fuel system, although the testing and data mining activity carried out for this investigation suggested that this was very unlikely. Further, the likelihood of a separate restriction mechanism occurring within seven seconds of that for the right engine was determined to be very low.

The investigation identified the following probable causal factors that led to the fuel flow restrictions:

- 1) Accreted ice from within the fuel system released, causing a restriction to the engine fuel flow at the face of the FOHE, on both of the engines.
- 2) Ice had formed within the fuel system, from water that occurred naturally in the fuel, whilst the aircraft operated with low fuel flows over a long period and the localised fuel temperatures were in an area described as the 'sticky range'.
- 3) The FOHE, although compliant with the applicable certification requirements, was shown to be susceptible to restriction when presented with soft ice in a high concentration, with a fuel temperature that is below -10°C and a fuel flow above flight idle.
- 4) Certification requirements, with which the aircraft and engine fuel systems had to comply, did not take account of this phenomenon as the risk was unrecognised at that time.

## 4 Safety Recommendations

*Safety Recommendations made previously in SI/2008 published 18 February 2008*

- 4.1 Safety Recommendation 2008-009:** Boeing should notify all Boeing 777 operators of the necessity to operate the fuel control switch to CUTOFF prior to operation of the fire handle, for both the fire drill and the evacuation drill, and ensure that all versions of its checklists, including electronic and placarded versions of the drill, are consistent with this procedure.

*Safety Recommendations made previously in Interim Report published on 15 September 2008.*

- 4.2 Safety Recommendation 2008-047:** It is recommended that the Federal Aviation Administration and the European Aviation Safety Agency, in conjunction with Boeing and Rolls-Royce, introduce interim measures for the Boeing 777, powered by Trent 800 engines, to reduce the risk of ice formed from water in aviation turbine fuel causing a restriction in the fuel feed system.

- 4.3 Safety Recommendation 2008-048:** It is recommended that the Federal Aviation Administration and the European Aviation Safety Agency should take immediate action to Consider the implications of the findings of this investigation on other certificated airframe / engine combinations.

- 4.4 Safety Recommendation 2008-049:** It is recommended that the Federal Aviation Administration and the European Aviation Safety Agency review the current certification requirements to ensure that aircraft and engine fuel systems are tolerant to the potential build up and sudden release of ice in the fuel feed systems.

*Safety Recommendations made previously in Interim Report 2 published on 12 March 2009.*

- 4.5 Safety Recommendation 2009-028:** It is recommended that Boeing and Rolls-Royce jointly review the aircraft and engine fuel system design for the Boeing 777, powered by Rolls-Royce Trent 800 engines, to develop changes which prevent ice from causing a restriction to the fuel flow at the fuel oil heat exchanger.

- 4.6 Safety Recommendation 2009-029:** It is recommended that the Federal Aviation Administration and the European Aviation Safety Agency consider mandating design changes that are introduced as a result of recommendation 2009-028, developed to prevent ice from causing a restriction to the fuel flow at the fuel oil heat exchanger on Boeing 777 aircraft powered by Rolls-Royce Trent 800 engines.
- 4.7 Safety Recommendation 2009-030:** It is recommended that the Federal Aviation Administration and the European Aviation Safety Agency conduct a study into the feasibility of expanding the use of anti ice additives in aviation turbine fuel on civil aircraft.
- 4.8 Safety Recommendation 2009-031:** It is recommended that the Federal Aviation Administration and the European Aviation Safety Agency jointly conduct research into ice formation in aviation turbine fuels.
- 4.9 Safety Recommendation 2009-032:** It is recommended that the Federal Aviation Administration and the European Aviation Safety Agency jointly conduct research into ice accumulation and subsequent release mechanisms within aircraft and engine fuel systems.

*Safety Recommendations made in this report*

- 4.10 Safety Recommendation 2009-091:** It is recommended that the European Aviation Safety Agency introduce a requirement to record, on a DFDR, the operational position of each engine fuel metering device where practicable.
- 4.11 Safety Recommendation 2009-092:** It is recommended that the Federal Aviation Administration introduce a requirement to record, on a DFDR, the operational position of each engine fuel metering device where practicable.
- 4.12 Safety Recommendation 2009-093:** It is recommended that Boeing minimise the amount of buffering of data, prior to its being recorded on a QAR, on all Boeing 777 aircraft.
- 4.13 Safety Recommendation 2009-094:** It is recommended that Boeing apply the modified design of the B777-200LR main landing gear drag brace, or an equivalent measure, to prevent fuel tank rupture, on future Boeing 777 models and continuing production of existing models of the type.
- 4.14 Safety Recommendation 2009-095:** It is recommended that the Federal Aviation Administration amend their requirements for landing gear emergency loading conditions to include combinations of side loads.



- 4.15 Safety Recommendation 2009-096:** It is recommended that the Federal Aviation Administration, in conjunction with the European Aviation Safety Agency review the requirements for landing gear failures to include the effects of landing on different types of surface.
- 4.16 Safety Recommendation 2009-097:** It is recommended that the Federal Aviation Administration require that Boeing modify the design, for the Boeing 777, of the indirect ceiling light assemblies, their associated attachments, and their immediate surroundings to ensure that the fluorescent tubes, or their fragments, will be retained in a survivable impact.
- 4.17 Safety Recommendation 2009-098:** It is recommended that the Federal Aviation Administration and the European Aviation Safety Agency, review the qualification testing requirements applied by manufacturers to cabin fittings, to allow for dynamic flexing of fuselage and cabin structure.
- 4.18 Safety Recommendation 2009-100:** It is recommended that the European Aviation Safety Agency mandate MSB4400-25MB059 Revision 3 to require the inspection and replacement of the video monitor fittings on the Recaro seat model 4400.

Mr P A Sleight & Mr R D G Carter  
Inspectors of Air Accidents  
Air Accidents Investigation Branch  
Department for Transport



## Appendix A

## Temperature Conversion Chart

°C	°F	°C	°F	°C	°F	°C	°F	°C	°F	°C	°F
-60	-76	-30	-22	0	32	30	86	60	140	90	194
-59	-74	-29	-20	1	34	31	88	61	142	91	196
-58	-72	-28	-18	2	36	32	90	62	144	92	198
-57	-71	-27	-17	3	37	33	91	63	145	93	199
-56	-69	-26	-15	4	39	34	93	64	147	94	201
-55	-67	-25	-13	5	41	35	95	65	149	95	203
-54	-65	-24	-11	6	43	36	97	66	151	96	205
-53	-63	-23	-9	7	45	37	99	67	153	97	207
-52	-62	-22	-8	8	46	38	100	68	154	98	208
-51	-60	-21	-6	9	48	39	102	69	156	99	210
-50	-58	-20	-4	10	50	40	104	70	158	100	212
-49	-56	-19	-2	11	52	41	106	71	160	101	214
-48	-54	-18	0	12	54	42	108	72	162	102	216
-47	-53	-17	1	13	55	43	109	73	163	103	217
-46	-51	-16	3	14	57	44	111	74	165	104	219
-45	-49	-15	5	15	59	45	113	75	167	105	221
-44	-47	-14	7	16	61	46	115	76	169	106	223
-43	-45	-13	9	17	63	47	117	77	171	107	225
-42	-44	-12	10	18	64	48	118	78	172	108	226
-41	-42	-11	12	19	66	49	120	79	174	109	228
-40	-40	-10	14	20	68	50	122	80	176	110	230
-39	-38	-9	16	21	70	51	124	81	178	111	232
-38	-36	-8	18	22	72	52	126	82	180	112	234
-37	-35	-7	19	23	73	53	127	83	181	113	235
-36	-33	-6	21	24	75	54	129	84	183	114	237
-35	-31	-5	23	25	77	55	131	85	185	115	239
-34	-29	-4	25	26	79	56	133	86	187	116	241
-33	-27	-3	27	27	81	57	135	87	189	117	243
-32	-26	-2	28	28	82	58	136	88	190	118	244
-31	-24	-1	30	29	84	59	138	89	192	119	246

Appendix B

Evacuation Check List



BRITISH AIRWAYS  
B777 FCOM QRH

0.27

---

**U PASSENGER EVACUATION**

Condition: **Evacuation of passengers and crew is required.**

**CAPTAIN:**

**# PARKING BRAKE . . . . . SET**

**# FUEL CONTROL SWITCHES (Both) . . . . . CUTOFF**  
 [Shuts down engines to reduce the possibility of slide damage or injury to personnel, unlocks engine fire switches, and ensures passenger entry door flight locks are unlocked.]

**# PASSENGER EVACUATION . . . . . INITIATE**  
 Announce “This is an Emergency, Evacuate, Evacuate” over the PA and activate Evac Alarm.  
 Notify ATC/ground crew of evacuation.

**FIRST OFFICER:**

**# OUTFLOW VALVE SWITCHES (Both) . . . . . MAN**

**# OUTFLOW VALVE MANUAL SWITCHES (Both) . . . . . OPEN**  
 Position outflow valves fully open.  
 [Ensure airplane is depressurized for opening passenger entry doors.]

**# ENGINE FIRE SWITCHES (Both) . . . . . PULL**

**# (if required) . . . . . ROTATE**  
 Rotate switches in opposite directions. Rotate to the stop and hold for 1 second.  
 [Shut off combustibles. Discharges fire extinguisher bottles to reduce potential risk of fire].

**# APU FIRE SWITCH . . . . . PULL**

**# (if required) . . . . . ROTATE**  
 Rotate to the stop and hold for 1 second.  
 [Shut down APU and removes electrical power which ensures passenger entry door flight locks are unlocked. Discharges fire extinguisher bottle to reduce potential risk of fire].

■ ■ ■ ■

---

May 2007

Revision 34

0.27

**Appendix B**

  
777 Flight Crew Operations Manual

---

**Evacuation**

Condition: An evacuation is needed.

- 1 Parking brake . . . . . Set
- 2 OUTFLOW VALVE switches (both) . . . . .MAN
- 3 OUTFLOW VALVE MANUAL switches (both) . . . . . Push to OPEN and hold until the outflow valve displays show fully open
- 4 FUEL CONTROL switches (both) . . . . . CUTOFF
- 5 Advise the cabin to evacuate.
- 6 Advise the tower.
- 7 Engine fire switches (both) . . . . . Pull
- 8 APU fire switch . . . . . Override and pull
- 9 **If** an engine or APU fire warning light is illuminated:  
    Illuminated fire switch. . . . . Rotate to the stop and hold for 1 second

■ ■ ■ ■

---

Copyright © The Boeing Company. See title page for details.  
D632W001-BAB                      December 10, 2007

---

**Appendix C****Fuel Sampling***Approach to testing*

As a consequence of the disruption to the engine fuel system components, leakage of 6,750 kg of fuel through the fuel feed system and transfer of 1,500 kg of fuel between tanks, it was initially decided only to conduct detailed testing and analysis on the three samples taken from the APU fuel feed line and the left and right main tank sump drains. A smaller range of tests was carried out on some of remaining fuel samples.

*Standard tests*

During the detailed testing critical properties of the fuel such as the freezing point, density, flash point, low temperature viscosity, contamination, fuel additives and presence of water were tested against DEF STAN 91-91 and ATSM D1655 requirements. All three samples gave similar results and the fuel samples complied fully with the fuel specifications for Jet A-1.

*Additional tests*

Additional tests beyond those specified in the fuel specification were also carried out on the three samples to identify any contamination in the fuel. These tests included: trace metals content, particulate detection down to 4µm, gas chromatography with mass spectroscopy detection, high performance liquid chromatography, gel permeation chromatography and lubricity.

These tests were carried out to detect any unusual components in the fuel such as high molecular weight compounds, non-hydrocarbon compounds, fatty acid methyl esters (a type of bio-diesel), metallic species, and other substances which would not normally be found in aviation turbine fuel. No evidence of contamination was found.

*Fuel additives*

The list of approved fuel additives is detailed in the specification requirements and includes additives such as Fuel System Icing Inhibitor (FSII), antioxidants, corrosion inhibitors, metal deactivators and biocides. No additives other than the required Static dissipater were detected in any of the fuel samples.

---

**Appendix C***Presence of bio-fuel*

Bio-fuels are not currently approved for use in aviation turbine fuel and none were detected during the analysis of the fuel samples. However, if the bio-fuel had been made using the same molecules that are present in aviation turbine fuel then it might not be possible to detect its presence in the fuel samples.

Fatty Acid Methyl Esters (FAME) is a form of bio-diesel, which is used in automotive diesels. FAME and aviation turbine fuel can be transferred along the same pipelines and therefore it is possible for aviation fuel to be contaminated with FAME. As concentrations of FAME below 5 ppm are currently considered to be insignificant, a test for FAME was undertaken by first contaminating a sample of fuel from G-YMMM with 2 ppm of FAME and then testing the contaminated and uncontaminated samples from G-YMMM. The test detected FAME in the contaminated sample, but not in the uncontaminated sample, which proved that had a bio-fuel been present then it would have been at a concentration of less than 2 ppm, which is considered to be insignificant.

*Freezing point*

The freezing point of the fuel is established by cooling it until wax has formed. The fuel and wax are then warmed until the last crystal of wax visually disappears and it is the temperature at which this occurs which is defined as the freezing point of the fuel. The freezing point of the fuel samples taken from the APU fuel feed line and the left and right main tank sump drains was established, by this method, as being between -58°C and -58.5°C.

A second automatic test, which is considered to be more accurate than the manual method was also used to detect the warmest temperature at which wax crystals were present in the fuel samples taken from: the fuel leaking out of the engines, engine fuel filters and the main fuel tank drains. The automatic test detected no wax crystals at temperatures warmer than -57°C.

*Pour point*

The pour point is defined as the lowest temperature, on cooling, at which fuel still flows before it adopts a semi-rigid state. Whilst the pour point is normally around 6°C to 12°C below the freezing point of the fuel, the relationship between viscosity and fuel temperature is not linear and the viscosity of the fuel will increase rapidly as the temperature of the fuel approaches the pour point.

---

**Appendix C**

There is no requirement in the aviation turbine fuel specifications to establish the pour point of the fuel. Moreover, as two tests established that the freezing point of the fuel was significantly below the minimum specified temperature of  $-47^{\circ}\text{C}$  it was decided not to measure the pour point.

*Vapour pressure*

A low vapour pressure is necessary to prevent vaporisation of the fuel as it flows through the fuel system. However there is no requirement in the specification and no standard test to establish the vapour pressure of aviation turbine fuel. Nevertheless, testing was carried out and the vapour pressure of the fuel samples was found to be consistent with other samples of Jet A-1.

*Microbiological contamination (MBC)*

Microbiological contamination is an indicator that water has been present in fuel. Tests carried out on fuel samples taken from the APU fuel feed line and main fuel tanks were negative. Swabs were taken from the inside of the left and right water scavenge jet pumps and the tests established that there was negligible contamination in the right jet pump and a moderate amount of microbiological contamination in the left jet pump.

There was no visible evidence of microbiological contamination in the aircraft fuel system or in any of the fuel samples.

*Comparison with other fuel samples*

The fuel sampled from G-YMMM was compared with 1,245 batches of Jet A-1 tested in the UK during 2007; by volume this represented  $15.4 \times 10^6 \text{ m}^3$  of fuel. With regard to the distillation range, which is the boiling point of the fuel, the fuel from G-YMMM was approximately in the middle of the sampled range. The freezing point of the fuel sampled from G-YMMM ( $-57^{\circ}\text{C}$ ) was slightly below the average freezing point, but within the normal range for Jet A-1.



Appendix C

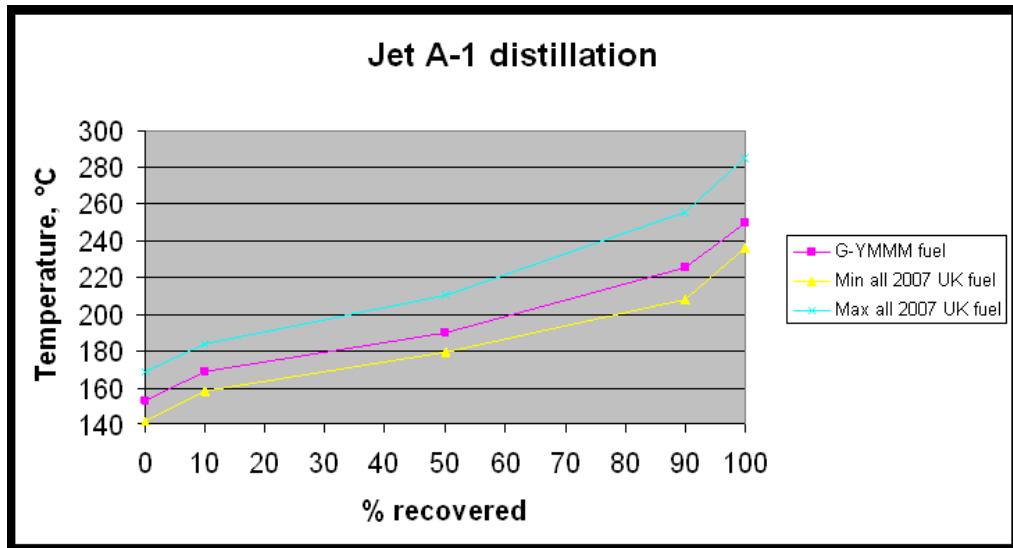

Figure 57

Jet A-1 Distillation curves

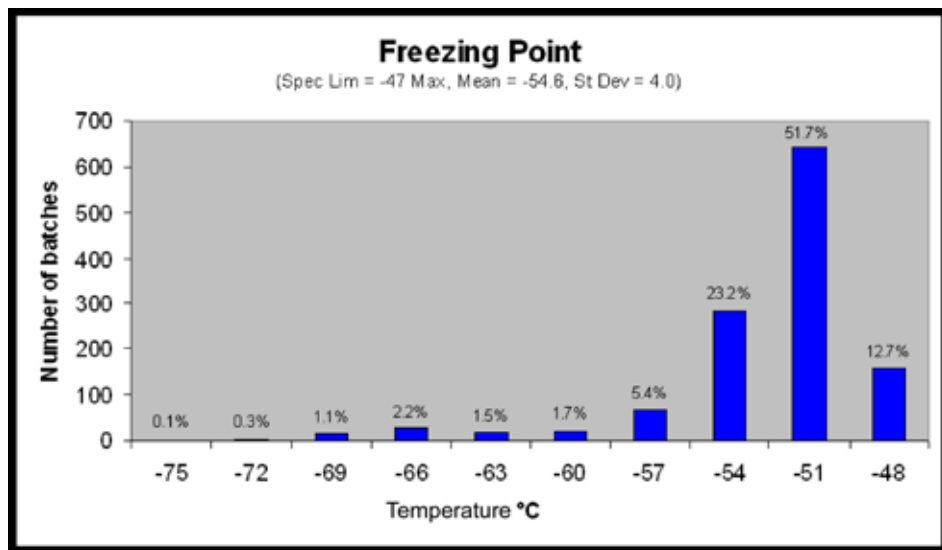

Figure 58

Freezing point

---

**Appendix C***Presence of water**Tests for water*

The requirement in the fuel specification is that the fuel should be clear, bright and free of water and sediment. Apart from the appearance test there is no fuel specification test to detect the presence of entrained or dissolved water in the fuel. Therefore, during the investigation a Karl Fischer test (ATSM D6304), which uses a chemical method to establish the total amount of water (dissolved and entrained) in the fuel, was carried out on a number of samples.

Shell Water Detector Capsules were used to check for the presence of water in the fuel loaded onto the aircraft at Beijing and the bulk fuel removed from the aircraft after the accident at Heathrow. These detectors only detected undissolved water, that is entrained and free, and change colour when the undissolved water content reaches 30 ppm.

*Results of tests for water*

With the exception of some of the fuel drained out of the main tanks and the samples taken from the engine fuel filters and housings, all the remaining samples passed the appearance tests.

The bulk fuel was removed from the aircraft on 23 January 2008 and stored in a clean bowser. The fuel was then allowed to settle before it was tested on 30 January 2008 by the AAIB using a Shell Water Detector capsule. The sampled fuel, taken from the bowser sump, was bright and clear with no visual sign of free water. The water detector capsule did not change colour indicating that the entrained water content was less than 30 ppm.

Small water droplets were observed in the fuel samples taken from the engine fuel filters and housings. The amount of water was too small to measure and so was classified by reference to the QinetiQ fuel appearance table as being 'small'. Figure 59 is a reconstruction of the QinetiQ description of 'small' using water coloured with food dye.

As a comparison, fuel samples were taken from the engine fuel filters and housings of another of the operator's aircraft, G-YMMN, on 15 October 2008 after it had completed a 13 hour flight from Singapore to Heathrow. Similar quantities of water were found in the engine filter and housings.

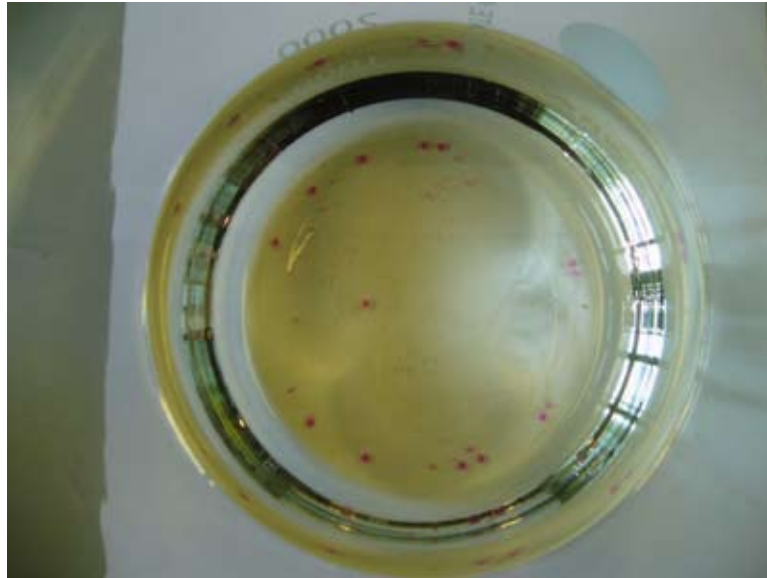
**Appendix C****Figure 59**

Reconstruction of a 'small' amount of dyed water in aviation turbine fuel

Samples of fuel taken from the left main tank fuel sump, APU fuel line and the right engine Variable Stator Vane (VSV) actuator were tested by QinetiQ using the Karl Fischer test. The samples contained no visual free water, but had a total water content (dissolved and entrained) of between 35 to 40 ppm. As a comparison, fuel samples taken from the engine fuel filters and housings on G-YMMN on 15 October 2008 were found to have a total water content of 45 to 50 ppm. Given the accuracy of the Karl Fischer test these results are considered to be very similar and QinetiQ have advised that they are typical for aviation turbine fuel.

---

**Appendix D****HIRF/EMI of Spar Valve and Control System**

The spar valve, its control system and wiring was exposed to the following radiation fields during testing in the laboratory.

A radiated Radio Frequency (RF) transmitted through a drive antenna:

- Continuous Wave (CW) – a mono-frequency sine wave with the frequency between 100 MHz through to 12 GHz. The electric field generated reached peaks of 300 volts/metre.
- Square Wave Modulation (SqW) – a mono-frequency square wave gated on and off at 1 kHz intervals with the frequency between 100 MHz and 12 GHz. The electric field generated reached peaks of 300 volts/metre.
- Pulse Modulation – a mono-frequency sine wave gated on and off at 1 kHz intervals, with a duration of 1 microsecond. The electric field generated reached peaks of 1,000 volts/metre.

A conducted radio frequency using a toroidal current probe clamped around each wire bundle:

- Continuous Wave (CW) – a mono-frequency sine wave with the frequency between 10 kHz through to 400 MHz.

Audio frequency from 400 Hz to 15 kHz:

- Electric field into wiring. Voltage and current injected onto each separate wire bundle from a high voltage source wire. A mono-frequency sine wave with a frequency between 400 MHz to 15 kHz. The level was greater than 5400 volt-metres at 400 Hz reducing proportionally to 1,350 volt-metres at 15 kHz.
- Magnetic field into wiring. Voltage injected into each separate wire bundle using a magnetic field coupling from a high current source. A mono-frequency sine wave with a frequency between 400 Hz to 15 kHz. The level was 120 ampere-metres at 400 Hz and reduced proportionally to 4.5 ampere-metres at 15 kHz.

**Appendix D**

- AF conducted. Voltage injected onto the 28 VDC line by transformer coupling from a 100 Watt power source. A mono-frequency sine wave with a frequency between 380 MHz to 15 kHz.

## Transients:

- AF Conducted. 600 Volt-peak transient pulses applied to power wires and cables by using a coupling transformer. This applied large short duration volts and currents normally associated with switching.

**Appendix E****Gear Pump Cavitation**

Gear-type fluid pumps are commonly used for applications where relatively high pressures are required to be generated. The principle of operation is depicted in pictures 1 to 3 below and is as follows:

- Picture 1

The gear teeth coming out of mesh create volume, which is filled by fluid.

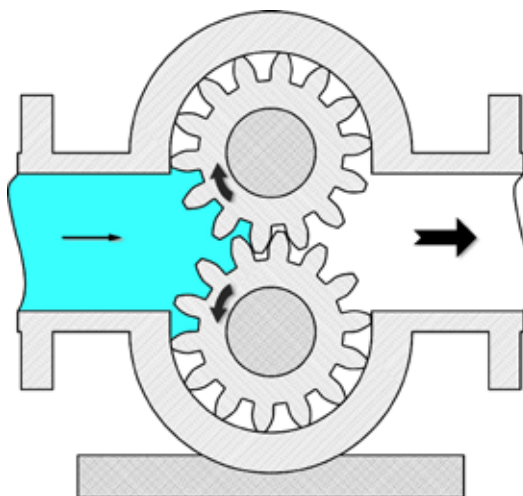

- Picture 2

The fluid is carried around the outside of the gears to the delivery side. The fluid is still nominally at inlet pressure until the delivery port is exposed.

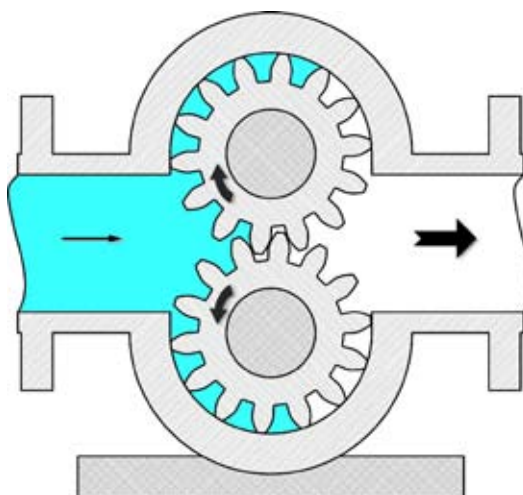

**Appendix E**

- Picture 3  
 Closure of the meshing teeth forces fluid out of the delivery port at high pressure

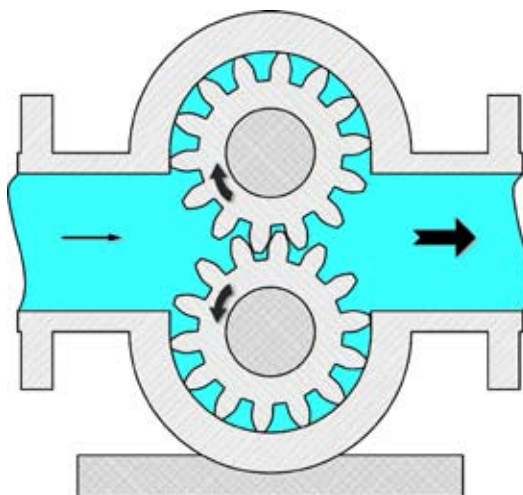

Cavitation can occur with the presence of fuel vapour or air bubbles in the fluid and, given the low inlet pressure and high velocities, a certain amount of cavitation erosion is not unusual. The erosion is caused by the collapse of the bubbles which occurs violently and creates a shock wave of fluid. Striking a solid surface, the shock wave can cause progressive damage if it persists. In the case of the HP pumps fitted to G-YMMM, a degree of ‘normal’ cavitation damage is expected on the bearings where the teeth mesh and on the teeth themselves (Picture 4). The rate of erosion is a known quantity and does not affect operation of the pump within its overhaul life.

- Picture 4

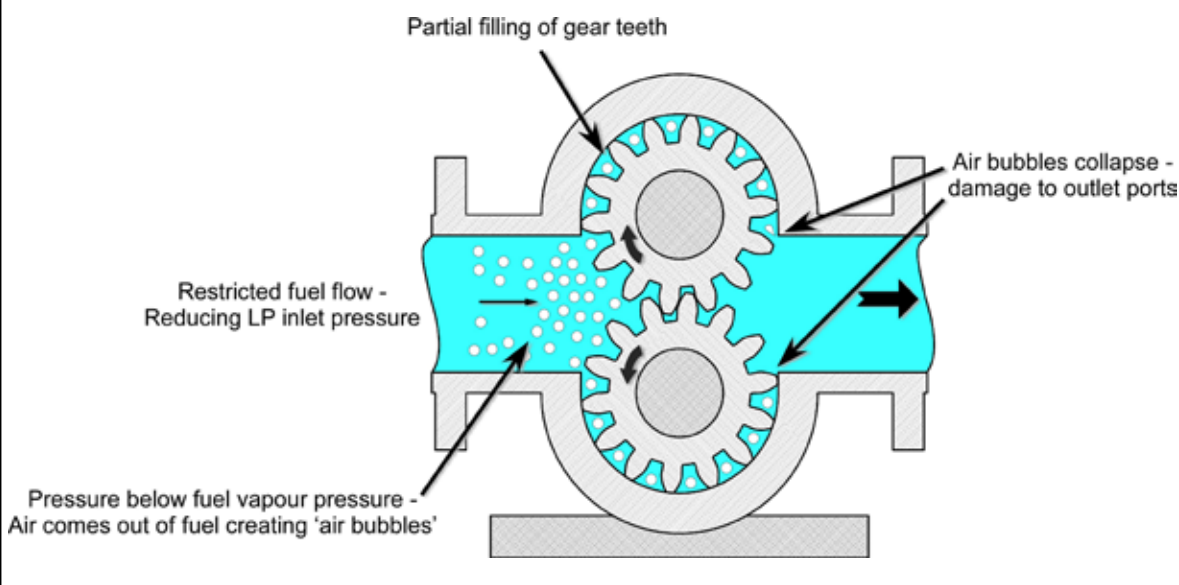

**Appendix E**

The inlet pressure to the pump should be maintained such that formation of air/vapour bubbles is minimised and, on most jet aircraft, this is achieved by the combination of aircraft booster and engine low pressure pumps. However, even if these are working correctly, a restriction in fuel flow upstream can result in the HP pump lowering its inlet pressure to the point at which a large quantity of air and vapour bubbles are formed. This gives rise to a mixture of fluid and gas bubbles filling the gear teeth. As these gear teeth open to the high pressure outlet port of the pump, the gas bubbles collapse and the high pressure fuel in the outlet port rapidly fills the available space. Both these actions result in shock waves being formed that cause damage to the outlet port and the delivery side of the bearing faces. This is the abnormal cavitation damage seen on both HP pumps from G-YMMM.



---

**Appendix F****Data Mining**

This appendix contains a summary of the data mining group activity carried out in support of the investigation.

Data sources available to the investigation - Boeing 777 aircraft:

- Takeoff fuel temperature from approximately 610,000 flights (468,000 Rolls-Royce powered and 142,000 Pratt and Whitney).
  - Rolls-Royce data for 11 operators from across the Northern and Southern Hemispheres with data covering the period 2004 to 2008.
  - Pratt and Whitney data was provided by an American operator based in the Northern Hemisphere. Data covered the period 2003 to 2008 with the flights being from both short and long-haul<sup>1</sup> routes. The operator also provided minimum fuel temperature and snapshot data (referenced below) for the same period.
- Minimum fuel temperature from approximately 191,000 flights (approximately 35,000 Rolls-Royce powered, 142,000 Pratt and Whitney and 14,000 General Electric).
  - Rolls-Royce data was predominantly provided by three operators.
    - \* Approximately 13,500 flights provided by the operator of G-YMMM. They were mainly from 2006 through 2008 and were predominantly long-haul flights.
    - \* Approximately 17,500 flights provided by a Tropics-based operator and consisting of both short and long-haul flights. The data covered the period November 2007 through November 2008.
    - \* Approximately 4,000 flights provided by a Southern-Hemisphere based operator. The flights were both short and long-haul and covered the period 2008 through 2009.

---

<sup>1</sup> Long-haul routes may be considered those which are typically more than about 6 hours in duration.

## Appendix F

- o General Electric data was provided by the operator of G-YMMM and covered the period 2006 through 2008. The aircraft were operated on long-haul routes.
- Snapshots of fuel flow and fuel temperature data during the takeoff, cruise and approach phases of flight from approximately 178,000 flights (approximately 35,000 Rolls-Royce powered, 1,000 General Electric and 142,000 Pratt and Whitney) were provided by the same operators who had already supplied their minimum fuel temperature data.
- QAR (second by second) data from approximately 13,500 flights of Boeing 777 aircraft powered by Rolls-Royce engines. The data was primarily provided by the operator of G-YMMM and covered the period 2006 through March 2008.

### *Takeoff, Cruise and Minimum fuel temperatures*

The accident flight had taken off with fuel in the left main tank at a temperature of  $-2^{\circ}\text{C}$ . Fuel temperature in the left main tank had remained below  $0^{\circ}\text{C}$  for the duration of the flight and reached a minimum temperature of  $-34^{\circ}\text{C}$ .

From 610,000 flights, about 3,950 (0.65%) had taken off with fuel at below  $0^{\circ}\text{C}$  in the left main tank. The lowest was  $-20^{\circ}\text{C}$ , which was from a Rolls-Royce powered aircraft departing Moscow. For a Pratt and Whitney powered aircraft it was  $-16^{\circ}\text{C}$ . From the 13,500 flights provided by the operator of G-YMMM, the lowest was  $-11^{\circ}\text{C}$ , and 50 flights had the same takeoff fuel temperature as the accident flight.

The minimum fuel temperature from 35,000 Rolls-Royce powered flights had been  $-37^{\circ}\text{C}$ , about  $3^{\circ}\text{C}$  lower than the accident flight. Minimum temperatures for both Pratt and Whitney and General Electric powered aircraft were also similar. From the 13,500 flights provided by the operator of G-YMMM, 14 had the same minimum temperature as the accident flight and 17 had a lower minimum temperature (see Figure 60). Ten flights also operated for longer periods at a lower temperature than the accident flight and 20 flights had a lower average temperature during the cruise (see Figure 61). The lowest fuel temperatures were repeatedly experienced by Rolls-Royce powered Boeing 777 aircraft operating on the Chicago-Delhi, New York-Mumbai and London-Beijing and London-Shanghai routes.

## Appendix F

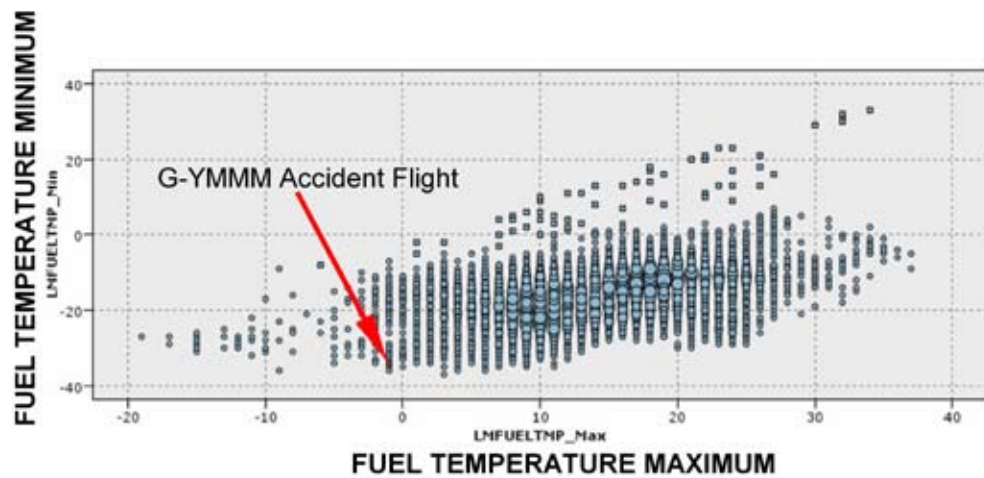

Figure 60

Minimum and Maximum Fuel Temperature during the cruise  
(13,500 flights)

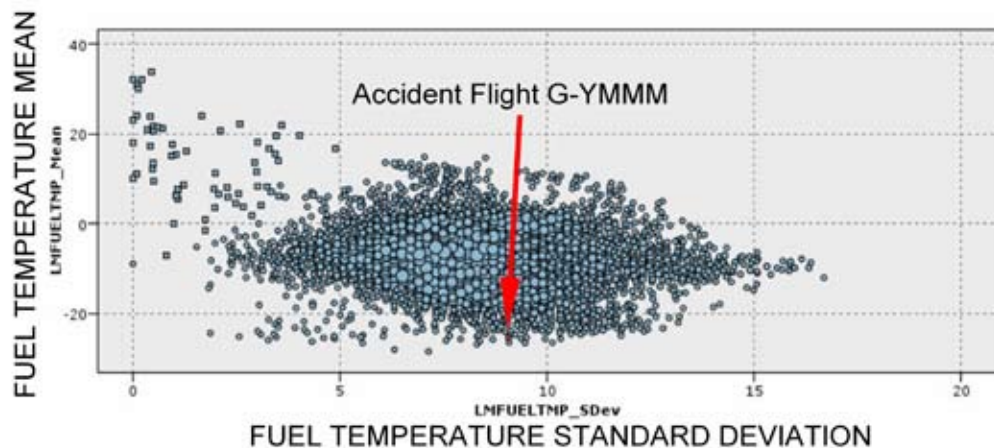

Figure 61

Mean and Standard Deviation Fuel Temperature during the cruise  
(13,500 flights)

It is not unusual for the Boeing 777 to experience fuel temperatures of below 0°C. Although relatively few flights had taken off with fuel below 0°C, about 50 % of the Rolls-Royce powered flights evaluated had fuel temperatures that later reduced below 0°C when in the cruise. It was also not unusual for flights to operate for the entire cruise period at temperatures below 0°C, with 5,000 of the 13,500 flights provided by the operator of G-YMMM having this feature. Flights from both the Northern and the Southern-based operators were also similar. The Tropics-based operator had a similar percentage of

## Appendix F

flights having fuel temperatures that reduced below 0°C, but a lower percentage of its flights had fuel temperatures that remained below 0°C when in the cruise; about 400 from 17,500 flights. The difference was primarily attributed to the operator's route structure.

### *Fuel cooling and warming rates*

Fuel cooling and warming rates of the accident flight were evaluated against the 13,500 flights provided by the operator of G-YMMM. The accident flight was not found to be unique or unusual.

### *Engine Fuel flows during the cruise and approach phase.*

During the accident flight, the average fuel flow to each engine during the cruise had been about 7,000 pph (see Figure 62). There had been two step climbs during the cruise, with maximum fuel flows of 8,688 pph and 8,896 pph<sup>2</sup> respectively. During the approach, fuel flow had reached a maximum of 12,288 pph. This was shortly before the fuel restriction to both engines had occurred.

A flow rate of 10,000 pph was selected, being near to the median of the accident flights maximum cruise and approach fuel flows, and 178,000 flights analysed for having fuel flows of less than 10,000 pph in the cruise and in excess of 10,000 pph during approach. A total of 3,211 flights were found to have a combination of both features, with 2,900 being from Pratt and Whitney powered aircraft and 311 from Rolls-Royce powered aircraft.

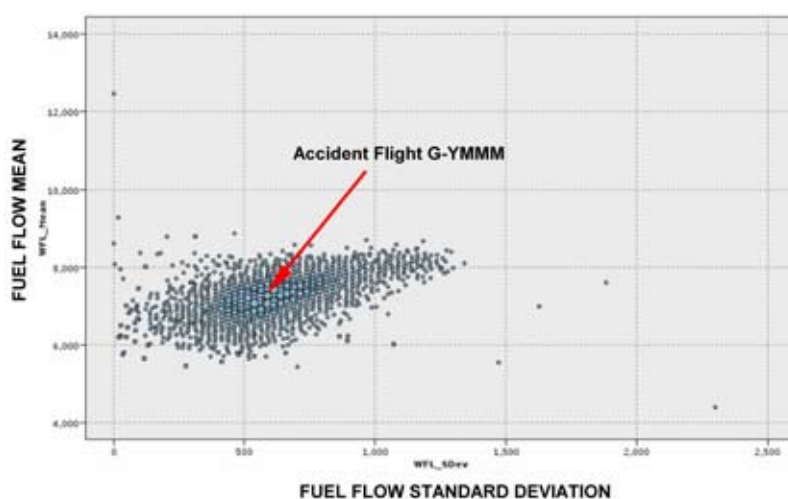

**Figure 62**

Mean and Standard Deviation Fuel Flow during the cruise (13,500 flights)

<sup>2</sup> Both step climbs during the accident flight were performed using the VS mode of the autopilot. The VS mode may command a lower thrust setting when compared to the alternate VNAV mode.

**Appendix F***Fuel quantities delivered at fuel flows of less than 10,000 pph, 11,000 pph and 12,000 pph*

The accident flight operated with fuel supplied from the left and right main fuel tanks for just over the last eight hours of flight. During this time, fuel temperatures remained below  $-20^{\circ}\text{C}$  and until the final series of engine accelerations, about 24,000 kg of fuel had been delivered from each main tank with fuel flows having remained below 12,000 pph. Analysis of the 13,500 flights provided by the operator of G-YMMM identified that the majority of flights delivered no more than 20,000 kg to each engine under the same conditions. At maximum flow settings of 10,000 pph (Figure 63), 11,000 pph (Figure 64) and 12,000 pph (Figure 65), the accident flight remained one of only a few aircraft having delivered more than 20,000 kg of fuel from each main tank, before a high level of fuel flow had been commanded.

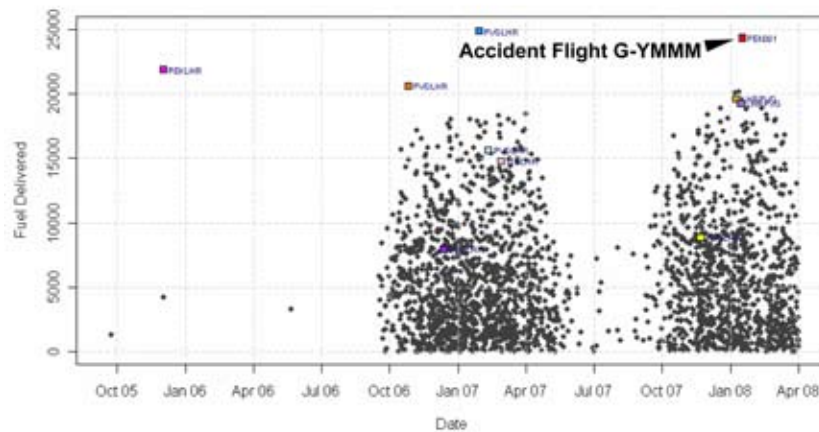
**Figure 63**

Fuel delivered at less than  $-20^{\circ}\text{C}$  and max fuel flow of 10,000 pph

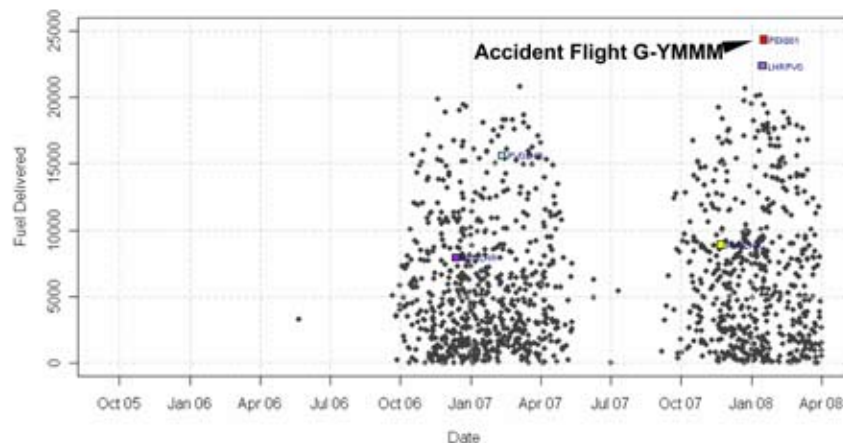
**Figure 64**

Fuel delivered at less than  $-20^{\circ}\text{C}$  and max fuel flow of 11,000 pph

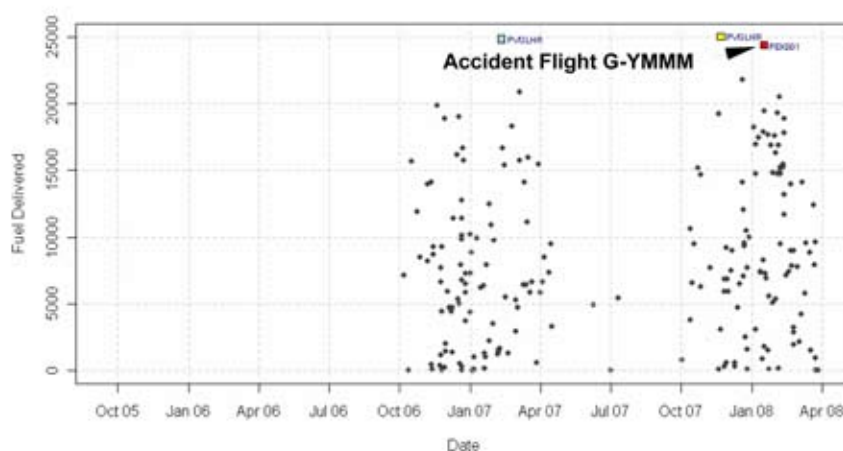
**Appendix F****Figure 65**

Fuel delivered at less than  $-20^{\circ}\text{C}$  and max fuel flow of 12,000 pph

*Combination of Fuel Temperatures and Fuel Flows of 178,000 flights*

Test observations indicated that ice could form at flow rates and temperatures similar to those experienced during the accident flight. Ice could then be released at a higher flow rate, similar to that which occurred shortly before the fuel flow had been restricted. Testing also established that water, when introduced into the fuel flow at the boost pump inlet at extremely high concentrations, can form sufficient ice to restrict fuel flow through the FOHE. During these tests it was concluded that it was not possible to restrict the fuel flow through the FOHE when the temperature of the fuel in the main tank was above  $-10^{\circ}\text{C}$  and the fuel flow was less than 12,000 pph. Fuel temperature during the accident flight approach was  $-22^{\circ}\text{C}$ .

Initial analysis of a combination of takeoff, cruise and approach fuel temperatures and flows identified that the accident flight was unique under the following conditions:

- Features
  - Fuel temperature in the main tanks below  $0^{\circ}\text{C}$  at takeoff.
  - Fuel flow from the main fuel tanks less than 10,000 pph and fuel temperature in the main tanks remaining below  $0^{\circ}\text{C}$  during the cruise.
  - Fuel flow from the main tanks greater than 10,000 pph and fuel temperature in the main tanks at or below  $-10^{\circ}\text{C}$  during the approach.

---

**Appendix F**

- Results
  - Accident flight
  - 32 Pratt and Whitney powered aircraft flights

Following further laboratory testing and analysis of the N862DA<sup>3</sup> incident, the takeoff fuel temperature criterion was removed. This identified a total of 66 Rolls-Royce powered aircraft flights, with 36 having a lower maximum cruise fuel flow and 17 a higher maximum fuel flow during the approach than the accident flight. Of these, eight Rolls-Royce powered aircraft flights and 30 Pratt and Whitney flights had a combination of lower cruise and higher approach fuel flows than the accident flight. However, of the eight Rolls-Royce flights, the accident flight had both the lowest minimum fuel temperature during both the cruise and approach, by 11°C and 7°C respectively. Compared to the Pratt and Whitney powered aircraft flights, the accident flight had the lowest fuel temperature in the cruise by 1°C and one flight had the same temperature during the approach.

- Features
  - Fuel flow from the main fuel tanks less than 10,000 pph and fuel temperature in the main tanks remaining below 0°C during the cruise.
  - Fuel flow from the main tanks greater than 10,000 pph and fuel temperature in the main tanks at or below -10°C during the approach.
- Results
  - 55 Rolls-Royce powered aircraft flights from the operator of G-YMMM (including the accident flight).
  - 6 Rolls-Royce powered aircraft flights - Tropics-based operator.
  - 5 Rolls-Royce powered aircraft flights - Southern Hemisphere operator.
  - 984 Pratt and Whitney powered aircraft flights - Northern Hemisphere operator

---

<sup>3</sup> The incident to N862DA is explained in more detail in section 1.18.2.1.

---

**Appendix F**

Fuel temperatures at the time of both the G-YMMM accident and N862DA incident were approximately  $-22^{\circ}\text{C}$ . Test results also indicated that the accident flight had a lower approach temperature than any of the other flights having similar fuel flow features. When the approach fuel temperature feature was reduced to  $-22^{\circ}\text{C}$ , 14 flights had the same features, with the accident flight being unique among the Rolls-Royce powered flights.

- Features
  - Fuel flow from the main fuel tanks less than 10,000 pph and fuel temperature in the main tanks remaining below  $0^{\circ}\text{C}$  during the cruise.
  - Fuel flow from the main tanks greater than 10,000 pph and fuel temperature in the main tanks at or below  $-22^{\circ}\text{C}$  during the approach.
- Flights having both features
  - Accident flight
  - 13 Pratt and Whitney powered flights

When the accident flights maximum cruise and approach fuel flows of 8,896 pph and 12,288 pph were applied, the accident flight remained unique among the Rolls-Royce powered aircraft and only two flights from 142,000 Pratt and Whitney powered aircraft flights had the same features. Of the two Pratt and Whitney flights, the approach temperatures were  $-22^{\circ}\text{C}$  and  $-23^{\circ}\text{C}$  and the approach fuel flows were 12,490 pph and 16,600 pph respectively.

- Features
  - Fuel flow from the main fuel tanks less than 8,897 pph and fuel temperature in the main tanks remaining below  $0^{\circ}\text{C}$  during the cruise.
  - Fuel flow from the main tanks greater than 12,287 pph and fuel temperature in the main tanks at or below  $-22^{\circ}\text{C}$  during the approach.
- Flights having both features
  - Accident flight
  - 2 Pratt and Whitney powered flights



## Appendix F

### *Flights having similar features as the N862DA incident flight*

During the incident flight of N862DA, fuel temperatures did not reduce below 0°C until about three hours into the flight, when the aircraft was in the cruise. Fuel temperatures then progressively reduced to a minimum of -23°C. Unlike the accident flight, N862DA had made four step climbs at fuel flows in excess of 11,000 pph prior to the restriction occurring. The third and fourth step climbs both occurred at fuel temperatures below 0°C. The third occurred shortly after the fuel temperature had reduced below 0°C and the fourth, just over three hours later when the fuel temperature was approaching -15°C. The fuel then continued to reduce to its minimum temperature. About three hours later the aircraft carried out a further step climb, with a maximum fuel flow of just over 11,000 pph. It was during this engine acceleration that engine oil temperature was observed to rise due to a loss of FOHE efficiency. The restriction gradually increased over a number of minutes before the restriction resulted in the FMV moving to its fully open position and the EEC Control Loop 17 being activated. Fuel temperature at the time was -22°C.

Approximately 20,000 Rolls-Royce powered flights were analysed for a combination of a maximum fuel flow of 11,000 pph and greater when in the cruise and fuel temperatures of -22°C or below. 60 flights were identified.

### *Previous occurrences of fuel flow restriction*

Following the reduction in fuel flow, the EEC control loop had changed to Control Loop 17, an indication that the EEC was commanding maximum fuel flow to its respective engine. The FMVs also moved to their fully open positions without the expected increase in fuel flows to both engines.

A retrospective analysis of the 13,500 flights provided by the operator of G-YMMM was conducted for cases of EEC Control Loop 17 and a mismatch between the FMV position and the expected fuel flow. Other than the accident flight, no occurrences were detected. It should be noted though that recording limitations meant that the FMV position and expected fuel flow algorithm was incapable of detecting FMV position and expected fuel flow mismatches of less than 2,000 pph (the accident flight had a mismatch of over 20,000 pph). Both detection methods were also implemented by the operator of G-YMMM as part of its ongoing fleet monitoring program. No further occurrences have been detected.

When an EEC Control Loop 17 has been activated, a message is logged by the aircraft Central Maintenance Computer (CMC). For the previous 10 years, the aircraft manufacturer had

**Appendix F**

records of six occurrences of EEC Control Loop 17. Explanations were available for all of the occurrences and they were all for reasons not relevant to the accident to G-YMMM.

Following the incident to N862DA, retrospective analysis for previous occurrences of anomalous oil pressure behaviour was evaluated. Due to complexities of the engine oil pressure and FOHE relationship, an automated search of the 13,500 flights could not be readily implemented. A small subset of flights were analysed, with no anomalies found. The incident flight was also processed through the FMV position and expected fuel flow algorithm. The characteristics of the restriction to the FOHE on N862DA were different to that of G-YMMM, with a progressive rather than almost instantaneous restriction having occurred. The restriction was not detected by the algorithm until several minutes after the FOHE had started to restrict. This was due to the initial restriction resulting in less than a 2,000 pph mismatch.

---

**Appendix G****Constraints and Limitations of the Fuel Rig Test Procedures**

Testing a large aircraft fuel system is extremely difficult and therefore there were a number of constraints and limitations on the test procedures used during the investigation.

- Whilst Jet A-1 was used on the accident flight all the testing was carried out using Jet A. This was considered acceptable as the fuel temperatures reached during the testing were never low enough to cause the fuel to wax.
- Previous testing has indicated that Jet A might contain slightly heavier compounds than Jet A-1 and therefore might contain slightly more water. This was considered acceptable as the water content was closely monitored throughout the tests.
- Previous testing has indicated that different batches of fuel might have different icing characteristics. Given the large variation in hydrocarbon molecules in different batches of aviation fuel, it was not possible to match the molecular make-up of the fuel used on the accident flight.
- It was not possible to fully explore the effect of weathered fuel, or the release and absorption of gas, on the generation of ice crystals within the fuel.
- The variation in the measured water content of the fuel, and the accuracy of the Karl Fischer tests, could not be improved and were, therefore, accepted as test limitations.
- It was not possible to include the effects of vibration and changes in pitch of the aircraft.
- A change in fuel flow will cause a change in the engine speed which will have an impact on the engine oil temperature and the discharge pressure from the engine LP fuel pump. During testing these variables were controlled separately with only one variable changed at a time. Sensitivity analysis indicated that this approach would have little impact on the test results.
- Prior to the environmental tests, the pipes, couplings and the layout of the test rig was not identical (materials and geometry) to the aircraft installation. However, this was only considered to have an impact on the accumulation and release testing and would have had little impact on the snowball tests.

---

**Appendix G**

- Approximately 70% of the pipes removed from the right fuel feed system on G-YMMM were used on the environmental test rig. All the pipes were connected with bonding leads to ensure that there was no localised build up of static, which may have affected the build up of ice. Because of constraints within the building, the FOHE was mounted 5 feet, instead of 10 feet, above the MEP. It was also necessary to change the position of two of the pipes that run through the main fuel tank. However, all the critical components were included and the gradients of the pipes were the same as the aircraft installation. It was assessed that these changes would have little impact on the results of the accumulation and release tests.
- Given the large quantities of fuel required for the tests it was not possible to conduct single pass testing, which is where fresh conditioned fuel passes each component once. Instead it was necessary to recirculate and condition the fuel with water prior to each pass. The disadvantage of this system is that the temperature cycling and agitation results in ice forming on the fuel rig heat exchangers and the inside of the storage tank with a significant reduction of the water content and the number of nuclei on which ice crystals can grow. The agitation of the fuel also means that the amount of supercooled water in the storage tank is probably less than in the main fuel tanks on the aircraft.
- The size of the water droplets is dependent on the cooling rate and the amount of agitation within the fuel. The water droplets will form ice when they come into contact with nuclei, a surface or reach a critical temperature. Research in other areas has indicated that the type and properties of the ice is dependent on a number of factors such as the temperature, rate of cooling, agitation and size of water droplet. During the accumulation tests, water was added to the fuel by spraying it directly into the acrylic box surrounding the boost pump inlet, which resulted in ice being produced from a high concentration of entrained water. Whereas, on the accident flight the ice crystals would have formed from a lower concentration of entrained water. Some of this entrained water would have already been present in the fuel and some would have formed as dissolved water was released as the fuel cooled. These processes may produce varying sizes of water droplet which, with the different concentrations and agitation of the fuel, might influence the properties of the ice crystals and the ice which subsequently formed on the inside of the fuel feed pipes. Similarly it is not known if during the testing of the FOHE the ice crystals, which formed by injecting a mixture of water, at very high concentrations, and fuel directly into the boost pump housing had the same properties as the ice which released

**Appendix G**

from the inside of the fuel feed pipes. However, during the testing the nature of the FOHE restriction (in terms of the flow and pressure response) produced by the shedding of accreted ice was similar to the response produced when water was injected directly into the fuel pump inlet.

**Appendix H****Relevant Certification Requirements – Landing Gear**

## FAA FAR Landing Gear requirements

*25.561(b) Emergency Landing Conditions*

*The structure must be designed to give each occupant every reasonable chance of escaping serious injury in a minor crash landing when—*

- (1) Proper use is made of seats, belts, and all other safety design provisions;*
- (2) The wheels are retracted (where applicable); and*
- (3) The occupant experiences the following ultimate inertia forces acting separately relative to the surrounding structure:*
  - (i) Upward, 3.0g*
  - (ii) Forward, 9.0g*
  - (iii) Sideward, 3.0g on the airframe; and 4.0g on the seats and their attachments.*
  - (iv) Downward, 6.0g*
  - (v) Rearward, 1.5g*

*25.721 Landing Gear: General*

*a) The main landing gear system must be designed so that if it fails due to overloads during takeoff and landing (assuming the overloads to act in the upward and aft directions), the failure mode is not likely to cause—*

- (1) For airplanes that have passenger seating configuration, excluding pilots seats, of nine seats or less, the spillage of enough fuel from any fuel system in the fuselage to constitute a fire hazard; and*
- (2) For airplanes that have a passenger seating configuration, excluding pilots seats, of 10 seats or more, the spillage of enough fuel from any part of the fuel system to constitute a fire hazard.*

**Appendix H**

*(b) Each airplane that has a passenger seating configuration excluding pilots seats, of 10 seats or more must be designed so that with the airplane under control it can be landed on a paved runway with any one or more landing gear legs not extended without sustaining a structural component failure that is likely to cause the spillage of enough fuel to constitute a fire hazard.*

*(c) Compliance with the provisions of this section may be shown by analysis or tests, or both.'*

Additionally, to satisfy JAA (now EASA) certification requirements, compliance was also demonstrated with the following CS:

*'JAR 25.963(d) Fuel Tanks: General*

*Fuel tanks must, so far as it is practicable, be designed, located and installed so that no fuel is released in or near the fuselage or near the engines in quantities sufficient to start a serious fire in otherwise survivable crash conditions. (See also ACJ 25.963(d).)*

*ACJ 25.963(d)*

*Fuel tank installations should be such that the tanks will not be ruptured by the aeroplane sliding with its landing gear retracted, nor by a landing gear, nor an engine mounting tearing away. Fuel tanks inboard of the landing gear or inboard of or adjacent to the most outboard engine, should have the strength to withstand fuel inertia loads appropriate to the accelerations specified in JAR 25.561(b)(3) considering the maximum likely volume of fuel in the tank(s). For the purposes of this substantiation it will not be necessary to consider a fuel volume beyond 85% of the maximum permissible volume in each tank. For calculation of inertia pressures a typical density of the appropriate fuel may be used.*

*Certification Review Items (CRI) C-251; 1.1, 1.3, and 2.2*

*The aircraft must be designed to avoid ruptures that could be catastrophic for the safety of the occupants, including ruptures leading to fuel spillage under the following conditions.*

**Appendix H**

*1.1 Impact with the ground at 5fps vertical velocity at maximum landing weight*

*With all gears retracted*

*With any one or any two gears retracted*

*1.3 Failure of the landing gear under overload, assuming the overload conditions to be any reasonable combination of drag and vertical loads.*

*Consideration should also be given to:*

*2.2 The possible failure of the landing gear under overload conditions including side loads.'*

**Current EASA CS Landing Gear requirements**

*'CS 25 is currently at Amendment 6. The relevant requirements were amended at Amendment 3 with an effective date of 19 September 2007. The applicable requirements are as follows:*

*CS 25.721 General (See AMC 25.963(d))*

*(a) The landing gear system must be designed so that when it fails due to overloads during takeoff and landing, the failure mode is not likely to cause spillage of enough fuel to constitute a fire hazard. The overloads must be assumed to act in the upward and aft directions in combination with side loads acting inboard and outboard. In the absence of a more rational analysis, the side loads must be assumed to be up to 20% of the vertical load or 20% of the drag load, whichever is greater.*

*(b) The aeroplane must be designed to avoid any rupture leading to the spillage of enough fuel to constitute a fire hazard as a result of a wheels-up landing on a paved runway, under the following minor crash landing conditions:*

*(1) Impact at 1.52 m/s (5 fps) vertical velocity, with the aeroplane under control, at Maximum Design Landing Weight,*

*(i) with the landing gear fully retracted and, as separate conditions,*

*(ii) with any other combination of landing gear legs not extended.*



**Appendix H**

*(2) Sliding on the ground, with -*

*(i) the landing gear fully retracted and with up to a 20° yaw angle and, as separate conditions,*

*(ii) any other combination of landing gear legs not extended and with 0° yaw angle.*

*(c) For configurations where the engine nacelle is likely to come into contact with the ground, the engine pylon or engine mounting must be designed so that when it fails due to overloads (assuming the overloads to act predominantly in the upward direction and separately predominantly in the aft direction), the failure mode is not likely to cause the spillage of enough fuel to constitute a fire hazard.*

*CS 25.963 Fuel tanks: general*

*(a) Each fuel tank must be able to withstand, without failure, the vibration, inertia, fluid and structural loads that it may be subjected to in operation. (See AMC 25.963 (a).)*

*(b) Flexible fuel tank liners must be approved or must be shown to be suitable for the particular application.*

*(c) Integral fuel tanks must have facilities for interior inspection and repair.*

*(d) Fuel tanks must, so far as it is practicable, be designed, located and installed so that no fuel is released in or near the fuselage or near the engines in quantities sufficient to start a serious fire in otherwise survivable emergency landing conditions and:*

*(1) Fuel tanks must be able to resist rupture and to retain fuel under ultimate hydrostatic design conditions in which the pressure  $P$  within the tank varies in accordance with the formula:*

$$P = K\rho gL$$

*where:*

*$P$  = fuel pressure in Pa (lb/ft<sup>2</sup>) at each point within the tank*

**Appendix H**

*L = a reference distance in m (ft) between the point of pressure and the tank farthest boundary in the direction of loading.*

*$\rho$  = typical fuel density in kg/m<sup>3</sup> (slugs/ft<sup>3</sup>)*

*g = acceleration due to gravity in m/s<sup>2</sup> (ft/s<sup>2</sup>)*

*K = 4.5 for the forward loading condition for fuel tanks outside the fuselage contour*

*K = 9 for the forward loading condition for fuel tanks within the fuselage contour*

*K = 1.5 for the aft loading condition*

*K = 3.0 for the inboard and outboard loading conditions for fuel tanks within the fuselage contour*

*K = 1.5 for the inboard and outboard loading conditions for fuel tanks outside of the fuselage contour*

*K = 6 for the downward loading condition*

*K = 3 for the upward loading condition*

*(2) For those (parts of) wing fuel tanks near the fuselage or near the engines, the greater of the fuel pressures resulting from subparagraphs*

*(i) and (ii) must be used:*

*(i) the fuel pressures resulting from subparagraph (d)(1) above, and:*

*(ii) the lesser of the two following conditions:*

*(A) Fuel pressures resulting from the accelerations as specified in CS 25.561(b)(3) considering the fuel tank full of fuel at maximum fuel density. Fuel pressures based on the .0g forward acceleration may be calculated using the fuel static head equal to the streamwise local chord of the tank. For inboard and outboard conditions, an acceleration of 1.5g may be used in lieu of 3.0g as specified in CS 25.561(b)(3); and:*

**Appendix H**

*(B) Fuel pressures resulting from the accelerations as specified in CS 25.561(b)(3) considering a fuel volume beyond 85% of the maximum permissible volume in each tank using the static head associated with the 85% fuel level. A typical density of the appropriate fuel may be used. For inboard and outboard conditions, an acceleration of 1.5g may be used in lieu of 3.0g as specified in CS25.561(b)(3).*

*(3) Fuel tank internal barriers and baffles may be considered as solid boundaries if shown to be effective in limiting fuel flow.*

*(4) For each fuel tank and surrounding airframe structure, the effects of crushing and scraping actions with the ground should not cause the spillage of enough fuel, or generate temperatures that would constitute a fire hazard under the conditions specified in CS 25.721(b).*

*(5) Fuel tank installations must be such that the tanks will not rupture as a result of an engine pylon or engine mount or landing gear, tearing away as specified in CS 25.721(a) and (c). (See AMC 25.963(d).)*

*(e) Fuel tank access covers must comply with the following criteria in order to avoid loss of hazardous quantities of fuel:*

*(1) All covers located in an area where experience or analysis indicates a strike is likely, must be shown by analysis or tests to minimize penetration and deformation by tyre fragments, low energy engine debris, or other likely debris.*

*(2) All covers must have the capacity to withstand the heat associated with fire at least as well as an access cover made from aluminium alloy in dimensions appropriate for the purpose for which they are to be used, except that the access covers need not be more resistant to fire than an access cover made from the base fuel tank structural material. (See AMC 25.963(e).)*

*(f) For pressurised fuel tanks, a means with failsafe features must be provided to prevent the build-up of an excessive pressure difference between the inside and the outside of the tank.*

*(g) Reserved.*

*AMC subpart E 25.963(d) Fuel tank Strength in Emergency landing Conditions sets out an acceptable means of compliance as follows:*

**Appendix H**

*e. Landing gear separation. (Compliance with CS 25.721(a) and CS 25.963(d)(5).)*

*Failure of the landing gear under overload should be considered, assuming the overloads to act in any reasonable combination of vertical and drag loads, in combination with side loads acting both inboard and outboard. In the absence of a more rational analysis, the side loads must be assumed to be up to 20% of the vertical load or 20% of the drag load, whichever is greater. It should be shown that at the time of separation the fuel tank itself is not ruptured at or near the landing gear attachments. The assessment of secondary impacts of the airframe with the ground following landing gear separation is not required. If the subsequent trajectory of a separated landing gear would likely puncture an adjacent fuel tank, design precautions should be taken to minimise the risk of fuel leakage.*

*f. Compliance with the provisions of this paragraph may be shown by analysis or tests, or both.'*

**Appendix I****Relevant Certification Requirements - Passenger Seats**

14 CFR 25.785 (b) states

*'Each seat ... must be designed so that a person making proper use of these facilities will not suffer serious injury in an emergency landing'*

14 CFR 25.785 (d)(2) states

*'Each occupant ... must be protected from the head injury by ... the elimination of any injurious object within striking radius of the head.'*

14 CFR 25.562 (c)(5) = Head Injury Criteria (HIC)

*'Each occupant must be protected from serious head injury under the conditions {of a 16G dynamic test}. Where head contact with seats or other structure can occur, protection must be provided so that the head impact does not exceed a Head Injury Criterion (HIC) of 1,000 units.'*

The pass/fail criteria of the test include:

HIC value must be less than 1000.

All items of mass (more than 1/3 lb) must be retained.

No sharp edges may be present (neither pre nor post test).

Permanent set deformation (including items that deployed) must not impede rapid egress.

**Appendix J****Manufacturer's Analysis of the Accident Landing Gear Breakaway Sequence****Left MLG**

1. Initial impact: Gear beam outboard attachment fuse pins failed  
Forward trunnion upper and lower housing fuse pins failed  
Drag brace fuse pin 'crankshafted'

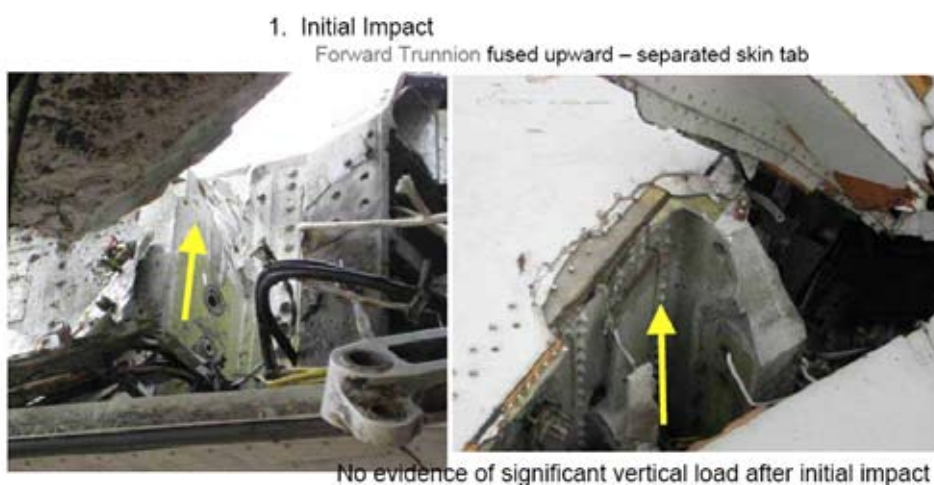

Note the piece of upper wing skin removed by the separation of the upper and lower housings. This impact had pried open the wing tank.

2. Aft trunnion separation



**Appendix J**

3. Aircraft continued to slide with landing gear attached.

3. Rolling with airplane to rest



4. Final Configuration: Gear beam inboard end damaged but still attached, drag and side brace both folded but still attached.

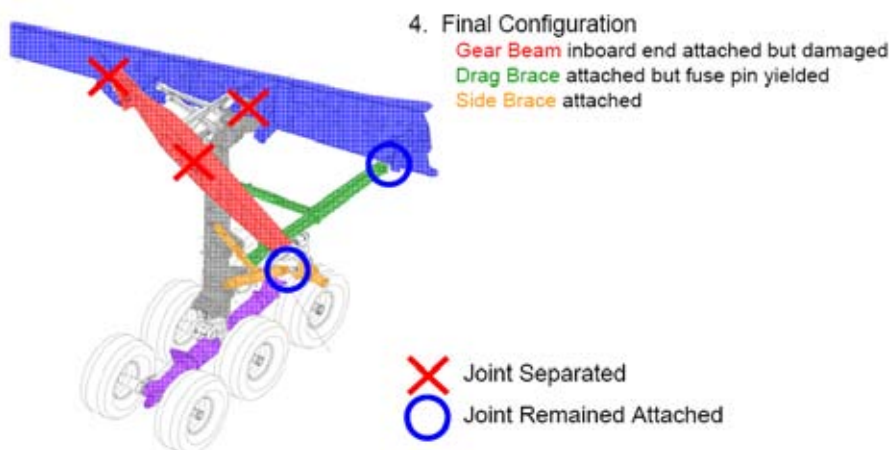

**Appendix J**

**Right MLG**

- 1. Initial impact: Gear beam outboard end fuse pins fail and gear beam forced upwards
- Side brace folded and gear beam forced inboard
- Gear beam rotated upwards and contacted the aft trunnion pin
- Forward trunnion lower housing (H block) fuse pins failed

1. Initial Impact  
Gear Beam fused upwards

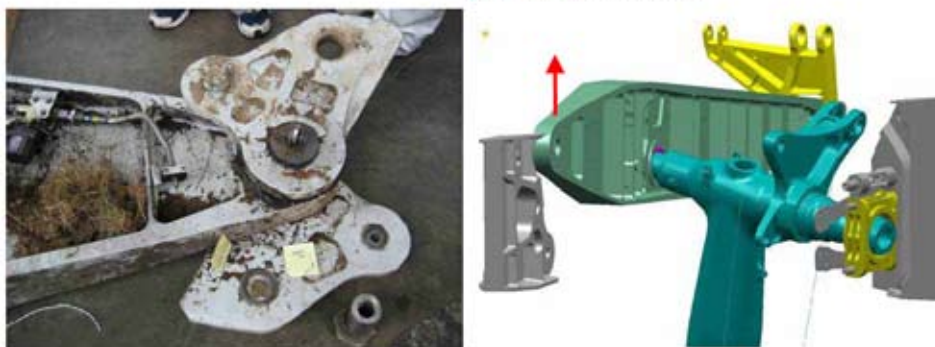

Gear Beam forced Inboard, reaches rotation limit and drives through swing link





**Appendix J**

**Gear Beam** forced Inboard, reaches rotation limit and drives through swing link



Fwd Trunnion reaches pivot limit on 'H-block' Housing

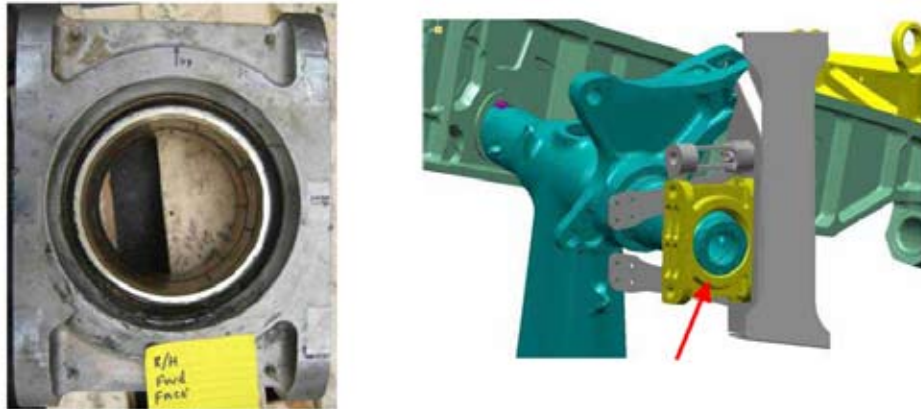

1. Initial Impact  
Forward Trunnion fused

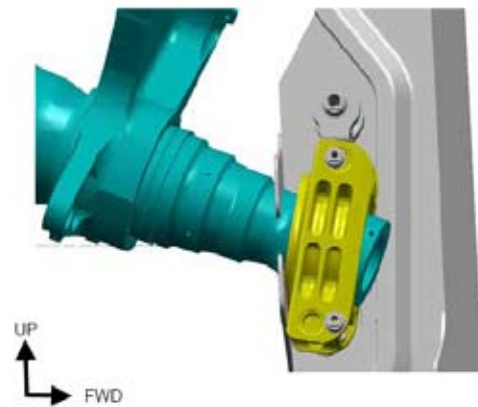

Appendix J

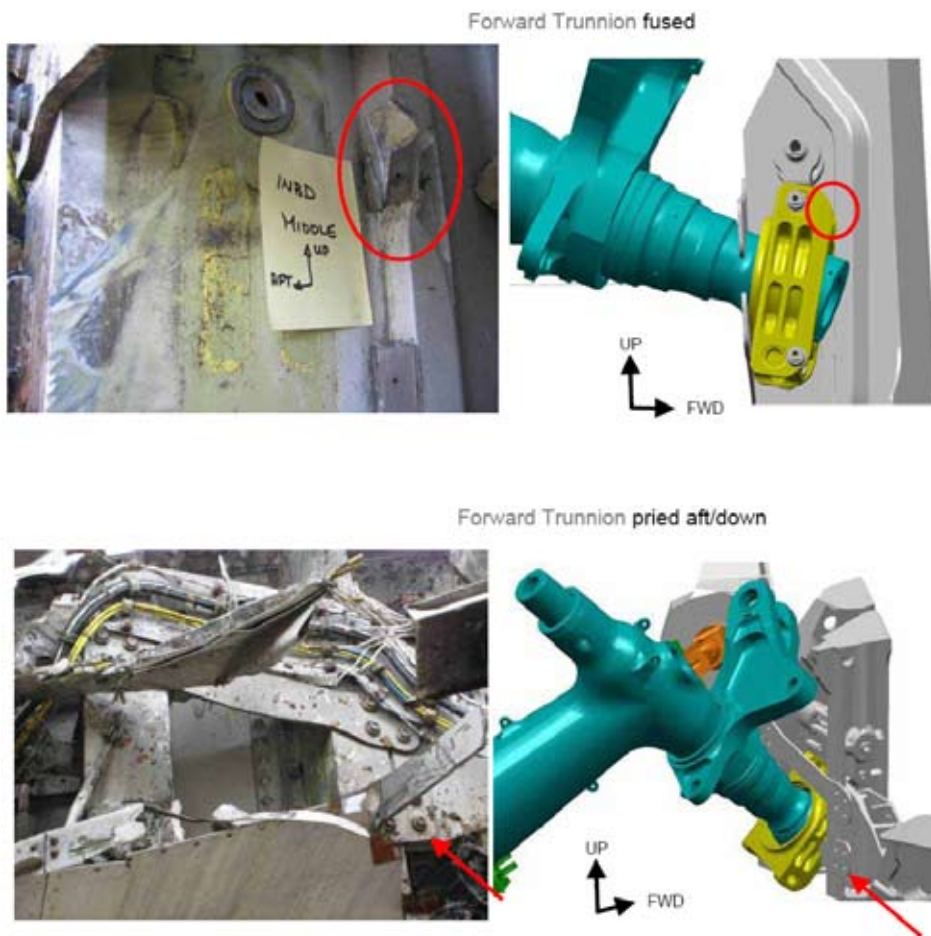

2. Subsequent motion: Forward trunnion levered aft and down

Aft trunnion separated and/or gear beam separated at side brace attachment

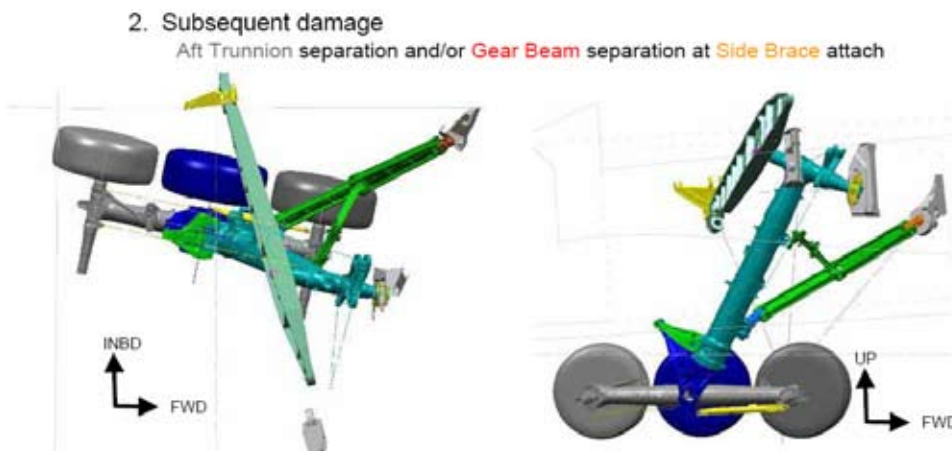

**Appendix J**

3. Subsequent ground slide: Truck beam fractured

Retract arm jammed against spar fittings

Aft fuselage impact from forward truck beam

Gear twisted about shock strut axis and contacted drag brace lock link

Rear spar web and backup fitting failure and drag brace separation

Truck Beam reaches pitch up limit on Shock Strut/Inner Cylinder and fractures

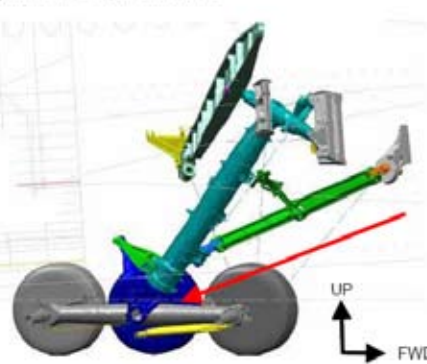

3. Shock Strut / Retract Arm Jams on and destroys upper part of inboard Trunnion Support Fitting



**Appendix J**

4. Collateral damage: Forward truck beam punctured fuselage skin

Right MLG struck horizontal stabilizer

3. Gear twists on Shock Strut axis and Aft tires impinge on body.

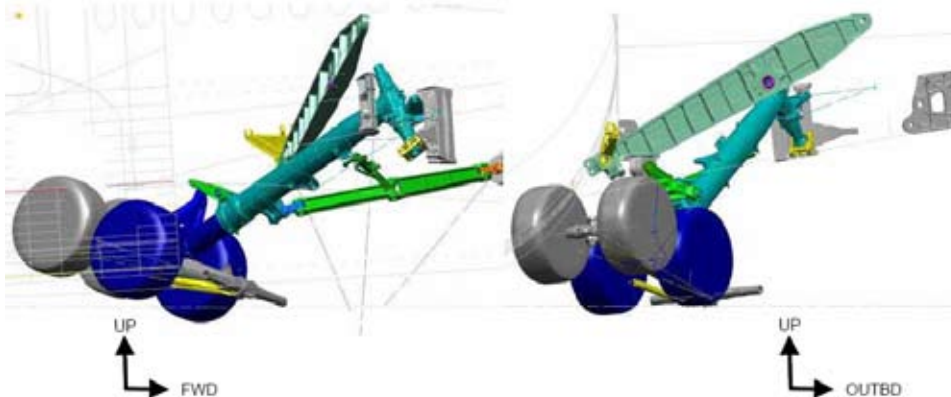

Gear continues twisting until Retract Actuator drives through Drag Brace Lock Link. Drag Brace separation – occurs sometime after this

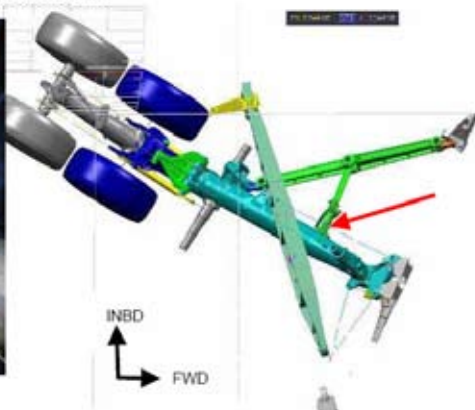

4. Aft Body impact completed after failure of Drag Brace Fitting to Rear Spar attachment

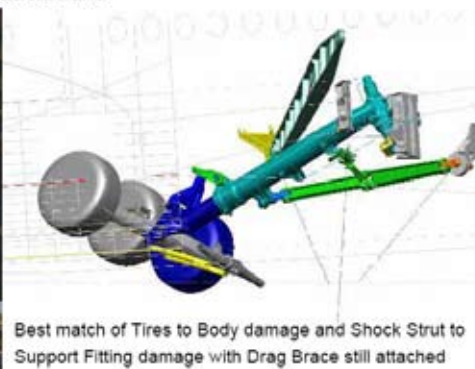

**Appendix J**

**4. Fwd truck beam punctures fuselage skin**



**4. Right MLG strikes horizontal stabilizer**



**5. Final Configuration**

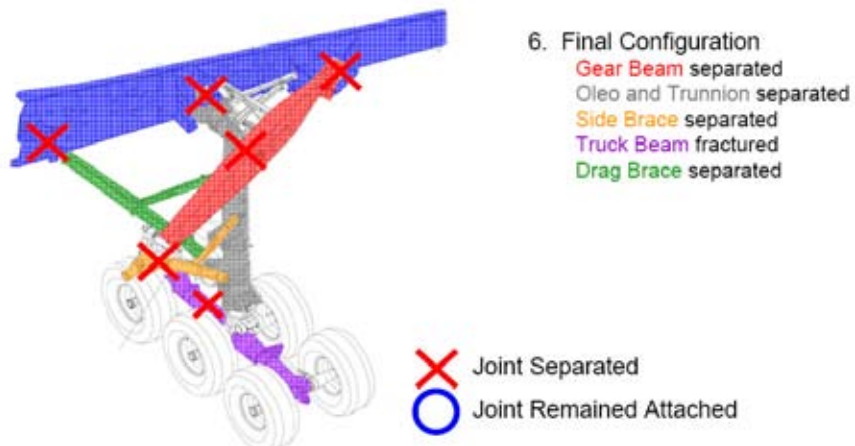

**Appendix K****Crashworthiness Analysis by Cranfield Impact Centre (CIC)***Introduction*

The landing of the Boeing 777-236 ER G-YMMM at London Heathrow on 17th January 2008 was analysed by CIC using a non-linear, dynamic, Finite Element analysis (LS-DYNA) to reconstruct the impact conditions. A Finite Element (FE) model of the aircraft based on data from the manufacturer was combined with a FE model of the accident site using measured properties of soil samples taken from the area. The soil samples were taken approximately six months after the date of the accident.

The FE model of the aircraft was validated against measured data from a normal landing case provided by the aircraft manufacturer. Several sub-component models were also individually validated against sub-component test data also provided by the manufacturer. The FE model of the soil was validated against 'Plate Sinkage' soil compression tests conducted at the accident site. However, these were limited to a total soil compression of some 0.04 metres due to test equipment capacity. The FE model indicated reasonable comparison with the test data over this range of compression. However, the actual impact resulted in depression and abrasion of the soil (from tyre and wheel contact) in excess of 0.3 metres depth.

The study considered two principal simulations, both using the impact conditions from the accident. These simulations were identical with the exception of the use of a hard runway or soft ground conditions as measured at the accident site.

*Simulation runs performed using the FE model*

Run A comprised a 'landing' validation case of the model against data provided by the manufacture which related to a 9.9° nose-up pitch attitude landing (with zero roll attitude and zero yaw) at a ground speed of 100 kt and a sink rate of 10 ft/s.

Run B comprised a simulation using the G-YMMM accident parameters (1° right roll, 9.0° nose-up pitch attitude and yaw 5° nose left), with a ground speed of 103 kt and sink rate of 25 ft/s. This was onto a hard runway surface to provide a comparative measure at the accident impact conditions of the effect of impacting a hard surface.

The first fuse pin failure occurred at the outboard end of the Gear Beam followed by failure of the fuse pins at the lower (H block) and upper housing positions. Thereafter, the gear beam rotated around its pivotal axis at the hanger link end. The drag brace fuse

**Appendix K**

pins were not predicted to have failed on either side. The peak vertical acceleration at the aircraft centre of gravity (CG) predicted was approximately 4g.

Figure 66 shows a view from behind the right wing during the impact sequence, at the point when the outboard end of the gear beam and the lower and upper housings have failed.

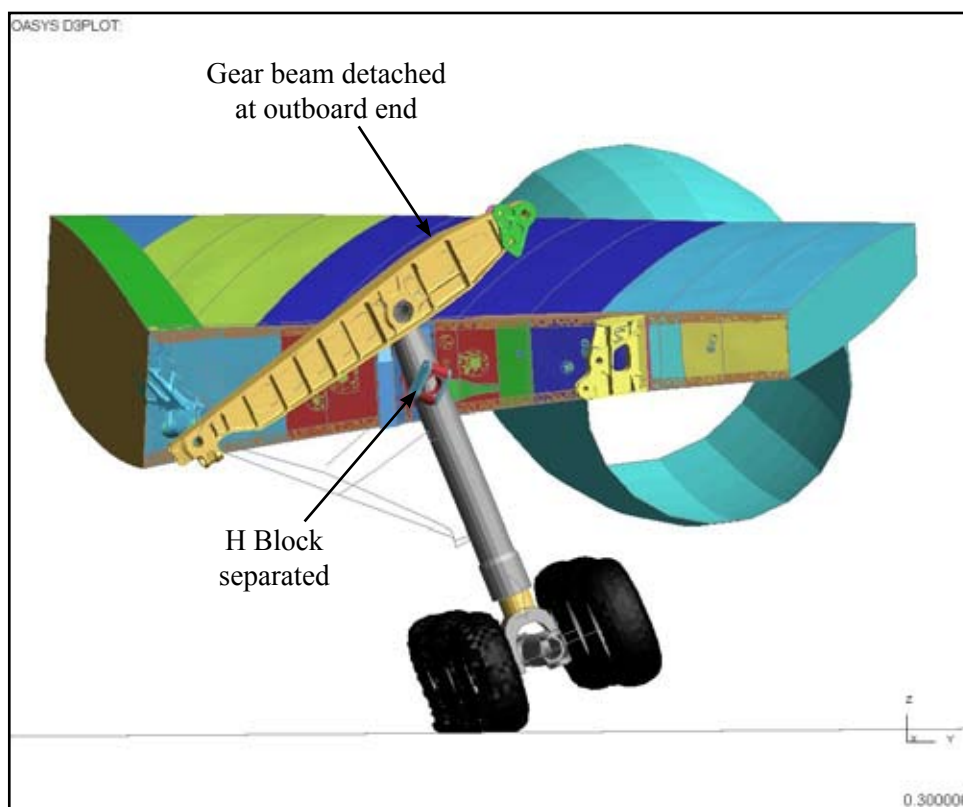

**Figure 66**

View from rear of right wing – Run B (TIME = 0.30 SECS)

Run C repeated the accident parameters of the hard runway simulation of Run B but onto the accident site soft ground model. This was intended to represent the accident scenario.

It was evident that the behaviour of the model on soft ground was different to that on a hard runway (Run B) in that only one fuse pin failed (the lower pin in the right outboard gear beam).

In the absence of any other fuse pin failures, loads could continue to be transferred into the rear spar. This led to distortion of both rear spars and is illustrated in Figure 67 which shows the right spar. A similar effect was seen in the left rear spar.

## Appendix K

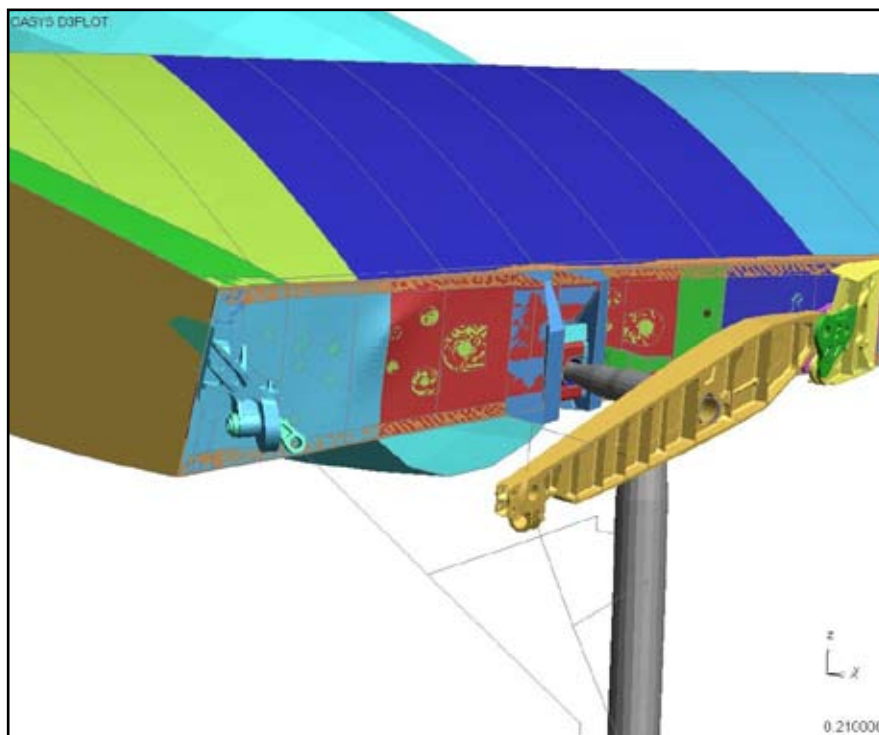
**Figure 67**

Right wing rear spar buckling – Run C (TIME = 0.21 SECS)

Figure 68 shows a comparison of the Von-Mises stress<sup>1</sup> in Run B (hard runway) and Run C; the red colours indicate higher stresses.

The peak CG vertical acceleration was around 3.5g just prior to termination of the simulation.

The Figure 69 shows the soft ground deformation.

Run D represented a repeat of the hard runway simulation of Run B, but with zero roll attitude and zero yaw. This case was included in order to investigate the contribution of the yaw/roll to the outcome of the accident. The results were similar to Run B.

Run E represented a repeat of the hard runway simulation of Run B but with yaw increased from 5° to 20° (nose left). This run was included to explore the effect of an extreme yaw condition in the impact onto hard ground. The increased yaw angle resulted in both gears being displaced to the left together with extensive fuse pin failures, although again neither drag brace fuse pins failed. The sequence of release was different to that of Run B.

<sup>1</sup> Von Mises is a criterion used in predicting the onset of yield in ductile materials.



Appendix K

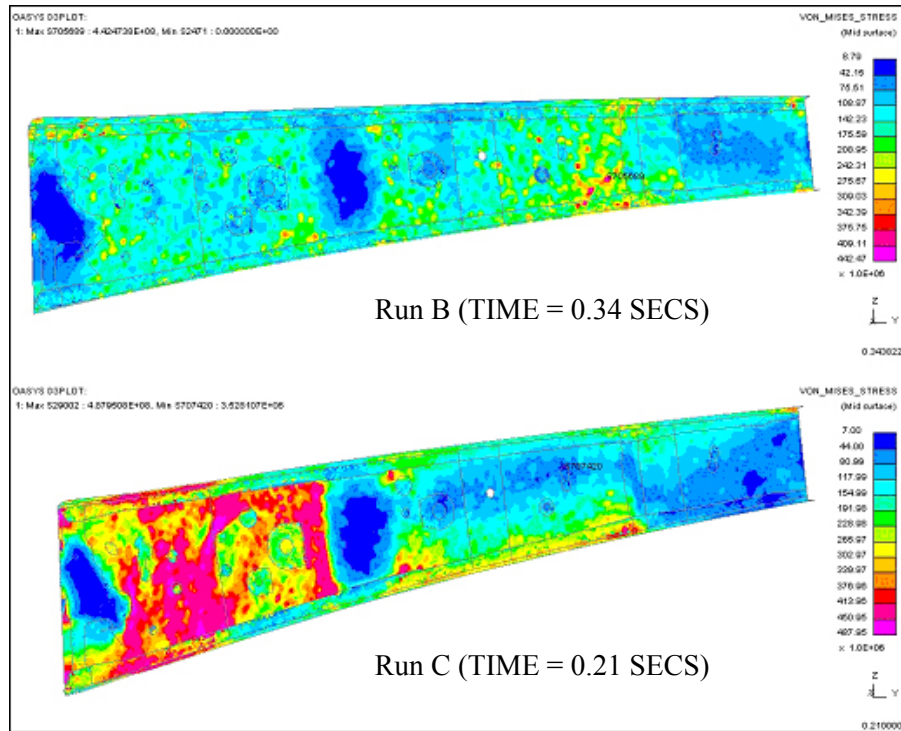

Figure 68

Right wing rear spar buckling Von-Mises stress

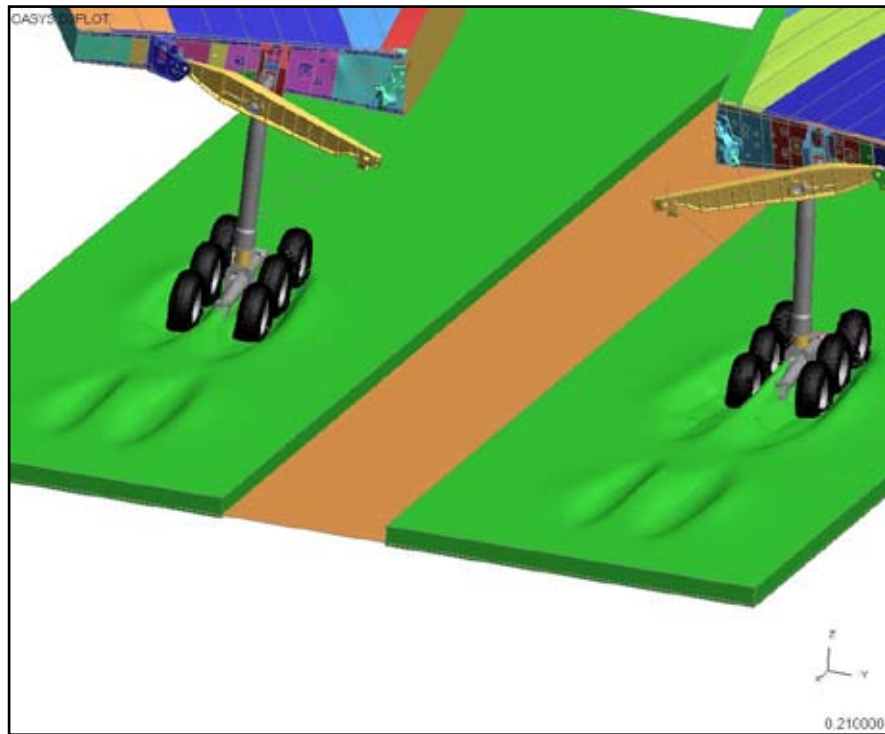

Figure 69

Soft ground deformation Run C (TIME = 0.21 SECS)

---

## Appendix K

Run F represented a repeat of the soft ground simulation of Run C but with yaw increased from 5° to 20° (nose left). This explored the effect of extreme yaw in the impact onto soft ground. This run was characterised by sequential fuse pin failures on the right MLG which resulted in its collapse inboard due to soil drag forces. Some fuse pin failures occurred on the left MLG and a rupture of the rear spar around the outboard end of the gear beam attachment.

### *Conclusions*

The hard runway model (Run B) indicated that the MLG fuse pins sheared in a progressive manner during impact, allowing each landing gear to rotate about the inboard end of the gear beam. However, the drag brace fuse pins did not fail in either the left or right wing. The simulation also indicated that the sequence of fuse pin failure was rapid, with only 0.057 seconds between the first and last of the failures.

The soft ground impact model (Run C), which was intended to most closely match the actual accident, showed a different behaviour. In this case the model indicated that all the fuse pins, except one in the outboard end of the gear beam, did not fail. This resulted in increased loads being transferred into the both wing rear spars. Review of force time history data from the fuse pins indicated that impact with soft ground delayed the build-up of shear forces in the pins (when compared to impact with hard ground) and prevented most of them from reaching their programmed shear failure trigger force. This delaying action allowed the fuse pins to continue transferring forces into the rear spars and resulted in distortion in the region of the drag brace attachment. It was concluded that the difference in outcome was due to the soil behaviour in the model under predicting the compression characteristics of the soil at the accident site.

The soft soil impact model was based on the assumption that the soil was a homogenous material. However, the accident site soil survey had shown it to contain a significant amount of broken concrete and other non-homogeneous rubble, which was difficult to represent. Had the soil strength in the soil model been greater, it is probable that more fuse pins would have failed and the rear spar distortions would have been less. However, this simulation did indicate that landing gear interaction with soft ground can modify the breakaway sequence. In addition, as in the case of the hard runway model, the drag brace fuse pin did not shear in either the left or right wing.

In none of the runs did the drag brace fuse pins fail. It is possible that this is due to the large changes in geometry, and therefore the load paths, of the deformed drag braces, thus reducing the anticipated forces transmitted through the drag brace fuse

**Appendix K**

pins. Notwithstanding the possible limitations of the model to fully represent real world behaviour, this large and difficult to predict 'change of geometry' effect is of significance in the design of the breakaway sequence.

The measured material properties of the soil have been found to have a significant effect on the outcome of this analysis. Due to the variability of soil properties with factors such as soil moisture content and temperature, extraction of soil samples from the site during the field phase of the investigation should be considered in order that key properties can be measured. Additionally, analysis in future investigations would benefit from additional research into the behaviour of soil under impact conditions, along with corresponding soil properties measurement techniques. This would be particularly important for severe impacts where fuselage deformation may result in ploughing and scooping of soil into the airframe resulting in high deceleration levels in the passenger cabin.