

# Report on Indian Standards for Electric Vehicle Charging Infrastructure

## Distributed Charge Points

1. AC Light EV Charge Point
2. DC Light EV Charge Point
3. AC Parkbay Charge Point
4. DC Parkbay Charge Point

## High Power Charge Points

5. DC Charging Station
6. eBus Dual Gun Charging
7. eBus Automated Pantograph

## Replaceable Battery

8. Light EV Battery Swap
9. eBus Battery Swap

**August 2021**

<b>1</b>	<b>Introduction</b>	
1.1	Policy & Guidelines	3
1.2	Overview of Standards	5
	International Standards	
	Indian Standards	
<b>2</b>	<b>Group on EV Charging Standards</b>	
2.1	NITI Aayog decisions	7
2.2	Light EV AC Charge Point	8
2.3	Light EV Removable Battery Packs	9
2.4	eBus High Power Charging Systems	9
<b>3</b>	<b>EV Infrastructure Categories</b>	
3.1	MoP/ CEA Classification	11
3.2	Classification by Power Classes	11
<b>4</b>	<b>EV Charging Systems</b>	
4.1	Charging methods	14
4.2	Modes of connecting EV to Charger	16
4.3	Grid Supportive EV Infrastructure	16
<b>5</b>	<b>Indian Standards for EV Infrastructure</b>	
5.1	General Requirements	18
5.2	Distributed Charge Points	19
	Light EV Infrastructure	
	Parkbay Charging of cars	
5.3	High Power Charging Stations	22
	DC Fast Charging Station	
	eBus Charging Station	
5.4	Removable Battery Packs	25
	Light EV Battery Swap	
	eBus Battery Swap	

## 1 Introduction

1.1 Policy & Guidelines	3
1.2 Overview of Standards	4
International Standards	
Indian Standards	

### 1.1 Policy & Guidelines

A safe, reliable, accessible & affordable infrastructure will enable faster adoption of electric vehicles. The specific objectives for the Electricity Distribution Infrastructure are to:

- i. Promote affordable tariff chargeable from EV owners and charging station operators/owners
- ii. Generate employment/ income opportunities for small entrepreneurs
- iii. Proactively support creation of EV charging infrastructure in the initial phase and eventually create market for EV charging business
- iv. Encourage preparedness of Electricity Distribution system to adopt EV charging infrastructure

#### (A) Ministry of Power

[MoP: Apr 2018] Clarification on EV Charging Infrastructure

[MoP: Dec 2018/ Oct 2019/ Jun 2020] Guidelines & Standards for EV Charging Infrastructure

[MoP/ CEA: Regulations 2019 ]

- (Feb 2019) Technical Standards for connectivity of the Distributed Generation Resources
- (Jun 2019) Measures relating to the Safety and Electric Supply

EV charging business does not require any licence under the provisions of the Electricity Act 2003, as it does not involve transmission, distribution or trading of electricity. Electricity is not sold. It is consumed at the charging station.

#### EV Charging Facilities

Charging Point: Facility for recharging of batteries of electric vehicle for private or public non-commercial use, connected at 415/220 Volts;

Charging Station: Facility for recharging of batteries of electric vehicles for commercial use and shall also include multiple charging points for non-commercial public use and capable of transferring power from electric vehicle to the grid

Battery Swapping Station (BSS): shall mean a station where any electric vehicle can get its discharged battery or partially charged battery replaced by a charged battery & shall be treated at par with a PCS and the applicable tariff for electricity supply shall also be same as for PCS

#### Type of Connection

Applicant: Generating company, charging station, prosumer or a person seeking connectivity to the electricity system at voltage level below 33 kV

User: Charging station, prosumer or a person who is connected to the electricity system or a generating company whose distributed generation resource is connected to the electricity system.

Prosumer: Person, including energy storage system, which consumes electricity from the grid and can also inject electricity into the grid, using same point of connection.

#### (B) MoHUA/ Town & Country Planning Organisation: Feb 2019

##### **Amendments in Model Building Bye-Laws for EV Charging Infrastructure**

The amendment provisions for establishing public charging stations in the local areas including urban CBD for installing charging infrastructure in the building premises. Based on the Occupancy pattern and the total parking provisions in the premises of various building types, charging Infrastructures should be provided for EV; 20% of all vehicle holding capacity/ parking capacity at the premise.

#### (C) Ministry of Road Transport & Highways: Aug. 2020

Registration of electricity vehicles without pre-fitted batteries is allowed. Vehicle without battery can be sold & registered with type approval certificate issued by Test Agency, based on prototype of EV & battery. This will bring down upfront cost of electric 2 or 3 wheeler lower than ICE counter parts. The battery could be provided separately by the OEM or energy service provider.

#### (D) Interoperability of EV Charging Facility

The GoI policy actively promotes interoperability among all public EV charging & battery swap facilities, for all vehicles, charging equipment & removable battery packs.

- "Public Charge Points/ Charging Station": Any facility that offer "charging services" to customers who own the vehicles. It applies to single vehicle owner, fleet owners and "hire-purchase" schemes.
- Captive charging facility may be permitted for:
  - ➔ A company that manufactures & use the vehicles
  - ➔ Leased EV fleet that will be returned to the manufacture at end of contract

## 1.2 Overview of Standards

### 1.2.1 International Standards

International Electrotechnical Council (IEC) issues International Standards for all electrical & electronic industries. The standards for the electrical industry in India is fully aligned to IEC International Standards.

IEC has the mandate, under the "ISO/IEC agreement" for publishing International Standards in Electrotechnology for Road Vehicles. Standards for all interfaces between EV and the electricity supply infrastructure shall be developed by IEC

While ISO/Technical Committee TC22 "Road Vehicles" is responsible for standards for road vehicles. It accepts IEC standards for electrical & electronic components.

IEC Technical Committees (TC) membership is nominated by various National Committees. A dozen IEC Technical Committees are relevant. Technical Committee 69 (IEC-TC69) is the main committee for EV Charging Standards.

The first set of International Standards were published in 2014 for AC & DC Charging Devices (IEC 61851 series), Connection assemblies (IEC 62196) & EV to Charger Communications (IEC ). This set of standards have focused on the passenger car segment.

- AC Charge Points (1-phase & 3-phase systems)
- Three alternate DC Charging Systems:
  - "System-A": Japan (Chademo);
  - "System-B": China (GB/T) &
  - "System-C": Europe / USA (CCS)

The basic set of standards are under revision, beginning 2017 when the revised Part-1 was published. The rest of the revised standards in the series are expected in 2022-23.

New International Standards are being developed for Light EV, Heavy EV, Battery Swap, Wireless Charging Dock, Wireless charging on the move, for the backend networking and grid interactions.

### 1.2.2 Indian Standards

In 2017 Bureau of Indian Standards (BIS) set up the Sectional Committee ETD51 "Electrotechnology in Mobility" that has membership of 50+ agencies, representing all stakeholders in electric mobility, and is managed by DST for the BIS. ETD-51 is the national (mirror) committee for the IEC Technical Committees on EV Charging Standards. It studies the draft International Standards and advice BIS on the vote on documents circulated by IEC to the member-countries.

Secretary DST was requested by the NITI Aayog, in 2019, to guide the development of charging infrastructure standards. In 2020, Secretary DST set up the "Group on EV Charging Infrastructure Standards" chaired by Dr. V. Sumantran.

At BIS ETD51, the topics of standardization directed by the Government is taken up under the Priority-1 Process.

### **Phase-1**

#### Standards developed for all devices specified in MoP Guidelines

The BIS developed 16 Standards to cover all the devices approved under the MoP Guidelines (Car AC Charge Point; DC Fast Charging Stations). This work was carried out during 2017 to 2020.

IEC International Standards published in 2014 is taken as the base for national standards in all countries, since it covered both AC & DC Charging for EV. The 2014 version focused on the passenger car segment.

IEC began to revise the EV Charging Standards and published the first standard, Part-1 in late 2017. The BIS decided to take the latest/ revised IEC Standards as the base for developing Indian Standards. The IS-17017 Part-1:2018 is based on the IEC 61851-Part-1:2017.

While this a forwarding looking move, it was also a miscalculation in a way. The IEC timelines for publishing the full revised set of standards is 2022-23, which the committee was not aware of. Most countries still follow the 2014 version.

However, ETD51 members participate in half dozen Working Groups under IEC-TC69 and had access to the draft IEC International Standards at every stage of its development. So the Indian Standards were developed based on advanced drafts of IEC standards. This was one reason for the longer time required to publish the Indian Standards.

#### Effort for Unique India EV connectors & inlets

DST was requested to oversee an effort to develop unique Vehicle Connectors & Inlets, for the Charging Systems specified in the MoP Guidelines. A Grand Challenge Program did not yield results as manufacturers & researchers in India do not have experience. This redirection of efforts caused delay in the program.

FAME Mission mainly promotes Light EV and eBuses. Both were not part of the International Standards 2014 version and the MoP Guidelines. DST proposed the development of Standards for Light EV (in 2019) but it did not gain acceptance.

### **Phase-2: DST/ BIS program**

Indian Standards will be provided for all use cases listed below. The two items underlined in the list below were developed during Phase-1, and all the rest are being developed in the current phase.

- The several standards already published include the following:
  - General Requirements for EV Charging, EMI/ EMC
  - General Requirements for Connection Systems, and specific connections for all options listed under the MoP Guidelines.
  - Communication Standards required for the CCS System

- The specifications for Light EV and eBus Systems are being developed by the Group on EV Charging Infrastructure.
- The Standards for the Parkbay Charge Points & Light EV Battery Swap are being developed by the DST/ BIS ETD51.

### Distributed Charge Points

AC Light EV Charge Point	Completed. BIS is printing the Standard.
DC Light EV Charge Point	Completed. BIS is printing the Standard.
AC Parkbay Charge Point	Completed in Phase-1. Published.
DC Parkbay Charge Point	Under Development.

### High Power Charge Points

DC Charging Station	Completed in Phase-1. BIS is printing the Standard.
Dual Gun Charging Station	Under Development. Draft standard in 2 months.
Automated Pantograph	Under Development. Draft standard in 2 months.

### Replaceable Battery

Light EV Battery Swap	Under Development. Specifications being finalized.
Ebus Battery Swap	Under Development.

## **2 Group on EV Charging Standards**

2.1	NITI Aayog decisions	7
2.2	Light EV AC Charge Point	8
2.3	Light EV Removable Battery Packs	9
2.4	eBus High Power Charging Systems	9

### 2.1 NITI Aayog decisions

The Vice Chairman, NITI Aayog held two review meetings jointly with the Principal Scientific Advisor (PSA), and Secretary DST on 'Electric Vehicle Charging Standards',

#### (A) Review on May 20, 2020:

It was decided that DST, PSA Office and NITI Aayog will synergise the efforts to develop the following EV Charging Systems:

- Affordable AC Charge Point for Light EV (scooters, autorickshaw etc.)
- Electric Bus Charging System for India, including battery swapping.

### Group on EV Infrastructure Standards

DST-PSAO "Group on EV Infrastructure Standards" was constituted, Chaired by Dr. V. Sumantran. to consult with stakeholders to finalize the design specifications, and to provide the preliminary draft standards to the BIS. The Group includes senior officials from the PSA Office, DST, Bureau of Indian Standards and NITI Aayog. It works closely with the BIS ETD51 Sectional Committee.

#### (B) Review on October 2020

##### Light EV AC Charge Point

The configuration for Light EV AC Charge Point was presented and approved. LEV Charge Point is a radically new design for a low-cost, reliable, mobile app-based charge point that can be deployed by shopkeepers, parking facilities, malls, schools and offices. ARAI has filed patents. Four manufacturers prototyped the device; 150 units will be installed for field demonstrations. The draft Standard submitted to BIS was approved & is under printing

##### eBus Charging Systems

It was recommended that the Group may now take up the work on interoperable high power eBus Charging Stations and eBus Battery Swap Systems.

#### (C) Review of Battery Swap System on June 2021

VC NITI Aayog held a round of meetings to consider **interoperable Battery Swap Systems for Light EV**. He requested Secretary, DST to oversee the development of specifications for an Interoperable Battery Swap System for Light EV.

---

## 2.2 Light EV AC Charge Point

### Completed

The Low-Cost AC Chargepoint (LAC) allows up to 3 kW of power to be drawn charging eScooters and eAutorickshaws. It uses Bluetooth to communicate with mobile phone of EV User & Charge Point Operator, and links up to a back-end where transaction payment and analytics are enabled. The user's smartphone can be used for multiple accounts and payment options. The Group set a target price of Rs.3500 (\$50), for a breakthrough affordable EV charge point.

The LAC device is intended to be highly scalable and deployed in any place where a 220V 15A single phase line is available – mainly targeting parking lots of metro and railway stations, shopping malls, hospitals, office complexes, apartments and even kirana and other shops. It is expected that a new industry sector will emerge catering to the high volume, low-cost charging infrastructure for EVs.

The design was finalized through consultations with stakeholder in the automotive, electrical & electronics, power distribution companies and regulatory testing



agencies to arrive at specifications of the Charge Point Device. Three subgroups were formed: (a) Charge Point Device (b) Electronics and (c) Metering. The project for Validation/ Demonstration led by ARAI was supported with funds by DST, to implement 150 prototypes through four manufacturers (Exicom, Masstech & Bharat Electronics Ltd & Havells). The TCS volunteered and developed a demo Mobile App.

The standard was approved in July 2021 & is under printing. The Delhi Govt has included this Indian Standard in their recent tender for 30,000 charge points for Light EV.

## 2.3 Light EV Removable Battery Packs

### Specifications being finalized

The goal is to enable interoperability, so that the user may utilize any vehicle/ any battery/ any swapping station. Safety & affordability are high priority. Standardisation of battery pack dimensions & weight, connectors & communication are necessary, along with uniform user-interfaces & communications. A Technical Jury chaired by Secretary DST met three times (1st July, 12 July & 14 Aug. 2021).

- The Jury reviewed specific inputs received from the stakeholders (Vehicle OEMs, battery manufacturers/ suppliers and R&D labs) on
  - Battery pack dimensions & energy content for various cells & battery chemistries
  - Connector configurations
  - Communication for interoperability.
- It was decided that separate battery pack standards will be needed for
  - two-wheeled EV &
  - 3-wheeled EV/ eQuadricycles.
- The candidate connector designs were shortlisted & a subgroup was requested to examine the specifications to select the best option.

## 2.4 eBus High Power Charging Systems

The stakeholders consulted include manufacturers of eBuses, Charging stations, Discoms, Transit authorities, Telecom providers, and Regulatory agencies. Three new systems for Interoperable eBus Charging Infrastructure are being developed by the "Group":

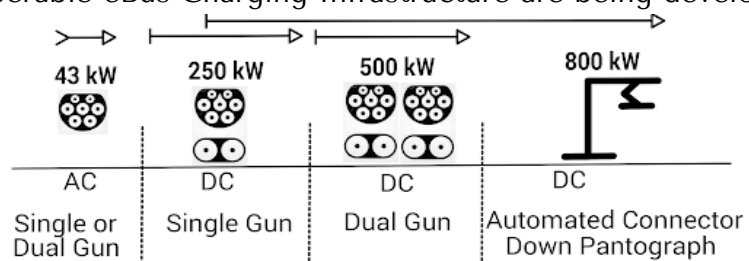

### (A) Dual Gun DC Charging System

#### Draft Standards under preparation

The current requirement for eBus can be met by the published standards for DC Charging Station can provide up to 250 kW power. However, fast charging ~500 kW will be required in future. Liquid cooled cables are costly, and standardization is yet to be done. Indian Standards for Dual Gun Charging is proposed (Planned). CCS is preferred to ensure interoperability.

### (B) Automated Pantograph

#### Draft Standards under preparation

Infrastructure-mounted Panto Down preferred based on qualitative and commercial comparison: Deployment, System performance, Reliability, Maintenance, Safety and Market presence

Indian Standards on ACD charging are being formulated with SAE J 3105 as base standard. The standard is under review for updation/ modification for Indian specific requirements such as environmental conditions; rail positioning; roof orientation and related Safety provisions. The committee noted the challenges on account of rail positioning and orientation due to non-fixed front vehicle door location and limited packing space on vehicle roof.

### (C) eBus Removable Battery Pack

#### Specifications being finalized

eBus Battery Swap standards to facilitate mass adoption, by reducing the Procurement Cost, Range anxiety & Charging time. Two sets of standards are planned.

- General Guidelines; Safety Requirements and Communication /protocol from the Battery Pack to the EV and to the Swap-cum-Charging Station.
- Standards for Battery Connection System; Swappable Battery/enclosure; and Standards Operating Procedures

## 3 EV Infrastructure Categories

### 3.1 MoP/ CEA Classification

#### 3.2 Classification by Power Classes

### 3.1 MoP/ CEA Classification

The MoP classification (2018) only recognized two categories: Home Charging and Charging Stations. It was based on the size of these power conversion devices and their location viz., AC charger inside the EV & DC charger outside the EV, on the kerb side. The equipment specified in the MoP Guidelines are meant for cars. The requirements of Light EV charging and eBus High Power Charging can't be adequately met by these charging devices.

- AC 3-phase supply using Type-2 socket (Slow Charger)
- DC Fast Charging Systems
  - CCS & Chademo for DC charging of High Voltage cars (> 350 volts and above)

The terms **Chademo** & **CCS** were used in place of the International Standards System-A and System-C. The implications were not foreseen. Manufacturers now refer only to the Chademo or CharIn standards & not International Standards. It must be mandated now to follow the Indian Standards for these equipment.

- Bharat DC charger for low voltage cars (of 48V & 72V battery packs).

The System-B (GBT) was modified as the **Bharat Charger** specifications for the initial EV car models like E2O (48V system) & Verito (72 V system). Among the three DC Charging Systems, the System-B connection could carry the maximum current, and was chosen for Bharat Charger. This option has less relevance now, since EV cars are designed as high voltage systems now.

### 3.2 Classification by Power Classes

A good basic classification can be seen in the EU Directive (2014) which recognized two categories (for EV Car Charging) viz., Normal Power Recharging Points and High Power Recharging Points. The EV Infrastructure can be classified based on the Power levels required to be accessed from the Electricity Grid.

Over the next decade a huge transition is expected to light electric vehicles (LEVs), comprising two-wheelers (scooters, motorcycles) and three-wheelers (passenger and cargo). The demand for EV cars and light commercial vehicles (LCVs) depend on many factors, whereas the fleet of Electric buses will significantly large in India.

The power required to charge the EV depend on the specifications of EV batteries, as power must be supplied to the battery at the right voltage and current levels to permit charging. Similarly, the EVSEs have different power ratings or levels based on charging

requirements, which in turn determine the input power requirements for charging infrastructure.

#### (A) Distributed/ Normal Power Charge Points:

EV can be charged where it is parked using comparatively lower cost devices.

Single-phase AC chargers, with a maximum power rating of 7kW, are adequate for LEVs and cars with single phase on-board chargers. Three-phase AC chargers, with a power rating up to 22kW, are required for e-cars with larger on-board chargers. Input power supply for normal power charging can be provided from the standard electricity distribution network.

- Normal power AC charging is adequate for e-2Ws, e-3Ws and e-cars.
- Normal power DC charging is unique to India, due to the prevalence of LEVs, and the use of low-voltage batteries in e-cars.

MoHUA Guidelines (see para 1.1.B) require Charge Points to be provided in parking areas. This distributed network of EV charge points at residences, apartment buildings, office campuses, shopping malls, metro and railway stations, bus depots, etc. has many advantages, ranging from ease of access to financial viability. This will assist the small entrepreneurs and meet many of the Policy Objective (see para 1.1).

Infrastructure Power Class	EV Supply Equipment		Minimum Input	Power Output	EV to Supply Equipment Communication
(A) Light EV <120V battery	1	AC Light EV	Single Phase Connection	Normal Power ~7 kW	IS-17017-22-1 Bluetooth
	2	DC Light EV			IS-17017-25 [CAN]
(B) Cars, SUV <500V battery	3	AC Parkbay	3 Phase Connection	Normal Power ~11kW/ 22 kW	IS-15118 [PLC]
	4	DC Parkbay			IS-17017-24 [CAN] & IS-15118 PLC

Four types of EVSEs (table above) will be permitted to utilise a removable cable having charger socket/ plug and vehicle inlet/ connector to enable reparability and accessibility (to different charging systems).

Specific advantages of Distributed Charging Infrastructure are:

- It will utilise regular supply connections and available parking area. However, the access to power has to be ensured in the parking areas.
- Smart Charging is possible as EV will be plugged in for longer periods in car park. When implemented on large scale, this can help to delay the upgradation of the Electricity Distribution grid.
- A technology project is planned to implement an advanced Parkbay EV Charging System which will be agnostic to the CCS & Chademo, and be able to charge any EV that will arrive at the Parking area.

**(B) High Power Charging Stations:**

High Power DC Charging with cable fixed permanently to the Charger, and capable of carrying digital communications. EVSE Power Classes C & D will require the installation of a dedication transformer.

Infrastructure Power Class	EV Supply Equipment		Power Output	EV to Supply Equipment Communication
(C) All EV (except Light EV)	5	DC Charging Station	DC 50 kW to 250 kW	IS-17017-24 [CAN] & IS-15118 [PLC]
(D) eBus <1000V battery	6	Dual Gun Charger	DC High Power 250 kW --> 500 kW	IS-15118 [PLC]
	7	Automated Pantograph Charger		

**DC Charging Station**

For high-voltage e-cars with battery capacities between 30-80kWh, high-power DC charging of 50kW is used. The power level of DC chargers in the market ranges between 25kW and 60kW. However higher- powered DC chargers will be available in the near future.

Large charging stations are expensive to install. A dedicated transformer has to be installed since they may cause grid impact due to the intermittent withdrawal at high power, high cost of parking space at busy urban locations, and many overhead expenditures are also involved. So the charging stations have high gestation periods for financial returns, and will need Government support & supervision in the initial stages.

**Ebus Charging Stations**

Electric Buses is high priority program under the Transformative Mobility Program.

**Dual Socket DC Fast Charging of eBus**

The concept of Dual Socket Charging is indigenous developed in India to cater to the high Power Class that may soon emerge for Commercial Heavy Electric Vehicles with large battery packs requiring a very high power delivery for its Fast Charging.

Each Gun/ Socket arrangement shall function as per the requirements specified in IS 17017-23 and IS 17017 Part-24. This set-up shall overcome the limitation of the commercially available charging connection couplers which can only carry power upto 200 kW. With the use of two Socket arrangement, the double the power can be delivered for the same amount of time. This is being developed as a highly interoperable solutions.

**Automated Connection Device based DC Fast Charging Standard**

The SAE J3105 standards will be the base reference for developing the Indian ACD charging standards.

## 4 EV Charging Systems

4.1	Charging methods	14
4.2	Modes of connecting EV to Charger	16
4.3	Grid Supportive EV Infrastructure	16

### 4.1 Charging methods

$$\text{Charging Time (h)} = \frac{\text{Battery capacity (kWh)}}{\text{Charging power (kW)}}$$

The BMS determines the amount of Charging Power that can be accepted by the Battery

#### (A) Basic Communication (Analog Signal)

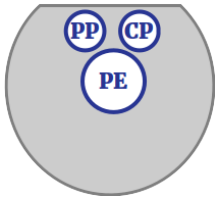

Basic signalling (BS) is used for safety-related functions, indicating for example if the connector is plugged in, before contacts are made live (or energized) and if both charging station and electric vehicle are ready for charging. Communication takes place over the signalling pins **Proximity Pilot (PP)** & **Control Pilot (CP)** between the charger, cable, and vehicle to ensure that the highest common denominator of voltage and current is selected.

Proximity Pilot (PP) = "Plug Present" provides a signal to the vehicle's control system so it can prevent movement while connected to the EVSE, and signals the latch release button to the vehicle.

Control Pilot (CP) line is used to signal charging level between the EV & EVSE, and can be manipulated by vehicle to initiate charging as well as other information. The signal is generated by the EVSE to detect the presence of the vehicle, communicate the maximum allowable charging current, and control charging begin/end.

Protective earth (PE) / full-current protective earthing system: The live wires of public charging stations are always dead if the CP-PE (Protective Earth) circuit is open

#### (B) AC EV supply equipment

AC Charge Points can supply up to 22 kW power. The EV has an onboard charger to feed DC power to the Battery. AC Slow Charging means a small onboard charger & AC Fast Charging requires a big onboard charger. AC EVSE use analog communications between Charger & EV, to ensure safety, handshake to start the charging & method to close the charging connection after charging.

#### (C) DC EV supply equipment

DC Charge Points convert the power from AC to DC before it enters the vehicle. After conversion, the power goes directly into the car battery. DC power can be utilized to fast charge any vehicle. DC Chargers use analog communications for the handshake and then makes a data connection through one of the following

methods: Controller Area Network (CAN), Power Line Communications (PLC) or Wireless Communications. The data communication enables functions like:

- Safety Interlock to avoid energizing the connector before it is safe,
- Transmit battery parameters to the charging station like the target voltage, total battery capacity, and when to stop charging (top battery percentage, usually 80%),
- Vary the power flow during charging, as requested by the BMS.

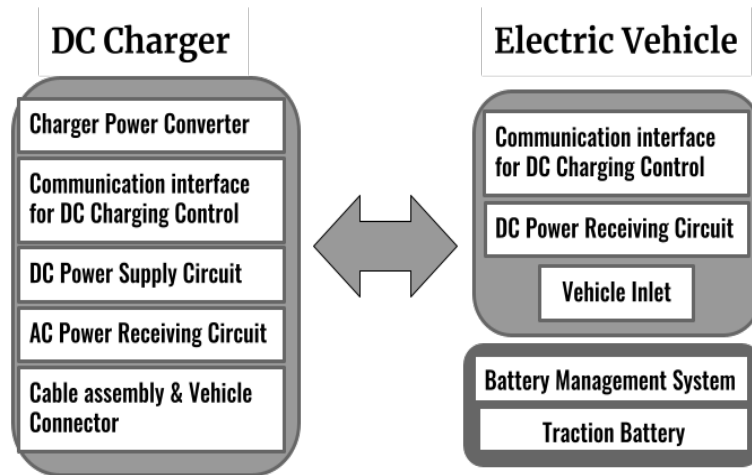

*Same Communication pins can be used for Data/ Digital Communications in PLC/ CCS System*

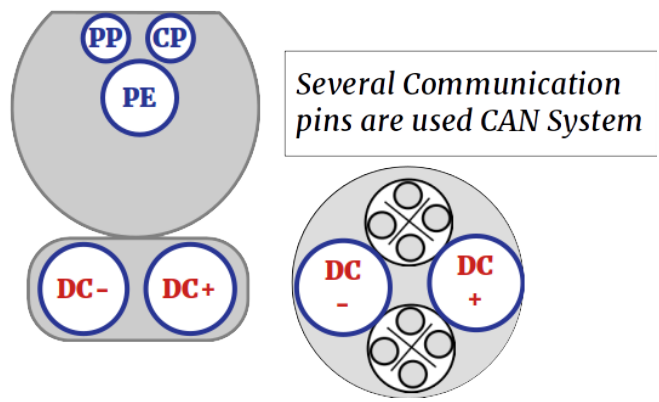

## 4.2 Modes of connecting EV to Charger

The connection modes are specified based on the protection levels required in the various use cases. The accessories consist of the following:

- Specific Vehicle Connectors/Vehicle Inlets for each Charging System.
- For Normal Power Supply, the cable may be connected using Plugs & Socket to the
- For High Power Supply, the cable is permanently fixed to the charger

### **Modes 1 & 2: Normal Power/ Distributed Charge Point**

- Mode 1 is a simple cable with no control circuit. It is permitted only in Category-1 Light EV AC Charge Point since the communication is established through bluetooth wireless.
- Mode 2 has limited protection arrangement, usually a control box embedded in the cable itself. The cable is connected to the charger by means of a socket and plug.

### **Mode 3: Normal Power/ Distributed Charge Point**

The Distributed Charge Points (Normal Power) are specified with control & protection functions provided in the "Wall-box Charge Point" and a removable cable is connected to it by means of a socket and plug. EVSE Power Class -1 (upto 7 kW ~ single phase connection) & EVSE Power Class -2 (upto 22 kW ~ 3 phase connection)



### **Mode 4: High Power DC Charging Station**

High Power Charging Stations are specified with control & protection functions provided in the Charging Station, and the cable is fixed permanently to it (& cannot be removed by the user).

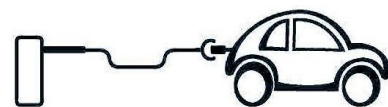

- EVSE Power Class -3 (dedication transformer; 50 kW to 250 kW DC output)
- EVSE Power Class -4 (dedication transformer; upto 500 kW DC output). This category includes the Dual Gun Charger and the Automated Connection Devices

## 4.3 Grid Supportive EV Infrastructure

### (A) OCPP

Open Charge Point Protocol (OCPP) is an application protocol for communication between EV charging stations and a central management system. Its aim is to allow EV charging stations and central management systems from different vendors to communicate with each other.

An associated service is "roaming" where the customers can charge at any station with just one customer account.



### (B) Smart Charging

When the EVSE is enabled for Digital Communications, then it is possible to control the rate of charging externally by the Discom or the network operator. The two "smart" services that can be possible by using the data connection are:

- Network authentication process to link the EV driver, charging point & charging event, to enable automatic money transaction.
- The station owner can monitor, manage, and restrict the use of their devices remotely to optimize energy consumption. So the charging event will be subject to settings and prices set by the station owner.
- Assist in the management of load/ demand in the grid. A time of day differential tariff that can help shift consumer behaviour and avoid charging events when there is stress on the Grid. Such services to the grid but without actual electrical flow from the vehicles to the grid is called unidirectional V2G

### (C) V2G/ Bidirectional Charging

Bidirectional Vehicle-to-grid (V2G) system allows EV to communicate with the power grid to sell demand response services by either returning electricity to the grid or by throttling their charging rate.

- V2G storage capabilities can enable EVs to store and discharge electricity generated from renewable energy sources such as solar and wind, with output that fluctuates depending on weather and time of day.
- V2G vehicles can assist in Peak load leveling in the distribution grid.
  - The EV can provide power to help balance loads by "valley filling" (charging at night when demand is low) and "peak shaving" (sending power back to the grid when demand is high, see duck curve).
  - Peak load leveling can enable utilities to maintain stable voltage and frequency and provide spinning reserves to meet sudden demands for power.
  - These services operate through "smart-meters".

## 5 Indian Standards for EV Infrastructure

5.1	General Requirements	18
5.2	Distributed Charge Points	19
	Light EV Infrastructure	
	Parkbay Charging of cars	
5.3	High Power Charging Stations	22
	DC Fast Charging Station	
	eBus Charging Station	
5.4	Removable Battery Packs	25
	Light EV Battery Swap	
	eBus Battery Swap	

### 5.1 General Requirements

The EVSE accesses power from the local electricity supply and utilizes a control system and wired connection to safely charge EVs. An EVSE control system enables various functions such as user authentication, authorization for charging, information recording and exchange for network management, and data privacy and security. Requirements of EVSE for conductive charging depend on factors such as vehicle type, battery capacity, charging methods, and power ratings.

#### (A) General requirements for Charging Systems

##### **Indian Standard Published**

##### IS-17017 Part-1:2018

The basic standard for EV Supply Equipment (EVSE) for charging of EV, with a rated supply voltage up to 1000 V a.c./ 1500 V d.c. and a rated output voltage up to 1000 V a.c./ 1500 V d.c. The standard covers: characteristics & operating conditions; specification of the connection between the EVSE and the EV; and requirements for electrical safety

##### Basic Communication

Key steps in the charging control process, such as start of charging and normal/emergency shutdown, shall be managed through the basic communication with signal exchange via the control pilot lines in d.c. EV charging system. These include the process before the start of charging (initialization); during charging (energy transfer); & of shutdown (shutdown).

##### Pilot functions by EVSE Control System

- Continuous continuity checking of the protective conductor
- Verification that the EV is properly connected to the EV supply equipment
- Energization of the power supply to the EV
- De-energization of the power supply to the EV
- Maximum allowable current

**(B) General requirements for Connectors****Indian Standard Published**IS-17017 Part-2 Section-1:2020

It specifies dedicated plugs, socket outlets, vehicle connectors and vehicle inlets and covers the mechanical, electrical and performance requirements. The accessories provide control means, is rated for operating voltage up to: AC 690V @ rated current not exceeding 250 A; and DC 1500V @ rated current not exceeding 200A.

**(C) IS-17017 Part-21: EMI/ EMC****Indian Standards Published**IS-17017 Part-21 Section-1 (Onboard)

This document covers the electromagnetic compatibility (EMC) requirements for on-board charging units on the EV, and together with IS-17017-1, gives requirements for conductive connection of an electric vehicle (EV) to an AC or DC supply.

IS-17017 Part-21 Section-2 (Offboard)

This document covers off-board charging equipment for mode 1, mode 2, mode 3 and mode 4 charging. It defines the EMC requirements for any off-board components or equipment used to charge EV by conductive power transfer (CPT), with a rated input voltage up to 1000 V AC or 1500 V DC and an output voltage up to 1000 V AC or 1500 V DC.

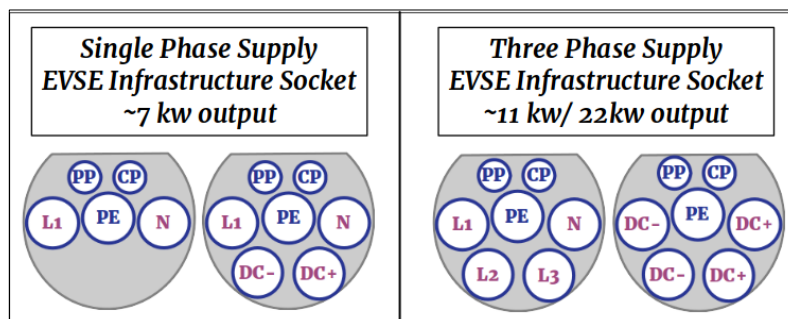
**5.2 Distributed Charge Points****5.2.1 Light EV Infrastructure**

Light EV has battery pack with voltage less than 120V, and a normal power connection upto 7 kW is adequate to charge them.

Normal Power EVSE ~7 kW			Charging Device	EV-EVSE Communication	Socket/ Connector
1	AC Light EV	~7 kW	IS-17017-22-1	Bluetooth Low Energy	IS-60309/ --
2	DC Light EV		IS-17017-25 [CAN]	IS-17017-25 [CAN]	Hardwired/ IS-17017-2-6

#### (A) Light EV AC Charge Point

##### **Indian Standard Under Printing**

###### IS-17017 Part-22 Section-1

This standard is applicable to a basic conductive AC charging option for charging light electric road vehicles with rated supply voltage 240 V a.c. and current up to 16A a.c. It covers requirements of functionality, environmental aspects, energy measurement, mechanical and electrical safety considerations. It also describes communication provisions.

Light Electric Vehicle AC Charge Point is proposed to cater the charging needs of mainly electric powered two or three wheelers and Quadricycles (hereafter LEVs). It is envisaged that the portable charge point can be easily installed at small shops, residential parking places, parking areas of commercial complexes, etc .

#### (B) Light EV DC Charge Point

##### **Indian Standard Under Printing**

###### IS-17017 Part-25

DC EV supply equipment where protection relies on electrical separation.

It provides the requirements for the control and the communication between DC EV supply equipment for a Light EV to supply up to 120 V DC and current up to 100 A DC. The standard covers: characteristics & operating conditions; specification of connection between the DC Charger & EV; and requirements for electrical safety

#### (C) Light EV DC Vehicle Connector/ Inlet

##### **Indian Standard Under Printing**

###### IS-17017 Part-2 Section-6

Dimensional compatibility requirements for DC pin and contact tube vehicle couplers intended to be used for DC EV supply equipment where protection relies on electrical separation

For EV charging systems with control means & rated operating voltage up to 120 V DC and rated current up to 100 A.

## 5.2.2 Parkbay Charging of cars

Destination Charging, where the EV is charged in the parking itself

Normal Power ~11kW/ 22 kW	Device/ Protocol	EV-EVSE Communications	Infrastructure Socket	Vehicle Connector
3 AC Parkbay (Destination Charger)	IS-17017-1 {Published: 2018}	IS-15118 [PLC] for Smart Charging {Published: 2019}	IS-17017-2-2 {Published: 2020}	IS-17017-2-2 {Published: 2020}
4 DC Parkbay (Destination Charger)	IS-17017-23 {Under Printing: 2021}	IS-17017-24 [CAN] {Under Printing: 2021}  IS-15118 [PLC] {Published: 2019}	IS-17017-22-2 Parkbay/ (Planned)	IS-17017-2-3 {Published: 2020}

### (A) Parkbay AC Charge Point

#### **Indian Standard Published**

#### IS-17017 Part-2 Section-2:2020

Dimensional compatibility and interchangeability requirements for a.c. pin and contact-tube accessories. It covers the basic interface accessories for vehicle supply, which may be used for bidirectional power transfer.

- Nominal rated operating voltage not exceeding 415 V a.c., 50 Hz and a rated current not exceeding 63 A three-phase or 70 A single phase.
- Vehicle Inlet & Vehicle Connector for charging in modes 1, 2 and 3, cases B and C.
- Socket-Outlets & Plugs for charging mode 3 only, case A and B.

**AC Fast Charger:** New power electronics devices are small & powerful, and large capacity on-board charger can be fitted in the EV. Some Renault cars carry 22 kW onboard charger, Tesla Cars have 17 kW charger. Globally the norm is 11 kW onboard charger. BYD eBuses carry two 40 kW onboard chargers. The infrastructure costs are reduced significantly, while the EV cost may go up slightly.

### (B) Parkbay DC Charge Point

#### **Specifications to be prepared**

#### IS-17017-22-2 (Planned) Normal Power DC EVSE

Small DC EVSE can be utilized as destination chargers, which can be an effective and low cost solution that is easy to be rolled out across the country. Currently the Government is encouraging the development of standards and prototypes for small DC EVSE that can convert the power available from single and three phase normal power, so that these low cost units can be used in the parking area itself.

IEC 62196-2 specification permits both the charging with alternating current and direct current. Tesla is the only automaker which offers Combined Connector (AC + DC) using Type-2.

The IEC Standards have listed the Type-2 Combined Connector as a "future option", and hence no other manufacturer has implemented this option. Indian Standards will implement this option, along with a removable cable for Normal Power/ Distributed Charge Point, in order to provide an economical, repairable option and also to accommodate various charging systems (AC, DC, Combined). An agnostic approach of allowing any EV to charge from the Distributed Charge Point is a consumer right/ basic principle to be implemented. A car park locked only to "CCS" or "Chademo" is not advisable for economic reasons.

### 5.3 High Power Charging Stations

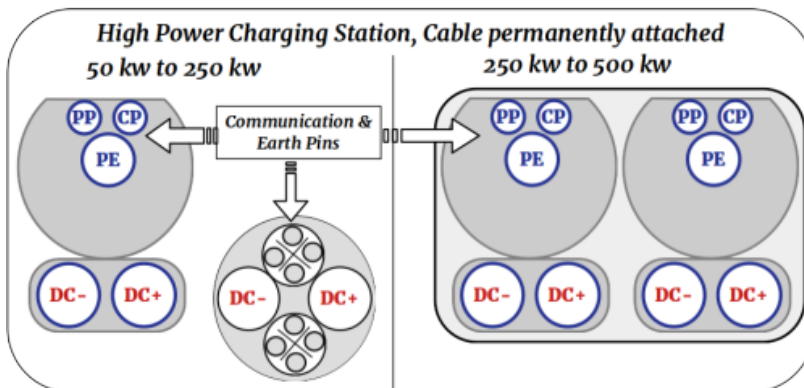

Ebus Pantograph uses WiFi Communications



#### 5.3.1 DC Fast Charging Station

##### Indian Standard Under Printing

##### IS-17017 Part-23

DC EVSE that supply power between 50 kW to 250 kW DC output are usually called a charging station. These commercial charging stations will have a few charge points to enable fast charging of cars, in less than an hour. This requires larger supply from the grid, a local dedicated distribution transformer, accessories and establishment costs leading to an expensive solution.

High Power EVSE		Charging Device	EV-EVSE Communication	Connector
5	DC Charging Station	DC 50 kW to 250 kW	IS-17017-24 [CAN] IS-15118 [PLC]	IS-17017-2-3

The charging process is managed by the vehicle and the DC EV charging stations allow the vehicles to control the charging parameters.

Digital communication is used to exchange the control parameters using either

- Controller Area Network (CAN) over dedicated digital communication circuit for Systems A (Chademo), &
- Power Line Communication (PLC) over control pilot circuit for System C (CCS)

#### (A) Digital Communications - CAN

##### **Indian Standard Under Printing**

###### IS-17017 Part-24

This standard applies to digital communication between a DC EV supply equipment and an electric road vehicle (EV) for control of conductive DC power transfer, with a rated supply voltage up to 1 000 V AC or up to 1 500 V DC and a rated output voltage up to 1 500 V DC.

Digital communication can be based on CAN using a dedicated data communication circuit; or based on Homeplug Green PHY™1 over the control pilot line.

The charging control process use the following signals and information to synchronize control process between d.c. EV charging station and the vehicle

- signals through the pilot wire circuit;
- parameters through the digital communication circuit;
- measurement values such as voltage and current level of the d.c. charging circuit.

#### (B) Digital Communications IS-15118 [PLC] Series

##### **Indian Standards Published**

###### ISO 15118 Road vehicles -- Vehicle to grid communication interface

It defines communication interface for bi-directional charging/ discharging of EV, and can be used for both wired (AC and DC charging) and wireless charging for electric vehicles.

It also provides the Plug & Charge feature that enables an EV to automatically identify & authorize itself to a charging station on behalf of the driver, to receive energy for recharging its battery. The only action required by the driver is to plug the charging cable into the EV and/or charging station.

ISO 15118-1: General information and use-case definition

ISO 15118-2: Network and application protocol requirements

ISO 15118-3: Physical and data link layer requirements

ISO 15118-4: Network and application protocol conformance test

ISO 15118-5: Physical and data link layer conformance test

ISO 15118-8: Physical layer and data link layer requirements for wireless communication

ISO 15118-20: 2nd generation network and application protocol requirements

### (C) High Power DC Connector (IS 62196-3)

#### Indian Standard Published

IS-17017 Part-2 Section-3:2020

Dimensional compatibility and interchangeability requirements for d.c. and a.c./d.c. pin and contact-tube vehicle couplers

Specific connectors have been defined for Systems A (Chademo) & System C (CCS) methods of DC Charging. These vehicle connectors will be used both in the Parkbay DC Charge Points and in the High Power DC Charging Stations.

### 5.3.2 eBus Charging Station

DC High Power 250 kW → 500 kW.

High Power EVSE		Charging Device	EV-EVSE Communication	Connector
6	Dual Gun Charger	DC High Power 250 kW --> 500 kW	IS-17017-23-2	IS-15118 [PLC]
7	Automated Pantograph Charger			

#### (A) Dual Gun (eBus Charger)

#### Drafts under Preparation

IS-17017-23-2

In order to provide the high power levels required for eBus Charging in future, the method of Dual Socket/ Dual Gun Charging is being standardized. Since interoperability is the key objective, CCS standard has been recommended for mass adoption in India. India specific requirements such as operating temperature; Ingress Protection; Max Current (per gun); Max Voltage (per gun) and max Altitude to bring in economic advantage for majority of eBus population has been worked out and finalized.



## (B) Automated Pantograph (eBus Charger) | DC High Power 250 kW → 500 kW.

### Drafts under Preparation

#### IS-17017-3-1

It specifies the Electrical Interface; Power Flow (Voltage and Currents); Communications and Safety Systems. The Control Pilot will be used for communications once the vehicle is connected to the infrastructure. Wireless communications will be used to pair the vehicle with the charger- IEEE 802.11n. Testing requirements are defined

#### IS-17017-3-2

Describes the connection arrangement and the parts including connection locations, bus geometry, and alignment.

---

## 5.4 Removable Battery Packs

Separate standards projects have been initiated for battery swapping for light electric vehicles and for buses. They will be two separate series of standard documents, covering the specific form factor of the battery pack, the interoperable connection systems, the communication necessary for BMS to communicate with the EV and also with the Charging Station, and a network management system standard, since any EV may utilize any battery pack conforming to these standards. The removable battery packs may be charged using the AC or DC Charging Systems that have already been discussed above.

### 5.4.1 Light EV Battery Swap

#### **Draft Indian Standard prepared**

- Light EV Battery Swap Communication Interface.

Draft Indian Standard has been circulated among the ETD51 membership. This has been accepted by the ETD membership. Now document being prepared as per BIS format for wide circulation

#### **Specifications to be developed**

- General provisions for LEV battery swap system; including Dimension of the battery pack
- Connector for Removable Light EV Battery Pack

#### 5.4.2 eBus Battery Swap

##### **Draft from IEC for adoption**

- General guidelines: Swapping station, Supporting systems, Power supply systems, Monitoring systems, Constructional requirements including holding structures and Automated Swapping mechanism
- Safety requirements: Protective methods for the entire swapping system

##### **Draft Specifications available; To write draft Standard**

- Communication: Battery to the station and vehicle, for control of the onboard battery; and for data exchange with the EV Infrastructure Network

##### **Specifications to be developed**

- Battery Connection System
- Swappable battery/ enclosure: Dimensions of the pack & standard placement within bus.
- Standard Operating Procedures (SOP)