

# National School Transportation Specifications & Procedures

---



**May 2010**

Adopted by the Fifteenth National Congress on School Transportation

# **NATIONAL SCHOOL TRANSPORTATION SPECIFICATIONS and PROCEDURES**

**2010 Revised Edition**

**Adopted by:**

**THE FIFTEENTH NATIONAL CONGRESS ON  
SCHOOL TRANSPORTATION**

**University of Central Missouri  
Warrensburg, Missouri  
May 16-20, 2010**

**Co-Sponsored by:**

**National Association of State Directors of Pupil Transportation Services  
National Association for Pupil Transportation  
National School Transportation Association  
School Transportation Section, National Safety Council  
School Bus Manufacturers Technical Council  
Missouri Safety Center, University of Central Missouri**

**This publication is available from:**

**Missouri Safety Center  
University of Central Missouri  
Humphreys Suite 201  
Warrensburg, MO 64093  
Phone: (660) 543-4830  
Fax: (660) 543-4482**



# CONTENTS

Foreword.....	1
About this Document and Guiding Principles.....	5
Intended Use.....	6
Interpretations and Information; Interim Committee.....	8
Chronicling Innovations in School Transportation.....	9
School Bus Types.....	15
Bus Body and Chassis Specifications.....	17
Air Cleaner.....	19
Aisle.....	19
Axles.....	19
Back-up Warning Alarm.....	19
Brakes: General.....	19
Brakes: Hydraulic.....	20
Brakes: Air.....	20
Bumper: Front.....	21
Bumper: Rear.....	21
Certification.....	22
Clutch.....	22
Color.....	22
Communications Systems.....	22
Construction.....	23
Crossing Control Arm (Optional).....	23
Defrosters.....	24
Doors.....	24
Drive Shaft.....	25
Electrical System.....	25
Emergency Equipment.....	29
Emergency Exits.....	30
Exhaust System.....	32
Fenders: Front.....	33
Fire Suppression Systems (Optional).....	33
Floors.....	33
Frame.....	34
Fuel System.....	34
Governor.....	35
Handrails.....	35

Heating and Air Conditioning Systems .....	35
Hinges .....	39
Horn .....	39
Identification .....	39
Inside Height .....	40
Instruments and Instrument Panel .....	41
Insulation (Optional) .....	42
Interior .....	42
Lamps and Signals .....	43
Metal Treatment .....	45
Mirrors .....	46
Mounting .....	46
Oil Filter .....	46
Openings .....	46
Overall Length .....	47
Overall Width .....	47
Passenger Load .....	47
Public Address System .....	47
Retarder System (Optional Equipment) .....	47
Retroreflective Material .....	47
Road Speed Control .....	48
Rub Rails .....	48
Seats and Restraining Barriers .....	49
Shock Absorbers .....	51
Side Skirts .....	51
Steering Gear .....	51
Steps .....	51
Step Treads .....	52
Stirrup Steps .....	52
Stop Signal Arm .....	53
Storage Compartment (Optional) .....	53
Sun Shield .....	53
Suspension Systems .....	53
Throttle .....	53
Tires and Rims .....	53
Towing Attachment Points .....	54
Traction Assisting Devices (Optional) .....	54
Transmission .....	55
Trash Container and Holding Device (Optional) .....	55
Turning Radius .....	55
Undercoating .....	56
Ventilation .....	56
Wheelhousing .....	56
Windows .....	57
Windshield Washers .....	57
Windshield Wipers .....	57

<b>Specially Equipped School Bus Specifications</b> .....	59
Introduction.....	61
Definition .....	61
General Requirements.....	62
Aisles.....	62
Glazing.....	62
Identification .....	62
Passenger Capacity Rating.....	62
Power Lifts.....	62
Ramps .....	65
Regular Service Entrance.....	65
Restraining Devices .....	66
Seating Arrangements.....	66
Securement and Restraint System for Wheelchairs and Wheelchair-seated Occupants....	66
Special Light .....	67
Special Service Entrance.....	68
Special Service Entrance Doors.....	68
Support Equipment and Accessories .....	69
Technology and Equipment, New.....	70
 <b>School Bus Inspection</b> .....	 71
State Inspection Program .....	73
Inspection Procedure.....	73
Out-of-Service Criteria .....	73
Recommended School Bus Out-of-Service Criteria .....	74
Recommended School Bus Inspection Procedures.....	85
 <b>Alternative Fuels</b> .....	 105
Introduction.....	107
General Requirements.....	107
Characteristics of Alternative Fuels.....	109
 <b>Operations</b> .....	 123
Introduction.....	125
School Travel Choices .....	125
School Bus Use.....	125
State Administration .....	126
Local School District Administration .....	129
 Responsibilities .....	 134
Driver .....	134
Parent/Guardian .....	139
Student .....	139

Operational Procedures.....	141
Selection and Training of Bus Drivers.....	164
Selection and Training of Bus Attendants .....	168
Staffing and Training of Maintenance and Service Personnel.....	170
Routing and Scheduling.....	171
Maintenance of Equipment.....	176
Emergency and Rescue Procedures .....	178
Evaluation of the Student Transportation System .....	180
School Site Selection and Facility Planning .....	182
No Child Left Behind (NCLB) .....	183
McKinney-Vento Homeless Assistance Act.....	186
Activity Bus Operations: Transportation Other Than to and From School or Head Start.....	189
School Transportation Security and Emergency Preparedness .....	197
Transportation for Students with Disabilities and Special Health Care Needs .....	213
Laws Affecting Transportation for Students with Disabilities .....	215
Individualized Education Program (IEP) - Individualized Family Service Plan (IFSP) Process .....	217
Guidelines .....	218
Confidentiality .....	228
Development.....	229
Emergency Evacuation of Students with Disabilities.....	230
Extended School Year.....	230
Transportation for Infants, Toddlers, and Preschool Children .....	233
Introduction.....	235
Transportation Services for Infants and Toddlers with Disabilities .....	236
Transportation Services for Preschool Children with Disabilities.....	236
Head Start.....	238
Guidelines for Infants, Toddlers and Pre-School Children.....	238

## APPENDICES

Appendix A – Terms and Definitions .....	259
Introduction .....	261
Terms and Definitions .....	261
Appendix B – School Bus Chassis and Body .....	289
National School Bus Yellow .....	291
Bus Body Heating System Test .....	291
Placement of Retroreflective Markings and White Roof .....	301
Placement of Retroreflective Markings (front and back view) .....	302
Noise Test Procedure .....	303
Retroreflective Sheeting Daytime Color Specification .....	304
School Bus Seat Upholstery Fire Block Test .....	304
Appendix C – Alternative Fuels .....	309
Bibliography .....	311
Glossary of Alternative Fuels .....	312
Alternative Fuels Comparison Chart .....	315
Appendix D – School Bus Operations .....	317
Highway Safety Program Guideline #17 .....	319
School Bus Driver Application .....	326
Actions to be Taken During and Following the Observations of School Bus Routes .....	328
Guidelines for En Route Emergency Bus Evacuation Procedures .....	329
Sample Crash Reporting Form .....	332
Identification and Evaluation of School Bus Route and Hazard Marking Systems .....	347
Planning School Sites for School Bus Safety .....	361
Policies and Procedures for Student Management .....	366
How to Cross the Road Safely (When Boarding the Bus) .....	369
How to Cross the Road Safely (When Leaving the Bus) .....	370
Recommended Procedures for Escorted Crossing .....	371
Recommended Procedures for School Bus Drivers at Railroad Grade Crossings .....	373
Instructions for Conducting Emergency Exit Drills .....	375
School Bus Danger Zone .....	379
Sample Job Descriptions and Hiring New Employees .....	380



Appendix E – Transportation for Students with Disabilities and Special Health Care Needs .....	399
Special Education Department Forms .....	401
Consent for Disclosure of Medical Information and Records .....	401
Request for Medical Verification of Health Status and Needs .....	402
Medical Procedure Authorization .....	404
Student Transportation Card – Students with Disabilities .....	405
Transportation Service Requirements for Passengers with Health Concerns.....	408
Transportation Checklist.....	412
Transporting Oxygen in School Buses .....	414
Procedure for Lifting Passengers .....	415
Characteristics of Disabilities as Defined by IDEA .....	417
Sample Continuum of Transportation Services for Students with Disabilities .....	420
IDEA-Part B Final Regulations – Discipline Procedures .....	421
Resources .....	423
Appendix F – Transportation for Infants, Toddlers and Pre-School Children .....	443
Definitions: Infants, Toddlers and Pre-school Children .....	445
Laws: Transportation of Infants, Toddlers and Pre-school Children.....	445
Definitions: Infants and Toddlers under the Individuals with Disabilities Education Act....	450
Appendix G – Activity Bus Operations .....	457
Operational Guidelines .....	459
Activity Bus Use for School Activity Trips.....	467
Evacuation Procedures for Activity Trips and Field Trips .....	475
Sample Trip Request Form .....	476
Appendix H – School Transportation Security and Emergency Preparedness .....	477
School Transportation Best Practices for Emergency Management Planning .....	479
(Transportation Safety Administration) Security Assessment and Plan Checklist.....	487
Committees .....	493
Roster of Delegates and Alternates.....	499
Roster of Attendance.....	507
University of Central Missouri ~ Missouri Safety Center Staff .....	531

## FOREWORD

The 2010 National Congress on School Transportation was the latest in a series beginning in 1939 and continuing in 1945, 1948, 1951, 1954, 1959, 1964, 1970, 1980, 1985, 1990, 1995, 2000, and 2005. All congresses (referred to as “conferences” before 2005) have been made up of official representatives of state departments of education, public safety, motor vehicles, and police or other state agencies having state-wide responsibilities for the administration of student transportation; local school district personnel; contract operators; advisors from industry and representatives from other interested professional organizations and groups. Each conference has resulted in one or more publications that contain the recommendations of the respective conference.

The recommendations of specifications and procedures for school buses and their operation has been a major purpose of all conferences. The 1939 Conference was called for this sole purpose and formulated a set of recommended standards for school buses of 20 or more passengers. The 1945 Conference revised the 1939 recommendations and added standards for small vehicles with capacities of 10 to 18 passengers. Both standards were further revised by the 1948 Conference. There were additional revisions in 1959, and the 1964 Conference added standards for school buses to be used in transporting students with disabilities. In addition to revising standards for larger vehicles, the 1970 Conference refined the standards for school buses designed to transport fewer than 24 passengers.

Other major issues in student transportation have received attention at these national conferences. On several occasions, recommendations concerned primarily with other vehicles overtaking and passing school buses were transmitted to the National Committee on Uniform Traffic Laws and Ordinances for consideration in connection with revisions of the Uniform Vehicle Code. The 1948 Conference made recommendations on uniform records and reports for student transportation. The major purpose of the 1948 Conference was the formulation of recommendations related to standards and training programs for school bus drivers. These recommendations were revised by the 1959 Conference, and a new publication on the topic was issued. The 1954 Conference gave considerable time to the discussion of the extended use of school buses in the school program. The 1970 Conference also adopted standards for school bus operation (issued in a separate report).

The 1980 Conference updated the standards for school bus chassis and bodies, rewrote the complete standards for the specially equipped school bus, and included definitions for Types A, B, C and D buses. One of the major tasks of the 1980 Conference was to revise the standards to remove any conflicts with superseding federal regulations, many of which were mandated by sections of the Motor Vehicle and School Bus Safety Amendments of 1974 (Public Law 93-492).

The 1985 Conference updated the standards for school bus chassis, bodies, special education and operations procedures. A major project was completed in the adoption of a uniform school bus accident reporting form. This form was designed to standardize school bus accident data reporting throughout the school transportation industry. Major issues such as safety inside the vehicle, loading and unloading, emergency procedures and special education were discussed with appropriate resolutions calling for future research and implementation being passed.

The 1990 Conference removed the word *minimum* from the title of the Conference publication. The format of the conference publication was reorganized into two parts: Standards for School Buses and Standards for Operations. All sub-parts, such as Accident Reporting and Special Education Transportation, were incorporated into the section on the School Bus or the section on Operations. A major change also was incorporated into the procedures for the 1990 Conference. Any mandatory standard could be recommended for a special vote for forwarding action to the appropriate federal agency with a request for rulemaking. This rulemaking request would be an attempt to have a standard adopted at the Conference become a federally mandated requirement. For this forwarding action to be approved, any such item had to receive a two-thirds affirmative vote. The delegation approved forwarding action on standards for mirrors, emergency exits, accident-reporting and special education transportation. This procedural change was carried forward for the 1995 Conference.

The 1995 Conference was the first to begin to address the expanded role of student transportation as prescribed in the revised Highway Safety Program Guideline #17 - Pupil Transportation Safety. The revised Guideline became effective May 29, 1991, and this was the first conference convened since its adoption. Transportation of pre-kindergarten age students, including infants and toddlers, was addressed for the first time. A comprehensive section dealing with the use of alternative fuels in school bus operations was discussed and included in the publication. A new section, "Terms and Definitions," was added to the appendices to promote consistency throughout the industry, to consolidate into one resource the acronyms, abbreviations and standard terms used in the industry and to provide easy access to definitions of terms used or referenced within the Specifications and Procedures document.

The 2000 Conference included significant discussion of the purpose and intended use of the document, which had been known in previous conferences as the *National Standards for School Transportation*. Leading up to the 2000 Conference, arguments were made for retention in the title of the term *Standards* or adoption of the new term *Guidelines*. These deliberations were an attempt to accurately describe the document to state and local transportation providers, industry suppliers, governmental oversight agencies, representatives of the legal profession and other users. The new title approved by the delegates was the *National School Transportation Specifications and Procedures*. A significant majority of the delegates believed that title described the actual contents and intended use of the document more precisely. The Introduction was expanded to explain clearly that the *National School Transportation Specifications and Procedures* comprises recommendations of the delegates to the states and other potential users of the document. It also clarified that these entities may choose, under their respective regulatory authorities, to adopt all, part or none of the specifications and procedures into laws or regulations, as they deemed appropriate.

Other significant changes or additions adopted by the 2000 Conference delegates included a new side intrusion test for school bus bodies, a strong recommendation to states to require the use of school buses or buses having equivalent crash protection for all student transportation, reorganization of the operations sections into a more user-friendly format, sanctioning of the recent federal guidelines for seating of pre-school age students, conformance of the procedures

for transportation of students with disabilities with updated federal regulations, and a new section on school bus inspection.

In 2005, the delegates changed the name of the conference to the National Congress on School Transportation to describe more accurately the longstanding nature of the proceedings, involving deliberation and decision-making following parliamentary procedure. Significant changes or additions adopted by the 2005 Congress delegates included a request to the School Bus Manufacturers Technical Council (SBMTC) to develop specifications for the fire-blocking performance of school bus chassis firewalls; clarification of the allowance for either black or yellow trim coloration on school bus bodies; augmentation of the recently updated Federal Motor Vehicle Safety Standard 217 (Bus Emergency Exits and Windows, Retention and Release) to include additional roof hatches; accommodation of the new Multifunction School Activity Bus sub-category of school buses; a recommendation to require “high-back” passenger seats in all large school buses as a further improvement to school bus passenger crash protection; a recommendation to require noise-canceling switches for use by school bus operators during railroad crossings; a recommendation, based on research findings, to prohibit the installation of two-point lap belts in large school buses, except to secure child safety restraint systems; elimination of requirements that were duplicative of recent federal and Society of Automotive Engineers (SAE) standards for specially equipped school buses; new operational procedures calling for reduced school bus engine idling, use of two-way communications systems, and required post-trip checks of buses by drivers for unattended children; the addition of new sections on School Transportation Security and School Activity Transportation; and updating the sections “Transportation for Students with Disabilities and Special Health Care Needs” and “Infants, Toddlers, and Pre-school Children” to conform to recent federal reauthorizations.

On a sad note, the Congress Steering Committee and the New Jersey delegation lost one of their own on May 19, 2005. Dennis Hammell died during the Congress of an apparent heart attack. Mr. Hammell, president of the Lafayette, New Jersey-based Village Bus Company, had recently sold the company to First Student, Inc. A board member of the National School Transportation Association (NSTA), he also represented NSTA on the NCST Steering Committee through three congresses. He was the Chief of the Sparta Township Fire Department and was active in music education in his community and through the Rowan University Foundation. The Congress will miss Dennis’s friendship and his spirited contributions to the important work of the congresses.

With the enactment in 1966 of the National Traffic and Motor Vehicle Safety Act, the federal government was given responsibility for developing and promulgating motor vehicle safety standards for motor vehicles sold in the United States. These Federal Motor Vehicle Safety Standards (FMVSSs) are continually evaluated and revised, as needed. Such standards in their present form or as subsequently amended, will void any action taken during the 2005 Congress wherever there is a conflict. Whenever specifications and procedures adopted by the 2005 Congress go beyond, or exceed the FMVSSs, they remain valid.

For the 2010 Congress the Steering Committee developed and implemented several operational and procedural improvements consisting of an interim amendment process and new rules for debating the recommendations of the writing committees.

The amendment process provides the Steering Committee a method to address matters occurring between congresses that are too important to delay until the next five-year cycle. For example, in 2005 the delegates adopted a new section to the Specifications and Procedures document on security and emergency preparedness—almost five years after September 11, 2001. The Steering Committee believed that for the congress publication to remain current, be relevant, and serve as a model of the school transportation industry’s best practices, such a process is a necessity.

To encourage greater state delegation participation and debate in the writing committee activities, the Steering Committee adopted new procedures limiting floor debate at the Congress to only those segments of the specifications and procedures document where the respective writing committee recommended new, amended, or deleted language. As a result of the new procedure, along with use of electronic voting for the first time, the 2010 Congress completed its work in three days rather than the traditional four or five days of previous congresses.

Other significant delegate actions in 2010 consisted of merging the school bus body and chassis sections into a new section entitled School Bus Specifications, and the School Bus Inspection section, initially voted down by the delegates, was later re-opened and adopted with language mirroring federal inspection criteria for commercial vehicles and buses. The Operations introduction was amended to state that when transportation is provided, students *shall be*, rather than *should be*, transported by a school bus. Best practices recommended by the U.S. Department of Homeland Security of the Transportation Security Administration were adopted as a new appendix, supplementing the “Security and Emergency Preparedness” section. A new section, “Chronicling Innovations in School Transportation,” was adopted. Unlike action taken in previous congresses, there were no resolutions.

Like the 2005 Congress, the structure for the 2010 Congress and its operating guidelines were carried out by the Steering Committee. Funding for the Congress was shared solely by each individual participant of the Steering Committee, the writing committees and all delegates at the congress.

Pete Baxter  
General Congress Chairperson

[Back to Contents](#)

## ABOUT THIS DOCUMENT

Certain objectives and guiding principles have a vital role in the development of the specifications for school buses and procedures for their operation. These objectives and guiding principles have been reaffirmed and emphasized at the National Congresses (formerly Conferences) since 1939. The major objectives, safety, security and efficiency, along with the guiding principles stated herein, have served as guideposts for making decisions regarding the specifications and procedures and in arriving at sound and common agreement.

Adequate state and federal regulations governing school bus specifications and operations provide the key ingredients for the safe, secure and efficient transportation of students. Safety and security include all factors relating to school bus equipment, performance specifications and operational procedures that may directly or indirectly affect the safety, security and welfare of students transported. Efficiency includes the management of specifications, procurement and maintenance of school buses, the operational practices and procedures of staff consistent with the safety and welfare of students and the effective use of financial resources.

### GUIDING PRINCIPLES

- A. Federal standards and state specifications for school buses and procedures for their operation should:
  1. Be consistent with the objectives of safety, security and efficiency;
  2. Ensure the construction and use of safe buses;
  3. Reduce conflicting specifications and procedures among states, wherever possible; and
  4. Specify exact dimensions, where necessary, to increase the quality and efficiency of manufacture.
- B. Any adaptation of these national specifications and procedures should be made by states only in order to adjust to local needs and only when such adaptations do not...
  1. Conflict with Federal Motor Vehicle Safety Standards (FMVSSs);
  2. Conflict with the National Highway Traffic Safety Administration's Highway Safety Guideline #17 - Pupil Transportation Safety; and
  3. Unduly increase operation or production costs.
- C. State specifications for school buses and operational procedures should be written in terms of the performance desired, thus assuring that the resulting state regulations are enforceable.

- D. Provisions should be made within each state for periodic review and revision of its specifications for school buses and procedures for their operation.
- E. State specifications for school buses and procedures for their operation should allow for state approval of the use of new inventions and improvements that are consistent with safety, security and efficiency.
- F. State specifications for school buses should provide for a degree of flexibility (consistent with safety, security and efficiency) to accommodate the various manufacturers.
- G. State specifications for school buses should recognize that the actual design of school buses is a responsibility of the manufacturers.
- H. The *National School Transportation Specifications and Procedures* of the 15<sup>th</sup> Congress comprise recommendations to the states. Revisions of these specifications and procedures are made only when evidence indicates that such revisions are needed.

[Back to Contents](#)

#### **INTENDED USE**

These specifications for school buses and operational procedures are available for states to consider when establishing their standards, specifications, recommendations and guidelines. As a general rule, state legislatures should confer upon the appropriate state agency or regulatory body the general responsibility for establishing and revising state-wide rules and regulations regarding the specifications for school bus chassis, bodies and equipment and procedures related to school transportation operations.

The specifications and procedures for school transportation appearing in this report represent the official actions of the delegates to the 15th National Congress on School Transportation and comprise recommendations to regulatory authorities or other parties. Except for restatements of federal standards, laws and rules that may be contained herein, these recommendations are not regulatory until they are officially adopted by the appropriate state regulatory authority or local school district or Head Start authority (if permitted) to become legally effective within that state, the school district or authorized transportation agent. It should be noted that some items in this report are informational only and do not constitute “recommendations” of the delegates.

In considering these specifications and procedures for adoption into state or local regulations, each portion or individual content item should be reviewed by the state or local transportation provider to determine its applicability, as recommended by the delegates. The following terms are used throughout this document to define the recommended applicability within states or local providers adopting these specifications and procedures:

- A. *SHALL*: a mandatory condition. Where certain school bus designs, equipment or operations are described with the *shall* stipulation, it is *mandatory* that all school buses and all school bus operations meet those requirements, as written.

**Note:** The word *shall* also is used when referring to items that are already adopted into federal laws, standards or regulations.

- B. **SHOULD:** an advisory condition. Where certain school bus designs, equipment or operations are described with the word *should*, such items are considered to be advisable usage. In other words, the item is *recommended*, but not mandatory, for all school buses or all school bus operations.
- C. **MAY:** a permissive condition. Where certain school bus designs, equipment or operations are described with the word *may*, such items are considered for *possible* usage. However, there is no intent that the item be required for all school buses or all school bus operations.

Recognizing that many of these specifications and procedures (those using the above definition of *shall*) are recommended as requirements and will become requirements when they are adopted into regulations by individual states, Head Start agencies or local transportation providers, the principles and guidelines for the intended use of this report are consistent with the following “Statement of Understanding” adopted by the Steering Committee of the 14<sup>th</sup> National Congress on School Transportation and reaffirmed by the Steering Committee of the 15<sup>th</sup> Congress for inclusion herein. **In the context of this overall report, the following statement reminds persons using the report that until these specifications and procedures are adopted into state regulations, either by reference or directly, adherence to their provisions is voluntary:**

The purpose of this publication is to serve as a basis for the separate states to establish specifications, rules and/or regulations for school transportation within those states. This publication is representative of the consensus of professional practitioners from the states represented at the National Congress on School Transportation. Its emphasis on practices, procedures and performance encompasses school transportation in total and includes guidelines for school buses and school bus operations. The material contained herein will provide useful guidance for school transportation specialists in each state; however, it does not establish specifications or standards for any state. **Use of this publication in part or in its entirety is completely voluntary.**

The vehicle specifications contained herein are intended to apply primarily to **new** vehicles, including all types of school buses, as defined in APPENDIX H: GLOSSARY OF TERMS AND DEFINITIONS, under *Bus, School Bus*, which lists the various types of “school buses.” It should be noted that vehicles with a capacity of ten (10) or fewer persons, including the driver, cannot be certified as *school buses* under federal regulations.

States should allow sufficient lead-time between publication of their respective specifications and the effective dates of implementation. Effective dates should be expressed, as in this sample statement: “These specifications apply respectively to school bus chassis and bodies placed in production on or after (month, day, year).”

[Back to Contents](#)



## **INTERPRETATIONS AND INFORMATION**

Requests for interpretation of these specifications and procedures should be mailed to the chairman of the Interpretations Committee, addressed as follows: John Green, California Department of Education, 825 Riverside Parkway, Suite 110, West Sacramento, CA 95605. Complete information on the National Congress on School Transportation is available at [www.ncstonline.org](http://www.ncstonline.org). Interested parties are encouraged to visit the website for the most current information on all aspects of the 2010 15<sup>th</sup> NCST, the next NCST, and for any published interpretations to these *National School Transportation Specifications and Procedures*.

## **INTERIM INQUIRIES AND REQUESTS**

The Steering Committee acts on behalf of the Congress between congresses. Inquiries, requests for modifications of the specifications and procedures and development of new ones should be directed to the chairman of the Steering Committee. Contact the Steering Committee Chair as listed at [www.ncstonline.org](http://www.ncstonline.org).

[Back to Contents](#)

**CHRONICLING  
INNOVATIONS  
IN SCHOOL  
TRANSPORTATION**

**Page Intentionally Left Blank**

# Chronicling Innovations in School Transportation

## INTRODUCTION

The Innovations Committee was established by the 14<sup>th</sup> National Congress on School Transportation. The Innovations Committee will not write any sections of the innovations material; instead, the Committee's intent is to provide an initial reference for innovations in the school transportation industry. The Committee will collect innovations for inclusion, chronicle their progress, provide assistance to those proposing innovations, be a resource to individual writing committees considering adopting innovations into specifications and procedures and where appropriate, will make recommendations to those writing committees regarding any innovations studied.

## PURPOSE

This section will outline the procedure for identifying innovations, referring them to the Innovations Committee, chronicling and record-keeping of those innovations.

## DEFINITIONS

*Innovation*: "Any practice, procedure, process or product that is not recorded in the *National School Transportation Specifications and Procedures* document, a national best practice or a routine industry practice." Only those innovations that have application for use on a broader scale than a single school or school system should be considered under this definition.

## IDENTIFICATION OF INNOVATIONS

Any individual associated with the school transportation industry is eligible to submit an innovation. Anyone who feels that he/she has a new or innovative way to accomplish any part of the student transportation, mission or a new product or product application should send that innovation to the innovation web site at [NAPT.org](http://NAPT.org).

Submitted innovations will be collected by the Committee and shared with its members for assessment and evaluation for inclusion as a current innovation on the web site.

## REFERRING THE INNOVATION

To enable the Committee to understand the innovation, the *who*, *what*, *how* and *why* must be clearly stated. The NCST Innovations in School Transportation Submission Form (included in this section) is to be used for submission. Brevity and clarity of the submission is important. The Committee will routinely adapt and improve this process, and post revised procedures on the web site, as experience and lessons learned dictate.

- A. *Who* is both recommending the innovation and *who* is providing it. This must provide complete contact information, to include web sites where appropriate, and a description of the role in the industry each person holds. **Without this information, the innovation will not be considered.**

- B. *What* is being recommended or provided? If it is an innovative process, practice or procedure, ensure that the description is understandable to the layperson. The environment in which the submitter works in school transportation may not be the same environment others work in. What problem does the innovation solve or what improvement does it provide?
- C. *How* does the innovation work? *How* is it going to help school transportation? *How* would it be implemented?
- D. *Why* should the Committee adopt this innovation? *Why* is it worthy of consideration? *Why* is it being recommended? The information submitted should include cost benefit information and any other data supportive of the innovation.

## **CHRONICLING THE INNOVATION**

Once the Committee reviews the innovation, it may request additional data and information to support the benefit or value of the recommendation. The Committee will then succinctly record its reported results on the web site. On each innovation, the Committee will establish broad milestones for required updates to keep the innovation active. Continued chronicling will keep the innovation active. Any innovation approved for inclusion in the Committee's record of innovations will remain there for at least one year. If there is no activity after one year, the "innovation" will be considered for removal from the active records, following communications with the submitter. At any time after one year, the innovation can be considered for removal from active records based upon the success and or value of the chronicled information. The individual recommending the innovation is responsible to ensure chronicling occurs. The Committee is responsible for posting the innovations but has no responsibility to ensure that innovations are submitted.

## **RECORD-KEEPING**

The Committee will keep a record of all innovations submitted that were considered. If an innovation is submitted but not clear or understood, it will be returned to the submitter. Any submission submitted will either be *archived*, will be *in process*, or will be *in the active record*.

## **ACTIVE RECORD**

The active record will be a reference to all innovations the Committee has currently included on the website. The record is intended to be a source of ideas for the consideration of all members of the school transportation industry. It is not a recommendation of any process, procedure or product, but rather a record of those that have been recommended and are being evaluated. The active record will have the appropriate contact information for any interested person to get more information both on the innovation and from the individual(s) who submitted the innovations for consideration.

## **RECOMMENDATION**

If at some point the Committee believes the innovation has matured to the point that it merits inclusion in the *Specifications and Procedures*, it will make that recommendation to the appropriate writing committee. Also, any writing committee member may solicit the input of the Innovations Committee for any new innovations a specific committee may consider adding to its document.

# NCST Innovations in School Transportation Submission Form

**Submitter Information:**

Person(s) submitting the innovation: \_\_\_\_\_

Organization: \_\_\_\_\_ Position: \_\_\_\_\_

Contact Information: email address: \_\_\_\_\_

Phone number: \_\_\_\_\_

**Title/Name of Innovation:** \_\_\_\_\_

**Description of Innovation:** (Provide a brief description of the innovation and its use and indicate why you believe this to be innovative. Explain how it works. Additional pages may be attached to this form.)

---

---

---

---

---

---

---

---

**Benefits of Innovation:** (Describe how the use of the innovative practice, process, procedure or product improves/impacts and benefits the student transportation mission. Additional pages may be attached to this form.)

---

---

---

---

---

---

---

---

**Data Supporting the Innovation:** (Briefly provide data to support the benefits described above. Additional pages may be attached to this form.)

---

---

---

---

---

---

---

---

[Back to Contents](#)

# SCHOOL BUS TYPES

Type A: A Type A school bus is a conversion bus constructed utilizing a cutaway front section vehicle with a left side driver's door. This definition includes two classifications: Type A-1, with a Gross Vehicle Weight Rating (GVWR) of 14,500 pounds or less; and Type A-2, with a GVWR greater than 14,500 pounds and less than or equal to 21,500 pounds.

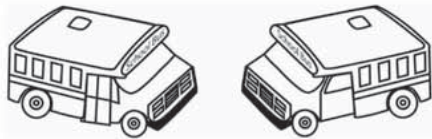

Type A-1

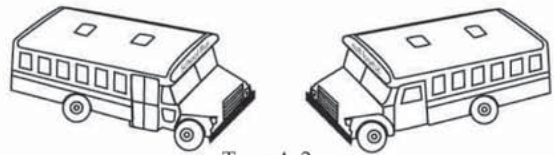

Type A-2

Type B: A Type B school bus is constructed utilizing a stripped chassis. The entrance door is behind the front wheels. This definition includes two classifications: Type B-1, with a GVWR of 10,000 pounds or less, and Type B-2, with a GVWR greater than 10,000 pounds.

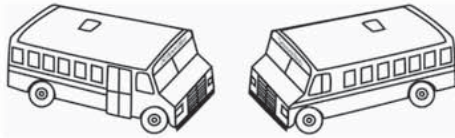

Type B

Type C: A Type C school bus is constructed utilizing a chassis with a hood and front fender assembly. The entrance door is behind the front wheels—also known as a conventional style school bus. This type also includes the cutaway truck chassis or truck chassis with cab with or without a left side door and with a GVWR greater than 21,500 pounds.

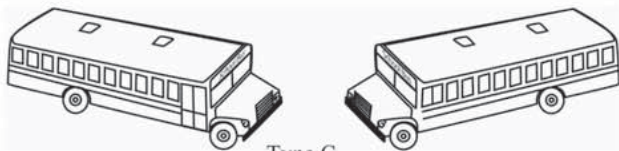

Type C  
Conventional



Type C  
Cutaway

Type D: A Type D school bus is constructed utilizing a stripped chassis. The entrance door is ahead of the front wheels—also known as a rear engine or front engine transit style school bus.

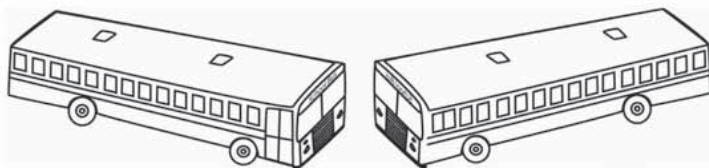

Type D



## INTRODUCTION TO SCHOOL BUS SPECIFICATIONS

This portion of the report is divided into four sections: Bus Body and Chassis Specifications, Specially Equipped School Bus Specifications, and Specifications for School Bus Inspection and Alternative Fuel School Buses. If these specifications are adopted by a state or states, special attention must be given to them by the chassis and the body manufacturer, as appropriate or necessary.

Every attempt has been made by the Writing Committees, the Congress itself and the Editing Committee to eliminate conflicts between these specifications and federal regulations. Should conflicts be found to exist or arise through new federal regulations or legally binding interpretations of those regulations, they should be brought to the attention of the Interpretations Committee, who, in turn, will report them to the Interim Committee.

For new vehicles, it is the responsibility of the vehicle manufacturer to certify compliance with applicable federal standards by installing a certification plate or label in the driver's area on each vehicle. However, as the vehicle is maintained over its useful life, it is the responsibility of those who supervise and perform work on the vehicle to assure on-going compliance with all applicable federal and state standards and specifications, as well to coordinate recalls. For this reason, maintenance personnel training, quality components, quality workmanship and thorough maintenance records are essential.

Finally, in order to ensure that specifications are being met by manufacturers, states are urged to adopt and carry out effective pre-delivery inspection programs.

[Back to Contents](#)

# **BUS BODY AND CHASSIS SPECIFICATIONS**

**Page Intentionally Left Blank**

## **BUS BODY AND CHASSIS SPECIFICATIONS**

### **AIR CLEANER**

- A. A dry element air cleaner shall be provided.
- B. All diesel engine air filters shall include a latch-type restriction indicator that retains the maximum restriction developed during operation of the engine. The indicator should include a reset control so the indicator can be returned to zero when desired.

### **AISLE**

All emergency exit doors shall be accessible by a 12-inch minimum aisle. The aisle shall be unobstructed at all times by any type of barrier, seat, wheelchair or tie-down, unless a flip seat is installed and occupied. The track of a track seating system is exempt from this requirement. A flip seat in the unoccupied (up) position shall not obstruct the 12-inch minimum aisle to any side emergency exit door.

### **AXLES**

The front and rear axle and suspension systems shall have a gross axle weight rating (GAWR) at ground commensurate with the respective front and rear weight loads of the bus loaded to the rated passenger capacity.

### **BACK-UP WARNING ALARM**

An automatic audible alarm shall be installed behind the rear axle and shall comply with the published Backup Alarm Standards (SAE J994b), providing a minimum of 112 dBA, or shall have a variable volume feature that allows the alarm to vary from 87 dBA to 112 dBA sound level, staying at least 5 dBA above the ambient noise level.

### **BRAKES: GENERAL**

- A. The chassis brake system shall conform to the provisions of FMVSS Nos. 105, *Hydraulic and Electric Brake Systems*, 106, *Brake Hoses*, and 121, *Air Brake Systems*, as applicable.
- B. The anti-lock brake system (ABS), provided in accordance with FMVSS No. 105, *Hydraulic and Electric Brake Systems* or No. 121, *Air Brake Systems*, shall provide wheel speed sensors for each front wheel and for each wheel on at least one rear axle. The system shall provide anti-lock braking performance for each wheel equipped with sensors (Four Channel System).
- C. All brake systems shall be designed to permit visual inspection of brake lining wear without removal of any chassis component(s).

- D. The brake lines, booster-assist lines, and control cables shall be protected from excessive heat, vibration and corrosion and installed in a manner that prevents chafing.
- E. The parking brake system for either air or hydraulic service brake systems may be of a power-assisted design. The power parking brake actuator should be a device located on the instrument panel within reach of seated a 5th percentile female driver. As an option, the parking brake may be set by placing the automatic transmission shift control mechanism in the “park” position.
- F. The power-operated parking brake system may be interlocked to the engine key switch. Once the parking brake has been set and the ignition switch turned to the “off” position, the parking brake cannot be released until the key switch is turned back to the “on” position.

### **BRAKES: HYDRAULIC**

Buses using a hydraulic-assist brake shall be equipped with audible and visible warning signals that provide a continuous warning to the driver indicating a loss of fluid flow from the primary source or a failure of the back-up pump system.

### **BRAKES: AIR**

- A. The air pressure supply system shall include a desiccant-type air dryer installed according to the manufacturer’s recommendations. The air pressure storage tank system may incorporate an automatic drain valve.
- B. The chassis manufacturer shall provide an accessory outlet for air-operated systems installed by the body manufacturer. This outlet shall include a pressure protection valve to prevent loss of air pressure in the service brake reservoir.
- C. For air brake systems, an air pressure gauge shall be provided in the instrument panel capable of complying with Commercial Driver’s License (CDL) pre-trip inspection requirements.
- D. Air brake-equipped buses may be equipped with a service brake interlock. If equipped with a service brake interlock, the parking brake cannot be released until the brake pedal is depressed.
- E. Air brake systems shall include a system for anti-compounding of the service brakes and parking brakes.
- F. Air brakes shall have both a visible and audible warning device whenever the air pressure falls below the level where warnings are required under FMVSS No. 121, *Air Brake Systems*.

## **BUMPER: FRONT**

- A. School buses shall be equipped with a front bumper.
- B. The front bumper on buses of Type A-2 (with GVWR greater than 14,500 pounds), Type B, Type C, and Type D shall be equivalent in strength and durability to pressed steel channel at least 3/16 inches thick and not less than 8 inches wide (high). It shall extend beyond the forward-most part of the body, grille, hood and fenders and shall extend to the outer edges of the fenders at the bumper's top line. Type A buses having a GVWR of 14,500 pounds or less may be equipped with an OEM-supplied front bumper. The front bumper shall be of sufficient strength to permit being pushed by another vehicle on a smooth surface with a 5 degree, (8.7 percent) grade, without permanent distortion. The contact point on the front bumper is intended to be between the frame rails, with as wide a contact area as possible. If the front bumper is used for lifting, the contact points shall be under the bumper attachments to the frame rail brackets unless the manufacturer specifies different lifting points in the owner's manual. Contact and lifting pressures should be applied simultaneously at both lifting points.
- C. The front bumper, except breakaway bumper ends, shall be of sufficient strength to permit pushing a vehicle of equal gross vehicle weight, per Section B, without permanent distortion to the bumper, chassis or body.
- D. The bumper shall be designed or reinforced so that it will not deform when the bus is lifted by a chain that is passed under the bumper (or through the bumper if holes are provided for this purpose) and attached to both tow hooks/eyes. For the purpose of meeting this specification, the bus shall be empty and positioned on a level, hard surface and both tow hooks/eyes shall share the load equally.

## **BUMPER: REAR**

- A. The bumper on Type A-1 buses shall be a minimum of 8 inches wide (high). Bumpers on Types A-2, B, C and D buses shall be a minimum of 9½ inches wide (high). The bumper shall be of sufficient strength to permit being pushed by another vehicle of similar size and being lifted by the bumper without permanent distortion.
- B. The bumper shall wrap around the back corners of the bus. It shall extend forward at least 12 inches, measured from the rear-most point of the body at the floor line, and shall be mounted flush with the sides of the body or protected with an end panel.
- C. The bumper shall be attached to the chassis frame in such a manner that it may be removed. It shall be braced to resist deformation of the bumper resulting from impact from the rear or the side. It shall be designed to discourage hitching of rides by an individual.

- D. The bumper shall extend at least one inch beyond the rear-most part of the body surface, measured at the floor line.
- E. The bottom of the rear bumper shall not be more than 30 inches above ground level.

## **CERTIFICATION**

Upon request of the state agency having student transportation jurisdiction, the chassis and body manufacturer(s) shall certify that its(their) product(s) meets the state's minimum standards on items which are not covered by FMVSS certification requirements of 49 CFR, Part 567: *Certification*.

## **CLUTCH**

- A. Clutch torque capacity shall be equal to or greater than the engine torque output.
- B. A starter interlock shall be installed to prevent actuation of the starter if the clutch pedal is not depressed.

## **COLOR**

- A. The school bus body shall be painted National School Bus Yellow (NSBY). (See APPENDIX B.)
- B. The body exterior trim, as defined by individual states, shall be black or NSBY.
- C. Except for the vertical portion of the front and rear roof caps, the roof of the bus may be painted white. (See illustration in APPENDIX B, Placement of Retroreflective Markings.)
- D. The chassis and front bumper, shall be black. Body, cowl, hood and fenders shall be in National School Bus Yellow (NSBY). The flat top surface of the hood may be non-reflective black or NSBY. (See APPENDIX B.)
- E. Wheels may be silver, gray, white, yellow or black.
- F. Multi-Function School Activity Buses (MFSABs) shall be exempt from these requirements.

## **COMMUNICATIONS SYSTEMS**

(See OPERATIONS section.)

## **CONSTRUCTION**

- A. Side Intrusion Test: The bus body shall be constructed to withstand an intrusion force equal to the curb weight of the vehicle or 20,000 pounds, whichever is less. Each vehicle shall be capable of meeting this requirement when tested in accordance with the procedures set forth below. The complete body structure, or a representative seven-body section mock up with seats installed, shall be load-tested at a location  $24\pm 2$  inches above the floor line, with a maximum 10 inch diameter cylinder, 48 inches long, mounted in a horizontal plane.

The cylinder shall be placed as close as practical to the mid-point of the tested structure, spanning two internal vertical structural members. The cylinder shall be statically loaded to the required force of curb weight or 20,000 pounds, whichever is less, in a horizontal plane with the load applied from the exterior toward the interior of the test structure. When the minimum load has been applied, the penetration of the loading cylinder into the passenger compartment shall not exceed 10 inches from its original point of contact. There can be no separation of lapped panels or construction joints. Punctures, tears or breaks in the external panels are acceptable but are not permitted on any adjacent interior panel. Body companies shall certify compliance with this intrusion requirement, and include test results, as requested.

- B. Construction shall be reasonably dust-proof and watertight.

## **CROSSING CONTROL ARM**

- A. School buses may be equipped with a crossing control arm mounted on the right side of the front bumper. When opened, this arm shall extend in a line parallel to the body side and aligned with the right front wheel.
- B. All components of the crossing control arm and all connections shall be weatherproofed.
- C. The crossing control arm shall incorporate system connectors (electrical, vacuum or air) at the gate and shall be easily removable to allow for towing of the bus.
- D. The crossing control arm shall be constructed of non-corrodible or nonferrous material or shall be treated in accordance with the body sheet metal specification. (See BUS BODY AND CHASSIS SPECIFICATIONS, Metal Treatment.)
- E. There shall be no sharp edges or projections that could cause injury or be a hazard to students. The end of the arm shall be rounded.
- F. The crossing control arm shall extend a minimum of 70 inches (measured from the bumper at the arm assembly attachment point) when in the extended position.



The crossing control arm shall not extend past the end of the bumper when in the stowed position.

- G. The crossing control arm shall extend simultaneously with the stop signal arm(s), activated by stop signal arm controls.
- H. An automatic recycling interrupt switch may be installed for temporarily disabling the crossing control arm.
- I. The assembly shall include a device attached to the bumper near the end of the arm to automatically retain the arm while in the stowed position. That device shall not interfere with normal operations of the crossing control arm.

## **DEFROSTERS**

- A. Defrosting and defogging equipment shall direct a sufficient flow of heated air onto the windshield, the window to the left of the driver and the glass in the viewing area directly to the right of the driver to eliminate frost, fog and snow. (**Exception:** The requirements of this standard do not apply to the exterior surfaces of double pane storm windows.)
- B. The defrosting system shall conform to SAE J381, *Windshield Defrosting Systems Test Procedure and Performance Requirements—Trucks, Buses, and Multipurpose Vehicles*.
- C. The defroster and defogging system shall be capable of furnishing heated, outside ambient air, except that the part of the system furnishing additional air to the windshield, entrance door and stepwell may be the re-circulating air type.
- D. Auxiliary fans are not considered defrosting or defogging systems.
- E. Portable heaters shall not be used.

## **DOORS**

- A. The entrance door shall be under the driver's control, designed to afford easy release and to provide a positive latching device on manual operating doors to prevent accidental opening. When a hand lever is used, no part shall come together that will shear or crush fingers. Manual door controls shall not require more than 25 pounds of force to operate at any point throughout the range of operation, as tested on a 10% grade, both uphill and downhill.
- B. The entrance door shall be located on the right side of the bus, opposite and within direct view of the driver.

- C. The entrance door shall have a minimum horizontal opening of 24 inches and a minimum vertical opening of 68 inches.
- D. The entrance door shall be a split-type door and shall open outward.
- E. All entrance door glass shall be approved safety glass. The bottom of each lower glass panel shall be not more than 10 inches from the top surface of the bottom step. The top of each upper glass panel when viewed from the interior shall be not more than 3 inches below the interior door control cover or header pad.
- F. Vertical closing edges on entrance doors shall be equipped with flexible material.
- G. All door openings shall be equipped with padding at the top edge of the opening. Padding shall be at least three inches wide and one inch thick and extend the full width of the door opening.
- H. On power-operated entrance doors, the emergency release valve, switch or device to release the entrance door must be placed above or to the immediate left or immediate right of the entrance door and must be clearly labeled. The emergency release valve, switch or device shall work in the absence of power.

## **DRIVE SHAFT**

The drive shaft shall be protected by a metal guard or guards around the circumference of the drive shaft to reduce the possibility of its whipping through the floor or dropping to the ground, if broken.

## **ELECTRICAL SYSTEM**

- A. Battery
  - 1. The storage batteries shall have minimum cold cranking capacity rating (cold cranking amps) equal to the cranking current required for 30 seconds at 0 degrees Fahrenheit and a minimum reserve capacity rating of 120 minutes at 25 amps. Higher capacities may be required, depending upon optional equipment and local environmental conditions.
  - 2. The manufacturer shall securely attach the battery on a slide-out or swing-out tray in a closed, vented compartment in the body skirt so that the battery is accessible for convenient servicing from the outside. When in the stored position, the tray shall be retained by a securing mechanism capable of holding the tray [with battery(ies)] in position when subjected to a 5g load from any direction. The battery compartment door or cover, if separate from the tray, shall be hinged at the front or top. It shall be secured by a positive operated latching system or other type fastener. The door may be an integral part of the battery slide tray. The door or cover

must fit tightly to the body, and not present sharp edges or snagging points. Battery cables shall meet SAE requirements. Battery cables shall be of sufficient length to allow the battery tray to fully extend. The battery compartment is required on Type A-1 diesel buses, and any battery(ies) mounted on the frame by the chassis manufacturer shall be relocated to the battery compartment.

3. All batteries are to be secured in a sliding tray except that on van conversion or cutaway front-section chassis, batteries may be secured in accordance with the manufacturer's standard configuration. In these cases, the final location of the battery and the appropriate cable lengths shall be agreed upon mutually by the chassis and body manufacturers. However, in all cases the battery cable provided with the chassis shall have sufficient length to allow some slack, and shall be of sufficient gauge to carry the required amperage.
4. Buses may be equipped with a battery shut-off switch. The switch is to be placed in a location not readily accessible to the driver or passengers.

#### B. Alternator

1. All Type A-2 and Type B buses with a GVWR of 15,000 pounds or less shall have a minimum 130-amp alternator.
2. All buses over 15,000 pounds GVWR shall be equipped with a heavy-duty truck-or bus-type alternator having a minimum output rating of 160 amps or higher, and should produce a minimum current output of 50 percent of the rating at engine idle speed.
3. Buses equipped with an electrically powered wheelchair lift, air conditioning or other accessories may be equipped with a device that monitors the electrical system voltage and advances the engine idle speed when the voltage drops to, or below, a pre-set level.
4. A belt-driven alternator shall be capable of handling the rated capacity of the alternator with no detrimental effect on any other driven components. (For estimating required alternator capacity, see School Bus Manufacturers Technical Council's publication, "School Bus Technical Reference," available at <http://www.nasdpts.org>.)
5. A direct/gear-drive alternator is permissible in lieu of a belt-driven alternator.

#### C. Electrical Components

Materials in all electrical components shall contain no mercury.

D. Wiring, Chassis

1. All wiring shall conform to current applicable recommended practices of the Society of Automotive Engineers (SAE). All wiring shall use color and at least one other method for identification. The other method shall be either a number code or name code, and each chassis shall be delivered with a wiring diagram that illustrates the wiring of the chassis.
2. The chassis manufacturer of an incomplete vehicle shall install a readily accessible terminal strip or connector on the body side of the cowl or in an accessible location in the engine compartment of vehicles designed without a cowl. The strip or connector shall contain the following terminals for the body connections:
  - a. Main 100-amp body circuit;
  - b. Tail lamps;
  - c. Right turn signal;
  - d. Left turn signal;
  - e. Stop lamps;
  - f. Back-up lamps; and
  - g. Instrument panel lamps (controlled by dimmer switch).
3. An appropriate identifying diagram (color plus a name or number code) for all chassis electrical circuits shall be provided to the body manufacturer for distribution to the end user.
4. Wiring for the headlamp system must be separate from the electronic controlled body solenoid/module.

E. Wiring, Body

1. All wiring shall conform to current SAE standards.
2. All wiring shall have an amperage capacity exceeding the design load by at least 25%. All wiring splices are to be accessible and noted as splices on the wiring diagram.
3. A body wiring diagram, sized to be easily read, shall be furnished with each bus body or affixed to an area convenient to the electrical accessory control panel.

4. The body power wire shall be attached to a special terminal on the chassis.
5. Each wire passing through metal openings shall be protected by a grommet.
6. Wires not enclosed within the body shall be fastened securely at intervals of not more than 18 inches. All joints shall be soldered or joined by equally effective connectors, which shall be water-resistant and corrosion-resistant.
7. Wiring shall be arranged in circuits, as required, with each circuit protected by a fuse breaker or electronic protection device. A system of color and number-coding shall be used and an appropriate identifying diagram shall be provided to the end user, along with the wiring diagram provided by the chassis manufacturer. The wiring diagrams shall be specific to the bus model supplied and shall include any changes to wiring made by the body manufacturer. Chassis wiring diagrams shall be supplied to the end user. The following body interconnecting circuits shall be color-coded, as noted:

<u>FUNCTION</u>	<u>COLOR</u>
Left Rear Directional Lamp	Yellow
Right Rear Directional Lamp	Dark Green
Stop Lamps	Red
Back-up Lamps	Blue
Tail Lamps	Brown
Ground	White
Ignition Feed, Primary Feed	Black

The color of the cables shall correspond to SAE J1128, *Low-Tension Primary Cable*.

8. Wiring shall be arranged in at least six regular circuits, as follows:
  - a. Head, tail, stop (brake), clearance and instrument panel lamps;
  - b. Step well lamps shall be actuated when the entrance door is open;
  - c. Dome lamps;
  - d. Ignition and emergency door signal;
  - e. Turn signal lamps; and
  - f. Alternately flashing signal lamps.

9. Any of the above combination circuits may be subdivided into additional independent circuits.
  10. Heaters and defrosters shall be wired on an independent circuit.
  11. Whenever possible, all other electrical functions (such as sanders and electric- type windshield wipers) shall be provided with independent and properly protected circuits.
  12. Each body circuit shall be coded by number or letter on a diagram of circuits and shall be attached to the body in a readily accessible location.
- F. Buses may be equipped with a 12-volt power port in the driver's area.
- G. There shall be a manual noise suppression switch installed in the control panel. The switch shall be labeled and alternately colored. This switch shall be an on/off type that deactivates body equipment that produces noise, including at least the AM/FM radio, heaters, air conditioners, fans and defrosters. This switch shall not deactivate safety systems, such as windshield wipers or lighting systems.
- H. The entire electrical system of the body shall be designed for the same voltage as the chassis on which the body is mounted.

## **EMERGENCY EQUIPMENT**

- A. Fire extinguisher
1. The bus shall be equipped with at least one UL-approved pressurized, dry chemical fire extinguisher. The extinguisher shall be secured in a mounted bracket, located in the driver's compartment and readily accessible to the driver and passengers. A pressure gauge shall be mounted on the extinguisher and shall be easily read without moving the extinguisher from its mounted position.
  2. The fire extinguisher shall have a rating of 2-A:10-BC, or greater. The operating mechanism shall be secured with a type of seal that will not interfere with the use of the fire extinguisher.
- B. First aid kit
1. The bus shall have a removable, moisture-proof and dust-proof first aid kit in an accessible place in the driver's compartment. It shall be mounted and identified as a first aid kit. The location for the first aid kit shall be marked. Contents of the first aid kit shall be in compliance with state standards.

2. Suggested contents include:

- 2 – 1-inch x 2½ yards of adhesive tape rolls
- 24 – Sterile gauze pads 3x3 inches
- 100 – ¾ x 3 inches adhesive bandages
- 8 – 2-inch bandage compress
- 10 – 3-inch bandage compress
- 2 – 2-inch x 6 feet sterile gauze roller bandages
- 2 – Non-sterile triangular bandages, minimum 39x35x54 inches with two safety pins
- 3 – Sterile gauze pads 36x36 inches
- 3 – Sterile eye pads
- 1 – Rounded-end scissors
- 1 – Pair medical examination gloves
- 1 – Mouth-to-mouth airway

C. Body fluid clean-up kit

Each bus shall have a removable and moisture-proof body fluid clean-up kit accessible to the driver. It shall be mounted and identified as a body fluid clean-up kit. Contents of the body fluid clean-up kit shall be in compliance with state standards.

D. Warning devices

Each school bus shall contain at least three retroreflective triangle road warning devices that meet the requirements of FMVSS No. 125, *Warning Devices*. They shall be mounted in an accessible place.

E. Any piece of emergency equipment may be mounted in an enclosed compartment, provided the compartment is labeled in not less than one inch letters, identifying each piece of equipment contained therein.

## **EMERGENCY EXITS**

A. Any installed emergency exit shall comply with the design and performance requirements of FMVSS No. 217, *Bus Emergency Exits and Window Retention and Release*, applicable to that type of exit, regardless of whether or not that exit is required by FMVSS No. 217.

B. Emergency window requirements

1. The rear emergency window shall have a lifting assistance device that will aid in lifting and holding the rear emergency window open.

2. Side emergency exit windows, when installed, may be vertically hinged on the forward side of the window. No side emergency exit window will be located above a stop arm.

C. Emergency door requirements

1. The upper portion of the emergency door shall be equipped with approved safety glazing, the exposed area of which shall be at least 400 square inches. The lower portion of the rear emergency door on Types A-2, B, C and D vehicles shall be equipped with a minimum of 350 square inches of approved safety glazing.
2. There shall be no steps leading to an emergency door except on Types C and D all-wheel drive buses.
3. Padding shall be affixed to the top edge of each emergency door opening. Padding shall be at least three inches wide and one inch thick and shall extend the full width of the door opening.
4. There shall be no obstruction higher than  $\frac{1}{4}$  inch across the bottom of any emergency door opening. Fasteners used within the emergency exit opening shall be free of sharp edges or burrs.

D. Emergency exit requirements: The use of the following tables is to determine the required number and types of emergency exits to comply with this specification, based on the bus manufacturer's equipped seating capacity.

1. Use **Table 1** if the bus contains a rear emergency door, or
2. Use **Table 2** if the bus contains a rear pushout emergency window AND a left side emergency door, as required by FMVSS No. 217 for school buses without a rear emergency door.
3. When using either Table 1 or Table 2:
  - a. Enter the Table at the appropriate "CAPACITY" and select the desired row from the options for that capacity.
  - b. A school bus will meet the requirements of this specification and the requirements of FMVSS 217 if it contains the types and quantities of emergency exits listed on the row selected.



<b>TABLE 1</b> BUSES WITH REAR EMERGENCY DOOR (All Front Engine Buses)						<b>TABLE 2</b> BUSES WITH REAR PUSHOUT WINDOW AND LEFT SIDE EMERGENCY DOOR (All Rear Engine Buses)					
Available Combinations By Capacity	Manufacturers Equipped Capacity	Shall Have	And Shall Also Have			Available Combinations By Capacity	Manufacturers Equipped Capacity	Shall Have	And Shall Also Have		
		Roof Hatch	L. Side Emerg. Exit Windows	R. Side Emerg. Exit Windows	L. Side Emerg. Exit Door			Roof Hatch	L. Side Emerg. Exit Windows	R. Side Emerg. Exit Windows	R. Side Emerg. Exit Door
1-45	1-45	1	0	0	0	1-45	1-45	1	0	0	0
46-77	46-77	2	1	1	0	46-89	46-89	2	1	1	0
	46-77	2	0	0	1		46-89	2	0	0	1
78-93	78-93	2	2	2	0	90-105	90-105	2	2	2	0
	78-93	2	1	1	1		90-105	2	1	1	1

## EXHAUST SYSTEM

- A. The exhaust pipe, after-treatment system and tailpipe shall be outside the bus body compartment and shall be attached to the chassis so any other chassis component is not damaged.
- B. The tailpipe and after-treatment system shall be constructed of a corrosion-resistant tubing material at least equal in strength and durability to 16-gauge steel tubing of equal diameter.
- C. The tailpipe may be flush with, or shall not extend more than two inches beyond, the perimeter of the body for side-exit pipe or the bumper for rear-exit pipe. The exhaust system shall be designed such that exhaust gas will not be trapped under the body of the bus.
- D. The tailpipe shall exit to the left or right of the emergency exit door in the rear of the vehicle or to the left side of the bus in front of or behind the rear drive axle. The tailpipe exit location on all Types A-1 or B-1 buses may be in accordance to the manufacturer's standards. The tailpipe shall not exit beneath any fuel filler location, emergency door or lift door.
- E. The exhaust system shall be insulated in a manner to prevent any damage to any fuel system component.
- F. The design of the after treatment systems shall not allow active (non-manual) regeneration of the particulate filter during the loading and unloading of passengers. Manual regeneration systems will be designed such that unintentional operation will not occur.

- G. For after treatment systems that require Diesel Exhaust Fluid (DEF) to meet federally mandated emissions:
  - 1. The composition of Diesel Exhaust Fluid (DEF) must comply with International Standard ISO 22241-1. Refer to engine manufacturer for any additional DEF requirements.
  - 2. The DEF supply tank should be designed to meet a minimum ratio of 3 diesel fills to 1 DEF fill.

#### **FENDERS: FRONT**

- A. When measured at the fender line, the total spread of the outer edges of front fenders shall exceed the total spread of front tires when front wheels are in a straight-ahead position.
- B. Front fenders shall be properly braced and shall not require attachment to any part of the body.

#### **FIRE SUPPRESSION SYSTEMS (OPTIONAL)**

- A. The chassis manufacturer may provide an automatic fire extinguisher system in the engine compartment.
- B. Fire suppression system nozzles shall be located in the engine compartment, under the bus, in the electrical panel or under the dash, but they shall not be located in the passenger compartment. The system must include a lamp or buzzer to alert the driver that the system has been activated.

#### **FLOORS**

- A. The floor in the under-seat area, including tops of wheel housings, driver's compartment and toeboard, shall be covered with an elastomer floor covering, having a minimum overall thickness of  $\frac{1}{8}$  inch and a calculated burn rate of 0.1 or less, using the test methods, procedures and formulas listed in FMVSS No. 302, *Flammability of Interior Materials*. The driver's area and toeboard area in all Type-A buses may be manufacturer's standard flooring and floor covering.
- B. The floor covering in the aisles shall be ribbed or other raised pattern elastomer and have a calculated burn rate of 0.1 or less using the test methods, procedures and formulas listed in FMVSS No. 302. Minimum overall thickness shall be  $\frac{3}{16}$  inch measured from tops of ribs.
- C. The floor covering must be permanently bonded to the floor and must not crack when subjected to sudden changes in temperature. Bonding or adhesive material

shall be waterproof and shall be a type recommended by the manufacturer of floor-covering material. All seams shall be sealed with waterproof sealer.

- D. On Types B, C and D buses, a flush-mounted, screw-down plate that is secured and sealed shall be provided to access the fuel tank sending unit and/or fuel pump. This plate shall not be installed under flooring material.

## **FRAME**

- A. Frame lengths shall be established in accordance with the design criteria for the complete vehicle.
- B. Making holes in top or bottom flanges or side units of the frame and welding to the frame shall not be permitted except as provided or accepted by the chassis manufacturer.
- C. Frames shall not be modified for the purpose of extending the wheel base.
- D. Any secondary manufacturer that modifies the original chassis frame shall provide a warranty at least equal to the warranty offered by the original equipment manufacturer (OEM), and shall certify that the modification and other parts or equipment affected by the modification shall be free from defects in material and workmanship under normal use and service intended by the OEM.

## **FUEL SYSTEM**

- A. Fuel tank(s) having a minimum 30-gallon capacity shall be provided by the chassis manufacturer. Each tank shall be filled from and vented to the outside of the passenger compartment, and each fuel filler should be placed in a location where accidental fuel spillage will not drip or drain on any part of the exhaust system.
- B. The fuel system shall comply with FMVSS No. 301, *Fuel System Integrity*.
- C. Fuel tank(s) may be mounted between the chassis frame rails or outboard of the frame rails on either the left or right side of the vehicle.
- D. The actual draw capacity of each fuel tank shall be a minimum of 83 percent of the tank capacity.
- E. Installation of alternative fuel systems, including fuel tanks and piping from the tank to the engine, shall comply with all applicable fire codes in effect on the date of manufacture of the bus.
- F. Installation of Liquefied Petroleum Gas (LPG) tanks shall comply with National Fire Protection Association (NFPA) 58, *Liquefied Petroleum Gas Code*.

- G. Installation of Compressed Natural Gas (CNG) containers shall comply with FMVSS No. 304, *Compressed Natural Gas Fuel Container Integrity*.
- H. The CNG Fuel System shall comply with FMVSS No. 303, *Fuel System Integrity of Compressed Natural Gas Vehicles*.

## **GOVERNOR**

An electronic engine speed limiter shall be provided and set to limit engine speed, not to exceed the maximum revolutions per minute, as recommended by the engine manufacturer.

## **HANDRAILS**

At least one handrail shall be installed. The handrail(s) shall assist passengers during entry or exit, and shall be designed to prevent entanglement, as evidenced by the passing of the NHTSA string and nut test.

## **HEATING SYSTEM, PROVISION FOR**

The chassis engine shall have plugged openings for the purpose of supplying hot water for the bus heating system. The engine shall be capable of supplying coolant at a temperature of at least 170 degrees Fahrenheit at the engine coolant thermostat opening. The coolant flow rate shall be 50 pounds per minute at the return end of 30 feet of one inch inside diameter automotive hot water heater hose. (See SBMTC-001, *Standard Code for Testing and Rating Automotive Bus Hot Water Heating and Ventilating Equipment*.)

## **HEATING AND AIR CONDITIONING SYSTEMS**

- A. Heating System
  - 1. The heater shall be hot water and/or combustion type.
  - 2. If only one heater is used, it shall be fresh-air or combination fresh-air and recirculation type.
  - 3. If more than one heater is used, additional heaters may be re-circulating air type.
  - 4. The heating system shall be capable of maintaining bus interior temperatures, as specified in test procedure SAE J2233.
  - 5. Auxiliary fuel-fired heating systems are permitted, provided they comply with the following:

- a. The auxiliary heating system shall utilize the same type fuel as specified for the vehicle engine;
  - b. The heater(s) may be direct, hot air-type or may be connected to the engine coolant system;
  - c. An auxiliary heating system, when connected to the engine coolant system, may be used to preheat the engine coolant or preheat and add supplementary heat to the heating system;
  - d. Auxiliary heating systems must be installed pursuant to the manufacturer's recommendations and shall not direct exhaust in such a manner that will endanger bus passengers;
  - e. All combustion heaters shall be in compliance with current Federal Motor Carrier Safety Regulations;
  - f. The auxiliary heating system shall require low voltage.
  - g. Auxiliary heating systems shall comply with FMVSS No. 301, *Fuel System Integrity*, and all other applicable FMVSS's, as well as with SAE test procedures.
6. All forced-air heaters installed by body manufacturers shall bear a name plate that indicates the heater rating in accordance with SBMTC-001, *Standard Code for Testing and Rating Automotive Bus Hot Water Heating and Ventilating Equipment*. The plate shall be affixed by the heater manufacturer and shall constitute certification that the heater performance is as shown on the plate.
  7. Heater hoses shall be adequately supported to guard against excessive wear due to vibration. The hoses shall not dangle or rub against the chassis or any sharp edges and shall not interfere with or restrict the operation of any engine function. Heater hoses shall conform to SAE J20c, *Coolant System Hoses*. Heater lines on the interior of the bus shall be shielded to prevent scalding of the driver or passengers.
  8. Each hot water system installed by a body manufacturer shall include one shutoff valve in the pressure line and one shut-off valve in the return line, with both valves at the engine in an accessible location, except that on Types A and B buses the valves may be installed in another accessible location.
  9. All heaters in the passenger compartment shall be equipped with a device, installed in the hot water pressure line, which regulates the water flow to

all passenger heaters. The device shall be conveniently operated by the driver while seated. The driver and passenger heaters may operate independently of each other for maximum comfort.

10. Accessible bleeder valves for removing air from the heater shall be installed in an appropriate place in the return lines of body company-installed heater.
11. Access panels shall be provided to make heater motors, cores and fans readily accessible for service. An exterior access panel to the driver's heater may be provided.

**B. Passenger Compartment Air Conditioning (Optional)**

The following specifications are applicable to all types of school buses that may be equipped with air conditioning. This section is divided into three parts. Part 1 covers performance specifications, Part 2 covers test conditions and Part 3 covers other requirements applicable to all buses.

**1. Performance Specifications**

**a. Standard Performance**

The installed air conditioning system should cool the interior of the bus from 100 degrees to 80 degrees Fahrenheit, measured at three points (minimum) located four feet above the floor on the longitudinal centerline of the bus. The three required points shall be: (1) three feet above the center point of the horizontal driver seat surface, (2) at the longitudinal midpoint of the body, and (3) three feet forward of the rear emergency door or, for Type D rear-engine buses, three feet forward of the end of the aisle. Note for the Type A vehicles placement of the rear thermocouple should be centered in the bus over the rear axle. The independent temperature reading of each temperature probe inside the bus shall be within a range of +/- 3 degrees Fahrenheit of the average temperature at the conclusion of the test.

**b. High Performance**

The installed air conditioning system should cool the interior of the bus from 100 degrees to 70 degrees Fahrenheit, measured at three points (minimum) located four feet above the floor on the longitudinal centerline of the bus. The three required points shall be: (1) three feet above the center point of the horizontal driver seat surface, (2) at the longitudinal midpoint of the body, and (3) three feet forward of the rear emergency door or, for Type D rear-engine buses, three feet forward of the end of the aisle. Note for

the Type A vehicles placement of the rear thermocouple should be centered in the bus over the rear axle. The independent temperature reading of each temperature probe inside the bus shall be within a range of +/- 3 degrees Fahrenheit of the average temperature at the conclusion of the test.

## 2. Test Conditions

The test conditions under which the above performance standards must be achieved shall consist of (1) placing the bus in a room (such as a paint booth) where ambient temperature can be maintained at 100 degrees Fahrenheit; (2) heat-soaking the bus at 100 degrees Fahrenheit at a point measured two feet horizontally from the top of the windows on both sides of the bus, with windows open for two hours; and (3) closing windows, turning on the air conditioner with the engine running at 1250 +/- 50 RPM, and cooling the interior of the bus to 80 degrees Fahrenheit, (standard performance) or 70 degrees Fahrenheit (high performance), within 30 minutes while maintaining 100 degrees Fahrenheit outside temperature.

The manufacturer shall provide facilities for the user or user's representative to confirm that a pilot model of each bus design meets the above performance requirements.

## 3. Other Requirements

- a. Evaporator cases, lines and ducting (as equipped) shall be designed in such a manner that all condensation is effectively drained to the exterior of the bus below the floor level under all conditions of vehicle movement and without leakage on any interior portion of the bus;
- b. Evaporators and ducting systems shall be designed and installed to be free of projections or sharp edges. Ductwork shall be installed so that exposed edges face the front of the bus and do not present sharp edges;
- c. On school buses equipped with Type-2 seatbelts having anchorages above the windows, the ducting (if used) shall be placed at a height sufficient to not obstruct occupant securement anchorages. This clearance shall be provided along the entire length (except at evaporator locations) of the passenger area on both sides of the bus interior;
- d. The body may be equipped with insulation, including sidewalls, roof, firewall, rear, inside body bows and plywood or composite floor insulation to reduce thermal transfer;

- e. All glass (windshield, service and emergency doors, side and rear windows) may be equipped with maximum integral tinting allowed by federal, state or ANSI standards for the respective locations, except that windows rear of the driver's compartment, if tinted, shall have approximately 28 percent light transmission;
- f. Electrical generating capacity shall be provided to accommodate the additional electrical demands imposed by the air conditioning system;
- g. Roofs may be painted white to aid in heat dissipation (See APPENDIX B); and
- h. Air intake for any evaporator assembly(ies), except for front evaporator of Type A-1, shall be equipped with replaceable air filter(s) accessible without disassembly of evaporator case.
- i. For all buses (except Type D rear engine transit) equipped with a rear evaporator assembly, evaporator shall not encroach upon head impact zone, but may occupy an area of less than 26.5 inches from the rear wall and 14 inches from the ceiling.
- j. For Type D rear engine transit buses equipped with a rear evaporator over the davenport, the evaporator assembly may not interfere with rear exit window and may not extend above the rear seating row.

## **HINGES**

All exterior metal door hinges shall be designed to allow lubrication to be channeled to the center 75% of each hinge loop without disassembly, unless they are constructed of stainless steel, brass or non-metallic hinge pins or other designs that prevent corrosion.

## **HORN**

The bus shall be equipped with a horn(s) of standard make with the horn(s) capable of producing a complex sound in bands of audio frequencies between 250 and 2,000 cycles per second, and tested in accordance with SAE J377, *Horn—Forward Warning—Electric—Performance, Test, and Application*.

## **IDENTIFICATION**

- A. The body shall bear the words "SCHOOL BUS" in black letters at least eight inches high on both front and rear of the body or on signs attached thereto. Lettering shall be placed as high as possible without impairment of its visibility. Letters shall conform to "Series B" of Standard Alphabets for Highway Signs.



“SCHOOL BUS” lettering shall have a reflective background, or as an option, may be illuminated by backlighting. MFSABs are exempt from these requirements.

- B. Required lettering and numbering shall include:
  - 1. District, company name or owner of the bus displayed at the beltline.
  - 2. The bus identification number displayed on the sides, on the rear and on the front.
- C. Other lettering, numbering or symbols which may be displayed on the exterior of the bus shall be limited to:
  - 1. Bus identification number, minimum 12-inch high characters, on top of the bus, in addition to required numbering on the sides, rear and front;
  - 2. The location of the battery(ies) identified by the word “BATTERY” or “BATTERIES” on the battery compartment door in two inch lettering;
  - 3. Symbols or letters not to exceed 64 square inches of total display near the entrance door, displaying information for identification by the students of the bus or route served;
  - 4. Manufacturer, dealer or school identification or logos;
  - 5. Symbols identifying the bus as equipped for or transporting students with special needs as noted in SPECIALLY EQUIPPED SCHOOL BUS SPECIFICATIONS;
  - 6. Lettering on the rear of the bus relating to school bus flashing signal lamps or railroad stop procedures; and
  - 7. Identification of fuel type in 2-inch lettering adjacent to the fuel filler opening.

## **INSIDE HEIGHT**

Inside body height shall be 72 inches or more, measured metal to metal, at any point on the longitudinal centerline from the front vertical bow to the rear vertical bow. Inside body height of Type A-1 buses shall be 62 inches or more. Inside height measurement does not apply to air conditioning equipment.

## INSTRUMENTS AND INSTRUMENT PANEL

- A. The chassis shall be equipped with the instruments and gauges listed below: (Telltale warning lamps in lieu of gauges are not acceptable, except as noted.)
1. Speedometer;
  2. Odometer that can be read without using a key and that will give accrued mileage (to seven digits), including tenths of miles, unless tenths of miles are registered on a trip odometer.
  3. Tachometer (**Note:** For types B, C and D buses, a tachometer shall be installed so as to be visible to the driver while seated in a normal driving position.);
  4. Voltmeter (**Note:** An ammeter with graduated charge and discharge indications is permitted in lieu of a voltmeter; however, when used, the ammeter wiring must be compatible with the current flow of the system.);
  5. Oil pressure gauge;
  6. Water temperature gauge;
  7. Fuel gauge;
  8. High beam headlamp indicator;
  9. Brake air pressure gauge (air brakes), brake indicator lamp (vacuum/ hydraulic brakes), or brake indicator lamp (hydraulic/hydraulic);
  10. Turn signal indicator; and
  11. Glow-plug indicator lamp, where appropriate.
- B. All instruments shall be easily accessible for maintenance and repair.
- C. The instruments and gauges shall be mounted on the instrument panel so that each is clearly visible to the driver while seated in a normal driving position.
- D. Instruments and controls must be illuminated as required by FMVSS No. 101, *Controls and Displays*.

- E. Multi-function gauge (MFG)
  - 1. The driver must be able to manually select any displayable function of the gauge on a MFG, whenever desired.
  - 2. Whenever an out-of-limits condition that would be displayed on one or more functions of a MFG occurs, the MFG controller should automatically display this condition on the instrument cluster. This should be in the form of an illuminated telltale warning lamp, as well as having the MFG automatically display the out-of-limits indications. If two or more functions displayed on the MFG go out of limits simultaneously, then the MFG should sequence automatically between those functions continuously until the condition(s) are corrected.
  - 3. The use of a MFG does not relieve the need for audible warning devices, where required.

#### **INSULATION (OPTIONAL)**

- A. If thermal insulation is specified, it shall be fire-resistant, UL approved, with minimum R-value of 5.5. Insulation shall be installed so as to prevent sagging.
- B. If floor insulation is required, it shall be five-ply softwood plywood, nominal  $\frac{5}{8}$  inch thickness and shall be equal to or exceed properties of the exterior-type, C-D Grade, as specified in the standard issued by U.S. Department of Commerce. When plywood is used, all exposed edges shall be sealed. Type A-1 buses may be equipped with nominal  $\frac{1}{2}$  inch-thick plywood or equivalent material meeting the above requirements.  
Equivalent material may be used to replace plywood, provided it has equal or greater insulation R-value, sound abatement, deterioration-resistant and moisture-resistant properties.

#### **INTERIOR**

- A. The interior of the bus shall be free of all unnecessary projections, which include luggage racks and attendant handrails, to minimize the potential for injury. This specification requires inner lining on ceilings and walls. If the ceiling is constructed with lap joints, the forward panel shall be lapped by rear panel and exposed edges shall be beaded, hemmed, flanged or otherwise treated to minimize sharp edges. Buses may be equipped with a storage compartment for tools, tire chains and/or tow chains. (See BUS BODY AND BODY SPECIFICATIONS, Storage Compartment.)

- B. Interior overhead storage compartments may be provided if they meet the following criteria:
  - 1. Head protection requirements of FMVSS No. 222, *School Bus Passenger Seating and Crash Protection*, where applicable;
  - 2. Be completely enclosed and equipped with latching door (both door and latch sufficient to withstand a pushing force of 50 pounds applied at the inside center of the door);
  - 3. Have all corners and edges rounded with a minimum radius of one inch or be padded equivalent to door header padding;
  - 4. Be attached to the bus sufficiently to withstand a force equal to 20 times the maximum rated capacity of the compartment; and
  - 5. Have no protrusions greater than ¼ inch.
- C. The driver's area forward of the foremost padded barriers will permit the mounting of required safety equipment and vehicle operation equipment.
- D. Every school bus shall be constructed so that the noise level at the ear of the occupant nearest to the primary vehicle noise source shall not exceed 85 DBA when tested according to the procedure described in APPENDIX B.

## LAMPS AND SIGNALS

- A. Interior lamps which illuminate the aisle and the stepwell shall be provided. The stepwell lamp shall be illuminated by an entrance door-operated switch, to illuminate only when headlamps and clearance lamps are on and the entrance door is open.
- B. Body instrument panel lamps may be controlled by an independent dimmer switch or may be controlled by the dimmer that operates the gauge lighting.
- C. School bus alternately flashing signal lamps shall be provided, as described by law. MFSAB's are exempt from this requirement.
  - 1. The bus shall be equipped with two red lamps at the rear of the vehicle and two red lamps at the front of the vehicle.
  - 2. In addition to the four red lamps described above, four amber lamps shall be installed so that one amber lamp is located near each red signal lamp, at the same level, but closer to the vertical centerline of the bus. The system of red and amber signal lamps shall be wired so that amber lamps are energized manually. The red lamps are automatically energized and amber

lamps are automatically de-energized when stop signal arms are extended or when the bus entrance door is opened.

The above mentioned activation sequence can be accomplished with either a “sequential operation” or a “non-sequential operation” warning lamp system. While each of the systems can be configured to include components such as a master switch, amber activation switch, interrupt switch, etc., the presence (or absence) of these components does not affect the classification of the system as either *sequential* or *non-sequential*.

Both *sequential* and *non-sequential* systems can be configured with a multitude of switch combinations to provide a unique system meeting specific user requirements. An amber pilot lamp and a red pilot lamp shall be installed adjacent to the driver controls for the flashing signal lamp to indicate to the driver which lamp system is activated.

3. For background color requirements, refer to appropriate state specification requirements.
4. Red lamps shall flash at any time the stop signal arm is extended.
5. All flashers for alternately flashing red and amber signal lamps shall be enclosed in the body in a readily accessible location.

D. Turn signal and stop/tail lamps

1. The bus body shall be equipped with amber rear turn signal lamps that are at least seven inches in diameter or, if a shape other than round, a minimum 38 square inches of illuminated area and shall meet FMVSS No. 108, *Lamps, Reflective Devices, and Associated Equipment*. These signal lamps must be connected to the chassis hazard warning switch to cause simultaneous flashing of turn signal lamps when needed as a vehicular traffic hazard warning. Turn signal lamps are to be placed as wide apart as practical and their horizontal centerline shall be a maximum of 12 inches below the rear window.
2. Buses shall be equipped with amber side-mounted turn signal lamps. The turn signal lamp on the left side shall be mounted rearward of the stop signal arm and the turn signal lamp on the right side shall be mounted rearward of the entrance door.
3. Buses shall be equipped with four combination red stop/tail lamps.
  - a. Two combination lamps with a minimum diameter of seven inches, or if a shape other than round, a minimum 38 square inches of illuminated area shall be mounted on the rear of the bus just inside the turn signal lamps.

- b. Two combination lamps with a minimum diameter of four inches, or if a shape other than round, a minimum of 12 square inches of illuminated area, shall be placed on the rear of the body between the beltline and the floor line. The rear license plate lamp may be combined with 1 lower tail lamp. Stop lamps shall be activated by the service brakes and shall emit a steady light when illuminated.
- E. On buses equipped with a monitor for the front and rear lamps of the school bus, the monitor shall be mounted in full view of the driver. If the full circuit current passes through the monitor, each circuit shall be protected against any short circuit or intermittent shorts by a fuse circuit breaker, or electronic protection device.
- F. An optional white flashing strobe lamp may be installed on the roof of a school bus, at a location not to exceed  $\frac{1}{4}$  the body length forward from the rear of the roof edge. The lamp shall have a single clear lens emitting light 360 degrees around its vertical axis and it may not extend above the roof more than the maximum legal height. A manual switch and a pilot lamp shall be included to indicate when the lamp is in operation. Optionally, the strobe lamp may be mounted on the roof in the area directly over the restraining barrier on the driver's side; may be wired to activate with the amber alternately flashing signal lamps, continuing through the full loading or unloading cycle; and may be equipped with an override switch to allow activation of the strobe at any time for use in inclement weather.
- G. The bus body shall be equipped with two white rear backup lamps that are at least four inches in diameter or, if a shape other than round, a minimum of 12 square inches of illuminated area and shall meet FMVSS No. 108. If backup lamps are placed on the same horizontal line as the brake lamps and turn signal lamps, they shall be to the inside.
- H. A daytime running lamps (DRL) system shall be provided.

## **METAL TREATMENT**

- A. All metal except high-grade stainless steel or aluminum used in construction of the bus body shall be zinc-coated or aluminum-coated or treated to prevent corrosion. This includes but is not limited to such items as structural members, inside and outside panels, door panels and floor sills. Excluded are such items as door handles, grab handles, interior decorative parts and other interior plated parts.
- B. All metal parts that will be painted, in addition to the above requirements, shall be chemically cleaned, etched, zinc phosphate-coated and zinc chromate or epoxy-primed to improve paint adhesion. This includes, but is not limited to, such items as crossing control arm and stop arm.

- C. In providing for these requirements, particular attention shall be given to lapped surfaces, welded connections of structural members, cut edges on punched or drilled hole areas in sheet metal, closed or box sections, un-vented or un-drained areas and surfaces subjected to abrasion during vehicle operation.
- D. As evidence that the above requirements have been met, samples of materials and sections used in the construction of the bus body shall be subjected to a cyclic corrosion testing as outlined in SAE J1563.

## **MIRRORS**

- A. The interior glass mirror shall be either laminated or tempered and shall have rounded corners and protected edges. Mirrors shall be 6x16 inches minimum for Type A buses and be 6x30 inches minimum for Types C and D buses.
- B. Each school bus shall be equipped with exterior mirrors meeting the requirements of FMVSS No. 111, *Rearview Mirrors*. The right side rear view mirror shall not be obscured by the un-wiped portion of the windshield. Mirrors shall be easily adjustable, but shall be rigidly braced, so as to reduce vibration.
- C. Heated external mirrors may be used.
- D. Remote controlled external rear view mirrors may be used.

## **MOUNTING**

- A. The rear body cross member shall be supported by the chassis frame. Except where chassis components interfere, the bus body shall be attached to the chassis frame at each main floor sill in such a manner as to prevent shifting or separation of the body from the chassis under severe operating conditions.
- B. Isolators shall be installed at all contact points between the body and the chassis frame on Types A-2, B, C and D buses, and shall be secured by a positive means to the chassis frame or body to prevent shifting, separation, or displacement of the isolators under severe operating conditions.

## **OIL FILTER**

An oil filter with a replaceable element shall be provided and connected by flexible oil lines if it is not a built-in or an engine-mounted design. The oil filter shall have a capacity in accordance with the engine manufacturer's recommendation.

## **OPENINGS**

All openings in the floorboard or firewall between the chassis and the passenger compartment (e.g., for gearshift selector and parking brakes lever) shall be sealed.

## **OVERALL LENGTH**

Overall length of the bus shall not exceed 45 feet, excluding accessories.

## **OVERALL WIDTH**

Overall width of bus shall not exceed 102 inches, excluding accessories.

## **PASSENGER LOAD**

- A. Actual gross vehicle weight (GVW) is the sum of the chassis weight plus the body weight, plus the driver's weight, plus total seated student weight. For purposes of calculation, the driver's weight is 150 pounds and the student weight is 120 pounds per student.
- B. Actual GVW shall not exceed the chassis manufacturer's GVWR for the chassis, nor shall the actual weight carried on any axle exceed the chassis manufacturer's Gross Axle Weight Rating (GAWR).

## **PUBLIC ADDRESS SYSTEM**

- A. Buses may be equipped with an AM/FM/audio and/or public address system having interior and exterior speakers.
- B. No internal speakers, other than the driver's communication systems, may be installed within four feet of the driver's seat back in its rearmost upright position.

## **RETARDER SYSTEM (OPTIONAL EQUIPMENT)**

A retarder system, if used, shall limit the speed of a fully loaded school bus to 19.0 mph on a seven percent grade for 3.6 miles.

## **RETROREFLECTIVE MATERIAL**

(See also APPENDICES A and B, Retroreflective Sheeting.)

- A. The front and/or rear bumper may be marked diagonally 45 degrees down toward the centerline of the pavement with two  $\pm$  ¼-inch wide strips of non-contrasting retroreflective material.
- B. The rear of the bus body shall be marked with strips of retroreflective NSBY material to outline the perimeter of the back of the bus using material which conforms with the requirements of FMVSS No. 131, *School Bus Pedestrian Safety Devices*, Table 1. The perimeter marking of rear emergency exits per



FMVSS No. 217, *Bus Emergency Exits and Window Retention and Release*, and/or the use of retroreflective “SCHOOL BUS” signs partially accomplishes the objective of this requirement. To complete the perimeter marking of the back of the bus, strips of retroreflective NSBY material, a minimum of 1 inch and a maximum of 2 inches in width shall be applied horizontally above the rear windows and above the rear bumper, extending from the rear emergency exit perimeter, marking outward to the left and right rear corners of the bus. Vertical strips shall be applied at the corners connecting these horizontal strips.

- C. “SCHOOL BUS” signs, if not a lighted design, shall be marked with retroreflective NSBY material comprising background for lettering of the front and/or rear “SCHOOL BUS” signs.
- D. Sides of the bus body shall be marked with at least 1¾-inch retroreflective NSBY material, extending the length of the bus body and located (vertically) between the floor line and the beltline.
- E. If used, signs placed on the rear of the bus relating to school bus flashing signal lamps or railroad stop procedures may be retroreflective material, as specified by each state.

## **ROAD SPEED CONTROL**

When it is desired to accurately control vehicle maximum speed, a vehicle speed limiter may be utilized.

## **RUB RAILS**

- A. There shall be one rub rail on each side of the bus located at, or no more than eight inches above, the seat cushion level. They shall extend from the rear side of the entrance door completely around the bus body (except at the emergency door or any maintenance access door) to the point of curvature near the outside cowl on the left side.
- B. There shall be one additional rub rail on each side located 10 inches or less above the floor line. The rub rail shall cover the same longitudinal span as the upper rub rail, except at the wheel housing, and it shall extend only to the longitudinal tangent of the right and left rear corners.
- C. Rub rails above the floor line shall be attached at each body post and at all other upright structural members.
- D. Each rub rail shall be four inches or more in width in its finished form and shall be constructed of 16-gauge metal or other material of equivalent strength suitable to help protect body side panels from damage. Rub rails shall be constructed in corrugated or ribbed fashion.

- E. Rub rails shall be applied outside the body or outside the body posts. (Pressed-in or snap-on rub rails do not satisfy this requirement.) For Type A-1 vehicles using the body provided by the chassis manufacturer or for Types A-2, B, C and D buses containing the rear luggage or the rear engine compartment, rub rails need not extend around the rear corners.
- F. The bottom edge of the body side skirts shall be stiffened by application of a rub rail, or the edge may be stiffened by providing a flange or other stiffeners.

## **SEATS AND RESTRAINING BARRIERS**

### **A. Passenger Seating**

1. School bus design capacities shall be in accordance with 49 CFR, Part 571.3, *Definitions*, and FMVSS No. 222, *School Bus Passenger Seating and Crash Protection*.
2. All seats shall have a minimum cushion depth of 15 inches, a seat back height of 24 inches above the seating reference point, and must comply with all other requirements of FMVSS No. 222.
3. All restraining barriers and passenger seats shall be constructed with materials that enable them to meet the criteria of the *School Bus Seat Upholstery Fire Block Test*.
4. Each seat leg shall be secured to the floor by a minimum of two bolts, washers and nuts. Flange-head nuts may be used in lieu of nuts and washers. All seat frames attached to the seat rail shall be fastened with two or more bolts, washers and nuts, or with flange-head nuts. Seats may be track-mounted in conformance with FMVSS No. 222.
5. If track seating is installed, the manufacturer shall supply minimum and maximum seat spacing dimensions (applicable to the bus) which comply with FMVSS No. 222. This information shall be on a label permanently affixed to the bus.
6. All school buses (including Type A) shall be equipped with restraining barriers which conform to FMVSS No. 222.
7. A flip-up seat may be installed at any side emergency door. If provided, the flip-up seat shall conform to FMVSS No. 222 and aisle clearance requirements of FMVSS No. 217, *Bus Emergency Exits and Window Retention and Release*. The flip-up seat shall be free of sharp projections on the underside of the seat bottom. The underside of the flip-up seat bottoms shall be padded or contoured to reduce the possibility of clothing being snagged. Flip-up seats shall be constructed to prevent passenger limbs from becoming entrapped between the seat back and the seat

cushion when the seat is in the upright position. The seat cushion shall be designed to rise to a vertical position automatically when it is not occupied.

8. Lap belts shall not be installed on passenger seats in large school buses (over 10,000 pounds GVWR) except in conjunction with child safety restraint systems that comply with the requirements of FMVSS No. 213, *Child Restraint Systems*.

B. Pre-School Age Seating

Passenger seats designed to accommodate a child or infant carrier seat shall comply with FMVSS No. 225, *Child Restraint Anchorage Systems*. These seats shall be in compliance with NHTSA's "Guideline for the Safe Transportation of Pre-school Age Children in School Buses." (Note: See A.8, above.)

C. Driver Seat

1. The driver's seat supplied by the body manufacturer shall be a high back seat. The seat back shall be adjustable to 15 degrees minimum, without requiring the use of tools. The seat shall be equipped with a head restraint to accommodate a 5th percentile female to a 95th percentile adult male, as defined in FMVSS No. 208, *Occupant Crash Protection*.
2. Type A buses may utilize the standard driver's seat provided by the chassis manufacturer.

D. Driver Restraint System

A Type 2 lap/shoulder belt shall be provided for the driver. On buses where the driver's seat and upper anchorage for the shoulder belt are both attached to the body structure, a driver's seat with an integrated Type 2 lap/shoulder belt may be substituted. On buses where the driver's seat and upper anchorage for the shoulder belt are separately attached to both body and chassis structures (i.e., one attached to the chassis and the other attached to the body), a driver's seat with an integrated Type 2 lap/shoulder belt should be used.

The assembly shall be equipped with an emergency locking retractor for the continuous belt system. On all buses except Type A that are equipped with a standard chassis manufacturer's driver's seat, the lap portion of the belt system shall be guided or anchored to prevent the driver from sliding sideways under the belt system. The lap/shoulder belt shall be designed to allow for easy adjustment in order to fit properly and to effectively protect drivers varying in size from 5th percentile adult female to 95th percentile adult male.

- E. Each bus shall be equipped with a durable webbing cutter having a full width handgrip and a protected, replaceable or non-corrodible blade. The required webbing cutter shall be mounted in a location accessible to the seated driver in an easily detachable manner.

## **SHOCK ABSORBERS**

The bus shall be equipped with double-action shock absorbers compatible with the manufacturer's rated axle capacity at each wheel location.

## **SIDE SKIRTS**

School bus body side skirts between the front and rear axles shall extend down to within two inches plus or minus, of the horizontal line from the center of the front spindle to the center of the rear axle. The manufacturer may offer optional side skirt lengths that extend lower than this requirement. This measurement shall apply to a new unloaded school bus located on a flat, level surface.

## **STEERING GEAR**

- A. The steering gear shall be approved by the chassis manufacturer and designed to ensure safe and accurate performance when the vehicle is operated with maximum load and at maximum speed.
- B. If external adjustments are required, the steering mechanism shall be accessible to make adjustments.
- C. Changes shall not be made to the steering apparatus which are not approved by the chassis manufacturer.
- D. There shall be a clearance of at least two inches between the steering wheel and cowl, instrument panel, windshield or any other surface.
- E. Power steering is required and shall be of the integral type with integral valves.
- F. The steering system shall be designed to provide a means for lubrication of all wear-points that are not permanently lubricated.

## **STEPS**

- A. The first step at the entrance door shall be not less than 10 inches and not more than 14 inches from the ground when measured from the top surface of the step to the ground, based on standard chassis specifications, except that on Type D vehicles, the first step at the entrance door shall be 12 inches to 16 inches from the ground. An auxiliary step may be provided to compensate for the increase in ground-to-first-step clearance. The auxiliary step is not required to be enclosed.

- B. Step risers shall not exceed a height of 10 inches. **Exception:** When plywood is used on a steel floor or step, the riser height may be increased by the thickness of the plywood.
- C. Steps shall be enclosed to prevent accumulation of ice and snow.
- D. Steps shall not protrude beyond the side body line.

## STEP TREADS

- A. All steps, including the floor line platform area, shall be covered with an elastomer floor covering having a minimum overall thickness of 0.187 inch.
- B. The step covering shall be permanently bonded to a durable backing material that is resistant to corrosion.
- C. Steps, including the floor line platform area, shall have a 1½-inch nosing that contrasts in color by at least 70 percent measured in accordance with the contrasting color specification in 36 CFR, Part 1192, ADA, *Accessibility Guidelines for Transportation Vehicles*.
- D. Step treads shall have the following characteristics:
  - 1. Abrasion resistance: Step tread material weight loss shall not exceed 0.40 percent, as tested under ASTM D-4060, *Standard Test Method for Abrasion Resistance of Organic Coatings by the Taber Abraser*, (CS-17 Wheel, 1000 gram, 1000 cycle).
  - 2. Weathering resistance: Step treads shall not break, crack, or check after ozone exposure (seven days at 50 phm at 40 degrees C) and Weatherometer exposure (ASTM D-750, *Standard Test Method for Rubber Deterioration in Carbon-Arc Weathering Apparatus*, seven days).
  - 3. Flame resistance: Step treads shall have a calculated burn rate of .01 or less using the test methods, procedures and formulas listed in FMVSS No. 302, *Flammability of Interior Materials*.

## STIRRUP STEPS

If the windshield and lamps are not easily accessible from the ground, there may be at least one folding stirrup step or recessed foothold installed on each side of the front of the body for easy accessibility for cleaning. There also may be a grab handle installed in conjunction with the step. Steps are permitted in or on the front bumper in lieu of the stirrup steps if the windshield and lamps are easily accessible for cleaning from that position.

## **STOP SIGNAL ARM**

The stop signal arm(s) shall comply with the requirements of FMVSS No. 131, *School Bus Pedestrian Safety Devices*. MFSABs are exempt from these requirements.

## **STORAGE COMPARTMENT (OPTIONAL)**

A storage container for tools, tire chains and/or other equipment may be located either inside or outside the passenger compartment. If inside, it shall be fastened to the floor and have a cover with a positive fastening device.

## **SUN SHIELD**

- A. On Types B, C and D vehicles, an interior adjustable transparent sun shield, with a finished edge and dimensions not less than 6x30 inches, shall be installed in a position convenient for use by the driver.
- B. On Type A buses, the sun shield (visor) shall be installed by the chassis manufacturer.

## **SUSPENSION SYSTEMS**

- A. The capacity of springs or suspension assemblies shall be commensurate with the chassis manufacturer's GVWR.
- B. Rear leaf springs shall be of a progressive rate or multi-stage design. Front leaf springs shall have a stationary eye at one end and shall be protected by a wrapped leaf, in addition to the main leaf.

## **THROTTLE**

The force required to operate the throttle shall not exceed 16 pounds throughout the full range of accelerator pedal travel.

## **TIRES AND RIMS**

- A. Rims and tires of the proper size and load rating commensurate with the chassis manufacturer's GVWR shall be provided. The use of multi-piece rims and/or tube-type tires shall not be permitted on any school bus ordered after December 31, 1995.
- B. Dual rear tires shall be provided on Type A-2, Type B, Type C and Type D school buses.

- C. All tires on a vehicle shall be of the same size, and the load range of the tires shall meet or exceed the GVWR, as required by FMVSS No. 120, *Tire Selection and Rims for Vehicles other than Passenger Car*.
- D. If the vehicle is equipped with a spare tire and rim assembly, it shall be the same size as those mounted on the vehicle.
- E. If a tire carrier is required, it shall be suitably mounted in an accessible location outside of the passenger compartment.

## **TOWING ATTACHMENT POINTS**

Front and or/rear towing devices (i.e., tow hooks, tow eyes, or other designated towing attachment points) shall be furnished to assist in the retrieval of buses that are stuck and/or for towing buses when a wrecker with a “wheel lift” or an “axle lift” is not available or cannot be applied to the towed vehicle.

- A. Towing devices shall be attached to the chassis frame either by the chassis manufacturer or in accordance with the chassis manufacturer’s specifications.
- B. Each towing device shall have a strength rating of 13,500 pounds each, for a combined rating of 27,000 pounds with the force applied in the rearward direction, parallel to the ground, and parallel to the longitudinal axis of the chassis frame rail. For pulling and lifting purposes, tow hooks are meant to be used simultaneously. For pulling, angularity applied to the tow hooks will decrease the capacities of the tow hooks.
- C. The towing devices shall be mounted such that they do not project forward of the front bumper or rearward of the rear bumper.

**Note:** Type A buses are exempt from the requirement for front tow hooks or eyes due to built-in crush zones.

## **TRACTION ASSISTING DEVICES (OPTIONAL)**

- A. Where required or used, sanders shall:
  1. Be hopper cartridge-valve type;
  2. Have a metal hopper with all interior surfaces treated to prevent condensation of moisture;
  3. Have at least 100 pounds (grit) capacity;
  4. Have a cover that screws in place on the filler opening of the hopper, thereby sealing the unit airtight;

5. Have discharge tubes extending under the fender wheelhousing to the front of each rear wheel;
  6. Have non-clogging discharge tubes with slush-proof, non-freezing rubber nozzles;
  7. Be operated by an electric switch with a pilot lamp mounted on the instrument panel located so as to be exclusively controlled by the driver;
  8. Be equipped with a gauge to indicate that the hopper has reached the one-quarter level (and needs to be refilled); and
  9. Be designed to prevent freezing of all activation components and moving parts.
- B. Automatic traction chains may be installed.

## **TRANSMISSION**

- A. Automatic transmissions shall have no fewer than three forward speeds and one reverse speed. Mechanical shift selectors shall provide a detent between each gear position when the gear selector quadrant and shift selector are not steering-column mounted.
- B. In manual transmissions, second gear and higher shall be synchronized, except when incompatible with engine power. A minimum of three forward speeds and one reverse speed shall be provided.
- C. Automatic transmissions incorporating a parking pawl shall have a transmission shifter interlock controlled by the application of the service brake to prohibit accidental engagement of the transmission. All non-park pawl transmissions shall incorporate a park brake interlock that requires the service brake to be applied to allow release of the parking brake.

## **TRASH CONTAINER AND HOLDING DEVICE (OPTIONAL)**

When requested or used, the trash container shall be secured by a holding device that is designed to prevent movement and to allow easy removal and replacement. It shall be installed in an accessible location in the driver's compartment, not obstructing passenger access to the entrance door.

## **TURNING RADIUS**

- A. A chassis with a wheelbase of 264 inches or less shall have a right and left turning radius of not more than 42½ feet, curb-to-curb measurement.



- B. A chassis with a wheelbase of 265 inches or more shall have a right and left turning radius of not more than 44½ feet, curb-to-curb measurement.

## UNDERCOATING

- A. The entire underside of the bus body, including floor sections, cross member and below floor-line side panels, shall be coated with rust-proofing material for which the material manufacturer has issued to the bus body manufacturer a notarized certification to the bus body manufacturer that materials meet or exceed all performance requirements of SAE J1959.
- B. The undercoating material shall be applied with suitable airless or conventional spray equipment to the undercoating material manufacturer recommended film thickness and shall show no evidence of voids in the cured film.
- C. The undercoating material shall not cover any exhaust components of the chassis.

## VENTILATION

- A. Auxiliary Fans (**optional**) shall meet the following requirements:
  - 1. Fans for left and right sides of the windshield shall be placed in a location where they can be adjusted for maximum effectiveness and where they do not obstruct vision to any mirror. **Note:** Type A buses may be equipped with one fan.
  - 2. Fans shall have six-inch (nominal) diameter.
  - 3. Fan blades shall be enclosed in a protective cage. Each fan shall be controlled by a separate switch.
- B. The bus body shall be equipped with a suitably controlled ventilating system with capacity sufficient to maintain the proper quantity of air flow under operating conditions without having to open a window except in extremely warm weather.
- C. Static-type, non-closeable exhaust ventilation shall be installed in a low-pressure area of the roof.
- D. Roof hatches designed to provide ventilation in all types of exterior weather conditions may be provided.

## WHEELHOUSING

- A. The wheelhousing opening shall allow for easy tire removal and service.

- B. Wheelhousings shall be attached to the floor panels in a manner to prevent any dust, water or fumes from entering the body. Wheelhousings shall be constructed of 16- gauge (or thicker) steel.
- C. The inside height of the wheelhousings above the floor line shall not exceed 12 inches.
- D. The wheelhousings shall provide clearance for installation and use of tire chains on single or dual (if so equipped) power-driving wheels.
- E. No part of a raised wheelhousing shall extend into the emergency door opening.

## **WINDOWS**

- A. Other than emergency exits designated to comply with FMVSS No. 217, *Bus Emergency Exits and Window Retention and Release*, each side window shall provide an unobstructed opening of at least nine inches high (but not more than 13 inches high) and at least 22 inches wide, obtained by lowering the window. One window on each side of the bus may be less than 22 inches wide.
- B. Optional tinted and/or frost-free glazing may be installed in all doors or windows.
- C. Windshields shall comply with federal, state and local regulations.

## **WINDSHIELD WASHERS**

A windshield washer system shall be provided.

## **WINDSHIELD WIPERS**

- A. A two-speed or variable speed windshield wiping system, with an intermittent feature, shall be provided and shall be operated by a single switch.
- B. The wipers shall meet the requirements of FMVSS No. 104, *Windshield Wiping and Washing Systems*.

[Back to Contents](#)

**Page Intentionally Left Blank**

**SPECIALLY  
EQUIPPED  
SCHOOL BUS  
SPECIFICATIONS**

**Page Intentionally Left Blank**

# SPECIALLY EQUIPPED SCHOOL BUS SPECIFICATIONS

## INTRODUCTION

Equipping buses to accommodate students with disabilities is dependent upon the needs of the passengers. While one bus may be fitted with a lift, another may have belts installed to secure child seats. Buses so equipped are not to be considered a separate class of school bus, but simply a regular school bus that is equipped for special accommodations.

The specifications in this section are intended to supplement specifications in the BODY AND CHASSIS section. In general, specially equipped buses shall meet all the requirements of the preceding sections, plus those listed in this section. It is recognized that the field of special transportation is characterized by varied needs for individual cases and by rapidly emerging technologies for meeting individual student needs. A flexible, “common sense” approach to the adoption and enforcement of specifications for these vehicles, therefore, is prudent.

As defined by 49 Code of Federal Regulations (CFR) §571.3, “*Bus* means a motor vehicle with motive power, except a trailer, designed for carrying more than ten persons” (11 or more including the driver). This definition also embraces the more specific category, *school bus*. Vehicles with 10 or fewer occupant positions (including the driver) are not classified as buses. For this reason, the federal vehicle classification, *multipurpose passenger vehicle* (49 CFR § 571.3), or MPV, must be used by manufacturers for these vehicles in lieu of the classification *school bus*.

The definition of *designated seating position* in 49 CFR § 571.3 states that, in the case of “vehicles sold or introduced into interstate commerce for purposes that include carrying students to and from school or related events” and which are “intended for securement of an occupied wheelchair during vehicle operations,” each wheelchair securement position shall be counted as four designated seating positions when determining the classification (whether *school bus* or *MPV*). This classification system does not preclude state or local agencies or these national specifications from requiring compliance of school bus-type MPVs with the more stringent federal standards for school buses. The following specifications address modifications as they pertain to school buses that, with standard seating arrangements prior to modification, would accommodate eleven or more occupants including the driver. If by addition of a power lift, wheelchair positions or other modifications, the capacity is reduced such that vehicles become MPVs, the intent of these specifications is to require these vehicles to meet the same specifications they would have had to meet prior to such modifications, and such MPVs are included in all references to school buses and requirements for school buses which follow.

## DEFINITION

A *specially equipped school bus* is any school bus that is designed, equipped and/or modified to accommodate students with special transportation needs.

## **GENERAL REQUIREMENTS**

- A. Specially equipped school buses shall comply with the *National School Transportation Specifications and Procedures* and with the Federal Motor Vehicle Safety Standards (FMVSS) applicable to their Gross Vehicle Weight Rating (GVWR) category.
- B. Any school bus to be used for the transportation of children who utilize a wheelchair or other mobile positioning device, or who require life-support equipment that prohibits use of the regular service entrance, shall be equipped with a power lift, unless a ramp is needed for unusual circumstances related to passenger needs.

## **AISLES**

All school buses equipped with a power lift shall provide a minimum 30-inch pathway leading from any wheelchair position to at least one 30 inches wide emergency exit door. A wheelchair securement position shall never be located directly in front of (blocking) a power lift door location.

## **GLAZING**

Tinted glazing may be installed in all doors, windows and windshields consistent with federal, state and local regulations.

## **IDENTIFICATION**

Specially equipped school buses shall display the International Symbol of Accessibility below the window line. Such emblems shall be white on blue or black background, shall not exceed 12 inches square in size and shall be of a high-intensity retroreflective material meeting the requirements of Federal Highway Administration (FHWA) FP-85, *Standard Specifications for Construction of Roads and Bridges on Federal Highway Projects*.

## **PASSENGER CAPACITY RATING**

In determining the passenger capacity of a school bus for purposes other than actual passenger load (e.g., vehicle classification or various billing/reimbursement models), any location in a school bus intended for securement of a wheelchair during vehicle operation shall be regarded as four designated seating positions, and each lift area shall count as four designated seating positions.

## **POWER LIFTS**

- A. The power lift shall be located on the right side of the bus body.

Exception: The lift may be located on the left side of the bus if, and only if, the bus is used to deliver students only to the left side of one-way streets.

B. All specially equipped school buses shall provide a level-change mechanism or boarding device (e.g., lift or ramp), complying with this section or the RAMP section, with sufficient clearances to permit a wheelchair user to reach a securement location.

C. Vehicle lift and installation

General: Vehicle lifts and installations shall comply with the requirements set forth in FMVSS 403, *Platform Lift Systems for Motor Vehicles*, and FMVSS 404, *Platform Lift Installations in Motor Vehicles*.

Design loads: The design load of the lift shall be at least 800 pounds. Working parts, such as cables, pulleys and shafts, which can be expected to wear, and upon which the lift depends for support of the load, shall have a safety factor of at least six, based on the ultimate strength of the material. Non-working parts, such as platform, frame and attachment hardware that would not be expected to wear, shall have a safety factor of at least three, based on the ultimate strength of the material.

Lift capacity: The lifting mechanism and platform shall be capable of operating effectively with a wheelchair and occupant mass of at least 800 pounds.

Controls: (See 49 CFR 571.403, S6.7, *Control systems*.)

Emergency operations: (See 49 CFR 571.403, S6.9, *Backup operation*.)

Power or equipment failures: (See 49 CFR 571.403, S6.2.2, *Maximum platform velocity*.)

Platform barriers: (See 49 CFR 571.403, S6.4.7, *Wheelchair retention*.)

Platform surface: (See 49 CFR 571.403, S6.4.2, S6.4.3, *Platform requirements*.) (See also “Wheelchair or Mobility Aid Envelope” figure at the end of this subsection.)

Platform gaps and entrance ramps: (See 49 CFR 571.403, S6.4.4, *Gaps, transitions and openings*.)

Platform deflection: (See 49 CFR 571.403, S6.4.5, *Platform deflection*.)

Platform movement: (See 49 CFR 571.403, S6.2.3, *Maximum platform acceleration*.)

Boarding direction: The lift shall permit both inboard and outboard facing of wheelchair and mobility aid users.

Handrails: (See 49 CFR 571.403, S6.4.9, *Handrails*.)

Circuit breaker: A resettable circuit breaker shall be installed between the power source and the lift motor if electrical power is used. It shall be located as close to the power source as possible, but not within the passenger/driver compartment.



Excessive pressure: (See 49 CFR 571.403, S6.8, *Jacking prevention*.)

Documentation: The following information shall be provided with each vehicle equipped with a lift:

A phone number where information can be obtained about installation, repair and parts. (Detailed written instructions and a parts list shall be available upon request.)

Detailed instructions regarding use of the lift shall be readily visible when the lift door is open, including a diagram showing the proper placement and positioning of wheelchair/mobility aids on the lift.

Training materials: The lift manufacturer shall make training materials available to ensure the proper use and maintenance of the lift. These may include instructional videos, classroom curriculum, system test results or other related materials.

Identification and certification: Each lift shall be permanently and legibly marked or shall incorporate a non-removable label or tag that states it conforms to all applicable requirements of the current National School Transportation Specifications and Procedures. In addition and upon request of the original titled purchaser, the lift manufacturer or an authorized representative shall provide a notarized Certificate of Conformance, either original or photocopied, which states that the lift system meets all the applicable requirements of the current National School Transportation Specifications and Procedures.

Note: graphic of wheelchair or mobility aid envelope (Figure 1).

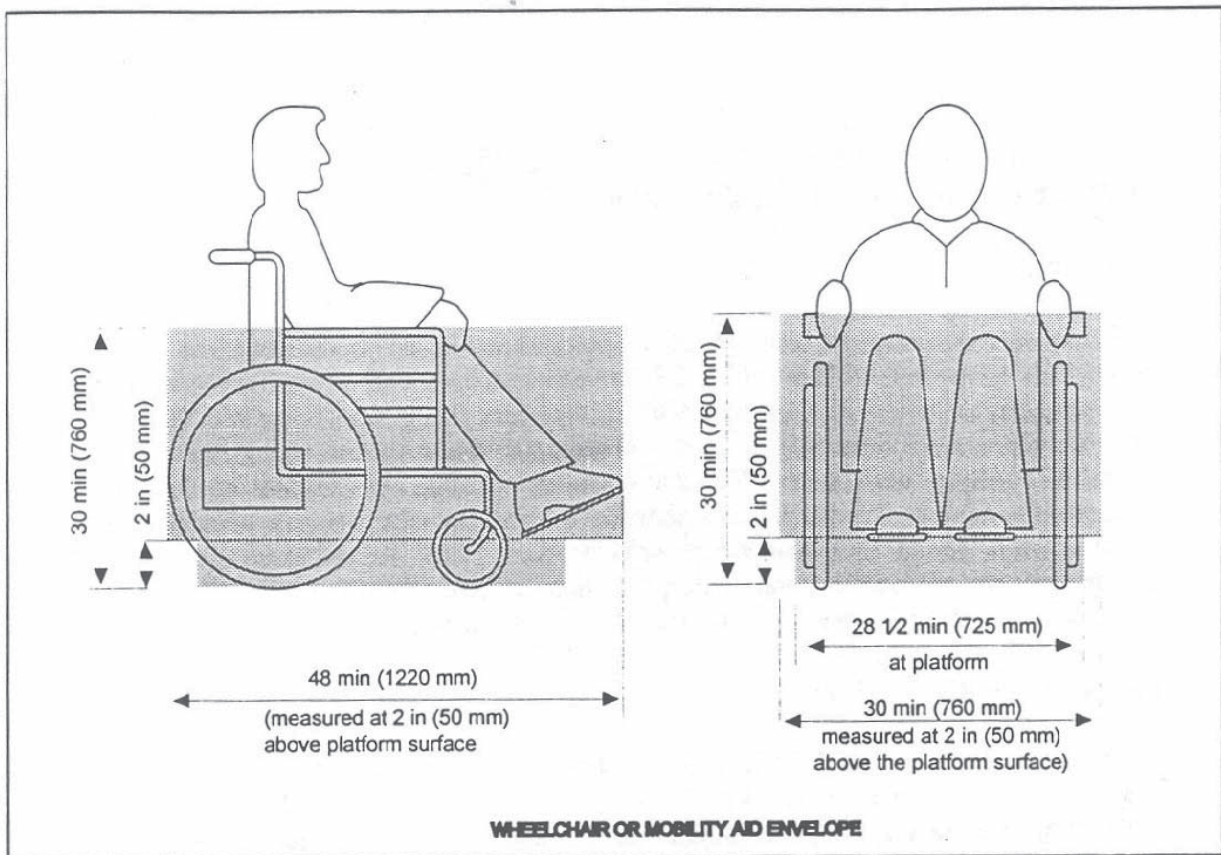

## RAMPS

- A. If a ramp is used, it shall be of sufficient strength and rigidity to support at least 800 pounds over an area of 26 x 26 inches. It shall be equipped with a protective flange on each longitudinal side to keep the special device on the ramp.
- B. The surface of the ramp shall be constructed of non-skid material.
- C. The ramp shall be equipped with handles and shall be of weight and design to permit one person to put the ramp in place and return it to its storage place. It shall be stored outside the passenger compartment.

## REGULAR SERVICE ENTRANCE

- A. On power lift-equipped vehicles, steps shall be the full width of the step well, excluding the thickness of the doors in the open position.
- B. In addition to the handrail required in the BUS BODY AND CHASSIS section, an additional handrail may be provided on all. This handrail shall be located on the opposite

side of the entrance door from the handrail required in the BUS BODY AND CHASSIS section and shall meet the same requirements for handrails.

## **RESTRAINING DEVICES**

- A. On power lift-equipped school buses with a GVWR of 10,000 pounds or more, seat frames may be equipped with attachment points to which belt assemblies can be attached for use with child safety restraint systems (CSRSs) that comply with FMVSS No. 213, *Child Restraint Systems*. Any belt assembly anchorage shall comply with FMVSS No. 210, *Seat Belt Assembly Anchorages*.
- B. Alternatively, a child restraint anchorage system that complies with FMVSS No. 225, *Child Restraint Anchorage Systems*, may be installed.
- C. Seat belt assemblies, if installed, shall conform to FMVSS No. 209, *Seat Belt Assemblies*.
- D. Child safety restraint systems, which are used to facilitate the transportation of children who in other modes of transportation would be required to use a child, infant or booster seat, shall conform to FMVSS No. 213.

## **SEATING ARRANGEMENTS**

Flexibility in seat spacing to accommodate special devices shall be permitted to meet passenger requirements. All seating shall meet the requirements of FMVSS No. 222, *School Bus Passenger Seating and Crash Protection*.

## **SECUREMENT AND RESTRAINT SYSTEM FOR WHEELCHAIRS AND WHEELCHAIR-SEATED OCCUPANTS**

For purposes of understanding the various aspects and components of this section, the terms *securement* and *tie down* and the phrases *securement system* or *tie down system* are used exclusively in reference to the devices that anchor the wheelchair to the vehicle. The term *restraint* and the phrase *restraint system* are used exclusively in reference to the equipment that is intended to limit the movement of the wheelchair occupant in a crash or sudden maneuver. The term *wheelchair tie down and occupant restraint system (WTORS)* is used to refer to the total system that secures the wheelchair and restrains the wheelchair occupant.

- A. **WTORS**—general requirements:
  - 1. A wheelchair tie down and occupant restraint system installed in specially equipped school buses shall be designed, installed, and operated for use with forward-facing wheelchair-seated passengers and shall comply with all applicable requirements of FMVSS 222, *School Bus Passenger Seating and Crash Protection*, and SAE J2249, *Wheelchair Tie down and Occupant Restraint Systems for Use in Motor Vehicles*.<sup>1</sup>

2. The WTORS, including the anchorage track, floor plates, pockets or other anchorages, shall be provided by the same manufacturer or shall be certified to be compatible by manufacturers of all equipment/systems used.
  3. Wheelchair securement positions shall be located such that wheelchairs and their occupants do not block access to the lift door.
  4. A device for storage of the WTORS shall be provided. When the system is not in use, the storage device shall allow for clean storage of the system, shall keep the system securely contained within the passenger compartment, shall provide reasonable protection from vandalism and shall enable the system to be readily accessed for use.
  5. The WTORS, including the storage device, shall meet the flammability standards established in FMVSS No. 302, *Flammability of Interior Materials*.
  6. The following information shall be provided with each vehicle equipped with a securement and restraint system:
    - a. A phone number where information can be obtained about installation, repair and parts. (Detailed written instructions and a parts list shall be available upon request.)
    - b. Detailed instructions regarding use, including a diagram showing the proper placement of the wheelchair/mobility aids and positioning of securement devices and occupant restraints, including correct belt angles.
  7. The WTORS manufacturer shall make training materials available to ensure the proper use and maintenance of the WTORS. These may include instructional videos, classroom curriculum, system test results or other related materials.
- B. Wheelchair Securement/Tiedown: (See 49 CFR 571.222, S5.4.1, S5.4.2.) Each wheelchair position in a specially equipped school bus shall have a minimum clear floor area of 30 inches laterally by 48 inches longitudinally. Additional floor area may be required for some wheelchairs. Consultation between the user and the manufacturer is recommended to ensure that adequate area is provided.
- C. Occupant restraint system: (See 49 CFR 571.222, S5.4.3, S5.4.4.)

## **SPECIAL LIGHT**

Doorways in which lifts are installed shall be equipped with a special light that provides a minimum of two foot-candles of illumination measured on the floor of the bus immediately adjacent to the lift during lift operation.

## **SPECIAL SERVICE ENTRANCE**

- A. Power lift-equipped bodies shall have a special service entrance to accommodate the power lift.

Exception: A special service entrance shall not be required if the lift is designed to operate within the regular service entrance, is capable of stowing such that the regular service entrance is not blocked in any way and a person entering or exiting the bus is not impeded in any way.

- B. The special service entrance and door shall be located on the right side of the bus and shall be designed so as not to obstruct the regular service entrance.

Exception: A special service entrance and door may be located on the left side of the bus only if the bus is used only to deliver students to the left side of one-way streets and its use is limited to that function.

- C. The opening may extend below the floor through the bottom of the body skirt. If such an opening is used, reinforcements shall be installed at the front and rear of the floor opening to support the floor and give the same strength as other floor openings.
- D. A drip molding shall be installed above the special service entrance to effectively divert water from the entrance.
- E. Door posts and headers at the special service entrance shall be reinforced sufficiently to provide support and strength equivalent to the areas of the side of the bus not used for the special service entrance.

## **SPECIAL SERVICE ENTRANCE DOORS**

- A. A single door or double doors may be used for the special service entrance.
- B. A single door shall be hinged to the forward side of the entrance unless this would obstruct the regular service entrance. If the door is hinged to the rearward side of the doorway, the door shall utilize a safety mechanism that will prevent the door from swinging open should the primary door latch fail. If double doors are used, the system shall be designed to prevent the door(s) from being blown open by the aerodynamic forces created by the forward motion of the bus, and/or shall incorporate a safety mechanism to provide secondary protection should the primary latching mechanism(s) fail.
- C. All doors shall have positive fastening devices to hold doors in the “open” position when the special service entrance is in use.
- D. All doors shall be weather sealed.

- E. When manually operated dual doors are provided, the rear door shall have at least a one-point fastening device to the header. The forward-mounted door shall have at least three one-point fastening devices. One shall be to the header, one to the floor line of the body, and the other shall be into the rear door. The door and hinge mechanism shall have strength that is greater than, or equivalent to, the strength of the emergency exit door.
- F. Door materials, panels and structural components shall have strength equivalent to the conventional service and emergency doors. Color, rub rail extensions, lettering and other exterior features shall match adjacent sections of the body.
- G. Each door shall have windows set in a waterproof manner that are visually similar in size and location to adjacent non-door windows. Glazing shall be of the same type and tinting (if applicable) as standard fixed glass in other body locations.
- H. Door(s) shall be equipped with a device that will actuate an audible or visible signal located in the driver's compartment when the door(s) is not securely closed and the ignition is in the "on" position.
- I. A switch shall be installed so that the lift mechanism will not operate when the lift platform door(s) is closed.
- J. Special service entrance doors shall be equipped with padding at the top edge of the door opening. The padding shall be at least three inches wide and one inch thick and shall extend the full width of the door opening.

## **SUPPORT EQUIPMENT AND ACCESSORIES**

- A. In addition to the webbing cutter required in the BUS BODY AND CHASSIS section, each specially equipped school bus that is set up to accommodate wheelchairs or other assistive or restraint devices with webbing attached shall contain an additional webbing cutter properly secured in a location to be determined by the purchaser. The webbing cutter shall meet the requirements listed in the BUS BODY AND CHASSIS section, seats and Restraining Barriers, paragraph E.
- B. Special equipment or supplies that are used in the bus for mobility assistance, health support or safety purposes shall meet local, federal and engineering standards that may apply, including requirements for proper identification. Equipment that may be used for these purposes includes, but is not limited to:
  - 1. Wheelchairs and other mobile seating devices. (See subsection on Securement and Restraint System for Wheelchairs and Wheelchair-seated Occupants.)
  - 2. Crutches, walkers, canes and other ambulating devices to assist ambulation.
  - 3. Medical support equipment. This may include respiratory devices, such as oxygen bottles (which should be no larger than 38 cubic feet for compressed gas) or

ventilators. Tanks and valves should be located and positioned to protect them from direct sunlight, bus heater vents or other heat sources. Other equipment may include intravenous and fluid drainage apparatus.

## **TECHNOLOGY AND EQUIPMENT, NEW**

It is the intent of these specifications to accommodate new technologies and equipment that will better facilitate the transportation of students with special needs. New technology and equipment is acceptable for use in specially equipped vehicles if:

- A. It does not compromise the effectiveness or integrity of any major safety system. (Examples of safety systems include, but are not limited to, compartmentalization, the eight-lamp warning system, emergency exits and the approved color scheme.)
- B. It does not diminish the safety of the bus interior.
- C. It does not create additional risk to students who are boarding or exiting the bus or are in or near the school bus loading zone.
- D. It does not require undue additional activity and/or responsibility for the driver.
- E. It generally increases efficiency and/or safety of the bus, generally provides for a safer or more pleasant experience for the occupants and pedestrians in the vicinity of the bus and/or generally assists the driver and makes his/her many tasks easier to perform.

[Back to Contents](#)

# **SCHOOL BUS INSPECTION**



**Page Intentionally Left Blank**

## **SCHOOL BUS INSPECTION PROGRAM**

### **STATE INSPECTION PROGRAMS**

School bus safety programs vary greatly from state to state. Each state is urged to establish a neutral third-party inspection program. Personnel conducting school bus safety inspections must be knowledgeable in the mechanical components of a school bus and be aware of all the applicable construction standards, laws, rules and all other requirements of their jurisdiction.

### **INSPECTION PROCEDURE**

School bus safety inspections should consist of a standardized inspection where vehicles are placed out-of-service based on uniform criteria. States should also develop specific inspection regulations, rules, procedures and out-of-service criteria for all vehicles utilized in student transportation. States are encouraged to develop a system to compile the data for analysis.

### **OUT-OF-SERVICE CRITERIA**

The purpose of criteria is to identify critical school bus components and provide tolerances that inspectors can utilize to determine if a school bus is safe for student transportation. While it is recognized that each state may enforce more stringent standards, this document is intended to establish a baseline for inspecting and placing school buses out-of-service.

### **RESOURCE INFORMATION**

- 49 CFR PARTS 570.1-570.63: Vehicle in Use Inspection Standards
- 49 CFR PARTS 400-599: Federal Motor Vehicle Safety Standards
- 49 CFR PARTS 393, 396: Federal Motor Carrier Safety Regulations
- 49 CFR APPENDIX G to Subchapter B: Minimum Periodic Inspection Standards

## **SCHOOL BUS RECOMMENDED OUT-OF-SERVICE CRITERIA**

### **BRAKE SYSTEM(S)**

#### **Adjustment**

Any one brake beyond the adjustment limit (See Table 1: Brake Adjustment Specifications.)

#### **Axle Brakes, General**

1. Chamber size mismatched on axle [393.47(b)];
2. Mismatched brake chamber long stroke verses regular stroke [393.47(b)]; or
3. Mismatched slack adjuster length [393.47(c)].

#### **Air System**

1. Absence of effective braking action upon application of service brakes [393.48 (a)];
2. Audible air leak at chamber. (e.g., ruptured diaphragm); or
3. System fails to maintain pressure when:
  - a. Loss rate exceeds 2psi/min with brakes released [396.3(a)(1)];
  - b. Loss rate exceeds 3psi/min with brakes applied [396.3(a)(1)]; or
  - c. Engine idle and service brakes applied [396.3(a)(1)].

#### **Hoses and Tubing**

1. Brake hose with any damage extending through the outer reinforcement ply [393.45(a)];
2. Audible leak at other than a proper fitting or connection [393.45(a)];
3. Any bulge or swelling when brake are applied [393.45(a)];
4. Any restriction due to cracked, broken or crimped line/hose [393.45(a)]; or
5. Any line, tubing, hose or connection that is not constructed to meet standard (571.106).

### **Brake Shoe/Pad/Lining**

1. Any lining thickness less than allowed by 393.47;
2. Lining pad is cracked, broken, not firmly attached or missing (393.47) (*surface or heat cracks in the lining should not be considered out of service*);
3. The friction surface of drum, rotor or friction material are contaminated by oil, grease or brake fluid (393.47);
4. Loose component (e.g., chambers, spiders, support brackets) (393.47);
5. Fails to make contact with drum (e.g., frozen, binding, uneven) [393.48(a)]; or
6. Absence of braking action on any axle (e.g., failing to move upon application of a wedge, S-cam, cam or disc brake).

### **Drums/Rotors**

1. External crack(s) that open upon application [393.47(a)]; or
2. Any portion of the drum or rotor (discs) missing, broken, misplaced or cracked through rotor to center vent [393.47(a)].

### **Parking Brake**

Fails to hold vehicle in stationary position on normal roadway conditions (absence of ice or snow) in forward or reverse (393.41) [571.105 S5.2.1 and S5.2.3(b)].

### **Hydraulic Brake System**

1. System brake failure light or low fluid light on or inoperative (393.51);
2. Reservoir is below minimum level [393.45(a)] (571.106);
3. Any seeping, leaking or swelling of hose(s) under pressure [393.45(a)]; or
4. Any leak in master cylinder unit [393.45(a)] (571.106).

### **Pedal Reserve**

No pedal reserve with engine running [393.40(b)].

### **Power Assist Unit**

Fails to operate [396.3(a)(1)].

## **STEERING SYSTEM**

### **Steering**

1. Any modification or condition that interferes with free movement of any steering component [393.209(d)]; or
2. Steering travel restricted through the limit of travel in both directions [570.60(c)].

### **Steering Column/Wheel**

1. Absence or looseness of U-bolts or other positioning part(s) [393.209(c)];
2. Welded or repaired universal joint(s) [393.209(d)];
3. Steering wheel not properly secured [393.209(a)]; or
4. Steering wheel lash/free play exceeds performance test (see Table #2) [393.209(b)].

### **Front Axle Beam**

Any crack(s) or obvious welded repair [393.3(a)(1)].

### **Steering Gear Box**

1. Mounting bolt(s) loose or missing [393.209(d)];
2. Crack(s) in gearbox or mounting brackets (393.209(d)) [396.3(a)(1)];
3. Any obvious welded repair(s) [396.3(a)(1)] [393.209(d)]; or
4. Looseness of yoke-coupling to the steering gear input shaft [393.209(d)].

### **Pitman Arm**

1. Looseness of the pitman arm on the steering gear output shaft [393.209(d)]; or
2. Any obvious welded repair [396.3(a)(1)] [393.209(d)].

### **Power Steering**

1. Auxiliary power assist cylinder loose [393.2(e)] [393.209(e)];
2. Power steering system belts frayed, cracked or slipping [393.209(2)(e)]; or
3. Power steering system leaking or insufficient fluid in reservoir [393.209(2)(e)].

### **Ball/Socket Joints**

1. Any movement under steering load of a nut stud [393.3(a)(1)];
2. Any motion, other than rotational, between any linkage member and its attachment point of more than  $\frac{1}{8}$  inch measured with hand pressure only [393.209(d)]; or
3. Any obvious welded repair [393.209(d)].

### **Tie Rods/Drag Links**

1. Loose clamp(s) or clamp bolt(s) on tie rod or drag link(s) [393.3(a)(1)]; or
2. Any looseness in any threaded joint [396.3(a)(1)].

### **Nuts**

Loose or missing fasteners on tie rod, pitman arm, drag link, steering arm or tie rod arm [396.3(a)(1)].

## **SUSPENSION COMPONENTS**

### **Axle Parts/Members**

1. Any U-bolt or other spring to axle clamp bolt(s) which are cracked, broken, loose or missing [393.207(a)];
2. Any axle, axle housing, spring hanger(s), or other axle positioning parts which are cracked, broken, loose or missing that results in shifting of an axle from its normal position [393.207(a)];
3. Any worn (beyond manufacturer specifications) or improperly assembled U-bolt, shock, kingpin, ball joint, strut, air bag or positioning component [570.61 (a)];
4. Any spring hanger, assembly part or portion of leaf which is broken, separated or missing [393.207(c)]; or
5. Any broken coil spring [393.207(d)].

### **Chassis/Frame/Unibody**

1. Any cracked, loose, sagging or broken, frame side rail. [393.201(a)];
2. Any damage permitting the shifting of the body or imminent collapse of frame [393.201(a)];

3. Any cracked, loose, broken frame member affecting support of functional components (e.g., steering gear, engine, transmission, body part or suspension) [393.201(a)];
4. Any crack 1½ inch or longer in the frame side rail web which is directed toward bottom flange [393.201(a)]; or
5. Any crack extending from the frame side rail web around the radius and into the bottom flange [393.201(a)].

### **Crossmembers**

1. Any cross member, outrigger or other structural support which is cracked, missing or deformed that affects the structural integrity of the vehicle (393.201);
2. Three or more adjacent crossmembers broken or detached (393.201); or
3. Any area of the floor that is sagging or soft due to broken crossmembers (393.201).

### **Outriggers/Body Supports**

Any cross member, outrigger or other structural support which is cracked, missing, deformed or has rust holes where damage affects the safe operation of the vehicle.

### **Bumpers**

1. Front bumper is missing or not properly secured [393.203(e)]; or
2. Rear bumper is missing or not secured (393.86).

### **EXHAUST SYSTEM**

1. The exhaust system is leaking or discharging directly below the driver or passenger compartment [393.83(e)] NOTE: does not apply to proper venting for emission systems; or
2. No part of the exhaust system shall be located and likely to result in burning, charring or damaging the electrical wiring, the fuel supply or any combustible part of the vehicle [393.83(a)].

### **FUEL SYSTEM**

1. Any part of the fuel tank or fuel system not securely attached to the vehicle (393.65);
2. A fuel system with a dripping leak at any point (393.67 Tank); or
3. Dripping leak (396.3(a)(1) leak other than tank).

## **DRIVESHAFT**

1. Driveshaft guard loose, missing, improper placement or bent (393.89); or
2. Universal joint(s) worn or faulty, or obvious welded repair [393.209(2)(d)].

## **DIFFERENTIAL**

Cracked or leaking housing [393.207(a)].

## **ENGINE**

1. Any critical component that fails to function as designed (396.3); or
2. Any fluid leaks that would affect the safe operation of the vehicle (396.3).

## **TIRES/WHEELS/HUBS**

### **Tire Type**

1. Any school bus operated with regrooved, recapped or retreaded tires on the front axle [393.75(d)]; or
2. Any tire not of proper type (e.g., load range, size, mismatched on axle).

### **Tire Tread Depth**

1. Any front tire worn to less than  $\frac{4}{32}$  inch [393.75(b)]; or
2. Any rear tire worn to less than  $\frac{2}{32}$  inch [393.75(c)].

### **Tire Sidewall**

1. Any sidewall cut, worn or damaged to the extent that the steel or fabric cord is exposed [393.75(a)]; or
2. Any observable bump, bulge or knot related to sidewall or tread separation [393.75(a)].

### **Tire Inflation**

Tire is flat or has noticeable leak [393.75(a)(3)].

### **Wheels/Rims/Spiders**

1. Any nuts, bolts, studs, lugs or holes that are elongated, broken, missing, damaged or loose [393.205(b)];



2. Any cracked or broken wheel or rim [393.205(a)]; or
3. Any lock or slide ring broken, cracked, improperly seated, sprung or has mismatched rings [393.205(a)].

### **Hub**

Excessive wheel bearing or kingpin play that exceeds ¼ inch (393.70) (570.61).

## **ELECTRICAL/BATTERY**

### **Cables**

1. Electrical cable insulation chafed, frayed, damaged or compromised insulation burnt, causing bare cable to be exposed [393.28, 396.3(a)(1)];
2. Loose or corroded connections at battery posts or compromised insulation protection to electrical components [393.28, 393.77(b), 396.3(a)(1)]; or
3. Missing or damaged protective grommets insulating main electrical cables through metal compartment panels (393.30).

### **Components**

1. Broken or unsecured mounting of electrical components [396.3(a)(1)]; or
2. Electrical cable unsupported, hanging or missing clamps that may cause chafing or frayed conditions [393.28, 396.3(a)(1)].

### **Battery**

1. Battery not secured (393.30);
2. Signs of leaking or excessive corrosion; or
3. Battery lacks cranking capacity to start engine.

### **Windshield Wipers**

1. Inoperative, missing or damaged wiper (393.78); or
2. Wiper does not clean sweep area of driver's windshield (393.78).

## **BODY INTERIOR**

### **Aisle**

1. Aisle does not have the required clearance (571.217); or
2. Obstructions in aisle that prevent passengers from egress to emergency exits (393.62) (393.203).

### **Panels**

Any panel (e.g., ceiling, side or wheel well) protruding, having sharp edges or not secured so is likely to cause injury.

### **Floor**

Floor not maintained to prevent slipping or tripping by passenger(s).

### **Stepwell**

1. Any part of the step well or support structure that is damaged; or
2. Any part of the step well tread that is loose, torn or damaged that would present a tripping hazard.

### **Handrail**

1. Handrail loose or missing; or
2. Handrail fails the nut/drawstring test as defined by NHTSA.

### **Seat(s) and Barrier(s)**

1. Any seat or barrier that is not securely attached to the vehicle (393.91);
2. Any seat or barrier material(s) that compromises the integrity of compartmentalization and occupant protection (571.222); or
3. Seat spacing fails to comply with 571.222.

### **Seat (Driver)**

1. Driver seat is not securely fastened to vehicle and/or fails to maintain adjusted position (393.93); or
2. Any part of the driver's safety restraint assembly is missing, not properly installed or defective as to prevent proper securement of occupant [393.93(a)(b)] (571.209).

## **Door (Entrance)**

1. The student entrance door does not open or close properly;
2. Door control handle does not lock in the closed position; or
3. Door is equipped with a padlock or similar locking device (excludes interlock systems).

## **EMERGENCY EXITS**

1. Any emergency door, window or roof hatch that fail to open freely or completely as defined in 571.217;
2. Door prop-rod device is missing or inoperative (571.217);
3. Any emergency exit equipped with a padlock or similar locking device (excludes interlock systems);
4. Any vehicle that lacks the required number of emergency exits (571.217);
5. Any emergency exit not properly labeled and marked both inside and outside the vehicle as specified by 571.217;
6. Any item or modification that reduces the size of the opening and limits egress to the emergency exit by all passengers; or
7. Emergency exit warning device is not audible in the driver seating position and/or the vicinity of the emergency door or window (571.217).

## **WINDOWS**

1. Any glass or glazing that is broken through or missing (393.60);
2. Any glass not of approved type [393.60(a)];
3. Windshield has discoloration or other damage in that portion extending upward from the height of the topmost portion of the steering wheel, but not including a two-inch border at the top and a one-inch border at each side of the windshield or each panel thereof, except as follows:
  - a. Color or tint applied by the manufacturer for the reduction of glare;
  - b. Any crack not over  $\frac{1}{4}$  inch long, if not intersected by any other crack;
  - c. Any damaged area, that can be covered by a disc  $\frac{3}{4}$  inch in diameter, if not closer than three inches to any other such damaged area; or

- d. Driver's side area window(s) have chips, clouding, or cracks that obscure the driver's vision [393.60(c)]; or
4. No operable defrosting and defogging system to clear the driver's windshield (571.103).

### **BODY EXTERIOR**

1. Any panel, rub rail or trim that is loose, torn, dislocated or protruding from the surface of the bus, creating a hazard (393.203); or
2. Any engine, battery or other door that is not properly secured (393.203).

### **MIRRORS (571.111)**

1. Any mirror required to provide the driver with the entire field of view, missing, damaged, clouded or otherwise obscured so as to place children in a hazardous position;
2. Any crossover mirror system or portion thereof that fails to hold a set adjustment;
3. Any crossover mirrors directed to view any area other than for which they were intended; or
4. Any part of the required field of vision obscured or not visible from the driver seated position.

### **LAMPS/SIGNALS**

1. Any one of the following lamps not working: brake, turn signal, tail, head (low beam), school bus overhead warning light (amber or red), hazard warning or stop arm lamp (571.108, 571.131);
2. Horn fails to function as designed (393.81);
3. Any critical brake, telltale lamp, buzzer or gauge that fails to function as designed;
4. Required stop arm(s) fail to operate with overhead red lights as mandated (571.131); or
5. If equipped, a crossing control device fails to extend and retract as designed.

### **EMERGENCY EQUIPMENT**

1. Fire extinguisher missing, out-of-date certification, not of proper type or size, not fully charged, has no pressure gauge, is not secured or is not readily accessible to the driver (393.95);

2. Any additional state-specific equipment (e.g., first aid kit, body fluid kit, webbing cutter and emergency reflectors) that fail to meet state specifications and places the vehicle out of service; or
3. Missing emergency triangles (571.125).

### **WHEELCHAIR LIFT-EQUIPPED VEHICLES**

1. Wheelchair lift does not function as designed or is inoperable ;
2. Platform lift manufactured after April 1, 2005 must meet all the following criteria:
  - a. Jacking prevention;
  - b. Manual backup operating mode;
  - c. Interlocks to prevent forward or rearward mobility of the vehicle unless lift is stowed;
  - d. Wheelchair retention device;
  - e. Platform outer barrier and inner roll stop;
3. Any hydraulic line leaking during lift operation;
4. Wheelchair restraint system is missing, incomplete or improperly installed, loose or damaged; or
5. Any required wheelchair occupant restraint system not in compliance (571.222)

## RECOMMENDED SCHOOL BUS INSPECTION PROCEDURES

**WARNING!** Please **READ and follow** these instructions to avoid personal injury or death. Prior to performing any inspection procedures always ensure that the vehicle is properly secured, wheels chocked, and that the ignition key is controlled. Proper safety equipment should always be used.

When working on or around a vehicle, the following general precautions should be observed at all times:

1. Park the vehicle on a level surface, apply the parking brakes and always block the wheels.
2. Always wear safety glasses and other appropriate safety gear.
3. Stop the engine and remove ignition key when working under or around the vehicle.
4. When working in the engine compartment, the engine should be shut off and the ignition key should be removed. Where circumstances require that the engine be in operation, **EXTREME CAUTION** should be used to prevent personal injury resulting from contact with moving, rotating, leaking, heated or electrically charged components.

### BRAKE SYSTEMS

#### Air Brakes Measurement

The following procedure is based on the applied stroke method for measuring the movement of the brake chamber push rod:

1. Release the spring brakes and visually check each brake to ensure that it is in the normal released position.
2. With the brakes released, make a mark where the pushrod exits the brake chamber.
3. With the engine off, make a series of brake applications to reduce the reservoir pressure to between 90 to 100 psi.
4. Apply and hold a full brake application (90 to 100 psi).
5. Measure the distance between the mark and the face of the brake chamber. The difference between measurements is called the chamber applied stroke.

Any brake that is beyond the re-adjustment limit will require repairs and/or adjustment. (See Table 1: Brake Adjustment Specifications below.)

**Table 1: Brake Adjustment Specifications**

Brake adjustment: Shall be less than those specifications contained herein relating to "Brake Adjustment Limit." (Dimensions are in inches.)

<b>CLAMP TYPE BRAKE CHAMBER DATA</b>		
<b>TYPE</b>	<b>OUTSIDE DIAMETER</b>	<b>BRAKE ADJUSTMENT LIMIT</b>
6	4 1/2	1 1/4
9	5 1/4	1 3/8
12	5 11/16	1 3/8
16	6 3/8	1 3/4
20	6 25/32	1 3/4
24	7 7/32	1 3/4
30	8 3/32	2
36	9	2 1/4

<b>'LONG STROKE' CLAMP TYPE BRAKE CHAMBER DATA</b>		
<b>TYPE</b>	<b>OUTSIDE DIAMETER</b>	<b>BRAKE ADJUSTMENT LIMIT</b>
16	6 3/8	2.0
20	6 25/32	2.0
24	7 7/32	2.0
24*	7 7/32	2.5
30	8 3/32	2.5

\* For 3" maximum stroke type 24 chambers

<b>DD-3 BRAKE CHAMBER DATA</b>		
<b>TYPE</b>	<b>OUTSIDE DIAMETER</b>	<b>BRAKE ADJUSTMENT LIMIT</b>
30	8 1/8	2 1/4

NOTE: This chamber has three air lines and is found on motorcoaches.

<b>WEDGE BRAKE DATA</b>
The combined movement of both brake shoe lining scribe marks shall not exceed 1/8 inch (3.18mm).

**Hydraulic Brakes Measurement**

1. With the brake pedal in the full upright position, the inspector shall measure the distance between the brake pedal and the floor or firewall. With the engine running, a single firm brake application shall be made and the distance between the brake pedal and the floor or firewall shall be measured a second time. The difference shall be recorded.
2. With vehicle stopped and engine running, depress brake pedal. The system must be able to maintain brake pedal height under moderate foot force (40-60 pounds) for one

minute without pumping. With vehicle in stopped position and brake pedal depressed under moderate foot force (40-60 pounds) there should be a minimum of one-third of the total available pedal travel (manufacturer's specification) remaining on non-powered systems.

### **Chamber Size**

Visually inspect all brake chambers to ensure they are properly marked, in good operating condition, have no visible damage, and are properly matched. Chambers must be matched by size, type and stroke.

### **Slack Adjuster Length**

Measure from the center of the S-cam to the center of the push rod clevis pin. All slack adjusters on a single axle shall be of the same type and length.

### **Air System**

1. With full system air pressure, depress the brake pedal and inspect each wheel end brake to determine if effective braking forces are applied to each wheel end brake. There should be no audible air loss at supply lines, fittings, valves or brake chambers.
2. With full system pressure, make a single full service brake application with the parking brake and ignition off. Note the gauges and listen for air leaks. Release the service brake.
3. With full system pressure, the engine stopped, and the parking brakes released; allow pressure to stabilize for at least one minute and observe the dash pressure gauges for one minute. Make note of any pressure drop. The maximum allowable drop is 2 psi within one minute for either reservoir.
4. With full system pressure, the engine stopped, and the parking brakes released; make and hold a full service brake application. Allow pressure to stabilize for at least one minute and observe the dash pressure gauges for two minutes. Make note of any pressure drop. The maximum allowable drop is 3 psi within one minute for either reservoir.

### **Hoses and Tubing**

1. Carefully perform a visual inspection of all system hoses, lines, and tubing.
2. Inspect all hoses, lines, and tubing for any audible leak (if air), or visible leak (if hydraulic), any bulging/swelling when the system is pressurized, any hose, line, or tubing is cracked, broken or crimped in such a manner as to restrict flow, any hose abraded (chafed) through outer cover to fabric layer or any line/tubing, and for proper securement and support.



## **Brake Shoe/Pad/Lining**

1. Visually inspect all brake linings/shoes/pads. Linings may be checked through inspection slots. All shoes/pads/linings shall comply with the applicable standards.
2. The brake lining/pad thickness shall not be less than  $\frac{3}{16}$  inch at the shoe center for a shoe with a continuous strip of lining; less than  $\frac{1}{4}$  inch at the shoe center for a shoe with two pads; or worn to the wear indicator if the lining is so marked, for air drum brakes.
3. The brake lining/pad thickness shall not be less than  $\frac{1}{8}$  inch for air disc brakes, or  $\frac{1}{16}$  inch or less for hydraulic disc brakes.
4. Visually inspect the brake lining/pad to ensure that it is firmly attached to the shoe, is not cracked or broken, and that the friction surface is not saturated with oil, grease, or brake fluid.
5. Visually inspect all brake components mounting hardware for any loose, cracked, broken or missing items. This inspection should be performed with the brakes released and with the brakes applied. It may be necessary to remove inspection access covers, brake dust covers or, in some instances, pull wheels and drums to accomplish the inspection.

## **Drums/Rotors**

1. Visually inspect all brake drums/rotors for any external cracks that open when brakes are applied. (Do not confuse short hairline internal check cracks with flexural cracks.)
2. Inspect for any portion of the drum/rotor missing or in danger of falling away.

**Note:** It may be necessary to remove inspection access covers, brake dust covers or, in some instances, pull wheels and drums to accomplish the inspection.)

## **Parking Brake**

1. With the engine operating and the park brakes set, place the transmission in both forward and reverse gears to determine if brakes will hold vehicle stationary.
2. Visually and physically check condition of parking brake system and parking brake warning light.

## **Hydraulic Brake System**

1. With the engine off, turn the ignition switch to the “on” position and check the instrument panel for visible and audible warning signals to indicate system malfunction. If bus is equipped with vacuum assist, it shall have a visible warning signal and gauge to indicate any loss of vacuum. Audible signals must be loud enough to be heard over engine noise.

2. Visually inspect the master cylinder to determine if it is below the minimum fill requirements, is leaking, is loose or improperly mounted.
3. Visually inspect the hydraulic fluid reservoir level in the master cylinder unit. Inspect for any fluid leaks on wheel cylinders/calipers, master cylinders, hose connection and hydrovac and on buses using vacuum assisted brakes. Check for brake fluid around the brake booster between the booster and firewall.

### **Pedal Reserve**

1. With the brake pedal in the full upright position, the inspector shall measure the distance between the brake pedal and the floor or firewall. With the engine running, a single firm brake application shall be made and the distance between the brake pedal and the floor or firewall shall be measured a second time. The difference shall be recorded.
2. With vehicle stopped and engine running, depress brake pedal. The system must be able to maintain brake pedal height under moderate foot force (40-60 pounds) for one minute without pumping. With vehicle in stopped position and brake pedal depressed under moderate foot force (40-60 pounds) there should be a minimum of one-third of the total available pedal travel (manufacturer's specification) remaining on non-powered systems.

### **Power Assist Unit**

1. Electric/Hydraulic Assist: With engine off, depress the brake pedal. The electric/hydraulic brake assist motor must operate.
2. Hydrovac Assist: With engine off, the driver shall pump the brakes to exhaust all reserve. Hold firm pressure on the brake pedal and start the engine. The pedal should fall slightly. Failure of the pedal to fall slightly indicates a malfunction of the power-assist unit.

## **STEERING SYSTEM**

### **Steering**

1. Visually inspect for any modification or other condition that interferes with free movement of any steering component. Turn steering wheel through a full right and left turn and feel for binding or jamming conditions. Both front wheels must be capable of being turned to full right or full left without binding or interference.
2. Inspect turn stops by observing for shiny spots and/or signs of wear on the sides of tires, drag links, shock absorbers or brake lines.

## Steering Column/Wheel

1. Inspect steering column for any looseness in bolts, clamps, positioning parts or universal joints. Inspect flexible coupling in steering column (if the vehicle is so equipped) for excessive misalignment and tightness of clamp bolt or nut.
2. The steering column and components shall also be inspected for damage, cracks or welded repairs. Inspect steering wheel to ensure that it is properly positioned and secured.
3. Place steering axle wheels in a straight ahead position have an assistant turn the steering wheel until movement is observed at the left road wheel and measure the steering wheel movement from starting position to wheel movement position. Compare this measurement to the applicable listing in Table 2: Steering Wheel Free Play, below.

**Table 2: Steering Wheel Free Play**

Steering Wheel Free Play: Steering wheel free play shall not exceed the requirements listed in the following chart:

Steering Wheel Diameter	Manual System Movement 30	Power System Movement 45
16" (41cm)	2" (5.1cm)	4 1/2" (11.5cm)
18" (46cm)	2 1/4" (5.4cm)	4 3/4" (12cm)
20" (51cm)	2 1/2" (6.4cm)	5 1/4" (13.5cm)
22" (56cm)	2 3/4" (7cm)	5 3/4" (14.5cm)

## Front Axle Beam

Visually examine the front axle beam for any obvious bend or twist, any cracks, or any welded repair.

## Steering Gear Box

1. Visually examine the steering gear box for any loose, damaged or missing mounting bolts. Inspect for cracks in the gear box, mounting brackets or any obvious welded repairs.
2. While having an assistant rock the steering wheel back-and-forth; visually inspect the steering shaft and gear box for any looseness where the steering gear box is mounted to the frame. Visually inspect steering shaft coupler for cracks, damage or looseness.
3. With the engine operating inspect for excessive fluid and/or oil leak (observable movement of fluid).

### **Pitman Arm**

1. While the steering wheel is being rotated in a back-and-forth motion; visually inspect the pitman arm and output shaft connection for looseness at the output shaft joint.
2. The pitman arm shall also be inspected for damage, cracks or welded repairs.

### **Power Steering**

1. The inspector shall manually manipulate the auxiliary power assist cylinder to check for looseness. The inspector shall start the bus and rotate the steering wheel in a back-and-forth action to ensure the power steering pump is operable.
2. With the engine stopped inspect the system drive belt(s) for any fraying, cracks or fluid saturation. Check belt tension. On units equipped with automatic tensioner ensure that tensioner moves freely.
3. Inspect the fluid reservoir when hot to ensure that the fluid level is not below add mark. Inspect for signs of fluid leakage.

### **Ball and Socket Joints**

1. With the bus on the ground, the inspector shall examine the ball joint nut stud for movement while the steering wheel is being rocked in a back-and-forth action. The inspector shall examine the ball/socket joint for weld repairs.
2. Check for lateral and vertical movement by grasping the tie rod and drag link sockets attempting to laterally and vertically move the ball joint. (Rotational movement will not be considered.) Any motion other than rotational, greater than  $\frac{1}{8}$  inch that can be detected by movement with two hands with moderate strength in any connecting joint is a defect.

### **Tie Rods/Drag Links**

1. While having an assistant to rock the steering wheel back-and-forth, visually inspect the tie rod ends, crossbar, and drag links any looseness at the steering linkage pivot points.
2. Check for lateral and vertical movement by grasping the tie rod and drag link sockets attempting to laterally and vertically move the ball joint (rotational movement will not be considered). Any motion, other than rotational, greater than  $\frac{1}{8}$  inch that can be detected by movement with two hands with moderate strength in any connecting joint is a defect.
3. Check crossbar for structural damage and crossbar clamps for secure mounting.

## Nuts

Visually examine all tie rods, pitman arm, drag link, steering arm and tie rod arm for looseness and missing fasteners.

## Hoses/Fluids

Visually examine the power steering fluid reservoir for proper fluid level. With the system operating, inspect all system components, hoses and fittings for leaks.

## SUSPENSION COMPONENTS

### Axle Parts/Members

1. Visually and physically inspect all front and rear axle components. Inspect all U-bolts and other suspension to axle mounting hardware for cracks, breaks, looseness or improper type.
2. Inspect axle, axle housing, spring hanger(s), shackles or other axle components for alignment, cracks, breaks and loose or missing items that could result in shifting of an axle from its normal position.
3. Inspect front axle beam for signs of improper repair (e.g., welding or heating).
4. Inspect for any worn (beyond manufacturer specifications) or improperly assembled U-bolt, shock, kingpin, ball joint, strut, air spring or positioning components.
5. Inspect all leaf spring hangers, hanger assemblies or portions of leaf for broken, separated, sagging, bent, abnormally worn (beyond manufacturer specifications), shifted or missing components.
6. Inspect pins and bushings for wear, off-center spring eye, rubbing shackle, or non-symmetric joints. Inspect for any broken, weak or damaged coil spring and mounting assemblies.
7. Visually and physically inspect all hydraulic shock absorbers for leaks, looseness, damage or missing components.
8. Inspect air suspension (if equipped). Observe that the vehicle is lifting level. With the air system fully charged, inspect for any audible or visual air leakage at the air spring assembly, supply hoses, and connections.

**Caution:** Inspector should use caution whenever underneath the vehicle. There may not be sufficient room underneath the vehicle should a problem occur with the air suspension system.

## **Chassis/Frame/Unibody**

1. Visually inspect frame for cracks, loose attaching hardware, sagging, broken, or unapproved welds to frame side rail or flange.
2. Visually and physically inspect for body hold-down components for damage that would permit the shifting of the body.
3. Inspect for cracked, loose, bent, broken or unapproved welds to frame member that affect support of functional components (e.g., steering gear, engine, transmission, body parts or suspension). Welding to frame should be performed only by manufacturer or designee.

**NOTE:** Inspect for any crack 1½ inch or longer in the frame side rail web which is directed toward bottom flange or any crack extending from the frame side rail web around the radius and into the bottom flange.

## **Crossmembers**

1. Visually and physically inspect all crossmembers, attaching hardware and other structural supports for cracks or deformations. Visually inspect for three or more adjacent cross members that are missing, broken, damaged or loose.
2. Inspect any area of the floor that is sagging, weak or damaged due to broken, damaged or loose crossmembers.

## **Outriggers/Body Supports**

Visually inspect all outriggers and attaching hardware for cracks, missing bolts and damage.

## **Bumpers**

Visually inspect front and rear bumpers for missing attaching hardware, broken hardware. Ensure bumpers are properly mounted and secure and that there is no point protruding beyond the confines of the vehicle so as to create a hazard.

## **EXHAUST SYSTEM**

1. Visually and audibly inspect the complete exhaust system including muffler, diesel particulate filter (DPF) and diesel oxidation catalyst (DOC) for leaks, restrictions, damage and to ensure that it's not discharging directly below the driver or passenger compartment. All exhaust emission control devices shall be installed and operating per the manufacturer's recommendations.
2. Inspect for the presence and condition of heat shielding over and around all piping, and components where specified by vehicle manufacturer.

3. Visually and physically inspect all exhaust system mounting hardware for loose, missing or damaged components and that it is securely attached. Inspect to ensure that all clamps are in place and secure.
4. Visually inspect exhaust system for indications of, and areas likely to result in, burning, charring or damaging the electrical wiring, the fuel supply or any combustible part of the vehicle.

## FUEL SYSTEM

1. Visually inspect all parts of the fuel tank, fuel tank cage and fuel system to include lines, hoses, filters, fill cap and fittings for indications of damage or leaks.
2. Visually and physically inspect fuel lines and hoses for proper securement, routing and missing or loose clamps that may cause chafing or come in contact with electrical components.

## DRIVESHAFT

1. Visually and physically inspect each segment of the driveshaft and associated hardware. Inspect for bends, cracks, missing weights or debris entangled in the shaft. Each shaft more than 18 inches long shall be equipped with a suitable guard to prevent an accident or injury in the event of its fracture or disconnection. The inspector shall check to ensure that the driveshaft guards(s) are not loose, bent or missing.
2. Visually and physically inspect each universal joint and center bearing. The universal joint(s) and center bearing(s) shall not be loose or worn and shall have all attaching hardware securely fastened. The inspector shall check for lateral and vertical movement of the universal joints and center bearing by grasping the universal joint and attempting to move the joint laterally and vertically. Inspector shall inspect universal joints for substandard or welded repairs.
3. Visually inspect driveshaft for proper phasing. (See illustration.)

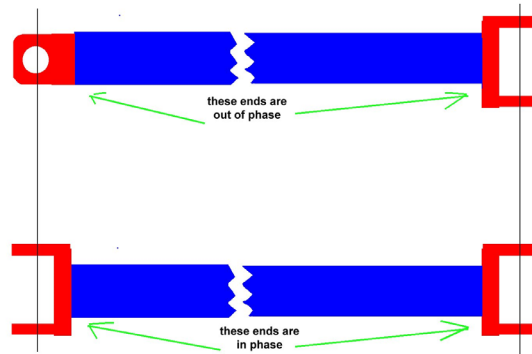

## DIFFERENTIAL

The Inspector shall visually inspect the differential and differential housing for cracks and leaks. Careful attention shall be made to the areas of mounting attaching hardware and wheel end areas. Housing vent shall be inspected to ensure that it is not clogged and is functional by twisting the vent cap by hand.

## **ENGINE**

1. Visually inspect engine and surrounding components for evidence of fluid leaks and loose or damaged components. Inspector shall start engine. While engine is operating, inspector shall visually and audibly monitor engine for proper operation, leaks and unusual noises of engine or components.
2. Inspect cooling fan per manufacturer's recommendations.
3. Visually and physically inspect all drive belts for proper alignment and tension per manufacturer's recommendations. All belts shall be free of cracking, frays, fluid, glazing and excessive wear. Inspect belt-tensioner per manufacturer's recommendations.
4. Visually inspect all hydraulic, coolant, fuel and pneumatic hoses for damage, proper routing, proper type and proper securement. Hoses shall be routed in such a way as to avoid contact with exhaust, rotating or moving engine components or sharp edges. Hoses shall not be cracked, leaking, swollen or chaffed.

## **TIRES/WHEELS/HUBS**

### **Tire Type**

1. Visually inspect the steer axle (front) to ensure that no recapped, re-grooved tires are present.
2. Visually inspect tires for improper wear patterns. (See Tire Wear Chart below.)
3. Check proper type. (i.e., load range, size, mismatched on axle).

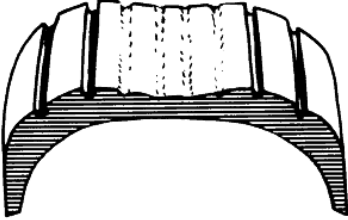
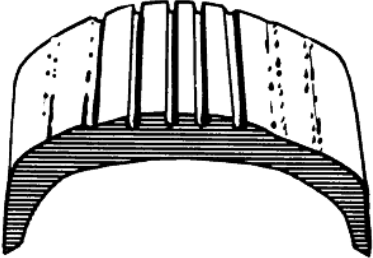
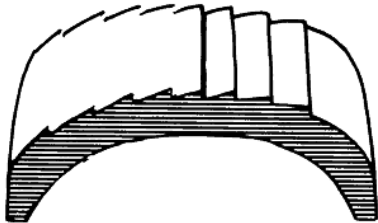
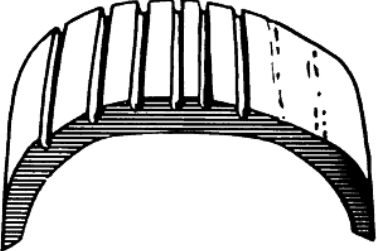
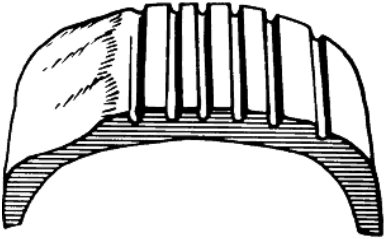

## TIRE WEAR CHART

	<p><b>Over Inflation:</b> Excessive wear at the center of the tread indicates that the air pressure in the tire is consistently too high. The tire is riding on the center of the tread and wearing it prematurely. Many times, this visual method of inflation (inflating the tires up until there is no bulge at the bottom) is at fault; tire inflation pressure should always be checked with a reliable tire pressure gauge.</p>
	<p><b>Under Inflation:</b> This type of wear usually results from consistent under inflation. When a tire is under inflated, there is too much contact with the road by the outer treads, which wear prematurely. Tire pressure should be checked with a reliable pressure gauge. When this type of wear occurs, and the tire pressure is known to be consistently correct, a bent or worn steering component or the need for wheel alignment could be indicated. Bent steering or idler arms cause incorrect toe-in and abnormal handling characteristics on turns.</p>
	<p><b>Feathering:</b> Feathering is a condition when the edge of each tread rib develops a slightly rounded edge on one side and a sharp edge on the other. By running your hand over the tire, you can usually feel the sharper edges before you'll be able to see them. The most common cause of feathering is incorrect toe-in setting, which can be cured by having it set correctly. Occasionally toe-in will be set correctly and this wear pattern still occurs.</p>
	<p><b>Side Wear:</b> When an inner or outer rib wears faster than the rest of the tire, the need for alignment is indicated. There is excessive camber in the front suspension, causing the wheel to lean too much to the inside or outside and putting too much load on one side of the tire. Misalignment could be due to sagging springs, worn ball joints, worn control arm bushings or worn kingpin bushings.</p>
	<p><b>Cupping:</b> Cups or scalloped dips appearing around the edge of the tread on one side or the other, almost always indicate worn (sometimes bent) suspension parts. Adjustment of wheel alignment alone will seldom cure the problem. Any worn component that connects the wheel assembly to the vehicle (ball joint, kingpins, wheel bearing, shock absorber, springs, bushings, etc.) can cause this condition. Occasionally, wheels that are out of balance will wear like this, but wheel imbalance usually shows up as bald spots between the outside edges and center of the tread.</p>

### **Tire Tread Depth**

1. Visually inspect for any front tire worn to less than  $\frac{4}{32}$  inch.
2. Visually inspect for any rear tire worn to less than  $\frac{2}{32}$  inch.
3. If a visual inspection cannot determine that the tire meets the minimum depth requirement, the inspector shall use a commercial tire depth gauge to verify tread depth.

### **Tire Sidewall**

Inspector shall inspect tire sidewall for cuts, wear and any observable bumps or bulges.

### **Tire Inflation**

1. Visually inspect that tires are properly inflated and does not have noticeable leaks. (See 393.76 (h)(1),(2).) If pressure is questionable, inspector shall use a tire pressure gauge to verify pressure.
2. Visually inspect valve stem for damage and presence of valve cap.

### **Wheels/Rims/Spiders**

1. Inspector shall inspect all nuts, bolts, studs, lugs and holes for damage. Visually inspect for broken, damaged, missing or loose fasteners. Rust around fasteners or on rim surface is sometimes an indication of cracked or loose mounting hardware.
2. Visually inspect rim for, cracks, welds or broken components. Visually inspect for any lock or slide ring that is broken, cracked, improperly seated, sprung or has mismatched rings.

### **Hub & Assemblies**

1. Visually inspect kingpin and wheel bearing assemblies for looseness, damage, missing or loose fasteners. This shall include lockingpins, draw keys, caps and bearings.
2. Physically inspect kingpin and bearing assemblies for play as follows: grasp tire at top and attempt to move the wheel assembly in and out. If movement is present, inspector can help to identify the source by following these procedures.
3. Have an assistant fully apply brakes while rechecking play. If movement disappears with brakes applied, then play is in the wheel bearings. If movement remains, it is most likely in the kingpin area. Assembly shall not have excessive kingpin play that exceeds .250 inch measured at outside edge of tire or wheel bearing movement that exceeds .010 inch measured at bearing hub.

4. Visually inspect A-frames and bushings on Type A vehicles. Inspect bushings for wear, cracking, splitting, or severe extrusion from suspension parts.

## **ELECTRICAL/BATTERY**

### **Cables**

1. Visually inspect all electrical cabling and wiring for chafed, frayed, damaged, or burnt insulation.
2. Visually and physically inspect for corroded or loose connections at the battery terminals. Inspect for unsuitable insulation to electrical cabling.
3. Inspect for missing or damaged protective grommets insulating all electrical cables through metal compartment panels. All electrical cabling passing through a metal surface shall pass through an insulated grommet as to provide adequate protection against chaffing and shorting.
4. Visually and physically inspect for any broken or unsecured mounting of electrical components.
5. Visually and physically inspect electrical cabling for securement, routing or any unsecured wiring that may cause chafing or frayed conditions.

### **Battery**

1. Visually and physically inspect that the battery(ies) is(are) securely mounted and no signs of leaking, or excessive corrosion.
2. Crank engine to ensure adequate battery capacity to start engine.

### **Windshield Wipers**

Operate wiper and washer system. The wiping system should be power-driven with at least two speeds and should be able to clean the area of the windshield within the wiping pattern. Wipers should operate with a minimum of 45 cycles per minute.

## **BODY INTERIOR**

### **Panels**

Visually inspect all interior sidewall, rear, ceiling and driver's area paneling for secure fastening, projections or sharp edges and general condition.

**Floor**

Visually inspect floor covering, aisle and cove molding strips for condition and adhesion. Check fastening holes for cracks, and check condition of rubber in aisle to ensure that there are no unsealed holes or cracks through the underside of the bus and that there is no damage to the coverings which could cause a trip or slip hazard.

**Stepwell**

Visually inspect the stepwell for condition of support structure, to ensure structural stability. Inspect stepwell treads to ensure proper securing and adhesion to stepwell. Visually inspect step treads for any excessive worn areas that may pose a tripping or slip hazard.  $\frac{1}{8}$

**Handrail**

Handrail must be securely mounted and all OEM hardware present. Perform the NHTSA Nut and String Test as described below. (See illustration.)

## NUT AND STRING TEST



### The Handrail Inspection Tool and Procedure

The inspection tool is inexpensive and the procedure for detecting potentially fatal handrail designs is quite simple. The inspection tool is a standard  $\frac{1}{2}$  inch hex nut measuring  $\frac{3}{4}$  inch across the flats. This nut is tied to  $\frac{1}{8}$  inch thick cotton cord measuring 36 inch in length with overhand knots. The drawstring should have a minimum length of 30 inch when tied to the nut and attached so that a pull of at least 10 pounds does not separate the nut from or break the drawstring.

Steps to conduct a handrail inspection are:

- Stand on the ground outside of the bus ;
- Drop the inspection tool between the handrail and step well wall, simulating the typical way students exit the bus ;
- Draw the inspection tool through the handrail in a smooth, continuous slow motion; and
- Repeat this procedure several times (minimum of three times).

**Note:** It is important to drop the inspection tool over the handrail in such a way as to simulate a child exiting the bus. This is a drop-and-drag test. Do not create a snagging situation by placing the nut in an area that would not be exposed to a drawstring or other articles.

### Inspection Results

Take the bus out of service and repair it if the inspection tool catches or snags anywhere on the handrail. If the nut separates from the drawstring or the drawstring breaks, reassemble the tool and retest. If the inspection tool pulls freely without catching or snagging, the bus should not be rejected.

## Aisle

1. Visually inspect the aisle to ensure that all aisles, including aisle (or passageway between seats) leading to emergency door are a minimum of 12 inches.
2. Visually inspect to ensure that there are no obstructions in an aisle that would prevent passengers from egress to emergency exits.
3. On school buses with a side emergency door, check that aisle space from center aisle to side of emergency door is 12 inches by measuring between the vertical line of the seat back and the face of the next seat cushion or bottom of a flip seat.

### **Seat(s) and Barrier(s)**

1. Visually inspect all seats and barriers to ensure that all are securely mounted and not loose or broken.
2. All seats shall be forward-facing and securely fastened to the bus body. Passenger seat cushions shall be fastened to prevent the cushions from disengaging from the seat frames in the event of an accident. There shall be a minimum space of 24 inches between the forward surface of a seat back and the rear surface of the seat or barrier ahead measured across the seat cushion with out depressing any surface. The forward surface may have side bolsters that briefly reduce the width to less than 24 inches provided the remainder of the seat measures at least 24 inches.
3. Seats and barriers should appear symmetrical. Seats/barriers that do not appear symmetrical should be physically inspected to ensure seat covering and/or padding is not significantly compromised and complies with FMVSS 571.222.

### **Seat, Driver**

1. Visually inspect driver's seat to ensure that it is securely fastened to the vehicle.
2. Visually inspect the driver's seat for its ability to maintain the adjusted position. Inspect driver's restraining device (seat belt) for fraying, attaching hardware and the capacity of the seat belt for maintaining the driver in the seated position.

### **Door, Entrance**

Visually inspect and operate entrance door and inspect door to properly open and close without any obstruction of movement. Inspect manually operated door to make sure door will maintain an open and closed position. Door shall not have any locking device except for interlock systems. On power-operated entrance doors, the emergency release valve, switch or device to release the entrance door must be placed above or to the immediate left or immediate right of the entrance door and must be clearly labeled.

### **EMERGENCY EXITS**

1. Visually inspect all emergency exits. Operate all emergency exits. Exits must open freely and completely. Door prop rods must operate freely and hold door or exit in open position without obstructing exit. There shall be no padlocks or any other locking devices on exits except interlocking systems.
2. Visually inspect all exits to ensure they are clearly labeled and marked on both the inside and outside of the bus.

3. Ensure that all exits have an audible device to alert the driver of an open exit door or window.
4. FMVSS 571.217 defines the number of exits for each type of bus.

## **WINDOWS**

1. Visually inspect all glass for missing or broken glazing and are approved type. Visually inspect windshield to ensure that there is no discoloration or damage in that portion extending upward from the height of the top-most portion of the steering wheel, but not including a two inch border at the top and a one inch border at each side of the windshield or each panel thereof except as follows:
  - a. Color or tint applied by manufacturer for the reduction of glare;
  - b. Any crack not over  $\frac{1}{4}$  inch long, if not intersected by another crack;
  - c. Any damaged area, that can be covered by a disc  $\frac{3}{4}$  inch in diameter, if not closer than three inches to any other such damaged area;
  - d. Any damage to the driver's side area window(s), or chips, clouding or cracks that obscure the driver's vision.
2. Inspect that the defrosting and defogging system is operable to clear the driver's windshield.

## **BODY EXTERIOR**

1. Visually inspect the body exterior to ensure that there is not any panel, rub rail or trim that is loose, torn, dislocated or protruding from the surface of the bus that would create a hazard.
2. All engine, battery or other doors must be securely mounted and properly installed.

## **MIRRORS**

Visually inspect all mirrors to identify any mirror that is damaged, clouded or otherwise has an obscured area. All mirrors should hold a set adjustment. All mirrors should be directed to view the intended area for which they are designed.

## **LAMPS/SIGNALS**

1. Visually inspect all lamps, such as brakes, turn signals, tail, head (low beam), overhead warning lights (amber and red), hazard warning and stop arm lights to ensure proper visibility and operation. Turn signals should flash at a rate of 60 to 120 times per minute.

2. Inspect that the horn functions and it is audible from approximately 200 feet away.
3. Inspect the crossing control device, if equipped, for proper operation (e.g., that it extends and retracts as designed).

### **EMERGENCY EQUIPMENT**

1. Visually inspect that the fire extinguisher is readily accessible to the driver and that it is fully charged of proper type and size and has a working pressure gauge.
2. Visually inspect any other state-required equipment such as first aid kits, body fluid kits, webbing cutters and emergency reflectors and ensure that these items are fully stocked and functional.

### **WHEELCHAIR LIFT-EQUIPPED VEHICLES**

1. Visually inspect and operate wheelchair lift to ensure proper function as designed. Inspect for any leaks that would hinder the operation of the lift. Inspect all safety systems of the wheelchair lift (e.g., hand rails, ramp stops, etc.) are functioning as designed.
2. Visually inspect all wheelchair securement devices to make sure none are missing or broken and that straps are not frayed.

[Back to Contents](#)



**Page Intentionally Left Blank**

# **ALTERNATIVE FUELS**

**Page Intentionally Left Blank**

# ALTERNATIVE FUELS

## INTRODUCTION

This section is designed to be used as an overview of the alternative fuels being utilized for school transportation. It is not designed to replace current applicable federal, state, manufacturing or safety specifications that may exceed requirements within this section. There may be advancements in engineering and improvements in equipment fabrication methods and operating practices that differ from those specifically called for in this section. Such deviations or improvements may provide safety and may meet the intent of, and be compatible with, this section. Entities wishing to purchase alternative-fuel school buses should use this section only as a starting point. More detailed specifications, including specific design and performance criteria and safety specifications, should be researched by prospective purchasers of alternative-fuel school buses.

## GENERAL REQUIREMENTS

Alternative-fuel school buses shall meet the following requirements:

- A. Chassis shall meet all specifications previously mentioned in BUS CHASSIS SPECIFICATIONS.
- B. Chassis shall meet all applicable Federal Motor Vehicle Safety Standards (FMVSSs).
- C. The fuel system integrity shall meet the specified leakage performance standards when impacted by a moving contoured barrier in accordance with test conditions specified in FMVSS No. 301, *Fuel System Integrity*, or FMVSS No. 303, *Fuel System Integrity of Compressed Natural Gas Vehicles*, as applicable.
- D. Original equipment manufacturers (OEMs) and conversion systems using compressed natural gas (CNG) shall comply with National Fire Protection Association (NFPA) Specification 52A, *Compressed Natural Gas Vehicular Fuel Systems*, in effect at the time of installation. Fuel systems using liquefied petroleum gas (LPG) shall comply with NFPA Specification 58A, *Liquefied Petroleum Gases Engine Fuel Systems*, in effect at the time of installation.
- E. All alternative fuel buses shall be capable of traveling not less than 200 miles with a full load, except that those powered solely by electricity shall be capable of traveling not less than 80 miles.
- F. Natural gas-powered buses shall be equipped with an interior/exterior gas detection system. All natural gas-powered buses shall be equipped with an automatic or manual fire detection and suppression system.
- G. All materials and assemblies used to transfer or store alternative fuels shall be installed outside the passenger/driver compartment.

- H. All Types C and D buses using alternative fuels shall meet the same base requirements of BUS CHASSIS SPECIFICATIONS for passenger load.
- I. The total weight shall not exceed the vehicle's GVWR when loaded to rated capacity.
- J. The manufacturer supplying the alternative fuel equipment must provide the owner and operator with adequate training and certification in fueling procedures, scheduled maintenance, troubleshooting and repair of alternative fuel equipment.
- K. All fueling equipment shall be designed specifically for fueling motor vehicles and shall be certified by the manufacturer as meeting all applicable federal, state and industry standards.
- L. All on-board fuel supply containers shall meet all appropriate requirements of the American Society for Mechanical Engineering (ASME) code, DOT regulations or applicable FMVSSs and NFPA standards.
- M. All fuel supply containers shall be securely mounted to withstand a static force of eight times their weight in any direction.
- N. All safety devices that discharge to the atmosphere shall be vented to the outside of the vehicle. The discharge line from the safety relief valve on all school buses shall be located in a manner appropriate to the characteristics of the alternative fuel. Discharge lines shall not pass through the passenger compartment.
- O. A positive, quick-acting ( $\frac{1}{4}$  turn) shut-off control valve shall be installed in each gaseous fuel supply line, as close as possible to the fuel supply containers. The valve controls shall be placed in a location easily operable from the exterior of the vehicle. The location of the valve controls shall be clearly marked on the exterior surface of the bus.
- P. An electrical grounding system shall be required for grounding of the fuel system during maintenance-related venting.
- Q. Bio-Diesel must conform to the specifications of ASTM 6751, *Biodiesel Standard*.
- R. High Voltage-Powered Vehicles.

Buses utilizing a high voltage propulsion system (more than 48 nominal volts) shall meet the requirements of FMVSS 305, *Electric Powered Vehicles: Electrolyte Spillage and Electrical Shock Protection*, except for the following:

1. The propulsion power source (batteries, fuel cells, etc.) shall be located outside the passenger compartment.

2. The propulsion power source enclosure shall be constructed to conform to the power source manufacturer's requirements and recommendations.
3. Due to the much larger size and quantities of the propulsion power sources on larger vehicles, buses over 10,000 lbs are permitted to exceed the 5.0 liter spillage constraint of Section S5.1, "Electrolyte damage from propulsion batteries."

## CHARACTERISTICS OF ALTERNATIVE FUELS

For the purpose of this section, alternative fuels refer to the specific fuels listed below. A brief description of each fuel and the advantages and disadvantages of each fuel are shown. (Also see APPENDIX C, Alternative Fuels Comparison Chart.) **Note:** Two other more exotic fuels are being examined: hydrogen and solar power. These two energy sources are in their infancy as alternative fuels for motor vehicles and are not covered within the scope of this section.

### A. Liquid alternative fuels

#### 1. Methanol

Methanol, a liquid at normal ambient temperatures, is colorless and is made primarily from natural gas or coal. Extensive experiments have been conducted with automobile and truck engines powered by methanol. There are a number of urban transit bus fleets currently using methanol. California has experience with methanol as an alternative fuel for school buses through its School Bus Demonstration Project. The findings clearly determined methanol fuel to be costly to operate and unreliable.

##### a. Advantages:

- (1) The principal advantage of methanol is that the emissions produced are quite low in particulates and NO<sub>x</sub>.
- (2) Methanol mixes with gasoline and can be used as M85 which is 15 percent gasoline and 85 percent methanol with flexible-fuel vehicles running on a blend of the two fuels.
- (3) Methanol has a high octane rating which assists gasoline (spark ignition) engine performance.
- (4) Methanol is biodegradable and readily assimilates with water.
- (5) Methanol burns smokeless.
- (6) Methanol is a domestically produced energy source.

b. Disadvantages:

- (1) Methanol is corrosive, particularly to aluminum. Engines and fuel systems specially designed to handle it use different materials, such as stainless steel.
- (2) Methanol has less than half the power per equivalent gallon (BTU value) as diesel fuel. For an equivalent range, this requires storage tanks twice the size of diesel tanks.
- (3) Methanol is quite toxic. Direct exposure to the human body has the potential of causing blindness and kidney failure. Since it is tasteless and colorless, it cannot easily be detected should it get into a water supply.
- (4) Methanol combustion generates high amounts of formaldehyde, a potential cancer-causing substance. This effect can be offset with exhaust after-treatment, such as the use of special catalytic converters.
- (5) In its pure state, methanol burns with a colorless flame, so a fire is hard to see. It is less volatile than gasoline but has a relatively low flash point of 54 degrees Fahrenheit.
- (6) The distribution system and infrastructure for methanol fueling are considerably less widespread than for gasoline and diesel.
- (7) Methanol has a low cetane rating, which inhibits diesel engine performance. It is not suitable for blending with diesel fuel.
- (8) Methanol has been proven to be unsafe when operating in certain ambient temperature ranges.

2. Ethanol

Ethanol is a distilled agricultural alcohol product that is a liquid and is colorless at normal ambient temperatures. Corn is the current primary grain source. It has many of the same characteristics as methanol. Currently, ethanol is used primarily in a mixture with gasoline, usually no more than 10% ethanol.

a. Advantages:

- (1) Ethanol emissions are quite low in particulates and  $\text{NO}_x$ .

- (2) Like methanol, ethanol readily mixes with gasoline.
- (3) Ethanol is biodegradable and readily assimilates with water.
- (4) Ethanol is less corrosive and less toxic than methanol.
- (5) Ethanol is a domestically produced energy source.

b. Disadvantages:

- (1) The production process is extensive and the steps involved (i.e., planting, fertilizing, harvesting, shipping and processing) consume nearly as much energy as is created by the fuel.
- (2) The energy output of ethanol, though higher than methanol, is still only about half that of diesel fuel; thus, the range of ethanol-powered vehicles is limited for a given fuel storage capacity.
- (3) Ethanol emissions have some visible smoke.
- (4) Ethanol produces formaldehyde; however, this can be offset with an exhaust after-treatment.
- (5) The distribution system and infrastructure for ethanol fueling are considerably less widespread than for gasoline and diesel.

3. Reformulated gasoline

Reformulated gasoline is specially blended fuel with the following properties: a. lower vapor pressure that reduces evaporation during operation and refueling, and b. more efficient combustion through the addition of high-octane oxygenates. Reformulated gasoline aromatic levels have been lowered, which provides less in the way of hydrocarbon tail pipe emissions. Reformulated gasoline (RFG) is required by the EPA in certain metropolitan areas. However, those areas are becoming fewer.

a. Advantages:

- (1) Reformulated gasoline is compatible with all existing gasoline engines.
- (2) The existing fuel-delivery infrastructure is unchanged by this change in fuel properties.



- (3) Reformulated gasoline is a cost-effective alternative in spite of some additional refining costs.

b. Disadvantages:

- (1) Currently there is insufficient oxygenate production and storage (as well as transportation) to provide the oxygenate when and where it is needed.
- (2) Like regular gasoline, reformulated gasoline has a lower caloric (BTU) value than diesel and, thus, provides less engine efficiency than diesel and less range for a given fuel capacity.
- (3) Reformulated gasoline is a fossil fuel and, as such, still leaves the country dependent on foreign sources.
- (4) Reformulated gasoline is not as effective on newer computer-controlled vehicles and is being phased out in some cities.

B. Gaseous alternative fuels

1. Natural gas

Natural gas is primarily methane as it comes from the well, and it burns quite cleanly in its unprocessed state. Natural gas has a higher ignition point (temperature) and a narrower fuel/oxygen mixture combustion range than other fuels. Energy is consumed in processing natural gas to achieve sufficient vehicle storage (i.e., compression or cryogenic processes). (See “Compressed natural gas” and “Liquefied natural gas” sub-sections below.) Natural gas is lighter than air in ambient conditions and does not pool on the ground, a condition that requires buildings used for indoor housing of natural gas vehicles to be adequately ventilated at the ceiling.

2. Compressed natural gas (CNG)

CNG consists primarily of mixtures of hydrocarbon gases and vapors, principally methane (CH<sub>4</sub>) in a gaseous form, which is compressed for use as a vehicular fuel.

a. Advantages:

- (1) Natural gas is readily available as a domestic energy source, is inexpensive and generally produces lower emissions than most other alternative fuels.

- (2) CNG already is in use as a viable alternative for light-duty vehicles. The American Gas Association reports over 700,000 natural gas-powered vehicles in operation in 38 countries. CNG has proven viable for use in school buses.
- (3) CNG burns cleaner and minimizes carbon buildup, thus extending oil change intervals and reducing maintenance.

b. Disadvantages:

- (1) The pressure of CNG requires heavy storage tanks. The tanks are large, even for short-range use. These two factors reduce passenger capacity. Maintaining reasonable passenger capacity restricts tank size and limits range. Lower caloric (BTU) value per equivalent gallon than diesel also limits engine efficiency and vehicle range.
- (2) The high pressure experienced by the CNG fuel storage system requires careful design and location on the vehicle, protection from damage, plus periodic maintenance and upkeep. Periodic tank testing for structural safety is required, and tank replacement during the life cycle of the vehicle may be necessary.
- (3) Refueling time is dependent on the type of fueling system used and can be quite lengthy. There are two methods: (a) “slow-fill,” which takes from five to eight hours and is typically called “overnight” or “time-fill” refueling, and (b) “fast-fill,” which takes about 5 to 10 minutes and requires high-volume compression and special filling apparatus.
- (4) Natural gas compression and refueling equipment is expensive and must be maintained. Fast-fill capability requires an additional “cascade” of high volume storage cylinders, which adds considerable expense to the fueling station.
- (5) There are composition variations in natural gas and the percentage of methane content varies from one area to another. Additional processing is required to get uniform natural gas available in all areas.
- (6) Natural gas has poor lubricative properties.

- (7) There are few fueling stations around the country that are open to the public. Users of CNG, therefore, usually are restricted to operating their buses within range of their own refueling stations.
- (8) The cost of a CNG bus is 40 percent to 50 percent more than that of a conventionally-fueled bus.
- (9) The compressor for a CNG fueling station, whether time-fill or fast-fill has a short life span of approximately 400 hours between rebuilds.

### 3. Liquefied natural gas (LNG)

LNG utilizes the same natural gas source (primarily methane) as CNG, but requires cooling the gas to temperatures below -260 degrees Fahrenheit (-163 degrees Celsius) to liquefy the natural gas. Converting natural gas to liquid form allows storage of a much greater amount on the vehicle than can be achieved in the gaseous state. The process of liquefying the natural gas also yields almost pure methane gas with predictable performance characteristics.

#### a. Advantages:

- (1) LNG has all of the combustion advantages of CNG, is readily available, clean burning and generally produces lower emissions than alternatives other than CNG.
- (2) An engine will operate just as easily on LNG as it does on CNG. Though one is stored by compression and the other by cryogenic liquefaction, when CNG or LNG arrives at the point of combustion in the engine it has been converted to its gaseous natural gas state.
- (3) The range of an LNG vehicle is greater than that of a CNG vehicle due to the greater fuel density.
- (4) The LNG fuel system pressure is less than 100 psig as compared to 3000 psig in a CNG system.
- (5) LNG provides almost pure methane with known performance characteristics.
- (6) LNG is capable of being transported in trucks to outlying filling stations, and vehicles may be refueled from the truck.

b. Disadvantages:

- (1) Maintaining the super-cool temperature requires large, heavy, highly insulated tanks which forces a compromise between vehicle range and cargo carried. A lower caloric (BTU) value per equivalent gallon than diesel also limits engine efficiency and vehicle range.
- (2) Equipment to super-cool and liquefy gas is expensive to purchase, operate, and maintain.
- (3) LNG can be kept in the insulated storage tank for seven to ten days. After that, it must be bled off to maintain the cold temperature required to hold the gas in liquid form.
- (4) The bleeding-off process releases hydrocarbons which, in turn, requires treatment to avoid direct release into the atmosphere.
- (5) Natural gas has poor lubricative properties.
- (6) Skin contact with LNG will cause frost burns.

4. Propane (also known as liquefied petroleum gas or LPG)

Propane, or LPG, is sometimes available directly from wells, but is normally produced as a by-product of the gasoline refining process. It has been used for a number of years in light-duty commercial vehicles in urban areas around the world.

a. Advantages:

- (1) Propane burns relatively cleanly. It emits less NO<sub>x</sub> and contains less particulate matter than diesel, and emits less carbon monoxide with fewer hydrocarbons than gasoline.
- (2) The cleaner burning minimizes carbon buildup in the engine, resulting in less maintenance.
- (3) Propane-powered engines start easier in cold weather than either diesel- or gasoline-powered engines.
- (4) The infrastructure for distribution and storage of propane is relatively widespread.

b. Disadvantages:

- (1) As with CNG, propane requires large and heavy fuel tanks to achieve reasonable driving range, due to reduced engine efficiency per equivalent gallon.
- (2) Propane vapors, like gasoline, are heavier than air and are volatile. These explosive mixtures settle in service pits or other spots; therefore, indoor storage is a safety concern.
- (3) As a by-product, propane is dependent on the gasoline process, which limits supply. Further, it does little toward the reduction of dependency on foreign oil.
- (4) Propane has poor lubricative properties.

5. Electric power

The use of electricity as a power source for school buses is an emerging technology that is under considerable research due to the potential for reduced overall emissions. Research is centering on ways to increase the capacity and reduce the weight of batteries, as well as to improve the motors used to power the vehicles and the associated electronics. Battery-charging technology is also developing rapidly. Most of these efforts have the goals of improving the range and performance of electric vehicles, reducing their cost and addressing operational concerns, such as recharging.

a. Advantages:

- (1) Electric-powered vehicles produce no tail pipe emissions.
- (2) The electricity distribution system is currently available since power lines are already in place.
- (3) Electricity can be, and often is, produced from renewable, domestic energy sources.
- (4) Electric-powered vehicles are extremely quiet, due to the lack of internal combustion engines.
- (5) Electric school buses can be produced as hybrid vehicles, which would have a small internal combustion engine to recharge batteries, or to supply heating systems or various other chassis accessories.

- (6) The cost per mile to operate electric-powered vehicles is low. In other words, power source maintenance is practically nil, compared to internal combustion engines.
- (7) Vehicles powered by electric motors offer high torque at low speeds and good overall performance.
- (8) Most purpose-built electric vehicles utilize regenerative braking, which recharges batteries, improves braking performance and improves the life of brake linings.

b. Disadvantages:

- (1) Electric-powered vehicles have a low range due to battery weight and limited electrical storage capacity of current batteries.
- (2) Electric-powered vehicles may not eliminate overall emissions and/or foreign oil dependency if electricity to charge vehicle batteries is produced from coal or oil.
- (3) Current cost of electric power systems for vehicles, including batteries, is extremely high.
- (4) Battery disposal is an environmental concern.
- (5) Significant weight of current batteries limits passenger-carrying capacity.
- (6) Batteries need to be replaced periodically. In some applications, this expense can be a significant portion of the life-cycle cost of operating electric vehicles.

6. Hybrid Electric and Plug-In Hybrid Electric

While technically not an alternative fuel, hybrid vehicles are treated as such in most federal and state programs due to the novel approach to energy use. Straight hybrid electric vehicles are, by far, the largest and fastest growing sector of alternative-fuel vehicles. Plug-in hybrid electric vehicles take advantage of the straight hybrid system, but also allow the user to pre-charge the battery packs to gain additional range and reduce combustion engine usage.

a. Advantages:

- (1) Hybrid vehicles produce significantly less tail pipe emissions.

- (2) Plug-in hybrid vehicles produce even lower emissions when using power from electricity, even considering the power plant emissions.
- (3) Engine wear on hybrids is reduced significantly by reducing strain on the combustion engine and allowing the combustion engine to operate at more optimal points.
- (4) Brake life and performance are significantly increased, due to the use of regenerative braking by the hybrid system to recharge battery packs.
- (5) Hybrid and plug-in hybrid vehicles reduce or eliminate idling, both improving fuel economy and reducing exposure to local vehicle emissions.
- (6) Hybrid electric vehicles are very quiet at low speeds when the electric motors are driving the vehicle alone.
- (7) The cost per mile to operate hybrid electric and plug-in hybrid electric vehicles is low.
- (8) By using electric motors, both hybrid electric and plug-in hybrid electric vehicles offer very high torque at low speeds, and offer superior overall performance. Electric motor reliability is also very high. These motors are often inherently rated many times the life of the vehicle.
- (9) The range of hybrid electric and plug-in hybrid electric is much greater than that of conventional vehicles due to the increase in fuel economy.

b. Disadvantages:

- (1) The use of hybrid and plug-in hybrid vehicles does not eliminate the use of foreign-based petroleum products, nor does it eliminate the production of local and total emissions.
- (2) Hybrid and plug-in hybrid school buses are currently very expensive and are limited in availability.
- (3) Disposal of batteries is difficult, and possibly an environmental concern depending on the choice of battery type by the manufacturer.

- (4) Batteries will need to be replaced periodically. Depending on the choice of battery chemistry, these replacements may be expensive and/or more frequent.
- (5) The choice of battery will also affect the overall weight of the vehicle possibly limiting passenger carrying capacity.

## 7. Bio-diesel

Bio-diesel is a domestic renewable fuel for diesel engines derived from natural oils like soybean oil or animal fat. Bio-diesel can be used in any concentration with petroleum based diesel fuel in existing diesel engines, with little or no modification. While bio-diesel can be used without blending (designated B100), it is generally blended with petroleum-based diesel fuel at 20 to 50 percent (designated B20 or B50 representing the volume percent of bio-diesel). Bio-diesel reduces exhaust pollutants in hydrocarbons (HC), carbon monoxide (CO) and particulate matter (PM). Depending on the engine and duty cycle, nitrogen oxides (NOx) may increase or decrease.

### a. Advantages:

- (1) Significant reduction in three of the four EPA regulated exhaust gases (HC, CO and PM) over petroleum-based diesel.
- (2) Can be blended with petroleum-based diesel to enhance both fuels characteristics.
- (3) Will operate in current diesel engines with little or no modifications.
- (4) Is a domestically produced, renewable source reducing dependency on foreign oil.
- (5) Is biodegradable, less toxic than table salt and degrades faster than sugar.

### b. Disadvantages:

- (1) Bio-diesel can cause deterioration of some seals and hoses, causing fuel or oil leaks, plugged filters and damaged injection pumps. These affects are minimized when using a blend such as B20.



- (2) Bio-diesel acts as a cleaning agent, breaking loose buildup in tanks, causing filter plugging for initial few weeks of operation.
- (3) Refining costs are substantial; therefore, the cost is passed down to the end user. This can be minimized by blending with diesel. It is not available in all areas.
- (4) Use of bio-diesel may result in an increase in exhaust emissions of NO<sub>x</sub>.
- (5) Engine starting ability will be affected in colder climates. The cloud point and pour point is higher than for petroleum-based diesel. Bio-diesel's cloud point is -3 to 12 degrees F and diesel is -15 to 5 degrees F. Pour point of Bio-diesel is -15 to 10 degrees F and diesel is -35 to -15 degrees F.
- (6) Bio-diesel at concentrations of 100 percent (B100) produces 8 percent less energy than petroleum diesel and about 2 percent less with B20.

8. Clean diesel/Ultra-low sulfur diesel

Clean diesel was one of the alternative fuels approved in the Clean Air Act Amendments of 1990. The first step to be undertaken was further refining to reduce sulfur contents and hence the significant particulate emissions caused by the sulfur. Significant advancement in this process has resulted in the development of ultra-low sulfur content diesel fuel. Refinery techniques can now produce diesel fuel with a sulfur content below 15 parts per million (PPM). The availability of this fuel supports the installation of an advanced exhaust after-treatment device in the form of a continuously regenerating filter, known as a diesel particulate filter. This technology reduces the exhaust particulate content by approximately 90 percent from currently mandated levels (to essentially zero). Further steps are being developed to add cetane boosters, which increase efficient combustion.

a. Advantages:

- (1) The additional processing costs are small, so clean ultra-low sulfur diesels are cost-effective relative to other alternative fuels.
- (2) All existing diesel engines currently in service can use clean, ultra-low sulfur diesel without modification.

- (3) The present systems for distribution of diesel fuel are unchanged and are fully usable with clean diesel
- (4) Clean, ultra-low sulfur diesel retains the low level of diesel fuel volatility. This makes it safer than many other alternatives.
- (5) Clean and ultra-low sulfur diesel has a higher BTU value per gallon or equivalent gallon than any other alternative fuel, and thus provides more engine efficiency, as well as more vehicle range.
- (6) Ultra-low sulfur diesel offers significant reductions in emissions.

b. Disadvantages:

- (1) Clean diesel is still relatively high in particulates and NO<sub>x</sub>.
- (2) Clean, ultra-low sulfur diesel are fossil fuels and, as such, still leave the country dependent on foreign sources.
- (3) When operating under cold conditions, starting is a problem, as with all diesel fuels.
- (4) Ultra-low sulfur diesel is not readily available in most areas of the country.
- (5) Some additives may cause plugging of the fuel filters if they are not compatible with the additives used by the refiner to add lubricity once the sulfur is reduced.

[Back to Contents](#)

**Page Intentionally Left Blank**

# **OPERATIONS**

**Page Intentionally Left Blank**

## OPERATIONS

### INTRODUCTION

The success of any school transportation operation depends largely on the performance and degree of dedication displayed by those involved. These recommendations are designed to assist state agencies, school districts, school and Head Start administrators and private operators in understanding their student transportation programs and developing applicable policies, including those for transporting students with special needs.

The school bus is an extension of the classroom and as such, the ride to school should be safe and efficient in an atmosphere conducive to learning readiness. Open and honest communication between all stakeholders is vital for the success of the transportation program. Transportation is critical to the education process, and the school bus is the safest form of transportation; therefore, transportation to and from school on a school bus shall be offered to all eligible students. Districts or the governing body responsible for pupil transportation shall have an eligibility policy, which takes safety into account and which addresses distances from school for all age groups. If transportation eligibility is maximized, the result will be more students on school buses.

### SCHOOL TRAVEL CHOICES

Children in the United States travel to and from pre-school, school and related activities by a variety of modes. Administrators, parents and students often choose, or encourage the use of modes of, travel for reasons other than maximizing safety or minimizing risk (e.g., convenience, flexibility, and cost). **It is recommended that all school students be transported in a school bus.**

Each travel mode has its inherent risks, which vary from community to community, school to school and program to program, and any shifts from one mode to another can have a marked effect on the overall safety of travel for a particular community, school or program. Each state, school district, private school, Head Start agency and any other agencies or organizations that transport school-age children must assess their own situations and circumstances and apply the information presented in “The Relative Risks of School Travel—A National Perspective and Guidance for Local Community Risk Assessment” (published by the Transportation Research Board of the National Academies of Sciences and Engineering), in order to make sound, informed decisions. The goal is to improve safety for all children traveling to and from pre-school, school and related activities and to provide communities with the information needed to make informed choices that balance their needs and resources.

### SCHOOL BUS USE

On July 6, 1999, the National Transportation Safety Board (NTSB) transmitted a Safety Recommendation letter to the Steering Committee of the 13th National Conference on School Transportation containing the findings and recommendation of the Special Investigative Report

“Pupil Transportation in Vehicles Not Meeting Federal School Bus Standards” (NTSB/SIR-99/02). This special investigation report was based on the NTSB’s finding in four crashes involving “nonconforming buses”: that a number of children were ejected and fatally injured in three 15-passenger vans and a 25-passenger specialty bus that “... did not and were not required to meet federal school bus occupant crash protection standards.” Recommendation H-99-25, issued in the letter to the National Conference on School Transportation and a number of other national associations and churches, urged recipients to “...inform their members about the circumstances of the accidents discussed in this special investigation report and urge that they use school buses or buses having equivalent occupant protection to school buses to transport children.”

On January 18, 2001, the *Federal Register* (Vol. 66, No. 12) published 45 CFR 1310, “Head Start Transportation,” which included a requirement that on or before January 18, 2006, except as otherwise provided in §1310, Head Start and Early Head Start passengers shall be transported to and from their respective programs in school buses or allowable alternate vehicles (AAVs), which are like school buses in all respects except that they do not meet FMVSSs for crash avoidance. (In short, AAVs include all school bus design standards except that they may not be painted “school bus” yellow and they are not equipped with stop arms and alternately flashing signal lamps for passenger loading and unloading.) The directive (§1310.12) was based on the documented safety of school buses and the knowledge that alternatives to school buses per se would be required by specific states (thus the allowance for AAVs).

The National Highway Traffic Safety Administration, on July 31, 2003, issued the Final Rule for 49 CFR 571 (*Federal Register*, Vol. 68, No. 147) that established a new class of school buses called “multifunction school activity buses” (MFSABs) to fulfill the requirements for AAVs (as required by Early Head Start and Head Start) or for “...enabling schools and other institutions to choose the new buses instead of a 15-passenger van [which] will provide them with a safer transportation alternative” (p. 44892).

Therefore, to assure the highest level of safety for children, consistent with the NTSB’s recommendation and 45 CFR 1310, all students transported to and from public and private pre-school programs and schools and to related activities shall be transported in school buses as defined in Title 49, CFR Part 571 or in vehicles having passenger crash protection equivalent to school buses, such as multifunction school activity buses (MFSABs).

## **STATE ADMINISTRATION**

### **A. Services Provided**

The state agency(ies) responsible for student transportation should provide the following services:

1. Leadership in the development of a comprehensive student transportation program for state-wide application;

2. A state director of student transportation with the staff and other resources necessary for optimal job performance;
3. Clear, concise student transportation policies;
4. A cost accounting system for all expenditures in the area of student transportation;
5. A state-wide management information system to accommodate student transportation data (e.g., costs, information gleaned from the uniform school bus crash reporting criteria, manpower availability, etc);
6. Promotion of a student transportation safety program utilizing community and school district resources, school bus contractors, school transportation associations, legislation, media, law enforcement and state agencies concerned with student transportation;
7. A manual or handbook for local student transportation supervisors, school administrators and private contractors containing detailed instructions for implementing the state's student transportation laws, regulations and policies;
8. Manuals or handbooks for each school bus driver and each bus attendant containing the state student transportation regulations and recommended safety practices;
9. A comprehensive series of training programs that covers all aspects of student transportation, including, but not limited to, the following areas:
  - a. A school bus driver program for both pre-service and in-service instruction, including documentation of successful completion of classroom and behind-the-wheel instruction;
  - b. Workshops, seminars and/or conferences for all student transportation personnel;
  - c. Encouragement for state institutions of higher learning to provide undergraduate and graduate courses acceptable for certification purposes in student transportation, operation and safety; and
  - d. Safety and safe travel curricula for student passengers;
10. Manuals or handbooks for school bus maintenance personnel, containing technical issues and administrative issues to include appropriate school bus preventive maintenance procedures and ongoing maintenance programs;



11. Regular visits to local school systems to evaluate transportation systems and to provide necessary direction;
12. Bus and equipment standards that ensure safe and efficient student transportation;
13. Coordination with other agencies having responsibility for student transportation services and use of the uniform school bus crash reporting criteria; and
14. Adequate funding necessary to comply with mandates adopted and approved by state legislatures and the federal government.

B. State Student Transportation Director

1. The State Director of Student Transportation's specific duties may include, but are not limited to, the following administrative areas:
  - a. Assisting in the implementation, interpretation and understanding of student transportation laws, regulations and policies;
  - b. Managing the state's student transportation program, which includes planning, budgeting and forecasting requirements for the operation;
  - c. Supervising the preparation of manuals, handbooks and information for distribution to local transportation personnel and private operators;
  - d. Providing assistance and direction on request to local school administrators and Early Head Start and Head Start grantees or their transporters;
  - e. Assisting in evaluation of state and local operations, including bus routes, and providing recommendations for policies and procedures;
  - f. Planning, directing and participating in safety education for student transportation personnel;
  - g. Assisting local personnel in planning and conducting student safety education programs;
  - h. Requiring and maintaining appropriate reports and records;

- i. Assisting and/or consulting with groups involved in student transportation safety;
  - j. Representing the interests of the student transportation industry;
  - k. Working cooperatively with school transportation associations, school districts, Early Head Start and Head Start grantees or transporters, parents and private contractors to promote school bus safety and efficiency;
  - l. Developing and publishing easy-to-understand information on the hazards of using prescription drugs and over-the-counter medications when driving;
  - m. Developing and implementing appropriate curricula for training of transportation supervisors, drivers, technicians, attendants and other staff, as well as parents and students;
  - n. Developing and maintaining state-wide data collection and distribution systems regarding safety incident investigations, best practices and general industry information; and
  - o. Developing and maintaining a state-wide process for investigating and reporting safety incidents.
2. The State Director of Student Transportation should be an active member of regional and national organizations and should participate in activities that promote student transportation safety.

**LOCAL SCHOOL DISTRICT ADMINISTRATION**

A. Activities

The local agency responsible for student transportation should supervise the overall transportation operation within the respective agency. Recommended activities include, but are not limited to, the following:

- 1. Assign adequately trained staff the responsibility for implementing and/or supervising a comprehensive student transportation program;
- 2. Participate in student transportation operations within its jurisdiction, including training programs for all transportation personnel, review of school bus routes, investigation and reporting of crashes and other transportation problems and evaluation of the student transportation system;

3. Ensure compliance with federal and state student transportation laws, regulations and policies, including drug/alcohol testing programs as required in the Omnibus Transportation Employee Testing Act of 1991, and in compliance with 49 CFR, Parts 40 and 382 and with 45 CFR 1310 and other Head Start regulations, as may be applicable;
4. Ensure that instruction in passenger safety, including student participation in emergency evacuation drills, is an integral part of the school and/or Head Start curriculum.

**Note:** Instruction should comply with state requirements and/or Federal Highway Safety Guideline 17 (copy in APPENDIX D) and with 45 CFR 1310, as may be applicable.

Instruction should include, but not be limited to, the following items:

- a. At least once each school semester, provide all students transported to and from schools or Head Start Centers in a school bus or multifunction school activity bus with instruction in the location and operation of all emergency exits, provide supervised emergency exit drills to each student transported to or from schools or Head Start Centers in a school bus or multifunction school activity bus and provide all students with an age-appropriate safe travel curriculum consistent with the modes of travel available for each age group/grade level;
  - b. Before departure on each activity trip, provide all students transported in a school bus, school-chartered bus or multifunction school activity bus instruction on the location of all emergency exits and demonstrations of their operation, including a general review of safe riding practices, rules and procedures;
  - c. Limit the amount of carry-on items, especially large items (e.g., luggage, coolers, sports/band equipment, etc.) in school buses, school-chartered buses or multifunction school activity buses; keeps aisles and emergency exits in school buses, school-chartered buses and multifunction school activity buses clear at all times; safely stow and secure away from any aisle or emergency exit any item that is brought on board;
5. Provide supervision of loading and unloading areas at or near the school or Head Start Center and provide ongoing evaluation of route pick-up and drop-off locations for safety;

6. Provide adequate supervision for students whose bus schedules necessitate their early arrival or late departure from school or Head Start;
7. Promote public understanding of, and support for, the school transportation program;
8. Develop and implement local student transportation policies and regulations, including those for students with special needs;
9. Provide transportation personnel with opportunities for growth in job-related activities;
10. Provide a library of resources to ensure that transportation personnel have the proper tools to operate a safe and efficient program, including but not limited to, the following resources:
  - a. Applicable federal, state and local laws, codes and regulations;
  - b. Applicable manuals and guidelines;
  - c. On-line connectivity for access to all internet and other resources;
  - d. Applicable trade journals and organizations' publications; and
11. Provide contract management (if applicable).

**Note:** If a private carrier is utilized in a school transportation operation, it is imperative that a clear partnership is established with all parties. Clear expectations and contract review, along with on-going training, communication and practice/procedures should be developed with a working partnership in mind.

## B. Staffing

The tasks associated with the successful operation of the local transportation department are many and varied. Depending on the size of the school district, many duties may be consolidated in a single position, or each position may have very specific duties. The leadership of a truly effective transportation department promotes career paths and succession plans that will ensure continuity and consistency of the operation.

The following duties are classified by the type of position that would have stand-alone responsibility, recognizing that an individual may have the responsibilities of several of the designated positions.

1. Administrative

a. Director, manager, supervisor and/or private operator

This position is in charge of daily transportation functions. Duties are to plan, direct, coordinate and oversee all functions pertaining to the operation and maintenance of the district transportation department, including personnel, equipment and facilities. Prime concern is safe, efficient and economical transportation of students between home and school on a regular schedule and to other destinations, as required by the students' programs or school activities.

b. Area supervisor/assistant supervisor

This position oversees a wide variety of operational functions in a specified area or for specific schools.

c. Transportation specialist

This position is often a combination of several job functions. Duties may include dispatching, routing (computer or pin maps) and driver training.

2. Support

a. Dispatcher

This position is responsible for scheduling and coordinating the transportation of students to and from school and related school district-sponsored activities and for covering all bus routes by drivers daily. The dispatcher may also schedule motor pool vehicles for district employees and may maintain records.

b. Instructor/trainer

Duties of this position include conducting training for potential new bus drivers and attendants, conducting training for veteran bus drivers and attendants and ensuring that training is completed according to federal, state and district requirements.

c. Routing specialist

Duties of this position include developing and maintaining safe, efficient and cost-effective bus stops and routes and assigning routes to bus drivers.

d. Secretary

This position provides secretarial support to the transportation supervisor. Duties may include preparing department correspondence, answering phones, fielding questions and complaints, referring calls to appropriate staff, preparing payroll and providing support to the dispatcher, instructor/trainer, routing specialist and to shop personnel.

e. Bookkeeper

This position provides accounting support for management and issues invoices for services, extracurricular bus trips and maintenance of other department vehicles. Duties may also include preparing purchase orders, authorizing and/or issuing related payment documents and budget reports and ensuring that all financial transactions are properly recorded, totaled, balanced and reconciled with budgeted amounts.

3. Operations

a. Bus driver

The bus driver operates school buses safely under all types of weather, traffic and road conditions, and transports students and other authorized persons on regular and special program routes to and from school and on field, extracurricular and other special activity trips, as authorized by school district officials.

b. Bus attendant (monitor or aide)

The attendant teams with drivers of students with special needs or children enrolled in Head Start or other special programs to provide passengers with a safe ride to and from school, school activities or Head Start Centers. Attendants specialize in meeting students' needs while en route, thus providing students a safe environment in the bus and allowing the driver to focus on operating the bus. Attendants complete specialized training in duties and responsibilities of the position.

4. Vehicle maintenance

a. Vehicle maintenance supervisor, foreman or manager

Duties of this position include oversight of preventive maintenance, service and repair of school buses and other district vehicles and equipment, as may be assigned.

b. Journey technician

Under the direction of the vehicle maintenance supervisor, the journey technician has primary responsibility for maintaining and repairing all school buses and other vehicles, as assigned.

c. Assistant technician

Under the supervision and direction of the vehicle maintenance supervisor, the assistant technician assists with all mechanical repair and preventive maintenance activities.

(**Note:** Recommended job descriptions for the aforementioned job titles may be found in APPENDIX D.)

## **RESPONSIBILITIES**

### **Driver Responsibilities**

- A. Drivers should be familiar with and abide by all rules, policies and procedures affecting student transportation. They should be trained and display proficiency in the appropriate use of all equipment and tools in the bus, including electronic communication devices.
- B. Drivers should recognize the importance of establishing rapport with parents, their supervisors, and school or Center administrators when working to ensure proper student management.
- C. Drivers should establish proper rapport with students.
- D. Drivers should instruct students in appropriate behavior, consequences of improper behavior, general procedures and evacuation drills and safe travel practices. (See APPENDIX D.)

- E. Drivers should maintain order and safety and protect the rights of others in the school bus. They should exercise good judgment and prudence in this pursuit, using appropriate verbal interventions. This includes, but is not limited to, the following:
1. Minimizing interior noise;
  2. Requiring an orderly entrance and exit;
  3. Eliminating movement or potential movement of objects;
  4. Requiring silence at railroad crossings; and
  5. Prohibiting transportation of unauthorized materials.
- F. Drivers should handle minor infractions with on-board consequences and discussions approved by the school district or Head Start agency.
- G. Drivers, in instances of serious or recurring misconduct, should follow school district or Head Start policies pertaining to the misconduct and should submit written reports on appropriate forms to administrators or other persons designated to deal with discipline problems. (See APPENDIX D.)
- H. Drivers should be aware that they represent the school system, Head Start agency and/or the bus company and should present a positive image in dress, language and manner while on duty.
- I. Drivers, including substitute or spare bus drivers, should be provided with and should be familiar with written instructions of the assigned route that would include any existing railroad crossings and any fixed route hazard(s).
- J. The school bus driver is the key to an effective daily inspection program. It is the driver's responsibility to make a planned and systematic inspection of the bus before each route and/or trip, or to assure that the inspection has been completed properly in a timely manner. A recommended procedure requires both stationary and operating inspections. The following inspection outline is not suggested as a model for use, but rather is included as a guide for transportation personnel to use in developing a systematic inspection procedure.

Although this section identifies most items to be inspected, state commercial driver's licensing (CDL) requirements may include additional items. All items should be inspected in the method prescribed by CDL requirements and any other applicable regulations.



1. Stationary inspection:
  - a. Observe the bus for evidence of oil, fuel, coolant, grease or water leaks, vandalism or damage to the vehicle.
  - b. Observe areas around the vehicle for hazards detrimental to vehicle movement.
  - c. Be familiar with the under-hood inspection and conduct the under-hood inspection, if required to do so.

2. Walk-around inspection:

Before starting the inspection, place the transmission in neutral and set the parking brake (or fully depress the clutch pedal in manual transmission-equipped vehicles), start the engine and inspect the bus from top to bottom and end to end. Check these items:

- a. Tires (under inflated, flat, excessively worn or damaged, valve stems and caps);
- b. Wheels (loose or missing nuts, excessive corrosion, cracks or other damage and any sign of misalignment);
- c. Fluid leaks (evidence of wetness on inner wheels and tires);
- d. Windows (for dirt, stickers or other obstructions to vision and clean, if necessary);
- e. Mirrors (clean, properly aimed and tightly adjusted);
- f. Warning systems (clean, properly working running lamps, backup lamps, signals and signs, reflectors, turn signals, stop lamps and warning flashers);
- g. Exhaust system (sagging exhaust pipes, short and leaky tailpipes and defective mufflers);
- h. Emergency exit seals (to prevent possible entrance of dangerous carbon monoxide fumes), hinges and warning buzzer; and
- i. Body for sharp edges, missing or damaged panels, loose rub rails and bumper securement.

3. Inside safety check
  - a. Passenger compartment, seats, frames, emergency exits and windows must be carefully checked.
  - b. Inspect instruments and controls. With the engine operating, check the following:
    - (1) Vacuum or air pressure gauge or hydraulic indicator lamps, which should indicate adequate capacity to operate brakes. Loss of air or hydraulic pressure or vacuum indicates a braking deficiency that must be corrected immediately. For buses equipped with electric hydraulic brakes, the driver shall depress the brake pedal with the engine off to check the operation of the backup system.
    - (2) The oil pressure gauge, indicating adequate pressure. The engine should be turned off in the event of inadequate pressure and reported immediately.
    - (3) Warning lamps:
      - (a) Prolonged oil pressure warning lamp, display is a signal of oil pressure problems, and the defect should be reported immediately.
      - (b) Service brake warning lamp displayed during brake application indicates that the brake system is not operating properly.
      - (c) Alternator/generator warning lamp displaying a continuous light "on" after the engine is running indicates a malfunction in the charging system.
      - (d) Ammeter and/or voltmeter indicating any continuous discharge should be reported immediately.
      - (e) Water temperature gauge should always indicate "cool" or "warm." If it indicates "hot," the engine should be stopped immediately. The same action should be taken if the temperature warning lamp goes on.

- (f) Anti-lock brake system warning lamp being “on” indicates that the brakes are still functional but the anti-lock system is not.

- 4. Check each of the following items for proper operation, adjustments or condition:
  - a. Lamps and signals: turn signals, stop lamps, special warning lamps, emergency flashers, clearance (marker) lamps, headlamps, interior lamps and stop arm lamps;
  - b. Stop arm control;
  - c. Windshield fan, defrosters and heaters;
  - d. Horns;
  - e. Entrance (service) door and control;
  - f. Mirrors: rear view, side view, convex and elliptical;
  - g. Three emergency triangles;
  - h. Driver’s seat and restraint system;
  - i. Fire extinguisher\*;
  - j. First aid kit\*;
  - k. Body fluid cleanup kit;
  - l. Webbing cutter\*;
  - m. Wipers/washers;
  - n. Sanders (when equipped);
  - o. Power lift (when equipped);
  - p. Spare electrical fuses (if required);
  - q. Adaptive equipment devices;
  - r. Crossing control arm (if equipped), and

- s. Post-trip inspections (student check alarm if equipped)
- \*(with required signage for Head Start vehicles)

### **Parent/Guardian Responsibilities**

Parents, guardians and persons acting in *loco parentis* should:

- A. Understand and support district or Head Start Center rules and policies, regulations and principles of school bus safety;
- B. Assist children in understanding safety rules and encourage them to abide by them;
- C. Recognize their own responsibilities for the actions of their children. Understanding this, parents or guardians shall be responsible and accountable for the conduct and safety of their children at all times prior to the arrival and after the departure of the school bus at the assigned school bus stop;
- D. Support safe riding practices and reasonable discipline efforts;
- E. Teach children proper procedures for safely crossing the roadway before boarding and after leaving the bus, as described in APPENDIX D;
- F. Support procedures for emergency evacuation as prescribed by states and school districts and Head Start Centers;
- G. Respect the rights and privileges of others;
- H. Communicate safety concerns to school administrators;
- I. Monitor bus stops, if possible;
- J. Support all efforts to improve school bus safety; and
- K. Be aware of illegal or undesirable activities and other dangers involved in and around the loading and unloading zone, including the dangers of loose clothing, drawstrings, clothing accessories, back-packs and other loose personal items.

### **Student Responsibilities**

Proper student behavior is important because the distraction of the driver can contribute to crashes. Students and parents should be made aware of, and should abide by, reasonable regulations to enhance safety. The consequences of unacceptable behavior

should be clearly understood. The following actions will help to protect the student's rights and to maintain order in the bus:

- A. Students should be aware that they are responsible for their actions and behavior.
- B. Students should receive a copy of the rules and procedures and should be required to abide by them.
- C. Students should display respect for the rights and comfort of others.
- D. Students should be taught to realize that school bus transportation can be denied if they do not conduct themselves properly.
- E. Students should be made aware that any driver distraction is potentially hazardous to their safety.
- F. Students should be made aware of the dangers involved in and around the loading and unloading zone, including the dangers of loose clothing, drawstrings, clothing accessories, back-packs and other loose personal items. Students should be trained to cross the road safely at the bus stop. (Refer to APPENDIX D, "Here's How to Cross the Road SAFELY." These safety training diagrams show a 12-foot minimum walk distance in front of the bus.)
- G. To train students to understand, remember and practice the 12-foot minimum walk distance, one or more of the following instructional methods should be used:
  - 1. Mark the 12-foot walk distance on the ground and have each student, in normal or giant steps, walk off the distance and count the steps. The student's total steps shall be recorded and the student should be informed and repeatedly reminded of this total number of steps required for the walk distance.
  - 2. Have each student practice walking ahead of the bus on the right shoulder of the road until the student can clearly see the bus driver's eyes. (Refer to APPENDIX D, "Crossing the Road Safely.")
- H. Students should be taught to avoid retrieving articles dropped around the bus during loading and unloading, or around the bus, without explicit directions from the driver. They should also be taught to move away from the bus (out of the danger zones) after unloading.

## OPERATIONAL PROCEDURES

### A. Policies and Guidelines:

The responsible state agency and the local school district or Head Start agency should have clear and concise policies and guidelines for the operation of their student transportation programs. These are important for two reasons: (1) they have the effect of law when laws or regulations do not specifically address a situation; (2) they serve as the rule book for use by persons charged with the administration of transportation services within the district or qualified agency.

Once established, these policies and guidelines become the basis for development of operating procedures. This allows decisions about operational details to be made at the administrative level rather than by the school board. These policies and guidelines should be precise and in writing and should include the following topics:

1. A statement of philosophy;
2. A definition of the agency's goals and objectives;
3. Procedures for determining eligibility for transportation;
4. A description of all types of transportation provided;
5. The days on which service will be available;
6. School starting and closing times;
7. Administrative responsibilities related to program service;
8. Essential routing constraints, such as walking distances and age/grade of students for whom the appropriate agency will provide transportation;
9. The extent of special transportation services;
10. A compilation of student rules and regulations;
11. Provisions and guidelines for the use of contracted transportation and/or charter buses;
12. Provisions and guidelines for the emergency use of personal vehicles to transport students;
13. Acceptable purchasing procedures;

14. Required minimum limits of insurance coverage;
15. The essentials of a crash prevention program, including the uniform school bus crash reporting criteria;
16. A system to communicate procedures between administrators and parents, and between administrators and the bus company or drivers, including student discipline procedures and compliance;
17. A procedure for providing drivers and bus attendants with essential information about students they transport;
18. Emergency procedures and/or contingency plans to be followed in the event of a crash, unexpected school closing or unforeseen route change;
19. Use of special lighting and signaling equipment, as indicated below:
  - a. If the bus is so equipped, use of alternately flashing amber lamps to warn motorists that the bus is preparing to stop to take on or discharge passengers;
  - b. Use of alternately flashing red lamps to inform motorists that the bus is stopped on the roadway to take on or discharge passengers;
  - c. Operating the stop arm(s) in conjunction with the flashing red signal lamps;
  - d. Use of a white flashing strobe lamp (if equipped) to increase the visibility of the school bus on the roadway during adverse visibility conditions;
  - e. Use of a crossing control arm, when installed, to encourage children to cross properly in front of school buses; and
  - f. Use of an outside public address system for instructing children in crossing roadways and for informing them of potentially life-threatening situations.
20. Personnel
  - a. An organization chart identifying the flow of responsibility from the board of education or Head Start agency to the employees;
  - b. Job specifications and descriptions (provided at the time of employment); and

- c. Identification of pre-employment and continued employment requirements and procedures.

21. Harassment

- a. School districts shall develop written policies and procedures dealing with all forms of harassment in the school bus. (*Harassment* is the use or tolerance of verbal or physical behavior, which serves to threaten, demean, annoy or torment another person. Harassment includes unwanted activities or comments based on race, religion, gender, sexual preference, personal attributes and other acts, as may be determined in local policy.)
- b. School districts shall develop training programs to assist all employees in recognizing harassment and in identifying appropriate interventions and reporting strategies.
- c. School district policies and procedures shall also address assisting and follow-up with the victims of harassment.
- d. The service provider shall ensure that school district policies and procedures are implemented.
- e. School districts shall develop and implement guidelines for administering appropriate disciplinary actions resulting from acts of harassment.

22. Weapons; and

23. Drugs and alcohol.

B. Driver's and Attendant's Manual/Handbook

Each employer should provide a manual or handbook to each school bus driver and attendant at the time of employment. This manual should include the following subjects:

- 1. Applicable federal and state transportation laws, regulations and policies;
- 2. Motor vehicle rules and regulations applicable to school bus operation;
- 3. Vehicle operation and maintenance, including inspections;
- 4. Pre-trip and post-trip inspection procedures (including equipment required for transporting passengers), securing the vehicle and checking for



passengers and property at the end of each run, as well as any state or locally required documentation;

**Note:** Drivers are responsible for conducting a walk-through inspection of the school bus following drop-offs at each school and after the last delivery on each run segment. Prior to departing the bus for any length of time, a walkthrough inspection must be conducted. The purpose of the walk-through inspection is to check on and under the seats for sleeping or hiding students and to identify any items that may have been dropped or left aboard the bus. Warning flag systems and/or electronic means may be used. Written policies and procedures should be in place for post-trip and post-run segment checks.

5. Procedures to follow when involved in a crash or safety-related incident, when witnessing a crash and when involved with post-crash reporting;
6. Elements of basic first aid procedures with knowledge of universal precautions, plus any local practices and policies that may vary from, but should not conflict with, state requirements;
7. Elements of student management, including techniques for dealing with students with specific disabilities; and
8. Local school district, Head Start and employer policies.

C. Seating and occupant restraints

1. School buses provide the safest form of student transportation. An integral part of providing “safe” transportation in a school bus is that the passengers must be properly seated. A person who is either standing or improperly seated in a school bus is not afforded the benefits of the safety protection designed into the vehicle and is in increased jeopardy of injury in the event of a crash or sudden driving maneuver.

Additionally, there must be sufficient space on the school bus seat for each passenger’s body to be completely contained within the seat compartment. In the event of a crash or sudden driving maneuver, students who are not properly seated within the seat compartment may not benefit from the passenger crash protection systems built into the school bus under federal and state regulations.

In practice, school buses transport students of various sizes, typically from pre-schoolers to 12<sup>th</sup> graders. While a 39-inch seat may safely accommodate three pre-schoolers and/or primary school-aged children, it may not safely accommodate the same number of older children. Since

the size of growing children varies, the number of students that can safely occupy a school bus seat also changes. Consequently, the “in use” capacity of a school bus varies depending on the size of the students transported. The use of a child safety seat or other child safety restraint for an infant, a toddler or other pre-kindergarten passenger or the use of special equipment, including mobility devices needed for a child with disabilities, may further impact the “in-use” capacity of a school bus.

It is important to consider the size of the passengers on each school bus route when determining the “in-use” capacity of a school bus. It is recognized that at certain times (for example at the beginning of a school year), it may not be possible to know exactly how many students will arrive at school bus stops on a route. For that reason, there may be instances when overcrowding exists temporarily on some school buses. In such situations, efforts should be made to provide safe seating to all school bus passengers in a timely and efficient manner, so that during regular operations all passengers are safely seated.

**(Note:** specific state laws or local regulations may prohibit overloading a bus, even in temporary situations.)

Highway Safety Program Guideline No.17, “Pupil Transportation Safety,” as issued by the National Highway Traffic Safety Administration and printed in APPENDIX D, includes the following statements with respect to passenger seating:

- a. “Standing while school buses and school-charter buses are in motion should not be permitted. Routing and seating plans should be coordinated so as to eliminate passengers standing when a school bus or school-charter bus is in motion” [IV.C.2.e.(1)].
  - b. “...Due to variations in sizes of children of different ages, states and school districts should exercise judgment in deciding how many students are actually transported in a school bus or school-charter bus” [IV.C.2.e.(2)].
  - c. “There should be no auxiliary seating accommodations, such as temporary or folding jump seats in school buses” [IV.C.2.e.(3)].”
2. All children riding in school buses or other buses used to transport students to and from school, Head Start or related activities shall be properly and safely seated facing forward, unless otherwise required by a child safety restraint system (CSRS). There shall be adequate space on the seat for the child to be seated completely within the seating compartment.

The growing number of pre-school-age children who are transported in school buses has increasingly focused attention on the safety of these passengers. In response to questions and concerns raised by parents and by transporters, the National Highway Traffic Safety Administration (NHTSA) conducted crash tests involving pre-school child-size dummies on school bus seats.

According to NHTSA, "...the test results showed that pre-school age children in school buses are safest when transported in child safety restraint systems (CSRSs) that meets [sic] FMVSS 213, Child Restraint Systems, and are correctly attached to the seats." This quotation, contained in the "Introduction" of NHTSA's *Guideline for the Safe Transportation of Pre-School Age Children in School Buses* (February 1999), summarizes the basis for the document's recommendations, which have drawn industry-wide attention and have initiated intense discussions with respect to practicability. (See entire document in APPENDIX F.)

The publication defines a child safety restraint system (CSRS) as "...any device (except a passenger system lap seat belt or lap/shoulder seat belt), designed for use in a motor vehicle to restrain, seat or position a child who weights less than fifty pounds." CSRSs include infant seats, convertible seats, forward-facing-only seats, booster seats with built-in harness, integrated seats and safety vests.

NHTSA's "Guideline..." was a primary source for requirements for Head Start transportation services contained in 45 CFR 1310, disseminated in the *Federal Register* on January 18, 2001. Among many other requirements, §1310 specified, mandatory use of CSRSs in vehicles that transport children to and from Head Start programs and related activities, and the regulation set deadlines for compliance. [A subsequent interim Rule, published in the *Federal Register* (Vol. 69, No. 11) on January 16, 2004, extended the deadline for compliance and included provisions for further justified and approved extensions.]

Due to the evolutionary nature of the entire issue of CSRSs—product design and construction, appropriate usage, varied state laws and regulations, applicability (recommendation versus regulation), implementation deadlines, etc.—the OPERATIONS section of the *NCST Specifications and Procedures* does not contain specific details regarding applicability, selection, use, maintenance and replacement of CSRSs. More detailed information may be found elsewhere in this publication: BUS BODY SPECIFICATIONS—Seat and Restraining Barriers; SPECIALLY EQUIPPED SCHOOL BUS SPECIFICATIONS—Restraining Devices; GUIDELINES FOR INFANTS, TODDLERS AND PRE-SCHOOL CHILDREN—Equipment, Child Safety Restraint Systems

(CSRS), Bus Seat Designated for a Child Safety Restraint System and Special Considerations; and APPENDIX F.

Additional information and guidance are available in “Proper Use of Child Safety Restraint Systems,” “Choosing the Correct School Bus for Transporting Pre-School Age Children” and other NHTSA publications ([www.nhtsa.dot.gov](http://www.nhtsa.dot.gov)), in “Safe Ride News” ([www.saferidenews.com](http://www.saferidenews.com)), from local NHTSA-trained Child Safety Seat Technicians and from local physical therapists.

Transporters of pre-school age and older children in vehicles that use CSRSs minimally should adhere to the following recommendations:

- a. Establish written policies and procedures for...
  - (1) Procurement, maintenance, cleaning and replacement of CSRSs;
  - (2) Registration and tracking equipment recall notices;
  - (3) Inspection;
  - (4) Installation and usage training;
  - (5) Occupancy of non-restrained passengers on seats behind restrained passengers;
  - (6) Locations of restrained passengers with respect to emergency exits;
  - (7) Retrofitting school buses with CSRSs; and
  - (8) Emergency procedures.
- b. Ensure adequate training of personnel in the installation, use, care and upkeep of CSRSs.
- c. Assure age-, height- and weight-appropriate applications of CSRSs.
- d. Require periodic passenger evacuation drills.
- e. Establish records files for all CSRSs, to include a complete history of each restraint device.

- f. Incorporate CSRS usage and proper seat spacing in school bus specifications
- g. Monitor developments and changes at the state and federal levels with respect to CSRSs.

D. Student Management

An effective student management program is a collaborative effort involving many groups of people in the school community or Head Start agency. Parents, students, school bus drivers, school or Head Start administrators, contract managers (where contract transportation is provided), law enforcement and social service agencies must be part of the ongoing process to motivate students to good behavior. It is the responsibility of the school district or Head Start agency to ensure that a comprehensive student management program is developed, so that all persons involved in the process are familiar with their responsibilities.

**Seating Charts:** The use of a seating chart that is enforced and continuously updated is an accepted practice and is recommended as a tool for student management and safety. The seating chart, in addition to maintaining accurate student lists/rosters or manifests, should be considered an operational “best practice.”

1. School, school district, Head Start and/or carrier responsibilities

No public or private school, school district, county board of education, county superintendent of schools or any officer or employee of the school or board of education or Head Start Center shall be responsible or in any way liable for the conduct or safety of any student of the school or Head Start Center at any time when the student is not on school or Head Start Center property, unless the school, school board, Head Start agency or person has undertaken to provide transportation for the student to and from the school or Head Start premises, has undertaken a school- or Head Start-sponsored activity off the premises of the school or Head Start Center, has otherwise specifically assumed the responsibility or liability or has failed to exercise reasonable care under the circumstances.

In the event of the specific undertaking, the school, school district, board of education, Head Start agency or person shall be liable or responsible for the conduct or safety of any student only while the student is, or should be, under the immediate and direct supervision of an employee of the school, school district, board of education or Head Start agency.

In addition, no entity that provides transportation services for students, pursuant to a contract with a school, school district, city or county board of education, county superintendent of schools or Head Start agency, shall be responsible or in any way liable for the conduct or safety of any student of the public or private school or Head Start agency at any time when the student is not under the immediate and direct supervision of an employee of the entity.

Specific responsibilities include, but are not limited to, the following:

- a. Establish policies and procedures by which the program functions. These should include, but not be limited to, the examples listed in APPENDIX D.
- b. Establish regulations governing the behavior and safety of students at the bus stop and while boarding, riding and disembarking from the school bus. The rules students are expected to follow should be limited in number, should be age-appropriate and should be posted in the bus and/or otherwise made available to all riders. (See APPENDIX D.)
- c. Institute and administer an instructional program that teaches students proper conduct and transportation safety procedures. (See APPENDIX D.)
- d. Conduct a training program for school bus drivers and attendants to ensure that all policies, procedures, regulations and their enforcement are understood.
- e. Ensure that parents receive written copies of the bus rules and regulations. Ensure that parents are informed about their responsibilities for the supervision and safety of students going to and from bus stops and while at the bus stops. (See APPENDIX D.) Clearly establish parents' roles and obligations with respect to student promptness, attitude and behavior.
- f. Initiate procedures to ensure open lines of communication and cooperation among school and Head Start administrators, bus company officials, state agencies, bus drivers and attendants.
- g. Train drivers and attendants in specific skills that will enable them to maintain order, safety and respect for the rights of others. These skills should include at least the following:

- (1) Specific verbal intervention techniques used to maintain order and safety; and
  - (2) Communication skills that promote rapport and mutual respect and that encourage student compliance.
- h. Ensure that administrators support and enforce disciplinary procedures, policies and reasonable actions by the driver.

E. Use of video/audio monitoring systems

School systems and Head Start agencies should promulgate, communicate and enforce policies and procedures to be followed when using on-board video/audio monitoring systems. Video/audio monitoring in a school bus should be used only as an aid to monitor student and driver behavior and should not replace the discipline policy, the authority of the driver or the responsibility of school or Head Start officials. The basic safe riding rules must prevail, and the consequences of misconduct must be carried out.

1. All students and drivers shall be notified that they are subject to being video/ audio-recorded in the school bus at any time. Notification to parents of all students shall be made by the school district or Head Start agency. Prior to actual recording, parents and students shall be advised that student conduct prohibited by state and school district or Head Start student disciplinary code will result in appropriate consequences, as defined in policy.
2. Ongoing notification regarding video/audio recording must occur, addressing the continued need for personal awareness of safety issues. This communication is particularly important to warn against a false sense of security, especially when cameras are moved between buses. Newsletters, student handouts and notices posted in the bus should be considered.
3. If video/audio monitoring systems are to be used for monitoring drivers, the drivers must be notified as to the extent of their use and for what purposes they will be used.
4. When a camera rotational plan is used, cameras should be moved so as not to select only certain buses. However, the transportation supervisor and/or school or Head Start administrator may decide when video monitoring of a bus route should be done more frequently based on the number of incidents of misconduct or the seriousness of incident reports. Such additional monitoring is meant to supplement the written disciplinary reports by the bus driver, not to take the place of reports.

5. The transportation supervisor or designee may periodically review recordings as needed to ensure proper student conduct. If no incidents are reported within a period defined by local policy, the tapes will be recycled or the digital recordings deleted. If incidents are reported, or if incidents are viewed during random selection, the video tapes or digital recordings are to be kept until final resolution and time for any appeals.

Tapes or digital recordings must be dated and have the bus number and driver's name in order to ensure proper identification.

6. When action is taken as a result of information obtained from the videotape or digital recording, the driver, supervisor, school administrator, student, and parents or guardians will be contacted. A meeting of the aforementioned parties may be necessary to achieve a resolution of the problem. The videotape or digital recording may be used as evidence in that meeting if state law and school district or Head Start policy allows it. All requests for review shall be made in writing.
7. Each district or Head Start agency must designate by policy those persons who are allowed to review the tapes or digital recordings.

#### F. Records

1. Crash and safety incident investigation records function as the data base for statistical analysis, which, in turn, provides material for crash prevention programs. In addition to the uniform school bus crash reporting criteria, additional crash safety incident investigation records may include the following information:
  - a. If injuries occurred, a list of all students injured, their home addresses phone numbers and dates of birth, the extent of their injuries and appropriate explanations;
  - b. A list of bus occupants and witnesses, including addresses, ages, phone numbers and statements;
  - c. Extent of damages and an estimate of repair costs;
  - d. Post-crash data [i.e., disposition of litigation and/or summonses, driver deposition, net effect of personal injuries, remediation (if any), assigned in-service, etc.];
  - e. A signed statement from the bus driver and bus attendant or monitor (if applicable) concerning the particulars of the crash;



- f. Complaints, challenges and disposition of hearings, etc.; and
  - g. A clear description of the circumstances regarding what happened:
    - (1) What, where, when, who, and related roadway, area, weather and hazardous conditions information;
    - (2) Related vehicle operating and mechanical information; and
    - (3) Related procedural and operating information for all vehicles and operators involved.
2. Personnel records should contain the information required and allowed under federal and state laws.
  3. U.S. Department of Justice, Employment Eligibility Verification and I-9 Forms should be maintained in a separate file or binder.
  4. Driver qualification records should contain at least the following items:
    - a. An application for employment;
    - b. Confirmed work history;
    - c. Driving record;
    - d. Criminal record;
    - e. Physical examination, as required for the type of license and/or special school bus certificate held;
    - f. Copy of drug and alcohol testing information in compliance with current federal, state and company testing requirements; and
    - g. All other items as required by federal and state laws and rules.
  5. Training records should contain, at a minimum, accurate information certifying attendance and satisfactory completion of all state- and company-required training. Details about each training activity, including date of instruction and instructor signature, should be documented and included. The following is a list of minimum training to be documented:
    - a. Classroom Training
      - (1) Pre-service;

- (2) In-service; and
    - (3) Post-crash or evaluation follow-up.
  - b. Behind-the-Wheel Training
    - (1) Written documentation of each activity;
    - (2) A written assessment tool showing satisfactory completion, with rating;
    - (3) Documentation of the type of equipment used, both vehicle and safety; and
    - (4) A log of the number of hours of instruction and practice driving.
6. Route records should contain:
- a. Types of routes (urban, suburban, rural);
  - b. Route descriptions, including accurate route maps;
  - c. Route miles;
  - d. Information about the needs of special education students;
  - e. Information pertaining to road conditions and hazards utilizing “Identification and Evaluation of School Bus Route and Hazard Marking Systems” developed by NASDPTS (as presented in APPENDIX D); and
  - f. Scheduled pick-up and drop-off times at each bus stop.
7. Maintenance records should contain the following items:
- a. Line setting tickets;
  - b. Work orders and repair records;
  - c. Preventive maintenance records;
  - d. Vehicle depreciation;
  - e. Equipment specifications; and

f. Inspection reports.

8. Cost records should contain data in the following categories:

a. Vehicles;

b. Labor for vehicle maintenance and repairs;

c. Parts;

d. Inventory;

e. Administration; and

f. Fuel, lube, coolant, etc.

G. Communication

1. Each bus shall have a two-way communication system capable of providing communication with the operational base, or at least local 911 operators where technologically feasible. All school buses that transport individuals with disabilities should be equipped with a two-way electronic voice communication system that can be used at any point on the vehicle's route.

2. It is necessary to keep persons in charge of the system, bus companies, parents and students informed of all operational procedures. The school district or Head Start agency must ensure that the channels of communication are set up so that information can be disseminated quickly and effectively. The school district or Head Start agency must ensure that inquiries, requests, suggestions and recommendations are given prompt and appropriate attention and are handled efficiently. Some of the ways information can be disseminated and their purposes are listed below:

a. Bulletins: to explain the school district's or Head Start agency's transportation policy to school and Head Start administrators, teachers, bus companies, drivers, attendants, parents, students and others associated with the operation and to clarify new laws and safety policies so that all persons involved know what is expected of them;

b. Meetings: to provide an opportunity for those associated with the transportation program to share their views and to help build broad community support for safe transportation;

- c. Public press: to inform parents of policy, route, stop and schedule changes, of the safety record of the operation and positive driver achievement records;
- d. Conferences: to discuss solutions to disciplinary problems with drivers, attendants or monitors, disruptive students and their parents and to review policy decisions affecting drivers, contractors, students and school or Head Start administrators;
- e. Letters: to inform parents of all school or Head Start and state regulations, new routes, etc. and to reply to more urgent inquiries regarding student transportation safety, policy and procedures;
- f. Telephone calls: to provide quick contact between bus drivers and the school or Head Start Center or between parents and the school or Center in the event of urgent or emergency situations;
- g. Radio, television or web page announcements: to inform the public of procedures the schools or Centers will follow in case of severe weather conditions or other natural phenomena, new policies, laws, etc.;
- h. Formal hearings: to be used, as required, for student suspensions from transportation, route challenges, serious complaints against drivers, attendants or monitors, etc.; and
- i. Wireless communication devices: to be used by drivers and attendants only for emergency or business-related communication. (Devices, and particularly cell phones, should not be used for personal communication.)

#### H. Crash Reporting

Each state's generic traffic collision report for motor vehicle crashes should include at least the information contained in the "Sample Crash Reporting Form" in APPENDIX D.

#### A. Transportation Other Than To and From School or Head Start

##### 1. School- or Head Start- Related Activity Operations

Each school system or Head Start agency providing activity bus operations should have comprehensive policies and guidelines that delegate responsibility for this function to the supervisor of student transportation. To provide safe and efficient activity transportation, lines of responsibility

and authority need to be defined and personnel involved must have an understanding of their respective responsibilities.

In the interest of providing the safest means of transportation available, students should be transported to school- and or Head Start-sponsored activities in school buses or allowable alternate vehicles that meet state and federal standards, unless circumstances require an alternate mode of transportation.

These school- or Head Start-related activity trips may include field trips that are extensions of the instructional program, athletic trips, vocational and trade training, volunteer activities and recreational outings, such as dances, picnics and overnight camping trips. These trips range from a few miles to those extending over several days and covering large distances.

The following items need to be considered when developing criteria for activity trip transportation:

- a. Policies and guidelines, including:
  - (1) Purpose of trip (instructional, athletic, students'/spectators' recreation, etc.);
  - (2) Funding source (district or individual school funds, individual charge, parent group, etc.); and
  - (3) Administrative approval (the persons having authority to approve the trip).
- b. A priority guideline should be developed for trip scheduling when all requests cannot be accommodated.
  - (1) Advance notification should allow adequate time for the approval process and for making driver and vehicle arrangements.
  - (2) Methods of travel may include district- or agency-owned or contracted bus, commercial carrier or local transit equipment, air, boat, rail or combination of the above, private or school passenger automobile, when required by special or unique needs.

**Note:** Operational Guidelines for the use of buses other than school buses are outlined in APPENDIX G.

- (3) A trip request form should include all necessary information for trip arrangements, special equipment, payroll, reimbursement and other local needs. (See sample form in APPENDIX G.)
  - (4) Adult chaperones should be required on all activity trips. Responsibilities include passenger control, with the driver having final authority.
  - (5) Discipline and emergency medical procedures should require a trip release to be signed by parents and should include procedures concerning difficult or severe behavioral and medical problems and emergency policies and contacts.
- c. Communication is essential. Drivers, students, chaperones and parents should be made aware of applicable rules and regulations. A signed authorization for student participation from the parent or guardian is important. A detailed itinerary for all persons involved may be advisable. Identification of special medical problems in the event of an emergency en route is necessary.
- (1) Luggage accommodations, if applicable, must be included. A procedure for transporting luggage or equipment prohibited in the passenger compartment by state law and/or local regulations is necessary. Loose luggage or equipment which could cause injury or block passageways should never be transported in the passenger compartment.
  - (2) Policies should detail whether or not out-of-state trips are permitted and, if so, any applicable restrictions. Regulations for states to be visited should be reviewed prior to the trip.
  - (3) Insurance policies should be reviewed or agents contacted to determine adequacy of coverage. This is an absolute necessity for trips scheduled to another state or country. If vehicles other than district-owned vehicles are used, the Board of Education or Head Start agency should determine the minimum insurance coverage to be carried. A current copy of the contract or commercial carrier's insurance should be on file with the school district or Head Start agency.

- (4) Road and weather checks should be made by the designated person. School transportation personnel from other districts, state patrols, highway divisions and auto clubs are generally cooperative in supplying road information. If warranted, the weather bureau should also be contacted. A planned route and any contingent route for trips should be determined prior to initiation of the trip.
- (5) Contingency plans require policies and procedures that detail persons who have authority to make decisions if the unexpected happens during a trip. Impassable roads, crashes or mechanical breakdowns are examples. Drivers and chaperones should have access to that authority's phone number. It is also advisable to obtain phone numbers of transportation personnel in various communities and school districts where activity vehicles regularly travel. Provisions should include plans for staying overnight if conditions do not permit a safe trip home. It is advisable to develop a mutual aid directory for contact within athletic league boundaries which could provide assistance in the event of mechanical emergencies. Drivers should be trained in procedures and regulations relating to trip crashes.
- (6) Driving hours shall be regulated. School districts and Head Start agencies shall have regulations based on the application of the Federal Motor Carrier Safety Regulation 49 CFR 395.3 (15 hours on duty of which no more than 10 hours are driving time; 8 hours continuous off-duty prior to a long trip; no more than 60 hours driving in a week).
- (7) Driver selection and assignment criteria are necessary to avoid conflict and confusion. The criteria should include a driver's knowledge, skill, experience and familiarity with activity trip vehicles. The area to be traveled should also be a consideration. Drivers should be notified at least three days in advance of the trip date. Drivers who drive only activity trips should be tested periodically for driving ability and vehicle familiarity. They should hold the same license and certification as regular school bus drivers.
- (8) Passenger manifests (a list of all passengers being transported) should be kept by the driver and left with proper authorities at the school or institution.

- (9) Evacuation instruction, including an emergency evacuation drill, or at least verbal instructions, should be given by the driver before each trip. (See APPENDIX G.)

d. Vehicles and equipment:

- (1) The following items should be taken into consideration when selecting trip vehicles:
  - (a) Miles to be traveled;
  - (b) Terrain and climate conditions;
  - (c) Number and age group of students;
  - (d) Luggage and equipment requirements;
  - (e) Driver familiarity with the vehicle and route; and
  - (f) Federal Motor Carrier Safety Administration regulations, if contract operated and crossing state lines.
- (2) Consideration should be given for specialized equipment, or other items needed, such as these:
  - (a) Luggage storage;
  - (b) Chains (pre-fitted prior to the trip) or sanders;
  - (c) Extra heaters or air conditioning;
  - (d) Public address system;
  - (e) Electronics (am/fm, two-way, music system) or cellular telephone;
  - (f) Tires, including off-road tread or recaps on the rear axle (recaps on front axle are prohibited);
  - (g) Spare tire;
  - (h) A tool kit containing items such as a flashlight, pliers, screwdrivers, de-icer, extra chain tighteners, etc., and additional equipment for an extended trip,



as may be recommended by transportation personal at the destination;

- (i) Cash for telephone, fuel, bridge tolls, parking fees and personal needs;
  - (j) Emergency telephone numbers and other information; and
  - (k) Global Positioning Systems (GPS), as appropriate.
- (3) Inspection requirements should be the same as for regular route buses, and a detailed check should be made prior to activity trips.
  - (4) School buses shall be prohibited from towing a trailer or any vehicle when students are on board the bus.

e. Training

- (1) Specialized training should be provided for activity trip drivers. Training should include, but not be limited to, the following topics:
  - (a) State laws and applicable policies and rules;
  - (b) Familiarity with the activity trip vehicle and its components;
  - (c) Familiarity with specialized equipment and how to use it, including cellular telephone and onboard global positioning system (GPS);
  - (d) Familiarity with local and state trip requirements;
  - (e) Route familiarization, which might include a dry run prior to the trip date, especially if extreme conditions, terrain or road difficulties may be encountered;
  - (f) Discipline procedures on trips;
  - (g) Driving under adverse conditions (night driving, slippery roads or unfamiliar mountainous driving);
  - (h) Maps, destination locations and parking areas;

- (i) Parking location, if other than the student destination; and
- (j) Provisions for bus security at the destination.

2. Non-related activity operations

a. Introduction

This sub-section is intended to address the various uses of a school bus for operations other than to and from school and school-related activities.

b. Use, procedures and policies

- (1) The school bus operator, in accordance with state regulations and/or laws governing school bus use, should establish procedures whereby school buses can be scheduled for non-routine use. Such scheduling should not conflict with, or be given priority over, the regular class-related demands for school buses by the school system or Head Start agency.
- (2) The school system or Head Start agency, as part of local government or in cooperation with transportation contractors, may utilize buses during times of community emergency or crisis, when demand for other public vehicles, such as trains and transit buses, is so great as to exceed available supply.

c. Legal requirements

- (1) School buses operating on public roads and crossing state and national boundaries must adhere to the rules of the road in the jurisdictions in which they are operating.
- (2) All applicable permits need to be procured in accordance with applicable state and local laws before the trip is undertaken.

d. Operational requirements

- (1) Vehicle equipment used for activities must be in good working order, well-maintained, and otherwise capable of withstanding the demands of the trip.

- (2) All activity buses and drivers should comply with all applicable state and federal requirements, including Federal Motor Carrier Safety Administration regulations applicable to inter- and intra-state passenger transportation.
- (3) Aisles and exits must be kept clear and free of blockages at all times.

## J. Air Quality

The school transportation community is supportive of efforts to reduce emissions and improve air quality, particularly for the students served by school bus transportation. In fact, the school bus industry has been at the forefront of environmental improvements and is committed to a continuing involvement and leadership role in improving engine emissions.

An accelerated replacement of older buses with new school buses equipped with the latest emission controls and engine technologies would be ideal. Likewise, retrofitting newer school buses with the latest emission control technologies can help improve air quality, but at additional costs.

While the student transportation industry and other entities work to develop new and increased sources of funds, states and local districts can institute policies that will contribute to improvements in air quality, especially for children.

### 1. Idling control measures

- a. States and local districts should develop programs to eliminate unnecessary engine idling...

- (1) At school site loading and unloading zones; and
- (2) At school bus stops, located out of traffic during extended wait times.

- b. Consideration should be given to varying climatic conditions within the state or local district and to the individual needs of students with disabilities.

### 2. Driving in traffic

States and local districts should develop programs to inform school bus drivers of the effects of closely following other vehicles, particularly large commercial motor vehicles, including other school buses, since the

exhaust emissions from those other large vehicles can contribute significantly to the air quality inside the school bus.

3. School bus utilization
4. School bus maintenance programs

States and local districts should continue to improve the inspection and maintenance programs that have been established, with a renewed attention to factors impacting emissions.

#### K. Using New Technologies and Products

1. Operators should explore the use of new technologies and products, whenever practicable, to improve the safety, effectiveness, accountability and efficiency of student transportation operations. While it may be considered a “best practice” to utilize the latest emerging technologies, a prudent administrator must recognize that there are core competencies inherent to school bus operations and bus driver responsibility. It is recommended that transporters be aware of the possibility of over-reliance on technology.
2. Current technologies include, but are not limited to:
  - a. Computerized...
    - (1) Routing;
    - (2) Timekeeping;
    - (3) Activity trips;
    - (4) Student tracking;
    - (5) Employee tracking;
    - (6) Vehicle maintenance; and
    - (7) Training records.
  - b. Automatic vehicle location;
  - c. Global positioning systems (GPSs);
  - d. Electronic pre-trip and post-trip inspections; and

- e. Electronic fuel dispensers.

## SELECTION AND TRAINING OF BUS DRIVERS

- A. Procedures for selection of school bus drivers should include the following items:
  - 1. An appropriate application form (See APPENDIX D);
  - 2. Written criteria for accepting and rejecting applicants\*;
  - 3. Written notification to all applicants that driving records checks, criminal records checks and drug/alcohol screening will be conducted\*;
  - 4. A check of each applicant's driving record; (Checks of the National Driver Register and the CDL Information System of the appropriate state department of motor vehicles are considered essential\* in the case of an individual who is applying for a position as a school bus driver.)
  - 5. A check through both state and national criminal identification agencies to determine if each applicant has a record of criminal convictions\*;
  - 6. One or more personal interviews (which can be one of the most important of the selection procedures);
  - 7. Physical examinations and drug and alcohol testing administered in accordance with local, state and federal requirements; and
  - 8. A determination of educational attainment to demonstrate the applicant's ability to follow detailed, written instructions and to be able to record and report data accurately.

\*(**Note:** Driver applicants for Head Start positions **must** be informed in writing of all background checks and other requirements, as required in 45 CFR 1310.)

- B. Pre-service and In-service Training Programs
  - 1. Prior to transporting students, bus drivers should be required to complete a state-approved pre-service training program that includes classroom and behind-the-wheel training to enable safe and efficient vehicle operation. While there are many possible and helpful topics for pre-employment and annual in-service training, the following are examples of essential topics:
    - a. The importance of Pre-trip and Post-trip Inspections;
    - b. School bus evacuations (for all eligible students);

- c. School bus evacuations (for students with special needs);
- d. Loading and unloading procedures;
- e. Reduced-idling laws and policies (if applicable);
- f. Cell Phone and Electronic Communication Device Restrictions in accordance with all regulations/laws and local policies.
- g. Road rage;
- h. Distracted driving;
- i. Aggressive driving;
- j. Blood borne pathogens/first aid;
- k. Bullying on the school bus;
- l. Sexual harassment prevention;
- m. Drug and alcohol compliance/pre and post-accident testing, random testing and reasonable suspicion testing, in compliance with the Omnibus Transportation Employee Testing act of 1991;
- n. Emergency and disaster preparedness;
- o. Confidential records;
- p. Requirements for reporting inappropriate behavior of other adults including the bus attendant;
- q. School bus held hostage;
- r. Personal protective equipment (PPE);
- s. Child safety restraint systems (CSRSs);
- t. Student management; and
- u. Railroad crossings.

**(Note:** When lap/shoulder/3-point occupant securement systems are used, follow manufacturer's guidelines for proper use and positioning. It is recommended that passengers receive instruction in proper usage.)

2. Prior to transporting students with disabilities, the driver should receive appropriate training in compliance with the Individuals with Disabilities Education Act (IDEA).
3. Drivers of Head Start passengers must fulfill pre-service and in-service training requirements, as specified in 45 CFR 1310.
4. Employers of school bus drivers are encouraged to provide ongoing education for bus drivers.

C. Behind-the-Wheel Instruction

Behind-the-wheel instruction should be given in the same type and size bus the driver will be operating. When a driver is expected to operate more than one size and type vehicle, instruction should be related to the specific handling characteristics of each. All instruction should include the following topics:

1. Familiarization with the bus and its equipment;
2. Procedures for performing pre-trip and post-trip vehicle inspections;
 

**Note:** Post-trip inspections should include child-check procedures and proper bus securement following the route.
3. Techniques for safe driving, including mirror use and adjustment, smooth starts and stops, shifting, turning, and backing;
4. Defensive driving skills;
5. Techniques for reference point driving;
6. Procedures for loading and unloading students at bus stops, including moving the bus only after all children are safely seated after loading and out of the danger zones, are at least 12 feet from the sides of the bus, are at least 12 feet from the rear of the bus and cross roadways at least 12 feet in front of the bus;
 

**Note:** When/if an escorted cross is used during the loading and unloading process, the “Escorted Cross” procedure as written in APPENDIX D may be used.
7. Procedures for railroad crossings, as recommended in APPENDIX D, and other specialized driving requirements for school bus operations;
8. Techniques to identify and avoid practices that result in driver-related vehicle abuse;

9. Procedures for en route emergencies, including driving emergencies, emergency evacuations, and use of emergency equipment, as described in APPENDIX D;
10. Guidelines for safely running a route, including entrance to and departure from the bus garage and yard, following a route sheet or map, use of global positioning systems (GPSs), entrance to and departure from school zones, appropriate use of wireless communication systems, mechanical difficulties and breakdown;
11. Procedures for fueling buses and handling/preventing fuel spills; and
12. Laws, policies and procedures specific to activity trips, including interstate transportation regulations.

D. Physical/Mental Preparedness

All school bus drivers should be prepared both physically and mentally each day to perform adequately the following duties:

1. Operating the vehicle in a safe and efficient manner;
2. Conducting thorough pre-trip and post-trip inspections of the vehicle and special equipment, including required documentation;
3. Ensuring the safety, welfare and orderly conduct of passengers while in the bus;
4. Handling emergency situations in accordance with generally accepted operating procedures;
5. Communicating effectively with school staff, students, parents, law enforcement officials and the motoring public;
6. Completing required reports;
7. Completing required training programs successfully;
8. Providing maximum safety for passengers during loading and unloading;
9. Wearing the driver's seat belt whenever the bus is in motion; and
10. Checking at the end of the route and at the bus storage location to ensure that all students have disembarked from the bus.



E. Evaluation

School bus drivers should be evaluated at regular intervals. These evaluations may include the following items:

1. Continuous on-the-road monitoring, otherwise known as *field observation/ride-along evaluation* and road supervision [required for Head Start in 45 CFR 1310)];
2. Written test;
3. Road performance checks;
4. Evaluation interviews;
5. Student management;
6. Adherence to procedures;
7. Teamwork; and
8. Local policies.

## SELECTION AND TRAINING OF BUS ATTENDANTS

A. Procedures for selection of bus attendants should include the following items:

1. An appropriate application form (sample provided in APPENDIX D);
2. Written criteria for accepting and rejecting applicants\*;
3. A check through both state and national criminal identification agencies, to determine if the applicant has a record of criminal convictions\*;
4. One or more personal interviews (which can be one of the most important of the selection procedures); and
5. A determination of educational attainment to demonstrate the applicant's ability to follow detailed, written instructions and be able to record and report data accurately.

\*(**Note:** Head Start attendant or monitor applicants **must** be informed in writing of all background checks and other requirements, as specified in 45 CFR 1310.)

B. Pre-service and In-service Training Program

1. Prior to transporting students, bus attendants should be required to complete a state-approved or Head Start-approved pre-service training program that includes classroom and in-the-bus training in order to enable safe, efficient and effective student transportation. Attendant training, with the exception of the driving components, should be the same as for the driver in every respect. Each attendant should be equally conversant in every other aspect of operations and student management. Training should include, but not be limited to, the following topics:
  - a. The bus and its equipment;
  - b. Use of emergency exits;
  - c. First aid;
  - d. Safe loading and unloading of students at their stops and securement of passengers, as may be required;
  - e. Student management training and policy training, including state and federal regulations related to the transportation of students with disabilities, consistent with those required for school bus drivers;
  - f. Safety, welfare and orderly conduct of passengers while in the bus;
  - g. Handling emergency situations in accordance with generally accepted operating procedures;
  - h. Effective communications with school or Head Start staff, students, bus drivers, parents, law enforcement officials and the motoring public;
  - i. Completion of required written reports;
  - j. Requirements for reporting inappropriate behavior of other adults, including the bus driver;
  - k. Checking at the end of the route and at the bus storage location to ensure that all students have disembarked from the bus;
  - l. Confidentiality; and

- m. Other topics included in the bus attendant’s manual/handbook and local policies.
  - 2. Participate in annual state-approved in-service training, if available.
  - 3. Prior to transporting students with disabilities, the bus attendant should receive appropriate training in compliance with the Individuals with Disabilities Education Act (IDEA).
  - 4. Bus attendants (monitors) who assist with the transportation of Head Start passengers must fulfill pre-service and in-service training requirements as specified in 45 CFR 1310.
- C. In-the-Bus Training
  - 1. Familiarization with the bus and its equipment;
  - 2. Procedures for performing pre-trip and post-trip inspections; and
  - 3. Procedures for loading and unloading passengers, passenger securement and emergency evacuation, as may be required.
- D. Physical/Mental Preparedness
- E. Evaluation
- F. Bus attendant, Special Education (See TRANSPORTATION FOR STUDENTS WITH DISABILITIES AND SPECIAL HEALTH CARE NEEDS section: driver/attendant.)

**STAFFING AND TRAINING OF MAINTENANCE AND SERVICE PERSONNEL**

- A. Staffing
 

Adequate staff should be employed to perform maintenance functions on a timely basis consistent with safe transportation practices.
- B. In-service Training Program
  - 1. The transportation system should make available to maintenance and service personnel the necessary maintenance and service publications for the equipment serviced.
  - 2. The transportation system should arrange at regular intervals for pre-service and in-service training for maintenance and service personnel, and

maintenance personnel should be required or encouraged to attend state-sponsored or other approved workshops or training institutes.

3. Training should include instruction in the following areas:
  - a. Preventive maintenance procedures;
  - b. Repair and/or installation procedures for each type of fleet vehicle and its varied equipment;
  - c. Procedures for specialized equipment and certifications if applicable;
  - d. Inspection of the vehicle and its equipment;
  - e. Recovery procedures for vehicles involved in a crash or breakdown;
  - f. Preparation and retention of maintenance records;
  - g. Maintaining parts and equipment inventory;
  - h. Establishment of parts inventory control procedures;
  - i. Repair and installation of adaptive equipment;
  - j. Safety and environmental compliance; and
  - k. Proper usage and maintenance of shop equipment/shop cleanliness.
4. Vehicle maintenance and service personnel should be encouraged to receive certifications in all areas in which they perform work.

## **ROUTING AND SCHEDULING**

It is necessary to procure a map of the area served by a particular school, school system or Head Start program in order to establish bus routes that will adequately meet the needs of students in a particular area. Information on road conditions, railroad crossings and other factors that might affect the particular operation should be recorded, along with the location of homes and the number of school-age children in each household. (See also “Identification and Evaluation of School Bus Route and Hazard Marking Systems” in APPENDIX D.) Satisfactory school bus stops must be identified along streets and highways where buses can travel with the least amount of risk. The number of students to be transported and the distance to be traveled are primary factors in allocating equipment for a particular area. Students should be assigned to specific stops according to walking distances, grade level and the school or Head Start Center attended. Consideration should

be given to the distances between stops to comply with the minimum distance required to activate the red and amber lighting systems.

- A. Bus routes reflect an infinite number of routing techniques, including the following examples:
  - 1. A circular route circumscribes an area by using different roads on out-going and in-coming trips. It has the advantage of equalizing time in transit for transported students, since the first child on in the morning is the first child off in the evening.
  - 2. A shoestring route extends from the school to some terminal point in the district. If the bus is stored at the school, the same road or roads may be used on the out-going and in-coming trips; consequently, children are always traveling more or less directly toward the school.
  - 3. A feeder route extends from a point farther out in the district to a transfer point on the main route. This method may be advisable for one or more of the following reasons:
    - a. To limit the use of large buses to improved roads;
    - b. To reduce travel time on the main route; or
    - c. To provide some form of transportation on roads which at times may be impassable by larger, more desirable motor vehicles.
  - 4. A shuttle route extends between two or more school buildings. Such routes are often required for the transfer of students in districts operating two or more schools.
  - 5. Retracing routes requires the bus to travel over the same route in the same direction and may be used to eliminate the need for students to cross the roadway. It may also equalize time in transit for transported students, since the first child on in the morning is the first child off in the evening.
- B. Emergency routes should be established and utilized in all school systems when weather or road conditions dictate that it is not safe to travel on other than hard-surfaced roads. Announcements can be made by radio or other means when emergency routings are to be used.
- C. Computer-assisted routing and scheduling, which require the use of a computerized database of students, streets and bus routes, is a key part of the routing operation. Student records are computerized, and downloading student names, addresses, school names and grades is a routine task. Some student information systems even incorporate bus routing information. The key is for

transportation staff to have quick access to the location of students to be used in establishing bus stops.

Many routing systems, through a geographic information system (GIS) component, have optimization features that allow the system to create bus routes based on the locations of students. It is important to make sure that before implementation, transportation staff analyze any computer-generated routes, because they will almost certainly need some level of adjustment. Computer-assisted routing can help to generate a more efficient routing system than a completely manual process. A computer system can also be of use in providing information needed to stagger bell times in order to share buses among schools or Head Start Centers.

The same information that is needed for bus routing can be very useful in school district planning. The grades and locations of students displayed in a graphic format is invaluable to school administrators as school district lines are redrawn or new schools are opened. Accessing this information from a routing system also may provide a side benefit of involving the transportation staff in the planning process.

#### D. Methods of serving bus routes

1. The “single-trip plan” involves a morning and an afternoon trip by one bus on each route. This form of service is well adapted to sparsely populated areas. It also meets the needs of schools where the instructional program requires both elementary and secondary students to arrive at the same time, or where time required for the route prohibits additional assignments.
2. The “double-trip plan” calls for each bus to cover two different routes in the morning and afternoon. This plan is suited to districts of relatively dense population where distances are not great. As children of all grades may be carried on each trip, program adjustments in the instructional schedule are necessary to avoid idle waiting time at the school. If these adjustments can be made without sacrificing the interests of the children, the double trip may be economical by requiring fewer buses.
3. The “multiple trip plan” or “dual-trip plan” calls for more than two trips each morning and afternoon by each bus. This arrangement is feasible only where route distances are relatively short or time differences between locations are great. High school students, for example, may be brought to school on the first morning trip, with elementary children arriving on the second trip. In the afternoon, the elementary children should be brought home first if it is desired that the elementary day be shorter than the high school day. Districts whose program requires a day of equal lengths for

both groups may transport the high school students on the first trip in the morning and return them on the first trip in the afternoon.

E. Survey and stops

The student transportation director should conduct a survey for the purpose of identifying factors that might indicate the need for a route change. After the survey is completed, driving over the route in the same equipment that will be used in the actual operation, the director should require a time study. The driver(s) who will operate the bus(es) over the route(s) should regard the trip as a dry run. All scheduled stops and times between stops should be indicated. This data, if accurately obtained, will permit the development of a schedule which probably will need little revision once it is placed into effect.

After the route has been established, a schedule showing individual stops should be available in the bus for the information of substitute drivers. Requests for new or additional service should be investigated thoroughly before a change is made. Stops should be established only after thorough investigation has revealed the location to be the most desirable in the area. It is considered poor practice to negotiate a U-turn on main arteries of traffic even though provisions for such turns may have been made. The projection of the rear end of the bus into inside traffic lanes from medians that are too narrow to accommodate bus length often creates traffic interference that places the lives of transported students in jeopardy. Stops should always be located at a safe distance from the crest of a hill or curve to allow motorists traveling at the posted speed to stop within the sight distance.

**Each state should establish a uniform set of procedures for drivers to signal students when it is safe to cross the roadway upon which the bus is stopped.**

Additional precautions should include, but may not be limited to, the following:

1. Plan routes that will permit optimum and effective student safety, program efficiency and operational economy.
2. Specified criteria should be used when selecting stops. Criteria examples include, but may not be limited to, the following:
  - a. Visibility;
  - b. Safe waiting distance from roadway;
  - c. Proximity to intersection;
  - d. Adjacent property;

- e. Line-of-sight distance to the stop by approaching traffic from any direction; and
  - f. Ability to add signage and/or warning devices to alert oncoming traffic of a stop ahead.
3. On highways divided into separate roadways and highways with three or more marked traffic lanes, fleet operators, schools and Head Start Centers should design bus routes that serve each side of the highway so that students do not have to cross the highway unless there is a traffic control signal or an adult crossing guard within three hundred feet of the bus stop to assist students while crossing such multiple-lane highways. A bus shall never be routed such that students are required to cross lanes of traffic in which vehicles are not required by law to stop for a school bus displaying red lamps and stop signs.
4. Determine the location and destination of all students to be transported.
5. For each general education route, late route or similar home-to-school route, drivers shall be provided with a route sheet or manifest, with stops sequenced by, or under the direction of, the transportation director, and containing the following elements:
- a. The name and address of all students in the bus(es);
  - b. The location or written description of each stop (where an intersection is involved, the compass orientation of the stop location within the intersection) and an optional map for orientation purposes;
  - c. Scheduled arrival times for each pick-up and drop-off point;
  - d. Blank lines adjacent to the scheduled arrival time in which the driver may notate his/her **actual** arrival time;
  - e. The routine crossing status (i.e., “cross” or “no-cross”) of each student on the route;
  - f. The school of attendance (or destination) of each student;
  - g. Shuttle or transfer information for students, if applicable;
  - h. Identification of students with dormant medical problems that may require specific actions from the driver in the event the problem becomes active; and



- i. An updated copy of the route sheet or manifest should be kept at the transportation and attendance offices.
6. Every school, school district, Head Start or other agency should develop age-appropriate training for children who ride buses or other passenger vehicles to and from attendance centers and on activity trips. Instruction should begin as soon after the beginning of the school year or program year as practicable and should be reinforced as often as necessary to assure optimum understanding by the respective passengers.

Instruction should include, but may not be limited to, the following topics:

- a. Travel to and from bus stops;
  - b. Roadway crossings;
  - c. Loading and unloading procedures;
  - d. Behavior at bus stops;
  - e. Behavior on board vehicles; and
  - f. Use of applicable passenger restraints and other safety items identified by transportation safety experts.
7. Provide parents or guardians of all students with the driver's name, bus number, pick-up and return times, school closing information, school calendar, procedures to challenge routing decisions, etc.
8. Determine the advisability of utilizing computer-assisted route scheduling.

## **MAINTENANCE OF EQUIPMENT**

- A. Teamwork and written policies are essential to a well-organized maintenance program.
  1. Strong and reasonable school bus maintenance policies and appropriate training that provide efficient guidelines for the transportation supervisor, maintenance personnel, and operators of the vehicles should be adopted.
  2. Such policies should include the maintenance responsibilities of each person involved and should provide for a planned preventive maintenance program.

- B. Preventive maintenance is a carefully organized system of inspections at regular mileage or time intervals combined with the immediate attention to all reported defects.
1. Manufacturer's service manuals and warranty protection guidelines, as well as state inspection guidelines, contain valuable information for successful preventive maintenance programs. These instructions and procedures should be followed carefully for maximum efficiency and safety in fleet operation. Vehicle and component manufacturers (transmission, electrical, occupant restraints, etc.) offer training for fleet technicians. Those interested in efficient operation will take advantage of these training programs.
  2. Objectives of a planned maintenance program:
    - a. Keeping the vehicles in safe and efficient operating condition;
    - b. Preventing road failures;
    - c. Conserving fuel;
    - d. Lowering maintenance costs by reducing the need for major repairs or overhaul;
    - e. Extending the useful life of the vehicle and its components, as referenced in D, below; and
    - f. Enhancing vehicle appearance.
- C. School districts or private contractors should develop a system whereby written communication would allow interchange and feedback relative to maintenance work needed and maintenance work completed. An efficient system should include:
1. Driver's report form to initiate needed maintenance;
  2. Technician certification of completed work;
  3. A method for permanently recording repairs and the maintenance history of each vehicle and special equipment; and
  4. Inspection by the appropriate state agency or its designee.

#### D. Life-Cycle Analysis

It is prudent for a school transportation director, contractor and/or vehicle maintenance manager to be aware of the on-going efficiencies associated with vehicle replacement. While it may not always be possible to purchase new vehicles, analyzing the intended life-cycle and developing purchasing specifications consistent with anticipated use is recommended.

### **EMERGENCY AND RESCUE PROCEDURES**

“Emergency and Rescue Procedures: A Guideline Manual For School Bus Involvement” was developed by the National Association of State Directors of Pupil Transportation Services and disseminated to each state director of transportation for reproduction in the respective states. Distribution of the manual was intended for police, fire and ambulance personnel, emergency medical technicians and any other entity designated to respond to a school bus crash, emergency or disaster. (Head Start agencies may contact their respective state directors of transportation for copies.)

This manual is a reference to be used by school systems (and can be used by Head Start agencies) in developing their own specific emergency plans. Copies of the school system’s (or Head Start agency’s) plan should be carried in each bus. This plan should be developed in cooperation with the personnel in those agencies that will render service during emergencies. The school or Head Start transportation director, school and Center administrators, teachers, drivers, attendants, maintenance and service personnel, students and others should be instructed in the procedures to be followed in the event of the following situations:

#### A. Crashes

1. How to evacuate and control students;
2. How to evaluate the need for medical assistance;
3. How to get help from the police, the fire department and the garage;
4. How to collect and record data essential to the preparation of the required crash reports and an operational plan to provide two-way communication with parents and/or guardians which is imperative; and
5. How to prevent further crashes.

#### B. Sudden disability of the driver

Procedures for handling situations resulting in the fatal injury or disability of the bus driver should be established and communicated to appropriate persons. A list

that includes the name of the bus operator, emergency telephone numbers, names of students assigned to the bus and any special needs of students should be in the bus.

C. Bus breakdown

The emergency plan should cover procedures for the following events:

1. Securing the bus;
2. Controlling the passengers;
3. Diagnosing the cause(s) of the bus breakdowns;
4. Notifying school or Head Start officials;
5. Recovering the disabled school bus; and
6. Providing replacement transportation for passengers.

D. Inclement weather conditions

The emergency plan should provide procedures for actions to be taken in the following events:

1. When schools or Head Start Centers are to be closed;
2. Who is to make such decisions;
3. How decisions are to be relayed to parents, students, school or Head Start officials and staff (including teachers and cafeteria managers), drivers, contractors, maintenance and service personnel, the news media and others; and
4. How to react to such natural phenomena as floods, hurricanes, tornadoes, earthquakes, tsunamis, etc.

E. Other types of emergency situations

The emergency plan should include communication norms, data collection and stress reduction and should cover such conditions and events as the following:

1. Defense/disaster drills;
2. Strikes or other job action by school staff, teachers, drivers or contractors;

3. Road or bridge washouts and landslides that might block school bus routes;
4. Bus hijacking;
5. Weapons on board or at bus stops;
6. Unauthorized boarding;
7. Student health emergencies;
8. Student fights; and
9. Suspected explosives on board buses or at bus stops.

### **EVALUATION OF THE STUDENT TRANSPORTATION SYSTEM**

- A. Each school district or Head Start agency should have a plan for evaluating its student transportation program. Such evaluations should enable school districts or Head Start agencies to:
  1. Verify compliance with rules, regulations and laws;
  2. Audit the efficiency of program service;
  3. Monitor operational economy;
  4. Ensure the safety of the program in operation;
  5. Improve the quality of service; and
  6. Verify student knowledge of school bus rules and procedures.
- B. Major types of evaluations include the following:
  1. Informal reviews by district personnel;
  2. Formal evaluations by:
    - a. A private consultant;
    - b. A state agency; or
    - c. PRISM (Program Review Instrument for Systems Monitoring of Head Start and Early Head Start Grantees).

3. Periodic evaluations:
  - a. Monthly;
  - b. Annually; and
  - c. Biennially.

C. Areas subject to evaluation include:

1. Board of Education or Head Start policies;
2. Routing procedures and processes for route hazard analysis;
3. Types of service provided;
4. Financial obligations;
5. Quality of service;
6. Training of staff and students;
7. Maintenance of buses, other vehicles and equipment;
8. Record keeping systems; and
9. Other areas as determined by state and local policy.

D. Key Performance Indicators (KPIs)—Measuring Success

Key performance indicators are used as a best practice to measure performance, goals, efficiency and productivity. Standard measures and metrics can be molded to fit many different sized transportation operations.

Examples of performance indicators that can easily help a department focus on success include the following:

1. Cost per student transported;
2. Percentage of students receiving transportation;
3. Number of individual routes per bus per day;
4. Number of student riders per bus;
5. Cost per bus per year to operate;

6. Percent of the district's budget spent on transportation;
7. Number of drivers employed versus the number of active buses;
8. Percentage of bus stops made at individual homes versus group stops;
9. Age of the bus fleet;
10. Crash frequency, costs, and injuries;
11. Ratio of buses per mechanic;
12. Average student ride time;
13. Seat utilization/passenger capacity; and
14. Time on road vs. number of routes.

**Note:** (See APPENDIX D for KPI samples.)

## **SCHOOL SITE SELECTION AND FACILITY PLANNING**

When school or Head Start sites are being selected, consideration should be given to the safety of the students riding school buses. School buses will be required to utilize the roads in and around the school site, plus public roadways leading into and away from the school area. High-density traffic flow near exits and entrances should be avoided. Proper site selection, ingress and egress and facility planning for improved transportation are extremely important. (See APPENDIX D.) More specifically, school officials should provide the following items:

- A. Separate and adequate space for school bus loading zones;
- B. Clearly marked and controlled walkways through school bus loading/unloading zones;
- C. Traffic flow and parking patterns for the public and non-bused students separate from the school bus loading zone;
- D. A designated loading area for passengers with special needs, if required;
- E. An organized schedule of loading areas with stops clearly marked;
- F. A loading and unloading site to eliminate the backing of transportation equipment;
- G. Written procedures for evaluating each school site plan annually; and

- H. Appropriate signage.

## **NO CHILD LEFT BEHIND (NCLB)**

- A. Overview

In January 2002, President George W. Bush signed into law the reauthorization of the Elementary and Secondary Education Act (ESEA), known as “No Child Left Behind” (NCLB). The act makes substantial new requirements for state and local education agencies (LEAs; or “school districts”) in order to continue to receive Federal money for education. The act also provides additional rights for students and parents. Information on how the ESEA relates to pupil transportation and descriptions of transportation choice options and requirements for school districts follows.

- B. Attendance choice options

- 1. Low performing

If a school receiving Title I, Part A funds is identified as “low performing” for two consecutive years, parents have the option of enrolling their students in another public school that has not been identified as *low performing*. There are many rules and regulations controlling this process, including the determination of which school the parent can select as the alternate school. The Act does not provide for unlimited choice, however. For instance, if the “low performing” school is the sole elementary school in a school district, there is no obligation to provide an alternate school choice. If a school continues not to show “adequate yearly progress” (as defined in the NCLB), students continue to have a right to transportation to a choice school.

- 2. Persistently dangerous

If a school receiving Title I, Part A funds is identified as “persistently dangerous,” students have the right to be offered other optional public school enrollment opportunities. (A discussion of the process leading to the “persistently dangerous” designation is beyond the scope of this material.) Once a school is designated as “persistently dangerous,” parents are afforded rights to school choice for their students at that school.

- 3. Violent Students

Students involved in violent incidents have a right to attend another public school. All of these situations require LEAs to provide students and parents the option of enrolling in an appropriate alternate public school, i.e., *school choice*.



C. School categories for choice

An LEA must offer all students in identified Title I schools the opportunity to transfer to another public school when those schools fall within one of the four stages of improvement detailed in the ESEA. Those stages are based upon the number of years in which a school has failed to make adequate yearly progress. Schools in the following categories must offer public school choice to their students:

1. Schools that are in their first year of school improvement;
2. Schools that are in their second year of school improvement;
3. Schools that are in corrective action; or
4. Schools that are in restructuring.

D. Transportation

1. When required

If a parent has the choice option to select an alternate public school because the student's school is identified as, "low performing," or "persistently dangerous," or the student was involved in a violent incident, transportation to the alternate public school must be provided by the school district. There is no requirement for a particular mode of transportation, however. For instance, if there is a local transit system with an appropriate schedule, providing a transit pass would meet the requirement for provision of transportation service. If a school building is not receiving Title I, Part A funds, choice transportation is not required to be provided.

2. Length of transportation service

If an eligible student exercises the option to transfer to another public school, a local LEA must permit the student to remain in that school until he or she has completed the highest grade in the school. However, the LEA is no longer obligated to provide transportation for the student after the end of the school year in which the student's school of origin is no longer identified for school improvement, corrective action or restructuring.

3. Out-of-district transportation

The ESEA does not require that transportation be provided to schools outside the LEA. For example, if a school district has only one elementary

school, and that school has been identified as low performing for two consecutive years, the school district is not required to provide enrollment opportunities and transportation to schools in other school districts. (In the case of homeless students, however, transportation is required across district boundaries to the original school of enrollment.)

4. Payment for choice-related transportation

Unless a lesser amount is needed to meet demand for choice-related transportation and, if applicable, to satisfy all requests for supplemental services, an LEA must spend up to an amount equal to 20% of its Title I, Part A allocation, before any reservations, on the following items:

- a. Choice-related transportation;
- b. Supplemental education services; or
- c. A combination of (a.) and (b.).

This flexible-funding approach means that the amount of funding that an LEA must devote to choice-related transportation depends in part on how much the LEA spends on supplemental education services. However, if the cost of satisfying all requests for supplemental education services exceeds an amount equal to five percent of an LEA's Title I, Part A allocation, the LEA may not spend less than five percent on those services. An LEA may, but is not required to, spend an amount exceeding 20% of its Title I, Part A allocation if additional funds are needed to meet all demands for choice-related transportation and supplemental education services. A school district could also spend state or local funds to assist in paying for transportation. (See D7 regarding *supplementing* and *supplanting*.)

5. Insufficient funds

If the funds available are insufficient to provide transportation to each student who requests a transfer, the LEA must give priority to the lowest achieving eligible students from low-income families. However, the LEA must still offer the opportunity to transfer to all students.

6. Optional fund sources

The statutory phrase *an amount equal to* means that the funds required to pay the costs of choice-related transportation and supplemental educational services need not come from Title I allocations, but may be provided from other allowable federal, state, local, or private sources.

7. Title I funds and transportation funds

Like other Title I funds, transportation funds must be used only to supplement the level of funds that, in the absence of Title I funds, would be made available from non-federal sources for the education of children participating in Title I programs. For example, if a particular state provides funding for transportation, a local school district could not use Title I funds to supplant the state or local funds that it would otherwise use to provide for transportation, even though transportation costs are generally an allowable use of Title I funds. However, if the state funds were not adequate to cover the entire costs of the school choice-related transportation, Title I funds, within the statutory limits, could be appropriately used to cover the unfunded portion of the school choice related transportation.

8. Transportation Zones

LEAs have latitude in deciding which options to provide for eligible students. For example, they may establish transportation zones based on geographic location and may fully fund transportation to different schools within each respective zone. This option would allow the district to offer more than one choice school while ensuring that transportation can reasonably be provided or arranged. Outside the transportation zone, the district could pay for only part of the transportation to the school. Parents may select a school outside of a designated attendance zone, but they should be informed prior to making this decision that they may be responsible for providing or arranging transportation for their children. If transportation zones are developed, they should be drawn to provide genuine choice and to address only issues of geographical distance. LEAs should ensure that there is sufficient capacity to accommodate the demand for choice within each zone.

## **MCKINNEY-VENTO HOMELESS ASSISTANCE ACT**

A. Overview

The following information describes how the McKinney–Vento Homeless Assistance Act relates to pupil transportation and describes transportation choices and requirements.

B. Requirements of the McKinney-Vento Homeless Assistance Act

If “homeless” eligibility is determined and placement in the student’s school of origin is determined to be in the best interest of the student, local education agencies (LEAs) may be required to provide transportation to and from the student’s schools of origin for students experiencing

homelessness, upon the request of the parent or guardian. For an unaccompanied youth, the request would originate with the LEA's homeless liaison.

C. Transportation for the homeless in relation to distance

There is an assumption of "reasonableness" with the transportation of the homeless student, unless attending the school of origin is against the student's best interest. Every LEA has a homeless liaison that should make the determination of whether or not the transportation of the student is in the student's best interest or not. *Reasonableness* should not be determined solely on the basis of cost. Air flights, extensive travel time, or other circumstances that result in extremely unusual travel demands may all result in appropriate denial of transportation to the school of origin. There is an appeal process that a parent can use when the parent disagrees with the decision of the school district.

D. Other considerations regarding homeless transportation

Providing sensitivity training to bus drivers and arranging bus stops to keep student's living situations confidential is important in being able to assist these students through this difficult time in their lives with as little disruption as possible. Developing close ties among school district homeless liaisons, school staff and pupil transportation staff will help make this process work smoothly.

E. School District Responsibilities for Transportation Costs When a Homeless Student Requires Transportation Across District Boundaries

When a homeless student requires transportation to the school of origin and that school is outside the current school district, the two districts involved should collaborate to determine which district is going to assume responsibility for transportation and how the cost is to be shared. If there is no agreement between the two districts, the responsibility and cost for transportation shall be shared equally. Each district is required to pay half the cost.

F. Length of Time Transportation Needs to Be Provided after a Homeless Student Has Moved into Permanent Housing.

Students can stay in their school of origin the entire time they are homeless and until the end of any academic year in which they move into permanent housing.

G. Mode of Transportation

There is no requirement that provided transportation be of any specific mode. (School buses are not necessarily required.) Transportation must be safe and appropriate for the individual student's situation and age. Modes may include school bus, transit passes, gas vouchers or reimbursement for parents or youths with cars, contracts with taxi companies (with driver background checks required) or contracts with Medicaid transportation brokers (with driver background checks required).

[Back to Contents](#)

**ACTIVITY BUS  
OPERATIONS:  
TRANSPORTATION  
OTHER THAN  
TO AND FROM  
SCHOOL OR  
HEAD START**

**Page Intentionally Left Blank**

## **ACTIVITY BUS OPERATIONS: Transportation Other Than To and From School or Head Start**

Each school system or Head Start agency providing activity bus operations should have comprehensive policies and guidelines which delegate responsibility for this function to the supervisor of student transportation. To provide safe and efficient activity transportation, lines of responsibility and authority need to be defined, and personnel involved must have an understanding of their respective responsibilities.

In the interest of providing the safest means of transportation available, students should be transported to school- or Head Start-sponsored activities in school buses or allowable alternate vehicles that meet state and federal standards, unless circumstances require an alternate mode of transportation.

**\*Note:** Operational Guidelines for the use of buses other than school buses are outlined in APPENDIX G.

### A. School- or Head Start-Related Activity Operations

School- or Head Start-related activity trips may include field trips that are extensions of the instructional program, athletic trips, vocational and trade training, volunteer activities and recreational outings, such as dances, picnics and overnight camping trips. These trips range from a few miles to those extending over several days and covering large distances.

The following items need to be considered when developing criteria for activity trip transportation:

1. Policies and guidelines, including, but not limited to, the following:
  - a. Purpose of trip (i.e., instructional, athletic, students'/spectators' recreation);
  - b. Funding source (e.g., district or individual school funds, individual charge, parent group); and
  - c. Administrative approval (e.g., the person who has authority to approve the trip).
2. A priority guideline, developed for trip scheduling that addresses situations when all requests cannot be accommodated, such as the following:
  - a. Advance notification that allows adequate time for the approval process and for making driver and vehicle arrangements;
  - b. Methods of travel, which may include district- or agency-owned or contracted bus, commercial carrier or local transit equipment, air, boat, rail



- or combinations of these commercial carriers or private or school passenger automobiles, when required by special or unique needs;
- c. A trip request form that includes all necessary information for trip arrangements, special equipment, payroll, reimbursement and other local needs; (See Sample forms in APPENDIX G.)
  - d. Adult chaperones, which should be required on all activity trips and whose responsibilities include passenger control, with the driver having final authority; and
  - e. Discipline and emergency medical procedures that should require a trip release to be signed by parents and should include procedures concerning difficult or severe behavioral or medical problems and emergency policies and contacts.
3. Communication is essential. Drivers, students, chaperones and parents should be made aware of applicable rules and regulations. Parents should have destination information, mode of transportation, names of chaperones, departure and return times, appropriate dress and items that the students should bring with them. A signed authorization for student participation from the parent or guardian is important. A detailed itinerary for all persons involved may be advisable. Identification of special medical problems in the event of an emergency en route is necessary.
- a. Luggage accommodations, if applicable, must be included. A procedure for transporting luggage or equipment prohibited in the passenger compartment by state law and/or local regulations is necessary. Loose luggage or equipment that could cause injury or block passageways should never be transported in the passenger compartment.
  - b. Policies should detail whether or not out-of-state trips are permitted and, if so, any applicable restrictions. Regulations for states to be visited should be reviewed prior to the trip.
  - c. Insurance policies should be reviewed or agents contacted to determine adequacy of coverage. This is an absolute necessity for trips scheduled to another state or country. If vehicles other than district-owned vehicles are used, the Board of Education or Head Start grantee should determine the minimum insurance coverage to be carried. A current copy of the contract or commercial carrier's insurance verification should be on file with the school district or Head Start.
  - d. Road and weather checks should be made by the designated person. School transportation personnel from other districts, state patrols, highway divisions and auto clubs are generally cooperative in supplying road

information. If warranted, the weather bureau should also be contacted. A planned route and any contingent route for trips should be determined prior to initiation of the trip.

- e. Contingency plans require policies and procedures that detail persons who have authority to make decisions if the unexpected happens during a trip (e.g., impassable roads, crashes, mechanical breakdowns). Drivers and chaperones should have access to that authority's phone number. It is also advisable to obtain phone numbers of transportation personnel in various communities and school districts where activity vehicles regularly travel. Provisions should include plans for staying overnight if conditions do not permit a safe trip home. It is advisable to develop a mutual aid directory for contact within athletic league boundaries that could provide assistance in the event of mechanical emergencies. Drivers should be trained in procedures and regulations relating to trip crashes.
  - f. Driving hours shall be regulated. School districts and Head Start agencies shall have regulations based on the Federal Motor Carrier Safety Administration regulation 49 CFR 395.3 (15 hours on duty of which no more than 10 hours are driving time; 8 hours continuous off-duty prior to a long trip; no more than 60 hours driving in a week).
  - g. Driver selection and assignment criteria are necessary to avoid conflict and confusion. The criteria should include a driver's knowledge, skill, experience and familiarity with activity trip vehicles, as well as the driver's suitability for the area to be traveled.
  - h. Drivers should be notified at least three days in advance of the trip date.
  - i. Drivers who drive only activity trips should be tested periodically for driving ability and vehicle familiarity. They should hold the same license and certification as regular school bus drivers.
  - j. Passenger manifests (a list of all passengers being transported) should be kept by the driver and left with proper authorities at the school or institution.
  - k. Evacuation instruction, including an emergency evacuation drill, or at least verbal instructions, should be given by the driver before each trip. (See sample format, APPENDIX G.)
4. Vehicles and equipment:
- a. The following criteria should be taken into consideration when selecting trip vehicles:

- (1) Miles to be traveled;
  - (2) Terrain and climate conditions;
  - (3) Number and age group of students;
  - (4) Luggage and equipment requirements;
  - (5) Driver familiarity with the vehicle and route; and
  - (6) Federal Motor Carrier Safety Administration regulations, if contract-operated and crossing state lines.
- b. Consideration should be given for specialized equipment, or other items needed, such as the following:
- (1) Luggage storage;
  - (2) Chains (pre-fitted prior to the trip) or sanders;
  - (3) Extra heaters or air conditioning;
  - (4) Public address system;
  - (5) Electronics: am/fm radio or music system, and two-way radio or cellular telephone;
  - (6) Tires, including off-road tread or recaps on the rear axle—recaps on front axle are prohibited;
  - (7) Spare tire;
  - (8) A tool kit containing items such as a flashlight, pliers, screwdrivers, de-icer, extra chain tighteners, etc., and additional equipment for an extended trip, as may be recommended by transportation personal at the destination;
  - (9) Cash for telephone, fuel, bridge tolls, parking fees and personal needs;
  - (10) Emergency telephone numbers and other information; and
  - (11) Maps or global positioning systems (GPS), as appropriate.
- c. Inspection requirements should be the same as for regular route buses, and a detailed check should be made prior to activity trips.

- d. School buses shall be prohibited from towing a trailer or any vehicle when students are on board the bus.

5. Training

- a. Specialized training should be provided for activity trip drivers. Training should include, but not be limited to, the following:

- (1) State laws and applicable policies and rules;
- (2) Familiarity with the activity trip vehicle and its components;
- (3) Familiarity with specialized equipment and how to use it, including cellular telephone and onboard global positioning system (GPS);
- (4) Familiarity with local and state trip requirements;
- (5) Route familiarization, which might include a dry run prior to the trip date, especially if extreme conditions, terrain or road difficulties may be encountered;
- (6) Discipline procedures on trips;
- (7) Driving under adverse conditions (night driving, slippery roads or unfamiliar mountainous driving);
- (8) Maps, destination locations and parking areas;
- (9) Parking location, if other than the student destination; and
- (10) Provisions for bus security at the destination.

- b. Specialized training should be provided for all trip chaperones and should include at least the following topics:

- (1) All regulations related to student rider behavior;
- (2) The specific roles and responsibilities of a chaperone both on and off the vehicle, as defined by applicable regulations and policies;
- (3) The communication expectations between chaperone and driver; and
- (4) Emergency procedures, including evacuations.

## B. Non School- or Head Start Agency- Related Activity Operations

### 1. Introduction

This sub-section is intended to address the various uses of a school bus for operations other than to and from school and school-related activities.

### 2. Use, Procedures and Policies

- a. The school bus operator, in accordance with state regulations and/or laws governing school bus use, should establish procedures whereby school buses can be scheduled for non-routine use. Such scheduling should not conflict with, or be given priority over, the regular class-related demands for school buses by the school system or Head Start agency.
- b. The school system or Head Start agency, as part of local government or in cooperation with transportation contractors, may utilize buses during times of community emergency or crisis when demand for other public vehicles, such as trains and transit buses, is so great as to exceed available supply.

### 3. Legal Requirements

- a. School buses operating on public roadways and crossing state and national boundaries must adhere to the rules of the road in the jurisdictions in which they are operating.
- b. All applicable permits need to be procured in accordance with applicable state and local laws.

### 4. Operational requirements

- a. Vehicle equipment used for activities must be in good working order, well-maintained and otherwise capable of withstanding the demands of the trip.
- b. All activity buses and drivers should comply with all applicable state and federal requirements, including Federal Motor Carrier Safety Administration Regulations applicable to interstate and intrastate passenger transportation.
- c. Aisles and exits must be kept clear and free of blockages at all times.

[Back to Contents](#)

**SCHOOL  
TRANSPORTATION  
SECURITY AND  
EMERGENCY  
PREPAREDNESS**

**Page Intentionally Left Blank**

# **SCHOOL TRANSPORTATION SECURITY AND EMERGENCY PREPAREDNESS**

## **INTRODUCTION**

Each school day almost 20 percent (50 million) of the United States' population is located in our nation's schools. Approximately half of these children (25 million) use a school bus for transportation to and from school each day. Additionally, millions of children ride school buses each day for school activity trips.

A review of past criminal and terrorist actions and statements makes it clear that buses, including school buses, can be used as weapons, as well as being viable targets.

Until recently, school transportation has been centered on two main objectives: safety and efficiency of school bus operations. Since September 11, 2001, transportation system security has been added into the equation. In addition to the threat from foreign and domestic terrorist groups, the school bus driver and passengers may be targets of violence from students, unauthorized boarders and criminal elements outside the school bus. School transportation professionals must give school transportation security and emergency preparedness at least the same level of commitment as has been given to safety and efficiency.

Recent events demonstrate that terrorists totally disregard the sanctity of education facilities and school children. Individual terrorists and/or terrorist organizations look for targets that will strike fear into our society. Terrorists select emotional targets when actions against the more traditional military, government and economic targets do not achieve their desired goals. Current terrorist activities indicate a change in tactics and targets.

School transportation is a lot like the electric and water companies—service performed flawlessly attracts little notice. Society rarely gives school bus transportation a second thought—unless something goes wrong, which is a relatively rare event.

Complacency and the attitude that “it won't happen here” set the stage for terrorists to perpetrate their crimes. The transportation industry must increase awareness and mitigate the potential for terrorist attacks on school transportation systems. The initial step is for transporters to become aware of potential problems and to indentify reasonable and practical solutions.

Following a systematic and reasonable plan will help transporters not only to improve their ability to prevent acts of terrorism, but also to strengthen their ability to react to the more common events that plague the transportation industry. Transporters will be better prepared to address vandalism, property loss, petty theft, fights or disturbances, child abductions and sexual predators, thus giving an added bonus of increased level of student and employee protection and safety.



The information in this segment is not intended to be a comprehensive guide on school transportation security or to supersede any federal, state or local policies and plans. Rather, the purpose of this information is to assist school transportation officials and school transportation service providers when establishing or revising their state or local policies and plans concerning school transportation security. Another resource to consider is “Best Practices for School Transportation,” published by the Transportation Security Administration (TSA). (See APPENDIX H.)

School transportation providers should also seek to be part of the community emergency management plans. It is important to know where school buses fit into the larger picture. Transportation departments need to know where their buses are on the priority scale compared to other segments of the community, should a large-scale emergency occur in the local area. Things to consider may vary, depending on time of day (i.e., route time) or year. Transportation departments can also play a vital role during emergency situations that require a large-scale evacuation from an area. In addition to moving students from school buildings, unutilized buses can serve the community as well.

### **Planning and Policy Considerations**

- A. Does the school district have a written security policy and crisis response plan, including procedures that include transportation personnel, equipment and facilities? Does the plan/policy coordinate with procedures in the school buildings? Is the plan/policy site-specific for all school facility locations?
- B. Has a transportation system security and emergency procedures assessment been performed? (See APPENDIX H.)
- C. Does the plan/policy contain information on threat vulnerability identification and consequence?
- D. Does the plan/policy provide for any proactive or preventive technology solutions, that are currently available and that can potentially act as early detection or prevention of potential threats?
- E. Does the planning and policy process include appropriate stakeholders (e.g., first responders, law enforcement, fire department and media, such as print, radio, television, etc.)?
- F. Is the plan disseminated only to authorized personnel or persons with a documented “need to know,” and are non-disclosure statements being utilized?
- G. Are the procedures of the plan/policy routinely tested and exercised with means for assessment, evaluation and improvement at least annually?

- H. Does the plan/policy provide information on how to recognize suspicious people, activities, packages and devices?
- I. Does the plan/policy require security inspections of vehicles and facilities?
- J. Does the plan/policy require pre-trip, post-trip and unattended stoppage period vehicle security inspections?
- K. Does the plan/policy address commonly used terrorist weapons (e.g., improvised explosive devices, chemical, biological and radiological agents)?
- L. Does the plan/policy contain directives on incident management and command?

### **Security Assessments**

Vigilance, which requires an awareness of vulnerabilities, is the first step to better security. In order to determine the threat level to the student transportation system, a system-wide security assessment should be conducted. The assessment should include participation by school administrators, local and state police and medical and hospital administrators. The assessment will help to identify weaknesses and strengths within the operation. The assessment should begin at the front line of any transportation system—the driver—and support employees (i.e., cleaning and fueling personnel) and continue up through all levels of the organization. This should also include any viable means by which to immediately detect or prevent threats on board. After completing the security assessment, appropriate plans/policies and procedures can be developed and implemented.

A security assessment should consider the following security issues:

- A. Review current security plans/policies and procedures by asking the following questions:
  - 1. What security plans/policies and procedures exist?
  - 2. Do they address facilities, equipment, personnel and passengers?
  - 3. Have these plans/policies and procedures ever been tested in an exercise?
  - 4. Have the plans/policies and procedures ever been used for a real emergency?
  - 5. Were the plans/policies effective?
  - 6. Do the security plans and policies identify a “security coordinator” for each school and facility with written responsibilities?

7. Do the security plans/policies include policies and procedures for vetting of transportation personnel?
- B. Review existing lines of communication by asking the following questions:
1. What lines of communication exist within the operation?
  2. Do they interrelate with local law enforcement, fire and emergency services?
  3. Are they clearly defined and documented?
  4. Are all employees trained and familiar with them?
  5. Have these lines of communication been tested and proven?
  6. Is there an alternate communication plan if the normal systems are unavailable?
  7. Were the communications effective, as tested?
- C. Review personnel security by asking the following questions:
1. Are all employees and visitors required to wear identification badges? Do they wear them?
  2. Is there a “sign in/sign out” system or a personnel identification measure in place?
  3. Are all employees required to wear uniforms? Do they comply?
  4. Are students registered on a particular bus?
  5. Are drivers provided with a list of riders, or are students carrying an ID?
  6. Are there procedures for accounting for each individual student, especially on activity trips?
  7. Do evacuation plans exist?
  8. Is there a designated place to relocate staff or students?
  9. On activity, field or extracurricular or school-chartered bus trips, are students instructed in safe riding practices and on the location and operation of emergency exits?

D. Review operational security by asking the following questions:

1. Are all vehicle doors, hatches and compartments locked when vehicles are unattended? Are keys left in the bus or ignition?
2. Are facilities and buses equipped with camera or video surveillance equipment or intrusion alarms that are monitored?
3. Do plans/policies and procedures for locking doors and gates exist? Are the codes or combinations changed regularly?
4. Are off-site parking locations secure?
5. Is the exterior of the transportation facility, administration building and maintenance facility secure?
6. Is the bus yard secure?
7. Are fencing, walls or vehicle or personnel gates and lighting available?
8. Is there surveillance equipment being monitored and/or recording? What is being surveyed?
9. Is the interior, (i.e., all rooms, storage areas and closets) of the transportation facility, administration building and maintenance facility secure?
10. Are roofs secure?
11. Are all bus routes being evaluated with safety and security issues considered?
12. Where are buses staged during the route if there is a layover period?
13. Are buses left unattended at schools during layover periods?
14. Are all schools and school parking areas safe and secure?
15. Are commonly used school activity sites safe and secure?
16. Do drivers leave the bus to watch the activity?
17. Is there a pre-trip inspection prior to departure for home?
18. Do computer and communications systems exist?

19. How is access to computers or systems controlled? What are their limitations?
20. How can computers be compromised? If they can be compromised, what can be done to prevent it?
21. Is the communication system (e.g., two-way radio, land telephone line, cellular telephone, etc.) capable of recording?
22. Is the bus fleet equipped with real time GPS?
23. Does the communication system have redundancy, and is it routinely tested?
24. Is there a code system to identify emergencies or threats?
25. Do emergency back-up systems for information and communication exist? What are their limitations?
26. How can emergency back-up systems be compromised, and if they can be compromised, what can be done to prevent it?
27. Are the back-up systems stored off site? Are they secure?
28. Is there a plan available that does not require electrical energy?

### **Security Plans/Policies and Procedures**

The assessment should indicate any gaps in existing plans/policies and procedures. Also, board- and administration-approved security plans, policies and procedures should be developed. These plans, policies and procedures must be supported and enforced by the entire transportation organization. Plan/policy recommendations should include, but not be limited to, the following items:

- A. Consider the security interest of students when establishing district plans/policies which make routes, schedules and locations available to parents and guardians on the internet.
- B. Establish board-approved plans/policies on the use of employee uniforms and identification badges and student registration (bus passes). Consideration should be given for a means to appropriately identify that a student may be met by a parent, guardian or other authorized person.

- C. Establish board-approved plans/policies on property security, (e.g., locked doors and gates, security cameras, alarms, employee photographs, public entry, etc.).
- D. Establish communication procedures regarding the use of two-way radios, cell phones, VHF radios, combination phones, etc.
- E. Establish command and control procedures that include a chain of command, and specify the decision-makers in any given situation.
- F. Establish emergency or security reporting procedures, (e.g., whom the driver calls in a security threat or emergency). Determine what circumstances constitute a security threat or emergency and when a driver must report a security threat or emergency to a supervisor.
- G. Establish a board-approved plan/policy regarding regular system safety and security training.
- H. Establish a board-approved plan/policy for enforcing safety and security policies and procedures.
- I. Establish post-trip inspection practices before the driver leaves the vehicle.

## **TRANSPORTATION PERSONNEL AND THEIR TRAINING**

School transportation already focuses on safety training. A security assessment likely will indicate a need for renewed and expanded focus on security—especially extreme threats. Security training should be a primary element of plans/policies and procedures. Individual awareness is among the best weapons for preventing crime and increasing personal and business security. Any person armed with awareness is less likely to become a victim or to allow a crime to be committed. Armed with awareness, most school bus drivers and administrators can either eliminate or significantly reduce property losses and crime. While not the primary goal of a good security program, it is highly likely that routine vandalism and crime will be reduced.

Drivers should be thoroughly familiar with their vehicles, their students, the area and conditions on their routes. They should have a thorough knowledge of the operational plans, policies, procedures and training on possible threats. Armed with this knowledge, drivers can better assess the level of threat in any given situation and respond according to established plans and policies.

### **Suggested Training Topics**

- A. Plans/Policies and Procedures
  - 1. What to do in case of emergencies or an increase in security threat;
  - 2. How to use available communication systems;

3. Rules for hostage situations;
4. How to conduct security inspections of vehicles (similar to basic bus pre-trip safety inspection);
5. How to respond to threats of violence from students, unauthorized boarders and others outside the school bus; and
6. How to respond to directives from incident management and commands.

B. Identification and Prevention

1. How to determine the threat level;
2. How to identify and prevent suspicious, criminal or terrorist activity;
3. How to identify and prevent entry of suspicious people, packages and placement of suspicious packages or devices;
4. How to identify illegal entry (structure or vehicle); and
5. How to identify and respond to improvised explosive devices (IEDs).

C. Response and Reports

1. How to respond to shootings or snipers;
2. How to respond to fights or disturbances;
3. How to respond to vandalism or property damage;
4. How to respond to child abductions, sexual predators or child custody issues;
5. How to respond to threats of violence from students, unauthorized boarders and criminal elements outside the school bus;
6. How to respond to weapons on the bus; and
7. How to raise drivers' level of awareness to identify suspicious people, activities, packages and devices.

D. Safety and Security Equipment

How to use all the safety and security equipment available to drivers.

Training processes should include the use of drills and table top exercises to test and practice the plans/policies and procedures.

## **SCHOOL BUS SECURITY EQUIPMENT AND EMERGING TECHNOLOGY**

- A. Global Positioning System technology;
- B. Silent alarm and two-way communication system (e.g., “panic button”);
- C. Flashing front and rear marker identification lamps to signal predetermined emergency message (e.g., hostage, intruder on board, etc.);
- D. Name of student transportation provider and identification number on the bus roof;
- E. Ability to lock entrance (service) door, emergency door(s), roof hatches and outside compartments;
- F. A reinforced entrance (service) door to prevent forced entry into the bus; and
- G. Video and audio in bus cabin such that first responders may see and hear the threat real-time (i.e., as it is happening) for maximum assessment and real time solutions.

### **Unauthorized Riders and Visitors**

School bus transportation systems have dealt with unauthorized visitors, from the neighborhood dog to upset parents. Once an uninvited person enters the bus, drivers lose ultimate control of their vehicle. The only persons authorized to gain access to a school bus are those students who meet the eligibility requirements, school administrators, law enforcement and transportation personnel. Non-students, including the driver’s friend, are never allowed on a school bus. The driver should make every effort short of physical confrontation to ensure that students who are not eligible are not permitted on the bus. Districts should have procedures in place that address whether or not parents are allowed to enter the school bus even if it is to assist with the securement or loading and unloading of their children. Drivers should receive training and education on these policies. If the district allows a guest to ride home with regular riders, districts should have a procedure that has written documentation giving parental approval that includes the date. Drivers should be trained to be aware of surroundings at bus stops. This should include a plan if an unrecognized or suspicious person is loitering at the bus stop. For the safety of all students, once the students board the bus, they will not be allowed off the bus until the bus reaches their assigned stop.

Providing drivers with a list of eligible riders for their routes will allow drivers to become more familiar with their day-to-day student riders. Policies can state whether students are allowed to ride a particular bus without prior registration or written permission. This practice can help



districts monitor the load capacity of buses and assist drivers with pupil management. During activity trips the number of students should be included when dispatching the bus. Student counts should be confirmed after stops where students are allowed to leave the bus.

### **Child Abductions**

While there is heightened awareness today about children being abducted from bus stops or while walking to and from bus stops or school, the transportation industry has dealt with parental or custody abductions during loading or unloading. School bus drivers should be apprised if a child riding the school bus is involved in a custody dispute. Drivers should be trained to notice unusual cars or people at bus stops and how to respond. Drivers should maintain schedules as close as possible to minimize students' exposure to elements or potential abductions.

### **ROUTE HAZARDS**

Transporters are more likely to experience hundreds of small security incidents during their careers than they are likely to experience a terrorist attack. If plans are developed for reasonable preventive measures for extreme threat, transporters will be better prepared to respond to more common security incidents, such as a suspicious person or vehicle at a bus stop, a vehicle following a school bus on its route, an angry parent entering the bus, a vehicle driving recklessly around the bus (road rage), an unusual package left on the bus, or a hostile student making threats to other students or the driver.

School transportation officials should establish a program to routinely evaluate all school bus stops and routes for potential hazards. There are fixed hazards that cannot be avoided (e.g., railroad crossings, streams, limited visibility, traffic congestion, etc.). Another hazard more prevalent today is the residences of sexual predators. Great care must be used if stops must be placed near the residence of a known sexual predator.

Weather conditions, such as snow, ice, fog, extreme heat or cold and rain, can create a route hazard that had not previously existed. Route evaluations should note areas that may flood during rain or hills that frequently become icy.

Events such as earthquakes and tornados may give little advance warning to drivers. Route information could also include the location of police/fire/rescue stations, hospitals, schools and other emergency care facilities where a school bus may pull off the road and await aid in the event of an emergency. It is important that school bus drivers and substitute drivers be provided with route hazard information in a standard, consistent manner, and the information should be available to the driver no matter which bus is driven on that day.

## **VULNERABLE ACTIVITIES**

### **A. Bus Stop**

School bus drivers must participate in some activities that make them especially vulnerable. During these activities, drivers should have heightened awareness. When the bus driver opens the door, an entrance into the school bus is created where the driver has little control over who will enter the bus. At school bus stops, drivers should be aware of abnormal behavior or unidentified people loitering or parked cars that usually are not parked at the stop. Regular drivers learn to recognize waiting parents, but if strangers are at the stop, it would be appropriate to ask students who is at the stop to meet them. If other adults are not present, it may be best for the school bus driver to wait before opening the door to give more time to observe the behavior of the person in question. Drivers should be trained to observe gang clothing and clothing that may obscure weapons. Additionally, drivers should be alert to people taking photos or making suspicious notes at bus stops or schools.

### **B. Railroad Crossing**

Opening the door and driver's window prior to crossing is required at almost all railroad crossings. Prior to opening the door, the driver should observe if there are people that are out of place, loitering at the railroad crossing. Drivers should be trained and empowered to decide if obeying the law and opening the door creates more of a safety hazard than purposely not completing the process at the railroad stop and thus violating a law or rule. Keen observation would tell a driver if the behavior outside the bus is suspicious and a greater threat than failing to open the door.

### **C. Fueling Facilities**

If drivers fuel their buses at locations other than the compound where the buses are stored, the drivers may find themselves and/or their buses vulnerable. External fueling stations often do not have limited access, and the public does not keep a regular schedule. Therefore, school bus drivers would find it difficult to observe things out of the ordinary. The facts that school buses usually fuel on a regular schedule and that drivers exit the bus are factors that expose buses during fueling. Drivers should always remove the key from the ignition when they leave the driver compartment. Training may help drivers increase their awareness.

### **D. Activity Trips**

Often drivers are allowed to leave their buses during activities when students are engaged elsewhere. Districts should have policies and training that inform the driver about what action they should take when returning to their vehicles. The vehicle should be locked when the driver is not present and a post-trip inspection completed prior to departure.

#### E. Rented or Leased Buses

Operations that allow school buses to be rented or leased should have a process in place to assure that the driver is properly licensed. Consideration should be given to the security threat of allowing vehicles to be used in high risk areas.

### **WEAPONS**

Weapons (or objects that look like and/or could be used as weapons) are not permitted on school buses or school grounds. Drivers should receive training to learn behaviors that students may exhibit when carrying a weapon. Unusual gait, pocket sag and nervous behavior are all identifiable. Any time students say they have a weapon, the situation should be treated as such. Drivers should practice steps they would take to protect other students. Conversations that promise retaliation should be taken seriously. Student transportation providers should have policies and procedures in place that prohibit weapons on campus, and the policies and procedures should extend to the school bus.

Drivers should be trained to watch for suspicious packages left unattended on the bus or around the transportation facility. Transportation facilities should promote good housekeeping practices so that unattended packages stand out and are not lost in clutter.

In the event that a school shooting is unfolding on campus, student transportation providers and transportation centers should have a communication plan and routing options so that additional students can be diverted and not delivered into an unsafe setting.

During lockdown procedures at schools, drivers should be trained and should have a designated alternate drop site so that students can be delivered to a safe location.

### **EMERGENCY RELEASE OF STUDENTS**

Many types of events can cause a school to release students early. Stormy weather, building fire, school violence or bomb threat, for example, can unexpectedly expose students to the elements and lack of building cover. Districts should have plans in place that spell out where students will be relocated and how parents will be notified. If students are being transported home early, the district should have a plan in place to ensure that parents are notified. Operations should have alternate load zones established for each school in case the primary location is unavailable or more buses are needed to evacuate an entire school.

Buses that frequently travel during inclement weather should be prepared for situations that prohibit the bus from continuing on its route. Drivers should receive training regarding appropriate procedures to employ in the event that weather emergencies occur while they are on their routes.

Transportation centers should have a backup plan in case of a power failure. Normal communication methods may not work during a catastrophe.

## **FACILITIES AND BUS PARKING**

School bus facilities should have limited access both during the day and night. Fencing and gates should be installed around the premises. Keys should not be left in the ignition when the buses are unattended. If the facilities are equipped with camera or video surveillance equipment, the district should have plans in place to monitor the cameras. The plan should include what is surveyed and recorded. Transportation centers should have policies and procedures for locking doors and gates. If codes or combinations are used, then a procedure should be in place to routinely change the codes. If keys are used, a process should be in place to retrieve keys from employees who separate from employment. The security plan should address school buses that are routinely stored off site.

Plans should include whether drivers may leave the school bus during layover periods and activities and where they may park the bus. Plans should address to what extent the drivers will secure the bus (e.g., all doors, hatches and compartments) and the type of inspection a driver should complete before using the bus following non-active periods.

If possible, school bus drivers should have a method to check in or contact transportation supervisors or emergency officials should the drivers need assistance.

At the school bus facility, all employees and visitors should be required to wear identification badges or have a method to check in. Drivers should have some type of check-in process prior to dispatch.

## **HIRING PROCESS**

Operations should conduct background checks on all supervisors, trainers, drivers, bus attendants, technicians and dispatchers. Backgrounds may be checked through fingerprinting, local criminal record search, driving records and employment history. Specific criteria should be determined prior to hiring transportation personnel. APPENDIX D of this publication includes sample school bus driver applications, sample job description and new employee hiring procedures.

## **SCHOOL BUS EQUIPMENT GUIDE FOR LAW ENFORCEMENT AND FIRE DEPARTMENT PERSONNEL**

School transportation providers should work with local emergency responders (law enforcement, fire departments, medical services, etc.) to ensure that they have appropriate fleet information when responding to an emergency involving a school bus. Information required by emergency responders will vary, depending on their individual needs and abilities. Good communication with emergency responders prior to an emergency occurring will ensure that responders will have the information that they need. Information issues to discuss include variation of fleet vehicles, ways to quickly identify bus specifics (e.g., passenger capacity and presence of wheelchairs) and how to operate the various emergency exits of their buses.

## RESOURCES

- Department of Homeland Security, [www.dhs.gov](http://www.dhs.gov)
- Transportation Security Administration, [www.tsa.gov](http://www.tsa.gov)
- Federal Bureau of Investigation, [www.fbi.gov](http://www.fbi.gov)
- Federal Emergency Management Agency, [www.fema.gov](http://www.fema.gov)
- Department of Education, [www.ed.gov](http://www.ed.gov)
- State Departments of Education, [www.doe.state.in.us/htmls/states.html](http://www.doe.state.in.us/htmls/states.html)
- Department of Transportation agencies, [www.dot.gov](http://www.dot.gov)
- National Highway Traffic Safety Administration, [www.nhtsa.dot.gov](http://www.nhtsa.dot.gov)
- Federal Highway Administration, [www.fhwa.dot.gov](http://www.fhwa.dot.gov)
- Federal Transit Administration, [www.fta.dot.gov](http://www.fta.dot.gov)
- Federal Motor Carrier Safety Administration, [www.fmcsa.dot.gov](http://www.fmcsa.dot.gov)
- First Observer, [www.firstobserver.com](http://www.firstobserver.com)
- First Observer, Information Sharing and Analysis Center, [www.highwayisac.org](http://www.highwayisac.org)

[Back to Contents](#)

**TRANSPORTATION  
FOR STUDENTS  
WITH  
DISABILITIES  
AND SPECIAL  
HEALTH CARE  
NEEDS**

**Page Intentionally Left Blank**

## **TRANSPORTATION FOR STUDENTS WITH DISABILITIES AND SPECIAL HEALTH CARE NEEDS**

The purpose of this section is to recommend standard policies, procedures and guidelines for persons entrusted with the responsibility of managing transportation for students with disabilities. The term *special education* means, “specially designed instruction to meet the unique needs of a child with a disability.” When transportation is required to provide access to such instruction, it is considered a “related service.”

As part of the mandate of a free appropriate public education (FAPE), related services are required when determined necessary to assist a child with a disability to benefit from special education. *Transportation* as defined in The Individuals with Disabilities Education Improvement Act (IDEIA) includes:

- A. Travel to and from school and between schools;
- B. Travel in and around school buildings; and
- C. Specialized equipment (such as special or adaptive buses, lifts, and ramps), if required to provide special education for a child with a disability.

Though general in nature, the recommended guidelines, policies and procedures do contain adequate information as of the date of adoption of these guidelines to guide those persons responsible for student transportation in developing an action plan for the safe and appropriate delivery of transportation services for students with disabilities.

This section reviews the current laws and regulations governing special transportation related to the individualized education program (IEP) process, recommended staff training and policy development.

The transportation administrator and pertinent staff shall become familiar with the laws, guidelines, policies and procedures listed below.

### **LAWS AFFECTING TRANSPORTATION FOR STUDENTS WITH DISABILITIES**

- A. Laws
  - 1. It is possible for a school district to be required to provide specialized transportation services to a student with disabilities who is not in special education. Section 504 of P.L. 93-112, of the Rehabilitation Act of 1973, states in part, “No otherwise qualified disabled individual in the United States shall, solely by reason of his handicap, be excluded from participating in, be denied the benefits of, or be subjected to discrimination under any program or activity receiving federal financial assistance.” In general terms, Section 504 of P.L. 93-112 (1), part of the Rehabilitation Act of 1973, “... requires that all students with disabilities



(regardless of age) are eligible for a free appropriate public education [FAPE].” It also requires that the facility, services and activities provided to the disabled to be comparable to those provided to the non-disabled, and that students with disabilities must have an equal opportunity for participation in any nonacademic and extracurricular services and activities provided by a school district.

2. Congress passed P.L. 94-142, in 1975, and regulations were promulgated by implementation of Part B of the Education for All Handicapped Children Act, effective October 1, 1977. A free appropriate public education (FAPE) is required for all students between the ages of 3 and 21 years who are deemed *disabled* and who need special education.
3. 2004, the reauthorization of the Education for All Handicapped Children Act of 1975 changed the name to Individuals with Disabilities Education Improvement Act (IDEIA). Subsequent reauthorizations made significant additional changes. These guidelines reflect the 2004 reauthorization of the law and the 2006 regulations implementing that law.

**Note:** IDEA requires the public agency “...to provide non-academic and extracurricular services and activities in such manner necessary as to afford children with disabilities an equal opportunity for participation in those services” (Section 300.107). One of the ways to access those non-academic services is transportation. This continues the emphasis on the transportation of children with disabilities in the same ways children without disabilities are transported. Section 300.17 provides that a child with a disability must be allowed to participate in non-academic activities as much as possible with children without disabilities. Thus, the beginning point for consideration of the appropriate way in which to transport a child with disabilities is the “regular” (i.e., non-special needs) school bus. This “regular” environment must occur unless a child cannot travel safely on the regular bus, even with the use of specialized equipment or other supplementary aids and services.

B. Characteristics/Conditions:

To be *disabled* under IDEA, a student must have certain characteristics or conditions that adversely affect educational performance, and, therefore, that require special education and related services. The disabilities are defined in the IDEA under Part B: Regulations. They appear in 34 Code of Federal Regulations (CFR), Part 300 Child with a Disability. The *terms* will be listed in this section as they appear in the CFR. The *definitions* can be found in APPENDIX E.

Disabilities are classified as follows:

1. Autism;
2. Deaf-Blindness;
3. Deafness;
4. Emotional Disturbance;
5. Hearing Impairment;
6. Mental Retardation;
7. Multiple Disabilities;
8. Orthopedic Impairment;
9. Other Health Impairment;
10. Specific Learning Disability;
11. Speech and/or Language Disability;
12. Traumatic Brain Injury; and
13. Visual Impairment, including Blindness.

### **INDIVIDUALIZED EDUCATION PROGRAM (IEP)—INDIVIDUALIZED FAMILY SERVICE PLAN (IFSP) PROCESS**

The 2006 IDEA Regulations echo the statutory purpose stated in the 2004 Reauthorization of the IDEA statute: "...to ensure that all children with disabilities have available to them a free appropriate public education that emphasizes special education and related services designed to meet their unique needs and prepare them for further education, employment and independent living; to ensure that the rights of children with disabilities and their parents are protected... and to assess and ensure the effectiveness of efforts to educate children with disabilities."

The IEP team is the formal group that designs a student's educational program, establishes measurable academic and functional goals and determines the related services that are necessary for a student to access special education. When transportation is considered as a related service, appropriate transportation staff, as related service providers, must be included in the IEP process to address safety and feasibility of various transportation options.

The safe transportation of a child with special needs requires a plan that considers and adapts the transportation services to the individual needs of the student. This plan is called an "Individual

Transportation Plan” (ITP) and functions as a sub-part of the IEP when transportation is a related service. The ITP addresses (but is not limited to) the following considerations and decisions:

A. Legal Considerations

The intent of the law is that the IEP committee considers a number of stated issues related to the student’s educational program. “A continuum of alternative placements [must be] available to meet the needs of children with disabilities for special education and related services.” When transportation is considered as a related service, consideration needs to be given to the range of transportation services, including the use of supplementary aids and modifications available to students with disabilities to address questions about the appropriate mode of transportation for the student. The requirement that students with disabilities be transported “to the maximum extent appropriate” with students without disabilities (the “least restrictive environment,” or LRE) includes the focus on provision for safe transportation for each student.

B. The Individualized Education Program (IEP)

The IEP is a written statement of services a student is to receive. With respect to transportation, this information should contain necessary specificity so that transportation professionals, school personnel, parent and student know what services to expect.

Generally, modification of the IEP requires an IEP meeting. When change in transportation provisions is deemed necessary, transportation services personnel should contact the student’s case manager or other appropriate staff member. Such contact should also occur when transportation services personnel find they need more information or assistance from team members or if they find the program to be in any way unsafe or not meeting the student’s needs.

## **GUIDELINES**

The following guidelines are intended to assist in establishing a training program for administrative and school-based personnel enabling them to respond to the concerns presented by students with disabilities, as required by IDEA. The goal of such a training program is to teach the skills needed to respond to routine and emergency circumstances concerning transportation.

A. School/Education Administration

School administrators and education staff who help make program decisions for students with disabilities, including the requirement for transportation as a related service, are frequently unfamiliar with transportation capabilities and limits.

Those persons should have training in areas that include, but are not limited to, the following:

1. Situations under which transportation staff would be consulted, or included in the IEP Team process;
2. State and local transportation policies and procedures, including communications, reporting procedures, establishment of walk distances and pick-up and drop-off locations;
3. Transportation regulations and guidelines that could assist in determining if transportation would be appropriate as a related service;
4. Alternative transportation options;
5. Current legislative, legal and administrative decisions;
6. The application of least restrictive environment regulations to transportation placements;
7. The extent of training and skill levels available within the transportation staff and any additional training necessary to meet standards for qualified staff, as defined by local, state and federal standards;
8. The types of vehicles available for transporting students with disabilities;
9. The types of equipment and occupant securement systems available; and
10. Do Not Resuscitate (DNR) policies for local school districts, as well as current legislative and administrative decisions concerning this topic.

B. Transportation Administration

With increased responsibility being imposed on transportation providers through actions taken by legislative, legal and administrative authorities, persons in leadership roles must involve themselves to a greater degree.

The duties and responsibilities of transportation leadership likely will differ between various transportation providers; however, listed below are some areas of knowledge that are necessary to satisfactorily perform the leadership responsibilities.

1. Federal, state and local laws and regulations regarding the equipment required on vehicles used for transporting students with disabilities;

2. Federal, state and local laws and regulations regarding necessary personnel and training;
3. Operational regulations, such as student pick-up/drop-off, including service criteria requiring neighborhood bus stop, curb-to-school or door-to-school;
4. Special education transportation regulations and guidelines, such as student riding time and suspension period limitations;
5. Due-process rights and procedures for a student with disabilities;
6. Student referral, evaluation and IEP process;
7. A general knowledge of available resource persons and the location and availability of appropriate training;
8. Vehicle staffing requirements, including when an attendant might be needed, how and when substitutes will be assigned and how appropriate information and training will be shared with substitutes;
9. The availability of emergency medical services in the community and the identity of those who could assist if such an emergency were to occur during transportation;
10. State and local laws relating to child abuse and harassment/bullying reporting procedures;
11. State or local laws relating to limits of liability and policies and procedures for risk management;
12. Federal and state rules of confidentiality; and
13. Legislative and administrative decisions and procedures concerning DNR.

C. Drivers and Attendants

As direct service providers to students with disabilities, drivers and attendants have a hands-on responsibility to provide safe and appropriate transportation to students with disabilities, including operation of special equipment, management of student behavior and basic first aid, as necessary. Additionally, they must be knowledgeable in passenger-positioning, securing adaptive and assistive devices and child safety restraint systems (CSRSs) and must be familiar with the nature, needs and characteristics of the types of students they transport.

D. Training components

To perform the responsibilities assigned in a safe and effective manner requires a substantial degree of specific training. Some training components that transportation staff must have are the following:

1. Introduction to special education, including characteristics of disabling conditions, the student referral, assessment, IEP process and confidentiality of student information;
2. Legal issues, including federal and state laws, administrative rules and local policy;
3. Operational policies and procedures, including:
  - a. Pre-trip and post-trip inspection procedures for all assistive equipment and devices, CSRSs, securement systems and safety equipment.
  - b. Loading/unloading;

**Note:** During loading and unloading, the driver should remain in the driver's seat to observe traffic flow and the overall safety of the school bus relative to highway and surrounding activity unless it is necessary for the driver to leave this position to assist with the loading or unloading of students. The driver must secure the bus before leaving the driver's seat. [See item (3) below.]

- c. Securing the bus:
  - (1) Engage the emergency brake;
  - (2) Place the vehicle transmission in "neutral" or "park"; and
  - (3) Activate the side stop arm and traffic control lights when allowable by state law;
- d. Pick-up/drop-off location;
- e. Evacuation procedures, including the use of emergency equipment, such as webbing cutter(s), fire blanket(s), evacuation aids etc.;
- f. Lifting/positioning procedures/body mechanics;

- g. Student accountability and observation, including recognizing signs of neglect or abuse;
- h. Post-trip vehicle interior inspections for students or articles left in the bus prior to parking;
- i. Reporting and record-keeping;
- j. Lines of responsibility relative to individuals' roles as educational team members;
- k. Lines of communication, including parents and educational staff;
- l. Route hazard analysis and route management, including medical emergencies, no adult at home, inclement weather, field trips, etc.;
- m. Behavior management:
  - (1) Techniques for behavior modification and the development of appropriate behavior;
  - (2) Procedures and techniques for dealing with inappropriate or unacceptable student behavior that creates emergency conditions or poses a risk to health and safety, including possession and transportation of weapons, drugs, etc., and awareness of gang activities, harassment/bullying and/or other inappropriate behaviors;
  - (3) Procedures for documenting and reporting inappropriate or unacceptable student behavior; and
  - (4) Intervention strategies and techniques and emergency response procedures for use with individual students as outlined in their respective IEP and ITP;
- n. Blood borne pathogens and universal precaution procedures, including use of personal protective equipment;
- o. Policies and procedures that ensure confidentiality of personal identifying information; and
- p. Basic First Aid, CPR and proper medical support equipment usage as students' conditions require.

## E. Special Equipment Securement, Use and Operation

A variety of equipment is required on vehicles used to transport students with special needs. It is necessary for transportation staff to be familiar with the design and operating procedures for this special equipment, as well as to know how to conduct equipment inspection and (depending on local policy) to make simple “field adjustments” to correct minor equipment breakdowns or malfunctions. It is the driver’s responsibility to assure that all assistive and safety-related equipment on the bus is inspected prior to and following each trip as part of an overall vehicle pre-trip and post-trip inspection protocol. Defects or missing equipment must be documented and reported immediately to the transportation or maintenance office in writing or electronically in a standard inspection format. All safety- and operations-related defects must be repaired and missing equipment replaced prior to operating the school bus to transport students. Depending on local policy and training, an attendant may assist the driver with the actual inspection process.

Equipment and procedures include, but are not limited to, the following examples:

### 1. Power lifts, including procedures for manual operation

- a. During lift operations (including manual) no one shall be allowed to stand on the lift platform.

**Note:** Children using mobility aids/devices other than a wheelchair or equivalent (resulting in other than a seated position) who need to use the lift, should use a wheelchair or other wheel-based mobility device for boarding or exiting the bus, and then should be transferred to a bus seat for the ride. If the wheelchair is to be transported, it must be secured properly.

- b. Wheelchairs or other wheel-based mobility devices should not be placed on the lift unless they are equipped with a functional wheel-locking system. Powered/motorized wheel chairs must have the power switched to “off” and the motor locks engaged before the lift is activated to raise or lower the chair.

**Note:** Always adhere to state-specific requirements.

- c. Mobility device placement on the lift platform is outward, facing away from the side of the bus, with wheels locked and/or motor locks activated. Platform safety straps, if provided, must be properly secured before the lift platform is raised or lowered. Mobility device occupant positioning belts/harness must be properly worn by the occupant. The lift is operated by a trained adult standing outside the bus at ground level, adjacent to the lift



platform. A second adult should be positioned inside the bus to either unload or load the wheel chair (and occupant) from or onto the lift platform at the passenger compartment level. Subject to local policy and resolution of potential liability issues, parents, guardians or other persons authorized and trained by the local school administration may assist with the loading or unloading of students.

2. Emergency escape exits, including doors, windows and roof hatches;

**Note:** The width of aisles and emergency exits may limit the evacuation and emergency response procedures possible in any given scenario. The evacuation planning process and training provided must include strategies to offset these limiting factors.

3. Special fire suppression systems, including emergency fire blanket and evacuation aid;
4. Power cut-off switches;
5. Emergency communications systems;
6. Climate-control;
7. Adaptive and assistive devices used to support and secure students, including mobile seating devices, child safety restraint systems (CSRSs), safety vests, wheelchair tie down/occupant restraint systems (WTORS), assistive technology devices, trays and securement hardware, including their storage and securement when not in use;
9. Two-way electronic voice communication THAT CAN BE USED AT ANY POINT IN THE VEHICLE'S ROUTE should be provided in all school buses equipped, as well as used, to transport passengers with disabilities and special health care needs;
10. Service animals that can be transported to assist the student with disabilities.

**Note:** District policies and procedures, as well as training, should be established prior to transport.

11. All portable equipment and special accessory items, including the equipment listed in the SPECIALLY EQUIPPED BUS SPECIFICATIONS Section shall be secured at the mounting location to withstand a pulling force of five times the weight of the item or shall be retained in an enclosed, latched compartment. The compartment shall be

capable of withstanding forces applied to its interior equal to five times the weight of its contents without failure of the box's integrity and securement to the bus.

**Exception:** If these specifications provide specific requirements for securement of a particular type of equipment (e.g., wheelchairs), the specific specification shall prevail.

#### F. Selecting Securement Points on Wheelchairs

Decision-making should be a TEAM effort, not an individual's responsibility. Information on wheelchairs, to include WC19-compliant chairs, shall be made available to transportation personnel. Always consult school staff or a qualified professional.

1. Wheelchairs should be transported in a forward-facing orientation.
2. Securement systems for wheelchairs should be used in accordance with the manufacturer's specifications and recommendations and should include an occupant restraint of a minimum of a lap/shoulder belt and a 4-point wheelchair tie down (Refer to the SPECIALLY EQUIPPED SCHOOL BUS SPECIFICATIONS section.)
3. Wheelchairs designed for transportation safety have securement points called "transit options," which will be labeled appropriately. The manufacturer's designated securement point shall be used. (Refer to APPENDIX E for guidelines on WC19 from the Ride Safe information provided by ANSI/RESNA, University of Michigan transportation Research Institute [UMTRI].)
4. On wheelchairs without the transit options, points are frequently located just below the wheelchair's seat on non-detachable structural frame members. In addition, the following beneficial criteria should be taken into account:
  - a. Welded sites are preferred; but
  - b. Frame members held together with hardened bolts are acceptable.
5. Rear tiedown straps should be anchored directly behind the securement points on the wheelchair, with the front straps angled slightly outward to increase stability.
6. The lap portion of the occupant restraint system should be threaded through the space between the armrest and the seating frame to achieve

proper placement low over the hip bones of the occupant. The lap belt should never be placed over the armrest or with the belt assembly twisted. When optimally placed, the belt's webbing's bottom edge should be touching the occupant's thighs. When looking at the lap belt's path to the floor from the side of the chair, the belt should be angled between 45 and 75 degrees to the horizontal. When using an integrated system (in which the occupant restraint is attached to the rear tiedowns of the wheelchair securement system), the rear wheel chair securement site must be selected with this in mind. Whether using an integrated or a parallel system (in which occupant restraint belts are separate of tiedown belts), at no time should the occupant ever carry the load of the wheelchair or its tiedown system. The occupant must be secured separate of the wheelchair and its tiedowns.

7. Proper positioning for the shoulder restraint is over the shoulder and across the upper chest or torso of the occupant when connecting it to the lap belt. The shoulder belt shall not be placed across the neck of the occupant. A height adjuster may be required to achieve appropriate belt position for the torso portion of the occupant restraint.
8. On a tilt-in-space wheelchair, the four sites must be either on the base of the wheel chair or on the seat/frame portion of the chair. For example, it is not effective to have the front hooks on the base of the chair and the rear hooks on the seat/frame portion of the chair since that combination would create a "teetertotter" effect. (This warning does not apply to wheelchairs that meet WC19 specifications.)

**Note:** With advances in wheelchair manufacturing design and specifications, verify manufacturer's instructions and/or recommendations for maximum attachment strength.

9. Wheelchair securements must **not** be attached to the crossbar, since this may cause the wheelchair to collapse.
10. Some wheelchair manufacturers make an add-on bracket that can be used as an alternative tie down site for some wheelchairs. Homemade brackets are never acceptable. Securement and restraint systems installed to secure wheelchair/mobility aids and to restrain the occupants should be used all together and in accordance with the manufacturer's recommendations.
11. Immediately after their use, all securement hardware not permanently affixed to vehicle floors and sidewalls (tracks, plates) should be detached and stored in a bag, box or other compartment.
12. Wheelchair tracks or plates should be swept, vacuumed or otherwise cleaned as needed to keep the equipment functional.

F. Medical/Health Issues:

Legal mandates make it necessary to transport most students who have severe medical/health conditions, and transportation staff may find it necessary to obtain or provide emergency health care to students during the transportation process. Staff may be exposed to contagious and/or communicable diseases; therefore, training regarding medical health issues, including universal precautions, intervention and management, should be given to all personnel.

1. Precautionary handling

All transportation staff, including drivers, attendants, technicians and service personnel (e.g., washing and cleaning staff) should be trained in universal precautions relative to the handling of and exposure to contagious and communicable disease, and they should be informed about available immunizations.

Suggested topics for training with respect to the precautionary approach to medical and health issues may include, but also not limited to, the following topics:

- a. Characteristics of contagious and communicable diseases;
- b. Disease management techniques; and
- c. Use of protective equipment and devices.

2. Care, intervention and management

Medically complex, technology-dependent and/or highly disruptive students require specific care and intervention. Knowledge of basic first aid and cardiopulmonary resuscitation (CPR) procedures provides adequate training to care for most health concerns during transportation. For those students who need additional care, management or intervention, or who present specific health risks, a health care plan shall be developed during the assessment/evaluation process by the IEP Team. This plan details the care and training needed, as well as the qualifications necessary for those who will carry out the plan, and specifies and provides the transportation department with the following information:

- a. A brief description of the student's current medical, health or behavioral status, as well as an emergency card including the student's photo (when available) with current information that shall include address, emergency phone numbers, etc.;

- b. A description of the medical/health care or intervention necessary during transportation, including the frequency required;
- c. A description of who should provide the care or intervention;
- d. Types and extent of additional training or skills necessary for the driver and/or attendant;

**Note:** Training may include the inspection, operation and use and care of the student's special adaptive/assistive equipment, including items such as oxygen containment systems, suctioning equipment, apnea monitors, ventilation equipment, etc.

- e. A description of emergency procedures to be implemented during a medical/health crisis, including specific observable signs/symptoms that prompt action, and appropriate communication with medical staff;
- f. A description of the procedures to be followed in changing the care plan when conditions indicate a change is warranted;
- g. A written emergency evacuation plan that gives detailed, student-specific procedures; and
- h. A description of the precautionary measures, if any, that need to be taken in regard to severe allergies, oxygen dependency, etc.

**Note:** Although it is recommended that drivers and/or attendants provide only routine/customary, non-medical assistance as needed, there are some necessary tasks which non-medical personnel can be trained to handle. However, those issues that require either ongoing care or diagnosis should be handled only by a trained medical professional. Specialized training, when necessary, should be provided.

## **CONFIDENTIALITY**

Information provided to transportation staff to assist in the orderly and safe transportation of a student, including disabling condition, medical/health issues, or other personal characteristics or information, is protected by the provisions of the Family Educational Rights and Privacy Act (FERPA) and the IDEA; therefore, and transportation staff shall be trained regarding confidentiality requirements.

## DEVELOPMENT

In education, there are many laws, rules and regulations that dictate the service that *must* be provided, but few of them offer directions or suggestions as to *how* the service is to be provided. Transportation policies and procedures should be developed, adopted by the governing board or superintendent, as appropriate, and periodically updated to reflect changes in federal, state and local regulations. Despite such policies and procedures, an individual student's IEP or Section 504 plan or a behavioral intervention plan (BIP) may override specific provisions.

- A. Local policies and procedures should address the following issues:
1. Transporting medications;
  2. Student management and discipline;
  3. Physical intervention and management;
  4. Securing the vehicle, loading and unloading;
  5. Safety vests and other positioning devices;
  6. A plan for students with disabilities during early closing of school due to inclement weather or other emergencies;
  7. Authority to operate special equipment (driver, attendant, parent, students, school staff or others);
  8. A plan to address occasions when no adult is home to receive a student who requires assistance and/or supervision, which plan may include an alternative, supervised drop-off location;
  9. A plan to remove from service those pieces of specially designed equipment that are damaged or that present a safety hazard;
  10. A plan to address insufficient information in the student referral process;
  11. Student pick-up and drop-off locations;
  12. Control and management of confidential information;
  13. A plan for community emergency medical and law enforcement personnel involvement; and

14. District policy for Do Not Resuscitate (DNR) requests from parents, to include all appropriate school and transportation personnel.

**Note:** Classroom and school bus policies may differ; however, drivers and attendants should adhere to transportation policies.

## B. Policy Approval

All policies shall be in writing, and formally approved by the appropriate education authority. Procedures shall include establishing time lines for periodic reviews or revisions.

## **EMERGENCY EVACUATION OF STUDENTS WITH DISABILITIES**

Each bus route should have a written emergency evacuation plan. This plan should reflect each student's ability to evacuate or help others. Students with disabilities should participate in required evacuation drills and should only be excluded if their participation would present a health risk. Parents should be notified in advance of such barriers to their child's participation. Every effort should be made to ensure that ALL students have a reasonable understanding of the concept of an emergency.

The driver and the attendant must be familiar with any equipment in the bus that would aid in an actual evacuation, (e.g., the use of all emergency exits, emergency/fire blankets, webbing cutters, etc.). It is important to enlist the help of school liaisons, parents and other personnel (e.g., physical therapists) to train and help students understand emergency procedures. Local emergency personnel should be involved in developing the plans, especially if the students transported have complex medical conditions.

## **EXTENDED SCHOOL YEAR**

Transportation as a related service may be required under Extended School Year provisions of IDEA:

### A. Extended School Year (§300.106) IDEA Definition:

1. The term *extended school year services* means "special education and related services that are provided to a child with a disability...
  - a. Beyond the normal school year of the public agency;
  - b. In accordance with the child's IEP; and
  - c. At no cost to the parents of the child and that meet the standards of the State Education Agency (SEA)."

2. Each public agency shall ensure that extended school year services are available, as necessary to provide Free Appropriate Public Education (FAPE).

B. OH Subpart C - 6

1. Extended school year services must be provided only if a child's IEP team determines on an individual basis and in accordance with the IEP provisions that the services are necessary for the provision of FAPE to the child.
2. In implementing these requirements, a public agency may not...
  - a. Limit extended school year services to particular categories of disabilities; or
  - b. Unilaterally limit the type, amount or duration of those services.

[Back to Contents](#)



**Page Intentionally Left Blank**

**TRANSPORTATION  
FOR INFANTS,  
TODDLERS AND  
PRE-SCHOOL  
CHILDREN**

**Page Intentionally Left Blank**

# INFANTS, TODDLERS AND PRE-SCHOOL CHILDREN

## INTRODUCTION

Infants, toddlers and pre-school children are the youngest, most vulnerable passengers on school buses. They depend on transportation personnel to provide a safe ride to and from early intervention, Head Start programs and Teen Parent Programs. Transportation is a critical component for children and their families, accessing services to support a child's growth and development. Transportation should be established as the mutual responsibility of parents, transportation and service-providers.

Programs supported and funded by federal, state and local governments have made great strides in developing, designing and providing services for young children and their families to develop each child's full potential. The school bus, for many children, is the primary vehicle that provides access to programs and services designed to meet individual needs of young children and families.

Transportation providers need to be knowledgeable and to develop skills to provide for the safety of young children while being transported in school buses. Infants, toddlers and pre-school children, in addition to those young children with special physical, cognitive or behavioral needs, present new challenges and responsibilities for transportation providers. These children require a great deal of supervision during the time they are in and around the school bus. Some issues that must be addressed to assure safe transportation in the school bus include physical handling, communication with young children, behavior management, knowledge of child safety restraint systems (CSRSs), wheelchair tiedown and occupant restraint systems, special equipment management, medically fragile and complex conditions, confidentiality, length of ride, personnel training and parental responsibilities.

Children under the age of five who reside in rural, suburban and urban areas are daily passengers in school buses. Since the exact number of children under the age of five riding in school buses is unknown, uniform transportation data on this population should be collected. This population includes children served in several programs for children from birth through age five. These programs include the Early Intervention Programs for Infants and Toddlers With Disabilities (Part C, Individuals with Disabilities Education Act), the Pre-schools Grant Program, the Early Education Program for Children with Disabilities, Head Start, Bureau of Indian Affairs Programs and Teen Parent programs. In addition, federal programs support a number of discretionary projects that are designed to promote services for young children with disabilities and their families.

Due to the numbers of young children under the age of five who are transported in school buses, it is essential to recommend guidelines for the use of child safety seats, occupant child safety restraint systems and securement systems. The purpose of this section is to assist transportation personnel by recommending policies, procedures and guidelines, while simultaneously recognizing the need for continued research studies to meet the needs of young children from birth to age five who ride school buses nationwide. (Refer to APPENDIX F for listings of laws and characteristics of disabilities.)

## **TRANSPORTATION SERVICES FOR INFANTS AND TODDLERS WITH DISABILITIES**

The Individualized Family Service Plan (IFSP), under Part C of the Individuals with Disabilities Education Act (IDEA), is the mechanism for addressing the unique needs of infants and toddlers with disabilities and their families. The IFSP process has two main parts: (1) the IFSP meeting, where parents and interagency personnel jointly make decisions about an eligible child's early intervention services; and (2) the IFSP document, itself, which is a written plan for the provision of early intervention services for the child and family.

The decision to provide the early intervention service of transportation is made on a case-by-case basis and is directly related to the need for this service. Given the significance of the IFSP process, there are numerous requirements concerning the IFSP document. The decision for a transportation representative to attend the IFSP meeting should be made on a case-by-case basis when a school bus is considered as the appropriate vehicle for transporting an infant or toddler to and from a program location. This decision should be based on the individual needs of the child and family, as well as the service provider. The transportation representative should be a member of the IFSP team whenever the unique needs of an individual child require specialized service beyond the scope of what is traditionally provided. The involvement of transportation personnel should occur as soon as it is known that a child with a specialized need requires transportation on a school bus.

## **TRANSPORTATION SERVICES FOR PRE-SCHOOL CHILDREN WITH DISABILITIES**

Pre-school children who ride school buses include children with and without disabilities. All pre-school children require careful planning when a school bus is selected as the mode of transportation to and from a state or local government early intervention program, special education, Head Start or Early Head Start program. These programs may have significantly different requirements governing transportation, and the transportation requirements should be reviewed carefully.

If a child is eligible for special education and the related service transportation under Part B of IDEA, the mechanism for addressing transportation services is the Individualized Education Program (IEP). The IEP process has two main parts: (1) the IEP meeting(s), when parents and school personnel jointly make decisions about a child's special educational program; and (2) the IEP itself, which is a written record of the decisions agreed upon at the IEP meeting. The IEP document is a written commitment and management tool for the school district. The IEP defines resources and services to be provided to the student at no cost to the parents, and it states when and for how long these services will be provided. As such, the IEP becomes the tool to monitor compliance.

The "1997 IDEA Amendments" require that a public agency provide transportation to a pre-school age child as a related service to the site at which the public agency provides

special education and related services to the child, if that site is different from the site at which the child receives other pre-school or day care services.

One of the major differences between the IFSP services and IEP is that the early intervention program under Part C for infants and toddlers is a year-round program, whereas special education services under Part B represent a school-year program, unless otherwise specified by the IEP Committee.

The decision for transportation personnel to attend IFSP and IEP meetings should be made on a case-by-case basis. This decision should be based on the individual needs of the child and family and the need for transportation personnel to provide this service safely. Transporting young children requires careful planning prior to initiating transportation services in school buses. Due to the ages of these children, the type of service required and frequency and duration of transportation must be determined on a case-by-case basis.

Prior to initiation of service, the following questions and concerns should be addressed:

- A. Is the child medically stable to be transported? (This decision should be made in conjunction with a physician or school nurse whenever the question arises.)
- B. What is the length of the ride? Does the length of ride place the child at risk based upon the child's age, developmental and functional level and environmental factors, such as weather and temperature in the bus? (This decision should be made in conjunction with a physician or school nurse whenever the question arises.)
- C. Which physical, cognitive, communicative, social-emotional and behavioral concerns should be addressed prior to initiating transportation services? (Each of these areas should be addressed by qualified personnel.)
- D. Which assistive or adaptive devices are necessary to accommodate the special needs of a child during the provision of transportation services? (This should be addressed by qualified personnel.)
- E. What type of supervision is necessary to assure safe transportation? What parental responsibilities are to be addressed on the IFSP or IEP documents? (These decisions should be made by the full IFSP or IEP Committee.)
- F. When a child is medically fragile and requires special handling, who is responsible for emergency procedures? Who is responsible for monitoring universal precautions in the school bus if it is known that a child has an infectious disease that requires special precautions? (This decision should be made by the full IFSP or IEP Committee.)

- G. If a child is provided with a private-duty nurse (non-IEP), how are the services addressed on an IEP? It is recommended that authorized transportation and special education and early intervention personnel committed to special services converse prior to the IFSP or IEP team meeting? The mechanism for decision-making for all special services is the IFSP or IEP process for children receiving services under IDEA.
- H. What transportation equipment or equipment modification is required to accommodate the child's special needs and safety? (This decision should be made by the full IFSP or IEP Committee.)

## **HEAD START**

Head Start programs are required to provide special services for three- through five-year-old children with disabilities. Head Start programs are required to have a “Disabilities Coordinator” who is responsible for developing a disabilities service plan that provides for the special needs of children with disabilities and their parents. This plan must specify those services to be provided directly by Head Start and those that are provided by other agencies. Transportation is one of the related services addressed under 1308.4(o)(5).

The Department of Health and Human Services, Administration on Children, Youth and Families (ACYF), Administration for Children and Families (ACF) issued 45 CFR 1310 Head Start Program, Final Rule on January 18, 2001 (Volume 66, Federal Register Number 12). This final rule implements the statutory provision for establishing requirements for the safety features and safe operation of vehicles used by Head Start agencies to transport children participating in Head Start programs. The reference to obtain this final rule is listed in APPENDIX F.

Additional information is available from The Department of Health and Human Services, Administration on Children, Youth and Families (ACYF), Administration for Children and Families (ACF), issued January 16, 2004; 45 CFR 1310 Head Start Program [Federal Register: January 16, 2004 (Volume 69, Number 11)]. The reference to obtain this rule is listed in APPENDIX F.

Transportation is a related service to be provided to children with disabilities. When transportation to the program site and to special services can be accessed from other agencies, it should be used. When it is not available, program funds are to be used. Use of taxis is an allowable expense if there are no alternatives available and transportation is necessary to enable a child to be served.

## **GUIDELINES FOR INFANTS, TODDLERS AND PRE-SCHOOL CHILDREN**

The following guidelines are designed specifically to assist with transportation decision-making for infants, toddlers and pre-school children, including training drivers and attendants who transport infants, toddlers and preschool children.

## A. Administrator's Role

The transportation supervisor (or designee) should be responsible for the supervision of transportation services for infants, toddlers and pre-school children. It is essential that this individual be knowledgeable about the unique needs of children in this age group.

Transportation personnel responsible for the daily transportation of young children should receive appropriate training from professionals qualified to make decisions regarding child safety, seating, communication, physical handling, health and medical needs and other special circumstances, based on a curriculum developed by The National Highway Traffic Safety Administration (NHTSA) and The National Safe Kids Coalition which certifies child passenger safety technicians. The child passenger safety technician training is sponsored by a variety of organizations, including law enforcement, hospitals, public health, insurance companies, etc.

Each school district should have policies and procedures in place regarding the transportation of children from birth to age five. The policies and procedures should specify when it is required that the transportation supervisor or a designee attends IFSP, IEP or Head Start meetings. Transportation of children with special needs should be addressed on the IFSP or IEP when this service is provided.

The transportation supervisor or designee should be responsible for the following activities:

1. Selecting vehicles used for infants, toddlers and pre-school children;
2. Selecting equipment and CSRSs specific to the transportation of infants, toddlers, and pre-school children;
3. Disseminating information about "parents' responsibilities" in their native language, whenever possible;
4. Providing information about appropriate practices when transporting young children with special needs, including confidentiality of information;
5. Establishing emergency policies and procedures, including practicing evacuation drills;
6. Establishing staffing requirements;
7. Assuring that transportation decisions for a child are made on a case-by-case basis and are appropriate to meet individual needs of a child in accordance with what is recorded on a child's IFSP or IEP; and



8. Dissemination of pertinent student medical and behavioral information to support the school bus ride to and from school, including emergency information.

B. School Bus Drivers

The driver must be knowledgeable about his responsibility for each child in the school bus. This includes safely operating the school bus and supervising the safety of all young passengers. These recommendations should be followed with or without the presence of a bus attendant. In addition to their regular duties, the drivers shall have knowledge and responsibility for the following:

1. General knowledge about the development of young children, including specific disability conditions;
2. Age-appropriate physical handling, communication and behavior management of young children;
3. Appropriate use of all the equipment (e.g., power lifts, child safety restraint systems, wheelchair tie down and occupant restraint systems);
4. Loading and unloading of children who are ambulatory or non-ambulatory;
5. Evacuation and evacuation drills, including practicing evacuation drills;
6. Transportation requirements on a child's IFSP or IEP, including confidentiality;
7. Special needs in the vehicle [e.g., apnea, asthma or other respiratory conditions, life-threatening allergies and their potential triggers, assistive devices, communicable diseases, gastrostomy tubes, oxygen, technological dependence, shunts, trachostomy tubes, medical devices, medically complex and fragile conditions, uncontrollable seizure disorders and "Do Not Resuscitate" (DNR) orders];
8. Child protection laws (e.g., abuse and neglect); and
9. Effective communication skills with school staff, students, parents, law enforcement officials and the motoring public.

### C. Bus Attendants (Rides or Monitors)

The bus attendant should assume primary responsibility for the supervision and safety of children in the school bus during its operation. Bus attendants should be knowledgeable and well-informed about infant, toddler and pre-school child development for both children with and without special needs. Attendants should be knowledgeable about the following:

1. The cognitive, communication, physical, social-emotional, behavioral development and functional level of young children, including the unique needs of specific children in relationship to their disabilities;
2. Using age-appropriate physical handling, communication and behavior management of young children;
3. Appropriate use of equipment in the school bus (e.g., power lifts; child safety restraint systems, such as child safety seats, safety vests and integrated seats; related securement systems, including vest mounting and safety belts; wheelchairs and wheelchair tiedowns and occupant restraint systems);
4. Loading and unloading of children who are ambulatory or non-ambulatory;
5. Evacuation and evacuation drills, including practicing evacuation drills;
6. Transportation requirements on the IFSP or IEP, including confidentiality;
7. Special needs in the vehicle [e.g., apnea, asthma or other respiratory conditions, life threatening allergies, and their potential triggers, assistive devices, communicable diseases, gastrostomy tubes, shunts, oxygen, technological dependence, tracheostomy tubes, medical devices, medically complex and fragile conditions, uncontrollable seizure disorders and “Do Not Resuscitate” (DNR) orders];
8. Child protection laws (e.g., abuse and neglect); and
9. Communicating effectively with school staff, students, parents, law enforcement officials and the motoring public.

### D. Training

It is essential that all transportation personnel responsible for infants, toddlers and pre-school children receive training, which should include the following guidelines:

1. Training should be conducted by staff knowledgeable about the needs of young children who must be transported. Staff may include child passenger safety technicians, child development specialists, representatives of manufacturers of specialized equipment, nurses, occupational therapists, physical therapists, psychologists, respiratory therapists, special educators, transportation supervisors and other personnel, depending on the unique needs of the individuals being transported.
2. Training should take place both in a classroom and in the school bus.
3. There should be a checklist for the purpose of recording specific skills that have been mastered.
4. It is essential that all first aid training be specifically designed for infants, toddlers and pre-school children.
5. All personnel transporting young children should be required to have a first aid course. On-going training should be conducted by certified personnel in their respective areas of expertise. The type of training provided should be directly related to the specific special services that the driver and attendant are required to provide, including developmental-appropriate practices. At a minimum, drivers and attendants should be able to operate any special equipment for which they are responsible, know how to manage infants, toddlers and pre-school children, be capable of implementing an IFSP- or IEP-approved health care service in accordance with state law and be trained about use and securement of adaptive and assistive devices.

Comprehensive training for transportation personnel providing daily services should include the following topics to support safe and appropriate transportation services for this young population and their families:

- a. Assistive-device management;
- b. Child Safety Restraint Systems (CSRSs);
- c. Communicable disease management practices;
- d. Communication (supervisors, school personnel, and parents);
- e. Confidentiality;
- f. Emergencies;

- g. Emergency evacuation drills, including practicing evacuation drills;
- h. Emergency information management requirements;
- i. Equipment;
- j. Federal and state regulations;
- k. General characteristics of children with disabilities impacting the school bus ride;
- l. Individualized Education Programs (IEPs);
- m. Individualized Family Service Plans (IFSPs);
- n. Loading and unloading;
- o. Medically fragile children;
- p. Medicine transport;
- q. Pick-up and drop-off, including provisions addressing when an authorized adult is not at the scheduled drop-off;
- r. Reports;
- s. Required record-keeping;
- t. Specialized communication;
- u. Special medical conditions;
- v. Technology-dependent conditions;
- w. Development of infants, toddlers and pre-school children with developmental delays and disabilities;
- x. Universal precautions;
- y. Use of webbing cutters;
- z. Vehicle selection;
  - aa. Proper use of wheelchair tiedown and occupant restraint system (WTORS); and

bb. Best practices in wheelchair transportation safety.

E. Equipment

Great strides have been made in the type of equipment used to assist infants, toddlers and pre-school children with special needs. These children present multiple challenges to providers of transportation. The school bus vehicle is significant because it is the mechanism for transporting young children who have special needs to and from support and development programs. To assure child passenger safety in the school bus, transportation personnel will need training to work with infants, toddlers and pre-school children who use a variety of equipment. Challenges relating to proper use and installation of Child Safety Restraint Systems (CSRSs), including car seats, arise. Many of these challenges are addressed in NHTSA's "Guideline for the Safe Transportation of Pre-school Age Children in School Buses" (February 1999).

**Note:** Refer to "Proper Use of Child Safety Restraint Systems in School Buses" <http://www.nhtsa.dot.gov/people/injury/buses/buseatbelt/index.html>.

Infants, toddlers and pre-school children with special needs present a challenge for transportation personnel because school buses were not designed to transport young children as passengers.

Each pre-school age school bus passenger should use a child safety restraint system appropriate for the child's age, weight, height and specialized needs, as determined by the IEP or IFSP team.

**Note:** The following standards are applicable to this section.

FMVSS No. 208	Occupant Protection
FMVSS No. 209	Seat Belt Assemblies
FMVSS No. 210	Seat Belt Assembly Anchorages
FMVSS No. 213	Child Restraint Systems
FMVSS No. 217	Bus Emergency Exits and Window Retention Release
FMVSS No. 222	School Bus Passenger Seating and Crash Protection
FMVSS No. 225	Uniform Child Restraint Anchorages

All CSRSs used in the school bus must...

1. Meet requirements of FMVSS No. 213;
2. Be installed and used according to the manufacturer's instructions;
3. Not be under a recall that recommends non-use of the CSRS;
4. Have all parts intact and in working order;

5. Be secured to a vehicle seat with a safety belt that meets FMVSS No. 209 or anchorages to meet FMVSS No. 225 or FMVSS No. 210; and
6. Use safety belts or latch systems that are installed only on bus seats that meet FMVSS No. 210.

F. Child Safety Restraint Systems (CSRSs)

CSRSs used in school buses must be appropriate for the individual child and must be used correctly. All of the restraint systems used for transportation must be secured to the bus seat in the manner prescribed and approved by both the school bus and CSRS manufacturer.

1. Elements of Correct Installation of CSRSs

It is recognized that compartmentalization, the passive safety restraint system required in school buses under FMVSS No. 222, provides a higher level of safety to children over 40 pounds. Children diagnosed with medical complexities or fragility might require special securement or positioning systems.

a. Direction

Position (rear- or forward-facing) and adjust recline angle accordingly. Some rear-facing seats are designed for rear-facing only and may not be used in a forward-facing position. (Check manufacturer's instructions.)

b. Belt Paths and Harness Strap Location

Use the correct belt path and harness strap slots on the CSRS as directed by the manufacturer's instructions.

**(Note:** Heavy coats should be removed to ensure a tighter fit.)

c. Installation

To achieve tight installation, place hand on and push down in the CSRS to compress the bus seat cushion. With the buckle(s) engaged, pull the loose end of the seat belt(s) to tighten and lock the safety belt. The CSRS should not move more than one inch forward or side-to-side when tested by grasping the seat at the belt path.

2. Types of Restraints

a. Rear-facing CSRS (infant-only)

- (1) These seats are designed for infants from birth to twenty or twenty-two pounds (manufacturer's instructions) and who usually are less than 26 inches in length. These seats are used in rear-facing position at a 45 degree recline, which provides support to the infant's head, neck and back.
- (2) Harness straps must be at or below the infant's shoulders and must be snug. A snug strap should not allow any slack, should lie in a relatively straight line without sagging and should not press on the child's flesh or push the child's body into an unnatural position. When properly fitted, harness strap material should not be able to be pinched between thumb and forefinger. The harness retainer clip, which is designed to hold the harness straps in place, should always be placed at armpit level.
- (3) Avoid any extra padding or blankets behind or beneath the infant.

b. Convertible CSRS (Rear-Facing)

- (1) Rear-facing infant position is designed for children from birth to twenty pounds, one year of age (manufacturer's instructions), weighing up to twenty pounds and usually less than 26 inches in length. Many CSRSs are now available to accommodate larger children (30 to 35 lbs.) in the rear-facing position.

**Note:** See manufacturer's guidelines for weight and height restrictions. It is recommended that children ride rear-facing as long as recommended or allowed by the CSRS manufacturer.

- (2) The rear-facing position at a 45 degree recline supports the infant's head, neck and back.
- (3) The harness straps must be at or below the infant's shoulders.
  - (a) Harness straps must be snug. A snug strap should not allow any slack, should lie in a relatively straight line without sagging and should not press on the child's flesh or push the child's body into an unnatural position. When properly fitted, harness

strap material should not be able to be pinched between the thumb and forefinger.

- (b) The harness retainer clip, which is designed to hold the harness straps in place, is always at armpit level.
- (4) Do not use any extra padding or blankets behind or beneath the infant.
- (5) Avoid the use of a T-shield or tray shield with infants or young children with eyeglasses, feeding tubes, shunts or other medical devices that may come in contact with the shield. Avoid use of CSRSs with a shield with children who, due to their stature, may not fit into the seat snugly or may make contact with the shield with their face or neck.

c. Convertible CSRSs (Forward-Facing)

- (1) Forward-facing CSRSs with five-point harness, T-Shield or tray-shield are designed for children above twenty to sixty pounds. (Rear-facing position should be maintained for as long as recommended or advised by the manufacturer.) Some forward-facing-only seats are available to accommodate larger children.
- (2) All forward-facing seats should be adjusted to the upright position.
- (3) Harness straps must be in the upper slot at or above the child's shoulders. (Follow manufacturer's guidelines.)
- (4) The seat may be used until the child reaches the maximum weight or height allowed per the manufacturer's guidelines or until the top of the child's ears are above the back of the shell.
- (5) Harness straps must be snug. A snug strap should not allow any slack, should lie in a relatively straight line without sagging and should not press on the child's flesh or push the child's body into an unnatural position. When properly fitted, harness strap material should not be able to be pinched between the thumb and forefinger.
- (6) Avoid the use of a T-shield or tray shield with infants or young children with eyeglasses, feeding tubes, shunts or other medical devices that may come in contact with the



shield. Avoid use of CSRSs with a shield with children who may not fit into the seat snugly due to their stature.

**Note:** Some CSRSs cannot be installed properly in a twenty-inch bus seat (i.e. tray-shield and some convertible seats).

d. Car Beds

**Note:** A car bed for infants up to 20 pounds allows the infant to lie flat. The use of a car bed should be predicated on the advice of a physician or an appropriate medical support professional (e.g. physical/occupational therapist) and approved by qualified personnel at an IFSP team meeting.

- (1) Lateral support can be added with rolled-up towels or receiving blankets at both sides of the infant. Do not place around the infant's head padding that would cause an airway blockage.
- (2) Beds must be secured to the bus seat, with the seat belt passing through both slide loops. Check and use manufacturer's instructions before using beds.
- (3) Adjust the harness system to a snug fit as specified by the manufacturer. Harness straps should lie flat (not twisted).
- (4) Caution should be given to gastrostomy tubes, tracheostomies and shunts.

e. Specialized Positioning Seats

- (1) Specialized positioning seats are used only when a child does not fit in a standard CSRS or has a particular condition warranting more support.
- (2) As per NHTSA's, "*Child Passenger Safety Training Instructor Guide For School Buses*," tether straps are not required in school buses; however, some special needs CSRSs require a tether strap. (See manufacturer's instructions and all NHTSA curricula to determine the specifics.)

When a tether strap is used, the seat to which it is tethered must be unoccupied. For further clarification on the proper use of tethers, consult with a CPS (Child Passenger Safety) technician.

- (3) The safety belt must be routed through the appropriate belt path specified by the manufacturer's instructions to secure the CSRS.
- (4) If a retainer clip is used, it must be positioned at armpit level.
- (5) Caution should be given to gastrostomy tubes, tracheostomies and shunts.

f. **Booster Safety Seats (Belt Positioning Boosters Only)**

When a school bus is equipped with lap-shoulder belts, belt positioning booster seats should be used according to state law and manufacturer's instructions.

g. **Safety Vests**

**Note:** This restraint must be used only on school bus seats. The entire seat directly behind the child in the seat-mounted vest must be unoccupied or have restrained occupants.

- (1) Vest selection should be appropriate for the size and needs of the child. Proper fit must account for seasonal changes in clothing.
- (2) The decision to use a vest should be made by an IFSP or IEP team that includes qualified personnel and the parent.
- (3) The use of safety vests should be noted on the IFSP or IEP.
- (4) Vests should be anchored, as specified by the manufacturer.
- (5) Caution should be given to gastrostomy tubes, tracheostomies and shunts.
- (6) Pre-school children, due to their age, weight, physical development and their overall mental ability, should be securely fitted with a crotch strap supplied by the manufacturer. (Only vests required under FMVSS 213 will have a crotch strap supplied by the manufacturer. It is not optional.)
- (7) If unrestrained students share the seat with a student in a child safety restraint, the student using the restraint should

be placed in a window seating position, but never in front of an emergency window.

- (9) The seat behind the child in a vest must be kept empty or occupied by a child who is also in a child safety restraint system.
- (10) Portable seat mounting straps should be checked for proper fit by transportation personnel during pre-trip inspections.

h. Wheelchairs

- (1) All decisions regarding the use of wheelchairs in the school bus must be made by an IFSP or IEP team that includes qualified personnel and the parent and should be noted on the IFSP or IEP.
- (2) Appropriate positioning of a child in a wheelchair should be made by qualified personnel, including IFSP or IEP committee members, and should be noted on the IFSP or IEP.
- (3) The IFSP or IEP team, including qualified personnel, should determine when it is appropriate to transfer a child from a wheelchair and place the child in an age-appropriate CSRS on the original manufacturer's seat.

G. Bus Seat Designated for a Child Safety Restraint System

The transportation provider should ensure installation and use in accordance with the following NHTSA guidelines:

1. Locations of school bus seats designated for CSRSs should start at the front of the vehicle to provide drivers with quick access to the CSRS occupants.
2. CSRS anchorages on school bus seats should meet all applicable FMVSSs.
3. The non-adjustable end of the lap belt should be positioned at the center for a CSRS placed next to the window; or, at the aisle for a CSRS placed next to the aisle.
4. The non-adjustable end of the lap belt must not extend more than one to two inches from the seat.

5. When ordering new school buses, the maximum spacing specified under FMVSS No. 222, School Bus Passenger Seating and Crash Protection, (within 24 inches space from the seating reference point) is recommended for seats designated for CSRSs to provide adequate space for the CSRSs.
6. The combined width of CSRSs and/or other passengers on a single seat does not exceed the width of the seat.
7. If other students share seat positions with CSRSs, the CSRSs are placed in the window-seating position, excluding emergency exit windows.

#### H. Medical Equipment

All decisions regarding medical equipment in the school bus should be made in accordance with state laws and regulations. Decisions regarding medical equipment should be the joint decision of trained personnel who are knowledgeable about the type of medical assistance and support an infant, toddler or pre-school child may need while in a school bus. Decisions should be made by qualified team members in attendance at IFSP or IEP meetings, including the parent. The IFSP or IEP document should include all the appropriate information. Safe transportation specifications should be documented on the IFSP or IEP.

Some special considerations and recommendations are as follows:

1. All medical support equipment shall be secured at the mounting location to withstand a pulling force of five times the weight of the item.
2. Latched compartments are the preferred methods of transport.
3. All medical equipment should be secured below the window.
4. Oxygen equipment (liquid or gas) should be approved by the manufacturer for transport, and should be securely mounted and fastened to prevent damage and exposure to intense heat levels.

**Note:** Refer to the SPECIALLY EQUIPPED SCHOOL BUS SPECIFICATIONS section.

#### I. Special Considerations

Because of the dependency of young children and the need to make decisions on a case-by-case basis, the following section on special considerations is provided for guidance on a variety of issues related to the transportation of infants, toddlers and pre-school children.

1. Confidentiality

Confidentiality of information should be assured in accordance with the requirements of the Individuals with Disabilities Education Act Amendment of 1997 (Part B and Part C), Head Start Regulations and the Family Education Rights and Privacy Act Amendments of 1996. All transportation personnel should receive annual training regarding confidentiality requirements.

2. Emergency information

All parents, guardians or persons who are acting in *loco parentis* should be requested to fill out emergency transportation cards prior to initiating services. At a minimum, each emergency information card should request the following information: child's name, date of birth, program attending, height, weight, parents' names, address, (two) emergency contacts, child's doctor, hospital preferences, allergies, current medications, medical, communication and behavioral concerns, bus equipment required and special conditions, in accordance with state regulations. This information should be reviewed semiannually and updated at minimum annually, based upon the growth of infants and toddlers. The bus driver and attendant shall have access to this information in the school bus to safely transport students in CSRSs. A photo is recommended in accordance with the school district's policy. (This is especially helpful to substitute personnel and emergency personnel.)

3. Equipment Maintenance

Procedures should be established for scheduled maintenance, cleaning and inspection of all equipment, including CSRSs. Procedures should be in place to assure that all equipment is checked regularly for recalls and for product expiration dates. Procedures must be in place for cleaning CSRSs according to manufacturers' instructions. Proper disposal of outdated equipment is important.

**Note:** A recall list may be found at [www.nhtsa.dot.gov](http://www.nhtsa.dot.gov).

4. Evacuation

A written evacuation plan shall be prepared for all school buses transporting infants, toddlers and pre-school children. Evacuation drills shall be practiced on a scheduled basis, in accordance with approved written policies and procedures. Children attending Head Start are required to participate in at least three evacuation drills annually, including one in the bus in which the child will be riding. All buses shall

be equipped with child-safe webbing cutters to assist in the emergency evacuation of children in child safety restraint systems and wheelchairs.

Written evacuation plans should consider the following questions:

- a. What are the child's physical and mental abilities?
- b. Can the child exit the bus independently?
- c. Which children can be removed from the bus without their CSRS or specialized equipment?
- d. Which children cannot be removed from the bus without their CSRS or specialized equipment?
- e. How can children be kept safe when removed from the bus?

**Note:** If possible, depending on the width of the bus aisle, children in car seats should be evacuated from the bus in their car seats in order to maintain a controlled and safe environment once off the bus.

#### 5. Accessory Adaptive Equipment

All lap boards or trays, augmentative communication devices and ambulation equipment that attach to wheelchairs should be removed and secured during the time the child is transported in the school bus. The IEP team should address case-by-case where this is not advisable.

#### 6. Medically Complex and Fragile Children

Decisions regarding the safe transportation of medically complex and fragile children should be made by qualified personnel and addressed on the child's IFSP or IEP prior to initiating transportation services. All school buses transporting medically complex and fragile children should be staffed by personnel who are knowledgeable about an individual child's specific medical needs and should be trained to administer first aid to young children. IEPs for medically fragile children should contain a healthcare plan written by the school nurse based on doctor's orders and/or standard medical practices for applicable health issues.

#### 7. Transporting Medications

A written policy and procedure should address transporting medication between home and school. In no instance should a child be allowed to transport medicine to and from the school on his person.

8. Radios/Two Way Communication and Cell Phones

All school buses transporting infants, toddlers and pre-school children should have two-way communications systems and designated contact persons during the time the children are transported in the school bus. Cell phones may be utilized as a communication means, when approved by the school district or Head Start agency.

9. Supervision

All infants, toddlers and pre-school children should be supervised in the school bus, using the appropriate child-staff ratios based upon individually determined needs and state licensing requirements, if transportation to school and/or child care center is involved. Additional supervisory personnel required to transport individual students should be determined on a case-by-case basis by qualified personnel. This information should be recorded on the IFSP or IEP document. If Head Start children must cross the street before boarding or after leaving the vehicle because curbside drop-off or pick-up is not feasible, they must be escorted across the street by the bus attendant or another adult. All children in these categories must be met by a responsible person, preferably an adult. Plans for alternative delivery, such as to Children's Protective Services, should be proceduralized, and a notice of disposition should be placed on the door. Unmet students should be returned to the school or other preplanned location, and school officials can attempt to contact parents for resolution.

10. Seating Plans

All school buses transporting infants, toddlers and pre-school children should have a seating chart that is kept in the school bus. This is necessary in the event there is an emergency or there is a substitute driver or attendant. Decisions regarding seating should be made on an individual child basis using information known about the child's special needs and occupant protection requirements.

**Note:** The placement and use of CSRSs should be according to NHTSA's, "*Guideline for the Safe Transportation of Pre-School Age Children in School Buses*" (February 1999).

11. Technology-Dependent Children

Decisions regarding the safe transportation of technology-dependent children should be made by qualified personnel and addressed on the child's IFSP or IEP. In all school buses transporting children who are technology-dependent, there should be qualified personnel who are knowledgeable about an individual child's specific medical needs and are

trained to administer first aid or to carry out procedures specified on the child's IFSP or IEP. All medical service provisions should be in accordance with federal and state laws.

12. Universal Precautions

All transportation personnel involved in direct-service delivery for infants, toddlers and pre-school children should be directly trained in universal precautions related to the physical, day-to-day handling of young children and potential exposure to communicable and contagious diseases.

13. Post-Trip and Post-Run Segment Checks

Drivers are responsible for conducting a walk-through inspection of the school bus following drop-offs at each school and after the last delivery on each run segment. Prior to departing the bus for any length of time, a walk-through inspection must be conducted. The purpose of the walk-through inspection is to check on and under the seats for sleeping or hiding students and to identify any items which may have been dropped or left aboard the bus. Warning flag systems and/or electronic means may be used; however, the school bus driver is responsible for assuming that the post-trip inspection has been made. Written policies and procedures should be in place for post-trip and post-run segment checks.

[Back to Contents](#)



**Page Intentionally Left Blank**

# **APPENDICES**

## **A-G**

**Page Intentionally Left Blank**

# **APPENDIX A**

## **Terms and Definitions**

**Page Intentionally Left Blank**

## **APPENDIX A**

### **Terms and Definitions**

#### **INTRODUCTION**

This glossary was developed with three purposes in mind:

1. To provide easy access to the definition of terms used or referenced within the document;
2. To consolidate, in one resource, the acronyms, abbreviations and standard terms commonly used in the industry; and
3. To promote consistency throughout the student transportation industry by providing standard definitions or preferred usages for terms that may be used differently in different parts of the country.

The Glossary is not intended to be all-inclusive. There are and will be terms that are excluded and definitions that differ from regional usages. The Glossary is an attempt to reflect the language of student transportation, which, like all language, is ever-changing.

#### **TERMS AND DEFINITIONS**

**Access panel:** A body panel which must be moved or removed to provide access to one or more serviceable components.

**Accessibility:** The ability of vehicles or facilities to accommodate people with mobility impairments.

**Accident:** A loss involving personal injury or property as follows:

1. A motor vehicle collision involving a school bus, a school activity bus or a school tripper bus, resulting in any personal injury or death or any disabling damage to one or more motor vehicles requiring the vehicle(s) to be transported away from the scene by a tow truck or other vehicle;
2. A collision involving any vehicle with any student at any time during the loading or unloading process of the school bus, school activity bus, or school tripper bus; or
3. An injury to any student inside the school bus, school activity bus, or school tripper bus as a result of negligent/unsafe acceleration, deceleration, or other movement of the bus.  
(See also *Crash, school bus*)

**Preventable:** A crash that could have been prevented by reasonable action on the part of the school bus driver.

**Reportable:** A crash required to be reported under FMCSR (i.e., a crash involving a CMV on a public road in which there is a fatality or an injury treated away from the scene, or that requires a vehicle to be towed from the scene).

**Activity trip:** The transportation of students to any event sanctioned for student attendance or authorized by an officer, employee or agent of a public or private school, other than to-and-from school transportation. (See also *Field trip*.)

**ADA:** The Americans with Disabilities Act, PL 101-336, 42 USC 12101, *et seq.* When referenced in regard to student transportation, ADA generally refers to the specifications of 49 USC 38, Americans with Disabilities Act Accessibility Specification for Transportation Vehicles.

**Adaptive device:** Any item or piece of equipment used to increase, maintain or improve functional capabilities of children with disabilities; also known as *assistive technology device*.

**Advanced EGR:** A-EGR; An exhaust gas recirculation system (EGR) utilizing advanced electronic fuel management systems combined with proprietary piston bowl design and twin turbo air management systems.

**Alcohol:** The intoxicating agent in beverage alcohol, ethyl alcohol, or other low molecular weight alcohols, including methyl and isopropyl alcohol.

**Allowable alternate vehicle:** A vehicle designed for carrying eleven or more people, including the driver, that meets all the Federal Motor Vehicle Safety Standards applicable to school buses except 49 CFR 571.108 and 571.131. (See also under *Multifunction school activity bus* under *Bus*.)

**Alternately flashing signal lamps:** A system of red or red and amber signal lamps mounted horizontally both front and rear, intended to identify a vehicle as a school bus and to inform other users of the highway that the bus is about to stop or is stopped to load or unload children. The system of red and amber signal lamps is available in either sequential or non-sequential operation. Also known as school bus warning lamps, pupil warning lights, eight-light warning systems, alternately flashing warning bus safety light, school bus signal lamp, alternately flashing school bus warning lights.

**Sequential Operation:** The system of red and amber signal lamps is designed to operate in sequence. Amber signal lamps must be activated before the red signal lamps can be activated. (Amber lamps are deactivated when the red lamps are activated.)

**Non-Sequential Operation:** The system of red and amber signal lamps is designed so that red lamps are activated whenever the entrance doors are opened, regardless of whether the amber lamps have been activated.

**Alternative-fuel vehicle (AFV):** A vehicle designed to operate on an energy source other than petroleum-based gasoline or diesel fuel. Such fuels include, but are not limited to, CNG, LNG, LPG and electricity.

**Bi-fuel:** A vehicle designed to operate on two different fuels, but not simultaneously.

**Dual fuel:** A vehicle designed to operate on a mixture of two different fuels.

**Hybrid power:** The use of two or more power sources to provide the motive force for the vehicle (e.g., electricity to drive the wheels with internal combustion to supplement the battery).

**Anchorage point:** The point of attachment of a securement system or occupant restraint to the vehicle structure.

**ANPRM:** Advanced Notice of Proposed Rulemaking. A notice published in the *Federal Register* by a federal agency, such as NHTSA, requesting information and inviting comment on a proposed change of regulation.

**ANSI:** American National Standards Institute, an organization which administers and coordinates the development of voluntary industry standards.

**Antilock brakes:** Brake systems with sensors that automatically control the degree of wheel slip during braking and that relieve brake pressure on wheels that are about to lock up. Also known as *ABS*.

**Aspect ratio:** Percentage used to express the ratio of a tire's height to its width; also known as *tire profile*.

**Assessment team:** A group of persons, including the parent or guardian of a student with disabilities, who develop a profile of the student in terms of his or her mental and physical functioning in order to determine the student's eligibility for special education. (See also *MDC*.)

**Assistive device** (See *Adaptive device*.)

**ASTM:** ASTM International (originally known as the American Society for Testing and Materials); a voluntary standards development organization and a source for technical standards for materials, products, systems and services.

**Attendant:** A person assigned to assist one or more individual students with special needs on a school bus or school vehicle. (See also *monitor*.)

**BAC:** Blood or breath alcohol concentration; the measure used to determine alcohol impairment.

**BAT:** Breath Alcohol Technician; an individual who instructs and assists persons in the alcohol testing process and operates an EBT.

**Behavior management:** Methods of influencing student conduct on the school bus.

**Biodiesel:** Vehicle fuel made from plant or animal matter and used alone or mixed with diesel fuel in engines. B100, or "neat biodiesel," refers to the pure form. Biodiesel can be mixed with petrodiesel in any proportion, but the most common form is B20, which is 20% biodiesel and 80% petrodiesel. Biodiesel, as defined in ASTM D 6751, is registered with the US EPA as a fuel and a fuel additive under Section 211(b) of the Clean Air Act.

**Bloodborne Pathogens:** Common name for standards adopted by OSHA in 29 CFR 1910 to protect workers against the health hazards of exposure to blood and other potentially infectious body fluids or materials; also refers to the pathogenic microorganisms present in human blood.

**Boarding:** The process of loading passengers into a school bus.

**Body fluids cleanup kit:** Package of materials including, but not limited to, latex gloves, disposal bag and absorbent material, used to clean up spills of potentially infected bodily fluids, under OSHA's Bloodborne Pathogens regulations and Universal Precautions practices; also known as *hygiene kit*.



**Booster seat:** A firm platform, used with a lap-shoulder belt, which raises the child so that the height of his thighs and shoulders are closer to those of an adult and which helps route both portions of the lap-shoulder belt to fit the smaller body; also called *belt-positioning booster*.

**Brake:** A device or mechanism used to retard and stop the speed of a moving vehicle or to prevent the movement of a stopped vehicle.

**Emergency brake:** A mechanism designed to stop a motor vehicle after a failure of the service brake system.

**Foundation brake:** An assembly of the non-rotational components of a brake including its mechanism for developing a frictional force.

**Retarder:** An auxiliary braking device used to reduce brake wear and/or improve braking performance.

**Service brake:** The primary mechanism designed to retard and stop a moving vehicle.

**Parking brake:** A mechanism designed to prevent the movement of a stationary motor vehicle.

**Brake fade:** A condition that occurs as brakes become less effective.

**Bus:** A motor vehicle with motive power, except a trailer, designed for carrying more than ten (10) persons, including the driver.

**Activity bus:** A bus owned, leased or contracted by a school district and regularly used to transport students on field trips, athletic trips or other curricular or extracurricular activities, but not used for to-and-from school transportation; must meet all FMVSSs for school buses.

**Charter bus:** A bus that is operated under a short-term contract with a school district or other sponsor who has acquired the exclusive use of the vehicle at a fixed charge to transport students to a school-related event.

**DOT bus:** A school bus that meets the FMCSR standards for interstate transportation set forth in 49 CFR 390.

**Intercity bus:** A large bus with front doors only, high-back seats and under-floor luggage storage for high-speed, long distance trips; also known as *motorcoach* and *over-the-road coach*.

**Nonconforming bus:** Any vehicle designed to carry more than ten (10) passengers, including the driver that is used to transport students to or from school or school-related activities and that does not meet the federal standards specific to school buses.

**School bus:** A bus owned, leased, contracted to or operated by a school or school district and regularly used to transport students to and from school or school-related activities, but not including a charter bus or transit bus. A school bus must meet all applicable FMVSSs and is readily identified by alternately flashing lamps, National School Bus Yellow paint, and the legend "School Bus," except as may be provided for the multifunction school activity bus.

**Type A:** A Type "A" school bus is a conversion or bus constructed utilizing a cutaway front-section vehicle with a left side driver's door. This definition includes two

classifications: Type A-1, with a Gross Vehicle Weight Rating (GVWR) of 14,500 pounds or less; and Type A-2, with a GVWR greater than 14,500 and less than or equal to 21,500 pounds.

**Type B:** A Type “B” school bus is constructed utilizing a stripped chassis. The entrance door is behind the front wheels. This definition includes two classifications: Type B-1, with a GVWR of 10,000 pounds or less; and Type B-2, with a GVWR greater than 10,000 pounds.

**Type C:** A Type “C” school bus is constructed utilizing a chassis with a hood and front fender assembly. The entrance door is behind the front wheels; also known as a *conventional school bus*. This type also includes cutaway truck chassis or truck chassis with cab with or without a left side door and a GVWR greater than 21,500 pounds.

**Type D:** A Type “D” school bus is constructed utilizing a stripped chassis. The entrance door is ahead of the front wheels; also known as *rear* or *front engine transit style school bus*.

**Multifunction School Activity Bus (MFSAB):** “A school bus whose purposes do not include transporting students to and from home or school bus stops,” as defined in 49 CFR 571.3. This subcategory of school bus meets all FMVSS for school buses except the traffic control requirements (alternately flashing signal and stop arm).

**Specially equipped:** A school bus designed, equipped, or modified to accommodate students with special needs.

**School activity bus:** Any motorcoach other than a school bus or transit bus used for the transportation of any students enrolled in a public or private school at or below the 12<sup>th</sup> grade level, to or from school-related activities.

**School tripper bus:** Any motor vehicle routed by, or in the vicinity of, a public or private school, and used for to- or from-school transportation of any student enrolled in that public or private school at or above the ninth-grade level and operated or contracted by, and under the exclusive jurisdiction of, a publicly owned or operated transit system.

**Transit bus:** A bus designed for frequent stops, with front and back-center doors and low-back seating, operated on a fixed schedule and route to provide public transportation by indiscriminately taking on passengers at designated bus stops.

**Bus body:** The portion of a bus that encloses the occupant space exclusive of the bumpers, the chassis frame, and any structure forward of the forward-most point of the windshield mounting.

**Bus pass:** Authorization to ride a school bus other than the student’s assigned bus; or prepayment for transit bus rides.

**Bus yard:** An area for storage and maintenance of buses.

**CAA:** Clean Air Act; also known as CAAA, the Clean Air Act Amendments of 1990.

**Cam Wrap:** A seat-mounted system for attaching a safety harness to a school bus seat.

**Capacity** (See *Seating capacity*.)

**Capital costs:** Long-term costs associated with the purchase of vehicles, buildings and property.

**Captive:** Refers to a non-removable attachment, part or fitting on a securement system.

**Carrier:** Any public school district, any public or private educational institution providing preschool, elementary or secondary education, or any person, firm or corporation under contract to such a district or institution, engaged in transporting students.

**Casualty insurance** (See *Liability insurance*.)

**CDIP:** Commercial Drivers Instructional Permit. The learner's permit that a CDL applicant receives when he/she passes the knowledge tests; it allows the applicant to drive a CMV when accompanied by a driver with a CDL.

**CDL:** Commercial Drivers License.

**CFR:** Code of Federal Regulations.

**Chassis:** Vehicle frame with all operating parts, including engine frame, transmission, wheels and brakes.

**Chassis starting interlock circuit:** A device which prevents the engine of a bus from starting if any of the emergency exits are locked or not fully closed and latched.

**Clean diesel:** A combination of improved emission controls and cleaner-burning diesel fuel (see *ULSD*) that significantly reduces the pollutants from diesel engines. Can refer to new vehicles that meet EPA's 2007 standards or to older vehicles retrofitted with emission control technology.

**CMV:** Commercial Motor Vehicle. A motor vehicle defined in 49 CFR 390.5.

**CMVSA:** Commercial Motor Vehicle Safety Act of 1986; among other things, authorization for CDL.

**CNG:** Compressed natural gas.

**Common carrier:** A public bus, train or airplane that travels on a prescribed route and schedule, and accepts passengers indiscriminately.

**Communicable disease:** Any illness that can be transmitted from one person to another, including most common childhood diseases, the common cold and serious illnesses, such as hepatitis and AIDS.

**Community transportation:** Services that address all transit needs of a community, including general and special populations, such as the elderly and disabled.

**Companion animal:** An animal trained to provide assistance for persons with disabilities; can be a guide animal, assistive animal or service animal.

**Completed vehicle:** A vehicle that requires no further manufacturing operation to perform its intended function other than the addition of readily attachable components, such as mirrors or tire and rim assemblies, or minor finishing operations such as painting.

**Conduct report:** A form authorized by school officials for use by drivers to report instances of unacceptable behavior by school bus passengers; also known as *discipline report*.

**Continuum of services:** The range of possible options, from least restrictive to most restrictive, available to students with disabilities for transportation services.

**Conspicuity:** The ability of an object to be noticed and recognized without any confusion or ambiguity (SAE J1967).

**COWHAT:** Committee on Wheelchairs and Transportation: a group comprised of safety experts, rehabilitation engineers, clinicians, manufacturers and other stakeholders who work under the auspices of RESNA to develop voluntary equipment standards related to providing safer transportation for wheelchair-seated occupants of motor vehicles.

**Crash, school bus:** (1) A motor vehicle collision involving a school bus with or without a student on board, resulting in any personal injury or death or any disabling damage to one or more motor vehicles requiring the vehicle(s) to be transported away from the scene by a tow truck or other vehicle; or (2) A collision involving any vehicle with any student or with a school bus at any time during the loading or unloading process. (See also *Accident*.)

**Preventable:** A crash that could have been prevented by reasonable action on the part of the school bus driver.

**Reportable:** A crash required to be reported under FMCSR (i.e., a crash involving a CMV on a public road in which there is a fatality or an injury treated away from the scene, or that requires a vehicle to be towed from the scene).

**Crash test** (See *impact test*.)

**Criminal record check:** The investigation of a person's criminal history through submission of fingerprints to state and/or federal authorities; also known as *background check*.

**Crossing arm:** A device attached to the front bumper of a school bus that is activated during loading and unloading and designed to force the students to walk far enough away from the front of the bus to be seen by the driver; also known as *crossing control arm*.

**CSRS:** Child Safety Restraint System; a device (other than lap or lap/shoulder seatbelts) meeting the requirements of FMVSS No. 213, designed for use in a motor vehicle to restrain, seat or position a child who weighs 30 kg (66 lbs) or less; also known as *child safety seat* and *car seat*.

**Curb cut:** Area where the street curb has been cut and sloped to allow the sidewalk to lead smoothly to the roadway.

**Curb weight:** The weight of a motor vehicle with standard equipment, maximum capacity of engine fuel, oil, and coolant and, if applicable, air conditioning and additional weight of optional engine, but without passengers.

**Danger zone:** A twelve-foot area immediately surrounding the stopped school bus.

**Deadhead:** Movement of a bus without passengers (e.g., from school to bus yard).

**Deadtime:** The period between arriving at an activity trip destination and leaving the destination for the trip home; also known as *waiting time* and *stand-by time*.

**Dealer:** Any person who is engaged in the sale and distribution of new motor vehicles or motor vehicle equipment. Refers primarily to purchasers who, in good faith, purchase any such vehicle or equipment for purposes other than resale.

**Decibel (dB):** A unit used to express the relative intensity of a sound as it is heard by the human ear. The decibel measuring scale is logarithmic. Zero (0 dB) on the scale is the lowest sound level that a normal ear can detect under very quiet (“laboratory” conditions) and is referred to as the “threshold” of human hearing. On a logarithmic scale, 10 decibels are 10 times more intense, 20 decibels are 100 times more intense, and 30 decibels are 1,000 times more intense than 1 decibel.

**Decibel “A-Weighted” (dBA):** The scale for measuring sound in decibels that assigns weights to different frequency ranges to reduce the effects of low and high frequencies in order to simulate human hearing.

**DEF:** Diesel Exhaust Fluid; the reactant necessary for the functionality of the SCR system. It is prepared by dissolving solid urea to create 32.5% solution in water. DEF breaks down into ammonia (NH<sub>3</sub>) and reacts with NO<sub>x</sub> in the SCR system to produce Nitrogen (N<sub>2</sub>) and water (H<sub>2</sub>O).

**Distributor:** Any person or company primarily engaged in the sale and distribution of motor vehicles or motor vehicle equipment and/or parts for resale.

**Dispatch:** To relay service instructions to drivers.

**DNR:** Do Not Resuscitate; an order from a parent, legal guardian or court that prohibits the use of emergency measures to prolong the life of an individual.

**DOC:** Diesel oxygenation catalyst. Devices that use a chemical process to break down pollutants in the exhaust stream of diesel engines into less harmful components.

**DOT:** United States Department of Transportation.

**DOT driver:** A driver who meets the FMCSR standards, set forth in 49 CFR 391.

**Double run:** One bus making two trips over the same route each morning and afternoon (e.g., first picking up high school students and then returning for elementary students).

**Downtime:** The period when a vehicle is not in service (e.g., due to mechanical failure or scheduled maintenance).

**DPF:** Diesel particulate filter; ceramic devices that collect particulate matter in the exhaust stream of diesel engines. The high temperature of the exhaust heats the ceramic structure and allows the particles inside to break down (or oxidize) into less harmful components.

**Driver applicant:** A person who applies for a position as a school bus driver.

**Driver training:** Instructional program designed to impart knowledge and improve the skills necessary for school bus drivers, including but not limited to knowledge of the vehicle, safe driving practices, emergency procedures and passenger control.

**In-service:** Training provided annually, or more often, to school bus-certified drivers.

**Pre-service:** Training provided to driver applicants prior to school bus certification and/or transporting students.

**Driver qualifications:** Restrictions of state and federal law which determine a person's eligibility to become a school bus driver (e.g., age limits, physical condition, criminal record, driving history, etc).

**DRL:** Daytime running lamps; head lamps that operate automatically at a reduced voltage during the day to increase the vehicle's visibility; also known as *daytime running lights*.

**Drug:** Any substance other than alcohol considered to be a controlled substance listed on schedules I through V in 21 CFR 1308.

**Dry run:** A trip on a route without student passengers for driver training or familiarization of the route.

**Dual brake system** (See *Split brake system*.)

**Dual fuel system** (See *Alternative fuel*.)

**DVIR:** Driver vehicle inspection report. Federal, state or local approved form for reporting results of pre-trip and post-trip inspections; also known as *daily vehicle inspection report* and *pre-trip inspection form*.

**Dynamic testing:** The process of subjecting vehicle, mobility aid, or mobility aid/securement system components to a simulated crash condition.

**EAP:** Employee Assistance Program; a program of education and counseling required by 49 CFR 391 as part of a carrier's drug and alcohol testing program; may also include optional rehabilitation services.

**EBT:** Evidential Breath Testing device; a device approved by NHTSA for testing drivers for alcohol use.

**EDR:** Event Data Recorder; a device which records vehicle functions (e.g. speed change during a crash).

**EGR:** Exhaust Gas Recirculation; A type of in-cylinder NO<sub>x</sub> reducing technology that involves the re-introduction of metered quantities of cooled exhaust gas back into the cylinder as it fills with air, displacing some of the air volume and hence some of the oxygen. Replacing a proportion of this oxygen reduces the NO<sub>x</sub> formed during combustion.

**EHA:** The Education for all Handicapped Children Act, passed in 1975 as P.L.94-142. (See also *IDEA*.)

**EPA:** The United States Environmental Protection Agency.

**Early bus:** A bus scheduled to run prior to the regular morning run (e.g. to take children to day care programs located in schools).

**Early intervention service:** Education and related services provided to infants and toddlers from birth through two years of age.

**Effective date:** The date at which a regulation or standard takes effect, on or after which compliance is legally required.

**Elastomer:** An elastic substance occurring naturally, as natural rubber, or produced synthetically (e.g., butyl rubber, vinyl, etc.).

**Electronic voice communication system:** A means by which the driver of a vehicle can communicate with a dispatcher or other person at a remote location (e.g., two-way radio, cellular phone).

**Emergency roof exit:** An opening in the roof of the bus meeting the requirements of FMVSS No. 217 which provides emergency egress and sometimes ventilation; also known as *roof hatch*.

**Emergency response plan:** A detailed approach to identifying and responding to potential accidents involving hazardous substances; required for every community by the Emergency Planning and Right-to-Know Act of 1986.

**EOBR:** Electronic on-board recorders; an electronic device that collects, stores, and displays data relative to driver and vehicle performance, including such elements as location, time, speed, and distance traveled.

**Ergonomics:** The study of the design of equipment to reduce human fatigue and discomfort.

**Ethanol:** Grain alcohol, distilled from fermented organic matter and used as a vehicle fuel.

**Evacuation drill:** Performance of a mock school bus evacuation in order to teach students proper emergency procedures and to provide practice in the use of emergency exits; also known as *bus safety drills*.

**Extended-year service:** Transportation provided for students subsequent to the end of the traditional school year; especially, transportation as a related service for students with disabilities beyond the normal school year in accordance with the IEP.

**Extraboard driver** (See *Substitute driver*.)

**FAPE:** Free Appropriate Public Education; it refers to special education and related services, including transportation, provided at public expense in accordance with a child's IEP (34 CFR 300.13 and 300.121).

**FBI background check:** The national criminal record check.

**FERPA:** The Family Educational Rights and Privacy Act of 1974, 20 USC 1232, which requires confidentiality of student records in public schools, but allows access to necessary information regarding student disabilities and/or health needs to those who have a need to know, including school bus drivers.

**FHWA:** Federal Highway Administration; an agency of the U.S. Department of Transportation.

**Field trip:** The transportation of students to an event or destination which is an extension of classroom activity (i.e., a part of the curriculum). A field trip is one type of *activity trip*.

**Final Rule:** Notice published in the *Federal Register* by a federal agency announcing a new or changed regulation.

**Final stage manufacturer:** A person who performs such manufacturing operations on an incomplete vehicle that it becomes a completed vehicle.

**First aid:** Emergency treatment given to an ill or injured person before regular medical help is available.

**Fixed route:** Transportation service that runs on regular, prescheduled routes, usually with bus schedules and designated bus stops.

**FMCSA:** Federal Motor Carrier Safety Administration; an agency of the U.S. Department of Transportation; formerly the Office of Motor Carrier Highway Safety within the Federal Highway Administration.

**FMCSR:** Federal Motor Carrier Safety Regulations, 49 CFR 383, 390-397, and 399; motor vehicle safety and construction standards under FMCSA that apply to commercial motor vehicles and drivers transporting passengers in interstate commerce.

**FMLA:** Family and Medical Leave Act; requires employers to grant time off to employees for medical reasons or to care for family members.

**FMVSS:** Federal Motor Vehicle Safety Standards, 49 CFR 571; construction standards developed and enforced by NHTSA that apply to all new motor vehicles and items of motor vehicle safety equipment.

**Forward control bus:** a school bus in which more than half of the engine length is rearward of the foremost point of the windshield base and the steering wheel hub is in the forward quarter of the vehicle length; also known as *transit-style*. (See also *School bus, type D*.)

**Forward-facing:** Installation of a seat (fixed bus seat or secured mobile seating device) in such a way that the seat and its occupant face the front of the vehicle when secured.

**Four-point tiedown:** A securement system in which four strap assemblies attach to the wheelchair frame at four separate points and anchor to the vehicle floor at four separate points.

**FSS:** Fire suppressant system; a fire extinguisher system installed in the engine compartment of a vehicle and activated automatically in response to a fire sensor or manually in response to an alarm.

**FTA:** Federal Transit Administration, part of U.S. Department of Transportation; formerly Urban Mass Transit Administration (UMTA).

**Fuel injection:** System that uses no carburetor but sprays fuel directly into cylinders or into the intake manifold.

**Glazing:** The glass or glass-like portion of a window.

**Laminated glass:** Any glazing material that consists of one or more sheets of glass and an inboard-facing surface sheet of plastic, the components being held together by intervening plies of plastic interlayer or by the self-bonding characteristic of the inboard plastic layer.

**Safety glass:** Glazing material constructed, treated or combined with other materials so as to reduce, in comparison with ordinary glass, the likelihood of injury to persons as a result of contact with the glass, either broken or unbroken.

**Storm window:** Two or more sheets of safety glazing material separated by airspace to provide insulating properties and fixed in a common frame or mounting.



**Tempered glass:** Glazing which consists of glass that has been tempered to meet the properties of safety glass.

**GAWR:** Gross axle weight rating; the value specified by the manufacturer as the load-carrying capacity of a single axle system, as measured at the tire-ground interfaces.

**GPS:** Global Positioning System; a satellite tracking system that enables a receiver to compute the position and speed of a vehicle.

**Guideline 17:** A highway safety program guide for student transportation safety issued by NHTSA in 23 CFR 1204; formerly Standard 17.

**GVWR:** Gross vehicle weight rating; the value specified by the vehicle manufacturer as the load-carrying capacity of a single vehicle as measured at the tire-ground interfaces. For school buses, NHTSA has defined in Title 49 CFR, Section 567.4(g)(3), the minimum occupant weight allowance as 120 pounds per passenger times the number of the vehicle's designated seating positions and 150 pounds for the driver.

**GVW:** Gross vehicle weight; the actual weight of the fully loaded vehicle, including all cargo, fluids, passengers and optional equipment as measured by a scale.

**Handrail inspection tool:** A device formed by tying a half-inch hex nut to a 36-inch cord, used to inspect school bus handrails and other areas for possible snagging hazards.

**Hazard lamps:** Lamps that flash simultaneously to the front and rear on the right and left sides of a vehicle, used to indicate caution; also known as *four-way flashers*.

**Head protection zone:** The empty space above and in front of each school bus passenger seat which is not occupied by side wall, window or door structure, the dimensions of which are detailed in FMVSS No. 222.

**Head Start:** A program initiated in 1965 to provide comprehensive child development services to pre-school children of predominantly low-income families.

**Headsign:** A sign above the windshield of the bus which can be changed from *School Bus* to other wording, such as *Charter*.

**Health care plan:** A plan of action used to outline the care for a medically fragile individual.

**Highway:** Any public highway, road, street, alley, parkway or other place open to public motor vehicle travel.

**Horsepower:** The measurement of an engine's ability to do work. One horsepower is the ability to lift 33,000 pounds one foot in one minute.

**Hours of service:** The consecutive or cumulative period of time that a commercial driver may be on duty; for details see reference in the sub-section, "Transportation Other Than To and From School" in the OPERATIONS section of this document.

**HOV:** High Occupancy Vehicle; a vehicle that can carry two or more passengers.

**ICC:** The former Interstate Commerce Commission, the economic regulation agency within the Department of Transportation. The agency was disbanded in 1997 as a result of economic deregulation, and most functions were transferred to the Federal Highway Administration.

**IDEA:** The Individuals with Disabilities Education Act, passed in 1990 as P.L. 101-476, to replace the EHA (20 USC 1400 *et. seq.*); also the regulations at 34 CFR Parts 300 and 303.

**IEP:** Individualized Education Program; a written statement developed by an assessment team for each child with a defined disability, as required under IDEA.

**IFSP:** Individualized Family Service Plan; a written plan for providing early intervention services to an eligible child and his or her family under Part H of IDEA.

**Impact test:** A simulated crash condition which evaluates the ability of a vehicle or any component or device to withstand crash forces; also known as *sled test* and *crash test*.

**Inclusion:** Integration of a student with disabilities into a regular classroom and onto a regular school bus; also known as *mainstreaming*.

**Incomplete vehicle:** An assemblage consisting, as a minimum, of frame and chassis structure, power train, steering system, suspension system and braking system (to the extent that those systems are to be part of the completed vehicle) and requiring further manufacturing operations other than the addition of readily attachable components, such as mirrors and tire and rim assemblies, or minor finishing operations such as painting, to become a completed vehicle.

**Incomplete vehicle manufacturer:** A manufacturer of an incomplete vehicle (i.e., a person who performs the first stage of manufacture on a vehicle manufactured in two or more stages of manufacture). (See also *intermediate manufacturer* and *final-stage manufacturer*.)

**Injury incident, school bus:** Any non-crash event resulting in injury to a person while in the bus or while boarding/leaving the bus.

**In loco parentis** (See *Loco parentis*.)

**Inspection:** A close examination of a motor vehicle performed in accordance with local, state and/or federal requirements by an authorized agent of the local, state or federal government.

**Integrated restraint system:** A system in which the occupant restraint for an individual in a wheelchair/mobility aid connects directly to, and is dependent upon, the rear strap assemblies of the mobility aid's securement system.

**Intermediate manufacturer:** A person, other than the incomplete vehicle manufacturer or the final-stage manufacturer, who performs manufacturing operations on an incomplete vehicle.

**International symbol of accessibility:** A white emblem on blue background used to indicate that a vehicle can accommodate individuals with disabilities.

**ITP:** Individualized Transportation Plan; a plan established to transport a student with a defined disability.

**Kneeling bus:** A bus on which the front or rear end is lowered to allow easier access for passengers with disabilities.

**Lap belt:** A Type 1 belt assembly meeting the requirements of FMVSS No. 209 and intended to limit movement of the pelvis.

**Lap/shoulder belt:** A Type 2 belt assembly meeting the requirements of FMVSS No. 209 and intended to limit the movement of the pelvis and upper torso.

**Lap tray:** An accessory for a wheelchair or other mobile seating device, to offer support and convenience for the occupant.

**LATCH system:** Lower Anchors and Tethers for Children system; incorporates standardized hardware in vehicle seats including the lower anchorages and the upper tether anchorage. It is designed to allow installation of CSRS without using the vehicle's seat belt system. All CSRSs sold in the US after 2002 are required to be LATCH compatible.

**Late bus:** A bus scheduled to leave school at a time subsequent to the end of the school day, usually to provide transportation for students involved in after-school activities.

**Layover time:** Time built into a trip schedule between arrival and departure.

**LEA:** Local Education Agency.

**LED:** Light emitting diode; an electronic semiconductor device that emits light when an electric current passes through it. LEDs are commonly used in lamps and digital displays.

**Left:** Left position is determined from the normal driving position as seated in the driver's seat looking in the direction of forward travel.

**Liability insurance:** Protection against the claims of others for injury or property damage; also known as *casualty insurance*.

**Life cycle procurement:** A procurement contract based on both the initial capital cost and the cost of operation over the life of a vehicle, intended to identify the most cost-effective time to replace an asset.

**Lift** (See *Power lift*.)

**Live time:** The time when students are in the bus, beginning when the first passenger boards and ending when the last passenger leaves.

**LNG:** Liquefied Natural Gas.

**Load:** To pick up students at a designated bus stop or at school.

**Load factor:** The ratio of passengers actually carried to the vehicle's passenger capacity.

**Loading zone:** Any area where students are boarding or leaving a school bus.

**Loco parentis:** (also in *loco parentis*); legal term meaning the formal authority of a person to act for or in place of the parent of a minor child.

**Low-bid procurement:** Competitive procedure in which the lowest bidder is awarded the contract. (See also *performance-based procurement*.)

**Low-floor vehicle:** A bus in which the floor and entrance are closer to the ground, for easier access by students with disabilities or pre-schoolers.

**Longitudinal:** Parallel to the longitudinal centerline of the vehicle, front to rear.

**LPG:** Liquefied Petroleum Gas; also known as *propane*.

**LRE:** Least Restrictive Environment; a concept embodied in IDEA which requires that children with disabilities be integrated as fully as possible into situations and settings with their non-disabled peers.

**Mainstreaming** (See *inclusion*.)

**Manufacturer:** Any person engaged in the manufacturing or assembling of motor vehicles or items of motor vehicle equipment, including any person importing motor vehicle equipment for resale.

**MDC:** Multi-Disciplinary Conference; an assessment meeting for a student with disabilities which leads to an IEP. (See also *assessment team*.)

**MDT:** Multi-Disciplinary Team; also known as PET, Pupil Evaluation Team: (See also *Assessment team*.)

**Mediation:** Efforts by a third party to bring about agreement between dissenting parties (e.g., labor and management or parents and school administration); usually less formal than arbitration.

**Medical support equipment:** Portable equipment used by students to maintain life functions, such as oxygen bottles, intravenous or fluid drainage apparatus.

**Medically fragile:** Refers to students who require specialized technological health care procedures for life support and/or health support.

**MFSAB** (See *Multifunction school activity bus* under *Bus*.)

**Minibus:** A small school bus, usually a Type A-1 or A-2 or Type B-1 or B-2.

**Minivan:** A multi-purpose vehicle (MPV) designed to carry seven to ten passengers.

**Mirrors:** The system of mirrors required to be installed on school buses in accordance with FMVSS No. 111 and applicable state laws.

**Crossview:** Convex mirrors mounted on the front of the school bus and designed for student detection during loading and unloading, also known as *System B mirrors* and including *elliptical, quadri-spherical, banana, or standard convex* mirrors.

**Driving:** Flat and convex mirrors mounted on each side of the bus designed for viewing the road along the sides to the rear while driving; also known as *rearview, double nickel, west coast, or System A* mirrors.

**MIS:** Management Information System; a means of data collection for analysis by management.

**Mobility aid:** A wheelchair, walker, crutch, cane or other device that is used to support and help convey a person with a physical disability.

**Mobile Seating Device:** A mobility aid designed to support a person in the seated position.

**Modesty panel:** A panel located in front of a seat or row of seats to preserve the modesty of the passengers, usually supported by a stanchion and cross bar, and does not meet the performance standards of a *barrier* as defined in FMVSS No. 222. Also, a short panel which extends from the bottom of a *barrier* to or near to the floor for the purpose of reducing the draft from the entrance door—also known as *kick panel*.

**Monitor:** A person assigned to assist the school bus driver to control behavior of students in the bus and/or to ensure the safety of students getting on and off the bus and to check the loading zone before the driver pulls out. (See also *Attendant*.)

**Motor carrier or carrier:** The registered owner, lessee, licensee or bailee of any vehicle who operates or directs the operations of any such vehicle on either a for-hire or a not-for-hire basis.

**MPV:** Multipurpose Passenger Vehicle; any vehicle with a seating capacity of ten or fewer, including the driver, which is built on a truck chassis or with special features for occasional off-road use.

**MRO:** Medical Review Officer; a licensed physician with knowledge of substance abuse disorders required by 49 CFR 40 to receive and evaluate laboratory results generated by a carrier's drug testing program.

**MVR:** Motor Vehicle Record of the driver; also known as *driving history*.

**NAPT:** National Association for Pupil Transportation; a membership organization comprised of individuals and organizations representing all facets of school transportation.

**NASDPTS:** National Association of State Directors of Pupil Transportation Services; a membership organization primarily comprised of state officials responsible for student transportation.

**National school bus yellow:** The color defined in the publication "National School Bus Color Standard" SBMTC-008.

**NDR:** National Driver Registry.

**Neutral safety switch:** A device which prevents the bus from starting unless the transmission is in neutral gear or the clutch is depressed.

**NGV:** Natural Gas Vehicle.

**NHTSA:** National Highway Traffic Safety Administration; an agency of the U.S. Department of Transportation.

**NIST:** National Institute of Standards and Technology.

**NOx:** Oxides of Nitrogen; a regulated diesel emission which is a collective term for gaseous emissions composed of nitrogen and oxygen.

**Nominal dimension:** A dimension which exists in name only (e.g. 5/8" plywood, which is actually 19/32" thick, but is 5/8" nominal thickness). The variation between the actual dimension and the nominal dimension is the result of manufacturing practices and tolerances.

**Non-conforming van:** A vehicle smaller than a bus, designed to carry seven to ten passengers including the driver, and used to transport students, that does not meet FMVSS for school buses.

**NPRM:** Notice of Proposed Rulemaking; a notice published in the *Federal Register* by a federal agency of a proposed change in regulation.

**NSC:** National Safety Council.

**NSBY:** National School Bus Yellow: (See also SBMTC-008 for colorimetric specifications.)

**NSTA:** National School Transportation Association, a membership organization comprising primarily school transportation contractor companies.

**NSTSP:** National School Transportation Specifications and Procedures; a publication of the National Congress on School Transportation.

**NTSB:** National Transportation Safety Board, an independent federal agency authorized by Congress to investigate accidents and to issue safety recommendations.

**Occupant:** A person who occupies space inside a school bus; refers to both passenger and driver.

**OCR:** Office of Civil Rights, an agency of the U.S. Department of Education.

**OEM:** Original Equipment Manufacturer.

**On-board monitoring system:** Computerized tracking of driver and vehicle performance, including speed, fuel consumption, etc. (See also *EOBR*.)

**Operating costs:** All costs associated with running the transportation system, which are distinct from capital costs.

**Operator:** The carrier who is responsible for running the transportation system, regardless of ownership of the vehicle.

**OSEP:** Office of Special Education Programs; an agency of the U.S. Department of Education.

**OSERS:** Office of Special Education and Rehabilitative Services; an agency of the U.S. Department of Education.

**OSHA:** Occupational Safety and Health Administration, an agency of the U.S. Department of Labor.

**OTETA:** The Omnibus Transportation Employees Testing Act of 1991, requiring drivers holding CDLs to participate in a drug and alcohol testing program.

**Out of Service:** The removal of a school bus from passenger service due to a defective condition.

**Overall vehicle width:** The nominal design dimension of the widest part of the vehicle, exclusive of signal lamps, marker lamps, outside rearview mirrors, flexible fender extensions and mud flaps, determined with the doors and windows closed and the wheels in the straight-ahead position.

**Overhang:** The distance from the center of the rear axle to the rearmost end of the body or from the center of the front axle to the forward edge of the front bumper.

**P. A. system:** A public address system which allows the driver of a bus to communicate with persons inside and/or outside the bus through a speaker installed on the inside and/or outside of the bus; also known as *external loudspeaker*.

**Parallel restraint system:** A system in which the occupant restraint lap belt anchors directly to the floor track or plates, and is independent of the wheelchair/mobility aid securement system.

**Paratransit:** Public transit service which is more flexible than a fixed-route system, commonly providing special service for elderly and disabled passengers.

**Parking Pawl:** A device fitted to a motor vehicle's automatic transmission designed to engage when the transmission shift lever selector is placed in the PARK position. The parking pawl locks the transmission's output shaft, stopping the shaft (and thus the driven wheels) from rotating.

**Part B:** Refers to the section of IDEA (20 USC 1400 *et. Seq.*) applicable to special education and related services for children with disabilities and to the implementing regulations at 34 CFR 300.

**Part HC:** Refers to the section of the IDEA related to early intervention services for infants and toddlers and to the implementing regulations at 34 CFR 303. Formerly referred to as Part H.

**Particulate trap:** A device on diesel buses to clean the exhaust of particulate matter. (See also *DPF*.)

**Passenger:** A person who rides in a school bus but does not operate it. (See also *Occupant*.)

**Passenger compartment:** Space within the school bus interior measured from a point 30 inches ahead of the forward most passenger seating reference point (SRP) rearward to the inside surface of the rear end of the bus at the center of the rear emergency exit.

**Passenger Endorsement:** A designation (*P*) on a CDL that indicates the driver is qualified to drive a commercial passenger vehicle. Must accompany an *S* endorsement.

**Passenger miles:** The total number of miles traveled by the aggregate number of passengers on a vehicle. (Example: Two students traveling four miles would equal 8 passenger miles and five students traveling three miles would equal 15 passenger miles—totaling 23 passenger miles.)

**Performance Base procurement:** Competitive procedure in which contracts are awarded based on a combination of price and past performance; also known as *Best Value Procurement*.

**P.L.94-142:** (See *EHA*.)

**Positive-locking:** A design feature of the mobility aid securement and occupant restraint system where the attachment and anchoring hardware cannot be inadvertently released or disengaged once properly installed.

**Post-trip interior inspection:** A check of the interior of the bus by the driver at the end of the run to ensure that no children or student belongings have been left behind.

**Postural support:** A seat, belt or other component used to support a child with disabilities in a desired position but not designed or intended to provide occupant restraint in a crash; also known as *positioning device*.

**Power base:** A powered, wheeled platform used to mount a seating device for carrying an individual with a disability; usually characterized by smaller diameter tires.

**Power cut-off switch:** A device that cancels all power from the vehicle batteries.

**Power lift:** A mechanized platform designed to provide access to a vehicle for an occupied mobility aid/wheelchair; also known as a *wheelchair lift*.

**Powertrain:** The group of components used to transmit engine power to the wheels; includes engine, transmission, universal joints, driveshaft, drive axles and gears; also known as *drivetrain*.

**Pre-school:** Refers to a child between the ages of three and five years who is not yet in kindergarten or to a program serving children in that age range.

**Pre-trip inspection:** A systematic inspection of the bus by the driver before every trip or shift to ensure that the bus is in safe operating condition. The same procedure performed after the trip/shift is the *post-trip inspection*.

**Privatization:** The process of transferring the operation of public services from the public agencies to private companies or nonprofit organizations; also known as *contracting* or *outsourcing*.

**Pupil** (See *Student*.)

**Pusher:** A school bus in which the engine is mounted in the rear of the vehicle; also known as *rear-engine bus*. (See also *School bus, Type D*.)

**Pushout window:** A bus window that is hinged at the top or front to enable the window to be swung upward or outward relative to the side of the bus and to provide a means of emergency egress from the bus; also known as *emergency window*.

**Railroad crossing:** The intersection of a highway, street or roadway and railroad tracks; also known as *grade crossing*.

**Ramp:** An inclined plane for use between the ground and the floor of the vehicle to permit access by persons in wheelchairs/mobility aids.

**Reflective:** Refers to the property of materials that cause them, when they are illuminated, to reflect the light to some extent.



**Related services:** Transportation and other supportive services that are required to assist a child with a disability to benefit from special education.

**Remanufactured:** Refers to a vehicle component that has been structurally restored.

**RESNA:** Rehabilitation Engineering and Assistive Technology Society of North America; an organization engaged in research and development of assistive technology for persons with disabilities.

**Restraining barrier:** An assembly similar to a seat back located immediately in front of a single school bus passenger seat or row of seats to provide crash protection in accordance with FMVSS No. 222; also known as *barrier*, *crash barrier* and *seat barrier*.

**Restraint system:** A generic term for one or more devices intended to secure and protect a passenger with or without a mobility aid in a vehicle, including lap belts, lap/shoulder belts, child safety seats, safety vests, etc.

**Restraint/securement system** (See *Securement and restraint system*.)

**Retractor, automatic-locking:** A retractor incorporating adjustment by means of a positive self-locking mechanism which is capable of withstanding restraint forces.

**Retractor, emergency-locking:** A retractor that incorporates adjustment by means of a locking mechanism that is activated by vehicle acceleration, webbing movement relative to the vehicle, or automatic action during an emergency, and that is capable of withstanding restraint forces.

**Retroreflective:** Refers to material that is designed to direct light back to its source.

**RFP:** Request For Proposals; an invitation to submit a contract proposal, less restrictive than an invitation to bid on a contract.

**Ridership:** The number of passengers using a transportation system during a given time period.

**Right:** Right position is determined from the normal driving position as seated in the driver's seat looking in the forward direction of travel.

**Rim:** The part of the wheel on which the tire is mounted and supported.

**Risk management:** Practices and procedures designed to protect against losses from accidents, passenger and worker injuries, vehicle damage and other losses, and to reduce insurance costs.

**Rolling stock:** The vehicles in a transportation system.

**Roof hatch** (See *emergency roof exit*.)

**Route:** A designated course regularly traveled by a school bus to pick up students and take them to school, or to deliver students from school to their homes or designated bus stops.

**Route miles:** The total number of miles in one or more routes in the system.

**Route sheet:** A list of all the designated stops on a route.

**Run:** A complete trip on a route. [To illustrate the difference between a run and a route, it is possible to have six daily runs on the same route (i.e., one high school, one middle school, and one elementary run both morning and afternoon).]

**Running gear:** The wheels, axles, springs, frames and other carrying parts of the vehicle.

**SAE:** Society of Automotive Engineers; the leading standards-writing organization for the automotive industry.

**SAP:** Substance Abuse Professional; a licensed physician, psychologist, social worker or alcohol and drug counselor who is required to evaluate any employee who violates a carrier's drug and alcohol testing program.

**Safety Incident:** An occurrence that represents a close call/near miss or recognized heightened level of risk to students traveling to and from school or school-related activities.

**Safe travel training:** Educational programs provided for students to teach safe procedures for travel to and from school and home and to and from school-related activities.

**Safety vest/harness:** A combination pelvic and upper torso child restraint system that consists primarily of flexible material, such as straps, webbing or similar material, and that does not include a rigid seating structure for the child. Can be used with a cam wrap on a school bus seat or with a tether in other vehicles.

**Safety patrol:** Students whose duties may include acting as crossing guards and safety assistants.

**Safety ridership training:** Educational programs provided for students to teach proper behavior while waiting for, riding in, boarding or leaving school buses; also known as *ridership programs*.

**SBMTC:** School Bus Manufacturers Technical Council; formerly the School Bus Manufacturers Institute (SBMI); a membership organization within NASDPTS which serves as a technical advisor regarding school bus technology and construction.

**School:** An educational institution for children at the pre-primary, primary, elementary, or secondary level, including nursery schools and Head Start programs, but not including day care programs.

**School bus equipment:** Equipment designed primarily as a system, part or component of a school bus, or any similar part or component manufactured or sold for replacement or as an accessory or addition to a school bus.

**School bus stop:** An area on the street or highway designated by school officials for picking up and discharging students.

**School bus traffic warning lamps:** (See *Alternately flashing signal lamps*.)

**School endorsement:** A designation (S) on a CDL that indicates the driver is licensed to operate a school bus.

**School trip** (See *Activity trip*.)

**School tripper trip:** The transportation in a school tripper bus of any student enrolled in a public or private school to or from school or to or from a school-related activity.

**School vehicle:** Any vehicle owned, leased, contracted to or operated by a school or school district and regularly used to transport students to and from school or school-related activities. Includes school buses, activity buses, vans and passenger cars, but does not include transit or charter buses.

**SCR:** Selective catalyst reduction; A type of NO<sub>x</sub> reducing technology which uses a chemical reductant (diesel exhaust fluid, or DEF) injected into the exhaust stream where it transforms into ammonia and reacts with NO<sub>x</sub> on a catalyst, converting the NO<sub>x</sub> to nitrogen gas and water vapor. The reducing agent needs to be periodically replenished.

**Scooter:** A motorized mobility aid with three wheels, handle bar or tiller and a swiveling seat.

**SEA:** State Education Agency.

**Seat:** A device designed and installed to provide seating accommodations.

**Activity seat:** A seat designed for passenger comfort with contoured seats and backs with the result that passengers' positions are distinctly separate; characterized by fixed seat backs; may have arm rests and head rests; can be manufactured to meet FMVSS No. 222.

**Bench seat:** A seat designed to accommodate more than one passenger with no apparent partitioning between positions, which is characterized by fixed legs and a fixed back (e.g., the standard school bus seat which meets FMVSS No. 222).

**Davenport seat:** A bench seat that extends from side wall to side wall at the rearmost seating position in the bus; not permitted in school buses.

**Flex seat:** A type of bench seat equipped with lap/shoulder seat belts that can be reconfigured so that the number of seating positions on the seat can change. An example is a seat that can be reconfigured to accommodate either three smaller students or two larger students; also known as *flexible seating systems* or *flexible occupancy seats*.

**Flip seat:** A school bus bench seat designed so that the cushion flips up when the seat is not occupied, similar to a theater seat; used to provide aisle clearance, as required by FMVSS No. 217, when a passenger seat is located adjacent to a side emergency door.

**Integrated child safety seat:** A child safety seat meeting the requirements of FMVSS No. 213 which is built into, and thus an integral part of, a bench seat.

**Jump seat:** A seat designed to fold down to provide supplemental seating in a bus (e.g., in the aisle, in front of the door or along the side wall); not permitted in school buses.

**Reclining seat:** An activity seat with a reclining seat back; not permitted in school buses.

**Seat belt ready seat:** A bench seat meeting the requirements of FMVSS No. 222, the frame of which is designed for the installation of lap belts or CSRS attachment devices under FMVSS 210.

**Seat belt:** A passenger restraint system incorporating lap belts or lap/shoulder belts and meeting the requirements of FMVSS Nos. 209 and 210.

**Seating capacity:** The number of designated seating positions provided in a vehicle, including the driver's position. In determining vehicle classification, each wheelchair securement location shall be counted as four (4) designated seating positions.

**Designed seating capacity:** The theoretical passenger capacity that a vehicle would have if it were constructed with the maximum number of seating positions according to standard seating plans; also known as *manufacturer's seating capacity*.

**Equipped Seating Capacity:** The number of designated seating positions provided in a new bus per manufacturer's body/seating plan.

**Reduced capacity:** The capacity that is achieved when one or more seats are removed from the standard design during or after manufacture of the vehicle.

**Seating position:** The space on a school bus bench seat designated for one student. The number of such positions per seat is determined by dividing the width of the seat by 15" and rounding to the nearest whole number, as described in FMVSS No. 222.

**Seating reference point:** The manufacturer's design point, with coordinates relative to the vehicle structure, which establishes the rearmost normal driving or riding position of each designated seating position and simulates the position of the pivot center of the human torso and thigh.

**Section 402:** Section of 23 CFR that authorizes grant funds for highway safety projects.

**Section 504:** Section of the Rehabilitation Act of 1973, PL 93-112, which prohibits discrimination against individuals with disabilities by any recipient of federal funding.

**Securement points:** Locations on the base or seat frame of the wheelchair/mobility aid where the securement system should be attached.

**Securement system:** The means of securing a mobile seating device to a vehicle in accordance with FMVSS No. 222, including all necessary buckles, anchors, webbing/straps and other fasteners.

**Securement and restraint system:** The total system which secures and restrains both a wheelchair/mobility aid and its occupant; also known as *WTORS*.

**Self-insured:** Refers to a company or school district which provides reserved funds against claims or losses.

**Sensor:** An electronic device installed on a school bus for the purpose of detecting animate objects in the loading zone; also known as *object detection system*.

**Seizure:** A reaction to an electrical discharge in the brain, resulting in symptoms which can range from a blank stare of a few seconds to full convulsions.

**Shuttle:** A trip run back and forth over a short route (e.g., between two schools).

**Skid plate:** Stout metal plate attached to the underside of a vehicle to protect the oil pan, transmission, step well or fuel tank from scraping on rocks, curbs and road surface.

**Slack adjuster:** Adjustable device connected to the brake chamber pushrod that transmits brake application force and compensates for lining wear.

**SOS lights:** Stop on signal lights. (See also *Alternately flashing signal lamps*.)

**Special education:** Specially designed instruction to meet the unique needs of a child with disabilities.

**Specially equipped school bus:** Any school bus designed, equipped or modified to accommodate students with special needs.

**Split-brake system:** A service brake system with two separate hydraulic circuits which, upon failure of either, retains full or partial braking ability.

**Stanchion:** An upright post or bar, usually installed from floor to ceiling in a bus, that provides support for other structural members and/or provides a hand-hold for passengers.

**State:** As used in this document, “state” shall refer to any of the 50 states and commonwealths and any United States territory, possession, or federal agency (e.g., the General Services Administration or the Department of Defense) that may consider, follow or adopt part or all of the specifications and procedures contained herein for school buses and operations.

**State director:** The chief government administrator in charge of a state’s student transportation program and responsible for oversight of regulatory functions.

**Stop arm:** A device in the form of a red octagon extending outward from the side of a school bus to signal that the bus has stopped to load or unload passengers and meeting FMVSS No. 131; also known as *stop semaphore* and *stop signal arm*.

**Stopping distance:** Braking distance plus reaction distance.

**Braking distance:** The distance a vehicle travels between the time the brakes are applied and the time forward motion ceases.

**Reaction distance:** Distance a vehicle travels during the time it takes for a driver to recognize the need to stop and to apply the brakes.

**Strobe light:** A bright short duration light that flashes as a result of an electronic discharge of electricity through a gas.

**Stroller:** A light weight folding mobility aid.

**Student:** Any child who attends a school, as previously defined.

**Student rides:** The number of students transported in a given system multiplied by the number of one-way trips in a school bus. (For example, a school district that transports 1000 students provides 2000 student rides daily or 360,000 student rides to and from school annually, assuming 180 school days. To determine the total number of student rides annually, the district would add the actual or estimated number of students transported on activity trips [times 2] to the figure above.)

**Substitute driver:** A driver who is not assigned to a regular route but is employed to provide immediate coverage, when necessary, due to driver absences or emergencies; also known as *spare driver* and *extraboard driver*.

**Surrogate wheelchair:** A wheelchair device which is subjected to impact tests to test securement and restraint systems.

**Suspension system:** The components of the vehicle that transmit the load of the vehicle's weight from the chassis framework to the ground, including the springs, axles, wheels, tires and related connecting components.

**TDD:** Telecommunication devices for the deaf.

**Temperature control system:** The means of heating or cooling the interior of the vehicle.

**Tether:** An upper anchor strap used in addition to a seat belt to hold certain types of restraint devices in place.

**Tie down system** (See *Securement system*.)

**Tire:** The continuous solid or pneumatic rubber elastomeric cushion encircling a wheel intended for contact with the road.

**Bias ply:** A pneumatic tire in which the ply cords extending to the beads are laid at alternate angles substantially less than 90 degrees to the centerline of the tire.

**Low profile:** A tire that has a section height that is less than 85 percent of its nominal section width (e.g., a tire with an aspect ratio of less than 0.85).

**Radial:** A pneumatic tire in which the ply cords which extend to the beads are laid substantially at 90 degrees to the centerline of the tread.

**Retread:** A worn tire casing to which tread rubber has been affixed to extend the usable life of the tire; also known as *re-capped* or *retreaded tire*.

**Siped:** A tire which has been scored or cut perpendicular to the direction of rotation (across the tread) to improve traction.

**Snow:** A tire with an obvious aggressive or lug-type tread across the entire width that is designed to be self-cleaning.

**Studded:** A tire to which metal protrusions have been added to improve traction.

**Tire cords:** The strands forming the reinforcement structure in a tire.

**To-and-from school:** Transportation from home to school and from school to home; also transportation from school to school or from school to job training site.

**Tour:** Transportation of a group on a longer trip, usually by *charter bus* (e.g., senior class trip to Washington).

**Tow devices:** Attachments on the chassis frame for use in retrieving a stuck vehicle and/or for towing the vehicle backwards or forwards; also known as *tow eyes*, *tow hooks* or *towing attachment points*.

**Track seating:** A seating system in which seating units, including mobility aids, are secured to the vehicle structure by attaching them to tracks on the vehicle floor.

**Traffic lights:** Traffic signals which control the flow of traffic at intersections.

**Transverse:** Perpendicular to the longitudinal centerline of the vehicle (i.e., from side to side).

**Trip:** The transportation of students from school to any destination, followed by a return trip back to school. The two together make a *round trip*.

**Tripper service:** Regularly scheduled mass transit service which is open to the public, and which is designed or modified to accommodate the needs of school students and personnel, using various fare collections or subsidy systems. Must be part of the regular route service as indicated in published route schedules.

**TSA:** Transportation Security Administration; an agency of the Department of Homeland Security.

**Turbocharger:** a device which uses the pressure of exhaust gases to drive a turbine that, in turn, pressurizes air normally drawn into the engine's chambers.

**Turnkey:** Partial privatization in which a school district hires a company to supply drivers, maintenance management and/or vehicles; also known as *management contract*.

**Two-way radio:** Electronic communication system which uses a designated airway for transmission between a bus and a base station.

**ULSD:** Ultra-low sulfur diesel; Diesel fuel that has a sulfur content of not more than 15 ppm (parts per million). Regular diesel fuel has a sulfur content of 200 ppm.

**UMTA:** Urban Mass Transit Administration; predecessor to FTA.

**Unload:** To discharge passengers from a school bus.

**Unloaded vehicle weight:** The weight of a vehicle with maximum capacity of all fluids necessary for operation, but without cargo or occupants or accessories that are ordinarily removed from the vehicle when they are not in use.

**Universal precautions:** Method of infection control designed to protect the individual from exposure to disease, which requires that all bodily fluids and secretions are treated as though they were infectious.

**UST:** Underground storage tank.

**Vapor lock:** Boiling or vaporization of fuel in the lines from excessive heat, which interferes with liquid fuel movement and in some cases stops the flow.

**Vehicle miles:** The aggregate number of miles a vehicle travels in a given period.

**Video system:** A means of monitoring student behavior in a school bus. The system includes one or more video cameras to tape activity. Camera housing units mounted in each bus appear to hold a camera, whether or not one is actually in place; also known as *surveillance*.

**VIN:** Vehicle Identification Number; a series of Arabic numbers and Roman letters which is assigned to a motor vehicle for identification purposes.

**Viscosity:** A measure of internal resistance to flow or motion offered by a fluid lubricant.

**Walking distance:** The maximum distance a student can be required to walk to school before transportation must be provided; also known as *non-transportation zone*.

**Weather emergencies:** Weather conditions that require a deviation from normal transportation procedures (e.g., flooding, snowstorm).

**WC-19:** A voluntary industry standard that establishes minimum design and performance requirements for wheelchairs that are occupied by users traveling in motor vehicles. The standard applies to a wide range of wheelchair types and styles, including manual wheelchairs, powerbase wheelchairs, three wheeled scooters, tilt-in-place wheelchairs and specialized mobile seating bases with removable seating inserts.

**Weight distribution:** The distribution proportion of the vehicle load divided between the front and rear axles.

**Wheel:** A rotating load-carrying member between the tire and the hub, usually consisting of two major parts—the rim and the wheel disc—which may be integral, permanently attached or detachable.

**Ball seat nut mounting:** A wheel mounting system wherein the wheel centering is provided by the wheel mounting studs and the ball seat nuts which, when properly tightened, assure the centering alignment of the wheel.

**Disc:** The part of the wheel which is the supporting member between the hub and the rim.

**Disc wheel:** A permanent combination of a rim and wheel disc.

**Hub:** The rotating outer member of the axle assembly which provides for wheel disc mounting.

**Locking ring:** A removable, split rim ring that holds the rim flange in place on a multi-piece rim.

**Piloted hub mounting:** A wheel mounting system wherein the wheel centering is provided by a close fit between the wheel disc and the hub.

**Rim:** The part of the wheel on which the tire is mounted and supported.

**Spoke wheel:** A rotating member which provides for mounting and support of one or two demountable rims; also known as *wheel for demountable rim*.

**Wheelbase:** The distance between the centerline of the front axle and the centerline of the rear axle.

**Wheelchair:** A seating system comprised of at least a frame, a seat and wheels that is designed to provide support and mobility for a person with physical disabilities. For the purpose of this standard, this term



encompasses standard manual wheelchairs, powered wheelchairs, power-based wheelchairs, three-wheel scooter-type wheelchairs and specialized seating bases; also known as *mobile seating device*.

**Wheelchair lift** (See *Power lift*.)

**ZEB:** Zero-emissions bus.

**ZEV:** Zero-emissions vehicle.

[Back to Contents](#)

**APPENDIX B**  
**School Bus**  
**Body and**  
**Chassis**  
**Specifications**

**Page Intentionally Left Blank**

## APPENDIX B

### SCHOOL BUS BODY AND CHASSIS

#### National School Bus Yellow Standard

The color known as “National School Bus Yellow” (NSBY) is specified and described in the School Bus Manufacturers Technical Council publication SBMTC-008, *National School Bus Yellow Color Standard*.

**Note:** Information concerning the purchase of this standard may be obtained from the Executive Director of the National Association of State Directors of Pupil Transportation Services (NASDPTS) at 1-800-585-0340 or [execdir@nasdpts.org](mailto:execdir@nasdpts.org).

#### Bus Body Heating System Test

##### 1. Scope

This procedure, limited to liquid coolant systems, establishes uniform cold weather bus vehicle heating system test procedures for all vehicles designed to transport ten (10) or more passengers. Required test equipment, facilities and definitions are included. Defrosting and defogging procedures and requirements are established by SAE J381, *Windshield Defrosting Systems Test Procedure and Performance Requirements—Trucks, Buses, and Multipurpose Vehicles*, and SAE J382, *Windshield Defrosting Systems Performance Guidelines—Trucks, Buses, and Multi-Purpose Vehicles*, which are hereby included by reference.

##### 1.1 Purpose

This procedure is designed to provide bus manufacturers with a cost-effective, standardized test method to provide relative approximations of cold weather interior temperatures.

##### 2. Definitions

**2.1 Heat Exchanger System** - Means will exist for providing heating and windshield defrosting and defogging capability in a bus. The system shall consist of an integral assembly or assemblies, having a core assembly or assemblies, blower(s), fan(s) and necessary duct systems and controls to provide heating, defrosting and defogging functions. If the bus body structure makes up some portion of the duct system, this structure or a simulation of this structure must be included as part of the system.

**2.2 Heat Exchanger Core Assembly** - The core shall consist of a liquid-to-air heat transfer surface(s), liquid inlet and discharge tubes or pipes.

- 2.3 **Heat Exchanger-Defroster Blower** - An air moving device(s) compatible with energies available on the bus body.
- 2.4 **Coolant** - A 50-50 solution of commercially available glycol antifreeze and commercial purity water. Commercial purity water is defined as “that water obtained from a municipal water supply system.”
- 2.5 **Heat Exchanger-Defroster Duct System** - Passages that conduct inlet and discharge air throughout the heater system. The discharge outlet louvers shall be included as part of the system.
- 2.6 **Heater Test Vehicle** - The completed bus as designed by the manufacturer with or without a chassis, engine and driver train, including the defined heat exchanger system. If the vehicle is without a chassis, it shall be placed on the test site in such a way that the finished floor of the body is at a height, from the test site floor, equal to its installed height when on a chassis, and all holes and other openings normally filled when installed on a chassis will be plugged.
- 2.7 **Heat Transfer** - The transfer of heat from liquid to air is directly proportional to the difference between the temperatures of the liquid and air entering the transfer system, for a given rate of liquid and air flow measured in pounds per minute, and that heat removed from liquid is equal to heat given to air.

### 3. Equipment

- 3.1 **Test Site** - A suitable location capable of maintaining an average ambient temperature not to exceed 25°F (-3.9°C) for the duration of the test period. The maximum air velocity across the vehicle shall be 5 mph (8 kph).
- 3.2 **Coolant Supply** - A closed loop system, independent of any engine/drive train system, capable of delivering a 50-50 (by volume) solution of antifreeze-water, as defined in 2.4, at 150°±5° (65.5°±1.7°C) above the test site ambient temperature, and 50 lbs (22.7 kg) per minute flow. The coolant supply device shall be equipped with an outlet diverter valve to circulate coolant within the device during its warm-up period. The valve will then permit switching the coolant supply to the bus heat exchanger system at the start of the test.
- 3.3 **Power Equipment Supply** - A source capable of providing the required test voltage and current for the heater system.
- 3.4 **Heat Exchange Units** - The heat exchangers used shall be labeled as specified by the School Bus Manufacturers Technical Council Standard No. 001, *Procedure for Testing and Rating Automotive Bus Hot Water and Heating and Ventilating Equipment* (Revised 4/94). The test rating of each unit, and quantity used, shall be recorded.

## 4. Instrumentation

### 4.1 Air Temperature

**4.1.1 Interior** - Recommended air temperature measuring instrumentation are thermocouples or resistance temperature detectors (RTDs). Thermometers are not recommended because of their slow response to rapid temperature changes. Measuring instrumentation shall be placed on alternate seat rows beginning  $39\pm 5$  inches ( $99\pm 13$  cm) from the rear of the body, at  $36\pm 2$  inches ( $91\pm 5$  cm) from the finished floor of the body, and on the longitudinal centerline of the body.

**4.1.2 Ambient** - A set of four electrically averaged temperature measuring devices shall be placed  $18\pm 5$  inches ( $46\pm 13$  cm) from the nearest body surface,  $96\pm 5$  inches ( $243\pm 13$  cm) above the floor of test site. One measuring device shall be placed at each of the following locations:

- (1) Midline of body forward of windshield;
- (2) Midline of body aft of the rear surface; and
- (3) Midway between the axles on the right and left sides of the body.

**4.1.3 Driver** - Measuring devices shall be placed at appropriate locations to measure ankle, knee, and breath level temperatures with the driver's seat in rearmost, lowest and body center-most position.

- (1) Ankle Level - Place a minimum of four electrically averaged temperature measuring devices at the corners of a 10 x 10 inches (25x25cm) square area, the rearmost edge of which begins 8 inches (20 cm) forward of the front edge of, and centered on, the seat cushion. The devices shall be located  $3\pm 0.5$  inches ( $7.5\pm 1.3$  cm) above floor surface.
- (2) Knee Level - Place a minimum of one measuring device at the height of the front top edge of the seat cushion and on the centerline of the seat. This measurement shall be  $4\pm 1$  inches ( $10\pm 2.5$  cm) forward of the extreme front edge of the seat cushion and parallel to the floor.
- (3) Breath Level - Place a minimum of one measuring device  $42\pm 2$  inches ( $107\pm 5$  cm) above the floor and  $10\pm 2$  inches ( $25\pm 5$  cm) forward of the seat back. The forward dimension shall be measured from the upper edge of the seat back and parallel to the floor.

**4.1.4 (Optional) Heat Exchanger Inlet and Outlet Temperature** - A minimum of four electrically averaged temperature measuring devices shall be used to measure the inlet air temperature of each heat exchange unit. Additionally, a

minimum of four electronically averaged temperature measuring devices shall be used to measure the outlet air temperature of each heat exchange unit. These sensors shall be placed no closer than 2.0 inches (5.1 cm) from the face of any heater core, to prevent any incidence of radiant heat transfer. Outlet sensors shall be distributed throughout the outlet air stream(s)  $1.0 \pm 0.25$  inches ( $2.5 \pm 0.6$  cm) from the outlet aperture(s) of the unit heater.

**4.1.5 (Optional) Defrost Air Temperature** - The temperature of the defrost air shall be measured at a point in the defroster outlet(s) that is in the main air flow and which is at least 1.0 inch (2.54 cm) below (upstream of) the plane of the defroster outlet opening. At least one temperature measurement shall be made in each outlet unit. The interior surface temperature(s) of the windshield shall be measured at a point located on the vertical and horizontal centerline(s) of the windshield.

**4.1.6 (Optional) Entrance Area Temperature** - The temperature of the vehicle entrance area shall be measured by two sets of three each electrically averaged temperature measuring devices. One set of three devices shall be placed 1.0 inch (2.54 cm) above the lowest tread of the entrance step, equally spaced on the longitudinal centerline of the tread. The second set of devices shall be placed on the next horizontal surface above the lowest entrance step, 4.0 inches (10.2 cm) from the outboard edge of that surface, spaced identically to the first set of sensors, and placed parallel with the outboard edge of the surface being measured.

- 4.2 Coolant Temperature** - The temperature entering and leaving the heat exchanger/defroster system shall be measured as close to the entrance and exit points of the bus body as possible with an immersion thermocouple or RTD device which can be read within  $\pm 0.5^\circ\text{F}$  ( $\pm 0.3^\circ\text{C}$ ).
- 4.3 Coolant Flow** - The quantity of coolant flowing shall be measured by means of a calibrated flow meter or weighing tank to an accuracy of at least 2% of setpoint.
- 4.4 Coolant Pressure** - The coolant differential pressure shall be measured by suitable connection as close as possible to the inlet and outlet of the heat exchanger/defrosting system. Pressure may be read as inlet and outlet pressure and the differential calculated, or read directly as PSID. Pressure readings shall be made with the use of gauges, manometers or transducers capable of reading within  $\pm 0.1$  psi (689.5 Pa), accurate to  $\pm 0.5\%$  of full scale.
- 4.5 Additional Instrumentation** - Additional instrumentation required for vehicle heat exchanger system testing is a voltmeter and a shunt-type ammeter to read the voltage and current of the complete system. The ammeter and voltmeter shall be capable of an accuracy of  $\pm 1\%$  of the reading.
- 5. Test Procedures** - Install the heater test vehicle on the test site. Testing shall be conducted in such a way as to prevent the effects of solar heating. At an outdoor test site,

testing shall commence and data shall be recorded during the hours following sunset and prior to sunrise, regardless of cloud cover or facility roof. Instrumentation is required to obtain the following readings:

- (a) Vehicle interior (4.1.1);
- (b) Inlet coolant temperature, at entrance to the bus body (4.2);
- (c) Discharge coolant temperature, at exit from the bus body (4.2);
- (d) Voltage and current at main bus bar connection of driver's control panel;
- (e) Ambient temperature (4.1.2);
- (f) Rate of coolant flow (4.3);
- (g) Coolant flow pressure (4.4);
- (h) Elapsed time (stop watch);
- (i) Driver's station temperatures (4.1.3);
- (j) (Optional) Heat Exchanger Inlet and Outlet Temperatures (4.1.4);
- (k) (Optional) Defrost Air Temperature (4.1.5); and
- (l) (Optional) Entrance Area Temperature (4.1.6).

Soak the test vehicle, with doors open, for the length of time necessary to stabilize the interior temperature for a 30-minute period as recorded by the vehicle interior temperature measuring devices, and the coolant temperature as measured by the inlet and outlet coolant temperature measuring devices, at the test site temperature,  $\pm 5^{\circ}\text{F}$  ( $\pm 2.5^{\circ}\text{C}$ ), not to exceed  $25^{\circ}\text{F}$  ( $-3.9^{\circ}\text{C}$ ). Warm up the coolant device to the test temperature immediately prior to the start of the test. Use the coolant supply outlet diverter valve to prevent heated coolant from entering the bus heating system prior to the start of the test.

At this time, set the heater controls and all fan controls at maximum, and close all doors. A maximum of two windows may be left open a total of 1.0 inch (2.5 cm) each. A maximum of two occupants may be in the body during the test period. Record all instrumentation readings at five-minute intervals for a period of 1 hour. Recording time shall begin with the initial introduction of heated coolant from the independent coolant supply. The electrical system shall be operated at a maximum of 115% of nominal system voltage  $\pm 0.2$  volts, for example: 13.8 VDC  $\pm 0.2$  volts for a 12 volt (DC) system, and the heat exchanger system shall be wired with the normal vehicle wiring.

*Optional:* Additional flow rates and/or coolant temperatures may also be used to generate supplementary data. Procedure shall be repeated (see 5. Test Procedure) for each additional flow rate and/or coolant temperature.

## 6. Computations

**6.1 Chart and Computations - Customary Units -** Data shall be recorded on Chart 6.1, or equivalent. Temperature data shall be recorded at the actual temperatures occurring at the time of testing. Air temperature data shall then be adjusted to a  $0^{\circ}\text{F}$  base prior to the construction of graphs. This data reduction shall be directly proportional to the difference between the actual ambient temperature, at the time of test, and  $0^{\circ}\text{F}$  (i.e., actual ambient of  $18^{\circ}\text{F}$  shall result in a reduction of all air



temperatures by 18°F and actual ambient temperature of -8°F shall result in an increase of all air temperatures by 8°F). Temperature data shall be presented in graph form as well as tabular form. One graph shall be constructed for the body interior air temperatures (4.1.1) wherein the recording intervals shall be the X-axis and the °F the Y-axis. A separate graph shall be constructed for the driver's temperatures (4.1.3) using the same units for the axes. Optional temperature data (4.1.4, 4.1.5, 4.1.6) may be similarly graphed separate from the interior data.

### 6.1.1 Optional Computations BTU/Hr. Coolant

Heat Transfer:  $Q_w = C_p W_w (T_{in} - T_{out}) \times 60$  where:

1.  $W_w$  = Flow of Coolant (lb/min) — *measured to ± 2 percent*
2.  $T_{in}$  = Temperature of Coolant into System (°F) — *measured quantity*
3.  $T_{out}$  = Temperature of Coolant out of System (°F) — *measured quantity*
4.  $Q_w$  = Heat removed From Coolant (Btu/hr) — *calculated quantity*
5.  $C_p$  = Specific Heat of Coolant = 0.8515 (BTU/lb/°F) — *given quantity*

**6.2 Chart and Computations - Metric Units -** Data shall be recorded on Chart 6.2, or equivalent. Temperature data shall be recorded at the actual temperatures occurring at the time of testing. Air temperature data shall then be adjusted to a -18°C base prior to the construction of graphs. This data reduction shall be directly proportional to the difference between the actual ambient temperature, at the time of test, and -18°C (i.e., actual ambient of -7.8°C shall result in a reduction of all air temperatures by 10.2°C and actual ambient temperature of -22.2°C shall result in an increase of all air temperatures by 4.2°C). Temperature data shall be presented in graph form as well as tabular form. One graph shall be constructed for the body interior air temperatures (4.1.1) wherein the recording intervals shall be the X-axis and °C the Y-axis. A separate graph shall be constructed for the driver's temperatures (4.1.3) using the same units for the axes. Optional temperature data (4.1.4, 4.1.5, 4.1.6) may be similarly graphed separate from the interior data.

### 6.2.1 Optional Computations BTU/Hr – Coolant

Heat Transfer:  $Q_w = C_p W_w (T_{in} - T_{out}) \times 60$  where:

1.  $W_w$  = Flow of Coolant (kg/min) — *measured to ± 2 percent*
2.  $T_{in}$  = Temperature of Coolant into System (°C) — *measured quantity*
3.  $T_{out}$  = Temperature of Coolant out of System (°C) — *measured quantity*
4.  $Q_w$  = Heat removed From Coolant (Joules/hr) — *calculated quantity*
5.  $C_p$  = Specific Heat of Coolant = 3559 (joule/kg/°C) — *given quantity*

**Chart 6.1**

Description of Unit

Purpose of Test

Date	Location							Observers						
	5	10	15	20	25	30	35	40	45	50	55	60		
Readings/Calculations														
Water														
Flow-lb/min														
Flow Pressure-PSID														
T-in °F														
T-out °F														
Air Temperature														
T1 rear- °F														
T2- °F														
T3- °F														
T4- °F														
T5- °F														
T6-front- °F														
T7-ambient- °F														
T8-Driver Ankle- °F														
T9-Driver Knee- °F														
T10-Driver Breath-°F														
Electrical System														
Volts														
Amps														

COMPUTATIONAL CHART 6.1 (Fahrenheit)

**Chart 6.1-Optional Measurements**

Readings/Calculations	0	5	10	15	20	25	30	35	40	45	50	55	60
T11-Windshield CL Left- °F													
T12-Windshield CL Right- °F													
T13-Defrost Outlet Left- °F													
T14-Defrost Outlet Right °F													
T15-Heater-Inlet °F													
T15-Heater-Outlet °F													
T16-Heater-Inlet °F													
T16-Heater-Outlet °F													
T17-Heater-Inlet °F													
T17-Heater-Outlet °F													
T18-Heater-Inlet °F													
T18-Heater-Outlet °F													
T19-1st Entrance Step													
T20-2nd Entrance Step													
Heat Transfer-BTU/Hr-coolant													

COMPUTATIONAL CHART 6.1-Optional (Fahrenheit)

Chart 6.2

Description of Unit \_\_\_\_\_

Purpose of Test \_\_\_\_\_

Date	Location	Observers																		
		5	10	15	20	25	30	35	40	45	50	55	60							
Readings/Calculations																				
Water																				
Flow-kg/min																				
Flow Pressure-PaD																				
T-in °C																				
T-out °C																				
Air Temperature																				
T1 rear- °C																				
T2- °C																				
T3- °C																				
T4- °C																				
T5- °C																				
T6-front- °C																				
T7-ambient- °C																				
T8-Driver Ankle- °C																				
T9-Driver Knee- °C																				
T10-Driver Breath- °C																				
Electrical System																				
Volts																				
Amps																				

COMPUTATIONAL CHART 6.2 (Celsius)

**Chart 6.2-Optional Measurements**

Readings/Calculations	0	5	10	15	20	25	30	35	40	45	50	55	60
T11-Windshield CL Left- °C													
T12-Windshield CL Right- °C													
T13-Defrost Outlet Left- °C													
T14-Defrost Outlet Right °C													
T15-Heater-Inlet °C													
T15-Heater-Outlet °C													
T16-Heater-Inlet °C													
T16-Heater-Outlet °C													
T17-Heater-Inlet °C													
T17-Heater-Outlet °C													
T18-Heater-Inlet °C													
T18-Heater-Outlet °C													
T19-1st Entrance Step													
T20-2nd Entrance Step													
Heat Transfer-1/Hr-coolant													

COMPUTATIONAL CHART 6.2 - Optional (Celsius)

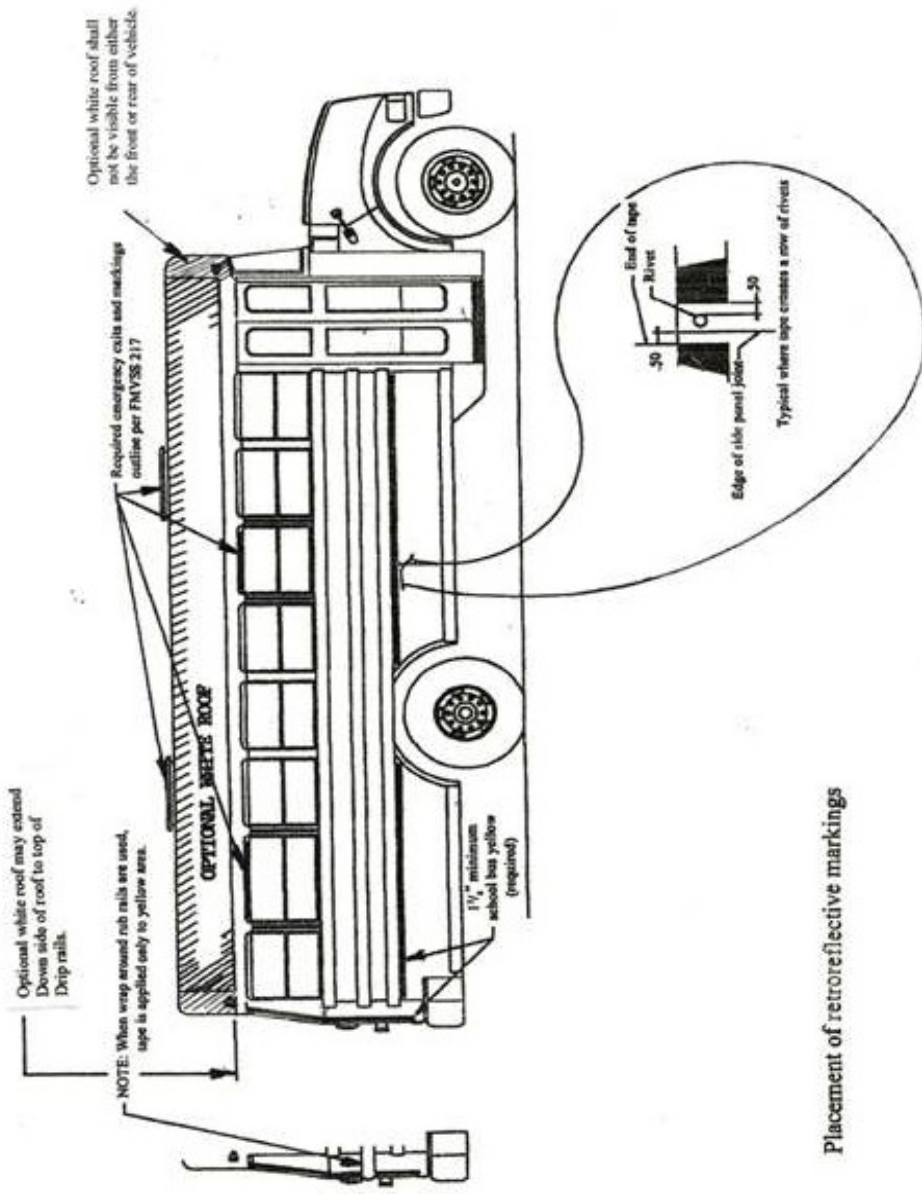

Placement of retroreflective markings

PLACEMENT OF RETROREFLECTIVE MARKINGS AND WHITE ROOF

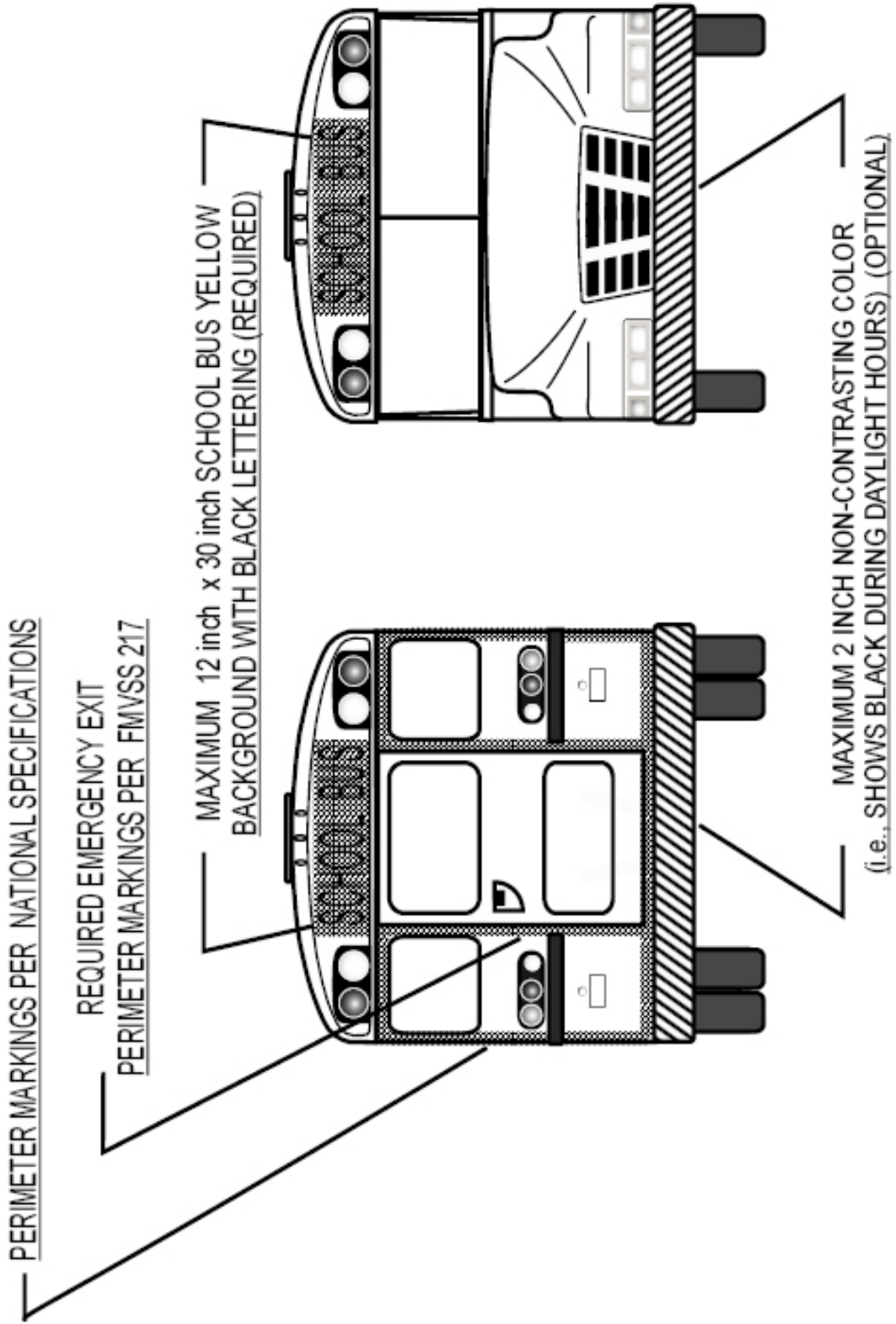

PLACEMENT OF RETROREFLECTIVE MARKINGS

## NOISE TEST PROCEDURE

- A. The vehicle is located so that no other vehicle or signboard, building, hill or other large reflecting surface is within 15.2 m (50 feet) of the occupant's seating position.
- B. All vehicle doors, windows and ventilators are closed.
- C. All power-operated accessories are turned off.
- D. The driver is in the normal seated driving position and the person conducting the test is the only other person in the vehicle.
- E. A sound level meter is used that is set at the "A-weighting fast" meter response and meets the requirements of:
  - 1. The American National Standards Institute, Standard ANSI S1.4-1971: *Specifications for Sound Level Meters*, for Type 1 Meters; or
  - 2. The International Electrotechnical Commission (IEC), Publication No. 179 (1973): *Precision Sound Level Meters*.
- F. The microphone is located so that it points vertically upward 6 inches to the right and directly in line with, and on the same plane as, the occupant's ear, adjacent to the primary noise source.
- G. If the motor vehicle's engine radiator fan drive is equipped with a clutch or similar device that automatically either reduces the rotational speed of the fan or completely disengages the fan from its power source in response to reduced engine cooling loads, the vehicle may be parked before testing with its engine running at high idle or any other speed the operator chooses for sufficient time, but not more than 10 minutes, to permit the engine radiator fan to automatically disengage.
- H. With the vehicle's transmission in neutral gear, the engine is accelerated to:
  - 1. Its maximum governed speed, if it is equipped with an engine governor; or
  - 2. Its speed at its maximum rated horsepower, if it is not equipped with an engine governor, and the engine is stabilized at that speed.
- I. The A-weighted sound level reading on the sound level meter for the stabilized engine speed condition referred to in H.1. or H.2., above, is observed and, if it has not been influenced by extraneous noise sources, is recorded.
- J. The vehicle's engine speed is returned to idle and the procedures set out in paragraphs H. and I. are repeated until 2 maximum sound levels within 2 dBA of each other are recorded. The 2 maximum sound level readings are then averaged; and
- K. The average obtained in accordance with paragraph J., with a value of 2 dBA subtracted therefrom to allow for variations in the test conditions and in the capabilities of meters, is the vehicle's interior sound level at the driver's seating position for the purposes of determining compliance with the requirements of this test procedure.



## RETROREFLECTIVE SHEETING DAYTIME COLOR SPECIFICATION

The daytime color of the RETROREFLECTIVE sheeting used to enhance school bus safety requires different color tolerances in order to assure optimum safety benefit, as well as to be consistent with the color of the school bus. The color of the RETROREFLECTIVE sheeting shall conform to the table below when samples applied to aluminum test panels are measured as specified in ASTM E1164. For colorimetric measurements, material is illuminated by Standard Illuminant D65 at an angle of 45 degrees with the normal to the surface the observations are made in the direction of the normal (45/0 degree geometry). The inverse (0/45 degree geometry) with the illuminant at the normal to the surface and the observations at 45 degrees with the normal to the surface may also be used. For materials which are directionally sensitive (e.g., prismatic sheeting), the colorimetric measurements are made using circumferential illumination and viewing and the various measurements are averaged. Calculations shall be done in accordance with ASTM E308 using the CIE 1931 (2 degree) Standard Observer.

Retroreflective Sheeting Daytime Color Chromaticity Coordinates of Corner Points Determining the Permitted Color Area				
	1	2	3	4
Yellow X	0.484	0.513	0.517	0.544
Y	0.455	0.426	0.482	0.455
Luminance Factor (Y%)			Minimum	10.0
			Maximum	36.0

## SCHOOL BUS SEAT UPHOLSTERY FIRE BLOCK TEST

### A. Test Chamber

#### Cross Section

The suggested test chamber is the same cross section as the bus body in which seats are used with the rear section on each end. If a bus section is not used, the cross section is to be 91±1 inch in width x 75 inches ±3 inches in height. There shall be a door, which does not provide ventilation, in the center of each end of the test chamber. The doors shall be 38±3 inches in width and 53±3 inches in height and include a latch to keep the doors closed during the test. (See Figure 1.)

#### Length

The length of the test chamber shall allow three rows of seats at the minimum spacing recommended by the installer. (See Figure 1, Detail A.)

In order that different types of seats may be tested in the same chamber, a length tolerance of plus 45 inches is allowed.

#### Ventilation

One ventilation opening shall be in each end of the test chamber and shall be 325 square inches ±25 square inches. The bottom of the opening shall be 30 inches ±3 inches above the chamber floor. Ventilation openings shall be on the same side of the test chamber. (See Figure 1.)

There shall be no ventilation openings along the length of the test chamber.

A forced-air ventilation system may not be used.

Baffles shall be used to prevent wind from blowing directly into the ventilation openings.

### Camera View Area

An opening covered with glass shall be provided at the midpoint of the test chamber length for camera viewing. The opening shall allow the camera to view the seat parallel to the seat width. (See Figure 1.)

### B. Test Sample

The sample shall be a fully-assembled seat.

Record the weight of all padding and upholstery prior to assembly. Record the weight of the fully-assembled seat.

### C. Ignition Source

A paper grocery bag with dimensions of approximately 7x11x18 inches is used to contain double sheets of newsprint (black print only, approximately 22x28 inches). The total combined weight of bag and newspaper shall be seven ounces  $\pm$ 0.5 ounces.

### D. Test Procedure

1. Install three seats in the test chamber at minimum spacing, per installer recommendation. Seats shall be perpendicular to the dimension indicated as "length" in Figure 1. Install so that seat frames will not fall during the test. Seat width shall be determined so that maximum passenger capacity per row (two seats) for the seat style shall be tested.
2. For each test, position the ignition source in the following positions outlined.

Figure 1

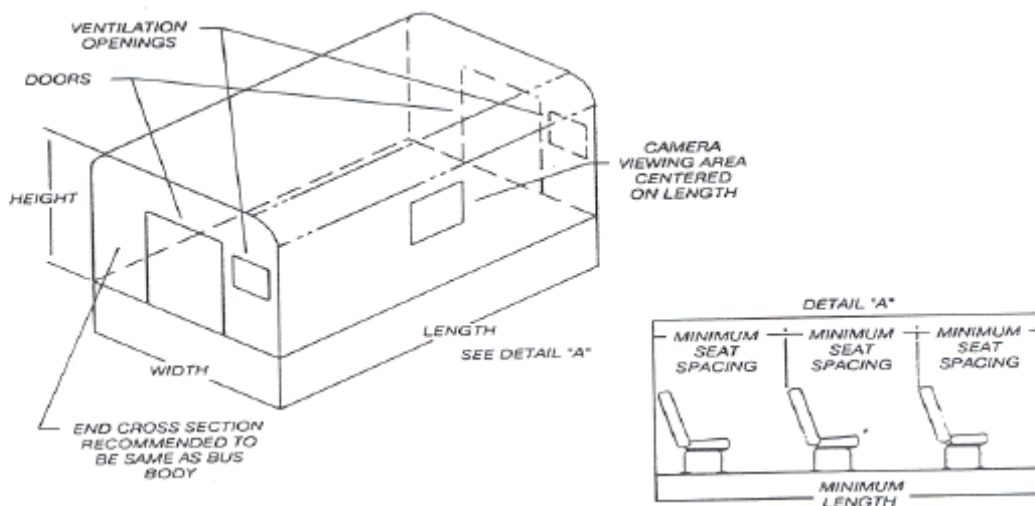

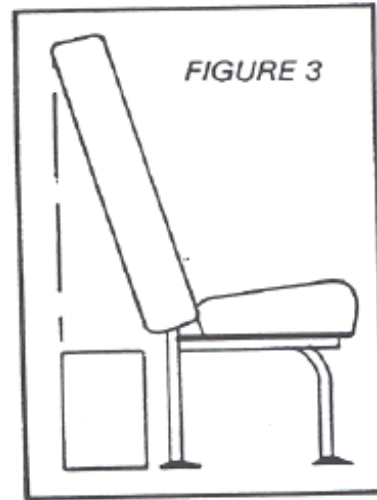
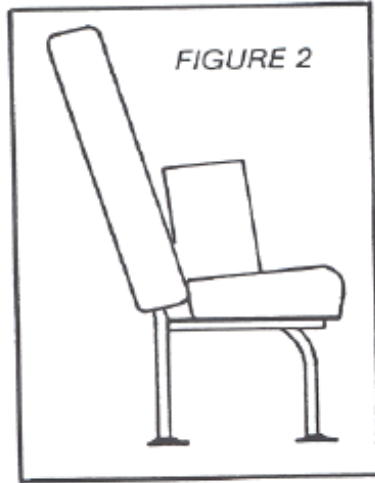

214

**Position A.**

Position ignition source with 18-inch dimension in contact with the seat cushion and touching the seat back. Center the bag on top of the cushion. (See Figure 2.)

**Position B.**

Position the ignition source on the floor behind the seat with 18-inch side resting on the floor and parallel to seat width, centered on width so that the rear of bag does not extend beyond the rear seat back. (See Figure 3.)

**Position C.**

Position the ignition source on the floor on the aisle side of the seat with 18-inch dimension on the floor and perpendicular to the seat width touching the seat leg, with centerline of the bag at the center of the seat back. (See Figure 4.)

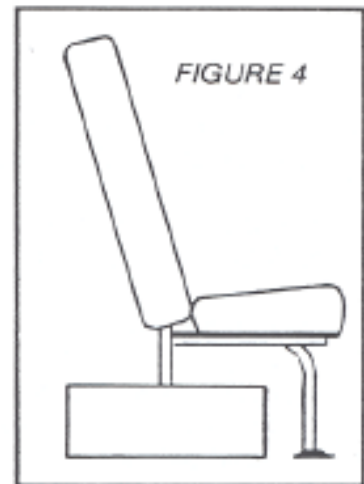

3. A wooden match shall be used to light the ignition source. Time the test, beginning when the ignition source is on fire and ending when all flames are out.
4. After each ignition source position test, weigh seat assembly, including loose material which has fallen off the seat onto the floor.

## **E. Performance Criteria**

For each ignition source position test, the seat tested must meet all of the following criteria. A new seat specimen may be used for each ignition source position test.

1. Maximum time from ignition to flameout shall be 8 minutes.
2. Flame shall not spread to any other seat with the ignition source in Position A and Position C.
3. Weight loss may not exceed 10% of the pretest weight of padding and upholstery. Padding and upholstery may be combined in the form of integrally bonded seat foam.

[Back to Contents](#)

**Page Intentionally Left Blank**

# **APPENDIX C**

## **Alternative Fuels**

**Page Intentionally Left Blank**

## APPENDIX C

### BIBLIOGRAPHY

49 CFR Part 571, Federal Motor Vehicle Safety Standards. NHTSA (400 Seventh Street SW, Washington, DC 20590).

*A.G.A. Requirements for Natural Gas Vehicle (NGV) Conversion Kits*, No. 1-85. American Gas Association Laboratories, August 20, 1995.

*An Alternative Transportation Fuel*, “The LNG Option.” Roy E. Adkins Cryogenic Fuels, Inc., September 1989.

*An Analysis of the Economic and Environmental Effects of Natural Gas as An Alternative Fuel*, EA 1989-10. December 15, 1989.

*Basic Requirements for Compressed Natural Gas Vehicle (NGV) Fuel Containers*, ANSI/AGA NGV2, American Gas Association Laboratories, 1992.

“CAA Clean Fuel Fleet Requirements.” Presented by Glenn W. Passavant, U.S. EPA. 1992 SAE Government/Industry Meeting, Washington, D.C., April 30, 1992.

“Campaigning for NGV’s”: 4th Annual Meeting Proceedings. Dallas, Texas: The Natural Gas Vehicle Coalition, June 24-25, 1992.

*Compressed Natural Gas Conference Proceedings*, SAE P - 129 (compilation of papers). Pittsburgh, Pennsylvania, June 22-23, 1993.

*Compressed Natural Gas (CNG) Demonstration Project: Transit Facility for Buses*. M.S. Consultants, Inc. for the Ohio Department of Transportation, June 1991.

*Compressed Natural Gas (CNG) Vehicular Fuel Systems*, ANSI/NFPA 52 - 1988 Edition. National Fire Protection Association.

*Directory of Natural Gas Vehicle Refueling Stations, Products and Services*, 1991 & 1992 Editions American Gas Association.

“Extent of Indoor Flammable Plumes Resulting from CNG Bus Fuel System Leaks SAE 922486” by Michael J. Murphy, Susan T. Brown, & David B. Phillips-Battelle, November 1992.

*Florida School Bus Alternate Fuel Manual*. Florida Department of Education (Suite 824, 325 West Gaines Street, Tallahassee, FL 322399-0400), 1992.

*Methanol Use in School Transportation: An Expedition Through the Mind Set of America*, SAE 951966 by Wayne B. Johnston and George Karbowski. Presented to SAE Future Transportation Technology Conference and Exposition, Costa Mesa, CA.

National Biodiesel Board, compilation of papers, [www.nbb.org](http://www.nbb.org), 1998 – 2005.



*Potential for Compressed Natural Gas Vehicles in Centrally-Fueled Automobile, Truck and Bus Fleet Applications*, by Michael E. Samsa. Gas Research Institute, Strategic Planning and Analysis Division, June 1991.

“Putting the Future of Methanol in Proper Perspective” by J.R. Crocco - Presented to 1992 SAE Government/ Industry Meeting, Washington, DC, April 1992.

Technology Conference Proceedings, The Natural Gas Vehicle Coalition, Dallas, Texas, June 24-25, 1992.

### **Glossary of Alternative Fuels**

**ARB:** The abbreviation for the (California) Air Resources Board, the state agency in California which sets the state’s emission standards.

**BTU:** A unit of work or energy known as a British Thermal Unit. One BTU is the energy required to increase the temperature of one pound of water by one degree Fahrenheit.

**Bi-fuel:** Used to describe a bus capable of running on either of two fuels, although not simultaneously. Engines which can be switched to run on either CNG or gasoline are examples.

**Bio-Diesel:** Is typically produced by a reaction of a vegetable oil or animal fat with an alcohol such as methanol or ethanol. Can be blended with petroleum-based diesel.

**Carbon monoxide:** A product of incomplete combustion; this gas is colorless, odorless and very poisonous. It does not contribute to smog.

**Catalytic converter:** An exhaust after-treatment device containing a catalytic material that is used to burn off or reduce unburned fuel or gases and thus reduce emissions, particularly NO<sub>x</sub> and hydrocarbons. Diesel converters run at cooler temperatures than do gasoline converters and require different catalysts.

**Cetane number:** A measure of self-ignition properties of a fuel after injection in a diesel engine. It relates to the knock properties of fuel. The higher the number, the more easily the fuel will ignite under compression; therefore, higher cetane fuels are usually preferred in diesels engines.

**Combustible gas sensor:** Detector capable of sensing the presence of natural gas.

**Cryogenic:** Relates to storage and use at very low temperatures. LNG requires cryogenic systems.

**Dual-fuel engine:** Also “flex fuel,” used to describe a gasoline-methanol dual-fuel engine using mixtures of gasoline and methanol, such as M85, which is 15 percent gasoline and 85 percent methanol. Dual-fuel engine can also refer to engines operating on any other mixture of fuels simultaneously, such as engines which run on a mixture of CNG and diesel.

**FMVSS:** Federal Motor Vehicle Safety Standard.

**Formaldehyde:** A chemical compound that is a by-product of combustion from engines. Concentrations may be particularly high in emissions from engines fueled by methanol.

**Fumigate:** Literally means “to form a gas or disperse one gas in another.” The term is used to describe the injecting of gas, usually CNG, into the intake air of the engine.

**G/bhp-hr:** The amount of a pollutant generated in one hour measured in grams per brake horsepower.

**GVWR:** Gross Vehicle Weight Rating means the value specified by the manufacturer as the loaded weight in pounds of a single vehicle, which shall not be less than the sum of the unloaded vehicle weight, plus the rated cargo load. For school buses, the rated cargo load is 120 pounds times the vehicle’s designated seating capacity, plus 150 pounds for the driver.

**Greenhouse gases:** some of these gases are formed by vehicle emissions causing a rise in temperature of the earth’s atmosphere.

**Hybrid vehicle:** Generally refers to a vehicle designed to run on electric power and an internal combustion engine.

**Hydrogen fuel cell:** A chemical reaction process to develop electrical current from oxygen and hydrogen.

**Hydrocarbons:** A gaseous compound formed by incomplete combustion and comprised of unburned and partially burned fuel. It combines with NO<sub>x</sub> and sunlight to form ozone and is a major contributor to smog.

**Lean burn:** Uses more air than is needed for theoretical complete combustion. This added air allows combustion to take place at a lower temperature, thus reducing the emission of NO<sub>x</sub> and CO.

**Nebula combustion chamber:** A unique high-turbulence combustion chamber in the top of a piston, which is particularly effective in efficient burning of lean gas-air mixtures.

**NFPA:** National Fire Protection Association

**NO<sub>x</sub>:** Abbreviation for nitrogen oxides, the gaseous compounds which combine with hydrocarbons and sun light to form ozone, an air pollutant that contributes to smog.

**Octane number:** A measure of anti-knock properties of a fuel that relates to spark ignition engines. The higher the number, the more resistant to knocking. Higher output and more efficient engine designs can be used with higher octane fuel.

**Ozone:** A pollutant formed from nitrogen oxides (NO<sub>x</sub>), hydrocarbons and sunlight. This gas has an irritating odor, is poisonous and is used as an oxidizing agent for bleaching.

**Particulate traps:** An exhaust treatment device used to collect (trap) and periodically burn off particulates and other potential problem emission gases formed in engine exhaust.

**Particulates:** Small solid particles (soot, etc.) formed by engine combustion. Visible particulates are seen in smoke; however, invisible particles may be present in smokeless exhaust.

**Pilot ignition engine:** An engine using a small quantity of diesel fuel to provide an ignition source for an alternative fuel that will not ignite on its own in a compression cycle.

**Port injection:** Similar to the throttle body system except that the fuel is injected near each cylinder intake port. The injectors and their controls can be individually controlled for maximum performance and emissions control.

**Reformulated gasoline:** Also known as “oxygenated gasoline,” reformulated gasoline has oxygen added to improve combustion and reduce emissions.

**Repower installation:** A dedicated natural gas or other engine which was not part of the original chassis at the time of manufacturing.

**Stoichiometric burn:** Use of fuel and air (or oxygen) in the exact ratio needed for complete combustion to generate maximum efficiency and power.

**Throttle body injection:** A gasoline fuel injection system in which the fuel is injected directly into the air intake pipe or manifold. No carburetor is required; electronics monitor engine variables and control the rate of fuel injected.

**UL:** Underwriters Laboratory.

## ALTERNATIVE FUELS COMPARISON CHART

	ENVIRONMENTAL ISSUES		OPERATIONAL ISSUES	
	Pro	Con	Pro	Con
<b>Electric Power</b>	<ul style="list-style-type: none"> <li>• Zero emissions</li> <li>• Electricity often produced from renewable domestic energy resource</li> <li>• Extremely quiet</li> </ul>	<ul style="list-style-type: none"> <li>• Electric power from coal or oil does not eliminate overall emissions</li> <li>• Battery disposal is a concern</li> </ul>	<ul style="list-style-type: none"> <li>• Distribution systems already in place. (Power generation and transmission system)</li> <li>• Extremely quiet</li> <li>• Low operating cost per mile</li> </ul>	<ul style="list-style-type: none"> <li>• Low range due to weight and storage capacity of batteries</li> <li>• Current cost for vehicles extremely high</li> <li>• Overall vehicle weight, limits passenger capacity</li> <li>• Current technology requires battery replacement during life of vehicle</li> </ul>
<b>Hybrid Electric</b>	<ul style="list-style-type: none"> <li>• Used with any internal combustion engine</li> <li>• Reduced emissions over all</li> <li>• Low operating cost per mile</li> </ul>	<ul style="list-style-type: none"> <li>• Still has some emissions</li> <li>• In some areas, emissions are produced generating electricity for plug-in</li> <li>• Battery disposal</li> </ul>	<ul style="list-style-type: none"> <li>• Plug-in type charges overnight</li> <li>• Very quiet in electric mode</li> <li>• Lower operating cost per mile</li> <li>• Reduces foreign oil dependency</li> </ul>	<ul style="list-style-type: none"> <li>• Batteries need to be replaced every 7 years</li> <li>• Availability is limited and therefore expensive</li> </ul>
<b>Clean Diesel</b>	<ul style="list-style-type: none"> <li>• Reduced emissions</li> <li>• Reduces particulate matter 20% - 30% in older engines</li> <li>• Few safety problems</li> </ul>	<ul style="list-style-type: none"> <li>• Needs particulate and NO<sub>x</sub> reduction</li> <li>• Still some smoke (cold and high altitude)</li> <li>• Spill leakage contamination</li> </ul>	<ul style="list-style-type: none"> <li>• Readily available and uses current distribution</li> <li>• Minimal cost increase</li> <li>• Very efficient, good mileage</li> <li>• Useable in older engines</li> </ul>	<ul style="list-style-type: none"> <li>• Hard cold starting</li> <li>• Foreign oil dependency</li> <li>• Not available in all areas</li> </ul>
<b>Bio-Diesel</b>	<ul style="list-style-type: none"> <li>• Significant emissions reduction</li> <li>• Blends with petroleum fuel and will run in current engines reducing emissions</li> </ul>	<ul style="list-style-type: none"> <li>• In some engines NO<sub>x</sub> emissions are higher</li> </ul>	<ul style="list-style-type: none"> <li>• Derived from natural renewable oils</li> <li>• Reduces foreign oil dependency</li> <li>• Dispenses with current systems</li> </ul>	<ul style="list-style-type: none"> <li>• May degrade rubber parts in fuel system</li> <li>• Higher cloud point and pour point, poor cold start-ability</li> <li>• Eight percent less energy</li> <li>• May clog systems at first</li> </ul>
<b>Reformulated Gasoline</b>	<ul style="list-style-type: none"> <li>• Reduced emissions in older engines</li> <li>• Can be used in any gasoline engine</li> </ul>	<ul style="list-style-type: none"> <li>• Still high in smog forming emissions</li> <li>• Spill leakage contamination</li> <li>• Non-renewable resource</li> </ul>	<ul style="list-style-type: none"> <li>• Will be readily available when required by EPA</li> <li>• Minimal cost increase</li> <li>• Usable in older engines</li> </ul>	<ul style="list-style-type: none"> <li>• Over twice the cost per mile vs. diesel</li> <li>• Foreign oil dependency</li> </ul>
<b>Methanol</b>	<ul style="list-style-type: none"> <li>• Low NO<sub>x</sub> particulate</li> <li>• Dissipation in water and bio-degradable</li> <li>• Diverse fuel sources</li> </ul>	<ul style="list-style-type: none"> <li>• Generates formaldehyde</li> <li>• Very toxic</li> </ul>	<ul style="list-style-type: none"> <li>• High octane for efficient spark ignition combustion</li> <li>• Liquid borne easy to distribute</li> <li>• Blends well with gasoline</li> </ul>	<ul style="list-style-type: none"> <li>• Corrosive</li> <li>• Invisible flame</li> <li>• Explosive vapors</li> <li>• Hard cold starting</li> <li>• Limited production</li> <li>• Limited fuel locations</li> <li>• 45% energy of diesel</li> </ul>
<b>Ethanol</b>	<ul style="list-style-type: none"> <li>• Low in NO<sub>x</sub> and particulates</li> <li>• Dissipation in water and bio-degradable</li> <li>• Renewable resource</li> </ul>	<ul style="list-style-type: none"> <li>• Slight smoking</li> <li>• Generates formaldehyde, but less than methanol</li> <li>• Uses about the same energy to produce as it generates</li> </ul>	<ul style="list-style-type: none"> <li>• High octane for efficient spark ignition combustion.</li> <li>• Liquid borne easy to distribute</li> <li>• Blends well with gasoline</li> </ul>	<ul style="list-style-type: none"> <li>• High cost to produce</li> <li>• Limited production capability</li> <li>• Limited fuel locations</li> <li>• 50% of energy of diesel (low range or large fuel tanks)</li> </ul>
<b>Compressed Natural Gas (CNG)</b>	<ul style="list-style-type: none"> <li>• Low emissions</li> <li>• Smokeless</li> <li>• Available from the well, minimum processing</li> </ul>	<ul style="list-style-type: none"> <li>• Needs NO<sub>x</sub> reduction</li> <li>• Requires energy to compress</li> </ul>	<ul style="list-style-type: none"> <li>• Gasoline conversion available</li> <li>• Attractive fuel cost</li> <li>• Ample domestic supply</li> <li>• Low engine maintenance</li> <li>• Minimum explosion hazard</li> <li>• Vapors lighter than air, dissipates quickly</li> </ul>	<ul style="list-style-type: none"> <li>• Slow refueling</li> <li>• Limited vehicle fuel distribution</li> <li>• Fuel quality variation</li> <li>• High pressure on-board fuel storage, heavy and complex</li> <li>• Limited energy and range, relative to diesel.</li> </ul>
<b>Liquid Natural Gas (LNG)</b>	<ul style="list-style-type: none"> <li>• Low emissions</li> <li>• Smokeless</li> <li>• Available from the well, minimum processing</li> </ul>	<ul style="list-style-type: none"> <li>• Needs NO<sub>x</sub> reduction</li> <li>• Requires energy to liquefy and cool</li> </ul>	<ul style="list-style-type: none"> <li>• Basic engine same as CNG</li> <li>• Attractive fuel cost</li> <li>• Ample domestic supply</li> <li>• Less than ½ tank space of CNG</li> <li>• Low engine maintenance</li> <li>• Minimal explosion hazard</li> <li>• Vapors lighter than air</li> </ul>	<ul style="list-style-type: none"> <li>• Slow refueling</li> <li>• Limited availability today</li> <li>• Cryogenic handling (-260F)</li> <li>• Must vent fuel system after 7 to 10 days</li> <li>• High pressure on board fuel storage,</li> <li>• Heavy and complex</li> </ul>
<b>LPG (Propane)</b>	<ul style="list-style-type: none"> <li>• Low emissions</li> <li>• Smokeless</li> </ul>	<ul style="list-style-type: none"> <li>• Needs NO<sub>x</sub> reduction</li> <li>• Requires energy to liquefy</li> </ul>	<ul style="list-style-type: none"> <li>• Fairly wide distribution</li> <li>• Long term experience in vehicle</li> <li>• Good cold starting</li> </ul>	<ul style="list-style-type: none"> <li>• Slow refueling</li> <li>• Limited energy and range, relative to diesel</li> <li>• Vapors heavier than air</li> <li>• Explosion potential</li> </ul>

**Page Intentionally Left Blank**

# **APPENDIX D**

## **School Bus Operations**

**Page Intentionally Left Blank**

## APPENDIX D

### National Highway Traffic Safety Administration Highway Safety Program Guideline #17 PUPIL TRANSPORTATION SAFETY

- I. **Scope.** This guideline establishes minimum recommendations for a State Highway Safety Program for pupil transportation safety including the identification, operation and maintenance of buses used for carrying students; training of passengers, pedestrians and bicycle riders; and administration.
- II. **Purpose.** The purpose of this guideline is to minimize, to the greatest extent possible, the danger of death or injury to school children while they are traveling to and from school and school-related events.
- III. **Definitions.** “Bus” is a motor vehicle designed for carrying more than 10 persons (including the driver).

“Federal Motor Carrier Safety Regulations (FMCSR)” are the regulations of the Federal Motor Carrier Safety Administration (FMCSA) for commercial motor vehicles in interstate commerce, including buses with a gross vehicle weight rating (GVWR) greater than 10,000 pounds or designed to carry 16 or more persons (including the driver), other than buses used to transport school children from home to school and from school to home. (The FMCSR are set forth in 49 CFR Parts 383-399.)

“School-chartered bus” is a “bus” that is operated under a short-term contract with state or school authorities who have acquired the exclusive use of the vehicle at a fixed charge to provide transportation for a group of students to a special school-related event.

“School bus” is a “bus” that is used for purposes that include carrying students to and from school or related events on a regular basis, but does not include a transit bus or a school-chartered bus.

- IV. **Pupil Transportation Safety Program Administration and Operations.**  
**Recommendation.** Each state, in cooperation with its school districts and other political subdivisions, should have a comprehensive pupil transportation safety program to ensure that school buses and school-chartered buses are operated and maintained so as to achieve the highest possible level of safety.

A. **Administration.**

1. There should be a single state agency having primary administrative responsibility for pupil transportation, and employing at least one full-time professional to carry out these responsibilities.
2. The responsible state agency should develop an operating system for collecting and reporting information needed to improve the safety of



operating school buses and school-chartered buses. This includes the collection and evaluation of uniform crash data consistent with the criteria set forth in Highway Safety Program Guidelines No. 10, "Traffic Records" and No. 19, "Accident Investigation and Reporting."

**B. Identification and Equipment of School Buses.** Each state should establish procedures to meet the following recommendations for identification and equipment of school buses.

1. All school buses should:
  - a. Be identified with the words "School Bus" printed in letters not less than eight inches high, located between the warning signal lamps as high as possible without impairing visibility of the lettering from both front and rear, and have no other lettering on the front or rear of the vehicle, except as required by Federal Motor Vehicle Safety Standards (FMVSS), 49 CFR Part 571.
  - b. Be painted National School Bus Yellow, in accordance with the colorimetric specification of National Institute of Standards and Technology (NIST) Federal Standard No. 595a, Color 13432, except that the hood should be either that color or lusterless black, matching NIST Federal Standard No. 595a, Color 37038.
  - c. Have bumpers of glossy black, matching NIST Federal Standard No. 595a, Color 17038, unless, for increased visibility, they are covered with a reflective material.
  - d. Be equipped with safety equipment for use in an emergency, including a charged fire extinguisher, that is properly mounted near the driver's seat, with signs indicating the location of such equipment.
  - e. Be equipped with device(s) demonstrated to enhance the safe operation of school vehicles, such as a stop signal arm.
  - f. Be equipped with a system of signal lamps that conforms to the school bus requirements of FMVSS No. 108, 49 CFR 571.108.
  - g. Have a system of mirrors that conforms to the school bus requirements of FMVSS No. 111, 49 CFR 571.111, and provides the seated driver a view to the rear along both sides of the bus and a view of the front bumper and the area in front of the bus. Mirrors should be positioned and adjusted such that when a rod, 30 inches long, is placed upright on the ground at any point along a traverse line one-foot forward of the forward-most point of a school bus, at

least seven 1/2 inches of the length of the rod should be visible to the driver, either by direct view or by the system of mirrors.

- h. Comply with all FMVSS applicable to school buses at the time of their manufacture.
- 2. Any school bus meeting the identification recommendations of sections 1. a.-h. above, that is permanently converted for use wholly for purposes other than transporting children to and from school or school-related events, should be painted a color other than National School Bus Yellow, and should have the stop arms and school bus signal lamps described by sections 1. e. & f. removed.
  - 3. School buses, while being operated on a public highway and transporting primarily passengers other than school children, should have the words "School Bus" covered, removed, or otherwise concealed, and the stop arm and signal lamps described by sections 1. e & f should not be operated.
  - 4. School-chartered buses should comply with all applicable FMCSR and FMVSS.
- C. **Operations.** Each state should establish procedures to meet the following recommendations for operating school buses and school-chartered buses:
- 1. Personnel.
    - a. Every person who drives a school bus or school-chartered bus occupied by school children should, as a minimum:
      - (1) Have a valid state driver's license to operate such a vehicle. All drivers who operate a vehicle designed to carry 16 or more persons (including the driver) are required by FMCSA's Commercial Driver's License Standards by April 1, 1992 (49 CFR Part 383) to have a valid commercial driver's license.
      - (2) Meet all physical, mental, moral and other requirements established by the state agency having primary responsibility for pupil transportation, including requirements for drug and/or alcohol misuse or abuse; and
      - (3) Be qualified as a driver under the Federal Motor Carrier Safety regulations of the FMCSA, 49 CFR Part 391, if the driver or the drivers' employer is subject to those regulations.

2. Vehicles.

- a. Each state should enact legislation that provides for uniform procedures regarding school buses stopping on public highways for loading and discharge of children. Public information campaigns should be conducted on a regular basis to ensure that the driving public fully understands the implications of school bus warning signals and requirements to stop for school buses that are loading or discharging school children.
- b. Each state should develop plans for minimizing highway use hazards to school bus and school-chartered bus occupants, other highway users, pedestrians, bicycle riders and property. They should include, but not be limited to:
  - (1) Careful planning and annual review of routes for safety hazards;
  - (2) Planning routes to ensure maximum use of school buses and school-chartered buses, and to ensure that passengers are not standing while these vehicles are in operation;
  - (3) Providing loading and unloading zones off the main traveled part of highways, whenever it is practical to do so;
  - (4) Establishing restricted loading and unloading areas for school buses and school-chartered buses at or near schools;
  - (5) Ensuring that school bus operators, when stopping on a highway to take on or discharge children, adhere to state regulations for loading and discharging including the use of signal lamps as specified in section B. 1. f. of this guideline;
  - (6) Prohibiting, by legislation or regulation, operation of any school bus unless it meets the equipment and identification recommendations of this guideline;
  - (7) Replacing, consistent with the economic realities which typically face school districts, those school buses which are not manufactured to meet the April 1, 1977 FMVSS for school buses, with those manufactured to meet the stricter school bus standards, and not chartering any pre-1977 school buses; and
  - (8) Informing potential buyers of pre-1977 school buses that these buses may not meet current standards for newly

manufactured buses and of the need for continued maintenance of these buses and adequate safety instruction.

- c. Use of amber signal lamps to indicate that a school bus is preparing to stop to load or unload children is at the option of the state. Use of red warning signal lamps as specified in section B 1. f. of this guideline for any purpose or at any time other than when the school bus is stopped to load or discharge passengers should be prohibited.
- d. When school buses are equipped with stop arms, such devices should be operated only in conjunction with red warning signal lamps, when vehicles are stopped.
- e. Seating
  - (1) Standing while school buses and school-chartered buses are in motion should not be permitted. Routing and seating plans should be coordinated so as to eliminate passengers standing when a school bus or school-chartered bus is in motion.
  - (2) Seating should be provided that will permit each occupant to sit in a seat intended by the vehicles' manufacturer to provide accommodation for a person at least as large as a 5th percentile adult female, as defined in 49 CFR 571.208. Due to the variation in sizes of children of different ages, states and school districts should exercise judgement in deciding how many students are actually transported in a school bus or school-chartered bus.
  - (3) There should be no auxiliary seating accommodations such as temporary or folding jump seats in school buses.
  - (4) Drivers of school buses and school-chartered buses should be required to wear occupant restraints whenever the vehicle is in motion.
  - (5) Passengers in school buses and school-chartered buses with a gross vehicle weight rating (GVWR) of 10,000 pounds or less should be required to wear occupant restraints (where provided) whenever the vehicle is in motion. Occupant restraints should comply with the requirement of FMVSS Nos. 208, 209 and 210, as they apply to multipurpose vehicles.

- f. Emergency exit access. Baggage and other items transported in the passenger compartment should be stored and secured so that the aisles are kept clear and the door(s) and emergency exit(s) remain unobstructed at all times. When school buses are equipped with interior luggage racks, the racks should be capable of retaining their contents in a crash or sudden driving maneuver.

D. **Vehicle Maintenance.** Each state should establish procedures to meet the following recommendations for maintaining buses used to carry school children:

1. School buses should be maintained in safe operating condition through a systematic preventive maintenance program.
2. All school buses should be inspected at least semi-annually. In addition, school buses and school-chartered buses subject to the Federal Motor Carrier Safety Regulations of FMCSA should be inspected and maintained in accordance with those regulations (49 CFR Parts 393 and 396).
3. School bus drivers should be required to perform daily pre-trip inspections of their vehicles, and the safety equipment thereon (especially fire extinguishers), and to report promptly and in writing any problems discovered that may affect the safety of the vehicles's operation or result in its technical breakdown. Pre-trip inspection and condition reports for school buses and school-chartered buses subject to the Federal Motor Carrier Safety Regulations of FMCSA should be performed in accordance with those regulations (49 CFR 392.7, 392.8, and 396).

E. **Other Aspects of Student Transportation Safety.**

1. At least once during each school semester, each pupil transported from home to school in a school bus should be instructed in safe riding practices, proper loading and unloading techniques, proper street crossing to and from school bus stops and should participate in supervised emergency evacuation drills, which are timed. Prior to each departure, each pupil transported to an activity or field trip in a school bus or school-chartered bus should be instructed in safe riding practices and on the location and operation of emergency exits.
2. Parents and school officials should work together to select and designate the safety pedestrian and bicycle routes for the use of school children.
3. All school children should be instructed in safe transportation practices for walking to and from school. For those children who routinely walk to school, training should include preselected routes and the importance of adhering to those routes.

4. Children riding bicycles to and from school should receive bicycle safety education, wear bicycle safety helmets, and not deviate from preselected routes.
  5. Local school officials and law enforcement personnel should work together to establish crossing guard programs.
  6. Local school officials should investigate programs which incorporate the practice of escorting students across streets and highways when they leave school buses. These programs may include the use of school safety patrols or adult attendants.
  7. Local school officials should establish passenger vehicle loading and unloading points at schools that are separate from the school bus loading zones.
- F. **Program evaluation.** The pupil transportation safety program should be evaluated at least annually by the state agency having primary administrative responsibility for pupil transportation.

**SCHOOL BUS DRIVER APPLICATION**  
**(Sample Form)**

Applicant Name: \_\_\_\_\_

Present Address: \_\_\_\_\_

Date of Birth: \_\_\_\_\_ Social Security No. \_\_\_\_\_

Addresses at which applicant has resided during the past three (3) years: \_\_\_\_\_

\_\_\_\_\_

Current Driver's License Number: \_\_\_\_\_

State of Issue: \_\_\_\_\_ Expiration Date: \_\_\_\_\_

Class of License: \_\_\_\_\_ Endorsements: \_\_\_\_\_ Restrictions: \_\_\_\_\_

Have you had any type of vehicle accident in the last three (3) years?  yes  no

If yes, give dates and explain:

\_\_\_\_\_  
\_\_\_\_\_

Have you ever been terminated or suspended from previous employment because of a positive drug or alcohol test?

yes  no

Have you been convicted of a moving traffic violation in the last three (3) years?  yes  no

If yes, give dates and explain:

\_\_\_\_\_  
\_\_\_\_\_

Has your driver's license been suspended or revoked during the last three (3) years?  yes  no

If yes, give dates and explain:

\_\_\_\_\_  
\_\_\_\_\_

Has your license ever been revoked, suspended or denied since the time you obtained your original license?  yes  no

If yes, give dates and explain:

\_\_\_\_\_  
\_\_\_\_\_

Have you held a license in another state during the last three (3) years?  yes  no

Which state(s)?

\_\_\_\_\_

**Employment**

List the names and addresses of your current and previous employers during the ten (10) years preceding the date of this application.

Current Employer:

\_\_\_\_\_

Address: \_\_\_\_\_

Dates: \_\_\_\_\_

Reason for leaving:

\_\_\_\_\_

Job Title & Duties:

\_\_\_\_\_

Previous Employer:

\_\_\_\_\_

Address:

\_\_\_\_\_

Dates:

\_\_\_\_\_

Reason for leaving:

\_\_\_\_\_

Job Title & Duties:

\_\_\_\_\_

Additional employers may be listed on a separate sheet.

**Education and training**

Education completed:    High School       College       Graduate School

Degrees earned and school(s): \_\_\_\_\_

Specific experience or formal training related to transportation of students: \_\_\_\_\_

\_\_\_\_\_

I understand that the information provided by me may be checked, and previous employers may be contacted for the purpose of investigating my background. This certifies that this application was completed by me, and that all entries and information on it are true and complete to the best of my knowledge.

Date: \_\_\_\_\_

Signature: \_\_\_\_\_

I authorize the employer to conduct a criminal history check and to investigate all written information contained on this application.

Date: \_\_\_\_\_

Signature: \_\_\_\_\_



**ACTIONS TO BE TAKEN DURING AND  
FOLLOWING THE OBSERVATIONS OF SCHOOL  
BUS ROUTES**

Supervisory actions that should be taken during and after the transportation director completes a review of bus routes are listed below:

1. Check the route and schedule for accuracy.
2. Determine that loading and unloading occurs only at authorized stops.
3. Check for bus stop hazards.
4. Check to see that vehicles are operated in compliance with prescribed regulations.
5. Observe the driver-student relationship.
6. Check loading and unloading conditions at school centers.
7. Check for evidence of supervision in loading zones.
8. Note hazardous road conditions.
9. Note the nature, frequency and locations of bus stop law violations.
10. Observe conditions of bus [e.g., cleanliness, tires, windows, emergency exit(s), first aid kits, fire extinguisher, seats, etc.].
11. Observe vehicle inspection guide for evidence of pre-trip inspection.
12. Note driver attitude toward other motorists and pedestrians.
13. Follow the observation with a written report and discussion with the driver (and others, as appropriate). The discussion should be used to encourage the driver to become self-auditing and participate in giving supervisors information that is helpful in improving the overall safety, effectiveness and efficiency of the student transportation system.
14. File the written report in the driver's permanent record.

## **GUIDELINES FOR EN ROUTE EMERGENCY BUS EVACUATION PROCEDURES**

The intent of these procedures is to provide guidelines for evacuating a bus only when absolutely necessary in an emergency situation, for the safety of students and staff.

### **Preparing an Emergency Evacuation Plan:**

Each bus should have an emergency evacuation plan, which should be kept in the bus. The plan should allow for individual capabilities and needs of each student, the type of behaviors that might be exhibited during an emergency evacuation and the types of wheelchair or support equipment being used for students. A floor plan with student location and special needs should be in the bus. Issues that should be considered when establishing an evacuation plan are listed below.

- A. Whether or not students can help, and to what extent;
- B. How to deal with individual emergencies (e.g., seizures) during the evacuation process;
- C. Whether students should be evacuated in their wheelchairs, or removed from their wheelchairs before evacuation;
- D. How to disconnect or cut wheelchair securement and occupant protection equipment, including belts, trays and other support equipment;
- E. The order or sequence in which students should be evacuated;
- F. The length of time a student requiring life support equipment or medical care procedures can survive if such service is interrupted or delayed during the evacuation process;
- G. Where to gather once off the bus and how to evaluate different scenarios to make the best decision about where to gather;
- H. Training plan and schedules for drivers and students; and
- I. Specific emergency equipment needed, training in use and assignment of responsibility to remove from the bus when evacuations occur.

### **Assessing the Need to Evacuate:**

Student safety and control are best maintained by keeping students in the bus during an emergency and/or impending crisis situation if doing so does not expose them to unnecessary risk or injury. A decision to evacuate should include consideration of the following conditions:

- A. Is there a fire involved?
- B. Is fuel leaking?
- C. Might the bus roll or tip, thereby causing further threat to safety?
- D. Is the bus likely to be hit by other vehicles?
- E. Is the bus in the direct path of a sighted tornado or other natural disaster, such as rising water?
- F. Would evacuating students expose them to speeding traffic, severe weather or another dangerous environment?
- G. Considering the medical, physical and emotional condition of the students, does staying in the bus or evacuating pose the greater danger to the students' safety?

**General Procedures to Follow for Emergency Evacuation:**

- A. Keep the situation as orderly and low-key as possible.
- B. If time and conditions permit, the bus driver should use the communication system to advise the office of the following information:
  - 1. The exact location, including nearest intersecting road or familiar landmark;
  - 2. The condition creating the emergency;
  - 3. The type of assistance needed (police-fire-ambulance); and
  - 4. Notification that the bus is being evacuated.
- C. Analyze conditions to determine the safest exit from the bus and safest gathering location.
- D. During evacuation, monitor conditions and adjust procedures to meet unexpected circumstances.
- E. Move evacuated students to the nearest safe location at least 100 feet from the bus.
- F. Be prepared to give information to emergency medical personnel regarding individual students' medical or physical requirements.

### **Equipment Considerations:**

- A. As part of their pre-trip inspection, bus staff should familiarize themselves with the location and method of opening all emergency exits.
- B. If time permits, a lift platform can be lowered half the distance to the ground, providing a step for evacuating wheelchairs. If there is a smell of spilled fuel, the lift should be operated manually.
- C. When re-entry to the bus is not probable, communication equipment and first aid kits can frequently be passed through a window, making them accessible outside the bus. Consideration should also be made for student medication, if carried and needed.
- D. If a large bus is being used and evacuation is made through the rear exit door, consideration should be given to the method to be used for re-entry to the bus, if necessary, considering the height of the floor from the ground. (Some states allow a stirrup-type step on the rear bumper.)
- E. If a battering ram is needed, a fire extinguisher can often serve that purpose.
- F. A webbing cutter shall be stored in the bus in a location readily accessible to the driver when he/she is seated in the normal driving position and location. The cutter should have a protected mouth to restrict the entry of fingers, etc.

### **Local District Policy:**

Bus staff should be familiar with local district policy regarding the following items:

- A. Evacuation procedures to follow when students are en route; or, what to do if a tornado or flash flood, etc. is sighted and no shelter is near.
- B. The type of medical information to be available on long distance trips in case of student injury.

**Note:** THE SAFETY OF THE BUS AND EQUIPMENT IS SECONDARY TO THE SAFETY OF THE STUDENTS. NO ATTEMPT SHOULD BE MADE TO SAVE EQUIPMENT OR PERSONAL ITEMS UNTIL ALL STUDENTS ARE REMOVED FROM THE BUS SAFELY, ARE OUT OF DANGER AND ARE ADEQUATELY SUPERVISED.

**Sample Crash Reporting Form  
(For Injury Events Where the School Bus is Physically Involved)**

The school bus crash reporting form has been harmonized with other national crash data collection methods and is provided in two formats: in hardcopy and as an electronic form that can be use to enter data that can be subsequently exported to a spreadsheet or database. This will support efforts to automate data collection on a national level to assist states in developing a uniform web-based format to gather important collision data. This format allows for collection of collision data involving students traveling to and from school and school activities, as occupants in school buses, and as pedestrians. The form collects additional information specific to students riding while seated in wheelchairs or child safety restraint devices.

This form suggests what data is helpful to collect and is designed to allow data to be tabulated, analyzed and compared using consistent criteria. The option of a uniform web-based reporting system allows states to gather information according to reporting criteria established by the individual state mandates, but allows that information to be analyzed nationally by sorting the data by uniform fields and terminology, resulting in timely responses to national organizations or federal agencies that request the crash data. The adoption of this format will provide a realistic uniform database that could be utilized to enhance the safety and economy of student travel in each state.

**SCHOOL BUS CRASH REPORT FORM**

**Date form completed:** \_\_\_\_\_

**Person filling out form:** \_\_\_\_\_

**Title of person filling out form:** \_\_\_\_\_

**Sources of information (check all that apply):**

- Police accident report (PAR)
- Bus driver interview
- Student interviews
- Witness interviews
- Medical records
- Other: describe \_\_\_\_\_

**Event type (check all that apply):**

- Bus Crash (fill out pages 2-8)
- Pedestrian hit by bus or other vehicle
- Entering/exiting bus
- Moving vehicle injury incident (includes braking, turning)

**Outcomes (check all that apply):**

- School bus damage exceeded \$1,000
- Property damage exceeded \$1,000
- Vehicles towed from scene
- Bus driver or bus passenger injuries
- Bus driver or bus passengers transported for medical treatment
- Fatality





## **Crash Information**

\_\_\_\_\_ Yes \_\_\_\_\_ No **Did the bus strike any objects?**

**Describe Objects** (check all that apply)

- |  |  |
|--|--|
| <input type="checkbox"/> Tree<br><input type="checkbox"/> Utility Pole<br><input type="checkbox"/> Sign<br><input type="checkbox"/> Animal<br><input type="checkbox"/> Pedestrian<br><input type="checkbox"/> Bicyclist<br><input type="checkbox"/> Embankment, snow bank<br><input type="checkbox"/> Fence<br><input type="checkbox"/> Fire hydrant, stump, short post<br><input type="checkbox"/> Building | <input type="checkbox"/> Small post, mailbox, delineator<br><input type="checkbox"/> Guardrail<br><input type="checkbox"/> Bridge rail<br><input type="checkbox"/> Culvert, ditch<br><input type="checkbox"/> Median/concrete barrier<br><input type="checkbox"/> Retaining wall, abutment<br><input type="checkbox"/> Curb<br><input type="checkbox"/> Parked vehicle<br><input type="checkbox"/> Ground (rollover)<br><input type="checkbox"/> Other: describe _____ |
|--|--|

**Contributing Circumstances** (check all that apply):

	<b>School Bus Driver</b>	<b>Other Vehicle Driver</b>
No improper action	_____	_____
Speed	_____	_____
Failed to yield right-of-way	_____	_____
Stop sign violation	_____	_____
Traffic light violation	_____	_____
Improper warning lights used	_____	_____
Crossed centerline	_____	_____
Drove wrong way	_____	_____
Improper passing	_____	_____
Improper turning	_____	_____
Following too close	_____	_____
Backing up	_____	_____
Sudden movement	_____	_____
Improper distance judgment	_____	_____
Reckless endangerment	_____	_____
Other: describe	_____	_____

- \_\_\_\_\_ Preventable collision (Y/N)  
 \_\_\_\_\_ Drug/alcohol tested after crash (Y/N)  
 \_\_\_\_\_ School bus driver cited (Y/ N)

- \_\_\_\_\_ Preventable collision (Y/N)  
 \_\_\_\_\_ Drug/alcohol tested after crash (Y/N)  
 \_\_\_\_\_ Other driver cited (Y/N)

Specify citation \_\_\_\_\_  
 \_\_\_\_\_

Specify citation \_\_\_\_\_  
 \_\_\_\_\_

Determined by: \_\_\_\_\_

Determined by: \_\_\_\_\_



**Vehicle Information**

**School Bus VIN No.:** \_\_\_\_\_ **Year, Make, Model:** \_\_\_\_\_

**School bus use at time of crash:**

\_\_\_\_ Regular route  
 \_\_\_\_ Field/activity/sport trip  
 \_\_\_\_ Special needs route  
 \_\_\_\_ Other: describe \_\_\_\_\_

**School Bus Defects Visible:**

\_\_\_\_ None \_\_\_\_\_ Lamps  
 \_\_\_\_ Tires \_\_\_\_\_ Other: describe \_\_\_\_\_  
 \_\_\_\_ Brakes  
 \_\_\_\_ Steering

\_\_\_\_ **Was school bus towed (Y/N)**

**School bus towed to:** \_\_\_\_\_

**Type of School Bus:** \_\_\_\_ A1 \_\_\_\_ A2 \_\_\_\_ B1 \_\_\_\_ B2 \_\_\_\_ C \_\_\_\_ D

Engine Location: \_\_\_\_ Front \_\_\_\_ Rear

Other Features: \_\_\_\_ MFASB/MPV \_\_\_\_ Lift Equipped

\_\_\_\_ **Any damage to bus Y/N** information below taken from police accident report (PAR)

**Area of greatest damage to bus:**

\_\_\_\_ Front \_\_\_\_\_ Top  
 \_\_\_\_ Right (passenger side) \_\_\_\_\_ Undercarriage  
 \_\_\_\_ Left (driver side) \_\_\_\_\_ Unknown  
 \_\_\_\_ Back (rear)

**Greatest extent of damage to the bus:**

\_\_\_\_ Code 0 – 7 Select the degree of severity. If a vehicle sustained no damage, a “0” (zero) rating is used. “1” being the least severe and “7” being the most severe.

\_\_\_\_ **Secondary impact to bus: (Y/N)**

\_\_\_\_ Front \_\_\_\_\_ Top  
 \_\_\_\_ Right (passenger side) \_\_\_\_\_ Undercarriage  
 \_\_\_\_ Left (driver side) \_\_\_\_\_ Unknown  
 \_\_\_\_ Back (rear)

**Greatest extent of damage from secondary impact to bus:**

\_\_\_\_ Code 0 – 7

**Other vehicle Year, Make, Model (if applicable)** \_\_\_\_\_

**VIN No.: other vehicle** \_\_\_\_\_

**Area of greatest damage to other vehicle:**

\_\_\_\_ Front \_\_\_\_\_ Top  
 \_\_\_\_ Right (passenger side) \_\_\_\_\_ Undercarriage  
 \_\_\_\_ Left (driver side) \_\_\_\_\_ Unknown  
 \_\_\_\_ Back (rear)

**Greatest extent of damage to other vehicle:**

\_\_\_\_ Code 0 – 7

\_\_\_\_ **Secondary impact (Y/N)** \_\_\_\_\_ **Area of damage** \_\_\_\_\_ **Extent of damage**

0	vehicle not damaged
1	superficial damage and vehicle can be driven
2	minor damage and vehicle can be drive
3	moderate damage and vehicle can be driven
4	minor damage and vehicle cannot be driven
5	moderate damage and vehicle cannot be driven
6	severe damage and vehicle cannot be driven
7	vehicle totaled and not repairable

**Occupant Information**

**Bus driver's name:** \_\_\_\_\_

**Date of birth:** \_\_\_\_\_ **Age:** \_\_\_\_\_ **Male/Female:** \_\_\_\_\_

\_\_\_\_\_ Seatbelt used (Y/N) \_\_\_\_\_ Type of Belt (see page 7)

\_\_\_\_\_ Airbag Equipped (Y/N) \_\_\_\_\_ Airbag Deployed

**Bus Driver's Experience:** \_\_\_\_\_ number of crashes/accidents in past three years

	Pre-service training		In-service within last 12 months	
	Hours	Dates	Hours	Dates
Driving (classroom)				
Driving (in-vehicle)				
Wheelchair transportation				
First aid				
Evacuation				
Special needs				
Child passenger safety				
Behavior management				
Policies and procedures/laws				
Other: describe _____				

Within 24 hours prior to crash: \_\_\_\_\_ hours of drive time \_\_\_\_\_ hours on duty \_\_\_\_\_ hours off duty

---

**Most severe injuries to bus driver and passengers** (from police accident report):

_____ O – no injury	_____ A – incapacitating injury (serious)
_____ C – possible injury (minor)	_____ K – fatality
_____ B – non-incapacitating injury (moderate)	_____ U – unknown injuries

**Driver:**  
\_\_\_\_\_ injury

**Bus Passengers:**  
\_\_\_\_\_ injury

\_\_\_\_\_ Was the bus driver transported for treatment (Y//N)

\_\_\_\_\_ Were any passengers transported for treatment (Y/N)

**Please use the following codes for bus driver and passenger information and to fill out the bus occupant form on the following page. (Code all equipment that applies.)**

**Age/Male or Female**

**Equipment in use at time of crash:**

AB     airbag  
LS     lap & shoulder belt  
LAP    lap belt only  
SH     shoulder belt only  
CSRS   child safety restraint system (supplemental form)  
WC     wheelchair; scooter (supplemental form)  
TD     wheelchair tie down/securement  
O     none  
U     unknown

**Injury Codes**

O     no injury  
C     possible injury (minor)  
B     non-incapacitating injury (moderate)  
A     incapacitating injury (severe)  
K     fatality  
U     unknown

Code on the following page in seat locations: Age/gender, equipment use, injury code

Examples:

**12/F, LS, C** 12-year-old female in lap/shoulder belt with a minor injury

**5/M, CSRS, L, B** 5-year-old male in child safety restraint system secured by lap belt with a moderate injury

**56/F, LAP, WC, U** 56-year-old female seated in wheelchair with lap belt with unknown injuries

**School Bus Occupants:**

Total passengers including driver \_\_\_\_\_

Indicate locations of lifts (L), window emergency exits (W), door emergency exits (X), and Roof exits (R)

Front of bus ↑

<i>L/W/X/R</i>	<i>Driver</i>						<i>Entry/Exit Door</i>	<i>L/W/X/R</i>
	<i>A</i>	<i>B</i>	<i>C</i>	<b>Aisle Row</b>	<i>D</i>	<i>E</i>	<i>F</i>	
				1				
				2				
				3				
				4				
				5				
				6				
				7				
				8				
				9				
				10				
				11				
				12				
				13				
				14				

## School Bus Types

**School bus:** A bus owned, leased, contracted to or operated by a school or school district and regularly used to transport students to and from school or school-related activities, but not including a charter bus or transit bus. A school bus must meet all applicable FMVSSs and is readily identified by alternately flashing lamps, National School Bus Yellow paint, and the legend “School Bus,” except as may be provided for the multifunction school activity bus. The following describes each of these types and styles of vehicle.

**Type A:** A Type “A” school bus is a conversion or bus constructed utilizing a cutaway front section vehicle with a left side driver’s door. This definition includes two classifications:

**Type A-1,** with a Gross Vehicle Weight Rating (GVWR) of 14,500 pounds or less; and

**Type A-2,** with a GVWR greater than 14,500 and less than or equal to 21,500 pounds.



**Type B:** A Type “B” school bus is constructed utilizing a stripped chassis. The entrance door is behind the front wheels. This definition includes two classifications: **Type B-1,** with a GVWR of 10,000 pounds or less; and **Type B-2,** with a GVWR greater than 10,000 pounds.



**Type C:** A Type “C” school bus is constructed utilizing a chassis with a hood and front fender assembly. The entrance door is behind the front wheels; also known as a *conventional school bus*. This type also includes cutaway truck chassis or truck chassis with cab with or without a left side door and a GVWR greater than 21,500 pounds.



**Type D:** A Type “D” school bus is constructed utilizing a stripped chassis. The entrance door is ahead of the front wheels; also known as *rear or front engine transit style school buses*.



**Multifunction School Activity Bus (MFSAB) or Multi-Purpose Vehicle (MPV):** “A school bus whose purposes do not include transporting students to and from home or school bus stops,” as defined in 49 CFR 571.3. This subcategory of school bus meets all FMVSS for school buses except the traffic control requirements (alternately flashing signal and stop arm).

Supplemental Crash Data

**Bus Loading/Unloading-Type Incident**

Yes  No Was the bus involved in a non-collision type incident? (If yes, continue.)

**Did the incident occur at school?**

Yes  No

**Where was the bus at the time of the incident?**

Approaching the bus stop  Leaving the bus stop  
 Stopped at the bus stop  Not in sight of the bus stop

**Were any traffic warning devices activated when incident occurred? (Check all that apply.)**

None  Red lights activated  
 Amber lights activated  Other: describe \_\_\_\_\_  
 Swing out stop arm  
 Unknown

**Where was the student(s) at the time of the incident?**

Getting on the bus  Standing at the bus stop  
 Getting off the bus  Unknown  
 Walking to or from the bus  Other: describe \_\_\_\_\_  
 Loading or unloading from a lift (fill out supplemental wheelchair pages)

**Location of student:**

On the side of the road  In a private driveway  
 On the sidewalk  Moving to seat  
 In the road  Other: describe \_\_\_\_\_  
 Unknown

**Student injured by:**

Bus  Another vehicle  
 Falling  Other: describe \_\_\_\_\_  
 Unknown

**What area of the bus or other vehicle contacted student?**

Front  Back  
 Passenger side (right)  Driver side (left)  
 Unknown  Other: describe \_\_\_\_\_

**Did student(s) sustain any injuries? (Y/N) Describe:** \_\_\_\_\_

\_\_\_\_\_  
\_\_\_\_\_

**Describe student(s) behavior:** \_\_\_\_\_

\_\_\_\_\_  
\_\_\_\_\_  
\_\_\_\_\_

**Describe any other information about the incident:** \_\_\_\_\_

\_\_\_\_\_  
\_\_\_\_\_

**Wheelchair Securement/Restraint Supplement Report**

Yes  No Was a bus passenger seated in a wheelchair? (If yes, continue.)

***The Wheelchair***

**Make/model/year of wheelchair:** \_\_\_\_\_

**Location of Wheelchair:**

- Row number
- Seat location
- Orientation in vehicle (facing forward, to left, right, rear, angle)
- On lift
- Unknown position in vehicle

**Wheelchair type:**

- Standard Manual
- Stroller
- Ultra light/sport manual
- Powered
- 3 or 4-wheeled power scooter
- Other: specify \_\_\_\_\_
- Unknown

**Wheelchair WC19-compliance:**

- Yes
- No
- Unknown

**Post-crash condition of wheelchair:**

- No damage
- Minor damage/repairable
- Major damage/not repairable
- Unknown

**Describe damage to wheelchair:** \_\_\_\_\_

\_\_\_\_\_  
\_\_\_\_\_

**Rear head rest:**

- No head rest available
- Yes – attached to wheelchair
- Yes – not attached to wheelchair
- Unknown
- Other specify \_\_\_\_\_

**Post-crash condition of head rest:**

- No head rest available
- No damage
- Detached from wheelchair
- Detached from vehicle
- Deformed
- Unknown

**Wheelchair seating system:**

- Sling seat and seatback
- Rigid seat and seatback
- Special contoured seating
- Fixed seat and reclining seatback
- Tilt seating system
- Degree of tilt <30° <45°
- Other: specify \_\_\_\_\_
- Unknown

**Condition of wheelchair seating system after the crash/incident:**

- No damage to seat or seatback
- Seat broken/deformed
- Seatback broken/deformed
- Seat and seatback broken/deformed
- Frame deformed/damaged
- Other: specify \_\_\_\_\_
- Unknown

***The Lift***

**Vehicle access for wheelchair:**

- Powered lift
- Ramp
- Other: specify \_\_\_\_\_
- Unknown

**Access location:**

- Passenger side (right)
- Driver side (left)
- Rear (back)
- Unknown



*The Postural Belts*

**Wheelchair postural belts/supports used**

(check all that apply):

- None used or not available
- Lap belt
- Chest belt
- Harness
- Side pads: describe \_\_\_\_\_
- Other: describe \_\_\_\_\_
- Unknown

**Condition of postural belts/supports after crash:**

- None used or not available
- No signs of damage
- Detached from wheelchair
- Deformed or unbuckled
- Other: describe \_\_\_\_\_

**Were postural belts used properly? (Y/N) Describe:** \_\_\_\_\_

\_\_\_\_\_

*Securement of the wheelchair to the vehicle*

**Type of tiedown used:**

- None used, but available
- None available
- Four-point straps
- Docking system
- Wheel-rim clamps
- Frame clamps
- Other: specify \_\_\_\_\_
- Unknown

**Condition of tiedowns after incident:**

- None used or none available
- No damage; system intact
- System intact but deformed
- Partial failure; but did not release chair
- Failure; released wheelchair
- Other: specify \_\_\_\_\_
- Unknown

**Tiedown damage location:**

- No damage or none available
- Strap or webbing
- D-ring
- Securement hooks (S-hooks)
- Anchorage on vehicle/tie down
- Seat anchorage
- Other: specify \_\_\_\_\_
- Unknown

**Year, manufacturer, model of all tiedowns:** \_\_\_\_\_

\_\_\_\_\_

\_\_\_\_\_

**Describe where tiedowns were secured to the vehicle:** \_\_\_\_\_

\_\_\_\_\_

\_\_\_\_\_

**Were tiedowns used properly? (Y/N) Describe:** \_\_\_\_\_

\_\_\_\_\_

**Did wheelchair tip over? (Y/N) Describe:** \_\_\_\_\_

\_\_\_\_\_

*Occupant Restraint for the wheelchair user*

**Occupant restraint used:**

- None used, but available
- None available
- Lap belt only
- Lap belt with separate shoulder belt
- Lap belt with separate shoulder harness
- Shoulder belt only
- 3-point belt
- 4-point belt
- 4-point harness
- 5-point harness
- Other: specify \_\_\_\_\_
- Unknown

**Condition of belt restraints after incident:**

(Check all that apply.)

- No damage or none available
- Webbing damage
- Hardware damage
- Other: describe \_\_\_\_\_
- Unknown

**Year, manufacturer, model of all restraints:**

---

---

---

**Were restraints used properly? (Y/N) Describe:** \_\_\_\_\_

---

**Describe where restraints were attached:**

---

**Was occupant ejected out of wheelchair? (Y/N) Describe:** \_\_\_\_\_

**Child Safety Restraint System (CSRS)**

Yes  No Was the student using a CSRS? (If yes, continue.)  
\_\_\_\_\_ Where was the student seated on the bus? (See page 8 on crash form.)

CSRS Make, Model, Year \_\_\_\_\_

Was the child rear-facing?  Was the child forward-facing?

Yes  No Was the student in a CSRS seated at an emergency exit window?

\_\_\_\_\_ Height and weight of student, if known.

**Type of child safety seat:**

Infant seat with base (rear-facing only)

Infant seat without base (rear-facing only)

Forward-facing seat with harness

Booster seat with back

Booster seat without back

Safety vest

Integrated child seat

Other: describe \_\_\_\_\_

Unknown

**Type of restraint protecting child: (Check all that apply.)**

None

5-point harness on child seat (five attachments; 2 at the shoulder, 2 at the hip, and one between the legs)

3-point harness on child seat (2 at the shoulder, one between the legs)

3-point belt on vehicle (lap and shoulder)

Lap belt on vehicle

Shoulder belt on vehicle

Other: describe \_\_\_\_\_

Unknown

**Observed CSRS usage: (Check all that apply.)**

Loose CSRS installation

Shoulder straps of harness positioned at or below shoulders

Shoulder straps of harness positioned above shoulders

Harness straps snug

Harness straps loose

Child is less than 1 year old and facing forward

Child is under 40 pounds and seated on a booster seat

Booster used with lap belt only

Other: describe \_\_\_\_\_

Unknown

**Child safety restraint system securement to vehicle:**

Not secured

Lap belt only

Lap/shoulder belt (3-point)

Shoulder belt only

Latch system (lower anchors and tethers for children)

Tether strap (an additional belt that anchors the top of the CSR to the vehicle)

Cam strap

Other: describe \_\_\_\_\_

Unknown

Describe bus seat \_\_\_\_\_

Collision with Pedestrian \_\_\_\_\_

**Identification and Evaluation  
of  
School Bus Route and Hazard Marking Systems**

**Final Report**

**Work Performed Under a Grant From  
The National Highway Traffic Safety Administration  
U.S. Department of Transportation**

**Grant # DTNH22-97-G-05155  
June 1998**

**National Association of State Directors of Pupil Transportation**

**116 Howe Drive  
Dover, DE 19901\***

\*(Editor's note: This document is posted at the NASDPTS website: [www.nasdpts.org](http://www.nasdpts.org).)

**Identification and Evaluation of School Bus Route and Hazard Marking Systems  
Grant # DTNH22-97-G-05155 NHTSA**

## National Association of State Directors of Pupil Transportation

### **Background:**

An estimated 23 million public school students ride over 400,000 school buses twice daily to go to and from school. Additionally, it has been estimated that another one to two million students ride school buses to and from school-related activities each day. In the course of a school year, school buses transport students over four billion miles. The safety of pupil transportation is of significant concern to Federal, State and local governments, school districts, school administrators, parents, and the general public.

Within the school transportation industry itself, there is a long history of significant efforts to make school transportation safe and efficient. Pupil transportation programs date back to the earliest years of the 20th century. By 1910, thirty states had pupil transportation programs in place. The first “vehicles” used to transport students were nothing more than horse-drawn carts which were borrowed from local farmers. With the development of automobiles and trucks with gasoline-powered engines, the school “wagon” was replaced with the school “truck.” During the 1920’s and 1930’s, the Nation’s roadway system was expanding, especially in rural communities. This led to a greater need for vehicles to transport schoolchildren and the formation of an industry of school bus manufacturers.

As the number of school buses operating on the roadways increased, there came the inevitable problems. Several serious tragedies occurred involving school buses which caused school officials to think seriously about developing safety guidelines for school buses. In 1939, representatives from 48 states gathered to develop recommendations for school buses. Since that time, there have been a total of 12 National Conferences on School Transportation where representatives from each state gather to revise existing and establish new safety guidelines for school buses and operating procedures for the safe transportation of schoolchildren, including those with disabilities. The product of these national conferences are referred to as the National Guidelines for School Transportation. The National Conferences are jointly sponsored by the National Association of State Directors of Pupil Transportation Services (which includes the School Bus Manufacturers Technical Council), the National Association for Pupil Transportation, and the National School Transportation Association, the National Safety Council, and Central Missouri State University.

To help ensure the transportation safety of students on school buses, the National Highway Traffic Safety Administration (NHTSA) establishes and enforces a series of Federal Motor Vehicle Safety Standards governing the safety performance and manufacture of school buses. NHTSA also conducts a safety defects investigation program to identify safety defects in motor vehicles, including school buses, and requires manufacturers to recall and remedy defective vehicles free of charge. In addition, NHTSA’s Guideline #17, “Pupil Transportation Safety,” establishes minimum recommendations for a pupil transportation safety program, including the identification, operation, and maintenance of buses used for transporting students; training of passengers, pedestrians, and bicycle riders; and administration.

Even with the school bus-specific Federal Motor Vehicle Safety Standards, NHTSA’s safety defect investigation and recall program, NHTSA’s Guideline #17, and the school transportation industry’s National Guidelines for School Transportation, a few school bus safety problems continue to persist. One of these problems was identified as a contributing factor in a tragic crash that occurred on October 25, 1995, in Fox River Grove, Illinois. On that day, a commuter train hit a school bus that was stopped at a highway-railway grade crossing. Seven students were killed and the school bus driver and 24 other students were injured. The school bus driver had taken all of the appropriate actions prior to crossing the railroad tracks, but unknowingly failed to completely clear the railway track while the school bus was stopped at a red traffic light. The commuter train struck the rearmost side of the school bus.

At the conclusion of its investigation of the crash, the National Transportation Safety Board identified one of the factors contributing to the crash as an inadequate school district routing and hazard marking system. The Safety

Board noted that the substitute school bus driver operating the bus that day was unaware of the hazard at the highway-railroad crossing because “the methods employed by the school district to identify and evaluate route hazards were ineffective.”

In addition to the Safety Board's investigation of the Fox River Grove crash, the U.S. Department of Transportation formed a Grade Crossing Task Force to review the decision-making process for designing, constructing, and operating rail crossings. The Task Force published its findings in a March 1996 report, "Accidents That Shouldn't Happen." One recommendation from that report calls for NHTSA to "work with State directors of pupil transportation, through relevant national organizations, to develop a system to improve school bus routing safety by focusing on highway-railroad grade crossings."

As a result of the recommendations from the Safety Board and the Grade Crossing Task Force, NHTSA provided a grant to the National Association of State Directors of Pupil Transportation to:

1. Research the issue of school bus route hazards and route hazard marking systems;
2. Develop a set of guidelines that school transportation officials could utilize in developing a system for identifying school bus route hazards that meets the needs of their locality;
3. Provide suggestions for reasonable and appropriate means of informing school bus drivers of potential school bus route hazards so as to educate them on how to deal with any route hazards that can not be avoided; and
4. Suggest methods to disseminate the information developed during this project to the school transportation community.

### **School Bus Driver Training:**

School bus driver training is one of the most important components of the school bus transportation system. A critical component of school bus driver training is the recognition of potential driving hazards and appropriate adjustment of driving behavior to ensure the safety of the school bus occupants. The goal of this project and report is to provide school bus drivers and substitute drivers with a list of locations/situations that should be recognized as being potentially hazardous. School bus drivers should be properly trained to deal with these potentially hazardous conditions. In addition, school bus drivers should be trained to deal with hazardous conditions that occur suddenly or are of a temporary nature. Constant dialogue between school bus drivers and route planners is critical to ensure the continued safe transportation of students in school buses.

### **Methodology:**

The National Association of State Directors of Pupil Transportation undertook the following activities to develop a school bus route hazard identification system and a means of educating school bus drivers about such hazards. Each of the activities included review and comment by the various state directors of pupil transportation. Throughout this report, specific comments from states are included to illustrate the involvement and insight provided by the state directors.

#### **1. Define School Bus Route Hazard**

The first, and most critical, step was to develop an acceptable and reasonable definition of what constitutes a "school bus route hazard." From a practicable perspective, "school bus route hazards" can be grouped into two distinct categories. First, there are "driving hazards" that are encountered while operating a school bus route, such as railroad grade crossings and industrial intersections. Second, there are "school bus loading zone hazards" that are encountered at a school bus stop, such as a narrow, busy street without sidewalks or dangerous curves that do not provide the school bus driver, the students, or other motorists with an adequate view of the school bus loading zone. The scope of work for this project only included the first category of school bus route hazards - driving hazards.

2. **Develop a “Model” School Bus Route Hazard Identification System**

Based on the knowledge and expertise of individuals within the school transportation industry, an ideal program that could be used to assist states and local school districts in identifying and evaluating potential school bus route hazards was defined. This ideal program became the “model” against which existing school bus route hazard identification programs were compared.

3. **Review Existing Materials/Information**

Examples of existing state or local school district route hazard identification programs were reviewed and compared with the “model” system described above. The existing programs were reviewed in terms of the ability of the program to identify route hazards and communicate that information to the appropriate individuals.

4. **Develop a Recommended System**

Based on the review of existing programs, as compared to the “model” system, a recommended school bus driving route hazard identification system was developed that could provide states and local school districts with an efficient method for identifying potential school bus route hazards and a means of communicating information about those hazards to school bus drivers and trainers, route planners, and other appropriate school transportation officials.

5. **Dissemination Approaches**

Finally, suggestions were made on how to disseminate the “recommended” system to the school transportation community, and what approaches should be taken to educate state and local school transportation providers on the importance of adopting such a school bus driving route hazard identification system.

**Results of Program Activities:**

**Result #1 — Definition of a School Bus Route Driving Hazard**

While it is possible to develop a list of the potential hazardous locations/situations that a school bus driver could encounter in the course of driving a school bus route, it is not possible to develop a definitive list of every potential driving hazard. As was pointed out by the state of Indiana during discussions of this project, “Regular review of the route hazards list is encouraged. This will keep the document accurate and permit the addition of ‘yet-to-be-discovered’ hazards.”

Some potential school bus route driving hazards can be considered as “fixed,” in that the situation or condition exists (such as a railroad crossing), can be identified, and drivers can be informed and educated about the potential hazard. Other potential driving hazards occur without advanced warning — examples include: (1) inclement weather conditions, such as fog, sand storms, blinding sunlight, snow storms, etc.; (2) conditions that result from weather conditions, such as flooded roadways, fallen trees, downed power lines; and (3) accident locations. This report focuses on potential school bus route driving hazards that are of a “fixed” nature.

**Discussion:**

Table 1 details many of the potentially hazardous locations/situations that a school bus driver could encounter in the course of driving a school bus route. These potential driving hazards were selected based on the belief that the mere existence of any one of these conditions poses possible serious consequences if the school bus driver is not aware of the existence of the hazard. While a hazard could develop at any time while driving a school bus (for example, a tree could fall across a road during a storm, or a stream could overflow, or a wet road could suddenly ice over), this list defines only fixed conditions that, by their presence, have been deemed a potential driving hazard. Also, this list is

limited to the hazardous locations/situations encountered while driving the school bus, not during loading and unloading operations.

For each potential school bus route driving hazard, a list of factors or situations that could contribute to causing the hazard is provided. It is important to remember that this list of potential school bus route driving hazards, and the factors/situations within them, is not “all-inclusive.” States and local school districts may encounter factors and situations that are not listed in Table 1, but which they deem are potentially hazardous.



**Table 1.**

**List of Potentially Hazardous Locations/Situations on School Bus Routes**

**Railroad Grade Crossing**

- \* Number of tracks
- \* Visual obstructions to determine type and travel speeds of trains
- \* Train schedules (consider unscheduled trains also)
- \* Presence or absence of grade crossing controls
- \* Unique characteristics or operation of grade crossing controls
- \* Presence or absence of traffic control signals, including interaction with grade crossing controls
- \* Size of queuing area before and after the tracks
- \* Expected traffic conditions at various times during the day
- \* Roadway design near the grade crossing

**Dangerous Intersections and Roadways**

- \* High-frequency crash locations as defined by state transportation and/or law enforcement officials
- \* Uncontrolled intersections
- \* Curves and intersections with limited sight distances
- \* Areas with no shoulders or drop-off to shoulder
- \* Visibility of traffic control signals
- \* Coordination of traffic control signals with others in the immediate area

**Bridges, Tunnels/Underpasses and Overpasses**

- \* Weight capacity
- \* Height clearances
- \* Lane width

**Queuing/Storage Areas**

- \* Short acceleration/deceleration lanes
- \* Limited median areas crossing multi-lane highways
  - Turning lanes
    - Bus turnarounds
    - Areas that require backing of the bus to turnaround or park

**Industrial Intersections and Construction Zones**

- \* Areas where heavy vehicles/equipment operate on a regular basis, and may be entering, exiting, or crossing the roadway

**Steep Downgrades**

- \* Mountainous areas where brake condition and braking operations are important
- \* Location of out-of-control vehicle run-off areas

**Areas of Significant Speed Differential Between Vehicles**

- \* On-off ramps to high-speed roads
- \* Farm vehicle areas, including non-motorized vehicles on the road
- \* Mountain terrain

## **Pedestrian Areas**

- \* School bus loading/unloading zones
- \* Narrow streets with parked motor vehicles - children darting between vehicles
- \* Congested shopping and business areas
- \* Parks or intersections with pedestrian/bicycle paths

## **Other Conditions Identified in Local Area**

1. Unique roadway locations, for example:
  - a. Roadways without guardrails that are next to rivers, lakes, etc.
  - b. Dirt or gravel roads that could affect braking
  - c. Rock quarry or open pits
  - d. Areas with problems related to right-turn-on-red laws
  - e. Areas with visibility problems due to air quality/industrial smoke/etc.
  - f. Areas where emergency equipment operate on a regular basis
    - (1) fire stations
    - (2) hospitals

## **Result #2 - Development of a “Model” School Bus Route Hazard Identification System**

During the course of this project, a “model” school route hazard identification system was outlined. It was recognized that such a system would consist of three major components:

1. A list of potential driving hazards;
2. A specified procedure/schedule for conducting on-site reviews of school bus routes; and
3. An efficient and effective means of informing school bus drivers of the presence of potential driving route hazards.

Of the three components, the first was determined to be the most critical, since without a definition of what constitutes a school bus route driving hazard, the other components would have little utility. Additionally, developing a procedure and schedule for reviewing school bus routes and an information dissemination plan were viewed as administrative policy decisions that were independent of the technical issues related to identifying potential school bus route driving hazards. Accordingly, the focus of the effort was placed on identifying and listing potential school bus route driving hazards.

An initial list of potential hazards was prepared during a Working Session of state directors during the 1997 annual conference of the National Association of State Directors of Pupil Transportation Services. The results of that session were summarized and provided for review to all state directors of pupil transportation. The final results of that effort are discussed in the previous section of this report, “Result #1 - Definition of a School Bus Route Driving Hazard.”

## **Result #3 — Review of Existing Materials/Information**

A review of existing school bus route hazard identification systems was made to see if any system assessed all of the potential driving hazards developed during the Working Session at the 1997 annual conference. Not one was found. However, this effort identified additional potential hazards that were not previously considered, but were ultimately included in the final list of school bus route driving hazards as defined in Result #1 above.

## **Result #4 — Defining a Route Hazard Identification System**

The major goal of this project was to develop a system that a state or a local school district could use to:

- \* Identify any fixed locations/situations that constitute a potential school bus driving hazard; and

\* Inform school bus drivers and substitute drivers of each identified potential route hazard on the school bus route(s) they drive.

### **Identification**

The first component of such a system would consist of an established, systematic process to evaluate all school bus routes to determine whether any potential fixed driving hazards exist. An annual review of each school bus route by a person trained to identify potential route driving hazards would provide the basis for identifying any potential hazards. In addition, school bus drivers should be trained in how to recognize a potential school bus route driving hazard, and to report any new potential hazardous conditions to the appropriate school transportation officials. In effect, this would provide for continual monitoring and review of school bus routes so school bus drivers are aware of all potential fixed driving hazards on their routes. As stated by Connecticut, “constant communication between school bus drivers and route planners is critical to safety.” Hazards can and do change, even on a daily basis. As such, “daily updates of critical route hazards should be foremost in the minds of dispatchers and drivers.” A checklist format based on the above list of potential school bus driving route hazards (Result #1 — Table 1) would provide for a consistent means of ensuring that such items were considered during the review of each school bus route. An example of such a checklist for the items identified in Result #1 appears as Appendix A to this report,\* and is based on a format utilized in Oklahoma. It is important to remember that a state or a local school district should ensure that any potential hazards that may be unique to their area, or any potential hazards that they believe were missing, are added to the checklist. In addition to regular school bus routes, there also can be potential driving hazards along routes taken for field trips or extra-curricular activities. In such cases, drivers may be able to identify potential route driving hazards based on their personal knowledge of the route or on a previous trip to the same location.

*\* Report being quoted above; checklist found in the appendix following.*

### **Information**

The second component of a school bus route driving hazard identification system consists of a means of informing all regular and substitute school bus drivers of the potential driving hazards on their school bus route(s). New Jersey stressed the importance of “the need for drivers and driver trainers to make clear notes of these hazards for all substitute drivers.” In addition to the drivers, school bus route planners/schedulers/dispatchers, etc. should be made aware of all information about potential driving hazards on the school bus routes. This information would allow them to make changes or adjustments to the routes, when reasonable and practicable, so as to minimize or eliminate the exposure of school buses to these route driving hazards. Informing the necessary people about potential school bus route driving hazards can be accomplished in a number of ways. The most practical, and possibly most easily understandable, appears to be through the use of a map that is visually annotated to identify potential route hazards. The same map could obviously be used for other purposes, including designating the actual school bus route and student pick-up/drop-off locations. Additionally, as the states of Ohio and Virginia noted in their comments to this project, information on the location of police/fire/rescue stations, hospitals, and other emergency care facilities, and “possible ‘safe stops’ where a school bus may pull off the road and await aid in the event of an emergency” could be added to the map. A number of local school districts currently use mapping techniques to document the streets in their district, the location of the students’ homes, the school bus stops, and the routes traveled by school buses. Inexpensive color printers allow school districts to print color maps of their bus routes, and computer software allows route planners to incorporate custom information, such as route hazards, on the map. Whatever means is chosen, it is important that school bus drivers be provided with route hazard information in a standardized, consistent manner. Also, the route hazard information should be available to the school bus driver every day, no matter which school bus is driven on that day.

### **Training**

While not a specific part of this project, the importance of training school transportation providers about school bus route driving hazards can not be understated. In their comments, Ohio noted that the contents of a route hazard identification system are “only good if utilized.” In other words, if drivers are not made aware of the potential driving hazards and trained on how to deal with such potential hazards, then no benefits will accrue from efforts to

identify potential route hazards. Mississippi commented that its training in route hazards constantly works “to instill in each driver the concept of Expect the Unexpected.”

However, training alone does not guarantee success. As Connecticut stated, “Route hazards is an area in which some training can be afforded, but common sense and networking among drivers, local officials, and school district personnel is paramount to a safe and successful route hazard notification program.”

### **Result #5 - Dissemination Approaches**

Based on the belief that the ultimate success of a school bus route driving hazard identification system is dependent on the awareness and use of the system by school transportation providers, it is strongly suggested that the results of this project be provided to all state directors of pupil transportation, the appropriate student transportation officials in each school district, and organizations affiliated with private/parochial schools. The dissemination to state directors and public schools districts could be made by use of direct mailings. The dissemination to private/parochial schools could be made through national associations that represent such schools.

As a supplement to direct mailings, the report on this project should be made available on the NHTSA and various school transportation web sites in a form that can be downloaded. In addition, the results of this project should be publicized through the various media that deal with pupil transportation.

### **Non-Fixed School Bus Route Hazards:**

As mentioned earlier, this project only dealt with school bus route driving hazards that are “fixed.” However, it is recognized that other driving hazards can occur without advanced warning. These often result from inclement/adverse weather conditions or poor visibility conditions. It is important for school bus drivers to be aware of such possibilities and be trained on how to deal with such sudden potential hazards. As an example of some non-fixed driving hazards, Iowa includes in its School Bus Driver’s Handbook procedures to follow should a school bus encounter a tornado or Agri-Chemical clouding along school bus routes. Also, Delaware provides drivers with information in its School Bus Driver’s Handbook to prepare them for the following:

#### Adverse weather conditions

- \* Extreme
- \* Extreme heat
- \* Rain
- \* Fog
- \* Snow/ice

#### Conditions affecting visibility

- \* Sun glare
- \* Darkness
- \* Curves and hills

Wild animals are another example of a non-fixed school bus route driving hazard. In many rural and suburban areas, animals such as deer and livestock can be a serious danger to motorists. School bus drivers should be made aware of such situations and learn how to deal with them.

### **Conclusions:**

Recognizing the importance of identifying school bus route driving hazards, the National Association of State Directors of Pupil Transportation Services has conducted this study for the National Highway Traffic Safety Administration. Verbal and written information from members of the Association was consolidated to focus on the key issues and the best approach for addressing the problem of driving hazards on school bus routes. The following conclusions were reached during the study:

- \* Driving hazards can and do exist on school bus routes.
- \* Driving hazards on school bus routes that are of a “fixed” nature can be identified.
- \* School transportation officials should establish a program to routinely and systematically evaluate all school bus routes for potential driving hazards.
- \* A list of potential fixed school bus route driving hazards has been developed for use in evaluating school bus routes.
- \* Information on potential school bus route driving hazards should be provided to all regular and substitute school bus drivers, route planners, dispatchers, and other appropriate personnel.
- \* School bus drivers should be trained on how to effectively deal with potential school bus route driving hazards, of both a fixed or sudden nature.

The results of this project should receive wide dissemination.

The National Association of State Directors of Pupil Transportation encourages states, local school districts, and private/parochial schools to review this report in conjunction with their school transportation operations and take whatever actions are necessary to ensure that school bus route driving hazards are identified and made known to all appropriate school bus drivers and school transportation personnel.

*(Reference Table 1 Report)*  
**Appendix A**  
**Checklist for Identifying Potential School Bus Route**  
**Fixed Driving Hazards**

**Railroad Grade Crossings**

Railroad Grade Crossing Identification Number: \_\_\_\_\_

Location: \_\_\_\_\_

How many tracks are present? \_\_\_\_\_

What are the times of the scheduled trains? \_\_\_\_\_

What types of trains use the track? Passenger \_\_\_\_\_ Freight \_\_\_\_\_ Commuter \_\_\_\_\_

What are the travel speeds of the scheduled trains? \_\_\_\_\_

	Yes	No
* Are the regulatory signs (crossbucks) clearly visible?	_____	_____
* Are there regulatory devices (lights/gates/bells) present?	_____	_____
* Are there any unique characteristics to the operation of the crossing controls?	_____	_____
What are they? _____		
_____		

* When stopped approximately 15 feet from the nearest railroad track, is there an unobstructed sight distance of approximately 1,000 feet in both directions?	_____	_____
* Is there at least enough room on the other side of the furthest railroad track for the largest school bus to stop without encroaching on the train's right-of-way?	_____	_____
* Are there any roadway design features that could affect the safe operation of a school bus at the railroad crossing?	_____	_____
What are they? _____		
_____		

**Dangerous Intersections and Roadways**

Location \_\_\_\_\_

	Yes	No
* Is this a high-frequency crash location?	_____	_____
* Are traffic control devices present?	_____	_____
* Are there visibility obstructions?	_____	_____
What are they? _____		
<hr/>		
* Are there areas with no shoulders <u>or drop to shoulder</u> ?	_____	_____
* Are there peculiar roadway features?	_____	_____
What are they? _____		
<hr/>		

**Bridges, Tunnels/Underpasses and Overpasses**

Location \_\_\_\_\_

	Yes	No
* Is the weight capacity of the bridge/overpass sufficient for a fully-loaded school bus?	_____	_____
* Is the height of the tunnel/underpass adequate for the tallest school bus, including open roof hatches?	_____	_____
* Is the lane width of the bridge, tunnel/underpass, or overpass adequate for the widest school bus, including the mirrors?	_____	_____

**Queuing /Storage Areas**

Location \_\_\_\_\_

	Yes	No
* Is there sufficient area for the largest school bus in the acceleration/deceleration lane?	_____	_____
* Is there sufficient area for the largest school bus in the median area between a multi-lane road?	_____	_____
* Is there sufficient area for the largest school bus in the turning lane?	_____	_____

**Industrial Intersections and Construction Zones**  
**Steep Downgrades**

Location \_\_\_\_\_

	Yes	No
* Do heavy vehicles enter/exit/cross the roadway frequently?	_____	_____
* Are there highway signs alerting drivers of the industrial/construction traffic?	_____	_____
* Are there highway signs alerting drivers to the downgrade?	_____	_____
* Are there signs alerting drivers to "Check Brakes?"	_____	_____
* Are there areas marked and designated for vehicles to safely leave the road (run-off areas)?	_____	_____

**Areas of Significant Speed Differential Between Vehicles**

Location \_\_\_\_\_

	Yes	No
* Is there sufficient space to accelerate/decelerate a school bus when entering/exiting a high-speed road?	_____	_____
* Does slow-moving farm equipment operate on the road?	_____	_____
* Do non-motorized vehicles, e.g., horse-drawn carriages, operate on the road?	_____	_____
* Are there roadway conditions, e.g., mountainous terrain, that result in vehicles operating at high speeds and low speeds?	_____	_____

What are they? \_\_\_\_\_

\_\_\_\_\_



**Pedestrian Areas**

Location \_\_\_\_\_

	Yes	No
* Are there difficulties seeing pedestrians at school bus stops?	_____	_____
* Are there narrow streets with parked vehicles where children may run into the street?	_____	_____
* Are there areas of heavy pedestrian congestion, e.g., shopping and business areas?	_____	_____

**Other Conditions Identified in Local Area**

Location \_\_\_\_\_

	Yes	No
* Are there unique roadway conditions?	_____	_____
* Roads without guardrails that pose a danger, e.g., next to rivers, lakes, quarries?	_____	_____
* Dirt or gravel roads that could affect braking?	_____	_____
* Others?	_____	_____
What are they? _____		
_____		
* Are there roadway conditions that make it difficult to make a "right turn on red?"	_____	_____
What are they? _____		
_____		
* Are there areas with visibility problems due to industrial smoke, air quality, etc.?	_____	_____
* Are there areas where emergency equipment operate on a regular basis, e.g., fire stations or hospitals?	_____	_____

## **PLANNING SCHOOL SITES FOR SCHOOL BUS SAFETY**

1. In the selection of school sites, major consideration should be given to the safety of students riding school buses. School buses will be forced to utilize the roads in and around the school site, plus public highways leading into the school area. High-density traffic flow near school exits and entrances due to the proximity of freeways, periodic commercial traffic or massive commuter traffic from industrial plants should be avoided. It must be recognized, in many cases, that the area designated for the school site has been selected prior to hiring an architect. It is suggested, therefore, that this information be issued to boards of education and municipal planning authorities, alerting them to the dangers inherent in the process of site selection. It is also suggested that boards of education discuss the selection with the superintendent of schools, traffic engineers and the state office of school plant planning and solicit their help in evaluating possible school sites.
2. The location of the school plant on a site should be determined so as to provide a safe means of entrance and exit for all students. When boards of education are considering school sites, the state, county and local roads servicing the area should have a minimum 30-foot paved width where loading and unloading is contemplated off the main thoroughfare. If it is necessary to load or unload students on the main thoroughfare in front of the school, at least a 40-foot wide paved road should be provided.
3. All school bus traffic should be considered as one-way traffic flow, preferably with the entrance door side of the bus always next to the loading and unloading zone.
4. Whenever possible, separate pick-up and delivery points some distance from the teacher and student parking areas should be designated for parents, delivery, service, teacher and administrative traffic. Accident-inducing conditions are created by haphazard pick-up and delivery of students in the bus loading zones, particularly during inclement weather.
5. Whenever possible, roads that completely encircle a school should not be constructed. Areas that students must cross to engage in outside activities should be free of all vehicular traffic.
6. All school bus roads entering into or exiting from main arteries should have a 50- to 100-foot radius turn on the inner edge of pavement. Within the school site, roads should have at least a 60-foot radius on the inner edge of pavement on all curves. At least a 50-foot tangent section should be provided between reverse curves. In order to minimize driveway entrance and exit widths, island construction may be required. Driveway openings must conform to local requirements, and driveways opening onto state highways should be approved by the state highway department.

7. Curbing, with suitable drainage, should be constructed on all roads utilized by school buses within the school site. Consideration should be given to state highway department performance specifications. A minimum of 30 feet should be maintained for one-way traffic and 36 feet for two-way traffic, with roads being wider on all curves.
8. It is desirable to separate all parking areas; however, it might be advantageous if only the visitor parking area were located in close proximity to the school. Care should be exercised in the placement of these areas to preclude the visitor from crossing the school bus traffic pattern.
9. Prior to designing and laying out roads and parking lots, architects should consult with the school administration on the following items:
  - a. Total number of students and school personnel;
  - b. Number of present and projected students to be transported;
  - c. Number of school buses;
  - d. Type of schedule:
    - (1) Staggered opening and closing times or
    - (2) Single opening and closing times; and
  - e. Extra-curricular activities that would necessitate use of school buses.
10. It is desirable to locate parked buses on school grounds to prevent glare from reflective surfaces of windows, doors and windshields from being transmitted to the students in the classroom.
11. Attention should be given in planning school bus parking, loading and unloading areas. Parking should exclude the necessity for backing the bus.
12. Sidewalk plans for students walking to school should eliminate crosswalks in front of the buses.
13. Architects' plans for school buildings often include bus canopies. Such units are not considered feasible for schools with large enrollments. Canopies are advantageous in schools attended by students with disabilities. The height of the canopy should accommodate the highest school buses. Each canopy support post adjacent to the driveway curb should have a three-foot minimum setback from the curb to minimize the possibility of crushing a student between the support post and arriving school buses.

14. For areas that will be constantly utilized by heavy school buses, the type of pavement and base should conform to state highway department specifications.
15. All roads within the school site should be graded to avoid configurations that could impair a motorist's vision. It is suggested that a maximum 5% grade be allowed on all roads and a maximum 2% grade at entrance and exit points. Blind corners and intersections should be eliminated. Trees and shrubbery planted on the school site should not obstruct a motorist's vision.
16. Plans for the location of access and service roads should exclude conditions that would require school buses to be backed on the school premises.
17. Safety at all student loading and unloading areas should be considered and provided on the school site.
18. Plans for loading facilities should include separate areas specially designed for students with disabilities. Attention should be given to entrance ramps and handrails.
19. Plans for roads and loading areas should accommodate emergency vehicles which must have access to the school at all times.
20. Where necessary, traffic control devices should be provided to assist school traffic to enter the regular traffic flow.

**EVALUATION CHECKLIST FOR SCHOOL BUS  
DRIVEWAYS IN THE VICINITY OF THE SCHOOL**

NAME OF THE SCHOOL: \_\_\_\_\_ DATE: \_\_\_\_\_

LOCATION OF THE SCHOOL: \_\_\_\_\_

		YES	NO	DOES NOT APPLY
1.	School bus loading areas are provided on the school site.	<input type="checkbox"/>	<input type="checkbox"/>	<input type="checkbox"/>
2.	When loading and unloading of school students take place on a main thoroughfare in front of the school, the roadway has a minimum width of 40 feet of hard surface.	<input type="checkbox"/>	<input type="checkbox"/>	<input type="checkbox"/>
3.	The driveway leading to and from the loading and unloading area for school buses has a minimum width of 30 feet of paved surface.	<input type="checkbox"/>	<input type="checkbox"/>	<input type="checkbox"/>
4.	If diagonal parking is provided for buses in the loading and unloading area, a minimum width of 60 feet of paved surface is available.	<input type="checkbox"/>	<input type="checkbox"/>	<input type="checkbox"/>
5.	Parking for loading and unloading of students at school is bumper-to-bumper or diagonal; in either case, the necessity for backing does not exist.	<input type="checkbox"/>	<input type="checkbox"/>	<input type="checkbox"/>
6.	The school bus is not required to back anywhere on school property.	<input type="checkbox"/>	<input type="checkbox"/>	<input type="checkbox"/>
7.	All school bus movement on the school grounds is one-way in a counter-clockwise direction.	<input type="checkbox"/>	<input type="checkbox"/>	<input type="checkbox"/>
8.	School bus traffic does not completely encircle the school building.	<input type="checkbox"/>	<input type="checkbox"/>	<input type="checkbox"/>
9.	The driver has proper sight distance at all points along the driveway.	<input type="checkbox"/>	<input type="checkbox"/>	<input type="checkbox"/>
10.	Crosswalks for students do not exist at the entrance to the school bus driveway.	<input type="checkbox"/>	<input type="checkbox"/>	<input type="checkbox"/>
11.	Separation is maintained between school bus traffic and all other traffic.	<input type="checkbox"/>	<input type="checkbox"/>	<input type="checkbox"/>
12.	Vehicular pick-up points for non-bus students are on a separate driveway from that used by school buses.	<input type="checkbox"/>	<input type="checkbox"/>	<input type="checkbox"/>
13.	Curbing and suitable drainage are provided along driveways.	<input type="checkbox"/>	<input type="checkbox"/>	<input type="checkbox"/>

	YES	NO	DOES NOT APPLY
14. Curbing and driveway construction comply with state highway specifications.	<input type="checkbox"/>	<input type="checkbox"/>	<input type="checkbox"/>
15. At ingress and egress areas to and from the school, there is a minimum radius on inner edge of driveway pavement from 50 to 100 feet.	<input type="checkbox"/>	<input type="checkbox"/>	<input type="checkbox"/>
16. On the school site, there is a minimum radius of inner edge of driveway pavement of 60 feet.	<input type="checkbox"/>	<input type="checkbox"/>	<input type="checkbox"/>
17. Between reverse curves, at least a 50-foot tangent section is provided.	<input type="checkbox"/>	<input type="checkbox"/>	<input type="checkbox"/>
18. At ingress and egress points a maximum grade of 2% is adhered to.	<input type="checkbox"/>	<input type="checkbox"/>	<input type="checkbox"/>
19. A maximum grade of 5% is adhered to on the school bus driveway within the school site.	<input type="checkbox"/>	<input type="checkbox"/>	<input type="checkbox"/>

**Note:** A “yes” answer for each of the items indicates a well-planned traffic pattern for school buses.

**SIGNATURES:**

Person making the report: \_\_\_\_\_

Title: \_\_\_\_\_

Director of School Transportation: \_\_\_\_\_

**Note:** Most of the items included in this Evaluation Checklist are based on a 1966 Report of the Special Committee on School Plant Evaluation “School Planning: Safe Transporting,” Bureau of Pupil Transportation, Department of Education, Trenton, New Jersey 08652.

## **POLICIES, PROCEDURES AND TOPICS FOR STUDENT MANAGEMENT**

Policies and procedures that address the following topics should be developed and implemented by school districts:

1. The bus driver's authority over, and responsibility for, students while in transit;
2. The student's right to due process when disciplinary action is taken;
3. A step-by-step procedure for resolving problems when the driver needs assistance;
4. The conditions under which a student might be temporarily or permanently suspended from the bus-riding privilege;
5. Procedures for handling emergencies;
6. Use of bus attendants or monitors;
7. Requirements and responsibility for school bus passenger and pedestrian safety instruction;
8. Parent's or guardian's responsibility for damage caused by their children to the bus or its equipment;
9. Rules and procedures for safe travel;
10. Driver, attendant, student and parent training for student management;
11. Special needs—teamwork, collaboration, and communication between transportation staff, special education staff, health services personnel and parents in the development of an Individual Transportation Plan (ITP) for each student with a defined disability;
12. Rules and procedures for safe travel; and
13. Driver, attendant, student and parent training for student management.

**STUDENT RULES**  
**Supervision and Disciplinary Guidelines**

1. Student shall follow directions of the driver the first time given.
2. Student shall arrive at the bus stop before the bus arrives.
3. Student shall wait in a safe place, clear of traffic and away from where the bus stops.
4. Student shall wait in an orderly line and shall avoid horseplay.
5. Student shall cross the road or street in front of the bus only after the bus has come to a complete stop and upon direction of the driver.
6. Student shall go directly to an available or assigned seat when entering the bus.
7. Student shall remain seated and keep aisles and exits clear.
8. Student shall exhibit classroom conduct at all times.
9. Student shall refrain from throwing or passing objects in, from or into buses.
10. Student is permitted to carry only objects that can be held on his/her lap.
11. Student shall not use profane language, obscene gestures, tobacco, alcohol, drugs or any other controlled substance in the bus.
12. Student shall refrain from eating and drinking in the bus.
13. Student shall not carry hazardous materials or non-service animals into the bus.
14. Student shall respect the rights and safety of others.
15. Student shall refrain from leaving or boarding the bus at locations other than the assigned stop.
16. Student shall refrain from extending head, arms or objects out of the bus windows.
17. Student shall refrain from hitching rides via the rear bumper or other parts of the bus.



**BUS CONDUCT REPORT**

BUS NO. \_\_\_\_\_ SCHOOL: \_\_\_\_\_ DATE: \_\_\_\_\_

Students in the School District who ride buses are subject to rules and regulations designed to provide safe transportation to and from school. Any behavior which distracts the driver is a serious hazard to the safe operation of the vehicle, and as such, jeopardizes the safety of all passengers. Consequence of continued inappropriate behavior could result in your child being denied the bus riding privilege.

\_\_\_\_\_ has been cited for an infraction of the rule(s) checked below:  
(name)

- |  |   |
|--|---|
| <input type="checkbox"/> Failure to remain seated                | <input type="checkbox"/> Lighting matches             |
| <input type="checkbox"/> Scuffling or fighting                   | <input type="checkbox"/> Throwing objects from window |
| <input type="checkbox"/> Profanity or obscene language           | <input type="checkbox"/> Refusing to obey driver      |
| <input type="checkbox"/> Smoking in the bus                      | <input type="checkbox"/> Bothering others             |
| <input type="checkbox"/> Extending arm or head out window        | <input type="checkbox"/> Throwing objects in bus      |
| <input type="checkbox"/> Possession of harmful or illegal items. | <input type="checkbox"/> Other (See Comment)          |

COMMENT: \_\_\_\_\_  
\_\_\_\_\_  
\_\_\_\_\_

DRIVER'S SIGNATURE: \_\_\_\_\_ DATE: \_\_\_\_\_

PRINT NAME: \_\_\_\_\_

DATE OF OFFENSE: \_\_\_\_\_ FIRST OFFENSE: \_\_\_\_\_

SECOND OFFENSE: \_\_\_\_\_ THIRD OFFENSE: \_\_\_\_\_

SCHOOL ADMINISTRATOR'S ACTION: \_\_\_\_\_  
\_\_\_\_\_

SCHOOL ADMINISTRATOR'S SIGNATURE: \_\_\_\_\_ DATE: \_\_\_\_\_

PRINT NAME: \_\_\_\_\_

PARENT/GUARDIAN'S COMMENT: \_\_\_\_\_  
\_\_\_\_\_  
\_\_\_\_\_

PLEASE SIGN AND RETURN TO SCHOOL ADMINISTRATOR

Parent's/Guardian's Signature: \_\_\_\_\_ Date: \_\_\_\_\_

Print Name: \_\_\_\_\_

White Copy: School Administrator Canary Copy: Bus Driver Pink Copy: Parent/Guardian Gold Copy: Student

[**Note:** A form, such as the one above, should be used for reporting purposes. First offenses require at least a notification to the student and parent or guardian (either by phone or in person) by appropriate school personnel. Second and subsequent offenses may require a conference with the student, parent or guardian, driver and school administrator(s), which may result in a period of suspension of the student's riding privileges.]

# WHEN BOARDING THE BUS

## Here's How to Cross the Road

# SAFELY

- STAY** – on your side of the road, far away from the traffic.
- WAIT** – for the bus to stop and for your driver's signal to cross.
- CHECK** – traffic both ways, then check again,
- CROSS** – walk directly across, checking traffic both ways.
- WALK** – approximately 12 feet ahead of the bumper and board the bus quickly.

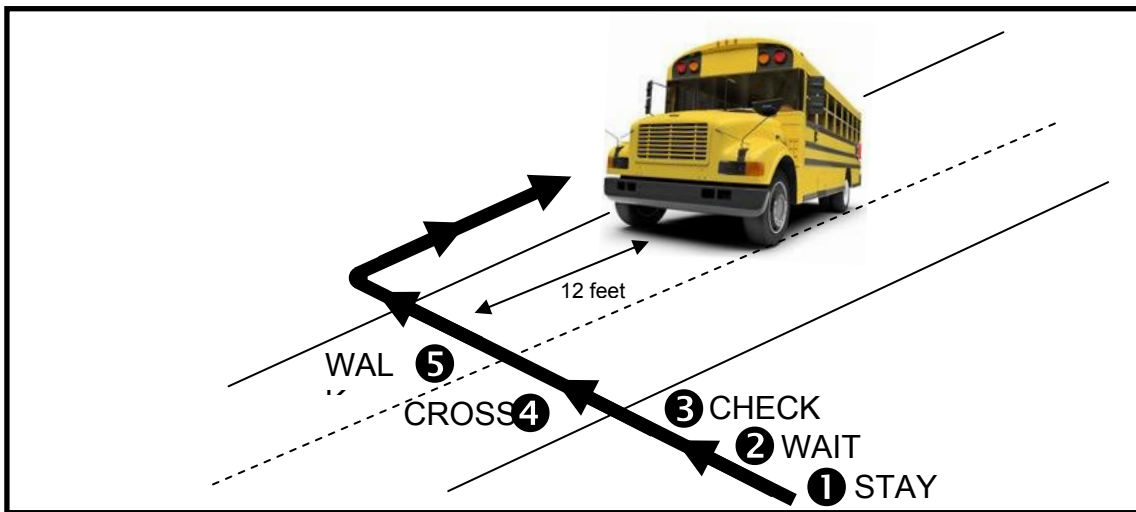

*Crossing the Highway is DANGEROUS!*

## Remember

- Stay on your side of the road until your driver signals you to cross.
- Check and recheck for traffic.
- Follow the 12-foot rule.
- Board the bus quickly and go directly to your seat.

**Drivers SHOULD stop...But  
THEY MAY NOT!**

# WHEN LEAVING YOUR BUS

## Here's How to Cross the Road

# SAFELY

**WALK** – along the side of the road until you can see your driver.

**STOP** – wait for the signal to cross.

**WALK & STOP** – go to the Driver's side cross view mirror and look both ways – wait for the driver's signal to cross.

**WALK & LOOK** – for traffic both ways – if you see a vehicle that has not stopped, go back to the bus – if all vehicles have stopped, cross the road quickly.

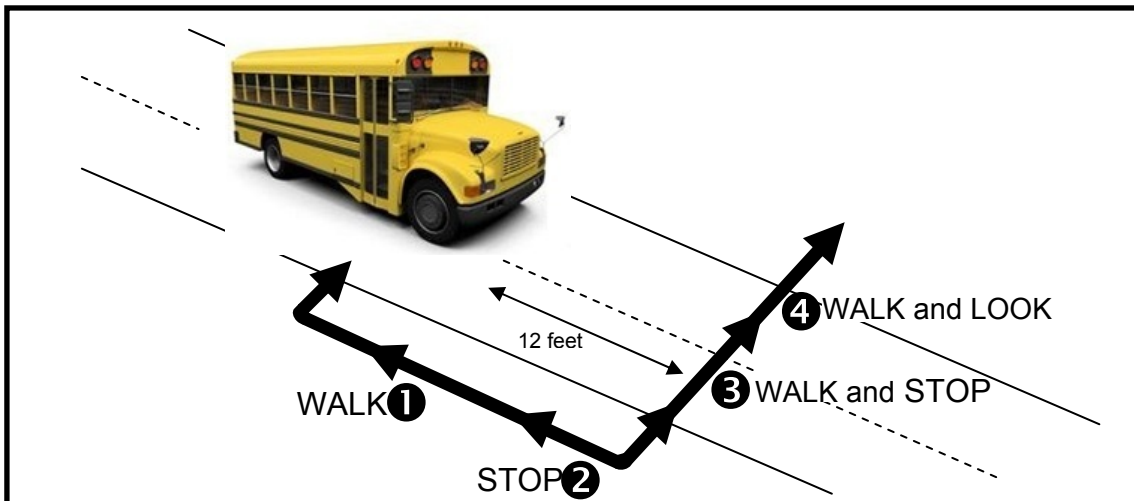

*Crossing the Highway is DANGEROUS!*

# Remember

- ① Walk
- ② Stop
- ③ Walk and Stop
- ④ Walk and Look

**Drivers SHOULD stop...But  
THEY MAY NOT!**

## RECOMMENDED PROCEDURES FOR ESCORTED CROSSING

*(Legal references in this procedure can be found within California Code of Regulations (CCR) and CA Education Code (EC) and may be adapted for other states)*

1. Begin slowing the bus to get ready for the designated stop.
2. As you approach the stop, turn on the amber warning light, if the bus is so equipped, beginning 200 feet before the bus stop.
3. Apply the brakes with enough pressure to activate the stop lights so that following vehicles will anticipate the bus is preparing to stop.
4. Check all mirrors to ensure that traffic is gone and it is safe to turn to the right and stop.
5. Turn on the right-side turn signal lights during the last 100 feet before turning into the stop.
6. Approach the pupils slowly and with extreme care, considering the roadway surface (wet or slippery, sloped or flat, rough or smooth ground).
7. Do not stop any closer than 12 feet from the waiting pupils. They should be facing the approaching bus. (Refer to Figure SL5-2, "Danger zones.")
8. Once the bus is stopped, cancel the right-side turn signal lights and apply the parking brake.
9. Place a standard transmission in first or reverse gear or, if an automatic transmission, place in the park position. On buses equipped with an automatic transmission that does not have a park position, place the transmission in neutral.
10. Turn off the engine.
11. Remove the ignition key and keep it in your possession.
12. Deactivate the amber warning light.
13. Check all mirrors; activate the flashing red light signal (crossover lights) and stop signal arm, if the bus is so equipped, and wait for traffic to stop.
14. Open the entrance door and look in all directions on the right side of the bus before exiting.
15. Remove the handheld stop sign from the holder.
16. Step off the bus and walk approximately 12 feet in front of the bus before turning to enter the roadway.
17. Turn toward the bus, look up, and verify that the amber warning light is off and the red light signal is flashing.
18. Walk from the right edge of the roadway away from the bus at a 45-degree angle and toward the center of the roadway. Stop before entering the traffic lane and look in all directions for traffic. This position allows the best view of traffic coming from the left and is protected. The handheld stop sign shall be used for all escorted crossings and should be held vertically, above waist level, with the word STOP facing traffic in both directions. This is one of the most dangerous places on earth; a public highway. Do not assume that vehicles will stop or that all pupils will follow procedures. Vehicles may try to pass the bus, and pupils may attempt to run across the roadway before you are ready. Take charge of the situation. Upon reaching the center of the roadway, turn and face the pupils (left side of the roadway). This position enables you to have a clear view of the pupils and traffic in both directions.

*Note:* Traffic might not be able to stop immediately during adverse weather (e.g., rain, snow, ice).

*Note:* The signal for pupils to enter the bus will be the flashing of the red light signal, the school bus driver holding a handheld stop sign in the center of the highway or private road

on which the school bus is stopped and verbal direction by the school bus driver to begin crossing the highway to enter the bus, and not simply the bus coming to a stop. Pupils must have received written instruction in school bus emergency procedures and passenger safety before riding a school bus for the first time. Once each year pupils in prekindergarten through grade eight who receive home-to-school transportation shall receive safety instruction on proper loading and unloading procedures, escorting by the driver, and crossing the street, highway or private road (*EC 39831.5*).

*Note:* If the flashing red light signal (crossover lights) becomes inoperative prior to or during the escorting of pupils, the escort procedures must stop. Pupils may cross the highway only under the protection of a properly functioning flashing red light signal system.

(Refer to Figure SL5-8)

19. When traffic has stopped in both directions, tell the pupils to walk, not run, as they cross the highway or private road. Do not use hand motions or gestures to signal pupils. Some motorists may mistake a hand gesture as a signal for them to proceed. The pupils must cross the roadway between you and the front of the bus, never behind you or to the rear of the bus.
20. When the last pupil has crossed the middle of the roadway, turn and face the bus (right side of the roadway). When the last pupil has reached the right side of the roadway, walk immediately to the right side of the roadway, continuing to hold the stop sign so it is visible to traffic in both directions. Check under and around the exterior of the bus to make sure that no pupil is in the danger zones. Enter the bus.
21. On entering the bus, ensure that all pupils have safely boarded and are seated.
22. Immediately place the handheld stop sign in the holder, close the entrance door, and turn off the flashing red light signal (crossover lights) and the stop signal arm if the bus is so equipped.
23. Sit down in the driver's seat and fasten the driver's seat belt.
24. Check to see that all pupils are accounted for and properly seated. Pupils must be seated before you set the bus in motion.
25. Check all mirrors for pupils, other pedestrians, and traffic. Be sure to check the front cross-view mirror(s) for pupils who may be in front of the bus.
26. Restart the engine. Account for all pupils before moving the bus.
27. Place the transmission in gear and release the parking brake.
28. Check the traffic and the danger zones by using all mirrors before moving the bus; activate the left-side turn signal lights, and when it is safe to do so, pull into the flow of traffic; cancel the left-side turn signal lights; regain road speed; and proceed to the next stop.

*Note:* School transportation administrators and other transportation officials should adopt policies that standardize signs or signals used by school bus drivers to inform hearing-impaired pupils of when it is safe to cross the highway.

## **RECOMMENDED PROCEDURES FOR SCHOOL BUS DRIVERS AT RAILROAD GRADE CROSSINGS**

Each year, approximately 4,000 train/vehicle collisions occur at railroad crossings. These 4,000 collisions result in about 500 fatalities and 1,500 injuries. Unfortunately, some of the crashes involve school buses that result in injuries and fatalities to students. In an effort to avert these crashes, the following procedures are recommended to school bus drivers. It is important to note that these recommendations must be considered within the context of individual state laws and regulations.

1. When making stops for railroad crossings, carefully observe all traffic. Use the school bus's hazard warning lamps, and tap the brakes to communicate to traffic that the bus is about to stop. Take these actions far enough in advance to avoid startling motorists behind the bus, which could cause panic stops or rear-end collisions.
2. Bring the bus to a full and complete stop before crossing any track, whether or not the bus is carrying passengers. Stop the bus not less than 15 feet nor more than 50 feet from the rail nearest the front of the bus.
3. On multiple-lane roads, stop only in the right lane unless it is necessary to make a left turn immediately after crossing the railroad tracks.
4. After stopping the bus, fully open the entrance (service) door and the driver's side window, turn off all noisy equipment (radios, fans, etc.), instruct students to be quiet and look and listen in both directions along the track or tracks for approaching trains. In instances where the school bus loading/unloading red warning lamps are activated by opening the entrance (service) door, deactivate such lamps by using the master control switch.
5. If the view of the railroad track or tracks is not adequate, do not attempt to cross the tracks.
6. If a train passes from one direction, make sure that another train, possibly hidden by the first train, is not approaching on an adjacent track.
7. For railroad crossings equipped with warning devices such as lights, bells and/or gates, always obey the signals. Never ignore railroad crossing signals. If a police officer or flagman is present at the crossing, obey their directions, but be sure to make your own visual check.
8. Before crossing the tracks, ensure there is adequate room on the other side of the tracks and train right-of-way for the entire bus. It is always possible that the bus may have to stop immediately after crossing the railroad tracks.
9. When the tracks are clear, completely close the bus entrance door and place the transmission in a gear that will not require changing gears while crossing the tracks. In instances where the loading/unloading red school bus alternately flashing signal lamps

are activated by opening the entrance door and such lamps were deactivated by using the master control switch, reactivate the school bus loading/unloading lamps. Leave all noisy equipment turned off, and continue looking in all directions as the bus crosses the tracks. After safely crossing the tracks, turn off the hazard warning lamps.

10. If the bus stalls while crossing the tracks, evacuate the students and move them a safe distance away from the bus as quickly as possible. If a train is approaching, have everyone walk in the direction of the train at a 45 degree angle away from the train tracks. If a radio or telephone is available, notify the school dispatcher of the situation.
11. Weather conditions, such as fog, snow, rain and wind, can affect the driver's ability to see and hear an approaching train and to determine the safety of crossing the railroad tracks. Additional caution must be exercised during such conditions.
12. Report malfunctioning railroad signals or hazardous railroad crossing conditions to the appropriate school transportation personnel.

Additional information and training materials on railroad crossing safety are available from:

Operation Lifesaver, Inc.  
1420 King Street  
Alexandria, VA 22314  
1-800-537-6224

Although the information and recommendations contained in this publication have been compiled from sources believed to be reliable, other or additional safety measures may be required under particular circumstances.

(Adapted from Fact Sheet, "Recommended Procedures for School Bus Drivers at Railroad Crossings," revised, School Transportation Section, 1998, National Safety Council, 1121 Spring Lake Drive, Itasca, IL 60143-3201, (630) 285-1121.)

## INSTRUCTIONS FOR CONDUCTING EMERGENCY EXIT DRILLS

Due to the increased number of students being transported and the increased number of accidents on the highways, there is an urgent need to instruct students on how to properly vacate a school bus in case of an emergency. It is possible for students to block the emergency door if all are trying to get out at the same time. Also, there is a possibility of danger when students jump from the rear emergency door exit. To avoid these situations, schools should organize and conduct emergency exit drills for all students who ride the school bus, even occasionally.

### A. Reasons for actual emergency evacuations:

#### 1. Fire or danger of fire

Being near an existing fire and unable to move the bus, or being near the presence of gasoline or other combustible material is considered dangerous, and students should be evacuated. The bus should be stopped and evacuated immediately if the engine or any portion of the bus is on fire. Students should be moved to a safe place 100 feet or more from the bus and instructed to remain there until the driver has determined that the danger has passed.

#### 2. Unsafe position

When the bus is stopped because of an accident, mechanical failure, road conditions or human failure, the driver must determine immediately whether it is safer for students to remain in or to evacuate the bus.

#### 3. Mandatory evacuations

The driver must evacuate the bus when the following situations arise:

- a. Fire or threat of fire is apparent.
- b. The final stopping point is in the path of a train or is adjacent to railroad tracks.
- c. The stopped position of the bus may change and increase the danger (e.g., a bus comes to rest near a body of water or at a precipice where it could still move and go into the water or over a cliff). The driver should be certain that the evacuation is carried out in a manner which affords maximum safety for the students.
- d. The stopped position of the bus is such that there is danger of collision.



4. Sight distance

In normal traffic conditions, the bus should be visible for a distance of 300 feet or more. A position over a hill or around a curve where such visibility does not exist should be considered reason for evacuation.

B. Important factors pertaining to school bus evacuation drills

1. Safety of students is of the utmost importance and must first be considered.
2. All drills should be supervised by the principal or by persons assigned to act in a supervisory capacity.
3. The bus driver is responsible for the safety of the students. When the driver is incapacitated and unable to direct the evacuation, school patrol members, appointed students or adult attendants should be authorized to direct these drills. It is important to have **REGULAR SUBSTITUTES AVAILABLE**.
4. **IF OPERABLE, THE SCHOOL BUS ALTERNATELY FLASHING SIGNAL LAMPS (RED TRAFFIC CONTROL LAMPS) MUST BE ACTIVATED AND SIDE STOP ARM EXTENDED TO ALERT ONCOMING TRAFFIC.**
5. Students appointed to direct evacuation drills should possess the following qualifications:
  - a. Maturity; and
  - b. Live near the beginning of the morning bus route or end of the afternoon bus route.
6. Passengers should receive instruction on how to:
  - a. Turn off ignition switch/shut down engine;
  - b. Set emergency brake;
  - c. Summon help when and where needed;
  - d. Use kick out windows or emergency escape exits;
  - e. Set warning devices;
  - f. Open and close doors and account for all students passing the station;
  - g. Help small students off the bus;
  - h. Perform other assignments; and

- i. Use electronic voice equipment to summon help.
7. School bus drivers and attendants should be active participants.
8. Drills should be scheduled in a manner similar to fire drills that are held regularly in schools. They should be held more often during fall and spring months and conducted when the bus arrives at the school building with the students.
9. Drills should be restricted to school property and conducted under the supervision of school officials.
10. Types of drills should be varied.
11. The driver should stay in the bus during evacuation drills. He/she must set the parking brake, turn the engine off and place the manual transmission in the appropriate gear.
12. Students should not be permitted to take lunch boxes, books, etc., with them when they leave the bus. (The objectives are to get students off safely in the shortest time possible and in an orderly fashion.)
13. Students should travel a distance of at least 100 feet from the bus in an emergency drill and remain there until given further directions.
14. All students should participate in the drill, including those who ride only on special trips.
15. Each student should be instructed in proper safety precautions.
16. Students should be instructed in how and where to obtain assistance in emergencies. Written instructions and telephone numbers should be posted in the bus.
17. Sample drill formats:
  - a. Everyone exits through the front entrance doors and emergency door configurations.
  - b. Everyone exits through the rear-most emergency door(s).
  - c. Front half exits through the front door and rear half exits through the rear-most door.
  - d. Other emergency exits (e.g., windows, hatches) are included in drills.
18. All rear-engine buses are equipped with a side emergency exit door in lieu of a rear emergency door. This exit should also be utilized for evacuation drills.

19. Some states also require side emergency exits in addition to rear emergency doors.
20. Students should be familiar with the operation of emergency windows (both side and rear) and roof hatches. All exits should be opened by students during evacuation drills to ensure the students' ability to operate such devices.
21. All school bus drivers shall ensure the students assigned to their buses are familiar with the emergency exit configuration of their assigned bus.
22. Identification of seat rows and positions similar to airline seating is recommended (i.e., left front seat 1, a, b, c, right front seat 1, d, e, f, etc.)
23. Education staff and coaches should be trained regarding safe travel practices and procedures and should be required to participate in school bus evacuation drills.

# School Bus Danger Zone

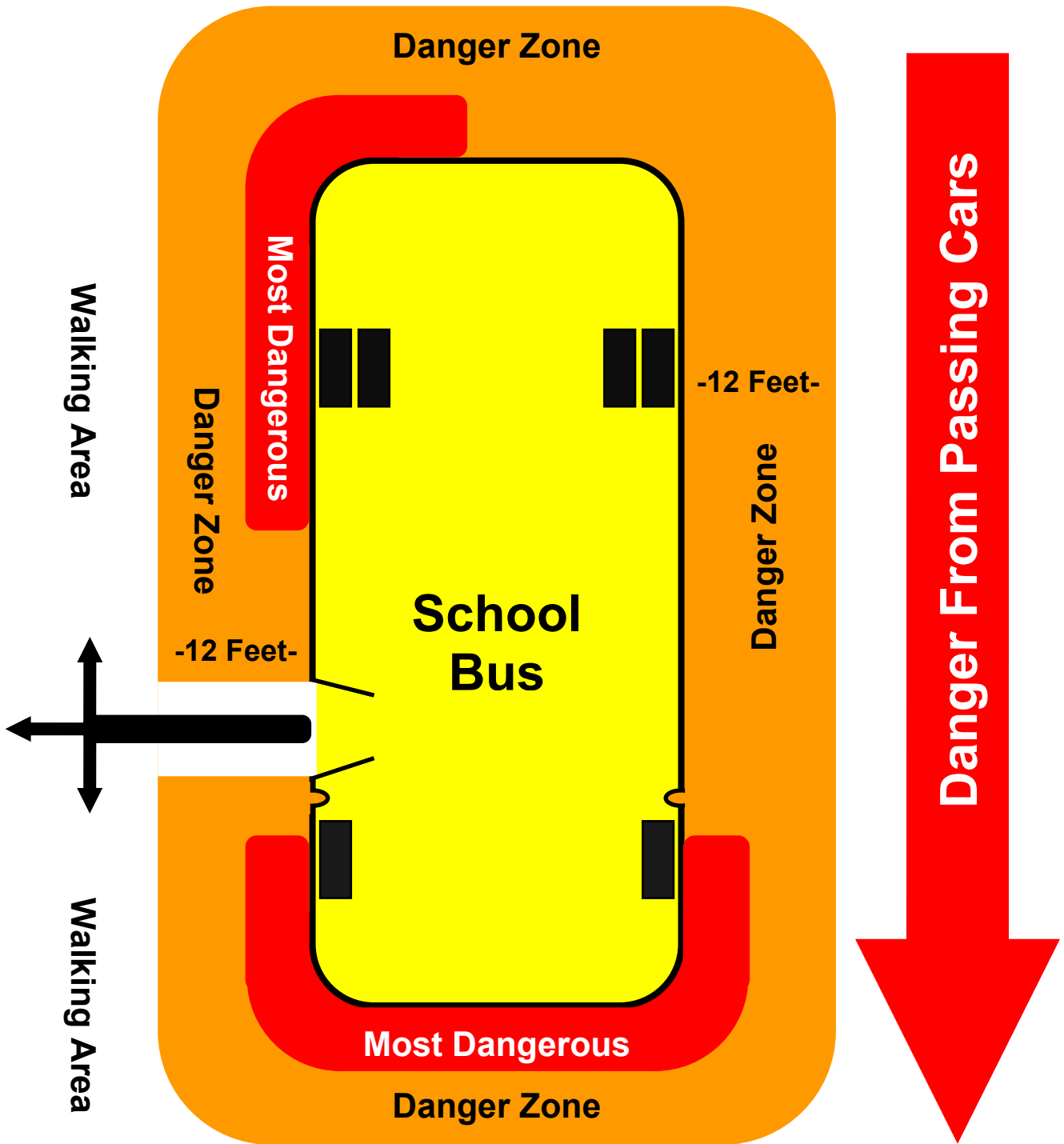

## SAMPLE JOB DESCRIPTIONS

### Local Student Transportation Director, Manager, Supervisor and Private Operator

- A. The local student transportation director's and private operator's specific duties should include, but are not limited to, the following activities:
1. Providing assistance in planning, budgeting and forecasting for the student transportation system;
  2. Assisting in school site selection and facility planning;
  3. Providing, when appropriate, chassis, body and related equipment procurement;
  4. Developing and implementing a plan for preventive and on-going equipment maintenance;
  5. Recruiting, selecting, instructing, evaluating and supervising personnel;
  6. Routing and scheduling buses for safe, efficient and economical transportation service;
  7. Assisting in the development and implementation of student safety education programs;
  8. Working with administrators, teachers, transportation personnel, students, parents and various public and private agencies to improve their knowledge and the quality of the transportation system;
  9. Investigating and reporting crashes and safety-related incidents, when applicable, using the uniform school bus crash reporting criteria and standard safety incident investigation process;
  10. Investigating reported problems;
  11. Maintaining records and preparing reports, as required;
  12. Developing and supervising an on-going evaluation plan for the student transportation system;
  13. Implementing a drug/alcohol testing program in compliance with federal regulations for persons in safety-sensitive positions and for commercially licensed drivers;
  14. Establishing and ensuring appropriate staffing levels;

15. Recommending vehicle and equipment replacement schedules; and
  16. Exhibiting effective skills in conflict-resolution and problem-solving.
- B. Minimum qualifications for the student transportation director and private operator who supervise transportation should include the following:
1. An undergraduate degree, equivalent experience or industry certification in one or more of the following fields of study is desirable:
    - a. Education;
    - b. Business Administration;
    - c. Management; or
    - d. Transportation or a related field;
  2. Formal instruction in student transportation management, including classroom instruction and field experience or student transportation industry certification;
  3. A basic understanding of the educational process and the corresponding role of transportation;
  4. The ability to manage personnel and resources;
  5. Basic user-level computer competency with accounting and word processing software and knowledge of web-based information systems;
  6. The ability to communicate effectively with school or Head Start Center administrators, teachers, parents, students, bus drivers, law enforcement officials, etc.; and
  7. Knowledge of state and federal regulations applicable to transportation of students.

### **Transportation Specialist**

- A. The specific duties should include, but are not limited to, the following activities:
1. Design and regularly update all routes and time schedules;
  2. Assign drivers to routes and extra-curricular trips;

3. Prepare routes for bidding (if applicable), including schools served and time expectations;
4. Assign substitute drivers;
5. Accept bus trouble calls, coordinate replacement buses and drivers;
6. Advise building officials and parents of route changes, bus changes, late arrivals and departures;
7. Prepare annual route schedule for distribution and notification to schools and parents;
8. Assist in planning and presenting staff development programs and annual in-service training for drivers;
9. Assist district in designing new school service areas and boundaries, when necessary;
10. Assist with road checking all drivers annually;
11. Relief-drive, when necessary; and
12. Investigate school bus crashes, unsafe practices and safety-related incidents and recommend system and procedural improvements leading to improved safety of operations.

B. Minimum qualifications should include, but are not limited to these:

1. Certified state driver instructor (if applicable);
2. Two years of college, equivalent experience or industry certification;
3. Basic computer skills (routing software knowledge preferred);
4. Minimum of one year of experience in an office setting;
5. Knowledge of district, state and federal regulations, policies and requirements pertaining to driver training and student safety;
6. Ability to plan, schedule, evaluate and dispatch buses for all district bus routes and extra-curricular trips;
7. Ability to recommend, train and evaluate drivers, meeting all district, state and federal requirements;
8. Ability to recommend equipment and personnel requirements for transportation;

9. Ability to effectively work with and direct bus drivers;
10. Ability to maintain cooperative and effective communication with administrators, students, parents, public and other department employees;
11. Familiarity with vehicle maintenance concepts;
12. Ability to read and interpret road maps; and
13. Ability to communicate on the district's two-way voice communication system.

### **Dispatcher**

- A. The specific duties should include, but are not limited to, the following activities:
  1. Schedule and dispatch buses and district vehicles to appropriate routes;
  2. Dispatch and coordinate bus and driver assignments for school-sponsored trips;
  3. Secure substitute drivers due to absences and review routes with substitutes, as necessary;
  4. Communicate with drivers via the transportation communication system regarding routes, emergencies and student problems;
  5. Develop and maintain records for driver assignments and vehicle scheduling and use;
  6. Receive and respond to phone calls from parents or the public concerning transportation by providing information or referring calls to appropriate staff members;
  7. Assist in the development of bus routes and schedules and updating routes and schedules throughout the school year; and
  8. Assist staff by checking roads during inclement weather.
- B. Minimum qualifications should include, but are not limited to these:
  1. High school graduate or equivalent;
  2. Class "B" CDL with P and S endorsements;
  3. Two years of experience in public or student transportation;



4. Experience as a route planner or dispatcher;
5. Effective oral and written communication skills;
6. Ability to work effectively under pressure;
7. Ability to make independent decisions;
8. Ability to maintain accurate records;
9. Ability to maintain confidentiality;
10. Ability to operate communications systems;
11. Ability to schedule and coordinate activities;
12. Ability to communicate and work effectively with building and department personnel; and
13. Knowledge of student transportation rules and regulations.

**Instructor/Trainer**

- A. The specific duties should include, but are not limited to, the following activities:
  1. Assist with pre-interview and recommendation to train;
  2. Train and retrain, as necessary, all bus drivers and bus attendants;
  3. Organize and present safety messages and programs to students;
  4. Annually conduct on-the-road evaluations of all bus drivers;
  5. Maintain all driver records and notify drivers of license or certification expirations;
  6. Recommend hiring, retraining and disciplinary action for bus drivers and bus attendants; and
  7. Work with vehicle maintenance personnel on possible driver training to avoid equipment abuse.
- B. Minimum qualifications should include, but are not limited to these:
  1. High school graduate or equivalent;
  2. Class “B” CDL with P and S endorsements;

3. Certified state driver instructor (if applicable);
4. Certified first aid instructor;
5. Knowledge of state and federal laws and regulations related to bus drivers;
6. Skill in operating a bus and troubleshooting minor problems;
7. Ability to teach required subjects to obtain state school bus driver's authorization;
8. Ability to instruct CDL requirements;
9. Ability to provide effective instruction in soft skills categories (i.e. confidentiality and intervention strategies);
10. Ability to effectively communicate with staff, peers and community;
11. Ability to establish and maintain effective working relationships;
12. Evidence of effective oral and written communications; and
13. Proficiency in basic computer and presentation skills.

### **Routing Specialist**

- A. The specific duties should include, but are not limited to, the following activities:
  1. Coordinate the development and maintenance of bus stops, runs, routes and schedules consistent with district policies and state requirements;
  2. Gather criteria necessary for the development of the school district's school boundaries, street address ranges, speed limits, one-way streets, traffic hazards and hazardous walkway areas;
  3. Review all bus route change requests;
  4. Communicate with drivers and dispatchers to resolve problems with routes;
  5. Communicate with parents, teachers, principals and others regarding the transportation of students;
  6. Generate transportation-related reports, as required by the Transportation Director; and

7. Evaluate existing hazardous walkway areas and determine route revisions, making recommendations to appropriate individuals.
- B. Minimum qualifications should include, but are not limited to these:
1. High school graduate or equivalent;
  2. Three years of computerized routing experience;
  3. Knowledge of operating procedures for student transportation;
  4. Knowledge of routing procedures and methods;
  5. Ability to analyze and make recommendations regarding bus routing activities;
  6. Ability to work under pressure;
  7. Ability to organize, set priorities and meet deadlines;
  8. Ability to maintain accurate records and generate computerized reports;
  9. Ability to establish and maintain effective working relationships with a variety of people;
  10. Ability to establish a customer service environment; and
  11. Working knowledge of computerized routing systems and boundary analysis software applications.

### **Secretary**

- A. The specific duties should include, but are not limited to, the following activities:
1. Develop and maintain filing and record-keeping systems, both physical and electronic;
  2. Finalize correspondence and reports prepared by others, prepare correspondence, reports and other documents, as directed, perform data entry of pertinent information;
  3. Design, format and prepare forms and other documents;
  4. Ensure that documents are free from typographical errors, misspellings, omissions, logical inconsistencies and grammatical errors;
  5. Ensure that sufficient levels of office supplies are maintained;

6. Arrange for meeting space, send notices and track responses, ensure appropriate refreshments are available and rooms and equipment are properly set up;
7. Use standard office equipment;
8. Coordinate activities with other clerical staff, departments and outside agencies;
9. Report employees' hours of work, sick leave, vacation and other leaves to the payroll department, per district policy and procedures;
10. Maintain permanent employee records, including payroll, evaluations and leaves, per district policy and procedures;
11. Answer phones while maintaining professional demeanor and answering queries or redirecting caller to the appropriate personnel;
12. Facilitate purchase of equipment by obtaining quotes, and preparing purchase orders. (Which may be the duty of the Purchasing Agent); and
13. Ensure that all financial transactions are properly recorded, totaled, balanced and reconciled with budget. (Which may be the duty of the Bookkeeper).

B. Minimum qualifications should include, but are not limited to these:

1. High school graduate or equivalent;
2. Computer experience in word processing, database, spreadsheet and desktop publishing;
3. Two years' secretarial experience in an office setting;
4. Ability to create and maintain a filing system;
5. Ability to enter data;
6. Ability to create forms, documents, and pamphlets, using desktop publishing;
7. Ability to maintain good telephone skills;
8. Good organizational and time management skills;
9. Excellent oral and written skills;

10. Ability to handle changing priorities;
11. Knowledge of payroll practices and procedures;
12. Knowledge of general accounting and purchasing procedures;
13. Ability to work effectively under high stress situations; and
14. Ability to maintain confidentiality,

### **Bookkeeper**

- A. The specific duties should include, but are not limited to, the following activities:
  1. Develop and maintain records of budget data, both physical and electronic;
  2. Prepare special reports, as required by the Transportation Director;
  3. Prepare purchase orders and maintain records;
  4. Ensure that all financial transactions are properly recorded, totaled, balanced and reconciled with budgeted amounts;
  5. Invoice departments, schools and other agencies for transportation services performed;
  6. Obtain quotes and prepare purchase orders for buses, supplies, office and shop equipment;
  7. Maintain inventory of all buses and district vehicles, including VIN and license numbers, model, chassis, seat and vehicle-rated capacity, wheelchairs and occupant restraint systems;
  8. Remove and add vehicles for insurance purposes;
  9. Assist with insurance claims and warranty work;
  10. Assist with development of annual budget;
  11. Assist with answering phones while maintaining professional demeanor and answering queries or redirecting caller to the appropriate personnel; and
  12. Use copiers and other office equipment.

- B. Minimum qualifications should include, but are not limited to these:
1. High school graduate or equivalent;
  2. Experience with word processing, spreadsheets and database;
  3. Experience as bookkeeper in an office setting;
  4. Ability to organize tasks and documents in a logical manner;
  5. Ability to complete basic formulas and operations, such as sorting and extracting;
  6. Ability to operate a ten-key calculator;
  7. Ability to use various types of office equipment;
  8. Ability to reconcile checking accounts or bank statements;
  9. Ability to maintain good telephone skills;
  10. Ability to enter data;
  11. Knowledge of general mathematics applications;
  12. Knowledge of general accounting procedures;
  13. Knowledge of purchasing regulations;
  14. Knowledge of bidding and/or low-quote purchase of school buses; and
  15. Ability to maintain confidentiality.

### **Bus Driver**

- A. The specific duties should include, but are not limited to, the following activities:
1. Report defective school bus equipment and accessories, including but not limited to, fire extinguishers, highway warning kits, first aid and body fluid cleanup kits, snow chains, sanders, etc., and when necessary install, service or replace defective equipment;
  2. Perform required operational and safety inspections of the school bus and all related equipment;
  3. Ability to clean and service the school bus to include interior cleaning and exterior bus washing, installation of fuel, oil and other fluids, as directed;

4. Operate all hand and foot controls installed in a school bus, as required;
5. Perform basic first aid, as appropriate, which may include CPR;
6. Work effectively with a group of students of different grade levels, abilities or program placement;
7. Complete legibly and accurately forms, records, reports and other documentation/data-logging activities, as required by state or district policy.
8. Be punctual;
9. Dress appropriately and wear proper foot protection;
10. Manage passengers in the school bus;
11. Report unsafe acts or conditions that require the attention of any person other than the driver; and
12. Successfully complete school bus driver training programs and courses established by the state or school district.

B. Minimum qualifications should include, but are not limited to these:

1. High school graduate or equivalent.
2. Hold and maintain a class license with all applicable endorsements for the type of vehicle being driven;
3. Excellent driving record;
4. Physical ability to drive and perform all duties related to school bus operations;
5. Ability to relate effectively with parents, staff and public in a multicultural and multiracial community;
6. Possess sufficient command of local language so as to communicate with students, parents, district staff members and other concerned individuals regarding all aspects of their job-related activities;
7. Ability to pass a criminal history background check;
8. Ability to pass a state or DOT medical examination: and
9. Ability to pass a federally mandated drug/alcohol screen.

### **Bus Attendant (Monitor or Attendant)**

- A. The specific duties should include, but are not limited to, the following activities:
  - 1. Assist the school bus driver;
  - 2. Assist students to safely embark and disembark from a school bus;
  - 3. Ensure a safe trip for every student;
  - 4. Ensure that students get off at the correct bus stop;
  - 5. Help implement safety standards on board the bus;
  - 6. When applicable, assist with loading/unloading and securing of assistive devices and safety restraints; and
  - 7. Assist driver with student management.
  
- B. Minimum qualifications should include, but are not limited to these:
  - 1. High school graduate or equivalent;
  - 2. Ability to work with all students;
  - 3. Ability to physically move wheelchairs onto wheelchair ramp and into the bus;
  - 4. Ability to physically remove students from a disabled bus;
  - 5. Ability to get along with co-workers, parents, students and other staff;
  - 6. Ability to interact with students;
  - 7. Ability to follow directions; and
  - 8. Ability to communicate with staff.

### **Vehicle Maintenance Supervisor, Foreman and Manager**

- A. The specific duties should include, but are not limited to, the following activities:
  - 1. Supervise and work with technicians in diagnosing malfunctions on vehicles;
  - 2. Supervise and work with technicians to overhaul and rebuild engines, transmissions and other vehicle components;



3. Purchase parts, materials and supplies required for proper maintenance of district vehicles, related equipment and shop facilities, per district procedures;
4. Coordinate maintenance of buses with dispatchers to ensure the bus fleet is ready to meet operational requirements;
5. Recommend and assist with short- and long-term bus purchase planning;
6. Oversee record-keeping, evaluate reports for work assignments, inspect work, as needed, review time and parts used for repair and maintain inventory at required levels;
7. Evaluate needs and recommend purchase of new or replacement shop equipment, machines, tools and related items;
8. Assist in evaluating bids and recommend awards for jobs performed by outside vendors;
9. Assume responsibility for cleanliness, upkeep and organization of shop building, as well as safety, security, equipment and parts;
10. Assume responsibility for hazardous material disposal, following all governmental regulations and required reporting and record-keeping;
11. Assume responsibility for evaluating all shop personnel; and
12. Prepare and maintain preventive maintenance schedules.

B. Minimum qualifications should include, but are not limited to these:

1. High school graduate or equivalent;
2. Minimum of five years of experience in automotive technician field;
3. One year of full-time experience as a journeyman technician in a truck or bus maintenance facility;
4. One year of full-time experience at the supervisory level in an automotive maintenance facility;
5. Class "B" CDL with P and S endorsements;
6. Knowledgeable user of computer-based business and fleet management software;
7. Ability to direct and coordinate employees;

8. Ability to communicate with staff;
9. Ability to understand job functions in relationship to school district requirements.;
10. Ability to work under pressure;
11. Ability to teach/instruct;
12. Ability to maintain and analyze vehicle records; and
13. Ability to use and understand diagnostic equipment.

### **Journeyman Technician**

- A. The specific duties should include, but are not limited to, the following activities:
  1. Diagnose and repair mechanical, electrical and engine defects in buses and other automotive equipment;
  2. Overhaul and rebuild engines, transmissions, differentials, brake systems and other major components by repair and replacement of parts;
  3. Repair and rebuild generators, alternators and all other electrical components utilizing testing devices and machine equipment, as required;
  4. Perform general tune-ups, utilizing diagnostic equipment;
  5. Make roadside repairs, as required;
  6. Repair and replace seats, glass, sheet metal, latches and other body components and assemblies;
  7. Change oil and filters' install antifreeze and snow chains, repair tire,; adjust brakes, lubricate chassis, wheel bearings and other assemblies, as required;
  8. Perform all required preventive maintenance and regular bus safety inspections;
  9. Operate battery chargers, valve re-facing and reseating machines, compression gauges, torque wrenches, welding equipment, grinders, reamers, timing lamps, hoists, jacks, presses, headlight adjustment machines, air wrenches, small lathes, spark plug testers and other equipment for performing repair and maintenance of motor vehicles;

10. Assist in cleaning and organizing the shop, parts room and other maintenance facilities; and
  11. Complete vehicle maintenance forms and records.
- B. Minimum qualifications should include, but are not limited to these:
1. High school graduate or equivalent;
  2. Class “B” CDL with P and S endorsements;
  3. Completion of a recognized apprenticeship as an automotive technician, full “journeyman” status as an automotive technician or a minimum of four years’ applicable work experience of any equivalent combination of experience and training;
  4. Experience in repair and maintenance of heavy duty and diesel vehicles and special vehicular equipment;
  5. Ability to identify, diagnose and repair vehicle malfunctions;
  6. Ability to communicate with staff, peers and students;
  7. Ability to understand job functions in relationship to school district needs;
  8. Ability to work under pressure;
  9. Ability to maintain accurate bus repair and other records; and
  10. Be in good physical condition.

### **Assistant Technician**

- A. The specific duties should include, but are not limited to, the following activities:
1. Assist journeyman technicians in overhaul, rebuilding and replacing major assemblies and components;
  2. Lubricate buses and other automotive equipment to include chassis lube, oil and filter changes, gearbox fill or drain and flush, wheel bearing pack and all other lubricating and air cleaner service procedures, as required;
  3. Verify operational safety of equipment and devices, such as brakes, clutch, lamps, mirrors, glass, fire extinguishers, first aid kits, highway warning kits, horn, warning lamps and buzzers, emergency exits, wipers, signs, tires, etc;

4. Change and repair tires, perform complete battery service and brake adjustments;
5. Install antifreeze and service cooling systems, inspect and replace hoses, caps valves etc;
6. Make minor repairs by replacing lamps, spark plugs, ignition parts, patches and switches, as required;
7. Operate lubrication equipment, hoist, compressor, battery charger, diagnostic equipment, headlight adjustment machine, alignment board, spark plug tester, drills, presses, air wrenches and other tools and equipment, as required in the performance of assigned duties;
8. Drive service truck for roadside service, as required; and
9. Assist in cleaning and organizing the shop, parts room and other maintenance facilities.

B. Minimum qualifications should include, but are not limited to these:

1. High school graduate or equivalent;
2. Class “B” CDL with P and S endorsements;
3. Minimum two years of general experience in service station-type automotive maintenance, plus one year related experience on buses, trucks or other heavy duty vehicular equipment;
4. Possess a basic set of auto technician hand tools and storage cabinet, if required;
5. Be in good physical condition;
6. Ability to work under pressure;
7. Able to follow directions; and
8. Ability to communicate with staff.

#### Hiring New Employees

Employment procedures should be clearly stated in writing and followed by all parties involved in the procedures. There should be no discrimination in the advertisement of a job opening, in the application review process or in the interview. All applicants must be treated equally and interviewed/not interviewed or hired/not hired based on objective and measurable criteria. It is illegal to make any inquiry or keep any record of race, creed,

color, national origin, age, sex, marital status or disability before, during or after employment for the purpose of discriminating on these grounds.

The following are essential steps to be incorporated in screening and hiring procedures:

A. Advertising

1. Contact the Personnel Department/Human Resources Office for possible applications on file. (Some offices have a phone jobline available for posting job openings.) Advertising by word of mouth, newspapers, employment office, school lunch menus and notices in retail stores or local fire departments are also good methods to get word out to the community regarding job openings.
2. Provide written procedures, job requirements and duties to applicants. Pre-employment screening requirements (e.g., criminal background checks, driving record checks, drug screening, etc.) should be listed in each packet of information provided to potential applicants.

B. Applicant screening

1. Check application forms for completeness. Contact applicants as soon as possible to obtain any information that was omitted from the original application documents. One method is to formulate a check-off list to verify the completeness of the applications and that the applicants meet all requirements for the position. A point system or some other grading criteria should be developed that will result in an objectively obtained score. It is advisable for the Personnel Department/Human Resources Office to keep these screening sheets on file, should the district be challenged by an applicant that feels he/she has been discriminated against. The successful applicants should be scheduled for an interview when screening and background checks are completed. This may be done by phone or letter.
2. Conduct background checks, as may be required. Advise applicants of procedures for fingerprinting for criminal records checks, authorization for driving records check, drug/alcohol screening and any other background checks that are required. Obtain written authorization for any such checks. If a CDL is required prior to employment, a copy of the applicant's current license and physical examination form may be requested at this stage in the procedure.
3. Contact personal references and previous employers listed on application forms. It is very important to check references;

however, because personnel issues are confidential, it is very important to receive written permission from the applicant to allow the former employer(s) to release all information, including any available drug and alcohol test results. If you do not have this release, the only information you will usually obtain is date(s) of employment and position held. One question they may answer is this: "Would you rehire?" If the answer is "No," you may want to more thoroughly evaluate the applicant.

4. Determine amount of pre-service training required for applicants to fulfill job requirements.

### C. Interview

1. Planning the interview

Interviews should be held in a pre-determined, pre-appointed setting. The interview team should be selected, seating arrangements determined and questions prepared before the interview begins. Applicants should not have to wait. It is very important to plan the number of questions to be asked and about how long the interview should take. Allow time in the schedule for the interview team to exchange any thoughts or concerns about the applicants while information is fresh.

2. Interview questions

Questions should be open-ended. Try to avoid asking questions that can be answered with a "yes" or "no." The number of questions depends on the kind of information the interview team wishes to gather and evaluate. Always allow the applicant to ask the team any questions he/she may have. "Look for" answers, pre-determined by human resources staff and/or the interview team, must be resolved before the interview. The answer(s) are what the team is "looking for" when the applicant is interviewed. Each member of the team would then grade the answer he/she hears on a pre-designed sliding scale.

Do not ask illegal questions. The perception by the candidate could be that he or she was not picked because of the answer of an illegal/personal question.

The interview team should meet in advance to determine assignments and to stress that all candidates for the position must be treated equally and asked the same questions, preferably by the same interview team member.

3. Concluding interview activities

After all interviews are completed, interview team members should grade their interview sheets. (These must be kept in the event the district may be challenged about the decision by an unsuccessful applicant at a later date.) Applicants' composite scores should be tallied and recommendations prepared.

D. Recommend hiring

Applicants for all positions must be screened, and only those applicants that qualify in terms of education, job skills and experience should be recommended for final consideration.

E. Hire

Hiring an employee is a process with many steps that usually begins with the need to fill an open or new position. Hiring, the final step, should follow a clearly established written procedure, which often must be ratified by the governing authority of the agency involved.

[Back to Contents](#)

**APPENDIX E**  
**Transportation for**  
**Students with**  
**Disabilities and**  
**Special Health Care**  
**Needs**



**Page Intentionally Left Blank**

**APPENDIX E**

**SPECIAL EDUCATION DEPARTMENT FORMS**

**Sample Form 1**

**CONSENT FOR DISCLOSURE OF MEDICAL INFORMATION AND RECORDS**

**Note: MOST MEDICAL PROFESSIONALS WILL NOW REQUIRE A HIPAA FORM**

TO: \_\_\_\_\_  
(Physician's Name and Address)

I, \_\_\_\_\_, the (parent/guardian) of \_\_\_\_\_ (Student) consent and authorize you to disclose and provide to the \_\_\_\_\_ (School District), its nursing and other necessary service providers, upon the school district's request, any information or records which you have concerning the diagnosis, evaluations, tests, medical problems or conditions, medications, or treatments of my child or ward named above.

I hereby waive any and all privileges which I or my child or ward might have with respect to disclosure of the above information and records to the school district, including the doctor-patient privilege, psychologist-client privilege, and social worker-client privilege.

Signature of Parent or Guardian: \_\_\_\_\_

Print Name: \_\_\_\_\_ Dated: \_\_\_\_\_

PLEASE RETURN TO: \_\_\_\_\_

\_\_\_\_\_

**REQUEST FOR MEDICAL VERIFICATION OF HEALTH STATUS AND NEEDS**

**Sample Form 2**

SCHOOL DISTRICT: \_\_\_\_\_  
(Address)

NAME: \_\_\_\_\_ BIRTH DATE: \_\_\_\_\_

ADDRESS: \_\_\_\_\_ PHONE: \_\_\_\_\_

PARENT/GUARDIAN NAME: \_\_\_\_\_ PHONE: \_\_\_\_\_

ADDRESS (IF DIFFERENT): \_\_\_\_\_

PHYSICIAN: \_\_\_\_\_

NOTE TO PHYSICIAN: Should you have any questions regarding this request, please contact:

\_\_\_\_\_  
PHONE: \_\_\_\_\_

**A. VERIFICATION OF MEDICAL, HEALTH AND BEHAVIOR STATUS.**

1. Briefly describe the current medical, health and behavioral status.
2. Identify any medical conditions not addressed above which could impact the student's participation in the school day including transportation.
3. Identify any health concerns that are not addressed above which could impact the student's participation in the school day including transportation.
4. Identify any behavioral concerns that are not addressed above which could impact the student's participation in the school day including transportation. Give specific consideration to the potential space limitations of a school bus.

**B. PARTICIPATION IN THE SCHOOL DAY PROGRAM**

1. Briefly describe the staff supervision and interventions necessary for the student to safely participate in the normal school day program, given the student's health and medical status.
2. Identify the training required for all staff, including bus attendants and drivers, to provide the supervision and interventions addressed above.

3. Identify any additional restrictions or modifications in school activities or medical care that would be necessary for the student to safely participate in the school day program.
4. Identify any additional special equipment, aids, restraints, or mobility assistance needed for the student to safely participate in the school day program.

**MEDICAL PROCEDURE AUTHORIZATION**

**Sample Form 3**

I delegate and authorize the staff of the \_\_\_\_\_ School District to perform for \_\_\_\_\_ (student) the acts, tasks and functions indicated on the Request for Medical Verification of Health Status and Needs, dated \_\_\_\_\_, which I previously provided to the district. This authorization is subject to the condition that district staff assigned to perform these activities has been provided the required training, as specified in the above request.

I have reviewed the attached procedures for \_\_\_\_\_ (procedure) that will be utilized, and I approve them, subject to any specific modifications necessary for this student, which I have noted on the procedures.

I agree to supervise the performance of these activities and procedures by being continuously available through direct communications with district staff performing them and by regularly reviewing the student's health/medical status and needs, as well as the procedures being utilized by the staff.

\_\_\_\_\_  
Signature of Physician

\_\_\_\_\_  
Date

**STUDENT TRANSPORTATION CARD-STUDENTS WITH DISABILITIES**

**Sample Form 4**

Student's Name: \_\_\_\_\_ Date: \_\_\_\_\_

Address: \_\_\_\_\_ Phone: \_\_\_\_\_

Father's Work Phone: \_\_\_\_\_ Mother's Work Phone: \_\_\_\_\_

Emergency Phone: \_\_\_\_\_

Please indicate your ideas regarding appropriate type of transportation for your child:

- Walks to bus unassisted
- Requires a car seat
- Needs to be carried
- Positioning devices
- Needs to be met at school
- On return/home, needs to be met at bus stop
- Requires assistance to board or exit the school bus
- Walks to bus, but needs assist.
- Wheelchair
- Requires special restraint
- Special equipment
- Other (Specify) \_\_\_\_\_

Please explain in more detail for each box checked above

\_\_\_\_\_  
\_\_\_\_\_

Names and Addresses of persons near student's residence who have consented to care for the student if the parents are not available:

Name: \_\_\_\_\_ Address: \_\_\_\_\_ Phone: \_\_\_\_\_  
Alternate Phone \_\_\_\_\_

Name: \_\_\_\_\_ Address: \_\_\_\_\_ Phone: \_\_\_\_\_  
Alternate Phone \_\_\_\_\_

Name: \_\_\_\_\_ Address: \_\_\_\_\_ Phone: \_\_\_\_\_  
Alternate Phone \_\_\_\_\_

Please check if any of the following applies to your child:

- Asthma
- Diabetes
- Deaf
- Non-Verbal
- Hemophiliac
- Non Ambulatory
- Medically Complex
- Heart Disease
- Blind
- Chronic Respiratory Problems
- Bee Sting Reaction
- Allergies—to what?
- Aggressive Behavior

Please explain in more detail for each box checked above

Other conditions or medical circumstances likely to impact school transportation

Seizures:

How long does seizure last? \_\_\_\_\_

How often does it occur? \_\_\_\_\_

Action needed, if any: \_\_\_\_\_

Individualized Student Health Plan attached

Is your child on medication?       Yes       No

If yes, what medication, for what diagnosis, what dosage, and when given? \_\_\_\_\_

If local policy allows, is this medication to be transported on the school bus?

Family Doctor: \_\_\_\_\_

Address: \_\_\_\_\_

Doctor's Phone Number: \_\_\_\_\_ Family Designated Hospital: \_\_\_\_\_

**Parental Contact:** If possible and practical, in the event of major emergency, parent contact will be made.

**Parental Approval:** If, in the opinion of the school transportation department, a major emergency exists, the parent(s) have agreed in writing and will assume the cost of:

- |  |                          |     |                          |    |
|--|--------------------------|-----|--------------------------|----|
| 1. Contacting the family doctor        | <input type="checkbox"/> | Yes | <input type="checkbox"/> | No |
| 2. Contacting any doctor available     | <input type="checkbox"/> | Yes | <input type="checkbox"/> | No |
| 3. Contacting rescue squad             | <input type="checkbox"/> | Yes | <input type="checkbox"/> | No |
| 4. Transporting to designated hospital | <input type="checkbox"/> | Yes | <input type="checkbox"/> | No |

Other Helpful Information: \_\_\_\_\_

As parent or guardian, I agree to one or more of the above procedures, as indicated, and agree that this information may be shared with my child's transporter.

CONFIDENTIALITY WILL BE MAINTAINED EXCEPT WITH RESPECT TO EMERGENCY PERSONNEL AND AS OTHERWISE PROVIDED BY LAW.

\_\_\_\_\_  
Parent's or Guardian's Signature

\_\_\_\_\_  
Date

**DO NOT WRITE BELOW THIS LINE**

Bus Company:\_\_\_\_\_

Bus No.:\_\_\_\_\_ Telephone:\_\_\_\_\_

Special Instructions for Driver:\_\_\_\_\_

\_\_\_\_\_



**TRANSPORTATION SERVICE REQUIREMENTS FOR  
PASSENGERS WITH HEALTH CONCERNS**

**Sample Form 5**

SCHOOL DISTRICT: \_\_\_\_\_

ADDRESS: \_\_\_\_\_

DATE: \_\_\_\_\_ ASSIGNED SCHOOL: \_\_\_\_\_

GRADE LEVEL: \_\_\_\_\_ SPECIFIC PROGRAM: \_\_\_\_\_

HOME SCHOOL: \_\_\_\_\_ NAME OF STUDENT: \_\_\_\_\_

BIRTH DATE: \_\_\_\_\_ STUDENT I.D. #: \_\_\_\_\_

HOME ADDRESS: \_\_\_\_\_ APT. NO.: \_\_\_\_\_ ZIP: \_\_\_\_\_

HOME PHONE: \_\_\_\_\_

A.M. PICK-UP LOCATION: \_\_\_\_\_ PHONE: \_\_\_\_\_

P.M. DROP-OFF LOCATION: \_\_\_\_\_ PHONE: \_\_\_\_\_

PARENT(S) NAME: \_\_\_\_\_

FATHER'S WORK PHONE: \_\_\_\_\_ MOTHER'S WORK PHONE: \_\_\_\_\_

**1<sup>st</sup> EMERGENCY / ALTERNATE CONTACT:**

Name: \_\_\_\_\_ Phone: \_\_\_\_\_

Address: \_\_\_\_\_

Name: \_\_\_\_\_ Phone: \_\_\_\_\_

Address: \_\_\_\_\_

**2<sup>nd</sup> EMERGENCY/ALTERNATE CONTACT:**

Name \_\_\_\_\_ Phone: \_\_\_\_\_

Address: \_\_\_\_\_

Name \_\_\_\_\_ Phone: \_\_\_\_\_

Address \_\_\_\_\_

**EMERGENCY MEDICAL INFORMATION:**

Student's Doctor: \_\_\_\_\_ Phone: \_\_\_\_\_

Hospital Preference: \_\_\_\_\_ Address: \_\_\_\_\_

Allergy: \_\_\_\_\_ Reaction? \_\_\_\_\_

Allergy: \_\_\_\_\_ Reaction? \_\_\_\_\_

Allergy: \_\_\_\_\_ Reaction? \_\_\_\_\_

MEDICATION(S) STUDENT IS TAKING: \_\_\_\_\_

\_\_\_\_\_

DOSAGE: \_\_\_\_\_

SPECIAL INSTRUCTIONS FOR ATTENDING PHYSICIAN(S): \_\_\_\_\_

\_\_\_\_\_

SPECIFIC INSTRUCTIONS IF PARENT(S) ARE NOT AT HOME: \_\_\_\_\_

\_\_\_\_\_

LEVEL OF SUPERVISION REQUIRED (Attach Medical Procedure Authorization and Procedures): \_\_\_\_\_

REQUIRED TRAINING FOR SUPERVISION: \_\_\_\_\_

\_\_\_\_\_

INTERVENTIONS REQUIRED (Attach Medical Procedure Authorization and Procedures): \_\_\_\_\_

\_\_\_\_\_

REQUIRED TRAINING FOR INTERVENTIONS: \_\_\_\_\_

\_\_\_\_\_

OTHER ADDITIONAL RESTRICTIONS OR MODIFICATIONS NECESSARY TO TRANSPORT STUDENT: \_\_\_\_\_

\_\_\_\_\_

DISABILITY CONDITIONS AFFECTING TRANSPORTATION: \_\_\_\_\_

IN WHAT WAYS DO THESE CONDITIONS AFFECT TRANSPORTATION? \_\_\_\_\_

SPECIAL EQUIPMENT, AIDS OR MOBILITY REQUIRED: \_\_\_\_\_

SPECIAL TRAINING NEEDED? \_\_\_\_\_

ADDITIONAL COMMENTS/INSTRUCTIONS: \_\_\_\_\_

PROCEDURE IF CHANGE IN SERVICE IS NECESSARY: If there are any changes in the student's health, medical or behavior status which the parent(s), physician, transportation or other school staff believe may merit changes in staffing, precautions to be taken, interventions, restraints, or any other procedure noted above, the concerned party shall immediately contact: \_\_\_\_\_ (phone: \_\_\_\_\_) who will, in turn, initiate the process to evaluate and recommend necessary changes with the involvement of parents(s), physician, school and transportation staff.

### **APPROVAL OF TRANSPORTATION SERVICE REQUIREMENTS**

Each of the following persons has participated in the development of these transportation service requirements and by signing below approves them for implementation.

Dated: \_\_\_\_\_ Signature of Parent / Guardian: \_\_\_\_\_

Print Name: \_\_\_\_\_

Dated: \_\_\_\_\_ Signature of School District Representative: \_\_\_\_\_

Title: \_\_\_\_\_

Dated: \_\_\_\_\_ Signature of Transportation Staff Representative: \_\_\_\_\_

Title: \_\_\_\_\_

Dated: \_\_\_\_\_ \*Signature of Private Contracted Transporter: \_\_\_\_\_

Title: \_\_\_\_\_

Dated: \_\_\_\_\_ \*Signature of School Nurse: \_\_\_\_\_

Dated: \_\_\_\_\_ \*Signature of Physician: \_\_\_\_\_

Dated: \_\_\_\_\_ Signature of 1<sup>st</sup> Emergency Contact \_\_\_\_\_

Dated: \_\_\_\_\_ Signature of 2<sup>nd</sup> Emergency Contact \_\_\_\_\_

\*If an appropriate signature under the circumstances.

cc: All transportation service providers.

**TRANSPORTATION CHECKLIST**

**Sample Form 6**

Student Name: \_\_\_\_\_ ID: \_\_\_\_\_

School: \_\_\_\_\_ Grade: \_\_\_\_\_ Date: \_\_\_\_\_

Yes No **Special Education Services**

- 1.   Will all services be provided at the school of residence?
- 2.   Is the student eligible for extended school year services that may be located at a school other than the school of residence?
- 3.   Will the student's IEP address goals and objectives related to transportation access?

**Transportation Concerns**

- 4.   Have parents been informed of their role and responsibility in transportation of their child?
- 5.   Does the student require adult supervision at the bus stop? If yes, parent or designee must meet the child at the stop.
- 6.   Are there circumstances that affect the location of the pick-up and/or drop-off locations? If yes, specify: \_\_\_\_\_  
\_\_\_\_\_
- 7.   Are there specific types of assistance that the bus driver or attendant must provide? If yes, specify: \_\_\_\_\_  
\_\_\_\_\_

List any other characteristics, behaviors or needs (such as seating concerns) that may impact transportation. \_\_\_\_\_  
\_\_\_\_\_

List any behaviors that could present safety concerns on the school bus. \_\_\_\_\_  
\_\_\_\_\_  
\_\_\_\_\_

List anything specific to the school bus environment (such as the diesel engine noise etc.) that may affect your child. \_\_\_\_\_

List anything that comforts your child should they become upset? (please be specific) \_\_\_\_\_

8.            If it is in the best interest of the student to provide atypical transportation services (a vehicle other than a bus), please specify:

---

**Medical Concerns**

To be completed in conjunction with the Nurse/Physician Assessment, Behavior Support Plan and/or Behavior Intervention Plan (BIP). Attach supporting documentation:

9.            Does the student have a physical disability that is life-threatening and requires monitoring, interpretation or intervention, as determined by the site or special education itinerant nurse?

10.           Is the student affected by a medical condition that limits the length of time he or she is able to ride on a bus? (Attach assessment and explain.) \_\_\_\_\_

- 
11.           Does the student use technology or assistive devices such as tube feeding, a helmet, a ventilator, require oxygen or frequent suctioning? Circle which, and attach assessment.

12.           Does the student experience uncontrolled seizures, severe hypotonia causing potentially obstructed airway or apnea? Circle which, and attach assessment.

13.           Does the student use a walker, manual wheelchair, power wheelchair? Circle which, and indicate wheelchair width, if applicable;

14.           Is the student affected by a chronic medical condition that limits his or her ability to walk to and from school? If yes, explain: \_\_\_\_\_

Does the student have difficulty communicating? If yes explain:

Does the student have a Do Not Resuscitate Order (DNR)

**TRANSPORTING OXYGEN IN SCHOOL BUSES**

**Administrative Tracking Form**

**Sample Form 7**

Student Name: \_\_\_\_\_

Grade: \_\_\_\_\_

Program: \_\_\_\_\_

Nurse/Practitioner Release on File:  Yes  No

Address: \_\_\_\_\_

\_\_\_\_\_

Telephone: \_\_\_\_\_

Bus/Track #: \_\_\_\_\_

Type of Oxygen Transported:

Medical e-grade (less than 24 liquid cubic feet)

Liquid Medical d-grade (up to 12 cubic feet)

Transported Only

Administered During Transport

Secured to 5X Weight

Method of Securement (explain): \_\_\_\_\_

\_\_\_\_\_

\_\_\_\_\_

Driver/Attendant Training Completed, as Necessary: \_\_\_\_\_

Signature: \_\_\_\_\_

Date: \_\_\_\_\_

## **PROCEDURE FOR LIFTING PASSENGERS**

**PURPOSE:** The purpose of proper lifting techniques is to move the passenger without injury to you or the passenger.

### **BASIC RULES**

1. Tell the passenger what you are going to do.
2. Estimate the weight of the passenger. **NEVER ATTEMPT TO CARRY ALONE A STUDENT WHO WEIGHS MORE THAN 50 POUNDS** unless the student is in immediate danger and no assistance is available.
3. Always attempt to get help if you have any doubts about your ability to lift the student. If there is only a driver in a bus, and the necessity for an emergency evacuation develops, some districts suggest that the driver activate the school bus alternately flashing signal lamps (alternating red lights), as the evacuation procedure is truly an **UNLOADING PROCEDURE**. Such action can draw attention from motorists that you need assistance. District policy should determine if this procedure is appropriate.
4. Be sure your path is **CLEAR**.
5. Stand with both feet firmly planted about shoulder-width apart for good balance.
6. Always bend from knees, not from back, so that you use your thigh muscles and buttock muscles rather than your back muscles to do the lifting.
7. When lifting and carrying, keep the student as close to your own body as possible.
8. Shift the position of your feet to move. **DO NOT TWIST YOUR BODY**. Take small steps to turn.

### **SINGLE-PERSON LIFT**

1. Follow the basic rules 1-8. Most strains, fatigue and back injuries caused by lifting are due to using the **WRONG** muscles. Use your **STRONG LEG AND BUTTOCK MUSCLES** (by bending at the knees and hips), **NOT YOUR BACK MUSCLES**. Maintain the normal curves of the spine when lifting and avoid rounding of the upper back.
2. Keep equal weight on both feet, and lower yourself to the level of the student by bending your knees and hips before lifting.
3. Once in position, put one arm around the student's upper back and the other under both knees.



## **TWO-PERSON LIFT**

1. Follow Basic Rules 1-8.
2. TO LIFT FROM A WHEELCHAIR:
  - A. Position the wheelchair as close to your destination as possible. In an emergency situation, to save time and congestion, leave the chair where it is strapped and blanket-pull or carry the student to the appropriate exit location.
  - B. One person stands to the side in front; the other person stands in back.
  - C. The person in front removes the arm rest (if detachable) and folds up the footrest if time allows.
  - D. The person in back removes or cuts the seat belt and any other positioning device.
  - E. The person in front, bending from knees and hips, lowers himself or herself to place hands under the student's thighs.
  - F. The person in back places his or her arms under student's armpits, reaching forward to grasp both students' wrists firmly (right hand to student's right wrist; left hand to left wrist).
  - G. Lift together on the count of 3. (REMEMBER TO USE YOUR LEGS AND BUTTOCK MUSCLES TO LIFT.)
  - H. Walk to the area where the student is to be placed and lowered on the count of 3, bending from the knees and hips.
3. TO LIFT FROM A BUS SEAT:

Use the same procedure as above, but first, SLIDE THE STUDENT TO THE EDGE OF THE BUS SEAT NEAR THE AISLE.

## **EVACUATION AID/BLANKET LIFT**

1. Use an evacuation aid/blanket that has been approved for this purpose by its manufacturer.
2. If a blanket is used, fold the blanket in half, place it on the floor as close to the student as possible.
3. Follow Basic Rules 1-8, and lower the student to the blanket.
4. ONE PERSON LIFT: Place the student's head toward the direction of the exit, lift the blanket from the head and slide the student to safety.

## Characteristics of Disabilities as Defined by IDEA

Definitions of disability terms. The terms used in this definition are defined as follows:

A. *Autism* means:

1. A developmental disability significantly affecting verbal and nonverbal communication and social interaction, generally evident before age 3, that adversely affects a child's educational performance. Other characteristics often associated with autism are engagement in repetitive activities and stereotyped movements, resistance to environmental change or change in daily routines, and unusual responses to sensory experiences. The term does not apply if a child's educational performance is adversely affected primarily because the child has an emotional disturbance, as defined in paragraph (b)(4) of section 300.7 to 300.18.
2. A child who manifests the characteristics of autism after age 3 could be diagnosed as having autism if the criteria in paragraph (c)(1)(i) of section 300.7 to 300.18 are satisfied.

B. *Deaf-blindness* means concomitant hearing and visual impairments, the combination of which causes such severe communication and other developmental and educational needs that they cannot be accommodated in special education programs solely for children with deafness or children with blindness.

C. *Deafness* means a hearing impairment that is so severe that the child is impaired in processing linguistic information through hearing, with or without amplification, that adversely affects a child's educational performance.

D. *Emotional disturbance* is defined as follows:

1. The term means a condition exhibiting one or more of the following characteristics over a long period of time and to a marked degree that adversely affects a child's educational performance:
  - (a) An inability to learn that cannot be explained by intellectual, sensory or health factors.
  - (b) An inability to build or maintain satisfactory interpersonal relationships with peers and teachers.
  - (c) Inappropriate types of behavior or feelings under normal circumstances.
  - (d) A general pervasive mood of unhappiness or depression.
  - (e) A tendency to develop physical symptoms or fears associated with personal or school problems.

2. The term includes schizophrenia. The term does not apply to children who are socially maladjusted, unless it is determined that they have an emotional disturbance.
- E. *Hearing impairment* means impairment in hearing, whether permanent or fluctuating, that adversely affects a child's educational performance but that is not included under the definition of deafness in this section.
- F. *Mental retardation* means significantly sub-average general intellectual functioning, existing concurrently with deficits in adaptive behavior and manifested during the developmental period that adversely affects a child's educational performance.
- G. *Multiple disabilities* means concomitant impairments (such as mental retardation-blindness, mental retardation-orthopedic impairment, etc.), the combination of which causes such severe educational needs that they cannot be accommodated in special education programs solely for one of the impairments. The term does not include deaf-blindness.
- H. *Orthopedic impairment* means a severe orthopedic impairment that adversely affects a child's educational performance. The term includes impairments caused by congenital anomaly (e.g., clubfoot, absence of some member, etc.), impairments caused by disease (e.g., poliomyelitis, bone tuberculosis, etc.), and impairments from other causes (e.g., cerebral palsy, amputations, and fractures or burns that cause contractures).
- I. *Other health impairment* means having limited strength, vitality or alertness, including a heightened alertness to environmental stimuli, that results in limited alertness with respect to the educational environment, that—
1. Is due to chronic or acute health problems such as asthma, attention deficit disorder or attention deficit hyperactivity disorder, diabetes, epilepsy, a heart condition, hemophilia, lead poisoning, leukemia, nephritis, rheumatic fever, and sickle cell anemia; and Tourette syndrome; and
  2. Adversely affects a child's educational performance.
- J. *Specific learning disability* is defined as follows:
1. The term means a disorder in one or more of the basic psychological processes involved in understanding or in using language, spoken or written, that may manifest itself in an imperfect ability to listen, think, speak, read, write, spell, or to do mathematical calculations, including conditions such as perceptual disabilities, brain injury, minimal brain dysfunction, dyslexia and developmental aphasia.

2. The term does not include learning problems that are primarily the result of visual, hearing, or motor disabilities, of mental retardation, of emotional disturbance or of environmental, cultural or economic disadvantage.
- K. *Speech or language impairment* means a communication disorder, such as stuttering, impaired articulation, language impairment, or a voice impairment, that adversely affects a child's educational performance.
- L. *Traumatic brain injury* means an acquired injury to the brain caused by an external physical force, resulting in total or partial functional disability or psychosocial impairment, or both, that adversely affects a child's educational performance. The term applies to open or closed head injuries resulting in impairments in one or more areas, such as cognition; language; memory; attention; reasoning; abstract thinking; judgment; problem-solving; sensory, perceptual, and motor abilities; psychosocial behavior; physical functions; information processing; and speech. The term does not apply to brain injuries that are congenital or degenerative, or to brain injuries induced by birth trauma.
- M. *Visual impairment*, including *blindness*, means an impairment in vision that, even with correction, adversely affects a child's educational performance. The term includes both partial sight and blindness.

**SAMPLE CONTINUUM  
OF TRANSPORTATION SERVICES FOR STUDENTS WITH DISABILITIES  
(CHOICE OF OPTION THAT MAY BE AVAILABLE, AS APPROPRIATE)**

Least Restrictive	Parent/guardian to provide their own child's transportation with district reimbursement							Most Restrictive	
Student walks to school alone or with peers	Student uses public transit one way	Student uses public transit both ways	Student rides school bus with modifications on or lift	Student rides school bus with support network w/ w/o adaptive equipment	Student integrates school bus with support network	Student rides modified bus with attendant w/ w/o adaptive equipment	Student rides modified bus with attendant and/or nurse with special training	Student needs specialized bus ride with specialized attendant	Transportation inappropriate for student (may be eligible for home/hospital teacher)
Student combines school bus with public transit	Student uses public transit	Student uses public transit both ways	Student rides school bus with support network w/ w/o adaptive equipment	Student rides modified bus with students with disabilities w/ w/o adaptive equipment	Student rides integrated bus with support network	Student rides modified bus with attendant w/ w/o adaptive equipment	Student needs specialized bus ride with specialized attendant	HOME OR INSTITUTION PICK-UP	
HOME PICK-UP OR HOME CORNER PICK-UP									
USE CORNER BUS STOPS OR SCHOOL PICK-UP SITES									

**IDEA-PART B FINAL REGULATIONS\***  
**DISCIPLINE PROCEDURES**  
**(October 2006)**

**Introduction**

- A. The IDEA Amendments of 2004 and implementing Regulations of 2006
1. Schools can remove a child with disabilities for up to ten consecutive school days at a time for any violation of school rules as long as there was not a pattern of removals, and so long as such removal was also applied to children without disabilities.
  2. Schools can remove a child with disabilities for additional periods of not more than 10 consecutive school days in the same school year for separate incidents of code of conduct violations as long as there is no pattern of removals that would amount to a change of placement.
  3. If behavior that violates the school's code of conduct is determined not to be a manifestation of the child's disability, the school may suspend the child for more than 10 days if that suspension is applicable to children without disabilities, as long as that child continues to be able to participate in the general education curriculum and progress toward meeting IEP goals, although in another setting.
  4. A child with a disability cannot be long-term suspended or expelled from school for behavior that is a manifestation of his or her disability: and
  5. Services must continue for children with disabilities who are suspended for up to 10 days if such services are provided to a child without disabilities who is similarly suspended.
  6. If the child is removed because of a subsequent suspension in that same school year, school personnel or the IEP team, depending upon whether the suspension amounts to a change of placement, determine the extent to which services are needed to enable the child to participate in the general education curriculum and progress toward meeting IEP goals, although that may be in another setting.
  7. Schools may remove a student to an interim alternative educational setting for not more than 45 school days, whether or not the behavior is a manifestation of the child's disability, if the child (1) carries a weapon to or posses a weapon at school, on school premises, or at a school function, (2) is found to be in possession of or the sale of illegal drugs or (3) inflicts serious bodily injury upon another person while at school, on school premises or at a school function. "serious bodily injury" is defined by federal law, and refers to a substantial risk of death; extreme physical pain; protracted and obvious disfigurement; protracted loss or impairment of bodily function, organ, or mental faculty.

- B. The Amendments also added new provisions that require schools to assess a child's troubling behavior and develop positive behavioral interventions to address that behavior, and that describe how to determine whether the behavior was a manifestation of the child's disability.
- C. The final regulations incorporate the statutory provisions described above, and provide additional specificity on a number of key issues:

**1 Conducting Behavioral Assessments and Developing Behavioral Interventions**

The child must receive a Functional Behavioral Assessment to attempt to determine the circumstances around exhibition of particular behaviors by a student with disabilities when a child is suspended for more than 10 days. The child's IEP will develop a behavioral intervention plan designed to address the behavior violations so that it does not recur.

**2. Change of Placement; Manifestation Determinations**

The regulations provide that a change of placement occurs if a child is removed for more than ten consecutive school days or is subjected to a series of removals that constitute a pattern because they cumulate to more than ten school days in a school year, and because of factors such as the behavior is substantially similar to the child's behavior in previous incidents that resulted in a series of suspensions, the length of each removal, the total amount of time the child is removed, and the proximity of the removals to one another.

Manifestation determinations are required only if a school is implementing a removal that constitutes a change in placement.

# **APPENDIX E**

## **Resources**



**Page Intentionally Left Blank**

Dated August 22, 2003

Office of Special Education and  
Rehabilitative Services  
U.S. Department of Education  
400 Maryland Ave., S.W.  
Washington, DC 20202-7100  
Phone (202) 245 7468

OSEP 03-10

**MEMORANDUM**

TO: State Directors of Special Education

FROM: Stephanie Smith Lee  
Director  
Office of Special Education Programs

SUBJECT: Ensuring Safe and Appropriate Transportation for Children with Disabilities

As you know, being transported to and from school by school bus is a major factor of school life for millions of children, nationally, including many children with disabilities. Transportation is a costly venture. For example, during the 1999-2000 school year, the nation's school districts spent over **\$13 billion** on home-to-school and school-to-school transportation for students in public schools. Of that amount, an estimated **\$3.7 billion** (or 28% of the \$13.1 billion) was for special transportation services for children with disabilities.<sup>1</sup>

In meetings (and correspondence) with representatives of two major national transportation associations (i.e., the National School Transportation Association, and the National Association for Pupil Transportation), these representatives have expressed concerns that transportation providers are often not included in local school district plans or training related to transporting

---

<sup>1</sup> American Institutes for Research, Center for Special Education Finance, Report 3: *What Are We Spending on Transportation Services for Students with Disabilities, 1999-2000?* (Revised 4/17/03).

children with disabilities. They also provided examples of problems resulting from not having prior knowledge about the needs of some of these children, and expressed interest in finding ways to ensure that transportation of children with disabilities is safely and appropriately provided.

The current regulations implementing Part B of the Individuals with Disabilities Education Act (IDEA) include a number of provisions related to transportation of children with disabilities. See e.g., -- (1) the definition of related services, which lists transportation, and includes a separate definition of “transportation” (34 CFR §300.24(a); (b)(15)); (2) Appendix A--Notice of Interpretation, which includes questions and answers regarding the provision of transportation in individualized education programs (i.e., Q-30 (64 FR 12478, March 12, 1999) and Q-33 (64 FR 12479); and (3) Attachment 1 to the 1999 Part B Regulations (Analysis of Comments and Changes) that includes a discussion about transportation as a related service (64 FR 12551).

To the extent appropriate, we encourage you to contact the local educational agencies in your State to call their attention to the transportation provisions in the regulations, and to encourage them, as appropriate, (consistent with the confidentiality provisions in §§300-560-300.576), to ensure that there is meaningful and effective communication -- before the fact -- between school district personnel and transportation providers about the transportation needs and potential problems of individual students with disabilities. This effort should be beneficial to all affected parties, but especially the children who are being transported.

Transportation providers play an integral role in the school lives of many children, including children with disabilities, which makes effective communication between the school and the providers essential. We believe that, for the safety and well-being of all children who ride school buses, including children with disabilities, it is crucial that they are appropriately and effectively transported by well-informed and well-trained transportation providers.

If you have questions or comments about this memorandum, please contact your Part B State contact or the persons listed above.

cc: Chief State School Officers  
Federal Resource Center  
Regional Resource Centers  
Parent Training Centers  
Protection and Advocacy Agencies  
Section 619 Coordinators



**NATIONAL ASSOCIATION OF  
STATE DIRECTORS OF  
PUPIL TRANSPORTATION SERVICES**

**Excerpts From  
Information Report**

**Sharing Student Health and Medical Information with  
School Transporters**

**by Peggy A. Burns, Esq.**

**Background**

This Information Report is not intended to be an exhaustive discussion of records disclosure and confidentiality provisions, since there are multiple situations in which school transporters require student information in order to safely and efficiently carry out their responsibilities. Rather, it focuses on communicating to school transporters and special education directors the necessity -- and legitimacy -- of disclosure of student health and medical information. Included in the category of "school transporters" are transportation administrators, drivers, and other appropriate school transportation staff members, as well as bus contractors hired by school districts and educational units to transport students to and from school and school-related activities. School transporters and special education directors are urged to seek legal advice regarding specific applications of this information.

It is critical that school transporters have relevant health and medical information about the students who ride their buses, and in some cases it is legally mandated. Even where there is not a statutory or regulatory mandate to provide this information to school transporters, any reasonable risk management analysis readily leads to the conclusion that the potential harm from failure to share this information far outweighs any risk that a school district or contractor could incur as a result of transporters having this information.

Despite these facts, however, special education and other school personnel are often reluctant to share student health and medical information with school transporters. Many are adamant about their "inability" to provide information about students' conditions and needs which may impact travel on the school bus. The reason -- misinformation about "and/or misunderstanding of confidentiality requirements.

**Questions**

- Can school transporters legally receive health and medical information about students who ride their buses?

- What factors should be considered in determining whether transportation personnel, special education personnel, medical personnel and parents should collaborate to accomplish this sharing of information?
- What are the prerequisites to the sharing of student health information with school transporters?
- How can compliance with these prerequisites be achieved?

## Discussion

### *Application of relevant statutory and regulatory information.*

Several clear, guiding principles emerge from an understanding of applicable law, especially the Regulations implementing Part B of the Individuals with Disabilities Education Act (hereafter, “IDEA”), and the Family Educational Rights and Privacy Act of 1974 (hereafter, “FERPA.”)

### **Principle 1 -- Rationale for Disclosure**

When transportation is provided as a related service to a special education student -- that is, because transportation is necessary for the child to access Individualized Education Program (IEP) services -- then transporters are related service providers. [See IDEA Regulations (hereafter “Regs”), Section 300.24.] Under such circumstances, the school district *must* provide necessary information to school transporters. That information includes setting forth the role of transportation personnel in meeting the unique needs of the child as identified in his/her IEP, and those “accommodations, modifications, and supports” identified in the child’s IEP which relate in any way to the transportation environment. [See Regs., Section 300.342(b) (2) and (3).]

While the IDEA Regulations impose a mandatory duty on school districts when transportation is a related service, FERPA provides for broader permission to disclose information about a child under two situations:

- (1) when a parent consents to the disclosure; or
- (2) when “school officials” have a “legitimate educational interest,” even when the district has not obtained such prior consent.

### ***Who is a school official with a legitimate educational interest?***

When FERPA was modified in 1996, a “Model Notification of Rights Under FERPA for Elementary and Secondary Institutions” was included in Appendix B. That Model Notification clearly demonstrates Congressional intent as to who might reasonably be entitled to receive student information:

“A **school official** is a person employed by the District as an administrator, supervisor, instructor or **support staff member**. . . ; a person serving on the School Board; a **person or company with whom the District has contracted to perform a special task**. . .”

And, a school official has “a **legitimate educational interest** if the official needs to review an education record in order to fulfill his or her professional responsibility.”

It is clear that school transporters meet this standard when student health and medical information is necessary to enable the safe and efficient transport of a student.

### **Principle 2 -- Publication of List**

Under IDEA, school districts and contractors must publish a notice setting forth those staff members who will have access to student information. [See Regs., Sec. 300.572(d).] FERPA requires that school districts that share information with staff members or contractors, recognized as needing student information, specify “criteria” for determining who will receive such information and under what circumstances.

These requirements are easily met by including in student/parent handbooks a statement like the following, as suggested in Appendix B to FERPA:

“Federal law permits the school district to disclose personally identifiable information in the student’s education records to ‘school officials with legitimate educational interests.’ School officials include persons employed by the district as an administrator, supervisor, teacher, or support staff member (including but not limited to . . . transportation personnel. . .); . . . or a person, agency, or company with whom the District has contracted, or otherwise arranged to perform a special task or service. . . Such individuals have a legitimate educational interest if s/he needs to review an education record in order to fulfill his or her professional and/or official responsibility.

A legitimate educational interest also exists where the staff member or other individual works directly with students and needs to review education records to increase his/her awareness of steps necessary for the safety and welfare of students and staff members.”

### **Principle 3 – Confidentiality**

The IDEA Regulations recognize that confidentiality requirements apply to the provision of necessary student information to school district employees and school transportation contractors. These requirements do not prohibit disclosure, but merely impose on the “agency or institution that collects, maintains or uses personally identifiable information, or from which information is obtained” the duty to protect the confidentiality of such information “at collection, storage, disclosure and destruction stages.” [See Regs., Sec. 300.572 (a).] This duty is further defined by the FERPA requirement that a school district share personally identifiable information from an education record only on the condition that the recipient of the information will not disclose the information to any other party without the prior consent of the parent or eligible student.

### **Principle 4 -- Training**

In order to receive student information which is otherwise confidential, school transporters must receive training -- like all other personnel who receive this information in the course of their job duties.

All related services personnel must be “trained,” and the Official Commentary to Section 300.24 of the Regs specifically includes “bus drivers” among such personnel. The Regs further state that “all persons collecting or using personally identifiable information must receive training or instruction regarding” limitations imposed by IDEA and FERPA and state policies and procedures which implement the disclosure and confidentiality provisions of these federal laws. [See Regs., Section 300. 572 (c).]

### **The Bottom Line: Why Should School Districts Ensure That Pupil Transportation Official Have Access to Student Information?**

#### ***Participation in IEP Meetings.***

As indicated above, the duty to inform is mandatory under IDEA Regulations when school transportation is provided as a related service. School transporters are essential participants in the decision which must be made as to whether transportation is a related service for a particular child. Section 300.344 of the Regs. provides that a local education agency may include related services personnel as appropriate at the

IEP meeting. Appendix A of the IDEA Regulations includes many useful questions and answers on this subject.

- The answer to Question 30 states: “. . . [I]t is appropriate for [related services personnel] to be included if a particular related service is to be discussed as part of the IEP meeting.”
- The answer to Question 33 states: “In determining whether to include transportation in a child’s IEP and whether the child needs to receive transportation as a related service, it would be appropriate to have at the IEP meeting a person with expertise in that area.” That expertise will be most evident -- and most valuable -- when members of the IEP team have necessary information about the needs of the student.

In its *Letter to Smith* (July 12, 1995), and in a number of letters and opinions since then, the Office of Special Education Programs (OSEP) of the U.S. Department of Education stated that the IEP must include more than a “yes” or “no” to the question, “Is transportation a related service?” Rather, it must include accommodation, modifications, and supports which must be provided for the child in accordance with his/her unique needs. Transporters are likely to be more aware of the availability of assistive technology devices applicable to transportation than anyone else on the IEP team, and certainly will have the responsibility to properly use such devices in response to the child’s needs. Health and medical information is essential to this end. OSEP specifically noted in *Letter to Smith*: “In all instances, each student’s need for transportation as a related service and the type of transportation to be provided are issues to be discussed and decided during the evaluation process and individualized education program (IEP) meeting, and the transportation arrangements agreed upon should be included in the disabled student’s IEP.”

“Transportation arrangements” are obvious components of the information transporters must receive. But remember, Section 300.342(b)(3) of the Regulations implementing Part B of the IDEA mandates that each related service provider know what s/he must do specifically to implement the IDEA. Consequently, other information, such as behavior intervention plans or assistive technology details, must be shared with school transporters in order to comply with this provision.

Finally, in order to determine necessary components of training for transporters, it is critical to share student health and medical information with driver trainers, and the occupational therapists, physical therapists, nurses and others who will work with them. How else can drivers and attendants (aides) be aware of proper responses to the unique medical needs of students?

***Supporting the district’s proposed transportation plan.***

A recent California case shows how driver training and provision of health and medical information can be an invaluable tool to help demonstrate that your chosen method of transportation for a particular student is reasonably calculated to meet his/her needs.

In Pleasant Valley School District, (37 IDELR 265, August 21, 2002), parents of a student with short-gut syndrome objected to the district’s proposal to provide regular district transportation instead of continuing the door-to-door transportation the boy had received for more than three years.

Among the parents’ concerns was the possibility that the student’s g-tube would become dislodged or that he would have a seizure. The school nurse had trained the driver on whose bus the student had ridden, and could train other drivers accordingly. An emergency care plan, which would be shared with anyone who

drove the student, embodied the proper procedures to employ in the event that the g-tube became dislodged. The plan also included the proper procedures to undertake should the student suffer a seizure. The fact that the driver would be ready if an emergency occurred was instrumental in the Hearing Officer's concluding that proper accommodations could be made on the regular education bus to address the unique needs of the child.

While school districts cannot be insurers of students' safety, they do have an obligation to take reasonable steps to respond to known dangers which may threaten the welfare of students and others. Students who, though not requiring special education, have health or medical challenges, may have a health action plan or other protocol which could have a bearing on school transportation.

### **Are There Risks to School Districts if Information is Shared With Transporters?**

Generally, a single mistake by a school district or contractor will not amount to a violation of FERPA. However, the Family Compliance Office of the U.S. Department of Education, which investigates, processes and reviews complaints and violations under FERPA, may take steps regarding individuals who improperly disclose information from education records. Section 99.33 of the Regulations implementing FERPA provides:

“If this Office determines that a third party improperly re-discloses personally identifiable information from education records in violation of [FERPA], the educational agency or institution may not allow that third-party access to personally identifiable information from education records for at least five years.”

The implications of this section are significant. Since a school district makes a commitment when sharing information with a bus driver that the driver will not inappropriately “re-disclose” the information to a third party, there can be strong sanctions if that condition is not met. Since a driver needs certain information in order to do his/her job, a restriction which prevents access to necessary information for at least five years means that the driver cannot do his or her job. That situation would most likely result in termination. Even absent federal agency determination of a breach of confidentiality, or a privately brought action based on invasion of privacy or inaccuracy of the information, a school district might well consider this a sufficiently serious rule violation to impose consequences up to and including termination.

A school district violates FERPA if it has a policy of denying access to records to parents, or it has a policy of wrongly disclosing information to third parties. A parent or student over the age of 18 may file a complaint giving specifics about why that person thinks a school district has violated FERPA. The complaint must be submitted within 180 days of the alleged violation or of the date that the complainant knew of, or reasonably should have known of, the alleged violation.

Following an agency investigation in which it is determined that a violation had occurred, the Family Compliance Office may take a number of steps:

- It will give the school district a reasonable period of time to comply with specific steps set out by the Office; and
- If the school district does not comply within that period, the Office may withhold federal monies, and/or issue an order to compel compliance.

Before the extreme sanction of loss of eligibility for federal funds is applied, a school district must not only have a policy and practice of violating FERPA, but also refuse to take steps to comply with FERPA within a reasonable period of time.



Therefore, the school district which shares necessary information with drivers risks little. That is especially true in comparison with the potential risks to the safety and welfare of the student if important information is not shared. On the other hand, the driver who does not take that responsibility seriously risks losing his or her job.

### **Conclusion**

School transporters can legally receive information about students' health and medical conditions when these conditions may impact transportation planning and implementation.

Factors to be considered in setting conditions for such disclosure include:

- (1) the determination of legitimate educational interest;
- (2) compliance with FERPA requirements of notice;
- (3) requiring confidentiality of the school transporters to whom the information is disclosed; and
- (4) training.

It is clear that once school transporters are trained regarding the requirements of confidentiality, school district and medical personnel are well-advised to share this information.

© National Association of State Directors of Pupil Transportation Services. All rights reserved.  
March 2003, used by permission from NASDPTS.

## APPENDIX

### Relevant Federal Regulations

#### ***IDEA Regulations***

*Sec. 300.323(d) (1 and 2):* “Each public agency shall ensure that. . .[t]he child’s IEP is accessible to each. . .related service provider. . .who is responsible for its implementation;” and “Each. . . provider described in paragraph (b)(2) of this section is informed of - (i) His or her specific responsibilities related to implementing the child’s IEP; and (ii) The specific accommodations, modifications, and supports that must be provided for the child in accordance with the IEP.”

*Sec. 300.611:* “Participating agency means any agency or institution that collects, maintains, or uses personally identifiable information, or from which information is obtained, under Part B of the Act.”

*Sec. 300.611):* “Education records means the type of records covered under the definition of ‘education records’ in 34 CFR part 99 (the regulations implementing the Family Educational Rights and Privacy Act of 1974).”

*Sec. 300.611:* “Each participating agency shall keep a record of parties obtaining access to education records collected, maintained, or used under Part B of the Act (except access by parents and authorized employees of the participating agency), including the name of the party, the date access was given, and the purpose for which the party is authorized to use the records.”

*Sec. 300.623(a):* “Each participating agency shall protect the confidentiality of personally identifiable information at collection, storage, disclosure and destruction stages.”

*Sec. 300.623(c):* “All persons collecting or using personally identifiable information must receive training or instruction regarding the State’s policies and procedures under Sec. 300.127 and 34 CFR part 99.”

*Sec. 300.623(d):* “Each participating agency shall maintain, for public inspection, a current listing of the names and positions of those employees within the agency who may have access to personally identifiable information.”

#### ***FERPA Regulations***

*Sec. 99.3:* “‘Education Records’ . . .means those records that are: (1) Directly related to a student; and (2) Maintained by an educational agency or institution or by a party acting for the agency or institution.”

*Sec.99.7(3):* “The notice [which must be provided annually to parents concerning their rights under FERPA] . . .must include. . .if the educational agency or institution has a policy of disclosing education records under Sec. 9.31(a)(1), a specification of criteria for determining who constitutes a school official and what constitutes a legitimate educational interest.”

*Sec. 99.31(a)(1)(A) and (B):* “An educational agency or institution may disclose personally identifiable information from an education record of a student without the consent required by Sec. 99.30 if the disclosure meets one or more of the following conditions: (1) The disclosure is to other school officials, including teachers, within the agency or institution whom the agency or institution has determined to have a legitimate educational interest.”

A contractor, consultant, volunteer, or other party to whom an agency or institution has outsourced institutional services or functions may be considered a school official under this paragraph provided that the outside party--

- (1) Performs an institutional service or function for which the agency or institution would otherwise use employees.
- (2) Is under the direct control of the agency or institution with respect to the use and maintenance of education records; and
- (3) Is subject to the requirements [of FERPA] governing the use of redisclosure of personally identifiable information from education records.

# Ride Safe

Information to help you travel more safely  
in motor vehicles while seated in your wheelchair.



Rehabilitation Engineering Research Center  
on Wheelchair Transportation Safety



University of Michigan  
Health System

University of Michigan  
Transportation Research Institute

Initially funded through a grant from the FRIENDS  
of the University of Michigan Hospitals

2008

**W**hen traveling in a motor vehicle, it is generally safest for wheelchair users to transfer to a vehicle seat and use the vehicle seatbelt system or a child safety seat that complies with federal safety standards. The wheelchair should then be stored and secured in the vehicle.

If transferring is not feasible, it is very important to secure the wheelchair to the vehicle facing forward and to use crash-tested seatbelts for the wheelchair-seated rider.

## 1 START WITH THE RIGHT EQUIPMENT

### The Wheelchair

It is best if you have a wheelchair that has been designed and tested for use as a seat in motor vehicles, often referred to as a **WC19 wheelchair or a transit wheelchair**. These wheelchairs comply with ANSI/RESNA WC19, a voluntary standard developed by safety and rehabilitation experts. Wheelchairs that meet the design and performance requirements of this standard will be labeled to show that they comply with WC19.

Most importantly, a WC19 wheelchair has four, crash-tested securement points where tiedown straps and hooks can be easily attached. These points are clearly marked with a hook symbol.

If a WC19 wheelchair is not available, the next best choice is a wheelchair with an accessible metal frame where tiedown straps and hooks can be attached at frame junctions.

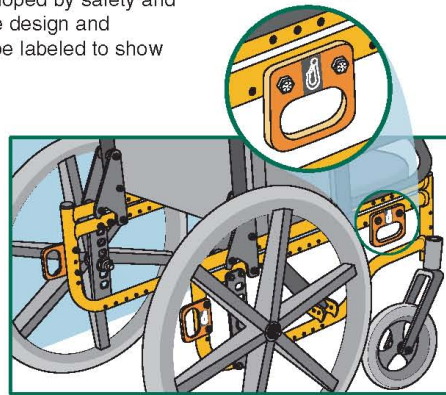

### The Wheelchair Tiedown and Occupant Restraint System (WTORS)

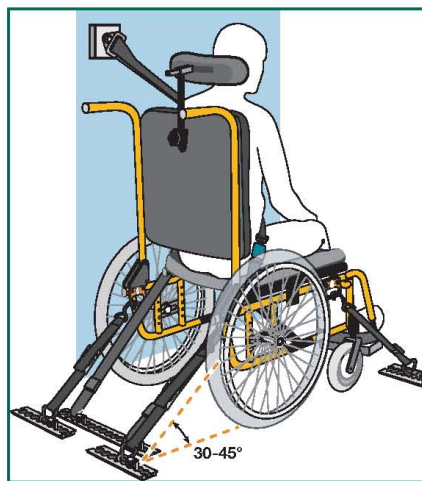

It is important to use a complete WTORS to secure the wheelchair and provide the wheelchair occupant with a properly designed and tested seatbelt system.

**Always use a WTORS that has been crash tested and labeled as complying with SAE J2249**, a voluntary standard developed by safety and rehabilitation experts. The most common type of wheelchair tiedown uses four straps to secure the wheelchair to the vehicle. Although it requires someone other than the wheelchair rider to secure and release the wheelchair, this tiedown can secure a wide range of WC19 and non-WC19 wheelchairs.

To protect the rider during a crash or sudden braking, and to minimize the likelihood of injury caused by contact with the vehicle, a seatbelt system with both pelvic and upper torso belts must be used.

## 2

## SECURE THE WHEELCHAIR

### Four-Point Tiedowns

- ▶ Always position the wheelchair and rider facing forward in the vehicle.
- ▶ When securing a WC19 wheelchair, attach the four tiedown straps to the securement points provided on the wheelchair. Tighten the straps to remove all slack.

▶ If you do not have a WC19 wheelchair, it is best to attach the tiedown straps to welded junctions of the wheelchair frame or to other structural areas where the frame is fastened together with hardened steel bolts indicated by six raised lines or bumps on the bolt head.

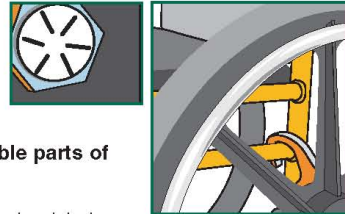

▶ **Do not attach tiedowns to adjustable, moving, or removable parts of the wheelchair such as armrests, footrests, and wheels.**

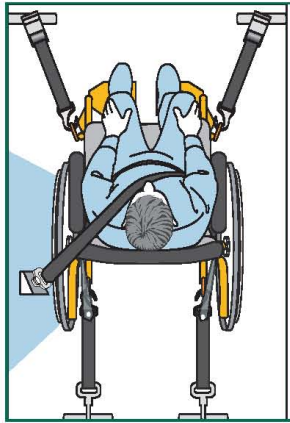

▶ When securing non-WC19 wheelchairs, choose structural securement points as close to the seat surface as possible to provide greater wheelchair stability during travel. It is best if the rear securement points are high enough to result in angles of the rear tiedown straps between 30 and 45 degrees to the horizontal.

▶ If you have a non-WC19 wheelchair with a tilt seat, make sure to attach both the front and rear straps to either the seat frame or to the base frame. Mixing wheelchair securement points between the seat and base can result in the tiedown straps becoming slack if the angle of the seat changes during a crash.

▶ It is best if floor anchor points for rear tiedown straps are located directly behind the rear securement points on the wheelchair. If possible, the front tiedown straps should anchor to the floor at points that are spaced wider than the wheelchair to increase lateral stability during travel.

### Other Methods of Wheelchair Securement

▶ In addition to securing wheelchairs using a four-point tiedown, wheelchairs can also be secured using a docking tiedown device. This method is primarily used in private vehicles since it requires the addition of adaptor hardware to the wheelchair frame that will engage with the docking tiedown device in the vehicle. Docking securement devices allow the wheelchair rider to secure and release the wheelchair without assistance.

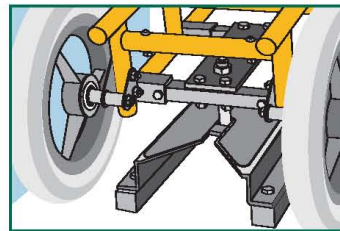

▶ If you plan to secure your wheelchair with a docking tiedown device, you should check with the WTORS or wheelchair manufacturer to ensure that your wheelchair model has been successfully crash tested with their system.

▶ Clamp-type securement devices are not recommended since they do not provide effective wheelchair securement in frontal crash testing.

### 3

## PROTECT THE WHEELCHAIR RIDER

▶ In addition to securing the wheelchair, **it is very important to provide effective restraint for the wheelchair user with a crash-tested lap and shoulder belt or with a child restraint harness.**

Postural support belts attached to the wheelchair are not strong enough to withstand crash forces and are usually not positioned correctly to restrain the occupant safely in a crash.

▶ The lap belt should be placed low across the front of the pelvis near the upper thighs, not high over the abdomen. When possible, the lap belt should be angled between 45 and 75 degrees to the horizontal when viewed from the side. Some wheelchair features, like armrests, can interfere with good belt fit. To avoid placing the lap belt over the armrest and to keep the lap belt low on the pelvis, it may be necessary to insert the belt between the armrest and the seatback, or through openings between the backrest and seat.

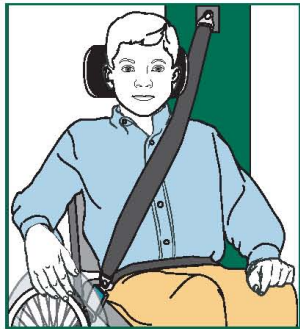
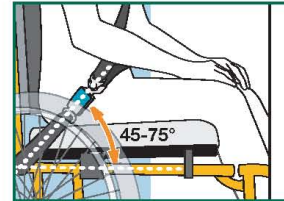

▶ A diagonal shoulder belt should cross the middle of the shoulder and the center of the chest, and should connect to the lap belt near the hip of the wheelchair rider. The upper shoulder-belt anchor point or D-ring guide should be anchored above and behind the top of the occupant's shoulder, so that the belt is in good contact with the shoulder and chest while traveling.

▶ Newer WC19 wheelchairs offer the option of a crash-tested lap belt that is anchored to the wheelchair frame. If the wheelchair has an onboard crash-tested lapbelt, complete the belt system by attaching the lower end of a shoulder belt to the lap belt. Crash-tested wheelchair-anchored lap belts will be labeled to indicate that they comply with ANSI/RESNA WC19.

### Other Important Points

- Read and follow all manufacturers' instructions.
- It is best to ride with the wheelchair backrest positioned at an angle of 30 degrees or less to the vertical. If a greater recline angle is needed, the shoulder belt anchor point should be moved rearward along the vehicle sidewall so the belt maintains contact with the rider's shoulder and chest.
- Maximize the clear space around the rider to reduce the possibility of contact with vehicle components and other passengers in a crash. Cover vehicle components that are close to the rider with dense padding.
- Check WTORS equipment regularly and replace worn or broken components. Keep anchorage track free of dirt and debris.
- If a WTORS and wheelchair have been involved in a vehicle crash, check with the manufacturers to determine if the equipment needs to be repaired or replaced.
- If possible, remove hard trays and secure them elsewhere in the vehicle to reduce the chance of rider injury from contact with the tray. Consider the use of foam trays instead of rigid trays during transit. If it is not possible to remove a hard tray, place dense padding between the rider and the tray and make sure that the tray is securely attached to the wheelchair so it will not break loose and cause injury to other occupants in a crash.
- A properly positioned headrest can help protect the neck in a rear impact.
- If it is necessary to use a head and neck support during travel, choose a soft, light, neck collar because stiff collars or head straps are more likely to cause neck injury in a crash. The soft collar should not be attached to the seating system.
- Secure medical and other equipment to the wheelchair or vehicle to prevent it from breaking loose and causing injuries in a crash.



## RESOURCES

### Organizations

Rehabilitation Engineering and Research Center  
on Wheelchair Transportation Safety  
[www.ercwts.org](http://www.ercwts.org)

University of Michigan Transportation Research  
Institute  
[www.umtri.umich.edu](http://www.umtri.umich.edu)

University of Pittsburgh  
[www.wheelchairnet.org](http://www.wheelchairnet.org)

Society of Automotive Engineers  
[www.sae.org](http://www.sae.org)

RESNA Rehabilitation Engineering Society of  
North America  
[www.resna.org](http://www.resna.org)

### Wheelchair and Seating Manufacturers (Ask for Products that have been Successfully Tested to WC19)

Adaptive Engineering Lab  
800-327-6080 ([www.aelseating.com](http://www.aelseating.com))

Adaptive Equipment Systems  
800-237-2370 ([www.aesys.com](http://www.aesys.com))

Bergeron Health Care  
866-529-8407 ([www.specialtomato.com](http://www.specialtomato.com))

Colours N Motion  
800-892-8998 ([www.colourswheelchairs.com](http://www.colourswheelchairs.com))

Convoid  
888-266-8243 ([www.convoid.com](http://www.convoid.com))

Freedom Designs  
800-331-8551 ([www.freedomdesigns.com](http://www.freedomdesigns.com))

GOVAN + wheelchair and docking system  
204-975-3004 ([www.smd-abitech.com](http://www.smd-abitech.com))

Gunnell  
800-551-0055 ([www.gunnell-inc.com](http://www.gunnell-inc.com))

Innovative Products  
800-950-5185 ([www.mobility4kids.com](http://www.mobility4kids.com))

Invacare  
800-333-6900 ([www.invacare.com](http://www.invacare.com))

Kids Up  
877-454-3787 ([www.kidsupco.com](http://www.kidsupco.com))

Metalcraft Industries  
888-399-3232 ([www.metalcraft-industries.com](http://www.metalcraft-industries.com))

Mulholland Positioning Systems  
800-543-4769 ([www.mulhollandinc.com](http://www.mulhollandinc.com))

Otto Bock  
800-328-4058 ([www.ottobock.com](http://www.ottobock.com))

Performance Health Products  
866-632-1755 ([www.php-usa.com](http://www.php-usa.com))

Pride Mobility  
800-800-8586 ([www.pridemobility.com](http://www.pridemobility.com))

Product Design Group  
888-858-4422 ([www.pdgmobility.com](http://www.pdgmobility.com))

Sammons Preston  
800-323-5547 ([www.sammonspreston.com](http://www.sammonspreston.com))

Snug Seat  
800-336-7684 ([www.snugseat.com](http://www.snugseat.com))

Sunrise Medical  
800-333-4000 ([www.sunrisemedicalonline.com](http://www.sunrisemedicalonline.com))

Tilite  
800-545-2266 ([www.tilite.com](http://www.tilite.com))

### Wheelchair Tiedown and Occupant Restraint Manufacturers (Ask for Products that Comply with SAE J2249)

Creative Controls  
800-539-7237 ([www.creativecontrolsinc.com](http://www.creativecontrolsinc.com))

EZ-Lock  
225-214-4620 ([www.ezlock.net](http://www.ezlock.net))

Orthosafe  
609-587-9444 ([www.orthosafe.com](http://www.orthosafe.com))

Q'Straint  
800-987-9987 ([www.qstraint.com](http://www.qstraint.com))

SureLok  
866-787-3565 ([www.sure-lok.com](http://www.sure-lok.com))





## GLOSSARY OF TERMS

**Anchor point:** The location on a vehicle, wheelchair, or wheelchair tiedown where a belt-restraint or wheelchair-tiedown anchorage is attached.

**ANSI-RESNA WC19 (officially, SECTION 19 ANSI/RESNA WC/VOL. 1 *Wheelchairs for use in Motor Vehicles*):** A voluntary standard for wheelchairs designed for use when traveling facing forward in a motor vehicle. NOTE: ISO 7176/19 is an international transit wheelchair standard that specifies similar design and performance requirements as ANSI/RESNA WC19.

**Belt:** A length of energy-absorbing webbing material used in occupant restraint systems.

**Docking tiedown:** A method for securing wheelchairs where portions of the wheelchair frame, or add-on components fastened to the wheelchair frame, engage with a securement device anchored to the vehicle.

**Four-point strap-type tiedown:** A method for securing a wheelchair where four straps are attached to the wheelchair at four separate securement points and attached to the vehicle at four separate anchor points.

**Occupant restraint:** A system or device designed to restrain a motor vehicle occupant in a crash by keeping the occupant in the vehicle seat and minimizing contact with the vehicle interior, other occupants, or objects outside the vehicle.

**Postural support:** A padded component and/or belt used to help maintain a person in a desired position during normal wheelchair use. In general postural supports are **not** designed to provide effective occupant restraint in a motor vehicle crash.

**SAE Recommended Practice J2249 (officially, SAE J2249 *Wheelchair Tiedowns and Occupant Restraints for Use in Motor Vehicles*):** A Society of Automotive Engineers Recommended Practice that specifies design and performance requirements for wheelchair tiedown and occupant restraint systems. NOTE: ISO 10542 is an international WTORS standard that specifies comparable design and performance requirements as SAE J2249.

**Securement points:** Specific structural points on the wheelchair base or seat frame that are designed for attachment of wheelchair tiedowns.

**Strap:** A length of webbing material used in wheelchair tiedown systems.

**WC19 wheelchair:** A crash-tested wheelchair with four clearly identified securement points that meets the design and performance requirements of ANSI-RESNA WC19 Wheelchairs Used as Seats in Motor Vehicles, and is sometimes called a transit wheelchair.

**Wheelchair tiedown and occupant-restraint system (WTORS):** A complete system for use by wheelchair-seated occupants comprised of a system or device for securing the wheelchair and a belt-type restraint system for limiting occupant movement in a motor vehicle crash.

### Regents of the University of Michigan

David A. Brandon, Ann Arbor; Laurence B. Deitch, Bingham Farms; Olivia P. Maynard, Goodrich; Rebecca McGowan, Ann Arbor; Andrea Fischer Newman, Ann Arbor; Andrew C. Richner, Grosse Pointe Park; S. Martin Taylor, Grosse Pointe Farms; Katherine E. White, Ann Arbor; Mary Sue Coleman (ex officio)

The University of Michigan, as an equal opportunity/affirmative action employer, complies with all applicable federal and state laws regarding nondiscrimination and affirmative action, including Title IX of the Education Amendments of 1972 and Section 504 of the Rehabilitation Act of 1973. The University of Michigan is committed to a policy of nondiscrimination and equal opportunity for all persons regardless of race, sex, color, religion, creed, national origin or ancestry, age, marital status, sexual orientation, disability, or Vietnam-era veteran status in employment, educational programs and activities, and admissions. Inquiries or complaints may be addressed to the University's Director of Affirmative Action and Title IX/Section 504 Coordinator, at the Office of Multicultural Community, 2072 Administrative Services Building, Ann Arbor, Michigan 48109-1432, 734-763-0235, TTY 734-647-1388. For other University of Michigan information, call 734-764-1817

## Reference

[www.5041dea.org](http://www.5041dea.org) for information on IDEA/504/NCLB

[Back to Contents](#)

**Page Intentionally Left Blank**

**APPENDIX F**  
**Transportation**  
**for Infants,**  
**Toddlers and**  
**Pre-School**  
**Children**

**Page Intentionally Left Blank**

**APPENDIX F**  
**TRANSPORTING INFANTS, TODDLERS AND PRE-SCHOOL CHILDREN**

**A. Definitions: Infants, Toddlers, and Pre-school Children**

For the purpose of clarification, the following terms are defined:

*Newborn* is a child from birth to one month.

*Infant* is a child from one month to one year.

*Toddler* is a child from one year to three years.

*Pre-school child* is a child from three years to five years.

**Note:** Individual programs may have variations in the usage of these four terms. State laws, policies and guidelines may contain variations in the age range used to define the terms *infants*, *toddlers*, and *pre-school children*. If not specified, newborns will be included in the *infant* category.

**B. Laws: Transportation of Infants, Toddlers and Pre-school Children**

A number of laws impact decision-making and the transportation of infants, toddlers and pre-school children. They include the following:

**1. Public Law 93-112: The Rehabilitation Act of 1973 (§504)**

This law constituted the first national declaration of the rights of the disabled. Section 504 prohibits the discrimination against individuals with disabilities by any recipient of federal funding. It covers persons with disabilities that would otherwise be qualified to participate in and benefit from programs or other activities receiving federal financial assistance. Section 504 of the Rehabilitation Act states, in part:

No otherwise qualified individual with a disability in the United States...shall, solely by reason of her or his disability, be excluded from the participation in, be denied the benefits of, or be subjected to discrimination under any program or activity receiving Federal financial assistance.

The Office of Civil Rights (OCR) in the U.S. Department of Education (USDE) is responsible for enforcing Section 504 of the Rehabilitation Act of 1973 in programs and activities that receive assistance from the USDE. The OCR is also responsible for the enforcement of Title II of the Americans with Disabilities Act (ADA) of 1990, which is applicable to state and local governments.

Section 504 has been the basis for filing transportation complaints for over two decades. Disputes include, but are not limited to the following issues:

- a. Access to transportation service;
- b. Field trips;
- c. Length of ride;
- d. Transportation to and from extra-curricular activities;
- e. Reimbursement of transportation costs to parents;
- f. Loss of instructional time;
- g. School bus suspension;
- h. Method of transport; and
- i. Integrated busing of children with disabilities with non-disabled peers in the LRE.

**Note:** Integrated busing is frequently referred to as “inclusion” or “LRE services.”

## **2. Public Law 94-142: The Education for all Handicapped Children Act of 1975**

This law guaranteed that a “free appropriate public education” (FAPE), including special education and related services, be provided to all handicapped children. This law detailed the required steps that must be taken in identifying and evaluating children and provided that handicapped children must be educated with other non-handicapped children to the maximum extent appropriate in the least restrictive environment (LRE) P.L. 94-142 established an elaborate system of procedural safeguards to ensure parental participation in the development and approval of the Individualized Education Program IEP. The importance of transportation is firmly acknowledged because it is the service that provides access to all other special education and related services.

## **3. Public Law 97-35: The Head Start Act**

The Head Start program was initiated in 1965 as a comprehensive child development program to serve primarily low income children. Predominately, the ages served are from three years to compulsory school attendance age. However,

this program has been expanded to provide services that include infants, toddlers, and children with disabilities.

The regulations require that a minimum of 10 percent enrollment be available to children with disabilities. While Head Start is intended to serve children from low income families, the regulations permit up to 10 percent of the children served to be from families that are not low income. To assist young children to reach their full potential, Head Start provides a comprehensive program that includes health, nutritional, educational, social and other services. One of the requirements of Head Start is the direct participation of parents of children enrolled. Eligible children with disabilities may be dually enrolled in special education and Head Start. Under dual enrollment, there is a requirement to work out which program is responsible for transportation services.

**4. Public Law 99-372: The Handicapped Children’s Protection Act of 1986**

This law amended the Education for all Handicapped Children Act of 1975 to authorize the award of “reasonable attorneys’ fees” to parents who prevail in due process hearings and judicial proceedings under Part B of the Education for all Handicapped Children Act of 1975. This is extremely important because disputes that arise about the related-service transportation under Part B can result in costly recovery of attorney fees awarded by the courts to parents. Because of this law, school districts have recognized the importance of all school district personnel working together to avoid costly procedural safeguard violations. Transportation and Special Education Offices are recommended to work jointly to develop policies, procedures and guidelines that clearly define service delivery practices for the school district. The IDEA Amendments of 1997 strongly encourage mediation as an option to more formal due process hearings. A mechanism for addressing problems in a timely manner is advisable.

**5. Public Law 99-457, Part H: The Education of the Handicapped Act Amendments of 1986**

Within a decade of the passage of the P.L. 94-142, Part H was passed to assist states in establishing statewide, comprehensive early intervention services for children with handicaps from birth through age two and their families. Based on the recognition that early intervention enhances the development of handicapped children, this law provides states with financial incentives. Borrowing from IDEA, this law requires that children receive early intervention services as specified in an Individualized Family Service Plan (IFSP). As used in this part, “developmental delay” is defined by the states. Transportation is considered an early intervention service.



With the passage of Part H, transportation personnel faced multiple new issues regarding the birth through two-year-old population. Challenges included the following issues:

- a. The use of school buses designed to transport older children;
- b. The need for age-appropriate child safety restraint systems;
- c. Safety considerations including adequate supervision during transport;
- d. Program location;
- e. Transport to and from day care centers; and
- f. Increased personnel training requirements for serving this young vulnerable population.

**6. Public Law 101-336: The Americans with Disabilities Act of 1990**

The Americans with Disabilities Act (ADA) is a comprehensive civil rights law that enforces the nondiscrimination of persons with disabilities and applies to public agencies. Transportation is specifically addressed in this law. The ADA does not change or diminish existing provisions of federal law protecting individuals with disabilities under Section 504 or IDEA. The ADA creates a higher standard of nondiscrimination than does Section 504 in that it applies regardless of whether or not federal funding is received. As stated in the statute, the purpose of the ADA is:

- a. To provide a clear and comprehensive national mandate for the elimination of discrimination against individuals with disabilities;
- b. To provide clear, strong, consistent and enforceable standards addressing discrimination against individuals with disabilities;
- c. To ensure that the federal government plays a central role in enforcing the standards established in this Act on behalf of individuals with disabilities; and
- d. To invoke the sweep of congressional authority, including the power to enforce the fourteenth amendment, and to regulate commerce in order to address the major areas of discrimination faced day-to-day by people with disabilities.

**7. Public Law 101-476, Part B: Individuals with Disabilities Education Act of 1990**

This act renamed the Education of the Handicapped Act (EHA) as the Individuals with Disabilities Education Act (IDEA). All previous references to “handicapped children” were changed to “children with disabilities.” Transportation is defined in the regulations as a related service under the Act. In addition, two new categories of disability were added: “autism” and “traumatic brain injury.” This law also broadened the definition of the terms “assistive technology device” and “assistive technology service.” The addition of assistive technology service raised questions regarding responsibility for purchase, lease, selection, adaptation, maintenance, repair or replacement of equipment under IDEA.

**8. Public Law 105-17: The Individuals with Disabilities Education Act Amendments of 1997**

The Individuals with Disabilities Education Act (IDEA) Amendments of 1997 was passed by Congress and signed into law on June 4, 1997. General Provisions include: PART B, Assistance for Education of All Children With Disabilities (school age/preschool); PART C, Infants & Toddlers with Disabilities; and PART D, National Activities to Improve the Education of Children with Disabilities (support programs). P.L. 105-17 retains the major earlier provisions including assurance of a FAPE in the least restrictive environment (LRE) and the guarantee of due process procedures. Transportation remains one of the most significant related services, as it provides access to special education and other related services.

**9. Public Law 108-446: The Individuals with Disabilities Education Improvement Act of 2004**

The Individuals with Disabilities Education Improvement Act (IDEIA) of 2004 was passed by Congress on November 17, 2004 and signed into law by the President on December 3, 2004. The IDEIA is known as IDEA 2004. PART A includes General Provisions; PART B Assistance for Education of All Children With Disabilities (school age/preschool); PART C, Infants and Toddlers With Disabilities; and, PART D, National Activities To Improve Education of Children With Disabilities. The definition of the related-service transportation remains unchanged; however it is essential to understand the requirements for transportation services for children with disabilities under both the McKinney-Vento Homeless Assistance Act and No Child Left Behind (NCLB).

### C. **Definitions: Transportation and Related Terms**

Section 504 of the Rehabilitation Act, and Part B of IDEA 2004 both identify transportation as a “related service.”

**Transportation (Part B) includes the following transportation issues:**

1. Travel to and from school and between schools;
2. Travel in and around school buildings; and
3. Specialized equipment (such as special or adapted buses, lifts, and ramps), if required to provide special transportation for a child with a disability. §300.34 (c) (16)

In addition to the definition of transportation, there are other definitions (terms) having a direct impact on the provision of transportation services for children with disabilities. These definitions and related terms are listed below:

1. **Assistive Technology Device (Part B):** As used in this part, *assistive technology device* means any item, piece of equipment, or product system, whether acquired commercially off the shelf, modified, or customized, that is used to increase, maintain, or improve the functional capabilities of a child with a disability. This term does not include a medical device that is surgically implanted or the replacement of such device. §300.5
2. **Assistive Technology Service (Part B):** As used in this part *assistive technology service* means any service that directly assists a child with a disability in the selection, acquisition, or use of an assistive technology device.

The term incorporates the following functions:

- a. The evaluation of the needs of a child with a disability, including a functional evaluation of the child in the child’s customary environment;
- b. Purchasing, leasing, or otherwise providing for the acquisition of assistive technology devices by children with disabilities;
- c. Selecting, designing, fitting, customizing, adapting, applying, retaining, repairing, or replacing assistive technology devices;
- d. Coordinating and using other therapies, interventions, or services with

assistive technology devices, such as those associated with existing education and rehabilitation plans and programs;

- e. Training or technical assistance for a child with a disability or, if appropriate, that child's family; and
- f. Training or technical assistance for professionals (including individuals providing education or rehabilitation services), employers, or other individuals who provide services to, employ, or are otherwise substantially involved in the major life functions of that child. §300.6

**Charter Schools (Part B):** (Treatment of Charter Schools and their Students); Rights of children with disabilities. Children with disabilities who attend public charter schools and their parents retain all rights under this part. §300.29

**Homeless Children (Part B):** The term *homeless children* has the meaning given the term *homeless children and youths'* in section 725 of the McKinney-Vento Homeless Assistance Act (42 U.S.C.11434a), as amended, 42 U.S.C. 1401(11). §300.19

**Location of Services and Transportation (Part B):** If necessary for the child to benefit from or participate in the services provided under this Part, a parentally-placed private school child with a disability must be provided transportation under the following conditions:

- A. From the child's school or the child's home to a site other than the private school; and
- B. From the service site to the private school, or to the child's home, depending on the timing of the services.

LEAs are not required to provide transportation from the child's home to the private school.

Cost of transportation. The cost of the transportation described in paragraph (b)(1)(i) of this section may be included in calculating whether the LEA has met the requirement of Sec. 300.133.

§300.139

**Nonacademic Services (Part B):**

- A. Each public agency must take steps, including the provision of supplementary aids and services determined appropriate and necessary by the child's IEP Team,

to provide nonacademic and extracurricular services and activities in the manner necessary to afford children with disabilities an equal opportunity for participation in those services and activities.

- B. Nonacademic and extracurricular services and activities may include counseling services, athletics, transportation, health services, recreational activities, special interest groups or clubs sponsored by the public agency, referrals to agencies that provide assistance to individuals with disabilities, and employment of students, including both employment by the public agency and assistance in making outside employment available. §300.107

**Orientation and Mobility (Part B): Services provided to blind or visually impaired children by qualified personnel to enable those students to attain systematic orientation to and safe movement within their environments in school, home and community;** also includes teaching children the following, as appropriate:

- A. Spatial and environmental concepts and use of information received by the senses (such as sound, temperature and vibrations) to establish, maintain, or regain orientation and line of travel (e.g., using sound at a traffic light to cross the street);
- B. To use the long cane or a service animal to supplement visual travel skills or as a tool for safely negotiating the environment for children with no available travel vision;
- C. To understand and use remaining vision and distance low vision aids; and
- D. Other concepts, techniques, and tools. §300.34. (c) (7)

**Special Education-Travel Training (Part B):** Travel training means providing instruction, as appropriate, to children with significant cognitive disabilities, and any other children with disabilities who require this instruction, to enable them to--

- A. Develop an awareness of the environment in which they live; and
- B. Learn the skills necessary to move effectively and safely from place to place within that environment (e.g., in school, in the home, at work, and in the community). §300.39 (a) (2) (ii), (b) (4)

**Transfer During the Academic Year (Part B) §300.323 (e) (f)**

Part (e): IEPs for children who transfer public agencies in the same State. If a child with a disability (who had an IEP that was in effect in a previous public agency in the same State) transfers to a new public agency in the same State,

and enrolls in a new school within the same school year, the new public agency (in consultation with the parents) must provide FAPE to the child (including services comparable to those described in the child's IEP from the previous public agency), until the new public agency either...

- (1) Adopts the child's IEP from the previous public agency; or
- (2) Develops, adopts, and implements a new IEP that meets the applicable requirements in §§300.320 through 300.324.

Part (f): IEPs for children who transfer from another state. If a child with a disability (who had an IEP that was in effect in a previous public agency in another state) transfers to a public agency in a new state, and enrolls in a new school within the same school year, the new public agency (in consultation with the parents) must provide the child with FAPE (including services comparable to those described in the child's IEP from the previous public agency), until the new public agency...

- (1) Conducts an evaluation pursuant to §§300.304 through 300.306 (if determined to be necessary by the new public agency); and
- (2) Develops, adopts, and implements a new IEP, if appropriate, that meets the applicable requirements in §§300.320 through 300.324.

### **Early Intervention Program for Infants and Toddlers with Disabilities** (34 CFR Part 303)

The definition of transportation is somewhat broader under the Regulations for the Early Intervention Programs for Infants and Toddlers with Disabilities than in the IDEA 2004.

*Transportation and related costs* includes the cost of travel (e.g., mileage or travel by taxi, common carrier, or other means) and other costs (e.g., tolls and parking expenses) that are necessary to enable a child eligible under this part and the child's family to receive early intervention services. §303.12 (d) (15)

### **Head Start Program Performance Standards on Services for Children with Disabilities** (45-CFR 1308)

These standards set forth the requirements for providing special services for 3- through 5-year-old children with disabilities enrolled in Head Start programs. Transportation is addressed in Subpart B - Disabilities Service Plan (h) (6). *The related service transportation* is defined as follows:

Transportation for children with disabilities to and from the program and to special clinics or other service providers when the services cannot be provided on-site. Transportation includes adapted buses equipped to accommodate wheelchairs or other such devices if required. Transportation is a related service to be provided to children with disabilities. When transportation to the program site and to special services can be accessed from other agencies, it should be used. When it is not available, program funds are to be used to provide it. Special buses or use of taxis are allowable expenses if there are no alternatives available and they are necessary to enable a child to be served. § 1308.4 (o)(5)

**Head Start Transportation Regulation (45 CFR 1310) Subpart B—  
Transportation Requirements**

1310.22 Children with Disabilities.

- A. Effective January 18, 2006 each Head Start agency must ensure that there are school buses or allowable alternate vehicles adapted or designed for transportation of children with disabilities available as necessary to transport such children enrolled in the program. This requirement does not apply to the transportation of children receiving home-based services unless school buses or allowable alternate vehicles are used to transport the other children served under the home-based option by the grantee. Whenever possible, children with disabilities must be transported in the same vehicles used to transport other children enrolled in the Head Start or Early Head Start program.
- B. Each Head Start, Early Head Start and delegate agency must ensure compliance with the Americans with Disabilities Act (42 U.S.C. 12101 et seq.), the HHS regulations at 45 CFR Part 84, implementing Section 504 of the Rehabilitation Act of 1973 (29 U.S.C. 794), and the Head Start Program Performance Standards on Services for Children with Disabilities (45 CFR Part 1308) as they apply to transportation services.
- C. Each agency must specify any special transportation requirements for a child with a disability when preparing the child's Individualized Education Plan (IEP) or Individualized Family Service Plan (IFSP), and ensure that in all cases special transportation requirements in a child's IEP or IFSP are followed, including:
  - 1. Special pick-up and drop-off requirements;
  - 2. Special seating requirements;

3. Special equipment needs;
4. Any special assistance that may be required; and
5. Any special training for bus drivers and monitors.

**Note:** At the time of this printing, the Department of Health and Human Services, Administration for Children and Families (Federal Register May 30, 2006) approved annual waivers under circumstances, from two provisions in the current Head Start transportation regulation (45 CFR Part 1310): "The requirement that each child be seated in a child restraint system while the vehicle is in motion, and the requirement that each bus have at least one bus monitor on board at all times." The regulation also is being amended to reflect new effective dates on the required use of school buses or allowable alternate vehicles and required availability of such vehicles adapted for use of children with disabilities as the result of Public Law 109-149.

[Back to Contents](#)



**Page Intentionally Left Blank**

**APPENDIX G**  
**Activity Bus**  
**Operations:**  
**Transportation**  
**Other Than To**  
**And From School**  
**Or Head Start**

**Page Intentionally Left Blank**

## **ACTIVITY BUS OPERATIONS: TRANSPORTATION OTHER THAN TO AND FROM SCHOOL OR HEAD START OPERATIONAL GUIDELINES**

In order to ensure the safest transportation for students, the following guidelines and procedures provide information that can be used by schools, school districts, Head Start grantees and other transporters of pre-school and school-aged children when contracting for a school-chartered motorcoach. A sample trip request form can be found at the end of this section.

### **A. Drivers**

The following training requirements for school-chartered motorcoach drivers MAY be considered:

#### **1. Pre-service training**

In addition to successfully completing all pre-service training provided by the employer, a school-chartered motorcoach driver shall complete a required course of instruction which includes, but is not limited to, appropriate state laws, regulations and policies related to school transportation.

#### **2. In-service training**

All school-chartered motorcoach drivers shall receive a required amount of in-service training annually, with instruction on handling bodily fluids, and shall be required to maintain a current first aid card in accordance with state regulations.

### **B. Motor carriers**

The following requirements for motor carriers MAY be considered:

#### **1. Pre-qualification list of eligible motor carriers**

The school district should establish a list of eligible companies that it will use for charter motorcoach service by pre-qualifying potential providers. Public school systems and Head Start grantees should establish this list centrally so that individual schools do not have to duplicate efforts of other schools and so that motorcoach companies are not asked to provide the same information to multiple schools that are using the same criteria. Further, school districts and Head Start grantees may find it advantageous to join together in a consortium or other working group to cooperatively establish a regional list of eligible companies.

#### **2. Vehicle maintenance**

The school district or Head Start grantee should require documented assurance from the motor carrier that (1) it will not knowingly require or permit the

operation of any school-chartered motorcoach that is not in safe operating condition or not equipped and maintained, as required by any law or (2) it will not knowingly require or permit any driver to drive in violation of any law.

C. Trip-specific requirements

The following requirements MAY be considered:

Based on specific needs of the trip, the school or Head Start and the motor carrier must understand and establish in a written contract exactly what will be involved and must establish methods for verifying that the motor carrier meets all criteria for a given trip.

1. Inspection

Prior to operation, the driver shall inspect each school-chartered motorcoach to ascertain that it is in safe condition, that it is equipped as required by all provisions of law and that all equipment is in good working order. The inspection shall include, but is not limited to, the following items:

- a. All required emergency equipment, as well as, first aid and body fluid cleanup kit(s), fire extinguisher(s), reflectors;
- b. All gauges, indicators and warning devices;
- c. Horn(s);
- d. Driver's seat and seat belts;
- e. All doors, door emergency releases, overhead hatches and windows;
- f. All seats, handrails and modesty panels;
- g. Interior and exterior lighting systems;
- h. All heating, cooling and ventilating systems;
- i. All glass and mirrors, including adjustment of mirrors;
- j. Windshield wipers and washers;
- k. All tires, wheels, rims and lug nuts;
- l. Wheelchair restraints, tie-downs and loading devices, such as ramps and lifts; and
- m. Brake system;

- (1) Air compressor governor cut-in and cut-out pressures;
- (2) Static pressure for air loss;
- (3) Initial applied brake pressure loss;
- (4) Low air pressure warning devices;
- (5) Emergency stopping systems;
- (6) Parking brake;
- (7) Antiskid device (if equipped);
- (8) Vacuum gauge (if equipped), ensuring it reads not less than 15 inches of mercury;
- (9) Low vacuum warning device(s) (if equipped); and
- (10) Brake pedal adjustment.

(**Note:** Draining reservoirs in dual air systems is not required.)

## 2. Pre-trip inspection checklist

The coordinator of the trip should complete a pre-trip inspection checklist at the time of the trip to make sure that each driver and each vehicle meet all criteria immediately before departure. Motor carriers are required to meet many Federal Motor Carrier Safety Administration regulations.

The company is responsible for ensuring that each driver completes a thorough pre-trip inspection prior to each trip and is further required to repair any safety-related defects discovered prior to the trip. The completion of a pre-trip checklist by a trip coordinator does not relieve the company of the liability for the mechanical condition of the vehicle. The pre-trip checklist should validate the driver's medical card, CDL license with proper endorsements and a basic review of the vehicle (e.g., lamps, safety equipment, etc.).

## 3. Trip report

At the completion of the driver's work or tour of duty, each driver should submit a daily documented report to the employer indicating the condition of the vehicle and noting any defects found. Whether discovered by or reported to the driver, all vehicle defects and deficiencies likely to affect safe operation or cause

mechanical breakdown of the school-chartered motorcoach shall be listed, and a negative report shall indicate that no such conditions are present.

4. Transportation of property

a. Hazardous materials

Motor carriers and drivers shall not transport, or knowingly permit passengers to carry, any substance, material, or device posing an unreasonable risk to health and safety to any passenger. These restrictions shall not apply to the following items:

- (1) Portable oxygen tanks medically prescribed for, and in the possession of, a passenger and in a carrier designed for personal use;
- (2) Personal-use articles in the immediate possession of a passenger; and
- (3) Hazardous materials transported by a carrier subject to federal jurisdiction in compliance with provisions of 49 CFR, Part 177 (E).

b. Fuel

Fuel shall not be transported except in the vehicle's regular fuel tanks.

c. General property

Drivers and motor carriers shall not permit any greater quantity of baggage in vehicles than can be safely and conveniently carried and safely secured. In no event shall aisles, doors, steps or emergency exits be blocked.

d. Animals

A driver or motor carrier may refuse to transport dogs or other animals except certified guide, signal or service animals. All other animals shall be securely crated and stored to eliminate the possibility of injury to passengers.

5. Transportation of passengers

The driver shall not drive a school-chartered motorcoach transporting passengers in violation of the following provisions:

a. Emergency passenger safety training

Prior to travel, passengers transported in school-chartered motorcoaches shall receive emergency procedure and passenger safety training as prescribed by state law and/or regulations for school passengers transported in yellow school buses. Training shall include evacuation training on the specific charter motorcoach being used for each trip.

b. Interior lighting

During darkness, the driver shall ensure that the interior lighting is sufficient for passengers to enter and exit safely and whenever otherwise deemed necessary.

c. Ejection of passengers

The driver of a school-chartered motorcoach shall not allow nor require the disembarkment of any student passenger at any location except the scheduled destination, unless the passenger is given into the custody of a parent, guardian or any person designated by the parent, guardian, school authority or law enforcement official. In case such non-scheduled disembarkment is made, complete information will be provided to the trip coordinator at the first possible opportunity.

d. Fueling restrictions

No fueling will take place while passengers are on board the bus.

e. Seating capacity

The number of passengers shall not exceed the number of manufacturer-designated safe and adequate seating spaces. Parents/adults will be provided with and be required to use child safety restraint systems suitable for the age and weight of the individual child.

f. Weight

Passengers shall not exceed the number whose weight, in addition to the weight of any property transported, can be carried without exceeding the manufacturer's maximum gross vehicle weight rating or the combined maximum rating of the tires supporting each axle.



g. Standing passengers

A school-chartered motorcoach with school passengers on board shall not be put in motion until all passengers are seated. All passengers must remain seated while the vehicle is in motion, except for an adult chaperone, parent, guardian or school employee acting upon a request by the driver to supervise or assist a passenger. Passengers shall not be permitted in front of the “standee line” (if present) or forward of the drivers' seat back while the vehicle is in motion.

h. Open doors

A school-chartered motorcoach shall not be put in motion until the doors are closed. The doors shall not be opened until the vehicle is stopped and the parking brake applied.

i. Emergency exits

A school-chartered motorcoach shall not be put in motion with any emergency exit locked or otherwise secured against being opened from the inside or outside.

6. School-chartered motorcoach accident reporting and mechanical failure

a. Whenever any school-chartered motorcoach accident occurs, the driver shall stop at the scene and, in addition to any requisite law enforcement and/or EMS unit, immediately shall notify or cause to be notified the state agency responsible for investigating accidents involving buses engaged in the transportation of school students, the driver's employer and the school district, school or Head Start Center that the students attend.

b. In the event of an accident or emergency, the driver shall not leave the immediate vicinity of the school-chartered motorcoach to seek aid unless the bus is empty. If there are passengers on board, no less than two passengers should be sent to summon help.

c. When a school-chartered motorcoach is rendered unsafe for continued operation due to accident damage or a mechanical failure, the driver shall discontinue use of the bus and notify the motor carrier of these circumstances. The driver or motor carrier shall then make the necessary arrangements to have the passengers safely transported to their destinations.

d. A school-chartered motorcoach damaged by an accident or other cause shall not be driven from the location where the damage occurred until it

has been inspected by a qualified person who has determined that the vehicle is safe to drive.

7. Other operational issues

- a. Smoking is prohibited by the driver or any passengers either on the bus or within the loading/unloading area of the bus. (Use of tobacco on or near the school-chartered motorcoach is prohibited.)
- b. The driver's view of the roadway shall not be obstructed by any passenger.
- c. The driver shall wear the lap or lap/shoulder belt (as equipped) at all times while the bus is in motion.
- d. Headlamps shall be illuminated at all times while the bus is in motion.
- e. When any passenger is on board, the driver shall not leave the driver's compartment without first stopping the engine, setting the parking brake, placing the transmission in first or reverse gear or park position and removing the ignition keys (if applicable), which shall remain in the driver's possession. (On vehicles with automatic transmissions that do not have a park position, the transmission shall be placed in neutral.)
- f. School districts or Head Start grantees shall ensure that motor carriers require each school-chartered motorcoach driver to demonstrate proficiency in the safe operation of each different type and size of bus requiring different driving skills in conditions of daylight, darkness, roadway, and terrain before transporting passengers in those types of vehicles and in those conditions or terrain. Drivers should also receive training in bus operations under all weather conditions likely to be encountered prior to operating such vehicle(s) in those conditions. Once driver proficiency has been recorded, motor carriers shall ensure that driver proficiency is maintained as required by district policy, state regulations and federal requirements.
- g. School districts or Head Start grantees shall ensure that motor carriers equip each school-chartered motorcoach with at least one fully charged fire extinguisher having at least a 10 B:C rating. If the school-chartered motorcoach has been designed or modified to transport passengers in wheelchairs, the vehicle shall be equipped with two extinguishers, each one rated at not less than 8 B:C—one to be placed in the driver's compartment and the other at the wheelchair loading door or emergency exit. Each fire extinguisher shall be securely mounted in the school-chartered motorcoach in a conspicuous place or in a clearly marked compartment, readily accessible. Each fire extinguisher shall be

maintained in prescribed operating condition with a current inspection certification and equipped with some means of determining if it is fully charged.

h. First aid and body fluid cleanup kits

School districts shall require motor carriers to equip each school-chartered motorcoach with readily visible, accessible and plainly marked first aid and body fluid cleanup kits. The kits shall be constructed to prevent dust and moisture from reaching the contents and must be maintained in good condition. The kits shall be easily and rapidly removable from the place secured. The required contents of the first aid and body fluid cleanup kits shall conform to state school bus specifications.

## ACTIVITY BUS USE FOR SCHOOL ACTIVITY TRIPS

### A. General provisions

#### 1. Pre-service driver training

In addition to successfully completing all pre-service training provided by their employer, school activity bus drivers shall complete at least a state-required course of instruction.

#### 2. In-service driver training

All school activity bus drivers shall receive the state-required amount of in-service training annually and shall be required to maintain a current first aid certificate with instruction in universal precautions.

#### 3. Hours of service

Drivers shall comply with the provisions of CFR 49 395.5.

#### 4. Specially equipped

School activity buses may be designed or modified in accordance with federal motor vehicle safety standards or with the Americans with Disabilities Act requirements to transport passengers seated in wheelchairs.

#### 5. Vehicle condition

It shall be unlawful for the driver to drive a school activity bus that is not in safe operating condition or is not equipped, as required by all provisions of law. The driver is solely responsible for the vehicle condition.

#### 6. Pre-trip inspection

Prior to operation, the driver shall inspect each school activity bus to ascertain that it is in safe condition, that it is equipped as required by all provisions of law and that all equipment is in good working order. The inspection shall include, but is not limited to, the following items:

- a. All required emergency equipment, as well as first aid and body fluid cleanup kit(s), fire extinguisher(s) and reflectors;
- b. All gauges, indicators and warning devices;
- c. Horn(s);

- d. Driver's seat and seat belts;
- e. All doors, door emergency releases, overhead hatches and windows;
- f. All seats, handrails and modesty panels;
- g. Interior and exterior lighting systems;
- h. All heating, cooling and ventilating systems;
- i. All glass and mirrors, including adjustment of mirrors;
- j. Windshield wipers and washers;
- k. All tires, wheels, rims and lug nuts;
- l. Wheelchair restraints, tie downs and loading devices (such as ramps and lifts); and
- m. Brake system:
  - (1) Air compressor governor cut-in and cut-out pressures;
  - (2) Static pressure for air loss;
  - (3) Applied brake pressure loss;
  - (4) Low air pressure warning devices;
  - (5) Emergency stopping systems;
  - (6) Parking brake;
  - (7) Antiskid device (if equipped);
  - (8) Vacuum gauge (if equipped), ensuring it reads not less than 15 inches of mercury;
  - (9) Low vacuum warning device(s); and
  - (10) Brake pedal for brake adjustment.

**(Note:** Draining reservoirs in dual air systems is not required.)

7. Daily report

At the completion of the driver's work or tour of duty, each driver shall submit a daily documented report to the employer indicating the condition of the vehicle and noting any defects found. Whether discovered by or reported to the driver, all vehicle defects and deficiencies likely to affect safe operation or cause mechanical breakdown of the school activity bus shall be listed, and a negative report shall indicate that no such conditions are present.

8. Repairs

The driver shall not make any repairs to the bus or its equipment except necessary emergency repairs on the road.

B. Transportation of property

1. Hazardous materials

Motor carriers and drivers shall not transport or knowingly permit passengers to carry any substance, material or device posing an unreasonable risk to health and safety to any passenger. These restrictions shall not apply to the following items:

- a. Portable oxygen tanks medically prescribed for, and in the possession of, a passenger and in a carrier designed for personal use;
- b. Personal-use articles in the immediate possession of a passenger; and
- c. Hazardous materials transported by a carrier subject to federal jurisdiction in compliance with provisions of 49 CFR, Part 177 (E).

2. Fuel

Fuel shall not be transported except in the vehicle's regular fuel tanks.

3. General property

Drivers and motor carriers shall not permit any greater quantity of baggage in vehicles than can be safely and conveniently carried and safely secured. In no event shall aisles, doors, steps or emergency exits be blocked.

4. Animals

A driver or motor carrier may refuse to transport dogs or other animals except certified guide, signal or service animals. All other animals shall be securely crated and stored to eliminate the possibility of injury to passengers.

C. Transportation of passengers

The driver shall not drive a school activity bus transporting passengers in violation of the following provisions:

1. Seating capacity

The number of passengers (excluding infants in arms) shall not exceed the manufacturer-designated number of safe and adequate seating spaces.

2. Weight

Passengers shall not exceed the number whose weight, in addition to the weight of any property transported, can be carried without exceeding the manufacturer's maximum gross vehicle weight rating or the combined maximum rating of the tires supporting each axle.

3. Step wells

Passengers shall not be permitted in front of the "standee line" (if present) while the vehicle is in motion.

4. Standing passengers

A school activity bus with school student passengers on board shall not be put in motion until all passengers are seated. All passengers must remain seated while the vehicle is in motion, except for an adult chaperone, parent, guardian or school employee acting upon a request by the driver to supervise or assist a passenger, or when it is necessary for a passenger to use the on-board restroom at a location where the bus cannot be stopped in a safe place.

5. Open doors

A school activity bus shall not be put in motion until the doors are closed. The doors shall not be opened until the vehicle is stopped and the parking brake has been applied.

6. Emergency exits

A school activity bus shall not be put in motion with any emergency exit locked or otherwise secured against being opened from the inside or outside.

7. Interior lighting

During darkness, the driver shall ensure that the interior lighting is sufficient for passengers to enter and exit safely and whenever otherwise deemed necessary.

8. Ejection of passengers

The driver of a school activity bus shall not eject any student passenger unless the passenger is given into the custody of a parent, guardian or any person designated by the parent, guardian, school authority or law enforcement official.

9. Fueling restrictions

No fueling will take place while passengers are on board the bus.

10. School activity bus accidents reporting

a. Whenever any school activity bus accident occurs, the driver shall stop at the scene, immediately notify or cause to be notified the state agency responsible for investigating accidents involving buses engaged in the transportation of school student passengers, the driver's employer and the school district, private school, or Head Start Center that the students attend.

b. In the event of an accident or emergency, the driver shall not leave the immediate vicinity of the school activity bus to seek aid unless the bus is empty. If there are passengers on board, no less than two passengers can be sent to summon help. A passerby may be asked to call for help, or the driver or any students may use a cell phone to call for assistance. Students should be sent to summon help only in extreme emergencies and there is no other option.

c. Comply with Title 49 CFR 392.40.

11. Discontinuance from use

When a school activity bus is rendered unsafe for continued operation due to accident damage or a mechanical failure, the driver shall discontinue use of the bus and shall notify the motor carrier of these circumstances. The driver or motor carrier shall then make the necessary arrangements to have the passengers safely transported to their destinations.

12. Other operational issues

a. Smoking is prohibited

b. The driver's view in any direction shall not be obstructed by any passenger.

c. The driver shall wear the lap or lap shoulder belt (as equipped) at all times while the bus is in motion.



- d. Headlamps shall be illuminated at all times while the bus is in motion.
- e. When any passenger is on board, the driver shall not leave the driver's compartment without first stopping the engine, effectively setting the parking brake, placing the transmission in first or reverse gear or park position and removing the ignition keys (if applicable), which shall remain in the driver's possession. (On vehicles with automatic transmissions that do not have a park position, the transmission shall be placed in neutral.)
- f. School districts or Head Start grantees shall ensure that motor carriers require all school activity bus drivers to demonstrate proficiency in the safe operation of each different type and size of bus requiring different driving skills in conditions of daylight, darkness, roadway and terrain before transporting passengers in those conditions or terrain. Drivers shall also receive classroom training in bus operations under all weather conditions likely to be encountered prior to operating such vehicle(s) in those conditions. Once driver proficiency has been recorded, carriers shall ensure that driver proficiency is maintained.

13. Unlawful operation

- a. No motor carrier shall knowingly require or permit the operation of any school activity bus that is not in safe operating condition or is not equipped and maintained as required by any law and shall not knowingly require or permit any driver to drive in violation of any law.
- b. A school activity bus damaged by an accident or other cause shall not be driven from the location where the damage occurred until it has been inspected by a qualified person who has determined that the vehicle is safe to drive.

D. School activity bus stops

1. Designated stops

School activity bus stops made for receiving and discharging passengers shall be approved by the school district prior to the trip. Buses shall stop only at designated stops.

2. Prohibited stops

A school activity bus stop shall not be designated at the following locations:

- a. Within 200 feet of the nearest rail of any railroad crossing or grade, except at railroad stations or on highways that parallel the railroad tracks;

- b. The left hand side of any highway; or
- c. On a divided or multiple-lane highway where passengers must cross the highway to board or after exiting the bus, unless traffic is controlled by a traffic officer or official traffic control signal. For the purposes of this subsection, a multiple-lane highway is defined as “any highway having two or more lanes of travel in each direction.”

3. Fire extinguisher

Every school activity bus shall be equipped with at least one fully charged fire extinguisher having at least a 10 B:C rating. A bus designed to transport wheelchairs shall be equipped with two extinguishers—each one rated at not less than 8B:C—one to be placed in the driver's compartment and the other at the wheelchair loading door or emergency exit.

- a. Each fire extinguisher shall have been rated and labeled by one of the following test laboratories approved by the State Fire Marshal to test and label portable fire extinguisher for sale in the respective state:
  - 1. Underwriter's Laboratories, Northbrook, Illinois (all sizes and classifications); or
  - 2. Factory Mutual Research Corporation, Norwood, Massachusetts (sizes 10B:C, 1A 10B:C, 2A 40B:C, 3A 40B:C, and 4A 80B:C fire extinguisher filled with Halon 1211 or Halon 301).

b. Securement

Each fire extinguisher shall be securely mounted in the school activity bus in a conspicuous place or a clearly marked compartment and readily accessible.

c. Maintenance

Each fire extinguisher shall be maintained in prescribed operating condition with a current inspection certification and equipped with a gauge or some other means of determining if it is fully charged.

4. First aid and body fluid cleanup kit(s)

A school activity bus shall carry a readily visible, accessible and plainly marked first aid kit and a body fluid cleanup kit. The kits shall be constructed to prevent dust and moisture from reaching the contents and must be maintained in good condition. The kits shall be removable from the place secured. The required contents of school activity bus first aid and body fluid kits shall conform to the requirements of each respective state.

5. Emergency procedures and passenger safety training

Passengers transported in school activity buses shall receive emergency procedure and passenger safety training as prescribed by state law and/or regulations for school student-passengers transported in yellow school buses.

## EVACUATION PROCEDURES FOR ACTIVITY TRIPS AND FIELD TRIPS

(**Note:** See also APPENDIX D: Guidelines for En Route Emergency Bus Evacuation Procedures.) In order to ensure the safety of school bus passengers in an actual emergency, every school bus driver assigned to transport students on activity trips or field trips may assign an evacuation team prior to each trip. The team may consist of teachers, coaches, students or any other passenger. A roster should be provided to the driver, accounting for all passengers.

Passengers assigned to evacuation teams must be seated where they can effectively carry out their responsibilities in an emergency.

Each evacuation team will consist of at least the following:

1. A passenger assigned to set the parking brake, turn off the engine, turn on warning flashers and call on the radio or other means and report the incident to the Transportation Department, in case the driver is unable to do so;
2. A passenger assigned to lead passengers to a safe location at least 100 feet from the bus and to take the first aid kit off the bus;
3. Two passengers assigned to stand outside the bus, next to the entrance door, to help students exit the bus and to take the fire extinguisher; and
4. Two passengers assigned to stand outside the bus, next to the emergency exit door, to help students exit the bus.

In addition to assigning an evacuation team, the following information shall be discussed and/or demonstrated prior to each activity trip or field trip:

1. Location and use of the fire extinguisher;
2. Location of the first aid kit;
3. Location of the warning reflectors;
4. Location and use of all emergency exits;
5. How to shut off the engine and set the parking brake;
6. How to open the entrance door, to include, safety releases on manual, air or vacuum doors, if so equipped; and
7. The importance of passengers keeping aisles clear at all times and not blocking emergency exits.

THE DRIVER OF THIS TRIP DID ASSIGN AN EVACUATION TEAM AND EXPLAINED THE EMERGENCY PROCEDURES AND SAFE TRAVEL RULES TO OUR GROUP.

Sponsor's/trip leader's signature: \_\_\_\_\_ Date: \_\_\_\_\_

**SAMPLE TRIP REQUEST FORM**

Trip date: \_\_\_\_\_ School: \_\_\_\_\_

Trip destination: \_\_\_\_\_

Depart from: \_\_\_\_\_ No. passengers: \_\_\_\_\_

Departure time: \_\_\_\_\_ Arrival time: \_\_\_\_\_

Extra equipment: \_\_\_\_\_

Meal stop required?  yes  no If yes, where? \_\_\_\_\_  
\_\_\_\_\_

Equipment that will need to be transported: \_\_\_\_\_

Special needs equipment requirements: \_\_\_\_\_

Overnight travel requirement: \_\_\_\_\_

Number of adults accompanying the students: \_\_\_\_\_

Transportation requested by: \_\_\_\_\_ Date: \_\_\_\_\_

Approved by: \_\_\_\_\_ Date: \_\_\_\_\_

Reimbursement category: \_\_\_\_\_

**TRANSPORTATION USE:**

Vehicle assigned: \_\_\_\_\_ Driver: \_\_\_\_\_

Spot load time: \_\_\_\_\_ Spot location: \_\_\_\_\_

Routing information: \_\_\_\_\_

Dispatcher's signature: \_\_\_\_\_ Date: \_\_\_\_\_

Time out: \_\_\_\_\_ Time in: \_\_\_\_\_ Total time: \_\_\_\_\_

Mileage out: \_\_\_\_\_ Mileage in: \_\_\_\_\_ Total miles: \_\_\_\_\_

Actual no. passengers: \_\_\_\_\_ Remarks: \_\_\_\_\_

Driver's signature: \_\_\_\_\_ Date: \_\_\_\_\_

Pre-trip mechanical check completed (for overnight trips or trips exceeding \_\_\_\_\_ miles):

Technician's signature: \_\_\_\_\_ Date: \_\_\_\_\_

[Back to Contents](#)

**APPENDIX H**  
**School**  
**Transportation**  
**Security and**  
**Emergency**  
**Preparedness**

**Page Intentionally Left Blank**

## **School Transportation Best Practices for Emergency Management Planning**

This document contains best practices the Transportation Security Administration (TSA) believes could be useful to public and private School Student Transportation Providers and School Bus Operators to enhance security in each individual district. It is also important for all levels of employees (superintendents, managers, supervisors, administrators, and other frontline employees and those with security-sensitive functions) to be familiar with security practices relevant to their roles and responsibilities (or required by the provider or operator's security plan) and how to implement them.

These best practices have been compiled by TSA's Office of Transportation Sector Network Management, Highway and Motor Carrier Division after consultation with individual stakeholders and organizations representing this community, including the National School Transportation Association (NSTA), National Association of Pupil Transportation (NAPT), National Association of State Directors of Pupil Transportation Services (NASDPTS), as well as, other Federal and public security partners. They also reflect information obtained from TSA corporate security reviews (CSR), and the congressionally mandated TSA School Bus Risk Assessment.<sup>1</sup> These practices support the security goals for TSA and this mode identified in DHS sector-specific security plans.

The best practices identified in this document are voluntary and are not intended to conflict with or supersede any existing regulatory or statutory requirements. They remain dynamic and subject to revision as experience, continued security partner feedback and the identification of new threats may require. TSA intends to continue to sharing best practices with school transportation representatives and welcomes ongoing feedback from the industry. To the extent that TSA should develop more official guidance in the future, TSA will consider these ongoing discussions and all received comments as part of those efforts.

The following definitions are applicable to this document:

**Critical Assets.** TSA understands that the most critical asset in the school transportation business are the student passengers. In this document, however, critical assets also means equipment, facilities, *etc.* managed, owned or operated by School Bus Operators or School Student Transportation Providers that are identified through a Risk Assessment as necessary for the continuity of operation during security incidents.

**First Observer™** means the portion of the TSA-recognized security domain awareness training program specific to school bus transportation, which is available to providers and school bus operators to enhance provider employee recognition and reporting of suspected security threats.<sup>2</sup>

**Security-Sensitive Employee** means any employee of a School Bus Operator or School Student Transportation Provider that performs functions that are connected with, or responsible for, the secure movement of students and/or critical assets. It includes frontline employees such as drivers, security personnel, dispatchers, maintenance and maintenance support personnel.

**School Bus Operators or School Student Transportation Providers** means public and/or private entities providing transportation services for a school or school district.

---

<sup>1</sup> This classified document was submitted to Congress in February 2010

<sup>2</sup> More information is available at [www.FirstObserver.com](http://www.FirstObserver.com).



**School Bus Operators or School Student Transportation Provider Employees** means both full-time and part-time workers, including contractors, employed by public and/or private entities providing pupil transportation services for a school or school district.

**Secure Areas** means areas (both physical and virtual) identified, categorized and designated as needing to be protected and thereby restricted from general and public access (access may be limited through implementation of a tiered access control program).

**School Transportation Security Awareness (STSA)** means a TSA-created and distributed training video developed in cooperation with the school transportation organizations to provide security awareness information and training to the school transportation industry.<sup>3</sup>

## General Security

1. **Complete a Vulnerability Assessment** – School Student Transportation Providers and School Bus Operators can enhance security by conducting a comprehensive security vulnerability assessment of their operation. A vulnerability assessment is not a risk assessment.<sup>4</sup> In conducting a vulnerability assessment, the critical action is to identify gaps in physical or operational security that could be exploited by someone with malicious intent. Identification of vulnerabilities and identification of the consequences of a terrorist attack against critical assets will allow you to construct a security plan that devotes mitigation efforts based on protecting priority assets and to apply good business rules to the dedication of resources for that mitigation.
2. **Develop and Implement a Security Plan** – An effective security plan includes actions that close gaps identified in a vulnerability assessment (either permanently or as necessary in response to threat information) and provide procedures to mitigate the consequences of a security incident. Comprehensive security plans address known vulnerabilities and mitigation strategies through General Security, Personnel Security, Physical Security, En-Route Security and Training and Exercises during normal operations and increased levels of threat. Security plans are most valuable when they are developed and implemented as both district level and site specific plans and include clearly identify incident management chains of command, and designated persons to fill incident management roles.
  - a. **Designate Primary and Secondary Security Coordinators** – As part of the security planning process, designating primary and secondary Security Coordinators for each district and location, where applicable, can ensure immediate and effective coordination with local, state and federal law enforcement and emergency response agencies on security related activities. In addition to documenting Security Coordinator contact information and individual roles and responsibilities in the appropriate security plan(s), whenever possible, current information regarding Security Coordinators and contact information should be provided to appropriate enforcement and emergency response agencies. Because the role of

---

<sup>3</sup>The DVD is available online at [www.tsa.gov/highway](http://www.tsa.gov/highway) or by ordering the DVD by e-mailing a request to [highwaysecurity@dhs.gov](mailto:highwaysecurity@dhs.gov).

<sup>4</sup> A “risk assessment” is developed using an analysis similar to the following: *Threat x Vulnerabilities x Consequence = Risk*. “Threat” is the credible identification of a person or organization with both the intent to do harm intentionally and the capability to carry out that threat. In most cases, accurate threat information is not readily available absent information provided by DHS, local law enforcement or other entities with access to classified information. “Vulnerabilities” requires recognizing the critical assets and then determining whether they are adequately protected. “Consequence,” of course, represents the damage that can be done to critical assets (persons, property, user confidence, etc.).



workers at ports (see 49 CFR Part 1515). Providers and Operators should consider routing Criminal history records checks through the FBI to allow a check against the TSDB.

## Physical Security

6. **Enforce Employee Access Control Systems** - Access control systems, such as those requiring photo identification cards (IDs) or other visible forms of identification to all employees associated with transportation operations, enhance security. In addition to verifying employment (and who should or should not be anywhere on the premises), these IDs can be used to restrict access to designated secure areas (such as facilities, vehicle key control room, *etc.*). To the extent that IDs are issued, their usefulness is dependent on a requirement that they be conspicuously displayed by the holder at all times (a requirement that could be incorporated into a security plan). Photo ID's are especially useful to drivers or others whose duties place them in contact with the public to represent a bona fide employee of the provider. With such procedures, passengers, parents or others who have repeated contact with vehicle operators can be advised to challenge operators who cannot or do not display this ID. Similarly, more employees are then able to enhance security because they are better equipped to challenge individuals who do not display the appropriate identification.
7. **Establish Facility Security Measures** – There are many physical security measures available to School Student Transportation Providers and School Bus Operators that are appropriate for mitigating vulnerabilities identified for critical assets, as defined in the security plan. Measures may include the following:
  - Secure area monitoring
    - Closed-circuit television (CCTV)
    - Intrusion detection systems
  - Fencing, additional lighting
  - Gates
  - Keypad or other access control technologies
  - Jersey walls, barriers, or bollards
  - Security Personnel (*e.g.*, guards)
  - Other appropriate security systems and measures when assets are remotely located

## En-Route Security

8. **Establish Appropriate Vehicle Security Program** – Security depends on efforts to ensure all school transportation vehicles (including but not limited to school buses, maintenance vehicles, *etc.*) are secured when unattended. Security methods include:
  - Ensuring all unattended vehicles are locked if they have the capability to be locked or are subject to thorough pre- and post-trip security inspections.
  - Adopting a written policy that includes:
    - Procedures such as a key control program when a vehicle is not in active use,
    - Ensuring the vehicle engine is turned off, keys are removed from the vehicle, and windows are closed.
    - Appropriate pre- and post-event reporting for diversions from normal routing.
  - Incorporating other appropriate lockout control methods.

9. **Establish Security Inspection Policy and Procedures** – School Student Transportation Providers and School Bus Operators should consider establishing a security inspection policy and procedures for drivers to conduct security inspections. Just as the safety inspections required by 49 CFR Part 392 or State and local policies must be completed before operating a vehicle, it is important to conduct a security inspection at the beginning of the driver’s shift or trip (pre-departure) and after any stop en-route in which the vehicle is left unattended. A complete security inspection not only checks to determine if there has been any unauthorized access, it includes inspecting all areas where a suspicious item could be affixed to or placed in a vehicle.
10. **Planning Alternate Emergency Routes** – Providers and operators should consider implementing and communicating emergency routing protocols for drivers to follow when determined to be necessary by the driver, administrators or other officials. Pre-planning alternate emergency routes can help drivers avoid or minimize proximity to highly populated urban areas or critical infrastructure such as bridges, tunnels, and dams during an emergency situation. When incorporated into the security plan, the alternate route information can include procedures for drivers to notify administrators or appropriate officials when substantial or non-routine deviations from the scheduled route is necessary and allow administrators or appropriate officials to know where the bus may be located or heading if the driver is not able to provide complete information.
11. **Developing Protocols for Increased Alert Levels** – School Student Transportation Providers and School Bus Operators should consider establishing policies governing operations during periods of increased threat conditions, such as if DHS provides information regarding increased threat levels for the school transportation industry). Developing protocols in advance, providing them to appropriate by administrators, law enforcement or other appropriate officials, and documenting them in the appropriate security plans will enable a more rapid, coordinated and effective response if and when the alert levels are increased.
12. **Establish Emergency Communications Plan** – Emergency communications plans include procedures for communication between drivers, school administrators, and law enforcement or emergency responders during a security related incident accompanied by a meaningful course of instruction to both drivers and dispatchers on the protocol and use of key words or coded verbal commands. Plans include the appropriate methods of two-way communication technologies required to implement the plan, such as land-based or satellite-based systems. Incorporation of this best practice is not intended to support or preclude the use of personal or issued cell phones; providers and operators should encourage and drivers should follow the proper use of cell phones including observing State, Federal and local cell phone laws including those that may involve messaging, texting or other uses.
13. **Establish Reporting Policy and Procedures** – Responses are more effective when there are clear procedures implemented for drivers and non-driver employees to follow when reporting suspicious incidents, threats, persons, or other security concerns to administrators, School Bus First Observer™ (888-217-5902), or the TSA Transportation Security Operation Center-TSOC (Freedom Center, 866-615-5150) regarding school vehicles or facilities. Effective procedures include appropriate points of contact and information details to be communicated and are documented in the Provider’s and Operator’s security plan.
14. **Use School Bus Tracking Systems** – Recognizing it may not be possible for a driver to report when they are being hijacked or the bus has been stolen, commercially off-the-shelf (COTS) methods of tracking the school bus or other vehicles can increase security throughout the scheduled route with a land-based or satellite-based Global Positioning System (GPS). If incorporating such systems, features for consideration include ensuring the system can provide:

- Longitude and latitude
  - Geofencing
  - Real-time/scheduled updating route monitoring
  - Status reporting
  - Route exceptions
  - Unauthorized use of the vehicle.
15. **Use School Bus Video (surveillance) Cameras** – Security (surveillance) cameras that provide a method to monitor activities while school buses are in operation, such as live video feeds or digital video recorders (DVR). If this technology is used, policies and procedures should be established and communicated to affected personnel or persons as appropriate.
16. **Use Panic Button Capability** – Commercially off-the-shelf (COTS) systems are available for a driver to transmit an emergency alert notification while en-route. This panic button capability enables a driver to remotely send an emergency alert notification message via land-based or satellite-based communication systems, and can utilize a vehicle disabling feature if available. In lieu of electronic or mechanical trouble indicators, providers and operators could implement a capability for drivers to display a distress signal (trouble lights, signs, flags, etc.) capable of alerting observers in the immediate and surrounding area. Use of such trouble indicators should be accompanied by employee and community familiarization campaigns to explain the meaning of the indicators and guide observers to respond appropriately.

### Training and Exercises

17. **Establish Security Training** – In addition to providing general security awareness training to all employees, it is valuable to provide training to employees with security-sensitive functions on the aspects of these best practices incorporated into the Student Transportation Provider’s or School Bus Operator’s security program, including those related to General Security, Personnel Security, Physical Security, En-Route Security, and Training and Exercises security action items. There are many resources and tools available to assist providers and operators in the training of employees, including TSA’s School Bus Counterterrorism Guide, the School Transportation Security Awareness DVD, and the TSA sponsored domain awareness training (First Observer™ program (<http://firstobserver.com/>)).<sup>5</sup> In addition, incorporating training for those responsible for implementing the security training plan will not only provide an opportunity for providers and operators to educate employees regarding their security goals and objectives, but it enables each employee in a security-sensitive function to be aware of their individual roles and responsibilities in identifying, preventing, protecting and responding to a security incident. Training should prepare drivers for incidents ranging from armed or hostile intruders to shots fired at a bus or threats of violence.
18. **Coordinated Security Exercises and Drills** – Coordinating security exercises and drills with other school transportation providers and operators, state and local law enforcement and emergency response agencies, and other appropriate federal officials provides a meaningful training opportunity, method for testing effectiveness of security programs, and can identify vulnerabilities. Security exercises conducted periodically as a discussion-based tabletop exercises can identify strengths, weaknesses, disconnects and security gaps by focusing on the security plan and the appropriate countermeasures and mitigation strategies to be implemented during a heightened level of security or a transportation security incident. Such exercises and drills can

---

<sup>5</sup> Additional information can be found by visiting the TSA website at [www.tsa.gov/highway](http://www.tsa.gov/highway).

have significant benefits to the extent they include requirements for after-action reports, communication of lessons-learned, and implementation of security improvement efforts based on exercise results.

**Summary** – These voluntary best practices are not all inclusive but provide a starting point for School Student Transportation Providers and School Bus Operators to consider when conducting security planning. School transportation officials should continue to coordinate with State and local security officials and incorporate the appropriate best practices that fit their operation.

For more information regarding security planning or security training resources, please visit the TSA web site at [www.tsa.gov/highway](http://www.tsa.gov/highway) or you may contact TSA by sending an email to [highwaysecurity@dhs.gov](mailto:highwaysecurity@dhs.gov).

**Page Intentionally Left Blank**

Sample Security and Planning Checklist

<b>SECURITY ASSESSMENT AND PLANNING CHECKLIST</b>					
<b>Numbering</b>	<b>Evaluation Criteria</b>			<b>YES</b>	<b>NO</b>
<b>1.</b>			<b>MANAGEMENT AND OVERSIGHT OF SECURITY PLANS</b>		
	1.1		Does the school district have a written security policy and crisis response plan including procedures that include transportation personnel, equipment and facilities?		
		1.1.A	What elements does the security plan encompass?		
			Response Plan		
			Emergency Plan		
			Disaster Recovery Plan		
			Other:		
		1.1.B	Does someone review and update the Security Plan?		
			If so, how often?		
			Monthly		
			Quarterly		
			Annually		
			Every 3 years		
			Every 5 years		
			As needed		
			Other:		
		1.1.C	Does the student transportation provider/site limit access to the Security Plan to employees with a need to know?		
		1.1.D	Are the plan/policy and procedures communicated to all personnel?		
	1.2		Does the student transportation provider designate a security coordinator?		
		1.2.A	Are the security coordinator's duties documented?		
		1.2.B	Does the student transportation provider exchange unclassified security-related information with industry peers?		
	1.3		Is the security plan site-specific for all school and facility locations?		
	1.4		Does the plan/policy coordinate with procedures in the school buildings?		
	1.5		Does the planning and policy process include appropriate stakeholders (e.g., first responders, law enforcement, fire department and media: print, radio, television, etc.)?		
	1.6		Does the plan/policy provide for any proactive or preventive technology solutions, that are currently available and that can potentially act as early detection or prevention of potential threats?		
	1.7		Is there a plan available that does not require electrical energy?		
	1.8		Does the plan/policy contain directives on incident management and command?		
	1.9		Does the plan/policy include training requirements for school employees?		
	1.10		Does the plan/policy address pre- and post-trip requirements?		



<b>2.</b>		<b>THREAT ASSESSMENT</b>		
	2.1	Does the student transportation provider monitor external sources for threat information?		
	2.1.A	If so, what sources?		
		Federal Bureau of Investigation (FBI)		
		Homeland Security Advisory System Threat Level (DHS)		
		Law Enforcement Officer (LEO)		
		News		
		TSA/DHS threat specific information		
		Other:		
	2.2	Does the student transportation provider have a procedure for distributing threat information?		
	2.2.A	If so, is the procedure documented?		
	2.3	Are school bus routes evaluated annually?		
<b>3.</b>		<b>VULNERABILITY ASSESSMENT</b>		
	3.1	Does the student transportation provider conduct vulnerability assessments?		
	3.1.A	Where are the vulnerability assessments documented?		
		In the Security Plan		
		Other:		
	3.1.B	If so, how often are they reviewed?		
		Monthly		
		Quarterly		
		Annually		
		Every 3 years		
		Every 5 years		
		As needed		
		Other		
	3.1.C	Do the student transportation provider's vulnerability assessments recommend corrective actions?		
	3.1.D	Does the student transportation provider implement the security measures recommended by its vulnerability assessments?		
	3.2	Is a security coordinator identified for each school and facility?		
	3.3	Do computer and communications systems exist?		
	3.3.A	How is access to computers or systems controlled?		
		What are their limitations?		
	3.3.B	Can the computers be compromised?		
		If so, what can be done to prevent it?		
	3.4	Is the communication system (e.g., two-way radio, land telephone line, cellular telephone, etc.) capable of recording?		

	3.5	Is there a code system to identify emergencies or threats?		
	3.6	Do emergency back-up systems for information and communication exist?		
		If so, what are their limitations?		
	3.6.A	Can emergency back-up systems be compromised?		
		If they can be compromised, what can be done to prevent it?		
	3.6.B	Are the back-up systems stored off site?		
		Are they secure?		
	3.7	Do evacuation plans exist?		
	3.8	Is there a designated place to relocate staff or students?		
<b>4.</b>		<b>PERSONNEL SECURITY</b>		
	4.1	Does the student transportation provider conduct background checks?		
	4.1.A	If so, for which employees?		
		Drivers		
		Non-drivers		
		Management		
		Contractors		
	4.1.B	What background information is checked?		
		Driving Records		
		Criminal Records		
		Employment History		
		Employment Eligibility		
	4.2	Does the student transportation provider have criteria for disqualification for employment based on driving/criminal/employment history checks?		
	4.3	Does the student transportation provider provide identification cards to employees?		
	4.3.A	If so, what technologies do the identification cards incorporate?		
		Photographs		
		RFID/Proximity		
		Other:		
	4.3.B	Does the student transportation provider require employees to display their identification cards while on duty?		
	4.3.C	Does the student transportation provider issue identification cards to contractor personnel?		
	4.4	Is there a “sign in/sign out” system?		
	4.5	Are all employees required to wear uniforms? Do they comply?		
<b>5.</b>		<b>TRAINING</b>		
	5.1	Does the student transportation provider conduct security training for new employees? Do they comply?		
	5.1.A	If so, what type?		
		Security Awareness training		
		Security Plan training		

5.2		Does the student transportation provider conduct security training for current employees?	
	5.2.A	If so, when?	
		Annually	
		Every 1-3 years	
		More than 3 years	
		Change of job	
		Other:	
5.3		Does the student transportation provider conduct security training based on a formal curriculum?	
		If so, which curriculum?	
		Security Awareness Training CD (DOT)	
		First Observer (TSA)	
		School Transportation Security Awareness (TSA)	
		Secure Transport (TSA)	
		Security Self Assessment CD (TSA)	
		Other:	
5.4		Are the student transportation provider's drivers members of the First Observer program?	
5.5		Does the student transportation provider maintain employee security training records?	
<b>6.</b>		<b>PHYSICAL SECURITY COUNTERMEASURES</b>	
	6.1	Do the student transportation provider's facilities have physical security barriers?	
	6.1.A	If so, what type?	
		Fencing	
		Locking Gates	
		Keypad/PIN	
		Jersey Wall	
		Bollards	
		Other:	
	6.2	Do the student transportation provider's facilities have intrusion detection systems?	
	6.2.A	If so, what type?	
		Door/Window Detectors	
		Motion Alarms	
		Siren	
		Silent Alarm	
		Other:	
	6.3	Do the student transportation provider's facilities have security cameras?	
		If so:	
	6.3.A	Do the security cameras pan/tilt/zoom?	
	6.3.B	How are the security camera feeds monitored?	
		During operation hours	
		24/7	
		Cameras are not monitored	
	6.4	Does the student transportation provider have a key control program?	

	6.4.A	If so, what kind?	
		Facility key control program	
		Vehicle key control program	
	6.4.B	Are keys retrieved from departing employees?	
	6.4.C	Are access codes changed?	
		If so how frequently?	
		Annually	
		Every 1-3 months	
		Other:	
	6.5	Does the student transportation provider's facilities have designated secure areas?	
	6.5.A	If so, what kind?	
		Dispatch	
		IT/computer room	
		Admin offices	
		Maintenance	
		Financial	
		Loading dock	
		Warehouse	
		Storage tanks	
		Other:	
	6.5.B	Does the student transportation provider use security measures to protect secure areas?	
		If so, what areas?	
		Keys	
		Keypad/PIN	
		ID cards	
		Guards	
		Other:	
	6.6	Does the student transportation provider record access to secure areas?	
	6.6.A	If so, whose access to secure areas is recorded?	
		Employee access	
		Contractor access	
	6.6.B	Are the access records to secure areas periodically reviewed?	
	<b>7.</b>	<b>ENROUTE SECURITY</b>	
	7.1	Does the student transportation provider require drivers to conduct pre- and post-trip security inspections?	
	7.2	Does the student transportation provider have measures in place to ensure continuity of operations (including security) during a power/connectivity/facility outage?	
	7.2.A	If so, what measures?	
		Data back-up	
		Uninterruptible power supply	
		Back-up control center Remote access	
		Other:	
	7.3	Are students registered on a particular bus?	

	7.3.A	Do students have passes?		
	7.3.B	Do students have other identification?		
	7.4	Are drivers provided with a list of riders?		
	7.5	Are there procedures for accounting for each individual student, especially on activity trips?		
	7.6	On activity, field or extracurricular or school-chartered bus trips, are students instructed in safe riding practices and on the location and operation of emergency exits?		
	7.6.A	Are students counted at every stop prior to resuming the trip?		
	7.7	Are routes evaluated annually?		
	7.7.A	Are stops evaluated annually?		
	7.7.B	Are bus waiting areas evaluated annually?		
	7.7.C	Are school loading zones evaluated annually?		
<b>8.</b>		<b>COMMUNICATION</b>		
	8.1	What lines of communication exist within the operation?		
	8.2	Do they interrelate with local law enforcement, fire and emergency services?		
	8.3	Are they clearly defined and documented?		
	8.4	Are all employees trained and familiar with them?		
	8.5	Have these lines of communication been tested and proven?		
	8.6	Is there an alternate communication plan if the normal systems are unavailable?		
	8.7	Were the communications effective, as tested?		
<b>9.</b>		<b>SECURITY EXERCISES/DRILLS</b>		
	9.1	Does the student transportation provider conduct security exercises/drills?		
	9.1.A	If so, how often?		
		Monthly		
		Quarterly		
		Every 6 months		
		Annually		
		Other:		
	9.2	Does the student transportation provider include external personnel or agencies (e.g., law enforcement/first responders) when conducting security exercises/drills?		
	9.3	Does the student transportation provider maintain written documentation of the results/lessons learned from security exercises/drills?		
	9.4	Do the procedures of the plan/policy require routinely conducting security exercises/drills; along with a means for assessment, evaluation and improvement at least annually?		

[Back to Contents](#)

# **Committees**

---

## **15<sup>th</sup> National Congress On School Transportation**

### **Congress Committee List**

**Page Intentionally Left Blank**

**15<sup>th</sup> National Congress on School Transportation**  
**Congress Committee List**  
**\*Chair**

**Activity Bus Operations: Transportation Other Than To and From School or Head Start Writing Committee**

*Maxine Mougeot	Diana Hollander
Vicki Barnette	Allan Jones
Greg Beach	Doug Kellie
Nick Clawson	Larry Revier
John Fairchild	Debora L. Romine

**Appendices Coordination Writing Committee**

*Ted Finlayson-Schueler	Debora L. Romine
George F. Horne	Wayne Thompson
Chip Johnson	

**Crash Data Writing Committee**

*Miriam Manary	Ray Turner
Mary Ellen Buning	Dennis Zezas
Chuck Huber	

**Chronicling Innovations in School Transportation Writing Committee**

*Grant Reppert	Dale Goby
----------------	-----------

**Editing Committee**

*George F. Horne	Debora L. Romine
Ted Finlayson-Schueler	Wayne Thompson
Chip Johnson	

**General Operations Writing Committee**

*Alexandra Robinson	Bob Peters
Thomas Crumpton	Dan Roberts
Jerry Ford	Terri Roesler
Kathy Furneaux	Launi Schmutz
Tom Greufe	Michael Shields
George Horne	Kelly Stainbrook
Hugo Macias	Tony Ward
Pam McDonald	Marisa Weisinger
Randy Milhollen	



### **Infants, Toddlers and Pre-School Children Writing Committee**

*Charley Kennington	Kathy Furneaux
Donna Beauchea	Sue Shutrump
Linda Bluth	Cheryl Wolf
Harvey Boatman	Jean Zimmerman

### **Resolutions Writing Committee**

*Bill Loshbough	Jerry Milliken
Percy Abbott	Nancy Shultz
David Koskelowski	

### **School Bus Inspection Committee**

*Sharron VanCampen	Bob Petersen
Marshall Casey	Joseph Scesney
James Cole	Danny Thede
David Koskelowski	Bill Tousley

### **School Bus Specifications Writing Committee**

*Mike Kenney	Rick Lecker
Brad Barker	Dave McDonald
Brian Barrington	Rick Smith
Ron Briggler	Ricky Stanley
John P. Davis	Danny Thede
Charlie Hott	Philip Turner
Steven Huillett	Tony Woodard
Dan Kobussen	

### **School Transportation Security & Emergency Preparedness Writing Committee**

*Deborah Lincoln	John Green
Andy Chino	Pam McDonald
T. J. Crockett	Bob Ramsdale

### **Specially Equipped School Bus Writing Committee**

*W.R. (Bill) Schroyer	Launi Schmutz
Ed Cardona	Ricky Stanley
Denny Coughlin	Tony Woodard
Jayne Fahley	Jean Zimmerman
Miriam Manary	

### **Steering Committee**

*Pete Baxter	Bill Loshbough
Don Carnahan	Ron Love
Gary Catapano	Bruce Miles
Donnie Fowler	Leeds Pickering
John Green	Gena Spence
Ron Kinney	Bill Tousley
Dan Kobussen	Ken Whisnant

### **Technical Review Committee**

*Donnie Fowler	Bruce Miles
Monica Coburn	Rick Smith
Steve Gladow	Kenneth Whisnant

### **Terms & Definitions Writing Committee**

*Tony Woodard	Barbara V. Goodman
---------------	--------------------

### **Transportation for Students with Disabilities and Special Health Care Needs Writing Committee**

*Cheryl Wolf	Pete Meslin
Harvey Boatman	Susan Shutrump
Mary Ellen Buning	Ray Turner
Peggy Burns	Jean Zimmerman

[Back to Contents](#)

**Page Intentionally Left Blank**

# **Roster**

## **15<sup>th</sup> National Congress On School Transportation Delegate and Alternate List**

**Page Intentionally Left Blank**

**15<sup>th</sup> National Congress on School Transportation**  
**Official Delegate and Alternate List**  
**\*Delegation Chair**

**Alabama (D7)(Alt 4)**

\*Joe Lightsey  
Joe Beams  
Jerry Davidson  
Brad Holley  
James Knickrehm  
Maury Pettway  
Greg Ray

Alternates

Bob Brunson  
Mike Glassco  
Joey Hamm  
Jeff Snider

**Alaska (D7)(Alt 0)**

\*James Farrington  
Jay Adams  
Danny Allen  
Henry Cottle  
Steve Kalmas  
Elizabeth Sweeney  
Garry Wolske

**Arizona (D7)(Alt 2)**

\*Debbie Wheaton  
Gabe Cachora  
Josh Crosby  
Cathy Erwin  
Anthony Mendoza  
Kathy Roadlander  
Cathy Todecheene

Alternates

Jeff Lambert  
Jay Morris

**Arkansas (D2)(Alt 0)**

\*Mike Simmons  
Steve Avery

**California (D5)(Alt 0)**

\*John Green  
Anna Borges  
Pam McDonald  
Dano Rybar  
Robert Wigginton

**Colorado (D7)(Alt 0)**

\*Bruce Little  
David Anderson  
Greta Bleau  
Kanoë Cockett  
Cindy Hardin  
Dodie Hunker  
Marvin Shipley

**Connecticut (D7)(Alt 0)**

\*Garfield Green  
Lou Annino  
Donald Devivo  
Cathy Heath  
Leslie Sheldon  
Heather Smith  
George Whitney

**Delaware (D5)(Alt 0)**

\*Ronald Love  
Don Hartwig  
Barry Larkin  
George Middleton  
Dave Sutton

**Florida (D6)(Alt 0)**

\*Charlie Hood  
Greg Akin  
Mike Connors  
Tad Kledzik  
Jerry Klein  
Fred Murphy

**Georgia (D1)(Alt 0)**

\*Grant Reppert

**Idaho (D7)(Alt 1)**

\*Brad Jensen  
 Blain Aldous  
 Linda Braswell  
 Brent Carpenter  
 Lanette Daw  
 Mike Hally  
 Rob Zook  
 Alternate  
 Leon Hall

**Illinois (D7)(Alt 0)**

\*Cinda Meneghetti  
 Patrick Johnson  
 Vicki Mattson  
 Barbara Rizzo  
 Karen Rolofson  
 Chester Tindall  
 Michael Wagner

**Indiana (D7)(Alt 4)**

\*Pete Baxter  
 Michael Clark  
 Tim Fosbrink  
 Tom Merklng  
 Eric Reid  
 Karin Toth  
 Patricia Waites  
 Alternates  
 Susan Henderson  
 Terri Roesler  
 Pam Skogland  
 Linda Waites

**Iowa (D5)(Alt 0)**

\*Max C. Christensen  
 Owen Freese  
 Woody Harden  
 Danny Thede  
 Verlan Vos

**Kansas (D6)(Alt 0)**

\*Larry E. Bluthardt  
 Richard Fairchild  
 Michael Oyster  
 Barbara Pringle  
 Debora L. Romine  
 Jim Schwartzman

**Kentucky (D7)(Alt 1)**

\*Dave Mangum  
 John Akerman  
 David Jones  
 Wayne Keen  
 Terry Maggard  
 Wendell Spears  
 James Stewart  
 Alternate  
 Robbie Gaines

**Louisiana (D2)(Alt 0)**

\*George Horne  
 Gary Martin

**Maine (D6)(Alt 0)**

\* George P. Jones III  
 Harvey Boatman  
 Brent Boyington  
 David A. Leavitt  
 John Salter  
 Richard Soules

**Maryland (D6)(Alt 0)**

\*Leon Langley  
 Linda Bluth  
 Chris Carter  
 Lenny Ciufu  
 Larry Humbertson  
 Charlie Taibi

**Massachusetts (D5)(Alt 0)**

\*Judith A. Dupille  
 Peter Croscan  
 Clifton C. Johnson  
 John Salter  
 Gene Varney

**Michigan (D7)(Alt 0)**

\*Kenneth Micklash  
 Kellie Dean  
 Kevin Doty  
 Dale Goby  
 Kim Hooper  
 Matt Losch  
 Lori Richardson

**Minnesota (D5)(Alt 0)**

\*Duane Bartels  
Denny Coughlin  
Robert Duncan  
Brian Koch  
John Thomas

**Missouri (D7)(Alt 4)**

\*Roger Dorson  
Nick Boren  
Debra Clink  
Shirley Francis  
David Perkins  
Jerry Sides  
Linda Thompson  
Alternates  
Donald Fowler  
Dennis Robertson  
Jerry Schwartz  
Carol Woods

**Montana (D7)(Alt 1)**

\*Maxine Mougeot  
Nick Clawson  
Robert Evans  
Jerry Fleege  
Justin Hageness  
Steve Klippenes  
Wayne Thompson  
Alternate  
Jeremy Hageness

**Nebraska (D7)(Alt 0)**

\*Janice Eret  
Fred Craigie  
Cindy Houlden  
Bobbi Itzen  
Larry Schweitzer  
Scott Summers  
David Wolfe

**Nevada (D4)(Alt 0)**

\*Diana Hollander  
Steve Clifford  
Todd Duncan  
John Howard Sr.

**New Hampshire (D3)(Alt 0)**

\*Cathy McHugh  
Percy Abbott  
Katie Scholes

**New Jersey (D7)(Alt 0)**

\*Jerry Ford  
Glenn Barry  
Mark Jordan  
Shannon Murray  
Gerry Orem  
Rich Skibitski  
Timothy Wallace

**New Mexico (D7)(Alt 3)**

\*Gilbert A. Perea  
James Boone  
Jef Butcher  
John Griego  
Billy Huish  
Carlos Santiago  
Michael Whitehead  
Alternate  
Brett Kasten  
Ernie Sandoval  
Ray Trejo

**New York (D7)(Alt 4)**

\*John Corr  
Kathy Furneaux  
K.H. Pete James  
Alfred Karam  
Peter Lawrence  
James Minihan  
Paul Quinn Mori  
Alternates  
Ted Finlayson-Schueler  
Phil Vallone  
Joseph Van Aken  
Gale Winsper

**North Carolina (D6)(Alt 0)**

\*Derek Graham  
Franki Floyd  
Toni Floyd  
Harold Laflin  
William (Chip) Smith  
Craig Warren

**North Dakota (D1)(Alt 0)**

\*Barry Brooks



**Ohio (D7)(Alt 0)**

\*Pete Japikse  
Gary Catapano  
Fred Davis  
Mike Miller  
Brian Reigle  
Paul Stoneking  
Robert Widener

**Oklahoma (D5)(Alt 0)**

\*Floyd Gates  
Tammy Bowler  
Chuck Lawson  
James McNabb  
Billy Whittenberg

**Oregon (D7)(Alt 1)**

\* Steven Huillet  
T.J. Crockett  
Chris Ellison  
David Farley  
Susan Hunt  
Buckley Plummer  
Craig Pruitt

Alternate  
Deborah Lincoln

**Pennsylvania (D4)(Alt 0)**

\*Wayne Johnston  
Selina Pittenger  
Kevin Prady  
William Roenigk, Jr.

**South Carolina (D2)(Alt 0)**

\*Marshall Casey  
Mike Bullman

**South Dakota (D7)(Alt 0)**

\*Jim Shafer  
Ron Block  
Gene Deyo  
Dave Johnson  
Rick Meyer  
Tim Steichen  
Carol Uecker

**Tennessee (D6)(Alt 1)**

\*Larry Riggsbee  
Sam Cameron  
Ray Robinson  
Mike Simpson  
Mike Snell  
James Sumrell  
Alternate  
Guy Morgan

**Texas (D8)(Alt 2)**

\*Rebecca Rocha  
Christie Hebert  
Jim Norman  
William Powell  
Dan Roberts  
Rafael Salazar, Jr.  
Willie Tarleton  
Marisa Weisinger  
Alternates  
Kenneth Coleman  
Brian Weisinger

**Utah (D7)(Alt 0)**

\*Murrell Martin  
Jean Cannon  
Tom Given  
Stephan Olsen  
Glen Porter  
Launi Schmutz  
Jed Tate

**Vermont (D1)(Alt 0)**

\*Marty Dexter

**Virginia (D6)(Alt 0)**

\*June Eanes  
Michael Brown  
Danny Carroll  
Robert Clinebell  
Lonnie Reavis  
Tom Williams

**Washington (D7)(Alt 4)**

\*Allan J. Jones

Jan Clarence

Dan Cools

Scott Logan

Dan Payne

Sue Race

Mike Shahan

Alternates

Anna Esquibel

Clayton Kenney

Mike Kenney

Rick Lecker

**West Virginia (D3)(Alt 0)**

\*Benjamin Shew

Joe Meadows

Peggy Whitacre

**Wisconsin (D2)(Alt 0)**

Michael McManus

Tom Westlund

**Wyoming (D7)(Alt 0)**

\*D. Leeds Pickering

Bruce Bluemel

Edward (George) Dickerson

David Koskelowski

Travis Reinhardt

Kirk Schmidt

Dennis Zexas

[Back to Contents](#)

**Page Intentionally Left Blank**

# **Roster**

## **15<sup>th</sup> National Congress On School Transportation**

### **Attendance List**

**Page Intentionally Left Blank**

**15<sup>th</sup> National Congress on School Transportation**  
**Official Attendance List**  
**\*Delegation Chair**

Percy L. Abbott  
Region Safety Manager  
First Student, Inc.  
51 Lowell Road  
Salem, NH 03079

John Ackerman  
Director, Vehicle Maintenance Dept.  
Jefferson County-KY Public Schools  
3686 Parthenia Ave.  
Louisville, KY 40215

Virgil (Jay) Adams  
Supervisor, Vehicle Maintenance  
Anchorage School District  
3580 E. Tudor Rd.  
Anchorage, AK 99507

Gregory P. Akin  
Director, Student Transportation Services  
School Board of Volusia County  
1301 Shapiro Drive  
Deland, FL 32724

Blain Aldous  
Transportation Supervisor  
Challis School District #181  
1000 E. Bluff Ave.  
Challis, ID 83226

Danny Allen  
President/ CEO State Inspection Team  
School Bus Inspections/ For D.E.E.D AK  
66333 South Keiths Rd  
Sutton, AK 99674

Dave Anderson  
Director of Transportation  
Adams 12 Five Star School District  
444 East 144th Avenue  
Broomfield, CO 80020

Lou Annino  
CEO  
Access Transportation  
524 Wethersfield Avenue  
Hartford, CT 06144

Claire Atkinson  
Senior Editor  
School Bus Fleet Magazine/Bobit Business Media  
3520 Challenger St.  
Torrance, CA 90503

Steven Avery  
Transportation Director  
Siloam Spring School District  
PO Box 798  
Siloam Springs, AR 72761

Stephane Babcock  
Senior Editor  
School Transportation News  
PO Box 789  
Redondo Beach, CA 90277

Larry Bannon  
Vice President- New Business Development  
SynTec Seating Solutions  
200 Swathmore Ave  
High Point, NC 27263

Brian Barrington  
Account Manager  
Heavy Duty Bus Parts  
17850 I 45  
Willis, TX 77318

Glenn Barry  
Director of Transportation  
Hunterton Central Regional High School  
84 Route 31  
Fleminton, NJ 08822

\*Duane Bartels  
School Bus Inspection Supervisor  
Minnesota State Patrol  
1110 Centre Ponte Curve, Ste 410  
Mendota Heights, MN 55120

\*Pete Baxter  
Corporate Director of Business Relations  
Synovia Inc.  
Intuitive Fleet Tracking Technology  
9190 Priority Way West Suite 115  
Indianapolis, IN 46240

Brandon Billingsley  
President  
Heavy Duty Bus Parts  
17850 I 45  
Willis, TX 77318

Greta Bleau  
Senior Transportation Consultant  
Colorado Dept. of Education  
201 East Colfax  
Denver, CO 80203

Ron Block  
1H Bus Sales/Contractor  
Harlow's Bus Sales  
PO Box 419  
Webster, SD 57274

Bruce Bluemel  
Transportation Supervisor  
Uinta County School District #6  
P.O. Box 1090  
Lyman, WY 82937

Linda F. Bluth  
Education Program Specialist  
Maryland State Department of Education  
200 W. Baltimore Street  
Baltimore, MD 21201

\*Larry Bluthardt  
School Transportation Team Director  
Kansas State Department of Education  
120 Southeast Tenth Ave.  
Topeka, KS 66612

Harvey Boatman  
Maine Association for Pupil Transportation Member  
HCB3 Consulting and Training Services  
959 Cross Hill Road  
Vassalboro, ME 04989

Nick D. Boren  
Deputy Superintendent  
Columbia Public Schools  
1818 West Worley Street  
Columbia, MO 65203

Anna P. Borges  
Transportation Consultant  
California Department of Education  
825 Riverside Parkway Suite 110  
West Sacramento, CA 95605

Tammy Bowler  
Assistant Director of Transportation  
Colebrt Public Schools  
PO Box 310  
Colbert, OK 74733

Brent Boyington  
Transportation Specialist  
R.S.U. # 20  
P.O. Box 382  
Belfast, ME 04915

Ron Briggler  
Application Engineer  
IC Bus  
751 Harkrider  
Conway, AR 72032

\*Barry Brooks  
Director of Transportation  
Minot Public Schools  
215 2nd Street SE  
Minot, ND 58701

Michael Brown  
Associate Director of Pupil Transportation  
Virginia Dept. of Education  
101 N 14th St.  
Richmond, VA 23219

Mike Bullman  
Director of Training  
South Carolina Department of Education  
509 Duncan Reidville Road  
Duncan, SC 29334

Mary Ellen Buning  
Asst. Professor  
Rehab Engineering Research Center  
Wheelchair Training  
220 Abraham Flexner Way, #1112  
Louisville, KY 40202

Corky Bynum  
Vice President  
Safety Systems & Controls  
1729 Blvd E Brittmoore  
Houston, TX 77043

Gabriel J. Cachora Sr.  
Transportation Director  
Indian Oasis-Baboquivari USD #40  
P.O. Box 248  
Sells, AZ 85634

Sam Cameron  
Consultant  
State Dept of Education, Tennessee  
81 Cm Jones Rd.  
Greeneville, TN 37745

Jean Cannon  
Transportation Director  
Box Elder School District  
1675 N. 2000 W  
Brigham City, UT 84302

Don Carnahan  
Vice President Business Development  
Zonar Systems  
18200 Cascade Ave. S  
Seattle, WA 98188

Brent Carpenter  
Brown Bus Company  
Owner  
2111 E. Sherman Ave.  
Nampa, ID 83686

Chris Carter  
Supervisor  
Anne Arundel County Public Schools  
188 Green St  
Annapolis, MD 21401

\*Marshall Casey  
Director of Maintenance  
South Carolina Department of Education  
1429 Senate Street, Room 209  
Columbia, SC 29201



Gary Catapano  
Sr. Vice President of Safety  
First Group  
600 Vine Street  
Cincinnati, OH 45202

\*Max C. Christensen  
Executive Director  
Iowa Department of Education  
400 E 14th Street  
Des Moines, IA 50319

Lenny Ciufu  
President  
Maryland School Bus Contractor Association  
P. O. Box 959  
Aberdeen, MD 21001

Jan Clarence  
Regional Transportation Coordinator  
ESD 105  
33 S. 2nd Ave  
Yakima, WA 98902

Stephen Clifford  
District Transportation Supervisor  
Lyon County School District  
25 Goldfield Avenue  
Yerington, NV 89447

Vince Cline  
Engineering Manager  
Starcraft Bus  
2367 Century Dr.  
Goshen, IN 46528

Robert P. Clinebell  
Fleet Manager  
Virginia Beach City Public Schools  
1612 NY Ave  
VA Beach, VA 23454-4623

Debra Clink  
School Transportation Consultant  
MO Dept of Elementary & Secondary Ed  
PO Box 480  
Jefferson City, MO 65102-0480

Monica Coburn  
Transportation Manager  
Bartholomew Cons. School Corp  
1260 N Marr Rd  
Columbus, IN 47201

Kanoe Cockett  
Transportation Director  
Littleton Public Schools  
5565 South Crocker Street  
Littleton, CO 80120

Michael Connors  
Director, Transportation Services  
Brevard County School Board  
2091 W. King St.  
Cocoa, FL 32926

Dan Cools  
Transportation Supervisor  
Medical Lake SD  
P.O. Box 128  
Medical Lake, WA 99022

\*John D. Corr  
President  
The TransGroup  
56 West Church St.  
Spring Valley, NY 10977

Henry Cottle  
Director, Maintenance & Pupil Transportation  
Matanuska-Susitna Borough School District  
3901 E. Bogard Rd.  
Wasilla, AK 99654

Denny Coughlin  
Fleet Manager  
Minneapolis Public Schools  
1001 2nd Avenue North  
Minneapolis, MN 55405

John Crafton  
Director of Transportation  
Putnam City Public Schools  
7111 NW 42nd St.  
Bethany, OK 73008

Fred Craigie  
Assistant Supervisor  
Lincoln Public Schools  
2200 Park Blvd.  
Lincoln, NE 68502

TJ Crockett  
Program Analyst  
Oregon Department of Education  
255 Capitol Street NE  
Salem, OR 97310

Josh Crosby  
Director of Transportation  
Higley Unified School District  
2935 S Recker Road  
Gilbert, AZ 85925

Peter Croscan  
Fleet & Compliance Manager  
Boston Public Schools  
26 Court St.  
Boxton, MA 2108

Brenda Davis  
Motor Vehicle Inspection Analyst  
Missouri State Highway Patrol  
1510 East Elm St.  
Jefferson City, MO 65101

Fred E. Davis  
Vice President  
Edwin H. Davis and Son, Inc.  
13077 SR138  
Clarksburg, OH 43115

John P. Davis  
EF,HDX, S2, C2 Chassis Engineering FCCC  
FCCC  
552 Hyatt Street  
Gaffney, SC 29341

Lanette Daw  
Financial Specialist  
Idaho Department of Education  
650 W. State St.  
Boise, ID 83720

Kellie P. Dean  
President/Owner  
Dean Transportation, Inc.  
4812 Aurelius Road  
Lansing, MI 48910

Donald A. DeVivo  
President  
DATTCO, Inc.  
583 South Street  
New Britain, CT 06501

\*Marty Dexter  
Driver Training Coordinator  
Vermont Department of Motor Vehicles/AOT  
120 State St.  
Montpelier, VT 05603

Edward (George) Dickerson  
Transportation Director  
Uinta County School District No. 1  
PO Box 6002  
Evanston, WY 82931-6002

George Donn  
President  
Donn Associates  
1138 Lovebridge Rd NE  
Calhoun, GA 30701

\*Roger Dorson  
Coordinator, School Administrative Services  
MO Dept of Elementary & Secondary Ed.  
PO Box 480  
Jefferson City, MO 65102-0480

Kevin Doty  
Transportation Supervisor  
Mason Public Schools  
801 Kim Dr.  
Mason, MI 48854

Jeff Duke  
State School Bus Inspector  
Alabama State Dept. of Education  
50 North Ripley  
Montgomery, AL 36109

Robert Duncan  
Transportation Director  
Windom Area Schools  
1400 17th St. PO Box C-177  
Windom, MN 56101

Todd Duncan  
Fleet Operations Manager  
Washoe County School District  
1850 Kleppe Ln  
Sparks, NV 89431

Chris Ellison  
Transportation Director  
Greater Albany Public School District 8J  
718 Seventh Avenue SW  
Albany, OR 97321

\*Janice Eret  
Program Specialist  
Nebraska Department of Education  
301 Centennial Mall South  
Lincoln, NE 68528

Cathy Erwin  
Director of Transportation  
Creighton School District  
2802 E. McDowell Rd  
Phoenix, AZ 85008

Anna Esquibel  
Regional Transportation Coordinator  
OSPI/NWESD  
1601 R Ave.  
Anacortes, WA 98221

Robert Evans  
Bus Supervisor  
Belgrade School District No. 44 - MT  
312 N. Weaver Street, POB 166  
Belgrade, MT 59714

Jayne Fahle  
Application Engineer  
IC BUS LLC  
751 S Harkrider  
Conway, AR 72032

Richard Fairchild  
Transportation Director  
USD #204  
521 Edwards  
Larned, KS 67550

David Farley  
Head Mechanic  
Salem-Keizer SD, Transportation Dept.  
998 Hawthorne Ave. NE  
Salem, OR 97301

\*Jim Farrington  
School Finance Specialist  
State of Alaska Dept. of Education and Early Dev.  
801 West 10th Street, Suite 200  
Juneau, AK 99801

Shawn Finkbeiner  
Chair School Bus Manuf. Tech Council  
IC Bus  
751 S Harkrider  
Conway, AR 72032

Ted Finlayson-Schueler  
President  
Safety Rules!  
118 Shirley Road  
Syracuse, NY 13224

Richard Fischer  
11465 Dallas Rd  
Peyton, CO 80831

Jerry Fleege  
School Bus Manager  
Harlow School Bus Service Inc.  
75 Yellowstone Trail  
Whitehall, MT 59759

Frankie Floyd  
Technician  
Ashe County Schools  
PO Box 604  
Jefferson City, NC 28640

Toni Floyd  
Transportation Director  
Watuaga County Schools  
PO Box 1790  
Boone, NC 28607

\*Jerry Ford  
Transportation Supervisor  
DE Valley Regional HS Board of Education  
19 Senator Stout Rd  
Frenchtown, NJ 08825

Valerie Fortin  
Regulations and Standards Technician  
Corp. Micro Bird Inc.  
3000, Rue Girardin  
Drummondville (Quebec), Canada J2E 0A1

Tim Fosbrink  
Transportation Director  
Seymour Community Schools  
1638 S. Walnut  
Seymour, IN 47274

Donald Fowler  
President  
National School Transportation Association  
1213 East Main Street  
Richmond, MO 64085

Shirley R. Francis  
Pupil Transportation Consultant  
Access Management Group, Inc.  
6057 Gettysburg Ests. Dr.  
St. Louis, MO 63129

Owen Freese  
State School Bus Inspector  
Iowa Department of Education  
400 E 14th Street  
Des Moines, IA 50319

Kathleen A. Furneaux  
Executive Director  
Pupil Transportation Safety Institute  
224 Harrison Street - Suite 300  
Syracuse, NY 13202

Robbie Gaines  
Service Manager  
Laurel County Board of Education  
718 N. Main  
London, KY 40741

\*Floyd Gates  
Director of Transportation  
Moore Public Schools  
404 N Chestnut  
Moore, OK 73160

Thomas Given  
Director  
Granite School District  
3000 W. Parkway Blvd.  
West Valley City, UT 84119

Steve Gladow  
Engineering Manager  
Collins Bus Corp  
415 W 6th  
S Hutchinson, KS 67505

Dale Goby  
CEO  
Goby and Associates  
P.O. Box 601  
Clarkston, MI 48347

Malloy Gould  
25119 Ada Mae St.  
San Antonio, TX 78257

\*Derek Graham  
Section Chief, Transportation Services  
North Carolina Department of Public Instruction  
6319 Mail Service Center  
Raleigh, NC 27699-6319

\*Garfield Green  
Sgt/State Director of Pupil Transportation  
CT Department of Motor Vehicles - CVSD  
60 State Street, Rm 145  
Wethersfield, CT 06161

\*John Green  
Supervisor Office of School Transportation  
California Department of Education  
825 Riverside Parkway, Suite 110  
West Sacramento, CA 95605

John Griego  
Transportation Supervisor  
Bernalillo Public Schools  
N. 224 Camino del Pueblo  
Bernalillo, NM 87004

Justin Hageness  
Sales Rep  
Harlow's Bussales  
30772 US Hwy 2  
Libby, MT 59923

Jim Haigh  
Special Accounts Manager  
Specialty Manufacturing  
53411 Hunters Crossing Dr.  
Shelby Township, MI 48315

Leon Hall  
Transportation Supervisor  
School District #340  
1210 Warner  
Lewiston, ID 83501

Mike Hally  
Transportation Director  
New Plymouth School District  
700 S. Plymouth  
New Plymouth, ID 83655

Woody Harden  
Transportation Director  
Washington Community School District  
PO Box 926 / 404 West Main St.  
Washington, IA 52353

Cindy Hardin  
Transportation Director  
Falcon School District 49  
10850 Woodman Road  
Peyton, CO 80831

Don Hartwig  
Supervisor for transportation  
Colonial School District  
317 East Basin Road  
New Castle, DE 19720

Cathy Heath  
Transportation Coordinator  
LEARN  
44 Hatchetts Hill Rd.  
Old Lyme, CT 06371

Christie Hebert  
Administrative Assistant  
Texas Department of Public Safety  
5805 N. Lamar Blvd.  
Austin, TX 78752

Mike Hennessee  
Bus Inspector  
Arkansas Dept. of Education  
501 Woodlane  
Little Rock, AR

\*Diana Hollander  
Program Officer, Pupil Transportation  
Nevada Department of Education  
9890 S. Maryland Pkwy, Suite 221  
Las Vegas, NV 89183

Kim Hooper  
Transportation Consultant  
Wayne Co. Regional Ed. Service Agency  
33500 Van Born Road  
Wayne, MI 48184

\*George F. Horne  
President  
Horne Enterprises  
5017 Bissonet Drive  
Metairie, Louisiana 70003

Charles Hott  
Engineer  
Dept of Transportation, National Highway  
1200 NJ Ave, SE, Room 43-451  
WA, District of Columbia 20590

Cynthia Houlden  
Program Manager  
Nebraska Safety Center  
WSCT 233E  
Kearney, NE 68845

Jon Howard  
Acting Director Vehicle Maintenance  
Clark County School District  
975 W. Welpman Way  
Henderson, NV 89044

\*Steven Huillet  
Director of Pupil Transportation  
Oregon Department of Education  
255 Capitol Street NE  
Salem, OR 97310

Billy Huish  
Transportation Supervisor  
Farmington Municipal Schools  
3101 Southside River Rd  
Farmington, NM 87401

Larry S. Humbertson  
Assistant Supervisor of Transportation  
Allegany County Board of Education  
108 Washington St.  
Cumberland, MD 21502

Dodie Hunker  
Transportation Director  
Bennett School District 29J  
615 Seventh Street  
Bennett, CO 80102

Susan Hunt  
Lead Transportation Specialist  
Oregon Child Development Coalition  
9140 Sw Pioneer Ct. Suite E  
Wilsonville, OR 97071

Bobbie Itzen  
Transportation Supervisor  
Sutton Public Schools  
PO Box 590 1107 N. Saunders Ave.  
Sutton, NE 68979

Pete James  
President  
Chautauqua Transportation Services, Inc.  
PO Box 1100  
Chautauqua, NY 14722

\*Pete Japikse  
State Director of Pupil Transportation  
Ohio Department of Education, MS 710  
25 South Front Street  
Columbus, OH 43215

\*Brad Jensen  
Director Student Transportation  
Idaho Department of Education  
P.O. Box 83720 / 650 W. State St.  
Boise, ID 83720

Clifton C. Johnson  
Director of Business Development  
First Student  
39 West Stafford Rd  
Stafford Springs, CT 06076

Patrick W. Johnson  
Director of Training  
Lakeview Bus Line Inc.  
2400 Maywood Drive  
Bellwood, IL 60104

\*Wayne B. Johnston  
Director of Transportation  
School District of Springfield Township  
1901 E. Paper Mill Rd.  
Oreland, PA 19075

\*George P. Jones III  
President  
Pupil Transportation Consultants, LLC  
PO Box 71  
Summer, ME 4292

Guy Jukes  
Vice President of Marketing  
Bus-Watch by REI  
6534 L Street  
Omaha, NE 68117

J. Steven Kalmes  
Director, Transportation  
Anchorage School District  
3580 E. Tudor Rd.  
Anchorage, AK 99507

Alfred Karam  
Director of Transportation  
Bethlehem Central School District  
82 Van Dyke Road  
Delmar, NY 12054

Wayne Keen  
Director of Transportation  
Marion County Schools  
755 East Main Street  
Lebanon, KY 40033

Clayton Kenney  
Transportation Supervisor  
Reardon School Dist.  
PO Box 225  
Reardon, WA 99029

Mike Kenney  
Regional Transportation Coordinator  
Washington OSPI  
4202 S Regal St  
Spokane, WA 99223

Charley Kennington  
Director  
Innovative Transportation Solutions (ITS)  
7145 West Tidwell Road  
Houston, TX 77092-2021

Tad Kledzik  
Supervisor of Transportation Maintenance  
District School Board of Pasco County  
6125 Pinehill Road  
Port Richey, FL 34668

Jerry Klein  
Administrative Director  
Miami-Dade County Public Schools  
Department of Transportation  
15401 SW 117 Avenue  
Miami, FL 33177

Dan Kobussen  
President  
Kobussen Buses Ltd.  
W 914 Cth CE  
Kaukauna, WI 54130

Brian Koch  
President  
Koch School Bus Service, Inc.  
308 South Birch Street  
Waconia, MN 55387

David Koskelowski  
Program Manager  
Wyoming Department of Education  
2300 Capitol Ave, Hathaway bldg, 1st floor  
Cheyenn, WY 82002

Harold F. Laflin  
Director of Transportation  
Buncombe County Schools  
74 Wahsington Ave  
Asheville, NC 28804

Jeff Lambert  
Transportation Director  
Chino Valley Unified School District  
PO Box 225  
Chino Valley, AZ 86323

\*Leon Langley  
State Director of Pupil Transportation  
MD State Department of Education (MSDE)  
200 W. Baltimore Street  
Baltimore, MD 21201

Matt Lawrence  
Regional Manager  
Midwest Transit  
146 W. Issert Dr.  
Kankakee, IL 60901

Peter M. Lawrence  
Director of Transportation  
Fairport Central School District  
38 West Church St.  
Fairport, NY 14450



Chuck Lawson  
Director of Transportation  
El Reno Public Schools  
PO Box 580  
El Reno, OK 73036

David Leavitt  
Director of Support Services  
R.S.U.9  
108 Learning Lane  
Farmington, ME 04938

Rick Lecker  
Transportation Manager  
Longview School District  
2080 38th Avenue  
Longview, WA 98632

Deborah Lincoln  
Director of Employee Services  
Oregon Department of Education  
255 Capitol Street NE  
Salem, OR 97310

\*Bruce Little  
Senior Transportation Consultant  
Colorado Dept. of Education  
201 East Colfax  
Denver, CO 80203

Scott Logan  
Director of Transportation  
South Kitsap School District  
1962 Hoover Avenue SE  
Port Orchard, WA 98366

Matthew J. Losch  
Executive Director of Operations  
Grand Ledge Public Schools  
220 Lamson St.  
Grand Ledge, MI 48837

Bill Loshbough  
President  
ExecuWest Consultants  
P. O. Box 25944  
Albuquerque, NM 87125

\*Ron Love  
State Director  
Delaware Dept. of Education  
401 Federal Street  
Dover, DE 19901

Terry Maggard  
Transportation Director  
Carter County Schools  
10114 West US 62  
Olive Hill, KY 41164

Miriam Manary  
Senior Engineering Research Associate  
University of Michigan Transportation Research  
2901 Baxter Road  
Ann Arbor, MI 48109

\*David Mangum  
Program Consultant, Fleet Management  
Kentucky Department of Education  
15th Floor, Cpt, 500 Mero St.  
Frankfort, KY 40330

Brandon Marriott  
General Manager  
SynTec Seating Solutions  
200 Swathmore Ave  
High Point, NC 27263

Gary A. Martin  
Transportation Operations Coordinator  
St. Charles Parish Public Schools  
13855 River Rd.  
Luling, Louisiana 70070

Kyle Martin  
Vice President  
TransPar Group  
18 SW 3rd Street, Suite 200  
Lees Summit, MO 64063

Thomas (Matt) Matthews  
Engineering Specification Coordinator  
Blue Bird Body Company  
402 Blue Bird Blvd.  
Fort Valley, GA 31030

Dave McDonald  
Director: Technical Sales  
Rosco Vision Systems  
PO Box 213  
Fredericktown, OH 43109

\*Cathy L. McHugh  
Supervisor of Pupil Transportation  
N.H. Div. of Motor Vehicles  
23 Hazen Drive  
Concord, NH 03305

James McNabb  
Director of Transportation  
Jenks Public Schools  
2075 N. Elm  
Jenks, OK 74037

Anthony Mendoza  
Director of Transportation and Fleet Services  
Isaac School District No. 5  
3348 W. McDowell Road  
Phoenix, AZ 85009

Rick Meyer  
Bus Contractor  
B.J. School Buses, Inc.  
PO Box 507  
Scotland, SD 57059

\*Murrell Martin  
Pupil Transportation Director  
Utah State Office of Education  
250 East 500 South PO Box 1444200  
Salt Lake City, UT 84114

Vicki Mattson  
Director of Transportation  
Lincolnshire-Prarie View SD 103  
1370 Riverwoods Road  
Lincolnshire, IL 60069

Pamela McDonald  
Director of Transportation  
Orange Unified School District  
726 W. Collins Ave  
Orange, CA 92867

Michael McManus  
Executive Director  
WI School Bus Association  
7044 South 13th Street  
Oak Creek, WI 53154

Joe Meadows  
President  
West VA Association of Pupil Transportation  
1400 College Ave  
Barboursville, West VA 25504

\*Cinda E. Meneghetti  
IL State Director of Pupil Transportation  
Illinois State Board of Education  
100 North First Street, Mail Code E-320  
Springfield, IL 62777

\*Kenneth Micklash  
Pupil Transportation Consultant  
Michigan Department of Education  
608 W. Allegan St., PO Box 30008  
Lansing, MI 48909

George Middleton  
Transportation Manager  
Red Clay Consolidated School District-Transportation  
479 Old Airport Road  
New Castle, DE 19720

Bruce Miles  
Engineering Manager  
Blue Bird Body Company  
402 Blue Bird Blvd.  
Fort Valley, GA 31030

Mike Miller  
Area Operations Manager  
Petermann Transportation  
6947 Yankee Road  
Liberty Township, OH 45044

Jerry B. Milliken  
Consultant  
522 Clay Road  
Spencer, West VA 25276

James Minihan  
Transportation Supervisor  
Katonah-Lewisboro School District  
PO Box 387  
Katonah, NY 10536

Guy Morgan  
Transportation Director  
Metropolitan Nashville Public Schools  
336 Woodycrest Ave  
Nashville, TN 37072

Paul Mori  
Senior Manager  
Huntington Coach Corporation  
64 Bayville Ave./ PO Box 1386  
Bayville, NY 11709

\*Maxine Mougeot  
State Director of Transportation  
Office of Public Instruction  
PO Box 2025001  
Helena, MT 59620-2501

Shannon Murray  
President  
Kensington Bus Company, Inc.  
PO Box 549  
Lebanon, NJ 08833

Ruth Newby  
President  
TransPar Group  
18 SW 3rd Street, Suite 200  
Lees Summit, MO 64603

Jim Norman  
Director of Transportation  
Bowie County Schools  
PO Box 607  
New Boston, TX 75570

Stephen Olsen  
UAPT President  
USOE  
696 N Blue Mountain Rd  
Blanding, UT 84511

Gerald Oram  
District Transportation Coordinator  
N. Hunterdon-Voorhees BOE  
1445 State Route 31  
Annandale, NJ 08801

Michael Oyster  
President  
Apple Bus Company  
721 West K-31  
Garnett, KS 66032-0328

Dan Payne  
Transportation Program Manager  
Shoreline School District  
1216 NE 165th St  
Shoreline, WA 98155

\*Gilbert A. Perea  
Assistant Cabinet Secretary  
New Mexico Public Education Dept.  
300 Don Gasper  
Santa Fe, NM 87501

\*D. Leeds Pickering  
Director-Health, Safety and Nutrition  
Wyoming Department of Education  
Hathaway Bldg 2nd floor  
Cheyenne, WY 82002

Selina M. Pittenger  
Executive Director  
Pennsylvania School Bus Association  
355 N. 21st Street #200  
Camp Hill, PA 17011

Buckley Plummer  
Supervisor  
Ontario School District BC  
195 SW 3rd Ave  
Ontario, OR 97914

Glen Porter  
Sergeant  
Utah Highway Patrol  
5500 W Amelia Earhart Dr. Suite 360  
Salt Lake City, UT 84116

William Powell  
Assistant Director of Human Resources  
Cypress-Fairbanks ISD  
11430 Falcon Road  
Houston, TX 77064

Kevin Prady  
Director of Transportation  
Seneca Valley School District  
124 Seneca School Road  
Harmony, PA 16037

Barbara Pringle  
Executive Director  
KSPTA  
PO Box 1504  
Emporia, KS 66801

Craig Pruitt  
Program Analyst  
Oregon Department of Education  
255 Capitol Street NE  
Salem, OR 97310

Sue Race  
Director of Transportation  
Tacoma School District  
4002 S. Cedar  
Tacoma, WA 98409

Greg Ray  
School Bus Inspection Supervisor  
Alabama Department of Education  
5308 Gordon Persons Bldg.  
Montgomery, AL 36130

Lonnie Reavis  
Coordinator of Transportation  
Suffolk Public Schools  
120 Forest Glen Dr.  
Suffolk, VA 23494

Eric D. Reid  
Director of Transportation  
West Clark Community Schools  
601 Renz Avenue  
Sellersburg, IN 47172

Travis Reinhardt  
Transportation Director  
Goshen County School District  
810 West 25th Ave  
Torrington, WY 82240

Jeff Reitz  
Vice President  
Central States Bus Sales, Inc.  
2450 Cassens Drive  
Fenton, MO 63026

\*Grant Reppert  
Director of Transportation  
Gwinnett County Public Schools  
610 West Crogan Street  
Lawrenceville, GA 30046

Lori Richardson  
Program Director  
Oakland Schools  
2111 Pontiac Lake Road  
Waterford, MI 48328

\*Larry Riggsbee  
Executive Director  
Tennessee Association for Pupil Transportation  
342 Portland Blvd  
Portland, TN 37148

Bob Riley  
Executive Director  
NASDPTS  
PO Box 5446  
Steamboat Springs, CO 80477

Barbara Rizzo  
Director of Transportation  
Peotone CUSD 207U  
212 W. Wilson St.  
Peotone, IL 60468

Kathy Roadlander  
General Manager  
Bee Line  
PO Box 17391  
Tucson, AZ 85731

Dan Roberts  
Exec. Director Long Range Planning and Business  
Round Rock ISD  
921 Luther Peterson Pl.  
Round Rock, TX 78665

Dennis Robertson  
Director of Transportation  
Raytown C-2 School District  
5920 Hardy Ave  
Raytown, MO 64133

Alexandra Robinson  
President-Elect  
NAPT  
1033 Park Meadows Road  
Chula Vista, CA 91915

Ray Robinson  
Lieutenant  
State of Tennessee Public Transportation  
1150 Foster Avenue  
Nashville, TN 37249

\*Rebecca Rocha  
Program Administrator  
Texas Department of Public Safety  
5805 N. Lamar Blvd., Bldg. G-Annex  
Austin, TX 78752

William L. Roenigk, Jr.  
President  
W. L. Roenigk, Inc.  
798 Ekastown Road  
Sarver, PA 16055

Karen Rolofson  
Transportation Director  
Rolofson Bus Service, Inc.  
301 Route 48 NE  
Argenta, IL 62501

Deborah Romine  
School Transportation Safety Consultant  
Kansas State Department of Education  
120 Southeast Tenth Ave.  
Topeka, KS 66612

Mike Roscoe  
Director of School Bus Products  
The C.E. White Co.  
407 Wells Lane  
Versailles, KY 40383

Dana Rybar  
Instructor Coordinator  
California Department of Education  
825 Riverside Parkway, Suite 110  
West Sacramento, CA 95605

Rafael Salazar, Jr.  
Director of Transportation  
Northside ISD  
12005 Leslie Road  
Helotes, TX 78023

John Salter  
Consultant  
196 Scotland Rd  
Newbury, ME 01951

Carlos Santiago  
School Transportation Bureau Chief  
Public Education Department  
300 Don Gasper Ave.  
Santa Fe, NM 87501

Launi Schmultz  
Transportation Administrator  
Washington County School District  
855 East Brigham Road  
St. George, UT 84765

Katie Scholes  
President  
New Hampshire Student Transportation Association  
P.O. Box 172  
Fremont, NH 03044

Bill Schroyer  
Fleet Manager  
Escambia District Schools  
100 East Texar Drive  
Pensacola, FL 32503

Nancy Schulz  
18950 West 157<sup>th</sup> Terrace  
Olathe, KS 66062

Jim Schwartzman  
KSPTA President/Mechanic  
USD #204  
PO Box 435  
Bonner Springs, KS 66012

B. Lynn Sears  
Transportation Director  
Grove Public School  
517 W 10th/PO Box 450789  
Grove, OK 74345-0789

\*Jim Shafer  
General Manager  
School Bus, Inc.  
5100 W. 8th St.  
Sioux Falls, SD 57107

Michael D. Shahan  
Director of Transportation & Emergency/Safety Mng  
University Place School District #83  
9311 Chambers Creek Road West  
University Place, WA 98467

Leslie Sheldon  
All-star Transportation LLC  
146 Huntington Ave  
Waterbury, CT 06708

\*Benjamin Shew  
Exec. Dir. of School Transportation  
WV Department of Education  
1900 Kanawha Blvd. E.  
Charleston, West VA 25305

Marvin Shipley  
Contract Manager  
First Student  
320 North 24th Court  
Grand Junction, CO 81501

Jerry Sides  
General Manager  
MV Student Transportaton, Inc.  
330 north 29th street  
east st. louis, MO 62205

\*Mike Simmons  
Senior Transportation Manager  
Div. of Academic Facilities & Transportation  
501 Woodlane, Suite 311-S  
Little Rock, AR 72201

Richard Skibitski  
Fleet Manager  
Wayne Board of Education  
195 Dey road  
Wayne, NJ 07470

Heather Smith  
CEO  
STTAC Association  
19 A-2 Lakeshore Dr.  
Farmington, CT 6032

Rick Smith  
Fleet Standard and Engineering Specialist  
National Express Corp  
2408 Midview Drive  
High Point, NC 27265

W.D. Smith  
Director of Transportation  
Cleveland County Schools - NC  
300 Kemper Road  
Shelby, NC 28075

Mike Snell  
Transportation Director  
Rutherford County Schools  
2240 Southpark Blvd  
Murfreesboro, TN 37128

Wendell Spears  
Transportation Director  
Allen County Schools  
570 Oliver Street  
Scottsville, KY 42164

Ricky Stanley  
State Specifications Coordinator  
Thomas Built Buses  
1408 Courtesy Rd  
High Point, NC 27265

Tim Steichen  
Transportation Supervisor  
Watertown School Dist.  
PO Box 730  
Waertown, SD 57201

James Stewart  
Assistant Director of Transportation  
Oldham County Board of Education  
P.O. Box 294  
Buckner, KY 40010

Paul R. Stoneking  
Director of Transportation  
Norton City School District  
4128 S. Cleveland Massillon Road  
Norton, OH 44203

Doug Stufflebean  
Vice President of Sales  
Bus Air Manufacturing  
PO Box 279  
Justin, TX 76247

Scott Summers  
Legal Counsel III  
Nebraska Department of Education  
301 Centennial Mall South  
Lincoln, NE 68509

Jim Sumrell  
Chief Operations Officer  
Clarksville Montgomery County School System  
2620 Madison Street  
Clarksville, TN 37043

David Sutton  
Vice President  
Sutton Bus & Truck Co., Inc.  
5609 Old Capito Trail  
Wilmington, DE 19808

Elizabeth Sweeney  
School Finance Office Manager  
State of Alaska Dept. of Education & Early Dev.  
801 West 10th Street, Suite 200  
Juneau, AK 99801

Charles Taibi  
Director of Transportation  
Harford County Public Schools  
102 S. Hickory Avenue  
Bel Air, MD 21014

Willie A. Tarleton  
Director of Transportation Services  
Midland ISD  
Po Box 2298  
Midland, TX 79702

Danny Thede  
Transportation Director  
Indianola Community School District  
1304 E 2nd Avenue  
Indianola, IA 50125

John Thomas  
Transportation Coordinator  
Eastern Carver Co School  
11 Peavey Rd  
Chaska, MN 55318

Jeffrey Thompson  
Director of Transportation  
St. Mary's County Public Schools  
27190 Point Lookout Rd  
Loveville, 20656

Linda Thompson  
Director of Transportation Services  
Reorganized R-7 School District  
500 SE Transport Drive  
Lees Summit, MO 64081

Wayne Thompson  
Transportation Specialist  
Helena, Montana Public Schools  
3020 Big Sky Loop  
Helena, MT 59602



Chester Tindall  
Transportation Manager and Consultant  
TransPar Group  
5414 S. Eastview Park  
Chicago, IL 60615

Karin J. Toth  
Transportation Director  
Crown Point Community Schools  
1151 E Summit Street  
Crown Point, IN 46307

William Tousley  
Steering Committee Member  
NAPT  
1840 Western Ave  
Albany, NY 12203

Phil Vallone  
President  
Rolling V Bus Corp  
P.O Box 110  
South Fallsburg, NY 12779

Joseph Van Aken  
Director of Safety and Training  
21st/Ocean Avenue Transportation  
1973 60th Street PMB 115  
Brooklyn, NY 10305

Sharron VanCampen  
Sergeant  
Michigan State Police School Bus Inspections  
4000 Collins Rd  
Lansing, MI 48910

Gene Varney  
President  
Varney's Garage Inc./RMV  
174 W Main St.  
East Brookfield, MA 1535

Verlan Vos  
State School Bus Inspector  
Iowa Department of Education  
400 E 14th Street  
Des Moines, IA 50319

Terry Voy  
403 Market Ave. SW  
Mitchellville, IA 50169

Michael W. Wagner  
Owner/ CFO  
Lakeview Bus Line Inc.  
Polar Express School Bus  
2400 Maywood Drive  
Bellwood, IL 60104

Linda L. Waites  
Transportation Director  
MSD Pike Township  
3950 W 56th Street  
Indianapolis, IN 46254

Pat Waites  
Assistant Transportation Director  
Hamilton Southeastern Schools  
13485 Cumberland Road  
Fishers, IN 46038

Timothy Wallace  
President  
Rahway Bus Co.  
445 Inman Avenue  
Colonia, NJ 07067

Craig Warren  
Transportation Consultant  
NC Department of Public Instruction  
6319 Mail Service Center  
Raleigh, NC 27699-6319

Brian Weisinger  
Transportation Director  
Spring ISD  
341 E. Richey Road, Bldg. B  
Houston, TX 77073

Marisa Weisinger  
Technical Specialist  
Region 4 Education Service Center  
7145 W Tidwell Road  
Houston, TX 77092

Tom Westlund  
President  
Westlund Bus Lines  
P.O Box 691  
Marinette, WI 54143

\*Debbie Wheaton  
Transportation Director  
Cottonwood-Oak Creek School District  
1 N. Willard  
Cottonwood, AZ 86326

Kenneth E. Whisnant  
Development Engineer  
Thomas Built Buses  
1408 Courtesy Rd  
High Point, NC 27260

Peggy Whitacre  
Transportation Supervisor  
Hampshire County Board of Education  
495 N. Bolton Street  
Romney, WV 26757

Mike Whitehead  
President  
B&G Transportation, Inc.  
PO Box 247  
Hobbs, NM 88241

George Whitney  
Maintenance Director  
M.J. Bus Inc.  
130 Ingham Hill Rd.  
Old Saybrook, CT 06475

Billy Whittenburg  
Director  
Durant Public Schools  
PO Drawer 1160  
Durant, OK 74702

Robert W. Widener  
Mechanic  
Greenville City Schools  
215 W. Fourth St.  
Greenville, OH 45331

Bob Wigginton  
Director of Transportation  
Chino Valley Unified School District  
5130 Riverside Drive  
Chino Valley, CA 91710

Tom Williams  
Transportation Manager  
Washington Co. School Board  
812 Thompson Dr.  
Abingdon, VA 24210

Gale Winsper  
Transportation Director  
Longwood Central School District  
21 Everett Dr.  
Yaphank, NY 11980

Cheryl Wolf  
Transportation Supervisor  
Lafayette School Corporation  
2300 Cason Street  
Lafayette, IN 47904

Garry Wolske  
Resurrection VP / Inspector  
School Bus Inspections/ D.E.E.D. AK  
66333 S. Keith Rd  
Sutton, AK 99674

Tony Woodard  
Specification Coordinator  
Blue Bird Body Company  
PO Box 937  
Fort Valley, GA 31030

Carol Woods  
Transportation Director  
Jackson R-2 Public Schools  
614 E Adams  
Jackson, MO 63755

Bill Wright  
Transportation Supervisor  
School District #84  
1700 Baldy Mountain Rd  
Lake Pend Oreille, ID 83852

Dennis Zezas  
Transportation Director  
Johnson County School District #1  
601 West Lott  
Buffalo, WY 82834

[Back to Contents](#)

# **University of Central Missouri**

---

**15<sup>th</sup> National Congress  
On School Transportation**

**Missouri Safety Center  
Staff List**

**Page Intentionally Left Blank**

**15<sup>th</sup> National Congress on School Transportation**  
**University of Central Missouri ~ Missouri Safety Center Staff List**

Terry Butler  
Director, Missouri Safety Center  
University of Central Missouri  
Missouri Safety Center  
Humphreys Suite 200  
Warrensburg, MO 64093  
660-543-4830

Susan Malott  
Accountant II  
University of Central Missouri  
Missouri Safety Center  
Humphreys Suite 200  
Warrensburg, MO 64093  
660-543-4830

Jim Delap  
Program Manager/MMSP  
University of Central Missouri  
Missouri Safety Center  
Marshall Building  
Warrensburg, MO 64093  
660-543-4830

Kara Meyer  
Student Employee  
University of Central Missouri  
Missouri Safety Center  
Humphreys Suite 200  
Warrensburg, MO 64093  
660-543-4830

Pat Denkler  
Office Professional II  
University of Central Missouri  
Missouri Safety Center  
Marshall Building  
Warrensburg, MO 64093  
660-543-4830

Beverley Richardson  
Office Professional II  
University of Central Missouri  
Missouri Safety Center  
Humphreys Suite 200  
Warrensburg, MO 64093  
660-543-4830

Shane Diersen  
15<sup>th</sup> Congress Electronic Voting Operator  
Student Employee  
University of Central Missouri  
Missouri Safety Center  
Humphreys Suite 200  
Warrensburg, MO 64093  
660-543-4830

Tiffany A. Schnorenberg  
15<sup>th</sup> Congress Onsite Publication Coordinator  
Office Professional II  
University of Central Missouri  
Missouri Safety Center  
Humphreys Suite 200  
Warrensburg, MO 64093  
660-543-4830

Tracey Durbin  
Breath Alcohol Lab Coordinator  
University of Central Missouri  
Missouri Safety Center  
Marshall Building  
Warrensburg, MO 64093  
660-543-4830

LaGena Spence  
15<sup>th</sup> Congress Onsite Coordinator  
Program Manager/Grant Research Analyst  
University of Central Missouri  
Missouri Safety Center  
Humphreys Suite 200  
Warrensburg, MO 64093  
660-543-4830

[Back to Contents](#)

**Page Intentionally Left Blank**