

TRADOC HISTORICAL MONOGRAPH SERIES

# From Active Defense to AirLand Battle: The Development of Army Doctrine 1973-1982

by John L. Romjue

355.0497

3.  
R765f  
c 20

1  
United States Army Training and Doctrine Command

THE COMMAND AND GENERAL STAFF COLLEGE

**LIBRARY**



Fort Leavenworth, KS 66027-6900

Call Number \_\_\_\_\_

CGSC Label 13

182-2179

1 Jan 85 Edition of 11 Dec 72 is obsolete.

# **From Active Defense to AirLand Battle: The Development of Army Doctrine, 1973-1982**

**by John L. Romjue**

**Historical Office**

United States Army Training and Doctrine Command  
Fort Monroe, Virginia

**JUNE 1984**

## TRADOC HISTORICAL MONOGRAPH SERIES

Henry O. Malone, Jr., Editor

Library of Congress Cataloging in Publication Data

Romjue, John L., 1936-

From active defense to AirLand Battle.

(TRADOC historical monograph series)

Bibliography: p.

Includes index.

1. United States. Army—History—20th century. 2. Military art and science—United States—History—20th century. 3. Europe—Defenses. I. Title. **11** Title: Airland Battle. **III**. Series.

UA25.R69 1985 355' .00973 85-960

First Printing September **1984**  
Second Printing February 1985

355  
- 00973  
R765F  
C 20

## FOREWORD

The years 1973–1982 encompassed two major revisions of Army tactical doctrine. This monograph is an attempt to record and examine the causes and effects of the doctrinal ferment that led to the NATO-focused doctrine popularly known as the active defense, in 1976, followed six years later by the comprehensive doctrine, worldwide in scope, termed the AirLand Battle.

Controversy attends the development of military doctrine at all times. Within and outside the Army, the critique of the active defense was vigorous and led the doctrine planners and writers of the Army Training and Doctrine Command to a forthright reassessment, not only of the ideas, but of the assumptions, of that firepower-weighted doctrine. Changing national policy, reflecting the restoration of American strategic perspective occurring at the turn of the decade, influenced the reassessment in the direction of wider attack resources and worldwide contingency operations. Successive concepts formulated between 1977 and 1980 extended and deepened earlier views of the modern battlefield and pointed toward the revised doctrine of AirLand Battle formulated by the Command and General Staff College at Fort Leavenworth during 1980–1981. Leaving behind earlier emphasis on firepower and force ratios, the doctrine of AirLand Battle published in 1982 was an initiative-oriented military doctrine that restored the maneuver-firepower balance, turned attention anew to the moral factors and human dimension of combat, and signalled a return to the fundamental principles governing victory in battle.



WILLIAM R. RICHARDSON  
General, United States Army  
Commanding

# *PREFACE*

This volume is based on doctrine chapters prepared by the author for the TRADOC Annual Historical Reviews and on subsequent interviews with participants in the doctrinal process at TRADOC Headquarters and at the Combined Arms Center, Fort Leavenworth. Preparation of the volume owes much to the information, comments, and criticisms provided by the Headquarters staff of the Office of the Deputy Chief of Staff for Doctrine, and by officers of the Department of Tactics in the Command and General Staff College. The responsibility for interpreting the doctrinal developments treated and for any errors of fact that have eluded him rests with the author. The manuscript was typed in its several drafts, with admirable efficiency, by Mrs. Claudine D. Lovett.

This monograph is dedicated to the late Maj. Gen. Donald R. Morelli, U.S. Army, first Deputy Chief of Staff for Doctrine in the Army Training and Doctrine Command, December 1979 to July 1982, who served again in that post from March 1983 to January 1984. His inspired and untiring commitment to the wide public presentation of AirLand Battle doctrine was of major importance in securing its acceptance in the Congress and the executive branch.

JOHN L. ROMJUE

**To the Memory of  
MAJOR GENERAL DONALD R. MORELLI, U.S. ARMY**





# Contents

INTRODUCTION .....	1
1. THE ACTIVE DEFENSE AND THE REFOCUS ON NATO EUROPE, 1973–1976 .....	3
<i>Development of the 1976 Operations Field Manual</i> .....	3
<i>The New Doctrine</i> .....	6
<i>Weapons and Lethality</i> .....	6
<i>Battlefield Dynamics</i> .....	7
<i>Offense and Defense</i> .....	9
<i>Other Concerns</i> .....	10
2. THE DEBATE OF THE ACTIVE DEFENSE .....	13
<i>The Defense Emphasis</i> .....	14
<i>"First Battle" Orientation</i> .....	15
<i>Soviet Breakthrough Maneuver</i> .....	16
<i>Tactical Reserves Issue</i> .....	17
<i>Emphasis on Firepower</i> .....	18
<i>Concentration Tactics</i> .....	19
3. EXTENDING THE BATTLEFIELD: DOCTRINAL CURRENTS, 1977–1980 .....	23
<i>The Central Battle</i> .....	23
<i>Battlefield Development and the Second Echelon</i> .....	24
<i>Instituting a New Doctrinal Process</i> .....	27
<i>Converging Ideas. 1979–1980</i> .....	30
<i>Interdiction</i> .....	33
<i>The Integrated Battlefield</i> .....	34
<i>Worldwide Contingencies</i> .....	39
<i>Corps 86</i> .....	40
<i>The Revision of FM 100–5 Begins</i> .....	42
<i>The Extended Battlefield</i> .....	43
<i>Publication of the March 1981 Operational Concept of     AirLand Battle</i> .....	44

4. AIRLAND BATTLE DOCTRINE .....	51
<i>Writing the Doctrine</i> .....	51
<i>Staffing and Further Changes</i> .....	57
<i>The Tactical Air Dimension</i> .....	61
<i>Offensive Air Support</i> .....	62
<i>Joint Operational Concepts</i> .....	63
Introducing the New Doctrine .....	65
<i>The 1982 FM 100-5, Operations</i> .....	66
<i>The Strategic Challenge and the Next Battlefield</i> .....	66
<i>Fundamentals of Combat</i> .....	68
<i>The Offense</i> .....	70
<i>The Defense</i> .....	71
<i>Other Considerations</i> .....	71

## APPENDICES

A. AirLand Battle and AirLand Battle 2000/Army 21 .....	75
B. TRADOC Pamphlet 525- Series Operational Concepts .....	77
C. Selected Documents .....	79
NOTES.....	115
BIBLIOGRAPHY .....	123
INDEX .....	127

## CHARTS

No.	Page
1. A Substantial Step Toward Future Capabilities.....	47
2. The Second Echelon Threat .....	47
3 . See and Attack in Depth .....	49
4 . Why Deep Attack?.....	49

## ILLUSTRATIONS

	Page
General Donn A . Starry .....	ix
General William E . DePuy .....	x
Brigadier General Donald R . Morelli .....	28
General Edward C. Meyer .....	31
Major John S. Doerfel .....	35
Lieutenant Colonel Richmond B. Henriques.....	42
Lieutenant General William R. Richardson.....	52
Lieutenant Colonel Huba Wass de Czege.....	54
Lieutenant Colonel L. D. Holder .....	54
General Glenn K. Otis .....	60



General Donn A. Starry



General William E. DePuy

## *Introduction*

Any review of Army tactical doctrine in the post-Vietnam era must focus on the concepts that evolved into what came to be known as "the AirLand Battle." Represented in the fused syllables of this rubric were significant changes in battle doctrine, changes that were the culmination of several years of intensive work by the Training and Doctrine Command (TRADOC), the United States Army agency with executive responsibility for developing and promulgating tactical doctrine and for teaching the Army how to fight using that doctrine. Although these developments were marked by considerable debate, both within and outside the Army, the scope and intensity of the AirLand Battle project reflected the seriousness with which the Army, since the early 1970s, had regarded the technological edge which the Soviet Union gained during that decade in the tactical weaponry of its numerically stronger forces opposite NATO's Allied Command in Europe. In preliminary form, the new concept received its first formal statement and was published by TRADOC in 1981. Further developed, AirLand Battle became official doctrine when published in a new edition of the Army's key tactical handbook, Field Manual 100-5, *Operations*, in August 1982.

To a great extent, the AirLand Battle concept sprang from the doctrinal views of General Donn A. Starry, who began his four-year tenure as TRADOC commander in July 1977. Together with the major Army 86 Studies undertaken by Starry and his planners during 1978-1980 to define new tactical field organization, AirLand Battle doctrine bid fair to be the dominant influence on the modernizing Army of the 1980s. However, the doctrine that the Army adopted in 1982 was itself a product of, and reaction to doctrinal currents that extended deep into the preceding decade. This study will discuss those currents and trace their development. But neither those antecedents nor the doctrine to which they led can be understood outside the political context of that decade.

The passage of time will shed increasing illumination on the 1970s as a critical period in the national defense posture of the United States and as a time of formidable challenge for the United States Army. To look back over that decade is to be struck by the sluggish national awareness of the massive buildup of Soviet arms and the delayed political response to the Soviets' increasingly bold power moves, directly

and by Cuban proxy, in Africa, the Middle East, and Latin America.<sup>2</sup>

The political currents of the 1970s, affecting decisions on Army developments and preparedness, are complex. At risk of oversimplification, one may say that, throughout most of the decade, political counsels were divided about the prosecution of American foreign policy. "Come home, America" sentiments gripped a significant portion of the public mood during and following the withdrawal from the Vietnam War. Although the nation's defense commitment to the NATO alliance remained firm, neo-isolationist sentiments found voice both in Congressional restrictions that effectively excluded American action to counter Soviet proxy moves elsewhere, and in weak defense budgets that extended well into the mid-1970s. Noteworthy and symbolic was the largely uncontested military intervention by Cuban forces in Africa, beginning with Angola in 1975. Such sentiments were also strongly manifest in the new Carter Administration which assumed office in 1977.

Although increases in the defense budgets during the second half of the decade were significant, because they signalled the beginning of a turnaround in Congressional mood and support, this expansion was not large. At the same time, and in the face of an in-

creasing display of Soviet power, the assumptions and psychology of detente with the Soviet Union continued to prevail within the executive branch, abating only with the Soviet invasion of Afghanistan in late 1979. For the U.S. Army, these political currents of the 1970s translated into two operating parameters. The first was a decade of weapon budgets severely constrained initially, but gradually rising. The second was an almost exclusive focus on Europe and the NATO commitment.'

The decade's character influenced decisively the doctrinal views of the first TRADOC commander, General William E. DePuy, who took command in July 1973. With little future funding on the horizon, General DePuy, his staff, and subordinate commanders had gone to work early and assiduously to define and defend engineering development programs for the new generation of weapons needed. The pressing quantitative needs of the Vietnam War had severely interrupted the weapon development process for almost a decade, giving the Soviets nearly a generational gain in most categories of combat equipment. At the same time, General DePuy also took an intense interest in the reform of tactics and training, in line with the tactical lessons of the Arab-Israeli War of October 1973. Out of this interest and attendant study came the sharply revised Army tactical doctrine of the mid-1970s.

# *Chapter I*

## *The Active Defense and The Refocus on NATO Europe 1973-1976*

The doctrinal reassessment that began in the early 1970s took place within the larger framework of the Army's reorientation from the terminating infantry-airmobile war in Vietnam to the arena of conventional combined arms warfare in the theater of primary strategic concern to the United States, Western Europe. The Soviet military buildup of the late 1960s and 1970s sharpened the focus on NATO defense and on tactics of conventional land battle. But in addition, the reformulation of doctrine after the "Vietnam decade," if bound to come, gained first force from the push given it personally between 1974 and 1976 by General DePuy. The pace this doctrinal transformation assumed, the shape it took, and the ideas it carried bore a personal stamp.

### *Development of the 1976 Operations Field Manual*

Other factors contributed to the TRADOC reassessment of doctrine. Major in influence were the lessons drawn from the events of the Mideast War of 1973; the play of TRADOC's

standard regional battle scenarios, particularly those for European and Mideast contingencies; close coordination in ideas with the U.S. Army Forces Command; and consultations with the German Army and with the U.S. Air Force's Tactical Air Command.

Through the year 1974, TRADOC's study and analysis of the Mideast War with its stark lessons of the stunning advance in the lethality of modern weaponry and the essentiality of better suppressive tactics, use of terrain, camouflage, routes of advance, and combined arms coordination, were having a powerful impact on planners at the headquarters. This impact was felt the following year throughout the Army through TRADOC briefings based on the Mideast War analysis and on tactical insights gained from the Mideast scenarios and wargaming of heavy and light corps in their context. The wargaming and analyses affirmed the war lessons of the tremendously increased power and effect of all the arms. But particularly affirmed were the evident new destructiveness of tank guns and antitank and air defense missiles and the tactical consequences following therefrom. This experience and study confirmed in the mind of DePuy, and that of many military observers as well, that the tactical doctrine set forth in current training

literature had, in significant part, ceased to be valid on the modern battlefield.

In the midst of the doctrinal currents of 1974, General DePuy, on 23 July, wrote personal letters to seven of his center and school commanders, enclosing a draft concept paper which he described in terms of the French peasant's proverbial "pot of soup"—to which new ingredients were continually being added for the general benefit.<sup>4</sup> The first outline sketch of the new operations manual, the pot of soup version came out of the Concepts Branch of the Office of the Deputy Chief of Staff for Training, a special cell established by General DePuy in the headquarters to manage and expedite training literature.<sup>5</sup> Surveying the changes to modern land battle suggested by the Mideast experience, General DePuy invited contributions to what he described at this time as "an informal TRADOC document," not for wider use. Responses by the center and school commanders followed through the year.

At the same time, the training and combat developments staffs at the TRADOC schools were in the early process of incorporating the new doctrinal concerns into rewritten and better formatted field manuals and new training circulars. General DePuy told his training deputy, Brig. Gen. Paul F. Gorman, to make training doctrine current and readable. Certain elements of the training literature were critical, to the task, and these elements, required first attention. Effort thus, focused on training publications falling in the "how we fight" class.<sup>6</sup> The initiative soon became the "how to fight" manuals, which contained the particulars of tactical doctrine and were

directly keyed to the developing revision of FM 100-5.

The doctrinal efforts of TRADOC might have remained academic had they not, as well as their product, been perceived by the Army early on as a shared endeavor. Joining with the FORSCOM commander, General Walter T. Kerwin, Jr., General DePuy organized a seminar on combat tactics and techniques at the company-battery level, held at Fort Knox 1-2 October 1974. United States Army, Europe and Eighth U.S. Army representatives also attended these doctrinal discussions. Emphasizing the Mideast War lessons, the TRADOC "Octoberfest" briefings presented a picture of new tactical emphases, such as overwatch movement techniques and ways of maximizing combined arms effectiveness.<sup>7</sup>

The "Octoberfest" discussions had an impact that went beyond simply involving wider Army circles in the rethinking of tactics. By this time, it became apparent to the TRADOC commander that problems and challenges were present at every tactical echelon from corps to company. DePuy believed that a program to reorient and restructure the whole body of Army doctrine, from top to bottom, was needed. The key was the revision of Field Manual 100-5, Operations, last published in 1968.<sup>8</sup>

In November 1974, the TRADOC Chief of Staff, Maj. Gen. Burnside E. Huffman, Jr., outlined the commander's basic approach to the doctrinal effort. Tactics had to be based on hard, cold facts, had to be taken out of the abstract. TRADOC had to examine the most recent military experience, and employ the best weapon data—such as that being developed by the Army



Materiel Systems Analysis Agency on hit probabilities of Soviet weapons as a function of range. Concrete realities had to shape tactics. Questions had to be asked such as the range at which U.S. gunners could expect to engage each Soviet weapon system.<sup>9</sup>

Coordinated by the Combined Arms Center, the "pot of soup" paper and its school additions were growing into a comprehensive body of doctrinal ideas by late 1974. At that point, General DePuy concentrated and hastened the process with the first of several conferences with his subordinate commanders at Fort A.P. Hill, Va., 11-13 December 1974. The purpose was to outline the new FM 100-5 and key derivative how-to-fight manuals. A main problem of past manuals had been their evident committee authorship. General DePuy told his commanders that he wanted them involved personally in the effort: "If necessary, you must write them yourselves." Two similar commander-level conferences at Fort A.P. Hill followed the initial meeting: 30 April—2 May and 20-21 November 1975.<sup>10</sup>

The importance that DePuy attached to a reorientation of tactical doctrine was evident in the decision to transfer primary staff responsibility for FM 100-5 from the Combined Arms Center at Fort Leavenworth to the Concepts Branch of TRADOC headquarters at Fort Monroe in early 1975. Through the year, the manual went through a series of drafts, influenced among other things by doctrinal consultations with the German Army. The vital role to be played by tactical air in the air-land battle became a theme in the manual, aided by General DePuy's discussions about airspace management procedures and other concerns with the commander of the Tactical Air Command,

General Robert J. Dixon. To meet arguments that the "Octoberfest" meeting had signaled a doctrinal retreat from airmobility and had introduced too narrow a focus on mounted and mechanized warfare, TRADOC and FORSCOM held an intercommand conference on 8-9 October 1975 at Fort Hood, Tex.<sup>11</sup> Airmobile applications in conventional European warfare received an airing at this time. Throughout the year, TRADOC also coordinated the operations field manual drafts widely with three-star and four-star active Army generals, and consulted with many retired generals. This correspondence elicited many ideas. The USAREUR commander-in-chief, General George S. Blanchard, for example, to whom a preliminary version of FM 100-5 was presented in October 1975, contributed significant sections on the NATO allies' role and on military operations in built-up areas—a feature of any prospective battle in West Germany and a theme being simultaneously treated in the doctrinal exchange with the German Army. Advance copies were presented to the major commands and the Department of the Army staff at the Army Commanders Conference of 10-11 December 1975. FORSCOM endorsed the manual the same month.<sup>12</sup>

The appearance, in July 1976, of the new Army Field Manual 100-5, *Operations* established a new set of basic concepts of U.S. Army doctrine.<sup>13</sup> This "capstone" doctrinal handbook grew out of deep and penetrating inquiries into the meaning of the new technology of weaponry. It confronted directly the prime strategic problem the Army faced: a U.S. force quantitatively inferior in men and equipment on an armor dominated European battlefield. Such influences discouraged the hypothetical, and a reading of the 1976 FM

100-5 reveals its writers' deliberate intent to depict a corpus of tactics bound by the concrete. Tactics were tied firmly to the capabilities of weapons employed on the well-studied terrain of most likely deployment, all in the context of actual strategic circumstances believed likely to continue for the foreseeable future.

## *The New Doctrine*

The stated aim of the operations manual was to set forth the basic concepts of U.S. Army doctrine that would be the foundation of service school instruction and the guide for training and combat developments throughout the Army, and that would provide the principles for success in the Army's primary mission of winning the land battle.

In its vision of the Army's strategic challenge, the new doctrinal statement was succinct and candid:

We cannot know when or where the U.S. Army will again be ordered into battle, but we must assume the enemy we face will possess weapons generally as effective as our own. And we must calculate that he will have them in greater numbers than we will be able to deploy. . . . Because the lethality of modern weapons continues to increase sharply, we can expect very high losses to occur in short periods of time. Entire forces could be destroyed quickly if they are improperly employed.

Therefore the first battle of our next war could well be its last battle. . . . The United States could find itself

in a short, intense war—the outcome of which may be dictated by the results of initial combat. This circumstance is unprecedented: We are an Army historically unprepared for its first battle. We are accustomed to victory wrought with the weight of materiel and population brought to bear after the onset of hostilities. Today the U.S. Army must above all else, prepare to win the first battle of the next war.<sup>15</sup>

The doctrine of 1976 thus laid great stress on the demise of the old mobilization concept as a strategic factor. Equally attuned to realities was an orientation to actual, not hypothetical threat: battle in Central Europe against forces of the Warsaw Pact was the "most demanding mission the U.S. Army could be assigned." Facing expected superior forces, "The U. S. Army must prepare its units to fight out numbered, and to win."<sup>16</sup>

Readiness and effectiveness were keynotes of the volume. Training had to yield standards and techniques that matched the realities of the modern battlefield, in combined arms terms. The Army's units must be "ready to fight and win now." The manual writers paraphrased the historian Josephus on Roman training methods: "our drills must be 'bloodless battles' and our battles 'bloody drills'."<sup>17</sup>

## *Weapons and Lethality*

The manual's key chapter on weapons drew a stark and frank picture of the effects of modern arms. The Israeli and Arab armies, in clashes of

massed armor not witnessed in thirty years, had sustained materiel losses in 1973 of 50 percent in less than two weeks of combat. The firepower, intensity, tempo, and mobility of tactical fighting as revealed in that war, and as simulated in TRADOCs scenarios and other studies, had introduced a "new lethality" to modern battle. Analysis of trends in all major categories of weapons bore out the fundamental change that had occurred.

In tank comparisons, for example, the American medium tank of World War II had needed thirteen rounds to obtain a 50-50 probability of hit on a standing tank at 1,500 meters; a mid-1970s medium tank needed one round. Tank gun muzzle velocity, both U.S. and Russian, had more than doubled since World War II, with projectiles traveling nearly one mile a second.<sup>19</sup>

Antitank weapons had increased vastly in range and armor penetration. Missiles such as the TOW had a 50-50 probability of a hit at 3,500 meters—compared to 1,500 meters for the tank gun. Weapons could penetrate over eighteen inches of armor. In field artillery, self-propelled guns were increasingly the rule, and ranges of direct and general support guns had increased significantly. The introduction of precision guided projectiles fired from standard cannon would facilitate high probabilities of first round kills on tanks. Response times to provide suppressive fire had been reduced from minutes to seconds. Laser rangefinders introduced significantly greater accuracy.<sup>20</sup>

In air defense weaponry, automatic guidance, improved radar, and optical sights had greatly increased the hit probabilities. Surface to air missiles

such as the Soviet SA-7, used in great quantities in the Sinai fighting, had demonstrated devastating effects against low-flying helicopters and airplanes. In tactical airpower, the ordnance load of a U.S. fighter aircraft had risen from 500 pounds in 1945 to 16,000 pounds in 1975, in a great variety of guided and unguided bombs and missiles and automatic cannon fire. The coming of the advanced attack helicopter and HELLFIRE missile promised a unique new long-range tank-killing power.<sup>21</sup>

The technology of night vision devices had developed to the point that night maneuvers and engagements similar to those in daylight would soon be a reality. Night device ranges of from 450-2000 meters would equal in many cases the range effectiveness of the weapons with which they were used. Scatterable mines launched by artillery and helicopters in great numbers could establish mine-fields in a matter of minutes. Use of the electromagnetic environment had added a new dimension to battle, and electronic warfare was described to be "now a form of combat power."<sup>22</sup>

## *Battlefield Dynamics*

It was against this background of a new lethality that the 1976 operations manual spelled out the principles of how to fight the future battle. Stressed repeatedly was conflict with the Warsaw Pact in Central Europe as the most demanding mission that the Army could expect to face. The key terrain factor, considered in terms not merely of contour, but surface conditions, drainage, vegetation, and especially of man-made built-up features, received emphatic treatment.<sup>23</sup>

At the heart of the doctrinal overview, described as "battlefield dynamics," was a clear and simple delineation of responsibilities: Generals, commanding corps and divisions, concentrate the forces. Colonels and lieutenant colonels, in brigades and battalions, control and direct the battle. Captains, in companies, troops, and batteries, fight the battle. To these missions were geared the prerequisites of winning the battle--concentration of adequate forces and weapons at the critical times and places; control and direction of the battle to ensure that the maximum effect of fire and maneuver was concentrated at decisive locations; fighting the battle using cover, concealment, suppression, and combined arms teamwork to maximize effectiveness and to minimize that of the enemy; and training crews and teams to the maximum capabilities of their weapons.<sup>24</sup>

The lessons of lethality and terrain permeated these missions. TRADOC's doctrinal writers laid stress on the advantages of the defender--full use of cover and concealment, selection of the ground on which to fight, weapons sited for maximum effectiveness, reinforcement of terrain with mines and obstacles, and the choice of firing first. The defender could expect to defeat an attacker three times as strong. The attacker's forces were the more vulnerable, and his weapons were not as effective as the weapons of the defender. In the attack, a ratio of 6:1 was required.<sup>25</sup>

The doctrine of 1976 stressed strongly the commander's substitution of firepower for manpower, and the potential of U.S. weapons--self-propelled artillery, totally mobile tank and mechanized infantry battalions, air-mobile antiarmor weapons, attack

helicopters, and close air support aircraft--for swift massing to concentrate combat power to decisively alter force ratios when and where chosen. Important was the role of strong covering forces not only to fight with sufficient strength and tenacity to force the enemy to disclose the size and direction of his main attack, but also to begin to engage and destroy the enemy. Swift movement in the main battle area to concentration was an imperative.<sup>26</sup>

With their forces outnumbered on the battlefield, generals had the prime responsibility to concentrate these forces never to be outnumbered or outgunned beyond the permissible rough ratios at the point and time of decision. Concentration of winning force involved full use of intelligence from all sources; allocation of fire support for support of maneuver, for counterfire, for destruction of enemy air defense, and for interdiction and deep fires; joint operations with the U.S. Air Force; integration of electronic warfare systems; and concentration of logistical units to "arm, fuel, fix, and feed forward."<sup>27</sup>

Coordinating the forces put at their disposal, the brigade and battalion commanders worked in the defense with basic building blocks of cross-reinforced tank or mechanized company team or battalion task forces. They moved these forces from battle position to battle position in the highly active defense or in attack or counter-attack. The battalion commander put the combined arms team together. In the fast moving action of the highly lethal battlefield, combined arms teamwork had to stress the use of the best cover, concealment, and suppressive tactics."<sup>28</sup>

At the fighting level of the company commanders, platoon leaders, squad leaders, and tank commanders, the tactics of cover, concealment, suppression, and teamwork were in fact the rules of battle. Captains had to understand completely the capabilities and limitations of their weapons and of those facing them. They had to train and lead decisively and had to combine tactics of maneuver and suppression skillfully. Here and elsewhere in the 1976 doctrine, its authors gave concrete examples of what was required. Thus, armor commanders should not seek duels with antitank guided missiles at ranges beyond 2,000 meters.<sup>29</sup>

## *Offense and Defense*

In the frame of the general-colonel-captain scheme, the doctrine writers turned successively to the guiding precepts of the offense and defense on the modern battlefield.

If strategic presuppositions made clear that the defense was the Army's major concern, it was none the less true that "the outcome of combat derives from the results of offensive operations."<sup>30</sup> Yet the commander should attack *"only if he expects the outcome to result in decisively greater enemy losses than his own, or result in the capture of objectives crucial to the outcome of the larger battle."*<sup>31</sup> The attack had to be planned around several basic concepts. The best intelligence was required in order to "see" the battlefield. Overwhelming combat power had to be concentrated on a narrow front. The enemy's defenses had first to be suppressed by every means at hand—antitank guided missiles, tanks, direct fires, artillery and mortars, smoke, and

air attack. The attack had to be shock attack—narrow, deep, fast, and without let-up to the enemy rear—with overwhelming force, continuously supported by mobile logistic and service support elements. Combined arms had to be the commander's approach, and the combined arms task force had to be the basic combat element, weighted to the needs of the specific situation.<sup>32</sup>

In the defense, a first fundamental was the commander's absolute need to understand the opposing force—the Soviet tactics, for example, of tremendously massed artillery fire. The commander had to visualize clearly the battlefield and to anticipate attack points, concentrating at the critical times and places, and be willing to take risks on the flanks of the division. In the strategic situation in which U.S. divisions found themselves in Europe, the doctrine of two brigades forward, one in reserve, was abandoned. Division commanders had to be willing to concentrate six to eight of their maneuver battalions on one-fifth of their front to meet breakthrough forces of twenty to twenty-five battalions. They had to be ready to cover the remaining ground with air and ground cavalry, with any battalions left over, and with attack helicopter units. The high mobility of armored and mechanized forces permitted rapid reinforcement. The defense had to be, in sum, an *active defense*, using maneuver to concentrate at the right place and time. As in the offense, the defense was a combined arms enterprise employing great combat power with massed fires of artillery and with tank-killing helicopters firing from 3,000 meters range. Firing first was a cardinal rule of the "new lethality," in defense as well as in the attack. The covering force, forward of the main battle area, had the main function-

by the aggressiveness and power of its contact—to force the enemy to reveal the strength, location, and general direction of his main thrust and to engage that thrust as the first line of defense. Trading space for time, the covering force enabled the main body of defending forces to deploy to prepared defenses. Deployed forward, the defending main force, built around tanks and antitank guided missiles, had to be sited to achieve maximum effective ranges.<sup>33</sup>

## *Other Concerns*

Subsequent chapters in the 1976 Operations dealt with retrograde operations, intelligence, the Air Force-Army air-land battle, electronic warfare, tactical nuclear operations, and chemical operations. Doctrine included logistics, too, in a chapter emphasizing the forward missions of combat service support. Operations within NATO, the primary strategic theater, were treated. A final chapter discussed the special environments of tactical warfare and the major considerations bearing on how to fight in mountains, jungles, deserts, and northern regions. Military operations in built-up areas were extensively treated.

In these as well as in the earlier chapters, doctrine writers pressed the delineated spheres of responsibility. In all the chapters, too, the paramount strategic situation of outnumbered forces, and the central themes of terrain use, rapid suppression, and full use of intelligence repeatedly were stressed, intermixed with germane data on Soviet tactics and weapons capabilities, points of doctrine, basic procedures, and practical reminders. A

concise and clear declarative style characterized the doctrinal manual. Clear graphics, varied print size and color, and bold-type marginal summations enhanced its readability, and pertinent historical data and battle examples gave it depth. Chapter 11, for example, spelled out in a few concise paragraphs past and present U.S. policies governing chemical warfare, followed by a clear elucidation of the Soviet Union's well-prepared capabilities in this field of combat, and an ordered resumé of what to do, how to fight, in the offense, defense, and retrograde.

The focus of doctrine writers in 1976 on realities rather than theoretics led consequentially to concrete doctrinal specifics. Years earlier, planners of the old Continental Army Command and Combat Developments Command had, with some heat, argued the issue of which training literature was "doctrinal," and which was "applied."<sup>34</sup> No such artificial distinction confused the method and intent of the mid-1970s doctrine. Addressing NATO operations and military operations in built-up areas, the manual writers included such practical reminders and precise data as seasonal mean temperatures, rainfall, and frequency of morning fog in Central Europe, as well as data about cloud layer ceilings (of interest to Cobra pilots) and "intervisibility segments" or the average length of clear uninterrupted lines of fire characteristic of different types of terrain in West Germany. The engagement times of antitank guided missiles at various ranges, according to speeds of enemy tanks, were given. Doctrine gained full immediacy in discussions of the nature of cover provided by the characteristic stone, concrete, and brick buildings of German towns and villages, and the minimum room size and

space venting needed to fire the light antitank weapon, and DRAGON and TOW guided missiles from inside such buildings.

\* \* \*

In the early 1970s, a fundamental change occurred in the technology of land battle. The Army's capstone manual on operations recognized that change and provided a new and ordered handbook of how to fight in the 1970s and beyond. If a disarming simplicity

of ideas characterized its doctrine, this was General DePuy's intent.<sup>35</sup> An ordered clarity was needed--an exact and demanding concept of battle, one that met the demands of the new and unprecedentedly lethal context in which conventional warfare had evolved. Both dominant strategic realities and the political currents of the decade shaped the tactics and strong defensive themes of the 1976 doctrine. The doctrinal stress on firepower and on a tailored maneuver doctrine accommodated these prevailing realities.





## Chapter II

# *The Debate of the Active Defense*

The publication of the Army's new tactical doctrine in July 1976 was widely recognized in military circles as a significant event. Not only was it a symbol of the Army's reorientation from Vietnam back to Europe and the arena of primary strategic concern, it presented a distinctly new vision of tactical warfare. Sharp in its grasp of strategic realities and recognition of the lethal force of modern weaponry, attuned to concrete particulars and clear in delineation, the operations manual was a powerful, tightly written document that at once established itself as the new point of departure for tactical discussion, inviting an intensity of critical attention. A spirited debate in the military professional journals followed its appearance.

The general reception of the new doctrine was good, even enthusiastic. For example, in October 1976, the noted defense analyst Philip A. Karber described the new *Operations* as the start of a "doctrinal renaissance."<sup>1</sup> A review the following spring by a Canadian critic, Dan G. Loomis, saw the manual to be of "tremendous strategic importance" as a milestone in the U.S. Army's reorientation to the projected battle in Europe.<sup>2</sup> In February 1978, Dr. Archer Jones, a professor of history and former occupant of the Morrison Chair of Military History at the U.S.

Army Command and General Staff College, hailed the new doctrinal manual for bringing the Army back to a greater clarity about the principle of concentration and about "the old truth, the primacy of the defensive."<sup>3</sup> In April of the same year, Colin S. Gray of the Hudson Institute and former Assistant Director of the International Institute for Strategic Studies, referred to the 1976 FM 100-5 as the "excellent new master operations manual" of the Army.<sup>4</sup> An early dissenting voice was that of William S. Lind, a Congressional staffer in the employ of Senator Gary Hart of Colorado, whose critique in March 1977, found the new doctrinal schema seriously deficient.<sup>5</sup> But while generally well accepted, the doctrinal manual raised penetrating questions, even among its admirers, and the general critique was wide-ranging. It was probably true, as a student of tactical doctrine, Major Robert A. Doughty, wrote, that the 1976 operations manual was one of the most controversial field manuals ever published by the U.S. Army.<sup>6</sup>

Why was this? For all the European "first battle" immediacy, the weapons-mindedness, the concrete battle facts, and the ordered clarity that the 1976 FM 100-5 brought to Army commanders, it was clear that the

"revolution" in tactical doctrine attributed to it by critics, friendly and skeptical, was much more. Army tactical doctrine, as fashioned by the 1976 field manual, was a corpus of thought that overturned some old ways of thinking. The manual asserted new and, to many, disturbing assumptions about such questions as the forward shift of the fighting balance, the lack of the traditional tactical reserve, and the ease and efficacy of the active defenses's tactically critical lateral moves to concentration. A significant external question, but one that went to the heart of the tactical assumptions of FM 100-5, was whether the most representative Soviet offensive operation had been depicted. A larger issue was the import of the overemphasis which the 1976 manual was perceived to have given to the defense. Other peripheral questions filled out the general critique of the new doctrine by military officers, analysts, and scholars during the period.

## *The Defense Emphasis*

Of the many criticisms that the 1976 doctrine drew, the charge of its emphasis on defense struck perhaps the deepest chord of opposition initially. This reaction had not been expected by the manual's authors. They had pointedly recognized "that the outcome of combat derives from the results of offensive operations," and had fully provided for the offense in a chapter developed with the same care given the chapter on the defense that followed it. But the perception that the increased attention paid to the defense signified a dominating defense emphasis or a

defense orientation was one with which the doctrine writers had to struggle. The perception was voiced not only by detractors but to some degree by supporters as well.

The Lind critique, pursuing an argument for the maneuver, charged that the doctrine gave insufficient attention to the offensive.<sup>8</sup> But Philip Karber suggested, after first asserting that any suggestion of an offensive mission on the theater level was "patently absurd," that on the operational level the benefits of giving up the real advantages of the defense for the "dubious prospects of 'offensive elan' " were more than questionable. Karber also noted the distinct provision in the doctrine for tactical level counteroffensives.<sup>9</sup> The Lind critique (covering a range of points that will be discussed in turn) had been circulated several months prior to its March 1977 publication. In a statement, appearing in *Armed Forces Journal* in October 1976, TRADOC replied officially to Lind's defense emphasis point, among others. "The manual is clear that offensive action is the preferred form of combat, and advocates bold maneuver in conjunction with both the offense and the defense."<sup>10</sup>

Various comments followed. Describing the "future battlefield" in January 1978, Majors Robert A. Doughty and L. D. Holder maintained that the defense would predominate over the offense and noted the Clausewitzian axiom that defense has always been the strongest form of combat.<sup>11</sup> Archer Jones viewed the Army's "rediscovery" of the superiority of the defense as a significant and beneficial development, supported by historical trends. The doctrine writers' grasp of the new lethality of technology

had served to reinstall the primacy of the defense. Jones went on to see in the 1976 Operations' theory of the defense a significant development with respect to the tactical reserve.<sup>12</sup>

General Donn Starry, who succeeded DePuy as TRADOC commander in July 1977, noted the criticism on this point in remarks about FM 100-5 to the Symposium on Tactics and Military Posture, held by the U.S. Army Combined Arms Center in conjunction with the Inter-University Seminar on Armed Forces and Society at Fort Leavenworth, 30 March - 1 April 1978. Starry, whose remarks were later published, viewed as a misperception the criticism that the doctrine paid too little attention to the offense. It was indeed the active defense which stopped the enemy and destroyed his attacking force first, before U.S. forces would go over to the offense.<sup>13</sup>

By the close of 1978, opinion was divided about whether the new doctrine, whatever the presumed loss to the spirit of the offensive, had held its own in defending the case for the defense as the realistic initial operations posture in Central Europe. But while TRADOC took pains to stress that offensive action was "the preferred form" in the derivative "how-to-fight" manuals that followed FM 100-5, both those manuals, and FM 100-5, clearly rejected the notion of a ceaseless offensive unaffected by the realities of the new lethal weaponry.<sup>14</sup>

## *"First Battle" Orientation*

Another issue of some consequence was encapsulated in the 1976 manual's

phrase that the U.S. Army must "win the first battle of the next war." Meant to convey the destructiveness, tempo, and conclusiveness of modern battle and the likely exclusion of a fallback on national mobilization, the phrase soon became a slogan that tended to be criticized in isolation from the thoughts that had completed and accompanied it on the manual's first page. "The first battle of our next war could well be our last battle. . . . The United States could find itself in a short intense war—the outcome of which may be dictated by the result of initial combat."<sup>15</sup>

Thus, William Lind's early critique perceived a "preoccupation with the first battle." The organization of the Soviet forces in echelons, Lind argued, permitted them to lose the first battle, if necessary, and then go on to win the second. This argument did not note that the defender lacked the strength of echelons permitting a like luxury of losing the first battle. TRADOC's "Reply" in October 1976 stressed that winning the first battle was "an attempt to offset the assumptions which have governed U.S. military policy in the past: that time and materiel will eventually rectify any initial disadvantage." Philip Karber at the same time pointed out that FM 100-5 clearly indicated an extended engagement in which the attacker was continually forced to take high attrition in successive U.S. fire and maneuver actions. "FM 100-5's emphasis on the first battle is not misplaced, it is mandatory. Unless the U.S. forces can win the first series of engagements they will have little opportunity to prevent being overrun or outflanked."<sup>16</sup>

This issue proved short lived as a closer reading of FM 100-5 and an increasing familiarization with the new

doctrine appeared to return the slogan to context. A subsequent description -- a come-as-you-are war"-- seemed to make the point more effectively. In addition, the introduction by General Starry of a larger corps battle concept -- the "Central Battle" --in 1977-1978 acted to some extent to absorb the first battle emphasis, and in so doing, the controversy about it.

## *Soviet Breakthrough Maneuver*

If the revised doctrine of 1976 was to prove vulnerable on any point, it was one based on a scenario that may already have ceased to be realistic by 1976: the classic massed armor breakthrough as the assumed Soviet operational maneuver. Since the manual's tactical descriptions proceeded in reaction to this type of penetration, the issue was of no small importance. The doctrinal manual depicted an attack by the enemy on very narrow fronts in great depth, with massed firepower in the breakthrough sector. Warsaw Pact forces might throw as many as 600 tanks against a U.S. division in the leading echelon, followed shortly by 600 more. "This doctrine . . . is deeply ingrained in the Soviet Army and if we should go to war in Europe, those are exactly the tactics we would face."<sup>17</sup> But, already in 1976, Philip Karber was pursuing the operational maneuver question in connection with the lessons the Soviets had drawn from the Mideast War. At the Annual Army Operations Research Symposium that year, Karber noted the extensive discussion of antitank weaponry in the Soviet literature of 1974-1975. By 1976, Karber wrote, "a major shift in tactical operational concepts" had occurred.<sup>18</sup>

Then, in two widely read articles appearing in 1977, Karber pointed out that the Soviets' concern since 1973 about antitank guided missiles had produced a strong awareness of the vulnerability of their BMP infantry fighting vehicle--the indispensable support element to the tactics of the rapid and deep classic armor breakthrough. Karber noted the consequent revival in recent Soviet exercises of another operational maneuver--the concept of multi-pronged attacks by BMP regiments reinforced with armor across the entire battlefield seeking holes and weakspots. In training, the Soviets were spending quadruple the time practicing the multi-prong attacks and meeting engagements as they were rehearsing conventional frontal breakthroughs. Though many combat support, logistical and leadership problems were evident in the new maneuver, there was no doubt, Karber said, about a "tactical revolution" in Soviet military doctrine.<sup>19</sup>

This theme was picked up in the U.S. military journals early in 1978 and pursued into the following year.<sup>20</sup> It was noted, too, at the spring 1978 Symposium on Tactics and Military Posture at Fort Leavenworth. Captains Gregory Fontenot and Matthew Roberts asserted even further that a Soviet perception existed that U.S. and Western military responses were geared to past Soviet methods. The presumption of both FM 100-5 and the how-to-fight manuals that the enemy would act as predicted (mass for breakthrough, permitting U.S. forces to concentrate) was a weakness entailing no little peril, Fontenot and Roberts wrote. Could the defender "safely denude four-fifths of his frontage," especially in the face of the change in

Soviet operational maneuvers? A wrong guess by the commander "could be fatal."<sup>21</sup>

Steven L. Canby, a widely experienced defense consultant, added to these thoughts in a report written for the Assistant Secretary of Defense for Program Analysis and Evaluation, and provided to the Department of the Army in October 1978. Canby described the new dominant Soviet operational maneuver—meeting engagement followed by flexible response—as an "ex post and opportunistic" maneuver not discernible in advance, a maneuver that would have serious consequences for the FM 100–5 tactics of defense built on the strength of a series of battle positions. "Severe ramifications fall from FM 100–5 having built its edifice on but one of the possible Soviet operational maneuvers."<sup>22</sup>

Tactical doctrine could be adjusted to changes in Soviet offensive maneuver planning, and corrections were soon underway by doctrine writers at TRADOC. Planning documents such as the Battlefield Development Plan of November 1978 and the Division 86 Study that began that year were, in depiction of Soviet doctrine, to fix upon the onset of battle in Europe as a series of meeting engagements.<sup>23</sup>

## *Tactical Reserves Issue*

Another prominent issue in the critique of the 1976 doctrine was the perceived elimination of the tactical reserve by the doctrinal call for the fullest application and concentration of

the division's maneuver battalions at critical points on the battlefield as the enemy attack unfolded. These tactics amounted to abandonment of the traditional disposition in the defense of "two up – one back". Critics perceived the issue as a central one and made it a main point of debate.

One of the most extensive, and favorable, critiques was that provided in February 1978 by Archer Jones who saw the doctrinal commitment of most or all battalions to action as an original contribution to the theory of the defense. Jones saw in this development, the "unsubtracted tactical reserve," the last, logical step in a process since de Bourcet and de Guibert in the 18th Century.<sup>24</sup> The tactical defense had always depended on the subtracted reserve of two tactical organizations forward and one in the rear in reserve, since, unlike the tactical offensive, it was not mobile and did not enjoy the option of choosing movement and suspending the defense. FM 100-5 broke new ground by asserting that the tactical defense could be constructed in the same manner as the strategic defense and tactical offense. That is, there need not be a subtracted reserve because all forces not irrevocably engaged were in reserve. FM 100-5 was asking whether the tactical defense could not concentrate against strength without resort to a subtracted reserve. Jones added the caution that the theory had never had a systematic trial. Was it too facile? It was unsafe to assume, he added, that the defense could not be surprised and penetrated.<sup>25</sup>

TRADOC was aware of the reserves dilemma and was far from declaring a "no reserves" dogma. A reserve was desirable if forces were available, and it could be expected that at least one

echelon, either brigade or division, would have a reserve. Addressing the issue publicly in 1978, General Starry acknowledged the lack of a large reserve, pointing out that the target servicing task was so acute, it was impossible to afford one.<sup>26</sup>

## Emphasis on Firepower

In an Army historically accustomed to the offense and schooled in the example of a war of movement, a body of tactical doctrine stressing firepower at the perceived expense of maneuver was bound to raise some suspicion. There was no doubt about the emphasis the 1976 doctrine placed on firepower. Nor were its authors alone in their sober appreciation of that enhanced factor in modern battle—as the earlier discussion of the Soviets' reading of the 1973 Mideast War has noted. But was it true that the firepower emphasis signalled a self-crippling antimanuever doctrine? Or had firepower been accorded an ascendancy required by the onset of a new era in tactical warfare?

William Lind's critique scored the 1976 *Operations*' adherence to an alleged "firepower/attrition doctrine," in contrast to a Soviet doctrinal commitment to maneuver. Lind noted, for example, that the first capability of the tank that the doctrinal manual discussed was not tank mobility but tank firepower. Lind attempted a historical example to underscore his point and drew parallels between the 1976 doctrine and the ill-fated doctrine of the French Army in 1940, which stated: "of the two elements, fire and movement, fire is predominant."<sup>27</sup>

Philip Karber, answering Lind directly, asked whether the new technology, particularly antitank guided missiles and improved artillery munitions, did not portend a firepower ascendancy over maneuver. Karber also pointed out the increasing and acute Soviet awareness of the tactical ramifications of the new technology and their increasing worry about anti-tank guided weapons. "Quite clearly the Soviets increasingly see firepower as a prerequisite for maneuver when facing a prepared defense which incorporates the new technology." Further, Karber contended, TRADOC was placing much greater emphasis on maneuver than in the past, but maneuver tailored to the European battlefield.<sup>28</sup>

TRADOC's October 1976 statement in *Armed Forces Journal* asserted that a dependence on firepower and attrition did not exist at the expense of maneuver. Army doctrine advocated bold maneuver in conjunction with both offense and defense. Concentration, as described in FM 100-5, "is 'maneuver and maneuver therefore is the basis of the entire doctrine.'"<sup>29</sup> As boughty noted, this reply pointed up, as well, the key element of concentration in the doctrine of the active defense—maneuver in the sense of moving to deliver firepower or to increase combat power.<sup>30</sup>

In the new doctrine, firepower had not displaced maneuver in the defense, but it was a firepower-weighted doctrine. And this was inherent in the defense stance seen as imposed by the strategic reality of inferior defending numbers. Soon after General Starry assumed command of TRADOC in July 1977, his schema of the Central Battle gained strong doctrinal influence -- actually underlining, in such concepts

as "target servicing," the firepower emphasis of the active defense.<sup>31</sup>

## *Concentration Tactics*

Critiques of the 1976 doctrine focused invariably on the tactics of the defense—the operation perceived by the manual writers and critics alike as the immediate first requirement for fighting and winning the land battle. Within this operation, the active defense tactics of concentration drew the most comment. As a prelude to discussion of the points at issue, the leading ideas of the active defense bear brief summary.

The most significant elements were the strong detection, defending, and time gaining role of the covering force; a forward focus and deployment of the division's maneuver units; a considerable reliance on sensor and electronic technology to locate positions, enemy strength, and movement; central dependence on reliable communications, facilitating controlled highly mobile lateral movements toward critical points and alternate defensive positions; an emphasis on rapid defensive concentrations to present effective force ratios and combat power at the points of clashing forces; as a consequence of this, a willingness to take risks on the flanks and elsewhere; and, as noted earlier, a commitment to action of forces traditionally held in reserve.

The Lind critique led off the debate on defensive tactics as it had on other aspects and assumptions of the doctrine of 1976. This discussion questioned the

provision for "bounding overwatch" withdrawal operations to alternate defensive positions as requiring a "precisely choreographed series" of movements difficult if not impossible to time effectively and subject to the enemy's superior jamming and electronic warfare capabilities to disrupt communications and control. Lind also questioned whether the enemy would permit U.S. commanders to call in forces from the flanks for concentration. Would the enemy not maintain sufficient pressure to force the defending force to remain deployed and so prevent the maneuver to concentration so critical in the doctrine? Would communications remain sufficiently undisrupted to permit the defenders' quick lateral movement toward the enemy's axes of attack? Lind's critique went on to interpret the defend-forward doctrine as appearing to advocate a linear defense in the main battle area.<sup>32</sup> The last point seemed the least valid, and Karber, in his discussion of October 1976, countered that deployment and engagement forward were specifically not the linear defense logic—two up – one back—but a mobile defense of greater depth.<sup>33</sup>

In July 1977, John F. Sloan raised two additional issues. Did the new doctrine sufficiently attend to the overwhelming Soviet artillery ratios? Sloan also believed that forces drawing in their flank support rendered themselves vulnerable to encirclement.<sup>34</sup> All together the above points fairly well rounded out the main criticisms. Individual critiques that followed pursued them more closely.

In his thoughtful assessment, Archer Jones gave the doctrine high marks for enunciating clearly and applying consistently what he believed to

be the fundamental principle of operations—on the offensive, concentrate on the enemy's weak point; on the defensive, concentrate at his strong point. But Jones found the concentration issue nonetheless troubling. The Army's doctrinal manual did not, Jones said, treat an enemy turning of an inferior front when the defender concentrated at the point of attack, leaving other sectors vastly outnumbered (perhaps 21 to 1 in some instances) and defenseless against secondary thrusts. Jones found that the manual implicitly assumed the impossibility of a continuous front with today's manning—but did not face the consequent need to treat the strategy and command tactics of discontinuous fronts. Had the new doctrine overlooked the problem of actual or apparent pressure all along the line, Jones asked?<sup>35</sup>

The Jones critique also argued that the doctrine of the active defense did not cover what happens "when things go wrong," as for example, when communications don't work very well. Further, had technological improvements in intelligence gathering raised too high expectations about the quality of intelligence? Jones, too, raised the artillery factor—would an enemy artillery barrage destroy the force concentration on the main line? Jones suggested a perhaps neglected antidote to the vulnerable defense—a greater stress on field fortifications.<sup>36</sup>

In the spring of 1978, Fontenot and Roberts joined the issue of exposed flanks and fronts, seeing, in the presumption that the enemy would act as predicted, a general weakness of the active defense doctrine. This was a reference to the assumption of the Soviet classic breakthrough as the expected operational maneuver. Both

commentators saw the knottiest problem in the question of how to fight in the covering force area and still be able to react to penetration of the main battle area.<sup>37</sup>

At the same time, Captain Adolph Carlson conveyed an infantryman's skepticism that the linch-pin of the active defense—tactics dependent on powerful antiarmor fire—was truly representative of the future battle in Europe. The Soviet offense, Carlson argued, was built around flat trajectory tanks and short ranges and would avoid long range antitank guided missiles—our most effective counter. European terrain was a misrepresented factor altogether, possessing serious obstructions to the defender's lateral movements along with the advantages. This critique, too, stressed the tactical problems of rapid lateral movements to concentrate combat power. In the less than perfect conditions likely to prevail, such as poor visibility, inadequate fields of observation and fire, and restricted avenues of lateral movement, infantry would be critical. Infantry should have a more prominent place in the tactics of the active defense.<sup>38</sup>

One early outcome of the doctrinal debate was the Army's reemphasis on its principles of war. A general criticism of the doctrine of 1976 was that it was not firmly grounded in enduring principles. The 1976 FM 100-5 indeed did not identify or even list them. In September 1978 the Army mended the omission with publication of FM 100-1, *The Army*. The principles of war, as set forth in that manual, spelled out the fundamental principles on which military strategy and tactics had to be based. FM 100-1 also discussed the Army's role in the wide spectrum of conflict including the nuclear,



biological, and chemical dimension; stressed leadership; and noted the relationship of the military mission to the national purpose and to national policy.<sup>39</sup> There were all themes that would see application in the doctrinal revisions to come.

\* \* \*

The vigorous doctrinal debate following on the publication of *Operations* in 1976 brought the tactics of the active defense seriously into question. Concentration tactics demanded an ease of lateral movement that seemed unlikely, and the lack of dedicated reserves entailed risks that were seen to be unacceptable. The perception was widespread that the primary emphasis on a Soviet deep thrust maneuver encouraged a firepower-attrition vision of the battlefield.

The active defense was a tactics of limits-limits imposed on the U.S. Army by the political context of the mid-1970s in which the assumptions of detente excluded a forthright tactical orientation to the offensive, but in which at the same time the reality of the Soviet military buildup required serious attention to the tactics of fighting outnumbered against a technologically proficient enemy. The lasting contribution of the mid-1970s doctrine was that it confronted the changed technological situation and created a close awareness of the new lethality of the modern weaponry the U.S. Army faced. That lesson would not be lost in the doctrinal changes of the late 1970s. By 1978, new tactical ideas were gaining ground, and more would soon follow.



## *Chapter III*

# *Extending The Battlefield: Doctrinal Currents, 1977-1980*

General Donn Starry, who, as noted earlier, assumed command of the Training and Doctrine Command in July 1977, made significant additions and changes to the doctrinal positions reflected in the 1976 operations manual. Some of these came directly out of his experience as a corps commander in Europe during 1976 to 1977. Others arose from the continuing discussion and critique of FM 100-5 and varying perceptions of it. Still other changes were set in motion by evolving political conceptions in the Congress and among officials of the Carter Administration, at the end of the decade.

General Starry had been closely involved in the TRADOC doctrinal initiatives as commander of the U.S. Army Armor Center and Fort Knox from 1973 to early 1976. In February of the latter year, he had taken command of a major forward deployed force in Europe, V Corps, an assignment that carried with it for any commander a sense of immediacy about "the first battle." This conflict General Starry came to place in a somewhat larger frame of reference, which he called the "Central Battle." His view would extend TRADOC's appreciation of its doctrinal tasks into wider and deeper dimensions.

## *The Central Battle*

In the early weeks at Fort Monroe, General Starry propounded to his staff officers and commanders the Central Battle as a conceptual framework for what he saw to be TRADOC's development mission. Commanding a corps opposite major forces that were themselves in advanced stages of the Soviet buildup of the 1970s, he had had ample incentive to put thought to the definition and analysis of the corps' primary function.

Given the situation of the active defense against a major, armor-heavy attack by the Warsaw Pact forces, Starry envisioned the corps' response in terms of a structured Central Battle, which he defined as that part of the battlefield where all elements of firepower and maneuver came together to cause a decision. An analysis by V Corps of 150 battle situations in its sector and a separate array of tank battles of the past, together with intensive observation of actual enemy advance maneuvers and intelligence reflecting their locations, routes of movement, and tactics of attack, permitted a "calculus" of the Central Battle. Carefully marshaled tactics and a "bat-

the calculus" characterized the defenders' actions. U.S. units would give battle at known ranges. Terrain determined the number of enemy units that could advance and their rate and routes of advance. Specific initial and subsequent defending positions were identifiable.

In the battle calculus, measurable quantities were computed and analyzed in terms of minutes into the battle. Analytical categories included ratios of opposing forces by troop strength and weapon type, rate of enemy advance, intervisibilities across terrain, best ranges of fire by weapon type, comparative rates of fire, number and opportunities to fire, number of commander decisions, and time lengths to call for and receive attack helicopter support and Air Force close air support.

These factors and others permitted calculations of targets to be "serviced"-- the central task of the Central Battle. Kill rates by weapon type at various points and times and tactical levels could be estimated. The calculus suggested that large attacker-to-defender ratios (5:1 or greater) would be required to overcome an organized, determined defense. Close air support would play a critical role. Delaying or disrupting the enemy's second echelon forces was an enterprise inviting much attention.

The V Corps historical analysis added depth to the then current TRADOC perspective which had drawn chiefly on the most recent experience of significant armored and combined arms battle, the 1973 Mideast War. Also added, by the Central Battle frame of reference, was the implication of a planning framework. During 1977, General Starry described his long-term

goal for TRADOC as "to analytically describe the "Central Battle"--the place where all the combat systems and combat support systems interact on the battlefield."<sup>1</sup> As he explained to his staff in late 1977, what was needed was a battlefield technology plan.<sup>2</sup>

## *Battlefield Development and the Second Echelon*

During the following months, a larger development scheme was fleshed out by analytical planners at TRADOC Headquarters under Colonel Anthony G. Pokorny, Chief of the Combat Developments Analysis Directorate. The fundamental ideas soon fell in place. General Starry's corps overview in the Central Battle, his command goal to describe it analytically, and his desire for a battlefield technology plan set this goal in the mold of a major plan, to be assembled by a systems, approach.

Two other concerns helped develop the main idea. One was Starry's extension of the development period further into the future -- eight years ahead. This was a measured departure from General DePuy's concentration on immediate development problems-itself a sharp revision of the earlier habit of the old Combat Developments Command to cast long looks of up to twenty-five years into a hypothetical future. The Starry swing to a mid-future point of planning was much closer than had been the Combat Developments Command's distant perspectives. It also was a move into the known dimension of the oncoming 1980s weaponry, much of

which was, by 1978, well into engineering development and nearing production. General Starry's V Corps experience evoked another concern—the enormous factor of the Warsaw Pact's second echelon and follow-on forces, which intelligence indicated would efficiently follow to exploit the first-echelon attack. These forces "lined up" in somewhat predictable patterns. Could they, too, be "target-serviced" by the corps by feasible means and methods? There had been a too narrow emphasis on winning only the first echelon fight, General Starry believed. How to disrupt or delay the second echelon imposed a far wider planning dimension than that of the Central Battle alone.<sup>3</sup>

In order to explore a planning framework, both for combat developments and for the command's wider management tasks, and one that incorporated the corps overview as a frame of reference, Starry set his combat development planners to work in August 1977. As their deliberations extended into the last weeks of 1977, the corps commander's problems of "seeing deep" and dealing with the second echelon suggested the idea of "Force Generation" as a second prime corps function and functional concept alongside the Central Battle. On these dual concepts, in the ensuing months, planners constructed the functional framework of the Battlefield Development Plan.<sup>4</sup>

What had been conceived in late 1977 was a new planner's view of battle: a battlefield much deeper in its physical dimensions and with a fresh conceptual framework. It remained to work out the fundamental components of the Central Battle and Force Generation functions—the conceptual ele-

ments to which all individual development goals could be tied. Employing an analytical time frame extending into the mid-1980s and using data on existing and planned materiel systems, planners saw the Battlefield Development Plan as a basis for setting priorities and for influencing planning, programing, and budgeting by the Department of the Army. An analytical method termed "multi-attribute utility modeling" was adopted as a schema of the battlefield developed according to what were perceived to be the ten critical tasks of battle.<sup>5</sup>

Critical tasks of the Central Battle were defined as target servicing, air defense, suppression-counterfire, command-control-communications-electronic warfare, and logistical support. Those of Force Generation were interdiction, command-control-communications, force mobility, surveillance-fusion, and reconstitution. The ten critical tasks were envisaged as encompassing all aspects or subtasks of battle. Prepared in four chapters, the BDP was published and distributed throughout the Army in November 1978.<sup>6</sup>

The Battlefield Development Plan forecast an "environment" in the coming ten years in which the rapid change of U.S. Army technology would have first-order impact. Technologies such as special armor protection, near-instantaneous communication of battlefield data, thermal imagery, and command and control synthesis would create great problems of cost and complexity, imposing the most difficult issues of selection, priority, and training. The materiel development cycle would have to proceed faster than ever, with accelerated fielding of new systems running concurrently with both improvement programs and development of

future systems. A total systems approach had to prevail. Serious problems of trainability were expected to grow severe, as weapons and equipment became ever more complex.<sup>7</sup>

The Battlefield Development Plan next presented a detailed net assessment of U.S. and Soviet military capabilities and potentials in personnel, force structure, sustainability, training, nuclear-biological-chemical warfare, radio-electronic warfare, and force modernization. Some of the unclassified observations and conclusions of this SECRET analysis pointed to such realities as a ratio of major weapon and equipment systems per man in the U.S. Army of .7 to 1.0 and, at the very same time that the requirements of individual training would be expanding, a decrease in training resources. Furthermore, new logistical concepts would have to be structured into organization and doctrine.<sup>8</sup>

The heart of the Battlefield Development Plan was a comprehensive "air-land" battlefield analysis built upon the framework of the separate but inter-related battlefield functions of the Central Battle and Force Generation, along with their derivative tasks. All of this was viewed from the perspective of a division operating in a corps in Europe. Though the Central Battle and Force Generation concepts were mutually supportive, the Central Battle was the principal function at battalion and brigade levels, while Force Generation functions increased at each echelon up through the corps and theater level.<sup>9</sup>

The Central Battle was "the collision of battalions and brigades in a decisive battle," combining

all elements of air-land confrontation—firepower, maneuver, and support. It consists of tank-antitank, mechanized, and dismounted infantry combat, supported by artillery, air defense, close air support, helicopters, engineers, electronic warfare, command-control-communications, and essential logistic support. It is characterized by the integration of all air and ground systems and the decisiveness of the outcome.<sup>10</sup>

For U.S. forces, the Central Battle concept conceded the strategic initiative to the stronger opponent. Soviet attack was posed as starting with a series of meeting engagements, followed either by concentration of forces on key axes of advance or by an attack into the defender's rear area. In order to strip away the enemy's reconnaissance screen, to slow or stop his breakthrough attempt or his attack on the rear area, and to go over to the offensive, the five tasks of the Central Battle would predominate.

Force Generation was the concept by which "NATO commanders must anticipate Central Battles and the opportunities they would provide. . . ." <sup>11</sup> Whereas Central Battle focused on combat effectiveness, Force Generation concentrated combat power at the decisive time and place in order to win Central Battles, simultaneously impeding the enemy's ability to do the same thing. Force Generation occurred as the enemy's second echelon was being sought and as U.S. defenders prepared for the next Central Battle. All-source surveillance systems would be used to track the enemy's movement and massing, and his concentrations of command-control-communications. U.S. forces would disrupt enemy movement, using such interdiction means as

tactical air and a new long range weapon, the general support rocket system. Force mobility would emphasize the massing of forces to respond. Personnel and materiel would be reconstituted for the impending battle. Command-control-communications would be an obviously key task.<sup>12</sup>

In Force Generation, also, the Central Battle commander had a responsibility at least as important as the initial assault. This responsibility was "seeing deep" into the enemy's rear areas and concentrating combat power to attack the enemy second echelon forces, before they reached the battlefield. General Starry's aim in using the new functional framework of the Battlefield Development Plan was to get division and corps commanders away from thinking in terms of branch organizations and capabilities. Instead, he wanted them to think in terms of the new functions and concepts that he felt had become critically important in modern battle.<sup>13</sup>

In the Central Battle view and concern about the great factor of the Soviet second-echelon forces, the Battlefield Development Plan of late 1978 furnished the beginnings of what would emerge in the succeeding period as the deep battle concept. The Battlefield Development Plan also laid the basis for the major Division 86 project by TRADOC, launched in October 1978. The Division 86 Study, a command wide effort, was structured on the plan's functional battlefield view and concepts. It stimulated many doctrinal ideas. In late 1979, it was extended by the Chief of Staff of the Army into the larger Army 86 Study, encompassing not only the heavy division but the light division, corps, and echelons above corps organizations of the future Army.<sup>14</sup>

## *Instituting a New Doctrinal Process*

The way to a new prominence for doctrinal work at TRADOC Headquarters and to new approaches in the command-wide development process was opened in 1979—with the establishment in the headquarters of an Office of the Deputy Chief of Staff for Doctrine (ODCSDOC)—provisionally in May and formally in October.<sup>15</sup> General Starry believed in the primacy of "operational concepts" in development work, and in the new ODCSDOC, he had a strong staff advocate for that view. The ODCSDOC had the potential to be far more effective than the small Headquarters Tactical Doctrine Office that had supervised production of the "how-to-fight" doctrine manuals and associated literature between 1976 and 1979.

Personnel from the Old Tactical Doctrine Office transferred to the new ODCSDOC, among them Colonel Edwin G. Scribner as acting Deputy Chief of Staff. The new doctrine office, initially organized with a threat director and air-land and nuclear offices, at first divided its major effort between two directorates for operational concepts and for doctrine development. Essentially, this was a production-phase arrangement that soon proved unsatisfactory. In November 1979, Colonel Scribner realigned the two major directorates into functional combat and support directorates, just prior to assignment of the first general officer to head the function. In December 1979, Brig. Gen. Donald R. Morelli assumed the position of Deputy Chief of Staff for Doctrine. In January 1980, a separate Doctrine Management Office within



Brigadier General Donald R. Morelli



ODCSDOC was established to begin development of a management system for the Army's doctrinal program. The work of this office was to lay out responsibilities for operational concepts and doctrinal literature, to create a doctrinal literature program, and to revise procedures and regulations accordingly. By late 1980, the separate nuclear and air-land entities had been absorbed by the combat directorate.<sup>16</sup>

As TRADOC's doctrinal developers set about their work in the latter half of 1979, they faced the common transition problem of coexisting approaches—one inherited, the other new. Already in place was the TRADOC program, under way since the mid-1970s, to produce key how-to-fight and logistical how-to-support field manuals. These manuals were the major doctrinal statements in all fields of combat and support from which the Army's training literature and other training products were derived. Rooted in the latest tactical doctrine set forth in the FM 100-5 of 1976, the how-to-fight manuals were focused on the near- to mid-term. They expressed the revised tactics and support operations that had grown out of the lessons doctrinal thinkers drew from the Mideast War of 1973, and that were implicit in the new generation of weapons and equipment which was in initial distribution to the divisions by the late 1970s.

Almost from the beginning of his tenure at TRADOC, General Starry put emphasis on operational concepts as a developmental starting point and in early 1979, he systemized this approach. In February of that year, several weeks before establishment of the provisional Office of the Deputy Chief of Staff for Doctrine, he described how operational concepts should lead

to doctrine, viewing them as "a description of military combat, combat support and combat service support systems, organizations, and tactical and training systems necessary to achieve a desired goal."<sup>17</sup> Concepts had to be the first-agreed upon part of any project. They were dynamic and changing, as perceptions and circumstances changed. They were not tied to specific pieces of materiel but to more general requirements. Concepts did not become doctrine until tested, approved, and accepted, and not all concepts would result in doctrine. He defined doctrine as "what is written, approved by an appropriate authority and published concerning the conduct of military affairs."<sup>18</sup> An initial concept proceeded to operational concept by states: concept statement, expansion into an interim operational concept, evaluation, and, lastly, approval and issuance as an operational concept. Once published, it served as the basis for analysis, evaluation, and development of relevant doctrine. It was the basis for field manuals, and for the development of the equipment, organizations, and training required to prepare individuals and units to employ the concepts in battle.<sup>19</sup>

The first of these operational concepts, on tactical intelligence and tactical command control, appeared in June 1980. Others followed in the ensuing years on such subjects as the AirLand Battle and heavy division operations. A total of twenty-one operational concepts had been provided and disseminated by December 1982.<sup>20</sup>

Formalization of a doctrinal literature program followed TRADOC's establishment of operational concepts as the basis of doctrinal formulation. Early in 1980, General Starry told his subordinate commanders within

TRADOC that the time had come to begin a second generation of the "how-to-fight" doctrinal field manuals that had come out of the mid-1970s doctrinal effort. The new manuals would incorporate the Army's move onto the integrated battlefield,<sup>21</sup> and they would encompass the tactics, systems, and organizations stemming from the Army 86 studies. In August 1980, Starry approved a regulation for a doctrinal literature program—Operational Concepts and Army Doctrine—which was published in December 1980."<sup>22</sup>

The new doctrinal literature program affirmed the procedures established in 1979 to make operational concepts the first state of doctrinal development. The program also outlined a changed management scheme. Doctrinal literature would no longer be managed from TRADOC Headquarters, nor would selected field manuals be written there. Instead, the program settled upon the Combined Arms Center at Fort Leavenworth the formal and actual responsibility for managing the writing and production of the doctrinal field manuals by the integrating centers and schools. Further, the new Doctrinal Literature Program restored to the instructors at the schools the central role of doctrinal formulation and writing that they had previously had. In 1976, TRADOC had separated doctrine writers from instructor groups, and General Starry believed that the separation was hampering the doctrinal literature effort. Transfer of the essential management responsibilities placed the function in the Command and General Staff College.<sup>23</sup> The formal formal transfer postdated somewhat the doctrine writing effort that had already begun in the Command and General Staff College at

Fort Leavenworth, as well as other important doctrinal developments, to which we will now turn.

## *Converging Ideas, 1979-1980*

The institutionalization of a doctrinal process by TRADOC during 1979 was accompanied by other noteworthy developments. We have already discussed the reaction to several aspects of the 1976 doctrine by doctrinal thinkers and critics both within and outside the Army. The intensity of that debate was a measure of the misgivings that existed within the Army itself about the doctrine of the active defense—misgivings which the debate did not satisfactorily resolve. Some of these views were shared by Lt. Gen. Edward C. Meyer, who in early June 1979, as the then Deputy Chief of Staff for Operations and Plans in the Department of the Army (and to be appointed, within the month, as Chief of Staff of the Army), suggested to General Starry that TRADOC begin to consider the revision of the 1976 operations manual.

General Meyer had two primary concerns. The first was that FM 100-5, written for battle in Central Europe, lacked worldwide doctrinal application. Meyer believed that wars outside NATO Europe, while less important from the standpoint of national survival, were more likely to occur than a European war. FM 100-5, therefore, needed to be made applicable across the board and not only to Central Europe. General Meyer's second major concern was the widespread perception of the



General Edward C. Meyer

defensive orientation of the 1976 manual. Whether that perception was right or wrong, it needed to be overcome. There was also a feeling in the Army Staff that the active defense was not understood well, that it was viewed in some units in the field as nothing more than a delay. Meyer additionally thought that FM 100-5 needed to be enlarged in scope to embody the concept of the corps and theater battlefields and that it needed to reexamine the presumption of single-axis breakthrough tactics by the Warsaw Pact. Replying to General Meyer in late June, General Starry noted TRADOC's ongoing second echelon efforts as an approach to the active defense problem, and agreed that doctrine for other world regions and types of warfare needed attention.<sup>24</sup>

General Meyer's push for an FM 100-5 revision found doctrinal activity in TRADOC in a state of rapid evolution. Throughout most of 1979, the Division 86 planners at the Combined Arms Center, Headquarters TRADOC, the Field Artillery School, and the other centers and branch schools were working with the idea of second echelon interdiction by the division as it sought ways to deal with the overwhelming numbers and firepower of the Warsaw Pact armies. The tactical corollary of "seeing deep" was operating deep, and the subject of deep interdicting operations was of first-order importance. It was one of the most important aspects of the whole doctrinal problem and central to the debate in which firepower, maneuver, and the air-land forces relationship all were prominent issues.

In addition, the subjects of tactical nuclear and chemical warfare in NATO's Central European theater were reemerging as a focus of interest

in the late 1970s, as American policymakers entertained more candid appraisals of these aspects of the Soviet threat. It was in this context that TRADOC undertook planning for two major "systems program reviews"<sup>M</sup>--one for tactical nuclear systems, to be held in December 1979, and the other for chemical operations, in May 1980. A major responsibility assigned to TRADOC, the system program reviews were periodic summings-up of the status of materiel, doctrinal, and training developments in the major branches, for the specific information of the Vice Chief of Staff of the Army but also for the Army at large. Reviews of field artillery, infantry, and other systems, through the 1970s, were widely attended. Those for the tactical nuclear and chemical fields were on the schedule in 1979-1980 for the first time in the post-Vietnam era.

The concept work on interdiction and tactical nuclear operations was brought together in meetings and special studies of late 1979 and early 1980. On 11 October 1979, the TRADOC Planning Air-Land Directorate at TRADOC Headquarters presented an Army view of the air and land battle to a meeting attended by both the Army and Air Force Chiefs of Staff, General Meyer and General Lew Allen, Jr., the Vice Chief of Staff of the Army, General John W. Vessey, Jr., the commander of the Tactical Air Command, General William L. Creech, and General Starry. This so-called "twenty-star" meeting took up issues deriving from joint air and land doctrinal efforts by Army and Air Force planners at TRADOC and TAC headquarters—to be discussed later in this history. The meeting was also important, however, for the airing of concepts coming out of the Division 86

Study and for a recognition by participants that the attack of the second echelon that was increasingly being emphasized included the opportunity to go on the offensive. The air-land briefing raised the subject of non-NATO contingencies as well as the prime NATO mission. The TRADOC concept briefing envisioned, on the NATO front, a variety of Soviet operational maneuvers, stressed the time factor of the arriving Soviet echelons, and described sortie requirements for the required air interdiction.<sup>25</sup>

The "twenty star" Air Force-Army meeting was followed shortly, on 18 October 1979, by formal presentation of the concept and organization of the Division 86 heavy division to General Meyer. Approving the new heavy division in concept, Meyer directed a major expansion of the Army 86 Studies to include the light division, corps, and echelons above corps.<sup>26</sup> The Corps 86 Study, already under way for some weeks at the Combined Arms Center, would serve as a useful planning vehicle in deliberations through 1980, as planners worked out the concept of corps battle in interdiction, tactical nuclear, and air-land frameworks.

Significant to the whole direction of the doctrinal effort at this point was a third meeting, the Nuclear Systems Program Review held at Fort Sill on 18-19 December 1979. Field Artillery School planners presented a concept of an "integrated battlefield" which included the tactical nuclear option and spelled out tactical approaches to and results of interdiction by conventional and non-conventional means.

Finally, as noted earlier, the years 1979-1980 were bringing a sharp change to the perceptions of the Carter Administration about the proper state

of military readiness vis-a-vis the Soviet Union and an unstable Third World. In the mid-1970's, that world outside NATO's European theater had become increasingly characterized by Soviet and Cuban-aided insurgencies and, with Afghanistan in late 1979, by outright Soviet invasion. Almost simultaneously with the Afghanistan invasion occurred the opening episode of the year-long Iranian hostage crisis. These momentous events led to a shift of approach on the national level during 1979-1980 that gave impetus to policy changes regarding the tactical nuclear issue and rapid deployment worldwide, having immediate impact on Army doctrine. We will turn briefly to each of these converging events of 1979-1980.

## *Interdiction*

The interdiction of enemy forces in their rear areas by tactical air strikes, ground maneuver, and long-range artillery fires was hardly a new idea. What was different in the interdiction challenge facing Army doctrinal planners in the late 1970s was the situation of Soviet echelonment and the possibilities which such a line-up of enemy units offered to the imaginative U.S. commander.

Late in 1979, the Field Artillery School developed an interdiction concept which departed from the traditional view of interdiction as a tactic primarily to interrupt the enemy's sustaining resources by attacking his lines of communications, logistics, and replacements.<sup>27</sup> Improved technology in the categories of target acquisition, real-time communications, and long-range strike capabilities, it was argued,

had greatly changed the interdiction picture. The concept noted a developing consensus that a credible theater nuclear employment concept, both for political and for operational reasons, would have to focus heavily on targets well beyond the front-line battle. Further, regulating the pace of the Central Battle at the front-line might delay eventual defeat but could not by itself guarantee victory, if the numerically superior Warsaw Pact forces were willing to pay the price in casualties.

What was needed was an interdiction concept that abandoned the random interruption idea—one that could itself “set the terms of battle.” A concept was needed that could seize the tactical initiative to find a way to use the enemy's very momentum in order to defeat his attack, disrupt his plan of operation, and force him to fight in a time, place, and manner that negated his numerical advantage. In short, Army doctrine had to “shape the central battle, producing a configuration of enemy forces in time, space, and strength adapted to their defeat.”<sup>28</sup> The battle had to be managed in depth. Central Battle and Force Generation could no longer be viewed as independent problems—there was only one battle.

Specifically, the concept split the interdiction mission between division and corps. At corps, interdiction was oriented to attrition and targets, at division to maneuver and interdiction actions linked to the division's own operations plan. Further, interdiction by the corps was far more time-sensitive, and it had a critical requirement for rapid strike planning. Interdiction by the division was sensitive more to battle events, since so closely linked to the division's own plan of ac-

tion. Carefully planned interdiction could, in conjunction with the defensive battle plan, help influence when, where, how, and with what forces the Central Battle took place. Enemy forces could be canalized, gaps in their formations could be opened or widened, and their reserves could be delayed or destroyed. These interdiction measures could turn the enemy's momentum into a vulnerability. By protecting the movement of U.S. counterattacking forces, interdiction could at the same time help gain freedom of maneuver. It could, in sum, help wrest the initiative from the attacker and permit the waging of the Central Battle on U.S. terms. These efforts depended foremost on effective intelligence, surveillance, and target acquisition and command, control, and communications means. Those capabilities were indeed among the most important elements of all in dealing with the second echelon, as the Field Artillery commander, Maj. Gen. Jack N. Merritt, wrote General Starry the following year.<sup>29</sup>

The interdiction concept was only one part of the larger issue, in which corps systems and corps coordination with tactical air would play a major role. The whole subject, including the tactical nuclear option, was being opened up in late 1979 by doctrinal planners at the Field Artillery School who were preparing for the December Nuclear Systems Program Review.

## *The Integrated Battlefield*

The objective of the Nuclear Systems Program Review, which convened at Fort Sill on 18–19 December



Major John S. Doerfel

1979, was to describe a "war-fighting strategy" and the doctrine to implement it, as well as to determine the current capabilities and future needs for fighting on a conventional, nuclear, and chemical battlefield. Preparations were geared to four review panels—for operations, command and control, logistics, and training—but were not restricted to the work of the four panels proper.

At the Field Artillery School, a special doctrinal group was formed which was led by Col. Anthony G. Pokorny, the Director of Combat Developments at the Field Artillery School, who had earlier had an important part in developing the ideas of the Battlefield Development Plan at TRADOC Headquarters, and Maj. John S. Doerfel, an officer assigned to the Concepts Division under Pokorny. Several in the group had earlier had

doctrinal planning responsibilities under General Starry in V Corps. Reexamining active defense doctrine and working with concepts of second-echelon interdiction, including the battlefield interdiction proposals, together with ideas on time-lines, targeting cells, and the nuclear/chemical battlefield from the former V Corps planners, and other emerging concepts, the Pokorny-Doerfel group developed an operational concept for what they called the "integrated battlefield."<sup>30</sup>

The operational concept presented by Major Doerfel on 18 December advanced a battlefield view that, for the first time, integrated the tactical nuclear option and the deep second-echelon interdiction ideas into a general scheme of tactics and operational maneuver. By an integrated battlefield, the Fort Sill planners meant more than the option of tactical nuclear use. They meant integrated conventional and tactical nuclear fire support, integrated maneuver and fire support, and integrated air-land operations. The integrated battle was an air-land battle—the only context in which they believed it could be logically discussed.<sup>31</sup>

There were several key principles. Enemy forces had to be interdicted before they joined the battle. Tactical use of nuclear weapons provided an opportunity for initiating offensive operations. Planning, coordination, and use of nuclear weapons had to be integrated into maneuver force operations, both offensive and defensive. Integration had to employ means common to both non-nuclear and nuclear operations for intelligence collection; target acquisition; command, control, and communications; operations planning; and fire support.

Applying these principles would open doctrinal opportunities. They would counter Soviet capabilities to commit fresh combat power into the battle. The echelonment of Soviet forces afforded space and time windows in which to act and offered lucrative targets. Targeting "high pay-off" elements of the second echelons delayed those echelons' arrival, disrupted their closely coordinated commitment, and stripped enemy tanks of their support structure.

We have already noted the Army's concern about the powerful second-echelon forces of the Warsaw Pact. Doerfel presented a close analysis of the line-up of those echelons in terms of regiments, divisions, and armies in relation to their distance from the forward edge of the battle area. The overwhelming evidence of the argument was that no matter how effectively the Soviet assault echelons were defeated, the advancing second echelons would at some point overwhelm the target-servicing capabilities of the worn-down defending forces. A battle without interdiction would, in short, end in eventual defeat before the enemy's superior firepower and numbers. Firepower alone would only protract the battle of attrition; it would not offset the enemy's momentum, and it was essentially a reactive strategy.

Thus, a new battle strategy was needed and one that regarded the assault battle and interdiction of the second echelon not as two separate battles but as two elements of the same battle. In the general conception, timelines were a significant factor. Brigade commanders looked out beyond the forward line of troops to about fifteen kilometers, division commanders to thirty kilometers, and corps com-

manders to 150 kilometers. But more important than these approximate distances, were the approximate times separating commanders from the enemy second echelons with which they had to contend. The brigade commander looking beyond the enemy assault echelon to the second echelon forces had a planning horizon of about 12 hours, the division commander 24 hours, and the corps commander 72 hours. These time-spans were seen as germane regardless of what type of operational maneuver the enemy used. The time-conception just outlined placed upon U.S. commanders the requirement for initiative. They had to regard the oncoming echelons in terms of momentum, and specifically the elements of that momentum—mass and velocity. The momentum of enemy forces could be altered by destruction and attrition of the enemy's mass. Velocity could be altered by measures to disrupt and delay.

In the Field Artillery School's concept of the integrated battle, the need for a credible and integrated tactical nuclear-conventional response was seen as mandatory. This capability itself would act to hold the enemy at risk. The prospect of tactical nuclear strikes would also discourage the enemy from forming the relatively dense formations required for breakthrough operations. The enemy's dispersion to make himself less vulnerable to nuclear strikes would, on the other hand, negate the potential of his echelonment. Attack on enemy combat support and combat service support elements in the rear could achieve maximum delay, because these elements contributed more to the velocity and cohesion of the enemy's battle at extended ranges than did his combat systems.



The briefing by Major Doerfel pointed out, however, that the very procedure of preparing to execute tactical nuclear strikes, which required "national command authority" for release, reduced the effectiveness of the fighting force. To convert from conventional to tactical nuclear operations, and to convert back again should release authority not be granted, greatly weakened the fighting unit's ability to engage in the operations of conventional battle. In addition, the planning of nuclear strikes while recovering from the enemy's preemptive nuclear strikes imposed very significant difficulties. The whole point was that, in terms of attrition to U.S. forces, the time needed to plan for tactical nuclear operations was not without significant costs.

The answer to the dilemma was an integrated approach to battle specifically including the tactical nuclear option. Doerfel presented the significant implications: There was no non-nuclear battlefield environment anymore. By the time a commander could clearly demonstrate the time to be right for use of nuclear weapons, it would already be too late. Commanders could not afford to plan and prepare for nuclear-dependent maneuver operations unless release was assured. Air and long-range missile systems alone might provide the only viable counterstrike capability. Integrated battle planning had to produce a decisive change in the course of the battle. The aim of fighting the integrated battle should be to win—not to avert defeat.

The requirements following from those implications were also significant. Commanders had to take a whole-battle view, plan for preemptive enemy strikes, and develop an engagement strategy. The tactical nuclear release

procedure had to be simplified. Command, control, and communications had to be organized to withstand a massive enemy strike. Both maneuver planning and targeting had to be continuous and concurrent. Battlefield interdiction had to be a joint air-land endeavor, had to include early and deep attack, and had to produce disruption, delay, and attrition. Doctrinal manuals and current war plans had to be revised accordingly.<sup>32</sup>

At the December 1979 meeting, which was widely attended by major Army commanders, the Field Artillery School planners laid out analytical descriptions of the conventional and tactical nuclear battlefield in Europe for the Army to see. General Vessey endorsed the principle of planning for tactical nuclear battle. He specified that the integrated battlefield concept would be developed within the framework of NATO planning and would not require a change of NATO strategy. That it was to be considered a joint concept for Air Force and Army was signalled by description of the integrated battlefield as "air-land<sup>m</sup>"—a term which was also in the NATO lexicon.<sup>33</sup>

As the Field Artillery School planners briefed the concept of the integrated battlefield within the Army during the early part of 1980, further work by the Combined Arms Center planners at Fort Leavenworth on the concept, followed by a target analysis executed by the Field Artillery School, demonstrated that well-planned interdiction of the enemy's second echelons not only could blunt the force of the attack but could critically interrupt its momentum. Interdiction could create periods with sufficient time to act, and during which nuclear release

authority, if needed, could be secured. Well planned interdiction, thus, created the "time windows" for action that would not otherwise have existed, given the enemy's great superiority in numbers and firepower. Interdiction widened greatly the possibilities for offensive action and for maneuver.<sup>34</sup>

In January 1980, General Starry sent General Meyer a report of the Nuclear Systems Program Review, outlining TRADOC's action plan to eliminate deficiencies in the Army's nuclear realm. The planning concepts for integrated battle, for preventing enemy victory through surprise use by the Warsaw Pact of nuclear weapons, for ensuring that U.S. use was designed to win, for gaining the initiative, for coping with the enemy follow-on forces—all these concepts required the revision of Army doctrinal and training literature and instruction, Starry wrote Meyer. They would accordingly be the basis for a three-year effort to develop tactical, training, organizational, and materiel requirements. The Department of the Army approved the review recommendations, and the Combined Arms Center incorporated them into a revised tactical nuclear/chemical action plan.<sup>35</sup>

Preparation for the integrated battlefield had immense significance for Army doctrine and training. The next order of business, was to revise FM 100-5, Operations, as General Meyer had advised General Starry in June 1979, along with the related doctrinal manuals and training literature. In February, Meyer enunciated the Army's commitment to war planning that encompassed non-conventional battle in a widely circulated "White Paper": "We must aggressively define our nuclear and chemical doc-

trine. . . and gain its acceptance by the national leadership and our allies."<sup>36</sup>

The function of the Combined Arms Center as the integrating center for combined arms developments made it the focus of the command-wide effort that was coming to a head in early 1980. Traditionally the center of tactical thinking in the Army, Fort Leavenworth had seen that role hampered when, several years earlier, General DePuy had moved responsibility for the operations manual published in 1976 from Fort Leavenworth to Fort Monroe. As noted, TRADOC Headquarters had at that time also instituted a school model in the command which, as an efficiency measure, had separated the writing and teaching of doctrine within the schools. As General Starry saw it, the separation had not been successful. Under the school model, those charged with teaching, explaining, and defending doctrine to their students had no part in formulating and writing the doctrine. Starry gave instructions in April 1980 to correct that anomaly. Doctrine writers were to be merged with the instructor groups throughout the school system.<sup>37</sup>

In early 1980, the doctrinal responsibility at Fort Leavenworth resided with the Concepts and Doctrinal Management Directorate of the Combined Arms Combat Developments Activity, and it was with that organization that the drafting of the new FM 100-5 initially rested. Meanwhile, with interest rising in the tactical nuclear and chemical realm, the Department of Tactics (DTAC) of the Command and General Staff College had formed a nuclear-chemical committee in 1979 to

plan implementation of these subjects into the curriculum, and some thirty hours of instruction were being given by January 1980 on the integrated battlefield. A main purpose of the committee was to determine the impact of nuclear weapons on tactics. The integrated battlefield remained the overarching concept well into 1980, and its ideas were developed within a reference book (RB 134) written by the committee. This work drew upon the Fort Sill integrated battlefield concept, although there were early concerns about the concept's heavy reliance on firepower models. There was also concern about an over-emphasis in the concept on the feasibility of deep attack to do more than delay the enemy's follow-on echelons. In July 1980, a TRADOC-wide symposium on the integrated battlefield was held at Fort Leavenworth to develop a comprehensive base of information.<sup>38</sup> That month General Starry directed commandants and commanders to incorporate operational concepts on the integrated battlefield in all doctrinal and training literature, studies, analyses, and requirements documents. He stressed that commanders had to get personally involved in that doctrinal task.<sup>39</sup>

## *Worldwide Contingencies*

A second major change resulting from evolving national policy, centering on the Army's role in a rapid deployment force, was the shift of attention in 1979–1980 to the doctrinal demands of the non-NATO world. This change, too, was announced formally in the February 1980 White Paper. Viewing "the critical decade of the 1980's"

ahead, the Chief of Staff of the Army presented a statement of the strategic requirements and discussed the needs and challenges of the force structure, of manning the total force, of the management of modernization, and of training and mobilization. The Army had to prepare for the "three days of war." It had to deter the day *before* the war, fight the day *of* war, and terminate the conflict in such a manner that, on the day *after* the war, the United States and its allies possessed an acceptable level of security.

While the commitment to NATO remained the cornerstone of 1980s foreign policy, General Meyer stressed that "the most demanding challenge confronting the U.S. military in the decade of the 80s is to develop and demonstrate the capability to successfully meet threats to vital U.S. interests outside of Europe, without compromising the decisive theater in Central Europe."<sup>40</sup> Citing the diverse threats posed worldwide by the Soviet Union and its surrogates, as well as by militarily sophisticated Third World states, and noting the decline of United States strength relative to that of the Soviet Union, Meyer declared that the Army of the 1980s faced a strategic requirement for "unprecedented flexibility."<sup>41</sup>

The Light Division Study conducted by the U.S. Army Combined Arms Center at Fort Leavenworth and the High Technology Test Bed project at Fort Lewis, Wash. inaugurated work in tactical concepts in the non-NATO arena in 1980 and after. To these projects were added studies of a contingency corps and its higher command echelon in late 1980 and 1981.<sup>42</sup>

## Corps 86

Throughout the first half of 1980, the integrated battlefield work within TRADOC paralleled the Division 86 and Corps 86 Studies under way at the Combined Arms Center under a group headed by Col. John R. Greenway with task forces at the other TRADOC integrating centers and the branch schools.<sup>43</sup> Most germane of the Army 86 Studies to doctrinal developments was the Corps 86 project, which had begun in the fall of 1979. The corps possessed the principal interdiction means crucial to disruption of, or attack upon, the enemy second echelons. Also, the corps was the Army headquarters at which the concerted air and land battle had to be coordinated with the Air Force. The second echelon battle and air-land operations were two of the study's principal focuses.<sup>44</sup>

In the Corps 86 planning meetings of the early months of 1980, the Combined Arms Center emphasized the second echelon as a paramount concern. The corps artillery function of interdiction presented a major challenge and was not easy to define,<sup>45</sup> but by May 1980, a preliminary operational concept was formulated and presented to a Corps 86 workshop on 19–20 May at Fort Leavenworth.

The concept emphasized the forward defense strategy of the NATO defense. Tactically, it embodied the commander's view of the "deep battle area" beyond the forward line of troops (FLOT). This zone would include a corps area of *influence* out to 150 kilometers and an area of *interest* out to 300 kilometers beyond the FLOT—concepts that originated in the doctrinal work in CACDA and that were published as a TRADOC operational

concept in June 1980.<sup>46</sup> Coordinating his divisions and corps troops and allocating his other units, the corps commander coordinated the air-land battle, coordinated operations with allies, integrated all U.S. and allied and sensor data, and protected the rear area. It was his specific responsibility to "see" the enemy second echelon Army and to attack second echelon forces out to 72 hours beyond the FLOT. Interdiction was only one of the several corps artillery functions, but an all-important one for the concept. Inclusion of tactical nuclear and chemical options was a significant addition to the corps concept.<sup>47</sup>

Not yet clear in May 1980, however, were the exact responsibilities for nuclear and chemical operations. General Starry directed that the operational concept state clearly that the battle against the enemy's assault and follow-on forces would begin immediately upon the outbreak of hostilities. After further work, the corps interdiction concept was approved by Starry in June,<sup>48</sup> and the Corps 86 operational concept was published internally in July 1980.

Strong emphasis was placed on the necessity for commanders to think in the space-time terms required to defeat enemy forces in contact before the arrival of follow-on forces. Commanders had to divide their time between the area of the battlefield they needed to influence immediately and the farther-distant area of interest. Times and distances would always vary according to factors of mobility, mission, enemy, terrain, weather, and troops available. But time and distance guidelines, by level of command, were also important in the corps application of the deep interdiction concept. Guidelines for commanders' areas of *influence* were:

<u>Level of Command</u>	<u>Time</u>	<u>Approximate Distance Beyond Forward Line of Own Troops</u>
Battalion	0- 3 hrs	5 km.
Brigade	0-12 hrs	15 km.
Division	0-24 hrs	70 km.
Corps	0-72 hrs	150 km.
Echelons Above Corps	72+ hrs	150+ km.

Guidelines for commanders' areas of *interest* were as follows:

<u>Level of Command</u>	<u>Time</u>	<u>Approximate Distance Beyond Forward Line of Own Troops</u>
Battalion	0-12 hrs	15 km.
Brigade	0-24 hrs	70 km.
Division	0-72 hrs	150 km.
Corps	0-96 hrs	300 km.
Echelons Above Corps	96+ hrs	Out to 1000 km.

The emphasis lay in attacking deep echelons early in order to delay, disrupt, or destroy them while simultaneously fighting the assaulting forces. The corps operated against the deep defensive echelons, reserves, and reinforcing forces, and interdicted second echelon divisions of the first echelon armies. While defending, the corps conducted operations to destroy assaulting enemy echelons while simultaneously acting to break up the mass, slow the momentum, and disrupt the enemy's ability to conduct continuous operations. When attacking, the corps sought to destroy or bypass enemy forward defenses, to move rapidly into the enemy rear to destroy command and control, logistics, and other "soft" targets, and reserves. In the defense, dispersal in depth was a watchword against the enemy's likely use of tactical nuclear and chemical weapons. In the attack, multiple routes to the objective and concentration on arrival were the maxims.

As the principal headquarters for nuclear fire planning, the corps, if cleared by the national command authority, would use nuclear weapons to disrupt enemy follow-on echelons or, if necessary, to destroy first echelon divisions. In the attack, nuclear weapons could create gaps for maneuver, destroy enemy reserves, obstruct areas in order to restrict enemy movement, and disrupt enemy electronic operations with bursts calculated to energize the effects of electromagnetic pulse.

Chemical weapons might be employed together with tactical nuclear or conventional weapons to disrupt follow-on echelons. Primarily, however, they were defensive in nature, and their best use was to deny the enemy rapid passage through an area or intercept or stop his approach. First use of chemical weapons by U.S. forces remained excluded.<sup>49</sup>

Applications of the new concept were, thus, being tentatively formulated by the late summer of 1980. General Starry sent the internal operational concept for Corps 86 to the Chief of Staff of the Army on 1 August, the same day General Meyer approved the Corps 86 heavy corps designs for force planning.<sup>50</sup>

## *The Revision of FM 100-5 Begins*

As a planning vehicle for the development of a corps concept and structure, the Corps 86 Study helped bring together conceptual ideas during the early months of 1980. Separately from that force structuring effort, however, General Starry, early in 1980, took steps to start the formulation and writing of a revised FM 100-5 out of the ideas that were converging. This process drew upon doctrinal currents that we have earlier described, but it also came to contain new elements, as earlier assumptions were reexamined. In important respects it signalled a shift to a new doctrinal emphasis. The process, which culminated in the doctrine of AirLand Battle, was guided by and took place to a significant extent in the thinking of General Starry and his deputy at Fort Leavenworth, General William R. Richardson. The doctrine and combat developments staffs at TRADOC Headquarters made contributions to the concept stage. The Department of Tactics, or DTAC, in the Command and General Staff College at Fort Leavenworth, working directly with Starry and Richardson, formulated and wrote the doctrine. The assignment of revising the key doctrinal manual to Fort Leavenworth

was an earnest of General Starry's desire to return doctrine management to the Combined Arms Center and to re-involve instructors throughout the TRADOC school system in doctrinal formulation.

Initial work on a new FM 100-5 began in March 1980 after General Starry visited the Combined Arms Center that month to review the progress of several of the how-to-fight doctrinal manuals. The work began in the Concepts and Doctrinal Management Directorate of CACDA but was soon transferred to the Department of Tactics in the Command and General Staff College, as part of the general migration of doctrinal management to the College during 1980 in line with Starry's command-wide directives. Lt. Col. Richmond B. Henriques was assigned by Lt. Gen. Richardson to prepare the initial drafts for what was seen at that time as a revision of the



Lieutenant Colonel Richmond B. Henriques

1976 manual, rather than the materially different doctrine that would soon eventuate. The specific early directive was to correct the 1976 manual's deficiencies—in particular the much-criticized active defense doctrine and the firepower orientation—and to produce a manual of more general application not oriented specifically to NATO Europe. General Starry directed the full incorporation into the manual of the concepts of the integrated battlefield—in its conventional battle and its nuclear and chemical dimensions. He also urged the manual writers to give close attention to General George C. Marshall's doctrine manual of 1941, impressive for its clarity, as well as to the current German Army doctrinal manual, Army Service Regulation HDv 100-100, Command and Control in Battle, which had greatly impressed him and with which he wanted a doctrinal compatibility. Preliminary drafts consistent with NATO's Allied Tactical Publication, ATP-35, and heavily influenced by the German manual were prepared by mid-1980. General Richardson selected two more doctrine writers in the summer of 1980—Lt. Col. Huba Wass de Czege as lead author and Lt. Col. L. D. Holder. They worked under the formal supervision of the DTAC director, Colonel Clyde J. Tate.<sup>51</sup>

The formulation and writing of the revised FM 100-5 by DTAC proceeded to the end of the year. An initial coordinating draft was prepared by January 1981 and staffed throughout the Army the following month, and revisions and additions followed to mid-1981.<sup>52</sup> This process, centered at Fort Leavenworth, which would lead to publication of a new operations manual in August 1982, will be described in the following chapter. We will first turn to

related events which resulted in publication of an AirLand Battle concept by General Starry in early 1981.

## *The Extended Battlefield*

In mid-1980 General Starry invested the developing doctrine with a new tentative title: the "extended battlefield." This term was the latest in the sequence of doctrinal terms, sometimes overlapping in usage and in meaning, which defined the evolution of doctrine from active defense to AirLand Battle. The problem in mid-1980 was that the foregoing term, the integrated battlefield, had come to be associated by many with its nuclear-chemical dimension only. General Richardson raised this matter, and the doctrine writers realized that they needed a term free of that connotation; and one that described the depth dimension of the overall concept.<sup>53</sup>

It was under the new title that the emerging concept was briefed to the Army Commanders Conference on 30 October 1980. General Meyer, the Chief of Staff of the Army, approved it at that time. General Starry played an important role at this juncture as a catalyst for the evolving concept. Soon after its approval by General Meyer, he wrote an extensive article on extending the deep, integrated battlefield in the several dimensions of distance, time, and additional combat resources that we have discussed earlier. In the article, which would be published early in 1981, Starry also developed the idea of the importance of maneuver in the opening up of the battlefield that was necessary for a strategy of winning.<sup>54</sup>

The extended battlefield emphasized the deeper physical dimension of the modern battlefield along with the time and air-land dimensions and the chemical and tactical nuclear options already noted. The *deep attack* was a leading idea. Deep, extended attack was an integral feature of U.S. combat capability. *Collapsing* the enemy's ability to fight by means of the wide range of Army systems and organizations on the deep battlefield was stressed. Deep attack was not a luxury, but an absolute necessity to winning. The deep attack and close-in battles were to be fought as all one battle. New weapons of significant capability were entering the force, by which the concept could be realized. The real goal of deep attack was to create opportunities for commanders to seize—including not only reconstitution of the defense, but attack and counterattack.<sup>55</sup>

General Starry's extended battlefield thinking of late 1980 presented an altogether more initiative-oriented view than that of his Central Battle concepts of two years earlier. It reflected the effects of the doctrinal debate about the 1976 manual's perceived emphasis on the defense and attrition warfare. But the extended-battle view also encompassed the very significant additional element of an extension into other tactical war options—in answer to the manifest readiness of Warsaw Pact forces to employ tactical nuclear and chemical weaponry.

However, it was soon evident that the term, extended battlefield, failed as had integrated battlefield to convey the full meaning of the evolving concept. This was a general conclusion of the TRADOC planners and writers, and soon after approval of the extended bat-

tlefield concept, General Morelli, the TRADOC Deputy Chief of Staff for Doctrine, stressed to General Starry the need for a better descriptive title. Following discussions with General Richardson, Starry selected the term "AirLand Battle" to describe the whole concept of interaction—not only that between the Air Force and Army, but also that which occurred between all air and all ground capabilities, in a firepower and maneuver context. On 29 January 1981, he announced the term to the TRADOC commandants and commanders as the overarching term that more accurately described the battlefield in its totality.

It should be noted that, concurrently with General Starry's action, the Combined Arms Center was developing the concept further during the fall and winter months of 1980–1981 and was briefing the extended battlefield and AirLand Battle concepts widely. This effort will be described in the following chapter.<sup>56</sup>

## *Publication of the March 1981 Operational Concept of the AirLand Battle*

On 25 March 1981, General Starry formally published an operational concept for the AirLand Battle, together with an operational concept for Corps 86 and disseminated this document Army-wide.<sup>57</sup> The March 1981 concept was written from General Starry's article on the extended battlefield, noted earlier, which was published the same month as the operational concept.<sup>58</sup>



Starry's article expounded the extended battlefield to the general public, as did an article by Lt. Gen. Richardson on the same subject and emphasizing the initiative thrust of the new doctrine, which followed in June.<sup>59</sup> These articles were the first of several published during 1981–1982 to inform the military and general public of the AirLand Battle concept.<sup>60</sup>

Although the evolving AirLand Battle concept had been briefed and discussed within the Army for several months, it was, in early 1981 for the first time, out of the briefing rooms and "on the street." The operational concept was explicit about the conditions of modern battle and was correspondingly candid about how Army units in combat had to meet those conditions if they were to survive and win. When TRADOC published it as an Army operational concept in March 1981, formerly sacrosanct topics, whose official discussion had heretofore been hampered by prevailing national policies, came into the open forum. Holding the heavily armored, numerically superior Warsaw Pact forces at risk by early continuous planning to employ tactical nuclear weapons if attacked, and to retaliate with chemical weapons should the Warsaw Pact employ its own well-trained and sizable chemical forces, the operational concept set forth options that once more began to be discussed publicly, as indeed they had been earlier, in the 1950s and 1960s.

The AirLand Battle concept was described as an approach to military operations that realized the full potential of U.S. forces by blending the notions of extending the battlefield and integrating conventional, nuclear, chemical, and electronic means to permit attack of the enemy to the full

depth of his formations.<sup>61</sup> The concept aimed for early offensive action, both in the air and on land, in order to end the battle on U.S. terms. Mindful of the absence of clear and consistent American political aims in the Vietnam War, and of the Clausewitzian maxim that "war is a continuation of policy by other means," the concept stated that

... once political authorities commit military forces in pursuit of political aims, military forces must win something—else there will be no basis from which political authorities can bargain to win politically. Therefore, the purpose of military operations cannot be simply to avert defeat—but rather it must be to win.<sup>62</sup>

Although the political aim defined might be a limited one, the enemy had to be led to perceive from United States military doctrine and action that the situation he had created would not be one which would eventuate in a status quo ante bellum, but one that "will be resolved on new terms."<sup>63</sup> These were forthright statements, clear in intent and disabusing to the Soviet Union of any perception that shifting strategic power had opened for it a new freedom of action at theater levels.

The AirLand Battle concept dealt primarily with war against modern well-equipped forces, but it was not limited in application to the Warsaw Pact and Central Europe. The concept was germane also to large scale mechanized war in the Middle East and to the threat in Korea. It thus dealt with the Army's major and most serious challenge—armored, mechanized, combined arms battle. Physically, it projected a view to the front, with an explicit offensive emphasis.

The deep, extended view was the distinguishing feature of the March 1981 concept. The term "extended," as already noted, had three important meanings: in depth forward, in the dimension of time, and in a wider means of attack. All were directed to collapsing the enemy's ability to fight.

The message of the March 1981 concept was distilled into a few primary notions. First, deep attack was not a luxury, but an absolute necessity in order to win. Second, deep attack required tight coordination with the decisive close-in or assault battle, and with the rear battle so that scarce means of attack would not be wasted on attractive targets whose destruction actually had little impact on the end result. Such coordination required anticipation of enemy vulnerabilities and required a view of the deep, close-in, and rear battles as one.

Third, the concept required an alert mental grasp of the potentialities of the new Army 86 equipment already in production and oncoming (See *Chart 1*). Commanders had to have the feel of its greater lethality and range, the more responsive command and control created by its automated systems, and exactly how the new sensor systems opened up new means to find, identify, and target the enemy deep and assess the results. But the AirLand Battle concept was not tomorrow's doctrine only. It was not intended to remain on the shelf until all the new systems were fielded. Rather it could, with adjustments, be implemented immediately and with great payoff.

Deep attack was necessitated by the nature of the Soviet operational maneuver, whether this was a breakthrough maneuver, a daring

thrust, or something else. What was significant was not the type of maneuver but the great numerical superiority contained in the enemy's follow-on echelons. Regardless of whether stylistically structured, (See *Chart 2*), the oncoming second echelon had to be slowed, disrupted, broken up, dispersed, or destroyed in a deep battle, fought simultaneously with the close-in contest, so that it could not advance in strength sufficient to decide the contest by sheer weight of numbers. In that way the enemy's operational scheme could be destroyed, and he would thereby be forced to call off the attack, as the initiative was seized from him.

The concept called for employment of sensors and surveillance systems to prevent surprise attack and to gain targeting and surveillance information. It was also based on dual capable conventional and nuclear systems with the range and destructiveness to keep the enemy at risk. And it called for command and control systems operating automatically and in near real time. So integrated, these systems made possible a defense far forward. Speed was of the essence. With the ability to see deep, commanders could begin early to delay and destroy follow-on echelons, move fast and strike quickly the assault echelons, finish rapidly the opening fight against both, then go on the attack and finish the battle before follow-on forces arrived.

The concept delineated clearly the time aspect of the deep battle. It specified in hours both the time given to brigade, division, and corps commanders to attack their respective

CHART I  
**A SUBSTANTIAL STEP  
 TOWARD FUTURE CAPABILITIES**

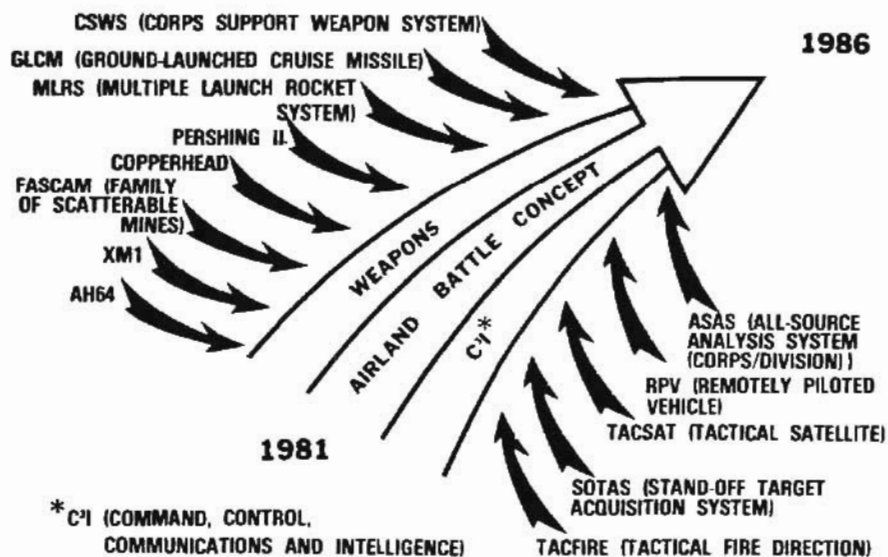

Source: TRADOC Pam 525-5, AirLand Battle and Corps Operations - 1986, 25 March 1981, p. 4.

CHART 2

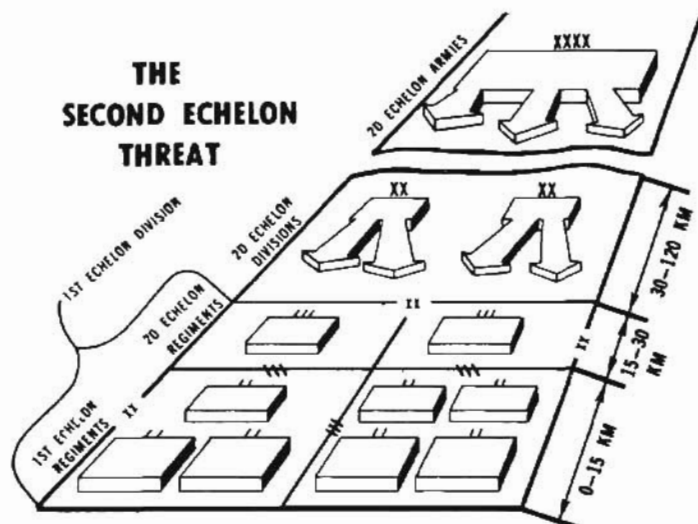

Source: TRADOC Pam 525-5, AirLand Battle and Corps Operations - 1986, 25 March 1981, p. 6.

elements of the second echelon formations, in the area each one could influence, and the time given to see enemy formations in their still more distant areas of interest (See *Chart 3*). Each commander-brigade, division, and corps-thus had dual responsibilities, for attack of both the enemy assault echelon and of the follow-on echelon.

The concept elaborated in detail the second echelon attack scenario. Critical here was the necessity for intelligence preparation of the battlefield. Aided by advances in sensor and communications systems, noted above, commanders would attack targets of high value in order to progressively disrupt the enemy's forward momentum. Three primary means of deep attack existed-those of interdiction, including air, artillery, and special operating forces; offensive electronic warfare; and deception. The concept stressed the crucial need for an attack plan against both assault and follow-on echelons, stemming from the concept of a single commander, so that "time windows" for offensive action could be created. Because of the depth of the attack against the second echelon, the air aspect would dominate the early phase of the single air and land battle.

Studies by TRADOC, including the target value analysis of European corps battles by the Field Artillery School, showed clearly that air and land interdiction impaired significantly the enemy's massive firepower and slowed his momentum. The enemy could mount fewer regimental attacks, and his first echelons would be defeated earlier. Enemy penetrations were far less extensive, and U.S. reserves were not needed so early. The overall effect of interdiction on enemy front line strength was dramatic (See *Chart 4*).

But advance planning was absolutely critical to the successful interdiction battle on which the outcome of the entire battle depended. The AirLand concept stressed the importance of continuous planning that would integrate fire support, electronic warfare, deception, and intelligence, with maneuver. The Army 86 equipment would provide such capabilities, but the question was whether existing equipment could. Since considerable interdiction capabilities already existed, these were to be used to the fullest extent. Also, 'transition to the tactical ideas of the AirLand Battle had to begin at once. In line with the maxim, "We must train as we will fight," commanders in the field had to begin at once practicing the concepts by which they expected to fight in the 1980s. Above all, /integrated targeting cells, capable of 'nuclear as well as conventional and chemical targeting, had to be established in all fire support elements, not only in Army units in Europe but in the Pacific as well. To make it all work, the corps had to have control of the requisite sensors such as the OV-1D, side looking airborne radar, Guardrail, Quicklook, and the interim tactical electronic intelligence processor. Data from national and theater systems had to be made available, along with the down-links necessary to pass the information on to the corps and division commanders.

In sum, the message conveyed by the AirLand Battle concept; of March 1981 was that the Army had to leave behind for good the restricted notion of winning the fight only in the traditional main battle area. The Army was now "entering a new dimension of battle which permits the simultaneous engagement of forces throughout the corps and division areas of influence."<sup>64</sup>

CHART 3

## SEE AND ATTACK IN DEPTH

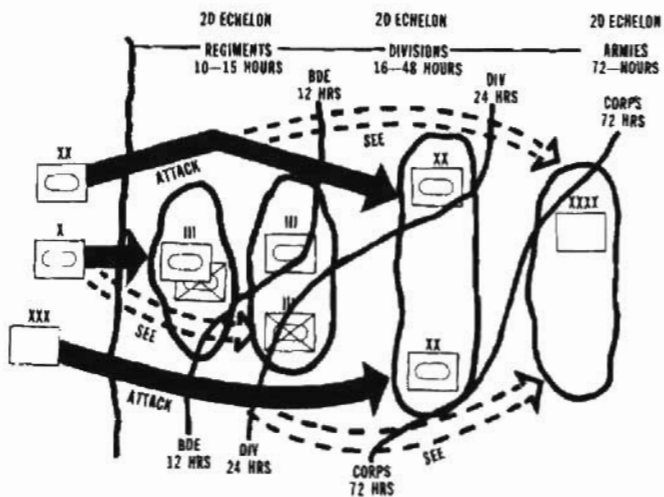

Source: TRADOC Pam 525-5, AirLand Battle and Corps Operations - 1986, 25 March 1981, p. 8.

CHART 4

## WHY DEEP ATTACK?

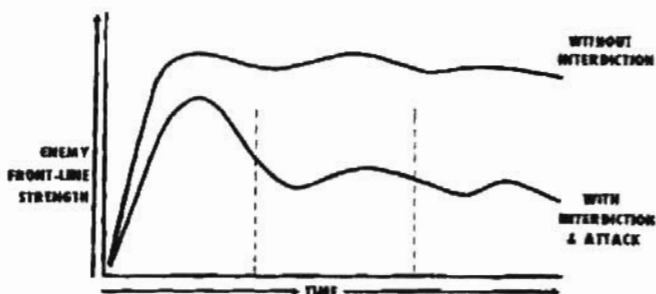

Source: TRADOC Pam 525-5, AirLand Battle and Corps Operations - 1986, 25 March 1981, p. 18.

It had to begin immediately to learn, practice, and refine the AirLand Battle concept.

\* \* \*

The development of tactical concepts between 1977 and 1980 drew on a succession of influences: the vigorous debate of and reaction to the deficiencies, real and perceived, of the mid-1970s doctrine; the Central Battle view formulated by General Starry from his command experience in V Corps and TRADOC's "functionalizing" of the battlefield which pointed the way to the new emphasis on second-echelon air-land interdiction and to the

vision of a deep and extended battlefield possessing air-land, distance, and time dimensions; and the forthright treatment, in the face of Soviet on-the-ground capabilities, of tactical nuclear and chemical retaliatory doctrine. All these doctrinal currents came together in the minds of General Starry and his doctrinal planners at Headquarters, TRADOC and the Combined Arms Center during 1979–1980. It remained to develop further these concepts into a new body of doctrine. But in that process, still further change was occurring that was to go beyond the deep battle emphasis of the AirLand Battle concept outlined by Starry in early 1981.

## Chapter IV

# *AirLand Battle Doctrine*

The development of FM 100–5, Operations, by the Department of Tactics in the Command and General Staff College at Fort Leavenworth that began in 1980 was an intensive effort that, late that year, was already moving in many of its particulars beyond General Starry's published concept of March 1981. While the DTAC effort drew upon the several doctrinal antecedents we have noted, it also introduced elements that, while they did not diminish the significant vision of deep attack<sup>7</sup> yielded a broader vision that extended beyond the physical dimension of battle to its human and moral dimensions. These additions themselves drew upon the thinking of senior Army officers both inside and outside of the Training and Doctrine Command, and rested also upon the intellectual patrimony of the classic military theorists.

What were these influences, and why were they important? How did the new doctrinal manual take shape? What developments were occurring in the all-important tactical air dimension of AirLand Battle? How did the concept gain Army-wide consensus, and how did it find a receptive audience in higher Department of Defense and political circles? We will turn to these questions before reviewing the elements of the doctrine of AirLand Bat-

tle published in the new FM 100–5 of August 1982 and summarizing its departures from the doctrine of the 1970s.

## *Writing the Doctrine*

The writing of the new FM 100–5 that began in early 1980 commenced from an approach critical of the force-ratio and firepower-based battle views that had been prominent in the 1970s. To many in the Army, the Central Battle depiction of combat power in terms of targets to be serviced suggested a mechanistic approach that discounted all too easily the human element and the moral dimension of battleel

In the course instruction at the Command and General Staff College during 1978, one observer wrote, target servicing rates had displaced tactical precepts such as the maintenance of mobility, the expansion of maneuver space, and flank exploitation—precepts that were time honored but now neglected.l In October 1980, a staff officer at Fort Leavenworth who had recently spent more than four years in assignments in U.S. Army, Europe, wrote to the TRADOC Deputy Commander, Lt. Gen. Richardson, of the widespread lack of understanding and



Lieutenant General William R. Richardson



lack of confidence in the precepts of the active defense, which he had observed during his USAREUR assignment. Among cited problems were the severe lack of reserves anywhere below division, and the movement and response problems that would arise for the active defense from enemy electronic warfare and interdiction.<sup>3</sup>

Writing in early 1981, two Department of Tactics planners also described the "hardening" that had taken place in the tenets of the active defense. That tendency had turned the active defense into a stylized doctrine exaggerating the mechanical aspects of war and overstressing firepower while totally suppressing moral factors that could not be reduced to numbers. Such factors were lost in the "calculus of battle" that was being taught in the late 1970s.<sup>4</sup>

Our earlier discussions have described how the force-ratio legacy had begun to dissipate by late 1979, as the concepts associated with interdiction and the integrated battlefield gained ground. But the influence of that legacy lingered. To an extent it was present in the formulations of the extended battlefield and in the published operational concept of March 1981, the DTAC doctrine writers believed. That concept, while it declared the function of deep attack in seizing and retaining the initiative and in opening up opportunities for maneuver,<sup>5</sup> still seemed to rely too heavily on the difficult and perhaps not feasible operation of wearing-down the enemy's follow-on echelons. As a portrayal of AirLand Battle, it seemed to place too much emphasis on the extended battle as a separate activity.<sup>6</sup>

An early injunction of Lt. Gen. Richardson to the FM 100-5 effort at Fort Leavenworth was the need to eschew a formulaic doctrine of any kind—anything that suggested a "recipe" for combat. The new doctrine, rather should lay out principles, and should educate Army officers in how to apply them. Richardson's inclination to a broader doctrinal view of combat power furnished a significant influence on the DTAC effort that he, together with General Starry, supervised—an influence away from the mechanistic and toward the prominence of other factors. The initial view of the project as a revision to correct the 1976 manual's deficiencies was soon laid aside as the outlines of a broader doctrine became apparent.<sup>7</sup>

The DTAC writers, Lt. Col. Wass de Czege, aided by Lt. Col. Holder and Lt. Col. Henriques, completed the chapter drafts of the doctrinal manual through the latter half of 1980. Chapters were provided one by one to General Starry and Lt. Gen. Richardson, whose comments were worked into an initial coordinating draft. Communications and meetings with Starry and Richardson were frequent, and the mark that both made upon the new and broader doctrine was strong, as we shall see.<sup>8</sup>

Another major influence in the direction of a wider view of combat power was that of Lt. Gen. Richard E. Cavazos, an exponent of the importance of the moral aspect of combat, who was then commander of the U.S. Army III Corps. Cavazos' approach to the defense was to view it foremost as a clash of wills, and as dependent on the psychological faculties required to withstand the assault in battle. A squad defense, for example, needed to be oriented both to psychological and



Lieutenant Colonel Huba Wass de Czege



Lieutenant Colonel L. D. Holder

physical inter-support—as illustrated by the situating of foxholes so that one could overwatch another.

Cavazos' influence was indirect but important. He turned the attention of the doctrine writers to two military thinkers, Ardant du Picq and the influential British military historian John Keegan, whose *Battle Studies* and *The Face of Battle*, respectively, depicted and highlighted the human side of war—the moral dimension of combat, involving leadership, courage, endurance, and fear.<sup>9</sup> From these influences and others, the DTAC writers attempted to describe a doctrine based on a recognition that soldiers in the 1980s would respond to the stresses of battle as soldiers always had throughout the history of war. They sought a doctrine firmly centered on how soldiers, not systems, fight and win.<sup>10</sup>

Early in the effort, the writers were convinced that a return to fundamentals was one of their main tasks. It may be suggested in passing that the exclusion of the principles of war per se in the 1976 doctrinal manual may have left readers in doubt as to how important the Army considered those principles to be. We have noted the principles' fairly rapid official reinstatement in 1978 by means of FM 100-1, *The Army*. The principles of war inarguably provided clarities with which to illuminate ideas, and the DTAC writers rooted their thinking in them, expending considerable effort in the definition of fundamentals of combat.

The initial list of fundamentals provided in the coordinating draft was to the point, but lengthy: insure effective command control of the battle; understand the mission; make a continuous estimate of the situation; see the bat-

tlefield; know the enemy; establish clear, obtainable objectives; prepare simple plans; seek to exploit vulnerabilities; use terrain; concentrate forces and fires; deceive the enemy; fight an integrated combined arms battle; seize and hold the initiative; provide timely, continuous support; deploy forces in depth; fight the enemy in depth; attack the enemy rear; provide security; recognize the human factor; prepare for continuous combat; encourage aggressive, independent action.<sup>11</sup>

The foregoing enumeration, when staffed during early 1981 in the coordinating draft, met criticism for its length, and the Department of Tactics subsequently reworked the fundamentals down to seven in number. These were published in the final manual as "combat imperatives." Based on the principles of war and oriented to contemporary battle, the imperatives included: insure unity of effort, direct friendly strengths against enemy weaknesses, designate and sustain the main effort, and sustain the fight. Included also was General Starry's formulation—based on the principles of maneuver and mass—to move fast, strike hard, and finish rapidly. Other imperatives of combat reworked from the initial list were to use terrain and weather and protect the force.<sup>12</sup>

The need to redefine defensive tactics was one of the principal reasons for the new doctrine. The DTAC writers greatly broadened the defensive sphere by their view of the defense as a continuum that might range from a static positional defense to a deeper, more dynamic force-oriented defense of maneuver, as the situation demanded. Defensive operations might be forward, or in depth, or might rely on strongpoints. Defense Committee instructors

in the College contributed considerably to more flexible defensive formulations of the new doctrine. Out of their discussions and the manual drafts came an early statement of a "new doctrine for the defense," by the DTAC Director, Colonel Tate, and the manual co-author Lt. Col. Holder, which was published in March 1981.<sup>13</sup>

The writing of the offense chapters drew significantly on the tactical concepts of Basil H. Liddell Hart and J.F.C. Fuller. Initial tactical precepts for the attack on the nuclear-chemical-conventional battlefield set forth four dominating principles: use of the indirect approach, concentration of forces, speed of attack, and a well-conceived feasible plan.<sup>14</sup> These precepts were to emerge as five operational concepts for the attack in the final draft of the new FM 100-5: surprise (emphasizing the indirect approach), concentration, speed, flexibility, and audacity.

Different concepts for interdicting the enemy second echelon and deep battle and regarding maneuver came out of the DTAC work. In line with the thinking of Lt. Gen. Richardson, a more flexible view of operations against the second echelon than the distance and time scheme noted earlier was developed. The challenge of the second echelon was to be confronted in terms of the specific mission, the enemy force, terrain, troops, and the time available.

Deep attack was differently defined. The doctrine writers believed that U.S. forces did not have sufficient combat systems to achieve a deep attack aim of significantly reducing or wearing down the enemy echelons closing on the battle line. Instead, they emphasized deep attack in the AirLand Battle as complementing the central con-

cept of the operation, and as an inseparable part of a unified plan. Deep attack efforts should always be directed toward a specific goal, it was emphasized, if an actual tactical or operational advantage was to be obtained.

In the foregoing distinction, the doctrine writers differentiated several forms and aims of deep attack. The first of these was attack by fire to disrupt enemy forces in depth to delay their arrival in the battle area so that the enemy forces in contact could be isolated and defeated. The second form of deep attack was the attack of enemy forces in depth with fire to prevent them from intervening in the close-in battle—giving U.S. forces opportunity to maneuver against the flanks and rear of the enemy forces in contact. The most difficult form of deep battle was the engagement of the follow-on echelon with firepower *and* maneuver forces while the close-in battle was being fought, so as to isolate those echelons from the close-in battle and deny the enemy the massing and momentum of forces on which he depended. A fourth form of deep attack was to destroy or neutralize particular enemy threats or advantages, such as enemy nuclear-capable weapon systems.<sup>15</sup>

But maneuver was viewed as the better way of interdicting the enemy. Returning maneuver to doctrine and restoring the maneuver-firepower balance was an early directive of General Richardson who, during 1980, was pressing to get maneuver into both the CGSC curriculum and the FM 100-5 draft. The lack of maneuver doctrine was a common criticism of the 1976 manual, and that criticism was

being heard more and more. Maneuver was applicable to defense and offense, and the manual writers, in their efforts, made it a part of both. Not maneuver for maneuver's sake, but its proper balance with firepower was what they were after. In meetings during this time, General Starry discussed battles in which inferior forces had acted to defeat larger ones, and gave his support to the increased emphasis on maneuver. Maneuver and its relation to firepower were to receive continuing attention until defined in final form relatively late in the doctrinal effort.<sup>16</sup>

Another important development was the reduction of concepts to four key elements that together were to emerge as the heart of AirLand Battle doctrine. Main doctrinal themes were apparent to readers of the doctrinal formulations of late 1980, in which the writers were describing a new defense doctrine and were placing emphasis on maneuver in operations. These apparent main themes were initially seen to be: initiative—implying an offensive spirit and encompassing independent action by subordinate leaders in the context of the overall plan, as well as maneuver; depth—the deep, extended battle; violence; and integration. When the doctrine writers proposed the idea of emphasizing the four themes in the manual, General Starry and Lt. Gen. Richardson agreed, and the themes went into the coordinating draft.<sup>17</sup>

Subsequent consideration changed the four elements. General Starry rejected two of them, violence and integration, in favor of two other concepts. One of the new elements was synchronization, a concept suggested by an article written by Starry's

predecessor, General DePuy. DePuy contended that there was a combat-power value to effective command control, and that command control could synchronize combat power. The concept of synchronization was also supported by Brig. Gen. Morelli. The idea of agility, also suggestive of maneuver, was advanced in April 1981 by General Richardson, and was adopted. The four concepts—applicable to offense and defense—formed the thrust of AirLand Battle doctrine—the idea of seizing and retaining the initiative and exercising it aggressively to defeat the enemy.<sup>18</sup>

## *Staffing and Further Changes*

Incorporating the ideas of the extended battlefield and AirLand Battle, the coordinating draft of the new FM 100-5 was completed in January 1981. General Starry wanted early comment from the field, and the draft was staffed throughout the Army in February, reaching in some units, the battalion commanders. Readers responded with encouragement and criticism. The response on the whole was favorable. The changes in defensive doctrine, the tendency toward maneuver, the stress on principles and concepts, and the lack of formula—all evoked a positive reaction. The influence of the responses from the field was considerable, and revisions to the coordinating draft followed through the first half of 1981.<sup>19</sup>

Briefing to the field by a special Combined Arms Center team, headed by the CACDA Deputy Commander Maj. Gen. Jack A. Walker preceded and accompanied the staffing of FM 100-5.

The team's efforts were organized by Lt. Col. Holder, the CGSC representative on the team, Maj. Dennis H. Long of CACDA, and Maj. Robert W. Zawilski of the Field Artillery School. The extended battlefield contact team provided the major Army commands, corps, and divisions an initial program of briefings and seminars as well as follow-up assistance in working toward implementation of deep attack in the air-land battle. The team included an Air Force representative, who provided air perspectives on the doctrine. The deep attack was the focus of the extended battle briefings, though the broader AirLand Battle ideas were also presented.

In extending the battlefield for deep attack, four simultaneous steps applied. First, defeating the enemy forces in initial contact rapidly was essential to the air-land battle. But simply slowing down the enemy's arrival rate was not enough; local intervals of superiority for U.S. forces had to be exploited with decisive offensive action. Secondly, deep attack was used to influence the future battle by forcing the enemy follow-on echelons to deviate from their plans, and by focusing U.S. efforts toward decisive collision with and defeat by maneuver of enemy forces. Third, wresting the initiative from the enemy and retaining it was essential; the commander had to act more rapidly than his opponent and present the enemy with repeated, continuous, disrupting and menacing actions more rapidly than he could react to them. Finally, the results of the commander's actions had to be directed to the *collapse* of the enemy's fighting ability.<sup>20</sup>

The FORSCOM commander, General Robert M. Shoemaker, was briefed

in late December 1980, and expressed strong support for the extended battlefield concept.<sup>21</sup> From late December to mid-January 1981, the contact team briefed the concept to all other major Army command headquarters and to the U.S. Readiness Command, where it found good reception. Favorable response also came from briefings given to U.S. Air Force and Army units in Germany and Korea. In January 1981, the Army Chief of Staff approved further team visits, to the corps and divisions. The briefing team also took part in a 3d Armored Division test in Germany of a special fire support targeting cell concept, which was developed to select high-value targets for interdiction.<sup>22</sup> In late March, in V Corps, the briefing team demonstrated how tactical air control systems could support the targeting cell to press the deep attack. Restyled the AirLand Battle team, the briefers completed their corps and division visits in June 1981, rounding out the task with briefings as well to the TRADOC schools. Besides the wide staffing of FM 100-5 throughout the Army, prominent defense writers, including Edward N. Luttwak and Bill Lind, were invited to review and discuss the drafts. TRADOC regarded as exaggerated the charge by some of the civilian critics that the 1976 FM 100-5 was pure attrition doctrine, and found the critics' own maneuver views to be oversimplified in many cases, but their views on the new manual were taken into account.<sup>23</sup>

A significant addition that resulted from the Army-wide staffing of the manual was the adaptation of the German conception of mission orders—*Auftragstaktik*. This concept had already drawn the interest of planners at the TRADOC Headquarters and the Combined Arms Center, but it was the

FORSCOM commander, General Shoemaker, who precipitated action on it. Shoemaker saw a need for a concept of command control under adverse conditions. The chaos of the next battlefield, he believed, would make centralized control of subordinates always difficult and sometimes impossible. The subject was raised at the FORSCOM Commanders Conference held at Fort Leavenworth in April 1981, which General Starry attended. Starry, too, readily supported adapting the German concept of mission orders—in which subordinate leaders were trained to choose an alternative way, within their commander's intent, to execute a mission when the original way no longer made sense under changed combat conditions. General Starry and Lt. Gen. Richardson both promoted this inclusion, which became an important feature of the new doctrine. Indeed, the German influence on the new FM 100–5 was strong. HDv 100–100 had only limited applicability to a worldwide U.S. Army doctrine, but it was a highly relevant companion doctrine which Starry and the manual writers studied closely early on. That study also resulted in the manual's adaptation of the German concept of emphasizing a center of gravity' (*Schwerpunkt*) or point of main effort, of attack. The key idea, and an imperative of the new manual, was designating and sustaining the main effort at the point of enemy vulnerability.<sup>24</sup>

At the FORSCOM Commanders Conference, the DTAC doctrine writers laid out the conceptual changes to the defense. They described the new doctrine as a departure from earlier views in which there had been a hesitancy to take offensive action as part of defensive operations, and in which there had

been too narrow emphasis on the *initial* advantages of the defender. The new defensive doctrine attempted to broaden defensive operations to the full use of *all* the advantages of the defender. The strong covering force role was broadened; the covering force might fight in strength forward and would not automatically withdraw where not heavily contested. The decisive battle could as before be expected to be fought in the main battle area, with the rear area still organized for the support of operations. New emphasis was placed both on the tactical interdiction battle—the deep component of the battle, which was conducted simultaneously in the area beyond the line of contact—and on the protection of rear areas.

Using a flexible approach, corps and division commanders had to allocate combat capability among all these components of the defensive battle—the deep or extended battle, the covering force battle, the battle forward in the main battle area, the reserve, and the rear area battle. In the changed doctrine, the active defense would no longer exist as a *form* of defense, but was, rather, a defensive technique among others employed within the overall defensive framework. The right technique was to be determined by what was required in terms of the mission, enemy, terrain, troops, and time available. The ideal defense was a bold, flexible, offensive-oriented defense—following Clausewitz, a "shield of blows."<sup>25</sup>

In the new doctrine characterized by the commander's initiative, deep attack to delay and disrupt remained important—but it was seen as one part of the defensive whole.<sup>26</sup> Thus, the deep



General Glenn K. Otis



attack component supported the commander's scheme of maneuver by disrupting enemy forces in depth. In the offense, it weakened the defending enemy. In the defense, it prevented him from concentrating overwhelming combat power. By reducing the enemy's closure rate, deep attack opened opportunities for decisive action. It was, it was stressed, an inseparable part of a unified plan of operations.

Incorporating the changes that had come out of the staffing and further discussions, the final draft of the new FM 100-5 was rewritten and completed in June 1981. General Starry that month directed a final editing of the draft, and a team from TRADOC Headquarters headed by Brig. Gen. Morelli reviewed the manual at Fort Leavenworth. Starry approved the manual in July and sent it to the Army Chief of Staff. General Meyer approved the new FM 100-5 in August.

Further changes were to follow which together delayed final publication from late 1981 to August 1982. One change was inclusion of the term, AirLand Battle, in the text as a descriptor of the doctrine, rather than the word, doctrine, only. This change was directed by General Glenn K. Otis soon after he succeeded General Starry as TRADOC commander in August 1981.<sup>27</sup> More significant for the substance of the doctrine was a decision by General Otis to add the operational level war, that is, the intermediate, level between tactics and strategy traditionally recognized by the German and other armies. The addition was strongly recommended by the Army War College during the manual's staffing and was discussed with the German Army reviewers of the draft. Ironically, the Germans had deleted the opera-

tional level from the 1973 edition of their doctrinal manual, HDv 100-100, after adhering to this concept, introduced by von Moltke, for over one hundred years. The deletion was, however, under review by the German Army. The operational level was a significant addition, in particular in its relation to Air Force-Army coordination of AirLand Battle, which took place at that level. The AirLand Battle *was* the operational level.<sup>28</sup>

The AirLand Battle concept was transferred to the departments of the Command and General Staff College in early July 1981 for integration into the doctrinal base. The College was charged to train intensively those officers destined for future assignments where they would be implementing AirLand Battle doctrine. The Combined Arms Training Development Activity was directed to incorporate the doctrine in Army Training Evaluation Programs for unit training and to ensure its implementation in the curricula of the branch schools.<sup>29</sup>

## *The Tactical Air Dimension*

Any visualization of deep battlefield fronts extending well into the zone of the enemy's second echelon forces was implicitly an air-land view of the battle—one requiring significant air support by tactical units of the Air Force. Since 1973, TRADOC commanders had met regularly with their counterparts of the Air Force Tactical Air Command, located at Langley Air Force Base, only a few miles distant from TRADOC Headquarters at Fort Monroe. A permanent joint Air-Land

Forces Application Agency (ALFA) had been established at the Air Force base in 1975 to manage cooperative programs, and each command established subsequently an Air-Land Programs Office to convert joint service applications into their respective programs. The Army's air-land office, initially under the TRADOC Office of the Deputy Chief of Staff for Combat Developments, became a part of the new doctrine office in 1979. Since the mid-1970s, under TRADOC auspices, the Combined Arms Center had been active in the formulation of the air-land efforts.<sup>30</sup>

The TAC-TRADOC projects saw a marked evolution between the early and late 1970s. Early efforts were limited to joint procedures, but cooperation expanded in the late 1970s into joint tactical training projects, tests and evaluations, mission area analyses, and materiel requirements. Such ventures led logically to joint doctrinal endeavors, and by 1979, planners in both commands were exploring joint operational concepts, both within and outside the major Army 86 Studies. The logical end of doctrinal cooperation was a truly integrated air-land battle concept—a goal transformed into a necessity by the nature of modern battle. Particularly was this goal germane to the emerging doctrinal view of a deep battlefield extending well into the zone of the enemy's second echelon forces.

## *Offensive Air Support*

The central doctrinal and procedural question of the air-land battle was offensive air support, in particular

its interdiction aspect. Work on an offensive air support agreement began in 1976. Based upon the growing requirement, perceived by Army corps commanders in Europe, to interdict the Warsaw Pact's second echelon forces, NATO's Central Army Group and Fourth Allied Tactical Air Force established a new dimension in offensive air support called battlefield air interdiction. Allied Air Forces Central Europe put the new term and principle into its 80-2 manual on offensive air support. As envisaged, battlefield air interdiction would enable the corps commander to engage the second echelon with air sorties before those forces became a first echelon problem.

In 1978, the drafting committee for NATO's Allied Tactical Publication on Offensive Air Support, ATP 27(A), rewrote this manual, including battlefield air interdiction (BAI) as part of offensive air support for the first time in a doctrinal manual. The United States subsequently ratified the NATO manual, ATP 27(B), and it was published in 1979. The requirement for a bi-service U.S. agreement came from the NATO work. There was as yet no joint binding U.S. doctrine on battlefield air interdiction, and the problem became more critical when, in December 1979, the Air Force issued a new position on apportionment and allocation of offensive air support. In that position paper, the Air Force proposed changes by which control and direction of the BAI missions would be retained by the air component commander rather than distributed to the Army corps commander for control.

The Air Force position of December 1979 represented a doctrinal step backward from TAC-TRADOC agreements existing since 1976 on coordination of air support. Consequently,

in early 1980 planners from both service commands met and developed a proposed change in the Air Force's December position as a memorandum of understanding. The memorandum, TAC-TRADOC Agreement on Battlefield Air Interdiction, was signed on 4 April 1980 by the TAC Deputy Chief of Staff, Plans, Maj. Gen. Fred A. Haeffner, and the TRADOC DCS for Doctrine, General Morelli. Further consideration of the memorandum through the year then led to a broad joint offensive air support agreement which the TAC and TRADOC commanders approved in September 1980. Though primarily oriented to U.S. forces operating outside NATO, the September 1980 statement was compatible with procedures being used in the NATO central region, and it paved the way for endorsement of a general agreement by the Air Force and Army Staffs in 1981.

On 23 May 1981, the Air Staff and Army Staff endorsed the TAC-TRADOC agreement, issuing it as an official Air Force–Army position on apportionment and allocation of offensive air support. The agreement adequately established for the Army the corps commander's role in prioritizing targets for BAI. On 22 September 1981, Headquarters, U.S. Air Force declared that the agreement was authoritative Air Force doctrine and would be incorporated into relevant Air Force doctrinal manuals.

By the agreement, the Air Force component commander apportioned his tactical aircraft to various roles and missions, based on the combined or joint force commander's decisions and guidance. From these apportionments, air sorties were allocated by the air component's tactical air control center.

The Air Force component commander and the Army battle coordination element in the tactical air control center then would distribute air sorties based on the joint force commander's decisions and guidance. The key feature was Army recognition of Air Force management and selection of its deep attack capabilities, and Air Force recognition of the corps function of locating and prioritizing targets for battlefield air interdiction. Though Air Force controlled during execution, BAI was jointly planned—responsive to corps-identified targets. There was no doctrinal change in close air support—that part of offensive air support closest to the front line and responsive to the ground force commander at all stages of execution.<sup>31</sup>

## *Joint Operational Concepts*

In 1979, work began on two significant Air Force–Army studies to produce joint concepts for two central air-land tasks—joint suppression of enemy air defenses, and joint interdiction of the Warsaw Pact second echelon. Monitored by ALFA, these studies were assigned to the Air Force Tactical Fighter Weapons Center at Nellis Air Force Base, Nev., and to the Combined Arms Combat Developments Activity at Fort Leavenworth. During the meeting of the two service chiefs in October 1979 at Fort Monroe, noted earlier, both General Meyer and General Allen endorsed the projects as needed elements of air-land cooperation. The joint operational concepts bore directly on the concept of AirLand Battle being developed in 1980–1981, and the CACDA work, which was

linked to the doctrine-writing effort through the extended battlefield contact team, had productive results.<sup>32</sup>

The Joint Second Echelon Attack, or J-SAK, Study was the more significant of the two joint studies. Begun under the title, Joint Second Echelon Interdiction, the J-SAK interim concept was recast in late 1980 so that it would include the chemical and nuclear considerations of the integrated battlefield as well as offensive operations. Both these additions were in line with the general shift in doctrine taking place at that time. Directly relevant to the AirLand Battle concept, the aims of J-SAK were to develop a joint concept for attacking the second echelon, to produce detailed joint procedures for both the early 1980s and the mid-to-late 1980s, and to stimulate thinking on materiel required for the latter period.

Toward the end of 1981, a new interim concept, approved by General Starry, was distributed throughout both services for comment. Further development, staffing, and revisions required some time, but in December 1982, the TAC, TRADOC, and U.S. Readiness Command commanders approved a final J-SAK concept. It was published on 13 December. General operating procedures were in development in late 1982.<sup>33</sup>

The J-SAK concept described the responsibilities and coordination required to accommodate J-SAK operations. At each level of command, Army units would identify and develop targets. Using Air Force tactical air control party advice concerning the capabilities and limitations of tactical air, unit commanders would determine whether to attack targets with organic assets or to identify targets to the next

higher level of command. Those identified for attack by the Air Force would be prioritized at the senior Army level/transmitted to the battle coordination element, and used by the tactical air control center in the detailed planning of those interdiction sorties in support of the land commander's objectives.<sup>34</sup>

General Starry and the TAC commander, General Creech, approved an interim concept produced by the second study, the Joint Suppression of Enemy Air Defenses (J-SEAD) project, in July 1980. Following its staffing, the two commanders signed the concept on 3 April 1981, and it was published as a joint operational concept on that date.

The J-SEAD operational concept spelled out key changes in joint suppression efforts. The Army assumed primary responsibility for joint suppression from the forward line of troops put to the limits of observed fire. But Air Force crews were authorized to attack independently surface air defense points as targets of opportunity inside the fire support coordination line in accordance with certain carefully designed rules of engagement when such attacks did not interfere with mission objectives. The right to self-protection was considered inherent for all air crews regardless of location of a threatening air defense point. Air Force forward air controllers were authorized to request Army fires on surface air defenses through the Army fire support coordination element. The published concept, classified secret, described and set forth time priorities for enemy air defense targets, outlined planning responsibilities, and delineated procedures. An unclassified version was published in June 1982 and distributed to Army and Air Force units worldwide. TAC and TRADOC

were cooperating in late 1982 to secure approval by the service chiefs of the J-SEAD concept as joint Air Force-Army doctrine.<sup>35</sup>

Another important joint effort was the Air-Land Forces Interface (ALFI) project, begun by TAC and TRADOC in 1976. The ALFI project was an attempt to deal with the disruption to Air Force-Army coordination created in 1973 when then Chief of Staff of the Army, General Creighton W. Abrams, had eliminated the field army headquarters from the operational chain of command. This act had left the corps as the highest Army headquarters for tactical operations. For the Air Force, however, tactical operations took place, as before, theater-wide. The ensuing attempt to bridge the gap had resulted in a concept approved by the TAC and TRADOC commanders and staffed in 1978 for comment. "How-to" procedures, organization, personnel, and communication requirements all were addressed. Early in 1980, as changes were being worked into the concept, TAC had recommended eliminating much of the procedure and detail of the ALFI idea and limiting it to a basic concept and organization. TRADOC planners had agreed to this approach.

In the meantime, the two services, in late 1980 and early 1981, reached accord on an offensive air support agreement, as noted earlier. The OAS agreement provided a stronger basis for coming to final terms on the important question of the actual bi-service links. Essential agreement was reached by March 1981, and the final draft of the ALFI concept approved by the two commanders was staffed out in May for comment and use. At the close of the year, TAC completed final details with

both U.S. Air Forces in Europe and Pacific Air Forces prior to implementation.

Worldwide in its application, the ALFI concept focused on two organizational interface points—the corps, and the Air Force tactical air control center (TACC). At the corps, the Air Force air support operations center was realigned to provide the improved lines necessary to support the fire and movement of ground forces. At the TACC, the Army battle coordination element was established to provide, interpret and exchange information regarding all aspects of the ground battle for the TACC. TRADOC believed the ALFI concept to be a key advance in AirLand Battle doctrine.<sup>36</sup>

## *Introducing the New Doctrine*

The formulation and writing of the new doctrine were one thing, its acceptance not only by the Army but by an influential cadre of civilian defense writers and critics was another. Fresh in memory was the debate over the 1976 operations manual and its doctrine of the active defense. But in 1981, TRADOC did two things differently than it had on the previous occasion. First, just as he had with the Army 86 reorganization, General Starry took pains not only to lay the doctrine of the AirLand Battle before the Army but to include the Army at large in its development. He did this by means of the Combined Arms Center's briefing to the field and wide circulation of the draft FM 100-5 to the Army during 1981. These efforts fell on receptive ears. AirLand Battle was an offensively

oriented doctrine that the Army found intellectually and analytically convincing.<sup>37</sup>

Further, TRADOC seized the initiative in presenting to the military and civilian public the doctrine that General Meyer had approved. General Morelli and the doctrinal staff at the headquarters developed briefings on the AirLand Battle, as well as on a future battle concept for the 1995–2015 period, termed AirLand Battle 2000. These briefings drew immediate and widening interest. Early on, Morelli and his assistants briefed Army Staff action officers on the concept. A briefing to the Deputy Secretary of Defense Frank C. Carlucci III was followed by briefings to the Department of Defense Under Secretaries and Assistant Secretaries. The AirLand Battle presentation was also received positively when briefed during this period to Congressmen G. William Whitehurst of Virginia and Newt Gingrich of Georgia, both members of the Congressional Reform Caucus. The same was true of subsequent briefings to other members of Congress. Briefings were also given to all principals of the Department of the Army staff, and ultimately, to all the Service Chiefs and their deputies and, in March 1982, to Vice President George Bush.<sup>38</sup>

Morelli and the other briefers, following his lead, stressed the importance of unfettered, imaginative doctrinal thinking. Against Soviet power, attrition answers could not succeed. The Army had to rely on the strength of western man, had to exploit his innovativeness, independent thinking, flexibility, and adaptiveness to change.<sup>39</sup>

The AirLand Battle briefings, which continued into 1982, thus informed influential Congressional and Administration officials about the doctrinal developments accompanying the transition to Army 86 and the new weaponry coming into production and deployment. The briefings of 1981–1982 presented a doctrine that was convincing and that corrected the major problems, real and perceived, of the 1976 FM 100–5. The broad acceptance of the new doctrine could be in no small measure attributed to General Morelli's dedication to that goal.

## *The 1982 FM 100–5, Operations*

Like its 1976 predecessor, the 1982 manual was a significant doctrinal statement. It reflected, in line with the shift in national strategic perceptions since the late 1970s, the more confident tone of an offense-oriented military operational doctrine.<sup>40</sup>

## *The Strategic Challenge and the Next Battlefield*

In the 1980s, the Army could find itself at war in any one of a great number of places, the new FM 100–5 noted.<sup>41</sup> Enemies might range from the modern mechanized armies of the Warsaw Pact, to similarly organized Soviet "surrogates" in Southwest or Northeast Asia, to lighter, well-equipped Soviet-supported insurgents or terrorist groups in other parts of the world. The

manual was explicit about the seriousness of the major challenge—the land forces of the Soviet Union. Soviet doctrine emphasized the principles of mass and maneuver and sought victory through a relentless prosecution of the offensive. If nuclear and chemical weapons were required in order to assure the success of their operations, the Soviets would use them. Indeed, their basic doctrine assumed such use, and their armies were equipped, armed, and trained to use nuclear and chemical weapons without needing to pause for transition. Against such an enemy, the manual writers said, all available military force of all the services had to be applied: "The AirLand Battle will be dominated by the force that retains the initiative and, with deep attack and decisive maneuver, destroys its opponent's abilities to fight and to organize in depth".<sup>42</sup>

A battlefield no longer characterized by distinct area lines but by rapid movement and intense volumes of fire, and with distinctions between forward and rear areas blurred, was the picture forecast in the manual. The range and lethality of enemy weapons would equal or exceed those of the U.S. Army, concentrating enormous combat power. Emergence of a wide range of surveillance systems, target acquisition sensors, and communications would provide battle intelligence to commanders in almost instantaneous time, facilitating the waging of deep battle. U.S. forces had to plan from the outset to expect nuclear and chemical operations. First use of such weapons by the enemy could not be permitted to decide the conflict. "On the modern battlefield, nuclear fires may become the predominant expression of combat power, and small tactical forces will exploit their effects." Thus, such

"engagements will be short and violent. Decisive battles may last hours instead of days or weeks".<sup>43</sup>

Modern electronic countermeasures would severely disrupt effective command control, placing a premium on the initiative of subordinate commanders. Such initiative was a point of emphasis of the manual, adapting the *Auftragstaktik* principle. Airmobility, now a Soviet as well as American capability, would, together with airpower, extend the battlefield to great depths. For the U.S. Army, logistical lines would be long and vulnerable. Rear areas would be subject as never before to attack and disruption by subversive and terroristic actions and by airmobile, amphibious, and airborne forces, as well as by long range fires. Combat in built-up areas, including the near continuous urban character of sections of West Germany, would be inevitable. In other areas of the world, desert and jungle warfare posed both special problems and opportunities. Desert warfare with its extreme demands could be expected, and this prospect required a high order of skillful adaptation and imagination.

The extremely fluid nature of the 1980s battle placed a premium on leadership, unit cohesion, and effective independent operations. Leaders had to be more skillful, imaginative, and flexible than ever before. Training, the new doctrine affirmed, was the cornerstone of success in battle, and it placed emphasis on leadership and unit cohesion: "Training is a full-time job for all commanders in peace-time . . . On the day of battle, soldiers and units will fight as well as or as poorly as they were trained before battle".<sup>44</sup> This injunction applied to the Reserve Components as well as to the Active Army. Training

occurred mostly in the Army's units and it had to concentrate on leaders and teams. Commanders had to focus on training, on building confidence and initiative in their subordinate leaders. Unit training had to be realistic and as rigorous for support units as for combat units.

## *Fundamentals of Combat*

The Army's operational concept in the 1980s, AirLand Battle was the source for derivation of the tactics, procedures, organizations, support structures, equipment, and training of the 1980s Army. It was significant that the new manual again placed the principles of war, and their application to classical and modern theory, at the foundation of the Army's doctrine.<sup>45</sup>

The 1982 field manual was explicit about the intent of U.S. Army doctrine and it conveyed a vigorous offensive spirit. "AirLand Battle doctrine . . . is based on securing or retaining the initiative and exercising it aggressively to defeat the enemy. Destruction of the opposing force is achieved by throwing the enemy off balance with powerful initial blows from unexpected directions and then following up rapidly to prevent his recovery. . . . Army units will . . . attack the enemy in depth with fire and maneuver and synchronize all efforts to attain the objective. They will maintain the agility necessary to shift forces and fires to the points of enemy weakness. **Our** operations must be rapid, unpredictable, violent, and disorienting to the enemy."<sup>46</sup>

The four watchwords noted earlier defined the AirLand Battle—initiative,

depth, agility, and synchronization. The requirement for thorough understanding of the commander's intention throughout the force was inherent. But subordinate commanders were to be given freedom and responsibility to develop and exploit opportunities they discovered or created, to act independently within the overall plan. "Improvisation, initiative, and aggressiveness . . . must be particularly strong in our leaders."<sup>47</sup>

The dimensions of depth were time, distance, and resources. Battle in depth should delay, disrupt, or destroy the enemy's uncommitted forces and isolate his committed forces. The deep battle was closely related to the close in fight. Whether attacking or defending, a timely and well-considered deep attack against the enemy second echelon forces to support the close-in battle was now an important adjunct to doctrine. Reserves would play a key role in achieving depth and were best used to strike a decisive blow. Agility emphasized quick-minded flexible leaders and flexible organizations attuned to the specific on-the-spot dictates of mission, enemy, terrain, and troops and time available. Synchronization was indispensable. Synchronized, violent execution was "the essence of decisive combat."<sup>48</sup> But synchronization was more than the cliché of coordinated action. It meant a constant grasp by subordinate commanders of their commander's overall plan. Synchronization also meant the fullest use of the combined arms to achieve complementary and reinforcing effects—as well as the tactical nuclear and chemical options, if authorized by the national command authority.

Great clarity was added by the inclusion of the operational level of war,



applicable to the operations of army and corps below the level of military strategy and above the tactics of battles and engagements—in practice, the planning and conduct of campaigns. In the manual, the writers held to a clarifying distinction between circumstances and actions at the tactical level and those at the operational level.

The new manual stressed that the dynamics of battle encompassed not only tangible factors such as the effects of fire and maneuver, but intangible factors that often predominated—the state of training, troop motivation, leader skill, firmness of purpose, and boldness. An understanding of combat power was essential to an understanding of battle dynamics. Combat power was a complex combination of tangible and intangible, quantifiable and non-quantifiable factors. Combat power was relative and never absolute, and it had meaning only as it compared to that of the enemy. The appropriate combination of maneuver, firepower, and protection by a skillful leader within a sound operational plan could turn combat potential into actual combat power. Superior combat power applied at the decisive time and place decided the battle.

Outlining the elements of combat power, the doctrine departed from that of 1976 in emphasizing maneuver as "the dynamic element of combat." Maneuver was

the means of concentrating forces in critical areas to gain and to use the advantages of surprise, psychological shock, position, and momentum which enable smaller forces to defeat larger ones . . . . it is the employment of forces through movement supported by fire to achieve a

position of advantage from which to destroy or threaten destruction of the enemy.<sup>49</sup>

The object of maneuver at the operational level was to focus maximum strength against the enemy's weakest point, thereby gaining strategic advantage. It was achieved by the skillful coordination of fire in depth with the movement of large units. Successful maneuver at the tactical level contributed significantly to sustaining the initiative and depended upon skillful movement along indirect approaches supported by direct and indirect fires.

**Firepower** provided "the enabling destructive force essential to successful maneuver," but was also used independently of maneuver to destroy, delay, or disrupt enemy forces. Maneuver and firepower were "inseparable and complementary elements of combat."<sup>50</sup> **Protection** was the shielding of the fighting potential of the force so that it could be applied at the decisive time and place. The elements of protection were security, dispersion, cover, camouflage, deception, operations security, suppression, and mobility, as well as soldier morale and health factors. Finally, combat power encompassed competent and confident **leadership**. Leadership was "the crucial element of combat power."<sup>51</sup>

The new doctrine put considerably more emphasis on leadership than had the doctrine of the mid-1970s. If not measurable, leadership was an enduring military constant. Leaders had to be men of character who knew and understood soldiers as well as the physical tools of battle and who could motivate soldiers to do difficult things

under trying circumstances. Continuous training throughout campaigns, on and near the battlefield, was another attribute of the successful commander. In the final analysis and once the force was engaged, superior combat power derived from the courage of soldiers, the excellence of their training, and the quality of their leadership.<sup>52</sup>

The doctrine comprised seven combat imperatives which were based on the enduring principles of war. As he planned and fought the battle, the commander had to insure unity of effort; to direct friendly strengths against enemy weakness; to designate and maintain the main effort; to sustain the fight; to move fast, strike hard, and finish rapidly; to make skillful use of terrain and weather; and lastly, to protect the force.

In these additions it can be seen that the manual registered a decisive shift away from TRADOC's brief fascination in the late-1970s with a systems-oriented view and its suggestion of a "battle calculus," built around firepower models and force ratios. The text also gave much attention to terrain analysis and how to use terrain to advantage, to the effects of weather and visibility on battle, to the problems of combat in urban and built-up suburban areas, and to combat in mountains, jungles, deserts, and winter conditions.

## *The Offense*

Into its doctrine of the offense—the destruction of enemy forces—the new

FM 100-5 introduced Clausewitz's idea that "when we speak of destroying the enemy's forces. . . nothing obliges us to limit this idea to physical forces; the moral element must also be considered."<sup>53</sup> Thus, attacks that avoided the enemy main strength but shattered his will or reduced his fighting capability were preferred. Such attacks were the quickest and cheapest way of winning. Attack against enemy weakness rather than force-on-force attrition battle, and maintaining the momentum of the initiative were the keynotes of the offensive doctrine. The doctrine writers drew freely on Clausewitz's emphasis on violent effect and Liddell Hart's "indirect approach"—joining these to the AirLand Battle points of initiative, depth, agility, and synchronization. Five elements of offensive action were highlighted as the most fundamental: concentration of effort, surprise, speed of attack, flexibility, and audacity.

Offensive operations were to be characterized by aggressive initiative on the part of subordinate commanders, by speed and violence, by the seeking of soft spots, by rapid shifts in the main effort to take advantage of opportunities, by momentum, and by the deepest, most rapid destruction of enemy defenses possible. The ideal attack should resemble, the manual writers said, the Liddell Hart concept of the expanding torrent. It should move fast, follow reconnaissance units or successful probes through gaps in enemy defenses, and shift its strength quickly to widen penetrations and to reinforce successes, thereby carrying the battle deep into the enemy rear. It should destroy or bring under control the forces or areas critical to the enemy's overall defensive organization before the enemy could react.<sup>54</sup>

## *The Defense*

New emphases in defensive doctrine, as noted before, were marked. The active defense, dependent on carefully concerted lateral movements by elements of the defending force, had been one of the most controversial features of the 1976 doctrine. It now gave way to a defensive doctrine seen as a continuum with no single technique alone prescribed. Defensive techniques would range from a static positional defense to a deeper, more dynamic force-oriented defense of maneuver to disrupt or destroy as the situation demanded. Defense might be forward, or in depth, and might rely heavily on strongpoints. It had five complementary elements: deep battle operations in the area of influence that was forward of the contact line, covering force operations to support the main effort, the main effort in the main battle area, rear area protection operations, and reserve operations in support of the main effort.

As with the offense, the operational concept of the defense called for seizing the initiative and engaging the enemy throughout the depth of his formation in order to disorganize him and create opportunities for offensive action. Initiative, agility, and synchronization similarly were elements of defensive action. The deep battle in its defensive aspect would take full advantage of air-delivered weapons, field artillery fires, tactical nuclear weapons—should their use be approved, air maneuver units, and unconventional warfare forces. The covering force served as a forward security echelon and protected the main force from surprise. Its role in the defense was to gain and maintain con-

tact to develop the situation and to delay or defeat the enemy's leading elements.<sup>55</sup>

Rear area protection operations were expected to assume great importance, and the commander had to be prepared to take the risks necessary to deal effectively with dangerous concentrations of enemy elements in his rear areas.<sup>56</sup>

AirLand Battle doctrine was more explicit than active defense doctrine about the question of reserves. Whereas the 1976 manual had asserted that a division commander who spread two of his brigades thinly across a wide area, while holding his third brigade in reserve, would be defeated by a breakthrough attack,<sup>57</sup> the new manual returned to a more traditional reliance on reserves. In his direction to the doctrine writers, Lt. Gen. Richardson took a firm stand on this controversial point of the 1976 doctrine and insisted on maintaining a reserve and to use it to strike a decisive blow.<sup>58</sup> Commanders down to brigade normally would retain about one-third of their maneuver strength in reserve.<sup>59</sup> Also discouraged was the shifting of forces by lateral movement that had characterized the active defense. This movement now was seen to be an especially vulnerable operation. The enemy could easily disrupt or prevent it by air or artillery interdiction. Moreover, vacating a sector in order to move laterally actually invited enemy penetration and was, in any case, psychologically difficult.<sup>60</sup>

## *Other Considerations*

Guidelines on the problems of how to support a fighting force with enormous consumption of ammunition, fuel,

repair parts, and other logistical supplies were presented. The emphasis was on fast forward resupply, forward maintenance, and, where possible, conservation. The new doctrine recognized the inseparability of tactics and logistics, according to the maxim that what could not be supported logistically could not be accomplished tactically.<sup>61</sup>

A doctrinal addition in 1982 was a special section on joint and combined operations, since the Army, in the most likely case, would be fighting alongside another service or as part of a combined force. The field manual also spelled out the special problems of coordination and environmental considerations in each major area involving allied operations.<sup>62</sup>

The 1982 FM 100-5 demonstrated a pronounced sense of history in a selection of germane military maxims and examples. With Clausewitz, the manual writers repeated, for example, the truism of the "friction" of battle conditions, where "the simplest things become difficult." They noted the use by General Patton of the Norman roads to gain surprise, rather than well defended modern routes, and the injunction of Sun Tzu that "the worst policy of all is to besiege walled cities," as borne out, for the writers, at Stalingrad and Tobruk.<sup>63</sup> The manual detailed briefly a number of battles to illustrate doctrinal points. Two examples were the Vicksburg Campaign, for its elements of speed and surprise in the indirect approach, and Tannenberg for its demonstration of exploiting fluid conditions in the transition from the defense to the attack.

Significantly, Army doctrine now noted, as it had not in the mid-1970s, the political aspect of warfare.

Defeating enemy forces in battle did not always assure victory. "Other national instruments of power and persuasion will influence or even determine the results of wars. Wars cannot be won. . . without a national will and military equal to the task."<sup>64</sup>

The mid-1970's doctrine had also reflected the immediacy and importance for its authors of the 1973 Arab-Israeli War, whose tactical lessons it fully embodied. The new doctrine, oriented to both the tactical and operational levels of war, did not reflect the same preoccupation with the Middle East War lessons, which indeed had long since been absorbed. Campaigns and battles, rather than a crucial first battle, were the focus of the new broader approach.

Significantly, also, the "air-land war" changed in definition from its 1976 meaning of cooperation and mutual support between the land and air arms. AirLand Battle in 1982 referred to simultaneous battles on the forward line and deep in the enemy's rear echelons, in close concert by airpower and ground forces. A preparedness to transition without loss of momentum to fight on a nuclear or chemical battlefield if necessary was another significant addition. In 1982, Army doctrine again spoke of contingencies worldwide, emphasizing once more the missions beyond NATO. The new doctrine was applicable anywhere the U.S. Army was called on to fight. The harnessing of new weapons and new reconnaissance, surveillance, and target acquisition capabilities, and the implications of increased urbanization and large arid expanses all were recognized.

A much stronger spirit of the offense was now evident, particularly in the shift of emphasis from the active tactical defense to a view of securing and maintaining the initiative in defensive and offensive operations. The role of maneuver was strengthened in all operations. The new offensive spirit required and encouraged a more emphatic stress of leadership, and here the German principle of *Auftragstaktik* and the principle of unit cohesion were noteworthy.

Finally and not least, the clear turn of phrase and apt metaphor that readers of the 1976 manual had found striking were not lost in the new version. Conscious that clear ideas turn on cogent phrase and lucid writing, the manual writers worked to avoid the pitfalls of jargon and specialty speech. Here, they both borrowed and invented, employing, for example, the arresting Clausewitzian image of the defense as "a shield of blows," along with the AirLand Battle concepts of *deep battle* and of *collapsing* the enemy's fighting structure.

\* \* \*

With publication of the revised FM 100-5 of August 1982, the concept of AirLand Battle was sanctioned as the Army's fighting doctrine for the decade

ahead. Intimately bound up with the restoration of American strategic perspective in the early 1980s, the new doctrine provided the forthright intellectual basis for an Army reassuming an explicitly offense-oriented readiness posture. Thus, AirLand Battle was a notable contribution to deterrence as well.

Commitment to the new dynamic fighting doctrine also signalled the ebbing of the systems-analysis "management" view of battle. That view, at its peak in the 1960s, sought measurable quantitative outcomes as the linch-pin of military success and tended to overlook the immeasurable but enduring principles constant in the experience of men in battle, such as leadership, initiative, and the commander's intuitive feel and sense of time and maneuver—the *Fingerspitzengefühl* possessed by schooled, skilled, imaginative tacticians and battle captains. AirLand Battle again emphasized the resourceful leader as the dynamic element of decision. It reaffirmed the maxim, true in tactical doctrine as in all human experience, that what is true must be repeated if it is not to be forgotten. AirLand Battle was a return to the tried and true principles of experience in war.

\* \* \*



**\$ SSHQGLI \$**

## *AirLand Battle and AirLand Battle 2000/Army 21*

In 1980 TRADOC doctrinal planners began to develop an overarching concept beyond the AirLand Battle for the far term. Encompassing the period 1995-2015, this effort was titled, in 1981, AirLand Battle 2000 to distinguish it as a far-future oriented concept while referring to its roots in the AirLand Battle doctrine of the 1980s. AirLand Battle 2000 was envisaged as a concept that would be the starting point of all future weapon acquisition as well as future doctrine, force design, and training requirements. During 1981, combat developments planners worked out a concept based requirements strategy as a mechanism by which to translate the broad operational concept into those requirements. AirLand Battle 2000 was also featured prominently in Army staff talks with the armies of the United Kingdom and the Federal Republic of Germany as a vehicle for future doctrinal cooperation. General Edward C. Meyer, the Chief of Staff of the Army, approved the basic concept in September 1981.

The AirLand Battle 2000 concept drew a picture of a future battlefield with sophisticated weapon and equipment systems whose range, lethality, and potential would surpass anything known in contemporary warfare. Bat-

ties would encompass the full depth of enemy formations—300 kilometers or more—and the airspace above would be saturated with aerial and space surveillance, reconnaissance, and target acquisition systems. The conflict would be intense and devastating, particularly at the point of the decisive battle. Command and control would be exceedingly difficult. Battle would be waged with the systems of all the services integrated. Mobility would be an absolute essential. U.S. forces had to plan from the outset to fight dispersed on a conventional-nuclear-biological-chemical-electronic battlefield on which they would possess no qualitative advantage in weaponry. AirLand Battle 2000 was described, in essence, as a style of waging war in which agility, deception, and maneuver, firepower, and all other tools of combat were used to face the enemy with a succession of dangerous and unexpected situations more rapidly than he could react to them. Planners reduced the concept to nine major battlefield functions—close combat; air defense; communications; command and control; combat service support; intelligence and electronic warfare; combat support, engineer and mine warfare; fire support; and aviation. The individual concepts for the functional

divisions of AirLand Battle 2000 were worked out during 1981-1982 and published by TRADOC in August 1982.

Because of the similarity in name of the far-future concept with AirLand Battle, confusion of the two resulted, and in November 1983 TRADOC re-titled the warfighting concept for the 21st century "Army 21," while also adding several new features. The Army 21 concept, as outlined in late 1983, would emphasize the essence of AirLand Battle 2000 but would seek a greater specificity in ideas. It would also add concepts relating to the military implications of space, the human dimension, joint air and ground operations, worldwide command and control of forces, leadership and a "warrior ethic," low-intensity conflict and terrorism, the organization of air and ground forces for combat, and the role of air support. In NATO and in the arena of bilateral army staff talks, the title, AirLand 2000, was retained, although the Army planned to introduce Army 21 to those forums as it matured. Like AirLand Battle 2000

before it, the Army 21 concept was envisaged as the framework for future doctrine and as a basis and focus for materiel, training, and other developments. Army 21 would also provide the Army's contribution to the joint Air Force—Army long range planning effort, "Focus 21."

---

**Sources:** (1) *AirLand Battle 2000 Concept*, 4 September 1981, HQ TRADOC, Fort Monroe, Va. (SECRET—Info used is UNCLASSIFIED) (2) *AirLand Battle 2000 Concept*, 10 August 1982, HQ TRADOC, Fort Monroe, Va (3) *Msg, Cdr TRADOC to distr, 212115Z November 1983, subj: AirLand Battle 2000 (ALB 2000)/Army 21.* (4) *Paper, "Airland Battle 2000 Becomes Army 21," Maj. Gen Donald R. Morelli, DCS for Doctrine, HQ TRADOC, no date.*



## *Appendix B*

### *TRADOC PAMPHLET 525-SERIES OPERATIONAL CONCEPTS Published as of 31 December 1982*

	Title	Date Published
525-1	Army Tactical Intelligence	20 Jun 80
525-2	Army Tactical Command Control	20 Jun 80
525-3	Employment of Smoke	26 Sep 80
525-4	Heavy Division Operations—1986	1 Dec 80
525-5	AirLand Battle and Corps Operations—1986	25 Mar 81
525-6	Operations Security, Doctrinal Guidelines for Tactical Units and Trainers	1 May 81
525-7	Command, Control, and Communications Countermeasures (C3CM)(SECRET)	15 Dec 81
525-8	US Army Aviation Self-Deployment	6 Mar 81
525-9	Joint Suppression of Enemy Air Defenses (J-SEAD) (SECRET)	3 Apr 81
525-10	Comptroller-Finance Services in the Theater	29 May 81
525-11	Near Term Water Resources Management	15 Jun 81
525-12	Communications Zone (COMMZ) Logistics Operations	30 Jul 81
525-13	Use of Army Bands in Combat Areas	6 Nov 81
525-14	Contingency Corps Operations—1986	14 Jun 82
525-15	Aviation Class III and Class V Resupply of Aviation Units	19 Mar 82
525-16	Joint Attack of the Second Echelon (J-SAK)	13 Dec 82
525-17	Intelligence—Electronic Warfare at Echelons Above Corps (SECRET)	28 May 82
525-18	Countermining Operations	30 Jun 82
525-19	Land Mine Warfare	18 Jun 82
525-20	Individual and Collective Measures for Chemical, Biological, and Radiological (CBR) Defense	30 Jul 82
525-21	Tactical Weather Support	4 Oct 82

Source: Above noted documents.



## *Appendix C*

### *SELECTED DOCUMENTS*

1. Letter, General W. E. DePuy, CG TRADOC, to multiple addresses, 23 July 1974.
2. Letter, General W. E. DePuy to General Fred C. Weyand, Chief of Staff, Army, 18 February 1976.
3. Commanders Notes No 3, Operational Concepts and Doctrine, 20 February 1979.
4. Message, Commander TRADOC to distribution, 091530Z July 1980, subject: Integrated Operations.
5. Message, Commander TRADOC to distribution, 291305Z January 1981, subject: The AirLand Battle.
6. Memorandum, 23 May 1981, subject: US Army and US Air Force Agreement on Apportionment and Allocation of Offensive Air Support (OAS), signed/LTG Glenn K. Otis, Deputy Chief of Staff for Operations and Plans, Department of the Army, and Lt Gen Jerome F. O'Malley, Deputy Chief of Staff, Plans and Operations, Department of the Air Force.
7. Article, General Glenn K. Otis, "Doctrinal Perspectives of War," Headquarters TRADOC, Fort Monroe, Va.

23 July 1974

Dear Tom, Donn, Dave, CJ, Bill, Jack and Hal,

In France in the house of a peasant there is always a pot of soup boiling in the fireplace. From time to time someone throws in a potato, leek, some chicken stock or beef gravy, an occasional carrot or whatever. Over time the soup gets better and better. Everyone can add to it and anyone may partake. I view the attached paper somewhat the same way.

I do not intend to publish this paper as a TRADOC Headquarters publication. I would like to have you discuss it with me or send comments, recommendations or amendments and particularly additions to it. From time to time we will gather to discuss it or aspects of it.

Those parts of it which seem relevant and useful to your business should find their way into your doctrinal manuals and your instruction in both officer and NCO schools and should provide a conceptual basis for the determination of weapons systems requirements. Operational tests, force development tests evaluations and experiments should be conducted in a manner consistent with the tactical concepts on which I hope we can agree through the medium of this paper.

I do not expect or wish to whip up a lot of additional paperwork. I do want the Air Defense School to contribute some obviously missing parts. Treatment of the Engineer aspects are much too thin and I expect some input from that quarter. In short, I want this paper to stay alive and improve, but I want to keep it as an informal TRADOC document which will not see the light of day as a separate official publication. I don't care who sees it or how many copies are made. I just want to keep it like that pot of French soup.

Sincerely,

Incl  
As stated

W. E. DePUY  
General, United States Army  
Commanding

Major General Thomas M. Tarpley  
Commander  
US Army Infantry Center &  
Commandant, US Army Infantry School  
Fort Benning, GA 31905

Major General Donn A. Starry  
Commander  
USA Armor Center &  
Commandant, USA Armor School  
Fort Knox, KY 40131

Major General David E. Ott  
Commander, USA Field Artillery Center &  
Commandant, USA Field Artillery School  
Fort Sill, OK 73503

Major General CJ LeVan  
Commander  
USA Air Defense Center &  
Commandant, USA Air Defense School  
Fort Bliss, TX 79916

Major General William J. Maddox, Jr.  
Commander  
US Army Aviation Center &  
Commandant, US Army Aviation School  
Fort Rucker, AL 36360

Major General John N. Cushman  
Commander, USA Combined Arms Center &  
Commandant, USAC&GSC  
Fort Leavenworth, KS 66027

Major General Harold E. Parfitt  
Commander  
USA Engineer Center &  
Commandant, USA Engineer School  
Fort Belvoir, VA 22060



REPLY TO  
ATTENTION OF

**DEPARTMENT OF THE ARMY**  
HEADQUARTERS UNITED STATES ARMY TRAINING AND DOCTRINE COMMAND  
OFFICE OF THE COMMANDING GENERAL  
FORT MONROE, VIRGINIA 23651

18 February 1976

Dear Fred,

The Army has now developed and articulated its doctrine for combat on the modern battlefield in FM 100-5 which with the comments and concurrence of your staff is on its way to the printer.

The importance of FM 100-5 to the effectiveness of the Army and the security of the United States demands a high level of confidence in its validity. This is because it contains the doctrine which directs the manner in which we intend to fight and from which we derive the requirements for our weapons systems. The process by which this manual has been developed should inspire such confidence. Therefore, I think it important to set forth the major features of that process in this letter.

As you recall, in the summer and fall of 1973 the Army was in the process of recovering from the numerous effects of the Vietnam war and deep into the challenge of the all-volunteer Army. The Army was preoccupied--unavoidably and understandably--with problems of morale, motivation, and the directly related problem of attracting and retaining volunteers. It was an inward looking time.

Then, in October of 1973, the Arabs attacked Israel. In 18 days, about two thousand Arab tanks were destroyed along with 4 or 5 hundred Israeli tanks and all sorts of other fascinating consequences became apparent. This was the first large scale confrontation between two forces equipped with modern weapons representative of those found in the hands of NATO and the Warsaw Pact.

General Abrams directed TRADOC to analyze the war and its meaning and its lessons for the US Army. We have been in the process ever since. Our first reactions are still valid:

- Proliferation of modern weapons.
- High lethality.
- Requirement for suppression.
- Importance of balanced teams of combined arms.
- Difficulty facing close air support.
- Electronic Warfare.
- Importance of training.
- Many others.

When we looked at the state of doctrine, tactics, techniques and training in the US Army, measured against the demanding standards of the Middle East battlefield, we found them wanting. We also found an Army with its attention focused elsewhere.

During the winter, spring and summer of 1974, we concentrated on a review of all US weapons system characteristics against the lessons of the Middle East War. We also concentrated on the implication of that war on the tactics, techniques and training of our tank, mechanized infantry and armored cavalry elements and their supporting artillery and air defense. We started at the bottom--squad, platoon, company, battery and troop. Circulars were published and quick-fix pamphlets were produced.

In October of 1974, TRADOC and FORSCOM conducted a joint demonstration and seminar on tactics and techniques for combat on the modern battlefield at company--battery level. (OCTOBERFEST)

All FORSCOM, Corps and Division Commanders attended, along with representatives from Alaska, Panama and Korea. All TRADOC Commandants from the combat arms attended. We reached a consensus on the problem and the solutions at the lower tactical echelons.

It became apparent, however, that the implications of the Middle East War and our review of our status involved problems and challenges at every echelon from Corps to Company. TRADOC therefore embarked on a program to reorient and restructure the whole body of Army doctrine from top to bottom. We perceived that the key would have to be the substantial revision of FM 100-5 - Operations, the basic statement of our solutions to the challenge of modern weapons across the whole integrated battlefield, most certainly including the air-land battle in every aspect. We set out in late 1974 to develop and publish 100-5 by the summer of 1975. It turned out to be a bigger job than that. It has taken nearly an additional year--FM 100-5 will be out by June 1976 in the hands of the Army in the field.

It became apparent early on that we were at an historic turning point in the evolution of Army forces. In the past, the Army has been characterized by large formations of men equipped with the weapons which would facilitate the accomplishment of the unit mission. Now, we are at or very, very close to the point in which we must organize the Army to employ and maintain the modern weapons which can drive the outcome on the battlefield. Thus, we started FM 100-5 with a rather long discussion of weapons--weapons effectiveness trends--and implications. By the way, the German Army is lifting this part of FM 100-5 in its entirety into their basic doctrinal manuals. The Israeli Army is clearly weapons oriented. By weapons orientation, we mean the weapon itself, its tactical employment, the techniques of operation and siting, the selection and training and replacement of crews and the maintenance and supply system behind it all the way back to the CONUS.

In the spring of 1975, it became apparent that certain elements of the Army felt that OCTOBERFEST signaled a retreat from air mobility and too narrow a focus on mounted or mechanized warfare. Consequently, FORSCOM and TRADOC organized the sequel to OCTOBERFEST in the form of OFTCON which you attended. An expanded FORSCOM/TRADOC attendance was also extended to include a principal Reserve Component Commanders and USAREUR participation. USAREUR and TRADOC are now deep into the planning for a European-style (NATO/Germany) OFTCON-type demonstration and tactical seminar next fall.

Immediately following OFTCON, at your direction, we met for 3 days with the high command of the German Army on doctrine concepts and weapons systems. USAREUR involvement was complete and important.

You have my report on that meeting which was a very constructive first step toward improved cooperation on weapons and joint development of concepts and doctrine. The first German reaction to FM 100-5 (early draft) was that we placed too much emphasis on company level operations--too much cross-reinforcement--too little involvement of battalion commanders and too little emphasis on fighting forward. Part of this reaction was justified and part interpretation.

Since then, the Vice Chief of Staff of the Bundeswehr, Lieutenant General Von Reichert, has expressed satisfaction with the latest version--a version, by the way, which benefited greatly from our discussions with the Germans. There are some subtle and other organization differences which remain which I will explain later.

Concurrently, with OFTCON and the German meetings the TRADOC schools have been pressing on with the company, battalion, brigade and division manuals which are derivative of the doctrine in FM 100-5. During the past 6 months, the III Corps, with 2d Armored and 1st Cavalry Divisions has been exercising the tactics set forth in the draft manuals and circulars. They found problems--problems of understanding and problems of execution. In the last week of January, we met with all the involved commanders at Fort Hood (including, for example, all battalion commanders and many company commanders) for two solid days of talks, demonstrations and presentations. We came away with agreement, all around, on how to conduct operations at Brigade, Battalion, and Company in accordance with the "How to Fight" concepts in FM 100-5 and derivative manuals.

All the while our work with TAC had been progressing. We established a joint coordination staff at Langley Air Force Base and have made substantial progress on:

- Air Space Management.
- Air Defense Suppression and Electronic Warfare.
- Close Air Support Procedures.
- Air Logistics
- etc.



The product of this effort is incorporated into FM 100-5.

We have also included a weapons oriented logistic system after extended work with your staff, DARCOM and the commands. Additionally, a tactical nuclear chapter has been added and cleared with and through your staff.

USAREUR has submitted a chapter on operations in NATO. A chapter on Military Operations in Built-up Areas (from USAREUR, ARPA and TRADOC) is in final stages but may not make the first edition.

After repeated postponement, we met in the third week of January with the Israeli delegation at Fort Knox for 3 days of discussions on doctrine, concepts, tactics, techniques and systems.

These discussions with the Chief of Israeli Armored Forces, Artillery, Infantry, Engineer and Training enabled us to measure the Army's new doctrine against their experience and opinion. We are very close on almost all points.

Nothing came out of our discussions and correspondence with the Germans and Israelis which should delay our publication of FM 100-5. Your staff has given us their comments and urges us to proceed.

There are some differences between the Israelis, Germans and our organization and doctrine which deserve careful analysis and very possibly some changes in the future.

Both the Germans and Israelis have three tank platoons instead of five. They believe that a platoon of five is too cumbersome and that only officers can command successfully on the fast moving battlefield. In short, they think we should drop out the two-tank light section in each platoon commanded by the platoon sergeant. They are both fighting in their own backyard and can replace faster. Incidentally, we have one officer for five tanks and they have one for three. This means we could create three tank battalions out of two of our currently larger battalions. This would be costly in officers at a time when we are cutting the number of officers overall. Therefore, we are not recommending a change at this time. We will study the matter carefully and with emphasis on the best arrangement for the XM-1 Tank.

Correspondingly, both German and Israeli Armies consider that we are asking our captains to do more than the average captain can do--particularly war-time captains. They refer to the coordination of tanks with Infantry, Artillery, Mortars, Engineers, Close Air Support and sometimes helicopters. Thus, they feel we cross-reinforce too much at company level whereas we should rely more on battalion commanders to effect this complex coordination. This is a valid concern to which we must give careful thought. In our new company and battalion manuals we will bring the battalion commanders into center stage. This is a direct result of our discussions with the Germans, Israelis and the III Corps. However, there is no need to delay on this score at this time.

So, we have a doctrine in FM 100-5 which reflects the views of the major commands, selected Corps and Divisions and the German and Israeli Armies as well as TRADOC. I thought you would want this record of the development process and I hope it adds to your confidence in the product.

Lastly, you will want to know that the ARTEP are being fine tuned to this doctrine. The first versions of ARTEP need some adjustment.

It will be two more years before all of the hierarchy of manuals and supporting literature will be properly aligned with FM 100-5. The critical manuals for the combat arms have first priority. It will be several more years before 51% of the commanders in the Army--Generals through Captains--operate instinctively in accordance with the principles of FM 100-5. At that time, it will be genuine doctrine.

Respectfully,

W. E. DePUY  
General, United States Army  
Commanding

General Fred C. Weyand  
Chief of Staff  
United States Army  
Washington, D. C. 20310



# Commander's Notes...

no. 3

20 February 1979

## OPERATIONAL CONCEPTS AND DOCTRINE

### 1. Concepts.

All professions have vocabularies of professional terms. Over time, many such terms become establishment "in-words," and are so ill-used that their original meaning is lost. Often it is only necessary to use the words to evoke affirmative head nodding; even though no meaning is conveyed, everyone professes to understand what is meant.

The US Army has its "in-words." Among them is the word concepts. There are concepts for many things; there are concept papers on many subjects; there is visible nodding of heads when the word concept is used. However, it is apparent that the word means different things to all too many of us.

When the Central Battle idea was first conceived, I made the point that operational concepts had to be the driving force for describing interactions that were to occur on the most intense part of the battlefield. While everyone seemed to agree, more and more I have the impression that concepts are being created not to describe the Central Battle, but to justify some individual weapon or other system or piece of equipment. If this is true, we have got the concept of concepts just exactly backwards.

Since we now have signed or are working on concept papers with several US Army agencies and allied nations, it's past time we agreed on what a concept is and what it's supposed to do.

A concept is an idea, a thought, a general notion. In its broadest sense a concept describes what is to be done; in its more specific sense it can be used to describe how something is done. The Soviet notion that numbers win is an example of the former; the implementing notions of mass, momentum, and continuous land combat are examples of the latter. Concepts are therefore rather broad and general; they can also be more specific.

In the sense that the term is used here, concepts are military in nature, relating to ideas, thoughts, general notions about the conduct of military affairs--the operational concepts alluded to earlier. How might the term operational concept be defined? Here is a definition:

Operational Concept - A description of military combat, combat support and combat service support systems, organizations, tactical and training systems necessary to achieve a desired goal.

Concepts are and must be the first agreed upon part of any project. They must also be dynamic--changing as perceptions and circumstances change. For our purposes, TRADOC concepts must be tested in the Central Battle; effects on and interactions with other concepts--tactical, organizational, training and materiel concepts--must be defined.

## 2. Doctrine.

Concepts are not doctrine until tested, approved, and accepted. Not all concepts will eventuate in doctrine. This is why concepts are dynamic, not fixed; this is why they are not tied to a specific piece of materiel or a system. Rather they address themselves to the needs--requirements that flow from the Central Battle.

Doctrine is what is written, approved by an appropriate authority and published concerning the conduct of military affairs. Doctrine generally describes how the Army fights tactically; how tactics and weapon systems are integrated; how command control and combat service support are provided; how forces are mobilized, trained, deployed and employed.

## 3. Concept Formulation.

As a general rule the need for an operational concept may be generated by:

- a. Recognition of a problem for which no doctrine exists.
- b. Recognition or assignment of a mission for which no doctrine exists.
- c. New or improved technology having military application, not yet exploited.

COMMANDER'S NOTES  
OPERATIONAL CONCEPTS AND DOCTRINE

NUMBER 3

20 February 1979

An operational concept, then, is a statement of a way of doing business. Once formed, an operational concept is evaluated. This can be done in a variety of ways: by one of several battlefield simulation processes; by field testing and evaluation; or perhaps by routine staffing.

How are concepts born, and how do they become TRADOC products? Concepts should derive from some perceived imbalance in our ability either to fight the Central Battle or to generate forces to fight the Central Battle. The Tactical Doctrine Office is the keeper of concepts--the clearing house and catalyst for evaluation and infusing of new concepts into all our work.

Anyone can formulate a concept. Concept testing and approval, however, are the business of TRADOC. We should solicit concepts from many sources. We must not drive away new ideas about the Central Battle and force generation simply because they were not invented here.

4. Concept Approval.

By message, memorandum, letter, telephone call or word of mouth, the need for an operational concept will be communicated to the Deputy Chief of Staff for Combat Developments. The DCSCD will develop a draft concept statement to meet the need. Working with the proponent integrating center/school, an author will be named and a milestone schedule developed. Initially, a draft concept statement should be brief--a page or two--but must note the Central Battle implications. The Tactical Doctrine Office will evaluate all concept statements. In early stages of concept formulation, brevity, clarity, and speed are essential. Twenty days should be sufficient to write up a concept, get it through TDO to me.

Approval of a concept statement sets the stage for the writing of a concept paper that can be staffed and fully developed. Concept papers provide the means for setting forth operational concepts. The concept paper is the first step in the doctrinal process. It provides the basis for analysis, evaluation, and development of doctrine, the rationale for writing field manuals, and for the development of equipment, organizations, and the training required to prepare individuals and units to employ the concepts in battle. Concept papers describe:

- . What needs to be done and why--the desired result.
- . The concept:

COMMANDER'S NOTES  
OPERATIONAL CONCEPTS AND DOCTRINE

NUMBER 3  
20 February 1979

- How it is to be done.
  - Where it is to be done.
  - When it needs to be done.
  - Who does it.
- . What is needed to do it--tactics, equipment, organizations, training--in general terms.

Concept papers approved for full staffing must include a description of how the concept affects tactics, organization, equipment and training in the framework of the Central Battle and force generation. Once a concept paper is staffed and approved, it will be released for discussion with other Services, Armies, and for briefing at bilateral and multi-lateral national staff talks. Informal discussions with counterparts may be necessary, but draft papers alleging to be a US position will not be provided to other nations unless they are in fact approved Army concept papers.

No materiel or other developments will begin until a concept is approved. Concepts that address themselves to procedures, tactics or organizations often have a higher payoff and are easier, cheaper and quicker to implement than those requiring equipment development. More attention is needed in this area.

5. Types of Concept Papers.

a. US Army Concept Paper - developed in coordination with other MACOM's and HQ DA. It may be the initial concept effort or it may continue work already begun.

b. Joint Concept Paper - developed with one or more US Services.

c. Combined Concept Paper - developed in conjunction with one or more allied armies. It may be bilateral or multilateral. Examples of bilateral papers are US/GE Concept Papers and US/UK Concept Papers. An example of a multilateral paper is a NATO Concept Paper.

6. Development and Staffing Concept Papers. The charts at inclosures 1 and 2 illustrate the development process for US Army, Joint, and Combined Concept Papers.

7. Responsibilities: Responsibilities are at inclosure 3.

COMMANDER'S NOTES  
OPERATIONAL CONCEPTS AND DOCTRINE

NUMBER 3  
20 February 1979

8. Format: Concept paper format is at inclosure 4. Instructions relating to content and use of this format are included in script type. This format is a guide and, as stated in the instructions, it may need to be augmented or varied depending on the specific guidance the author receives when tasked to develop a particular concept; for example, formats agreed to for bilateral purposes.

9. Distribution: Distribution will vary from paper to paper and will be determined by this headquarters.



DONN A. STARRY  
General, United States Army  
Commanding

4 Incl  
as

DISTRIBUTION:  
H1

THE CONCEPTS/DOCTRINE PROCESS

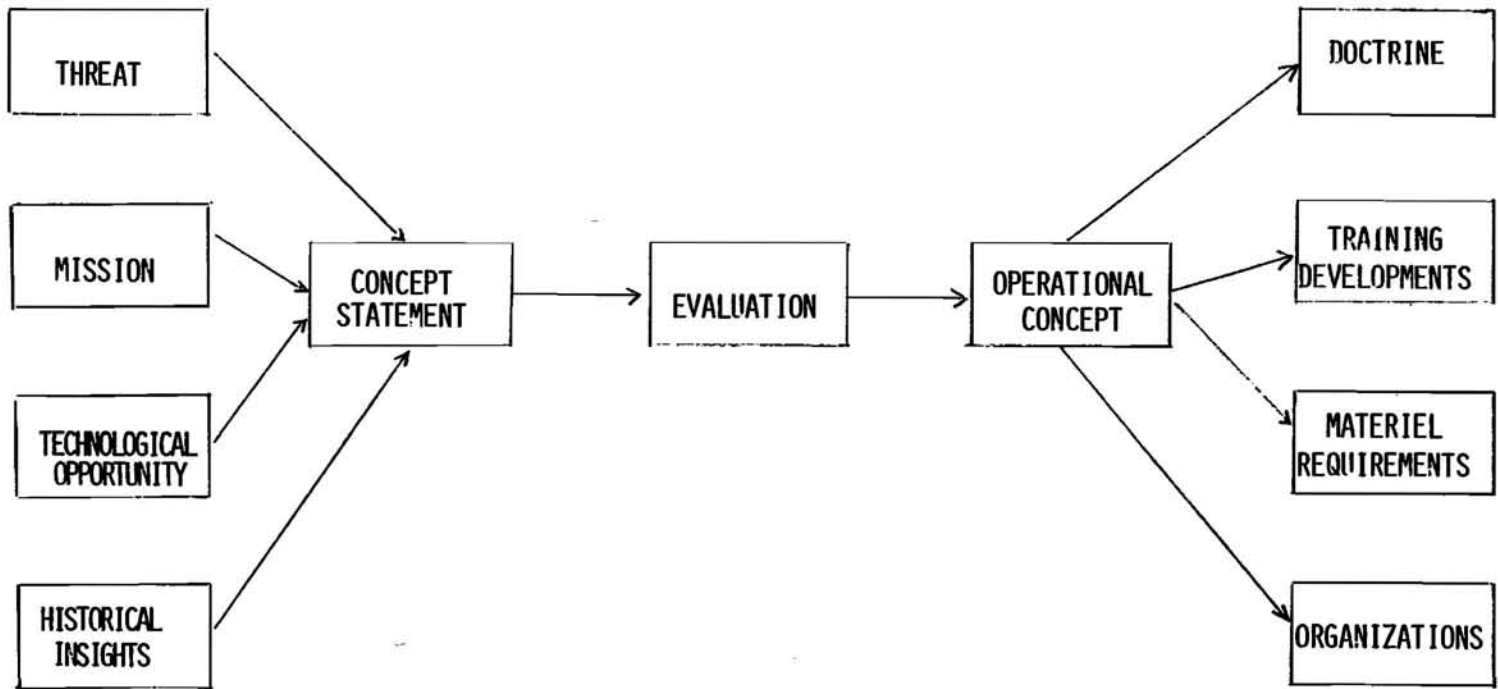

Inclosure 1



CONCEPT EVALUATION

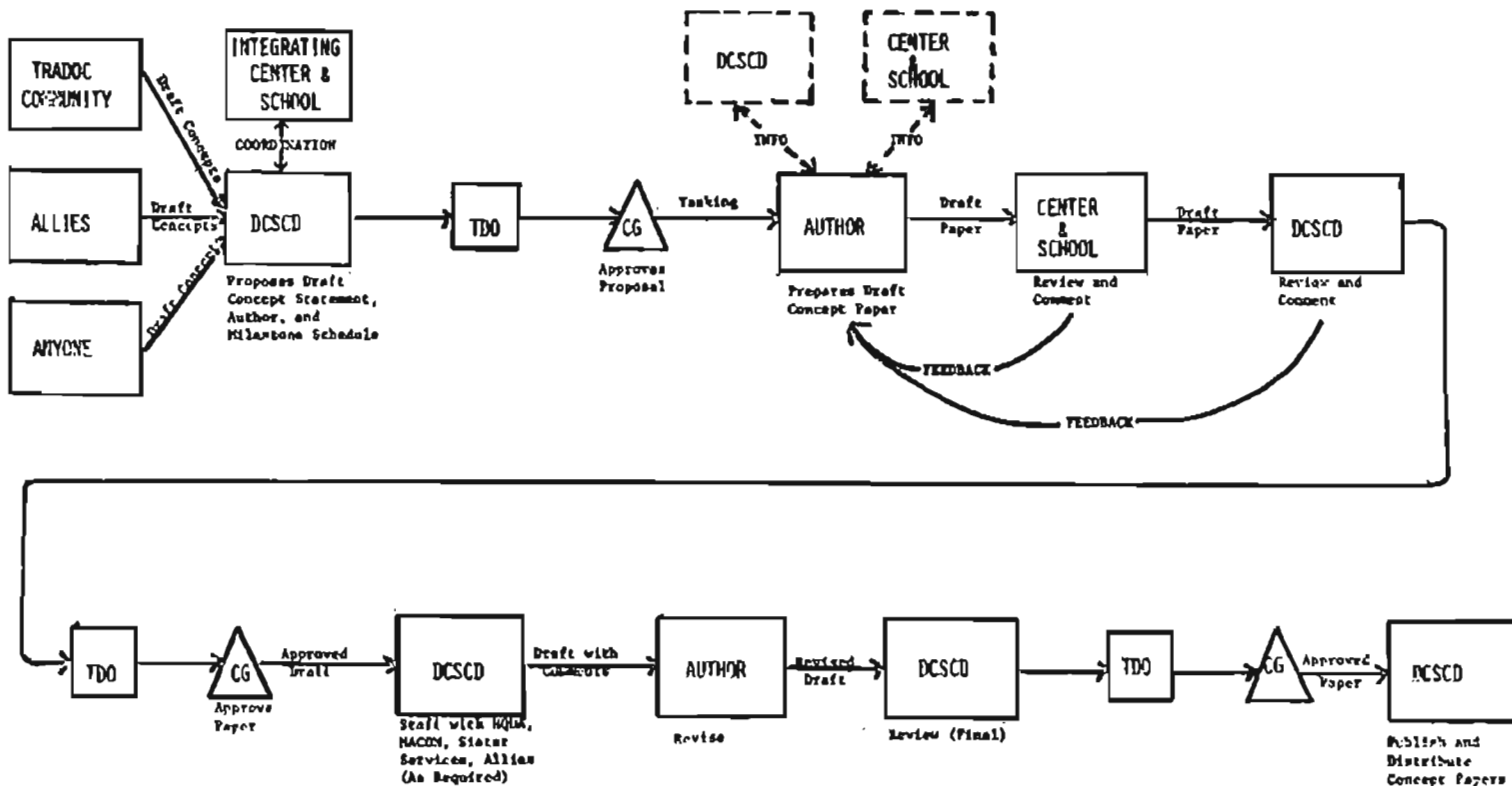

## RESPONSIBILITIES

Deputy Chief of Staff for Combat Developments:

- Primary staff responsibility for concept paper development.
- Processes and staffs papers as shown in the concept paper development chart.

Author:

- Develops concept paper in accordance with TRADOC instructions and specific tasking.
- Coordinates concept development with proponent integrating center, school, and TRADOC Headquarters.

Integrating Center:

- Reviews paper for proper format, accuracy, brevity, and clarity.
- Staffs paper with TRADOC activities.
- Consolidates comments and forwards paper to DCSCD, TRADOC.

Tactical Doctrine Office:

- Primary staff responsibility for concepts and doctrine.
- Evaluates all proposed concepts for quality.
- Reviews all concept papers as shown in the concept paper development chart.

## CONCEPT PAPER FORMAT

## 1. PURPOSE:

The need for the concept--what needs to be done and why--the desired result of the operational concept. Influences of geography, climate, threat and technology may be described in this paragraph. However, when this is done, such descriptions should be limited to only that information necessary to appreciate the need for the operational concept. In the case of geography and threat, reference to other papers, for example US/GE threat concept, is generally sufficient. If a lengthy description of the purpose is necessary, details should be addressed in an annex.

2. LIMITATIONS: Any limiting assumptions or facts; e.g., concept does not apply to nuclear conflict.

## 3. THE OPERATIONAL CONCEPT:

A description of:

- a. How the task is to be done--a brief description of the concept.
- b. Where it is to be done on the battlefield, e.g., covering force area, main battle area, enemy main defense belt, distance forward of the line of contact.
- c. When it is to be done in relation to other battlefield activity, e.g., the covering force battle.
- d. Who does it--the echelon of command, the force.

4. Annexes which may be included (potential for joint development may be included here if applicable):

Terms and definitions

Doctrinal requirements

Equipment requirement

Organization requirement

Training requirement

Rationalization, Standardization and Interoperability

Bibliography

UNCLAS

01 02

RR

UU

091538Z JUL 80

CDR TRADOC FT MONROE VA//ATDO-ZA//

AIG 7573

UNCLAS

SUBJ INTEGRATED OPERATIONS

STARRY SENDS

1. I AM INCREASINGLY CONCERNED REGARDING THE RELUCTANCE AND, IN SOME CASES, COMPLETE FAILURE TO ACCEPT AND INCORPORATE THE IDEA OF INTEGRATED OPERATIONS ON THE MODERN BATTLEFIELD.
2. WE HAVE BEEN TALKING A LONG TIME ABOUT INTEGRATED OPERATIONS. THE DIRECTION WAS APPROVED BY THE VCSA AT THE NUCLEAR SPR AND SHORTLY YOU WILL HAVE A FORMALLY WRITTEN INTEGRATED BATTLEFIELD CONCEPT TO COMMENT UPON. WE HAVE A FORMIDABLE TASK AHEAD IN GETTING ALL THIS TOGETHER; YET EVERYWHERE I GO, I SEE AND HEAR EVIDENCE THAT WE SIMPLY AREN'T THINKING THROUGH OR ATTEMPTING TO WORK THE PROBLEM. WE PERSIST IN PRESENTING OUR PRODUCTS IN A CONVENTIONAL FRAMEWORK. WE CAN'T ACCEPT REASONS THAT IT IS TOO DIFFICULT OR THAT THERE ISN'T SUFFICIENT INFORMATION AVAILABLE OR THE CONCEPTS HAVEN'T BEEN FLESHED OUT. IT IS IN THE ATTEMPT TO WORK THE INTEGRATED BATTLEFIELD THAT THESE PROBLEMS ARE RESOLVED, I.E., THE CONCEPTS GET

1 CY - EACH STAFF OFFICE, HQ TRADOC

Philip L. Getzinger, DAC/ATDO-C  
3675/7 Jul 80

COORDINATION: N/R

UNCLAS

DOCUMENT 4

02 02

091538Z JUL 80

FLESHED OUT AND DATA BECOMES AVAILABLE:

3. IT IS EXTREMELY IMPORTANT THAT ALL DOCTRINAL AND TRAINING LITERATURE, STUDIES, ANALYSES AND REQUIREMENTS DOCUMENTS ADDRESS APPROPRIATE ASPECTS OF INTEGRATED OPERATIONS. WHAT I PREFER TO SEE IS US ABLE TO DROP THE WORD INTEGRATED AND AUTOMATICALLY UNDERSTAND THE BATTLEFIELD AS INCLUDING NUCLEAR AND CHEMICAL. IF THERE IS TO BE A STUDY OR ANALYTICAL EXCURSION, THE EXCURSION SHOULD BE THE EXCEPTION, I.E., CONVENTIONAL. I RECOGNIZE THERE ARE DIFFERENCES IN APPROACHING CONTINGENCY OPERATIONS. IF YOU HAVE IDEAS ON HOW WE CAN GET ON WITH IT, I'M OPEN, IN THE MEANTIME WE MUST PUT SUBSTANCE TO OUR PRONOUNCEMENTS.

UNCLASSIFIED

01 02 291305Z JAN 81 PP UUUU 0291245Z

NO

CDRTRADOC FT MONROE VA//ATCG//

AIG 7573

UNCLAS

0000

FOR COMMANDANTS AND COMMANDERS FROM GENERAL DONN A. STARRY

SUBJECT: THE AIR LAND BATTLE

1. NOW THAT THE INTEGRATED BATTLEFIELD AND EXTENDED BATTLEFIELD CONCEPTS ARE BEING ASSIMILATED BY THE TRADOC COMMUNITY, A NEED EXISTS TO TIE THESE CONCEPTS INTO ONE OVERARCHING DESCRIPTIVE TERM. THOUGH THE WORDS "INTEGRATED" AND "EXTENDED" CONVEY CONCEPTS, THEY DO NOT ACCURATELY DESCRIBE THE BATTLEFIELD IN ITS TOTALITY. THEY DO, HOWEVER, HAVE UTILITY WHEN WE TALK ACADEMICALLY OR DOCTRINALLY ABOUT SUBSETS OF THE BATTLEFIELD. THE TERM "AIR LAND BATTLE" BEST DESCRIBES AND TIES THESE TWO CONCEPTS, AND ALL OTHERS, TOGETHER. HENCEFORTH, WHEN WE TALK ABOUT THE TOTAL BATTLEFIELD THE TERM "AIR LAND BATTLE" WILL BE USED. COMBAT DEVELOPERS WORKING ON FUTURE SYSTEMS ALSO NEED A TERM TO USE AS A CONCEPTUAL BASIS FOR THE DEVELOPMENT OF REQUIREMENTS. THAT TERM WILL BE "AIR LAND BATTLE OF THE 90'S."

*for* DONN A. STARRY, GEN, CDR, ATCG, 3514,  
29 JANUARY 1981

\*COLIN L. MCARTHUR, MAJ, XO, ATCG



UNCLASSIFIED

UNCLASSIFIED

02 02 291305Z JAN 81 PP UUUU 0291245Z  
NO

2. I'D LIKE YOU ALL TO TAKE THE ACTIONS NECESSARY TO INSURE THAT OUR INSTRUCTORS, TRAINERS, AND DOCTRINE WRITERS CLEARLY UNDERSTAND THESE TERMS, AND THAT THE TERM AIR LAND BATTLE IS INCORPORATED INTO OUR CURRENT AND FUTURE LITERATURE REWRITES. ALL OF US MUST EMPHASIZE THIS TERM AS WE GO ABOUT OUR DAILY TASKS.

UNCLASSIFIED



DEPARTMENT OF THE AIR FORCE  
 HEADQUARTERS UNITED STATES AIR FORCE  
 WASHINGTON, D.C.  
 20330

23 MAY 1961

MEMORANDUM FOR ATTACHED ADDRESSEE LIST

SUBJECT: USA and USAF Agreement on Apportionment and Allocation  
 of Offensive Air Support (OAS) -- INFORMATION MEMORANDUM

Changes to the definition and description of OAS in ATP 27(B),  
 Offensive Air Support Operations Doctrine, have precipitated  
 additional discussions between the USAF and USA.

The subject of discussion has been the proper apportionment and  
 allocation of OAS assets which directly and indirectly support  
 the ground commander -- close air support (CAS) and battlefield  
 air interdiction (BAI).

The USA/USAF agreement (Atch 2) on Apportionment and Allocation  
 of OAS provides for the maximum utilization of limited tactical  
 air assets while still being responsive to the land forces'  
 operations.

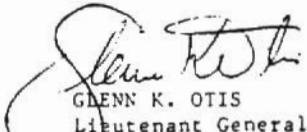
  
 GLENN K. OTIS  
 Lieutenant General, GS  
 Deputy Chief of Staff for  
 Operations and Plans  
 2 Atchs  
 1. Addressee List  
 2. USA/USAF Agreement

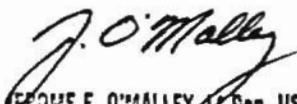
  
 JEROME F. O'MALLEY, Lt Gen, USAF  
 Deputy Chief of Staff  
 Plans and Operations

cc: AF/CVA



ADDRESSEE LIST FOR USA/USAF  
AGREEMENT ON APPORTIONMENT AND ALLOCATION  
OF OFFENSIVE AIR SUPPORT (OAS)

US ARMY

HQ TRADOC  
DCSDOC  
ATTN: ATDO-C

HQ 8th US ARMY

HQ US ARMY EUROPE

HQ DA (DAMO-RQS)  
(DAMO-ODO)

US AIR FORCE

HQ TAC  
HQ PACAF  
HQ USAFE  
HQ USAF (XOO)  
(XOX)

USA AND USAF POSITION  
ON  
APPORTIONMENT/ALLOCATION OF OAS

The Combined or Joint Force Commander has overall operational command of all assigned assets and determines priorities for their application. Apportionment to offensive air support (OAS) is accomplished by the air component commander based upon the Combined Commander's or Joint Force Commander's guidance.

Allocation of OAS occurs at the air component or subordinate air component command level with ground commander inputs. This level allocates sorties to the appropriate tactical operations as required.

The allocation of offensive air support assets presents unique opportunities to apply the inherent flexibility of airpower in support of surface operations. Tactical air reconnaissance, close air support (CAS) , and battlefield air interdiction(BAI), are apportioned at the air component level. CAS is normally distributed by the appropriate air operations center down to corps level: BAI, on the other band, is managed at the air component level in response to corps-identified targets.

This position provides for the maximum utilization of limited tactical air assets while still being responsive to the land forces' operations.

Specific procedures, using the Central Region as a model, are contained herein.

APPORTIONMENT AND ALLOCATION OF OFFENSIVE  
AIR SUPPORT

1. GENERAL. The NATO Tactical Air Working Party (TAWP) under the Military Agency for Standardization, Air Board, has redefined offensive air support (OAS) operations.

Offensive Air Support, as defined in Allied Tactical Publication (ATP) 27 (B), Offensive Air Support Operations doctrine, is that part of Tactical Air Support of Land Operations that consists of tactical air reconnaissance, battlefield air interdiction and close air support, which are conducted in direct support of land operations. These OAS tasks are defined as follows:

Tactical Air Reconnaissance. Tactical air reconnaissance is air action to acquire intelligence information employing visual observation and/or sensors in air vehicles. (ATP 33 (A)/ATP 27 (B))

Battlefield Air Interdiction (BAI). BAI is air action against hostile surface targets which are in a position to directly affect friendly forces and which requires joint planning and coordination. While BAI missions require coordination in joint planning they may not require continuous coordination during the execution stage. (ATP 33(A)/ATP 27(B))

Close Air Support (CAS). CAS is air action against hostile targets which are in close proximity to friendly forces and which requires detailed integration of each air mission with the fire and movement of those forces. (ATP 33(A)/ATP 27(B)) This means that aircraft are under positive or procedural control.

NATO National Representatives to the TAWP, including the United States, have agreed to the definition/description of OAS as outlined in ATP 33(A)/ATP 27(B). Additionally, the US has ratified ATP 33(A) and ATP 27(B).

Changes to ATP 27(B) have necessitated certain changes to the apportionment and allocation process for OAS. Based upon these changes, the USAF has developed procedures for apportioning and allocating one task under OAS--battlefield air interdiction. Current procedures for close air support and tactical air reconnaissance remain unchanged.

2. BACKGROUND ON APPORTIONMENT AND ALLOCATION PROCESS. It is essential that the apportionment and allocation of tactical air assets be accomplished at the highest appropriate level to insure the inherent flexibility of airpower is maintained.

The apportionment and allocation process is designed to assure optimum distribution of limited assets which must perform

a wide range of missions. These assets can be tasked to perform counter air, air interdiction, offensive air support and tactical air reconnaissance as dictated by the tactical situation.

Apportionment is the determination and assignment of the total expected effort by percentage and/or priority that should be devoted to the various air operations and/or geographic areas for a given period of time. (ATP 33(A)) Apportionment must be accomplished at the highest command level. (In the Central Region, this is Allied Forces Central Europe (AFCENT)/Allied Air Forces Central Europe (AAFCE)). This determination is based upon priorities established during consultations among subordinate commanders and the theater commander. The strategy, objectives, and priorities of the latter will be a primary factor in the apportionment decision.

Allocation is the translation of the apportionment into total numbers of sorties by aircraft type available for each operation/task. (ATP 33(A)) It is accomplished at the level of command where the proper army/air force interface occurs. In the Central Region, this is at the Allied Tactical Air Force (ATAF)/Army Group level.

Based upon the apportionment decision, the actual allocation of sorties to perform specific tasks is accomplished at the tasking agency. Tasking should be based upon the capabilities of the unit assigned the specific mission.

Factors which should be considered before determining apportionment, allotment of resources, and tasking the units are: (Ref ATP 33 (A)).

- a. The objective to be achieved.
- b. The nature and intensity of the conflict, tactical and strategic objectives, the strategy being employed, and in particular, the threat, the types of probable targets, and the likely response times required.
- c. The operational capabilities, limitations, and security of each type of weapons system, the terrain, and weather conditions.
- d. The availability of logistic support.
- e. The political restraints in effect.

The distribution of tactical air resources is made on the basis of response to the threat and the overall objectives to be achieved. (When requesting air support, the land force commander will state his requirements for OAS in terms of specific targets and target arrays that will affect his operations, the degree of threat to his operations, and his target priorities. This allows OAS to be viewed as an entity which provides direct support to

the land force commander, rather than as the separate contributions of the three parts of OAS--tactical air reconnaissance, battlefield air interdiction, and close air support (ATP) 27(B).

3. DISCUSSION ON BATTLEFIELD AIR INTERDICTION AND CLOSE AIR SUPPORT. The basic difference between CAS and BAI lies in the proximity of targets to friendly forces, and the control arrangements which are therefore needed. Both CAS and BAI are tasked in support of the land commander against targets directly threatening land operations. Close air support missions require detailed control to integrate them with the fire and/or movement of friendly forces and must therefore be responsive to direction by the land force at all stages of execution. On the other hand, BAI missions once requested by the land commander are conducted entirely under air force direction, though fire coordination arrangements are necessary if the targets are short of the Fire Support Coordination Line (FSCL). (ATP 27(B)).

4. PLANNING AND COORDINATION. Of the major tactical air functions, offensive air support presents particular planning and coordination problems because OAS is employed in direct support of surface forces. With the introduction of battlefield air interdiction into OAS, the appropriate command level for planning and coordination must be codified.

While CAS is normally distributed down to Corps level., BAI is managed at the air component level. (In the Central Region, this is no lower than the ATAF level.,) The joint interface occurs at the Corps/Air Support Operations Centres (ASOC) level for CAS and initial EAI planning. Regional management of BAI occurs at the ATAF/Army Group level.

The organization for OAS is based upon centralized control of air power with decentralized execution. An essential ingredient of all OAS operations, at all stages and levels of command, is coordinated joint planning.

5. COMMAND RELATIONS. Using the Central Region as a model, the following command relationships should apply:

a. AAFCE has overall operational command of allied air forces and:

(1) Determines priorities in relation to CINCENT's objectives.

(2) Allots and apportions attack and reconnaissance forces to ATAFs for the conduct of mutually supporting OAS operations and reallots these forces as required.

(3) Allots critical air resources such as electronic warfare and defense suppression units in support of OAS.

b. ATAFs have operational control of assigned and allotted resources and:

- (1) Coordinate priorities with Army Groups.
- (2) Jointly analyze Army Group requests to determine the OAS effort.
- (3) In coordination with the Army Group, divide the OAS effort into preplanned and immediate sorties available for OAS operations.
- (4) Designate weapon systems for employment in OAS.
- (5) Allocate aircraft and delegate the related tactical planning for CAS to the appropriate Allied Tactical Operations Centres (ATOC).
- (6) Perform tactical planning for BAI.
- (7) Allocate aircraft to the appropriate ATOC for execution of BAI.

NOTE: In the case of forces allotted to an ATAF for employment in mutually supporting operations, the gaining ATAF will allocate the task to a gaining ATOC and inform the dispatching ATOC of general mission details. Specific functions of the dispatching and gaining ATOCs in such cases are given below as part of the ATOC discussion.

c. ATOCs have tactical control of allocated forces and:

- (1) Conduct tactical planning in coordination with the ASOCs involve\* to include selection of weapons systems/units, mission composition, TOTS, ordnance selection as well as details on tactical control arrangements.
- (2) Dispatch Air Task Messages to flying units and all concerned agencies.
- (3) Direct execution of immediate offensive air support missions to flying units and coordinate details with concerned agencies.

NOTES: 1. In cases where an ATOC is employing forces from another ATAF which were allotted for mutual supporting operations, the gaining ATOC will pass all detailed tasking information to the dispatching ATOC. The dispatching ATOC of the flying unit involved will dispatch Air Task Messages directly to the flying base and direct launch of alert aircraft for those units which are providing immediate air support.

2. An ATOC may delegate detailed aspects of tactical planning, as well as tasking and execution, to a specific ASOC in

those cases where ASOCs have the necessary communications capabilities.

d . ASOCs:-

(1) Jointly plan and pass Corps requests for OAS sorties through the Army Group to the ATAF.

(2) Pass Corps requests for additional CAS sorties through the Army Group to the ATAF for those mission requests which cannot be supported within the Corps' current distribution.

(3) Request execution of immediate support to ATOC.

(4) Pass all necessary details concerning tactical control and targeting information to pertinent ATOC.

(5) Control final CAS mission execution through assigned TACP/FAC .

NOTE: ASOCs also conduct detailed tasking and direct execution of OAS missions when authorized by the appropriate ATOC.

6. PLANNING. The basic concept of planning for OAS is continuous dialogue and coordination between appropriate land and air headquarters echelons. Although there is no fixed sequence of events, the general planning flow is outlined below:

a. Based on CINCENT's priorities and objectives, COMAAFCE will issue resource employment and execution directives to the ATAFs. These directives will establish priorities for conventional attack resources by function, i.e., offensive air support, counter-air and air interdiction, or by specific task. Following this the Army Groups will present the ATAF commanders with their prioritized target lists which are based upon their operational plans. The ATAF commander will apply his allocated resources against this prioritized list and inform the Army Group commander of his ability to meet the OAS requirements.

b. The attack resources within the allocation for OAS will be used in either close air support or battlefield air interdiction. This decision is made at the ATAF/Army Group level. Normally, close air support will only be employed when army organic firepower cannot cope with a threat. Battlefield air interdiction should be employed against targets such as armor, troops, soft skinned vehicles, artillery, etc. which are located in concentrations of sufficient size and importance to have a potentially decisive effect on the land battle in the near term .

c. After the ATAF Commanders have decide3 on the basic allocation of their forces to support the ground forces, all related planning should be on a joint basis in order to insure coordination of joint air/ground matters as well as integration

of air and ground plans.

d. The Army will have up-to-date intelligence on the front line tactical ground situation and will be continuously assessing the threat and assigning priorities to targets as well as reacting to changing tactical situations. Generally, only at Corps level will sufficient information be available to determine whether it is possible to engage and counter a threat with conventional organic firepower or whether it is necessary to have this organic firepower supplemented by OAS.

e. The Army Groups will obtain from their respective ATAF offensive operations staff the OAS effort available for the period. Based on the current tactical situation and their forecast plans, the Army Groups will establish priorities for the distribution of OAS resources. An Air Allocation Message will be forwarded from each Army Group to their appropriate Corps HQ as well as to the Allied Tactical Operations Centres.

f. The AEOC has direct contact with army fire support agencies and is responsible for ensuring that CAS and BAI are employed effectively and economically. The land force commander, at Corps level and below, should consult with his air force representative (ASOC commander, Air Liaison Officers (ALO), or FAC as appropriate) on all matters concerning OAS. Corps/ASOCs will keep their Army Group/ATAF continuously informed on their planning activities. This will ensure required coordination and deconfliction with all other air activity in the area and facilitates weaponeering, force sizing, and coordination of support activities such as electronic warfare, suppression of enemy air defenses, escort, etc.

7. REQUESTING OAS. Requests for OAS may be initiated at any level of command. Air Liaison Officers and FACs are assigned to army command echelons and they advise and assist in the transmission of requests for OAS. Normally, fire support by air units should not be requested for targets which can be engaged by organic army firepower unless the added firepower will produce decisive results or the tactical situation is such that organic army firepower must be supplemented by air power.

---

**SOURCES:**

1. AFM 1-1 Functions and Basic Doctrine of the USAF
2. ATP 33(A), NATO Tactical Air Doctrine
3. ATP 27 (R), Offensive Air Support Operations
4. AAFCE Offensive Air Support Manual 80-2



## INTRODUCTION

### DOCTRINAL PERSPECTIVES OF WAR

Fundamental to an understanding of our doctrine is an appreciation of the three levels of war—the doctrinal perspectives which enable us to understand the whole spectrum of war. While most of our military literature has dealt with strategy and tactics, AirLand Battle doctrine and FM 100-5 articulate the operational level as well. Herein described as the intermediate level of war between strategy and tactics, the operational level is the planning and conduct of campaigns—the use of battles and their result by corps and larger units to attain major military goals. While we have practiced operational art in past wars, we have not always given it its rightful name nor related its lessons to strategy and tactics.

### DOCTRINAL PERSPECTIVES OF WAR

General Glenn Otis

Commander, U.S. Army Training and Doctrine Command

Current U.S. Army doctrine addresses three levels of war—strategic, operational, and tactical. These are sometimes referred to as doctrinal perspectives; "perspective" meaning roughly, "the view of the parts and the whole regarded from a particular position or point in time." Each military leader from squad through the executive branch of government has a different perspective of the parts and the whole of war.

The doctrinal perspectives of different levels of war applies to all forms of warfare—land, sea, and air—and has impact on all-services—Army, Air Force, Navy and Marine Corps. There is an underlying unity of basic principles and fundamentals that applies to all forms of organized conflict.

The levels of war concept applies to other elements of warfare and is not confined to organizations and units as discussed above. For example, the levels of war can be reviewed from the various aspects of objectives, doctrine, planning, future concepts, and current implementation.

The definitions and descriptions which follow build on the general notion that strategy is associated with the National Command Authority; operational art focuses on war at the corps level and higher; tactics refers to war at the division and lower levels.

### The Strategic Level of Warfare

The strategic level of war sets goals and objectives for military forces. Achieving or preserving economic, social, religious and political goals of a nation may, in varying degrees, require the use of military force or the threat of force. Strategy is concerned with what is necessary to "win" in the furtherance of national objectives.

The strategic perspective is world wide and long range. The strategic planner deals with resources, capabilities, limitations, and force postures. He sets broad priorities for allocation of resources and time frames for accomplishment. Working within a broad perspective of forces and capabilities, strategy concerns itself with strategic mobility, mobilization, civil defense, forward force deployments, nuclear deterrence, rapid reinforcements and rapid deployment. Cooperation among the services and allied nations to produce a unity of effort is of vital concern in the strategic arena. Strategic planning is not a military function only. It is formulated by input from the Joint Chiefs of Staff, The National Security Council, members of Congress, and selected advisors to the President.

### The Operational Level of Warfare

The primary purpose of the operational level is to gain a relative positional advantage over the enemy. The perspective of the commander at this level is one of "anticipation" of opportunities to gain indirect

leverage. These opportunities may occur because of bold planning and maneuvering at the operational level and aggressive execution at the tactical level; they may result from enemy mistakes; they may arise from situations that are created by friendly forces at the tactical level; or they may be the results of reaction to enemy force dispositions and intentions.

The operational art of war is practiced by large field, air, and fleet units of the services. It involves joint, combined, and coalition forces that maneuver with the objective of defeating the enemy and achieving strategic objectives within a theater of operations.

Defeat of the enemy can be achieved by several means: making the enemy believe he cannot win, making him withdraw from the conflict or by destroying his equipment and forces. Usually a combination of these means is employed.

Operational art is primarily the planning and conduct of campaigns. The commander's perspective is of a theater of operations, rather than a battlefield. At the operational level the forces are usually large and often multiservice. The commander who conducts "operations," in this special context of the operational art of war, must be capable of, and have the command and control apparatus, to orchestrate land, sea, and air forces.

Operations take the form of large scale maneuvers such as penetrations, envelopments, double envelopments, frontal attacks, naval blockades, air interdiction, turning movements, feints, amphibious landings, and airborne assaults. At the operational level, maneuver may be sometimes entirely movement.

### The Tactical Level of Warfare

The objective of the tactical level of war is primarily the detailed destruction of enemy forces or the direct thwarting of enemy intentions. It is the employment of division size and smaller units in weapons engagements and battles with the enemy. Close support, interdiction, destroying equipment, disrupting facilities, reconnaissance and sur-

veillance, killing or capturing personnel, positioning and displacement of weapons systems, and supply and support are tactical activities.

The tactical commander's perspective is one of a battle or engagement where he "executes" a plan of movement with fire support to achieve a specific objective such as clearing an area, blocking enemy movement, protecting a flank, gaining fire superiority or seizing a location. The room for anticipating opportunities and risk taking is somewhat limited by the confines of the immediate aspects of the battle and the specificity of the objective.

Maneuver at the tactical level is nearly always a combination of movement and supporting fires. These two functions are tightly integrated instead of being somewhat discrete as they may frequently be at the operational level. Movement, instead of resulting from opportunities for positional advantage, is usually to position forces to concentrate fires on the enemy or to escape enemy fires.

Tactical unit commanders depend on their higher operational level commander to move them effectively into and out of battles and engagements. Successes and failures at the tactical level, when viewed as a whole by the operational level commander, are the basis for a wider scheme of maneuver. Small unit actions stimulate the operational level commander's anticipation for opportunities for relative positional advantage which will defeat the enemy and result in victory. The perspective of the tactical commander is somewhat more subjective—his concern is destruction of the enemy forces in his zone of action and his own force's survival. He must concentrate on executing his portion of the overall mission effectively, at the same time visualizing the overall operational level perspective.

### Application of the Level of War

The levels of war have a wide application to the total military environment. Figure 1 is a matrix of ideas that applies the levels of war to several areas where the differences in perspective from strategy to

operational art to tactics are essential. Understanding these differences in perspective and their linkage to one another provides a more unified view of the conduct of the military art.

---

<b>DOCTRINAL PERSPECTIVES</b>			
APPLICATIONS	STRATEGIC LEVEL	OPERATIONAL ART LEVEL	TACTICAL <b>LEVEL</b>
IMPLEMENTING ECHELONS	● NCA, NATO, Army Group	Army Group. Corps	Corps, Div, Bde. Bn
OBJECTIVES	<ul style="list-style-type: none"> <li>● Preserve National Interest</li> <li>● Deter Threat</li> <li>● Continuation of Policy by Other <b>Means</b></li> <li>● <b>Win</b> Something</li> </ul>	<ul style="list-style-type: none"> <li>● Conduct Campaigns</li> <li>● Defeat Enemy by Maneuver</li> </ul>	<ul style="list-style-type: none"> <li>● Destroy. Disrupt by Firepower &amp; Movement</li> </ul>
DOCTRINE (CURRENT)	<ul style="list-style-type: none"> <li>● Nuclear Deterrence</li> <li>● 14/3</li> <li>● Forward Deployment</li> <li>● Rapid Reinforcement</li> <li>● <b>FM 100-1</b></li> </ul>	<ul style="list-style-type: none"> <li>● <b>FM 100.5</b></li> <li>● Airland Battle</li> </ul>	<ul style="list-style-type: none"> <li>● FM 71-2 (Bn TF)</li> <li>● <b>FM 71-110</b>(Bde, Div)</li> <li>● Airland Battle</li> <li>● Combined Arms Tactics</li> </ul>
PLANNING	<ul style="list-style-type: none"> <li>● JSCP</li> <li>● 4102</li> <li>● 1003</li> </ul>	<ul style="list-style-type: none"> <li>● GDP Plans (Corps)</li> </ul>	<ul style="list-style-type: none"> <li>● Div. Bde. Bn OPWNS</li> <li>● BattleBooks</li> </ul>
CURRENT IMPLEMENTATION	<ul style="list-style-type: none"> <li>● Strat Arms Reduction Talks</li> <li>● Civil Defense</li> <li>● RDJTF</li> <li>● Forward Deployed Forces</li> </ul>	<ul style="list-style-type: none"> <li>● Stationing</li> <li>● Flexible, Tailored RDF</li> <li>● Delta Force</li> <li>● Reforger</li> </ul>	<ul style="list-style-type: none"> <li>● 9th HTLD</li> <li>● Op Bright Star</li> <li>● Ex Spear Point (USAREUR)</li> </ul>
CONCEPTS (10-20 <b>YRS</b> )	<ul style="list-style-type: none"> <li>● Strategy <b>2000</b></li> </ul>	<ul style="list-style-type: none"> <li>● Airland Battle <b>2000</b></li> </ul>	<ul style="list-style-type: none"> <li>● IndepClose Cbt Forces</li> </ul>

---

*Figure 1*

## Summary

In summary, different doctrinal perspectives of war are powerful tools in military doctrine which can be used to analyze the total military-environment. No military action can be isolated as a purely strategic, operational, or tactical action. The proper doctrinal perspective permits us to view warfare in its totality—as a complete spectrum of activity with linkages between the strategic and operational, and operational and tactical. All must be developed to their full potential, and practiced as a unified whole.

## Notes

### Introduction

1. For an historical-analytical view of military reform and a look backward over changes to the Army by reformers during the decade following 1973, see General Donn A. Starry, "To Change an Army," *Military Review*, March 1983, pp. 20-27. For a discussion of the military reform debate and the new doctrine in an analytical framework of the military constants of soldiers, weapons, and doctrine, see COL Huba Wass de Czege, "Toward a New American Approach to Warfare," *The Art of War Quarterly*, Vol. II, September 1983, pp. 31-62.
2. James Schlesinger's "A Testing Time for America," *Fortune*, February 1976, pp. 74-77, 147-49, 153, published within a year of the fall of Saigon to North Vietnamese forces (in April 1975) conveys the flavor of public and official apathy with regard to the shifting military balance. Henry Kissinger's interview in *Economist*, "Kissinger's Critique," 3 and 10 February 1979, notes the persisting phenomenon late in the decade. See also Edward N. Luttwak, "Defense Reconsidered," *Commentary*, March 1977, pp. 51-58; and Sen. Sam Nunn (D-GA), "The New Soviet Threat to NATO," *Reader's Digest*, July 1977, pp. 73-77. For two contrasting perceptions, both by prominent spokesmen, of Soviet expansionism and American neo-isolationism in the 1970s, see Norman Podhoretz' warning of the decline of American power, *The Present Danger* (New York: Simon and Schuster, 1980); and George F. Kennan's accommodationist *The Cloud of Danger: Current Realities in American Foreign Policy* (New York: Little, Brown, 1977).

### Chapter I

1. For a discussion of the effects of the Mideast War, see TRADOC Annual Report of Major Activities, FY 1974, TRADOC Historical Office, pp. 14-19, and FY 1975, Ch. I.
2. For discussion of the scenarios, see TRADOC Annual Report of Major Activities, FY 1974, pp. 246-54; for discussion of coordination with FORSCOM, FY 1975, pp. 8-9. For a discussion of consultations with the German Army and the Tactical Air Command (USAF), see TRADOC Annual Historical Review, FY 1976, Ch. V.
3. For a discussion of the lessons and impact of the 1973 war, see TRADOC Annual Report of Major Activities, FY 1975, Ch. I and pp. 138-43.
4. For example, see ltr, General W. E. DePuy, CG TRADOC, to MG Donn A. Starry, Cdr US Army Armor Center, 23 July 1974.
5. Later, on 26 March 1976, the Concepts Branch became a separate entity as the Tactical Doctrine Office, directly under the commander. Encl, "Staff Responsibilities (of Tactical Doctrine Office)," to Semiannual Hist Rept, Tactical Doctrine Office, 26 March-30 September 1976.
6. TRADOC Annual Report of Major Activities, FY 1974, pp. 100-02. (SECRET—Info used is UNCLASSIFIED)
7. (1) *Ibid.*, FY 1975, pp. 8-9 (CONFIDENTIAL—Info used is UNCLASSIFIED) (2) Ltr ATING-SC-C, TRADOC Chief of Staff to DA, 29 October 1974, subj: FORSCOM/TRADOC Training Conference, 1-2 October 1974.

8. Ltr, General W. E. DePuy to General Fred C. Weyand, Chief of Staff, Army, 18 February 1976, no subject.
9. MFR, TRADOC Hist Ofc, 7 November 1974, subj: MG Huffman's Comments on Selected Subjects for FY 1974 History.
10. (1) Fact Sheet on FM 100-5, DCST/TSD Concepts Branch, 19 January 1976. (2) TRADOC Annual Report of Major Activities, FY 1975, pp. 93-94. (CONFIDENTIAL—Info used is UNCLASSIFIED) (3) TRADOC Historical Office Notes on Interview with TRADOC Chief of Staff, MG Burnside E. Huffman, Jr., 13 February 1975.
11. Styled "OFTCON II," for October FORSCOM-TRADOC Conference.
12. (1) Booklet, Commanders Conference, 10-11 December 1975, pp. 1-12. (2) Fact Sheet on FM 100-5, DCST/TSD—Concepts Br, 19 January 1976. (3) Ltr, DePuy to Weyand, 18 February 1976. (4) TRADOC Combined Arms Test Activity Hist Rept, July 1975—September 1976, pp. 46-47.
13. Department of the Army, FM 100-5, *Operations*, 1 July 1976. Designed for easy revision by exchange of supeseded material, the manual was bound in a looseleaf ring binder.
14. Semiannual Hist Repts, Tactical Doctrine Office, 26 March—30 September 1976, and ODCST, January—September 1976. Publication of the first one thousand copies took place on 1 July 1976 for distribution to the Department of the Army and to the major commands, the corps, divisions, and TRADOC schools. Another 175,000 copies were printed by 30 August for wider distribution to the Active Army and to Reserve and National Guard units.
15. FM 100-5, *Operations*, 1 July 1976, pp. i and 1-1.
16. *Ibid.*, p. 1-2.
17. *Ibid.*, pp. 1-4 to 1-5.
18. *Ibid.*, pp. 2-1 to 2-2.
19. *Ibid.*, pp. 2-3 to 2-4.
20. *Ibid.*, pp. 2-5, 2-8, 2-13 to 2-17.
21. *Ibid.*, pp. 2-18 to 2-22.
22. *Ibid.*, pp. 2-23 to 2-27.
23. *Ibid.*, pp. 3-2 to 3-3.
24. *Ibid.*, pp. 3-3 to 3-4.
25. *Ibid.*, pp. 3-4.
26. *Ibid.*, pp. 3-4 to 3-7.
27. *Ibid.*, pp. 3-5 to 3-9.
28. *Ibid.*, pp. 3-9 to 3-10.
29. *Ibid.*, pp. 3-11 to 3-17.
30. *Ibid.*, pp. 5-2.
31. *Ibid.*, pp. 4-3.
32. *Ibid.*, pp. 4-2 to 4-12.
33. *Ibid.*, pp. 5-1 to 5-14.
34. *The U.S. Army Combat Developments Command: Its Formative Years*. FYs 1963-64, USACDC Annual Historical Summary, December 1966, pp. 80-88. (SECRET—Info used is UNCLASSIFIED)
35. MFR, TRADOC Historical Office, 5 September 1975, subj: Historical Staff Meeting (Interview) with General DePuy, 5 September 1975.

## Chapter II

1. Philip A. Karber, "Dynamic Doctrine for Dynamic Defense," *Armed Forces Journal*, October 1976, p. 28.
2. BGen Dan G. Loomis, Canadian Armed Forces, "FM 100-5, Operations: A Review," *Military Review*, March 1977, pp. 66-69.
3. Archer Jones, "The New FM 100-5: A View from the Ivory Tower," *Military Review*, February 1978, pp. 27-36.
4. Colin S. Gray, "Force Planning, Political Guidance and the Decision to Fight," *Military Review*, April 1978, pp. 5-16.
5. William S. Lind, "FM 100-5, Operations: Some Doctrinal Questions for the United States Army," *Military Review*, March 1977, pp. 54-65.



6. MAJ Robert A. Doughty, U.S. Army, *The Evolution of U.S. Army Tactical Doctrine, 1946-76* (Leavenworth Papers, No. 1), Ft. Leavenworth, Kans., August 1979), p. 43.
7. FM 100-5, 1976, p. 5-2.
8. See below in this chapter, pp. 19-20.
9. Karber, "Dynamic Doctrine for Dynamic Defense," p. 29.
10. "TRADOC's Reply," *Armed Forces Journal*, October 1976, p. 27.
11. Majors Robert A. Doughty and L. D. Holder, "Images of the Future Battlefield," *Military Review*, January 1978, pp. 56-69. The authors also suggested that the "new tactics" were an intermediate step to change which would produce much different combat relationships, organizations, and doctrine.
12. Jones, "The New FM 100-5: A View from the Ivory Tower." On the question of the tactical reserve, see below, p. 17.
13. Starry's April address was adapted and published in the summer: General Donn A. Starry, "A Tactical Evolution-FM 100-5," *Military Review*, August 1978, pp. 2-11.
14. Doughty, *The Evolution of U.S. Army Tactical Doctrine, 1946-76*, p. 44.
15. FM 100-5, 1976, p. 1-1.
16. (1) "TRADOC's Reply," *Armed Forces Journal*, October 1976, p. 27. (2) Karber, "Dynamic Doctrine for Dynamic Defense," p. 29.
17. FM 100-5, 1976, p. 5-2.
18. Philip A. Karber, "Soviet Lessons of Middle East War," in "15th Annual Army Operations Research Symposium," *Army Research and Development*, November-December 1976, pp. 11-15.
19. Philip A. Karber, "The Tactical Revolution in Soviet Military Doctrine," *Military Review*, November 1977, pp. 83-85, and December 1977, pp. 33-34, a reprint and condensation of articles in *Europäische Wehrkunde*, June and July 1977.
20. (1) LTC George F. Steger, "More Dilemmas in Studying Soviet Tactics," *Military Review*, February 1978, pp. 88-91. (2) CPT Gregory Fontenot and CPT Matthew D. Roberts, "Plugging Holes and Mending Fences," *Infantry*, May-June 1978, pp. 32-36. (3) MAJ Donald K. Griffin, "If the Soviets Don't Mass," *Military Review*, February 1979, pp. 2-13.
21. Fontenot and Roberts, "Plugging Holes and Mending Fences," pp. 32-36.
22. Memo DAMO-RQS, MG William R. Richardson, Dir of Requirements, ODCSOPS DA, to LTG Meyer, DCSOPS, 24 October 1978, w/encl: Final Rept, Defense Concepts and Short War Responses, Dr Steven L. Canby.
23. (1) Encl, "Battlefield Development Plan, p. 3-2," to Ltr ATCD-PD, TRADOC to distr, 17 November 1978, same subj. (SECRET-Info used is UNCLASSIFIED). (2) Ltr ATCD-D-A, General Starry to distr, 13 November 1978, subj: Operational Concept for Division 86, p. 4-10: "The meeting engagement is the form of combat action most frequently planned for by the Soviets."
24. Jones, "The New FM 100-5: A View from the Ivory Tower," pp. 27-36. Jones raised several other questions, based on the 1976 manual's assumption of a tactical defense stressing movement, treated later below, pp. 19-20. Count H. de Guibert and Pierre de Bourcet's works on the tactics and combination of forces were influential in shaping the tactics of the armies of the French Revolution and Napoleon.
25. *Ibid.*, pp. 34-36.
26. Starry, "A Tactical Evolution-FM 100-5," p. 9.
27. Lind, "FM 100-5, Operations: Some Doctrinal Questions for the United States Army," p. 59.
28. Karber, "Dynamic Doctrine for Dynamic Defense," p. 29.
29. "TRADOC's Reply," *Armed Forces Journal*, October 1976, p. 27.
30. Doughty, *The Evolution of U.S. Army Tactical Doctrine, 1946-76*, p. 43.
31. See below, pp. 23-27, for a discussion of the concepts of the Central Battle and the Battlefield Development Plan.
32. Lind, "FM 100-5, Operations: Some Doctrinal Questions for the United States Army," pp. 63-64.
33. Karber, "Dynamic Doctrine for Dynamic Defense," p. 29.
34. Ltr, John F. Sloan, Historical Evaluation and Research Organization, Dunn Loring, Va., *Military Review*, July 1977, pp. 111-12.
35. Jones, "The New FM 100-5: A View from the Ivory Tower," pp. 27, 30-31.
36. *Ibid.*, pp. 35-36.
37. Fontenot and Roberts, "Plugging Holes and Mending Fences," pp. 32-36.
38. CPT Adolf Carlson, "A Revisionist's View," *Infantry*, May-June 1978, pp. 37-39.
39. Department of the Army, FM 100-1, *The Army*, 29 September 1978. Elaborating the principles of war in an AirLand doctrine framework, FM 100-1 was reissued in a new edition on 14 August 1981.

## Chapter III

1. Comments by General Donn A. Starry, Fort Monroe, Va., July 1977, in Booklet, "Analysis: Selected Papers," ODCSCD Anl Ofc, 1 August 1977.
2. (1) *Ibid.* (2) MFRs, TRADOC Hist Ofc, 3 August 1977, subj: Starry's Comments to His Staff, and 22 September 1977, subj: General Starry's Talk to TRADOC HQ Staff, 16 September 1977. (3) For a fuller version of the Central Battle remarks, see Starry, "Armor Conference Keynote Address," *Armor*, July–August 1978, pp. 32–36.
3. MFR, TRADOC Historical Office, 14 September 1977, subj: Interview (by author) with COL Anthony G. Pokorny, Chief, ODCSCD Studies and Analysis Office.
4. MFR, TRADOC Historical Office, 13 June 1979, subj: Hist Ofc Interview (by author) with COL Pokorny.
5. See Booklet, "Division 86, Blueprint of the Battlefield," HQ TRADOC, April 1979, for a detailed analytical structure.
6. Encl, "Battlefield Development Plan," to ltr ATCD-PD, TRADOC to distr, 17 November 1978, same subject. (SECRET—Info used is UNCLASSIFIED) Several of the "critical tasks" subsumed under the Central Battle and Force Generation were later retitled and revised.
7. *Ibid.*, pp. 1–1 to 1–5.
8. *Ibid.*, pp. 2–16 to 2–18.
9. *Ibid.*, pp. 3–1 to 3–5.
10. *Ibid.*, pp. 3–2.
11. *Ibid.*, pp. 3–4.
12. *Ibid.*, pp. 3–4 to 3–5.
13. MFR, TRADOC Historical Office, 13 June 1979, subj: Historical Office Interview (by author) with COL Pokorny.
14. See John L. Romjue, *A History of Army 86, Vol I: Division 86: The Development of the Heavy Division, September 1978–October 1979; Vol II: The Development of the Light Division, the Corps, and Echelons Above Corps, November 1979–December 1980*, HQ TRADOC, Ft Monroe, Va., June 1982.
15. (1) For a discussion of the establishment of ODCSDOC, see TRADOC Annual Historical Review, FY 1979, p. 60 ff. (2) TRADOC Permanent Orders 59–3, 25 May 1979, effective 1 May 1979, and 113–1, 9 October 1979, effective 1 October 1979.
16. Paper by Col Edwin G. Scribner, ADCSDOC, Doctrine Development by TRADOC, May 1973–December 1979, 20 February 1980.
17. Commander's Note No. 3, Operational Concepts and Doctrine, 20 February 1979.
18. *Ibid.*
19. *Ibid.*
20. See Appendix B for a list of operational concepts published between 1980 and 1982.
21. See below, pp. 34–39.
22. TRADOC Regulation 11–7, Operational Concepts and Army Doctrine, 29 December 1980.
23. *Ibid.*
24. (1) Ltr, LTG E.C. Meyer, Deputy Chief of Staff for Operations and Plans, Department of the Army to General Donn A. Starry, Commander, TRADOC, 13 June 1979. (2) Ltr, Starry to Meyer, 26 June 1979. (3) Extract of Interview by Mr Joe Huddleston, I Corps Historian with GEN William R. Richardson, 12 June 1984.
25. (1) MFR ATCD-ALFA/XP-ALFA, 12 October 1979, subj: "20-Star" Meeting, HQ TRADOC, 11 October 1979. (2) MFR, TRADOC Historical Office, 18 October 1979, subj: Twenty Stars.
26. MFR, TRADOC Historical Office, 20 November 1979, subj: Division 86: In-Process Review for Chief of Staff, Army, General Meyer, and Army Commanders Conference.
27. The concept was published in early 1980. BG Edward A. Dinges and MAJ Richard H. Sinnreich, "Battlefield Interdiction: Old Term, New Problem," *Field Artillery Journal*, January–February 1980, pp. 14–17.
28. *Ibid.*, p. 15.
29. (1) *Ibid.*, pp. 14–17. (2) Encl, "End of Tour Report, October 1977–June 1980," to ltr, MG Jack N. Merritt to General Donn A. Starry, 10 November 1980.
30. This section is based on information supplied to the author by COL John P. Stewart, a member of the planning cell at Fort Sill during October–December 1979. Many individuals contributed to this small but significant effort. They included MAJ Robert W. Zawilski and MAJ Howard H. Rubin,

- both of the Field Artillery School, along with Mr. David P. Porreca, a research analyst with R.& D. Associates of Marina del Rey, California. Mr. Jim Struve from Sandia Laboratories Livermore contributed an analysis of the V Corps general defense plan using the DIVWAG division wargame. COL (Ret.) Art Winn of the BDM Corporation, who had been General Starry's G-2 officer at V Corps, worked with intelligence aspects of the concept, and Mr Reed Stone of the TRADOC Combined Arms Test Activity brought his earlier work for V Corps to bear on the time factors of command and control; LTC Howard Clark, G-3 Plans Officer in V Corps contributed to this important aspect of the study. Stewart, also a former V Corps planner in nuclear and command-control operations, had worked on a concept study titled "Integrated Battlefield Control System" under the old Army Combat Developments Command in 1970, and contributed to the themes of the "integrated battlefield" and "air-land" as representing the totality of the battlefield and the dependence of the concept on close interworking with the Air Force.
31. Briefing, "An Operational Concept for the Integrated Battlefield," presented to the Nuclear Systems Program Review, Fort Sill, Okla., 18 December 1979, by MAJ John S. Doerfel.
  32. *Ibid.*
  33. Information supplied to author by COL Stewart.
  34. (1) MFR, ATCS-H, TRADOC Historical Office, 21 January 1983, subj: Interview (by author) with BG Donald R. Morelli, 12 January 1983 (hereinafter: Morelli Interview, 12 January 1983). (2) See also: General Donn A. Starry, "Extending the Battlefield," *Military Review*, March 1981, pp. 31-50, for the further development of these concepts.
  35. (1) Ltr ATCG, General Donn A. Starry, Cdr TRADOC to General Edward C. Meyer, CSA, 17 January 1980, with enclosure: ltr ATCG, Starry to HQ DA (DACS-ZA), 17 January 1980, subj: Summary Report, Tactical Nuclear Systems Program Review (SPR). (SECRET—Info used is UNCLASSIFIED) (2) Ltr ATCD-ZXA, DCSCD to distr, 16 January 1980, subj: Status of Current Actions. (CONFIDENTIAL—Info used is UNCLASSIFIED).
  36. Chief of Staff, US Army White Paper 1980, A Framework for Molding the Army of the 1980s into a Disciplined, Well-Trained Fighting Force, 25 February 1980.
  37. (1) Msg, CG TRADOC to distr, 282000Z April 1980, subj: The TRADOC Doctrinal Literature Program. (2) Msg, Cdr TRADOC to distr, 292030Z April 1980, subj: The Writing of Doctrine.
  38. (1) Interview by author with LTC Thomas Kelly, Department of Tactics, US Army Command and General Staff College, 17 April 1984. (2) Memoranda of Interview by W.G. Robertson, Combined Arms Center Historical Office, with LTC Jimmy Stallings, DACTS, 29 July 1983, and LTC Thomas Kelly, DTAC, 9 August 1983. (3) Annual Historical Summary, US Army Combined Arms Center, 1980, pp. 202-03. (4) Author's telephone interview with LTC Richard B. Henriques (US Army Ret.), 14 May 1984.
  39. Msg, Cdr TRADOC to distr, 091530Z July 1980, subj: Integrated Operations.
  40. CSA White Paper 1980.
  41. *Ibid.*
  42. For a discussion of these subjects through late 1981, see TRADOC Annual Historical Reviews, FY 1980, Ch I, and FY 1981, Ch III and IV. These projects were followed in 1983 by efforts to organize a 10,000-man light division.
  43. See Romjue, *A History of Army 86*, Vol. II, Chapter III.
  44. The other study focuses were covering force operations and rear area combat operations.
  45. Msg, Cdr CAC to distr 121600Z March 1980, subj: 6 March Corps, 86 Workshop Results/Taskings.
  46. (1) Interview by author with COL Huba Wass de Czege, Director, Advanced Military Studies Program, US Army Command and General Staff College, 16-17 April 1984. (2) TRADOC Pam 525-2, Tactical Command Control, 20 June 1980.
  47. Army 86 Task Force Briefings presented to Corps 86/EAC 86 General Officer Workshop, 19-20 May 1980, Fort Leavenworth, Kans. (CONFIDENTIAL—Info used is CLASSIFIED)
  48. (1) Msg, Cdr TRADOC to distr, 302400Z May 1980, subj: Corps 86-EAC 86 Guidance. (2) Msg, Cdr TRADOC to Cdr CAC, 041500Z June 1980, subj: Corps 86 Operational Concept. (3) Msg, Cdr CAC to distr, 241600Z June 1980, subj: 16-17 June Army 86 In-Process Review-Results/Taskings.
  49. Encl 3, "Corps 86 Operational Concept, July 1980," to ltr ATCD, General Donn A. Starry to General E.C. Meyer, 1 August 1980, subj: Army 86.
  50. Romjue, *A History of Army 86*, Vol II, pp. 83-85.

51. (1) Henriques Interview, 14 May 1984. (2) Author's telephone interview with LTC L.D. Holder, 3d Armored Cavalry Regiment, 8 May 1984. (3) The Marshall doctrine manual was Field Service Regulations: *Operations-FM 100-5*, 22 May 1941. The manual was prepared under the direction of General Marshall, who had assumed duties as Chief of Staff of the Army in September 1939.
52. Wass de Czege Interview, 16–17 April 1984.
53. *Ibid.*
54. Morelli Interview, 12 January 1983.
55. See Starry, "Extending the Battlefield", pp. 31–50.
56. (1) Morelli Interview, 12 January 1983. (2) Msg, Cdr TRADOC to distr, 291305Z January 1981, subj: The AirLand Battle. (3) Holder Interview, 8 May 1984.
57. TRADOC Pam 525-5, Military Operations: Operational Concepts for the AirLand Battle and Corps Operations—1986, 25 March 1981.
58. Morelli Interview, 12 January 1983.
59. (1) Starry, "Extending the Battlefield." (2) Lt. Gen. William R. Richardson, "Winning on the Extended Battlefield," *Army*, June 1981, pp. 35–42.
60. (1) GEN Donn A. Starry, "Extending the Battlefield," *Field Artillery Journal*, September–October 1981, pp. 6–19. (2) "Implementing the AirLand Battle," no author listed, *ibid.*, pp. 20-27. (3) MG David E. Grange, Jr., "Infantry and Air Defense in the AirLand Battle," *Air Defense Magazine*, October–December 1981, pp. 24–25. (4) MAJ Michael S. Lancaster, "The Armor Force in the AirLand Battle," *Armor*, January–February 1982, pp. 26–32. (5) LTC Jimmy Griffis, MAJ Kurt Pierce, MAJ Ed Sherwood, "The Mechanized Infantry Battalion Task Force in the AirLand Battle," *Infantry*, July–August 1982, pp. 21–24. (6) LTC Jerry M. Sollinger, "AirLand Battle: Implications for the Infantry," *Infantry*, March–April 1982, pp. 22–25. (7) MG Carl H. McNair and CPT Josef Reinsprecht, "Army Aviation Forces in the AirLand Battle," *US Army Aviation Digest*, July 1981, pp. 6–13.
61. This section is based on TRADOC Pam 525-5, pp. 2–30.
62. TRADOC Pam 525-5, p. 2.
63. *Ibid.*, p. 5.
64. *Ibid.*, p. 21.

## Chapter IV

1. This section is based, except where otherwise noted, on the author's interview with the principal doctrine writer of the 1982 edition of FM 100-5, COL Huba Wass de Czege, 16–17 Apr 1984.
2. David P. Porreca, "New Tactics and Beyond," *Military Review*, May 1979, pp. 21-29.
3. Memo, LTC Lawrence J. Dacunto to LTG Richardson, 15 October 1980.
4. COL Clyde J. Tate and LTC L.D. Holder, "New Doctrine for the Defense," *Military Review*, March 1981, pp. 2–9.
5. TRADOC Pam 525-5, pp. 2 and 10.
6. Wass de Czege Interview, 16–17 April 1984, Holder Interview, 8 May 1984.
7. (1) *Ibid.* (2) Author's interview with LTC Thomas Kelly, Department of Tactics, Command and General Staff College, 17 April 1984. (3) Henriques Interview, 14 May 1984.
8. (1) *Ibid.* (2) Morelli Interview, 12 January 1983.
9. Wass de Czege Interview, 16–17 April 1984. (2) The manual writers were also heavily influenced by Martin van Creveld, "Fighting Power: German Military Performance, 1914–1945," a paper submitted to: Office of Net Assessment, Department of Defense, December 1980; Marshal Maurice De Saxe, *Reveries on War*; and Brig. Gen. S.L.A. Marshall, *Men Against Fire*. COL Huba Wass de Czege, "Toward a New American Approach to Warfare," *The Art of War Quarterly*, Vol. II, September 1983, p. 62 fn.
10. DTAC Briefing, Overview of FM 100-5, presented to FORSCOM Commander's Conference, 8 April 1981.
11. DTAC draft of attack fundamentals, January 1981.
12. Wass de Czege Interview, 16–17 April 1984.
13. (1) *Ibid.* (2) Tate and Holder, "New Doctrine for the Defense."
14. DTAC Draft, Tactical Precepts for the Attack on the Nuclear-Chemical Conventional Battlefield, February 1981.

15. Department of the Army, FM 100-5, *Operations*, 20 August 1982, pp. 7–16 to 7–17.
16. (1) Wass de Czege Interview, 16–17 April 1984; Holder Interview, 8 May 84; and Henriques Interview, 14 May 1984. (2) Memorandum ATZL-SWT, BG Robert H. Forman, Deputy Commander, US Army Command and General Staff College, to LTG Richardson, 20 October 1980, subj: Maneuver.
17. Wass de Czege Interview, 16–17 April 1984.
18. *Ibid.*
19. *Ibid.*
20. (1) Richardson, "Winning on the Extended Battlefield." This article provides a summary of the extended battlefield ideas presented during early 1981 by the contact team. (2) Holder Interview, 8 May 1984.
21. Ltr ATCD-ZXA, DCSCD to distr, 20 January 1981, subj: Status of Current Actions. (CONFIDENTIAL—Info used is UNCLASSIFIED).
22. For a description of the targeting cell and its field-testing by the 3d Armored Division, see MAJ Earl P. Guy, "The Targeting Cell: A Reality Today," *Field Artillery Journal*, September–October 1981, pp. 38–40.
23. (1) Ltr ATZL-CAC-IC, LTG William R. Richardson to Cdr TRADOC, 20 July 1981, subj: AirLand Battle After Action Report. (2) Semiannual Hist Repts, ODCSCD, October 1980–March 1981, pp. 19–20, and Apr–September 1981, p. 85. (3) Morelli Interview, 12 January 1983.
24. Wass de Czege Interview, 16–17 April 1984; Morelli Interview, 12 January 1983; Holder Interview, 8 May 1984; and Henriques Interview, 14 May 1984.
25. DTAC Briefing, Defensive Doctrine Overview, FORSCOM Commander's Conference, 8 April 1981.
26. Wass de Czege Interview, 16–17 April 1984.
27. *Ibid.*
28. (1) Morelli Interview, 12 January 1983. (2) Author's discussions with COL Andreas F. Wittenberg, German Senior Liaison Officer to Headquarters, TRADOC, 30 January 1984. (3) Kelly Interview, 17 April 1984.
29. Letter ATZL-CAC-IC, LTG William R. Richardson to Cdr TRADOC, 20 July 1981, subj: AirLand Battle After Action Report.
30. For detailed discussions of TAC-TRADOC cooperation and air-land programs and summaries of the many joint projects resulting from the "TAC-TRADOC dialogue," see the relevant portions of TRADOC Annual Historical Reviews, FY 1976 through FY 1981.
31. (1) TRADOC Annual Historical Review, FY 1980, pp. 80–81. (CONFIDENTIAL—Info used is UNCLASSIFIED) (2) Memo, 23 May 1981, subj: USA and USAF Agreement on Apportionment and Allocation of Offensive Air Support (OAS), s/LTG Glenn K. Otis, DCSOPS, DA, and Lt. Gen. Jerome F. O'Malley, Deputy Chief of Staff, Plans and Operations, DAF. (3) Briefing on OAS Agreement presented to Mr James R. Ambrose, Under Secretary of the Army, by LTC A.J. Whitcomb, ODCSDOC, 30 November 1981. (4) COL Charles L. Wesen, USA and USAF Agreement on Apportionment and Allocation of Offensive Air Support (OAS)—Information Memorandum, 23 May 1981, TAC-TRADOC ALFA Air-Land Bulletin 82-1, pp. 5–6.
32. (1) Ltr ATCD-XA, DCSCD to distr, 16 January 1980, subj: Status of Current Actions. (CONFIDENTIAL—Info used is UNCLASSIFIED) (2) Holder Interview, 8 May 1984.
33. (1) TRADOC Annual Historical Review, FY 1980, p. 79, and FY 1981, pp. 41–42. (Both CONFIDENTIAL—Info used is UNCLASSIFIED) (2) MAJ Glenn Rother, "Joint Attack of the Second Echelon (J-SAK) Study," TAC-TRADOC ALFA Air-Land Bulletin 81-2, 25 September 1981, p. 5. (3) TAC-TRADOC-USREDCOM Joint Operational Concept, Joint Attack of the Second Echelon (J-SAK), TAC Pam 50-26/TRADOC Pam 525-16/USREDCOM Pam 525-4, 13 December 1982.
34. LTC Glenn Rother and MAJ Jim Machos, "Joint Attack of the Second Echelon (J-SAK)," TAC-TRADOC ALFA Air Land Bulletin 83-1, 13 May 1983, p. 9.
35. (1) TRADOC Annual Historical Review, FY 1981, pp. 42–43. (CONFIDENTIAL—Info used is UNCLASSIFIED) (2) TAC Pam 50-24/TRADOC Pam 525-9, TAC/TRADOC Concept, Joint Suppression of Enemy Air Defenses, 3 April 1981. (SECRET—Info used is UNCLASSIFIED) (3) USREDCOM Pam 525-3/TRADOC TT 100-44-1/TACP 50-23, J-SEAD Operations, 11 June 1982. (4) TAC-TRADOC ALFA Air Land Bulletin 82-2, 25 June 1982, p. 4.
36. (1) TRADOC Annual Historical Review, FY 1980, p. 81. (CONFIDENTIAL—Info used is UNCLASSIFIED) (2) MAJ Billy Baker, "Air-Land Forces Interface (ALFI)," TAC-TRADOC ALFA Air-Land Bulletin 81-2, 25 September 1981, pp. 6–7. (3) Semiannual Hist Rept, ODCSCD, October 1980–March 1981, p. 26. (CONFIDENTIAL—Info used is UNCLASSIFIED).

37. This section is based on Morelli Interview, 12 January 1983.
38. *Ibid.*
39. (1) *Ibid.* The AirLand Battle 2000 concept was aptly expressed, General Morelli suggested, not by the traditional football metaphor with its terrain orientation. Rather, it should be seen in terms of a soccer field where the orientation was on the enemy and on which the action was fluid and continuous, proceeding according to an overall plan, where independent action and maneuver could lead to collapse of the enemy's overloaded system. (2) MFR, TRADOC Historical Office, 30 January 1981, subj: Concepts and Doctrine Conference, 28-29 January 1981, HQ TRADOC.
40. For a digest of the 1982 FM 100-5 and a summary of the reasons for change, by the manual's authors, see LTC(P) Huba Wass de Czege and LTC L. D. Holder, "The New FM 100-5," *Military Review*, July 1982, pp. 53-70. LTC John S. Doerfel details "The Operational Art of the AirLand Battle" in *Military Review*, May 1982, pp. 3-10. For an explanation of the doctrinal emphasis on operations in depth, see LTC L.D. Holder, "Maneuver in the Deep Battle," *ibid.*, pp. 54-61.
41. FM 100-5, *Operations*, 1982.
42. *Ibid.*, pp. 1-5 and 4-1.
43. *Ibid.*, pp. 1-3 and 4-4.
44. *Ibid.*, p. 1-4
45. *Ibid.*, pp. 2-1 and B-1 to B-5.
46. *Ibid.*, p. 2-1.
47. *Ibid.*, pp. 2-1 and 2-2.
48. *Ibid.*, p. 2-3.
49. *Ibid.*, p. 2-4.
50. *Ibid.*, pp. 2-4 and 7-7.
51. *Ibid.*, p. 2-5.
52. *Ibid.*, pp. 2-5 and 2-6.
53. *Ibid.*, p. 8-4.
54. *Ibid.*, pp. 8-1 to 9-20.
55. *Ibid.*, pp. 10-1 to 11-12.
56. *Ibid.*, pp. 14-1 to 14-5.
57. FM 100-5, *Operations*, 1976, p. 5-3
58. Wass de Czege Interview, 16-17 April 1984.
59. FM 100-5, *Operations*, 1982, p. 11-8.
60. *Ibid.*, p. 11-9.
61. *Ibid.*, pp. 5-1 to 5-11.
62. *Ibid.*, pp. 15-1 to 17-13.
63. *Ibid.*, pp. 4-1, 3-5 and 3-8.
64. *Ibid.*, p. 1-1.



## BIBLIOGRAPHY

- Andrews, Lt. Col. Andrew E., "Toward a Tactical Nuclear Doctrine," *Military Review*, October 1980, pp. 13-19.
- Barbara, Maj. James C. and Maj. Robert F. Brown, "Deep Thrust on the Extended Battlefield," *Military Review*, October 1982, pp. 21-32.
- Canby, Steven L., Final Report, *Defense Concepts and Short War Responses*, Technology Service Corporation, Silver Spring, Md., prepared for Assistant Secretary of Defense (Program Analysis and Evaluation), 22 September 1978.
- \_\_\_\_\_, "NATO Strategy: Political-Military Problems of Divergent Interests and Operational Concept," *Military Review*, April 1979, pp. 50-58.
- Carlson, Cpt. Adolf, "A Revisionist's View," *Infantry*, May-June 1978, pp. 37-39.
- Cate, Maj. Paul E., "Large-Unit Operational Doctrine," *Military Review*, December 1978, pp. 40-47.
- Chief of Staff, US Army White Paper 1980, A Framework for Molding the Army of the 1980s into a Disciplined, Well-Trained Fighting Force, Department of the Army, Washington, D.C., 25 February 1980.
- Colanto, Joseph D., "Intelligence Preparation of the Battlefield for the AirLand Battle," Headquarters, US Army Intelligence Center and School, Fort Huachuca, Ariz.
- Coroalles, Anthony M., "Manuever to Win: A Realistic Alternative," *Military Review*, September 1981, pp. 35-46.
- \_\_\_\_\_, "Implementing a Maneuver Style of War," *Military Review*, December 1982, pp. 20-25.
- Deal, Maj. C. Lanier, Jr., "The Key to the Deep Battle," *Military Review*, March 1982, pp. 51-54.
- DePuy, General William E. (US Army, Retired), "The U.S. Army: Are We Ready for the Future," *Army*, September 1978, pp. 22-29.
- \_\_\_\_\_, "FM 100-5 Revisited," *Army*, November 1980, pp. 12-17.
- DeVries, Lt. Col. Paul T., "Maneuver and the Operational Level of War," *Military Review*, February 1983, pp. 13-34.
- Dinges, Brig. Gen. Edward A., and Maj. Richard H. Sinnreich, "Battlefield Interdiction: Old Term, New Problem" *Field Artillery Journal*, January-February 1980, pp. 14-17.
- Doerfel, Lt. Col. John S., "The Operational Art of the AirLand Battle," *Military Review*, May 1982, pp. 3-10.
- \_\_\_\_\_, (John) Steve, "Meeting the Strategic Challenge," *International Defense Review*, Vol. 17, No. 3, 1984, pp. 251-55.
- Doughty, Maj. Robert A., *The Evolution of U.S. Army Tactical Doctrine, 1946-76* (Leavenworth Papers, No. 1), Ft Leavenworth, Kan., August 1979.
- \_\_\_\_\_, and Maj. L.D. Holder, "Images of the Future Battlefield," *Military Review*, January 1978, pp. 56-69.
- Downing, Col. Wayne A., "US Army Operations Doctrine: A Challenge for the 1980s and Beyond," *Military Review*, January 1981, pp. 64-73.
- Dubik, Maj. James M., "FM 100-5, Comparing the Operational Concept and the Defense," *Military Review*, December 1982, pp. 13-19.
- FM 100-1, *The Army*, Department of the Army, Washington, D.C., 29 September 1978.
- FM 100-1, *The Army*, Department of the Army, Washington, D.C., 14 August 1981.
- FM 100-5, *Operations*, Department of the Army, Washington, D.C., 1 July 1976.
- FM 100-5, *Operations*, Department of the Army, Washington, D.C., 20 August 1982.
- Fontenot, Cpt. Gregory, and Cpt. Matthew D. Roberts, "Plugging Holes and Mending Fences," *Infantry*, May-June 1978, pp. 32-36.

- Franz, Col. Wallace P., "Grand Tactics," *Military Review*, December 1981, pp. 32-39.
- \_\_\_\_\_, "Maneuver: The Dynamic Element of Combat," *Military Review*, May 1983, pp. 2-12.
- Gans, Col. Daniel (US Army Retired), "Fight Outnumbered and Win,' Against What Odds," *Military Review*, December 1980, pp. 31-46, and January 1981, pp. 24-33.
- Grange, Maj. Gen. David E., Jr., "Infantry and Air Defense in the AirLand Battle," *Air Defense Magazine*, October-December 1981, pp. 24-25.
- Gray, Colin S., "Force Planning, Political Guidance and the Decision to Fight," *Military Review*, April 1978, pp. 5-16.
- Griffin, Maj. Donald K., "If the Soviets Don't Mass," *Military Review*, February 1979, pp. 2-13.
- Griffis, Lt. Col. Jimmy, Maj. Kurt Pierce, and Maj. Ed Sherwood, "The Mechanized Infantry Battalion Task Force in the AirLand Battle," *Infantry*, July-August, 1982, pp. 21-24.
- Guy, Maj. Earl P., "The Targeting Cell: A Reality Today," *Field Artillery Journal*, September-October 1981, pp. 38-40.
- Hanne, Col. William G., "The Integrated Battlefield," *Military Review*, June 1982, pp. 34-44.
- \_\_\_\_\_, "AirLand Battle: Doctrine, Not Dogma," *Military Review*, June 1983, pp. 11-25.
- Holder, Lt. Col. L. D., "Maneuver in the Deep Battle," *Military Review*, May 1982, pp. 54-61.
- \_\_\_\_\_, "FM 100-5 and the AirLand Battle," U.S. Army Command and General Staff College, Fort Leavenworth, Kans.
- "Implementing the AirLand Battle," *Field Artillery Journal*, September-October 1981, pp. 20-27.
- Joint Attack of the Second Echelon, (J-SAK)*, TAC-TRADOC-USREDCOM Joint Operational Concept, TAC Pam 50-26/TRADOC Pam 525-16/USREDCOM Pam 525-4, 13 December 1982.
- Joint Suppression of Enemy Air Defenses Operations*, USREDCOM Pam 525-3/TRADOC TT 100-44-1/TAC Pam 50-23, 11 June 1982.
- Jones, Archer, "The New FM 100-5: A View from the Ivory Tower," *Military Review*, February 1978, pp. 27-36.
- \_\_\_\_\_, "FM 100-5: A View from the Ivory Tower," *Military Review*, May 1984, pp. 17-22.
- Karber, Philip A., "Dynamic Doctrine for Dynamic Defense," *Armed Forces Journal*, October 1976, p. 28.
- \_\_\_\_\_, "Soviet Lessons of Middle East War" in "15th Annual Army Operations Research Symposium," *Army Research and Development*, November-December 1976, pp. 11-15.
- \_\_\_\_\_, "The Tactical Revolution in Soviet Military Doctrine," *Military Review*, November 1977, pp. 83-85, and December 1977, pp. 33-34 (A reprint and condensation of articles in *Europaische Wehrkunde*, June and July 1977).
- Lancaster, Maj. Michael S., "The Armor Force in the AirLand Battle," *Armor*, January-February 1982, pp. 26-32.
- Letonoff, Col. Victor T. and Lt. Col. Edward H. Robertson, "Deep Attack," Headquarters, TRADOC, Fort Monroe, Va.
- Lind, William S., "FM 100-5, Operations: Some Doctrinal Questions for the United States Army," *Military Review*, March 1977, pp. 54-65.
- Loomis, BGen. Dan G., Canadian Armed Forces, "FM 100-5, Operations: A Review," *Military Review*, March 1977, pp. 66-69.
- Luttwak, Edward N., "The American Style of Warfare and the Military Balance," *Survival*, March-April 1979, pp. 146-49. (Reprinted in *Air Force Magazine*, August 1979, pp. 86-88.
- Machos, Maj. James A., USAF, "AirLand Battles or AirLand Battle?" *Military Review*, July 1983, pp. 33-40.
- McNair, Maj. Gen. Carl H., and Cpt. Josef Reinsprecht, "Army Aviation Forces in the AirLand Battle," *US Army Aviation Digest*, July 1981, pp. 6-13.
- Military Operations: Operational Concepts for the AirLand Battle and Corps Operations—1986*, TRADOC Pam 525-5, HQ TRADOC, 25 March 1981.
- Oseth, Maj. John M., "FM 100-5 Revisited: A Need for Better 'Foundation Concepts,'" *Military Review*, March 1980, pp. 13-19.
- Otis, General Glenn K., "Doctrinal Perspectives of War," Headquarters, TRADOC, Fort Monroe, Va.
- Porreca, David P., "New Tactics and Beyond," *Military Review*, May 1979, pp. 21-29.
- Richardson, Lt. Gen. William R., "Winning on the Extended Battlefield," *Army*, June 1981, pp. 35-42.
- \_\_\_\_\_, "Training for Maneuver Warfare," *Armor*, July-August 1981, pp. 31-34.
- Richey, Cadet Stephen W., "The Philosophical Basis of the AirLand Battle," *Military Review*, May 1984, pp. 48-53.
- Romjue, John L., *A History of Army 86*, Vol I: *Division 86: The Development of the Heavy Division*, September 1978-October 1979; Vol II: *The Development of the Light Division, the Corps, and Echelons Above Corps*, November 1979-December 1980, HQ TRADOC Ft Monroe, Va., June 1982.



- Saunders, Robert, "Combat Service Support Perspective," Headquarters, U.S. Army Logistics Center, Fort Lee, Va.
- Sinnreich, Maj. Richard H., "Tactical Doctrine or Dogma," *Army*, September 1979, pp. 16-19.
- Sollinger, Lt. Col. Jerry M., "AirLand Battle: Implications for the Infantry," *Infantry*, March-April 1982, pp. 22-25.
- Starry, General Donn A., "Armor Conference Keynote Address," *Armor*, July-August 1978, pp. 32-36.
- \_\_\_\_\_, "A Tactical Evolution—FM 100-5," *Military Review*, August 1978, pp. 2-11.
- \_\_\_\_\_, "Extending the Battlefield," *Military Review*, March 1981, pp. 31-50, and *Field Artillery Journal*, September-October 1981, pp. 6-19.
- \_\_\_\_\_, "The Principles of War," *Military Review*, September 1981, pp. 2-12.
- \_\_\_\_\_, "To Change an Army," *Military Review*, March 1983, pp. 20-27.
- Steger, Lt. Col. George F., "More Dilemmas in Studying Soviet Tactics," *Military Review*, February 1978, pp. 88-91.
- Tate, Col. Clyde J., and Lt. Col. L.D. Holder, "New Doctrine for the Defense," *Military Review*, March 1981, pp. 2-9.
- Taylor, Maj. John W., "A Method for Developing Doctrine," *Military Review*, March 1979, pp. 70-75.
- Tillson, John C.F., IV, "The Forward Defense of Europe," *Military Review*, May 1981, pp. 66-76.
- "TRADOC'S Reply," *Armed Forces Journal*, October 1976, p. 27.
- Wagner, Col. Robert E., "Active Defense and All That," *Military Review*, August 1980, pp. 4-13.
- Wass de Czege, Col. Huba, "Toward a New American Approach to Warfare," *The Art of War Quarterly*, Vol. II, U.S. Army War College, Carlisle Barracks, Pa., September 1983, pp. 31-62.
- \_\_\_\_\_, and Lt. Col. L.D. Holder, "The New FM 100-5," *Military Review*, July 1982, pp. 53-70.



# Index

- Abrams, Gen. Creighton W., 65
- Active defense doctrine, 3, 6–10, 13–21, 35
- battlefield dynamics, 7–9
  - concentration tactics, 8, 18, 19–20, 21
  - covering force tactics, 8, 9–10
  - debate of, 13–21, 30, 51, 53
  - defense emphasis of, 14–15, 30, 32
  - defensive tactics, 8, 9
  - firepower emphasis, 18–19, 21, 58
  - first-battle focus, 6, 15–16
  - and maneuver doctrine, 18–19, 56–57
  - NATO Europe focus, 30
  - offensive tactics, 9
  - reserves doctrine, 9, 17–18, 21, 53
  - training considerations, 6
- Afghanistan
- Soviet invasion of, 2, 33
- Air-Land Forces Application Agency, 61–62, 63
- Air-Land Forces Interface project, 65
- AirLand Battle, *See also* FM 100-5 (1982). 1, 42, 43, 44–50, 66–73
- and active defense doctrine, 51, 53, 59, 71
  - Auftragstaktik*, 58–59, 67, 73
  - briefing of, 57–58, 65–66
  - characteristics of battlefield, 66–67
  - combat imperatives, 55, 70
  - combat power, 69–70
  - concept of March 1981, 44–50, 51, 53
  - covering force operations, 59
  - deep attack doctrine, 56, 58–59, 61, 71
  - defensive doctrine, 55–56, 59, 71
  - formulation and writing, 51–57, 58–61
  - fundamentals of combat, 68–70
  - interdiction doctrine, 56, 58, 59, 61
  - leadership and training, 67–68, 69–70
  - maneuver doctrine, 56–57, 69
  - moral dimension of battle, 51, 53, 55, 70
  - nuclear and chemical operations, 67
  - offensive doctrine, 56, 70
  - operational level of war, 61, 68–69
  - political aspect of warfare, 72
  - reserves, 71
  - staffing of, 57–61
  - tactical air dimension, 61–65
  - AirLand Battle 2000, 66, 75–76
  - Allen, Gen. Lew Jr., USAF, 32, 63
  - Allied Tactical Publication-35, 43
  - Allied Tactical Publication, Offensive Air Support, ATP-27, 62
- Angola
- military intervention by Cuban forces in, 2
- Arab-Israeli War of 1973, 2, 3
- tactical lessons of, 3, 4, 6–7, 18, 24, 29, 72
- Area of influence/area of interest concept, 40–41
- Armed Forces Journal*, 14, 18
- Army 86 Study, 1, 27, 30, 33, 62
- Army 21, 75–76
- Battle calculus, 23–24, 53, 70
- Battle Studies*, 55
- Battlefield air interdiction, 62–63
- Battlefield Development Plan, 17, 24–27, 35
- Blanchard, Gen. George S., 5
- BMP infantry fighting vehicle, 16
- de Bourcet, Pierre, 17
- Bush, Vice President George, 66
- Canby, Steven L., 17
- Carlson, Cpt. Adolph, 20
- Carlucci, Frank C. III, 66
- Carter Administration
- defense policies of, 23, 33
- Cavazos, Lt. Gen. Richard E., 53, 55
- Central Battle concept, 16, 18–19, 23–24, 25–26, 27, 34, 44, 51
- Chemical warfare. *See* Tactical nuclear and chemical warfare.
- Clausewitz, Carl von, 59, 70, 72
- Concepts Branch, HQ TRADOC, 4, 5
- Congressional Reform Caucus, 66
- Corps
- III Corps, 53
  - V Corps, 23, 58
- Corps 86 Study, 33, 40–42, 44
- Creech, Gen. William L., USAF, 32, 64

- Deep attack, 39, 44, 46, 48-49, 56, 58  
 Deep battle concept. *See also* Deep attack concept. 27  
 Department of Tactics (DTAC)  
   CGSC, 38-39, 42-43, 51, 53, 56  
 DePuy, Gen. William E., 2, 3-5, 11, 24, 38, 57  
 Division 86 Study, 17, 27, 32-33, 40  
 Dixon, Gen. Robert J., USAF, 5  
 Doctrinal literature program, 29-30  
 Doctrine management, 27, 29-30  
 Doerfel, Maj. John S., 35, 36, 37  
 Doughty, Maj. Robert A., 13, 14, 18  
 DRAGON antitank missile, 11
- Echelonment of Soviet forces. *See* Soviet second echelon.  
 Eighth U.S. Army, 4  
 Extended battlefield concept, 43-44, 45, 53, 57  
   briefing of, 57-58
- The Face of Battle*, 55  
 Firepower models, 39  
 FM 100-1, The Army, 20-21, 55  
 FM 100-5 (1976). *See also* Active defense doctrine.  
   3-11, 14, 15, 16, 17, 18, 21, 23, 29, 30, 32, 42, 53,  
   55, 58, 65, 66, 71  
   development of, 3-6  
   publication of, 5-6, 13  
   revision recommended, 30, 32, 38  
 FM 100-5 (1982). *See also* AirLand Battle. 1, 38,  
   66-73  
   staffing, 57-61  
   writing of, 42-43, 51, 53-57  
 Fontenot, Capt. Gregory, 16, 20  
 Force generation, 25, 26-27, 34  
 Fort A.P. Hill  
   doctrinal conferences held at, 5  
 Fort Hood, 5  
 Fort Knox, 4, 23  
 Fort Leavenworth, 5, 15, 16, 30, 37, 38, 39, 40, 42,  
   43, 51, 53, 59, 63  
 Fort Lewis, 39  
 Fort Monroe, 38, 61  
 Fort Sill, 34, 39  
 Fuller, J.F.C., 56
- German Army  
   doctrinal consultations with, 3, 5  
   influence on AirLand Battle, 43, 58-59, 61  
 Gingrich, Rep. Newt, 66  
 Gorman, Brig. Gen. Paul F., 4  
 Gray, Colin, S., 13  
 Greenway, Col. John R., 40  
 de Guibert, Count H., 17
- Haeffner, Maj. Gen. Fred A., USAF, 63  
 Hart, Sen. Gary, 13  
 HDv 100-100, Command and Control in Battle, 43
- HELLFIRE missile, 7  
 Henriques, Lt. Col. Richmond B., 42, 53  
 High Technology Test Bed project, 39  
 Holder, Lt. Col. L.D., 14, 43, 53, 56, 58  
 "How-to-fight" field manuals, 4, 15, 16, 29, 30  
 Hudson Institute, 13  
 Huffman, Maj. Gen. Burnside E., Jr., 4
- Integrated battlefield concept, 30, 33, 34-39, 43, 53,  
   58  
 Integrated targeting cells, 48, 58  
 Interdiction of enemy second echelon, 32, 33, 35,  
   36-39, 46-48, 53, 56, 58, 64  
   concept, 33-34  
   in Corps 86 concept, 40-41  
 International Institute for Strategic Studies, 13  
 Iranian hostage crisis, 33
- Joint Second Echelon Attack Study, 64  
 Joint Suppression of Enemy Air Defenses Study,  
   64-65  
 Jones, Archer, 13, 14, 17, 19-20  
 Josephus, 6
- Karber, Phillip A., 13, 14, 15, 16, 18, 19  
 Keegan, John, 55  
 Kerwin, Gen. Walter T. Jr., 4
- Langley Air Force Base, 61  
 Liddell Hart, Basil H., 56, 70  
 Light Division Study, 39  
 Lind, William S., 13, 14, 15, 18, 19, 58  
 Long, Maj. Dennis H., 58  
 Loomis, Dan G., 13  
 Luttwak, Edward B., 58
- Marshall, Gen. George C. 1941 doctrine manual, 43  
 Merritt, Maj. Gen. Jack N., 34  
 Meyer, Gen. Edward C., 30, 32, 33, 38, 39, 42, 43, 61,  
   63  
 Morelli, Brig. Gen. Donald R., 27, 44, 57, 61, 63, 66
- NATO Alliance, 2, 3  
 Nellis Air Force Base, 63  
 Neo-isolationism, 2  
 Nuclear Systems Program Review, 33, 34-35, 37, 38
- "Octoberfest" conference, 4, 5  
 Offensive air support, 62-63, 65  
 Office of the Deputy Chief of Staff for Combat  
   Developments, 62  
 Office of the Deputy Chief of Staff for Doctrine  
   establishment of, 27, 29  
 Operational concepts, 27, 28, 77  
 Operations field manual. *See* FM 100-5 (1976); FM  
   100-5 (1982)  
 Otis, Gen. Glenn K., 61

- Pacific Air Forces, **65**  
**Patton**, Gen. George, **72**  
 du Picq, Ardant, **55**  
 Planning Air-Land Directorate, HQ TRADOC, **32**  
 Pokorny, Col., Anthony G., **24, 35**  
 Principles of war, **20, 55, 68**
- Richardson, Lt. Gen. William R., **42, 43, 44, 45, 51**  
 role in formulation of **AirLand Battle**, **53, 56, 59, 71**  
 Roberts, Cpt. Matthew, **16, 20**
- SA-7 Soviet missile, **7**  
 School model, **30, 38**  
 Scribner, Col. Edwin G., **27**  
 Shoemaker, Gen. Robert M., **58, 59**  
 Sloan, John F., **19**  
 Soviet operational maneuvers, **14, 16–17, 21, 46**  
 Soviet second echelon, **15, 16, 24, 25, 27, 33, 36, 47, 56**  
 Soviet tactics and doctrine, **9, 16–17, 18, 19, 20, 26, 32, 67**  
 Soviet Union  
 arms buildup, **1–2, 3, 23**  
 power moves of, **1–2, 33, 39**  
 weaponry, **5**  
 Starry, Gen. Donn A., **1, 15, 16, 18, 23, 32, 40, 48, 64, 65**  
 and **AirLand Battle**, **1, 42–43, 44–45, 53, 57, 59, 61**  
 and **Battlefield Development Plan**, **24–27**  
 and **Central Battle concept**, **23–24, 27**  
 directs revision of **FM 100-5**, **42–43**  
 and doctrinal literature program, **29–30**  
 and extended battlefield concept, **43–44**  
 and institution of operational concepts, **29**  
 and integrated battlefield concept, **35, 38, 39**  
 and interdiction of **Soviet second echelon**, **24–25, 27**  
 Sun Tzu, **72**  
 Symposium on Tactics and Military Posture, **15, 16**  
 System program reviews, **32**
- Tactical Doctrine Office, HQ TRADOC, **27**  
 Tactical nuclear and chemical warfare. See also Integrated battlefield concept. **32, 33, 34, 35, 36–38, 40, 41, 45**
- Tannenberg, **72**  
 Tate, Col. Clyde J., **43, 56**  
 3d Armored Division, **58**  
 Time-lines, **36, 40–41, 46, 48**  
 TOW (tube-launched, optically-tracked, wire-guided) antitank missile, **7, 11**  
 TRADOC scenarios, **3, 7**
- U.S. Continental Army Command, **10**  
 U.S. Readiness Command, **58**  
 U.S. Army Armor Center, **23**  
 U.S. Army Combat Developments Command, **10, 24**  
 U.S. Army Combined Arms Center, **5, 15, 30, 32, 33, 37, 38, 40, 42, 44, 48, 58, 62, 65**  
 U.S. Army Combined Arms Training Development Activity, **61**  
 U.S. Army Command and General Staff College, **30, 38, 42, 51, 56, 61**  
 U.S. Army Europe, **4, 51**  
 U.S. Army Field Artillery School, **32, 33, 34, 35, 36, 37, 48, 58**  
 U.S. Army Forces Command, **3, 4, 5, 59**  
 U.S. Army Materiel Systems Analysis Agency, **4–5**  
 U.S. Army War College, **61**  
 U.S. Air Force, **61, 62, 63**  
 U.S. Air Force Tactical Air Command, **3, 32, 61, 62–63, 64, 65**  
 U.S. Air Force Tactical Fighter Weapons Center, **63**  
 U.S. Air Forces Europe, **65**
- Vessey, Gen. John W., Jr., **32, 37**  
 Vicksburg Campaign, **72**  
 Vietnam War, **2, 3, 13, 45**
- Walker, Maj. Gen. Jack A., **57**  
 Warsaw Pact, **6, 7, 16, 23, 32, 36, 38, 45, 66**  
 Wass de Czege, Lt. Col. Huba, **43, 53**  
 Weapon development, **2, 7, 45, 47**  
 Weapon lethality, **3, 6–7, 9, 18**  
 White Paper of Feb 1980, **38, 39**  
**Whitehurst**, Rep. G. William, **66**  
 Worldwide contingency doctrine, **30, 32, 33, 39, 66, 72**
- Zawilski, Maj. Robert W., **58**





3 1695 00155 5598

A391  
NCO

## *The Author*

John L. Romjue was born in Washington, D.C., served on active Army duty in Germany, and studied at the universities of Missouri and California, Berkeley, and in Germany at Heidelberg University as a Fulbright Scholar. He has written *A History of Army 86*, published in 1982, in addition to several other historical monographs in the area of Army field experimentation. He has also written articles, reviews and short stories for several journals and literary magazines. Before joining the Training and Doctrine Command historical staff in 1974, Mr. Romjue served as a historian in the Naval Facilities Engineering Command and as the Command Historian of the Army Combat Developments Experimentation Command. Since August 1983, he has been Deputy Staff Historian for Field History Programs, US Army Training and Doctrine Command.



### **TRADOC Historical Office**

The TRADOC Historical Office, a separate Staff agency aligned under the Chief of Staff of the U.S. Army Training and Doctrine Command, has the mission of planning, developing, and directing a command historical program that provides the TRADOC commander with the capability to meet his command responsibility for preparation and use of military history, in accordance with the requirements of the Army Historical Program. That mission is carried out through accomplishment of the following staff and operating functions:

1. Preparation of command history in the form of periodic historical monographs, special historical studies, and Annual Historical Reviews.
2. Supervision of subordinate command historical programs and activities.
3. Supervision of Army museum operations within the command.
4. Maintenance of a repository of selected historical source documentation as the corporate memory of the command, enabling planners and operating officials to apply the lessons of past experience to the resolution of current and future problems in the areas of combat developments, training, and support operations.
5. Provision of historical reference services to the commander, staff, subordinate commands, other agencies, and the public.

