

# Popular Radio

★ MAY · 1926

25¢

*For the Broadcast Listener—*  
**THE ONE BEST WAY TO  
INSTALL A LOUDSPEAKER**

*For the Home Builder—*  
**HOW TO BUILD THE IM-  
PROVED RAYTHEON UNIT**

*For the Experimenter—*  
**15 WAYS TO REDUCE STATIC**

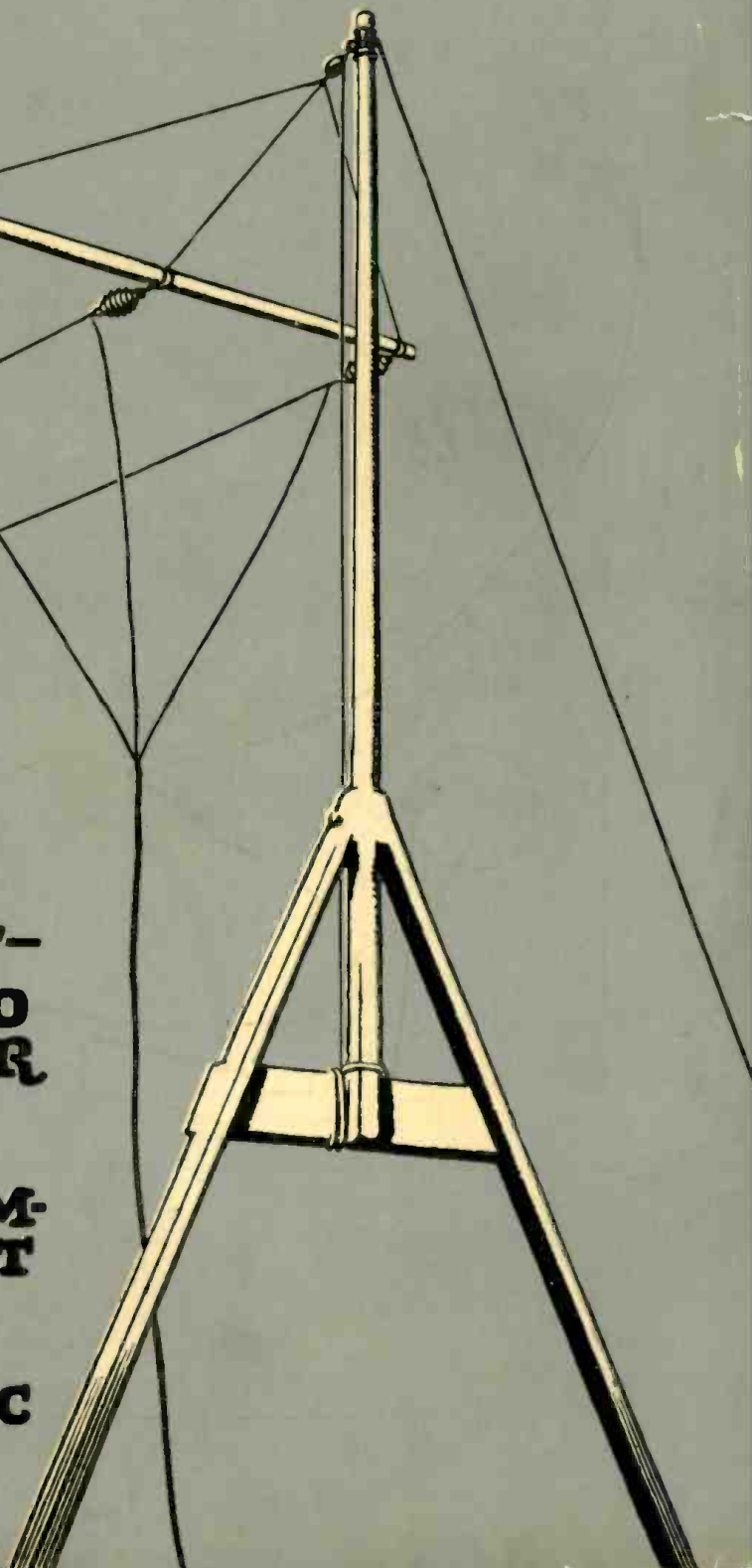



\$35



RCA  
Loudspeaker  
**MODEL  
100**

Get the boom of bass notes. Get the clear sweetness of high overtones. Give your set rare tone quality with this RCA Loudspeaker. It is particularly adapted to sets that use the new power Radiotrons.

Radio Corporation of America  
New York Chicago San Francisco

# RCA Loudspeaker

MADE BY THE MAKERS OF RADIOLAS

*A remarkable Cone Speaker,  
housed in a beautiful acoustically  
perfect cabinet.*

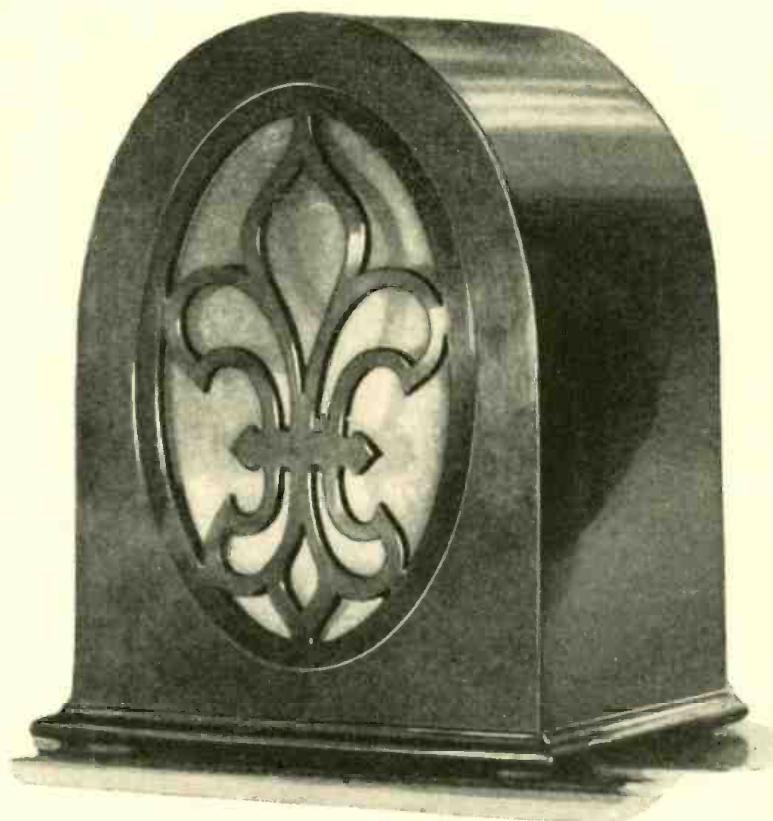

## Cone Quality—and More For Those Who Appreciate the Ultimate

Midst a maze of claims, those who own this wonderful Brandes Cone sit back and listen with all the satisfaction of having attained an ideal. Nothing else is quite so satisfactory — no reproduction so true, so mellow, so natural.

And this is as it should be for Brandes has specialized since 1908 in advanced acoustics. Who but Brandes could be expected to have perfected a Cone like this?

Who but Brandes, having perfected a Cone of such remarkable quality, could then house it with such precision that there results a perfect alliance for pleasing both ear and eye?

*Acoustics by*  
**Brandes**  
*means the ultimate in reproduction*

# Popular Radio

EDITED by KENDALL BANNING



FOUNDED 1911

VOLUME X

May, 1926

NUMBER 1

## CONTENTS

(Cover design by Frank B. Masters)

### Does the Aurora Borealis Affect Radio Reception?

By *W. D. Terrell* . . . . . PAGE 11

### A Measurement Chart

No. 14: For Use in Designing a Circular Section Toroid Coil  
By *Raoul J. Hoffman* . . . . . PAGE 15

### How to Draw Up Your Own "Tuning Graphs"

By *K. B. Humphrey* . . . . . PAGE 16

### How to Build the Improved Raytheon Power-Pack

By *Laurence M. Cockaday* . . . . . PAGE 19

### A Rescue that Was "Up to the Radio Compass"

By *Kenneth Upton* . . . . . PAGE 26

### How to Build an Antenna Mast for \$15.00

By *Henry Simon* . . . . . PAGE 28

### The Atom

Article No. 5: The Nature of Crystals: Ice and Snow  
By *Sir William Bragg* . . . . . PAGE 30

### A "Radio Studio" in Your Home

By *The Technical Editor* . . . . . PAGE 33

### Fifteen Ways to Reduce Static

By *The Technical Staff* . . . . . PAGE 35

### Simple "How-to-Build" Articles for Beginners

No. 16: How to Build an Inexpensive Charger  
for Storage "B" Batteries  
By *S. Gordon Taylor* . . . . . PAGE 36

### How I Made My LC-26 an Objet d'Art

By *Everett L. Thompson, Jr.* . . . . . PAGE 39

### Do Your Coils Broadcast?

By *Irving Nachumsohn* . . . . . PAGE 40

## DEPARTMENTS

With the Experimenters . . . . .	<i>Laurence M. Cockaday</i> . . . . .	42
In the World's Laboratories . . . . .	<i>E. E. Free</i> . . . . .	44
With the Inventors . . . . .	<i>Wm. G. H. Finch</i> . . . . .	52
What Readers Ask . . . . .	<i>Hugh S. Knowles</i> . . . . .	60
Listening In . . . . .	<i>Lloyd Jacquet</i> . . . . .	78
Broadcasts . . . . .	<i>Richard Lord</i> . . . . .	82
Broadcast Listener . . . . .	<i>Raymond Francis Yates</i> . . . . .	90
What's New in Radio . . . . .	<i>The Technical Staff</i> . . . . .	94

VOLUME X

MAY, 1926

NUMBER 1

Published monthly by Popular Radio, Inc., 627 West 43rd St., New York, N. Y., telephone number, Chickering 1906; Douglas H. Cooke, President and Treasurer; Kendall Banning, Vice-President; Laurence M. Cockaday, Secretary; Joseph T. Cooney, Asst. Treasurer. Price 25 cents a copy; subscription \$3.00 a year in the U. S., Canada and all countries within the domestic postal zone; elsewhere \$3.50 a year, payable in advance. The International News Company, Ltd., No. 5 Bream's Bldg., London, E. C. 4, sole distributors in England. Entered as second class matter April 7, 1922, at the Post Office at New York, N. Y., under the act of March 3, 1879. Copyright, 1926, and title registered as a trade-mark by Popular Radio, Inc. Copyright in Great Britain by Popular Radio, Inc., 6 Henrietta St., Covent Garden, W. C., London, England. For advertising rates address E. R. Crowe & Company, Inc., 25 Vanderbilt Ave., N. Y., or 225 North Michigan Ave., Chicago. Printed in U. S. A.

E. E. FREE, Ph.D., Contributing Editor

LAURENCE M. COCKADAY, Technical Editor

JOHN V. L. HOGAN, Contributing Editor

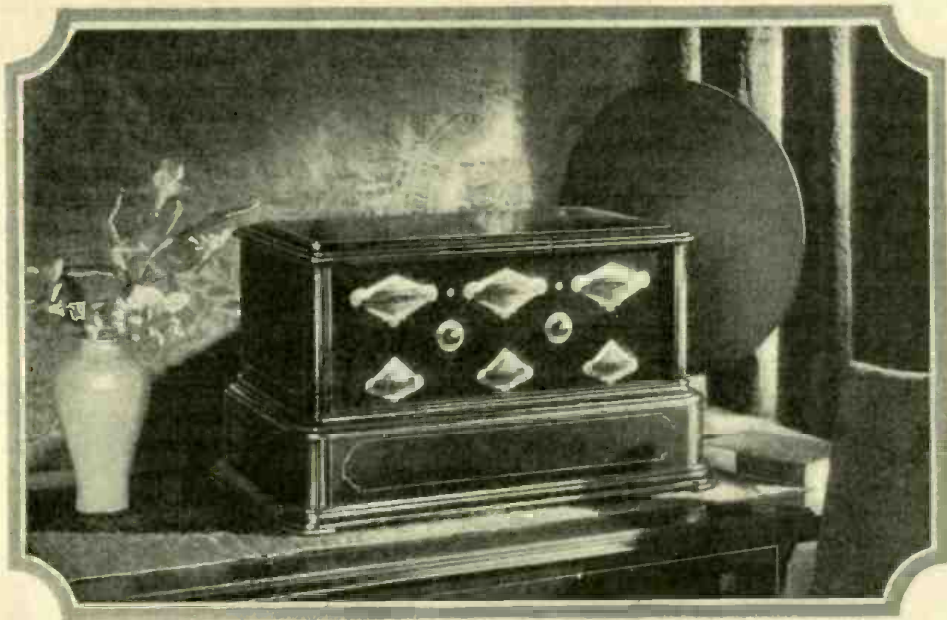

## Why the Synchronphase Appeals to the "Fan"

HE, more than any one else, understands what Grebe quality means. He best realizes why Grebe construction is reflected so surely in the superior reception of the Synchronphase.

The Grebe Synchronphase, built to satisfy the "fan", has quickly won first place in the opinion of the average radio user.

*Ask your dealer to show you what Grebe reception means.*

A. H. Grebe & Co., Inc., 109 West 57th St., New York  
 Factory: Richmond Hill, New York  
 Western Branch: 443 So. San Pedro St., Los Angeles, Cal.

*This Company owns and operates stations WAHG and WBOQ; also low-wave re-broadcasting stations, mobile WGMU and marine WRMU.*

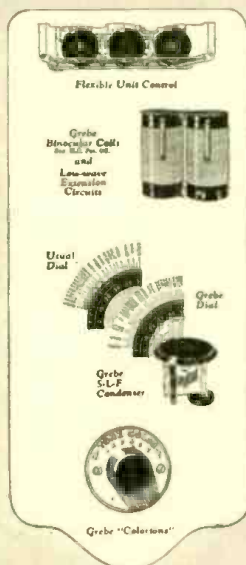

All Grebe apparatus is covered by patents granted and pending.

# The GREBE SYNCHROPHASE

TRADE MARK REG. U.S. PAT. OFF.



It is written:  
 "A perfect vase never came from a bad potter's wheel."  
 When one realizes its origin, the superior reception of the Synchronphase is not to be wondered at.

*Doctor Thayer*

# A PAGE WITH THE EDITOR

## *This Anniversary Number*

WITH this issue POPULAR RADIO enters upon its fifth year of existence.

IN celebration of the event, the magazine, in deference to the expressed wishes of its readers, is making its first appearance in its new, large size, with trimmed edges, better paper, color plates and many other editorial and physical improvements that many of its friends will identify as the results of the suggestions which they were good enough to submit in response to the ballot-form of questionnaire that appeared in our February number.

IN addition to this printed questionnaire, hundreds of personal letters were sent to subscribers—letters that asked for criticisms, suggestions and commentaries on the magazine.

THE result of this direct, personal contact with readers has been both gratifying and illuminating.

IN this issue which you are holding in your hands have been incorporated so many of the improvements and changes that have been suggested by our readers that, to a peculiar degree, this present number represents the kind of radio magazine that our readers themselves would produce if they were the editors.

SO helpful has been this friendly co-operation of our readers that the editors take pleasure in extending their invitation to them to keep on sending in their ideas and criticisms. For the radio magazine that best serves the interests of its readers is, naturally enough, best serving its own interests at the same time.

THE features planned for the coming twelve months are designed to be not only of interest but of practical value to all three of the main groups into which the readers of POPULAR RADIO may be classified:

- (1) *The experienced radio experimenter*—who is primarily interested in new circuits, new inventions and new radio apparatus:
- (2) *The average broadcast listener*—who is primarily interested in getting better reception on his set, and in getting better radio programs:
- (3) *The scientist*—who is primarily interested in laboratory research, new theories of radio phenomena and new applications of radio apparatus to the larger field of electrical science.

TO the first of this group—the radio experimenter—POPULAR RADIO, through its laboratory, has made many and important contributions that have had a far-reaching influence on the radio art and on the radio industry. Among the more important of these contributions may be included:

THE famous Cockaday Four-circuit Tuner (*May, 1923*).

THE Haynes Circuit (*September, 1923*).

THE first, Simplified Super-heterodyne Receiver (*November, 1923*).

THE first explanatory article on Resistance-coupled amplification (*January, 1924*).

THE “A” and “B” battery eliminators for DC current (*April, 1924*).

THE first description of the resistance-coupled and push-pull amplification (*May, 1924*).

THE first description of the Pressley Superheterodyne (also known as the Autodyne) (*November, 1924*).

THE early “B” battery eliminator (*December, 1924*).

THE eight-tube Superheterodyne Reflex Receiver (*January, 1925*).

THE first popular exposition of “Single-control” for receivers (*April, 1925*).

THE AC Receiver (*June, 1925*).

THE Vibrating-cone Loudspeaker (*August, 1925*).

THE Raytheon Plate Supply Unit (introducing the Raytheon tube) (*November, 1925*).

THE LC-26 Receiver (*December, 1925*).

THE Orthophase Receiver (*February, 1926*).

THE S-C Receiver (*March, 1926*).

THE Power-pack Amplifier (*April, 1926*).

FOR the second group—the broadcast listener—the service rendered by POPULAR RADIO has been no less noteworthy.

BEGINNING with the epoch-making event in broadcasting when, in August of 1922, POPULAR RADIO initiated and with conspicuous success carried through the project of broadcasting for the first time the concerts of the New York Philharmonic orchestra through WJZ, and extending to an enterprise of nationwide interest that has been in process of development for many months (and which will shortly be announced), the efforts of this magazine to add to the enjoyment of the everyday fan has been one of the distinguishing characteristics of the publication.

FOR this class of reader the simple, helpful articles on the operation of ready

made sets have been especially designed, as have the non-technical articles on tuning, on the installation of receivers, the erection of aerials, the preparation of tuning charts, the articles on “trouble shooting” and on innumerable other everyday problems that beset the layman whose main desire is merely to get better results from his receiver.

AND to the third group—the scientist and the man who is interested in science—POPULAR RADIO has furnished (and is furnishing) what many consider the most important series of contributions from the most distinguished scientists who have ever been gathered together in a corresponding period in any one magazine.

FROM the July, 1922, issue, in which the late Dr. Charles P. Steinmetz startled the scientific world by his revolutionary article “There Are No Ether Waves,” and from the spectacular three cornered controversy on the Heaviside Layer hypothesis that was carried on in the pages of this magazine by Sir Oliver Lodge, Dr. Elihu Thomson, and General George O. Squier, down to E. F. W. Alexanderson’s recently promulgated theory of wave propagation (in the March, 1926, number), POPULAR RADIO has been literally the battle ground of discussion among the world’s most able, most authentic and progressive scientists.

THE first successful experiments of C. F. Jenkins with the projection of motion pictures by radio were told for the first time in this magazine. The “glow” transmitter of Dr. Thomas; the “S” tube; the Finch radio typing device; the magnetic furnace of Dr. Northrup; the invention of Dr. Byron Eldred for aiding the deaf to hear; Dr. Belin’s system of transmitting pictures by code; Grindell-Matthew’s “death ray”; Dr. Reginald A. Fessenden’s new theory of transmission—these are but a few of the important developments in radio science that were first presented to the public in this magazine.

AT the very last minute, just before this May number went to press, the “How to Get the Most Out of Your Ready-made Receiver” article (on the Ferguson set) had to be taken off our over-crowded schedule, despite the fact that it had been announced for this month. But it will appear next month.

*Kendall Trauning*  
Editor, POPULAR RADIO



Use Type 719 across the transformer secondary.

Circuit diagram for Raytheon plate supply.

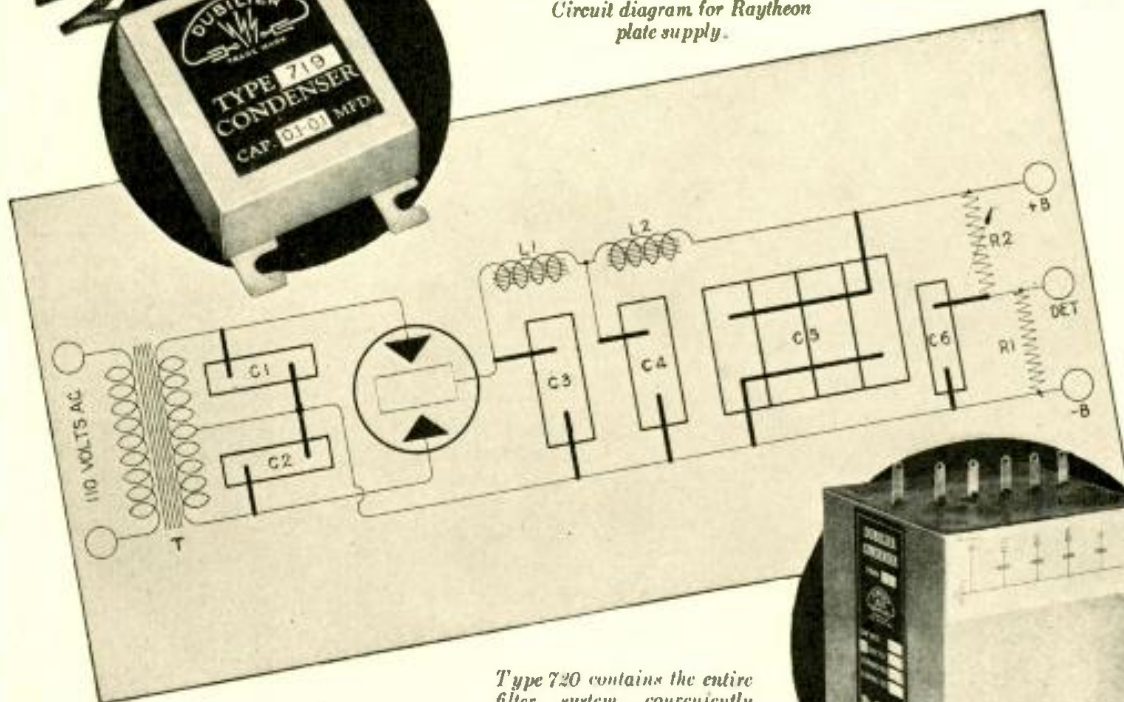

Type 720 contains the entire filter system conveniently tapped and marked.

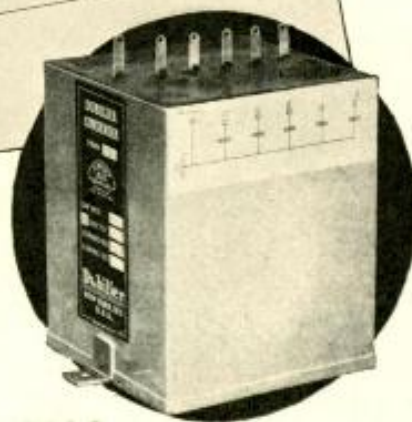

# Your filter condensers must be right!

One of the most popular types of home-built "B" battery eliminators uses the Raytheon tube as a rectifier.

As in every other type of plate supply unit, lasting satisfaction and safe operation depend on the use of proper filter condensers. Due to the high voltages impressed on the filter circuit by the input transformer, only condensers especially designed for this work will give permanent service. Ordinary By-pass condensers should not be used in filter circuits.

Dubilier Filter Condensers, Types 719 and 720 contain all capacities necessary for constructing a Raytheon plate supply unit. These condensers were specifically designed for this circuit.

You can't build right unless your parts are right!

Insist on getting DUBILIER Filter Condensers. If your dealer cannot supply you write directly to

# Dubilier

**CONDENSER AND RADIO CORPORATION**

4377 Bronx Boulevard, New York, N. Y.

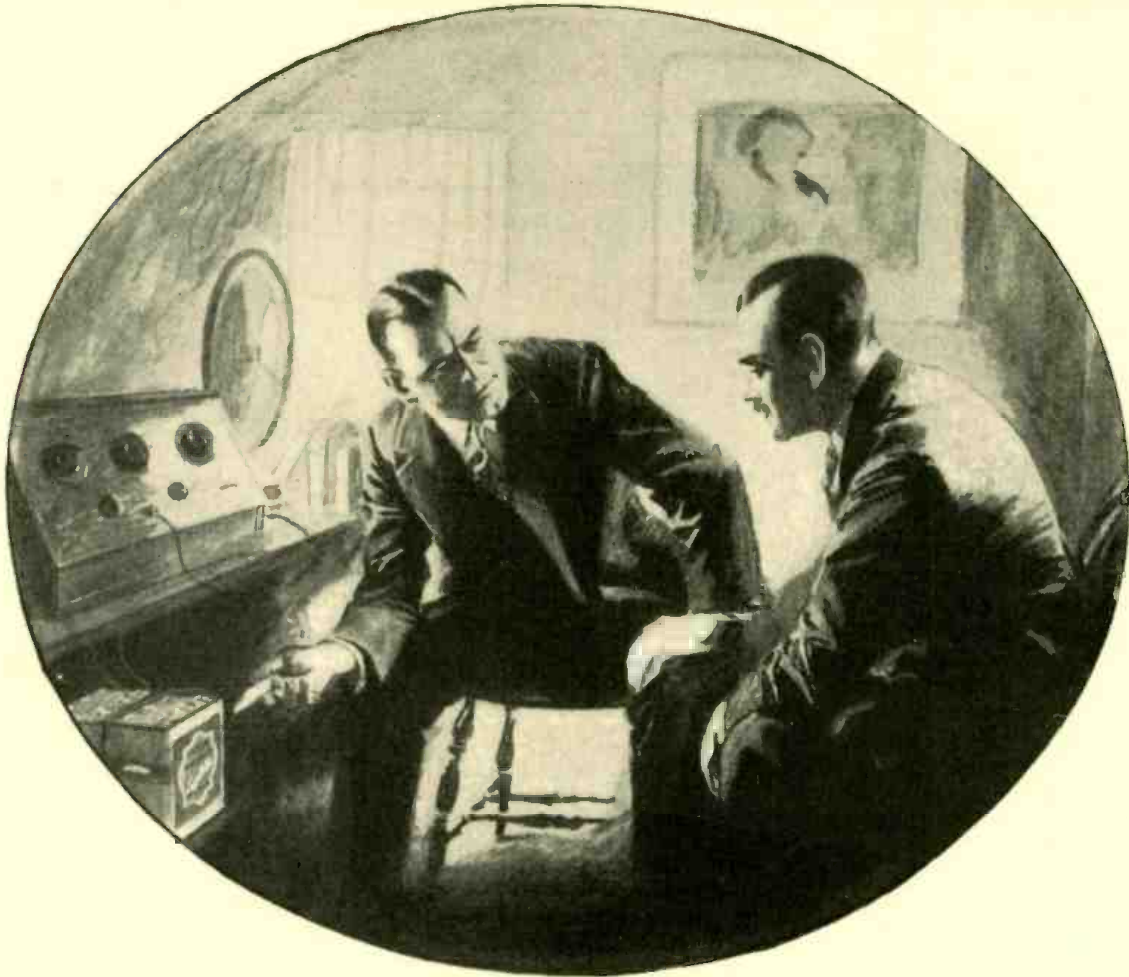

*“The little wrinkle that makes my ‘B’ batteries last longer is using the right size Evereadys with a ‘C’ battery”*



“I USED to think that because the Eveready ‘B’ Battery No. 772 cost less than either of the larger Heavy Duty Evereadys that I was saving money. As a matter of fact, on four or five tube sets, that was false economy.

“The right size Eveready ‘B’ Batteries to use depends on the number of tubes in your set. The life of the batteries depends on how much you listen in and on whether a ‘C’ battery is employed.”

To get the maximum of “B” battery life and satisfaction, follow these simple rules:

*On 1 to 3 tubes—Use Eveready No. 772.*

*On 4 or more tubes—Use the Heavy Duty “B” Batteries, either No. 770, or the even longer-lived Eveready Layerbilt No. 486.*

*On all but single tube sets—Use a “C” battery\*.*

Follow these rules, and No. 772, on 1 to 3 tube sets, will last a year or more; Heavy Duties, on sets of 4 or more tubes, eight months or longer.

The average year-round use of a set is two hours a day. If you listen longer,

your “B” batteries will have a somewhat shorter life. If you listen less, they will last longer.

Our new booklet, “Choosing and Using the Right Radio Batteries,” is free for the asking. It also tells about the proper battery equipment for the new power tubes.

\*NOTE: In addition to the increased life which an Eveready “C” Battery gives to your “B” batteries, it will add a quality of reception unobtainable without it.

Manufactured and guaranteed by  
**NATIONAL CARBON CO., INC.**  
 New York San Francisco  
 Canadian National Carbon Co., Limited  
 Toronto, Ontario



LEFT — No. 486, for 4, 5 or more tubes. \$5.50.

RIGHT—Eveready Dry Cell Radio “A” Battery, 1 1/2 volts.

**EVEREADY**  
**Radio Batteries**  
*—they last longer*

Tuesday night means Eveready Hour—9 P. M., Eastern Standard Time, through the following stations:

- |                  |                 |                  |
|------------------|-----------------|------------------|
| WEAF—New York    | WGR—Buffalo     | WGN—Chicago      |
| WJAR—Providence  | WCAR—Pittsburgh | WOC—Davenport    |
| WEEI—Boston      | WSAI—Cincinnati | WCCO—Minneapolis |
| WTAG—Worcester   | WEAR—Cleveland  | WCCO—St. Paul    |
| WFI—Philadelphia | WWJ—Detroit     | KSD—St. Louis    |





An Important Duty Performed by  
POPULAR RADIO

*"I feel that POPULAR RADIO is to be particularly commended for not having shirked the very difficult but equally important duty of keeping its readers posted as to the scientific and theoretical basis of all the more important advances made in the radio art. It has succeeded in accomplishing this purpose by articles couched in popular language but without materially sacrificing accuracy."*

*John S. ...*

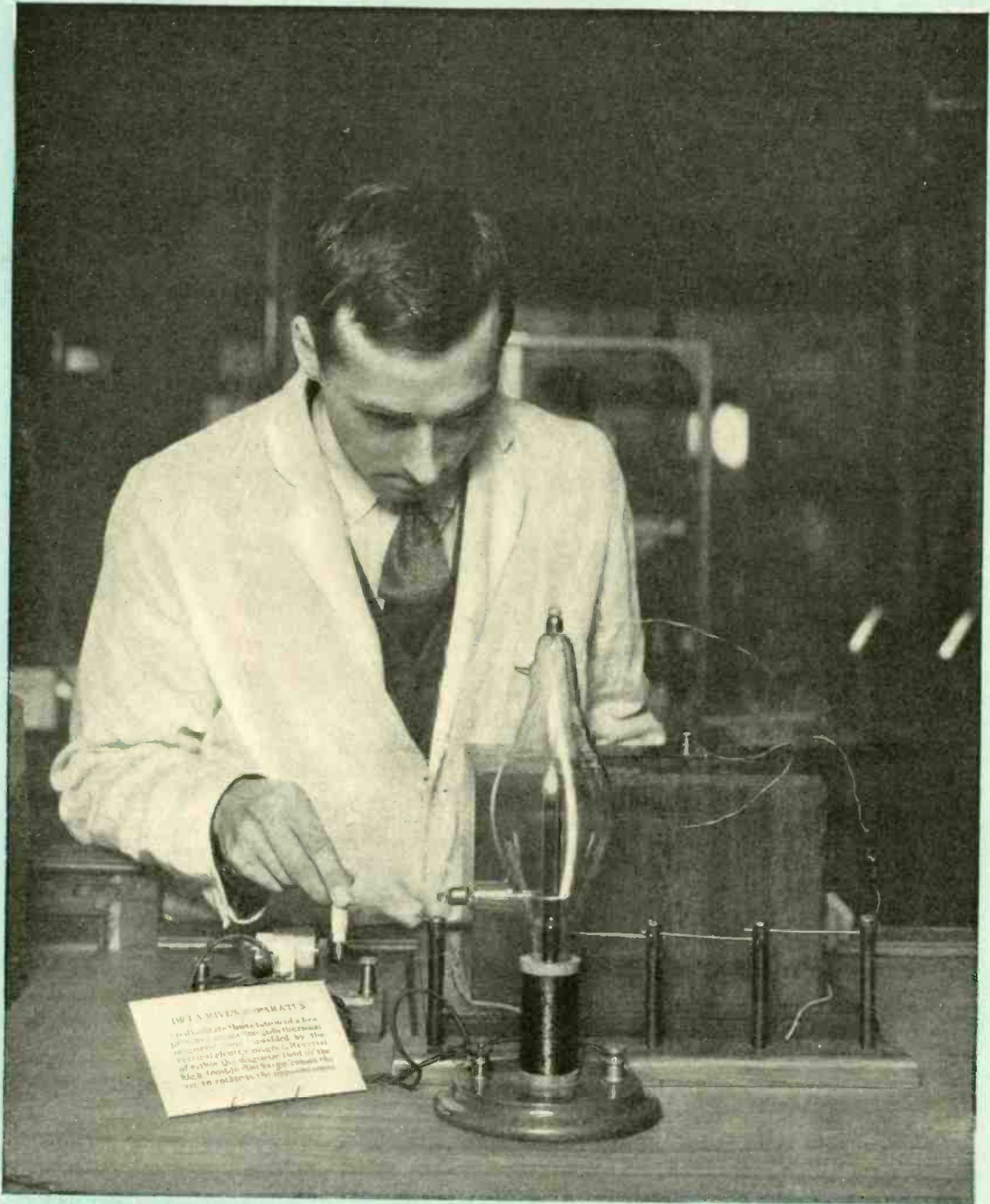

From a photograph made especially for POPULAR RADIO by Campbell-Gray, London.

### HOW ELECTRONS MAY CAUSE THE AURORA

The vertical streak of light inside this vacuum tube marks a stream of electrons, curved by the influence of the central magnet. Similar curved streamers seen in the Aurora may be due to beams of electrons coming from the sun and bent by the earth's magnetic field.

*The apparatus shown above was set up recently at the Science Exhibition at Wembley, England. The photograph is published by special permission of the Science Exhibition Committee of the Royal Society.*

# Popular Radio



VOLUME X

May, 1926

NUMBER I

## Does the Aurora Borealis Affect RADIO RECEPTION?

By W. D. TERRELL

CHIEF RADIO SUPERVISOR, UNITED STATES DEPARTMENT OF COMMERCE

Why did the recent International radio tests fail so completely? The chief reason, Mr. Terrell believes, was exceptional interference that accompanied unusual displays of the Aurora Borealis or Northern Lights. Special inquiries were sent to the Field Radio Supervisors of the United States Department of Commerce and in this important article, Mr. Terrell analyzes the significance of the reports received.

IT is a good thing for radio that the past winter was not its first. Had this been so, a popular appreciation of broadcasting might never have developed at all.

During the months of December, January and February unusual electrical disturbances practically ruined anything but local radio reception. These disturbances were at their height during the international radio tests and never has any important radio enterprise suffered so complete disaster as these tests did. There is probably no time since radio became well known at all that we have had such an epidemic of static, of disturbed transmission, and of a general blanketing effect which frequently made long distance reception entirely impossible.

Beginning early in December, radio fans have been reporting severe interference from all parts of the country. I have noted it myself, in Washington, using a superheterodyne receiver. It has been impossible to receive distant stations clearly. On several nights in January reception in Washington, was completely blanketed. Conditions were not very much better in February.

### FOUR WAYS TO FIND OUT—

*Radio experimenters who want to study the relations of radio and the Aurora can do four things:*

1. Record the exact times of unusual radio interference;
2. Look for a visible Aurora;
3. Note exceptional "swishing" noises;
4. Observe the earth's magnetism.

On many occasions electrical discharges were heard which sounded like static, but were more constant. Such interference is not easily confused with the noises produced by electrical machinery, with the high-pitched squeals of radiating receivers, with ordinary static, or with anything previously experienced at this time of the year. Repeated tests of the receiving apparatus showed everything in good shape and the batteries fully charged. The mysterious noises could not be blamed on the set.

Another unusual feature of the difficulties encountered in Washington was

that at times an absolute silence existed in the ether. Although there was apparently no static or other form of natural interference, not a single station outside of Washington could be picked up. Only the local stations, whose transmitting antennas were close at hand, could be heard at all.

That this unusual set of circumstances was not confined to Washington is indicated by the reports of many other radio men in the field and in other parts of the country.

Recent reports from field radio supervisors in most of the districts state that serious interference, the nature and source of which are not known positively, has been reported by numerous fans throughout all of the respective territories. In general, the supervisors agree that complete blanketing of all distant stations was frequent. Even when the blanketing was not complete, the western, northern, and northwestern stations were extremely hard to pick up and to hold, by fans in the east and in the south. Unusually severe fading was frequent everywhere. Practically all sections of the country, with the single exception of the New Orleans district,

encountered unusual interference of the types described during most of the months of December, January and February.

To account for these unusual phenomena is not easy, but it is possible to suggest that the trouble has been due to electrical effects brought about by, or accompanying, the Northern Lights, or Aurora Borealis.

Displays of the Northern Lights have been reported from many stations during this winter. Several observers report seeing an unusual display of this beautiful phenomenon while the radio interference was at its height. Some of the departmental radio supervisors with whom I have consulted concerning these phenomena agree with me that something about the Aurora is apparently responsible for at least a part of the unusual interference and the almost unique blanketing effect which has interfered so seriously with broadcast reception in all parts of the country except the southeast and portions of the south.

It is not improbable, we believe, that the discharges of atmospheric electricity related to the Aurora may create elec-

tromagnetic waves of irregular type, affecting practically all of the wavelengths used in broadcasting. This idea is, it must be admitted, a mere assumption. It may not stand up against scientific attack. It seems, however, to be well worth study and critical examination.

The connection of electrical troubles and unusual electrical conditions with the Aurora is no new thing.

In the days when I was a telegrapher we always had interference on the wires when the Aurora was visible. Furthermore, when unusual interference was encountered on the wires, sometimes making transmission entirely impossible, we found that we usually could see the rays of the Northern Lights or their reflection, provided, of course, that the weather was clear. Detailed scientific studies of earth magnetism have shown, as is well known, that the magnetic field of the earth is likely to be greatly disturbed when the Aurora is prominent. Such magnetic disturbances are accompanied, in turn, by stray currents and other abnormalities on the telegraph wires. So well are these relations known that experienced operators expect in-

terruptions of telegraph transmission whenever an unusual display of the Aurora is in progress. It is not unreasonable to expect similar disturbances of radio.

Even if the prevalent interference of the past few months, which some have called "winter static," is definitely traced to something accompanying the Aurora, we know of no way to eliminate or avoid this trouble. We have felt, nevertheless, that investigation is necessary, that it is desirable to discover whether there is sufficient practical reason for believing that the Aurora or some of its accompanying effects are responsible for the blanketing of our receiving sets.

To this end the Department of Commerce sent inquiries to each of its nine field radio supervisors, asking whether the peculiar forms of radio disturbances above described, were noted in their districts and whether these disturbances seemed to bear any relation to the Aurora Borealis. Reports were asked also of whether the Aurora was visible at any time and whether these occasions of visibility were definitely related to unusual amounts of blanketing or of

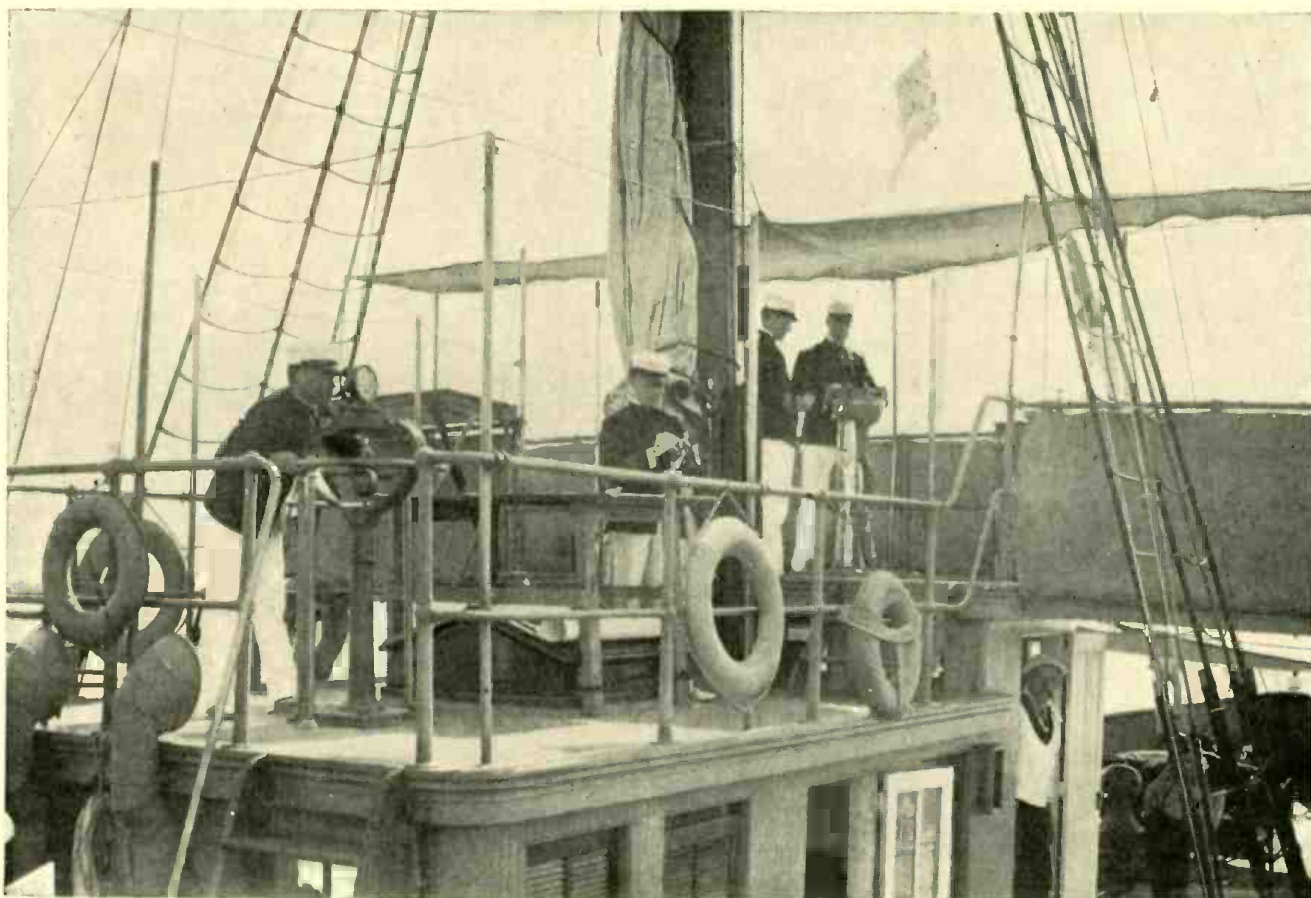

U. S. Coast and Geodetic Survey

#### CHECKING UP ON THE EARTH'S MAGNETIC FIELD

*The recent unusual radio interference has been accompanied by severe fluctuations of earth magnetism. By numerous shipboard observations, like those shown in this photograph, the United States Coast and Geodetic Survey keeps track of variations in the direction and intensity of the earth's magnetic field.*



Henry Woodhouse



#### A SIGN OF RADIO TROUBLE

*Actual photographs of the Aurora are rare. This remarkable curved streamer was photographed in Norway in March, 1910. Mr. W. D. Terrell (whose portrait is shown at the right), describes in this article the probable connection between these celestial streamers and the exceptional radio interference of recent months. The Aurora probably does not affect radio directly; it is merely a sign of powerful electromagnetic disturbances which do cause interference and blanketing.*

other disturbances. When replies to these inquiries have been received in full and studied comparatively, we hope to be able to determine whether or not there is practical reason for blaming these new types of radio interference on the Aurora.

We already know from the reports of the telegraph companies and from items in the press that at about the times when radio interference was at its height in Washington, the wire lines of the larger telegraph companies were paralyzed quite as thoroughly as were many radio receivers. In some instances the earth currents neutralized the battery currents altogether. Even with the batteries cut out of the circuit, the outside currents, due to some accompaniment of the Aurora, were sufficient to carry messages. Even the all-metal telephone circuits encountered difficulty. These disturbances were observed both

in the lines running north and south and in those running east and west.

Among the reports received from radio supervisors outside of Washington, Supervisor Cadmus writes from Baltimore, Maryland, that the radio signals from New Orleans and Florida stations were usually strong, but that broadcasts from the north and west were commonly quite difficult to receive. The blanketing effect, entirely preventing the reception of outside stations, was noticed frequently in Baltimore as well as in Washington. Supervisor Cadmus agrees that these effects were probably related to the Aurora.

Supervisor Redfern, at Seattle, Washington, reports that distant reception has been poor in his district since early in November, although the central and western stations have been coming in fairly well. Atmospherics have been unusually frequent. In general, radio re-

ception, taking all classes of reception into account, has been only about twenty-five percent as good as during the winter of 1924-1925. During the international tests of 1926, the interference from unknown sources was found to be greatest when the United States stations were silent. With United States stations on the air, the unusual interference seemed to be confined, Supervisor Redfern reports, to the shorter wavelengths of the broadcast band. On some occasions receivers in Seattle have been unable to pick up even so close and powerful a station as Denver. The interference has been similar in character to summer static, but accompanied by a large percentage of "swishing" noises.

Supervisor Beane, at Chicago, Illinois, reports a very large number of complaints of unusual types of radio interference. Displays of the Aurora were

reported during January, but Supervisor Beane states that these were not generally believed, in his district, to have been the direct cause of the interference.

From Detroit, Michigan, Supervisor Edwards reports that the only reliable reception this winter came from New Orleans and Florida. Among the stations in other parts of the country, those in the southwest were received more dependably than those in the east and west. All were more or less affected. It was sometimes impossible to receive even the high-powered stations, WGY and WJZ. On February seventh Supervisor Edwards noticed that practically all of the broadcasting stations in the United States faded out, so far as Detroit reception was concerned, at 9:40 p.m., Detroit time. As to the cause of the difficulties, Supervisor Edwards ascribes some of the interference to atmospheric changes, but he does not believe that the general electric disturbances producing the ground currents affected radio reception as severely as they did the telegraph wires.

In Boston, Massachusetts, radio reception has been poor all winter, reports

Supervisor Kolster. Again there has been the prevalence of unusual and unknown interference. This Supervisor agrees with the other officials that reception from the southern stations was better than from the others. Canadian stations are reported to have come in fairly well. Stations in the west came in very poorly, if at all. During the week of the international tests a number of observers reported to Supervisor Kolster that reception was exceptionally poor, ascribing this to the displays of the Aurora.

A report from Savannah, Georgia, echoes the complaint of unusual interference during the international tests. At this station the interference was accompanied by general and severe fading. At times a considerable voltage was generated spontaneously in the antenna, presumably from atmospheric sources. This observer reports that during practically the entire month of February nothing but the local stations could be received.

From Atlanta, Georgia, Supervisor Van Nostrand, reports that unusual atmospheric interference was noted and was attributed, at first, to leaky electric power lines in the neighborhood. It

was found, however, that this cause was not responsible. The interference must have come from something else. The stations in New Orleans and in Florida were received better than any others of equal power and at equal distances. Stations in the north and west came in very poorly. Even WJZ and KDKA were frequently very weak.

Among the field supervisors, only Supervisor Deiler, at New Orleans, Louisiana, seems to have had a really favorable winter. He reports that no unusual interference has been noted in his district.

All of these reports, taken in connection with the conditions which I have observed at Washington, seem to indicate that during most of the past winter the radio public has had to put up with conditions of reception no better than those encountered in mid-summer, and sometimes worse. This is, of course, very discouraging and unusual. It comes as a surprise and as a new trouble to be overcome by the radio fans and by the Department as well. We had been believing that most of the sources of radio interference were known and were being rapidly eliminated or  
(Continued on page 58)

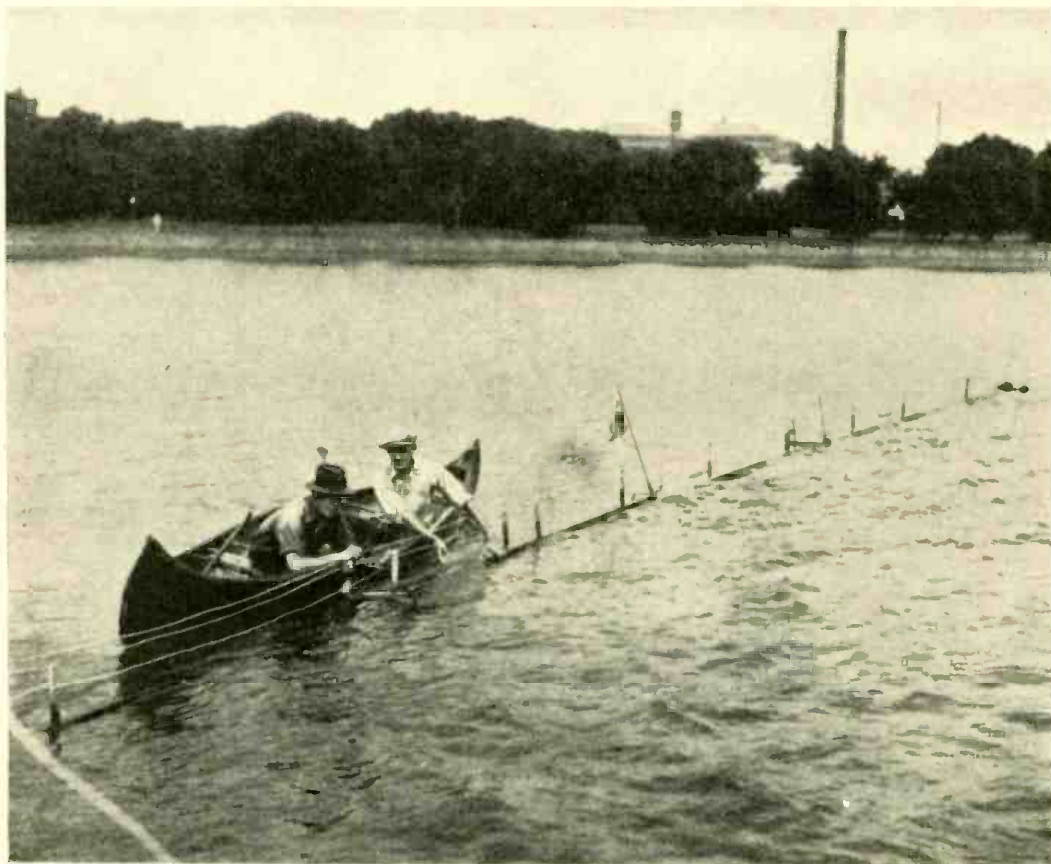

Department of Terrestrial Magnetism, Carnegie Institution of Washington

#### STUDYING THE RESISTIVITY OF THE EARTH

*The electric properties of the earth vary from time to time, as do its magnetic properties. This picture shows the experts of the Carnegie Institution studying the electric resistivity of the earth in the Tidal Basin at Washington, D. C. Earth currents and other electric disturbances often accompany brilliant Auroral displays and unusual radio interference.*

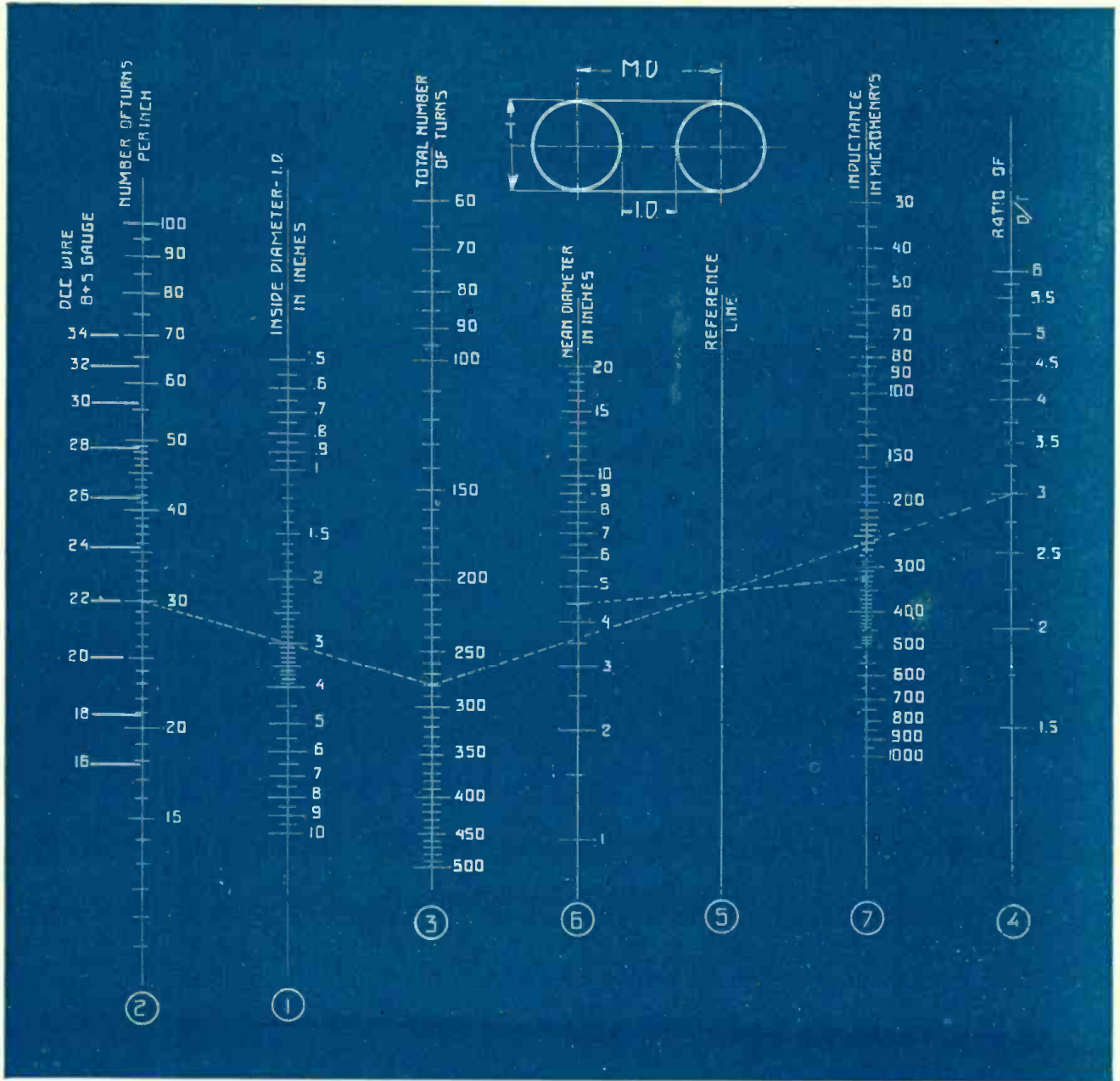

# A MEASUREMENT CHART

FOR USE IN DESIGNING A CIRCULAR SECTION TOROID COIL

By RAOUL J. HOFFMAN, A. M. E.

**T**HIS chart deals with the design of a toroid coil with a circular cross-section.

The standard equation by which the inductance of a toroid coil may be calculated is

$$L = .016n^2 [MD - \sqrt{MD^2 - T^2}]$$

where  $L$  denotes the inductance in microhenrys,  $n$  the total number of turns,  $MD$  the mean diameter of the torus and  $T$  the thickness (diameter) of the windings. All the dimensions, in these calculations, are taken in inches.

The alignment chart shown above on this page will be a substitute for this equation when you connect the number of turns on scale No. 3 with the ratio  $MD/T=3$  on scale No. 4, then connect the intersecting point on the reference line No. 5 with  $MD$  on scale No. 6 and read the inductance at the intersection on scale No. 7 in microhenrys.

To find the maximum number of turns of wire on the coil, connect the inside diameter on scale No. 1 with the gauge number of the wire on scale No. 2; and the number of turns may be read at the intersection on scale No. 3.

*Example:* To find the inductance of a torus with a mean diameter of 4.5 inches and with turns  $1\frac{1}{2}$  inches in diameter, which is wound closely with a No. 22 D.C.C. wire, connect the inside diameter 3 on scale No. 1 with No. 22 on scale No. 2. This line will intersect scale No. 3 at 280. Connect 280 on scale No. 3 with the ratio  $MD/T=3$  on scale No. 4; then connect the intersecting point on the reference line No. 5 with 4.5 on scale No. 6 and you will find that the line intersects scale No. 7 at 325. Thus 325 is the total inductance of the coil expressed in microhenrys.



From a photograph made especially for POPULAR RADIO

#### AS EASY AS THE COMBINATION OF A SAFE

*First, find the wavelength of the station you want to hear; then refer to the graph and find what the dial settings are—and merely tune in!*

#### HOW TO DRAW UP YOUR OWN

# “TUNING GRAPHS”

A simple and labor-saving method of picking up desired broadcasting stations by means of charts that any radio fan can make for himself at the cost of a few cents of cash and a few minutes of time.

By K. B. HUMPHREY

**T**HIS article is written for the special benefit of the broadcast listener—the average, everyday fan—who enjoys picking up programs but who, at the same time, wants to be able to select any one station within his range, and to do it quickly and with the least possible “fiddling around” with the dials.

This desirable end may be attained simply and efficiently with the aid of what is known as a “graph.”

The word “graph” sounds technical. But as a matter of fact it is a very simple thing both to understand and to make; and it may be used to great advantage in logging the present-day radio receiver.

Of course, a wave-meter could be used for this purpose by setting it at a predetermined wavelength and tuning the receiver to it; but the average fan does not have ready access to one. But the method of making a graph that is described here may be used with any

receiver, whether it has one dial or six; and the materials which are required may be obtained for a few cents from any store which handles stationery or drafting room supplies.

First, let us get a general idea as to what a curve is and how it may be drawn up.

Suppose that two straight lines are drawn at right angles to each other, as shown in Figure 1. Mark off the vertical line in equal parts and label it “wavelength.”

In a like manner mark off the horizontal line and call it “Dial Reading.”

Then, if a line is run parallel to the horizontal or base line at the point *a*, which represents a certain wavelength, and another line is drawn parallel to the vertical line at the point *b*, which represents a dial setting, these two lines will cross at a point marked *x*.

This may be considered as the first

part of the curve; by obtaining a series of these points a larger curve may be constructed. By drawing more parallel lines at different points (such as 1, 2, 3 and 4) and then connecting the intersecting points, a still longer curve is obtained. (These points, of course, are selected at random and should not be taken as an actual reading.)

Now that a general idea has been gained of how a curve is made, let us apply it to a specific case and make an actual drawing.

In practice, lines are not drawn on the paper as outlined above, but a type of paper is used which already has the lines printed on it. This paper is known as “cross-section paper” or “curve paper,” and may be obtained in the standard typewriter size. The ruling should be 10 to the inch, though 20 lines to the inch may be used. If the latter is used it will be found more dif-



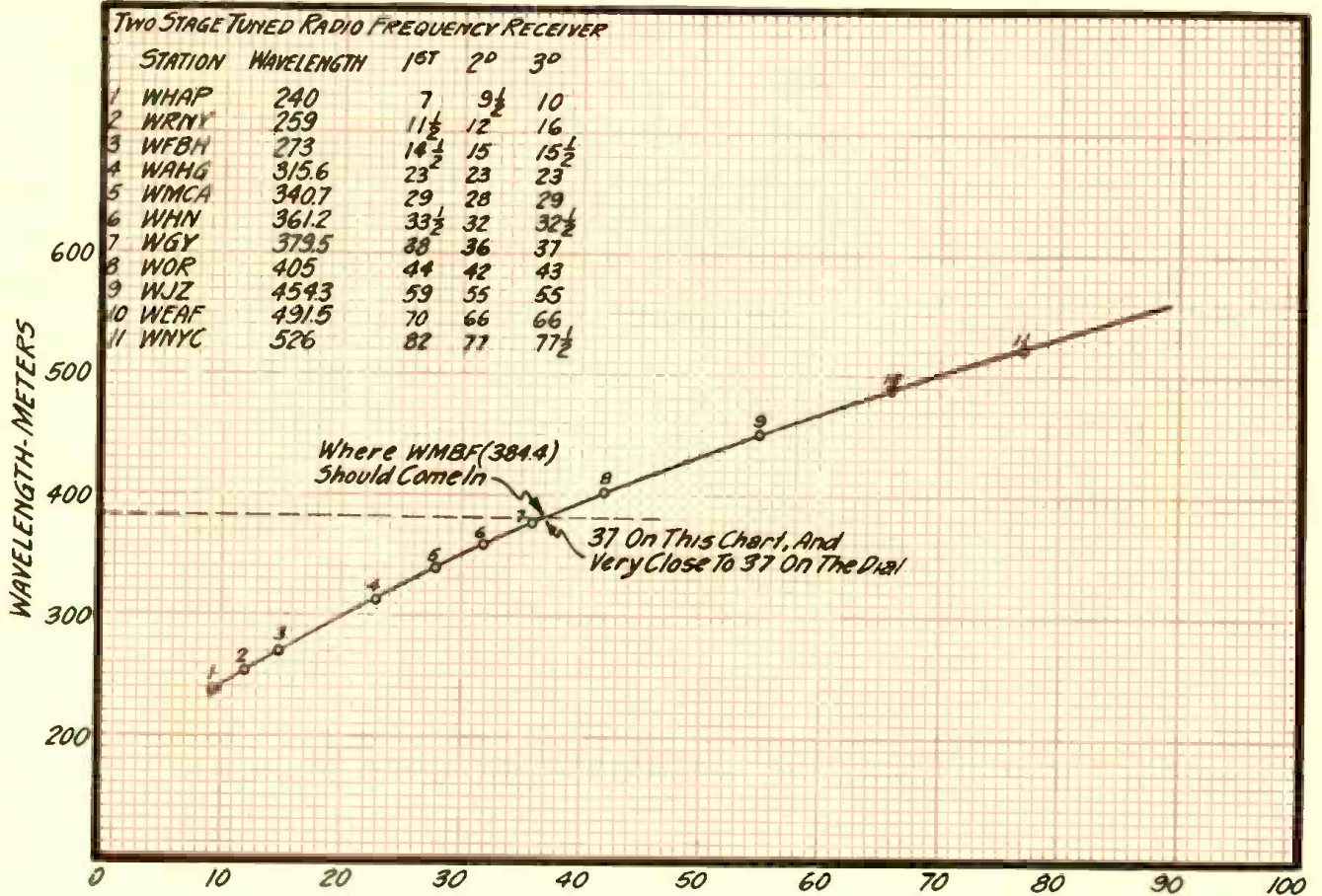

GRAPH I: THE TUNING CURVE FOR A TUNED-RADIO-FREQUENCY RECEIVER

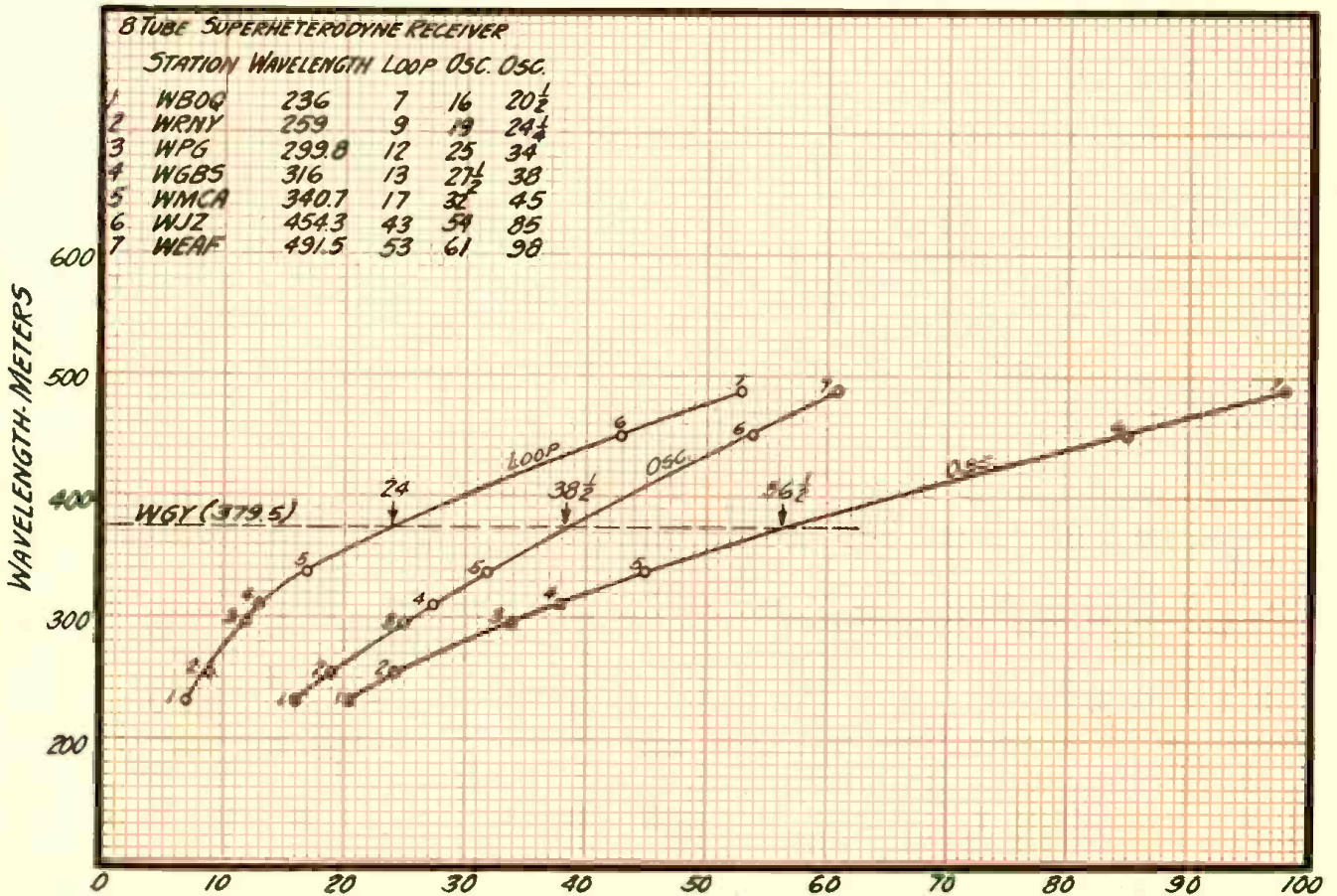

GRAPH II: THE GROUP OF CURVES FOR A SUPERHETERODYNE RECEIVER

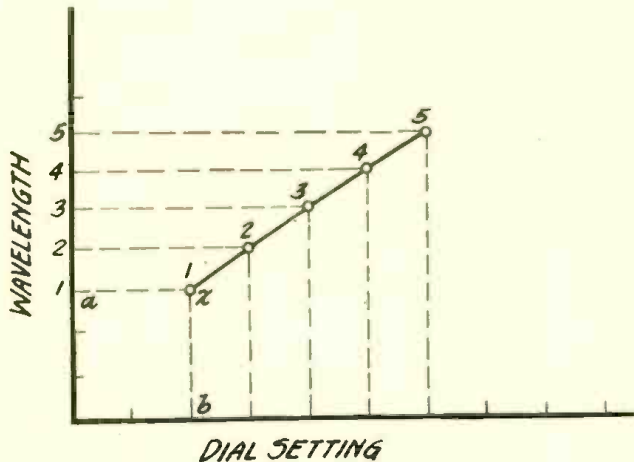

HOW TO PLOT OUT THE CHART

FIGURE 1: Draw two lines at right angles to each other, representing wavelength and dial setting respectively. From points on these lines draw perpendicular lines which give the points on the tuning curve as explained in the text of this article.

difficult to work with unless the fan is familiar with curves.

Use the paper with the long side down, and mark it "Dial Readings," as shown in Graph I.

The vertical left-hand side is labeled "wavelength-meters." The word kilocycles may be used but most fans are more familiar with the designation of stations by their wavelength in meters.

Notice that the long side is divided into 10 large divisions marked by the heavier lines, or 100 smaller divisions marked by lighter lines. Label each of the heavy lines; mark the first one 0, the second 10, the third 30 and so on up to 100. Most radio dials are graduated from 0 to 100 and each of the small divisions on the paper indicate a division on the dial. If the dial happens to be of the 0 to 180 or 0 to 200 type, the spaces should be marked so that the full scale is used as nearly as possible. Thus 200 would come where 100 is marked on the figure, and each small division would represent two degrees on the dial. The average wavelength band ranges from about 200 to 600 meters and each of the heavier lines on the vertical scale should be marked 200, 300, 400 and so on, as shown in the illustration.

We are now ready to proceed with the plotting of the curve.

Next, let us take a list of the stations and the dial settings something like that shown in the upper left-hand corner Graph I.

The list given here was obtained from an ordinary five-tube tuned-radio-fre-

quency set; to make this explanation clear they have been arranged in the order of their wavelengths and each one has been numbered. The more stations used for plotting, the more accurate the curve will be. The condensers used in this particular set happened to be of the straight-line-capacity type. The shape of the curve would be slightly different for different condensers, but this will make no material difference in using the curve for the purpose intended.

The readings are given for all three dials; but, for illustration, only the middle row of figures are plotted on the curve. It is not necessary to plot all three dials in most cases; but, should the operator wish to do so, it would be well to use three different colors of ink or to plot a curve for each dial.

For the purpose of constructing the curve take station No. 1, WHAP.

The reading on the dial is  $9\frac{1}{2}$ .

Count off 9 small spaces and  $\frac{1}{2}$  of the next space and lay a piece of paper with the edge parallel to the vertical line at this point.

The wave-length of No. 1 is 240 meters and each one of the small spaces on the curve is equivalent to 10 meters.

Count 4 spaces up on the line of the paper from the 200 mark and the first point is obtained. In the figure each point is marked with a small circle to show it off better, though a cross or a simple pencil mark will do as well.

Now take No. 2 (which happens to be WRNY) and lay the paper the same as before with the edge on 12.

The wavelength is 259 meters.

Count up as before from the 200 mark to 5, which gives 250, and then  $\frac{9}{10}$ ths of the next space. This gives the second point on the curve.

So if each station is taken in turn it will be found that a row of points will be obtained which follow in regular sequence. Each point is marked in the illustration as 1, 2, 3 and so on to correspond with the stations.

It is now only necessary to draw a line from 1 to 2, 2 to 3, 3 to 4, and so on until the curve is complete.

The connecting line should be fairly straight; if some points are found to be considerably out of line with the rest it may be assumed that a mistake has been made, either in taking the reading or placing the point on the curve sheet. These points may be disregarded or replotted correctly.

Graph II shows a curve which was obtained by logging a superheterodyne receiver and plotting the curve for the loop and the oscillator dial. Two curves are given for the oscillator dial because the stations come in at two readings.

The next step is to make use of the curve to find out where on the dial a certain wavelength may be tuned in on the receiver.

Suppose it is WMBF at Miami, Florida, is wanted.

The wavelength is found to be 384.4 meters, or practically 384.

Take a piece of paper (or a straight edge of any kind) and lay it on the curve sheet on a line which represents 384 meters on the vertical scale. The edge of the paper is indicated by a line drawn in the figure, and where it crosses the curve is the point at which Miami should come in.

Taking the reading from the lower scale it is seen that the dial setting should be just a little over 37 as shown in Graph I on page 17.

When Miami was actually tuned in it was found that the reading was exactly 37 on the receiver.

It is not always possible to get the reading accurately, but it is a certainty that the station must be in the immediate vicinity of the point as indicated on the curve.

Thus any station whose wavelength is known may easily be located on the receiver. A line is shown on curve Graph II at 379.5 meters and the readings on the dials would then be 24 on the loop dial and either  $38\frac{1}{2}$  or  $56\frac{1}{2}$  on the oscillator dial.

**I**N recognition of those experimenters or broadcast listeners who, through the medium of radio, have been instrumental in alleviating human suffering or saving human life, the Popular Radio Medal for Conspicuous Service was instituted last month. Read on another page of this magazine the conditions under which this medal may be awarded—and notify the Committee of Awards of anyone you may know who is deserving of this honor.



From a photograph made for POPULAR RADIO

#### A LABORATORY TEST OF SOME OF THE FINAL MODELS

Seven models of the new Raytheon unit were built and tested on the testing board shown in this picture. All of these models were found to be satisfactory; and they are all suitable for operating any receiver.

## HOW TO BUILD THE IMPROVED RAYTHEON POWER-PACK

By LAURENCE M. COCKADAY

COST OF PARTS: *Not more than \$45.00*

HERE IS A LIST OF PARTS THAT MAY BE USED—

- |   |   |   |
|---|---|---|
| <p>A—Raytheon tube;<br/>         B—step-up transformer manufactured by: Dongan Electric Company,* Acme Apparatus Co., General Radio Co., Thordarson Electric Mfg. Co., All-American Radio Corporation, Precise Mfg. Co., Jefferson Electric Co., Mayolian Radio Corp.;</p> <p>C1 and C2—filter choke coils manufactured by: Dongan Electric Co.* Acme Apparatus Co., General Radio Co., Thordarson Electric Mfg. Co., All American Radio Corporation, Precise Mfg. Co., Jeffer-</p> | <p>son Electric Co., and the Mayolian Radio Corp.;</p> <p>D1—small combination paper condenser block for Raytheon circuit comprising two units of .1 mfd. with a common terminal, manufactured by: Condenser Corp. of America*, Potter Mfg. Co., Dubilier Condenser &amp; Radio Corp., Aerovox Wireless Corp., Tohe C. Deutschmann;</p> <p>D2—large multiple condenser block for Raytheon circuit, comprising five units of 2, 2, 8, 1 and .5 mfd. with a common terminal, manufactured</p> | <p>by: Condenser Corp of America*, Potter Mfg. Co., Dubilier Condenser &amp; Radio Corp., Aerovox Wireless Corp., and Tohe C. Deutschmann;</p> <p>E—Airgap socket;<br/>         F—Bradleyohm No. 10, 100,000 ohms;<br/>         G—Bradleyohm No. 25, 250,000 ohms;<br/>         H—Bradleyunit resistance, 7,500 ohms;<br/>         I—Electrad resistance mounting;<br/>         J—hardwood base 9¼ inches by 12 inches;<br/>         K—composition binding post strip;<br/>         L—small brass brackets;<br/>         M—Bryant switch No. 678;<br/>         N—Hubbell socket plug.</p> |
|---|---|---|

\*The parts made by these manufacturers were used in the first experimental model which is described.

**Q** For the benefit of our readers in any locality, in the United States or abroad, who are unable to obtain parts which are necessary in making up these model receivers and power units, the POPULAR RADIO SERVICE BUREAU will undertake to supply the desired parts and have them forwarded C.O.D. If any reader cannot obtain any necessary part from his local dealer, he may send in his order to the POPULAR RADIO SERVICE BUREAU, 627 West 43rd Street, New York, which will have it filled for him as promptly as possible.

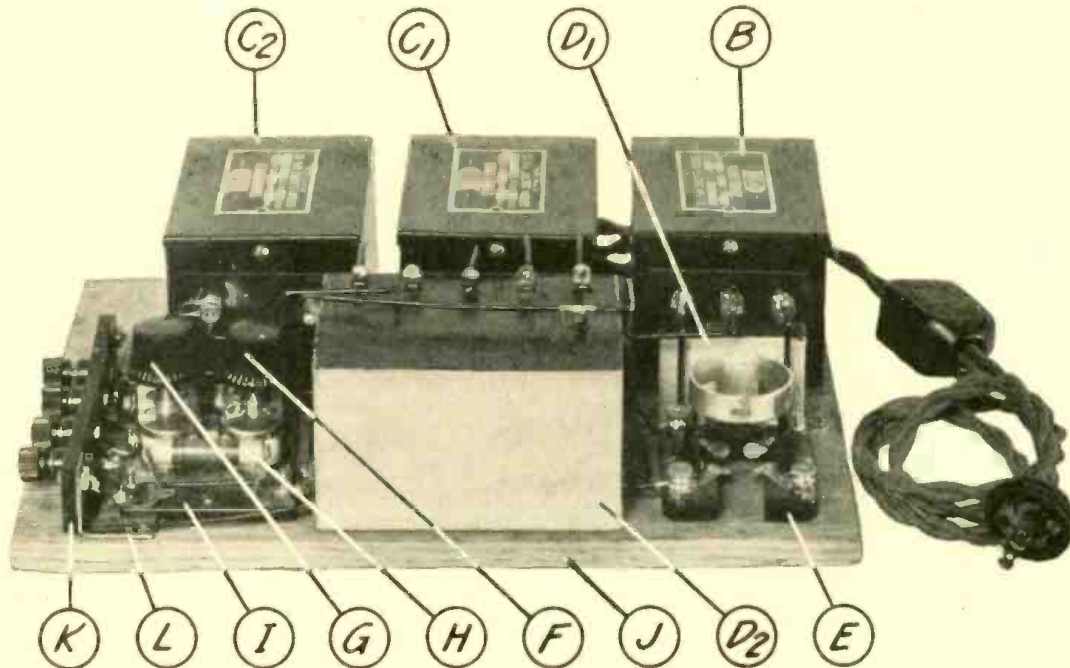

A REAR VIEW OF THE "POWER-PACK"

FIGURE 1: The arrangement of the various instruments that go to make up the unit; notice the switch, and the plug at the right that is used to connect the unit to the alternating-current mains.

READERS of POPULAR RADIO will remember that there appeared in the November, 1925, issue of this magazine, the first constructional article on the Raytheon "Power-pack." (The designation "Power-pack" is the new term which is now generally used in place of the old term "B" eliminator. It applies specifically to a device for supplying plate voltage to vacuum tubes through a rectifier and filter from an alternating current source.)

This unit met with instantaneous and continued popularity. It supplied a voltage of from 135 to 150 volts for the high-voltage plate supply and an intermediate voltage for the detector which could be varied to accommodate the sort of tube which was used with it.

But although this unit was suitable for a number of sets, there were some which needed a second intermediate voltage for low-power audio-frequency amplification and for certain types of radio-frequency amplification. This unit then, could not adequately supply some of the more complicated receivers which needed three variations in plate voltage.

There have been many requests, on this account, for a modification of the unit; and it just happens that these requests have paralleled experimental work in the laboratory that has developed and now offers a more complete and compact unit.

This new unit, which is here described, incorporates not only the additional voltage regulation that makes it suitable for use with any type of re-

ceiver but it also utilizes a condenser that combines all the various capacity units mounted in a single "can" that greatly facilitates construction and makes a much more compact and efficient device.

The description of the new device will include a number of variations in arrangement so that the reader may choose his favorite manufacturer's instruments for use in this new power-pack. Part I of this article describes the first of the models; and the description is accompanied with pictures of the other models; a more complete description of which will be given in Part II, which will appear in the succeeding issue of the magazine. Illustrations of these other models are given in Figures 8 to 13 inclusive.

In all of the models a variable voltage may be obtained for a detector tube varying from about 10 volts to 90 volts. A second variable voltage may be obtained for radio-frequency work or for low-power audio stages varying from about 30 volts to 125 volts. By using the high tap on the transformer, a high plate voltage of about 175 volts may be obtained for resistance-coupled amplification or for the power amplifier.

#### Parts Used in Building the Power Unit

In all of the diagrams in this article each part bears a designating letter so that the prospective builder of a set may easily determine how to mount the instruments in the correct places and to connect them properly in the electric circuit, without chancing the least mistake.

The same designating letters are used in the text and in the list of parts at the beginning of the article.

The list of parts there given includes the exact instruments used in the set from which these specifications were made up. The experienced amateur, however, will be able to pick out other reliable makes of instruments which may be used with equally good results. But we recommend that the novice follow the list, as the diagrams in this article will tell him exactly where to bore the holes and exactly where to place the connections.

If the instruments other than the ones listed are used, the only change that will be necessary will be the use of different spacings for the holes that are drilled in the sub-base for mounting the instruments.

#### How to Construct the Unit

After procuring all the instruments and materials for building the unit, the experimenter should prepare the baseboard, J. This should be made of one-half inch oak and should be cut to the size of 9¼ inches by 12 inches as shown in Figure 5. When this has been done, the baseboard should be dried out thoroughly by placing it in an oven or in a warm place for a few hours. During this drying out it should be fastened securely under heavy weights to prevent warping. Then it may be given a coat of shellac.

When it has finally dried, the instruments should be mounted upon it.

First of all, mount the transformer,

B, in the proper place as shown in Figure 5. This instrument should be fastened to the baseboard by means of two wood screws.

Fasten down the two choke coils, C1 and C2, as shown in the same Figure, and in the photographs. This places the three instruments side by side in a row. The transformer should be mounted with the input side facing toward the edge of the panel (this is the line voltage side). The output or high voltage side should be facing in toward the center of the baseboard.

Next, mount the small double condenser, D1, in the proper position, as given in Figure 5. It is also fastened to the baseboard by means of two round-head wood screws.

Then, attach the large condenser block, D2, in position, as shown in Figure 5: It also should be fastened by means of two wood screws. Mount the two Bradleyohms, F and G, in their respective places, as shown in Figure 5. These instruments should be screwed down to the baseboard by means of two very thin wood screws through the two holes running entirely through the instruments. They should be mounted with the two sets of terminals pointing to the left, when looking at the unit from the rear.

Next, mount the electrad resistance mounting, I, in proper position as shown in the same Figure. This mounting is fastened down with a single wood screw.

The socket, E, may now be fastened to the baseboard with two wood screws in the position indicated in Figure 5.

Next on the construction program is the preparation of the binding-post strip, K. This should be cut from hard rubber or bakelite and drilled as shown in Figure 6. When it has been completely drilled and finished, cut and bend the two brackets, L, as shown in the same Figure, and drill them for the screw holes that fasten them to the strip and also to the sub-base. After they have been connected to the strip by means of two machine bolts and nuts, the whole assembly may be tightened to the sub-base, as shown in the photographs in Figures 1, 2, 4 and 5, with two sturdy wood screws. The binding posts 1, 2, 3 and 4 may then be attached and firmly tightened.

When this work is completed the unit is ready to be wired up and installed in connection with the receiver which it is to provide plate current for.

*How to Wire the Unit*

The mechanical and electrical design of this device have been worked out

with extreme care through months of experiment and test. The whole unit is self-shielding; and it is due to this as well as to the electrical design of the circuit that no hum is produced in the receiving set to which it is attached.

It is recommended that all wiring be done with an insulated, solid, round bus-wire.\*

In wiring up refer constantly to the picture wiring diagram in Figure 4. Notice that in this arrangement of parts the alternating current, as applied to the socket, F, is isolated from the output as obtained from terminals 1, 2, 3 and 4 on the connection block, K. The alternating-current transformer, B, is also fully shielded from the output. Notice that the cases of the transformers and the chokes and all of the condensers are connected together on the negative side of the direct-current voltage which is on the center tap of the transformer and the binding post No. 1. This produces full electrostatic shielding throughout.

Start the wiring, as indicated in Figures 3 and 4. It is best to begin at the transformer and to wire up the small condenser and the socket. Then, follow this by wiring the two chokes, C1

\*The type of bus wire which is used in all of the experimental set-ups and in the model which is being described was "Celatsite."

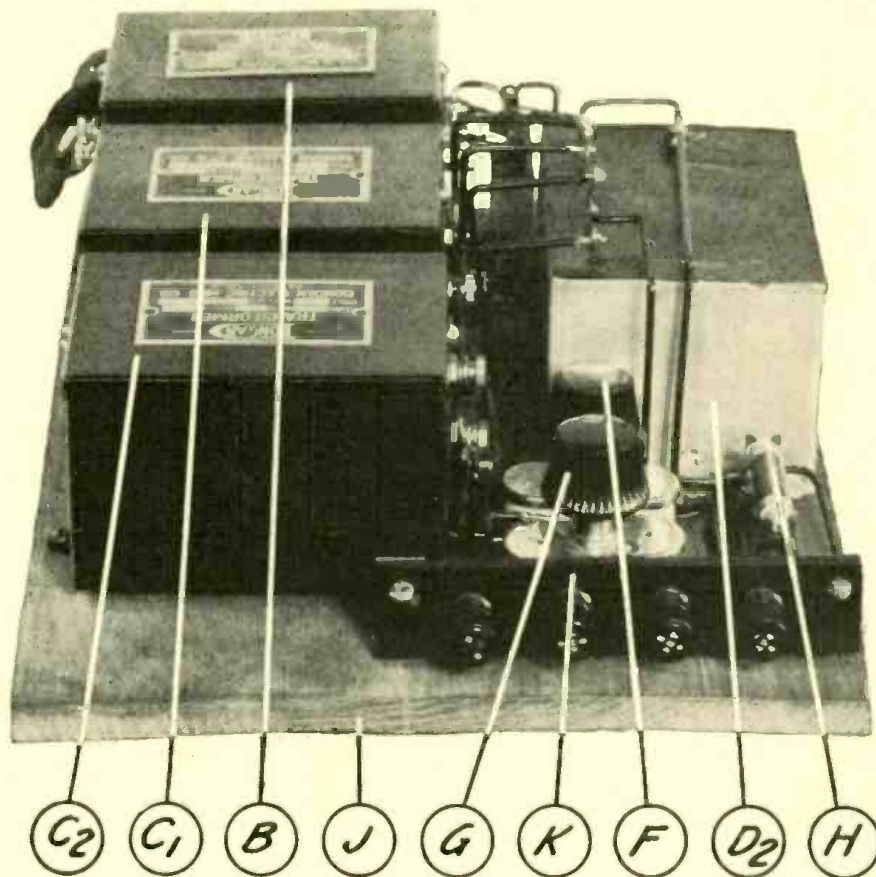

HOW THE UNIT LOOKS FROM THE RIGHT

FIGURE 2: This photograph shows the output end of the device with the four binding posts which must be connected to the set with which the "Power-pack" is used.

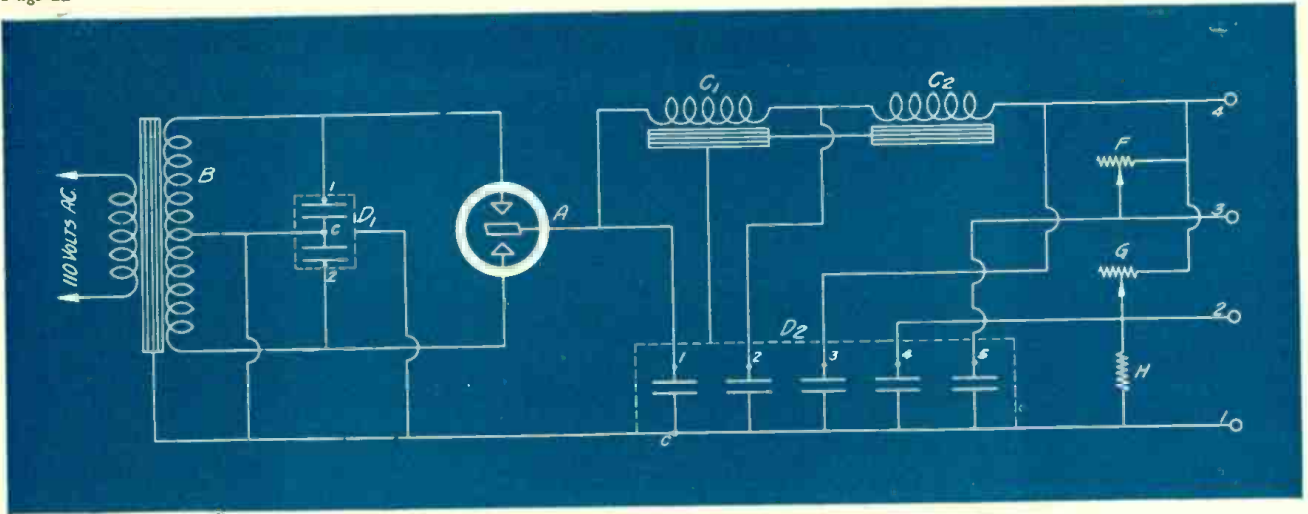

**THE COMPLETE CIRCUIT DIAGRAM**

**FIGURE 3:** The hook-up for the plate supply unit. All of the symbols for the instruments bear designating letters which are used consistently in the list of parts, text and illustrations.

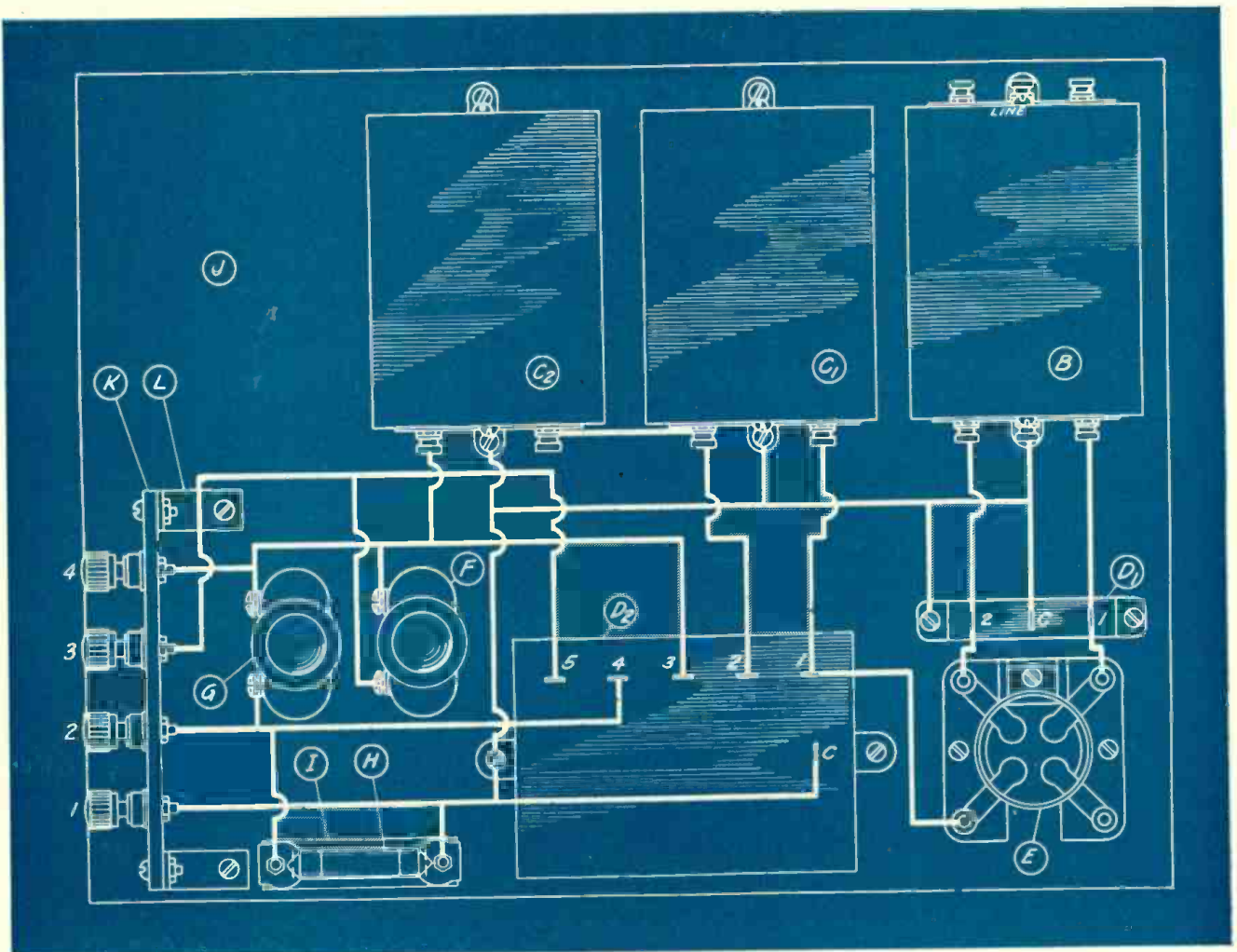

**THE PICTURE WIRING DIAGRAM FOR CONNECTING UP THE INSTRUMENTS**

**FIGURE 4:** All of the instruments have been drawn in their approximate positions. The heavy white lines show the exact way in which to run the wires for connecting up the various instruments.

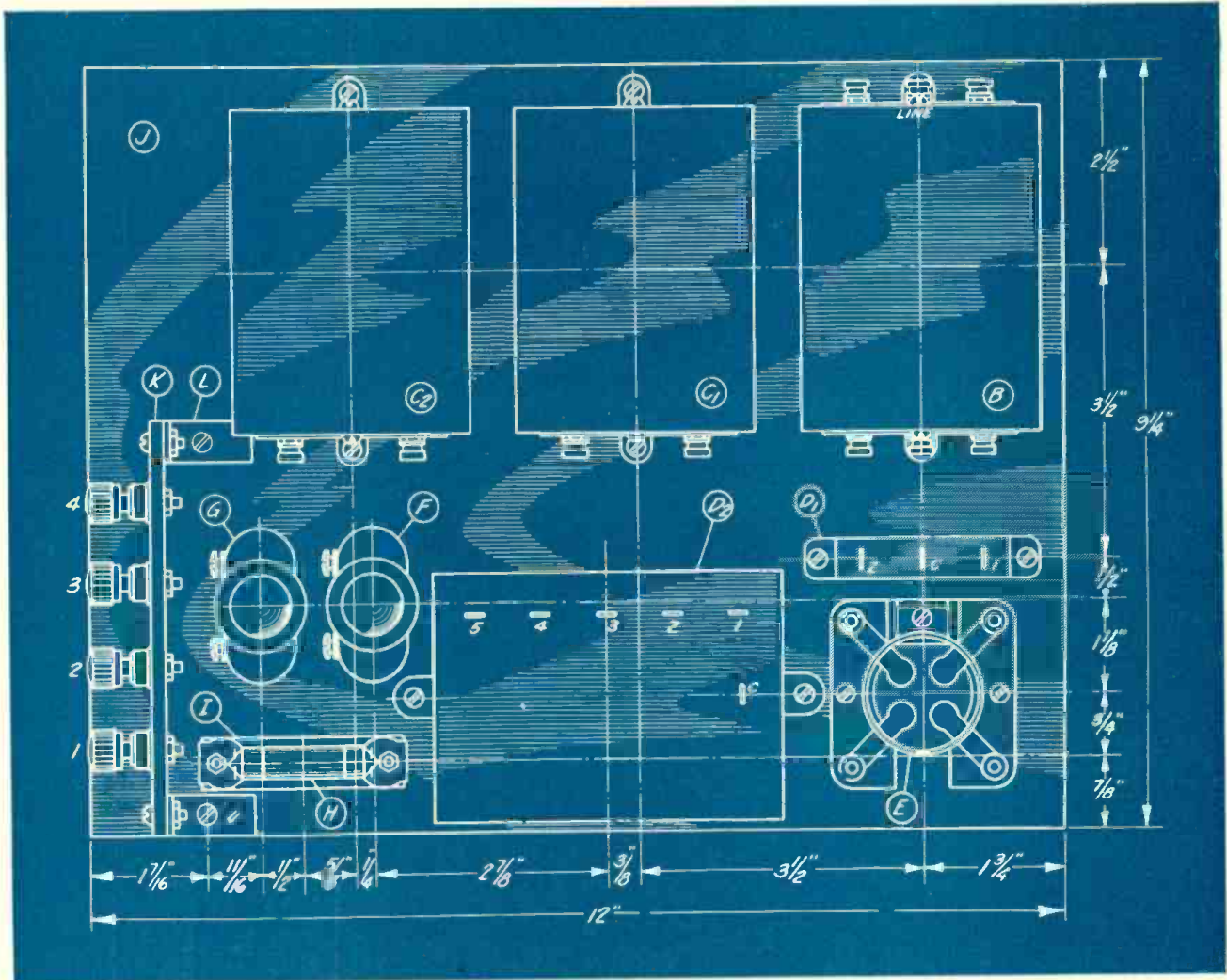

**THE WORKING DRAWING FOR CONSTRUCTION**

FIGURE 5: This drawing gives the correct dimensions and spacing for mounting all of the component parts which are used in the plate supply unit.

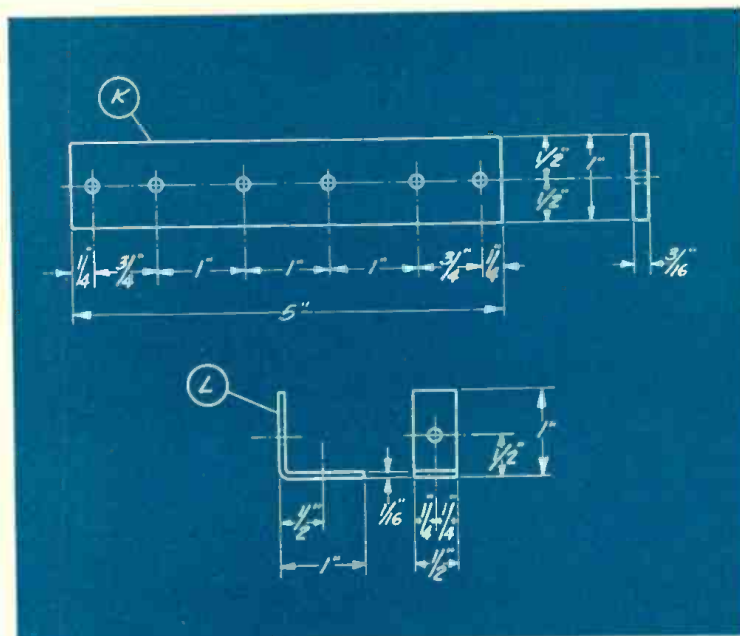

**DETAILS OF THE CONNECTION BLOCK AND SMALL BRASS BRACKETS**

FIGURE 6: This drawing gives the necessary data for making the insulating strip on which the binding posts are mounted and the dimensions for making the brackets which are used to fasten the strips to the base.

and C2, and the condenser block, D2; and end up with the two variable resistors, F and G, the fixed resistor, H, and the binding posts 1, 2, 3 and 4.

If the wiring diagram in Figure 4 is followed closely there can be no mistakes, as this diagram gives every connection and the exact manner in which it should be made.

Check over your connections a number of times to be sure that you have made no mistakes. If you make every connection exactly as shown you will have no trouble in getting the unit to work properly. In doing your wiring job remember that care and neatness will enable you to do an efficient job. Don't hurry, but take it easy. All of the instruments are marked with designating letters so that you should not make any mistakes.

#### How to Install the Unit

After the wiring has been completed the unit is ready to be installed and placed in operation so that it may furnish the direct current necessary for the operation of the receiver. Place the unit in the compartment of the radio table or cabinet where previously the "B" batteries were kept. The unit should be turned with the binding-post strip at the right.

Next obtain a double-conductor lamp cord of the correct length to run from the radio table over to a floor plug or a lamp socket and connect in it, in a

convenient position, the Bryant switch, M, and on the far end connect the socket plug N. Attach the two free ends of the cord to the transformer. This connection should be made to the two outside terminals on the "input" side or to the two left-hand terminals on the "input" side as you face the apparatus. This gives you the "high" or the "low" voltage rating of the transformer as either one may be desired.

Be sure that the switch, M, is turned off with the black button pushed in and the red button sticking out. The socket plug, N, may then be placed in the wall socket and the unit is ready to operate.

Of course, the Bradley unit, H, should be inserted in the two clips provided for it in the resistance mounting, I.

To connect up to the receiver, connect a wire from the negative "B" terminal on the receiver to binding post No. 1 on the power-pack. This is the rear binding post as you look at the unit as it stands in the cabinet.

Then connect a wire from the detector "B" battery post of the set to binding post No. 2 on the power-pack. This will provide a suitable voltage for the detector by simply adjusting the variable resistance, G, when the set is ready to be turned on.

Next connect the radio-frequency "B" battery tap and the 90-volt "B" battery tap, if there is one on the receiver with which the unit is used, to

binding post No. 3 on the power-pack.

The last connection will be from the high-voltage "B" battery binding post on the set to the binding post No. 4 on the power-pack unit. This completes the wiring up and the filaments of the tubes may now be turned on in the receiver.

Push in the red plug on the switch, M, and the unit should start to work provided that the tube, A, has been previously placed in the socket. Tune in a signal on the receiver, at the same time carefully adjusting the two knobs, F and G, until the proper voltage is obtained on the tubes. This will be easily noticeable by the volume and clarity that is obtained. Leave them at the best setting; and the Raytheon "Power-pack" is ready to serve indefinitely in a satisfactory manner.

To turn off the Raytheon unit all that is necessary is to turn off the current at the switch M as would ordinarily be done with a floor lamp or an electrical toaster. There is no upkeep beyond the expense of the extremely small current drawn by the transformer, B, which is negligible.

If all of the instructions that are given in this article are followed minutely, even a beginner can build this unit and obtain good results both on local and distant reception.\*

\*Those who do not wish to build a Raytheon Power-pack may obtain them complete from the following manufacturers: Acme Apparatus.; Webster Electric Co.; All American Radio Corp. and the Mayolian Co.

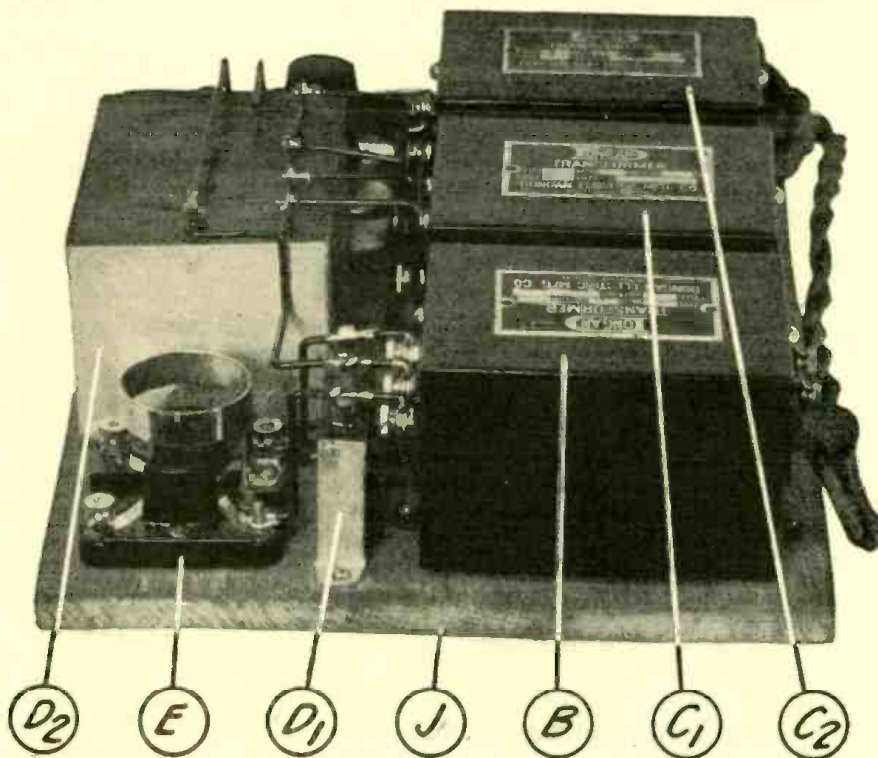

HOW THE UNIT LOOKS FROM THE LEFT

FIGURE 7: In this picture of the input end is shown the transformer with the chokes mounted in line and the tube socket connected up to the large and small condenser cans.



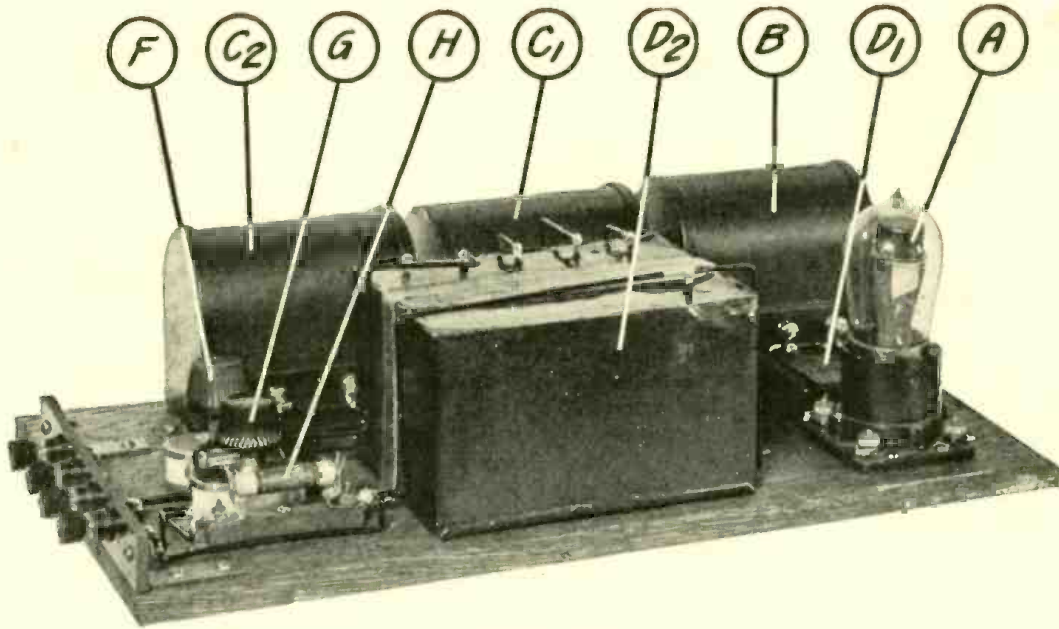

MODEL II

FIGURE 8: The second laboratory model, which was built up with All-American transformer and chokes and Potter condensers, is shown here. This model, with the succeeding five models, will be described in detail in the second part of this article, which will be published in the June issue of this magazine.

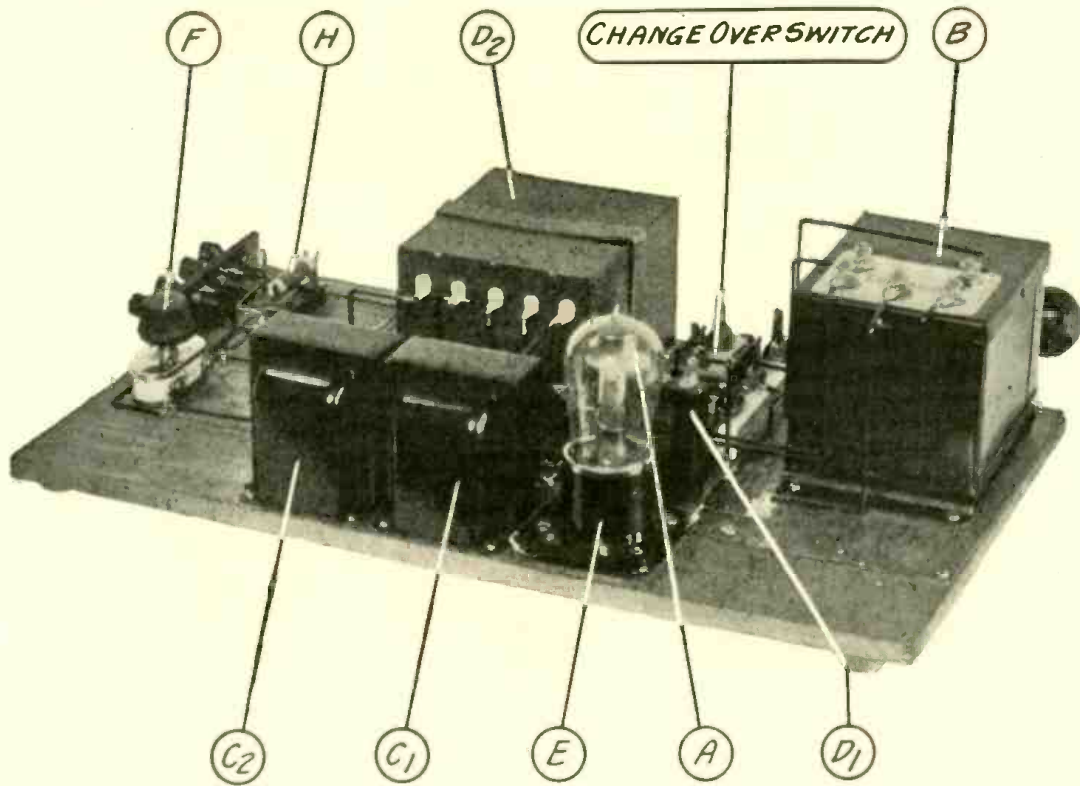

MODEL III

FIGURE 9: Another model of the improved Raytheon "Power-pack" that incorporates Thordarson transformer and chokes and Aerovox filter condensers. This model will give results similar to the other two previously shown.

(Continued on page 48)

# A Rescue that Was "Up



ARTHUR EVANS—  
Chief Radio Operator  
of the Ill-fated  
British Steamer  
"ANTINOE,"  
Whose SOS Calls  
Were at Last  
Picked Up  
at 5:40 A. M.  
on January 24th

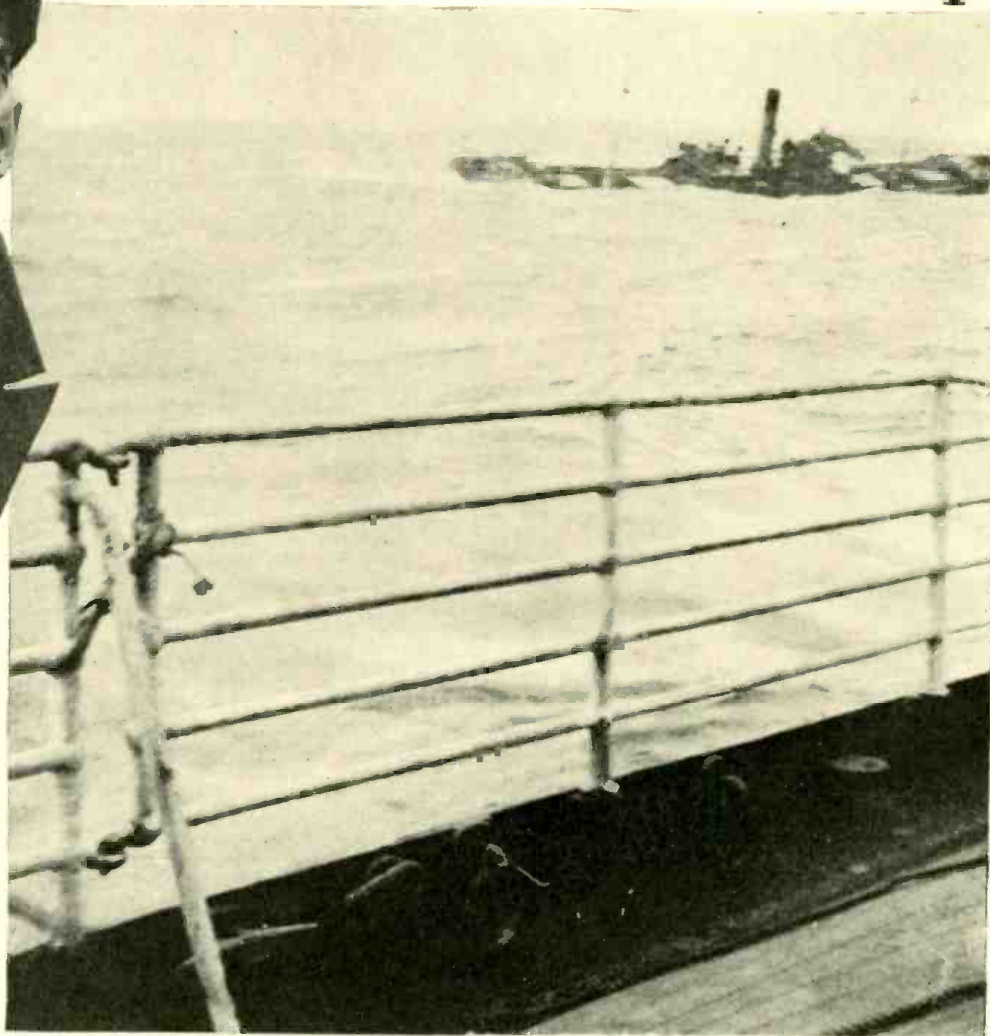

From a snapshot of the sinking *ANTINOE*, taken from the deck of the *PRESIDENT ROOSEVELT* by Pacific & Atlantic

"SOS de GKJY—. SOS—SOS—  
SOS de GKJY!—"

I heard the distress signals shortly after I had relieved Ransom, the third operator, on the four to eight watch on Sunday morning. We had heard some grief signals right along, since the heavy storm reports had been filtering in to us. There were signals from ships with shifting cargoes, or broken rudder chains.

But this was the first call for help.

The weather outside was bad. The wind was blowing with hurricane force. We had been receiving weather reports from many points and from ships around us. It looked as though even we would suffer. And the *Roosevelt* is no small ship!

Hastily, I looked up the QRA. It was the *Antinoe*, a British ship, reporting herself in a most serious condition and sending me her latest position, as accurate as her master could make it.

The bridge was notified at once and then began the real rescue work.

The first step, of course, was to verify

the position, and, determining our distance away from the doomed ship to decide whether we were the nearest. Upon reassuring the operator of the *Antinoe* and communicating with other ships in the vicinity, among which were the *Aquilania* a Cunarder, and the *France*, of the French Line, the *Roosevelt* was designated. We proceeded, after the various captains had wished our "old man," Captain Fried, good luck.

This matter being settled I had to have the air, so, following the general procedure in such cases, I sent out my QST broadcast. This was to tell the radio stations afloat and ashore that we would need silence in order to continue with the radio work. All interference, of course, melted away. Such an order is imperative.

From then on it was up to the radio compass.

**Q** The first - hand chronicle of a great drama  
Radio Operator Kenneth Upton of the

Because of the bad weather it was impossible to take accurate bearings from the sun. And we thought, although we could not know, that the position of the *Antinoe*, which located it at thirty miles distance, would bear checking. She must have been drifting; and in the seas that were then running she might be considerably off her course. We were taking no chances, and were relying entirely on the accuracy of the radio compass.

Every fifteen minutes the bearings were taken. Smith the second operator, handled the communication work with the *Antinoe*; and I trained the loop upon that ship's signals, so that we were following a course which should bring us directly to her by the shortest route.

Although it was had navigating we should have been at the position given within a few hours. It was not until fully eight hours after the SOS had been

# to the Radio Compass”



KENNETH UPTON—  
Chief Radio Operator  
of the U. S. Steamer  
“PRESIDENT  
ROOSEVELT,”  
Whose Crew Saved  
the Last One of  
Twenty-five Men  
from Death  
at 1:40 A. M.  
on January 28th

## of the sea, as it was reported by the Chief SS. PRESIDENT ROOSEVELT to Lloyd Jacquet

picked up, or at 12:08 P. M. Sunday that, after the last bearing was taken, we finally came in sight of the *Antinoe*.

The signals had been louder and louder, although the visibility had been getting worse. But we finally found her through the storm, squalls, mist and terrific wind. According to distance measurements, we had travelled 135 miles to the *Antinoe*.

Arthur Evans, the operator of the *Antinoe*, for the cargo ship of this type carries only one radio man, kept on gainely giving us information and asking for information in return. His radio shack was badly battered; it had been smashed in by a lifeboat that was dislodged from the boat deck. But he managed to piece his radio apparatus together and keep on transmitting, although rain, waves and wind were constantly interrupting him.

At times we received no answer to our

calls; and we thought that the elements had done what we had been fearing all along—the silencing of the set. But soon, we would hear the courageous spark again, and we would know that Evans was still hanging on. Afterwards we found out that it was necessary for him to communicate with the bridge in person—making the perilous trip along the exposed deck back and forth every time the captains wanted to exchange information or to ask advice. It was not funny for Evans; he must have made this hazardous trip dozens of times, on a deck which had a 30 degree list!

Around 4 P. M. that afternoon the *Antinoe's* spark was silenced. Although Evans tried to get the emergency apparatus working, it gave only a few unintelligible squawks and was abandoned. Besides, it was getting dark and the need for keeping in touch with each other was still of prime importance.

It was then that we missed the familiar radio voice.

It was around 11 o'clock that night that we had heard the few mutterings of the emergency set. It served to let us know that the *Antinoe* was still afloat. The bridge had lost sight of the *Antinoe* at 9 o'clock that night, and it was not until four o'clock the next morning that we sighted her again.

Undoubtedly it was the radio compass that saved her. You've read the reports of Captain Fried, in which he credits the compass with locating the *Antinoe*. In his log he says that after receiving the SOS we changed our course and proceeded, “bearing by radio.” It was the compass bearing, checked up by the astronomical observation which second officer Erickson had the fortune of making through a sudden clearing of the sky, which proved the original position given us by the *Antinoe* to have been a hundred miles in error!

What we should have done without the compass, we do not know.

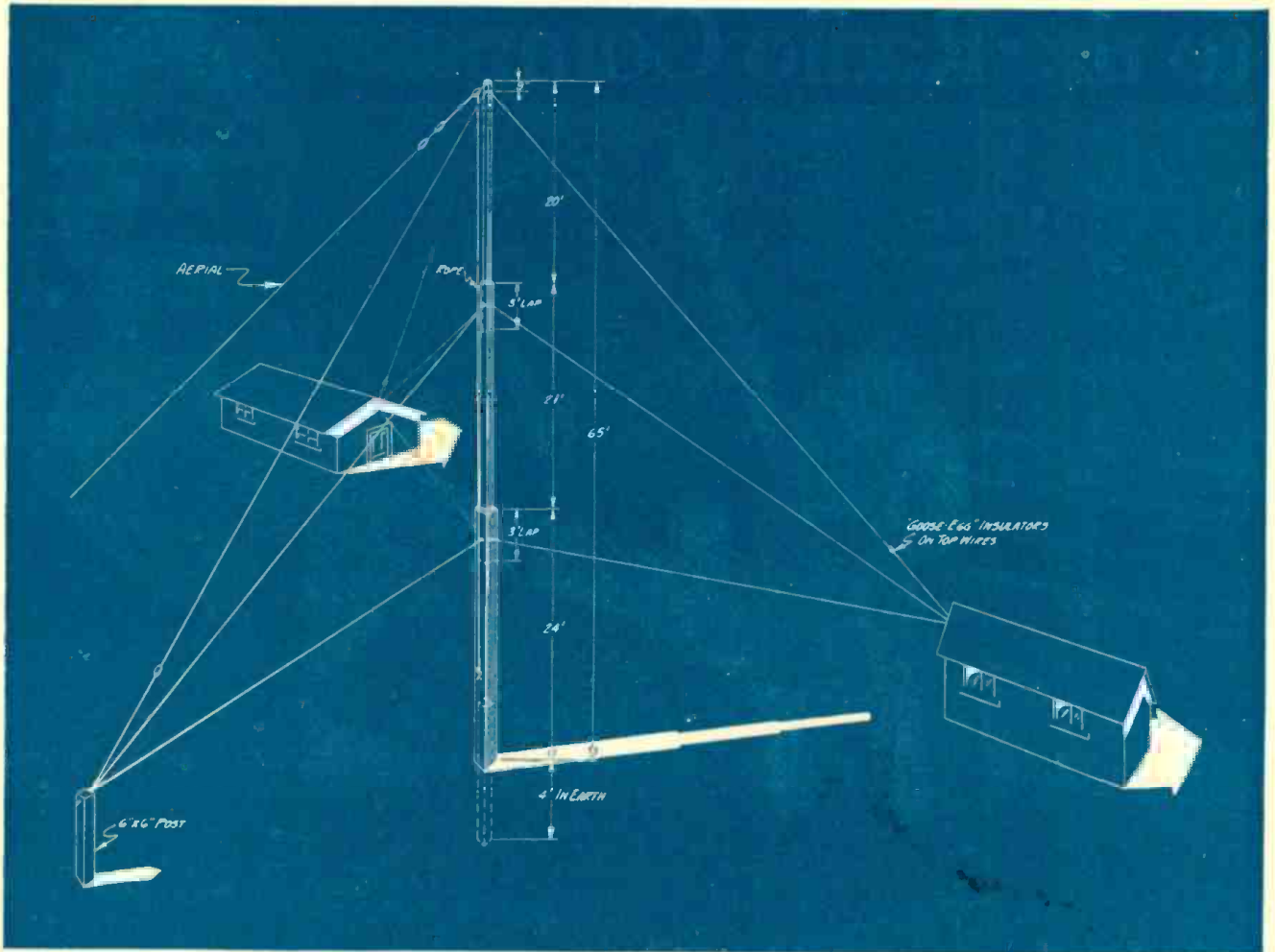

#### HOW THE MAST IS ERECTED AND STAYED

FIGURE 1: All of the vertical dimensions of the antenna mast are given in this drawing as well; and the manner in which the guy wires hold it erect is shown. Wherever it is possible the experimenter should make use of existing buildings as anchorages for the wires; but stout posts will do as well where other means are not available.

#### HOW TO BUILD

# An Antenna Mast for \$15.00

This strong, graceful mast, especially designed for the country radio fan who must depend upon distant stations for his radio entertainment, may double the range of the set that operates upon the ordinary type of aerial.

By HENRY SIMON

WE read and hear so much about the "unsightly aerial" and the desirability of eliminating it that most of us have become reconciled to the idea of unsightliness as associated with antennas.

If we stop to think for a moment, however, we will realize that it is not the hundred feet or so of small copper wire, but the poles and masts to which the antennas are attached which are the offenders. In many cases the trouble is, of course, simply due to indifference;

but in many others (and particularly in the case of the higher masts) it is caused by the difficulty of finding a construction which will at the same time answer the requirements of sufficient height, safety and pleasing design at a low cost.

The mast which is illustrated and described here answers all of these requirements. Its tapered shape, as the picture shows, gives it a graceful appearance together with a maximum of strength, as well as of durability. It may be safely carried to a height of

eighty feet or more by using the same type of construction, though the particular mast illustrated is only sixty-five feet high. And it is not expensive, as all necessary materials, including paint, may be bought for from \$12.00 to \$15.00, the price depending somewhat of course, upon the locality.

This mast makes use of the principle of the tubular column; and it has in marked degree the combination of strength, stiffness and light weight. The box-like construction of its lower

members makes for safety; for the four different pieces of timber are braced against each other and impart to it a strength which cannot be equaled by any other construction of the same weight. The mast is actually stronger at the joints than at any other place.

While the construction of the mast proper is the most important part, in so far as cost and appearance are concerned, it must be remembered that both appearance and price depend upon other necessary factors, namely, the guy-wires and their anchorage, both upon the mast and near the ground. Attention paid to little details in these matters will make for both safe construction and good appearance. Two good coats of paint will further enhance the

appearance of the mast and will considerably lengthen the span of its useful life.

In choosing the lumber for the construction, it is necessary to insist upon pieces which are not only straight and well seasoned, but which are also free from knots and "splitty" as well as "sap" grain. This is especially essential in regard to the top or crown-piece, which is a single stick and which therefore presents no chance for straightening or overcoming minor defects. The pieces must be surfaced on all sides and must be sized to the dimensions which are given in the diagram and which allow just enough over to make it possible to correct an imperfection here and there by a few strokes with a plane.

A level sidewalk furnishes a good place to put the mast together. Begin by sawing a couple of blocks, about 6 inches long, off of one end of the crown stick. These blocks will be used inside of the lower end of the middle section, one at its extreme lower end, the other at the point where it enters the lowest section, to help keep it square and true. The center section pieces are first fastened to the crown piece with a few nails, care being taken to overlap the corners nicely and to hug the other piece. If the corners overlap slightly, this may be corrected by planing when the mast has been completed.

If some of the pieces are slightly warped or sprung, arrange them so as to make the warpage of one neutralize that of the other. Make each section as nearly straight and true as you can, with blocks under the upper sections when working on lower ones. Do not start nailing them solid at one end, but nail them six or eight feet apart first, to enable you to correct any tendency to deviate from the straight. Use eight-penny box nails in the middle section and ten-penny nails for the bottom piece.

The foot of the mast should be formed by a piece of redwood or similar decay-resisting timber which has been well soaked in heavy crude oil. This should not be nailed to the mast, but shoved into the bottom piece, with four short pieces nailed to it to carry the mast.

When this has been done, the mast should be placed level on four or five boxes or saw-horses, any protruding edges planed off, the corners slightly rounded and the upper ends of each section beveled, both for looks and to facilitate the shedding of water. It should then be treated with two coats of good exterior paint. During all of this work, the mast should be kept as straight and true as possible.

The smaller details, such as the fastenings of wires and pulleys, should be both neat in appearance and correct along

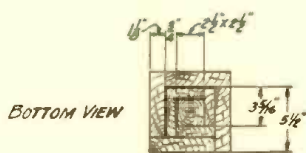
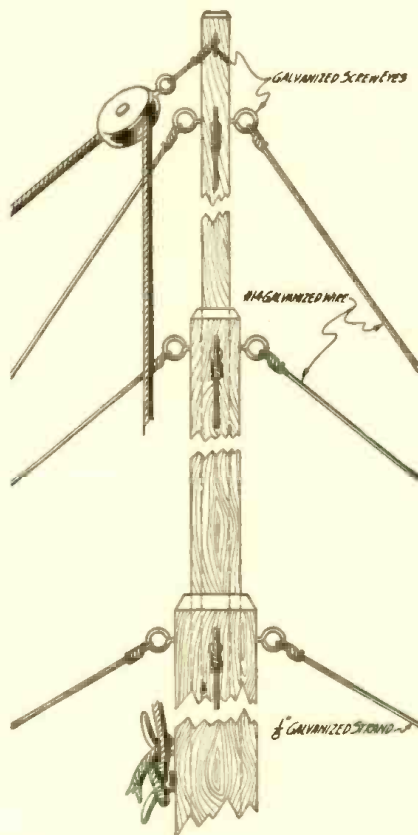

**HOW THE MAST IS MADE**

FIGURE 2: Exact dimensions are given in the cross-sectional view of the bottom of the mast. The guy wires and the pulley for the antenna rope are fastened to the sides of the mast with stout screw-eyes.

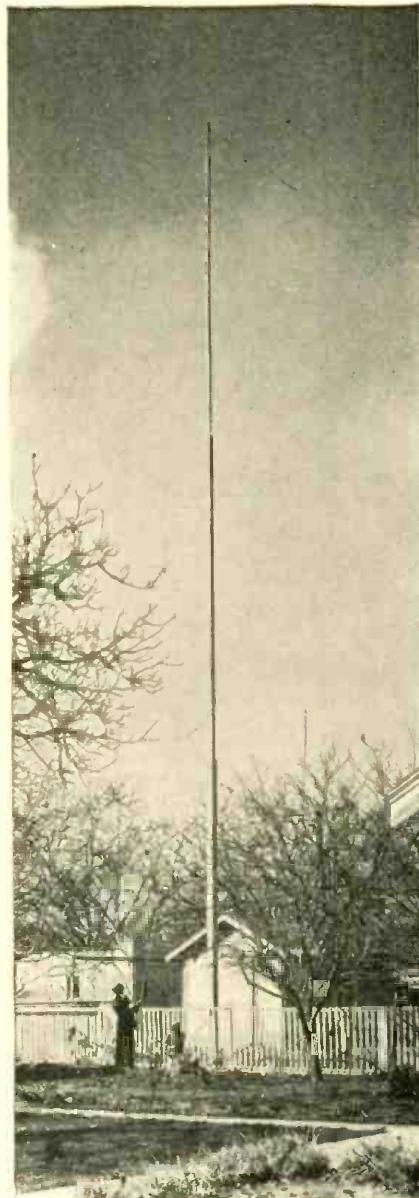

**THE COMPLETED MAST**

FIGURE 3: Tall, graceful and efficient is this antenna-mast when it is finally ready for use; a decided contrast to the usual flimsy, inefficient pole.

mechanical lines. Stout galvanized screw-eyes made from a 1/4-inch rod, and with a screw not less than one inch long, form an excellent anchorage for the wire to adjust itself to its angular position without the danger of kinking and thereby weakening it.

The wires themselves should also be neatly attached to the eyes; and care should be taken to keep them straight until the mast is up. For the two upper sections No. 14-gauge galvanized wire is amply strong; but the bottom section should be held by stronger wires, as it is the mainstay of the mast. Stranded galvanized clothes line, about 1/8-inch thick, makes an ideal guy material for this section; and it is safer than a single wire.

The anchorage of the guy-wires at or  
(Continued on page 67)

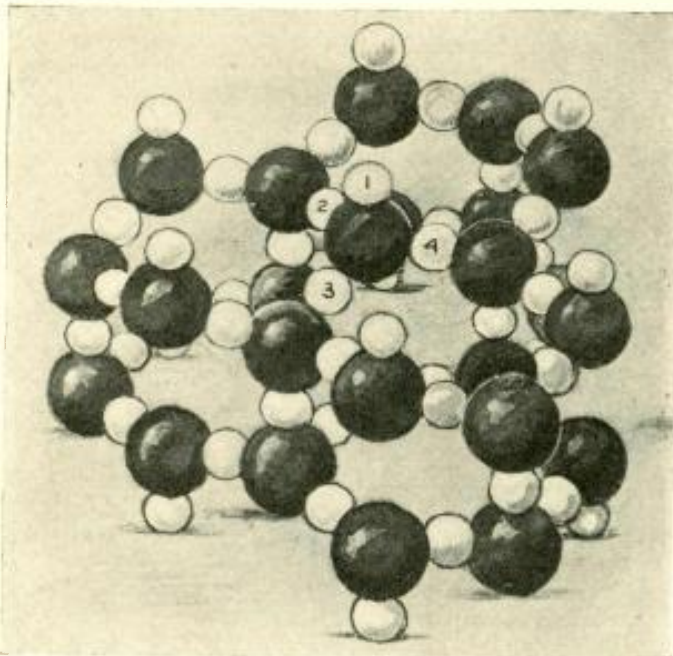

THE INTERNAL STRUCTURE OF THE ICE-CRYSTAL AS REVEALED BY X RAYS.

*In ice every two oxygen atoms (the large spheres) are separated by a hydrogen atom (the small spheres). Thus each oxygen touches four hydrogens (as 1, 2, 3 and 4 above) and each hydrogen touches two oxygens. In this diagram the outside oxygen spheres have not their full complement of hydrogen neighbors, as they would have if the model were continued indefinitely in all directions.*

## The ATOM

ARTICLE NO. 5

### The Nature of Crystals: Ice and Snow

Tremendous power is believed to lie within the minute and constantly moving particles of matter known as atoms. The entire universe, the scientists tell us, is made up of only ninety different kinds of atoms. One of these—the thorium atom—furnishes the activating power for modern vacuum-tube filaments as used in modern radio transmission and reception; this is one instance in which the energy that lies within the atom has been harnessed. To extract the energy from atoms and to make it of service to civilization is one of the most important problems that now comes before the experimenters in science.

By SIR WILLIAM BRAGG, K.B.E., D.Sc., F.R.S., M.R.I.

*Fullerton Professor of Chemistry at the Royal Institution of London and Director of the Davy-Faraday Research Laboratory*

**W**ATER is one of the most plentiful substances in the world and its properties affect our lives in innumerable ways. Its molecule is simple, consisting only of one atom of oxygen and two of hydrogen.

For both of these reasons the structure of the ice crystal invites consideration; and we may find yet another reason in the beauty of its design. However we will not look for them in the artificial ice we use in our homes. The manufacture of ice is too rapid; the crystalline structure is there; but the mass contains a multitude of minute crystals oriented in various ways; and it is full of occluded bubbles and streaks of ice.

To see what Nature will do if she is left to work in peace, we must examine the snowflakes as they fall in very cold weather. We may imagine that one or two molecules become associated in the upper air and descend gently and slowly molecule after molecule attaching itself to the growing crystal, working out the design, until at last an exquisitely formed structure falls to the earth. If the weather is cold enough and there is moisture in the air, the snowflakes will continue to grow, especially at night time, after they have reached the ground. Crystals which have been grown in this way have perfect little facets which glitter like diamonds in the sunlight.

In cold, dry countries the crystal forms shown in Figures 1, 2, 3 and 4 are often observed.

When the snow crystal first forms it is feathery: its six radii carry tiny projections and these again others. All the angles at the junctions are equal to the angles of an equilateral triangle so that the whole is like a six-pointed star of fine lace.

These feathery forms seem to be made when the crystallization is rapid. The nucleus reaches out to take in fresh fields of molecules because the nearer molecules which are ready to take their places have been absorbed into the structure.

This effect is often found in other cases of crystallization. A notable example is the early formation of skeleton crystals of metals in the crucible. If they are to be preserved, the rest of the liquid must be poured off before the crystal has had time to fill up its vacant spaces.

When the crystal of snow has grown its feathery arms and there is a supply of molecules available, the gaps fill up and the crystal becomes a hexagonal plate. Strange to say, these plates are often connected in pairs by a hexagonal prism. One plate is generally larger than the other and the form of the whole is like that of a fairy tea-table (Figure 2). These prisms are believed to be the cause of some of the halos and mock suns (Figure 10) that are seen in high latitudes. They refract the sun's rays through a definite angle (Figure 11). If they are plentiful in the sky and are disposed in all directions, some of them send rays into the eye of an observer from all points which are at a certain angular distance from the sun. Thus he sees a circular halo having the sun as its centre.

This effect is illustrated by the experiment shown in Figure 9. The eye of the observer receives a pencil of rays from the prism in every position to which the prism may be moved by rotation of the arm which supports it.

Prisms descending through a gas or liquid tend to set themselves horizontally; but when they end in plates, as in Figure 2, they become vertical during the fall. This may be illustrated by allowing similarly shaped bodies, made of ebonite or any convenient substance, to fall to the bottom of a tall jar filled with water, as in Figure 12. The jar ought to be very long to make the experiment completely successful; but if the prisms are dropped sideways into the water they will nearly always right themselves in a jar of the height shown in the picture. Curiously enough, if the length of the prism is greater than the width of the plate at the end, the prism tends to go down with the plate taking the

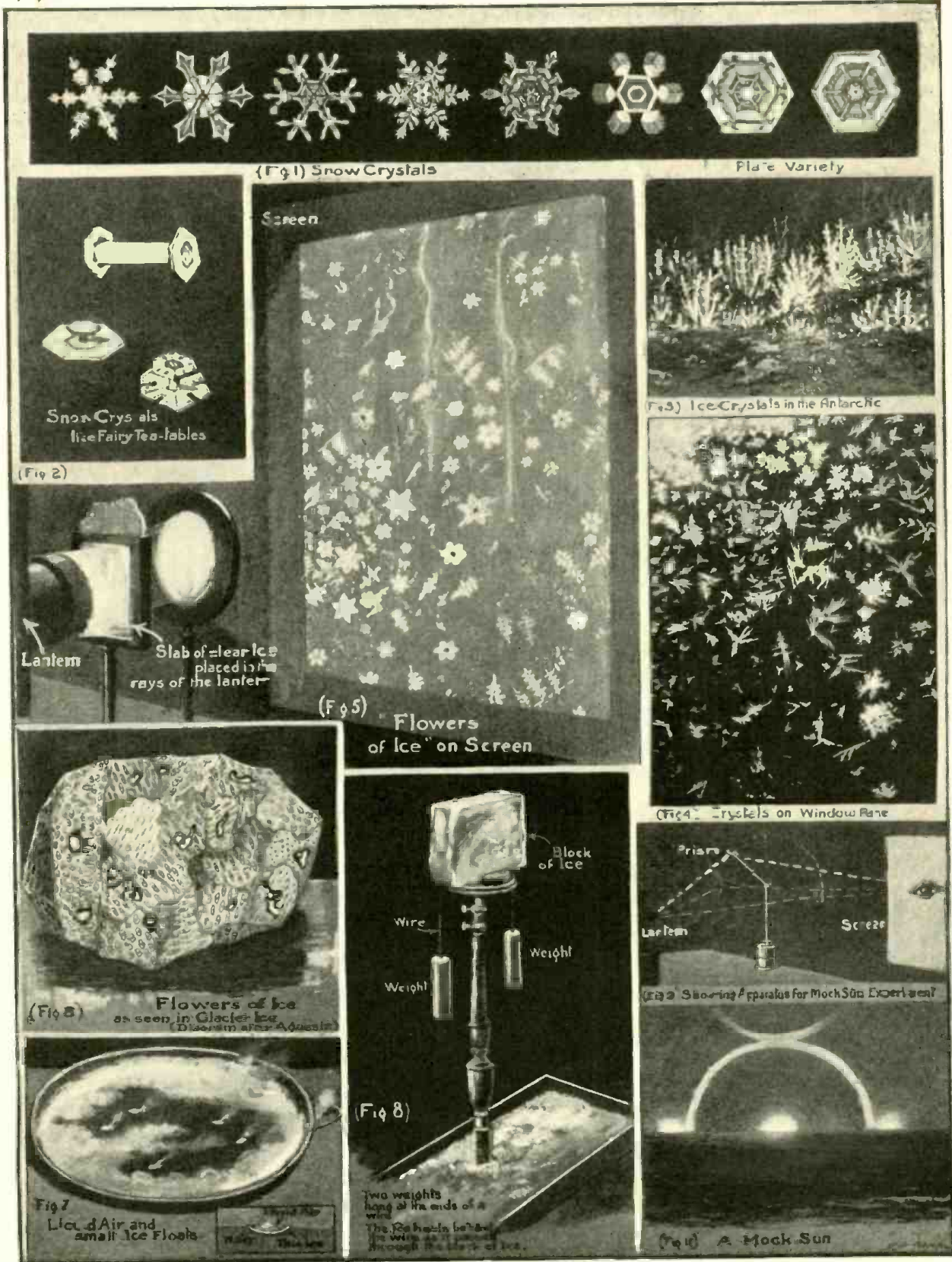

REPRESENTATIVE ICE CRYSTALS—SOME EXPERIMENTS WITH THEM

In the illustrated articles which have already been published in POPULAR RADIO, Sir William Bragg abridged the first four of his six lectures delivered at the Royal Institution of London under the general title, "Concerning the Nature of Things." The first four subjects were: "The Atoms of Which Things Are Made," "The Nature of Gases," "The Nature of Liquids" and "The Nature of Crystals: the Diamond." The present article, illustrated like the others with diagrams representing the chief experiments performed during the lecture, deals with the nature of ice crystals. The sixth and last article of the series will appear in a coming issue of this magazine

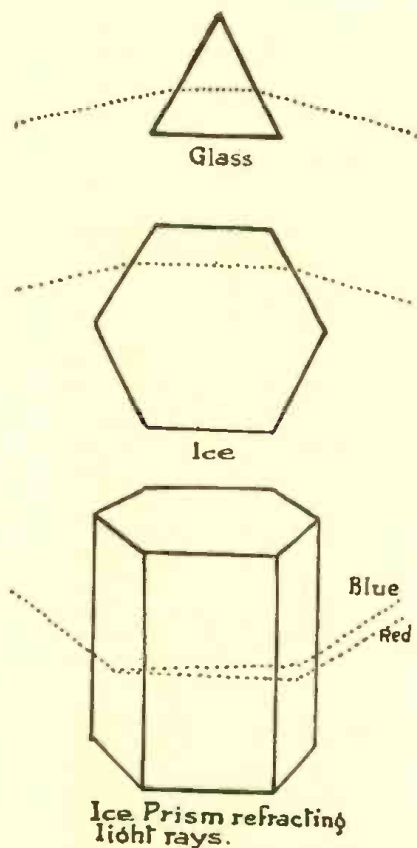

#### THE EXPLANATION OF HALOS

FIGURE 11: The refraction of light from the ice prisms, as shown above, is believed to cause the "mock suns" and the halos often seen in high latitudes.

lead; but, if the prism is short, the plate tends to bring up the rear. In either case, the falling prisms are mostly vertical or oscillate about a vertical position. If it is supposed that these are falling ice-crystals which tend to set themselves with their prisms vertical, and that there are enough of them, there will be bright spots on the halo at the ends of the horizontal diameter. These are the "mock" suns.

Ice, when it forms quietly on a water surface exposed to the sky, crystallizes in a form analogous to that of the snow crystals, all the six-sided figures being horizontal. It is not usually easy to see the hexagon in a piece of ice with the eye; but the hexagonal structure is beautifully seen in an experiment originated by Tyndall. A slab of clear ice is placed in the rays of the lantern, as shown in Figure 5, and is focused on the screen. The heat of the lantern begins to "undo" the crystals, and they come to pieces in the reverse order of their formation. Little six-rayed cavities appear and grow, and cavities having a fern-like form in which the fronds are inclined to the stem at the angle of the equilateral triangle. Soon the whole face of the crystal is covered with these "flowers of ice," as they are called, so

that it looks like a beautiful carving in low relief.

The ordinary commercial ice does not show this effect. Tyndall used Norway "ice," which was available in his time. It is clearly essential that the ice should grow quietly; probably also it is a condition that the water should lose heat slowly at one face, as the water of a pond does on a still, frosty night.

When the ice-flower forms in the body of the ice, the water from the melting does not quite fill the empty space. A portion of the space is empty and shows as a black spot in the centre of some of the flowers (Figure 5). Tyndall was of the opinion that as the melting took place the water did not contract at first, but was stretched under great tension by the forces binding molecule to molecule. A rupture occurred soon; and the water shrank to its proper size, the black spot appearing suddenly.

The flowers of ice may be seen in glacier ice where they are produced by the heat of the sun. They are very persistent. When a glacier is formed from the contributions of ice from various sides, the mass may consist of a pile of blocks all frozen together, each of them showing ice flowers. The orientations of the flowers show in each case the original lay of the block, for they are always formed in planes, which were once horizontal. In Figure 6, taken from an old volume by Agassiz, a section of glacier ice shows well the various positions of the cavities, some in full view, some on edge and some in intermediate positions.

X-rays allow us to examine the internal structure of the ice crystal. The design is shown on page 30, where each larger sphere represents an oxygen atom and each smaller a hydrogen. The structure is something like that of the diamond in so far as each oxygen is surrounded by four hydrogens, as the centre of a tetrahedron is surrounded by the four corners. This is also the arrangement of the carbon atoms in the diamond; but, whereas in the latter crystal the carbon atoms are in direct contact with their neighbors, in ice each pair of oxygen atoms is separated by a hydrogen atom. Thus each oxygen touches four hydrogens and each hydrogen touches two oxygens; this is a right proportion because there are twice as many hydrogen atoms as there are oxygens.

In consulting this figure, it should be remembered that the model has to be continued in all directions, as the atoms which are at present on the outside do not have their full complement of neighbors. The model shows the six-sided arrangement which is the origin of the six points of the snow star; it is hexagonal just as the prism which is drawn in Figure 11. We may also see in the

emptiness of the structure one reason for the feathery lightness of the snow. Another reason is, of course, the tendency to grow into lace-like forms such as those illustrated in Figure 1.

When liquid air is poured into water, the drops freeze portions of the water on which they fall, forming little boats in which they ride. The air over the vessel containing the water is filled with fog which must be blown away in order to show the tiny fleet. It is a striking experiment (Figure 7).

We see also in the model (page 30) some explanation of the fact that ice is lighter than water; for it is plain that, if the bonds between the spheres in the model are broken, the spheres may be packed together more tightly. Under pressure ice tends to melt, because the pressure breaks the bonds, as if the ice were a piece of empty honeycomb.

There is an old lecture-room experiment which shows this effect very well. Two weights hang at the ends of a wire which is strung over a block of ice, as in Figure 8. The wire slowly eats its way into the ice; but the ice heals again behind the wire as it passes through. The fact is that under the great pressure of the wire a little of the ice structure comes to pieces; and the molecules which are set free slip round to the other side of the wire where they join up again into the structure. The same effect is found when two pieces of ice are brought into contact, practically without pressure, and freeze together.

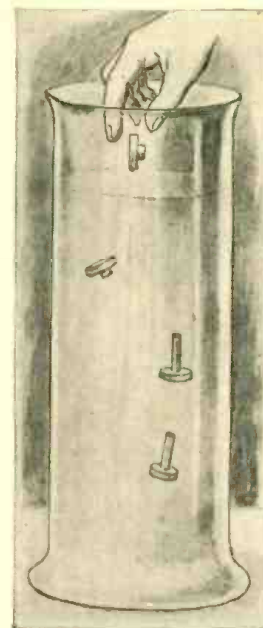

#### HOW PRISMS FALL

FIGURE 12: When they descend through a gas or liquid they tend to set themselves horizontally; but when these prisms end in plates (as shown above), they become vertical. This experiment may be made with similarly shaped bodies of ebonite (or other convenient substance) in a tall jar of water.



# A "Radio Studio" in Your Home



**Figure 1**

*When you arrange the radio portal, the soft wall drapes should first be hung in position by nailing them securely to the picture moulding.*



**Figure 2**

*Set the loudspeaker on a pedestal that is as close to the corner as it is possible to get it without having the cone touch the drapes.*

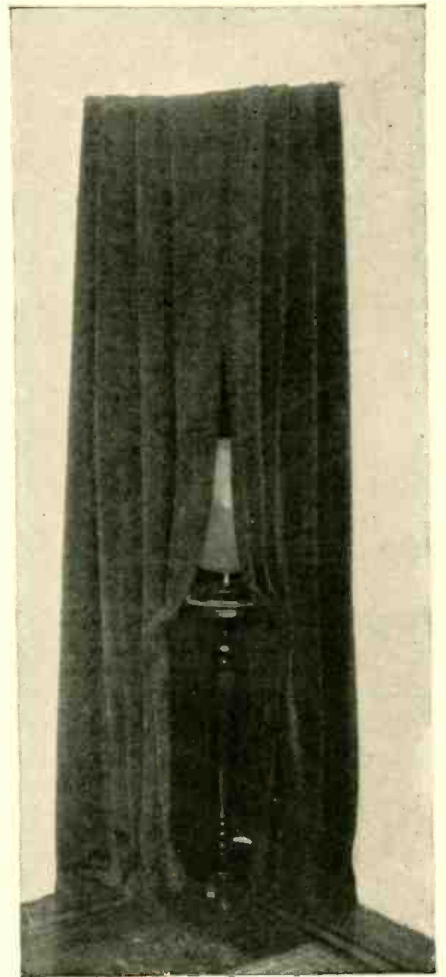

**Figure 3**

*The radio portal is completed by placing the heavy plush curtains in an artistic drape across the front of the triangular support.*

By THE TECHNICAL EDITOR

**T**HIS is the time of year when the average broadcast listener must prepare to face the seasonable problem of getting good reception. For the static-laden evenings that occasionally constitute such a nuisance to the radio fan during the spring and summer months will shortly be upon him.

Of course, the most practical method of getting good reception at any time of the year—and in the summer months particularly—is to tune in on the local broadcasting stations.

Good all-year-round reception at distances over 500 miles is exceptional. However clearly the receiving set may tune in on a station 4,000 or even 5,000 miles away, there is no such thing as reliable "night in" and "night out" loudspeaker reception from such dis-

tances. The weather conditions alone are too variable to permit that.

Broadcast listeners have been told how to obtain good clear reception in good volume through the medium of well-made and well-assembled receivers. They have been told—particularly in the pages of this magazine—how to install their sets, how to operate them, how to maintain them and how to solve the problems of radio reception in general.

In this article they will be told of a new phase of the problem of reception that has heretofore received little or no attention, but which involves a scientific principle of importance.

*Recent experiments show that it is necessary to install the loudspeaker in the home with the same intelligence and care*

*as are used in installing the microphone in the broadcasting studio.*

Some of the scientific problems that have been solved in the broadcasting studio have already been described in *POPULAR RADIO*. The arrangement of the studio, the location of the microphone, positions of the artists in relation to the microphone, the acoustical problems, the character of the floor and wall coverings, have been the subject of study and experimentation from the earliest days of broadcasting.

Now it has been learned that somewhat similar problems may be solved in the radio reception room as well as in the transmitting room. The arrangement of draperies in relation to the loudspeaker has been found to be as effective in obtaining good reception

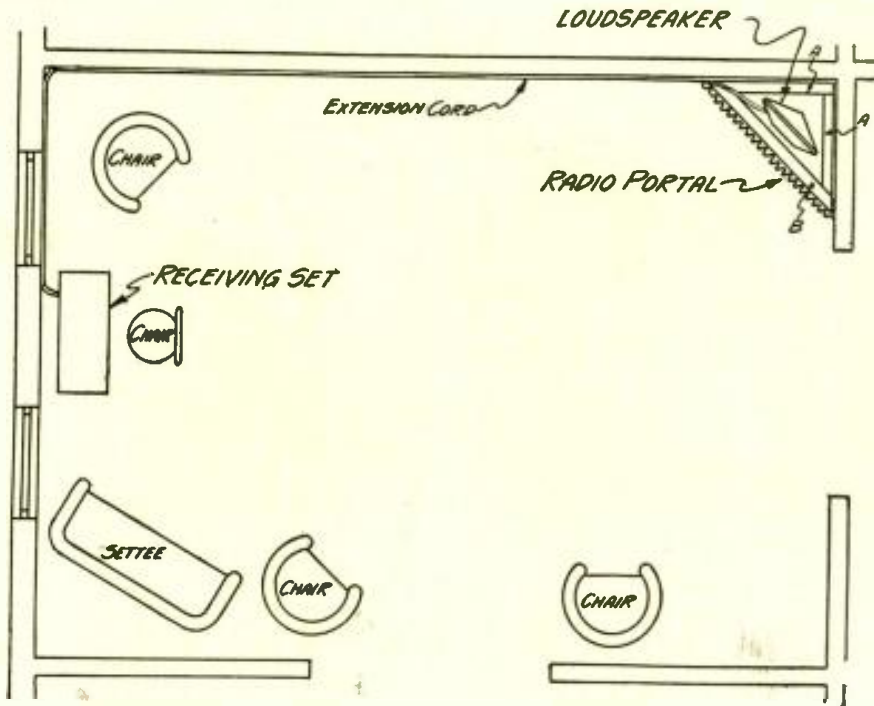

**HOW THE HOME STUDIO SHOULD BE ARRANGED**  
 FIGURE 4: The location of the receiving set and the position for the radio portal are shown here. Notice that the radio portal is installed on the OTHER side of the room from the receiving set and the listeners' chair.

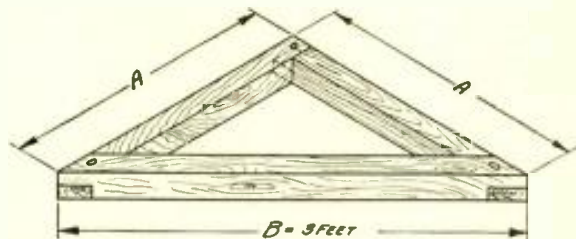

**THE FRAME FOR THE CURTAINS**

FIGURE 5: This simple support may be easily made at home; it should be placed in the corner, above the picture moulding.

as the use of draperies in transmitting from the broadcasting studio.

One of the most satisfactory, as well as one of the most easily arranged, installations of the loudspeaker in the home is here described; it has been designated as the "Radio Portal." The quality of the reception obtained by

this installation has been enormously improved—as any radio fan may easily determine for himself.

Install the "Radio Portal" in the corner of the room which is farthest away from the receiving set and also as far as possible from where the listeners sit. This is clearly shown in Figure 4.

The first step is to hang a single plush drape in the corner. Hang it flush with the walls, extending on each wall from the corner a distance equal to that shown at A in Figure 4. This drape should hang from the picture molding all the way down to the floor, as shown in Figure 1.

Next, prepare the triangular wooden form, according to the dimensions given in Figure 5, and nail it in place in the corner, with the side B spanning the two walls. The two sides, A, should be nailed down on top of the picture molding.

Now place the loudspeaker on a pedestal so that it will stand at the height of an ordinary person's chest above the floor, as shown in Figure 2.

The third step is to hang two sets of drapes over the front arm of the bracket B in an artistic fashion, with a small opening that shows just a bit of the loudspeaker and the pedestal, as shown in Figure 3.

The loudspeaker is then connected to the set on the other side of the room by means of an extension cord.

This arrangement of the drapes deadens the resonance that customarily accompanies the use of the loudspeaker when it is placed in an ordinary room. Although it would seem that the signals would be weakened by having a curtain hanging in front of the loudspeaker, this is not noticeably true. The reception of distant signals comes through just as clear as a bell, and signals may be tuned in from local stations more loudly than usual yet without distortion.

This installation was made in the author's home and has been demonstrated to many visitors, including several prominent New York musical critics. They all agreed that the musical reproduction was the best that they had ever heard.



Hadel & Herbert

**A TOY TRAIN RUN BY RADIO**

Any boy would gloat over this miniature radio-controlled train which Major Phillips, an English radio expert, is demonstrating to a group of envious schoolboys. The box in his hand controls the movement of the train up to a distance of 500 yards, by means of relays.

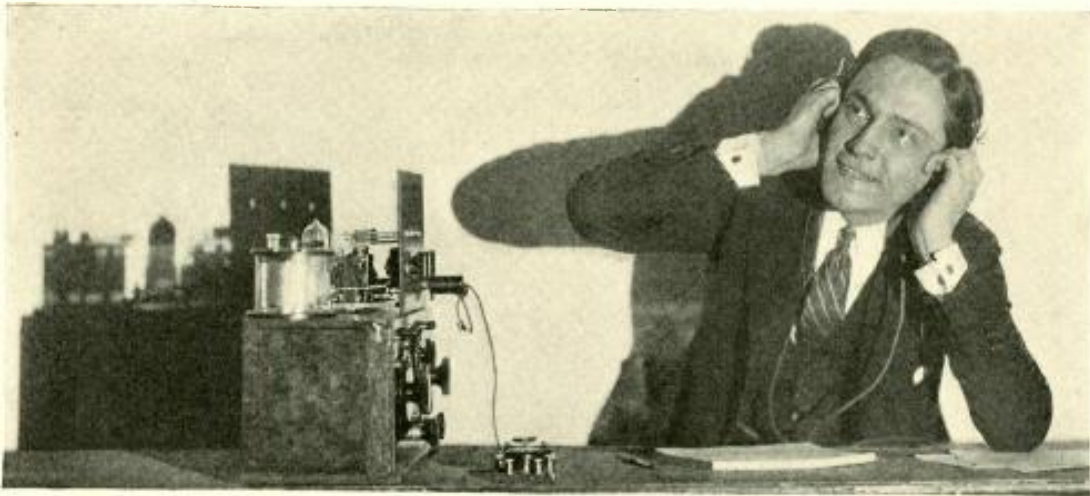

# 15 Ways to Reduce Static

1. Use a short, indoor antenna when local reception is all that is desired.
2. Employ extremely loose coupling between the antenna and secondary circuits for local reception.
3. Connect a fixed condenser with a capacity between .002 and .006 mfd. across the loudspeaker terminals.
4. Remove the ground wire from the set and attach it to the antenna post for local reception. In this case no aerial is used.
5. Use a short outdoor antenna in preference to a long one.
6. Employ a small amount of radio-frequency amplification and a large amount of audio-frequency amplification.
7. On a tuned-radio-frequency receiver with three tuning dials, leave the first one somewhat off the setting where maximum signal strength is obtained and carefully adjust the remaining two dials for maximum amplification.
8. Reduce the plate voltage on the first radio-frequency tube of tuned-radio-frequency receivers.
9. Use a buried antenna to help clear local signals.
10. Connect a variable high resistance across the antenna and ground for local reception.
11. Use a loop receiver if possible as a loop gives a higher signal to static ratio than the usual type of antenna.
12. Wherever possible use a short-wave receiver to copy the short-wave broadcasting or rebroadcasting stations such as KDKA, WGY and KFKX.
13. Try using a resonance wave coil.
14. Where reception is from any direction but the southwesterly (in the eastern states) use a small antenna and loop balanced to give unilateral reception.
15. When regeneration is employed in any circuits don't work too near the oscillating point but just close enough to make the set sharp and to give moderate volume. Don't "push" the receiver.

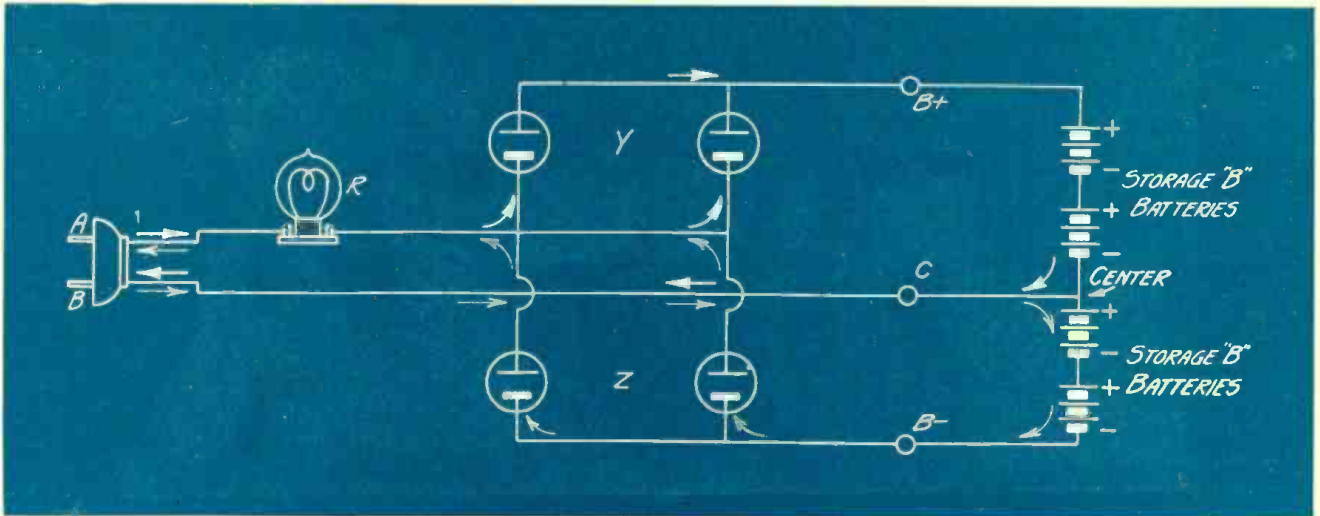

THE DIAGRAM THAT SHOWS THE ELECTRICAL CONNECTIONS  
 FIGURE 1: This drawing shows how the lamp, socket and rectifier jars should be connected to the storage "B" batteries for charging them directly from the alternating current line.

## Simple "How to Build" Articles for Beginners

### NUMBER 16

#### *How to build an inexpensive charger for storage "B" batteries*

By S. GORDON TAYLOR

COST: Not more than \$2.50

#### HERE IS A COMPLETE LIST OF THE MATERIAL REQUIRED—

- |   |   |
|---|---|
| Two feet of aluminum rod, 5/16-inch in diameter;                    | One package of "20 Mule Team" borax;  |
| Two feet of lead rod, 5/16-inch in diameter;                        | One standard lamp socket;   |
| Four half-pint salt-mouth jars with cork stoppers (see Figure 2);   | Three binding posts, also all necessary lumber, wire, screws for making the wooden container and a brass strip 1/2 by 1/8 by 7 inches for angles to mount the socket. |
| Four inches of glass tubing, 1/4-inch in diameter (for vent pipes); |   |

**T**HIS device, which may be used to charge storage "B" batteries up to a voltage of 150 volts using the 110-volt alternating-current house supply line, may be easily built by the beginner.

It may seem impossible, at first glance, to charge a 150-volt battery from a 110-volt source without first stepping up the charging voltage by means of a transformer.

However, the plan used is simplicity itself. Alternating current continually reverses its direction of flow, the rate of reversal depending on the frequency of the current. Most alternating-current, house-supply lines employ 60 cycle current which means that the current reverses itself 120 times per second. The frequency is not important in this case so far as battery charging is concerned. The main point of interest is the fact that the current flows in one direction half of the time and in a reverse direction the other half of the time.

In Figure 1 the arrangement of this

charging system is shown and the direction of current flow is indicated by arrows.

To illustrate this more clearly let us assume that during the first half of each cycle the current flows from terminal A of the AC line to terminal B. The current flows from A to rectifier Y, which allows it to pass on to the positive terminal of the "B" battery, through half the battery to the center tap and then out through the connecting wire to terminal B of the AC line as indicated by the heavy arrows.

During the second half of the cycle the current reverses itself, or, to continue our previous assumption, the current will flow from terminal B to terminal A, as indicated by the light arrows. The course is from terminal B to the battery center tap, through half of the battery to the negative end, then through the rectifier, Z, and the resistance lamp back to terminal A of the AC line. The fact that a rectifier will pass current only

from the lead to the aluminum electrode explains why the charging current on the second half of the cycle passes from the center tap of the battery to the negative end, rather than to the positive end.

The tungsten or carbon lamp, R, serves as a resistance and is used to regulate the charging rate. A low-power lamp, such as a 25-watt Mazda has a high resistance and will therefore allow only a small current to pass through. Larger lamps permit greater current flow.

There are other factors governing the amount of current flow also. For instance if a comparatively low-voltage battery, say 90 volts, is charged, the charging current will be much higher than is the case when a 150-volt battery is being charged. Therefore a low-power lamp (high resistance) should be used when charging low-voltage batteries (100 volts or less). With 125 volts or more, a 100 or 200-watt lamp may be used and for 150 volts of battery no

resistance is needed. In the latter case the two terminals of the series lamp socket may be short-circuited with a piece of wire.

The rectifier consists of four jars, a suitable container and a lamp socket, as shown in Figure 1. Actually, it is divided into two parts, represented as Y and Z in Figure 1. Each of these parts is made up of two jars connected in parallel, the parallel connection being necessary in order to provide sufficient current-carrying capacity without overloading.

Figure 2 provides all the details for the construction of the rectifier. The lead and especially the aluminum must be chemically pure metal and not the ordinary commercial grades.

Before assembling the jars the metal electrodes should be thoroughly cleaned and washed in a solution made up of two teaspoonfuls of lye to a quart of water. After the lye solution has been prepared (in a non-metallic vessel) lay the aluminum electrodes in the solution for a few seconds, or until they begin to froth violently. Then rinse them off in cold running water. The same process is then repeated with the lead elements.

The borax solution for the rectifier jars should be prepared in a bottle or crock. It is made by dissolving as much of the ordinary "20 Mule Team" borax as possible in two quarts of hot water.

After this is done, let the solution stand for 24 hours so that the excess borax will have time to settle on the bottom of the crock or crystalize on the sides. If this is not done, crystallization will take place in the rectifier and will prove to be extremely messy. The clear liquid is then poured off into the rectifier jars without disturbing the settings any more than necessary.

More complete details of the preparation and construction of a chemical rectifier of this type will be found by referring to the "Experimenter's Laboratory" department of the January, 1926, issue of POPULAR RADIO.

As a matter of convenience the laboratory model of this charging unit was mounted in a shallow wooden box 2½ inches in height which was just large enough to hold the four jars. A piece of hard rubber was used for one side of the box to serve as a binding post panel. This refinement is not necessary, however, as the binding posts may be mounted directly on one of the wooden sides of the box. The socket for the lamp, R, is mounted by means of brass brackets on one side of the box.

In this way the entire charger is mounted as a single unit.

The three terminals provided on the rubber are for the leads to the battery which is to be charged. If a 100-volt battery is to be charged, for instance,

the "B+" terminal of the charging unit is connected to the positive side of the battery, the center binding post is connected to the 50-volt terminal of the battery and the "B-" post is connected to the negative side of the battery. A suitable length of lamp cord is provided with an ordinary plug at one end to plug into an alternating current lamp socket.

With the charging unit completed, the rectifier jars should first be formed before connecting to the battery. For this purpose a 25-watt lamp is connected from the "B+" to the center terminals of the unit to serve as a resistance in place of the battery; and a 25-watt lamp is placed in the socket on the side of the unit. This will permit a current to flow through one half of the rectifier, when the unit is plugged into the AC line. The unit should be left connected in this manner for about five minutes for proper forming. Then the first lamp should be disconnected and reconnected between the "B-" and the center terminals of the unit.

In making this change disconnect the unit from the AC line. With the connections completed, plug the unit into the line again. This time the other half of the rectifier will be formed. After five minutes the forming process will be completed and the first lamp may be taken off.

When the unit is ready for use it

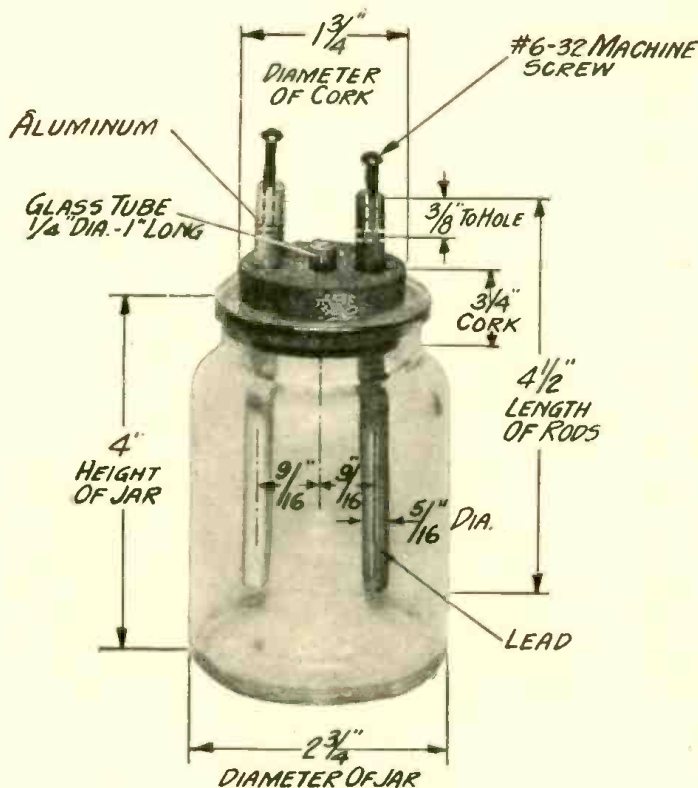

THE FINISHED RECTIFIER JAR

FIGURE 2: All the necessary dimensions are given here for the assembly of a rectifier jar. Complete constructional data are given in the accompanying text.

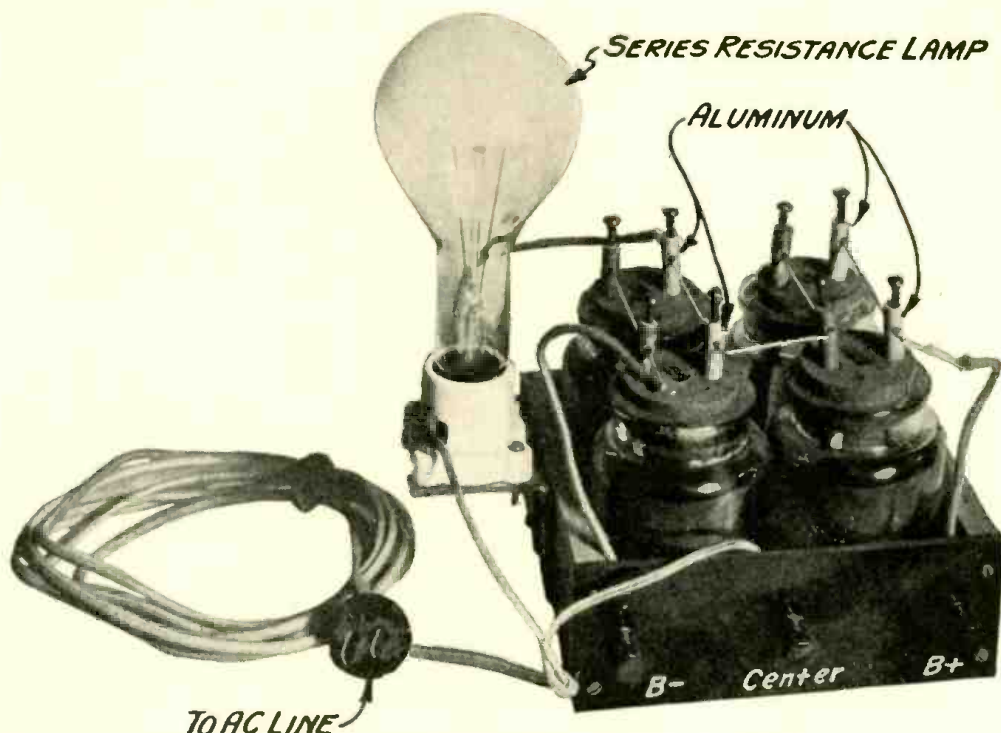

THE GENERAL APPEARANCE OF THE CHARGER

FIGURE 3: Before the rectifier jars are mounted in a wooden frame with three binding posts that should be attached to the storage "B" batteries as indicated, the plug may be connected to any alternating current lighting line of the correct voltage.

would be well to obtain a milliammeter (direct current) with a range of from zero to 500 milliamperes. Connect the battery to the charger, as shown in Figure 1; but connect the meter between the positive side of the battery and the "B+" terminal of the charger. When the current is turned on the amount of the charging current will be indicated by the meter.

At first it is well to use a 15-watt lamp in the charging unit socket. If the charging current is less than 100 milliamperes try a larger lamp. After the battery has been on charge for a few minutes, the charging current will drop somewhat. It is therefore best to keep the meter in the circuit for about 15 minutes and, if the

current drops too low, to put a larger lamp in the socket.

The proper charging rate for storage "B" batteries is usually given by the manufacturer in the literature which accompanies the batteries. The usual rate is about 220 milliamperes. After the proper size of the lamp is found to deliver a suitable charging current, the meter is no longer necessary.

The use of the meter is suggested because it is impossible to give definite specifications for the proper lamp because of the large number of variable factors which are involved, such as the exact voltage of the AC line, the resistance of the rectifier itself, and the voltage of the batteries to be charged.

It is also well to connect the meter for a moment between the "B-" terminal of the charger and the negative side of the battery, just to make sure that the other side of the rectifier is also functioning properly. Never connect the meter to the center tap of the battery, however, as the current flow between the center terminal and the middle of the battery is alternating current.

If it is desired at times to charge a low voltage storage "B" battery of 67½ volts or less, it should be connected with its positive terminal to the "B+" terminal of the charger and its negative terminal to the center terminal of the charger. This will give the proper voltage relations from rectifier to battery.



Kadel & Herbert

ANTENNA "MOVING DAY"

The coil of the "wide, open spaces" has taken the transmitting station of WGBS away from the crowded skyscraper district of New York to its new home at Astoria, L. I. where it is surrounded by water on three sides and flat open land on the other. The antenna is here being laid out at the new site, which was made necessary by the energy loss by absorption in New York's steel frame buildings.

# How I Made My LC-26 an *Objet d'Art*

An illustration of what the radio fan can do to install his receiver in a way that will harmonize with the atmosphere of his home.

By EVERETT L. THOMPSON, JR.

THE ordinary receiving set can hardly be considered an *objet d'art*. But that is no reason why it cannot be made so.

An artistically finished cabinet and a well laid out panel will help the appearance of the set itself, but how about the batteries and the loudspeaker? These accessories are no more beautiful and certainly have no more right to be displayed in the living room than has the refrigerator. And as it is practically impossible to make batteries decorative objects, the next best thing is to artistically conceal them.

It was with this idea in view that I set out to design a cabinet that would suitably house my LC-26 receiver—batteries and loudspeaker as well—and that would be at the same time a thing of beauty in itself.

After a tour of the furniture shops I concluded that if I was to get just what I wanted I would have to design the container myself. I found that there are cabinetmakers, who will not only make and finish a cabinet after a customer's design, but who will help in the details of design as well.

I decided upon the Chinese type of cabinet because it harmonized with my home and because it is undeniably beautiful in itself, with its rich but subdued colorings. And Chinese objects often give a distinctive tone when placed with furniture of almost any style, modern or antique.

The results of my efforts are shown in the pictures that accompany this article.

The color of the chest is hard to describe; it is rather like old parchment, sear and brown at the edges with raised decorations. It was copied after the decorations on old Chinese chests, and was done in old dull greens, gold, bronze, maroon and yellows.

The entire surface is lacquer-cracked and gives the appearance of great age. The hardware is of heavy bronze, which has been artificially "aged" by acid and is but slightly burnished.



From a photograph made for POPULAR RADIO

## A MODERN SET IN AN ANCIENT SETTING

*In this unusual chest a horn loudspeaker is concealed behind the grill at the top, while a compartment in the table houses the power plant of the receiver. Note that the panel arrangement has been considerably altered by the addition of a voltmeter and a milliammeter and by the substitution of larger dials.*

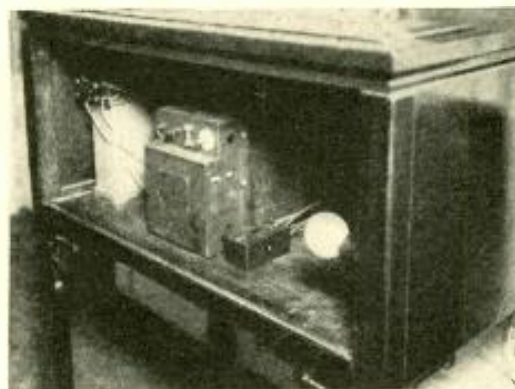

Open the doors and you will find the interior done in dusty old blue with decorations of old gold. The table is black lacquer with dull gold touches, and on it is a vague Chinese landscape, framed by the front panel.

Of the circuit itself—the LC-26—little needs to be said. We all expected great things of it and it has exceeded our demands. In this instance it has replaced with advantage a well-designed eight-tube superheterodyne.

Notice that the panel layout of the LC-26 receiver has been slightly changed. Large size Kursh Kaseh pointer knobs cover the screw heads of

the variometer and rheostat. Two Weston meters which are controlled by jack switches have been added. They are of the new two-inch type which are exceptionally neat in appearance and easy to install. On the left is the voltmeter which reads zero to  $7\frac{1}{2}$  volts and which is connected between the filament switch and the battery; this makes it possible to read the storage battery voltage, whether the filaments are lighted or not.

The other Weston meter is a milliammeter (range: zero to 50) which has been placed in series with the negative

*(Continued on page 59)*

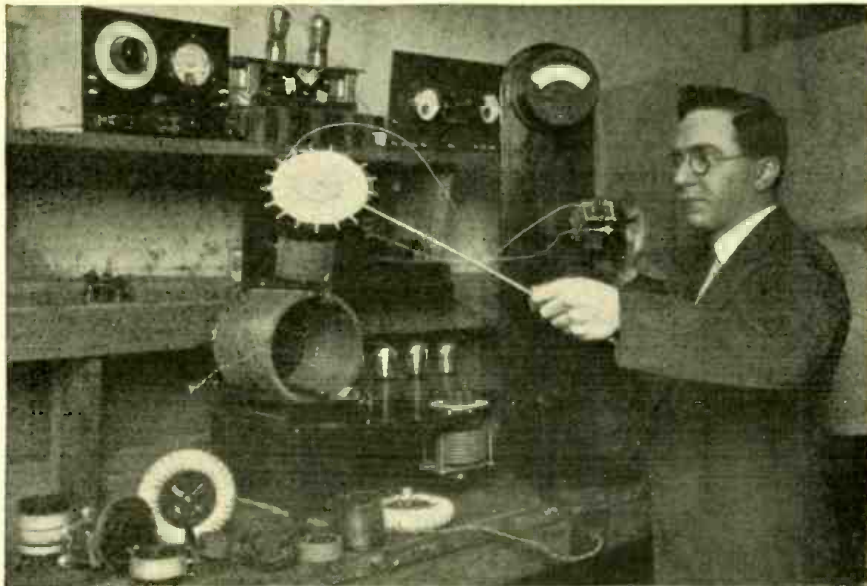

**HOW THE AMOUNT OF COIL "PICK-UP" IS DETERMINED**  
 FIGURE 1: An experimental set-up which contains an oscillator that supplies an electro-magnetic field in the surrounding space. The coil that Mr. Nachumsohn is picking up considerable energy from the large spiral-wound helix.

## Do Your Coils Broadcast?

If they radiate energy or if they pick it up in objectionable amounts, read this article and learn how the present popular toroid type of coil may entirely eliminate this common nuisance.

By IRVING NACHUMSOHN

**I**S the present popularity of the toroidal style coil merely a vogue brought about by manufacturers to exploit the set builder and to confuse him with new tricks of intricate windings and designs difficult to make at home? Or can it be proven that the toroidal coil has any advantages over the so-called ideal single-layer solenoid, or cylindrical winding?

We will consider the term "solenoid" as applicable to all such types of windings in which the magnetic field is not confined in a definite circular path.

In Figure 1 is shown an oscillator which was used for measuring the undesirable "pick-up" characteristics of the various types of windings. In actual tests all of the open-field coils picked up enough energy from the stray field of the large oscillator coil (also a solenoid) at a few feet distant to throw the needle of the thermocouple galvanometer to the end of its scale. The flat windings, such as spider-webs, pancake and a variety of weaved windings were the worst offenders; some of them picked up sufficient energy at a distance of two feet to

light up a fairly large sized flashlight bulb. In the design of solenoid windings

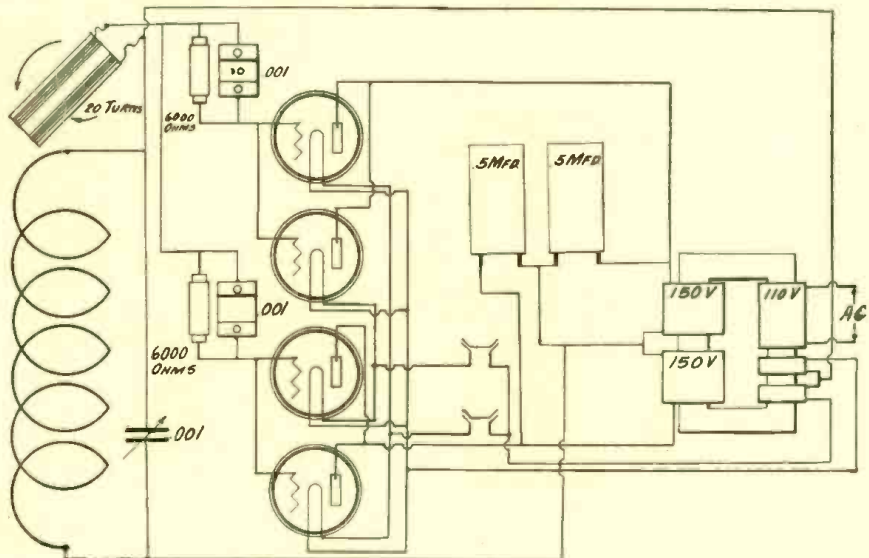

**THE OSCILLATOR CIRCUIT WHICH WAS USED IN THE TEST**

FIGURE 2: This diagram shows how the connections were made for the radio-frequency oscillator that was used in these experiments on all types of inductances which may be used in radio receiving set design.

manufacturers have been fairly consistent, in accordance with the old rule, in maintaining a length no greater than one and one-half times the diameter of the coil. When this rule was adhered to it was a simple matter to locate the primary winding so that an efficient transfer of energy would be obtained between primary and secondary. This was true for several reasons, but chiefly because the magnetic field of each secondary turn becomes additive to form a comparatively strong resultant field which sprays far beyond the ends of the winding.

This disadvantage, from an efficiency standpoint, became an advantage for the coil manufacturer because, unless the primary was disposed sufficiently remote from the secondary, it became an easy matter to link the primary field with the greater portion of the resultant secondary field, whether the primary was placed externally, internally, distributed, or confined at one end of, the secondary.

In toroid transformer design quite different conditions prevail in regard to this coupling, which have been apparently overlooked by manufacturers with few exceptions.

With toroidal windings the old rule of diameter-to-length, of course, cannot be maintained. The small diameter of each turn makes it necessary to have more turns for a given value of inductance. Because of the necessarily large axial dimension of the core (which is usually from 7 to 10½ inches) we can no longer locate the primary winding—as with solenoids—at one end of the secondary and still obtain an efficient magnetic coupling—largely because with such an undistributed primary its field



will not bend in a circular path (without a ferro-magnetic circuit to conduct it) and interlink with more than 30 percent of the secondary.

On the contrary, only a small part of the primary field will be induced into the little inductance of the secondary with which it is interlinked. This, of course, means a low step-up ratio while this ratio should be high in order to obtain volume on weak signals.

And finally, if the primary is not distributed evenly about the toroidal secondary, the former becomes an "unbalanced winding" and will pick up stray signals and cause the much undesired broad tuning, despite the fact that the secondary may be a perfect torus.

The coils of yesteryear, with their mysterious styles of windings like basket weaves, honey-combs, spider-webs and pie-, waffle-, or pan-cake wound coils, gradually gave way to the simplicity and usefulness of plain single-layer inductances. This was clearly explained in an interesting article in the October, 1925, issue of "POPULAR RADIO" by Charles T. Burke, entitled "What Makes a Low-loss Coil?"

With the appearance of many torus coils on the market, the old complicated and trick-style windings reappeared only to make the average radio fan wonder. It has been definitely proven that at every sharp bend in a wire carrying high frequency currents there is a loss of energy and that the higher the frequency the greater the loss. This loss is dissipated through the mechanical stress which tends to straighten out irregularities in the conductor. With even the comparatively low-frequency Tesla currents this dissipation of energy is readily apparent in the form of a "brush discharge" or blue flame emanating from sharp bends or

from other points on the conductor.

Let us assume that we have a typical radio-frequency receiver employing 3 toroidal transformers. If the secondaries of these transformers have a winding in which there are but four bends per turn and 250 turns per winding there will be a total of 3,000 bends in the circuit due to the coils alone. Thus, though the losses at each sharp bend may not be great, when we consider that we are dealing with very small currents to begin with, and that there are 3,000 "leaks" in the coils alone, the matter of toroidal turns becomes as important a consideration as the toroidal winding itself.

Returning to the matter of placing the primary we have omitted an important point with which considerable difficulty has been encountered by manufacturers. The disadvantages arising therefrom have been overcome in one case by means of a toroidal transformer which has an evenly distributed primary winding placed externally to the secondary.

The average resistance of these new toroids at the respective frequencies corresponding to 200, 400 and 600 meters, is 10.4 ohms. This is low for a toroidal winding and is lower than many of the solenoid types, particularly those with trick windings or the so-called low-loss types, which are so often doped with enough filler or varnish to waterproof a sponge.

These are a few of the many points in favor of toroidal windings that the writer has found to have been overlooked even by many of the dyed-in-the-wool fans. Of course, when the resistance of a toroid winding is very high, as some of them are, then the skeptically inclined may be justified in preferring the old solenoid coil if his conditions are such that he is not otherwise bothered with undesirable coil pick-up. But

when he can obtain a low enough resistance (which argues for sharp tuning) coupled with the inability to pick up undesirable stray fields, even if the resistance in the toroid should be a little higher than the best solenoid, it should also be considered:

- (1) That the more closely both primary and secondary windings approach perfect toroids, the less will be the undesirable pickup by, or intercoupling between the coils. Conversely, the more perfect the solenoid type approaches a true solenoid and the lower the resistance of its windings the more will be the unwanted pickup, and the greater will be the undesired magnetic feedback between coils;
- (2) That a tapped torus coil, and there are many of them, is no longer a toroidal winding and one should not expect it to behave as such, when used in the average radio circuit;
- (3) That because of the ability of solenoid coils to pick up unwanted signals, or to intercouple among themselves and produce oscillation when used in a tuned-radio-frequency receiver, some sort of resistance must be added to cut out this interference, whether it be a resistor in the circuit, a counter-feedback arrangement, or the effective resistance due to detuning from resonance.
- (4) That a toroidal transformer must have a distributed and not a confined primary winding; otherwise it should be considered as only partly toroidal, as far as its behavior in a set is concerned.

So after all, the principle of the toroidal winding is sound and possesses advantages over other types of windings; but one must not expect to utilize all of its proven advantages unless the design of the transformers in his set is such that the toroidal idea, with regard to primary, secondary, as well as the turns themselves, is carried out to the utmost degree which is possible.

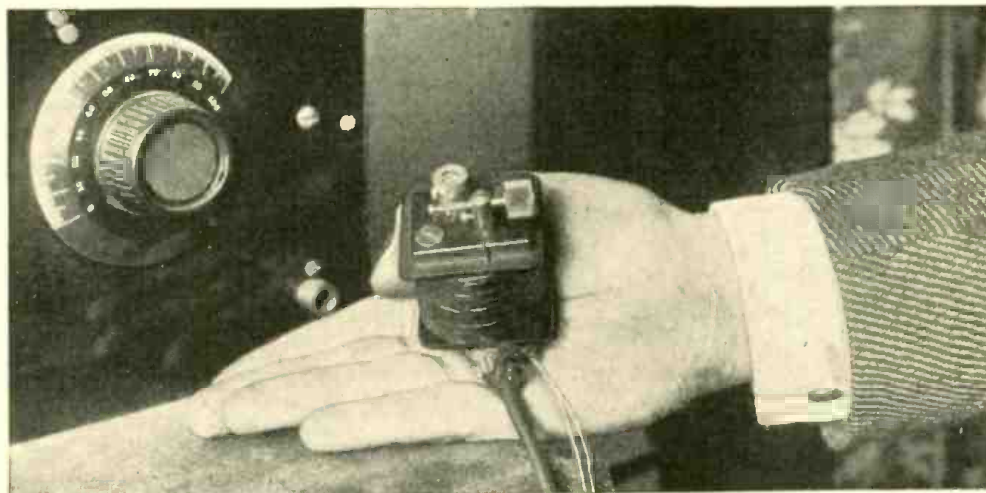

Eadel & Herbert

#### A LILLIPUTIAN RECEIVER

*A single condenser dial on the average receiver occupies more space than this tiny crystal set. The leads, at the bottom of the coil, go to the phones and to the antenna and ground.*



## WITH THE EXPERIMENTERS

CONDUCTED BY LAURENCE M. COCKADAY

### An Easy Method for Calculating Coil Inductance

MANY of our readers have asked us how many turns of wire it is necessary to wind a coil with to cover the broadcast range. Inquiries have also come in from experimenters who want to receive certain wavelengths only, while others want to use condensers of certain sizes. What is necessary, then, to accomplish the proper result and to build the proper sized coils?

First, we must start with the condenser. Its size must be predetermined; and this is left to the choice of the radio experimenter.

With this choice settled, the formula for the inductance,  $L$ , becomes

$$L = \frac{\lambda^2}{1885^2 C} \dots \dots (1)$$

where  $\lambda$  is the wavelength, in meters, that we wish to reach with our coil; and where  $C$  is the capacity, in microfarads, of the condenser to tune that coil. By reference to Figure 1, the above calculation may be simplified for various commercial sizes of condensers.

When the inductance has been calculated, the number of turns,  $n$ , may be evolved from the following formula:

$$n = \sqrt{\frac{1L}{.009871D^2K}} \dots \dots (2)$$

Where  $l$  is the length of the coil in centimeters,  $D$ , the diameter of the coil in centimeters (the diameter of the tube on which it is wound is sufficient for practical purposes) and  $K$ , a constant (a relation between the diameter and its length, which may be taken from the curve shown in Figure 2).

However, to eliminate the necessity of making these extensive calculations, the chart in Figure 3 has been prepared; and its use will be described with examples.

Let us take a practical problem. We want a coil to tune to a maximum of 550 meters with a condenser of .0005 mfd. capacity. The coil is to be wound on a tube 3 inches in diameter; and the winding is to be 1.7 inches long. It will be noticed that in this last chart the values of  $K$  are automatically taken care of by the line values  $D/l$ .

The first step is to find the intersection of the line of the diameter,  $D$ , with the line of the inductance,  $L$ . This is done by following the vertical line down (under 3 inches) until you meet the slanting line at the inductance of 170 microhenries. With this point drawn, make a horizontal extension to the intersection of the ratio,  $D/l$ ; then, follow down from this point to the number of turns on the bottom of the chart and the answer will be found to be

49 turns of wire, within practical accuracy.

Therefore, winding 49 turns of wire on a tube 3 inches in diameter, the winding to be 1.7 inches long, will give us a coil that will reach 550 meters with a .0005 mfd. condenser. These values are not empirical; but they are intended to give a close approximation of the problem at hand.

Should you wish to find either the wavelength of a certain coil already made by some other source than yourself, or its inductance, or the capacity necessary to tune it with, then careful manipulation of the curves, by retracing the steps made by the method just described, will give the desired result.

For example, in Figure 4 is shown a single layer solenoid of 100 turns, 2 inches in diameter and 4 inches long. What is its inductance?

Firstly, the ratio of diameter to length is .5. Follow the number of turns (100) up to the intersection of the ratio,  $D/l$  (.5). Then draw a horizontal line and carry the diameter (2") down to meet this line. This intersection, when drawn parallel to the slanted line of inductance, will show that the coil has an inductance of approximately 200 microhenries.

Going back to the chart in Figure 1, we find that, with a .00025 condenser, this will tune to 420 meters, with a .00035 condenser, to 500 meters, and so on.

— MORRIS M. SILVER

### Using the Raytheon Plate Supply Unit

For those who want to eliminate the "B" batteries entirely, and in place of them to use the alternating current house lighting supply to furnish the high voltage for the LC-26 receiver, the Raytheon unit (which was described in detail in the November, 1925, issue of POPULAR RADIO) is entirely practical. The results obtained from the receiver with the Raytheon unit as described in the same issue are as good in every respect as those obtained with the use of "B" batteries. This statement is made only after very thorough tests under various conditions. As a matter of fact the "log" of stations which were received in one evening, as printed elsewhere in this article, was made while using one of these units in place of the "B" batteries.

When a 201-a type of tube is used in the last audio-frequency amplifier stage of the receiver, the Raytheon unit may be used exactly as described in the November issue. In some cases, when a 112 type of tube is used in the last stage, however, some small changes will be necessary. These changes as about to be described, may be made to advantage in every case in which the Raytheon unit is used with this receiver, regardless of the type of tube which is used in the last audio stage of the receiver.

The Bradleyohm No. 10 which was specified for use in the Raytheon unit to vary the plate voltage to the detector tube is found to be somewhat too critical in adjustment when the UV-200 or UX-200 type of tube is used as the detector. This Bradleyohm should therefore be replaced with a Bradleyohm No. 25. This recommendation is made because the No. 10 resistance has a maximum value of 100,000 ohms and this is approximately the resistance which is required to supply the proper voltage for a UV-200 type of tube. In the case of the Bradleyohm No. 25 the proper resistance is found more nearly in the middle of the adjustment of this instrument.

This does not mean that the Bradleyohm No. 10 is to be discarded, however, as it is used to provide a means of adjust-

(Continued on page 70)

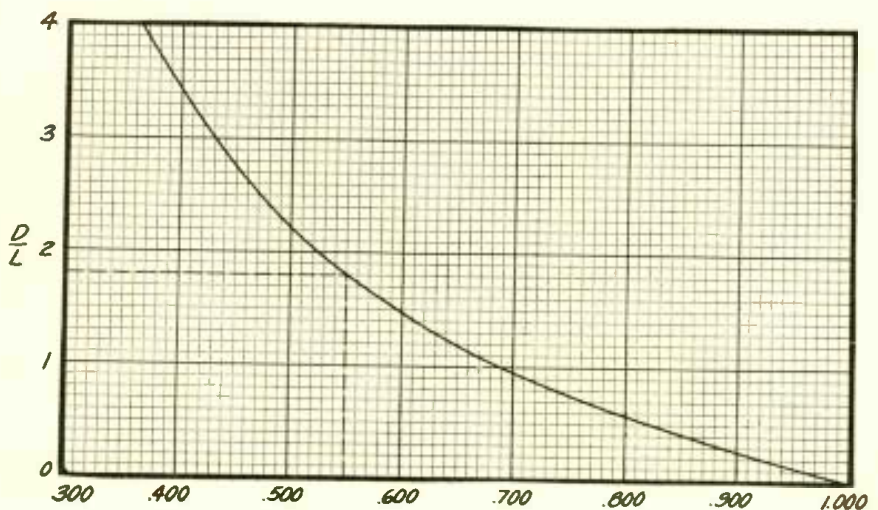

A GRAPHIC FORM OF NAGOAKA'S FORMULA

FIGURE 1: The constant  $K$ , which is mentioned elsewhere in the text, is shown here conveniently given in curve form. Each value of the ratio of diameter to length is expressed, by means of the chart, in its equivalent value of the constant  $K$ .

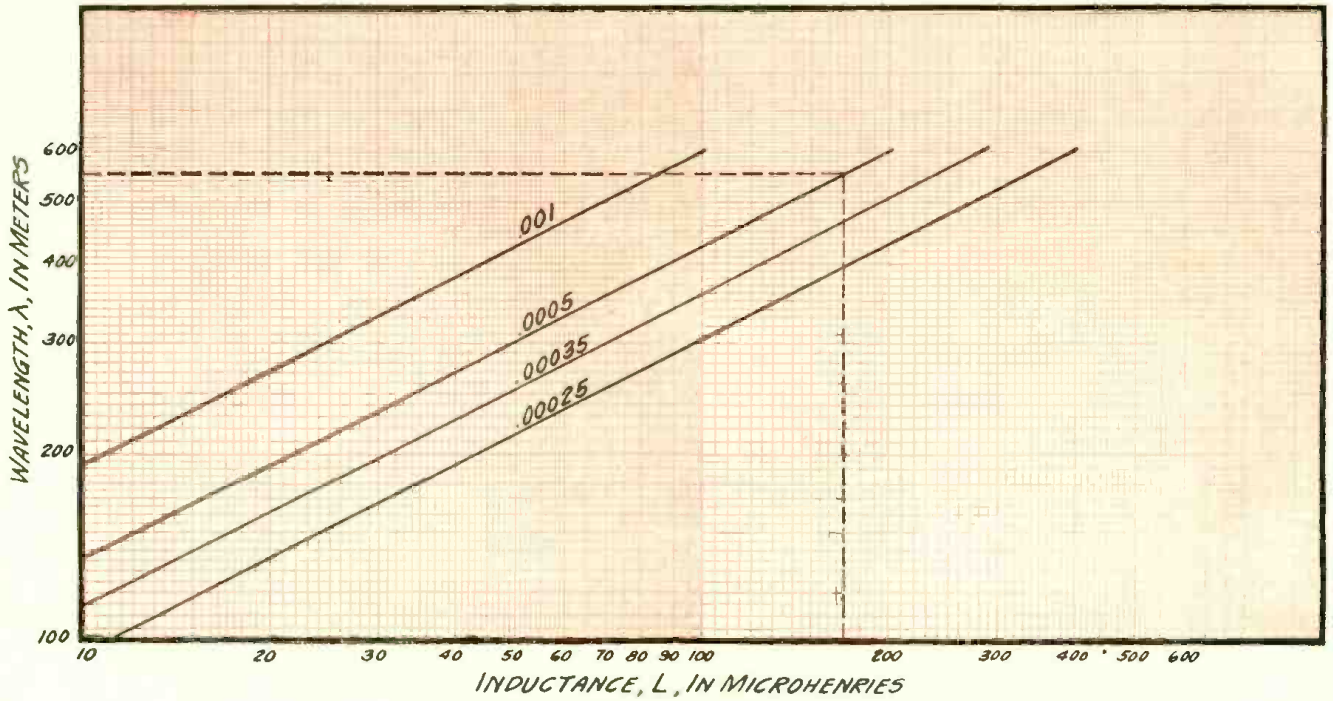

THE WAVELENGTH-INDUCTANCE CHART

FIGURE 2: This series of curves show the wavelength range which is covered by coils of various inductances when they are used in shunt to variable condensers for five different sizes. For instance, an inductance of 100 microhenries, when used with a .0005 mfd. condenser, will tune to approximately 425 meters.

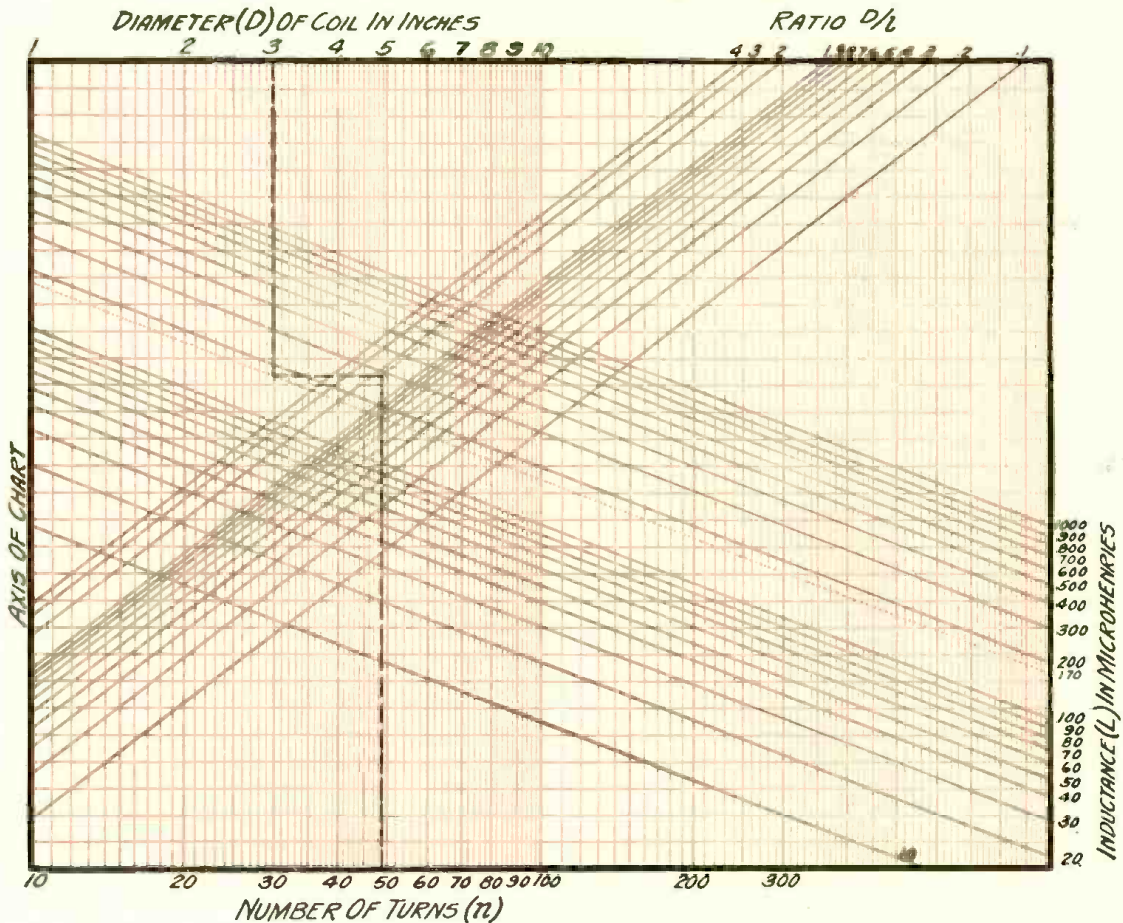

USE THIS CHART FOR CALCULATING YOUR COIL DATA

FIGURE 3: This chart, when used as explained in the text, will help you to solve your problems of coil design, including the proper diameter for the coil, the number of coils and their proper length. The chart applies only to the use of solenoid windings which are similar in general design to the one shown in Figure 4.



## IN THE WORLD'S LABORATORIES

CONDUCTED BY DR. E. E. FREE

### The Source of the Cosmic Rays

THE discovery by Dr. R. A. Millikan of the shortest ether waves so far found, those which come in continually from space to the earth's surface, has already been noted in this Department\*, as has also the idea that these rays may be coming from the vast atomic laboratories in the shining gas clouds of the nebu-

las billions on billions of miles off in the depths of space.† Some of the possible sources of these rays in atomic reactions have now been investigated mathematically by Professor A. L. Hughes and Dr. G. E. M. Jauncey, of Washington University, St. Louis.

\* POPULAR RADIO for February, 1926, pages 162-163. An admirable summary of the rays has recently appeared as "Cosmic Rays," by C. S. Wright, *Nature* (London), volume 117, pages 54-56 (January 9, 1926).

† POPULAR RADIO for March, 1926, pages 278-279.

The original suggestion of Dr. Millikan was that the rays may originate in the collision and mutual capture of a positive atomic nucleus, or proton, and an electron. It is possible to calculate, on reasonable assumptions, the wavelength of the ether waves which would be produced by such an atomic catastrophe. This calculated wavelength agrees, reasonably well, with the wavelength of the observed cosmic rays.

The calculations of Drs. Hughes and Jauncey indicate, however, that a simple collision of a proton and an electron, setting free a cosmic ray in this manner, is extremely unlikely if not impossible.‡ It is much more probable, they conclude, that the atomic change responsible for the cosmic rays is either the collision of two electrons with one proton, one of the electrons being captured, or the formation of one atom of helium from four atoms of hydrogen. Possibly both of these reactions, as well as others, occur throughout space and produce rays differing slightly in wavelength but all belonging in this new and extremely short region.

Whatever may prove to be the fact as to this, it is probable that the investigation of these newly-discovered rays and of the atomic or other changes which produce them, will give us a powerful tool with which to learn something further of the reactions that are going on in what we used to think of as the dark and empty void between the tiny light-specks of the stars.

‡ "Radiation Arising from Mutual Annihilation of Protons and Electrons," by A. L. Hughes and G. E. M. Jauncey. *Nature* (London), volume 117, pages 193-194 (February 6, 1926). Two papers by these same investigators were to be presented before the meeting of the American Physical Society, at Montreal, Canada, on February 26, 1926; see page 13 of the advance program of the meeting, issued by the Society, February 13, 1926.

### More "Atomic Twins"

ONE of the most significant of the many discoveries which have been made in recent years in the field of atoms and electrons, is that of what are called isotopes, or, facetiously, "atomic twins."

These are atoms which behave alike, according to all the chemical tests and according to most physical ones, but which differ, nevertheless, in the essential property of mass.

Copper atoms, for example, are really of two different kinds. Both kinds look alike; they constitute the same familiar reddish metal. Both kinds dissolve in acid to make the usual bluish solutions. Both kinds behave alike to all chemical tests. Both will serve equally well in copper wire for electric uses. But one kind of the copper atom weighs 63 times as much as an atom of hydrogen, while the other kind weighs 65 times as much. They differ in mass.

They are the atomic twins of copper.

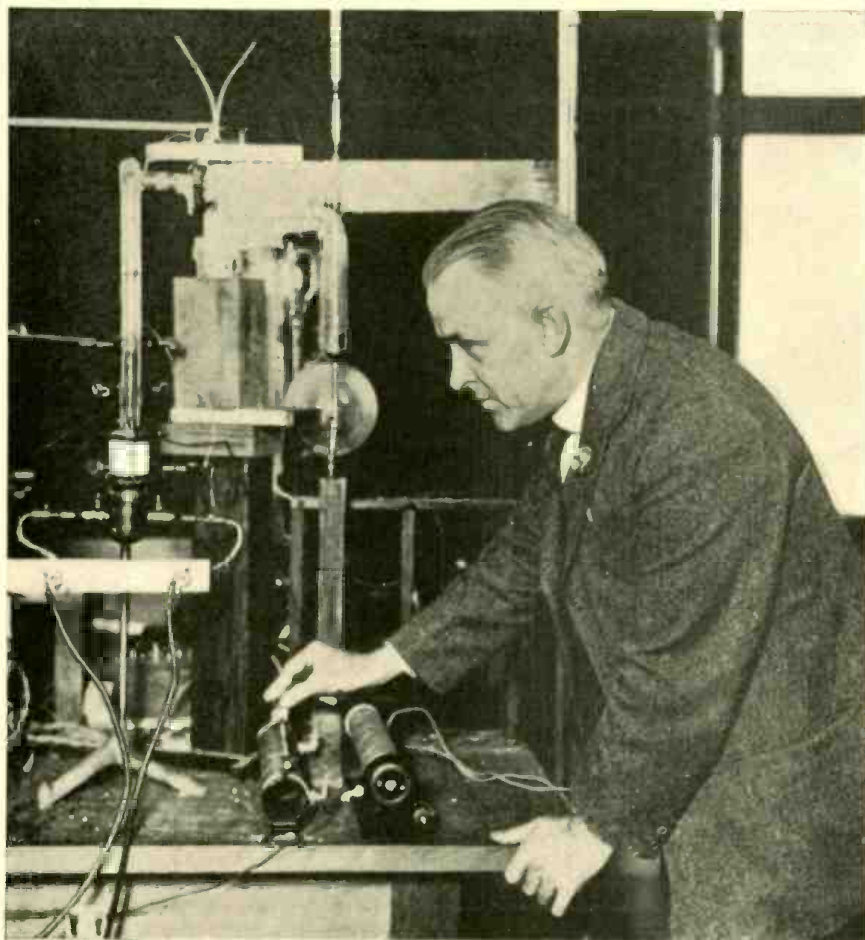

International

### THE MAN WHO DISCOVERED THE REMARKABLE COSMIC RAYS

Dr. R. A. Millikan, shown in his laboratory at Pasadena, is responsible not only for the discovery of the new ether waves from space, the shortest known to science, but also for having been the first to measure the electric charge of an electron.

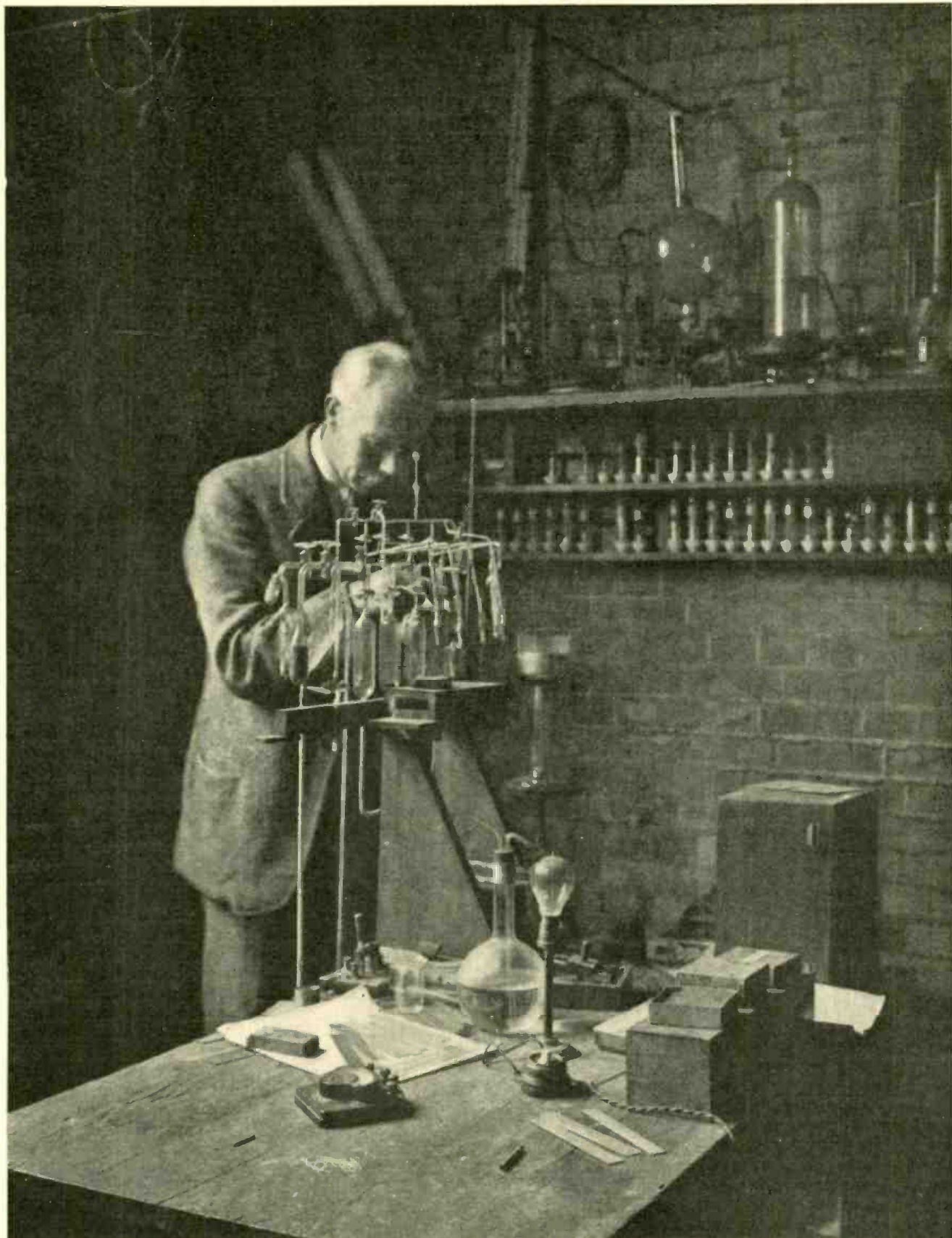

From a photograph made especially for POPULAR RADIO by W. H. Hayes

### Dr. F. W. Aston, Distinguished Physicist and Investigator of "Atomic Twins"

*The apparatus which Dr. Aston is using is that with which he investigated the twin atoms of neon, a very rare gas present in tiny proportion in the air, from which it is extracted and used to fill neon glow-lamps and some other kinds of electric lamps. There are two kinds of neon atoms. One weighs 20, the other, 22 times the weight of the hydrogen atom.*

All atoms are believed to consist, readers of this Department will remember, of a central nucleus about which a number of electrons revolve, much as the planets of our solar system revolve about our sun. The central nucleus is not, however, a mere inert lump of matter. It consists, we believe, of a number of electrons and of a different number of the positive electric particles, or protons. The numbers of each vary for different atoms; the simplest atom, that of hydrogen, having only one proton for its nucleus, while the extremely complicated atom of uranium possesses a nucleus composed, we believe, of at least 238 protons and about 150 electrons.

We know very little about how the protons and electrons are arranged in the more complicated atomic nuclei. If we did know this it might help us to understand some things which are still very mysterious; for example, the relations between matter and radiant energy.

When an element exists in twin forms, or isotopes, it is supposed that the nuclei of the twin types contain different numbers of protons and electrons.

For example, the metal lithium exists in two isotopes. One of these weighs six times as much as the hydrogen atom; the other weighs seven times as much. The first is supposed to contain six protons and three electrons; the second to contain seven protons and four electrons. Both, you observe, have a nuclear excess of three protons, so both are able to hold the same number, three, of the external or planetary electrons. It is these external electrons which encounter the outside world and which determine what we call the chemical properties of the atom. Accordingly both of the atomic twins of lithium look and act alike, just as human twins sometimes do. Only in their masses, or "atomic weights," do they show that they are unlike.

The chief accomplishments in the investigation of isotopes have fallen to the share of one man, Dr. F. W. Aston, of the Cavendish Physical Laboratory, Trinity College, Cambridge, England.\* His main method of study is to produce streams of ions of the element in question. An "ion," you remember, is an atom which has lost one (or more) of its planetary electrons and possesses, therefore, a positive electric charge. These ions are driven, by electric attraction, past the points of a powerful magnet or past a strong electric charge. Thus the ions are deflected, just as electrons are in a vacuum tube or in the cathode ray oscillograph. The amount of the deflection depends, however, on the weight of the ion as well as on the intensity of the magnetic or electric force which does

the deflecting. Accordingly, the mass of each ion can be measured. If the stream of ions divides into two or more streams, Dr. Aston knows that he has an atom which exists as twins, or triplets, or even as quadruplets.

Most of the known chemical elements have now been examined in this way or in one of the other ways used to detect isotopes. The isotopes which have been found are given in the following list, a list which is of great interest and value to the atomic theorists who are now attempting, so vigorously, to penetrate the mysterious nature of the atomic nucleus. The weights of the isotopes are given in the order of intensity with which they indicate their presence.

The really strange thing about this table is not that there are so many isotopes, but that there are so few. The chemical classification of the elements has room for 92 of them, these being distinguished, of course, by the number of the external, planetary electrons in each. Most of these might easily exist so far as we now know, in at least six or eight isotopic forms. Yet few of them do. Less than one-third of the 92 possible elements have been found to have isotopes. Nearly a third of the remainder (26 to be exact) are known not to exist in more than one atomic form.



Courtesy of the *Scientific American*

#### THE ELECTRIC TREE FARMER

Mr. Jose Gallegos, of Guatemala, succeeded in rejuvenating an ancient lime fruit tree by placing wire antennas on its branches.

Chemical Element	Number of Known Isotopes	Weights of the Isotopes (in terms of the hydrogen atom)
Lithium	2	7, 6
Boron	2	11, 10
Neon	2	20, 22
Magnesium	3	24, 25, 26
Silicon	3	28, 29, 30
Chlorine	2	35, 37
Argon	2	40, 36
Potassium	2	39, 41
Calcium	2	40, 44
Iron	2	56, 54
Nickel	2	58, 60
Copper	2	63, 65
Zinc	4	64, 66, 68, 70
Gallium	2	69, 71
Germanium	3	74, 72, 70
Selenium	6	80, 78, 76, 82, 77, 74
Bromine	2	79, 81
Krypton	6	84, 86, 82, 83, 80, 78
Rubidium	2	85, 87
Strontium	2	88, 86
Zirconium	4	90, 94, 92—96 (?)
Silver	2	107, 109
Cadmium	6	114, 112, 110, 113, 111, 116
Tin	8	120, 118, 116, 124, 119, 117, 122,—121 (?)
Antimony	2	121, 123
Tellurium	3	128, 130, 126
Xenon	9	129, 132, 131, 134, 136, 128, 130,—126 (?), 124 (?)
Cerium	2	140, 142
Neodymium	4	142, 144, 146—145 (?)
Mercury	6	202, 200, 199, 198, 201, 204

\* Dr. Aston's researches were published, mainly, in a series of papers in *The Philosophical Magazine* (London) between 1922 and 1925. The investigations up to 1924 are summarized in his book, "Isotopes," second edition, E. Arnold and Co., London, 1924, 187 pages. Some more recent determinations are given in "The Mass Spectra of the Chemical Elements, Part VI," the *Philosophical Magazine* (London), series 6, vol. 49, pages 1191-1201 (June, 1925). The most recent summary is "Atoms and X-Rays," by F. W. Aston, being extracts from his presidential address before the Röntgen Society (London), delivered November 3, 1925, published in *Nature* (London), vol. 116, pages 902-904 (December 19, 1925). POPULAR RADIO is indebted to Dr. Aston for kindly permitting the making of the special photographs which are reproduced here-with.

### Electric Waves as Tree Rejuvenators

It has been known for years to the plant scientists that electric currents, or frequent electric discharges in the nearby air, will sometimes increase the growth of living plants. Systems of "electroculture," so called, have been suggested and tried many times. Always, the exact facts have been uncertain, doubtless because the growth of a plant is an extremely complicated thing, almost as complicated as the growth of a human being. In most of the experiments, the surrounding conditions have been so imperfectly controlled that it has been possible to ascribe success or failure to something other than the electric relations.

In spite of these uncertainties, an experience described by Mr. Jose Gallegos, of Guatemala, is interesting.\* Mr. Gallegos possessed a lime-fruit tree which was old and no longer vigorous. Having made some previous experiments along the same line, Mr. Gallegos decided to discover what could be done for this tree by a dose of atmospheric

(Continued on page 74)

\* In a letter to *The Scientific American* (New York), volume 134, page 201 (March, 1926).

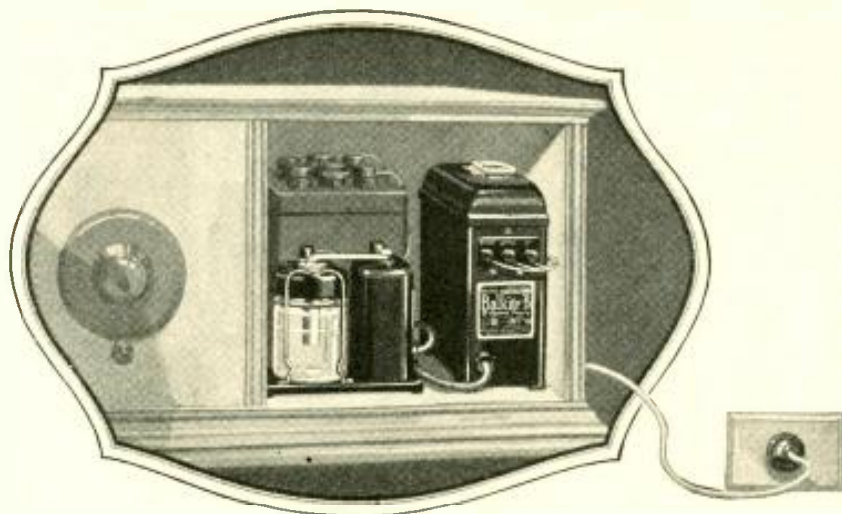

# Operate your present radio set from the light socket

*with Balkite "B" and a Balkite Trickle Charger*

The radio set you now own will operate from the light socket. No changes are necessary. You need only add Balkite "B" at \$35 and a Balkite Trickle Charger at \$10.

Balkite "B"—the noiseless "B" power supply—replaces your "B" batteries entirely and supplies plate current from the light socket. The Balkite Trickle Charger keeps your "A" battery always at full charge, also from the light socket. If you like you may also purchase from your dealer an automatic switch that cuts out the charger and turns on Balkite "B" when you turn on the set.

This type of installation is the last word in radio convenience and ease of operation. You never have to operate your set on a weak power supply or worry about replacing or recharging batteries. One turn of the switch and you have full, even power, exactly as required by the set. *And because you always have full power you secure a quality of reception possible in no other way.*

Both Balkite "B" and the Balkite Trickle Charger are entirely noiseless. Their first cost is the last. Both are permanent pieces of equipment with no bulbs, nothing to replace, break or get out of order. There is no further expense other than a negligible amount of household current.

Thousands of radio owners have already made this simple addition to their sets. You can make it too, and convert your set into a light socket receiver. *Ask your dealer.*

*Prices slightly higher West of Rockies and in Canada*

FANSTEEL  
**Balkite**  
*Radio Power Units*

MANUFACTURED BY FANSTEEL PRODUCTS COMPANY, INC., NORTH CHICAGO, ILLINOIS

Sole Licensees in the United Kingdom: Messrs. Radio

Accessories Ltd., 9-13 Hythe Rd., Willesden, London, N. W. 10

## How to Build the Improved Raytheon Power-pack

(Continued from page 25)

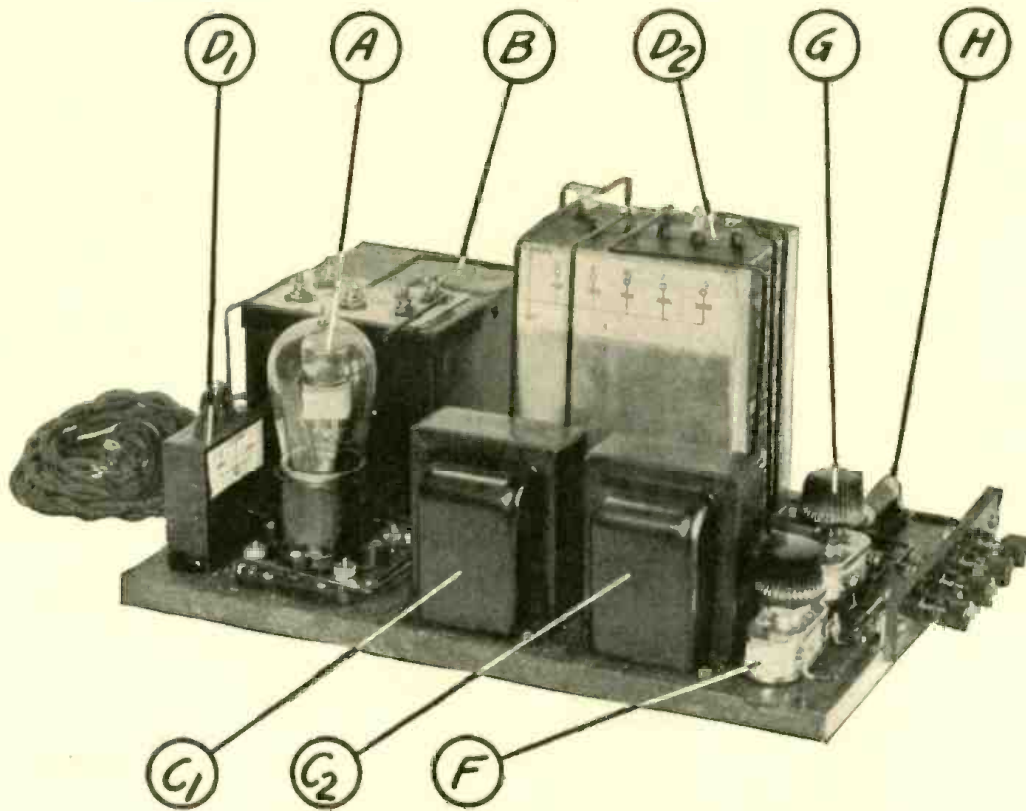

MODEL IV

FIGURE 10: Another variation of the improved "Power-pack" incorporating Thordarson transformer and chokes and the Dubilier condenser can. This model is very compact and employs the same circuit design as all of the other models.

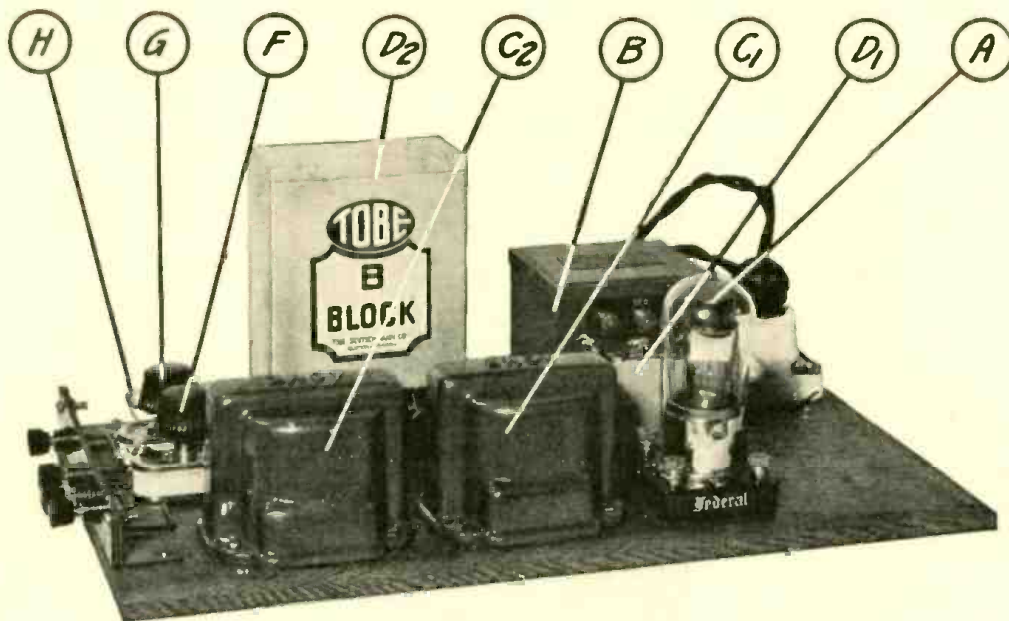

MODEL V

FIGURE 11: This laboratory model is built with the same makes of apparatus as were used in the original Raytheon plate-supply unit as described first in POPULAR RADIO for November, 1926. Experimenters who have the old unit may convert it into this new unit by substituting the condenser block for the old separate condensers. The unit uses the Acme transformer and chokes and the Tobe condensers.



## Contents of Acme B-Eliminator Kit

Wiring Diagrams with  
complete instructions

**Baseboard**

- 1 Acme B-4—Transformer
- 2 Acme B-2—30 Henry Chokes
- 1 Acme Condenser Block
- 1 Bradleyohm
- 1 Raytheon Tube and Socket Wire

**Price \$39.50**

Photo at right—Acme B-Eliminator, assembled from kit  
Photo below of factory-made Acme B-Eliminator  
Type E-1—110 Volts, 60 cycle

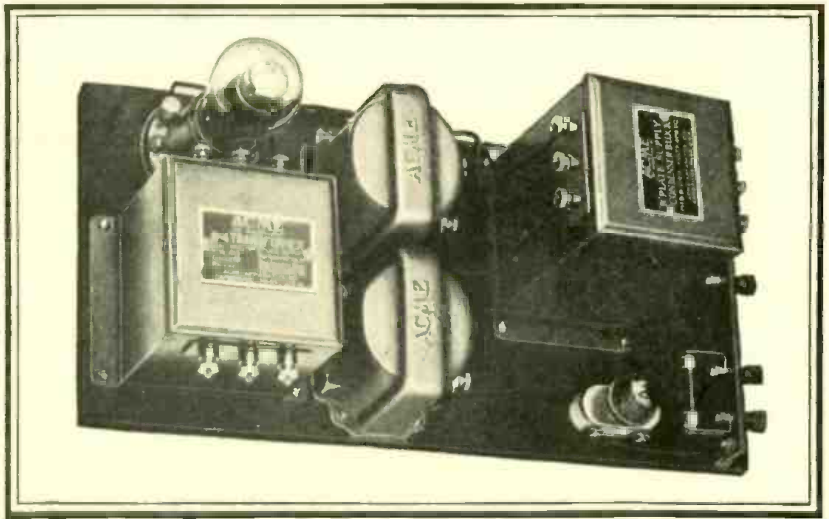

**Factory  
Made  
Price  
\$50.00**

# You can easily make this Acme B-Eliminator yourself

*The New Acme B-Eliminator Kit contains complete instructions and all the parts*

**G**ET tone of the new Acme B-Eliminator Kits—take it home and lay out the full size diagrams on the table in front of you. It only takes a few minutes to fasten the parts to the baseboard and connect them up. All the parts are there and the baseboard, too, and easily-followed instructions that explain each step. It's as easy as rolling off a log. You fellows who have tinkered with radio will do it in less time than it would take to tell about it.

Then you'll have an Acme B-Eliminator and save the difference between the cost of the Kit and a factory-built Acme B-Eliminator.

### Advantages of the Acme B-Eliminator

You get better quality and more distance, more volume, and *no hum* and *no distortion*. You can be sure of that. Also the Acme B-Eliminator maintains its voltage at all times and you get voltages up to 180 volts which prevents any chance of over-loading. It will supply sets using up to 10 tubes.

### A Permanent B-Supply

When you invest in an Acme B-Eliminator you get a permanent B-Supply. No more running out to get new B Batteries. There's nothing to wear out—the Raytheon Tube used has no filament to burn out and will last for thousands of hours—the current cost is practically nothing.

### Send Coupon for both Booklet and Circular

Send 10c. for our booklet, "Amplification without Distortion" which will tell you many things about improving the quality of your radio reception, together with special free circular on the B-Eliminator Kit, or ask us to mail the free circular. Check the coupon.

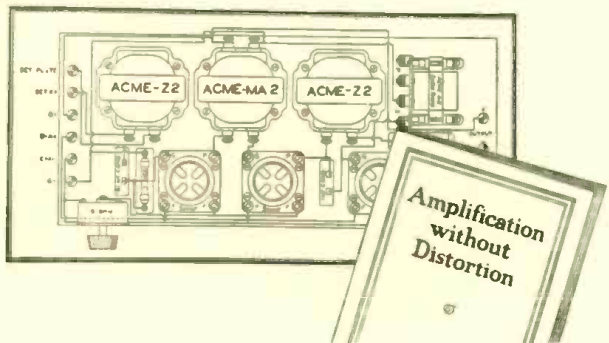

# ACME

*~ for amplification*

ACME APPARATUS COMPANY  
Dept. C-11, Cambridge, Mass.

- ( ) I enclose 10c. for copy of your booklet, "Amplification without Distortion" and circular on the B-Eliminator Kit.
- ( ) Please send only free circular on B-Eliminator Kit.

Name.....  
City.....  
Street..... State.....

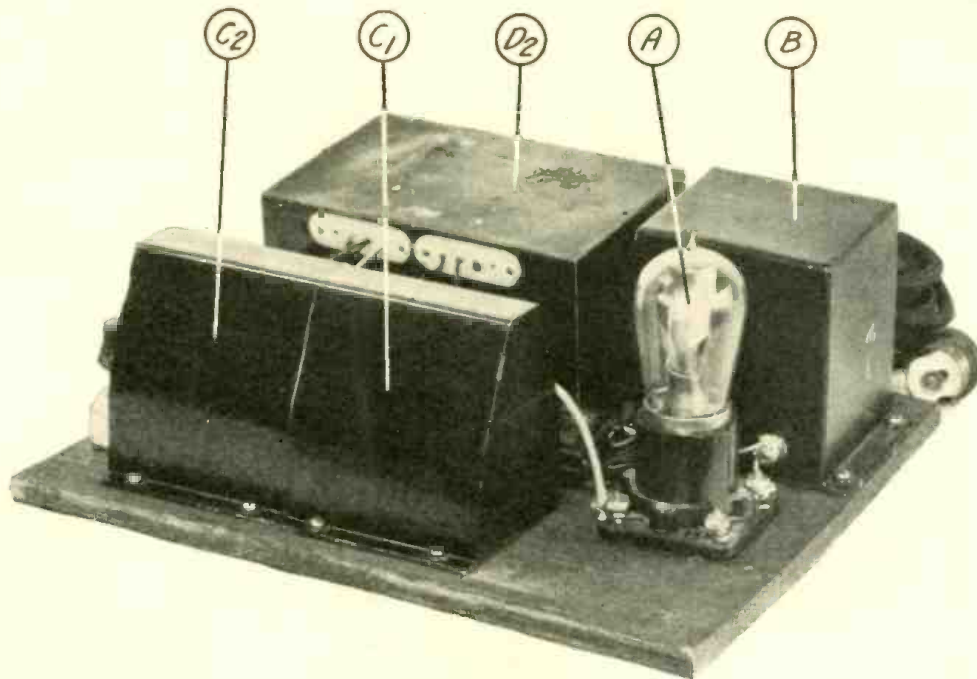

MODEL VI

FIGURE 12: Still another Raytheon "Power-pack." This unit gives another variation of the improved "Power-pack;" it uses the Precise transformer and chokes and the original Potter condenser can. A picture wiring diagram of this unit will appear in Part II.

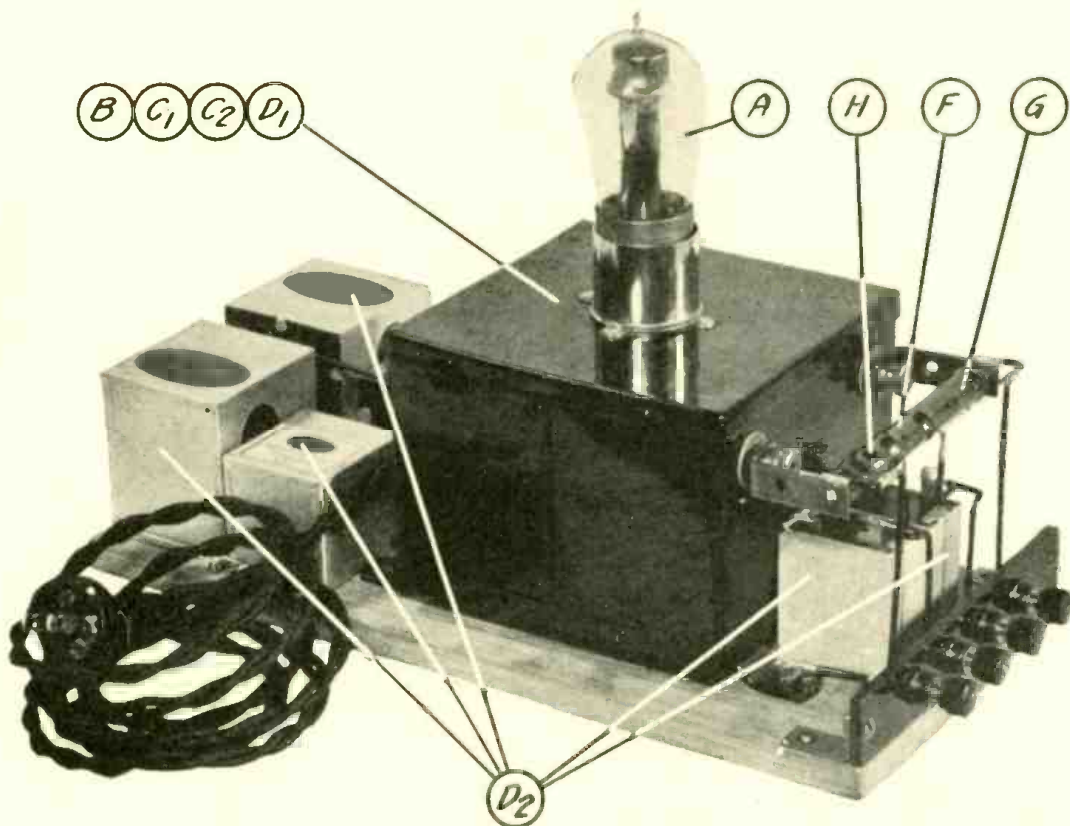

MODEL VII

FIGURE 13: In this laboratory model the Jefferson transformer and chokes, that are put out in a handy form with a tube socket mounted on top of the unit, are used in conjunction with separate condenser units, instead of the usual "can" arrangement. (See Part II of this article for the constructional data, to appear in POPULAR RADIO next month.)

# Send for this New Hookup

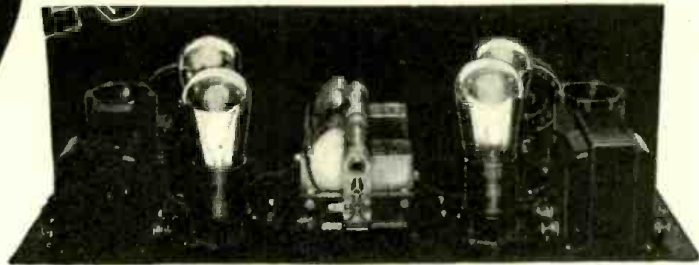

## The 4-Tube Single Control All Wave Receiver

Designed by Silver, Cockaday and the engineering staffs of the seven manufacturers listed below. . . . Sponsored by Popular Radio Magazine. . . . Endorsed and described by Radio News, Radio Engineering. . . . Radio. . . . On the Air Magazine. . . . Christian Science Monitor and Newspapers throughout the country. . . . The new S-C Receiver is presented to the Set-Builder with an astounding introduction that is his best assurance of a performance that will live up to promise. . . . An Introduction that compels attention and respect . . . that speaks volumes of praise . . . that has been accorded only to the S-C Receiver.

### NEW S-C FEATURES

Perfected single control—Unlimited wavelength range—Extraordinary volume equal to that of many 6-tube receivers—Quality unsurpassed—Hair-line selectivity that brought KFI through a blanket of local stations into New York City with ample loudspeaker volume. The S-C is adapted to any standard cabinets, tubes, batteries or eliminators, and to practically all installation conditions.

### ASSEMBLED EASILY

S-C assembly is a marvel of simplicity. A special, multi-color wiring harness eliminates soldering, unless desired, and prevents error. With only a screw driver and a pair of pliers, even an absolute novice can assemble the S-C with perfect success in a few hours.

### S-C Merchandising Co.

64 E. Jackson Blvd.  
Chicago

### GET THIS BOOK

from your dealer or mail  
the coupon today!

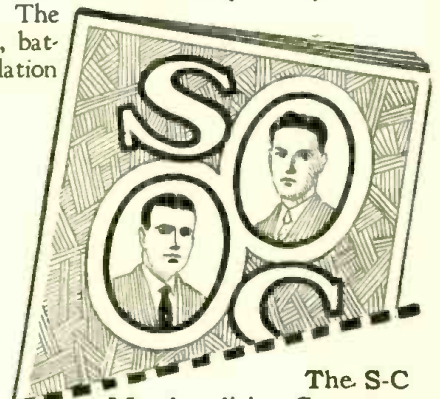

The S-C  
Merchandising Company  
64 E. Jackson Blvd., Chicago

Gentlemen: Please find enclosed 25c, for which send me hand book of the new S-C Receiver.

No choicer group of radio products has ever been embodied in a single radio receiver. Not only are these manufacturers nationally known and accepted as the leaders in radio design and construction, but they have developed for the S-C receiver many new features which will create a new standard in reception throughout the radio world.

#### Represented Manufacturers:

Belden Mfg. Co.  
S-C Wiring Harness

Central Radio Laboratories  
Centralab Resistance

Polymet Mfg. Corporation  
Fixed Condensers, Leak  
and Leak Clips

Silver-Marshall, Inc.  
Variable Condensers, Coil  
Sockets, Coils, Tube Sockets,  
Vernier Dial, Mounting  
Brackets

Thordarson Electric Mfg. Co.  
Equipformer Audio  
Transformers

Poster & Co.  
Drilled and Processed Front  
Panel and Drilled Sub-Panel

Yaxley Mfg. Co.  
Rheostat, Jacks, Switch

NAME \_\_\_\_\_

ADDRESS \_\_\_\_\_

# Mayolian "B" SUPPLY

"The 'B' Without a Buzz"

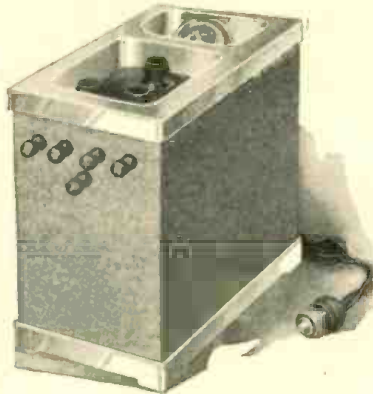

## Highest "B" Voltage Output

Mayolian produces a "B" voltage up to 180, insuring great volume, sharp selectivity and distortionless amplification.

The detector voltage is variable from 0 to 60 volts; the radio frequency or medium voltage is variable from 40 to 110 volts.

### Raytheon Rectifier

No filament tubes, chemicals or liquids of any kind are used in the Mayolian. As a full wave rectifier, it employs the Raytheon long life rectifier, the life and efficiency of which is practically indefinite.

### Guaranteed

Mayolian is backed by the established reputation of the Mayolian Radio Corporation and is absolutely guaranteed

Type 609—\$55      Type 607—\$25  
 Alternating current, 110 volts, 60 cycles, complete with tube.      Direct current, 110 volts.

Yes—Mayolian costs more than other "B" eliminators, but—it does more.

Mayolian Transformers, Chokes and Resistances	
for Building Raytheon Plate Supply	
Transformer No. 201	List pr. \$7.00
Chokes No. 202	" " 5.00
Resistances	
Types 5 and 7	" " 1.80
Raytheon Tubes	" " 6.00
Mayolian resistances and other products are the result of years of experience in "B" Battery elimination and especially designed for "B" supply units.	

If your dealer cannot supply you, send us your order direct.  
 Regular discounts to jobbers and dealers.  
 Write for the Mayolian circular.

# Mayolian "B" SUPPLY

MAYOLIAN  
 RADIO CORPORATION  
 1991 Broadway      New York City

# WITH THE INVENTORS



CONDUCTED BY WILLIAM G. H. FINCH

This department will keep you in touch with the latest inventions of interest on which patent rights have been granted, and which are significant contributions to radio art.

## A Novel Mounting for Radio Apparatus

PATENT No. 1,567,562 was issued to Harold H. Young and E. A. Ryder of Keyport, N. J., for a common support which is designed to accommodate a number of radio instruments or parts.

An inspection of Figure 1 shows how a number of variable condensers and vacuum tube sockets are assembled in this invention into a common unit, in this way affording an improved method for the manufacture of receivers.

## A Novel System of Radio-Frequency Amplification

SAMUEL COHEN of Brooklyn, New York, was recently granted patent No. 1,560,292 for the radio-frequency amplifier system which is illustrated in Figure 2.

This invention aims to provide a system of radio-frequency amplification, for the reception of high-frequency signaling currents, which will give both straight and regenerative amplification without distorting the signals received.

Another feature of the invention is a provision for a combined direct-amplifying electron tube system and regenerative-amplifying electron tube system which is associated with a detector circuit. The amount of regenerative amplification in these combined systems may be controlled so that undesired reaction with other electron tube cir-

cuits in the system may be prevented.

In addition, the invention provides for a regenerative compensator which may be connected in the stage of the radio-frequency amplifier which immediately precedes the detector circuit and which is so constructed that a large amplitude of radio-frequency energy is secured. This may be impressed upon the input circuit of the detector for operating a responsive device.

Finally, this invention provides for a coupling system which is interposed between the radio-frequency amplification system and the detector system and which is constructed so that the energy in the detector circuit is increased by regenerative action. Means are also provided here to prevent regenerative effects in the amplification stages which precede the coupling system and to allow regeneration, below the point of oscillation, in the coupling system. This is done so that the received signal energy may be impressed at large amplitude upon the detector.

Proposals have been made to regulate regeneration in a radio-frequency amplifier by means of a potentiometer shunted across the filament circuit of the amplifier and connected to the grid electrode of the several tubes of the system from a variable contact member upon the potentiometer.

By means of this method, regeneration may be stopped when the grids of the amplifier tubes are maintained at a positive potential. This method of

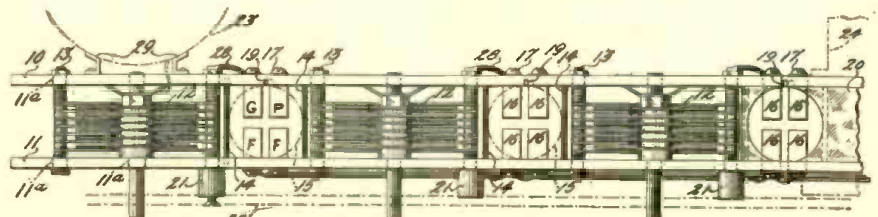

A NOVEL COMBINATION MOUNTING

FIGURE 1: The general arrangement of the mounting device for a radio-frequency amplifier in which the condensers, sockets and coils may be fastened on a single unit which may be installed easily in any receiver.



## Pioneers—Now Leaders

**S**INCE B-Eliminators first attracted the eager experimenters Dongan has pioneered in the building of transformers and chokes. Our 15 years experience in the production of transformers gave us a big impetus. Our forward-looking engineers told us B-Eliminators would predominate eventually.

### TRANSFORMERS

*Manufactured for 25, 40, 50, and 60 cycles*

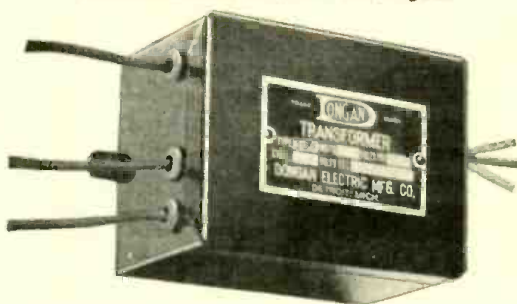

- 509 Full Wave For Raytheon Tubes.
- 537 Full Wave For R. C. A. UX 213 Tubes.
- 537 Full Wave For Cunningham CX 313 Tubes.
- 538 Half Wave For R. C. A. UX 216-B Tubes.
- 538 Half Wave For Cunningham CX 316-B Tubes.
- 561 For R. C. A. UX 216-B Tubes, or
- 561 For Cunningham CX 316 Tubes.

To be used with Power Amplifier Units.

(\$7.00 List)

### CHOKES

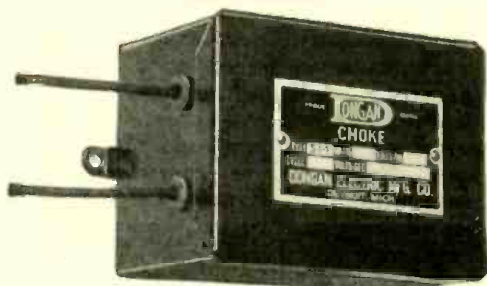

514-20 Henry—\$5.00 List

(Our specification of 539 Output Choke is adapted for bridging across loud speaker.)

Raytheon Tubes—\$6.00 List

### Fans—

**Build Your Own B-Eliminators!** You can do it easily with Dongan B-Power Units—simply constructed and inexpensive. You'll be happily surprised at the wonderful results you'll get with your set.

*If Your Dealer Cannot Supply You Send Money Order Direct*

## Dongan Electric Manufacturing Co.

2983-3001 Franklin Street, Detroit, Mich.

*Transformers of Merit for 15 Years*

Dongan has worked with Raytheon in the perfection of Raytheon B-Eliminators. Dongan B-Power Units are one of the most important factors in the operation and performance of Raytheon B-Eliminators, and were used by Laurence M. Cockaday in his laboratory model. Today we are supplying the leading manufacturers of Eliminators with Dongan B-Power Units. No matter what type you build we can supply you—mounted or unmounted types.

## Set Manufacturers Planning 1926 Production

**AUDIO TRANSFORMERS** of Dongan design have been standard equipment in leading sets for three years. When designing your new sets for the 1926 season take advantage of our new, improved audio transformer. Arrange for sample orders.



# ELECTRAD

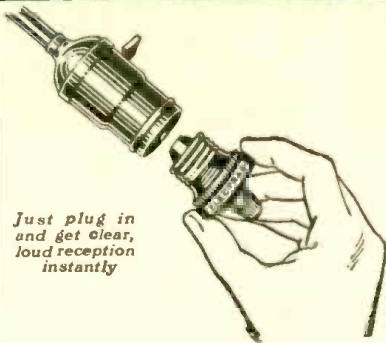

Just plug in and get clear, loud reception instantly

## Minimizes Static and Interference — Ends Summer Worries

HERE is the quick, easy way to good summer reception—the

### ELECTRAD LAMP SOCKET ANTENNA

Just screw it into any lamp socket or outlet in the house, and you have loud, clear reception, with a minimum of static and of interference from neighboring sets.

The Electrad Lamp Socket Antenna helps you get distance. It does away with all lightning worry. Uses no current. No danger.

Every one tested and certified electrically. U.S. price 75c, Canada \$1.10, at good radio stores and counters. For safety's sake insist on Electrad.

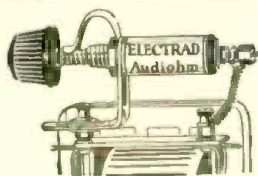

## For Clearer, Purer Reception, Do This

Place an ELECTRAD AUDIOHM across the secondary of your audio-transformer. Then you will enjoy your radio. Kills distortion, eliminates squeals and howls. Fits all audio-transformers. Easy to attach. For sale at all good radio stores and counters. U.S. \$1.50, Canada \$2.10.

For perfect control of tone and volume use the ELECTRAD 500,000-ohm Compensator.

For free hook-up write 428 Broadway, N. Y. City



# ELECTRAD Inc.

New York City

control, however, is not an efficient one as distortion of the signaling energy is introduced, and the amplification is considerably reduced.

With the regenerator compensator method, which is employed in this invention, these disadvantages are overcome as the grid electrodes are maintained at all times at a negative potential.

The amount of regeneration is controlled by the amount of counter E.M.F. which is introduced into the circuit, the amplitude of which may be equal to or greater than the regenerative E.M.F. In all cases it can be made equal but opposite in phase to the regenerative E.M.F.

By the arrangement of the regenerative compensator, which is employed, the sensitivity of the system is greatly increased. The regenerative action of a tube is employed at such an adjustment that it operates in a way that prevents distortion in the system.

To secure this result, the amplifying tube next to the detector tube should be allowed to operate in a state of regeneration.

At the same time means are provided for preventing regeneration by self-excitation in the tube circuits which immediately precede the regenerative compensator.

By the use of a variable capacity of a special character, which is connected with an independent winding which forms a part of the primary circuit of the inter-valve coupling transformer, the amount of regeneration may be controlled as desired. The grid electrode of the tube in the regenerator coupling circuit is maintained permanently at a negative potential.

The regenerative compensator consists of two parallel electrodes or plates whose capacity is equal to approximately five times the grid-plate capacity. A movable member or electrode is placed within the center of the parallel plates. This movable plate has an area slightly larger than the area of the parallel plates. When the entire area of the

movable plate is in the electrostatic field of the parallel plates, the electrostatic capacity between the parallel plates is reduced to a minimum by means of the circuit arrangement.

The regenerative action is obtained in the stage of amplification immediately preceding the detector. The output circuit of this tube contains a pair of coils which form the primary winding of the coupling transformer. These two coils have the same number of turns but they are wound in opposite directions.

The amount of regeneration in the circuit is controlled by the magnitude of the counter E.M.F. which is introduced into the circuit; and this is adjustable over a wide range by means of the special condenser and one of the coupling inductances.

The antenna, 1, is connected with ground system, 2, by the primary winding, 3, of the tuning transformer. The secondary winding, 5, is inductively related to the primary winding, 3; and it is tuned by the variable condenser, 6, to the frequency of the signals which it is desired to receive.

The first stage of radio-frequency amplification includes the electron tube, 7, which contains the filament electrode, 8, the grid electrode, 9, and the plate electrode 10. The input circuit of the tube across the grid electrode, 9, and the filament electrode, 8, is connected with the tuned circuit, 5 and 6. The output circuit of the tube, 7, includes the primary winding, 11, of the radio-frequency coupling transformer, 15, with one end of the winding, 11, connected to a source of "B" battery potential which is represented at 14.

The secondary winding, 16, of the coupling transformer, 15, is tuned by the variable condenser, 17, and is connected to the input circuit of the electron tube, 18, to form the second stage of radio-frequency amplification. The output circuit of the tube, 18, includes the primary winding, 19, of the coupling transformer, 20, and the source of "B" battery potential, 14. These tubes, 7 and 18, are connected in such

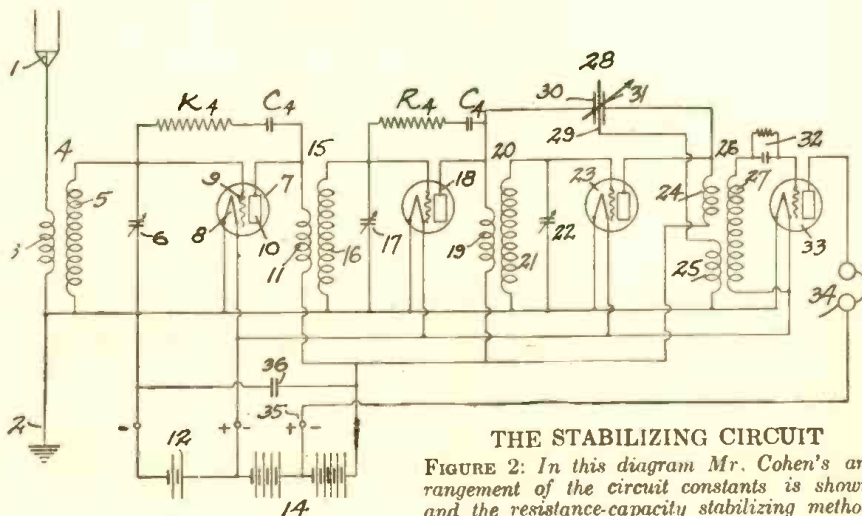

THE STABILIZING CIRCUIT

FIGURE 2: In this diagram Mr. Cohen's arrangement of the circuit constants is shown and the resistance-capacity stabilizing method which he employs.

# Cardwell

## Acclaimed!

By Every prominent engineer who has seen them, Taper Plate Type E Condensers represent the foremost step in condenser design since the original low-loss metal endplate, first made by Cardwell five years ago.

CLAYTON—Cockaday—Lynch—Best—Wing—Neely—the list of those who specify Taper Plate Cardwells reads like a roster of the greatest Technical Editors of Radio.

The Taper Plate Type E Receiving Condenser is designed to be practical rather than theoretically perfect. Its tuning characteristic is straight frequency over the lower part of the scale, tapering to approach straight wave-length at the top. Full size plates, far heavier than ever used before, assure positively permanent calibration.

The Type C approaches straight frequency on the very low portion of the scale only, changing to a modified straight wavelength as capacity is increased.

Type "C"	Type "E"	Capacity (Mmfda)	Price
168-C	167-E	150	\$4.00
170-C	168-E	250	4.25
171-C	169-E	350	4.75
172-C	192-E	500	5.00

The Allen D. Cardwell Mfg. Corp.  
81 PROSPECT STREET, BROOKLYN, N. Y.

5c. in stamps brings this booklet on the Best Super-Heterodyne.

If your dealer can't supply you, order direct. Write for illustrated catalogue and handbook.

5c. in stamps brings this booklet on the Best Super-Heterodyne.

If your dealer can't supply you, order direct. Write for illustrated catalogue and handbook.

The Type "C" has a modified straight wavelength tuning curve

The Taper Plate Type "E" with straight frequency tuning characteristics

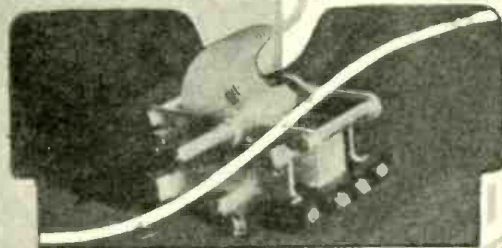
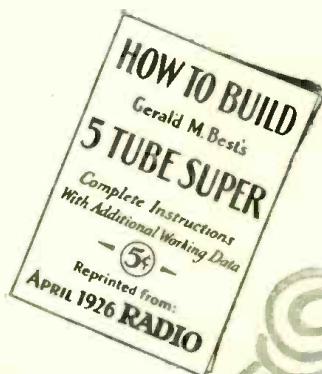

# Condensers

"THE STANDARD OF COMPARISON"

# Save Your Set from Lightning

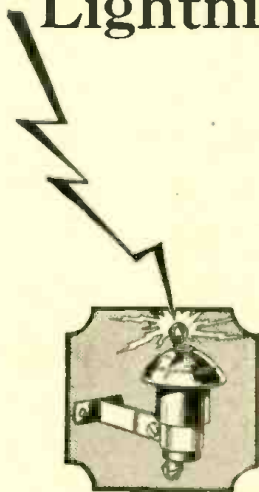

**YOU** never know what lightning will do and any radio set which is without the protection of a lightning arrester is at the mercy of a storm.

The National Board of Fire Underwriters specify that an approved Radio Lightning Arrester must be used with all out-door aerial installations.

Protection is easy. Insure your insurance and save your set with a **WIRT LIGHTNING ARRESTER** (listed as standard by the Underwriters' Laboratories). The cost is a trifle.

**THE WIRT LIGHTNING ARRESTER** is an approved air gap type, made of bakelite giving ample insulation, with brass terminals moulded in bakelite, far enough apart so that there is no leakage. A "petticoat" of bakelite shields the arrester from water and dust. Handsome and rigid. Lasts a lifetime. Easy to install. Full directions on box.

Don't wait for a warning from the elements—it may be too late then. Install the **WIRT LIGHTNING ARRESTER**—now.

When you install your **WIRT LIGHTNING ARRESTER**, get a **WIRT INSULATOR** and prevent leakage along your lead-in wire. It keeps the wire at the proper distance, provides perfect insulation, and prevents wear and tear on the wire by preventing sagging and swaying.



The Wirt Lightning Arrester is listed as standard by the Underwriters' Laboratories.

**Wirt Lightning Arrester . \$1.00**  
**Wirt Insulator . . . . . .35**

**SOLD BY LEADING RADIO DEALERS**

**WIRT COMPANY**  
PHILADELPHIA PENNSYLVANIA  
Makers of Dim-A-Lite

a manner that the tendency of the tubes to oscillate or regenerate is annulled.

The resistances and capacities, R4 and C4, are electrically related to the inherent tube capacities for shifting the phase of interfering currents with respect to the phase of the signaling currents.

Regeneration in the tube circuit, 23, is controlled by means of the regenerator compensator, 28, which comprises the parallel electrodes or plates, 30 and 31, between which the movable member or electrode, 29, is positioned in such manner that the special relation with plates, 31 or 30, may be regulated at will.

A radio-frequency coupling transformer, 26, is connected in the output circuit of the tube, 23. This coupling transformer includes a pair of primary windings, 24 and 25, each having the same number of turns but wound in opposite directions. Each of the primary windings, 24 and 25, are cumulatively coupled with the secondary winding, 27, which connects through the grid-leak and the grid condenser, 32, to the input circuit of the detector tube, 33.

The responsive device, 34, is operated in the output circuit of the detector tube, 33, and the tap connection, 35, which is taken from the "B" battery, 14.

The filaments of all of the tubes are heated from the battery, 12, while a by-pass condenser, 36, is shunted across batteries 12 and 14.

Referring more particularly to the regenerator compensator, 28, the primary winding, 25, is connected with the movable plate or electrode, 29. The fixed plate, 31, is connected with a point in the opposite circuit of the tube, 23, at one end of the oppositely wound primary coil, 24.

The fixed plate or electrode, 30, is connected indirectly with the opposite end of the primary winding, 24, through the primary winding, 19, of the coupling transformer, 20, in the output circuit of the preceding stage of radio-frequency amplification which is formed in circuit with the tube, 18. The plate, 29, has a larger area than the other plates, 20 and 31.

The regenerator compensator is so proportioned that the tube, 23, will operate at maximum efficiency in a condition of regenerative amplification for increasing the amplitude of the received energy for the detector tube, 33.

While this invention, in the description, is applied to a three-stage radio-frequency amplifier it is evident that it is applicable to many modifications of multi-stage amplifier circuits.

**Jim:** "Do you know how to eliminate static?"

**Bill:** "No."

**Jim:** Turn off your radio.

**FREE!**  
To Each Purchaser of a **WORLD 6 V. Auto or Radio BATTERY**

12-Cell—24 Volt Storage 'B' Battery  
Positively given free with each purchase of a **WORLD "A" Storage Battery**. You must send this ad. with your order. **WORLD Batteries** are famous for their guaranteed quality and service. Backed by years of successful manufacture and thousands of satisfied users. Equipped with **Solid Rubber Case**, an insurance against acid and leakage. You save 50 per cent and get a **2-Year Guarantee Bond in Writing**.

**WORLD Battery owners "tell their friends." That's our best word of performance. Send your order in today.**

**Solid Rubber Case Radio Batteries**  
6-Volt, 100-Amperes . . . \$11.25  
6-Volt, 120-Amperes . . . 13.25  
6-Volt, 140-Amperes . . . 14.00

**Solid Rubber Case Auto Batteries**  
6-Volt, 11-Plate . . . \$11.25  
6-Volt, 13-Plate . . . 13.25  
12-Volt, 7-Plate . . . 16.00

**SEND NO MONEY** wanted and we will ship day order is received, by Express C. O. D., subject to your examination on arrival. **FREE "B" Battery** included. Extra Offer: 5 per cent discount for cash in full with order. Buy now and get a guaranteed battery at 50 per cent saving to you.

**Approved and Listed as Standard by Leading Authorities**

including Radio News Laboratories; Popular Science Institute of Standards; Popular Radio Laboratories; Radio Broadcast Laboratories; Radio in the Home; and Lefax, Inc.

**WORLD BATTERY COMPANY**  
1219 So. Wabash Ave. Dept. 3 CHICAGO, ILL.

**World** For **AUTO and RADIO**  
**STORAGE BATTERIES**

**This Catalog Guarantees You Savings of 10 to 25%**

**New 1926 Edition**  
The Barawik Company, pioneers in radio, now offers you through its Radio Catalog and Guide, greater bargains than ever before in standard sets, parts, kits and supplies. No matter what parts you want, for whatever circuit or hook-up you may prefer, we can supply them to you at substantial savings. Special prices on tubes, batteries, cone speakers cabinets, etc.

**BARAWIK'S NEW 1926 RADIO GUIDE**

**Take Advantage of These Bargains**  
Complete parts for 8-C Receiver . . . \$55.00  
" " " LC 28 . . . 54.50  
" " " Hammarlund-Roberts . . . 47.95  
" " " McLaughlin 8-tube Super . . . 82.50  
" " " Silver Six . . . 46.50  
" " " Silver Autodyne . . . 58.50  
" " " Browning-Drake circuit . . . 34.50  
Guaranteed 201A type tubes . . . 98  
45 V large B batteries . . . 2.35

If you are in the market for any of the above, order direct from this ad, enclosing remittance and goods will be shipped you at once. All merchandise guaranteed.

Write today for our New 1926 Radio Catalog and Builders Guide, showing radio's newest creations. Also please include name of another radio fan when writing.

Send me my copy of your new Radio Catalog and Builder's Guide.

Name . . . . .  
Address . . . . .  
Friend . . . . .  
Address . . . . .

**The Barawik Co.**  
102-104 SO. CANAL ST., CHICAGO, ILL.



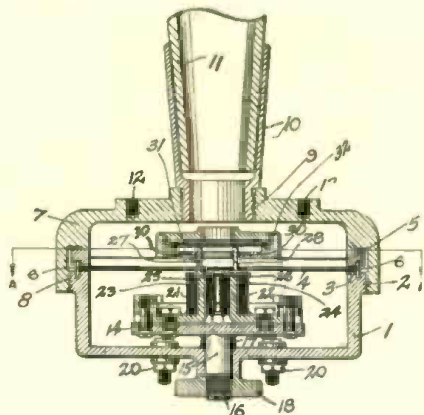

FIGURE 3: A cut-away view of the new loudspeaker unit with multiple diaphragms.

### A New Multi-Diaphragm Loudspeaker

An improved type of loudspeaker is described in patent No. 1,566,928 which was issued to M. C. Rypinski. The details of its construction are shown in Figures 3 and 4.

This invention relates to a particular type of electromagnetic loudspeaker for use in radio reception. Its purpose is

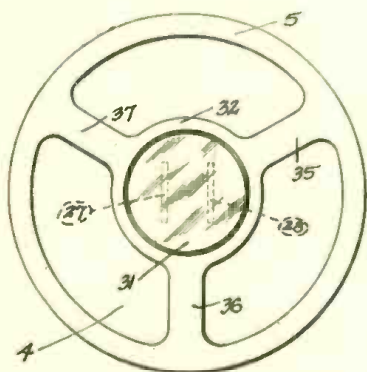
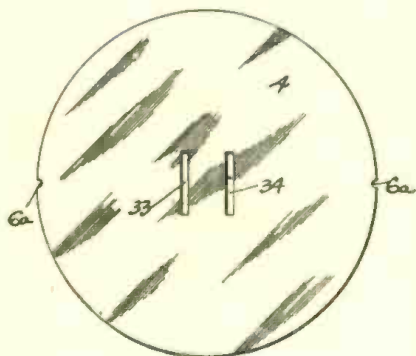
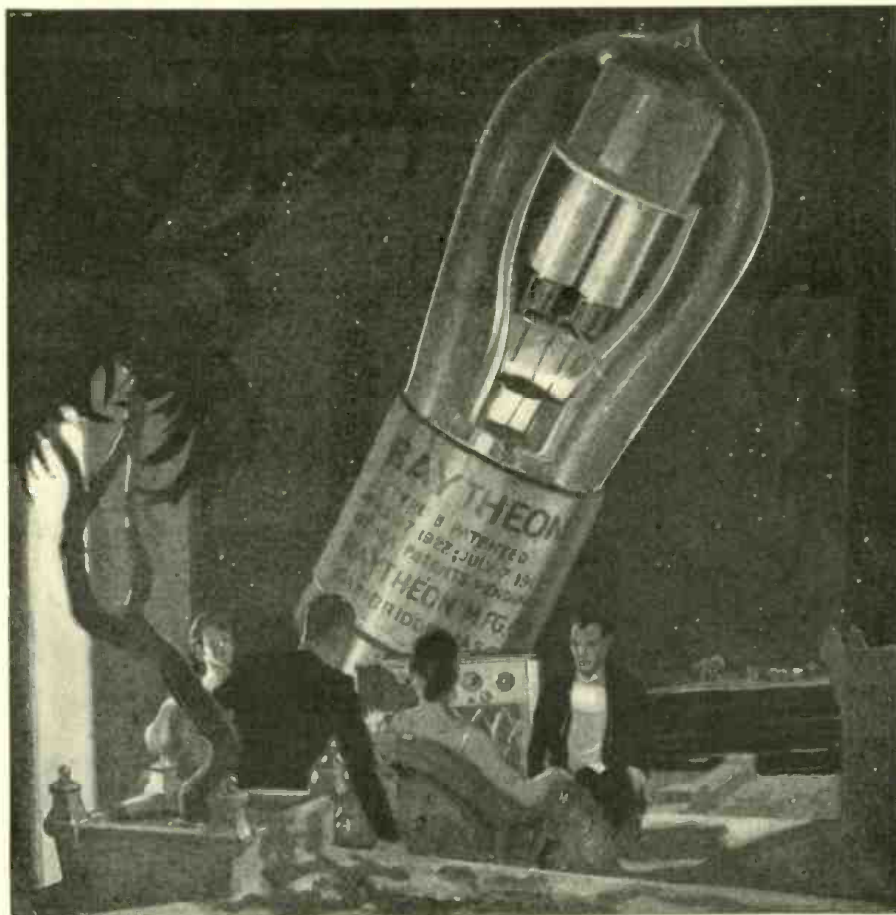

FIGURE 4: These two drawings show the details of the multiple discs which are used as diaphragms.

to provide a loudspeaker which is constructed so that the tone quality of the reproduced sound is greatly improved over that given by most loudspeakers.

In addition the invention aims to provide a construction of loudspeaker which has a plurality of concentrically positioned diaphragms of differing natural periods which are operated simultaneously from the same electromagnetic operating mechanism in order to reproduce sound efficiently over a broad range of tone frequencies.



# RAYTHEON

*The tube that perfects the B eliminator*

RAYTHEON is more than the name of a new type rectifier. It is the symbol of a research laboratory, the mark of an organization of engineers. Radio manufacturers, radio editors and radio dealers appreciate the value of *Full Wave Rectification, No Filament, No Chemicals, Ample Voltage and a Sixty Milliampere output*. Price six dollars.

RAYTHEON B eliminators or specially designed parts for home-built units are made and sold by these and other well-known manufacturers:

- Acme Apparatus Co.
- All-American Radio Corp.
- Dongan Electric Mfg. Co.
- General Radio Co.
- Jefferson Electric Mfg. Co.

- Mayolian Radio Corp.
- Modern Electric Mfg. Co.
- Thordarson Electric Mfg. Co.
- Tobe Deutschmann Co.
- Webster Co.

**RAYTHEON MANUFACTURING COMPANY**

Cambridge, Massachusetts

## A Radio Cabinet of Beauty and Elegance Direct to You at Lowest Cost

Lid splined both ends to prevent warping.  
Nicked piano hinge—Full length.  
Nicked lid support of artistic design.  
Anti-vibration cushion feet (not visible in cut).  
Edges of lid moulded to match bottom.  
Shipped securely packed in strong carton.  
Prompt shipment. Big stock ready.

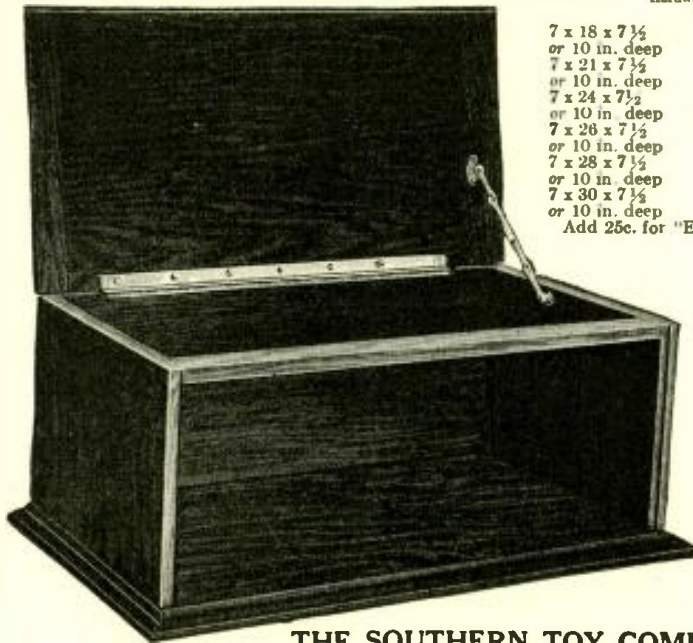

	Hardwood, Rubbed Mahogany Finish	Solid Black American Walnut
7 x 18 x 7 1/2 or 10 in. deep	\$3.50	\$5.00
7 x 21 x 7 1/2 or 10 in. deep	3.75	5.25
7 x 24 x 7 1/2 or 10 in. deep	4.00	5.50
7 x 26 x 7 1/2 or 10 in. deep	4.75	6.25
7 x 28 x 7 1/2 or 10 in. deep	5.50	7.00
7 x 30 x 7 1/2 or 10 in. deep	6.00	8.00

Add 25c. for "E-Z" Fone plug.

CASH WITH ORDER or C. O. D. if 1/4 of price is sent with order.

Prices F. O. B. Hickory, N. C. Order express shipment, often cheaper than mail and much safer from damage.

FREE WITH EACH CABINET a glued-up stock non-warping 1/2-inch BASEBOARD.

Free Catalogue.

THE SOUTHERN TOY COMPANY, INC.  
Dept. N. HICKORY, NORTH CAROLINA

## Does the Aurora Borealis Affect Radio Reception?

(Continued from page 14)

at least minimized. We must now study, apparently, a whole new source of possible radio disturbance.

It is not probable, the scientists tell us, that the Aurora Borealis is itself directly responsible for the radio difficulties. More probably both the Aurora itself and the radio troubles are parallel effects of some still greater cause, possibly a cause located in the sun. The luminous discharges which compose the banners and streamers of the Aurora are believed to be of electrical nature. They occur very high up in the atmosphere, perhaps as much as three hundred miles above the earth's surface. At that altitude the air is so thin that it is scarcely more than a perfect vacuum. It is probably much less dense, indeed, than the vacuum inside the most highly evacuated of the radio tubes. Obviously, nothing of the nature of flame or luminosity by heat could occur in an atmosphere so extremely tenuous as this. A much closer parallel to the kind of excitation which produces the Aurora light is to be found, doubtless, in the luminosity created by an electric current inside the very small residual gas in a vacuum tube.

The ultimate source of this electrical excitation which causes the Aurora is unknown. Quite possibly the phenomenon is due to streams of electrons arriving from the sun. On the other hand, it may be due to some form of electric-magnetic waves from the sun or to some interaction between solar electric forces and the electric charges and magnetic field of the earth. It is observed that the magnetic disturbances which affect telegraph lines tend to be most frequent and most violent at times of many sunspots.

During December and January, when the magnetic and radio disturbances were at their worst, the astronomers report also the presence of several unusually large spots on the sun. Sunspots are known to involve vast magnetic and electric disturbances in the sun's atmosphere. Just how these disturbances affect the earth and produce the Aurora is something upon which the scientific experts do not seem to have reached complete agreement.

That such electromagnetic disturbances would be likely to affect radio transmission follows from the newer theories of the propagation of radio waves. We used to think of radio waves as travelling through the empty ether, being unaffected by any material substance unless that substance happened to be a conducting wire. We now know that this simple picture of radio propagation is not an adequate one. The upper levels of the earth's atmosphere contain a vast number of electric particles in the form of ions and free elec-

## MORE PROFITS for the PROFESSIONAL SET BUILDER

WE have an unusually interesting proposition to make to the man who is now building (or has the ability to build) radio receiving sets for resale.

This is a real opportunity. Write to-day for full information.

Gearhart-Schlueter Radio Corp.

714 Voorman Ave.  
Fresno, California

SEE THAT SCREW



A screw driver adjusts an X-L in crowded places.

X-L

VARIODENSER

Results in easier tuning, more distance, volume and clarity—greater stability.

Indorsed by leading radio authorities

**Model "N"** A slight turn obtains correct tube oscillation on all tuned radio frequency circuits. Neutrodyne, Roberts two tube Brown-ing-Drake, McMurdo Silver's Knock-out, etc., capacity range 1/8 to 20 micro-micro farads. Price \$1.00.

**Model "G"** with grid clips obtains the proper grid capacity on Cockaday circuits, filter and intermediate frequency tuning in heterodyne and positive grid bias in all sets. Capacity range .00016 to .00055 and .0003 to .001 micro farads. Price \$1.50.

X-L PUSH POST

Push it down with your thumb, insert wire, remove pressure and wire is firmly held. Releases instantly. Price 15c.

X-L Radio Laboratories  
2422 LINCOLN AVE.,  
CHICAGO, ILL.



trons. These ions and electrons affect the passage of radio waves through these upper levels of the air. The ions are probably affected also by the sunlight, the electromagnetic waves and the streams of electrons which reach our earth from the sun. Anything which alters, as these solar forces may well do, the amount or character of the ionization of the upper air, is reasonably sure to affect in some manner the movement of the radio waves.

The natural interference accompanying the Aurora will probably be very difficult to cure or to minimize. However, with the remarkable devices now available for radio transmission and reception, it is believed to be well worth while to carry as far as possible the investigation of the actual causes of these Auroral relationships.

Fortunately, these unusual electrical disturbances do not occur every winter; so the difficulties and failures of this year should not be allowed to discourage the holding of another international test next winter. Perhaps the sun and the Aurora may be kinder and grant us better success.

### How I Made My LC-26 an *Objet d'Art*

(Continued from page 39)

plate lead. It permits the reading of the plate current passed by all of the tubes; and it is controlled by a single-pole double-throw jack switch.

The center tuning control is a Gee-Haw dial with a ratio of 100 to 1. Directly above the dial is a jeweled pilot light which indicates when the filaments are lighted.

Two Western Electric loudspeakers connected in series are used to give more even reproduction. A horn loudspeaker has been placed in back of the grill work of the cabinet while at the opposite side of the room is placed a cone speaker which is decorated in keeping with the cabinet.

Behind the front panel of the table (which is readily removable) is a compartment which affords ample space for any power supplies of today or the future. An Acme "B" Eliminator, using the Raytheon tube, supplies the plate current. A "B" voltage of 160 volts is used on the audio amplifier tubes, about 20 volts on the detector, and an additional tap with a variable resistance supplies the radio-frequency tube with about 90 volts.

A Gould Unipower, which is a storage battery and a variable trickle charger all in one, furnishes the filament current.

Altogether the container may properly be regarded as an object of art. And it offers suggestions to every owner who wants his receiving set to harmonize with the surroundings in his home.

# A Powerful Set now Easy to Build

## Using the New and Improved FRESHMAN "TRF" Low Loss Kit

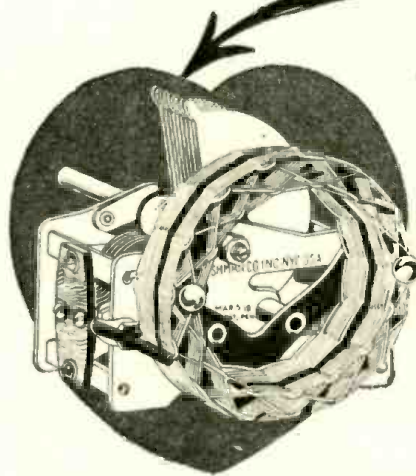

**\$9.50**

These are the identical units which have made the FRESHMAN MASTERPIECE factory built Receivers the World's Greatest Radio Sets.

### Straight Line Wave Length Condensers With Low Loss Self Balanced Coils . . .

Complete instructions for building this powerful five tube receiver, written in plain everyday English, together with actual size schematic wiring diagram, are furnished with every FRESHMAN "TRF" Kit.

Sold by Authorized  
Freshman Dealers Only!

**CHAS. FRESHMAN CO., Inc.**

Freshman Building  
New York

2626 W. Washington Blvd.  
Chicago

# Raytheon POWER-PACK Parts

	List Price
1 Raytheon Tube	\$6.00
1 Dongan Transformer, No. 509	7.00
2 Dongan Choke Coils, No. 514	10.00
1 Condenser Corp. small combination condenser for Raytheon circuit comprising 2 units 1 mfd. with a common terminal	1.25
1 Condenser Corp. multiple condenser for Raytheon circuit five units of 2, 8, 1 and 1/2 mfd. respectively with a common terminal	12.00
1 Airgap socket	.75
1 Bradleyohm No. 10—10,000 ohms	2.00
1 Bradleyohm No. 25—250,000 ohms	2.00
1 Bradleyunit resistance, 7,500 ohms	.75
1 Electrad resistance mounting	.25
1 Hardwood base	.35
1 Composition Binding post strip	.25
1 pr. small brass brackets	.25

Complete Parts **\$42.85**

# S. C. Receiver Parts

	Total
2 S-M antenna coils: Nos. 110A and detector coil No. 114A, equipped with 2 No. 515 coil sockets	\$7.00
2 S-M SIF variable condensers, No. 318, equipped with 1 vernier dial No. 801	13.75
4 S-M tube sockets, type 510	2.00
2 Thordarson S-C power transformers	16.00
1 Polymet mica fixed condenser, .002 mfd.	.40
1 Polymet mica fixed condenser, .005 mfd.	.60
1 Polymet gridleak, 2 megohms	.25
1 Polymet mica fixed condenser, equipped with gridleak clips, .00015 mfd.	.45
1 Yaxley rheostat, No. 16K, 6 ohms	1.35
1 Carter Switch	.50
1 Carter No. 101 Jack	.50
1 Carter No. 102A Jack	.50
1 Centralab variable resistance, 25,000 ohms	2.00
1 James Jr. midget condenser, .00045 mfd.	1.50
2 Gleason S-C mounting brackets	.70
1 Belden S-C connecting harness	4.00

Complete Parts **\$55.00**

# Cockaday L.C-26 Receiver Parts

PARTS AS USED BY MR. COCKADAY IN BUILDING HIS LABORATORY SET

	List Price
1 General Radio variometer, type 269, equipped with rheostat knob	\$6.30
1 General Radio rheostat, type 214a, 7 ohms, equipped with rheostat knob	2.25
1 Precision Octalgram coil set	5.50
1 Ameco special double unit condenser No. 1814, each section .0003 mfd.	6.25
1 Micasoid fixed condenser, .00015 mfd.	.35
1 Micasoid fixed condenser, .00025 mfd.	.35
2 Davon resisto-couplers (new type which incorporate 1 mfd. condenser in base)	2.00
1 American DeLuxe transformer, first stage	10.00
1 Bradleyunit, 1-4 to 10 meg.	1.85
3 Bradleyunits, 1-4 megohm	2.25
1 Bradleyunit, 1-2 megohm	.75
3 Amperites No. 1a	3.30
1 Amperite No. 112	1.10
1 Benjamin standard "Clearstone" sockets	8.00
1 Carter single circuit Jack, No. 101	.70
2 Carter Jack switches, No. 2	3.00
8 Eby binding posts	1.20
1 Fenur vernier control knob and dial	2.50
4 Small brass brackets	
1 Antenna connection block, 1 x 2 inches	.80
1 Battery connection block, 1 x 3 inches	
2 large brass brackets	

Complete Parts **\$59.75**

(including 1 Bakelite drilled and engraved Panel 8 x 22")

Mail Orders Shipped the Same Day They are Received  
**HEINS & BOLET**  
Radio and Electric Supply Corporation  
WHOLESALE AND RETAIL  
44 Park Place, New York



# WHAT READERS ASK

CONDUCTED BY HUGH S. KNOWLES

In justice to our regular subscribers a nominal fee of \$1.00 per question is charged to non-subscribers to cover the cost of this service, and this sum must be inclosed with the letter of inquiry. Subscribers' inquiries should be limited to one question or one subject.

## The Hammarlund-Roberts Circuit

QUESTION: I recently read a description of the Hammarlund-Roberts receiver and I should like to build one. However, I have been unable to obtain a list of the parts necessary and the circuit diagram. Would you mind publishing this information?

J. BARDIN

ANSWER: The diagram of this receiver is shown in Figure 1.

You will need the following parts:  
**L1, L2, L3, L4 and L5**—Coils, set of Hammarlund-Roberts;  
**VC1 and VC2**—Variable condensers, .0005 mfd. SLF, Hammarlund;  
**VC3**—Variable condenser, Hammarlund "Midget";  
**C1**—Fixed condenser, .006 mfd.;  
**C2**—Fixed condenser, .002 mfd.;  
**GC**—Grid condenser, fixed, .00025 mfd.  
**GL**—Grid-leak, (value varies with detector tube), Durham metalized or similar noiseless type;  
**R1**—Rheostat, 25 ohm, Carter "Imp";  
**R2, R3, R4 and R5**—Filament control cartridges, Amperite 1-A;  
**R6**—Resistance, fixed, 4 ohm;  
**AFT1 and AFT2**—Transformers, audio-frequency, Rauland Lyric;  
**J**—Jack, single circuit;  
**S**—Switch, filament, Carter "Imp".

These are the parts which are necessary in assembling the receiver. In addition you will need the following parts which are not lettered in the diagram: 1 Hammarlund-Roberts foundation unit (which includes the panel, brackets, wire and so forth); two 4-inch dials; one 1 1/4-inch dial; 5 Na-ald "De Luxe" sockets and 5 pairs of Union phone tip jacks.

Although other parts may be substituted we suggest that you use the ones recommended as they have all been carefully chosen. In addition, the panel is drilled for these particular units.

The arrowhead on the inductance, L1, indicates that its value may be changed. For this purpose a flexible lead is provided; and it may be connected for three different inductance values of the primary. The higher values of inductance give more volume but there is a decrease in selectivity. A good compromise may be found for your particular antenna by experiment.

The variable condenser, VC3, is used for balancing and also to prevent the radio-frequency tube from oscillating or feeding back energy from the detector through the inter-electrode capacity of the first tube, to the antenna circuit.

To set this balancing condenser, tune in a station of moderate intensity. Then turn off the rheostat (this rheostat is in the filament circuit of the radio-frequency tube and may be used as a volume control) and adjust the condenser, VC3, until a position is found which gives a distinct minimum in the signal strength of the

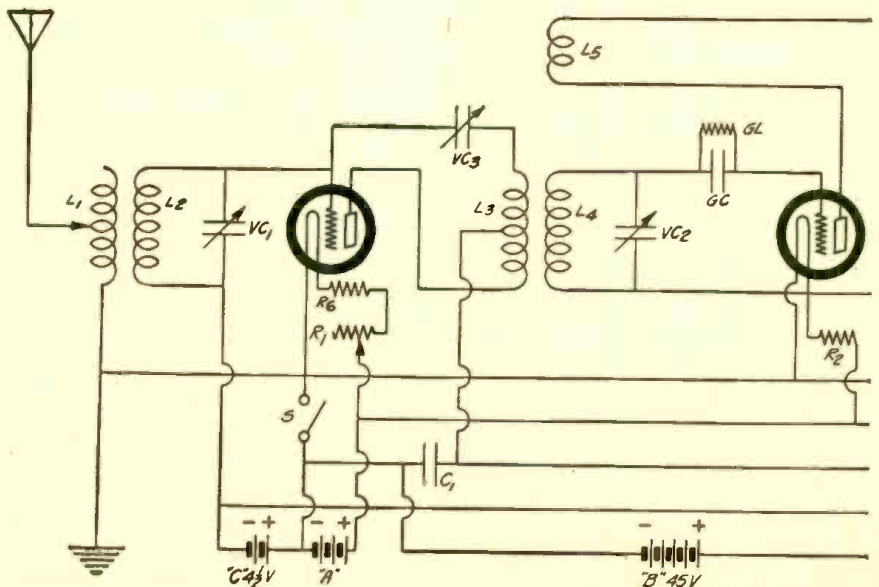

received station. Next light the filament, retune carefully and then repeat the whole process. This time there should be a more distinct minimum point.

The two "C" batteries may be in one unit with taps taken at approximately 4.5 volts negative and 4.5 to 9 volts negative, respectively, for the radio-frequency amplifier and for the first two stages of audio-frequency amplification.

The fixed resistance, R6, insures that no more than 5 volts will be applied to the filament of this tube.

### A Simple Non-Distorting Volume Control

**QUESTION:** Is there some way in which I may control the output of my receiver without making a radical change in the wiring or using many more parts? I have a receiver which uses a stage of transformer-coupled and two stages of resistance-coupled audio-frequency amplification. I have tried using a variable resistance across the secondary of the transformer and lowering the filament current in the amplifying tubes; but I don't like the resulting quality.

JAMES PETERBOROUGH

**ANSWER:** Either of the two systems shown in Figure 2 may be used. Both permit good control of volume without varying the characteristics of the amplifier. Thus neither introduces distortion.

As the transformer is essentially a power device its characteristics are governed by the load on the secondary. When a negative bias is used on a 201-a type tube the input resistance is almost infinite; and the transformer works into what may be considered an open circuit. Its operation may be improved by shunting approximately a .5 megohm resistance across the secondary.

As we want a volume control, this resistance should be that of a high-resistance potentiometer such as are manufactured by the Central Radio Laboratories or the Electrad Co., Inc. (R in both diagrams). The grid should be connected to the slider arm. This volume control is smooth since only the alternating current drop across the portion of the resistance between the slider arm and the filament is applied to the grid; and this resistance may be varied from 0 to .5 megohm. The load across

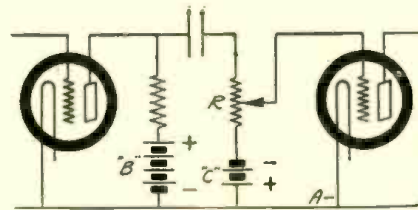
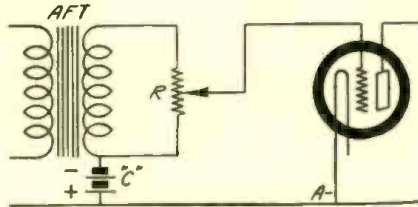

**TWO SIMPLE VOLUME CONTROLS**

FIGURE 2: These methods may both be used in audio-frequency amplifiers. Both permit good control of volume without varying the characteristics of the amplifier

the transformer at the same time remains constant (assuming proper biasing as before).

Substantially the same system may be used in resistance or impedance-coupled amplification by making this high resistance potentiometer the grid-leak, as shown in the lower part of Figure 2. In this case no more frequency discrimination is introduced than if a regular .5 megohm leak were used.

To secure maximum amplification from any type of amplifier a certain input is needed. It is therefore advisable to first design the amplifier to work with an input which will give the required output and then to adjust the input for volume control. This prevents distortion, due to overloading, in the tubes following the one on which the control is used.

As distortion is frequently introduced by an overloaded detector, it is best to use some sort of control ahead of the detector or preferably to detune slightly to prevent overloading.

Never use the rheostats in the amplifier as a volume control as this method almost invariably introduces distortion. For further details see the article on "How to Reduce Distortion in Amplification" in the February, 1926, issue of POPULAR RADIO.

### THE HAMMARLUND-ROBERTS HOOK-UP

FIGURE 1: This drawing shows how the various instruments are connected in the circuit.

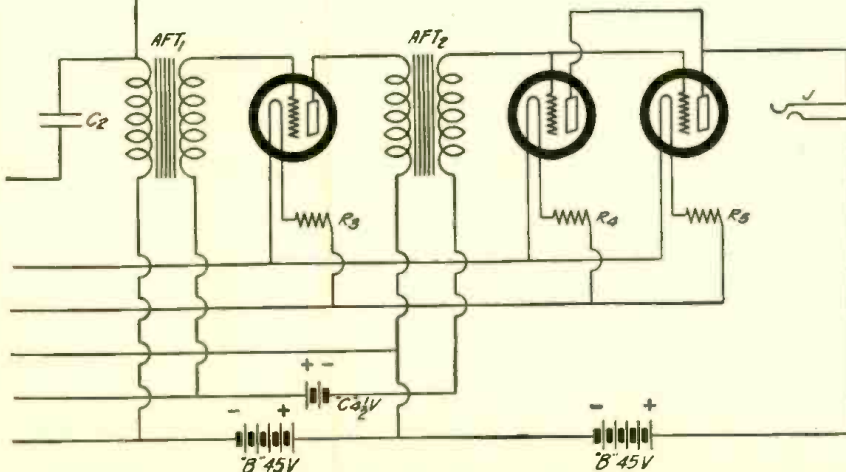

Here's Work That is Almost ROMANCE!



Many **EARN \$50. to \$250. a Week in RADIO**

Get into the great new BIG-Pay Industry—Radio. If you are earning a penny less than \$50 a week, clip coupon now. Send for AMAZING FREE BOOK. Be a Radio Expert, and draw down big money for the easiest and most fascinating work in the world. Positions everywhere. Need for Radio Experts in every community. Short hours. BIG PAY. Free book gives all the facts.

**Learn Quickly and Easily at Home**  
Master Radio Engineers will show you how to qualify, quickly and easily at home, for Radio's fine jobs. We guarantee to train you successfully. Every day N. R. I.-trained men are taking good places in the Radio field. Thousands of openings now awaiting the trained man. **FREE EMPLOYMENT SERVICE.** Many other big features. Get the facts—**CLIP COUPON.**

Get This Free Book  
Send coupon below for FREE BOOK—"Rich Rewards In Radio." Read for yourself. No previous experience needed. Common schooling enough. **WRITE NOW.**



"My charges for consultation, \$2.50 per hour. All success duo to you." R. W. Blackhill, Brooklyn.



"Radio a gold mine—your course worth thousands." A. R. Herke, Winton.



You get all these sets

Receiving sets, from simplest kind to thousand mile receiver, included to help you learn. An UNEQUALLED OFFER. Other special features for limited time only, so ACT QUICK!

**NATIONAL RADIO INSTITUTE**  
Dept. ET-8, Washington, D. C.

## MAIL COUPON

National Radio Institute,  
Dept. ET-8, Washington, D. C.

Without obligating me in any way please send me your free book, "Rich Rewards In Radio," also complete information on your practical, home-study Radio course.

Name.....Age.....

Address.....

Town.....State.....

# Power Pack

## D1 & D2

### Condensers



**Q** ACRACON Condensers have been specially designed and built for use in battery eliminator devices. They are electrically correct, mechanically rugged. Every unit is tested at 1,000 volts, for a minimum period of five minutes. This provides an ample safety operating margin for ordinary "B" battery eliminator requirements.

**Q** ACRACON Condensers are compact. For their capacity, they take up a minimum amount of space. This is because of the special way in which ACRACON Condensers are built. The method of winding layers eliminates inductive effects. The way the contact is made to these layers provides very low radio frequency resistance, and the condensers are quickly charged and discharged. And yet, there is no current waste, because the high dielectric resistance, and the improved method of impregnation reduce it to a negligible minimum. You can safely run an ACRACON Condenser equipped "Power Pack" for hours, without fear of heating the condensers. ACRACON Condensers are "low loss" condensers and perfectly safe.

**Q** ACRACON Condensers are not expensive, as high-grade, well-made condensers go. They are fully guaranteed by the manufacturers. And they are fully worth their price. Use ACRACON Condensers in your "Power Pack" for efficient, quiet, humless plate voltages. ACRACON Condensers will improve any battery eliminator in its input, filter, or output circuit. Whether your "Power Pack" is to be in service one hour, or twenty four; or whether you need 10 volts or 180 or more, you can depend on ACRACON Condensers for quiet, efficient, constant service.

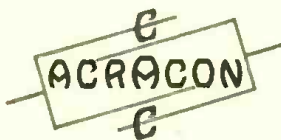

**Condenser Corporation of America**

**25 Waverly Place  
New York City**



MANUFACTURERS can use ACRACON Condensers in their "A" and "B" Battery eliminator units. ACRACON Condenser engineers will design and build special condensers to manufacturing specifications. Send us your requirements.

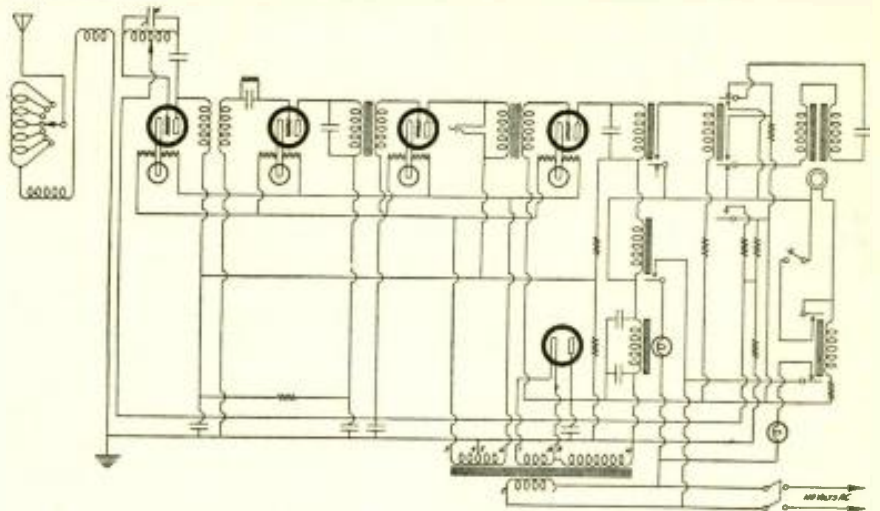

THE WIRING DIAGRAM FOR THE SELECTIVE RADIO SIGNAL SYSTEM

FIGURE 3: This drawing gives the electrical circuit connections for the receiver which was used by the Police Department in the radio signal system. The system functions by means of a series of selective relays.

### A Diagram of the Selective Signal System

**QUESTION:** I am interested in the selective radio signal system which was described in the article "Battling Bandits by Broadcasting" which appeared in the February, 1926, issue of POPULAR RADIO. Please tell me where I can get a copy of the circuit diagram.

T. S. GUNT

**ANSWER:** The schematic diagram of the selective radio signal system is shown in Figure 3. No other details are furnished because the theory and operation of both the transmitting and receiving apparatus were described in the February issue.

### The Standard Inductively-Coupled Crystal Receiver

**QUESTION:** Please show me how to connect up a standard crystal circuit, using a variable coupler for tuning.

JACK GRIFFITH

**ANSWER:** In Figure 4 appears the circuit diagram showing the correct connections for a variocoupler in co-operation with a crystal detector for broadcast reception. The extra parts you will need are:

- VCI—variable condenser, .0005 mfd.;
- C—mica fixed condenser, .0005 mfd.;
- DET—crystal detector;
- TEL—telephones.

All the tuning is done with the variable condenser. The coil, L<sub>2</sub>, which is the secondary of the variocoupler, should be rotated to control the coupling between

the antenna circuit and the secondary. By doing this the selectivity of the receiver is also controlled. With loose coupling, reception should tune sharply; and with close coupling, with the coils in position so that their axes are parallel and concentric, the tuning will be broad.

### How to Construct A Superheterodyne Without Repeat Points

**QUESTION:** Is it possible to build a superheterodyne which has no repeat points; that is, one on which a station can be received only at one point on both tuning and oscillator condensers?

JAMES O'MALLEY

**ANSWER:** This may be done by using intermediate frequency transformers designed to work on such a high frequency that one of the beat "points" on the oscillator dial is "moved off." In other words the frequency range of the oscillator necessary to cover the broadcast band is not sufficient to give both an upper and lower beat. Thus it is impossible to get both beats with the capacity variation (on 180 degrees of the dial) available.

For the present frequency band used in broadcasting this means that the intermediate frequency amplifier has to be operated at 240 kilo-cycles (1250 meters).

If properly designed transformers are used, satisfactory amplification may be secured at this frequency. Above this frequency the amplification obtainable per stage decreases rapidly. Such a transformer has been manufactured by the St. James Laboratories of Chicago, Ill.

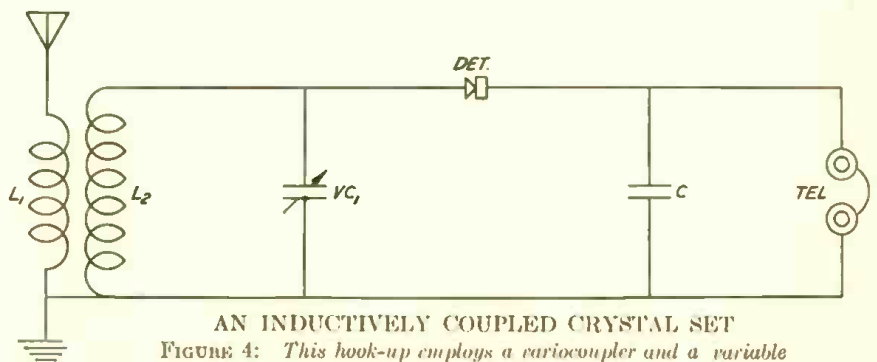

AN INDUCTIVELY COUPLED CRYSTAL SET

FIGURE 4: This hook-up employs a variocoupler and a variable condenser for tuning.

## How to Eliminate Distortion in Audio-Frequency Amplification

**QUESTION:** I am rebuilding my receiver and want to eliminate the distortion I have been getting in my audio-frequency amplifier. It had always sounded all right until recently when I brought over a friend's set and compared the two; his set uses an impedance-coupled amplifier. I understand that by using an autotformer, now being manufactured, I can get better and more amplification per stage than with a regular choke-coil coupled amplifier. Is this true?

T. JOYCE

**ANSWERS:** The only satisfactory way of determining audibly the quality of a receiver is to compare two receivers at the same time, as you have done. The ear can only approximately determine absolute quality. It can, however, get a good comparative idea of what is best.

An inspection of the amplification formulas for resistance and impedance or choke-coil amplification shows that there is an advantage in working with the latter, as far as amplification per stage is concerned.

An autotformer resembles a choke-coil rather than a transformer in operating characteristics. The output is conductively coupled to the input, that is, what is usually called the secondary is directly connected to the primary. The output circuit includes both the turns in the input circuit and some additional turns, which means that a step-up in voltage is secured. If the autotformer is properly designed this additional amplification may be secured without substantial variation in the operating characteristics from that of the usual choke-coil amplifier.

As the input and output are conductively coupled, a blocking or coupling condenser must be used to keep the "B" battery voltage off the grid of the following tube, just as in the case of the usual choke-coil amplifier. This should be at least .1 mfd. and preferably about .5. The leak should have a value of 1 megohm.

A "C" battery of about 1.5 volts should be used on the first stage and about a 3 volt one on the second stage. These should be in series with the grid-leaks, the negative side going to the leak and the positive to the negative "A" battery.

As the resistance of these coils is fairly low, a 90-volt "B" battery will be enough for all but the last stage, where 135 may be used if the signal is loud or if maximum amplification is wanted. For more complete details see the February, 1926, issue of POPULAR RADIO.

## How to Prevent Grating in the LC-26 Receiver

**QUESTION:** An intermittent grating noise interferes with reception in my LC-26 receiver. This can be minimized by adjusting the Bradleyleak; but this cuts down the volume to some extent. Is there some way to remedy this?

J. R. M.

**ANSWER:** We have found in cases of this type that the substitution of a fixed grid-leak remedied the trouble. This leak should have a value of approximately 6 megohms and should preferably be one of the metalized type or one having a constant resistance.

# MORISON'S SERVICE

is immediate on these

## OUTSTANDING 1926 CIRCUITS

We ship only the parts which are exact duplicates of those used in the laboratory models by the designers of the circuits.

### The S-C RECEIVER

A single control, universal wavelength set which can be built in an hour

#### EXACT PARTS USED

2 S-M No. 316 .00035 Condensers @ \$5.75.....	\$11.50	1 Polymet .00015 Condenser with grid leak clips.....	\$ .45
2 S-M No. 515 Coil Sockets @ \$1.00.....	2.00	1 Polymet .002 Condenser.....	.40
1 S-M No. 801 Vernier Dial.....	2.50	1 Polymet .005 Condenser.....	.60
1 S-M No. 110A Coil.....	2.50	1 Polymet 2 megohm leak.....	.25
1 S-M No. 114A Coil.....	2.50	2 Thordarson Equipformers @ \$8.00.....	16.00
4 S-M No. 510 Tube Sockets @ 50c.....	2.00	1 Centralab Resistance No. 25 M. S. R.....	2.00
1 S-M No. 340 Condenser—.000025.....	1.50	1 Drilled and Engraved Front Panel.....	4.50
1 S-M No. 540 Mounting Brackets (pr.).....	.70	1 Drilled and Engraved Sub-panel.....	2.50
1 Yaxley No. 16K 6 ohm Rheostat.....	1.35	1 S-C Wiring Harness.....	4.00
1 Yaxley No. 1 Jack.....	.50		
1 Yaxley No. 2 Jack.....	.60		
1 Yaxley No. 10 Switch.....	.50		

Total \$58.85

Complete Screw Assortment, \$.15. The Corbett Cabinet, \$8.55

### Parts for the RAYTHEON POWER PACK

1 Raytheon Tube.....	\$6.00
1 Dongan No. 509 Transformer.....	7.00
2 Dongan No. 514 Chokes.....	10.00
1 Condenser Corporation .1 mfd. Cond.....	1.25
1 Condenser Corporation Raytheon Condenser.....	12.00
1 Airgap Socket.....	.75
1 Bradleyohm No. 10.....	2.00
1 Bradleyohm No. 25.....	2.00
1 Bradleyunit 7,500 ohms.....	.75
1 Electrad Resistance Mounting.....	.25
1 Hardwood Baseboard.....	.35
1 Composition Binding Post Strip.....	.25
1 Pr. Small Brass Brackets.....	.10
1 Hubbel Socket Plug.....	.15
1 Bryant No. 678 Switch.....	1.00

The complete parts are \$43.85

### The Specified Parts for The SILVER SIX

3 S-M .00035 S. L. F. Condensers.....	\$17.25
3 Neald 4" Dials.....	2.25
3 S-M 515 Coil Sockets.....	3.00
2 S-M 112A Inductances.....	5.00
1 S-M 110A Inductances.....	2.50
6 S-M 510 Sockets.....	3.00
1 Carter 6 Ohm Imp Rheostat.....	1.00
1 Centralab 500,000 Ohm Mod.....	2.00
3 Daven Resisto-Couplers.....	4.50
6 Daven Resistances.....	3.75
1 Carter 101 Jack.....	.70
1 Carter 102A Jack.....	.80
1 Benjamin Battery Switch.....	.30
1 Dubilier .002 Condenser.....	.40
2 Deutchmann .5 mfd. Condenser.....	1.80
1 7 x 24 Drilled & Engraved Panel.....	5.00
1 Baseboard, Bus Bar, Screws, etc.....	1.40
1 Belden Color Cable.....	.75
THE COMPLETE SILVER SIX KIT.....	53.00
THE ESSENTIAL SILVER SIX KIT.....	27.75

Parts for the ORTHOPHASE including Corbett Cabinet are \$69.75

The McLAUGHLIN Single Control Receiver parts, complete are \$113.30

### The Standard in Radio Sets for 1926

#### THE LC-26

1 General Radio Type 269 Variometer with Knob.....	\$5.30
1 Set Special Precision Coils.....	5.50
1 Arnco .00032 Double Unit Condenser, No. 1814.....	6.25
1 Micamold .00015 mfd. Condenser.....	.35
1 Micamold .00025 mfd. Condenser.....	.35
1 Bradleyleak 1/4 to 10 megohms.....	1.85
1 Amertran De Luxe 1st Stage Transformer.....	10.00
2 Daven Resisto Couplers, with .1 mfd. Condensers.....	3.00
3 Bradleyunits 1/4 megohms.....	2.25
1 Bradleyunit 1/2 megohm.....	.75
3 Amperites, 1A.....	3.30
1 Amperite 112.....	1.10
1 General Radio 214A 7 ohm Rheostat.....	2.25
5 Benjamin Standard Cle-Ra-Tone Sockets.....	5.00
2 Carter Jack Switches, No. 2.....	2.00
1 Carter Single Circuit Jack.....	.70
1 8-in. x 22-in. Drilled and Engraved Panel.....	7.50
1 Hardwood Baseboard.....	.50
1 Special Mahogany or Walnut Finish Cabinet.....	14.50
1 Antenna Connection Block 1-in. x 2-in.....	.15
1 Battery Connection Block 1-in. x 9 in.....	.25
1 Fynur Vernier Dial.....	3.50
8 Eby Binding Posts.....	1.20
4 Brass Brackets.....	.35
2 Tait Cast Aluminum Brackets.....	2.00

The Complete Parts are \$79.90

### A Duplicate of the Laboratory Design

#### CRAIG POWER-PACK AMPLIFIER

1 Amertran Type PF52 Transformer.....	\$18.00
3 Amerchokes Type 854.....	18.00
2 Dubilier Filter Condenser No. 769.....	7.00
4 Dubilier Filter Condensers No. 766.....	8.00
2 Dubilier Filter Condensers No. 770.....	14.00
1 Ward-Leonard Vitrohm Resistor, Type C.....	8.50
1 Bradleyohm No. 25.....	2.00
2 Patent Single Circuit Jacks.....	1.00
1 Amertran DeLuxe 2nd Stage Transformer.....	10.00
2 Benjamin UX Sockets No. 9040.....	1.50
1 Bakelite Sub-base 7 x 21 x 1/4".....	4.45
1 Bakelite Binding Post Strip 1 x 7 x 1/4".....	.45
2 Brass Reinforcement Strips, pr.....	2.00
2 Brass Angles for Binding Post Strip, pr.....	.10
2 Brass Brackets for Resistor Unit, pr.....	.35
1 Brass Strip for Filter Condensers.....	.35

The Unit is priced at \$95.70

The Craig Power-Pack Amplifier supplies B & C current to the set, and A, B, and C current for the amplifier. Unit includes a distortionless audio amplifier.

WHOLESALE RETAIL

Have your name put on the mailing list of "BROADCASTS," a monthly bulletin giving the latest news of the radio world. There will be no obligation on your part.



15 East 40th Street, New York City

"The Key to the S-C RECEIVER" explains the new S-C Set. It will be sent to you on receipt of 25c.

# FREE RADIO CATALOG



Just off the press! Our second catalog for 1926. 100 pages of parts, accessories, kits, and sets—all the best and the latest. A copy is yours for the asking. Just drop us a line—do it today!

Dep't P R

**CHICAGO SALVAGE STOCK STORE**

509 S. STATE STREET  
CHICAGO, U. S. A.

## FOR CLEAR, QUIET "B" POWER

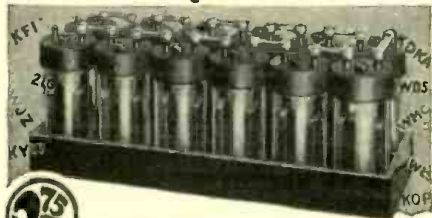

## RADIO STORAGE "B" BATTERY

12 Cells  
24 Volts  
Lasts Indefinitely—Pays for Itself

Economy and performance unheard of before. Recharged at a negligible cost. Delivers unflinching power that is clear, pure and quiet. Approved and listed as Standard by leading Radio Authorities, including Pop. Radio Laboratories, Pop. Sci. Inst. Standards, Radio News Lab., Lefax, Inc., and other important institutions. Equipped with Solid Rubber Case, an insurance against acid and leakage. Extra heavy glass jars. Heavy rugged plates. Order yours today!

Just state number of batteries wanted and we will ship day order is received. Extra offer: 4 batteries in series (96 volts), \$10.50. Pay expressman after examining batteries. 5 per cent discount for cash with order. Mail your order now!

**WORLD BATTERY COMPANY**  
1219 So. Wabash Ave., Dept. 77, Chicago, Ill.  
Makers of the Famous World Radio "A" Storage Battery

Prices: 6-volt, 100 Amp. \$11.25;  
120 Amp. \$13.25; 140 Amp. \$14.00  
All equipped with Solid Rubber Case.

**World STORAGE BATTERIES**  
Set your Radio Dial at 210 meters for the new 1000 watt World Storage Battery Station, WBSB, Chicago. Watch for announcements.  
LKA-WFAF-WGN-WJS-RH-KGO-KFAC-WJY-KO

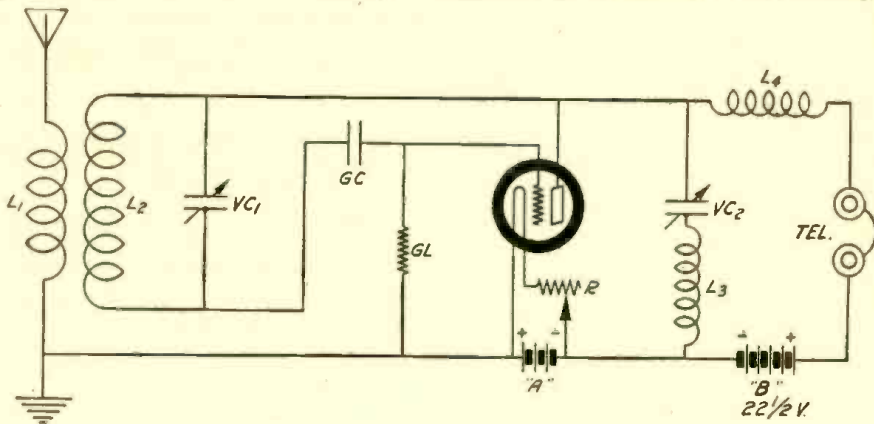

### AN EFFICIENT SHORT-WAVE CIRCUIT

FIGURE 5: In this single-tube receiver two variable condensers are employed for tuning.

### A Short-wave Circuit for Reception

QUESTION: I want to obtain a diagram which shows how to use a tuned plate circuit with shunt "B" battery feed for short-wave reception. I have heard that this idea is very popular in England for single-tube reception over great distances.

WALTER HAMMOND

ANSWER: If you will refer to Figure 5 you will find the diagram which has been prepared for you. It embodies a single-tube circuit in which an ordinary semi-periodic primary circuit is used with a tuned secondary connected across the grid and plate terminals of the tube. The filament circuit is grounded and the plate circuit is tuned by means of a variable condenser in series with a fixed inductance coil. A plate choke coil is also used to pass the direct current to the "B" battery to the plate circuit—at the same time preventing radio-frequency current from flowing through this extension. The parts you will need for building a set incorporating this novel circuit are the following:

- L1 and L2—primary and secondary coils respectively of a suitable variocoupler;
- VC1 and VC2—variable condenser, .0005 mfd.;
- GC—mica fixed condenser, .00025 mfd.;
- GL—variable grid-leak;
- R—filament rheostat, 6 ohms;
- L3—plate tuning coils;
- L4—radio-frequency choke coil;
- TEL—telephones.

Coil L3 consists of 35 turns of No. 18 DSC wire wound on a 3½ inch tube. It should be placed in the set in non-inductive relation to coils, L1, L2 and L4.

Coil L4 may be made by winding 300 turns of No. 28 DSC wire on a 1 inch tube.

The antenna is left tuned broadly to a band of wavelengths which include the broadcast range.

It is recommended that a UV-200 tube or a C-300 tube be used with this circuit and an ordinary 6-volt "A" battery.

### The Use of Proper "C" Batteries on a 5-tube Receiver

QUESTION: I have a five-tube set which employs two stages of tuned and neutralized radio-frequency amplification

and two stages of audio-frequency amplification. The two stages of audio-frequency amplification have a 3-volt (negative) grid bias; but even with this my "B" batteries have to be replaced rather often. I would like to know if I can use a "C" battery on the two radio-frequency stages to reduce the "B" battery drain and whether the economy secured would be worth the trouble.

J. S. K.

ANSWER: This change should be well worth while. Although the actual change in "B" battery current will not be great, an inspection of a discharge curve for a dry-cell "B" battery (particularly in the case of the small or medium sized type) will show that the milliampere-hour delivery rises rapidly with decrease in load. To keep the length of the grid return leads as short as possible, a separate three-cell "C" battery of the usual type should be used for the two radio-frequency stages. Connect the two "grid-return" leads from the secondaries of the first two neutroformers together and to the negative side of the "C" battery. The positive side of the "C" battery should be connected to the negative filament. One of the two leads should be flexible so the bias can be varied from 1.5 to 4.5 volts. Make the leads as short as possible. A .002 mfd. fixed condenser should be shunted across the "C" battery. If you wish to use the present "C" battery, the bias may be secured by connecting the common return to a negative tap on this battery. Use a short flexible lead on the end so the bias may be varied. If the grid return leads are rather long, connect two .002 mfd. condensers from the end of the secondaries directly to the negative filament lead.

If the coils have been carefully mounted so that there is negligible inductive coupling between the two stages or if the coils are of the torodial type with restricted fields, you should be able to prevent oscillation with about 3 volts negative bias. You will find that the balancing condensers are much more critical. If the neutroformers have a high primary impedance (large number of turns in the primary, say 16 to 24) the tendency to oscillate is greater and you may not be able to control oscillation with any more than 1.5 volts negative bias.

If under these conditions you wish to get the advantage of the higher bias it will be necessary to control oscillation by one of the numerous "losser" methods. A discussion of some of the methods appeared in the "In the Experimenter's Laboratory" department of the October, 1925, issue of POPULAR RADIO.



## Why a "Standard Antenna" Is Impractical

**QUESTION:** We sell quite a number of different types of receivers. If possible we should like to adopt a type of antenna as standard for all receivers. The average size recommended by the manufacturers is about a hundred feet long. Is this about right?

G. B. K.

**ANSWER:** There is really no such thing as a standard size or type of antenna at the present time. The most satisfactory size depends upon too many variable factors for this to be possible.

In the first place the size required varies with the characteristics of the input circuit of the receiver. Sets of the four-circuit type require large antennas of high capacity for best operation. The antenna should be about 150 feet long; and it should have one or preferably two wires (spaced about three feet).

Most other receivers, which use an untuned primary, work best on a one wire antenna which is about 100 feet long. The length which is referred to in each case is that of the flat top portion and does not include the lead-in which is usually about 25 feet long.

Where a receiver of the tuned-radio-frequency type is used, the antenna structure need not be quite as large and one about 75 feet long will give very good results. With all receivers using untuned or semi-tuned primaries (except the four-circuit tuner) the selectivity may be improved by decreasing the length of the antenna. There is, of course, some decrease in volume when this is done.

Where sets which have a tuned antenna circuit of one type or another are to be used, the antenna should be somewhat smaller to obtain a good signal to stray interference ratio.

Sets of this type which use one or more stages of tuned-radio-frequency amplification will give fairly good results with antennas only a few feet in length. Usually an antenna about 40 to 60 feet long will give good results. This type of set is therefore the most satisfactory for operation upon an indoor antenna.

## The Parts for a Shunt Plate Feed Unit

**QUESTION:** On page 20 of the January, 1926, issue of POPULAR RADIO is printed a diagram of a shunt plate feed unit to be used with the LC-26 receiver. I should like to obtain the specifications for the various parts.

R. SHELDON

**ANSWER:** This unit was described in "In the Experimenters' Laboratory" department of the December, 1925, issue of POPULAR RADIO. The only parts which are necessary are a Thordarson "Autoformer," a 4 mfd. paper condenser and a jack. Other types of chokes may also be used in this unit if it is connected as shown on page 556 of the December, 1925, issue of POPULAR RADIO.

Japanese stations now transmit time signals by radio twice daily.

A new vote-getter has been thought up by "Ma" Ferguson, Governor of Texas, who sends a special applause card to stations which have pleased her.

# with Benjamin Radio Parts

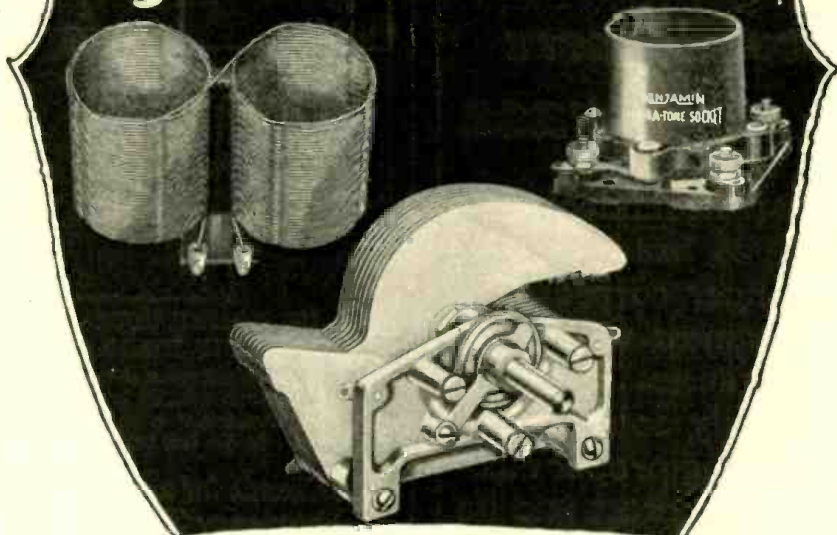

## Enjoy Radio all Year 'Round

With the right perspective and the use of the right radio parts, radio is an all year 'round source of entertainment. On the porch, in the garden, in camp and at the resort your radio may be a source of inspiration and amusement at all times. The longer days of Spring and Summer give us more time to plan and work. Our vacation periods are relatively short. For many of us it's just the time to do a lot of experimenting. The broadcast programs are just as fine. Except for distance, in extreme cases, reception on the average, is just as good.

Try it out. See what the right kind of radio parts mean in making radio good the year 'round.

Benjamin Radio Products increase sensitivity, aid selectivity and build up volume. Your radio dealer will show you.

If you haven't seen our latest 3-tube hookup, send for free instruction folder. And there's other literature for the asking to help radio 'round the year.

## Benjamin Electric Mfg. Co.

120-128 So. Sangamon St., Chicago

New York: 247 W. 17th St. San Francisco: 448 Bryant St.

Manufactured in Canada by Benjamin Electric Mfg. Co. of Canada, Ltd., Toronto, Ontario

# BENJAMIN

TRADE MARK

## best for condensers —brass

As plates and columns BRASS has the right temper to preserve alignment with small clearances. BRASS is readily soldered in making proper electrical contact and its easy machining qualities give economy in production.

**COPPER & BRASS**  
RESEARCH ASSOCIATION  
25 Broadway — New York



**Oh boy**  
**KESTER**  
Rosin Core  
**Radio SOLDER**  
Sure is Safe and Simple

Approved by  
**Radio Engineers**  
A Genuine Solder

CHICAGO SOLDER COMPANY  
4821 Wriabwood Ave., Chicago, U. S. A.

Originator and  
World's Largest Manufacturer of  
Soft Flowing Solder  
— YOUR HEALTH CAN AFFORD YOU —

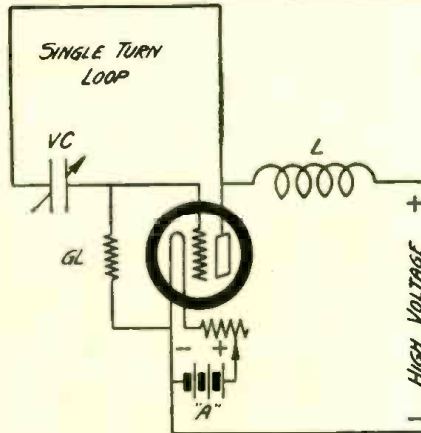

THE DE FOREST ULTRA-AUDION  
CIRCUIT DIAGRAM

FIGURE 00: This diagram shows how the instruments are connected up in the ultra high-frequency transmitter which is described in the text below.

### The Circuit for an Ultra High-Frequency Transmitter

**QUESTION:** Is there a simple circuit which I may use for transmission tests on very high frequencies? I have been working on the 20 meter band but I want to experiment on the 5 and 7 meter bands. I have tried the usual oscillating circuits such as the Hartley, Meissner, Colpitts and push-pull oscillator; but they do not work very satisfactorily on the higher frequencies.

T. S. ELIOT

**ANSWER:** A diagram of a transmitter which is easily constructed is shown in Figure 0. This, you will notice, is the one commonly called an ultra-audion, developed by Dr. De Forest, in which regeneration is secured through the capacity between the electrodes.

This capacity, in series with the capacity of VC (which should be a small two plate vernier condenser, spaced slightly to prevent sparking over if a high plate voltage is used), tunes the single turn loop. This capacity is very small; and as the inductance of a small single turn loop is also small the oscillating frequency is very high. For these very high frequencies the base of the tube should be removed. As the total capacity in the circuit is largely dependent on the inter-electrode capacity, which will vary considerably with the tube used, no dimensions for the loop can be given. Only the cut and try method is possible. Letcher wires should be used to measure the frequency (see back issue of QST or write to the Bureau of Standards for this circular and for more details on this method).

The variable condenser, VC, acts as a grid, blocking and tuning condenser. The grid-leak, GL, is connected as shown. If its resistance is fairly low it may be well to put a small choke in series with it at the grid end. This choke should be about an inch in diameter; and it should have about three turns of No. 30 DCC wire. L should be the same size and should have from four to twelve turns slightly spaced, the number depending upon the frequency.

### How to Add a Power Tube to the Cockaday Superheterodyne

**QUESTION:** I built the eight-tube reflex superheterodyne which was de-

scribed by Mr. Cockaday in the January, 1925 issue of POPULAR RADIO. It has been giving very good results but occasionally the last tube seems to be overloaded. Can a power tube be used in the last stage? If so, what changes are necessary and what tube is best?

JAMES SHAW

**ANSWER:** A power tube may very readily be added to this receiver; and it will improve both the volume and the quality of the music, especially on loud signals.

We suggest the use of a UX-112.

The rheostat on this receiver is already well loaded and, as this type of tube requires half an ampere for the filament, its filament current should be controlled by the use of one of the automatic filament control cartridges such as the Brachstat or Amperite. It should be of the 112 type capable of delivering .5 ampere.

The lead at present connected to the positive filament bus wire (the one leading to the filament switch) should be disconnected. Connect the cartridge from this binding post to the "A" plus binding post (V4 in the original diagram).

The necessary grid-bias should be secured by connecting a 9 volt "C" battery in series with the grid-leak of the last tube, the positive side going to the negative "A" battery lead.

Add another 22.5-volt "B" battery block to secure the necessary "B" battery voltage. This should be connected to the 135-volt tap.

The total amplification which is secured may also be improved by the use of a high- $\mu$  tube in the next to the last stage of audio-frequency amplification.

### Adjusting Straight-line-frequency Condensers

**QUESTION:** Since straight-line-frequency condensers require a certain coil and circuit capacity, how can I adjust my particular coil for straight-line-frequency operation?

WALTER STARRETT

**ANSWER:** Absolute straight-line-frequency is not necessary in the ordinary set. What is needed is a condenser approaching this to make separation of the lower-wave stations possible.

When the two condensers of a superheterodyne are used with a single control, it is essential that they be straight-line-frequency condensers, so that the frequency difference between the oscillator and the received wave be the same over the whole range to produce the proper beat for the intermediate amplifier.

The simplest way for the average amateur to adjust the receiver is to get a piece of cross-section paper and plot from 500 to 1,500 kilocycles on one side and 0 to 100 degrees (for condenser setting) on the other. Tune in a station on the condenser, read the dial setting, get the value of K.C. (kilocycles) from the newspaper and plot this point on the chart. After six points or so have been plotted a line should be drawn through them. This should closely approximate a straight line. If it does not, a small shunt variable capacity such as a vernier condenser should be connected across it and a little capacity added. Repeat the calibration with the new capacity. After this has been done once or twice you can tell the effect of the capacity on the curve and can adjust it properly. Some of the condensers now being manufactured have a small semi-fixed plate which should be adjusted and which takes the place of the small external capacity before mentioned.

## How to Build an Antenna Mast for \$15.00

(Continued from page 29)

near the ground, should be carefully considered. A chain is no stronger than its weakest link; and a guyed mast is no safer than the side which is the least strongly guyed. This means that the angle which the three different sets of guy-wires form to the mast should be equal. If three sets of wires are used, they should radiate from the mast so as to form three angles of about 120 degrees each, or of 90 if four are used.

There should be as many courses of guy-wires as the mast has sections. The number of sets of such wires depends upon circumstances; but three sets will often be found convenient, while it will seldom be necessary to exceed four. The anchorage points of these wires upon or near the ground should be carefully considered; and available anchorage places will often determine the number of sets of guy-ropes. In all cases, for the sake of appearance as well as of simplicity, each set of wires should be anchored upon a common point, from which they radiate to their respective sections upon the mast. In a general sense, it is best to place the anchorages upon existing buildings, or a little distance up a stout tree, because there they will not interfere or be apt to be tampered with. But no matter where they are put, they should be so located as to not only form equal angles between each set, as shown, in Figure 1, but also so as to present equal side elevations, as shown in Figure 2.

In the case illustrated, two of the anchorages are on garages, while the end of a fence midway between them formed a convenient third terminal. Either 1/2-inch eye-bolts or long screw-eyes which have at least a 2-inch thread should be used to fasten the wires; and between these and the wires there may be inserted turnbuckles for tightening.

It goes without saying that all other labor would be in vain, if the final details of rope and pulleys at the top of the mast, together with the insulation and fastening of the antenna, were not carefully carried out. Do not use anything smaller than 1/4-inch rope; and use a good galvanized pulley, securely and neatly attached to the mast within three or four inches of the top.

The particular mast, which is shown, is used by two neighbors for their receiving sets, ten feet of rope separating the antennas from the mast in each case and no interference of any kind has ever been felt. On the other hand, the increase in efficiency of the sets with the new mast as compared with former lower ones was very marked, manifesting itself in greater volume, and increase of the receiving range from a former 800 mile limit to 1,500 miles on the loudspeaker on a smaller two-tube unit, with a similar increase in a larger set.

# Within Reach of All

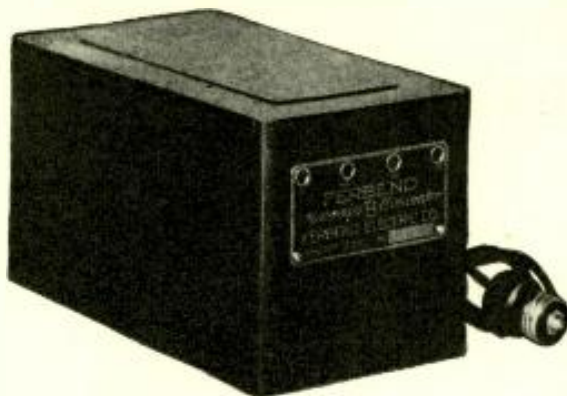

Convince yourself that the Ferbend "B" Eliminator is equal to any on the market regardless of price.

**\$12.50**

Complete, nothing else to buy. Supplied in two models, one for Direct and the other for Alternating Current.  
A. C. Model, price . . . . \$12.50  
D. C. Model, price . . . . \$ 9.75

## FERBEND "B" ELIMINATOR

### Superior Results!

**FERBEND**  
*Wave Trap*

This company also manufactures the famous Ferbend WAVE TRAP—the instrument which has been widely imitated but never equalled. It is the only original and genuine.

Now you can get permanent and efficient "B" current supply direct from your electric light socket at a

price scarcely higher than new "B" batteries. Ferbend has succeeded in combining results with first-cost economy, for your benefit. Equip your set NOW with this wonderful new instrument and be convinced.

### Ask Your Dealer or Send Direct

If you prefer, we will make shipment direct to you upon receipt of price, or C.O.D. if desired. *Use for 10 days to convince yourself, and if unsatisfactory return within that time and your money will be refunded.* USE THE COUPON NOW!

FERBEND ELECTRIC CO.  
419 W. Superior Street, Chicago, Ill.

## Ferbend Maxmin "B" Eliminator

Operates at a maximum efficiency at all times. Noiseless—no hum. Taps at 22 1/2—45—90 volts.

Maximum voltage, 100. (for 135 volts, simply add a 45 volt "B" battery.)

A. C. model gives *Full Wave Rectification*. Cost of operation less than 50c a year. Lasts indefinitely.

### Manufactured Not Assembled

All parts that go into the construction of the FERBEND MAXMIN "B" ELIMINATOR are especially designed and manufactured by the FERBEND ELECTRIC CO. for this purpose only. No standard parts or "makeshifts" used. Comes complete with nothing else to buy.

Ferbend Electric Co.  
419 W. Superior St., Chicago

- Send at once. Payment enclosed.
- Send C. O. D.     Send Literature.
- Send A.C. Model.     Send D.C. Model

Name.....

Address.....

City.....

State.....



All Utility Cabinets go through fifteen operations in the finishing room. Each cabinet is hand-rubbed and polished until the finished product is a rich piece of real furniture.

Only the most select lumber, which has been kiln dried and steamed, is used in Utility Cabinets. All tops are of selected figured walnut such as is used only in the highest grade furniture. Our imitation walnut cabinets are made from straight grain poplar, not gumwood or birch.

All joints, where possible, are double locked, glued and nailed, and all workmanship in general is strictly first class.

No.	For Panel	Deep	Imitation Walnut	Genuine Walnut
621	6x21	7"	\$3.90	\$ 5.90
712	7x12	7"	3.40	...
714	7x14	7"	3.60	5.80
718	7x18	7"	3.80	6.00
721	7x21	7"	4.25	6.50
724	7x24	7"	4.70	7.25
726	7x26	7"	5.25	7.80
728	7x28	7"	5.90	...
730	7x30	7"	6.50	...
718-10	7x18	10"	5.00	...
721-10	7x21	10"	5.70	9.00
724-10	7x24	10"	6.10	9.25
726-10	7x26	10"	6.75	9.80
728-10	7x28	10"	7.40	11.50
730-10	7x30	10"	7.75	12.00
836	8x36	8"	...	11.00
840	8x40	8"	8.00	...
921-10	9x21	10"	6.00	7.70
924-10	9x24	10"	7.50	9.50

F. O. B. Waukesha, Wis.

Write direct to  
**UTILITY CABINET CO.**  
Waukesha, Wis.

# Stop Shifting Tubes

NO TUBE will do equally well all the things that must be done to give perfect reception. Special characteristics are essential for Detectors, Radio Frequency Amplifiers, Audio Frequency Amplifiers, Hi-Mu Amplifiers and Oscillators.

Myers Tubes are made and marked specifically for the function they are to perform, therefore they increase distance, improve quality and enlarge the volume.

Myers Tubes are made and marked specifically for the function they are to perform, therefore they increase distance, improve quality and enlarge the volume.

**Don't Guess—  
Don't Match**

Order the Exact Tubes You Want.

Made by Pioneer Designers and Builders of Radio Tubes

**Type 01-A \$2.00  
Type 99 - 2.25**

At your dealers, or we will ship, postpaid

**Myers  
Radio Tube Corporation  
Cleveland, Ohio**



# MYERS



The obverse of the medal; this original is two-and-one-half inches in diameter.



The reverse; the name of each recipient will be engraved in the space provided.

## THE POPULAR RADIO

# Medal for Conspicuous Service

TO every radio amateur, to every amateur experimenter and broadcast listener, who is instrumental in alleviating human suffering or saving human life, directly through the medium of radio, recognition will hereafter be extended in the form of a medal that shall be known as "The Popular Radio Medal for Conspicuous Service." This medal is unique within the realms of radio in that it shall be awarded, not for scientific achievement or invention, but for service to humanity.

To insure a fair and unbiased consideration of all claims, a Committee of Awards has been appointed that includes five distinguished citizens of international fame. To assist this Committee of Awards, an Advisory Committee has been appointed that numbers among its members some of the most eminent citizens of the United States, including representatives of many of our most distinguished institutions.

The conditions under which the medal will be awarded are here specified:

1. The medal shall be known as the Popular Radio Medal for Conspicuous Service.
2. The medal shall be awarded, without discrimination as to sex, age, race, nationality, color or creed, to those radio amateurs, radio experimenters, broadcast listeners and other non-professionals through whose prompt and efficient action radio is utilized to perform an essential part in the alleviation of human suffering or in the saving of human life within the territorial confines of the United States and its possessions, or in the waters thereof.
3. The medal shall be awarded by a Committee of Awards that shall not exceed five in number. No member of this Committee shall be an employee, officer or stockholder of POPULAR RADIO, Inc., nor shall any such employee, officer or stockholder have a vote in the deliberations of the Committee.
4. An advisory Committee, which shall cooperate with the Committee of Awards and which shall be particularly charged with the responsibility of making recommendations for awards of this medal, shall be made up of men and women who, because of their interest in the public welfare or because of their connection with institutions that are consecrated to public service, are in positions to bring to the attention of the Committee of Awards the exploits of candidates who are within their own special fields of activity.
5. The medal will be awarded for services rendered since Armistice Day, November 11, 1918.
6. Recommendations for awards may be submitted to the Committee of Awards at any time and by any person. Every recommendation must contain the full name and address of the candidate, together with a detailed account of the accomplishment on which the proposed award is based, and must be accompanied by corroboratory evidence from persons who have first-hand knowledge of the circumstances and whose statements may be verified to the satisfaction of the Committee of Awards.
7. The medal will be awarded to as many individuals as qualify for it and at such times as the Committee of Awards may authorize.
8. All considerations not specified herein shall be left to the discretion of the Committee of Awards.

All communications to the Committee of Awards may be addressed to—

The Secretary of the Committee of Awards, POPULAR RADIO Medal for Conspicuous Service, 627 West 43rd Street, New York.

## The Committee of Awards

- HIRAM PERCY MAXIM, *President of the American Radio Relay League.*  
 E. F. J. W. ALEXANDERSON, *Chief Consulting Engineer of the Radio Corporation of America.*  
 MAJOR GENERAL CHARLES MCK. SALZEMAN, *Chief Signal Officer of the Army.*  
 REAR ADMIRAL W. A. MOFFETT, *Chief of the Bureau of Aeronautics, U. S. Navy.*  
 DR. JOHN H. FINLEY, *publicist and journalist.*  
 Secretary: Dr. E. E. Free.

## Advisory Committee

- SENATOR JAMES W. WADSWORTH, JR., *of New York.*  
 HON. JOHN BARTON PAYNE, *Chairman, American Red Cross.*  
 ADOLPHE LEWISOEN, *Publicist.*  
 JUDGE BEN S. LINDBAY, *of the Juvenile and Family Court, Denver, Col.*  
 DR. J. MCKEEN CATTELL, *Past President, American Association for the Advancement of Science.*  
 DR. J. H. DELLINGER, *Past President, Institute of Radio Engineers.*  
 FARLEY OSGOOD, *Past President, American Institute of Electrical Engineers.*  
 C. E. GRUNSKY, *Past President, American Society of Civil Engineers.*  
 DR. DAYTON C. MILLER, *President, The American Physical Society.*  
 W. L. ABBOTT, *President, the American Society of Mechanical Engineers.*  
 W. J. HOLLAND, *President, Carnegie Hero Fund Commission.*  
 GEORGE K. BURGESS, *Director, Bureau of Standards.*  
 COLIN H. LIVINGSTONE, *President, Boy Scouts of America.*  
 DANIEL C. BEARD, *Chairman, National Court of Honor, Boy Scouts of America.*  
 MISS SARAH LOUISE ARNOLD, *President, Girl Scouts.*  
 DR. W. D. HAGGARD, *President, American Medical Association.*  
 K. A. BICKEL, *President, United Press Association.*  
 KENT COOPER, *General Manager, the Associated Press.*  
 H. P. DAVIS, *Vice-President, Westinghouse Electric & Manufacturing Company.*  
 DR. VERNON KELLOGG, *General Secretary, National Research Council.*  
 JESSE LYNCH WILLIAMS, *Past President, Authors' League of America.*  
 PROFESSOR GEORGE B. PEGRAM, *Dean of the Faculty of Applied Science, Columbia University.*  
 PROFESSOR H. H. SHELDON, *Professor of Physics, New York University.*  
 WM. HAWLEY ATWELL, *Grand Exalted Ruler, Order of Elks.*  
 PROFESSOR EDWIN B. WILSON, *Harvard University, National Academy of Science.*  
 W. E. HARKNESS, *Vice-President, American Telephone & Telegraph Company.*  
 WILLIAM L. SAUNDERS, *President, United Engineering Societies.*  
 COL. J. R. QUIGG, *Commander, the American Legion.*  
 JOHN R. MOSS, *President, Kiwanis International.*

# Silence the Thunder of the Near-by Station

And Bring in the Ones You Want

KFI

WCCO

WEAF



THE  
STATION  
YOU  
DON'T  
WANT  
—  
GROUND  
IT  
OUT

Easy  
to  
Install

The Filtrola has four binding posts: Connect two of them to your antenna and ground leads, and the other two to the antenna and ground posts on your set. There are no tubes, and no battery connections to be made.

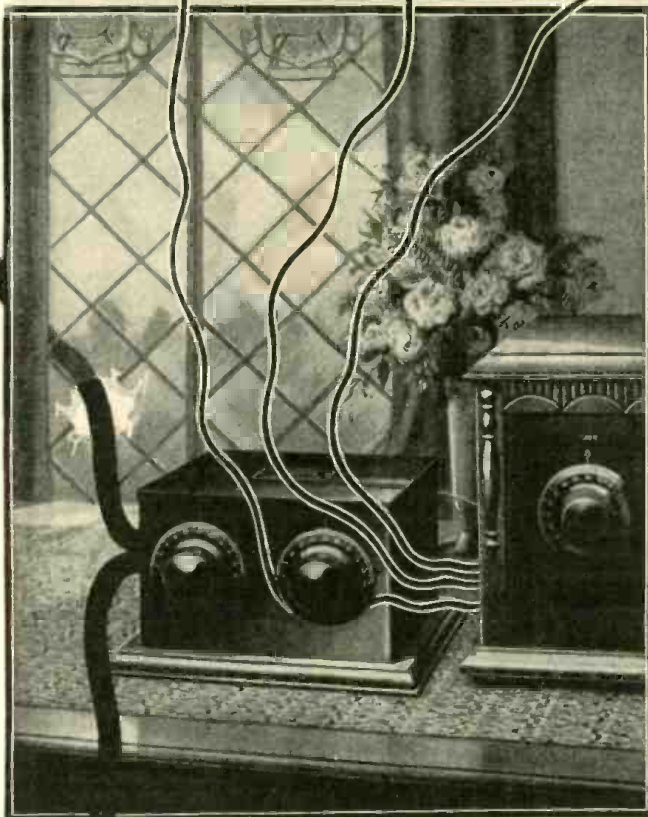

Easy  
to  
Operate

First tune in the interfering station on your own set. Then tune it out with the two dials of the Filtrola. Then tune in any station you want with the set—you need not touch the Filtrola again.

*Filtrola*  
ALL-AMERICAN  
STATION ELIMINATOR

Price \$15<sup>00</sup>

ALL-AMERICAN RADIO CORP.  
Pioneers in the Industry  
Belmont, Tripp & Kenosha Aves., Chicago

No longer need your radio set, if it is fairly selective, remain at the mercy of some near-by station whose signals are audible at all points on the dials. The Filtrola will “drop out” for you the station to which it is tuned, leaving the air as clear as though the near-by station had signed off.

OWNING AND OPERATING STATION WENR—266 METERS

**ALL-AMERICAN**

Radio Built for the Years to Come



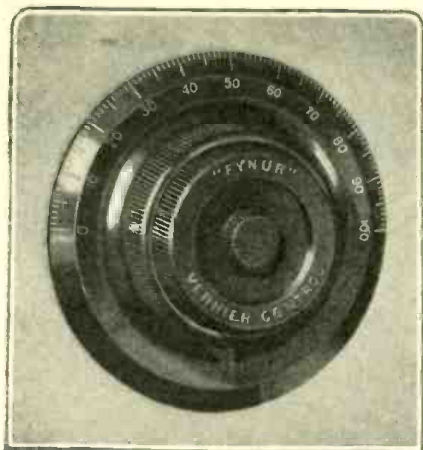

Price \$3.50

## FYNUR VERNIER CONTROL

A Quality Dial for Those Who Want the Best

Fynur Dials will separate the low wave length stations and get distant stations clearly and accurately. Dual control, simple and durable in construction. Will fit any 1/4 inch shaft. No lost motion. Ask to see one at your dealers or write to manufacturers.

Used in the Laboratory model of the L. C. - 26 Receiver, designed by L. M. Cockaday.

AUGUST GOERTZ & CO., INC.

270-286 Morris Ave. Newark, N. J.

## NEW MODEL "T" CABINET

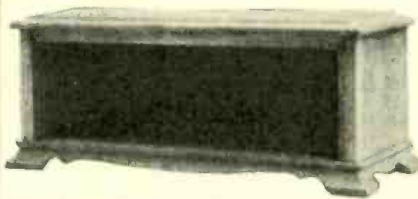

Sizes in stock. Have piano hinge, and are full 8" and 10" deep inside.

Size	Mahogany or Walnut Finish	Mahogany or Walnut	Size	Mahogany or Walnut Finish	Mahogany or Walnut
7x18-8	\$8.00	\$9.50	7x18-10	\$10.20	\$11.55
7x21-8	9.30	11.50	7x21-10	10.90	13.25
7x24-8	10.10	12.60	7x24-10	11.70	14.65
7x26-8	10.70	13.35	7x26-10	12.65	15.80
7x28-8	11.80	14.70	7x28-10	13.00	16.20
7x30-8	12.75	15.85	7x30-10	13.30	16.65

McLaughlin Superheterodyne... \$9.60 \$12.00  
 \*HAMMARLUND ROBERTS 6.40 7.90

\*With sloping front and fancy panel effect line grooves.

### LC-26 Cabinet

Mahogany or Walnut ..... \$15 00  
 Mahogany or Walnut Finish ..... 13 00

### For Your S-C Receiver

Our 18" model "T" cabinet is ideal. Hundreds being sold. Immediate delivery.

Shipping charges prepaid

"CORBETT'S CABINETS" have been preferred for several years by quality set builders and are unquestionably superior in design and finish. They are backed by our guarantee to please you. Carefully hand-rubbed piano finish. Well packed for shipment.

WRITE FOR BOOKLET showing attractive models for all sizes of radio cabinets, consoles and tables.

Jobbers and Dealers write for discounts.

CORBETT CABINET MFG. COMPANY

St. Marys

Pennsylvania

## With the Experimenters

(Continued from page 42)

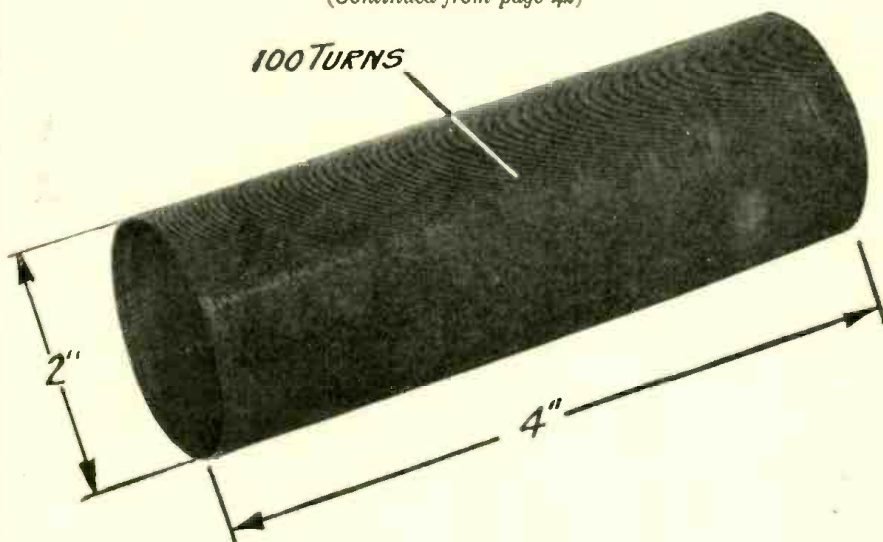

A SELF-SUPPORTING SOLENOID WINDING

FIGURE 4: This coil is a true solenoid; and it is of a design for which the preceding charts will be found extremely useful in determining wave-lengths, inductance and a number of other necessary dimensions.

ing the voltage to the plate of the radio-frequency amplifier tube. It is connected as shown in Figure 5. It may be mounted on the baseboard of the Raytheon unit if room can be found; otherwise it may be placed wherever is convenient and need not necessarily be fastened to anything other than its connecting wires. (The improved Raytheon which is described in this issue incorporates these changes.)

When adjusting the Bradleyohms for proper voltage on the radio-frequency amplifier tube, the knob of the Bradleyohm No. 10 should be screwed within a turn or two of all the way in, or to a point where signals are best. Later this may be readjusted while a distant station is tuned in. The setting at which the station comes in best is the proper setting for this instrument. To adjust the Bradleyohm No. 25, the knob should first be turned anti-clockwise until no pressure is felt as it is turned. Then turn clockwise to the point where a slight pressure is felt. The proper adjustment will be somewhere close to this point. Now, with the detector rheostat on the panel of the receiver turned fairly high, rotate the tuning dial slowly, at the same time turning the knob of the Bradleyohm No. 25.

When the Bradleyohm is properly adjusted whistles will be heard as the tuning dial passes over the settings for the different broadcasting stations. The best setting of this instrument will be that where the knob is turned out furthest but still not far enough to prevent whistling when the rheostat is turned high.

The changes in the receiver which must be made to obtain maximum results with the Raytheon unit are: The addition of a "C" battery, as discussed in the March, 1926, issue, and that replacing the grid resistances of the last two tubes (M1 and M2) with 100,000 ohm fixed resistances. M1 and M2 were originally 500,000 and 250,000 ohms respectively or Bradleyunits No. 500R and 250R. Bradleyunit No. 100R is the type to use for replacement.

With the connections shown in Figure 5, the Raytheon unit will supply its full voltage of approximately 135 to 150 volts to the high voltage terminal of the receiver, and a variable voltage (to be adjusted as required) for the radio-frequency amplifier tube, and also for the detector.

If it is desired to use the Raytheon unit without making any changes in the unit, probably the most practical plan is to use a 22 1/4-volt "B" battery for the detector plate supply, connecting it as in the original specifications in the December, 1925, issue of POPULAR RADIO. The negative terminal of the Raytheon unit should then be connected to the "B-" terminal of the receiver (together with the minus (-) terminal of the "B" battery). The detector "B+" terminal of the unit should be connected to the 90-volt binding post on the receiver and the high voltage terminal of the unit to the last binding post on the receiver.

The life of the detector "B" battery is somewhere in the neighborhood of a year, so it is not important that this battery be eliminated and some fans will probably

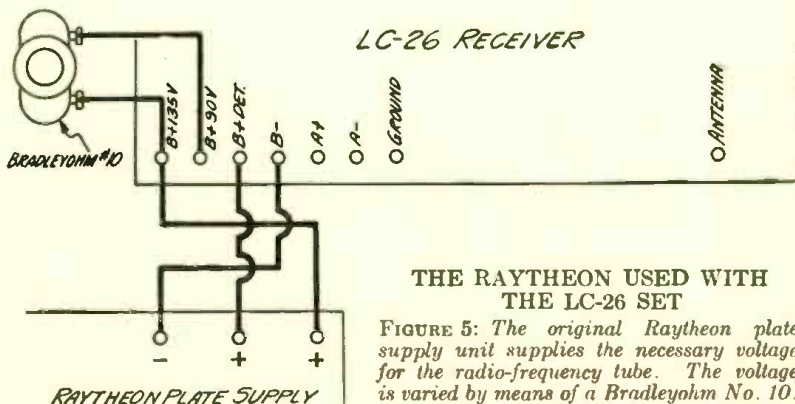

THE RAYTHEON USED WITH THE LC-26 SET

FIGURE 5: The original Raytheon plate supply unit supplies the necessary voltage for the radio-frequency tube. The voltage is varied by means of a Bradleyohm No. 10.

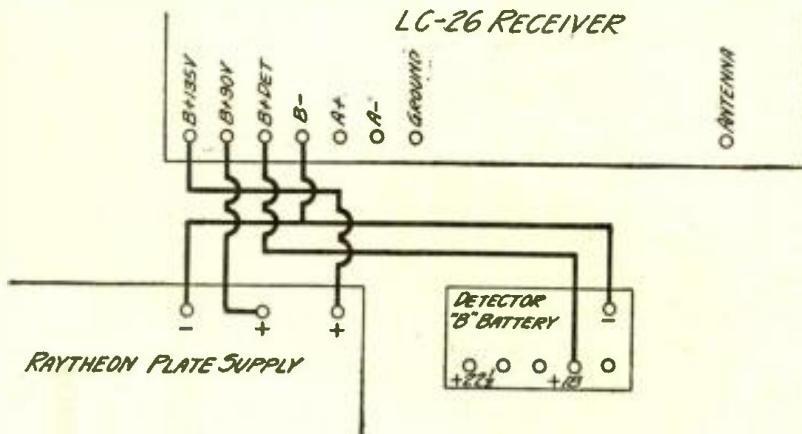

ANOTHER WAY TO CONNECT THE RAYTHEON TO THE LC-26 RECEIVER

FIGURE 6: This drawing shows the changes which are made in connecting the original Raytheon plate supply unit when a 22 1/4-volt "B" battery is used to supply the detector plate voltage.

prefer this scheme. Complete connections are shown in Figure 6.

Another plan is to connect the "B-" and detector "B+" terminals of the Raytheon unit to the similar binding posts of the receiver and to connect both the 90 and 157 1/2-volt binding posts of the receiver to the high voltage terminal of the Raytheon unit. This places a somewhat high voltage on the radio-frequency amplifier tube, however, and produces a high plate current for the RF tube. Connections are shown in Figure 7.

These several plans are given above to meet the requirements of all who desire to use the Raytheon unit with this receiver. All three of the plans are practical and will give satisfactory results. The first, however, is recommended as that which will give the greatest degree of satisfaction.

—S. GORDON TAYLOR

## Detector Blocking on Strong Signals

WHEN signals are received from a powerful local station there may be a certain amount of blurring or jumbling of the signals which is due to blocking of the detector tube. This will occur only in the case of powerful signals and, usually, only when a fairly large antenna is used.

There are several ways of eliminating this trouble. The blocking itself is due to a high input to the detector tube; and the solution of the problem, therefore, lies either in reducing this input or else in adjusting the detector circuit to handle the higher input satisfactorily.

The detector input may be reduced by cutting down on the plate voltage of the radio-frequency amplifier tube. Normally this voltage is 90, but for the recep-

tion of loud local signals it may be reduced to 67 1/2 or to 45 volts. As a result, the radio-frequency amplifier output, and therefore the detector input, will drop off considerably.

A simpler plan is to turn down on the grid-leak knob. This adjustment enables the detector to handle greater input volume to better advantage because it allows the negative grid charge to leak off more rapidly.

Other methods that have been used to reduce the detector input have to do, mainly, with the adjustment of the tuning dials so that they are slightly out of resonance with the transmitting station. When either of these controls is out of adjustment, less energy will be passed along to the detector tube, with a correspondingly smaller chance that the tube will block. In crowded broadcasting sections, this method has a distinct disadvantage in that throwing one of the dials off the setting of the received signals may bring it approximately onto the setting for another powerful local station. Thus, if one tuning control is set for one station and the other is set approximately on the setting of another station, there will probably be interference between the signals from the two stations.

This possibility exists also when the grid-leak knob is screwed down too far. When this happens, the tuning of the circuit which includes the main tuning control will be broadened. Therefore, when the receiver is operated in a city close to several broadcasting stations, the most practical plan is to reduce the plate voltage on the first tube. In more suburban locations, the use of any one of the three methods suggested is practical; and the choice should lie with the method which is most convenient.

—S. GORDON TAYLOR

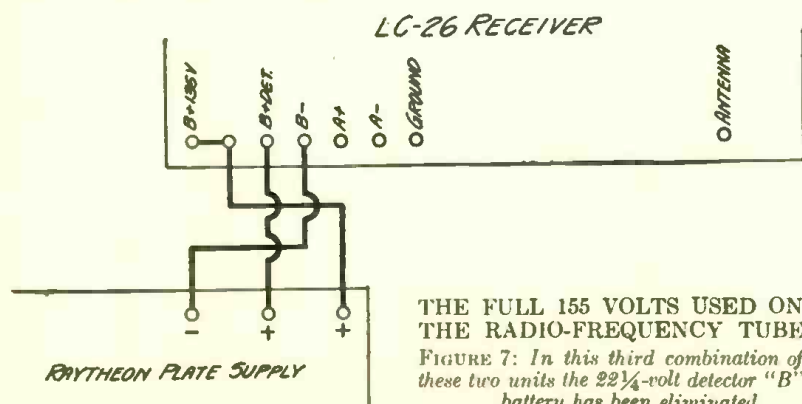

## THE FULL 155 VOLTS USED ON THE RADIO-FREQUENCY TUBE

FIGURE 7: In this third combination of these two units the 22 1/4-volt detector "B" battery has been eliminated.

# ELECTRAD

Certified Radio Essentials Specified for "THE BEST 5-TUBE SUPER"

Endorsed by Gerald M. Best, Technical Editor of RADIO

## Electrad Certified Mica Condensers

This is the famous "Six-Point Pressure" Condenser, without an equal for consistent performance. Uniform pressure insured by rigid binding at six points. Sheet copper—not tin-foil—soldering iron can't hurt it. Certified electrically and mechanically. Guaranteed to remain within 10% of calibration. Standard capacities—all types. In sealed packages, list 30c to 75c—in Canada, 45c to \$1.50.

## Electrad Certified Filament Switch

When it's on, it's 100% on; when it's off, it's 100% off. A better switch. Solid brass construction. Tinned soldering lugs, placed to make good connections easy. Neat design, genuine Bakelite knob. Requires less than 1" behind panel. Price, 40c—in Canada, 60c.

## Electrad Royalty 50,000-ohm Variable Resistance—Type C

Note these important features: Wire-wound. Genuine Bakelite base. No parts to wear, break or lose electrical efficiency. Resistance remains constant at every point. Made in various types and ranges. Write for circular and special hook-up diagram, sent free on request. Price \$1.50—in Canada \$2.10.

## Electrad Certified Single-Circuit Jack (Open)

The jack you can depend on. Positive acting spring of phosphor bronze. Tinned soldering lugs, placed to make good connections easy. Requires less than 1" behind panel. Certified and guaranteed electrically and mechanically. Price 25c—in Canada 35c.

## Electrad Metallic Grid Leaks

Clearer reception with greater signal strength. No carbon, paper, varnish or fiber. The metallic resistance element is fused to the inside of a glass tube. Noiseless, non-inductive, constant under any weather, temperature or working conditions. Permanently accurate. Non-hydroscopic. Paraffined under high vacuum. Capped with the exclusive Electrad ferrule. Sizes 1 to 10 megohms, price 60c—in Canada 85c.

For perfect control of tone and volume use the Electrad 500,000-ohm Compensator. For free hookup, write 428 B'way.

# ELECTRAD

New York City Inc.

MAIL THIS COUPON NOW:

Electrad, Inc., 428 Broadway, New York, Dept. B.

Send me complete instructions and working data on how to build "THE BEST 5-TUBE SUPER" for which I enclose 5 cents in stamps.

Name.....

Address.....

City..... State.....

*Hoyt*

**Radio Rotary Meter**

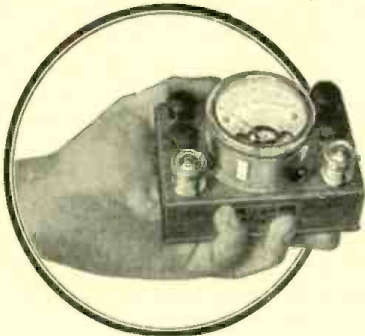

Price  
**\$24.00**

This is a unique 5-range precision, moving coil voltmeter, made specially for the Radio Service Man, Dealer and Owner. It will make all tests necessary on Radio Receiving Sets, tubes, batteries and battery eliminators. It is rugged and will last a lifetime, yet will retain its extreme accuracy. Operation is simple and accident-proof.

**BURTON - ROGERS CO.**  
26 BRIGHTON AVE. BOSTON, MASS.  
National Distributors

HOYT makes a complete line of Radio Meters. Send for booklet "HOYT Meters for Radio."

**CARTER**

**All Metal "IMP" Rheostat**

(Pat. Pend.)

Same Size  
Potentiometer  
200 or 400  
Ohms



All  
Resistances  
3 to 50 Ohms

**\$1.25**

**\$1**

"Hi-Ohm" Universal Volume Control 500,000 Ohms \$2.00.

Thousands of users have found this rheostat an unbelievable improvement. Small in size 1 5/8" dia. No moulded parts to break or crack. A contact arm that is positive yet works smoothly and without noise. Performs equally well on all circuits. Complete with knob.



Any dealer can supply.

In Canada—Carter Radio Co., Limited, Toronto

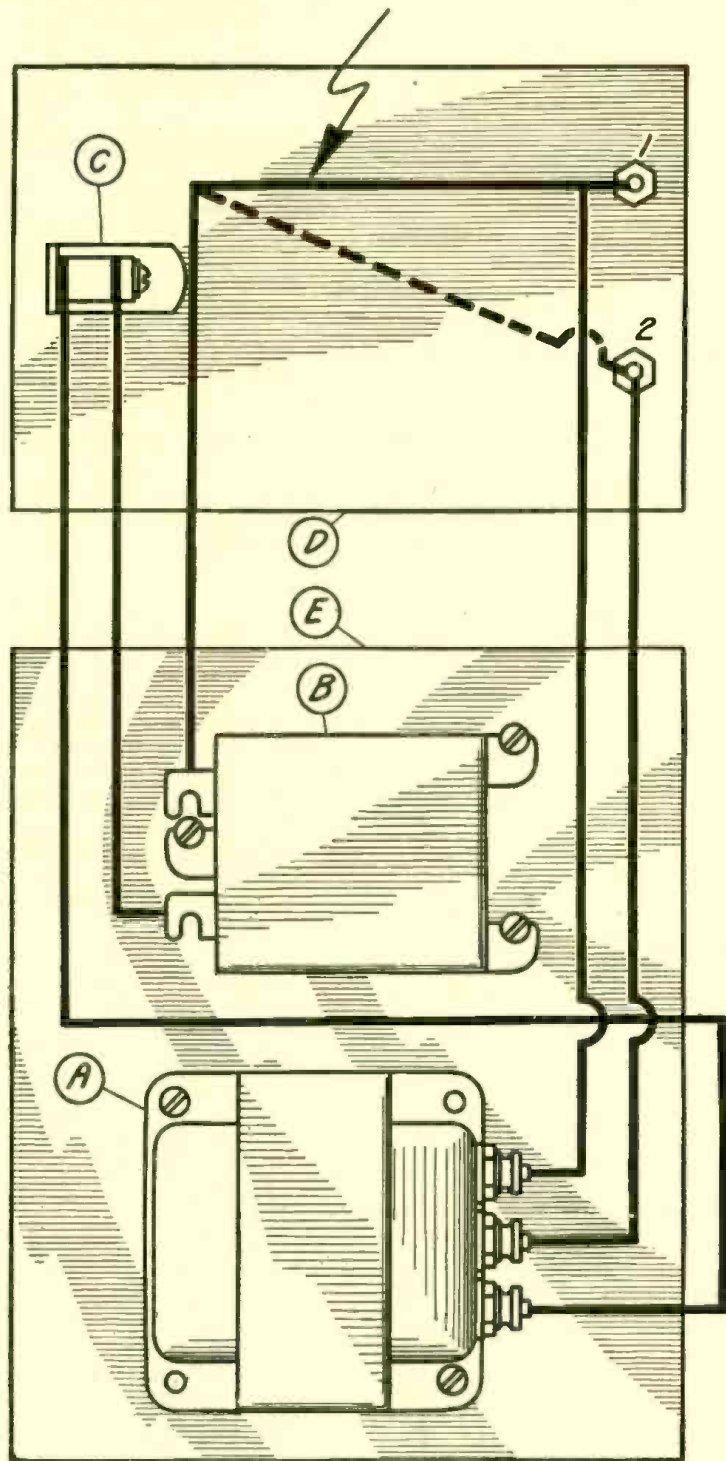

**TRY THIS CONNECTION ON YOUR FILTER UNIT**

FIGURE 8: An improvement in reception may be noted with the LC-26, in some cases, by changing the wire marked with an arrow over from binding post No. 1 to binding post No. 2, as indicated above by the dotted lines.

**How to Hook Up the Loudspeaker Filter Unit**

ON page 20 of the January, 1926, issue of POPULAR RADIO the hook-up was given for a shunt feed filter unit for use in connecting the loudspeaker to the LC-26 receiver. The connections for this unit will vary somewhat with the different tubes which may be used in the last audio stage of the receiver.

Two different hook-ups are given below for the wiring of this unit. It is suggested that builders of the unit try both hook-ups and, in each case, try connecting the lead from the large fixed condenser to each of the input binding posts, 1 and 2.

When the unit is properly hooked up and is connected to the receiver and loudspeaker one should not look for a 100 percent increase in volume. In large part the degree of improvement in reception will depend upon the loudspeaker used. If the unit is faultily hooked-up however there will be a considerable decrease in signal strength. In changing the type of tube used in the last audio stage of the receiver it may be found necessary to change the connection shown by the dotted lines in Figure 8.

—S. GORDON TAYLOR



# Announcing Ferguson

J. B.

INCORPORATED

*The Gold Standard of Radio Receivers*

## Model TEN



\$110

This 6-tube FERGUSON has two stages of balanced tuned r.f., non-radiating detector, and three stages of resistance—coupled amplification.

Being completely shielded, the tuning circuits are extremely selective. The tone quality—due to the distortionless characteristics of the resistance amplifier—is unsurpassed for absolute fidelity. A precision-built FERGUSON in every detail.

Investigate, at your Authorized FERGUSON Dealer's, or write us.

**J. B. FERGUSON, INC.**  
41 East 42nd Street, New York, N.Y.

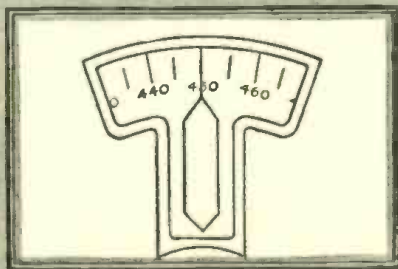

**One Tuning Control—  
Calibrated in Meters!**  
Select your program,  
turn up its wavelength  
and in comes your  
station.

*No Seasonal Models, Continually Developing Refinements*

# TUNE-RITE

The Straight Line Frequency Dial

Separates Low Wave Stations

Converts any set into a SLF set without expensive or bulky SLF condensers



No drilling to attach. Price \$3.50

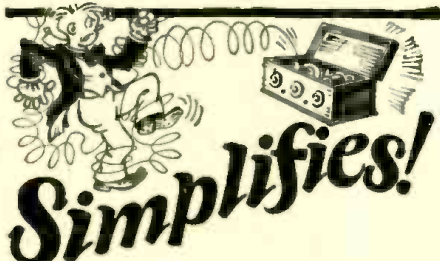

No guessing, less wiring and—no grief—with AMPERITE. Eliminates hand rheostats. AMPERITE is the only perfect filament control. Specified in all popular construction sets. Price \$1.10.

Radiall Company

Dept. P.R.-5 50 Franklin Street, New York City



Write for FREE Hook-ups

The "SELF-ADJUSTING" Rheostat



DAVEN Amplification

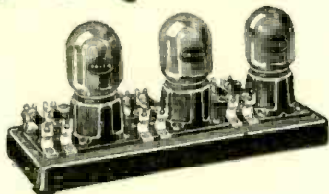

Simple to install—accurate in tone reproduction—inexpensive—and above all insures you against the fear of your radio set becoming obsolete!

Other Daven Accessories are—Super Amplifiers, Amplifier Tubes, Power Tubes, DRF Coils, Amplifier Kits, Resisto-Couplers, Leakandensers, Resistors and Ballast Resistors.

Send for your copy of our new FREE illustrated booklet

Resistor Specialists

DAVEN RADIO CORPORATION

"The Sine of Music"

Newark Reg. U. S. Pat. Off. New Jersey

USE THIS FREE COUPON

DAVEN RADIO CORPORATION

153 Summit Street Newark, New Jersey

Please send me the following on Resistance Coupled Amplification.

CHECK THE ONE YOU PREFER  Resistor Manual  Complete Catalogue (free) 25c is enclosed

Name.....

Address.....

FOR DEALERS: Send your letterhead or card, or this coupon and we will have our nearest distributor communicate with you.

## In the World's Laboratories

(Continued from page 46)

electricity. Copper wires were strung along the tree and its branches, pointing upward into the air in exactly the manner of lightning rods. Mr. Gallejos' description is not entirely clear, but apparently these wires were not connected to the ground. In addition, fifty turns of copper wire, also ungrounded, were wrapped around the trunk. In fifteen days the tree began to improve. After three months it had a full complement of new shoots and its fruit had bettered in quality.

Unfortunately, there are possible criticisms. Copper compounds are well known to be stimulating to the growth of plants, especially to plant roots. A tiny quantity of copper would dissolve from the copper wires in rainwater and would be carried down along the trunk and to the roots. Possibly this is what worked the wonder. Nevertheless, it may have been electricity, taken up from storms and from the air. Radio fans who have trees and country gardens are urged to try similar experiments this summer. But the wires used should be iron, or, better still, tinned copper busbar. Tin is virtually insoluble in rainwater and is much less stimulating to plants than is copper.

If there is any effect, it comes, of course, from the static electricity and the electromagnetic waves picked up by the wires along the tree and passing either from the ground to the air or in the reverse direction. That large charges do so pass up and down vertical conductors is well known. Two or three years ago a number of radio amateurs reported that grass and other vegetation seemed to grow more rapidly underneath transmitting antennas than in the space a little to one side. If this is

really true, here may be another electric effect on vegetation.

If fans who use transmitters this summer will notice the results on the vegetation underneath, POPULAR RADIO will be glad to know what they discover. Send your observations to the Editor of this Department.

## Teaching Radio With a Toy

YEARS ago, before the perfection of the motion picture, there was a common toy, variously named the "vivascope," the "zooscope" and other names implying that one saw things alive or in motion. It consisted of a strip of paper on which was printed a series of figures of a galloping horse or a running man or some similar moving thing. This paper was then fastened to the outer edge of a cylinder of metal and the cylinder was spun rapidly around. By an optical illusion, the object represented on the strip of paper seemed to move. The horse galloped swiftly; the man ran.

This once-familiar toy has been revived in Russia as a convenient way to teach some of the phenomena of radio. Instead of the old-time figures of the running man or the bounding horse, the strip of paper is inscribed with successive diagrams of wave forms or of radio circuits.\* On the rotation of the cylinder carrying this strip, the diagrams appear to move and the operation of the circuits is made clear. Wave forms and the changes of the electromagnetic forces can be shown equally well.

\*"The Use of the Stroboscope for the Demonstration of Radiotelegraphic Processes" (in Russian), by G. Fleischer. *Telegrafia i Telefonija bez Provodov* (Nishni-Novgorod), number 31, pages 381-386 (August, 1925).

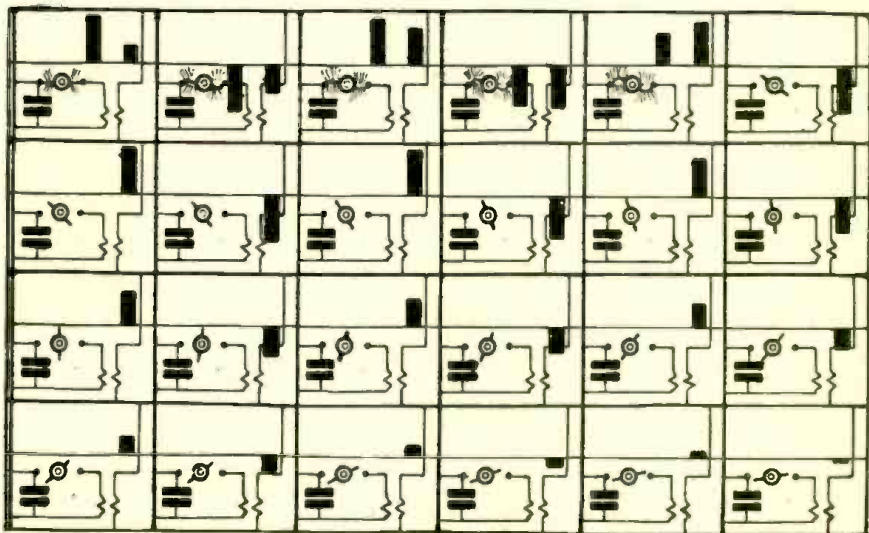

From *Telegrafia i Telefonija bez Provodov*

### A TOY USED TO TEACH RADIO IN RUSSIA

In the Radio school at Nishni-Novgorod Professor Fleischer is using this series of diagrams, arranged on a toy "vivascope," to show the dying away of the oscillations from a spark gap. The heavy black lines at the top of each diagram indicate the potentials in the two circuits.

### Crystal Film Detectors

THAT one does not need, for a crystal detector, a real mass of the galena or other compound which one is using, but merely a film of it, is the report of the French experimenter, M. H. Pelaron.\* If a strip of metallic lead is exposed briefly to the vapor of heated sulphur it takes on a thin film of lead sulphide. A cat-whisker, pressed against this film, will give, M. Pelaron reports, as good detection as is obtainable with a first-class crystal of galena. Similar sensitive films are obtained by treating with sulphur the surface of nickel, iron, bismuth, copper, tin, zinc and gold. A film of carbon may replace the film of sulphur. Detection may be accomplished, also, with films of some other elements, notably selenium, phosphorus, arsenic, antimony and iodine.

\* "On Detection in Wireless Telegraphy" (in French), by H. Pelaron. *La Nature* (Paris), number 2698, page 397. (December 19, 1925).

### Preventing Interference from Street Cars

THE experience, frequent enough in most American cities, of severe radio interference from the contacts and motors of street cars, has been causing trouble in Germany. The radio engineers of that country have been on the hunt for remedies. According to a recent note\*, the trolley systems which draw current from the wire by means of a wheel or other rolling contact usually make less radio interference than the systems which employ a sliding contact. Carbon contacts, which are seldom employed in the United States for this class of service, have been found less troublesome than metal ones. In the case of twenty-two trial cars in Berlin, the introduction of a condenser with a capacity of 30 microfarads, between the current-collector and the ground connection, was found to produce a considerable decrease in the interference.

\* A note by "H. K." in *The Wireless World* (London), volume 18, page 102 (January 29, 1926).

### A Book About Oscillographs

No radio engineer gets very deeply into his subject without needing to know something about oscillographs—or, literally, "wave writers." By means of these instruments, the form of the wave is actually written down on a sheet of paper or thrown luminously on a screen, or photographed as a dark line on a sensitive paper or plate. The construction, theory and operation of the different varieties of oscillographs, now in important use, are described in a recent small handbook by Mr. J. T. Irwin, formerly of the Imperial College of Science and Technology, in London.\*

\* "Oscillographs," by J. T. Irwin. Published by Isaac Pitman and Sons, New York, 1915. 164 pages. \$2.25.

# American Transformer Company

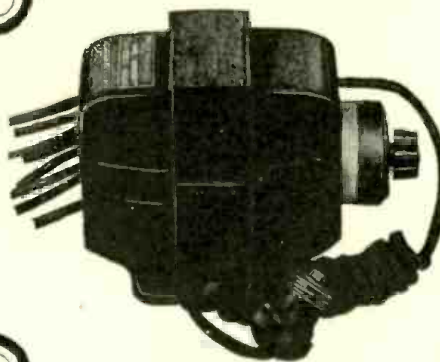

AmerTran Power Transformer  
Type PF-52



AmerChoke Type 854.

**A** REPUTATION for fine transformers that has been maintained for over a quarter-century! Today this high standard of manufacture is more apparent than ever—for radio has adopted each of the advanced, dependable AmerTran Products as the leader of its field.

The new AmerTran DeLuxe Audio Transformer actually puts the development of the "audio side" ahead of existing acoustical devices. Faithful amplification with natural quality over the *entire* audible range is consistently obtained with this audio transformer. The new tubes, cone speakers, and clear signals from the detector tube bring the most satisfactory results in combination with the AmerTran DeLuxe.

It is significant that in 1926 the AmerTran DeLuxe is an essential unit in the finest set designs. This is but another tribute to the AmerTran DeLuxe—made to give satisfaction where performance counts.

As the receiving set of the future is destined to be power operated the American Transformer Company is now offering two units of the finest type—especially adapted to the use of the new

7½ volt power tubes in the last audio stage. These are the AmerTran Power Transformer and the AmerChoke which are strictly up to standard, and may be depended on in the type of audio amplifier required. The Power Transformer also has filament supply windings for the power tube in the last stage and for the rectifying tube, and supplies sufficient plate current, after rectification, for the operation of the set.

AmerTran DeLuxe 1st Stage . . .	\$10.00
AmerTran DeLuxe 2d Stage . . .	10.00
AmerTran AF-7 (3½-1) . . .	5.00
AmerTran AF-6 (5-1) . . .	5.00
AmerTran Power Trans. PF-45 . . .	15.00
AmerTran Power Trans. PF-52 . . .	18.00
AmerChoke Type 854 . . .	6.00

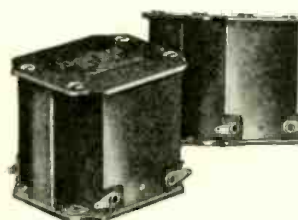

AmerTran DeLuxe  
two types for first and second stages.

Whether or not you are actually building a set, our booklet "Improving the Audio Amplifier" will prove decidedly interesting. It costs nothing and includes the most advanced information made practical for your use by our engineering staff.

**AmerTran Products Sold Only At Authorized AmerTran Dealers**

DEALERS: The Sale of AmerTran Radio Products East of the Rockies is handled exclusively by the AmerTran Sales Company, Inc., 178 Emmet Street, Newark, N. J. Direct to dealer sales policy. Some territories are available for parts dealers and service Stations.

AMERICAN TRANSFORMER CO., 178 Emmet St., NEWARK, N. J.

## Transformer Builders for Over Twenty-Five Years



**AEROVOX**

**By-Pass and Filter Condensers**  
*"Built to be Better"*

Also Filter Condenser Blocks and Craig Resistors as used in the Power-Pack Amplifier described in POPULAR RADIO and other circuits.

**AEROVOX WIRELESS CORPORATION**

489-491-493 Broome Street,  
 New York City

Branch Offices:

- Chicago, Ill.
- 53 W. Jackson Blvd.
- Cincinnati, Ohio
- 304 Palace Theatre Bldg.
- Boston, Mass.
- 104 Portland St.
- Los Angeles, Cal.
- 324 N. San Pedro St.

## SIMPLIFIED BLUE PRINTS FREE

You know how helpful, interesting and practical POPULAR RADIO is. You fully appreciate that at \$3.00 a year it is a real bargain. Consequently you should find it easy to convince one, two or more of your friends, who are not now subscribers, of the unusual value when any one of these seven sets of Simplified Blueprints (described on Page 82) is offered free with their twelve months' subscription for POPULAR RADIO at the regular price of \$3.00. In addition to the Blueprints given to your friends we will allow you one set free for each new subscription you send us with a \$3.00 remittance. Five new subscriptions and remittance of \$15.00 would entitle you to five sets free.

Only one set of Blueprints free with a renewal subscription whether your own or a friend's.

POPULAR RADIO, INC., Dept. 53  
 627 West 43d Street, New York City

Enclosed is my remittance of \$.....covering annual subscriptions for POPULAR RADIO (names on sheet attached). Send me set(s) checked below.

- |                                     |                                     |
|-------------------------------------|-------------------------------------|
| <input type="checkbox"/> Set No. 4  | <input type="checkbox"/> Set No. 14 |
| <input type="checkbox"/> Set No. 6  | <input type="checkbox"/> Set No. 15 |
| <input type="checkbox"/> Set No. 12 | <input type="checkbox"/> Set No. 16 |
| <input type="checkbox"/> Set No. 13 | <input type="checkbox"/> Set No. 17 |

(See page 82 for description of Sets)

Name.....

Address.....

Foreign postage 50c extra. No extra for Canada.

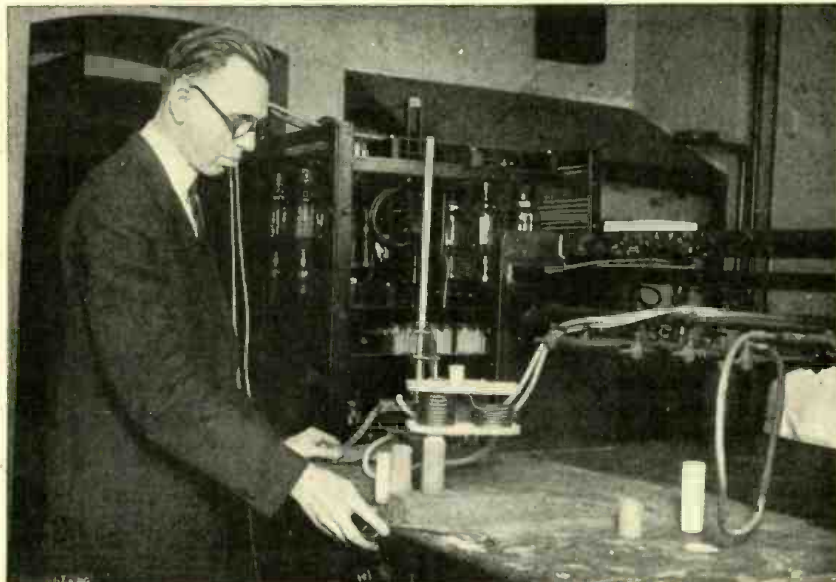

Harris & Ewing

### THE BUREAU OF STANDARDS USES RADIO FURNACE

*Oscillating currents through the heavy copper coils generate radio waves which are absorbed by the metal in the crucible and heat it. The Bureau of Standards, in Washington, uses this furnace to melt platinum and other precious metals.*

### Improving the Radio Furnace

JUST two years ago, in POPULAR RADIO, Dr. E. F. Northrup described his methods and apparatus for the generation of intense heat by radio waves.\* Energy sent out from a coil, in which a high-frequency current is oscillating, is picked up by another coil or by a mass of conducting material and is converted into heat, just as eddy currents are picked up and converted to heat in the neighborhood of a high-power oscillator of any kind. By the use of these "induction furnaces," metals may be melted conveniently and without coming in contact with the fuel or gases of a fire. They may even be melted in a vacuum.

The most recent developments of this interesting method are described in a recent address by Dr. Northrup before the Franklin Institute, in Philadelphia.† The frequencies now used range from less than 500 cycles, for melting large amounts of material, up to approximately 100,000 cycles, for laboratory furnaces and for small sized melts. For the higher frequencies, the current is obtained from a Tesla oscillator energized through a mercury spark-gap, essentially in the manner described in Dr. Northrup's article in POPULAR RADIO. For the lower frequencies—usually 480 cycles—a motor-driven electric generator is employed.

\* "Melting Metals by Radio," by E. F. Northrup. POPULAR RADIO for May, 1924, pages 430-437.

† "Inductive Heating," by E. F. Northrup. The Journal of the Franklin Institute (Philadelphia), volume 201, pages 221-244 (February, 1926).

### A New Use for Crystals of Carborundum

EVERY radio engineer knows that the crystals of carborundum, once much

used for detectors, differ from the ordinary rectifying crystals, such as galena, in that they require a constant, impressed voltage in order to be operative. This arises from the fact that the point contact on a carborundum crystal has a certain "threshold" voltage above which current passes, but below which no current at all can get through. It is like the safety valve on a steam boiler, which opens at a certain pressure but remains entirely closed at any pressure less than the critical value.

That this valve-like property of the carborundum crystal may be turned to advantage in making safety resistances, to relieve surge voltages and the like, is a suggestion made by the English physicist, Mr. H. M. Dowsett‡. The threshold voltage of a single carborundum-point contact is not large, about 2 volts. This may be increased, however, by taking a number of crystals in series or, more practically, by compressing carborundum powder in a tube, with the terminals connecting to the circuit placed at the two ends of the column of powder.

In one instance, Mr. Dowsett constructed a resistance in which carborundum powder which had passed a screen having eighty meshes to the inch was placed in a tube 6.5 centimeters (2½ inches) long and .28 square centimeter (.04 square inch) in cross-section. The powder was compressed with a force equal to ten pounds weight. The threshold voltage was 5,200 volts. Below the voltage no current passed. Just above this voltage, the tube transmitted a current of 750 micro-amperes. This might be increased by the use of a greater cross-section of carborundum column.

‡ "Crystal Safety Resistances: a Practical Application of the Threshold Effect in Carborundum Crystal Rectifiers," by H. M. Dowsett. The Wireless World (London), vol. 17, pages 937-939 (December 30, 1925).

## How the Ether May Be Apportioned Abroad

EUROPE, no less than ourselves, is increasingly disturbed by the impossibility of fitting the hundreds of broadcasting stations, which desire a share of the ether, into the strictly limited number of channels which are available for non-interfering communication. There exists, at present, no central European authority able to allocate the available wavelengths and to enforce these allocations against nations which refuse to conform. Accordingly, confusion grows.

In a talk before the Institution of Electrical Engineers, in London, on January 7, 1926, Captain P. P. Eckersley, Chief Engineer of the British Broadcasting Company, suggested the early adoption, by international agreement, of a fixed assignment of about one hundred wavelengths; it is the Captain's opinion that approximately this number of separate channels can be operated simultaneously without interference.\* Eighty-two of these channels, the Captain would assign to the more important stations in the different countries. Sixteen of the remainder, he would assign to groups of stations, the members of each group being so selected geographically that interference would be at a minimum.

In the United States we have been fortunate to have one central administration of broadcasting, ably managed by the officials of Mr. Hoover's Department. In spite of this, there are already far too many broadcasting stations in the United States; and there is great pressure for the granting of additional licenses. The authority of the Department of Commerce to refuse the use of a demanded wavelength is now being attacked legally by a Chicago station. Decision of the legal phases of this matter must be left to the courts; but there are three principles with which, in the light of European experience, all well-wishers of broadcasting must agree. First, some authority must have full and unquestioned power to grant, withhold or revoke broadcasting licenses; second, we need fewer broadcasting stations rather than more of them; third, if at all possible, some way should be devised to make the retention of a license by any station dependent on a reasonable degree of technical competence in its operation and a reasonably satisfactory quality of programs.

\* The address is reported in *Nature* (London), volume 117, page 96 (January 19, 1926) and in *The Wireless World* (London), volume 18, page 85 (January 20, 1926).

A nickel-in-the-slot radio machine has been developed by Joseph Pinto of Philadelphia. The set of five tubes can be operated by the house lighting current or batteries. A red light announces the expiration of the time allowance one minute before it is up.

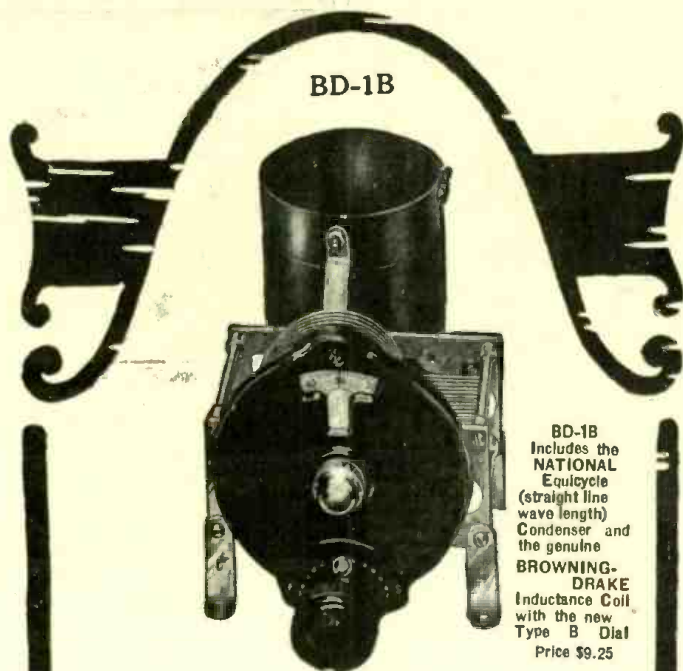

BD-1B  
Includes the NATIONAL Equicycle (straight line wave length) Condenser and the genuine BROWNING-DRAKE Inductance Coil with the new Type B Dial  
Price \$9.25

## The New NATIONAL Tuning Units

comprising the genuine

### BROWNING-DRAKE SPACE WOUND TRANSFORMER

and the

### NATIONAL Velvet Vernier Dials and Condensers

Are now in the hands of your dealer. Their beauty and efficiency will greatly surprise you. See them at your dealer's.

Send for Bulletin 105 P. R.

**NATIONAL COMPANY, Inc.**

W. A. READY, President  
Cambridge, Mass.

BD-2B

Includes the NATIONAL Equicycle (straight line wave length) Condenser and the genuine BROWNING-DRAKE Transformer with the new Type B Dial.

Price \$12.75

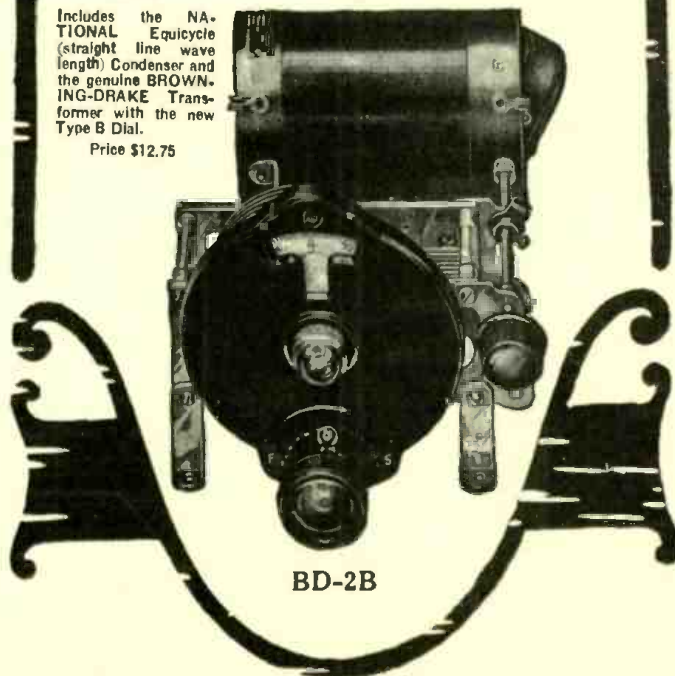

BD-2B

# \$35 Cone Speaker for \$10



if you will  
assemble  
it yourself

(All Parts Supplied)

Don't pay \$35 for a cone speaker when you can assemble one yourself for only \$10 and a few hours time. We send you all the parts, including special complete cone unit; also a blue print and directions for assembling. Everything is made as simple as A B C. Any one can set up this splendid, supersensitive loud speaker in a few interesting hours and actually save \$25. And there's absolutely no risk. You can get your money back instantly if you're not completely satisfied.

### Stands 18 inches high

This speaker stands 18 inches high, complete in every detail. It gives a wonderfully natural tone, not to be compared with the thin, megaphone sound of the ordinary horn speaker. With this new cone speaker you can shut your eyes and believe it's real. The only reason we are able to make this astonishing offer is because we save the labor costs and dealers' profits by dealing with you direct.

### Send No Money

Simply send name and address for the complete outfit. When postman brings package, deposit only \$10.00 in full payment. If not entirely satisfied simply return parts within ten days and your money will be instantly refunded. Never before has a better radio bargain been offered. These speakers are selling fast. Write at once if you want one.

**Scientific Radio Laboratories**  
Dept. 35, 254 W. 34th St., New York City

## D·E·A·L·E·R·S·



Write for  
**OUR MONTHLY  
DEALER'S  
GUIDE BOOK**  
EVERY month  
or more often, we  
issue a complete,  
up-to-the-minute  
catalog completely  
illustrating the  
very latest radio  
parts, kits equip-  
ments and ac-  
cessories devel-  
oped during the  
preceding month.  
A postal card  
brings our latest  
copy.  
**WRITE FOR  
YOUR COPY  
TODAY-NOW!**

### WHOLESALE DISTRIBUTORS RAYTHEON KITS

S-C RECEIVER KITS  
COCKADAY'S LC-26 RECEIVER  
POWER PACK KITS  
HAMMARLUND-ROBERTS  
SILVER-MARSHALL SIX

All WRS Kits contain only parts exactly as used by Kit Originators.  
SATISFACTION INSURANCE

You can get these National Lines here

- |                 |                 |
|-----------------|-----------------|
| Acme            | Remler          |
| Hammarlund      | Kurz-Kasch      |
| Daven           | Victoreen       |
| Silver-Marshall | Precise         |
| Amperite        | Aero Coils      |
| Carter          | Mar-co          |
| Yaxley          | Ultradyno       |
| All-American    | Dublier         |
| Allen Bradley   | Micamold        |
| Benjamin        | X-L             |
| Amertran        | Amso            |
| Thordarson      | TobeDeutschmann |
| Philco          | Kodel           |
| Weston          | B-M-S           |
| Frost           | Na-Aid          |

Large Stock      Immediate Delivery  
**WHOLESALE RADIO SERVICE CO.**  
Manufacturers and Wholesale Distributors  
Radio Apparatus  
6 CHURCH STREET  
Dept. 526 PR      New York City



## LISTENING IN

PRACTICAL pointers from experimenters and broadcast listeners. What helpful hints can YOU offer to your fellow fan? Readers are invited to address their letters to the Editor of this Department.

CONDUCTED BY LLOYD JACQUET

### How to Avoid "B" Battery Current Leakage

How many radio fans know that a relatively large amount of current leaks away from their small home-made storage "B" battery units, largely because of the defective construction of these units?

Generally, the wooden frame which holds the test-tubes becomes saturated with acid. This makes it a conductor of electric current. As the top of the test-tubes are flush, or nearly flush with this wooden strip, the leakage path is very short between the tubes and the binding posts.

A battery in this condition will take a much longer period of time to arrive at a fully charged condition; or it may even be found impossible to charge it up to its full rating, as registered by a testing hydrometer. The reason for this is

that the cells discharge between each other almost as quickly through the leakage path between the cells as the charging rate drives the current into them.

One easy and inexpensive way to obviate this is to place under the test tubes in the rack a strip of wood which has been heavily paraffined, or some other acid-proof material such as a strip of hard rubber, as shown in Figure 1.

The strip should be at least 1/2-inch thick; and it should be long enough to fit under the series of tubes. In this way the tops of all of the tubes will be brought far above the upper-strip level.

In this way the leakage path will be considerably lengthened; and as this faulty strip may be more easily kept clean, the leakage of current may be greatly reduced.

—MERRILL BARCLAY, Concord, Mass.

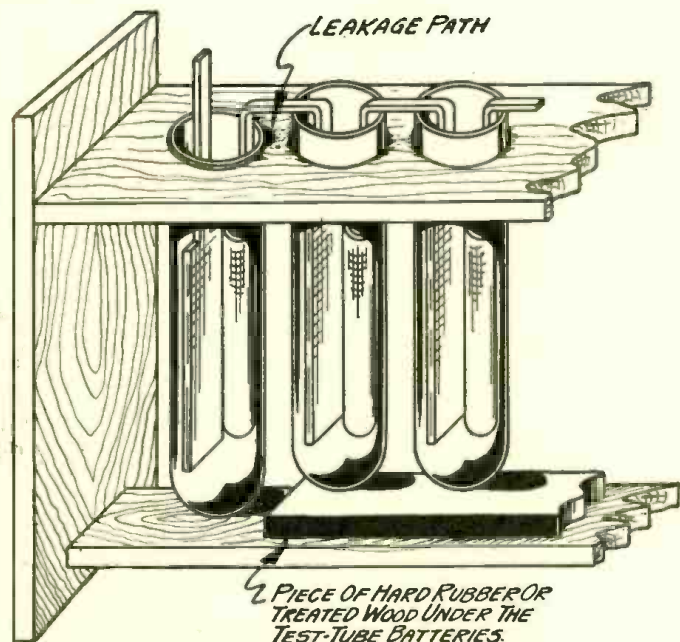

HOW TO PREVENT LEAKAGE FROM ONE CELL TO ANOTHER

FIGURE 1: By slipping a small slab of hard rubber underneath the glass tubes that form the separate cells of the storage battery, the leakage from cell to cell which is due to acid spilling will be greatly lessened.

## How to Install a Battery Voltmeter

A SMALL, inexpensive, battery voltmeter may be a very useful instrument to the radio set owner who wants to experiment with his radio apparatus.

It will be found to be a very handy instrument for reading the voltages of the filament circuit, and also for determining the voltages in the plate circuits of the various tubes which are used in the receiver. Nearly every experimenter owns one of these voltmeters which saves the relatively large expense of a more complicated laboratory instrument.

This instrument may easily be installed on the panel of a receiver, as shown in Figure 2.

First, bore a hole in the panel large enough to allow the face of the instrument to protrude through. The voltmeter may then be pushed as far through the panel as the contact bolt at the bottom and the ring support at the top will permit. If the panel is not too thick, the face of the instrument may extend sufficiently to afford a surface to retain it in place.

However, as the instrument is without a flange, special precautions must be taken to keep it in place. If a piece of rubber tubing is threaded with a thin wire, and adjusted to a diameter which is slightly smaller than that of the voltmeter, it may be slipped on the instrument to take the place of a flange.

The tubing may then be painted with a dull black varnish to give it the color of the panel. The varnish will also give the tubing a positive grip upon the instrument's rim.

Connections are made to the voltmeter in the usual way.

—G. MULLANE, *New York*

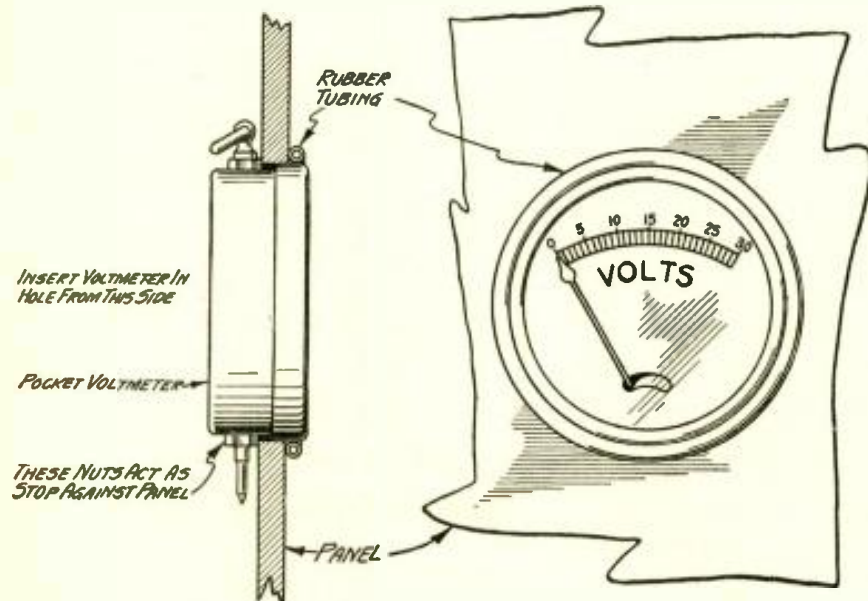

HOW THE POCKET VOLTMETER MAY BE MOUNTED ON A PANEL

FIGURE 2: These two drawings show an easy way to use the voltmeter in an experimental set by mounting it directly on the panel with the scale showing on the front of the receiver.

## How to Use Your Radio Set As a Weather Indicator

IN a recent number of POPULAR RADIO I found an article regarding the production of static by rain or snow. Within a few hours after reading the article I had a chance to test the theory.

This locality has just had a light precipitation, starting with rain and turning to snow. At the noon hour I was listening to a Boston station which was coming through with good volume and quality. In a few minutes there was a rushing sound in the phones which changed in a moment to a rapid succession of sharp clicks. On glancing through the window, I found that a gust of wind had filled the air with flying snow. As the wind died down, the disturbance ceased and the broadcasting became clear and clean again.

This condition was experienced several times while I listened in. And by hearing the different effects I could tell exactly what was going on outside.

It is not difficult for the experienced fan to tell of the approach of a storm. The electrical disturbances may be some miles away, but they will be recorded in the radio receiver nevertheless. The cracking sound referred to will be a little more irregular; but the rushing sound will be heard when the storm is overhead, with an occasional outburst when there is a lightning stroke.

There is no danger in listening in on a storm if the set has been properly protected by means of a lightning arrester. The discharges which cause these sounds in the receiving set are harmlessly conducted to the ground through the lightning arrester, if they are too large, and hurt no one.

—A. L. KEYES, *Milford, N. H.*

SM

## S-C KIT

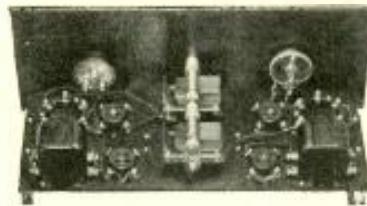

The famous S-C Receiver is now offered exclusively by Silver-Marshall, Inc. as a complete, Armstrong licensed kit, including all parts necessary to build this remarkable set in a few hours time.

Behind the S-C Receiver is the reputation of POPULAR RADIO—Laurence Cockaday—McMurdo Silver. And behind each and every part stands the pick of radio manufacturers—Belden Mfg. Co.—Central Radio Labs.—Polymet Mfg. Co.—Poster & Co.—Silver - Marshall, Inc.—Thordarson Elec. Mfg. Co.—Yaxley Mfg. Co. and the S-C Merchandising Co. What better guarantee could be demanded—or offered?

PRICE <sup>S-C KIT</sup> NO. 620 **\$59.00**

Licensed under Armstrong U. S. Patent No. 11113149. Manufactured by Treco. Exclusive Distributing Agents: Silver-Marshall, Inc.

## SENSITIVITY MEASUREMENT!



The Silver-Marshall Laboratories have perfected a new and radical method of transformer measuring that insures an unbelievable degree of selectivity and sensitivity to weak signals. All 210 long wave interstage and 211 tuned transformers are now measured by this remarkable system. Price singly or in matched groups . . . . . \$6.00 each.

For those experimenters desiring to avail themselves of this special service, S-M transformers will be measured and matched at 50c. each. All other makes at \$1. each, when returned accompanied by remittance.

See S-M Parts At Your Dealers

**SILVER-MARSHALL, Inc.**

844 W. Jackson Blvd.,

Chicago

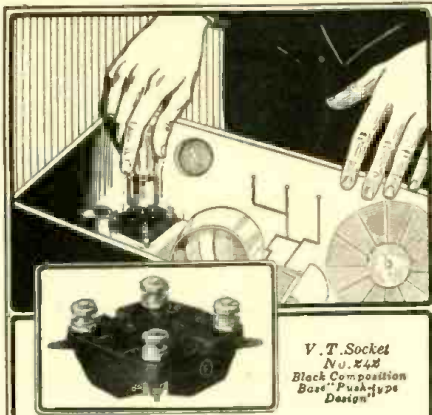

V. T. Socket  
No. 2428  
Black Composition  
Base "Push-type"  
Design

## U X Tube Socket

This new push-type socket is designed for use with the new tubes with U X Bases.

Contacts of Phosphor Bronze insure a smooth self-cleaning and wiping contact. The lamps are held rigidly in place.

Circle F V. T. Sockets are of the most modern design and only the best materials and workmanship are employed.

Ask Your Dealer

MFD. BY

**CIRCLE F MFG. CO.**

Trenton, New Jersey



75c

## Micamold

ALL WEATHER  
LIGHTNING ARRESTERS

Listed as Standard by Underwriters Laboratory

MADE of MICA and  
MOLDED in BAKELITE

SAFE—INDESTRUCTIBLE—RAINPROOF

A positive safeguard against static accumulation or lightning. Can be instantly attached to your set by means of Phosphor bronze snapover clamps, or outdoors directly to your aerial or casement window, for which purpose a suitable brass strap is furnished.

If your Dealer cannot supply you, write direct to  
Department P.

**MICAMOLD RADIO CORP.**  
Flushing and Porter Aves., Brooklyn, N. Y.

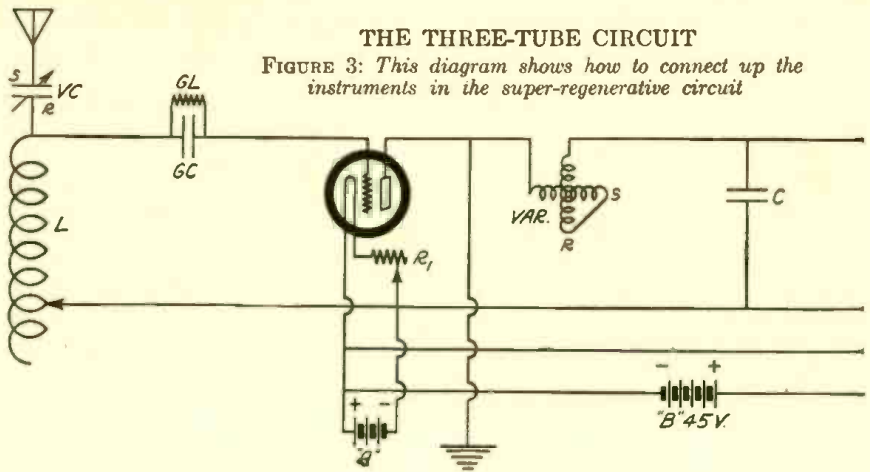

## A New Kink in Super-Regenerative Circuits

I HAVE during the past year, done considerable experimenting with various forms of the super-regenerative circuit. I have found that while the volume is sometimes increased by making use of super-regeneration, the majority of "super" circuits require extremely critical adjustment, and that even when they are properly adjusted they are noisy in operation.

In the circuit shown herein (Figure 3), I have eliminated all apparatus not absolutely necessary and have even discarded the large-sized honeycomb coils heretofore considered necessary in circuits of this kind. I am using three UV-199 tubes, one as the detector and the other two as audio-frequency amplifiers with only a single 45-volt "B" battery for all three tubes. With a single-wire antenna, 30 feet high and approximately 75 feet in length, and a water-pipe ground, this set operates a loudspeaker with volume equal to an ordinary regenerative set using UV-201-a tubes. When using UV-201-a tubes in this circuit, the amplification is simply tremendous. When the set is properly adjusted the music or speech comes in clearly and with little extraneous noise. The high-pitched whistle which is characteristic of the super-regenerative set will, of course, be evident, but it is faint and not at all bothersome.

The variometer shown in the diagram should be of a large type with a maximum number of turns. The grid inductance, or tuning coil, consists of a 3½-inch tube wound with 100 turns of No. 24 DCC wire. It should be tapped at least every ten turns in order to obtain sufficient variation in tuning.

A variometer may be substituted for this coil with very good results, thus doing away with taps. If a variometer is used it should also be of the large type and preferably of the same make as the plate variometer which is used in the receiver.

—LESLIE A. DIDSBUY, Bridgeport, Conn.

## A Simple Machine for Winding Coils at Home

It is safe to assume that there is a great amount of coil-winding done by hand which might be accomplished more advantageously on a simple home-made coil-winding machine. The apparatus described, has been used by the writer for winding many coils. It is convenient and operates satisfactorily. Coils with a regular factory-made appearance are easily turned out in a few minutes.

Those who care to build such an outfit will find its construction simple and its cost low in comparison with the service that it will render. The experimenter who owns one will find that he can easily make coils which he has long put off building because of the hand-winding difficulties involved or the fact that no machine has been handy.

The illustration shows a shaft, with handle, upon which are mounted two conical hardwood heads. One head remains stationary. The other is readily adjusted by tightening a wing nut so that it holds the tube rigid during the winding process. The shaft is supported by two metal brackets, one fixed and the other arranged with a slot so that the shaft can be removed when the coil tube is being slipped over the shaft and between the hardwood heads.

It will be noticed that one end of the shaft rotates on its threads in the hole of the metal support. This is in no way objectionable, although it does not conform to the standard principles involved in bearings. Those who care to turn down the threads and use a smaller bracket hole may do so.

Any woodworker can turn out the hardwood heads. Make certain that hardwood is used.

Procure from a hardware store the parts listed below:

- 2 Hardwood heads, 1½ inches thick, tapered from 1 inch diameter to 6 inches diameter, ¼-inch center hole;
- 1 Iron rod, ¼-inch diameter, 16¾ inches long, 6⅜ inches standard thread at one end; ½-inch standard thread at other end;



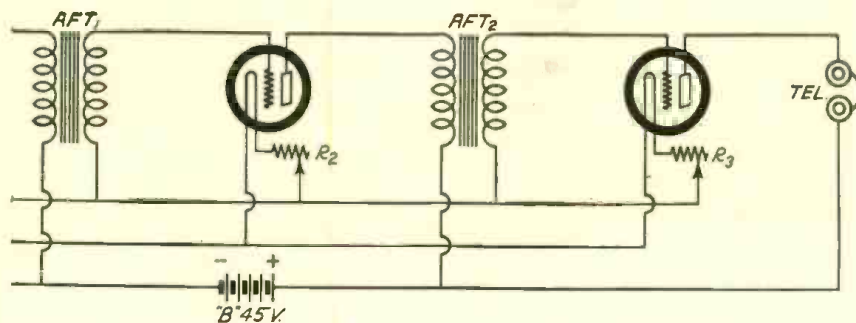

- 2 Iron strips,  $\frac{1}{4}$ -inch thick,  $7\frac{3}{8}$  inches long, 1 inch wide;
- 1 Wooden handle, 3 inches long, approximately;
- 6 Washers,  $\frac{1}{4}$ -inch hole, 1 inch diameter, approximately;
- 2 Wing nut,  $\frac{1}{4}$ -inch standard thread;
- 1 Bolt,  $\frac{1}{4}$ -inch diameter,  $\frac{1}{4}$ -inch standard thread, length depending upon base to which outfit is to be attached;
- 2 Wood screws,  $\frac{1}{4}$ -inch diameter;
- 3 Cotter pins,  $\frac{1}{6}$ -inch diameter,  $\frac{1}{2}$ -inch long;
- 1 Washer,  $\frac{1}{4}$ -inch hole,  $\frac{1}{8}$ -inch thick;
- 1 Nut,  $\frac{1}{4}$ -inch standard thread.

The shaft and the supports may be bent in a heavy vise, using a heavy hammer to shape them. A try-square must be used to obtain the correct right angles. If dies are not available, the hardware store can thread the shaft at the time of purchase.

When adjusting the heads to the coil tube before winding, make certain that the wing nut is as tight as the tube will allow. Otherwise the tube may slip and spoil a good winding. The spool of wire from which the coil is to be wound should be mounted on a rod in some convenient place so that the wire will run easily while the coil is being wound. Coils are most easily shellaced while still in the machine. It is a good plan to leave them there until they are dry.

—BERT LE JEUNE, Pasadena, Cal.

## A Good "A" Battery for Your Set

SEVERAL country radio fans whom I know use the battery from their automobile, during the winter, as an "A" battery; but I had to go fifty miles from home to find a man who is using his home lighting plant batteries for this purpose. He has the common 16-cell 32-volt system which is charged periodically by a gasoline engine and is located in the basement just under his radio room.

Two holes, properly insulated, were drilled in the floor and two No. 14 insulated wires, long enough to reach any of the 16 cells, were put through them. A spring clip was attached to the basement end of each wire to attach it to the battery poles.

He needs six volts, of course, for his set, so he connects only three cells of the lighting plant at one time. That is, one wire from the set is snapped to the negative pole of say No. 4 cell and the other is snapped to the positive pole of No. 6 cell.

In order that there will be no unequal drain on the lighting system he changes the connections every three days or even oftener at times if the set is used much.

Satisfactory results have been had from this plan for two years.

—T. H. WITKORN, Philadelphia, Pa.



Kadel & Herbert

### A REMARKABLE PORTABLE EIGHT-TUBE SUPER

A Boston fan, A. S. Moffat, has built this eight-tube superheterodyne set, together with its batteries, loudspeaker and loop, into a space no larger than that of a small suitcase. Its best pickup, so far, is CFCN, Calgary which is over 2,800 miles from Boston.

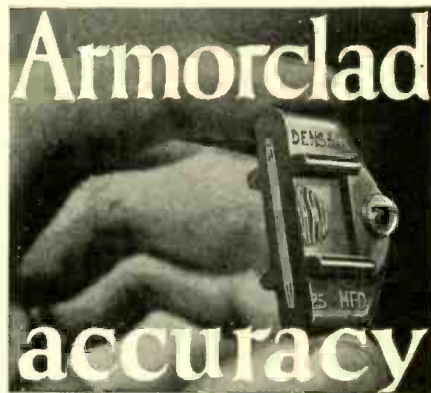

BE careful when choosing fixed condensers, if you want supreme results in radio. Look for permanent accuracy. These little valves must measure with perfect precision. If too much or too little energy is released at one time, the rest of the circuit chokes or starves.

## SANGAMO Mica Condensers

are accurate—and they stay accurate forever, being molded in an armor of bakelite that gives complete protection against heat, cold, moisture, corrosive fumes, or accidental contacts with tools. Not a crevice in the armor into which moisture can creep, for the accuracy of a condenser can be utterly ruined by dampness absorbed from the atmosphere.

The sustained accuracy of Sangamo Condensers makes an immense difference in the tone, range, volume and selectivity of any well-built receiver. There is no finer looking or more accurate condenser on the market—that's why Sangamos are used by so many professional builders of radio sets.

Approved by all nationally recognized radio laboratories



6332-3

SANGAMO BY-PASS CONDENSERS  
Surges won't break them down. Sizes to meet your requirements.

**Sangamo Electric Company**  
Springfield, Illinois

RADIO DIVISION  
50 Church Street, New York

SALES OFFICES—PRINCIPAL CITIES  
For Canada—Sangamo Electric Co. of Canada, Ltd., Toronto.  
For Europe—British Sangamo Co., Ponders End, Middlesex, Eng.  
For Far East—Aashida Engineering Co., Osaka, Japan

# BUILD YOUR SET WITH SIMPLIFIED BLUE PRINTS

LAURENCE M. COCKADAY has personally supervised the preparation of *Simplified Blueprints* of eight of POPULAR RADIO's most popular circuits. Each set consists of three or more *Actual Size* Blueprints: first a Panel Pattern; second, an Instrument Layout; and third, a Picture Wiring Diagram all simplified in the fullest sense of the word because

The panel Pattern can be laid on the panel and all holes drilled as indicated. No scaling to do and so accurate there is no danger of ruining the panel through faulty calculation.

The Instrument Layout placed on the sub-base permits you to indicate by pin-pricks the exact location of every screw.

The Picture Wiring Diagram gives every instrument in exact size, and position with every wire clearly indicated from one contact to the other. With no knowledge of radio symbols you can assemble every part and complete your wiring with no chance of error.

**Priced at \$1.00 Per Set**

Set No. 4—"Cockaday 4-Circuit Tuner with Resistance-Coupled Amplifier" (five tubes, distortionless, two dials, automatic vacuum tube control as described in the October 1924 issue of POPULAR RADIO).

Set No. 6—"The Cockaday 8-Tube Super-heterodyne Reflex Receiver" (eight tubes, two tuning dials, loop, non-radiating, distortionless, as described in January 1925 issue of POPULAR RADIO).

Set No. 12—"8-Tube Super-heterodyne with Single Control" (as described in October 1925 issue of POPULAR RADIO).

Set No. 13—"Raytheon Plate Supply Unit" (a really dependable method for obtaining a "B" source of supply as described in November 1925 issue of POPULAR RADIO).

Set No. 14—"The LC-26 Broadcast Receiver" (as described in December 1925 issue of POPULAR RADIO).

Set No. 15—"The OrthoPhase Receiver" (as described in the February 1926 issue of POPULAR RADIO).

Set No. 16—"The S-C All-Wave Receiver" (as described in the March 1926 issue of POPULAR RADIO).

Set No. 17—"The Power-pack Amplifier" (as described in the April 1926 issue of POPULAR RADIO).

Full constructional and parts details for these Receiving Sets will be found in the issue of POPULAR RADIO indicated. Back issues of POPULAR RADIO will be furnished at the rate of 35c a copy.

## POPULAR RADIO

Department 54

627 West 43d Street, New York

POPULAR RADIO, Inc., Dept. 54,  
627 West 43d St., New York City

Date.....

Enclosed is my remittance of \$..... for which kindly send me Blueprint Set (s) consisting of Panel Pattern, Instrument Layout and Wiring Diagram as checked below:

- |  |  |
|--|--|
| <input type="checkbox"/> Set Number 4  | <input type="checkbox"/> Set Number 14 |
| <input type="checkbox"/> Set Number 6  | <input type="checkbox"/> Set Number 15 |
| <input type="checkbox"/> Set Number 12 | <input type="checkbox"/> Set Number 16 |
| <input type="checkbox"/> Set Number 13 | <input type="checkbox"/> Set Number 17 |

Name.....

Address.....

City.....

State.....



# BROADCASTS

## Crossword Puzzles by Radio

CROSSWORD puzzles are not out of fashion yet; at least they are making as big a hit as ever in London, where crossword puzzlers who are also radio fans may now doubly enjoy themselves.

Every evening, between 8 and 10 o'clock, station 6BM sends out information, either in the spoken form, or in music, to help the devotees of the art to solve the puzzles printed in the newspaper that day.

The help tendered is far more interesting than the type. The announcer does not simply read the definition, both vertically and horizontally, of the white squares; instead, the orchestra supplies the clue in musical form. For instance, the title of the selection may contain the word, or, if a singer is giving a number, the word wanted may be slightly accentuated. In this way, both the crossword puzzling and broadcasting may be enjoyed together.

## A Desperate Radio Fan

APPARENTLY the only way that a certain radio fan in Cleveland, Ohio, can think of to get rid of the radiation evil in his neighborhood is to rebuild the offending apparatus. Accordingly, he has made the desperate offer to take apart and put together again in an improved way any regenerative receiver within several blocks of his home. This service he offers without cost, and "with great pleasure."

## A Broadcasting Station as a Business-Getter

WHILE music has often been termed the universal language, it remained for Station WSAI, at Cincinnati, to discover that music also has charms to produce business where no business was before. Six weeks of Community Concerts, styled "Cincinnati's contribution to the happiness of the world," demonstrated an unexpected and unsolicited commercial value. Persons who have been listening in to the series are now writing to the Chamber of Commerce to

inquire where they may place orders for various commodities. A man in San Salvador confided that he is organizing a band and asked to be put in touch with a firm dealing in musical instruments. In the same mail came a letter from Saskatchewan, written by a Northwest mounted policeman, asking that a ukulele be sent him C. O. D. The inquiries range from personal wearing apparel to jewelry and laundry machinery, soaps, adding machines and household furniture. And they have come from all parts of the United States, Canada and Mexico.

## How Europe Is Avoiding Interference in Reception

ONE of the hardest radio problems for Europe to adjust, until recently, has been the radio interference situation. However recent tests to determine how it would be possible for all of the continental broadcasting stations to transmit at the same time without causing difficulty showed that proper allocation of wavelengths will solve the difficulty.

American fans who consider a station five to six hundred miles away as a "local" can readily picture the condition of affairs in Europe, in which the different states, various radio regulations and petty national differences has made difficult the coordinating power which the United States, twice its size, has been able to create in broadcasting.

Experimenting with a ten kilocycle separation between wavelengths of over 100 broadcasting stations in Europe, an International Committee was able to separate all of the stations with ease. It was necessary to readjust the wavelengths of German and Spanish stations for the purposes, and the range was similar to the American one, 200 to 600 meters.

With headquarters in Paris, the observers heard English, Belgian, French, German and Spanish stations with loud-speaker volume. Italian stations, and one or two British and German stations were reported weak, however. The interference that was experienced was largely due to the stations' variations from their duly assigned frequencies.

## Broadcasting Alarms in Code to Lawbreakers

How complicated is the job of the broadcast director these days is illustrated by Freeman H. Talbot, of KOA, in making a few observations on the steersmanship which has to be given to a matter such as broadcasting the free radio information service which the Denver station maintains and which undoubtedly is looked upon by listeners as the most casual of routine announcements.

On an average of twenty times a month the aid of this station's microphone is enlisted in the search for missing persons. During a period of four weeks recently the requests of local and Federal police officers called for the broadcasting of information for the apprehension of criminals, ranging from a Wyoming arch-murderer and a band of North Dakota bank robbers to a wide variety of petty crooks. Nothing of this nature is permitted to go out on the air until it has been referred to and approved by police authorities, and many of the requests crumple under investigation.

For instance, a service such as this may be asked to aid in broadcasting an emergency message reading as follows:

"Tom and Jerry are sick at Pueblo. Mother is leaving Colorado Springs at once. Come with the rest of the family."

Transmitting this plea *via* the ether waves would seem to be a humanitarian act, but only by investigation can it be known whether it is genuine or a boot-legger's alarm—a veiled message whose real meaning would be:

"Police have seized two carloads of stuff at Pueblo. One car is leaving Colorado Springs. Rush the rest to Denver."

## The Unique Accomplishment of an English Amateur

A NEAT little job of broadcasting has been accomplished by Gerald Marcuse, of Caterham, Surrey, England. Working on a wavelength of 45 meters, he has succeeded in presenting a number of concerts given at the Savoy Hotel, London, to fellow radio amateurs in the eastern sections of Canada and the United States. The vocal parts of these re-broadcasts have been particularly good.

## From Philadelphia to Siberia on One Tube

THE Philadelphia amateur who received word that his signals had been heard in Siberia is entitled to all the elation the achievement undoubtedly brought to him. The "ham" is E. S. Rahn, who operates a 20-watt transmitter, 3LJ, at 1519 North Allison Street. The confirming letter came from Tomsk, Siberia, reporting that the Russian operator picked up the Philadelphia's signals on a one-tube Reinartz receiver.



### PRECISION OCTAFORM COIL

A new type of inductance used in the Cockaday LC-26 Receiver. The only coil that can be used in this set. Price \$5.50.

### COCKADAY COIL \$5.50 (New Octaform Base)

The fact that this coil was used in the 4-Circuit Tuner as designed by Mr. Cockaday, is significant recognition of the accuracy and efficiency of Precision Coils.

### PRECISION COIL SET

#### No. 300

For the new Orthophase Receiver described in the February Popular Radio. Price, per set of three, \$7.50.



## POPULAR RADIO "HOW TO BUILD" KITS

We carry every kit the Popular Radio Laboratories produce with exactly the same parts as used in each look-up. Write us for parts you cannot get.

### IMPROVED RAYTHEON POWER-PACK

1 Raytheon tube	\$ 6.00	1 Bradleyohm No. 10—	
1 Dongan transformer, No. 509		10,000 ohms	\$ 2.00
2 Dongan choke coils, No. 514	7.00	1 Bradleyohm No. 25—	
1 Condenser Corporation combination condenser, 2 units of .1 mfd. each	10.00	250,000 ohms	2.00
1 Condenser Corporation multiple condenser, five units of 2, 2, 8, 1 and 1/2 mfd. respectively	1.25	1 Bradleyunit resistance, 7,500	.75
1 Airgap socket	12.00	1 Electrad resistance mounting	.25
		1 Hardwood base	.35
		1 Composition binding post strip	.25
		1 pair small brass brackets	.10
		<b>Total</b>	<b>\$42.70</b>

### COCKADAY LC-26 KIT

1 General Radio variometer, type 360, equipped with rheostat knob	\$ 3.30	1 Bradleyunit, 1/2 megohm	\$ .75
1 General Radio rheostat, type 214-A, 7 ohms, equipped with rheostat knob	2.25	3 Amperites No. 1A	1.30
1 Precision Octaform coil set	5.50	1 Amperite No. 112	1.10
1 Amco special double unit condenser, No. 1814 each section .0003 mfd.	6.25	5 Benjamin standard "Cleara-tone" sockets	5.00
1 Micamold fixed condenser, .00015 mfd.	.35	1 Carter single circuit jack, No. 101	.70
1 Micamold fixed condenser, .00025 mfd.	.35	2 Carter Jack switches, No. 2	2.00
2 Davern resisto-couplers (new type which incorporates .1 mfd. condenser concealed in base)	3.00	8 Eby binding posts	1.20
1 Amertran DeLuxe transformer, first stage	10.00	1 Eymur vernier control knob and dial	3.50
Bradleyleak, 1/4 to 10 meg.	1.85	1 Universal decorated panel, 8x2 1/2 inches	7.50
3 Bradleyunits, 1/4 megohm	2.25	Blueprints	1.00
		4 Small brass brackets	
		1 Antenna connection block, 1x2 inches	} 1.75
		1 Battery connection block, 1x0 inches	
		2 Large brass brackets	
		Screws and buss wire	
		Solid Walnut Cabinet	17.00
		<b>Total</b>	<b>\$81.90</b>

### COMPLETE PARTS FOR

The S-C Receiver	\$58.85
Cockaday 3-Tube 4-Circuit Tuner	42.50
Power-Pack Amplifier	90.10
The Orthophase Receiver (Solid walnut cabinet)	73.00

Precision Coils and Kits Are Absolutely Guaranteed

**PRECISION COIL CO., Inc.**  
209 Centre Street, New York, N. Y.

## A. RADIO PHAN

ANYWHERE, U. S. A.

Mr. Mike Rofone.

Dear Mike:

Wrote you last month but forgot to tell you that my old friend Ed. Oman from Seattle told me where I could get the Loud Speaker I described. It was Sanford Bros. and they have offices in Seattle, San Francisco, Chicago and Chattanooga.

I sure wish a lot of my friends knew more about Loud Speakers and Radio Sets, too, for that matter. "A Set is no better than its Speaker" is also true the other way 'round. If the audio transformers are not constructed correctly there are many notes lost and of course not reproduced. If the Set will reproduce the notes Timbretone will sure give you a surprise in the way it will perform.

I personally believe the Set, unit, shape and material of the horn should all be made with the idea of being used as a unit. This is practically done in the Arborphone-Timbretone combination. Write Sanford for a circular.

Till next month,

Sincerely yours,

*Jim Bretone*

# SICKLES

## DIAMOND-WEAVE COILS

(Trade Mark registered Aug. 4, 1925)

*For Browning-Drake, Roberts, Craig, Aristocrat and Hoyt Circuits*

(Patented Aug. 21, 1923)

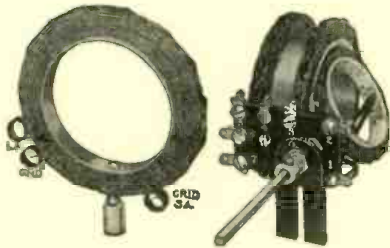

Sickles Coil Set No. 24 for Browning-Drake Circuit  
Price \$7.50

The Sickles No. 18A coil combination is designed specifically for the Roberts Reflex and other reflex circuits using neutralized radio frequency amplification, combined with regeneration controlled by a movable tickler.

The No. 25 coil combination is built for the Aristocrat Circuit, and it will also work admirably in all of the universal circuits using tuned radio frequency amplification, neutralized by the Rice Method and combined with regeneration.

Send for descriptive catalog

**The F. W. Sickles Co.**

134 Union Street

SPRINGFIELD, MASS.

### COIL PRICES

No. 18A	Roberts Circuit	\$8.00 set
No. 24	Browning-Drake	7.50 set
No. 20	Craig Circuits	4.50 set
No. 19	Acme Reflex	4.50 set
No. 8	Knockout Reflex	4.00 set
No. 21	Hoyt Circuit	10.00 set
No. 25	Aristocrat Circuit	8.00 set

### "How to Raise Turnips" —by Radio

With the best agricultural minds in America guiding the courses, WLS of Chicago has started instruction by radio with the aim of teaching methods for getting the maximum of profit from farm products. A regular school enrollment has been established among the farm listeners; pupils are expected to attend the sessions every day except Saturday and Sunday. Six o'clock in the evening is the assembly time; and the sessions last one hour. The curriculum is divided into three main branches, practical farming, practical marketing and rural life. Pupils of the school receive the lessons in printed form, as they are given through the ether; and they send in discussions concerning their individual problems and ideas for improvements; these are broadcast during the "recitation periods."

### Short Radio Waves Reach the Sphinx

SHORT waves were largely responsible for the 7,000 mile DX record achieved by R. H. Skinner, director of a round-the-world cruise, who heard KDKA (Pittsburgh), at the base of the Sphinx in the early part of February.

The short-wave receiver was set up in the shadow of the Sphinx; and American tourists heard the voice of Mr. Skinner's wife and of friends, which reached them there in the desert after crossing oceans and continents.

This demonstration of the DX possibilities of short waves should prove of special interest to American amateurs who think a 1,000-mile range a local one. There are many short-wave European stations which might be heard in America with the proper apparatus.

### How Radio Has Touched the Lives of the People

THERE are now about 1,000 broadcasting stations in the world. Only five years ago there was no such thing as "air entertainment." In twelve years, foreign ship and store stations have increased tenfold; and all together it appears that nearly 10,000 American professional operators are required to keep the commercial sets going. And there are more amateurs than commercial men in radio. It is estimated that no fewer than 100,000 persons are actually building receiving sets at this time and that a quarter-million residents of the United States are connected more or less directly with the radio industry. Statistics of this kind are stimulating to the imagination of the young man who is speculatively considering the future possibilities of this fast growing art and who believes that it may be possible to link its prospects of success with his own.

### "The Better Condensers"

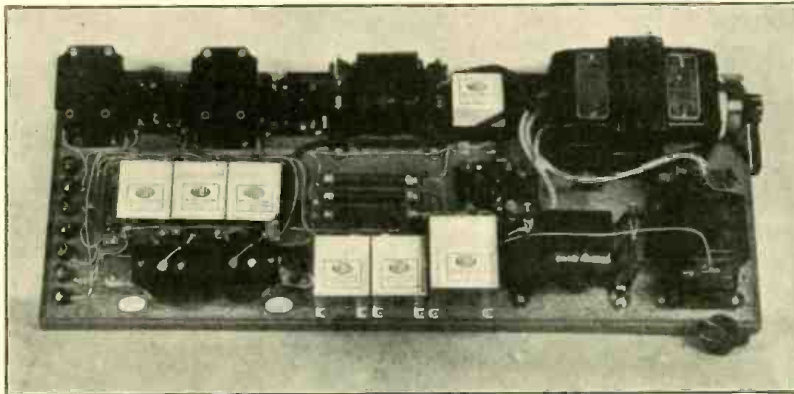

### AN IMPROVED POWER-PACK AMPLIFIER AND TOBE CONDENSERS

This Power-Pack Amplifier is like the latest POPULAR RADIO Power-Pack Amplifier, using AmerTran Transformers and Amerchokes, described in April 1926, but this has one more stage of audio, for attachment directly to the jack of any set. It will give perfect quality with great volume, and in addition, supply B current to the entire set, without batteries.

TOBE CONDENSERS are used throughout—and permanent satisfaction and quality are thereby assured. Condenser cost is reasonable.

6 TOBE Type 709, 2 Mfd., @ \$1.75..... \$10.50  
1 TOBE Type 711, 4 Mfd., @ 3.75..... 3.75

Total Condenser Cost..... \$14.25

Write us today for free drawings of this Power-Pack Amplifier.

The new Raytheon Power-Pack uses the TOBE B BLOCK—a filler condenser unit that saves money, space and wiring, and which adds to the appearance of any plate supply unit.

Remember Raytheon recommends Tobe Condensers as unsurpassed by any for use in Raytheon circuits.

**Tobe Deutschmann Co.**  
CORNHILL BOSTON, MASS.

### A "Radio Curfew" Law

RADIO has been the cause for many novel regulations and laws in our statute books. The latest one comes from Chicago, where Corporation Counsel Busch has decided that it should cost late radio fans between \$1 and \$200 for the privilege of operating their loud-speakers after midnight. The penalty is in the form of a fine.

This action was taken after many complaints had reached the City Prosecutor. These cases will be prosecuted in the same manner as a disorderly conduct case.

### The Low Costs of Listening In

A LEADING manufacturing company has at last figured out the cost of operating a radio receiver. On a three-tube receiver, without a "C" battery, the "B" battery cost is about two cents an hour; on the same receiver, but using both "B" and "C" batteries, the total cost is reduced to one cent an hour.

On a five-tube receiver of standard type, equipped with the larger type batteries designed for high current drains, the cost of "B" battery upkeep may be kept to three cents. A "C" battery reduces this average to two cents an hour.

The "A" battery cost is estimated to be less than the "B" battery cost of the same receiver. These calculations are based on a two-hour use of the instrument daily, and until the 45-volt battery units reached a 34 volts minimum.

### "Hello England! Are You There?"

IF you are equipped with a short wave receiver, you have no doubt heard the experimenting which has been going on between the Rocky Point station of the American Telephone and Telegraph Company on Long Island and the new super-power short wave station in Rugby, England. Recently these two stations carried on a radio telephone conversation that lasted ten hours. It may be expected that a regular commercial telephone service across the Atlantic will be the outcome of these very interesting and remarkable tests.

### A Chance to Check Up on Your Frequencies

RADIOISTS who rejoice in the possession of a wavemeter, or have some particular reason for calibration of transmitting and receiving apparatus to the official frequency standard, will be interested to know that the Bureau of Standards transmits, twice a month, radio signals of definitely announced frequencies from WWV, Washington, D. C., and from 6XBM, Stanford University, Calif. All the dope is given in Bureau of Standards Letter Circular No. 171.



MAIL THIS COUPON TODAY TO GOLDEN-LEUTZ, INC., 6th & WASHINGTON AVES., LONG ISLAND CITY, N. Y.

GOLDEN-LEUTZ, INC.  
6TH & WASHINGTON AVES.  
LONG ISLAND CITY, N. Y.

GENTLEMEN:

PLEASE MAIL IMMEDIATELY WHEN READY AND WITHOUT OBLIGATION ON MY PART FULL DESCRIPTIVE LITERATURE ON YOUR NEW LINE INCLUDING

1. STANDARD PLIO-6 A POWERFUL HIGH GRADE MEDIUM PRICED BROADCAST RECEIVER.
2. UNIVERSAL PLIO-6 HAVING THE EXCLUSIVE FEATURE OF TUNING ALL WAVELENGTHS FROM 35 TO 3600 METERS FOR PERFECT BROADCAST RECEPTION.
3. UNIVERSAL SUPER 8 A VERY HIGH GRADE SCIENTIFIC BROADCAST RECEIVER ALSO FOR ALL WAVE LENGTHS FROM 35 TO 3600 METERS.
4. UNIVERSAL TRANSOCEANIC THE MOST POWERFUL AND MOST ADVANCED RADIO BROADCAST RECEIVER IN THE WORLD.

CONSUMER

DEALER

JOBBER

INDICATE INTEREST WITH AN "X"

YOURS VERY TRULY

NAME.....

ADDRESS.....

# YOUR INDIVIDUAL PROBLEMS SOLVED

POPULAR RADIO maintains for the benefit of its readers a Technical Service Bureau and Laboratory, under the personal supervision of Laurence M. Cookday which will, without charge, answer by personal letter any question, problem or request for information submitted by a subscriber. This service is, however, also available to readers, other than subscribers, at the very nominal rate of 50 cents the inquiry.

In writing please confine your questions to one general subject, writing on one side of the paper only, and enclose a self-addressed and stamped envelope.

It is possible that your individual problem has been covered in an issue of POPULAR RADIO, and so as an aid to you we endeavor to keep a supply of back numbers in stock. The condensed index below gives a few of the subjects that have appeared recently, look this list over and if the information you want is covered, we will be pleased to supply back numbers at 35c. a copy.

**June, 1925**

- New Development in Vacuum Tubes.
- How to Build a Five-Tube A-C Receiver.
- How to Draw Up Your Own Tuning Chart.
- Walt's Law in a Nutshell.
- "What Set Shall I Buy?"
- First Installment.

**July, 1925**

- The Best 101 Hook-ups.
- "What Set Shall I Buy?"
- Second Installment.
- Broadcast Stations in the United States.
- What's New in Radio Apparatus.

**August, 1925**

- "Motion Pictures" by Ether Waves.
- A New Type of Hornless Loudspeaker.
- How to Build a 5-Tube Radio-Frequency Set with Simplified Control.
- Trouble Shooting.
- Hints for Amateurs.

**September, 1925**

- How the Air Affects Radio.
- When You Turn Your Dials.
- Useful Charts for Amateurs.
- Call Letters That Have a Past.
- Broadcasts.

**October, 1925**

- How Earth Magnetism Affects Radio Waves.
- How to Improve Broadcast Reception.
- What Makes a Low-loss Coil?
- How to Build the New 8-Tube Superheterodyne with a Single Control.

**November, 1925**

- Radio's Newest Instrument—the Photoelectric Cell.
- How to Build the Raytheon Plate Supply Unit.
- New Methods of Calibrating Your Receiver.
- Practical Pointers About Transformers.
- Multi-layer Coils.

**December, 1925**

- How to Build The New LC-26 Receiver
- How to Improve Broadcast Reception.
- What Every Radio Experimenter Should Know About Condensers.
- "Fruitful Reproduction," How to Get It from Your Set.
- Radio that Runs on a Beam.

**January, 1926**

- How to Get the Most Out of Your LC-26 Receiver.
- Some New and Useful Facts About Coils.
- When Your Set Won't Work.
- Straight-Line-Frequency Condensers.
- What's New in Radio Apparatus.

**February, 1926**

- How to Reduce Distortion in Amplification.
- Some Stunt Sets.
- Important Kinks in Wiring.
- How to Cut Down Your "B" Battery Bill.
- Hints for Amateurs.

**March, 1926**

- A New Theory of Wave Transmission.
- Why and How the Milliammeter Increases the Efficiency of Your Set.
- What "Inductance" Really Is.
- List of Broadcast Stations in the U. S.
- How to Build the S-C Receiver for Short and Long Waves.

**April, 1926**

- How to Get an Operator's "Ticket."
- What a Straight-line Frequency Condenser Really Is.
- How to Build a Power-pack Amplifier.
- The New "Crystal Pilot."
- How to Build and Operate a Low-Power Transmitter.
- The Popular Radio Medal for Conspicuous Service.

## POPULAR RADIO

Department 58

627 West 43d Street New York

## Canadian Broadcasters Organize

With the purpose of "protecting the interests of the radio listeners-in," a new organization, known as the Canadian Association of Broadcasters, has been formed. It includes every radiophone station in Canada.

## A Radio Listening Post

If the plan presented by M. C. Saylor, who is the radio engineer in charge of WIAP, New York, is accepted, New York City may have the first official observation post for broadcasting established in the country. Mr. Saylor proposes to establish a complete listening-in post, in charge of a competent radio operator, to check up on all of the complaints, interference, violations and other misdemeanors which a radio broadcasting station may fall into. The control of this listening post would be placed in the hands of a committee of broadcasters of the Metropolitan Area, with the District Radio Supervisor as the Chairman; and a continuous watch would be kept from 6 P.M. to 12 P.M. The operator would make measurements with a sensitive wavemeter of all the wavelengths, every half hour. Over-modulation, attention to SOS signals, proper frequencies transmission are only a few of the items which the observation station would have to watch. The District Supervisor has approved of the idea.

## The High Power Fad in Europe

AMERICAN broadcasting stations are just finishing the high and super-power craze which swept the country last fall. In Europe, the fad is just beginning. Several of the larger stations there will change over to increased power. Among them are Radio Belgique, which will use 10 kilowatts; Radio Paris goes up to 15 kilowatts; Hilversum, in Holland, is to have 20 kilowatts; and Moscow will send with 25 kilowatts.

With these increases in power, regular reception of European stations in America should be easier and more frequent.

## New York Is Radio Center

It has been estimated that more than 20,000 jobbers and dealers, representing all sections of the country, visit New York annually on radio business.

These thousands of radio merchants come to New York to see the very latest steps in radio achievement, and to look over the lines of some of the biggest manufacturers of radio equipment, which are located in the city. While the largest percentage of these commercial visitors come for the big radio shows and exhibitions, there is a constant stream coming and going daily.

Probably more than 65 percent of all radio business done in this country is carried by New York.

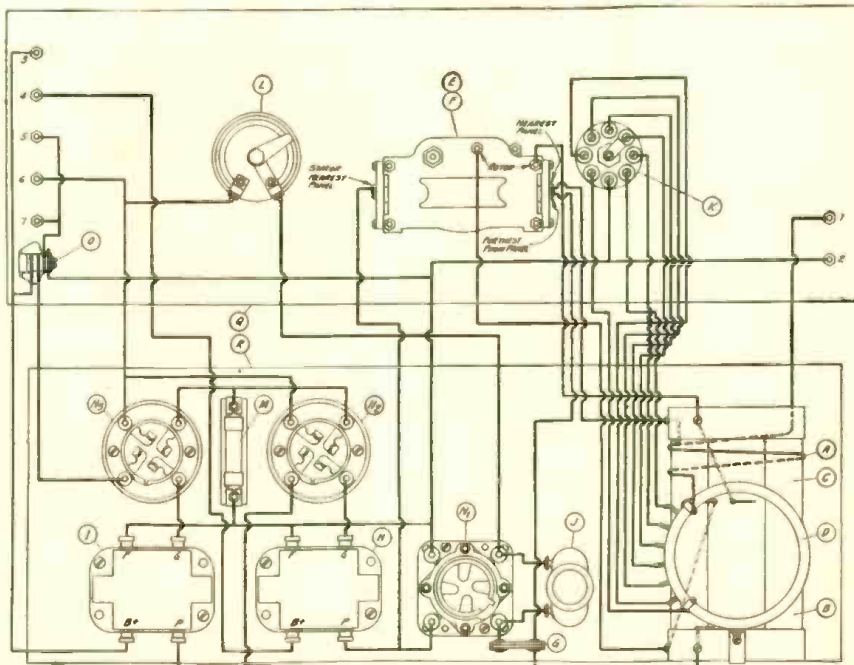

### A CORRECTION

In the diagram of the three-tube, four-circuit receiver on page 226 of the March, 1926, issue, an error was made in numbering the battery binding posts. In order to agree with the descriptive material in the text of the article which accompanied the diagram the numbers should be reversed, making the top binding post No. 2, next to the top No. 4, and so on down to No. 7 which should be the bottom terminal. This change means that, starting from the top, the connections should be "B-" 90 volts, "B+" 22½ volts, "B-", "A+", and "A-". The correct numbers on the binding posts are shown above.

### Quaint Explanations of the Phenomena of Radio

ONE of the important services to civilization that radio is rendering is the enlightenment that it is bringing to the ignorant and the superstitious, and the interest it is arousing in the subject of science generally. Why the progress of radio is slow in districts where education is meager is aptly illustrated by the following adventure that is reported by John Y. Ray of Glen Allen, Virginia:

Here is a story that will give you an idea of the frame of mind of the people in this territory, outside of the large cities.

This fall, while hunting turkeys, I came upon some people operating a "still." They were in the midst of a discussion on the subject of radio. After sampling some of the "jump steady" I listened to the argument. One man had a rather feeble belief in radio while six were trying to talk him down.

One man claimed that it was "nothing but a phonograph with a lot of records in it." When I called his attention to the fact that it had been possible to hear the President's speech made a day or so before, he replied by saying that "they knew what he was going to say a long time ago and made the record then."

Another man claimed that "there were wires running under the ground that people connected their sets to and that the broadcasting came over the wires like the telephone."

Still another debater maintained that "there was no such thing as radio," and that there "was a trick about it somewhere."

And one devout churchman could see nothing but a calamity coming upon the world as a result of radio; he kept repeating, "Folks are getting too wise; the Lord is sure going to punish them."

It will require a lot of education on the part of magazines, the dealers and manufacturers to get them to believe anything different.

### Changes in the List of Broadcasting Stations in the U. S.

These corrections and additions to the list which was published in the March, 1926, issue of POPULAR RADIO, make it correct as of March 20, 1926. Further changes will be published each month in this magazine.

STATIONS ADDED		
KFUM	Colorado Springs, Col.	239.9
KWUC	Le Mars, Ia.	252
WCDA	Pensacola, Fla.	222.1
WJBR	Omro, Wis.	227.1
WLB	Minneapolis, Minn.	277.6
WPDQ	Buffalo, N. Y.	205.4
WRAK	Escanaba, Mich.	256.3

STATIONS DELETED		
KDZB	Bakersfield, Cal.	209.7
KFAJ	Boulder, Col.	261
KFVH	Manhattan, Kan.	218.8
KUO	San Francisco, Cal.	250
WDBC	Lancaster, Pa.	258
WEBM	New York, N. Y.	226
WHBK	Ellsworth, Me.	231

CHANGES IN CALL LETTERS		
KFMQ	Fayetteville, Ark., Change to	KUDA
KFXC	Santa Maria, Cal., Change to	KSMR
WCCE	Elgin, Ill., Change to	WSWS
WHAT	Minneapolis, Minn., Change to	WGWY
WKBK	New York, N. Y., Change to	WBNY

CHANGES IN WAVELENGTHS		
WCBR	Providence, R. I., 205.4, Change to	208.7

CHANGES IN LOCATIONS		
WCCE	Elgin, Ill., Change to	Wooddale, Ill.
WJBG	Charlotte, N. C., Change to	Greensboro, N. C.
WTAQ	Ozeco, Wis., Change to	Eau Claire, Wis.

## NEW HETRO-MAGNETIC RECEIVER



\$48.50 MODEL HETRO-MAGNETIC

**SET** Wavelength range, 225 to 675 meters. In new regulation wavelength for broadcasting stations. Tube arrangements: Magnetic coil, equi-amplifier, detector, two stages audio.

#### GENERAL INFORMATION

Antenna: Single wire 10 to 150 feet. Works satisfactorily on indoor aerial.  
 Tubes: Dry cells, 100, or Storage Battery 201A.  
 Panel: 7 by 26, beautifully engraved Bakelite.  
 Dials: 4 inch—vernier optional.  
 Controls: Germania, Hetro-Magnetic.  
 Condensers: Foreign type, low loss.  
 Sockets: Special type, fits all tubes.  
 Cabinet: Beautifully finished 10½ x 10 x 29 solid walnut piano-hinged, \$7.00 extra.

For those that care to purchase a complete outfit, we have combined the following accessories, together with the instrument, at this exceptional low price.

- 1 Mercury Receiver
- 5 Tested RCA Tubes, 201A
- 1 Thorola Loud Speaker 2 45 Volt Batteries
- 1 Complete Aerial
- 1 Storage Battery

Special Price as described - - - **\$82.50**

Above set in 29" walnut cabinet..... \$48.50

Set less cabinet..... 39.50

Complete knock down kit..... 25.00

(These prices do not include accessories.)

Our circular containing guarantee gives complete description

MERCURY ELECTRIC CORP.

2032 Grand Ave., New York

### Sold On Trial

Explanation:

Look over very carefully every ad in this magazine and then you may read this one. Our story is simple.

This receiver is sold to you on a 10 day proposition. You have the privilege to compare it with any \$150.00 to \$200.00 Receiver, and if it does not give as good or better results in distance, volume and clarity, you may return it to us in good condition without any obligation, and we will refund to you your money.

Furthermore, if anyone in your locality, or you, can build so fine an instrument, using the same high grade parts as used in this instrument, for less money, you still have the same privilege to return it.

We recently secured a license and have adopted a policy to sell direct to the consumer, avoiding the middleman's profit.

Factories producing Hetro-Magnetic Receivers are months behind in production. Grasp this opportunity at once.

## Thordarson Equipped!

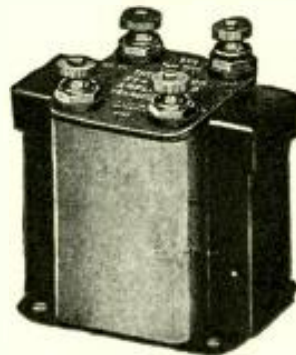

Standard on Majority of Quality Sets

Month after month, season after season, these leading receiving set makers continue to specify Thordarson Amplifying Transformers.

They have learned that Thordarsons will "stand the gaff"—that in tone quality they satisfy even the most fastidious—that even in hardest service they will not break down—that they are designed right, built right, and sound right.

Build or replace with Thordarsons.

Write for descriptive circulars

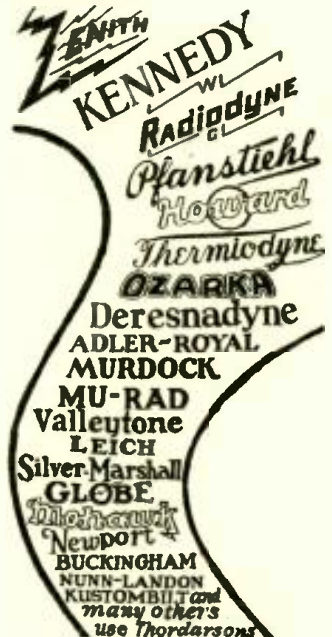

# THORDARSON ELECTRIC MFG. CO.

Transformer Specialists Since 1895

WORLD'S OLDEST AND LARGEST TRANSFORMER MAKERS  
 Chicago, U. S. A.



**-it's in the Tube**

Your receiving set can be no better than its tubes. CeCo Tubes give maximum results in clarity of tone, rich volume and long life. Our charted tests (results confirmed by laboratories of national reputation) PROVE CECO TUBES SUPERIORITY—as detectors, as amplifiers.

Buy CeCo Tubes whether your set takes one tube or eight. Now ready! CeCo Tubes with new type Long PRONG BASES. Also, power amplifier tubes, E (Dry Cell Type), F (Storage Battery), for last stage of Audio Frequency. Ask your radio dealer.

**C.E. Mfg. Co., Inc.**  
702 Eddy St.,  
Providence, R. I.

**CECO TUBES**

Statement of the ownership, management, circulation, etc., required by the act of Congress of August 24, 1912, of "Popular Radio," published monthly, at New York, N. Y., for April 1, 1926, State of New York, County of New York.

Before me, a Notary Public in and for the State and county aforesaid, personally appeared Douglas H. Cooke, who, having been duly sworn according to law, deposes and says that he is the Business Manager of "Popular Radio," and that the following is, to the best of his knowledge and belief, a true statement of the ownership, management, etc., of the aforesaid publication for the date shown in the above caption, required by the Act of August 24, 1912, embodied in section 411, Postal Laws and Regulations, to wit: 1. That the names and addresses of the publisher, editor, managing editor, and business managers are: Publisher, Popular Radio, Inc., 627 West 43rd Street, New York City; Editor, Kendall Banning, 927 West 43d Street, New York City; Managing Editor, None; Business Manager, Douglas H. Cooke, 627 West 43d Street, New York City. 2. That the owner is: Popular Radio, Inc., whose stockholders are: Laurence M. Cockaday, 627 West 43d Street, New York City; Kendall Banning, 627 West 43d Street, New York City; New Fiction Publishing Corporation, 627 West 43d Street, New York City, whose stockholders are: Douglas H. Cooke, 627 West 43d Street, New York City; Vernal W. Batez 46 George Street, New Haven, Conn.; Willey Blair, 4607 Ross Avenue, Dallas, Texas; Harold B. Emerson, 9 East 40th Street, New York City; Estate of William Green, 627 West 43d Street, New York City; \*Harris Corporation, 34 Pine Street, New York City; Le Roy Sargent, St. Petersburg, Fla.; Abel I. Smith, 120 Broadway, New York City; Louis H. Strouse, Samuel Falk and Frank C. Fisher, Trustees in bankruptcy of Metropolitan Finance Corporation, 9 East 40th Street, New York City. \*Harris Corporation with the following as Trustees in dissolution of Harvey Flsk & Sons (1921) now dissolved: John Donovan, 30 Church Street, New York City; Harvey Flsk, 34 Pine Street, New York City; Joseph M. Shellabarger, 30 Church Street, New York City. 3. That the known bondholders, mortgagees, and other security holders owning or holding 1 per cent. or more of total amount of bonds, mortgages, or other securities are: None. 4. That the two paragraphs next above, giving the names of the owners, stockholders, and security holders, if any, contain not only the list of stockholders and security holders as they appear upon the books of the company but also, in cases, where the stockholder or security holder appears upon the books of the company as trustee or in any other fiduciary relation, the name of the person or corporation for whom such trustee is acting, is given; also that the said two paragraphs contain statements embracing affiant's full knowledge and belief as to the circumstances and conditions under which stockholders and security holders who do not appear upon the books of the company as trustees, hold stock and securities in a capacity other than that of a bona fide owner; and this affiant has no reason to believe that any other person, association, or corporation has any interest direct or indirect in the said stock, bonds or other securities than as so stated by him. Douglas H. Cooke, Business Manager, Sworn to and subscribed before me this 27th day of March, 1926. Joseph T. Cooney, Notary Public, New York County. (My commission expires March 30, 1928.)



Kadel & Herbert

**ONE BROADCASTER WHO IS CASHING IN ON HIS TALKS TO MIKE**

Before the advent of broadcasting Dr. S. Parkes Cadman was a little-known Congregational minister in Brooklyn. Today his name is known to so many radio fans that it is bringing him in \$50,000 a year on the side as a newspaper syndicate feature.

**A New Freak in the Broadcasting Studio**

ONE of the listeners to WOC of Davenport, Iowa, proposes to broadcast, for the entertainment of other listeners, the peculiar noise which he can make by wiggling his ears. He says this click is as loud as that of a watch. Program managers who are looking for something really novel to broadcast could scarcely find anything more phenomenal.

**A Unique Experiment in Community Broadcasting**

THE Chamber of Commerce of Cincinnati is doing a laudable piece of broadcasting from station WSAI; and this department hastens to recommend the procedure to other cities of similar size.

Using a fund of voluntary contributions, the Cincinnati Symphony Orchestra (said to be one of the very best mediums of expression in the United States) is brought to the air weekly. The business men of Cincinnati feel that their contributions to the fund help to popularize the town, and

this, of course, is the big idea back of every Chamber of Commerce. Be that as it may, we feel that the improvement to broadcasting is the big thing; and hence this department very officially recommends the idea to all Chambers of Commerce in this country.

**Radio Replaces Magnetic Compass on Next Polar Flight**

A THOUSAND-MILE radio transmitter, together with very sensitive receiving apparatus and a special direction finder, will compose the radio equipment of the *Norge I*, the new airship in which Captain Amundsen and Lincoln Ellsworth will make their next flight to the North Pole.

The direction finder is of new design, and it was specially built for the airship.

"Just think, Aunt Lil, my husband got Hamburg and Java on the radio last night."

"Now, my dear child, you don't think I'll ever believe they can deliver groceries on that fool contraption."

—The Progressive Grocer

**The "How to Build" Set in Next Month's Issue**

For the experimenter and home-builder who has had little experience or no experience at all in assembling his own radio receiver, the constructional article in POPULAR RADIO for June will have a special interest. For this new set—which has been developed by Will Bradley, Jr., in collaboration with the POPULAR RADIO LABORATORY—not only combines good tone quality, and selectivity, but it is also remarkable because of new features that make possible the reception of distant stations on a loudspeaker, using only three tubes. So simple to build and to operate is this new set that any beginner in radio will be able to construct it from the detailed specifications, drawings and photographs that will explain every operation. The set may be assembled at a cost for parts (exclusive of the tubes, aerial, battery and cabinet) of about \$65.00.



## Penalties for "Libel by Radio"

WHILE modernizing the old penal code of Spain, cognizance was given to the possibilities of radio in crime. Although there have been, so far, no cases of blackmail or libel over the radio, Spanish judges will have a law to go by if such a thing happens in their country.

Severe penalties are provided for blackmailing or libel, either in newspapers or by radio. Slander, threats, or abusive utterances, either in the newspapers or by broadcasting, are other cases anticipated by the new penal code of Spain.

## A Practical Test of a Radio Voice

DAVID LIPTON, announcer for a firm that broadcasts over stations WMAQ, WGN and WEBH, in Chicago, recently went to the bank to cash his pay check. But as he carried no identification material, the cashier hesitated to hand over the cash. So it occurred to Lipton to make a real test of the power of the radio voice.

"Have you a radio set?" he asked of the man behind the bars.

"Certainly I have!" said the cashier.

"Then you'll recognize this," said Lipton, who thereupon made the customary announcement as if before the station microphone.

Lipton received his money.

## Broadcasting at the Word-rate

THE speed-rate of your speech does not determine how much you must pay for the use of the air for radio advertising over the Oslo, Norway, broadcasting station. The fee for broadcasting is two kronen a word, just as in classified advertisements.

In the United States, the usual method of charging is by the minute, or fraction of an hour.

In Oslo not more than 15 percent of the program may be made up of paid programs. Even at this low rate, and with those restrictions which the Government has placed on this form of propaganda, the Kringskasting Selskap, the operating company, has been able to make it profitable.

## The First Practical Radiophone Line in the U. S.

SINCE October, 1924, Hawaiians have been able to communicate between the Islands of Oahu and Lanai, T. H., (a distance of about fifty miles) by automatic radiotelephone. This is the first practical installation of the system in the United States. By means of the radio link, natives who are equipped with ordinary telephones on any island may communicate with others similarly outfitted on other islands.

# Control Volume with this Modulator Plug

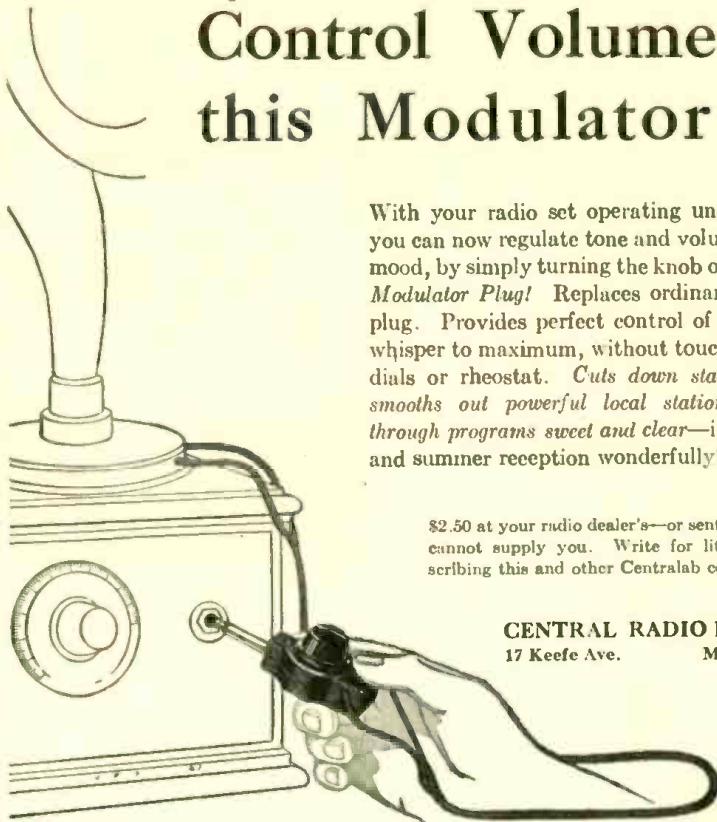

With your radio set operating under full power, you can now regulate tone and volume to suit your mood, by simply turning the knob on this *Centralab Modulator Plug*! Replaces ordinary loud-speaker plug. Provides perfect control of volume from a whisper to maximum, without touching the tuning dials or rheostat. *Cuts down static interference, smooths out powerful local stations, and brings through programs sweet and clear*—improves spring and summer reception wonderfully!

\$2.50 at your radio dealer's—or sent direct if he cannot supply you. Write for literature describing this and other Centralab controls.

CENTRAL RADIO LABORATORIES  
17 Keefe Ave. Milwaukee, Wisconsin

# Centralab



**Don't neglect your tubes—and good radio can be obtained all summer long!**

Give your radio set a spring- tonic by invigorating the tubes the Sterling way, and you will find that the quality of your reception is practically as good as you got in winter—always enjoyable for porch dancing, baseball scores, concerts, and musical entertainment to make warm evenings more enjoyable.

**KEEP YOUR TUBES FULL OF VIGOR**

with the Sterling Tube Reactivator. The meter on this device shows you when tubes need reactivation and proves their increased efficiency after treatment. A high class instrument, easy to operate, and no guesswork in its results.

Price \$12.50 (50-60 cycle)  
\$14.00 (25-40 cycle)

For your complete radio home service equipment also use Sterling Tube Testers, Sterling Battery Chargers and Sterling Pocket Meters.

Ask your dealer!  
The Sterling Mfg. Company  
Cleveland, Ohio, Dept. V

# Sterling TUBE REACTIVATOR

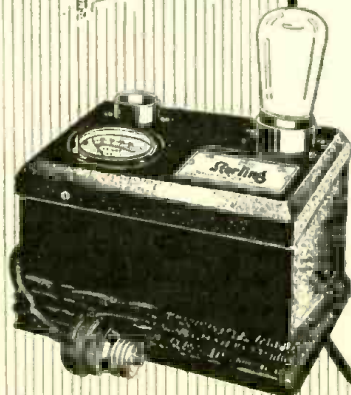

## De JUR AMPLIFIER

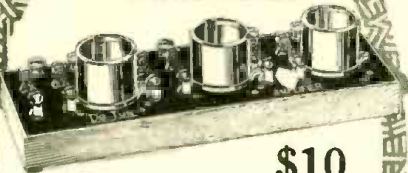

**\$10**

### DISTORTION LESS AMPLIFICATION

Equip your set with a DeJur Amplifier and enjoy REAL radio. Get tone, clarity and volume you never thought possible. Fits in the audio side of any set.

**Equipped With DeJur Parts**  
Sockets of Genuine Bakelite and take standard or new UX tubes. Built with .01 Bakelite Impregnated Mica Condensers and DeJur Resistors.

No bus bar in wiring. All metal strip connections are riveted. No screws, nuts or bolts to work loose.

Sold By All Dealers  
Get the Genuine

Write for Catalog of DeJur Parts

**De JUR PRODUCTS Co**

The World's Largest Manufacturers of Rheostats  
100 LAFAYETTE ST. NEW YORK CITY

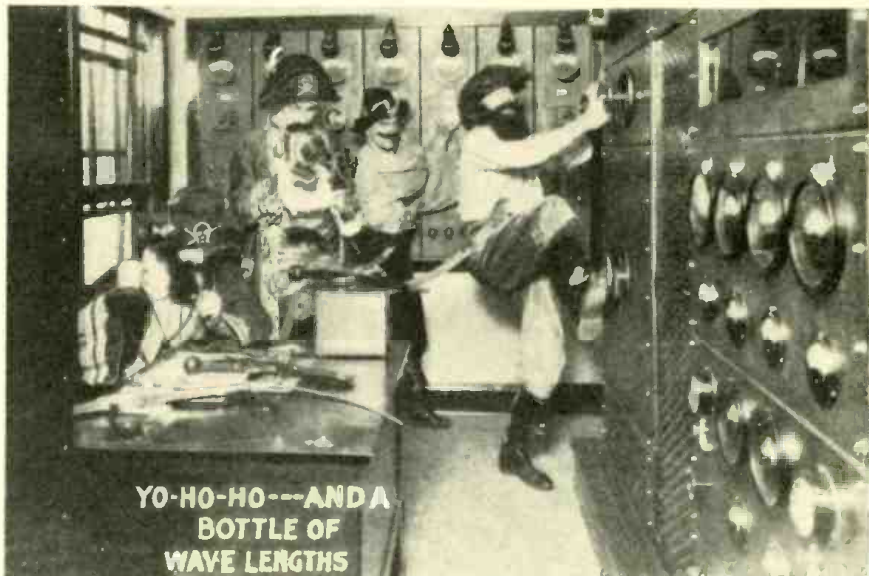

**YO-HO-HO---ANDA  
BOTTLE OF  
WAVE LENGTHS**

### THE CREW OF A "PIRATE STATION" IN ACTION

Undaunted by the disciplinary action of Uncle Sam in bringing suit against WJAZ on the ground that it has been pirating wave-lengths other than those assigned to it, the outlaw Chicago station recently—and appropriately—broadcast the operetta "The Pirate."

## BROADCAST LISTENER

Comments on radio programs, methods and technique  
—from the point of view of the average fan

By RAYMOND FRANCIS YATES

### Why Not Some "Continuity" in Broadcast Programs?

A FEW days ago we sat in the Players Club talking to one of the soundest radio listeners in these United States. This gentleman, in case you would like to know, was Mr. William Mackay, an artist and a lover of art and the first subscriber to POPULAR RADIO. He is one of the seven persons in this country who is painfully annoyed every time he turns to the radio and who still holds the opinion that broadcasting has much to learn before it shares the glory of its sister entertainments.

The gentleman in question was so enthusiastically disagreeable that we envied him—and that is about the heaviest confession we have made since we told our Sunday School teacher that it was we who had put the chewing gum on Sadie Lumb's chair.

Our good friend talked long and heatedly about continuity; and continuity is one of the things this naive old hulk has been steaming about since it was a critical pup. The Theory of the Psychological Value of Continuity is based on the (to studio managers) amazing fact that the average human being has in him the capacity for what is known as "sustained interest." If you shoot at a man with a single-barreled shotgun he is interested in dodging only one bullet, but if you use a machine gun you manage to keep his interest at high pitch without a great deal of extra effort.

Working on this same heavy line of thought, you eventually come to the astounding conclusion that the long periods of nothingness between radio programs are strictly anti-spellbinding and that a radio listener may suffer the severest kind of an æsthetic chill during the interim.

This theory, kind and gentle reader, is not the mental handiwork of this musty brain; it was old when George M. Cohan wrote his first comedy. And that was a long time ago.

It does seem as though our bravest efforts to entertain on the radio are rendered largely futile because of this lack of continuity. Perhaps we do not mean futile but certainly less effective.

Take the Victor programs as a classical example. The Victor company has put on some of the greatest poor programs ever broadcast; great with talent but anemic in execution. You can appreciate, too, that when a musical nobody like this reviewer criticises the Victor company he must be pretty sure that he is not talking through the old coo-coo clock.

A very terse description of the Victor hour would sound something like this:

Talking. *Silence.* Song. *Silence.*  
Talking. *Silence.* Song. *Silence.*  
Chamber Music. *Silence.* Talking. *Silence.*  
Song. *Silence.* Talking. *Silence.*  
Song. *Silence.* Talking. *Silence.*  
Chamber Music. *Silence.* Talking. *Silence.*  
Good night.

That may be a pretty crude descrip-

Price  
**\$4.00**  
Each

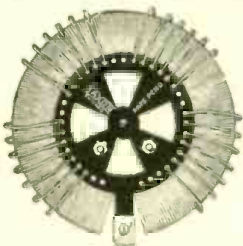

**\$12.00**  
Set of  
Three

**NAXON**

### TOROIDAL TRANSFORMERS

Developed by Irving Nachumsonn

#### Seven Points of Superiority

1. Correctly distributed external primary.
2. Absence of usual secondary eddy-current losses.
3. Maximum magnetic coupling with minimum capacity coupling.
4. Sturdy construction without coil hotspots to absorb energy.
5. Spaced low-resistance windings.
6. Silver plated primary reduces skin losses.
7. Each turn a perfect toroid. No trick-style windings with losses in every angular bend.

To be used with .0005 condensers only.

**Naxon Electrical Laboratories**  
Inductance Research Division  
4524-26 Cottage Grove Ave., Chicago

Naxon Electrical Laboratories,  
4524-26 Cottage Grove Ave.,  
Chicago, Ill.

Gentlemen: Kindly forward to my address the following:

- Complete literature on Naxon Coils.
- One set of 3 Naxon Coils with hook up diagram.

Name.....

Address.....

City..... State.....

Sent post paid for \$12.00 enclosed—otherwise C. O. D. plus postage.

tion but it at least emphasizes the periods of silence and talking; and, when you come to total up, it seems that the periods of silence and talking take almost as much time as the actual music. Some kindly voiced gentleman (perhaps it was Mr. Victor himself) has insisted upon painting beautiful word pictures (with orange blossom backgrounds) of each artist before the performance. He also introduces prolonged sketches between acts; and although he conducts himself like a gentleman in every respect, we cannot shake off the thought that he is a washing machine salesman. As a matter of fact, he acts like a washing machine salesman; he describes his articles of merchandise and ends with a demonstration, just as the whirlwind salesman of the Eazy Day washing machine winds up his sales talk No. 4 with a touch of the electric button. Mr. Victor might just as well say, "Now that I have described this beautiful machine to you, ladies and gentlemen, I am going to make it sing."

If we were running the Victor programs we should see to it that the music continued from beginning to end. The piano would fade into orchestra music and orchestra music would fade into the violin solo. Announcements, if they had to be made, would be short and with musical backgrounds. Not for one instant would the listener be permitted to cool off in a period of utter silence nor would even Mr. Victor himself be given the time to flatter his artists. A good artist does not need to be flattered and a poor artist should not be on the air.

We have done a lot of tough thinking about this matter of continuity; and now that we have got this big thesis off our chest we feel much better about it.

(Oh, that's all right, Mr. Victor; we knew you wouldn't feel that way about it. Sure, go right ahead and use the idea. We don't mind.)

### The Passing of Ham Radio Entertainment

ANYONE who has exposed his ears to the best that radio has had to offer, during the past winter, cannot help but feel that the day of ham radio entertainment is gradually passing. Three years ago, the general run of stuff was so hammy that it left you with a thirst at the completion of each recital.

Lately radio has afforded moments of supreme pleasure and often has ascended to magnificence. Atwater-Kent, the Victor Company, the National Carbon Co., the Edison Co., the B. F. Goodrich Co.; all have contributed to a greater radio.

This progress has been very satisfying when one stops to think how long it took the moving pictures to solicit the attention of the better talent and how long it took the Victor Company to talk contract to the real artists of 1910. This writer first heard a phonograph at the

First in the Field  
Specializing in  
Cockaday Kits

## S. HAMMER RADIO CO., 303 Atkins Ave. Brooklyn, New York

Cockaday Sets Now Made Easier to Build by Our New "Ready-to-Wire" Plan  
**50% of Your Time, Work and Worry SAVED!**

All you need do is to connect bus-bar according to diagram, solder and your set is finished. These Kits are sent to you completely mounted, and assembled on a Veneered Mahogany baseboard and genuine bakelite panel, drilled and engraved. Genuine parts used as listed below; exactly as used in Mr. Cockaday's Laboratory Model. COMPARE OUR OFFER!

### RAYTHEON POWER-PACK

These are the exact parts used in building the Laboratory Model.

1 Raytheon Tube	\$6.00
1 Dongan transformer, No. 509	7.00
2 Dongan choke coils No. 513	10.00
1 Condenser Corp. small combination condenser comprising 2 units of .1 mfd. with a common terminal	1.25
1 Condenser Corp. multiple condenser comprising five units of 2, 2, 8, 1 and 1/2 mfd respectively with a common terminal.	12.00
1 Allgap socket	.75
1 Bradleyohm No. 10—10,000 ohms	2.00
1 Bradleyohm No. 25—250,000 ohms	2.00
1 Bradleyunit resistance, 7,500 ohms	.75
1 Electric resistance mounting	.25
1 Hardwood base	.35
1 Composition Binding post strip	.25
1 Pr. small brass brackets	.10

### Cockaday's New LC-26 Receiver

1 General Radio Variometer type 269 with rheostat knob	\$5.30	3 Bradleyunits, 1/2 megohm	\$2.25
1 General Radio Rheostat type 214a, 7 ohms, with rheostat knob	2.25	1 Bradley unit 1/2 megohm	.75
1 Precision Octaform coil set	5.50	3 Ampertes No. 18	3.30
1 Ameco Double Unit Condenser No. 1814	6.25	1 Amperte No. 112	1.10
1 Micamold fixed Condenser .00015 mfd	.35	3 Benjamin standard "Circuit-tone" sockets	5.00
1 Micamold fixed Condenser .00025 mfd	.35	1 Carter single-circuit Jack No. 101	.70
2 Daven resisto-couplers (new type)	3.00	2 Carter Jack switches No. 2	2.00
1 American De-Luxe transformer, first stage	10.00	8 1/2" binding posts	1.20
1 Bradleytesk 1/2 to 10 meg...	1.85	1 Lbyr variable control knob and dial	3.50
		1 Universal decorated panel 8 x 22 inches	7.00
		4 Small brass brackets	
		2 Bakelite Connection Blocks 1 x 2 plus 1 x 3	
		2 Large Brass Brackets	.35

READY-TO-WIRE KIT, PRICE, **\$62.50**

COMPLETE KIT **\$42.70** WIRED COMPLETE In Genuine Mahogany Cabinet **\$77.00**

The following UNASSEMBLED and READY-TO-WIRE KITS in STOCK:—

<b>S-C RECEIVER</b>	<b>Best 5 Tube Superheterodyne</b>
<b>POWER - PACK AMPLIFIER</b>	<b>McLaughlin Single Control Superheterodyne</b>
<b>HAMMARLUND - ROBERTS KITS</b>	<b>GENERAL RADIO UNIVERSAL</b>

Send for Free Catalog and Complete Information About Our Parts and Kits | Inquiries from Dealers Invited

Transportation Prepaid. One-third must accompany all C. O. D. orders. Not insured unless insurance charges included.



TRF-120 Tuned R.F. Kit with Brackets \$12.00

## A Better Coil for Any Set

Greater distance and power—and perfect Selectivity, in any type of set—Aero Coils will best fill your needs.

The amazing performance of these inductances is due to their patented construction, which gives them a lower high frequency resistance and distributed capacity than others. At your dealers or direct from us.

### AERO PRODUCTS, INC.

1768-1772 Wilson Ave., Dept. 15, Chicago

# AERO COIL

TRF-120 Tuned R. F. Kit	..... \$12.00
RFR-110 R. F. Regen Kit	..... 11.00
CT-80 3 Circuit Tuner	..... 8.00
OS-55 Oscillator	..... 5.50
AX-45 Antennae Coupler	... 4.50
WT-40 Wave Trap Coil	.... 4.00
LWT-125 Low Wave Tuner Kit	12.50

# S Y D

LIFE LONG  
"B" BATTERY

## Better Reception From Any Radio Set



**UNCONDITIONAL  
2-Year Guarantee**

Type B2

100 Volts	With a Complete Charger	\$15.50
145 Volts	With a Complete Charger	\$21.50

*Fully Charged—Ready for Use*

MAIL ORDERS PROMPTLY FILLED

Manufactured and Sold Exclusively by  
**Syd Storage "B" Battery Co.**  
1452½ South Wabash Ave.  
CHICAGO  
Calumet 4911  
ORDERS SOLICITED

Toronto Exposition in 1907; and it was then comparable in its misery with the average radio of the present day. When one stops to carefully consider these histories of sister amusements, radio has made a record for itself. It was but four years ago that our musicians scoffed it; today, they fear it. The record of the past winter is enough to give any legitimate impresarios nausea. Concert managers are in a panic; and we have heard it stated, although not on any too good authority, that many of them are already putting in applications for future employment as motormen on the Green Car Lines.

### \* \* \* Applause Card No. 17

Just when we get settled down to write a one hundred percent raspberry column, we happen to think about something that was put on by the Eveready performers and lose heart.

Most of these Eveready concerts are so delightfully new that you can smell the varnish; but they have always managed to leave this reviewer in a cordial mood. It must put a lot of our studio managers to shame when they see how many new and good things can be done on the radio with a little thinking beyond the bounds of Radio Program Primer No. 1.

Who, but a very alert *entrepreneur*, would think of dramatizing the Billy Brown incident in Lincoln's life as a fitting piece of entertainment for Lincoln's birthday?

Here was a man telling the story of a visit to Lincoln, using the simple, homely language of the original narrator. It was not only an intensely human thing but it was a portrait of the man that showed every kindly wrinkle in his face, the tenderness in his eyes.

And what continuity! Occasionally Billy Brown's words, always soft and warm, would melt into the strains of an old Civil War song. Finally Billy Brown told how they were getting ready to receive Lincoln back in Springfield at the close of the War. Billy owned a store; and in that store was a chair Abe used to sit in. Billy was going to drape that chair in a big flag in honor of the visit. He was on his way to the store when he heard of Lincoln's death; and here he plunges into a piece of description that would bring tears to the eyes of an undertaker. We confess that we were deeply moved; and this is the first time that any radio performance has really managed to get under our skin. There was no deep purple sentiment about it; no melodramatic tricks of the 19th century playwright, but just cold, pure description so homely and awkward that it hurt.

This Billy Brown story renewed our faith in the art. It shows what a little thinking will do.

It showed, too, that radio is not yet bankrupt and that there is absolutely no excuse for much of the conventional clap-trap that fills the nightly air.

### \* \* \* That Cross Announcer

There is only one announcer in these United States who can explain music to us, and that is Milton J. Cross of WJZ.

Cross does not talk to you as though you were a musical bum nor does he attempt to create the impression that he is one of the few living authorities on music.

Yet we are old sport enough to wager that Mr. Brokensire has taken many a lesson from Mr. Cross, and further that Mr. Cross never once said to him "Of course you know that—."

## BROADCAST LISTENERS

The POPULAR RADIO ATLAS and LOG will give you a list of all the NEW Broadcasting Stations with wavelengths and other necessary information

### A Complete Atlas and Station Log

The "POPULAR RADIO International Radio Atlas and Log" will supply you with full information regarding broadcasting stations of the United States and Canada.

This most useful and practical Atlas consists of 16 pages, size 12" x 15", printed on good paper, from clear type in two colors and contains a complete series of double page maps, including—The World—The United States—Canada—North and South America, showing location of principal broadcasting, leading commercial and governmental radio stations.

### SPECIAL FREE OFFER

You may have a copy of the "POPULAR RADIO International Radio Atlas and Log" free, with POPULAR RADIO for (8) eight months.

For Only \$2.00

Pin \$2.00 in bills to the coupon below.

If you are a subscriber to POPULAR RADIO your subscription will be extended eight months.

Date.....

POPULAR RADIO, Dept. 52A  
627 West 43d St., New York City.

Enclosed is my remittance of \$2.00 for which you are to enter my subscription (extend my subscription) for (8) eight months for POPULAR RADIO and send FREE a copy of the "POPULAR RADIO International Radio Atlas and Log."

Name.....

Address.....

City.....State.....



Kadel & Herbert

### THE TOM THUMB OF BROADCASTERS

*Here is the 5-watt transmitter of station WDBX, New York City, said to be the smallest active broadcasting station in the world. It is scarcely larger than many receivers.*

## The Highroad to Fame

HERE is a delicate little thing that we composed some time ago:

If you plan on becoming famous,  
Why not turn to the radio?  
Correspondence schools have nothing  
On the radio for speed in making  
You a very, very successful person.  
In fact, about all you have to do  
Is learn to play a piccolo or a  
Harmonica or something like that.  
Perhaps you could get away  
With the comb and tissue paper act,  
But the big point is get on  
The air with something or other.  
If you made a speech when you  
Were admitted to the Owls or Elks  
Or the Woodman of the World,  
Take advantage of the training  
You have had and go on the  
Air with a fifteen-minute talk  
About something that sounds  
Important and learned.  
The studio managers will be  
Gosh darn glad to get you;  
There isn't any money in  
The game, but you get your  
Name in the papers a lot,  
And that won't make you feel bad,  
You know, it's kinda nice to  
Be introduced to a bunch of  
People and have them say,  
"Oh, you're the guy who does  
The broadcasting from WXS!"  
If you're really lucky, one  
Of the radio editors may  
Ask you for a picture,  
And then just watch your friends  
Sit up and take notice!  
About the nicest part of the  
Whole business is when they  
Have a radio show.  
Just pull around to one of the  
Newspapers' booths where  
They introduce all of the  
Radio stars and mention who  
You are, just offhand.  
The crowd sure does give you  
The double O for fair.  
I wouldn't lose my broadcasting  
For a lot of money;  
It's just like taking a pill at  
Night and waking up in the morning  
With a name, that everybody knows.

## The "Of Course You Know" in Announcing

If there is one thing that curls the lips of this 22-carat critic, it is the amusing attempt of some of our butter-and-egg announcers to "let you in" on this history of the musical masterpieces. Fresh from a careful and painstaking examination of their "Baker's Musical Dictionary," they come to the microphone and lead off with "Of course you know that—".

This is supposed to make you feel like a member of the Junior League for Musical Appreciation and that you are being "wised up" by one of the granddaddies of music.

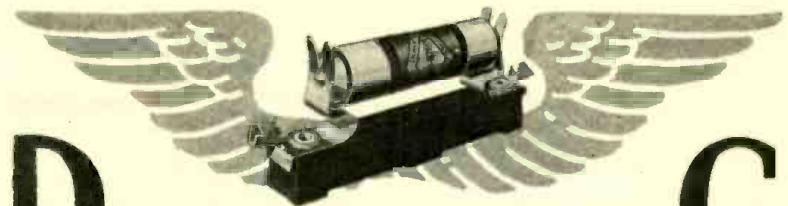

# DOMINATING ITS FIELD BECAUSE OF SUPERIOR MERIT BRACH-STAT - THE AUTOMATIC FILAMENT CONTROL

We are prepared at any time to prove Brach-Stat superiority over any other form of filament control ballast.

The life of a radio tube is materially shortened when even slightly overloaded. Leading set makers and discriminating engineers insist upon Brach-Stats because they positively prevent overloading and provide perfect filament control.

L. S. BRACH MFG. CO.  
NEWARK, N. J.



## OF IMPORTANCE TO RADIO ENGINEERS

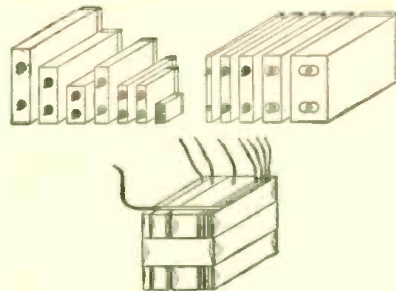

The Wireless Specialty Apparatus Company, following extensive specialized development, presents a complete group of condensers of

### FARADON QUALITY

for BY-PASS, FILTER, BLOCKING, and INTERFERENCE ELIMINATION application. Design and Manufacturing Equipment permits meeting

#### SET MANUFACTURERS' SPECIFICATIONS

In both capacitance and voltage requirements. Regularly Produced. In units and in gangs, incased or plain, with fixed terminals or flexible leads to suit particular equipments.

*Complete data and quotations will be furnished promptly upon receipt of advice as to just what is desired. Inquiries are requested.*

### 19 YEARS SPECIALIZATION IN THE RADIO FIELD

WIRELESS SPECIALTY APPARATUS COMPANY  
Jamaica Plain—Boston, Mass.

# The Raytheon Power Pack is an improved "B" Eliminator

### COMPLETE PARTS

1 Raytheon Tube.....	\$ 6.00
1 Acme Transformer...	7.00
2 Acme Choke Coils...	10.00
1 Tobe Combination Condenser .....	1.25
1 Tobe Multiple Con- denser .....	11.00
1 Airgap Socket .....	.75
1 Bradleyohm No. 10...	2.00
1 Bradleyohm No. 25...	2.00
1 Bradleyunit Resist- ance, 7,500 ohms...	.75
1 Electrad Resistance Mounting .....	.25
1 Hardwood Base .....	.35
1 Binding Post Strip ..	.25
1 Pr. Small Brass Brackets .....	.25
	<b>\$41.85</b>

Popular Radio Simplified Blue Prints \$1.00  
**COMPLETELY ASSEMBLED,  
Ready to Use \$49.00**

**LC-26** Complete Parts For This Set Exactly As Used By Mr. Laurence Cockaday. **62<sup>15</sup>**

**CORBETT CABINET FOR LC-26 14.50**

MAIL ORDERS PROMPTLY AND ACCURATELY ATTENDED TO

**THE RADIO SHOP** of Stamford  
20 Worth Street, Stamford, Conn.  
Service for Setbuilders—  
Write Us Your Needs



## WHAT'S NEW IN RADIO

This department is conducted by POPULAR RADIO LABORATORY for the purpose of keeping the radio experimenter and the broadcast listener informed concerning the newest inventions and the approved developments in radio equipment. Only such apparatus as has been tested and endorsed by the Laboratory is noted in these columns.

### A NOVEL TYPE OF SOCKET

Name of instrument: Vacuum-tube socket.

Description: This unit is made on a base of moulded bakelite which carries the spring contacts and soldering lugs in one piece. It is equipped with a small rigid table of bakelite in which are drilled the holes for the socket prongs of the vacuum tube. The contacts grip and hold the prongs of the vacuum tube when it is pushed down flush with the upper bakelite table.

Usage: In a radio unit for mounting vacuum tubes.

Outstanding features: Compactness. Good contact. Neat appearance. Ease of installation.

(Further details furnished on request.)



This socket is especially designed for the new UX tubes.

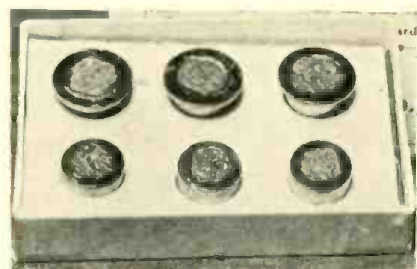

An assortment of mounted crystals for use as crystal detectors.

### A CRYSTAL DETECTOR ACCESSORY

Name of instrument: Detector crystal.

Description: These crystals, which have a good degree of sensitivity and are uniformly sensitive, are mounted neatly in two types of settings, as shown in the illustration. They will fit in any type of crystal mounting; and they are so constructed that the operator's hands need never touch the crystal to destroy its sensitivity.

Usage: In a crystal receiver as a rectifier or detector.

Outstanding features: Sensitivity. Uniformity. Neat mounting. Accessible crystal surface.

(Further details furnished on request.)

## Apparatus Approved by Popular Radio

This list of apparatus approved by the POPULAR RADIO LABORATORY will be continued as a part of the WHAT'S NEW IN RADIO department until all instruments, parts and complete sets have been included. The listing is alphabetical by manufacturer's name and the installment in this issue includes the letters H through K.

### AERIALS

Talking tape; Hope Webbing Co.  
"Goldenrod" aerial wire; Imp Radio Corp.  
Inside aerial; Inter-State Signal Co.

### AMPLIFIERS

Heath's "Radiant" resistance-coupled amplifier; Heath Radio & Electric Mfg. Co.

### AUDIO-FREQUENCY TRANSFORMERS

Audio-frequency transformer; Henry Hyman & Co., Inc.  
Audio-frequency transformer; Jos. W. Jones Mfg. Co., Inc.  
Karas Harmonik A. F. transformer; Karas Electric Co.  
Audio-frequency transformer; Kellark Electric Mfg. Co.  
Audio-frequency transformer; Kellogg Switchboard & Supply Co.

### BATTERIES

Wonder-Cell storage battery; Helios Battery Co., Inc.

Storage "B" batteries; Kelman Electric Co., Inc.  
"Kic-O" "B" Multi-Power unit; Kimley Electric Co., Inc.

### BATTERY CHARGERS AND RECTIFIERS

Wonder-Cell rectifier; Helios Battery Co., Inc.  
Handy battery charger; Interstate Electric Co.  
Simplex battery charger; Interstate Electric Co.  
Ultra-Handy charger; Interstate Electric Co.  
Twin bulb handy charger; Interstate Electric Co.  
"Kic-O" rectifier; Kimley Electric Co., Inc.  
"Kic-O" double potential charger; Kimley Electric Co.  
Radio-A re-charger; King Electric Mfg. Co., Inc.  
Gold Seal Homecharger; Kodel Mfg. Co.

### "B" BATTERY ELIMINATORS

Kellogg Trans-B-Former; Kellogg Switchboard & Supply Co.  
Multiformer "B" unit, C. E. Jacobs

### BINDING POSTS

King Quality binding post; King Quality Products, Inc.

## Radio Manual WITH Popular Radio

Kendall Banning, Editor, and Laurence M. Cockaday, Technical Editor of POPULAR RADIO, have compiled a book that will prove to anyone that he can build a set which will give distance, selectivity and tone volume, and at the same time a very definite basic knowledge of radio.

### BUILD YOUR OWN SET AND SAVE MONEY

In "How to Build Your Radio Receiver," you will find complete specifications, constructional diagrams, photographs and instructions for building all of the following sets:

- A \$5 Crystal Set
- The Haynes Single-Tube Receiver
- A Two-Stage Audio-frequency Amplifier
- The Cockaday 4-Circuit Tuner
- A 5-Tube Tuned Radio-frequency Receiver
- The "Improved" Cockaday 4-Circuit Tuner
- The Regenerative Super-Heterodyne Receiver

### ADVISORY SERVICE ALSO FREE

POPULAR RADIO maintains a big modern laboratory with a trained staff of investigators under the personal supervision of Mr. Cockaday. This Laboratory is always available through our Technical Service Bureau to answer, free to subscribers, by personal letter any problems you encounter which are not answered in either the "Handbook" or the magazine.

### SPECIAL BOOK OFFER

You can secure a copy of "How to Build Your Radio Receiver" FREE, and have all the privileges of the Technical Service Bureau without additional expense. If you will send a remittance of \$3.00 in full payment of 12 months' subscription for POPULAR RADIO. (Or as an alternative, you may have the book and privileges of the Technical Service Bureau with POPULAR RADIO for 7 months only—for \$2.00. A two-dollar bill will do.) Remember you take no chance—we will refund your money in full if you are not more than satisfied.

## POPULAR RADIO

Department 55

627 West 43rd Street, New York

## CRYSTAL DETECTORS

*Silver Dome fixed crystal detector*; C. E. & H. J. Hargraves  
\$1.00 crystal detector; Chas. M. Hick  
Crystal detector; Henry Hyman & Co., Inc.  
Atomite crystal; Keystone Products Co.

## DIALS

*A. C. H. sharp tuner dial*; A. C. Hayden Co.  
*Clock-wise 1/2-inch gold dial*; Heath Radio & Electric Mfg. Co.  
*Dial*; Henry Hyman & Co., Inc.  
*Jewett micro dial*; Jewett Radio & Phonograph Co.  
*Kellogg bakelite dial*; Kellogg Switchboard & Supply Co.  
*Dials and knobs*; King Quality Products, Inc.

## FIXED CONDENSERS

*Hilco fixed condenser*; A. E. Hill Mfg. Co.

## GRID-LEAKS AND RESISTANCES

*Grid-leak*; Jos. W. Jones Radio Mfg. Co., Inc.  
*Resistance*; Kellogg Switchboard & Supply Co.

## HEADPHONES

*No. 2 Universal headphones*; Holtzer-Cabot Electric Co.  
*No. 4 National headphone*; Holtzer-Cabot Electric Co.  
*Headphone*; Henry Hyman & Co., Inc.  
*Kellogg headset*; Kellogg Switchboard & Supply Co.

## INSULATORS

*Insulator*; Henry Hyman & Co., Inc.

## JACKS

*Hareo jacks*; Harris & Birdseye, Inc.  
*Jack*; Henry Hyman & Co., Inc.  
*Jack*; Jos. W. Jones Radio Mfg. Co., Inc.  
*Kellogg jacks*; Kellogg Switchboard & Supply Co.  
*Kings double-circuit jack*; Kings Mfg. Co., Inc.

## KITS

*Super-Hilco-Dyne kit*; A. E. Hill Mfg. Co.  
*Lo-Loss tuned-radio-frequency kit*; A. E. Hill Mfg. Co.  
*Hilcoaster kit*; A. E. Hill Mfg. Co.  
*4-tube knockdown kit*; Jos. W. Jones Radio Mfg. Co., Inc.  
*Kellogg kit*; Kellogg Switchboard & Supply Co.  
*King Quality neotrodynite kit*; King Quality Products, Inc.

## LIGHTNING ARRESTERS

*"Season" lightning arrester*; Heimann Electric Co.  
*Jewett lightning arrester*; Jewett Electrical Instrument Co.

## LOOPS

*Hartman loop aerial*; Hartman Electric Co.  
*Korach loop*; Korach Radio Co.

## LOUDSPEAKERS

*J. Andrew White loudspeaker*; Haynes-Griffin Radio Service, Inc.  
*Herald loudspeaker*; Herald Electric Co., Inc.  
*Holtzer-Cabot loudspeaker*; Holtzer-Cabot Electric Co.  
*Jewett cone*; Jewett Radio & Phonograph Co.  
*Jewett Super Speaker*; Jewett Radio & Phonograph Co.  
*Kellogg Symphony reproducer*; Kellogg Switchboard & Supply Co.  
*K-B loudspeaker*; Kirkman Engineering Corp.  
*Kodel microphone loudspeaker*; Kodel Mfg. Co.

## MISCELLANEOUS ACCESSORIES

*Nu-Way snap terminal*; Hatheway Mfg. Co.  
*A. C. H. phone connector*; A. C. Hayden Co.  
*Power-Plus lock-lugs*; A. F. Henninger Corp.  
*Glass insulated terminal strip*; August W. Hornig  
*Hercules aerial mast*; S. W. Hull & Co.  
*Jefferson AC tube transformer*; Jefferson Electric Mfg. Co.  
*Double choke*; Jefferson Electric Mfg. Co.  
*Jife low-loss antenna support*; Jife Co.  
*Snow white fluid*; J. W. Johnston  
*"Color-cap" connector*; Howard B. Jones  
*Kelbraket*; Kelleradio, Inc.  
*Contact points*; King Quality Products, Inc.  
*Panel mountings*; King Quality Products, Inc.  
*Choke coils*; Kellogg Switchboard & Supply Co.  
*K-B adjustable bearing*; Koemel Bros.  
*Mica diaphragm*; International Mica Co.

## PANELS

*Glass panel*; August W. Hornig

## PHONE PLUGS

*Hareo plugs*; Harris & Birdseye, Inc.  
*Haynes-Griffin phone plug*; Haynes-Griffin Radio Service, Inc.  
*Plugs*; Howard Mfg. Co.  
*Plug*; Henry Hyman & Co., Inc.  
*Jones Multi-plug*; Howard B. Jones  
*Plug*; Jos. W. Jones Radio Mfg. Co., Inc.  
*Plugs*; Kellogg Switchboard & Supply Co.  
*Plugs*; King Quality Products, Inc.

FOR THE FIRST TIME—

A transformer that really matches the characteristics of the tube.

CERTAINLY—A General Instrument Product

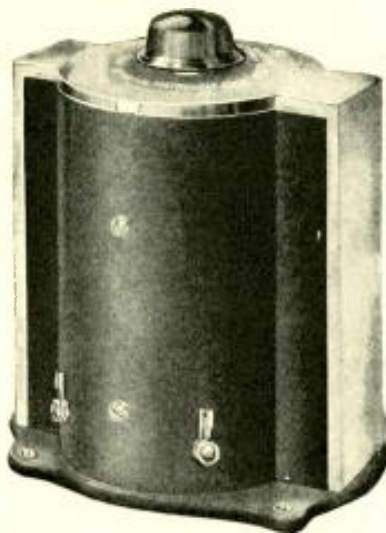

## The G. I. Variable Audio Transformer

(Type 101)

Without a doubt the most important radio development since the industry became generally popular.

It is easily adjustable — merely turn the knob until reception is clearest and sharpest—the result is perfect co-ordination between transformer and tube; positive absence of any signs of squeals and howls; perfect reproduction.

Designed for use in any set—in the detector circuit, and in any or all stages of amplification. Now for the first time can more than two stages of Audio Amplification easily be used by even the most inexperienced radio enthusiast.

PRICE

**\$10<sup>50</sup>**

At your dealers—otherwise send purchase price and you will be supplied postpaid.

**GENERAL INSTRUMENT CORPORATION**

Manufacturers of "Bureau of Standards" Variable Primary Condensers.

477 BROADWAY

NEW YORK CITY



22½ Volt un-acid everlasting rechargeable "B" Storage Battery

**\$2.95** includes chemical

45 Volts \$5.25, 90 volts \$10.00, 112½ volts \$12.50, 135 volts \$14.75, 157½ volts \$16.80. Truly the biggest buy today. Easily charged on any current including 32 volt systems. Any special detector plate voltage had. Tested and approved by leading authorities such as POPULAR RADIO laboratories. Over 3 years sold on a non-red tape 30 day offer with complete refund if not thoroughly satisfied. Further guaranteed 2 years. Knock-down kits at greater savings. Complete "Hawley" "B" Battery charger \$2.75. Sample cell 35c. Order direct—send no money—simply pay the expressman cost on delivery. Or write for my free literature, testimonials and guarantee. Same day shipments.

**B. HAWLEY SMITH**  
315 Washington Avenue  
Danbury, Conn.



## Filter Condensers for the Raytheon Power-Pack

In making your Raytheon Power-Pack, and in all "A" and "B" Eliminators, it is absolutely necessary to use the finest condensers to obtain good results.

Potter Filter Condensers are made with the best foil, best insulation and best impregnating compounds obtainable. They take the kinks out of current, remove all traces of A.C. impulses, eliminate all hum. They have unusually long life under continuous use.

There is a Potter Filter Condenser to fit every specification. Special models for the Raytheon Power-Pack and Raytheon "B" Eliminator.

At your dealer's or write direct

**Potter**  
FILTER  
**Condensers**

An American-Made Product

POTTER MFG. CO., N. CHICAGO, ILL.

### PHONOGRAPH ATTACHMENTS

Phonograph attachment; Herald Electric Co., Inc.  
Holtzer-Cabot phonograph attachment; Holtzer-Cabot Electric Co.  
Vemco reproducing unit; Jewett Radio & Phonograph Co.  
Wilson loudspeaker; J. W. Electric Co.

### POTENTIOMETERS

Potentiometer; Howard Mfg. Co., Inc.  
Potentiometer; Henry Hyman & Co., Inc.  
Potentiometer; Jos. W. Jones Radio Mfg. Co., Inc.  
Potentiometer; King Quality Products, Inc.

### RADIO CABINETS

Hale sectional radio cabinets; F. E. Hale Mfg. Co.  
Hines radio desk; Hines Radio Desk Co.  
Glass cabinet; August W. Ilorrig  
"Ideal" radio cabinets; Ideal Radio Cabinet Co.  
Radio cabinets; Kellogg Switchboard & Supply Co.

### RADIO-FREQUENCY TRANSFORMERS

H & H transformer; Hart & Hageman Mfg. Co.  
Intermediate-frequency transformer; Haynes-Griffin Radio Service, Inc.  
Hilco multiformer; A. E. Hill Mfg. Co.  
Kellogg radio-frequency transformer; Kellogg Switchboard & Supply Co.

### RECEIVING SETS

Hammarlund-Roberts receiver; Hammarlund-Roberts Co.  
A. C. H. receiver; A. C. Hayden Co.  
Haynes De Luxe superheterodyne receiver; Haynes-Griffin Radio Service, Inc.  
Worner Heteroplex receiver; Heteroplex Mfg. Co.  
Super-Hilco-Dyne receiver; A. E. Hill Mfg. Co.  
Howard neutrodyne receiver; Howard Mfg. Co., Inc.  
Howe radio receiver; Howe Auto Products Co.  
Bestone V-60 receiver; Henry Hyman & Co., Inc.  
Standardized Precision-made receiving set; Jos. W. Jones Radio Mfg. Co., Inc.  
Symphony receiver; Jones Radio Co.  
Kar straight-line receiver; Kar Engineering Co.  
Kompentrol receiver; Kardon Products Co., Inc.  
Kellogg "Wave Master" receiver; Kellogg Switchboard & Supply Co.  
Kennedy receivers; Colvin B. Kennedy Co.  
King Quality neutrodyne receiver; King Quality Products, Inc.  
Kodol receivers; Kodel Mfg. Co.  
Monarch receiving set; Krasco Mfg. Co.

### RHEOSTATS

Rheostat; Howard Mfg. Co., Inc.  
Rheostat; Henry Hyman & Co., Inc.  
Rheostat; Jos. W. Jones Radio Mfg. Co., Inc.  
Rheostat; Kellogg Switchboard & Supply Co.  
Rheostat; Keystone Radio Co.  
Rheostat; King Quality Products, Inc.  
Autostat; Kodel Mfg. Co.

### SOCKETS AND ADAPTERS

Sockets; Hart & Hageman Mfg. Co.  
Heath socket; Heath Radio & Electric Mfg. Co.  
V. T. socket; Henry Hyman & Co., Inc.  
Cushioned socket; Illinois Radio Co.  
Socket cushion; Illinois Radio Co.  
Socket; Jos. W. Jones Radio Mfg. Co.  
Sockets and adapters; Kellogg Switchboard & Supply Co.  
V. T. socket; Keystone Radio Co.

Sockets and adapters; King Quality Products, Inc.  
Caldwell socket; King Corp.

### SWITCHES

Switch; Jos. W. Jones Radio Mfg. Co., Inc.  
Tuner switch; Kellogg Switchboard & Supply Co.  
Back-mounting inductance switch; Keystone Radio Co.  
Switches; King Quality Products, Inc.

### TESTING INSTRUMENTS

Hoyt radio rotary meter; Hoyt Electrical Instrument Works  
Tube testers; Hoyt Electrical Instrument Works  
Voltmeters; Hoyt Electrical Instrument Works  
Socket tube tester; International Resistance Co.  
Voltmeter; International Supply Co.  
Jefferson tube rejuvenator; Jefferson Electric Mfg. Co.  
Jewell "A" and "B" battery voltmeter; Jewell Electrical Instrument Co.  
Multiple reading panel voltmeter; Jewell Electrical Instrument Co.

### TOOLS AND EQUIPMENT

Humphrey's radio coil winder; Fred Humphreys

### TUBES

DisXron vacuum tube; Justrite Sales Co.

### TUNING INDUCTANCE UNITS

Hammarlund low-loss coils; Hammarlund-Roberts  
Hartman variocoupler; Hartman Electric Co.  
Haynes bank-wound variocoupler; Haynes-Griffin Radio Service, Inc.  
Haynes-Griffin special oscillator coupler; Haynes-Griffin Radio Service, Inc.  
Power-Plus fieldless coil; A. F. Henninger Corp.  
Hilco 3-circuit tuner; A. E. Hill Mfg. Co.  
Variometers; Henry Hyman & Co., Inc.  
Variocouplers; Henry Hyman & Co., Inc.  
Variocouplers; Jos. W. Jones Radio Mfg. Co., Inc.  
Kellogg variometers; Kellogg Switchboard & Supply Co.  
Kellogg variocouplers; Kellogg Switchboard & Supply Co.

### VARIABLE CONDENSERS

Straight-line-frequency condenser; Haig & Haig Mfg. Co.  
Hammarlund S. L. F. condenser; Hammarlund Mfg. Co.  
Vernier variable condenser; Hammarlund Mfg. Co.  
Single-control capacity element; Hanscom Radio Devices  
Hargrave's neutra-condenser; C. E. & H. J. Hargrave  
"Hico" variable condenser; Hartford Instrument Co.  
Sexton variable condenser; Hartford Instrument Co.  
Low-loss grounded rotor condenser; Haynes-Griffin Radio Service, Inc.  
Straight-line "Radiant" condenser; Heath Radio & Electric Mfg. Co.  
Power-Plus S. L. F. condenser; A. F. Henninger Corp.  
Variable condenser; Henry Hyman & Co., Inc.  
Variable vernier condenser; Jos. W. Jones Radio Mfg. Co., Inc.  
Karas Orshometric condenser; Karas Electric Co.  
Kellogg low-loss variable condensers; Kellogg Switchboard & Supply Co.  
Variable condensers; King Quality Products, Inc.

### DUST-PROOF STRAIGHT-LINE-FREQUENCY VARIABLE CONDENSER

Name of instrument: Straight-line-frequency condenser.

Description: This capacitive tuning unit is entirely shielded by a combination metallic and celluloid container. The tuning element itself contains plates of necessary shape to produce the characteristic straight-line-frequency tuning curve. This method of constructing a condenser prevents dust from settling in between the plates and thus destroying the efficiency of the apparatus.

Usage: In any radio-frequency circuit for obtaining straight-line-frequency tuning.

Outstanding features: Compact. Makes tuning easy. Dust-proof. Efficient. Neat appearance.

(Further details furnished on request.)

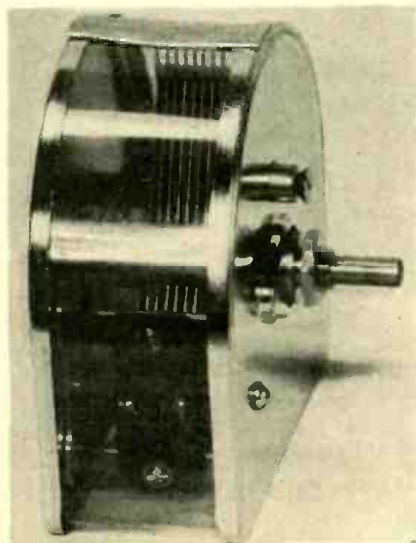



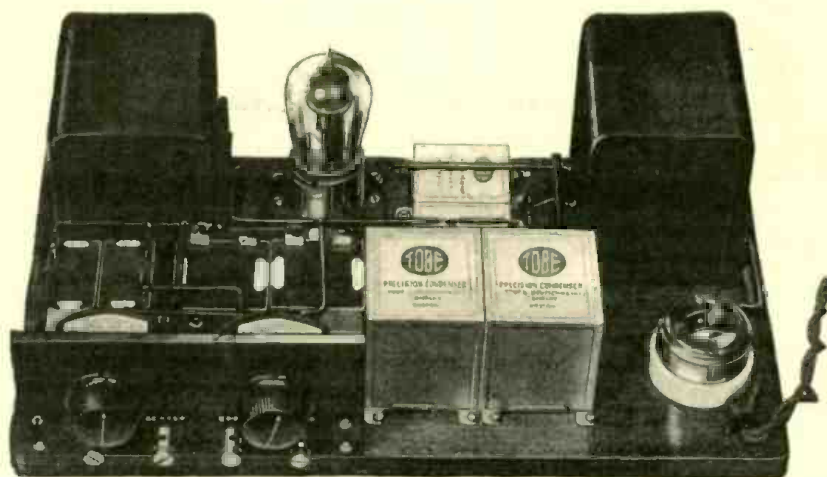

## An Unfailing Source of "B" Voltage

Ever since radio entered our household as a popular commodity there has been a continuous and concerted effort on the part of radio engineers to improve and simplify the operation of the family receiving set.

The "B" eliminator is but another step forward in the accomplishment of this aim.

With a present day "B" eliminator constant worry whether the "B's" are run down and their continual replacement is a thing of the past.

A properly built "B" eliminator provides an ever reliable source of plate voltage for detector and amplifier tubes without affecting the quality of reception.

For a dependable plate supply unit which will improve the operation of your set, and will require no attention other than its original installation build a "B" eliminator of General Radio parts.

Write today for descriptive data on General Radio Rectifier Transformers and Filter Chokes, and get our circular with full instructions for building a practical "B" eliminator.

The General Radio Company has endeavored to make it possible for the experimenter to obtain its products with a minimum of effort. A careful selection of distributors and dealers has been made. They are best fitted to serve you. If, however, you are unable to obtain our products in your particular locality they will be delivered to you, postpaid, direct from the factory upon receipt of list price.

Write for our latest catalog 924-B.

GENERAL RADIO CO., Cambridge 39, Mass.

# GENERAL RADIO

## INSTRUMENTS

*"Behind the Panels of Better Built Sets"*

# Make Your Radio Set More Efficient With Allen-Bradley Radio Devices

IT matters not whether you are building a receiver or own a factory-built set, in either case you can make your set more efficient by using Allen-Bradley Radio Devices in many parts of the receiver. In addition to the various devices for filament control, grid leak and potentiometer control, there also are the Bradley-switch and the Bradley-nier which are easily installed. The one-hole mounting makes installation quick and easy.

TO bring your set up-to-date, replace your old condensers with Bradleydensers and thereby enjoy the selectivity of straight-line-frequency tuning. The condenser is extremely compact and will not interfere with any other parts on your panel. Don't forget the Bradley-Amplifier for perfect audio amplification. This efficient amplifier is a complete unit ready for immediate use in your set. Try Allen-Bradley Devices tonight and hear the difference!

*Insist on Allen-Bradley Products Sold In Distinctive Checkered Cartons*

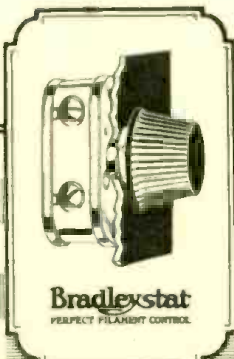

**Bradleystat**  
PERFECT FILAMENT CONTROL



**Bradleyleak**  
THE PERFECT GRID LEAK

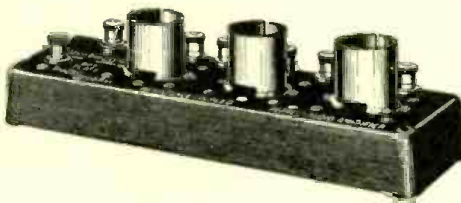

**Bradley-Amplifier**  
Resistance-Coupled  
PERFECT AUDIO AMPLIFIER

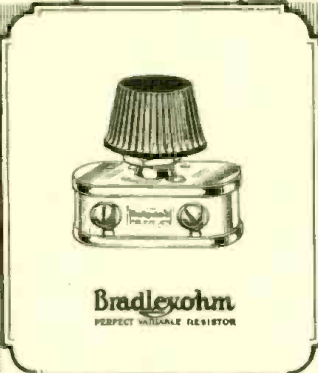

**Bradleyohm**  
PERFECT VARIABLE RESISTOR

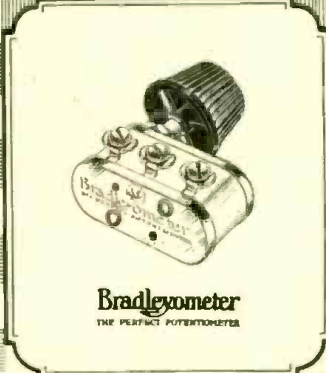

**Bradleyometer**  
THE PERFECT POTENTIOMETER

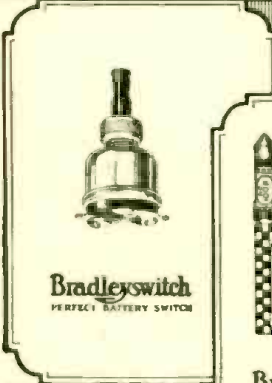

**Bradley-switch**  
PERFECT BATTERY SWITCH



**Bradleyunit**  
Amplifier Resistors

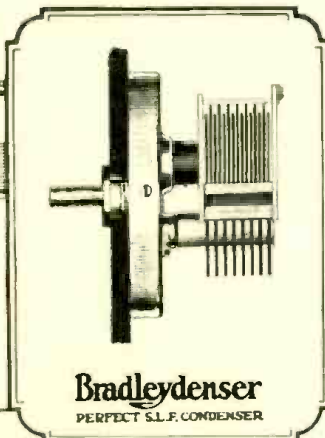

**Bradleydenser**  
PERFECT S.L.F. CONDENSER



**Bradleyunit**  
PERFECT FIXED RESISTOR

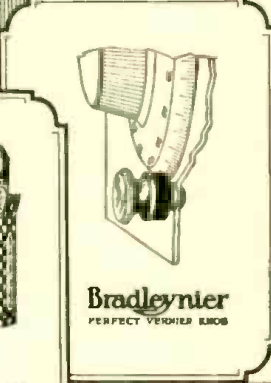

**Bradley-nier**  
PERFECT VARIABLE CAPACITOR



Allen-Bradley Company,  
278 Greenfield Ave., Milwaukee, Wis.

Please send me, immediately, your latest literature describing the entire Allen-Bradley line.

Name.....

Address.....

# Four New Radios

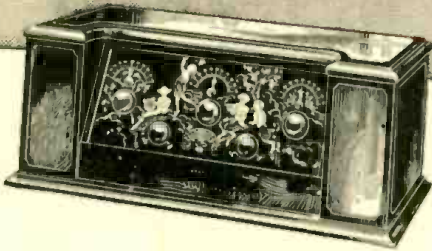

**The Crosley 5-Tube RFL-75**  
 Absolutely balanced radio frequency amplification. Non-oscillating under any handling. Exquisite two-tone mahogany cabinet—satin finish. Decorated panel with rose-gold metal fitting. Cabinet holds necessary dry cells. Price without accessories **\$75**

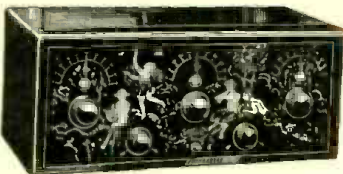

**The Crosley 5-Tube RFL-60**  
 Same as RFL-75 but in compact cabinet only 17½ inches long. Truly marvelous selectivity, sensitivity and purity of tone. Art panel—solid mahogany, cabinet—rose-gold fittings. Price without accessories **\$60**

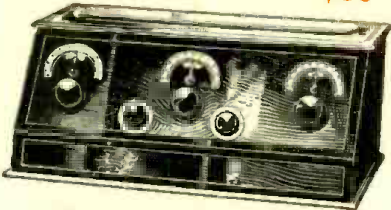

**The Crosley 5-Tube 5-38**  
 All the volume, selectivity, sensitivity and fine tone in the best 5-tube set you've heard—plus the CRESCENDON. Two toned mahogany finished cabinet—daintily striped in gold. Price without accessories **\$38**

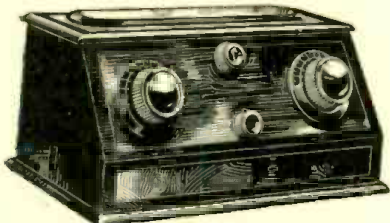

**The Crosley 4-Tube 4-29**  
 A beautifully designed set—both to ear and eye. Crescendon equivalent to one or more additional tubes of radio frequency amplification. Two toned mahogany finished cabinet. Price without accessories **\$29**

West of the Rockies add 10% to all prices

**“If inexperienced in radio, be sure your first set is a Crosley”**

It takes neither practice nor mechanical skill to tune in stations all over the country. Children and old people operate Crosley radios easily. They are fool proof.

They are inexpensive. They don't tie up a lot of money. They have proven their efficiency over a period of years. Thousands of letters report remarkable demonstrations. Hundreds of thousands of sets sold substantiate all claims to excellence.

They are made by a reliable, well known and financially strong concern, that guarantees them . . . absolutely.

The easy operation, tone and volume of these four new Crosley sets delight not only the expectant beginner; they arouse the most confirmed radio lover to realization that Powel Crosley, Jr., has again made a revolutionary improvement in radio—no less important than the Musicone which, at \$14.75, is rapidly replacing other types of loud-speakers.

And the RFL sets possess true cascade amplification. For Crosley has utilized an entirely new patented circuit which achieves cumulative amplification, actually approaching the theoretical maximum efficiency per tube.

## The Crescendon

In the 4-29 and the 5-38, the introduction of the Crescendon enables these two highly efficient radios to give almost unbelievable results and has lifted them away and beyond all competition.

The Crescendon is an exclusive Crosley device for increasing the weak signals of distant stations to full volume tones without distortion. Yet with these sets, loud nearby stations can always be softened practically to whispers. Their striking beauty will please your eye, and your ear will introduce to you new qualities in radio, which you are sure to pronounce a revelation.

See the new Crosley sets at your nearest dealers or write Dept. 16 for literature. Crosley manufactures radio receiving sets which are licensed under Armstrong U. S. Patent No. 1,113,149, or under patent applications of Radio Frequency Laboratories, Inc.

**THE CROSLLEY RADIO CORPORATION**  
 Powel Crosley, Jr., President  
 CINCINNATI, OHIO

Owning and Operating WLW, first remote control super-power broadcasting station in America.

# CROSLLEY RADIO

BETTER—COSTS LESS

FOR THE ENTERTAINMENT CORNER

PRESS OF WILLIAM GREEN, NEW YORK



# one fourth as much current as in 1921

When you tune in today on a storage battery set, your Radiotron UX-201-A uses only one fourth of the current a storage battery tube needed just five short years ago. This means that you need charge your "A" batteries only about one fourth as often!

The present Radiotron UX-201-A is also a better detector—is a better amplifier—has a greater output—all on less current.

RCA research has produced better tubes—better methods of making tubes, to lower their cost—and better test methods, too. These improvements have come from the laboratories of RCA and its associates, General Electric and Westinghouse—laboratories devoted to year-in and year-out study of vacuum tubes.

The standard of quality back in 1921 was an RCA Radiotron. And the standard of quality today is an RCA Radiotron!

RADIO CORPORATION OF AMERICA  
New York Chicago San Francisco

**Radiotron  
UX-201-A**

*is the standard tube  
for storage battery  
sets. Radiotron UV-  
201-A is exactly like  
it, but has the old type  
base.*



# RCA Radiotron

MADE BY THE MAKERS OF RADIOLAS