

2nd Generation Intel[®] Core[™] Processor Family Mobile

Datasheet – Volume 2

*Supporting Intel[®] Core[™] i7 Mobile Extreme Edition Processor Series and
Intel[®] Core[™] i5 and i7 Mobile Processor Series*

This is Volume 2 of 2

January 2011



INFORMATION IN THIS DOCUMENT IS PROVIDED IN CONNECTION WITH INTEL® PRODUCTS. NO LICENSE, EXPRESS OR IMPLIED, BY ESTOPPEL OR OTHERWISE, TO ANY INTELLECTUAL PROPERTY RIGHTS IS GRANTED BY THIS DOCUMENT. EXCEPT AS PROVIDED IN INTEL'S TERMS AND CONDITIONS OF SALE FOR SUCH PRODUCTS, INTEL ASSUMES NO LIABILITY WHATSOEVER, AND INTEL DISCLAIMS ANY EXPRESS OR IMPLIED WARRANTY, RELATING TO SALE AND/OR USE OF INTEL PRODUCTS INCLUDING LIABILITY OR WARRANTIES RELATING TO FITNESS FOR A PARTICULAR PURPOSE, MERCHANTABILITY, OR INFRINGEMENT OF ANY PATENT, COPYRIGHT OR OTHER INTELLECTUAL PROPERTY RIGHT. Intel products are not intended for use in medical, life saving, life sustaining, critical control or safety systems, or in nuclear facility applications.

Intel may make changes to specifications and product descriptions at any time, without notice.

Designers must not rely on the absence or characteristics of any features or instructions marked "reserved" or "undefined." Intel reserves these for future definition and shall have no responsibility whatsoever for conflicts or incompatibilities arising from future changes to them.

The Generation Intel® Core™ processor family mobile may contain design defects or errors known as errata which may cause the product to deviate from published specifications. Current characterized errata are available on request.

⁴Intel processor numbers are not a measure of performance. Processor numbers differentiate features within each processor family, not across different processor families. See http://www.intel.com/products/processor_number for details. Over time processor numbers will increment based on changes in clock, speed, cache, FSB, or other features, and increments are not intended to represent proportional or quantitative increases in any particular feature. Current roadmap processor number progression is not necessarily representative of future roadmaps. See www.intel.com/products/processor_number for details.

No computer system can provide absolute security under all conditions. Intel® Trusted Execution Technology (Intel® TXT) requires a computer system with Intel® Virtualization Technology, an Intel TXT-enabled processor, chipset, BIOS, Authenticated Code Modules and an Intel TXT-compatible measured launched environment (MLE). The MLE could consist of a virtual machine monitor, an OS or an application. In addition, Intel TXT requires the system to contain a TPM v1.2, as defined by the Trusted Computing Group and specific software for some uses. For more information, see <http://www.intel.com/technology/security/>.

Intel® Virtualization Technology requires a computer system with an enabled Intel® processor, BIOS, virtual machine monitor (VMM) and, for some uses, certain platform software enabled for it. Functionality, performance or other benefits will vary depending on hardware and software configurations and may require a BIOS update. Software applications may not be compatible with all operating systems. Please check with your application vendor.

Intel® Active Management Technology requires the computer system to have an Intel(R) AMT-enabled chipset, network hardware and software, as well as connection with a power source and a corporate network connection. Setup requires configuration by the purchaser and may require scripting with the management console or further integration into existing security frameworks to enable certain functionality. It may also require modifications of implementation of new business processes. With regard to notebooks, Intel AMT may not be available or certain capabilities may be limited over a host OS-based VPN or when connecting wirelessly, on battery power, sleeping, hibernating or powered off. For more information, see www.intel.com/technology/platform-technology/intel-amt/

Enabling Execute Disable Bit functionality requires a PC with a processor with Execute Disable Bit capability and a supporting operating system. Check with your PC manufacturer on whether your system delivers Execute Disable Bit functionality.

Contact your local Intel sales office or your distributor to obtain the latest specifications and before placing your product order.

Copies of documents which have an order number and are referenced in this document, or other Intel literature may be obtained by calling 1-800-548-4725 or by visiting Intel's website at <http://www.intel.com>.

Intel, Intel Core, Intel Scalable Memory Interconnect (Intel SMI), Intel Virtualization Technology for Directed I/O, Intel Trusted Execution Technology (Intel TXT), Intel Management Engine (Intel ME), Intel Interconnect BIST (Intel IBIST), and the Intel logo are trademarks of Intel Corporation in the U. S. and other countries.

*Other names and brands may be claimed as the property of others.

Copyright © 2011 Intel Corporation. All Rights Reserved.



Contents

1	Introduction	11
2	Processor Configuration Registers	13
2.1	Register Terminology	13
2.2	PCI Devices and Functions on Processor	14
2.3	System Address Map	15
2.3.1	Legacy Address Range	18
2.3.1.1	DOS Range (0h–9_FFFFh)	18
2.3.1.2	Legacy Video Area (A_0000h–B_FFFFh)	19
2.3.1.3	PAM (C_0000h–F_FFFFh)	20
2.3.2	Main Memory Address Range (1 MB - TOLUD)	20
2.3.2.1	ISA Hole (15 MB–16 MB)	21
2.3.2.2	TSEG	21
2.3.2.3	Protected Memory Range (PMR) – (programmable)	21
2.3.2.4	DRAM Protected Range (DPR)	22
2.3.2.5	Pre-allocated Memory	22
2.3.2.6	GFX Stolen Spaces	23
2.3.2.7	ME UMA	23
2.3.3	PCI Memory Address Range (TOLUD – 4 GB)	23
2.3.3.1	APIC Configuration Space (FECO_0000h–FECF_FFFFh)	25
2.3.3.2	HSEG (FEDA_0000h–FEDB_FFFFh)	25
2.3.3.3	MSI Interrupt Memory Space (FEE0_0000h–FEEF_FFFFh)	25
2.3.3.4	High BIOS Area	25
2.3.4	Main Memory Address Space (4 GB to TOUUD)	26
2.3.4.1	Memory Re-claim Background	27
2.3.4.2	Indirect Accesses to MCHBAR Registers	27
2.3.4.3	Memory Remapping	28
2.3.4.4	Hardware Remap Algorithm	28
2.3.4.5	Programming Model	28
2.3.5	PCI Express* Configuration Address Space	32
2.3.6	PCI Express* Graphics Attach (PEG)	33
2.3.7	Graphics Memory Address Ranges	34
2.3.7.1	IOBAR Mapped Access to Device 2 MMIO Space	34
2.3.7.2	Trusted Graphics Ranges	34
2.3.8	System Management Mode (SMM)	35
2.3.9	SMM and VGA Access through GTT TLB	35
2.3.10	ME Stolen Memory Accesses	35
2.3.11	I/O Address Space	36
2.3.11.1	PCI Express* I/O Address Mapping	36
2.3.12	MCTP and KVM Flows	37
2.3.13	Decode Rules and Cross-Bridge Address Mapping	37
2.3.13.1	DMI Interface Decode Rules	37
2.3.13.2	PCI Express* Interface Decode Rules	40
2.3.13.3	Legacy VGA and I/O Range Decode Rules	41
2.4	Processor Register Introduction	45
2.4.1	I/O Mapped Registers	46
2.5	PCI Device 0 Function 0 Configuration Space	46
2.5.1	VID—Vendor Identification Register	48
2.5.2	DID—Device Identification Register	48
2.5.3	PCICMD—PCI Command Register	49
2.5.4	PCISTS—PCI Status Register	50
2.5.5	RID—Revision Identification Register	52
2.5.6	CC—Class Code Register	53
2.5.7	HDR—Header Type Register	53
2.5.8	SVID—Subsystem Vendor Identification Register	54

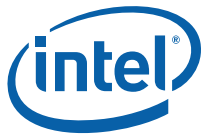

2.5.9	SID—Subsystem Identification Register	54
2.5.10	PXPEPBAR—PCI Express Egress Port Base Address Register	55
2.5.11	MCHBAR—Host Memory Mapped Register Range Base Register	56
2.5.12	GGC—GMCH Graphics Control Register Register	57
2.5.13	DEVEN—Device Enable Register	59
2.5.14	PCIEXBAR—PCI Express Register Range Base Address Register	60
2.5.15	DMIBAR—Root Complex Register Range Base Address Register	62
2.5.16	PAMO—Programmable Attribute Map 0 Register	63
2.5.17	PAM1—Programmable Attribute Map 1 Register	64
2.5.18	PAM2—Programmable Attribute Map 2 Register	65
2.5.19	PAM3—Programmable Attribute Map 3 Register	66
2.5.20	PAM4—Programmable Attribute Map 4 Register	67
2.5.21	PAM5—Programmable Attribute Map 5 Register	68
2.5.22	PAM6—Programmable Attribute Map 6 Register	69
2.5.23	LAC—Legacy Access Control Register	70
2.5.24	REMAPBASE—Remap Base Address Register	74
2.5.25	REMAPLIMIT—Remap Limit Address Register	74
2.5.26	TOM—Top of Memory Register	75
2.5.27	TOUUD—Top of Upper Usable DRAM Register	76
2.5.28	BDSM—Base Data of Stolen Memory Register	77
2.5.29	BGSM—Base of GTT stolen Memory Register	77
2.5.30	G Memory Base Register	78
2.5.31	TOLUD—Top of Low Usable DRAM Register	78
2.5.32	SKPD—Scratchpad Data Register	79
2.5.33	CAPID0_A—Capabilities A Register	80
2.6	PCI Device 1 Function 0–2 Configuration Space	82
2.6.1	VID1—Vendor Identification Register	84
2.6.2	DID1—Device Identification Register	84
2.6.3	PCICMD1—PCI Command Register	85
2.6.4	PCISTS1—PCI Status Register	87
2.6.5	RID1—Revision Identification Register	89
2.6.6	CC1—Class Code Register	89
2.6.7	CL1—Cache Line Size Register	90
2.6.8	HDR1—Header Type Register	90
2.6.9	PBUSN1—Primary Bus Number Register	90
2.6.10	SBUSN1—Secondary Bus Number Register	91
2.6.11	SUBUSN1—Subordinate Bus Number Register	91
2.6.12	IOBASE1—I/O Base Address Register	92
2.6.13	IOLIMIT1—I/O Limit Address Register	92
2.6.14	SSTS1—Secondary Status Register	93
2.6.15	MBASE1—Memory Base Address Register	94
2.6.16	MLIMIT1—Memory Limit Address Register	95
2.6.17	PMBASE1—Prefetchable Memory Base Address Register	96
2.6.18	PMLIMIT1—Prefetchable Memory Limit Address Register	97
2.6.19	PMBASEU1—Prefetchable Memory Base Address Upper Register	98
2.6.20	PMLIMITU1—Prefetchable Memory Limit Address Upper Register	98
2.6.21	CAPPTR1—Capabilities Pointer Register	99
2.6.22	INTRLINE1—Interrupt Line Register	99
2.6.23	INTRPIN1—Interrupt Pin Register	100
2.6.24	BCTRL1—Bridge Control Register	100
2.6.25	PM_CAPID1—Power Management Capabilities Register	102
2.6.26	PM_CS1—Power Management Control/Status Register	103
2.6.27	SS_CAPID—Subsystem ID and Vendor ID Capabilities Register	104
2.6.28	SS—Subsystem ID and Subsystem Vendor ID Register	105

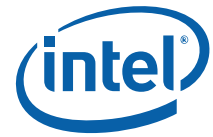

2.6.29	MSI_CAPID—Message Signaled Interrupts Capability ID Register	105
2.6.30	MC—Message Control Register	106
2.6.31	MA—Message Address Register	107
2.6.32	MD—Message Data Register	107
2.6.33	PEG_CAPL—PCI Express-G Capability List Register	107
2.6.34	PEG_CAP—PCI Express-G Capabilities Register	108
2.6.35	DCAP—Device Capabilities Register	108
2.6.36	DCTL—Device Control Register	109
2.6.37	DSTS—Device Status Register	110
2.6.38	LCTL—Link Control Register	111
2.6.39	LSTS—Link Status Register	113
2.6.40	SLOTCAP—Slot Capabilities Register	114
2.6.41	SLOTCTL—Slot Control Register	116
2.6.42	SLOTSTS—Slot Status Register	118
2.6.43	RCTL—Root Control Register	120
2.6.44	LCTL2—Link Control 2 Register	120
2.7	PCI Device 1 Function 0–2 Extended Configuration	123
2.7.1	PVCCAP1—Port VC Capability Register 1	123
2.7.2	PVCCAP2—Port VC Capability Register 2	124
2.7.3	PVCCTL—Port VC Control Register	124
2.7.4	VC0RCAP—VC0 Resource Capability Register	125
2.7.5	VC0RCTL—VC0 Resource Control Register	126
2.7.6	VC0RSTS—VC0 Resource Status Register	127
2.7.7	PEG_TC—PCI Express Completion Time-out Register	127
2.8	PCI Device 2 Configuration Space	128
2.8.1	VID2—Vendor Identification Register	129
2.8.2	DID2—Device Identification Register	129
2.8.3	PCICMD2—PCI Command Register	130
2.8.4	PCISTS2—PCI Status Register	131
2.8.5	RID2—Revision Identification Register	132
2.8.6	CC—Class Code Register	132
2.8.7	CLS—Cache Line Size Register	133
2.8.8	MTXT2—Master Latency Timer Register	133
2.8.9	HDR2—Header Type Register	133
2.8.10	GTTMMADR—Graphics Translation Table, Memory Mapped Range Address Register	134
2.8.11	GMADR—Graphics Memory Range Address Register	135
2.8.12	IOBAR—I/O Base Address Register	136
2.8.13	SVID2—Subsystem Vendor Identification Register	136
2.8.14	SID2—Subsystem Identification Register	137
2.8.15	ROMADR—Video BIOS ROM Base Address Register	137
2.8.16	INTRPIN—Interrupt Pin Register	137
2.8.17	MINGNT—Minimum Grant Register	138
2.8.18	MAXLAT—Maximum Latency Register	138
2.8.19	MSAC—Multi Size Aperture Control Register	139
2.9	Device 2 IO	140
2.9.1	INDEX—MMIO Address Register	140
2.9.2	DATA—MMIO Data Register	140
2.10	PCI Device 6	141
2.10.1	VID6—Vendor Identification Register	143
2.10.2	DID6—Device Identification Register	143
2.10.3	PCICMD6—PCI Command Register	144
2.10.4	PCISTS6—PCI Status Register	146
2.10.5	RID6—Revision Identification Register	148
2.10.6	CC6—Class Code Register	148
2.10.7	CL6—Cache Line Size Register	149



2.10.8	HDR6—Header Type Register	149
2.10.9	PBUSN6—Primary Bus Number Register.....	149
2.10.10	SBUSN6—Secondary Bus Number Register.....	150
2.10.11	SUBUSN6—Subordinate Bus Number Register	150
2.10.12	IOBASE6—I/O Base Address Register	151
2.10.13	IOLIMIT6—I/O Limit Address Register	151
2.10.14	SSTS6—Secondary Status Register	152
2.10.15	MBASE6—Memory Base Address Register.....	153
2.10.16	MLIMIT6—Memory Limit Address Register	154
2.10.17	PMBASE6—Prefetchable Memory Base Address Register	155
2.10.18	PMLIMIT6—Prefetchable Memory Limit Address Register	156
2.10.19	PMBASEU6—Prefetchable Memory Base Address Upper Register.....	157
2.10.20	PMLIMITU6—Prefetchable Memory Limit Address Upper Register	158
2.10.21	CAPPTR6—Capabilities Pointer Register	158
2.10.22	INTRLINE6—Interrupt Line Register	159
2.10.23	INTRPIN6—Interrupt Pin Register.....	159
2.10.24	BCTRL6—Bridge Control Register	160
2.10.25	PM_CAPID6—Power Management Capabilities Register	162
2.10.26	PM_CS6—Power Management Control/Status Register	163
2.10.27	SS_CAPID—Subsystem ID and Vendor ID Capabilities Register	164
2.10.28	SS—Subsystem ID and Subsystem Vendor ID Register	165
2.10.29	MSI_CAPID—Message Signaled Interrupts Capability ID Register	165
2.10.30	MC—Message Control Register.....	166
2.10.31	MA—Message Address Register.....	167
2.10.32	MD—Message Data Register	167
2.10.33	PEG_CAPL—PCI Express-G Capability List Register	167
2.10.34	PEG_CAP—PCI Express-G Capabilities Register	168
2.10.35	DCAP—Device Capabilities Register	168
2.10.36	DCTL—Device Control Register	169
2.10.37	DSTS—Device Status Register	170
2.10.38	LCTL—Link Control Register	171
2.10.39	LSTS—Link Status Register	173
2.10.40	SLOTCAP—Slot Capabilities Register.....	174
2.10.41	SLOTCTL—Slot Control Register.....	176
2.10.42	SLOTSTS—Slot Status Register.....	178
2.10.43	RCTL—Root Control Register	179
2.11	PCI Device 6 Extended Configuration.....	180
2.11.1	PVCCAP1—Port VC Capability Register 1	180
2.11.2	PVCCAP2—Port VC Capability Register 2	181
2.11.3	PVCCTL—Port VC Control Register.....	181
2.11.4	VCORCAP—VC0 Resource Capability Register	182
2.11.5	VCORCTL—VC0 Resource Control Register	183
2.11.6	VCORSTS—VC0 Resource Status Register.....	184
2.12	DMIBAR	185
2.12.1	DMIVCECH—DMI Virtual Channel Enhanced Capability Register	186
2.12.2	DMIPVCCAP1—DMI Port VC Capability Register 1	187
2.12.3	DMIPVCCAP2—DMI Port VC Capability Register 2	187
2.12.4	DMIPVCCTL—DMI Port VC Control Register.....	188
2.12.5	DMIVCORCAP—DMI VC0 Resource Capability Register	188
2.12.6	DMIVCORCTL—DMI VC0 Resource Control Register.....	189
2.12.7	DMIVCORSTS—DMI VC0 Resource Status Register.....	190
2.12.8	DMIVC1RCAP—DMI VC1 Resource Capability Register	190
2.12.9	DMIVC1RCTL—DMI VC1 Resource Control Register.....	191
2.12.10	DMIVC1RSTS—DMI VC1 Resource Status Register.....	192
2.12.11	DMIVCPRCAP—DMI VCp Resource Capability Register	192
2.12.12	DMIVCPRCTL—DMI VCp Resource Control Register	193

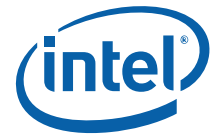

2.12.13	DMIVCPRSTS—DMI VCp Resource Status Register	194
2.12.14	DMIESD—DMI Element Self Description Register	195
2.12.15	DMILE1D—DMI Link Entry 1 Description Register	196
2.12.16	DMILE1A—DMI Link Entry 1 Address Register	196
2.12.17	DMILE2D—DMI Link Entry 2 Description Register	197
2.12.18	DMILE2A—DMI Link Entry 2 Address Register	197
2.12.19	LCAP—Link Capabilities Register	198
2.12.20	LCTL—Link Control Register	199
2.12.21	LSTS—DMI Link Status Register	200
2.12.22	LCTL2—Link Control 2 Register	201
2.12.23	LSTS2—Link Status 2 Register	203
2.13	MCHBAR Registers in Memory Controller – Channel 0	204
2.13.1	PM_PDWN_config_C0—Power-down Configuration Register	204
2.13.2	TC_RFP_C0—Refresh Parameters Register	205
2.13.3	TC_RFTP_C0—Refresh Parameters Register	205
2.14	MCHBAR Registers in Memory Controller – Channel 1	206
2.14.1	PM_PDWN_Config_C1—Power-down Configuration Register	206
2.14.2	TC_RFP_C1—Refresh Parameters Register	207
2.14.3	TC_RFTP_C1—Refresh Timing Parameters Register	207
2.15	MCHBAR Registers in Memory Controller – Integrated Memory Peripheral Hub (IMPH)	208
2.15.1	CRDTCTL3—Credit Control 3 Register	208
2.16	MCHBAR Registers in Memory Controller – Common	209
2.16.1	MAD_CHNL—Address Decoder Channel Configuration Register	209
2.16.2	MAD_DIMM_ch0—Address decode channel 0 Register	210
2.16.3	MAD_DIMM_ch1 - Address Decode Channel 1 Register	211
2.16.4	PM_SREF_config—Self Refresh Configuration Register	212
2.17	Memory Controller MMIO Registers Broadcast Group	213
2.17.1	PM_PDWN_Config—Power-down Configuration Register	213
2.17.2	PM_CMD_PWR—Power Management Command Power Register	214
2.17.3	PM_BW_LIMIT_config—BW Limit Configuration Register	214
2.18	Integrated Graphics VTd Remapping Engine Registers	215
2.18.1	VER_REG—Version Register	216
2.18.2	CAP_REG—Capability Register	217
2.18.3	ECAP_REG—Extended Capability Register	220
2.18.4	GCMD_REG—Global Command Register	222
2.18.5	GSTS_REG—Global Status Register	225
2.18.6	RTADDR_REG—Root-Entry Table Address Register	226
2.18.7	CCMD_REG—Context Command Register	227
2.18.8	FSTS_REG—Fault Status Register	229
2.18.9	FECTL_REG—Fault Event Control Register	231
2.18.10	FEDATA_REG—Fault Event Data Register	232
2.18.11	FEADDR_REG—Fault Event Address Register	232
2.18.12	FEUADDR_REG—Fault Event Upper Address Register	232
2.18.13	AFLOG_REG—Advanced Fault Log Register	233
2.18.14	PMEN_REG—Protected Memory Enable Register	234
2.18.15	PLMBASE_REG—Protected Low-Memory Base Register	235
2.18.16	PLMLIMIT_REG—Protected Low-Memory Limit Register	236
2.18.17	PHMBASE_REG—Protected High-Memory Base Register	237
2.18.18	PHMLIMIT_REG—Protected High-Memory Limit Register	238
2.18.19	IQH_REG—Invalidation Queue Head Register	239
2.18.20	IQT_REG—Invalidation Queue Tail Register	239
2.18.21	IQA_REG—Invalidation Queue Address Register	240
2.18.22	ICS_REG—Invalidation Completion Status Register	240
2.18.23	IECTL_REG—Invalidation Event Control Register	241
2.18.24	IEDATA_REG—Invalidation Event Data Register	242



2.18.25	IEUADDR_REG—Invalidation Event Upper Address Register	242
2.18.26	IRTA_REG—Interrupt Remapping Table Address Register	243
2.18.27	IVA_REG—Invalidate Address Register.....	244
2.18.28	IOTLB_REG—IOTLB Invalidate Register.....	245
2.18.29	FRCDL_REG—Fault Recording Low Register	247
2.18.30	FRCDH_REG—Fault Recording High Register.....	248
2.18.31	VTPOLICY—DMA Remap Engine Policy Control Register	249
2.19	PCU MCHBAR Registers.....	250
2.19.1	MEM_TRML_ESTIMATION_CONFIG—Memory Thermal Estimation Configuration Register	251
2.19.2	MEM_TRML_THRESHOLDS_CONFIG—Memory Thermal Thresholds Configuration Register	252
2.19.3	MEM_TRML_STATUS_REPORT—Memory Thermal Status Report Register ...	253
2.19.4	MEM_TRML_TEMPERATURE_REPORT—Memory Thermal Temperature Report Register	254
2.19.5	MEM_TRML_INTERRUPT—Memory Thermal Interrupt Register.....	254
2.19.6	GT_PERF_STATUS—GT Performance Status Register	255
2.19.7	RP_STATE_CAP—RP State Capability Register	255
2.19.8	SSKPD—Sticky Scratchpad Data Register	256
2.20	PXPEPBAR.....	258
2.20.1	EPVCORCTL—EP VC 0 Resource Control Register	258
2.21	Default PEG/DMI Vtd Remapping Engine Registers.....	259
2.21.1	VER_REG—Version Register	260
2.21.2	CAP_REG—Capability Register	261
2.21.3	ECAP_REG—Extended Capability Register	264
2.21.4	GCMD_REG—Global Command Register	266
2.21.5	GSTS_REG—Global Status Register	269
2.21.6	RTADDR_REG—Root-Entry Table Address Register	270
2.21.7	CCMD_REG—Context Command Register	271
2.21.8	FSTS_REG—Fault Status Register	273
2.21.9	FECTL_REG—Fault Event Control Register	275
2.21.10	FEDATA_REG—Fault Event Data Register	276
2.21.11	FEADDR_REG—Fault Event Address Register	276
2.21.12	FEUADDR_REG—Fault Event Upper Address Register	276
2.21.13	AFLOG_REG—Advanced Fault Log Register.....	277
2.21.14	PMEN_REG—Protected Memory Enable Register	278
2.21.15	PLMBASE_REG—Protected Low-Memory Base Register	279
2.21.16	PLMLIMIT_REG—Protected Low-Memory Limit Register	280
2.21.17	PHMBASE_REG—Protected High-Memory Base Register	281
2.21.18	PHMLIMIT_REG—Protected High-Memory Limit Register.....	282
2.21.19	IQH_REG—Invalidation Queue Head Register.....	283
2.21.20	EQ—Invalidation Queue Tail Register.....	283
2.21.21	IOA_REG—Invalidation Queue Address Register	284
2.21.22	ICS_REG—Invalidation Completion Status Register	284
2.21.23	IECTL_REG—Invalidation Event Control Register	285
2.21.24	IEDATA_REG—Invalidation Event Data Register	286
2.21.25	IEADDR_REG—Invalidation Event Address Register	286
2.21.26	IEUADDR_REG—Invalidation Event Upper Address Register	287
2.21.27	IRTA_REG—Interrupt Remapping Table Address Register	287
2.21.28	IVA_REG—Invalidate Address Register.....	288
2.21.29	IOTLB_REG—IOTLB Invalidate Register.....	289



Figures

2-1	System Address Range Example	17
2-2	DOS Legacy Address Range	18
2-3	Main Memory Address Range	20
2-4	PCI Memory Address Range	24
2-5	Case 1: Less than 4 GB of Physical Memory (no remap)	29
2-6	Case 2: Greater than 4 GB of Physical Memory.....	30
2-7	Example: DMI Upstream VC0 Memory Map	39
2-8	PEG Upstream VC0 Memory Map	41

Tables

2-1	Register Attributes and Terminology	13
2-2	Register Attribute Modifiers	14
2-3	SMM regions.....	35
2-4	IGD Frame Buffer Accesses.....	42
2-5	IGD VGA I/O Mapping	42
2-6	VGA and MDA I/O Transaction Mapping	43
2-7	PCI Device 0, Function 0 Register Address Map	46
2-8	PCI Device 1, Function 0–2 Configuration Register Address Map	82
2-9	PCI Device 1 Function 0–2 Extended Configuration Register Address Map.....	123
2-10	PCI Device 2 Configuration Register Address Map	128
2-11	Device 2 IO Register Address Map	140
2-12	PCI Device 6 Register Address Map	141
2-13	PCI Device 6 Extended Configuration Register Address Map	180
2-14	DMIBAR Register Address Map	185
2-15	MCHBAR Registers in Memory Controller – Channel 0 Register Address Map	204
2-16	MCHBAR Registers in Memory Controller – Channel 1 Register Address Map	206
2-17	MCHBAR Registers in Memory Controller – Integrated Memory Peripheral Hub	208
2-18	MCHBAR Registers in Memory Controller – Common Register Address Map.....	209
2-19	Memory Controller MMIO Registers Broadcast Group Register Address Map	213
2-20	Integrated Graphics VTd Remapping Engine Register Address Map.....	215
2-21	PCU MCHBAR Register Address Map	250
2-22	PXPEPBAR Register Address Map	258
2-23	Default PEG/DMI VTd Remapping Engine Register Address Map	259



Revision History

Revision Number	Description	Revision Date
001	Initial release	January 2011

§



1 Introduction

This is Volume 2 of the Datasheet for the 2nd Generation Intel® Core™ processor family mobile.

The processor contains one or more PCI devices within a single physical component. The configuration registers for these devices are mapped as devices residing on the PCI Bus assigned for the processor socket. This document describes these configuration space registers or device-specific control and status registers (CSRs) only. This document does NOT include Model Specific Registers (MSRs).

Note: Throughout this document, the Intel® Core™ i7 Mobile Extreme Edition processor series and Intel® Core™ i5 and i7 mobile processor series may be referred to as "processor".

Note: Throughout this document, the Intel® 6 Series Chipset Platform Controller Hub may also be referred to as "PCH".

Note: The term "MBL" refers to mobile platforms.

§





2 Processor Configuration Registers

This chapter contains the following:

- Register terminology
- PCI Devices and Functions on Processor
- System address map
- Processor register introduction
- Detailed register bit descriptions

2.1 Register Terminology

Table 2-1 shows the register-related terminology and register attributes that are used in this document. Attribute modifiers are listed in Table 2-2.

Table 2-1. Register Attributes and Terminology

Item	Description
RO	Read Only: These bits can only be read by software, writes have no effect. The value of the bits is determined by the hardware only.
RW	Read / Write: These bits can be read and written by software.
RW1C	Read / Write 1 to Clear: These bits can be read and cleared by software. Writing a '1' to a bit will clear it, while writing a '0' to a bit has no effect. Hardware sets these bits.
RW0C	Read / Write 0 to Clear: These bits can be read and cleared by software. Writing a '0' to a bit will clear it, while writing a '1' to a bit has no effect. Hardware sets these bits.
RW1S	Read / Write 1 to Set: These bits can be read and set by software. Writing a '1' to a bit will set it, while writing a '0' to a bit has no effect. Hardware clears these bits.
RsvdP	Reserved and Preserved: These bits are reserved for future RW implementations and their value must not be modified by software. When writing to these bits, software must preserve the value read. When SW updates a register that has RsvdP fields, it must read the register value first so that the appropriate merge between the RsvdP and updated fields will occur.
RsvdZ	Reserved and Zero: These bits are reserved for future RW1C implementations. SW must use 0 for writes.
WO	Write Only: These bits can only be written by software, reads return zero. Note: Use of this attribute type is deprecated and can only be used to describe bits without persistent state.
RC	Read Clear: These bits can only be read by software, but a read causes the bits to be cleared. Hardware sets these bits. Note: Use of this attribute type is only allowed on legacy functions, as side-effects on reads are not desirable.
RSW1C	Read Set / Write 1 to Clear: These bits can be read and cleared by software. Reading a bit will set the bit to '1'. Writing a '1' to a bit will clear it, while writing a '0' to a bit has no effect.
RCW	Read Clear / Write: These bits can be read and written by software, but a read causes the bits to be cleared. Note: Use of this attribute type is only allowed on legacy functions, as side-effects on reads are not desirable.



Table 2-2. Register Attribute Modifiers

Attribute Modifier	Applicable Attribute	Description
S	RO (w/ -V)	Sticky: These bits are only re-initialized to their default value by a "Power Good Reset". Note: Does not apply to RO (constant) bits.
	RW	
	RW1C	
	RW1S	
-K	RW	Key: These bits control the ability to write other bits (identified with a 'Lock' modifier)
-L	RW	Lock: Hardware can make these bits "Read Only" via a separate configuration bit or other logic. Note: Mutually exclusive with 'Once' modifier.
	WO	
-O	RW	Once: After reset, these bits can only be written by software once, after which they become "Read Only". Note: Mutually exclusive with 'Lock' modifier and does not make sense with 'Variant' modifier.
	WO	
-FW	RO	Firmware Write: The value of these bits can be updated by firmware (PCU, TAP, etc.).
-V	RO	Variant: The value of these bits can be updated by hardware. Note: RW1C and RC bits are variant by definition and therefore do not need to be modified.

2.2 PCI Devices and Functions on Processor

Description	DID	Device	Function
DRAM Controller	0104h	0	0
PCI Express Controller	0101h	1	0
PCI Express Controller	0105h	1	1
PCI Express Controller	0109h	1	2
Integrated Graphics Device	0106h	2	0
PCI Express Controller	010Dh	6	0

Note: Not all devices are enabled in all configurations.



2.3 System Address Map

The processor supports 512 GB (39 bit) of addressable memory space and 64 KB+3 of addressable I/O space.

This section focuses on how the memory space is partitioned and what the separate memory regions are used for. I/O address space has simpler mapping and is explained near the end of this section.

The processor supports PEG port upper prefetchable base/limit registers. This allows the PEG unit to claim I/O accesses above 32 bit. Addressing of greater than 4 GB is allowed on either the DMI Interface or PCI Express interface. The processor supports a maximum of 32 GB of DRAM. No DRAM memory will be accessible above 32 GB. DRAM capacity is limited by the number of address pins available. There is no hardware lock to stop someone from inserting more memory than is addressable.

When running in internal graphics mode, processor initiated TileX/TileY/linear reads/writes to GMADR range are supported. Write accesses to GMADR linear regions are supported from both DMI and PEG. GMADR write accesses to tileX and tileY regions (defined using fence registers) are not supported from DMI or the PEG port. GMADR read accesses are not supported from either DMI or PEG.

In the following sections, it is assumed that all of the compatibility memory ranges reside on the DMI Interface. The exception to this rule is VGA ranges, which may be mapped to PCI Express*, DMI, or to the internal graphics device (IGD). In the absence of more specific references, cycle descriptions referencing PCI should be interpreted as the DMI Interface/PCI, while cycle descriptions referencing PCI Express or IGD are related to the PCI Express bus or the internal graphics device respectively. The processor does not remap APIC or any other memory spaces above TOLUD (Top of Low Usable DRAM). The TOLUD register is set to the appropriate value by BIOS. The remapbase/remaplimit registers remap logical accesses bound for addresses above 4 GB onto physical addresses that fall within DRAM.

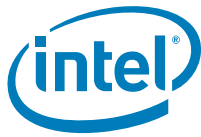

The Address Map includes a number of programmable ranges:

- Device 0
 - PXPEPBAR – PxP egress port registers. (4 KB window)
 - MCHBAR – Memory mapped range for internal MCH registers. (32 KB window)
 - DMIBAR – This window is used to access registers associated with the processor/PCH Serial Interconnect (DMI) register memory range. (4 KB window)
 - GGC.GMS – Graphics Mode Select. Used to select the amount of main memory that is pre-allocated to support the internal graphics device in VGA (non-linear) and Native (linear) modes. (0–512 MB options).
 - GGC.GGMS – GTT Graphics Memory Size. Used to select the amount of main memory that is pre-allocated to support the Internal Graphics Translation Table. (0–2 MB options).

For each of the following 4 device functions

- Device 1, Function 0
- Device 1, Function 1
- Device 1, Function 2
- Device 6, Function 0
 - MBASE/MLIMIT – PCI Express port non-prefetchable memory access window.
 - PMBASE/PMLIMIT – PCI Express port prefetchable memory access window.
 - PMUBASE/PMULIMIT – PCI Express port upper prefetchable memory access window
 - IOBASE/IOLIMIT – PCI Express port I/O access window.
- Device 2, Function 0
 - IOBAR – I/O access window for internal graphics. Through this window address/data register pair, using I/O semantics, the IGD and internal graphics instruction port registers can be accessed. Note, this allows accessing the same registers as GTTMMADR. The IOBAR can be used to issue writes to the GTTMMADR or the GTT table.
 - GMADR – Internal graphics translation window (128 MB, 256 MB, 512 MB window).
 - GTTMMADR – This register requests a 4 MB allocation for combined Graphics Translation Table Modification Range and Memory Mapped Range. GTTADR will be at GTTMMADR + 2 MB while the MMIO base address will be the same as GTTMMADR.

The rules for the above programmable ranges are:

1. For security reasons, the processor will now positively decode (FFE0_0000h to FFFF_FFFFh) to DMI. This ensures the boot vector and BIOS execute off PCH.
2. ALL of these ranges MUST be unique and NON-OVERLAPPING. It is the BIOS or system designers' responsibility to limit memory population so that adequate PCI, PCI Express, High BIOS, PCI Express Memory Mapped space, and APIC memory space can be allocated.
3. In the case of overlapping ranges with memory, the memory decode will be given priority. This is a Intel TXT requirement. It is necessary to get Intel TXT protection checks, avoiding potential attacks.
4. There are NO Hardware Interlocks to prevent problems in the case of overlapping ranges.
5. Accesses to overlapped ranges may produce indeterminate results.
6. Software must not access B0/D0/F0 32-bit memory-mapped registers with requests that cross a DW boundary



Figure 2-1 represents system memory address map in a simplified form.

Figure 2-1. System Address Range Example

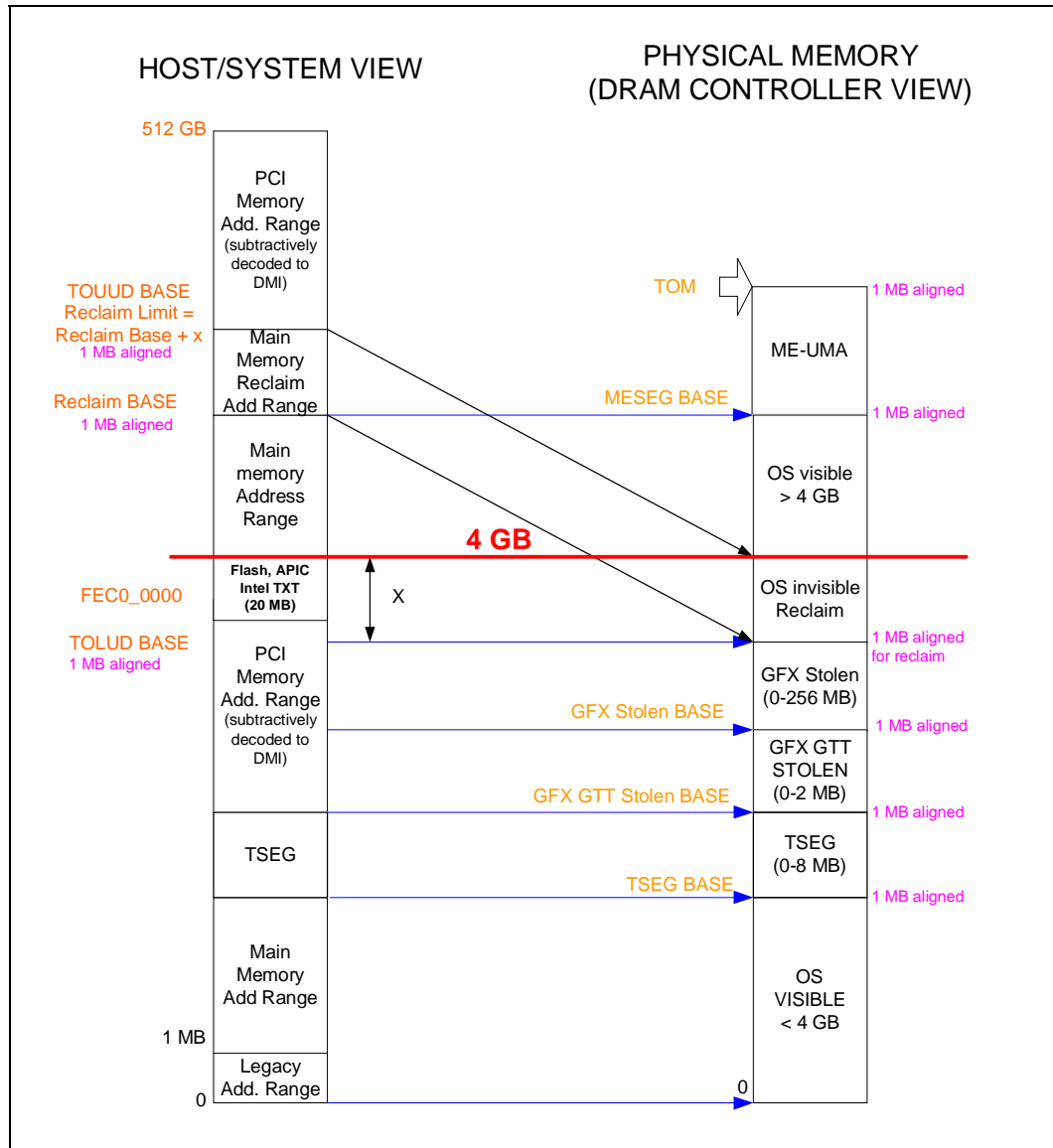



2.3.1 Legacy Address Range

This area is divided into the following address regions:

- 0–640 KB – DOS Area
- 640–768 KB – Legacy Video Buffer Area
- 768–896 KB in 16 KB sections (total of 8 sections) – Expansion Area
- 896–960 KB in 16 KB sections (total of 4 sections) – Extended System BIOS Area
- 960 KB–1 MB Memory – System BIOS Area

Figure 2-2. DOS Legacy Address Range

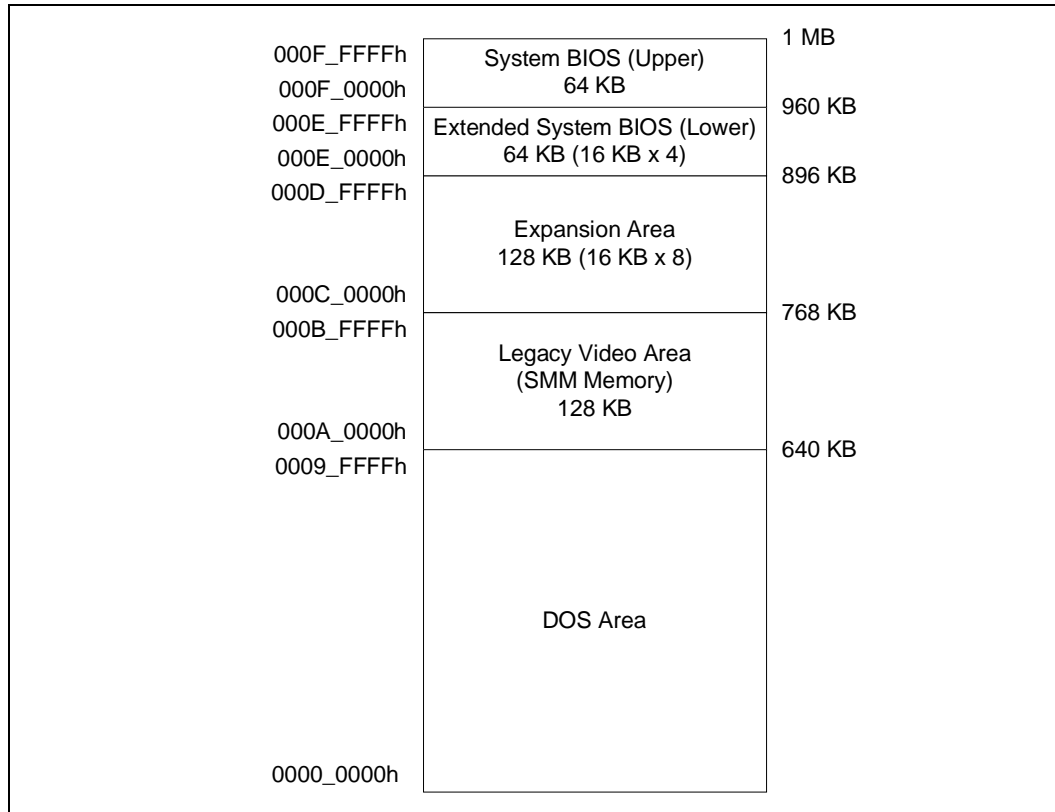

2.3.1.1 DOS Range (0h–9_FFFFh)

The DOS area is 640 KB (0000_0000h – 0009_FFFFh) in size and is always mapped to the main memory controlled by the MCH.

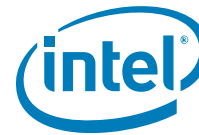

2.3.1.2 Legacy Video Area (A_0000h–B_FFFFh)

The legacy 128 KB VGA memory range, frame buffer, (000A_0000h – 000B_FFFFh) can be mapped to IGD (Device 2), to PCI Express (Device 1 or Device 6), and/or to the DMI Interface. The appropriate mapping depends on which devices are enabled and the programming of the VGA steering bits. Based on the VGA steering bits, priority for VGA mapping is constant. The processor always decodes internally mapped devices first.

Non-SMM-mode processor accesses to this range are considered to be to the Video Buffer Area as described above.

The processor always positively decodes internally mapped devices, namely the IGD and PCI-Express. Subsequent decoding of regions mapped to PCI Express or the DMI Interface depends on the Legacy VGA configuration bits (VGA Enable and MDAP). This region is also the default for SMM space.

Compatible SMRAM Address Range (A_0000h–B_FFFFh)

When compatible SMM space is enabled, SMM-mode processor accesses to this range route to physical system DRAM at 000A_0000h–000B_FFFFh.

PCI Express and DMI originated cycles to enable SMM space are not allowed and are considered to be to the Video Buffer Area, if IGD is not enabled as the VGA device. DMI initiated write cycles are attempted as peer write cycles to a VGA enabled PCIe port.

Monochrome Adapter (MDA) Range (B_0000h–B_7FFFh)

Legacy support requires the ability to have a second graphics controller (monochrome) in the system. Accesses in the standard VGA range are forwarded to IGD, PCI-Express, or the DMI Interface (depending on configuration bits). Since the monochrome adapter may be mapped to any of these devices, the processor must decode cycles in the MDA range (000B_0000h–000B_7FFFh) and forward either to IGD, PCI-Express, or the DMI Interface. This capability is controlled by the VGA steering bits and the legacy configuration bit (MDAP bit). In addition to the memory range B0000h to B7FFFh, the processor decodes I/O cycles at 3B4h, 3B5h, 3B8h, 3B9h, 3BAh, and 3BFh and forwards them to either IGD, PCI-Express, and/or the DMI Interface.

PEG 16-bit VGA Decode

In the *PCI to PCI Bridge Architecture Specification Revision 1.2* it is required that 16-bit VGA decode be a feature.

When 16-bit VGA decode is disabled, the decode of VGA I/O addresses is performed on 10 lower bits only, essentially mapping also the aliases of the defined I/O addresses.



2.3.1.3 PAM (C_0000h–F_FFFFh)

The 13 sections from 768 KB to 1 MB comprise what is also known as the PAM Memory Area. Each section has Read enable and Write enable attributes.

The PAM registers are mapped in Device 0 configuration space.

- ISA Expansion Area (C_0000h–D_FFFFh)
- Extended System BIOS Area (E_0000h–E_FFFFh)
- System BIOS Area (F_0000h–F_FFFFh)

The processor decodes the Core request, then routes to the appropriate destination (DRAM or DMI).

Snooped accesses from PCI Express or DMI to this region are snooped on processor caches.

Non-snooped accesses from PCI Express or DMI to this region are always sent to DRAM.

Graphics translated requests to this region are not allowed. If such a mapping error occurs, the request will be routed to C_0000h. Writes will have the byte enables de-asserted.

2.3.2 Main Memory Address Range (1 MB - TOLUD)

This address range extends from 1 MB to the top of Low Usable physical memory that is permitted to be accessible by the processor (as programmed in the TOLUD register). The processor will route all addresses within this range to the DRAM unless it falls into the optional TSEG, or optional ISA Hole, or optional IGD stolen VGA memory.

Figure 2-3. Main Memory Address Range

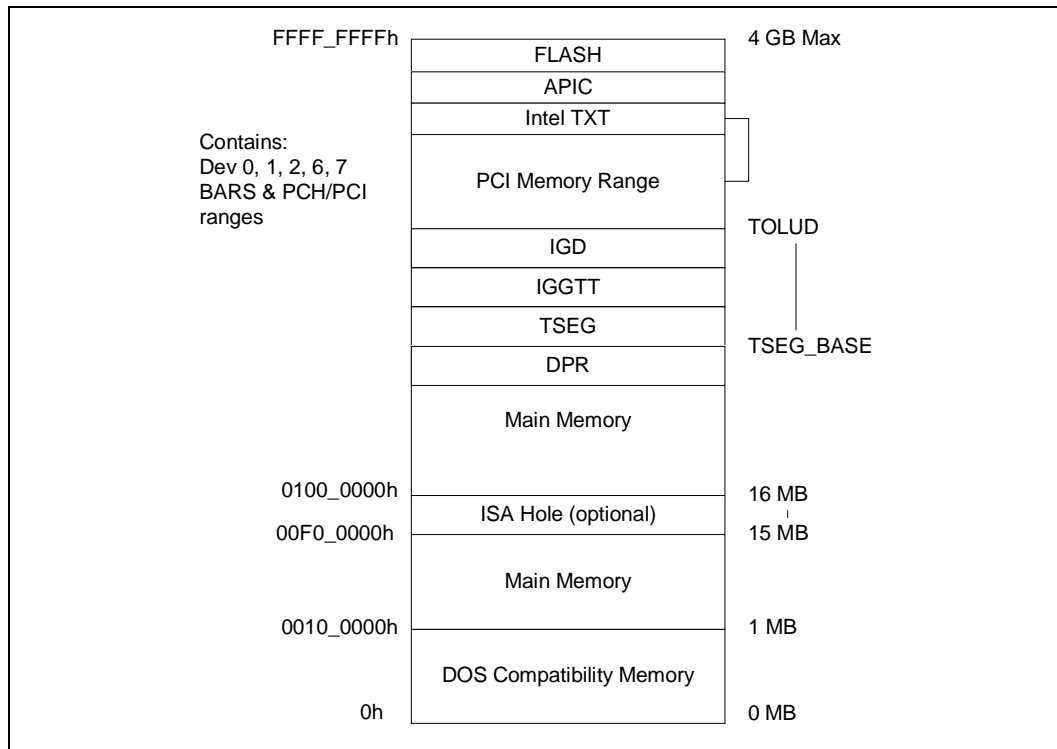

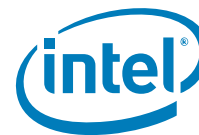

2.3.2.1 ISA Hole (15 MB–16 MB)

The ISA Hole is enabled in the Legacy Access Control Register in Device 0 configuration space. If no hole is created, the processor will route the request to DRAM. If a hole is created, the processor will route the request to DMI, since the request does not target DRAM.

Graphics translated requests to the range will always route to DRAM.

2.3.2.2 TSEG

For processor initiated transactions, the processor rely on correct programming of SMM Range Registers (SMRR) to enforce TSEG protection.

TSEG is below IGD stolen memory, which is at the Top of Low Usable physical memory (TOLUD). BIOS will calculate and program the TSEG BASE in Device 0 (TSEGMB), used protect this region from DMA access. The calculation is:

$$\text{TSEGMB} = \text{TOLUD} - \text{DSM SIZE} - \text{GSM SIZE} - \text{TSEG SIZE}$$

SMM-mode processor accesses to enabled TSEG access the physical DRAM at the same address.

When the extended SMRAM space is enabled, processor accesses to the TSEG range without SMM attribute or without WB attribute are handled by the processor as invalid accesses.

Non-processor originated accesses are not allowed to SMM space. PCI-Express, DMI, and Internal Graphics originated cycle to enabled SMM space are handled as invalid cycle type with reads and writes to location C_0000h and byte enables turned off for writes.

2.3.2.3 Protected Memory Range (PMR) – (programmable)

For robust and secure launch of the MVMM, the MVMM code and private data needs to be loaded to a memory region protected from bus master accesses. Support for protected memory region is required for DMA-remapping hardware implementations on platforms supporting Intel TXT, and is optional for non-Intel TXT platforms. Since the protected memory region needs to be enabled before the MVMM is launched, hardware must support enabling of the protected memory region independently from enabling the DMA-remapping hardware.

As part of the secure launch process, the SINIT-AC module verifies the protected memory regions are properly configured and enabled. Once launched, the MVMM can setup the initial DMA-remapping structures in protected memory (to ensure they are protected while being setup) before enabling the DMA-remapping hardware units.

To optimally support platform configurations supporting varying amounts of main memory, the protected memory region is defined as two non-overlapping regions:

- **Protected Low-memory Region** – This is defined as the protected memory region below 4 GB to hold the MVMM code/private data, and the initial DMA-remapping structures that control DMA to host physical addresses below 4 GB. DMA-remapping hardware implementations on platforms supporting Intel TXT are required to support protected low-memory region 5.
- **Protected High-memory Region** – This is defined as a variable sized protected memory region above 4 GB, enough to hold the initial DMA-remapping structures for managing DMA accesses to addresses above 4 GB. DMA-remapping hardware implementations on platforms supporting Intel TXT are required to support



protected high-memory region⁶, if the platform supports main memory above 4 GB.

Once the protected low/high memory region registers are configured, bus master protection to these regions is enabled through the Protected Memory Enable register. For platforms with multiple DMA-remapping hardware units, each of the DMA-remapping hardware units must be configured with the same protected memory regions and enabled.

2.3.2.4 DRAM Protected Range (DPR)

This protection range only applies to DMA accesses and GMADR translations. It serves a purpose of providing a memory range that is only accessible to processor streams.

The DPR range works independent of any other range, including the PMRC checks in VTd. It occurs post any VTd translation. Therefore, incoming cycles are checked against this range after the VTd translation and faulted if they hit this protected range, even if they passed the VTd translation.

The system will set up:

- 0 to (TSEG_BASE – DPR size – 1) for DMA traffic
- TSEG_BASE to (TSEG_BASE – DPR size) as no DMA.

After some time, software could request more space for not allowing DMA. It will get some more pages and make sure there are no DMA cycles to the new region. DPR size is changed to the new value. When it does this, there should not be any DMA cycles going to DRAM to the new region.

If there were cycles from a rogue device to the new region, then those could use the previous decode until the new decode can guarantee PV. No flushing of cycles is required. On a clock by clock basis proper decode with the previous or new decode needs to be ensured.

All upstream cycles from 0 to (TSEG_BASE – 1 – DPR size), and not in the legacy holes (VGA), are decoded to DRAM.

Because Bus Master cycles can occur when the DPR size is changed, the DPR size needs to be treated dynamically.

2.3.2.5 Pre-allocated Memory

Voids of physical addresses that are not accessible as general system memory and reside within system memory address range (< TOLUD) are created for SMM-mode, legacy VGA graphics compatibility, and GFX GTT stolen memory. **It is the responsibility of BIOS to properly initialize these regions.**

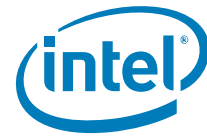

2.3.2.6 GFX Stolen Spaces

2.3.2.6.1 GTT Stolen Space (GSM)

GSM is allocated to store the GFX translation table entries.

GSM always exists regardless of VT-d as long as internal GFX is enabled. This space is allocated to store accesses as page table entries are getting updated through virtual GTTMMADR range. Hardware is responsible to map PTEs into this physical space.

Direct accesses to GSM are not allowed, only hardware translations and fetches can be directed to GSM.

2.3.2.7 ME UMA

ME (the iAMT Manageability Engine) can be allocated UMA memory. ME memory is “stolen” from the top of the Host address map. The ME stolen memory base is calculated by subtracting the amount of memory stolen by the Manageability Engine from TOM.

Only ME can access this space; it is not accessible by or coherent with any processor side accesses.

2.3.3 PCI Memory Address Range (TOLUD – 4 GB)

This address range, from the top of low usable DRAM (TOLUD) to 4 GB is normally mapped to the DMI Interface.

Device 0 exceptions are:

1. Addresses decoded to the egress port registers (PXPEPBAR)
2. Addresses decoded to the memory mapped range for internal MCH registers (MCHBAR)
3. Addresses decoded to the registers associated with the MCH/ICH Serial Interconnect (DMI) register memory range. (DMIBAR)

For each PCI Express port, there are two exceptions to this rule:

1. Addresses decoded to the PCI Express Memory Window defined by the MBASE, MLIMIT, registers are mapped to PCI Express.
2. Addresses decoded to the PCI Express prefetchable Memory Window defined by the PMBASE, PMLIMIT, registers are mapped to PCI Express.

In integrated graphics configurations, there are exceptions to this rule:

1. Addresses decode to the internal graphics translation window (GMADR)
2. Addresses decode to the Internal graphics translation table or IGD registers. (GTTMMADR)

In a VT enable configuration, there are exceptions to this rule:

1. Addresses decoded to the memory mapped window to PEG/DMI VC0 VT remap engine registers (VTDPVCOBAR)
2. Addresses decoded to the memory mapped window to Graphics VT remap engine registers (GFXVTBAR)
3. TCm accesses (to ME stolen memory) from PCH do not go through VT remap engines.

Some of the MMIO Bars may be mapped to this range or to the range above TOUUD.

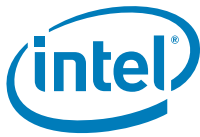

There are sub-ranges within the PCI Memory address range defined as APIC Configuration Space, MSI Interrupt Space, and High BIOS Address Range. The exceptions listed above for internal graphics and the PCI Express ports **MUST NOT** overlap with these ranges.

Figure 2-4. PCI Memory Address Range

FFFF_FFFFh	High BIOS	4 GB
FFE0_0000h	DMI Interface (subtractive decode)	4 GB – 2 MB
FEF0_0000h	MSI Interrupts	4 GB – 17 MB
FEE0_0000h	DMI Interface (subtractive decode)	4 GB – 18 MB
FED0_0000h	Local (CPU) APIC	4 GB – 19 MB
FEC8_0000h	I/O APIC	4 GB – 20 MB
FEC0_0000h	DMI Interface (subtractive decode)	4 GB – 20 MB
F000_0000h	PCI Express Configuration Space	4 GB – 256 MB <i>Possible address range/size (not ensured)</i>
E000_0000h	DMI Interface (subtractive decode)	4 GB – 512 MB <i>BARs, Internal Graphics ranges, PCI Express Port, CHAPADR could be here.</i>
		TOLUD



2.3.3.1 APIC Configuration Space (FEC0_0000h–FECF_FFFFh)

This range is reserved for APIC configuration space. The I/O APIC(s) usually reside in the PCH portion of the chip-set, but may also exist as stand-alone components like PXH.

The IOAPIC spaces are used to communicate with IOAPIC interrupt controllers that may be populated in the system. Since it is difficult to relocate an interrupt controller using plug-and-play software, fixed address decode regions have been allocated for them. Processor accesses to the default IOAPIC region (FEC0_0000h to FEC7_FFFFh) are always forwarded to DMI.

The processor optionally supports additional I/O APICs behind the PCI Express “Graphics” port. When enabled using the APIC_BASE and APIC_LIMIT registers (mapped PCI Express Configuration space offset 240h and 244h), the PCI Express port(s) will positively decode a subset of the APIC configuration space.

Memory requests to this range would then be forwarded to the PCI Express port. This mode is intended for the entry Workstation/Server SKUs of the processor, and would be disabled in typical Desktop systems. When disabled, any access within entire APIC Configuration space (FEC0_0000h to FECF_FFFFh) is forwarded to DMI.

2.3.3.2 HSEG (FEDA_0000h–FEDB_FFFFh)

This decode range is not supported on the 2nd Generation Intel® Core™ processor family mobile platform.

2.3.3.3 MSI Interrupt Memory Space (FEE0_0000h–FEEF_FFFFh)

Any PCI Express or DMI device may issue a Memory Write to 0FEE_xxxxxh. This Memory Write cycle does not go to DRAM. The system agent will forward this Memory Write along with the data to the processor as an Interrupt Message Transaction.

2.3.3.4 High BIOS Area

For security reasons, the processor will positively decode this range to DMI. This positive decode will ensure any overlapping ranges will be ignored.

The top 2 MB (FEE0_0000h–FFFF_FFFFh) of the PCI Memory Address Range is reserved for System BIOS (High BIOS), extended BIOS for PCI devices, and the A20 alias of the system BIOS. The processor begins execution from the High BIOS after reset. This region is positively decoded to DMI. The actual address space required for the BIOS is less than 2 MB but the minimum processor MTRR range for this region is 2 MB so that full 2 MB must be considered.



2.3.4 Main Memory Address Space (4 GB to TOUUD)

The processor supports 39-bit addressing.

The maximum main memory size supported is 32 GB total DRAM memory. A hole between TOLUD and 4 GB occurs when main memory size approaches 4 GB or larger. As a result, TOM, and TOUUD registers and REMAPBASE/REMAPLIMIT registers become relevant.

The remap configuration registers exist to remap lost main memory space. The greater than 32-bit remap handling will be handled similar to other MCHs.

Upstream read and write accesses above 39-bit addressing are treated as invalid cycles by PEG and DMI.

Top of Memory (TOM)

The “Top of Memory” (TOM) register reflects the total amount of populated physical memory. This is NOT necessarily the highest main memory address (holes may exist in main memory address map due to addresses allocated for memory mapped IO above TOM).

On FSB chipsets, the TOM was used to allocate the Manageability Engine’s stolen memory. The Manageability Engine’s (ME) stolen size register reflects the total amount of physical memory stolen by the Manageability Engine. The ME stolen memory is located at the top of physical memory. The ME stolen memory base is calculated by subtracting the amount of memory stolen by the Manageability Engine from TOM.

Top of Upper Usable DRAM (TOUUD)

The Top of Upper Usable Dram (TOUUD) register reflects the total amount of addressable DRAM. If remap is disabled, TOUUD will reflect TOM minus Manageability Engine’s stolen size. If remap is enabled, then it will reflect the remap limit. Note, when there is more than 4 GB of DRAM and reclaim is enabled, the reclaim base will be the same as TOM minus ME stolen memory size to the nearest 1 MB alignment (shown in case 2 below).

Top of Low Usable DRAM (TOLUD)

TOLUD register is restricted to 4 GB memory (A[31:20]), but the processor can support up to 32 GB, limited by DRAM pins. For physical memory greater than 4 GB, the TOUUD register helps identify the address range between the 4 GB boundary and the top of physical memory. This identifies memory that can be directly accessed (including remap address calculation), which is useful for memory access indication and early path indication. TOLUD can be 1 MB aligned.

TSEG_BASE

The “TSEG_BASE” register reflects the total amount of low addressable DRAM, below TOLUD. BIOS will calculate and program this register, so the system agent has knowledge of where (TOLUD)–(Gfx stolen)–(Gfx GTT stolen)–(TSEG) is located. I/O blocks use this minus DPR for upstream DRAM decode.

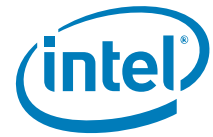

2.3.4.1 Memory Re-claim Background

The following are examples of Memory Mapped IO devices that are typically located below 4 GB:

- High BIOS
- TSEG
- GFX stolen
- GTT stolen
- XAPIC
- Local APIC
- MSI Interrupts
- Mbase/Mlimit
- Pmbase/Pmlimit
- Memory Mapped IO space that supports only 32B addressing

The processor provides the capability to re-claim the physical memory overlapped by the Memory Mapped IO logical address space. The processor re-maps physical memory from the Top of Low Memory (TOLUD) boundary up to the 4 GB boundary to an equivalent sized logical address range located just below the Manageability Engine's stolen memory.

2.3.4.2 Indirect Accesses to MCHBAR Registers

This access is similar to prior chipsets, MCHBAR registers can be indirectly accessed using:

- Direct MCHBAR access decode
 1. Cycle to memory from processor
 2. Hits MCHBAR base, AND
 3. MCHBAR is enabled, AND
 4. Within MMIO space (above and below 4 GB)
- GTTMMADR (10000h–13FFFh) range -> MCHBAR decode
 1. Cycle to memory from processor, AND
 2. Device 2 (IGD) is enabled, AND
 3. Memory accesses for device 2 is enabled, AND
 4. Targets GFX MMIO Function 0, AND
 5. MCHBAR is enabled or cycle is a read. If MCHBAR is disabled, only read access is allowed.
- MCHTMBAR -> MCHBAR (Thermal Monitor)
 1. Cycle to memory from processor, AND
 2. AND Targets MCHTMBAR base
- IOBAR -> GTTMMADR -> MCHBAR.
Follows IOBAR rules. See GTTMMADR information above as well.

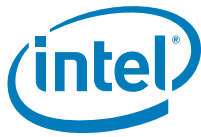

2.3.4.3 Memory Remapping

An incoming address (referred to as a logical address) is checked to see if it falls in the memory re-map window. The bottom of the re-map window is defined by the value in the REMAPBASE register. The top of the re-map window is defined by the value in the REMAPLIMIT register. An address that falls within this window is remapped to the physical memory starting at the address defined by the TOLUD register. The TOLUD register must be 1 MB aligned.

2.3.4.4 Hardware Remap Algorithm

The following pseudo-code defines the algorithm used to calculate the DRAM address to be used for a logical address above the top of physical memory made available using re-claiming.

```
IF (ADDRESS_IN[38:20] ≥ REMAP_BASE[35:20]) AND
(ADDRESS_IN[38:20] ≤ REMAP_LIMIT[35:20]) THEN
ADDRESS_OUT[38:20] = (ADDRESS_IN[38:20] – REMAP_BASE[35:20]) +
0000000b and TOLUD[31:20]
ADDRESS_OUT[19:0] = ADDRESS_IN[19:0]
```

2.3.4.5 Programming Model

The memory boundaries of interest are:

- Bottom of Logical Address Remap Window defined by the REMAPBASE register, which is calculated and loaded by BIOS.
- Top of Logical Address Remap Window defined by the REMAPLIMIT register, which is calculated and loaded by BIOS.
- Bottom of Physical Remap Memory defined by the existing TOLUD register.
- Top of Physical Remap Memory, which is implicitly defined by either 4 GB or TOM minus Manageability Engine stolen size.

Mapping steps:

1. Determine TOM
2. Determine TOM minus ME stolen size
3. Determine MMIO allocation
4. Determine TOLUD
5. Determine GFX stolen base
6. Determine GFX GTT stolen base
7. Determine TSEG base
8. Determine remap base/limit
9. Determine TOUUD

Figure 2-5 and Figure 2-6 show the two possible general cases of remapping.

- Case 1: Less than 4 GB of Physical Memory, no remap
- Case 2: Greater than 4 GB of Physical Memory



Case 1: Less than 4 GB of Physical Memory (no remap)

Figure 2-5. Case 1: Less than 4 GB of Physical Memory (no remap)

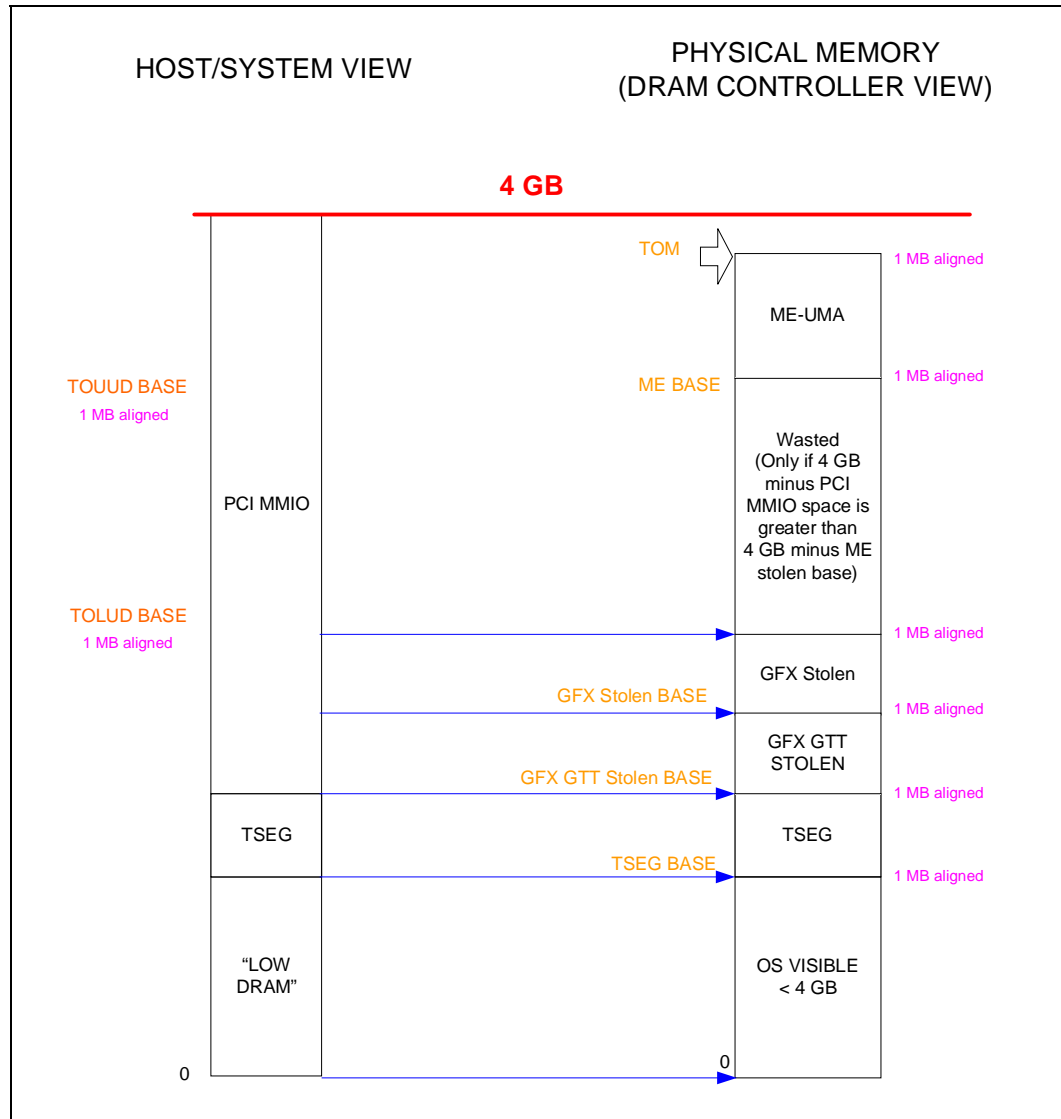

- Populated Physical Memory = 2 GB
- Address Space allocated to memory mapped IO = 1 GB
- Remapped Physical Memory = 0 GB
- TOM – 00_7FF0_0000h (2 GB)
- ME base – 00_7FF0_0000h (1 MB)
- ME Mask – 00_7FF0_0000h
- TOUUD – 00_0000_0000h (Disable - Avoid access above 4 GB)
- TOLUD – 00_7FE0_0000h (2 GB minus 1 MB)
- REMAPBASE – 7F_FFFF_0000h (default)
- REMAPLIMIT – 00_0000_0000h (0 GB boundary, default)

Case 2: Greater than 4 GB of Physical Memory

Figure 2-6. Case 2: Greater than 4 GB of Physical Memory

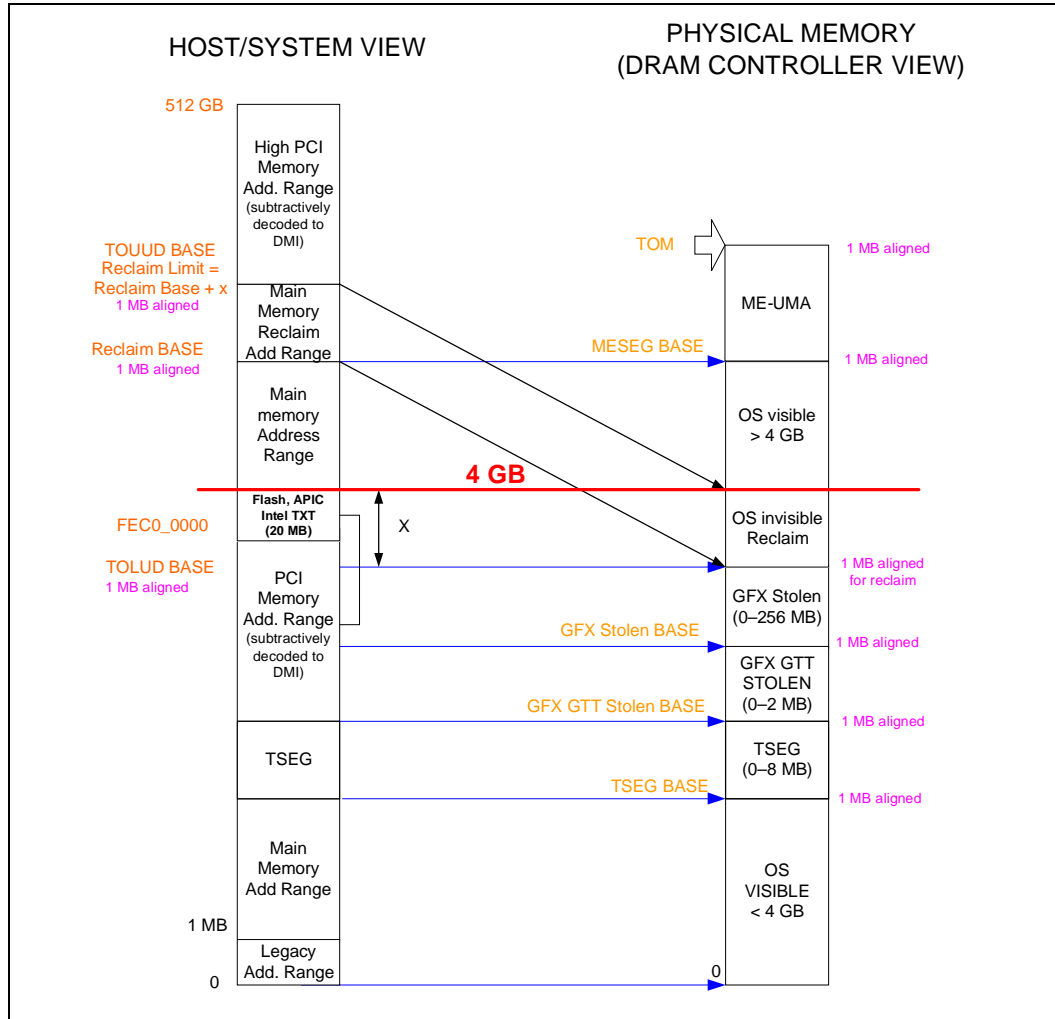

In this case the amount of memory remapped is the range between TOLUD and 4 GB. This physical memory will be mapped to the logical address range defined between the REMAPBASE and the REMAPLIMIT registers.

Example: 5 GB of Physical Memory, with 1 GB allocated to Memory Mapped IO:

- Populated Physical Memory = 5 GB
- Address Space allocated to memory mapped IO (including Flash, APIC, and Intel TXT) = 1 GB
- Remapped Physical Memory = 1 GB
- TOM – 01_4000_0000h (5 GB)
- ME stolen size – 00000b (0 MB)
- TOUUD – 01_8000_0000h (6 GB) (1 MB aligned)
- TOLUD – 00_C000_000h (3 GB)
- REMAPBASE – 01_4000_0000h (5 GB)
- REMAPLIMIT – 01_7FF0_0000h (6 GB-1)



The Remap window is inclusive of the Base and Limit addresses. In the decoder A[19:0] of the Remap Base Address are assumed to be 0s. Similarly, A[19:0] of the Remap Limit Address are assumed to be Fhs. Thus, the bottom of the defined memory range will be aligned to a megabyte boundary and the top of the defined range will be one less than a MB boundary.

Setting the Remap Base register to a value greater than that programmed into the Remap Limit register disables the remap function.

Software Responsibility and Restrictions

- BIOS is responsible for programming the REMAPBASE and REMAPLIMIT registers based on the values in the TOLUD, TOM, and ME stolen size registers.
- The amount of remapped memory defined by the REMAPBASE and REMAPLIMIT registers **must** be equal to the amount of physical memory between the TOLUD and the lower of either 4 GB or TOM minus the ME stolen size.
- Addresses of MMIO region must not overlap with any part of the Logical Address Memory Remap range.
- When TOM is equal to TOLUD, remap is not needed and must be disabled by programming REMAPBASE to a value greater than the value in the REMAPLIMIT register.

Interaction with other Overlapping Address Space

The following Memory Mapped IO address spaces are all logically addressed below 4 GB where they do not overlap the logical address of the re-mapped memory region:

GFXGTTstolen	At (TOLUD – GFXstolensize) to TOLUD
GFXstolen	At ((TOLUD – GFXstolensize) – GFXGTTstolensize) to (TOLUD – GFXstolensize)
TSEG	At ((TOLUD – GFXstolensize – GFXGTTstolensize) – TSEGSIZE) to (TOLUD – GFXGTTstolensize – GFXstolensize)
High BIOS	Reset vector just under 4GB boundary (Positive decode to DMI occurs)
XAPIC	At fixed address below 4 GB
Local APIC	At fixed address below 4 GB
MSI Interrupts	At fixed address below 4 GB
GMADR	64 bit BARs
GTTMMADR	64 bit BARs MBASE/MLIMIT
PXPEPBAR	39 bit BAR
DMIBAR	39 bit BAR
MCHBAR	39 bit BAR
TMBAR	64 bit BAR
PMBASE/PMLIMIT	64 bit BAR (using Upper PMBASE/PMLIMIT)
CHAPADR	64 bit BAR
GFXVTBAR	39 bit BARs
VTDPVCBAR	39 bit BARs

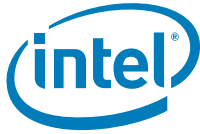

Implementation Notes

- Remap applies to transactions from all interfaces. All upstream PEG/DMI transactions that are snooped get remapped.
- Upstream PEG/DMI transactions that are not snooped ("Snoop not required" attribute set) get remapped.
- Upstream reads and writes above TOUUD are treated as invalid cycles.
- Remapped addresses remap starting at TOLUD. They do not remap starting at TSEG_BASE. DMI and PEG need to be careful with this for both snoop and non-snoop accesses. In other words, for upstream accesses, the range between (TOLUD – GFXStolensize-GFXGTTstolensize – TSEGSIZE-DPR) to TOLUD) will never map directly to memory.

Note: Accesses from PEG/DMI should be decoded as to the type of access before they are remapped. For instance a DMI write to FEEx_xxxx is an interrupt transaction, but there is a DMI address that will be re-mapped to the DRAM address of FEEx_xxxx. In all cases, the remapping of the address is done only after all other decodes have taken place.

Unmapped addresses between TOLUD and 4 GB

Accesses that do not hit DRAM or PCI space are subtractive decoded to DMI. Because the TOLUD register is used to mark the upper limit of DRAM space below the 4 GB boundary, no address between TOLUD and 4 GB ever decodes directly to main memory. Thus, even if remap is disabled, any address in this range has a non-memory destination.

The top of DRAM address space is either:

- TOLUD if there is less than 4 GB of DRAM or 32-bit addressing or
- TOUUD if there is more than 4 GB of DRAM and 36-bit addressing.

Note: The system address space includes the remapped range. For instance, if there is 8 GB of DRAM and 1 GB of PCI space, the system has a 9 GB address space, where DRAM lies from 0-3 GB and 4-9 GB. BIOS will report an address space of 9 GB to the OS.

2.3.5 PCI Express* Configuration Address Space

Unlike previous platforms, PCIEXBAR is located in device 0 configuration space as in FSB platforms. The processor detects memory accesses targeting PCIEXBAR. BIOS must assign this address range such that it will not conflict with any other address ranges.

See the configuration portion of this document for more details.



2.3.6 PCI Express* Graphics Attach (PEG)

The processor can be programmed to direct memory accesses to a PCI Express interface. When addresses are within either of two ranges specified using registers in each PEG(s) configuration space.

- The first range is controlled using the Memory Base Register (MBASE) and Memory Limit Register (MLIMIT) registers.
- The second range is controlled using the Pre-fetchable Memory Base (PMBASE) and Pre-fetchable Memory Limit (PMLIMIT) registers.

Conceptually, address decoding for each range follows the same basic concept. The top 12 bits of the respective Memory Base and Memory Limit registers correspond to address bits A[31:20] of a memory address. For the purpose of address decoding, the processor assumes that address bits A[19:0] of the memory base are zero and that address bits A[19:0] of the memory limit address are F_FFFFh. This forces each memory address range to be aligned to 1 MB boundary and to have a size granularity of 1 MB.

The processor positively decodes memory accesses to PCI Express memory address space as defined by the following equations:

$$\text{Memory_Base_Address} \leq \text{Address} \leq \text{Memory_Limit_Address}$$

$$\text{Prefetchable_Memory_Base_Address} \leq \text{Address} \leq \text{Prefetchable_Memory_Limit_Address}$$

The window size is programmed by the plug-and-play configuration software. The window size depends on the size of memory claimed by the PCI Express device. Normally these ranges will reside above the Top-of-Low Usable-DRAM and below High BIOS and APIC address ranges. They MUST reside above the top of low memory (TOLUD) if they reside below 4 GB and MUST reside above top of upper memory (TOUUD) if they reside above 4 GB or they will steal physical DRAM memory space.

It is essential to support a separate Pre-fetchable range in order to apply USWC attribute (from the processor point of view) to that range. The USWC attribute is used by the processor for write combining.

Note that the processor memory range registers described above are used to allocate memory address space for any PCI Express devices sitting on PCI Express that require such a window.

The PCICMD register can override the routing of memory accesses to PCI Express. In other words, the memory access enable bit must be set to enable the memory base/limit and pre-fetchable base/limit windows.

The upper PMUBASE/PMULIMIT registers are implemented for PCI Express Specification compliance. The processor locates MMIO space above 4 GB using these registers.

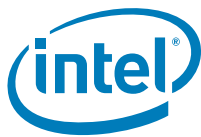

2.3.7 Graphics Memory Address Ranges

The MCH can be programmed to direct memory accesses to IGD when addresses are within any of five ranges specified using registers in the processor Device 2 configuration space.

1. The Graphics Memory Aperture Base Register (GMADR) is used to access graphics memory allocated using the graphics translation table.
2. The Graphics Translation Table Base Register (GTTADR) is used to access the translation table and graphics control registers. This is part of GTTMMADR register.

These ranges can reside above the Top-of-Low-DRAM and below High BIOS and APIC address ranges. They MUST reside above the top of memory (TOLUD) and below 4 GB so they do not steal any physical DRAM memory space.

Alternatively, these ranges can reside above 4 GB, similar to other BARs which are larger than 32 bits in size.

GMADR is a Prefetchable range in order to apply USWC attribute (from the processor point of view) to that range. The USWC attribute is used by the processor for write combining.

2.3.7.1 IOBAR Mapped Access to Device 2 MMIO Space

Device 2, integrated graphics device, contains an IOBAR register. If Device 2 is enabled, then IGD registers or the GTT table can be accessed using this IOBAR. The IOBAR is composed of an index register and a data register.

MMIO_Index – MMIO_INDEX is a 32-bit register. A 32-bit (all bytes enabled) I/O write to this port loads the offset of the MMIO register or offset into the GTT that needs to be accessed. An I/O Read returns the current value of this register. An I/O read/write accesses less than 32 bits in size (all bytes enabled) will not target this register.

MMIO_Data – MMIO_DATA is a 32-bit register. A 32-bit (all bytes enabled) I/O write to this port is re-directed to the MMIO register pointed to by the MMIO-index register. An I/O read to this port is re-directed to the MMIO register pointed to by the MMIO-index register. An I/O read/write accesses less than 32 bits in size (all bytes enabled) will not target this register.

The result of accesses through IOBAR can be:

- Accesses directed to the GTT table. (that is, route to DRAM)
- Accesses to internal graphics registers with the device.
- Accesses to internal graphics display registers now located within the PCH. (that is, route to DMI).

Note that GTT table space writes (GTTADR) are supported through this mapping mechanism.

This mechanism to access internal graphics MMIO registers must not be used to access VGA IO registers which are mapped through the MMIO space. VGA registers must be accessed directly through the dedicated VGA I/O ports.

2.3.7.2 Trusted Graphics Ranges

No trusted graphics ranges are supported.



2.3.8 System Management Mode (SMM)

Unlike FSB platforms, the Core handles all SMM mode transaction routing. Also, the platform no longer supports HSEG. The processor will never allow I/O devices access to CSEG/TSEG/HSEG ranges.

DMI Interface and PCI Express masters are not allowed to access the SMM space.

Table 2-3. SMM regions

SMM Space Enabled	Transaction Address Space	DRAM Space (DRAM)
Compatible (C)	000A_0000h to 000B_FFFFh	000A_0000h to 000B_FFFFh
TSEG (T)	(TOLUD-STOLEN-TSEG) to TOLUD-STOLEN	(TOLUD-STOLEN-TSEG) to TOLUD-STOLEN

2.3.9 SMM and VGA Access through GTT TLB

Accesses through GTT TLB address translation SMM DRAM space are not allowed. Writes will be routed to Memory address 000C_0000h with byte enables de-asserted and reads will be routed to Memory address 000C_0000h. If a GTT TLB translated address hits SMM DRAM space, an error is recorded in the PGTBL_ER register.

PCI Express and DMI Interface originated accesses are **never** allowed to access SMM space directly or through the GTT TLB address translation. If a GTT TLB translated address hits enabled SMM DRAM space, an error is recorded in the PGTBL_ER register.

PCI Express* and DMI Interface write accesses through GMADR range will not be snooped. Only PCI Express* and DMI accesses to GMADR linear range (defined using fence registers) are supported. PCI Express and DMI Interface tileY and tileX writes to GMADR are not supported. If, when translated, the resulting physical address is to enable SMM DRAM space, the request will be remapped to address 000C_0000h with de-asserted byte enables.

PCI Express and DMI Interface read accesses to the GMADR range are not supported, therefore will have no address translation concerns. PCI Express and DMI Interface reads to GMADR will be remapped to address 000C_0000h. The read will complete with UR (unsupported request) completion status.

GTT fetches are always decoded (at fetch time) to ensure not in SMM (actually, anything above base of TSEG or 640K-1M). Thus, they will be invalid and go to address 000C_0000h, but that is not specific to PCI Express or DMI; it applies to processor or internal graphics engines.

2.3.10 ME Stolen Memory Accesses

There are only 2 ways to legally access ME stolen memory.

- PCH accesses mapped to VCm will be decoded to ensure only ME stolen memory is targeted. These VCm accesses will route non-snooped directly to DRAM. This is the means by which the ME engine (located within the PCH) is able to access the ME stolen range.
- The Display engine is allowed to access MEstolen memory as part of KVM flows. Specifically, Display initiated HHP reads (for displaying a KVM frame) and display initiated LP non-snoop writes (for display writing a KVM captured frame) to ME stolen memory are allowed.



2.3.11 I/O Address Space

The system agent generates either DMI Interface or PCI Express* bus cycles for all processor I/O accesses that it does not claim. Configuration Address Register (CONFIG_ADDRESS) and the Configuration Data Register (CONFIG_DATA) are used to generate PCI configuration space access.

The processor allows 64 KB+3 bytes to be addressed within the I/O space. Note that the upper 3 locations can be accessed only during I/O address wrap-around when address bit 16 is asserted. Address bit 16 is asserted on the processor bus whenever an I/O access is made to 4 bytes from address 0FFFDh, 0FFFEh, or 0FFFFh. Address bit 16 is also asserted when an I/O access is made to 2 bytes from address 0FFFFh.

A set of I/O accesses are consumed by the internal graphics device if it is enabled. The mechanisms for internal graphics I/O decode and the associated control is explained later.

The I/O accesses are forwarded normally to the DMI Interface bus unless they fall within the PCI Express I/O address range as defined by the mechanisms explained below. I/O writes are NOT posted. Memory writes to PCH or PCI Express are posted. The PCI Express devices have a register that can disable the routing of I/O cycles to the PCI Express device.

The processor responds to I/O cycles initiated on PCI Express or DMI with an UR status. Upstream I/O cycles and configuration cycles should never occur. If one does occur, the transaction will complete with an UR completion status.

Similar to FSB processors, I/O reads that lie within 8-byte boundaries but cross 4-byte boundaries are issued from the processor as 1 transaction. It will be broke into 2 separate transactions. I/O writes that lie within 8-byte boundaries but cross 4-byte boundaries will be split into 2 transactions by the processor.

2.3.11.1 PCI Express* I/O Address Mapping

The processor can be programmed to direct non-memory (I/O) accesses to the PCI Express bus interface when processor initiated I/O cycle addresses are within the PCI Express I/O address range. This range is controlled using the I/O Base Address (IOBASE) and I/O Limit Address (IOLIMIT) registers in Device 1 functions 0, 1, 2 or Device 6 configuration space.

Address decoding for this range is based on the following concept. The top 4 bits of the respective I/O Base and I/O Limit registers correspond to address bits A[15:12] of an I/O address. For the purpose of address decoding, the device assumes that lower 12 address bits A[11:0] of the I/O base are zero and that address bits A[11:0] of the I/O limit address are FFFh. This forces the I/O address range alignment to 4 KB boundary and produces a size granularity of 4 KB.

The processor positively decodes I/O accesses to PCI Express I/O address space as defined by the following equation:

$$\text{I/O_Base_Address} \leq \text{processor I/O Cycle Address} \leq \text{I/O_Limit_Address}$$

The effective size of the range is programmed by the plug-and-play configuration software and it depends on the size of I/O space claimed by the PCI Express device.

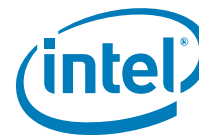

The processor also forwards accesses to the Legacy VGA I/O ranges according to the settings in the PEG configuration registers BCTRL (VGA Enable) and PCICMD (IOAE), unless a second adapter (monochrome) is present on the DMI Interface/PCI (or ISA). The presence of a second graphics adapter is determined by the MDAP configuration bit. When MDAP is set, the processor will decode legacy monochrome I/O ranges and forward them to the DMI Interface. The I/O ranges decoded for the monochrome adapter are 3B4h, 3B5h, 3B8h, 3B9h, 3BAh, and 3BFh.

Note that the PEG I/O address range registers defined above are used for all I/O space allocation for any devices requiring such a window on PCI-Express.

The PCICMD register can disable the routing of I/O cycles to PCI-Express.

2.3.12 MCTP and KVM Flows

Refer to the DMI2 specification for details.

MCTP cycles are not processed within the processor. MCTP cycles are merely passed from input port to destination port based on routing ID.

2.3.13 Decode Rules and Cross-Bridge Address Mapping

2.3.13.1 DMI Interface Decode Rules

All “SNOOP semantic” PCI Express* transactions are kept coherent with processor caches.

All “Snoop not required semantic” cycles must reference the main DRAM address range. PCI Express non-snoop initiated cycles are not snooped.

The processor accepts accesses from DMI Interface to the following address ranges:

- All snoop memory read and write accesses to Main DRAM including PAM region (except stolen memory ranges, TSEG, A0000h–BFFFFh space)
- Write accesses to enabled VGA range, MBASE/MLIMIT, and PMBASE/PMLIMIT will be routed as peer cycles to the PCI Express interface.
- Write accesses above the top of usable DRAM and below 4 GB (not decoding to PCI Express or GMADR space) will be treated as master aborts.
- Read accesses above the top of usable DRAM and below 4 GB (not decoding to PCI Express) will be treated as unsupported requests.
- Reads and accesses above the TOUUD will be treated as unsupported requests on VC0/VCp.

DMI Interface memory read accesses that fall between TOLUD and 4 GB are considered invalid and will master abort. These invalid read accesses will be reassigned to address 000C_0000h and dispatch to DRAM. Reads will return unsupported request completion. Writes targeting PCI Express space will be treated as peer-to-peer cycles.

There is a known usage model for peer writes from DMI to PEG. A video capture card can be plugged into the PCH PCI bus. The video capture card can send video capture data (writes) directly into the frame buffer on an external graphics card (writes to the PEG port). As a result, peer writes from DMI to PEG must be supported.

I/O cycles and configuration cycles are not supported in the upstream direction. The result will be an unsupported request completion status.

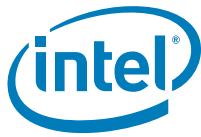

DMI Interface Accesses to the processor that Cross Device Boundaries

The processor does not support transactions that cross device boundaries. This should never occur because PCI Express transactions are not allowed to cross a 4 KB boundary.

For reads, the processor will provide separate completion status for each naturally-aligned 64 byte block or, if chaining is enabled, each 128 byte block. If the starting address of a transaction hits a valid address the portion of a request that hits that target device (PCI Express or DRAM) will complete normally.

If the starting transaction address hits an invalid address, the entire transaction will be remapped to address 000C_0000h and dispatched to DRAM. A single unsupported request completion will result.

2.3.13.1.1 TC/VC Mapping Details

- VCO (enabled by default)
 - Snoop port and Non-snoop Asynchronous transactions are supported.
 - Internal Graphics GMADR writes can occur. Unlike FSB chipsets, these will NOT be snooped regardless of the snoop not required (SNR) bit.
 - Internal Graphics GMADR reads (unsupported).
 - Peer writes can occur. The SNR bit is ignored.
 - MSI can occur. These will route and be sent to the cores as Intlogical/IntPhysical interrupts regardless of the SNR bit.
 - VLW messages can occur. These will route and be sent to the cores as VLW messages regardless of the SNR bit.
 - MCTP messages can occur. These are routed in a peer fashion.
- VCp (Optionally enabled)
 - Supports priority snoop traffic only. This VC is given higher priority at the snoop VC arbiter. Routed as an independent virtual channel and treated independently within the Cache module. VCp snoops are indicated as “high priority” in the snoop priority field. USB classic and USB2 traffic are expected to use this channel. Note, on prior chipsets, this was termed “snoop isochronous” traffic. “Snoop isochronous” is now termed “priority snoop” traffic.
 - SNR bit is ignored.
 - MSI on VCP is supported.
 - Peer read and write requests are not supported. Writes will route to address 000C_0000h with byte enables deasserted, while reads will route to address 000C_0000h and an unsupported request completion.
 - Internal Graphics GMADR writes are NOT supported. These will route to address 000C_0000h with byte enables de-asserted.
 - Internal Graphics GMADR reads are not supported.
 - See DMI2 TC mapping for expected TC to VCp mapping. This has changed from DMI to DMI2.
- VC1 (Optionally enabled)
 - Supports non-snoop transactions only. (Used for isochronous traffic). Note that the PCI Express Egress port (PXPEPBAR) must also be programmed appropriately.
 - The snoop not required (SNR) bit must be set. Any transaction with the SNR bit not set will be treated as an unsupported request.
 - MSI and peer transactions will be treated as unsupported requests.
 - No “pacer” arbitration or TWRR arbitration will occur. Never remaps to different port. (PCH takes care of Egress port remapping). The PCH will meter TCm ME accesses and Azalia TC1 access bandwidth.
 - Internal Graphics GMADR writes and GMADR reads are not supported.

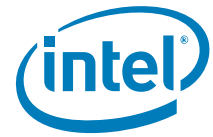

- VCm accesses
 - See the DMI2 specification for TC mapping to VCm. VCm access only map to ME stolen DRAM. These transactions carry the direct physical DRAM address (no redirection or remapping of any kind will occur). This is how the PCH Manageability engine accesses its dedicated DRAM stolen space.
 - DMI block will decode these transactions to ensure only ME stolen memory is targeted, and abort otherwise.
 - VCm transactions will only route non-snoop.
 - VCm transactions will not go through VTd remap tables.
 - The remapbase/remaplimit registers to not apply to VCm transactions.

Figure 2-7. Example: DMI Upstream VC0 Memory Map

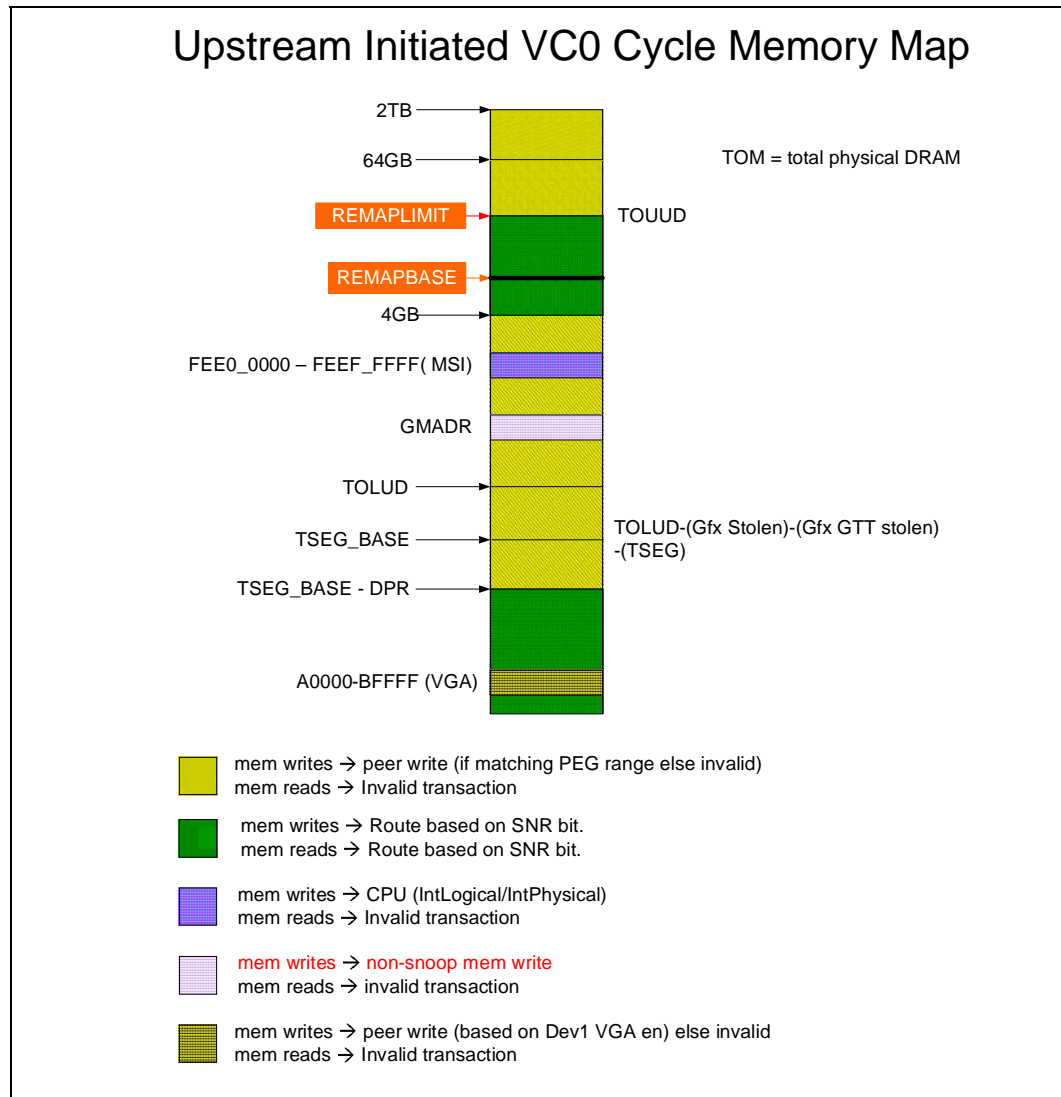



2.3.13.2 PCI Express* Interface Decode Rules

All "SNOOP semantic" PCI Express transactions are kept coherent with processor caches.

All "Snoop not required semantic" cycles must reference the direct DRAM address range. PCI-Express non-snoop initiated cycles are not snooped.

If a "Snoop not required semantic" cycle is outside of the address range mapped to system memory, then it will proceed as follows:

- Reads: Sent to DRAM address 000C_0000h (non-snooped) and will return "unsuccessful completion".
- Writes: Sent to DRAM address 000C_0000h (non-snooped) with byte enables all disabled Peer writes from PEG to DMI are not supported.

If PEG bus master enable is not set, all reads and writes are treated as unsupported requests.

2.3.13.2.1 TC/VC Mapping Details

- VC0 (enabled by default)
 - Snoop port and Non-snoop Asynchronous transactions are supported.
 - Internal Graphics GMADR writes can occur. Unlike FSB chipsets, these will NOT be snooped regardless of the snoop not required (SNR) bit.
 - Internal Graphics GMADR reads (unsupported).
 - Peer writes are only supported between PEG ports. PEG to DMI peer write accesses are NOT supported.
 - MSI can occur. These will route to the cores (IntLogical/IntPhysical) regardless of the SNR bit.
- VC1 is not supported.
- VCm is not supported.



Figure 2-8. PEG Upstream VC0 Memory Map

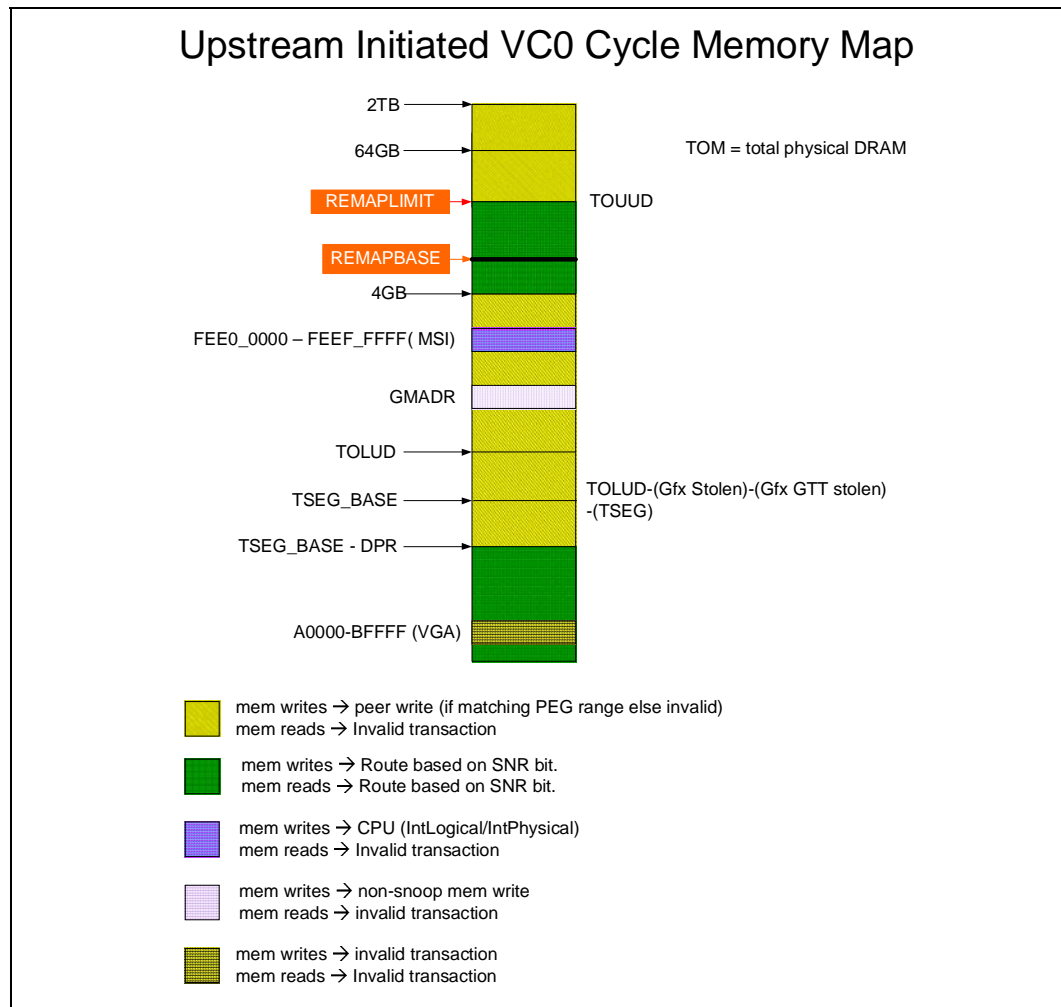

2.3.13.3 Legacy VGA and I/O Range Decode Rules

The legacy 128 KB VGA memory range 000A_0000h-000B_FFFFh can be mapped to IGD (Device 2), PCI Express (Device 1 functions or Device 6), and/or to the DMI Interface depending on the programming of the VGA steering bits. Priority for VGA mapping is constant in that the processor always decodes internally mapped devices first. Internal to the processor, decode precedence is always given to IGD. The processor always positively decodes internally mapped devices, namely the IGD. Subsequent decoding of regions mapped to either PCI Express port or the DMI Interface depends on the Legacy VGA configurations bits (VGA Enable and MDAP).

For the remainder of this section, PCI Express can refer to either the device 1 port functions or the device 6 port.

VGA range accesses will always be mapped as UC type memory.



Accesses to the VGA memory range are directed to IGD depend on the configuration. The configuration is specified by:

- Internal Graphics Controller in Device 2 is enabled (DEVEN.D2EN bit 4)
- Internal Graphics VGA in Device 0, function 0 is enabled through register GGC bit 1.
- IGD memory accesses (PCICMD2 04 – 05h, MAE bit 1) in Device 2 configuration space are enabled.
- VGA Compatibility Memory accesses (VGA Miscellaneous output Register - MSR Register, bit 1) are enabled.
- Software sets the proper value for VGA Memory Map Mode Register (VGA GR06 Register, bits 3-2). See [Table 2-4](#) for translations.

Table 2-4. IGD Frame Buffer Accesses

Mem Access→ GR06(3:2)	A0000h–AFFFFh	B0000h–B7FFFh MDA	B8000h–BFFFFh
00	IGD	IGD	IGD
01	IGD	PCI Express Bridge or DMI Interface	PCI Express Bridge or DMI Interface
10	PCI Express Bridge or DMI Interface	IGD	PCI Express Bridge or DMI Interface
11	PCI Express Bridge or DMI Interface	PCI Express Bridge or DMI Interface	IGD

Note: Additional qualification within IGD comprehends internal MDA support. The VGA and MDA enabling bits detailed below control segments not mapped to IGD.

VGA I/O range is defined as addresses where A[15:0] are in the ranges 03B0h to 03BBh, and 03C0h to 03DFh. VGA I/O accesses are directed to IGD depends on the following configuration.

- Internal Graphics Controller in Device 2 is enabled through register DEVEN.D2EN bit 4.
- Internal Graphics VGA in Device 0 function 0 is enabled through register GGC bit 1.
- IGD I/O accesses (PCICMD2 04 – 05h, IOAE bit 0) in Device 2 are enabled.
- VGA I/O decodes for IGD uses 16 address bits (15:0) there is no aliasing. Note that this is different when compared to a bridge device (Device 1) that used only 10 address bits (A 9:0) for VGA I/O decode.
- VGA I/O input/output address select (VGA Miscellaneous output Register – MSR Register, bit 0) used to select mapping of I/O access as defined in [Table 2-5](#).

Table 2-5. IGD VGA I/O Mapping

I/O Access → MSRb0	3CX	3DX	3B0–3BB	3BC–3BF
0	IGD	PCI Express Bridge or DMI Interface	IGD	PCI Express Bridge or DMI Interface
1	IGD	IGD	PCI Express Bridge or DMI Interface	PCI Express Bridge or DMI Interface

Note: Additional qualification within IGD comprehends internal MDA support. The VGA and MDA enabling bits detailed below control ranges not mapped to IGD.

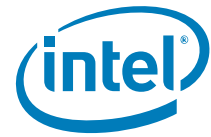

For regions mapped outside of the IGD (or if IGD is disabled), the legacy VGA memory range A0000h–BFFFFh is mapped either to the DMI Interface or PCI Express depending on the programming of the VGA Enable bit in the BCTRL configuration register in the PEG configuration space, and the MDAPxx bits in the Legacy Access Control (LAC) register in Device 0 configuration space. The same register controls mapping VGA I/O address ranges. VGA I/O range is defined as addresses where A[9:0] are in the ranges 3B0h to 3BBh and 3C0h to 3DFh (inclusive of ISA address aliases – A[15:10] are not decoded). The function and interaction of these two bits is described below:

VGA Enable: Controls the routing of processor initiated transactions targeting VGA compatible I/O and memory address ranges. When this bit is set, the following processor accesses will be forwarded to the PCI-Express:

- memory accesses in the range 0A0000h to 0BFFFFh
- I/O addresses where A[9:0] are in the ranges 3B0h to 3BBh and 3C0h to 3DFh (including ISA address aliases – A[15:10] are not decoded)

When this bit is set to a 1:

Forwarding of these accesses issued by the processor is independent of the I/O address and memory address ranges defined by the previously defined base and limit registers.

Forwarding of these accesses is also independent of the settings of the ISA Enable settings if this bit is “1”.

Accesses to I/O address range x3BCh–x3BFh are forwarded to DMI Interface.

When this bit is set to a 0:

Accesses to I/O address range x3BCh–x3BFh are treated just like any other I/O accesses. That is, the cycles are forwarded to PCI Express if the address is within IOBASE and IOLIMIT and ISA enable bit is not set; otherwise, they are forwarded to the DMI Interface.

VGA compatible memory and I/O range accesses are not forwarded to PCI Express but rather they are mapped to DMI Interface unless they are mapped to PCI Express using I/O and memory range registers defined above (IOBASE, IOLIMIT).

Table 2-6 shows the behavior for all combinations of MDA and VGA.

Table 2-6. VGA and MDA I/O Transaction Mapping

VGA_en	MDAP	Range	Destination	Exceptions/Notes
0	0	VGA, MDA	DMI Interface	
0	1	Invalid		Undefined behavior results
1	0	VGA	PCI Express	
1	1	VGA	PCI Express	
1	1	MDA	DMI Interface	Note: x3BCh–x3BEh will also go to DMI Interface

The same registers control mapping of VGA I/O address ranges. VGA I/O range is defined as addresses where A[9:0] are in the ranges 3B0h to 3BBh and 3C0h to 3DFh (inclusive of ISA address aliases – A[15:10] are not decoded). The function and interaction of these two bits is described below:



MDA Present (MDAP): This bit works with the VGA Enable bit in the BCTRL register of device 1 to control the routing of processor initiated transactions targeting MDA compatible I/O and memory address ranges. This bit should not be set when the VGA Enable bit is not set. If the VGA enable bit is set, then accesses to I/O address range x3BCh–x3BFh are forwarded to DMI Interface. If the VGA enable bit is not set, then accesses to I/O address range x3BCh–x3BFh are treated just like any other I/O accesses. That is, the cycles are forwarded to PCI Express if the address is within IOBASE and IOLIMIT and ISA enable bit is not set; otherwise, they are forwarded to DMI Interface. MDA resources are defined as the following:

Memory: 0B0000h–0B7FFFh

I/O: 3B4h, 3B5h, 3B8h, 3B9h, 3BAh, 3BFh,
(Including ISA address aliases, A[15:10] are not used in decode)

Any I/O reference that includes the I/O locations listed above, or their aliases, will be forwarded to the DMI Interface even if the reference includes I/O locations not listed above.

For I/O reads, which are split into multiple DWord accesses, this decode applies to each DWord independently. For example, a read to x3B3 and x3B4 (quadword read to x3B0 with BE#=E7h) will result in a DWord read from PEG at 3B0 (BE#=Eh), and a DWord read from DMI at 3B4 (BE=7h). Since the processor will not issue I/O writes crossing the DWord boundary, this special case does not exist for writes.

Summary of decode priority:

- A) Internal Graphics VGA, if enabled, gets:
 - 03C0h–03CFh: always
 - 03B0h–03BBh: if MSR[0]=0 (MSR is I/O register 03C2h)
 - 03D0h–03DFh: if MSR[0]=1
 - Note: 03BCh–03BFh never decodes to IGD; 3BCh–3BEh are parallel port I/Os, and 3BFh is only used by true MDA devices, apparently.
- B) Else, If MDA Present (if VGA on PEG is enabled), DMI gets:
 - x3B4,5,8,9,A,F (any access with any of these bytes enabled, regardless of the other BEs)
- C) Else, If VGA on PEG is enabled, PEG gets:
 - x3B0h–x3BBh
 - x3C0h–x3CFh
 - x3D0h–x3DFh
- D) Else, if ISA Enable=1, DMI gets:
 - upper 768 bytes of each 1K block
- E) Else, IOBASE/IOLIMIT apply

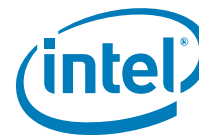

2.4 Processor Register Introduction

The processor contains two sets of software accessible registers, accessed using the Host processor I/O address space — Control registers and internal configuration registers.

- Control registers are I/O mapped into the processor I/O space, which control access to PCI and PCI Express configuration space (see [Section 2.4.1](#)).
- Internal configuration registers residing within the processor are partitioned into three logical device register sets ("logical" since they reside within a single physical device). The first register set is dedicated to Host Bridge functionality (that is, DRAM configuration, other chipset operating parameters and optional features). The second register block is dedicated to Host-PCI Express Bridge functions (controls PCI Express interface configurations and operating parameters). The third register block is for the internal graphics functions.

The processor internal registers (I/O Mapped, Configuration and PCI Express Extended Configuration registers) are accessible by the Host processor. The registers that reside within the lower 256 bytes of each device can be accessed as Byte, Word (16 bit), or DWord (32 bit) quantities, with the exception of CONFIG_ADDRESS, which can only be accessed as a DWord. All multi-byte numeric fields use "little-endian" ordering (that is, lower addresses contain the least significant parts of the field). Registers that reside in bytes 256 through 4095 of each device may only be accessed using memory mapped transactions in DWord (32 bit) quantities.

Some of the processor registers described in this section contain reserved bits. These bits are labeled "Reserved". Software must deal correctly with fields that are reserved. On reads, software must use appropriate masks to extract the defined bits and not rely on reserved bits being any particular value. On writes, software must ensure that the values of reserved bit positions are preserved. That is, the values of reserved bit positions must first be read, merged with the new values for other bit positions and then written back. Note the software does not need to perform read, merge, and write operation for the Configuration Address Register.

In addition to reserved bits within a register, the processor contains address locations in the configuration space of the Host Bridge entity that are marked either "Reserved" or "Intel Reserved". The processor responds to accesses to Reserved address locations by completing the host cycle. When a Reserved register location is read, a zero value is returned. (Reserved registers can be 8-, 16-, or 32 bits in size). Writes to Reserved registers have no effect on the processor. Registers that are marked as Intel Reserved must not be modified by system software. Writes to Intel Reserved registers may cause system failure. Reads from Intel Reserved registers may return a non-zero value.

Upon a Full Reset, the processor sets its entire set of internal configuration registers to predetermined default states. Some register values at reset are determined by external strapping options. The default state represents the minimum functionality feature set required to successfully bringing up the system. Hence, it does not represent the optimal system configuration. It is the responsibility of the system initialization software (usually BIOS) to properly determine the DRAM configurations, operating parameters and optional system features that are applicable, and to program the processor registers accordingly.



2.4.1 I/O Mapped Registers

The processor contains two registers that reside in the processor I/O address space—the Configuration Address (CONFIG_ADDRESS) Register and the Configuration Data (CONFIG_DATA) Register. The Configuration Address Register enables/disables the configuration space and determines what portion of configuration space is visible through the Configuration Data window.

2.5 PCI Device 0 Function 0 Configuration Space

Table 2-7 lists the registers arranged by address offset. Register bit descriptions are in the sections following the table.

Table 2-7. PCI Device 0, Function 0 Register Address Map (Sheet 1 of 2)

Address Offset	Register Symbol	Register Name	Reset Value	Access
0–1h	VID	Vendor Identification	8086h	RO
2–3h	DID	Device Identification	0100h	RO-FW, RO-V
4–5h	PCICMD	PCI Command	0006h	RO, RW
6–7h	PCISTS	PCI Status	0090h	RO, RW1C
8h	RID	Revision Identification	00h	RO-FW
9–Bh	CC	Class Code	060000h	RO
C–Dh	RSVD	Reserved	0h	RO
Eh	HDR	Header Type	00h	RO
F–2Bh	RSVD	Reserved	0h	RO
2C–2Dh	SVID	Subsystem Vendor Identification	0000h	RW-O
2E–2Fh	SID	Subsystem Identification	0000h	RW-O
30–33h	RSVD	Reserved	0h	RO
34h	RSVD	Reserved	E0h	RO
35–3Fh	RSVD	Reserved	0h	RO
40–47h	PXPEPBAR	PCI Express Egress Port Base Address	000000000000 00000h	RW
48–4Fh	MCHBAR	Host Memory Mapped Register Range Base	000000000000 00000h	RW
50–51h	GGC	GMCH Graphics Control Register	0028h	RW-KL, RW-L
52–53h	RSVD	Reserved	0h	RO
54–57h	DEVEN	Device Enable	0000209Fh	RW-L, RO, RW
58–5Bh	PAVPC	Protected Audio Video Path Control	00000000h	RW-L, RW-KL
5C–5Fh	DPR	DMA Protected Range	00000000h	RW-L, RO-V, RW-KL
60–67h	PCIEXBAR	PCI Express Register Range Base Address	000000000000 00000h	RW, RW-V
68–6Fh	DMIBAR	Root Complex Register Range Base Address	000000000000 00000h	RW
70–77h	RSVD	Reserved	0000007FFF 00000h	RW-L
78–7Fh	RSVD	Reserved	000000000000 00000h	RW-L, RW-KL
80h	PAMO	Programmable Attribute Map 0	00h	RW

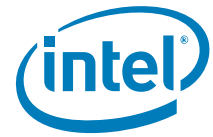

Table 2-7. PCI Device 0, Function 0 Register Address Map (Sheet 2 of 2)

Address Offset	Register Symbol	Register Name	Reset Value	Access
81h	PAM1	Programmable Attribute Map 1	00h	RW
82h	PAM2	Programmable Attribute Map 2	00h	RW
83h	PAM3	Programmable Attribute Map 3	00h	RW
84h	PAM4	Programmable Attribute Map 4	00h	RW
85h	PAM5	Programmable Attribute Map 5	00h	RW
86h	PAM6	Programmable Attribute Map 6	00h	RW
87h	LAC	Legacy Access Control	00h	RW
88h	RSVD	Reserved	02h	RW-L, RW-KL, RW-LV, RO
89–8Fh	RSVD	Reserved	0h	RO
90–97h	REMAPBASE	Remap Base Address Register	0000000FFFF 00000h	RW-KL, RW-L
98–9Fh	REMAPLIMIT	Remap Limit Address Register	00000000000 00000h	RW-KL, RW-L
A0–A7h	TOM	Top of Memory	0000007FFFF 00000h	RW-KL, RW-L
A8–AFh	TOUUD	Top of Upper Usable DRAM	00000000000 00000h	RW-KL, RW-L
B0–B3h	BDSM	Base Data of Stolen Memory	00000000h	RW-KL, RW-L
B4–B7h	BGSM	Base of GTT stolen Memory	00100000h	RW-KL, RW-L
B8–BBh	TSEGMB	TSEG Memory Base	00000000h	RW-KL, RW-L
BC–BFh	TOLUD	Top of Low Usable DRAM	00100000h	RW-KL, RW-L
C0–CFh	RSVD	Reserved	0h	RO
D0–DBh	RSVD	Reserved	0h	RO
DC–DFh	SKPD	Scratchpad Data	00000000h	RW
E0–E3h	RSVD	Reserved	0h	RO
E4–E7h	CAPID0_A	Capabilities A	00000000h	RO-FW, RO-KFW
E8–EBh	RSVD	Reserved	00000000h	RO-FW



2.5.1 VID—Vendor Identification Register

This register, combined with the Device Identification register, uniquely identifies any PCI device.

B/D/F/Type:		0/0/0/PCI		
Address Offset:		0–1h		
Reset Value:		8086h		
Access:		RO		
Size:		16 bits		
Bit	Attr	Reset Value	RST/PWR	Description
15:0	RO	8086h	Uncore	Vendor Identification Number (VID) PCI standard identification for Intel.

2.5.2 DID—Device Identification Register

This register, combined with the Vendor Identification register, uniquely identifies any PCI device.

B/D/F/Type:		0/0/0/PCI		
Address Offset:		2–3h		
Reset Value:		0100h		
Access:		RO-FW, RO-V		
Size:		16 bits		
Bit	Attr	Reset Value	RST/PWR	Description
15:4	RO-FW	010h	Uncore	Device Identification Number MSB (DID_MSB) This is the upper part of device identification assigned to the processor.
3:2	RO-V	00b	Uncore	Device Identification Number SKU (DID_SKU) This is the middle part of device identification assigned to the processor.
1:0	RO-FW	00b	Uncore	Device Identification Number LSB (DID_LSB) This is the lower part of device identification assigned to the processor.

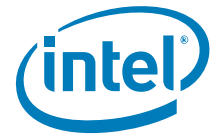

2.5.3 PCICMD—PCI Command Register

Since Device 0 does not physically reside on PCI_A, many of the bits are not implemented.

B/D/F/Type:		0/0/0/PCI		
Address Offset:		4–5h		
Reset Value:		0006h		
Access:		RO, RW		
Size:		16 bits		
BIOS Optimal Default		00h		
Bit	Attr	Reset Value	RST/PWR	Description
15:10	RO	0h		Reserved
9	RO	0b	Uncore	Fast Back-to-Back Enable (FB2B) This bit controls whether or not the master can do fast back-to-back write. Since device 0 is strictly a target this bit is not implemented and is hardwired to 0. Writes to this bit position have no effect.
8	RW	0b	Uncore	SERR Enable (SERRE) This bit is a global enable bit for Device 0 SERR messaging. The processor communicates the SERR condition by sending an SERR message over DMI to the PCH. 1 = The processor is enabled to generate SERR messages over DMI for specific Device 0 error conditions that are individually enabled in the ERRCMD and DMIUEMSK registers. The error status is reported in the ERRSTS, PCISTS, and DMIUEST registers. 0 = The SERR message is not generated by the Host for Device 0. This bit only controls SERR messaging for Device 0. Other integrated devices have their own SERRE bits to control error reporting for error conditions occurring in each device. The control bits are used in a logical OR manner to enable the SERR DMI message mechanism. 0 = Device 0 SERR disabled 1 = Device 0 SERR enabled
7	RO	0b	Uncore	Address/Data Stepping Enable (ADSTEP) Address/data stepping is not implemented in the processor, and this bit is hardwired to 0. Writes to this bit position have no effect.
6	RW	0b	Uncore	Parity Error Enable (PERRE) This bit controls whether or not the Master Data Parity Error bit in the PCI Status register can be set. 0 = Disable. Master Data Parity Error bit in PCI Status register can NOT be set. 1 = Enable. Master Data Parity Error bit in PCI Status register CAN be set.
5	RO	0b	Uncore	VGA Palette Snoop Enable (VGASNOOP) The processor does not implement this bit and it is hardwired to a 0. Writes to this bit position have no effect.
4	RO	0b	Uncore	Memory Write and Invalidate Enable (MWIE) The processor will never issue memory write and invalidate commands. This bit is therefore hardwired to 0. Writes to this bit position will have no effect.
3	RO	0h		Reserved



B/D/F/Type:		0/0/0/PCI		
Address Offset:		4–5h		
Reset Value:		0006h		
Access:		RO, RW		
Size:		16 bits		
BIOS Optimal Default		00h		
Bit	Attr	Reset Value	RST/PWR	Description
2	RO	1b	Uncore	Bus Master Enable (BME) The processor is always enabled as a master on the backbone. This bit is hardwired to a 1. Writes to this bit position have no effect.
1	RO	1b	Uncore	Memory Access Enable (MAE) The processor always allows access to main memory, except when such access would violate security principles. Such exceptions are outside the scope of PCI control. This bit is not implemented and is hardwired to 1. Writes to this bit position have no effect.
0	RO	0b	Uncore	I/O Access Enable (IOAE) This bit is not implemented in the processor and is hardwired to a 0. Writes to this bit position have no effect.

2.5.4 PCISTS—PCI Status Register

This status register reports the occurrence of error events on Device 0's PCI interface. Since Device 0 does not physically reside on PCI_A, many of the bits are not implemented.

B/D/F/Type:		0/0/0/PCI		
Address Offset:		6–7h		
Reset Value:		0090h		
Access:		RO, RW1C		
Size:		16 bits		
BIOS Optimal Default		00h		
Bit	Attr	Reset Value	RST/PWR	Description
15	RW1C	0b	Uncore	Detected Parity Error (DPE) This bit is set when this Device receives a Poisoned TLP.
14	RW1C	0b	Uncore	Signaled System Error (SSE) This bit is set to 1 when Device 0 generates an SERR message over DMI for any enabled Device 0 error condition. Device 0 error conditions are enabled in the PCICMD, ERRCMD, and DMIUEMSK registers. Device 0 error flags are read/reset from the PCISTS, ERRSTS, or DMIUEST registers. Software clears this bit by writing a 1 to it.
13	RW1C	0b	Uncore	Received Master Abort Status (RMAS) This bit is set when the processor generates a DMI request that receives an Unsupported Request completion packet. Software clears this bit by writing a 1 to it.
12	RW1C	0b	Uncore	Received Target Abort Status (RTAS) This bit is set when the processor generates a DMI request that receives a Completer Abort completion packet. Software clears this bit by writing a 1 to it.
11	RO	0b	Uncore	Signaled Target Abort Status (STAS) The processor will not generate a Target Abort DMI completion packet or Special Cycle. This bit is not implemented and is hardwired to a 0. Writes to this bit position have no effect.

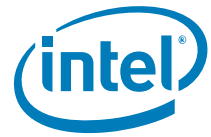

B/D/F/Type: Address Offset: Reset Value: Access: Size: BIOS Optimal Default		0/0/0/PCI 6–7h 0090h RO, RW1C 16 bits 00h		
Bit	Attr	Reset Value	RST/PWR	Description
10:9	RO	00b	Uncore	DEVSEL Timing (DEVT) These bits are hardwired to "00". Writes to these bit positions have no effect. Device 0 does not physically connect to PCI_A. These bits are set to "00" (fast decode) so that optimum DEVSEL timing for PCI_A is not limited by the Host.
8	RW1C	0b	Uncore	Master Data Parity Error Detected (DPD) This bit is set when DMI received a Poisoned completion from PCH. This bit can only be set when the Parity Error Enable bit in the PCI Command register is set.
7	RO	1b	Uncore	Fast Back-to-Back (FB2B) This bit is hardwired to 1. Writes to these bit positions have no effect. Device 0 does not physically connect to PCI_A. This bit is set to 1 (indicating fast back-to-back capability) so that the optimum setting for PCI_A is not limited by the Host.
6:6	RO	0h		Reserved
5	RO	0b	Uncore	66 MHz Capable (MC66) Does not apply to PCI Express. Must be hardwired to 0.
4	RO	1b	Uncore	Capability List (CLIST) This bit is hardwired to 1 to indicate to the configuration software that this device/function implements a list of new capabilities. A list of new capabilities is accessed using register CAPPTR at configuration address offset 34h. Register CAPPTR contains an offset pointing to the start address within configuration space of this device where the Capability Identification register resides.
3:0	RO	0h		Reserved



2.5.5 RID—Revision Identification Register

This register contains the revision number of Device 0. These bits are read only and writes to this register have no effect.

This register contains the revision number of the processor. The Revision ID (RID) is a traditional 8-bit Read Only (RO) register located at offset 08h in the standard PCI header of every PCI/PCI Express compatible device and function. Following reset, the SRID is returned when the RID is read at offset 08h. The SRID value reflects the actual product stepping. To select the CRID value, BIOS/configuration software writes a key value of 69h to Bus 0, Device 0, Function 0 (DMI device) of the processor’s RID register at offset 08h. This causes the CRID to be returned when the RID is read at offset 08h.

Stepping Revision ID (SRID)

This register contains the revision number of the processor. The SRID is a 8-bit hardwired value assigned by Intel, based on product stepping. The SRID is not a directly addressable PCI register. The SRID value is reflected through the RID register when appropriately addressed.

Compatible Revision ID (CRID)

The CRID is an 8-bit hardwired value assigned by Intel during manufacturing process. Normally, the value assigned as the CRID will be identical to the SRID value of a previous stepping of the product with which the new product is deemed “compatible”. The CRID is not a directly addressable PCI register. The CRID value is reflected through the RID register when appropriately addressed.

B/D/F/Type:		0/0/0/PCI		
Address Offset:		8h		
Reset Value:		00h		
Access:		RO-FW		
Size:		8 bits		
Bit	Attr	Reset Value	RST/PWR	Description
7:0	RO-FW	00h	Uncore	Revision Identification Number (RID) This is an 8-bit value that indicates the revision identification number for the Processor Device 0. Refer to the <i>Intel® Core™ Processor Family Mobile Specification update</i> for the value of the RID register.

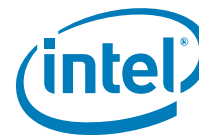

2.5.6 CC—Class Code Register

This register identifies the basic function of the device, a more specific sub-class, and a register-specific programming interface.

B/D/F/Type:		0/0/0/PCI		
Address Offset:		9–Bh		
Reset Value:		06000h		
Access:		RO		
Size:		24 bits		
Bit	Attr	Reset Value	RST/PWR	Description
23:16	RO	06h	Uncore	Base Class Code (BCC) This is an 8-bit value that indicates the base class code for the Host Bridge device. This code has the value 06h, indicating a Bridge device.
15:8	RO	00h	Uncore	Sub-Class Code (SUBCC) This is an 8-bit value that indicates the category of Bridge into which the Host Bridge device falls. The code is 00h indicating a Host Bridge.
7:0	RO	00h	Uncore	Programming Interface (PI) This is an 8-bit value that indicates the programming interface of this device. This value does not specify a particular register set layout and provides no practical use for this device.

2.5.7 HDR—Header Type Register

This register identifies the header layout of the configuration space. No physical register exists at this location.

B/D/F/Type:		0/0/0/PCI		
Address Offset:		Eh		
Reset Value:		00h		
Access:		RO		
Size:		8 bits		
Bit	Attr	Reset Value	RST/PWR	Description
7:0	RO	00h	Uncore	PCI Header (HDR) This field always returns 0 to indicate that the Host Bridge is a single function device with standard header layout. Reads and writes to this location have no effect.



2.5.8 SVID—Subsystem Vendor Identification Register

This value is used to identify the vendor of the subsystem.

B/D/F/Type:		0/0/0/PCI		
Address Offset:		2C–2Dh		
Reset Value:		0000h		
Access:		RW-O		
Size:		16 bits		
Bit	Attr	Reset Value	RST/PWR	Description
15:0	RW-O	0000h	Uncore	Subsystem Vendor ID (SUBVID) This field should be programmed during boot-up to indicate the vendor of the system board. After it has been written once, it becomes read only.

2.5.9 SID—Subsystem Identification Register

This value is used to identify a particular subsystem.

B/D/F/Type:		0/0/0/PCI		
Address Offset:		2E–2Fh		
Reset Value:		0000h		
Access:		RW-O		
Size:		16 bits		
Bit	Attr	Reset Value	RST/PWR	Description
15:0	RW-O	0000h	Uncore	Subsystem ID (SUBID) This field should be programmed during BIOS initialization. After it has been written once, it becomes read only.

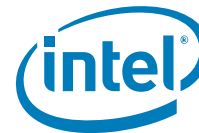

2.5.10 PXPEPBAR—PCI Express Egress Port Base Address Register

This is the base address for the PCI Express Egress Port MMIO Configuration space. There is no physical memory within this 4 KB window that can be addressed. The 4 KB reserved by this register does not alias to any PCI 2.3 compliant memory mapped space. On reset, the EGRESS port MMIO configuration space is disabled and must be enabled by writing a 1 to PXPEPBAREN [Device 0, offset 40h, bit 0].

All the bits in this register are locked in Intel TXT mode.

B/D/F/Type:		0/0/0/PCI		
Address Offset:		40–47h		
Reset Value:		0000000000000000h		
Access:		RW		
Size:		64 bits		
BIOS Optimal Default		00000000h		
Bit	Attr	Reset Value	RST/PWR	Description
63:39	RO	0h		Reserved
38:12	RW	0000000h	Uncore	PCI Express Egress Port MMIO Base Address (PXPEPBAR) This field corresponds to bits 38:12 of the base address PCI Express Egress Port MMIO configuration space. BIOS will program this register resulting in a base address for a 4 KB block of contiguous memory address space. This register ensures that a naturally aligned 4 KB space is allocated within the first 512 GB of addressable memory space. System Software uses this base address to program the PCI Express Egress Port MMIO register set. All the bits in this register are locked in Intel TXT mode.
11:1	RO	0h		Reserved
0	RW	0b	Uncore	PXPEPBAR Enable (PXPEPBAREN) 0 = Disabled. PXPEPBAR is disabled and does not claim any memory 1 = Enabled. PXPEPBAR memory mapped accesses are claimed and decoded appropriately This register is locked by Intel TXT.



2.5.11 MCHBAR—Host Memory Mapped Register Range Base Register

This is the base address for the Host Memory Mapped Configuration space. There is no physical memory within this 32 KB window that can be addressed. The 32 KB reserved by this register does not alias to any PCI 2.3 compliant memory mapped space. On reset, the Host MMIO Memory Mapped Configuration space is disabled and must be enabled by writing a 1 to MCHBAREN [Device 0, offset 48h, bit 0].

All the bits in this register are locked in Intel TXT mode.

The register space contains memory control, initialization, timing, and buffer strength registers; clocking registers; and power and thermal management registers.

B/D/F/Type:		0/0/0/PCI		
Address Offset:		48–4Fh		
Reset Value:		0000000000000000h		
Access:		RW		
Size:		64 bits		
BIOS Optimal Default		0000000000h		
Bit	Attr	Reset Value	RST/PWR	Description
63:39	RO	0h		Reserved
38:15	RW	000000h	Uncore	Host Memory Mapped Base Address (MCHBAR) This field corresponds to bits 38:15 of the base address Host Memory Mapped configuration space. BIOS will program this register resulting in a base address for a 32 KB block of contiguous memory address space. This register ensures that a naturally aligned 32 KB space is allocated within the first 512 GB of addressable memory space. System Software uses this base address to program the Host Memory Mapped register set. All the bits in this register are locked in Intel TXT mode.
14:1	RO	0h		Reserved
0	RW	0b	Uncore	MCHBAR Enable (MCHBAREN) 0 = Disabled. MCHBAR is disabled and does not claim any memory 1 = Enabled. MCHBAR memory mapped accesses are claimed and decoded appropriately This register is locked by Intel TXT.

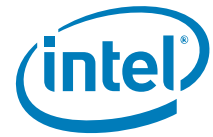

2.5.12 GGC—GMCH Graphics Control Register Register

All the bits in this register are Intel TXT lockable.

B/D/F/Type:		0/0/0/PCI		
Address Offset:		50–51h		
Reset Value:		0028h		
Access:		RW-KL, RW-L		
Size:		16 bits		
BIOS Optimal Default		00h		
Bit	Attr	Reset Value	RST/PWR	Description
15:15	RO	0h		Reserved
14	RW-L	0b	Uncore	Versatile Acceleration Mode Enable (VAMEN) Enables the use of the iGFX enable for Versatile Acceleration. 1 = iGFX engines are in Versatile Acceleration Mode. Device 2 Class Code is 048000h. 0 = iGFX engines are in iGFX Mode. Device 2 Class Code is 030000h.
13:10	RO	0h		Reserved
9:8	RW-L	0h	Uncore	GTT Graphics Memory Size (GGMS) This field is used to select the amount of Main Memory that is pre-allocated to support the Internal Graphics Translation Table. The BIOS ensures that memory is pre-allocated only when Internal graphics is enabled. GSM is assumed to be a contiguous physical DRAM space with DSM, and BIOS needs to allocate a contiguous memory chunk. Hardware will derive the base of GSM from DSM only using the GSM size programmed in the register. Hardware functionality in case of programming this value to Reserved is not ensured. Encoding: 1h = 1 MB of pre-allocated memory 2h = 2 MB of pre-allocated memory 3h = Reserved 0h = No pre-allocated memory

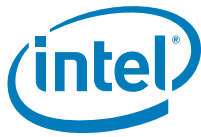

B/D/F/Type:		0/0/0/PCI		
Address Offset:		50–51h		
Reset Value:		0028h		
Access:		RW-KL, RW-L		
Size:		16 bits		
BIOS Optimal Default		00h		
Bit	Attr	Reset Value	RST/PWR	Description
7:3	RW-L	05h	Uncore	<p>Graphics Mode Select (GMS)</p> <p>This field is used to select the amount of main memory that is pre-allocated to support the Internal Graphics device in VGA (non-linear) and Native (linear) modes. BIOS ensures that memory is pre-allocated only when internal graphics is enabled.</p> <p>This register is also Intel TXT lockable.</p> <p>Hardware does not clear or set any of these bits automatically based on IGD being disabled/enabled.</p> <p>BIOS Requirement: BIOS must not set this field to 0h if IVD (bit 1 of this register) is 0.</p> <p>0h = 0 MB 1h = 32 MB 2h = 64 MB 3h = 96 MB 4h = 128 MB 5h = 160 MB 6h = 192 MB 7h = 224 MB 8h = 256 MB 9h = 288 MB Ah = 320 MB Bh = 352 MB Ch = 384 MB Dh = 416 MB Eh = 448MB Fh = 480 MB 10h = 512 MB Other = Reserved</p>
2	RO	0h		Reserved
1	RW-L	0b	Uncore	<p>IGD VGA Disable (IVD)</p> <p>0 = Enable. Device 2 (IGD) claims VGA memory and I/O cycles, the Sub-Class Code within Device 2 Class Code register is 00. 1 = Disable. Device 2 (IGD) does not claim VGA cycles (Memory and I/O), and the Sub- Class Code field within Device 2 function 0 Class Code register is 80h.</p> <p>BIOS Requirement: BIOS must not set this bit to 0 if the GMS field (bits 7:3 of this register) pre-allocates no memory.</p> <p>This bit MUST be set to 1 if Device 2 is disabled using a register (DEVEN[3] = 0).</p> <p>This register is locked by Intel TXT lock.</p>
0	RW-KL	0b	Uncore	<p>GGC Lock (GGCLCK)</p> <p>When set to 1b, this bit will lock all bits in this register.</p>

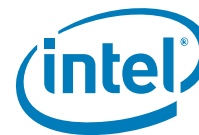

2.5.13 DEVEN—Device Enable Register

This register allows for enabling/disabling of PCI devices and functions that are within the processor package. In the following table the bit definitions describe the behavior of all combinations of transactions to devices controlled by this register.

All the bits in this register are Intel TXT Lockable.

B/D/F/Type:		0/0/0/PCI		
Address Offset:		54–57h		
Reset Value:		0000209Fh		
Access:		RW-L, RO, RW		
Size:		32 bits		
BIOS Optimal Default		000000h		
Bit	Attr	Reset Value	RST/PWR	Description
31:15	RO	0h		Reserved
14	RO	0h		Reserved
13	RW-L	1b	Uncore	PEG60 Enable (D6FOEN) 0 = Disabled. Bus 0 Device 6 Function 0 is disabled and hidden. 1 = Enabled. Bus 0 Device 6 Function 0 is enabled and visible. This bit will be set to 0b and remain 0b if PEG60 capability is disabled.
12:8	RO	0h		Reserved
7	RO	0h		Reserved
6:5	RO	0h		Reserved
4	RW-L	1b	Uncore	Internal Graphics Engine (D2EN) 0 = Disabled. Bus 0 Device 2 is disabled and hidden 1 = Enabled. Bus 0 Device 2 is enabled and visible This bit will be set to 0b and remain 0b if Device 2 capability is disabled.
3	RW-L	1b	Uncore	PEG10 Enable (D1FOEN) 0 = Disabled. Bus 0 Device 1 Function 0 is disabled and hidden. 1 = Enabled. Bus 0 Device 1 Function 0 is enabled and visible. This bit will be set to 0b and remain 0b if PEG10 capability is disabled.
2	RW-L	1b	Uncore	PEG11 Enable (D1F1EN) 0 = Disabled. Bus 0 Device 1 Function 1 is disabled and hidden. 1 = Enabled. Bus 0 Device 1 Function 1 is enabled and visible. This bit will be set to 0b and remain 0b if: • PEG11 is disabled by strap (PEGOCFGSEL)
1	RW-L	1b	Uncore	PEG12 Enable (D1F2EN) 0 = Disabled. Bus 0 Device 1 Function 2 is disabled and hidden. 1 = Enabled. Bus 0 Device 1 Function 2 is enabled and visible. This bit will be set to 0b and remain 0b if: • PEG12 is disabled by strap (PEGOCFGSEL)
0	RO	1b	Uncore	Host Bridge (DOEN) Bus 0 Device 0 Function 0 may not be disabled and is therefore hardwired to 1.

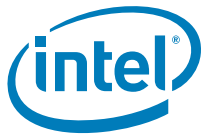

2.5.14 PCIEXBAR—PCI Express Register Range Base Address Register

This is the base address for the PCI Express configuration space. This window of addresses contains the 4 KB of configuration space for each PCI Express device that can potentially be part of the PCI Express Hierarchy associated with the Uncore. There is no actual physical memory within this window of up to 256 MB that can be addressed. The actual size of this range is determined by a field in this register.

Each PCI Express Hierarchy requires a PCI Express Base register. The Uncore supports one PCI Express Hierarchy. The region reserved by this register does not alias to any PCI2.3 compliant memory mapped space. For example, the range reserved for MCHBAR is outside of PCIEXBAR space.

On reset, this register is disabled and must be enabled by writing a 1 to the enable field in this register. This base address shall be assigned on a boundary consistent with the number of buses (defined by the length field in this register), above TOLUD and still within 39-bit addressable memory space.

The PCI Express Base Address cannot be less than the maximum address written to the Top of physical memory register (TOLUD). Software must ensure that these ranges do not overlap with known ranges located above TOLUD.

Software must ensure that the sum of the length of the enhanced configuration region + TOLUD + any other known ranges reserved above TOLUD is not greater than the 39-bit addressable limit of 512 GB. In general, system implementation and the number of PCI/PCI Express/PCI-X buses supported in the hierarchy will dictate the length of the region.

All the bits in this register are locked in Intel TXT mode.

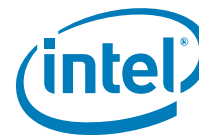

B/D/F/Type: 0/0/0/PCI Address Offset: 60–67h Reset Value: 0000000000000000h Access: RW, RW-V Size: 64 bits BIOS Optimal Default 000000000000h				
Bit	Attr	Reset Value	RST/PWR	Description
63:39	RO	0h		Reserved
38:28	RW	000h	Uncore	<p>PCI Express Base Address (PCIEXBAR)</p> <p>This field corresponds to bits 38:28 of the base address for PCI Express enhanced configuration space. BIOS will program this register resulting in a base address for a contiguous memory address space. The size of the range is defined by bits 2:1 of this register.</p> <p>This base address shall be assigned on a boundary consistent with the number of buses (defined by the Length field in this register) above TOLUD and still within the 39-bit addressable memory space. The address bits decoded depend on the length of the region defined by this register.</p> <p>This register is locked by Intel TXT.</p> <p>The address used to access the PCI Express configuration space for a specific device can be determined as follows: PCI Express Base Address + Bus Number * 1MB + Device Number * 32KB + Function Number * 4KB</p> <p>This address is the beginning of the 4 KB space that contains both the PCI compatible configuration space and the PCI Express extended configuration space.</p>
27	RW-V	0b	Uncore	<p>128MB Base Address Mask (ADMSK128)</p> <p>This bit is either part of the PCI Express Base Address (RW) or part of the Address Mask (RO, read 0b), depending on the value of bits [2:1] in this register.</p>
26	RW-V	0b	Uncore	<p>64MB Base Address Mask (ADMSK64)</p> <p>This bit is either part of the PCI Express Base Address (RW) or part of the Address Mask (RO, read 0b), depending on the value of bits [2:1] in this register.</p>
25:3	RO	0h		Reserved
2:1	RW	00b	Uncore	<p>Length (LENGTH)</p> <p>This field describes the length of this region.</p> <p>00 = 256 MB (buses 0–255). Bits 38:28 are decoded in the PCI Express Base Address field.</p> <p>01 = 128 MB (buses 0–127). Bits 38:27 are decoded in the PCI Express Base Address field.</p> <p>10 = 64 MB (buses 0–63). Bits 38:26 are decoded in the PCI Express Base Address field.</p> <p>11 = Reserved.</p> <p>This register is locked by Intel TXT.</p>
0	RW	0b	Uncore	<p>PCIEXBAR Enable (PCIEXBAREN)</p> <p>0 = The PCIEXBAR register is disabled. Memory read and write transactions proceed as if there were no PCIEXBAR register. PCIEXBAR bits 38:26 are RW with no functionality behind them.</p> <p>1 = The PCIEXBAR register is enabled. Memory read and write transactions whose address bits 38:26 match PCIEXBAR will be translated to configuration reads and writes within the Uncore. These translated cycles are routed as shown in the above table.</p> <p>This register is locked by Intel TXT.</p>



2.5.15 DMIBAR—Root Complex Register Range Base Address Register

This is the base address for the Root Complex configuration space. This window of addresses contains the Root Complex Register set for the PCI Express Hierarchy associated with the Host Bridge. There is no physical memory within this 4 KB window that can be addressed. The 4 KB reserved by this register does not alias to any PCI 2.3 compliant memory mapped space. On reset, the Root Complex configuration space is disabled and must be enabled by writing a 1 to DMIBAREN [Device 0, offset 68h, bit 0].

All the bits in this register are locked in Intel TXT mode.

B/D/F/Type:		0/0/0/PCI		
Address Offset:		68–6Fh		
Reset Value:		0000000000000000h		
Access:		RW		
Size:		64 bits		
BIOS Optimal Default		00000000h		
Bit	Attr	Reset Value	RST/PWR	Description
63:39	RO	0h		Reserved
38:12	RW	0000000h	Uncore	DMI Base Address (DMIBAR) This field corresponds to bits 38:12 of the base address DMI configuration space. BIOS will program this register resulting in a base address for a 4 KB block of contiguous memory address space. This register ensures that a naturally aligned 4 KB space is allocated within the first 512 GB of addressable memory space. System Software uses this base address to program the DMI register set. All the Bits in this register are locked in Intel TXT mode.
11:1	RO	0h		Reserved
0	RW	0b	Uncore	DMIBAR Enable (DMIBAREN) 0 = Disabled. DMIBAR is disabled and does not claim any memory 1 = Enabled. DMIBAR memory mapped accesses are claimed and decoded appropriately This register is locked by Intel TXT.



2.5.16 PAM0—Programmable Attribute Map 0 Register

This register controls the read, write and shadowing attributes of the BIOS range from F_0000h to F_FFFFh. The Uncore allows programmable memory attributes on 13 legacy memory segments of various sizes in the 768 KB to 1 MB address range. Seven Programmable Attribute Map (PAM) registers are used to support these features. Cacheability of these areas is controlled using the MTRR register in the core.

Two bits are used to specify memory attributes for each memory segment. These bits apply to host accesses to the PAM areas. These attributes are:

- **RE – Read Enable.** When RE=1, the host read accesses to the corresponding memory segment are claimed by the Uncore and directed to main memory. Conversely, when RE=0, the host read accesses are directed to DMI.
- **WE – Write Enable.** When WE=1, the host write accesses to the corresponding memory segment are claimed by the Uncore and directed to main memory. Conversely, when WE=0, the host read accesses are directed to DMI.

The RE and WE attributes permit a memory segment to be Read Only, Write Only, Read/Write or Disabled. For example, if a memory segment has RE=1 and WE=0, the segment is Read Only.

B/D/F/Type:		0/0/0/PCI		
Address Offset:		80h		
Reset Value:		00h		
Access:		RW		
Size:		8 bits		
BIOS Optimal Default		00h		
Bit	Attr	Reset Value	RST/PWR	Description
7:6	RO	0h		Reserved
5:4	RW	00b	Uncore	0F0000h–0FFFFFh Attribute (HIENABLE) This field controls the steering of read and write cycles that address the BIOS area from 0F_0000h to 0F_FFFFh. 00 = DRAM Disabled. All accesses are directed to DMI. 01 = Read Only. All reads are sent to DRAM, all writes are forwarded to DMI. 10 = Write Only. All writes are sent to DRAM, all reads are serviced by DMI. 11 = Normal DRAM Operation. All reads and writes are serviced by DRAM. This register is locked by Intel TXT.
3:0	RO	0h		Reserved

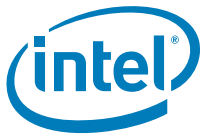

2.5.17 PAM1—Programmable Attribute Map 1 Register

This register controls the read, write and shadowing attributes of the BIOS range from C_0000h to C_7FFFh. The Uncore allows programmable memory attributes on 13 legacy memory segments of various sizes in the 768KB to 1MB address range. Seven Programmable Attribute Map (PAM) registers are used to support these features. Cacheability of these areas is controlled using the MTRR register in the core.

Two bits are used to specify memory attributes for each memory segment. These bits apply to host accesses to the PAM areas. These attributes are:

- **RE – Read Enable.** When RE=1, the host read accesses to the corresponding memory segment are claimed by the Uncore and directed to main memory. Conversely, when RE=0, the host read accesses are directed to DMI.
- **WE – Write Enable.** When WE=1, the host write accesses to the corresponding memory segment are claimed by the Uncore and directed to main memory. Conversely, when WE=0, the host read accesses are directed to DMI.

The RE and WE attributes permit a memory segment to be Read Only, Write Only, Read/Write or Disabled. For example, if a memory segment has RE=1 and WE=0, the segment is Read Only.

B/D/F/Type:		0/0/0/PCI		
Address Offset:		81h		
Reset Value:		00h		
Access:		RW		
Size:		8 bits		
BIOS Optimal Default		0h		
Bit	Attr	Reset Value	RST/PWR	Description
7:6	RO	0h		Reserved
5:4	RW	00b	Uncore	0C4000h–0C7FFFh Attribute (HIENABLE) This field controls the steering of read and write cycles that address the BIOS area from 0C_4000h to 0C_7FFFh. 00 = DRAM Disabled. All accesses are directed to DMI. 01 = Read Only. All reads are sent to DRAM, all writes are forwarded to DMI. 10 = Write Only. All writes are sent to DRAM, all reads are serviced by DMI. 11 = Normal DRAM Operation. All reads and writes are serviced by DRAM. This register is locked by Intel TXT.
3:2	RO	0h		Reserved
1:0	RW	00b	Uncore	0C0000h–0C3FFFh Attribute (LOENABLE) This field controls the steering of read and write cycles that address the BIOS area from 0C0000h to 0C3FFFh. 00 = DRAM Disabled. All accesses are directed to DMI. 01 = Read Only. All reads are sent to DRAM. All writes are forwarded to DMI. 10 = Write Only. All writes are sent to DRAM. All reads are serviced by DMI. 11 = Normal DRAM Operation. All reads and writes are serviced by DRAM. This register is locked by Intel TXT.

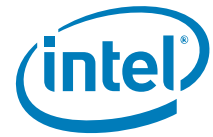

2.5.18 PAM2—Programmable Attribute Map 2 Register

This register controls the read, write and shadowing attributes of the BIOS range from C_8000h to C_FFFFh. The Uncore allows programmable memory attributes on 13 legacy memory segments of various sizes in the 768KB to 1MB address range. Seven Programmable Attribute Map (PAM) registers are used to support these features. Cacheability of these areas is controlled using the MTRR register in the core.

Two bits are used to specify memory attributes for each memory segment. These bits apply to host accesses to the PAM areas. These attributes are:

- RE – Read Enable. When RE=1, the host read accesses to the corresponding memory segment are claimed by the Uncore and directed to main memory. Conversely, when RE=0, the host read accesses are directed to DMI.
- WE – Write Enable. When WE=1, the host write accesses to the corresponding memory segment are claimed by the Uncore and directed to main memory. Conversely, when WE=0, the host read accesses are directed to DMI.

The RE and WE attributes permit a memory segment to be Read Only, Write Only, Read/Write or Disabled. For example, if a memory segment has RE=1 and WE=0, the segment is Read Only.

B/D/F/Type:		0/0/0/PCI		
Address Offset:		82h		
Reset Value:		00h		
Access:		RW		
Size:		8 bits		
BIOS Optimal Default		0h		
Bit	Attr	Reset Value	RST/PWR	Description
7:6	RO	0h		Reserved
5:4	RW	00b	Uncore	0CC000h–0CFFFFh Attribute (HIENABLE) This field controls the steering of read and write cycles that address the BIOS area from 0CC000h to 0CFFFFh. 00 = DRAM Disabled. All accesses are directed to DMI. 01 = Read Only. All reads are sent to DRAM, all writes are forwarded to DMI. 10 = Write Only. All writes are sent to DRAM, all reads are serviced by DMI. 11 = Normal DRAM Operation. All reads and writes are serviced by DRAM. This register is locked by Intel TXT.
3:2	RO	0h		Reserved
1:0	RW	00b	Uncore	0C8000h–0CBFFFh Attribute (LOENABLE) This field controls the steering of read and write cycles that address the BIOS area from 0C8000h to 0CBFFFh. 00 = DRAM Disabled. All accesses are directed to DMI. 01 = Read Only. All reads are sent to DRAM. All writes are forwarded to DMI. 10 = Write Only. All writes are sent to DRAM. All reads are serviced by DMI. 11 = Normal DRAM Operation. All reads and writes are serviced by DRAM. This register is locked by Intel TXT.



2.5.19 PAM3—Programmable Attribute Map 3 Register

This register controls the read, write and shadowing attributes of the BIOS range from D0000h to D7FFFh. The Uncore allows programmable memory attributes on 13 legacy memory segments of various sizes in the 768KB to 1MB address range. Seven Programmable Attribute Map (PAM) registers are used to support these features. Cacheability of these areas is controlled using the MTRR register in the core.

Two bits are used to specify memory attributes for each memory segment. These bits apply to host accesses to the PAM areas. These attributes are:

- **RE – Read Enable.** When RE=1, the host read accesses to the corresponding memory segment are claimed by the Uncore and directed to main memory. Conversely, when RE=0, the host read accesses are directed to DMI.
- **WE – Write Enable.** When WE=1, the host write accesses to the corresponding memory segment are claimed by the Uncore and directed to main memory. Conversely, when WE=0, the host read accesses are directed to DMI.

The RE and WE attributes permit a memory segment to be Read Only, Write Only, Read/Write or Disabled. For example, if a memory segment has RE=1 and WE=0, the segment is Read Only.

B/D/F/Type:		0/0/0/PCI		
Address Offset:		83h		
Reset Value:		00h		
Access:		RW		
Size:		8 bits		
BIOS Optimal Default		0h		
Bit	Attr	Reset Value	RST/PWR	Description
7:6	RO	0h		Reserved
5:4	RW	00b	Uncore	0D4000h–0D7FFFh Attribute (HIENABLE) This field controls the steering of read and write cycles that address the BIOS area from 0D4000h to 0D7FFFh. 00 = DRAM Disabled. All accesses are directed to DMI. 01 = Read Only. All reads are sent to DRAM, all writes are forwarded to DMI. 10 = Write Only. All writes are sent to DRAM, all reads are serviced by DMI. 11 = Normal DRAM Operation. All reads and writes are serviced by DRAM. This register is locked by Intel TXT.
3:2	RO	0h		Reserved
1:0	RW	00b	Uncore	0D0000h–0D3FFFh Attribute (LOENABLE) This field controls the steering of read and write cycles that address the BIOS area from 0D0000h to 0D3FFFh. 00 = DRAM Disabled. All accesses are directed to DMI. 01 = Read Only. All reads are sent to DRAM. All writes are forwarded to DMI. 10 = Write Only. All writes are sent to DRAM. All reads are serviced by DMI. 11 = Normal DRAM Operation. All reads and writes are serviced by DRAM. This register is locked by Intel TXT.

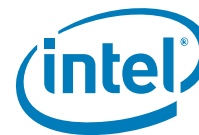

2.5.20 PAM4—Programmable Attribute Map 4 Register

This register controls the read, write and shadowing attributes of the BIOS range from D8000h to DFFFFh. The Uncore allows programmable memory attributes on 13 legacy memory segments of various sizes in the 768KB to 1MB address range. Seven Programmable Attribute Map (PAM) registers are used to support these features. Cacheability of these areas is controlled using the MTRR register in the core.

Two bits are used to specify memory attributes for each memory segment. These bits apply to host accesses to the PAM areas. These attributes are:

- **RE – Read Enable.** When RE=1, the host read accesses to the corresponding memory segment are claimed by the Uncore and directed to main memory. Conversely, when RE=0, the host read accesses are directed to DMI.
- **WE – Write Enable.** When WE=1, the host write accesses to the corresponding memory segment are claimed by the Uncore and directed to main memory. Conversely, when WE=0, the host read accesses are directed to DMI.

The RE and WE attributes permit a memory segment to be Read Only, Write Only, Read/Write or Disabled. For example, if a memory segment has RE=1 and WE=0, the segment is Read Only.

B/D/F/Type:		0/0/0/PCI		
Address Offset:		84h		
Reset Value:		00h		
Access:		RW		
Size:		8 bits		
BIOS Optimal Default		0h		
Bit	Attr	Reset Value	RST/PWR	Description
7:6	RO	0h		Reserved
5:4	RW	00b	Uncore	ODC000h–ODFFFFh Attribute (HIENABLE) This field controls the steering of read and write cycles that address the BIOS area from ODC000h to ODFFFFh. 00 = DRAM Disabled. All accesses are directed to DMI. 01 = Read Only. All reads are sent to DRAM, all writes are forwarded to DMI. 10 = Write Only. All writes are sent to DRAM, all reads are serviced by DMI. 11 = Normal DRAM Operation. All reads and writes are serviced by DRAM. This register is locked by Intel TXT.
3:2	RO	0h		Reserved
1:0	RW	00b	Uncore	OD8000h–ODBFFFh Attribute (LOENABLE) This field controls the steering of read and write cycles that address the BIOS area from OD8000h to ODBFFFh. 00 = DRAM Disabled. All accesses are directed to DMI. 01 = Read Only. All reads are sent to DRAM. All writes are forwarded to DMI. 10 = Write Only. All writes are sent to DRAM. All reads are serviced by DMI. 11 = Normal DRAM Operation. All reads and writes are serviced by DRAM. This register is locked by Intel TXT.

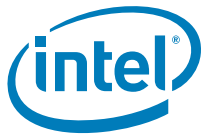

2.5.21 PAM5—Programmable Attribute Map 5 Register

This register controls the read, write and shadowing attributes of the BIOS range from E_0000h to E_7FFFh. The Uncore allows programmable memory attributes on 13 legacy memory segments of various sizes in the 768KB to 1MB address range. Seven Programmable Attribute Map (PAM) registers are used to support these features. Cacheability of these areas is controlled using the MTRR register in the core.

Two bits are used to specify memory attributes for each memory segment. These bits apply to host accesses to the PAM areas. These attributes are:

- **RE – Read Enable.** When RE=1, the host read accesses to the corresponding memory segment are claimed by the Uncore and directed to main memory. Conversely, when RE=0, the host read accesses are directed to DMI.
- **WE – Write Enable.** When WE=1, the host write accesses to the corresponding memory segment are claimed by the Uncore and directed to main memory. Conversely, when WE=0, the host read accesses are directed to DMI.

The RE and WE attributes permit a memory segment to be Read Only, Write Only, Read/Write or Disabled. For example, if a memory segment has RE=1 and WE=0, the segment is Read Only.

B/D/F/Type:		0/0/0/PCI		
Address Offset:		85h		
Reset Value:		00h		
Access:		RW		
Size:		8 bits		
BIOS Optimal Default		0h		
Bit	Attr	Reset Value	RST/PWR	Description
7:6	RO	0h		Reserved
5:4	RW	00b	Uncore	OE4000h–OE7FFFh Attribute (HIENABLE) This field controls the steering of read and write cycles that address the BIOS area from OE4000h to OE7FFFh. 00 = DRAM Disabled. All accesses are directed to DMI. 01 = Read Only. All reads are sent to DRAM, all writes are forwarded to DMI. 10 = Write Only. All writes are sent to DRAM, all reads are serviced by DMI. 11 = Normal DRAM Operation. All reads and writes are serviced by DRAM. This register is locked by Intel TXT.
3:2	RO	0h		Reserved
1:0	RW	00b	Uncore	OE0000h–OE3FFFh Attribute (LOENABLE) This field controls the steering of read and write cycles that address the BIOS area from OE0000h to OE3FFFh. 00 = DRAM Disabled. All accesses are directed to DMI. 01 = Read Only. All reads are sent to DRAM. All writes are forwarded to DMI. 10 = Write Only. All writes are sent to DRAM. All reads are serviced by DMI. 11 = Normal DRAM Operation. All reads and writes are serviced by DRAM. This register is locked by Intel TXT.

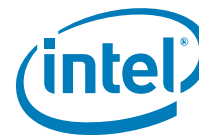

2.5.22 PAM6—Programmable Attribute Map 6 Register

This register controls the read, write and shadowing attributes of the BIOS range from E_8000h to E_FFFFh. The Uncore allows programmable memory attributes on 13 legacy memory segments of various sizes in the 768KB to 1MB address range. Seven Programmable Attribute Map (PAM) registers are used to support these features. Cacheability of these areas is controlled using the MTRR register in the core.

Two bits are used to specify memory attributes for each memory segment. These bits apply to host accesses to the PAM areas. These attributes are:

- **RE – Read Enable.** When RE=1, the host read accesses to the corresponding memory segment are claimed by the Uncore and directed to main memory. Conversely, when RE=0, the host read accesses are directed to DMI.
- **WE – Write Enable.** When WE=1, the host write accesses to the corresponding memory segment are claimed by the Uncore and directed to main memory. Conversely, when WE=0, the host read accesses are directed to DMI.

The RE and WE attributes permit a memory segment to be Read Only, Write Only, Read/Write or Disabled. For example, if a memory segment has RE=1 and WE=0, the segment is Read Only.

B/D/F/Type:		0/0/0/PCI		
Address Offset:		86h		
Reset Value:		00h		
Access:		RW		
Size:		8 bits		
BIOS Optimal Default		0h		
Bit	Attr	Reset Value	RST/PWR	Description
7:6	RO	0h		Reserved
5:4	RW	00b	Uncore	0EC000h–0EFFFFh Attribute (HIENABLE) This field controls the steering of read and write cycles that address the BIOS area from 0EC000h to 0EFFFFh. 00 = DRAM Disabled. All accesses are directed to DMI. 01 = Read Only. All reads are sent to DRAM, all writes are forwarded to DMI. 10 = Write Only. All writes are sent to DRAM, all reads are serviced by DMI. 11 = Normal DRAM Operation. All reads and writes are serviced by DRAM. This register is locked by Intel TXT.
3:2	RO	0h		Reserved
1:0	RW	00b	Uncore	0E8000h–0EBFFFh Attribute (LOENABLE) This field controls the steering of read and write cycles that address the BIOS area from 0E8000h to 0EBFFFh. 00 = DRAM Disabled. All accesses are directed to DMI. 01 = Read Only. All reads are sent to DRAM. All writes are forwarded to DMI. 10 = Write Only. All writes are sent to DRAM. All reads are serviced by DMI. 11 = Normal DRAM Operation. All reads and writes are serviced by DRAM. This register is locked by Intel TXT.

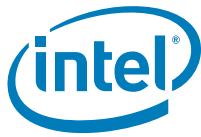

2.5.23 LAC—Legacy Access Control Register

This 8-bit register controls steering of MDA cycles and a fixed DRAM hole from 15-16 MB.

There can only be at most one MDA device in the system.

B/D/F/Type:		0/0/0/PCI																	
Address Offset:		87h																	
Reset Value:		00h																	
Access:		RW																	
Size:		8 bits																	
BIOS Optimal Default		0h																	
Bit	Attr	Reset Value	RST/PWR	Description															
7	RW	0b	Uncore	<p>Hole Enable (HEN) This field enables a memory hole in DRAM space. The DRAM that lies "behind" this space is not remapped. 0 = No memory hole. 1 = Memory hole from 15 MB to 16 MB. This bit is Intel TXT lockable.</p>															
6:4	RO	0h		Reserved															
3	RW	0b	Uncore	<p>PEG60 MDA Present (MDAP60) This bit works with the VGA Enable bits in the BCTRL register of Device 6 Function 0 to control the routing of processor initiated transactions targeting MDA compatible I/O and memory address ranges. This bit should not be set if device 6's VGA Enable bit is not set. If Device 6 Function 0 VGA enable bit is not set, then accesses to I/O address range x3BCh–x3BFh remain on the backbone. If the VGA enable bit is set and MDA is not present, then accesses to I/O address range x3BCh–x3BFh are forwarded to PCI Express through Device 6 Function 0, if the address is within the corresponding IOBASE and IOLIMIT; otherwise, they remain on the backbone. MDA resources are defined as the following: Memory: 0B0000h – 0B7FFFh I/O: 3B4h, 3B5h, 3B8h, 3B9h, 3BAh, 3BFh, (including ISA address aliases, A[15:10] are not used in decode) Any I/O reference that includes the I/O locations listed above, or their aliases, will remain on the backbone even if the reference also includes I/O locations not listed above. The following table shows the behavior for all combinations of MDA and VGA:</p> <table border="1"> <thead> <tr> <th>VGAEN</th> <th>MDAP</th> <th>Description</th> </tr> </thead> <tbody> <tr> <td>0</td> <td>0</td> <td>All References to MDA and VGA space are not claimed by Device 6 Function 0.</td> </tr> <tr> <td>0</td> <td>1</td> <td>Illegal combination</td> </tr> <tr> <td>1</td> <td>0</td> <td>All VGA and MDA references are routed to PCI Express Graphics Attach Device 6 Function 0.</td> </tr> <tr> <td>1</td> <td>1</td> <td>All VGA references are routed to PCI Express Graphics Attach Device 6 Function 0. MDA references are not claimed by Device 6 Function 0.</td> </tr> </tbody> </table> <p>VGA and MDA memory cycles can only be routed across PEG60 when MAE (PCICMD60[1]) is set. VGA and MDA I/O cycles can only be routed across PEG60 if IOAE (PCICMD60[0]) is set. Encoding: 0 = No MDA 1 = MDA Present</p>	VGAEN	MDAP	Description	0	0	All References to MDA and VGA space are not claimed by Device 6 Function 0.	0	1	Illegal combination	1	0	All VGA and MDA references are routed to PCI Express Graphics Attach Device 6 Function 0.	1	1	All VGA references are routed to PCI Express Graphics Attach Device 6 Function 0. MDA references are not claimed by Device 6 Function 0.
VGAEN	MDAP	Description																	
0	0	All References to MDA and VGA space are not claimed by Device 6 Function 0.																	
0	1	Illegal combination																	
1	0	All VGA and MDA references are routed to PCI Express Graphics Attach Device 6 Function 0.																	
1	1	All VGA references are routed to PCI Express Graphics Attach Device 6 Function 0. MDA references are not claimed by Device 6 Function 0.																	

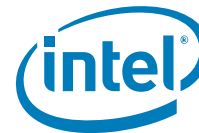

B/D/F/Type: 0/0/0/PCI Address Offset: 87h Reset Value: 00h Access: RW Size: 8 bits BIOS Optimal Default: 0h																			
Bit	Attr	Reset Value	RST/PWR	Description															
2	RW	0b	Uncore	<p>PEG12 MDA Present (MDAP12)</p> <p>This bit works with the VGA Enable bits in the BCTRL register of Device 1 Function 2 to control the routing of processor initiated transactions targeting MDA compatible I/O and memory address ranges. This bit should not be set if Device 1 Function 2 VGA Enable bit is not set.</p> <p>If Device 1 Function 2 VGA enable bit is not set, then accesses to I/O address range x3BCh–x3BFh remain on the backbone.</p> <p>If the VGA enable bit is set and MDA is not present, then accesses to I/O address range x3BCh–x3BFh are forwarded to PCI Express through Device 1 Function 2, if the address is within the corresponding IOBASE and IOLIMIT; otherwise, they remain on the backbone.</p> <p>MDA resources are defined as the following: Memory: 0B0000h – 0B7FFFh I/O: 3B4h, 3B5h, 3B8h, 3B9h, 3BAh, 3BFh, (including ISA address aliases, A[15:10] are not used in decode)</p> <p>Any I/O reference that includes the I/O locations listed above, or their aliases, will remain on the backbone even if the reference also includes I/O locations not listed above.</p> <p>The following table shows the behavior for all combinations of MDA and VGA:</p> <table border="1"> <thead> <tr> <th>VGAEN</th> <th>MDAP</th> <th>Description</th> </tr> </thead> <tbody> <tr> <td>0</td> <td>0</td> <td>All References to MDA and VGA space are not claimed by Device 1 Function 2.</td> </tr> <tr> <td>0</td> <td>1</td> <td>Illegal combination</td> </tr> <tr> <td>1</td> <td>0</td> <td>All VGA and MDA references are routed to PCI Express Graphics Attach Device 1 Function 2.</td> </tr> <tr> <td>1</td> <td>1</td> <td>All VGA references are routed to PCI Express Graphics Attach Device 1 Function 2. MDA references are not claimed by Device 1 Function 2.</td> </tr> </tbody> </table> <p>VGA and MDA memory cycles can only be routed across PEG12 when MAE (PCICMD12[1]) is set. VGA and MDA I/O cycles can only be routed across PEG12 if IOAE (PCICMD12[0]) is set.</p>	VGAEN	MDAP	Description	0	0	All References to MDA and VGA space are not claimed by Device 1 Function 2.	0	1	Illegal combination	1	0	All VGA and MDA references are routed to PCI Express Graphics Attach Device 1 Function 2.	1	1	All VGA references are routed to PCI Express Graphics Attach Device 1 Function 2. MDA references are not claimed by Device 1 Function 2.
VGAEN	MDAP	Description																	
0	0	All References to MDA and VGA space are not claimed by Device 1 Function 2.																	
0	1	Illegal combination																	
1	0	All VGA and MDA references are routed to PCI Express Graphics Attach Device 1 Function 2.																	
1	1	All VGA references are routed to PCI Express Graphics Attach Device 1 Function 2. MDA references are not claimed by Device 1 Function 2.																	



B/D/F/Type: 0/0/0/PCI Address Offset: 87h Reset Value: 00h Access: RW Size: 8 bits BIOS Optimal Default: 0h																			
Bit	Attr	Reset Value	RST/PWR	Description															
1	RW	0b	Uncore	<p>PEG11 MDA Present (MDAP11)</p> <p>This bit works with the VGA Enable bits in the BCTRL register of Device 1 Function 1 to control the routing of processor initiated transactions targeting MDA compatible I/O and memory address ranges. This bit should not be set if Device 1 Function 1 VGA Enable bit is not set.</p> <p>If Device 1 Function 1 VGA enable bit is not set, then accesses to I/O address range x3BCh–x3BFh remain on the backbone.</p> <p>If the VGA enable bit is set and MDA is not present, then accesses to I/O address range x3BCh–x3BFh are forwarded to PCI Express through Device 1 Function 1, if the address is within the corresponding IOBASE and IOLIMIT; otherwise, they remain on the backbone.</p> <p>MDA resources are defined as the following:</p> <p>Memory: 0B0000h – 0B7FFFh I/O: 3B4h, 3B5h, 3B8h, 3B9h, 3BAh, 3BFh, (including ISA address aliases, A[15:10] are not used in decode)</p> <p>Any I/O reference that includes the I/O locations listed above, or their aliases, will remain on the backbone even if the reference also includes I/O locations not listed above.</p> <p>The following table shows the behavior for all combinations of MDA and VGA:</p> <table border="1"> <thead> <tr> <th>VGAEN</th> <th>MDAP</th> <th>Description</th> </tr> </thead> <tbody> <tr> <td>0</td> <td>0</td> <td>All References to MDA and VGA space are not claimed by Device 1 Function 1.</td> </tr> <tr> <td>0</td> <td>1</td> <td>Illegal combination</td> </tr> <tr> <td>1</td> <td>0</td> <td>All VGA and MDA references are routed to PCI Express Graphics Attach Device 1 Function 1.</td> </tr> <tr> <td>1</td> <td>1</td> <td>All VGA references are routed to PCI Express Graphics Attach Device 1 Function 1. MDA references are not claimed by Device 1 Function 1.</td> </tr> </tbody> </table> <p>VGA and MDA memory cycles can only be routed across PEG11 when MAE (PCICMD11[1]) is set. VGA and MDA I/O cycles can only be routed across PEG11 if IOAE (PCICMD11[0]) is set.</p>	VGAEN	MDAP	Description	0	0	All References to MDA and VGA space are not claimed by Device 1 Function 1.	0	1	Illegal combination	1	0	All VGA and MDA references are routed to PCI Express Graphics Attach Device 1 Function 1.	1	1	All VGA references are routed to PCI Express Graphics Attach Device 1 Function 1. MDA references are not claimed by Device 1 Function 1.
VGAEN	MDAP	Description																	
0	0	All References to MDA and VGA space are not claimed by Device 1 Function 1.																	
0	1	Illegal combination																	
1	0	All VGA and MDA references are routed to PCI Express Graphics Attach Device 1 Function 1.																	
1	1	All VGA references are routed to PCI Express Graphics Attach Device 1 Function 1. MDA references are not claimed by Device 1 Function 1.																	

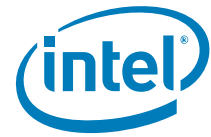

B/D/F/Type: 0/0/0/PCI Address Offset: 87h Reset Value: 00h Access: RW Size: 8 bits BIOS Optimal Default: 0h																			
Bit	Attr	Reset Value	RST/PWR	Description															
0	RW	0b	Uncore	<p>PEG10 MDA Present (MDAP10)</p> <p>This bit works with the VGA Enable bits in the BCTRL register of Device 1 Function 0 to control the routing of processor initiated transactions targeting MDA compatible I/O and memory address ranges. This bit should not be set if Device 1 Function 0 VGA Enable bit is not set.</p> <p>If Device 1 Function 0 VGA enable bit is not set, then accesses to I/O address range x3BCh–x3BFh remain on the backbone.</p> <p>If the VGA enable bit is set and MDA is not present, then accesses to I/O address range x3BCh–x3BFh are forwarded to PCI Express through Device 1 Function 0 if the address is within the corresponding IOBASE and IOLIMIT; otherwise, they remain on the backbone.</p> <p>MDA resources are defined as the following:</p> <p>Memory: 0B0000h – 0B7FFFh I/O: 3B4h, 3B5h, 3B8h, 3B9h, 3BAh, 3BFh, (including ISA address aliases, A[15:10] are not used in decode)</p> <p>Any I/O reference that includes the I/O locations listed above, or their aliases, will remain on the backbone even if the reference also includes I/O locations not listed above.</p> <p>The following table shows the behavior for all combinations of MDA and VGA:</p> <table border="1"> <thead> <tr> <th>VGAEN</th> <th>MDAP</th> <th>Description</th> </tr> </thead> <tbody> <tr> <td>0</td> <td>0</td> <td>All References to MDA and VGA space are not claimed by Device 1 Function 0.</td> </tr> <tr> <td>0</td> <td>1</td> <td>Illegal combination</td> </tr> <tr> <td>1</td> <td>0</td> <td>All VGA and MDA references are routed to PCI Express Graphics Attach Device 1 Function 0.</td> </tr> <tr> <td>1</td> <td>1</td> <td>All VGA references are routed to PCI Express Graphics Attach Device 1 Function 0. MDA references are not claimed by Device 1 Function 0.</td> </tr> </tbody> </table> <p>VGA and MDA memory cycles can only be routed across PEG10 when MAE (PCICMD10[1]) is set. VGA and MDA I/O cycles can only be routed across PEG10 if IOAE (PCICMD10[0]) is set.</p>	VGAEN	MDAP	Description	0	0	All References to MDA and VGA space are not claimed by Device 1 Function 0.	0	1	Illegal combination	1	0	All VGA and MDA references are routed to PCI Express Graphics Attach Device 1 Function 0.	1	1	All VGA references are routed to PCI Express Graphics Attach Device 1 Function 0. MDA references are not claimed by Device 1 Function 0.
VGAEN	MDAP	Description																	
0	0	All References to MDA and VGA space are not claimed by Device 1 Function 0.																	
0	1	Illegal combination																	
1	0	All VGA and MDA references are routed to PCI Express Graphics Attach Device 1 Function 0.																	
1	1	All VGA references are routed to PCI Express Graphics Attach Device 1 Function 0. MDA references are not claimed by Device 1 Function 0.																	

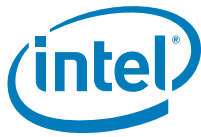

2.5.24 REMAPBASE—Remap Base Address Register

B/D/F/Type:		0/0/0/PCI		
Address Offset:		90–97h		
Reset Value:		000000FFFF00000h		
Access:		RW-KL, RW-L		
Size:		64 bits		
BIOS Optimal Default		000000000000h		
Bit	Attr	Reset Value	RST/PWR	Description
63:36	RO	0h		Reserved
35:20	RW-L	FFFFh	Uncore	<p>Remap Base Address (REMAPBASE)</p> <p>The value in this register defines the lower boundary of the Remap window. The Remap window is inclusive of this address. In the decoder A[19:0] of the Remap Base Address are assumed to be 0s. Thus, the bottom of the defined memory range will be aligned to a 1 MB boundary.</p> <p>When the value in this register is greater than the value programmed into the Remap Limit register, the Remap window is disabled.</p> <p>These bits are Intel TXT lockable.</p>
19:1	RO	0h		Reserved
0	RW-KL	0b	Uncore	<p>Lock (LOCK)</p> <p>This bit will lock all writeable settings in this register, including itself.</p>

2.5.25 REMAPLIMIT—Remap Limit Address Register

B/D/F/Type:		0/0/0/PCI		
Address Offset:		98–9Fh		
Reset Value:		000000000000000h		
Access:		RW-KL, RW-L		
Size:		64 bits		
BIOS Optimal Default		000000000000h		
Bit	Attr	Reset Value	RST/PWR	Description
63:36	RO	0h		Reserved
35:20	RW-L	0000h	Uncore	<p>Remap Limit Address (REMAPLMT)</p> <p>The value in this register defines the upper boundary of the Remap window. The Remap window is inclusive of this address. In the decoder A[19:0] of the remap limit address are assumed to be Fs. Thus, the top of the defined range will be one byte less than a 1 MB boundary.</p> <p>When the value in this register is less than the value programmed into the Remap Base register, the Remap window is disabled.</p> <p>These Bits are Intel TXT lockable.</p>
19:1	RO	0h		Reserved
0	RW-KL	0b	Uncore	<p>Lock (LOCK)</p> <p>This bit will lock all writeable settings in this register, including itself.</p>



2.5.26 TOM—Top of Memory Register

This register contains the size of physical memory. BIOS determines the memory size reported to the OS using this register.

B/D/F/Type:		0/0/0/PCI		
Address Offset:		A0–A7h		
Reset Value:		0000007FFFF00000h		
Access:		RW-KL, RW-L		
Size:		64 bits		
BIOS Optimal Default		000000000000h		
Bit	Attr	Reset Value	RST/PWR	Description
63:39	RO	0h		Reserved
38:20	RW-L	7FFFFh	Uncore	Top of Memory (TOM) This register reflects the total amount of populated physical memory. This is NOT necessarily the highest main memory address (holes may exist in main memory address map due to addresses allocated for memory mapped IO). These bits correspond to address bits 38:20 (1 MB granularity). Bits 19:0 are assumed to be 0. All the bits in this register are locked in Intel TXT mode.
19:1	RO	0h		Reserved
0	RW-KL	0b	Uncore	Lock (LOCK) This bit will lock all writeable settings in this register, including itself.

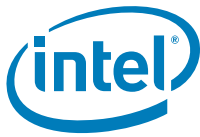

2.5.27 TOUUD—Top of Upper Usable DRAM Register

This 64-bit register defines the Top of Upper Usable DRAM.

Configuration software must set this value to TOM minus all ME stolen memory if reclaim is disabled. If reclaim is enabled, this value must be set to reclaim limit + 1 byte, 1 MB aligned, since reclaim limit is 1 MB aligned. Address bits 19:0 are assumed to be 000_0000h for the purposes of address comparison. The Host interface positively decodes an address towards DRAM if the incoming address is less than the value programmed in this register and greater than or equal to 4 GB.

BIOS Restriction: Minimum value for TOUUD is 4 GB.

These bits are Intel TXT lockable.

B/D/F/Type:		0/0/0/PCI		
Address Offset:		A8–AFh		
Reset Value:		0000000000000000h		
Access:		RW-KL, RW-L		
Size:		64 bits		
BIOS Optimal Default		000000000000h		
Bit	Attr	Reset Value	RST/PWR	Description
63:39	RO	0h		Reserved
38:20	RW-L	00000h	Uncore	TOUUD (TOUUD) This register contains bits 38:20 of an address one byte above the maximum DRAM memory above 4 GB that is usable by the operating system. Configuration software must set this value to TOM minus all ME stolen memory if reclaim is disabled. If reclaim is enabled, this value must be set to reclaim limit 1 MB aligned since reclaim limit + 1 byte is 1 MB aligned. Address bits 19:0 are assumed to be 000_0000h for the purposes of address comparison. The Host interface positively decodes an address towards DRAM if the incoming address is less than the value programmed in this register and greater than 4 GB. All the bits in this register are locked in Intel TXT mode.
19:1	RO	0h		Reserved
0	RW-KL	0b	Uncore	Lock (LOCK) This bit will lock all writeable settings in this register, including itself.

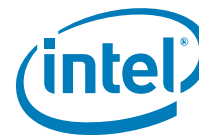

2.5.28 BDSM—Base Data of Stolen Memory Register

This register contains the base address of graphics data stolen DRAM memory. BIOS determines the base of graphics data stolen memory by subtracting the graphics data stolen memory size (PCI Device 0 offset 52 bits 7:4) from TOLUD (PCI Device 0, offset BCh, bits 31:20).

B/D/F/Type:		0/0/0/PCI		
Address Offset:		B0–B3h		
Reset Value:		00000000h		
Access:		RW-KL, RW-L		
Size:		32 bits		
BIOS Optimal Default		00000h		
Bit	Attr	Reset Value	RST/PWR	Description
31:20	RW-L	000h	Uncore	Graphics Base of Stolen Memory (BDSM) This register contains bits 31:20 of the base address of stolen DRAM memory. BIOS determines the base of graphics stolen memory by subtracting the graphics stolen memory size (PCI Device 0, offset 52h, bits 6:4) from TOLUD (PCI Device 0, offset BCh, bits 31:20).
19:1	RO	0h		Reserved
0	RW-KL	0b	Uncore	Lock (LOCK) This bit will lock all writeable settings in this register, including itself.

2.5.29 BGSM—Base of GTT stolen Memory Register

This register contains the base address of stolen DRAM memory for the GTT. BIOS determines the base of GTT stolen memory by subtracting the GTT graphics stolen memory size (PCI Device 0, offset 52h, bits 9:8) from the Graphics Base of Data Stolen Memory (PCI Device 0, offset B0h, bits 31:20).

B/D/F/Type:		0/0/0/PCI		
Address Offset:		B4–B7h		
Reset Value:		00100000h		
Access:		RW-KL, RW-L		
Size:		32 bits		
BIOS Optimal Default		00000h		
Bit	Attr	Reset Value	RST/PWR	Description
31:20	RW-L	001h	Uncore	Graphics Base of GTT Stolen Memory (BGSM) This register contains the base address of stolen DRAM memory for the GTT. BIOS determines the base of GTT stolen memory by subtracting the GTT graphics stolen memory size (PCI Device 0, offset 52h, bits 11:8) from the Graphics Base of Data Stolen Memory (PCI Device 0, offset B0h, bits 31:20).
19:1	RO	0h		Reserved
0	RW-KL	0b	Uncore	Lock (LOCK) This bit will lock all writeable settings in this register, including itself.

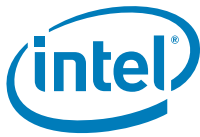

2.5.30 G Memory Base Register

This register contains the base address of TSEG DRAM memory. BIOS determines the base of TSEG memory which must be at or below Graphics Base of GTT Stolen Memory (PCI Device 0, Offset B4h, bits 31:20).

Note: BIOS must program TSEGMB to a 8 MB naturally aligned boundary.

B/D/F/Type:		0/0/0/PCI		
Address Offset:		B8–BBh		
Reset Value:		00000000h		
Access:		RW-KL, RW-L		
Size:		32 bits		
BIOS Optimal Default		00000h		
Bit	Attr	Reset Value	RST/PWR	Description
31:20	RW-L	000h	Uncore	TESG Memory base (TSEGMB) This register contains the base address of TSEG DRAM memory. BIOS determines the base of TSEG memory which must be at or below Graphics Base of GTT Stolen Memory (PCI Device 0, Offset B4h, bits 31:20).
19:1	RO	0h		Reserved
0	RW-KL	0b	Uncore	Lock (LOCK) This bit will lock all writeable settings in this register, including itself.

2.5.31 TOLUD—Top of Low Usable DRAM Register

This 32 bit register defines the Top of Low Usable DRAM. TSEG, GTT Graphics memory and Graphics Stolen Memory are within the DRAM space defined. From the top, the Host optionally claims 1 to 64 MBs of DRAM for internal graphics if enabled, 1 or 2 MB of DRAM for GTT Graphics Stolen Memory (if enabled) and 1, 2, or 8 MB of DRAM for TSEG if enabled.

Programming Example:

- C1DRB3 is set to 4 GB
- TSEG is enabled and TSEG size is set to 1 MB
- Internal Graphics is enabled, and Graphics Mode Select is set to 32 MB
- GTT Graphics Stolen Memory Size set to 2 MB
- BIOS knows the OS requires 1G of PCI space.
- BIOS also knows the range from 0_FEC0_0000h to 0_FFFF_FFFFh is not usable by the system. This 20 MB range at the very top of addressable memory space is lost to APIC and Intel TXT.
- According to the above equation, TOLUD is originally calculated to: 4 GB = 1_0000_0000h
- The system memory requirements are: 4 GB (max addressable space) – 1 GB (pci space) = 0_C000_0000h Since 0_C000_0000h (PCI and other system requirements) is less than 1_0000_0000h, TOLUD should be programmed to C00h.

These bits are Intel TXT lockable.



B/D/F/Type: 0/0/0/PCI Address Offset: BC–BFh Reset Value: 00100000h Access: RW-KL, RW-L Size: 32 bits BIOS Optimal Default: 00000h				
Bit	Attr	Reset Value	RST/PWR	Description
31:20	RW-L	001h	Uncore	Top of Low Usable DRAM (TOLUD) This register contains bits 31:20 of an address one byte above the maximum DRAM memory below 4 GB that is usable by the operating system. Address bits 31:20 programmed to 01h implies a minimum memory size of 1 MB. Configuration software must set this value to the smaller of the following 2 choices: maximum amount memory in the system minus ME stolen memory plus one byte or the minimum address allocated for PCI memory. Address bits 19:0 are assumed to be 0_0000h for the purposes of address comparison. The Host interface positively decodes an address towards DRAM if the incoming address is less than the value programmed in this register. The Top of Low Usable DRAM is the lowest address above both Graphics Stolen memory and TSEG. BIOS determines the base of Graphics Stolen Memory by subtracting the Graphics Stolen Memory Size from TOLUD and further decrements by TSEG size to determine base of TSEG. All the Bits in this register are locked in Intel TXT mode. This register must be 1MB aligned when reclaim is enabled.
19:1	RO	0h		Reserved
0	RW-KL	0b	Uncore	Lock (LOCK) This bit will lock all writeable settings in this register, including itself.

2.5.32 SKPD—Scratchpad Data Register

This register holds 32 writable bits with no functionality behind them. It is for the convenience of BIOS and graphics drivers.

B/D/F/Type: 0/0/0/PCI Address Offset: DC–DFh Reset Value: 00000000h Access: RW Size: 32 bits				
Bit	Attr	Reset Value	RST/PWR	Description
31:0	RW	00000000h	Uncore	Scratchpad Data (SKPD) 1 DWORD of data storage.



2.5.33 CAPI D0_A—Capabilities A Register

This register control of bits in this register are only required for customer visible SKU differentiation.

B/D/F/Type:		0/0/0/PCI		
Address Offset:		E4–E7h		
Default Value:		0000000h		
Access:		RO-FW, RO-KFW		
Size:		32 bits		
BIOS Optimal Default:		000000h		
Bit	Attr	Reset Value	RST/PWR	Description
31	RO-KFW	0b		Reserved
30	RO-KFW	0b		Reserved
29	RO-KFW	0b		Reserved
28	RO-KFW	0b		Reserved
27	RO-FW	0b		Reserved
26	RO-FW	0b		Reserved
25	RO-FW	0b		Reserved
24	RO-FW	0b		Reserved
23	RO-KFW	0b	Uncore	VTd Disable (VTDD) 0 = Enable VTd 1 = Disable VTd
22	RO-FW	0b		Reserved
21	RO-FW	0b		Reserved
20:19	RO-FW	00b		Reserved
18	RO-FW	0b		Reserved
17	RO-FW	0b		Reserved
16	RO-FW	0b		Reserved
15	RO-KFW	0b		Reserved
14	RO-FW	0b	Uncore	2 DIMMS per Channel Disable (DDPCD) Allows Dual Channel operation but only supports 1 DIMM per channel. 0 = 2 DIMMs per channel enabled 1 = 2 DIMMs per channel disabled. This setting hardwires bits 2 and 3 of the rank population field for each channel to zero. (MCHBAR offset 260h, bits 22–23 for channel 0 and MCHBAR offset 660h, bits 22–23 for channel 1)
13	RO-FW	0b		Reserved
12	RO-FW	0b		Reserved
11	RO-KFW	0b		Reserved
10	RO-FW	0b		Reserved
9:8	RO-FW	00b		Reserved



B/D/F/Type: 0/0/0/PCI Address Offset: E4–E7h Default Value: 00000000h Access: RO-FW, RO-KFW Size: 32 bits BIOS Optimal Default: 000000h				
Bit	Attr	Reset Value	RST/PWR	Description
7:4	RO-FW	0h		Reserved
3:3	RO	0h		Reserved
2:0	RO-FW	000b	Uncore	DDR3 Maximum Frequency Capability (DMFC) This field controls which values may be written to the Memory Frequency Select field 6:4 of the Clocking Configuration registers (MCHBAR Offset C00h). Any attempt to write an unsupported value will be ignored. 000 = MC capable of "All" memory frequencies 101 = MC capable of up to DDR3 1600 110 = MC capable of up to DDR3 1333 111 = MC capable of up to DDR3 1067

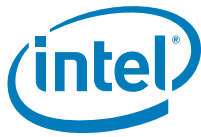

2.6 PCI Device 1 Function 0–2 Configuration Space

Table 2-8 lists the registers arranged by address offset. Register bit descriptions are in the sections following the table.

Table 2-8. PCI Device 1, Function 0–2 Configuration Register Address Map (Sheet 1 of 2)

Address Offset	Register Symbol	Register Name	Reset Value	Access
0–1h	VID1	Vendor Identification	8086h	RO
2–3h	DID1	Device Identification	See Section 2.2	RO-FW
4–5h	PCICMD1	PCI Command	0000h	RW, RO
6–7h	PCISTS1	PCI Status	0010h	RW1C, RO, RO-V
8h	RID1	Revision Identification	00h	RO-FW
9–Bh	CC1	Class Code	060400h	RO
Ch	CL1	Cache Line Size	00h	RW
Dh	RSVD	Reserved	0h	RO
Eh	HDR1	Header Type	81h	RO
F–17h	RSVD	Reserved	0h	RO
18h	PBUSN1	Primary Bus Number	00h	RO
19h	SBUSN1	Secondary Bus Number	00h	RW
1Ah	SUBUSN1	Subordinate Bus Number	00h	RW
1Bh	RSVD	Reserved	0h	RO
1Ch	IOBASE1	I/O Base Address	F0h	RW
1Dh	IOLIMIT1	I/O Limit Address	00h	RW
1E–1Fh	SSTS1	Secondary Status	0000h	RW1C, RO
20–21h	MBASE1	Memory Base Address	FFF0h	RW
22–23h	MLIMIT1	Memory Limit Address	0000h	RW
24–25h	PMBASE1	Prefetchable Memory Base Address	FFF1h	RW, RO
26–27h	PMLIMIT1	Prefetchable Memory Limit Address	0001h	RW, RO
28–2Bh	PMBASEU1	Prefetchable Memory Base Address Upper	00000000h	RW
2C–2Fh	PMLIMITU1	Prefetchable Memory Limit Address Upper	00000000h	RW
30–33h	RSVD	Reserved	0h	RO
34h	CAPPTR1	Capabilities Pointer	88h	RO
35–3Bh	RSVD	Reserved	0h	RO
3Ch	INTRLINE1	Interrupt Line	00h	RW
3Dh	INTRPIN1	Interrupt Pin	01h	RW-O, RO
3E–3Fh	BCTRL1	Bridge Control	0000h	RW, RO
40–7Fh	RSVD	Reserved	0h	RO
80–83h	PM_CAPID1	Power Management Capabilities	C8039001h	RO, RO-V
84–87h	PM_CS1	Power Management Control/Status	00000008h	RO, RW
88–8Bh	SS_CAPID	Subsystem ID and Vendor ID Capabilities	0000800Dh	RO
8C–8Fh	SS	Subsystem ID and Subsystem Vendor ID	00008086h	RW-O
90–91h	MSI_CAPID	Message Signaled Interrupts Capability ID	A005h	RO



Table 2-8. PCI Device 1, Function 0–2 Configuration Register Address Map (Sheet 2 of 2)

Address Offset	Register Symbol	Register Name	Reset Value	Access
92–93h	MC	Message Control	0000h	RO, RW
94–97h	MA	Message Address	00000000h	RW, RO
98–99h	MD	Message Data	0000h	RW
9A–9Fh	RSVD	Reserved	0h	RO
A0–A1h	PEG_CAPL	PCI Express-G Capability List	0010h	RO
A2–A3h	PEG_CAP	PCI Express-G Capabilities	0142h	RO, RW-O
A4–A7h	DCAP	Device Capabilities	00008000h	RO, RW-O
A8–A9h	DCTL	Device Control	0000h	RO, RW
AA–ABh	DSTS	Device Status	0000h	RW1C, RO
AC–AFh	RSVD	Reserved	0h	RO
B0–B1h	LCTL	Link Control	0000h	RW, RO, RW-V
B2–B3h	LSTS	Link Status	1001h	RO-V, RW1C, RO
B4–B7h	SLOTCAP	Slot Capabilities	00040000h	RW-O, RO
B8–B9h	SLOTCTL	Slot Control	0000h	RO
BA–BBh	SLOTSTS	Slot Status	0000h	RO, RO-V, RW1C
BC–BDh	RCTL	Root Control	0000h	RO, RW
BE–C3h	RSVD	Reserved	0h	RO
C4–C7h	RSVD	Reserved	00000800h	RO, RW-O
C8–C9h	RSVD	Reserved	0000h	RW-V, RW
CA–CFh	RSVD	Reserved	0h	RO
D0–D1h	LCTL2	Link Control 2	0002h	RWS, RWS-V
D2–D3h	RSVD	Reserved	0000h	RO-V



2.6.1 VID1—Vendor Identification Register

This register combined with the Device Identification register uniquely identify any PCI device.

B/D/F/Type:		0/1/0–2/PCI		
Address Offset:		0–1h		
Reset Value:		8086h		
Access:		RO		
Size:		16 bits		
Bit	Attr	Reset Value	RST/PWR	Description
15:0	RO	8086h	Uncore	Vendor Identification (VID) PCI standard identification for Intel.

2.6.2 DID1—Device Identification Register

This register combined with the Vendor Identification register uniquely identifies any PCI device.

B/D/F/Type:		0/1/0–2/PCI		
Address Offset:		2–3h		
Reset Value:		See Section 2.2		
Access:		RO-FW		
Size:		16 bits		
Bit	Attr	Reset Value	RST/PWR	Description
15:0	RO-FW	See Section 2.2	Uncore	Device Identification Number MSB (DID_MSB) Identifier assigned to the processor root port (virtual PCI-to-PCI bridge, PCI Express Graphics port).

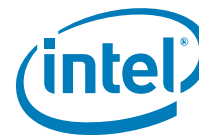

2.6.3 PCICMD1—PCI Command Register

B/D/F/Type:		0/1/0–2/PCI		
Address Offset:		4–5h		
Reset Value:		0000h		
Access:		RW, RO		
Size:		16 bits		
BIOS Optimal Default		00h		
Bit	Attr	Reset Value	RST/PWR	Description
15:11	RO	0h		Reserved
10	RW	0b	Uncore	<p>INTA Assertion Disable (INTAAD)</p> <p>0 = This device is permitted to generate INTA interrupt messages. 1 = This device is prevented from generating interrupt messages. Any INTA emulation interrupts already asserted must be deasserted when this bit is set.</p> <p>Only affects interrupts generated by the device (PCI INTA from a PME or Hot Plug event) controlled by this command register. It does not affect upstream MSIs, upstream PCI INTA–INTD assert and deassert messages.</p>
9	RO	0b	Uncore	<p>Fast Back-to-Back Enable (FB2B)</p> <p>Not Applicable or Implemented. Hardwired to 0.</p>
8	RW	0b	Uncore	<p>SERR# Message Enable (SERRE)</p> <p>This bit controls the root port's SERR# messaging. The processor communicates the SERR# condition by sending an SERR message to the PCH. This bit, when set, enables reporting of non-fatal and fatal errors detected by the device to the Root Complex. Note that errors are reported if enabled either through this bit or through the PCI-Express specific bits in the Device Control Register.</p> <p>In addition, for Type 1 configuration space header devices, this bit, when set, enables transmission by the primary interface of ERR_NONFATAL and ERR_FATAL error messages forwarded from the secondary interface. This bit does not affect the transmission of forwarded ERR_COR messages.</p> <p>0 = The SERR message is generated by the root port only under conditions enabled individually through the Device Control Register. 1 = The root port is enabled to generate SERR messages that will be sent to the PCH for specific root port error conditions generated/detected or received on the secondary side of the virtual PCI to PCI bridge. The status of SERRs generated is reported in the PCISTS register.</p>
7:7	RO	0h		Reserved
6	RW	0b	Uncore	<p>Parity Error Response Enable (PERRE)</p> <p>This bit controls whether or not the Master Data Parity Error bit in the PCI Status register can be set.</p> <p>0 = Master Data Parity Error bit in PCI Status register can NOT be set. 1 = Master Data Parity Error bit in PCI Status register CAN be set.</p>
5	RO	0b	Uncore	<p>VGA Palette Snoop (VGAPS)</p> <p>Not Applicable or Implemented. Hardwired to 0.</p>
4	RO	0b	Uncore	<p>Memory Write and Invalidate Enable (MWIE)</p> <p>Not Applicable or Implemented. Hardwired to 0.</p>
3	RO	0b	Uncore	<p>Special Cycle Enable (SCE)</p> <p>Not Applicable or Implemented. Hardwired to 0.</p>



B/D/F/Type: 0/1/0-2/PCI Address Offset: 4-5h Reset Value: 0000h Access: RW, RO Size: 16 bits BIOS Optimal Default: 00h				
Bit	Attr	Reset Value	RST/PWR	Description
2	RW	0b	Uncore	Bus Master Enable (BME) This bit controls the ability of the PEG port to forward Memory Read/Write Requests in the upstream direction. 0 = This device is prevented from making memory requests to its primary bus. Note that according to PCI Specification, as MSI interrupt messages are in-band memory writes, disabling the bus master enable bit prevents this device from generating MSI interrupt messages or passing them from its secondary bus to its primary bus. Upstream memory writes/reads, peer writes/reads, and MSIs will all be treated as illegal cycles. Writes are aborted. Reads are aborted and will return Unsupported Request status (or Master abort) in its completion packet. 1 = This device is allowed to issue requests to its primary bus. Completions for previously issued memory read requests on the primary bus will be issued when the data is available. This bit does not affect forwarding of Completions from the primary interface to the secondary interface.
1	RW	0b	Uncore	Memory Access Enable (MAE) 0 = Disable. All of device's memory space is disabled. 1 = Enable the Memory and Pre-fetchable memory address ranges defined in the MBASE, MLIMIT, PMBASE, and PMLIMIT registers.
0	RW	0b	Uncore	I/O Access Enable (IOAE) 0 = Disable. All of device's I/O space is disabled. 1 = Enable the I/O address range defined in the IOBASE, and IOLIMIT registers.



2.6.4 PCISTS1—PCI Status Register

This register reports the occurrence of error conditions associated with primary side of the "virtual" Host-PCI Express bridge embedded within the Root port.

B/D/F/Type:		0/1/0-2/PCI		
Address Offset:		6-7h		
Reset Value:		0010h		
Access:		RW1C, RO, RO-V		
Size:		16 bits		
BIOS Optimal Default		0h		
Bit	Attr	Reset Value	RST/PWR	Description
15	RW1C	0b	Uncore	<p>Detected Parity Error (DPE) This bit is Set by a Function whenever it receives a Poisoned TLP, regardless of the state the Parity Error Response bit in the Command register. On a Function with a Type 1 Configuration header, the bit is set when the Poisoned TLP is received by its Primary Side. This bit will be set only for completions of requests encountering ECC error in DRAM. Poisoned Peer-to-peer posted forwarded will not set this bit. They are reported at the receiving port.</p>
14	RW1C	0b	Uncore	<p>Signaled System Error (SSE) This bit is set when this Device sends an SERR due to detecting an ERR_FATAL or ERR_NONFATAL condition and the SERR Enable bit in the Command register is 1. Both received (if enabled by BCTRL1[1]) and internally detected error messages do not affect this field.</p>
13	RO	0b	Uncore	<p>Received Master Abort Status (RMAS) This bit is Set when a Requester receives a Completion with Unsupported Request Completion Status. On a Function with a Type 1 Configuration header, the bit is Set when the Unsupported Request is received by its Primary Side. Not applicable. UR is not on primary interface.</p>
12	RO	0b	Uncore	<p>Received Target Abort Status (RTAS) This bit is Set when a Requester receives a Completion with Completer Abort Completion Status. On a Function with a Type 1 Configuration header, the bit is Set when the Completer Abort is received by its Primary Side. Not Applicable or Implemented. Hardwired to 0. The concept of a Completer abort does not exist on primary side of this device.</p>
11	RO	0b	Uncore	<p>Signaled Target Abort Status (STAS) This bit is Set when a Function completes a Posted or Non-Posted Request as a Completer Abort error. This applies to a Function with a Type 1 Configuration header when the Completer Abort was generated by its Primary Side. Not Applicable or Implemented. Hardwired to 0. The concept of a target abort does not exist on primary side of this device.</p>
10:9	RO	00b	Uncore	<p>DEVSELB Timing (DEVT) This device is not the subtractive decoded device on bus 0. This bit field is therefore hardwired to 00 to indicate that the device uses the fastest possible decode. Does not apply to PCI Express and must be hardwired to 00b.</p>



B/D/F/Type:		0/1/0-2/PCI		
Address Offset:		6-7h		
Reset Value:		0010h		
Access:		RW1C, RO, RO-V		
Size:		16 bits		
BIOS Optimal Default		0h		
Bit	Attr	Reset Value	RST/PWR	Description
8	RW1C	0b	Uncore	<p>Master Data Parity Error (PMDPE)</p> <p>This bit is Set by a Requester (Primary Side for Type 1 Configuration Space header Function) if the Parity Error Response bit in the Command register is 1b and either of the following two conditions occurs:</p> <ul style="list-style-type: none"> Requester receives a Completion marked poisoned Requester poisons a write Request <p>If the Parity Error Response bit is 0b, this bit is never Set. This bit will be set only for completions of requests encountering ECC error in DRAM. Poisoned Peer-to-peer posted forwarded will not set this bit. They are reported at the receiving port.</p>
7	RO	0b	Uncore	<p>Fast Back-to-Back (FB2B)</p> <p>Not Applicable or Implemented. Hardwired to 0.</p>
6:6	RO	0h		Reserved
5	RO	0b	Uncore	<p>66/60 MHz capability (CAP66)</p> <p>Not Applicable or Implemented. Hardwired to 0.</p>
4	RO	1b	Uncore	<p>Capabilities List (CAPL)</p> <p>Indicates that a capabilities list is present. Hardwired to 1.</p>
3	RO-V	0b	Uncore	<p>INTx Status (INTAS)</p> <p>Indicates that an interrupt message is pending internally to the device. Only PME and Hot Plug sources feed into this status bit (not PCI INTA-INTD assert and deassert messages). The INTA Assertion Disable bit, PCICMD1[10], has no effect on this bit. Note that INTA emulation interrupts received across the link are not reflected in this bit.</p>
2:0	RO	0h		Reserved

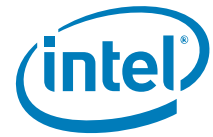

2.6.5 RID1—Revision Identification Register

This register contains the revision number of the processor root port. These bits are read only and writes to this register have no effect.

B/D/F/Type:		0/1/0-2/PCI		
Address Offset:		8h		
Reset Value:		00h		
Access:		RO-FW		
Size:		8 bits		
Bit	Attr	Reset Value	RST/PWR	Description
7:4	RO-FW	0h	Uncore	Revision Identification Number MSB (RID_MSB) This is an 8-bit value that indicates the revision identification number for the root port. Refer to the <i>Intel® Core™ Processor Family Mobile Specification update</i> for the value of the RID register.
3:0	RO-FW	0h	Uncore	Revision Identification Number (RID) This is an 8-bit value that indicates the revision identification number for the root port. Refer to the <i>Intel® Core™ Processor Family Mobile Specification update</i> for the value of the RID register.

2.6.6 CC1—Class Code Register

This register identifies the basic function of the device, a more specific sub-class, and a register- specific programming interface.

B/D/F/Type:		0/1/0-2/PCI		
Address Offset:		9-Bh		
Reset Value:		060400h		
Access:		RO		
Size:		24 bits		
Bit	Attr	Reset Value	RST/PWR	Description
23:16	RO	06h	Uncore	Base Class Code (BCC) This field indicates the base class code for this device. This code has the value 06h, indicating a Bridge device.
15:8	RO	04h	Uncore	Sub-Class Code (SUBCC) This field indicates the sub-class code for this device. The code is 04h indicating a PCI to PCI Bridge.
7:0	RO	00h	Uncore	Programming Interface (PI) This field indicates the programming interface of this device. This value does not specify a particular register set layout and provides no practical use for this device.



2.6.7 CL1—Cache Line Size Register

B/D/F/Type:		0/1/0–2/PCI		
Address Offset:		Ch		
Reset Value:		00h		
Access:		RW		
Size:		8 bits		
Bit	Attr	Reset Value	RST/PWR	Description
7:0	RW	00h	Uncore	Cache Line Size (CLS) Implemented by PCI Express devices as a read-write field for legacy compatibility purposes but has no impact on any PCI Express device functionality.

2.6.8 HDR1—Header Type Register

This register identifies the header layout of the configuration space. No physical register exists at this location.

B/D/F/Type:		0/1/0–2/PCI		
Address Offset:		Eh		
Reset Value:		81h		
Access:		RO		
Size:		8 bits		
Bit	Attr	Reset Value	RST/PWR	Description
7:0	RO	81h	Uncore	Header Type Register (HDR) Device 1 returns 81h to indicate that this is a multi function device with bridge header layout. Device 6 returns 01h to indicate that this is a single function device with bridge header layout.

2.6.9 PBUSN1—Primary Bus Number Register

This register identifies that this "virtual" Host-PCI Express bridge is connected to PCI bus 0.

B/D/F/Type:		0/1/0–2/PCI		
Address Offset:		18h		
Reset Value:		00h		
Access:		RO		
Size:		8 bits		
Bit	Attr	Reset Value	RST/PWR	Description
7:0	RO	00h	Uncore	Primary Bus Number (BUSN) Configuration software typically programs this field with the number of the bus on the primary side of the bridge. Since the processor root port is an internal device and its primary bus is always 0, these bits are read only and are hardwired to 0.



2.6.10 SBUSN1—Secondary Bus Number Register

This register identifies the bus number assigned to the second bus side of the "virtual" bridge (that is, to PCI Express-G). This number is programmed by the PCI configuration software to allow mapping of configuration cycles to PCI Express-G.

B/D/F/Type:		0/1/0–2/PCI		
Address Offset:		19h		
Reset Value:		00h		
Access:		RW		
Size:		8 bits		
Bit	Attr	Reset Value	RST/PWR	Description
7:0	RW	00h	Uncore	Secondary Bus Number (BUSN) This field is programmed by configuration software with the bus number assigned to PCI Express-G.

2.6.11 SUBUSN1—Subordinate Bus Number Register

This register identifies the subordinate bus (if any) that resides at the level below PCI Express-G. This number is programmed by the PCI configuration software to allow mapping of configuration cycles to PCI Express-G.

B/D/F/Type:		0/1/0–2/PCI		
Address Offset:		1Ah		
Reset Value:		00h		
Access:		RW		
Size:		8 bits		
Bit	Attr	Reset Value	RST/PWR	Description
7:0	RW	00h	Uncore	Subordinate Bus Number (BUSN) This register is programmed by configuration software with the number of the highest subordinate bus that lies behind the processor root port bridge. When only a single PCI device resides on the PCI Express-G segment, this register will contain the same value as the SBUSN1 register.



2.6.12 IOBASE1—I/O Base Address Register

This register controls the processor to PCI Express-G I/O access routing based on the following formula:

$$\text{IO_BASE} \leq \text{address} \leq \text{IO_LIMIT}$$

Only the upper 4 bits are programmable. For the purpose of address decode, address bits A[11:0] are treated as 0. Thus, the bottom of the defined I/O address range will be aligned to a 4 KB boundary.

B/D/F/Type:		0/1/0–2/PCI		
Address Offset:		1Ch		
Reset Value:		F0h		
Access:		RW		
Size:		8 bits		
BIOS Optimal Default		0h		
Bit	Attr	Reset Value	RST/PWR	Description
7:4	RW	Fh	Uncore	I/O Address Base (IOBASE) This field corresponds to A[15:12] of the I/O addresses passed by the root port to PCI Express-G.
3:0	RO	0h		Reserved

2.6.13 IOLIMIT1—I/O Limit Address Register

This register controls the processor to PCI Express-G I/O access routing based on the following formula:

$$\text{IO_BASE} \leq \text{address} \leq \text{IO_LIMIT}$$

Only upper 4 bits are programmable. For the purpose of address decode, address bits A[11:0] are assumed to be FFFh. Thus, the top of the defined I/O address range will be at the top of a 4 KB aligned address block.

B/D/F/Type:		0/1/0–2/PCI		
Address Offset:		1Dh		
Reset Value:		00h		
Access:		RW		
Size:		8 bits		
BIOS Optimal Default		0h		
Bit	Attr	Reset Value	RST/PWR	Description
7:4	RW	0h	Uncore	I/O Address Limit (IOLIMIT) This field corresponds to A[15:12] of the I/O address limit of the root port. Devices between this upper limit and IOBASE1 will be passed to the PCI Express hierarchy associated with this device.
3:0	RO	0h		Reserved

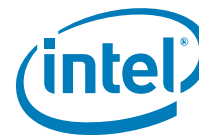

2.6.14 SSTS1—Secondary Status Register

SSTS is a 16-bit status register that reports the occurrence of error conditions associated with secondary side (that is, PCI Express-G side) of the "virtual" PCI-PCI bridge embedded within the processor.

B/D/F/Type:		0/1/0–2/PCI	
Address Offset:		1E–1Fh	
Reset Value:		0000h	
Access:		RW1C, RO	
Size:		16 bits	
BIOS Optimal Default		00h	

Bit	Attr	Reset Value	RST/PWR	Description
15	RW1C	0b	Uncore	Detected Parity Error (DPE) This bit is set by the Secondary Side for a Type 1 Configuration Space header device whenever it receives a Poisoned TLP, regardless of the state of the Parity Error Response Enable bit in the Bridge Control Register.
14	RW1C	0b	Uncore	Received System Error (RSE) This bit is set when the Secondary Side for a Type 1 configuration space header device receives an ERR_FATAL or ERR_NONFATAL.
13	RW1C	0b	Uncore	Received Master Abort (RMA) This bit is set when the Secondary Side for Type 1 Configuration Space Header Device (for requests initiated by the Type 1 Header Device itself) receives a Completion with Unsupported Request Completion Status.
12	RW1C	0b	Uncore	Received Target Abort (RTA) This bit is set when the Secondary Side for Type 1 Configuration Space Header Device (for requests initiated by the Type 1 Header Device itself) receives a Completion with Completer Abort Completion Status.
11	RO	0b	Uncore	Signaled Target Abort (STA) Not Applicable or Implemented. Hardwired to 0. The processor does not generate Target Aborts (The root port will never complete a request using the Completer Abort Completion status). UR detected inside the processor (such as in /MC will be reported in primary side status)
10:9	RO	00b	Uncore	DEVSELB Timing (DEVT) Not Applicable or Implemented. Hardwired to 0.
8	RW1C	0b	Uncore	Master Data Parity Error (SMDPE) When set, this bit indicates that the processor received across the link (upstream) a Read Data Completion Poisoned TLP (EP=1). This bit can only be set when the Parity Error Enable bit in the Bridge Control register is set.
7	RO	0b	Uncore	Fast Back-to-Back (FB2B) Not Applicable or Implemented. Hardwired to 0.
6:6	RO	0h		Reserved
5	RO	0b	Uncore	66/60 MHz capability (CAP66) Not Applicable or Implemented. Hardwired to 0.
4:0	RO	0h		Reserved



2.6.15 MBASE1—Memory Base Address Register

This register controls the processor to PCI Express-G non-prefetchable memory access routing based on the following formula:

$$\text{MEMORY_BASE} \leq \text{address} \leq \text{MEMORY_LIMIT}$$

The upper 12 bits of the register are read/write and correspond to the upper 12 address bits A[31:20] of the 32-bit address. The bottom 4 bits of this register are read-only and return zeroes when read. This register must be initialized by the configuration software. For the purpose of address decode, address bits A[19:0] are assumed to be 0. Thus, the bottom of the defined memory address range will be aligned to a 1 MB boundary.

B/D/F/Type:		0/1/0–2/PCI		
Address Offset:		20–21h		
Reset Value:		FFF0h		
Access:		RW		
Size:		16 bits		
BIOS Optimal Default		0h		
Bit	Attr	Reset Value	RST/PWR	Description
15:4	RW	FFFh	Uncore	Memory Address Base (MBASE) This field corresponds to A[31:20] of the lower limit of the memory range that will be passed to PCI Express-G.
3:0	RO	0h		Reserved



2.6.16 MLIMIT1—Memory Limit Address Register

This register controls the processor to PCI Express-G non-prefetchable memory access routing based on the following formula:

$$\text{MEMORY_BASE} \leq \text{address} \leq \text{MEMORY_LIMIT}$$

The upper 12 bits of the register are read/write and correspond to the upper 12 address bits A[31:20] of the 32-bit address. The bottom 4 bits of this register are read-only and return zeroes when read. This register must be initialized by the configuration software. For the purpose of address decode, address bits A[19:0] are assumed to be FFFFh. Thus, the top of the defined memory address range will be at the top of a 1 MB aligned memory block.

Note: Memory range covered by MBASE and MLIMIT registers are used to map non-prefetchable PCI Express-G address ranges (typically where control/status memory-mapped I/O data structures of the graphics controller will reside) and PMBASE and PMLIMIT are used to map prefetchable address ranges (typically graphics local memory). This segregation allows application of USWC space attribute to be performed in a true plug-and-play manner to the prefetchable address range for improved processor- PCI Express memory access performance.

Note: Configuration software is responsible for programming all address range registers (prefetchable, non-prefetchable) with the values that provide exclusive address ranges (that is, prevent overlap with each other and/or with the ranges covered with the main memory). There is no provision in the processor hardware to enforce prevention of overlap and operations of the system in the case of overlap are not ensured.

B/D/F/Type:		0/1/0-2/PCI		
Address Offset:		22-23h		
Reset Value:		0000h		
Access:		RW		
Size:		16 bits		
BIOS Optimal Default		0h		
Bit	Attr	Reset Value	RST/PWR	Description
15:4	RW	000h	Uncore	Memory Address Limit (MLIMIT) This field corresponds to A[31:20] of the upper limit of the address range passed to PCI Express-G.
3:0	RO	0h		Reserved



2.6.17 PMBASE1—Prefetchable Memory Base Address Register

This register in conjunction with the corresponding Upper Base Address register controls the processor to PCI Express-G prefetchable memory access routing based on the following formula:

$$\text{PREFETCHABLE_MEMORY_BASE} \leq \text{address} \leq \text{PREFETCHABLE_MEMORY_LIMIT}$$

The upper 12 bits of this register are read/write and correspond to address bits A[31:20] of the 40-bit address. The lower 8 bits of the Upper Base Address register are read/write and correspond to address bits A[39:32] of the 40-bit address. This register must be initialized by the configuration software. For the purpose of address decode, address bits A[19:0] are assumed to be 0. Thus, the bottom of the defined memory address range will be aligned to a 1 MB boundary.

B/D/F/Type:		0/1/0-2/PCI		
Address Offset:		24-25h		
Reset Value:		FFF1h		
Access:		RW, RO		
Size:		16 bits		
Bit	Attr	Reset Value	RST/PWR	Description
15:4	RW	FFFh	Uncore	Prefetchable Memory Base Address (PMBASE) This field corresponds to A[31:20] of the lower limit of the memory range that will be passed to PCI Express-G.
3:0	RO	1h	Uncore	64-bit Address Support (AS64) This field indicates that the upper 32 bits of the prefetchable memory region base address are contained in the Prefetchable Memory base Upper Address register at 28h.



2.6.18 PMLIMIT1—Prefetchable Memory Limit Address Register

This register in conjunction with the corresponding Upper Limit Address register controls the processor to PCI Express-G prefetchable memory access routing based on the following formula:

$$\text{PREFETCHABLE_MEMORY_BASE} \leq \text{address} \leq \text{PREFETCHABLE_MEMORY_LIMIT}$$

The upper 12 bits of this register are read/write and correspond to address bits A[31:20] of the 40-bit address. The lower 8 bits of the Upper Limit Address register are read/write and correspond to address bits A[39:32] of the 40-bit address. This register must be initialized by the configuration software. For the purpose of address decode, address bits A[19:0] are assumed to be FFFFh. Thus, the top of the defined memory address range will be at the top of a 1 MB aligned memory block.

Note: Prefetchable memory range is supported to allow segregation by the configuration software between the memory ranges that must be defined as UC and the ones that can be designated as a USWC (that is, prefetchable) from the processor perspective.

B/D/F/Type: Address Offset: Reset Value: Access: Size:		0/1/0-2/PCI 26-27h 0001h RW, RO 16 bits		
Bit	Attr	Reset Value	RST/PWR	Description
15:4	RW	000h	Uncore	Prefetchable Memory Address Limit (PMLIMIT) This field corresponds to A[31:20] of the upper limit of the address range passed to PCI Express-G.
3:0	RO	1h	Uncore	64-bit Address Support (AS64B) This field indicates that the upper 32 bits of the prefetchable memory region limit address are contained in the Prefetchable Memory Base Limit Address register at 2Ch



2.6.19 PMBASEU1—Prefetchable Memory Base Address Upper Register

The functionality associated with this register is present in the PEG design implementation. This register in conjunction with the corresponding Upper Base Address register controls the processor to PCI Express-G prefetchable memory access routing based on the following formula:

$$\text{PREFETCHABLE_MEMORY_BASE} \leq \text{address} \leq \text{PREFETCHABLE_MEMORY_LIMIT}$$

The upper 12 bits of this register are read/write and correspond to address bits A[31:20] of the 39-bit address. The lower 7 bits of the Upper Base Address register are read/write and correspond to address bits A[38:32] of the 39-bit address. This register must be initialized by the configuration software. For the purpose of address decode, address bits A[19:0] are assumed to be 0. Thus, the bottom of the defined memory address range will be aligned to a 1 MB boundary.

B/D/F/Type:		0/1/0–2/PCI		
Address Offset:		28–2Bh		
Reset Value:		00000000h		
Access:		RW		
Size:		32 bits		
Bit	Attr	Reset Value	RST/PWR	Description
31:0	RW	00000000h	Uncore	Prefetchable Memory Base Address (PMBASEU) This field corresponds to A[63:32] of the lower limit of the prefetchable memory range that will be passed to PCI Express-G.

2.6.20 PMLIMITU1—Prefetchable Memory Limit Address Upper Register

The functionality associated with this register is present in the PEG design implementation.

This register in conjunction with the corresponding Upper Limit Address register controls the processor to PCI Express-G prefetchable memory access routing based on the following formula:

$$\text{PREFETCHABLE_MEMORY_BASE} \leq \text{address} \leq \text{PREFETCHABLE_MEMORY_LIMIT}$$

The upper 12 bits of this register are read/write and correspond to address bits A[31:20] of the 39-bit address. The lower 7 bits of the Upper Limit Address register are read/write and correspond to address bits A[38:32] of the 39-bit address. This register must be initialized by the configuration software. For the purpose of address decode, address bits A[19:0] are assumed to be FFFFh. Thus, the top of the defined memory address range will be at the top of a 1 MB aligned memory block.

Note: Prefetchable memory range is supported to allow segregation by the configuration software between the memory ranges that must be defined as UC and the ones that can be designated as a USWC (that is, prefetchable) from the processor perspective.

B/D/F/Type:		0/1/0–2/PCI		
Address Offset:		2C–2Fh		
Reset Value:		00000000h		
Access:		RW		
Size:		32 bits		
Bit	Attr	Reset Value	RST/PWR	Description
31:0	RW	00000000h	Uncore	Prefetchable Memory Address Limit (PMLIMITU) This field corresponds to A[63:32] of the upper limit of the prefetchable Memory range that will be passed to PCI Express-G.



2.6.21 CAPPTR1—Capabilities Pointer Register

The capabilities pointer provides the address offset to the location of the first entry in this device's linked list of capabilities.

B/D/F/Type:		0/1/0-2/PCI		
Address Offset:		34h		
Reset Value:		88h		
Access:		RO		
Size:		8 bits		
Bit	Attr	Reset Value	RST/PWR	Description
7:0	RO	88h	Uncore	First Capability (CAPPTR1) The first capability in the list is the Subsystem ID and Subsystem Vendor ID Capability.

2.6.22 INTRLINE1—Interrupt Line Register

This register contains interrupt line routing information. The device itself does not use this value, rather it is used by device drivers and operating systems to determine priority and vector information.

B/D/F/Type:		0/1/0-2/PCI		
Address Offset:		3Ch		
Reset Value:		00h		
Access:		RW		
Size:		8 bits		
Bit	Attr	Reset Value	RST/PWR	Description
7:0	RW	00h	Uncore	Interrupt Connection (INTCON) Used to communicate interrupt line routing information. BIOS Requirement: POST software writes the routing information into this register as it initializes and configures the system. The value indicates to which input of the system interrupt controller this device's interrupt pin is connected.



2.6.23 INTRPIN1—Interrupt Pin Register

This register specifies which interrupt pin this device uses.

B/D/F/Type:		0/1/0–2/PCI		
Address Offset:		3Dh		
Reset Value:		01h		
Access:		RW-O, RO		
Size:		8 bits		
Bit	Attr	Reset Value	RST/PWR	Description
7:3	RO	00h	Uncore	Interrupt Pin High (INTRPINH)
2:0	RW-O	1h	Uncore	Interrupt Pin (INTRPIN) As a multifunction device, the PCI Express device may specify any INTx (x=A, B, C, D) as its interrupt pin. The Interrupt Pin register tells which interrupt pin the device (or device function) uses. 1h = Corresponds to INTA# (Default) 2h = Corresponds to INTB# 3h = Corresponds to INTC# 4h = Corresponds to INTD# 05h–FFh = Reserved. Devices (or device functions) that do not use an interrupt pin must put a 0 in this register. This register is write once. BIOS must set this register to select the INTx to be used by this root port.

2.6.24 BCTRL1—Bridge Control Register

This register provides extensions to the PCICMD register that are specific to PCI-to-PCI bridges. BCTRL1 provides additional control for the secondary interface (that is, PCI Express-G) as well as some bits that affect the overall behavior of the "virtual" Host-PCI Express bridge embedded within the processor (such as, VGA compatible address ranges mapping).

B/D/F/Type:		0/1/0–2/PCI		
Address Offset:		3E–3Fh		
Reset Value:		0000h		
Access:		RW, RO		
Size:		16 bits		
BIOS Optimal Default		0h		
Bit	Attr	Reset Value	RST/PWR	Description
15:12	RO	0h		Reserved
11	RO	0b	Uncore	Discard Timer SERR# Enable (DTSERRE) Not Applicable or Implemented. Hardwired to 0.
10	RO	0b	Uncore	Discard Timer Status (DTSTS) Not Applicable or Implemented. Hardwired to 0.
9	RO	0b	Uncore	Secondary Discard Timer (SDT) Not Applicable or Implemented. Hardwired to 0.
8	RO	0b	Uncore	Primary Discard Timer (PDT) Not Applicable or Implemented. Hardwired to 0.
7	RO	0b	Uncore	Fast Back-to-Back Enable (FB2BEN) Not Applicable or Implemented. Hardwired to 0.

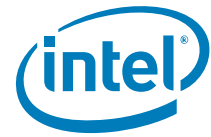

B/D/F/Type: 0/1/0-2/PCI Address Offset: 3E-3Fh Reset Value: 0000h Access: RW, RO Size: 16 bits BIOS Optimal Default: 0h				
Bit	Attr	Reset Value	RST/PWR	Description
6	RW	0b	Uncore	Secondary Bus Reset (SRESET) Setting this bit triggers a hot reset on the corresponding PCI Express Port. This will force the TXTSSM to transition to the Hot Reset state (using Recovery) from L0, L0s, or L1 states.
5	RO	0b	Uncore	Master Abort Mode (MAMODE) Does not apply to PCI Express. Hardwired to 0.
4	RW	0b	Uncore	VGA 16-bit Decode (VGA16D) This bit enables the PCI-to-PCI bridge to provide 16-bit decoding of VGA I/O address precluding the decoding of alias addresses every 1 KB. This bit only has meaning if bit 3 (VGA Enable) of this register is also set to 1, enabling VGA I/O decoding and forwarding by the bridge. 0 = Execute 10-bit address decodes on VGA I/O accesses. 1 = Execute 16-bit address decodes on VGA I/O accesses.
3	RW	0b	Uncore	VGA Enable (VGAEN) This bit controls the routing of processor-initiated transactions targeting VGA compatible I/O and memory address ranges. See the VGAEN/MDAP table in Device 0, offset 97h[0].
2	RW	0b	Uncore	ISA Enable (ISAEN) Needed to exclude legacy resource decode to route ISA resources to legacy decode path. Modifies the response by the root port to an I/O access issued by the processor that target ISA I/O addresses. This applies only to I/O addresses that are enabled by the IOBASE and IOLIMIT registers. 0 = All addresses defined by the IOBASE and IOLIMIT for processor I/O transactions will be mapped to PCI Express-G. 1 = The root port will not forward to PCI Express-G any I/O transactions addressing the last 768 bytes in each 1KB block even if the addresses are within the range defined by the IOBASE and IOLIMIT registers.
1	RW	0b	Uncore	SERR Enable (SERREN) 0 = No forwarding of error messages from secondary side to primary side that could result in an SERR. 1 = ERR_COR, ERR_NONFATAL, and ERR_FATAL messages result in SERR message when individually enabled by the Root Control register.
0	RW	0b	Uncore	Parity Error Response Enable (PEREN) This bit controls whether or not the Master Data Parity Error bit in the Secondary Status register is set when the root port receives across the link (upstream) a Read Data Completion Poisoned TLP 0 = Master Data Parity Error bit in Secondary Status register can NOT be set. 1 = Master Data Parity Error bit in Secondary Status register CAN be set.



2.6.25 PM_CAPID1—Power Management Capabilities Register

B/D/F/Type:		0/1/0–2/PCI		
Address Offset:		80–83h		
Reset Value:		C8039001h		
Access:		RO, RO-V		
Size:		32 bits		
Bit	Attr	Reset Value	RST/PWR	Description
31:27	RO	19h	Uncore	PME Support (PMES) This field indicates the power states in which this device may indicate PME wake using PCI Express messaging. D0, D3hot & D3cold. This device is not required to do anything to support D3hot & D3cold; it simply must report that those states are supported. Refer to the <i>PCI Power Management 1.1 Specification</i> for encoding explanation and other power management details.
26	RO	0b	Uncore	D2 Power State Support (D2PSS) Hardwired to 0 to indicate that the D2 power management state is NOT supported.
25	RO	0b	Uncore	D1 Power State Support (D1PSS) Hardwired to 0 to indicate that the D1 power management state is NOT supported.
24:22	RO	000b	Uncore	Auxiliary Current (AUXC) Hardwired to 0 to indicate that there are no 3.3Vaux auxiliary current requirements.
21	RO	0b	Uncore	Device Specific Initialization (DSI) Hardwired to 0 to indicate that special initialization of this device is NOT required before generic class device driver is to use it.
20	RO	0b	Uncore	Auxiliary Power Source (APS) Hardwired to 0.
19	RO	0b	Uncore	PME Clock (PMECLK) Hardwired to 0 to indicate this device does NOT support PME# generation.
18:16	RO	011b	Uncore	PCI PM CAP Version (PCIPMCV) Version - A value of 011b indicates that this function complies with revision 1.2 of the PCI Power Management Interface Specification.
15:8	RO-V	90h	Uncore	Pointer to Next Capability (PNC) This contains a pointer to the next item in the capabilities list. If MSICH (CAPL[0] @ 7Fh) is 0, then the next item in the capabilities list is the Message Signaled Interrupts (MSI) capability at 90h. If MSICH (CAPL[0] @ 7Fh) is 1, then the next item in the capabilities list is the PCI Express capability at A0h.
7:0	RO	01h	Uncore	Capability ID (CID) Value of 01h identifies this linked list item (capability structure) as being for PCI Power Management registers.



2.6.26 PM_CS1—Power Management Control/Status Register

B/D/F/Type:		0/1/0–2/PCI		
Address Offset:		84–87h		
Reset Value:		00000008h		
Access:		RO, RW		
Size:		32 bits		
BIOS Optimal Default		000000h		
Bit	Attr	Reset Value	RST/PWR	Description
31:16	RO	0h		Reserved
15	RO	0b	Uncore	PME Status (PMESTS) This bit indicates that this device does not support PME# generation from D3cold.
14:13	RO	00b	Uncore	Data Scale (DSCALE) This field indicates that this device does not support the power management data register.
12:9	RO	0h	Uncore	Data Select (DSEL) This field indicates that this device does not support the power management data register.
8	RW	0b	Uncore	PME Enable (PMEE) This bit indicates that this device does not generate PME# assertion from any D-state. 0 = PME# generation not possible from any D State 1 = PME# generation enabled from any D State The setting of this bit has no effect on hardware. See PM_CAP[15:11]
7:4	RO	0h		Reserved
3	RO	1b	Uncore	No Soft Reset (NSR) 1 = Device is transitioning from D3hot to D0 because the power state commands do not perform an internal reset. Configuration context is preserved. Upon transition, no additional operating system intervention is required to preserve configuration context beyond writing the power state bits. 0 = Devices do not perform an internal reset upon transitioning from D3hot to D0 using software control of the power state bits. Regardless of this bit, the devices that transition from a D3hot to D0 by a system or bus segment reset will return to the device state D0 uninitialized with only PME context preserved if PME is supported and enabled.
2	RO	0h		Reserved



B/D/F/Type:		0/1/0–2/PCI		
Address Offset:		84–87h		
Reset Value:		00000008h		
Access:		RO, RW		
Size:		32 bits		
BIOS Optimal Default		000000h		
Bit	Attr	Reset Value	RST/PWR	Description
1:0	RW	00b	Uncore	<p>Power State (PS)</p> <p>This field indicates the current power state of this device and can be used to set the device into a new power state. If software attempts to write an unsupported state to this field, the write operation must complete normally on the bus, but the data is discarded and no state change occurs.</p> <p>00 = D0 01 = D1 (Not supported in this device.) 10 = D2 (Not supported in this device.) 11 = D3</p> <p>Support of D3cold does not require any special action.</p> <p>While in the D3hot state, this device can only act as the target of PCI configuration transactions (for power management control). This device also cannot generate interrupts or respond to MMR cycles in the D3 state. The device must return to the D0 state in order to be fully-functional.</p> <p>When the Power State is other than D0, the bridge will Master Abort (that is, not claim) any downstream cycles (with the exception of type 0 configuration cycles). Consequently, these unclaimed cycles will go down DMI and come back up as Unsupported Requests, which the processor logs as Master Aborts in Device 0 PCISTS[13].</p> <p>There is no additional hardware functionality required to support these Power States.</p>

2.6.27 SS_CAPID—Subsystem ID and Vendor ID Capabilities Register

This capability is used to uniquely identify the subsystem where the PCI device resides. Because this device is an integrated part of the system and not an add-in device, it is anticipated that this capability will never be used. However, it is necessary because Microsoft will test for its presence.

B/D/F/Type:		0/1/0–2/PCI		
Address Offset:		88–8Bh		
Reset Value:		0000800Dh		
Access:		RO		
Size:		32 bits		
BIOS Optimal Default		0000h		
Bit	Attr	Reset Value	RST/PWR	Description
31:16	RO	0h		Reserved
15:8	RO	80h	Uncore	<p>Pointer to Next Capability (PNC)</p> <p>This contains a pointer to the next item in the capabilities list that is the PCI Power Management capability.</p>
7:0	RO	0Dh	Uncore	<p>Capability ID (CID)</p> <p>Value of 0Dh identifies this linked list item (capability structure) as being for SSID/SSVID registers in a PCI-to-PCI Bridge.</p>

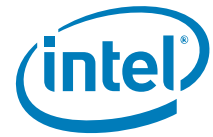

2.6.28 SS—Subsystem ID and Subsystem Vendor ID Register

System BIOS can be used as the mechanism for loading the SSID/SVID values. These values must be preserved through power management transitions and a hardware reset.

B/D/F/Type:		0/1/0–2/PCI		
Address Offset:		8C–8Fh		
Reset Value:		00008086h		
Access:		RW-O		
Size:		32 bits		
Bit	Attr	Reset Value	RST/ PWR	Description
31:16	RW-O	0000h	Uncore	Subsystem ID (SSID) Identifies the particular subsystem and is assigned by the vendor.
15:0	RW-O	8086h	Uncore	Subsystem Vendor ID (SSVID) Identifies the manufacturer of the subsystem and is the same as the vendor ID which is assigned by the PCI Special Interest Group.

2.6.29 MSI_CAPID—Message Signaled Interrupts Capability ID Register

When a device supports MSI, it can generate an interrupt request to the processor by writing a predefined data item (a message) to a predefined memory address.

The reporting of the existence of this capability can be disabled by setting MSICH (CAPL[0] @ 7Fh). In that case walking this linked list will skip this capability and instead go directly from the PCI PM capability to the PCI Express capability.

B/D/F/Type:		0/1/0–2/PCI		
Address Offset:		90–91h		
Reset Value:		A005h		
Access:		RO		
Size:		16 bits		
Bit	Attr	Reset Value	RST/ PWR	Description
15:8	RO	A0h	Uncore	Pointer to Next Capability (PNC) This contains a pointer to the next item in the capabilities list which is the PCI Express capability.
7:0	RO	05h	Uncore	Capability ID (CID) Value of 05h identifies this linked list item (capability structure) as being for MSI registers.



2.6.30 MC—Message Control Register

System software can modify bits in this register, but the device is prohibited from doing so.

If the device writes the same message multiple times, only one of those messages is ensured to be serviced. If all of them must be serviced, the device must not generate the same message again until the driver services the earlier one.

B/D/F/Type: 0/1/0–2/PCI Address Offset: 92–93h Reset Value: 0000h Access: RO, RW Size: 16 bits BIOS Optimal Default 00h				
Bit	Attr	Reset Value	RST/PWR	Description
15:8	RO	0h		Reserved
7	RO	0b	Uncore	64-bit Address Capable (B64AC) Hardwired to 0 to indicate that the function does not implement the upper 32 bits of the Message Address register and is incapable of generating a 64-bit memory address. This may need to change in future implementations when addressable system memory exceeds the 32b/4GB limit.
6:4	RW	000b	Uncore	Multiple Message Enable (MME) System software programs this field to indicate the actual number of messages allocated to this device. This number will be equal to or less than the number actually requested. The encoding is the same as for the MMC field below.
3:1	RO	000b	Uncore	Multiple Message Capable (MMC) System software reads this field to determine the number of messages being requested by this device. The encoding for the number of messages requested is: 000 = 1 All of the following are reserved in this implementation: 001 = 2 010 = 4 011 = 8 100 = 16 101 = 32 110 = Reserved 111 = Reserved
0	RW	0b	Uncore	MSI Enable (MSIEN) Controls the ability of this device to generate MSIs. 0 = MSI will not be generated. 1 = MSI will be generated when we receive PME messages. INTA will not be generated and INTA Status (PCISTS1[3]) will not be set.

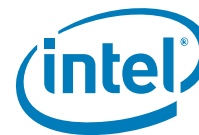

2.6.31 MA—Message Address Register

B/D/F/Type:		0/1/0–2/PCI		
Address Offset:		94–97h		
Reset Value:		00000000h		
Access:		RW, RO		
Size:		32 bits		
Bit	Attr	Reset Value	RST/PWR	Description
31:2	RW	00000000h	Uncore	Message Address (MA) Used by system software to assign an MSI address to the device. The device handles an MSI by writing the padded contents of the MD register to this address.
1:0	RO	00b	Uncore	Force DWord Align (FDWA) Hardwired to 0 so that addresses assigned by system software are always aligned on a dword address boundary.

2.6.32 MD—Message Data Register

B/D/F/Type:		0/1/0–2/PCI		
Address Offset:		98–99h		
Reset Value:		0000h		
Access:		RW		
Size:		16 bits		
Bit	Attr	Reset Value	RST/PWR	Description
15:0	RW	0000h	Uncore	Message Data (MD) Base message data pattern assigned by system software and used to handle an MSI from the device. When the device must generate an interrupt request, it writes a 32-bit value to the memory address specified in the MA register. The upper 16 bits are always set to 0. The lower 16 bits are supplied by this register.

2.6.33 PEG_CAPL—PCI Express-G Capability List Register

Enumerates the PCI Express capability structure.

B/D/F/Type:		0/1/0–2/PCI		
Address Offset:		A0–A1h		
Reset Value:		0010h		
Access:		RO		
Size:		16 bits		
Bit	Attr	Reset Value	RST/PWR	Description
15:8	RO	00h	Uncore	Pointer to Next Capability (PNC) This value terminates the capabilities list. The Virtual Channel capability and any other PCI Express specific capabilities that are reported using this mechanism are in a separate capabilities list located entirely within PCI Express Extended Configuration Space.
7:0	RO	10h	Uncore	Capability ID (CID) Identifies this linked list item (capability structure) as being for PCI Express registers.



2.6.34 PEG_CAP—PCI Express-G Capabilities Register

This register indicates PCI Express device capabilities.

B/D/F/Type:		0/1/0–2/PCI		
Address Offset:		A2–A3h		
Reset Value:		0142h		
Access:		RO, RW-O		
Size:		16 bits		
BIOS Optimal Default		0h		
Bit	Attr	Reset Value	RST/PWR	Description
15:14	RO	0h		Reserved
13:9	RO	00h	Uncore	Interrupt Message Number (IMN) Not Applicable or Implemented. Hardwired to 0.
8	RW-O	1b	Uncore	Slot Implemented (SI) 0 = The PCI Express Link associated with this port is connected to an integrated component or is disabled. 1 = The PCI Express Link associated with this port is connected to a slot. BIOS Requirement: This field must be initialized appropriately if a slot connection is not implemented.
7:4	RO	4h	Uncore	Device/Port Type (DPT) Hardwired to 4h to indicate root port of PCI Express Root Complex.
3:0	RO	2h	Uncore	PCI Express Capability Version (PCIECV) Hardwired to 2h to indicate compliance to the PCI Express Capabilities Register Expansion ECN.

2.6.35 DCAP—Device Capabilities Register

This register indicates PCI Express device capabilities.

B/D/F/Type:		0/1/0–2/PCI		
Address Offset:		A4–A7h		
Reset Value:		00008000h		
Access:		RO RW-O		
Size:		32 bits		
BIOS Optimal Default		0000000h		
Bit	Attr	Reset Value	RST/PWR	Description
31:16	RO	0h		Reserved
15	RO	1b	Uncore	Role Based Error Reporting (RBER) Indicates that this device implements the functionality defined in the Error Reporting ECN as required by the PCI Express 1.1 specification.
14:6	RO	0h		Reserved
5	RO	0b	Uncore	Extended Tag Field Supported (ETFS) Hardwired to indicate support for 5-bit Tags as a Requestor.
4:3	RO	00b	Uncore	Phantom Functions Supported (PFS) Not Applicable or Implemented. Hardwired to 0.
2:0	RW-O	000b	Uncore	Max Payload Size Default indicates 128B maximum supported payload for Transaction Layer Packets (TLP).

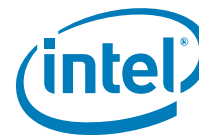

2.6.36 DCTL—Device Control Register

This register provides control for PCI Express device specific capabilities.

The error reporting enable bits are in reference to errors detected by this device, not error messages received across the link. The reporting of error messages (ERR_CORR, ERR_NONFATAL, ERR_FATAL) received by Root Port is controlled exclusively by Root Port Command Register.

B/D/F/Type:		0/1/0-2/PCI		
Address Offset:		A8-A9h		
Reset Value:		0000h		
Access:		RO RW		
Size:		16 bits		
BIOS Optimal Default		0h		
Bit	Attr	Reset Value	RST/PWR	Description
15:15	RO	0h		Reserved
14:12	RO	000b	Uncore	Reserved for Max Read Request Size (MRRS)
11	RO	0b	Uncore	Reserved for Enable No Snoop (NSE)
10:8	RO	0h		Reserved
7:5	RW	000b	Uncore	Max Payload Size 000 = 128B maximum payload for Transaction Layer Packets (TLP) All other encodings are reserved. As a receiver, the device must handle TLPs as larger as the value set in this field. As a transmitter, the device must not generate TLPs exceeding the value set in this field.
4	RO	0b	Uncore	Reserved for Enable Relaxed Ordering (ROE)
3	RW	0b	Uncore	Unsupported Request Reporting Enable (URRE) When set, allows signaling ERR_NONFATAL, ERR_FATAL, or ERR_CORR to the Root Control register when detecting an unmasked Unsupported Request (UR). An ERR_CORR is signaled when an unmasked Advisory Non-Fatal UR is received. An ERR_FATAL or ERR_NONFATAL is sent to the Root Control register when an uncorrectable non-Advisory UR is received with the severity bit set in the Uncorrectable Error Severity register.
2	RW	0b	Uncore	Fatal Error Reporting Enable (FERE) When set, enables signaling of ERR_FATAL to the Root Control register due to internally detected errors or error messages received across the link. Other bits also control the full scope of related error reporting.
1	RW	0b	Uncore	Non-Fatal Error Reporting Enable (NERE) When set, enables signaling of ERR_NONFATAL to the Root Control register due to internally detected errors or error messages received across the link. Other bits also control the full scope of related error reporting.
0	RW	0b	Uncore	Correctable Error Reporting Enable (CERE) When set, enables signaling of ERR_CORR to the Root Control register due to internally detected errors or error messages received across the link. Other bits also control the full scope of related error reporting.



2.6.37 DSTS—Device Status Register

Reflects status corresponding to controls in the Device Control register. The error reporting bits are in reference to errors detected by this device, not errors messages received across the link.

B/D/F/Type: Address Offset: Reset Value: Access: Size: BIOS Optimal Default		0/1/0–2/PCI AA–ABh 0000h RW1C, RO 16 bits 000h		
Bit	Attr	Reset Value	RST/PWR	Description
15:6	RO	0h		Reserved
5	RO	0b	Uncore	Transactions Pending (TP) 0 = All pending transactions (including completions for any outstanding non-posted requests on any used virtual channel) have been completed. 1 = Indicates that the device has transaction(s) pending (including completions for any outstanding non-posted requests for all used Traffic Classes). Not Applicable or Implemented. Hardwired to 0.
4:4	RO	0h		Reserved
3	RW1C	0b	Uncore	Unsupported Request Detected (URD) When set this bit indicates that the Device received an Unsupported Request. Errors are logged in this register regardless of whether error reporting is enabled or not in the Device Control Register. Additionally, the Non-Fatal Error Detected bit or the Fatal Error Detected bit is set according to the setting of the Unsupported Request Error Severity bit. In production systems setting the Fatal Error Detected bit is not an option as support for AER will not be reported.
2	RW1C	0b	Uncore	Fatal Error Detected (FED) When set this bit indicates that fatal error(s) were detected. Errors are logged in this register regardless of whether error reporting is enabled or not in the Device Control register. When Advanced Error Handling is enabled, errors are logged in this register regardless of the settings of the uncorrectable error mask register.
1	RW1C	0b	Uncore	Non-Fatal Error Detected (NFED) When set this bit indicates that non-fatal error(s) were detected. Errors are logged in this register regardless of whether error reporting is enabled or not in the Device Control register. When Advanced Error Handling is enabled, errors are logged in this register regardless of the settings of the uncorrectable error mask register.
0	RW1C	0b	Uncore	Correctable Error Detected (CED) When set this bit indicates that correctable error(s) were detected. Errors are logged in this register regardless of whether error reporting is enabled or not in the Device Control register. When Advanced Error Handling is enabled, errors are logged in this register regardless of the settings of the correctable error mask register.



2.6.38 LCTL—Link Control Register

This register allows control of PCI Express link.

B/D/F/Type: 0/1/0–2/PCI Address Offset: B0–B1h Reset Value: 0000h Access: RW, RO, RW-V Size: 16 bits BIOS Optimal Default: 00h				
Bit	Attr	Reset Value	RST/PWR	Description
15:12	RO	0h		Reserved
11	RW	0b	Uncore	Link Autonomous Bandwidth Interrupt Enable (LABIE) When Set, this bit enables the generation of an interrupt to indicate that the Link Autonomous Bandwidth Status bit has been Set. This bit is not applicable and is reserved for Endpoint devices, PCI Express to PCI/PCI-X bridges, and Upstream Ports of Switches. Devices that do not implement the Link Bandwidth Notification capability must hardwire this bit to 0b.
10	RW	0b	Uncore	Link Bandwidth Management Interrupt Enable (LBMIE) When Set, this bit enables the generation of an interrupt to indicate that the Link Bandwidth Management Status bit has been Set. This bit is not applicable and is reserved for Endpoint devices, PCI Express to PCI/PCI-X bridges, and Upstream Ports of Switches.
9	RW	0b	Uncore	Hardware Autonomous Width Disable (HAWD) When Set, this bit disables hardware from changing the Link width for reasons other than attempting to correct unreliable Link operation by reducing Link width. Devices that do not implement the ability autonomously to change Link width are permitted to hardwire this bit to 0b.
8	RO	0b	Uncore	Enable Clock Power Management (ECPM) Applicable only for form factors that support a "Clock Request" (CLKREQ#) mechanism, this enable functions as follows 0 = Clock power management is disabled and device must hold CLKREQ# signal low 1 = When this bit is set to 1 the device is permitted to use CLKREQ# signal to power manage link clock according to protocol defined in the appropriate form factor specification. Components that do not support Clock Power Management (as indicated by a 0b value in the Clock Power Management bit of the Link Capabilities Register) must hardwire this bit to 0b.
7	RW	0b	Uncore	Extended Synch (ES) 0 = Standard Fast Training Sequence (FTS). 1 = Forces the transmission of additional ordered sets when exiting the L0s state and when in the Recovery state. This mode provides external devices (such as, logic analyzers) monitoring the Link time to achieve bit and symbol lock before the link enters L0 and resumes communication. This is a test mode only and may cause other undesired side effects such as buffer overflows or underruns.



B/D/F/Type:		0/1/0-2/PCI		
Address Offset:		B0-B1h		
Reset Value:		0000h		
Access:		RW, RO, RW-V		
Size:		16 bits		
BIOS Optimal Default		00h		
Bit	Attr	Reset Value	RST/PWR	Description
6	RW	0b	Uncore	<p>Common Clock Configuration (CCC)</p> <p>0 = Indicates that this component and the component at the opposite end of this Link are operating with asynchronous reference clock.</p> <p>1 = Indicates that this component and the component at the opposite end of this Link are operating with a distributed common reference clock.</p> <p>The state of this bit affects the L0s Exit Latency reported in LCAP[14:12] and the N_FTS value advertised during link training. See LOSLAT at offset 22Ch.</p>
5	RW-V	0b	Uncore	<p>Retrain Link (RL)</p> <p>0 = Normal operation.</p> <p>1 = Full Link retraining is initiated by directing the Physical Layer TXTSSM from L0, L0s, or L1 states to the Recovery state.</p> <p>This bit always returns 0 when read. This bit is cleared automatically (no need to write a 0).</p>
4	RW	0b	Uncore	<p>Link Disable (LD)</p> <p>0 = Normal operation</p> <p>1 = Link is disabled. Forces the TXTSSM to transition to the Disabled state (using Recovery) from L0, L0s, or L1 states. Link retraining happens automatically on 0 to 1 transition, just like when coming out of reset.</p> <p>Writes to this bit are immediately reflected in the value read from the bit, regardless of actual Link state.</p>
3	RO	0b	Uncore	<p>Read Completion Boundary (RCB)</p> <p>Hardwired to 0 to indicate 64 byte.</p>
2:2	RO	0h		Reserved
1:0	RW	00b	Uncore	<p>Active State PM (ASPM)</p> <p>This field controls the level of ASPM (Active State Power Management) supported on the given PCI Express Link.</p> <p>00 = Disabled</p> <p>01 = L0s Entry Supported</p> <p>10 = Reserved</p> <p>11 = L0s and L1 Entry Supported</p>



2.6.39 LSTS—Link Status Register

This register indicates PCI Express link status.

B/D/F/Type: 0/1/0–2/PCI Address Offset: B2–B3h Reset Value: 1001h Access: RO-V, RW1C, RO Size: 16 bits BIOS Optimal Default: 0h				
Bit	Attr	Reset Value	RST/PWR	Description
15	RW1C	0b	Uncore	Link Autonomous Bandwidth Status (LABWS) This bit is set to 1 by hardware to indicate that hardware has autonomously changed link speed or width, without the port transitioning through DL_Down status, for reasons other than to attempt to correct unreliable link operation. This bit must be set if the Physical Layer reports a speed or width change was initiated by the downstream component that was indicated as an autonomous change.
14	RW1C	0b	Uncore	Link Bandwidth Management Status (LBWMS) This bit is set to 1 by hardware to indicate that either of the following has occurred without the port transitioning through DL_Down status: <ul style="list-style-type: none"> A link retraining initiated by a write of 1b to the Retrain Link bit has completed. Note that this bit is set following any write of 1b to the Retrain Link bit, including when the Link is in the process of retraining for some other reason. <ul style="list-style-type: none"> Hardware has autonomously changed link speed or width to attempt to correct unreliable link operation, either through an TXTSSM time-out or a higher level process. This bit must be set if the Physical Layer reports a speed or width change was initiated by the downstream component that was not indicated as an autonomous change.
13	RO-V	0b	Uncore	Data Link Layer Link Active (Optional) (DLLLA) This bit indicates the status of the Data Link Control and Management State Machine. It returns a 1b to indicate the DL_Active state, 0b otherwise. This bit must be implemented if the corresponding Data Link Layer Active Capability bit is implemented. Otherwise, this bit must be hardwired to 0b.
12	RO	1b	Uncore	Slot Clock Configuration (SCC) 0 = The device uses an independent clock irrespective of the presence of a reference on the connector. 1 = The device uses the same physical reference clock that the platform provides on the connector.
11	RO-V	0b	Uncore	Link Training (TXTRN) This bit indicates that the Physical Layer TXTSSM is in the Configuration or Recovery state, or that 1b was written to the Retrain Link bit but Link training has not yet begun. Hardware clears this bit when the TXTSSM exits the Configuration/Recovery state once Link training is complete.



B/D/F/Type: Address Offset: Reset Value: Access: Size: BIOS Optimal Default		0/1/0–2/PCI B2–B3h 1001h RO-V, RW1C, RO 16 bits 0h		
Bit	Attr	Reset Value	RST/PWR	Description
10:10	RO	0h		Reserved
9:4	RO-V	00h	Uncore	Negotiated Link Width (NLW) This field indicates negotiated link width. This field is valid only when the link is in the L0, L0s, or L1 states (after link width negotiation is successfully completed). 00h = Reserved 01h = X1 02h = X2 04h = X4 08h = X8 10h = X16 All other encodings are reserved.
3:0	RO-V	1h	Uncore	Current Link Speed (CLS) This field indicates the negotiated Link speed of the given PCI Express Link. 0001b = 2.5 GT/s PCI Express Link 0010b = 5.0 GT/s PCI Express Link All other encodings are reserved. The value in this field is undefined when the Link is not up.

2.6.40 SLOTCAP—Slot Capabilities Register

PCI Express Slot related registers allow for the support of Hot Plug.

B/D/F/Type: Address Offset: Reset Value: Access: Size:		0/1/0–2/PCI B4–B7h 00040000h RW-O, RO 32 bits		
Bit	Attr	Reset Value	RST/PWR	Description
31:19	RW-O	0000h	Uncore	Physical Slot Number (PSN) This field indicates the physical slot number attached to this Port. BIOS Requirement: This field must be initialized by BIOS to a value that assigns a slot number that is globally unique within the chassis.
18	RO	1b	Uncore	No Command Completed Support (NCCS) When set to 1, this bit indicates that this slot does not generate software notification when an issued command is completed by the Hot-Plug Controller. This bit is only permitted to be set to 1b if the hotplug capable port is able to accept writes to all fields of the Slot Control register without delay between successive writes.
17	RO	0b	Uncore	Reserved for Electromechanical Interlock Present (EIP) When set to 1, this bit indicates that an Electromechanical Interlock is implemented on the chassis for this slot.

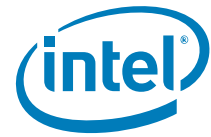

B/D/F/Type: Address Offset: Reset Value: Access: Size:		0/1/0-2/PCI B4-B7h 00040000h RW-O, RO 32 bits		
Bit	Attr	Reset Value	RST/PWR	Description
16:15	RW-O	00b	Uncore	Slot Power Limit Scale (SPLS) This field specifies the scale used for the Slot Power Limit Value. 00 = 1.0x 01 = 0.1x 10 = 0.01x 11 = 0.001x If this field is written, the link sends a Set_Slot_Power_Limit message.
14:7	RW-O	00h	Uncore	Slot Power Limit Value (SPLV) In combination with the Slot Power Limit Scale value, specifies the upper limit on power supplied by slot. Power limit (in Watts) is calculated by multiplying the value in this field by the value in the Slot Power Limit Scale field. If this field is written, the link sends a Set_Slot_Power_Limit message.
6	RO	0b	Uncore	Reserved for Hot-plug Capable (HPC) When set to 1, this bit indicates that this slot is capable of supporting hot-plug operations.
5	RO	0b	Uncore	Reserved for Hot-plug Surprise (HPS) When set to 1, this bit indicates that an adapter present in this slot might be removed from the system without any prior notification. This is a form factor specific capability. This bit is an indication to the operating system to allow for such removal without impacting continued software operation.
4	RO	0b	Uncore	Reserved for Power Indicator Present (PIP) When set to 1, this bit indicates that a Power Indicator is electrically controlled by the chassis for this slot.
3	RO	0b	Uncore	Reserved for Attention Indicator Present (AIP) When set to 1b, this bit indicates that an Attention Indicator is electrically controlled by the chassis.
2	RO	0b	Uncore	Reserved for MRL Sensor Present (MSP) When set to 1, this bit indicates that an MRL Sensor is implemented on the chassis for this slot.
1	RO	0b	Uncore	Reserved for Power Controller Present (PCP) When set to 1, this bit indicates that a software programmable Power Controller is implemented for this slot/adapter (depending on form factor).
0	RO	0b	Uncore	Reserved for Attention Button Present (ABP) When set to 1, this bit indicates that an Attention Button for this slot is electrically controlled by the chassis.



2.6.41 SLOTCTL—Slot Control Register

PCI Express Slot related registers allow for the support of Hot Plug.

B/D/F/Type:		0/1/0–2/PCI		
Address Offset:		B8–B9h		
Reset Value:		0000h		
Access:		RO		
Size:		16 bits		
BIOS Optimal Default		0h		
Bit	Attr	Reset Value	RST/PWR	Description
15:13	RO	0h		Reserved
12	RO	0b	Uncore	<p>Reserved for Data Link Layer State Changed Enable (DLLSCE) Reserved for Data Link Layer State Changed Enable (DLLSCE): If the Data Link Layer Link Active capability is implemented, when set to 1b, this field enables software notification when Data Link Layer Link Active field is changed. If the Data Link Layer Link Active capability is not implemented, this bit is permitted to be read-only with a value of 0b.</p>
11	RO	0b	Uncore	<p>Reserved for Electromechanical Interlock Control (EIC) If an Electromechanical Interlock is implemented, a write of 1b to this field causes the state of the interlock to toggle. A write of 0b to this field has no effect. A read to this register always returns a 0.</p>
10	RO	0b	Uncore	<p>Reserved for Power Controller Control (PCC) If a Power Controller is implemented, this field when written sets the power state of the slot per the defined encodings. Reads of this field must reflect the value from the latest write, even if the corresponding hotplug command is not complete, unless software issues a write without waiting for the previous command to complete in which case the read value is undefined. Depending on the form factor, the power is turned on/off either to the slot or within the adapter. Note that in some cases the power controller may autonomously remove slot power or not respond to a power-up request based on a detected fault condition, independent of the Power Controller Control setting. The defined encodings are: 0 = Power On 1 = Power Off If the Power Controller Implemented field in the Slot Capabilities register is set to 0b, then writes to this field have no effect and the read value of this field is undefined.</p>
9:8	RO	00b	Uncore	<p>Reserved Power Indicator Control (PIC) If a Power Indicator is implemented, writes to this field set the Power Indicator to the written state. Reads of this field must reflect the value from the latest write, even if the corresponding hot-plug command is not complete, unless software issues a write without waiting for the previous command to complete in which case the read value is undefined. 00 = Reserved 01 = On 10 = Blink 11 = Off If the Power Indicator Present bit in the Slot Capabilities register is 0b, this field is permitted to be read-only with a value of 00b.</p>

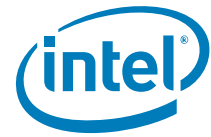

B/D/F/Type: 0/1/0-2/PCI Address Offset: B8-B9h Reset Value: 0000h Access: RO Size: 16 bits BIOS Optimal Default: 0h				
Bit	Attr	Reset Value	RST/PWR	Description
7:6	RO	00b	Uncore	Reserved for Attention Indicator Control (AIC) If an Attention Indicator is implemented, writes to this field set the Attention Indicator to the written state. Reads of this field must reflect the value from the latest write, even if the corresponding hot-plug command is not complete, unless software issues a write without waiting for the previous command to complete in which case the read value is undefined. If the indicator is electrically controlled by chassis, the indicator is controlled directly by the downstream port through implementation specific mechanisms. 00 = Reserved 01 = On 10 = Blink 11 = Off If the Attention Indicator Present bit in the Slot Capabilities register is 0b, this field is permitted to be read only with a value of 00b.
5	RO	0b	Uncore	Reserved for Hot-plug Interrupt Enable (HPIE) When set to 1, this bit enables generation of an interrupt on enabled hot-plug events. If the Hot Plug Capable field in the Slot Capabilities register is set to 0, this bit is permitted to be read only with a value of 0.
4	RO	0b	Uncore	Reserved for Command Completed Interrupt Enable (CCI) If Command Completed notification is supported (as indicated by No Command Completed Support field of Slot Capabilities Register), when set to 1b, this bit enables software notification when a hot-plug command is completed by the Hot-Plug Controller. Reset Value of this field is 0. If Command Completed notification is not supported, this bit must be hardwired to 0.
3	RO	0b	Uncore	Presence Detect Changed Enable (PDCE) When set to 1b, this bit enables software notification on a presence detect changed event.
2	RO	0b	Uncore	Reserved for MRL Sensor Changed Enable (MSCE) When set to 1b, this bit enables software notification on a MRL sensor changed event. Reset Value of this field is 0b. If the MRL Sensor Present field in the Slot Capabilities register is set to 0b, this bit is permitted to be read-only with a value of 0b.
1	RO	0b	Uncore	Reserved for Power Fault Detected Enable (PFDE) When set to 1b, this bit enables software notification on a power fault event. Reset Value of this field is 0b. If Power Fault detection is not supported, this bit is permitted to be read-only with a value of 0b.
0	RO	0b	Uncore	Reserved for Attention Button Pressed Enable (ABPE) When set to 1b, this bit enables software notification on an attention button pressed event.



2.6.42 SLOTSTS—Slot Status Register

PCI Express Slot related registers.

B/D/F/Type:		0/1/0–2/PCI		
Address Offset:		BA–BBh		
Reset Value:		0000h		
Access:		RO, RO-V, RW1C		
Size:		16 bits		
BIOS Optimal Default		00h		
Bit	Attr	Reset Value	RST/PWR	Description
15:9	RO	0h		Reserved
8	RO	0b	Uncore	Reserved for Data Link Layer State Changed (DLLSC) This bit is set when the value reported in the Data Link Layer Link Active field of the Link Status register is changed. In response to a Data Link Layer State Changed event, software must read the Data Link Layer Link Active field of the Link Status register to determine if the link is active before initiating configuration cycles to the hot plugged device.
7	RO	0b	Uncore	Reserved for Electromechanical Interlock Status (EIS) If an Electromechanical Interlock is implemented, this bit indicates the current status of the Electromechanical Interlock. 0 = Electromechanical Interlock Disengaged 1 = Electromechanical Interlock Engaged
6	RO-V	0b	Uncore	Presence Detect State (PDS) In band presence detect state: 0 = Slot Empty 1 = Card present in slot This bit indicates the presence of an adapter in the slot, reflected by the logical "OR" of the Physical Layer in-band presence detect mechanism and, if present, any out-of-band presence detect mechanism defined for the slot's corresponding form factor. Note that the in-band presence detect mechanism requires that power be applied to an adapter for its presence to be detected. Consequently, form factors that require a power controller for hot-plug must implement a physical pin presence detect mechanism. 0 = Slot Empty 1 = Card Present in slot This register must be implemented on all Downstream Ports that implement slots. For Downstream Ports not connected to slots (where the Slot Implemented bit of the PCI Express Capabilities Register is 0b), this bit must return 1b.
5	RO	0b	Uncore	Reserved for MRL Sensor State (MSS) This register reports the status of the MRL sensor if it is implemented. 0 = MRL Closed 1 = MRL Open
4	RO	0b	Uncore	Reserved for Command Completed (CC) If Command Completed notification is supported (as indicated by No Command Completed Support field of Slot Capabilities Register), this bit is set when a hot-plug command has completed and the Hot-Plug Controller is ready to accept a subsequent command. The Command Completed status bit is set as an indication to host software that the Hot-Plug Controller has processed the previous command and is ready to receive the next command; it provides no guarantee that the action corresponding to the command is complete. If Command Completed notification is not supported, this bit must be hardwired to 0b.



B/D/F/Type: Address Offset: Reset Value: Access: Size: BIOS Optimal Default		0/1/0–2/PCI BA–BBh 0000h RO, RO-V, RW1C 16 bits 00h		
Bit	Attr	Reset Value	RST/PWR	Description
3	RW1C	0b	Uncore	Presence Detect Changed (PDC) A pulse indication that the inband presence detect state has changed This bit is set when the value reported in Presence Detect State is changed.
2	RO	0b	Uncore	Reserved for MRL Sensor Changed (MSC) If an MRL sensor is implemented, this bit is set when a MRL Sensor state change is detected. If an MRL sensor is not implemented, this bit must not be set.
1	RO	0b	Uncore	Reserved for Power Fault Detected (PFD) If a Power Controller that supports power fault detection is implemented, this bit is set when the Power Controller detects a power fault at this slot. Note that, depending on hardware capability, it is possible that a power fault can be detected at any time, independent of the Power Controller Control setting or the occupancy of the slot. If power fault detection is not supported, this bit must not be set.
0	RO	0b	Uncore	Reserved for Attention Button Pressed (ABP) If an Attention Button is implemented, this bit is set when the attention button is pressed. If an Attention Button is not supported, this bit must not be set.



2.6.43 RCTL—Root Control Register

This register allows control of PCI Express Root Complex specific parameters. The system error control bits in this register determine if corresponding SERRs are generated when our device detects an error (reported in this device's Device Status register) or when an error message is received across the link. Reporting of SERR as controlled by these bits takes precedence over the SERR Enable in the PCI Command Register.

B/D/F/Type:		0/1/0–2/PCI		
Address Offset:		BC–BDh		
Reset Value:		0000h		
Access:		RO, RW		
Size:		16 bits		
BIOS Optimal Default		000h		
Bit	Attr	Reset Value	RST/PWR	Description
15:3	RO	0h		Reserved
2	RW	0b	Uncore	System Error on Fatal Error Enable (SEFEE) Controls the Root Complex's response to fatal errors. 0 = No SERR generated on receipt of fatal error. 1 = Indicates that an SERR should be generated if a fatal error is reported by any of the devices in the hierarchy associated with this Root Port, or by the Root Port itself.
1:0	RO	0h		Reserved

2.6.44 LCTL2—Link Control 2 Register

B/D/F/Type:		0/1/0–2/PCI		
Address Offset:		D0–D1h		
Reset Value:		0002h		
Access:		RWS, RWS-V		
Size:		16 bits		
BIOS Optimal Default		0h		
Bit	Attr	Reset Value	RST/PWR	Description
15:13	RO	0h		Reserved
12	RWS	0b	Powergood	Compliance De-emphasis (ComplianceDeemphasis) This bit sets the de-emphasis level in Polling.Compliance state if the entry occurred due to the Enter Compliance bit being 1b. 1 = -3.5 dB 0 = -6 dB When the Link is operating at 2.5 GT/s, the setting of this bit has no effect. Components that support only 2.5 GT/s speed are permitted to hardwire this bit to 0b. For a Multi-Function device associated with an Upstream Port, the bit in Function 0 is of type RWS, and only Function 0 controls the component's Link behavior. In all other Functions of that device, this bit is of type RsvdP. This bit is intended for debug, compliance testing purposes. System firmware and software is allowed to modify this bit only during debug or compliance testing.

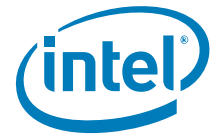

B/D/F/Type: 0/1/0-2/PCI Address Offset: D0-D1h Reset Value: 0002h Access: RWS, RWS-V Size: 16 bits BIOS Optimal Default: 0h				
Bit	Attr	Reset Value	RST/PWR	Description
11	RWS	0b	Powergood	Compliance SOS (compos) When set to 1b, the TXTSSM is required to send SKP Ordered Sets periodically in between the (modified) compliance patterns. For a Multi-Function device associated with an Upstream Port, the bit in Function 0 is of type RWS, and only Function 0 controls the component's Link behavior. In all other Functions of that device, this bit is of type RsvdP. The Reset Value of this bit is 0b. Components that support only the 2.5 GT/s speed are permitted to hardwire this field to 0b.
10	RWS	0b	Powergood	Enter Modified Compliance (entermodcompliance) When this bit is set to 1b, the device transmits modified compliance pattern if the TXTSSM enters Polling.Compliance state. Components that support only the 2.5GT/s speed are permitted to hardwire this bit to 0b.
9:7	RWS-V	000b	Powergood	Transmit Margin (txmargin) This field controls the value of the non-deemphasized voltage level at the Transmitter pins. This field is reset to 000b on entry to the TXTSSM Polling.Configuration substate. Encodings: 000 = Normal operating range 001 = 800-1200 mV for full swing and 400-700 mV for half-swing 010 - (n-1) = Values must be monotonic with a non-zero slope. The value of n must be greater than 3 and less than 7. At least two of these must be below the normal operating range n = 200-400 mV for full-swing and 100-200 mV for half-swing n -111 = Reserved Reset Value is 000b. Components that support only the 2.5 GT/s speed are permitted to hardwire this bit to 0b. When operating in 5 GT/s mode with full swing, the de-emphasis ratio must be maintained within +/- 1dB from the spec defined operational value (either -3.5 or -6 dB).
6	RWS	0b	Powergood	Selectable De-emphasis (selectabledeemphasis) When the Link is operating at 5GT/s speed, selects the level of de-emphasis. Encodings: 1 = -3.5 dB 0 = -6 dB Reset Value is implementation specific, unless a specific value is required for a selected form factor or platform. When the Link is operating at 2.5 GT/s speed, the setting of this bit has no effect. Components that support only the 2.5 GT/s speed are permitted to hardwire this bit to 0b.
5:5	RO	0h		Reserved
4	RWS	0b	Powergood	Enter Compliance (EC) Software is permitted to force a link to enter Compliance mode at the speed indicated in the Target Link Speed field by setting this bit to 1b in both components on a link and then initiating a hot reset on the link.



B/D/F/Type: 0/1/0–2/PCI Address Offset: D0–D1h Reset Value: 0002h Access: RWS, RWS-V Size: 16 bits BIOS Optimal Default: 0h				
Bit	Attr	Reset Value	RST/PWR	Description
3:0	RWS	2h	Powergood	<p>Target Link Speed (TLS)</p> <p>For Downstream ports, this field sets an upper limit on link operational speed by restricting the values advertised by the upstream component in its training sequences.</p> <p>Defined encodings are: 0001 = 2.5 Gb/s Target Link Speed 0010 = 5Gb/s Target Link Speed All other encodings are reserved.</p> <p>If a value is written to this field that does not correspond to a speed included in the Supported Link Speeds field, the result is undefined.</p> <p>The Reset Value of this field is the highest link speed supported by the component (as reported in the Supported Link Speeds field of the Link Capabilities Register) unless the corresponding platform / form factor requires a different Reset Value.</p> <p>For both Upstream and Downstream ports, this field is used to set the target compliance mode speed when software is using the Enter Compliance bit to force a link into compliance mode.</p>

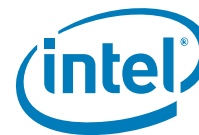

2.7 PCI Device 1 Function 0–2 Extended Configuration

Table 2-9 lists the registers arranged by address offset. Register bit descriptions are in the sections following the table.

Table 2-9. PCI Device 1 Function 0–2 Extended Configuration Register Address Map

Address Offset	Register Symbol	Register Name	Reset Value	Access
0–FFh	RSVD	Reserved	0h	RO
100–103h	RSVD	Reserved	14010002h	RO-V, RO
104–107h	PVCCAP1	Port VC Capability Register 1	00000000h	RO
108–10Bh	PVCCAP2	Port VC Capability Register 2	00000000h	RO
10C–10Dh	PVCCTL	Port VC Control	0000h	RW, RO
10E–10Fh	RSVD	Reserved	0h	RO
110–113h	VCORCAP	VC0 Resource Capability	00000001h	RO
114–117h	VCORCTL	VC0 Resource Control	800000FFh	RO, RW
118–119h	RSVD	Reserved	0h	RO
11A–11Bh	VCORSTS	VC0 Resource Status	0002h	RO-V
11C–207h	RSVD	Reserved	—	—
208–20Bh	PEG_TC	PCI Express Completion Time-out	00007000h	RW
20C–D37h	RSVD	Reserved	—	—

2.7.1 PVCCAP1—Port VC Capability Register 1

This register describes the configuration of PCI Express Virtual Channels associated with this port.

B/D/F/Type:		0/1/0–2/MMR		
Address Offset:		104–107h		
Reset Value:		00000000h		
Access:		RO		
Size:		32 bits		
BIOS Optimal Default		0000000h		
Bit	Attr	Reset Value	RST/PWR	Description
31:7	RO	0h		Reserved
6:4	RO	000b	Uncore	Low Priority Extended VC Count (LPEVCC) This field indicates the number of (extended) Virtual Channels in addition to the default VC belonging to the low-priority VC (LPVC) group that has the lowest priority with respect to other VC resources in a strict-priority VC Arbitration. The value of 0 in this field implies strict VC arbitration.
3:3	RO	0h		Reserved
2:0	RO	000b	Uncore	Extended VC Count (EVCC) This field indicates the number of (extended) Virtual Channels in addition to the default VC supported by the device.



2.7.2 PVCCAP2—Port VC Capability Register 2

This register describes the configuration of PCI Express Virtual Channels associated with this port.

B/D/F/Type:		0/1/0–2/MMR		
Address Offset:		108–10Bh		
Reset Value:		0000000h		
Access:		RO		
Size:		32 bits		
BIOS Optimal Default		0000h		
Bit	Attr	Reset Value	RST/PWR	Description
31:24	RO	00h	Uncore	VC Arbitration Table Offset (VCATO) Indicates the location of the VC Arbitration Table. This field contains the zero-based offset of the table in DQWORDS (16 bytes) from the base address of the Virtual Channel Capability Structure. A value of 0 indicates that the table is not present (due to fixed VC priority).
23:8	RO	0h		Reserved
7:0	RO	00h	Uncore	Reserved for VC Arbitration Capability (VCAC)

2.7.3 PVCCTL—Port VC Control Register

B/D/F/Type:		0/1/0–2/MMR		
Address Offset:		10C–10Dh		
Reset Value:		0000h		
Access:		RW, RO		
Size:		16 bits		
BIOS Optimal Default		000h		
Bit	Attr	Reset Value	RST/PWR	Description
15:4	RO	0h		Reserved
3:1	RW	000b	Uncore	VC Arbitration Select (VCAS) This field will be programmed by software to the only possible value as indicated in the VC Arbitration Capability field. Since there is no other VC supported than the default, this field is reserved.
0	RO	0b	Uncore	Reserved for Load VC Arbitration Table (VCARB) Used for software to update the VC Arbitration Table when VC arbitration uses the VC Arbitration Table. As a VC Arbitration Table is never used by this component this field will never be used.



2.7.4 VCORCAP—VCO Resource Capability Register

B/D/F/Type:		0/1/0–2/MMR	
Address Offset:		110–113h	
Reset Value:		00000001h	
Access:		RO	
Size:		32 bits	
BIOS Optimal Default		00h	

Bit	Attr	Reset Value	RST/PWR	Description
31:24	RO	00h	Uncore	Reserved for Port Arbitration Table Offset (PATO)
23:23	RO	0h		Reserved
22:16	RO	00h	Uncore	Reserved for Maximum Time Slots (MTS)
15	RO	0b	Uncore	Reject Snoop Transactions (RSNPT) 0 = Transactions with or without the No Snoop bit set within the TLP header are allowed on this VC. 1 = Any transaction for which the No Snoop attribute is applicable but is not Set within the TLP Header will be rejected as an Unsupported Request
14:8	RO	0h		Reserved
7:0	RO	01h	Uncore	Port Arbitration Capability (PAC) This field indicates types of Port Arbitration Supported by the VC resource. This field is valid for all Switch Ports, Root Ports that support peer-to-peer traffic, and RCRBs, but not for PCI Express Endpoint devices or Root Ports that do not support peer to peer traffic. Each bit location within this field corresponds to a Port Arbitration Capability defined below. When more than one bit in this field is set, it indicates that the VC resource can be configured to provide different arbitration services. Software selects among these capabilities by writing to the Port Arbitration Select field (see below). Defined bit positions are: Bit 0 Non-configurable hardware-fixed arbitration scheme, such as, Round Robin (RR) Bit 1 Weighted Round Robin (WRR) arbitration with 32 phases Bit 2 WRR arbitration with 64 phases Bit 3 WRR arbitration with 128 phases Bit 4 Time-based WRR with 128 phases Bit 5 WRR arbitration with 256 phases Bits 6–7 Reserved Processor only supported arbitration indicates "Non-configurable hardware-fixed arbitration scheme".



2.7.5 VCORCTL—VCO Resource Control Register

This register controls the resources associated with PCI Express Virtual Channel 0.

B/D/F/Type:		0/1/0–2/MMR		
Address Offset:		114–117h		
Reset Value:		80000FFh		
Access:		RO, RW		
Size:		32 bits		
BIOS Optimal Default		000h		
Bit	Attr	Reset Value	RST/PWR	Description
31	RO	1b	Uncore	VCO Enable (VCOE) For VCO, this is hardwired to 1 and read only as VCO can never be disabled.
30:27	RO	0h		Reserved
26:24	RO	000b	Uncore	VCO ID (VCOID) Assigns a VC ID to the VC resource. For VCO, this is hardwired to 0 and read only.
23:20	RO	0h		Reserved
19:17	RW	000b	Uncore	Port Arbitration Select (PAS) This field configures the VC resource to provide a particular Port Arbitration service. This field is valid for RCRBs, Root Ports that support peer-to-peer traffic, and Switch Ports, but not for PCI Express Endpoint devices or Root Ports that do not support peer-to-peer traffic. The permissible value of this field is a number corresponding to one of the asserted bits in the Port Arbitration Capability field of the VC resource. This field does not affect the root port behavior.
16:16	RO	0h		Reserved
15:8	RW	00h	Uncore	TC High VCO Map (TCHVCOM) Allow usage of high order TCs. BIOS should keep this field zeroed to allow usage of the reserved TC[3] for other purposes.
7:1	RW	7Fh	Uncore	TC/VCO Map (TCVCOM) Indicates the TCs (Traffic Classes) that are mapped to the VC resource. Bit locations within this field correspond to TC values. For example, when bit 7 is set in this field, TC7 is mapped to this VC resource. When more than one bit in this field is set, it indicates that multiple TCs are mapped to the VC resource. To remove one or more TCs from the TC/VC Map of an enabled VC, software must ensure that no new or outstanding transactions with the TC labels are targeted at the given Link.
0	RO	1b	Uncore	TC0/VCO Map (TCOVCOM) Traffic Class 0 is always routed to VCO.



2.7.6 VCORSTS—VCO Resource Status Register

This register reports the Virtual Channel specific status.

B/D/F/Type:		0/1/0–2/MMR		
Address Offset:		11A–11Bh		
Reset Value:		0002h		
Access:		RO-V		
Size:		16 bits		
BIOS Optimal Default		0000h		
Bit	Attr	Reset Value	RST/PWR	Description
15:2	RO	0h		Reserved
1	RO-V	1b	Uncore	<p>VCO Negotiation Pending (VCONP) 0 = The VC negotiation is complete. 1 = The VC resource is still in the process of negotiation (initialization or disabling).</p> <p>This bit indicates the status of the process of Flow Control initialization. It is set by default on Reset, as well as whenever the corresponding Virtual Channel is Disabled or the Link is in the DL_Down state. It is cleared when the link successfully exits the FC_INIT2 state.</p> <p>Before using a Virtual Channel, software must check whether the VC Negotiation Pending fields for that Virtual Channel are cleared in both Components on a Link.</p>
0:0	RO	0h		Reserved

2.7.7 PEG_TC—PCI Express Completion Time-out Register

This register reports PCI Express configuration control of PCI Express Completion Time-out related parameters that are not required by the PCI Express specification.

B/D/F/Type:		0/1/0–2/MMR		
Address Offset:		208–20Bh		
Access:		RW		
Bit	Attr	Reset Value	RST/PWR	Description
31:15	RO	00000000 00000000 0b		Reserved
14:12	RW	111b		<p>PCI Express Completion Time-out (PEG_TC) This register determines the number of milliseconds the Transaction Layer will wait to receive an expected completion. To avoid hang conditions, the Transaction Layer will generate a dummy completion to the requestor if it does not receive the completion within this time period.</p> <p>000 = Disable 001 = Reserved 010 = Reserved 100 = Reserved 101 = Reserved 110 = Reserved x11 = 48 ms – for normal operation</p>
11:0	RO	00000000 0000b		Reserved



2.8 PCI Device 2 Configuration Space

Table 2-10 lists the registers arranged by address offset. Register bit descriptions are in the sections following the table.

Table 2-10. PCI Device 2 Configuration Register Address Map

Address Offset	Register Symbol	Register Name	Reset Value	Access
0–1h	VID2	Vendor Identification	8086h	RO
2–3h	DID2	Device Identification	0102h	RO-V, RO-FW
4–5h	PCICMD2	PCI Command	0000h	RW, RO
6–7h	PCISTS2	PCI Status	0090h	RO, RO-V
8h	RID2	Revision Identification	00h	RO-FW
9–Bh	CC	Class Code	030000h	RO-V, RO
Ch	CLS	Cache Line Size	00h	RO
Dh	MTXT2	Master Latency Timer	00h	RO
Eh	HDR2	Header Type	00h	RO
Fh	RSVD	Reserved	0h	RO
10–17h	GTTMMADR	Graphics Translation Table, Memory Mapped Range Address	00000000 0000004h	RW, RO
18–1Fh	GMADR	Graphics Memory Range Address	00000000 000000Ch	RO, RW-L, RW
20–23h	IOBAR	I/O Base Address	00000001h	RW, RO
24–2Bh	RSVD	Reserved	0h	RO
2C–2Dh	SVID2	Subsystem Vendor Identification	0000h	RW-O
2E–2Fh	SID2	Subsystem Identification	0000h	RW-O
30–33h	ROMADR	Video BIOS ROM Base Address	00000000h	RO
34h	RSVD	Reserved	90h	RO-V
35–3Bh	RSVD	Reserved	0h	RO
3Ch	RSVD	Reserved	00h	RW
3Dh	INTRPIN	Interrupt Pin	01h	RO
3Eh	MINGNT	Minimum Grant	00h	RO
3Fh	MAXLAT	Maximum Latency	00h	RO
40–61h	RSVD	Reserved	—	—
62–62h	MSAC	Multi Size Aperture Control	02h	RW, RW-K
63–FFh	RSVD	Reserved	—	—



2.8.1 VID2—Vendor Identification Register

This register, combined with the Device Identification register, uniquely identifies any PCI device.

B/D/F/Type:		0/2/0/PCI		
Address Offset:		0-1h		
Reset Value:		8086h		
Access:		RO		
Size:		16 bits		
Bit	Attr	Reset Value	RST/PWR	Description
15:0	RO	8086h	Uncore	Vendor Identification Number (VID) PCI standard identification for Intel.

2.8.2 DID2—Device Identification Register

This register, combined with the Vendor Identification register, uniquely identifies any PCI device. This is a 16-bit value assigned to processor graphics device.

B/D/F/Type:		0/2/0/PCI		
Address Offset:		2-3h		
Reset Value:		0102h		
Access:		RO-V, RO-FW		
Size:		16 bits		
Bit	Attr	Reset Value	RST/PWR	Description
15:4	RO-FW	010h	Uncore	Device Identification Number MSB (DID_MSB) This is the upper part of a 16-bit value assigned to the Graphics device.
3:2	RO-V	00b	Uncore	Device Identification Number - SKU (DID_SKU) These are bits 3:2 of the 16-bit value assigned to processor graphics device. SKU 3:2 Mobile 01 Versatile Acceleration 00 If MGGC0[VAMEN] then DID2[3:2] ≤ '10'b Else If CAPID0_A[DIDOE] = 1 then DID2[3:2] ≤ DIDOVR[1:0] Else DID2[3:2] ≤ CAPID0_A[CDID]
1:0	RO-V	10b	Uncore	Device Identification Number LSB (DID_LSB) This is the lower part of a 16-bit value assigned to the processor graphics device.



2.8.3 PCICMD2—PCI Command Register

This 16-bit register provides basic control over the IGD's ability to respond to PCI cycles. The PCICMD Register in the IGD disables the IGD PCI compliant master accesses to main memory.

B/D/F/Type:		0/2/0/PCI		
Address Offset:		4–5h		
Reset Value:		0000h		
Access:		RW, RO		
Size:		16 bits		
BIOS Optimal Default		00h		
Bit	Attr	Reset Value	RST/PWR	Description
15:11	RO	0h		Reserved
10	RW	0b	FLR, Uncore	Interrupt Disable (INTDIS) This bit disables the device from asserting INTx#. 0 = Enable the assertion of this device's INTx# signal. 1 = Disable the assertion of this device's INTx# signal. DO_INTx messages will not be sent to DMI.
9	RO	0b	Uncore	Fast Back-to-Back (FB2B) Not Implemented. Hardwired to 0.
8	RO	0b	Uncore	SERR Enable (SERRE) Not Implemented. Hardwired to 0.
7	RO	0b	Uncore	Address/Data Stepping Enable (ADSTEP) Not Implemented. Hardwired to 0.
6	RO	0b	Uncore	Parity Error Enable (PERRE) Not Implemented. Hardwired to 0. Since the IGD belongs to the category of devices that does not corrupt programs or data in system memory or hard drives, the IGD ignores any parity error that it detects and continues with normal operation.
5	RO	0b	Uncore	Video Palette Snooping (VPS) This bit is hardwired to 0 to disable snooping.
4	RO	0b	Uncore	Memory Write and Invalidate Enable (MWIE) Hardwired to 0. The IGD does not support memory write and invalidate commands.
3	RO	0b	Uncore	Special Cycle Enable (SCE) This bit is hardwired to 0. The IGD ignores Special cycles.
2	RW	0b	FLR, Uncore	Bus Master Enable (BME) 0 = Disable IGD bus mastering. 1 = Enable the IGD to function as a PCI compliant master.
1	RW	0b	FLR, Uncore	Memory Access Enable (MAE) This bit controls the IGD's response to memory space accesses. 0 = Disable. 1 = Enable.
0	RW	0b	FLR, Uncore	I/O Access Enable (IOAE) This bit controls the IGD's response to I/O space accesses. 0 = Disable. 1 = Enable.

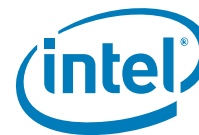

2.8.4 PCISTS2—PCI Status Register

PCISTS is a 16-bit status register that reports the occurrence of a PCI compliant master abort and PCI compliant target abort. PCISTS also indicates the DEVSEL# timing that has been set by the IGD.

B/D/F/Type:		0/2/0/PCI		
Address Offset:		6–7h		
Reset Value:		0090h		
Access:		RO, RO-V		
Size:		16 bits		
BIOS Optimal Default		0h		
Bit	Attr	Reset Value	RST/PWR	Description
15	RO	0b	Uncore	Detected Parity Error (DPE) Since the IGD does not detect parity, this bit is always hardwired to 0.
14	RO	0b	Uncore	Signaled System Error (SSE) The IGD never asserts SERR#; therefore, this bit is hardwired to 0.
13	RO	0b	Uncore	Received Master Abort Status (RMAS) The IGD never gets a Master Abort; therefore, this bit is hardwired to 0.
12	RO	0b	Uncore	Received Target Abort Status (RTAS) The IGD never gets a Target Abort; therefore, this bit is hardwired to 0.
11	RO	0b	Uncore	Signaled Target Abort Status (STAS) Hardwired to 0. The IGD does not use target abort semantics.
10:9	RO	00b	Uncore	DEVSEL Timing (DEVT) Not applicable. These bits are hardwired to "00".
8	RO	0b	Uncore	Master Data Parity Error Detected (DPD) Since Parity Error Response is hardwired to disabled (and the IGD does not do any parity detection), this bit is hardwired to 0.
7	RO	1b	Uncore	Fast Back-to-Back (FB2B) Hardwired to 1. The IGD accepts fast back-to-back when the transactions are not to the same agent.
6	RO	0b	Uncore	User Defined Format (UDF) Hardwired to 0.
5	RO	0b	Uncore	66 MHz PCI Capable (C66) Not applicable. Hardwired to 0.
4	RO	1b	Uncore	Capability List (CLIST) This bit is set to 1 to indicate that the register at 34h provides an offset into the function's PCI Configuration Space containing a pointer to the location of the first item in the list.
3	RO-V	0b	Uncore	Interrupt Status (INTSTS) This bit reflects the state of the interrupt in the device. Only when the Interrupt Disable bit in the Command register is a 0 and this Interrupt Status bit is a 1, will the devices INTx# signal be asserted.
2:0	RO	0h		Reserved

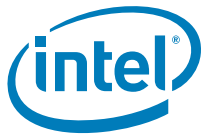

2.8.5 RID2—Revision Identification Register

This register contains the revision number for Device 2 Functions 0. These bits are read only and writes to this register have no effect.

B/D/F/Type:		0/2/0/PCI		
Address Offset:		8h		
Reset Value:		00h		
Access:		RO-FW		
Size:		8 bits		
Bit	Attr	Reset Value	RST/PWR	Description
7:4	RO-FW	0h	Uncore	Revision Identification Number MSB (RID_MSB) Four MSB of RID. Refer to the <i>Intel® Core™ Processor Family Mobile Specification update</i> for the value of the RID register.
3:0	RO-FW	0h	Uncore	Revision Identification Number (RID) Four LSB of RID. Refer to the <i>Intel® Core™ Processor Family Mobile Specification update</i> for the value of the RID register.

2.8.6 CC—Class Code Register

This register contains the device programming interface information related to the Sub-Class Code and Base Class Code definition for the IGD. This register also contains the Base Class Code and the function sub-class in relation to the Base Class Code.

B/D/F/Type:		0/2/0/PCI		
Address Offset:		9-Bh		
Reset Value:		030000h		
Access:		RO-V, RO		
Size:		24 bits		
Bit	Attr	Reset Value	RST/PWR	Description
23:16	RO-V	03h	Uncore	Base Class Code (BCC) This is an 8-bit value that indicates the base class code. When MGGC0[VAMEN] is 0, this code has the value 03h indicating a Display Controller. When MGGC0[VAMEN] is 1, this code has the value 04h indicating a Multimedia Device.
15:8	RO-V	00h	Uncore	Sub-Class Code (SUBCC) When MGGC0[VAMEN] is 0 this value will be determined based on Device 0 GGC register; GMS and IVD fields. 00h = VGA compatible 80h = Non VGA (GMS = "00h" or IVD = "1b") When MGGC0[VAMEN] is 1, this value is 80h indicating other multimedia device.
7:0	RO	00h	Uncore	Programming Interface (PI) When MGGC0[VAMEN] is 0, this value is 00h indicating a Display Controller. When MGGC0[VAMEN] is 1, this value is 00h indicating a NOP.

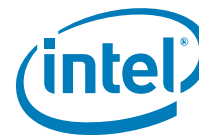

2.8.7 CLS—Cache Line Size Register

The IGD does not support this register as a PCI slave.

B/D/F/Type:		0/2/0/PCI		
Address Offset:		Ch		
Reset Value:		00h		
Access:		RO		
Size:		8 bits		
Bit	Attr	Reset Value	RST/PWR	Description
7:0	RO	00h	Uncore	Cache Line Size (CLS) This field is hardwired to 0s. The IGD as a PCI compliant master does not use the Memory Write and Invalidate command and, in general, does not perform operations based on cache line size.

2.8.8 MTXT2—Master Latency Timer Register

The IGD does not support the programmability of the master latency timer because it does not perform bursts.

B/D/F/Type:		0/2/0/PCI		
Address Offset:		Dh		
Reset Value:		00h		
Access:		RO		
Size:		8 bits		
Bit	Attr	Reset Value	RST/PWR	Description
7:0	RO	00h	Uncore	Master Latency Timer Count Value (MTXTCV) Hardwired to 0s.

2.8.9 HDR2—Header Type Register

This register contains the Header Type of the IGD.

B/D/F/Type:		0/2/0/PCI		
Address Offset:		Eh		
Reset Value:		00h		
Access:		RO		
Size:		8 bits		
Bit	Attr	Reset Value	RST/PWR	Description
7	RO	0b	Uncore	Multi Function Status (MFUNC) This bit indicates if the device is a Multi-Function Device. The Value of this register is hardwired to 0; the processor graphics is a single function.
6:0	RO	00h	Uncore	Header Code (H) This is a 7-bit value that indicates the Header Code for the IGD. This code has the value 00h, indicating a type 0 configuration space format.



2.8.10 GTTMMADR—Graphics Translation Table, Memory Mapped Range Address Register

This register requests allocation for the combined Graphics Translation Table Modification Range and Memory Mapped Range. The range requires 4 MB combined for MMIO and Global GTT aperture, with 2MB of that used by MMIO and 2 MB used by GTT. GTTADR will begin at (GTTMMADR + 2 MB) while the MMIO base address will be the same as GTTMMADR.

For the Global GTT, this range is defined as a memory BAR in graphics device configuration space. It is an alias into which software is required to write Page Table Entry values (PTEs). Software may read PTE values from the global Graphics Translation Table (GTT). PTEs cannot be written directly into the global GTT memory area.

The device snoops writes to this region in order to invalidate any cached translations within the various TLBs implemented on-chip.

The allocation is for 4 MB and the base address is defined by bits 38:22.

B/D/F/Type:		0/2/0/PCI		
Address Offset:		10–17h		
Reset Value:		0000000000000004h		
Access:		RW, RO		
Size:		64 bits		
Bit	Attr	Reset Value	RST/PWR	Description
63:39	RW	0000000h	FLR, Uncore	Reserved for Memory Base Address (RSVDRW) Must be set to 0 since addressing above 512 GB is not supported.
38:22	RW	00000h	FLR, Uncore	Memory Base Address (MBA) Set by the OS, these bits correspond to address signals [38:22]. 4 MB combined for MMIO and Global GTT table aperture (2 MB for MMIO and 2 MB for GTT).
21:4	RO	00000h	Uncore	Address Mask (ADM) Hardwired to 0s to indicate at least 4 MB address range.
3	RO	0b	Uncore	Prefetchable Memory (PREFMEM) Hardwired to 0 to prevent prefetching.
2:1	RO	10b	Uncore	Memory Type (MEMTYP) 00 = To indicate 32 bit base address 01 = Reserved 10 = To indicate 64 bit base address 11 = Reserved
0	RO	0b	Uncore	Memory/IO Space (MIOS) Hardwired to 0 to indicate memory space.

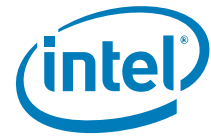

2.8.11 GMADR—Graphics Memory Range Address Register

GMADR is the PCI aperture used by software to access tiled GFX surfaces in a linear fashion.

B/D/F/Type:		0/2/0/PCI		
Address Offset:		18–1Fh		
Reset Value:		000000000000000Ch		
Access:		RO, RW-L, RW		
Size:		64 bits		
Bit	Attr	Reset Value	RST/PWR	Description
63:39	RW	0000000h	FLR, Uncore	Reserved for Memory Base Address (RSVDRW) Must be set to 0 since addressing above 512 GB is not supported.
38:29	RW	00000000 00b	FLR, Uncore	Memory Base Address (MBA) Memory Base Address (MBA): Set by the OS, these bits correspond to address signals [38:29].
28	RW-L	0b	FLR, Uncore	512 MB Address Mask (ADMSK512) This Bit is either part of the Memory Base Address (RW) or part of the Address Mask (RO), depending on the value of MSAC[2:1]. See MSAC (Device 2 Function 0, offset 62h) for details.
27	RW-L	0b	FLR, Uncore	256 MB Address Mask (ADMSK256) This bit is either part of the Memory Base Address (R/W) or part of the Address Mask (RO), depending on the value of MSAC[2:1]. See MSAC (Device 2 Function 0, offset 62h) for details.
26:4	RO	000000h	Uncore	Address Mask (ADM) Hardwired to 0s to indicate at least 128 MB address range.
3	RO	1b	Uncore	Prefetchable Memory (PREFMEM) Hardwired to 1 to enable prefetching.
2:1	RO	10b	Uncore	Memory Type (MEMTYP) 00 = 32-bit address. 10 = 64-bit address
0	RO	0b	Uncore	Memory/IO Space (MIOS) Hardwired to 0 to indicate memory space.



2.8.12 IOBAR—I/O Base Address Register

This register provides the Base offset of the I/O registers within Device 2. Bits 15:6 are programmable allowing the I/O Base to be located anywhere in 16-bit I/O Address Space. Bits 2:1 are fixed and return zero; bit 0 is hardwired to a one indicating that 8 bytes of I/O space are decoded. Access to the 8Bs of I/O space is allowed in PM state D0 when I/O Enable (PCICMD bit 0) is set. Access is disallowed in PM states D1-D3 or if I/O Enable is clear or if Device 2 is turned off.

Note that access to this I/O BAR is independent of VGA functionality within Device 2.

If accesses to this I/O bar is allowed, then all 8, 16, or 32 bit I/O cycles from IA cores that falls within the 8B are claimed.

B/D/F/Type:		0/2/0/PCI		
Address Offset:		20–23h		
Reset Value:		0000001h		
Access:		RW, RO		
Size:		32 bits		
BIOS Optimal Default		0000h		
Bit	Attr	Reset Value	RST/PWR	Description
31:16	RO	0h		Reserved
15:6	RW	000h	FLR, Uncore	I/O Base Address (IOBASE) Set by the OS, these bits correspond to address signals [15:6].
5:3	RO	0h		Reserved
2:1	RO	00b	Uncore	Memory Type (MEMTYPE) Hardwired to 0s to indicate 32-bit address.
0	RO	1b	Uncore	Memory/I/O Space (MIOS) Hardwired to 1 to indicate IO space.

2.8.13 SVID2—Subsystem Vendor Identification Register

This register is used to uniquely identify the subsystem where the PCI device resides.

B/D/F/Type:		0/2/0/PCI		
Address Offset:		2C–2Dh		
Reset Value:		0000h		
Access:		RW-O		
Size:		16 bits		
Bit	Attr	Reset Value	RST/PWR	Description
15:0	RW-O	0000h	Uncore	Subsystem Vendor ID (SUBVID) This value is used to identify the vendor of the subsystem. This register should be programmed by BIOS during boot-up. Once written, this register becomes Read Only. This register can only be cleared by a Reset.



2.8.14 SID2—Subsystem Identification Register

This register is used to uniquely identify the subsystem where the PCI device resides.

B/D/F/Type:		0/2/0/PCI		
Address Offset:		2E–2Fh		
Reset Value:		0000h		
Access:		RW-O		
Size:		16 bits		
Bit	Attr	Reset Value	RST/PWR	Description
15:0	RW-O	0000h	Uncore	Subsystem Identification (SUBID) This value is used to identify a particular subsystem. This field should be programmed by BIOS during boot-up. Once written, this register becomes Read Only. This register can only be cleared by a Reset.

2.8.15 ROMADR—Video BIOS ROM Base Address Register

The IGD does not use a separate BIOS ROM; therefore, this register is hardwired to 0s.

B/D/F/Type:		0/2/0/PCI		
Address Offset:		30–33h		
Reset Value:		00000000h		
Access:		RO		
Size:		32 bits		
BIOS Optimal Default		000h		
Bit	Attr	Reset Value	RST/PWR	Description
31:18	RO	0000h	Uncore	ROM Base Address (RBA) Hardwired to 0s.
17:11	RO	00h	Uncore	Address Mask (ADMSK) Hardwired to 0s to indicate 256 KB address range.
10:1	RO	0h		Reserved
0	RO	0b	Uncore	ROM BIOS Enable (RBE) 0 = ROM not accessible.

2.8.16 INTRPIN—Interrupt Pin Register

This register indicates which interrupt pin the device uses. The Integrated Graphics Device uses INTA#.

B/D/F/Type:		0/2/0/PCI		
Address Offset:		3Dh		
Reset Value:		01h		
Access:		RO		
Size:		8 bits		
Bit	Attr	Reset Value	RST/PWR	Description
7:0	RO	01h	Uncore	Interrupt Pin (INTRPIN) As a single function device, the IGD specifies INTA# as its interrupt pin. 01h =INTA#.



2.8.17 MINGNT—Minimum Grant Register

The Integrated Graphics Device has no requirement for the settings of Latency Timers.

B/D/F/Type:		0/2/0/PCI		
Address Offset:		3Eh		
Reset Value:		00h		
Access:		RO		
Size:		8 bits		
Bit	Attr	Reset Value	RST/PWR	Description
7:0	RO	00h	Uncore	Minimum Grant Value (MGV) The IGD does not burst as a PCI compliant master.

2.8.18 MAXLAT—Maximum Latency Register

The Integrated Graphics Device has no requirement for the settings of Latency Timers.

B/D/F/Type:		0/2/0/PCI		
Address Offset:		3Fh		
Reset Value:		00h		
Access:		RO		
Size:		8 bits		
Bit	Attr	Reset Value	RST/PWR	Description
7:0	RO	00h	Uncore	Maximum Latency Value (MLV) The IGD has no specific requirements for how often it needs to access the PCI bus.

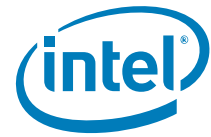

2.8.19 MSAC—Multi Size Aperture Control Register

This register determines the size of the graphics memory aperture in function 0 and in the trusted space. Only the system BIOS will write this register based on pre-boot address allocation efforts; however, the graphics may read this register to determine the correct aperture size. System BIOS needs to save this value on boot so that it can reset it correctly during S3 resume.

Note: This register is Intel TXT locked and becomes read only when the trusted environment is launched.

B/D/F/Type:		0/2/0/PCI		
Address Offset:		62h		
Reset Value:		02h		
Access:		RW, RW-K		
Size:		8 bits		
BIOS Optimal Default		0h		
Bit	Attr	Reset Value	RST/PWR	Description
7:3	RO	0h		Reserved
2	RW-K	0b	Uncore	Untrusted Aperture Size High (LHSASH) This field is used in conjunction with LHSASL. The description below is for both fields (LHSASH and LHSASL). 11b = Bits [28:27] of GMADR are RO, allowing 512 MB of GMADR 10b = Illegal Programming 01b = Bit [28] of GMADR is RW but bit [27] of GMADR is RO, allowing 256 MB of GMADR 00b = Bits [28:27] of GMADR are RW, allowing 128 MB of GMADR
1	RW-K	1b	Uncore	Untrusted Aperture Size Low (LHSASL) This field is used in conjunction with LHSASH. The description below is for both fields (LHSASH and LHSASL). 11b = Bits [28:27] of GMADR are RO, allowing 512 MB of GMADR 10b = Illegal Programming 01b = Bit [28] of GMADR is RW but bit [27] of GMADR is RO, allowing 256 MB of GMADR 00b = Bits [28:27] of GMADR are RW, allowing 128 MB of GMADR
0	RO	0h		Reserved



2.9 Device 2 IO

Table 2-11. Device 2 IO Register Address Map

Address Offset	Register Symbol	Register Name	Reset Value	Access
0–3h	Index	MMIO Address Register	00000000h	RW
4–7h	Data	MMIO Data Register	00000000h	RW

2.9.1 INDEX—MMIO Address Register

A 32-bit I/O write to this port loads the offset of the MMIO register or offset into the GTT that needs to be accessed. An I/O Read returns the current value of this register.

This mechanism to access internal graphics MMIO registers must not be used to access VGA IO registers which are mapped through the MMIO space. VGA registers must be accessed directly through the dedicated VGA IO ports.

B/D/F/Type: 0/2/0/PCI IO Address Offset: 0–3h Reset Value: 00000000h Access: RW Size: 32 bits BIOS Optimal Default: 00000000h				
Bit	Attr	Reset Value	RST/PWR	Description
31:21	RO	0h		Reserved
20:2	RW	00000h	FLR, Uncore	Register/GTT Offset (REGGTO) This field selects any one of the DWORD registers within the MMIO register space of Device 2 if the target is MMIO Registers. This field selects a GTT offset if the target is the GTT.
1:0	RW	00b	FLR, Uncore	Target (TARG) 00 = MMIO Registers 01 = GTT 1X = Reserved

2.9.2 DATA—MMIO Data Register

A 32-bit I/O write to this port is re-directed to the MMIO register/GTT location pointed to by the INDEX register. A 32 bit IO read to this port is re-directed to the MMIO register/GTT location pointed to by the INDEX register.

B/D/F/Type: 0/2/0/PCI IO Address Offset: 4–7h Reset Value: 00000000h Access: RW Size: 32 bits				
Bit	Attr	Reset Value	RST/PWR	Description
31:0	RW	00000000h	FLR, Uncore	MMIO Data Window (DATA) This field is the data field associated with the IO2MMIO access.

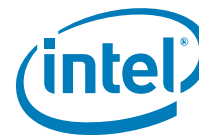

2.10 PCI Device 6

Table 2-12 lists the registers arranged by address offset. Register bit descriptions are in the sections following the table.

Table 2-12. PCI Device 6 Register Address Map (Sheet 1 of 2)

Address Offset	Register Symbol	Register Name	Reset Value	Access
0–1h	VID6	Vendor Identification	8086h	RO
2–3h	DID6	Device Identification	010Dh	RO-FW
4–5h	PCICMD6	PCI Command	0000h	RW, RO
6–7h	PCISTS6	PCI Status	0010h	RW1C, RO, RO-V
8h	RID6	Revision Identification	00h	RO-FW
9–Bh	CC6	Class Code	060400h	RO
Ch	CL6	Cache Line Size	00h	RW
Dh	RSVD	Reserved	0h	RO
Eh	HDR6	Header Type	01h	RO
F–17h	RSVD	Reserved	0h	RO
18h	PBUSN6	Primary Bus Number	00h	RO
19h	SBUSN6	Secondary Bus Number	00h	RW
1Ah	SUBUSN6	Subordinate Bus Number	00h	RW
1Bh	RSVD	Reserved	0h	RO
1Ch	IOBASE6	I/O Base Address	F0h	RW
1Dh	IOLIMIT6	I/O Limit Address	00h	RW
1E–1Fh	SSTS6	Secondary Status	0000h	RW1C, RO
20–21h	MBASE6	Memory Base Address	FFF0h	RW
22–23h	MLIMIT6	Memory Limit Address	0000h	RW
24–25h	PMBASE6	Prefetchable Memory Base Address	FFF1h	RW, RO
26–27h	PMLIMIT6	Prefetchable Memory Limit Address	0001h	RW, RO
28–2Bh	PMBASEU6	Prefetchable Memory Base Address Upper	00000000h	RW
2C–2Fh	PMLIMITU6	Prefetchable Memory Limit Address Upper	00000000h	RW
30–33h	RSVD	Reserved	0h	RO
34h	CAPPTR6	Capabilities Pointer	88h	RO
35–3Bh	RSVD	Reserved	0h	RO
3Ch	INTRLINE6	Interrupt Line	00h	RW
3Dh	INTRPIN6	Interrupt Pin	01h	RW-O, RO
3E–3Fh	BCTRL6	Bridge Control	0000h	RO, RW
40–7Fh	RSVD	Reserved	0h	RO
80–83h	PM_CAPID6	Power Management Capabilities	C8039001h	RO, RO-V
84–87h	PM_CS6	Power Management Control/Status	00000008h	RO, RW
88–8Bh	SS_CAPID	Subsystem ID and Vendor ID Capabilities	0000800Dh	RO
8C–8Fh	SS	Subsystem ID and Subsystem Vendor ID	00008086h	RW-O
90–91h	MSI_CAPID	Message Signaled Interrupts Capability ID	A005h	RO

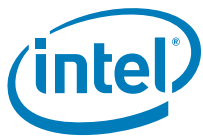
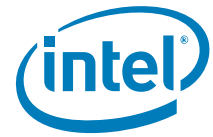

Table 2-12. PCI Device 6 Register Address Map (Sheet 2 of 2)

Address Offset	Register Symbol	Register Name	Reset Value	Access
92–93h	MC	Message Control	0000h	RO, RW
94–97h	MA	Message Address	00000000h	RW, RO
98–99h	MD	Message Data	0000h	RW
9A–9Fh	RSVD	Reserved	0h	RO
A0–A1h	PEG_CAPL	PCI Express-G Capability List	0010h	RO
A2–A3h	PEG_CAP	PCI Express-G Capabilities	0142h	RO, RW-O
A4–A7h	DCAP	Device Capabilities	00008000h	RO, RW-O
A8–A9h	DCTL	Device Control	0000h	RO, RW
AA–ABh	DSTS	Device Status	0000h	RO, RW1C
AC–AFh	RSVD	Reserved	0h	RO
B0–B1h	LCTL	Link Control	0000h	RO, RW, RW-V
B2–B3h	LSTS	Link Status	1001h	RW1C, RO-V, RO
B4–B7h	SLOTCAP	Slot Capabilities	00040000h	RW-O, RO
B8–B9h	SLOTCTL	Slot Control	0000h	RO
BA–BBh	SLOTSTS	Slot Status	0000h	RO, RO-V, RW1C
BC–BDh	RCTL	Root Control	0000h	RW, RO
BE–D3h	RSVD	Reserved	—	—



2.10.1 VID6—Vendor Identification Register

This register, combined with the Device Identification register, uniquely identify any PCI device.

B/D/F/Type:		0/6/0/PCI		
Address Offset:		0–1h		
Reset Value:		8086h		
Access:		RO		
Size:		16 bits		
Bit	Attr	Reset Value	RST/PWR	Description
15:0	RO	8086h	Uncore	Vendor Identification (VID) PCI standard identification for Intel.

2.10.2 DID6—Device Identification Register

This register, combined with the Vendor Identification register, uniquely identifies any PCI device.

B/D/F/Type:		0/6/0/PCI		
Address Offset:		2–3h		
Reset Value:		010Dh		
Access:		RO-FW		
Size:		16 bits		
Bit	Attr	Reset Value	RST/PWR	Description
15:0	RO-FW	010Dh	Uncore	Device Identification Number MSB (DID_MSB) Identifier assigned to the processor root port (virtual PCI-to-PCI bridge, PCI Express Graphics port).



2.10.3 PCICMD6—PCI Command Register

B/D/F/Type:		0/6/0/PCI		
Address Offset:		4–5h		
Reset Value:		0000h		
Access:		RW, RO		
Size:		16 bits		
BIOS Optimal Default		00h		
Bit	Attr	Reset Value	RST/PWR	Description
15:11	RO	0h		Reserved
10	RW	0b	Uncore	<p>INTA Assertion Disable (INTAAD)</p> <p>0 = This device is permitted to generate INTA interrupt messages. 1 = This device is prevented from generating interrupt messages. Any INTA emulation interrupts already asserted must be deasserted when this bit is set.</p> <p>This bit only affects interrupts generated by the device (PCI INTA from a PME or Hot Plug event) controlled by this command register. It does not affect upstream MSIs, upstream PCI INTA–INTD assert and deassert messages.</p>
9	RO	0b	Uncore	<p>Fast Back-to-Back Enable (FB2B)</p> <p>Not Applicable or Implemented. Hardwired to 0.</p>
8	RW	0b	Uncore	<p>SERR# Message Enable (SERRE)</p> <p>Controls the root port's SERR# messaging. The processor communicates the SERR# condition by sending an SERR message to the PCH. This bit, when set, enables reporting of non-fatal and fatal errors detected by the device to the Root Complex. Note that errors are reported if enabled either through this bit or through the PCI-Express specific bits in the Device Control register.</p> <p>In addition, for Type 1 configuration space header devices, this bit, when set, enables transmission by the primary interface of ERR_NONFATAL and ERR_FATAL error messages forwarded from the secondary interface. This bit does not affect the transmission of forwarded ERR_COR messages.</p> <p>0 = The SERR message is generated by the root port only under conditions enabled individually through the Device Control register. 1 = The root port is enabled to generate SERR messages that will be sent to the PCH for specific root port error conditions generated/detected or received on the secondary side of the virtual PCI-to-PCI bridge. The status of SERRs generated is reported in the PCISTS register.</p>
7:7	RO	0h		Reserved
6	RW	0b	Uncore	<p>Parity Error Response Enable (PERRE)</p> <p>Controls whether or not the Master Data Parity Error bit in the PCI Status register can be set.</p> <p>0 = Master Data Parity Error bit in PCI Status register can NOT be set. 1 = Master Data Parity Error bit in PCI Status register CAN be set.</p>
5	RO	0b	Uncore	<p>VGA Palette Snoop (VGAPS)</p> <p>Not Applicable or Implemented. Hardwired to 0.</p>
4	RO	0b	Uncore	<p>Memory Write and Invalidate Enable (MWIE)</p> <p>Not Applicable or Implemented. Hardwired to 0.</p>
3	RO	0b	Uncore	<p>Special Cycle Enable (SCE)</p> <p>Not Applicable or Implemented. Hardwired to 0.</p>

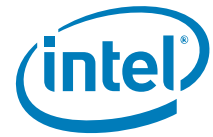

B/D/F/Type: 0/6/0/PCI Address Offset: 4–5h Reset Value: 0000h Access: RW, RO Size: 16 bits BIOS Optimal Default: 00h				
Bit	Attr	Reset Value	RST/PWR	Description
2	RW	0b	Uncore	Bus Master Enable (BME) Controls the ability of the PEG port to forward Memory Read/Write Requests in the upstream direction. 0 = This device is prevented from making memory requests to its primary bus. Note that according to PCI Specification, as MSI interrupt messages are in-band memory writes, disabling the bus master enable bit prevents this device from generating MSI interrupt messages or passing them from its secondary bus to its primary bus. Upstream memory writes/reads, peer writes/reads, and MSIs will all be treated as illegal cycles. Writes are aborted. Reads are aborted and will return Unsupported Request status (or Master abort) in its completion packet. 1 = This device is allowed to issue requests to its primary bus. Completions for previously issued memory read requests on the primary bus will be issued when the data is available. This bit does not affect forwarding of Completions from the primary interface to the secondary interface.
1	RW	0b	Uncore	Memory Access Enable (MAE) 0 = All of device memory space is disabled. 1 = Enable the Memory and Pre-fetchable memory address ranges defined in the MBASE, MLIMIT, PMBASE, and PMLIMIT registers.
0	RW	0b	Uncore	IO Access Enable (IOAE) 0 = All of device I/O space is disabled. 1 = Enable the I/O address range defined in the IOBASE, and IOLIMIT registers.

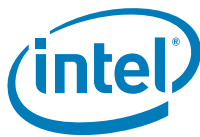

2.10.4 PCISTS6—PCI Status Register

This register reports the occurrence of error conditions associated with primary side of the "virtual" Host-PCI Express bridge embedded within the Root port.

B/D/F/Type: 0/6/0/PCI Address Offset: 6–7h Reset Value: 0010h Access: RW1C, RO, RO-V Size: 16 bits BIOS Optimal Default: 0h				
Bit	Attr	Reset Value	RST/PWR	Description
15	RW1C	0b	Uncore	Detected Parity Error (DPE) This bit is set by a Function when it receives a Poisoned TLP, regardless of the state the Parity Error Response bit in the Command register. On a Function with a Type 1 Configuration header, the bit is set when the Poisoned TLP is received by its Primary Side. This bit will be set only for completions of requests encountering ECC error in DRAM. Poisoned Peer-to-peer posted forwarded will not set this bit. They are reported at the receiving port.
14	RW1C	0b	Uncore	Signaled System Error (SSE) This bit is set when this Device sends an SERR due to detecting an ERR_FATAL or ERR_NONFATAL condition and the SERR Enable bit in the Command register is 1. Both received (if enabled by BCTRL1[1]) and internally detected error messages do not affect this field.
13	RO	0b	Uncore	Received Master Abort Status (RMAS) This bit is set when a Requester receives a Completion with Unsupported Request Completion Status. On a Function with a Type 1 Configuration header, the bit is set when the Unsupported Request is received by its Primary Side. Not applicable. There is not a UR on the primary interface
12	RO	0b	Uncore	Received Target Abort Status (RTAS) This bit is set when a Requester receives a Completion with Completer Abort Completion Status. On a Function with a Type 1 Configuration header, the bit is set when the Completer Abort is received by its Primary Side. Not Applicable or Implemented. Hardwired to 0. The concept of a Completer abort does not exist on primary side of this device.
11	RO	0b	Uncore	Signaled Target Abort Status (STAS) This bit is set when a Function completes a Posted or Non-Posted Request as a Completer Abort error. This applies to a Function with a Type 1 Configuration header when the Completer Abort was generated by its Primary Side. Not Applicable or Implemented. Hardwired to 0. The concept of a target abort does not exist on primary side of this device.
10:9	RO	00b	Uncore	DEVSELB Timing (DEVT) This device is not the subtractive decoded device on bus 0. This bit field is therefore hardwired to 00 to indicate that the device uses the fastest possible decode. Does not apply to PCI Express and must be hardwired to 00b.

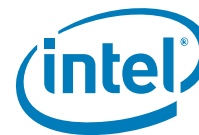

B/D/F/Type: 0/6/0/PCI Address Offset: 6–7h Reset Value: 0010h Access: RW1C, RO, RO-V Size: 16 bits BIOS Optimal Default: 0h				
Bit	Attr	Reset Value	RST/PWR	Description
8	RW1C	0b	Uncore	Master Data Parity Error (PMDPE) This bit is set by a Requester (Primary Side for Type 1 Configuration Space header Function) if the Parity Error Response bit in the Command register is 1b and either of the following two conditions occurs: <ul style="list-style-type: none"> Requester receives a Completion marked poisoned Requester poisons a write Request If the Parity Error Response bit is 0b, this bit is never set. This bit will be set only for completions of requests encountering ECC error in DRAM. Poisoned Peer-to-peer posted forwarded will not set this bit. They are reported at the receiving port.
7	RO	0b	Uncore	Fast Back-to-Back (FB2B) Not Applicable or Implemented. Hardwired to 0.
6:6	RO	0h		Reserved
5	RO	0b	Uncore	66/60 MHz capability (CAP66) Not Applicable or Implemented. Hardwired to 0.
4	RO	1b	Uncore	Capabilities List (CAPL) Indicates that a capabilities list is present. Hardwired to 1.
3	RO-V	0b	Uncore	INTx Status (INTAS) Indicates that an interrupt message is pending internally to the device. Only PME and Hot Plug sources feed into this status bit (not PCI INTA-INTD assert and deassert messages). The INTA Assertion Disable bit, PCICMD1[10], has no effect on this bit. Note that INTA emulation interrupts received across the link are not reflected in this bit.
2:0	RO	0h		Reserved



2.10.5 RID6—Revision Identification Register

This register contains the revision number of the processor root port. These bits are read only and writes to this register have no effect.

B/D/F/Type:		0/6/0/PCI		
Address Offset:		8h		
Reset Value:		00h		
Access:		RO-FW		
Size:		8 bits		
Bit	Attr	Reset Value	RST/PWR	Description
7:4	RO-FW	0h	Uncore	Revision Identification Number MSB (RID_MSB) This is an 8-bit value that indicates the revision identification number for the root port. Refer to the <i>Intel® Core™ Processor Family Mobile Specification update</i> for the value of the RID register.
3:0	RO-FW	0h	Uncore	Revision Identification Number (RID) This is an 8-bit value that indicates the revision identification number for the root port. Refer to the <i>Intel® Core™ Processor Family Mobile Specification update</i> for the value of the RID register.

2.10.6 CC6—Class Code Register

This register identifies the basic function of the device, a more specific sub-class, and a register- specific programming interface.

B/D/F/Type:		0/6/0/PCI		
Address Offset:		9–Bh		
Reset Value:		060400h		
Access:		RO		
Size:		24 bits		
Bit	Attr	Reset Value	RST/PWR	Description
23:16	RO	06h	Uncore	Base Class Code (BCC) Indicates the base class code for this device. This code has the value 06h, indicating a Bridge device.
15:8	RO	04h	Uncore	Sub-Class Code (SUBCC) Indicates the sub-class code for this device. The code is 04h indicating a PCI to PCI Bridge.
7:0	RO	00h	Uncore	Programming Interface (PI) Indicates the programming interface of this device. This value does not specify a particular register set layout and provides no practical use for this device.

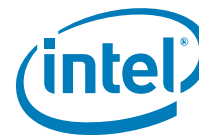

2.10.7 CL6—Cache Line Size Register

B/D/F/Type:		0/6/0/PCI		
Address Offset:		Ch		
Reset Value:		00h		
Access:		RW		
Size:		8 bits		
Bit	Attr	Reset Value	RST/PWR	Description
7:0	RW	00h	Uncore	Cache Line Size (CLS) Implemented by PCI Express devices as a read-write field for legacy compatibility purposes but has no impact on any PCI Express device functionality.

2.10.8 HDR6—Header Type Register

This register identifies the header layout of the configuration space. No physical register exists at this location.

B/D/F/Type:		0/6/0/PCI		
Address Offset:		Eh		
Reset Value:		01h		
Access:		RO		
Size:		8 bits		
Bit	Attr	Reset Value	RST/PWR	Description
7:0	RO	01h	Uncore	Header Type Register (HDR) Device 1 returns 81h to indicate that this is a multi function device with bridge header layout. Device 6 returns 01h to indicate that this is a single function device with bridge header layout.

2.10.9 PBUSN6—Primary Bus Number Register

This register identifies that this "virtual" Host-PCI Express bridge is connected to PCI bus 0.

B/D/F/Type:		0/6/0/PCI		
Address Offset:		18h		
Reset Value:		00h		
Access:		RO		
Size:		8 bits		
Bit	Attr	Reset Value	RST/PWR	Description
7:0	RO	00h	Uncore	Primary Bus Number (BUSN) Configuration software typically programs this field with the number of the bus on the primary side of the bridge. Since the processor root port is an internal device and its primary bus is always 0, these bits are read only and are hardwired to 0.



2.10.10 SBUSN6—Secondary Bus Number Register

This register identifies the bus number assigned to the second bus side of the "virtual" bridge (that is, to PCI Express-G). This number is programmed by the PCI configuration software to allow mapping of configuration cycles to PCI Express-G.

B/D/F/Type:		0/6/0/PCI		
Address Offset:		19h		
Reset Value:		00h		
Access:		RW		
Size:		8 bits		
Bit	Attr	Reset Value	RST/PWR	Description
7:0	RW	00h	Uncore	Secondary Bus Number (BUSN) This field is programmed by configuration software with the bus number assigned to PCI Express-G.

2.10.11 SUBUSN6—Subordinate Bus Number Register

This register identifies the subordinate bus (if any) that resides at the level below PCI Express-G. This number is programmed by the PCI configuration software to allow mapping of configuration cycles to PCI Express-G.

B/D/F/Type:		0/6/0/PCI		
Address Offset:		1Ah		
Reset Value:		00h		
Access:		RW		
Size:		8 bits		
Bit	Attr	Reset Value	RST/PWR	Description
7:0	RW	00h	Uncore	Subordinate Bus Number (BUSN) This register is programmed by configuration software with the number of the highest subordinate bus that lies behind the processor root port bridge. When only a single PCI device resides on the PCI Express-G segment, this register will contain the same value as the SBUSN1 register.



2.10.12 IOBASE6—I/O Base Address Register

This register controls the processor to PCI Express-G I/O access routing based on the following formula:

$$IO_BASE \leq address \leq IO_LIMIT$$

Only the upper 4 bits are programmable. For the purpose of address decode, address bits A[11:0] are treated as 0. Thus, the bottom of the defined I/O address range will be aligned to a 4 KB boundary.

B/D/F/Type:		0/6/0/PCI		
Address Offset:		1Ch		
Reset Value:		F0h		
Access:		RW		
Size:		8 bits		
BIOS Optimal Default		0h		
Bit	Attr	Reset Value	RST/PWR	Description
7:4	RW	Fh	Uncore	I/O Address Base (IOBASE) This field corresponds to A[15: 12] of the I/O addresses passed by the root port to PCI Express-G.
3:0	RO	0h		Reserved

2.10.13 IOLIMIT6—I/O Limit Address Register

This register controls the processor to PCI Express-G I/O access routing based on the following formula:

$$IO_BASE \leq address \leq IO_LIMIT$$

Only the upper 4 bits are programmable. For the purpose of address decode, address bits A[11:0] are assumed to be FFFh. Thus, the top of the defined I/O address range will be at the top of a 4 KB aligned address block.

B/D/F/Type:		0/6/0/PCI		
Address Offset:		1Dh		
Reset Value:		00h		
Access:		RW		
Size:		8 bits		
BIOS Optimal Default		0h		
Bit	Attr	Reset Value	RST/PWR	Description
7:4	RW	0h	Uncore	I/O Address Limit (IOLIMIT) This field corresponds to A[15: 12] of the I/O address limit of the root port. Devices between this upper limit and IOBASE1 will be passed to the PCI Express hierarchy associated with this device.
3:0	RO	0h		Reserved



2.10.14 SSTS6—Secondary Status Register

SSTS is a 16-bit status register that reports the occurrence of error conditions associated with secondary side (that is, PCI Express-G side) of the "virtual" PCI-PCI bridge embedded within the processor.

B/D/F/Type:		0/6/0/PCI		
Address Offset:		1E–1Fh		
Reset Value:		0000h		
Access:		RW1C, RO		
Size:		16 bits		
BIOS Optimal Default		00h		
Bit	Attr	Reset Value	RST/PWR	Description
15	RW1C	0b	Uncore	Detected Parity Error (DPE) This bit is set by the Secondary Side for a Type 1 Configuration Space header device when it receives a Poisoned TLP, regardless of the state of the Parity Error Response Enable bit in the Bridge Control Register.
14	RW1C	0b	Uncore	Received System Error (RSE) This bit is set when the Secondary Side for a Type 1 configuration space header device receives an ERR_FATAL or ERR_NONFATAL.
13	RW1C	0b	Uncore	Received Master Abort (RMA) This bit is set when the Secondary Side for Type 1 Configuration Space Header Device (for requests initiated by the Type 1 Header Device itself) receives a Completion with Unsupported Request Completion Status.
12	RW1C	0b	Uncore	Received Target Abort (RTA) This bit is set when the Secondary Side for Type 1 Configuration Space Header Device (for requests initiated by the Type 1 Header Device itself) receives a Completion with Completer Abort Completion Status.
11	RO	0b	Uncore	Signaled Target Abort (STA) Not Applicable or Implemented. Hardwired to 0. The processor does not generate Target Aborts (The root port will never complete a request using the Completer Abort Completion status). UR detected inside the processor (such as in iMPH/MC will be reported in primary side status)
10:9	RO	00b	Uncore	DEVSELB Timing (DEVT) Not Applicable or Implemented. Hardwired to 0.
8	RW1C	0b	Uncore	Master Data Parity Error (SMDPE) When set indicates that the processor received across the link (upstream) a Read Data Completion Poisoned TLP (EP=1). This bit can only be set when the Parity Error Enable bit in the Bridge Control register is set.
7	RO	0b	Uncore	Fast Back-to-Back (FB2B) Not Applicable or Implemented. Hardwired to 0.
6:6	RO	0h		Reserved
5	RO	0b	Uncore	66/60 MHz capability (CAP66) Not Applicable or Implemented. Hardwired to 0.
4:0	RO	0h		Reserved

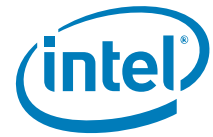

2.10.15 MBASE6—Memory Base Address Register

This register controls the processor to PCI Express-G non-prefetchable memory access routing based on the following formula:

$$\text{MEMORY_BASE} \leq \text{address} \leq \text{MEMORY_LIMIT}$$

The upper 12 bits of the register are read/write and correspond to the upper 12 address bits A[31:20] of the 32 bit address. The bottom 4 bits of this register are read-only and return zeroes when read. This register must be initialized by the configuration software. For the purpose of address decode address bits A[19:0] are assumed to be 0. Thus, the bottom of the defined memory address range will be aligned to a 1 MB boundary.

B/D/F/Type:		0/6/0/PCI		
Address Offset:		20–21h		
Reset Value:		FFF0h		
Access:		RW		
Size:		16 bits		
BIOS Optimal Default		0h		
Bit	Attr	Reset Value	RST/PWR	Description
15:4	RW	FFFh	Uncore	Memory Address Base (MBASE) This field corresponds to A[31:20] of the lower limit of the memory range that will be passed to PCI Express-G.
3:0	RO	0h		Reserved



2.10.16 MLIMIT6—Memory Limit Address Register

This register controls the processor to PCI Express-G non-prefetchable memory access routing based on the following formula:

$$\text{MEMORY_BASE} \leq \text{address} \leq \text{MEMORY_LIMIT}$$

The upper 12 bits of the register are read/write and correspond to the upper 12 address bits A[31:20] of the 32-bit address. The bottom 4 bits of this register are read-only and return zeroes when read. This register must be initialized by the configuration software. For the purpose of address decode, address bits A[19:0] are assumed to be FFFFh. Thus, the top of the defined memory address range will be at the top of a 1 MB aligned memory block.

Note: Memory range covered by MBASE and MLIMIT registers are used to map non-prefetchable PCI Express-G address ranges (typically, where control/status memory-mapped I/O data structures of the graphics controller will reside) and PMBASE and PMLIMIT are used to map prefetchable address ranges (typically, graphics local memory). This segregation allows application of USWC space attribute to be performed in a true plug-and-play manner to the prefetchable address range for improved processor-PCI Express memory access performance.

Note: Configuration software is responsible for programming all address range registers (prefetchable, non-prefetchable) with the values that provide exclusive address ranges (that is, prevent overlap with each other and/or with the ranges covered with the main memory). There is no provision in the processor hardware to enforce prevention of overlap and operations of the system in the case of overlap are not ensured.

B/D/F/Type:		0/6/0/PCI		
Address Offset:		22–23h		
Reset Value:		0000h		
Access:		RW		
Size:		16 bits		
BIOS Optimal Default		0h		
Bit	Attr	Reset Value	RST/PWR	Description
15:4	RW	000h	Uncore	Memory Address Limit (MLIMIT) This field corresponds to A[31:20] of the upper limit of the address range passed to PCI Express-G.
3:0	RO	0h		Reserved

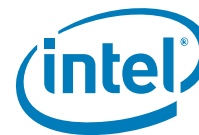

2.10.17 PMBASE6—Prefetchable Memory Base Address Register

This register, in conjunction with the corresponding Upper Base Address register, controls the processor to PCI Express-G prefetchable memory access routing based on the following formula:

$$\text{PREFETCHABLE_MEMORY_BASE} \leq \text{address} \leq \text{PREFETCHABLE_MEMORY_LIMIT}$$

The upper 12 bits of this register are read/write and correspond to address bits A[31:20] of the 40-bit address. The lower 8 bits of the Upper Base Address register are read/write and correspond to address bits A[39:32] of the 40-bit address. This register must be initialized by the configuration software. For the purpose of address decode, address bits A[19:0] are assumed to be 0. Thus, the bottom of the defined memory address range will be aligned to a 1 MB boundary.

B/D/F/Type:		0/6/0/PCI		
Address Offset:		24–25h		
Reset Value:		FFF1h		
Access:		RW, RO		
Size:		16 bits		
Bit	Attr	Reset Value	RST/PWR	Description
15:4	RW	FFFh	Uncore	Prefetchable Memory Base Address (PMBASE) This field corresponds to A[31:20] of the lower limit of the memory range that will be passed to PCI Express-G.
3:0	RO	1h	Uncore	64-bit Address Support (AS64) This field indicates that the upper 32 bits of the prefetchable memory region base address are contained in the Prefetchable Memory base Upper Address register at 28h.



2.10.18 PMLIMIT6—Prefetchable Memory Limit Address Register

This register, in conjunction with the corresponding Upper Limit Address register, controls the processor to PCI Express-G prefetchable memory access routing based on the following formula:

$$\text{PREFETCHABLE_MEMORY_BASE} \leq \text{address} \leq \text{PREFETCHABLE_MEMORY_LIMIT}$$

The upper 12 bits of this register are read/write and correspond to address bits A[31:20] of the 40-bit address. The lower 8 bits of the Upper Limit Address register are read/write and correspond to address bits A[39:32] of the 40-bit address. This register must be initialized by the configuration software. For the purpose of address decode, address bits A[19:0] are assumed to be FFFFh. Thus, the top of the defined memory address range will be at the top of a 1 MB aligned memory block. Note that prefetchable memory range is supported to allow segregation by the configuration software between the memory ranges that must be defined as UC and the ones that can be designated as a USWC (that is, prefetchable) from the processor perspective.

B/D/F/Type:		0/6/0/PCI		
Address Offset:		26–27h		
Reset Value:		0001h		
Access:		RW, RO		
Size:		16 bits		
Bit	Attr	Reset Value	RST/PWR	Description
15:4	RW	000h	Uncore	Prefetchable Memory Address Limit (PMLIMIT) This field corresponds to A[31:20] of the upper limit of the address range passed to PCI Express-G.
3:0	RO	1h	Uncore	64-bit Address Support (AS64B) This field indicates that the upper 32 bits of the prefetchable memory region limit address are contained in the Prefetchable Memory Base Limit Address register at 2Ch



2.10.19 PMBASEU6—Prefetchable Memory Base Address Upper Register

The functionality associated with this register is present in the PEG design implementation. This register in conjunction with the corresponding Upper Base Address register controls the processor to PCI Express-G prefetchable memory access routing based on the following formula:

$$\text{PREFETCHABLE_MEMORY_BASE} \leq \text{address} \leq \text{PREFETCHABLE_MEMORY_LIMIT}$$

The upper 12 bits of this register are read/write and correspond to address bits A[31:20] of the 39-bit address. The lower 7 bits of the Upper Base Address register are read/write and correspond to address bits A[38:32] of the 39-bit address. This register must be initialized by the configuration software. For the purpose of address decode, address bits A[19:0] are assumed to be 0. Thus, the bottom of the defined memory address range will be aligned to a 1 MB boundary.

B/D/F/Type:		0/6/0/PCI		
Address Offset:		28–2Bh		
Reset Value:		00000000h		
Access:		RW		
Size:		32 bits		
Bit	Attr	Reset Value	RST/PWR	Description
31:0	RW	00000000h	Uncore	Prefetchable Memory Base Address (PMBASEU) This field corresponds to A[63:32] of the lower limit of the prefetchable memory range that will be passed to PCI Express-G.



2.10.20 PMLIMITU6—Prefetchable Memory Limit Address Upper Register

The functionality associated with this register is present in the PEG design implementation.

This register in conjunction with the corresponding Upper Limit Address register controls the processor to PCI Express-G prefetchable memory access routing based on the following formula:

$$\text{PREFETCHABLE_MEMORY_BASE} \leq \text{address} \leq \text{PREFETCHABLE_MEMORY_LIMIT}$$

The upper 12 bits of this register are read/write and correspond to address bits A[31:20] of the 39-bit address. The lower 7 bits of the Upper Limit Address register are read/write and correspond to address bits A[38:32] of the 39-bit address. This register must be initialized by the configuration software. For the purpose of address decode, address bits A[19:0] are assumed to be FFFFh. Thus, the top of the defined memory address range will be at the top of a 1 MB aligned memory block.

Note that prefetchable memory range is supported to allow segregation by the configuration software between the memory ranges that must be defined as UC and the ones that can be designated as a USWC (that is, prefetchable) from the processor perspective.

B/D/F/Type: 0/6/0/PCI Address Offset: 2C–2Fh Reset Value: 00000000h Access: RW Size: 32 bits				
Bit	Attr	Reset Value	RST/PWR	Description
31:0	RW	00000000h	Uncore	Prefetchable Memory Address Limit (PMLIMITU) This field corresponds to A[63:32] of the upper limit of the prefetchable Memory range that will be passed to PCI Express-G.

2.10.21 CAPPTR6—Capabilities Pointer Register

The capabilities pointer provides the address offset to the location of the first entry in this device’s linked list of capabilities.

B/D/F/Type: 0/6/0/PCI Address Offset: 34h Reset Value: 88h Access: RO Size: 8 bits				
Bit	Attr	Reset Value	RST/PWR	Description
7:0	RO	88h	Uncore	First Capability (CAPPTR1) The first capability in the list is the Subsystem ID and Subsystem Vendor ID Capability.



2.10.22 INTRLINE6—Interrupt Line Register

This register contains interrupt line routing information. The device itself does not use this value, rather it is used by device drivers and operating systems to determine priority and vector information.

B/D/F/Type:		0/6/0/PCI		
Address Offset:		3Ch		
Reset Value:		00h		
Access:		RW		
Size:		8 bits		
Bit	Attr	Reset Value	RST/PWR	Description
7:0	RW	00h	Uncore	<p>Interrupt Connection (INTCON) This field is used to communicate interrupt line routing information.</p> <p>BIOS Requirement: POST software writes the routing information into this register as it initializes and configures the system. The value indicates to which input of the system interrupt controller this device's interrupt pin is connected.</p>

2.10.23 INTRPIN6—Interrupt Pin Register

This register specifies which interrupt pin this device uses.

B/D/F/Type:		0/6/0/PCI		
Address Offset:		3Dh		
Reset Value:		01h		
Access:		RW-O, RO		
Size:		8 bits		
Bit	Attr	Reset Value	RST/PWR	Description
7:3	RO	00h	Uncore	Interrupt Pin High (INTPINH)
2:0	RW-O	1h	Uncore	<p>Interrupt Pin (INTPIN) As a multifunction device, the PCI Express device may specify any INTx (x=A,B,C,D) as its interrupt pin. The Interrupt Pin register indicates which interrupt pin the device (or device function) uses. 1h = Corresponds to INTA# (Default) 2h = Corresponds to INTB# 3h = Corresponds to INTC# 4h = Corresponds to INTD# Devices (or device functions) that do not use an interrupt pin must put a 0 in this register. The values 05h through FFh are reserved. This register is write once. BIOS must set this register to select the INTx to be used by this root port.</p>



2.10.24 BCTRL6—Bridge Control Register

This register provides extensions to the PCICMD register that are specific to PCI-to-PCI bridges. The BCTRL provides additional control for the secondary interface (that is, PCI Express-G) as well as some bits that affect the overall behavior of the "virtual" Host-PCI Express bridge embedded within the processor (such as, VGA compatible address ranges mapping).

B/D/F/Type:		0/6/0/PCI		
Address Offset:		3E–3Fh		
Reset Value:		0000h		
Access:		RO, RW		
Size:		16 bits		
BIOS Optimal Default		0h		
Bit	Attr	Reset Value	RST/PWR	Description
15:12	RO	0h		Reserved
11	RO	0b	Uncore	Discard Timer SERR# Enable (DTSERRE) Not Applicable or Implemented. Hardwired to 0.
10	RO	0b	Uncore	Discard Timer Status (DTSTS) Not Applicable or Implemented. Hardwired to 0.
9	RO	0b	Uncore	Secondary Discard Timer (SDT) Not Applicable or Implemented. Hardwired to 0.
8	RO	0b	Uncore	Primary Discard Timer (PDT) Not Applicable or Implemented. Hardwired to 0.
7	RO	0b	Uncore	Fast Back-to-Back Enable (FB2BEN): Not Applicable or Implemented. Hardwired to 0.
6	RW	0b	Uncore	Secondary Bus Reset (SRESET) Setting this bit triggers a hot reset on the corresponding PCI Express Port. This will force the TXTSSM to transition to the Hot Reset state (using Recovery) from L0, L0s, or L1 states.
5	RO	0b	Uncore	Master Abort Mode (MAMODE) Does not apply to PCI Express. Hardwired to 0.
4	RW	0b	Uncore	VGA 16-bit Decode (VGA16D) This bit enables the PCI-to-PCI bridge to provide 16-bit decoding of VGA I/O address precluding the decoding of alias addresses every 1 KB. This bit only has meaning if bit 3 (VGA Enable) of this register is also set to 1, enabling VGA I/O decoding and forwarding by the bridge. 0 = Execute 10-bit address decodes on VGA I/O accesses. 1 = Execute 16-bit address decodes on VGA I/O accesses.
3	RW	0b	Uncore	VGA Enable (VGAEN) This bit controls the routing of processor-initiated transactions targeting VGA compatible I/O and memory address ranges. See the VGAEN/MDAP table in Device 0, offset 97h[0].

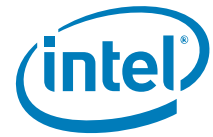

B/D/F/Type: 0/6/0/PCI Address Offset: 3E–3Fh Reset Value: 0000h Access: RO, RW Size: 16 bits BIOS Optimal Default: 0h				
Bit	Attr	Reset Value	RST/PWR	Description
2	RW	0b	Uncore	ISA Enable (ISAEN) Needed to exclude legacy resource decode to route ISA resources to legacy decode path. Modifies the response by the root port to an I/O access issued by the processor that target ISA I/O addresses. This applies only to I/O addresses that are enabled by the IOBASE and IOLIMIT registers. 0 = All addresses defined by the IOBASE and IOLIMIT for processor I/O transactions will be mapped to PCI Express-G. 1 = The root port will not forward to PCI Express-G any I/O transactions addressing the last 768 bytes in each 1KB block even if the addresses are within the range defined by the IOBASE and IOLIMIT registers.
1	RW	0b	Uncore	SERR Enable (SERREN) 0 = No forwarding of error messages from secondary side to primary side that could result in an SERR. 1 = ERR_COR, ERR_NONFATAL, and ERR_FATAL messages result in SERR message when individually enabled by the Root Control register.
0	RW	0b	Uncore	Parity Error Response Enable (PEREN) This bit controls whether or not the Master Data Parity Error bit in the Secondary Status register is set when the root port receives across the link (upstream) a Read Data Completion Poisoned TLP. 0 = Master Data Parity Error bit in Secondary Status register can NOT be set. 1 = Master Data Parity Error bit in Secondary Status register CAN be set.



2.10.25 PM_CAPID6—Power Management Capabilities Register

B/D/F/Type:		0/6/0/PCI		
Address Offset:		80–83h		
Reset Value:		C8039001h		
Access:		RO, RO-V		
Size:		32 bits		
Bit	Attr	Reset Value	RST/PWR	Description
31:27	RO	19h	Uncore	PME Support (PMES) This field indicates the power states in which this device may indicate PME wake using PCI Express messaging. D0, D3hot, and D3cold. This device is not required to do anything to support D3hot and D3cold, it simply must report that those states are supported. Refer to the <i>PCI Power Management 1.1 Specification</i> for encoding explanation and other power management details.
26	RO	0b	Uncore	D2 Power State Support (D2PSS) Hardwired to 0 to indicate that the D2 power management state is NOT supported.
25	RO	0b	Uncore	D1 Power State Support (D1PSS) Hardwired to 0 to indicate that the D1 power management state is NOT supported.
24:22	RO	000b	Uncore	Auxiliary Current (AUXC) Hardwired to 0 to indicate that there are no 3.3Vaux auxiliary current requirements.
21	RO	0b	Uncore	Device Specific Initialization (DSI) Hardwired to 0 to indicate that special initialization of this device is NOT required before generic class device driver is to use it.
20	RO	0b	Uncore	Auxiliary Power Source (APS) Hardwired to 0.
19	RO	0b	Uncore	PME Clock (PMECLK) Hardwired to 0 to indicate this device does NOT support PME# generation.
18:16	RO	011b	Uncore	PCI PM CAP Version (PCIPMCV) Version – A value of 011b indicates that this function complies with revision 1.2 of the PCI Power Management Interface Specification.
15:8	RO-V	90h	Uncore	Pointer to Next Capability (PNC) This contains a pointer to the next item in the capabilities list. If MSICH (CAPL[0] @ 7Fh) is 0, the next item in the capabilities list is the Message Signaled Interrupts (MSI) capability at 90h. If MSICH (CAPL[0] @ 7Fh) is 1, the next item in the capabilities list is the PCI Express capability at A0h.
7:0	RO	01h	Uncore	Capability ID (CID) Value of 01h identifies this linked list item (capability structure) as being for PCI Power Management registers.

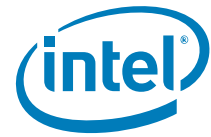

2.10.26 PM_CS6—Power Management Control/Status Register

B/D/F/Type:		0/6/0/PCI		
Address Offset:		84–87h		
Reset Value:		00000008h		
Access:		RO, RW		
Size:		32 bits		
BIOS Optimal Default		000000h		
Bit	Attr	Reset Value	RST/PWR	Description
31:16	RO	0h		Reserved
15	RO	0b	Uncore	PME Status (PMESTS) This bit indicates that this device does not support PME# generation from D3cold.
14:13	RO	00b	Uncore	Data Scale (DSCALE) This field indicates that this device does not support the power management data register.
12:9	RO	0h	Uncore	Data Select (DSEL) This field indicates that this device does not support the power management data register.
8	RW	0b	Uncore	PME Enable (PMEE) This bit indicates that this device does not generate PME# assertion from any D-state. 0 = Disable. PME# generation not possible from any D State 1 = Enable. PME# generation enabled from any D State The setting of this bit has no effect on hardware. See PM_CAP[15:11]
7:4	RO	0h		Reserved
3	RO	1b	Uncore	No Soft Reset (NSR) 1 = Device is transitioning from D3hot to D0 because the power state commands do not perform an internal reset. Configuration context is preserved. Upon transition, no additional operating system intervention is required to preserve configuration context beyond writing the power state bits. 0 = Devices do not perform an internal reset upon transitioning from D3hot to D0 using software control of the power state bits. Regardless of this bit, the devices that transition from a D3hot to D0 by a system or bus segment reset will return to the device state D0 uninitialized with only PME context preserved if PME is supported and enabled.
2	RO	0h		Reserved



B/D/F/Type: 0/6/0/PCI Address Offset: 84–87h Reset Value: 00000008h Access: RO, RW Size: 32 bits BIOS Optimal Default 000000h				
Bit	Attr	Reset Value	RST/PWR	Description
1:0	RW	00b	Uncore	Power State (PS) This field indicates the current power state of this device and can be used to set the device into a new power state. If software attempts to write an unsupported state to this field, write operation must complete normally on the bus, but the data is discarded and no state change occurs. 00 = D0 01 = D1 (Not supported in this device.) 10 = D2 (Not supported in this device.) 11 = D3 Support of D3cold does not require any special action. While in the D3hot state, this device can only act as the target of PCI configuration transactions (for power management control). This device also cannot generate interrupts or respond to MMR cycles in the D3 state. The device must return to the D0 state in order to be fully-functional. When the Power State is other than D0, the bridge will Master Abort (that is, not claim) any downstream cycles (with exception of type 0 configuration cycles). Consequently, these unclaimed cycles will go down DMI and come back up as Unsupported Requests, which the processor logs as Master Aborts in Device 0 PCISTS[13]. There is no additional hardware functionality required to support these Power States.

2.10.27 SS_CAPID—Subsystem ID and Vendor ID Capabilities Register

This capability is used to uniquely identify the subsystem where the PCI device resides. Because this device is an integrated part of the system and not an add-in device, it is anticipated that this capability will never be used. However, it is necessary because Microsoft will test for its presence.

B/D/F/Type: 0/6/0/PCI Address Offset: 88–8Bh Reset Value: 0000800Dh Access: RO Size: 32 bits BIOS Optimal Default 0000h				
Bit	Attr	Reset Value	RST/PWR	Description
31:16	RO	0h		Reserved
15:8	RO	80h	Uncore	Pointer to Next Capability (PNC) This contains a pointer to the next item in the capabilities list that is the PCI Power Management capability.
7:0	RO	0Dh	Uncore	Capability ID (CID) Value of 0Dh identifies this linked list item (capability structure) as being for SSID/SSVID registers in a PCI-to-PCI Bridge.



2.10.28 SS—Subsystem ID and Subsystem Vendor ID Register

System BIOS can be used as the mechanism for loading the SSID/SVID values. These values must be preserved through power management transitions and a hardware reset.

B/D/F/Type: 0/6/0/PCI Address Offset: 8C–8Fh Reset Value: 00008086h Access: RW-O Size: 32 bits				
Bit	Attr	Reset Value	RST/PWR	Description
31:16	RW-O	0000h	Uncore	Subsystem ID (SSID) Identifies the particular subsystem and is assigned by the vendor.
15:0	RW-O	8086h	Uncore	Subsystem Vendor ID (SSVID) Identifies the manufacturer of the subsystem and is the same as the vendor ID which is assigned by the PCI Special Interest Group.

2.10.29 MSI_CAPID—Message Signaled Interrupts Capability ID Register

When a device supports MSI it can generate an interrupt request to the processor by writing a predefined data item (a message) to a predefined memory address.

The reporting of the existence of this capability can be disabled by setting MSICH (CAPL[0] @ 7Fh). In that case walking this linked list will skip this capability and instead go directly from the PCI PM capability to the PCI Express capability.

B/D/F/Type: 0/6/0/PCI Address Offset: 90–91h Reset Value: A005h Access: RO Size: 16 bits				
Bit	Attr	Reset Value	RST/PWR	Description
15:8	RO	A0h	Uncore	Pointer to Next Capability (PNC) This field contains a pointer to the next item in the capabilities list that is the PCI Express capability.
7:0	RO	05h	Uncore	Capability ID (CID) The value of 05h identifies this linked list item (capability structure) as being for MSI registers.



2.10.30 MC—Message Control Register

System software can modify bits in this register, but the device is prohibited from doing so.

If the device writes the same message multiple times, only one of those messages is assured to be serviced. If all of them must be serviced, the device must not generate the same message again until the driver services the earlier one.

B/D/F/Type: 0/6/0/PCI Address Offset: 92–93h Reset Value: 0000h Access: RO, RW Size: 16 bits BIOS Optimal Default: 00h				
Bit	Attr	Reset Value	RST/PWR	Description
15:8	RO	0h		Reserved
7	RO	0b	Uncore	64-bit Address Capable (B64AC) Hardwired to 0 to indicate that the function does not implement the upper 32 bits of the Message Address register and is incapable of generating a 64-bit memory address. This may need to change in future implementations when addressable system memory exceeds the 32b/4 GB limit.
6:4	RW	000b	Uncore	Multiple Message Enable (MME) System software programs this field to indicate the actual number of messages allocated to this device. This number will be equal to or less than the number actually requested. The encoding is the same as for the MMC field below.
3:1	RO	000b	Uncore	Multiple Message Capable (MMC) System software reads this field to determine the number of messages being requested by this device. Encodings for the number of messages requested are: 000 = 1 All of the following are reserved in this implementation: 001 = 2 010 = 4 011 = 8 100 = 16 101 = 32 110 = Reserved 111 = Reserved
0	RW	0b	Uncore	MSI Enable (MSIEN) Controls the ability of this device to generate MSIs. 0 = MSI will not be generated. 1 = MSI will be generated when we receive PME messages. INTA will not be generated and INTA Status (PCISTS1[3]) will not be set.



2.10.31 MA—Message Address Register

B/D/F/Type:		0/6/0/PCI		
Address Offset:		94–97h		
Reset Value:		00000000h		
Access:		RW, RO		
Size:		32 bits		
Bit	Attr	Reset Value	RST/PWR	Description
31:2	RW	00000000h	Uncore	Message Address (MA) This field is used by system software to assign an MSI address to the device. The device handles an MSI by writing the padded contents of the MD register to this address.
1:0	RO	00b	Uncore	Force DWord Align (FDWA) Hardwired to 00 so that addresses assigned by system software are always aligned on a dword address boundary.

2.10.32 MD—Message Data Register

B/D/F/Type:		0/6/0/PCI		
Address Offset:		98–99h		
Reset Value:		0000h		
Access:		RW		
Size:		16 bits		
Bit	Attr	Reset Value	RST/PWR	Description
15:0	RW	0000h	Uncore	Message Data (MD) Base message data pattern assigned by system software and used to handle an MSI from the device. When the device must generate an interrupt request, it writes a 32-bit value to the memory address specified in the MA register. The upper 16 bits are always set to 0. The lower 16 bits are supplied by this register.

2.10.33 PEG_CAPL—PCI Express-G Capability List Register

This register enumerates the PCI Express capability structure.

B/D/F/Type:		0/6/0/PCI		
Address Offset:		A0–A1h		
Reset Value:		0010h		
Access:		RO		
Size:		16 bits		
Bit	Attr	Reset Value	RST/PWR	Description
15:8	RO	00h	Uncore	Pointer to Next Capability (PNC) This value terminates the capabilities list. The Virtual Channel capability and any other PCI Express specific capabilities that are reported using this mechanism are in a separate capabilities list located entirely within PCI Express Extended Configuration Space.
7:0	RO	10h	Uncore	Capability ID (CID) This field identifies this linked list item (capability structure) as being for PCI Express registers.



2.10.34 PEG_CAP—PCI Express-G Capabilities Register

This register indicates PCI Express device capabilities.

B/D/F/Type:		0/6/0/PCI		
Address Offset:		A2–A3h		
Reset Value:		0142h		
Access:		RO, RW-O		
Size:		16 bits		
BIOS Optimal Default		0h		
Bit	Attr	Reset Value	RST/PWR	Description
15:14	RO	0h		Reserved
13:9	RO	00h	Uncore	Interrupt Message Number (IMN) Not Applicable or Implemented. Hardwired to 0.
8	RW-O	1b	Uncore	Slot Implemented (SI) 0 = The PCI Express Link associated with this port is connected to an integrated component or is disabled. 1 = The PCI Express Link associated with this port is connected to a slot. BIOS Requirement: This field must be initialized appropriately if a slot connection is not implemented.
7:4	RO	4h	Uncore	Device/Port Type (DPT) Hardwired to 4h to indicate root port of PCI Express Root Complex.
3:0	RO	2h	Uncore	PCI Express Capability Version (PCIECV) Hardwired to 2h to indicate compliance to the PCI Express Capabilities Register Expansion ECN.

2.10.35 DCAP—Device Capabilities Register

This register indicates PCI Express device capabilities.

B/D/F/Type:		0/6/0/PCI		
Address Offset:		A4–A7h		
Reset Value:		00008000h		
Access:		RO, RW-O		
Size:		32 bits		
BIOS Optimal Default		0000000h		
Bit	Attr	Reset Value	RST/PWR	Description
31:16	RO	0h		Reserved
15	RO	1b	Uncore	Role Based Error Reporting (RBER) Indicates that this device implements the functionality defined in the Error Reporting ECN as required by the <i>PCI Express 1.1 specification</i> .
14:6	RO	0h		Reserved
5	RO	0b	Uncore	Extended Tag Field Supported (ETFS) Hardwired to indicate support for 5-bit Tags as a Requestor.
4:3	RO	00b	Uncore	Phantom Functions Supported (PFS) Not Applicable or Implemented. Hardwired to 0.
2:0	RW-O	000b	Uncore	Max Payload Size Default indicates 128B maximum supported payload for Transaction Layer Packets (TLP).



2.10.36 DCTL—Device Control Register

This register provides control for PCI Express device specific capabilities.

The error reporting enable bits are in reference to errors detected by this device, not error messages received across the link. The reporting of error messages (ERR_CORR, ERR_NONFATAL, ERR_FATAL) received by Root Port is controlled exclusively by Root Port Command Register.

B/D/F/Type:		0/6/0/PCI		
Address Offset:		A8–A9h		
Reset Value:		0000h		
Access:		RO, RW		
Size:		16 bits		
BIOS Optimal Default		0h		
Bit	Attr	Reset Value	RST/PWR	Description
15:15	RO	0h		Reserved
14:12	RO	000b	Uncore	Reserved for Max Read Request Size (MRRS)
11	RO	0b	Uncore	Reserved for Enable No Snoop (NSE)
10:8	RO	0h		Reserved
7:5	RW	000b	Uncore	Max Payload Size 000 = 128B maximum payload for Transaction Layer Packets (TLP) All other encodings are reserved. As a receiver, the device must handle TLPs as larger as the value set in this field. As a transmitter, the device must not generate TLPs exceeding the value set in this field.
4	RO	0b	Uncore	Reserved for Enable Relaxed Ordering (ROE)
3	RW	0b	Uncore	Unsupported Request Reporting Enable (URRE) When set, this bit allows signaling ERR_NONFATAL, ERR_FATAL, or ERR_CORR to the Root Control register when detecting an unmasked Unsupported Request (UR). An ERR_CORR is signaled when an unmasked Advisory Non-Fatal UR is received. An ERR_FATAL or ERR_NONFATAL is sent to the Root Control register when an uncorrectable non-Advisory UR is received with the severity bit set in the Uncorrectable Error Severity register.
2	RW	0b	Uncore	Fatal Error Reporting Enable (FERE) When set, this bit enables signaling of ERR_FATAL to the Root Control register due to internally detected errors or error messages received across the link. Other bits also control the full scope of related error reporting.
1	RW	0b	Uncore	Non-Fatal Error Reporting Enable (NERE) When set, this bit enables signaling of ERR_NONFATAL to the Root Control register due to internally detected errors or error messages received across the link. Other bits also control the full scope of related error reporting.
0	RW	0b	Uncore	Correctable Error Reporting Enable (CERE) When set, this bit enables signaling of ERR_CORR to the Root Control register due to internally detected errors or error messages received across the link. Other bits also control the full scope of related error reporting.



2.10.37 DSTS—Device Status Register

This register reflects status corresponding to controls in the Device Control register. The error reporting bits are in reference to errors detected by this device, not errors messages received across the link.

B/D/F/Type: 0/6/0/PCI Address Offset: AA–ABh Reset Value: 0000h Access: RO, RW1C Size: 16 bits BIOS Optimal Default 000h				
Bit	Attr	Reset Value	RST/PWR	Description
15:6	RO	0h		Reserved
5	RO	0b	Uncore	Transactions Pending (TP) 0 = All pending transactions (including completions for any outstanding non-posted requests on any used virtual channel) have been completed. 1 = Indicates that the device has transaction(s) pending (including completions for any outstanding non-posted requests for all used Traffic Classes). Not Applicable or Implemented. Hardwired to 0.
4:4	RO	0h		Reserved
3	RW1C	0b	Uncore	Unsupported Request Detected (URD) When set, this bit indicates that the Device received an Unsupported Request. Errors are logged in this register regardless of whether error reporting is enabled or not in the Device Control Register. Additionally, the Non-Fatal Error Detected bit or the Fatal Error Detected bit is set according to the setting of the Unsupported Request Error Severity bit. In production systems setting the Fatal Error Detected bit is not an option as support for AER will not be reported.
2	RW1C	0b	Uncore	Fatal Error Detected (FED) When set, this bit indicates that fatal error(s) were detected. Errors are logged in this register regardless of whether error reporting is enabled or not in the Device Control register. When Advanced Error Handling is enabled, errors are logged in this register regardless of the settings of the uncorrectable error mask register.
1	RW1C	0b	Uncore	Non-Fatal Error Detected (NFED) When set, this bit indicates that non-fatal error(s) were detected. Errors are logged in this register regardless of whether error reporting is enabled or not in the Device Control register. When Advanced Error Handling is enabled, errors are logged in this register regardless of the settings of the uncorrectable error mask register.
0	RW1C	0b	Uncore	Correctable Error Detected (CED) When set, this bit indicates that correctable error(s) were detected. Errors are logged in this register regardless of whether error reporting is enabled or not in the Device Control register. When Advanced Error Handling is enabled, errors are logged in this register regardless of the settings of the correctable error mask register.

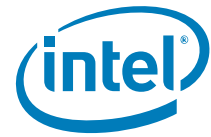

2.10.38 LCTL—Link Control Register

This register allows control of PCI Express link.

B/D/F/Type: 0/6/0/PCI Address Offset: B0–B1h Reset Value: 0000h Access: RO, RW, RW-V Size: 16 bits BIOS Optimal Default: 00h				
Bit	Attr	Reset Value	RST/PWR	Description
15:12	RO	0h		Reserved
11	RW	0b	Uncore	Link Autonomous Bandwidth Interrupt Enable (LABIE) When Set, this bit enables the generation of an interrupt to indicate that the Link Autonomous Bandwidth Status bit has been Set. This bit is not applicable and is reserved for Endpoint devices, PCI Express to PCI/PCI-X bridges, and Upstream Ports of Switches. Devices that do not implement the Link Bandwidth Notification capability must hardwire this bit to 0b.
10	RW	0b	Uncore	Link Bandwidth Management Interrupt Enable (LBMIE) When Set, this bit enables the generation of an interrupt to indicate that the Link Bandwidth Management Status bit has been Set. This bit is not applicable and is reserved for Endpoint devices, PCI Express to PCI/PCI-X bridges, and Upstream Ports of Switches.
9	RW	0b	Uncore	Hardware Autonomous Width Disable (HAWD) When Set, this bit disables hardware from changing the Link width for reasons other than attempting to correct unreliable Link operation by reducing Link width. Devices that do not implement the ability autonomously to change Link width are permitted to hardwire this bit to 0b.
8	RO	0b	Uncore	Enable Clock Power Management (ECPM) Applicable only for form factors that support a "Clock Request" (CLKREQ#) mechanism, this enable functions as follows: 0 = Clock power management is disabled and device must hold CLKREQ# signal low 1 = Device is permitted to use CLKREQ# signal to power manage link clock according to protocol defined in appropriate form factor specification. Components that do not support Clock Power Management (as indicated by a 0b value in the Clock Power Management bit of the Link Capabilities Register) must hardwire this bit to 0b.
7	RW	0b	Uncore	Extended Synch (ES) 0 = Standard Fast Training Sequence (FTS). 1 = Forces the transmission of additional ordered sets when exiting the L0s state and when in the Recovery state. This mode provides external devices (such as logic analyzers) monitoring the Link time to achieve bit and symbol lock before the link enters L0 and resumes communication. This is a test mode only and may cause other undesired side effects such as buffer overflows or underruns.

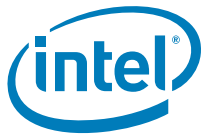

B/D/F/Type:		0/6/0/PCI		
Address Offset:		B0–B1h		
Reset Value:		0000h		
Access:		RO, RW, RW-V		
Size:		16 bits		
BIOS Optimal Default		00h		
Bit	Attr	Reset Value	RST/PWR	Description
6	RW	0b	Uncore	<p>Common Clock Configuration (CCC)</p> <p>0 = Indicates that this component and the component at the opposite end of this Link are operating with asynchronous reference clock.</p> <p>1 = Indicates that this component and the component at the opposite end of this Link are operating with a distributed common reference clock.</p> <p>The state of this bit affects the L0s Exit Latency reported in LCAP[14:12] and the N_FTS value advertised during link training. See LOSLAT at offset 22Ch.</p>
5	RW-V	0b	Uncore	<p>Retrain Link (RL)</p> <p>0 = Normal operation.</p> <p>1 = Full Link retraining is initiated by directing the Physical Layer TXTSSM from L0, L0s, or L1 states to the Recovery state.</p> <p>This bit always returns 0 when read. This bit is cleared automatically (no need to write a 0).</p>
4	RW	0b	Uncore	<p>Link Disable (LD)</p> <p>0 = Normal operation</p> <p>1 = Link is disabled. Forces the TXTSSM to transition to the Disabled state (using Recovery) from L0, L0s, or L1 states. Link retraining happens automatically on 0 to 1 transition, just like when coming out of reset.</p> <p>Writes to this bit are immediately reflected in the value read from the bit, regardless of actual Link state.</p>
3	RO	0b	Uncore	<p>Read Completion Boundary (RCB)</p> <p>Hardwired to 0 to indicate 64 byte.</p>
2:2	RO	0h		Reserved
1:0	RW	00b	Uncore	<p>Active State PM (ASPM)</p> <p>This field controls the level of ASPM (Active State Power Management) supported on the given PCI Express Link.</p> <p>00 = Disabled</p> <p>01 = L0s Entry Supported</p> <p>10 = Reserved</p> <p>11 = L0s and L1 Entry Supported</p>

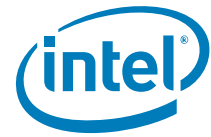

2.10.39 LSTS—Link Status Register

This register indicates PCI Express link status.

B/D/F/Type: 0/6/0/PCI Address Offset: B2–B3h Reset Value: 1001h Access: RW1C, RO-V, RO Size: 16 bits BIOS Optimal Default: 0h				
Bit	Attr	Reset Value	RST/PWR	Description
15	RW1C	0b	Uncore	Link Autonomous Bandwidth Status (LABWS) This bit is set to 1b by hardware to indicate that hardware has autonomously changed link speed or width, without the port transitioning through DL_Down status, for reasons other than to attempt to correct unreliable link operation. This bit must be set if the Physical Layer reports a speed or width change was initiated by the downstream component that was indicated as an autonomous change.
14	RW1C	0b	Uncore	Link Bandwidth Management Status (LBWMS) This bit is set to 1b by hardware to indicate that either of the following has occurred without the port transitioning through DL_Down status: A link retraining initiated by a write of 1b to the Retrain Link bit has completed. Note: This bit is Set following any write of 1b to the Retrain Link bit, including when the Link is in the process of retraining for some other reason. Hardware has autonomously changed link speed or width to attempt to correct unreliable link operation, either through an TXTSSM time-out or a higher level process. This bit must be set if the Physical Layer reports a speed or width change was initiated by the downstream component that was not indicated as an autonomous change.
13	RO-V	0b	Uncore	Data Link Layer Link Active (Optional) (DLLLA) This bit indicates the status of the Data Link Control and Management State Machine. It returns a 1b to indicate the DL_Active state, 0b otherwise. This bit must be implemented if the corresponding Data Link Layer Active Capability bit is implemented. Otherwise, this bit must be hardwired to 0b.
12	RO	1b	Uncore	Slot Clock Configuration (SCC) 0 = The device uses an independent clock irrespective of the presence of a reference on the connector. 1 = The device uses the same physical reference clock that the platform provides on the connector.
11	RO-V	0b	Uncore	Link Training (TXTRN) This bit indicates that the Physical Layer TXTSSM is in the Configuration or Recovery state, or that 1b was written to the Retrain Link bit but Link training has not yet begun. Hardware clears this bit when the TXTSSM exits the Configuration/Recovery state once Link training is complete.



B/D/F/Type: 0/6/0/PCI Address Offset: B2–B3h Reset Value: 1001h Access: RW1C, RO-V, RO Size: 16 bits BIOS Optimal Default: 0h				
Bit	Attr	Reset Value	RST/PWR	Description
10:10	RO	0h		Reserved
9:4	RO-V	00h	Uncore	Negotiated Link Width (NLW) This field indicates negotiated link width. This field is valid only when the link is in the L0, L0s, or L1 states (after link width negotiation is successfully completed). 00h = Reserved 01h = X1 02h = X2 04h = X4 08h = X8 10h = X16 All other encodings are reserved.
3:0	RO-V	1h	Uncore	Current Link Speed (CLS) This field indicates the negotiated Link speed of the given PCI Express Link. 0001b = 2.5 GT/s PCI Express Link 0010b = 5.0 GT/s PCI Express Link All other encodings are reserved. The value in this field is undefined when the Link is not up.

2.10.40 SLOTCAP—Slot Capabilities Register

PCI Express Slot related registers allow for the support of Hot Plug.

B/D/F/Type: 0/6/0/PCI Address Offset: B4–B7h Reset Value: 00040000h Access: RW-O, RO Size: 32 bits				
Bit	Attr	Reset Value	RST/PWR	Description
31:19	RW-O	0000h	Uncore	Physical Slot Number (PSN) This field indicates the physical slot number attached to this Port. BIOS Requirement: This field must be initialized by BIOS to a value that assigns a slot number that is globally unique within the chassis.
18	RO	1b	Uncore	No Command Completed Support (NCCS) When set to 1b, this bit indicates that this slot does not generate software notification when an issued command is completed by the Hot-Plug Controller. This bit is only permitted to be set to 1b if the hotplug capable port is able to accept writes to all fields of the Slot Control register without delay between successive writes.
17	RO	0b	Uncore	Reserved for Electromechanical Interlock Present (EIP) When set to 1b, this bit indicates that an Electromechanical Interlock is implemented on the chassis for this slot.

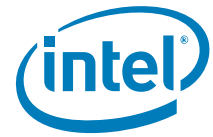

B/D/F/Type: Address Offset: Reset Value: Access: Size:		0/6/0/PCI B4–B7h 00040000h RW-O, RO 32 bits		
Bit	Attr	Reset Value	RST/PWR	Description
16:15	RW-O	00b	Uncore	Slot Power Limit Scale (SPLS) This field specifies the scale used for the Slot Power Limit Value. 00 = 1.0x 01 = 0.1x 10 = 0.01x 11 = 0.001x If this field is written, the link sends a Set_Slot_Power_Limit message.
14:7	RW-O	00h	Uncore	Slot Power Limit Value (SPLV) In combination with the Slot Power Limit Scale value, this field specifies the upper limit on power supplied by slot. Power limit (in Watts) is calculated by multiplying the value in this field by the value in the Slot Power Limit Scale field. If this field is written, the link sends a Set_Slot_Power_Limit message.
6	RO	0b	Uncore	Reserved for Hot-plug Capable (HPC) When set to 1b, this bit indicates that this slot is capable of supporting hot-plug operations.
5	RO	0b	Uncore	Reserved for Hot-plug Surprise (HPS) When set to 1b, this bit indicates that an adapter present in this slot might be removed from the system without any prior notification. This is a form factor specific capability. This bit is an indication to the operating system to allow for such removal without impacting continued software operation.
4	RO	0b	Uncore	Reserved for Power Indicator Present (PIP) When set to 1b, this bit indicates that a Power Indicator is electrically controlled by the chassis for this slot.
3	RO	0b	Uncore	Reserved for Attention Indicator Present (AIP) When set to 1b, this bit indicates that an Attention Indicator is electrically controlled by the chassis.
2	RO	0b	Uncore	Reserved for MRL Sensor Present (MSP) When set to 1b, this bit indicates that an MRL Sensor is implemented on the chassis for this slot.
1	RO	0b	Uncore	Reserved for Power Controller Present (PCP) When set to 1b, this bit indicates that a software programmable Power Controller is implemented for this slot/adapter (depending on form factor).
0	RO	0b	Uncore	Reserved for Attention Button Present (ABP) When set to 1b, this bit indicates that an Attention Button for this slot is electrically controlled by the chassis.

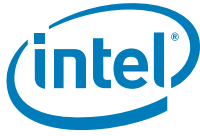

2.10.41 SLOTCTL—Slot Control Register

PCI Express Slot related registers allow for the support of Hot Plug.

B/D/F/Type:		0/6/0/PCI		
Address Offset:		B8–B9h		
Reset Value:		0000h		
Access:		RO,		
Size:		16 bits		
BIOS Optimal Default		0h		
Bit	Attr	Reset Value	RST/PWR	Description
15:13	RO	0h		Reserved
12	RO	0b	Uncore	Reserved for Data Link Layer State Changed Enable (DLLSCE) If the Data Link Layer Link Active capability is implemented, when set to 1b, this field enables software notification when Data Link Layer Link Active field is changed. If the Data Link Layer Link Active capability is not implemented, this bit is permitted to be read-only with a value of 0b.
11	RO	0b	Uncore	Reserved for Electromechanical Interlock Control (EIC) If an Electromechanical Interlock is implemented, a write of 1b to this field causes the state of the interlock to toggle. A write of 0b to this field has no effect. A read to this register always returns a 0.
10	RO	0b	Uncore	Reserved for Power Controller Control (PCC) If a Power Controller is implemented, this field when written sets the power state of the slot per the defined encodings. Reads of this field must reflect the value from the latest write, even if the corresponding hotplug command is not complete, unless software issues a write without waiting for the previous command to complete in which case the read value is undefined. Depending on the form factor, the power is turned on/off either to the slot or within the adapter. Note that in some cases the power controller may autonomously remove slot power or not respond to a power-up request based on a detected fault condition, independent of the Power Controller Control setting. 0 = Power On 1 = Power Off If the Power Controller Implemented field in the Slot Capabilities register is set to 0b, writes to this field have no effect and the read value of this field is undefined.
9:8	RO	00b	Uncore	Reserved Power Indicator Control (PIC) If a Power Indicator is implemented, writes to this field set the Power Indicator to the written state. Reads of this field must reflect the value from the latest write, even if the corresponding hot-plug command is not complete, unless software issues a write without waiting for the previous command to complete in which case the read value is undefined. 00 = Reserved 01 = On 10 = Blink 11 = Off If the Power Indicator Present bit in the Slot Capabilities register is 0b, this field is permitted to be read only with a value of 00b.

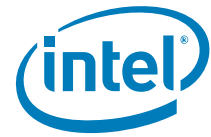

B/D/F/Type: 0/6/0/PCI Address Offset: B8–B9h Reset Value: 0000h Access: RO, Size: 16 bits BIOS Optimal Default 0h				
Bit	Attr	Reset Value	RST/PWR	Description
7:6	RO	00b	Uncore	Reserved for Attention Indicator Control (AIC) If an Attention Indicator is implemented, writes to this field set the Attention Indicator to the written state. Reads of this field must reflect the value from the latest write, even if the corresponding hot-plug command is not complete, unless software issues a write without waiting for the previous command to complete in which case the read value is undefined. If the indicator is electrically controlled by chassis, the indicator is controlled directly by the downstream port through implementation specific mechanisms. 00 = Reserved 01 = On 10 = Blink 11 = Off If the Attention Indicator Present bit in the Slot Capabilities register is 0b, this field is permitted to be read only with a value of 00b.
5	RO	0b	Uncore	Reserved for Hot-plug Interrupt Enable (HPIE) When set to 1b, this bit enables generation of an interrupt on enabled hot-plug events. The Reset Value of this field is 0b. If the Hot Plug Capable field in the Slot Capabilities register is set to 0b, this bit is permitted to be read only with a value of 0b.
4	RO	0b	Uncore	Reserved for Command Completed Interrupt Enable (CCI) If Command Completed notification is supported (as indicated by No Command Completed Support field of Slot Capabilities Register), when set to 1b, this bit enables software notification when a hot-plug command is completed by the Hot-Plug Controller. If Command Completed notification is not supported, this bit must be hardwired to 0b.
3	RO	0b	Uncore	Presence Detect Changed Enable (PDCE) When set to 1b, this bit enables software notification on a presence detect changed event.
2	RO	0b	Uncore	Reserved for MRL Sensor Changed Enable (MSCE) When set to 1b, this bit enables software notification on a MRL sensor changed event. If the MRL Sensor Present field in the Slot Capabilities register is set to 0b, this bit is permitted to be read only with a value of 0b.
1	RO	0b	Uncore	Reserved for Power Fault Detected Enable (PFDE) When set to 1b, this bit enables software notification on a power fault event. If Power Fault detection is not supported, this bit is permitted to be read only with a value of 0b
0	RO	0b	Uncore	Reserved for Attention Button Pressed Enable (ABPE) When set to 1b, this bit enables software notification on an attention button pressed event.



2.10.42 SLOTSTS—Slot Status Register

This is for PCI Express Slot related registers.

B/D/F/Type:		0/6/0/PCI		
Address Offset:		BA–BBh		
Reset Value:		0000h		
Access:		RO, RO-V, RW1C		
Size:		16 bits		
BIOS Optimal Default		00h		
Bit	Attr	Reset Value	RST/PWR	Description
15:9	RO	0h		Reserved
8	RO	0b	Uncore	Reserved for Data Link Layer State Changed (DLLSC) This bit is set when the value reported in the Data Link Layer Link Active field of the Link Status register is changed. In response to a Data Link Layer State Changed event, software must read the Data Link Layer Link Active field of the Link Status register to determine if the link is active before initiating configuration cycles to the hot plugged device.
7	RO	0b	Uncore	Reserved for Electromechanical Interlock Status (EIS) If an Electromechanical Interlock is implemented, this bit indicates the current status of the Electromechanical Interlock. 0 = Electromechanical Interlock Disengaged 1 = Electromechanical Interlock Engaged
6	RO-V	0b	Uncore	Presence Detect State (PDS) In band presence detect state: 0 = Slot Empty 1 = Card present in slot This bit indicates the presence of an adapter in the slot, reflected by the logical "OR" of the Physical Layer in-band presence detect mechanism and, if present, any out-of-band presence detect mechanism defined for the slot's corresponding form factor. Note that the in-band presence detect mechanism requires that power be applied to an adapter for its presence to be detected. Consequently, form factors that require a power controller for hot-plug must implement a physical pin presence detect mechanism. 0 = Slot Empty 1 = Card Present in slot This register must be implemented on all Downstream Ports that implement slots. For Downstream Ports not connected to slots (where the Slot Implemented bit of the PCI Express Capabilities Register is 0b), this bit must return 1b.
5	RO	0b	Uncore	Reserved for MRL Sensor State (MSS) This register reports the status of the MRL sensor if it is implemented. 0 = MRL Closed 1 = MRL Open
4	RO	0b	Uncore	Reserved for Command Completed (CC) If Command Completed notification is supported (as indicated by No Command Completed Support field of Slot Capabilities Register), this bit is set when a hot-plug command has completed and the Hot-Plug Controller is ready to accept a subsequent command. The Command Completed status bit is set as an indication to host software that the Hot-Plug Controller has processed the previous command and is ready to receive the next command; it provides no guarantee that the action corresponding to the command is complete. If Command Completed notification is not supported, this bit must be hardwired to 0b.

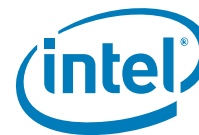

B/D/F/Type: 0/6/0/PCI Address Offset: BA–BBh Reset Value: 0000h Access: RO, RO-V, RW1C Size: 16 bits BIOS Optimal Default: 00h				
Bit	Attr	Reset Value	RST/PWR	Description
3	RW1C	0b	Uncore	Presence Detect Changed (PDC) A pulse indication that the inband presence detect state has changed. This bit is set when the value reported in Presence Detect State is changed.
2	RO	0b	Uncore	Reserved for MRL Sensor Changed (MSC) If an MRL sensor is implemented, this bit is set when a MRL Sensor state change is detected. If an MRL sensor is not implemented, this bit must not be set.
1	RO	0b	Uncore	Reserved for Power Fault Detected (PFD) If a Power Controller that supports power fault detection is implemented, this bit is set when the Power Controller detects a power fault at this slot. Note that, depending on hardware capability, it is possible that a power fault can be detected at any time, independent of the Power Controller Control setting or the occupancy of the slot. If power fault detection is not supported, this bit must not be set.
0	RO	0b	Uncore	Reserved for Attention Button Pressed (ABP) If an Attention Button is implemented, this bit is set when the attention button is pressed. If an Attention Button is not supported, this bit must not be set.

2.10.43 RCTL—Root Control Register

This register allows control of PCI Express Root Complex specific parameters. The system error control bits in this register determine if corresponding SERRs are generated when our device detects an error (reported in this device's Device Status register) or when an error message is received across the link. Reporting of SERR as controlled by these bits takes precedence over the SERR Enable in the PCI Command Register.

B/D/F/Type: 0/6/0/PCI Address Offset: BC–BDh Reset Value: 0000h Access: RW, RO Size: 16 bits BIOS Optimal Default: 000h				
Bit	Attr	Reset Value	RST/PWR	Description
15:3	RO	0h		Reserved
2	RW	0b	Uncore	System Error on Fatal Error Enable (SEFEE) Controls the Root Complex's response to fatal errors. 0 = No SERR generated on receipt of fatal error. 1 = Indicates that an SERR should be generated if a fatal error is reported by any of the devices in the hierarchy associated with this Root Port, or by the Root Port itself.
1:0	RO	0h		Reserved



2.11 PCI Device 6 Extended Configuration

Table 2-13 lists the registers arranged by address offset. Register bit descriptions are in the sections following the table.

Table 2-13. PCI Device 6 Extended Configuration Register Address Map

Address Offset	Register Symbol	Register Name	Reset Value	Access
0–FFh	RSVD	Reserved	0h	RO
100–103h	RSVD	Reserved	14010002h	RO-V, RO
104–107h	PVCCAP1	Port VC Capability Register 1	00000000h	RO
108–10Bh	PVCCAP2	Port VC Capability Register 2	00000000h	RO
10C–10Dh	PVCCTL	Port VC Control	0000h	RW, RO
10E–10Fh	RSVD	Reserved	0h	RO
110–113h	VCORCAP	VC0 Resource Capability	00000001h	RO
114–117h	VCORCTL	VC0 Resource Control	800000FFh	RO, RW
118–119h	RSVD	Reserved	0h	RO
11A–11Bh	VCORSTS	VC0 Resource Status	0002h	RO-V
11C–D37h	RSVD	Reserved	—	—

2.11.1 PVCCAP1—Port VC Capability Register 1

This register describes the configuration of PCI Express Virtual Channels associated with this port.

B/D/F/Type: 0/6/0/MMR Address Offset: 104–107h Reset Value: 00000000h Access: RO Size: 32 bits BIOS Optimal Default: 00000000h				
Bit	Attr	Reset Value	RST/PWR	Description
31:7	RO	0h		Reserved
6:4	RO	000b	Uncore	Low Priority Extended VC Count (LPEVCC) This field indicates the number of (extended) Virtual Channels in addition to the default VC belonging to the low-priority VC (LPVC) group that has the lowest priority with respect to other VC resources in a strict-priority VC Arbitration. The value of 0 in this field implies strict VC arbitration.
3:3	RO	0h		Reserved
2:0	RO	000b	Uncore	Extended VC Count (EVCC) This field indicates the number of (extended) Virtual Channels in addition to the default VC supported by the device.

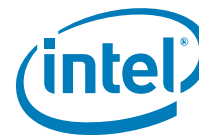

2.11.2 PVCCAP2—Port VC Capability Register 2

This register describes the configuration of PCI Express Virtual Channels associated with this port.

B/D/F/Type:		0/6/0/MMR		
Address Offset:		108–10Bh		
Reset Value:		00000000h		
Access:		RO		
Size:		32 bits		
BIOS Optimal Default		0000h		
Bit	Attr	Reset Value	RST/PWR	Description
31:24	RO	00h	Uncore	VC Arbitration Table Offset (VCATO) This field indicates the location of the VC Arbitration Table. This field contains the zero-based offset of the table in DQWORDS (16 bytes) from the base address of the Virtual Channel Capability Structure. A value of 0 indicates that the table is not present (due to fixed VC priority).
23:8	RO	0h		Reserved
7:0	RO	00h	Uncore	Reserved for VC Arbitration Capability (VCAC)

2.11.3 PVCCTL—Port VC Control Register

B/D/F/Type:		0/6/0/MMR		
Address Offset:		10C–10Dh		
Reset Value:		0000h		
Access:		RW, RO		
Size:		16 bits		
BIOS Optimal Default		000h		
Bit	Attr	Reset Value	RST/PWR	Description
15:4	RO	0h		Reserved
3:1	RW	000b	Uncore	VC Arbitration Select (VCAS) This field will be programmed by software to the only possible value as indicated in the VC Arbitration Capability field. Since there is no other VC supported than the default, this field is reserved.
0	RO	0b	Uncore	Reserved for Load VC Arbitration Table (VCARB) Used for software to update the VC Arbitration Table when VC arbitration uses the VC Arbitration Table. As a VC Arbitration Table is never used by this component this field will never be used.



2.11.4 VCORCAP—VCO Resource Capability Register

B/D/F/Type:		0/6/0/MMR		
Address Offset:		110–113h		
Reset Value:		0000001h		
Access:		RO		
Size:		32 bits		
BIOS Optimal Default		00h		
Bit	Attr	Reset Value	RST/PWR	Description
31:24	RO	00h	Uncore	Reserved for Port Arbitration Table Offset (PATO)
23:23	RO	0h		Reserved
22:16	RO	00h	Uncore	Reserved for Maximum Time Slots (MTS)
15	RO	0b	Uncore	Reject Snoop Transactions (RSNPT) 0 = Transactions with or without the No Snoop bit set within the TLP header are allowed on this VC. 1 = Any transaction for which the No Snoop attribute is applicable but is not Set within the TLP Header will be rejected as an Unsupported Request
14:8	RO	0h		Reserved
7:0	RO	01h	Uncore	Port Arbitration Capability (PAC) Indicates types of Port Arbitration supported by the VC resource. This field is valid for all Switch Ports, Root Ports that support peer-to-peer traffic, and RCRBs, but not for PCI Express Endpoint devices or Root Ports that do not support peer-to-peer traffic. Each bit location within this field corresponds to a Port Arbitration Capability defined below. When more than one bit in this field is set, it indicates that the VC resource can be configured to provide different arbitration services. Software selects among these capabilities by writing to the Port Arbitration Select field (see below). Defined bit positions are: Bit 0 Non-configurable hardware-fixed arbitration scheme, such as, Round Robin (RR) Bit 1 Weighted Round Robin (WRR) arbitration with 32 phases Bit 2 WRR arbitration with 64 phases Bit 3 WRR arbitration with 128 phases Bit 4 Time-based WRR with 128 phases Bit 5 WRR arbitration with 256 phases Bits 6–7 Reserved Processor only supported arbitration indicates "Non-configurable hardware-fixed arbitration scheme".



2.11.5 VCORCTL—VCO Resource Control Register

This register controls the resources associated with PCI Express Virtual Channel 0.

B/D/F/Type: 0/6/0/MMR Address Offset: 114–117h Reset Value: 80000FFh Access: RO, RW Size: 32 bits BIOS Optimal Default: 000h				
Bit	Attr	Reset Value	RST/PWR	Description
31	RO	1b	Uncore	VCO Enable (VCOE) For VCO, this is hardwired to 1 and read only as VCO can never be disabled.
30:27	RO	0h		Reserved
26:24	RO	000b	Uncore	VCO ID (VCOID) Assigns a VC ID to the VC resource. For VCO this is hardwired to 0 and read only.
23:20	RO	0h		Reserved
19:17	RW	000b	Uncore	Port Arbitration Select (PAS) This field configures the VC resource to provide a particular Port Arbitration service. This field is valid for RCRBs, Root Ports that support peer to peer traffic, and Switch Ports, but not for PCI Express Endpoint devices or Root Ports that do not support peer to peer traffic. The permissible value of this field is a number corresponding to one of the asserted bits in the Port Arbitration Capability field of the VC resource. This field does not affect the root port behavior.
16:16	RO	0h		Reserved
15:8	RW	00h	Uncore	TC High VCO Map (TCHVCOM) Allow usage of high order TCs. BIOS should keep this field zeroed to allow usage of the reserved TC[3] for other purposes
7:1	RW	7Fh	Uncore	TC/VCO Map (TCVCOM) Indicates the TCs (Traffic Classes) that are mapped to the VC resource. Bit locations within this field correspond to TC values. For example, when bit 7 is set in this field, TC7 is mapped to this VC resource. When more than one bit in this field is set, it indicates that multiple TCs are mapped to the VC resource. To remove one or more TCs from the TC/VC Map of an enabled VC, software must ensure that no new or outstanding transactions with the TC labels are targeted at the given Link.
0	RO	1b	Uncore	TCO/VCO Map (TCOVCOM) Traffic Class 0 is always routed to VCO.



2.11.6 VCORSTS—VCO Resource Status Register

This register reports the Virtual Channel specific status.

B/D/F/Type:		0/6/0/MMR		
Address Offset:		11A–11Bh		
Reset Value:		0002h		
Access:		RO-V		
Size:		16 bits		
BIOS Optimal Default		0000h		
Bit	Attr	Reset Value	RST/PWR	Description
15:2	RO	0h		Reserved
1	RO-V	1b	Uncore	<p>VCO Negotiation Pending (VCONP)</p> <p>0 = The VC negotiation is complete. 1 = The VC resource is still in the process of negotiation (initialization or disabling).</p> <p>This bit indicates the status of the process of Flow Control initialization. It is set by default on Reset, as well as whenever the corresponding Virtual Channel is Disabled or the Link is in the DL_Down state. It is cleared when the link successfully exits the FC_INIT2 state.</p> <p>Before using a Virtual Channel, software must check whether the VC Negotiation Pending fields for that Virtual Channel are cleared in both Components on a Link.</p>
0	RO	0h		Reserved



2.12 DMIBAR

Table 2-14 lists the registers arranged by address offset. Register bit descriptions are in the sections following the table.

Table 2-14. DMIBAR Register Address Map (Sheet 1 of 2)

Address Offset	Register Symbol	Register Name	Reset Value	Access
0–3h	DMIVCECH	DMI Virtual Channel Enhanced Capability	04010002h	RO
4–7h	DMIPVCCAP1	DMI Port VC Capability Register 1	00000000h	RO, RW-O
8–Bh	DMIPVCCAP2	DMI Port VC Capability Register 2	00000000h	RO
C–Dh	DMIPVCCCTL	DMI Port VC Control	0000h	RW, RO
E–Fh	RSVD	Reserved	0h	RO
10–13h	DMIVCORCAP	DMI VC0 Resource Capability	00000001h	RO
14–17h	DMIVCORCTL	DMI VC0 Resource Control	8000007Fh	RO, RW
18–19h	RSVD	Reserved	0h	RO
1A–1Bh	DMIVCORSTS	DMI VC0 Resource Status	0002h	RO-V
1C–1Fh	DMIVC1RCAP	DMI VC1 Resource Capability	00008001h	RO
20–23h	DMIVC1RCTL	DMI VC1 Resource Control	01000000h	RO, RW
24–25h	RSVD	Reserved	0h	RO
26–27h	DMIVC1RSTS	DMI VC1 Resource Status	0002h	RO-V
28–2Bh	DMIVCPRCAP	DMI VCp Resource Capability	00000001h	RO
2C–2Fh	DMIVCPRCTL	DMI VCp Resource Control	02000000h	RO, RW
30–31h	RSVD	Reserved	0h	RO
32–33h	DMIVCPRSTS	DMI VCp Resource Status	0002h	RO-V
34–37h	DMIVCMRCAP	DMI VCm Resource Capability	00008000h	RO
38–3Bh	DMIVCMRCTL	DMI VCm Resource Control	07000080h	RW, RO
3C–3Dh	RSVD	Reserved	0h	RO
3E–3Fh	DMIVCMRSTS	DMI VCm Resource Status	0002h	RO-V
40–43h	RSVD	Reserved	08010005h	RO
44–47h	DMIESD	DMI Element Self Description	01000202h	RO, RW-O
48–4Fh	RSVD	Reserved	0h	RO
50–53h	DMILE1D	DMI Link Entry 1 Description	00000000h	RW-O, RO
54–57h	RSVD	Reserved	0h	RO
58–5Bh	DMILE1A	DMI Link Entry 1 Address	00000000h	RW-O
5C–5Fh	DMILUE1A	DMI Link Upper Entry 1 Address	00000000h	RW-O
60–63h	DMILE2D	DMI Link Entry 2 Description	00000000h	RO, RW-O
64–67h	RSVD	Reserved	0h	RO
68–6Bh	DMILE2A	DMI Link Entry 2 Address	00000000h	RW-O
6C–6Fh	RSVD	Reserved	00000000h	RW-O
70–7Fh	RSVD	Reserved	0h	RO
80–83h	RSVD	Reserved	00010006h	RO
84–87h	LCAP	Link Capabilities	00012C41h	RW-O, RO, RW-OV



Table 2-14. DMI BAR Register Address Map (Sheet 2 of 2)

Address Offset	Register Symbol	Register Name	Reset Value	Access
88–89h	LCTL	Link Control	0000h	RW, RW-V
8A–8Bh	LSTS	DMI Link Status	0001h	RO-V
8C–97h	RSVD	Reserved	0h	RO
98–99h	LCTL2	Link Control 2	0002h	RWS, RWS-V
9A–9Bh	LSTS2	Link Status 2	0000h	RO-V
9C–D33h	RSVD	Reserved	0h	RO
D34–D37h	RSVD	Reserved	0000005Fh	RW, RW1CS

2.12.1 DMI VCECH—DMI Virtual Channel Enhanced Capability Register

This register indicates DMI Virtual Channel capabilities.

B/D/F/Type: 0/0/0/DMIBAR Address Offset: 0–3h Reset Value: 04010002h Access: RO Size: 32 bits				
Bit	Attr	Reset Value	RST/PWR	Description
31:20	RO	040h	Uncore	Pointer to Next Capability (PNC) This field contains the offset to the next PCI Express capability structure in the linked list of capabilities (Link Declaration Capability).
19:16	RO	1h	Uncore	PCI Express Virtual Channel Capability Version (PCIEVCCV) Hardwired to 1 to indicate compliances with the 1.1 version of the PCI Express specification. Note: This version does not change for 2.0 compliance.
15:0	RO	0002h	Uncore	Extended Capability ID (ECID) The value of 0002h identifies this linked list item (capability structure) as being for PCI Express Virtual Channel registers.

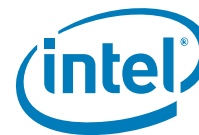

2.12.2 DMIPVCCAP1—DMI Port VC Capability Register 1

This register describes the configuration of PCI Express Virtual Channels associated with this port.

B/D/F/Type:		0/0/0/DMIBAR		
Address Offset:		4–7h		
Reset Value:		00000000h		
Access:		RO, RW-O		
Size:		32 bits		
BIOS Optimal Default		0000000h		
Bit	Attr	Reset Value	RST/PWR	Description
31:7	RO	0h		Reserved
6:4	RO	000b	Uncore	Low Priority Extended VC Count (LPEVCC) This field indicates the number of (extended) Virtual Channels in addition to the default VC belonging to the low-priority VC (LPVC) group that has the lowest priority with respect to other VC resources in a strict-priority VC Arbitration. The value of 0 in this field implies strict VC arbitration.
3:3	RO	0h		Reserved
2:0	RW-O	000b	Uncore	Extended VC Count (EVCC) This field indicates the number of (extended) Virtual Channels in addition to the default VC supported by the device.

2.12.3 DMIPVCCAP2—DMI Port VC Capability Register 2

This register describes the configuration of PCI Express Virtual Channels associated with this port.

B/D/F/Type:		0/0/0/DMIBAR		
Address Offset:		8–Bh		
Reset Value:		00000000h		
Access:		RO		
Size:		32 bits		
BIOS Optimal Default		0000h		
Bit	Attr	Reset Value	RST/PWR	Description
31:24	RO	00h	Uncore	Reserved for VC Arbitration Table Offset (VCATO)
23:8	RO	0h		Reserved
7:0	RO	00h	Uncore	Reserved for VC Arbitration Capability (VCAC)



2.12.4 DMIPVCCTL—DMI Port VC Control Register

B/D/F/Type:		0/0/0/DMIBAR		
Address Offset:		C–Dh		
Reset Value:		0000h		
Access:		RW, RO		
Size:		16 bits		
BIOS Optimal Default		000h		
Bit	Attr	Reset Value	RST/PWR	Description
15:4	RO	0h		Reserved
3:1	RW	000b	Uncore	VC Arbitration Select (VCAS) This field will be programmed by software to the only possible value as indicated in the VC Arbitration Capability field. The value 000b when written to this field will indicate the VC arbitration scheme is hardware fixed (in the root complex). This field cannot be modified when more than one VC in the LPVC group is enabled. 000 = Hardware fixed arbitration scheme (such as, Round Robin) Others = Reserved See the PCI express specification for more details.
0	RO	0b	Uncore	Reserved for Load VC Arbitration Table (LVCAT)

2.12.5 DMI VCORCAP—DMI VCO Resource Capability Register

B/D/F/Type:		0/0/0/DMIBAR		
Address Offset:		10–13h		
Reset Value:		00000001h		
Access:		RO		
Size:		32 bits		
BIOS Optimal Default		00h		
Bit	Attr	Reset Value	RST/PWR	Description
31:24	RO	00h	Uncore	Reserved for Port Arbitration Table Offset (PATO)
23:23	RO	0h		Reserved
22:16	RO	00h	Uncore	Reserved for Maximum Time Slots (MTS)
15	RO	0b	Uncore	Reject Snoop Transactions (REJSNPT) 0 = Transactions with or without the No Snoop bit set within the TLP header are allowed on this VC. 1 = Any transaction for which the No Snoop attribute is applicable but is not set within the TLP Header will be rejected as an Unsupported Request.
14:8	RO	0h		Reserved
7:0	RO	01h	Uncore	Port Arbitration Capability (PAC) Having only bit 0 set indicates that the only supported arbitration scheme for this VC is non-configurable hardware-fixed.

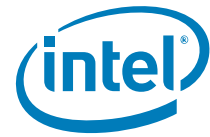

2.12.6 DMIVCORCTL—DMI VCO Resource Control Register

This register controls the resources associated with PCI Express Virtual Channel 0.

B/D/F/Type:		0/0/0/DMIBAR		
Address Offset:		14–17h		
Reset Value:		8000007Fh		
Access:		RO, RW		
Size:		32 bits		
BIOS Optimal Default		00000h		
Bit	Attr	Reset Value	RST/PWR	Description
31	RO	1b	Uncore	Virtual Channel 0 Enable (VCOE) For VCO, this is hardwired to 1 and read only as VCO can never be disabled.
30:27	RO	0h		Reserved
26:24	RO	000b	Uncore	Virtual Channel 0 ID (VCOID) Assigns a VC ID to the VC resource. For VCO, this is hardwired to 0 and read only.
23:20	RO	0h		Reserved
19:17	RW	000b	Uncore	Port Arbitration Select (PAS) Configures the VC resource to provide a particular Port Arbitration service. Valid value for this field is a number corresponding to one of the asserted bits in the Port Arbitration Capability field of the VC resource. Because only bit 0 of that field is asserted. This field will always be programmed to 1.
16:8	RO	0h		Reserved
7	RO	0b	Uncore	Traffic Class m / Virtual Channel 0 Map (TCMVCOM)
6:1	RW	3Fh	Uncore	Traffic Class / Virtual Channel 0 Map (TCVCOM) Indicates the TCs (Traffic Classes) that are mapped to the VC resource. Bit locations within this field correspond to TC values. For example, when bit 7 is set in this field, TC7 is mapped to this VC resource. When more than one bit in this field is set, it indicates that multiple TCs are mapped to the VC resource. To remove one or more TCs from the TC/VC Map of an enabled VC, software must ensure that no new or outstanding transactions with the TC labels are targeted at the given Link.
0	RO	1b	Uncore	Traffic Class 0 / Virtual Channel 0 Map (TCOVCOM) Traffic Class 0 is always routed to VCO.



2.12.7 DMI VC0RSTS—DMI VC0 Resource Status Register

This register reports the Virtual Channel specific status.

B/D/F/Type:		0/0/0/DMIBAR		
Address Offset:		1A–1Bh		
Reset Value:		0002h		
Access:		RO-V		
Size:		16 bits		
BIOS Optimal Default		0000h		
Bit	Attr	Reset Value	RST/PWR	Description
15:2	RO	0h		Reserved
1	RO-V	1b	Uncore	<p>Virtual Channel 0 Negotiation Pending (VCONP) 0 = The VC negotiation is complete. 1 = The VC resource is still in the process of negotiation (initialization or disabling).</p> <p>This bit indicates the status of the process of Flow Control initialization. It is set by default on Reset, as well as when the corresponding Virtual Channel is Disabled or the Link is in the DL_Down state.</p> <p>It is cleared when the link successfully exits the FC_INIT2 state.</p> <p>BIOS Requirement: Before using a Virtual Channel, software must check whether the VC Negotiation Pending fields for that Virtual Channel are cleared in both Components on a Link.</p>
0	RO	0h		Reserved

2.12.8 DMI VC1RCAP—DMI VC1 Resource Capability Register

B/D/F/Type:		0/0/0/DMIBAR		
Address Offset:		1C–1Fh		
Reset Value:		00008001h		
Access:		RO		
Size:		32 bits		
BIOS Optimal Default		00h		
Bit	Attr	Reset Value	RST/PWR	Description
31:24	RO	00h	Uncore	Reserved for Port Arbitration Table Offset (PATO)
23:23	RO	0h		Reserved
22:16	RO	00h	Uncore	Reserved for Maximum Time Slots (MTS)
15	RO	1b	Uncore	<p>Reject Snoop Transactions (REJSNPT) 0 = Transactions with or without the No Snoop bit set within the TLP header are allowed on this VC. 1 = When set, any transaction for which the No Snoop attribute is applicable but is not Set within the TLP Header will be rejected as an Unsupported Request.</p>
14:8	RO	0h		Reserved
7:0	RO	01h	Uncore	<p>Port Arbitration Capability (PAC) Having only bit 0 set indicates that the only supported arbitration scheme for this VC is non-configurable hardware-fixed.</p>

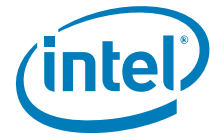

2.12.9 DMIVC1RCTL—DMI VC1 Resource Control Register

This register controls the resources associated with PCI Express Virtual Channel 1.

B/D/F/Type: 0/0/0/DMIBAR Address Offset: 20–23h Reset Value: 01000000h Access: RO, RW Size: 32 bits BIOS Optimal Default 00000h				
Bit	Attr	Reset Value	RST/PWR	Description
31	RW	0b	Uncore	Virtual Channel 1 Enable (VC1E) 0 = Disabled. 1 = Enabled. See exceptions below. Software must use the VC Negotiation Pending bit to check whether the VC negotiation is complete. When VC Negotiation Pending bit is cleared, a 1 read from this VC Enable bit indicates that the VC is enabled (Flow Control Initialization is completed for the PCI Express port). A 0 read from this bit indicates that the Virtual Channel is currently disabled. BIOS Requirement: <ol style="list-style-type: none"> To enable a Virtual Channel, the VC Enable bits for that Virtual Channel must be set in both Components on a Link. To disable a Virtual Channel, the VC Enable bits for that Virtual Channel must be cleared in both Components on a Link. Software must ensure that no traffic is using a Virtual Channel at the time it is disabled. Software must fully disable a Virtual Channel in both Components on a Link before re-enabling the Virtual Channel.
30:27	RO	0h		Reserved
26:24	RW	001b	Uncore	Virtual Channel 1 ID (VC1ID) Assigns a VC ID to the VC resource. Assigned value must be non-zero. This field can not be modified when the VC is already enabled.
23:20	RO	0h		Reserved
19:17	RW	000b	Uncore	Port Arbitration Select (PAS) Configures the VC resource to provide a particular Port Arbitration service. Valid value for this field is a number corresponding to one of the asserted bits in the Port Arbitration Capability field of the VC resource.
16:8	RO	0h		Reserved
7	RO	0b	Uncore	Traffic Class m / Virtual Channel 1 (TCMVC1M)
6:1	RW	00h	Uncore	Traffic Class / Virtual Channel 1 Map (TCVC1M) This field indicates the TCs (Traffic Classes) that are mapped to the VC resource. Bit locations within this field correspond to TC values. For example, when bit 6 is set in this field, TC6 is mapped to this VC resource. When more than one bit in this field is set, it indicates that multiple TCs are mapped to the VC resource. To remove one or more TCs from the TC/VC Map of an enabled VC, software must ensure that no new or outstanding transactions with the TC labels are targeted at the given Link. BIOS Requirement: Program this field with the value 010001b, which maps TC1 and TC5 to VC1.
0	RO	0b	Uncore	Traffic Class 0 / Virtual Channel 1 Map (TCOVC1M) Traffic Class 0 is always routed to VC0.



2.12.10 DMI VC1RSTS—DMI VC1 Resource Status Register

This register reports the Virtual Channel specific status.

B/D/F/Type:		0/0/0/DMIBAR		
Address Offset:		26–27h		
Reset Value:		0002h		
Access:		RO-V		
Size:		16 bits		
BIOS Optimal Default		0000h		
Bit	Attr	Reset Value	RST/PWR	Description
15:2	RO	0h		Reserved
1	RO-V	1b	Uncore	Virtual Channel 1 Negotiation Pending (VC1NP) 0 = The VC negotiation is complete. 1 = The VC resource is still in the process of negotiation (initialization or disabling). Software may use this bit when enabling or disabling the VC. This bit indicates the status of the process of Flow Control initialization. It is set by default on Reset, as well as when the corresponding Virtual Channel is Disabled or the Link is in the DL_Down state. It is cleared when the link successfully exits the FC_INIT2 state. Before using a Virtual Channel, software must check whether the VC Negotiation Pending fields for that Virtual Channel are cleared in both Components on a Link.
0	RO	0h		Reserved

2.12.11 DMI VCPRCAP—DMI VCp Resource Capability Register

B/D/F/Type:		0/0/0/DMIBAR		
Address Offset:		28–2Bh		
Reset Value:		00000001h		
Access:		RO		
Size:		32 bits		
BIOS Optimal Default		00h		
Bit	Attr	Reset Value	RST/PWR	Description
31:24	RO	00h	Uncore	Reserved for Port Arbitration Table Offset (PATO)
23:23	RO	0h		Reserved
22:16	RO	00h	Uncore	Reserved for Maximum Time Slots (MTS)
15	RO	0b	Uncore	Reject Snoop Transactions (REJSNPT) 0 = Transactions with or without the No Snoop bit set within the TLP header are allowed on this VC. 1 = Any transaction for which the No Snoop attribute is applicable but is not set within the TLP Header will be rejected as an Unsupported Request.
14:8	RO	0h		Reserved
7:0	RO	01h	Uncore	Reserved for Port Arbitration Capability (PAC)

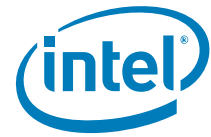

2.12.12 DMIVCPRCTL—DMI VCp Resource Control Register

This register controls the resources associated with the DMI Private Channel (VCp).

B/D/F/Type:		0/0/0/DMIBAR	
Address Offset:		2C–2Fh	
Reset Value:		02000000h	
Access:		RO, RW	
Size:		32 bits	
BIOS Optimal Default		00000h	

Bit	Attr	Reset Value	RST/PWR	Description
31	RW	0b	Uncore	<p>Virtual Channel private Enable (VCPE) 0 = Virtual Channel is disabled. 1 = Virtual Channel is enabled. See exceptions below. Software must use the VC Negotiation Pending bit to check whether the VC negotiation is complete. When VC Negotiation Pending bit is cleared, a 1 read from this VC Enable bit indicates that the VC is enabled (Flow Control Initialization is completed for the PCI Express port). A 0 read from this bit indicates that the Virtual Channel is currently disabled.</p> <p>BIOS Requirement:</p> <ol style="list-style-type: none"> To enable a Virtual Channel, the VC Enable bits for that Virtual Channel must be set in both Components on a Link. To disable a Virtual Channel, the VC Enable bits for that Virtual Channel must be cleared in both Components on a Link. Software must ensure that no traffic is using a Virtual Channel at the time it is disabled. Software must fully disable a Virtual Channel in both Components on a Link before re-enabling the Virtual Channel.
30:27	RO	0h		Reserved
26:24	RW	010b	Uncore	<p>Virtual Channel private ID (VCPID) Assigns a VC ID to the VC resource. This field can not be modified when the VC is already enabled.</p>
23:8	RO	0h		Reserved
7	RO	0b	Uncore	Traffic Class m / Virtual Channel private Map (TCMVCPM)
6:1	RW	00h	Uncore	<p>Traffic Class / Virtual Channel private Map (TCVCPM) It is recommended that private TC6 (01000000b) is the only value that should be programmed into this field for VCp traffic that will be translated by a virtualization engine, and TC2 (0000010b) is the only value that should be programmed into this field for VCp traffic that will not be translated by a virtualization engine. This strategy can simplify debug and limit validation permutations.</p> <p>BIOS Requirement: Program this field with the value 100010b, which maps TC2 and TC6 to VCp.</p>
0	RO	0b	Uncore	Tc0 VCp Map (TCOVCPM)



2.12.13 DMIVCPRSTS—DMI VCp Resource Status Register

This register reports the Virtual Channel specific status.

B/D/F/Type:		0/0/0/DMIBAR		
Address Offset:		32–33h		
Reset Value:		0002h		
Access:		RO-V		
Size:		16 bits		
BIOS Optimal Default		0000h		
Bit	Attr	Reset Value	RST/PWR	Description
15:2	RO	0h		Reserved
1	RO-V	1b	Uncore	<p>Virtual Channel private Negotiation Pending (VCPNP)</p> <p>0 = The VC negotiation is complete. 1 = The VC resource is still in the process of negotiation (initialization or disabling).</p> <p>Software may use this bit when enabling or disabling the VC. This bit indicates the status of the process of Flow Control initialization. It is set by default on Reset, as well as when the corresponding Virtual Channel is Disabled or the Link is in the DL_Down state. It is cleared when the link successfully exits the FC_INIT2 state.</p> <p>Before using a Virtual Channel, software must check whether the VC Negotiation Pending fields for that Virtual Channel are cleared in both Components on a Link.</p>
0	RO	0h		Reserved



2.12.14 DMIESD—DMI Element Self Description Register

This register provides information about the root complex element containing this Link Declaration Capability.

B/D/F/Type:		0/0/0/DMIBAR		
Address Offset:		44–47h		
Reset Value:		01000202h		
Access:		RO, RW-O		
Size:		32 bits		
BIOS Optimal Default		0h		
Bit	Attr	Reset Value	RST/PWR	Description
31:24	RO	01h	Uncore	Port Number (PORTNUM) This field specifies the port number associated with this element with respect to the component that contains this element. This port number value is utilized by the egress port of the component to provide arbitration to this Root Complex Element.
23:16	RW-O	00h	Uncore	Component ID (CID) This field identifies the physical component that contains this Root Complex Element. BIOS Requirement: Must be initialized according to guidelines in the PCI Express* Isochronous/Virtual Channel Support Hardware Programming Specification (HPS).
15:8	RO	02h	Uncore	Number of Link Entries (NLE) This field indicates the number of link entries following the Element Self Description. This field reports 2 (one for MCH egress port to main memory and one to egress port belonging to ICH on other side of internal link).
7:4	RO	0h		Reserved
3:0	RO	2h	Uncore	Element Type (ETYP) This field indicates the type of the Root Complex Element. A value of 2h represents an Internal Root Complex Link (DMI).



2.12.15 DMILE1D—DMI Link Entry 1 Description Register

This register provides the first part of a Link Entry that declares an internal link to another Root Complex Element.

B/D/F/Type:		0/0/0/DMIBAR		
Address Offset:		50–53h		
Reset Value:		00000000h		
Access:		RW-O, RO		
Size:		32 bits		
BIOS Optimal Default		0000h		
Bit	Attr	Reset Value	RST/PWR	Description
31:24	RW-O	00h	Uncore	Target Port Number (TPN) This field specifies the port number associated with the element targeted by this link entry (egress port of PCH). The target port number is with respect to the component that contains this element as specified by the target component ID. This can be programmed by BIOS, but the Reset Value will likely be correct because the DMI RCRB in the PCH will likely be associated with the default egress port for the PCH meaning it will be assigned port number 0.
23:16	RW-O	00h	Uncore	Target Component ID (TCID) This field identifies the physical component that is targeted by this link entry. BIOS Requirement: Must be initialized according to guidelines in the PCI Express* Isochronous/Virtual Channel Support Hardware Programming Specification (HPS).
15:2	RO	0h		Reserved
1	RO	0b	Uncore	Link Type (TXTYP) This bit indicates that the link points to memory-mapped space (for RCRB). The link address specifies the 64-bit base address of the target RCRB.
0	RW-O	0b	Uncore	Link Valid (LV) 0 = Link Entry is not valid and will be ignored. 1 = Link Entry specifies a valid link.

2.12.16 DMILE1A—DMI Link Entry 1 Address Register

This register provides the second part of a Link Entry that declares an internal link to another Root Complex Element.

B/D/F/Type:		0/0/0/DMIBAR		
Address Offset:		58–5Bh		
Reset Value:		00000000h		
Access:		RW-O		
Size:		32 bits		
BIOS Optimal Default		000h		
Bit	Attr	Reset Value	RST/PWR	Description
31:12	RW-O	00000h	Uncore	Link Address (LA) Memory mapped base address of the RCRB that is the target element (egress port of PCH) for this link entry.
11:0	RO	0h		Reserved

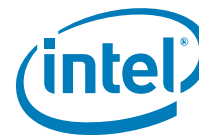

2.12.17 DMILE2D—DMI Link Entry 2 Description Register

This register provides the first part of a Link Entry that declares an internal link to another Root Complex Element.

B/D/F/Type:		0/0/0/DMIBAR		
Address Offset:		60–63h		
Reset Value:		00000000h		
Access:		RO, RW-O		
Size:		32 bits		
BIOS Optimal Default		0000h		
Bit	Attr	Reset Value	RST/PWR	Description
31:24	RO	00h	Uncore	Target Port Number (TPN) This field specifies the port number associated with the element targeted by this link entry (Egress Port). The target port number is with respect to the component that contains this element as specified by the target component ID.
23:16	RW-O	00h	Uncore	Target Component ID (TCID) This field identifies the physical or logical component that is targeted by this link entry. BIOS Requirement: Must be initialized according to guidelines in the PCI Express* Isochronous/Virtual Channel Support Hardware Programming Specification (HPS).
15:2	RO	0h		Reserved
1	RO	0b	Uncore	Link Type (TXTYP) This bit indicates that the link points to memory-mapped space (for RCRB). The link address specifies the 64-bit base address of the target RCRB.
0	RW-O	0b	Uncore	Link Valid (LV) 0 = Link Entry is not valid and will be ignored. 1 = Link Entry specifies a valid link.

2.12.18 DMILE2A—DMI Link Entry 2 Address Register

This register provides the second part of a Link Entry that declares an internal link to another Root Complex Element.

B/D/F/Type:		0/0/0/DMIBAR		
Address Offset:		68–6Bh		
Reset Value:		00000000h		
Access:		RW-O		
Size:		32 bits		
BIOS Optimal Default		000h		
Bit	Attr	Reset Value	RST/PWR	Description
31:12	RW-O	00000h	Uncore	Link Address (LA) Memory mapped base address of the RCRB that is the target element (Egress Port) for this link entry.
11:0	RO	0h		Reserved



2.12.19 LCAP—Link Capabilities Register

This register indicates DMI specific capabilities.

B/D/F/Type:		0/0/0/DMI BAR		
Address Offset:		84–87h		
Reset Value:		00012C41h		
Access:		RW-O, RO, RW-OV		
Size:		32 bits		
BIOS Optimal Default		00002h		
Bit	Attr	Reset Value	RST/PWR	Description
31:18	RO	0h		Reserved
17:15	RW-O	010b	Uncore	<p>L1 Exit Latency (L1SELAT) This field indicates the length of time this Port requires to complete the transition from L1 to L0. The value 010b indicates the range of 2 μs to less than 4 μs. 000 = Less than 1 μs 001 = 1 μs to less than 2 μs 010 = 2 μs to less than 4 μs 011 = 4 μs to less than 8 μs 100 = 8 μs to less than 16 μs 101 = 16 μs to less than 32 μs 110 = 32 μs–64 μs 111 = More than 64 μs Both bytes of this register that contain a portion of this field must be written simultaneously in order to prevent an intermediate (and undesired) value from ever existing.</p>
14:12	RW-O	010b	Uncore	<p>LOs Exit Latency (LOSELAT) This field indicates the length of time this Port requires to complete the transition from LOs to L0. 000 = Less than 64 ns 001 = 64 ns to less than 128 ns 010 = 128 ns to less than 256 ns 011 = 256 ns to less than 512 ns 100 = 512 ns to less than 1 μs 101 = 1 μs to less than 2 μs 110 = 2 μs–4 μs 111 = More than 4 μs</p>
11:10	RO	11b	Uncore	<p>Active State Link PM Support (ASLPMS) LOs & L1 entry supported.</p>
9:4	RO	04h	Uncore	<p>Max Link Width (MLW) This field indicates the maximum number of lanes supported for this link.</p>
3:0	RW-OV	0001b	Uncore	<p>Max Link Speed (MLS) This Reset Value reflects gen1. 0001 = 2.5 GT/s Link speed supported 0010 = 5.0 GT/s and 2.5 GT/s Link speeds supported All other combinations are reserved.</p>

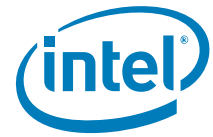

2.12.20 LCTL—Link Control Register

This register allows control of PCI Express link.

B/D/F/Type: 0/0/0/DMIBAR Address Offset: 88–89h Reset Value: 0000h Access: RW, RW-V Size: 16 bits BIOS Optimal Default 000h				
Bit	Attr	Reset Value	RST/PWR	Description
15:10	RO	0h		Reserved
9	RW	0b	Uncore	Hardware Autonomous Width Disable (HAWD) When set, this bit disables hardware from changing the Link width for reasons other than attempting to correct unreliable Link operation by reducing Link width. Devices that do not implement the ability autonomously to change Link width are permitted to hardwire this bit to 0b.
8:8	RO	0h		Reserved
7	RW	0b	Uncore	Extended Synch (ES) 0 = Standard Fast Training Sequence (FTS). 1 = Forces the transmission of additional ordered sets when exiting the L0s state and when in the Recovery state. This mode provides external devices (such as, logic analyzers) monitoring the Link time to achieve bit and symbol lock before the link enters L0 and resumes communication. This is a test mode only and may cause other undesired side effects such as buffer overflows or underruns.
6:6	RO	0h		Reserved
5	RW-V	0b	Uncore	Retrain Link (RL) 0 = Normal operation. 1 = Full Link retraining is initiated by directing the Physical Layer TXSSM from L0, L0s, or L1 states to the Recovery state. This bit always returns 0 when read. This bit is cleared automatically (no need to write a 0).
4:2	RO	0h		Reserved
1:0	RW	00b	Uncore	Active State PM (ASPM): This field controls the level of active state power management supported on the given link. 00 = Disabled 01 = L0s Entry Supported 10 = Reserved 11 = L0s and L1 Entry Supported



2.12.21 LSTS—DMI Link Status Register

This register indicates DMI status.

B/D/F/Type:		0/0/0/DMIBAR		
Address Offset:		8A–8Bh		
Reset Value:		0001h		
Access:		RO-V		
Size:		16 bits		
BIOS Optimal Default		00h		
Bit	Attr	Reset Value	RST/PWR	Description
15:12	RO	0h		Reserved
11	RO-V	0b	Uncore	Link Training (TXTRN) When set, this bit indicates that the Physical Layer TXTSSM is in the Configuration or Recovery state, or that 1b was written to the Retrain Link bit but Link training has not yet begun. Hardware clears this bit when the TXTSSM exits the Configuration/Recovery state once Link training is complete.
10:10	RO	0h		Reserved
9:4	RO-V	00h	Uncore	Negotiated Width (NWID) This field indicates negotiated link width. This field is valid only when the link is in the L0, L0s, or L1 states (after link width negotiation is successfully completed). 00h = Reserved 01h = X1 02h = X2 04h = X4 All other encodings are reserved.
3:0	RO-V	1h	Uncore	Negotiated Speed (NSPD) This field indicates negotiated link speed. 1h = 2.5 Gb/s 2h = 5.0 Gb/s All other encodings are reserved. The value in this field is undefined when the Link is not up.

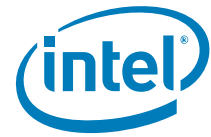

2.12.22 LCTL2—Link Control 2 Register

B/D/F/Type:		0/0/0/DMIBAR		
Address Offset:		98–99h		
Reset Value:		0002h		
Access:		RWS, RWS-V		
Size:		16 bits		
BIOS Optimal Default		0h		
Bit	Attr	Reset Value	RST/PWR	Description
15:13	RO	0h		Reserved
12	RWS	0b	Powergood	<p>Compliance De-emphasis (ComplianceDeemphasis)</p> <p>This bit sets the de-emphasis level in Polling. Compliance state if the entry occurred due to the Enter Compliance bit being 1b.</p> <p>1 = -3.5 dB 0 = -6 dB</p> <p>When the Link is operating at 2.5 GT/s, the setting of this bit has no effect. Components that support only 2.5 GT/s speed are permitted to hardwire this bit to 0b.</p> <p>For a Multi-Function device associated with an Upstream Port, the bit in Function 0 is of type RWS, and only Function 0 controls the component's Link behavior. In all other Functions of that device, this bit is RsvdP.</p> <p>This bit is intended for debug, compliance testing purposes. System firmware and software is allowed to modify this bit only during debug or compliance testing.</p>
11	RWS	0b	Powergood	<p>Compliance SOS (composos)</p> <p>When set to 1, the TXTSSM is required to send SKP Ordered Sets periodically in between the (modified) compliance patterns. For a Multi-Function device associated with an Upstream Port, the bit in Function 0 is of type RWS, and only Function 0 controls the component's Link behavior. In all other Functions of that device, this bit is RsvdP. Components that support only the 2.5 GT/s speed are permitted to hardwire this field to 0b.</p>
10	RWS	0b	Powergood	<p>Enter Modified Compliance (entermodcompliance)</p> <p>When this bit is set to 1, the device transmits modified compliance pattern if the TXTSSM enters Polling. Compliance state. Components that support only the 2.5GT/s speed are permitted to hardwire this bit to 0b.</p>
9:7	RWS-V	000b	Powergood	<p>Transmit Margin (txmargin)</p> <p>This field controls the value of the non-deemphasized voltage level at the Transmitter pins. This field is reset to 000b on entry to the TXTSSM Polling.Configuration substate</p> <p>000 = Normal operating range 001 = 800–1200 mV for full swing and 400–700 mV for half-swing 010 - (n-1) = Values must be monotonic with a non-zero slope. The value of n must be greater than 3 and less than 7. At least two of these must be below the normal operating range n = 200–400 mV for full-swing and 100–200 mV for half-swing n -111 = Reserved</p> <p>Components that support only the 2.5 GT/s speed are permitted to hardwire this bit to 0b.</p> <p>When operating in 5 GT/s mode with full swing, the de-emphasis ratio must be maintained within ±1 dB from the specification defined operational value (either -3.5 or -6 dB).</p>

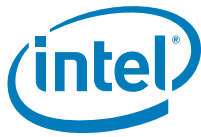

B/D/F/Type: Address Offset: Reset Value: Access: Size: BIOS Optimal Default		0/0/0/DMIBAR 98–99h 0002h RWS, RWS-V 16 bits 0h		
Bit	Attr	Reset Value	RST/PWR	Description
6	RWS	0b	Power good	Selectable De-emphasis (selectabledeemphasis) When the Link is operating at 5 GT/s speed, this bit selects the level of de-emphasis. Encodings: 1 = -3.5 dB 0 = -6 dB When the Link is operating at 2.5 GT/s speed, the setting of this bit has no effect. Components that support only the 2.5 GT/s speed are permitted to hardwire this bit to 0b. NOTE: For DMI, this bit has no effect in functional mode as DMI is half-swing and will use -3.5 dB when de-emphasis is enabled.
5	RWS	0b	Power good	Hardware Autonomous Speed Disable (HASD) 1 = Disables hardware from changing the link speed for reasons other than attempting to correct unreliable link operation by reducing link speed. 0 = Enable
4	RWS	0b	Power good	Enter Compliance (EC) Software is permitted to force a link to enter Compliance mode at the speed indicated in the Target Link Speed field by setting this bit to 1 in both components on a link and then initiating a hot reset on the link.
3:0	RWS	2h	Power good	Target Link Speed (TLS) For Downstream ports, this field sets an upper limit on link operational speed by restricting the values advertised by the upstream component in its training sequences. 0001b = 2.5 Gb/s Target Link Speed 0010b = 5 Gb/s Target Link Speed All other encodings are reserved. If a value is written to this field that does not correspond to a speed included in the Supported Link Speeds field, the result is undefined. The Reset Value of this field is the highest link speed supported by the component (as reported in the Supported Link Speeds field of the Link Capabilities Register) unless the corresponding platform / form factor requires a different Reset Value. For both Upstream and Downstream ports, this field is used to set the target compliance mode speed when software is using the Enter Compliance bit to force a link into compliance mode.



2.12.23 LSTS2—Link Status 2 Register

B/D/F/Type:		0/0/0/DMIBAR		
Address Offset:		9A–9Bh		
Reset Value:		0000h		
Access:		RO-V		
Size:		16 bits		
BIOS Optimal Default		0000h		
Bit	Attr	Reset Value	RST/PWR	Description
15:1	RO	0h		Reserved
0	RO-V	0b	Uncore	Current De-emphasis Level (CURDELVL) When the Link is operating at 5 GT/s speed, this reflects the level of de-emphasis. 1 = -3.5 dB 0 = -6 dB When the Link is operating at 2.5 GT/s speed, this bit is 0b.



2.13 MCHBAR Registers in Memory Controller – Channel 0

Table 2-15 lists the registers arranged by address offset. Register bit descriptions are in the sections following the table.

Table 2-15. MCHBAR Registers in Memory Controller – Channel 0 Register Address Map

Address Offset	Register Symbol	Register Name	Reset Value	Access
0–40AFh	RSVD	Reserved	—	—
40B0–40B3h	PM_PDWN_config_C0	Power-down Configuration	00000000h	RW-L
40B4–40C7h	RSVD	Reserved	—	—
40D0–438Fh	RSVD	Reserved	—	—
4294–4297h	TC_RFP_C0	Refresh Timing Parameters	46B41004h	RW-L
4298–429Bh	TC_RFTP_C0	Refresh Parameters	0000980Fh	RW-L
429C–438Fh	RSVD	Reserved	—	—

2.13.1 PM_PDWN_config_C0—Power-down Configuration Register

This register defines the power-down (CKE-off) operation – power-down mode, idle timer, and global / per rank decision.

B/D/F/Type:		0/0/0/MCHBAR MCO		
Address Offset:		40B0-40B3h		
Reset Value:		00000000h		
Access:		RW-L		
Size:		32 bits		
BIOS Optimal Default:		00000h		
Bit	Attr	Reset Value	RST/PWR	Description
31:13	RO	0h		Reserved
12	RW-L	0b	Uncore	Global power-down (GLPDN) 1 = Power-down decision is global for channel. 0 = A separate decision is taken for each rank.
11:0	RO	0h		Reserved

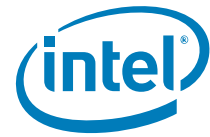

2.13.2 TC_RFP_CO—Refresh Parameters Register

B/D/F/Type:		0/0/0/MCHBAR MCO		
Address Offset:		4294-4297h		
Default Value:		0000980Fh		
Access:		RW-L		
Size:		32 bits		
BIOS Optimal Default:		0000h		
Bit	Attr	Reset Value	RST/ PWR	Description
31:18	RO	0h		Reserved
17:16	RW-L	00b	Uncore	Double Refresh Control (DOUBLE_REFRESH_CONTROL) This field will allow the double self refresh enable/disable. 00b = Double refresh rate when DRAM is WARM/HOT. 01b = Force double self refresh regardless of temperature. 10b = Disable double self refresh regardless of temperature. 11b = Reserved
15:12	RW-L	9h	Uncore	Refresh panic WM (Refresh_panic_wm) tREFI count level in which the refresh priority is panic (default is 9) It is recommended to set the panic WM at least to 9, in order to use the maximum no-refresh period possible.
11:8	RW-L	8h	Uncore	Refresh high priority WM (Refresh_HP_WM) tREFI count level that turns the refresh priority to high (default is 8)
7:0	RW-L	0Fh	Uncore	Rank idle timer for opportunistic refresh (OREF_RI) Rank idle period that defines an opportunity for refresh, in DCLK cycles.

2.13.3 TC_RFTP_CO—Refresh Parameters Register

B/D/F/Type:		0/0/0/MCHBAR MCO		
Address Offset:		4298-429Bh		
Default Value:		46B41004h		
Access:		RW-L		
Size:		32 bits		
Bit	Attr	Reset Value	RST/ PWR	Description
31:25	RW-L	23h	Uncore	9 * tREFI (tREFI x9) Period of minimum between 9*tREFI and tRAS maximum (normally 70 us) in 1024 * DCLK cycles (default is 35) - need to reduce 100 DCLK cycles - uncertainty on timing of panic refresh.
24:16	RW-L	0B4h	Uncore	Refresh execution time (tRFC) Time of refresh - from beginning of refresh until next ACT or refresh is allowed (in DCLK cycles, default is 180)
15:0	RW-L	1004h	Uncore	tREFI period in DCLK cycles (tREFI) defines the average period between refreshes, and the rate that tREFI counter is incremented (in DCLK cycles, default is 4100)



2.14 MCHBAR Registers in Memory Controller – Channel 1

Table 2-16 lists the registers arranged by address offset. Register bit descriptions are in the sections following the table.

Table 2-16. MCHBAR Registers in Memory Controller – Channel 1 Register Address Map

Address Offset	Register Symbol	Register Name	Reset Value	Access
0–44C7h	RSVD	Reserved	—	—
44B0–44B3h	PM_PDWN_Config_C1	Power-down Configuration	00000000h	RW-L
0–44C7h	RSVD	Reserved	—	—
44D0–4693h	RSVD	Reserved	—	—
4694–4697h	TC_RFP_C1	Refresh Parameters	0000980Fh	RW-L
4698–469Bh	TC_RFTP_C1	Refresh Parameters	46B41004h	RW-L
469C–438Fh	RSVD	Reserved	—	—

2.14.1 PM_PDWN_Config_C1—Power-down Configuration Register

This register defines the power-down (CKE-off) operation – power-down mode, idle timer, and global / per rank decision.

B/D/F/Type: 0/0/0/MCHBAR MC1 Address Offset: 44B0-44B3h Default Value: 00000000h Access: RW-L Size: 32 bits BIOS Optimal Default: 00000h				
Bit	Attr	Reset Value	RST/PWR	Description
31:13	RO	0h		Reserved
12	RW-L	0b	Uncore	Global power-down (GLPDN) 1 = Power-down decision is global for channel. 0 = A separate decision is taken for each rank.
11:8	RW-L	0h	Uncore	Power-down mode (PDWN_mode) Selects the mode of power-down. All encodings not in table are reserved. Note: When selecting DLL-off or APD-DLL off, DIMM MRO register bit 12 (PPD) must equal 0. Note: When selecting APD, PPD or APD-PPD, DIMM MRO register bit 12 (PPD) must equal 1. The value 0h (no power-down) is a don't care. 0h = No Power Down 1h = APD 2h = PPD 3h = APD - PPD 6h = DLL Off 7h = APD - DLL Off
7:0	RW-L	00h	Uncore	Power-down idle timer (PDWN_idle_counter) This defines the rank idle period in DCLK cycles that causes power-down entrance.



2.14.2 TC_RFP_C1—Refresh Parameters Register

B/D/F/Type:		0/0/0/MCHBAR MC1		
Address Offset:		4694–4697h		
Default Value:		0000980Fh		
Access:		RW-L		
Size:		32 bits		
BIOS Optimal Default:		0000h		
Bit	Attr	Reset Value	RST/PWR	Description
31:18	RO	0h		Reserved
17:16	RW-L	00b	Uncore	Double Refresh Control (DOUBLE_REFRESH_CONTROL) This field will allow the double self refresh enable/disable. 00b = Double refresh rate when DRAM is WARM/HOT. 01b = Force double self refresh regardless of temperature. 10b = Disable double self refresh regardless of temperature. 11b = Reserved
15:12	RW-L	9h	Uncore	Refresh panic WM (Refresh_panic_wm) tREFI count level in which the refresh priority is panic (default is 9) It is recommended to set the panic WM at least to 9, in order to use the maximum no-refresh period possible.
11:8	RW-L	8h	Uncore	Refresh high priority WM (Refresh_HP_WM) tREFI count level that turns the refresh priority to high (default is 8)
7:0	RW-L	0Fh	Uncore	Rank idle timer for opportunistic refresh (OREF_RI) Rank idle period that defines an opportunity for refresh, in DCLK cycles

2.14.3 TC_RFTP_C1—Refresh Timing Parameters Register

B/D/F/Type:		0/0/0/MCHBAR MC1		
Address Offset:		4698–469Bh		
Default Value:		46B41004h		
Access:		RW-L		
Size:		32 bits		
Bit	Attr	Reset Value	RST/PWR	Description
31:25	RW-L	23h	Uncore	9 * tREFI (tREFI x9) Period of minimum between 9*tREFI and tRAS maximum (normally 70 us) in 1024 * DCLK cycles (default is 35) – need to reduce 100 DCLK cycles – uncertainty on timing of panic refresh.
24:16	RW-L	0B4h	Uncore	Refresh execution time (trFC) Time of refresh from beginning of refresh until next ACT or refresh is allowed (in DCLK cycles, default is 180)
15:0	RW-L	1004h	Uncore	tREFI period in DCLK cycles (tREFI) This field defines the average period between refreshes, and the rate that tREFI counter is incremented (in DCLK cycles, default is 4100)



2.15 MCHBAR Registers in Memory Controller – Integrated Memory Peripheral Hub (IMPH)

Table 2-17 lists the registers arranged by address offset. Register bit descriptions are in the sections following the table.

Table 2-17. MCHBAR Registers in Memory Controller – Integrated Memory Peripheral Hub

Address Offset	Register Symbol	Register Name	Reset Value	Access
0–740Bh	RSVD	Reserved	—	—
740C–740Fh	CRDTCTL3	Credit Control 3	B124F851h	RW-L
7410h	RSVD	Reserved	—	—

2.15.1 CRDTCTL3—Credit Control 3 Register

This register will have the minimum Read Return Tracker credits for each of the PEG/DMI/GSA streams.

B/D/F/Type:		0/0/0/MCHBAR IMPH		
Address Offset:		740C–740Fh		
Reset Value:		B124F851h		
Access:		RW-L		
Size:		32 bits		
Bit	Access	Default Value	RST/PWR	Description
31:27	RW-L	16h	Uncore	GSA VC1 Minimum Completion Credits (GSAVC1) Minimum number of credits for GSA VC1 completions
26:24	RW-L	1h	Uncore	GSA VCO Minimum Completion Credits (GSAVC0) Minimum number of credits for GSA VCO completions
23:21	RW-L	1h	Uncore	PEG60 VCO Minimum Completion Credits (PEG60VCO) Minimum number of credits for PEG60 VCO completions
20:18	RW-L	1h	Uncore	PEG12 VCO Minimum Completion Credits (PEG12VCO) Minimum number of credits for PEG12 VCO completions
17:15	RW-L	1h	Uncore	PEG11 VCO Minimum Completion Credits (PEG11VCO) Minimum number of credits for PEG11 VCO completions
14:12	RW-L	7h	Uncore	PEG10 VCO Minimum Completion Credits (PEG10VCO) Minimum number of credits for PEG10 VCO completions
11:9	RW-L	4h	Uncore	DMI VC1 Minimum Completion Credits (DMIVC1) Minimum number of credits for DMI VC1 completions
8:6	RW-L	1h	Uncore	DMI VCm Minimum Completion Credits (DMIVCM) Minimum number of credits for DMI VCm completions
5:3	RW-L	2h	Uncore	DMI VCP Minimum Completion Credits (DMIVCP) Minimum number of credits for DMI VCP completions
2:0	RW-L	1h	Uncore	DMI VCO Minimum Completion Credits (DMIVCO) Minimum number of credits for DMI VCO completions



2.16 MCHBAR Registers in Memory Controller – Common

Table 2-18 lists the registers arranged by address offset. Register bit descriptions are in the sections following the table.

Table 2-18. MCHBAR Registers in Memory Controller – Common Register Address Map

Address Offset	Register Symbol	Register Name	Reset Value	Access
0–4FFh	RSVD	Reserved	0h	RO
5000–5003h	MAD_CHNL	Address decoder Channel Configuration	00000024h	RW-L
5004–5007h	MAD_DIMM_ch0	Address Decode Channel 0	00600000h	RW-L
5008–500Bh	MAD_DIMM_ch1	Address Decode Channel 1	00600000h	RW-L
500C–505Fh	RSVD	Reserved	—	—
5060–5063h	PM_SREF_config	Self Refresh Configuration	000100FFh	RW-L
5064–50FFh	RSVD	Reserved	—	—

2.16.1 MAD_CHNL—Address Decoder Channel Configuration Register

This register defines which channel is assigned to be channel A, channel B, and channel C according to the rule:

$$\text{size}(A) \geq \text{size}(B) \geq \text{size}(C)$$

Since the processor implements only two channels, channel C is always channel 2, and its size is always 0.

B/D/F/Type:		0/0/0/MCHBAR_MCMAIN		
Address Offset:		5000–5003h		
Reset Value:		00000024h		
Access:		RW-L		
Size:		32 bits		
BIOS Optimal Default		0000000h		
Bit	Attr	Reset Value	RST/PWR	Description
31:6	RO	0h		Reserved
5:4	RW-L	10b		Reserved
3:2	RW-L	01b	Uncore	Channel B assignment (CH_B) CH_B defines the mid-size channel: 00 = Channel 0 01 = Channel 1 10 = Channel 2
1:0	RW-L	00b	Uncore	Channel A assignment (CH_A) CH_A defines the largest channel: 00 = Channel 0 01 = Channel 1 10 = Channel 2



2.16.2 MAD_DIMM_ch0—Address decode channel 0 Register

This register defines channel characteristics—number of DIMMs, number of ranks, size, interleave options.

B/D/F/Type:		0/0/0/MCHBAR_MCMAIN		
Address Offset:		5004–5007h		
Reset Value:		00600000h		
Access:		RW-L		
Size:		32 bits		
BIOS Optimal Default		00h		
Bit	Attr	Reset Value	RST/PWR	Description
31:26	RO	0h		Reserved
25:24	RO	0h		Reserved
23:23	RO	0h		Reserved
22	RW-L	1b	Uncore	Enhanced Interleave mode (Enh_Interleave) 0 = Off 1 = On
21	RW-L	1b	Uncore	Rank Interleave (RI) 0 = Off 1 = On
20	RW-L	0b	Uncore	DIMM B DDR Width (DBW) DIMM B width of DDR chips 0 = X8 chips 1 = X16 chips
19	RW-L	0b	Uncore	DIMM A DDR Width (DAW) DIMM A width of DDR chips 0 = X8 chips 1 = X16 chips
18	RW-L	0b	Uncore	DIMM B number of Ranks (DBNOR) 0 = Single rank 1 = Dual rank
17	RW-L	0b	Uncore	DIMM A number of Ranks (DANOR) 0 = Single rank 1 = Dual rank
16	RW-L	0b	Uncore	DIMM A select (DAS) Selects which of the DIMMs is DIMM A - should be the larger DIMM: 0 = DIMM 0 1 = DIMM 1
15:8	RW-L	00h	Uncore	Size of DIMM B (DIMM_B_Size) Size of DIMM B in 256 MB multiples
7:0	RW-L	00h	Uncore	Size of DIMM A (DIMM_A_Size) Size of DIMM A in 256 MB multiples

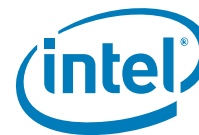

2.16.3 MAD_DIMM_ch1 - Address Decode Channel 1 Register

This register defines channel characteristics—number of DIMMs, number of ranks, size, interleave options

B/D/F/Type:		0/0/0/MCHBAR_MCMAIN		
Address Offset:		5008–500Bh		
Reset Value:		00600000h		
Access:		RW-L		
Size:		32 bits		
BIOS Optimal Default		00h		
Bit	Attr	Reset Value	RST/PWR	Description
31:26	RO	0h		Reserved
25:24	RW-L	00b	Uncore	Reserved
23:23	RO	0h		Reserved
22	RW-L	1b	Uncore	Enhanced Interleave mode (Enh_Interleave) 0 = Off 1 = On
21	RW-L	1b	Uncore	Rank Interleave (RI) 0 = Off 1 = On
20	RW-L	0b	Uncore	DIMM B DDR width (DBW) DIMM B width of DDR chips 0 = X8 chips 1 = X16 chips
19	RW-L	0b	Uncore	DIMM A DDR width (DAW) DIMM A width of DDR chips 0 = X8 chips 1 = X16 chips
18	RW-L	0b	Uncore	DIMM B number of ranks (DBNOR) 0 = Single rank 1 = Dual rank
17	RW-L	0b	Uncore	DIMM A number of ranks (DANOR) 0 = Single rank 1 = Dual rank
16	RW-L	0b	Uncore	DIMM A select (DAS) Selects which of the DIMMs is DIMM A - should be the larger DIMM: 0 = DIMM 0 1 = DIMM 1
15:8	RW-L	00h	Uncore	Size of DIMM B (DIMM_B_Size) Size of DIMM B in 256 MB multiples
7:0	RW-L	00h	Uncore	Size of DIMM A (DIMM_A_Size) Size of DIMM A in 256 MB multiples



2.16.4 PM_SREF_config—Self Refresh Configuration Register

This self refresh mode control register defines if and when DDR can go into SR.

B/D/F/Type:		0/0/0/MCHBAR_MCMAIN		
Address Offset:		5060–5063h		
Reset Value:		000100FFh		
Access:		RW-L		
Size:		32 bits		
BIOS Optimal Default		0000h		
Bit	Attr	Reset Value	RST/PWR	Description
31:17	RO	0h		Reserved
16	RW-L	1	Uncore	Self-refresh Enable This control bit is an INTEL RESERVED bit. It is for test and debug purposes only. This bit enables or disables self-refresh mechanism.
15:0	RW-L	00FFh	Uncore	Idle timer init value (Idle_timer) This value is used when the "SREF_enable" field is set. It defines the # of cycles, that there should not be any transaction to enter self-refresh. It is programmable 1 to 64K-1. In DCLK=800 it determines time of up to 82 us.

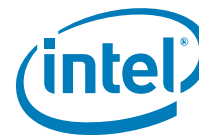

2.17 Memory Controller MMIO Registers Broadcast Group

Table 2-19 lists the registers arranged by address offset. Register bit descriptions are in the sections following the table.

Table 2-19. Memory Controller MMIO Registers Broadcast Group Register Address Map

Address Offset	Register Symbol	Register Name	Reset Value	Access
0–4CAFh	RSVD	Reserved	—	—
4CB0–4CB3h	PM_PDWN_config	Power-down Configuration	00000000h	RW-L
4CB4–4CC7h	RSVD	Reserved	—	—
4CD0–4F83h	RSVD	Reserved	—	—
4F84–4F87h	PM_CMD_PWR	Power Management Command Power	00000000h	RW-LV
4F88–4F8Bh	PM_BW_LIMIT_config	BW Limit Configuration	FFFF03FFh	RW-L
4F8C–4F8Fh	RSVD	Reserved	FF1D1519h	RW-L

2.17.1 PM_PDWN_Config—Power-down Configuration Register

This register defines the power-down (CKE-off) operation – power-down mode, idle timer, and global / per rank decision.

B/D/F/Type:		0/0/0/MCHBAR_MCBCAST		
Address Offset:		4CB0-4CB3h		
Default Value:		00000000h		
Access:		RW-L		
Size:		32 bits		
BIOS Optimal Default:		00000h		
Bit	Attr	Reset Value	RST/PWR	Description
31:13	RO	0h		Reserved
12	RW-L	0b	Uncore	Global power-down (GLPDN) 1 = Power-down decision is global for channel. 0 = A separate decision is taken for each rank.
11:8	RW-L	0h	Uncore	Power-down mode (PDWN_mode) Selects the mode of power-down. All encodings not in table are reserved. Note: When selecting DLL-off or APD-DLL off, DIMM MRO register bit 12 (PPD) must equal 0. Note: When selecting APD, PPD or APD-PPD, DIMM MRO register bit 12 (PPD) must equal 1. The value 0h (no power-down) is a don't care. 0h = No Power Down 1h = APD 2h = PPD 3h = APD - PPD 6h = DLL Off 7h = APD - DLL Off
7:0	RW-L	00h	Uncore	Power-down idle timer (PDWN_idle_counter) This defines the rank idle period in DCLK cycles that causes power-down entrance.



2.17.2 PM_CMD_PWR—Power Management Command Power Register

This register defines the power contribution of each command - ACT+PRE, CAS-read and CAS write. Assumption is that the ACT is always followed by a PRE (although not immediately), and REF commands are issued in a fixed rate and there is no need to count them. The register has three 8-bit fields.

B/D/F/Type:		0/0/0/MCHBAR_MCBCAST		
Address Offset:		4F84–4F87h		
Reset Value:		00000000h		
Access:		RW-LV		
Size:		32 bits		
BIOS Optimal Default		00h		
Bit	Attr	Reset Value	RST/PWR	Description
31:24	RO	0h		Reserved
23:16	RW-LV	00h	Uncore	Power contribution of CAS Write command (PWR_CAS_W)
15:8	RW-LV	00h	Uncore	Power contribution of CAS Read command (PWR_CAS_R)
7:0	RW-LV	00h	Uncore	Power contribution of RAS command and PRE command (PWR_RAS_PRE) Power contribution of RAS command and PRE command. The value should be the sum of the two commands, assuming that each RAS command for a given page is followed by a PRE command to the same page in the near future.

2.17.3 PM_BW_LIMIT_config—BW Limit Configuration Register

This register defines the BW throttling at temperature.

Note that the field “BW_limit_tf may not be changed in run-time. Other fields may be changed in run-time.

B/D/F/Type:		0/0/0/MCHBAR_MCBCAST		
Address Offset:		4F88–4F8Bh		
Reset Value:		FFFF03FFh		
Access:		RW-L		
Size:		32 bits		
BIOS Optimal Default		00h		
Bit	Attr	Reset Value	RST/PWR	Description
31:24	RW-L	FFh	Uncore	BW limit when rank is hot (BW_limit_hot) The number of transactions allowed per rank when status of rank is hot. Range = 0–255h
23:16	RW-L	FFh	Uncore	BW limit when rank is warm (BW_limit_warm) The number of transactions allowed per rank when status of rank is warm. Range = 0–255h
15:10	RO	0h		Reserved
9:0	RW-L	3FFh	Uncore	BW limit time frame (BW_limit_tf) Time frame in which the BW limit is enforced, in DCLK cycles. Range = 1–1023h Note that the field “BW_limit_tf may not be changed in run-time.

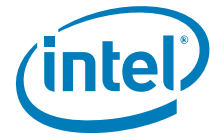

2.18 Integrated Graphics VTd Remapping Engine Registers

Table 2-20 lists the registers arranged by address offset. Register bit descriptions are in the sections following the table.

Table 2-20. Integrated Graphics VTd Remapping Engine Register Address Map (Sheet 1 of 2)

Address Offset	Register Symbol	Register Name	Reset Value	Access
0–3h	VER_REG	Version Register	00000010h	RO
4–7h	RSVD	Reserved	0h	RO
8–Fh	CAP_REG	Capability Register	00C0000020 E60262h	RO
10–17h	ECAP_REG	Extended Capability Register	000000000F 0101Ah	RO, RO-V
18–1Bh	GCMD_REG	Global Command Register	00000000h	RO, WO
1C–1Fh	GSTS_REG	Global Status Register	00000000h	RO, RO-V
20–27h	RTADDR_REG	Root-Entry Table Address Register	0000000000 000000h	RW
28–2Fh	CCMD_REG	Context Command Register	0800000000 000000h	RW, RW-V, RO-V
30–33h	RSVD	Reserved	0h	RO
34–37h	FSTS_REG	Fault Status Register	00000000h	RO, ROS-V, RW1CS
38–3Bh	FECTL_REG	Fault Event Control Register	80000000h	RW, RO-V
3C–3Fh	FEDATA_REG	Fault Event Data Register	00000000h	RW
40–43h	FEADDR_REG	Fault Event Address Register	00000000h	RW
44–47h	FEUADDR_REG	Fault Event Upper Address Register	00000000h	RW
48–57h	RSVD	Reserved	0h	RO
58–5Fh	AFLOG_REG	Advanced Fault Log Register	0000000000 000000h	RO
60–63h	RSVD	Reserved	0h	RO
64–67h	PMEN_REG	Protected Memory Enable Register	00000000h	RW, RO-V
68–6Bh	PLMBASE_REG	Protected Low-Memory Base Register	00000000h	RW
6C–6Fh	PLMLIMIT_REG	Protected Low-Memory Limit Register	00000000h	RW
70–77h	PHMBASE_REG	Protected High-Memory Base Register	0000000000 000000h	RW
78–7Fh	PHMLIMIT_REG	Protected High-Memory Limit Register	0000000000 000000h	RW
80–87h	IOH_REG	Invalidation Queue Head Register	0000000000 000000h	RO-V
88–8Fh	IQT_REG	Invalidation Queue Tail Register	0000000000 000000h	RW-L
90–97h	IOA_REG	Invalidation Queue Address Register	0000000000 000000h	RW-L
98–9Bh	RSVD	Reserved	0h	RO
9C–9Fh	ICS_REG	Invalidation Completion Status Register	00000000h	RW1CS
A0–A3h	IECTL_REG	Invalidation Event Control Register	80000000h	RW-L, RO-V
A4–A7h	IEDATA_REG	Invalidation Event Data Register	00000000h	RW-L



Table 2-20. Integrated Graphics VTd Remapping Engine Register Address Map (Sheet 2 of 2)

Address Offset	Register Symbol	Register Name	Reset Value	Access
A8-ABhh	IEADDR_REG	Invalidation Event Address Register	00000000h	RW-L
AC-AFh	IEUADDR_REG	Invalidation Event Upper Address Register	00000000h	RW-L
B0-B7h	RSVD	Reserved	0h	RO
B8-BFh	IRTA_REG	Interrupt Remapping Table Address Register	0000000000 000000h	RW-L
C0-FFh	RSVD	Reserved	0h	RO
100-107h	IVA_REG	Invalidate Address Register	0000000000 000000h	RW
108-10Fh	IOTLB_REG	IOTLB Invalidate Register	0200000000 000000h	RW-V, RW, RO-V
110-1FFh	RSVD	Reserved	0h	RO
200-207h	FRCDL_REG	Fault Recording Low Register	0000000000 000000h	ROS-V
208-20Fh	FRCDH_REG	Fault Recording High Register	0000000000 000000h	RO, RW1CS, ROS-V
210-FEFh	RSVD	Reserved	0h	RO
FF0-FF3h	VTPOLICY	DMA Remap Engine Policy Control	00000000h	RO, RO-KFW, RW-KL, RW-L

2.18.1 VER_REG—Version Register

This register reports the architecture version supported. Backward compatibility for the architecture is maintained with new revision numbers, allowing software to load remapping hardware drivers written for prior architecture versions.

B/D/F/Type:		0/0/0/GFXVTBAR		
Address Offset:		0-3h		
Reset Value:		00000010h		
Access:		RO		
Size:		32 bits		
BIOS Optimal Default		000000h		
Bit	Attr	Reset Value	RST/PWR	Description
31:8	RO	0h		Reserved
7:4	RO	0001b	Uncore	Major Version number (MAX) This field indicates supported architecture version.
3:0	RO	0000b	Uncore	Minor Version number (MIN) This field indicates supported architecture minor version.

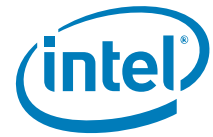

2.18.2 CAP_REG—Capability Register

This register reports general remapping hardware capabilities.

B/D/F/Type:		0/0/0/GFXVTBAR		
Address Offset:		8–Fh		
Reset Value:		00C0000020E60262h		
Access:		RO		
Size:		64 bits		
BIOS Optimal Default		000h		
Bit	Attr	Reset Value	RST/PWR	Description
63:56	RO	0h		Reserved
55	RO	1b	Uncore	DMA Read Draining (DRD): 0 = Hardware does not support draining of DMA read requests. 1 = Hardware supports draining of DMA read requests.
54	RO	1b	Uncore	DMA Write Draining (DWD) 0 = Hardware does not support draining of DMA write requests. 1 = Hardware supports draining of DMA write requests.
53:48	RO	000000b	Uncore	Maximum Address Mask Value (MAMV) The value in this field indicates the maximum supported value for the Address Mask (AM) field in the Invalidation Address register (IVA_REG) and IOTLB Invalidation Descriptor (iotlb_inv_dsc). This field is valid only when the PSI field in Capability register is reported as set.
47:40	RO	00000000 b	Uncore	Number of Fault-recording Registers (NFR) Number of fault recording registers is computed as N+1, where N is the value reported in this field. Implementations must support at least one fault recording register (NFR = 0) for each remapping hardware unit in the platform. The maximum number of fault recording registers per remapping hardware unit is 256.
39	RO	0b	Uncore	Page Selective Invalidation (PSI) 0 = Hardware supports only domain and global invalidates for IOTLB 1 = Hardware supports page selective, domain and global invalidates for IOTLB. Hardware implementations reporting this field as set are recommended to support a Maximum Address Mask Value (MAMV) value of at least 9.
38:38	RO	0h		Reserved
37:34	RO	0000b	Uncore	Super-Page Support (SPS) This field indicates the super page sizes supported by hardware. A value of 1 in any of these bits indicates the corresponding super-page size is supported. The super-page sizes corresponding to various bit positions within this field are: 0 = 21-bit offset to page frame (2 MB) 1 = 30-bit offset to page frame (1 GB) 2 = 39-bit offset to page frame (512 GB) 3 = 48-bit offset to page frame (1 TB) Hardware implementations supporting a specific super-page size must support all smaller super-page sizes (that is, only valid values for this field are 0001b, 0011b, 0111b, 1111b).
33:24	RO	020h	Uncore	Fault-recording Register offset (FRO) This field specifies the location to the first fault recording register relative to the register base address of this remapping hardware unit. If the register base address is X, and the value reported in this field is Y, the address for the first fault recording register is calculated as X+(16*Y).



B/D/F/Type:		0/0/0/GFXVTBAR		
Address Offset:		8–Fh		
Reset Value:		00C0000020E60262h		
Access:		RO		
Size:		64 bits		
BIOS Optimal Default		000h		
Bit	Attr	Reset Value	RST/PWR	Description
23	RO	1b	Uncore	<p>Isochrony (ISOCH)</p> <p>0 = Remapping hardware unit has no critical isochronous requesters in its scope.</p> <p>1 = Remapping hardware unit has one or more critical isochronous requesters in its scope. To ensure isochronous performance, software must ensure invalidation operations do not impact active DMA streams from such requesters. This implies, when DMA is active, software performs page-selective invalidations (and not coarser invalidations).</p>
22	RO	1b	Uncore	<p>Zero Length Read (ZLR)</p> <p>0 = Remapping hardware unit blocks (and treats as fault) zero length DMA read requests to write-only pages.</p> <p>1 = Remapping hardware unit supports zero length DMA read requests to write-only pages.</p> <p>DMA remapping hardware implementations are recommended to report ZLR field as set.</p>
21:16	RO	100110b	Uncore	<p>Maximum Guest Address Width (MGAW)</p> <p>This field indicates the maximum DMA virtual addressability supported by remapping hardware. The Maximum Guest Address Width (MGAW) is computed as $(N+1)$, where N is the value reported in this field. For example, a hardware implementation supporting 48-bit MGAW reports a value of 47 (101111b) in this field.</p> <p>If the value in this field is X, untranslated and translated DMA requests to addresses above $2^{(x+1)}-1$ are always blocked by hardware. Translations requests to address above $2^{(x+1)}-1$ from allowed devices return a null Translation Completion Data Entry with R=W=0.</p> <p>Guest addressability for a given DMA request is limited to the minimum of the value reported through this field and the adjusted guest address width of the corresponding page-table structure. (Adjusted guest address widths supported by hardware are reported through the SAGAW field).</p> <p>Implementations are recommended to support MGAW at least equal to the physical addressability (host address width) of the platform.</p>
15:13	RO	0h		Reserved
12:8	RO	00010b	Uncore	<p>Supported Adjusted Guest Address Widths (SAGAW)</p> <p>This 5-bit field indicates the supported adjusted guest address widths (which in turn represents the levels of page-table walks for the 4 KB base page size) supported by the hardware implementation.</p> <p>A value of 1 in any of these bits indicates the corresponding adjusted guest address width is supported. The adjusted guest address widths corresponding to various bit positions within this field are:</p> <ul style="list-style-type: none"> 0 = 30-bit AGAW (2-level page table) 1 = 39-bit AGAW (3-level page table) 2 = 48-bit AGAW (4-level page table) 3 = 57-bit AGAW (5-level page table) 4 = 64-bit AGAW (6-level page table) <p>Software must ensure that the adjusted guest address width used to setup the page tables is one of the supported guest address widths reported in this field.</p>

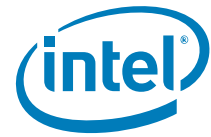

B/D/F/Type: Address Offset: Reset Value: Access: Size: BIOS Optimal Default		0/0/0/GFXVTBAR 8–Fh 00C0000020E60262h RO 64 bits 000h		
Bit	Attr	Reset Value	RST/PWR	Description
7	RO	0b	Uncore	Caching Mode (CM) 0 = Not-present and erroneous entries are not cached in any of the remapping caches. Invalidation is not required for modifications to individual not present or invalid entries. However, any modifications that result in decreasing the effective permissions or partial permission increases require invalidations for them to be effective. 1 = Not-present and erroneous mappings may be cached in the remapping caches. Any software updates to the remapping structures (including updates to "not-present" or erroneous entries) require explicit invalidation. Hardware implementations of this architecture must support a value of 0 in this field.
6	RO	1b	Uncore	Protected High-Memory Region (PHMR) 0 = Protected high-memory region is Not supported. 1 = Protected high-memory region is supported.
5	RO	1b	Uncore	Protected Low-Memory Region (PLMR) 0 = Protected low-memory region is Not supported. 1 = Protected low-memory region is supported.
4	RO	0b	Uncore	Required Write-Buffer Flushing (RWBF) 0 = No write-buffer flushing is needed to ensure changes to memory-resident structures are visible to hardware. 1 = Software must explicitly flush the write buffers to ensure updates made to memory-resident remapping structures are visible to hardware.
3	RO	0b	Uncore	Advanced Fault Logging (AFL) 0 = Advanced fault logging is not supported. Only primary fault logging is supported. 1 = Advanced fault logging is supported.
2:0	RO	010b	Uncore	Number of domains supported (ND) 000 = Hardware supports 4-bit domain-ids with support for up to 16 domains. 001 = Hardware supports 6-bit domain-ids with support for up to 64 domains. 010 = Hardware supports 8-bit domain-ids with support for up to 256 domains. 011 = Hardware supports 10-bit domain-ids with support for up to 1024 domains. 100 = Hardware supports 12-bit domain-ids with support for up to 4K domains. 100 = Hardware supports 14-bit domain-ids with support for up to 16K domains. 110 = Hardware supports 16-bit domain-ids with support for up to 64K domains. 111 = Reserved.

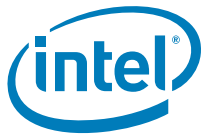

2.18.3 ECAP_REG—Extended Capability Register

This register reports remapping hardware extended capabilities.

B/D/F/Type:		0/0/0/GFXVTBAR		
Address Offset:		10–17h		
Reset Value:		000000000F0101Ah		
Access:		RO, RO-V		
Size:		64 bits		
BIOS Optimal Default		0000000000h		
Bit	Attr	Reset Value	RST/PWR	Description
63:24	RO	0h		Reserved
23:20	RO	1111b	Uncore	Maximum Handle Mask Value (MHMV) The value in this field indicates the maximum supported value for the Handle Mask (HM) field in the interrupt entry cache invalidation descriptor (iec_inv_dsc). This field is valid only when the IR field in Extended Capability register is reported as set.
19:18	RO	0h		Reserved
17:8	RO	010h	Uncore	IOTLB Register Offset (IRO) This field specifies the offset to the IOTLB registers relative to the register base address of this remapping hardware unit. If the register base address is X, and the value reported in this field is Y, the address for the first IOTLB invalidation register is calculated as X+(16*Y).
7	RO	0b	Uncore	Snoop Control (SC) 0 = Hardware does not support 1-setting of the SNP field in the page-table entries. 1 = Hardware supports the 1-setting of the SNP field in the page-table entries.
6	RO	0b	Uncore	Pass Through (PT) 0 = Hardware does Not support pass-through translation type in context entries. 1 = Hardware supports pass-through translation type in context entries.
5	RO	0b	Uncore	Caching Hints (CH) 0 = Hardware does Not support IOTLB caching hints (ALH and EH fields in context-entries are treated as reserved). 1 = Hardware supports IOTXTB caching hints through the ALH and EH fields in context entries.
4	RO-V	1b	Uncore	Extended Interrupt Mode (EIM) 0 = On Intel 64 platforms, hardware supports only 8-bit APIC-IDs (xAPIC mode). 1 = On Intel 64 platforms, hardware supports 32-bit APIC-IDs (x2APIC mode). This field is valid only on Intel 64 platforms reporting Interrupt Remapping support (IR field Set).
3	RO-V	1b	Uncore	Interrupt Remapping Support (IR) 0 = Hardware does Not support interrupt remapping. 1 = Hardware supports interrupt remapping. Implementations reporting this field as set must also support Queued Invalidation (QI).



B/D/F/Type: 0/0/0/GFXVTBAR Address Offset: 10–17h Reset Value: 000000000F0101Ah Access: RO, RO-V Size: 64 bits BIOS Optimal Default: 00000000000h				
Bit	Attr	Reset Value	RST/PWR	Description
2	RO	0b	Uncore	Device IOTLB Support (DI) 0 = Hardware does not support device-IOTLBs. 1 = Hardware supports Device-IOTLBs. Implementations reporting this field as set must also support Queued Invalidation (QI).
1	RO-V	1b	Uncore	Queued Invalidation Support (QI) 0 = Hardware does Not support queued invalidations. 1 = Hardware supports queued invalidations.
0	RO	0b	Uncore	Coherency (C) This field indicates if hardware access to the root, context, page-table and interrupt-remap structures are coherent (snooped) or not. 0 = Hardware accesses to remapping structures are non-coherent. 1 = Hardware accesses to remapping structures are coherent. Hardware access to advanced fault log and invalidation queue are always coherent.



2.18.4 GCMD_REG—Global Command Register

This register controls remapping hardware. If multiple control fields in this register need to be modified, software must serialize the modifications through multiple writes to this register.

B/D/F/Type: Address Offset: Reset Value: Access: Size: BIOS Optimal Default		0/0/0/GFXVTBAR 18–1Bh 00000000h RO, WO 32 bits 000000h		
Bit	Attr	Reset Value	RST/PWR	Description
31	WO	0b	Uncore	<p>Translation Enable (TE)</p> <p>Software writes to this field to request hardware to enable/disable DMA-remapping: 0 = Disable DMA remapping 1 = Enable DMA remapping</p> <p>Hardware reports the status of the translation enable operation through the TES field in the Global Status register.</p> <p>There may be active DMA requests in the platform when software updates this field. Hardware must enable or disable remapping logic only at deterministic transaction boundaries, so that any in-flight transaction is either subject to remapping or not at all.</p> <p>Hardware implementations supporting DMA draining must drain any in-flight DMA read/write requests queued within the Root-Complex before completing the translation enable command and reflecting the status of the command through the TES field in the Global Status register.</p> <p>The value returned on a read of this field is undefined.</p>
30	WO	0b	Uncore	<p>Set Root Table Pointer (SRTP)</p> <p>Software sets this field to set/update the root-entry table pointer used by hardware. The root-entry table pointer is specified through the Root-entry Table Address (RTA_REG) register.</p> <p>Hardware reports the status of the "Set Root Table Pointer" operation through the RTPS field in the Global Status register.</p> <p>The "Set Root Table Pointer" operation must be performed before enabling or re-enabling (after disabling) DMA remapping through the TE field.</p> <p>After a "Set Root Table Pointer" operation, software must globally invalidate the context cache and then globally invalidate of IOTLB. This is required to ensure hardware uses only the remapping structures referenced by the new root table pointer, and not stale cached entries.</p> <p>While DMA remapping hardware is active, software may update the root table pointer through this field. However, to ensure valid in-flight DMA requests are deterministically remapped, software must ensure that the structures referenced by the new root table pointer are programmed to provide the same remapping results as the structures referenced by the previous root-table pointer.</p> <p>Clearing this bit has no effect. The value returned on read of this field is undefined.</p>

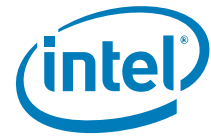

B/D/F/Type: Address Offset: Reset Value: Access: Size: BIOS Optimal Default		0/0/0/GFXVTBAR 18–1Bh 00000000h RO, WO 32 bits 000000h		
Bit	Attr	Reset Value	RST/ PWR	Description
29	RO	0b	Uncore	Set Fault Log (SFL) This field is valid only for implementations supporting advanced fault logging. Software sets this field to request hardware to set/update the fault-log pointer used by hardware. The fault-log pointer is specified through Advanced Fault Log register. Hardware reports the status of the 'Set Fault Log' operation through the FLS field in the Global Status register. The fault log pointer must be set before enabling advanced fault logging (through EAFL field). Once advanced fault logging is enabled, the fault log pointer may be updated through this field while DMA remapping is active. Clearing this bit has no effect. The value returned on read of this field is undefined.
28	RO	0b	Uncore	Enable Advanced Fault Logging (EAFL) This field is valid only for implementations supporting advanced fault logging. Software writes to this field to request hardware to enable or disable advanced fault logging: 0 = Disable advanced fault logging. In this case, translation faults are reported through the Fault Recording registers. 1 = Enable use of memory-resident fault log. When enabled, translation faults are recorded in the memory-resident log. The fault log pointer must be set in hardware (through the SFL field) before enabling advanced fault logging. Hardware reports the status of the advanced fault logging enable operation through the AFLS field in the Global Status register. The value returned on a read of this field is undefined.
27	RO	0b	Uncore	Write Buffer Flush (WBF) This bit is valid only for implementations requiring write buffer flushing. Software sets this field to request that hardware flush the Root-Complex internal write buffers. This is done to ensure any updates to the memory-resident remapping structures are not held in any internal write posting buffers. Hardware reports the status of the write buffer flushing operation through the WBFS field in the Global Status register. Clearing this bit has no effect. The value returned on a read of this field is undefined.
26	WO	0b	Uncore	Queued Invalidation Enable (QIE) This field is valid only for implementations supporting queued invalidations. Software writes to this field to enable or disable queued invalidations. 0 = Disable queued invalidations. 1 = Enable use of queued invalidations. Hardware reports the status of queued invalidation enable operation through QIES field in the Global Status register. The value returned on a read of this field is undefined.



B/D/F/Type:		0/0/0/GFXVTBAR		
Address Offset:		18–1Bh		
Reset Value:		00000000h		
Access:		RO, WO		
Size:		32 bits		
BIOS Optimal Default		000000h		
Bit	Attr	Reset Value	RST/PWR	Description
25	WO	0b	Uncore	<p>Interrupt Remapping Enable (IRE)</p> <p>This field is valid only for implementations supporting interrupt remapping.</p> <p>0 = Disable interrupt-remapping hardware 1 = Enable interrupt-remapping hardware</p> <p>Hardware reports the status of the interrupt remapping enable operation through the IRES field in the Global Status register. There may be active interrupt requests in the platform when software updates this field. Hardware must enable or disable interrupt-remapping logic only at deterministic transaction boundaries, so that any in-flight interrupts are either subject to remapping or not at all.</p> <p>Hardware implementations must drain any in-flight interrupt requests queued in the Root-Complex before completing the interrupt-remapping enable command and reflecting the status of the command through the IRES field in the Global Status register. The value returned on a read of this field is undefined.</p>
24	WO	0b	Uncore	<p>Set Interrupt Remap Table Pointer (SIRTP)</p> <p>This field is valid only for implementations supporting interrupt-remapping.</p> <p>Software sets this field to set/update the interrupt remapping table pointer used by hardware. The interrupt remapping table pointer is specified through the Interrupt Remapping Table Address (IRTA_REG) register.</p> <p>Hardware reports the status of the 'Set Interrupt Remap Table Pointer' operation through the IRTPS field in the Global Status register.</p> <p>The 'Set Interrupt Remap Table Pointer' operation must be performed before enabling or re-enabling (after disabling) interrupt-remapping hardware through the IRE field.</p> <p>After a 'Set Interrupt Remap Table Pointer' operation, software must globally invalidate the interrupt entry cache. This is required to ensure hardware uses only the interrupt-remapping entries referenced by the new interrupt remap table pointer, and not any stale cached entries.</p> <p>While interrupt remapping is active, software may update the interrupt remapping table pointer through this field. However, to ensure valid in-flight interrupt requests are deterministically remapped, software must ensure that the structures referenced by the new interrupt remap table pointer are programmed to provide the same remapping results as the structures referenced by the previous interrupt remap table pointer.</p> <p>Clearing this bit has no effect. The value returned on a read of this field is undefined.</p>
23	WO	0b	Uncore	<p>Compatibility Format Interrupt (CFI)</p> <p>This field is valid only for Intel 64 implementations supporting interrupt-remapping.</p> <p>Software writes to this field to enable or disable Compatibility Format interrupts on Intel 64 platforms. The value in this field is effective only when interrupt-remapping is enabled and Extended Interrupt Mode (x2APIC mode) is not enabled.</p> <p>0 = Block Compatibility format interrupts. 1 = Process Compatibility format interrupts as pass-through (bypass interrupt remapping).</p> <p>Hardware reports the status of updating this field through the CFIS field in the Global Status register.</p> <p>The value returned on a read of this field is undefined.</p>
22:0	RO	0h		Reserved



2.18.5 GSTS_REG—Global Status Register

This register reports general remapping hardware status.

B/D/F/Type:		0/0/0/GFXVTBAR		
Address Offset:		1C–1Fh		
Reset Value:		0000000h		
Access:		RO, RO-V		
Size:		32 bits		
BIOS Optimal Default		000000h		
Bit	Attr	Reset Value	RST/PWR	Description
31	RO-V	0b	Uncore	Translation Enable Status (TES) This field indicates the status of DMA-remapping hardware. 0 = DMA-remapping hardware is Not enabled 1 = DMA-remapping hardware is enabled
30	RO-V	0b	Uncore	Root Table Pointer Status (RTPS) This field indicates the status of the root- table pointer in hardware. This field is cleared by hardware when software sets the SRTP field in the Global Command register. This field is set by hardware when hardware completes the 'Set Root Table Pointer' operation using the value provided in the Root-Entry Table Address register.
29	RO	0b	Uncore	Fault Log Status (FLS) 0 = Cleared by hardware when software Sets the SFL field in the Global Command register. 1 = Set by hardware when hardware completes the 'Set Fault Log Pointer' operation using the value provided in the Advanced Fault Log register.
28	RO	0b	Uncore	Advanced Fault Logging Status (AFLS) This field is valid only for implementations supporting advanced fault logging. It indicates the advanced fault logging status: 0 = Advanced Fault Logging is Not enabled. 1 = Advanced Fault Logging is enabled.
27	RO	0b	Uncore	Write Buffer Flush Status (WBFS) This field is valid only for implementations requiring write buffer flushing. This field indicates the status of the write buffer flush command. It is: <ul style="list-style-type: none"> Set by hardware when software sets the WBF field in the Global Command register. Cleared by hardware when hardware completes the write buffer flushing operation.
26	RO-V	0b	Uncore	Queued Invalidation Enable Status (QIES) This field indicates queued invalidation enable status. 0 = Disabled. Queued invalidation is not enabled. 1 = Enabled. Queued invalidation is enabled.
25	RO-V	0b	Uncore	Interrupt Remapping Enable Status (IRES) This field indicates the status of Interrupt-remapping hardware. 0 = Interrupt-remapping hardware is Not enabled 1 = Interrupt-remapping hardware is enabled



B/D/F/Type:		0/0/0/GFXVTBAR		
Address Offset:		1C–1Fh		
Reset Value:		00000000h		
Access:		RO, RO-V		
Size:		32 bits		
BIOS Optimal Default		000000h		
Bit	Attr	Reset Value	RST/PWR	Description
24	RO-V	0b	Uncore	<p>Interrupt Remapping Table Pointer Status (IRTPS)</p> <p>This field indicates the status of the interrupt remapping table pointer in hardware.</p> <p>This field is cleared by hardware when software sets the SIRTP field in the Global Command register. This field is set by hardware when hardware completes the set interrupt remap table pointer operation using the value provided in the Interrupt Remapping Table Address register.</p>
23	RO-V	0b	Uncore	<p>Compatibility Format Interrupt Status (CFIS)</p> <p>This field indicates the status of Compatibility format interrupts on Intel 64 implementations supporting interrupt-remapping. The value reported in this field is applicable only when interrupt-remapping is enabled and Extended Interrupt Mode (x2APIC mode) is not enabled.</p> <p>0 = Compatibility format interrupts are blocked. 1 = Compatibility format interrupts are processed as pass-through (bypassing interrupt remapping).</p>
22:0	RO	0h		Reserved

2.18.6 RTADDR_REG—Root-Entry Table Address Register

This register provides the base address of root-entry table.

B/D/F/Type:		0/0/0/GFXVTBAR		
Address Offset:		20–27h		
Reset Value:		0000000000000000h		
Access:		RW		
Size:		64 bits		
BIOS Optimal Default		0000000000h		
Bit	Attr	Reset Value	RST/PWR	Description
63:39	RO	0h		Reserved
38:12	RW	0000000h	Uncore	<p>Root Table Address (RTA)</p> <p>This register points to base of page aligned, 4 KB-sized root-entry table in system memory. Hardware ignores and does not implement bits 63:HAW, where HAW is the host address width.</p> <p>Software specifies the base address of the root-entry table through this register, and programs it in hardware through the SRTP field in the Global Command register.</p> <p>Reads of this register returns value that was last programmed to it.</p>
11:0	RO	0h		Reserved

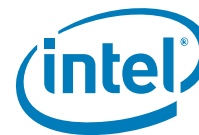

2.18.7 CCMD_REG—Context Command Register

This register manages context cache. The act of writing the upper most byte of the CCMD_REG with the ICC field set causes the hardware to perform the context-cache invalidation.

B/D/F/Type: 0/0/0/GFXVTBAR Address Offset: 28–2Fh Reset Value: 0800000000000000h Access: RW, RW-V, RO-V Size: 64 bits BIOS Optimal Default 00000000h				
Bit	Attr	Reset Value	RST/PWR	Description
63	RW-V	0h	Uncore	<p>Invalidate Context-Cache (ICC)</p> <p>Software requests invalidation of context-cache by setting this field. Software must also set the requested invalidation granularity by programming the CIRG field. Software must read back and check the ICC field is Clear to confirm the invalidation is complete. Software must not update this register when this field is set.</p> <p>Hardware clears the ICC field to indicate the invalidation request is complete. Hardware also indicates the granularity at which the invalidation operation was performed through the CAIG field.</p> <p>Software must submit a context-cache invalidation request through this field only when there are no invalidation requests pending at this remapping hardware unit.</p> <p>Since information from the context-cache may be used by hardware to tag IOTLB entries, software must perform domain-selective (or global) invalidation of IOTLB after the context cache invalidation has completed.</p> <p>Hardware implementations reporting write-buffer flushing requirement (RWBF=1 in Capability register) must implicitly perform a write buffer flush before invalidating the context cache.</p>
62:61	RW	0h	Uncore	<p>Context Invalidation Request Granularity (CIRG)</p> <p>Software provides the requested invalidation granularity through this field when setting the ICC field:</p> <ul style="list-style-type: none"> 00 = Reserved. 01 = Global Invalidation request. 10 = Domain-selective invalidation request. The target domain-id must be specified in the DID field. 11 = Device-selective invalidation request. The target source-id(s) must be specified through the SID and FM fields, and the domain-id (that was programmed in the context-entry for these device(s)) must be provided in the DID field. <p>Hardware implementations may process an invalidation request by performing invalidation at a coarser granularity than requested. Hardware indicates completion of the invalidation request by clearing the ICC field. At this time, hardware also indicates the granularity at which the actual invalidation was performed through the CAIG field.</p>

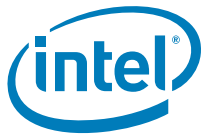

B/D/F/Type:		0/0/0/GFXVTBAR		
Address Offset:		28–2Fh		
Reset Value:		0800000000000000h		
Access:		RW, RW-V, RO-V		
Size:		64 bits		
BIOS Optimal Default		000000000h		
Bit	Attr	Reset Value	RST/PWR	Description
60:59	RO-V	1h	Uncore	<p>Context Actual Invalidation Granularity (CAIG)</p> <p>Hardware reports the granularity at which an invalidation request was processed through the CAIG field at the time of reporting invalidation completion (by clearing the ICC field).</p> <p>The following are the encodings for this field:</p> <p>00 = Reserved.</p> <p>01 = Global Invalidation performed. This could be in response to a global, domain-selective or device-selective invalidation request.</p> <p>10 = Domain-selective invalidation performed using the domain-id specified by software in the DID field. This could be in response to a domain-selective or device-selective invalidation request.</p> <p>11 = Device-selective invalidation performed using the source-id and domain-id specified by software in the SID and FM fields. This can only be in response to a device-selective invalidation request.</p>
58:34	RO	0h		Reserved
33:32	RW	0h	Uncore	<p>Function Mask (FM)</p> <p>Software may use the Function Mask to perform device-selective invalidations on behalf of devices supporting PCI Express Phantom Functions.</p> <p>This field specifies which bits of the function number portion (least significant three bits) of the SID field to mask when performing device-selective invalidations. The following encodings are defined for this field:</p> <p>00 = No bits in the SID field masked.</p> <p>01 = Mask most significant bit of function number in the SID field.</p> <p>10 = Mask two most significant bit of function number in the SID field.</p> <p>11 = Mask all three bits of function number in the SID field.</p> <p>The context-entries corresponding to all the source-ids specified through the FM and SID fields must have to the domain-id specified in the DID field.</p>
31:16	RW	0000h	Uncore	<p>Source ID (SID)</p> <p>This field indicates the source-id of the device whose corresponding context-entry needs to be selectively invalidated. This field along with the FM field must be programmed by software for device-selective invalidation requests.</p>
15:8	RO	0h		Reserved
7:0	RW	00h	Uncore	<p>Domain-ID (DID)</p> <p>this field indicates the id of the domain whose context-entries need to be selectively invalidated. This field must be programmed by software for both domain-selective and device-selective invalidation requests.</p> <p>The Capability register reports the domain-id width supported by hardware. Software must ensure that the value written to this field is within this limit. Hardware may ignore and not implement bits 15:N, where N is the supported domain-id width reported in the Capability register.</p>

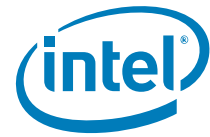

2.18.8 FSTS_REG—Fault Status Register

This register indicates the various error status.

B/D/F/Type: 0/0/0/GFXVTBAR Address Offset: 34–37h Reset Value: 0000000h Access: RO, ROS-V, RW1CS Size: 32 bits BIOS Optimal Default: 00000h				
Bit	Attr	Reset Value	RST/PWR	Description
31:16	RO	0h		Reserved
15:8	ROS-V	00h	Powergood	Fault Record Index (FRI) This field is valid only when the PPF field is set. The FRI field indicates the index (from base) of the fault recording register to which the first pending fault was recorded when the PPF field was Set by hardware. The value read from this field is undefined when the PPF field is clear.
7:7	RO	0h		Reserved
6	RO	0b	Uncore	Invalidation Time-out Error (ITE) Hardware detected a Device-IOTLB invalidation completion time-out. At this time, a fault event may be generated based on the programming of the Fault Event Control register. Hardware implementations not supporting device Device-IOTLBs implement this bit as RsvdZ.
5	RO	0b	Uncore	Invalidation Completion Error (ICE) Hardware received an unexpected or invalid Device-IOTLB invalidation completion. This could be due to either an invalid ITag or invalid source-id in an invalidation completion response. At this time, a fault event may be generated based on the programming of the Fault Event Control register. Hardware implementations not supporting Device-IOTLBs implement this bit as RsvdZ.
4	RW1CS	0b	Powergood	Invalidation Queue Error (IQE) Hardware detected an error associated with the invalidation queue. This could be due to either a hardware error while fetching a descriptor from the invalidation queue, or hardware detecting an erroneous or invalid descriptor in the invalidation queue. At this time, a fault event may be generated based on the programming of the Fault Event Control register. Hardware implementations not supporting queued invalidations implement this bit as RsvdZ.
3	RO	0b	Uncore	Advanced Pending Fault (APF) When this bit is 0, hardware sets this bit when the first fault record (at index 0) is written to a fault log. At this time, a fault event is generated based on the programming of the Fault Event Control register. Software writing 1 to this field clears it. Hardware implementations not supporting advanced fault logging implement this bit as RsvdZ.



B/D/F/Type: 0/0/0/GFXVTBAR Address Offset: 34–37h Reset Value: 00000000h Access: RO, ROS-V, RW1CS Size: 32 bits BIOS Optimal Default: 00000h				
Bit	Attr	Reset Value	RST/PWR	Description
2	RO	0b	Uncore	Advanced Fault Overflow (AFO) Hardware sets this bit to indicate advanced fault log overflow condition. At this time, a fault event is generated based on the programming of the Fault Event Control register. Software writing 1 to this field clears it. Hardware implementations not supporting advanced fault logging implement this bit as RsvdZ.
1	ROS-V	0b	Powergood	Primary Pending Fault (PPF) This bit indicates if there are one or more pending faults logged in the fault recording registers. Hardware computes this bit as the logical OR of Fault (F) fields across all the fault recording registers of this remapping hardware unit. 0 = No pending faults in any of the fault recording registers 1 = One or more fault recording registers has pending faults. The FRI field is updated by hardware when the PPF bit is set by hardware. Also, depending on the programming of Fault Event Control register, a fault event is generated when hardware sets this field.
0	RW1CS	0b	Powergood	Primary Fault Overflow (PFO) Hardware sets this bit to indicate overflow of fault recording registers. Software writing 1 clears this bit. When this bit is set, hardware does not record any new faults until software clears this bit.

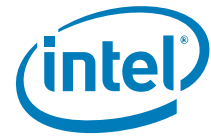

2.18.9 FECTL_REG—Fault Event Control Register

This register specifies the fault event interrupt message control bits.

B/D/F/Type: 0/0/0/GFXVTBAR Address Offset: 38–3Bh Reset Value: 80000000h Access: RW, RO-V Size: 32 bits BIOS Optimal Default: 00000000h				
Bit	Attr	Reset Value	RST/PWR	Description
31	RW	1b	Uncore	Interrupt Mask (IM) 0 = No masking of interrupt. When an interrupt condition is detected, hardware issues an interrupt message (using the Fault Event Data and Fault Event Address register values). 1 = This is the value on reset. Software may mask interrupt message generation by setting this bit. Hardware is prohibited from sending the interrupt message when this bit is set.
30	RO-V	0h	Uncore	Interrupt Pending (IP) Hardware sets the IP bit when it detects an interrupt condition, which is defined as: <ul style="list-style-type: none"> When primary fault logging is active, an interrupt condition occurs when hardware records a fault through one of the Fault Recording registers and sets the PPF bit in Fault Status register. When advanced fault logging is active, an interrupt condition occurs when hardware records a fault in the first fault record (at index 0) of the current fault log and sets the APF bit in the Fault Status register. Hardware detected error associated with the Invalidation Queue, setting the IQE bit in the Fault Status register. Hardware detected invalid Device-IOTLB invalidation completion, setting the ICE bit in the Fault Status register. Hardware detected Device-IOTLB invalidation completion timeout, setting the ITE bit in the Fault Status register. If any of the status fields in the Fault Status register was already Set at the time of setting any of these bits, it is not treated as a new interrupt condition. The IP bit is kept set by hardware while the interrupt message is held pending. The interrupt message could be held pending due to interrupt mask (IM field) being Set or other transient hardware conditions. The IP bit is cleared by hardware as soon as the interrupt message pending condition is serviced. This could be due to either: <ul style="list-style-type: none"> Hardware issuing the interrupt message due to either change in the transient hardware condition that caused interrupt message to be held pending, or due to Software clearing the IM bit. Software servicing all the pending interrupt status bits in the Fault Status register as follows: <ul style="list-style-type: none"> When primary fault logging is active, software clearing the Fault (F) bit in all the Fault Recording registers with faults, causing the PPF bit in Fault Status register to be evaluated as clear. Software clearing other status bit in the Fault Status register by writing back the value read from the respective bits.
29:0	RO	0h		Reserved



2.18.10 FEDATA_REG—Fault Event Data Register

This register specifies the interrupt message data.

B/D/F/Type:		0/0/0/GFXVTBAR		
Address Offset:		3C–3Fh		
Reset Value:		00000000h		
Access:		RW		
Size:		32 bits		
Bit	Attr	Reset Value	RST/PWR	Description
31:16	RW	0000h	Uncore	Extended Interrupt Message Data (EIMD) This field is valid only for implementations supporting 32-bit interrupt data fields. Hardware implementations supporting only 16-bit interrupt data may treat this field as RsvdZ.
15:0	RW	0000h	Uncore	Interrupt Message Data (IMD) Data value in the interrupt request.

2.18.11 FEADDR_REG—Fault Event Address Register

This register specifies the interrupt message address.

B/D/F/Type:		0/0/0/GFXVTBAR		
Address Offset:		40–43h		
Reset Value:		00000000h		
Access:		RW		
Size:		32 bits		
BIOS Optimal Default		0h		
Bit	Attr	Reset Value	RST/PWR	Description
31:2	RW	00000000h	Uncore	Message Address (MA) When fault events are enabled, the contents of this register specify the DWORD-aligned address (bits 31:2) for the interrupt request.
1:0	RO	0h		Reserved

2.18.12 FEUADDR_REG—Fault Event Upper Address Register

This register specifies the interrupt message upper address.

B/D/F/Type:		0/0/0/GFXVTBAR		
Address Offset:		44–47h		
Reset Value:		00000000h		
Access:		RW		
Size:		32 bits		
Bit	Attr	Reset Value	RST/PWR	Description
31:0	RW	00000000h	Uncore	Message upper address (MUA) Hardware implementations supporting Extended Interrupt Mode are required to implement this register. Hardware implementations not supporting Extended Interrupt Mode may treat this field as RsvdZ.

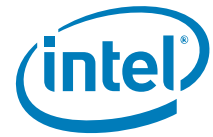

2.18.13 AFLOG_REG—Advanced Fault Log Register

This register specifies the base address of the memory-resident fault-log region. This register is treated as RsvdZ for implementations not supporting advanced translation fault logging (AFL field reported as 0 in the Capability register).

B/D/F/Type:		0/0/0/GFXVTBAR		
Address Offset:		58–5Fh		
Reset Value:		0000000000000000h		
Access:		RO		
Size:		64 bits		
BIOS Optimal Default		000h		
Bit	Attr	Reset Value	RST/PWR	Description
63:12	RO	00000000 00000h	Uncore	Fault Log Address (FLA) This field specifies the base of 4 KB aligned fault-log region in system memory. Hardware ignores and does not implement bits 63:HAW, where HAW is the host address width. Software specifies the base address and size of the fault log region through this register, and programs it in hardware through the SFL field in the Global Command register. When implemented, reads of this field return the value that was last programmed to it.
11:9	RO	0h	Uncore	Fault Log Size (FLS) This field specifies the size of the fault log region pointed by the FLA field. The size of the fault log region is $2^X * 4KB$, where X is the value programmed in this register. When implemented, reads of this field return the value that was last programmed to it.
8:0	RO	0h		Reserved



2.18.14 PMEN_REG—Protected Memory Enable Register

This register enables the DMA-protected memory regions setup through the PLMBASE, PLMLIMIT, PHMBASE, PHMLIMIT registers. This register is always treated as RO for implementations not supporting protected memory regions (PLMR and PHMR fields reported as Clear in the Capability register).

Protected memory regions may be used by software to securely initialize remapping structures in memory. To avoid impact to legacy BIOS usage of memory, software is recommended to not overlap protected memory regions with any reserved memory regions of the platform reported through the Reserved Memory Region Reporting (RMRR) structures.

B/D/F/Type:		0/0/0/GFXVTBAR		
Address Offset:		64–67h		
Reset Value:		00000000h		
Access:		RW, RO-V		
Size:		32 bits		
BIOS Optimal Default		00000000h		
Bit	Attr	Reset Value	RST/PWR	Description
31	RW	0h	Uncore	<p>Enable Protected Memory (EPM)</p> <p>This bit controls DMA accesses to the protected low-memory and protected high-memory regions.</p> <p>0 = Protected memory regions are disabled. 1 = Protected memory regions are enabled. DMA requests accessing protected memory regions are handled as follows:</p> <ul style="list-style-type: none"> — When DMA remapping is not enabled, all DMA requests accessing protected memory regions are blocked. — When DMA remapping is enabled: <ul style="list-style-type: none"> — DMA requests processed as pass-through (Translation Type value of 10b in Context-Entry) and accessing the protected memory regions are blocked. — DMA requests with translated address (AT=10b) and accessing the protected memory regions are blocked. — DMA requests that are subject to address remapping, and accessing the protected memory regions may or may not be blocked by hardware. For such requests, software must not depend on hardware protection of the protected memory regions, and instead program the DMA-remapping page-tables to not allow DMA to protected memory regions. <p>Remapping hardware access to the remapping structures are not subject to protected memory region checks.</p> <p>DMA requests blocked due to protected memory region violation are not recorded or reported as remapping faults.</p> <p>Hardware reports the status of the protected memory enable/disable operation through the PRS field in this register. Hardware implementations supporting DMA draining must drain any in-flight translated DMA requests queued within the Root-Complex before indicating the protected memory region as enabled through the PRS field.</p>
30:1	RO	0h		Reserved
0	RO-V	0h	Uncore	<p>Protected Region Status (PRS)</p> <p>This bit indicates the status of protected memory region(s):</p> <p>0 = Protected memory region(s) disabled. 1 = Protected memory region(s) enabled.</p>



2.18.15 PLMBASE_REG—Protected Low-Memory Base Register

This register sets up the base address of DMA-protected low-memory region below 4 GB. This register must be set up before enabling protected memory through PMEN_REG, and must not be updated when protected memory regions are enabled.

This register is always treated as RO for implementations not supporting protected low memory region (PLMR field reported as Clear in the Capability register).

The alignment of the protected low memory region base depends on the number of reserved bits (N:0) of this register. Software may determine N by writing all 1s to this register, and finding the most significant zero bit position with 0 in the value read back from the register. Bits N:0 of this register is decoded by hardware as all 0s.

Software must setup the protected low memory region below 4 GB.

Software must not modify this register when protected memory regions are enabled (PRS field Set in PMEN_REG).

B/D/F/Type:		0/0/0/GFXVTBAR		
Address Offset:		68–6Bh		
Reset Value:		00000000h		
Access:		RW		
Size:		32 bits		
BIOS Optimal Default		00000h		
Bit	Attr	Reset Value	RST/PWR	Description
31:20	RW	000h	Uncore	Protected Low-Memory Base (PLMB) This register specifies the base of protected low-memory region in system memory.
19:0	RO	0h		Reserved



2.18.16 PLMLIMIT_REG—Protected Low-Memory Limit Register

This register sets up the limit address of DMA-protected low-memory region below 4 GB. This register must be set up before enabling protected memory through PMEN_REG, and must not be updated when protected memory regions are enabled.

This register is always treated as RO for implementations not supporting protected low memory region (PLMR field reported as Clear in the Capability register).

The alignment of the protected low memory region limit depends on the number of reserved bits (N:0) of this register. Software may determine N by writing all 1s to this register, and finding most significant zero bit position with 0 in the value read back from the register. Bits N:0 of the limit register is decoded by hardware as all 1s.

The Protected low-memory base and limit registers functions as follows:

- Programming the protected low-memory base and limit registers with the same value in bits 31:(N+1) specifies a protected low-memory region of size $2^{(N+1)}$ bytes.
- Programming the protected low-memory limit register with a value less than the protected low-memory base register disables the protected low-memory region.

Software must not modify this register when protected memory regions are enabled (PRS field Set in PMEN_REG).

B/D/F/Type:		0/0/0/GFXVTBAR		
Address Offset:		6C–6Fh		
Reset Value:		0000000h		
Access:		RW		
Size:		32 bits		
BIOS Optimal Default		00000h		
Bit	Attr	Reset Value	RST/PWR	Description
31:20	RW	000h	Uncore	Protected Low-Memory Limit (PLML) This field specifies the last host physical address of the DMA-protected low-memory region in system memory.
19:0	RO	0h		Reserved

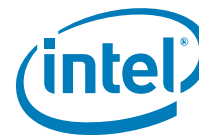

2.18.17 PHMBASE_REG—Protected High-Memory Base Register

This register sets up the base address of DMA-protected high-memory region. This register must be set up before enabling protected memory through PMEN_REG, and must not be updated when protected memory regions are enabled.

This register is always treated as RO for implementations not supporting protected high memory region (PHMR field reported as Clear in the Capability register).

The alignment of the protected high memory region base depends on the number of reserved bits (N:0) of this register. Software may determine N by writing all 1's to this register, and finding most significant zero bit position below host address width (HAW) in the value read back from the register. Bits N:0 of this register are decoded by hardware as all 0s.

Software may setup the protected high memory region either above or below 4 GB.

Software must not modify this register when protected memory regions are enabled (PRS field Set in PMEN_REG).

B/D/F/Type:		0/0/0/GFXVTBAR		
Address Offset:		70–77h		
Reset Value:		000000000000000h		
Access:		RW		
Size:		64 bits		
BIOS Optimal Default		000000000000h		
Bit	Attr	Reset Value	RST/PWR	Description
63:39	RO	0h		Reserved
38:20	RW	00000h	Uncore	Protected High-Memory Base (PHMB) This register specifies the base of protected (high) memory region in system memory. Hardware ignores, and does not implement, bits 63:HAW, where HAW is the host address width.
19:0	RO	0h		Reserved



2.18.18 PHMLIMIT_REG—Protected High-Memory Limit Register

This register sets up the limit address of DMA-protected high-memory region. This register must be set up before enabling protected memory through PMEN_REG, and must not be updated when protected memory regions are enabled.

This register is always treated as RO for implementations not supporting protected high memory region (PHMR field reported as Clear in the Capability register).

The alignment of the protected high memory region limit depends on the number of reserved bits (N:0) of this register. Software may determine the value of N by writing all 1s to this register, and finding most significant zero bit position below host address width (HAW) in the value read back from the register. Bits N:0 of the limit register is decoded by hardware as all 1s.

The protected high-memory base & limit registers functions as follows.

- Programming the protected low-memory base and limit registers with the same value in bits HAW:(N+1) specifies a protected low-memory region of size $2^{(N+1)}$ bytes.
- Programming the protected high-memory limit register with a value less than the protected high-memory base register disables the protected high-memory region.

Software must not modify this register when protected memory regions are enabled (PRS field Set in PMEN_REG).

B/D/F/Type:		0/0/0/GFXVTBAR		
Address Offset:		78–7Fh		
Reset Value:		0000000000000000h		
Access:		RW		
Size:		64 bits		
BIOS Optimal Default		000000000000h		
Bit	Attr	Reset Value	RST/PWR	Description
63:39	RO	0h		Reserved
38:20	RW	00000h	Uncore	Protected High-Memory Limit (PHML) This register specifies the last host physical address of the DMA-protected high-memory region in system memory. Hardware ignores and does not implement bits 63:HAW, where HAW is the host address width.
19:0	RO	0h		Reserved

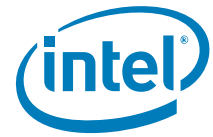

2.18.19 IQH_REG—Invalidation Queue Head Register

This register indicates the invalidation queue head. This register is treated as RsvdZ by implementations reporting Queued Invalidation (QI) as not supported in the Extended Capability register.

B/D/F/Type:		0/0/0/GFXVTBAR		
Address Offset:		80–87h		
Reset Value:		0000000000000000h		
Access:		RO-V		
Size:		64 bits		
BIOS Optimal Default		00000000000000h		
Bit	Attr	Reset Value	RST/PWR	Description
63:19	RO	0h		Reserved
18:4	RO-V	0000h	Uncore	Queue Head (QH) This field specifies the offset (128-bit aligned) to the invalidation queue for the command that will be fetched next by hardware. Hardware resets this field to 0 whenever the queued invalidation is disabled (QIES field Clear in the Global Status register).
3:0	RO	0h		Reserved

2.18.20 IQT_REG—Invalidation Queue Tail Register

This register indicates the invalidation tail head. This register is treated as RsvdZ by implementations reporting Queued Invalidation (QI) as not supported in the Extended Capability register.

B/D/F/Type:		0/0/0/GFXVTBAR		
Address Offset:		88–8Fh		
Reset Value:		0000000000000000h		
Access:		RW-L		
Size:		64 bits		
BIOS Optimal Default		00000000000000h		
Bit	Attr	Reset Value	RST/PWR	Description
63:19	RO	0h		Reserved
18:4	RW-L	0000h	Uncore	Queue Tail (QT) This field specifies the offset (128-bit aligned) to the invalidation queue for the command that will be written next by software.
3:0	RO	0h		Reserved



2.18.21 IQA_REG—Invalidation Queue Address Register

This register configures the base address and size of the invalidation queue. This register is treated as RsvdZ by implementations reporting Queued Invalidation (QI) as not supported in the Extended Capability register.

B/D/F/Type:		0/0/0/GFXVTBAR		
Address Offset:		90–97h		
Reset Value:		0000000000000000h		
Access:		RW-L		
Size:		64 bits		
BIOS Optimal Default		00000000h		
Bit	Attr	Reset Value	RST/PWR	Description
63:39	RO	0h		Reserved
38:12	RW-L	0000000h	Uncore	Invalidation Queue Base Address (IQA) This field points to the base of 4 KB aligned invalidation request queue. Hardware ignores and does not implement bits 63:HAW, where HAW is the host address width. Reads of this field return the value that was last programmed to it.
11:3	RO	0h		Reserved
2:0	RW-L	0h	Uncore	Queue Size (QS) This field specifies the size of the invalidation request queue. A value of X in this field indicates an invalidation request queue of (2^X) 4KB pages. The number of entries in the invalidation queue is $2^{(X + 8)}$.

2.18.22 ICS_REG—Invalidation Completion Status Register

This register reports the completion status of invalidation wait descriptor with the Interrupt Flag (IF) Set.

This register is treated as RsvdZ by implementations reporting Queued Invalidation (QI) as not supported in the Extended Capability register.

B/D/F/Type:		0/0/0/GFXVTBAR		
Address Offset:		9C–9Fh		
Reset Value:		00000000h		
Access:		RW1CS		
Size:		32 bits		
BIOS Optimal Default		00000000h		
Bit	Attr	Reset Value	RST/PWR	Description
31:1	RO	0h		Reserved
0	RW1CS	0b	Powergood	Invalidation Wait Descriptor Complete (IWC) This bit indicates completion of Invalidation Wait Descriptor with Interrupt Flag (IF) field Set. Hardware implementations not supporting queued invalidations implement this field as RsvdZ.

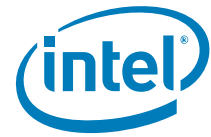

2.18.23 IECTL_REG—Invalidation Event Control Register

This register specifies the invalidation event interrupt control bits. This register is treated as RsvdZ by implementations reporting Queued Invalidation (QI) as not supported in the Extended Capability register.

B/D/F/Type: 0/0/0/GFXVTBAR Address Offset: A0–A3h Reset Value: 80000000h Access: RW-L, RO-V Size: 32 bits BIOS Optimal Default: 00000000h				
Bit	Attr	Reset Value	RST/PWR	Description
31	RW-L	1b	Uncore	Interrupt Mask (IM) 0 = No masking of interrupt. When an invalidation event condition is detected, hardware issues an interrupt message (using the Invalidation Event Data & Invalidation Event Address register values). 1 = This is the value on reset. Software may mask interrupt message generation by setting this field. Hardware is prohibited from sending the interrupt message when this field is set.
30	RO-V	0b	Uncore	Interrupt Pending (IP) Hardware sets the IP bit when it detects an interrupt condition. Interrupt condition is defined as: <ul style="list-style-type: none"> An Invalidation Wait Descriptor with Interrupt Flag (IF) bit set completed, setting the IWC field in the Invalidation Completion Status register. If the IWC bit in the Invalidation Completion Status register was already Set at the time of setting this field, it is not treated as a new interrupt condition. The IP bit is kept set by hardware while the interrupt message is held pending. The interrupt message could be held pending due to interrupt mask (IM bit) being set, or due to other transient hardware conditions. The IP bit is cleared by hardware as soon as the interrupt message pending condition is serviced. This could be due to either: <ul style="list-style-type: none"> Hardware issuing the interrupt message due to either change in the transient hardware condition that caused interrupt message to be held pending or due to software clearing the IM bit. Software servicing the IWC bit in the Invalidation Completion Status register.
29:0	RO	0h		Reserved



2.18.24 IEDATA_REG—Invalidation Event Data Register

This register specifies the Invalidation Event interrupt message data. This register is treated as RsvdZ by implementations reporting Queued Invalidation (QI) as not supported in the Extended Capability register.

B/D/F/Type:		0/0/0/GFXVTBAR		
Address Offset:		A4–A7h		
Reset Value:		00000000h		
Access:		RW-L		
Size:		32 bits		
Bit	Attr	Reset Value	RST/PWR	Description
31:16	RW-L	0000h	Uncore	Extended Interrupt Message Data (EIMD) This field is valid only for implementations supporting 32-bit interrupt data fields. Hardware implementations supporting only 16-bit interrupt data treat this field as RsvdZ.
15:0	RW-L	0000h	Uncore	Interrupt Message data (IMD) Data value in the interrupt request.

2.18.25 IEUADDR_REG—Invalidation Event Upper Address Register

This register specifies the Invalidation Event interrupt message upper address.

B/D/F/Type:		0/0/0/GFXVTBAR		
Address Offset:		AC–AFh		
Reset Value:		00000000h		
Access:		RW-L		
Size:		32 bits		
Bit	Attr	Reset Value	RST/PWR	Description
31:0	RW-L	00000000h	Uncore	Message Upper Address (MUA) Hardware implementations supporting Queued Invalidation and Extended Interrupt Mode are required to implement this register. Hardware implementations not supporting Queued Invalidation or Extended Interrupt Mode may treat this field as reserved.

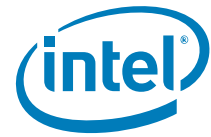

2.18.26 IRTA_REG—Interrupt Remapping Table Address Register

This register provides the base address of Interrupt remapping table. This register is treated as RsvdZ by implementations reporting Interrupt Remapping (IR) as not supported in the Extended Capability register.

B/D/F/Type:		0/0/0/GFXVTBAR		
Address Offset:		B8–BFh		
Reset Value:		0000000000000000h		
Access:		RW-L		
Size:		64 bits		
BIOS Optimal Default		00000000h		
Bit	Attr	Reset Value	RST/PWR	Description
63:39	RO	0h		Reserved
38:12	RW-L	0000000h	Uncore	Interrupt Remapping Table Address (IRTA) This field points to the base of 4 KB aligned interrupt remapping table. Hardware ignores and does not implement bits 63:HAW, where HAW is the host address width. Reads of this field returns value that was last programmed to it.
11	RW-L	0b	Uncore	Extended Interrupt Mode Enable (EIME) This field is used by hardware on Intel 64 platforms as follows: 0 = xAPIC mode is active. Hardware interprets only low 8-bits of Destination-ID field in the IRTEs. The high 24-bits of the Destination-ID field are treated as reserved. 1 = x2APIC mode is active. Hardware interprets all 32-bits of Destination-ID field in the IRTEs. This bit is implemented as RsvdZ on implementations reporting Extended Interrupt Mode (EIM) field as Clear in Extended Capability register.
10:4	RO	0h		Reserved
3:0	RW-L	0h	Uncore	Size (S) This field specifies the size of the interrupt remapping table. The number of entries in the interrupt remapping table is $2^{(X+1)}$, where X is the value programmed in this field.

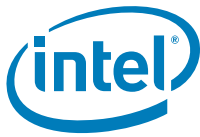

2.18.27 IVA_REG—Invalidate Address Register

This register provides the DMA address whose corresponding IOTLB entry needs to be invalidated through the corresponding IOTLB Invalidate register. This register is a write only register.

B/D/F/Type:		0/0/0/GFXVTBAR	
Address Offset:		100–107h	
Reset Value:		0000000000000000h	
Access:		RW	
Size:		64 bits	
BIOS Optimal Default		00000000h	

Bit	Attr	Reset Value	RST/PWR	Description																					
63:39	RO	0h		Reserved																					
38:12	RW	0000000h	Uncore	Address (ADDR) Software provides the DMA address that needs to be page-selectively invalidated. To make a page-selective invalidation request to hardware, software must first write the appropriate fields in this register, and then issue the appropriate page-selective invalidate command through the IOTLB_REG. Hardware ignores bits 63: N, where N is the maximum guest address width (MGAW) supported.																					
11:7	RO	0h		Reserved																					
6	RW	0h	Uncore	Invalidation Hint (IH) This bit provides hint to hardware about preserving or flushing the non-leaf (page-directory) entries that may be cached in hardware: 0 = Software may have modified both leaf and non-leaf page-table entries corresponding to mappings specified in the ADDR and AM fields. On a page-selective invalidation request, hardware must flush both the cached leaf and non-leaf page-table entries corresponding to the mappings specified by ADDR and AM fields. 1 = Software has not modified any non-leaf page-table entries corresponding to mappings specified in the ADDR and AM fields. On a page-selective invalidation request, hardware may preserve the cached non-leaf page-table entries corresponding to mappings specified by ADDR and AM fields.																					
5:0	RW	00h	Uncore	Address Mask (AM) The value in this field specifies the number of low-order bits of the ADDR field that must be masked for the invalidation operation. This field enables software to request invalidation of contiguous mappings for size-aligned regions. For example: <table border="1"> <thead> <tr> <th>Mask Value</th> <th>ADDR bits masked</th> <th>Pages invalidated</th> </tr> </thead> <tbody> <tr> <td>0</td> <td>None</td> <td>1</td> </tr> <tr> <td>1</td> <td>12</td> <td>2</td> </tr> <tr> <td>2</td> <td>13:12</td> <td>4</td> </tr> <tr> <td>3</td> <td>14:12</td> <td>8</td> </tr> <tr> <td>4</td> <td>15:12</td> <td>16</td> </tr> <tr> <td>...</td> <td>...</td> <td>...</td> </tr> </tbody> </table> When invalidating mappings for super-pages, software must specify the appropriate mask value. For example, when invalidating mapping for a 2 MB page, software must specify an address mask value of at least 9. Hardware implementations report the maximum supported mask value through the Capability register.	Mask Value	ADDR bits masked	Pages invalidated	0	None	1	1	12	2	2	13:12	4	3	14:12	8	4	15:12	16
Mask Value	ADDR bits masked	Pages invalidated																							
0	None	1																							
1	12	2																							
2	13:12	4																							
3	14:12	8																							
4	15:12	16																							
...																							

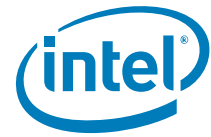

2.18.28 IOTLB_REG—IOTLB Invalidate Register

This register invalidates the IOTLB. The act of writing the upper byte of the IOTLB_REG with IVT bit set causes the hardware to perform the IOTLB invalidation.

B/D/F/Type:		0/0/0/GFXVTBAR		
Address Offset:		108–10Fh		
Reset Value:		0200000000000000h		
Access:		RW-V, RW, RO-V		
Size:		64 bits		
BIOS Optimal Default		000000000000000h		
Bit	Attr	Reset Value	RST/PWR	Description
63	RW-V	0h	Uncore	<p>Invalidate IOTLB (IVT) Software requests IOTLB invalidation by setting this bit. Software must also set the requested invalidation granularity by programming the IIRG field. Hardware clears the IVT bit to indicate the invalidation request is complete. Hardware also indicates the granularity at which the invalidation operation was performed through the IAIG field. Software must not submit another invalidation request through this register while the IVT field is Set, nor update the associated Invalidate Address register. Software must not submit IOTLB invalidation requests when there is a context-cache invalidation request pending at this remapping hardware unit. Hardware implementations reporting write-buffer flushing requirement (RWBF=1 in Capability register) must implicitly perform a write buffer flushing before invalidating the IOTLB.</p>
62:62	RO	0h		Reserved
61:60	RW	0h	Uncore	<p>IOTLB Invalidation Request Granularity (IIRG) When requesting hardware to invalidate the IOTLB (by setting the IVT bit), software writes the requested invalidation granularity through this field. The following are the encodings for the field. 00 = Reserved. 01 = Global invalidation request. 10 = Domain-selective invalidation request. The target domain-id must be specified in the DID field. 11 = Page-selective invalidation request. The target address, mask and invalidation hint must be specified in the Invalidate Address register, and the domain-id must be provided in the DID field. Hardware implementations may process an invalidation request by performing invalidation at a coarser granularity than requested. Hardware indicates completion of the invalidation request by clearing the IVT field. At this time, the granularity at which actual invalidation was performed is reported through the IAIG field</p>
59:59	RO	0h		Reserved



B/D/F/Type:		0/0/0/GFXVTBAR		
Address Offset:		108–10Fh		
Reset Value:		0200000000000000h		
Access:		RW-V, RW, RO-V		
Size:		64 bits		
BIOS Optimal Default		00000000000000h		
Bit	Attr	Reset Value	RST/PWR	Description
58:57	RO-V	1h	Uncore	<p>IOTLB Actual Invalidation Granularity (IAIG) Hardware reports the granularity at which an invalidation request was processed through this field when reporting invalidation completion (by clearing the IVT field). The following are the encodings for this field.</p> <p>00 = Reserved. This indicates hardware detected an incorrect invalidation request and ignored the request. Examples of incorrect invalidation requests include detecting an unsupported address mask value in Invalidate Address register for page-selective invalidation requests.</p> <p>01 = Global Invalidation performed. This could be in response to a global, domain-selective, or page-selective invalidation request.</p> <p>10 = Domain-selective invalidation performed using the domain-id specified by software in the DID field. This could be in response to a domain-selective or a page-selective invalidation request.</p> <p>11 = Domain-page-selective invalidation performed using the address, mask and hint specified by software in the Invalidate Address register and domain-id specified in DID field. This can be in response to a page-selective invalidation request.</p>
56:50	RO	0h		Reserved
49	RW	0b	Uncore	<p>Drain Reads (DR) This field is ignored by hardware if the DRD field is reported as clear in the Capability register. When the DRD field is reported as set in the Capability register, the following encodings are supported for this bit:</p> <p>0 = Hardware may complete the IOTLB invalidation without draining any translated DMA read requests. 1 = Hardware must drain DMA read requests.</p>
48	RW	0b	Uncore	<p>Drain Writes (DW) This bit is ignored by hardware if the DWD field is reported as clear in the Capability register. When the DWD field is reported as set in the Capability register, the following encodings are supported for this bit:</p> <p>0 = Hardware may complete the IOTLB invalidation without draining DMA write requests. 1 = Hardware must drain relevant translated DMA write requests.</p>
47:40	RO	0h		Reserved
39:32	RW	00h	Uncore	<p>Domain-ID (DID) This field indicates the ID of the domain whose IOTLB entries need to be selectively invalidated. This field must be programmed by software for domain-selective and page-selective invalidation requests. The Capability register reports the domain-id width supported by hardware. Software must ensure that the value written to this field is within this limit. Hardware ignores and does not implement bits 47: (32+N), where N is the supported domain-id width reported in the Capability register.</p>
31:0	RO	0h		Reserved



2.18.29 FRCDL_REG—Fault Recording Low Register

This register records fault information when primary fault logging is active. Hardware reports the number and location of fault recording registers through the Capability register. This register is relevant only for primary fault logging.

This register is sticky and can be cleared only through power good reset or by software clearing the RW1C fields by writing a 1.

B/D/F/Type:		0/0/0/GFXVTBAR		
Address Offset:		200–207h		
Reset Value:		0000000000000000h		
Access:		ROS-V		
Size:		64 bits		
BIOS Optimal Default		0000000000000000h		
Bit	Attr	Reset Value	RST/PWR	Description
63:12	ROS-V	00000000 00000h	Powergood	<p>Fault Info (FI)</p> <p>When the Fault Reason (FR) field indicates one of the DMA-remapping fault conditions, bits 63:12 of this field contain the page address in the faulted DMA request. Hardware treats bits 63:N as reserved (0), where N is the maximum guest address width (MGAW) supported.</p> <p>When the Fault Reason (FR) field indicates one of the interrupt-remapping fault conditions, bits 63:48 of this field indicate the interrupt_index computed for the faulted interrupt request, and bits 47:12 are cleared.</p> <p>This field is relevant only when the F bit is set.</p>
11:0	RO	0h		Reserved



2.18.30 FRCDH_REG—Fault Recording High Register

This register records fault information when primary fault logging is active. Hardware reports the number and location of fault recording registers through the Capability register. This register is relevant only for primary fault logging.

This register is sticky and can be cleared only through power good reset or by software clearing the RW1C fields by writing a 1.

B/D/F/Type:		0/0/0/GFXVTBAR		
Address Offset:		208–20Fh		
Reset Value:		0000000000000000h		
Access:		RO, RW1CS, ROS-V		
Size:		64 bits		
BIOS Optimal Default		0000000000000000h		
Bit	Attr	Reset Value	RST/PWR	Description
63	RW1CS	0b	Powergood	Fault (F) Hardware sets this bit to indicate a fault is logged in this Fault Recording register. The F field is set by hardware after the details of the fault is recorded in other fields. When this bit is set, hardware may collapse additional faults from the same source-id (SID). Software writes the value read from this field to clear it.
62	ROS-V	0b	Powergood	Type (T) Type of the faulted request: 0 = Write request 1 = Read request or AtomicOp request This field is relevant only when the F field is Set, and when the fault reason (FR) indicates one of the DMA-remapping fault conditions.
61:60	RO	00b	Uncore	Address Type (AT) This field captures the AT field from the faulted DMA request. Hardware implementations not supporting Device-IOTLBs (DI field clear in Extended Capability register) treat this field as RsvdZ. When supported, this field is valid only when the F bit is set, and when the fault reason (FR) indicates one of the DMA-remapping fault conditions.
59:40	RO	0h		Reserved
39:32	ROS-V	00h	Powergood	Fault Reason (FR) This field is relevant only when the F bit is set.
31:16	RO	0h		Reserved
15:0	ROS-V	00000000 0000000b	Powergood	Source Identifier (SID) Requester-id associated with the fault condition. This field is relevant only when the F bit is set.



2.18.31 VTPOLICY—DMA Remap Engine Policy Control Register

This register contains all the policy bits related to the DMA remap engine.

B/D/F/Type:		0/0/0/GFXVTBAR		
Address Offset:		FF0–FF3h		
Reset Value:		0000000h		
Access:		RO, RO-KFW, RW-KL, RW-L		
Size:		32 bits		
BIOS Optimal Default		0000h		
Bit	Attr	Reset Value	RST/PWR	Description
31	RW-KL	0b	Uncore	DMA Remap Engine Policy Lock-Down (DMAR_LCKDN) This bit protects all the DMA remap engine specific policy configuration registers. Once this bit is set by software all the DMA remap engine registers within the range F00h to FFCh will be read only. This bit can only be cleared through platform reset.
30:0	RO	0h		Reserved



2.19 PCU MCHBAR Registers

Table 2-21 lists the registers arranged by address offset. Register bit descriptions are in the sections following the table.

Table 2-21. PCU MCHBAR Register Address Map

Register Start	Register Symbol	Register Name	Reset Value	Access
0–587Fh	RSVD	Reserved	0h	RO
5880–5883	MEM_TRML_ESTIMATION_CONFIG	Memory Thermal Estimation Configuration	438C8324h	RW
5884–5887	RSVD	Reserved	00000000h	RW
5888–588B	MEM_TRML_THRESHOLDS_CONFIG	Memory Thermal Thresholds Configuration	00E4D5D0h	RW
588C–589Fh	RSVD	Reserved	—	—
58A0–58A3	MEM_TRML_STATUS_REPORT	Memory Thermal Status Report	00000000h	RO-V
58A4–58A7	MEM_TRML_TEMPERATURE_REPORT	Memory Thermal Temperature Report	00000000h	RO-V
58A8–58AB	MEM_TRML_INTERRUPT	Memory Thermal Interrupt	00000000h	RW
58AC–5D0Fh	RSVD	Reserved	—	—
5948–594Bh	GT_PERF_STATUS	GT Performance Status	00000000h	RO-V
58AC–5997	RSVD	Reserved	—	—
5998–599Bh	RP_STATE_CAP	RP State Capability	00000000h	RO-FW
599C–5D0Fh	RSVD	Reserved	—	—
5D10–5D17	SSKPD	Sticky Scratchpad Data	00000000 00000000h	RWS
5D18–5F0Bh	RSVD	Reserved	—	—

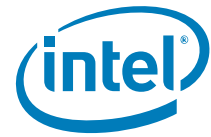

2.19.1 MEM_TRML_ESTIMATION_CONFIG—Memory Thermal Estimation Configuration Register

This register contains configuration regarding VTS temperature estimation calculations that are done by PCODE. For the BW estimation mode, the following formula is used:

$$\text{VTS temperature estimation} = T(n) + \text{VTS_Offset}$$

where $T(n) = (1 - \text{VTS_TIME_CONSTANT}) * T(n-1) + \text{VTS_MUTXTIPLIER} * (\text{MEM_ACC}(n) - \text{MEM_ACC}(n-1))$, where $(\text{MEM_ACC}(n) - \text{MEM_ACC}(n-1))$ equals memory bandwidth

This register is read by PCODE only during Reset Phase 4.

B/D/F/Type:		0/0/0/MCHBAR PCU		
Address Offset:		5880–5883h		
Reset Value:		438C8324h		
Access:		RW		
Size:		32 bits		
BIOS Optimal Default		0h		
Bit	Attr	Reset Value	RST/PWR	Description
31:22	RW	10Eh	Uncore	VTS multiplier (VTS_MUTXTIPLIER) The VTS multiplier serves as a multiplier for the translation of the memory BW to temperature. The units are given in $1 / \text{power}(2,44)$.
21:12	RW	0C8h	Uncore	VTS time constant (VTS_TIME_CONSTANT) This factor is relevant only for BW based temperature estimation. It is equal to "1 minus alpha". The value of the time constant $(1 - \alpha)$ is determined by $\text{VTS_TIME_CONSTANT} / \text{power}(2,25)$ per 1 mSec.
11:11	RO	0h		Reserved
10:4	RW	32h	Uncore	VTS offset adder (VTS_OFFSET) The offset is intended to provide a temperature proxy offset, so the option of having a fixed adder to VTS output is available.
3:3	RO	0h		Reserved
2	RW	1b	Uncore	Disable EXTTS (DISABLE_EXTTS) When set, PCODE should ignore EXTTS indication that is obtained from the PCH and will rely on PECCI or DDR BW estimations.
1	RW	0b	Uncore	Disable Bandwidth Estimation (DISABLE_BW_ESTIMATION) When set, PCODE should ignore DDR BW estimation that is obtained from the memory controller and will rely on PECCI or EXTTS.
0	RW	0b	Uncore	Disable PECCI Control (DISABLE_PECCI_CONTROL) When set, PCODE should ignore DDR temperature that is given by PECCI.



2.19.2 MEM_TRML_THRESHOLDS_CONFIG—Memory Thermal Thresholds Configuration Register

This register describes the thresholds for the memory thermal management in the MC.

- The warm threshold defines when self-refresh is at double rate. Throttling can also be applied at this threshold based on the configuration in the MC.
- The hot threshold defines what the acceptable limit of the temperature is. When this threshold is crossed, severe throttling takes place. The self refresh is also at double rate.
- The critical threshold continues to throttle a the hot threshold value while also generating an additional interrupt for other platform thermal management

Cold Temperature: TEMP < WARM_TH

Warm Temperature: TEMP ≥ WARM_TH & TEMP < HOT_TH

Hot Temperature: TEMP ≥ HOT_TH & TEMP < CRITICAL_TH

Critical Temperature: TEMP ≥ CRITICAL_TH

This register is read by PCODE only during Reset Phase 4.

NOTE: The threshold values must be programmed such that:

WARM_TH < HOT_TH < CRITICAL_TH

B/D/F/Type:		0/0/0/MCHBAR PCU		
Address Offset:		5888–588Bh		
Reset Value:		00E4D5D0h		
Access:		RW		
Size:		32 bits		
BIOS Optimal Default		002AD0h		
Bit	Attr	Reset Value	RST/PWR	Description
31:16	RO	0h		Reserved
15	RW	1b	Uncore	Hot Threshold Enable (HOT_THRESHOLD_ENABLE) This bit must be set to allow the hot threshold.
14:8	RW	1010101b	Uncore	Hot Threshold (HOT_THRESHOLD) This threshold defines what is the acceptable temperature limitation. When this threshold is crossed, severe throttling takes place. The self refresh is also at double rate.
7	RW	1b	Uncore	Warm Threshold Enable (WARM_THRESHOLD_ENABLE) This bit must be set to allow the warm threshold.
6:0	RW	1010000b	Uncore	Warm Threshold (WARM_THRESHOLD) The warm temperature threshold defines when the self refresh is at double rate. Throttling can also be applied at this threshold based on the configuration in the MC.



2.19.3 MEM_TRML_STATUS_REPORT—Memory Thermal Status Report Register

This register reports the thermal status of DRAM.

B/D/F/Type:		0/0/0/MCHBAR PCU		
Address Offset:		58A0–58A3h		
Reset Value:		00000000h		
Access:		RO-V		
Size:		32 bits		
BIOS Optimal Default		00h		
Bit	Attr	Reset Value	RST/PWR	Description
31:25	RO	0h		Reserved
24	RO-V	0b	Uncore	Double Self refresh (DSR) 0 = Normal self refresh 1 = Double self refresh
23:16	RO-V	00h		Reserved
15:8	RO-V	00h	Uncore	Channel 1 Status (CHANNEL1_STATUS) The format is for each channel is defined as follows: 00b = Cold 01b = Warm 11b = Hot Bits 8–9: Rank 0, Channel 1 Bits 10–11: Rank 1, Channel 1 Bits 12–13: Rank 2, Channel 1 Bits 14–15: Rank 3, Channel 1
7:0	RO-V	00h	Uncore	Channel 0 Status (CHANNELO_STATUS) The format is for each channel is defined as follows: 00b = Cold 01b = Warm 11b = Hot Bits 0–1: Rank 0, Channel 0 Bits 2–3: Rank 1, Channel 0 Bits 4–5: Rank 2, Channel 0 Bits 6–7: Rank 3, Channel 0



2.19.4 MEM_TRML_TEMPERATURE_REPORT—Memory Thermal Temperature Report Register

This register is used to report the estimated thermal status of the memory. The Channel VTS estimated maximum temperature field is used to report the estimated maximum temperature of all ranks.

B/D/F/Type:		0/0/0/MCHBAR PCU		
Address Offset:		58A4–58A7h		
Reset Value:		0000000h		
Access:		RO-V		
Size:		32 bits		
BIOS Optimal Default		00h		
Bit	Attr	Reset Value	RST/PWR	Description
31:24	RO	0h		Reserved
23:16	RO-V	00h		Reserved
15:8	RO-V	00h	Uncore	Channel 1 VTS Estimated Max Temperature (CHANNEL1_ESTIMATED_MAX_TEMPERATURE) VTS Estimated Temperature in Degrees C.
7:0	RO-V	00h	Uncore	Channel 0 VTS Estimated Max Temperature (CHANNEL0_ESTIMATED_MAX_TEMPERATURE) VTS Estimated Temperature in Degrees C.

2.19.5 MEM_TRML_INTERRUPT—Memory Thermal Interrupt Register

Hardware uses the information in this register to determine whether a memory thermal interrupt is to be generated or not.

B/D/F/Type:		0/0/0/MCHBAR PCU		
Address Offset:		58A8–58ABh		
Reset Value:		0000000h		
Access:		RW		
Size:		32 bits		
BIOS Optimal Default		0000000h		
Bit	Attr	Reset Value	RST/PWR	Description
31:5	RO	0h		Reserved
4	RW	0b	Uncore	Critical Threshold Interrupt Enable (CRITICAL_THRESHOLD_INT_ENABLE) This bit controls the generation of a thermal interrupt when the Critical Threshold temperature is crossed.
3:3	RO	0h		Reserved
2	RW	0b	Uncore	Hot Threshold Interrupt Enable (HOT_THRESHOLD_INT_ENABLE) This bit controls the generation of a thermal interrupt when the Hot Threshold temperature is crossed.
1:1	RO	0h		Reserved
0	RW	0b	Uncore	Warm Threshold Interrupt Enable (WARM_THRESHOLD_INT_ENABLE) This bit controls the generation of a thermal interrupt when the Warm Threshold temperature is crossed.



2.19.6 GT_PERF_STATUS—GT Performance Status Register

P-state encoding for the Secondary Power Plane's current PLL frequency and the current VID.

B/D/F/Type:		0/0/0/MCHBAR PCU		
Address Offset:		5948-594Bh		
Default Value:		00000000h		
Access:		RO-V;		
Size:		32 bits		
BIOS Optimal Default		0000h		
Bit	Attr	Reset Value	RST/PWR	Description
31:16	RO	0h		Reserved
15:8	RO-V	00h	Uncore	RP-State Ratio (RP_STATE_RATIO) Ratio of the current RP-state.
7:0	RO-V	00h	Uncore	RP-State VID (RP_STATE_VID) VID of the current RP-state.

2.19.7 RP_STATE_CAP—RP State Capability Register

This register contains the maximum base frequency capability for the Integrated Graphics Engine (GT).

B/D/F/Type:		0/0/0/MCHBAR PCU		
Address Offset:		5998-599Bh		
Default Value:		00000000h		
Access:		RO-FW		
Size:		32 bits		
BIOS Optimal Default:		00h		
Bit	Attr	Reset Value	RST/PWR	Description
31:24	RO	0h		Reserved
23:16	RO-FW	00h	Uncore	RPN Capability (RPN_CAP) This field indicates the maximum RPN base frequency capability for the Integrated GFX Engine (GT). Values are in units of 100 MHz.
15:8	RO-FW	00h	Uncore	RP1 Capability (RP1_CAP) This field indicates the maximum RP1 base frequency capability for the Integrated GFX Engine (GT). Values are in units of 100 MHz.
7:0	RO-FW	00h	Uncore	RP0 Capability (RP0_CAP) This field indicates the maximum RP0 base frequency capability for the Integrated GFX Engine (GT). Values are in units of 100 MHz.



2.19.8 SSKPD—Sticky Scratchpad Data Register

This register holds 64 writable bits with no functionality behind them. It is for the convenience of BIOS and graphics drivers.

B/D/F/Type: Address Offset: Reset Value: Access: Size:		0/0/0/MCHBAR PCU 5D10–5D17h 000000000000000h RWS 64 bits		
Bit	Attr	Reset Value	RST/PWR	Description
63:32	RWS	00000000h	Powergood	Scratchpad Data (SKPD) Field [34:32] contains the value to match with the PCI PMSYNC configuration done by BIOS required for discrete USB2PCI cards. Refer to BWG for more details. Field [47:35] contains the timer value on top of the PCH hysteresis value. It is given in units of 10.24 us. Refer to BWG for more details.
31:30	RWS	00b	Powergood	Reserved for Future Use (RWSVD3) Bit 30 controls the way BIOS calculate WM3 value. It reflects the value of PCU_MISC_ENABLES[LNPLLfastLockDisable]. Bit 31 is reserved for future use.
29:24	RWS	00h	Powergood	MPLL Shutdown Latency Time (WM3) Number of microseconds to access memory if memory is in Self Refresh (SR) with MDLLs and Memory PLLs shut off (0.5us granularity). 00h = 0 us 01h = 0.5 us 02h = 1 us ... 3Fh = 31.5 us NOTE: The value in this field corresponds to the memory latency requested to the Display Engine when Memory PLL Shutdown is enabled. The Display LP3 latency and watermark values (GTTMMADR offset 0x45110) should be programmed to match the latency in this register.
23:22	RWS	00b	Powergood	Reserved for Future Use (RWSVD2)
21:16	RWS	000000b	Powergood	MDLL Shutdown Latency Time (WM2) Number of microseconds to access memory if the MDLL is shutdown (requires memory in Self Refresh). The value is programmed in 0.5 us granularity. 00h = 0 us 01h = 0.5 us 02h = 1 us ... 3Fh = 31.5 us NOTE: The value in this field corresponds to the memory latency requested to the Display Engine when MDLL shutdown is enabled. The Display LP2 latency and watermark values (GTTMMADR offset 4511Ch) should be programmed to match the latency in this register.
15:14	RWS	00b	Powergood	Reserved for Future Use (RWSVD1)



B/D/F/Type: Address Offset: Reset Value: Access: Size:		0/0/0/MCHBAR PCU 5D10–5D17h 0000000000000000h RWS 64 bits		
Bit	Attr	Reset Value	RST/ PWR	Description
13:8	RWS	000000b	Powergood	Self Refresh Latency Time (WM1) Number of microseconds to access memory if memory is in Self Refresh (0.5 us granularity). 00h = 0 us 01h = 0.5 us 02h = 1 us ... 3Fh = 31.5 us NOTE: The value in this field corresponds to the memory latency requested to the Display Engine when Memory is in Self Refresh. The Display LP1 latency and watermark values (GTTMMADR offset 45118h) should be programmed to match the latency in this register.
7:6	RWS	00b	Powergood	Reserved for Future Use (RWSVD0)
5:0	RWS	000000b	Powergood	Normal Latency Time (WMO) Number of microseconds to access memory for normal memory operations (0.1 us granularity). 00h = 0 us 01h = 0.1 us 02h = 0.2 us ... 3Fh = 6.3 us



2.20 PXPEPBAR

Table 2-22 lists the registers arranged by address offset. Register bit descriptions are in the sections following the table.

Table 2-22. PXPEPBAR Register Address Map

Address Offset	Register Symbol	Register Name	Reset Value	Access
0–13h	RSVD	Reserved	0h	RO
14–17h	EPVCORCTL	EP VC 0 Resource Control	80000FFh	RO, RW
18–9F	RSVD	Reserved	—	—

2.20.1 EPVCORCTL—EP VC 0 Resource Control Register

This register controls the resources associated with Egress Port Virtual Channel 0.

B/D/F/Type:		0/0/0/PXPEPBAR		
Address Offset:		14–17h		
Reset Value:		80000FFh		
Access:		RO, RW		
Size:		32 bits		
BIOS Optimal Default		00000h		
Bit	Attr	Reset Value	RST/PWR	Description
31:20	RO	0h		Reserved
19:17	RW	000b	Uncore	Port Arbitration Select (PAS) This field configures the VC resource to provide a particular Port Arbitration service. The value of 0h corresponds to the bit position of the only asserted bit in the Port Arbitration Capability field.
16:0	RO	0h		Reserved

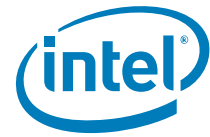

2.21 Default PEG/DMI VTd Remapping Engine Registers

Table 2-23 lists the registers arranged by address offset. Register bit descriptions are in the sections following the table.

Table 2-23. Default PEG/DMI VTd Remapping Engine Register Address Map (Sheet 1 of 2)

Address Offset	Register Symbol	Register Name	Reset Value	Access
0–3h	VER_REG	Version Register	00000010h	RO
4–7h	RSVD	Reserved	0h	RO
8–Fh	CAP_REG	Capability Register	00C9008020 660262h	RO
10–17h	ECAP_REG	Extended Capability Register	0000000000 F010DAh	RO-V, RO
18–1Bh	GCMD_REG	Global Command Register	00000000h	WO, RO
1C–1Fh	GSTS_REG	Global Status Register	00000000h	RO, RO-V
20–27h	RTADDR_REG	Root-Entry Table Address Register	0000000000 000000h	RW
28–2Fh	CCMD_REG	Context Command Register	0000000000 000000h	RW-V, RW, RO-V
30–33h	RSVD	Reserved	0h	RO
34–37h	FSTS_REG	Fault Status Register	00000000h	RW1CS, ROS- V, RO
38–3Bh	FECTL_REG	Fault Event Control Register	80000000h	RW, RO-V
3C–3Fh	FEDATA_REG	Fault Event Data Register	00000000h	RW
40–43h	FEADDR_REG	Fault Event Address Register	00000000h	RW
44–47h	FEUADDR_REG	Fault Event Upper Address Register	00000000h	RW
48–57h	RSVD	Reserved	0h	RO
58–5Fh	AFLOG_REG	Advanced Fault Log Register	0000000000 000000h	RO
60–63h	RSVD	Reserved	0h	RO
64–67h	PMEN_REG	Protected Memory Enable Register	00000000h	RW, RO-V
68–6Bh	PLMBASE_REG	Protected Low-Memory Base Register	00000000h	RW
6C–6Fh	PLMLIMIT_REG	Protected Low-Memory Limit Register	00000000h	RW
70–77h	PHMBASE_REG	Protected High-Memory Base Register	0000000000 000000h	RW
78–7Fh	PHMLIMIT_REG	Protected High-Memory Limit Register	0000000000 000000h	RW
80–87h	IQH_REG	Invalidation Queue Head Register	0000000000 000000h	RO-V
88–8Fh	IQT_REG	Invalidation Queue Tail Register	0000000000 000000h	RW-L
90–97h	IQA_REG	Invalidation Queue Address Register	0000000000 000000h	RW-L
98–9Bh	RSVD	Reserved	0h	RO
9C–9Fh	ICS_REG	Invalidation Completion Status Register	00000000h	RW1CS
A0–A3h	IECTL_REG	Invalidation Event Control Register	80000000h	RW-L, RO-V
A4–A7h	IEDATA_REG	Invalidation Event Data Register	00000000h	RW-L



Table 2-23. Default PEG/DMI VTd Remapping Engine Register Address Map (Sheet 2 of 2)

Address Offset	Register Symbol	Register Name	Reset Value	Access
A8–ABh	IEADDR_REG	Invalidation Event Address Register	00000000h	RW-L
AC–AFh	IEUADDR_REG	Invalidation Event Upper Address Register	00000000h	RW-L
B0–B7h	RSVD	Reserved	0h	RO
B8–BFh	IRTA_REG	Interrupt Remapping Table Address Register	0000000000 0000000h	RW-L
C0–FFh	RSVD	Reserved	0h	RO
100–107h	IVA_REG	Invalidate Address Register	0000000000 000000h	RW
108–10Fh	IOTLB_REG	IOTLB Invalidate Register	0000000000 000000h	RW, RO-V, RW-V
110–1FFh	RSVD	Reserved	0h	RO
200–207h	RSVD	Reserved	0000000000 000000h	ROS-V
208–20Fh	RSVD	Reserved	0000000000 000000h	ROS-V, RO, RW1CS
210–FEFh	RSVD	Reserved	0h	RO
FF0–FF3h	RSVD	Reserved	00000000h	RO-KFW, RW- KL, RW-L, RO

2.21.1 VER_REG—Version Register

This register reports the architecture version supported. Backward compatibility for the architecture is maintained with new revision numbers, allowing software to load remapping hardware drivers written for prior architecture versions.

B/D/F/Type:		0/0/0/VCOPREMAP		
Address Offset:		0–3h		
Reset Value:		00000010h		
Access:		RO		
Size:		32 bits		
BIOS Optimal Default		000000h		
Bit	Attr	Reset Value	RST/ PWR	Description
31:8	RO	0h		Reserved
7:4	RO	0001b	Uncore	Major Version number (MAX) This field indicates supported architecture version.
3:0	RO	0000b	Uncore	Minor Version number (MIN) This field indicates supported architecture minor version.

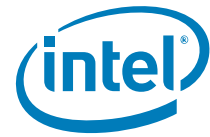

2.21.2 CAP_REG—Capability Register

This register reports general remapping hardware capabilities.

B/D/F/Type:		0/0/0/VCOPREMAP		
Address Offset:		8–Fh		
Reset Value:		00C9008020660262h		
Access:		RO		
Size:		64 bits		
BIOS Optimal Default		000h		
Bit	Attr	Reset Value	RST/PWR	Description
63:56	RO	0h		Reserved
55	RO	1b	Uncore	DMA Read Draining (DRD) 0 = Hardware does Not support draining of DMA read requests. 1 = Hardware supports draining of DMA read requests.
54	RO	1b	Uncore	DMA Write Draining (DWD) 0 = Hardware does Not support draining of DMA write requests. 1 = Hardware supports draining of DMA write requests.
53:48	RO	001001b	Uncore	Maximum Address Mask Value (MAMV) The value in this field indicates the maximum supported value for the Address Mask (AM) field in the Invalidation Address register (IVA_REG) and IOTLB Invalidation Descriptor (iotlb_inv_dsc). This field is valid only when the PSI field in Capability register is reported as set.
47:40	RO	00000000b	Uncore	Number of Fault-recording Registers (NFR) Number of fault recording registers is computed as N+1, where N is the value reported in this field. Implementations must support at least one fault recording register (NFR = 0) for each remapping hardware unit in the platform. The maximum number of fault recording registers per remapping hardware unit is 256.
39	RO	1b	Uncore	Page Selective Invalidation (PSI) 0 = Hardware supports only domain and global invalidates for IOTLB 1 = Hardware supports page selective, domain and global invalidates for IOTLB Hardware implementations reporting this field as set are recommended to support a Maximum Address Mask Value (MAMV) value of at least 9.
38:38	RO	0h		Reserved
37:34	RO	0000b	Uncore	Super-Page Support (SPS) This field indicates the super page sizes supported by hardware. A value of 1 in any of these bits indicates the corresponding super-page size is supported. The super-page sizes corresponding to various bit positions within this field are: 0h = 21-bit offset to page frame (2 MB) 1h = 30-bit offset to page frame (1 GB) 2h = 39-bit offset to page frame (512 GB) 3h = 48-bit offset to page frame (1 TB) Hardware implementations supporting a specific super-page size must support all smaller super-page sizes (that is, only valid values for this field are 0001b, 0011b, 0111b, 1111b).
33:24	RO	020h	Uncore	Fault-recording Register offset (FRO) This field specifies the location to the first fault recording register relative to the register base address of this remapping hardware unit. If the register base address is X, and the value reported in this field is Y, the address for the first fault recording register is calculated as X+(16*Y).



B/D/F/Type: Address Offset: Reset Value: Access: Size: BIOS Optimal Default		0/0/0/VCOPREMAP 8–Fh 00C9008020660262h RO 64 bits 000h		
Bit	Attr	Reset Value	RST/PWR	Description
23	RO	0b	Uncore	Isochrony (ISOCH) 0 = Remapping hardware unit has no critical isochronous requesters in its scope. 1 = Remapping hardware unit has one or more critical isochronous requesters in its scope. To guarantee isochronous performance, software must ensure invalidation operations do not impact active DMA streams from such requesters. This implies, when DMA is active, software performs page-selective invalidations (and not coarser invalidations).
22	RO	1b	Uncore	Zero Length Read (ZLR) 0 = Remapping hardware unit blocks (and treats as fault) zero length DMA read requests to write-only pages. 1 = Remapping hardware unit supports zero length DMA read requests to write-only pages. DMA remapping hardware implementations are recommended to report ZLR field as set.
21:16	RO	100110b	Uncore	Maximum Guest Address Width (MGAW) This field indicates the maximum DMA virtual addressability supported by remapping hardware. The Maximum Guest Address Width (MGAW) is computed as $(N+1)$, where N is the value reported in this field. For example, a hardware implementation supporting 48-bit MGAW reports a value of 47h (101111b) in this field. If the value in this field is X, untranslated and translated DMA requests to addresses above $2^{(x+1)}-1$ are always blocked by hardware. Translations requests to address above $2^{(x+1)}-1$ from allowed devices return a null Translation Completion Data Entry with R=W=0. Guest addressability for a given DMA request is limited to the minimum of the value reported through this field and the adjusted guest address width of the corresponding page-table structure. (Adjusted guest address widths supported by hardware are reported through the SAGAW field). Implementations are recommended to support MGAW at least equal to the physical addressability (host address width) of the platform.
15:13	RO	0h		Reserved
12:8	RO	00010b	Uncore	Supported Adjusted Guest Address Widths (SAGAW) This 5-bit field indicates the supported adjusted guest address widths (which in turn represents the levels of page-table walks for the 4 KB base page size) supported by the hardware implementation. A value of 1 in any of these bits indicates the corresponding adjusted guest address width is supported. The adjusted guest address widths corresponding to various bit positions within this field are: 0h = 30-bit AGAW (2-level page table) 1h = 39-bit AGAW (3-level page table) 2h = 48-bit AGAW (4-level page table) 3h = 57-bit AGAW (5-level page table) 4h = 64-bit AGAW (6-level page table) Software must ensure that the adjusted guest address width used to setup the page tables is one of the supported guest address widths reported in this field.

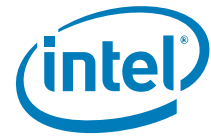

B/D/F/Type:		0/0/0/VCOPREMAP		
Address Offset:		8–Fh		
Reset Value:		00C9008020660262h		
Access:		RO		
Size:		64 bits		
BIOS Optimal Default		000h		
Bit	Attr	Reset Value	RST/PWR	Description
7	RO	0b	Uncore	<p>Caching Mode (CM)</p> <p>0 = Not-present and erroneous entries are Not cached in any of the remapping caches. Invalidation is not required for modifications to individual not present or invalid entries. However, any modifications that result in decreasing the effective permissions or partial permission increases require invalidations for them to be effective.</p> <p>1 = Not-present and erroneous mappings may be cached in the remapping caches. Any software updates to the remapping structures (including updates to "not-present" or erroneous entries) require explicit invalidation.</p> <p>Hardware implementations of this architecture must support a value of 0 in this field.</p>
6	RO	1b	Uncore	<p>Protected High-Memory Region (PHMR)</p> <p>0 = Indicates protected high-memory region is not supported.</p> <p>1 = Indicates protected high-memory region is supported.</p>
5	RO	1b	Uncore	<p>Protected Low-Memory Region (PLMR)</p> <p>0 = Indicates protected low-memory region is not supported.</p> <p>1 = Indicates protected low-memory region is supported.</p>
4	RO	0b	Uncore	<p>Required Write-Buffer Flushing (RWBF)</p> <p>0 = No write-buffer flushing is needed to ensure changes to memory-resident structures are visible to hardware.</p> <p>1 = Software must explicitly flush the write buffers to ensure updates made to memory-resident remapping structures are visible to hardware.</p>
3	RO	0b	Uncore	<p>Advanced Fault Logging (AFL)</p> <p>0 = Advanced fault logging is not supported. Only primary fault logging is supported.</p> <p>1 = Advanced fault logging is supported.</p>
2:0	RO	010b	Uncore	<p>Number of domains supported (ND)</p> <p>000 = Hardware supports 4-bit domain-ids with support for up to 16 domains.</p> <p>001 = Hardware supports 6-bit domain-ids with support for up to 64 domains.</p> <p>010 = Hardware supports 8-bit domain-ids with support for up to 256 domains.</p> <p>011 = Hardware supports 10-bit domain-ids with support for up to 1024 domains.</p> <p>100 = Hardware supports 12-bit domain-ids with support for up to 4K domains.</p> <p>100 = Hardware supports 14-bit domain-ids with support for up to 16K domains.</p> <p>110 = Hardware supports 16-bit domain-ids with support for up to 64K domains.</p> <p>111 = Reserved.</p>



2.21.3 ECAP_REG—Extended Capability Register

This register reports remapping hardware extended capabilities.

B/D/F/Type:		0/0/0/VCOPREMAP		
Address Offset:		10–17h		
Reset Value:		00000000F010DAh		
Access:		RO-V, RO		
Size:		64 bits		
BIOS Optimal Default		0000000000h		
Bit	Attr	Reset Value	RST/PWR	Description
63:24	RO	0h		Reserved
23:20	RO	1111b	Uncore	Maximum Handle Mask Value (MHMV) The value in this field indicates the maximum supported value for the Handle Mask (HM) field in the interrupt entry cache invalidation descriptor (iec_inv_dsc). This field is valid only when the IR field in Extended Capability register is reported as set.
19:18	RO	0h		Reserved
17:8	RO	010h	Uncore	IOTLB Register Offset (IRO) This field specifies the offset to the IOTLB registers relative to the register base address of this remapping hardware unit. If the register base address is X, and the value reported in this field is Y, the address for the first IOTLB invalidation register is calculated as X+(16*Y).
7	RO-V	1b	Uncore	Snoop Control (SC) 0 = Hardware does not support 1-setting of the SNP field in the page-table entries. 1 = Hardware supports the 1-setting of the SNP field in the page-table entries.
6	RO-V	1b	Uncore	Pass Through (PT): 0 = Hardware does not support pass-through translation type in context entries. 1 = Hardware supports pass-through translation type in context entries.
5	RO	0b	Uncore	Caching Hints (CH): 0 = Hardware does not support IOTLB caching hints (ALH and EH fields in context-entries are treated as reserved). 1 = Hardware supports IOTXTB caching hints through the ALH and EH fields in context-entries.
4	RO-V	1b	Uncore	Extended Interrupt Mode (EIM) 0 = On Intel 64 platforms, hardware supports only 8-bit APIC-IDs (xAPIC mode). 1 = On Intel 64 platforms, hardware supports 32-bit APIC-IDs (x2APIC mode). This field is valid only on Intel 64 platforms reporting Interrupt Remapping support (IR field Set).
3	RO-V	1b	Uncore	Interrupt Remapping Support (IR) 0 = Hardware does not support interrupt remapping. 1 = Hardware supports interrupt remapping. Implementations reporting this field as set must also support Queued Invalidation (QI).



B/D/F/Type: 0/0/0/VCOPREMAP Address Offset: 10–17h Reset Value: 000000000F010DAh Access: RO-V, RO Size: 64 bits BIOS Optimal Default: 00000000000h				
Bit	Attr	Reset Value	RST/PWR	Description
2	RO	0b	Uncore	Device IOTLB Support (DI) 0 = Hardware does not support device-IOTLBs. 1 = Hardware supports Device-IOTLBs. Implementations reporting this field as set must also support Queued Invalidation (QI).
1	RO-V	1b	Uncore	Queued Invalidation Support (QI) 0 = Hardware does not support queued invalidations. 1 = Hardware supports queued invalidations.
0	RO	0b	Uncore	Coherency (C) This field indicates if hardware access to the root, context, page-table and interrupt-remap structures are coherent (snooped) or not. 0 = Indicates hardware accesses to remapping structures are non-coherent. 1 = Indicates hardware accesses to remapping structures are coherent. Hardware access to advanced fault log and invalidation queue are always coherent.



2.21.4 GCMD_REG—Global Command Register

This register controls remapping hardware. If multiple control fields in this register need to be modified, software must serialize the modifications through multiple writes to this register.

B/D/F/Type: Address Offset: Reset Value: Access: Size: BIOS Optimal Default		0/0/0/VCOPREMAP 18–1Bh 00000000h WO, RO 32 bits 000000h		
Bit	Attr	Reset Value	RST/PWR	Description
31	WO	0b	Uncore	<p>Translation Enable (TE)</p> <p>Software writes to this field to request hardware to enable/disable DMA-remapping: 0 = Disable DMA remapping 1 = Enable DMA remapping</p> <p>Hardware reports the status of the translation enable operation through the TES field in the Global Status register.</p> <p>There may be active DMA requests in the platform when software updates this field. Hardware must enable or disable remapping logic only at deterministic transaction boundaries, so that any in-flight transaction is either subject to remapping or not at all.</p> <p>Hardware implementations supporting DMA draining must drain any in-flight DMA read/write requests queued within the Root-Complex before completing the translation enable command and reflecting the status of the command through the TES field in the Global Status register.</p> <p>The value returned on a read of this field is undefined.</p>
30	WO	0b	Uncore	<p>Set Root Table Pointer (SRTP)</p> <p>Software sets this field to set/update the root-entry table pointer used by hardware. The root-entry table pointer is specified through the Root-entry Table Address (RTA_REG) register.</p> <p>Hardware reports the status of the "Set Root Table Pointer" operation through the RTPS field in the Global Status register.</p> <p>The "Set Root Table Pointer" operation must be performed before enabling or re-enabling (after disabling) DMA remapping through the TE field.</p> <p>After a "Set Root Table Pointer" operation, software must globally invalidate the context cache and then globally invalidate of IOTLB. This is required to ensure hardware uses only the remapping structures referenced by the new root table pointer, and not stale cached entries.</p> <p>While DMA remapping hardware is active, software may update the root table pointer through this field. However, to ensure valid in-flight DMA requests are deterministically remapped, software must ensure that the structures referenced by the new root table pointer are programmed to provide the same remapping results as the structures referenced by the previous root-table pointer.</p> <p>Clearing this bit has no effect. The value returned on read of this field is undefined.</p>

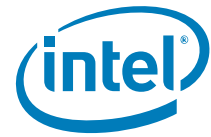

B/D/F/Type: Address Offset: Reset Value: Access: Size: BIOS Optimal Default		0/0/0/VCOPREMAP 18–1Bh 00000000h WO, RO 32 bits 000000h		
Bit	Attr	Reset Value	RST/ PWR	Description
29	RO	0b	Uncore	Set Fault Log (SFL) This field is valid only for implementations supporting advanced fault logging. Software sets this field to request hardware to set/update the fault-log pointer used by hardware. The fault-log pointer is specified through Advanced Fault Log register. Hardware reports the status of the 'Set Fault Log' operation through the FLS field in the Global Status register. The fault log pointer must be set before enabling advanced fault logging (through EAFL field). Once advanced fault logging is enabled, the fault log pointer may be updated through this field while DMA remapping is active. Clearing this bit has no effect. The value returned on read of this field is undefined.
28	RO	0b	Uncore	Enable Advanced Fault Logging (EAFL) This field is valid only for implementations supporting advanced fault logging. Software writes to this field to request hardware to enable or disable advanced fault logging: 0 = Disable advanced fault logging. In this case, translation faults are reported through the Fault Recording registers. 1 = Enable use of memory-resident fault log. When enabled, translation faults are recorded in the memory-resident log. The fault log pointer must be set in hardware (through the SFL field) before enabling advanced fault logging. Hardware reports the status of the advanced fault logging enable operation through the AFLS field in the Global Status register. The value returned on read of this field is undefined.
27	RO	0b	Uncore	Write Buffer Flush (WBF) This bit is valid only for implementations requiring write buffer flushing. Software sets this field to request that hardware flush the Root-Complex internal write buffers. This is done to ensure any updates to the memory-resident remapping structures are not held in any internal write posting buffers. Hardware reports the status of the write buffer flushing operation through the WBFS field in the Global Status register. Clearing this bit has no effect. The value returned on a read of this field is undefined.
26	WO	0b	Uncore	Queued Invalidation Enable (QIE) This field is valid only for implementations supporting queued invalidations. Software writes to this field to enable or disable queued invalidations. 0 = Disable queued invalidations. 1 = Enable use of queued invalidations. Hardware reports the status of queued invalidation enable operation through QIES field in the Global Status register. The value returned on a read of this field is undefined.



B/D/F/Type:		0/0/0/VCOPREMAP		
Address Offset:		18–1Bh		
Reset Value:		00000000h		
Access:		WO, RO		
Size:		32 bits		
BIOS Optimal Default		000000h		
Bit	Attr	Reset Value	RST/PWR	Description
25	WO	0b	Uncore	<p>Interrupt Remapping Enable (IRE)</p> <p>This field is valid only for implementations supporting interrupt remapping.</p> <p>0 = Disable interrupt-remapping hardware 1 = Enable interrupt-remapping hardware</p> <p>Hardware reports the status of the interrupt remapping enable operation through the IRES field in the Global Status register. There may be active interrupt requests in the platform when software updates this field. Hardware must enable or disable interrupt-remapping logic only at deterministic transaction boundaries, so that any in-flight interrupts are either subject to remapping or not at all.</p> <p>Hardware implementations must drain any in-flight interrupts requests queued in the Root-Complex before completing the interrupt-remapping enable command and reflecting the status of the command through the IRES field in the Global Status register. The value returned on a read of this field is undefined.</p>
24	WO	0b	Uncore	<p>Set Interrupt Remap Table Pointer (SIRTP)</p> <p>This field is valid only for implementations supporting interrupt-remapping.</p> <p>Software sets this field to set/update the interrupt remapping table pointer used by hardware. The interrupt remapping table pointer is specified through the Interrupt Remapping Table Address (IRTA_REG) register.</p> <p>Hardware reports the status of the 'Set Interrupt Remap Table Pointer' operation through the IRTPS field in the Global Status register.</p> <p>The 'Set Interrupt Remap Table Pointer' operation must be performed before enabling or re-enabling (after disabling) interrupt-remapping hardware through the IRE field.</p> <p>After a 'Set Interrupt Remap Table Pointer' operation, software must globally invalidate the interrupt entry cache. This is required to ensure hardware uses only the interrupt-remapping entries referenced by the new interrupt remap table pointer, and not any stale cached entries.</p> <p>While interrupt remapping is active, software may update the interrupt remapping table pointer through this field. However, to ensure valid in-flight interrupt requests are deterministically remapped, software must ensure that the structures referenced by the new interrupt remap table pointer are programmed to provide the same remapping results as the structures referenced by the previous interrupt remap table pointer.</p> <p>Clearing this bit has no effect. The value returned on a read of this field is undefined.</p>
23	WO	0b	Uncore	<p>Compatibility Format Interrupt (CFI)</p> <p>This field is valid only for Intel 64 implementations supporting interrupt-remapping.</p> <p>Software writes to this field to enable or disable Compatibility Format interrupts on Intel 64 platforms. The value in this field is effective only when interrupt-remapping is enabled and Extended Interrupt Mode (x2APIC mode) is not enabled.</p> <p>0 = Block Compatibility format interrupts. 1 = Process Compatibility format interrupts as pass-through (bypass interrupt remapping).</p> <p>Hardware reports the status of updating this field through the CFIS field in the Global Status register. The value returned on a read of this field is undefined.</p>
22:0	RO	0h		Reserved

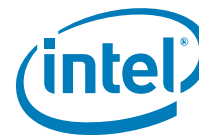

2.21.5 GSTS_REG—Global Status Register

This register reports general remapping hardware status.

B/D/F/Type:		0/0/0/VCOPREMAP		
Address Offset:		1C–1Fh		
Reset Value:		00000000h		
Access:		RO, RO-V		
Size:		32 bits		
BIOS Optimal Default		000000h		
Bit	Attr	Reset Value	RST/PWR	Description
31	RO-V	0b	Uncore	Translation Enable Status (TES) This bit indicates the status of DMA-remapping hardware. 0 = DMA-remapping hardware is not enabled 1 = DMA-remapping hardware is enabled
30	RO-V	0b	Uncore	Root Table Pointer Status (RTPS) This bit indicates the status of the root- table pointer in hardware. 0 = Cleared by hardware when software sets the SRTP field in the Global Command register. 1 = Set by hardware when hardware completes the 'Set Root Table Pointer' operation using the value provided in the Root-Entry Table Address register.
29	RO	0b	Uncore	Fault Log Status (FLS) 0 = Cleared by hardware when software Sets the SFL field in the Global Command register. 1 = Set by hardware when hardware completes the 'Set Fault Log Pointer' operation using the value provided in the Advanced Fault Log register.
28	RO	0b	Uncore	Advanced Fault Logging Status (AFLS) This field is valid only for implementations supporting advanced fault logging. It indicates the advanced fault logging status: 0 = Advanced Fault Logging is Not enabled. 1 = Advanced Fault Logging is enabled.
27	RO	0b	Uncore	Write Buffer Flush Status (WBFS) This field is valid only for implementations requiring write buffer flushing. This field indicates the status of the write buffer flush command. It is: <ul style="list-style-type: none"> Set by hardware when software sets the WBF field in the Global Command register. Cleared by hardware when hardware completes the write buffer flushing operation.
26	RO-V	0b	Uncore	Queued Invalidation Enable Status (QIES) This field indicates queued invalidation enable status. 0 = queued invalidation is not enabled 1 = queued invalidation is enabled
25	RO-V	0b	Uncore	Interrupt Remapping Enable Status (IRES) This field indicates the status of Interrupt-remapping hardware. 0 = Interrupt-remapping hardware is not enabled 1 = Interrupt-remapping hardware is enabled



B/D/F/Type:		0/0/0/VCOPREMAP		
Address Offset:		1C–1Fh		
Reset Value:		00000000h		
Access:		RO, RO-V		
Size:		32 bits		
BIOS Optimal Default		000000h		
Bit	Attr	Reset Value	RST/PWR	Description
24	RO-V	0b	Uncore	Interrupt Remapping Table Pointer Status (IRTPS) This field indicates the status of the interrupt remapping table pointer in hardware. This field is cleared by hardware when software sets the SIRTTP field in the Global Command register. This field is Set by hardware when hardware completes the set interrupt remap table pointer operation using the value provided in the Interrupt Remapping Table Address register.
23	RO-V	0b	Uncore	Compatibility Format Interrupt Status (CFIS) This field indicates the status of Compatibility format interrupts on Intel 64 implementations supporting interrupt-remapping. The value reported in this field is applicable only when interrupt-remapping is enabled and Extended Interrupt Mode (x2APIC mode) is not enabled. 0 = Compatibility format interrupts are blocked. 1 = Compatibility format interrupts are processed as pass-through (bypassing interrupt remapping).
22:0	RO	0h		Reserved

2.21.6 RTADDR_REG—Root-Entry Table Address Register

This register provides the base address of root-entry table.

B/D/F/Type:		0/0/0/VCOPREMAP		
Address Offset:		20–27h		
Reset Value:		0000000000000000h		
Access:		RW		
Size:		64 bits		
BIOS Optimal Default		0000000000h		
Bit	Attr	Reset Value	RST/PWR	Description
63:39	RO	0h		Reserved
38:12	RW	0000000h	Uncore	Root Table Address (RTA) This register points to base of page aligned, 4 KB-sized root-entry table in system memory. Hardware ignores and not implements bits 63:HAW, where HAW is the host address width. Software specifies the base address of the root-entry table through this register, and programs it in hardware through the SRTP field in the Global Command register. Reads of this register returns value that was last programmed to it.
11:0	RO	0h		Reserved

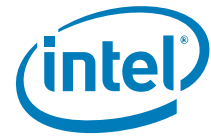

2.21.7 CCMD_REG—Context Command Register

This register manages context cache. The act of writing the upper most byte of the CCMD_REG with the ICC field set causes the hardware to perform the context-cache invalidation.

B/D/F/Type: 0/0/0/VCOPREMAP Address Offset: 28–2Fh Reset Value: 0000000000000000h Access: RW-V, RW, RO-V Size: 64 bits BIOS Optimal Default 00000000h				
Bit	Attr	Reset Value	RST/PWR	Description
63	RW-V	0h	Uncore	<p>Invalidate Context-Cache (ICC)</p> <p>Software requests invalidation of context-cache by setting this field. Software must also set the requested invalidation granularity by programming the CIRG field. Software must read back and check the ICC field is Clear to confirm the invalidation is complete. Software must not update this register when this field is set.</p> <p>Hardware clears the ICC field to indicate the invalidation request is complete. Hardware also indicates the granularity at which the invalidation operation was performed through the CAIG field.</p> <p>Software must submit a context-cache invalidation request through this field only when there are no invalidation requests pending at this remapping hardware unit.</p> <p>Since information from the context-cache may be used by hardware to tag IOTLB entries, software must perform domain-selective (or global) invalidation of IOTLB after the context cache invalidation has completed.</p> <p>Hardware implementations reporting write-buffer flushing requirement (RWBF=1 in Capability register) must implicitly perform a write buffer flush before invalidating the context cache.</p>
62:61	RW	0h	Uncore	<p>Context Invalidation Request Granularity (CIRG)</p> <p>Software provides the requested invalidation granularity through this field when setting the ICC field:</p> <ul style="list-style-type: none"> 00 = Reserved. 01 = Global Invalidation request. 10 = Domain-selective invalidation request. The target domain-id must be specified in the DID field. 11 = Device-selective invalidation request. The target source-id(s) must be specified through the SID and FM fields, and the domain-id (that was programmed in the context-entry for these device(s)) must be provided in the DID field. <p>Hardware implementations may process an invalidation request by performing invalidation at a coarser granularity than requested. Hardware indicates completion of the invalidation request by clearing the ICC field. At this time, hardware also indicates the granularity at which the actual invalidation was performed through the CAIG field.</p>



B/D/F/Type: Address Offset: Reset Value: Access: Size: BIOS Optimal Default		0/0/0/VCOPREMAP 28–2Fh 0000000000000000h RW-V, RW, RO-V 64 bits 000000000h		
Bit	Attr	Reset Value	RST/PWR	Description
60:59	RO-V	0h	Uncore	Context Actual Invalidation Granularity (CAIG) Hardware reports the granularity at which an invalidation request was processed through the CAIG field at the time of reporting invalidation completion (by clearing the ICC field). The following are the encodings for this field: 00 = Reserved. 01 = Global Invalidation performed. This could be in response to a global, domain-selective or device-selective invalidation request. 10 = Domain-selective invalidation performed using the domain-id specified by software in the DID field. This could be in response to a domain-selective or device-selective invalidation request. 11 = Device-selective invalidation performed using the source-id and domain-id specified by software in the SID and FM fields. This can only be in response to a device-selective invalidation request.
58:34	RO	0h		Reserved
33:32	RW	0h	Uncore	Function Mask (FM) Software may use the Function Mask to perform device-selective invalidations on behalf of devices supporting PCI Express Phantom Functions. This field specifies which bits of the function number portion (least significant three bits) of the SID field to mask when performing device-selective invalidations. The following encodings are defined for this field: 00 = No bits in the SID field masked. 01 = Mask most significant bit of function number in the SID field. 10 = Mask two most significant bit of function number in the SID field. 11 = Mask all three bits of function number in the SID field. The context-entries corresponding to all the source-ids specified through the FM and SID fields must have to the domain-id specified in the DID field.
31:16	RW	0000h	Uncore	Source ID (SID) Indicates the source-id of the device whose corresponding context-entry needs to be selectively invalidated. This field along with the FM field must be programmed by software for device-selective invalidation requests.
15:8	RO	0h		Reserved
7:0	RW	00h	Uncore	Domain-ID (DID) Indicates the id of the domain whose context-entries need to be selectively invalidated. This field must be programmed by software for both domain-selective and device-selective invalidation requests. The Capability register reports the domain-id width supported by hardware. Software must ensure that the value written to this field is within this limit. Hardware may ignore and not implement bits15:N, where N is the supported domain-id width reported in the Capability register.



2.21.8 FSTS_REG—Fault Status Register

This register indicates the various error status.

B/D/F/Type: 0/0/0/VC0PREMAP Address Offset: 34–37h Reset Value: 0000000h Access: RW1CS, ROS-V, RO Size: 32 bits BIOS Optimal Default: 00000h				
Bit	Attr	Reset Value	RST/PWR	Description
31:16	RO	0h		Reserved
15:8	ROS-V	00h	Powergood	Fault Record Index (FRI) This field is valid only when the PPF field is Set. The FRI field indicates the index (from base) of the fault recording register to which the first pending fault was recorded when the PPF field was Set by hardware. The value read from this field is undefined when the PPF field is clear.
7:7	RO	0h		Reserved
6	RO	0b	Uncore	Invalidation Time-out Error (ITE) Hardware detected a Device-IOTLB invalidation completion time-out. At this time, a fault event may be generated based on the programming of the Fault Event Control register. Hardware implementations not supporting device Device-IOTLBs implement this bit as RsvdZ.
5	RO	0b	Uncore	Invalidation Completion Error (ICE) Hardware received an unexpected or invalid Device-IOTLB invalidation completion. This could be due to either an invalid ITag or invalid source-id in an invalidation completion response. At this time, a fault event may be generated based on the programming of the Fault Event Control register. Hardware implementations not supporting Device-IOTLBs implement this bit as reserved.
4	RW1CS	0b	Powergood	Invalidation Queue Error (IQE) Hardware detected an error associated with the invalidation queue. This could be due to either a hardware error while fetching a descriptor from the invalidation queue, or hardware detecting an erroneous or invalid descriptor in the invalidation queue. At this time, a fault event may be generated based on the programming of the Fault Event Control register. Hardware implementations not supporting queued invalidations implement this bit as reserved.
3	RO	0b	Uncore	Advanced Pending Fault (APF) When this field is Clear, hardware sets this field when the first fault record (at index 0) is written to a fault log. At this time, a fault event is generated based on the programming of the Fault Event Control register. Software writing 1 to this field clears it. Hardware implementations not supporting advanced fault logging implement this bit as reserved.



B/D/F/Type: Address Offset: Reset Value: Access: Size: BIOS Optimal Default		0/0/0/VCOPREMAP 34–37h 0000000h RW1CS, ROS-V, RO 32 bits 00000h		
Bit	Attr	Reset Value	RST/PWR	Description
2	RO	0b	Uncore	Advanced Fault Overflow (AFO) Hardware sets this field to indicate advanced fault log overflow condition. At this time, a fault event is generated based on the programming of the Fault Event Control register. Software writing 1 to this field clears it. Hardware implementations not supporting advanced fault logging implement this bit as reserved.
1	ROS-V	0b	Powergood	Primary Pending Fault (PPF) This field indicates if there are one or more pending faults logged in the fault recording registers. Hardware computes this field as the logical OR of Fault (F) fields across all the fault recording registers of this remapping hardware unit. 0 = No pending faults in any of the fault recording registers 1 = One or more fault recording registers has pending faults. The FRI field is updated by hardware whenever the PPF field is set by hardware. Also, depending on the programming of Fault Event Control register, a fault event is generated when hardware sets this field.
0	RW1CS	0b	Powergood	Primary Fault Overflow (PFO) Hardware sets this field to indicate overflow of fault recording registers. Software writing 1 clears this field. When this field is set, hardware does not record any new faults until software clears this field.

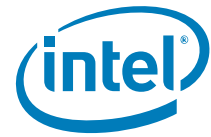

2.21.9 FECTL_REG—Fault Event Control Register

This register specifies the fault event interrupt message control bits.

B/D/F/Type: 0/0/0/VCOPREMAP Address Offset: 38-3Bh Reset Value: 80000000h Access: RW, RO-V Size: 32 bits BIOS Optimal Default: 00000000h				
Bit	Attr	Reset Value	RST/PWR	Description
31	RW	1b	Uncore	Interrupt Mask (IM) 0 = No masking of interrupt. When an interrupt condition is detected, hardware issues an interrupt message (using the Fault Event Data and Fault Event Address register values). 1 = This is the value on reset. Software may mask interrupt message generation by setting this field. Hardware is prohibited from sending the interrupt message when this field is set.
30	RO-V	0h	Uncore	Interrupt Pending (IP) Hardware sets the IP field when it detects an interrupt condition, which is defined as: <ul style="list-style-type: none"> When primary fault logging is active, an interrupt condition occurs when hardware records a fault through one of the Fault Recording registers and sets the PPF field in Fault Status register. When advanced fault logging is active, an interrupt condition occurs when hardware records a fault in the first fault record (at index 0) of the current fault log and sets the APF field in the Fault Status register. Hardware detected error associated with the Invalidation Queue, setting the IQE field in the Fault Status register. Hardware detected invalid Device-IOTLB invalidation completion, setting the ICE field in the Fault Status register. Hardware detected Device-IOTLB invalidation completion timeout, setting the ITE field in the Fault Status register. If any of the status fields in the Fault Status register was already set at the time of setting any of these fields, it is not treated as a new interrupt condition. The IP field is kept set by hardware while the interrupt message is held pending. The interrupt message could be held pending due to interrupt mask (IM field) being Set or other transient hardware conditions. The IP field is cleared by hardware as soon as the interrupt message pending condition is serviced. This could be due to either: <ul style="list-style-type: none"> Hardware issuing the interrupt message due to either change in the transient hardware condition that caused interrupt message to be held pending, or due to Software clearing the IM field. Software servicing all the pending interrupt status fields in the Fault Status register as follows: <ul style="list-style-type: none"> When primary fault logging is active, software clearing the Fault (F) field in all the Fault Recording registers with faults, causing the PPF field in Fault Status register to be evaluated as clear. Software clearing other status fields in the Fault Status register by writing back the value read from the respective fields.
29:0	RO	0h		Reserved



2.21.10 FEDATA_REG—Fault Event Data Register

This register specifies the interrupt message data.

B/D/F/Type:		0/0/0/VCOPREMAP		
Address Offset:		3C–3Fh		
Reset Value:		00000000h		
Access:		RW		
Size:		32 bits		
Bit	Attr	Reset Value	RST/PWR	Description
31:16	RW	0000h	Uncore	Extended Interrupt Message Data (EIMD) This field is valid only for implementations supporting 32-bit interrupt data fields. Hardware implementations supporting only 16-bit interrupt data may treat this field as RsvdZ.
15:0	RW	0000h	Uncore	Interrupt Message Data (IMD) Data value in the interrupt request.

2.21.11 FEADDR_REG—Fault Event Address Register

Register specifying the interrupt message address.

B/D/F/Type:		0/0/0/VCOPREMAP		
Address Offset:		40–43h		
Reset Value:		00000000h		
Access:		RW		
Size:		32 bits		
BIOS Optimal Default		0h		
Bit	Attr	Reset Value	RST/PWR	Description
31:2	RW	00000000h	Uncore	Message Address (MA) When fault events are enabled, the contents of this register specify the DWORD-aligned address (bits 31:2) for the interrupt request.
1:0	RO	0h		Reserved

2.21.12 FEUADDR_REG—Fault Event Upper Address Register

This register specifies the interrupt message upper address.

B/D/F/Type:		0/0/0/VCOPREMAP		
Address Offset:		44–47h		
Reset Value:		00000000h		
Access:		RW		
Size:		32 bits		
Bit	Attr	Reset Value	RST/PWR	Description
31:0	RW	00000000h	Uncore	Message upper address (MUA) Hardware implementations supporting Extended Interrupt Mode are required to implement this register. Hardware implementations not supporting Extended Interrupt Mode may treat this field as RsvdZ.

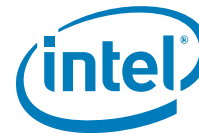

2.21.13 AFLOG_REG—Advanced Fault Log Register

This register specifies the base address of the memory-resident fault-log region. This register is treated as RsvdZ for implementations not supporting advanced translation fault logging (AFL field reported as 0 in the Capability register).

B/D/F/Type:		0/0/0/VCOPREMAP		
Address Offset:		58–5Fh		
Reset Value:		0000000000000000h		
Access:		RO		
Size:		64 bits		
BIOS Optimal Default		000h		
Bit	Attr	Reset Value	RST/PWR	Description
63:12	RO	00000000 00000h	Uncore	Fault Log Address (FLA) This field specifies the base of 4 KB aligned fault-log region in system memory. Hardware ignores and does not implement bits 63:HAW, where HAW is the host address width. Software specifies the base address and size of the fault log region through this register, and programs it in hardware through the SFL field in the Global Command register. When implemented, reads of this field return the value that was last programmed to it.
11:9	RO	0h	Uncore	Fault Log Size (FLS) This field specifies the size of the fault log region pointed by the FLA field. The size of the fault log region is $2^X * 4KB$, where X is the value programmed in this register. When implemented, reads of this field return the value that was last programmed to it.
8:0	RO	0h		Reserved



2.21.14 PMEN_REG—Protected Memory Enable Register

This register enables the DMA-protected memory regions setup through the PLMBASE, PLMLIMIT, PHMBASE, PHMLIMIT registers. This register is always treated as RO for implementations not supporting protected memory regions (PLMR and PHMR fields reported as Clear in the Capability register).

Protected memory regions may be used by software to securely initialize remapping structures in memory. To avoid impact to legacy BIOS usage of memory, software is recommended to not overlap protected memory regions with any reserved memory regions of the platform reported through the Reserved Memory Region Reporting (RMRR) structures.

B/D/F/Type:		0/0/0/VCOPREMAP		
Address Offset:		64–67h		
Reset Value:		00000000h		
Access:		RW, RO-V		
Size:		32 bits		
BIOS Optimal Default		00000000h		
Bit	Attr	Reset Value	RST/PWR	Description
31	RW	0h	Uncore	<p>Enable Protected Memory (EPM)</p> <p>This field controls DMA accesses to the protected low-memory and protected high-memory regions.</p> <p>0 = Protected memory regions are disabled. 1 = Protected memory regions are enabled. DMA requests accessing protected memory regions are handled as follows:</p> <ul style="list-style-type: none"> — When DMA remapping is not enabled, all DMA requests accessing protected memory regions are blocked. — When DMA remapping is enabled: <ul style="list-style-type: none"> — DMA requests processed as pass-through (Translation Type value of 10b in Context-Entry) and accessing the protected memory regions are blocked. — DMA requests with translated address (AT=10b) and accessing the protected memory regions are blocked. — DMA requests that are subject to address remapping, and accessing the protected memory regions may or may not be blocked by hardware. For such requests, software must not depend on hardware protection of the protected memory regions, and instead program the DMA-remapping page-tables to not allow DMA to protected memory regions. <p>Remapping hardware access to the remapping structures are not subject to protected memory region checks.</p> <p>DMA requests blocked due to protected memory region violation are not recorded or reported as remapping faults.</p> <p>Hardware reports the status of the protected memory enable/disable operation through the PRS field in this register. Hardware implementations supporting DMA draining must drain any in-flight translated DMA requests queued within the Root-Complex before indicating the protected memory region as enabled through the PRS field.</p>
30:1	RO	0h		Reserved
0	RO-V	0h	Uncore	<p>Protected Region Status (PRS)</p> <p>This field indicates the status of protected memory region(s):</p> <p>0 = Protected memory region(s) disabled. 1 = Protected memory region(s) enabled.</p>

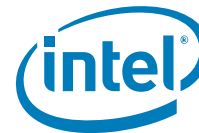

2.21.15 PLMBASE_REG—Protected Low-Memory Base Register

This register sets up the base address of DMA-protected low-memory region below 4 GB. This register must be set up before enabling protected memory through PMEN_REG, and must not be updated when protected memory regions are enabled.

This register is always treated as RO for implementations not supporting protected low memory region (PLMR field reported as Clear in the Capability register).

The alignment of the protected low memory region base depends on the number of reserved bits (N:0) of this register. Software may determine N by writing all 1s to this register, and finding the most significant zero bit position with 0 in the value read back from the register. Bits N:0 of this register is decoded by hardware as all 0s.

Software must setup the protected low memory region below 4 GB.

Software must not modify this register when protected memory regions are enabled (PRS field Set in PMEN_REG).

B/D/F/Type:		0/0/0/VCOPREMAP		
Address Offset:		68–6Bh		
Reset Value:		00000000h		
Access:		RW		
Size:		32 bits		
BIOS Optimal Default		00000h		
Bit	Attr	Reset Value	RST/PWR	Description
31:20	RW	000h	Uncore	Protected Low-Memory Base (PLMB) This field specifies the base of protected low-memory region in system memory.
19:0	RO	0h		Reserved



2.21.16 PLMLIMIT_REG—Protected Low-Memory Limit Register

This register sets up the limit address of DMA-protected low-memory region below 4 GB. This register must be set up before enabling protected memory through PMEN_REG, and must not be updated when protected memory regions are enabled.

This register is always treated as RO for implementations not supporting protected low memory region (PLMR field reported as Clear in the Capability register).

The alignment of the protected low memory region limit depends on the number of reserved bits (N:0) of this register. Software may determine N by writing all 1s to this register, and finding most significant zero bit position with 0 in the value read back from the register. Bits N:0 of the limit register is decoded by hardware as all 1s.

The Protected low-memory base and limit registers functions as follows:

- Programming the protected low-memory base and limit registers with the same value in bits 31:(N+1) specifies a protected low-memory region of size $2^{(N+1)}$ bytes.
- Programming the protected low-memory limit register with a value less than the protected low-memory base register disables the protected low-memory region.

Software must not modify this register when protected memory regions are enabled (PRS field Set in PMEN_REG).

B/D/F/Type:		0/0/0/VCOPREMAP		
Address Offset:		6C–6Fh		
Reset Value:		0000000h		
Access:		RW		
Size:		32 bits		
BIOS Optimal Default		00000h		
Bit	Attr	Reset Value	RST/PWR	Description
31:20	RW	000h	Uncore	Protected Low-Memory Limit (PLML) This register specifies the last host physical address of the DMA-protected low-memory region in system memory.
19:0	RO	0h		Reserved



2.21.17 PHMBASE_REG—Protected High-Memory Base Register

This register sets up the base address of DMA-protected high-memory region. This register must be set up before enabling protected memory through PMEN_REG, and must not be updated when protected memory regions are enabled.

This register is always treated as RO for implementations not supporting protected high memory region (PHMR field reported as Clear in the Capability register).

The alignment of the protected high memory region base depends on the number of reserved bits (N:0) of this register. Software may determine N by writing all 1s to this register, and finding most significant zero bit position below host address width (HAW) in the value read back from the register. Bits N:0 of this register are decoded by hardware as all 0s.

Software may setup the protected high memory region either above or below 4 GB.

Software must not modify this register when protected memory regions are enabled (PRS field Set in PMEN_REG).

B/D/F/Type:		0/0/0/VCOPREMAP		
Address Offset:		70–77h		
Reset Value:		000000000000000h		
Access:		RW		
Size:		64 bits		
BIOS Optimal Default		000000000000h		
Bit	Attr	Reset Value	RST/PWR	Description
63:39	RO	0h		Reserved
38:20	RW	00000h	Uncore	Protected High-Memory Base (PHMB) This register specifies the base of protected (high) memory region in system memory. Hardware ignores, and does not implement, bits 63:HAW, where HAW is the host address width.
19:0	RO	0h		Reserved



2.21.18 PHMLIMIT_REG—Protected High-Memory Limit Register

This register sets up the limit address of DMA-protected high-memory region. This register must be set up before enabling protected memory through PMEN_REG, and must not be updated when protected memory regions are enabled.

This register is always treated as RO for implementations not supporting protected high memory region (PHMR field reported as Clear in the Capability register).

The alignment of the protected high memory region limit depends on the number of reserved bits (N:0) of this register. Software may determine the value of N by writing all 1s to this register, and finding most significant zero bit position below host address width (HAW) in the value read back from the register. Bits N:0 of the limit register are decoded by hardware as all 1s.

The protected high-memory Base and Limit registers function as follows.

- Programming the protected low-memory base and limit registers with the same value in bits HAW:(N+1) specifies a protected low-memory region of size $2^{(N+1)}$ bytes.
- Programming the protected high-memory limit register with a value less than the protected high-memory base register disables the protected high-memory region.

Software must not modify this register when protected memory regions are enabled (PRS field Set in PMEN_REG).

B/D/F/Type:		0/0/0/VCOPREMAP		
Address Offset:		78–7Fh		
Reset Value:		0000000000000000h		
Access:		RW		
Size:		64 bits		
BIOS Optimal Default		000000000000h		
Bit	Attr	Reset Value	RST/PWR	Description
63:39	RO	0h		Reserved
38:20	RW	00000h	Uncore	Protected High-Memory Limit (PHML) This register specifies the last host physical address of the DMA-protected high-memory region in system memory. Hardware ignores and does not implement bits 63:HAW, where HAW is the host address width.
19:0	RO	0h		Reserved

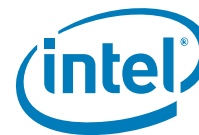

2.21.19 IQH_REG—Invalidation Queue Head Register

Register indicating the invalidation queue head. This register is treated as RsvdZ by implementations reporting Queued Invalidation (QI) as not supported in the Extended Capability register.

B/D/F/Type:		0/0/0/VCOPREMAP		
Address Offset:		80–87h		
Reset Value:		0000000000000000h		
Access:		RO-V		
Size:		64 bits		
BIOS Optimal Default		00000000000000h		
Bit	Attr	Reset Value	RST/PWR	Description
63:19	RO	0h		Reserved
18:4	RO-V	0000h	Uncore	Queue Head (QH) This field specifies the offset (128-bit aligned) to the invalidation queue for the command that will be fetched next by hardware. Hardware resets this field to 0 whenever the queued invalidation is disabled (QIES field Clear in the Global Status register).
3:0	RO	0h		Reserved

2.21.20 EG—Invalidation Queue Tail Register

Register indicating the invalidation tail head. This register is treated as RsvdZ by implementations reporting Queued Invalidation (QI) as not supported in the Extended Capability register.

B/D/F/Type:		0/0/0/VCOPREMAP		
Address Offset:		88–8Fh		
Reset Value:		0000000000000000h		
Access:		RW-L		
Size:		64 bits		
BIOS Optimal Default		00000000000000h		
Bit	Attr	Reset Value	RST/PWR	Description
63:19	RO	0h		Reserved
18:4	RW-L	0000h	Uncore	Queue Tail (QT) This field specifies the offset (128-bit aligned) to the invalidation queue for the command that will be written next by software.
3:0	RO	0h		Reserved



2.21.21 IQA_REG—Invalidation Queue Address Register

This register configures the base address and size of the invalidation queue. This register is treated as RsvdZ by implementations reporting Queued Invalidation (QI) as not supported in the Extended Capability register.

B/D/F/Type:		0/0/0/VCOPREMAP		
Address Offset:		90–97h		
Reset Value:		0000000000000000h		
Access:		RW-L		
Size:		64 bits		
BIOS Optimal Default		00000000h		
Bit	Attr	Reset Value	RST/PWR	Description
63:39	RO	0h		Reserved
38:12	RW-L	0000000h	Uncore	Invalidation Queue Base Address (IQA) This field points to the base of 4 KB aligned invalidation request queue. Hardware ignores and does not implement bits 63:HAW, where HAW is the host address width. Reads of this field return the value that was last programmed to it.
11:3	RO	0h		Reserved
2:0	RW-L	0h	Uncore	Queue Size (QS) This field specifies the size of the invalidation request queue. A value of X in this field indicates an invalidation request queue of (2^X) 4 KB pages. The number of entries in the invalidation queue is $2^{(X + 8)}$.

2.21.22 ICS_REG—Invalidation Completion Status Register

Register to report completion status of invalidation wait descriptor with Interrupt Flag (IF) Set. This register is treated as RsvdZ by implementations reporting Queued Invalidation (QI) as not supported in the Extended Capability register.

B/D/F/Type:		0/0/0/VCOPREMAP		
Address Offset:		9C–9Fh		
Reset Value:		00000000h		
Access:		RW1CS		
Size:		32 bits		
BIOS Optimal Default		00000000h		
Bit	Attr	Reset Value	RST/PWR	Description
31:1	RO	0h		Reserved
0	RW1CS	0b	Powergood	Invalidation Wait Descriptor Complete (IWC) This bit indicates completion of Invalidation Wait Descriptor with Interrupt Flag (IF) field Set. Hardware implementations not supporting queued invalidations implement this field as RsvdZ.

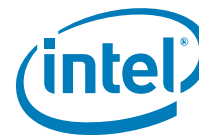

2.21.23 IECTL_REG—Invalidation Event Control Register

This register specifies the invalidation event interrupt control bits. This register is treated as RsvdZ by implementations reporting Queued Invalidation (QI) as not supported in the Extended Capability register.

B/D/F/Type: 0/0/0/VCOPREMAP Address Offset: A0–A3h Reset Value: 80000000h Access: RW-L, RO-V Size: 32 bits BIOS Optimal Default: 00000000h				
Bit	Attr	Reset Value	RST/PWR	Description
31	RW-L	1b	Uncore	Interrupt Mask (IM) 0 = No masking of interrupt. When an invalidation event condition is detected, hardware issues an interrupt message (using the Invalidation Event Data & Invalidation Event Address register values). 1 = This is the value on reset. Software may mask interrupt message generation by setting this field. Hardware is prohibited from sending the interrupt message when this field is Set.
30	RO-V	0b	Uncore	Interrupt Pending (IP) Hardware sets the IP field whenever it detects an interrupt condition. Interrupt condition is defined as: <ul style="list-style-type: none"> • An Invalidation Wait Descriptor with Interrupt Flag (IF) field Set completed, setting the IWC field in the Invalidation Completion Status register. • If the IWC field in the Invalidation Completion Status register was already Set at the time of setting this field, it is not treated as a new interrupt condition. The IP field is kept set by hardware while the interrupt message is held pending. The interrupt message could be held pending due to interrupt mask (IM field) being set, or due to other transient hardware conditions. The IP field is cleared by hardware as soon as the interrupt message pending condition is serviced. This could be due to either: <ul style="list-style-type: none"> • Hardware issuing the interrupt message due to either change in the transient hardware condition that caused interrupt message to be held pending or due to software clearing the IM field. • Software servicing the IWC field in the Invalidation Completion Status register.
29:0	RO	0h		Reserved

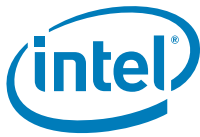

2.21.24 IEDATA_REG—Invalidation Event Data Register

This register specifies the Invalidation Event interrupt message data. This register is treated as RsvdZ by implementations reporting Queued Invalidation (QI) as not supported in the Extended Capability register.

B/D/F/Type: 0/0/0/VCOPREMAP Address Offset: A4–A7h Reset Value: 00000000h Access: RW-L Size: 32 bits				
Bit	Attr	Reset Value	RST/PWR	Description
31:16	RW-L	0000h	Uncore	Extended Interrupt Message Data (EIMD) This field is valid only for implementations supporting 32-bit interrupt data fields. Hardware implementations supporting only 16-bit interrupt data treat this field as Rsvd.
15:0	RW-L	0000h	Uncore	Interrupt Message data (IMD) Data value in the interrupt request.

2.21.25 IEADDR_REG—Invalidation Event Address Register

This register specifies the Invalidation Event Interrupt message address. This register is treated as RsvdZ by implementations reporting Queued Invalidation (QI) as not supported in the Extended Capability register.

B/D/F/Type: 0/0/0/VCOPREMAP Address Offset: A8–ABh Reset Value: 00000000h Access: RW-L Size: 32 bits BIOS Optimal Default: 0h				
Bit	Attr	Reset Value	RST/PWR	Description
31:2	RW-L	00000000h	Uncore	Message address (MA) When fault events are enabled, the contents of this register specify the DWORD-aligned address (bits 31:2) for the interrupt request.
1:0	RO	0h		Reserved



2.21.26 IEUADDR_REG—Invalidation Event Upper Address Register

This register specifies the Invalidation Event interrupt message upper address.

B/D/F/Type:		0/0/0/VCOPREMAP		
Address Offset:		AC–AFh		
Reset Value:		00000000h		
Access:		RW-L		
Size:		32 bits		
Bit	Attr	Reset Value	RST/PWR	Description
31:0	RW-L	00000000h	Uncore	Message Upper Address (MUA) Hardware implementations supporting Queued Invalidation and Extended Interrupt Mode are required to implement this register. Hardware implementations not supporting Queued Invalidation or Extended Interrupt Mode may treat this field as RsvdZ.

2.21.27 IRTA_REG—Interrupt Remapping Table Address Register

This register provides the base address of Interrupt remapping table. This register is treated as RsvdZ by implementations reporting Interrupt Remapping (IR) as not supported in the Extended Capability register.

B/D/F/Type:		0/0/0/VCOPREMAP		
Address Offset:		B8–BFh		
Reset Value:		0000000000000000h		
Access:		RW-L		
Size:		64 bits		
BIOS Optimal Default		00000000h		
Bit	Attr	Reset Value	RST/PWR	Description
63:39	RO	0h		Reserved
38:12	RW-L	00000000h	Uncore	Interrupt Remapping Table Address (IRTA) This field points to the base of 4KB aligned interrupt remapping table. Hardware ignores and does not implement bits 63:HAW, where HAW is the host address width. Reads of this field returns value that was last programmed to it.
11	RW-L	0b	Uncore	Extended Interrupt Mode Enable (EIME) This field is used by hardware on Intel 64 platforms as follows: 0 = xAPIC mode is active. Hardware interprets only low 8-bits of Destination-ID field in the IRTEs. The high 24-bits of the Destination-ID field are treated as reserved. 1 = x2APIC mode is active. Hardware interprets all 32-bits of Destination-ID field in the IRTEs. This field is implemented as RsvdZ on implementations reporting Extended Interrupt Mode (EIM) field as Clear in Extended Capability register.
10:4	RO	0h		Reserved
3:0	RW-L	0h	Uncore	Size (S) This field specifies the size of the interrupt remapping table. The number of entries in the interrupt remapping table is $2^{(X+1)}$, where X is the value programmed in this field.



2.21.28 IVA_REG—Invalidate Address Register

This register provides the DMA address whose corresponding IOTLB entry needs to be invalidated through the corresponding IOTLB Invalidate register. This register is a write only register.

B/D/F/Type:		0/0/0/VCOPREMAP																							
Address Offset:		100–107h																							
Reset Value:		0000000000000000h																							
Access:		RW																							
Size:		64 bits																							
BIOS Optimal Default		00000000h																							
Bit	Attr	Reset Value	RST/PWR	Description																					
63:39	RO	0h		Reserved																					
38:12	RW	0000000h	Uncore	Address (ADDR) Software provides the DMA address that needs to be page-selectively invalidated. To make a page-selective invalidation request to hardware, software must first write the appropriate fields in this register, and then issue the appropriate page-selective invalidate command through the IOTLB_REG. Hardware ignores bits 63 : N, where N is the maximum guest address width (MGAW) supported.																					
11:7	RO	0h		Reserved																					
6	RW	0h	Uncore	Invalidation Hint (IH) The field provides hint to hardware about preserving or flushing the non-leaf (page-directory) entries that may be cached in hardware: 0 = Software may have modified both leaf and non-leaf page-table entries corresponding to mappings specified in the ADDR and AM fields. On a page-selective invalidation request, hardware must flush both the cached leaf and non-leaf page-table entries corresponding to the mappings specified by ADDR and AM fields. 1 = Software has not modified any non-leaf page-table entries corresponding to mappings specified in the ADDR and AM fields. On a page-selective invalidation request, hardware may preserve the cached non-leaf page-table entries corresponding to mappings specified by ADDR and AM fields.																					
5:0	RW	00h	Uncore	Address Mask (AM) The value in this field specifies the number of low order bits of the ADDR field that must be masked for the invalidation operation. This field enables software to request invalidation of contiguous mappings for size-aligned regions. For example: <table border="1"> <thead> <tr> <th>Mask Value</th> <th>ADDR bits Masked</th> <th>Pages Invalidated</th> </tr> </thead> <tbody> <tr> <td>0</td> <td>None</td> <td>1</td> </tr> <tr> <td>1</td> <td>12</td> <td>2</td> </tr> <tr> <td>2</td> <td>13:12</td> <td>4</td> </tr> <tr> <td>3</td> <td>14:12</td> <td>8</td> </tr> <tr> <td>4</td> <td>15:12</td> <td>16</td> </tr> <tr> <td>...</td> <td>.....</td> <td>.....</td> </tr> </tbody> </table> When invalidating mappings for super-pages, software must specify the appropriate mask value. For example, when invalidating mapping for a 2 MB page, software must specify an address mask value of at least 9. Hardware implementations report the maximum supported mask value through the Capability register.	Mask Value	ADDR bits Masked	Pages Invalidated	0	None	1	1	12	2	2	13:12	4	3	14:12	8	4	15:12	16
Mask Value	ADDR bits Masked	Pages Invalidated																							
0	None	1																							
1	12	2																							
2	13:12	4																							
3	14:12	8																							
4	15:12	16																							
...																							

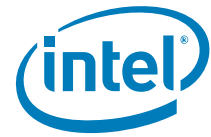

2.21.29 IOTLB_REG—IOTLB Invalidate Register

Register to invalidate IOTLB. The act of writing the upper byte of the IOTLB_REG with IVT field Set causes the hardware to perform the IOTLB invalidation.

B/D/F/Type:		0/0/0/VCOPREMAP		
Address Offset:		108–10Fh		
Reset Value:		0000000000000000h		
Access:		RW, RO-V, RW-V		
Size:		64 bits		
BIOS Optimal Default		00000000000000h		
Bit	Attr	Reset Value	RST/PWR	Description
63	RW-V	0h	Uncore	<p>Invalidate IOTLB (IVT)</p> <p>Software requests IOTLB invalidation by setting this field. Software must also set the requested invalidation granularity by programming the IIRG field.</p> <p>Hardware clears the IVT field to indicate the invalidation request is complete. Hardware also indicates the granularity at which the invalidation operation was performed through the IAIG field. Software must not submit another invalidation request through this register while the IVT field is set, nor update the associated Invalidate Address register.</p> <p>Software must not submit IOTLB invalidation requests when there is a context-cache invalidation request pending at this remapping hardware unit.</p> <p>Hardware implementations reporting write-buffer flushing requirement (RWBF=1 in Capability register) must implicitly perform a write buffer flushing before invalidating the IOTLB.</p>
62:62	RO	0h		Reserved
61:60	RW	0h	Uncore	<p>IOTLB Invalidation Request Granularity (IIRG)</p> <p>When requesting hardware to invalidate the IOTLB (by setting the IVT field), software writes the requested invalidation granularity through this field. The following are the encodings for the field.</p> <p>00 = Reserved.</p> <p>01 = Global invalidation request.</p> <p>10 = Domain-selective invalidation request. The target domain-id must be specified in the DID field.</p> <p>11 = Page-selective invalidation request. The target address, mask and invalidation hint must be specified in the Invalidate Address register, and the domain-id must be provided in the DID field.</p> <p>Hardware implementations may process an invalidation request by performing invalidation at a coarser granularity than requested. Hardware indicates completion of the invalidation request by clearing the IVT field. At this time, the granularity at which actual invalidation was performed is reported through the IAIG field.</p>
59:59	RO	0h		Reserved

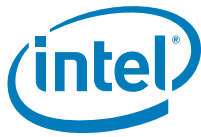

B/D/F/Type:		0/0/0/VCOPREMAP		
Address Offset:		108–10Fh		
Reset Value:		0000000000000000h		
Access:		RW, RO-V, RW-V		
Size:		64 bits		
BIOS Optimal Default		00000000000000h		
Bit	Attr	Reset Value	RST/PWR	Description
58:57	RO-V	0h	Uncore	<p>IOTLB Actual Invalidation Granularity (IAIG)</p> <p>Hardware reports the granularity at which an invalidation request was processed through this field when reporting invalidation completion (by clearing the IVT field).</p> <p>The following are the encodings for this field.</p> <p>00 = Reserved. This indicates hardware detected an incorrect invalidation request and ignored the request. Examples of incorrect invalidation requests include detecting an unsupported address mask value in Invalidate Address register for page-selective invalidation requests.</p> <p>01 = Global Invalidation performed. This could be in response to a global, domain-selective, or page-selective invalidation request.</p> <p>10 = Domain-selective invalidation performed using the domain-id specified by software in the DID field. This could be in response to a domain-selective or a page-selective invalidation request.</p> <p>11 = Domain-page-selective invalidation performed using the address, mask and hint specified by software in the Invalidate Address register and domain-id specified in DID field. This can be in response to a page-selective invalidation request.</p>
56:50	RO	0h		Reserved
49	RW	0b	Uncore	<p>Drain Reads (DR)</p> <p>This field is ignored by hardware if the DRD field is reported as Clear in the Capability register. When the DRD field is reported as Set in the Capability register, the following encodings are supported for this field:</p> <p>0 = Hardware may complete the IOTLB invalidation without draining any translated DMA read requests.</p> <p>1 = Hardware must drain DMA read requests.</p>
48	RW	0b	Uncore	<p>Drain Writes (DW)</p> <p>This field is ignored by hardware if the DWD field is reported as Clear in the Capability register. When the DWD field is reported as Set in the Capability register, the following encodings are supported for this field:</p> <p>0 = Hardware may complete the IOTLB invalidation without draining DMA write requests.</p> <p>1 = Hardware must drain relevant translated DMA write requests.</p>
47:40	RO	0h		Reserved
39:32	RW	00h	Uncore	<p>Domain-ID (DID)</p> <p>Indicates the ID of the domain whose IOTLB entries need to be selectively invalidated. This field must be programmed by software for domain-selective and page-selective invalidation requests.</p> <p>The Capability register reports the domain-id width supported by hardware. Software must ensure that the value written to this field is within this limit. Hardware ignores and not implements bits 47:(32+N), where N is the supported domain-id width reported in the Capability register.</p>
31:0	RO	0h		Reserved