

*When Reliability Matters - Trust Peerless*

Type PV



## Peerless Pump

GENERAL PURPOSE IN-LINE  
CENTRIFUGAL PUMPS



Brochure B-2200



# Outline Dimensions

PV PUMP SIZE	SUCTION & DISCHARGE FLANGE SIZE 125 LB. ANSI	PUMP DIMENSIONS (IN INCHES)					MAXIMUM PUMP WT. LBS.
		D	SD	X	HA	HE	
2x2x6A	2	4.88	13.50	6.50	9	7.88	75
2.5x2.5x6B	2.5	5.62	15.50	7.00	10	8.88	96
2x2x8A	2	4.88	15.50	7.50	9	7.88	97
2.5x2.5x8A	2.5	5.62	16.50	8.00	10	8.88	113
3x3x8A	3	5.88	18.00	8.50	10	8.88	139
3x3x11 ★	3	5.75	22.25	11.38	10	8.88	165
4x4x8A	4	6.50	21.00	10.00	11	9.88	175
4x4x8J	4	6.50	21.00	10.00	11	9.88	175
2x2x10A	2	5.50	19.00	9.50	9	7.88	119
3x3x10B	3	5.88	20.00	9.50	10	8.88	147
4x4x10B	4	5.50	22.00	11.00	11	9.88	178
5x5x7	5	7.00	20.50	9.50	11	9.88	150
5x5x11 ★	5	6.75	23.25	11.62	11	9.88	180

★ □ 250 Lb. ANSI Discharge Flange Furnished (3x3x11 or 5x5x11 only)

**NOTE 1:** CONDUIT BOX LOCATED 45° COUNTER-CLOCKWISE FROM SUCTION FLANGE WHEN VIEWED FROM MOTOR END. (MOTOR MAY BE ROTATED IN 90° INCREMENTS).

**NOTE 2:** MAINTAIN 'X' DIMENSION FROM CENTERLINE OF UNIT ON EACH SIDE OF CASING FOR MINIMUM CLEARANCE.

**NOTE 1:**

Conduit box located 45° counter-clockwise from suction flange when viewed from motor end. (Motor may be rotated in 90° increments.)

**Note 2:**

Maintain 'X' dimension from centerline of unit on each side of casing for minimum clearance.

SINGLE-PHASE MOTOR HP OPEN DRIP PROOF		MOTOR FRAME SIZE	UNIT DIMENSIONS (IN INCHES)		MAXIMUM MOTOR WT. LBS.
1750 RPM	3500 RPM		C (MAXIMUM)	O (MAXIMUM)	ODP
1	1.5	143JM, JP	15.75	8.50	42
1.5	2	145JM, JP	16.75	8.50	44
2	3	182JM, JP	20.50	10.50	63
3	5	184JM, JP	21.25	10.50	74
5	7.5	213JM, JP	23.25	12.12	105
7.5	10	215JM, JP	24.25	12.12	125
10	—	215JM, JP	24.25	12.12	143

3 PHASE MOTOR HORSEPOWER *				MOTOR FRAME SIZE	UNIT DIMENSIONS (IN INCHES)		MAXIMUM MOTOR WT. LBS.	
OPEN DRIP PROOF		TOTALLY ENCLOSED FAN-COOLED			C (MAX.)	O (MAX.)	ODP	TEFC
1750 RPM	3500 RPM	1750 RPM	3500 RPM					
1	1.5	1	1.5	143JM, JP	15.75	8.50	33	35
1.5	2	1.5	2	145JM, JP	16.75	8.50	34	39
2	3	2	—	145JM, JP	16.75	8.50	43	42
3	5	3	3	182JM, JP	20.50	10.50	65	96
5	7.5	5	5	184JM, JP	21.25	10.50	70	113
7.5	10	7.5	7.5	213JM, JP	23.25	12.12	97	158
10	15	10	10	215JM, JP	24.25	12.12	105	180
15	20	15	15	254JM, JP	30.25	14.50	203	270
20	25	20	20	256JM, JP	31.25	14.50	210	291
—	30	—	25	284JM, JP	33.25	15.75	295	398
—	40	—	30	286JM, JP	34.25	15.75	329	443
—	50	—	40	324JM, JP	41.00	16.75	400	430
—	60	—	50	326JM, JP	42.00	16.75	440	510
—	75	—	60	364JP	45.00	19.75	600	700
—	100	—	75	365JP	46.00	19.75	650	750

\* At factory option, a foot mounted motor may be furnished in lieu of footless motor. If footless motor is required, refer to the factory for availability and price addition (may not be available in some listed ratings).



# Typical PV Specifications

The following pump specifications include cast iron bronze fitted materials and all iron materials of construction. *All iron construction materials are printed in italics.* Select appropriate specification wording for desired construction materials. Pump shall be a Peerless PV In-Line centrifugal type capable of delivering \_\_\_\_\_ gpm at a total head of \_\_\_\_\_ feet with an efficiency of \_\_\_\_\_% at the specified condition. Pumped liquid will be \_\_\_\_\_ at a temperature of \_\_\_\_\_°F with a specific gravity of \_\_\_\_\_.

Pump casing shall be cast iron with smooth water passages and fitted with a (bronze) (*steel*) replaceable casing ring. Maximum casing working pressure shall be 175 psig. The pipe connection flanges shall be of identical dimensions, rated at 125 lb. ANSI, and displaced 180° with centerlines concentric on the same horizontal plane.

The impeller supplied for the specific conditions shall be a one piece (bronze) (*iron*) casting of a diameter not greater than 90% of the casing cutwater diameter. The impeller shall be in proper balance for smooth operation at \_\_\_\_\_ rpm.

Sealing of the pump liquid cavity shall be accomplished with:

### Mechanical Seal Pumps, Bronze Fitted

A face type mechanical seal with Ni-Resist stationary seat, carbon washer, Buna flexible members and 18-8 stainless steel spring and metal parts. Seal shall be mounted over a bronze shaft sleeve.

### Mechanical Seal Pumps, All Iron

A face type mechanical seal with Ni-Resist stationary seat, carbon washer, Buna flexible members and 18-8 stainless steel spring and metal parts. Seal shall be mounted over a 416 stainless steel shaft sleeve.

The motor/impeller shaft shall be equipped with a replaceable (bronze) (*stainless steel*) sleeve installed between the shaft and the mechanical seal.

Pump shall be close coupled to a HI/NEMA JM frame (ODP) (TEFC) (Explosion Proof) electric motor rated \_\_\_\_\_ hp, \_\_\_\_\_ rpm, \_\_\_\_\_ volt, \_\_\_\_\_ ph, \_\_\_\_\_ Hz. Motor shaft shall be carbon steel and of a size and design to limit shaft deflection at the mechanical seal faces to no more than .002 inches. Motor bearings shall be grease lubricated and sized for minimum of 20,000 hours L<sub>10</sub> basic rating life which is equivalent to 100,000 hours median bearing life. Pump should be provided (with) (without) cast iron pedestal mounting support.

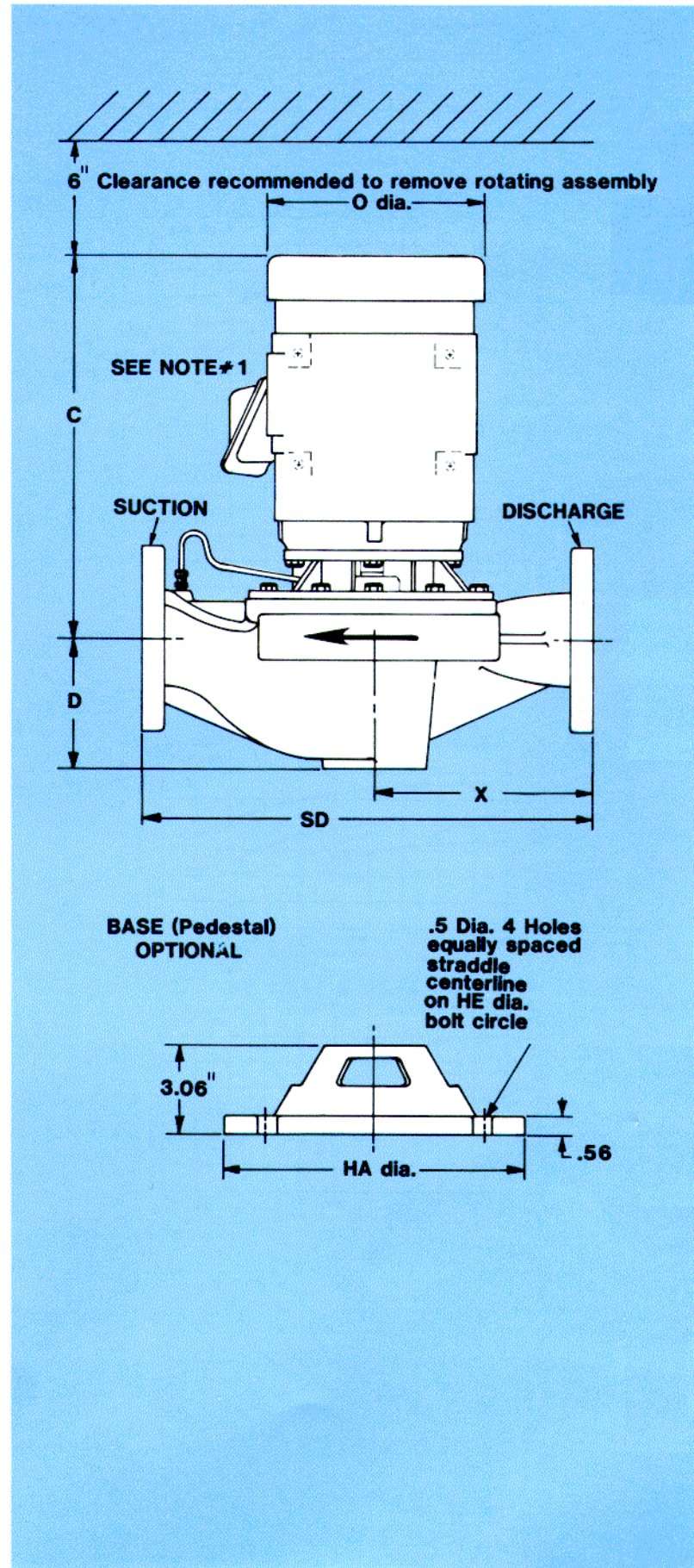



# Performance Curves 3500 rpm

**PV 2 x 2 x 6A**

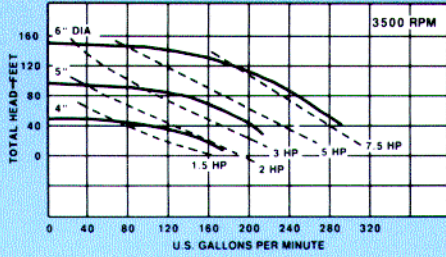

**PV 3 x 3 x 8A**

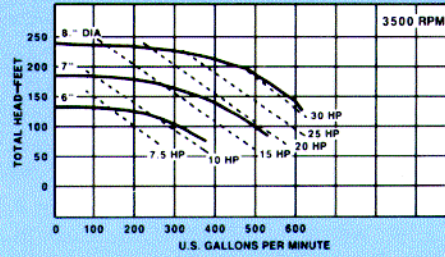

**PV 2 x 2 x 8A**

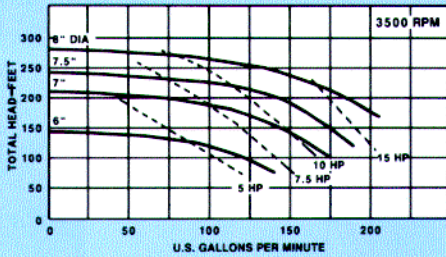

**PV 3 x 3 x 11**

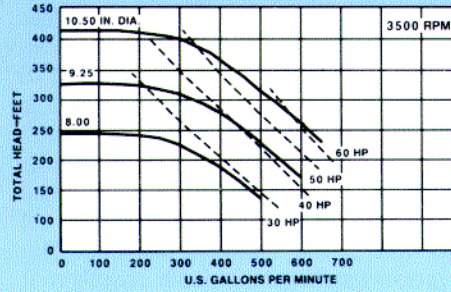

**PV 2 x 2 x 10A**

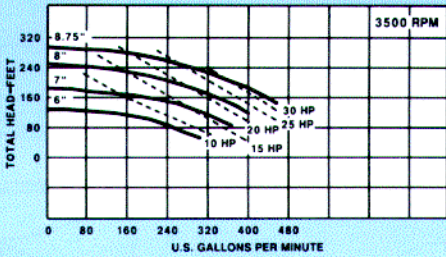

**PV 4 x 4 x 8A**

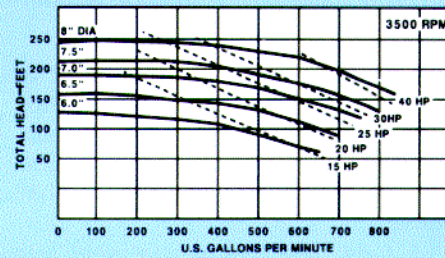

**PV 2 1/2 x 2 1/2 x 6B**

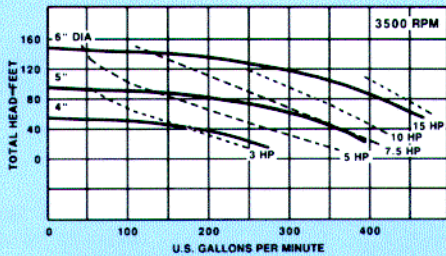

**PV 4 x 4 x 8J**

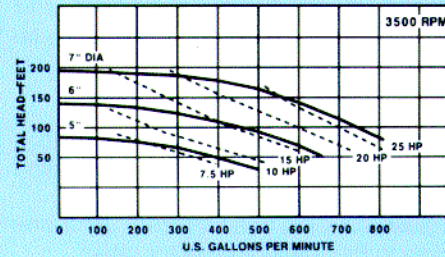

**PV 2 1/2 x 2 1/2 x 8A**

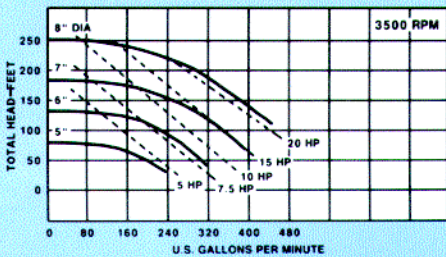

**PV 5 x 5 x 7**

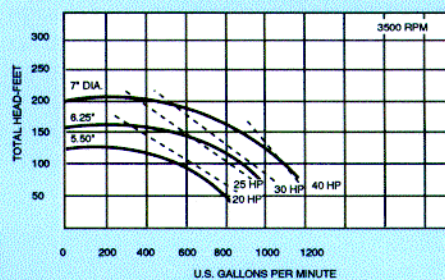

**PV 5 x 5 x 11**

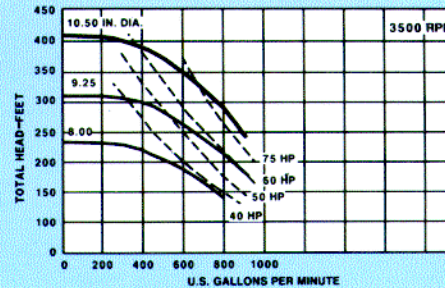



# Performance Curves 1750 rpm

**PV 2 x 2 x 6A**

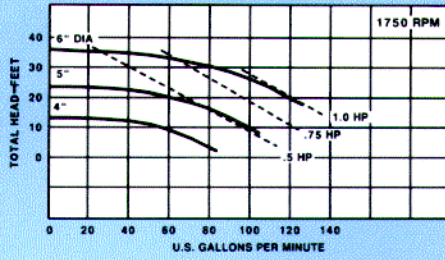

**PV 3 x 3 x 10B**

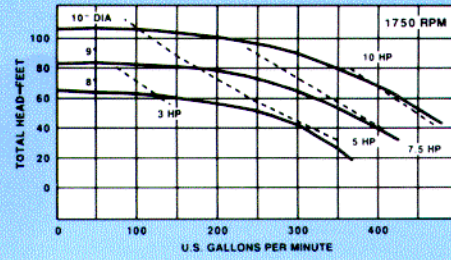

**PV 2 x 2 x 8A**

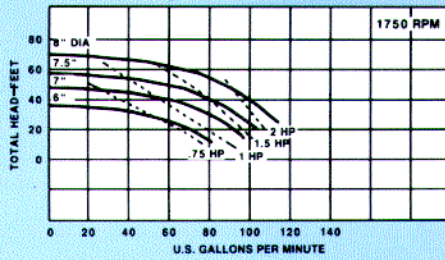

**PV 3 x 3 x 11**

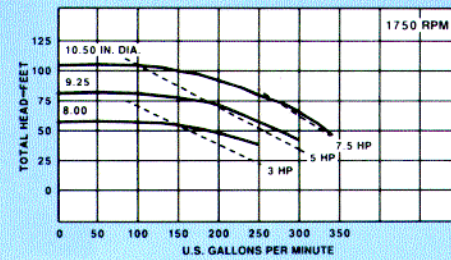

**PV 2 x 2 x 10A**

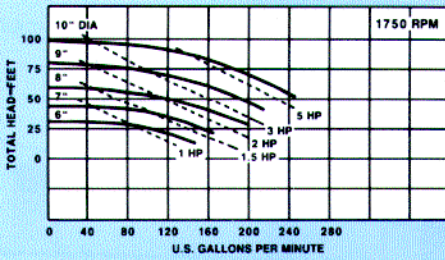

**PV 4 x 4 x 8A**

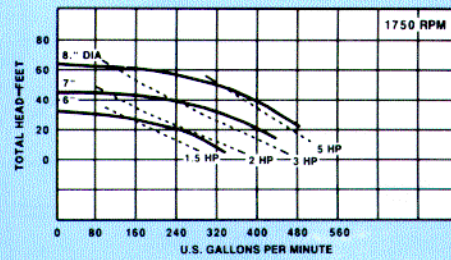

**PV 2 1/2 x 2 1/2 x 6B**

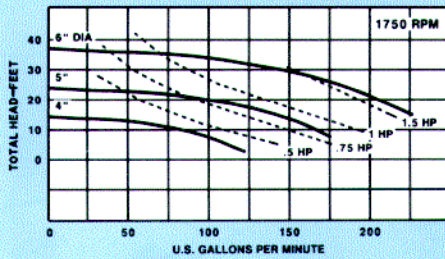

**PV 4 x 4 x 10B**

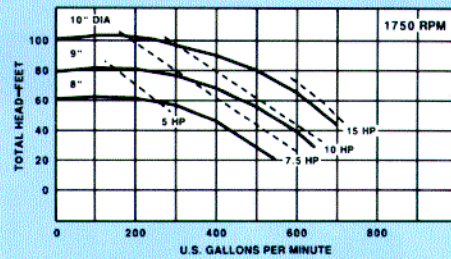

**PV 2 1/2 x 2 1/2 x 8A**

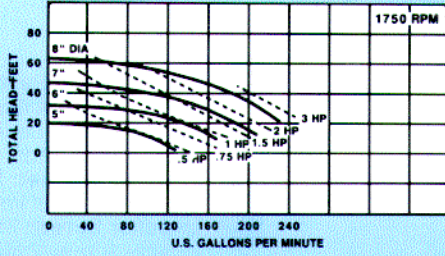

**PV 5 x 5 x 7**

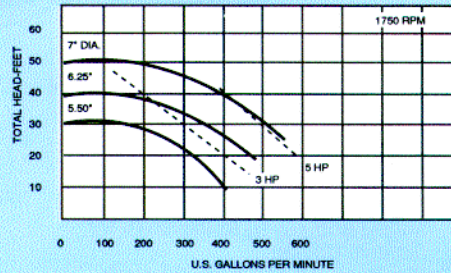

**PV 3 x 3 x 8A**

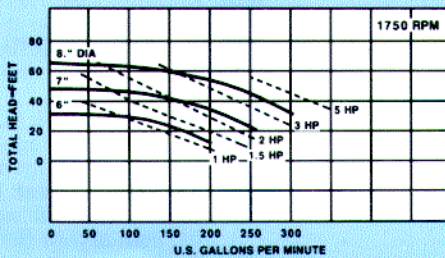

**PV 5 x 5 x 11**

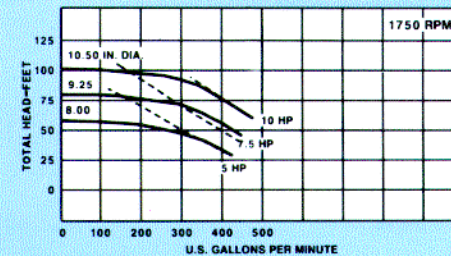



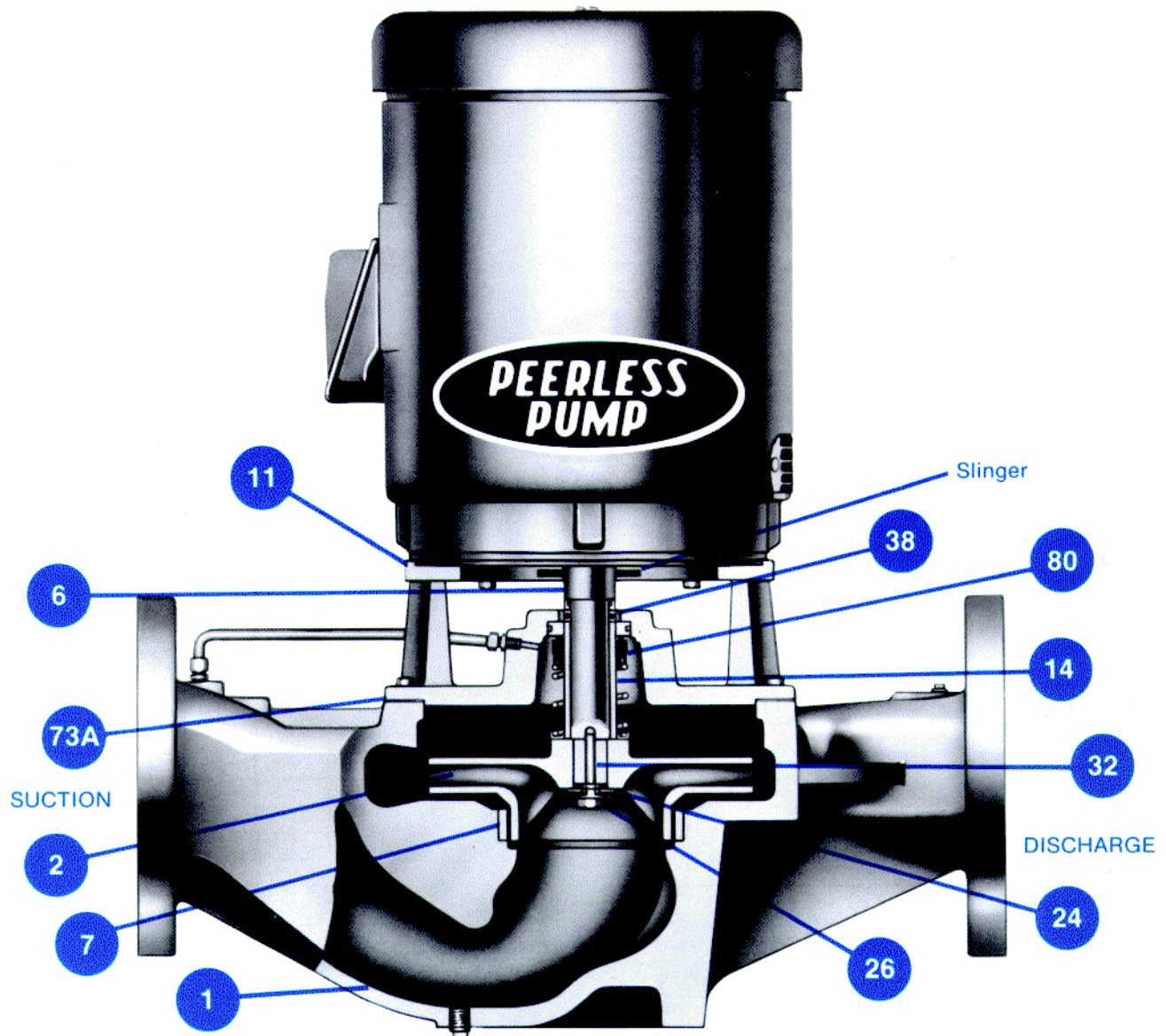

- 1 **Casing:** Cast iron with 125 psi ANSI flanges; suction and discharge of same size. 175 psi case working pressure.
- 2 **Impeller:** Enclosed type, smooth finish casting. Dynamically balanced and keyed to the shaft for positive driving.
- 6 **Shaft:** HI/NEMA type JM shaft designed for minimum deflection and long mechanical seal life.
- 7 **Casing Ring:** Replaceable close clearance ring limits recirculation around impeller resulting in sustained efficiency.
- 11 **Frame Adapter:** Precision register fit enables correct motor to pump alignment. Adapter provides mounting of stationary mechanical seal parts.

- 14 **Shaft Sleeve:** Replaceable metal sleeve provides non-corrosive mounting surface for mechanical seal rotating parts.
- 24 **Impeller Washer:** Stainless steel washer protects impeller hub.
- 26 **Impeller Screw:** Stainless steel locking screw holds impeller securely in place.
- 32 **Impeller Key:** Key provides positive shaft-to-impeller drive.
- 38 **Shaft Sleeve O Ring:** O ring seals sleeve to shaft to prevent leakage of pumped liquid.
- 73A **Casing Gasket:** Gasket seals casing to adapter register to prevent leakage of pumped liquid.
- 80 **Mechanical Seal:** Face type mechanical seal with carbon rotating seat and Ni-Resist stationary seat.

# In-Line Pumps

## Type PV Centrifugal Pumps

- Rates of flow: to 800 gpm.
- Heads: to 300 ft. TDH
- Horsepower: to 40 hp.
- Temperature Range: to 225°F.
- Speeds: 1,750 and 3,500 rpm.
- Maximum Working Pressure: to 175 psi.

Peerless PV In-Line close coupled single suction pumps, designed especially for applications in medium duty service, provide maximum pump value in heating and air conditioning, booster and general circulating service.

Peerless In-Line pumps are easy to install since there is no need to align driver-to-pump couplings. The pump is designed to be mounted in system piping, between pipe flanges, which saves floor space and simplifies plumbing. This arrangement allows the removal of the pump's rotating element for inspection and service without disturbing the system piping. Suction and discharge flanges are the same diameter and on the same centerline.

**User Benefits:** Pump can be installed just like a valve. This eliminates the need for pouring a base or providing millwrights for alignment or servicing.

### Unified Pump and Motor

Type PV In-Line pumps are close coupled with standard solid shaft ball bearing motors specifically designed for pump applications in accordance with standards developed by the Hydraulic Institute and the National Electrical Manufacturers Association. Thus, the standard HI/NEMA motor is better matched with the pump than ever before possible.

**User Benefits:** Better availability of motors means less down time; better control of tolerances with quieter, more uniform performance; longer mechanical seal life; and bearings sized for a  $L_{10}$  basic rating life of 20,000 hours or a median life of 100,000 hours.

### Performance Characteristics

Exceptional hydraulic performance is achieved in PV In-Line pumps through design processes which include testing of hydraulic passage contours with air flow tests verified with water tests. This results in optimum velocity patterns and smooth flow into the impeller eye, contributing to low NPSH requirements. Scientifically designed streamlined

water passages in the pump case and impeller system reduce frictional losses and result in increased efficiency.

**User Benefits:** The high efficiency designs of the PV In-Line pumps assure lower operating costs.

### Mechanical Design Features

Type PV pumps are furnished with dynamically balanced impellers for smooth, low vibration operation. The impeller is keyed to the shaft for positive driving and is secured in place with a corrosion resistant washer and self locking cap screw. The motor shaft on which the impeller mounts is protected by a replaceable shaft sleeve positioned under the mechanical seal. The impeller diameter is no more than 90 percent of the maximum diameter which the case tongue or cutwater could accommodate. This design feature results in low hydraulic noise levels which meets most sound level requirements.

Mechanical seals designed for water service and light hydrocarbons up to 225°F are furnished as standard. For service with other liquids, mechanical seals can be furnished to meet specific job conditions.

**User Benefits:** The mechanical design of Type PV pumps assures high sustained efficiency, smooth quiet operation and reliable service.

### Manufacturing Process

Machined metal patterns and core boxes produce smooth finish castings of uniform dimensions and quality. Peerless PV In-Line pump parts are manufactured to closely controlled dimensional tolerances on numerically controlled machining centers.

**User Benefits:** Consistent high quality castings and machining assures uniform tolerances resulting in long life and reliable service. Peerless PV pumps incorporate design techniques, quality features and manufacturing procedures to give efficient, reliable solutions to inline pump requirements.

**NOTE:** The content of this brochure is subject to change without notice.

### Three methods of mounting may be employed with the PV In-Line pump

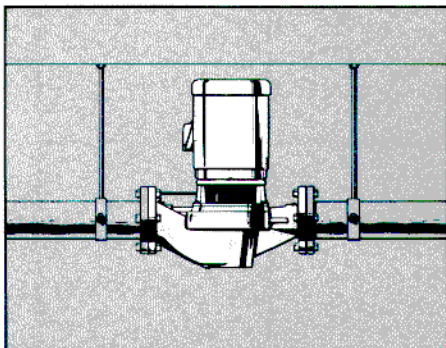

Suspension from overhead

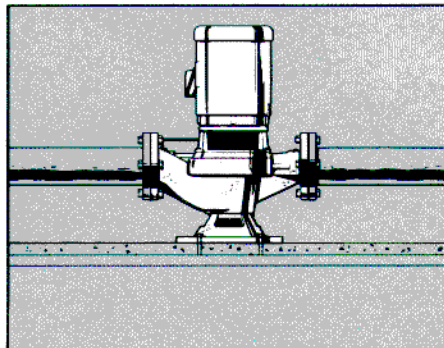

Base mount

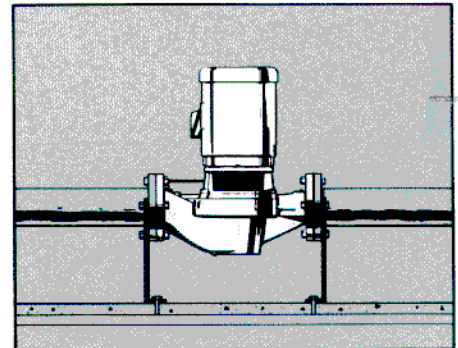

Flange support



# Peerless Centrifugal Pumps & Constant Pressure Systems

## Vertical Type VTM/VTP

Flows 80 to 500 gpm  
Heads 69 to 474 feet  
Pressures to 400 psi  
Horsepowers to 100 hp  
Temperature to 115°F  
Brochure B-2700

Pre-engineered, close-coupled vertical turbine pumps with fabricated steel suction barrels. Packing or mechanical seals.



## General Purpose Horizontal Split-Case Pumps



Single-Stage	Model AE	Model A
Flows	8,500 gpm	25,000 gpm
Heads to	675 ft.	280 ft.
Temps. to	225° F	250° F
Brochure	B-1200	B-1300

For high service, booster, transfer and general service pumping. Options include packed or sealed types, 125# or 250# flanges, shaft sleeves, wearing rings, oil or grease lubrication, stainless steel shaft, etc.

## General Purpose End Suction Pumps



Type	Close Coupled		Frame Mtd.
	PE	C	F
Flows, gpm to	320	2,000	3,400
Heads, ft.	to 275	430	430
Temps., °F	to 225	250	250
HP	1/3 to 15	to 100	to 125
Brochures	B-2310	B-2300	B-2300

For general purpose pumping in broad range of services. Horizontal single stage vertically split case centrifugal type. Packed or sealed types, close-coupled or frame mounted.

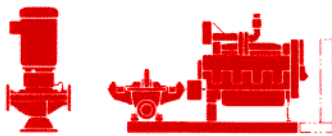

## Horizontal and Vertical Fire Pumps

Flows:  
Verticals to 5,000 gpm  
Horizontal to 5,000 gpm  
In-Lines to 500 gpm

Heads:  
Verticals to 1,176 ft.  
Horizontal to 630 ft.  
In-Lines to 406 ft.

Pressures:  
Verticals to 510 psi  
Horizontal to 640 psi  
In-Lines to 175 psi

Horsepowers to 800 hp  
Brochure B-1500



## Hydroconstant® Variable Speed Drives

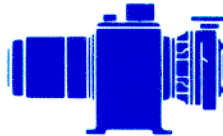

Horsepowers:  
Horizontal centrifugal pumps to 50 hp  
Brochure B-4100A

Variable speed couplings, pumps and motors unitized for simplified maintenance of water pressure regardless of system changes or variables. Eliminates need for tanks and many mechanical and electrical accessories.

## Horizontal Multi-Stage Diffuser Pumps



Flows to 600 gpm  
Pressures to 600 psi  
Temperatures to 392° F  
Brochure B-2900

General purpose 2- to 15-stage pumps. All iron or bronze fitted iron. Packed or sealed types. For booster, transfer, high and general service pumping.

## Multi-Stage

Flows to 4,500 gpm  
Heads to 1,600 ft.  
Pressures to 700 psi  
Horsepowers to 800 hp  
Temperature to 300°F  
Brochure B-1400 2-5 stage split case pump.



Multi-stage horizontal split-case designs for booster service, high service and general purpose pumping. Packed or sealed types.

## Vertical Enclosed Shaft Non-Clog Pumps

Flows to 1,100 gpm  
Heads to 110 ft.  
Brochure B-6300

For sump, storm water or sewage service. Single or duplex units.



## Heavy Duty Sump Pumps

Flows to 250 gpm  
Heads to 100 ft.  
Brochure B-6110

For automatic pumping of surface water, seepage, foundation drainage, etc. Single or duplex units with or without basins.



## Peerless Pump Company

P.O. Box 7026 • Indianapolis, IN 46207-7026  
Phone: (317) 925-9661 • Fax: (317) 924-7388