

THE MILITARY TECHNOLOGY OF CLASSICAL ISLAM

VOLUME III

David Nicolle

Thesis presented to the University of Edinburgh  
for the Degree of Doctor of Philosophy  
1982



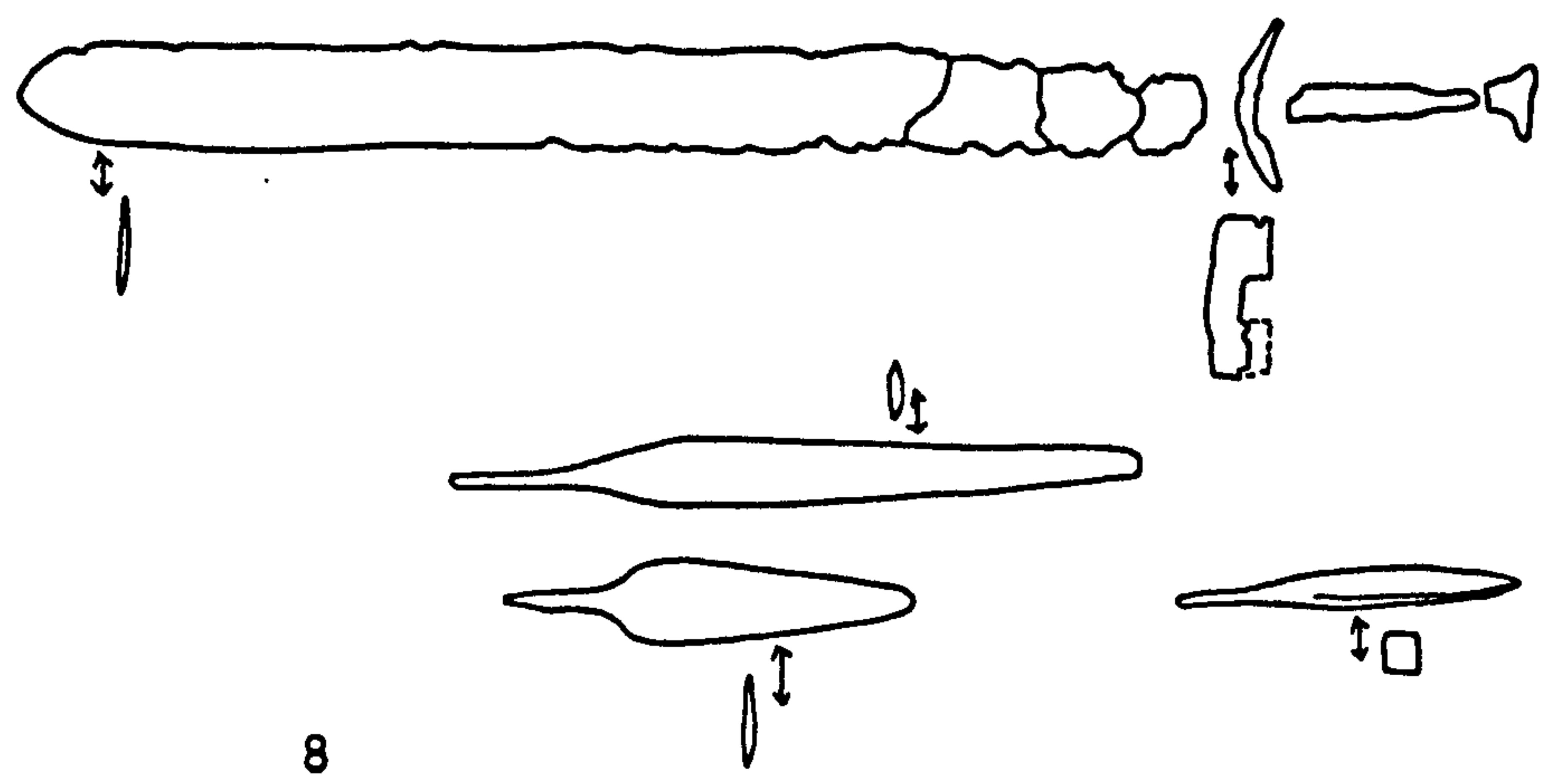
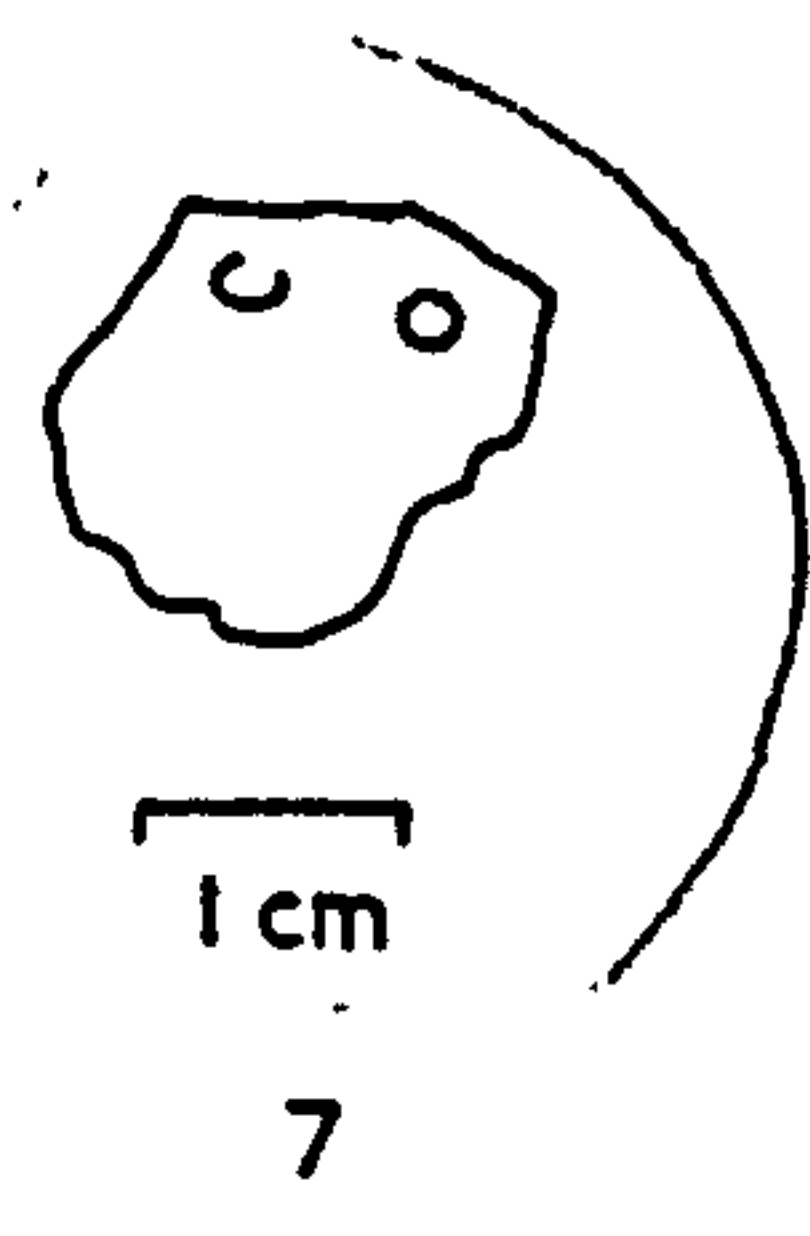
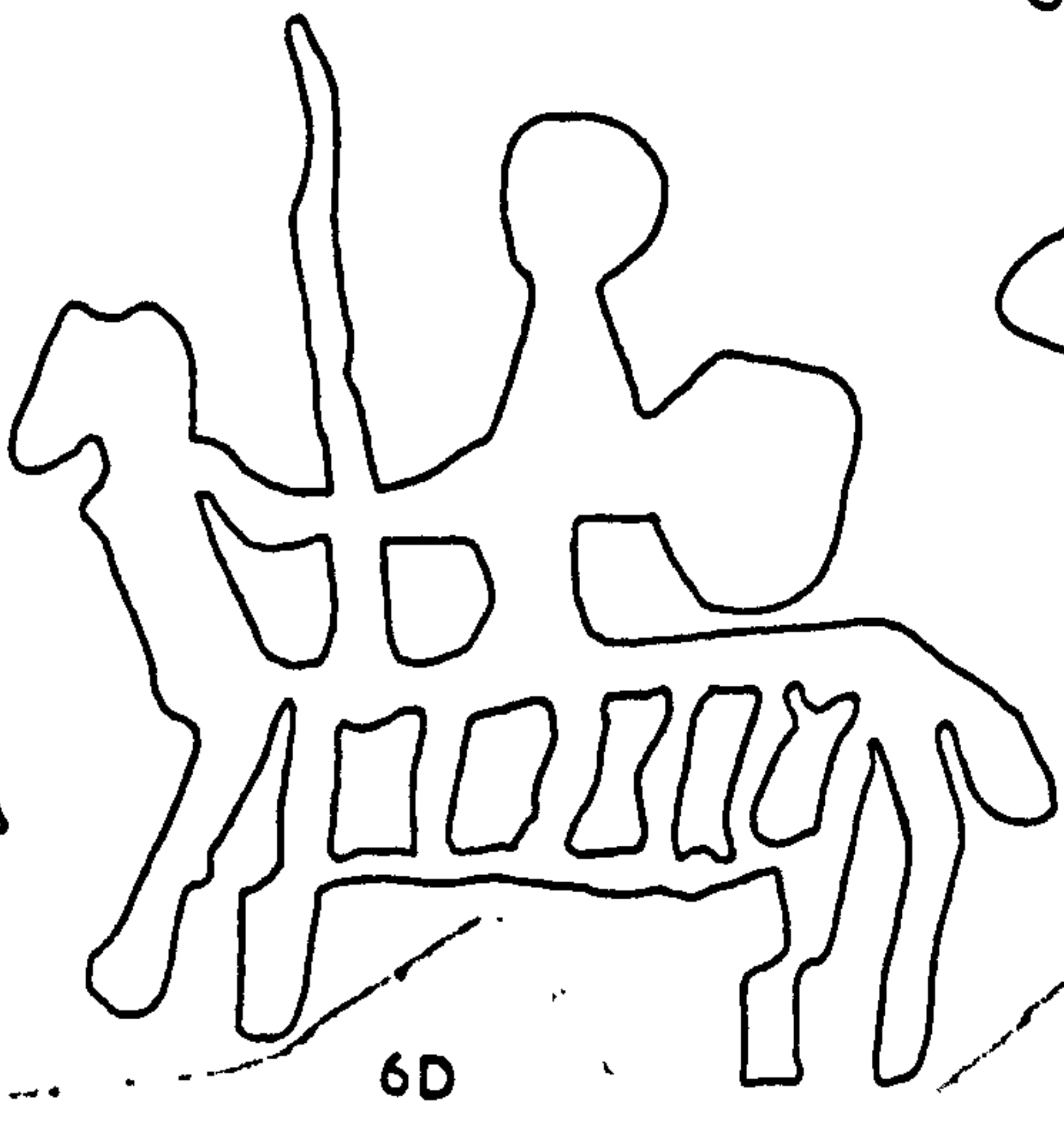
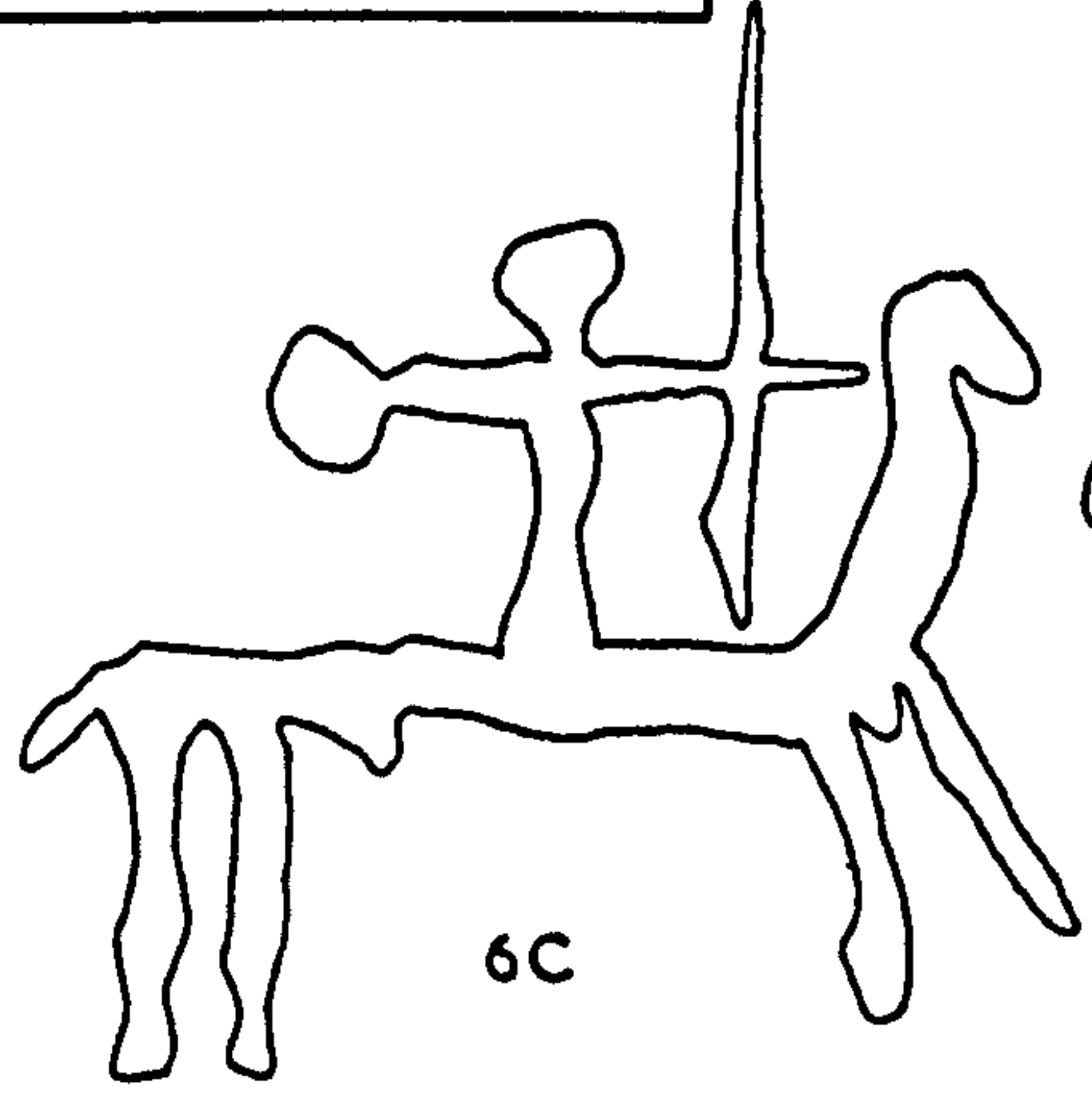
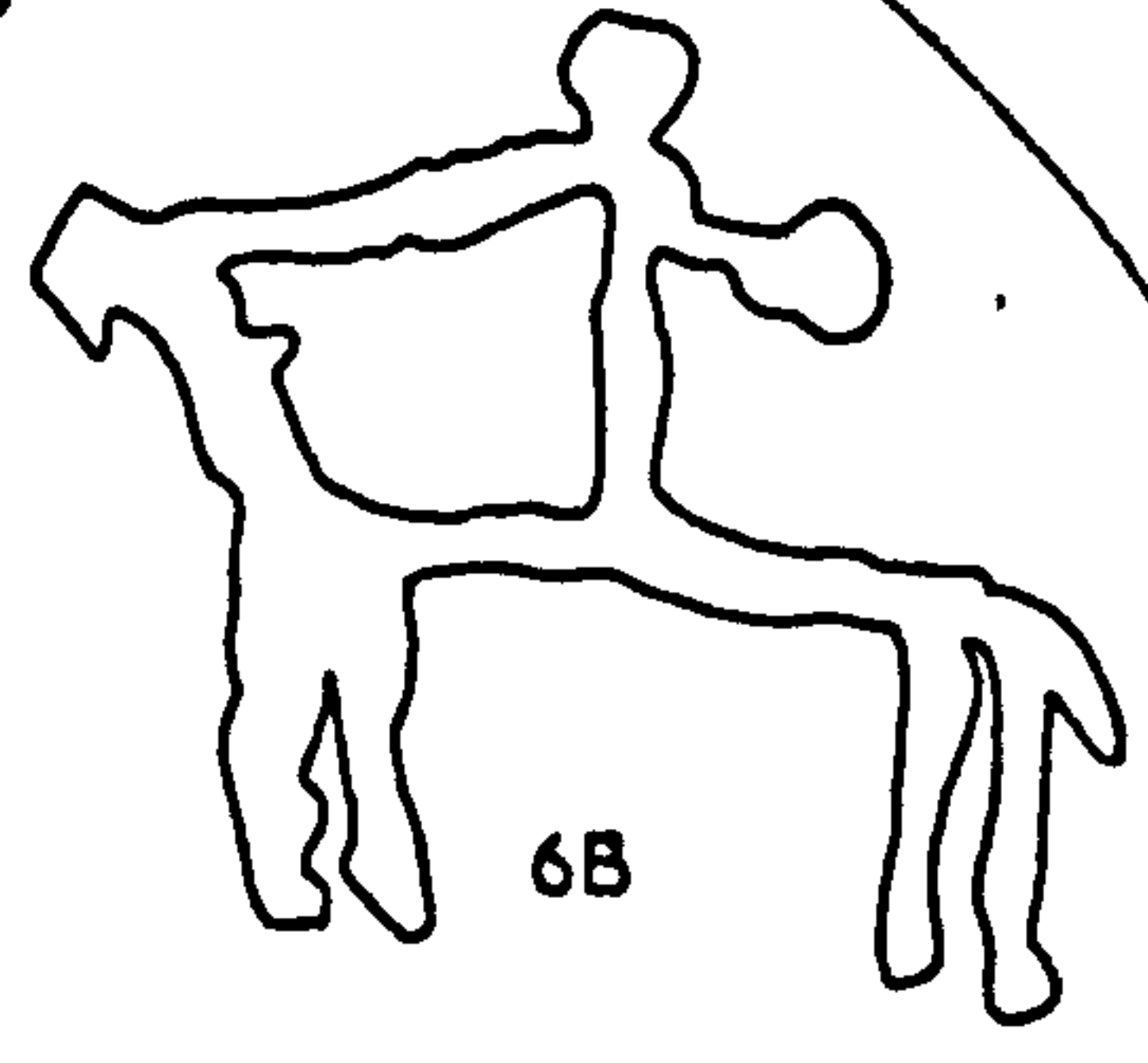
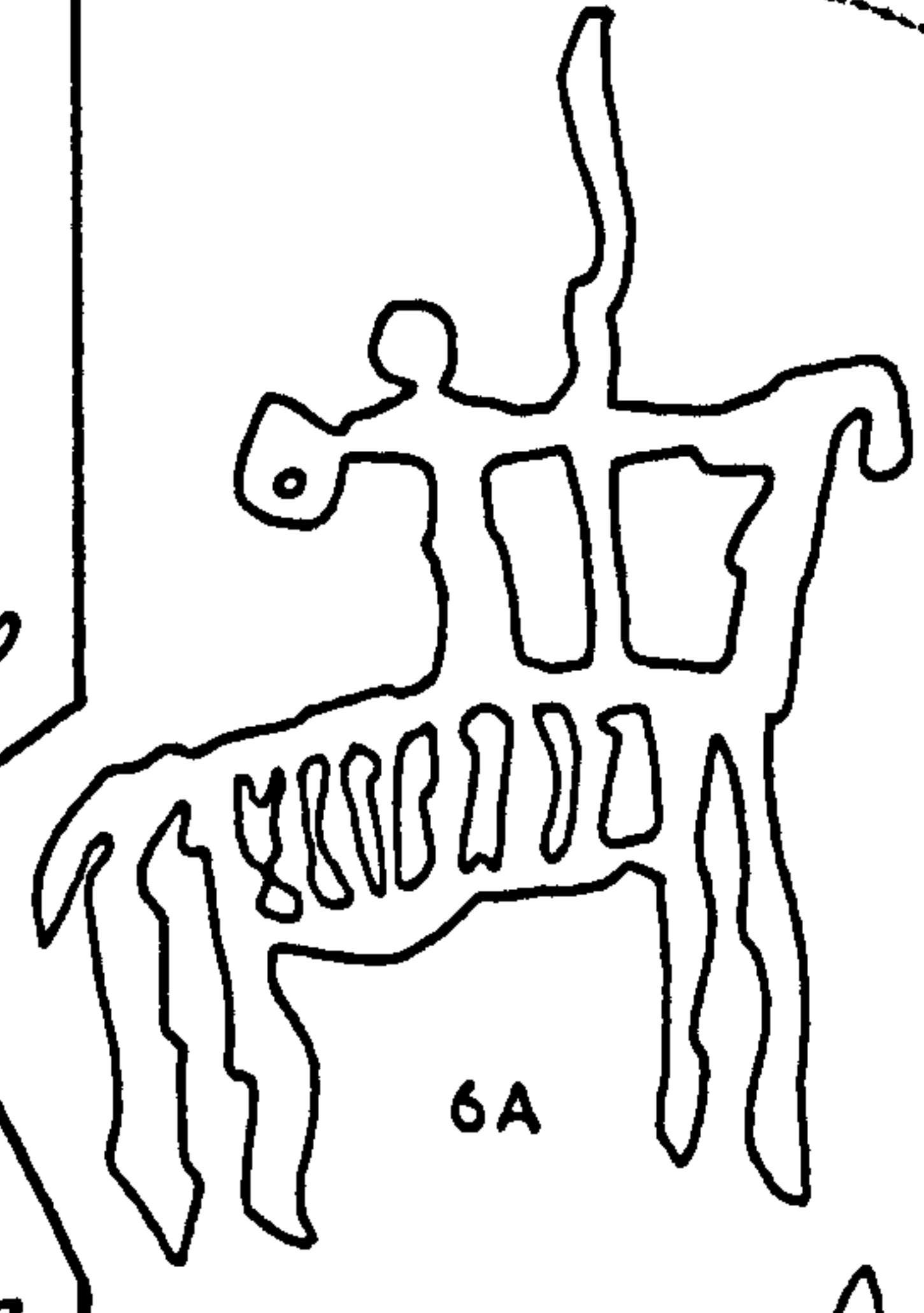
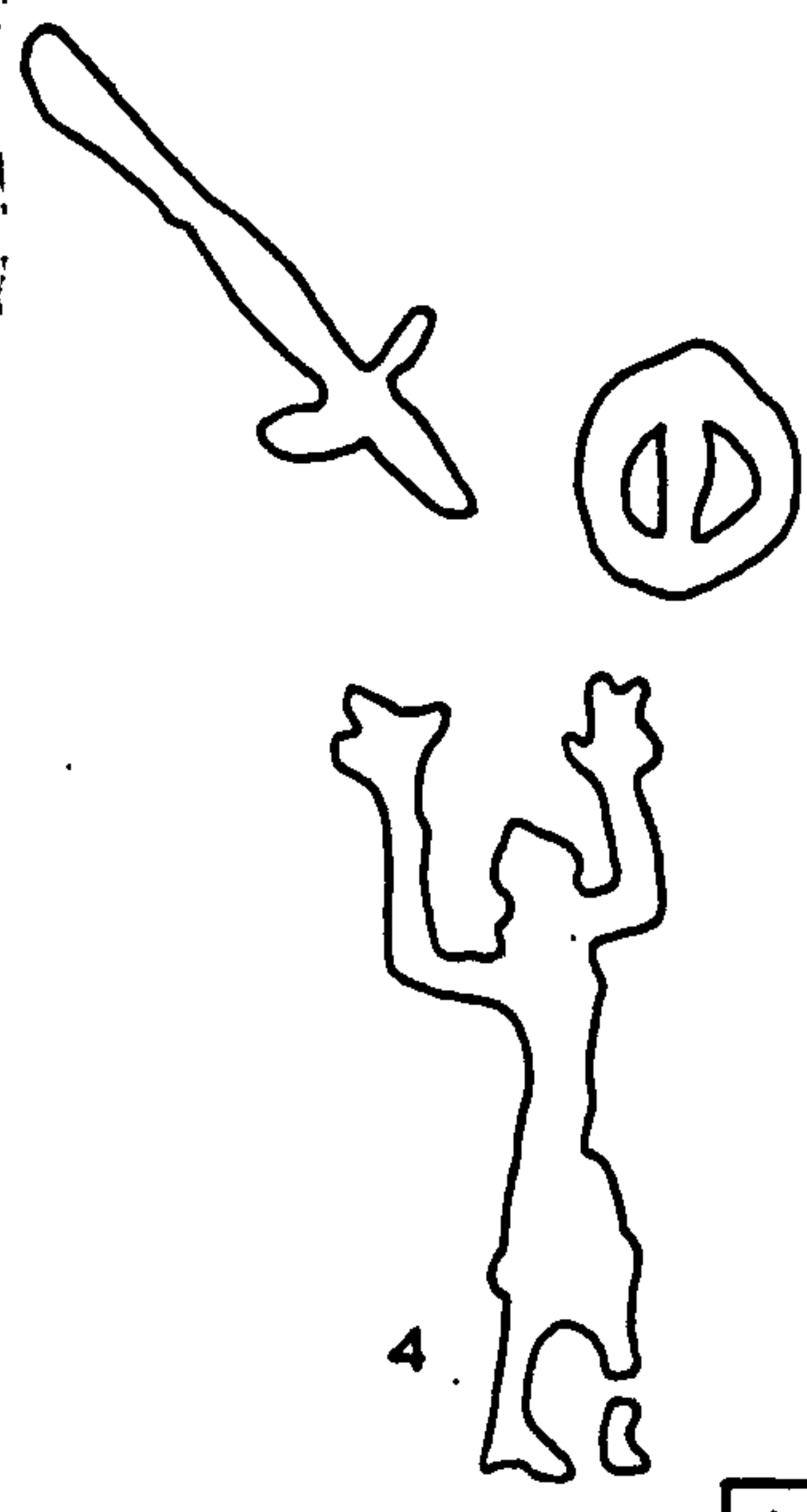
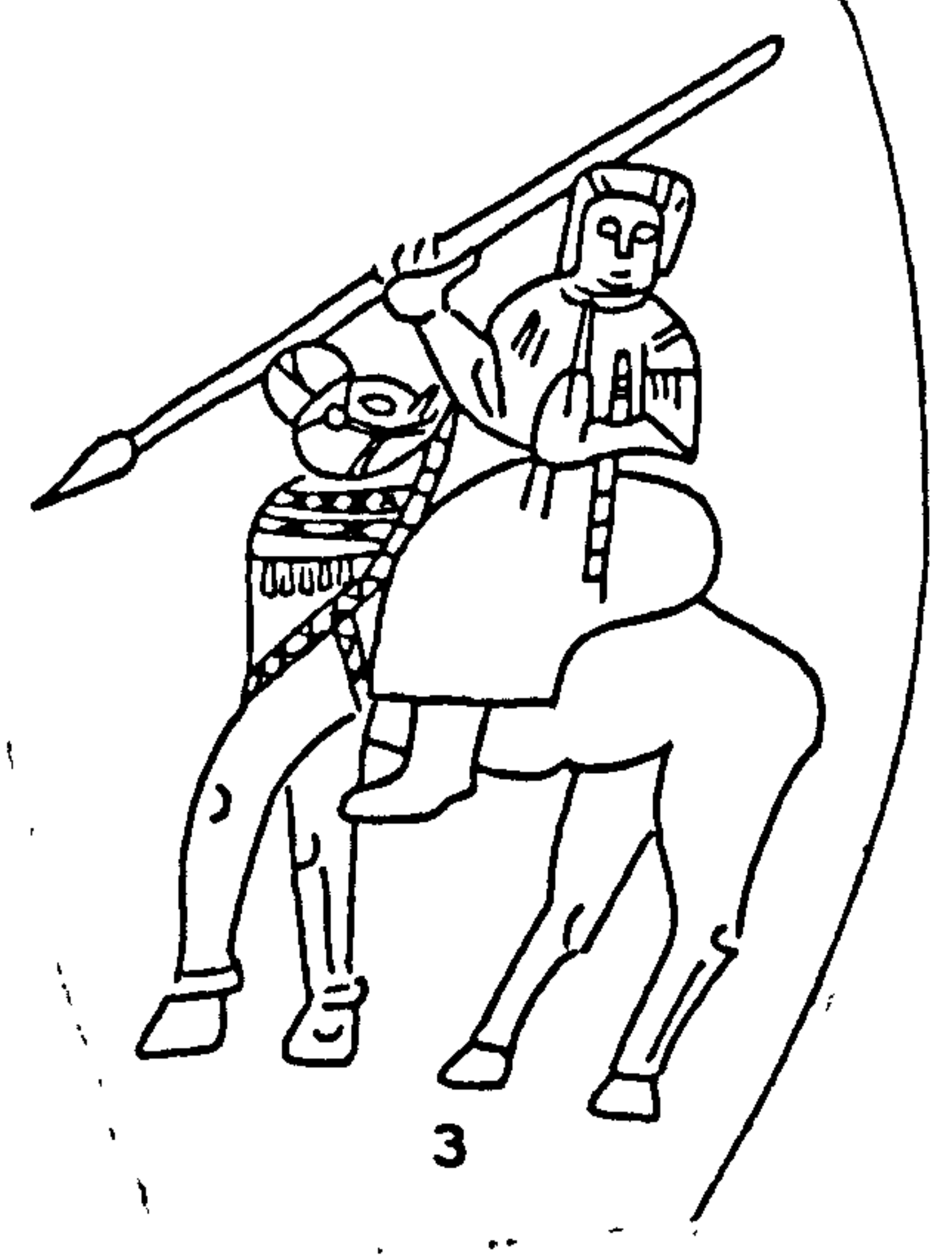
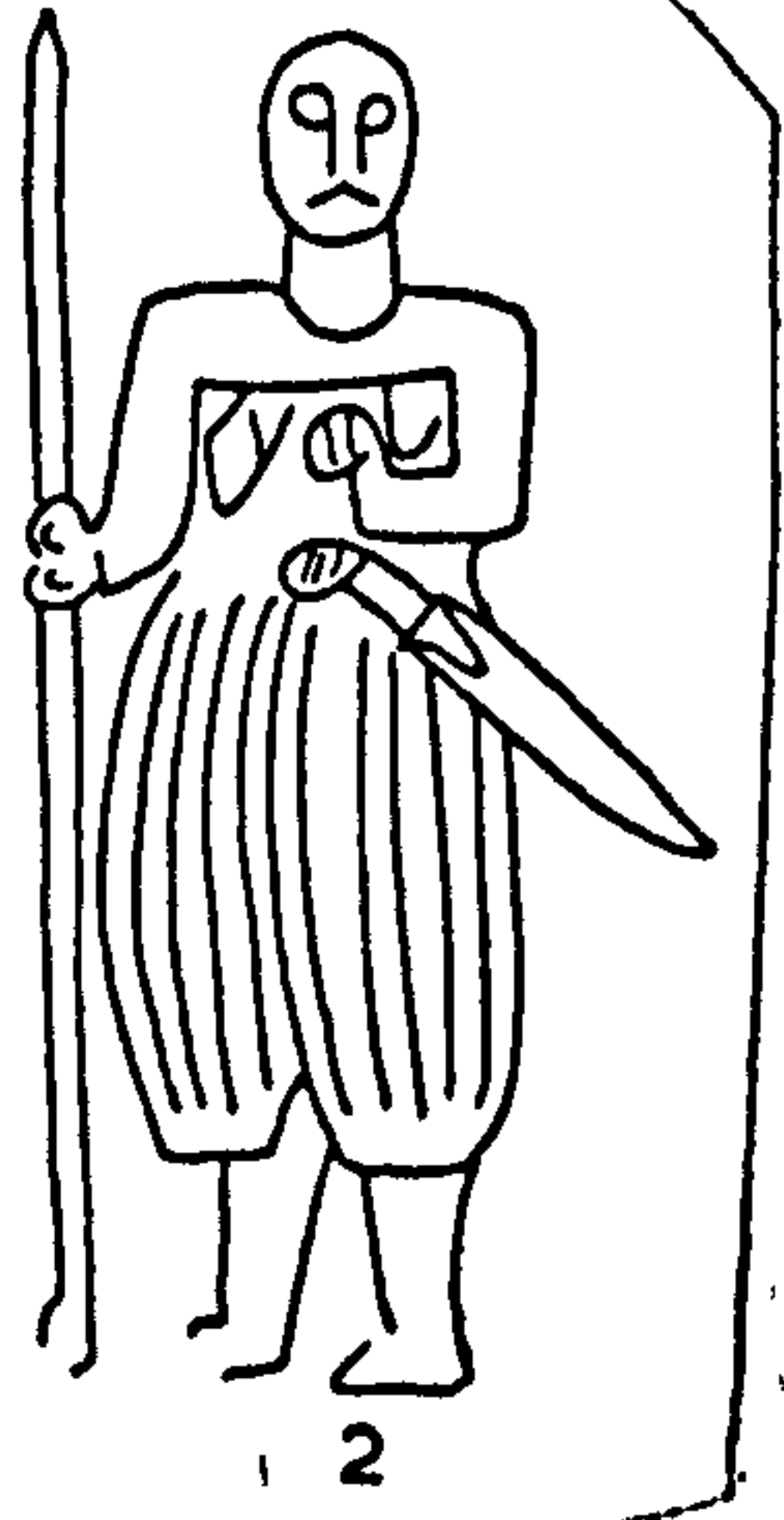
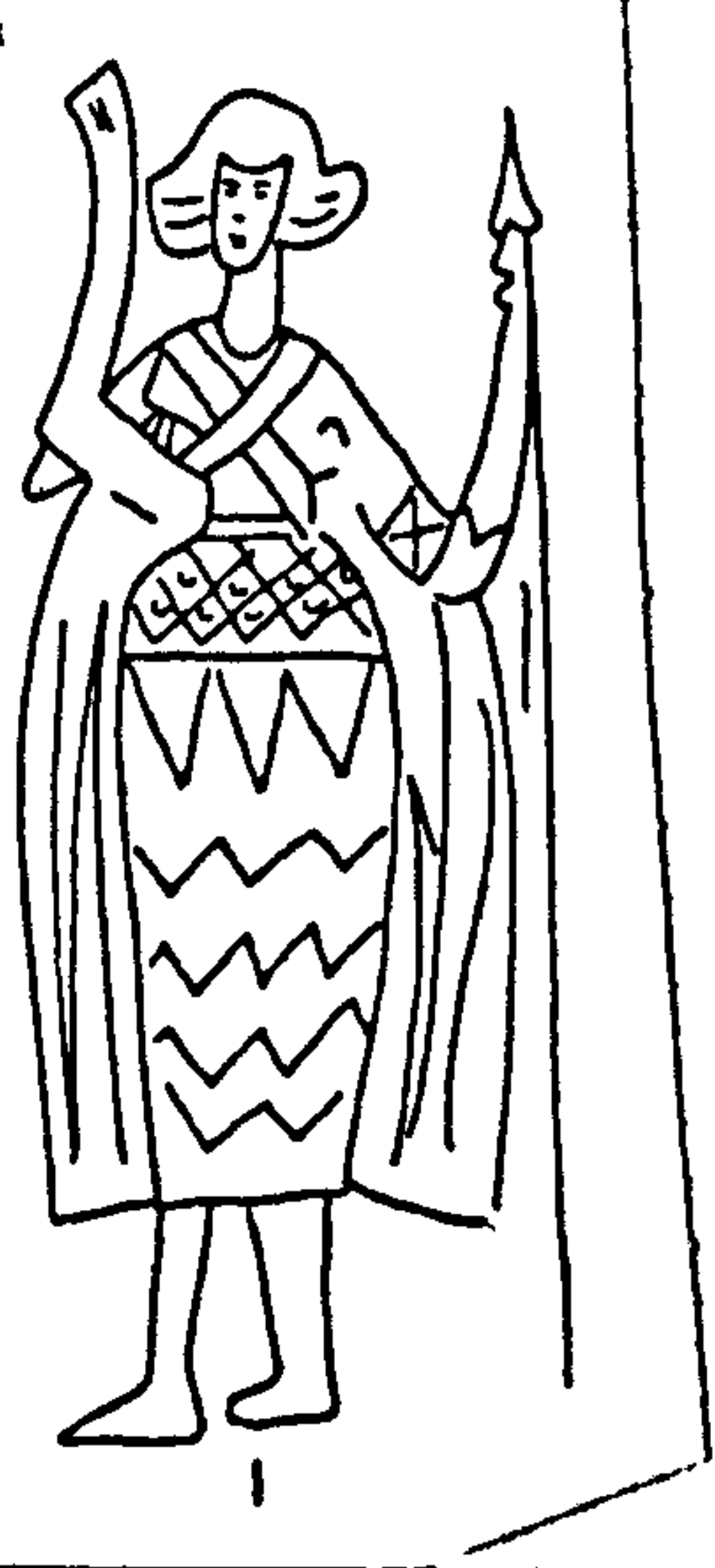

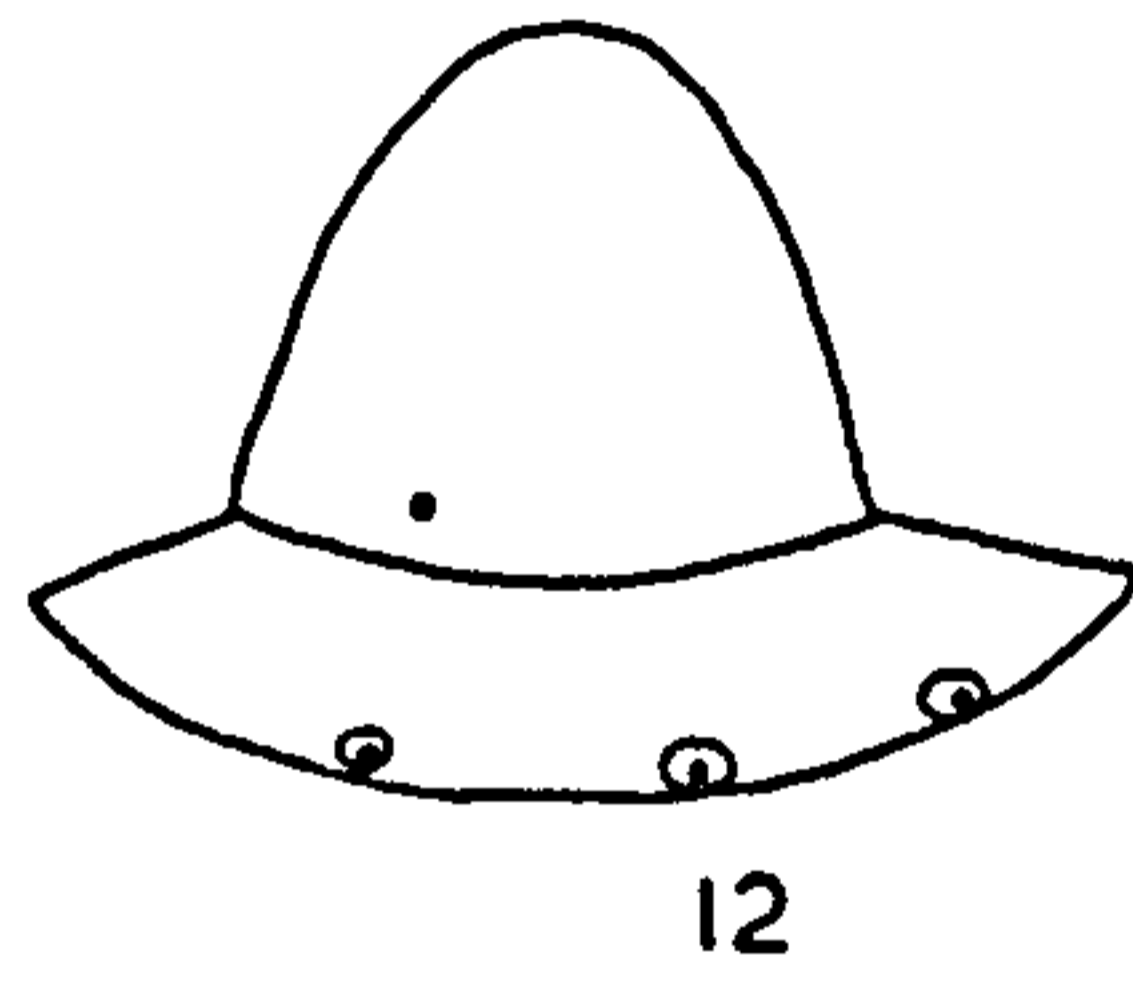
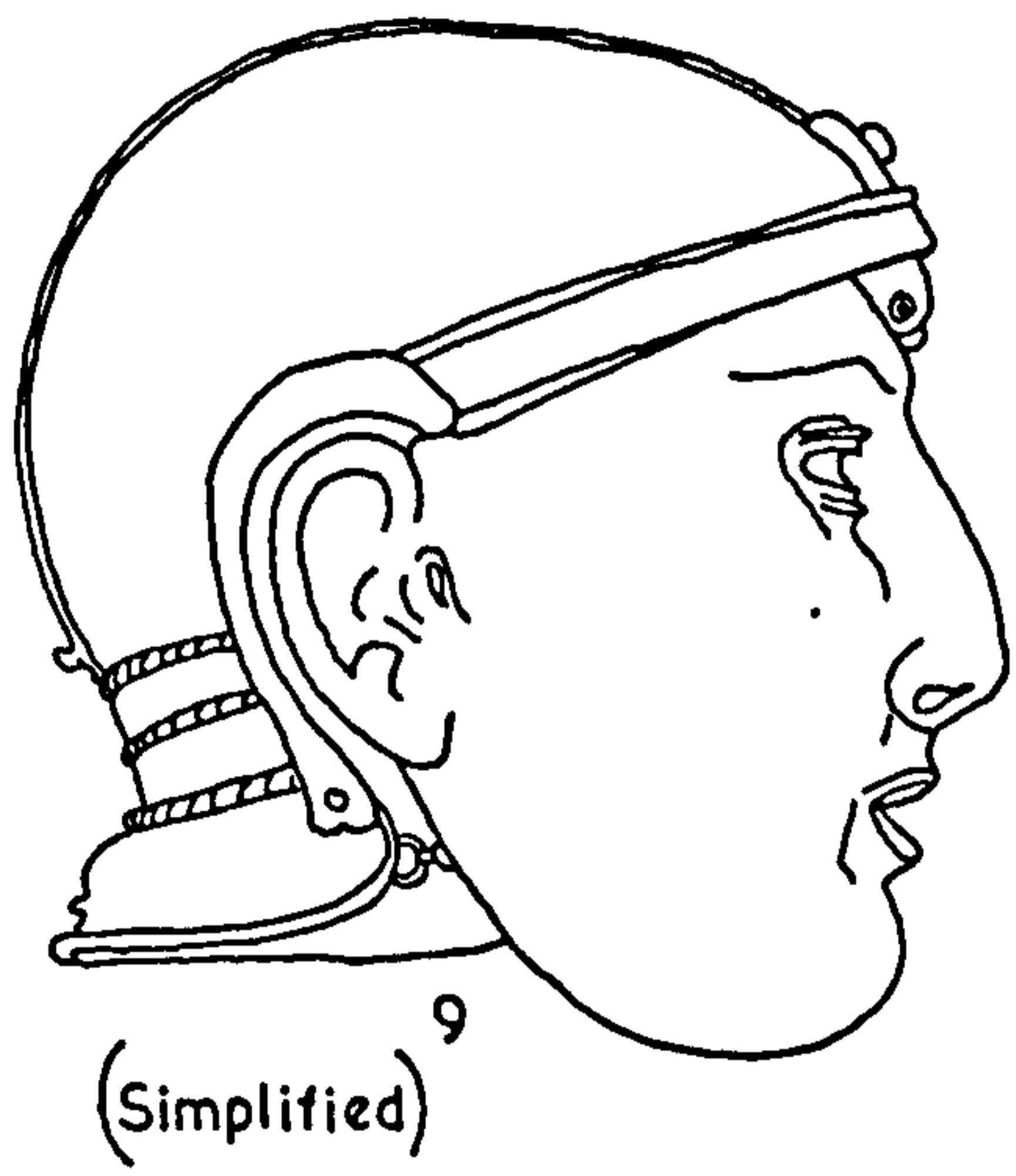

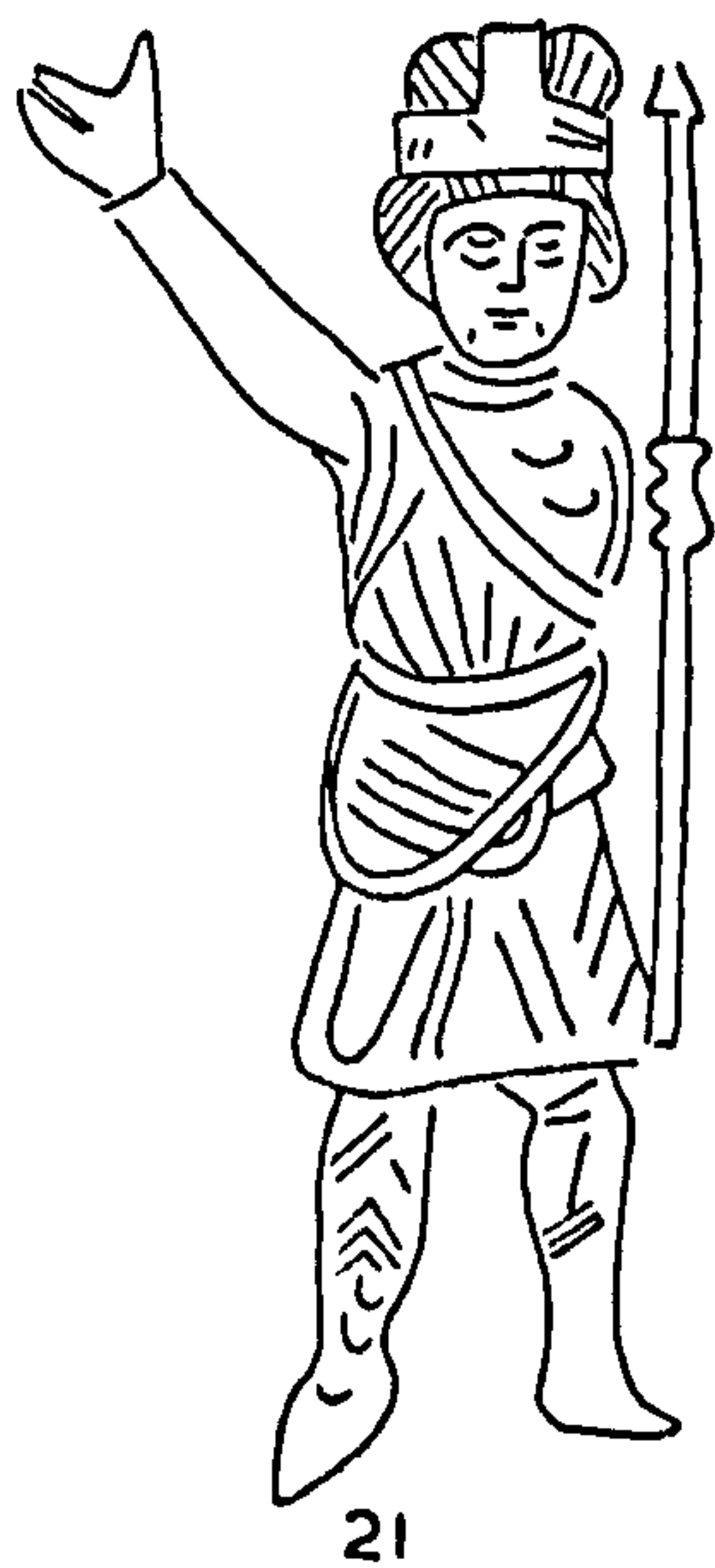
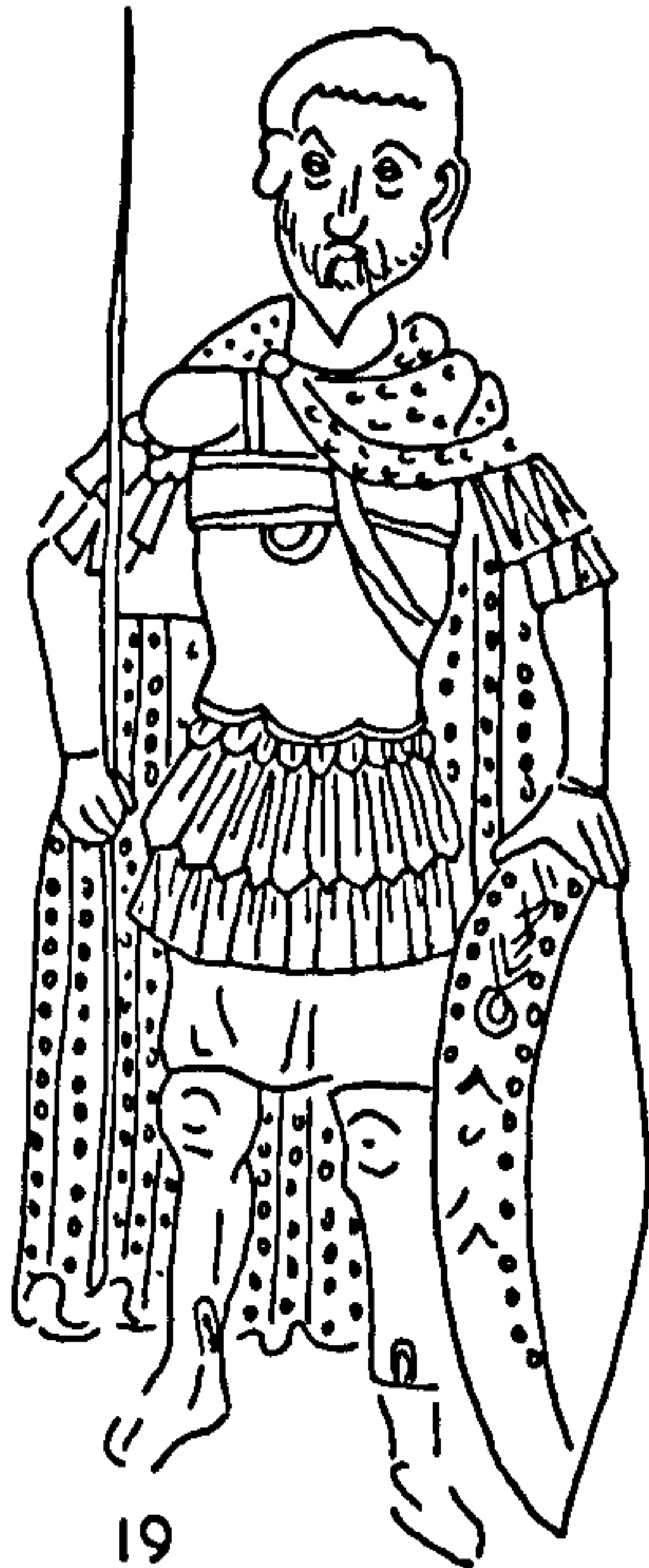
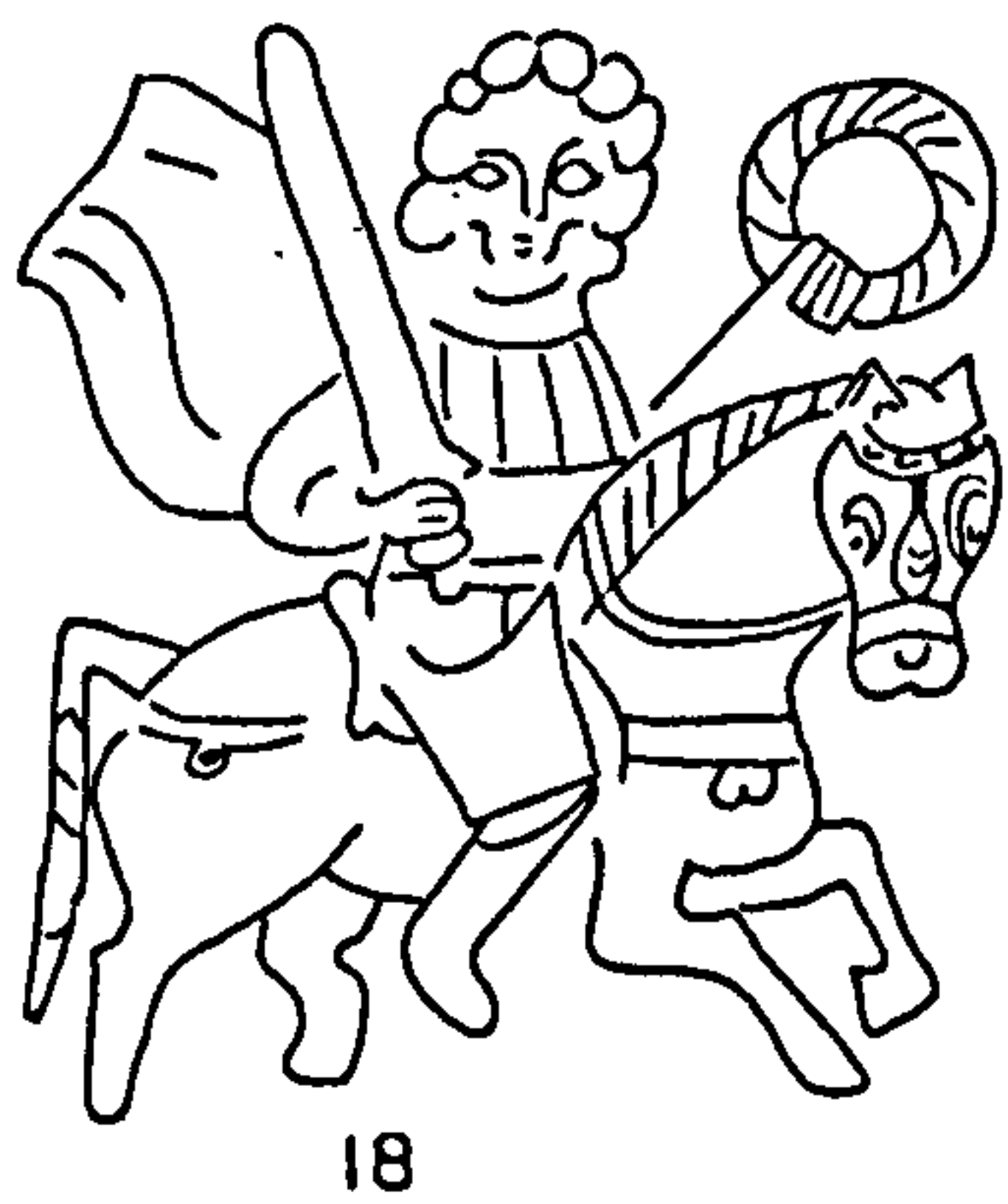
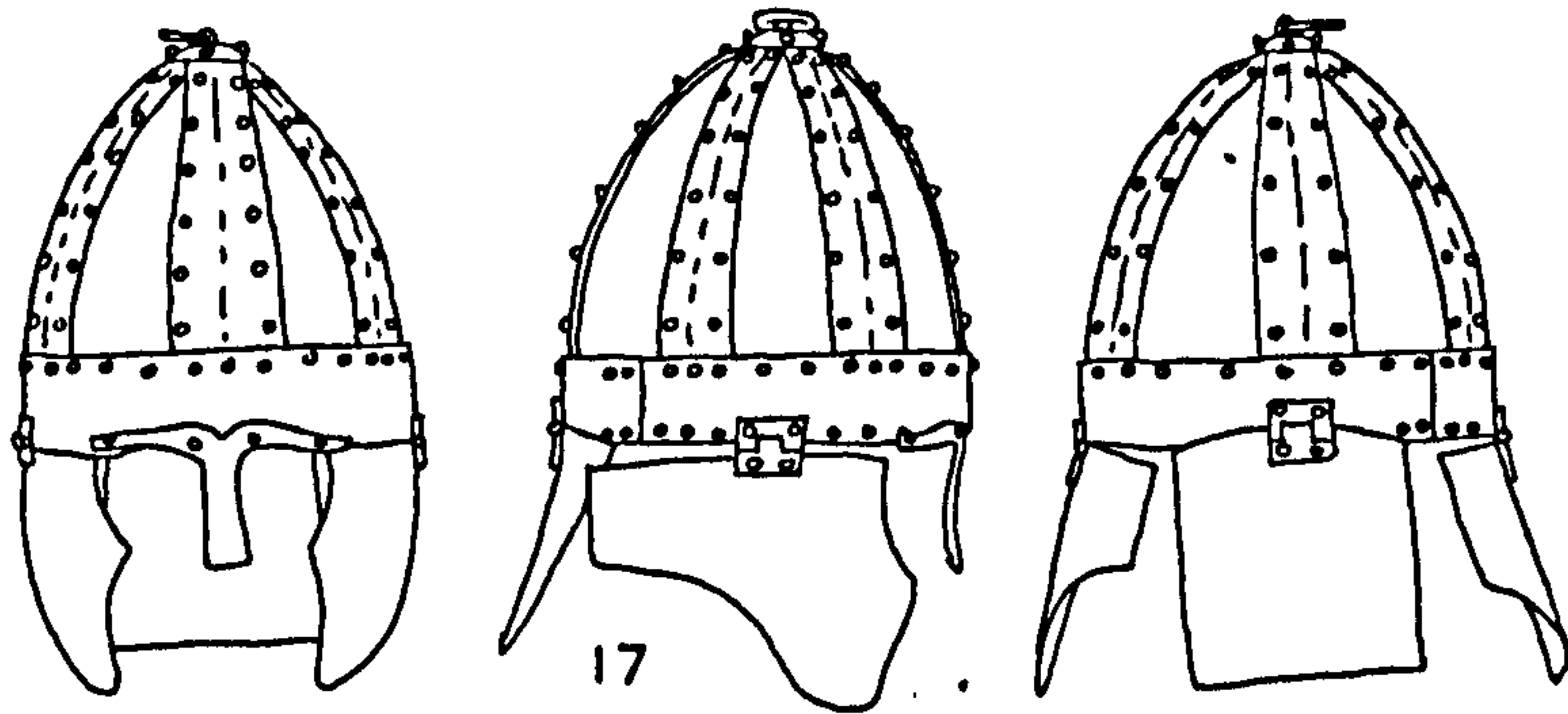
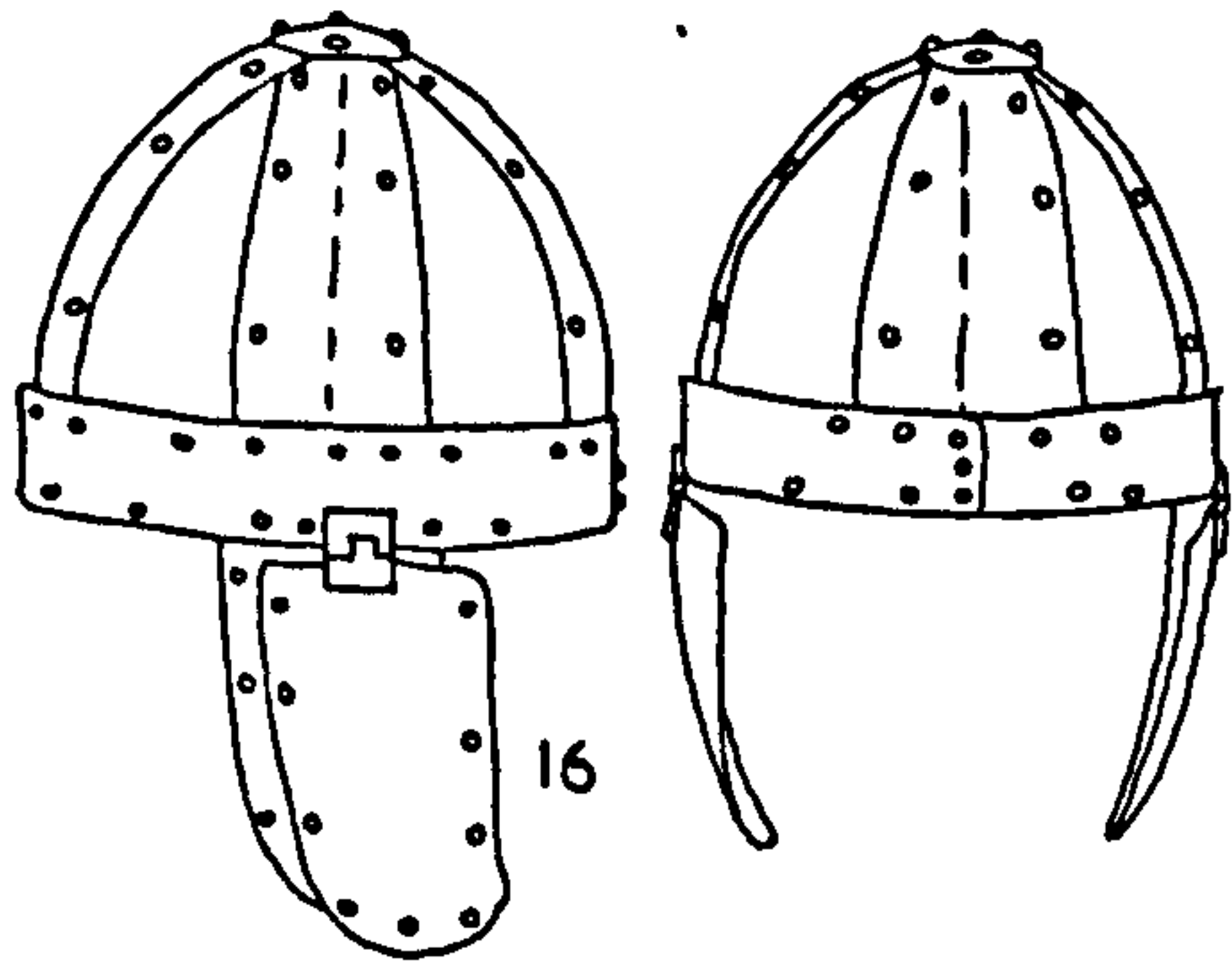
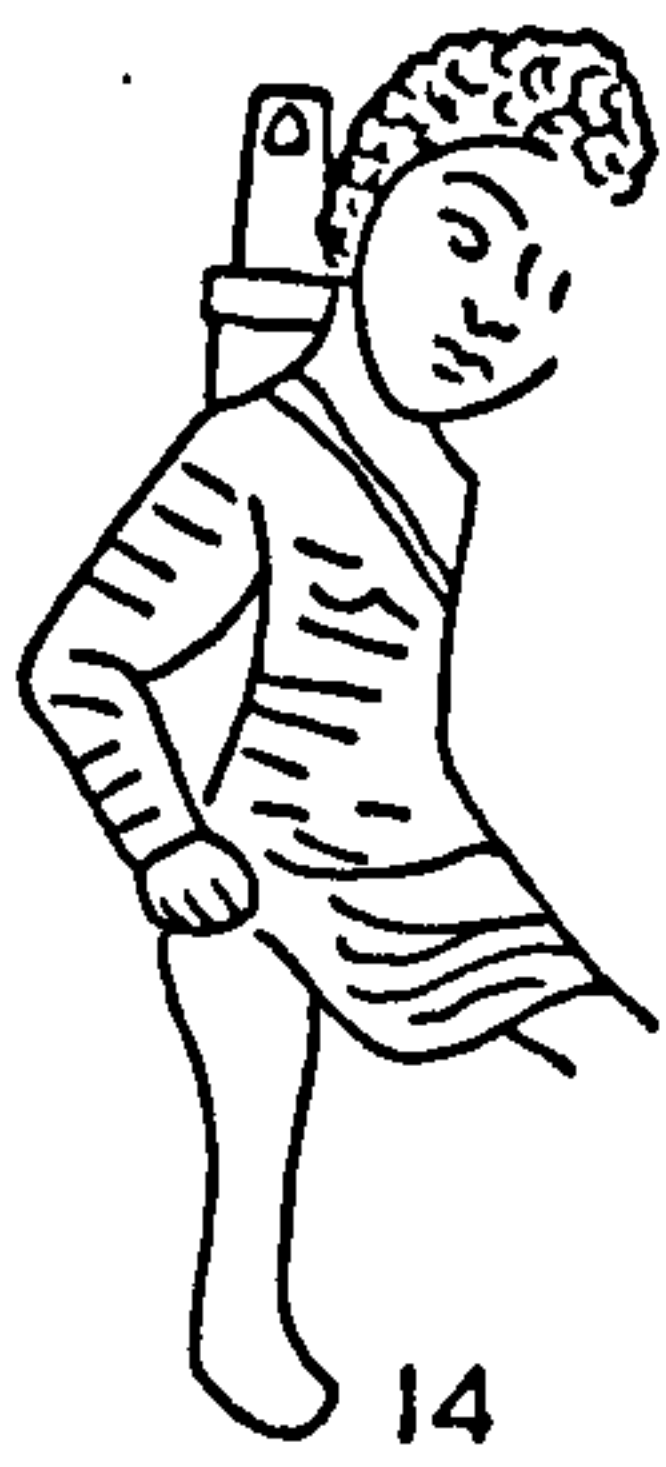



23

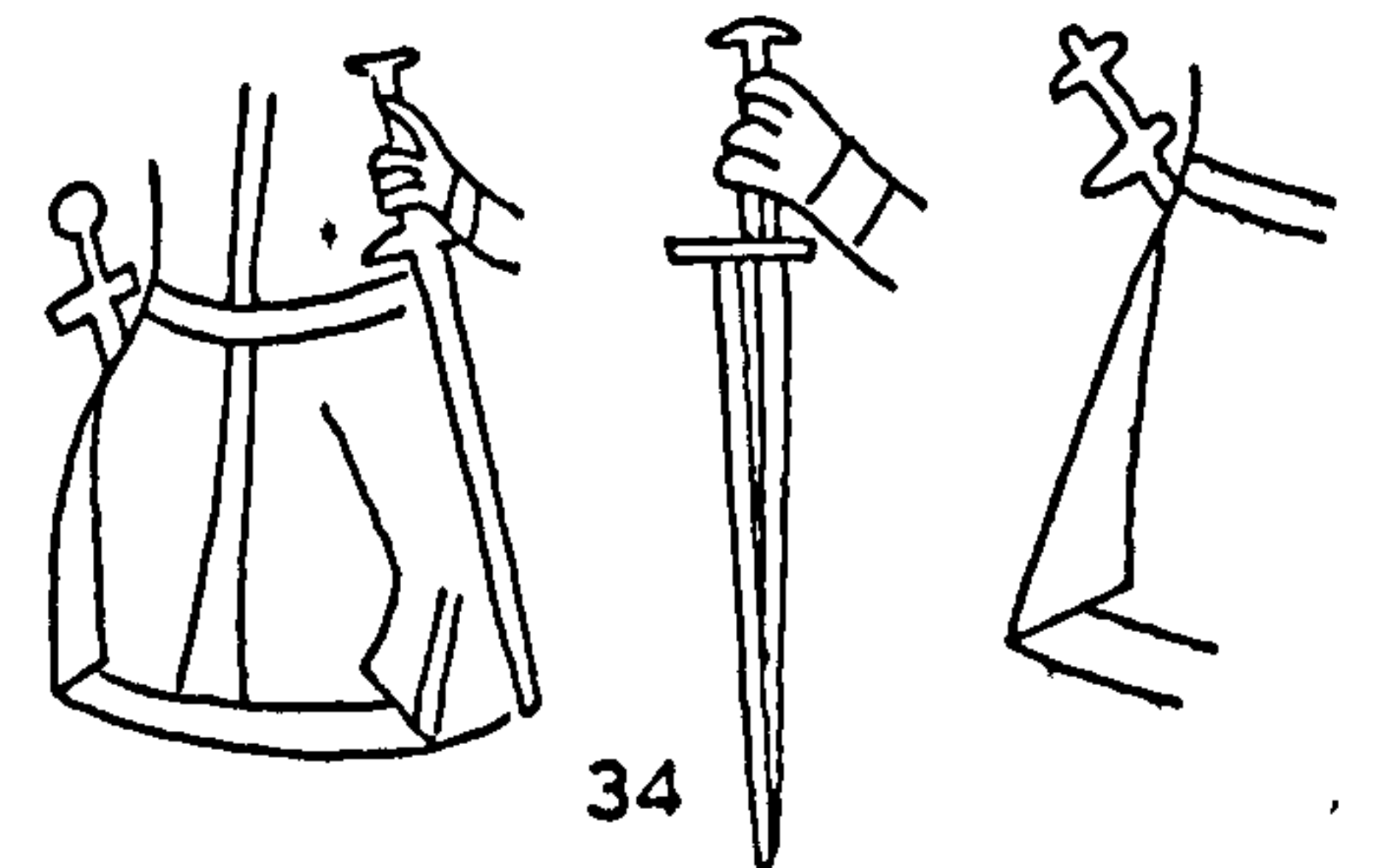
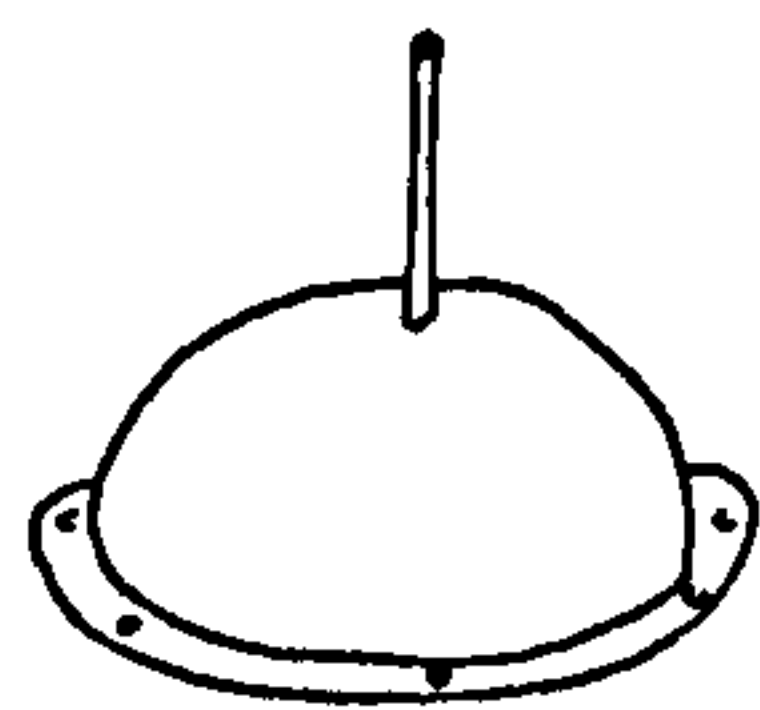
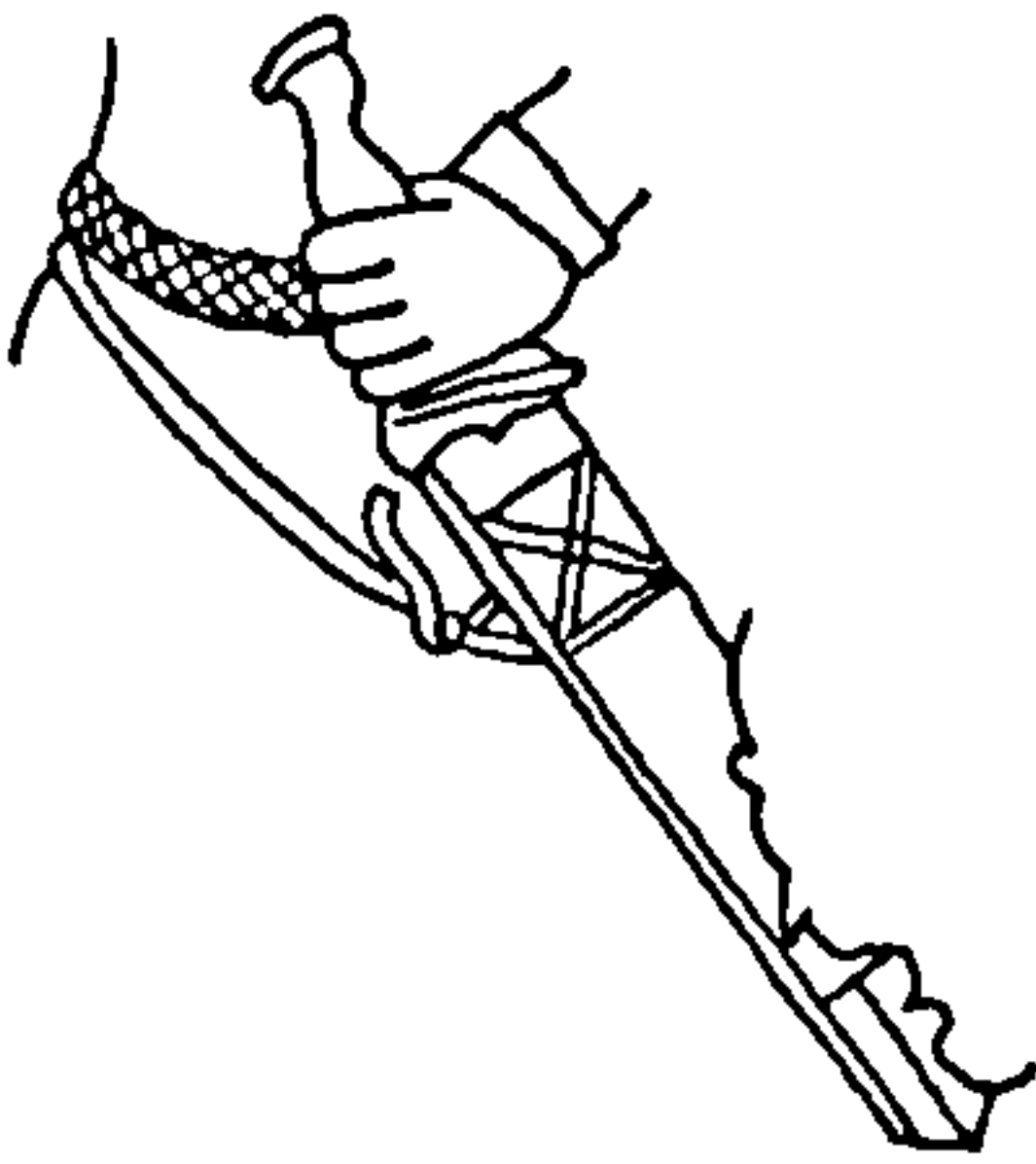
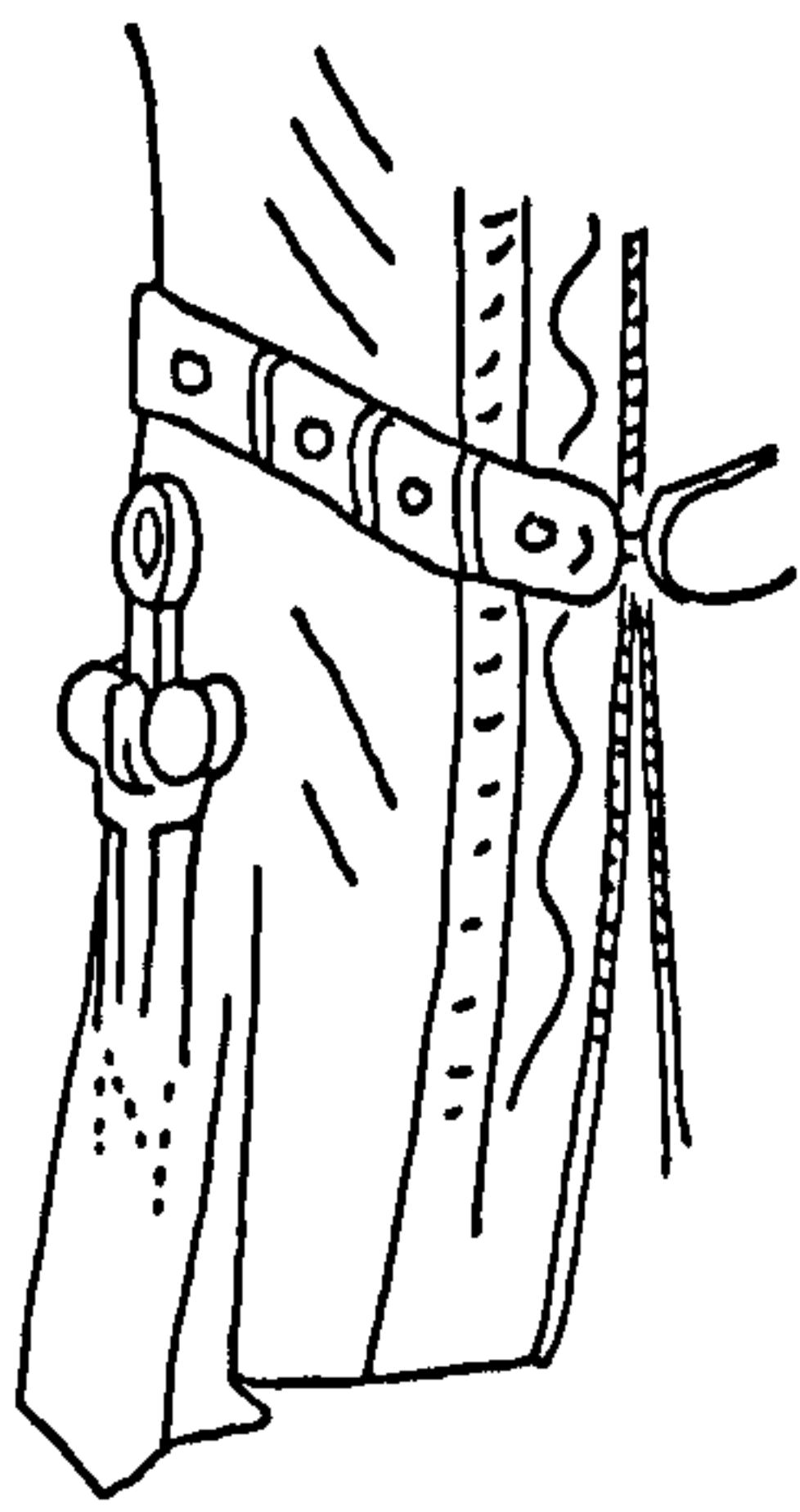
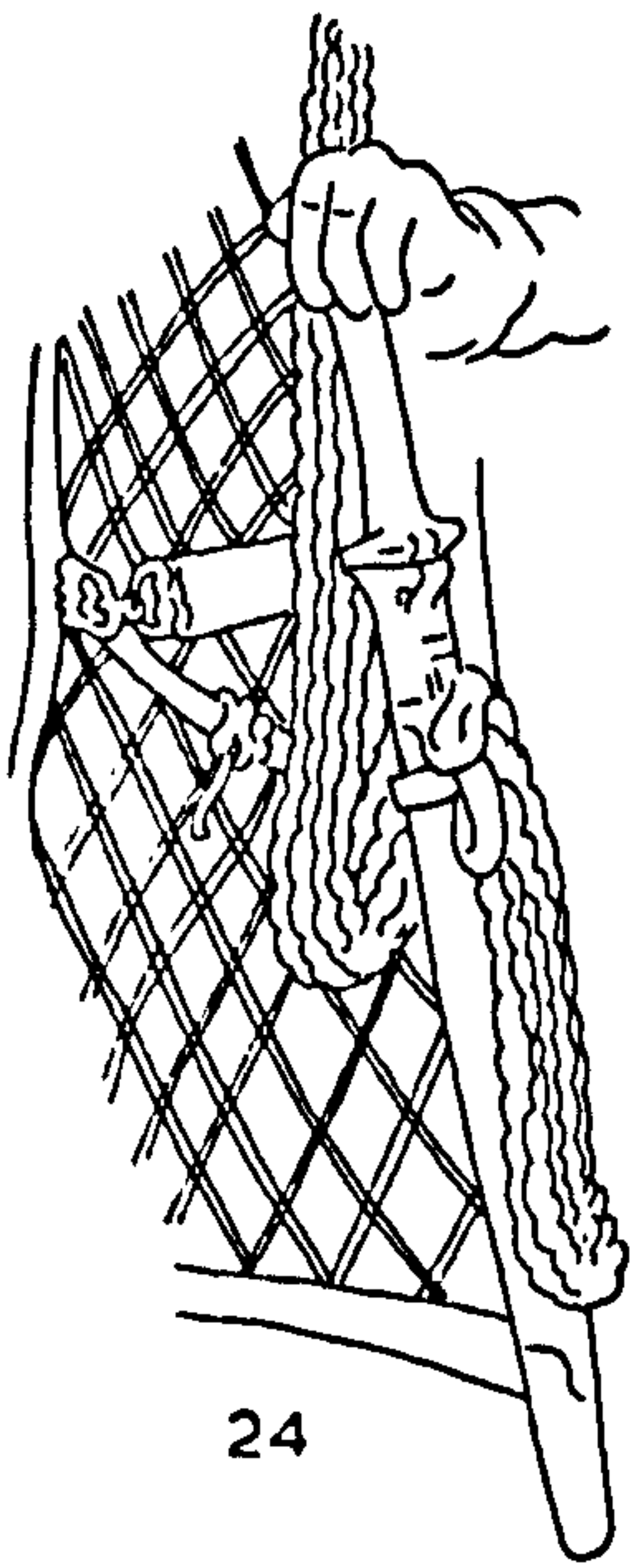

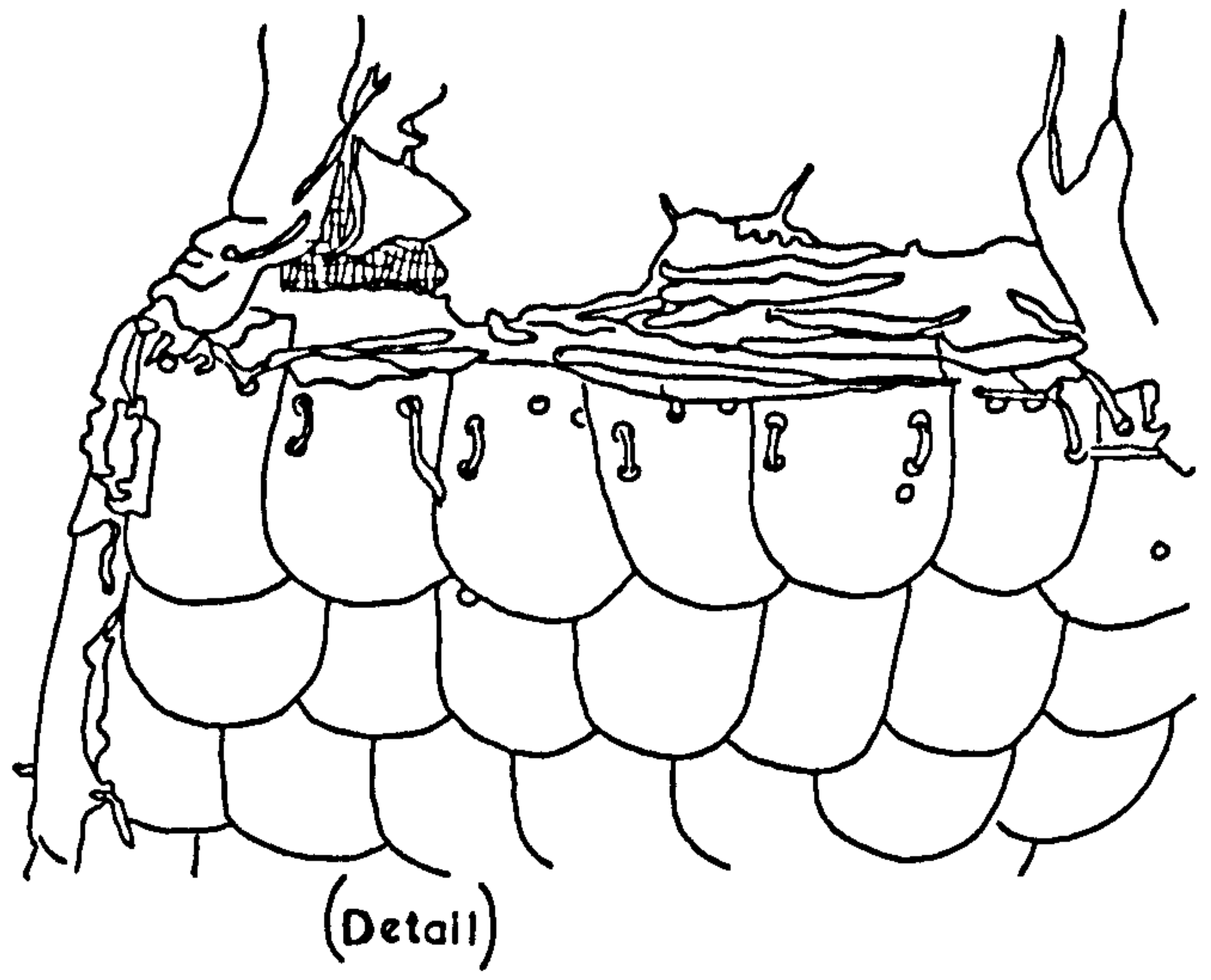
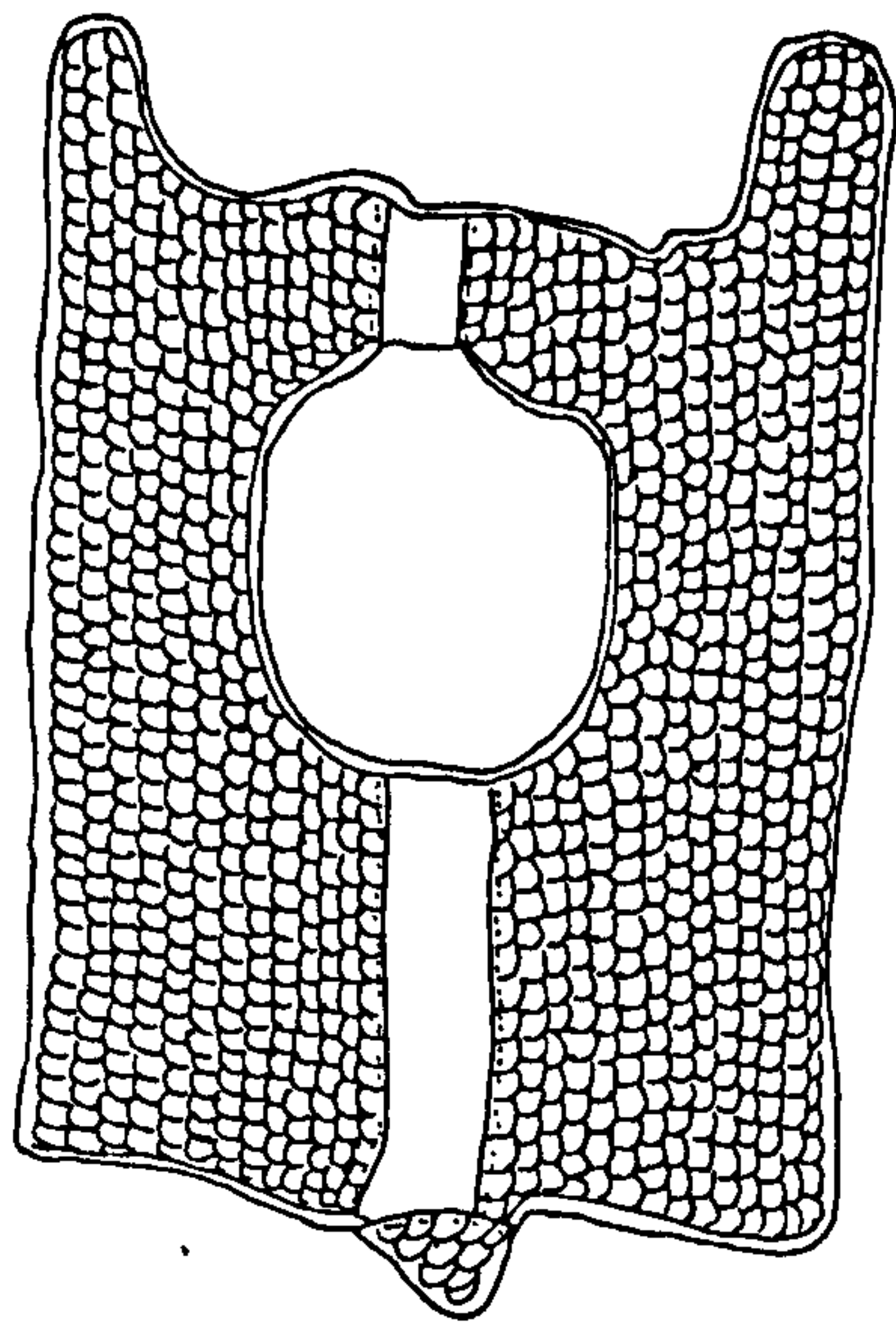

36

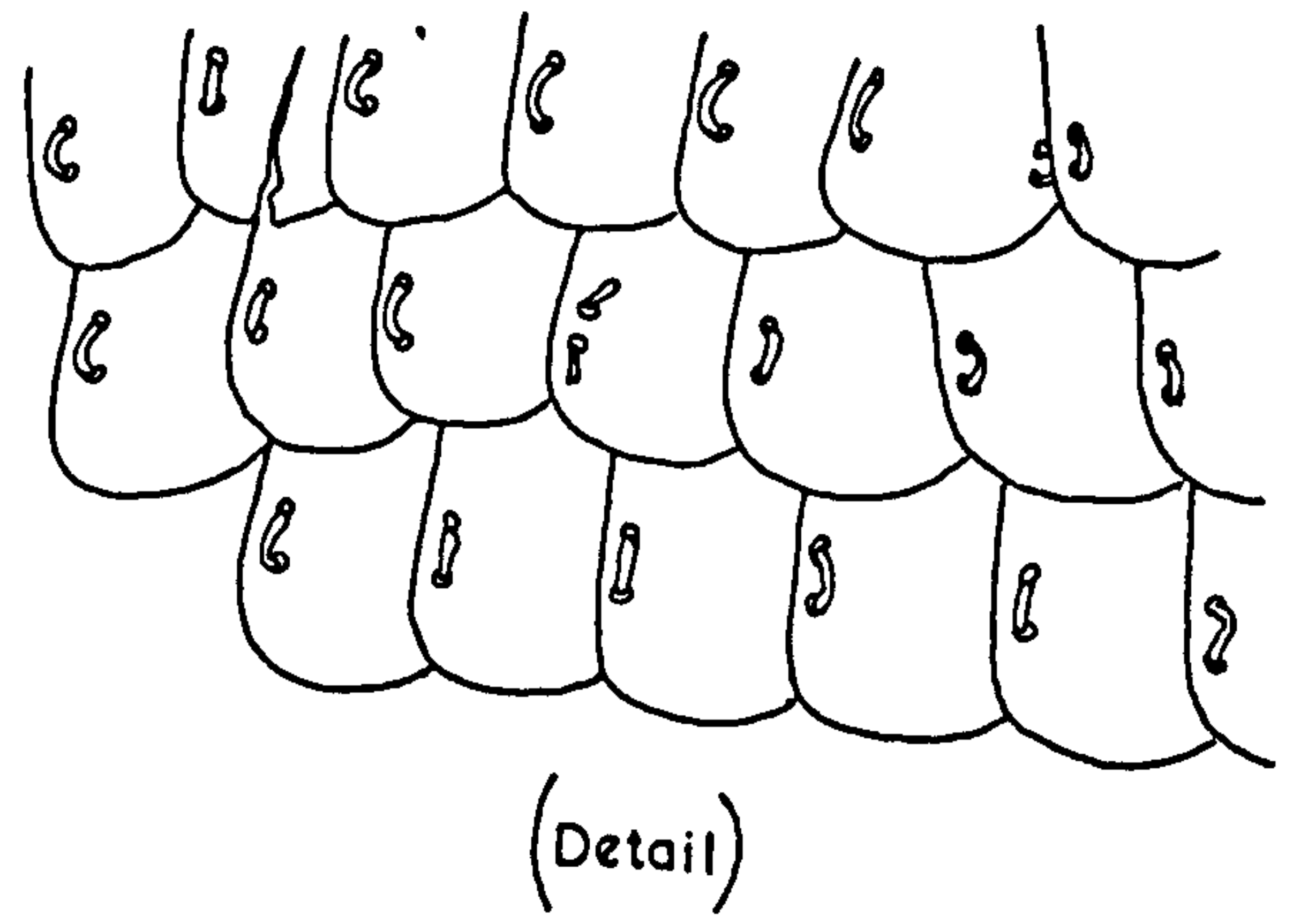
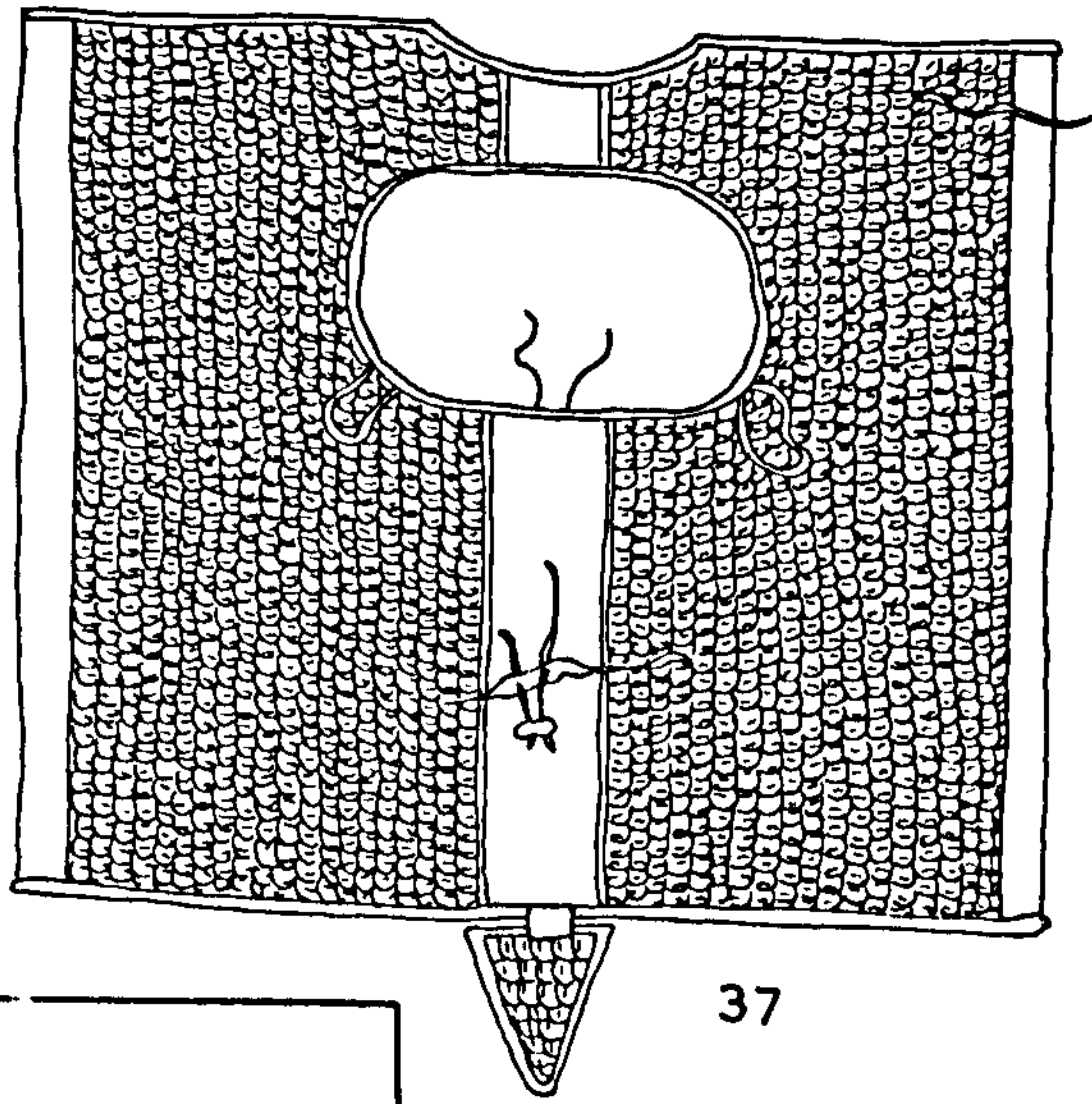

37

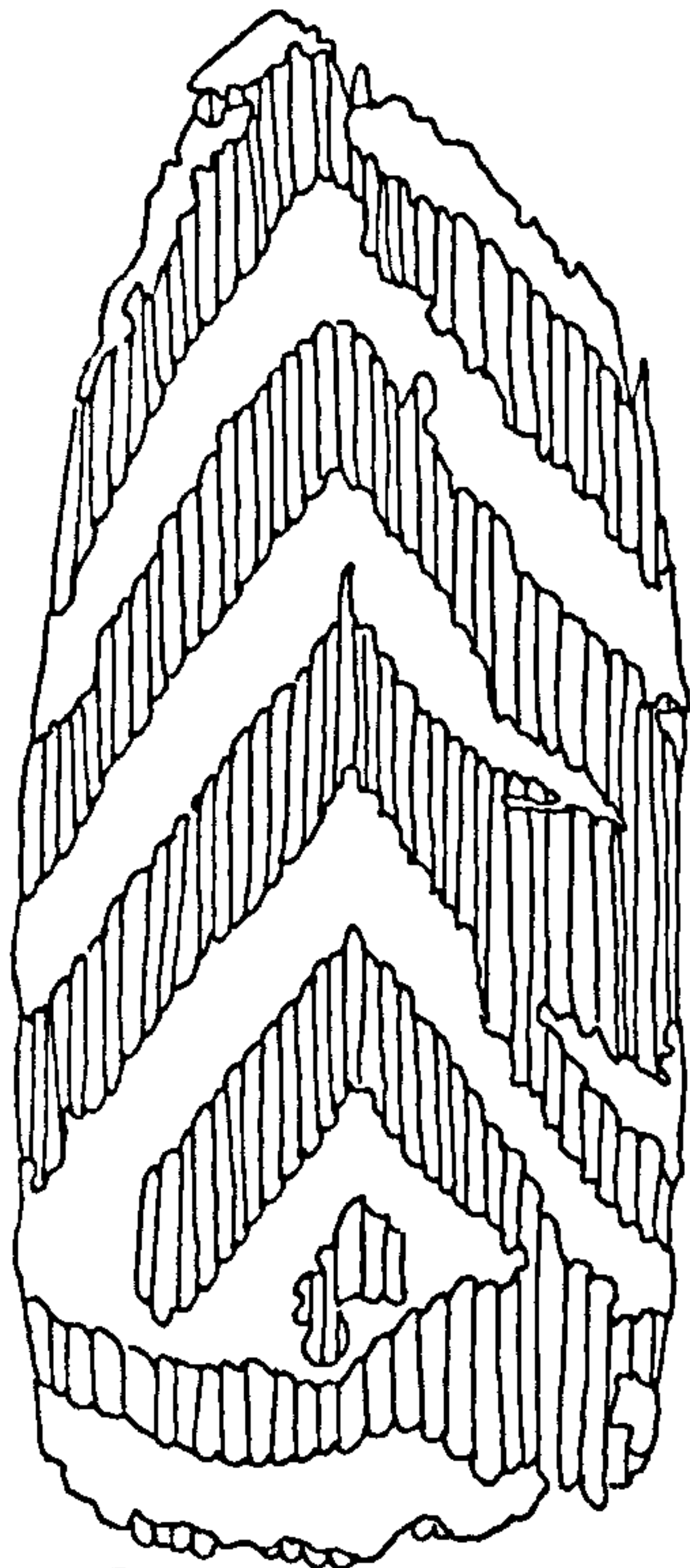

38

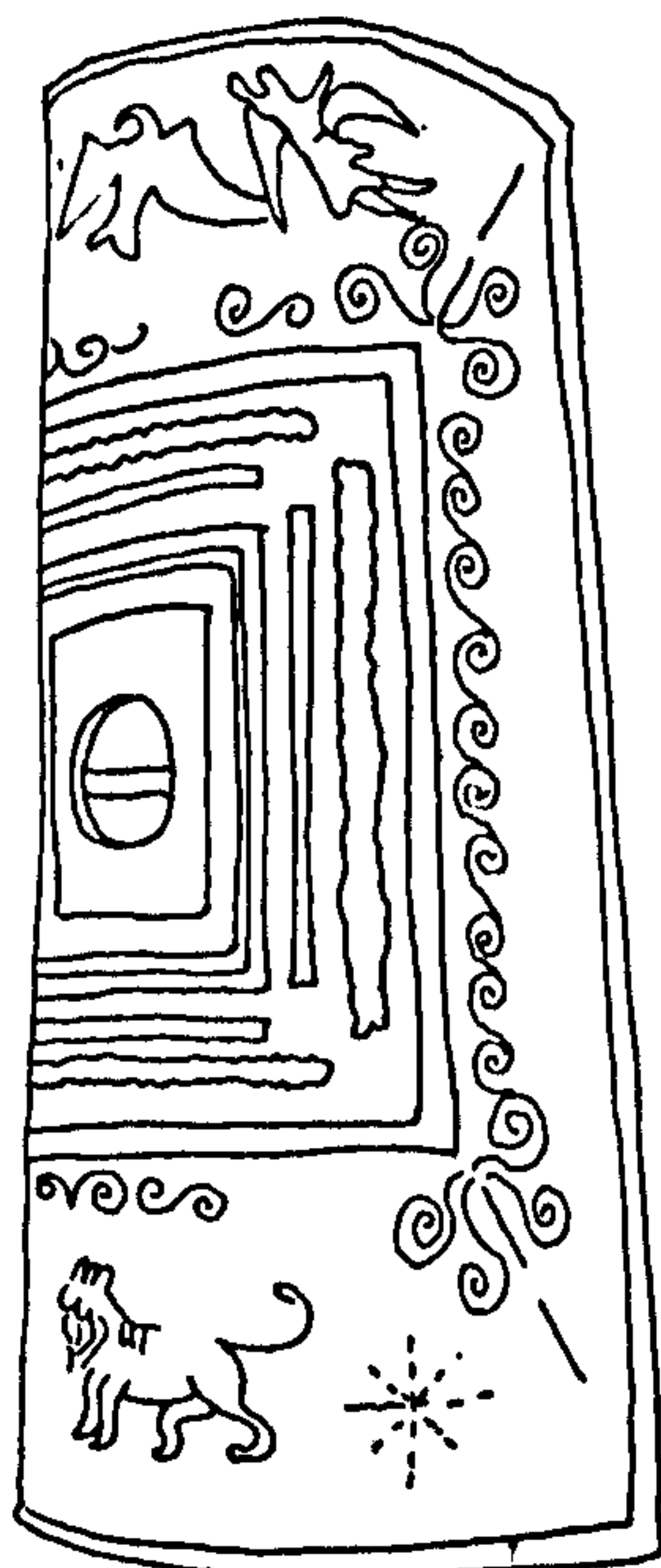

(Simplified)

39

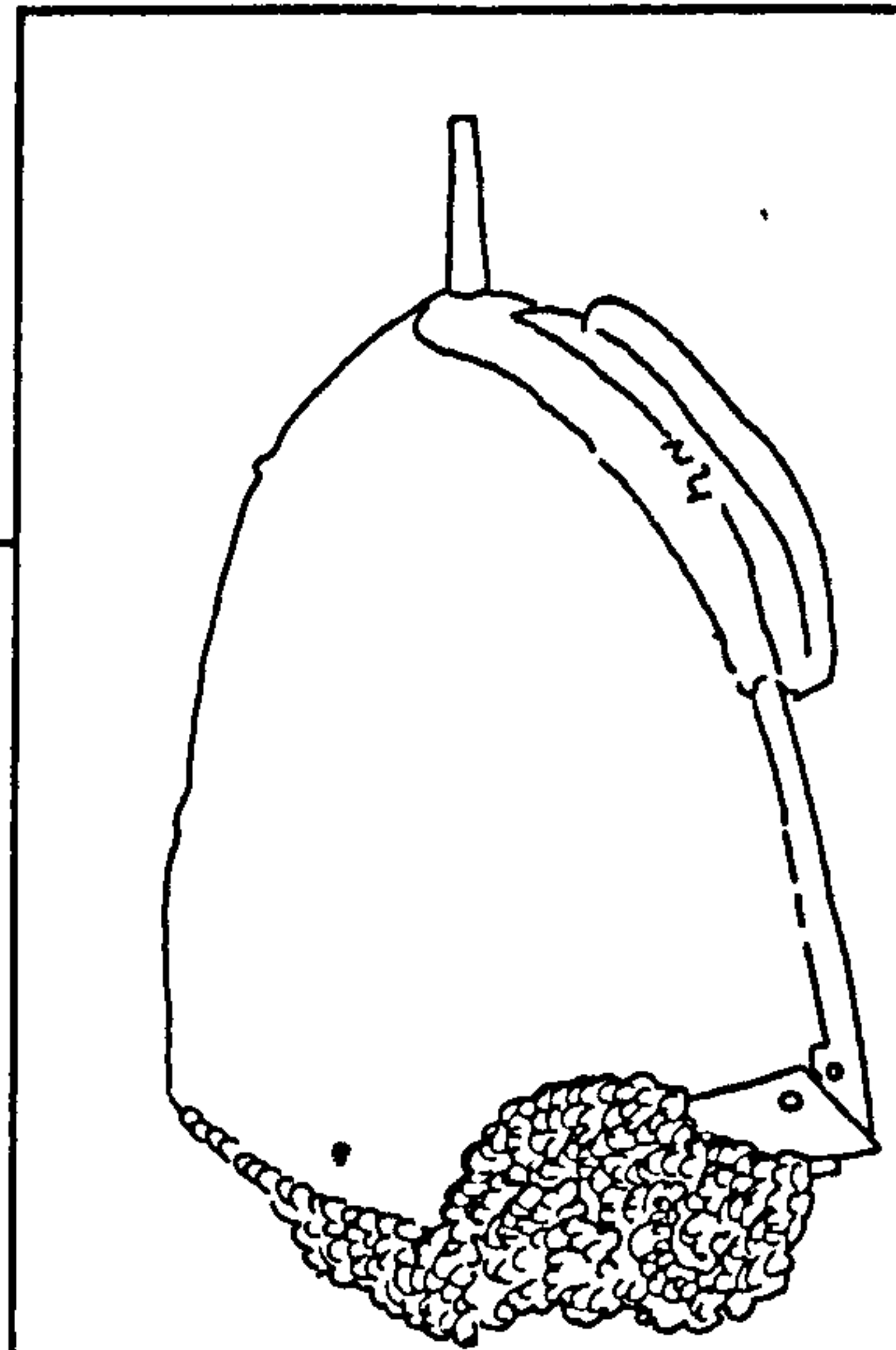
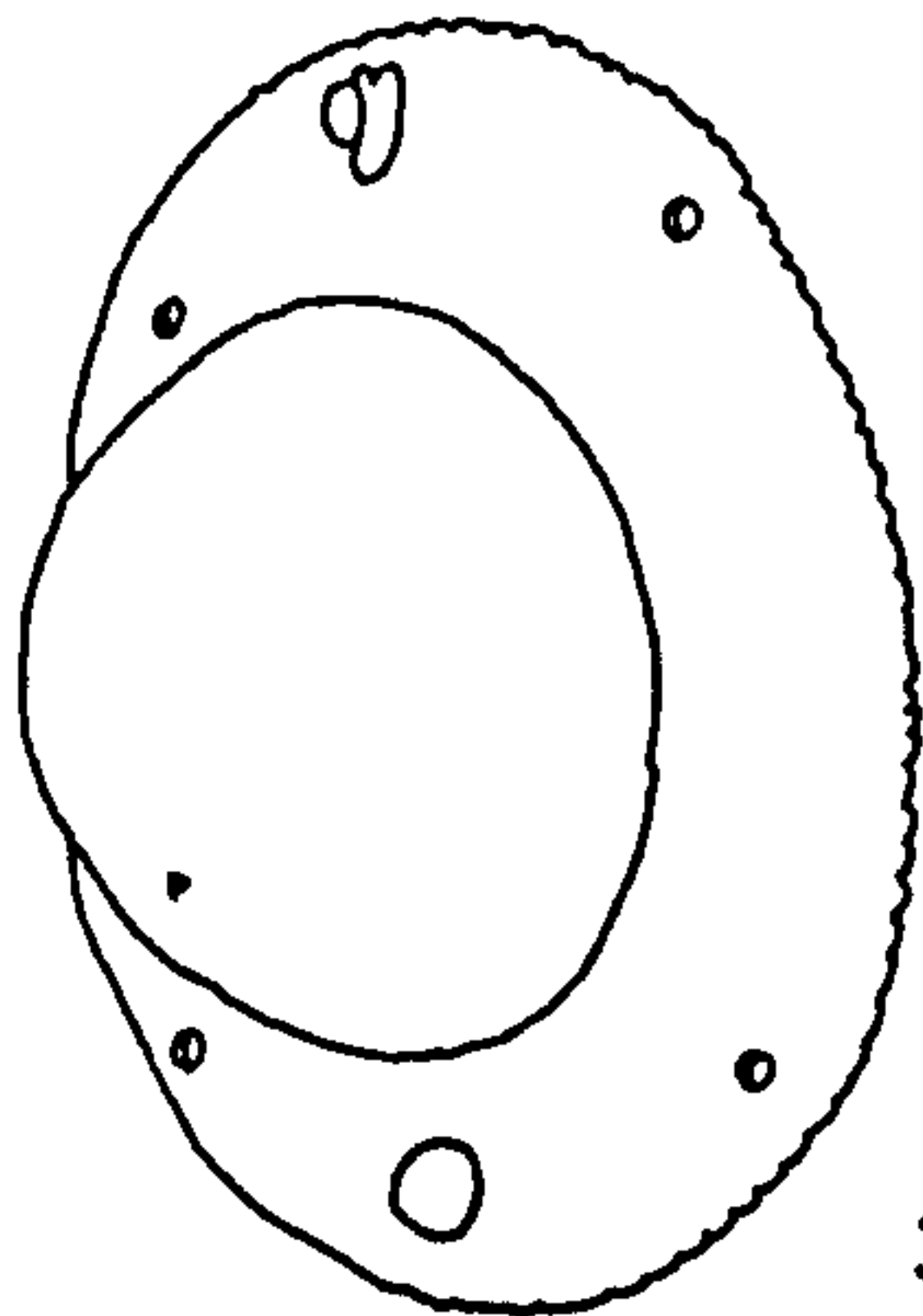

40

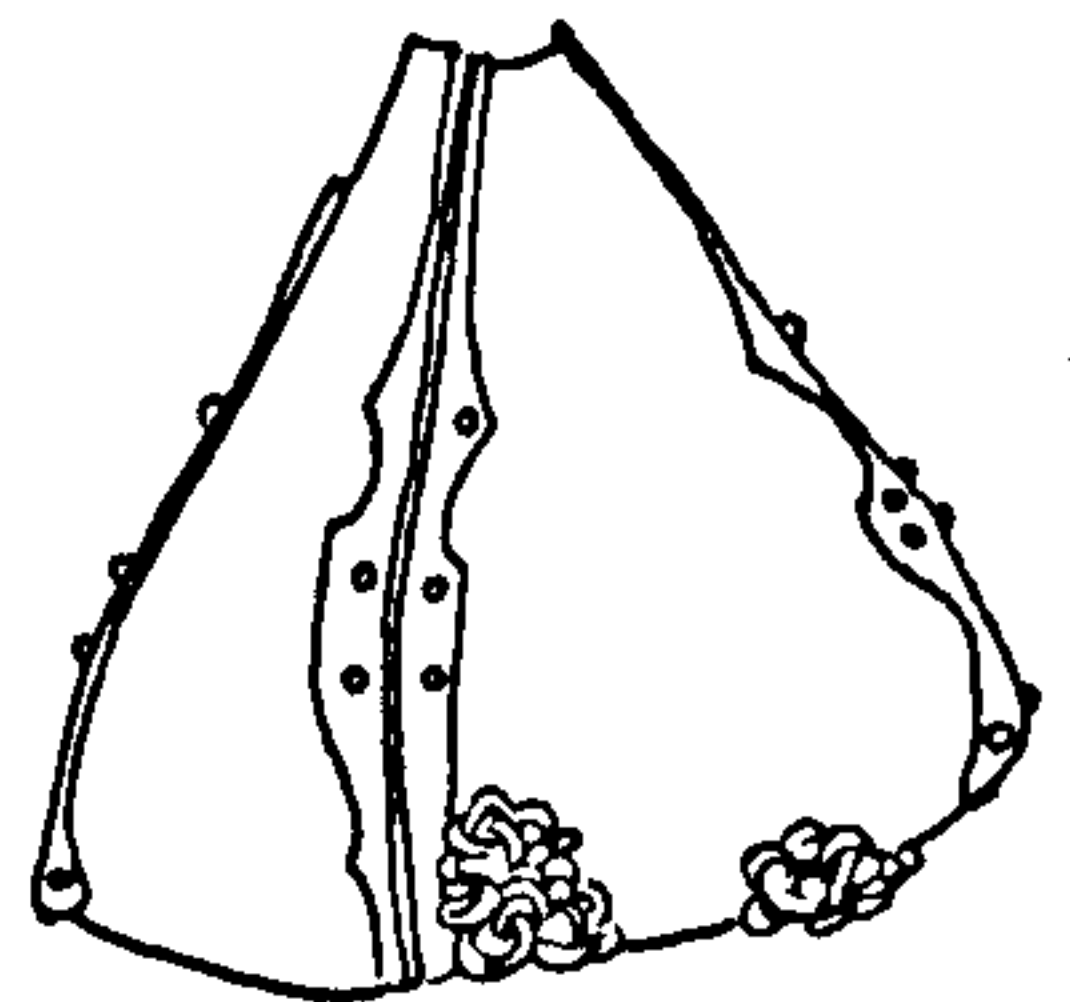

41



42



43



44



45

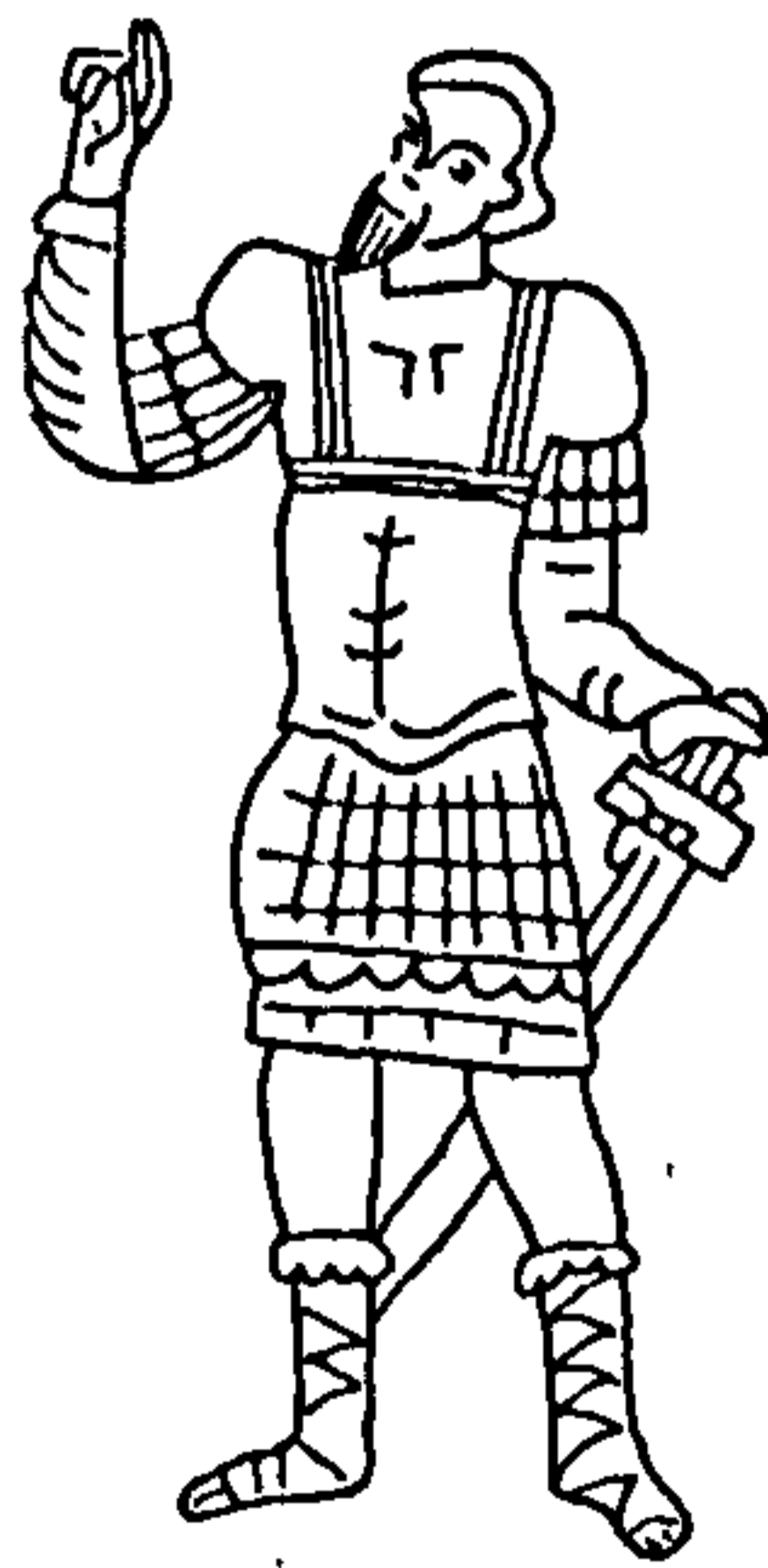

46



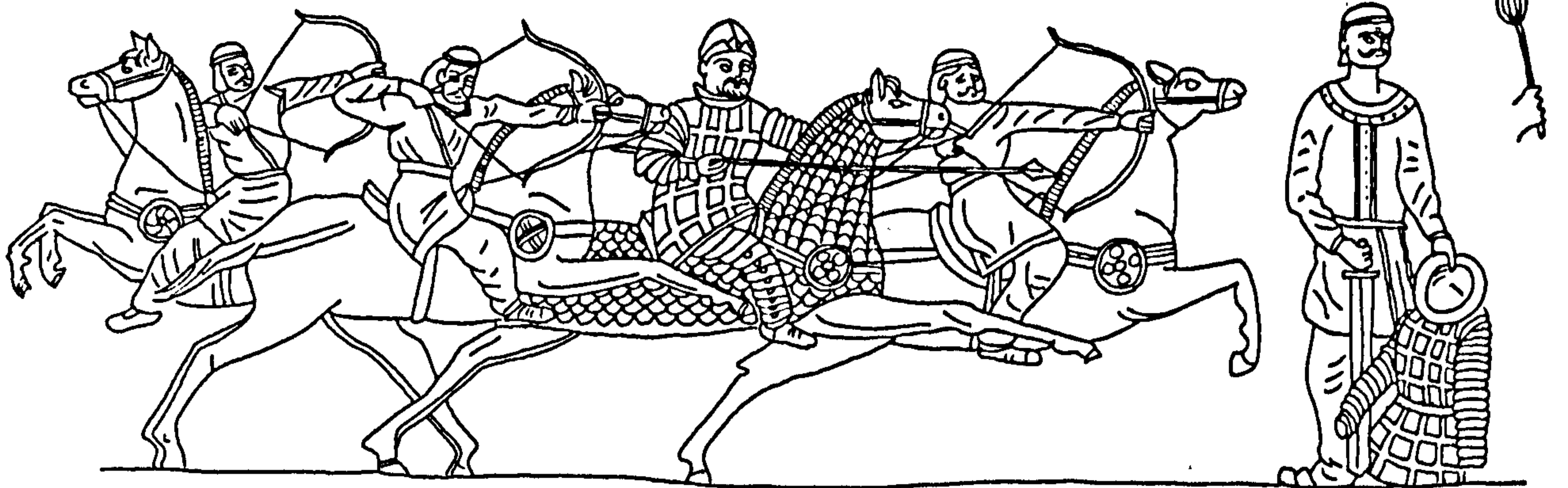

47



48

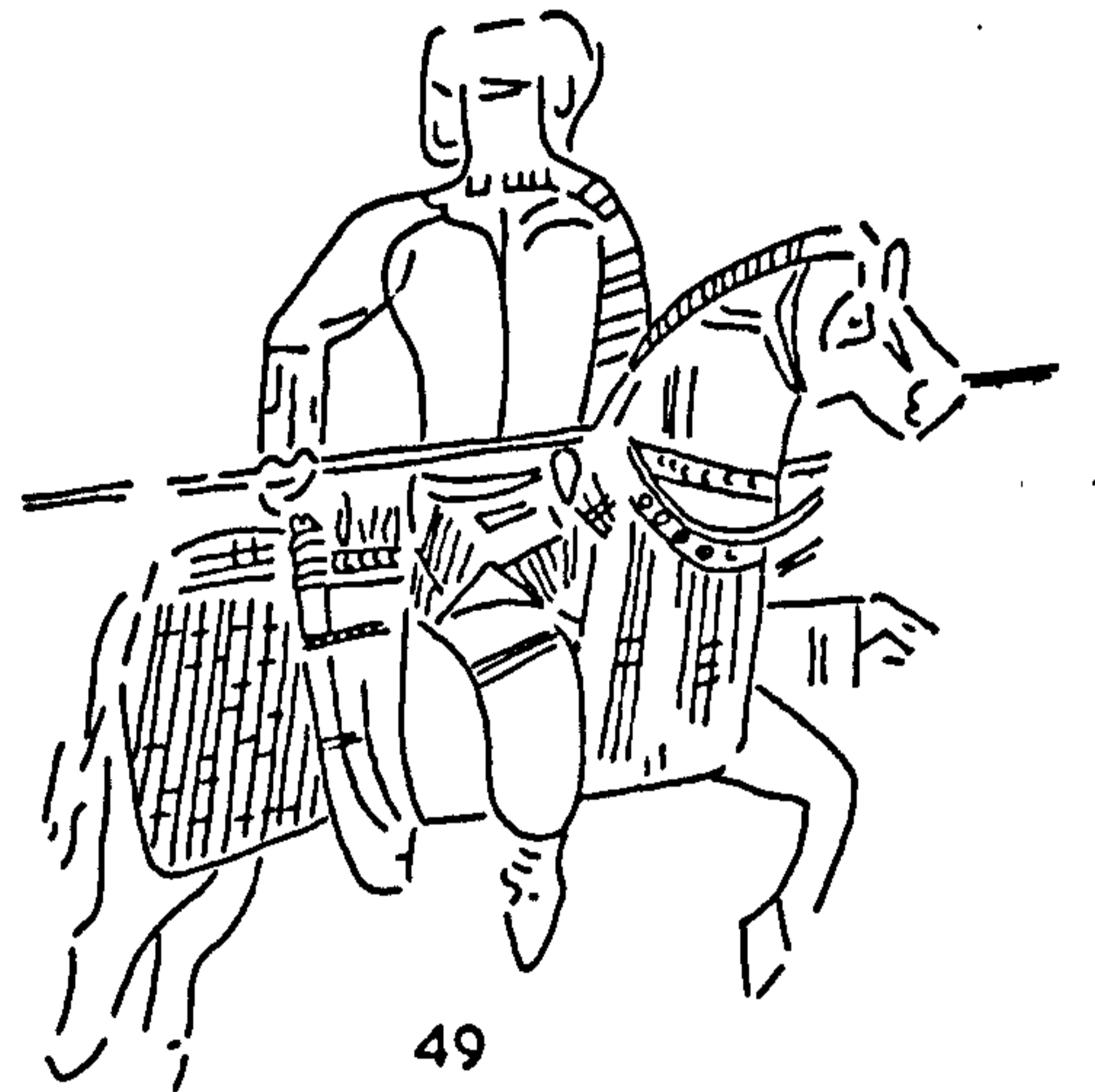

49



50A

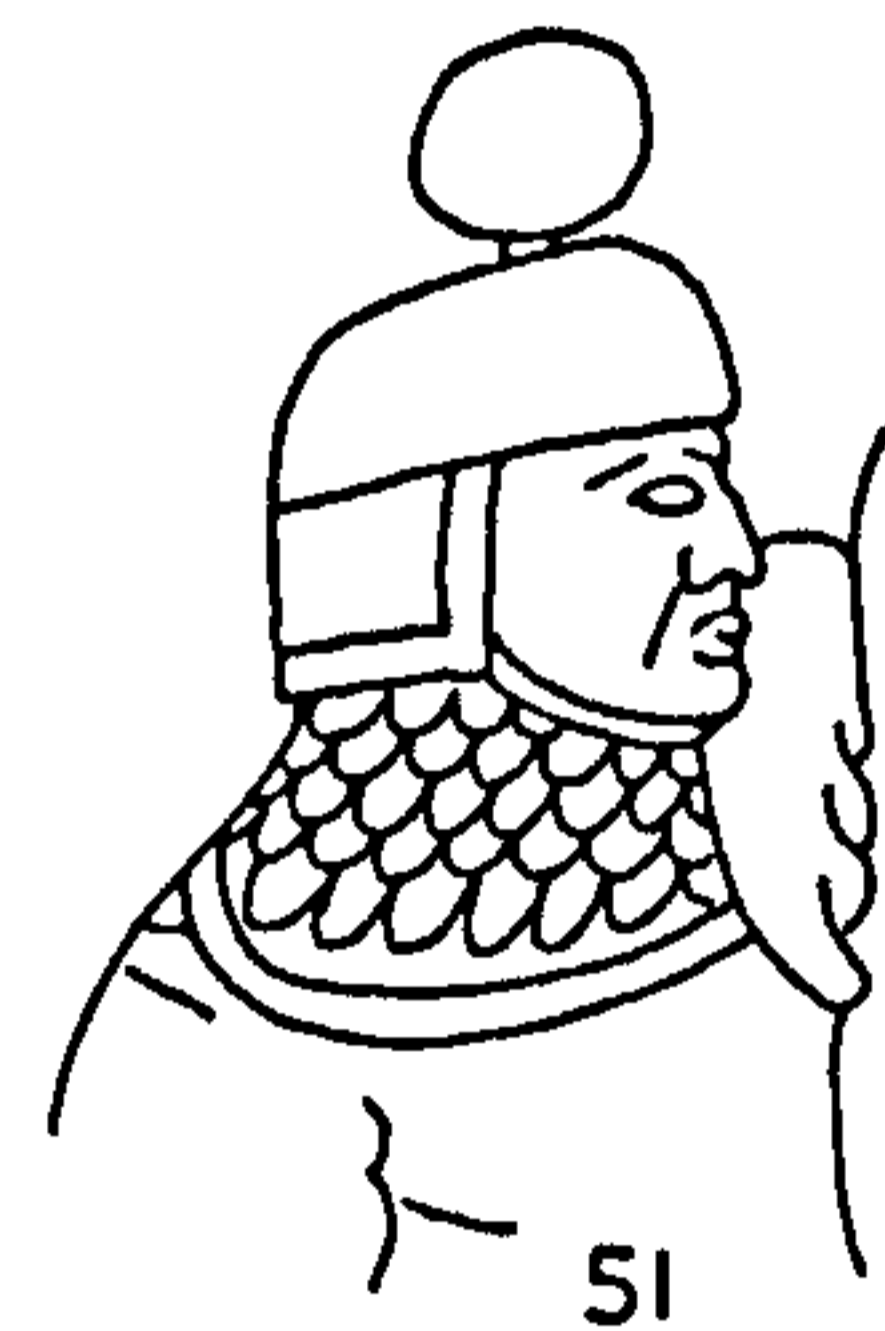

51

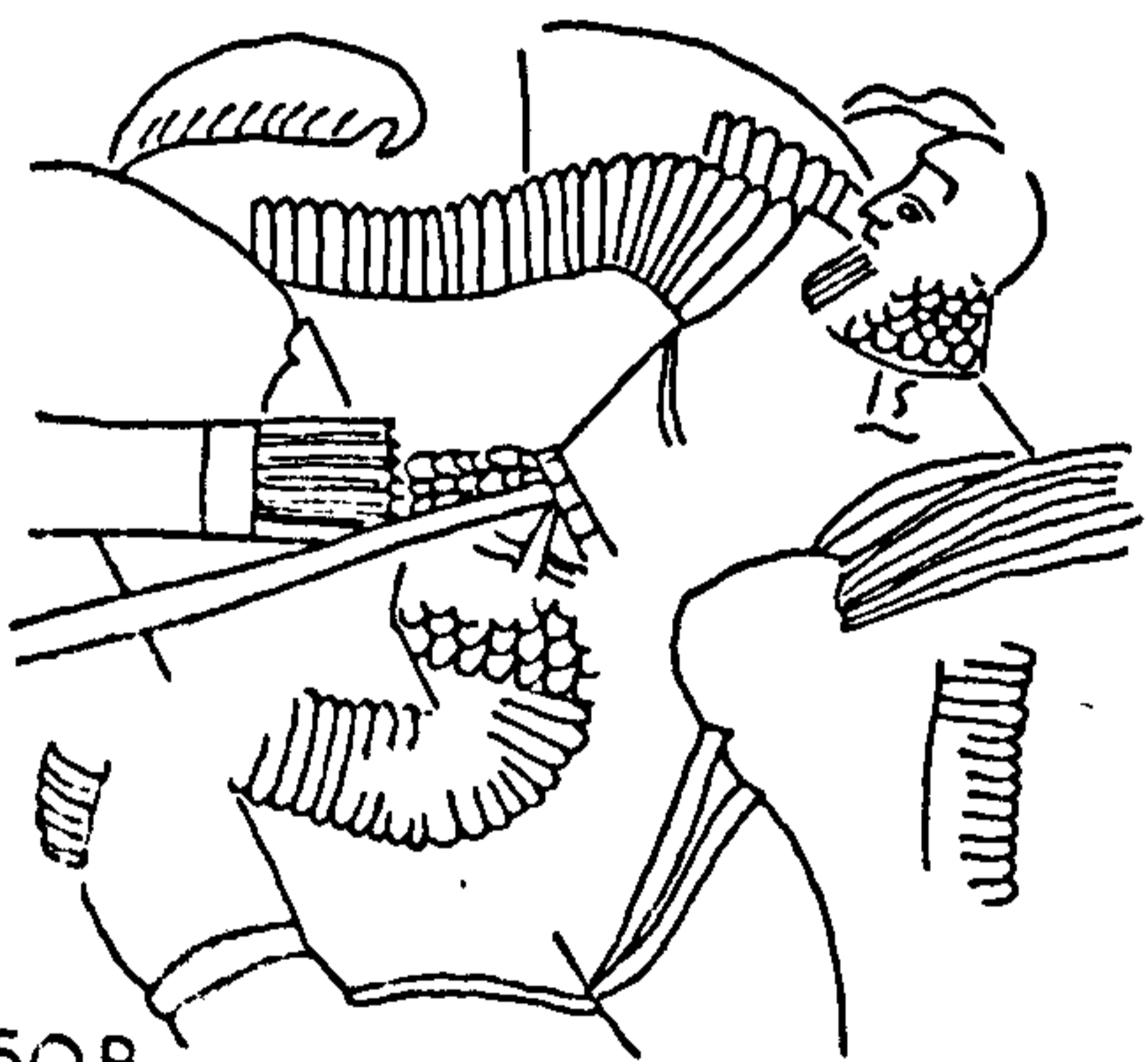

50B

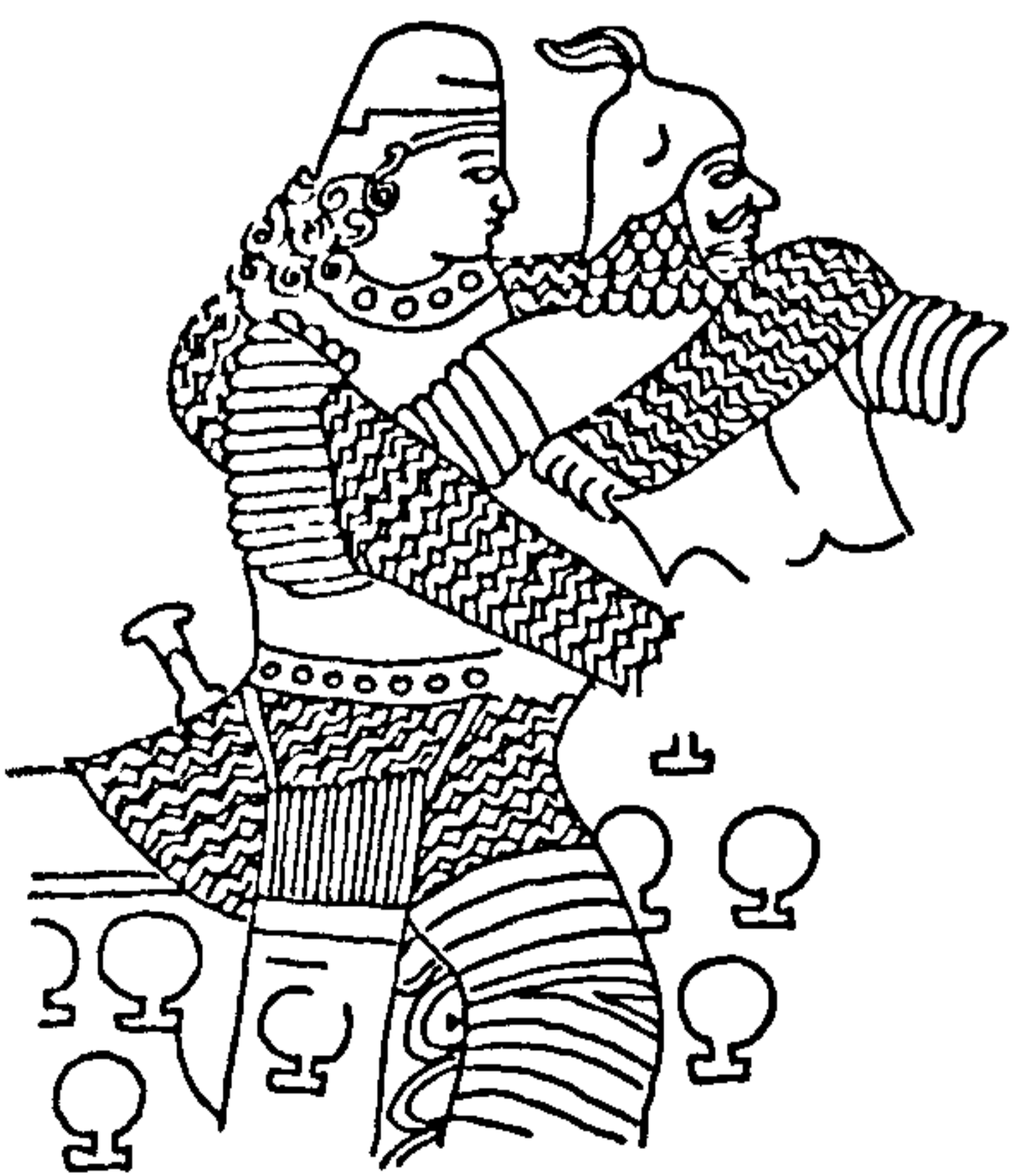

50C

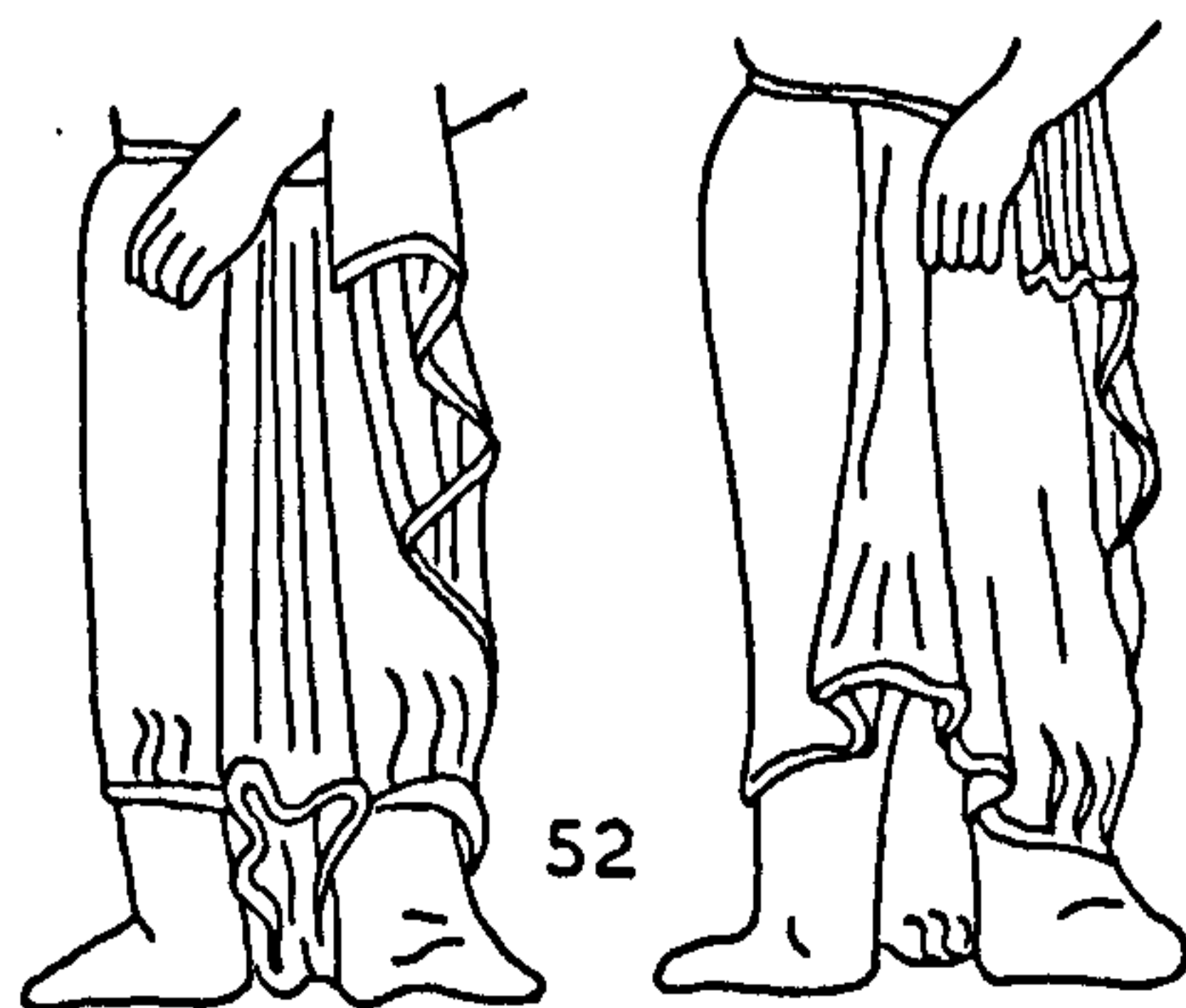

52

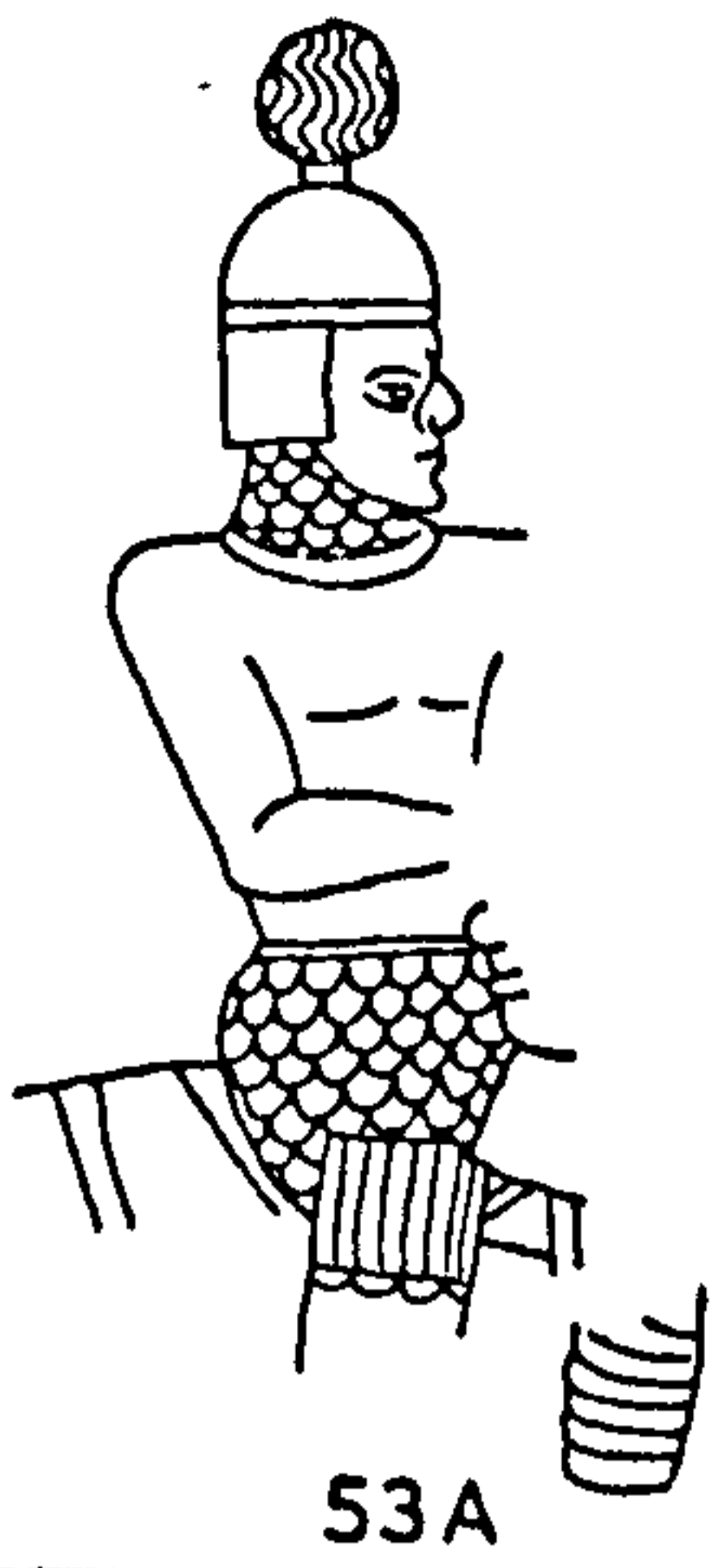

53A

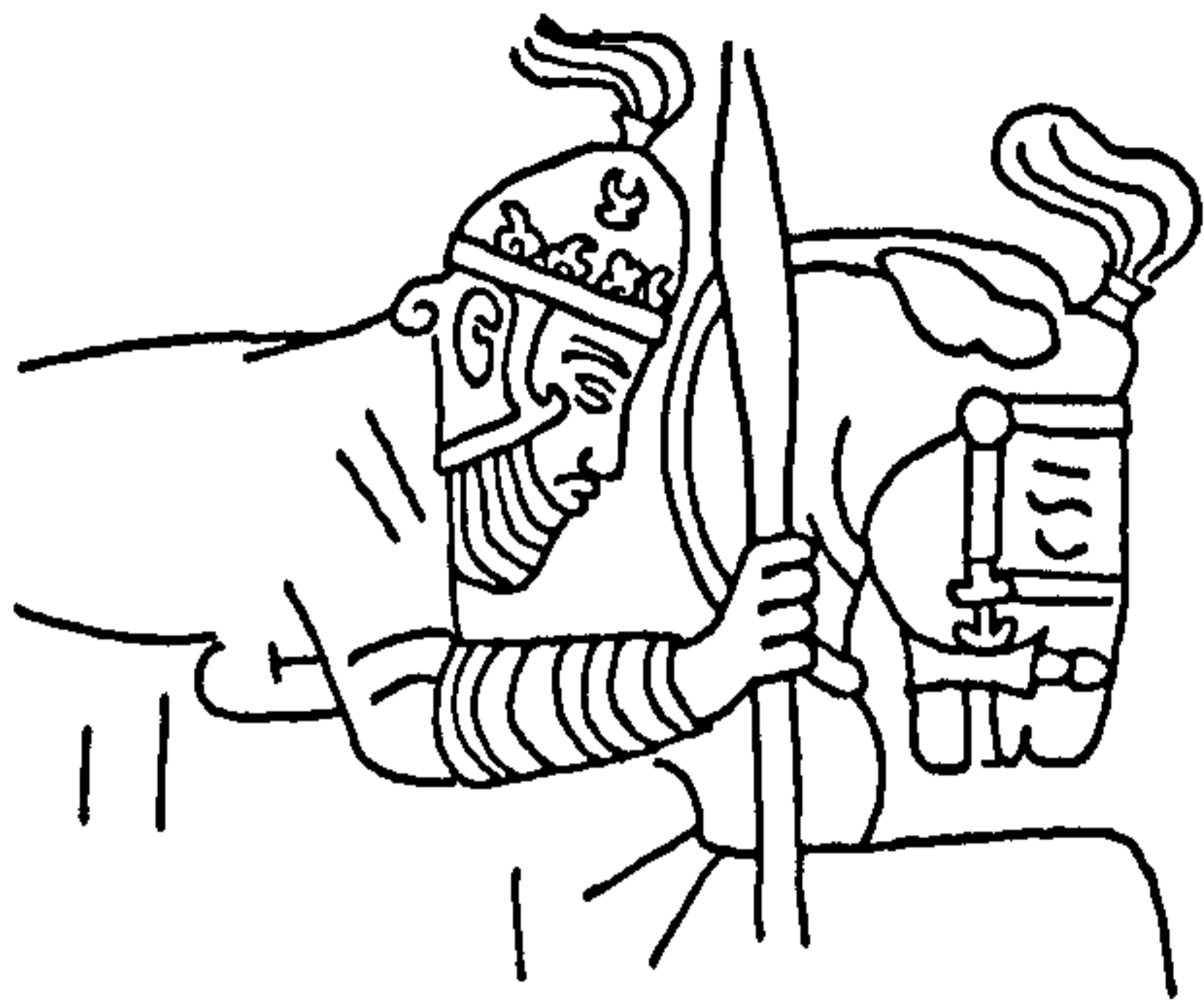

53B



54

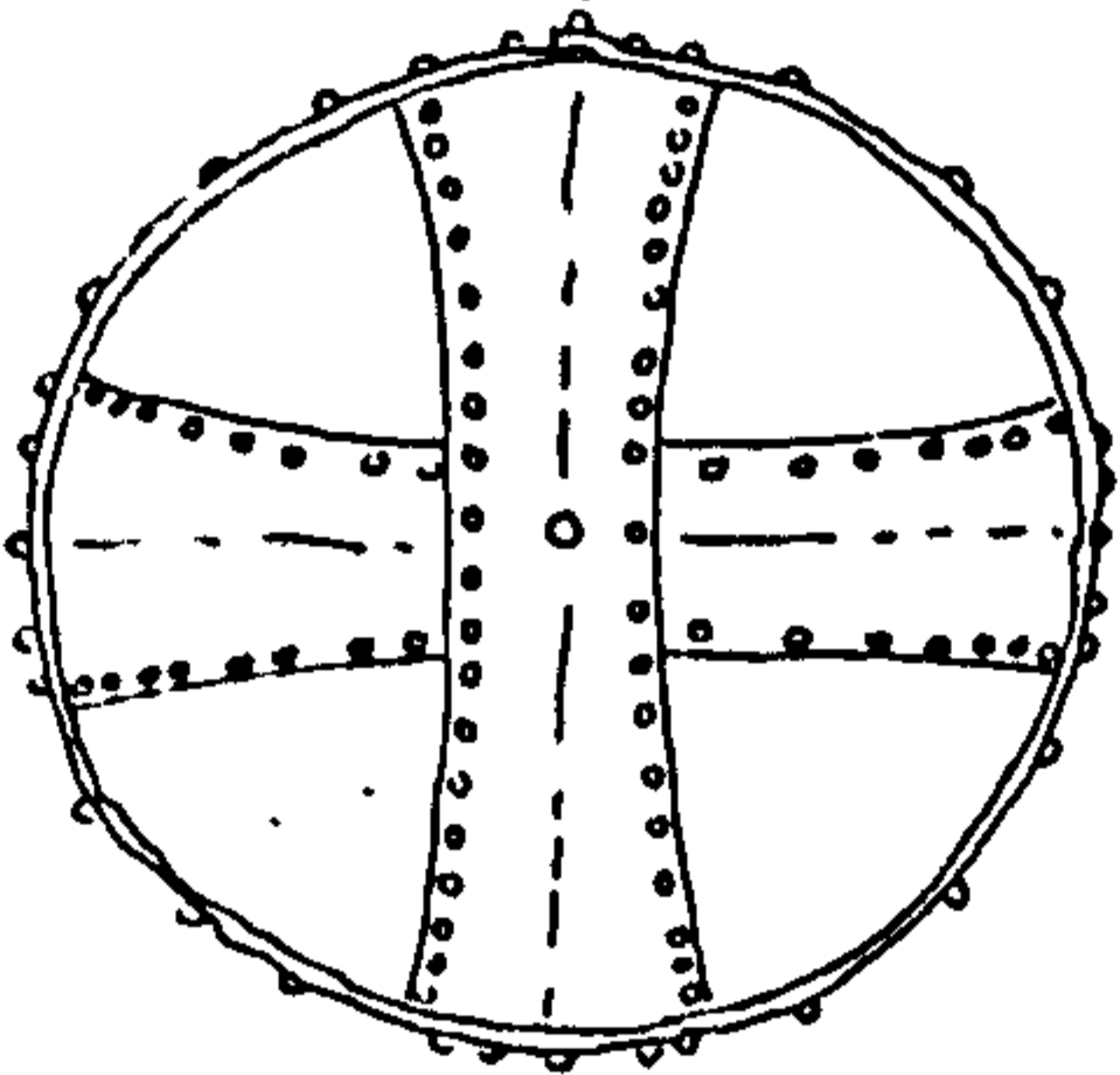
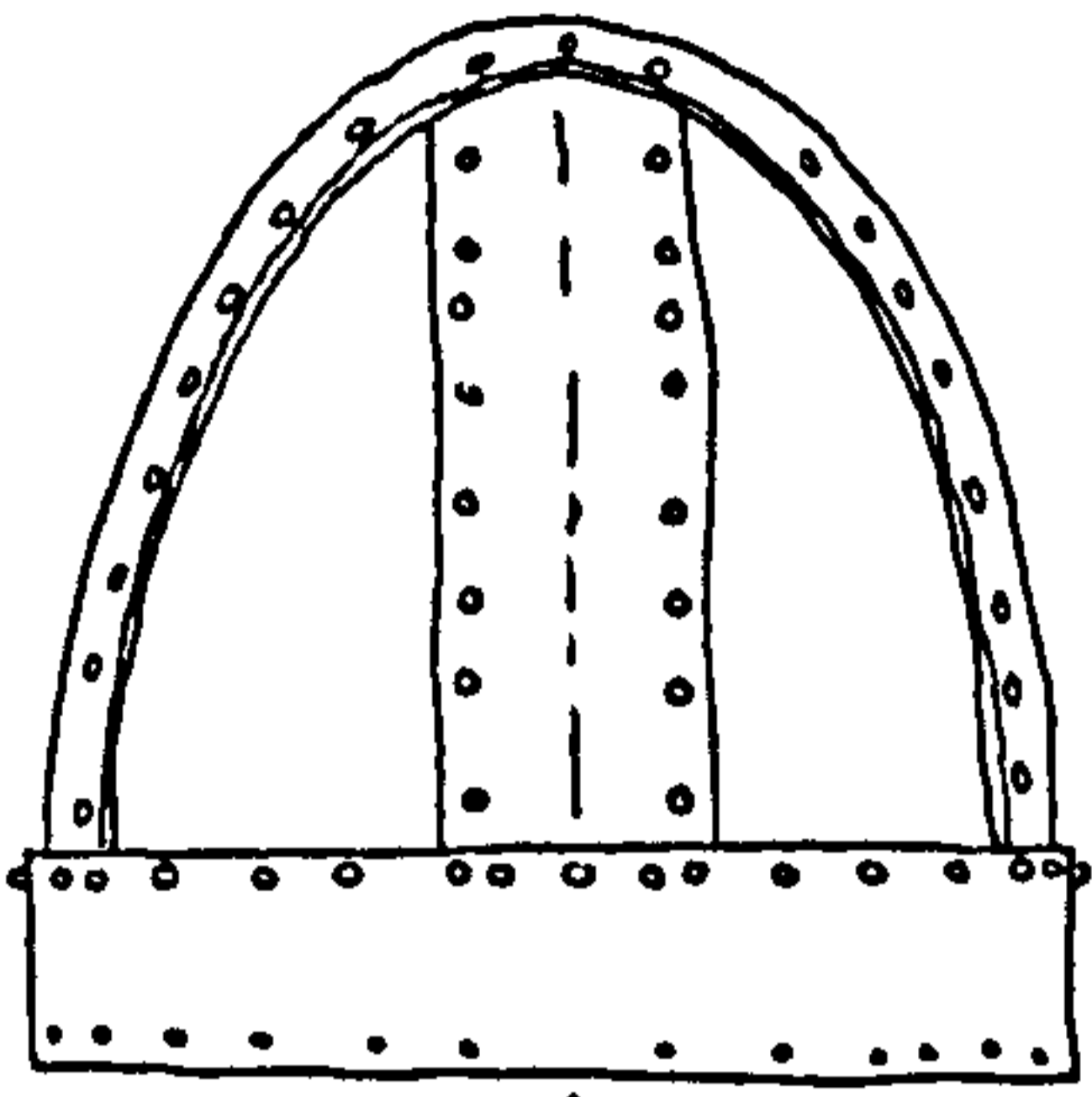

55

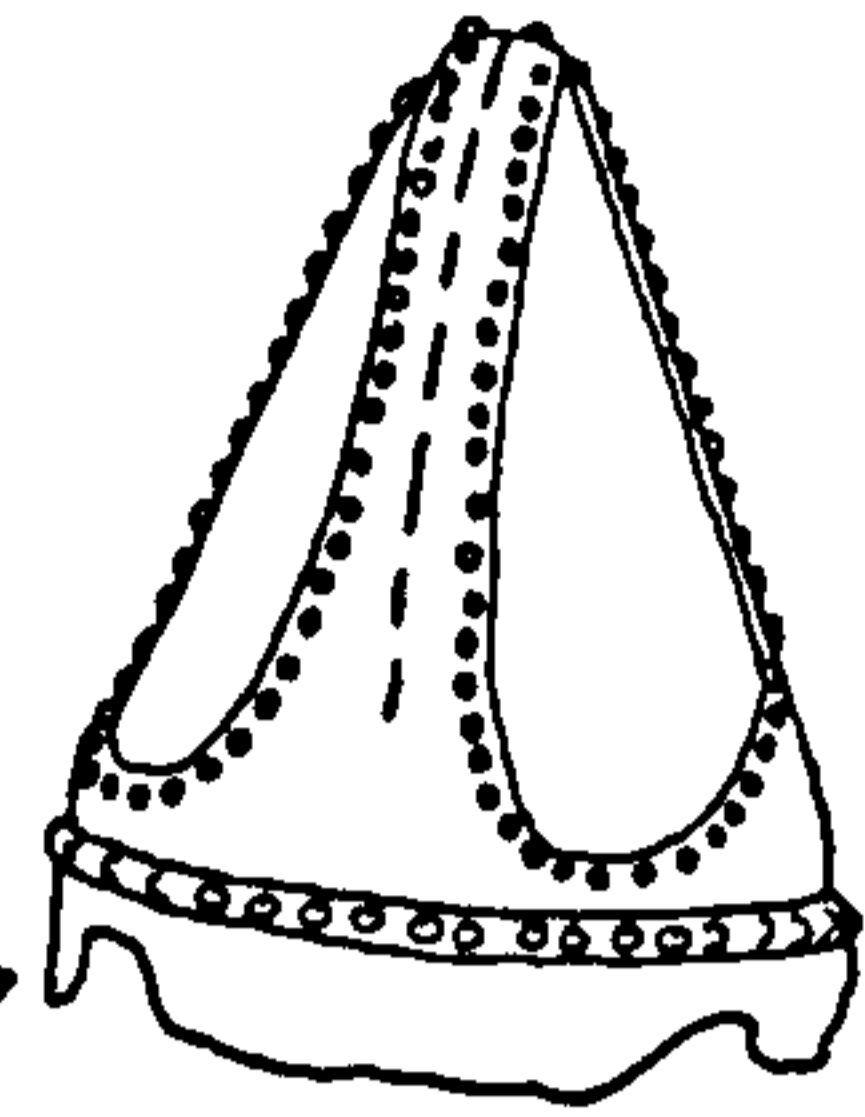
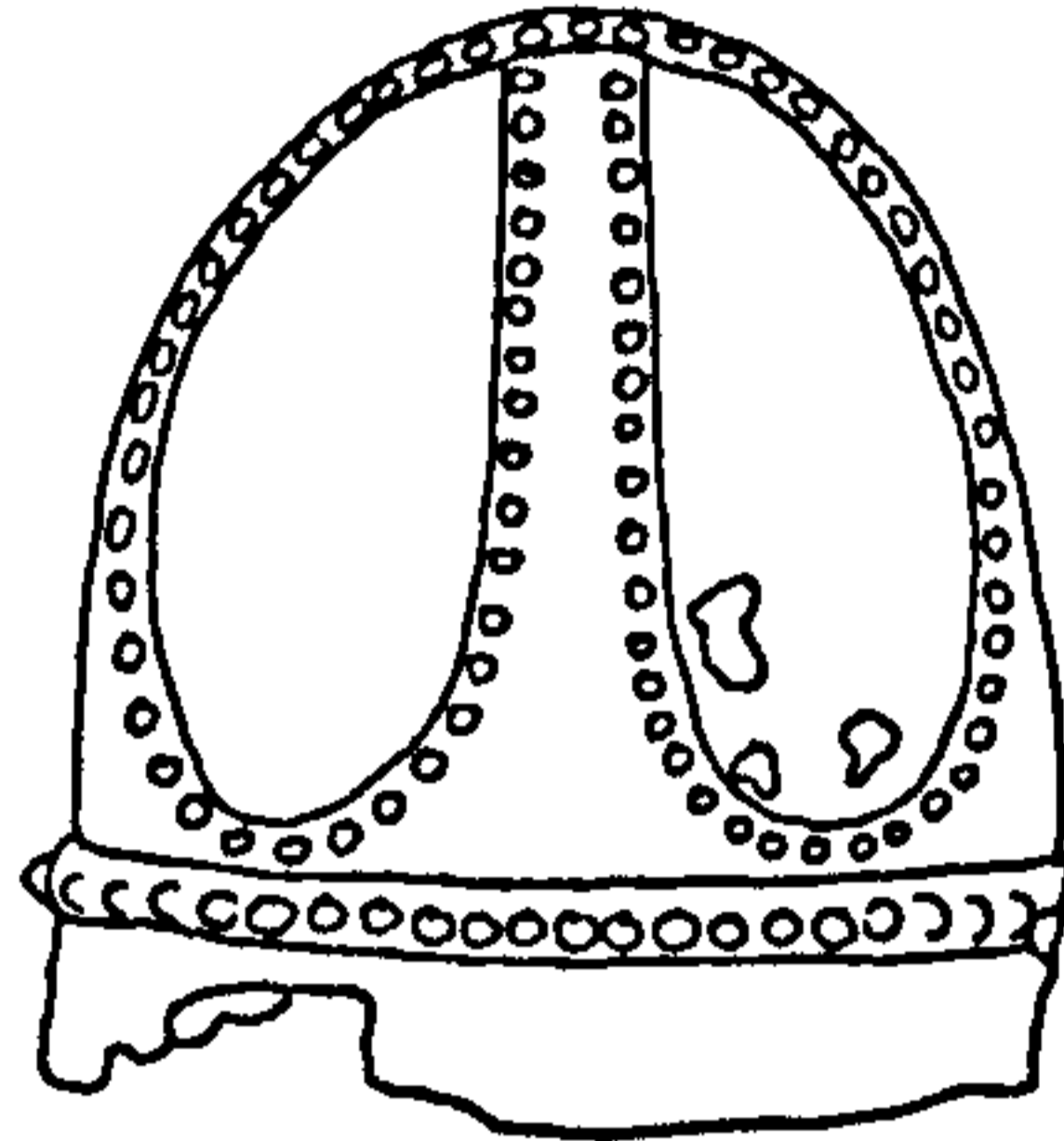

56



58A

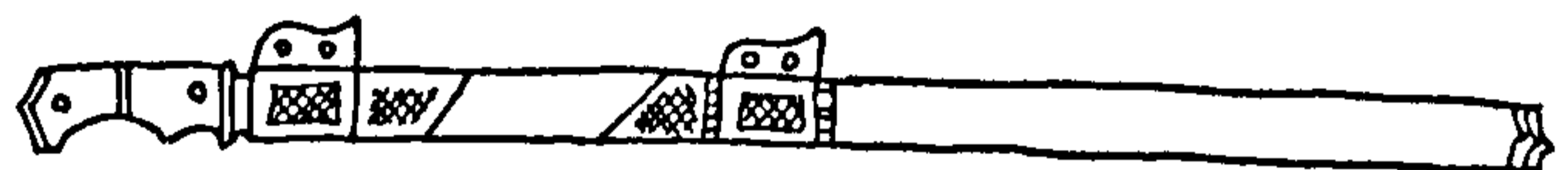

58B

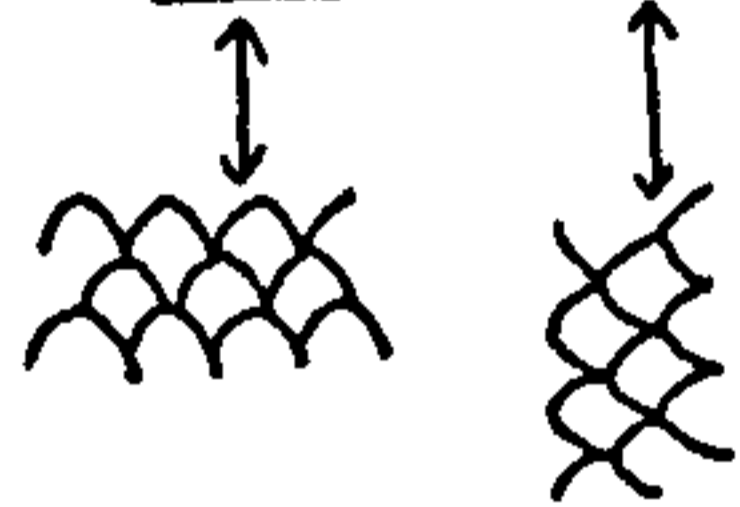

58C

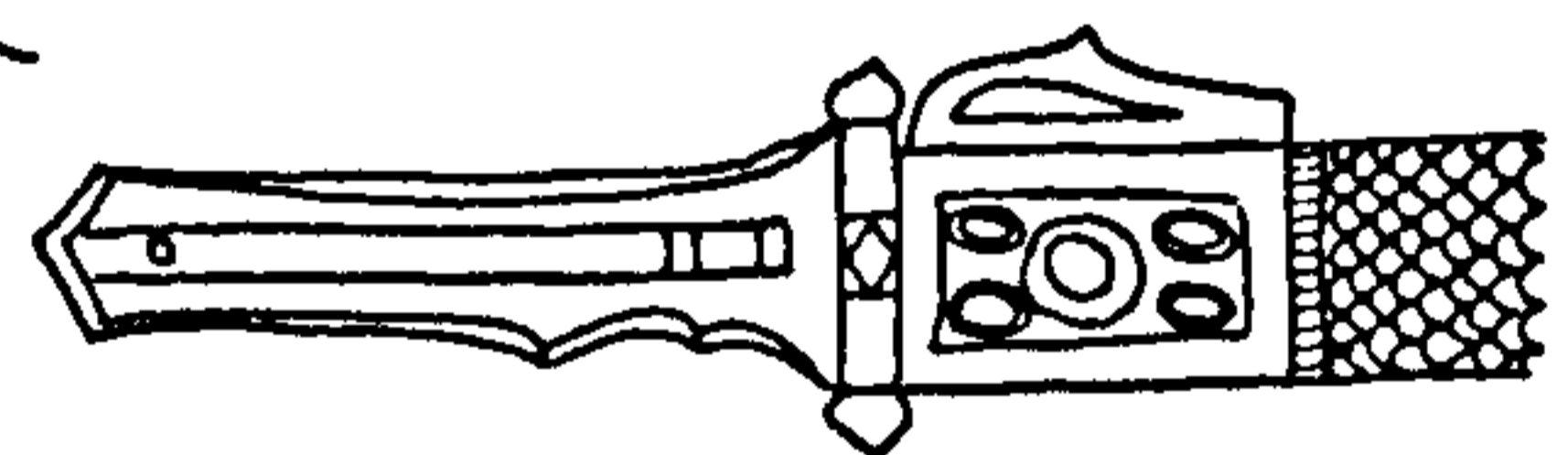

58D

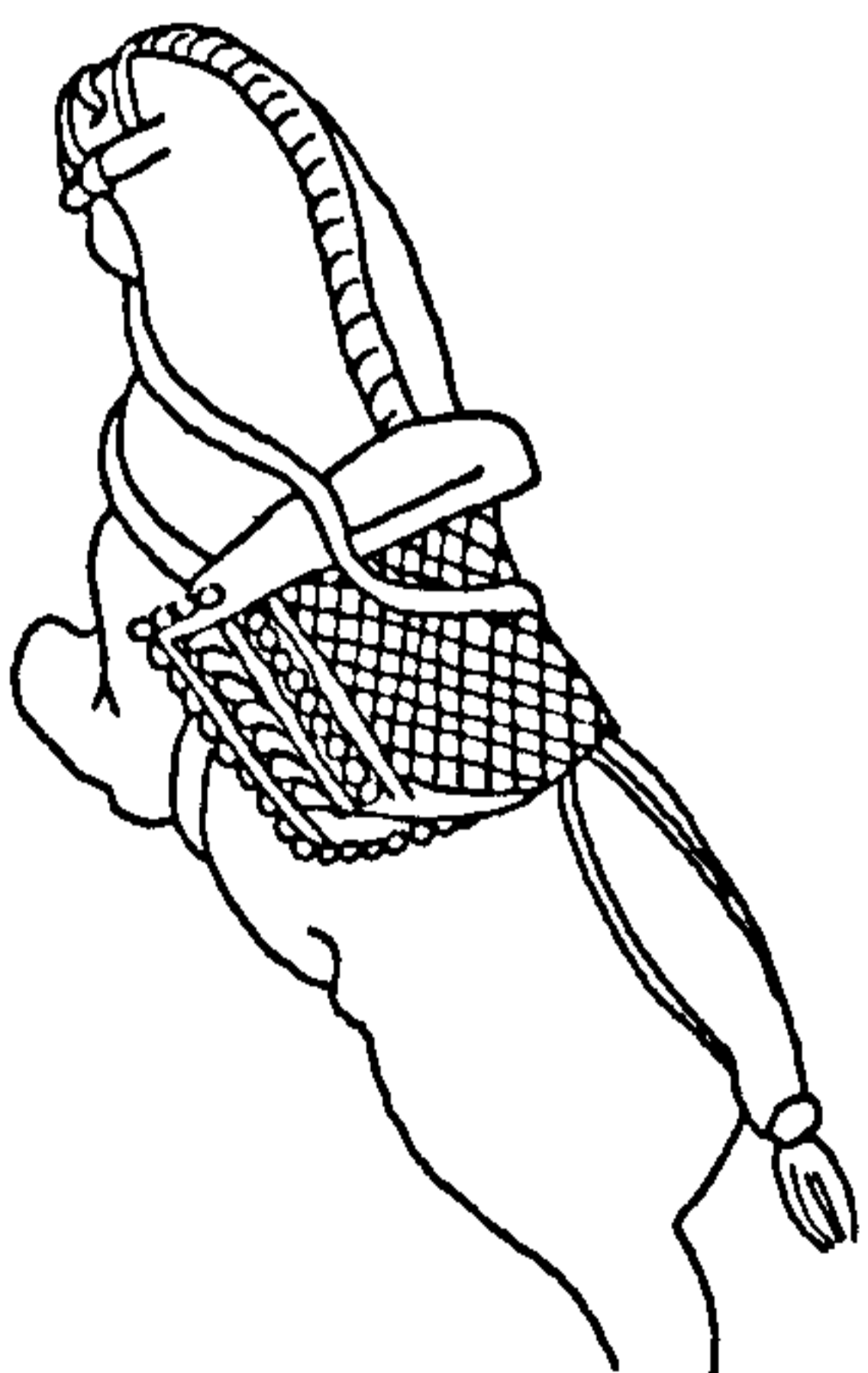

57

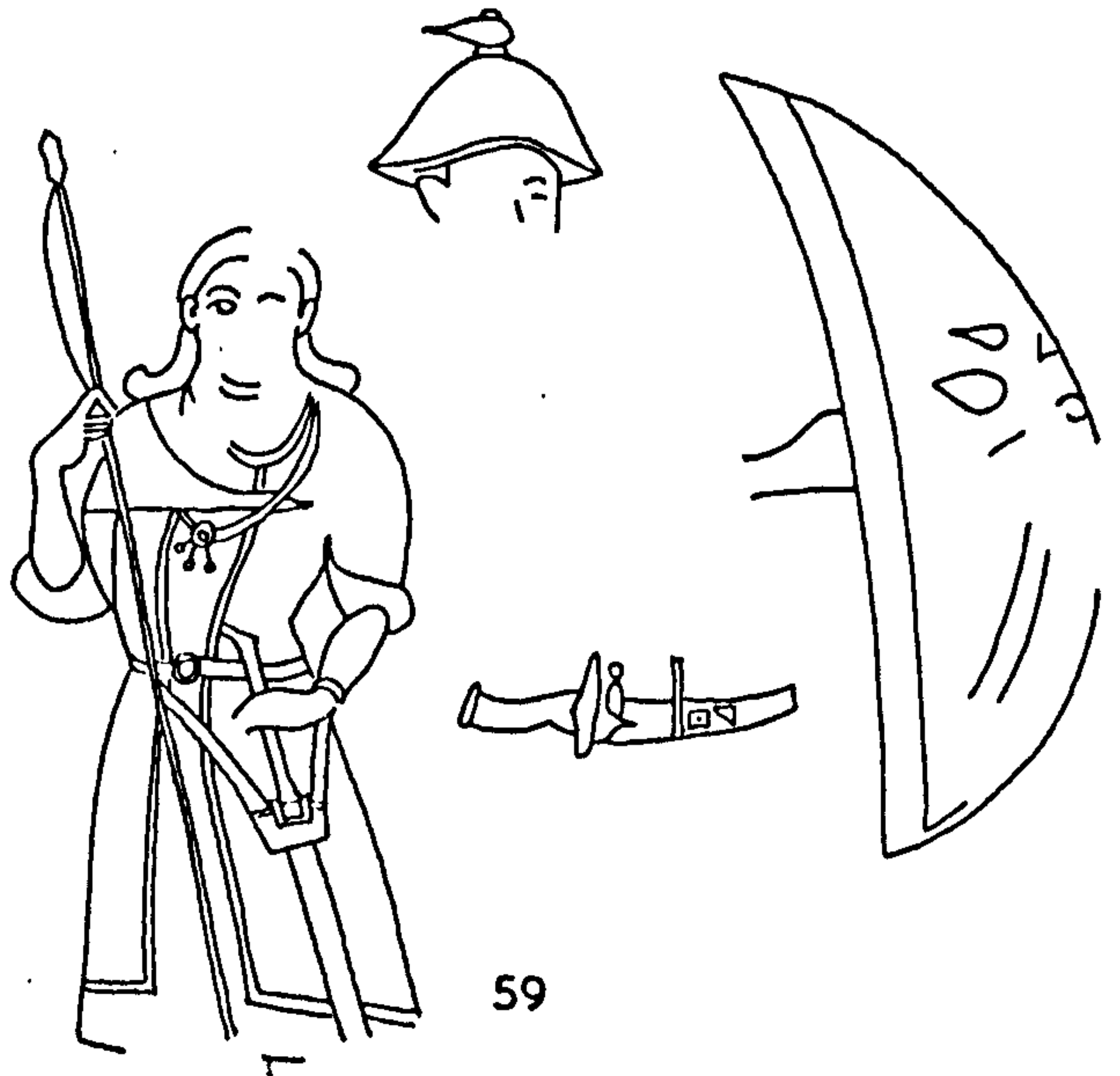

59

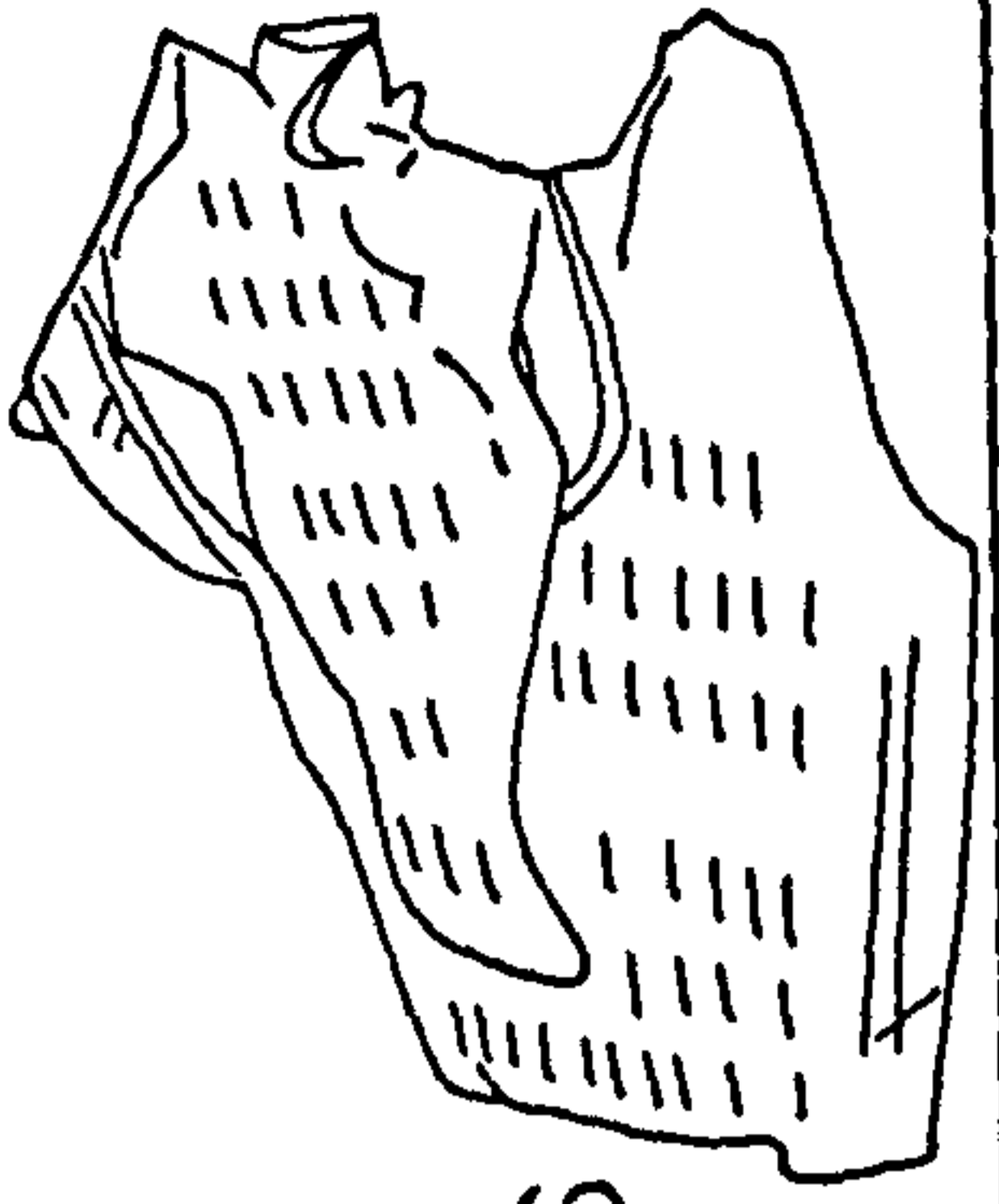

60



61A



61B

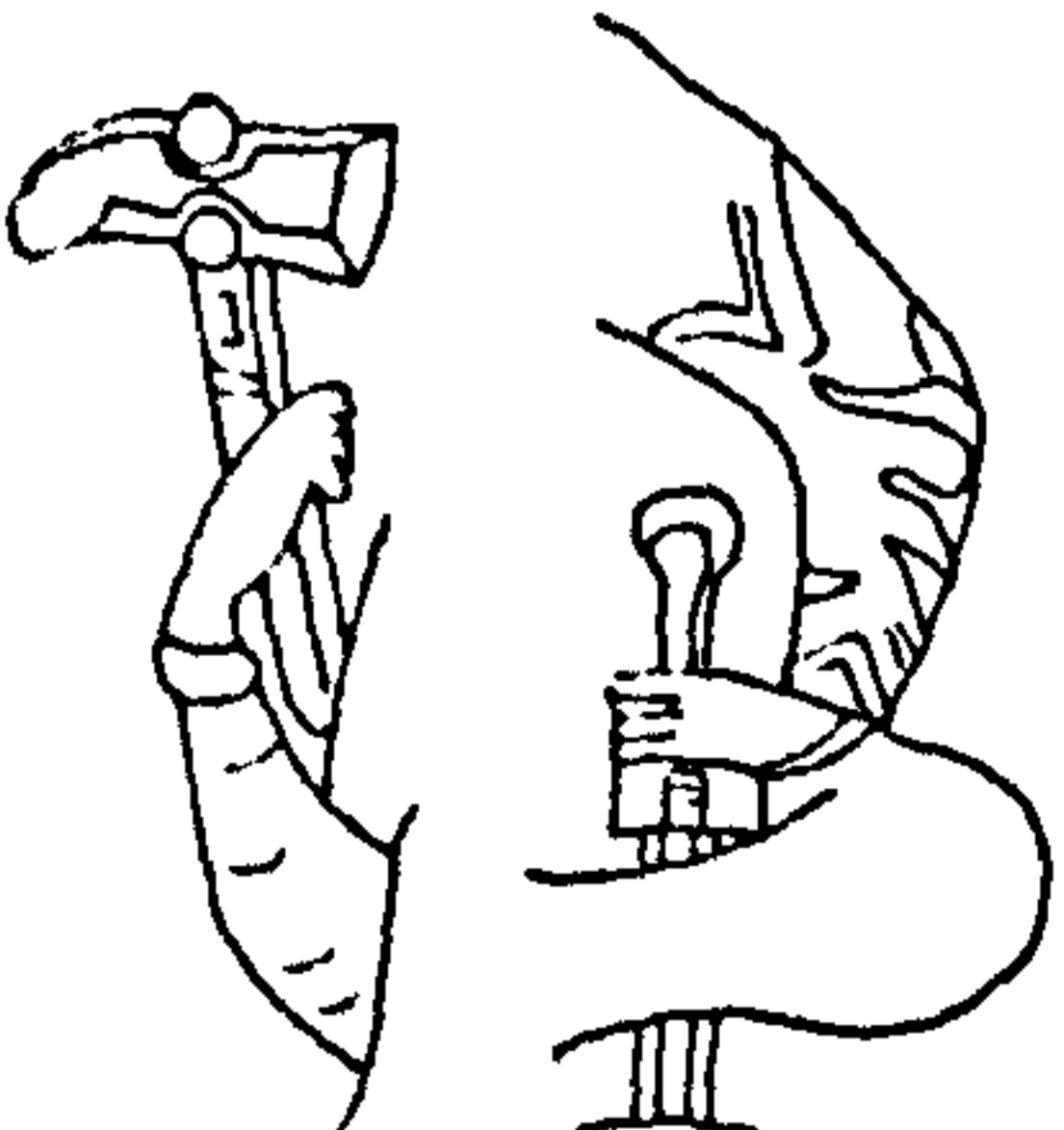

62

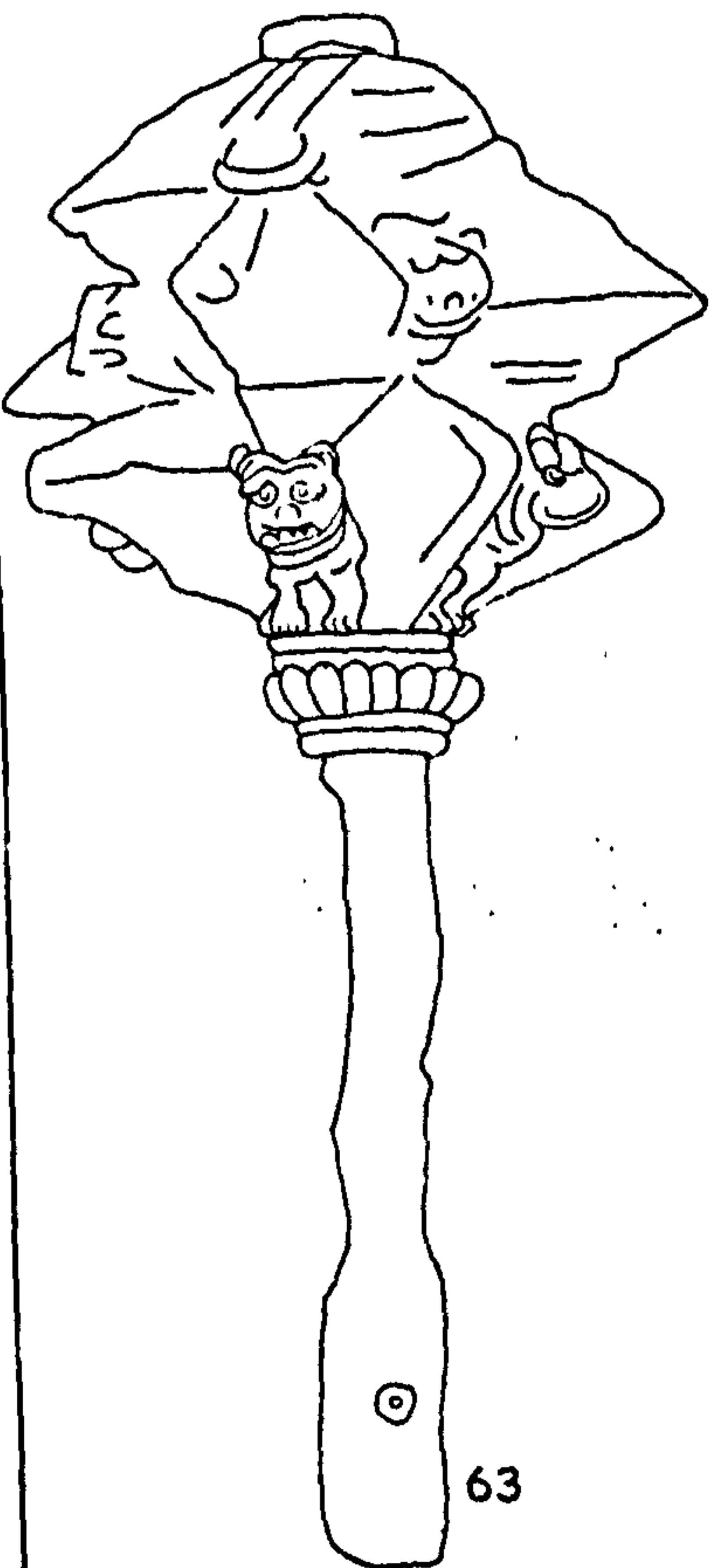

63



64



65

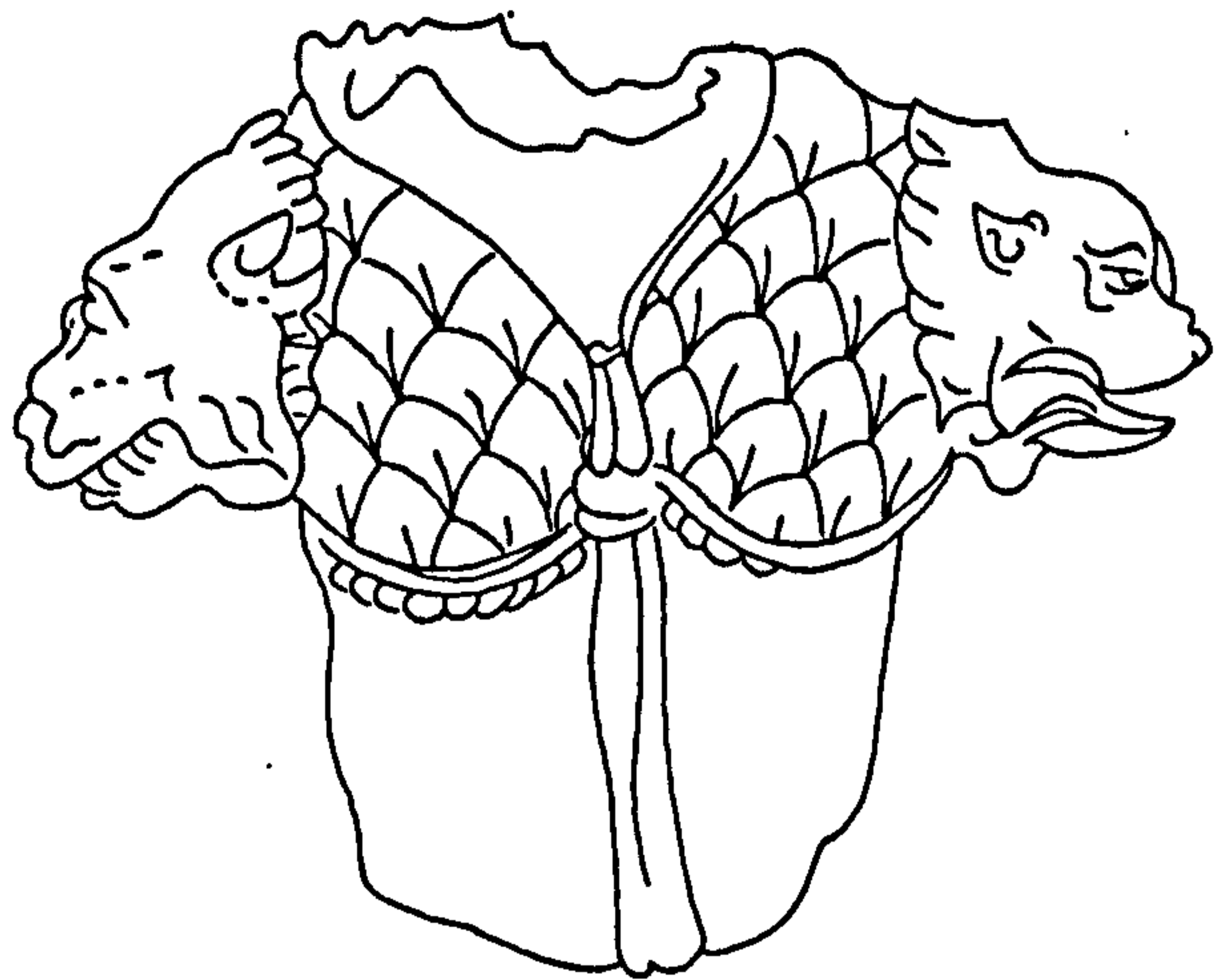

66

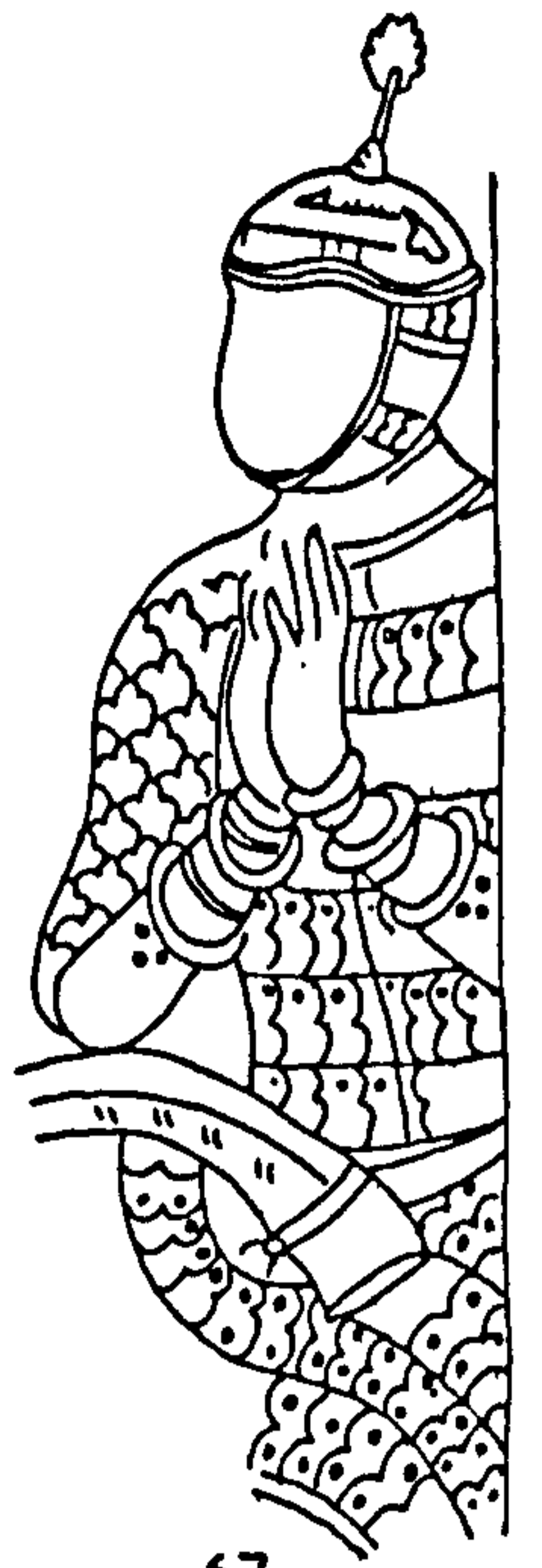

67

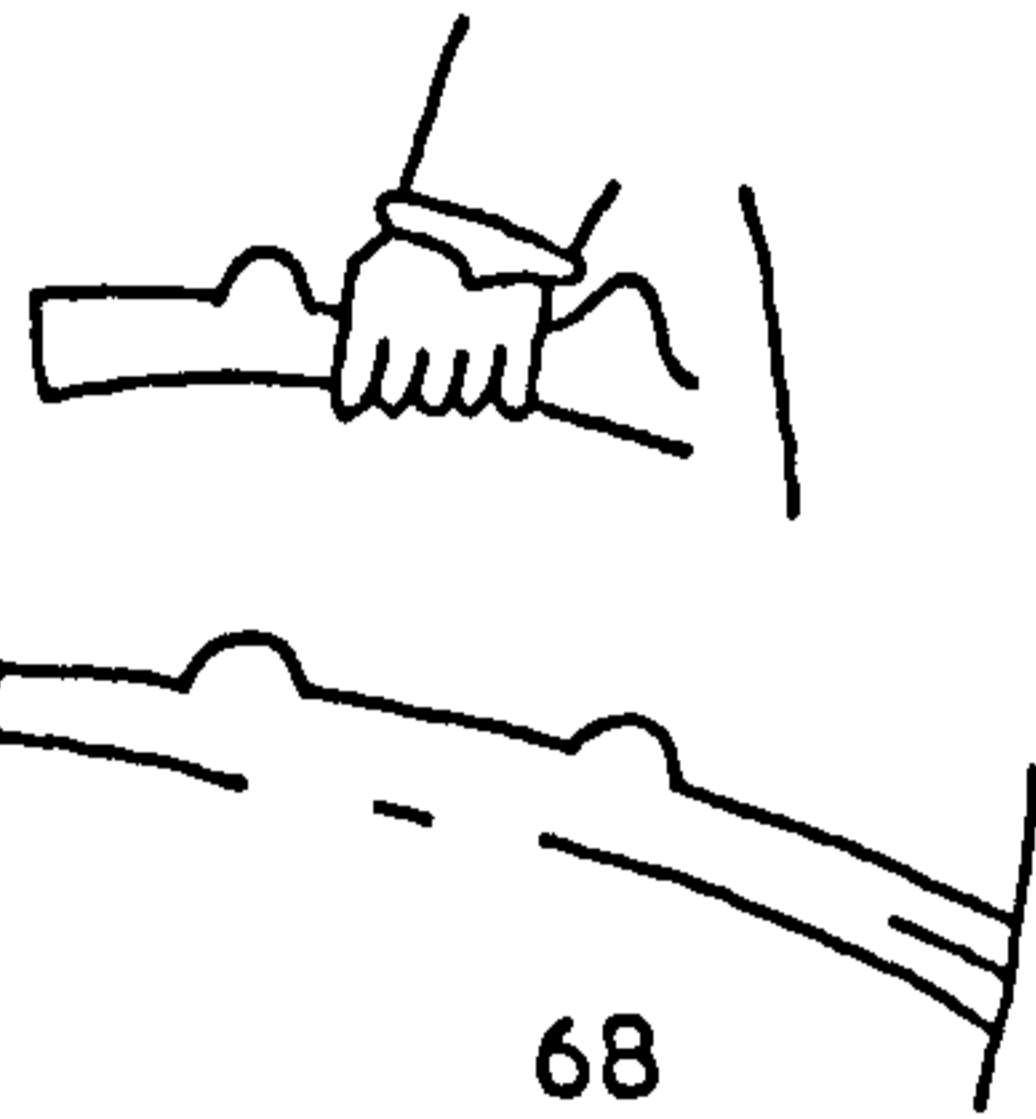

68

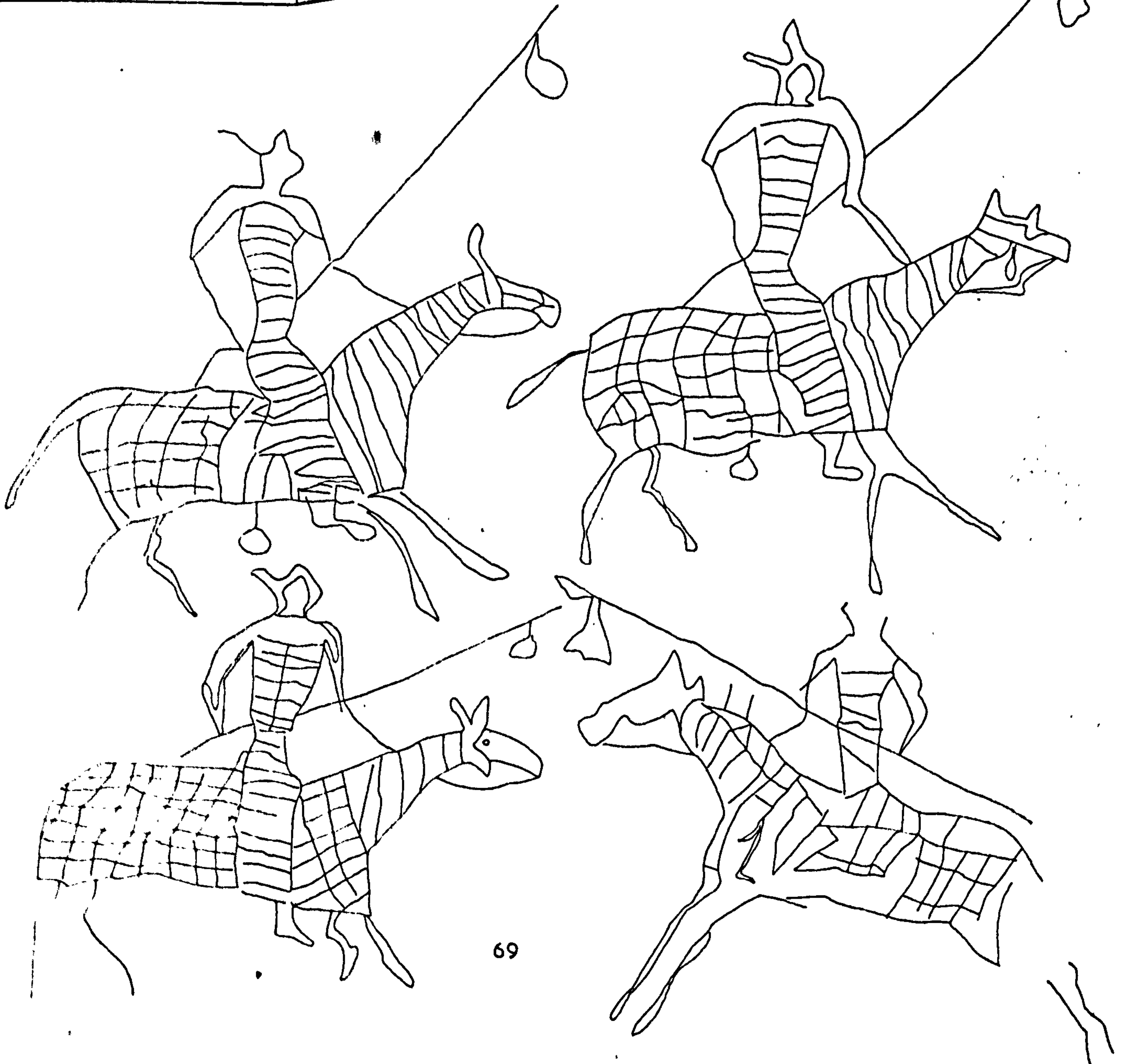

69

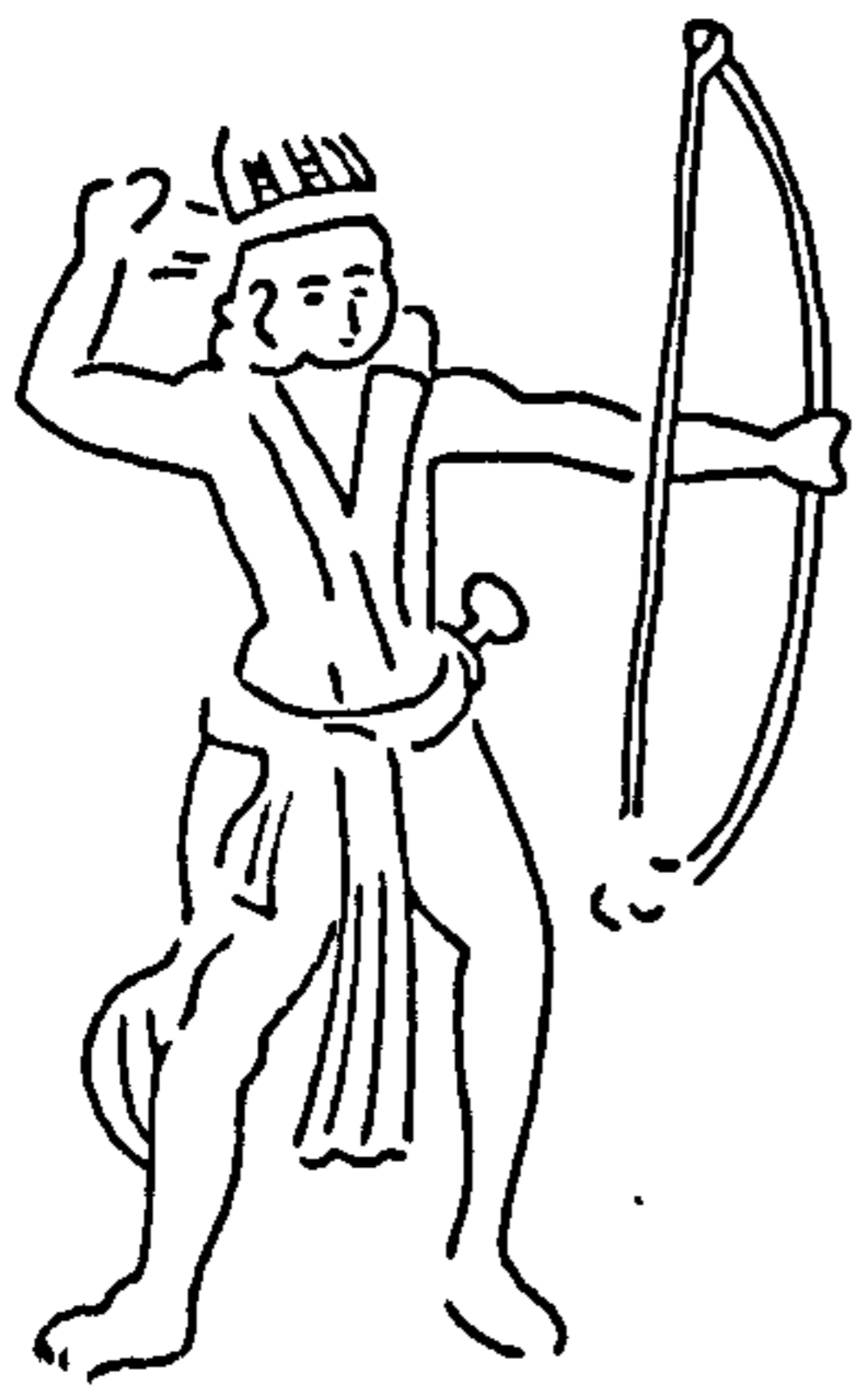

70



71



72



73

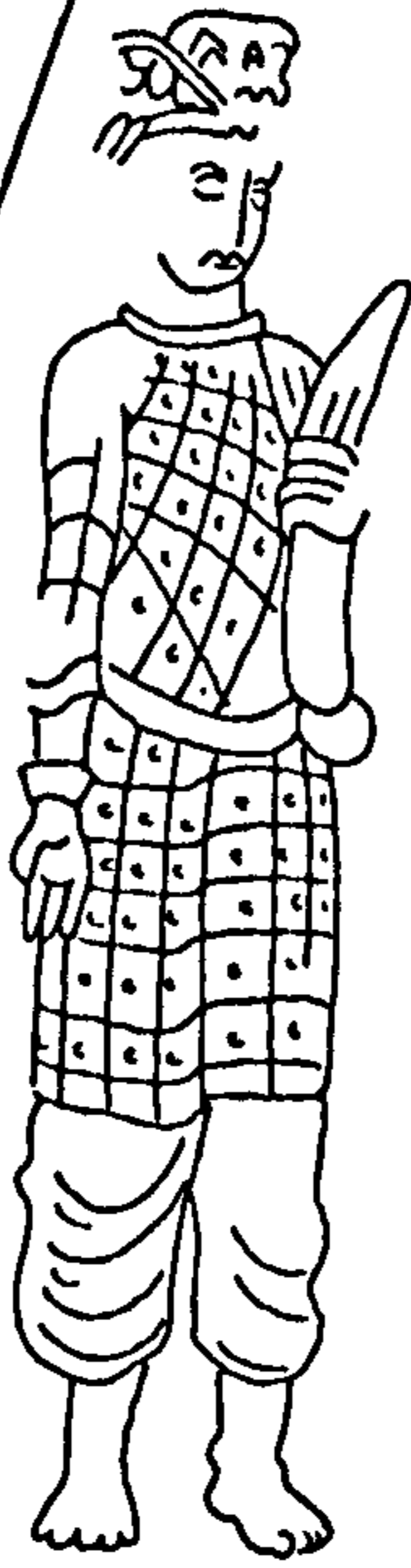

74

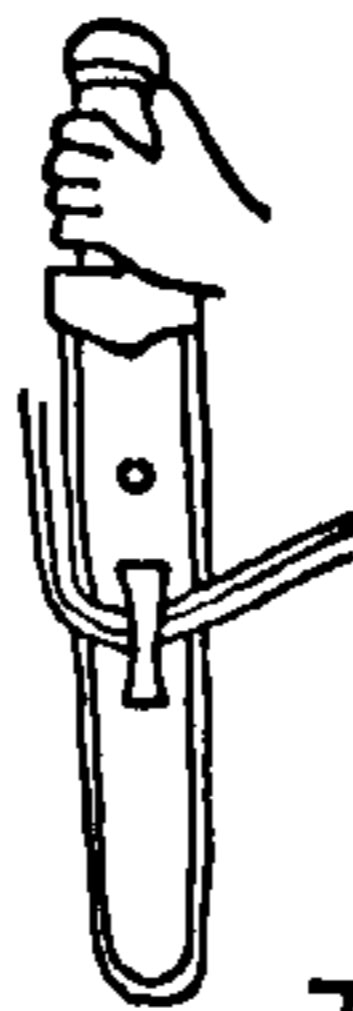

75



76

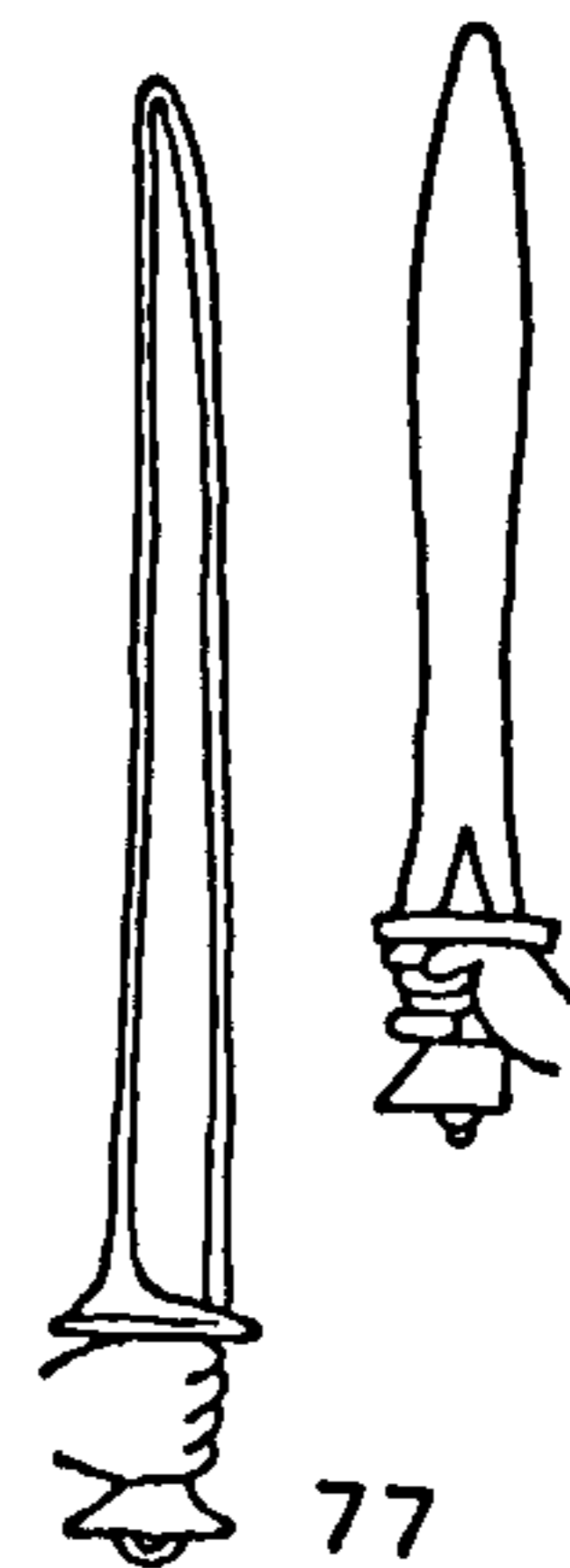
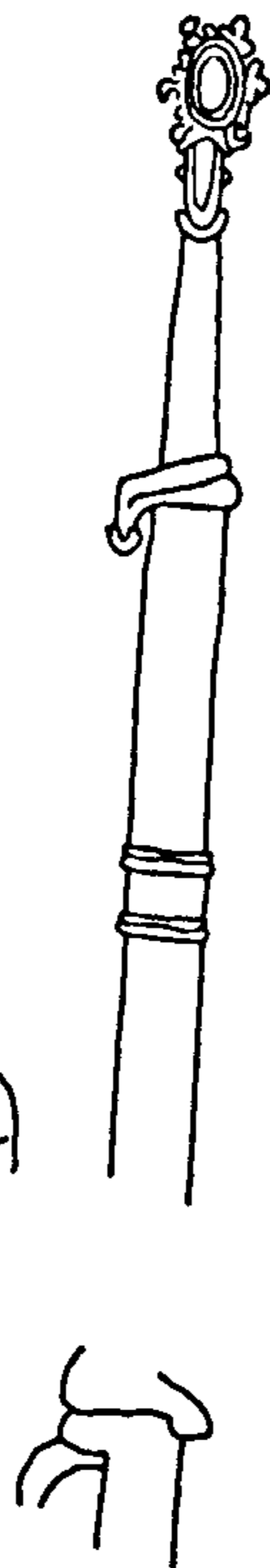

77

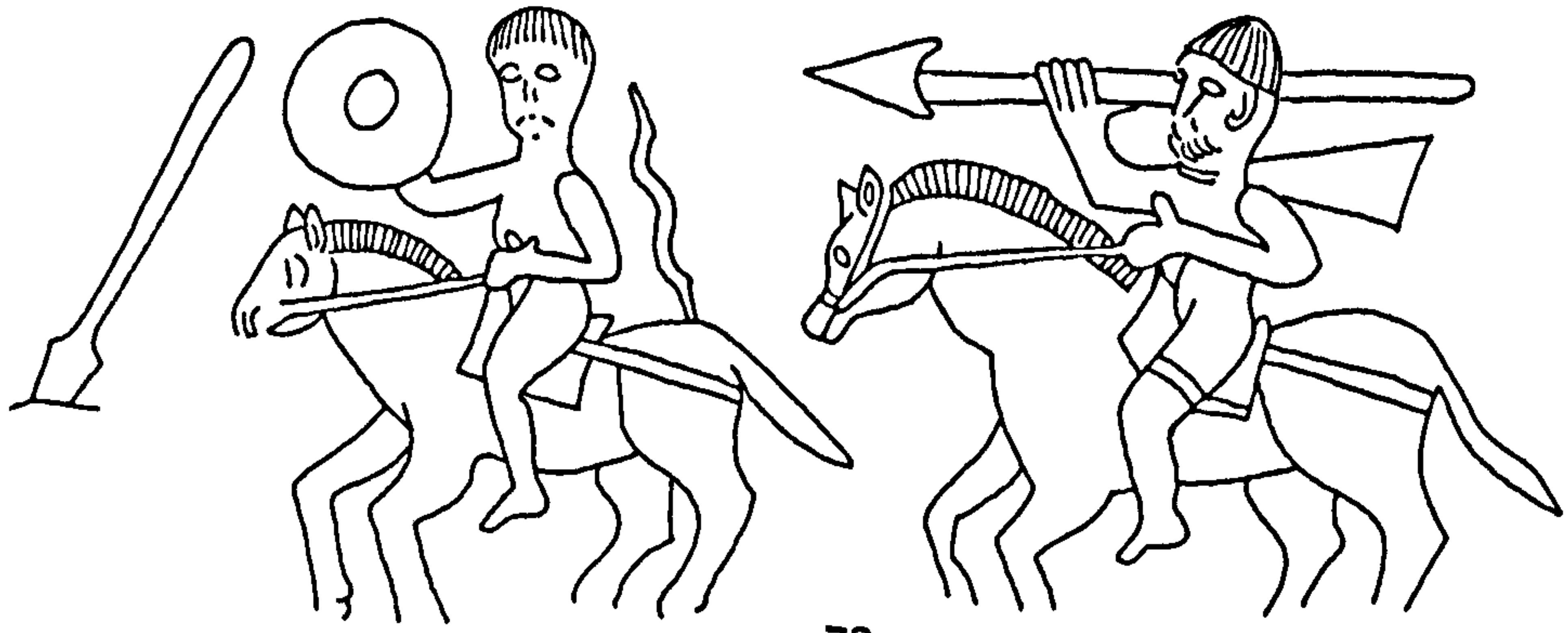

78

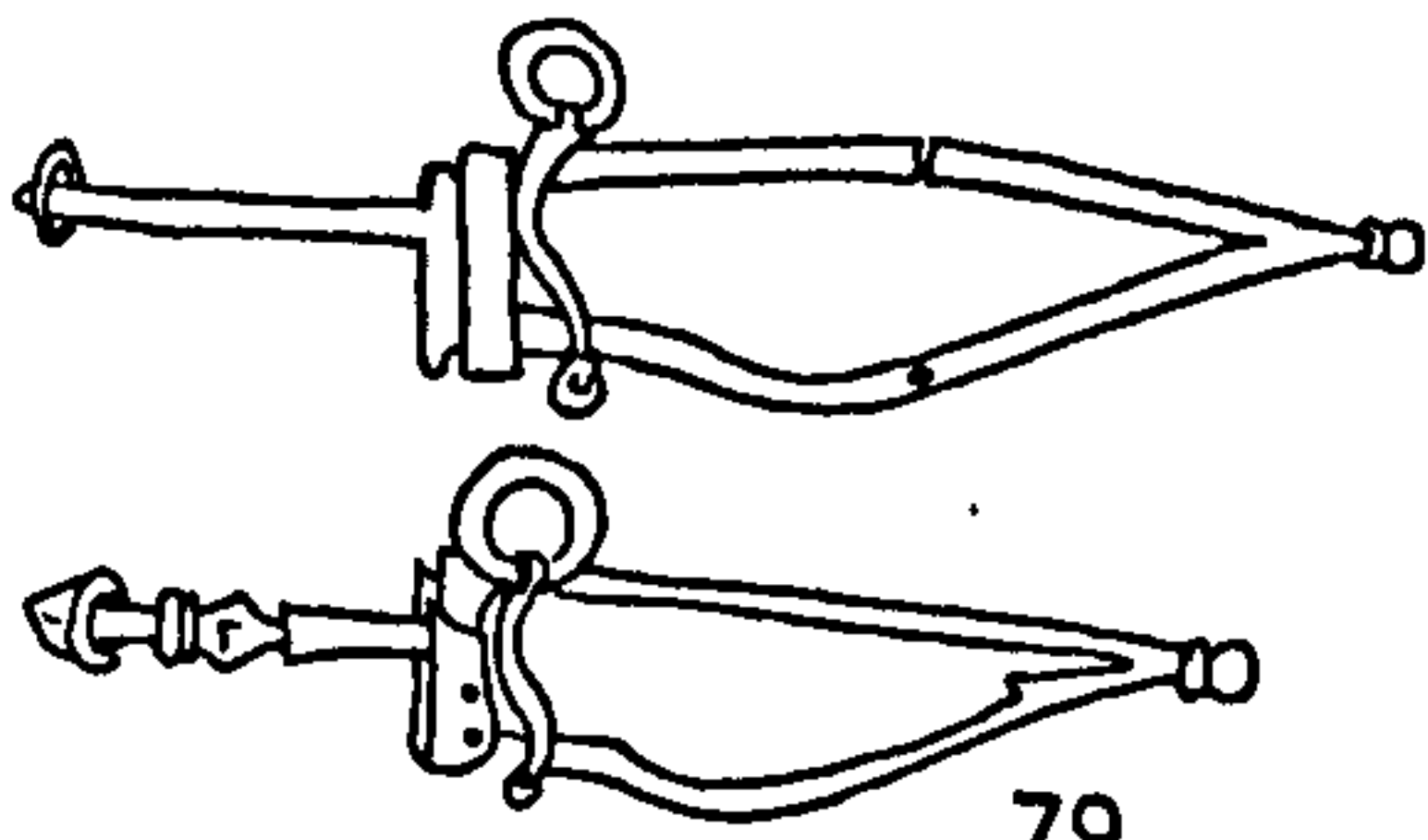

79

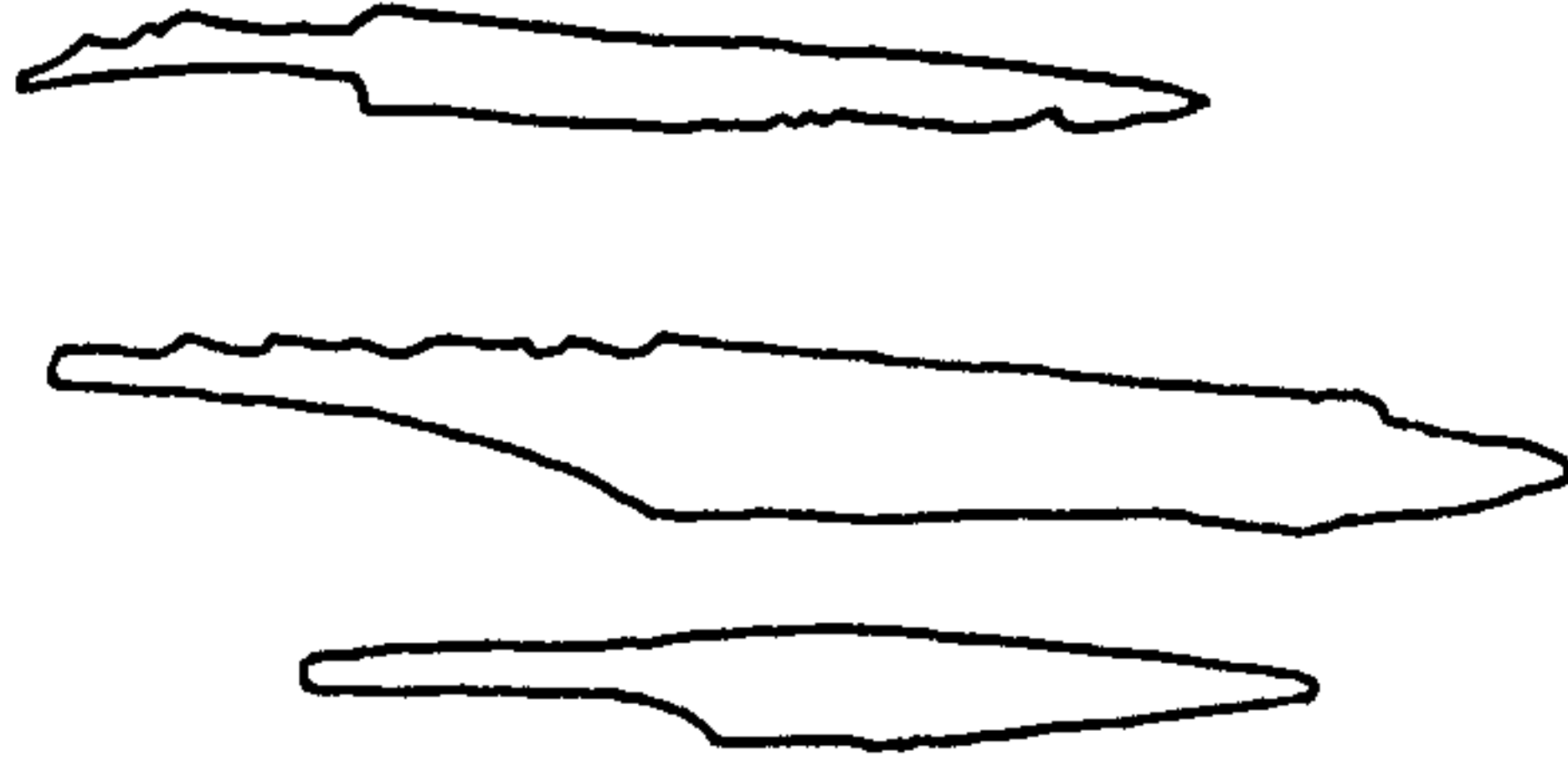

80

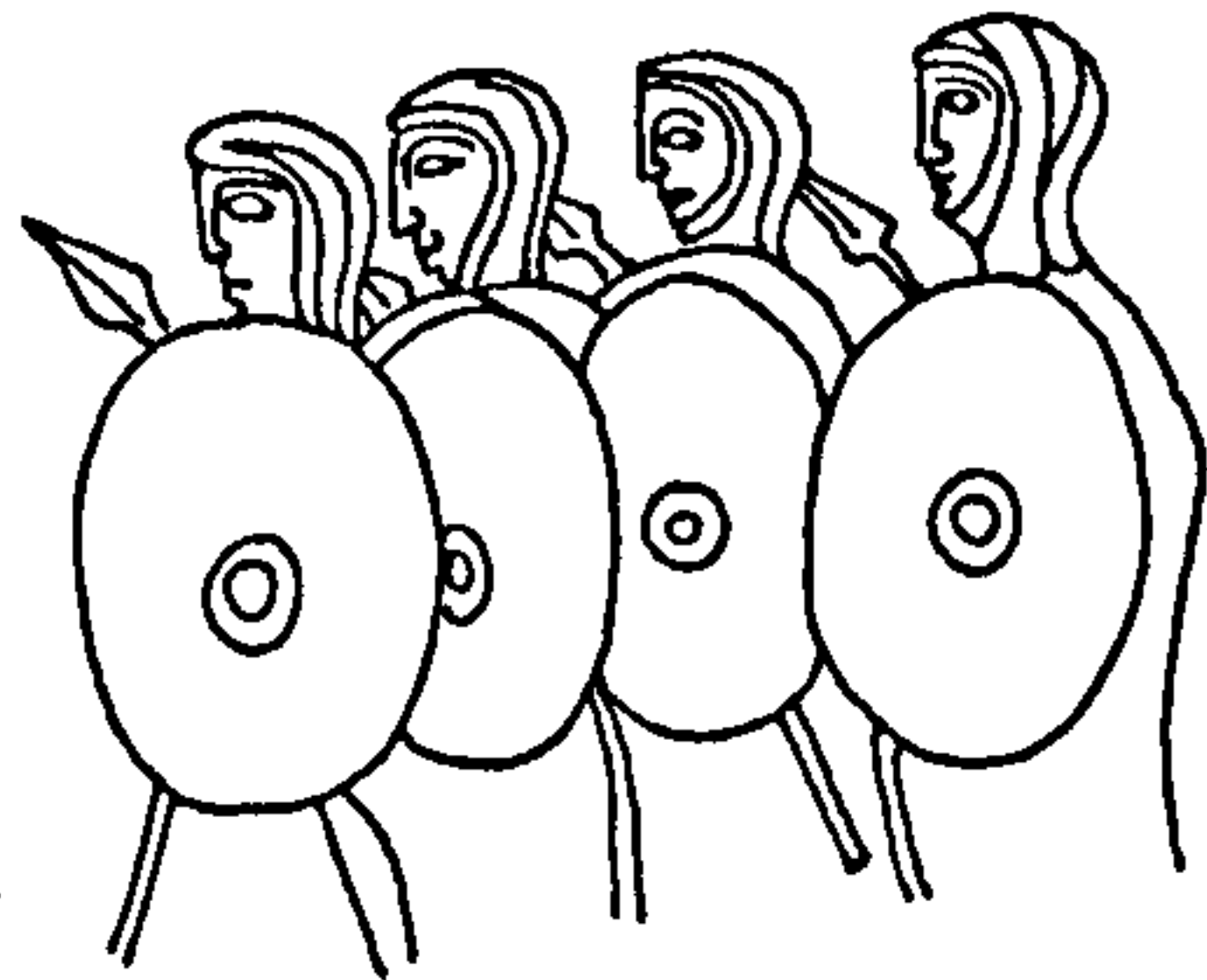

81



82

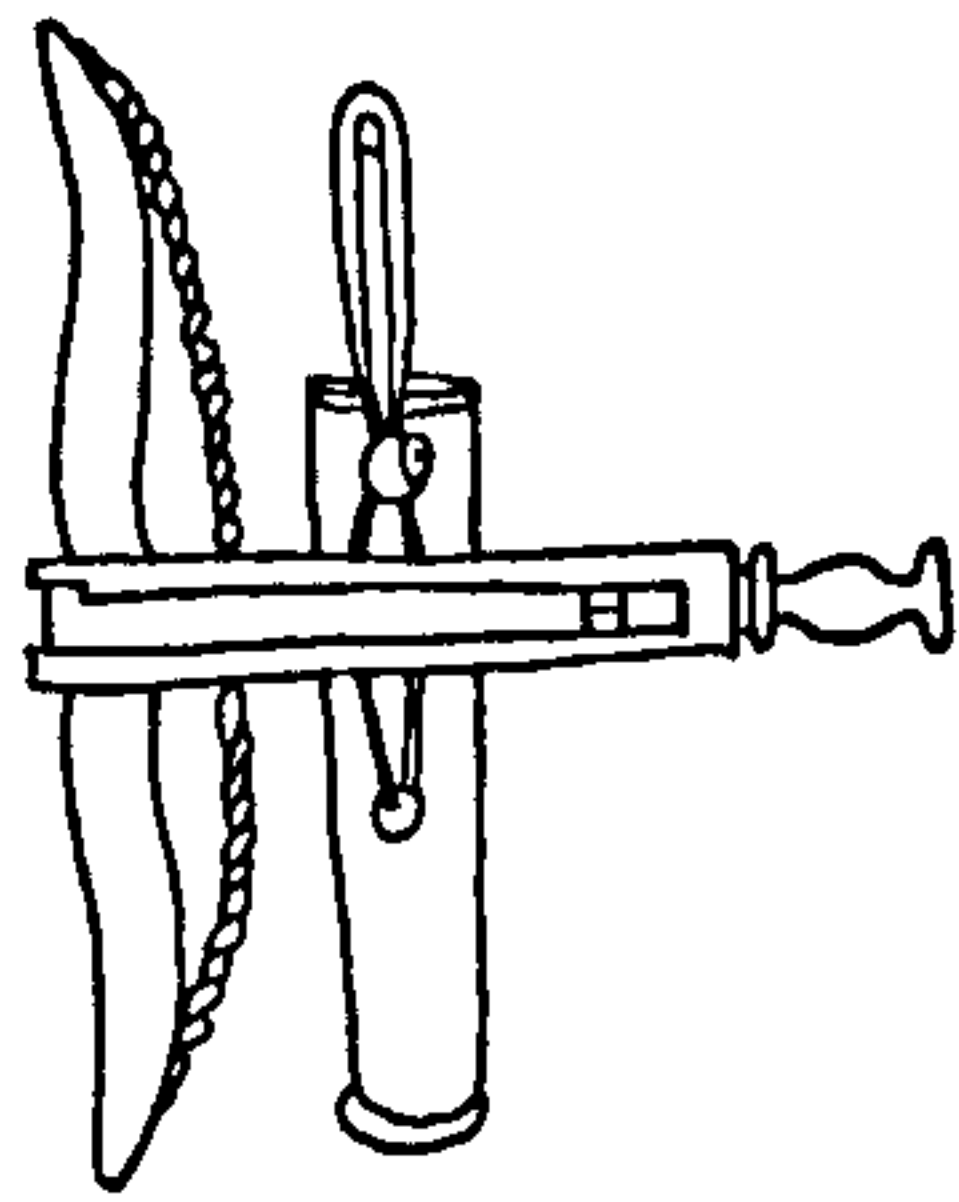

83

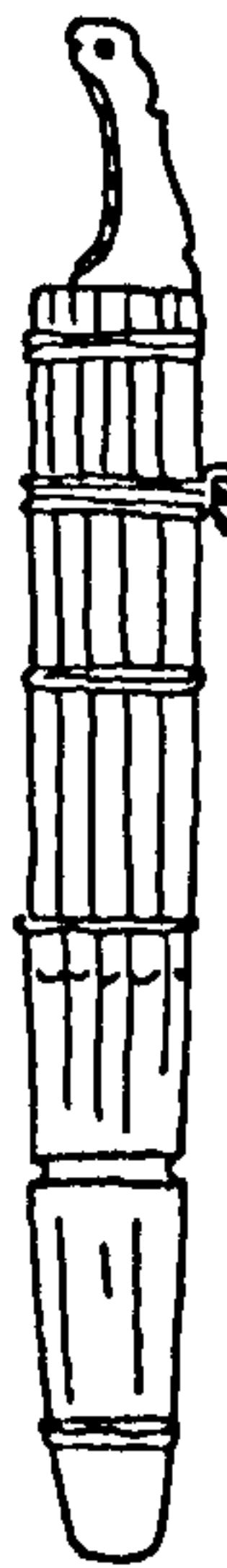

84

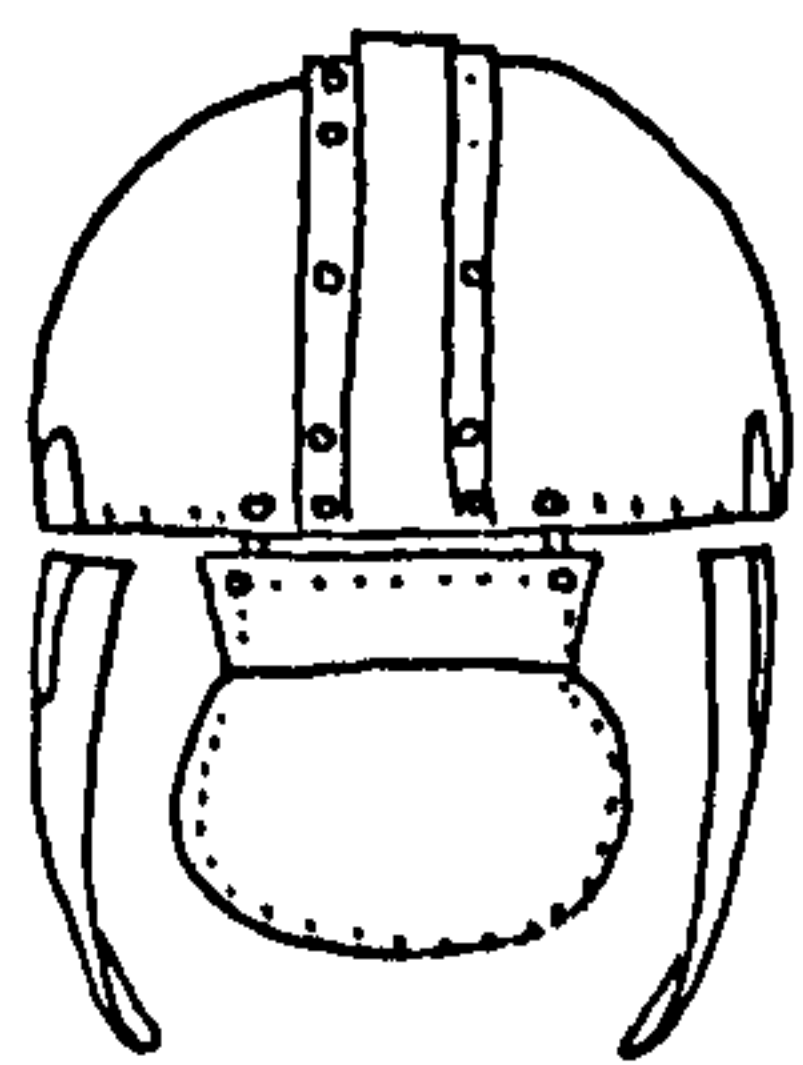
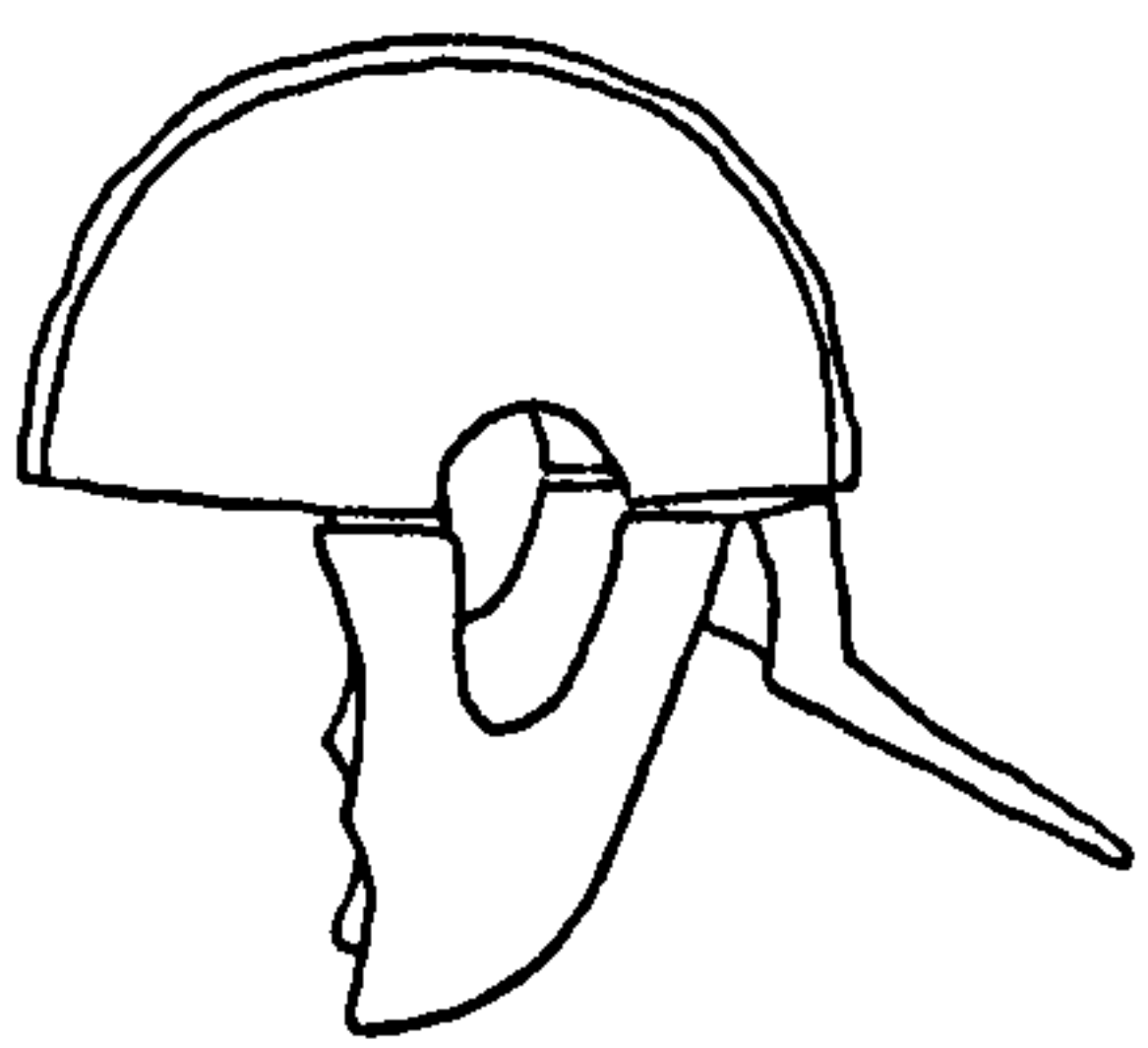

85

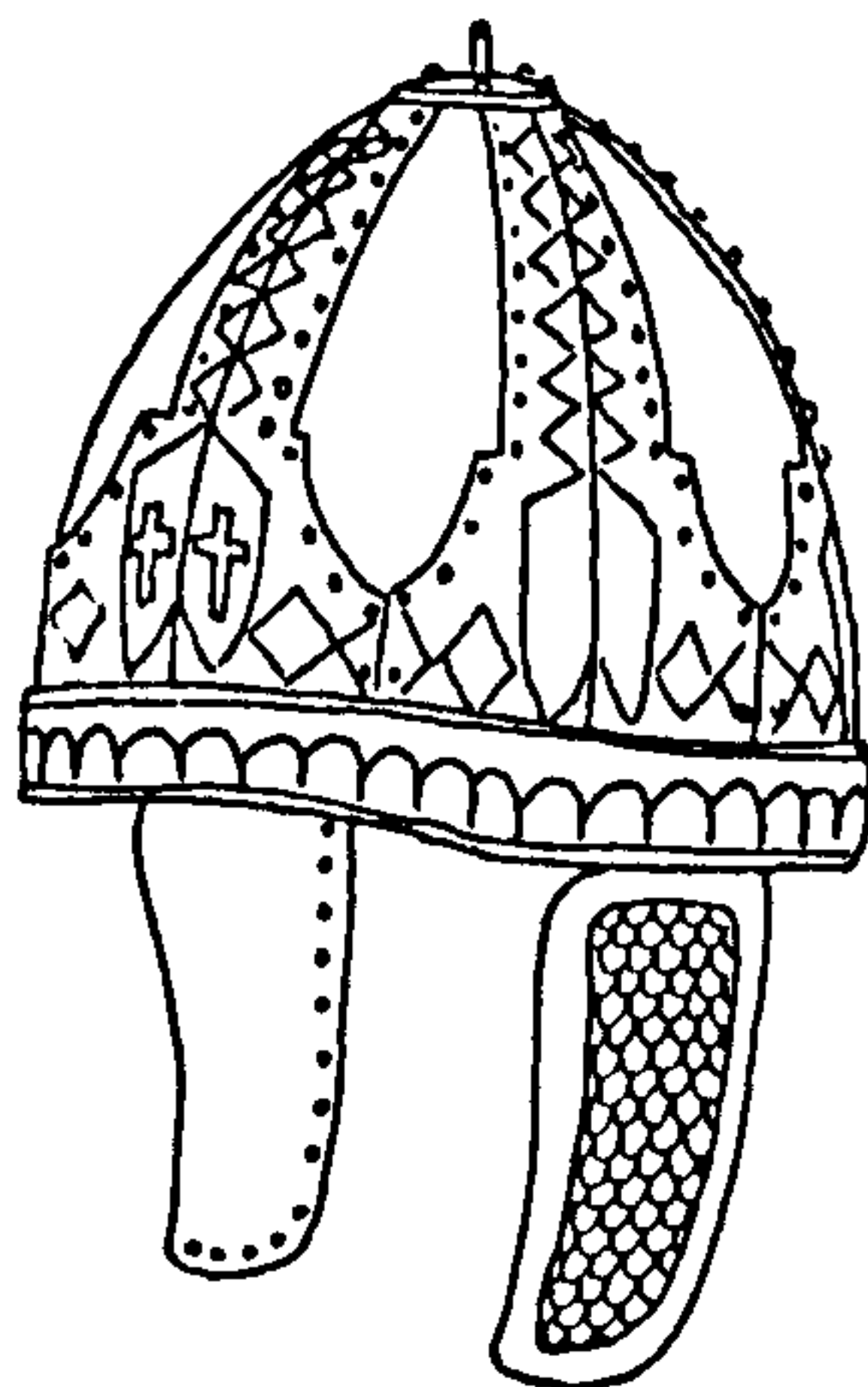

86

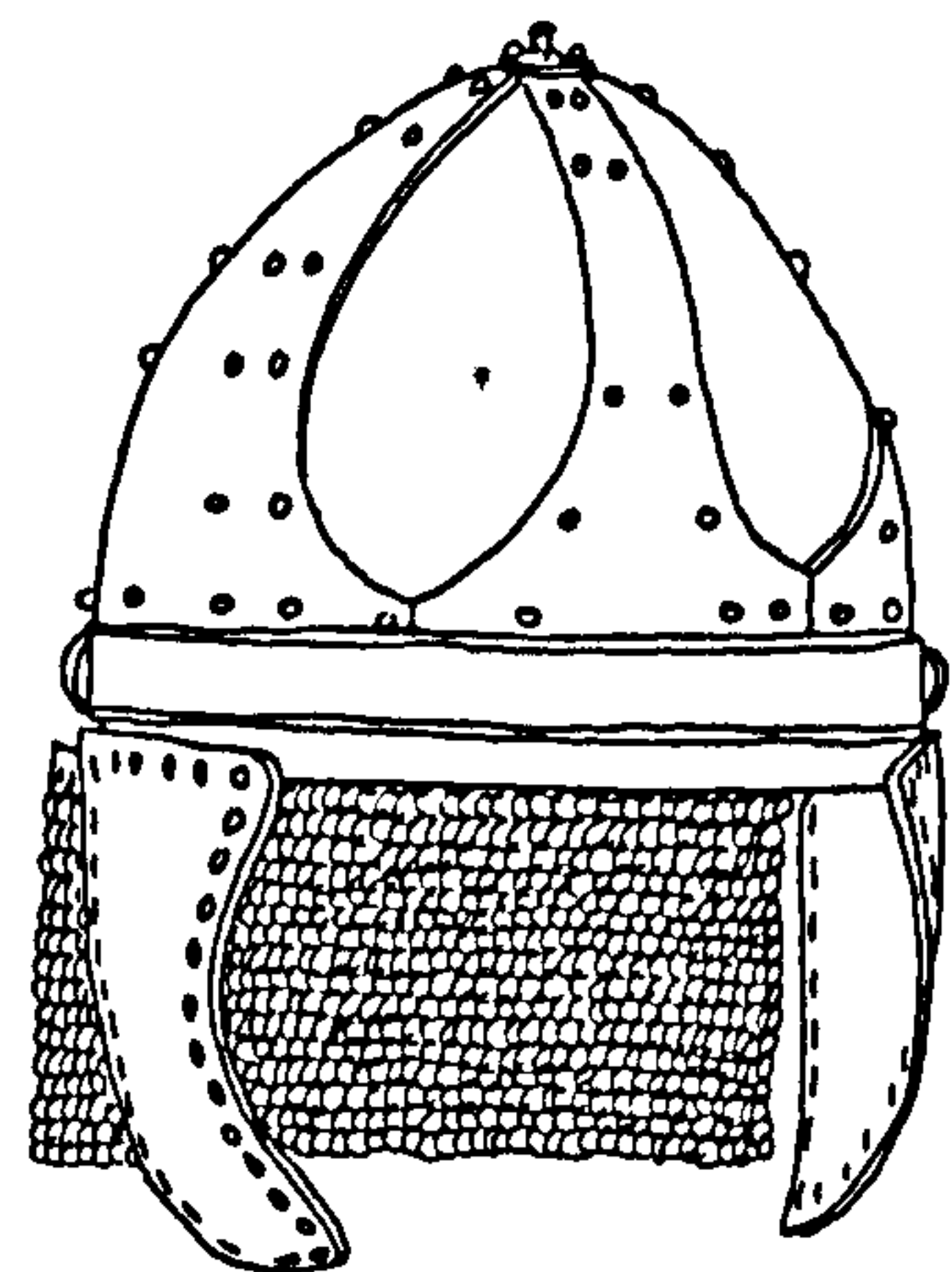

87

88

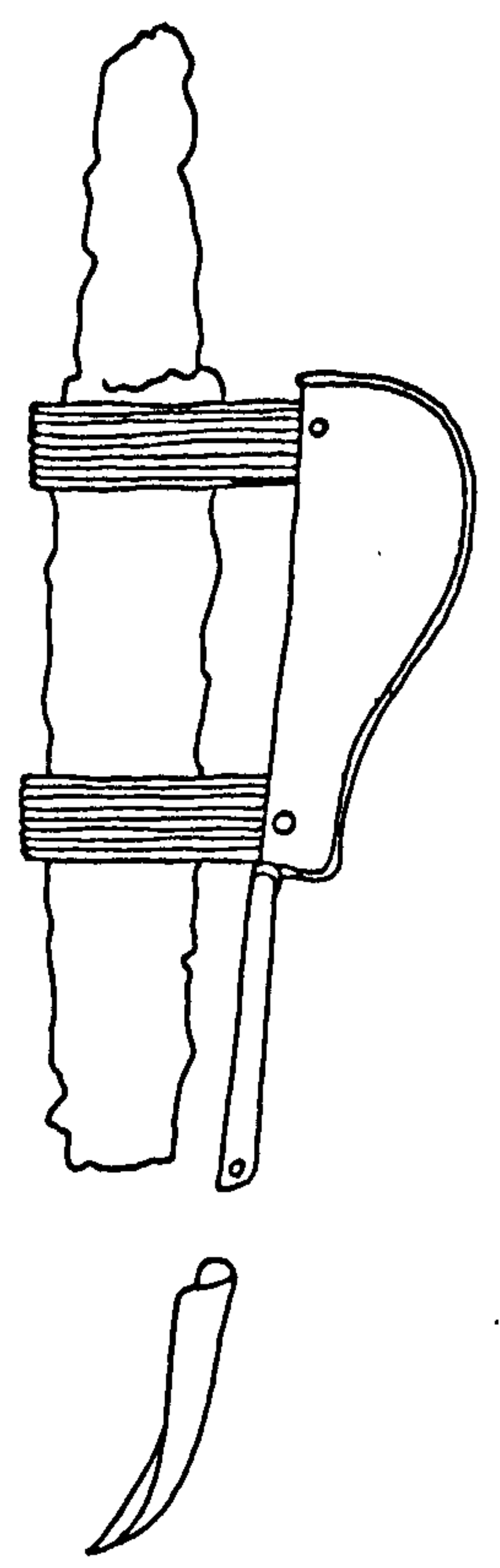
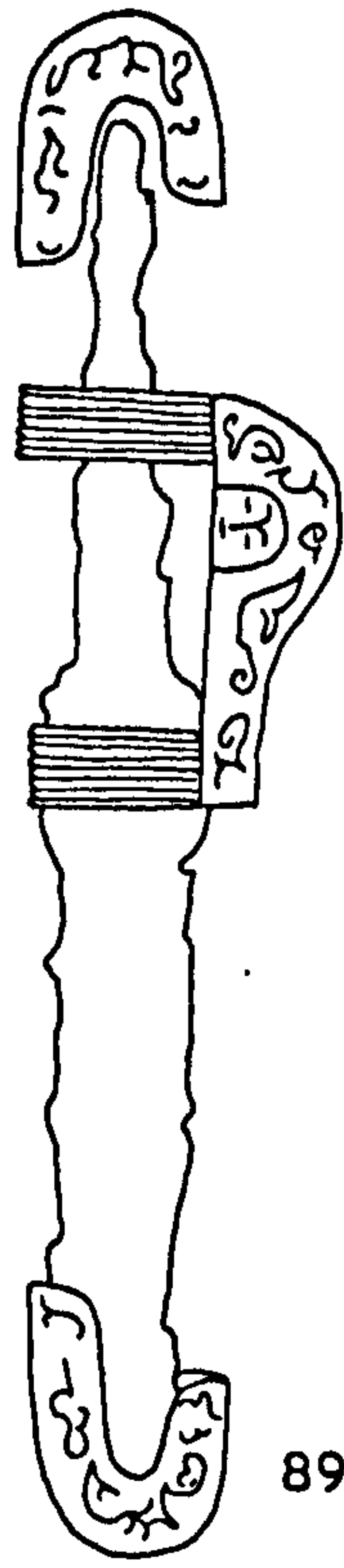
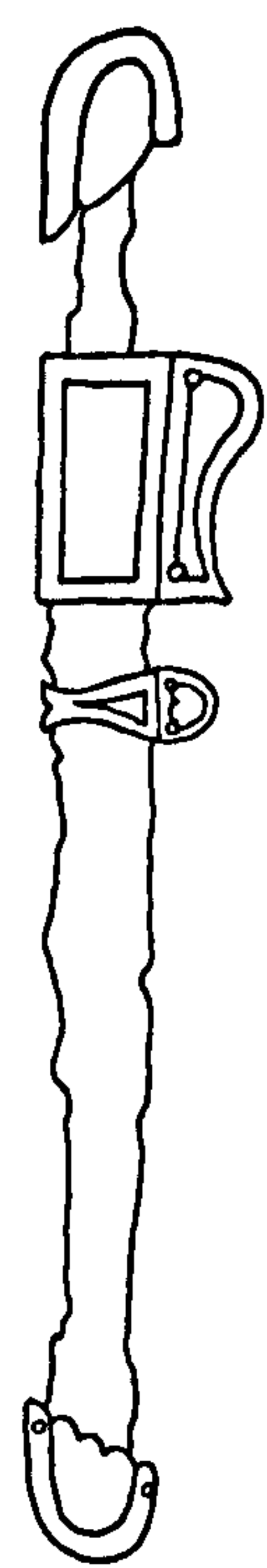

89

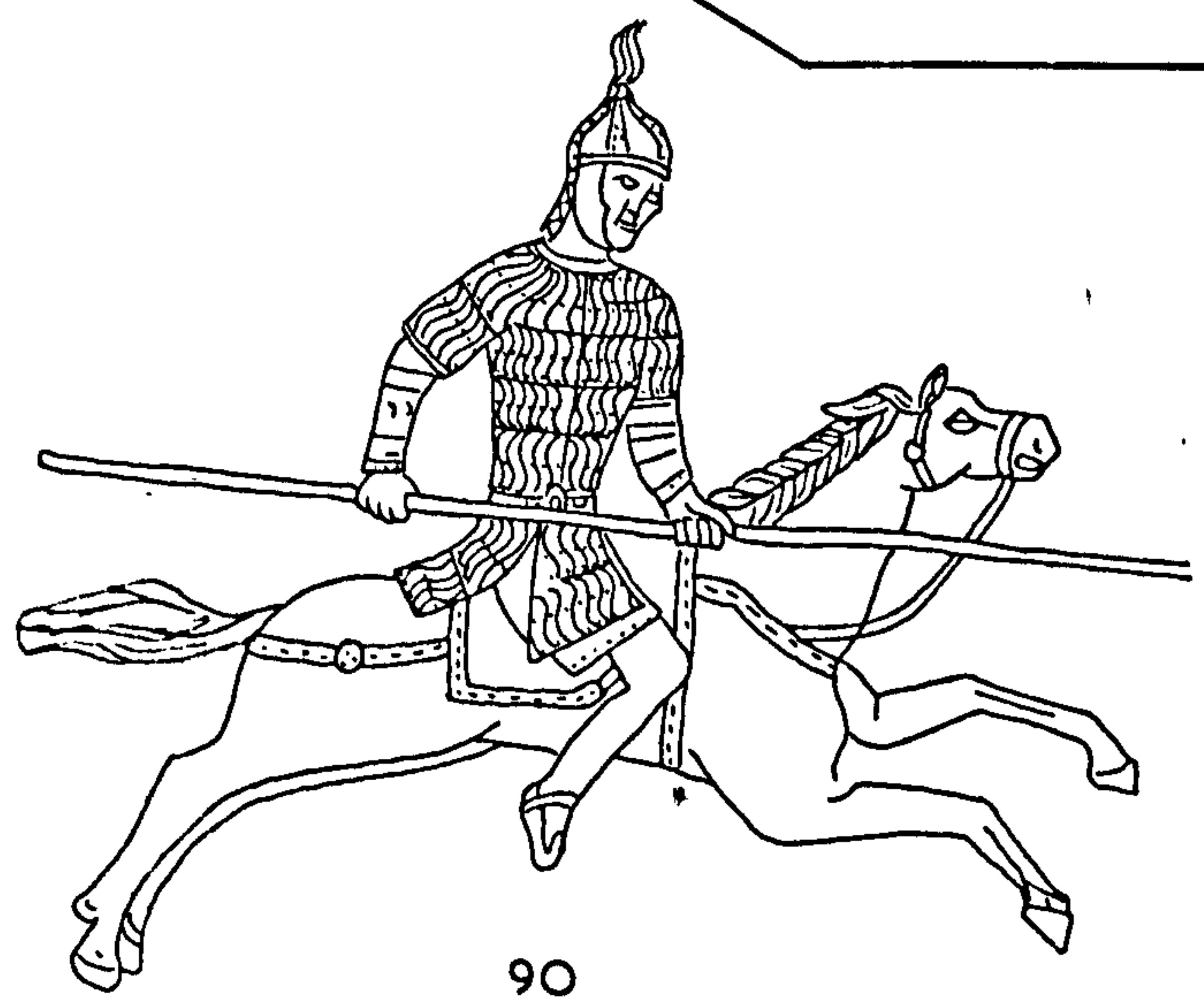

90

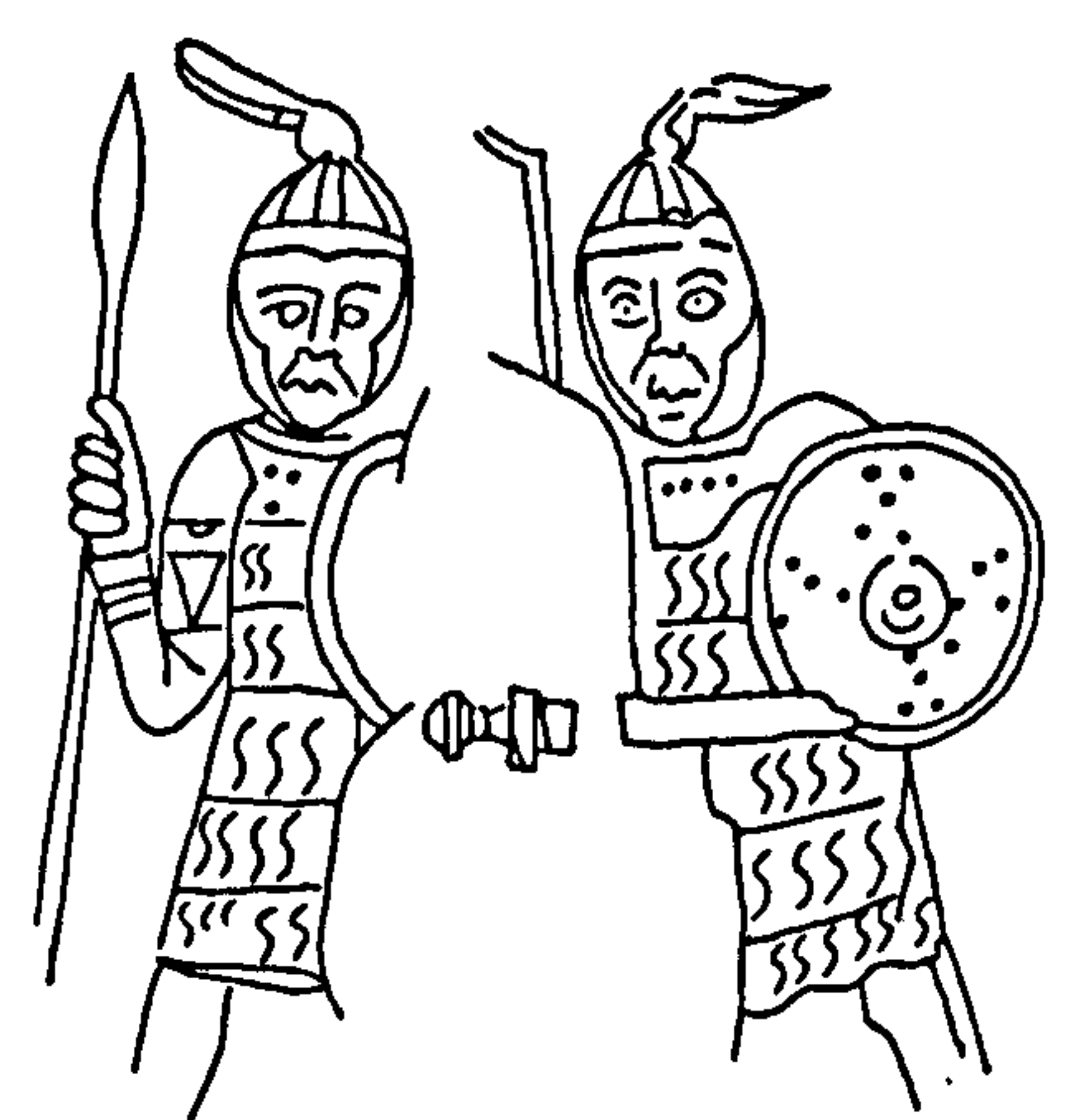

91

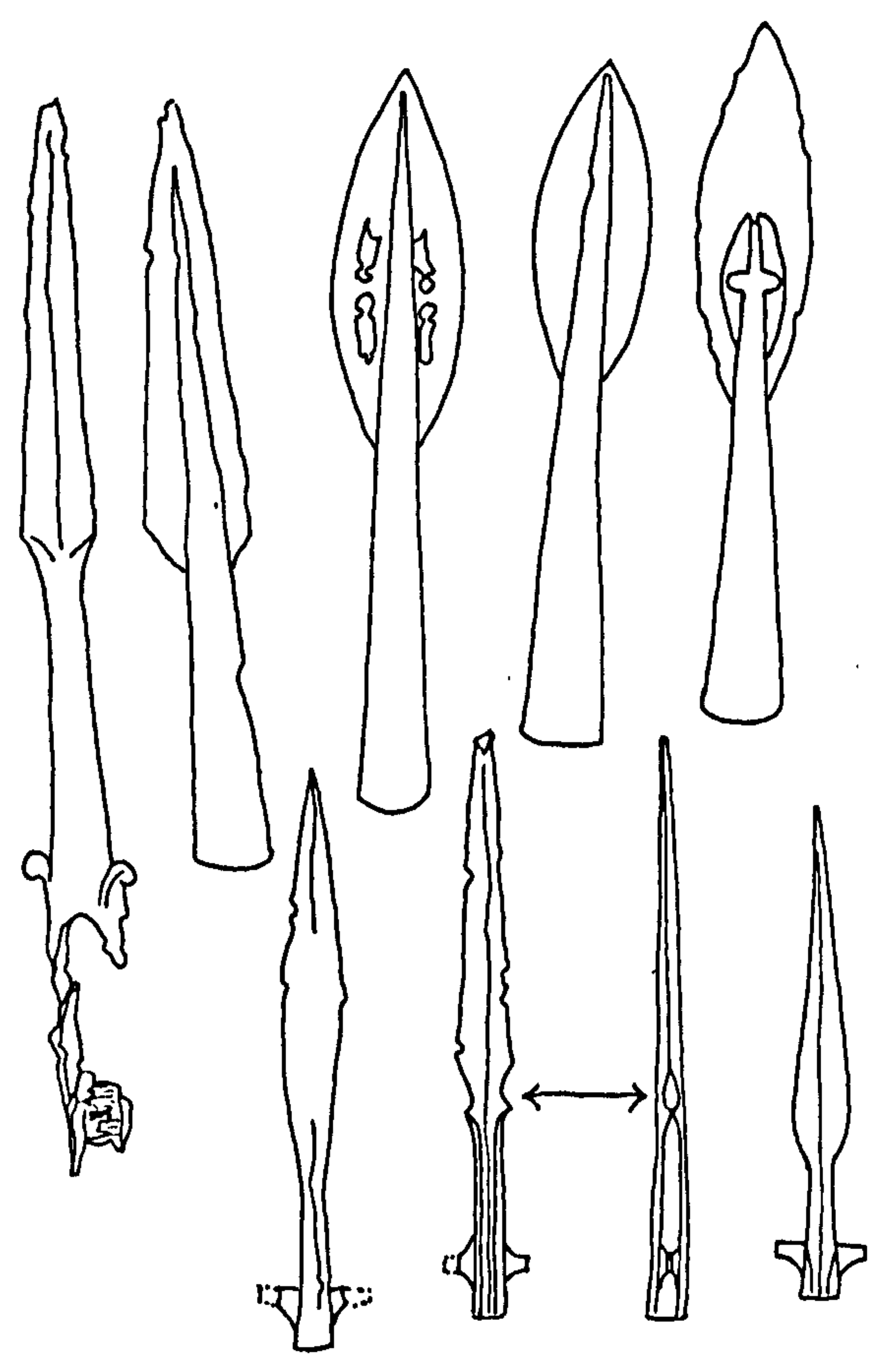

92



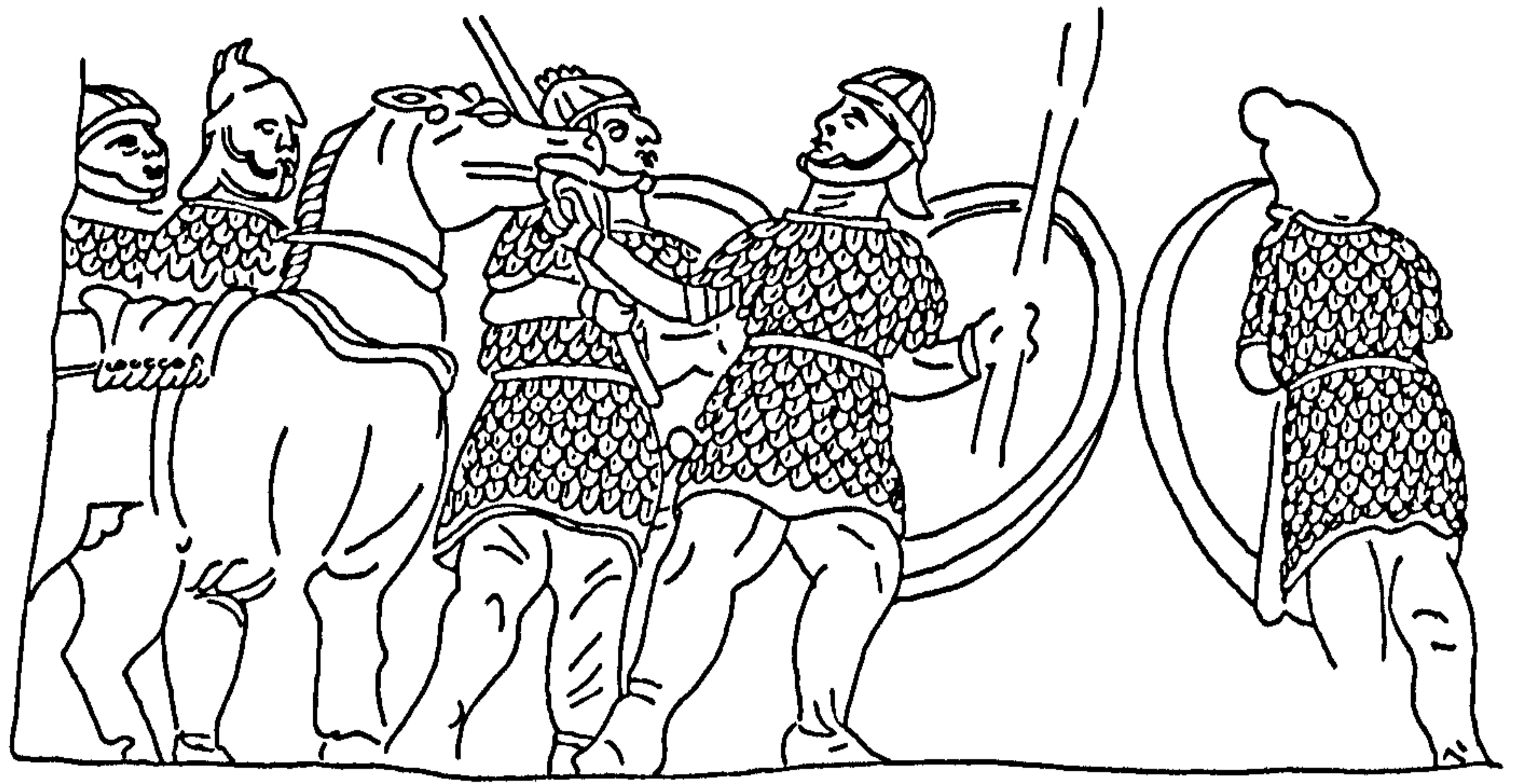

93



94

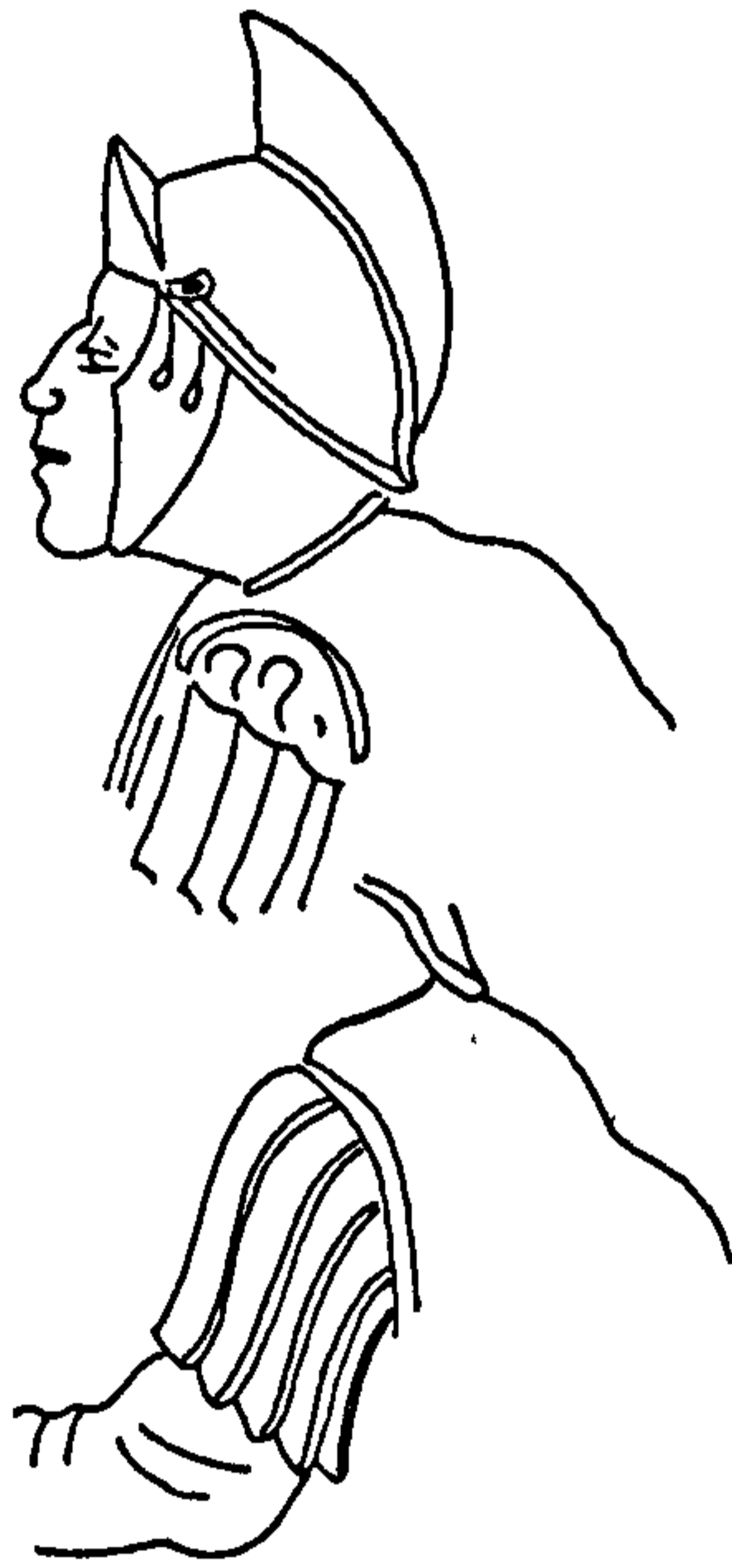

95

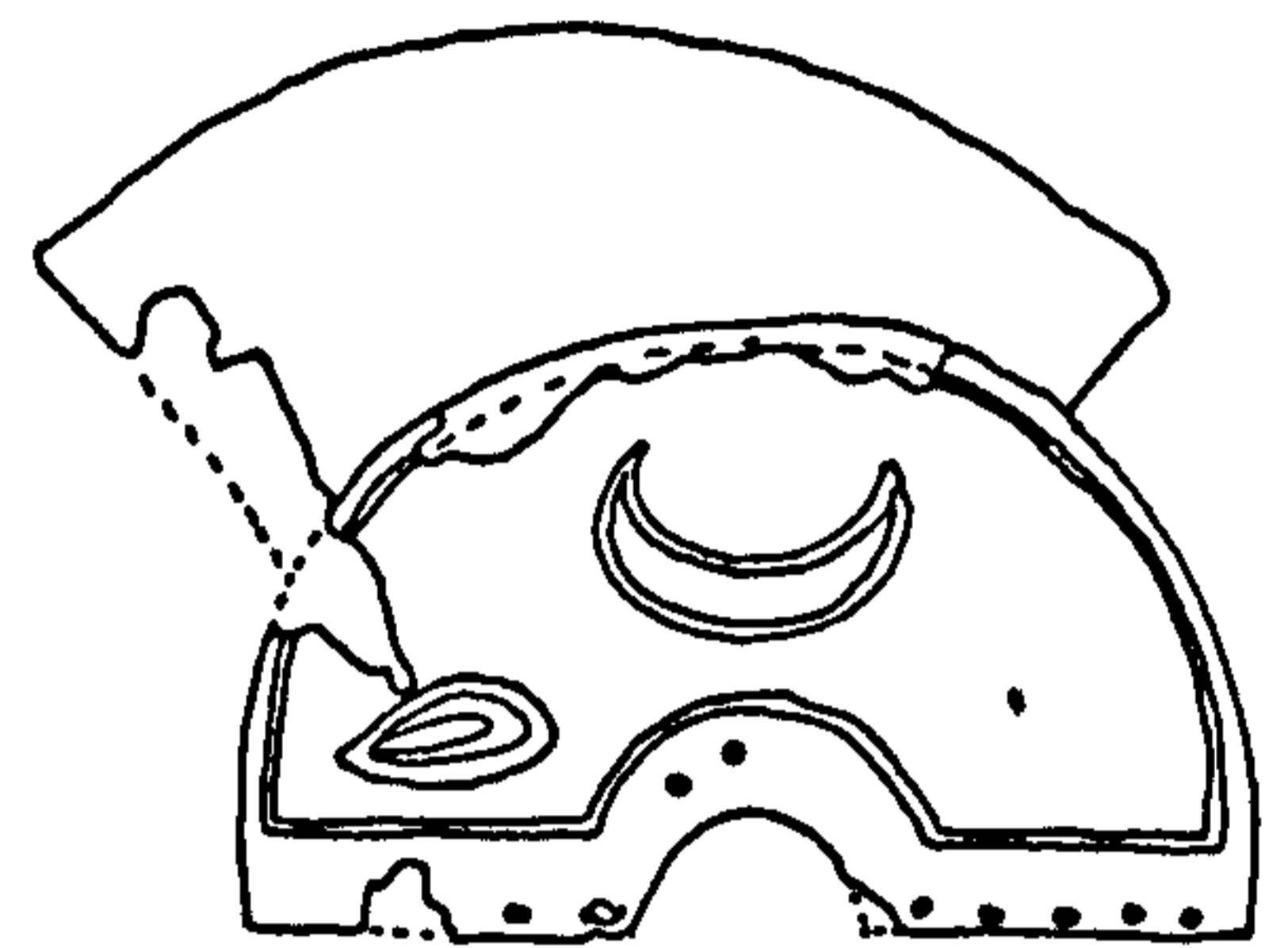

96

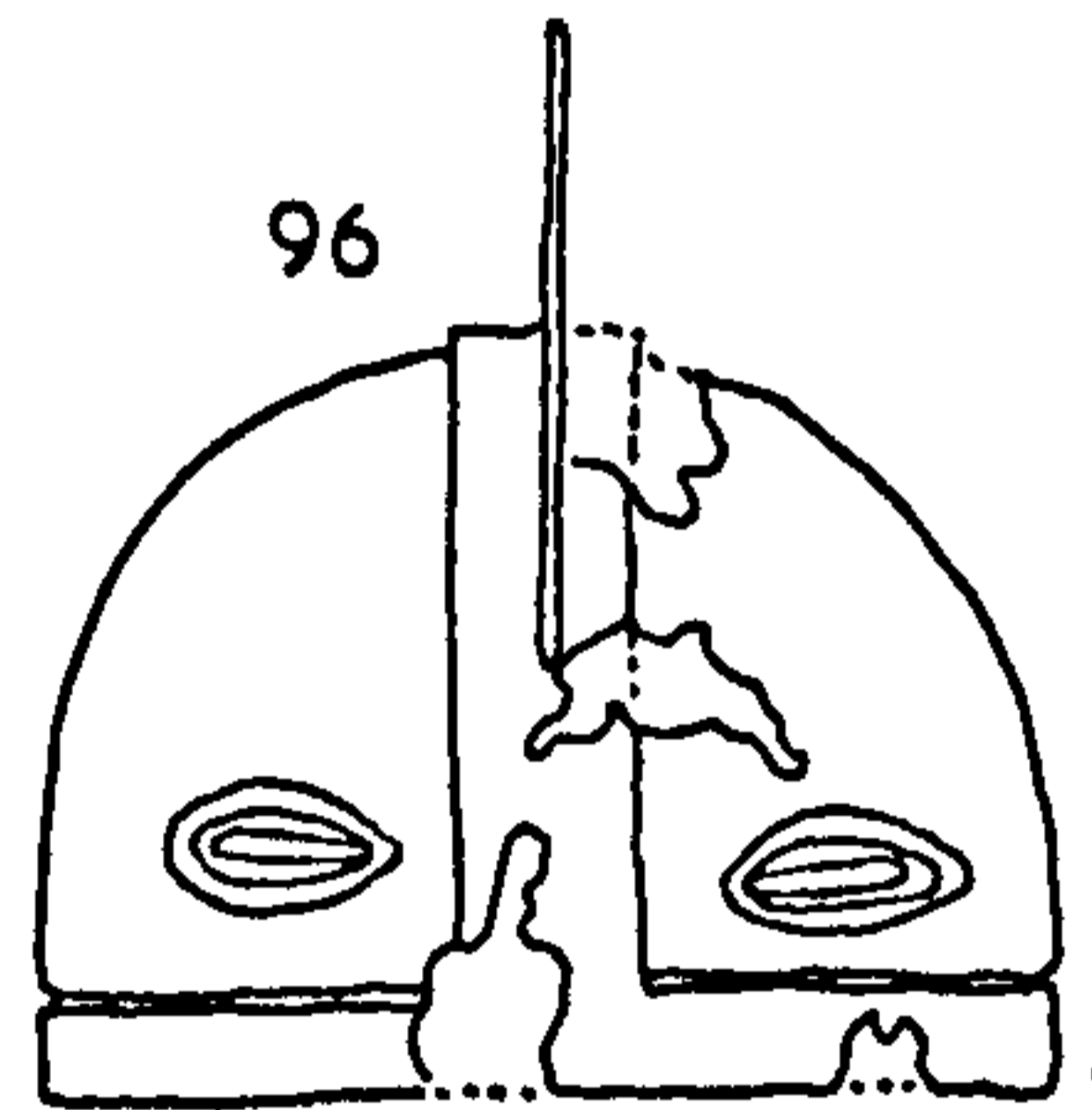

97

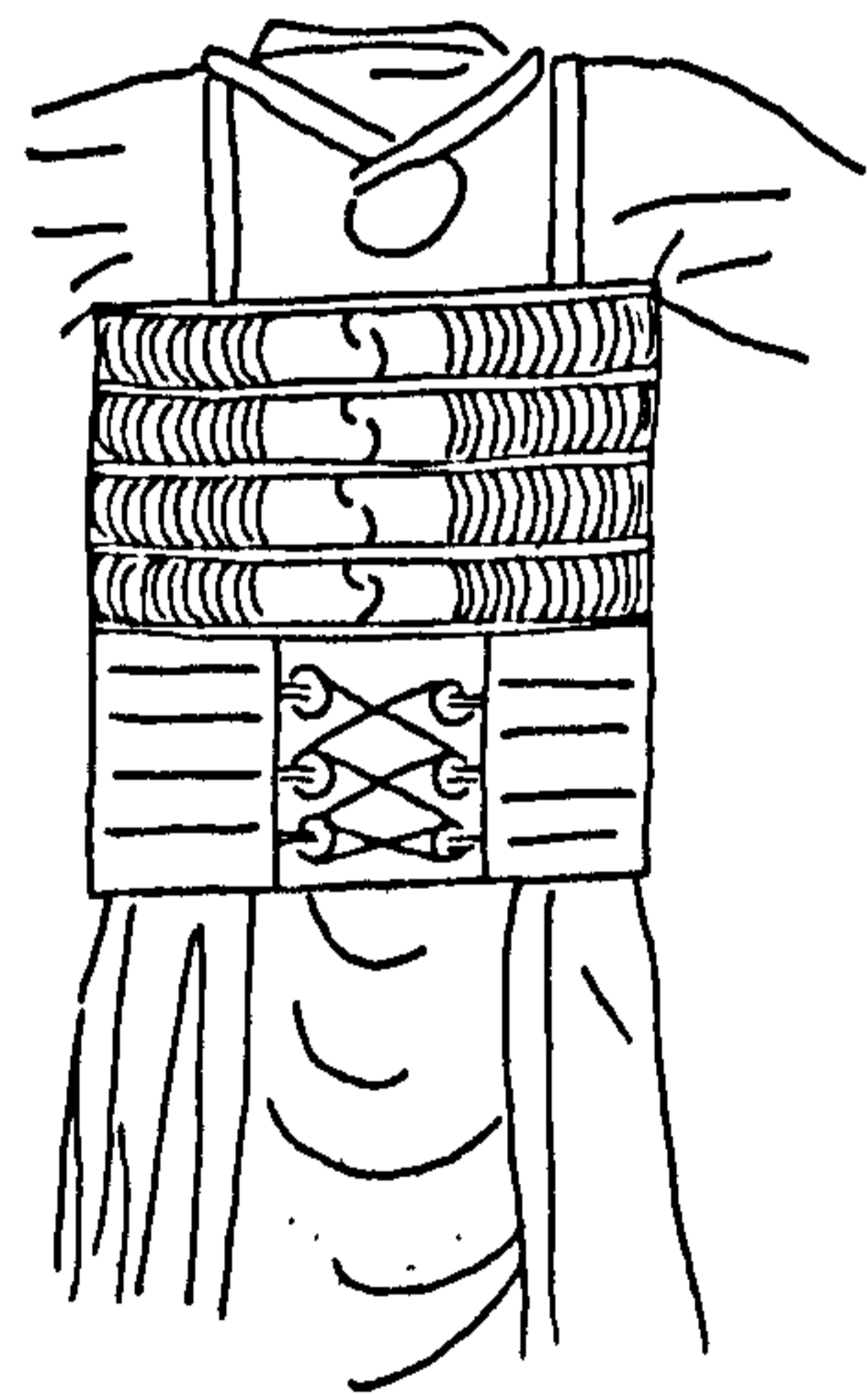

98

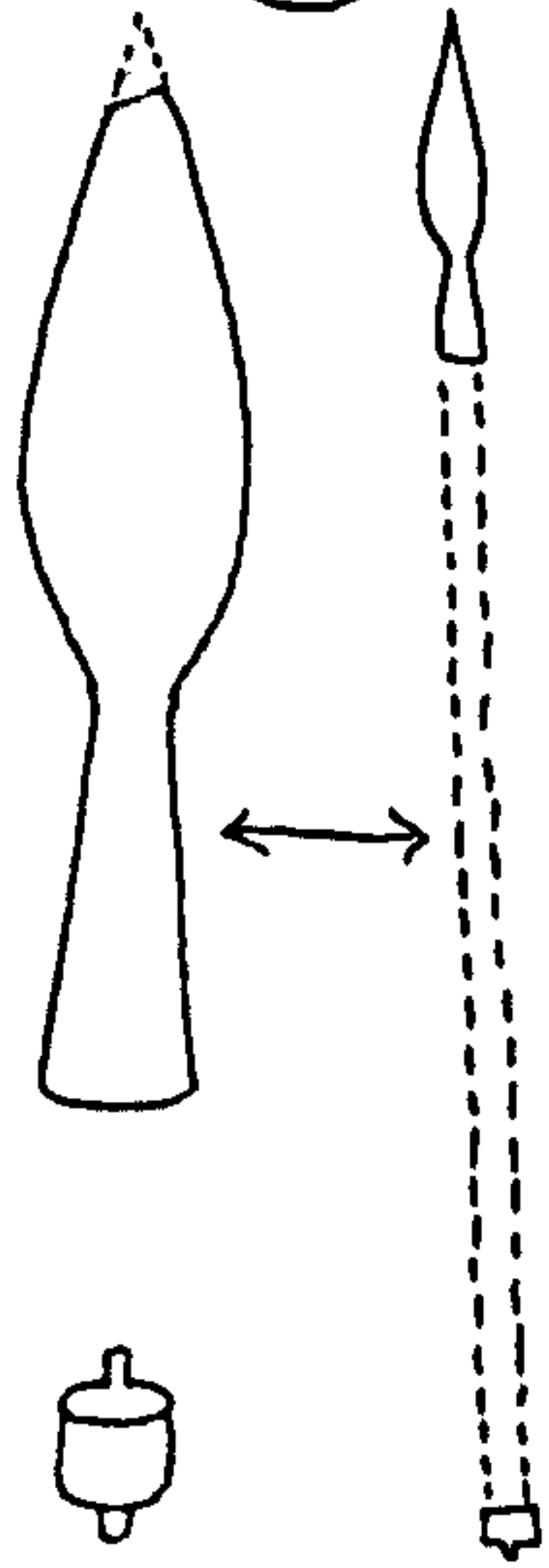
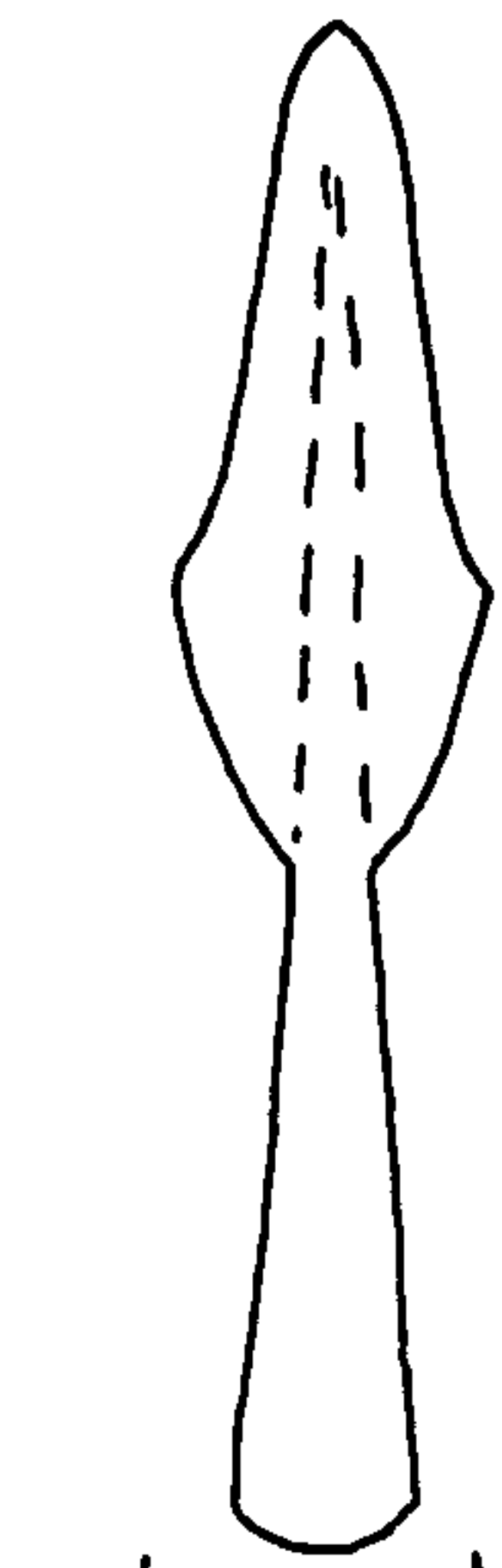

99

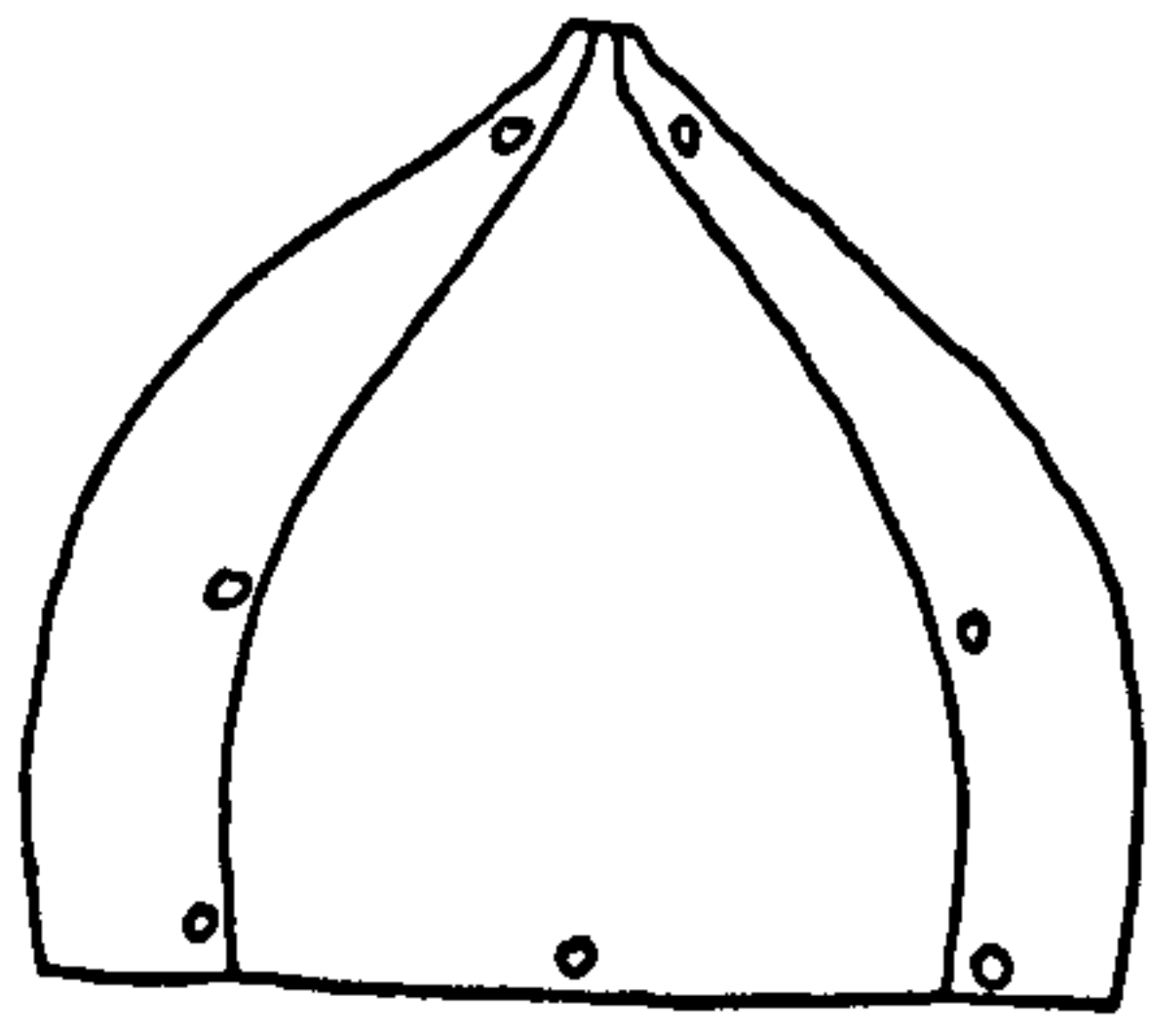

(Decorative band)

100

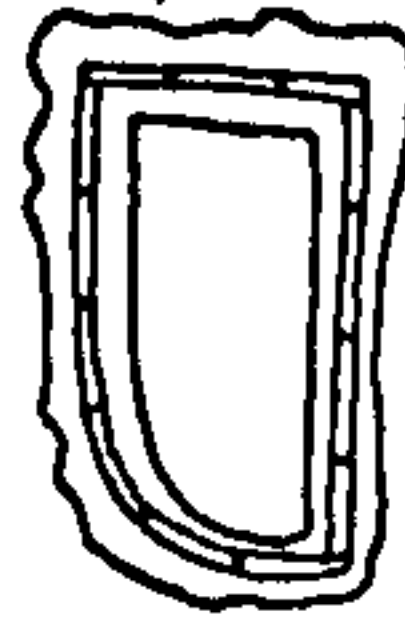
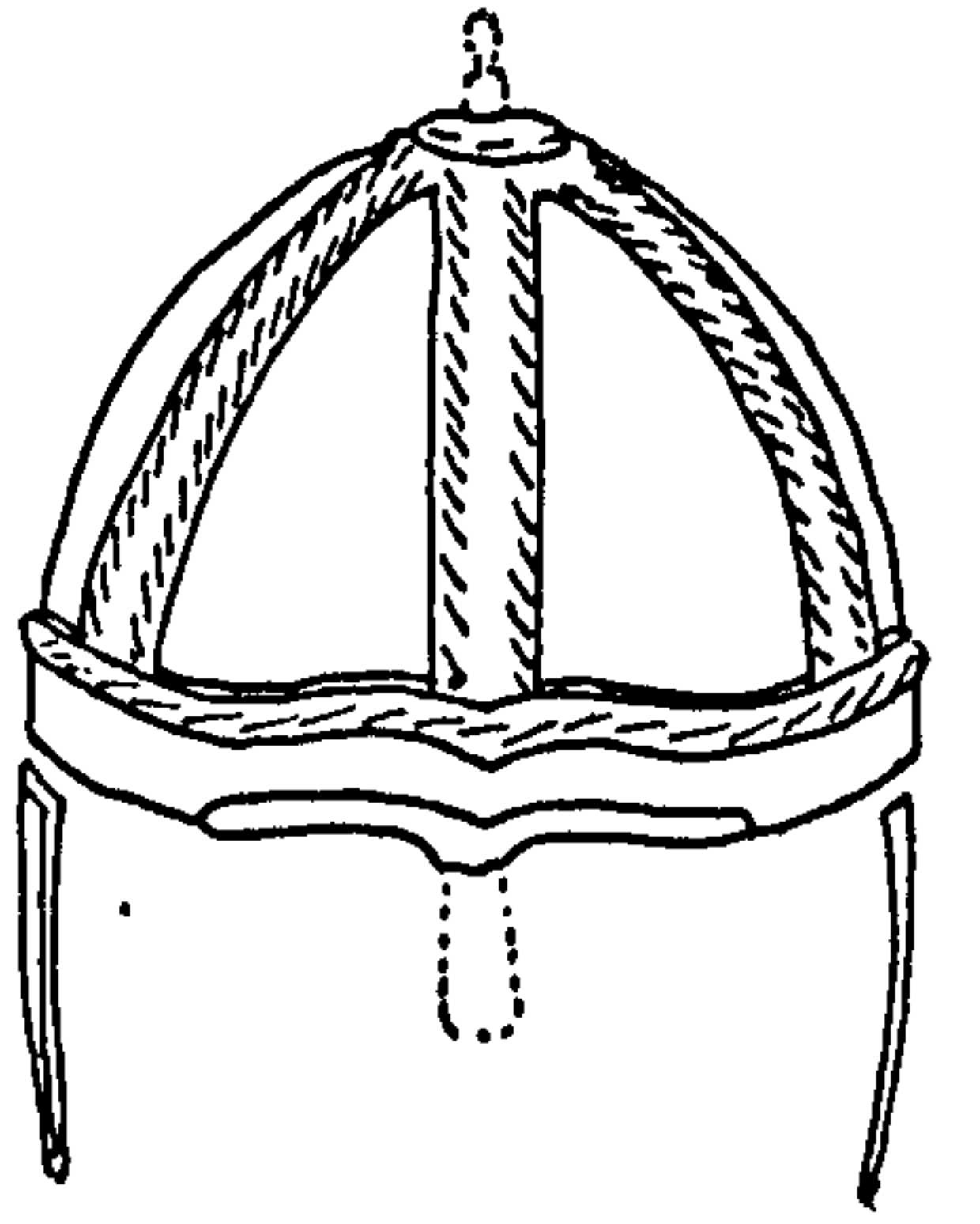
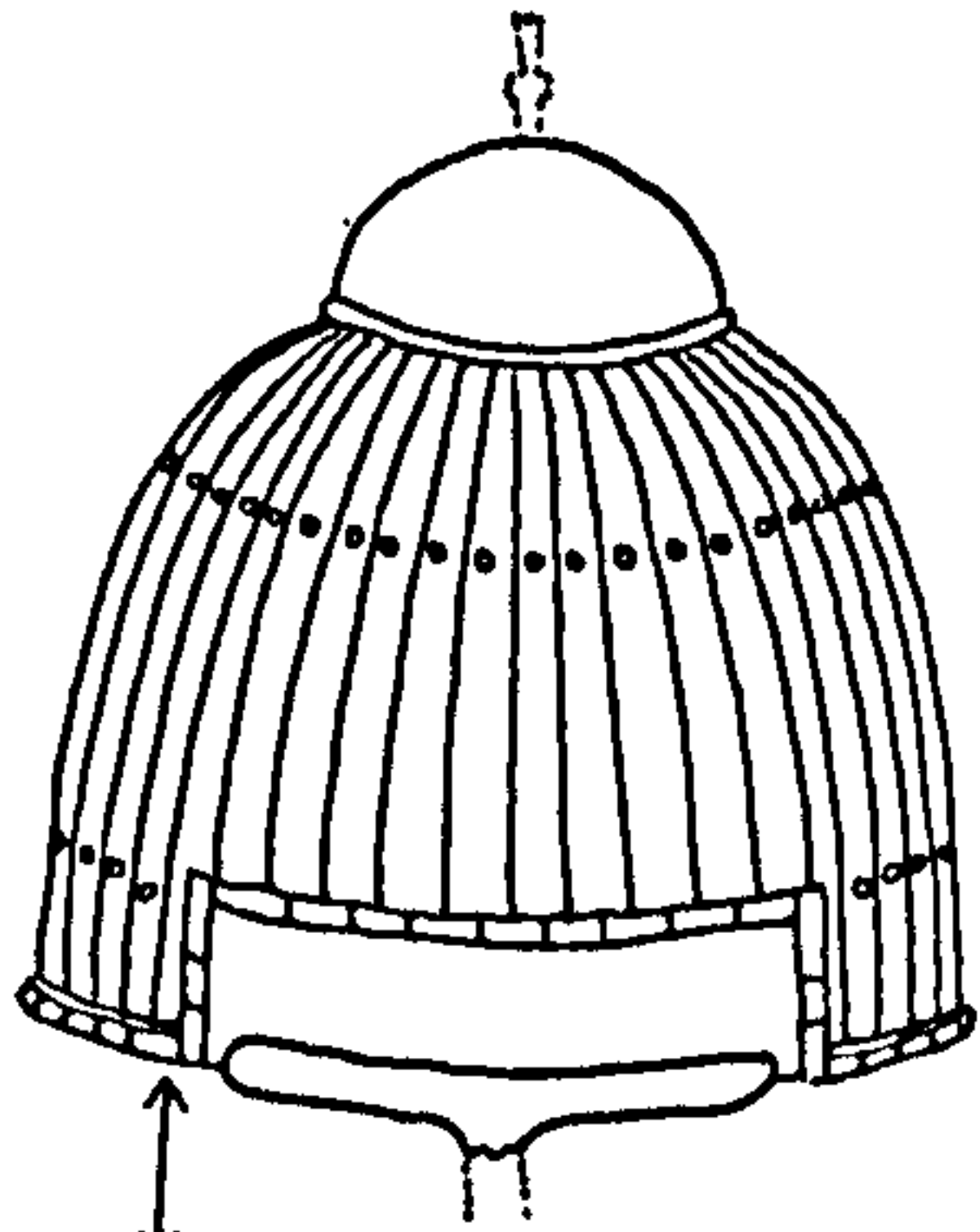

101

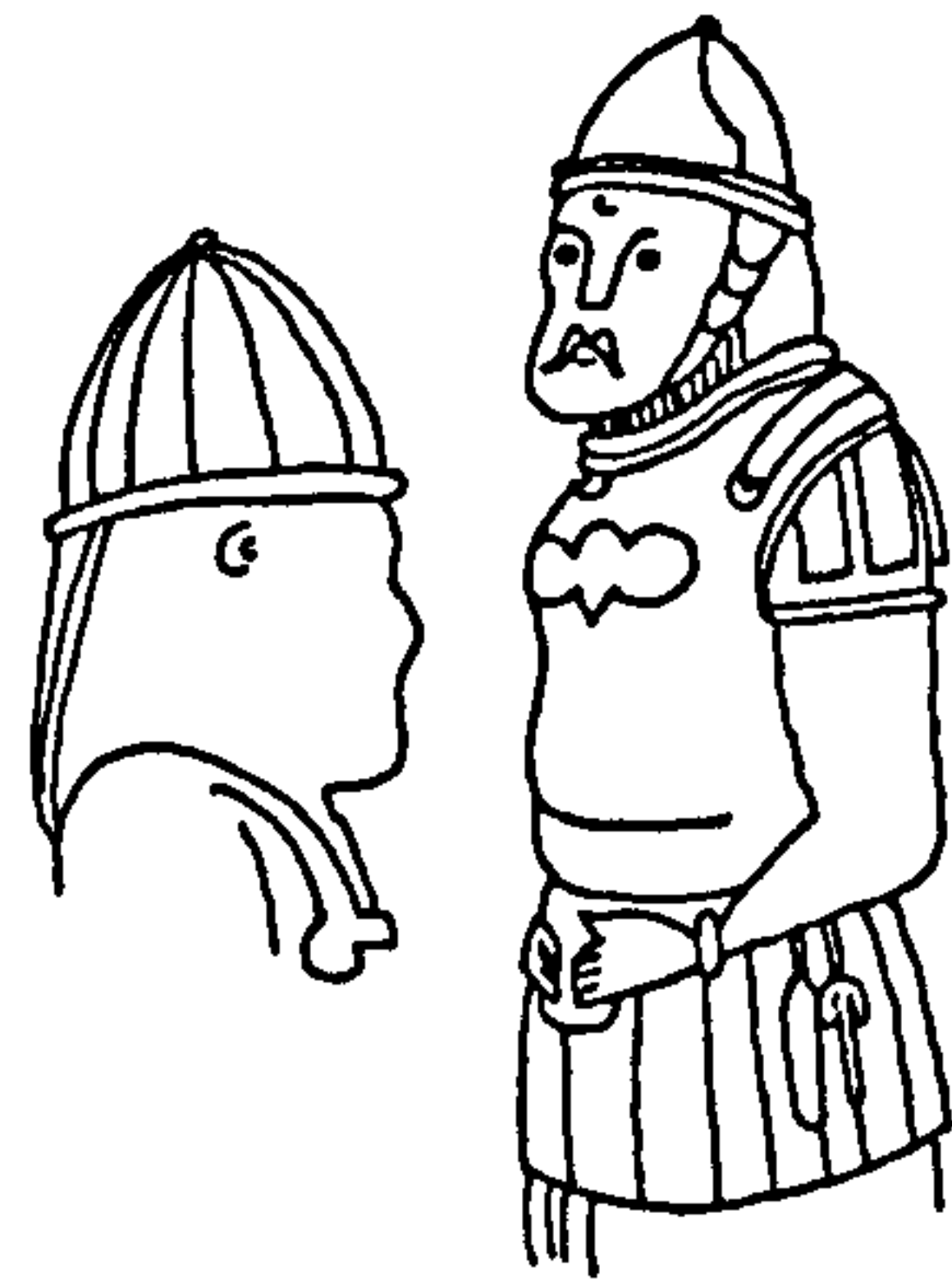

102

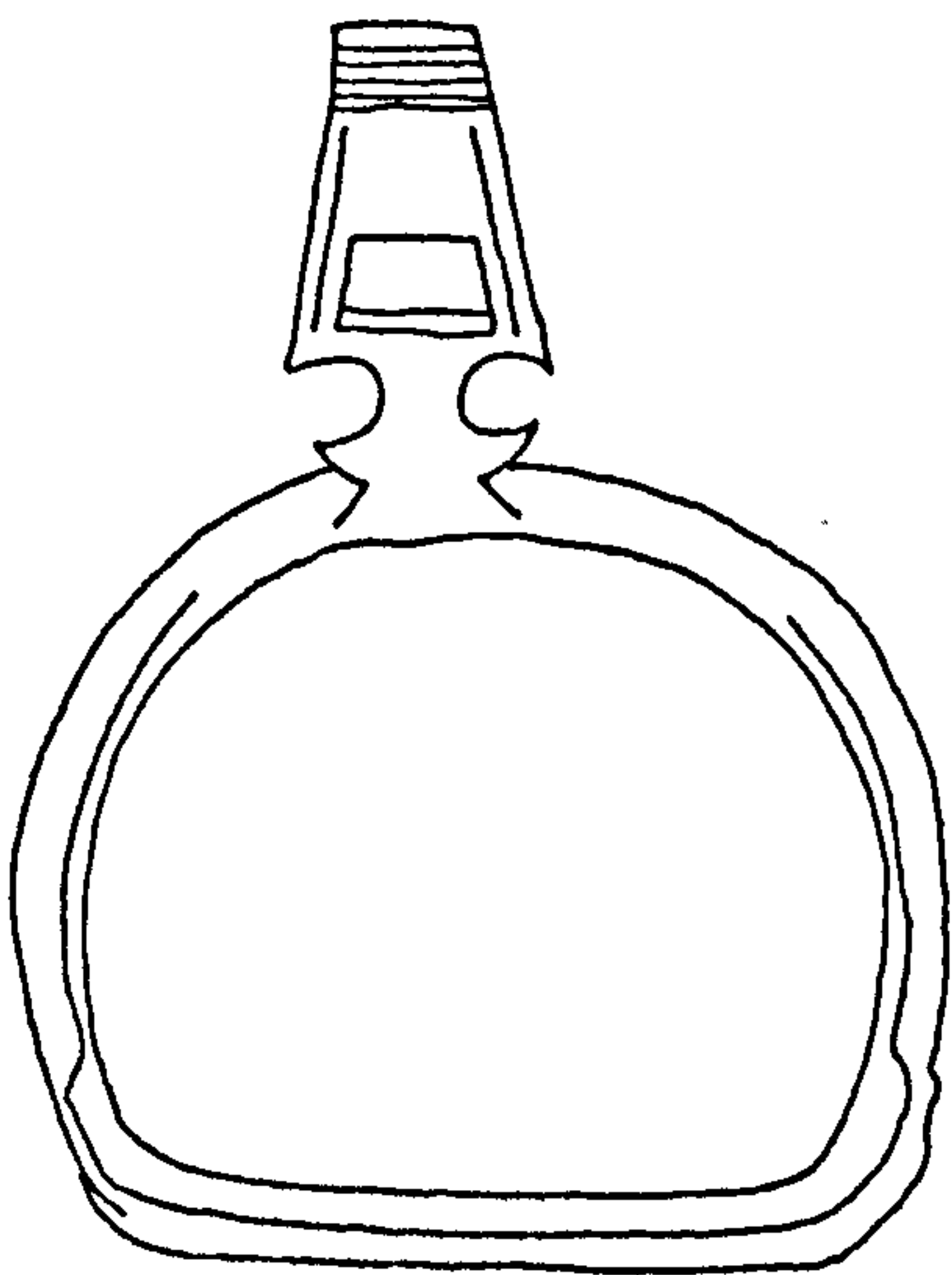

103

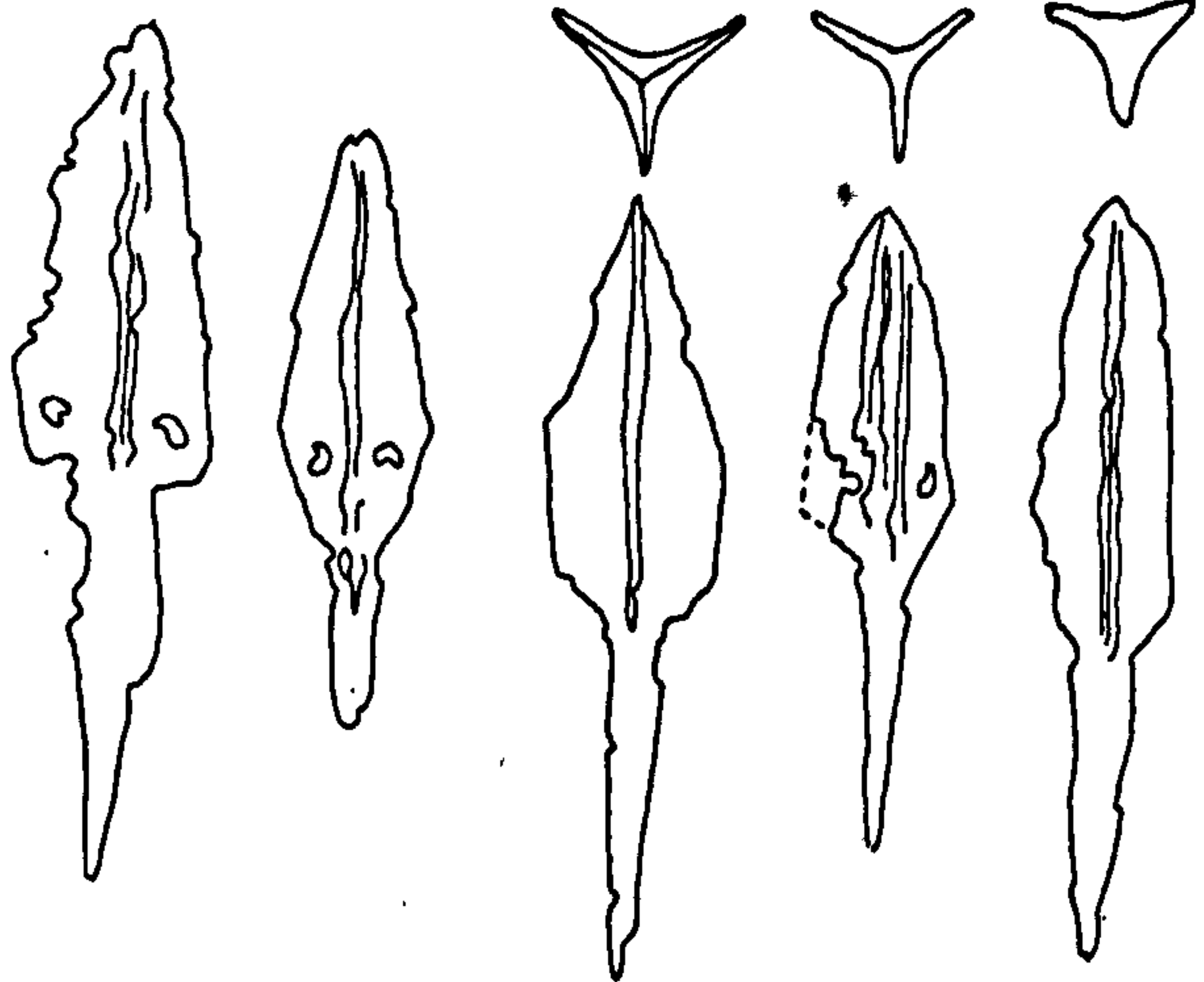

104

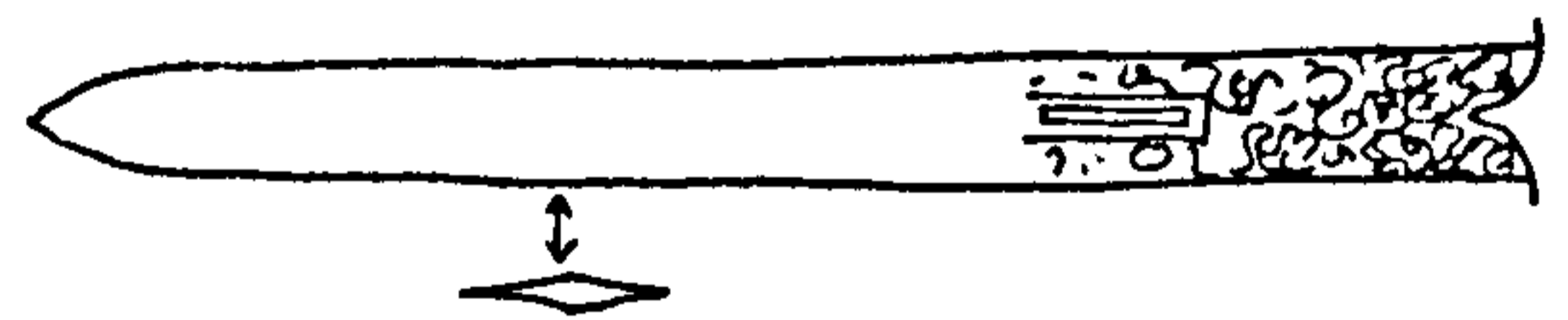
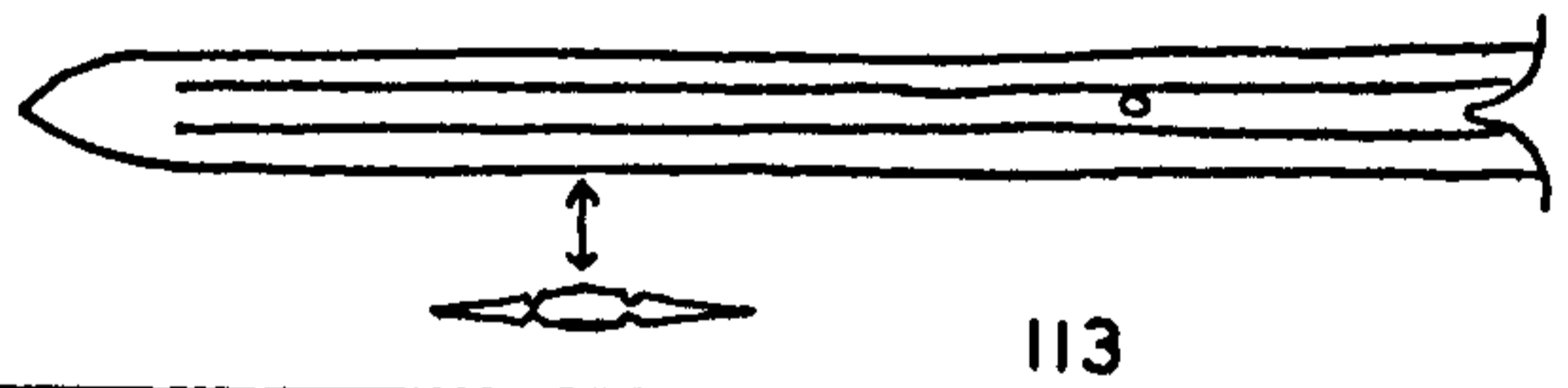
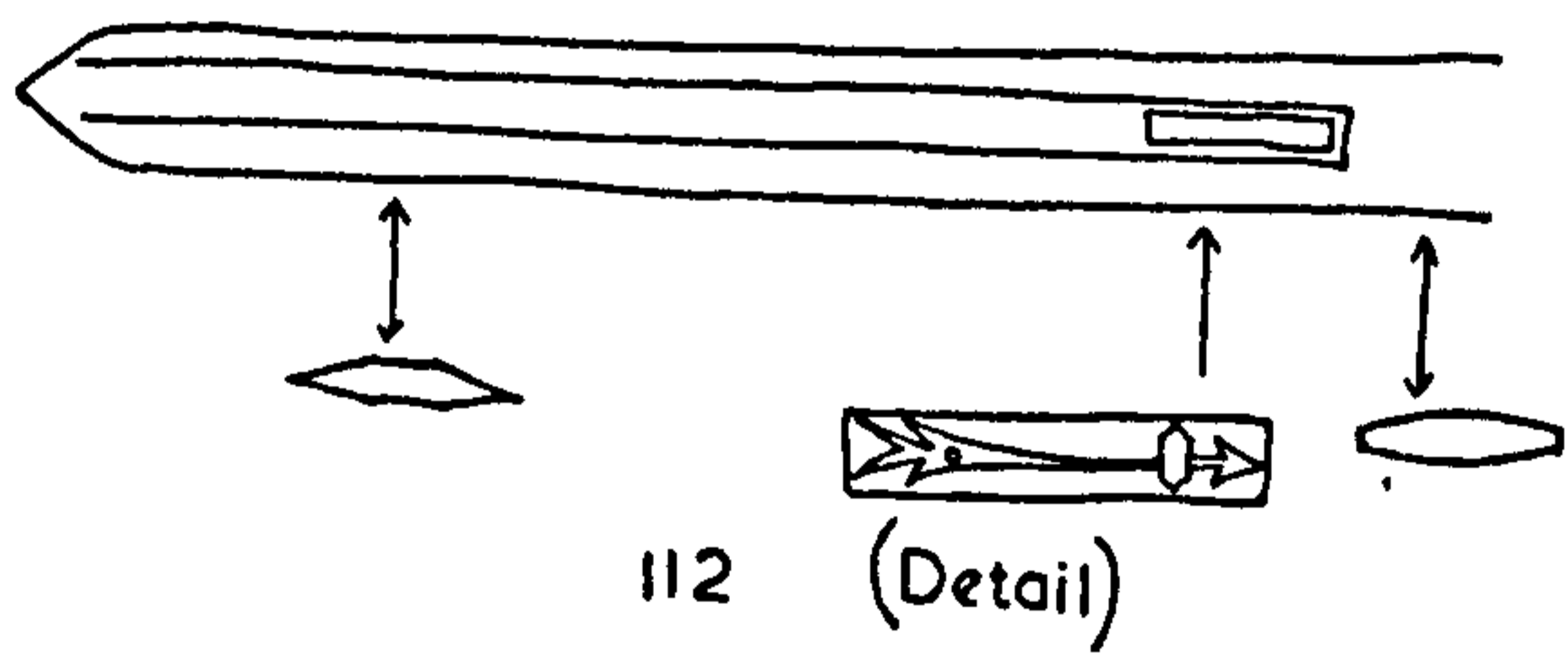
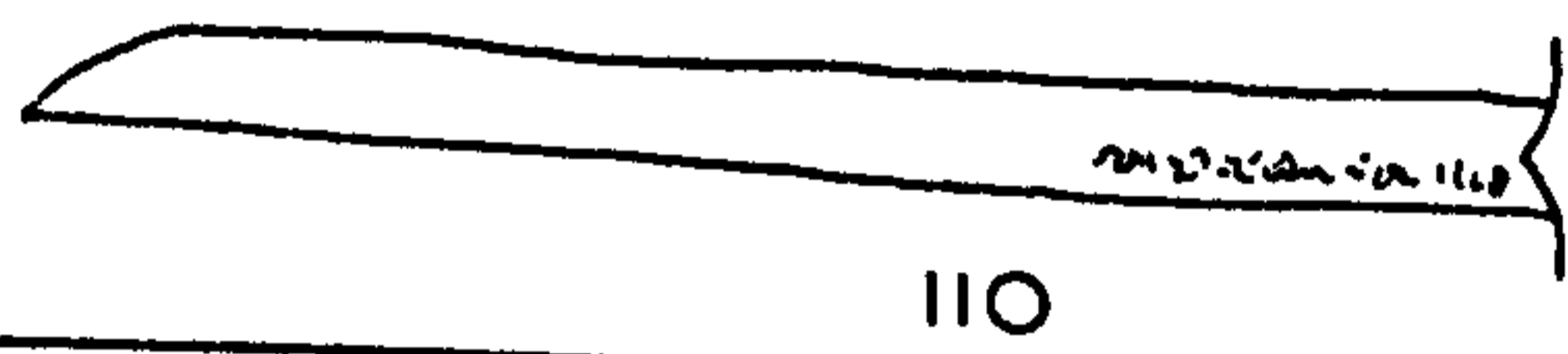
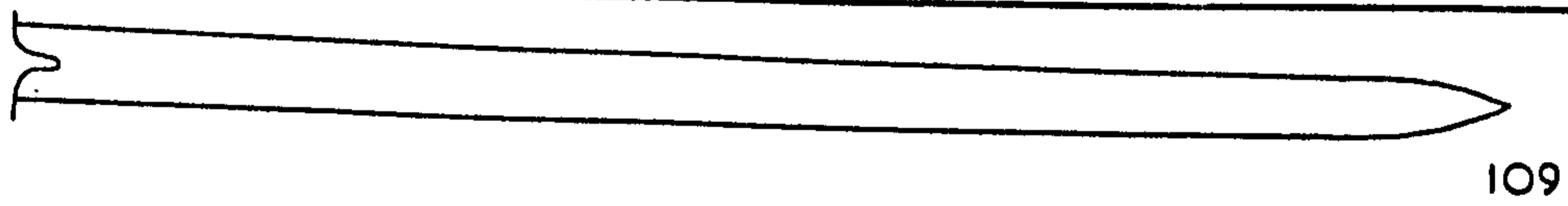
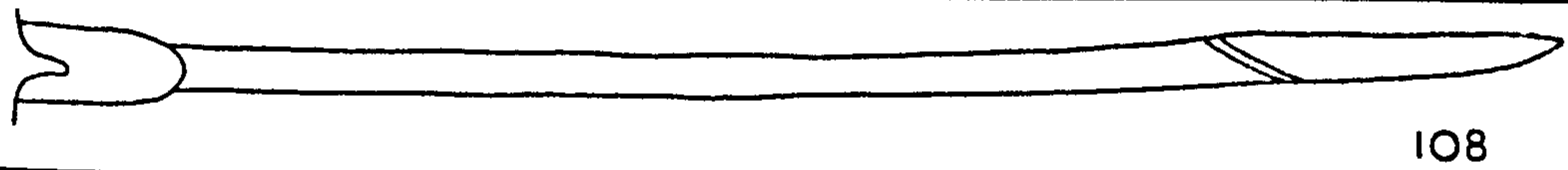
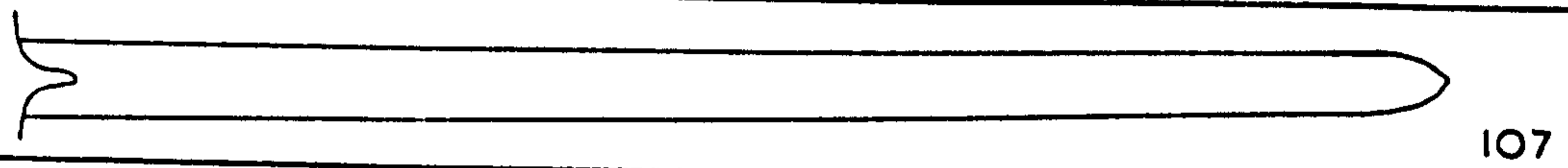
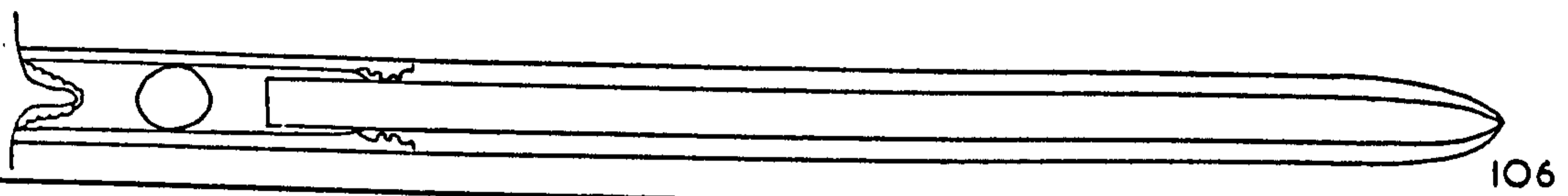
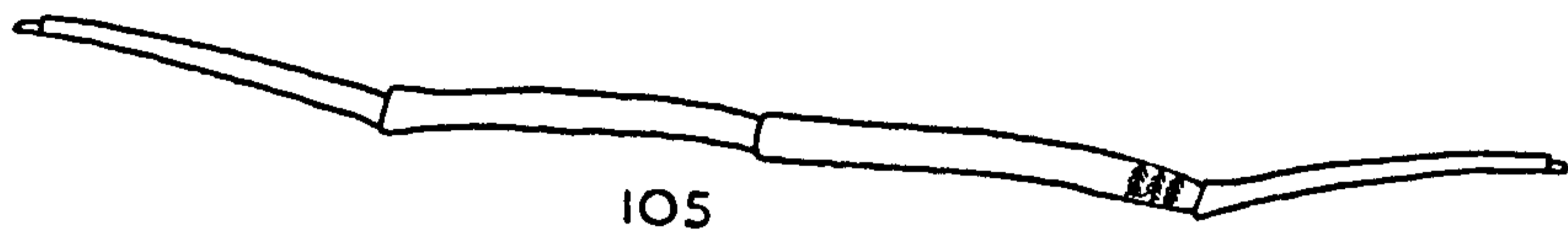

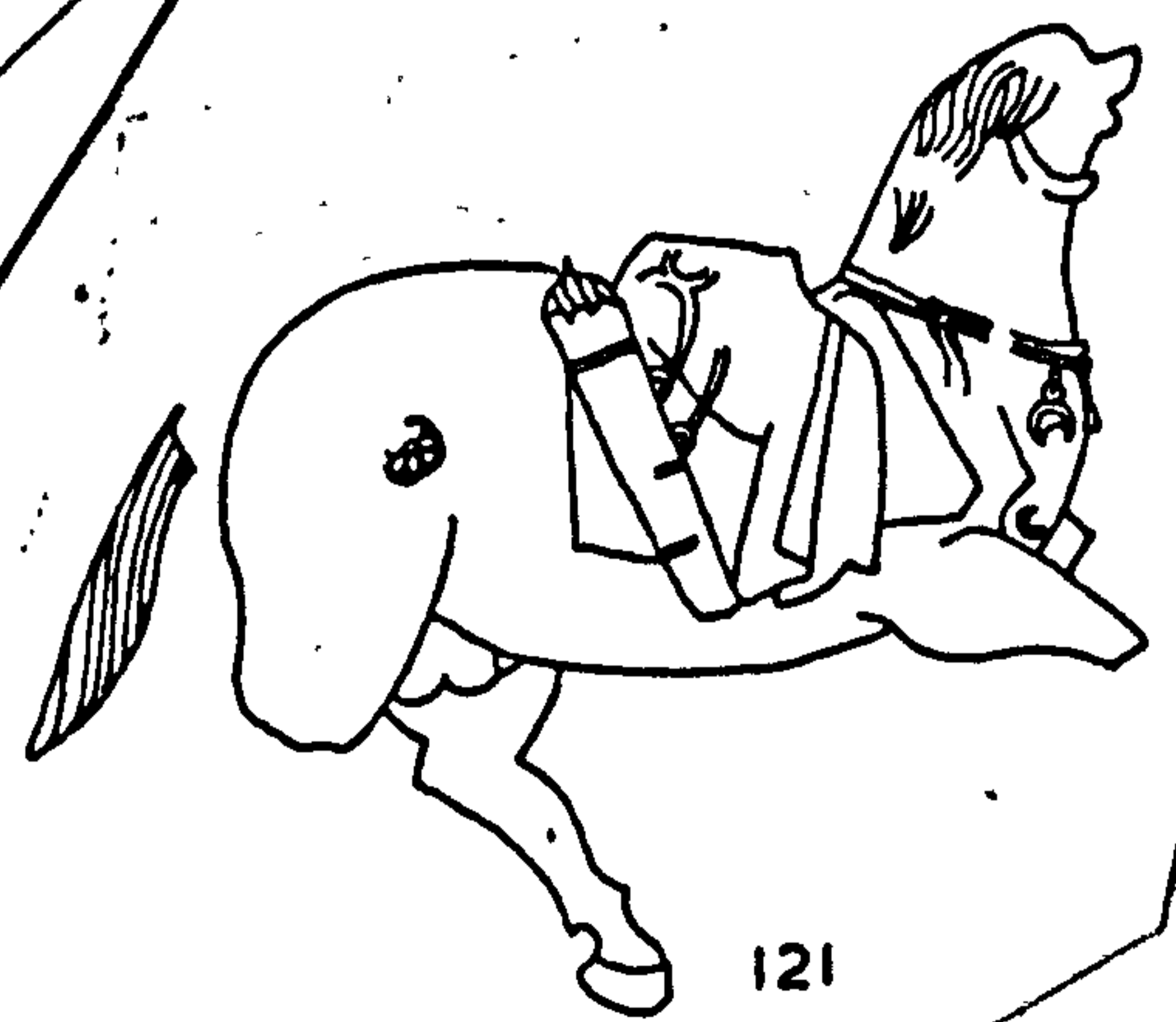
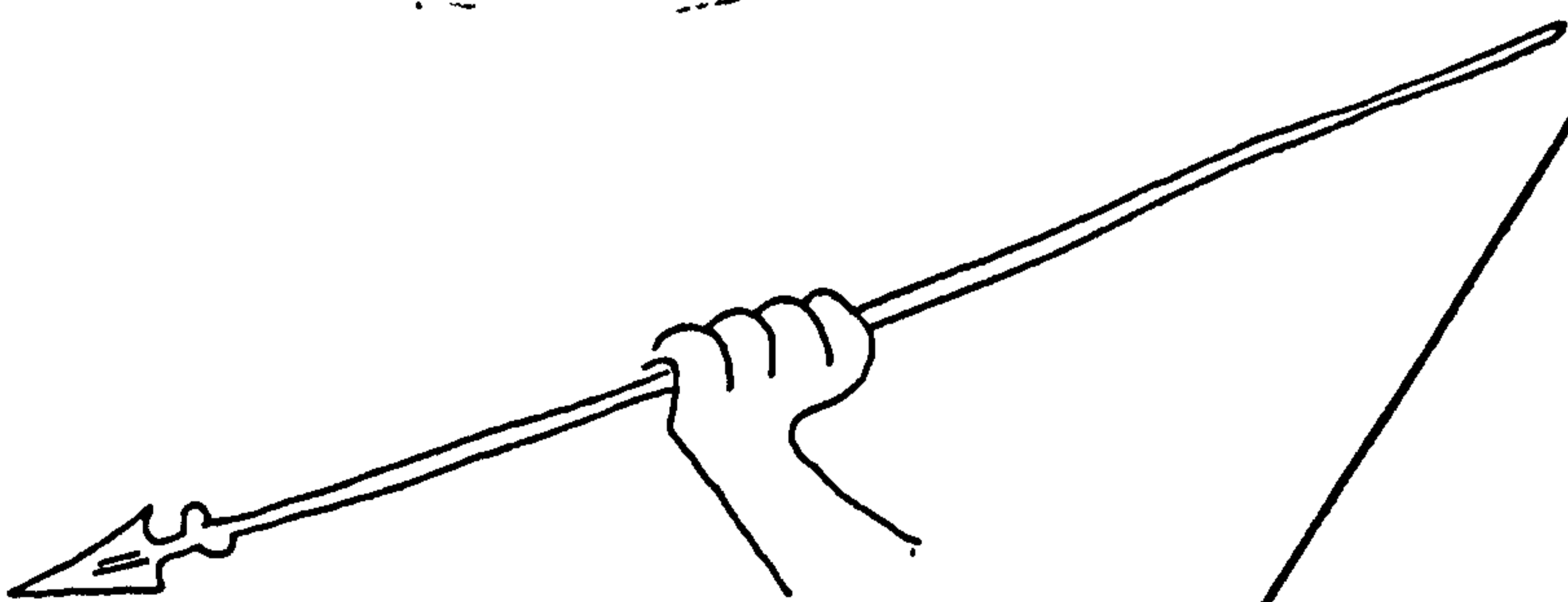
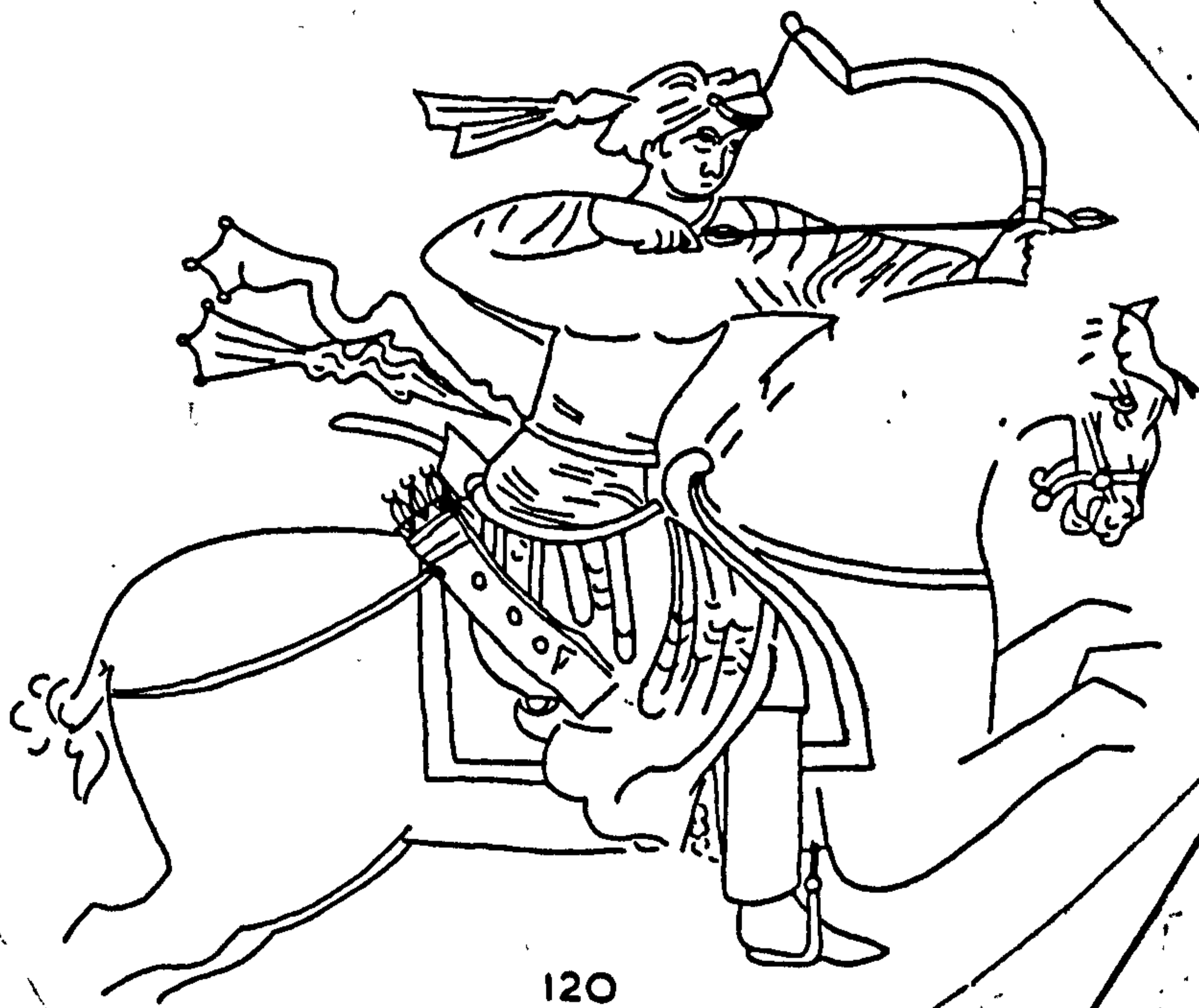
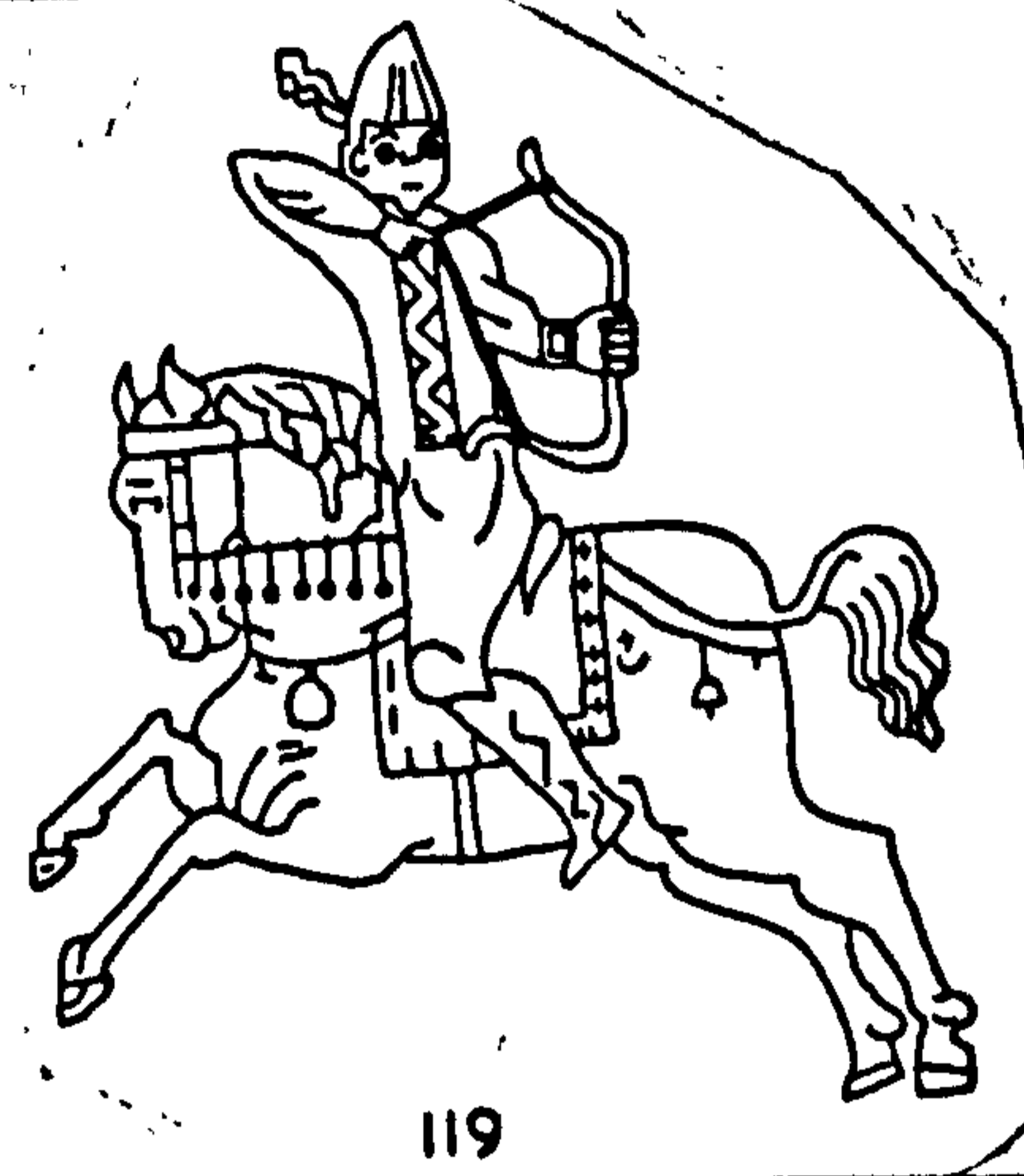
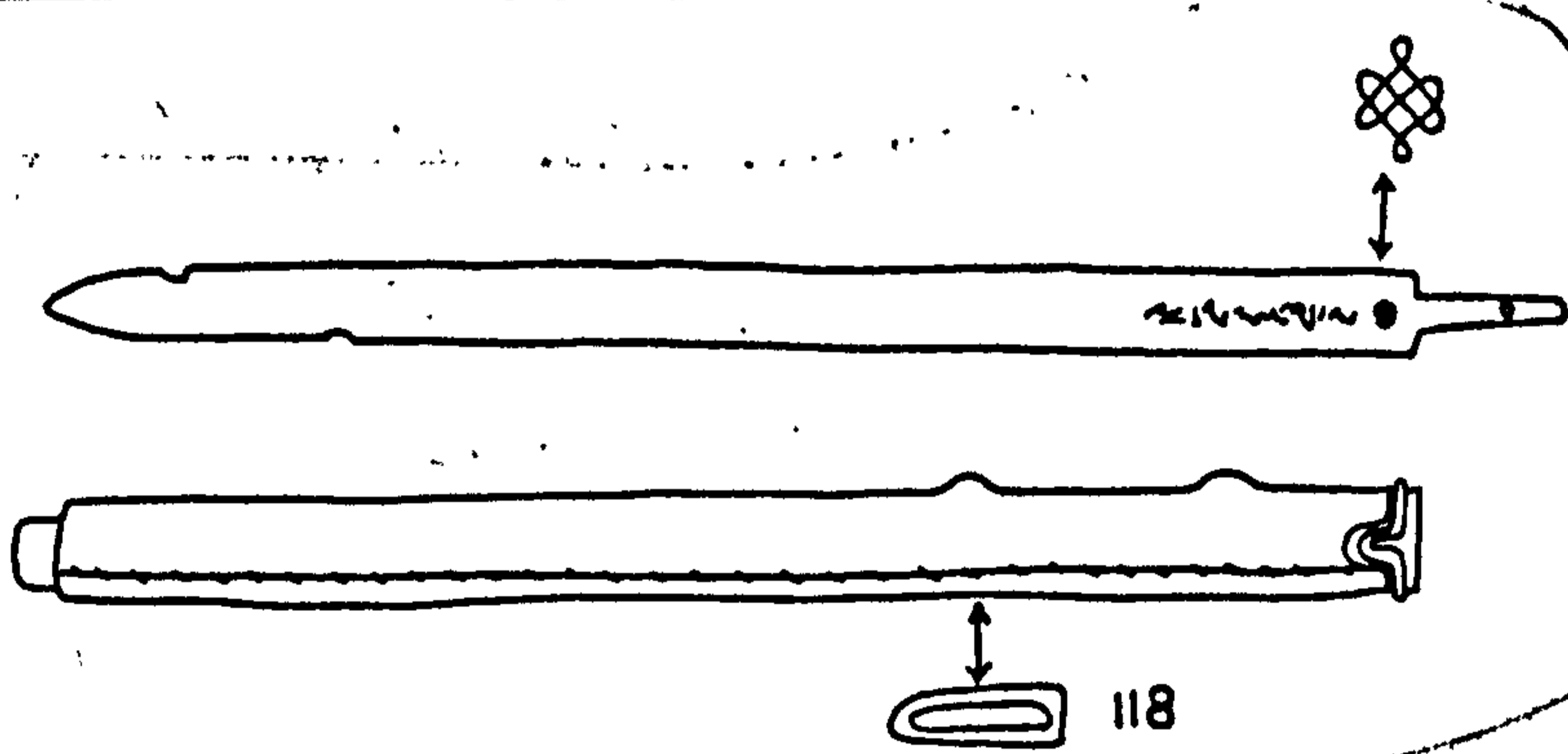
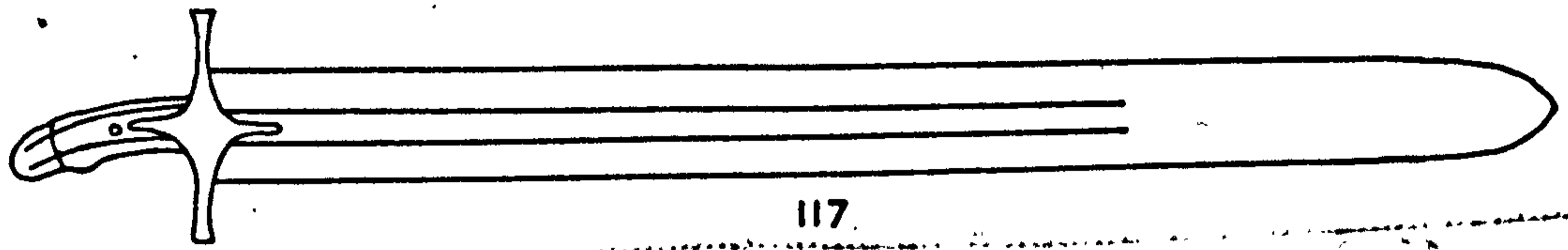
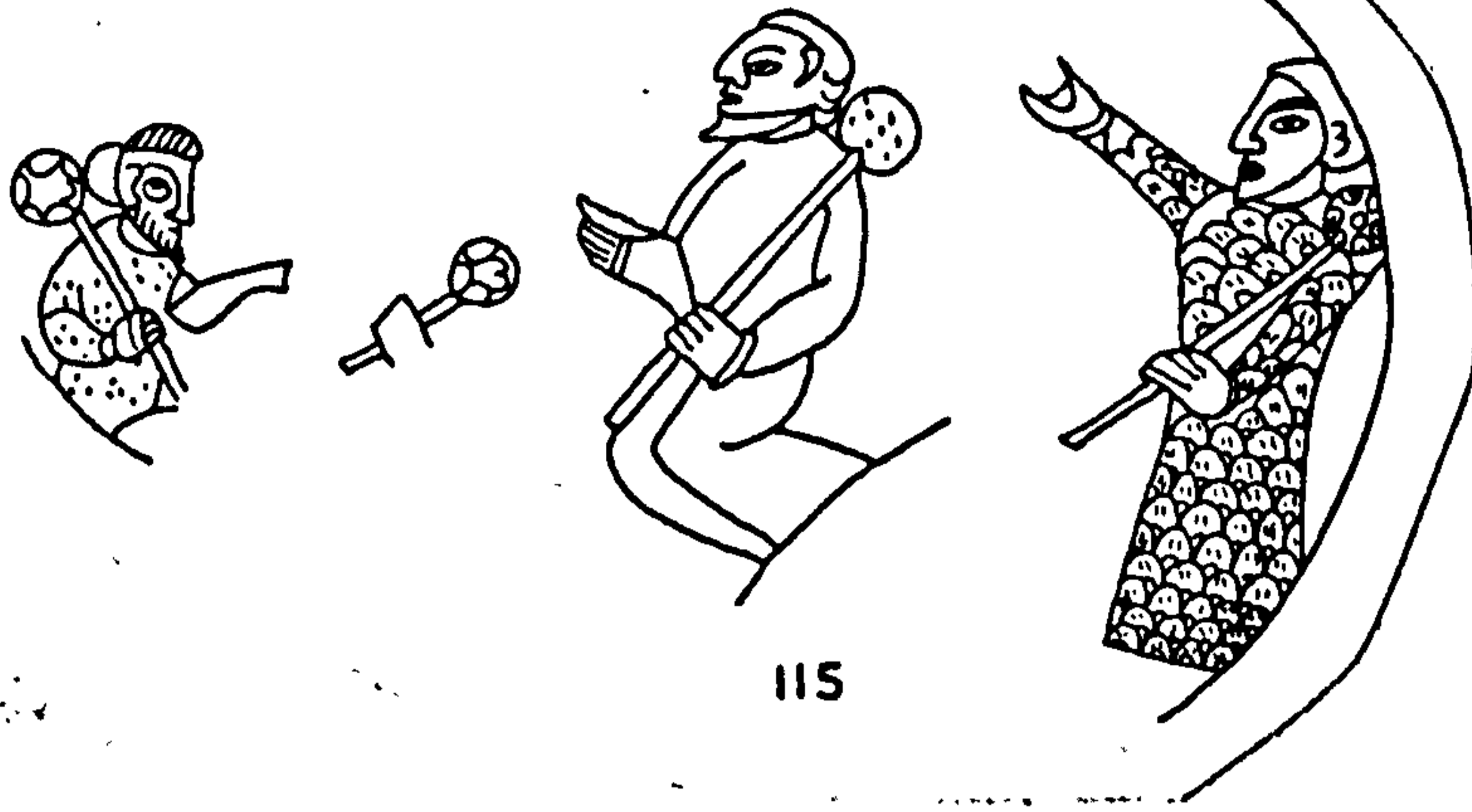

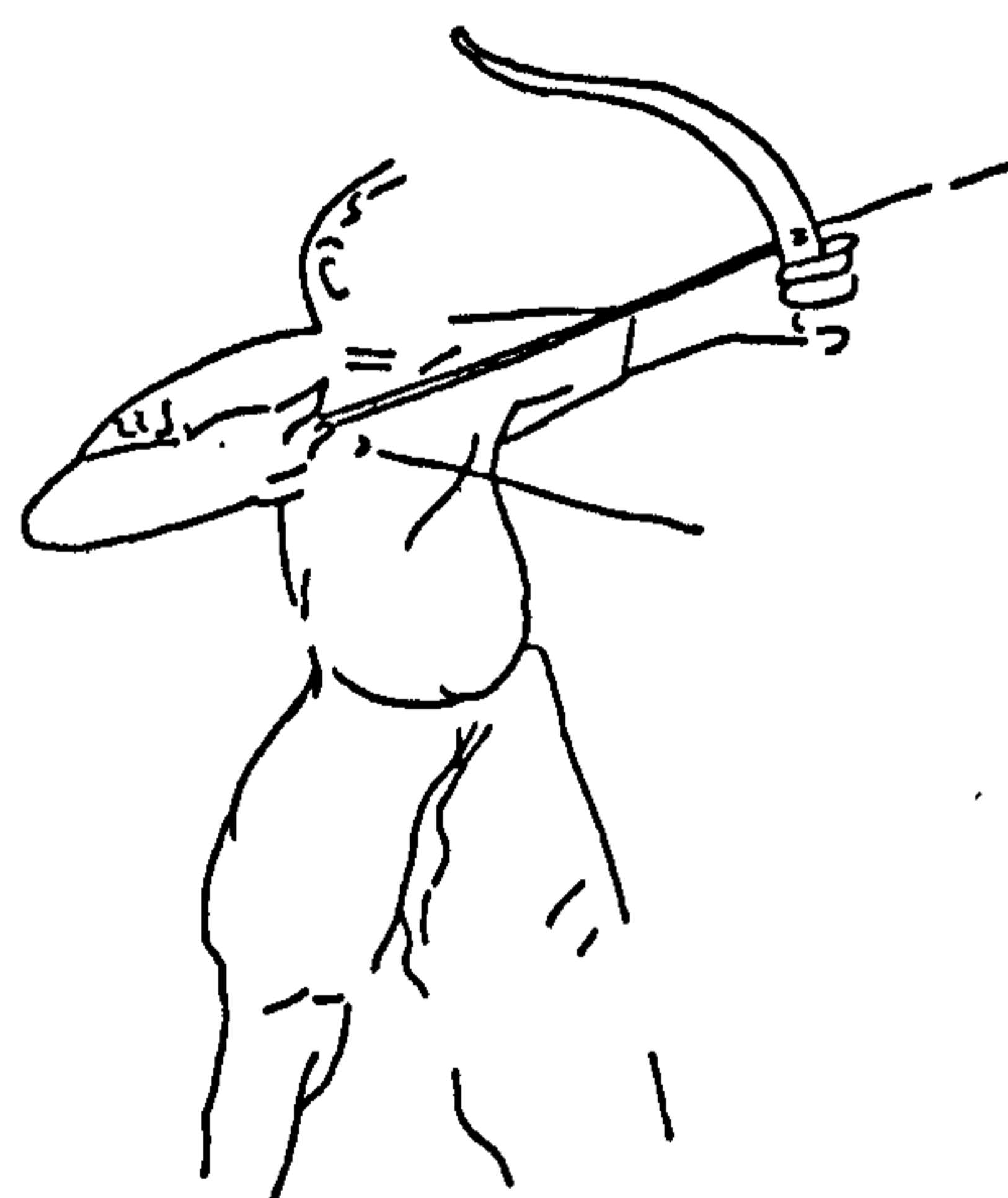
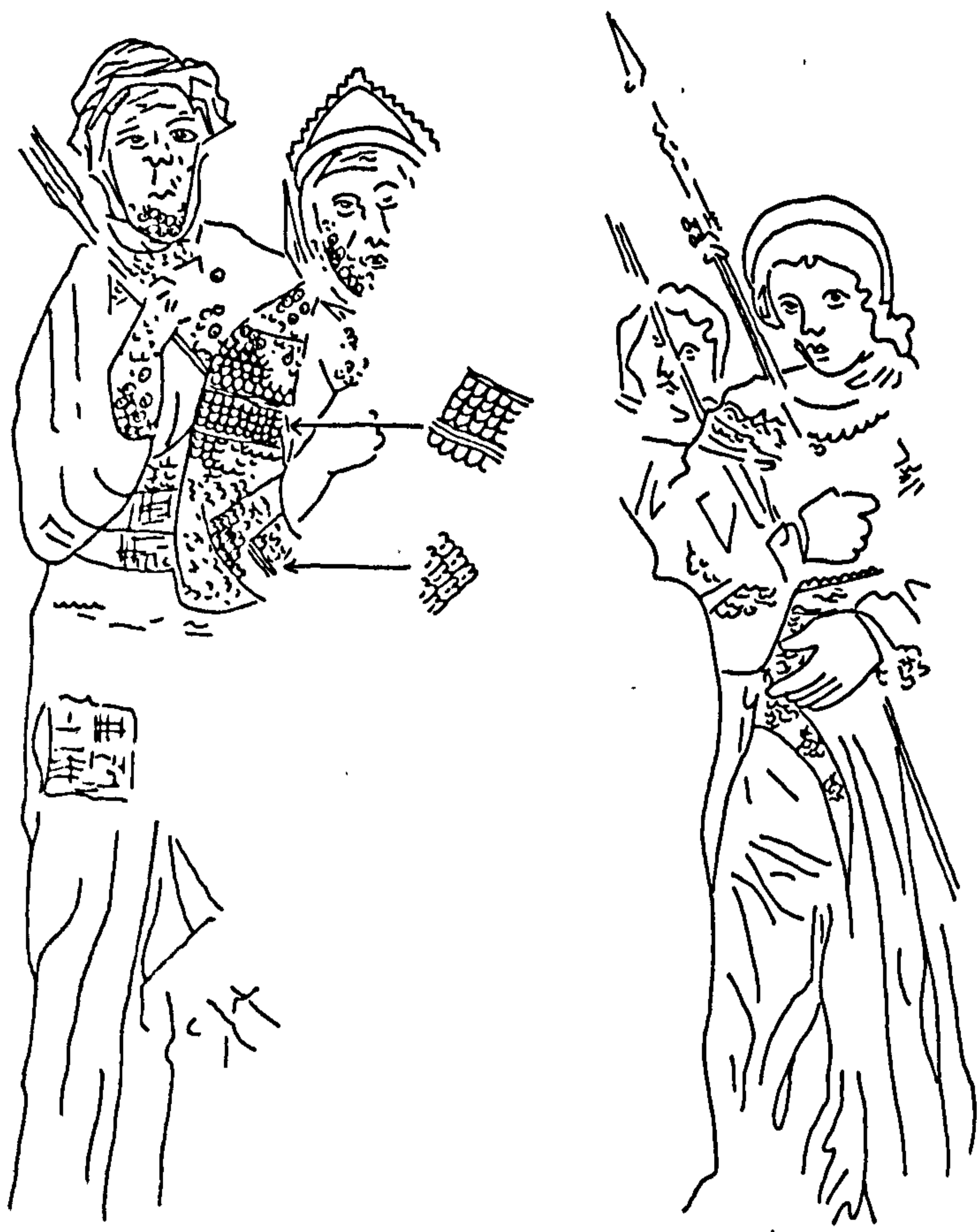

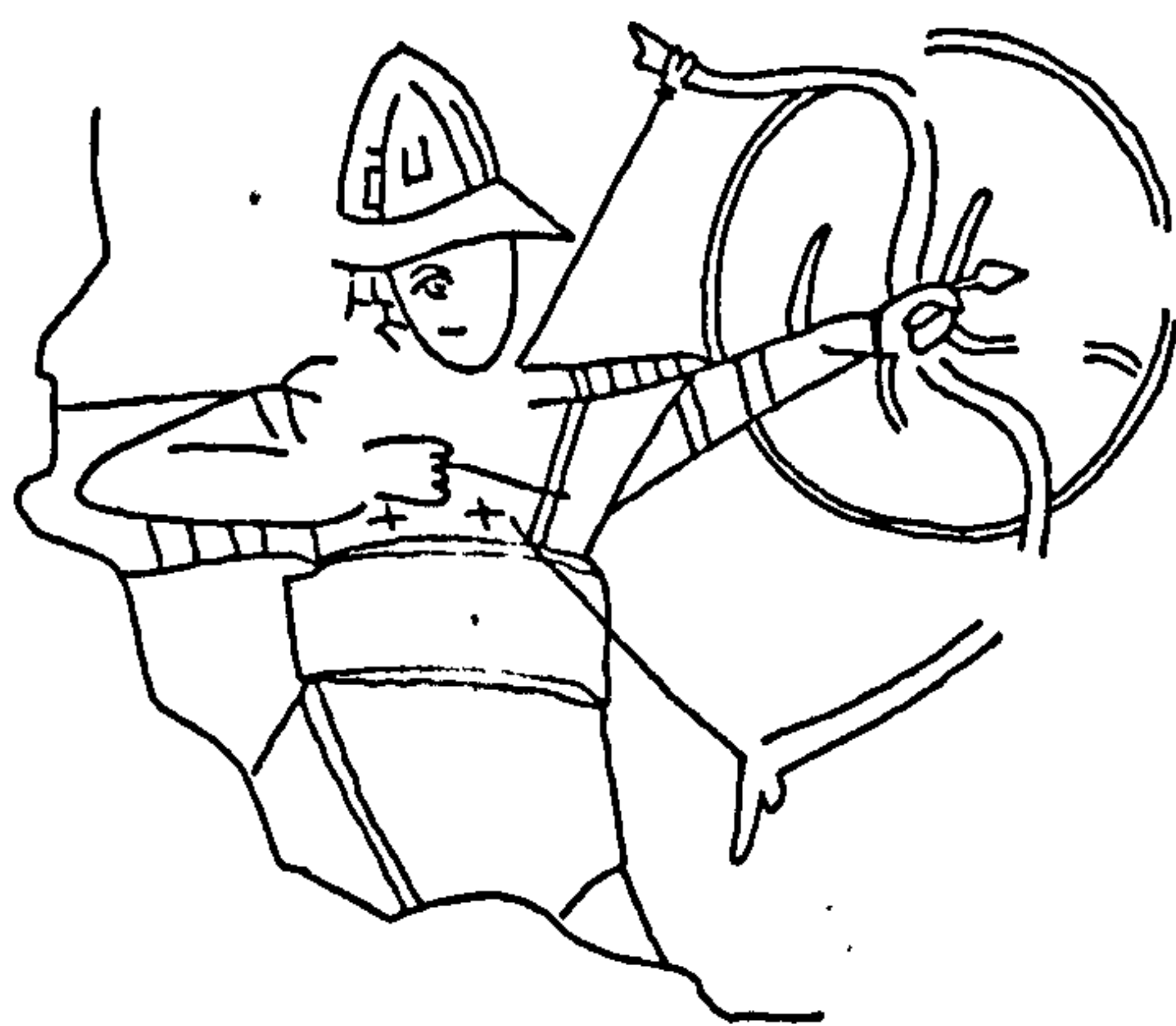
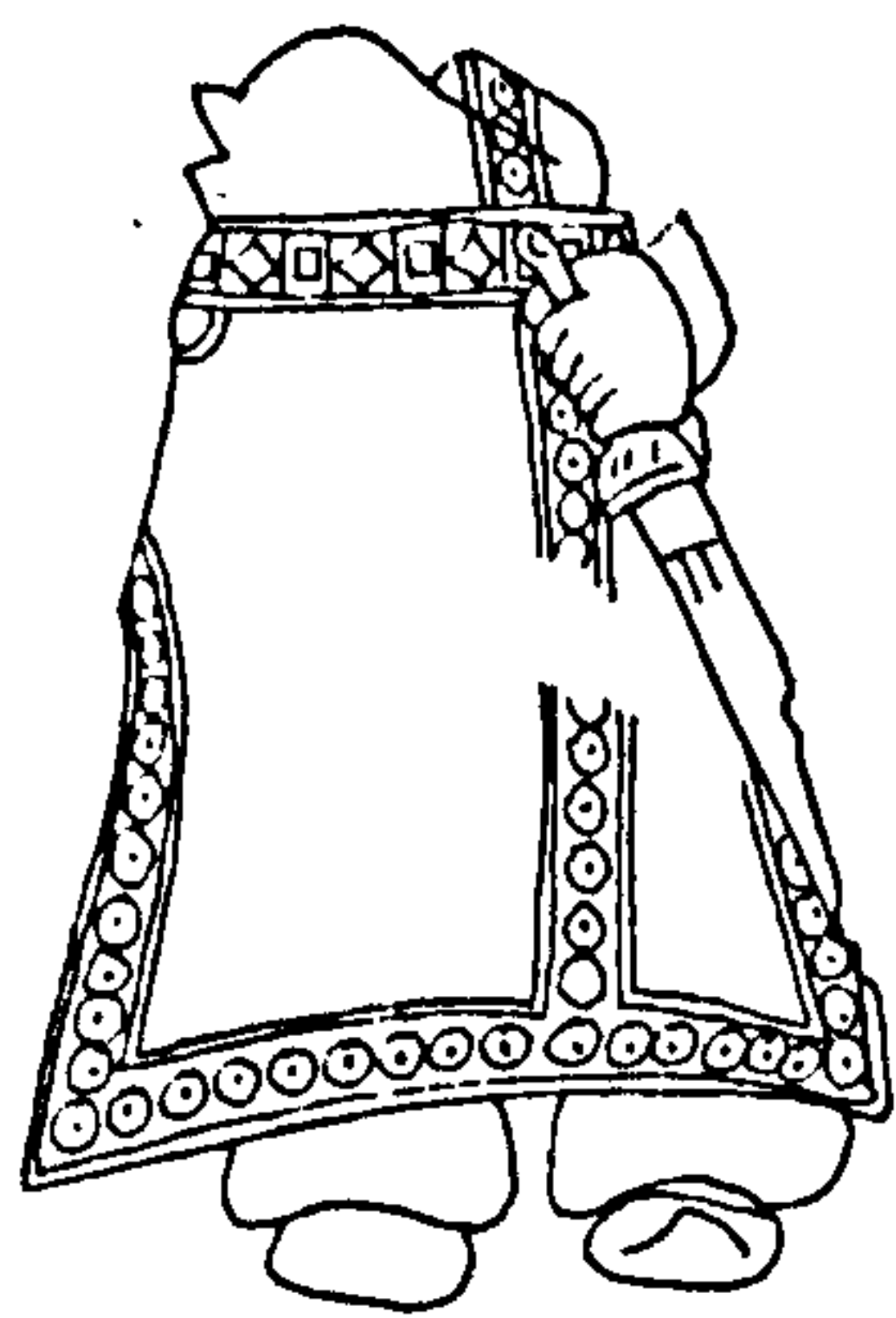
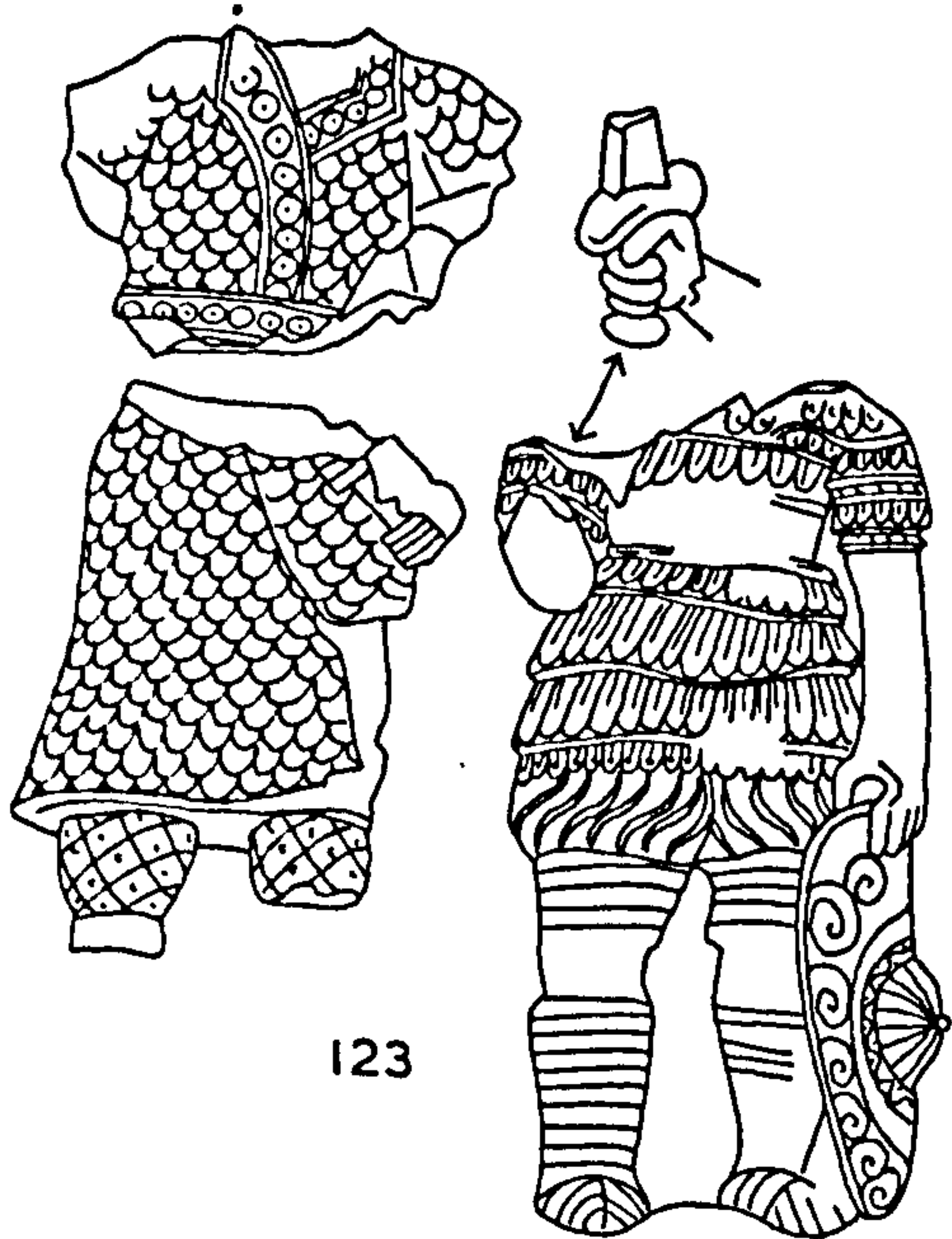



128A



128B

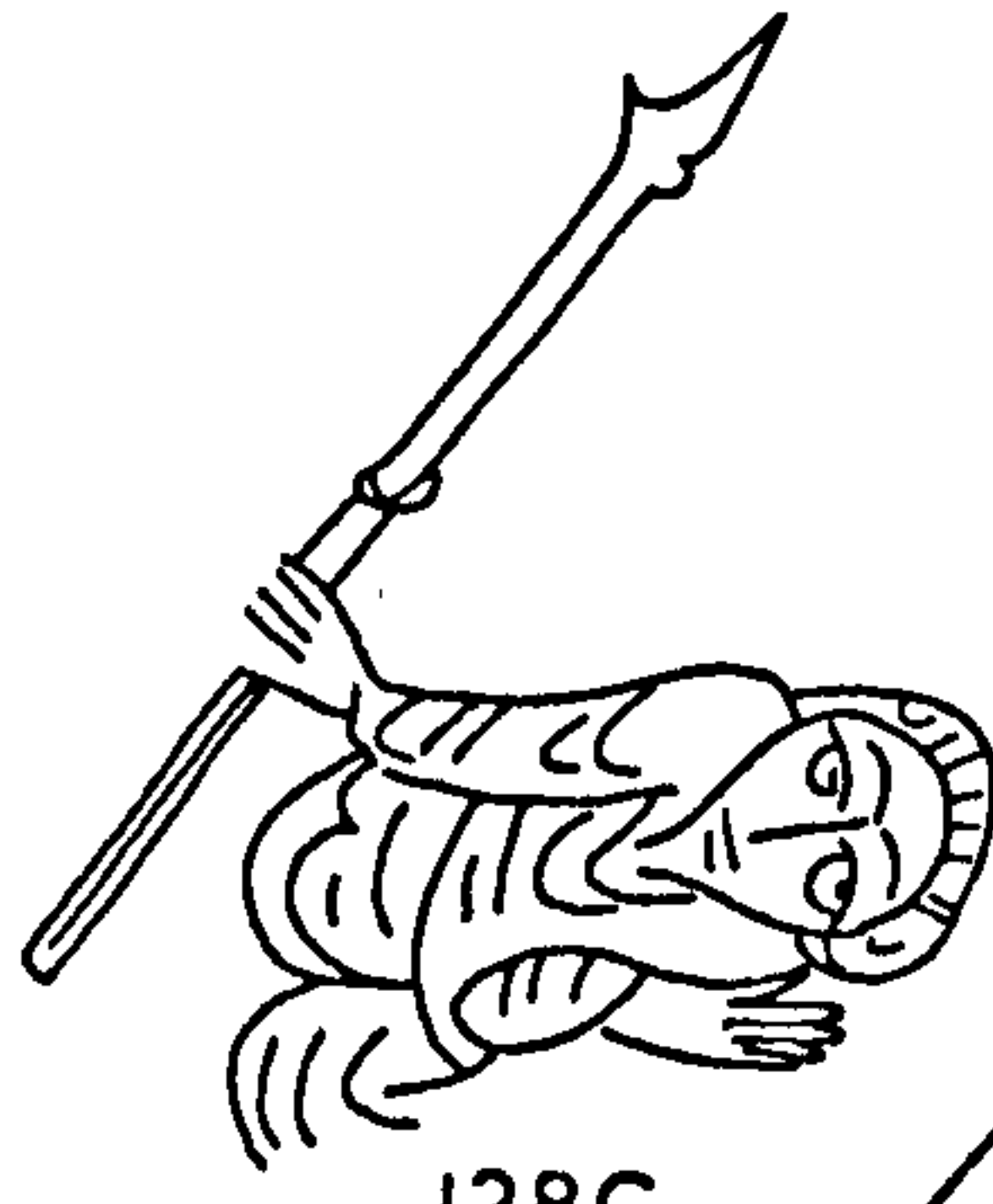

128C



129

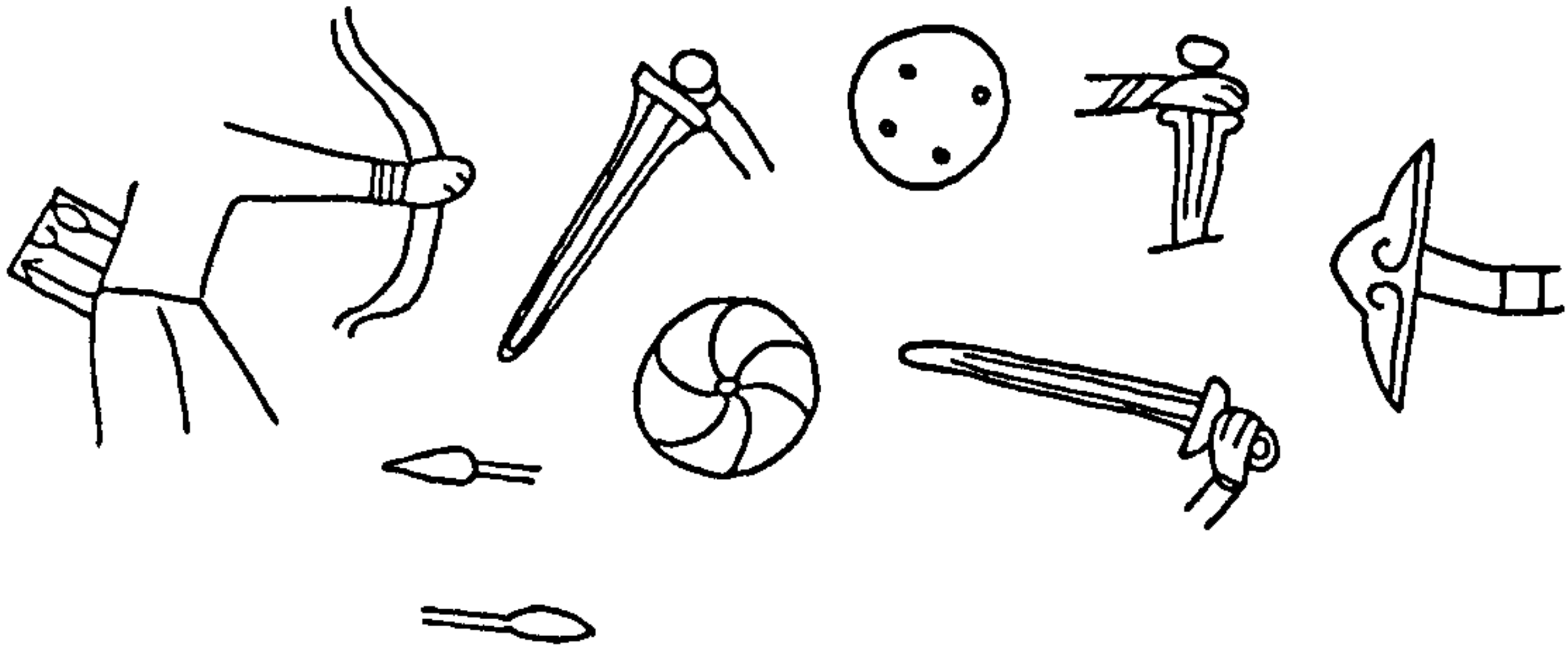

130

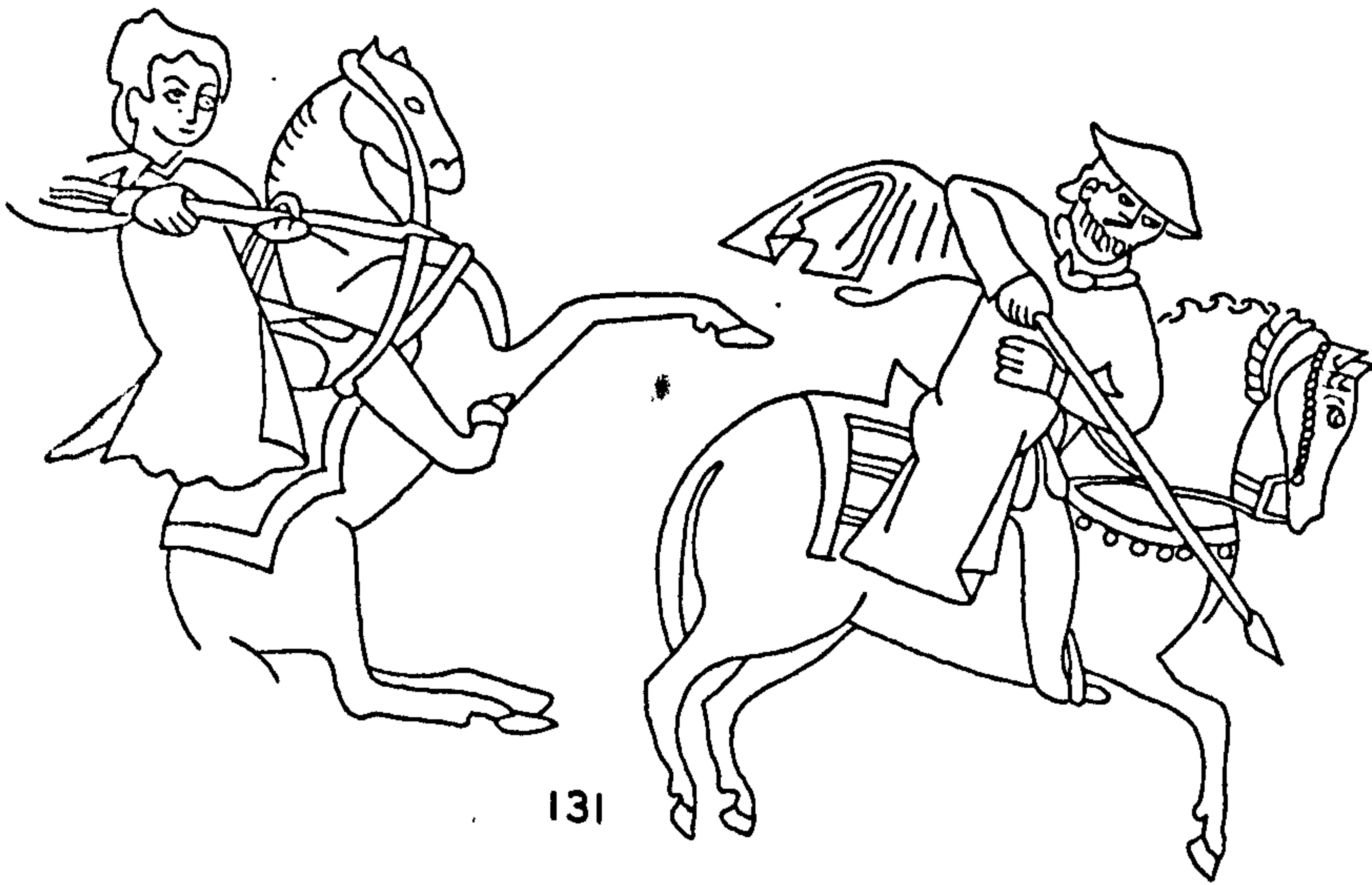

131

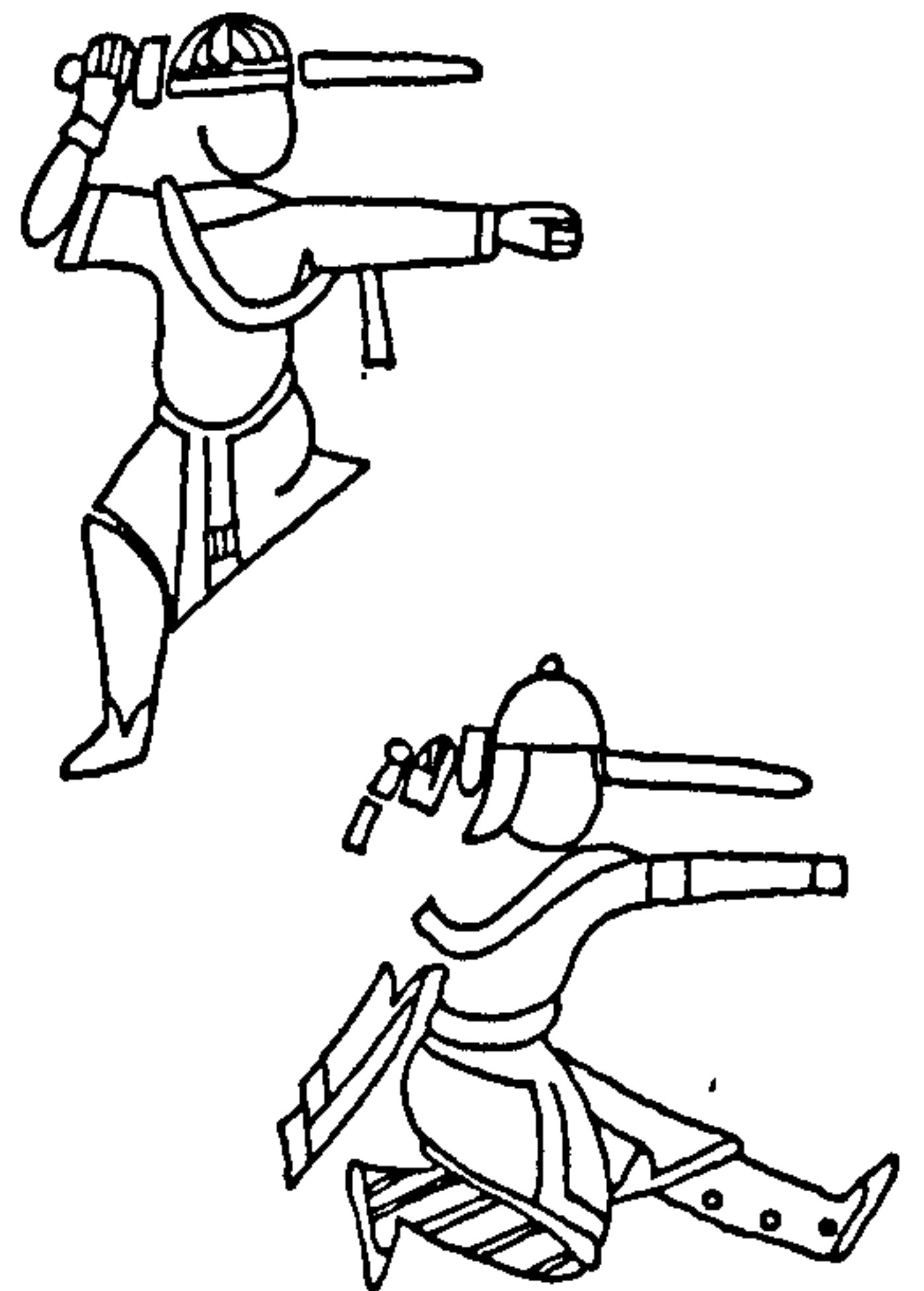

132

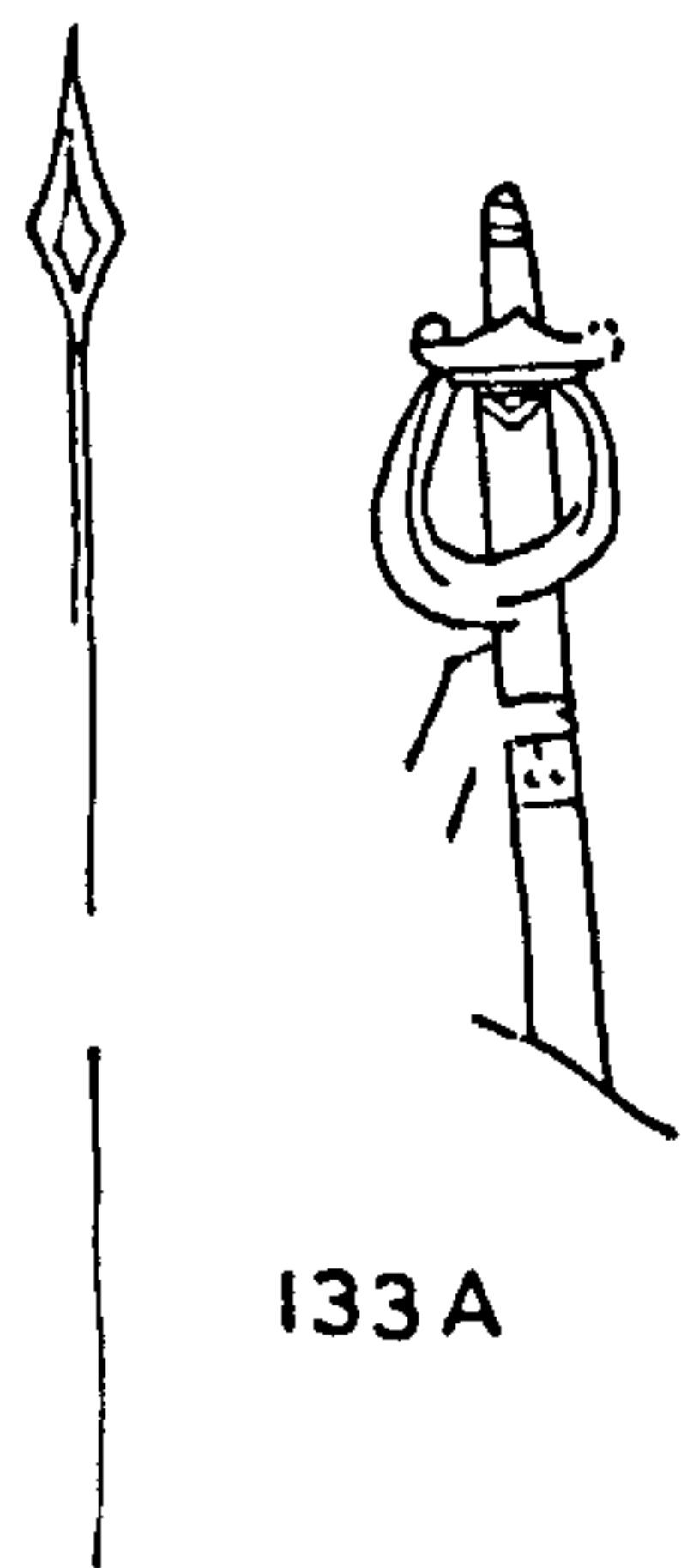

133A

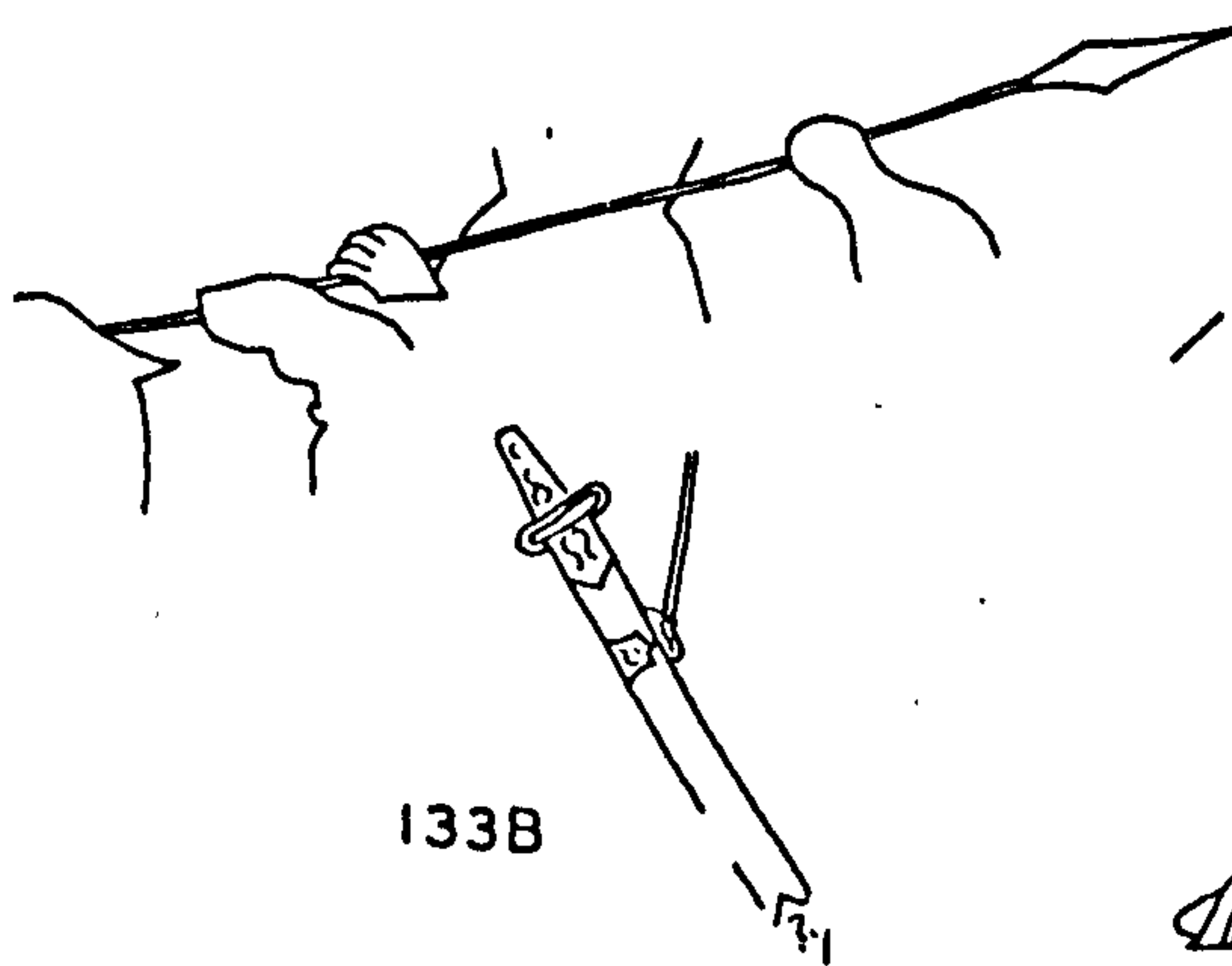

133B

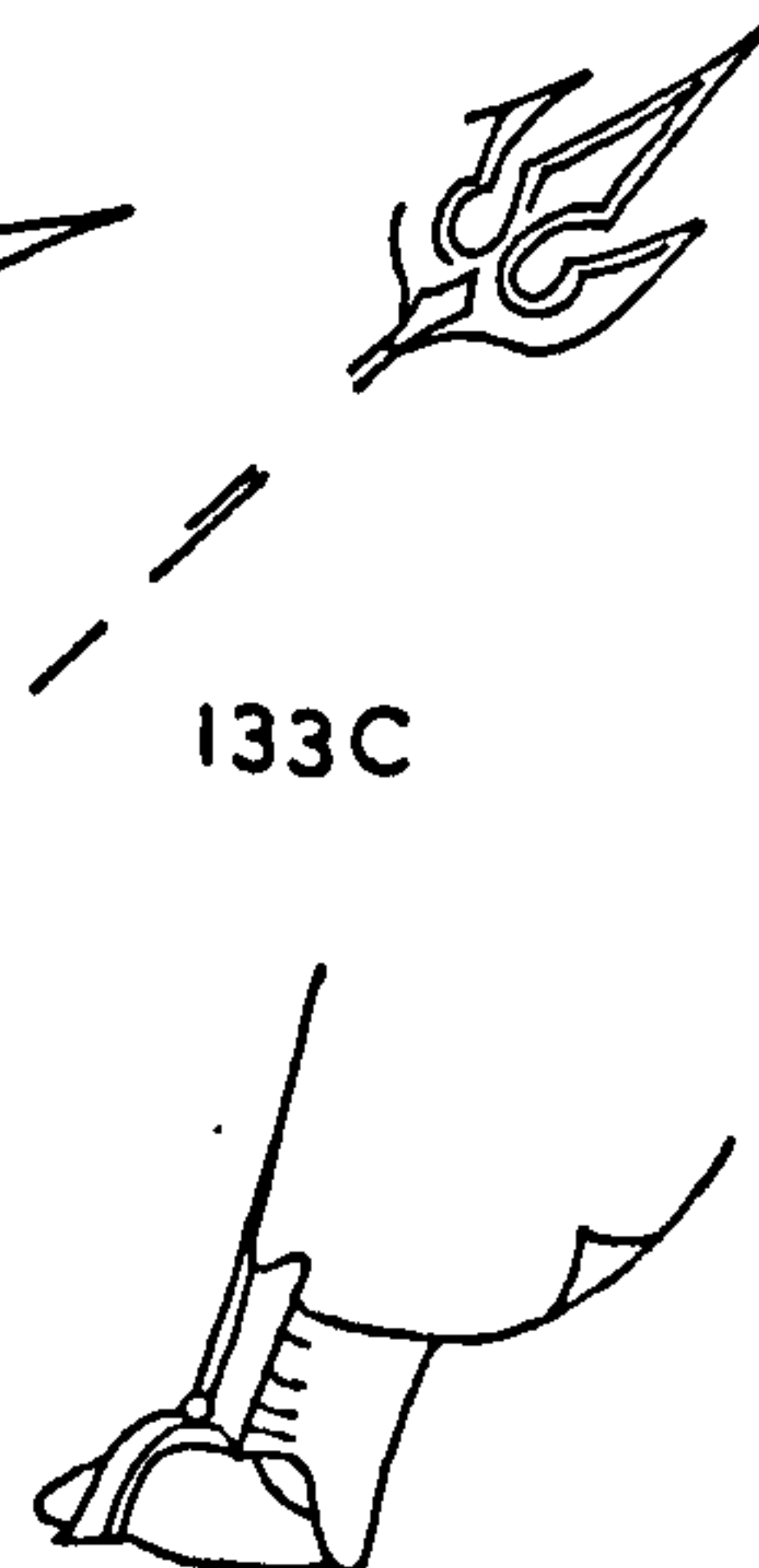

133C

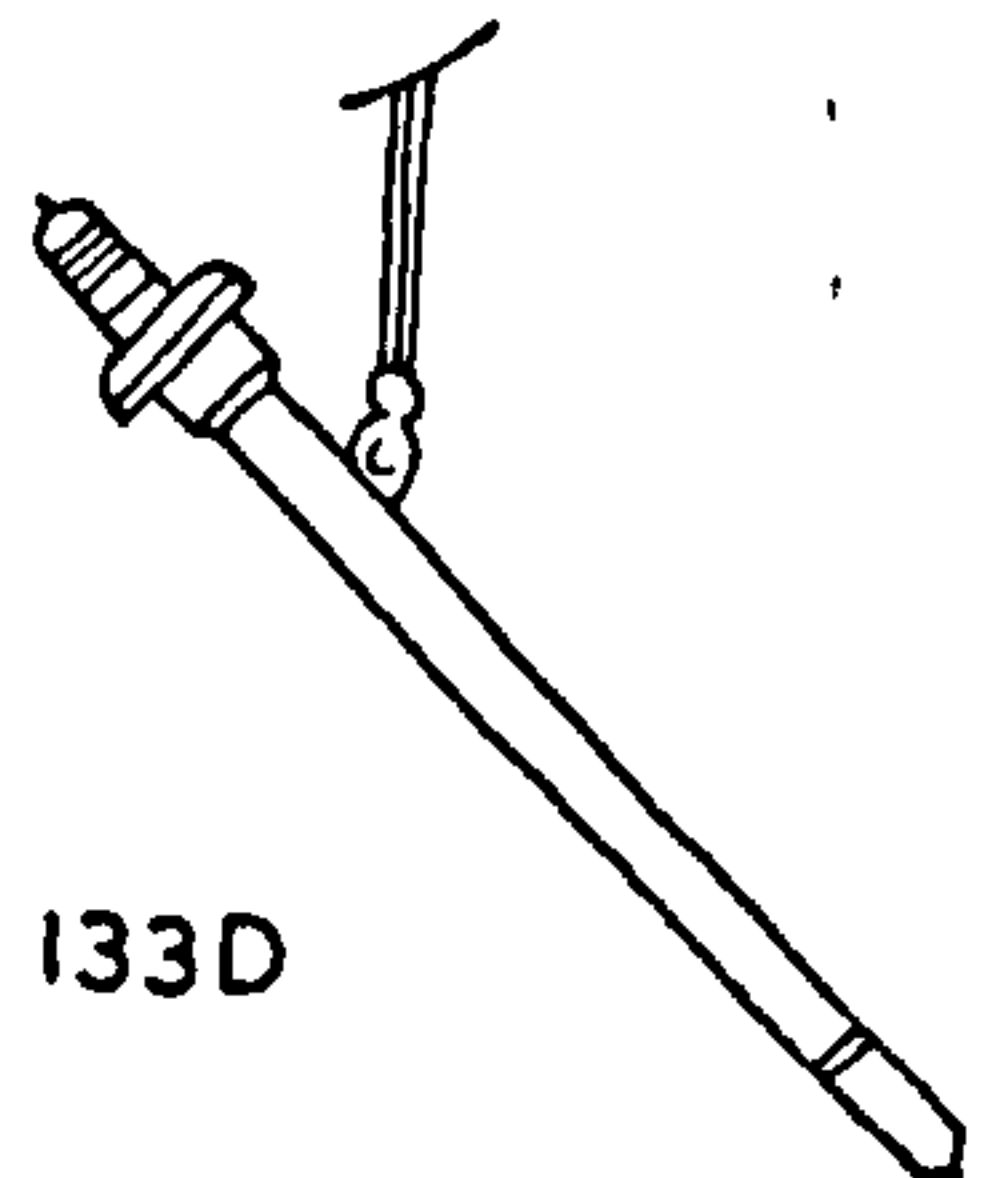

133D



134 UJ

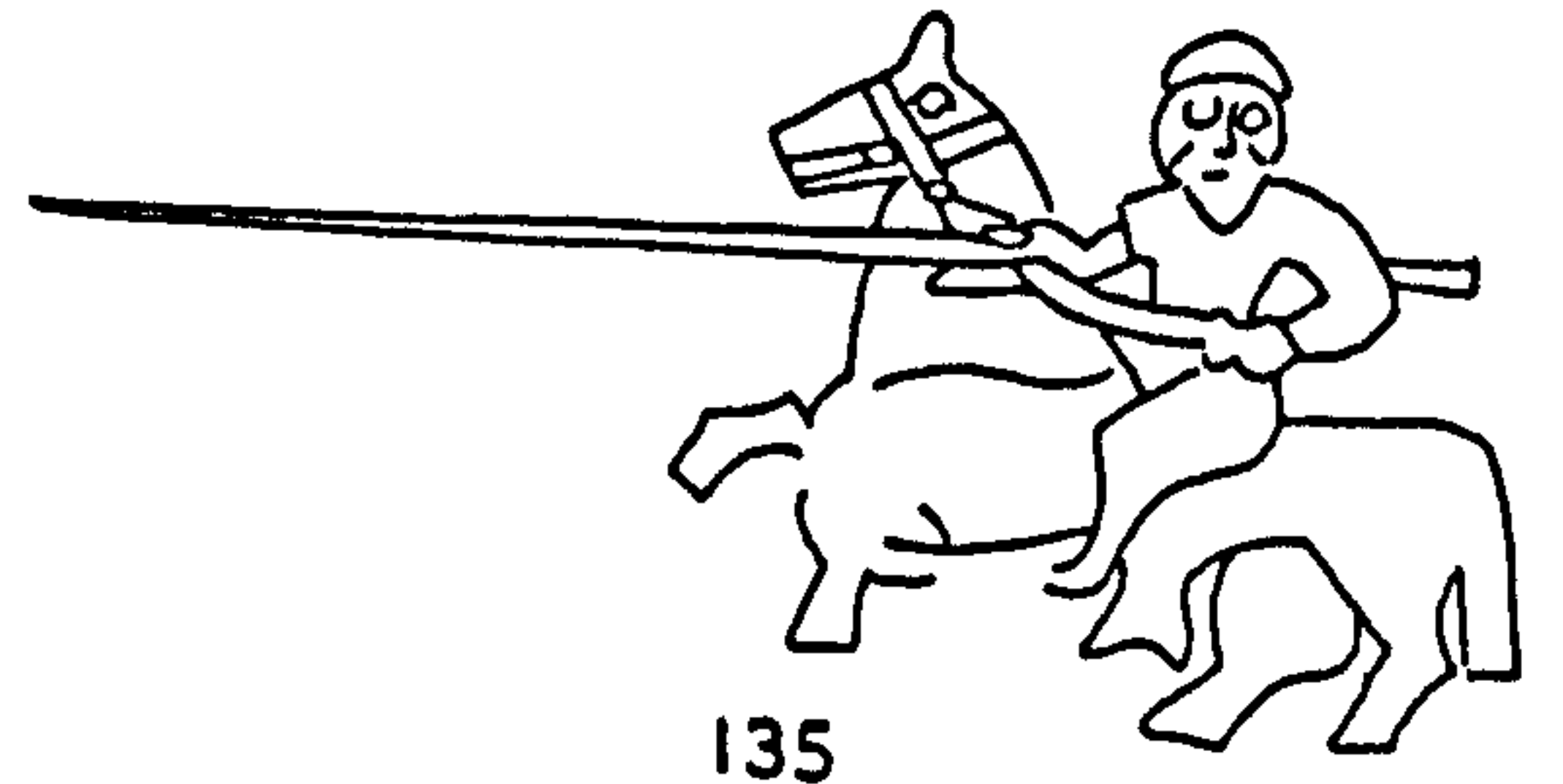

135

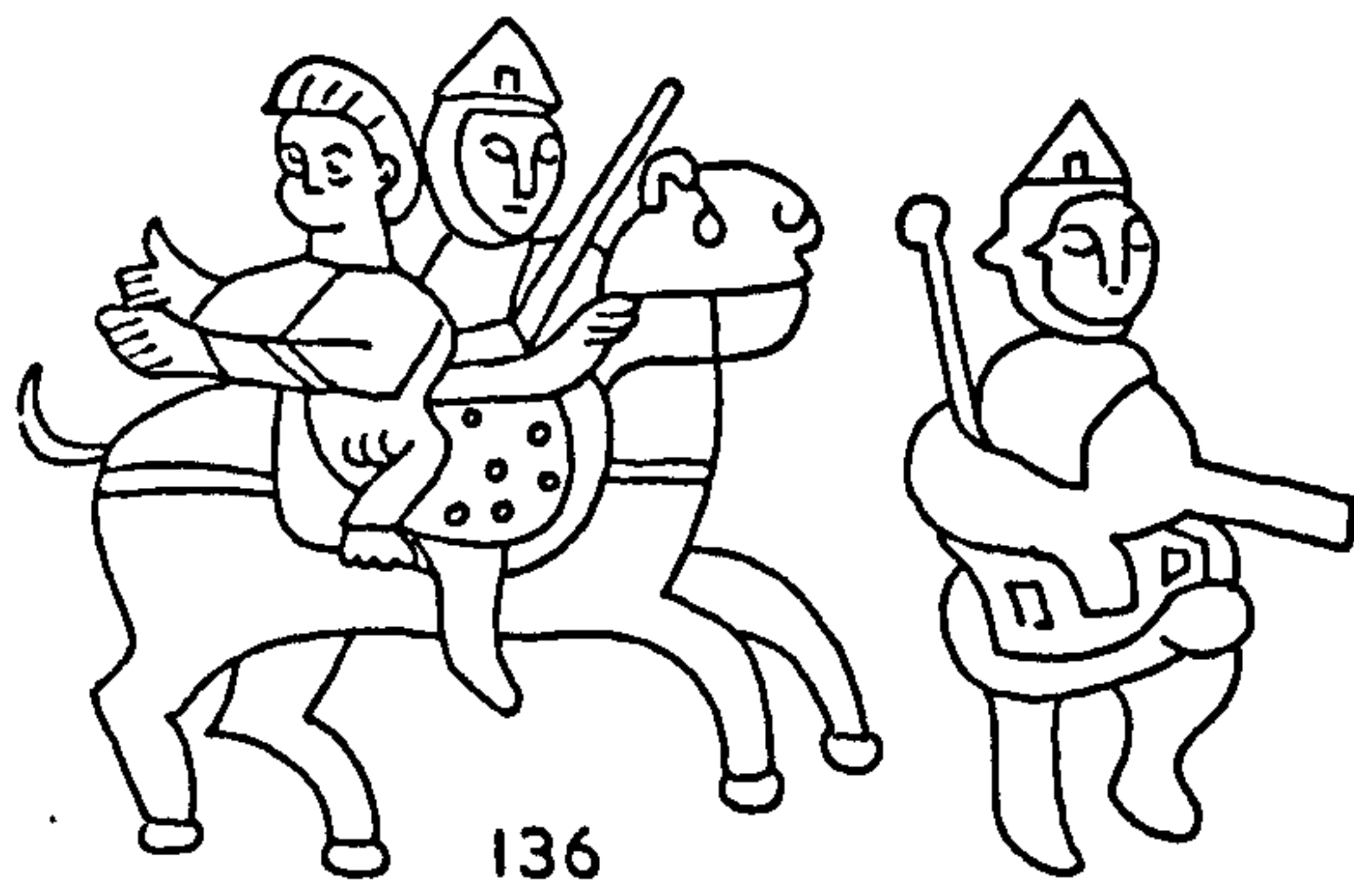

136



137

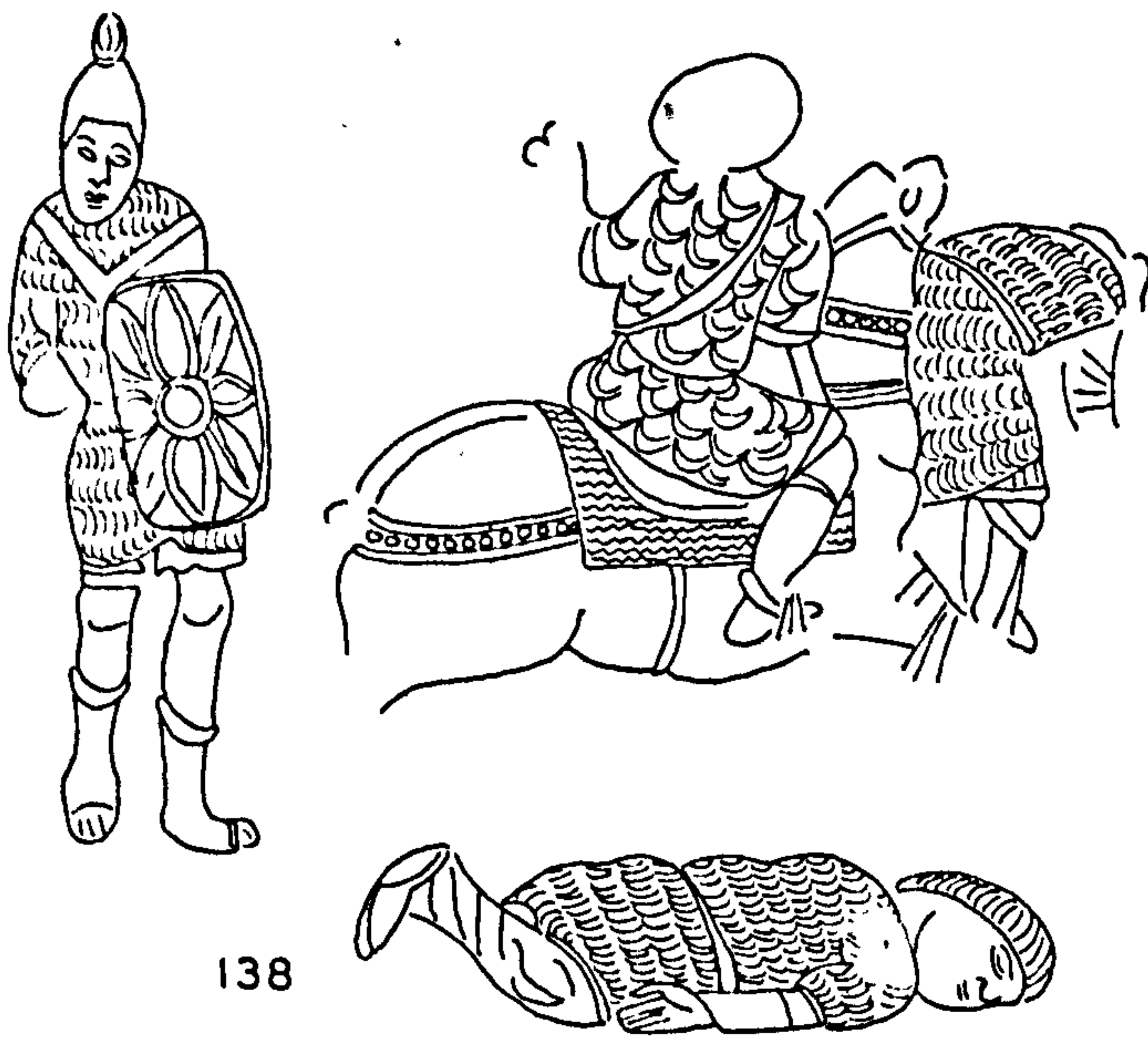

138



139



140

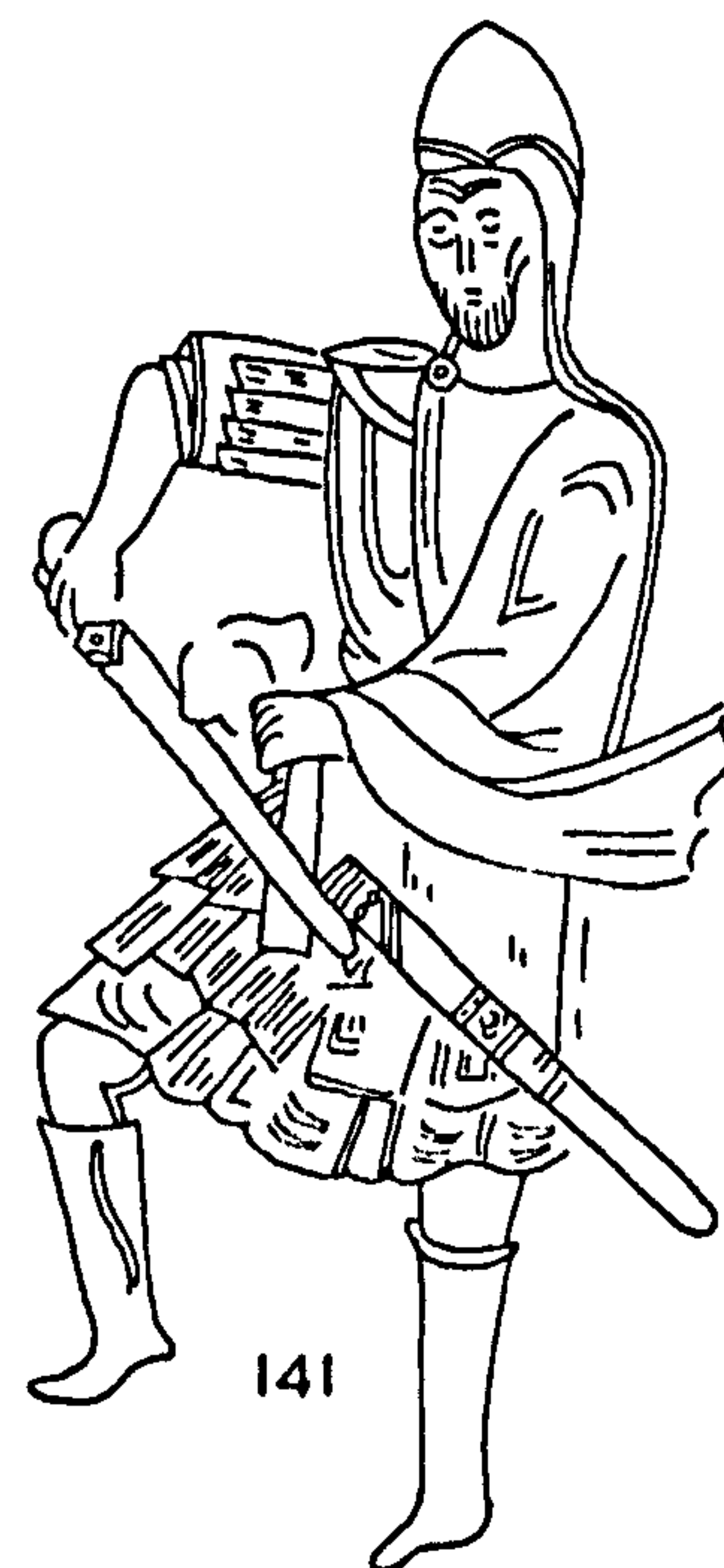

141





142



143

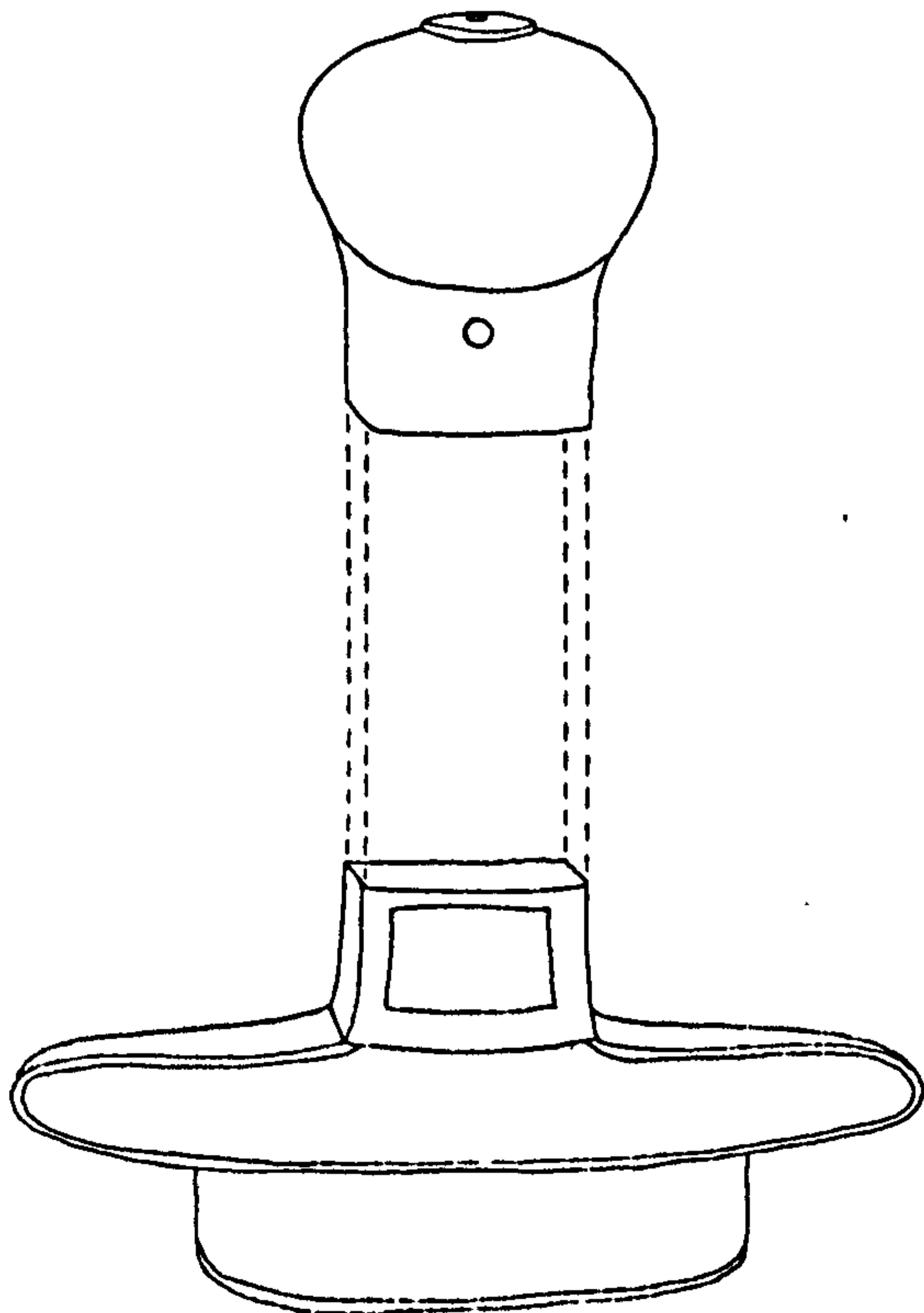

144 (Simplified)

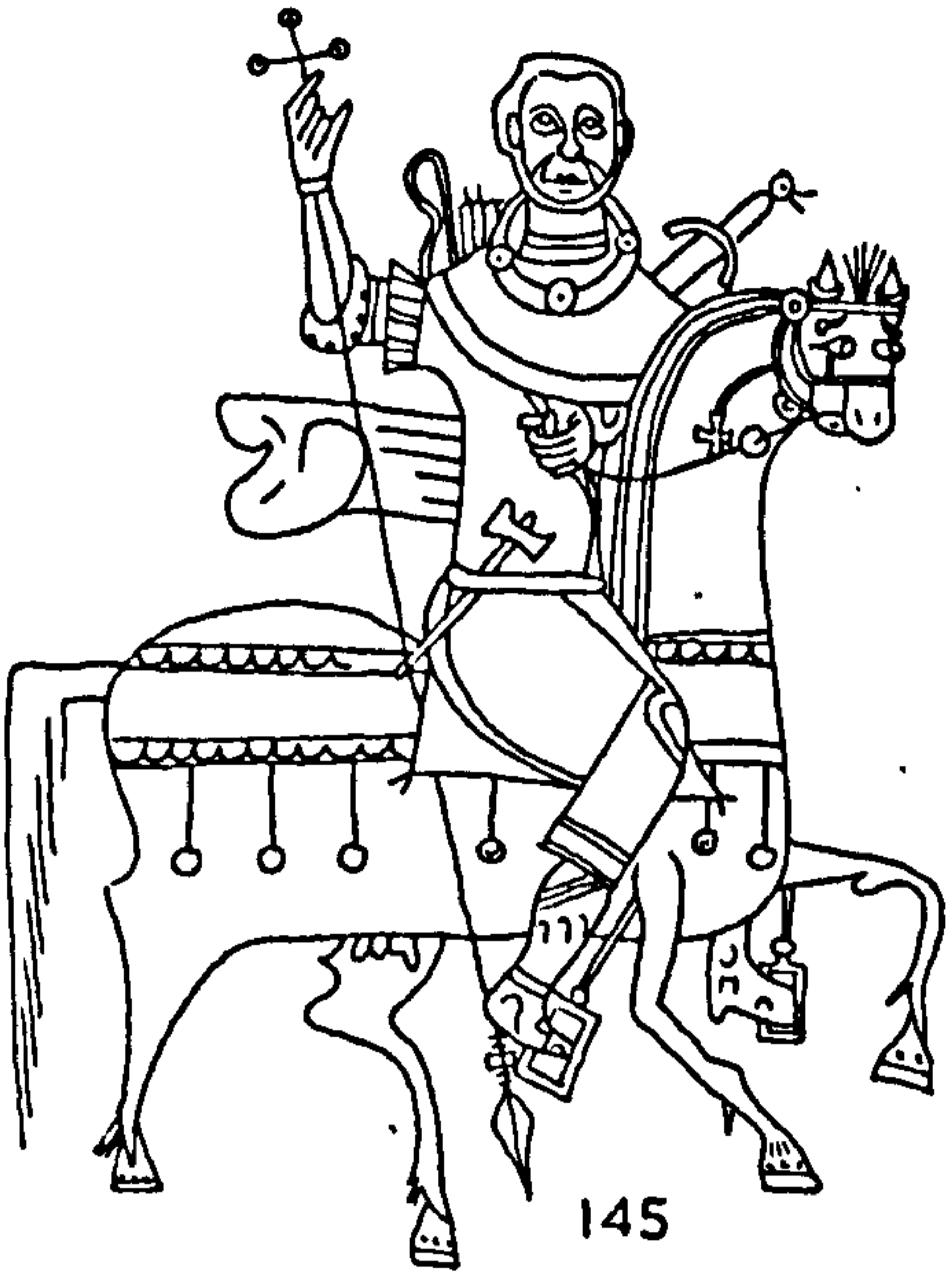

145



146

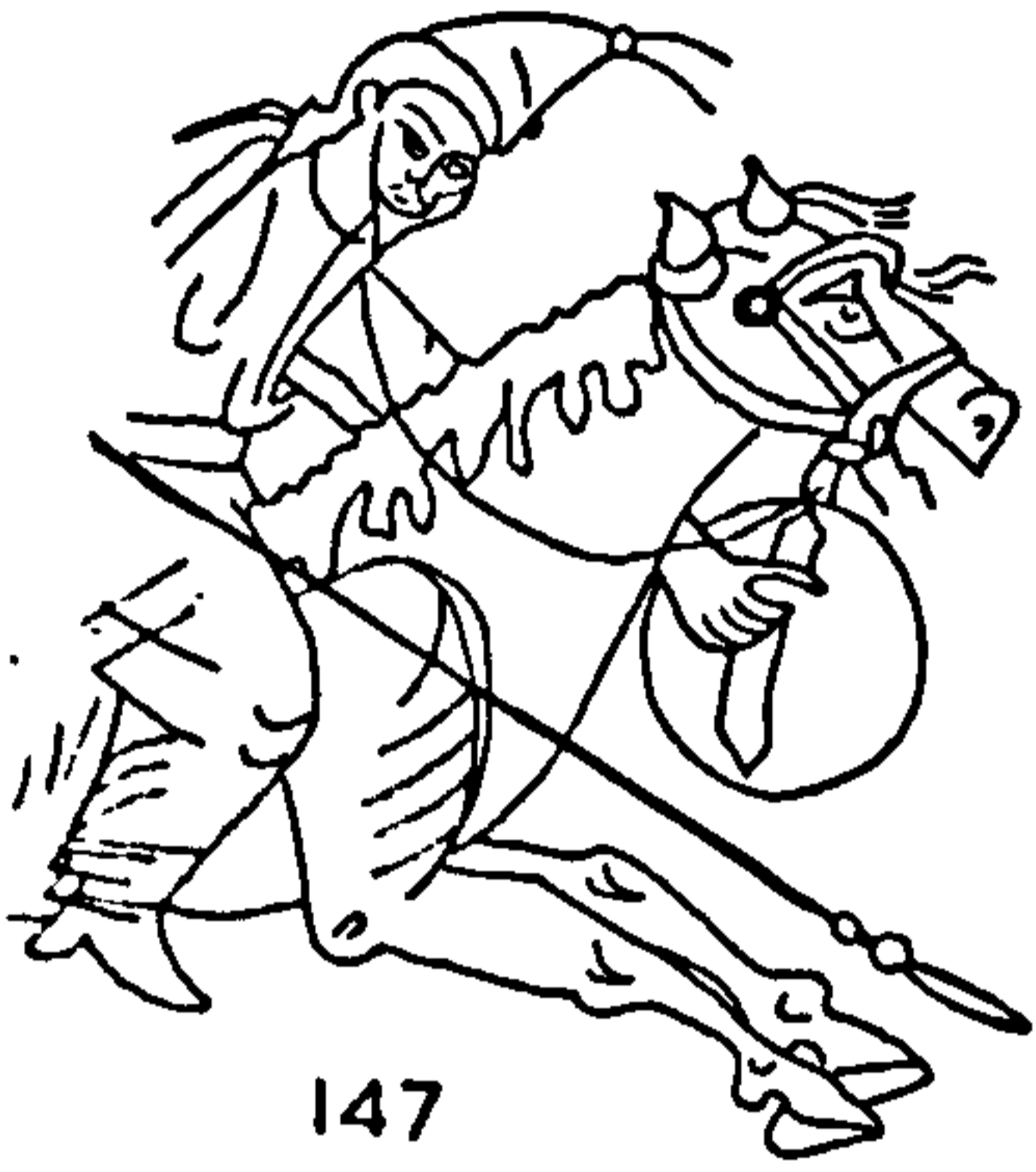

147



148



149

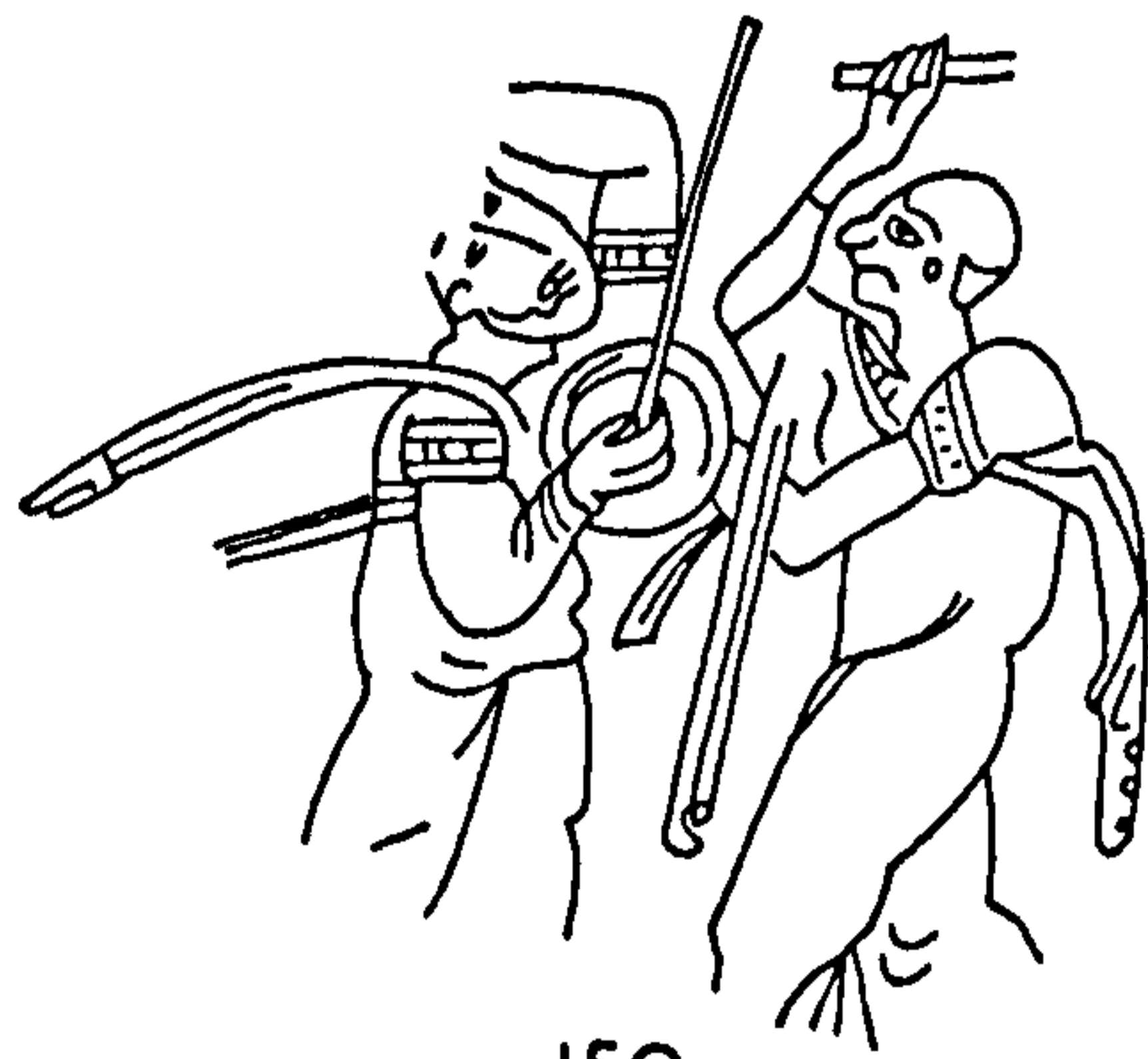

150



151



152

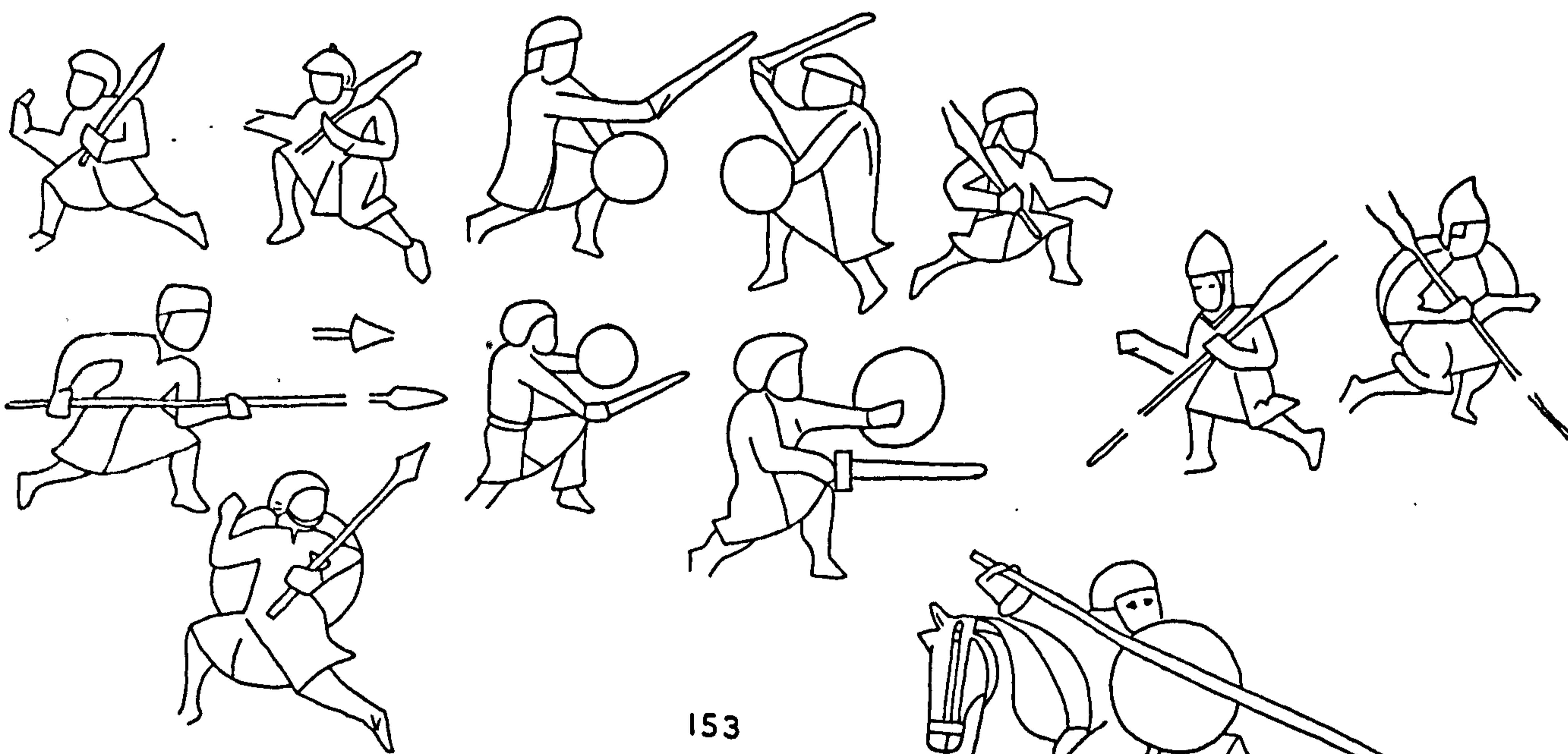

153

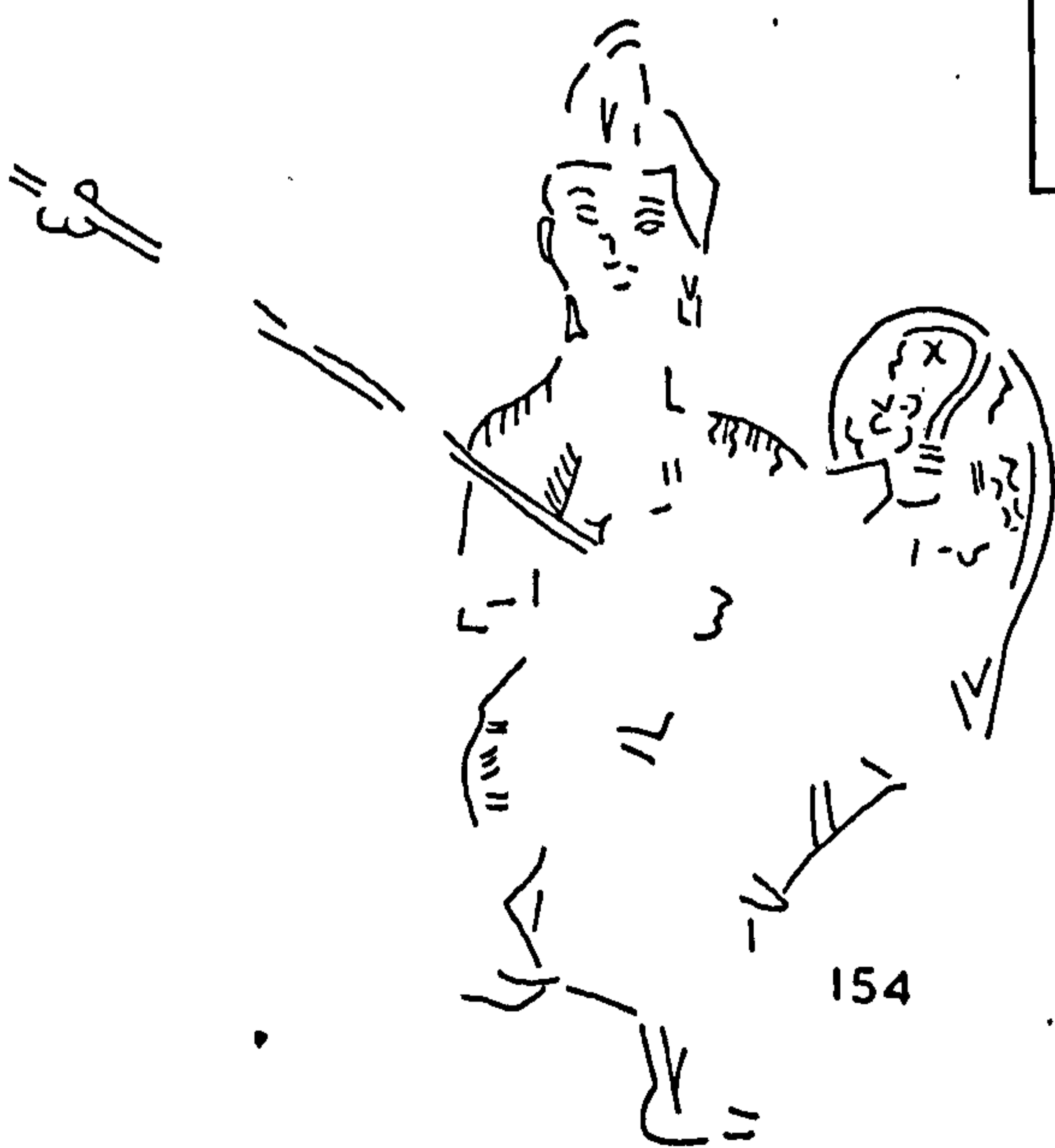

154



155



156



157



158

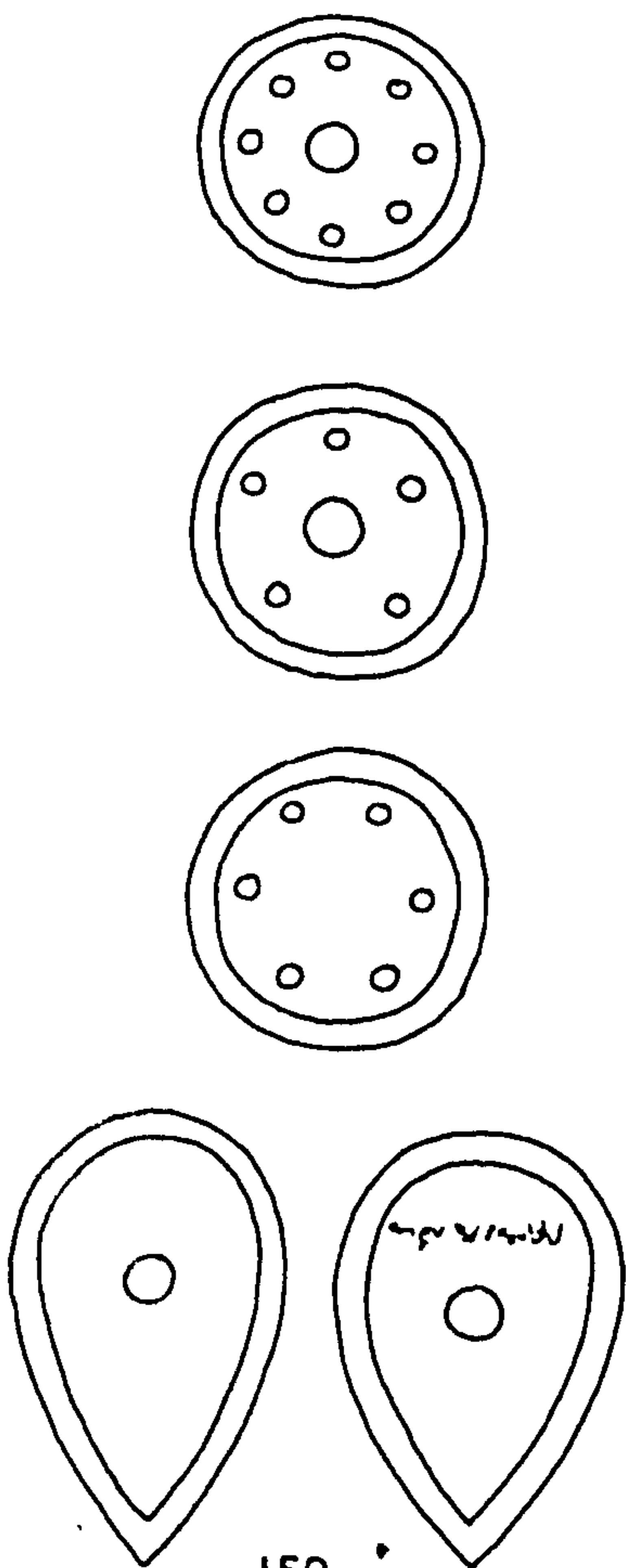

159



160

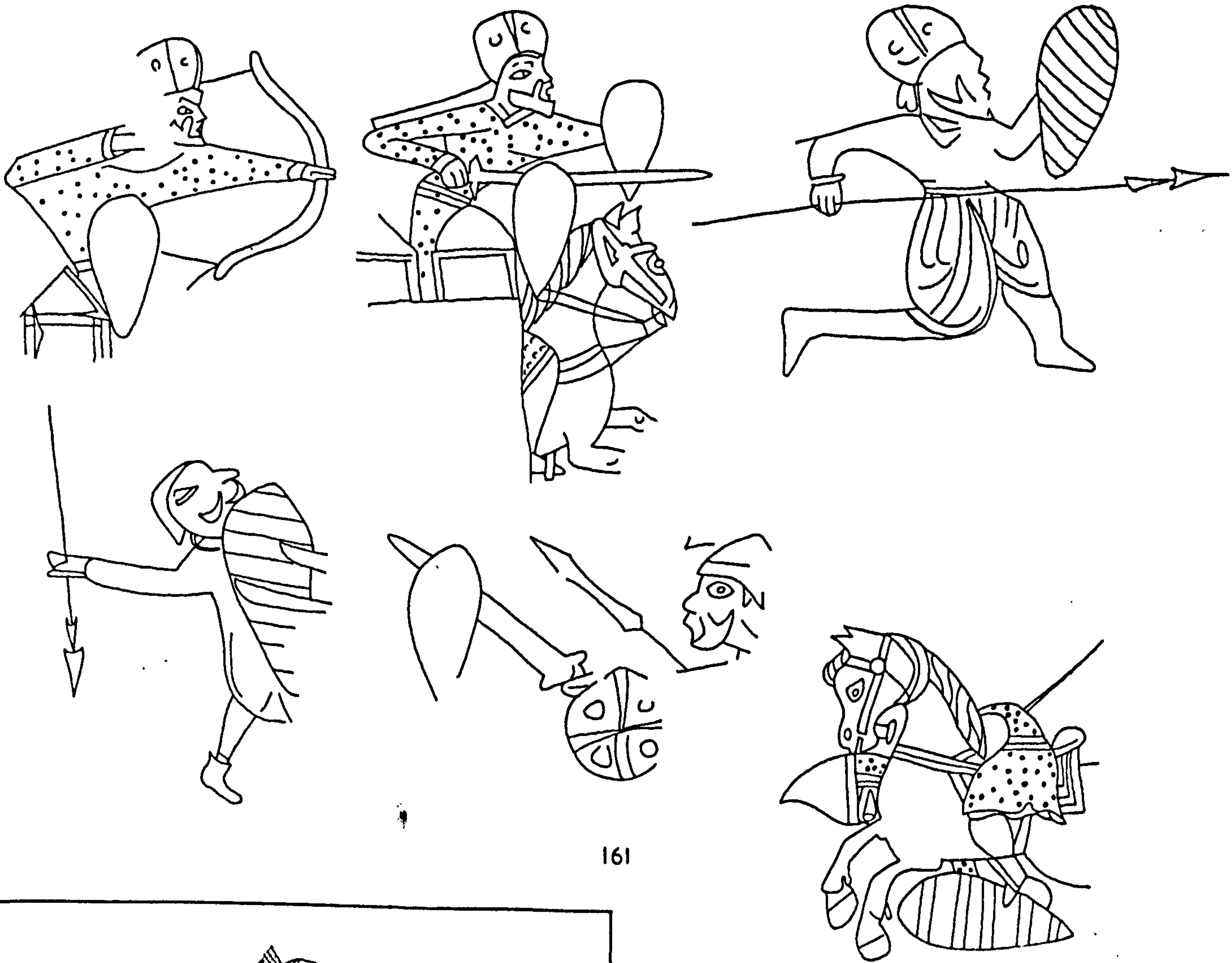

161



162



163

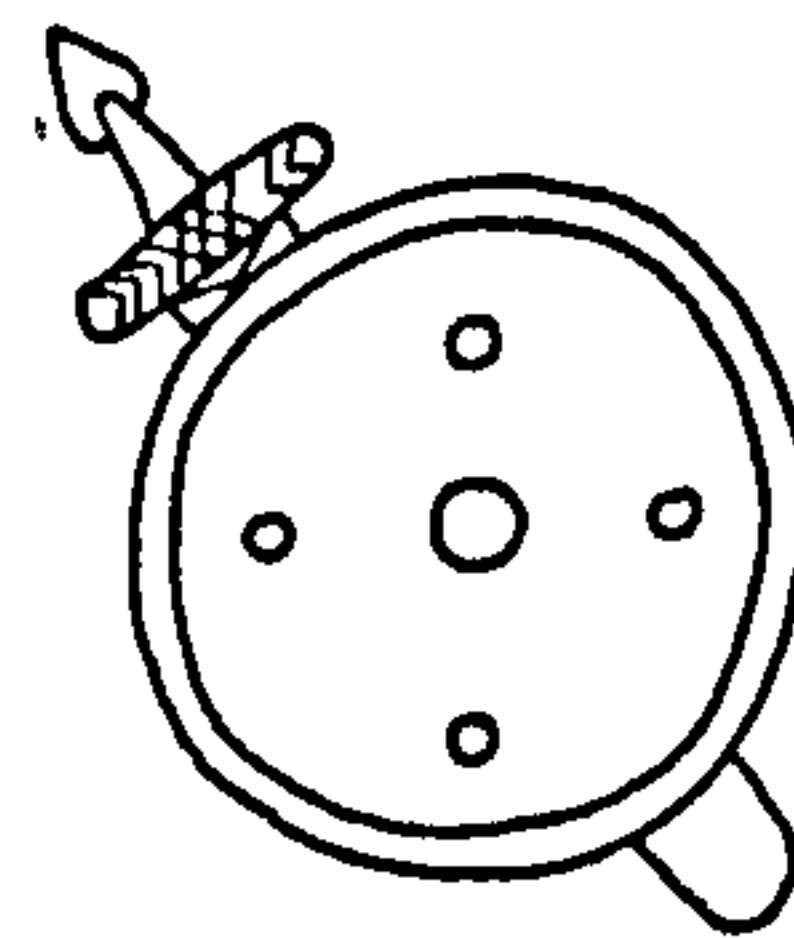

164

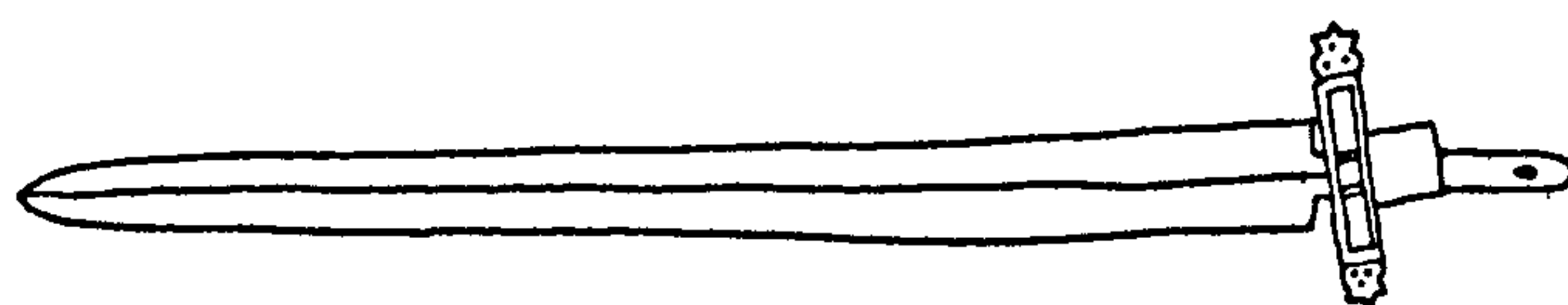

165



166A



166B

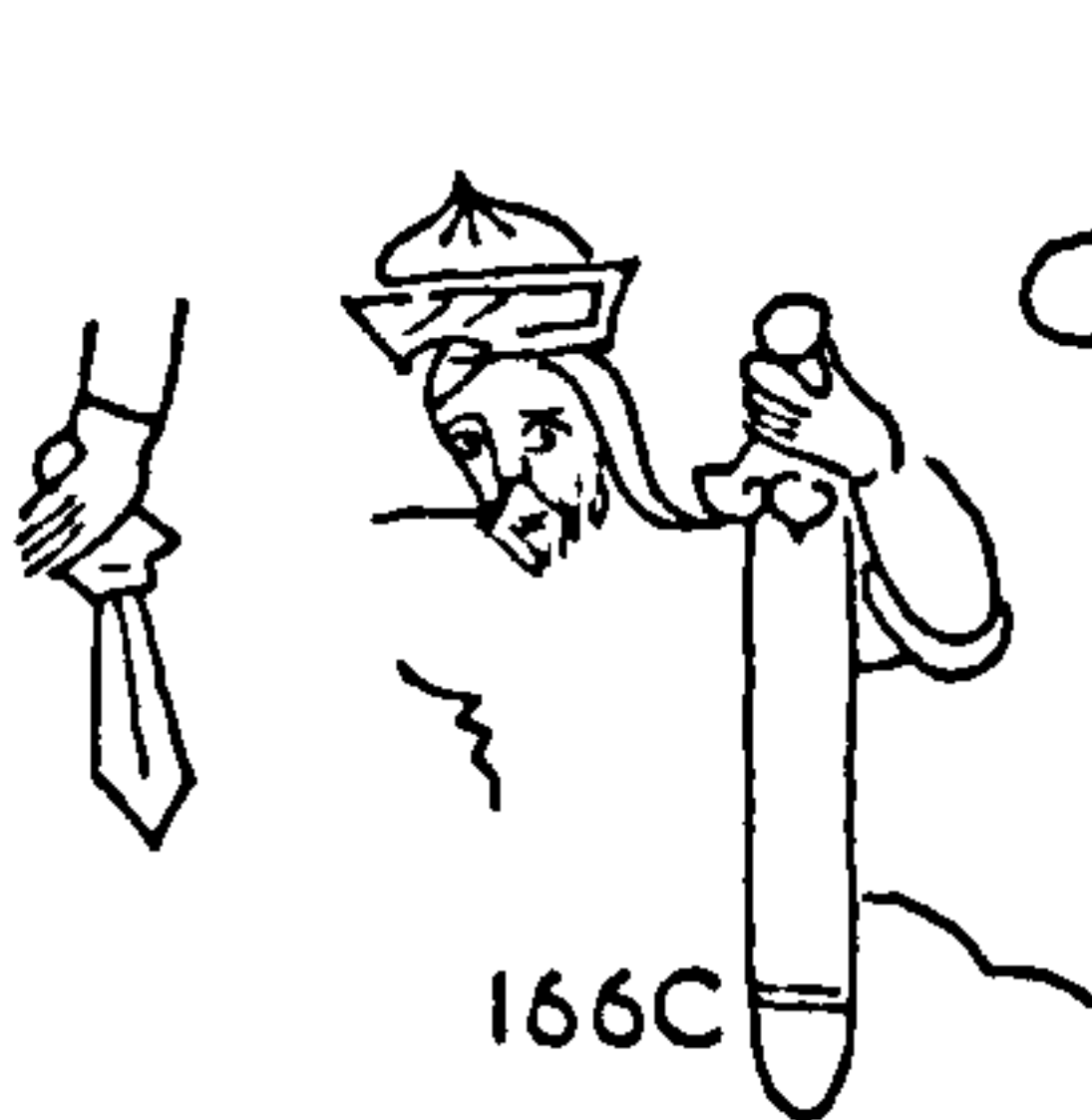

166C

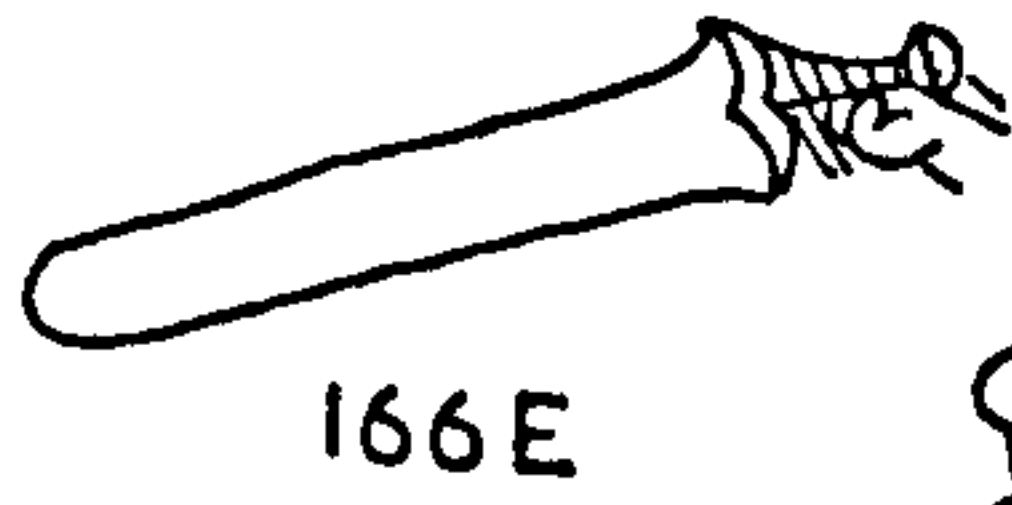

166E



166F



166G



166D



166H

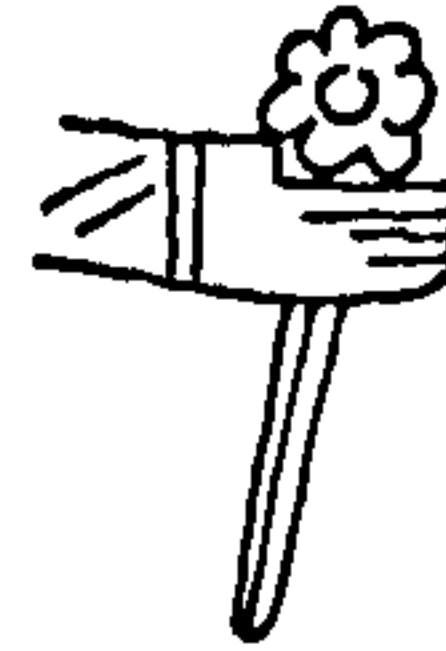
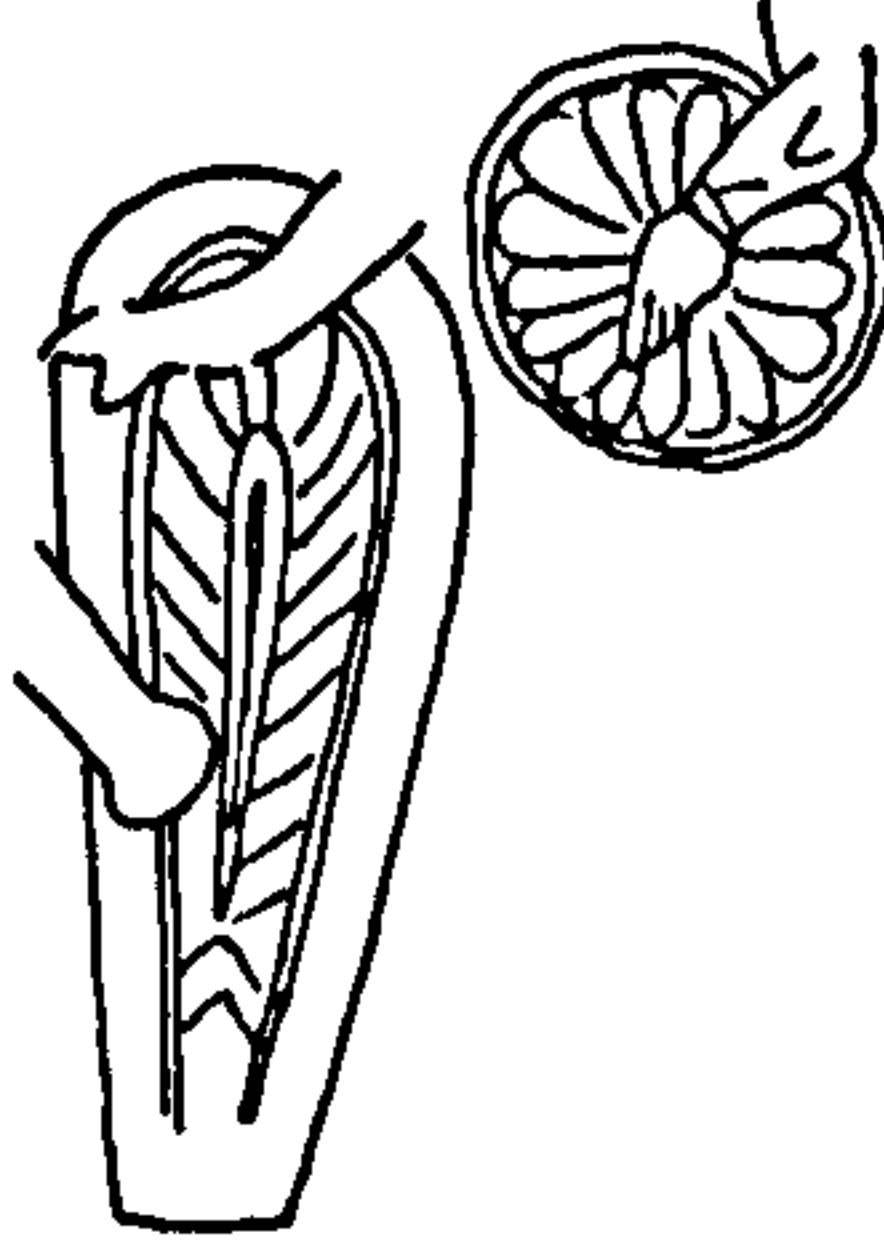

166I



166J

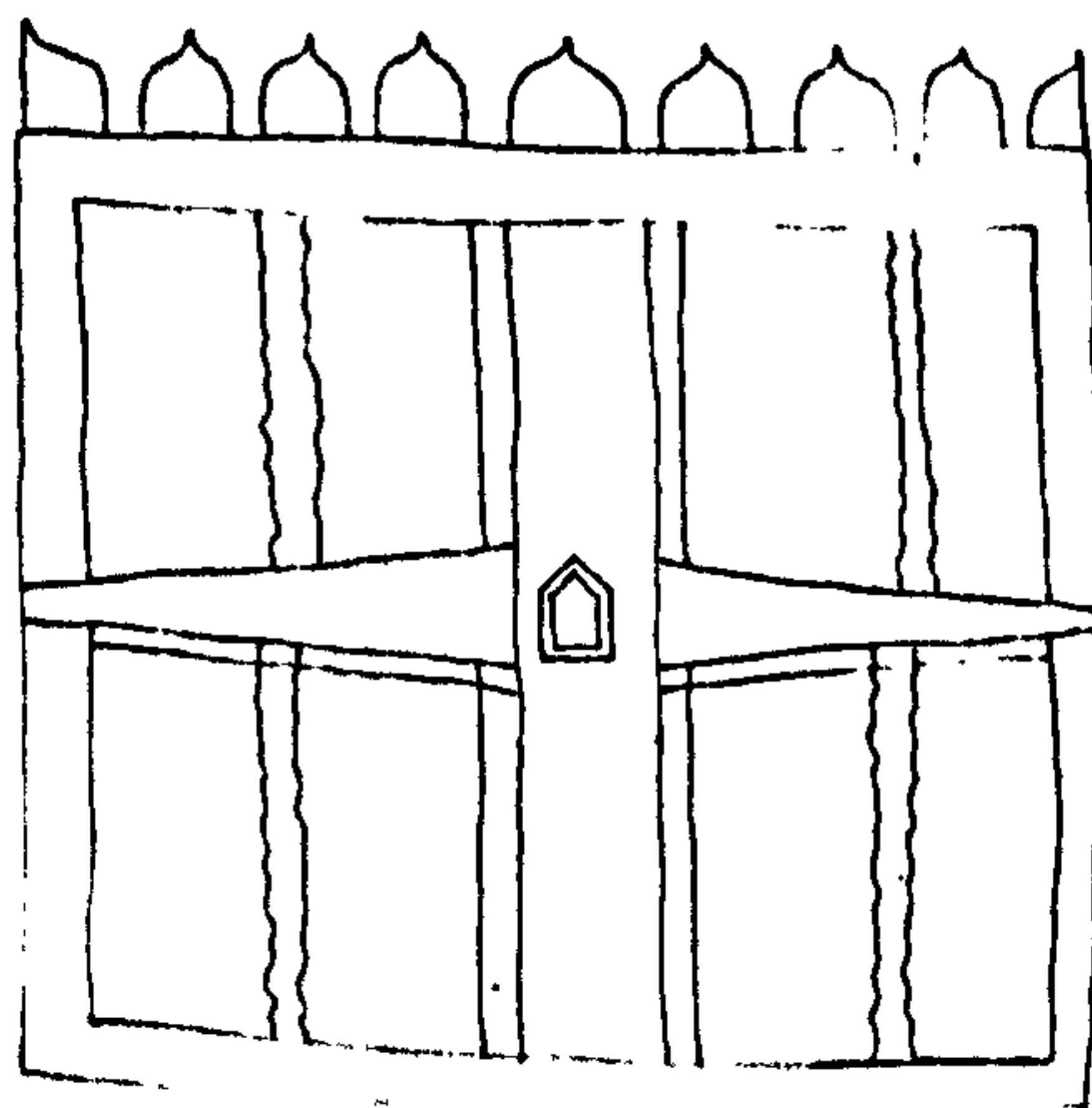

167A

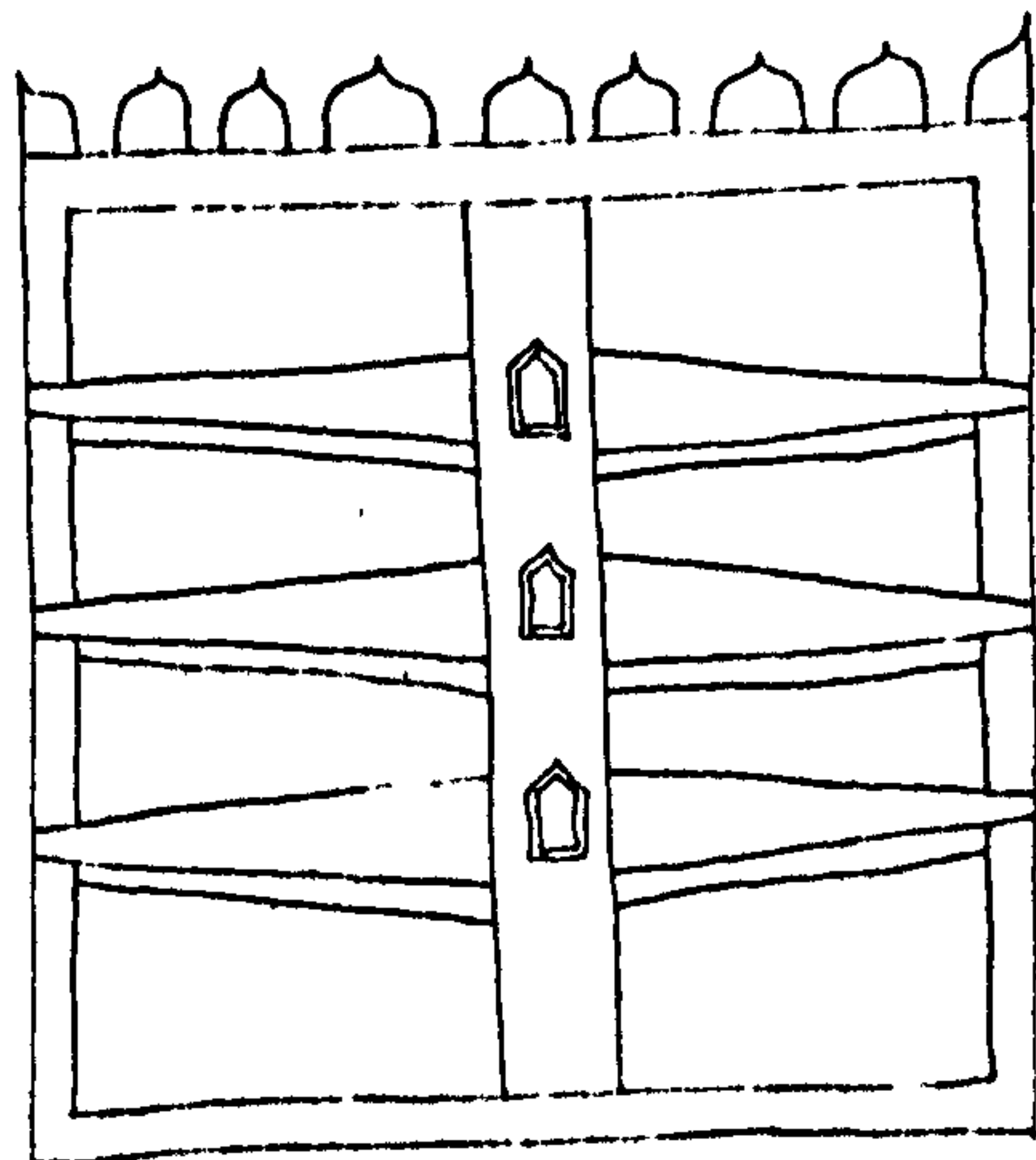

(Continued)

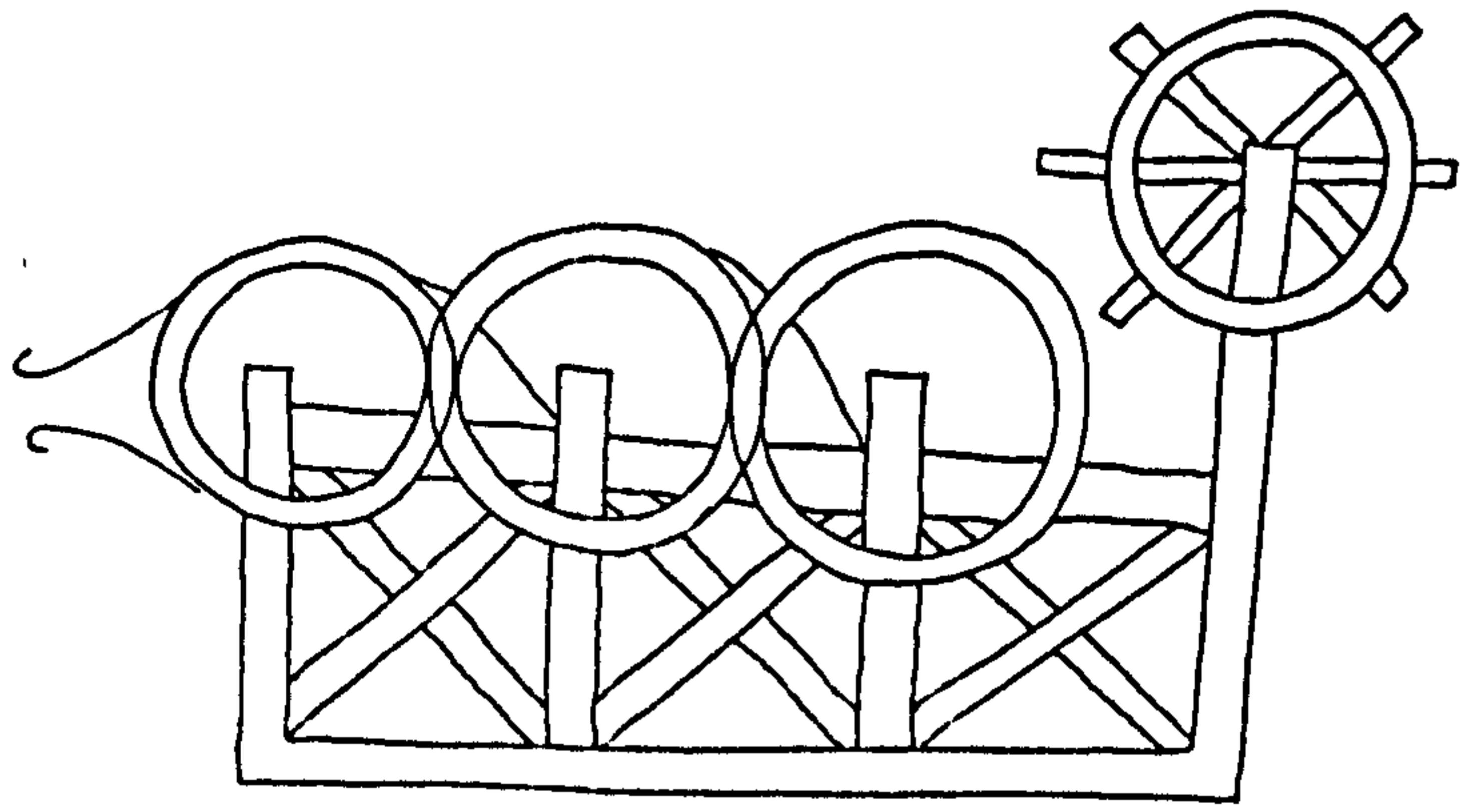

167 B

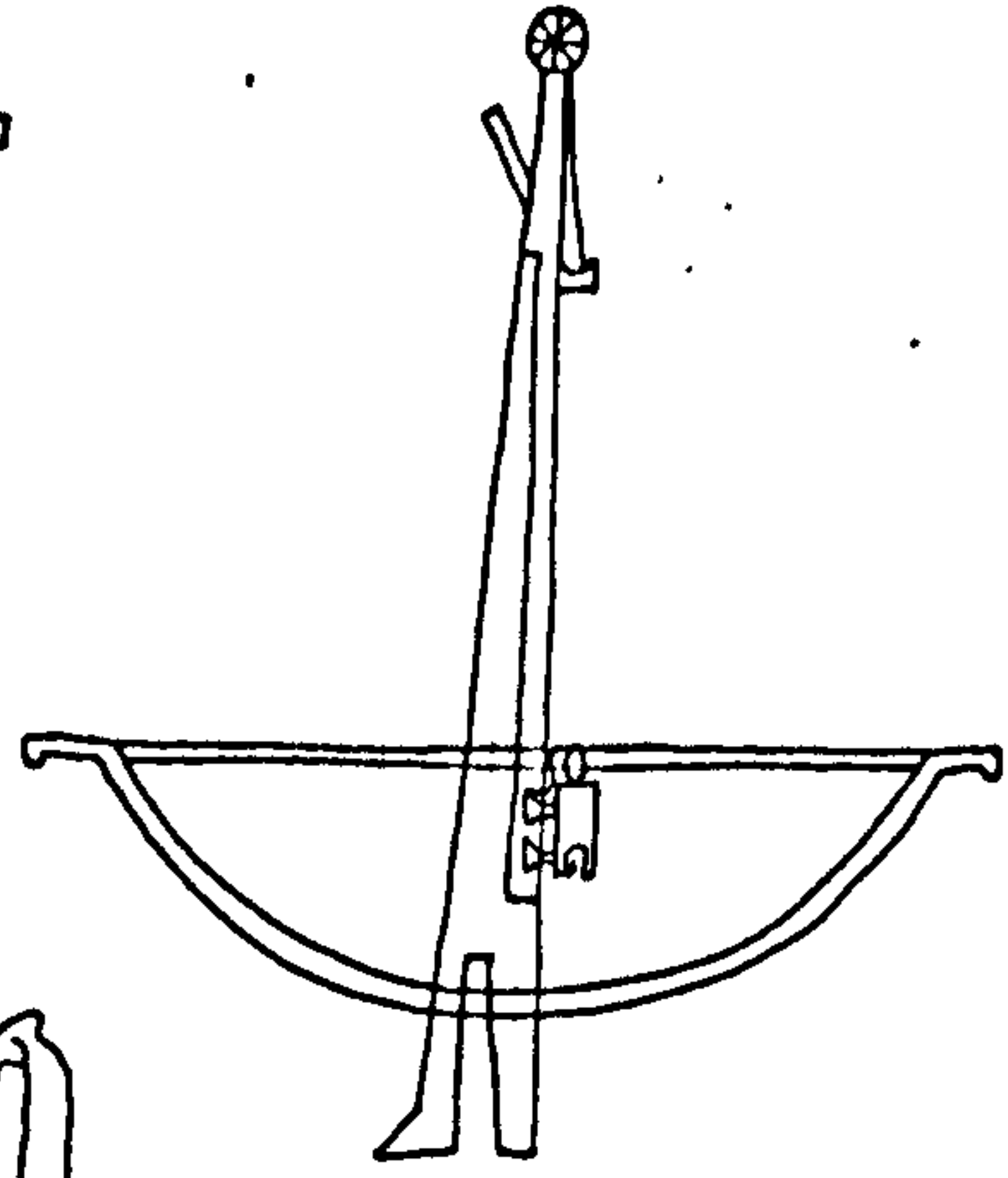

167 C

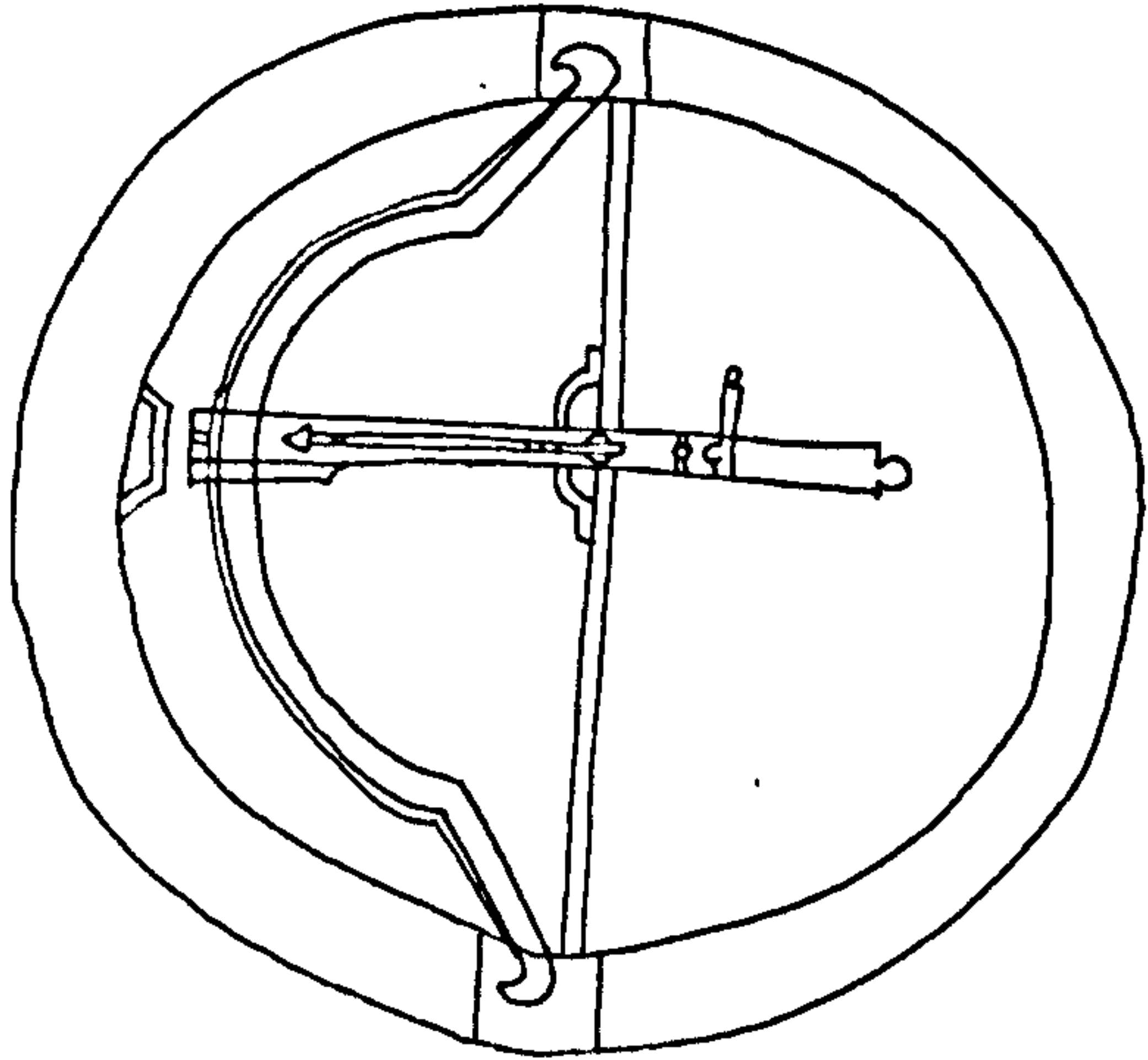

167 D

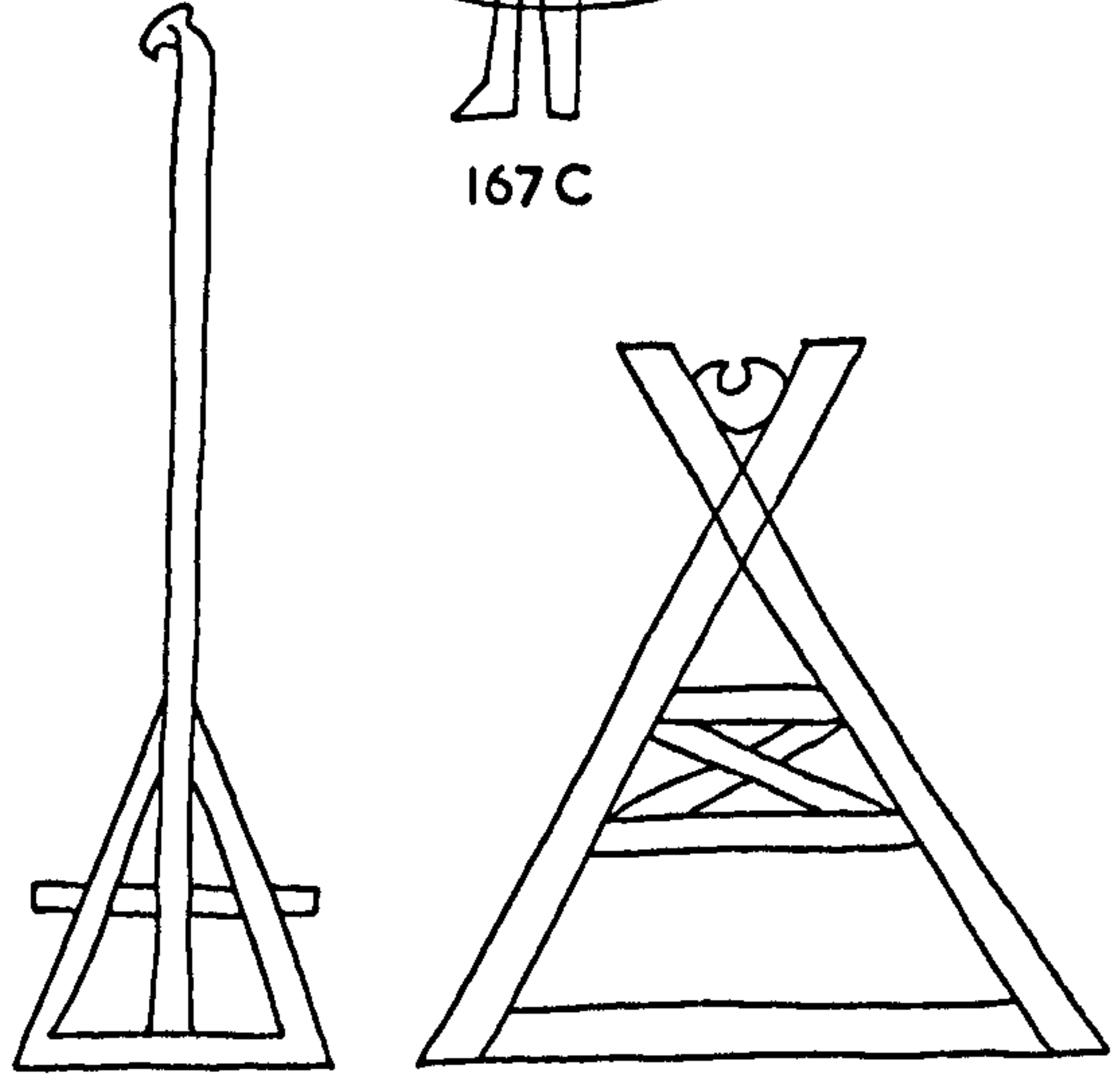

167 E

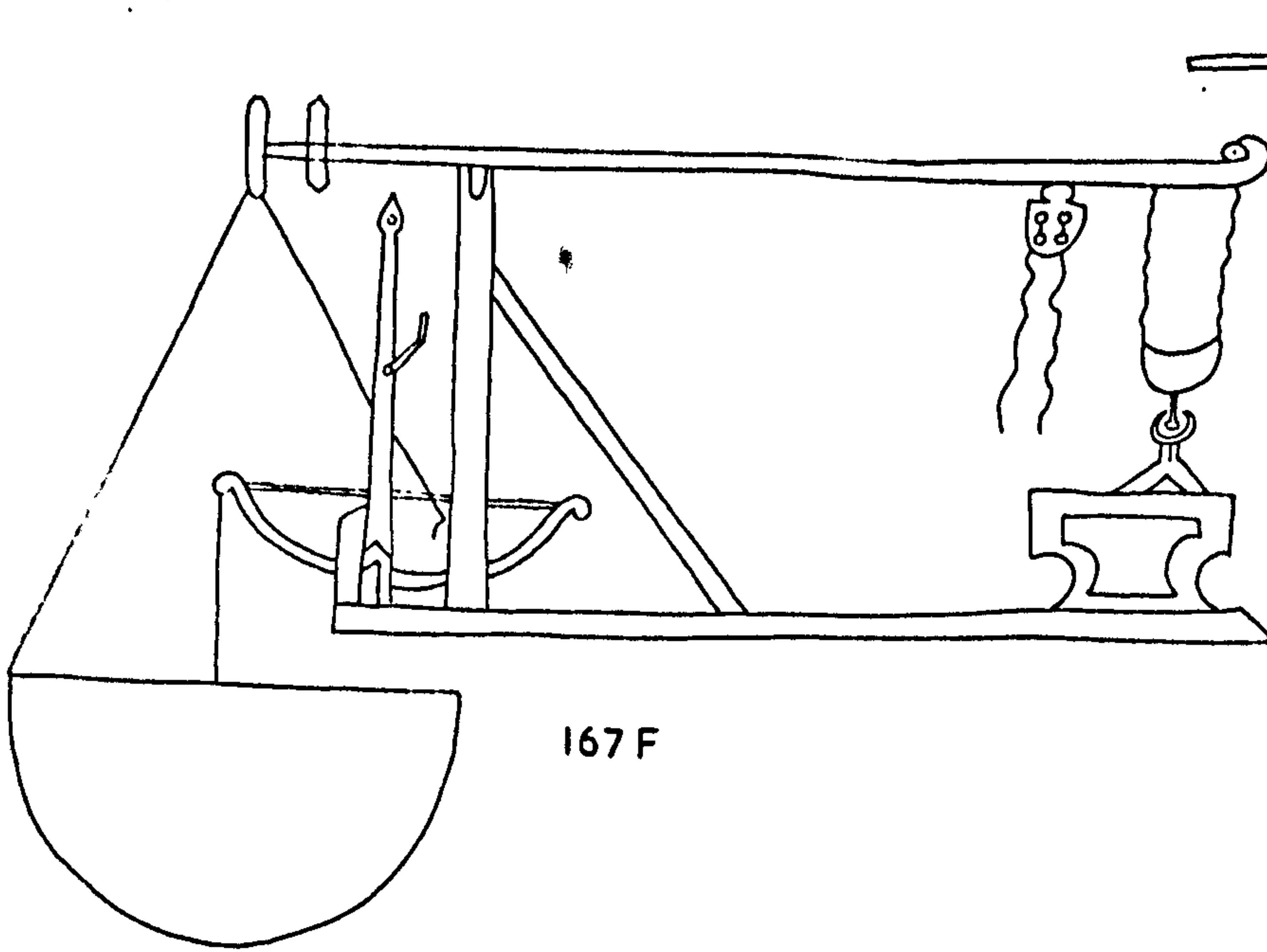

167 F

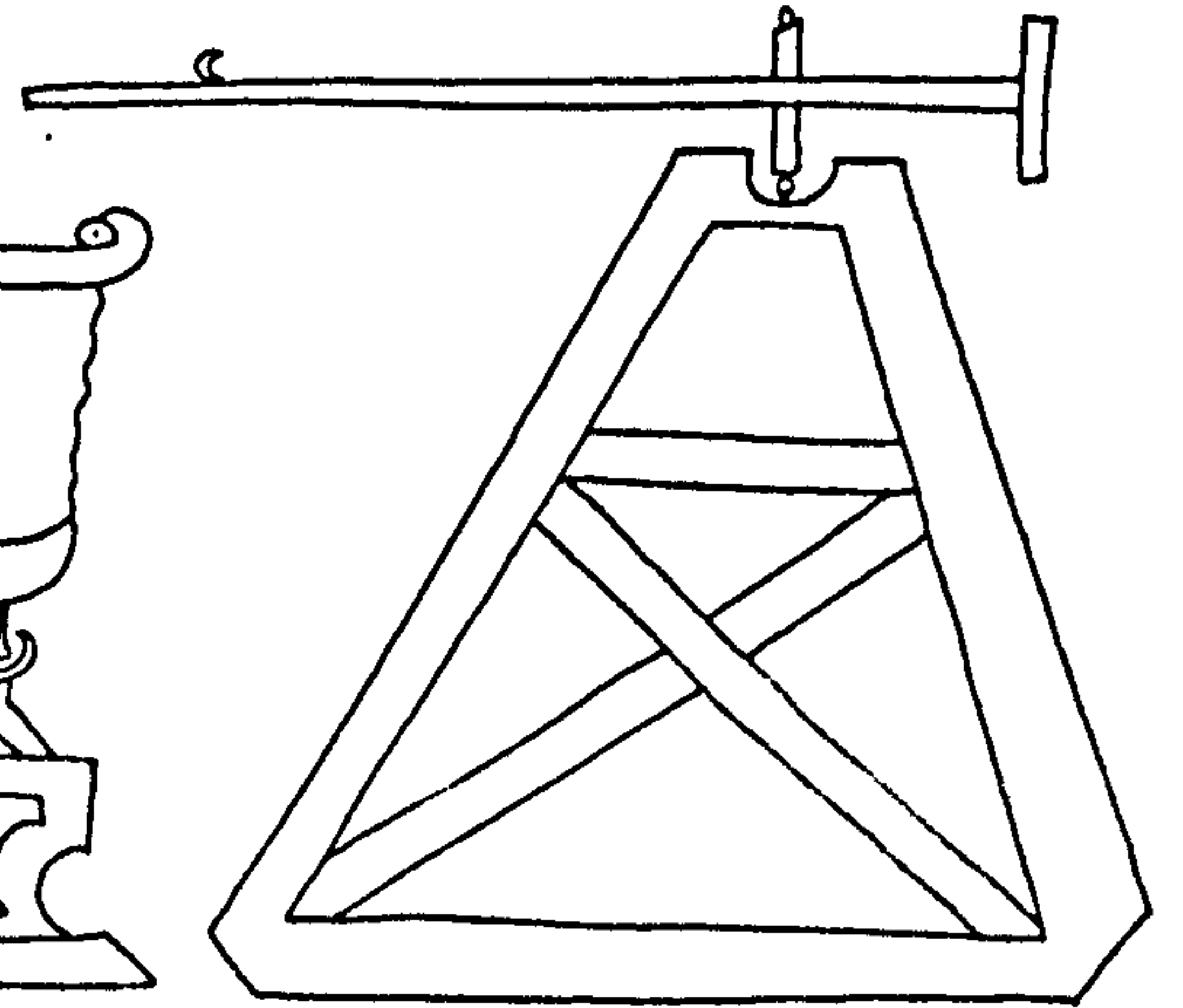

167 G

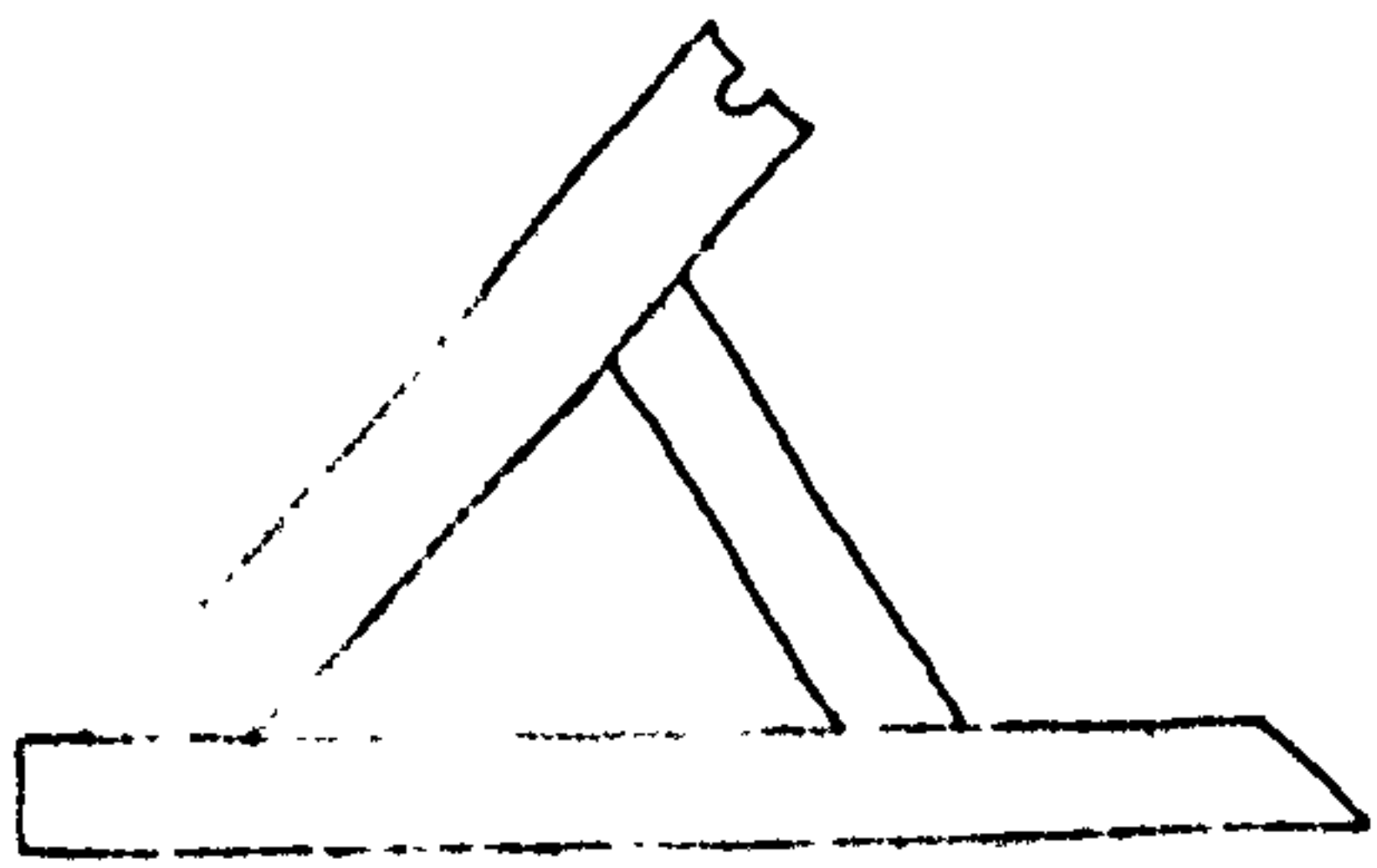

167 H

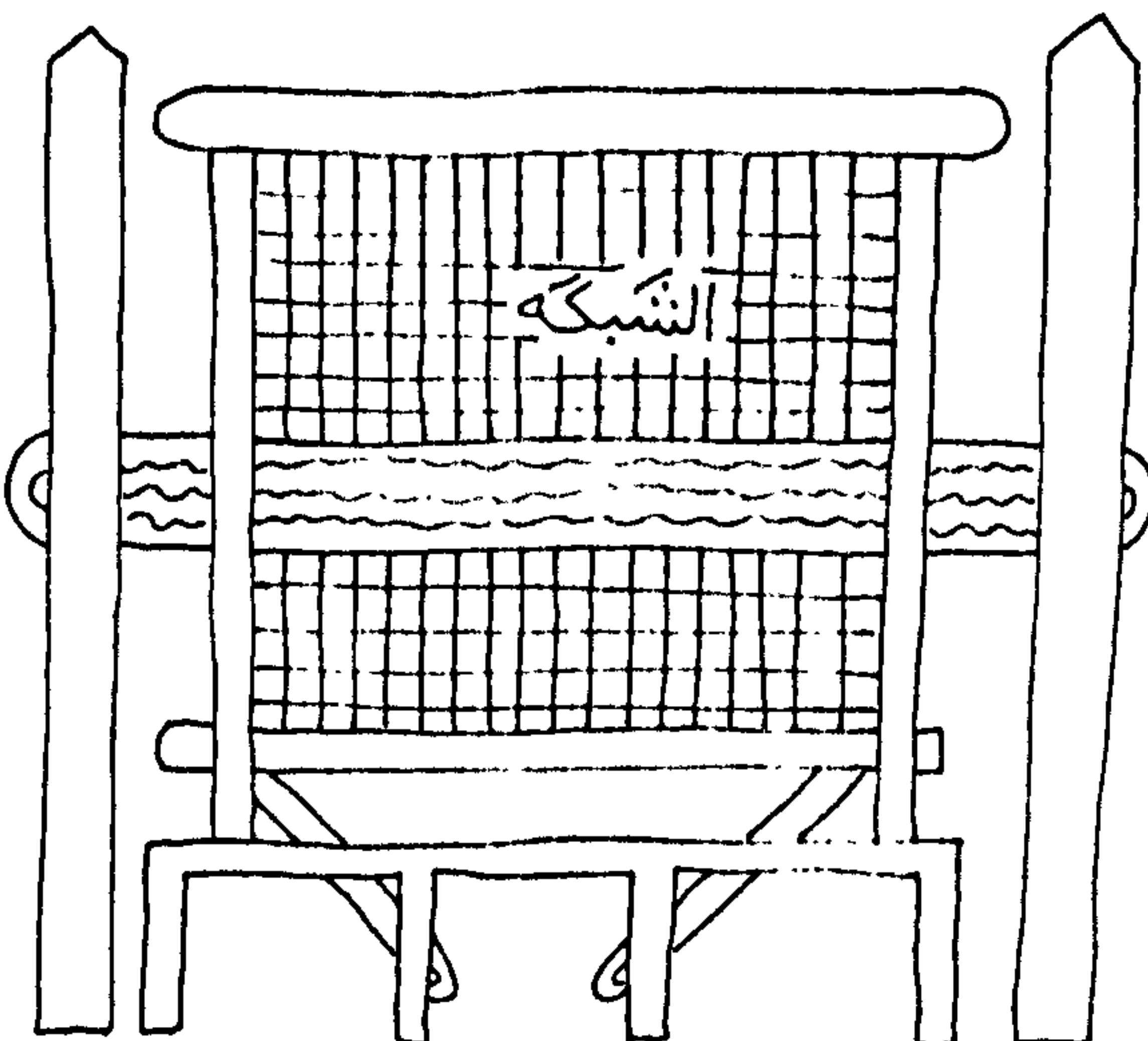

167 I

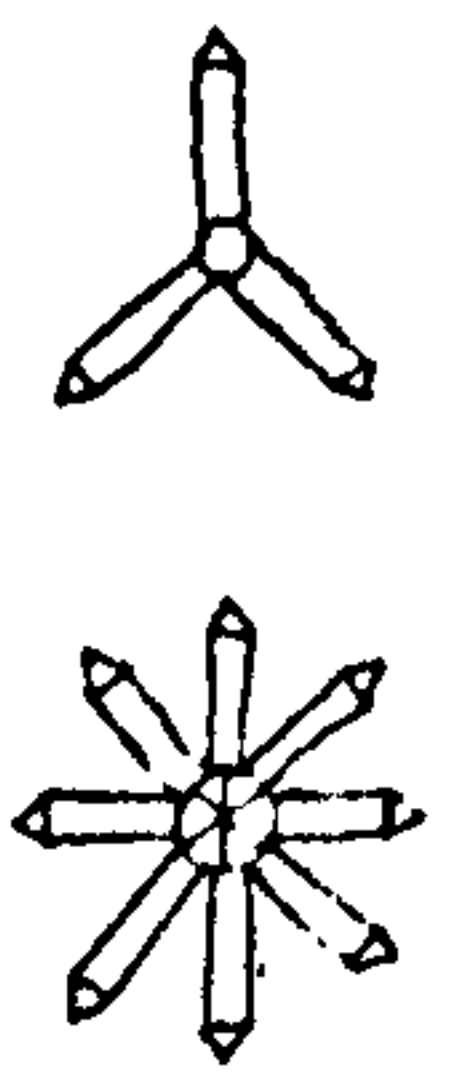

167 J

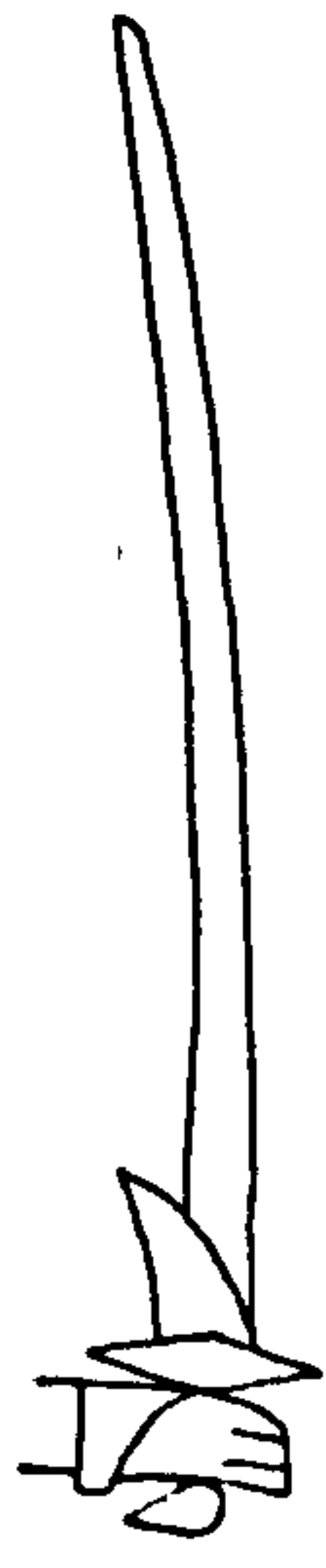

168

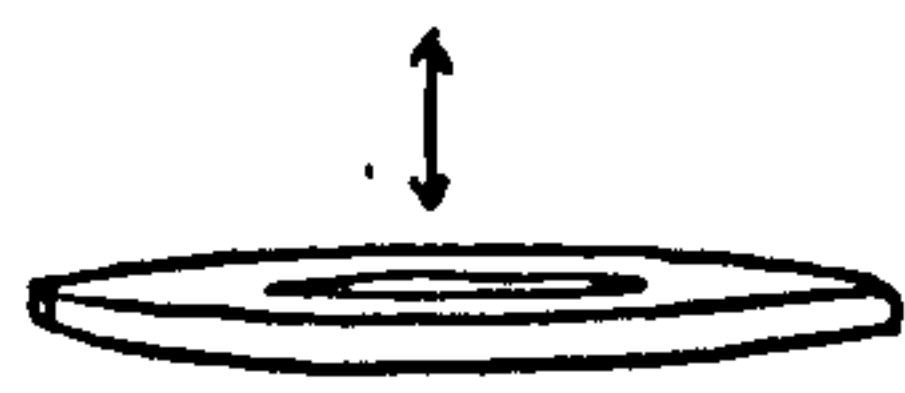
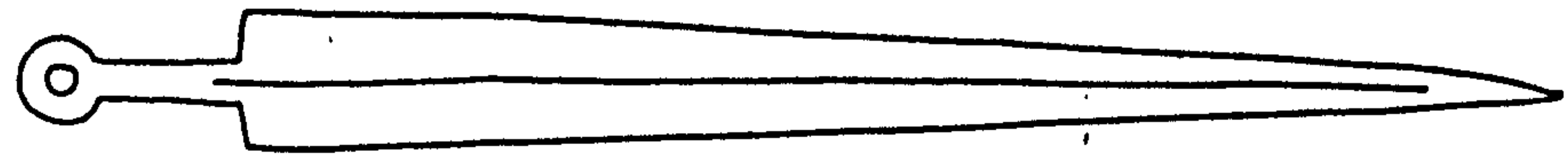

169



170

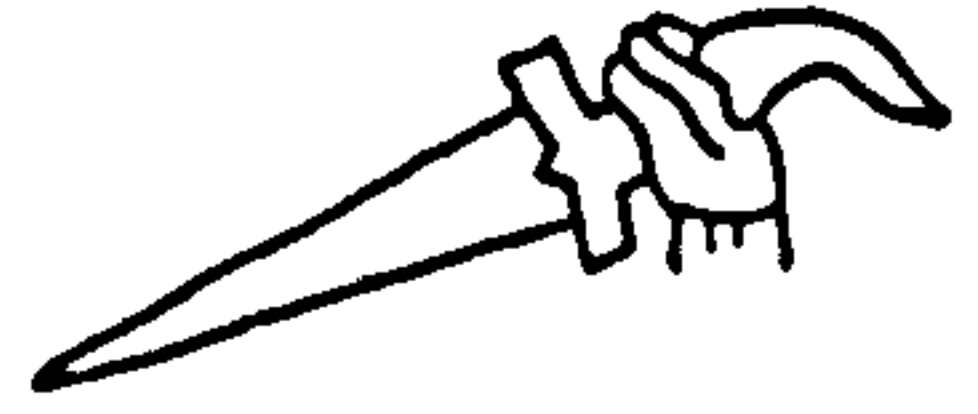

171



172B

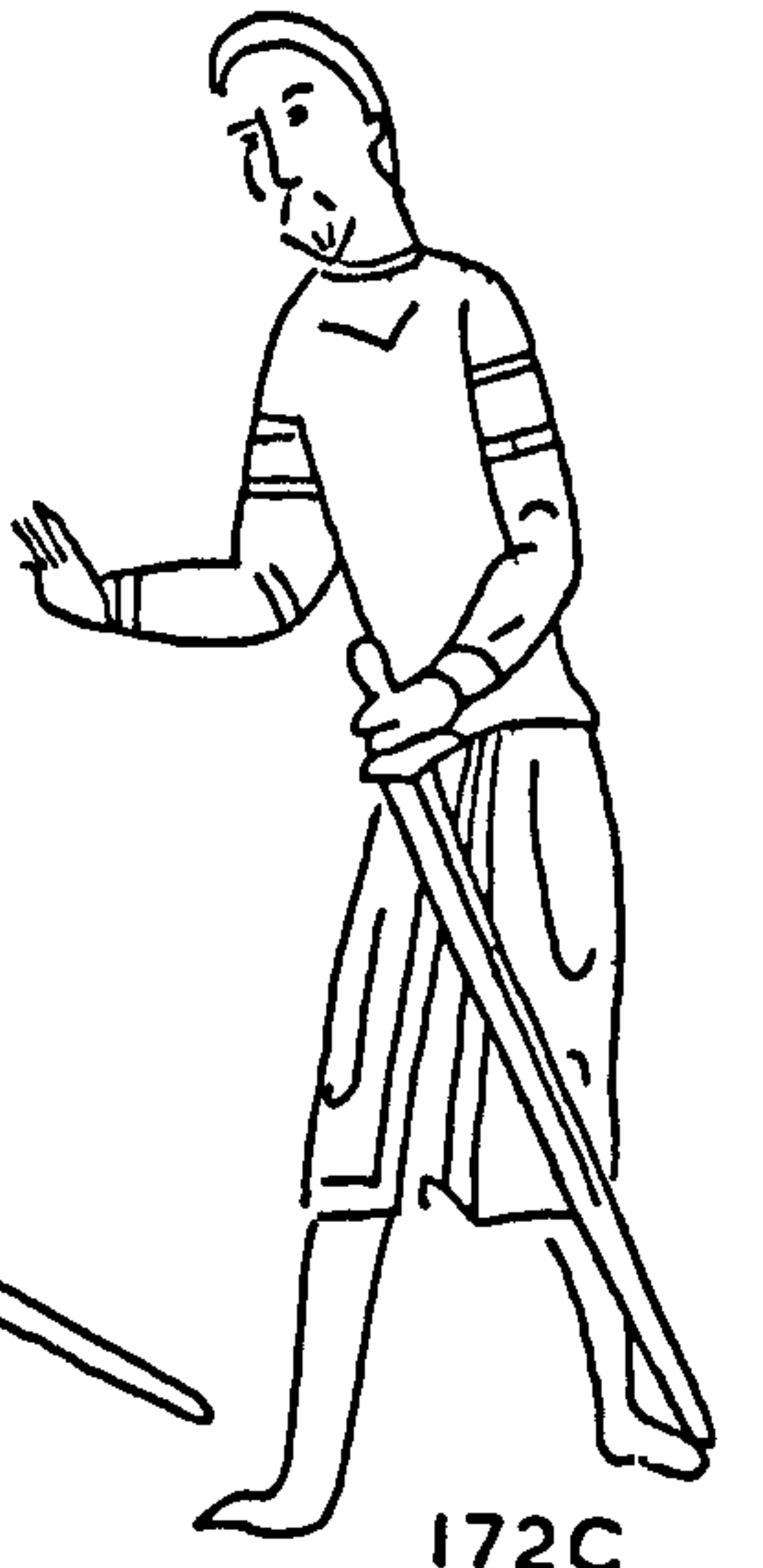

172C

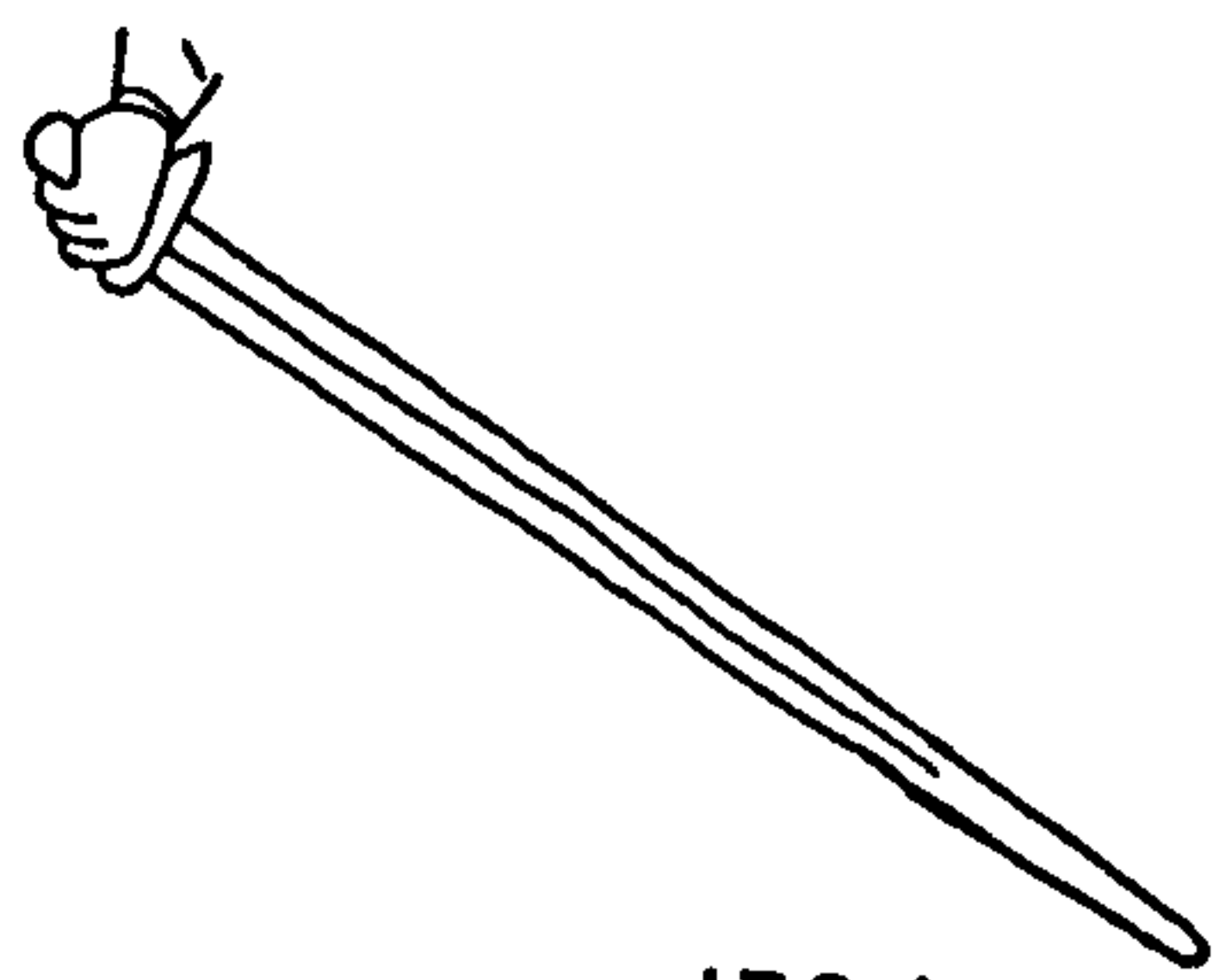

172A

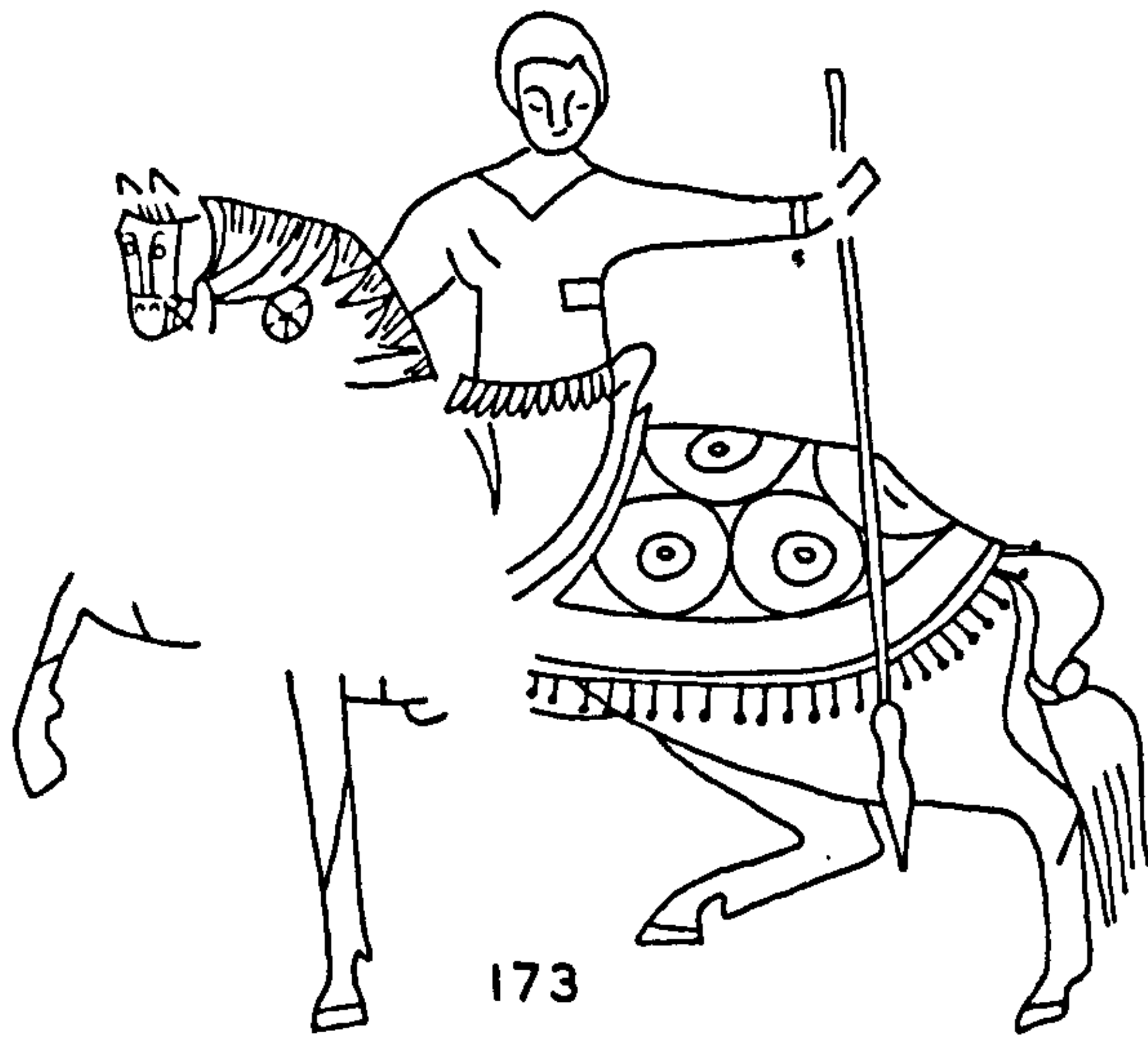

173



174

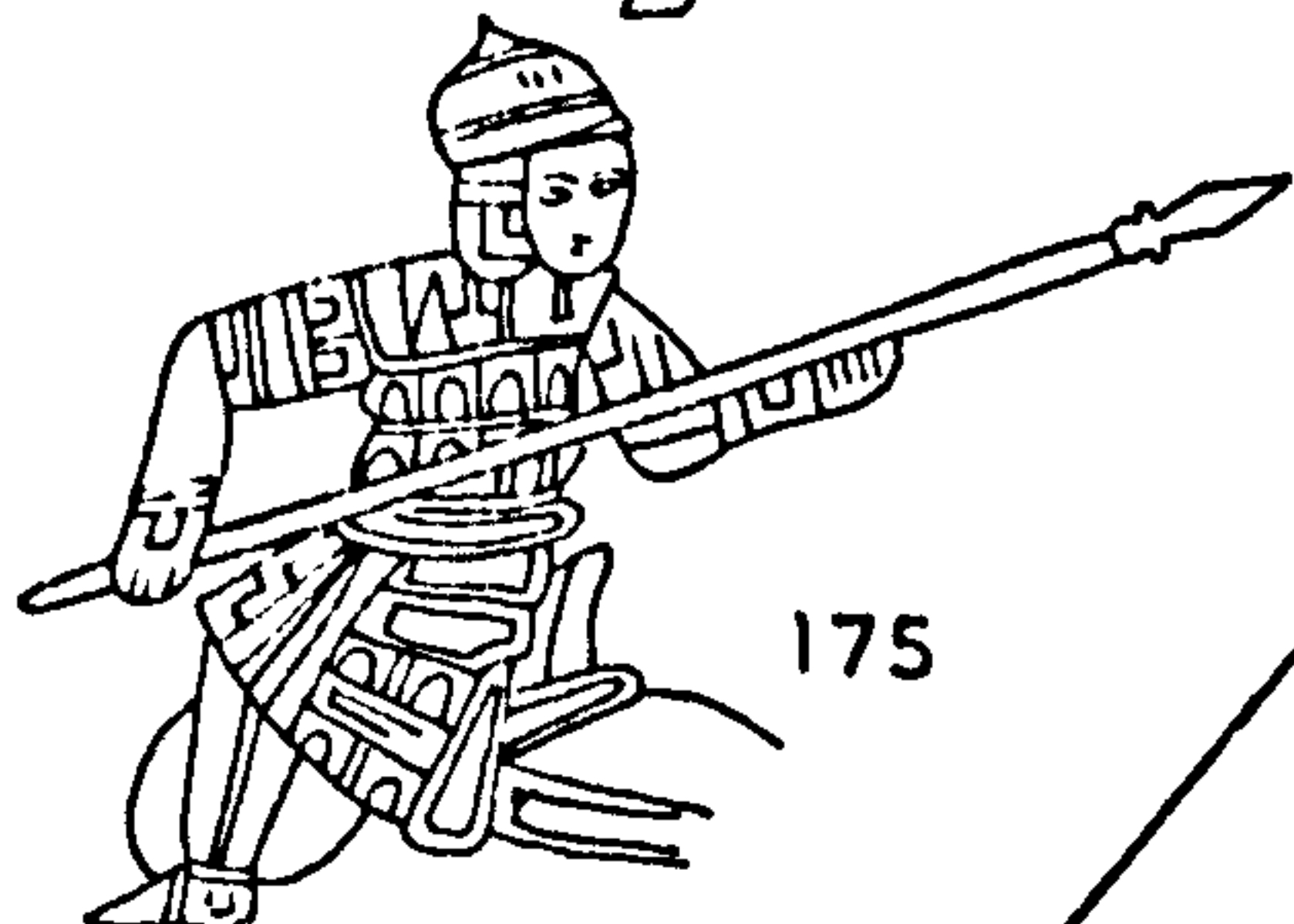
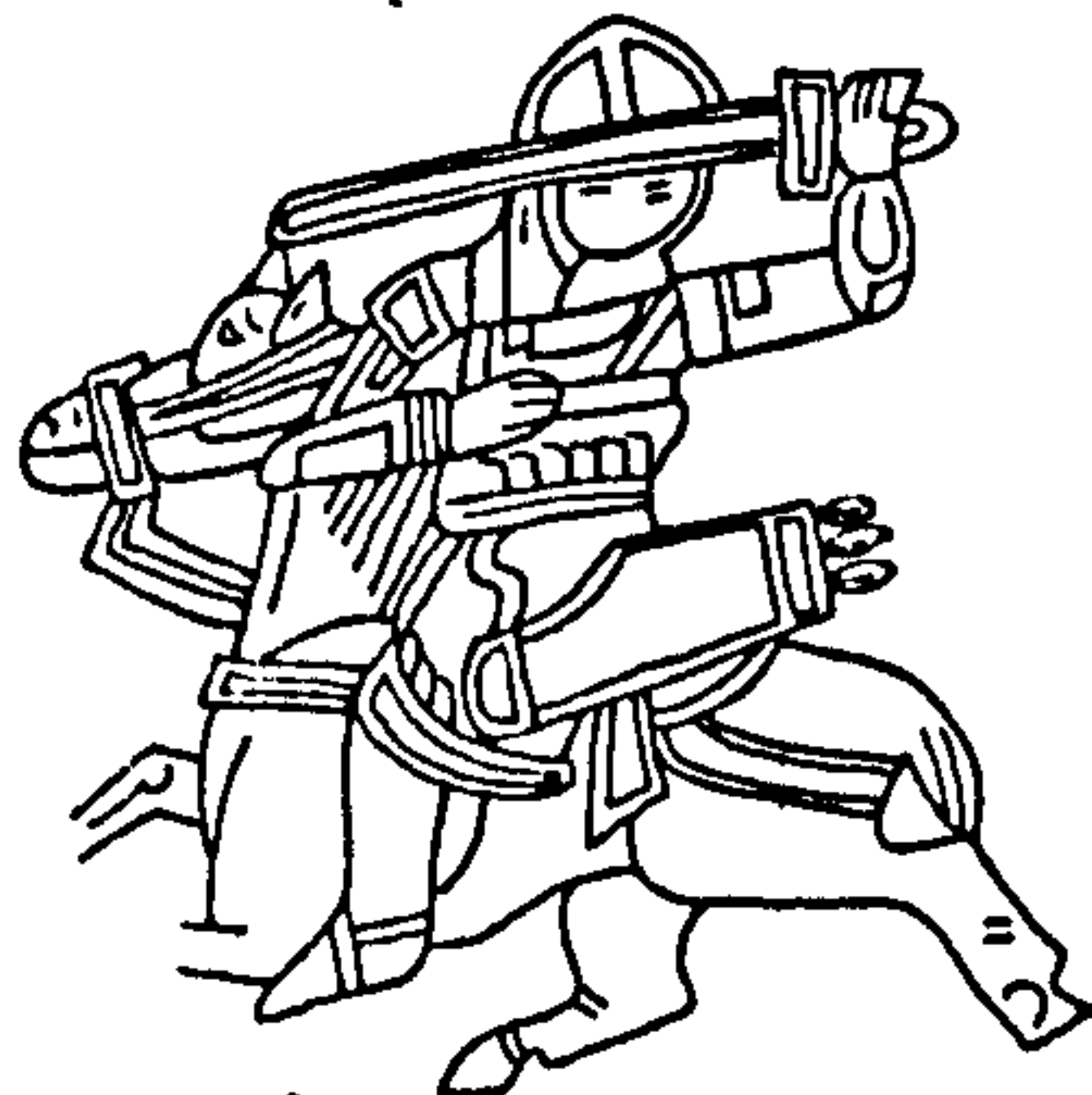

175

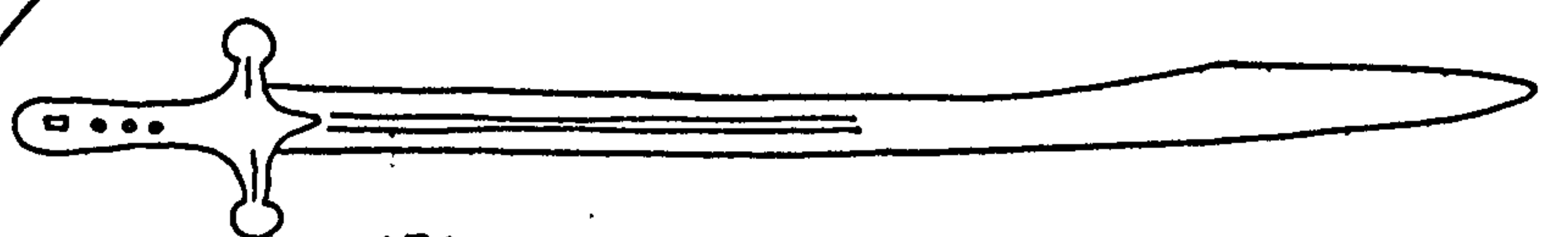

176



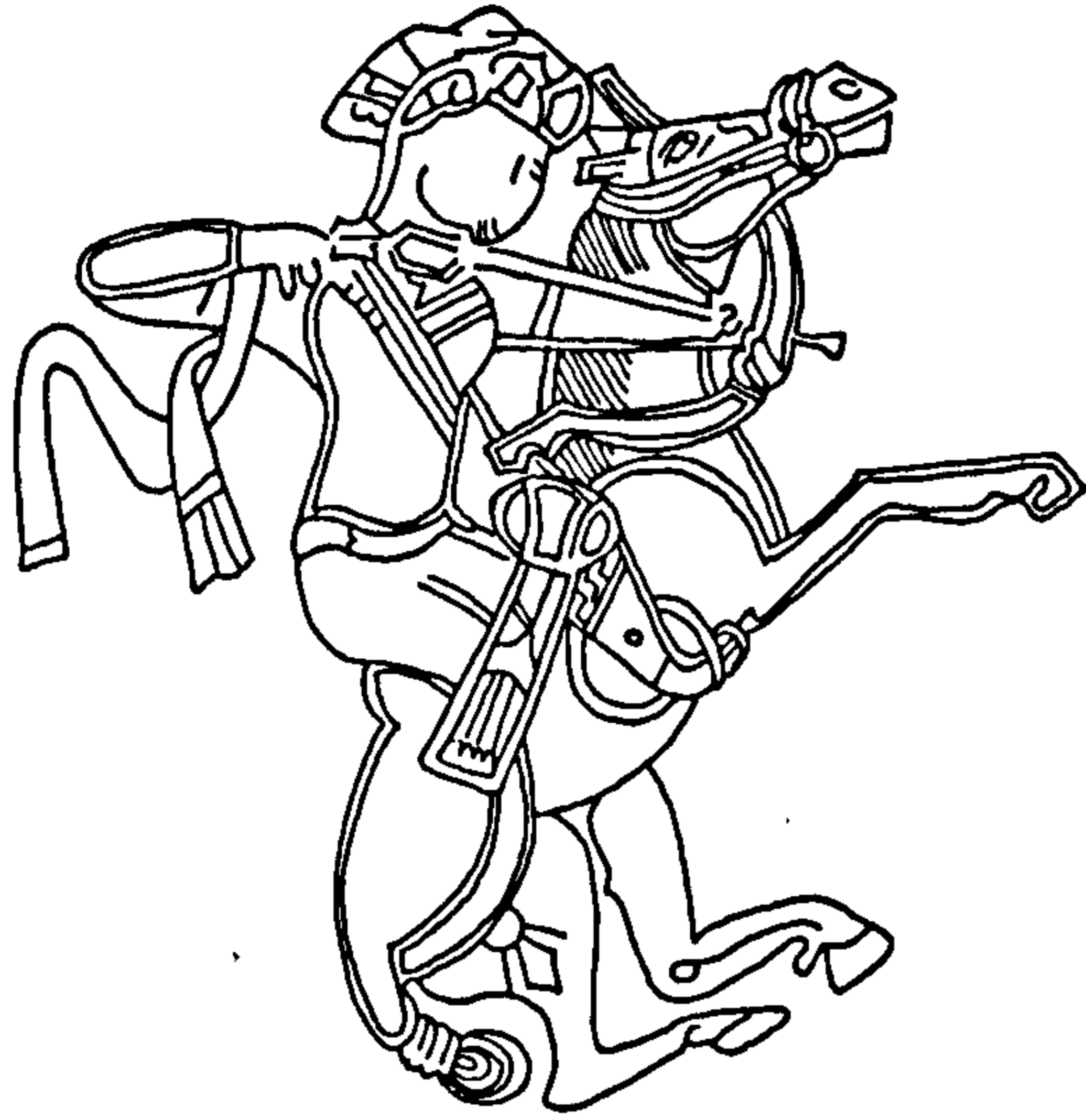

177A



177B



177C



177D



177E



177F

(Continued)



177G

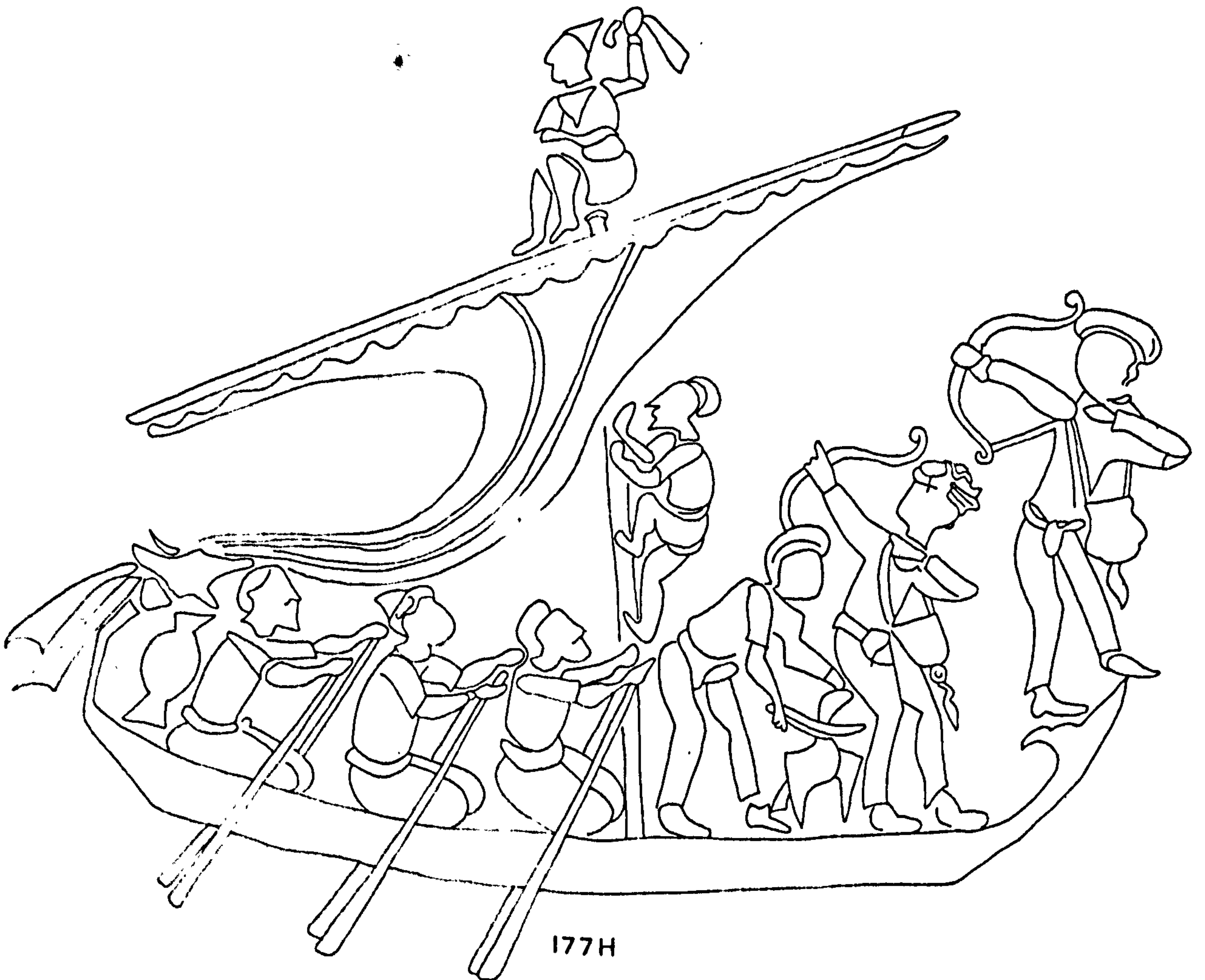

177H



178 A

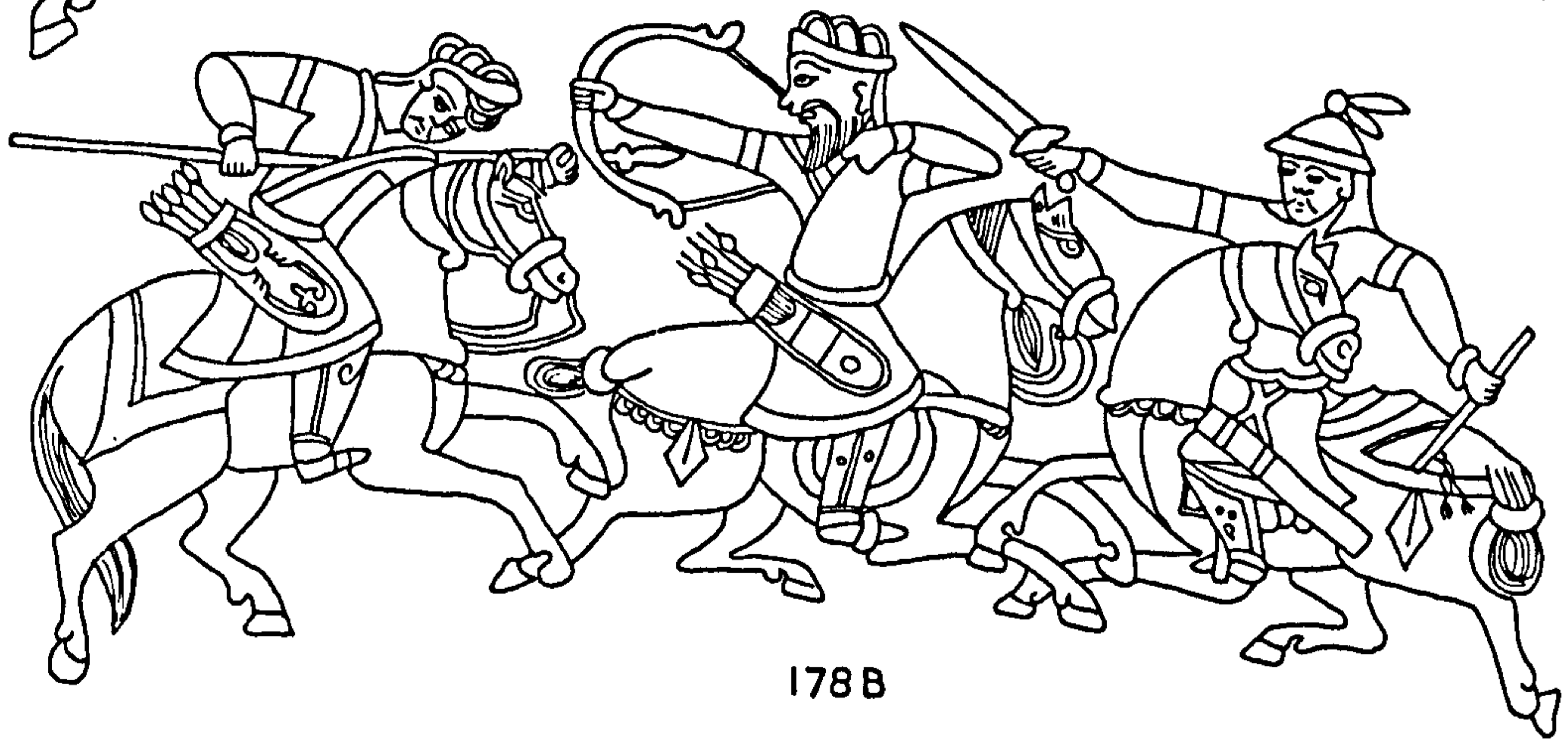
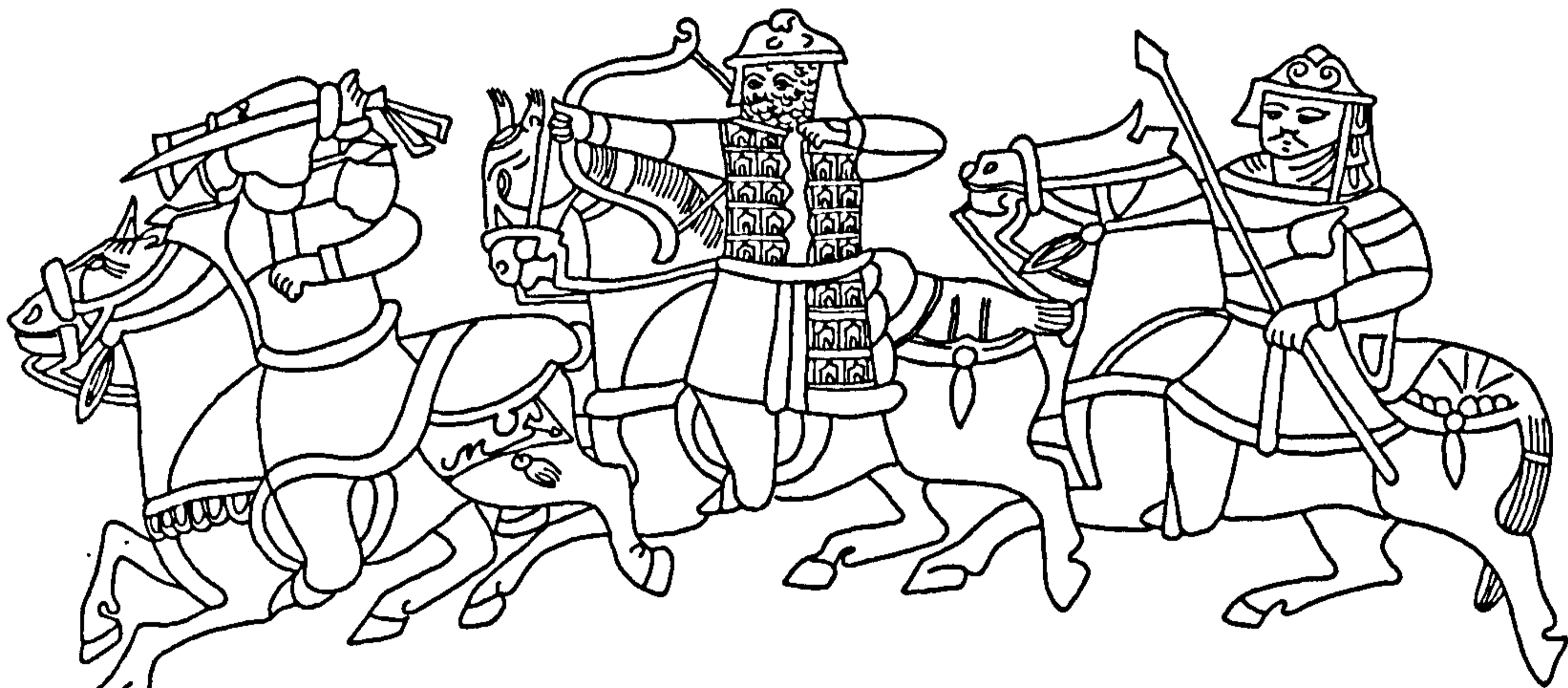

178 B



179



180

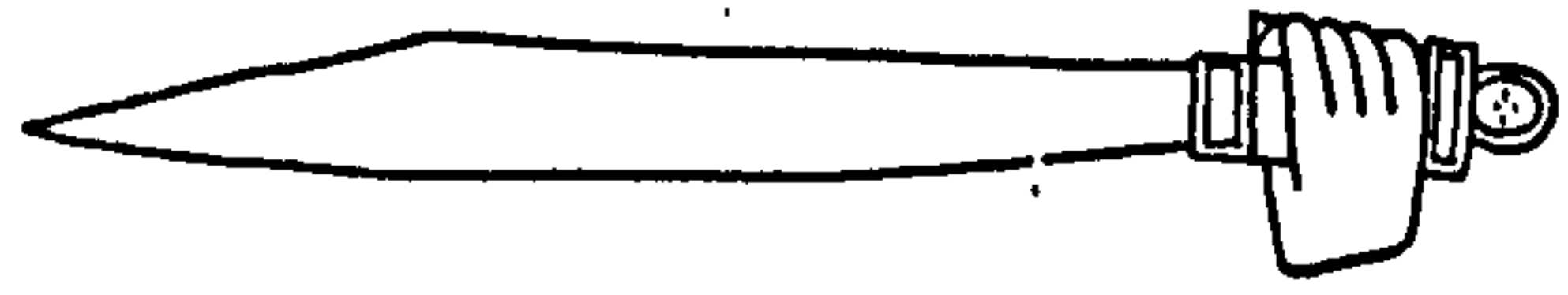

181

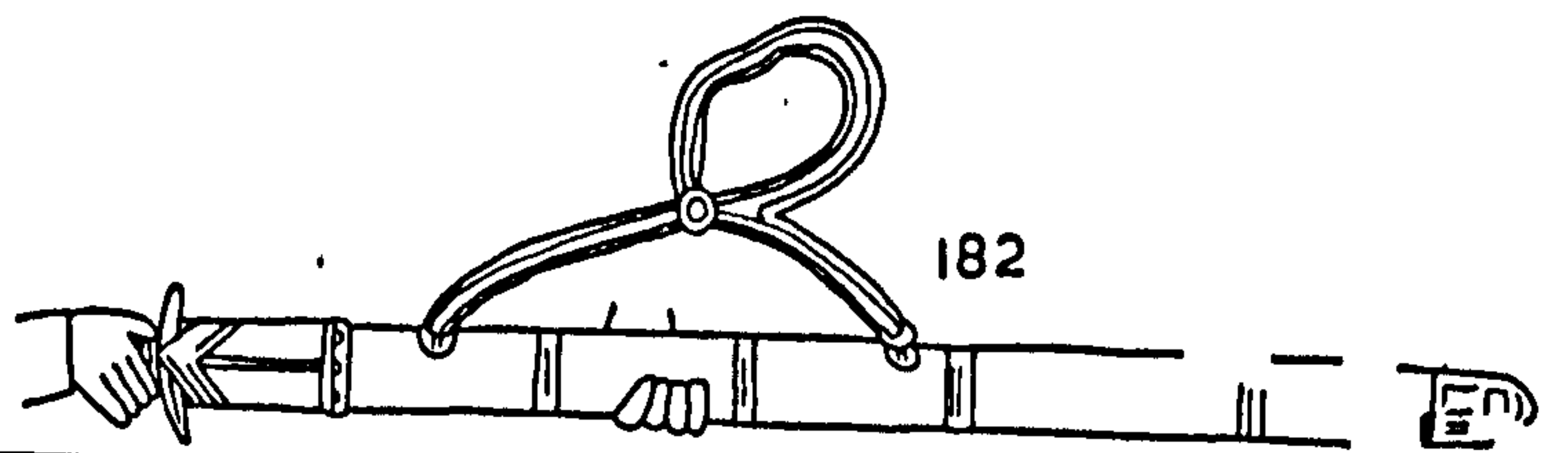

182

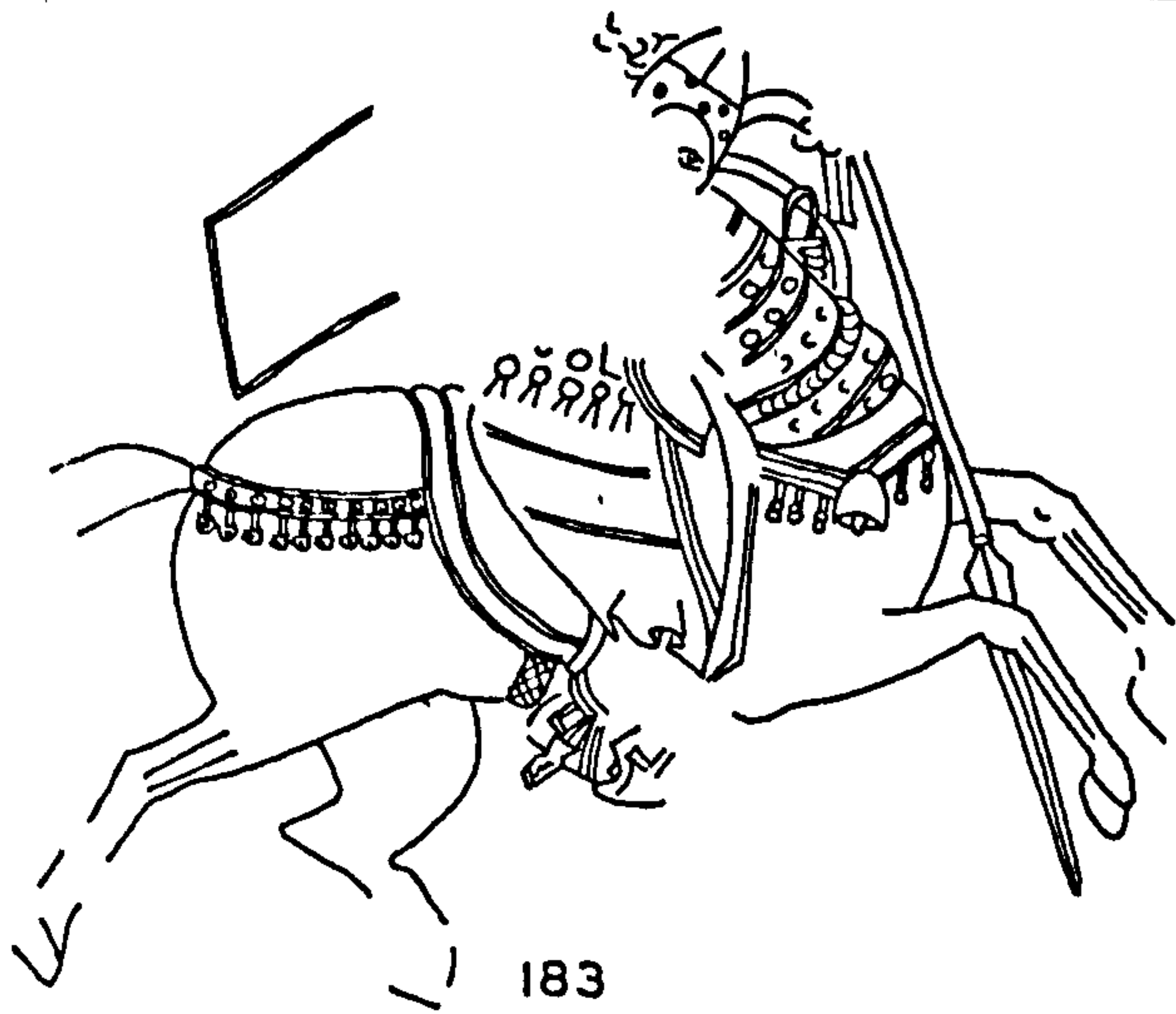

183



184

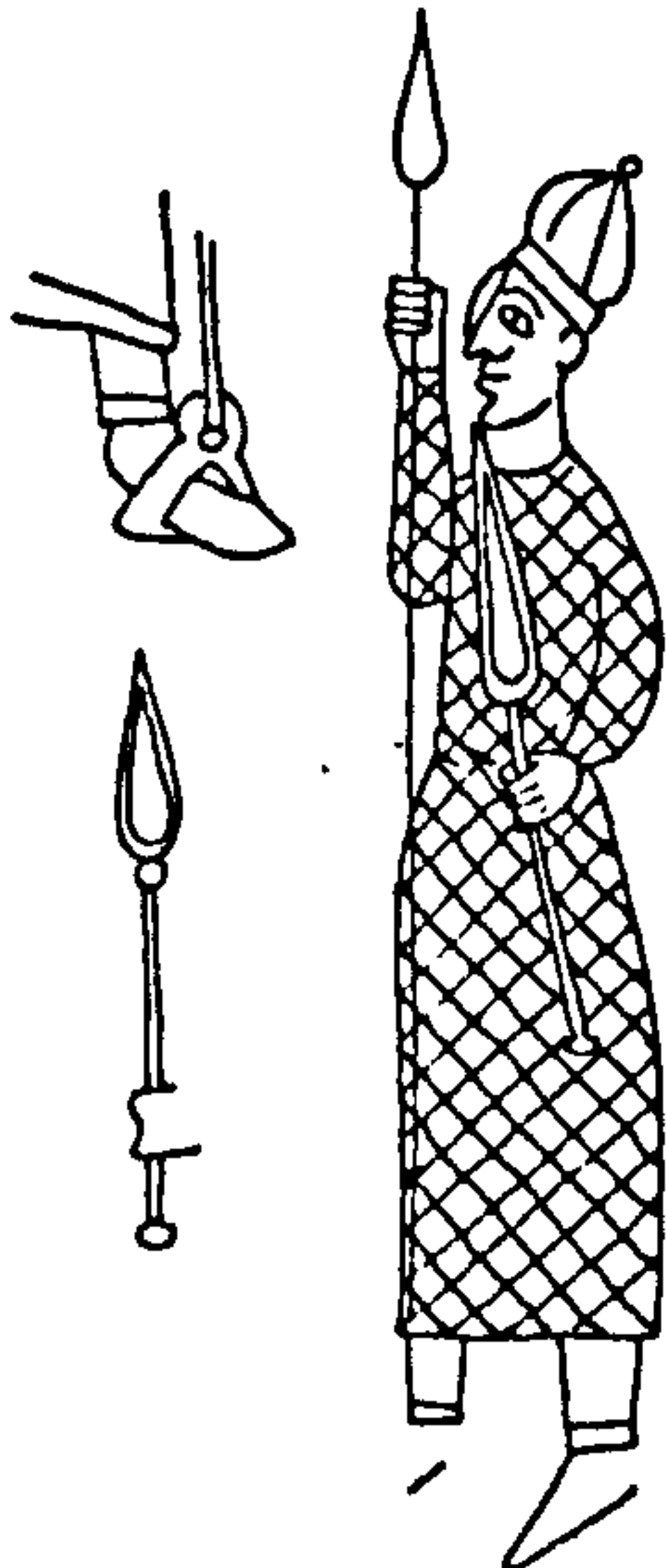

185

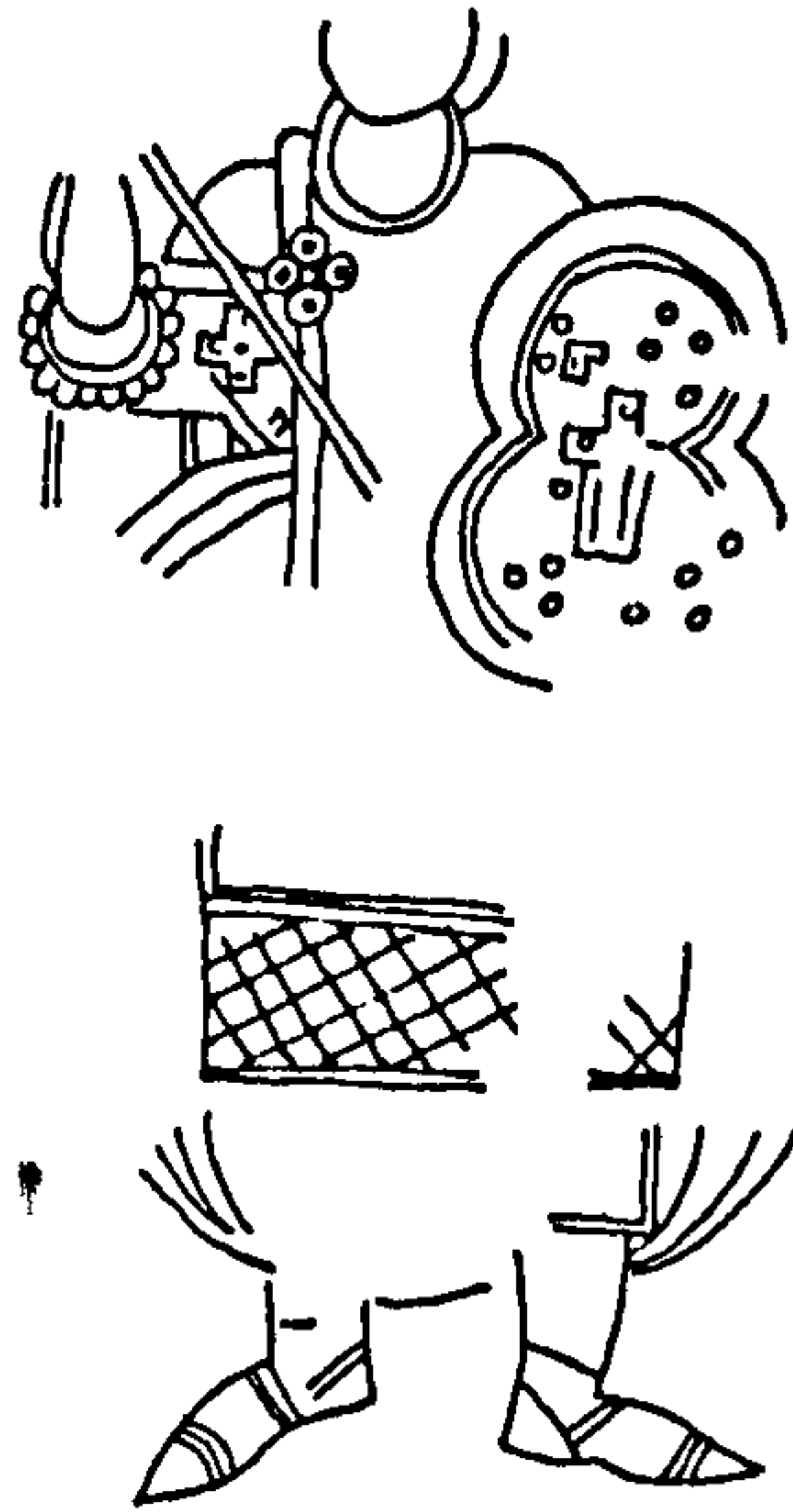

186



187

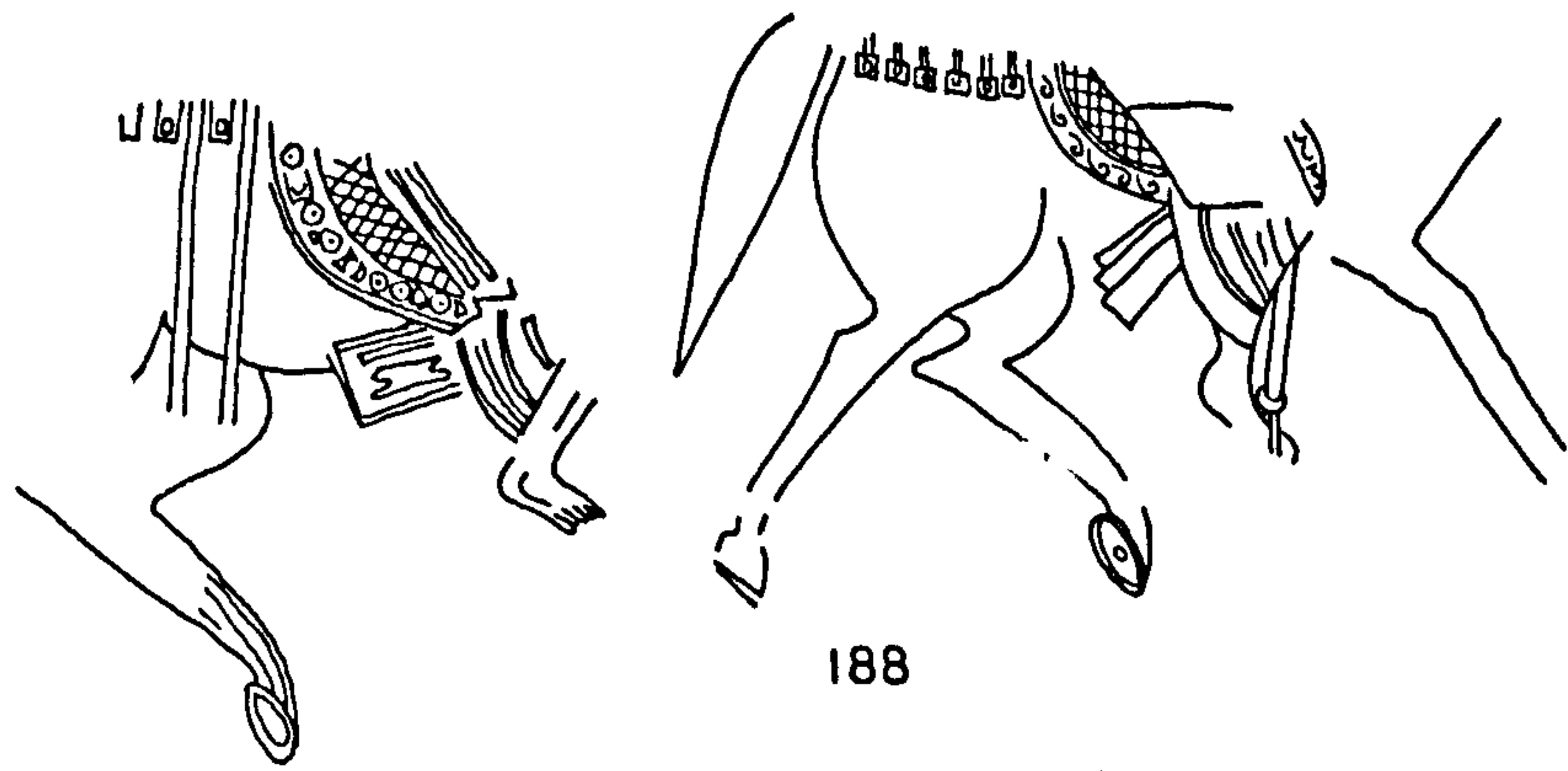

188

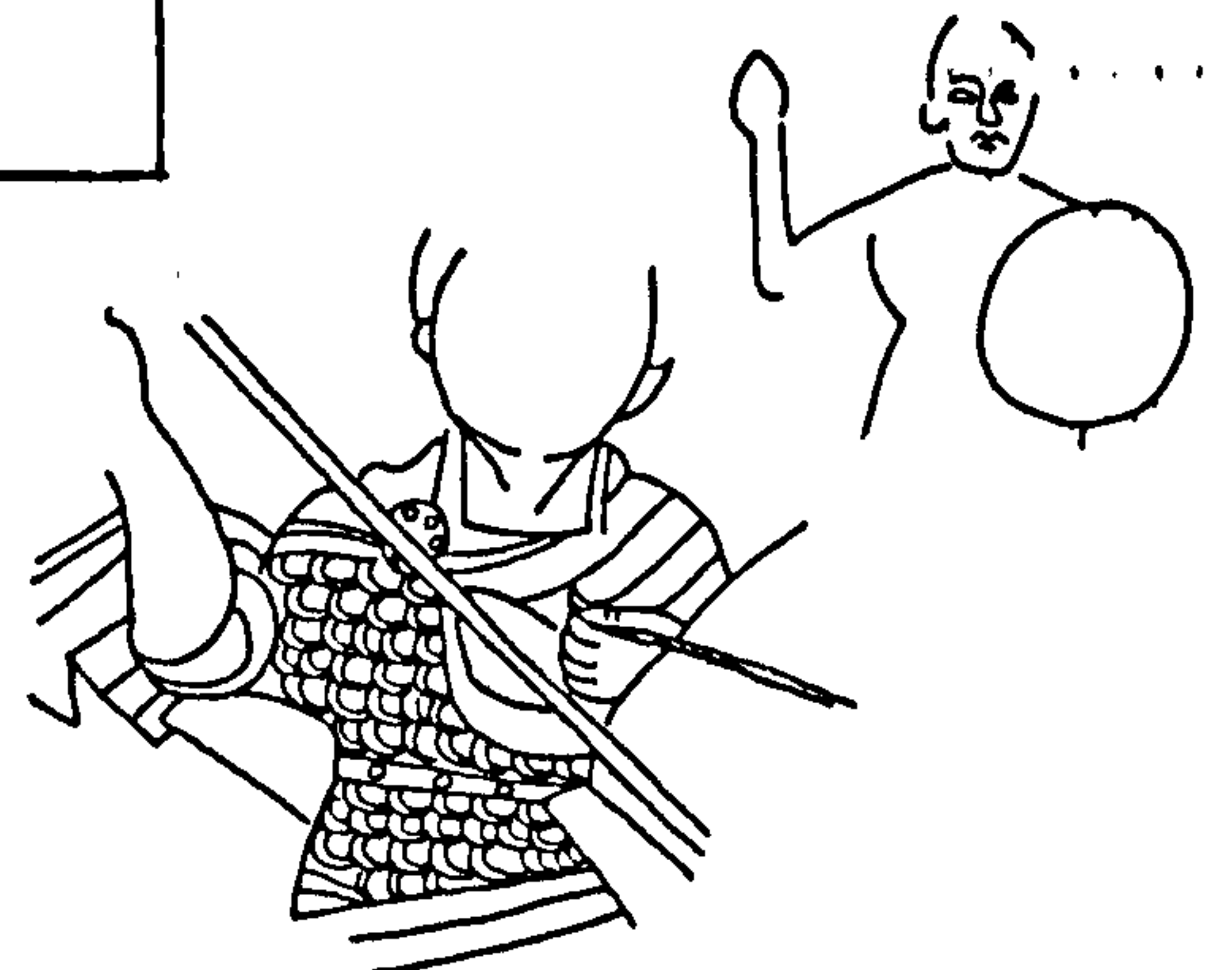

189

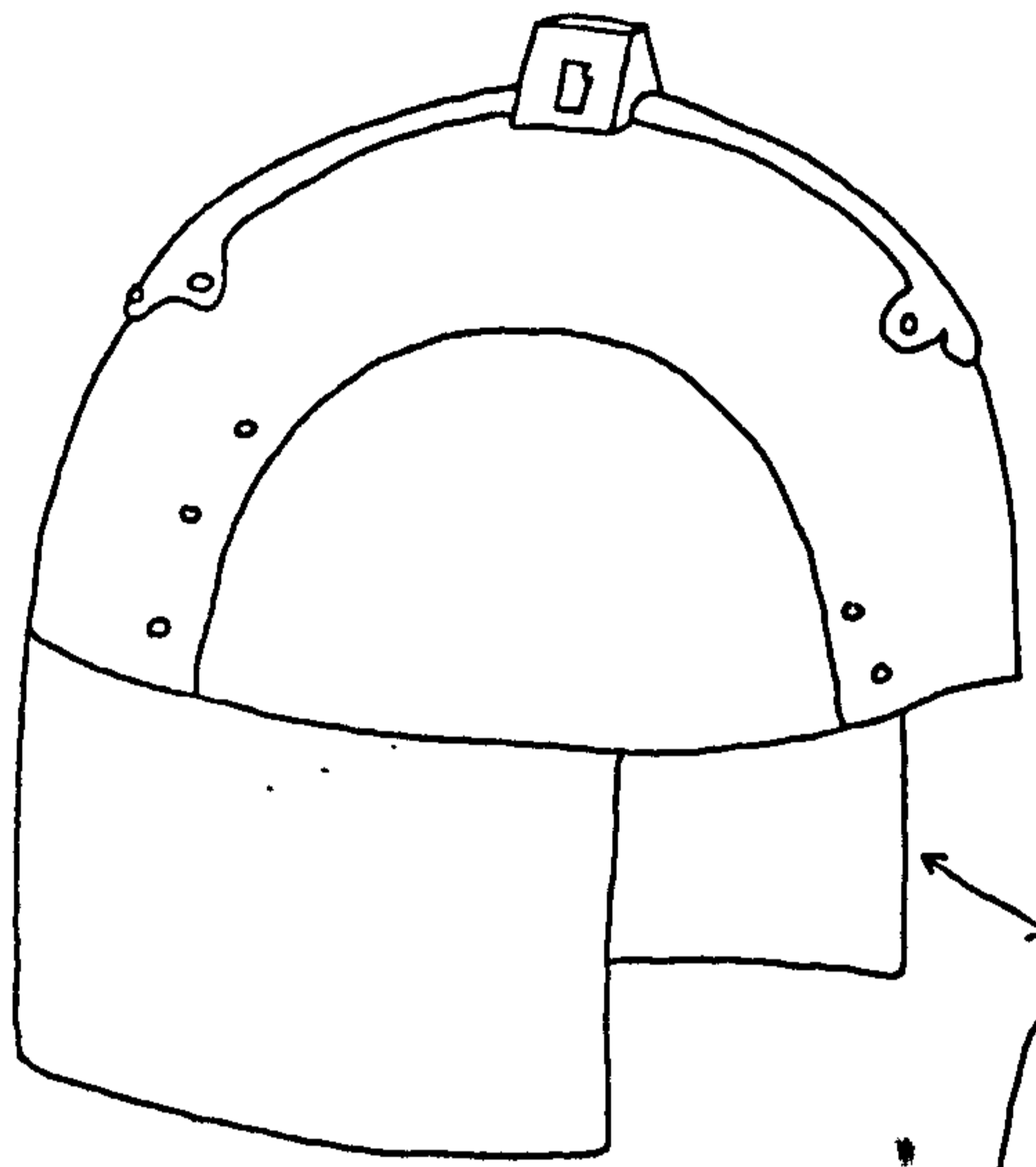
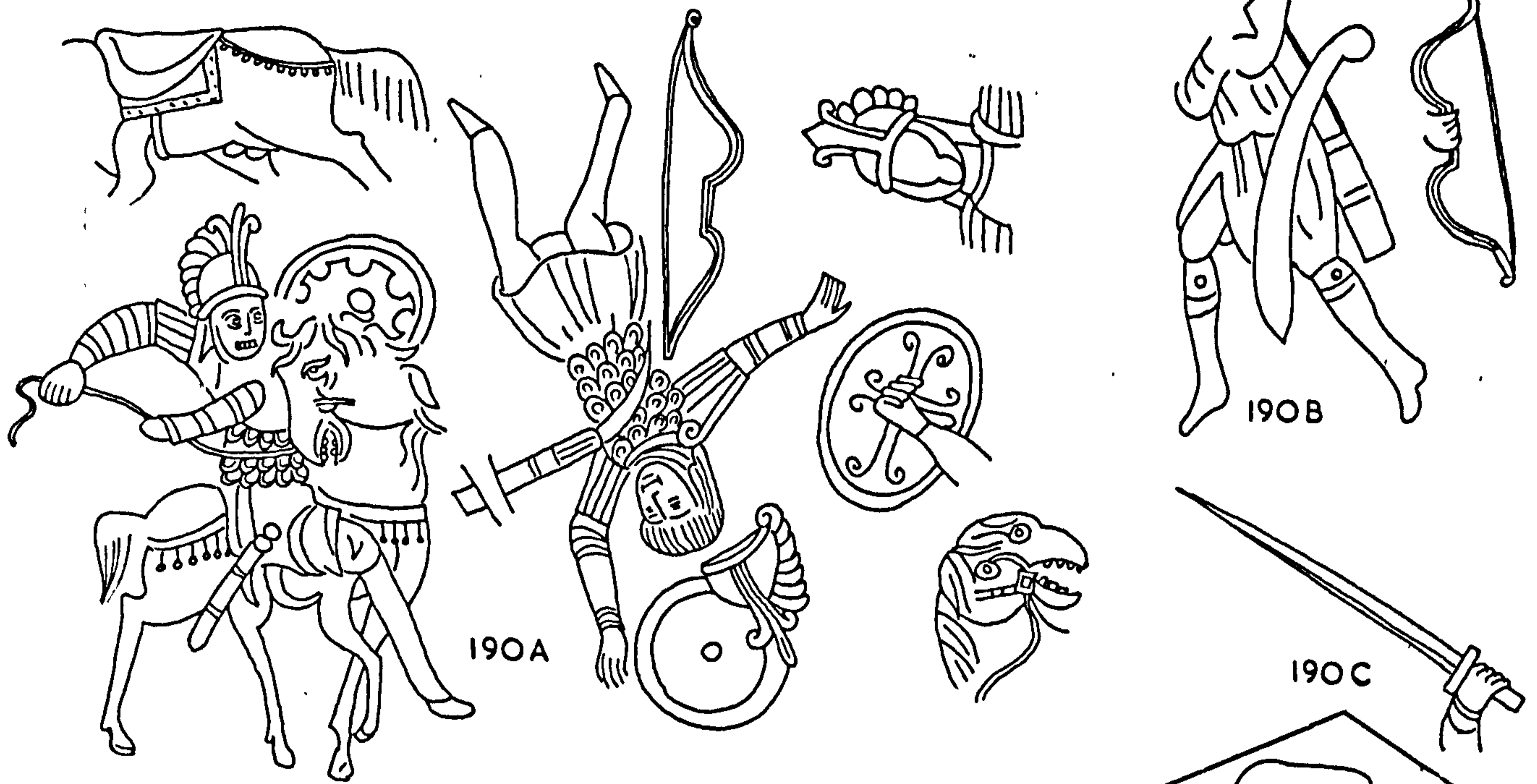

191

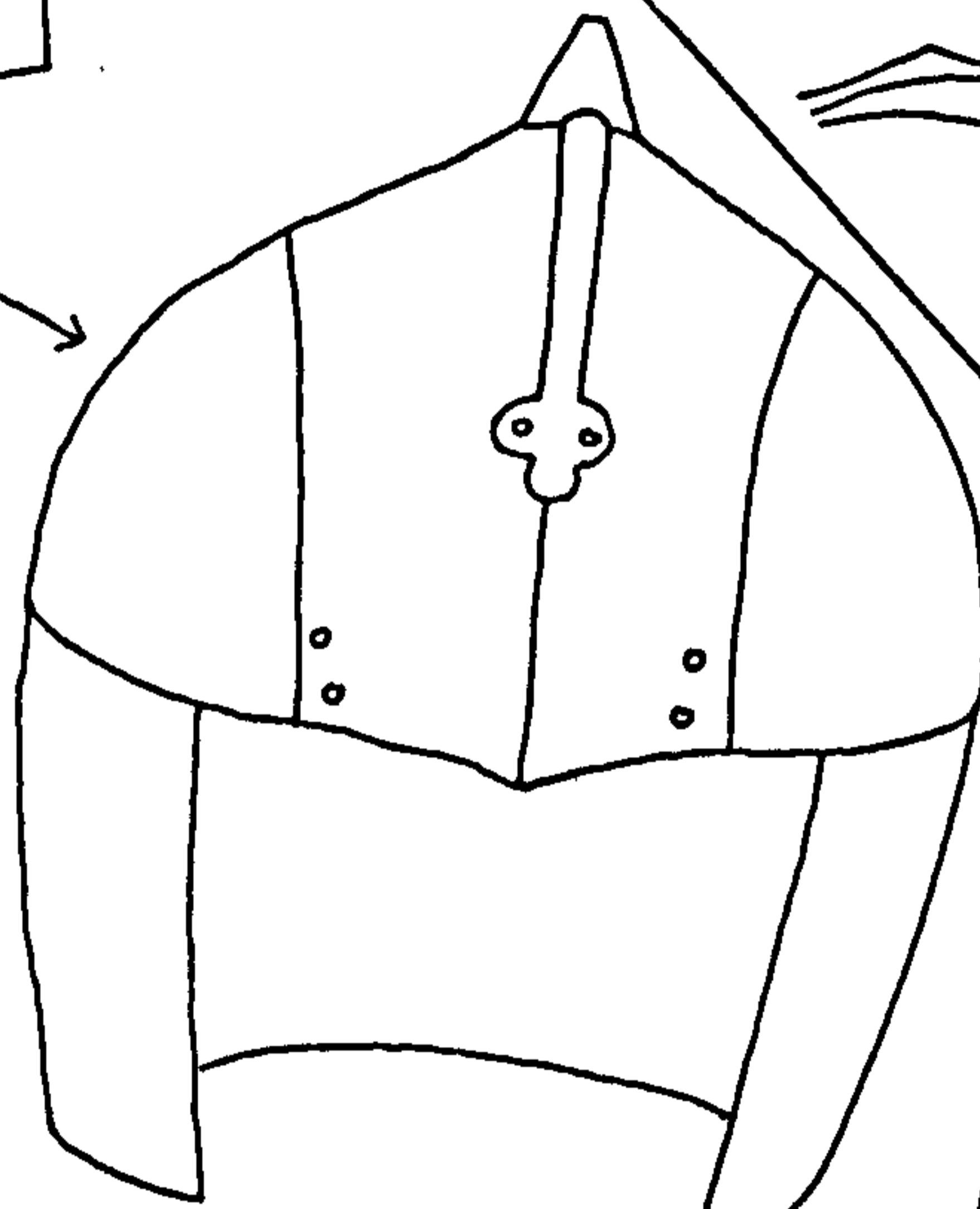

192

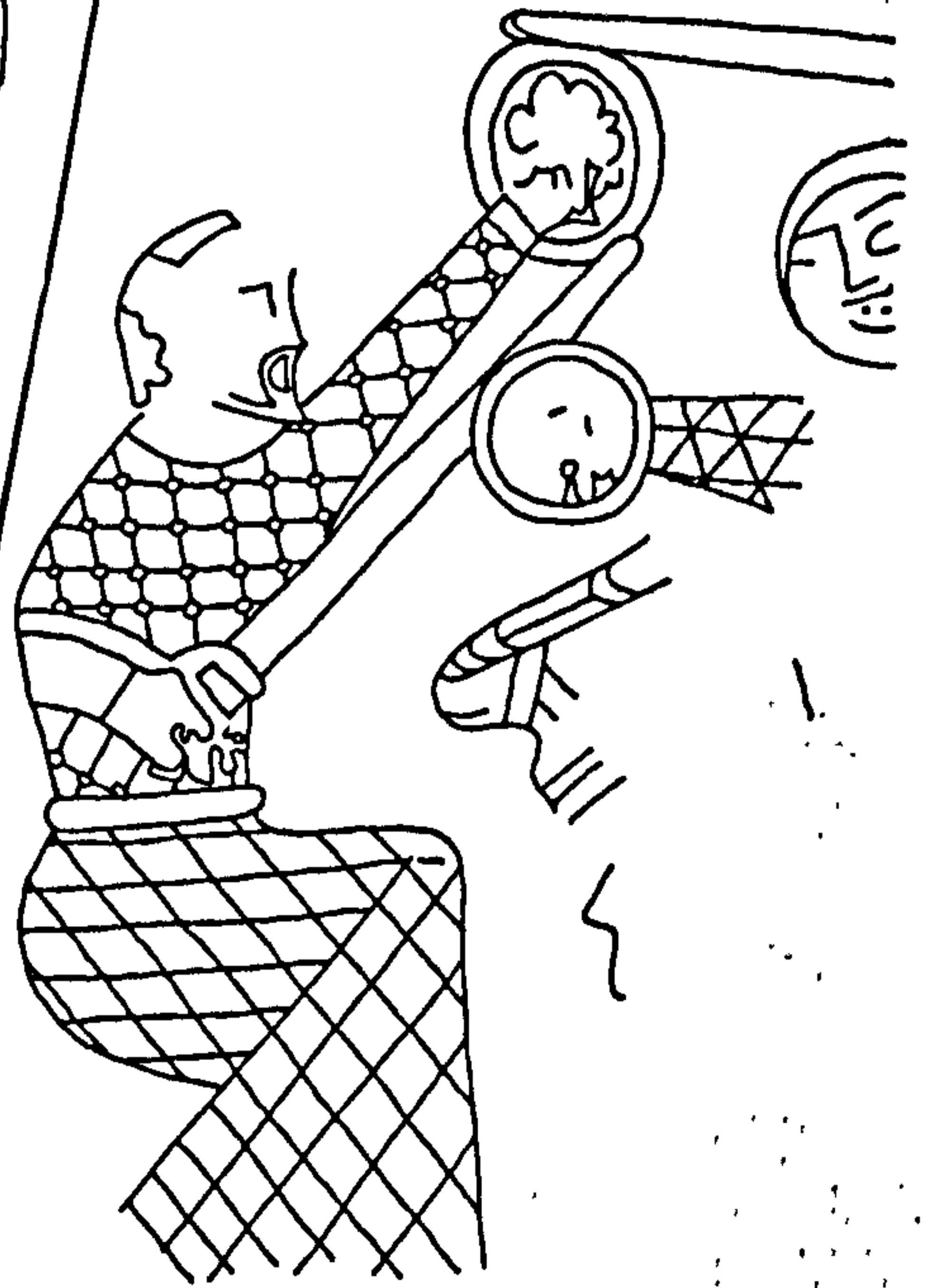

194

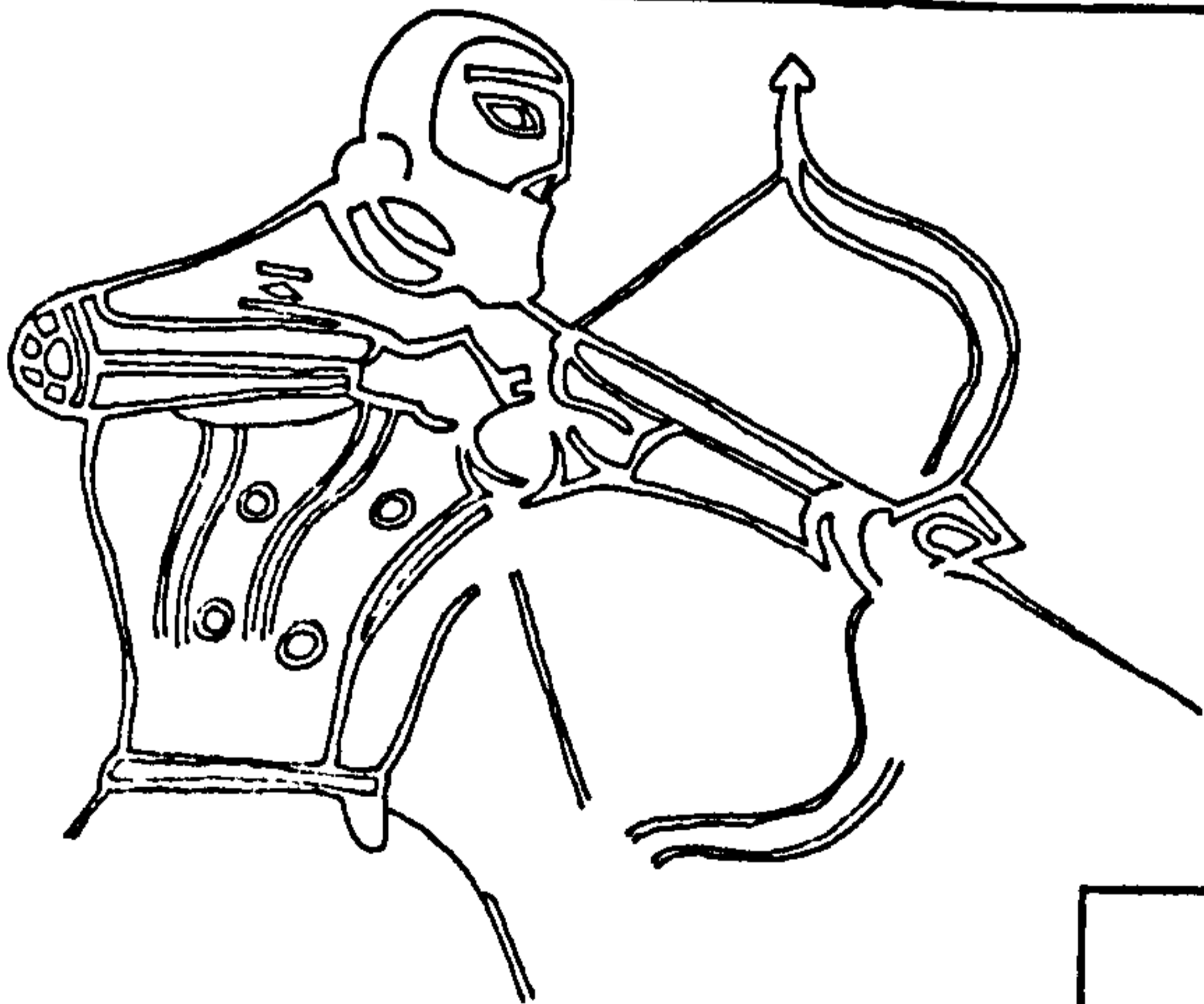

193

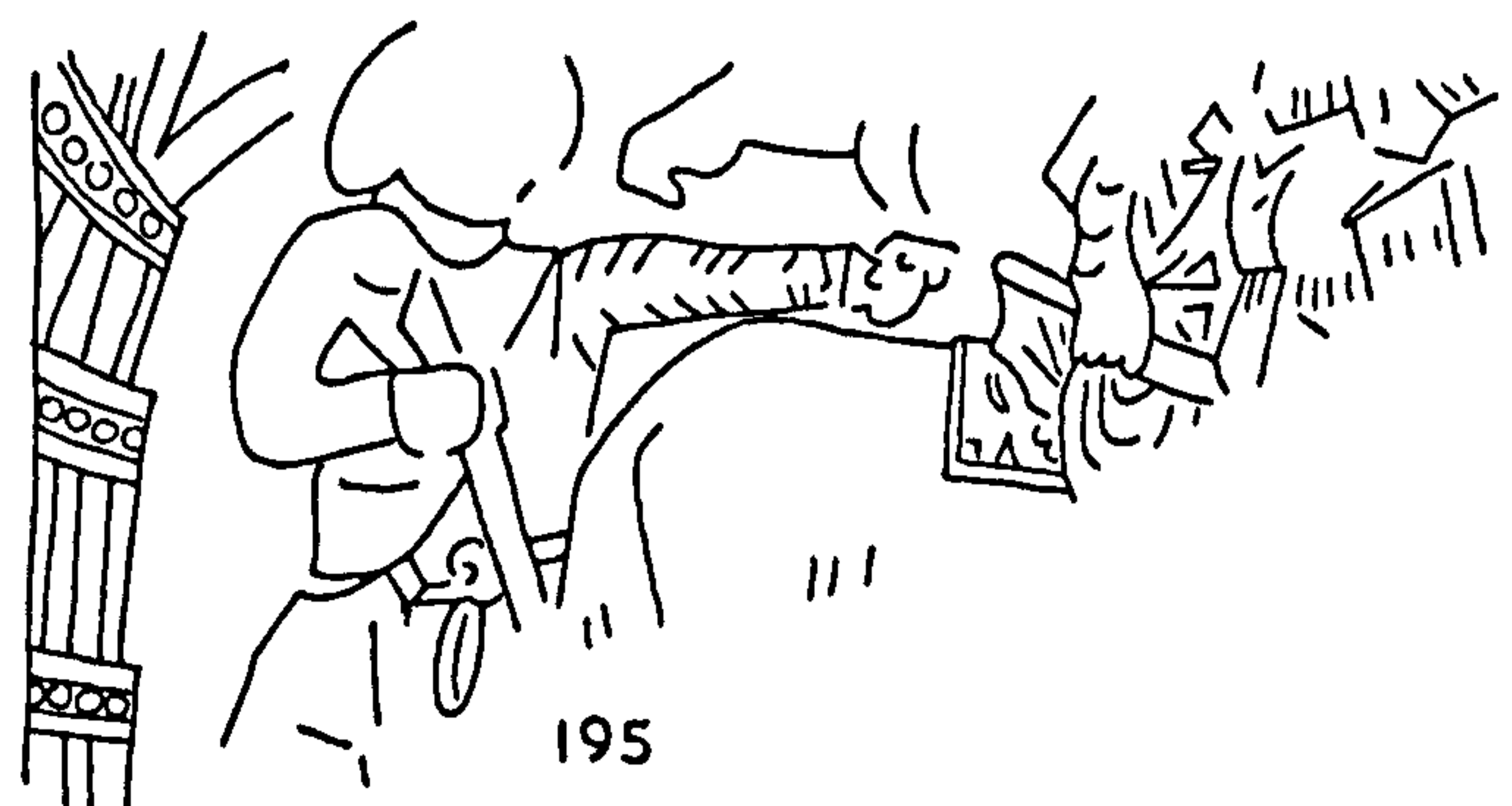

195

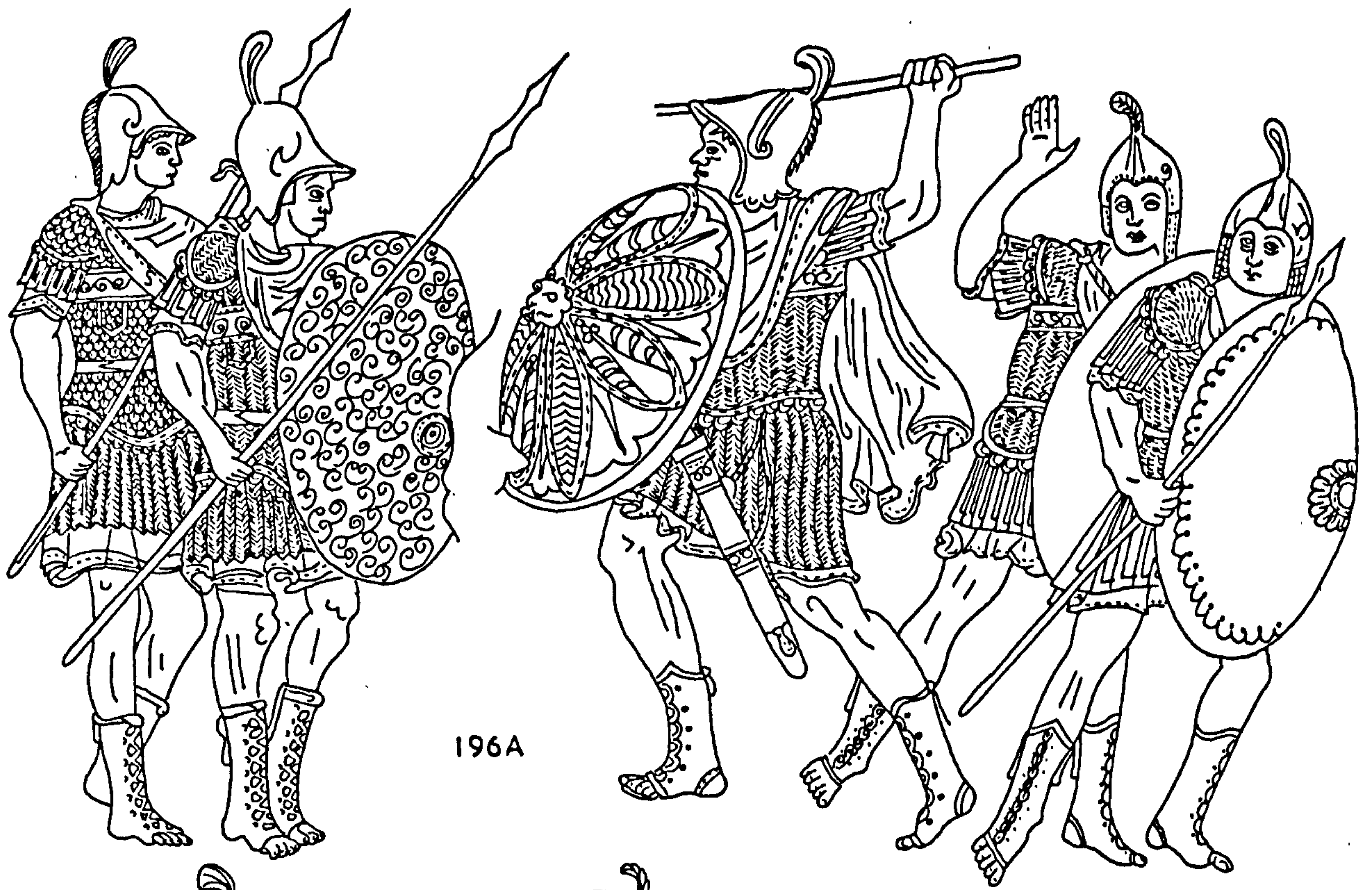

196A

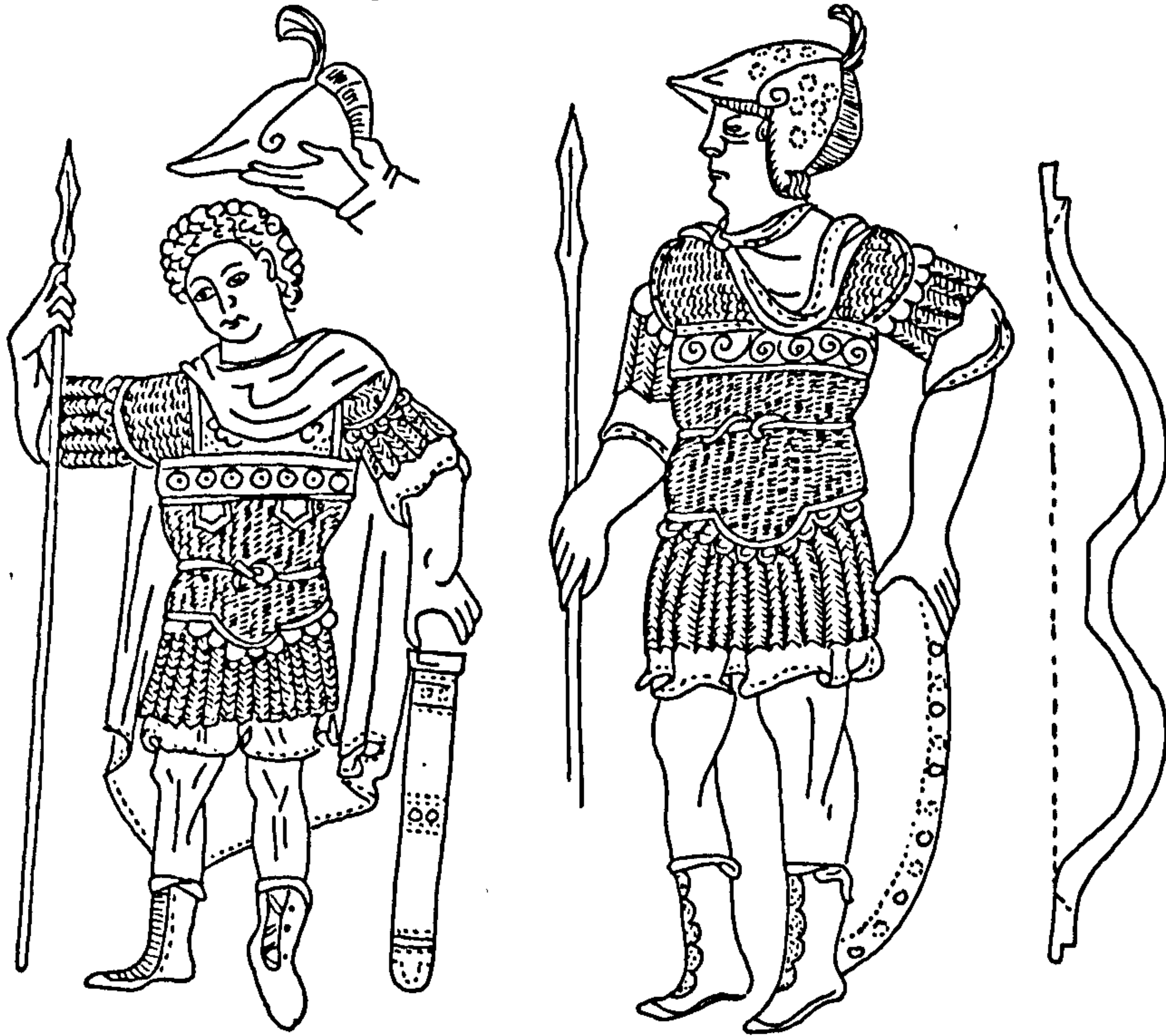

196B

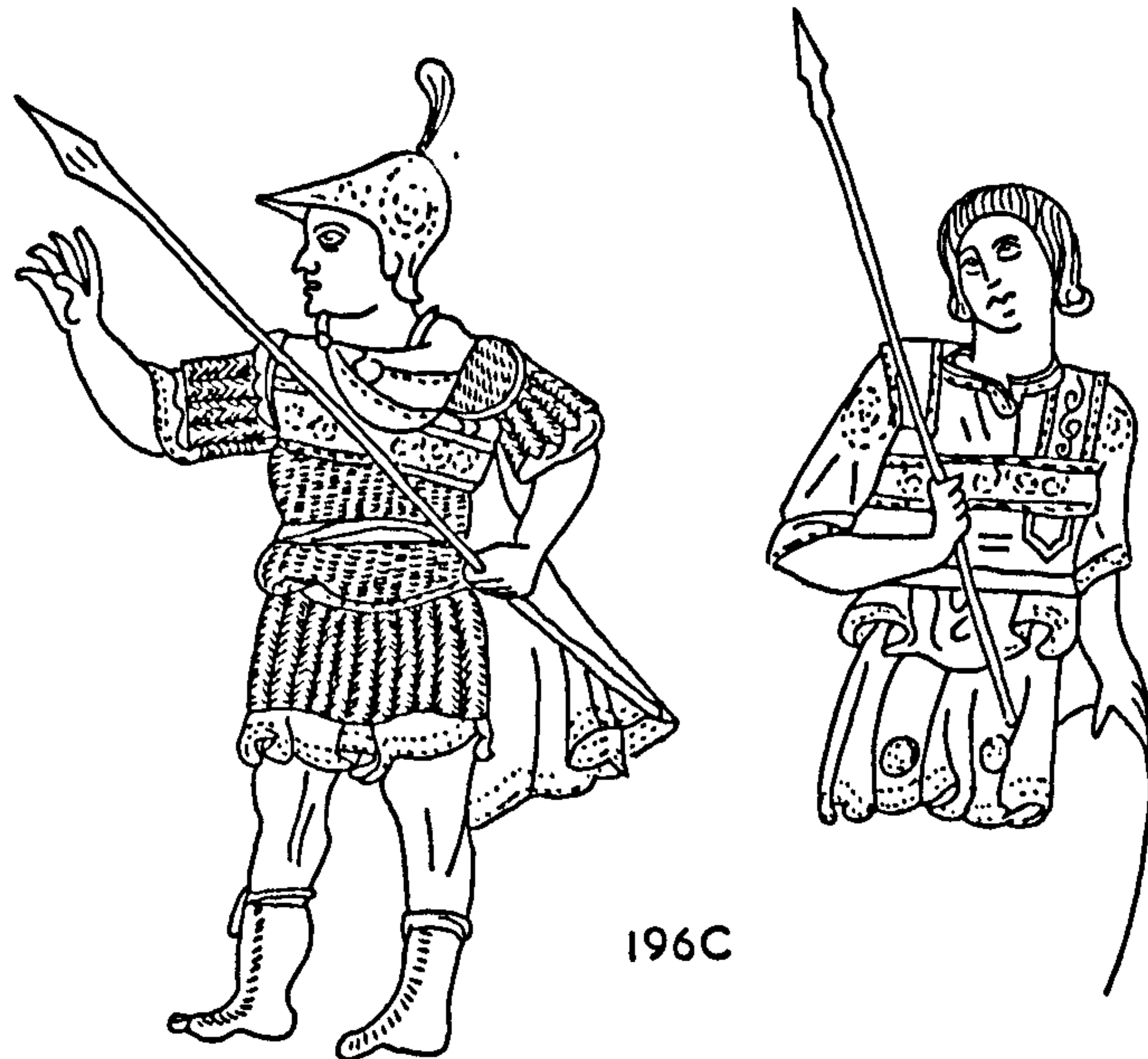

196C



196D

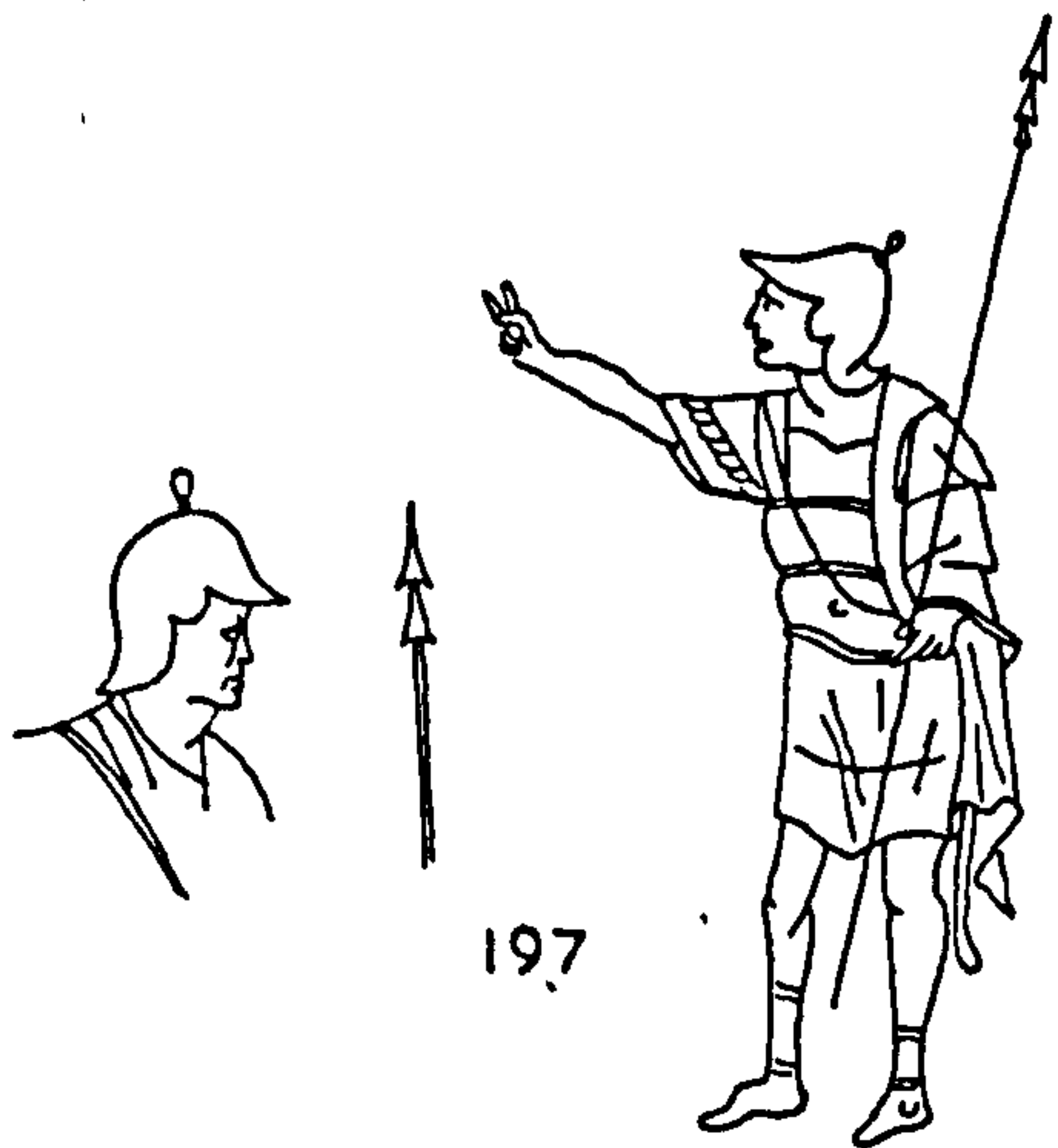

197

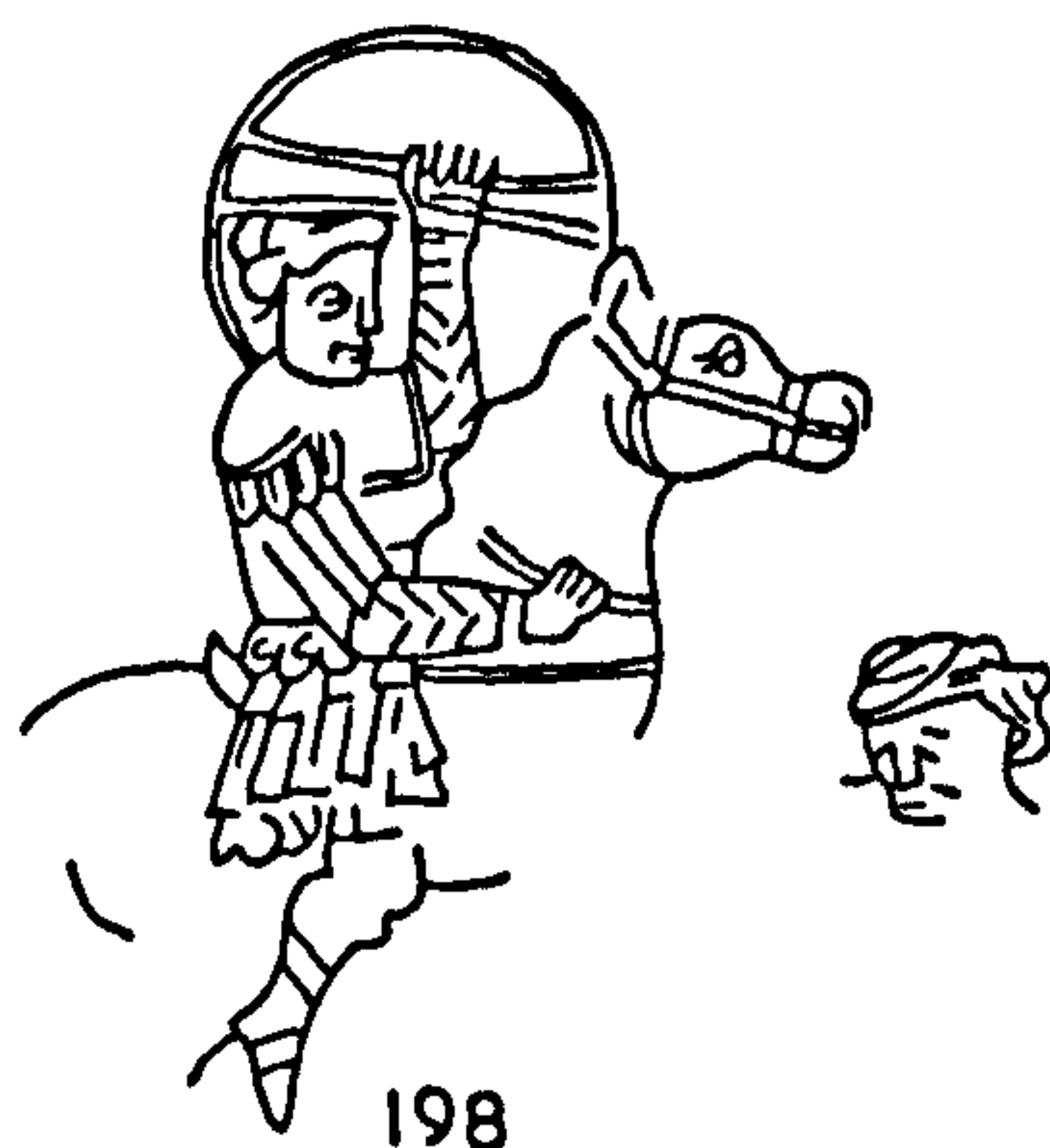

198

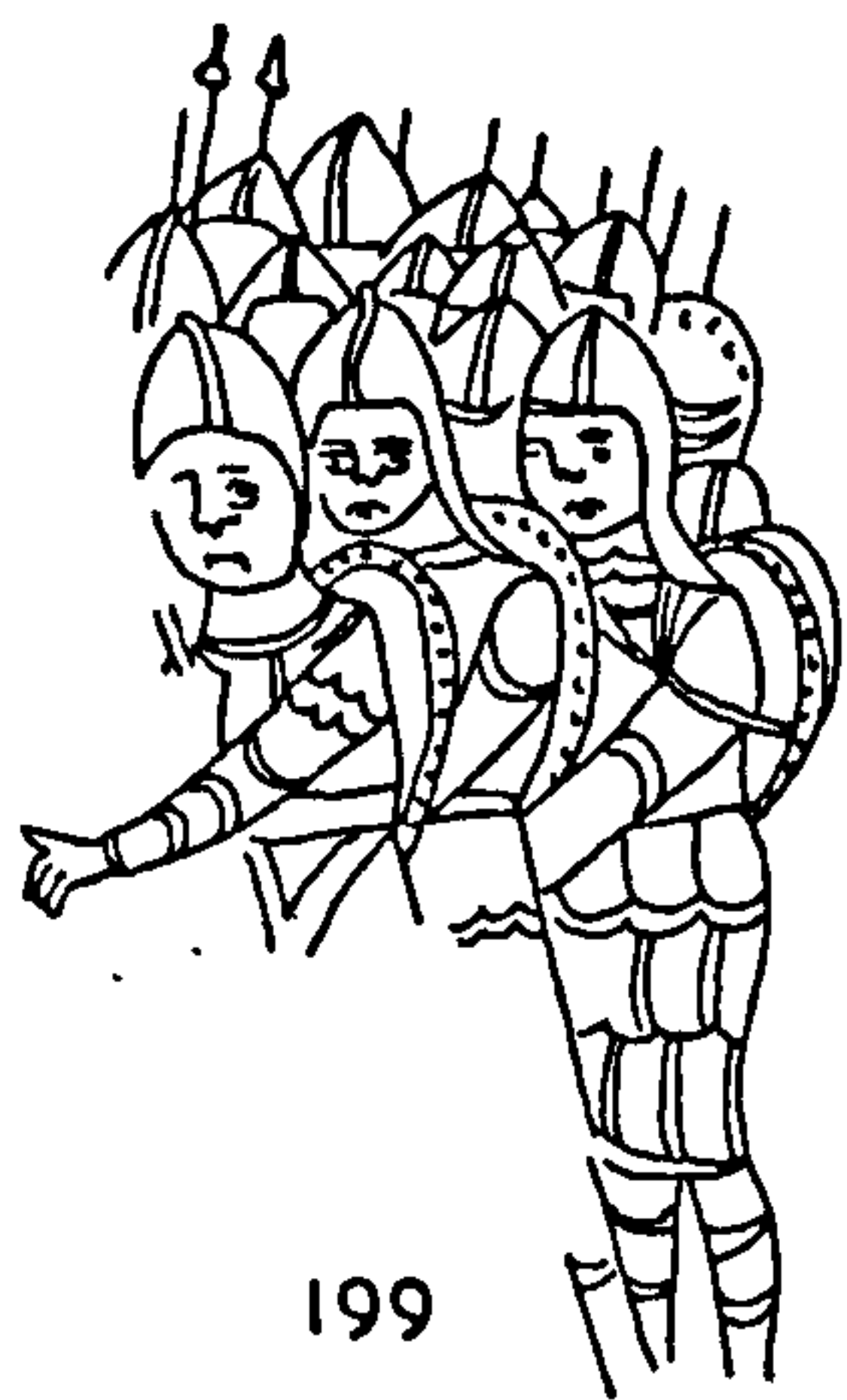

199



200

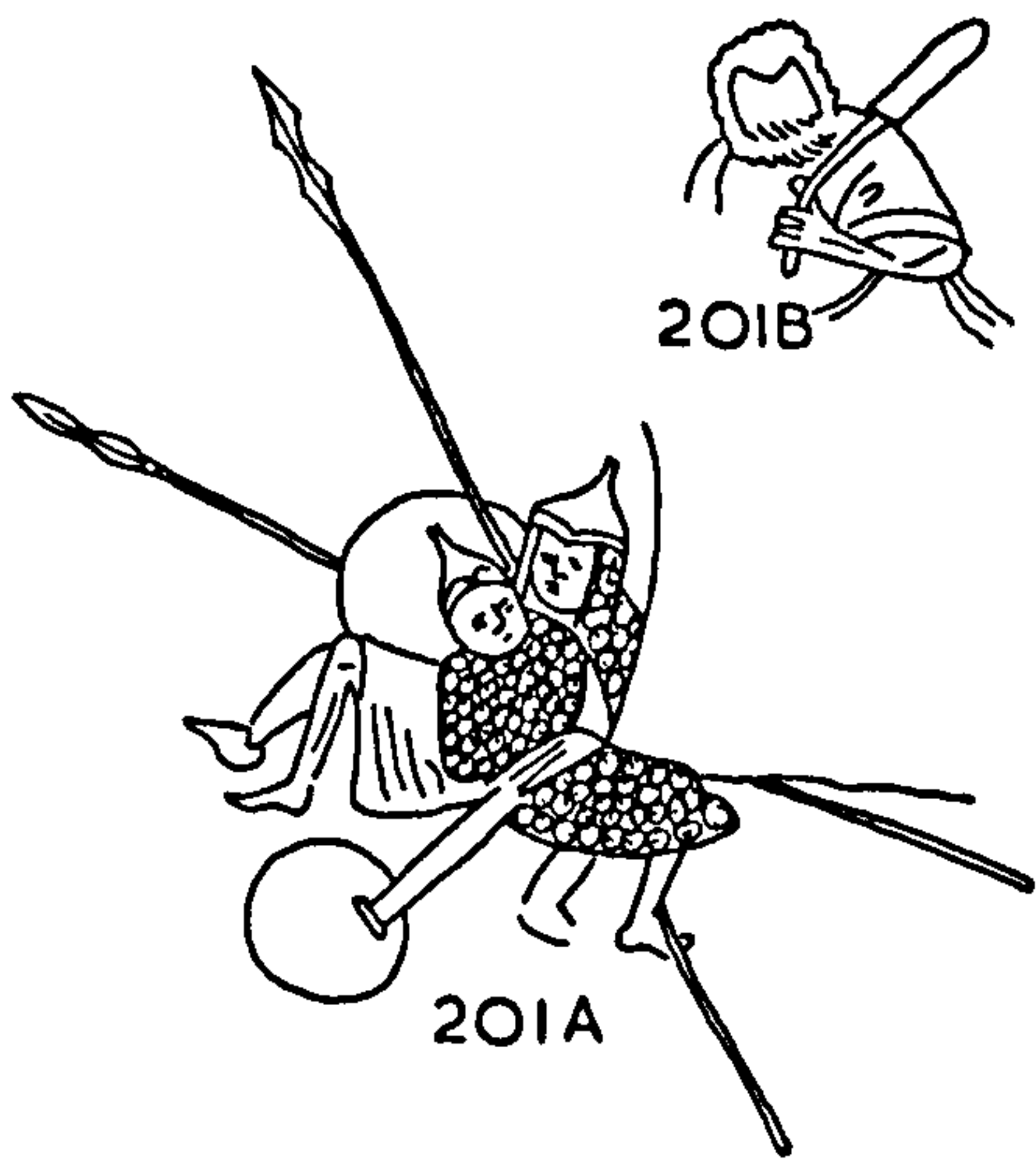

201A



201B

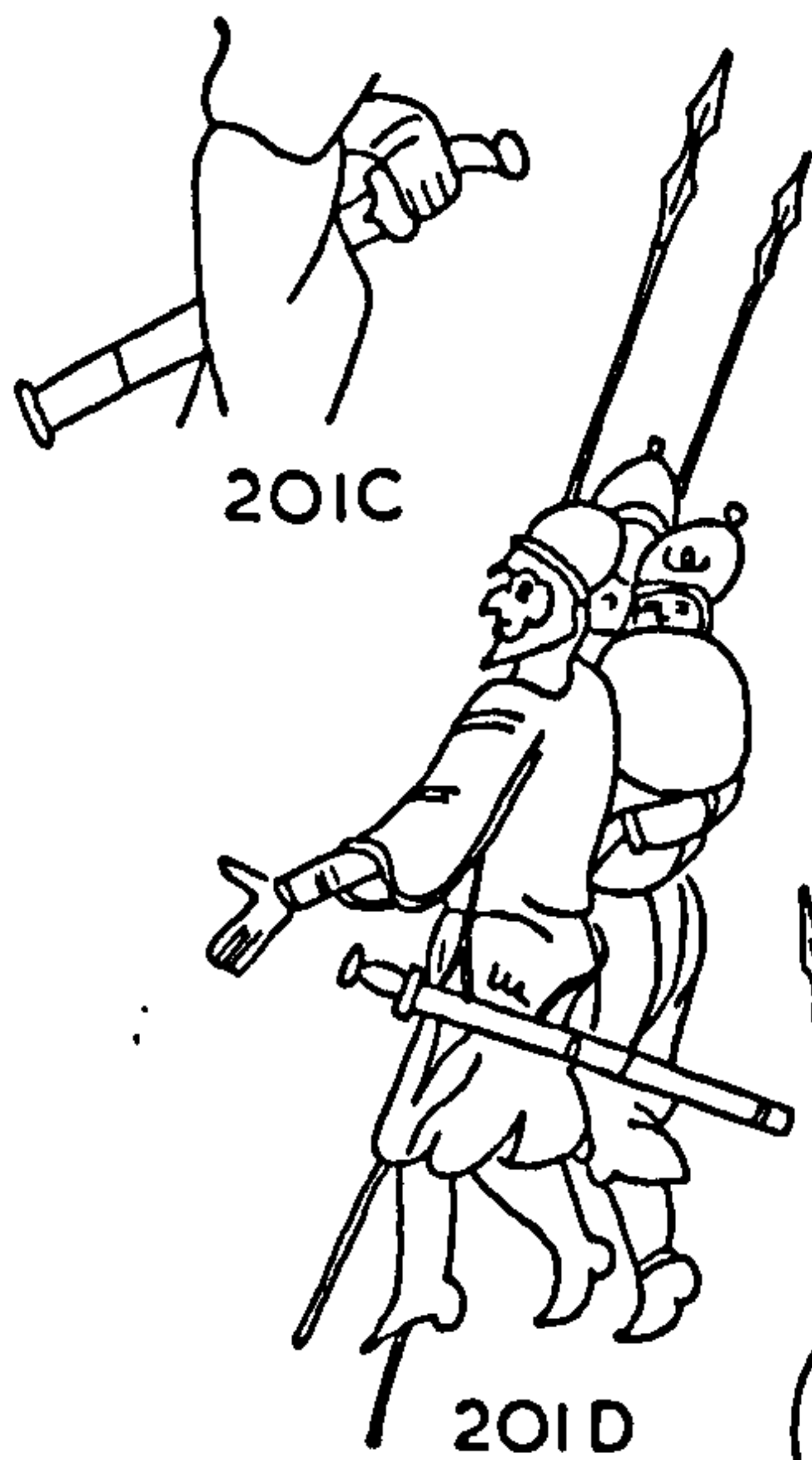

201C

201D



201E

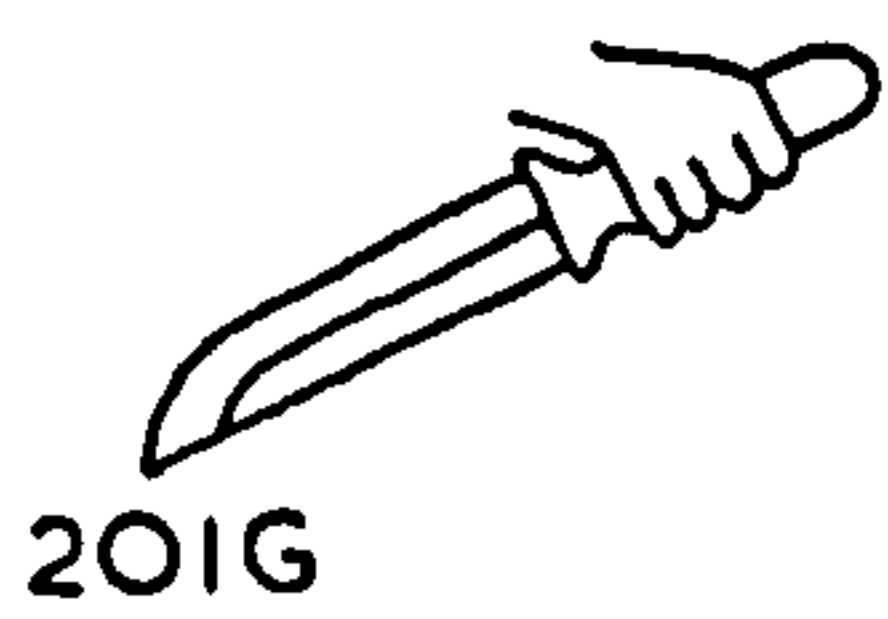

201G



201F

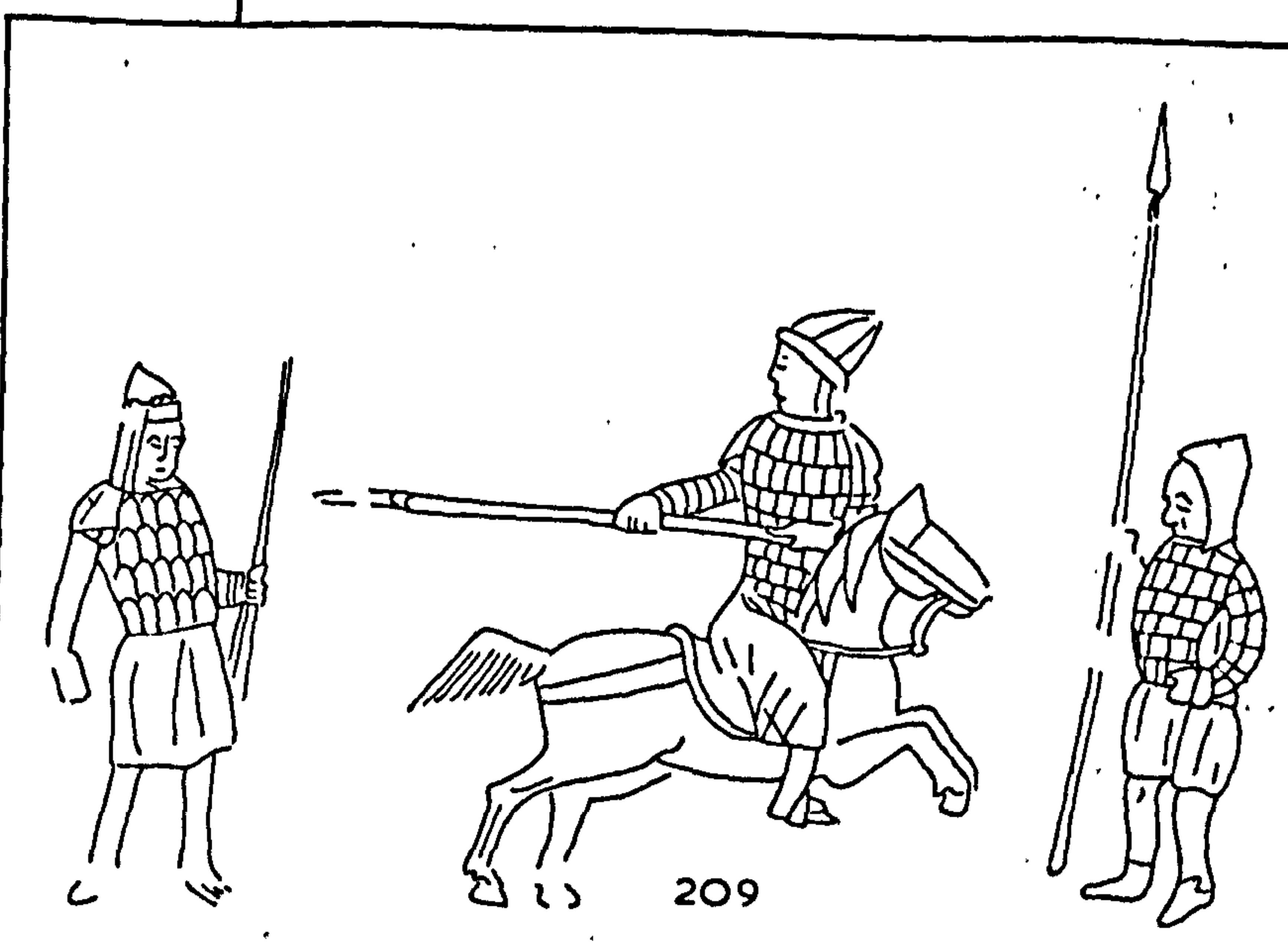
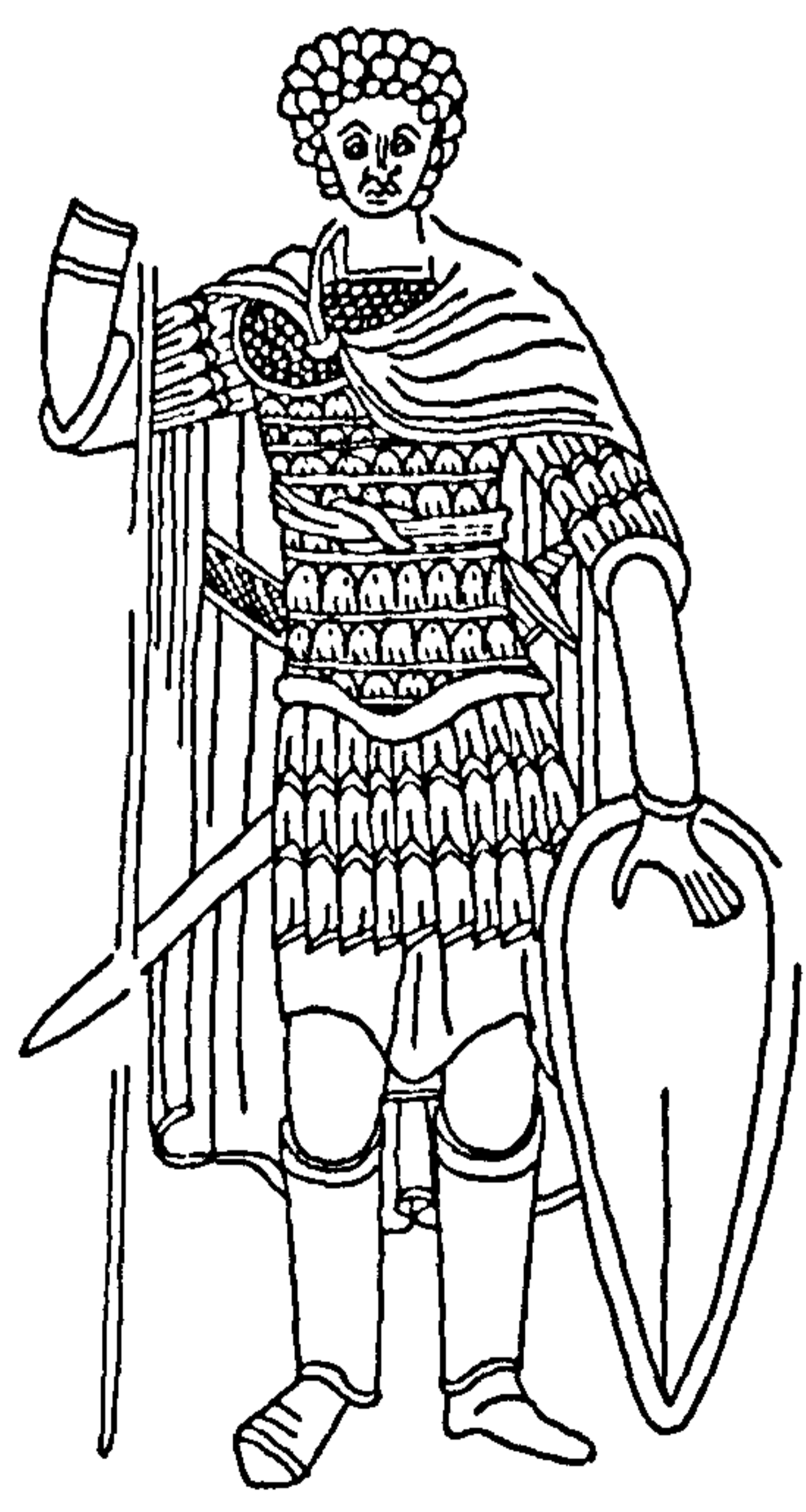
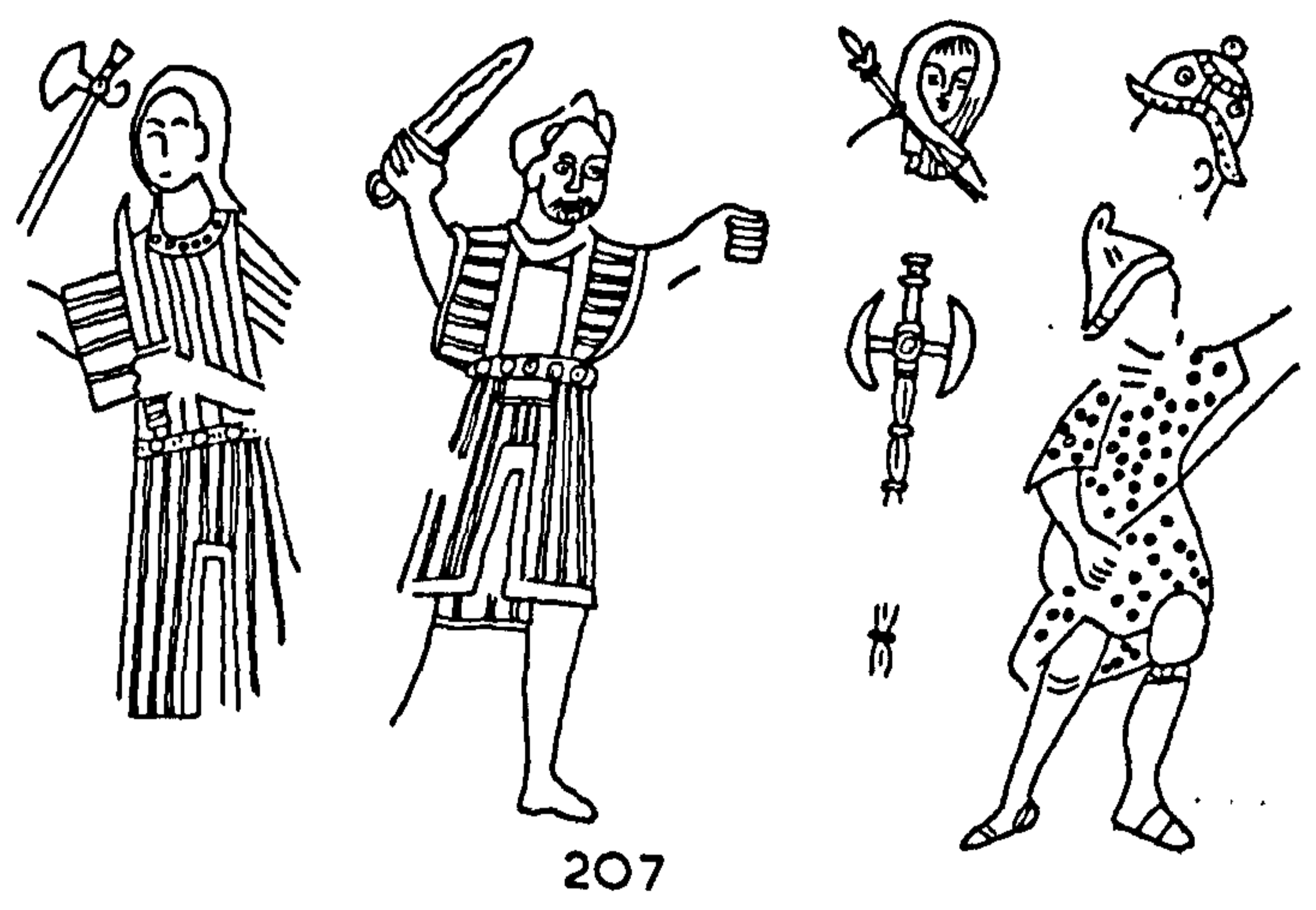
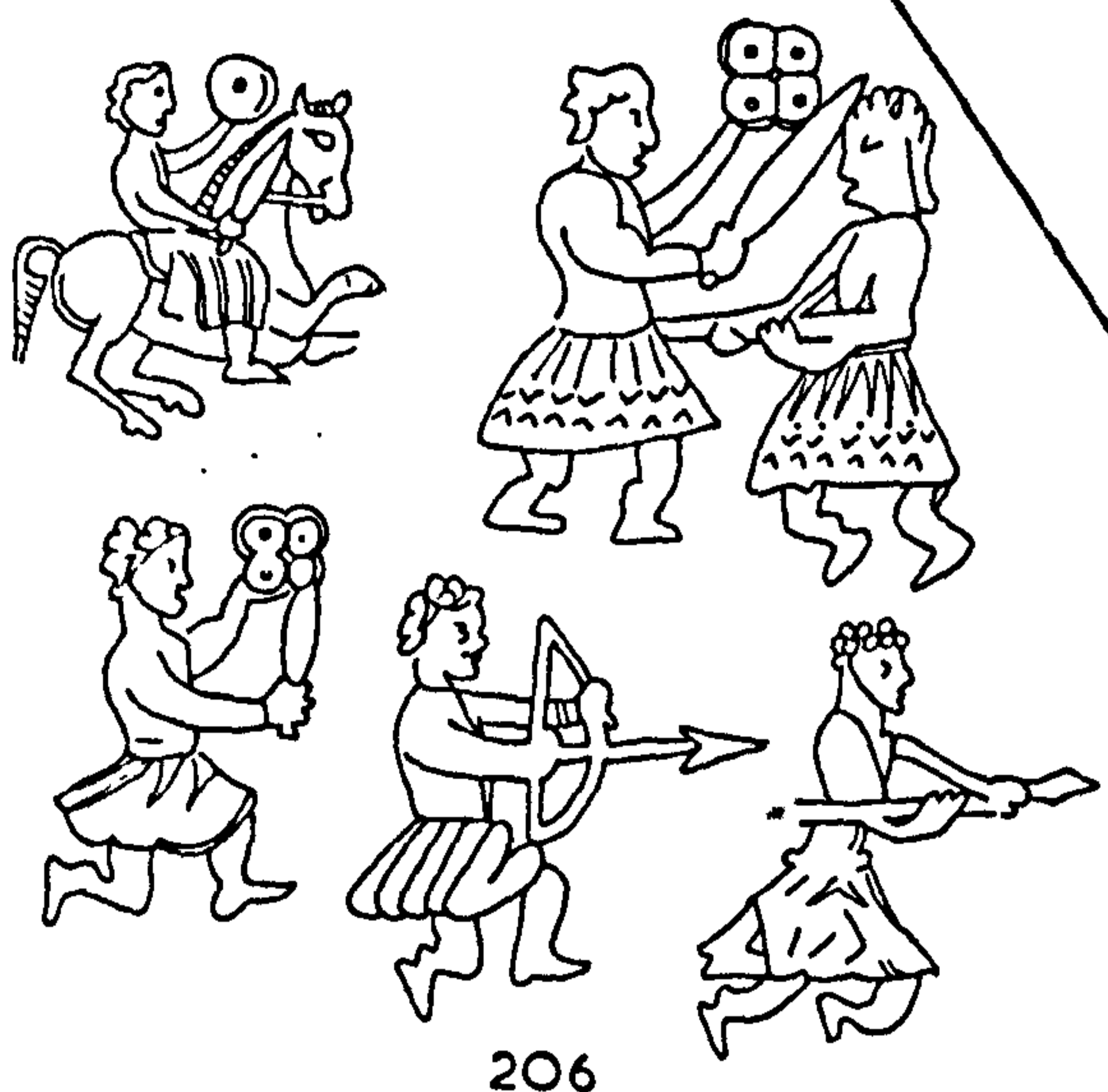
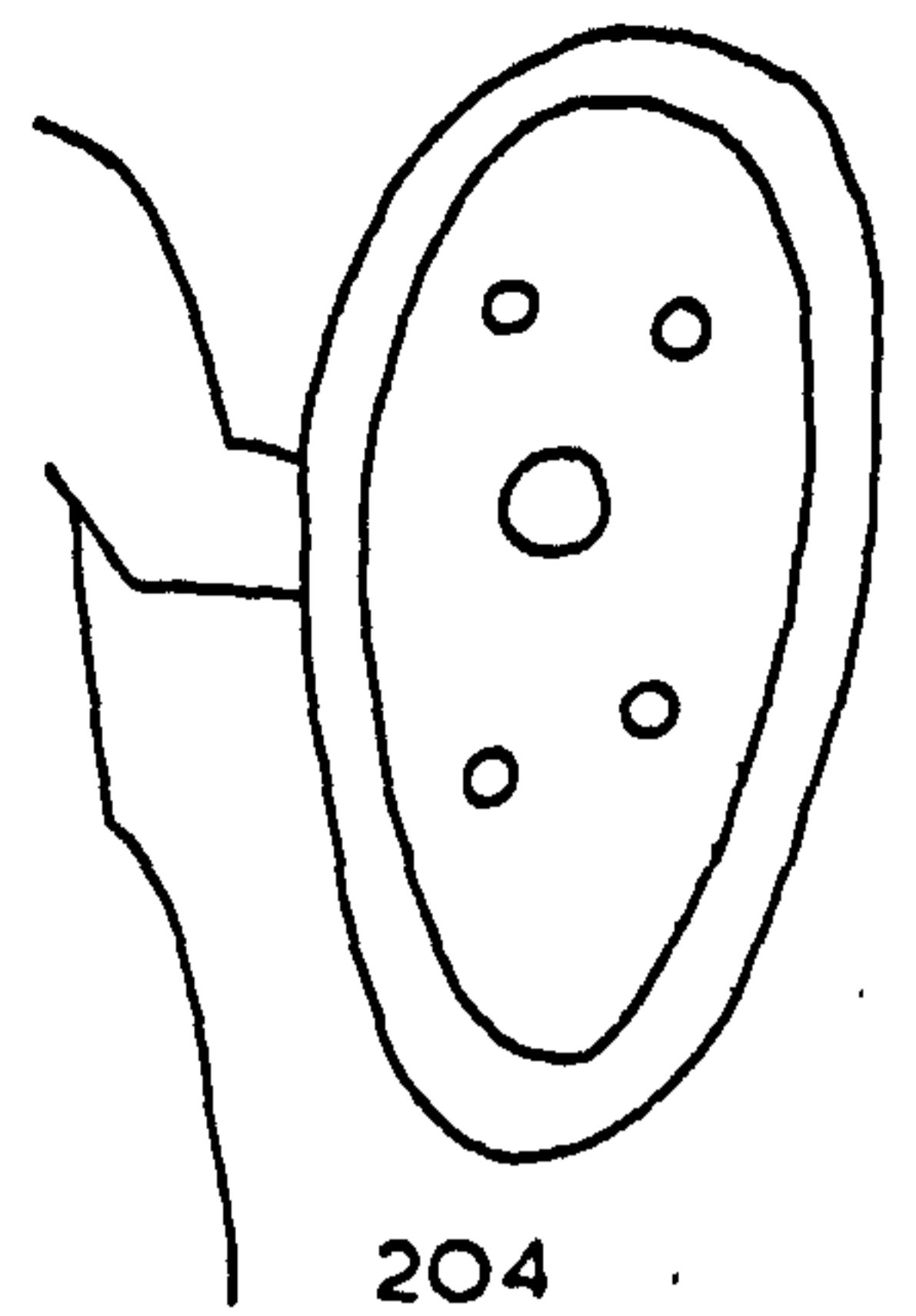
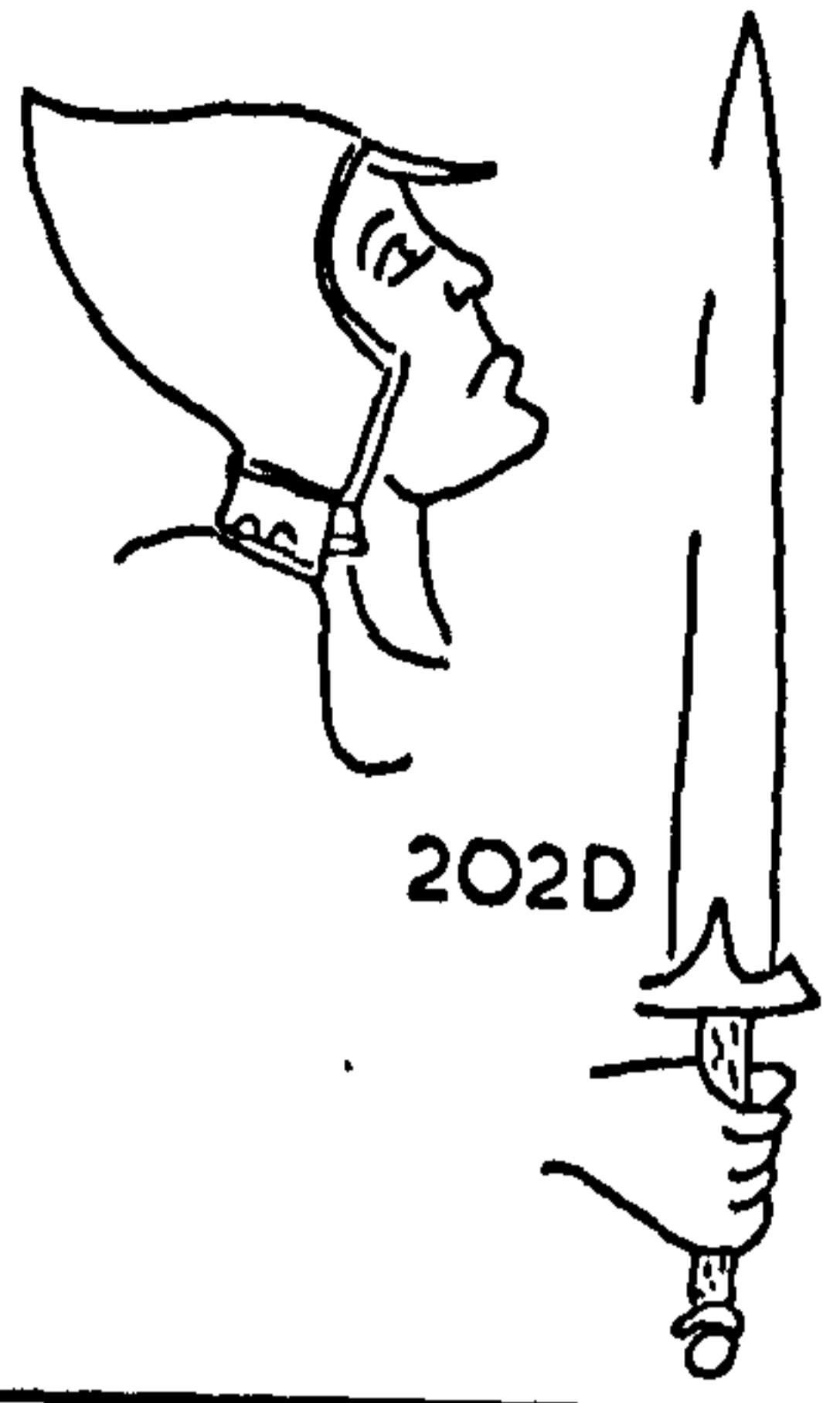
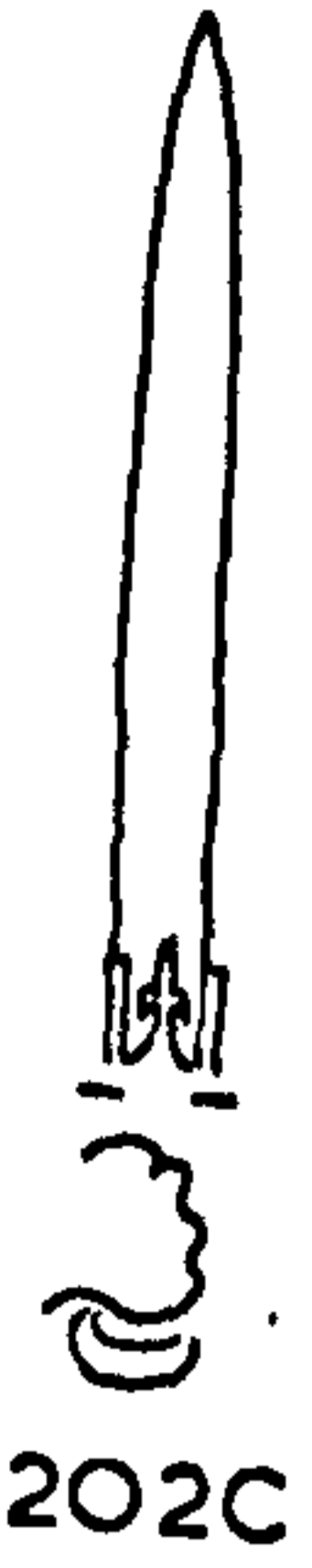





210



211



212

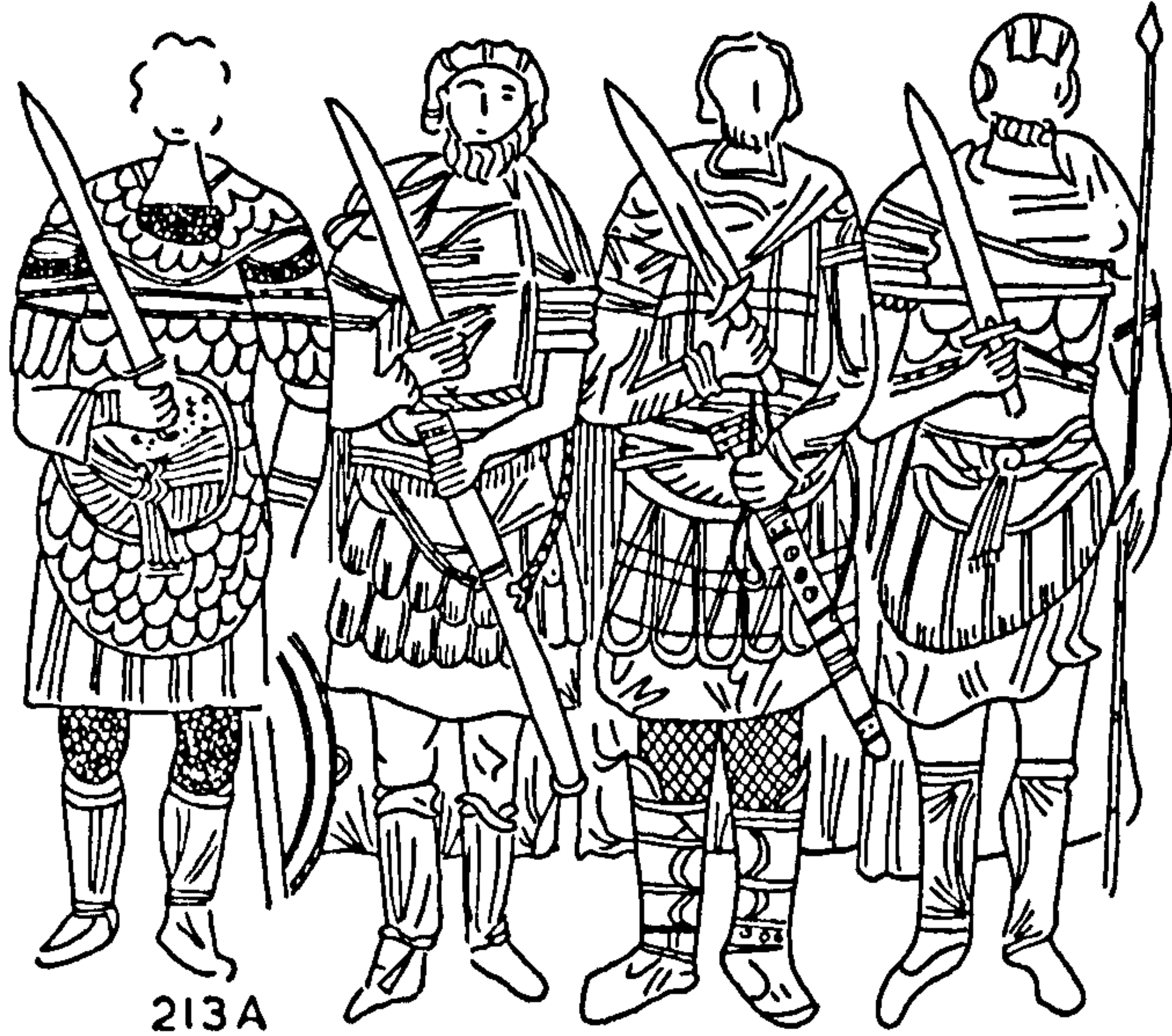

213A

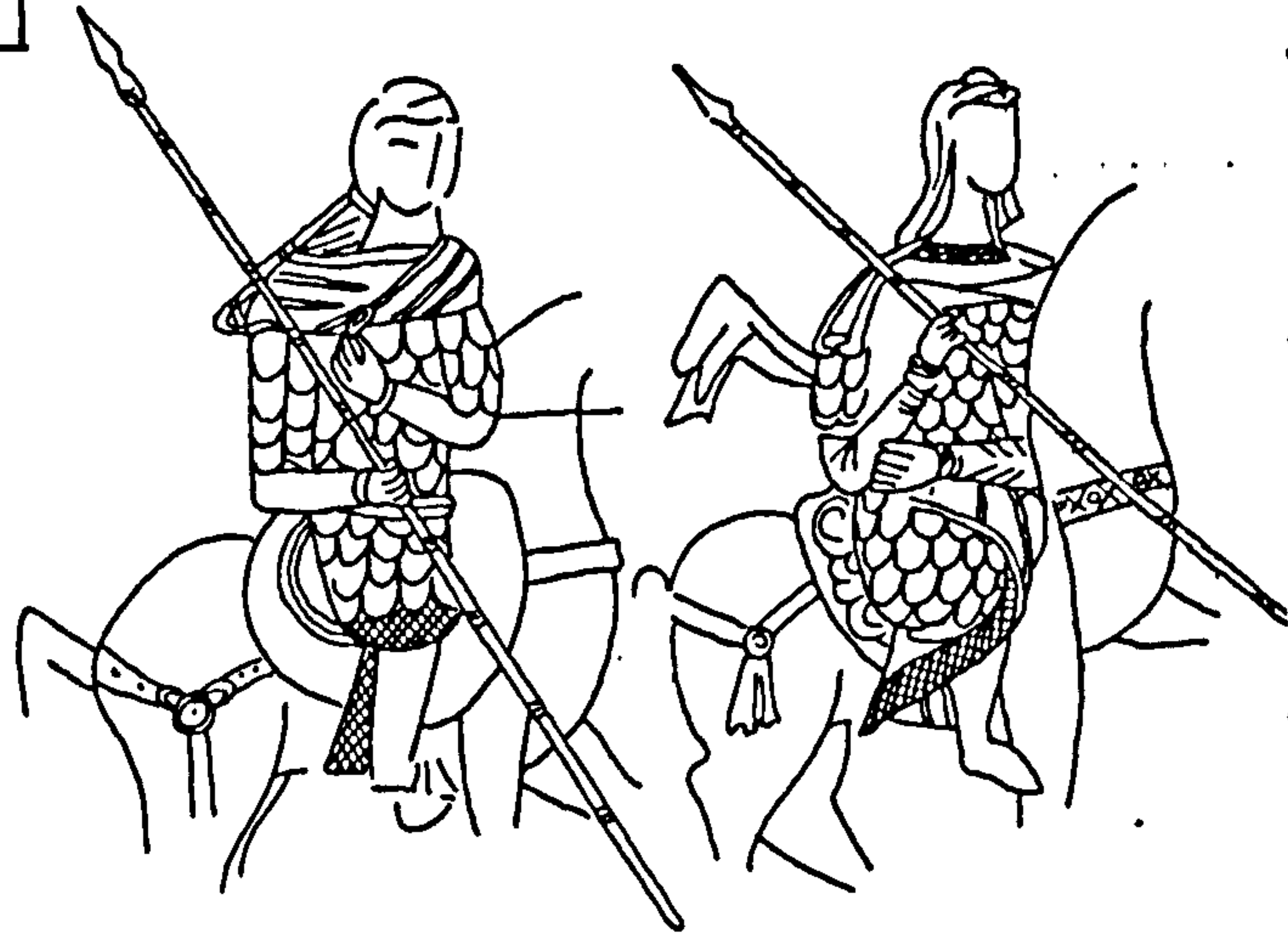

213B

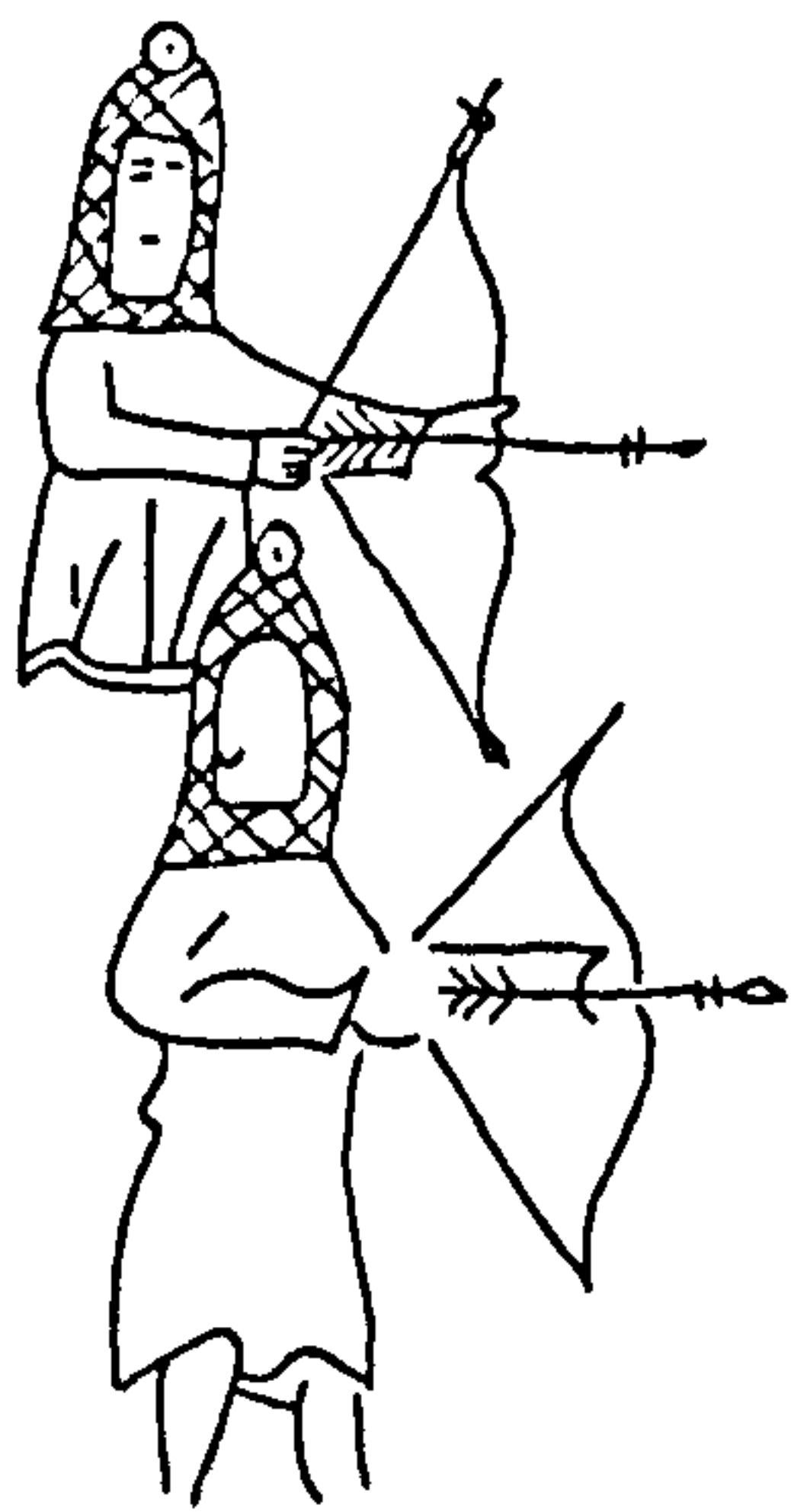

214

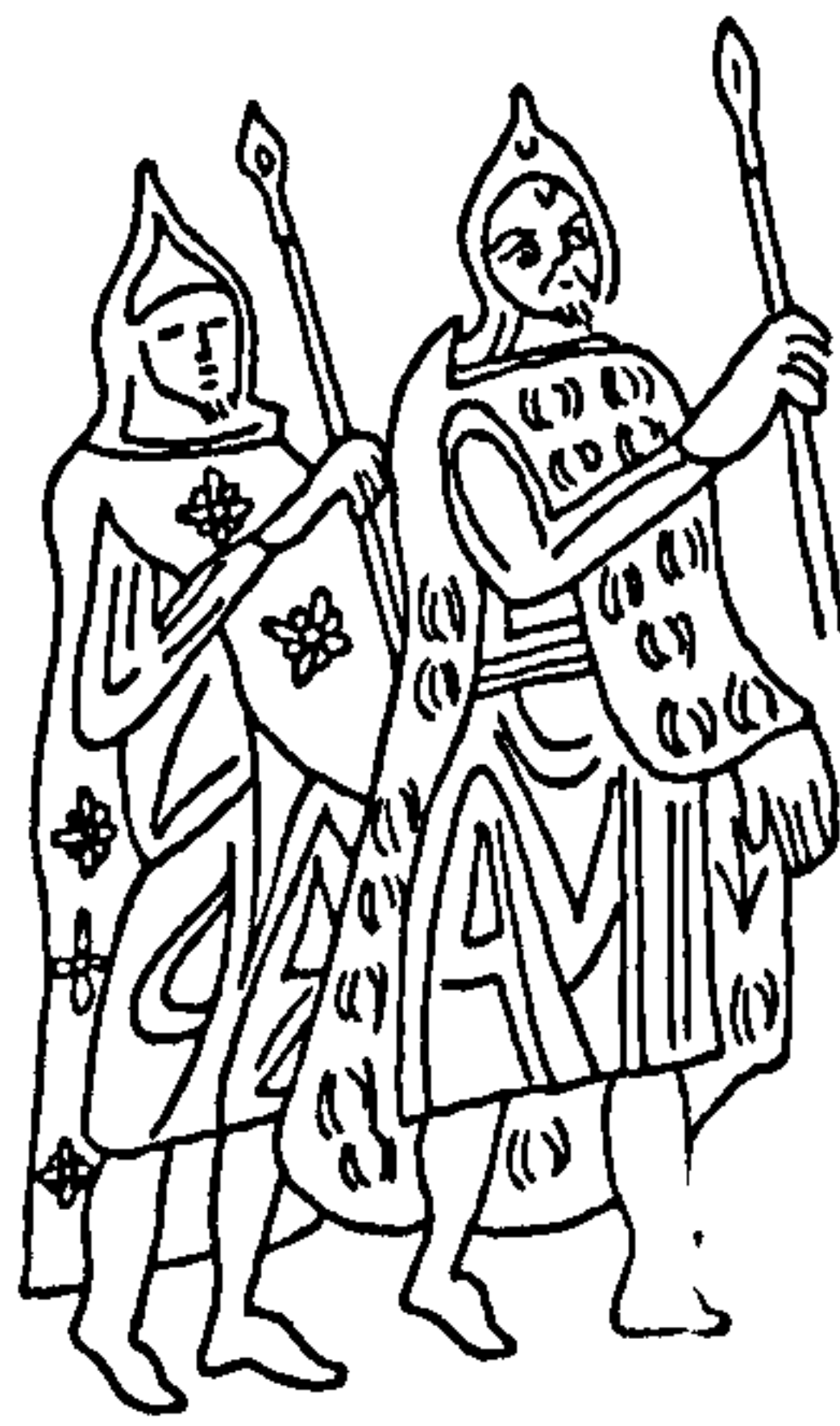

215A

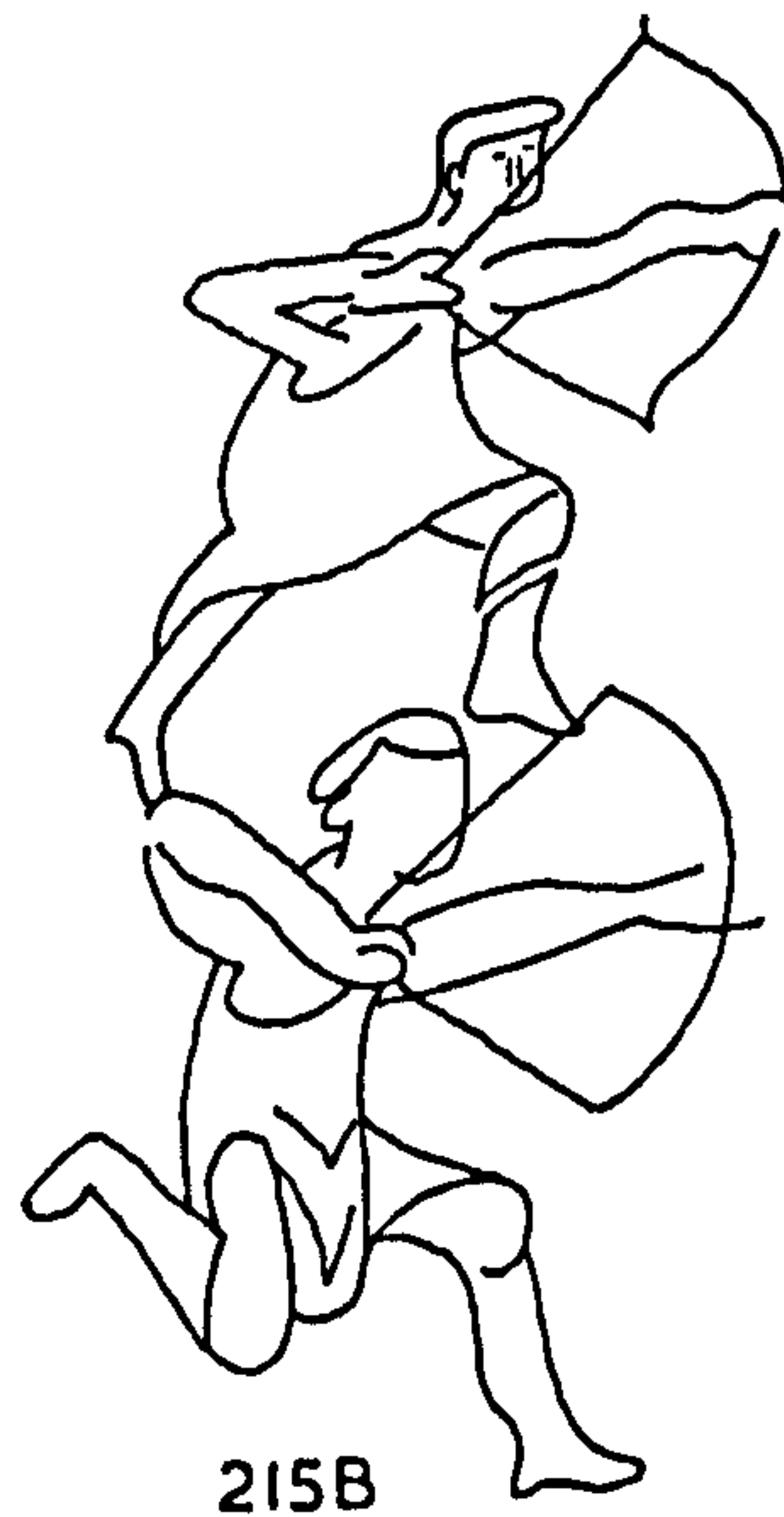

215B



216B

216A



217



218



219

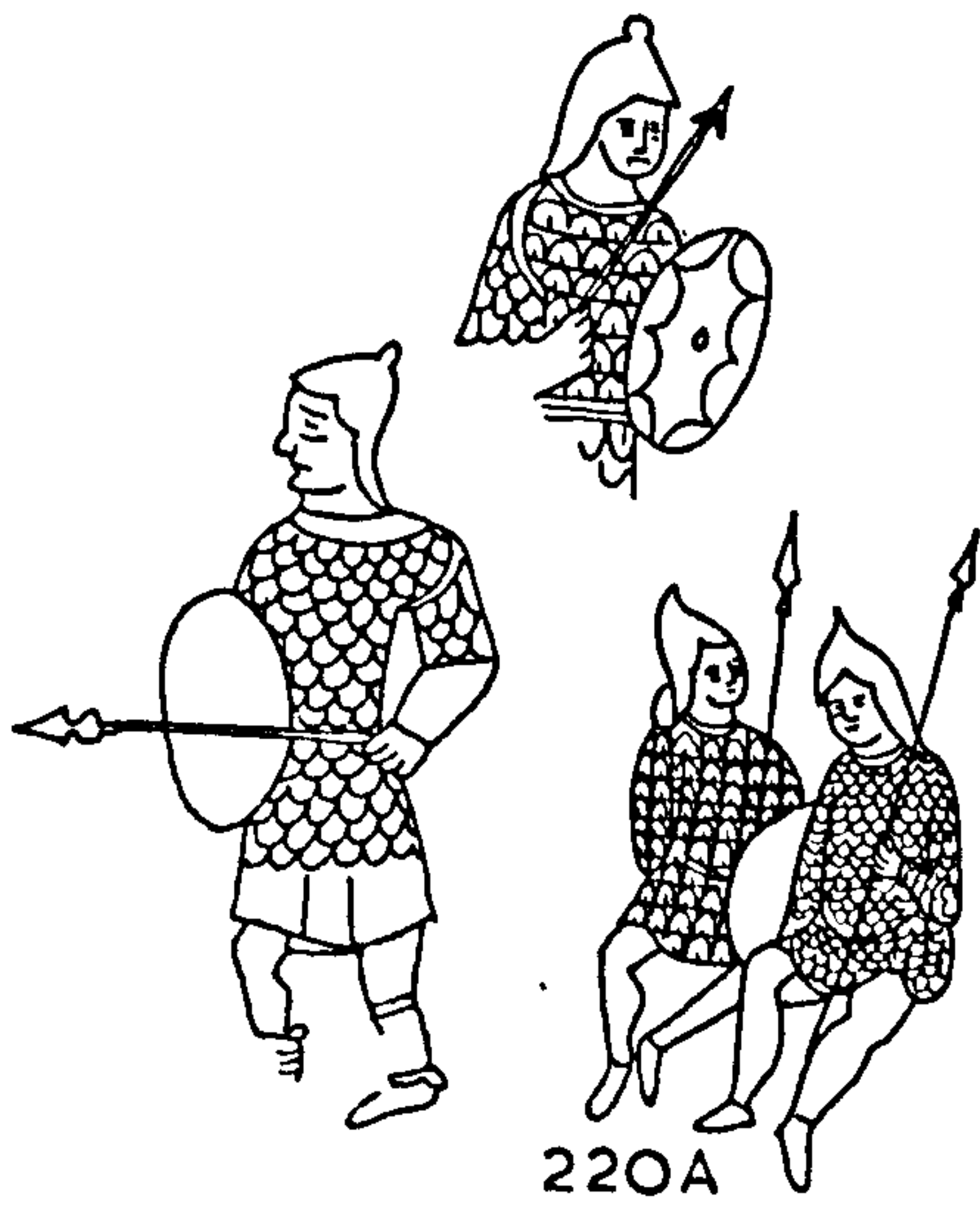

220A



220B



221



222



223



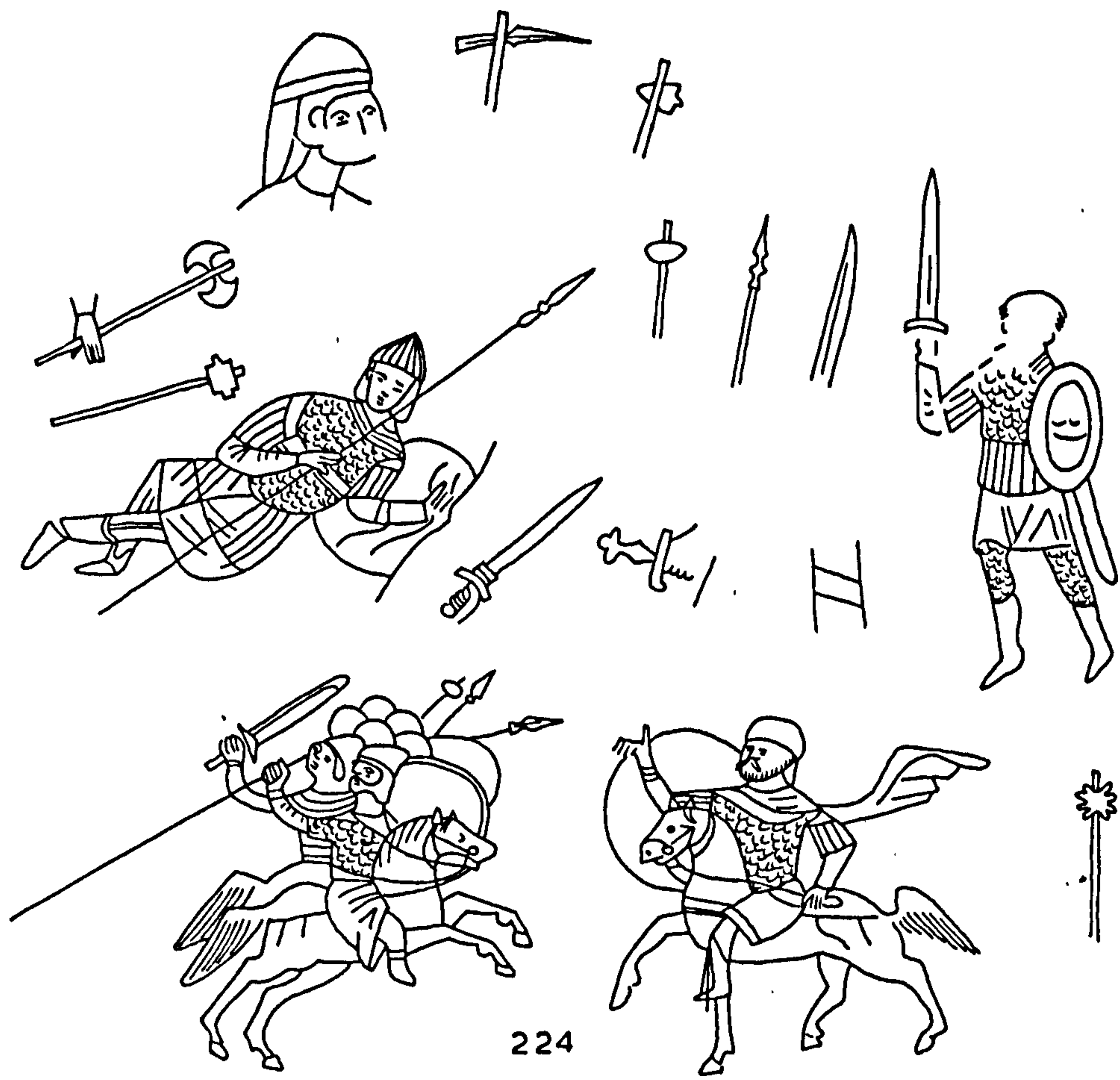

224



225



226



227

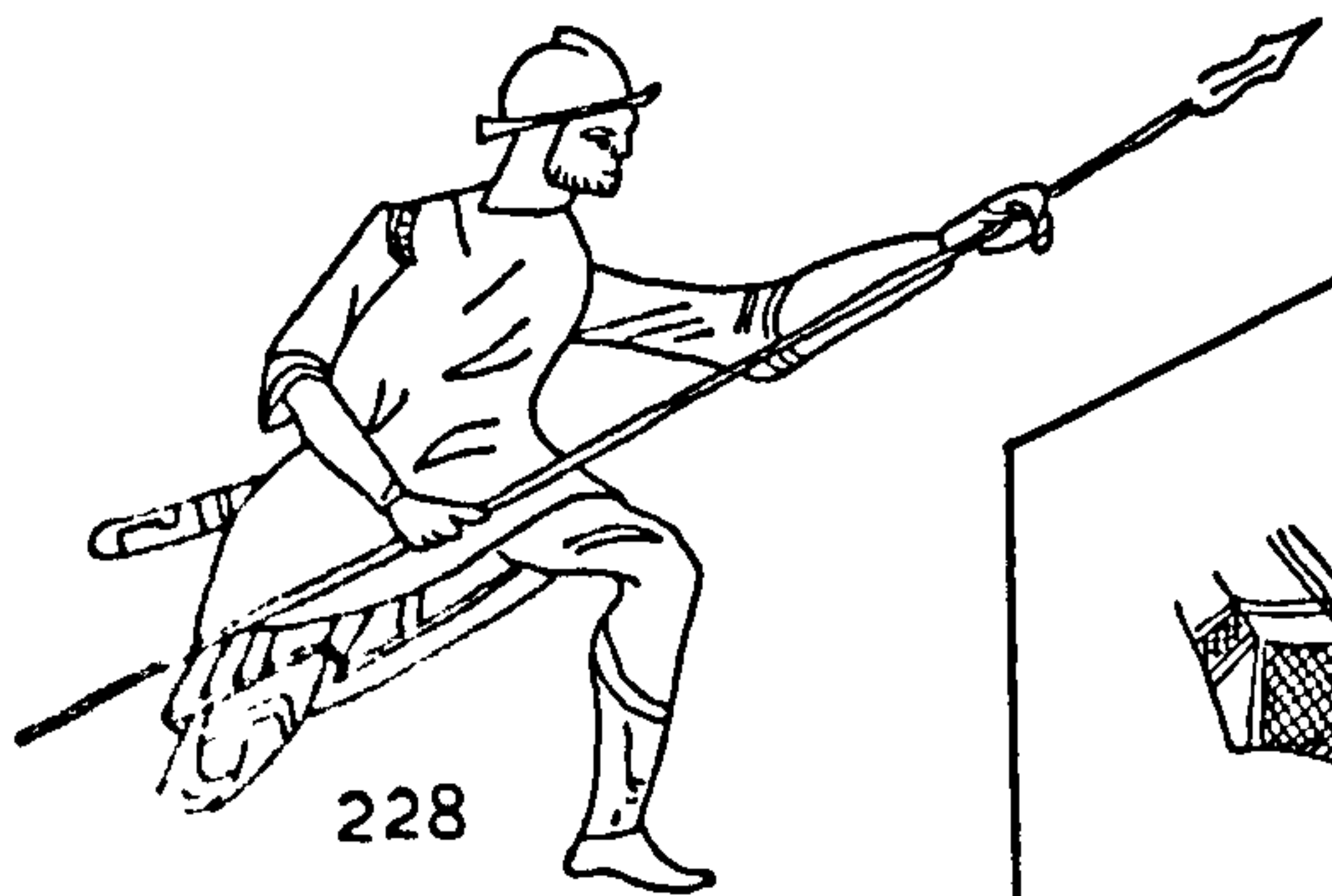

228



229



230



231A

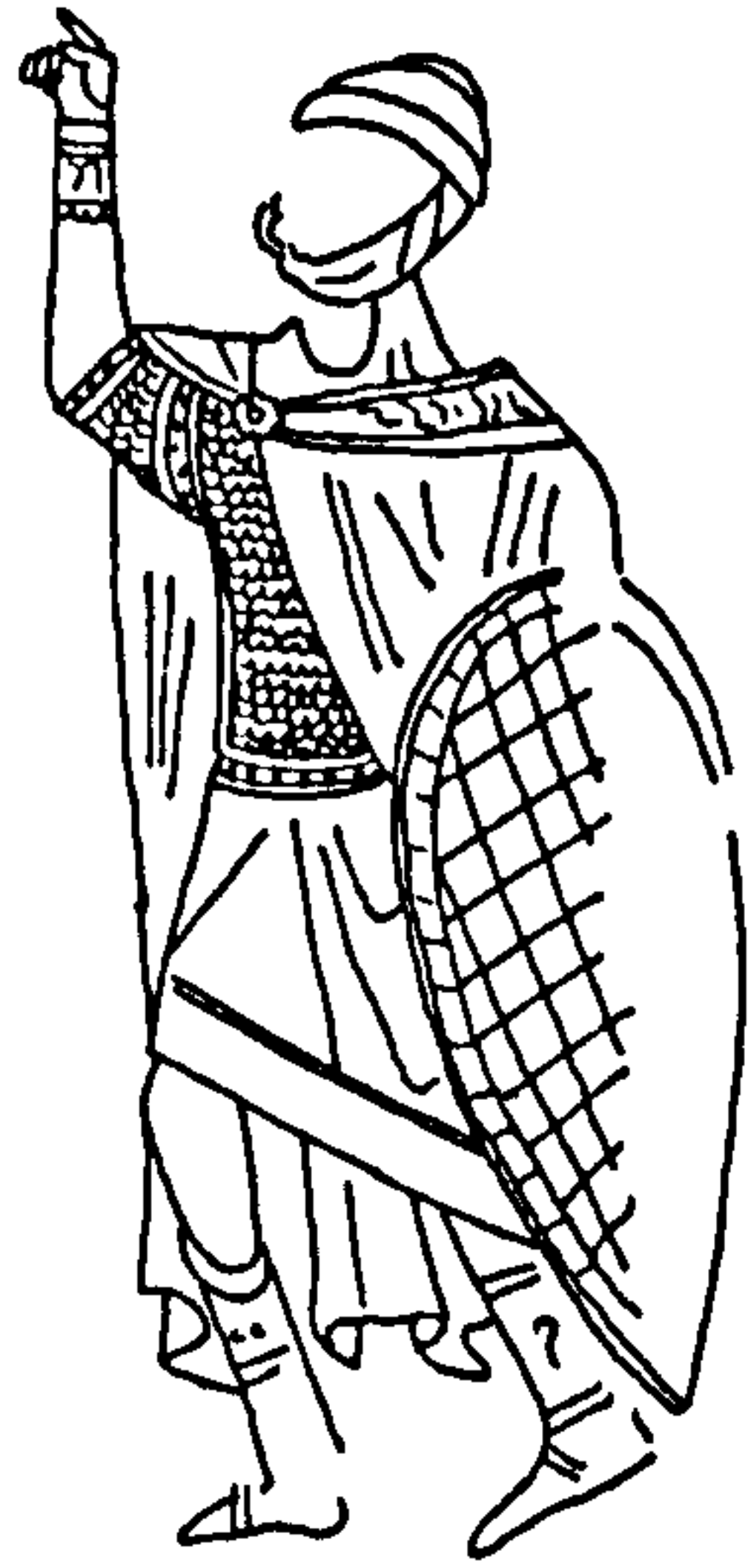

231B

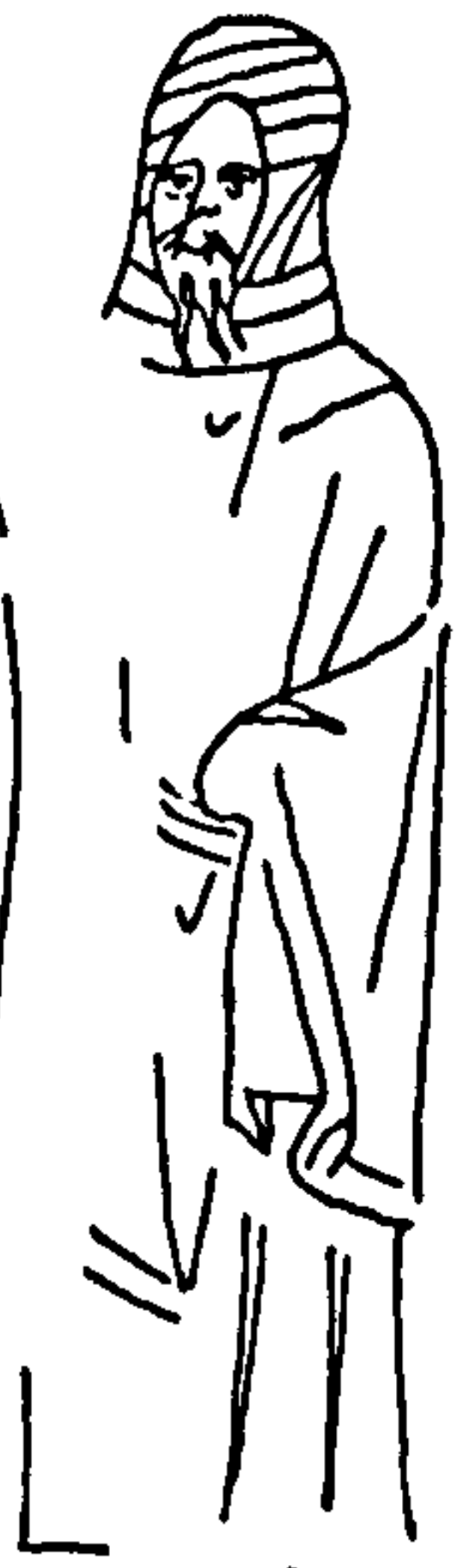

231C



231D



232

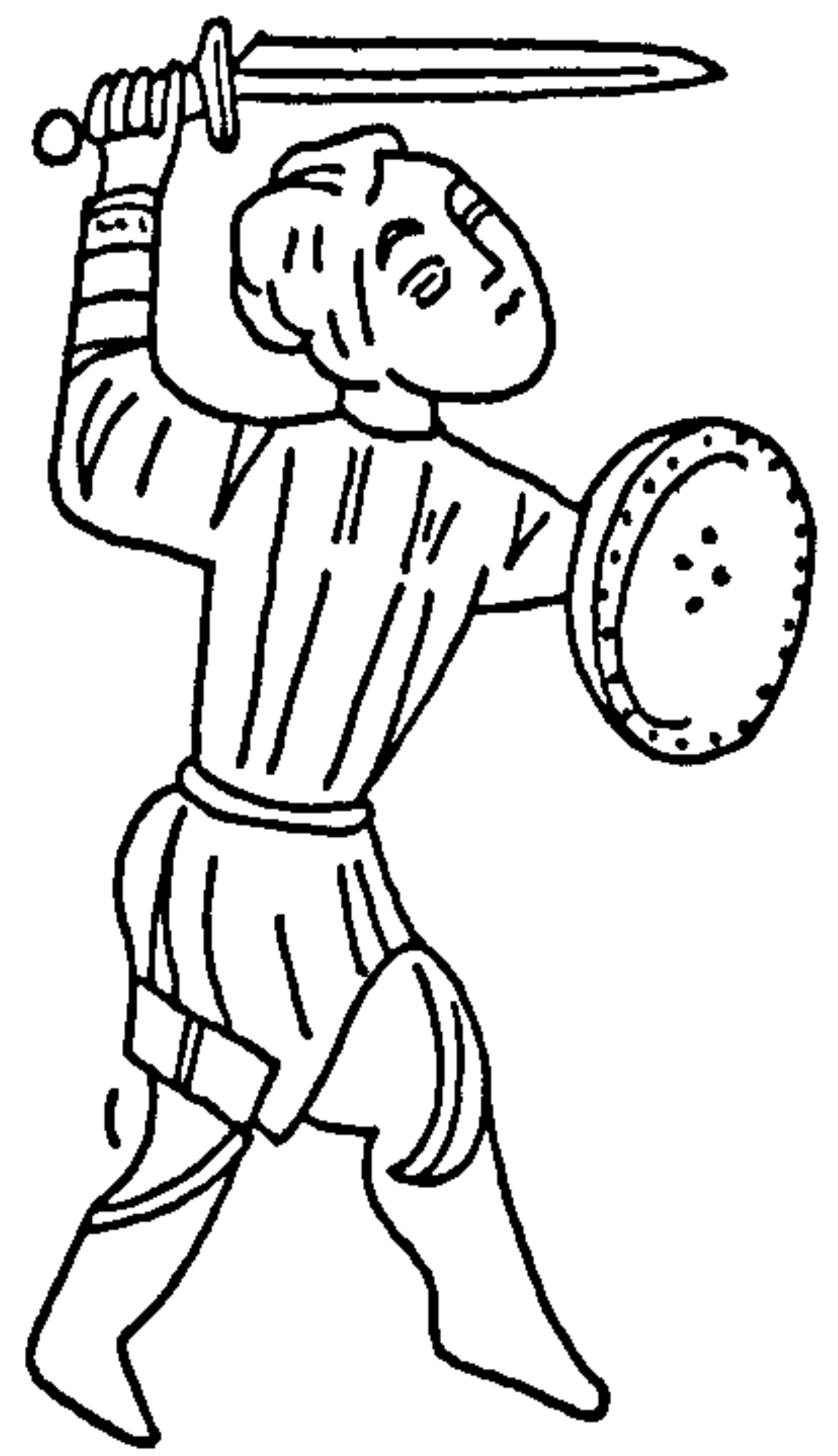

234



233

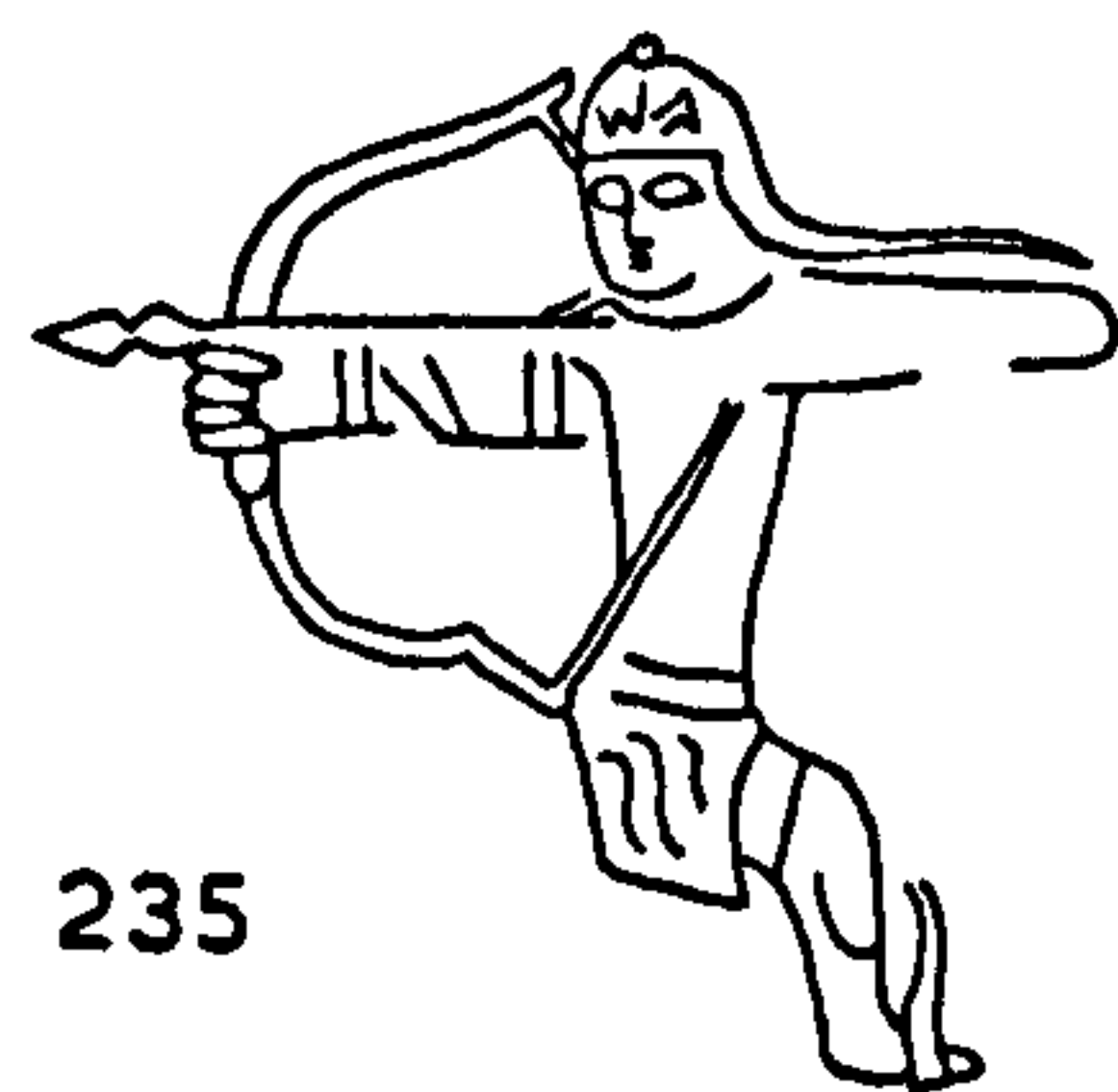
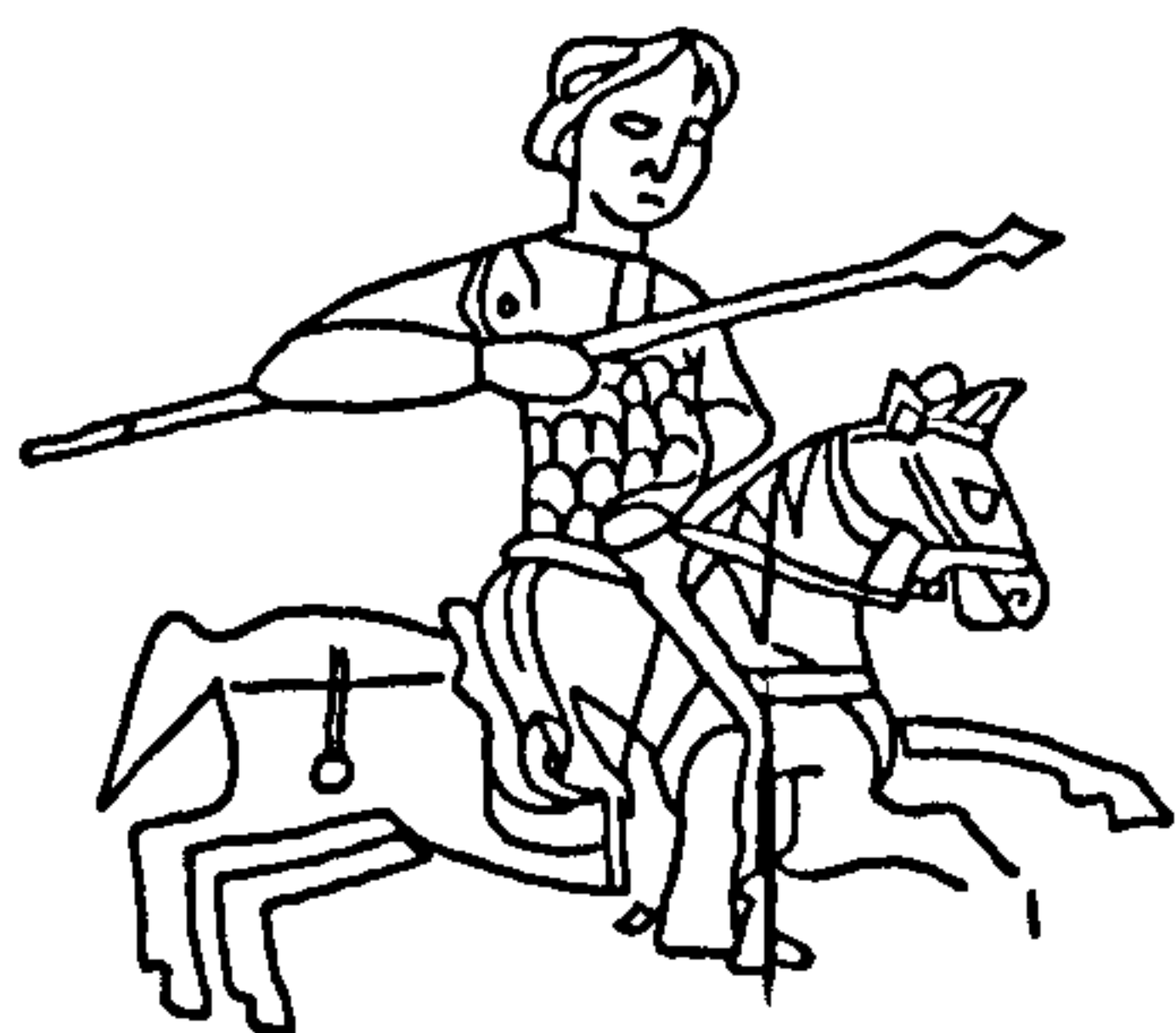
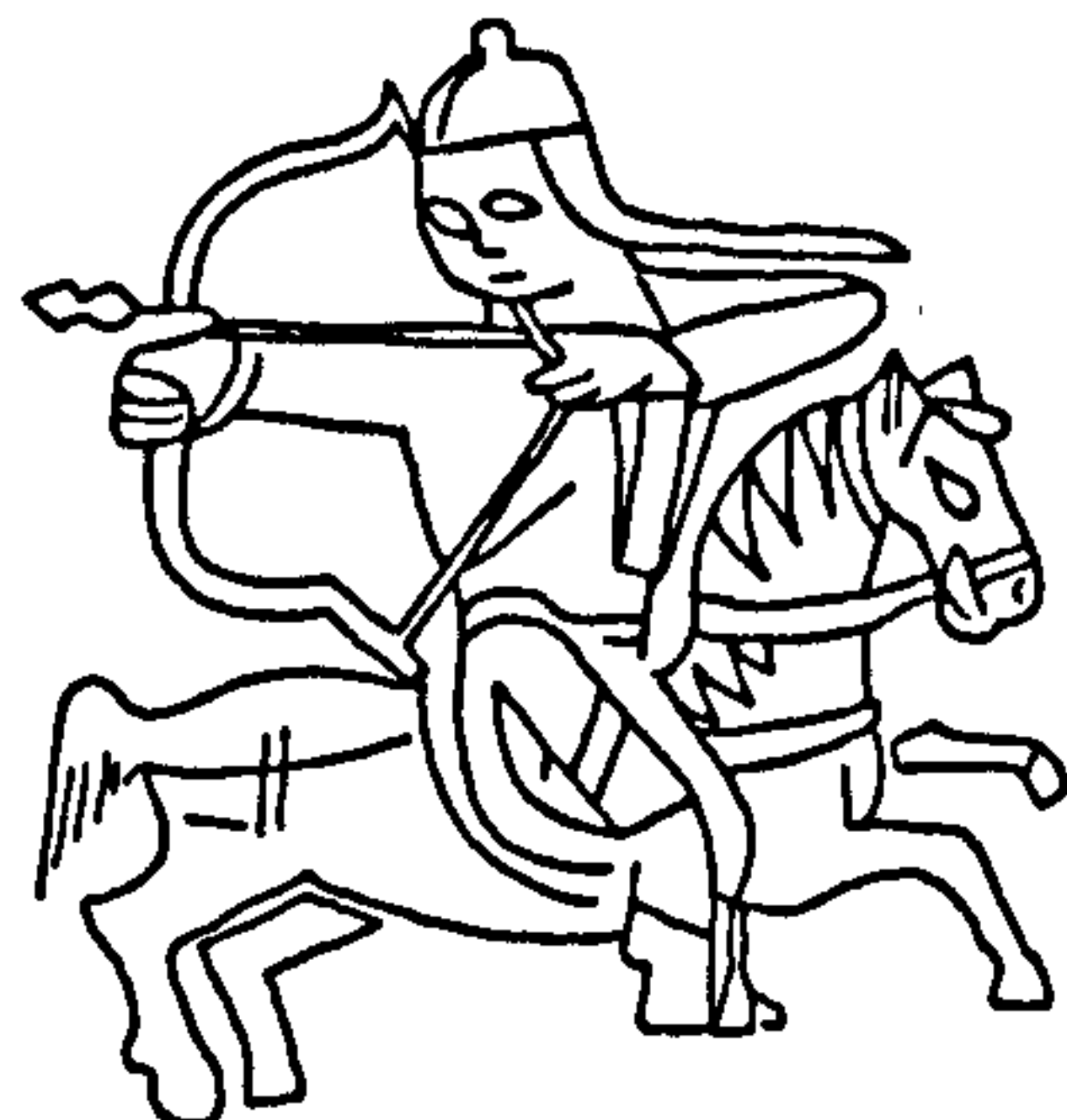

235

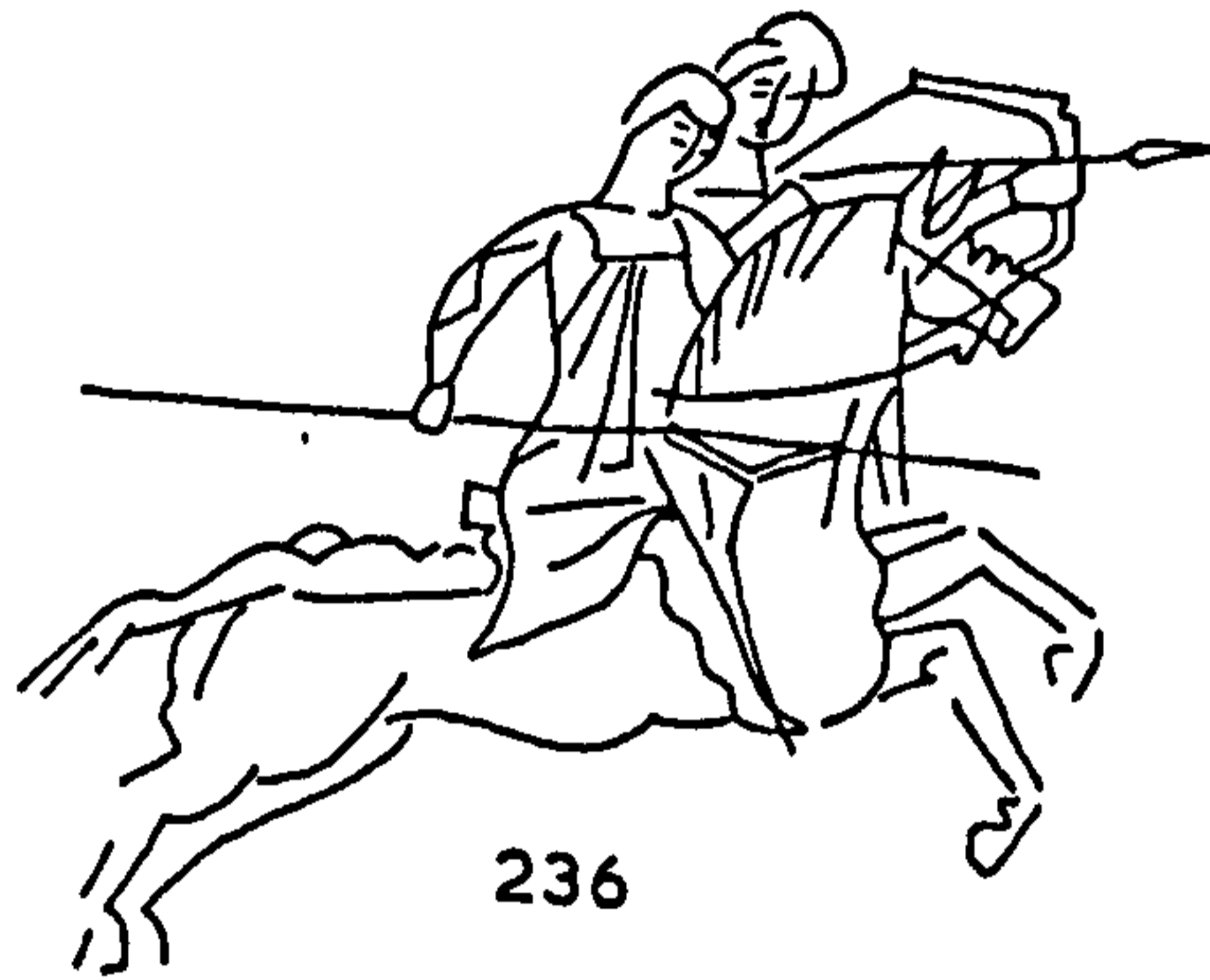

236



237A

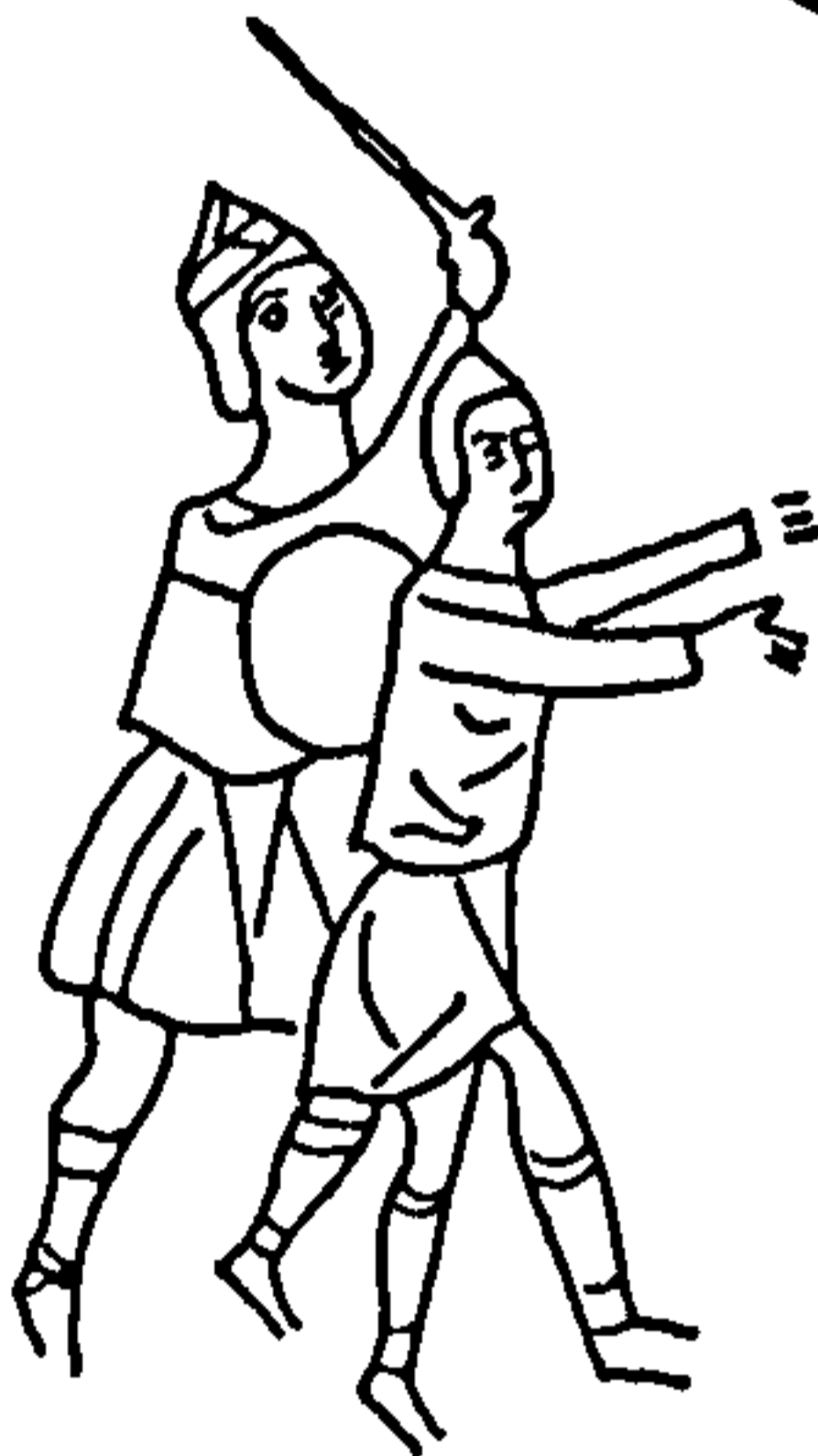

237B

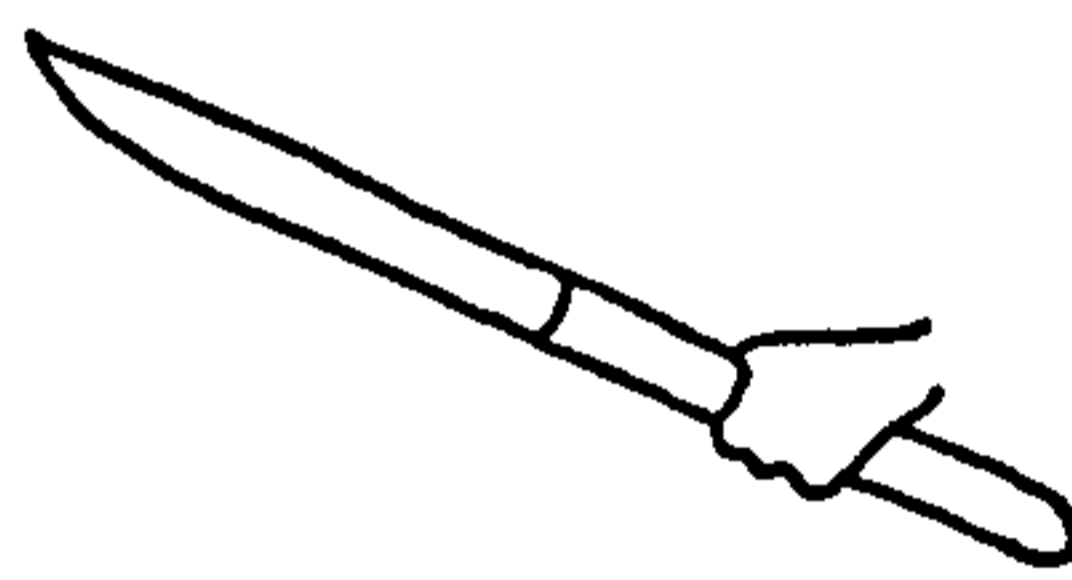

237C



238

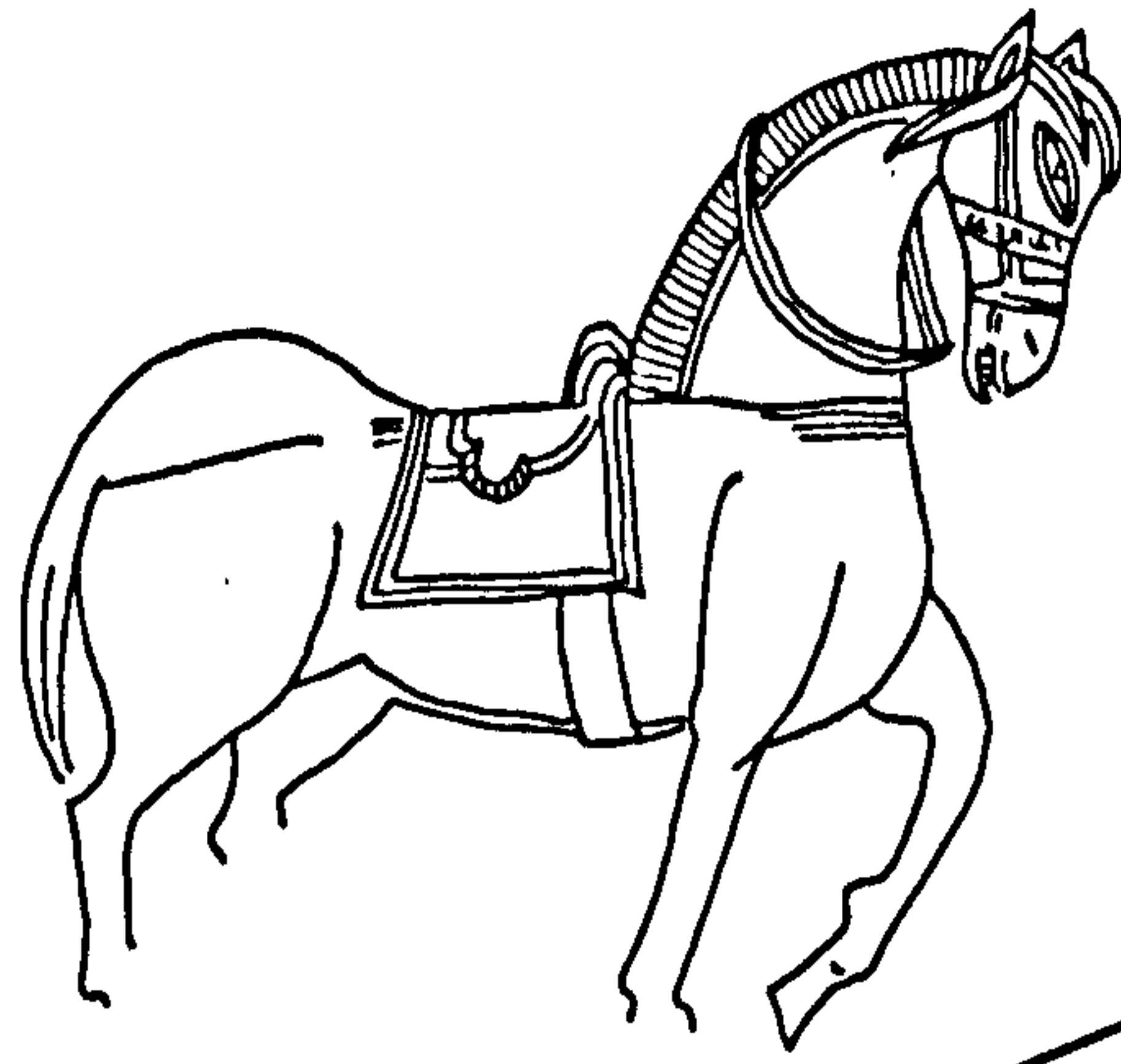
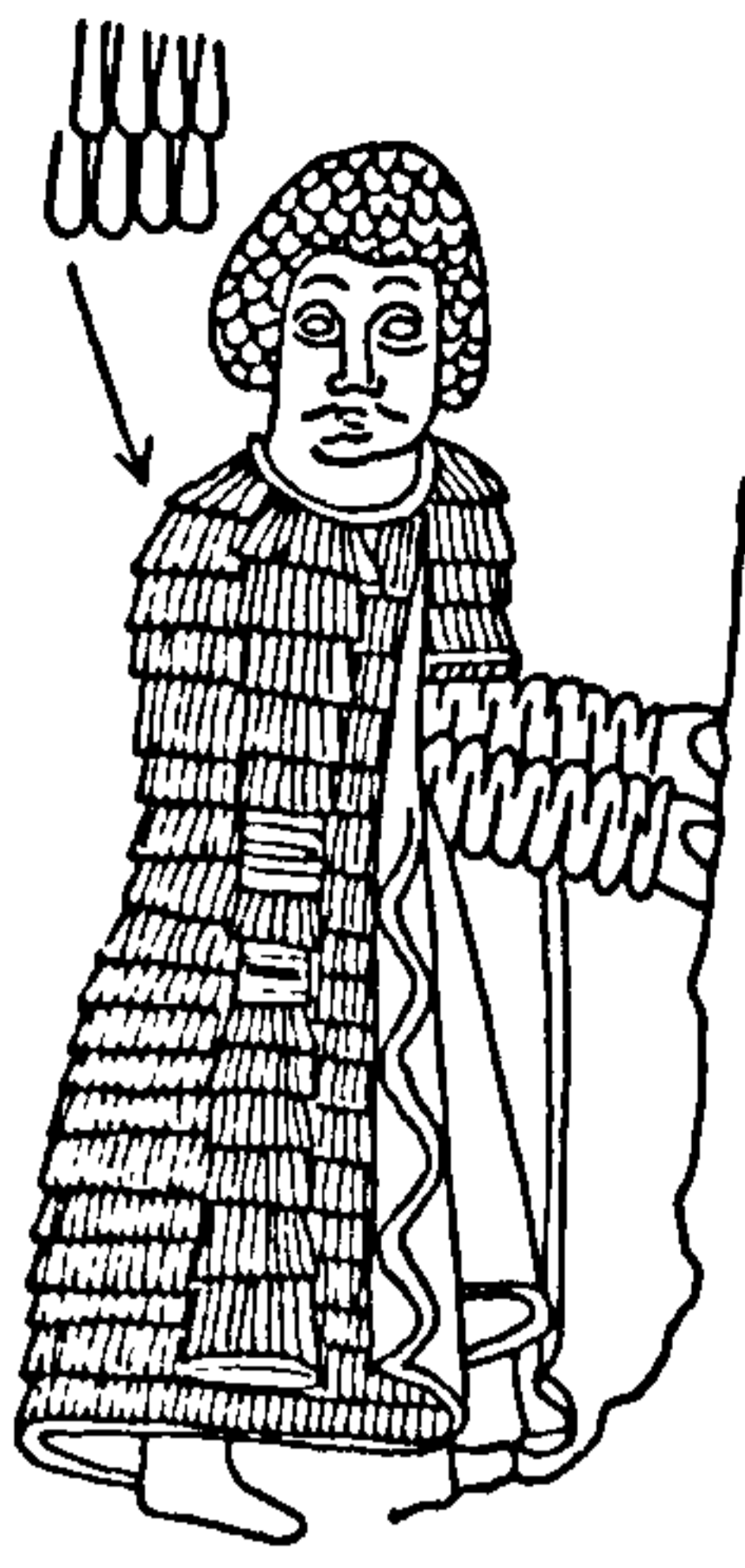

239

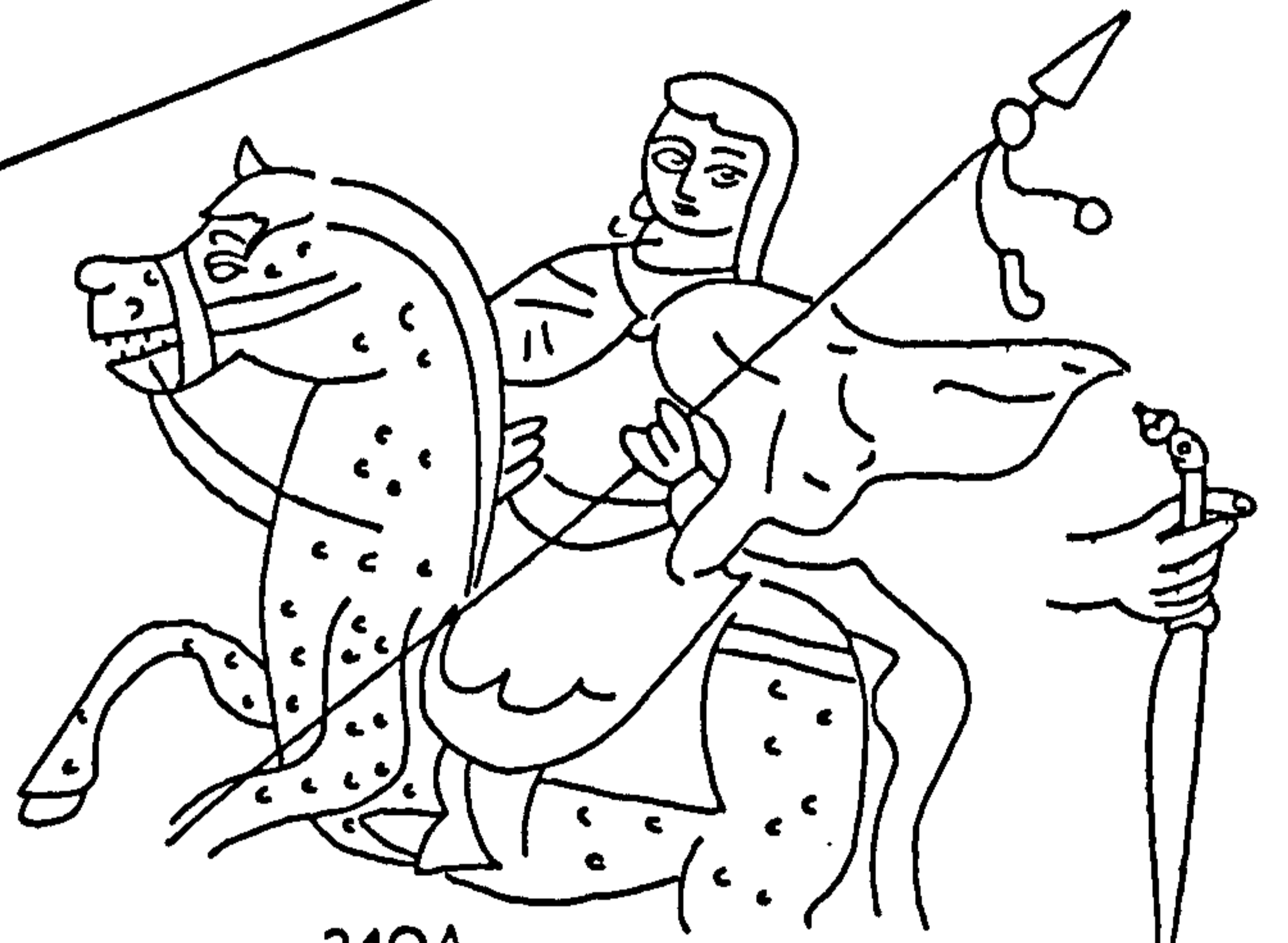

240A

240B



241A

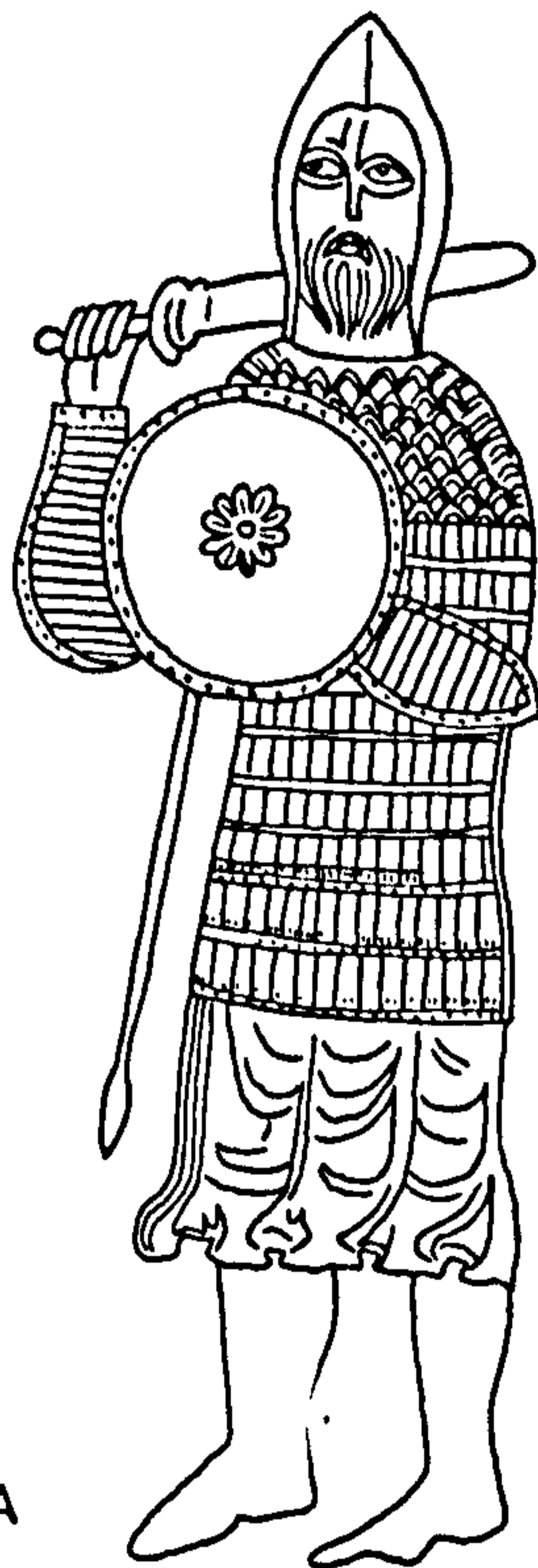

241B

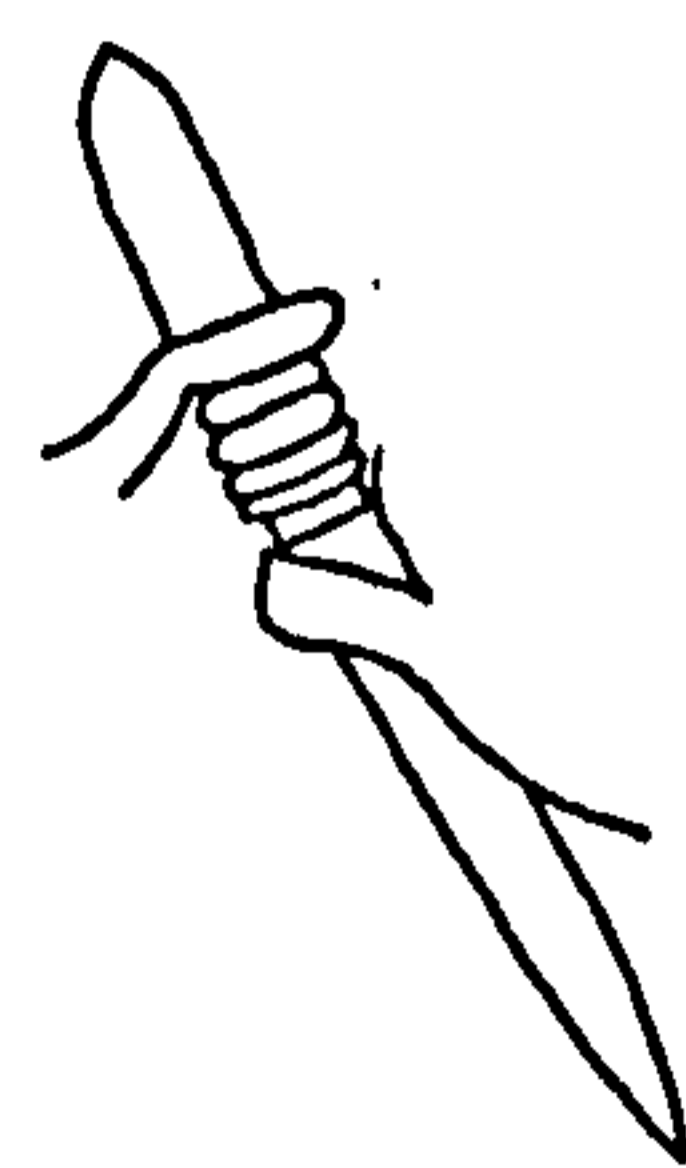
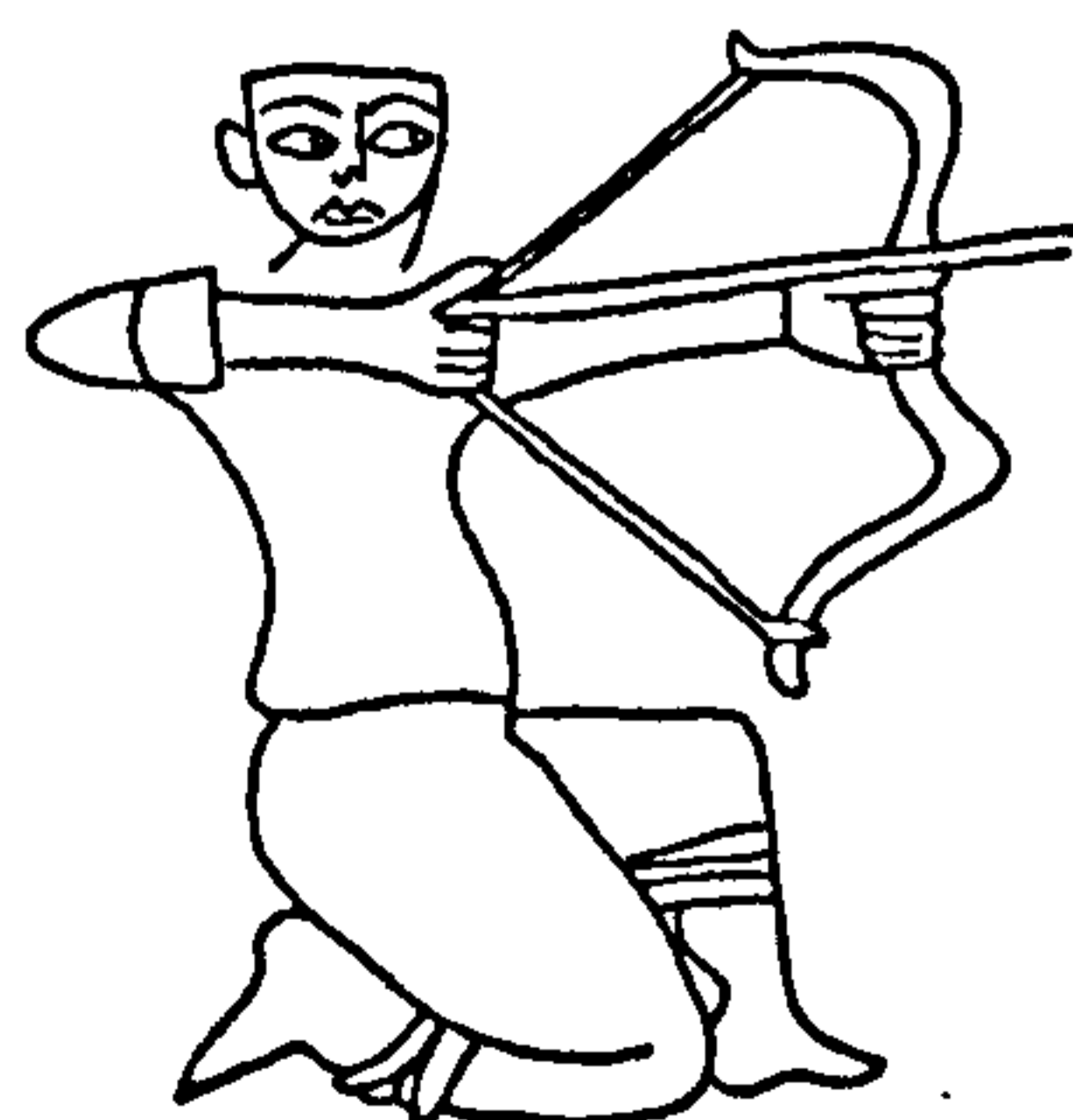

241C



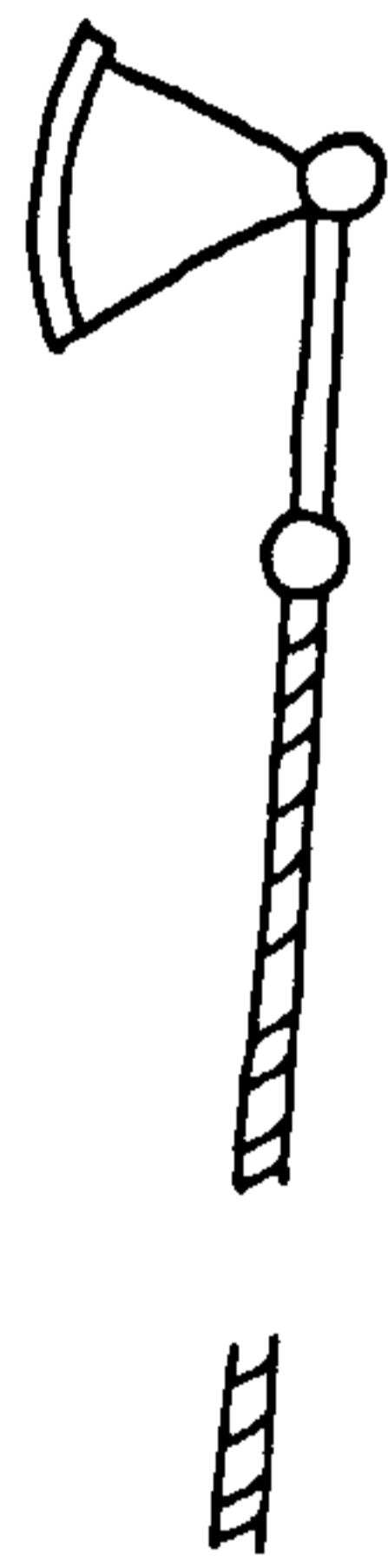
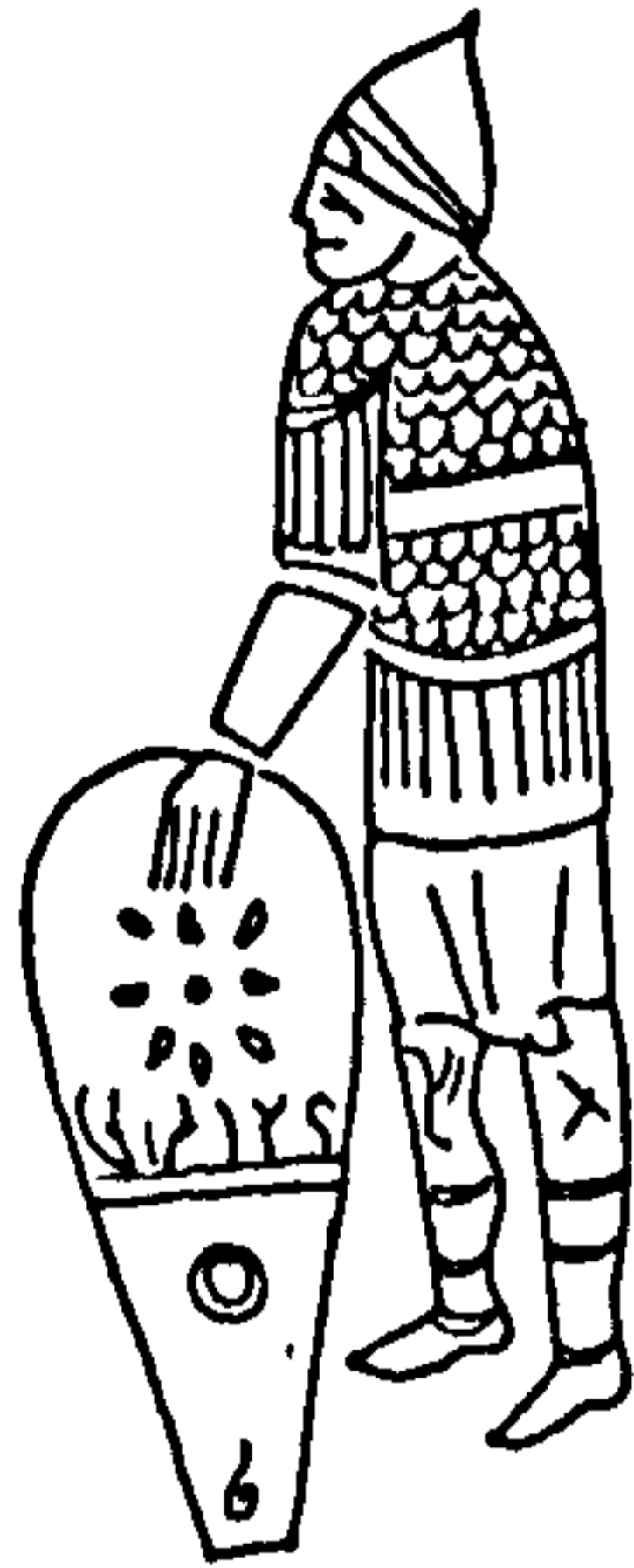
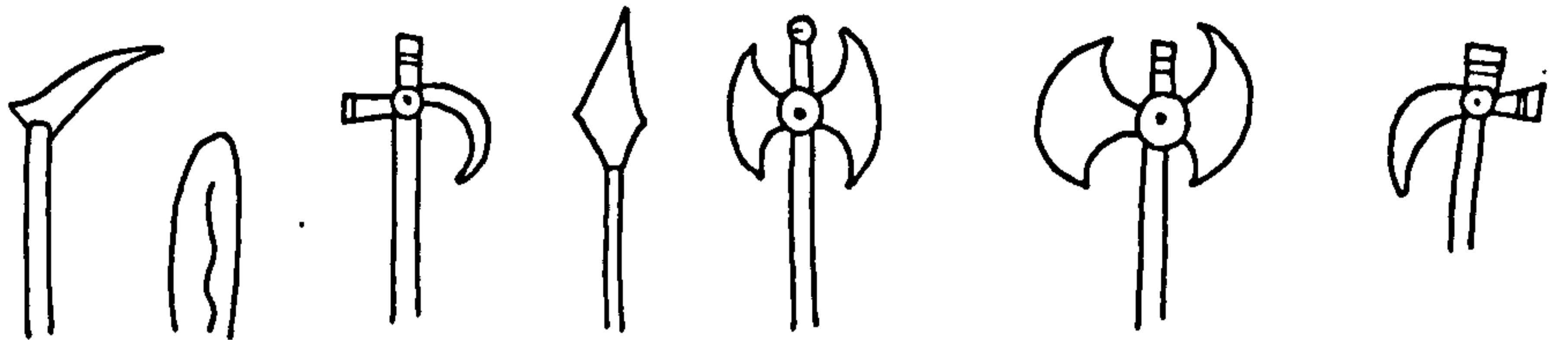
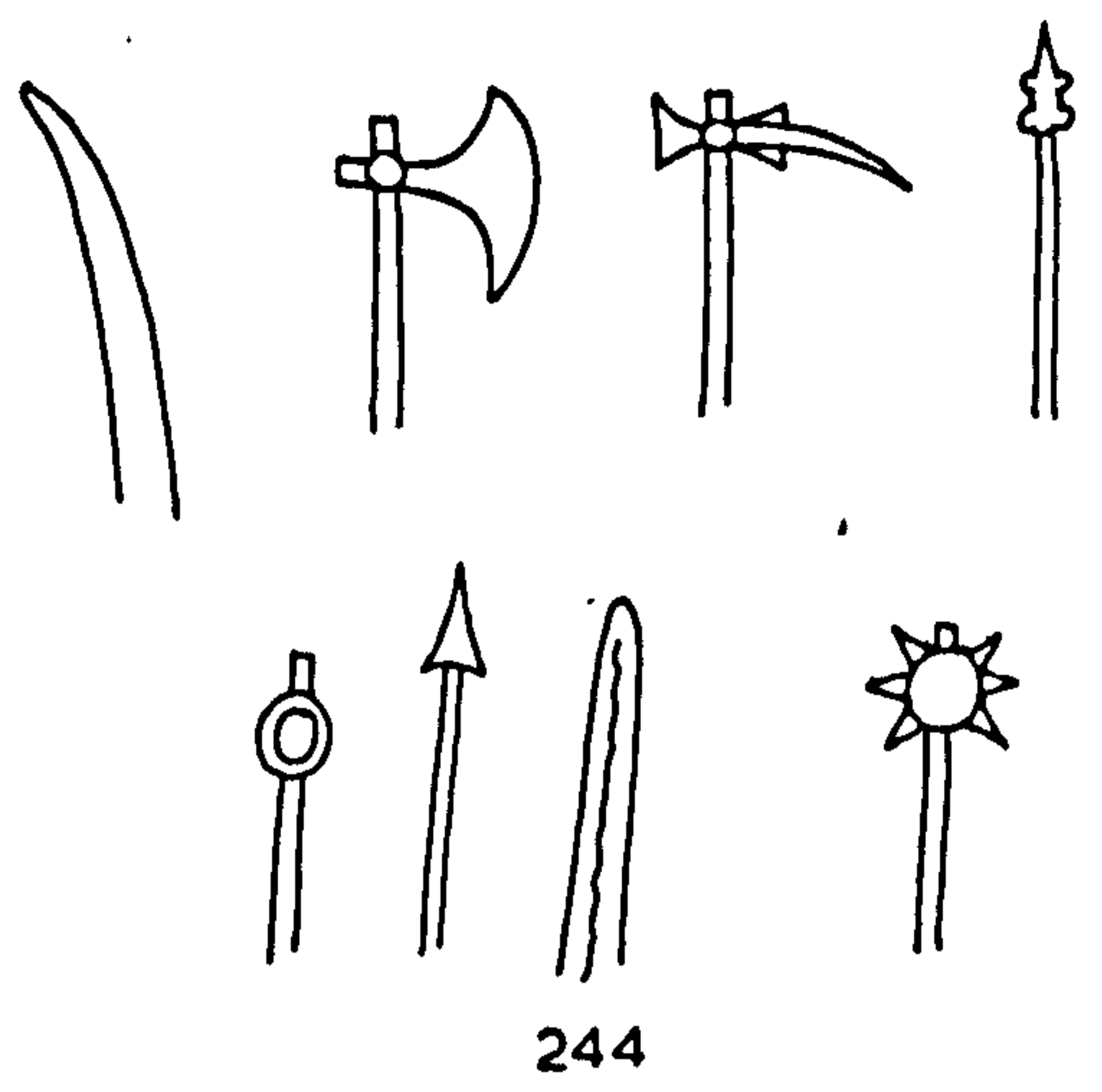
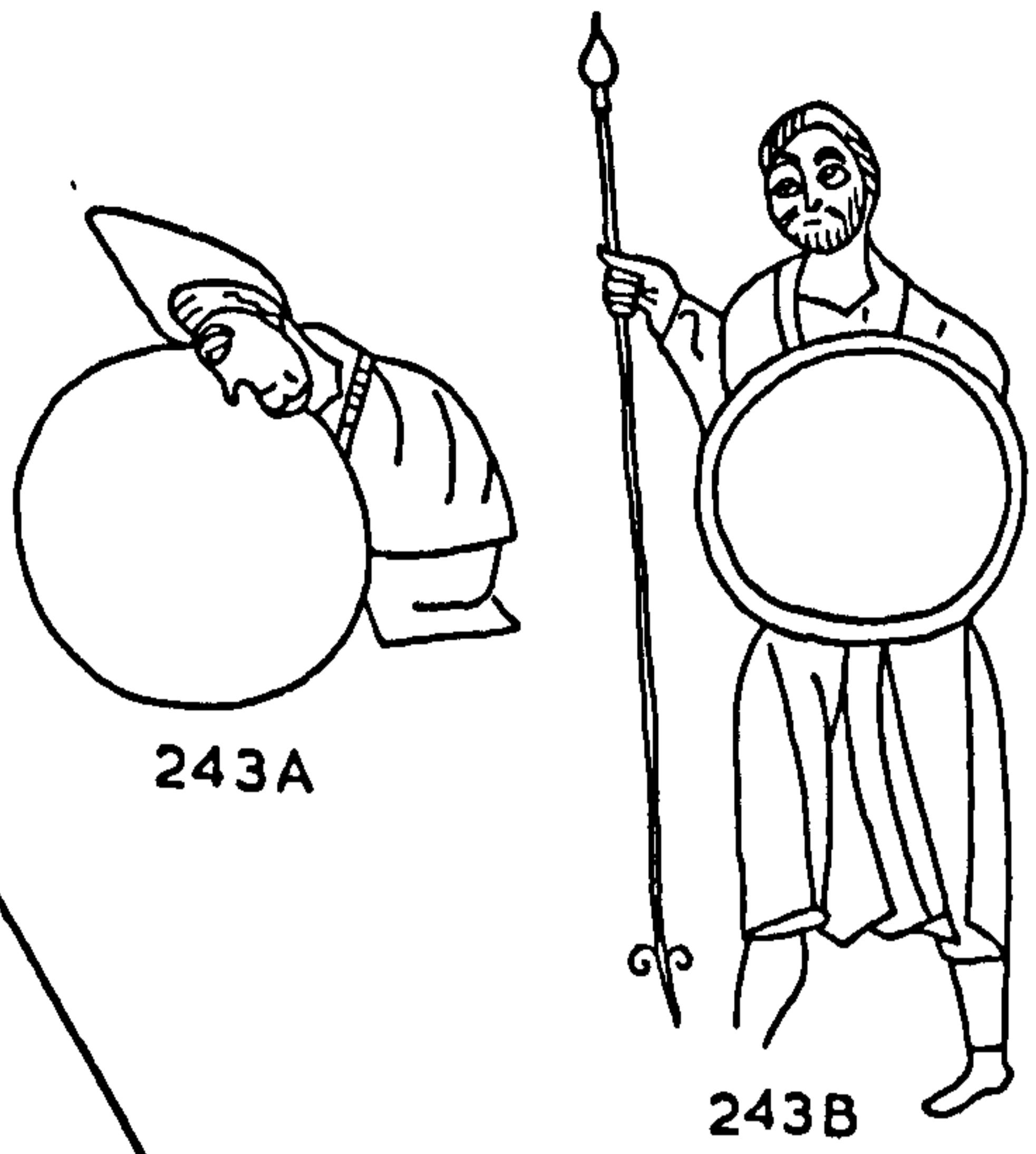

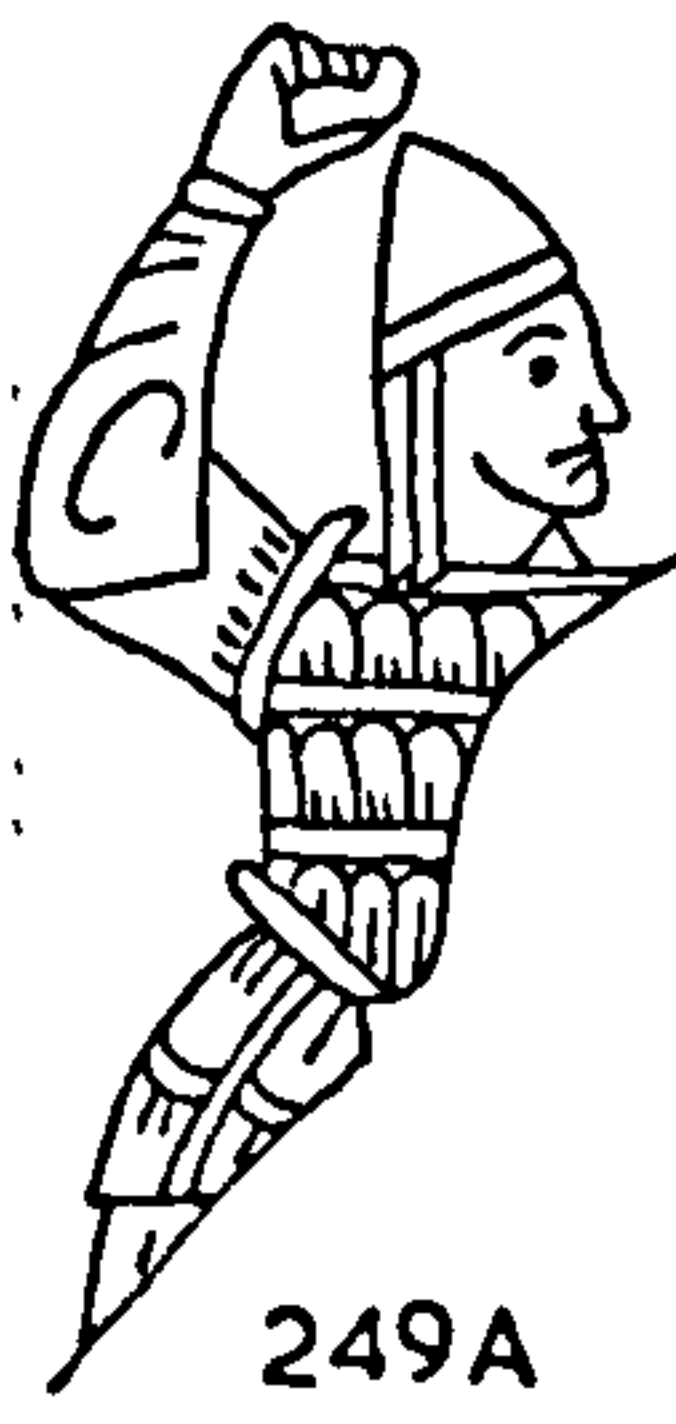

249A



249B



249C



250A

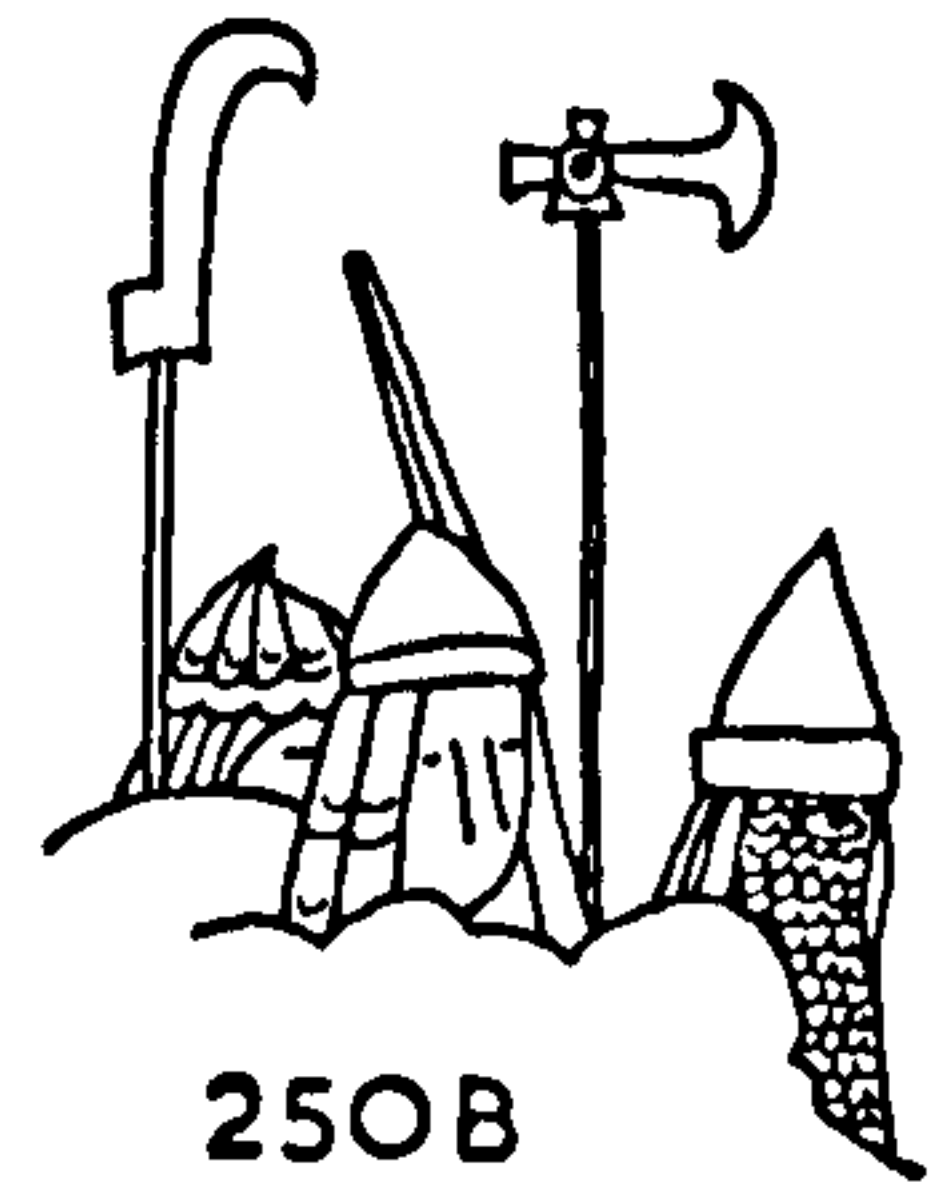

250B

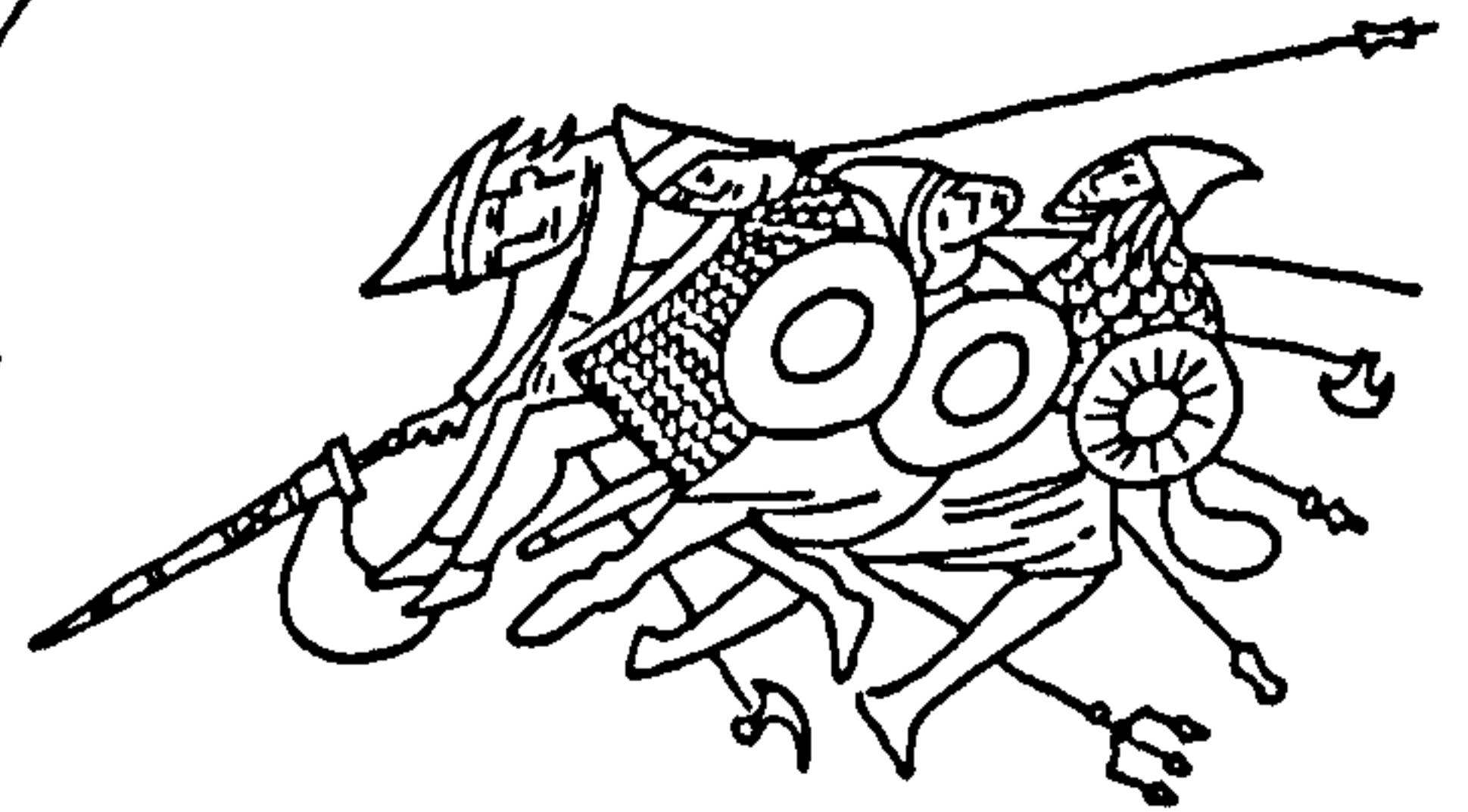

250C



250D



250E

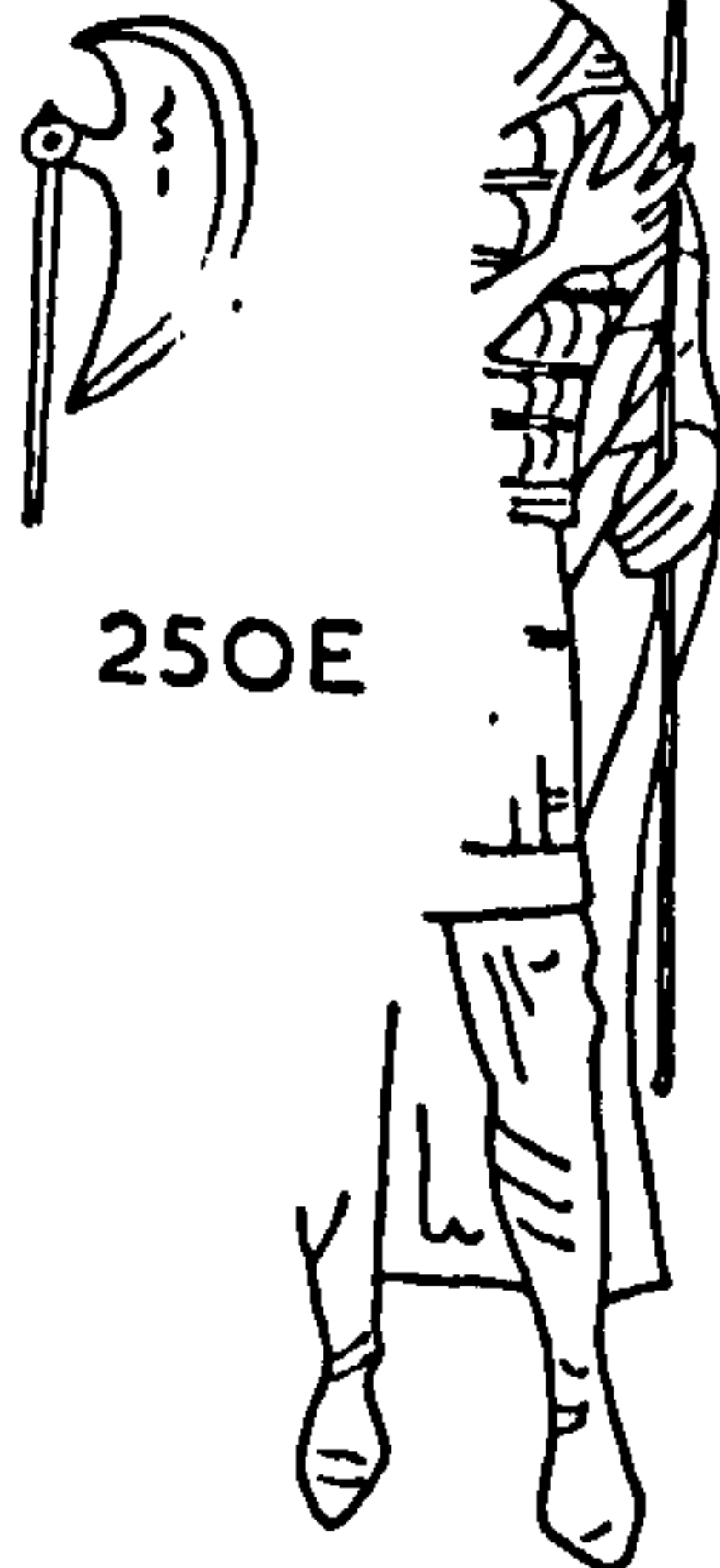

251



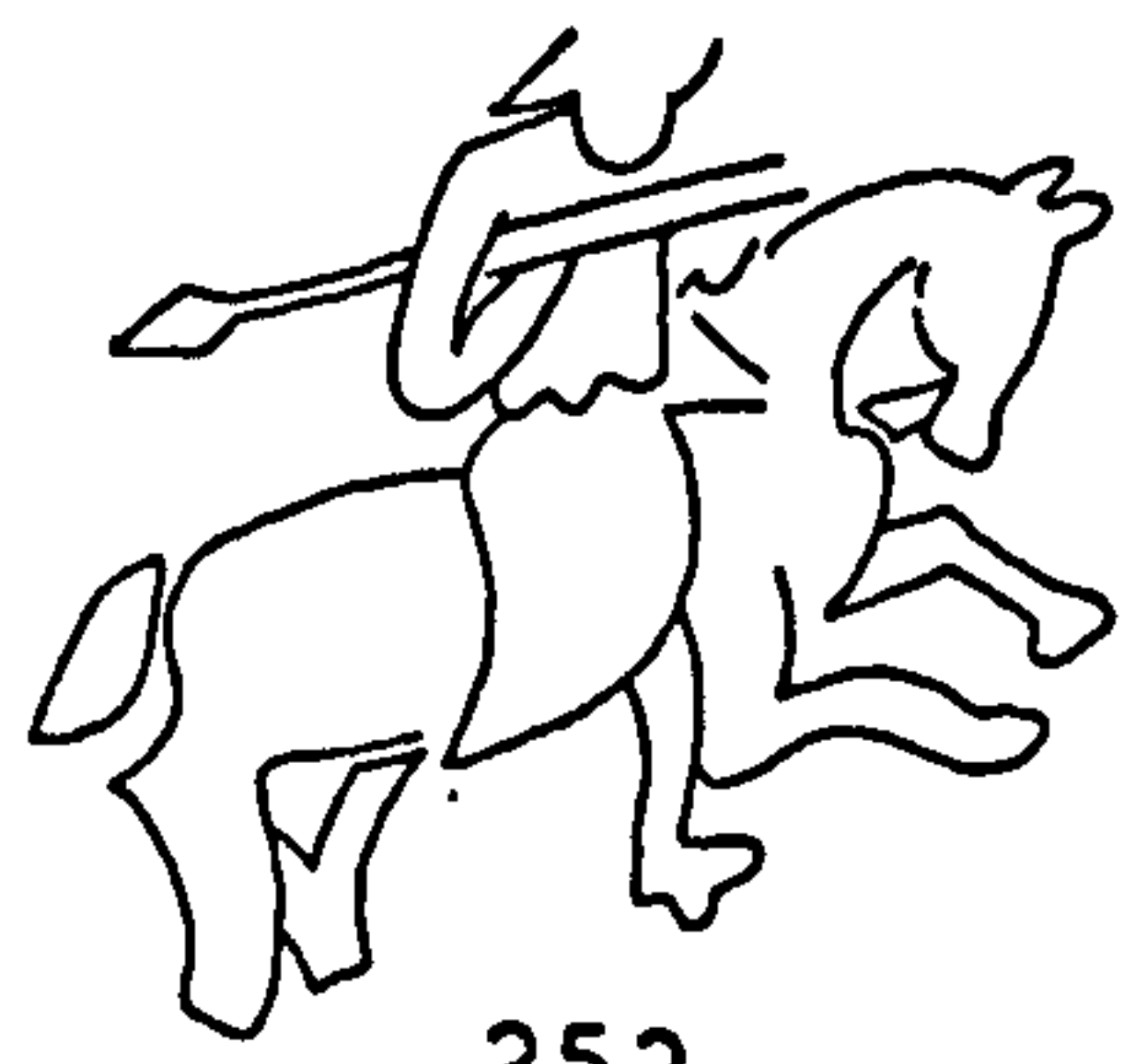

252



253

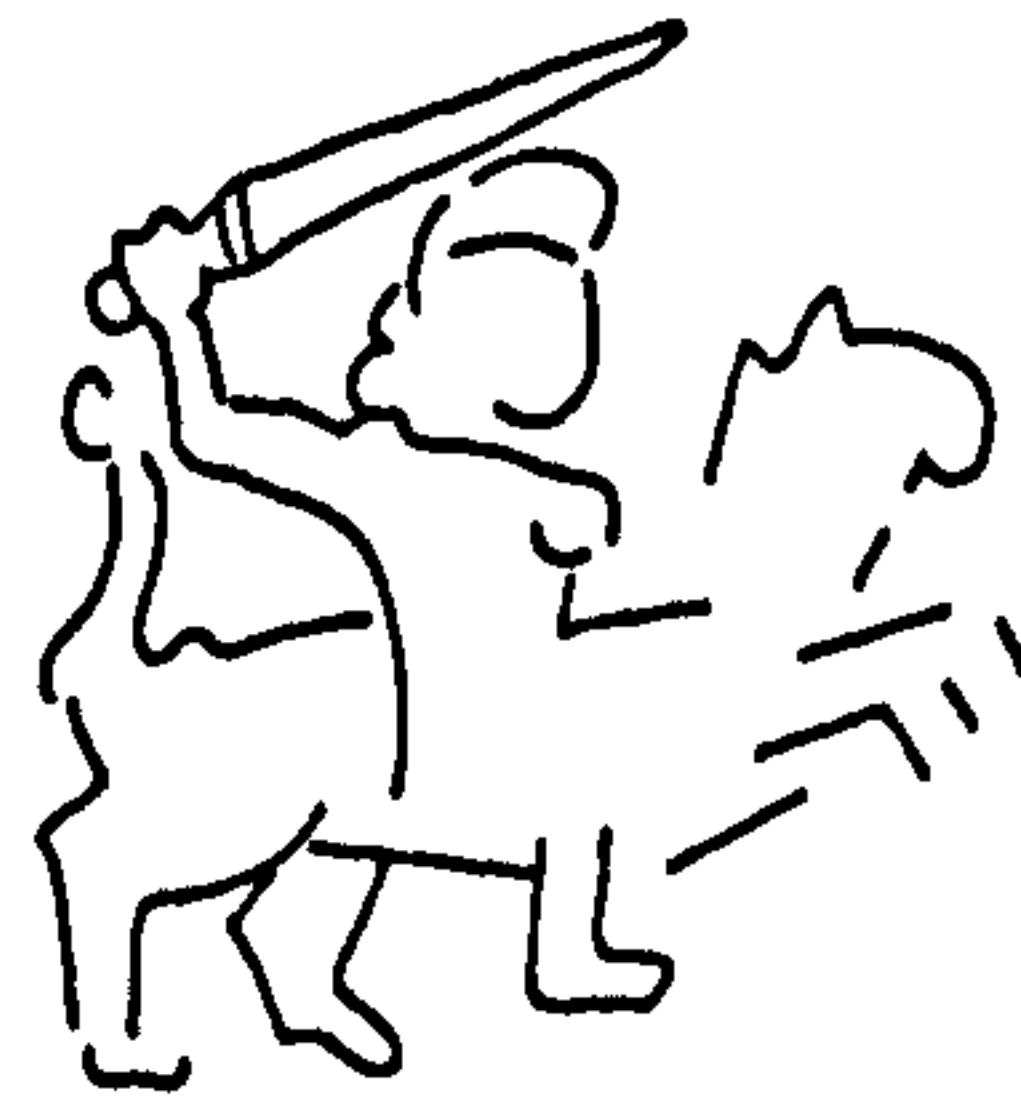

254

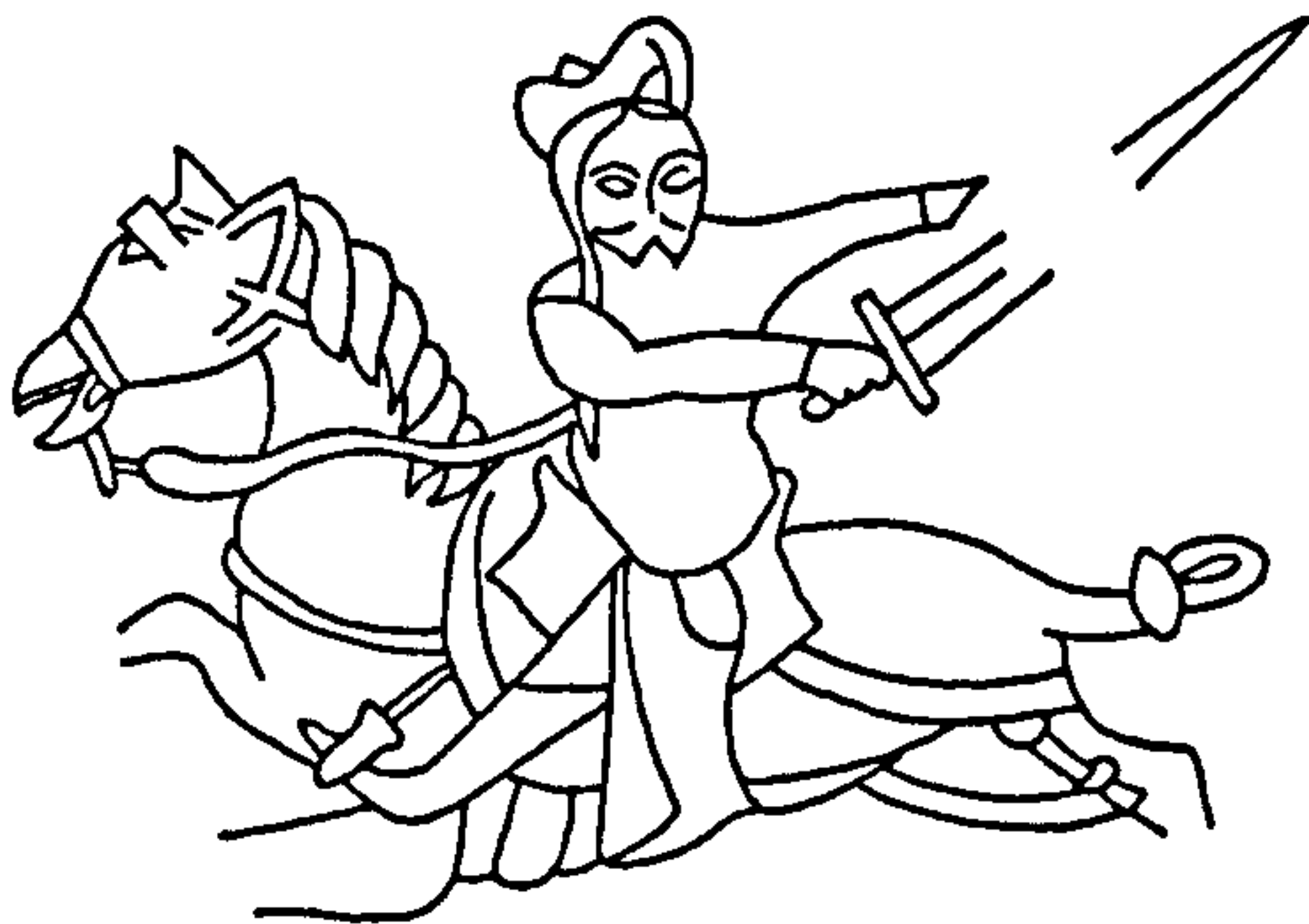

255

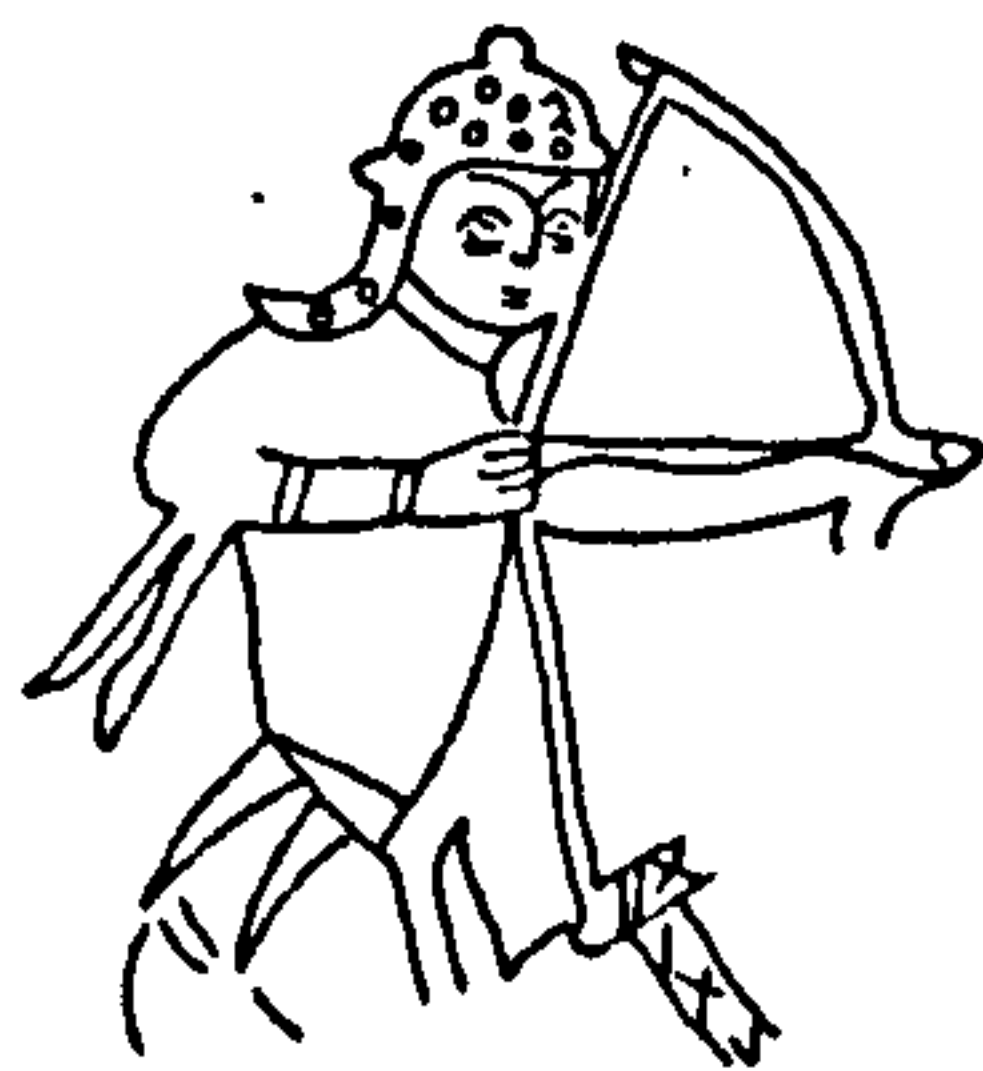
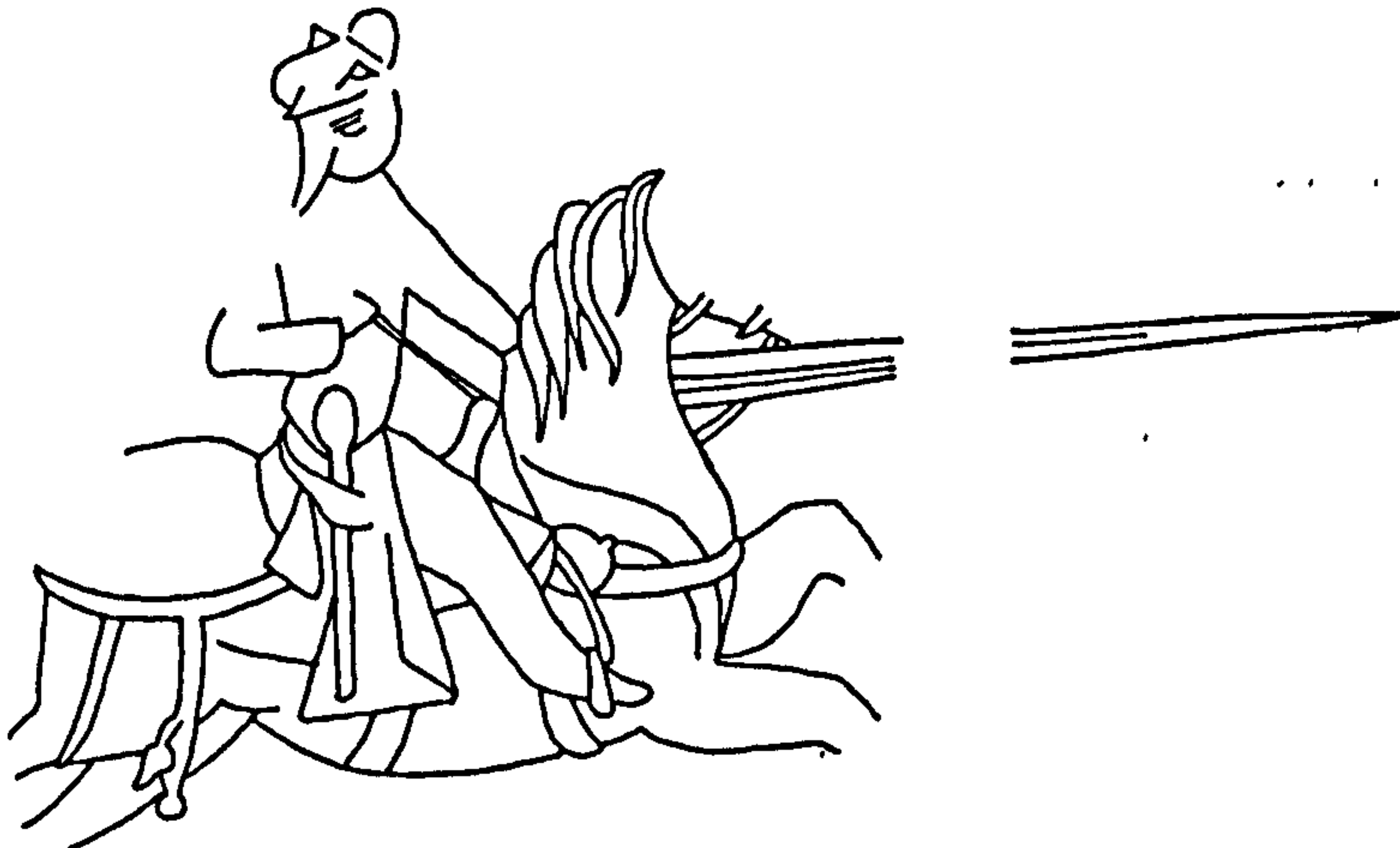

256



257



258

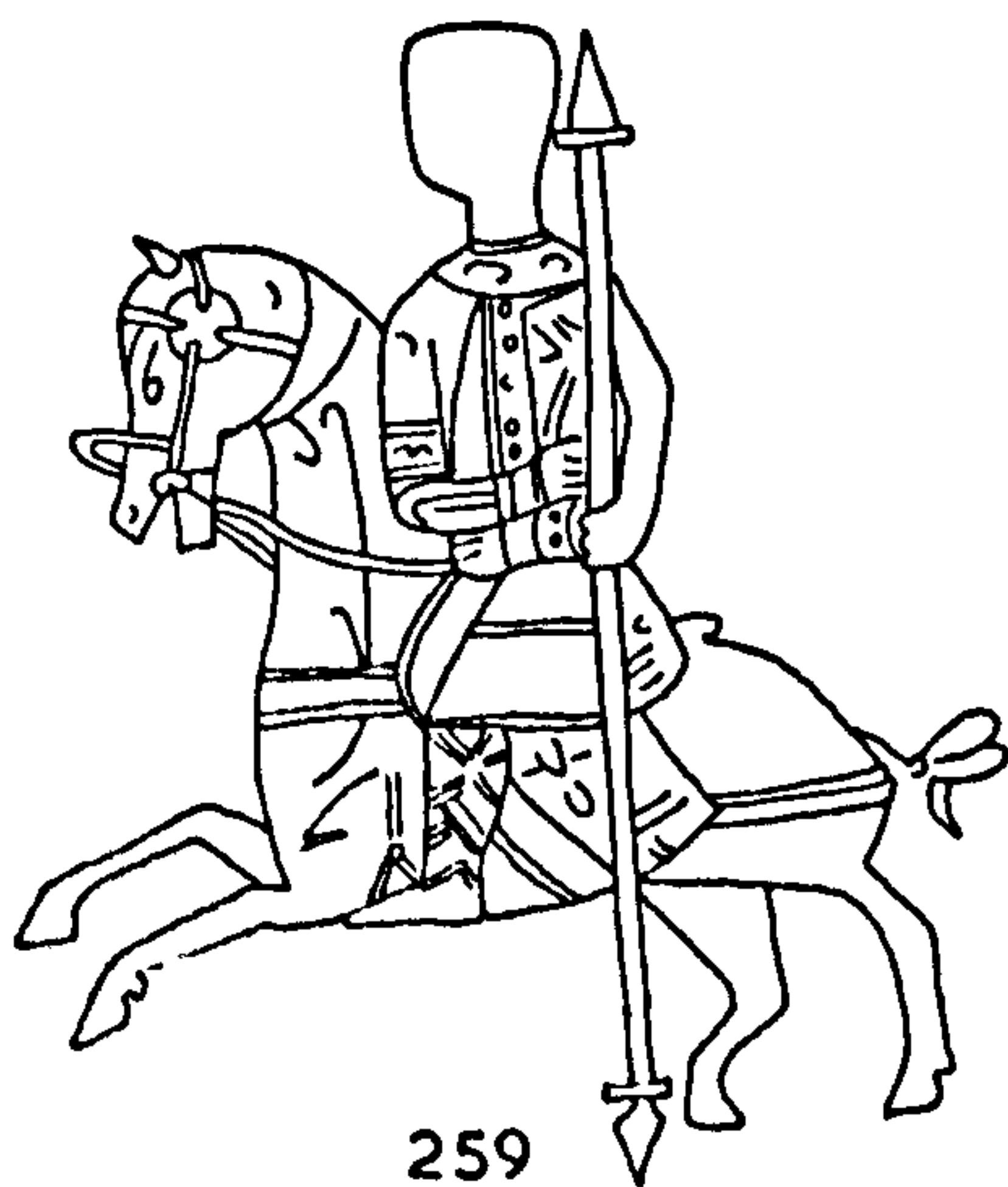

259



260

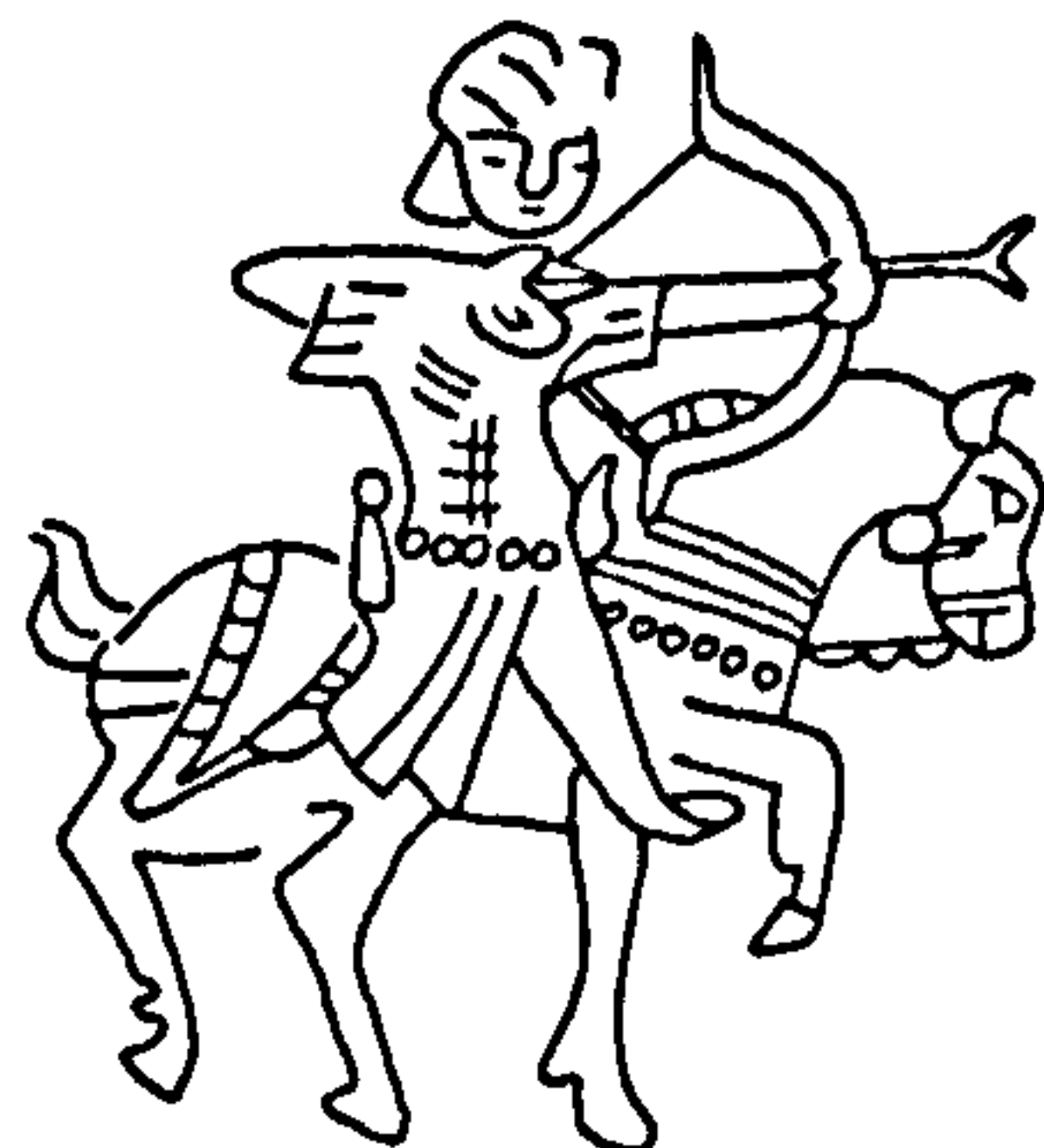

261



262A



262B



263

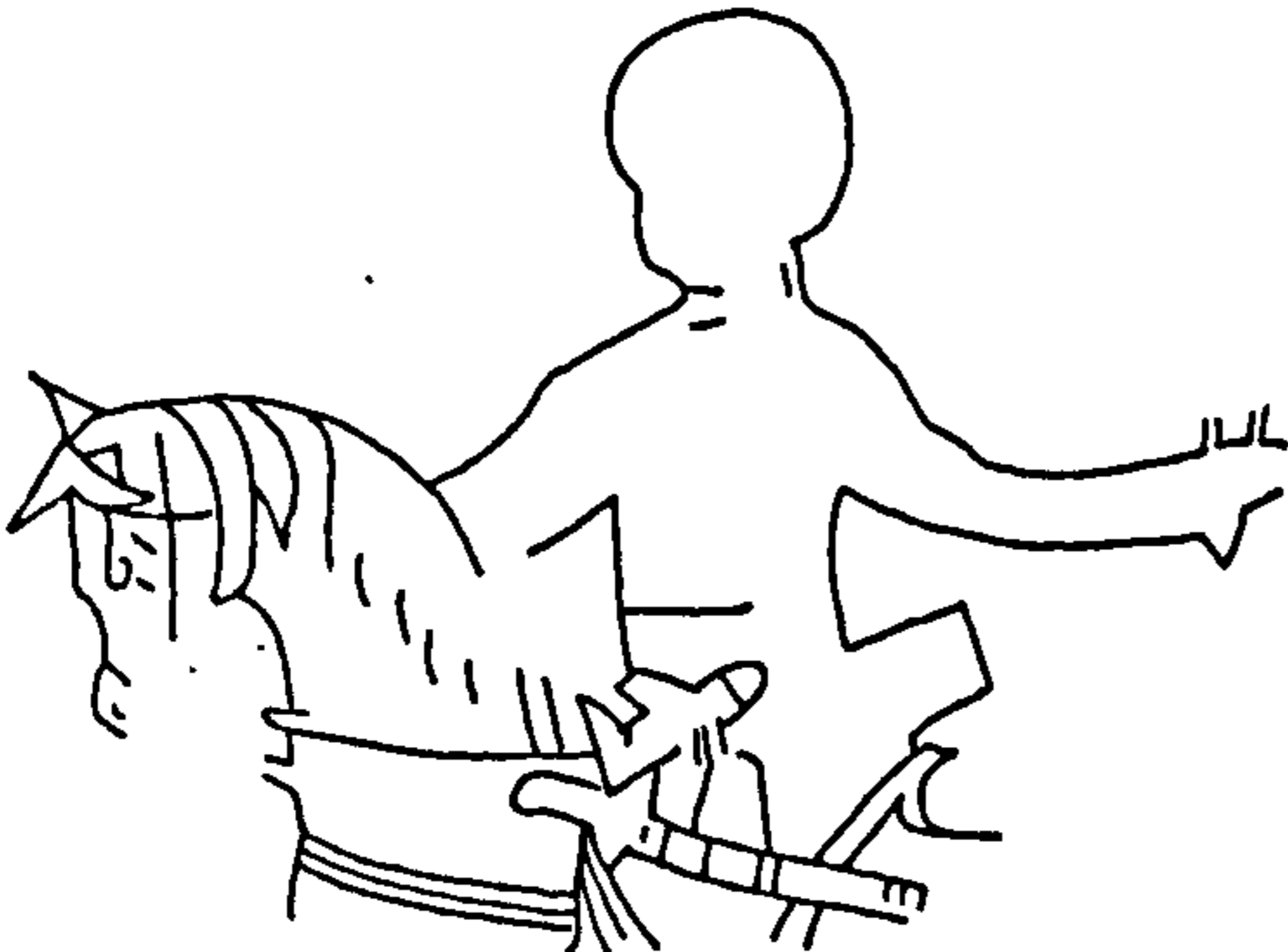

264

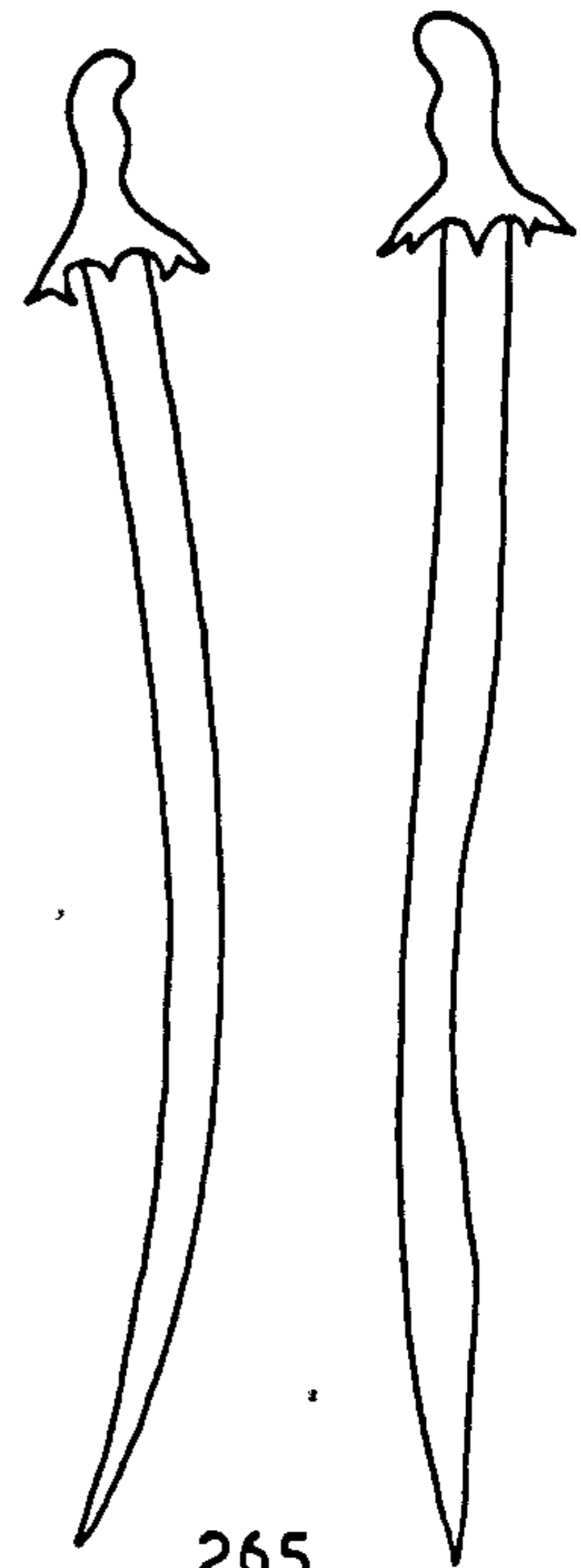

265

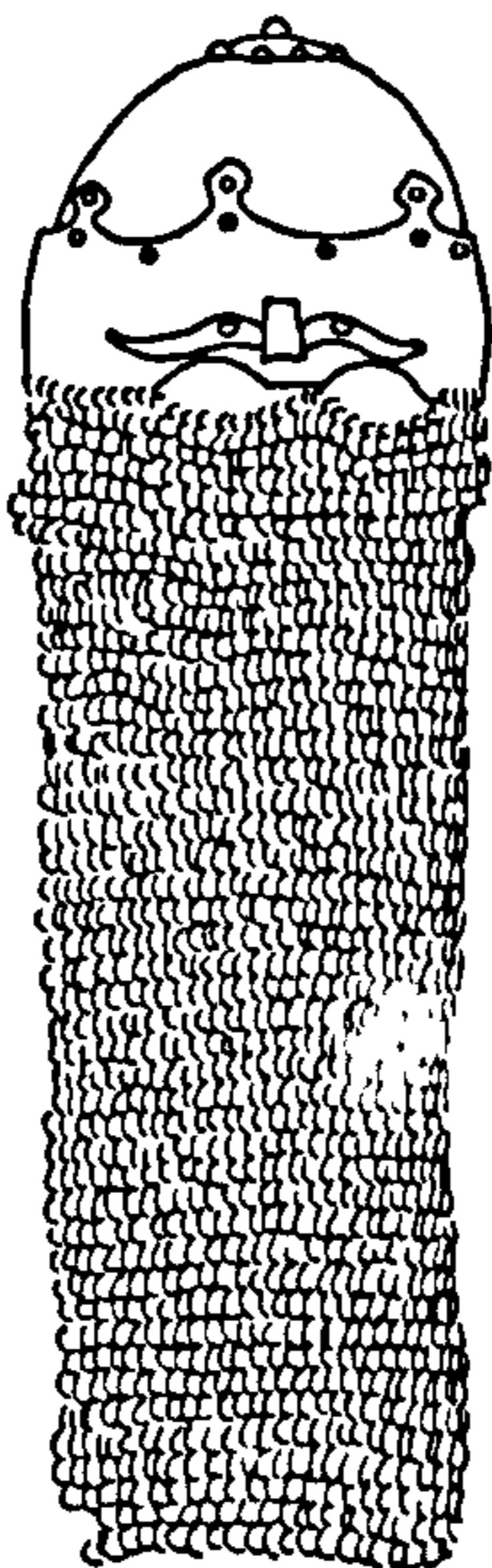
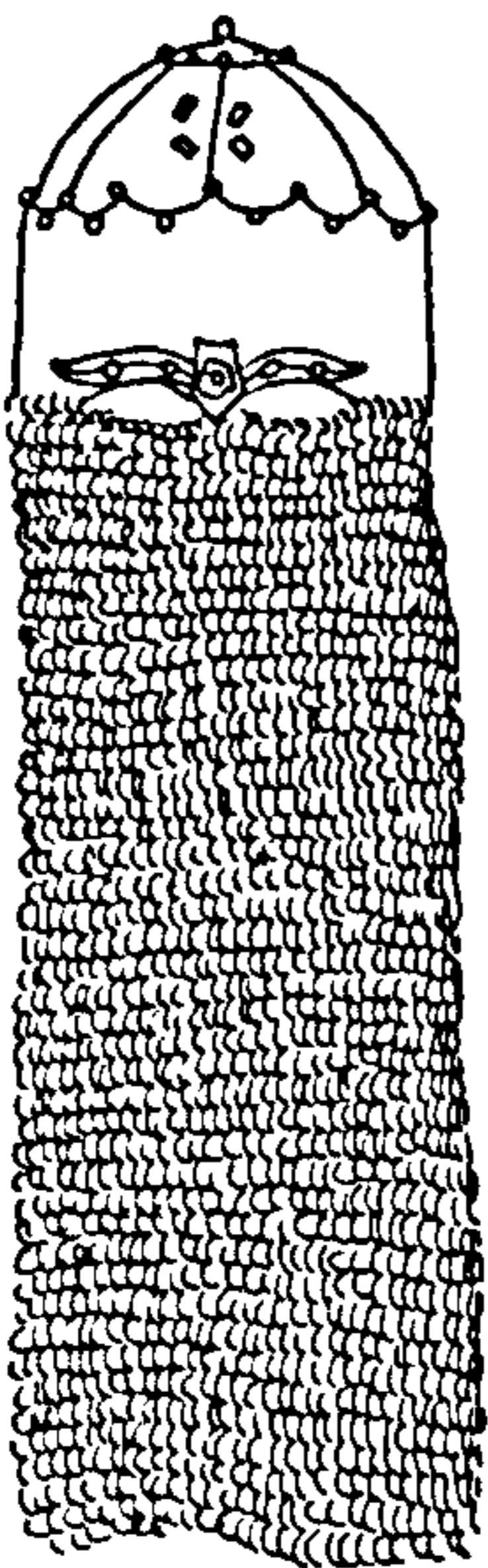

266

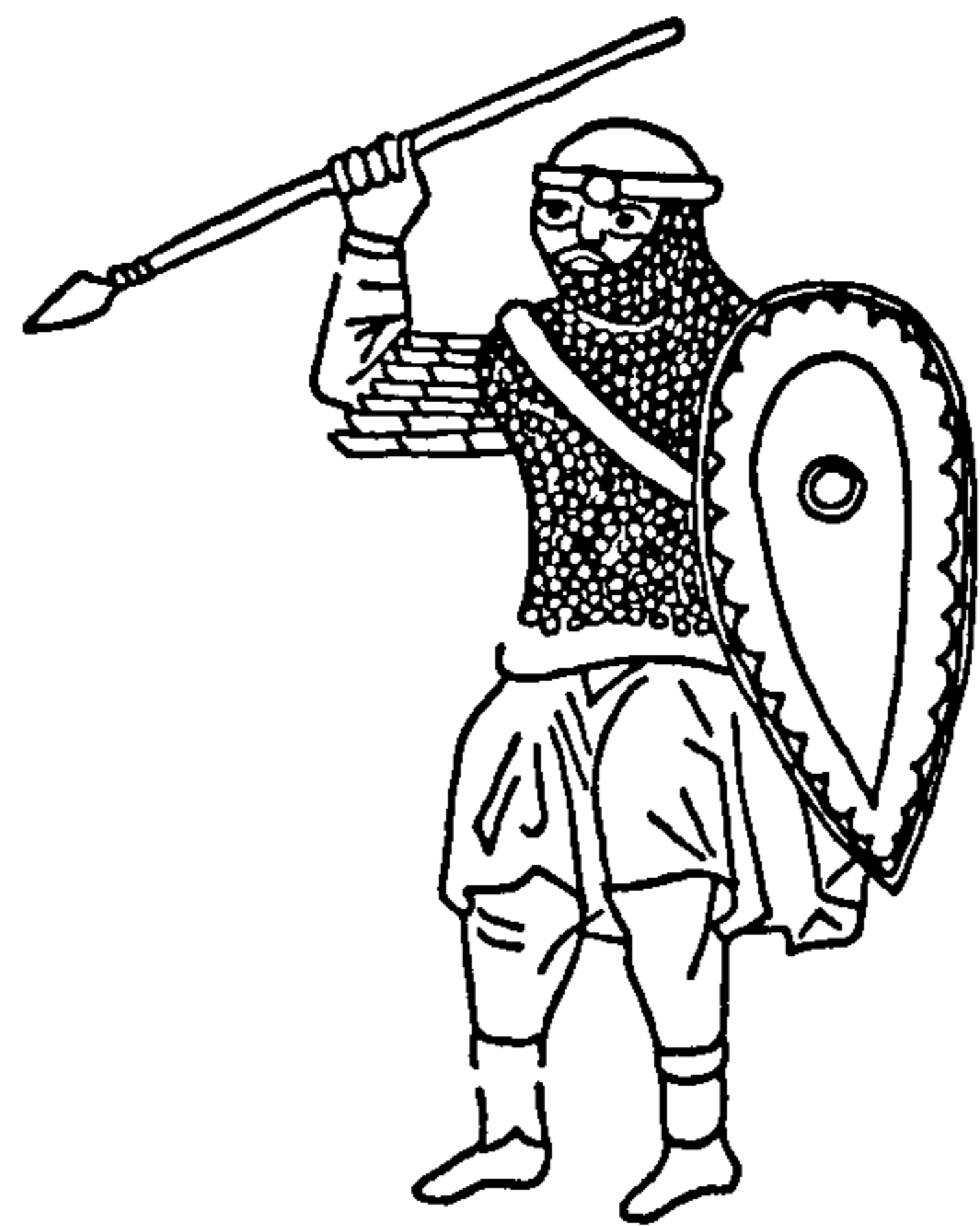

267A

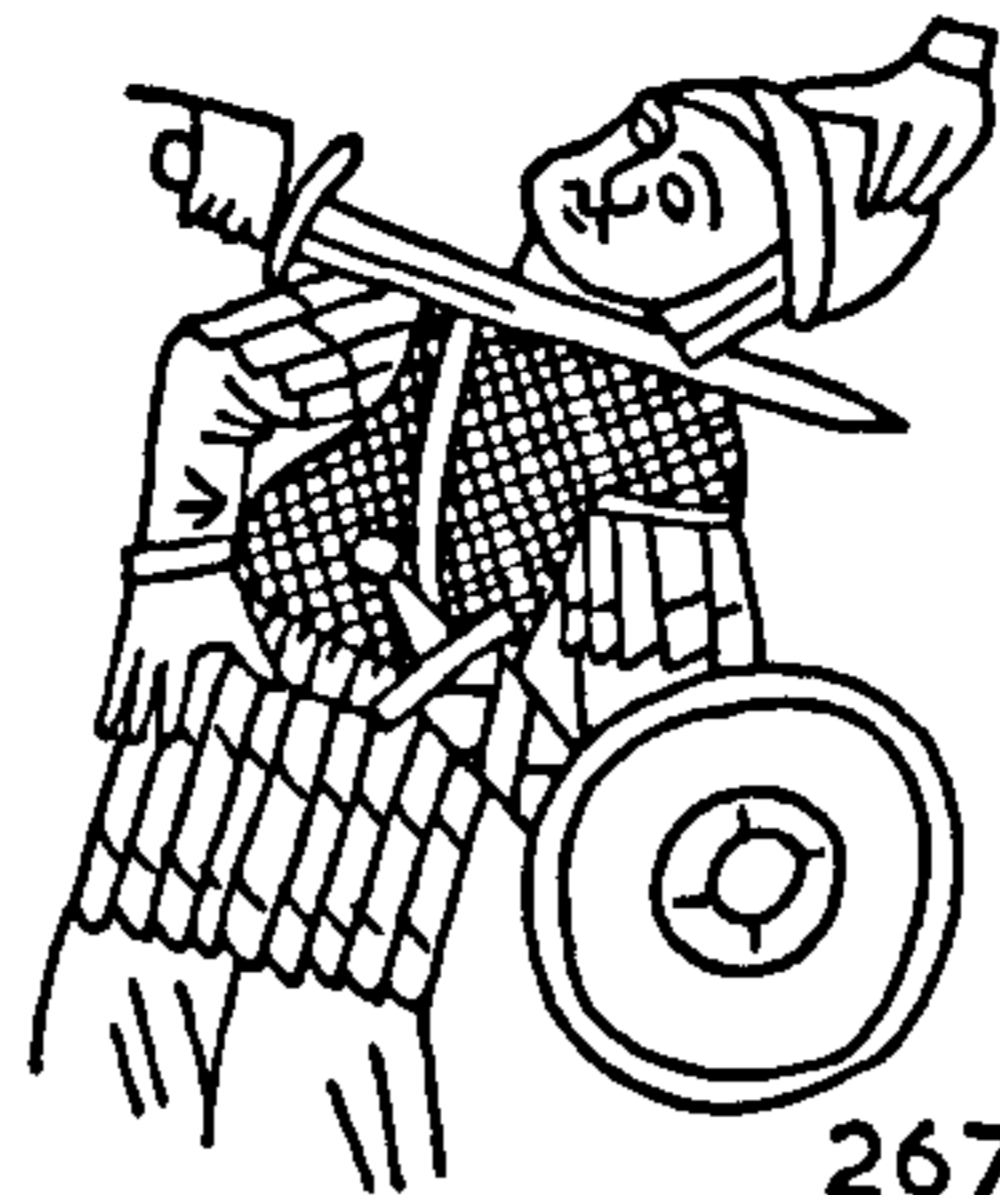

267B



267C

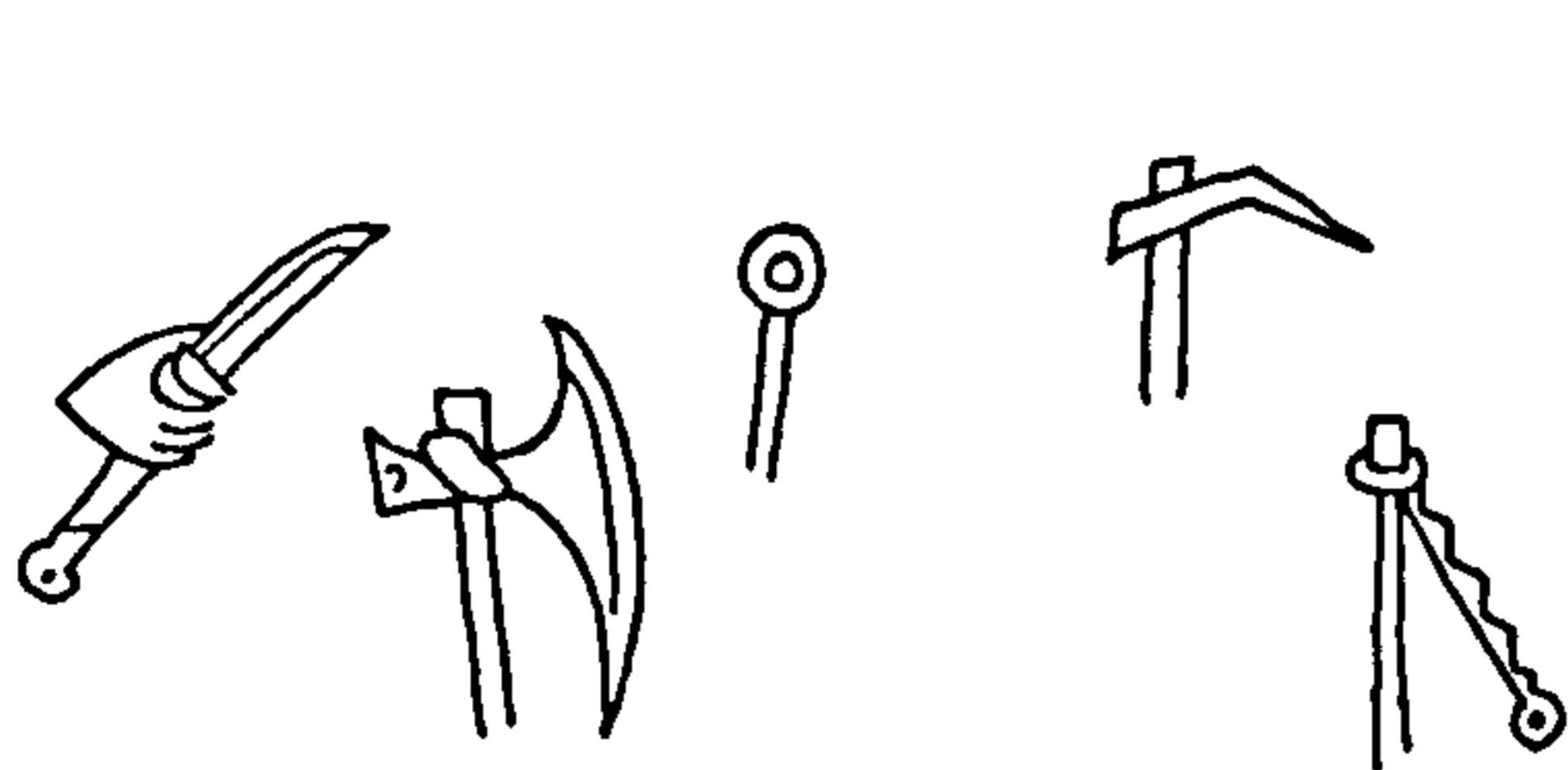

268

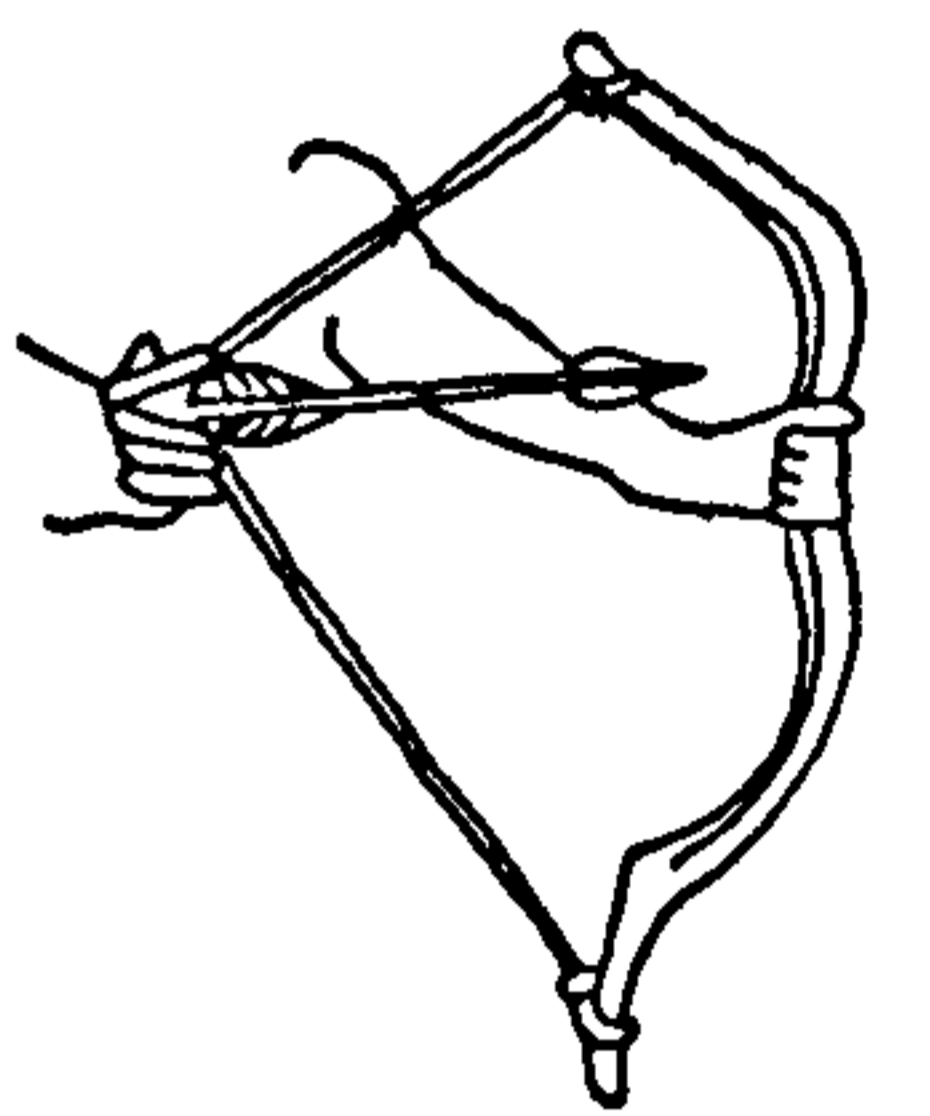
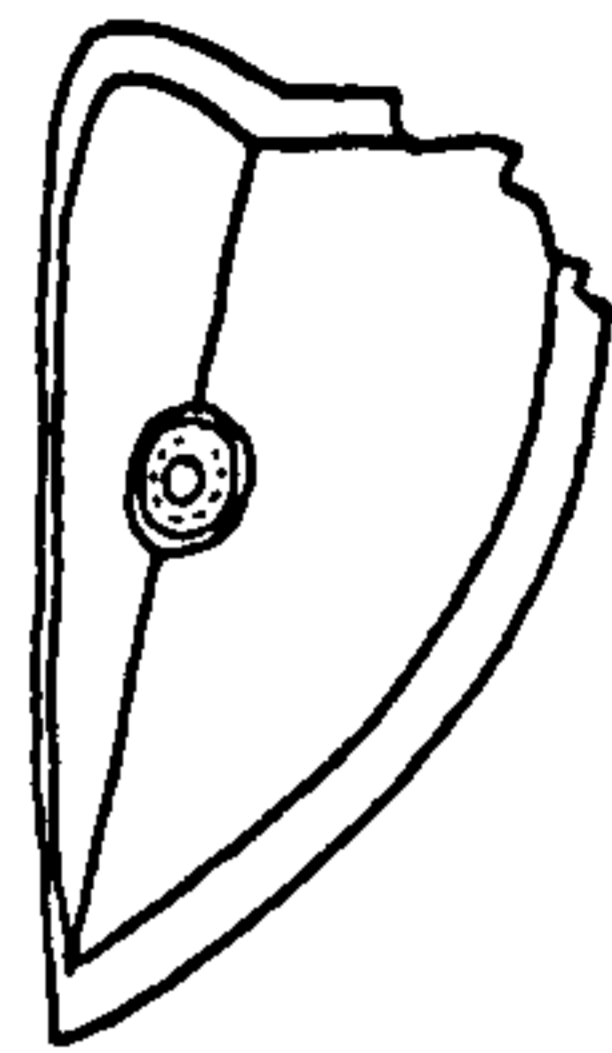

269

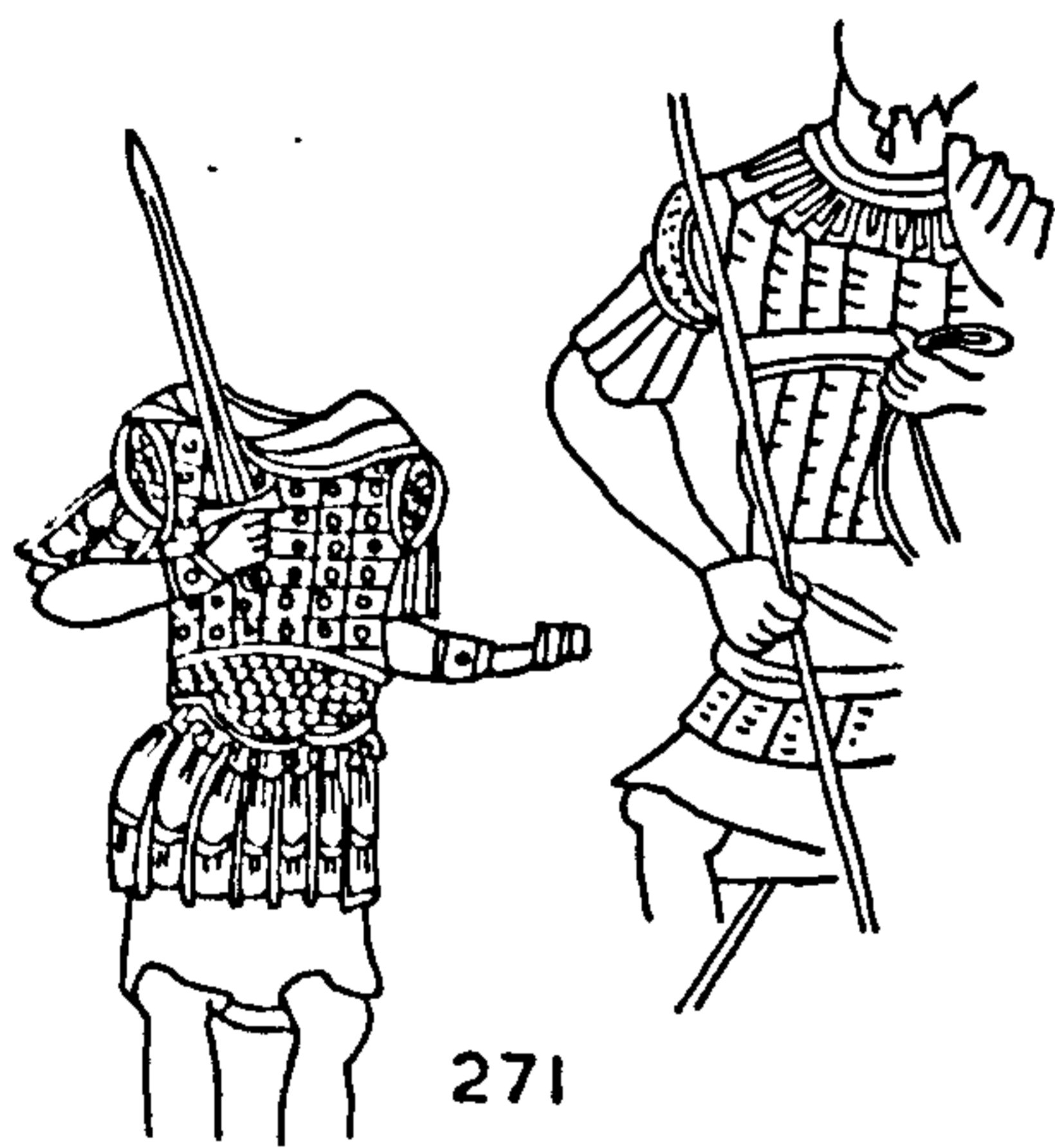

271



270



272

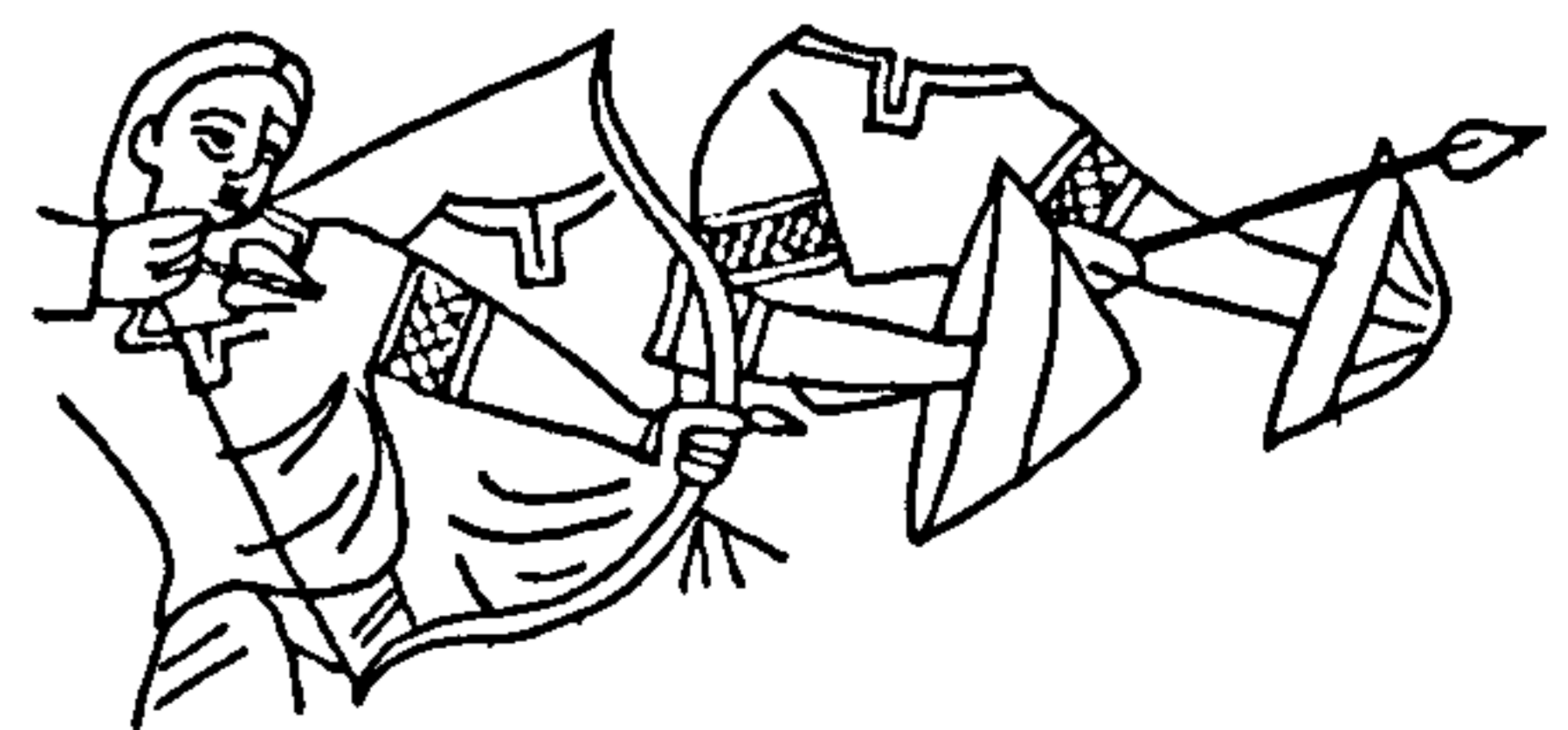
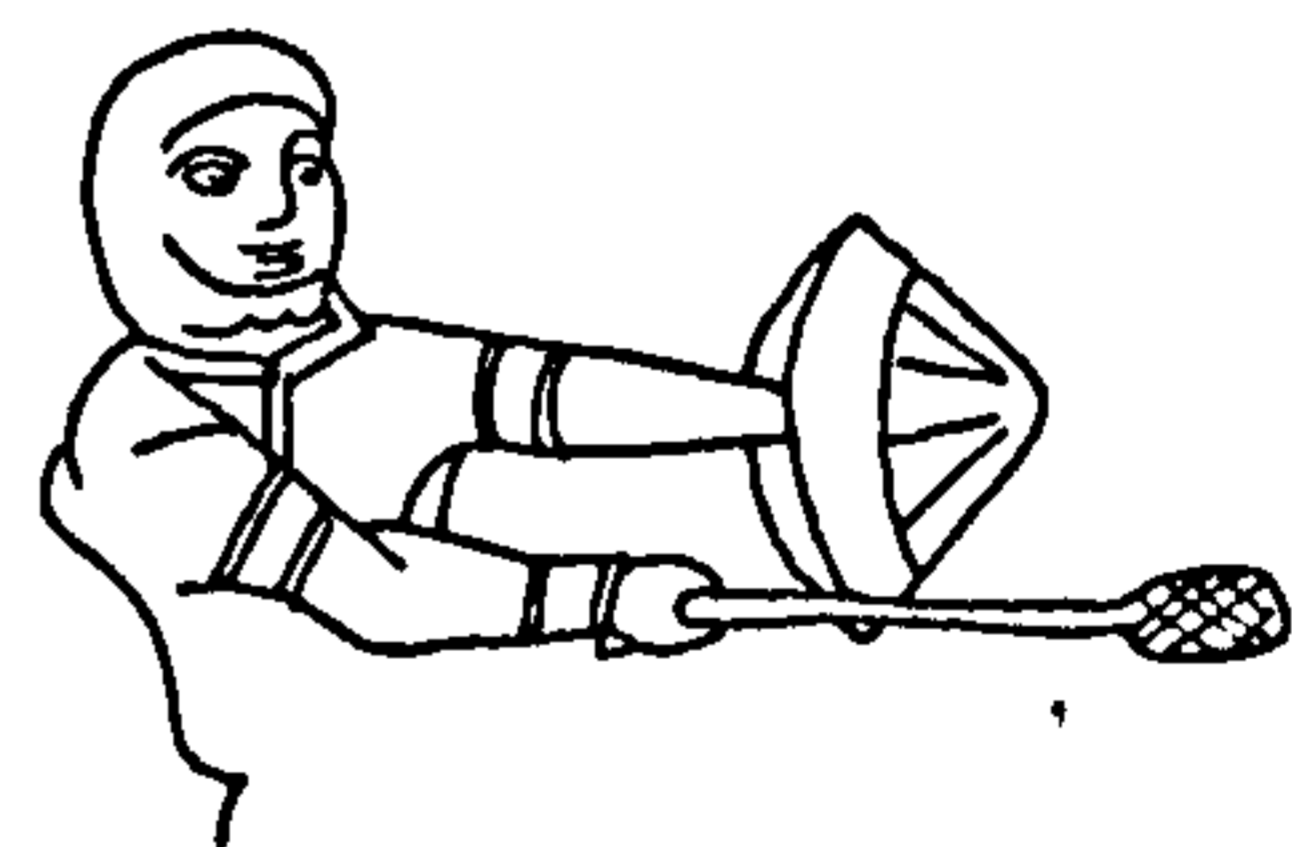

273

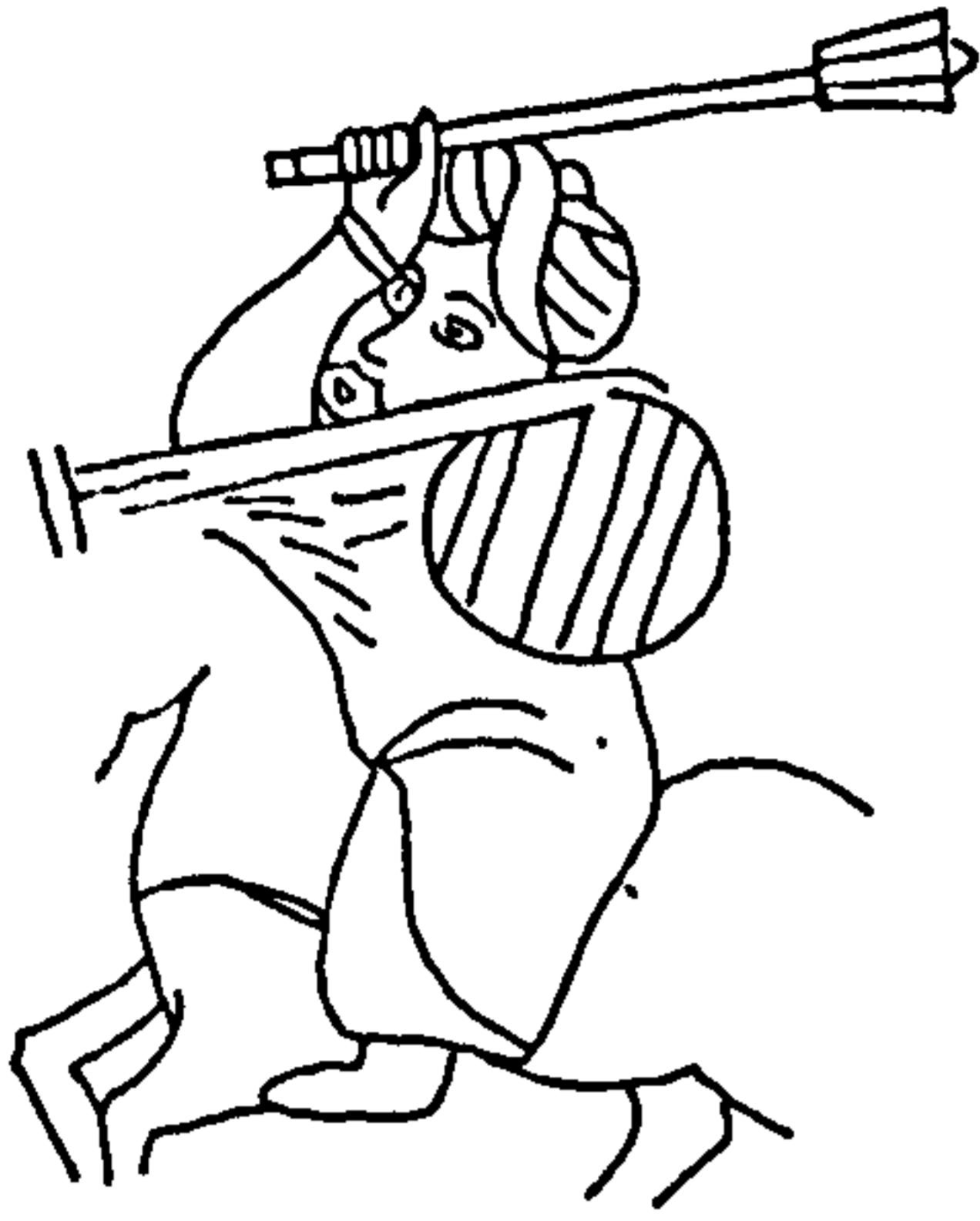

274A

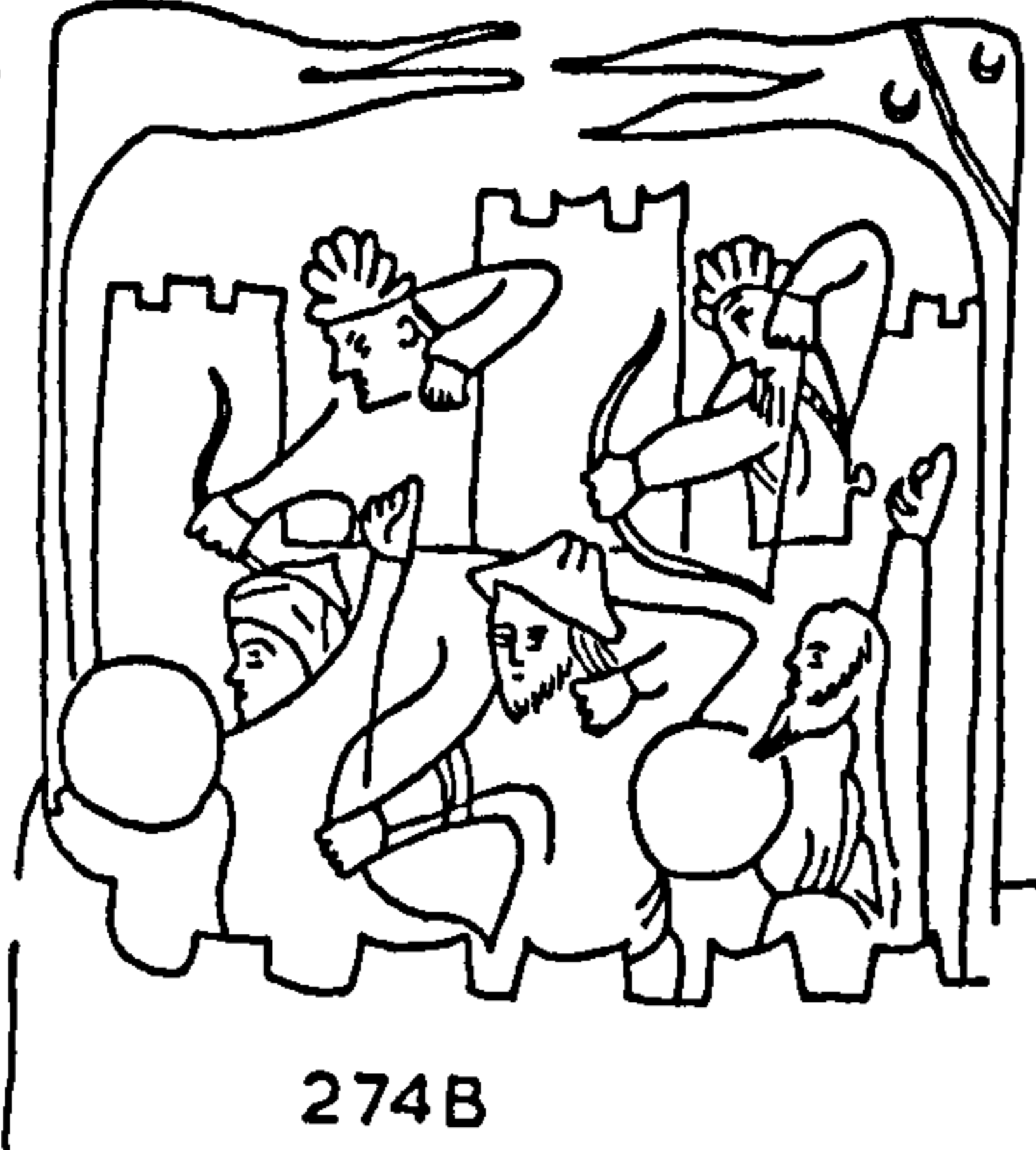

274B

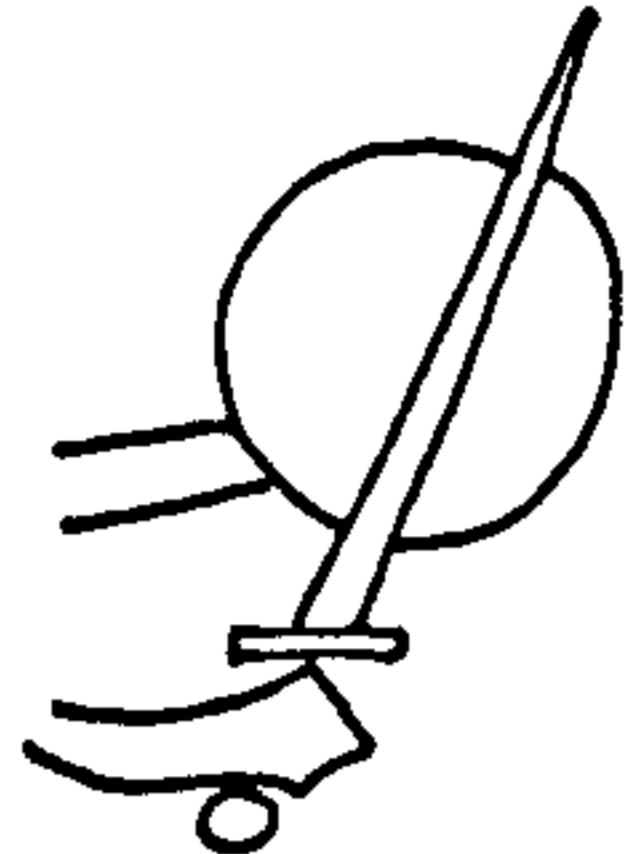

275A

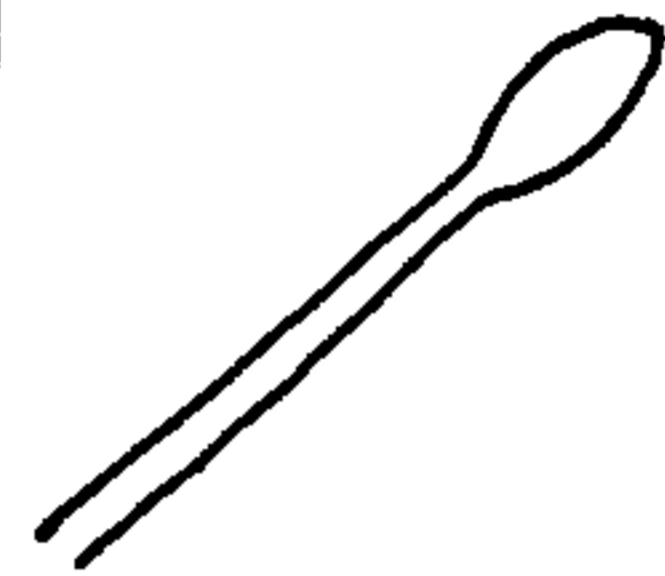

275C

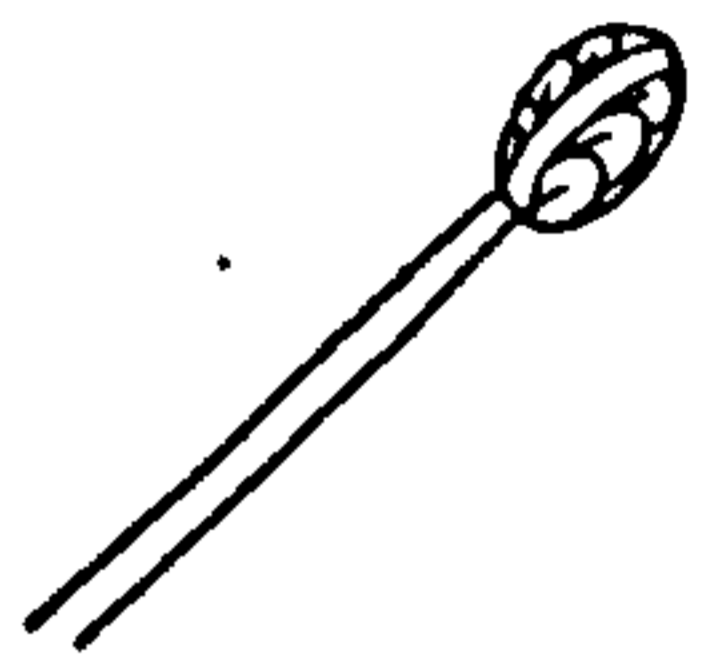

275F



275E



275I

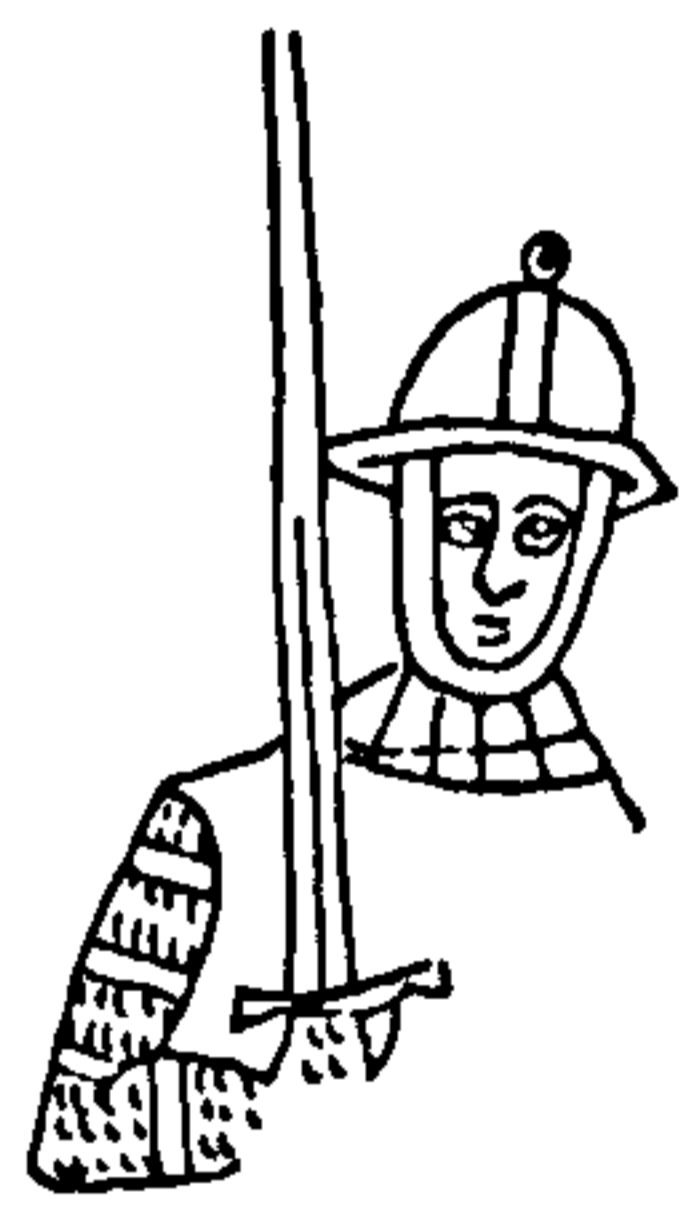

275H



275B



275D

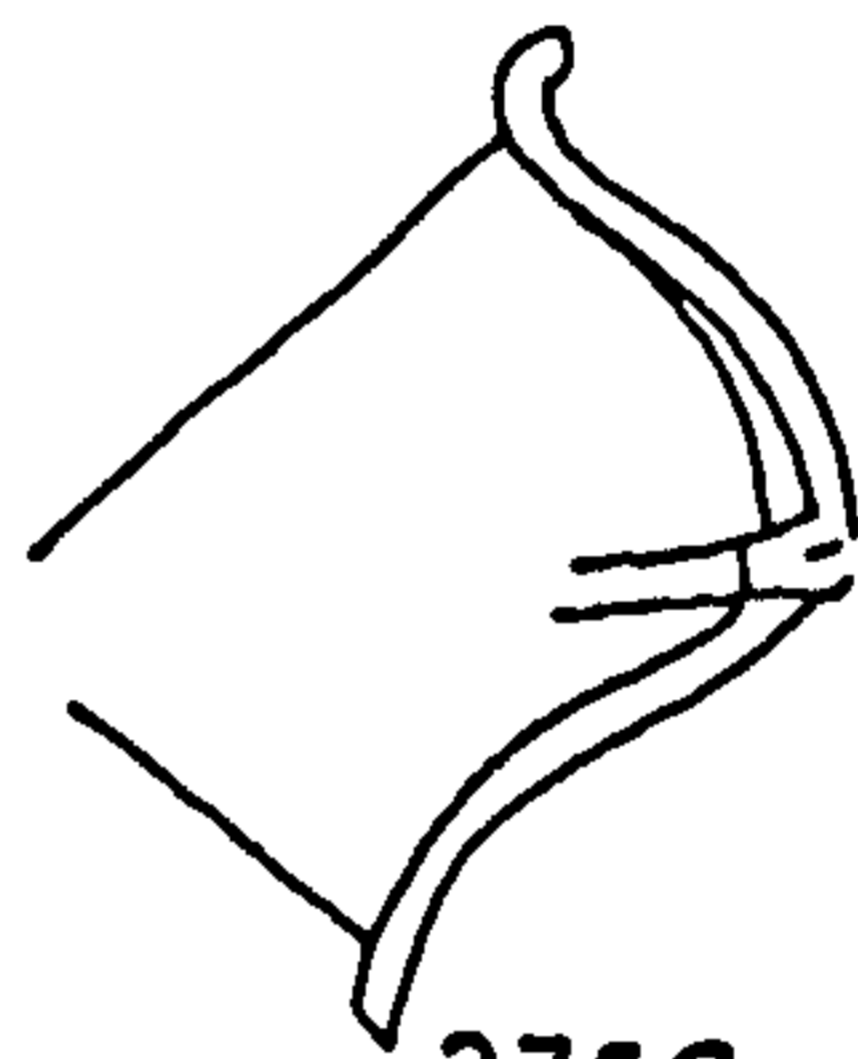

275G



275J

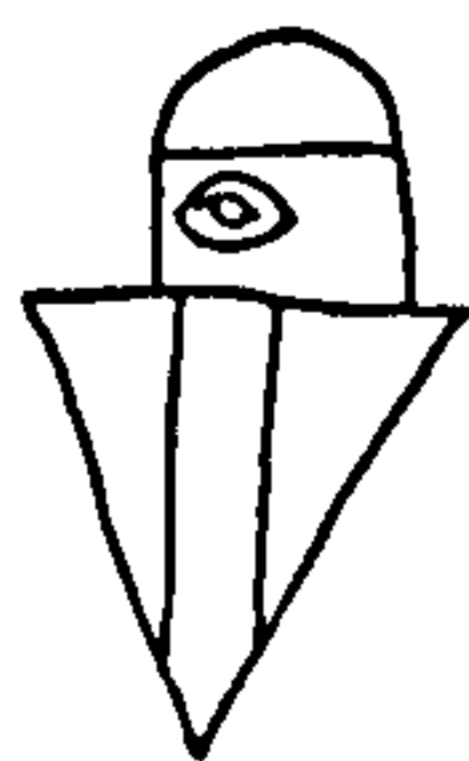

276A

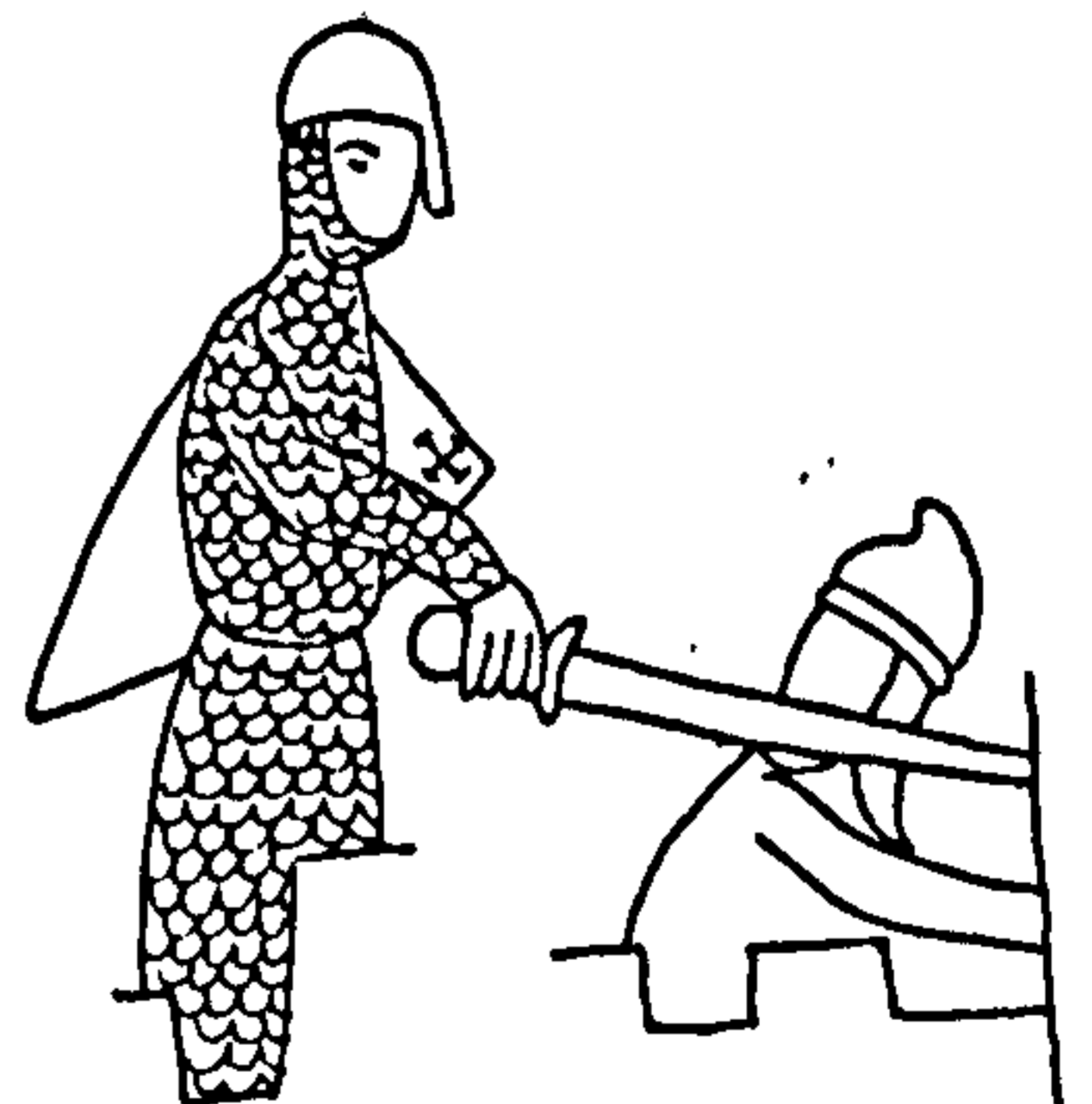

276B

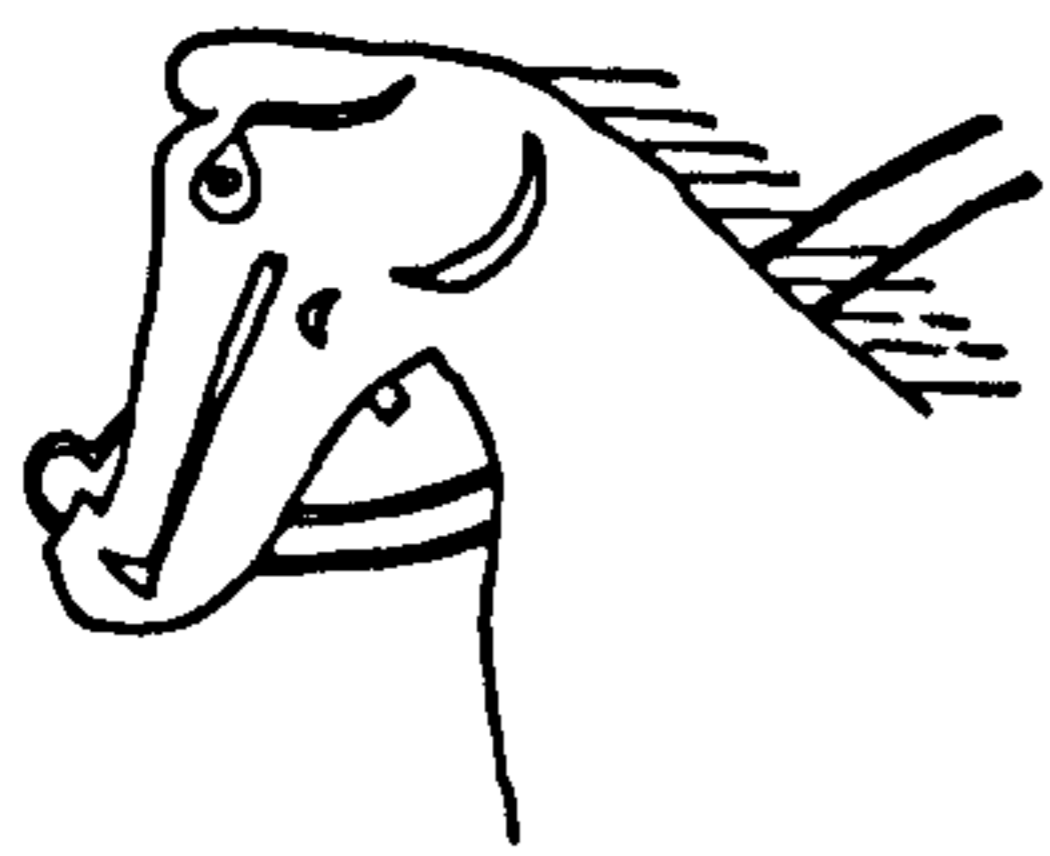

277

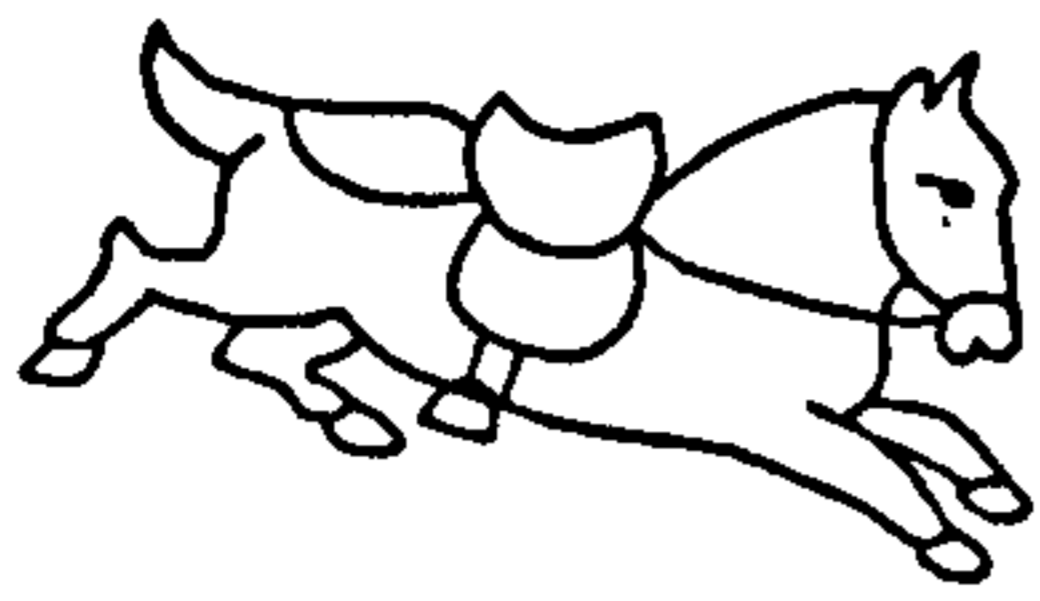

278

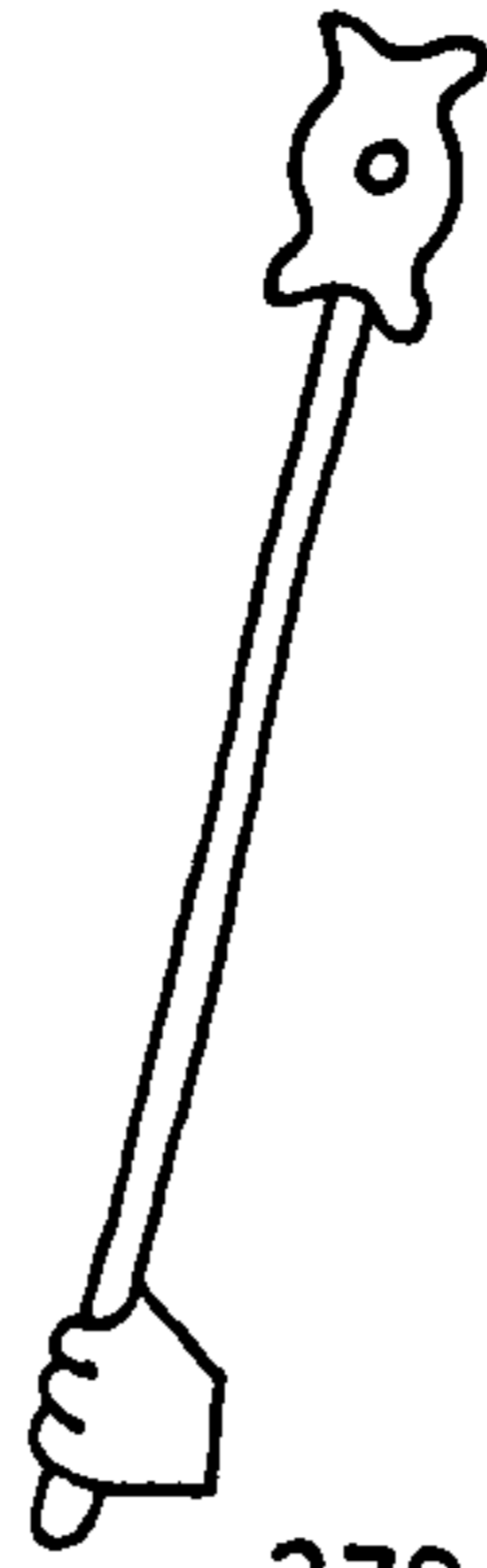

279

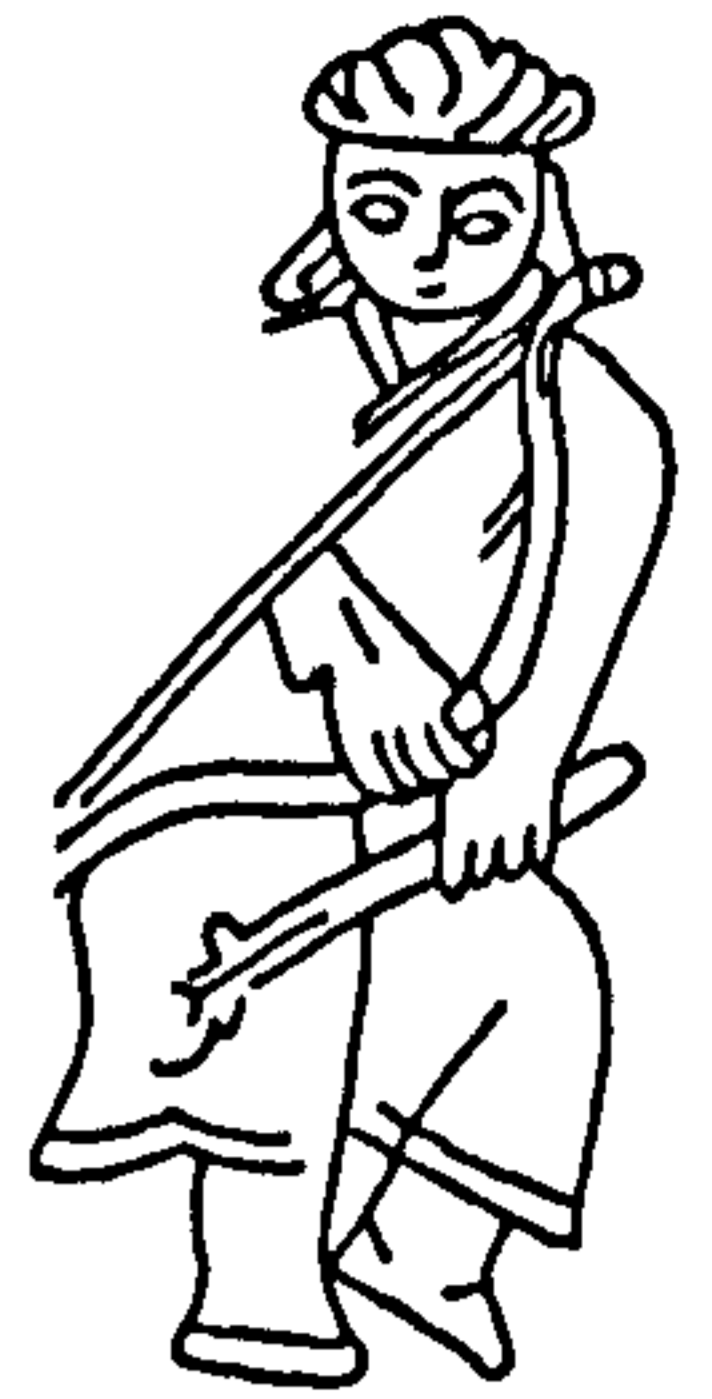

280

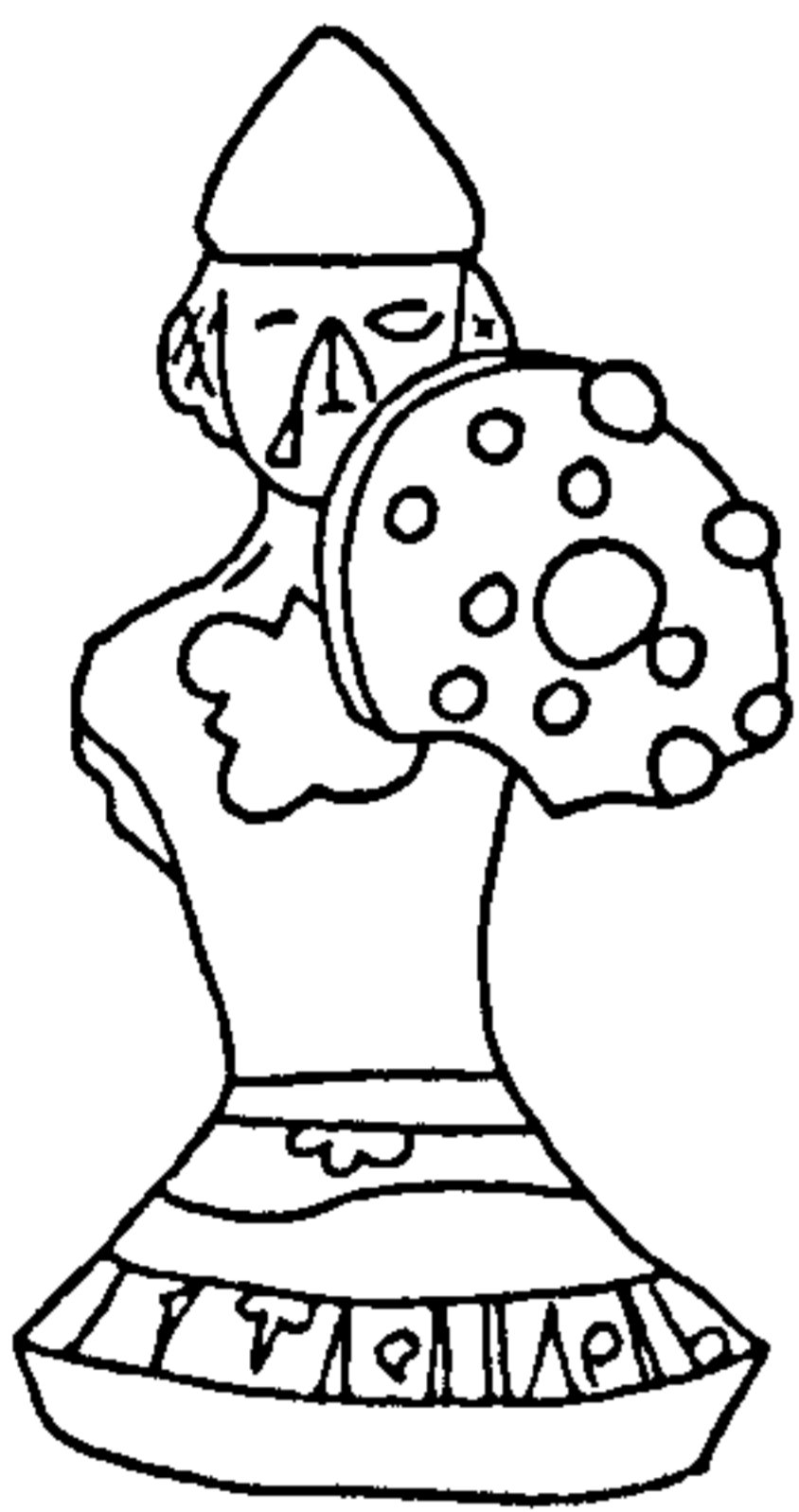

281

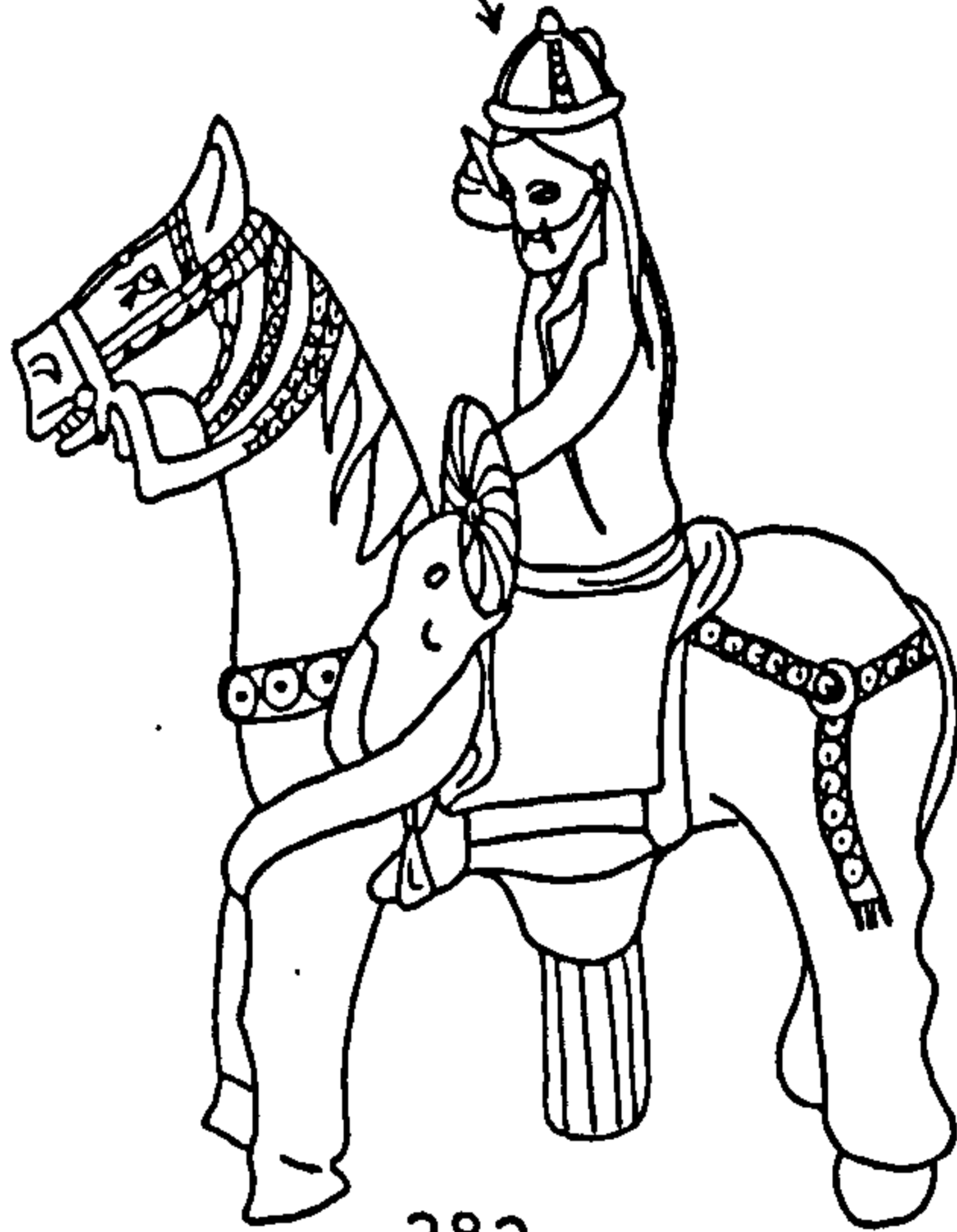
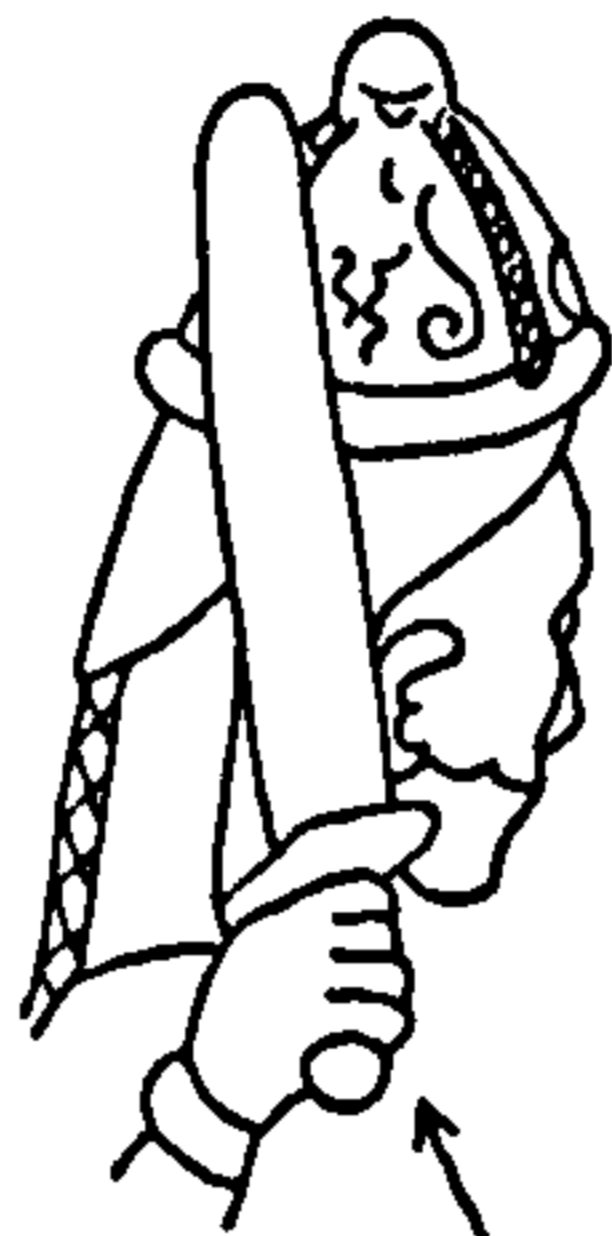

282



283



284



285

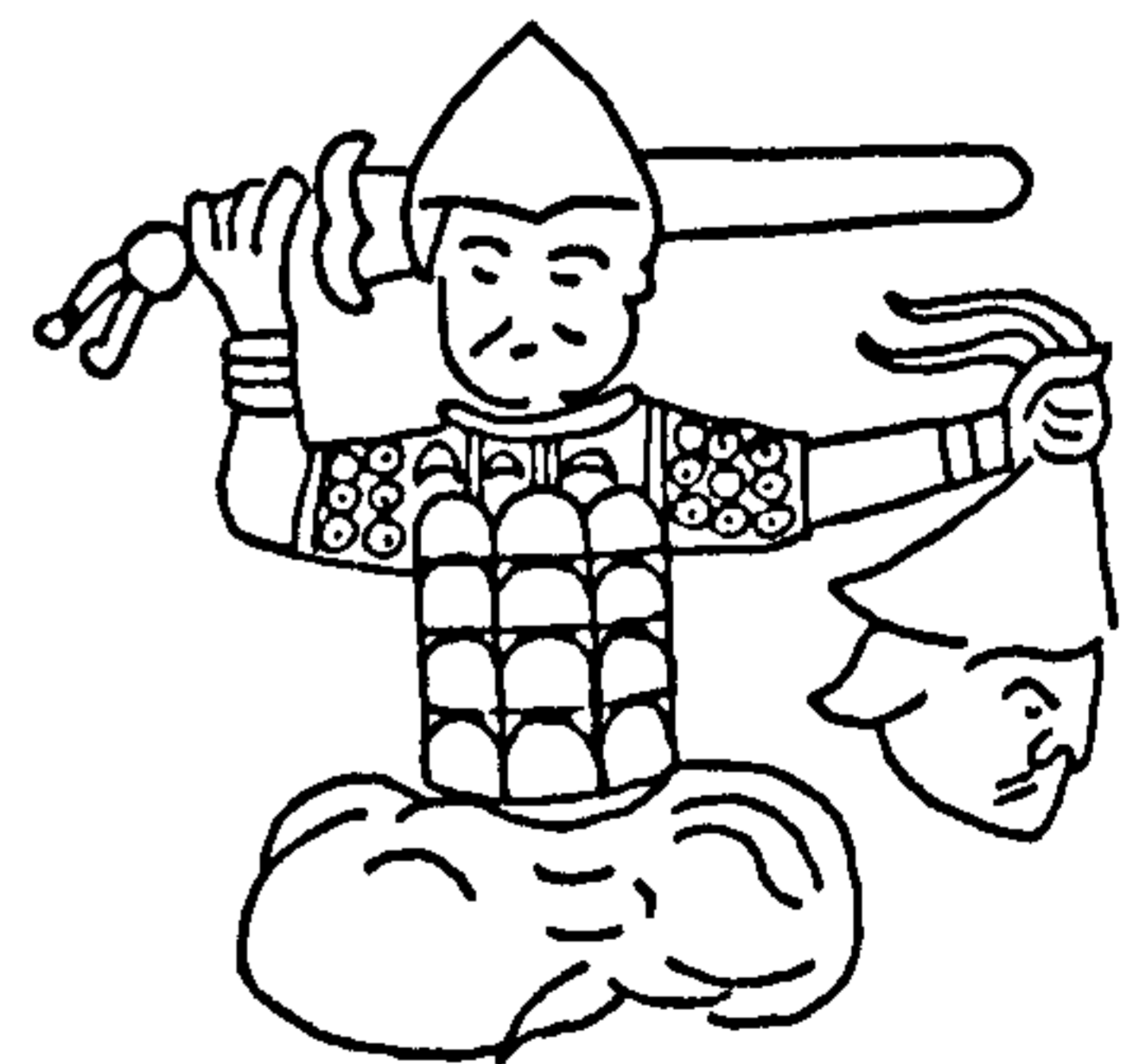

286

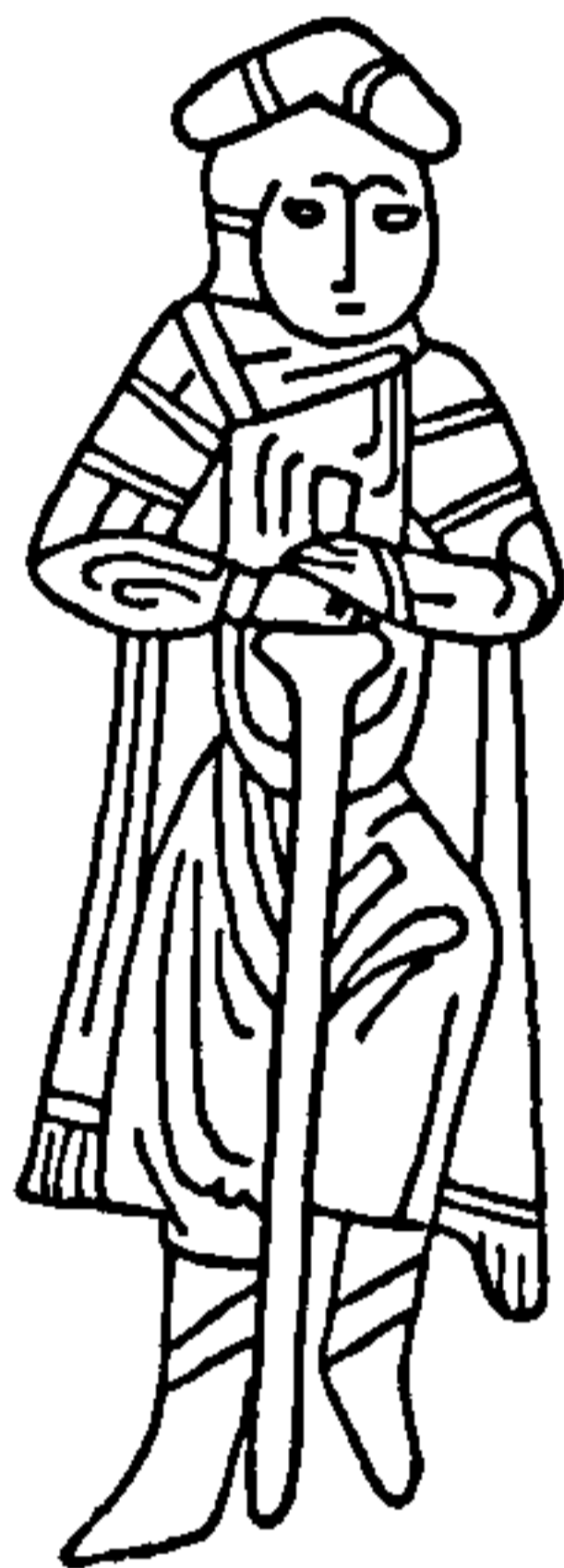

287

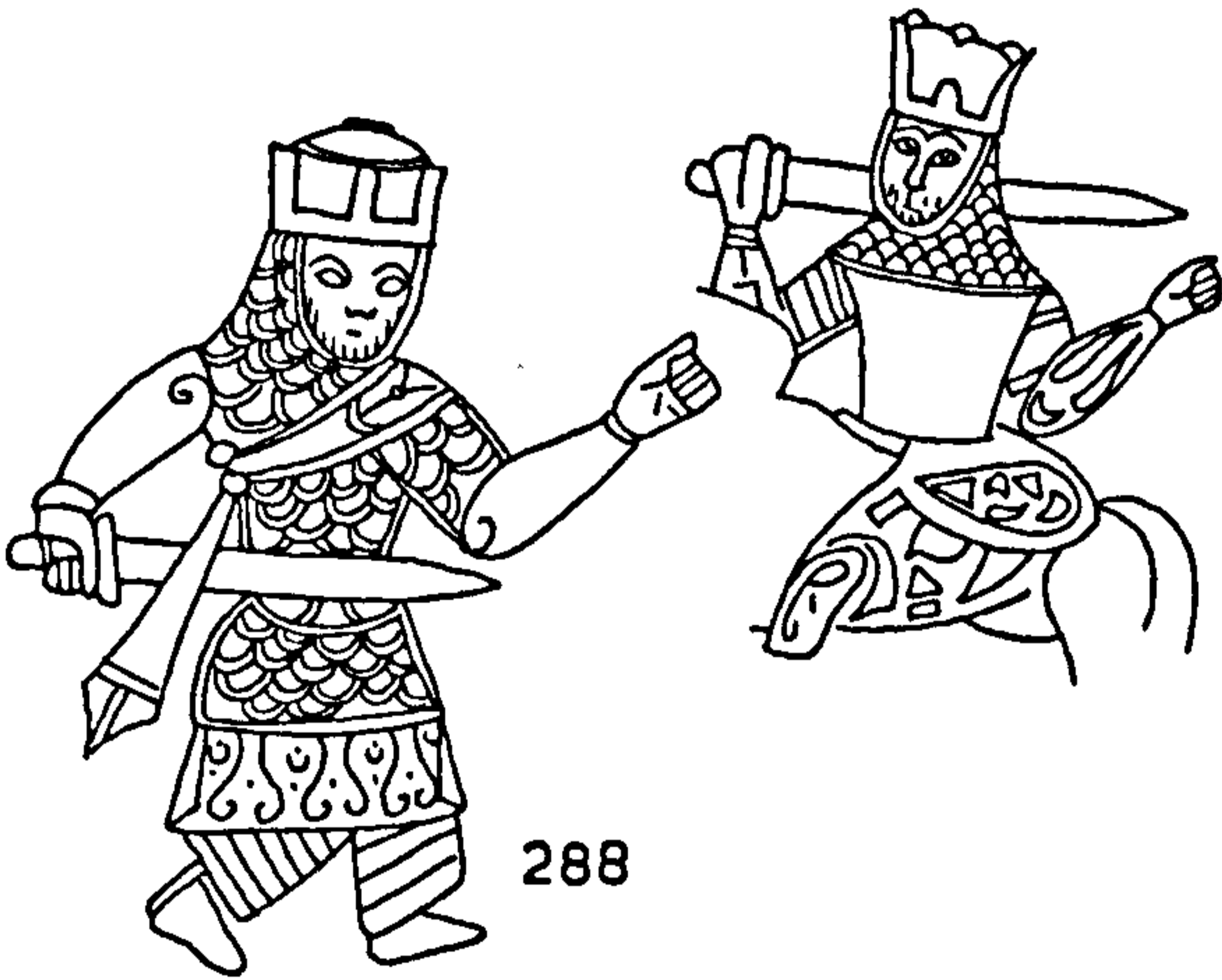

288



289

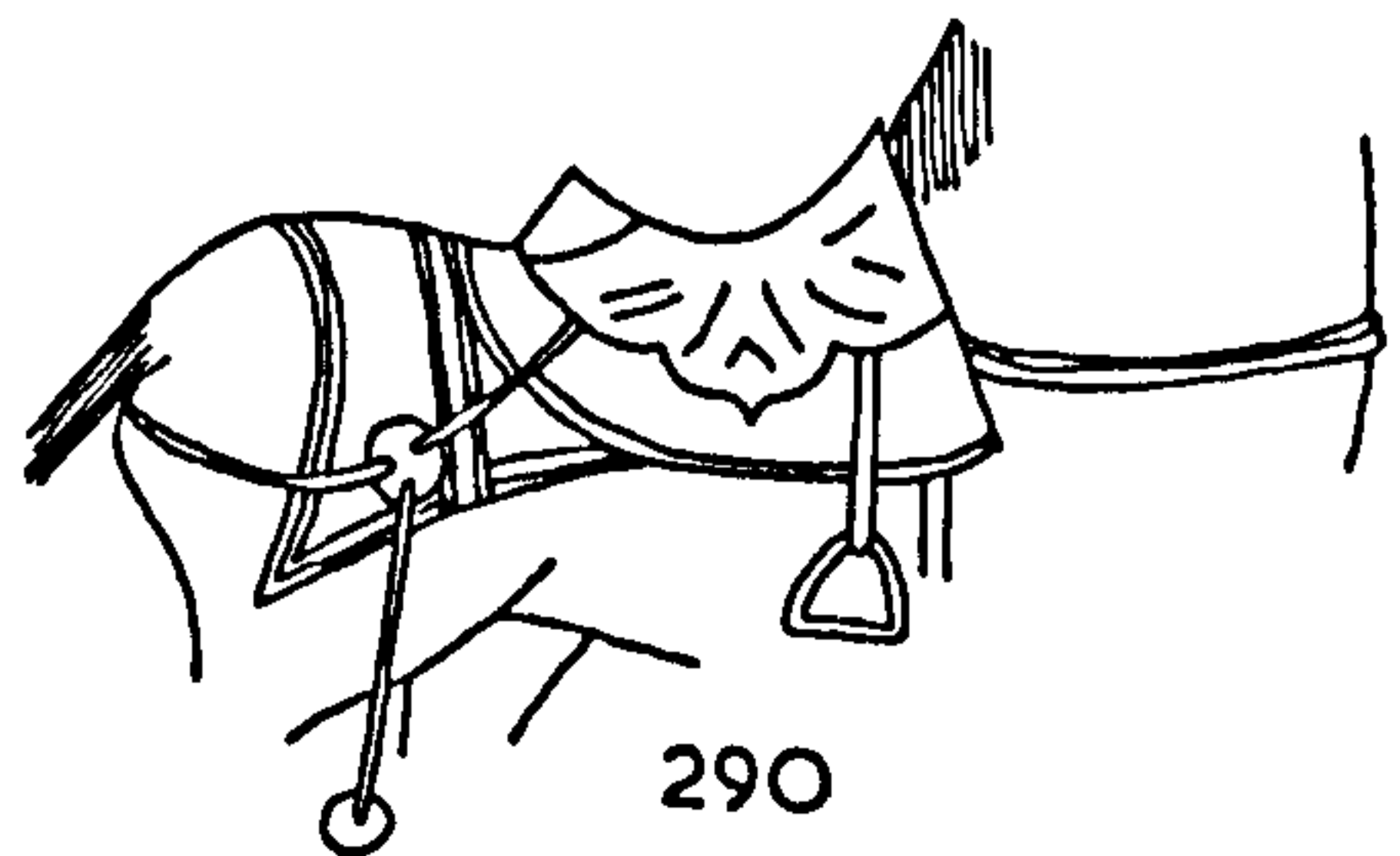

290



291



292A



292B

292C



292D

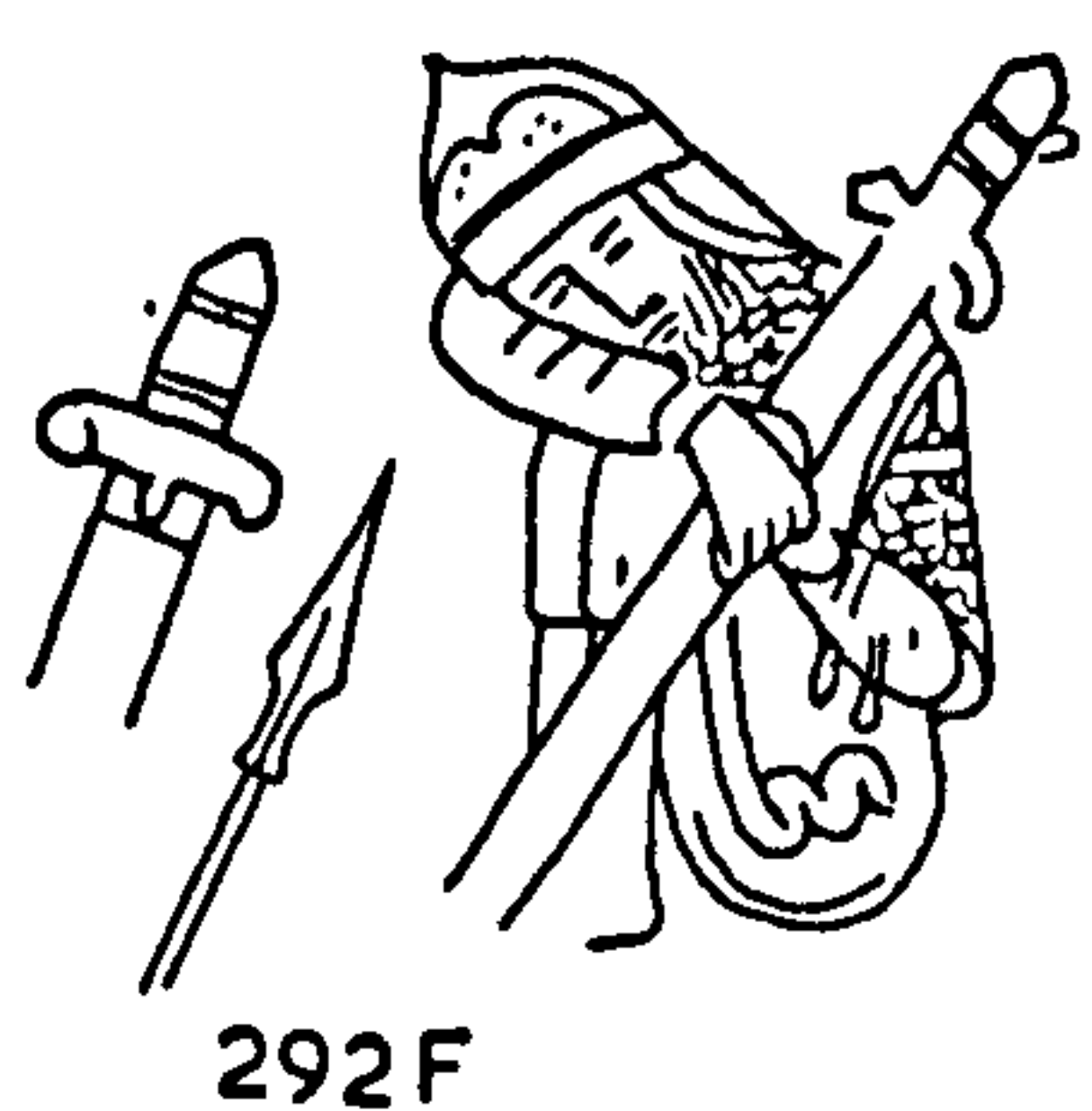

292F

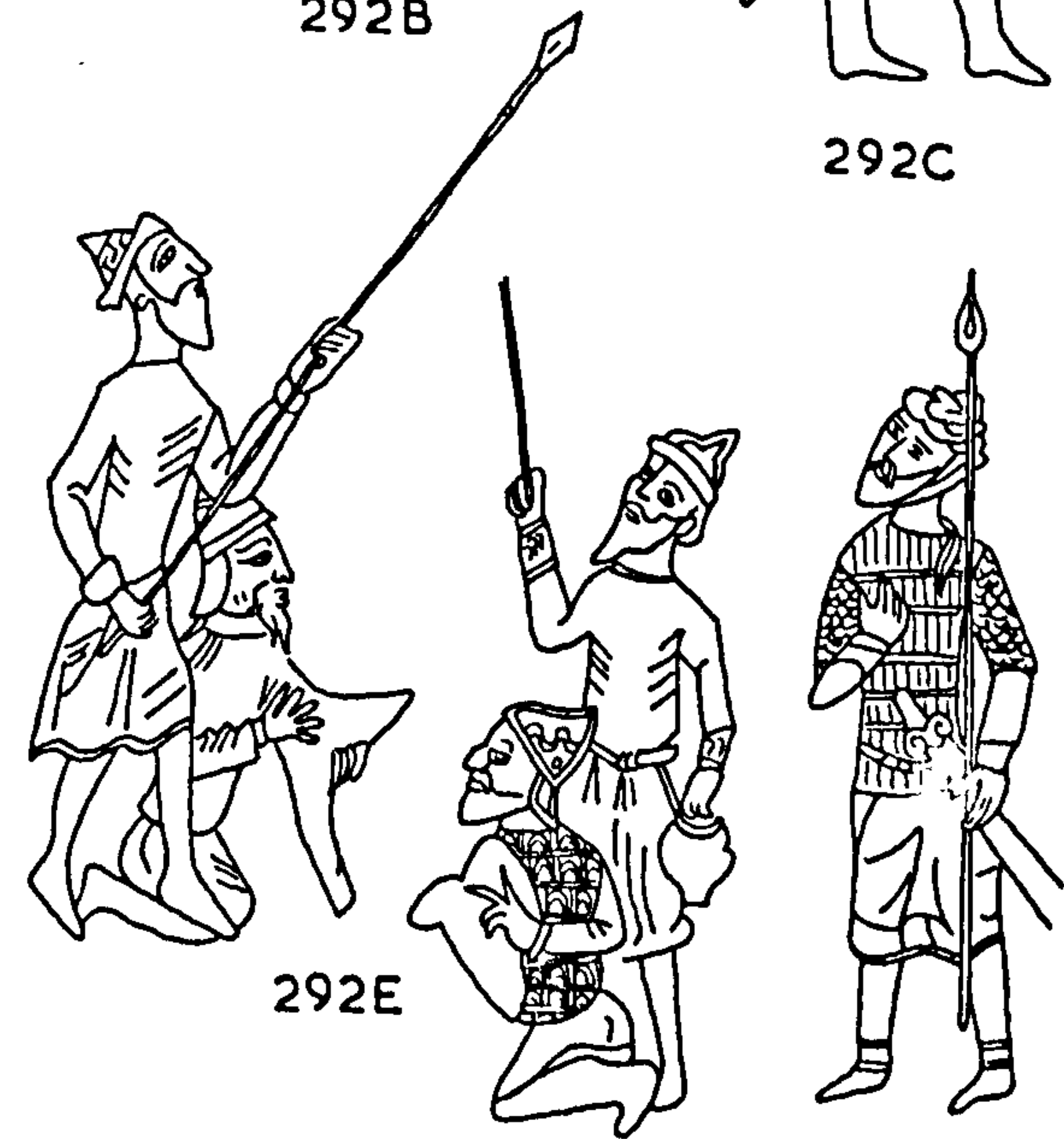

292E

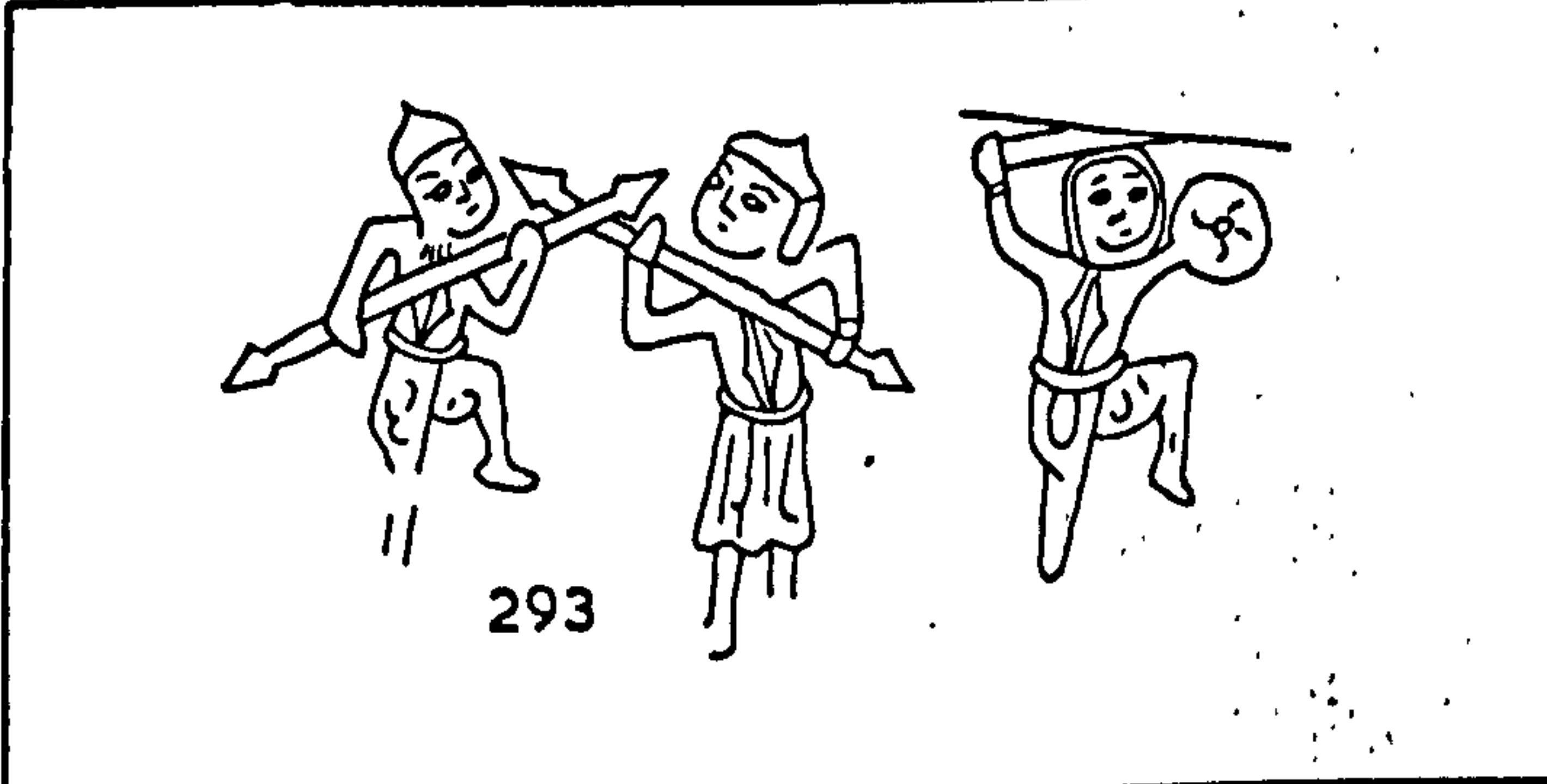

293

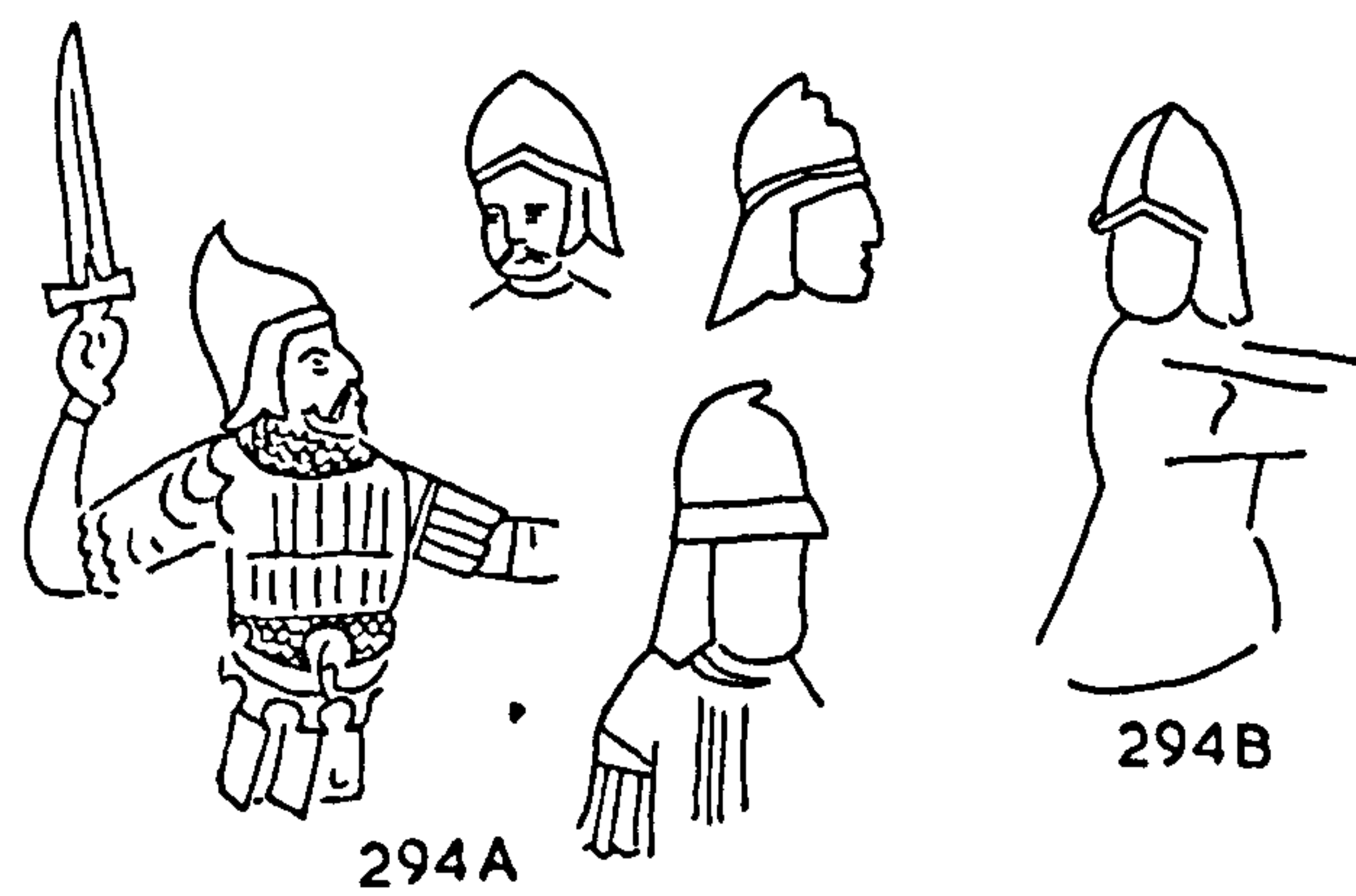

294A

294B

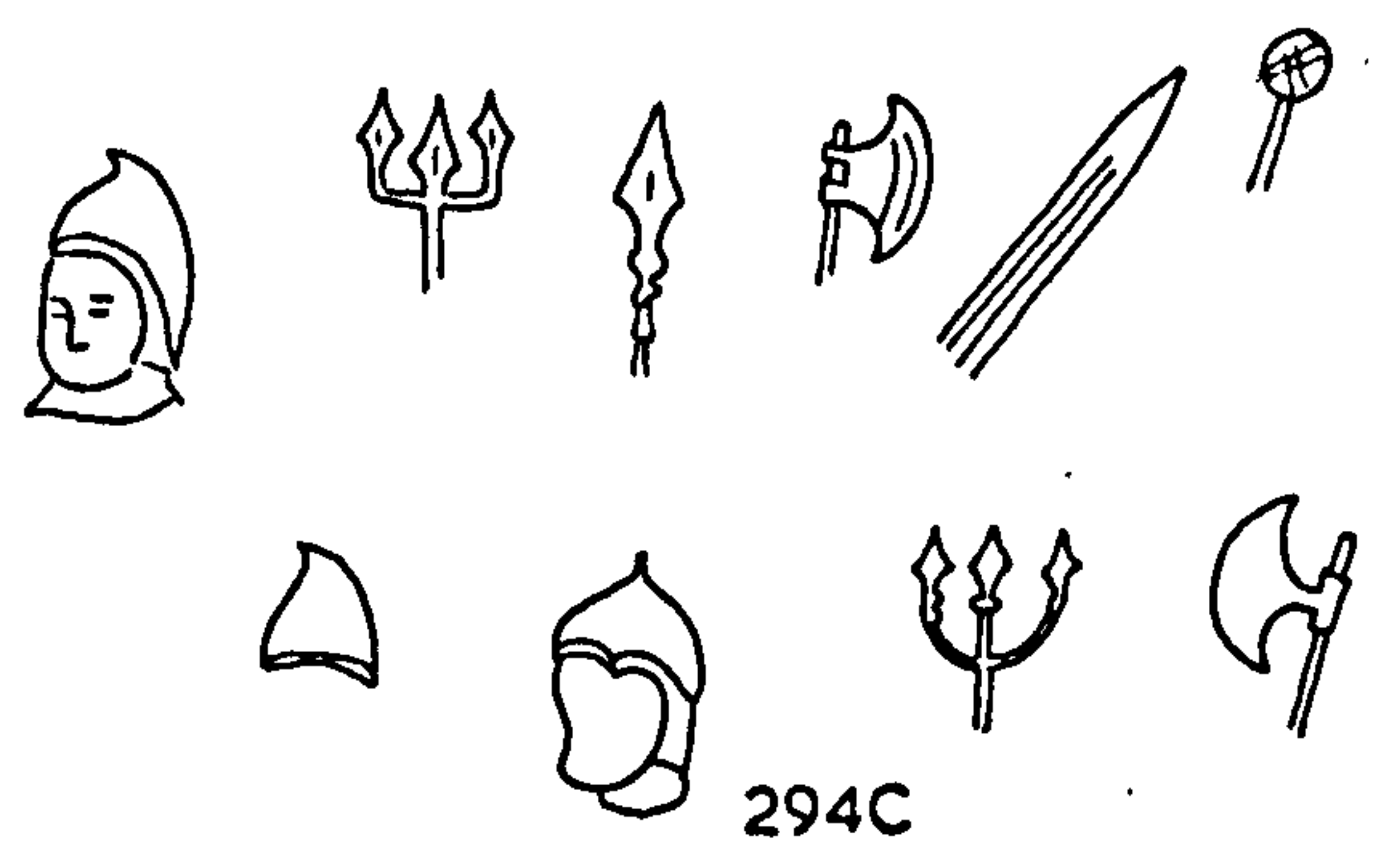

294C

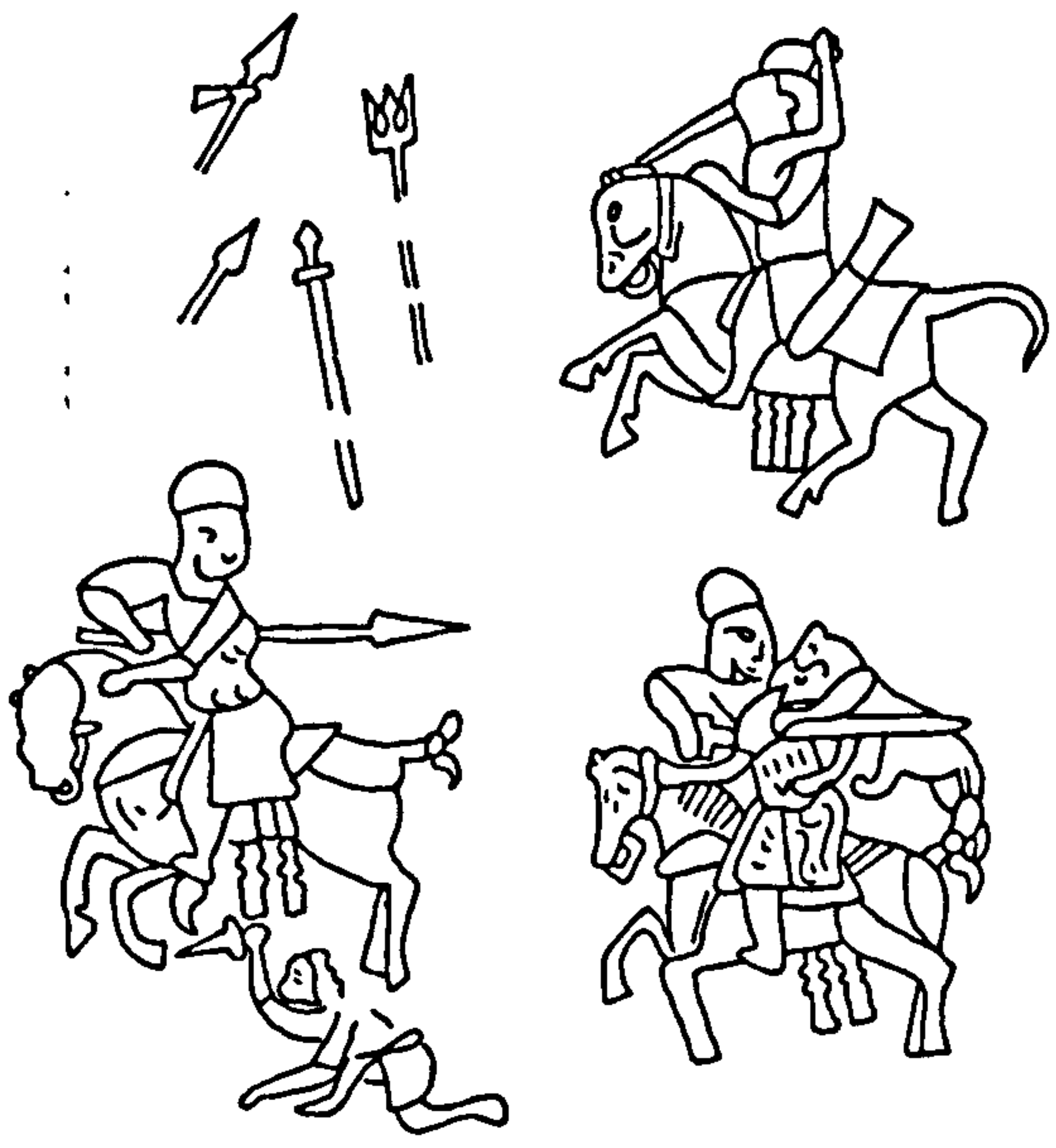

295

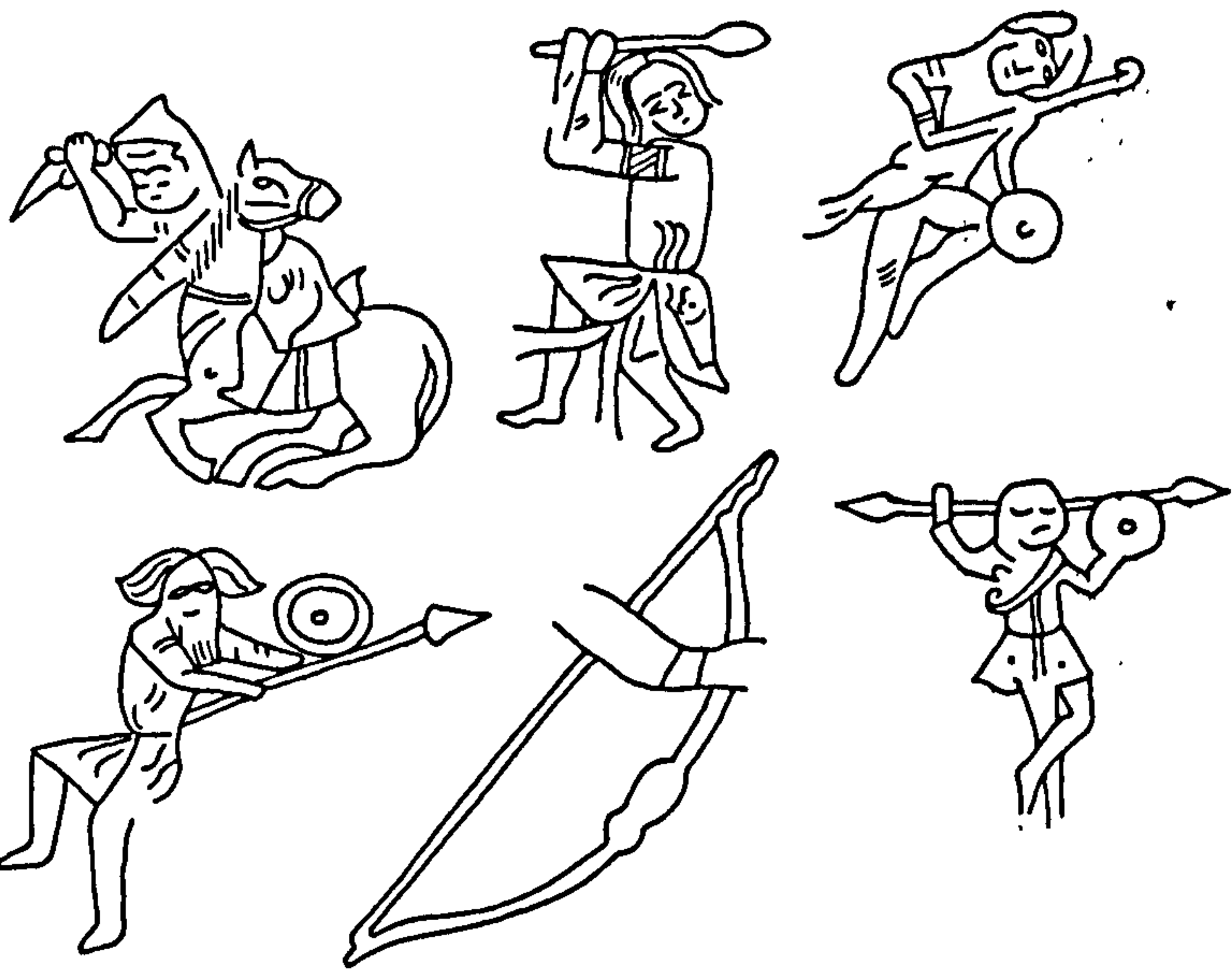

296



297



298

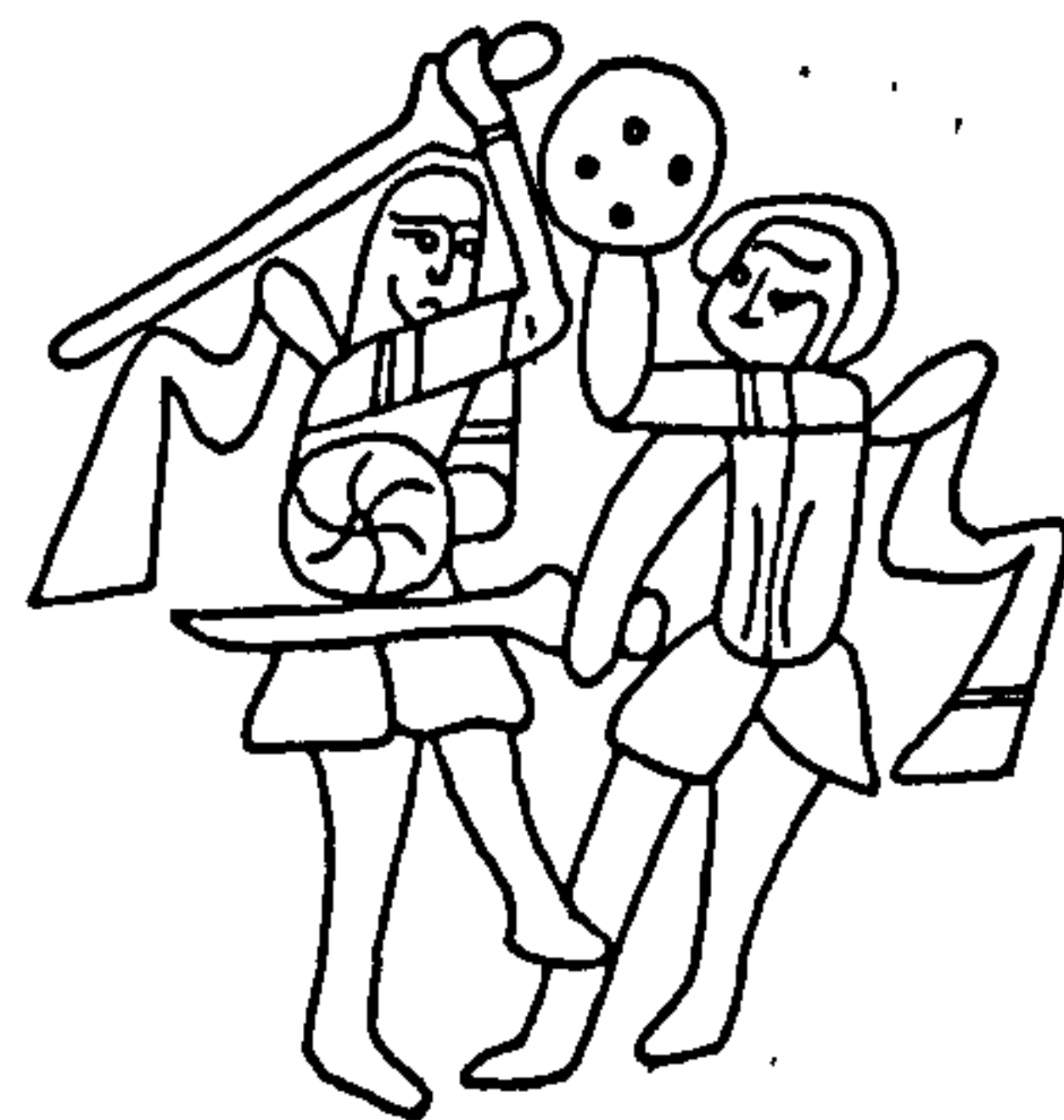
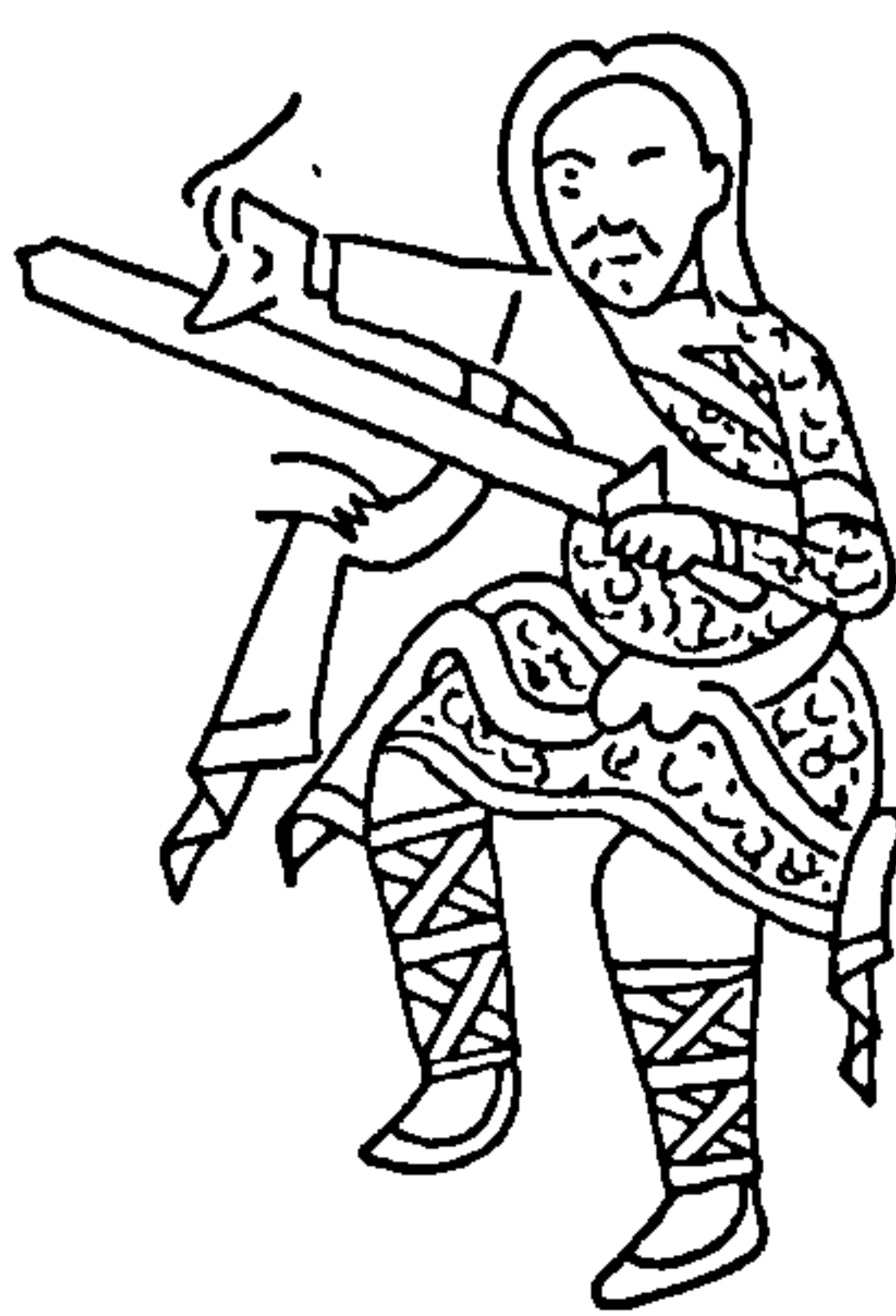

299



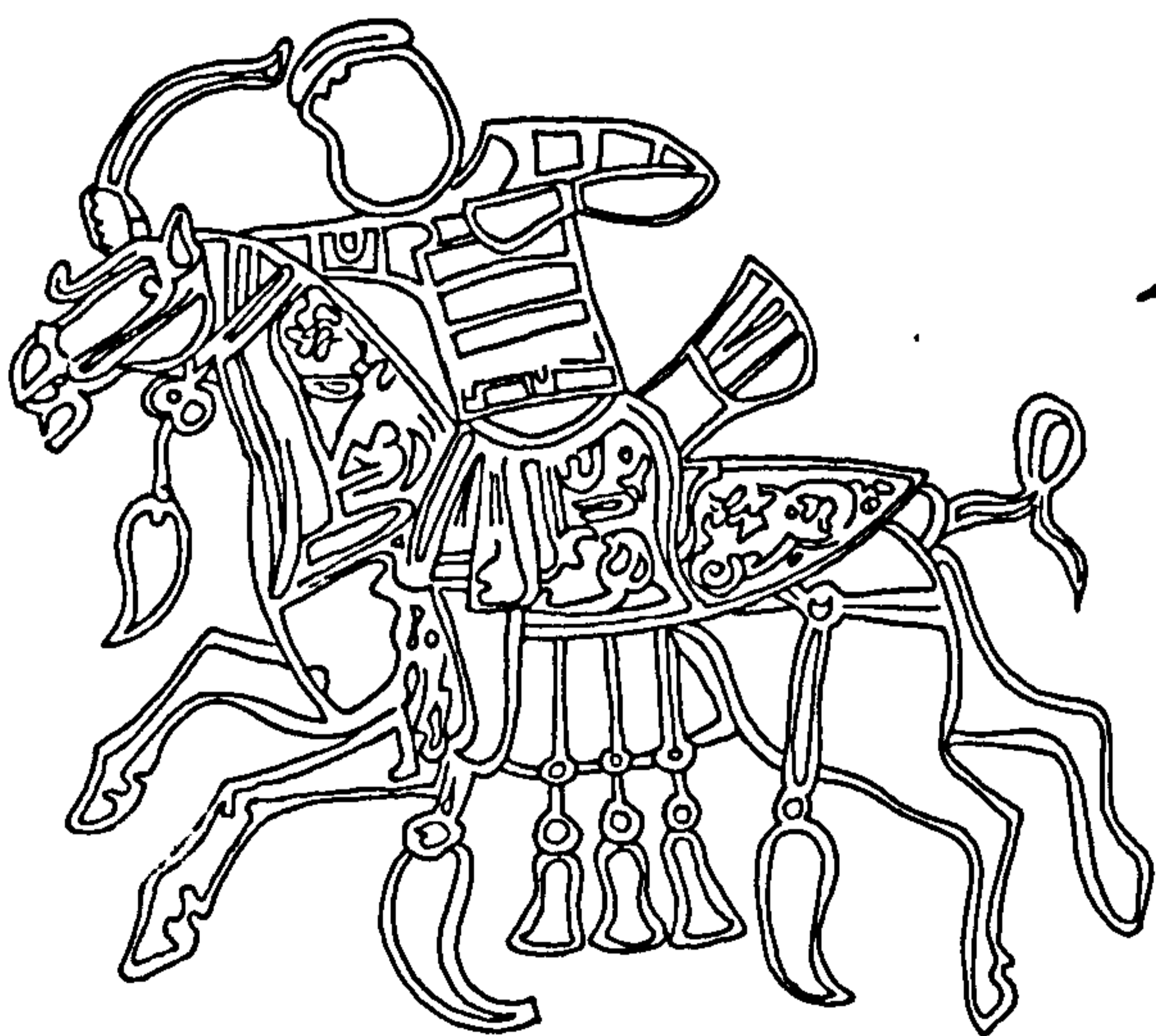
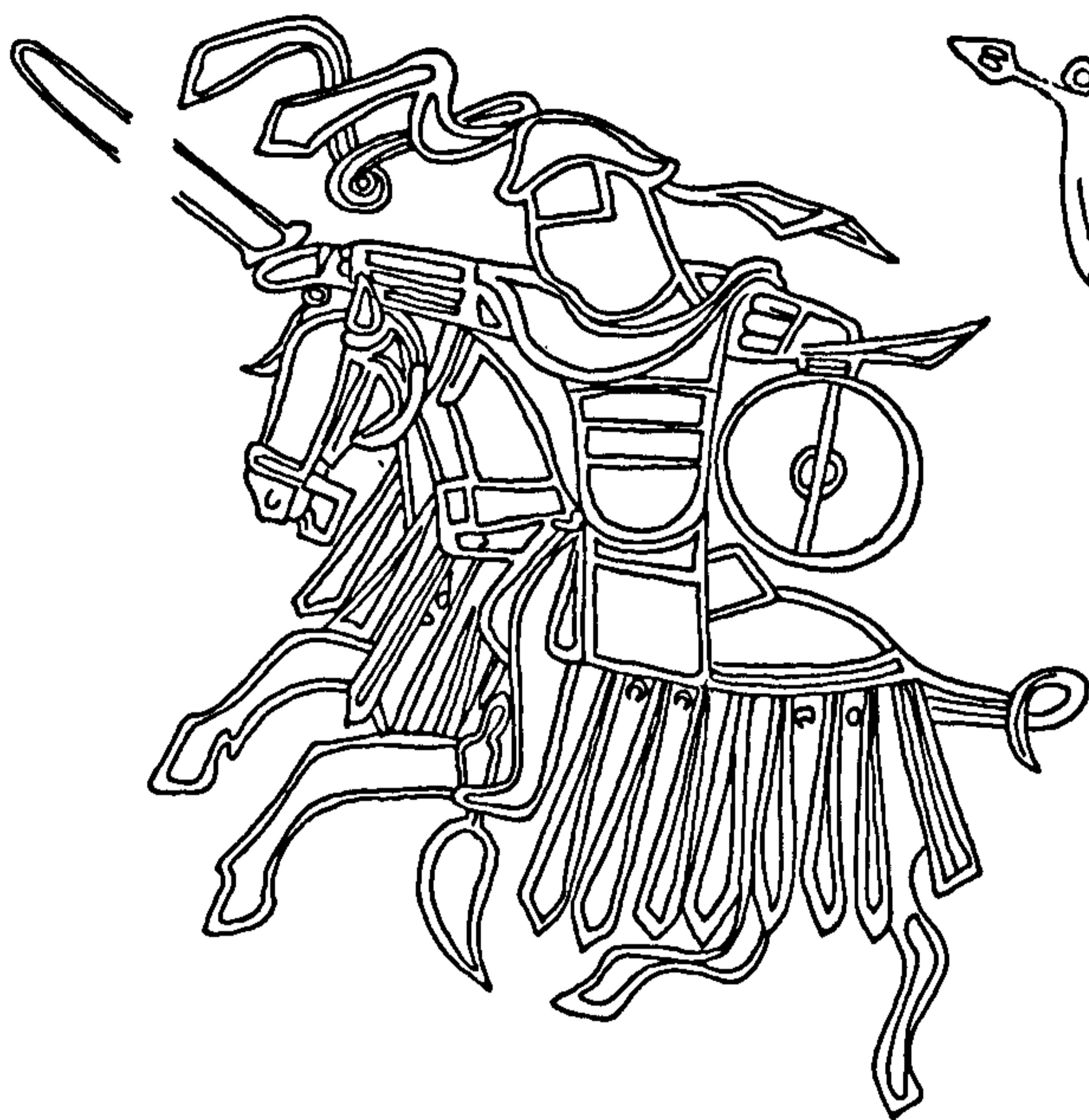

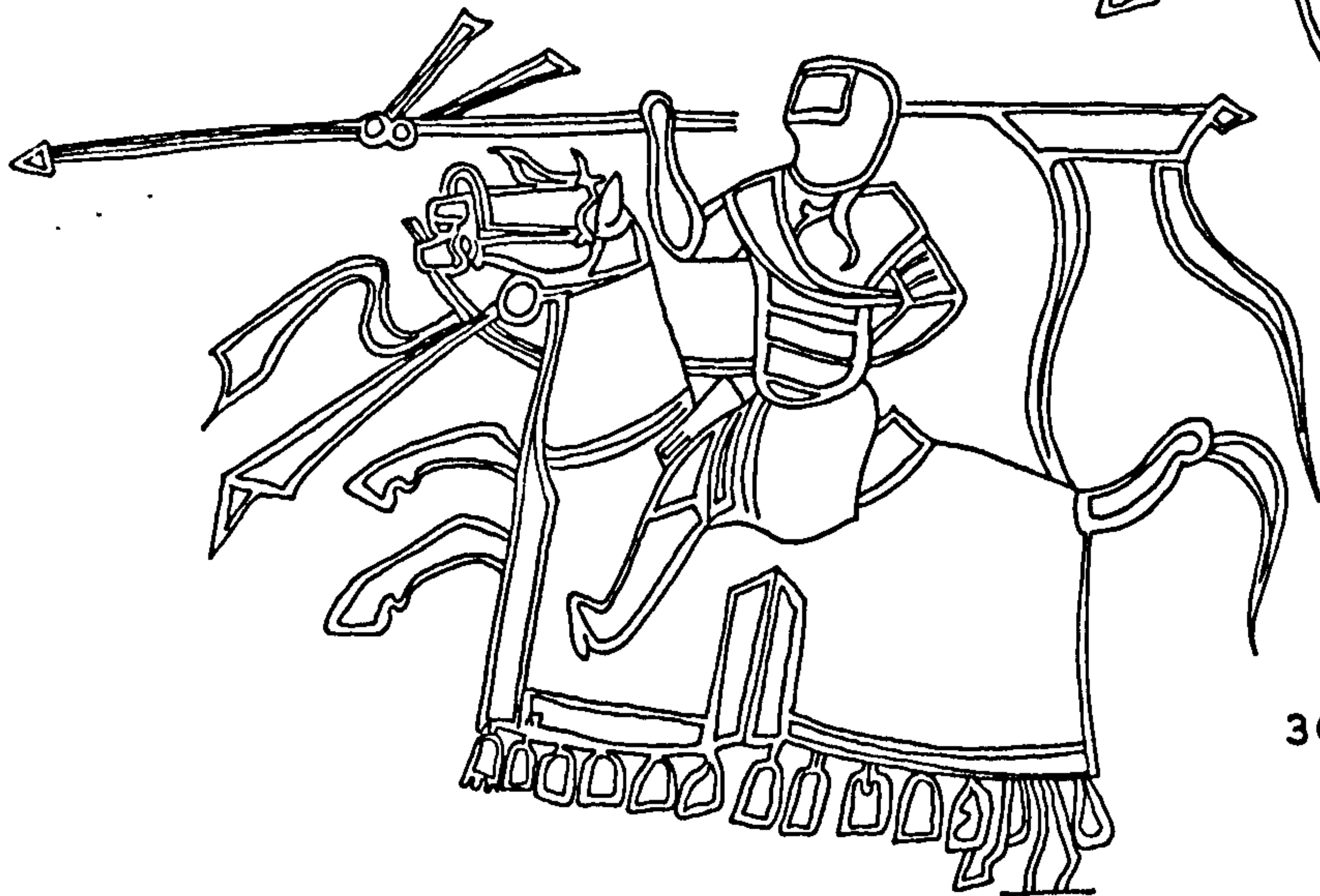
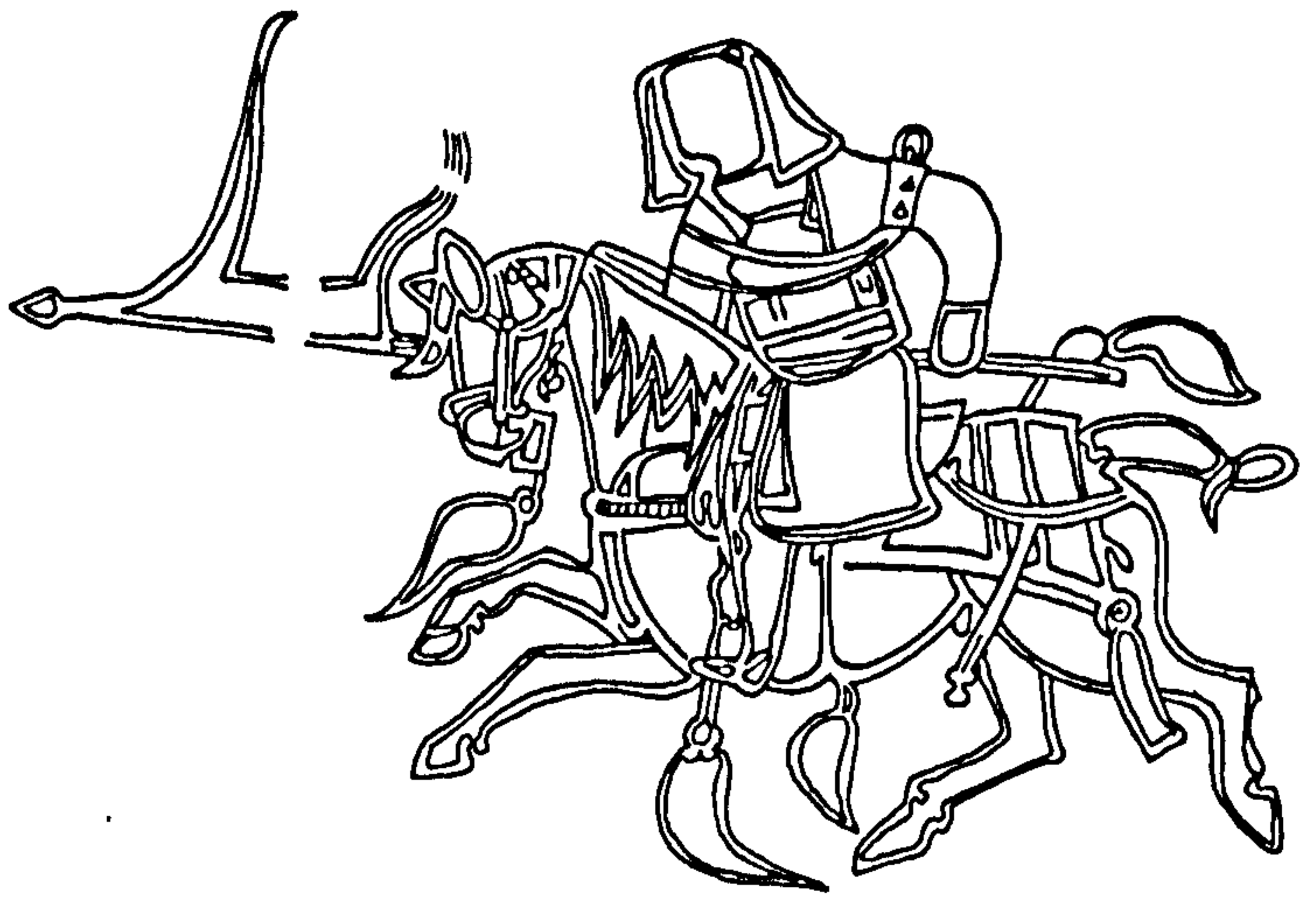

300

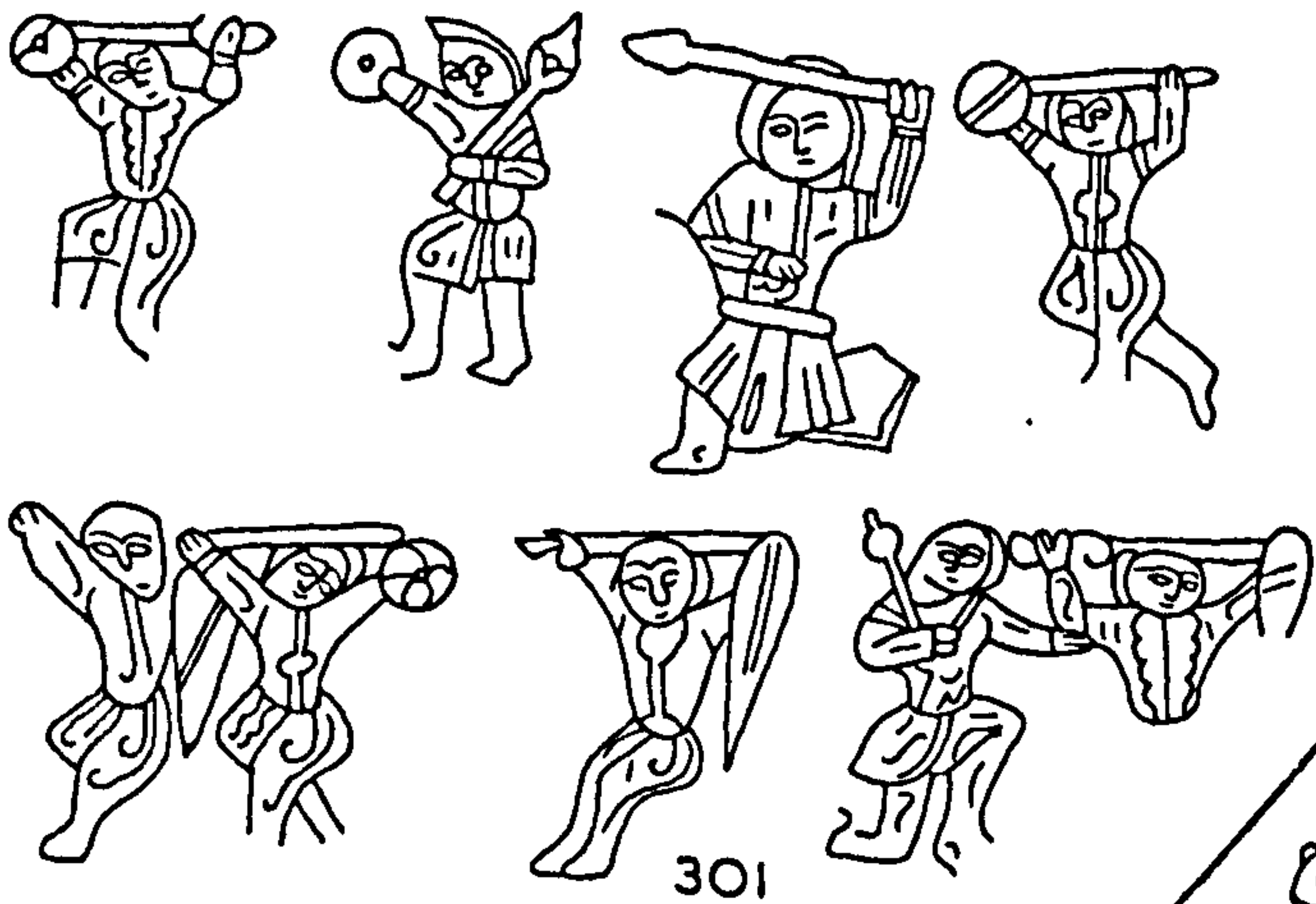

301

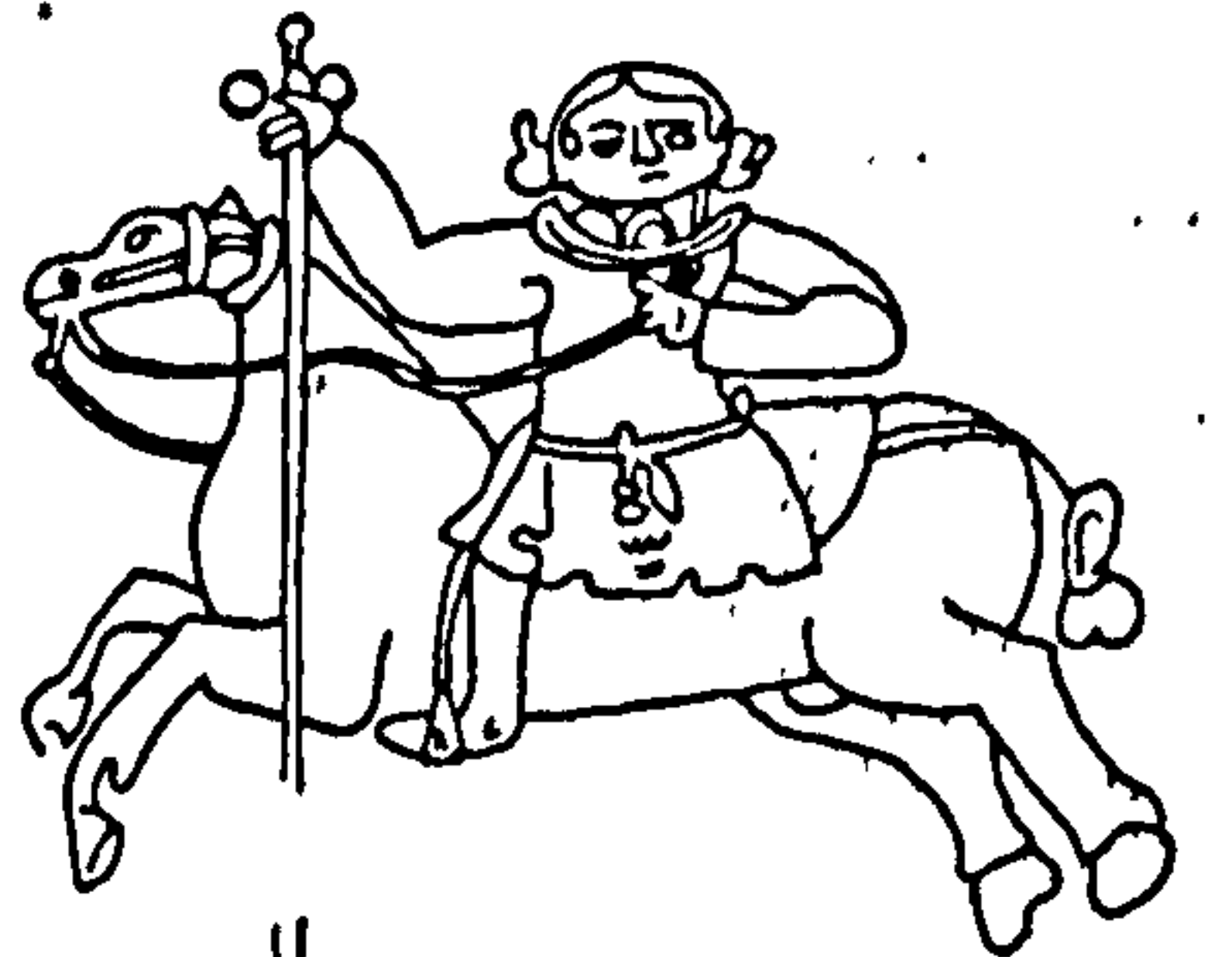

302



303



304

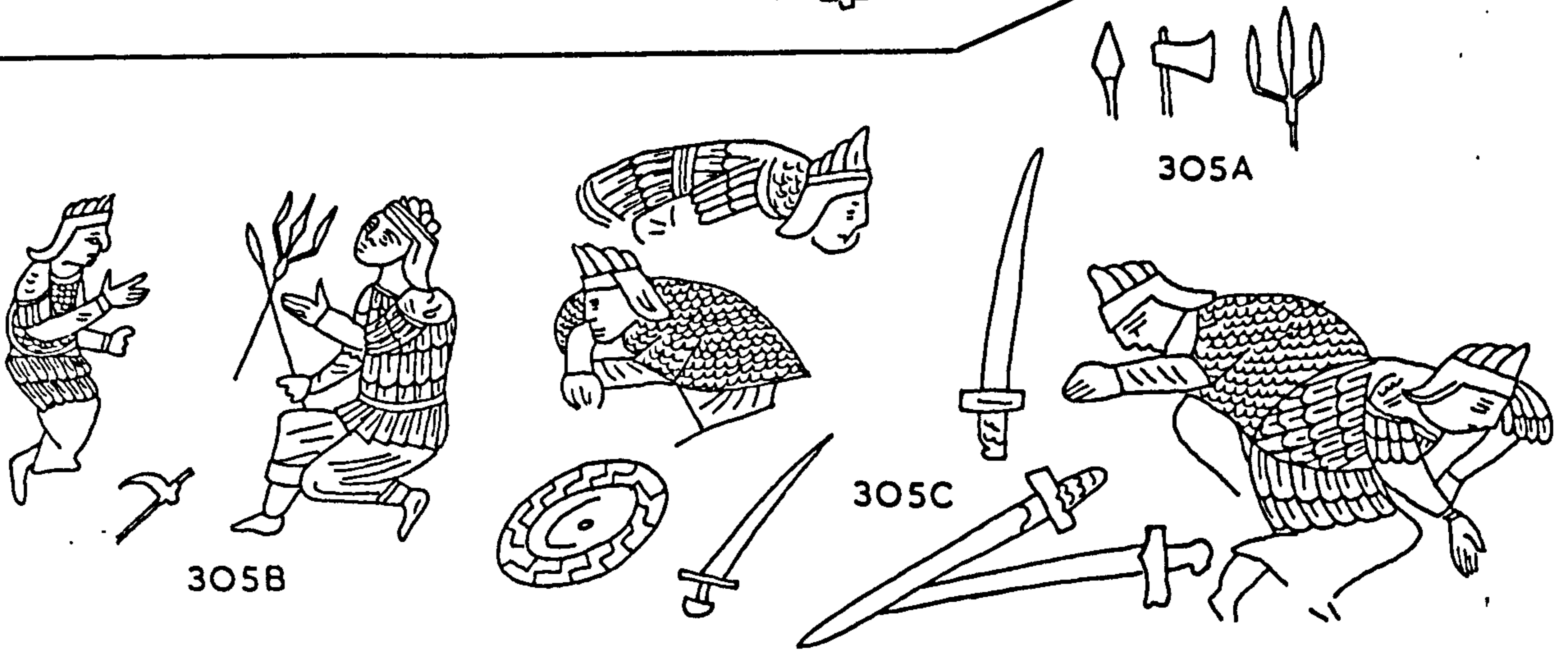

305A

305B

305C



306A

306B

306F

306C

306D

306E

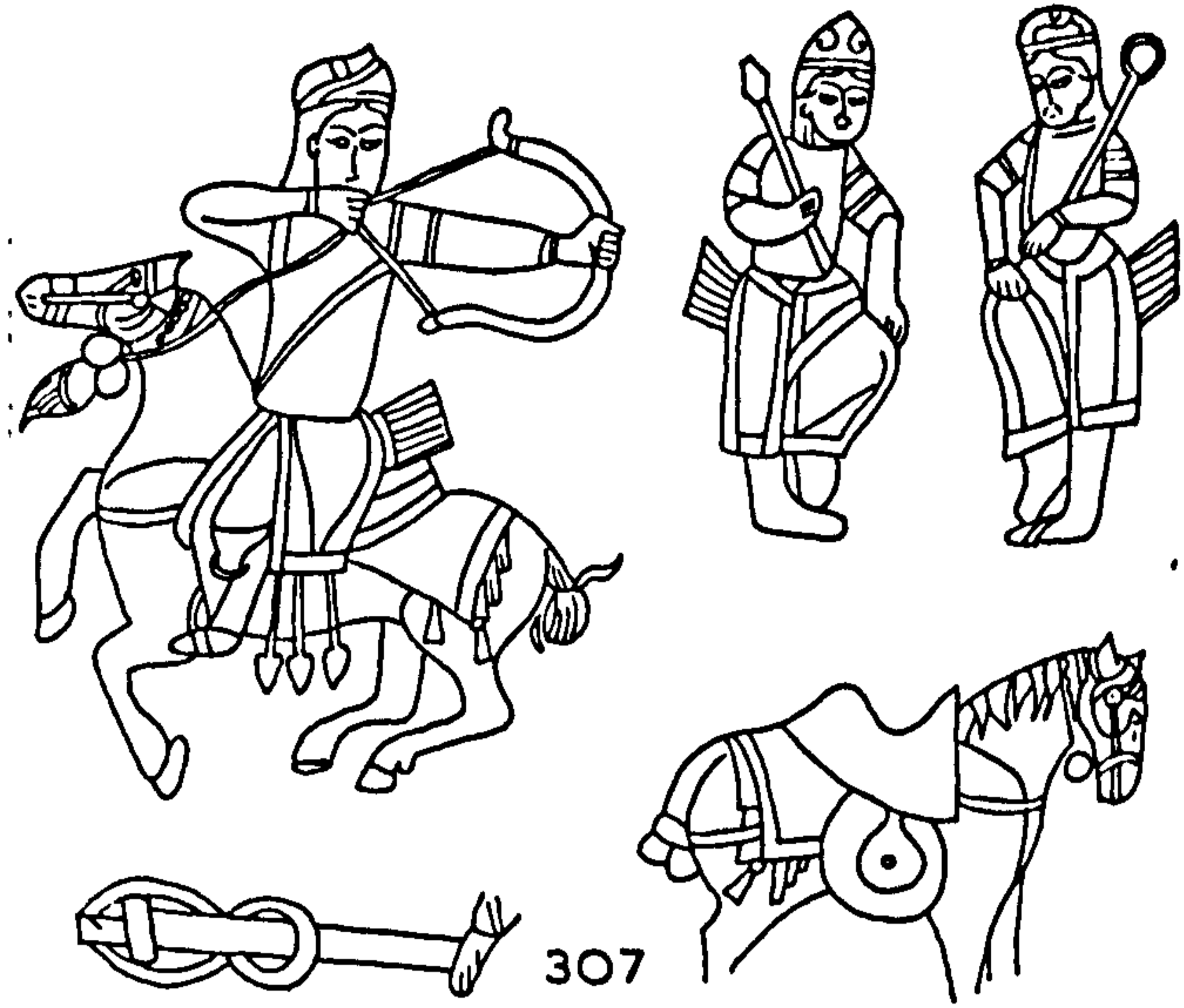

307



308



309



301

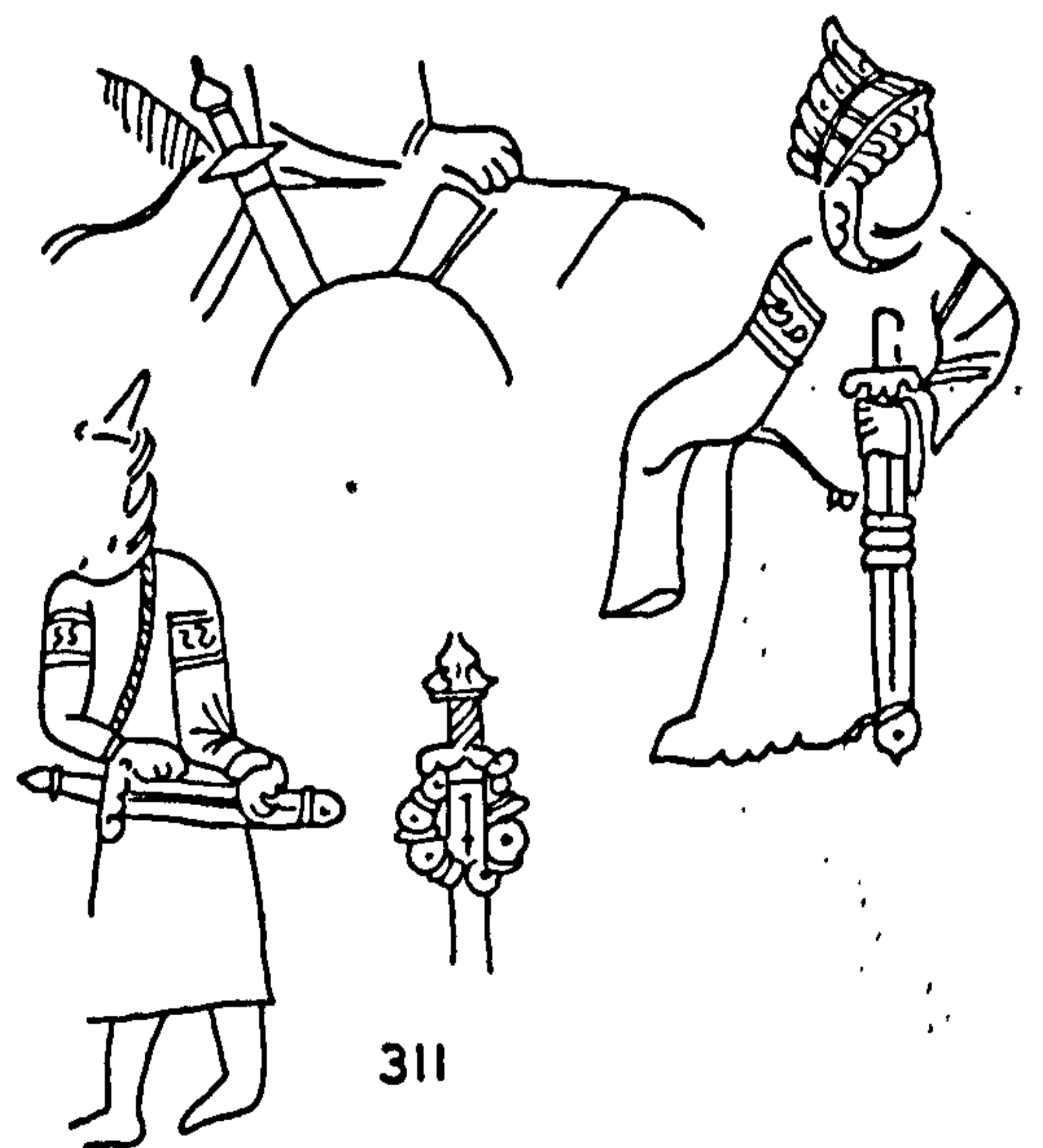

311



312

313

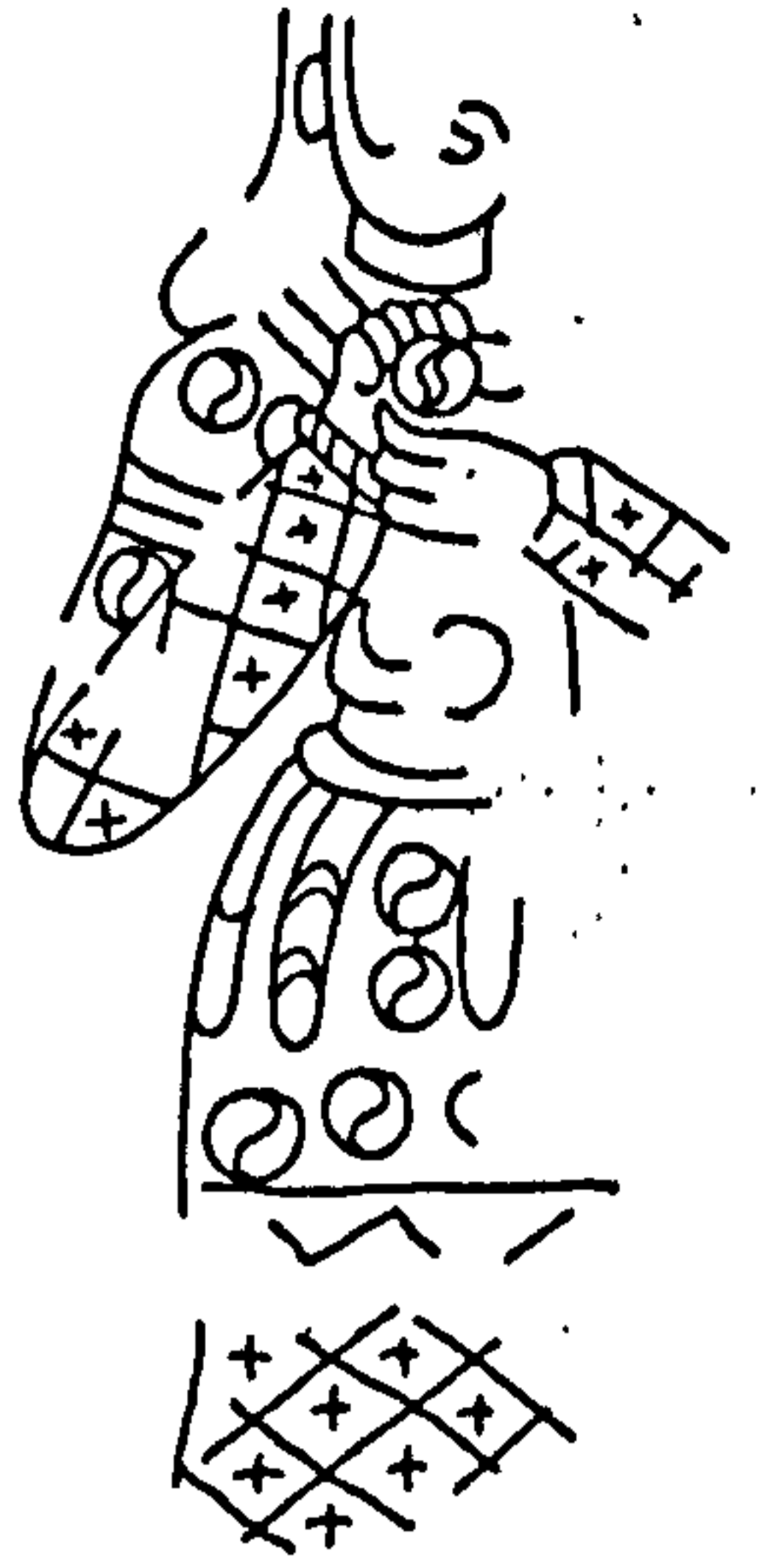
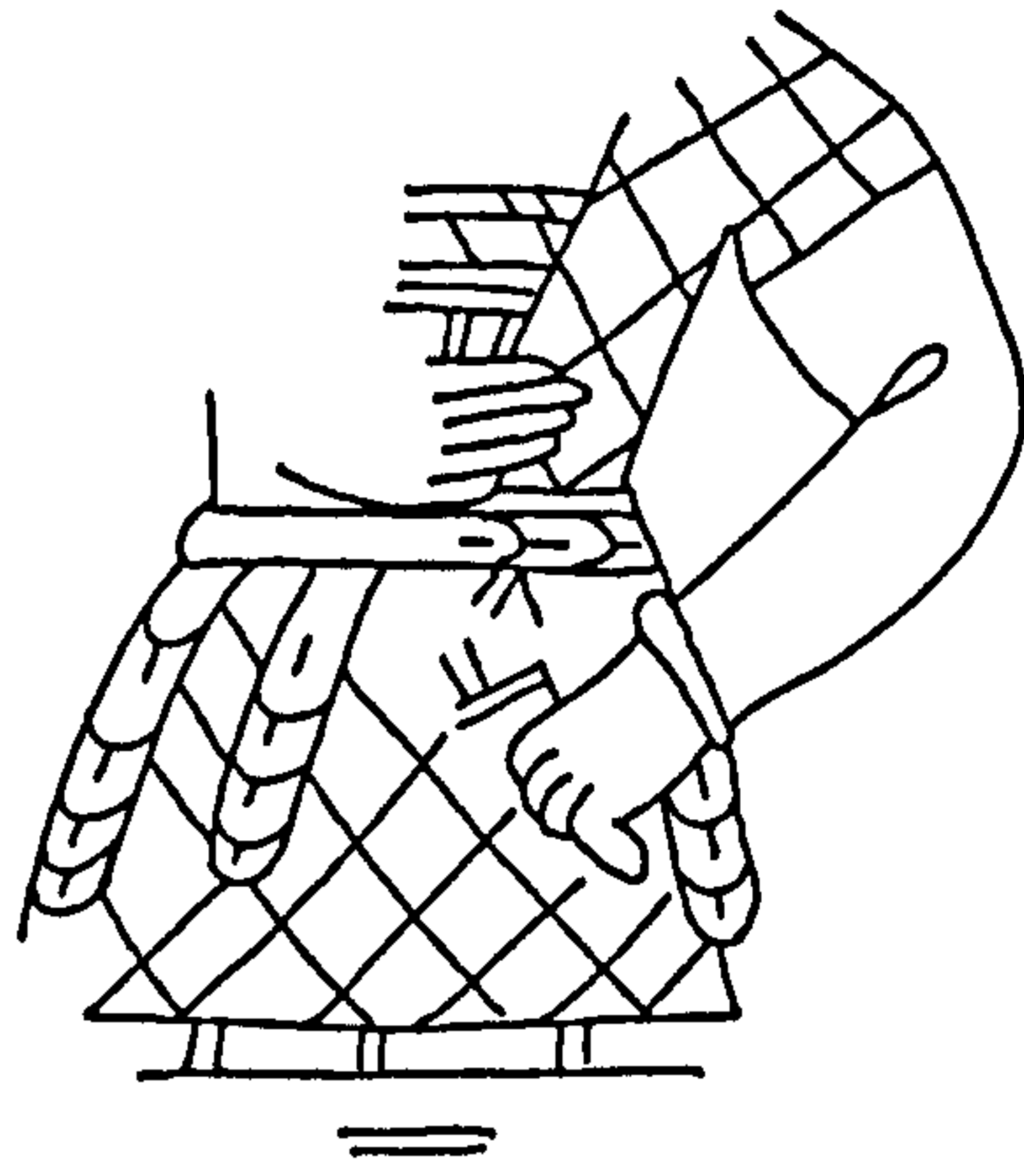

314



315



316



317

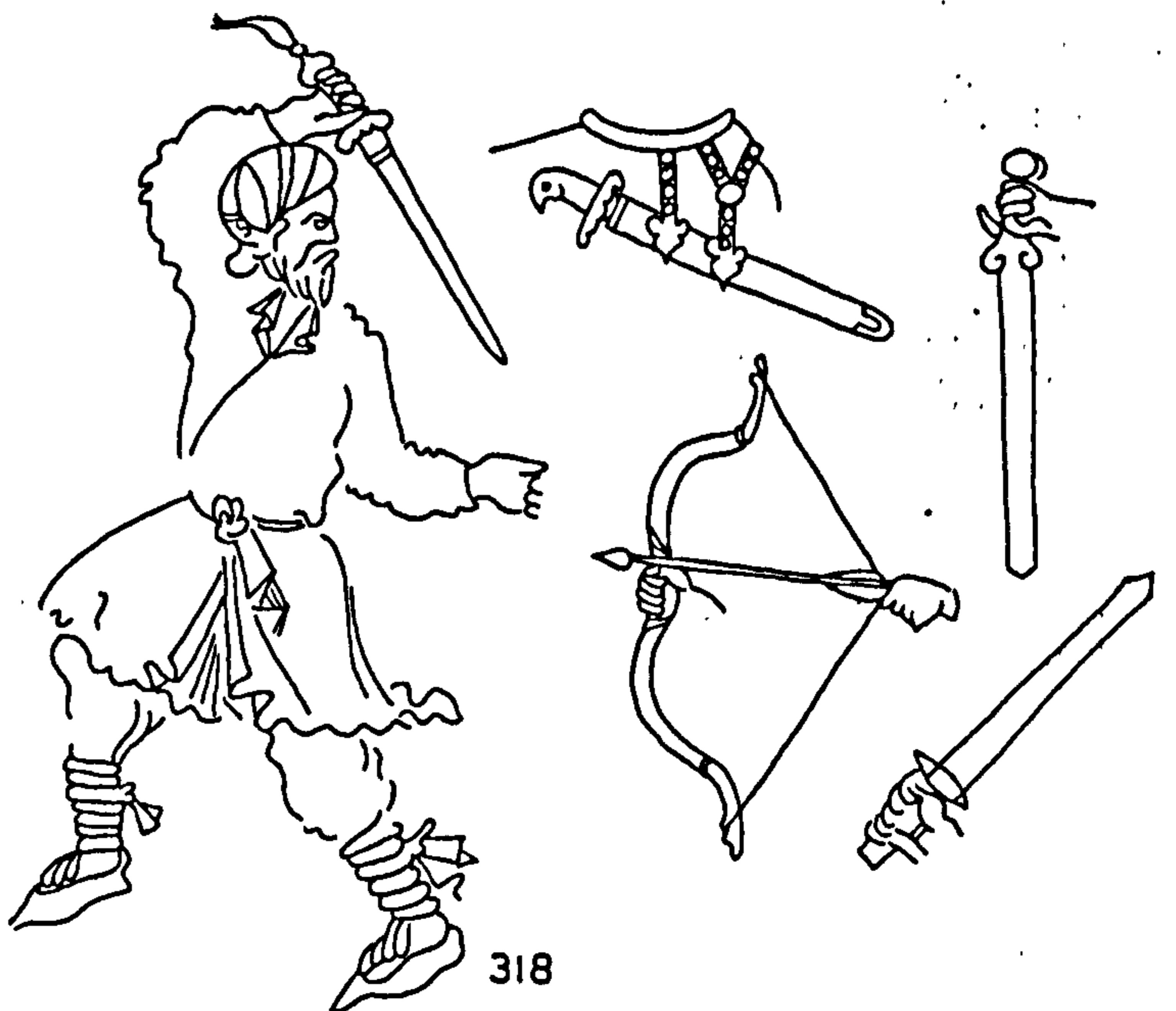

318

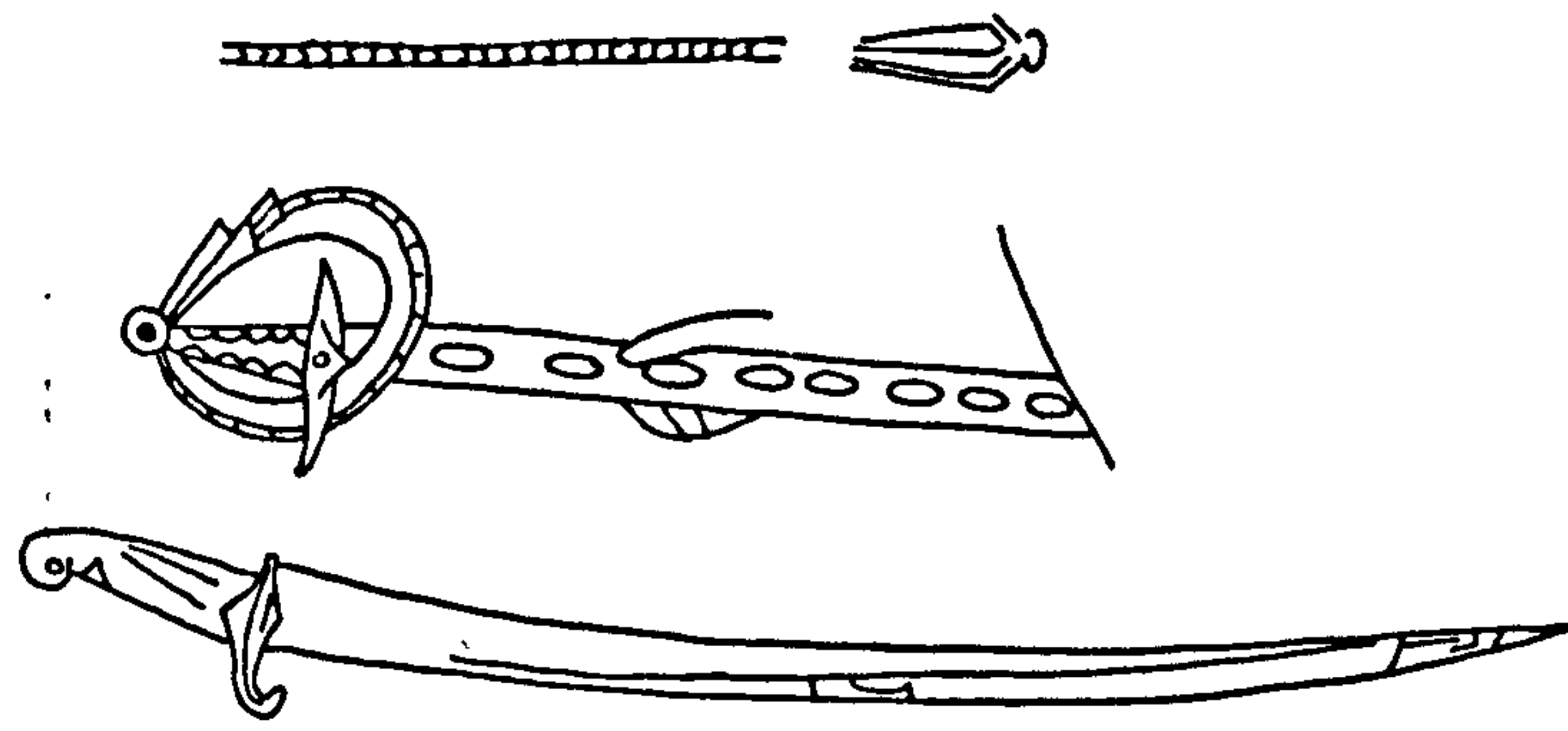

319



320

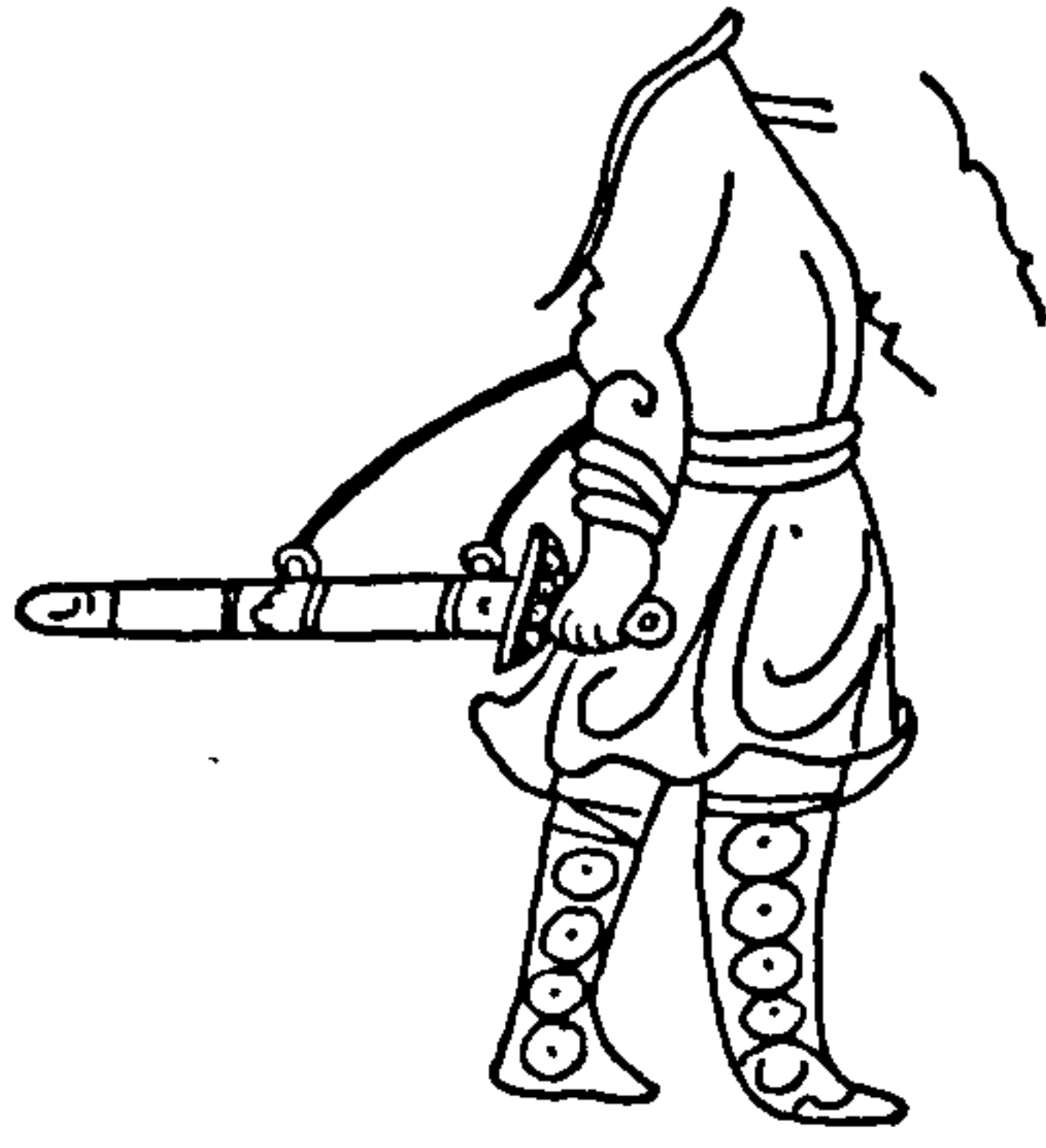

321

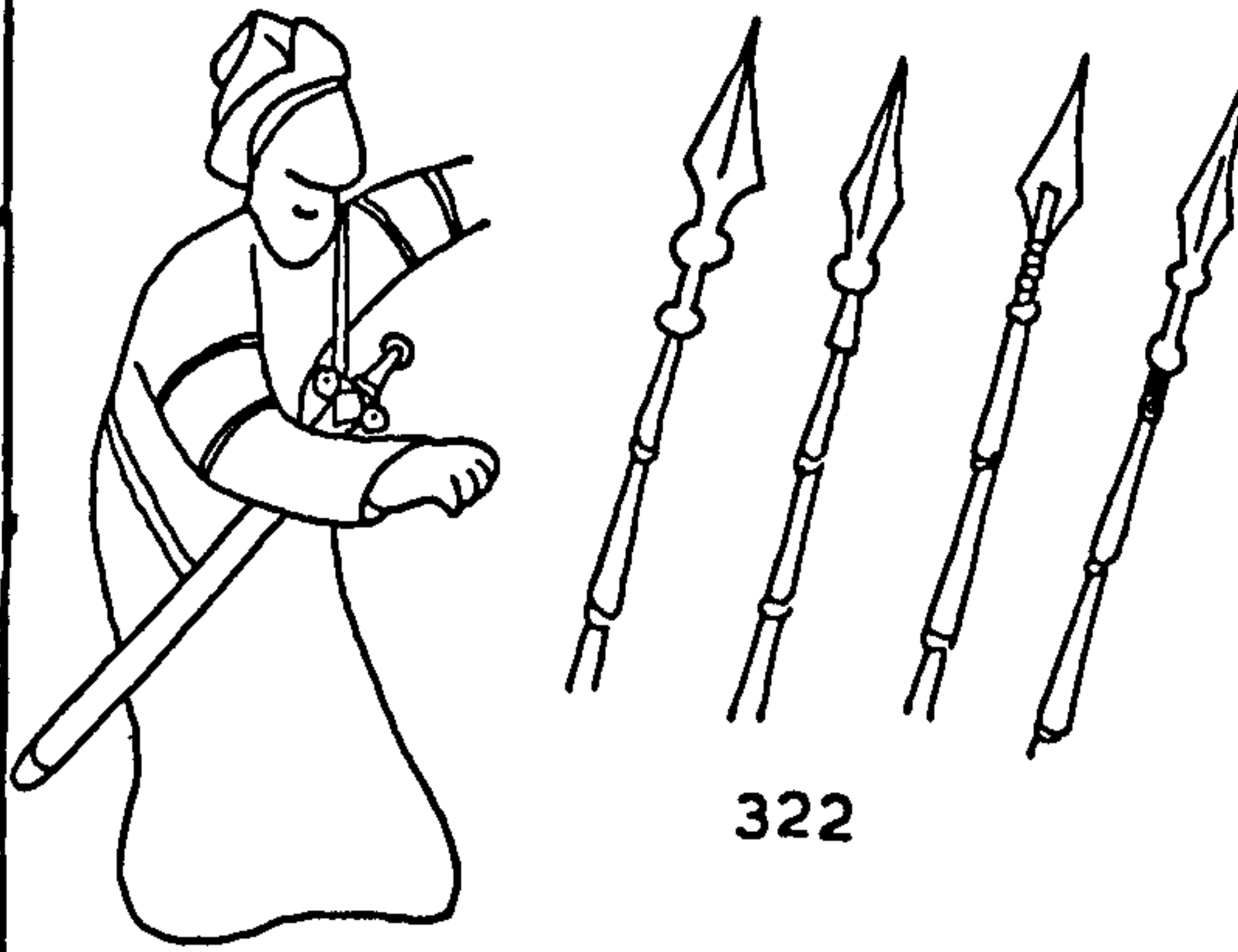

322



323

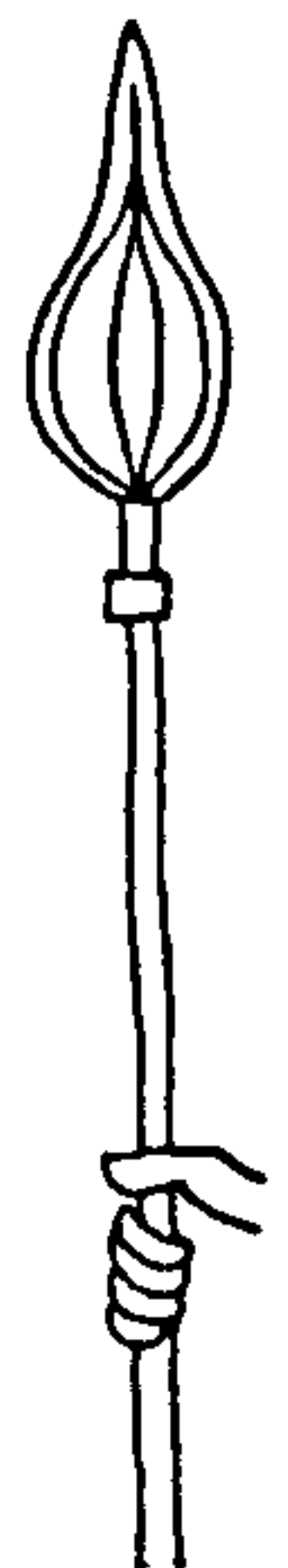

324 A

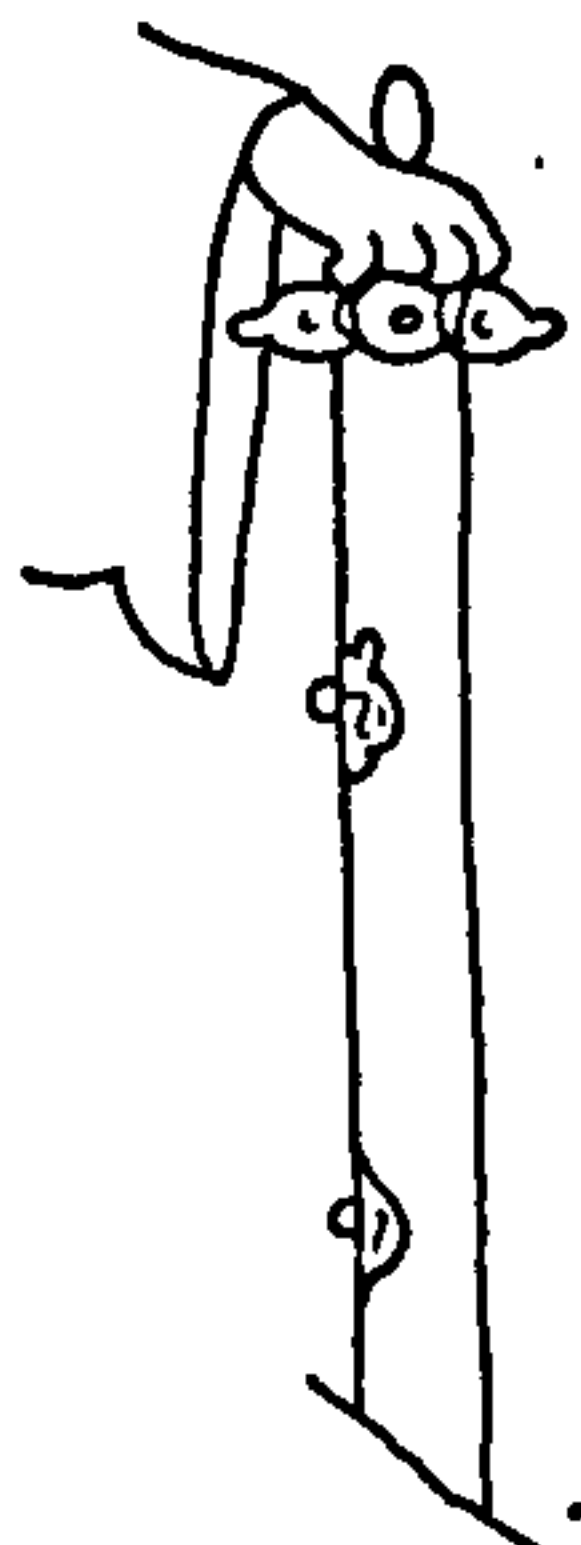

324 B



324 C

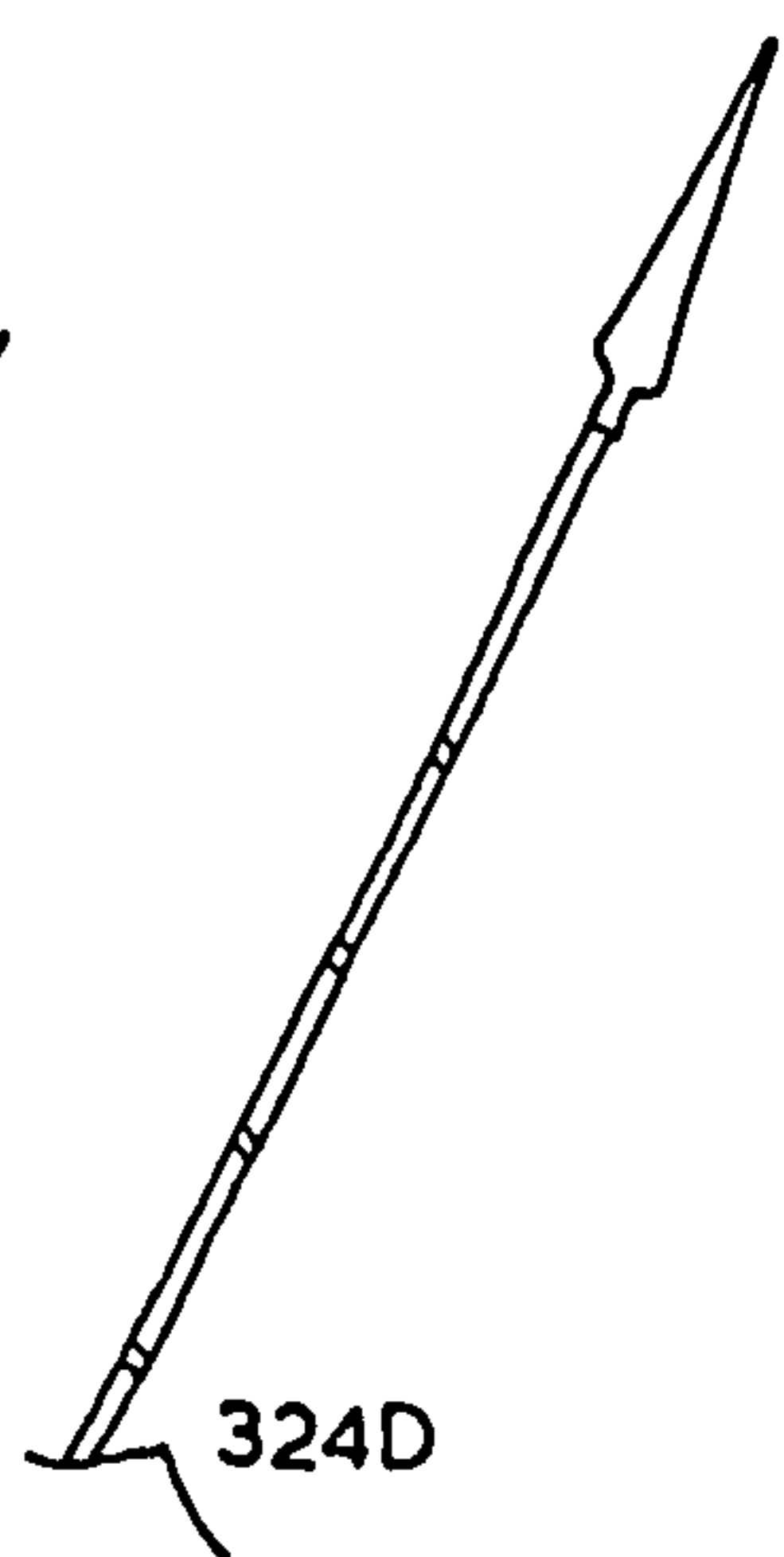

324 D

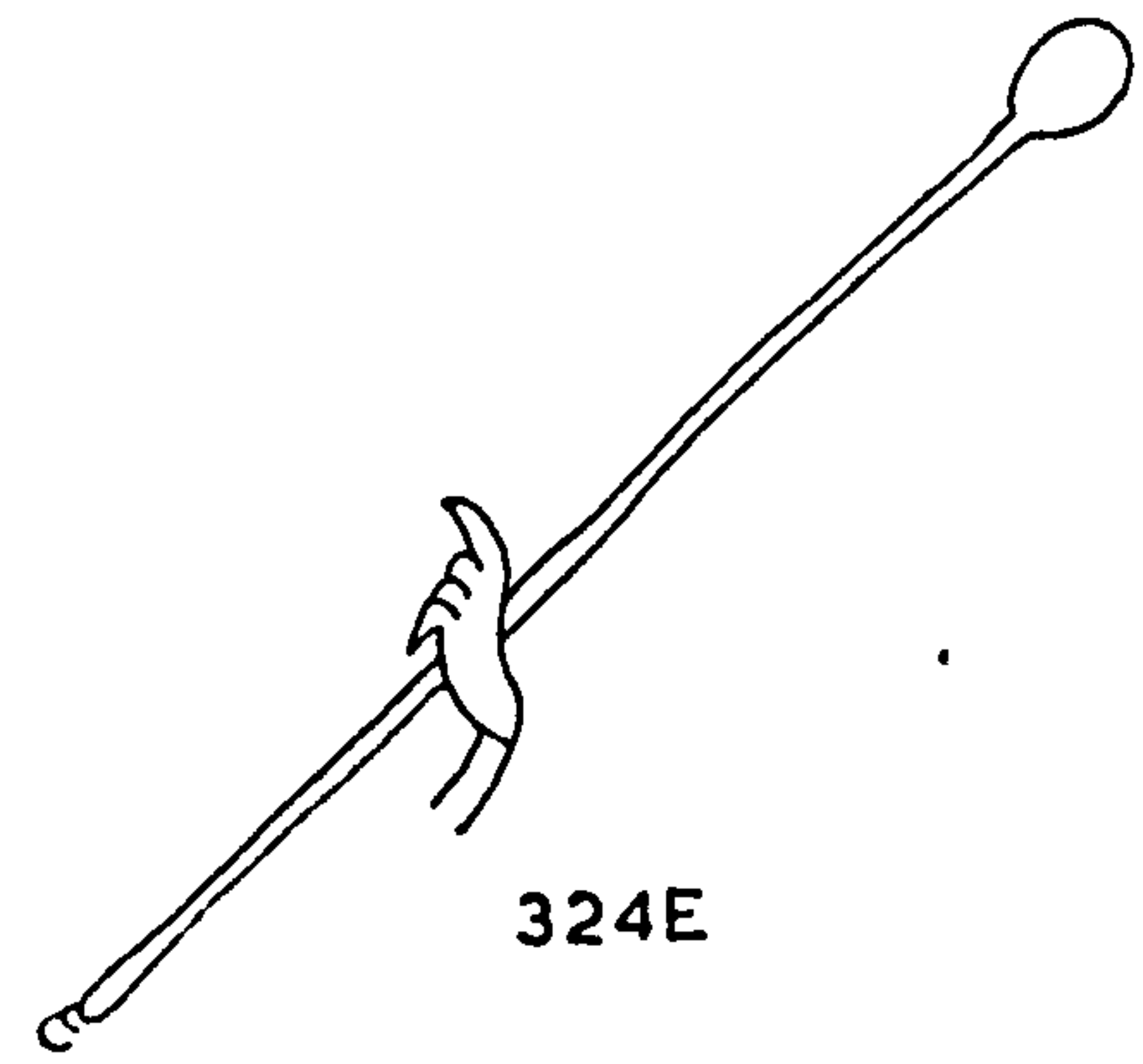

324 E

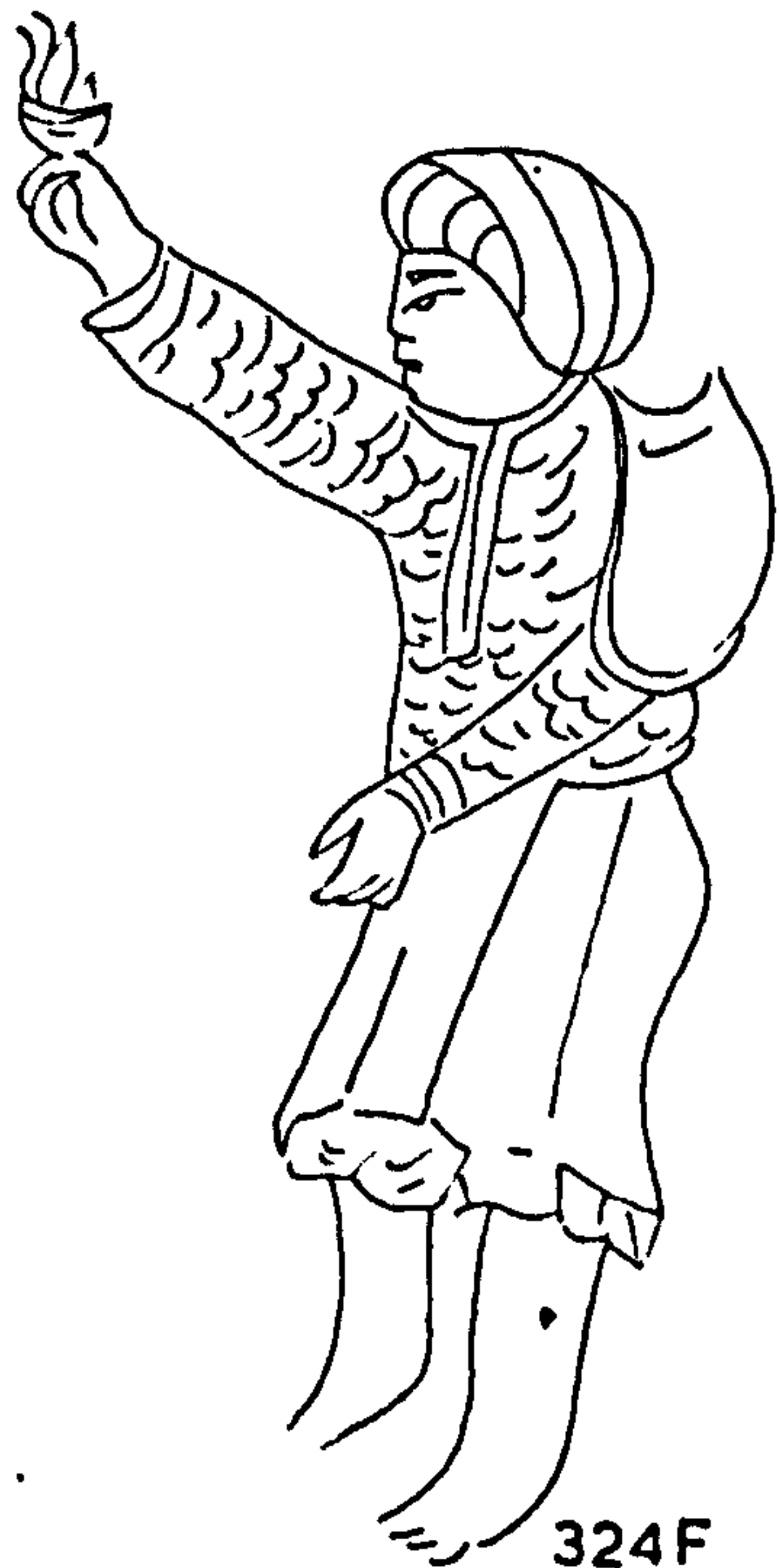

324 F

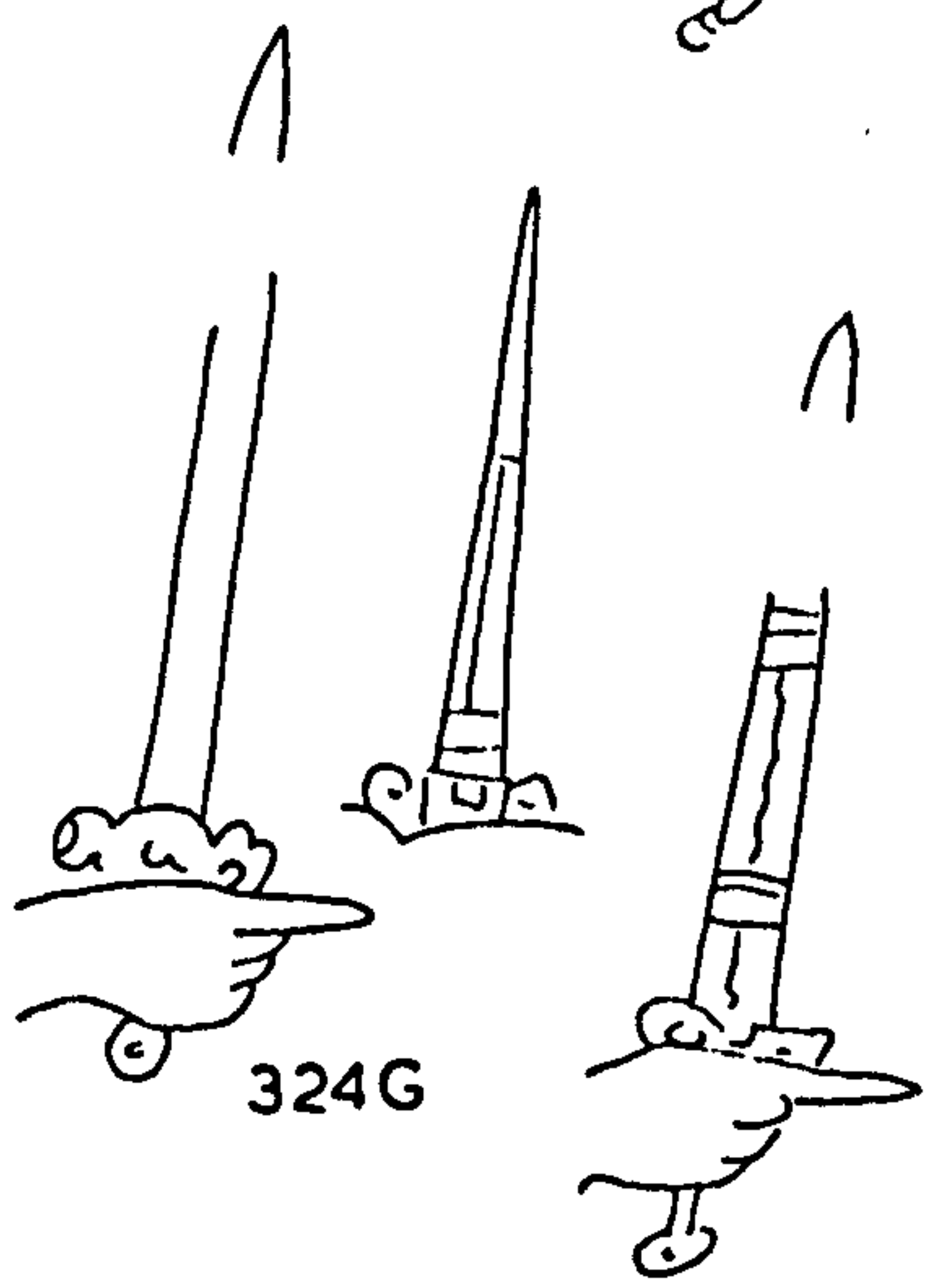

324 G

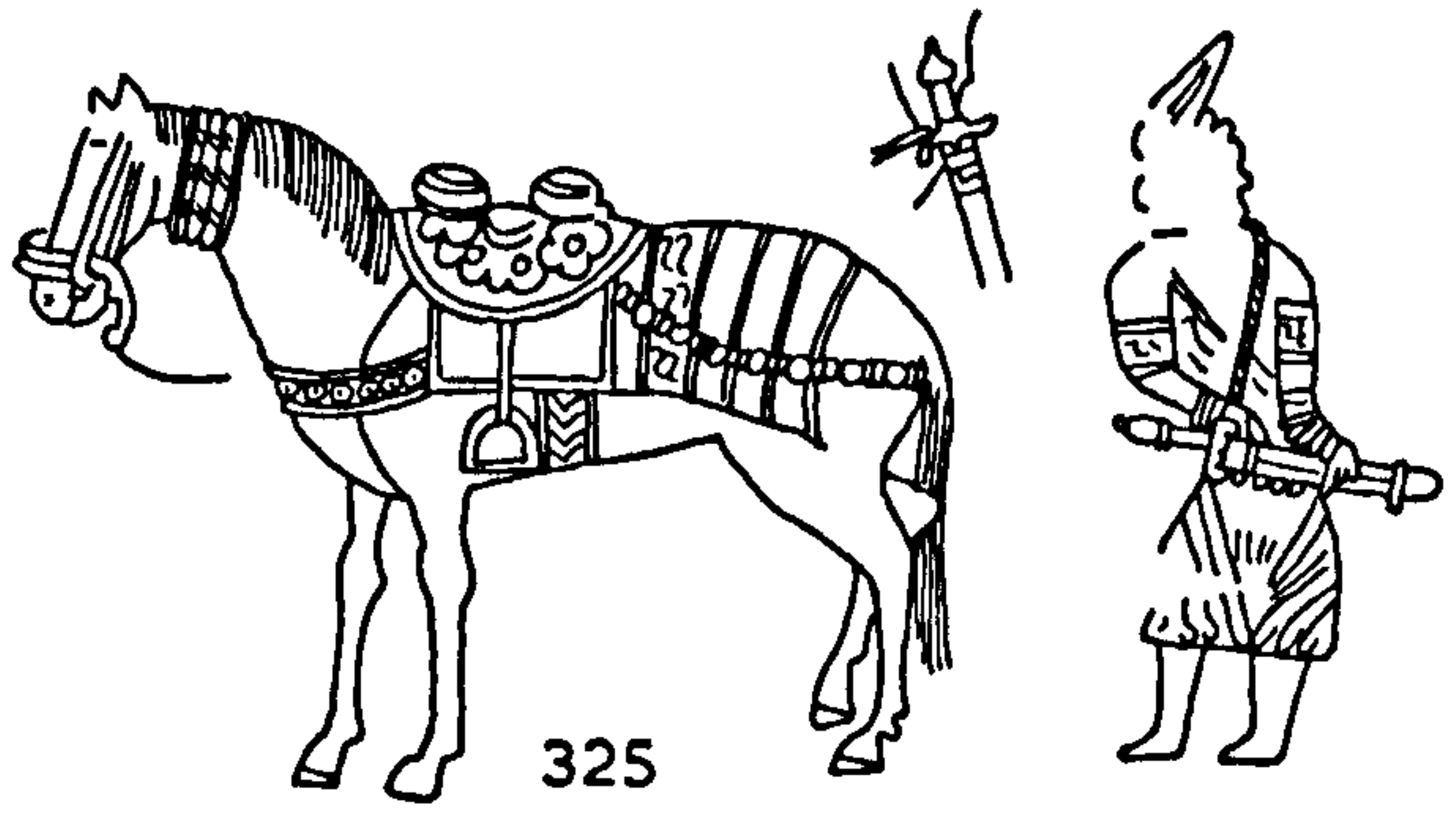

325

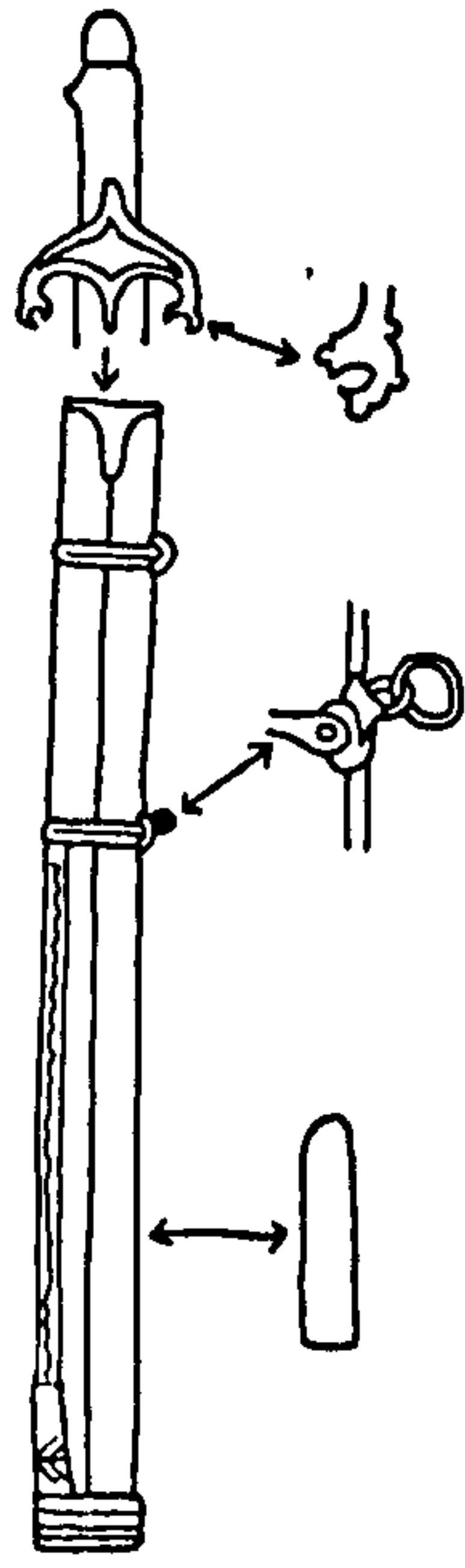

326

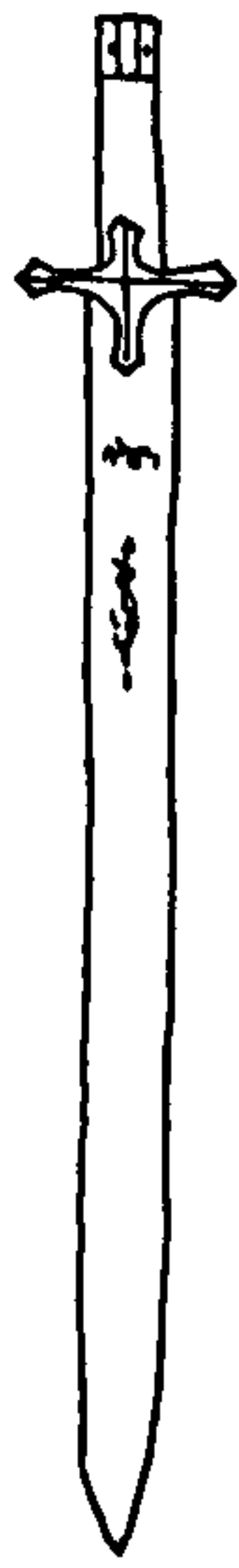

327



328



329

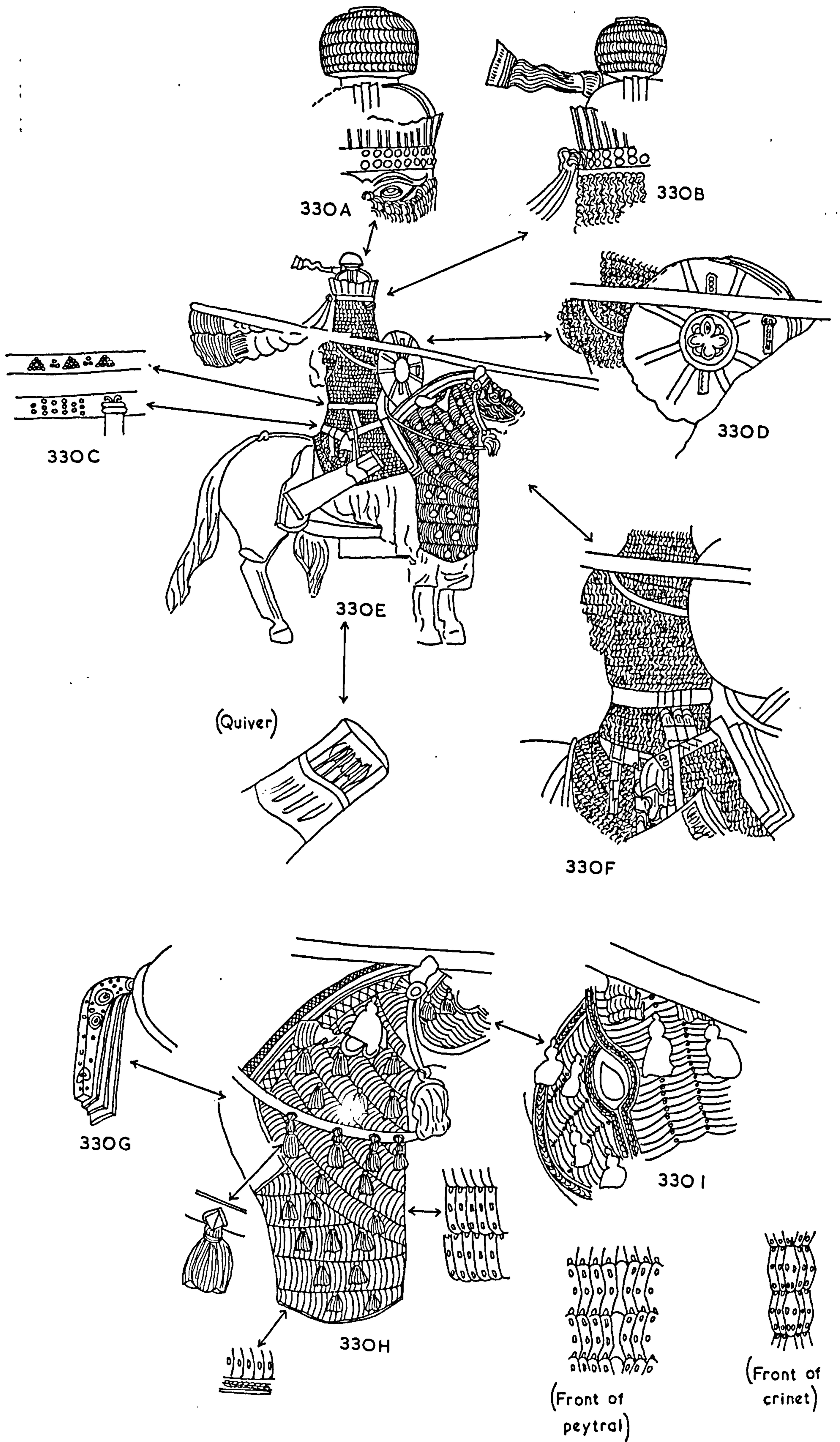



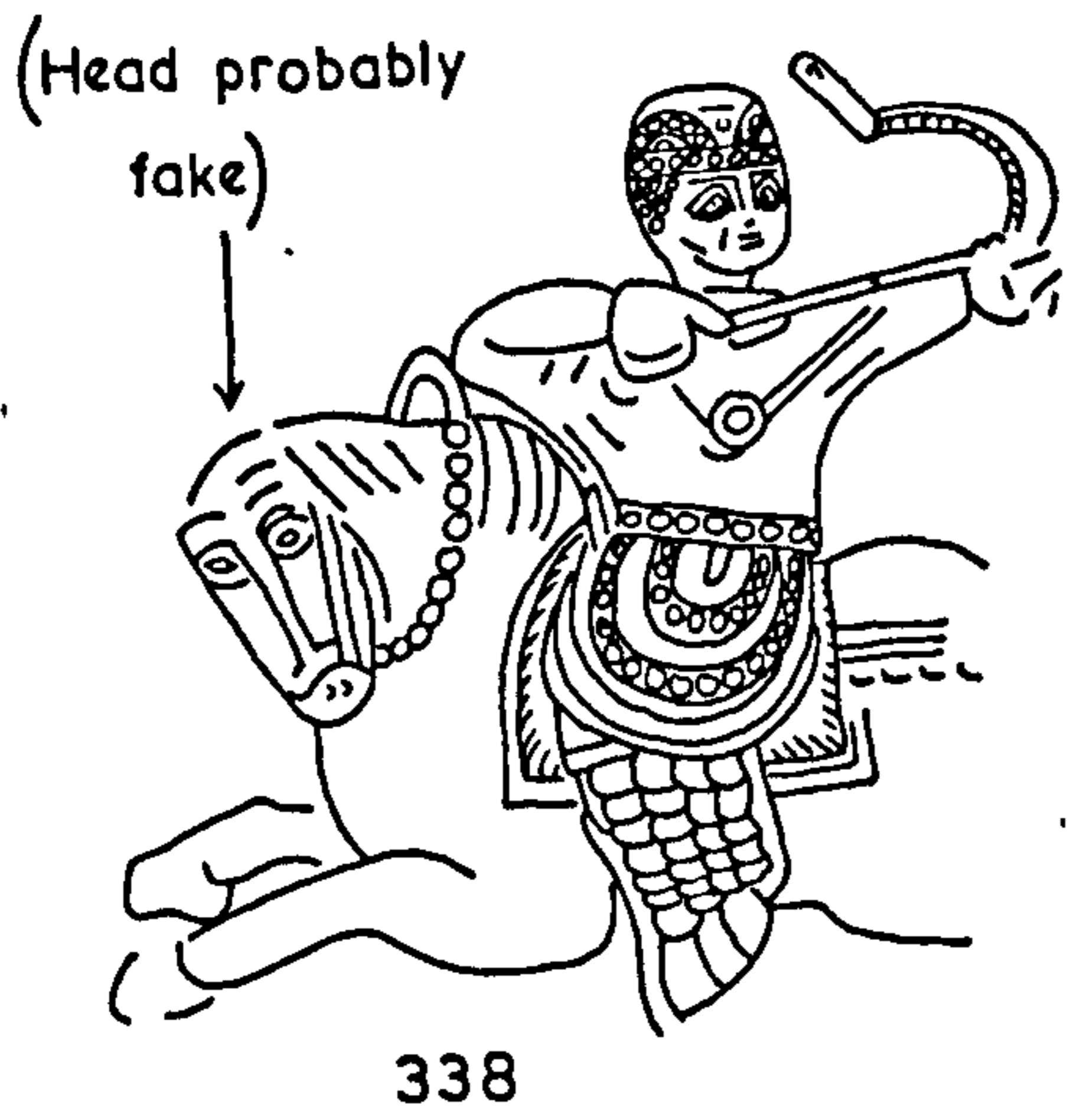
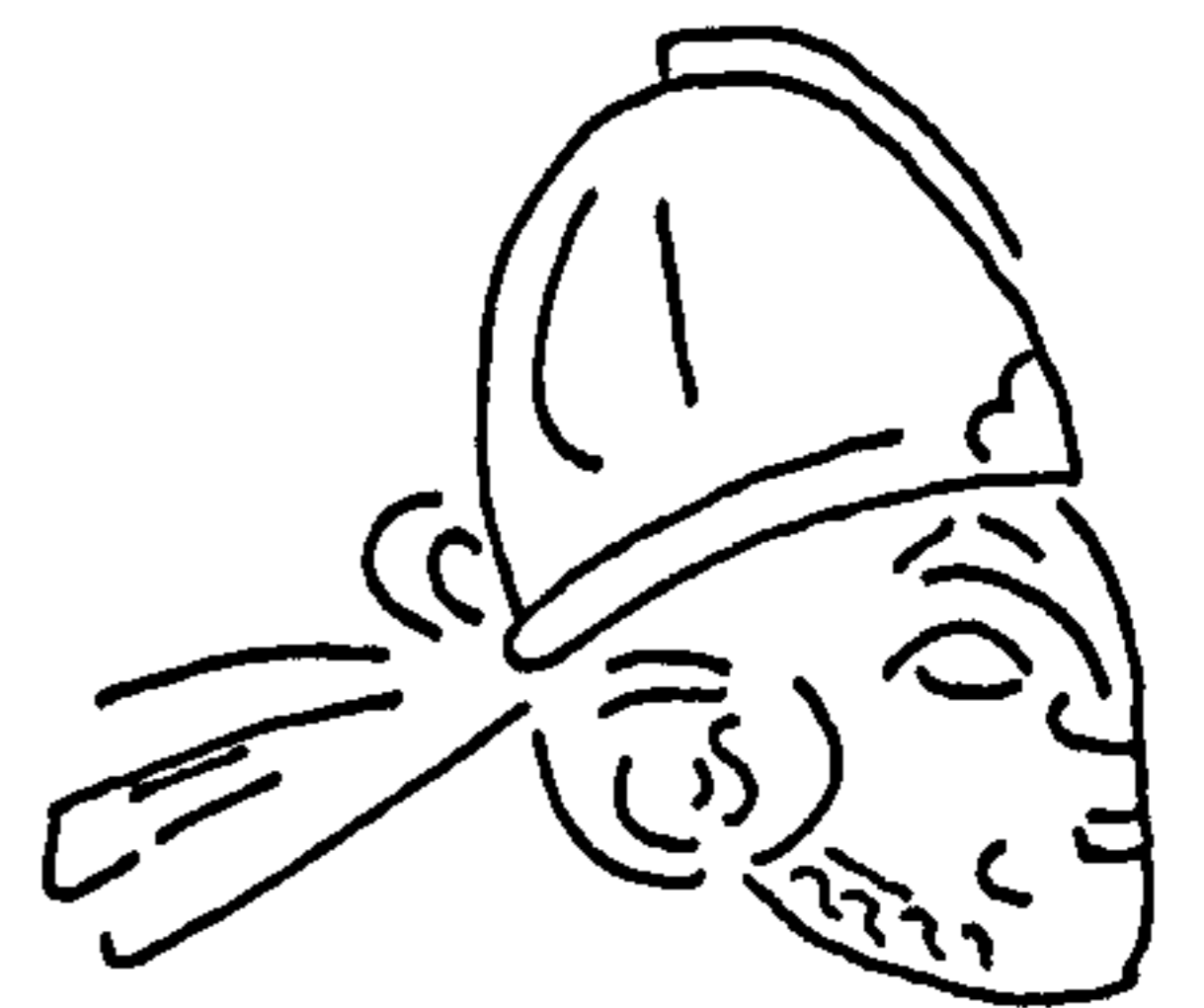
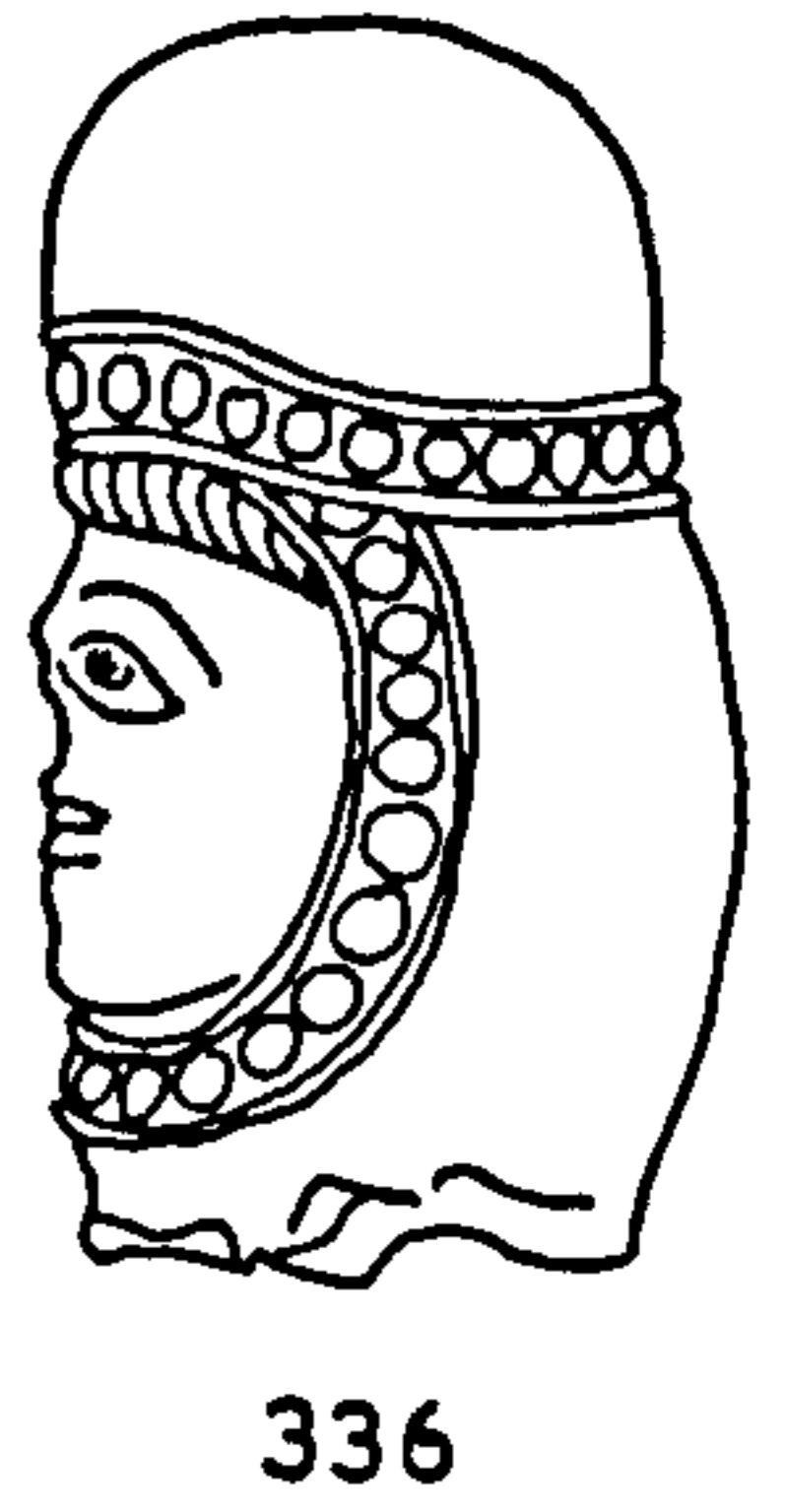
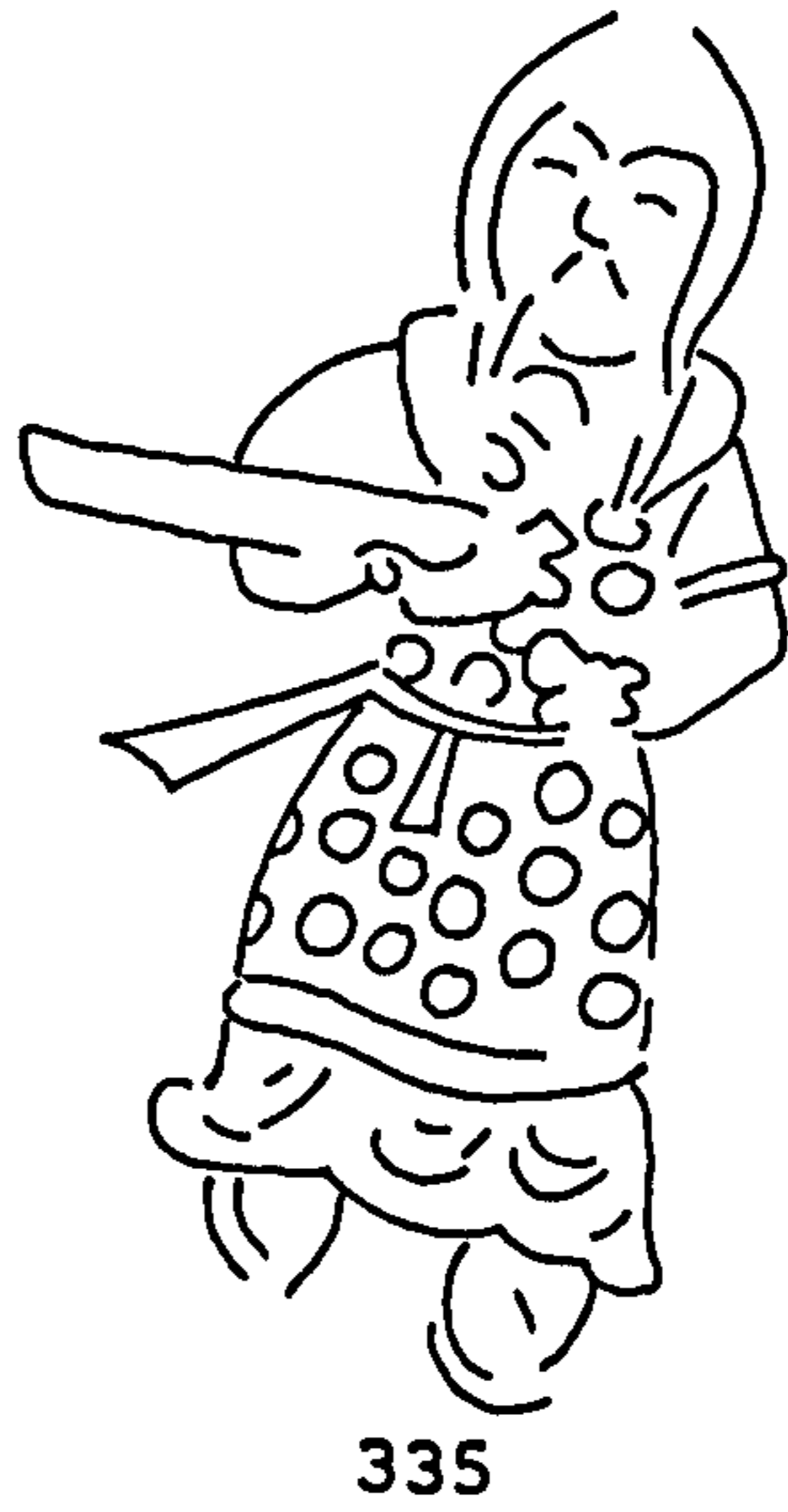
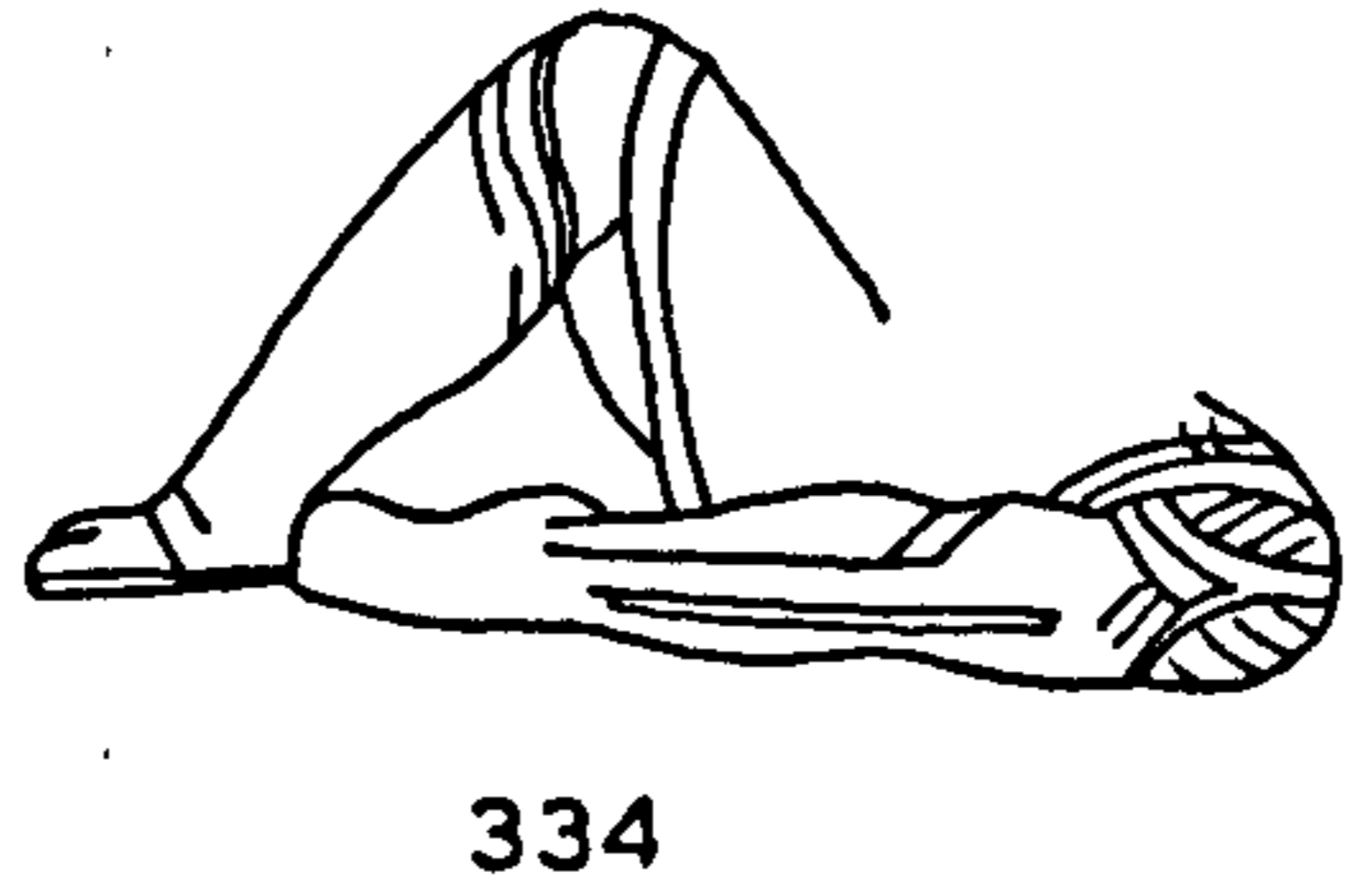
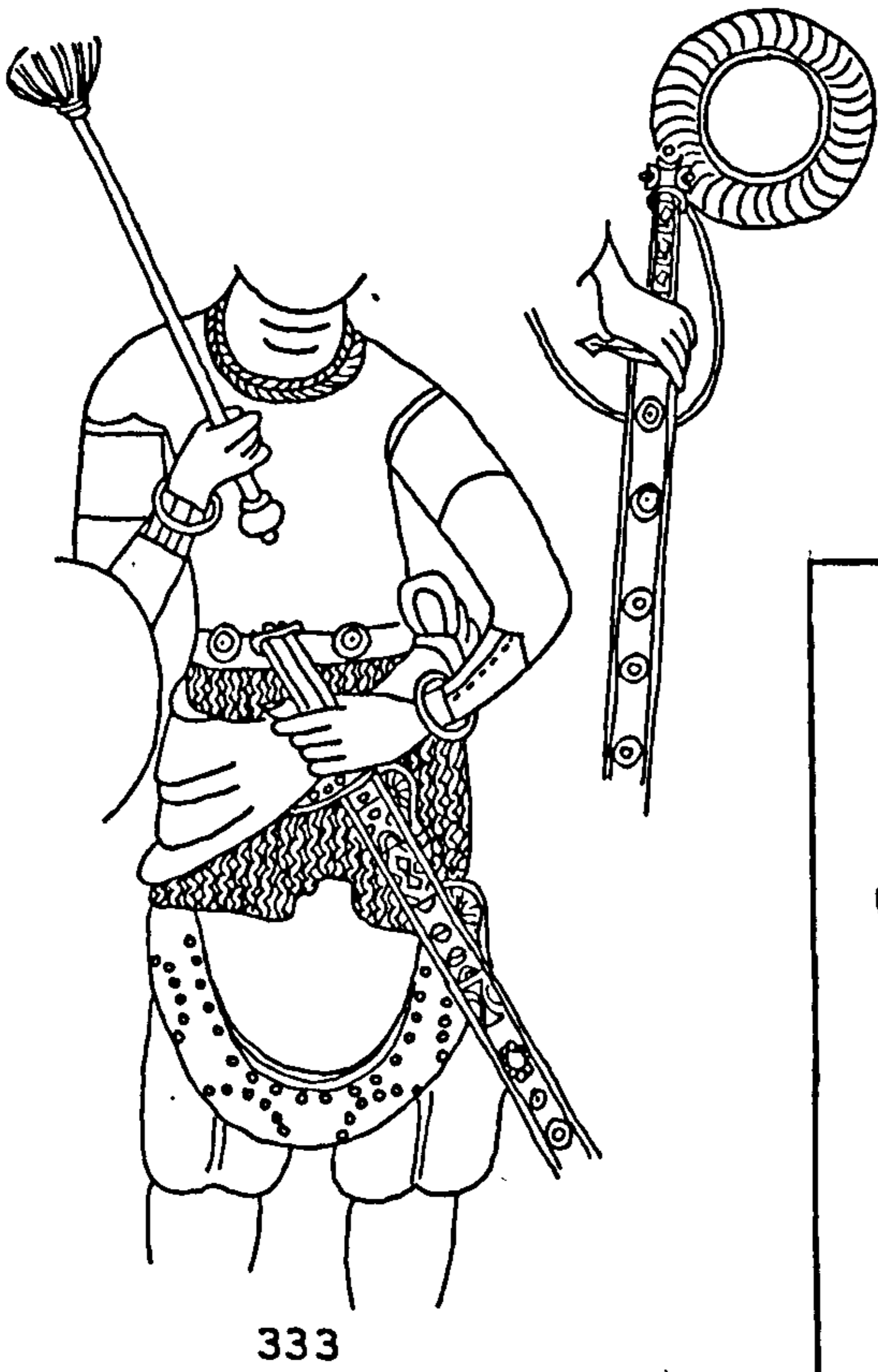
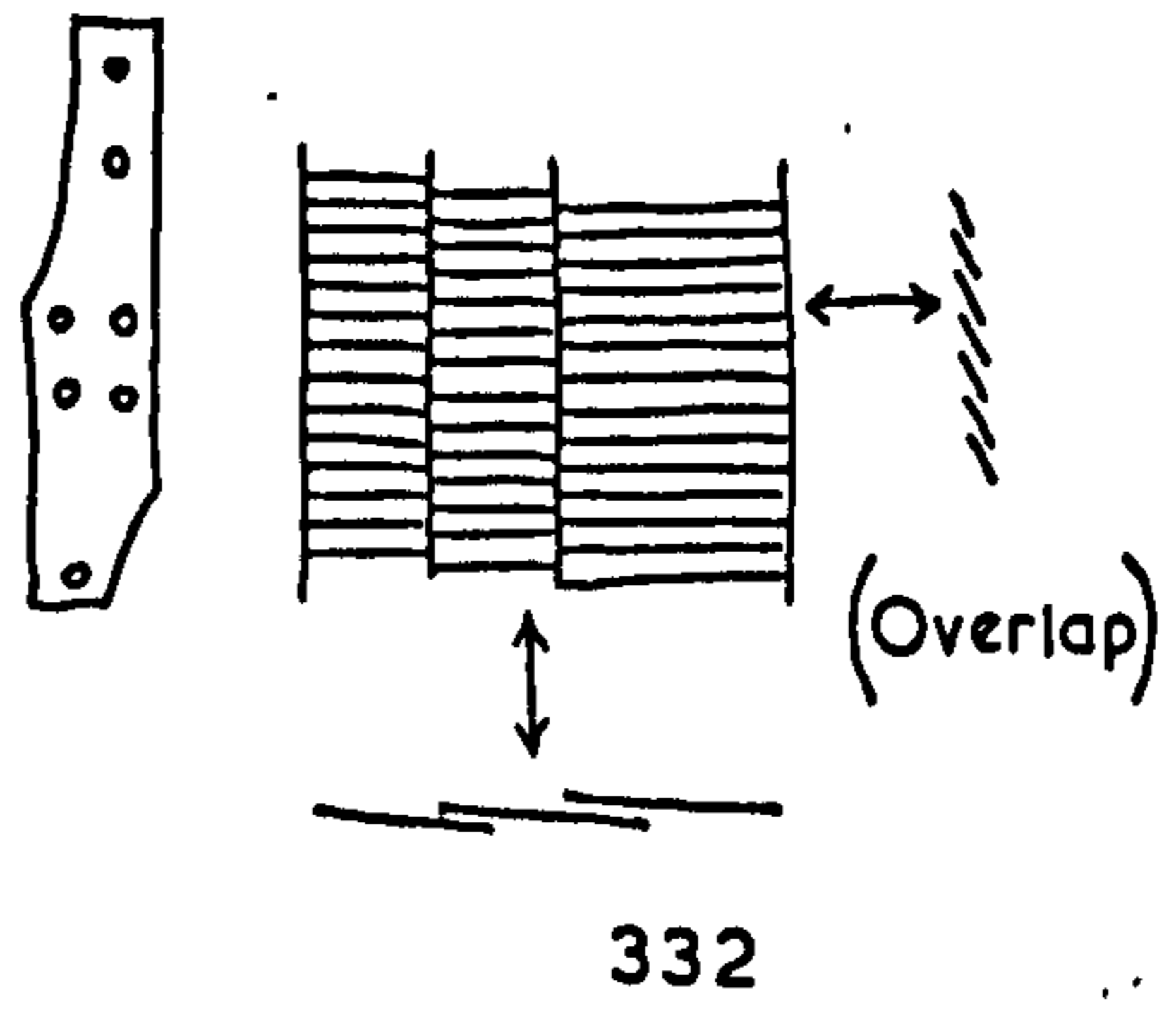
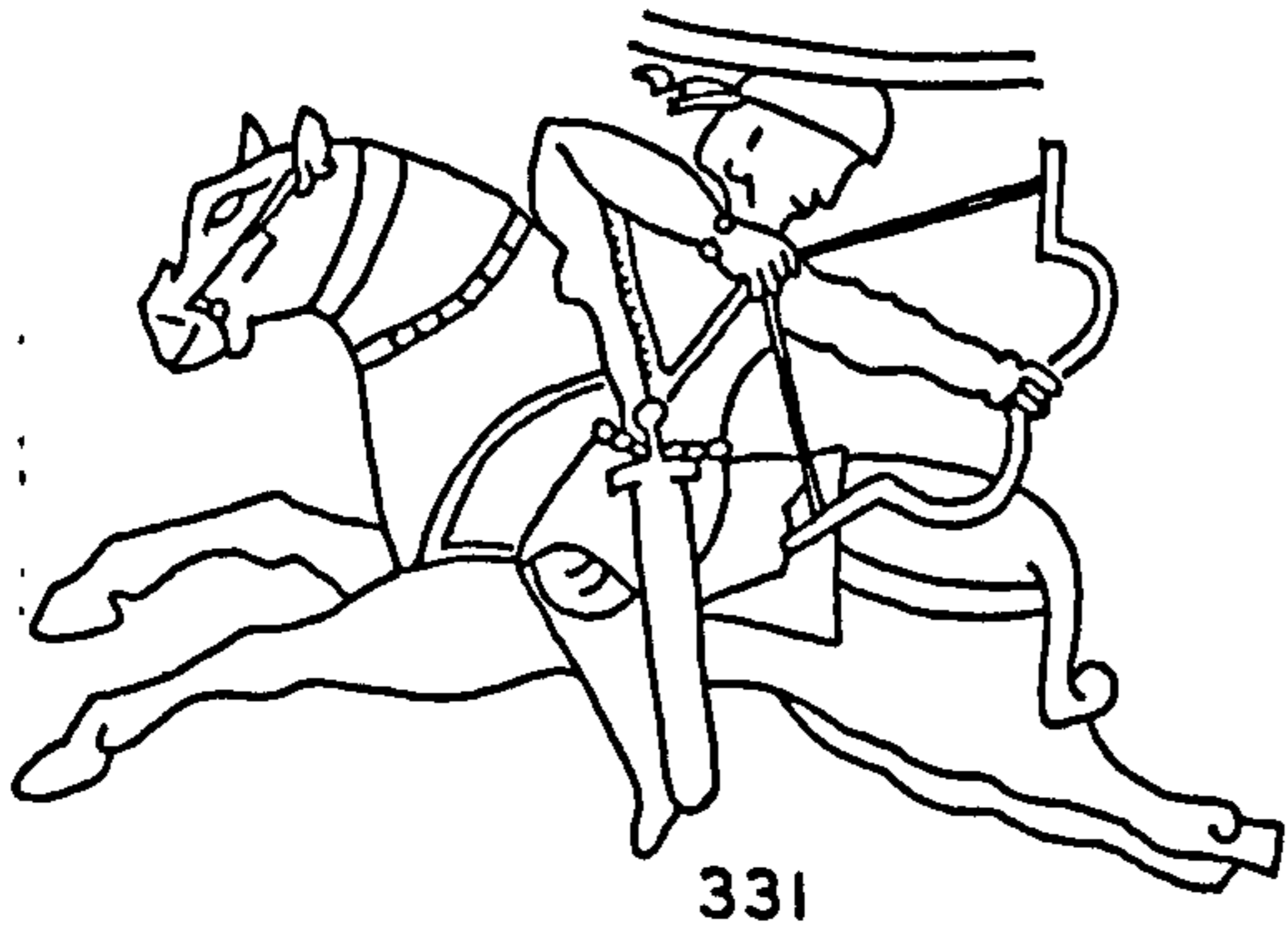



340



341

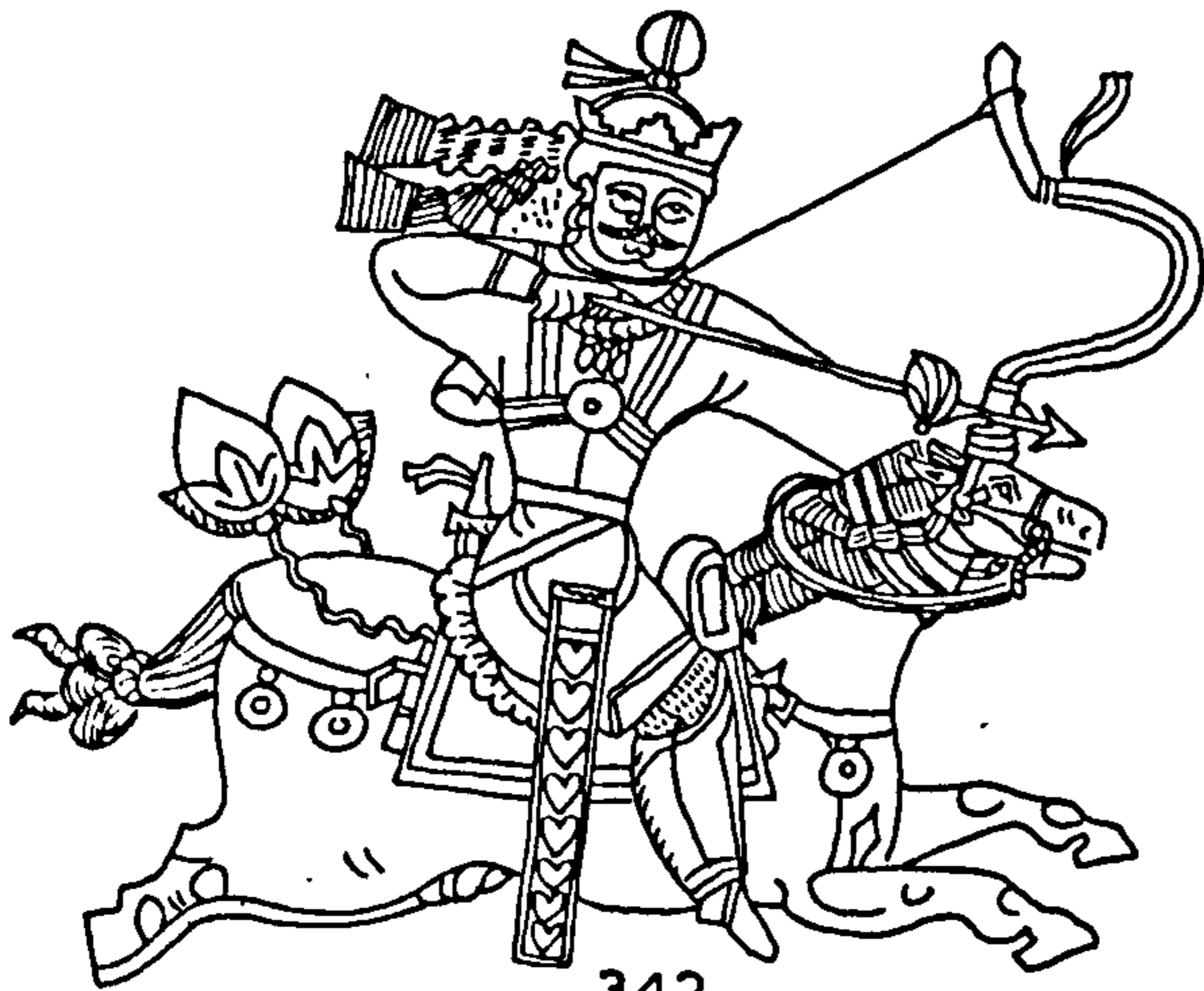

342

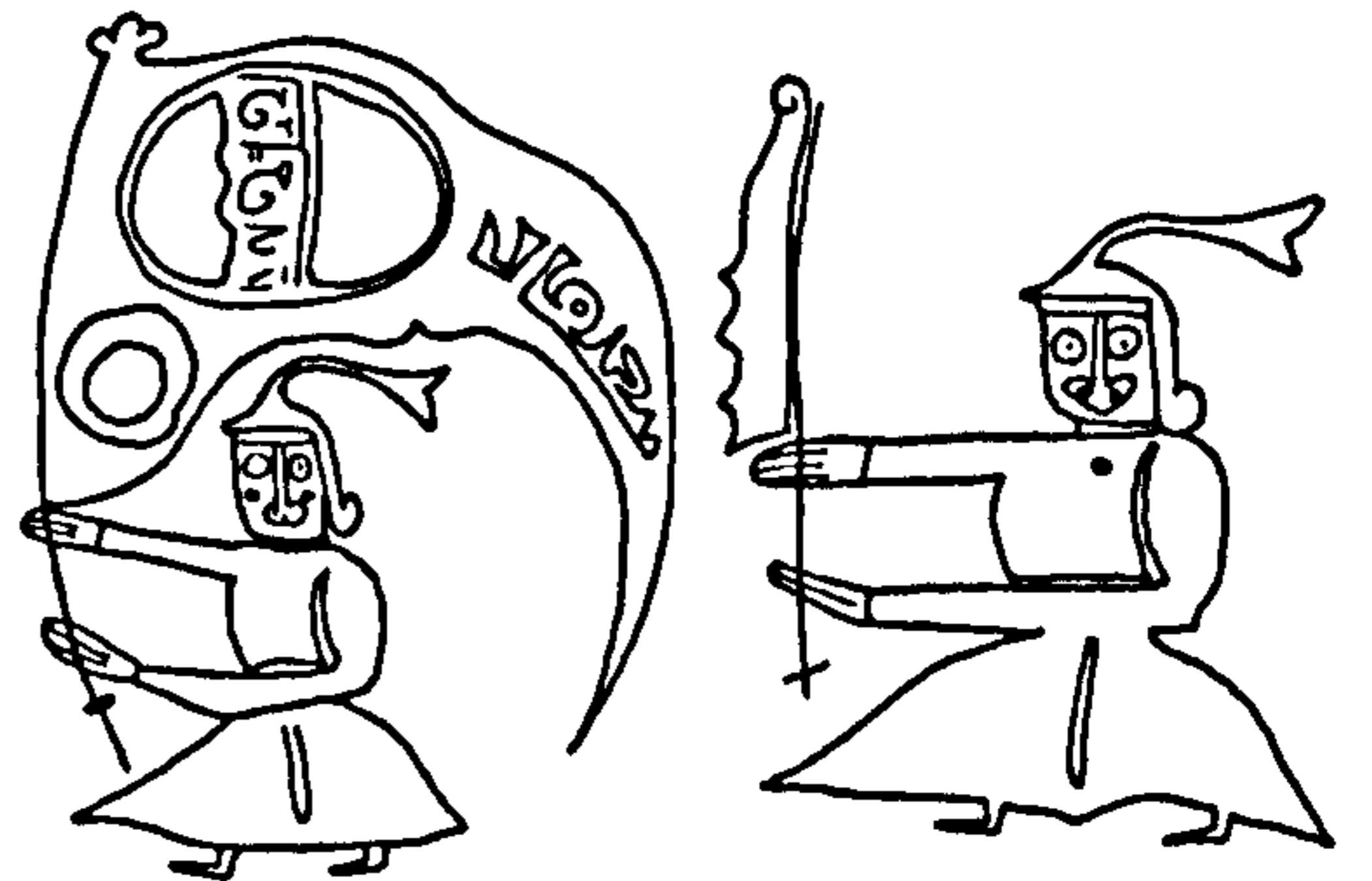

343

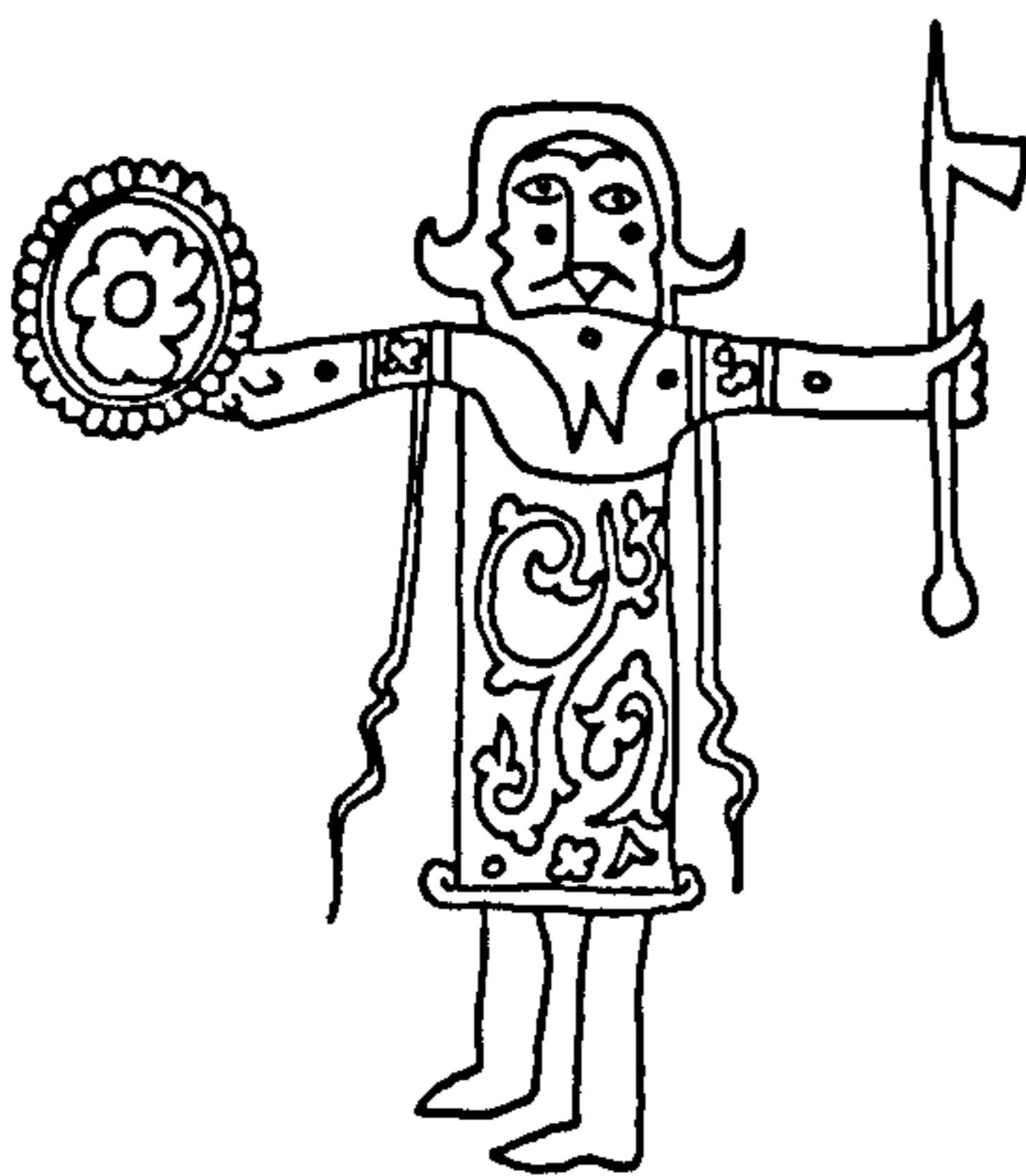

344



345



346



347

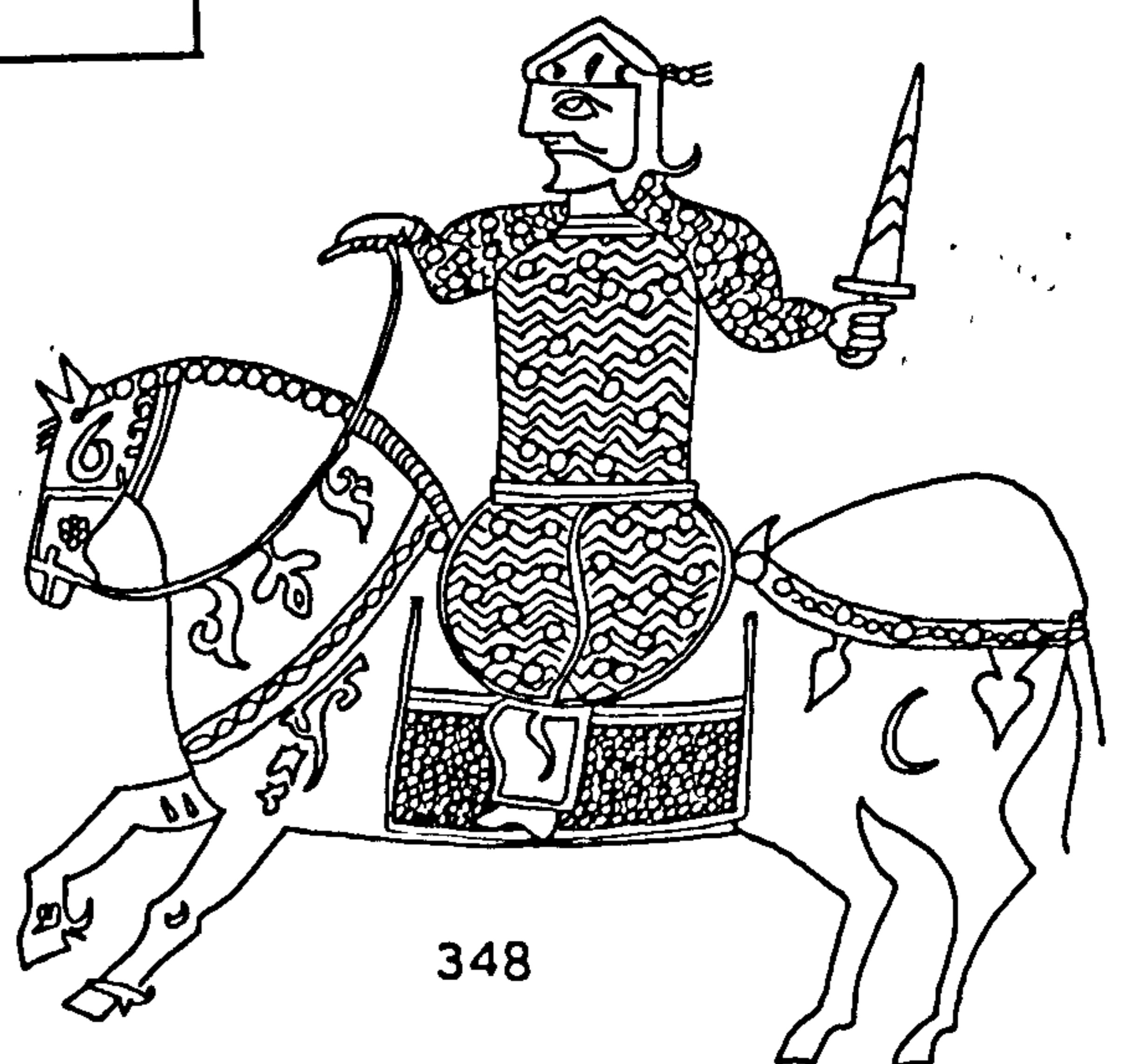

348

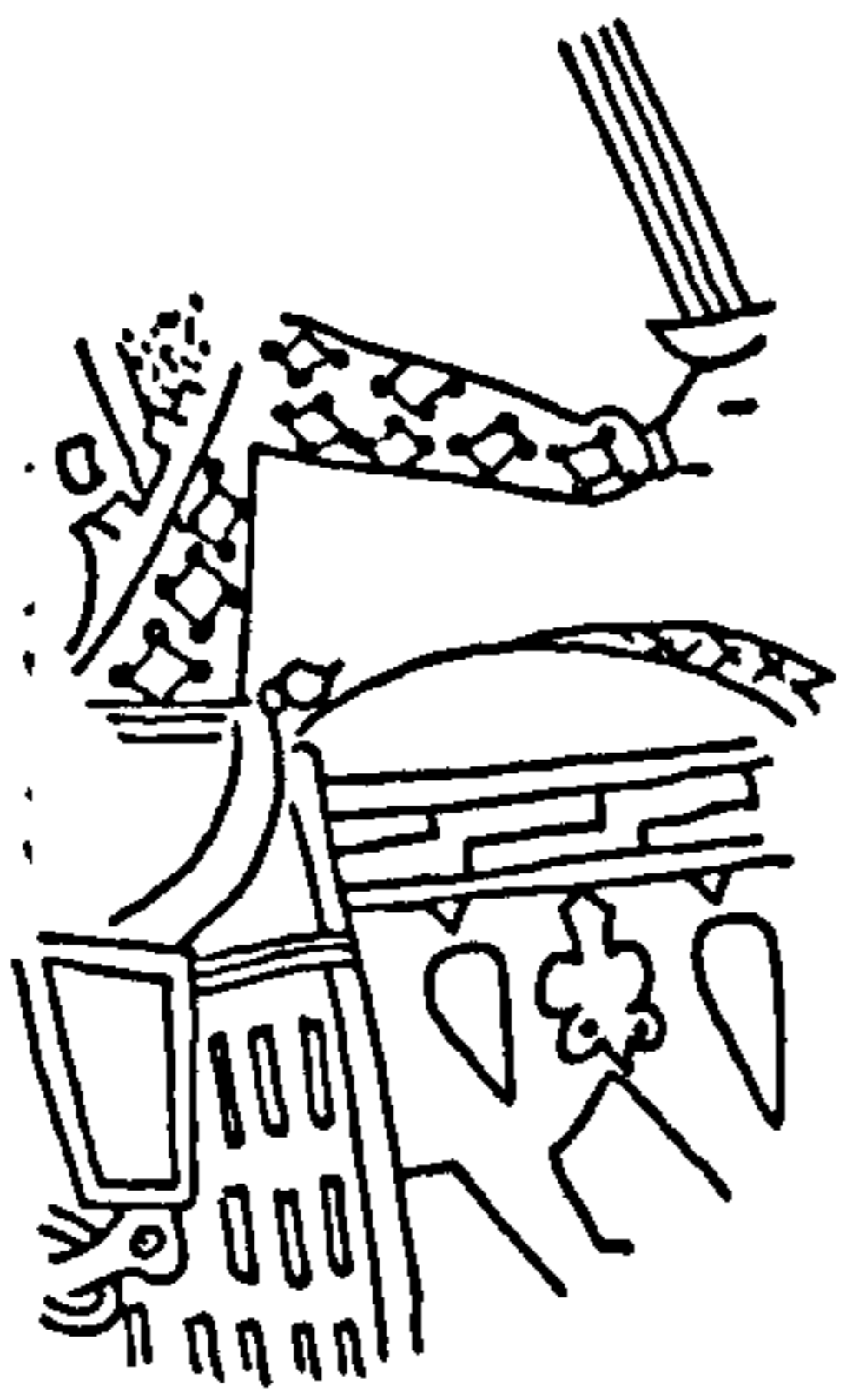

349



350



351



352

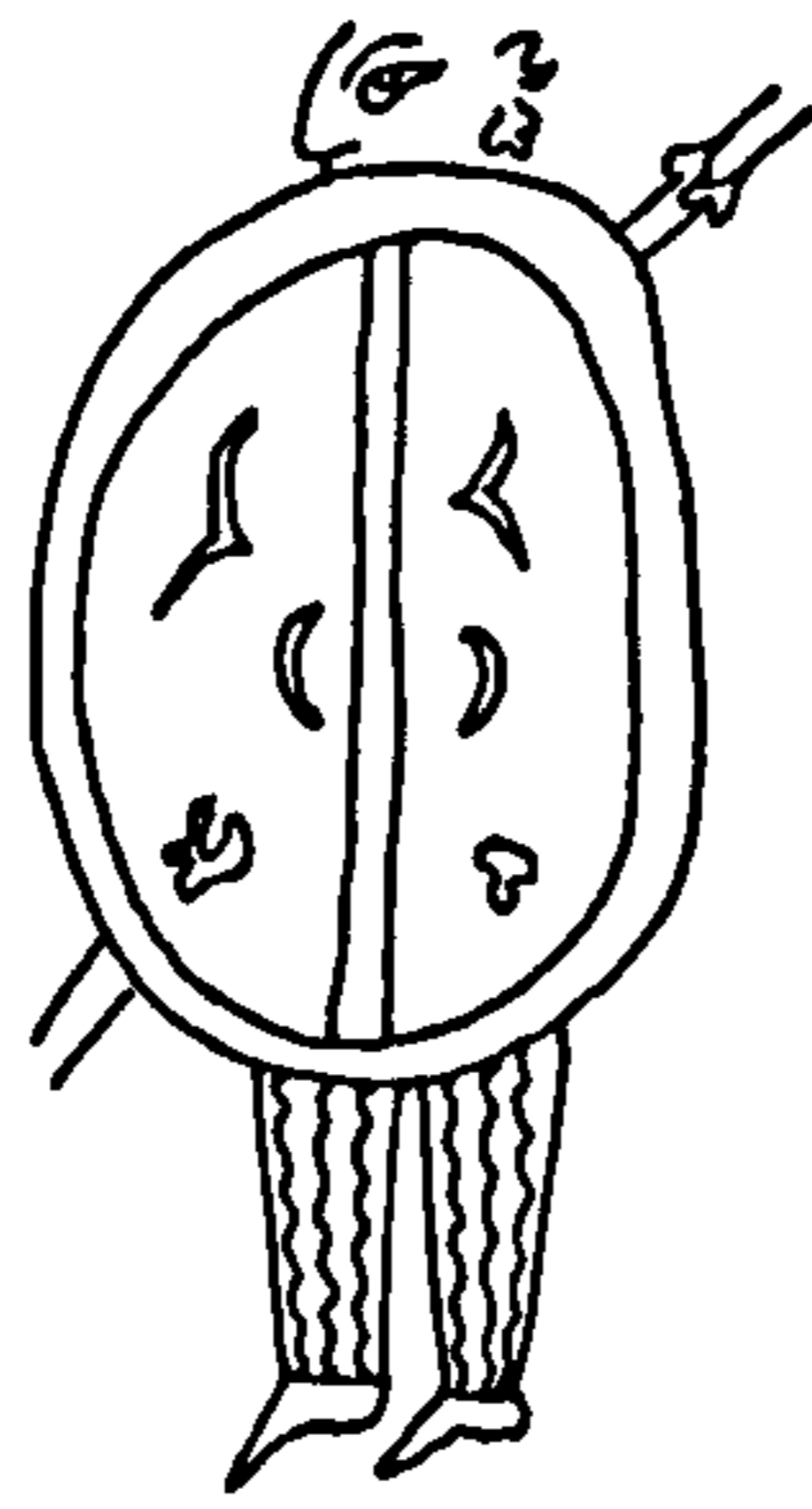

353

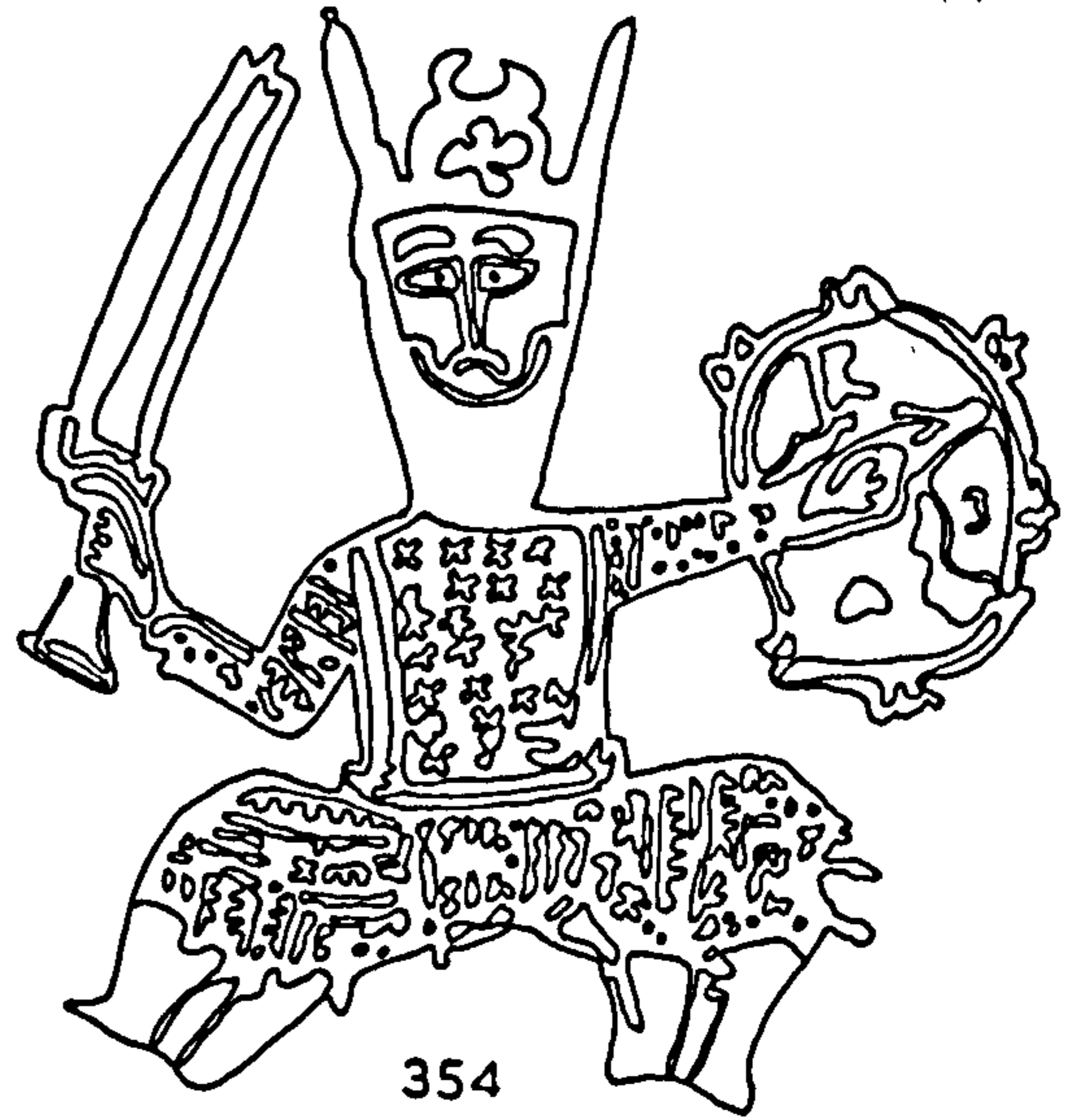

354



355

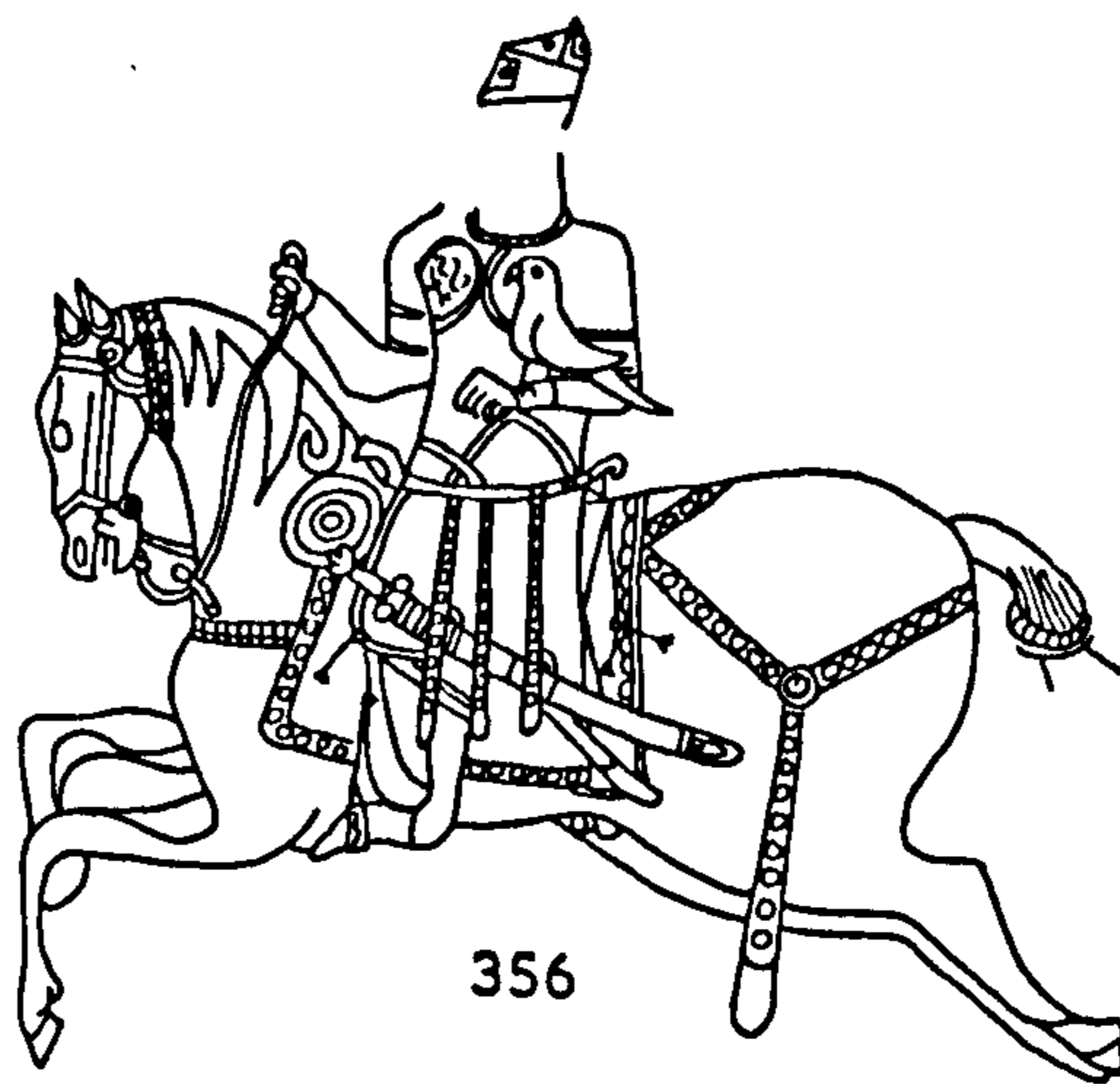

356

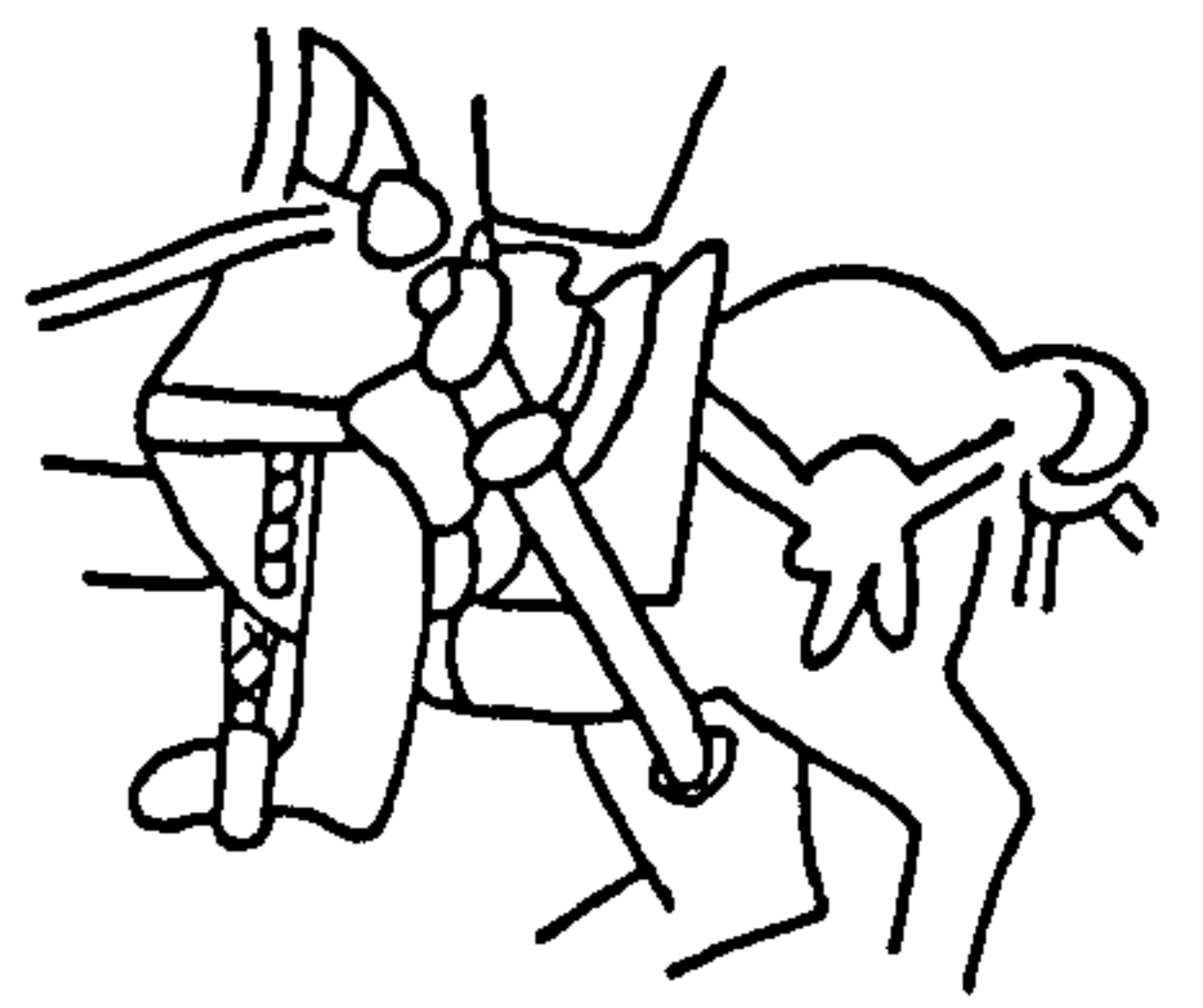

357



358



359

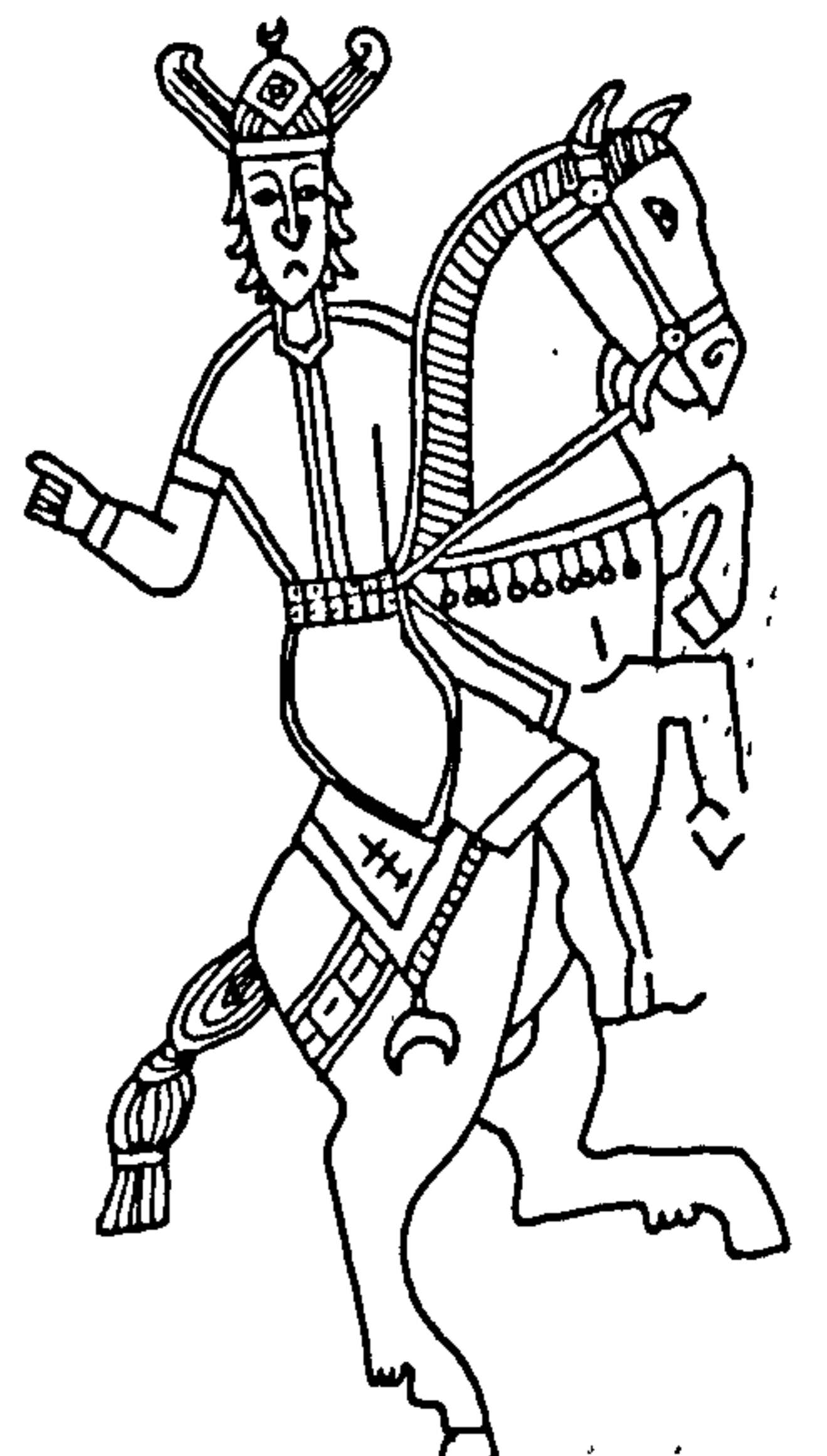

360

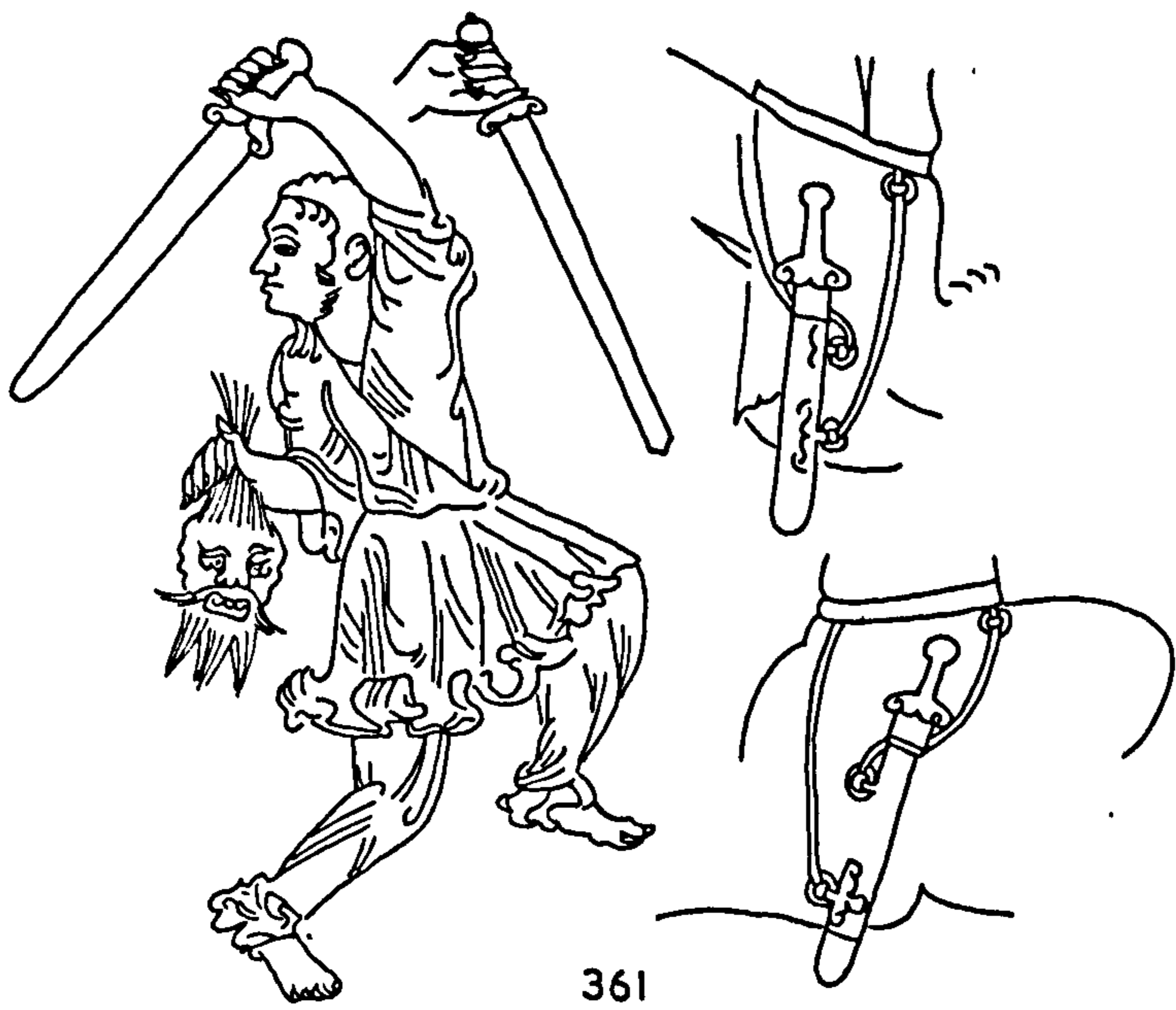

361

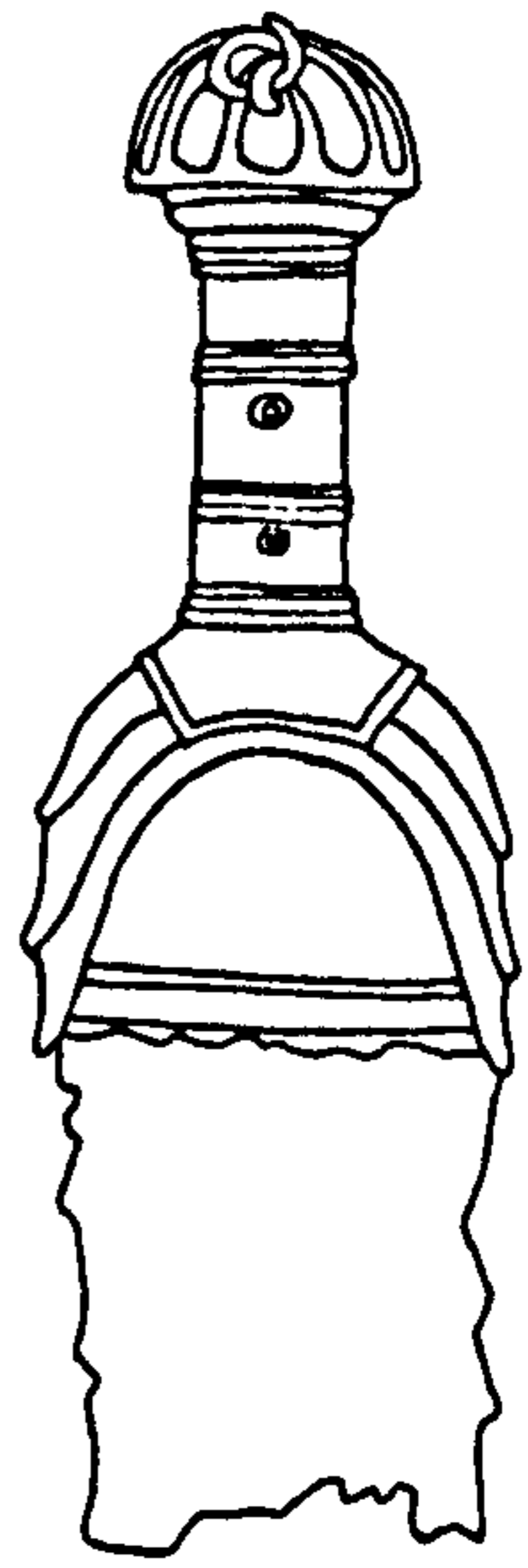

362

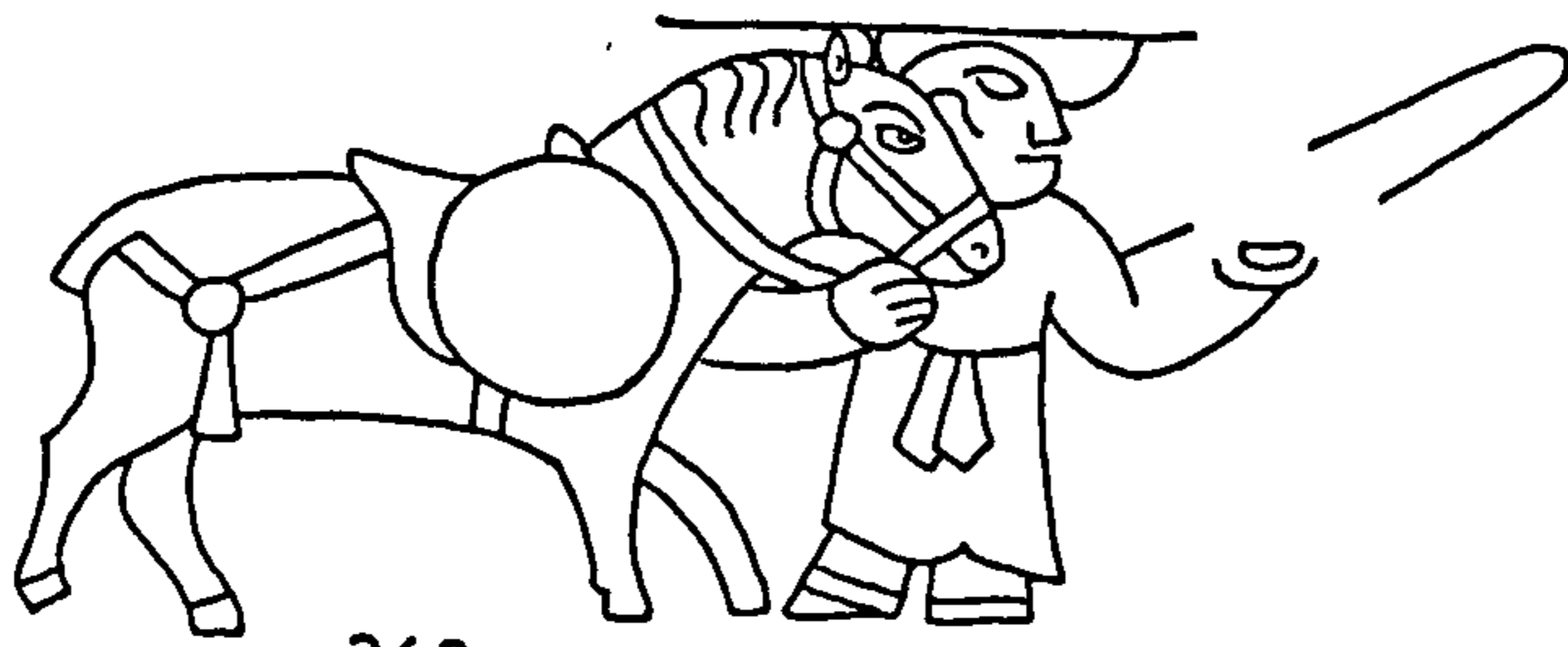

363

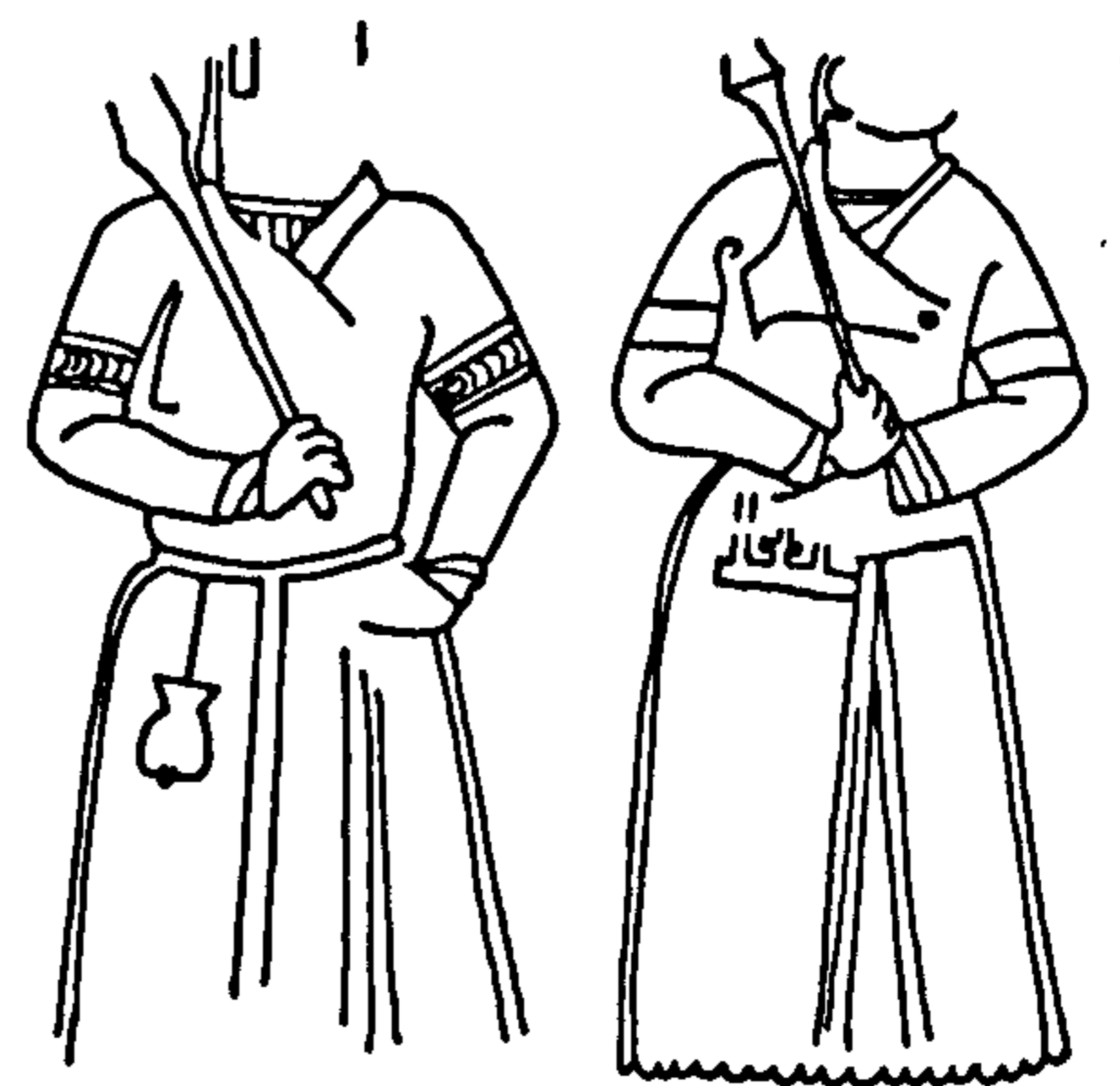

364

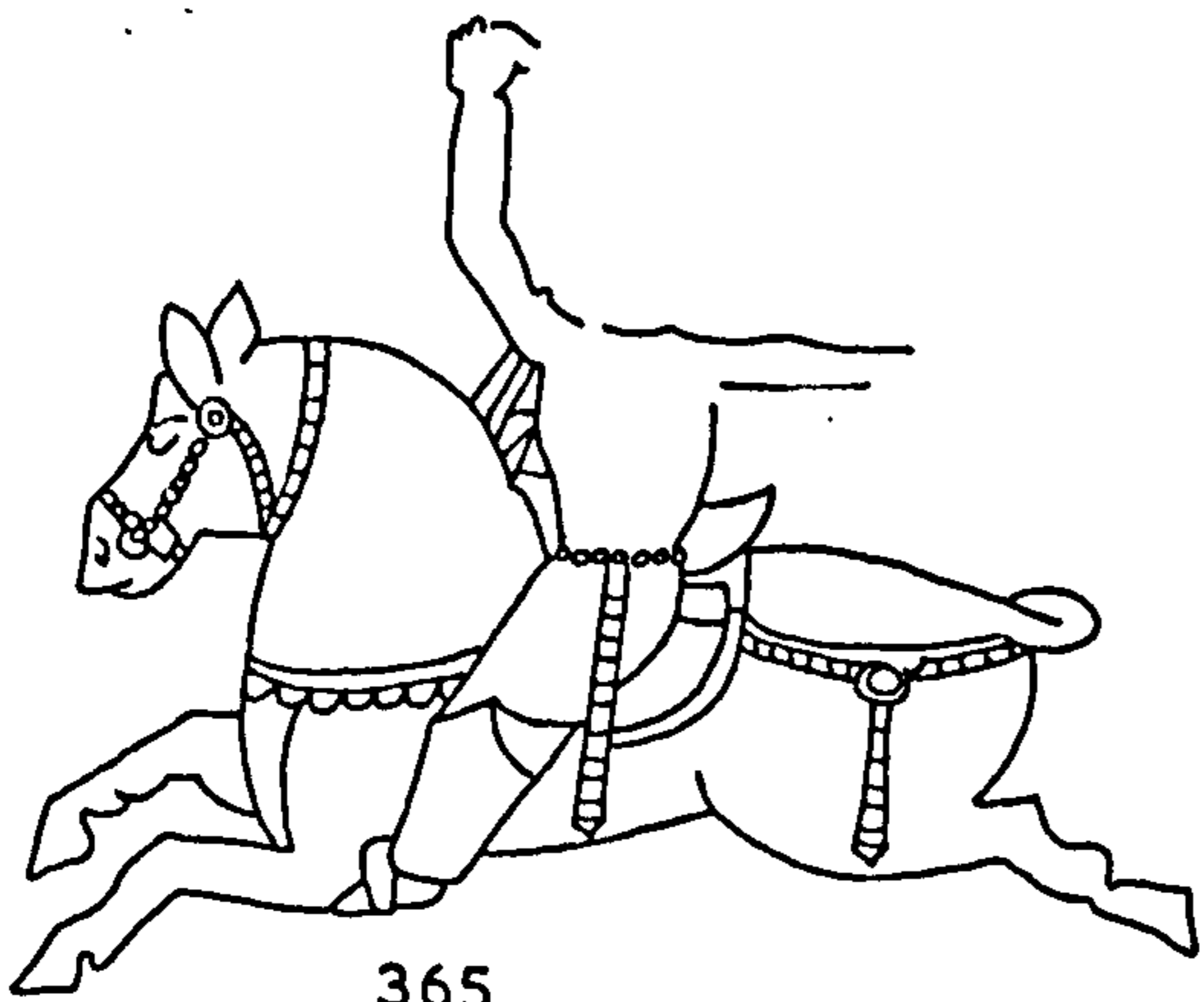

365

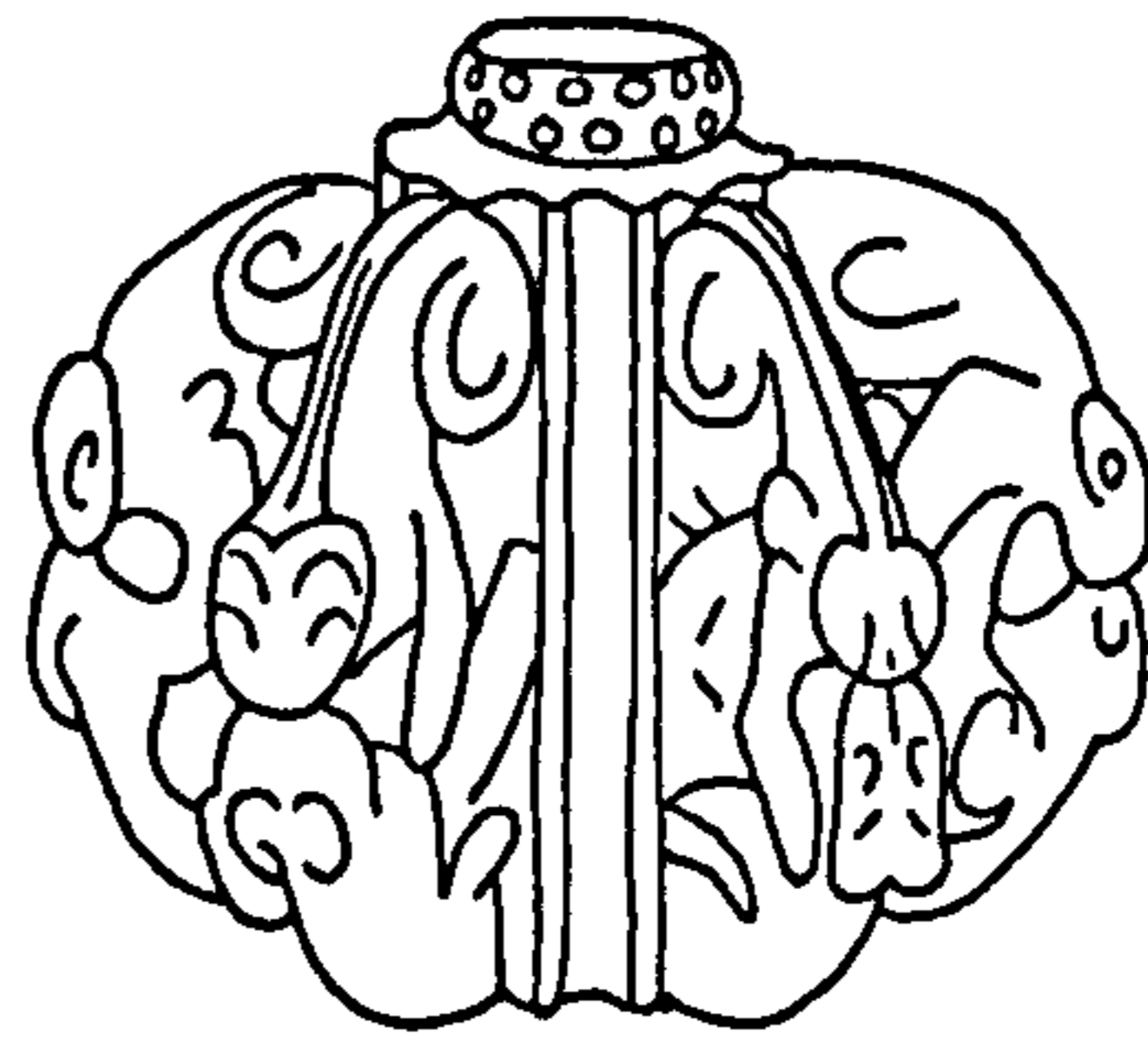

366

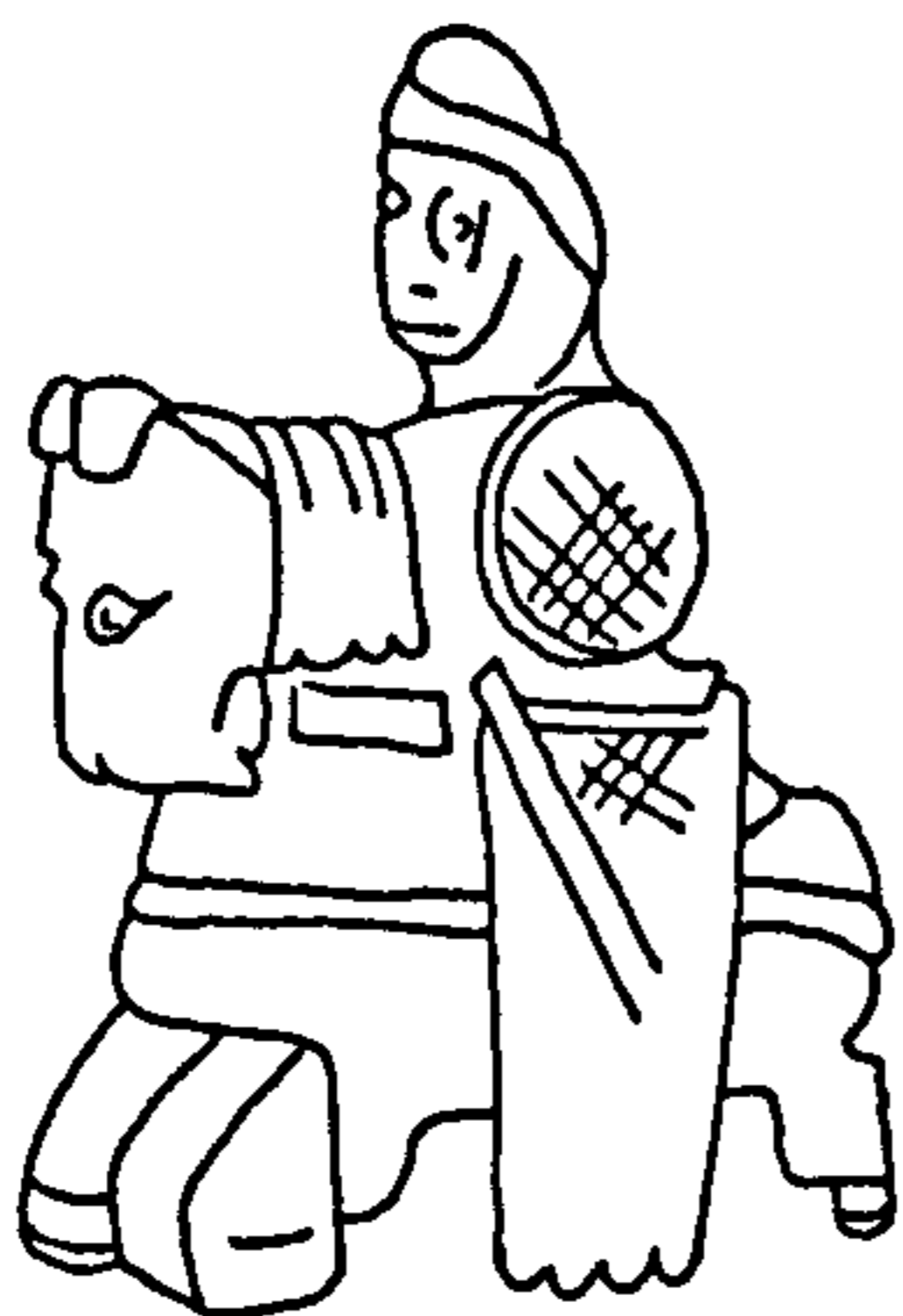
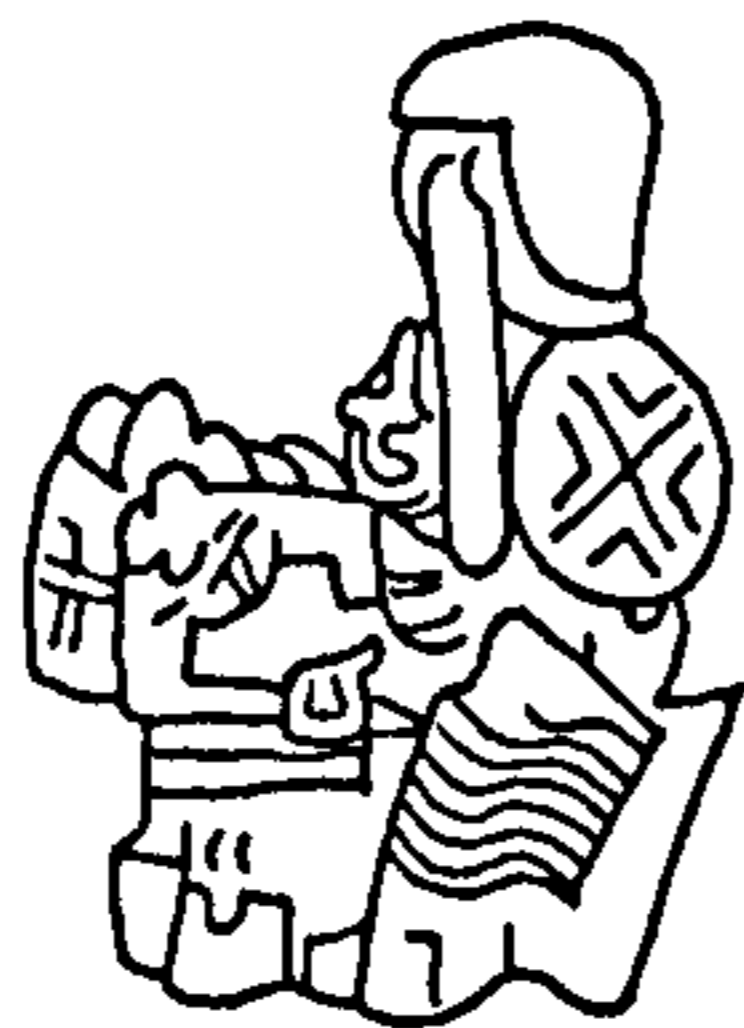

367



368



369

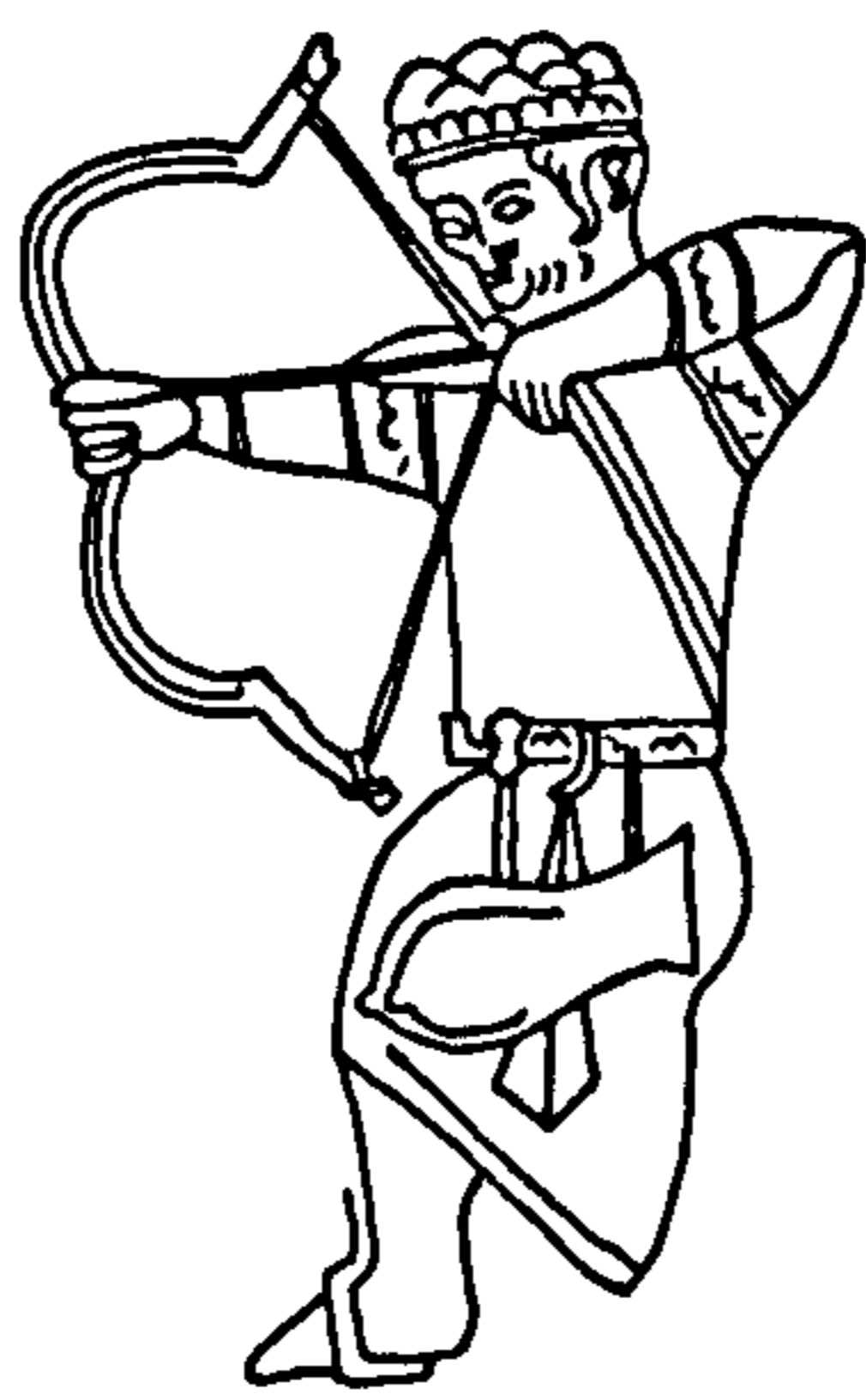

370



371

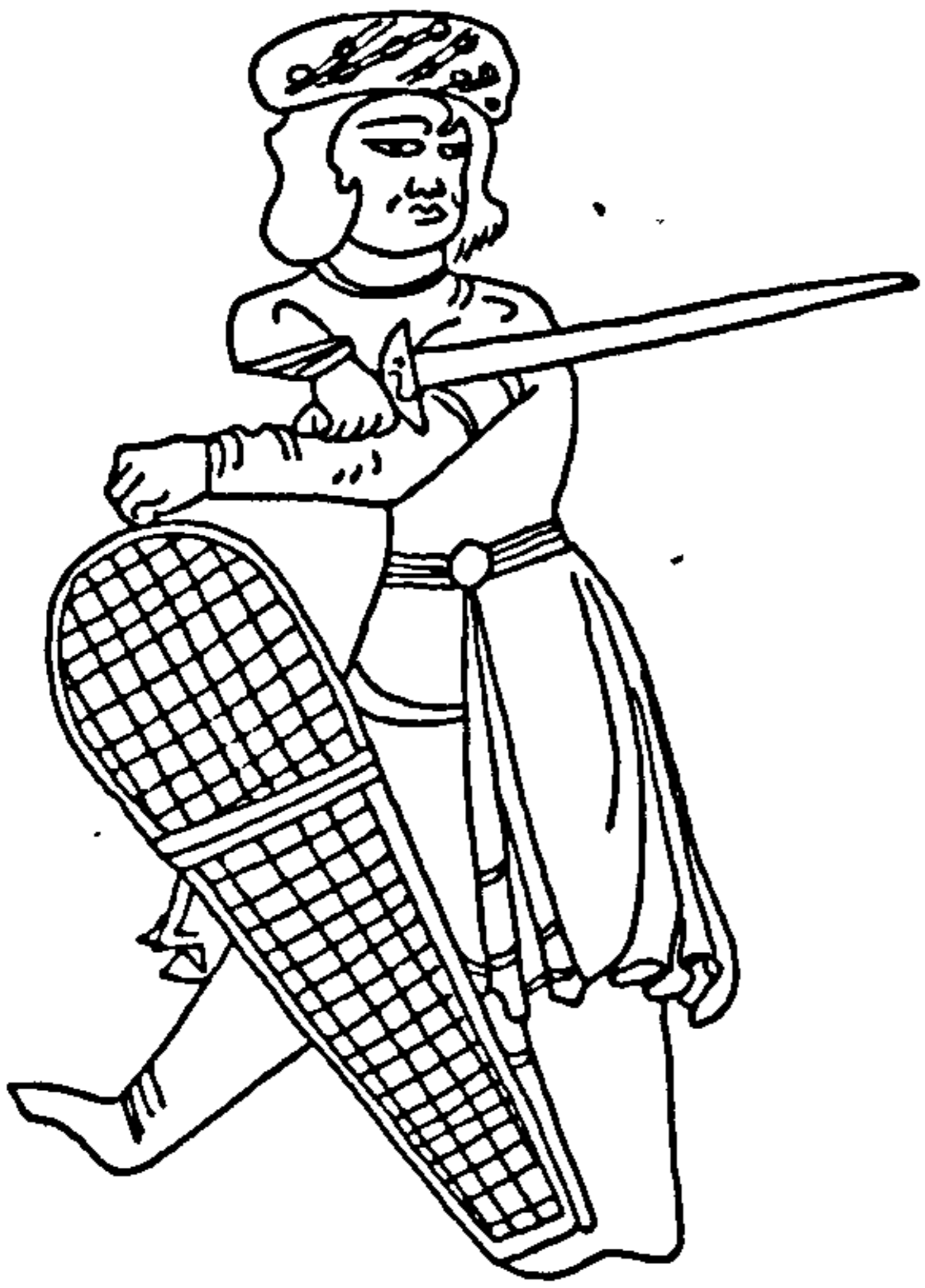

372



373

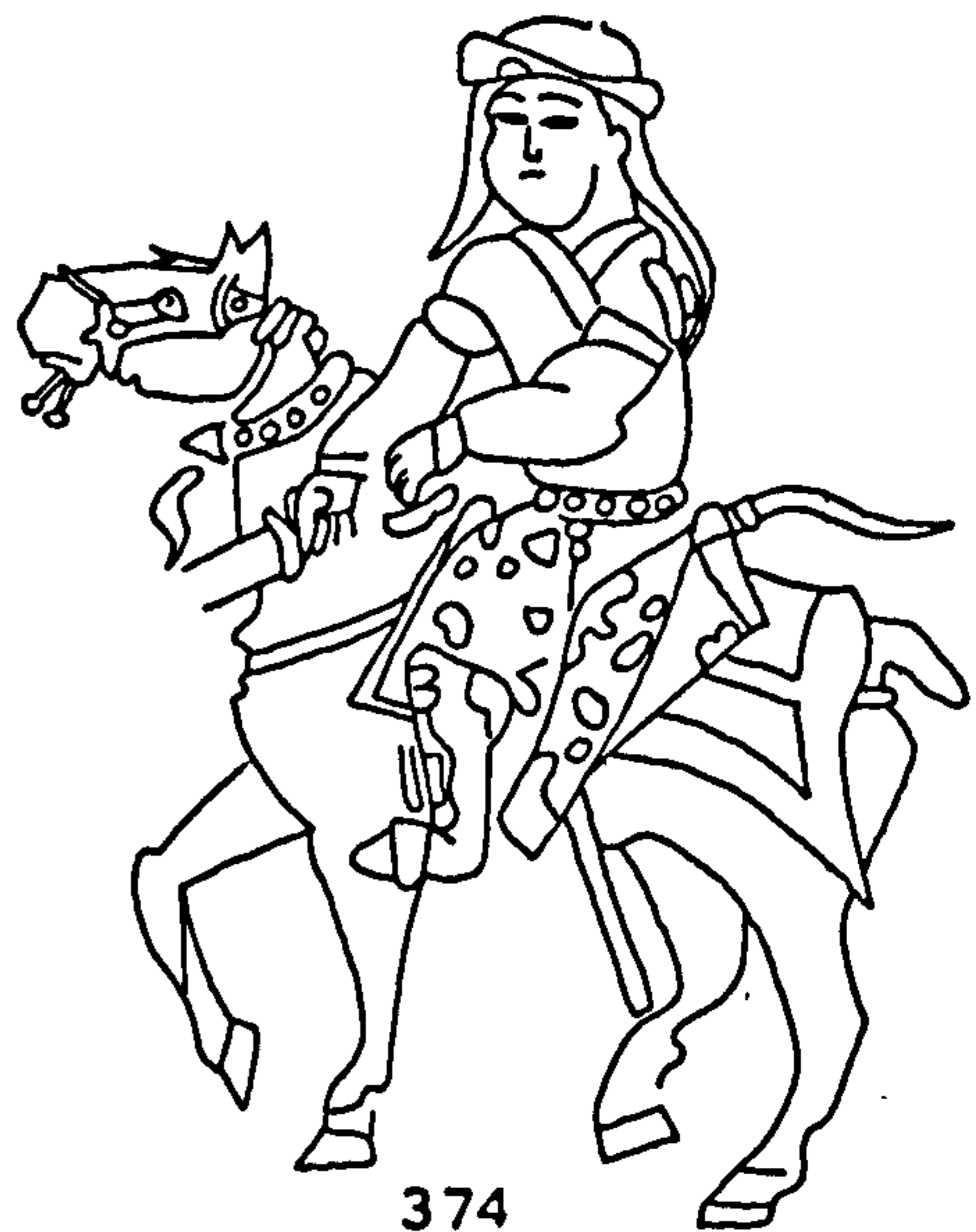

374



375



376



377

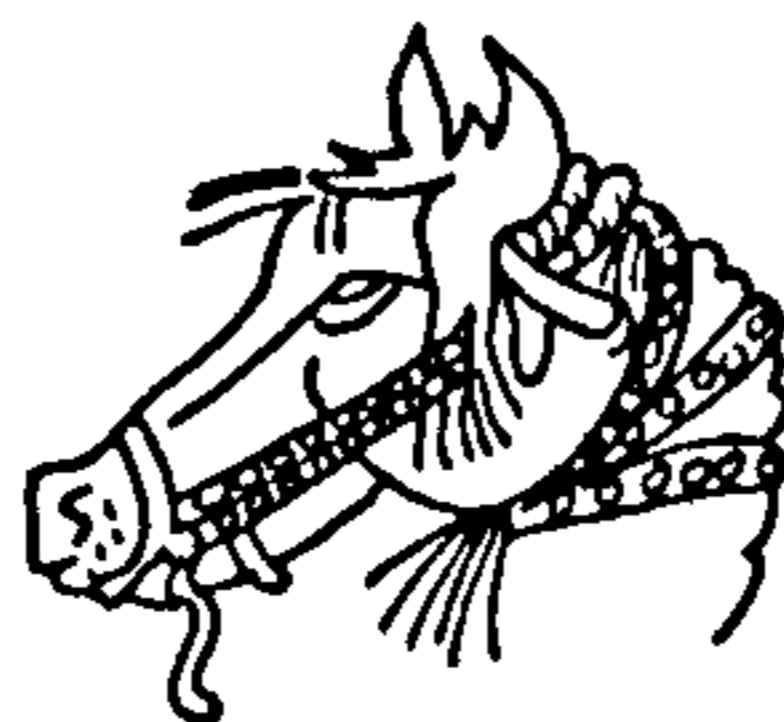

378





379

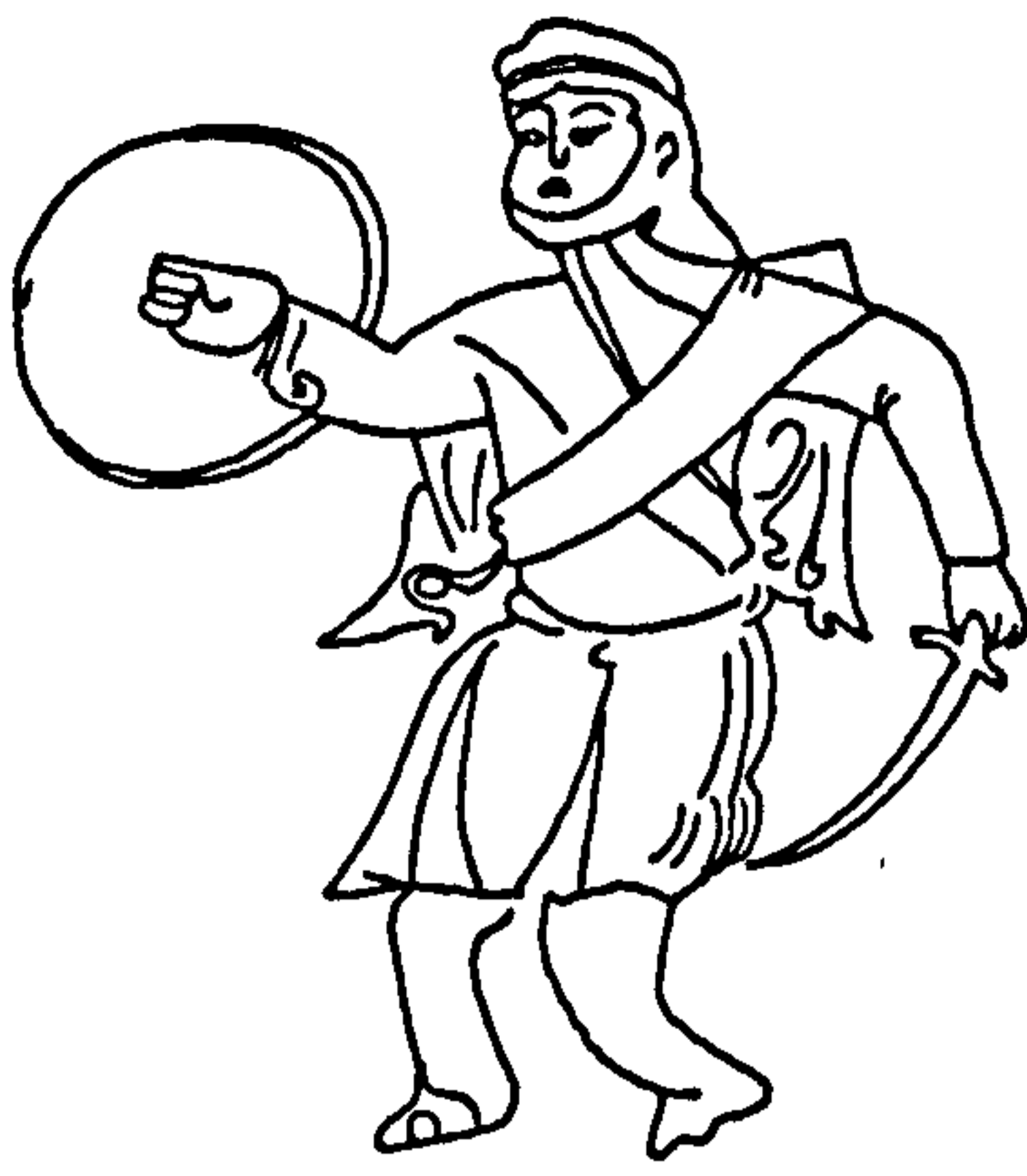

380

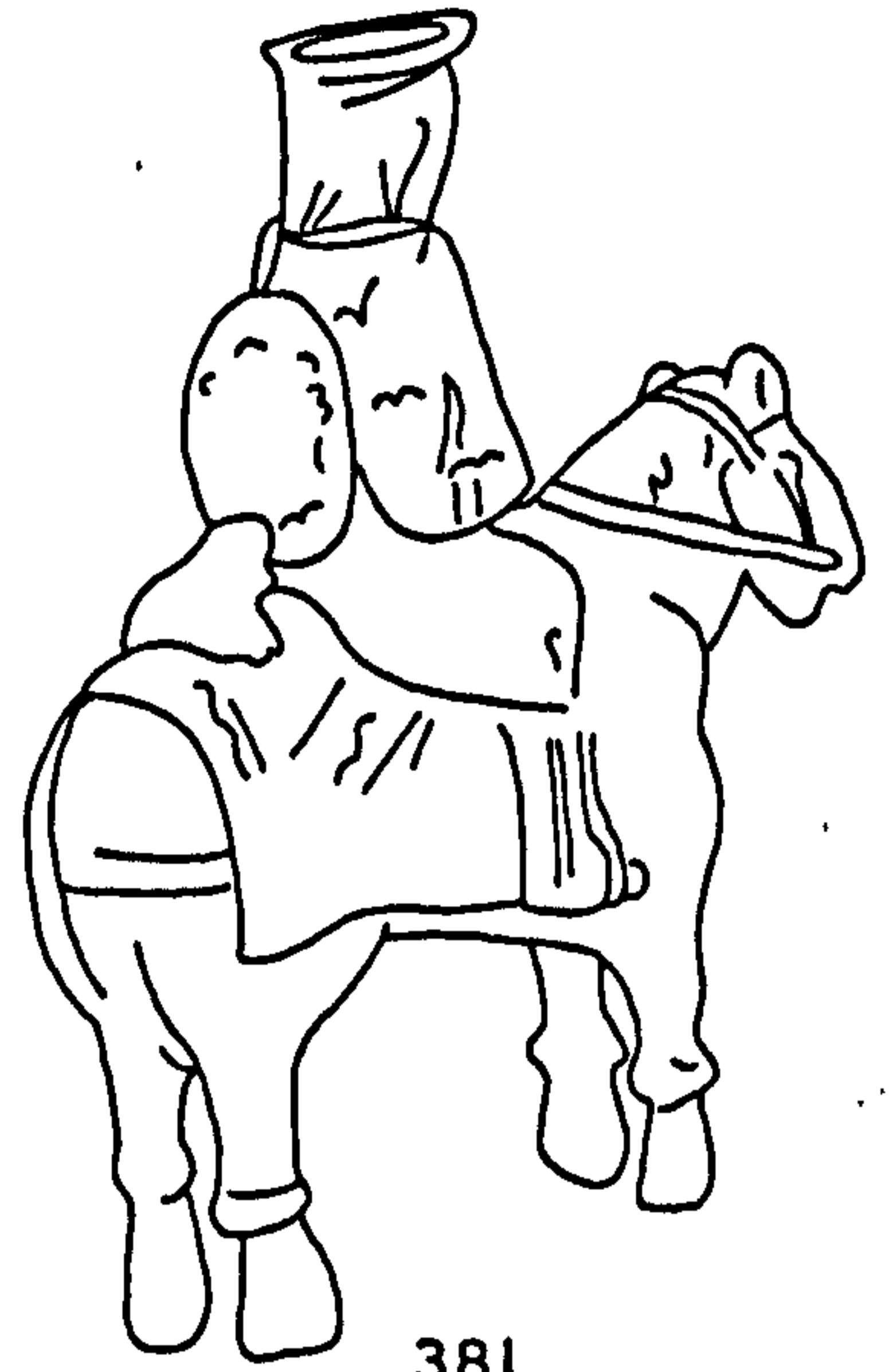

381

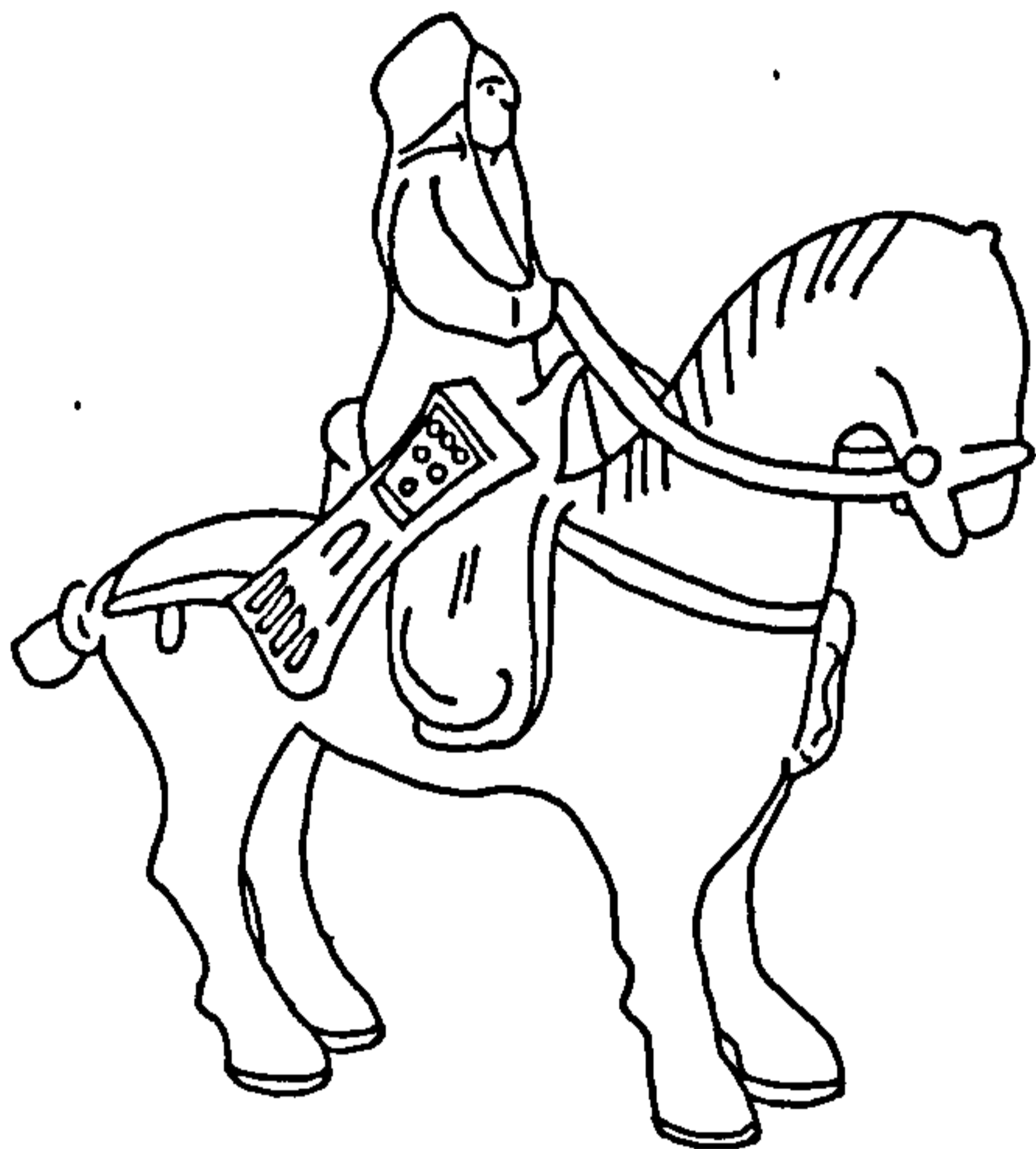

382

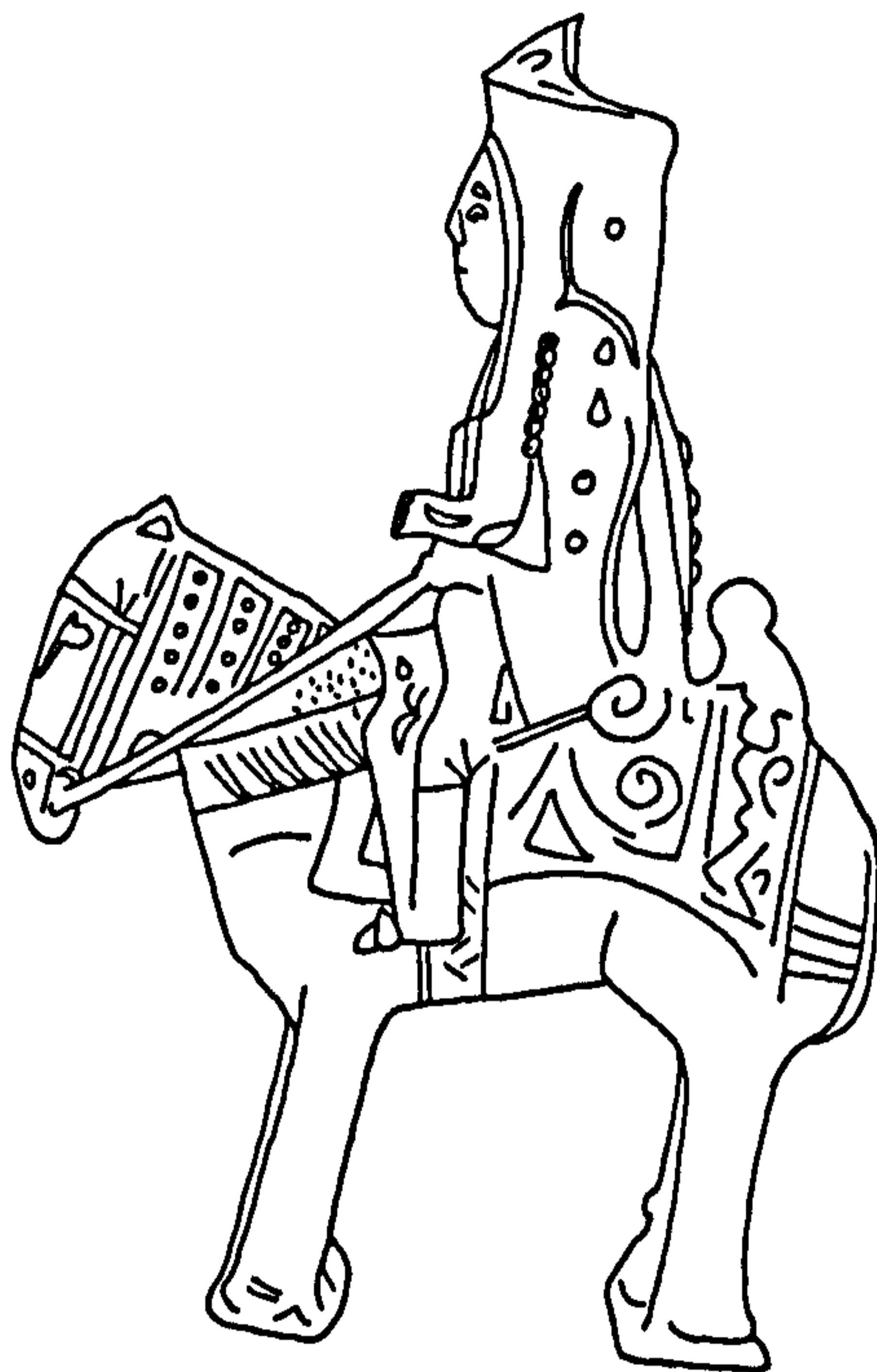

383



384

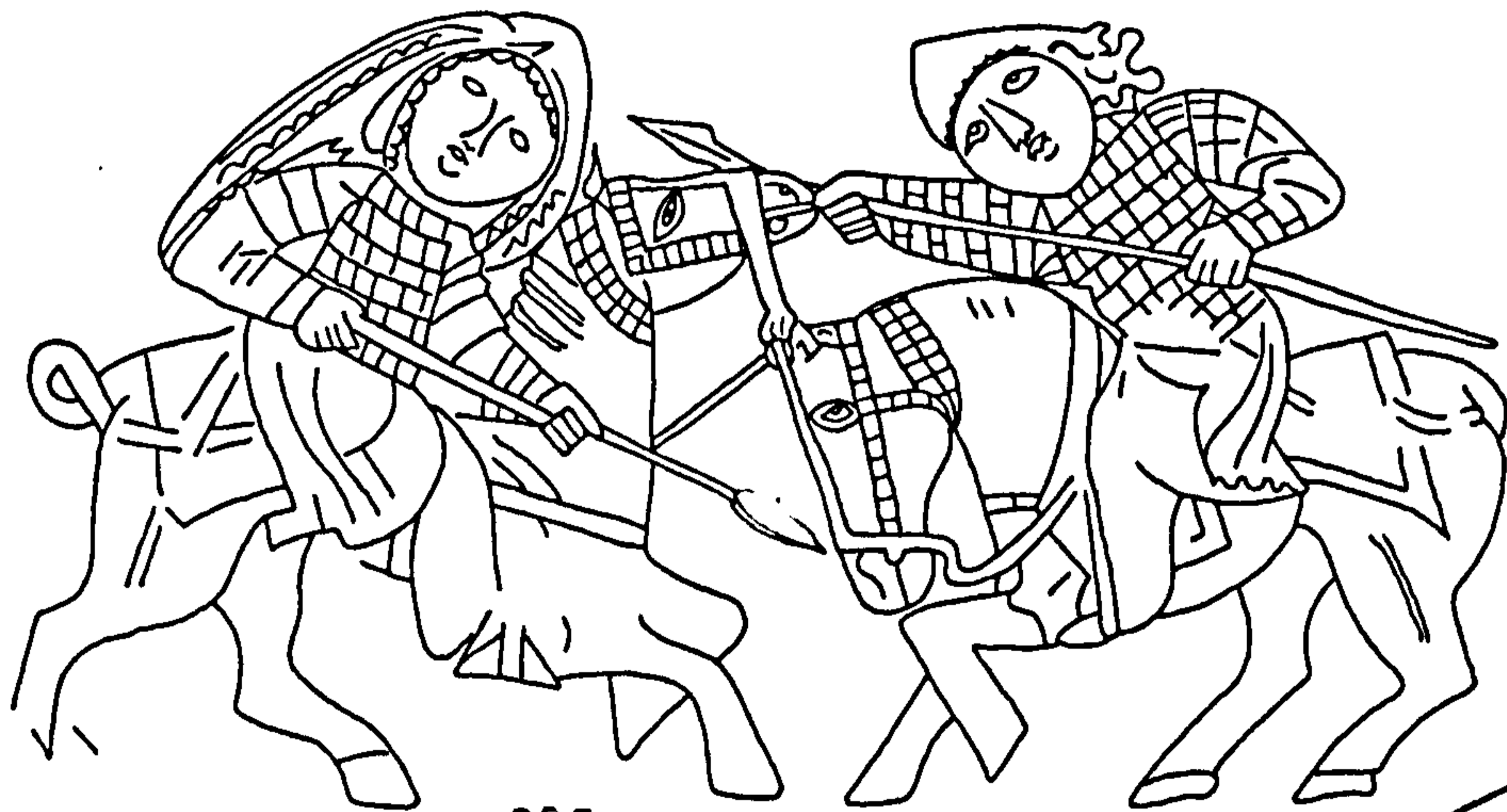

385

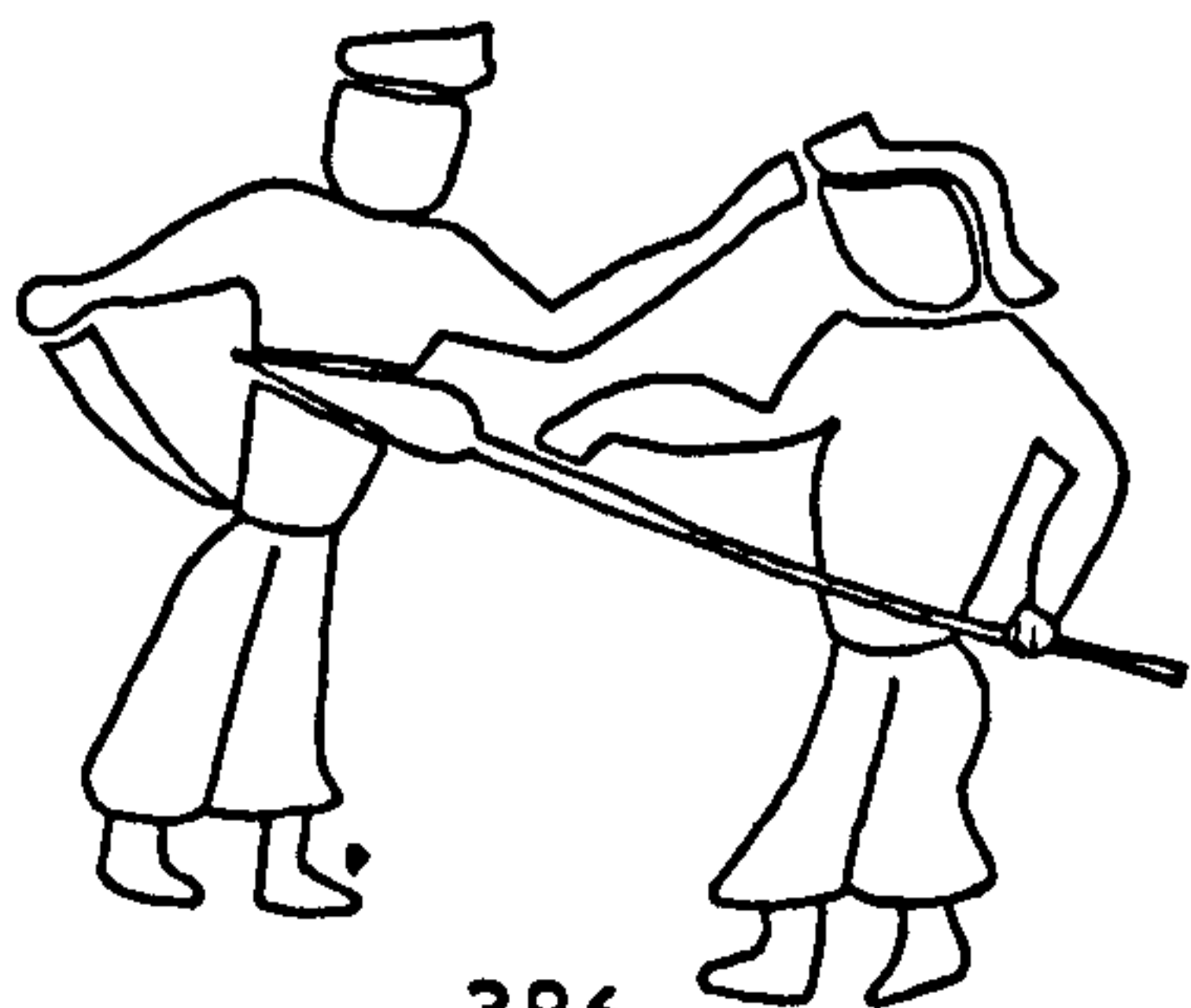

386

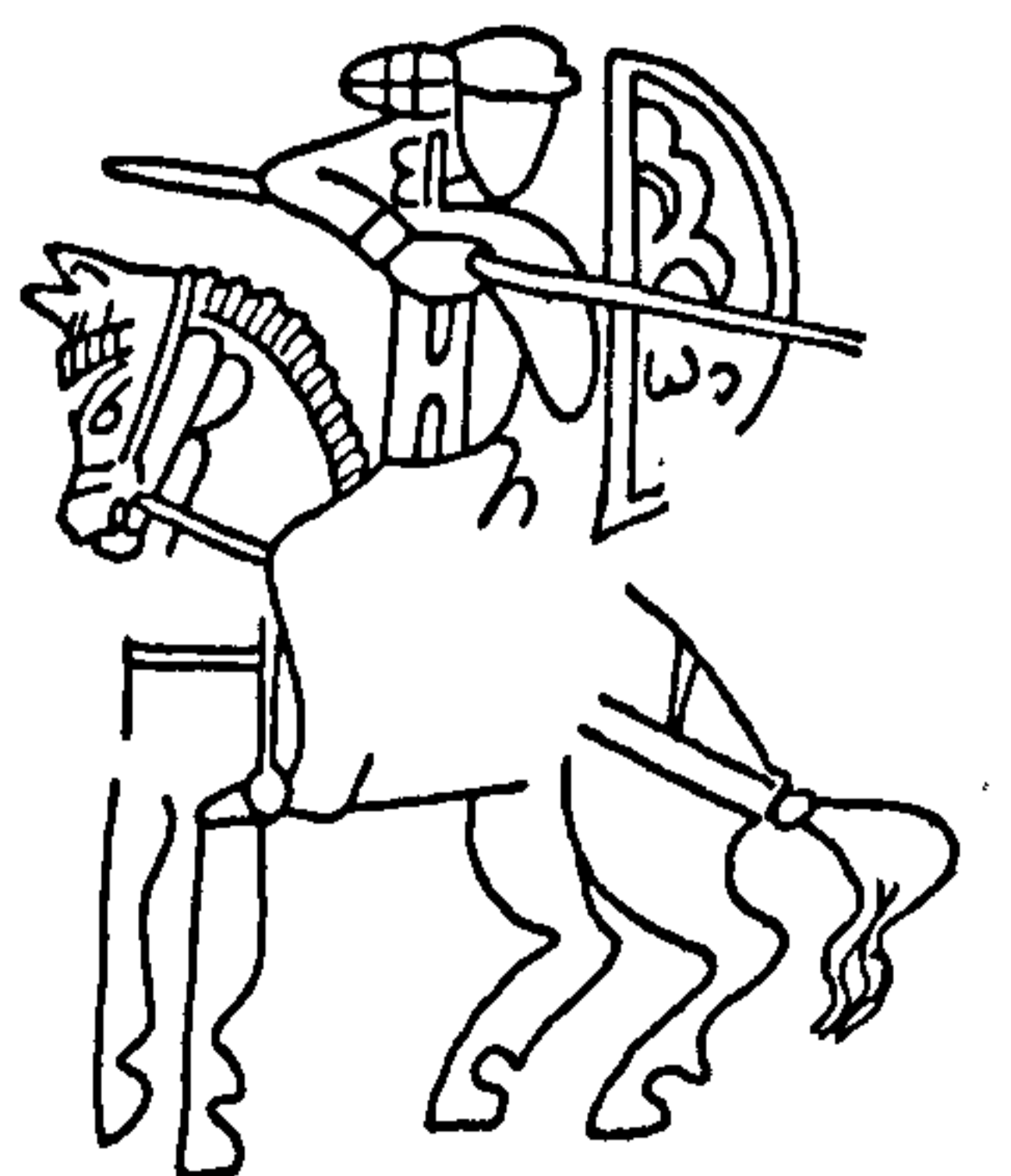

387

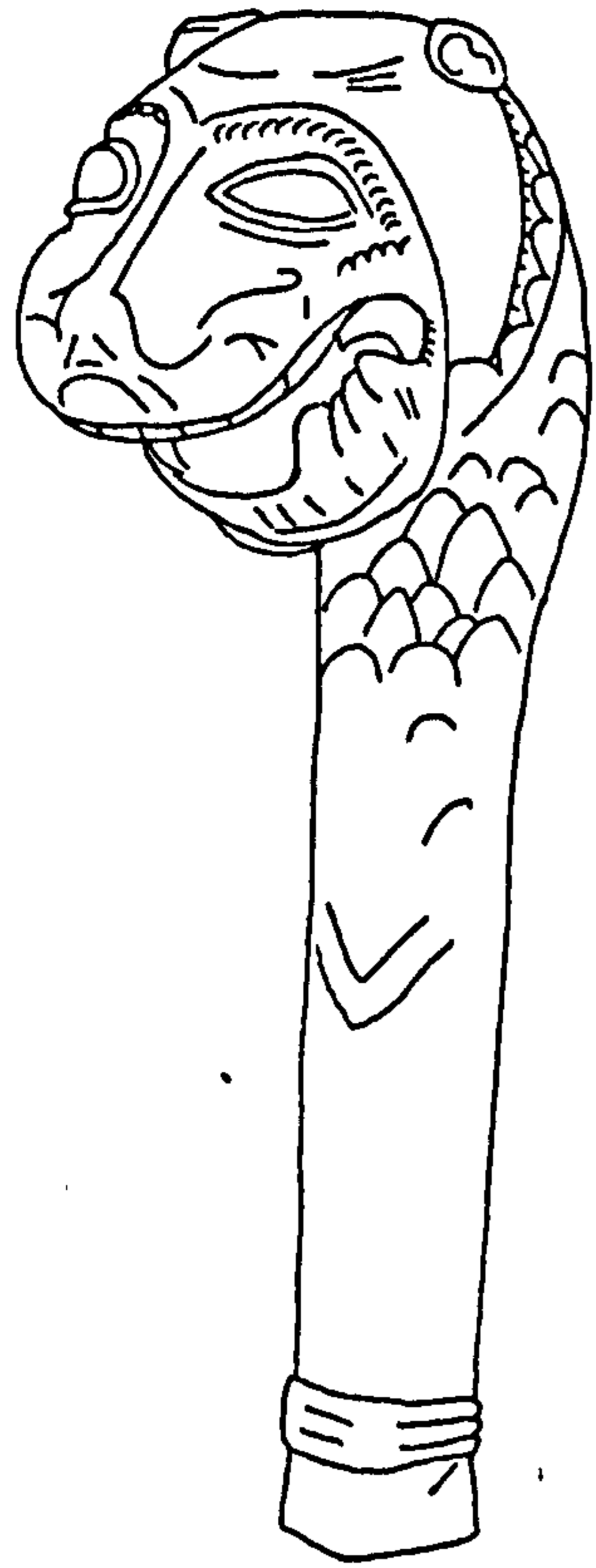

388A



388B

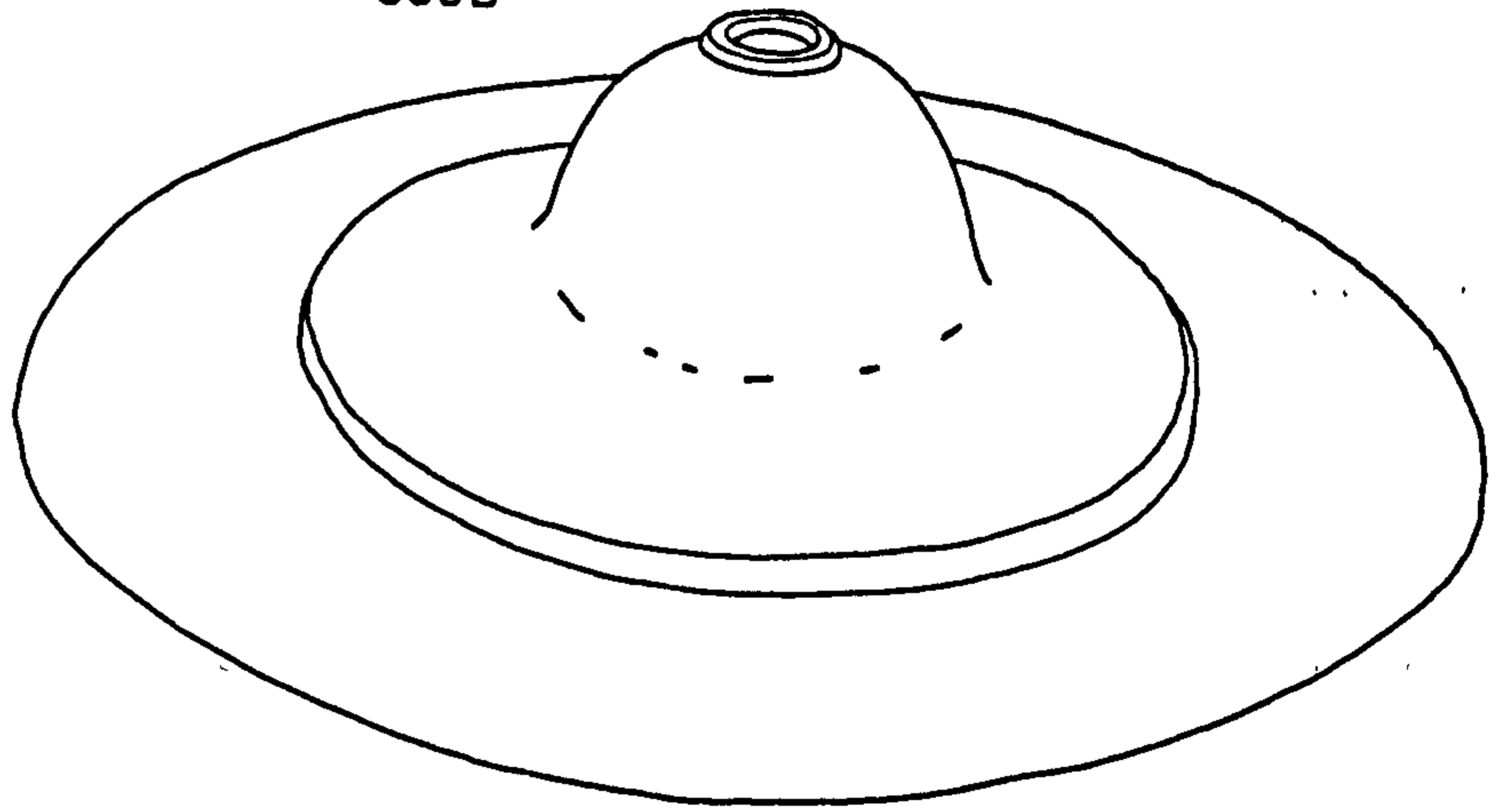

388C

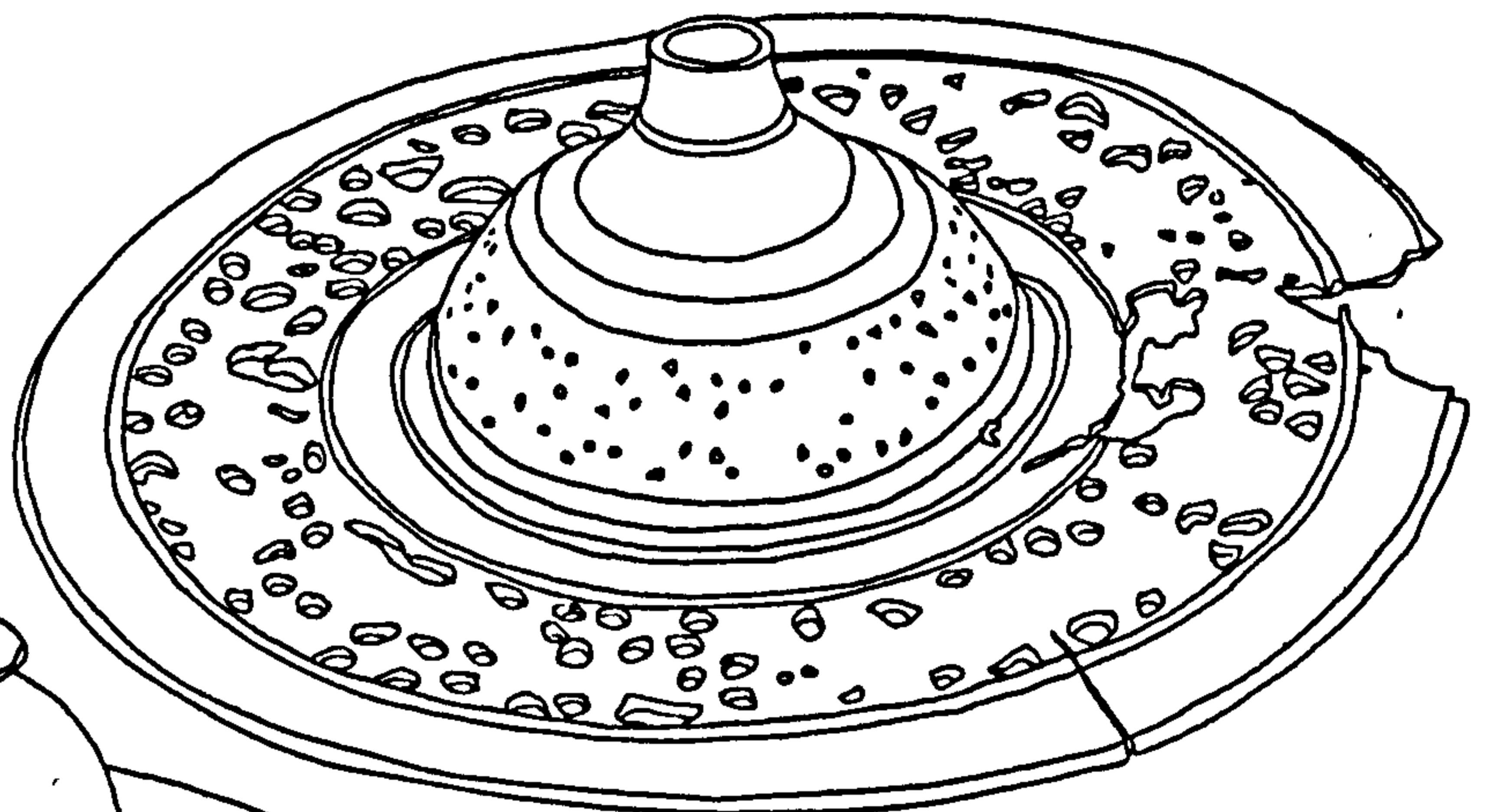

388D

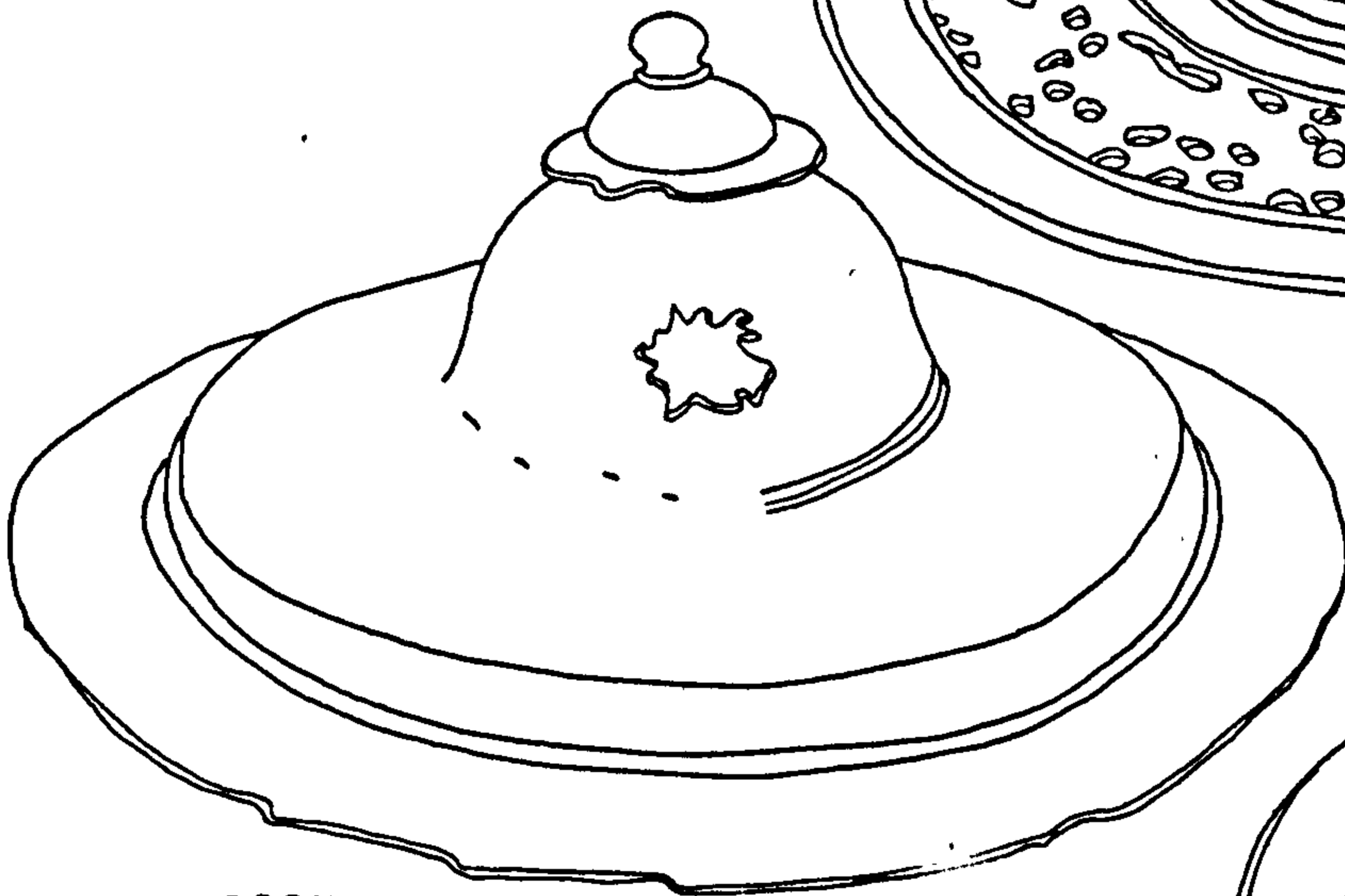

388E

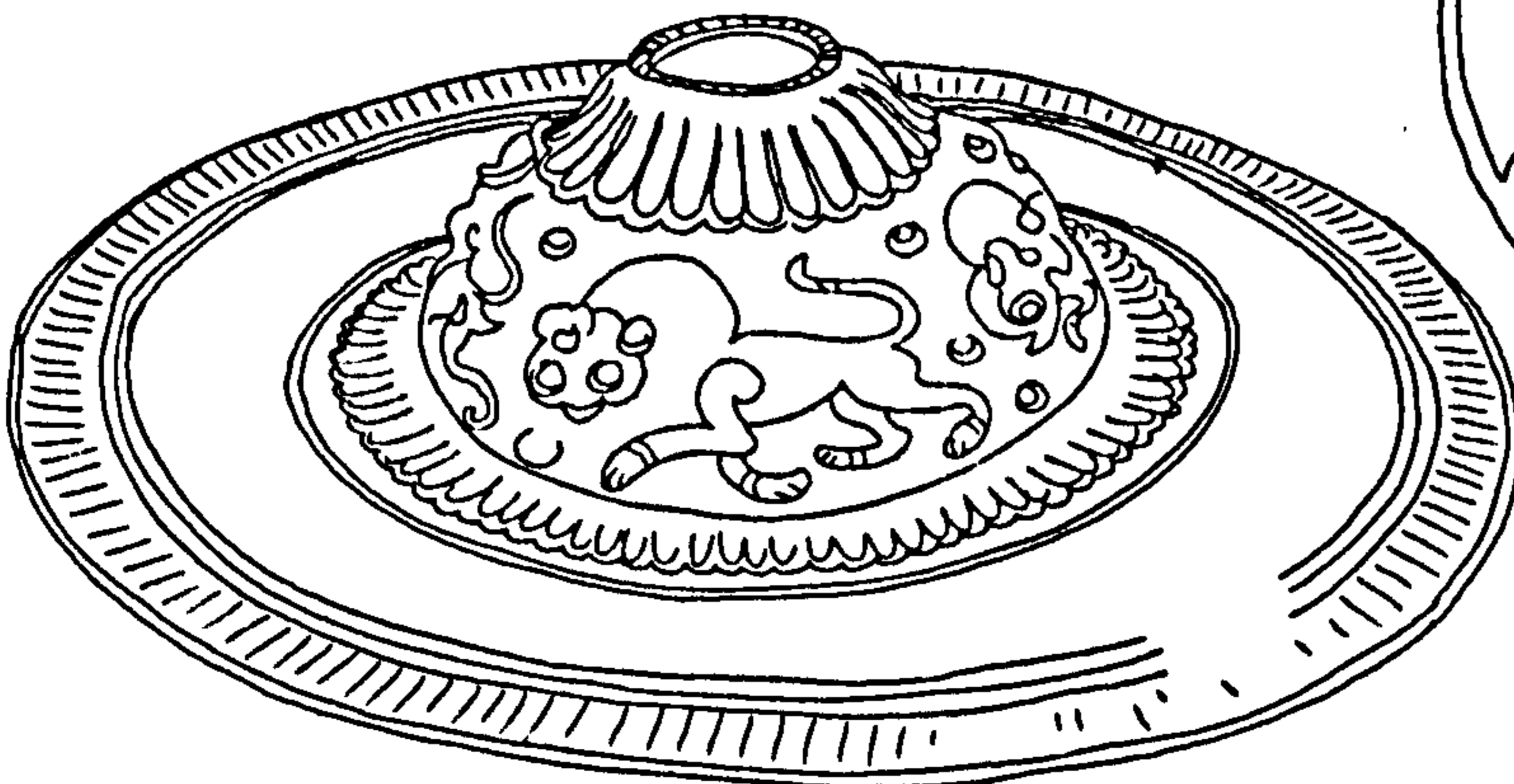

388G

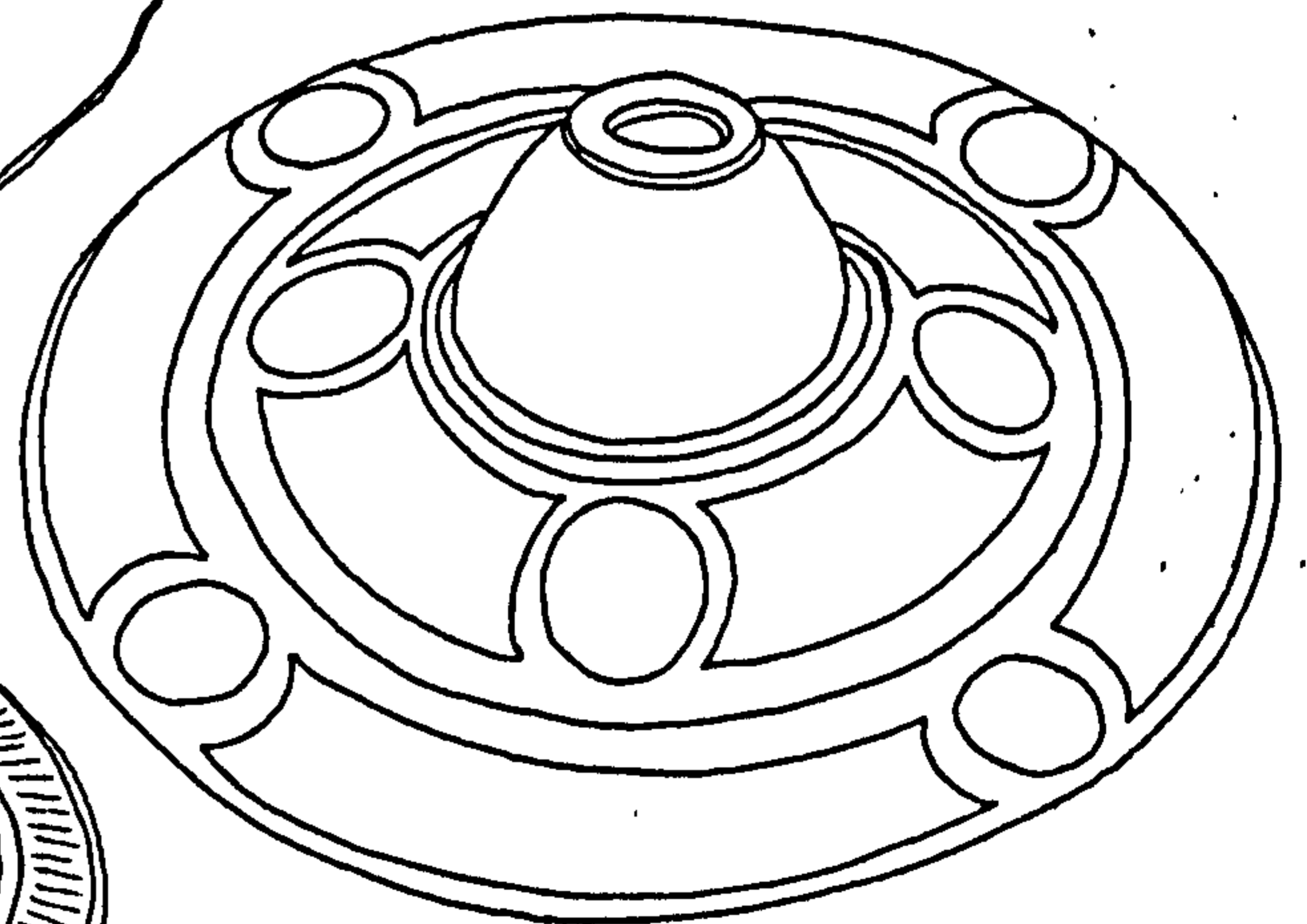

388F

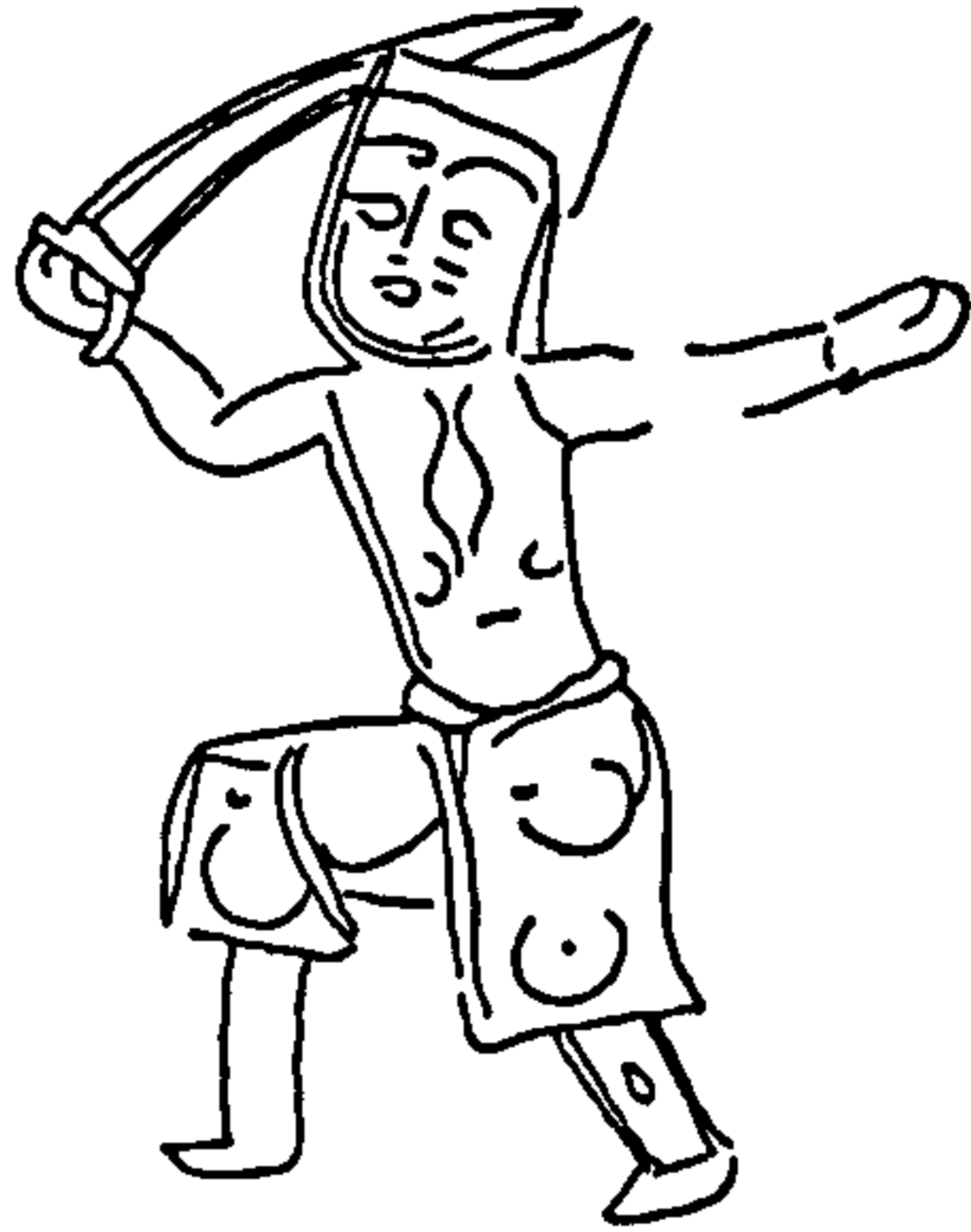
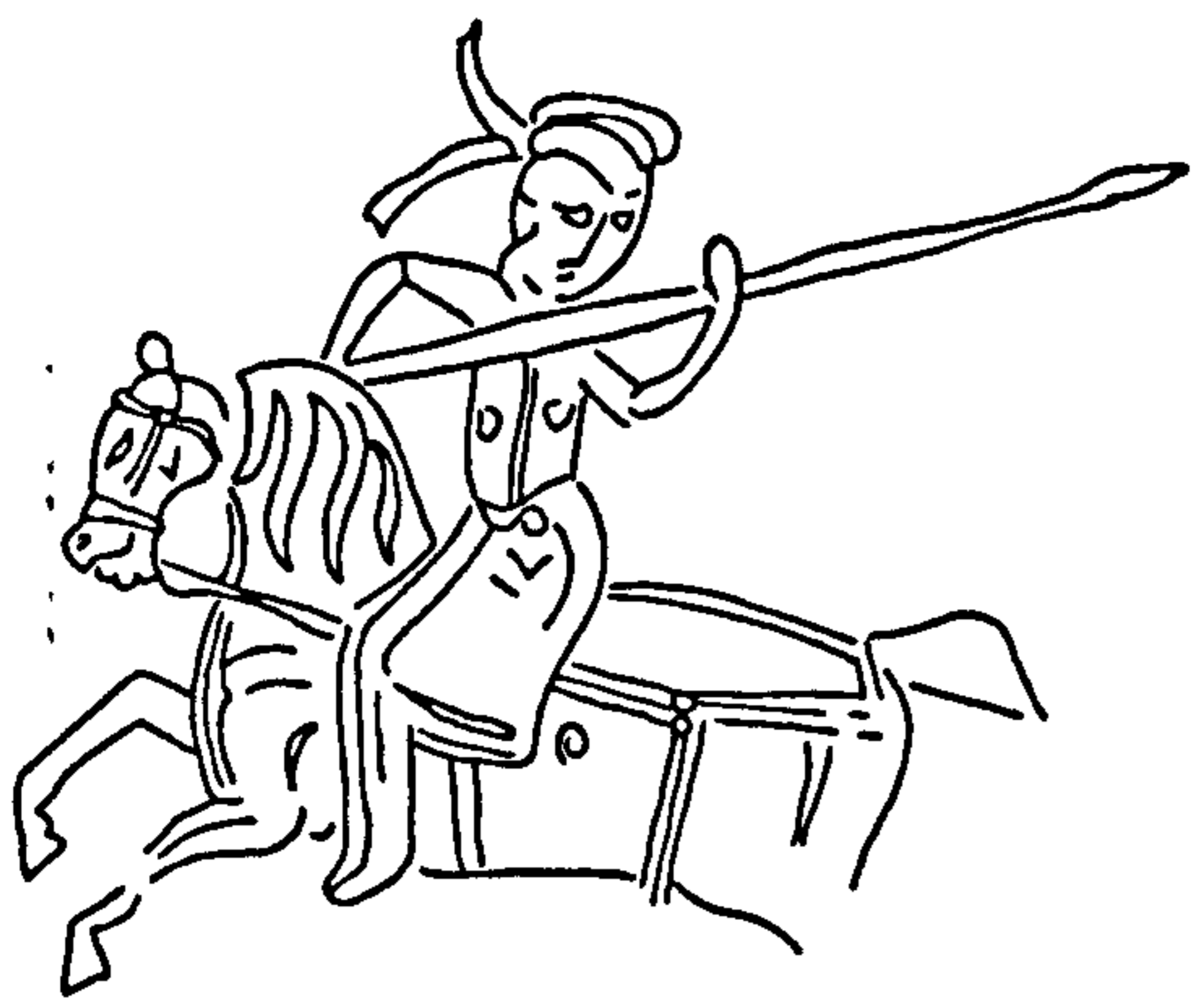

389

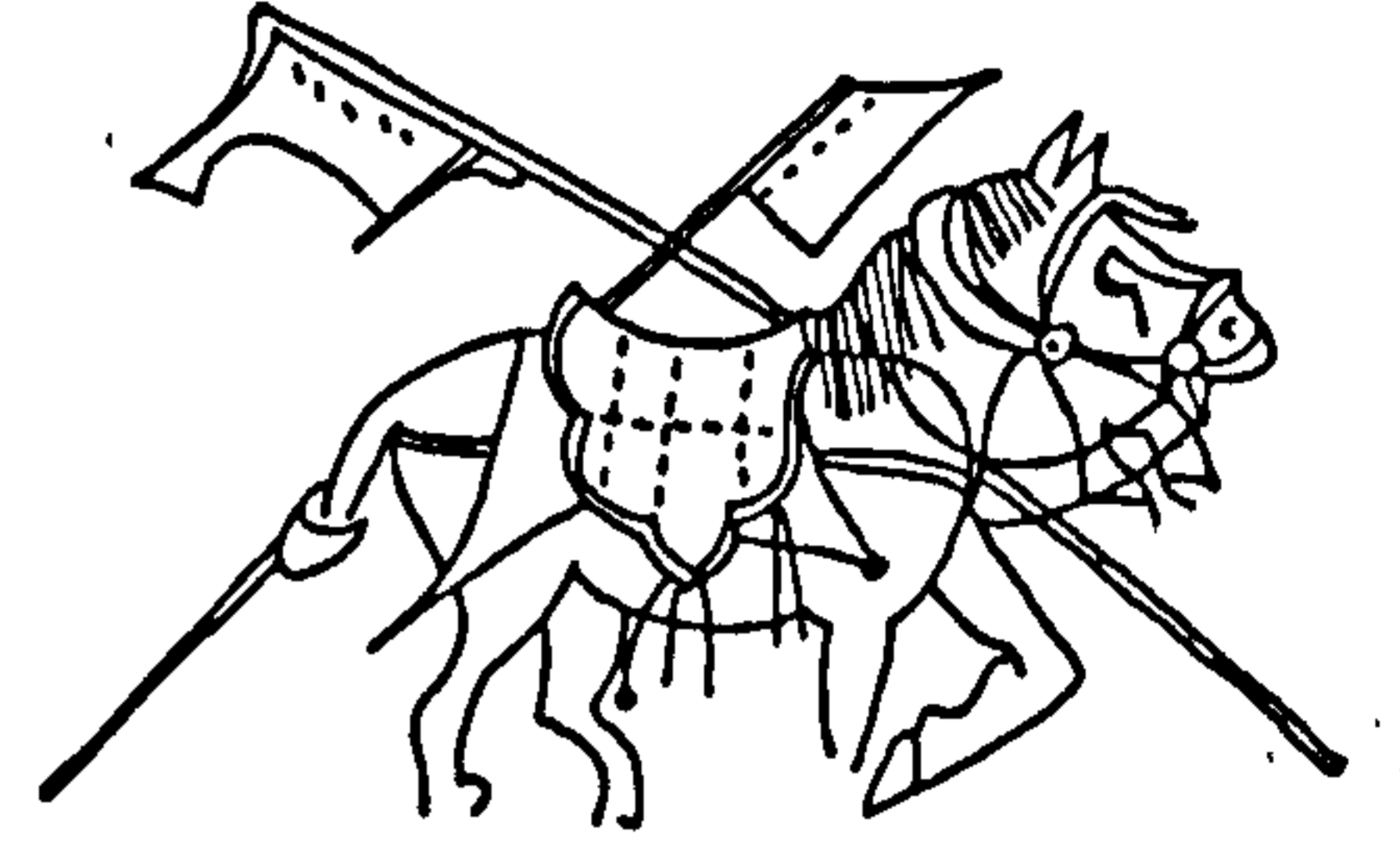

390

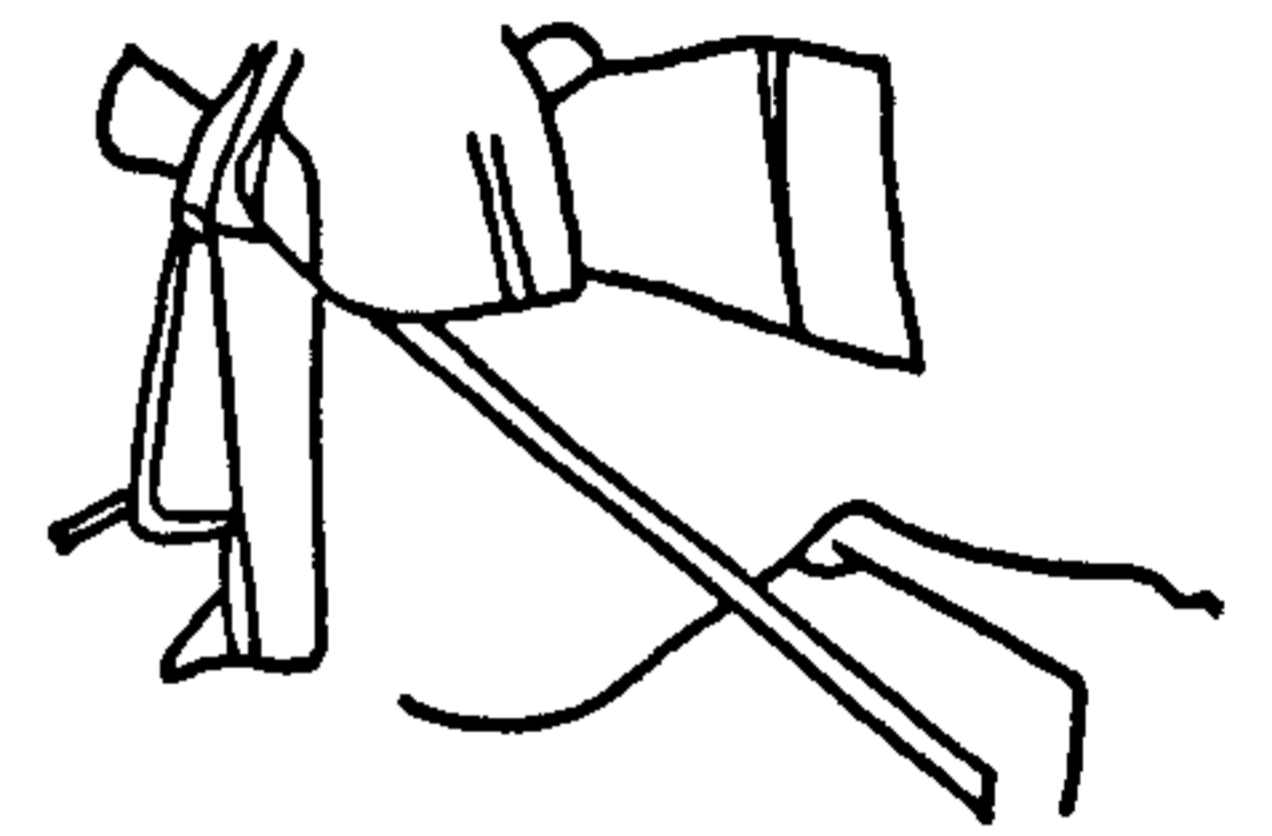

391

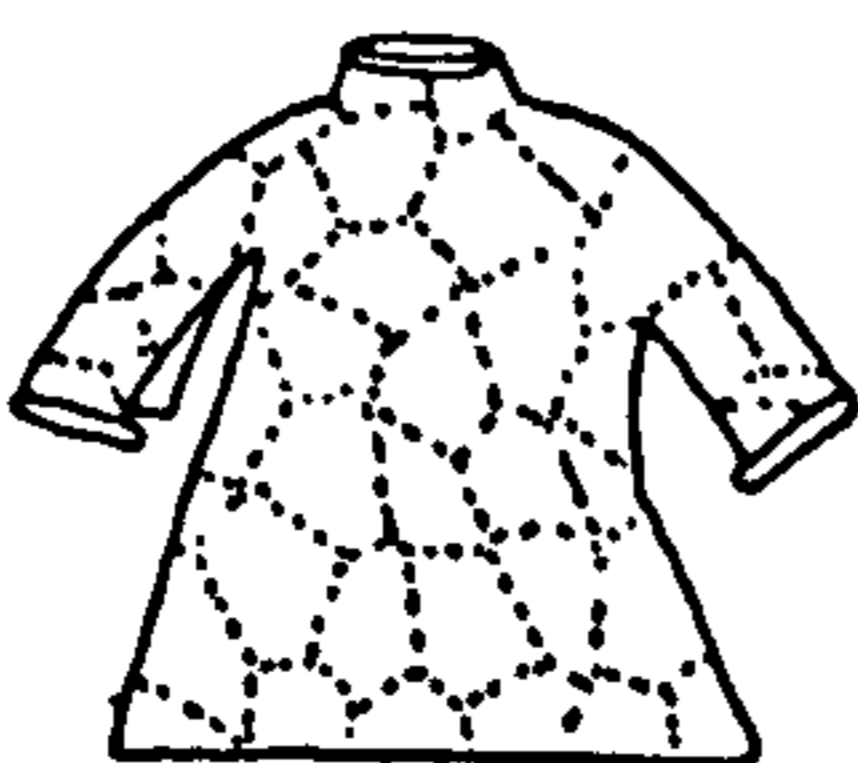
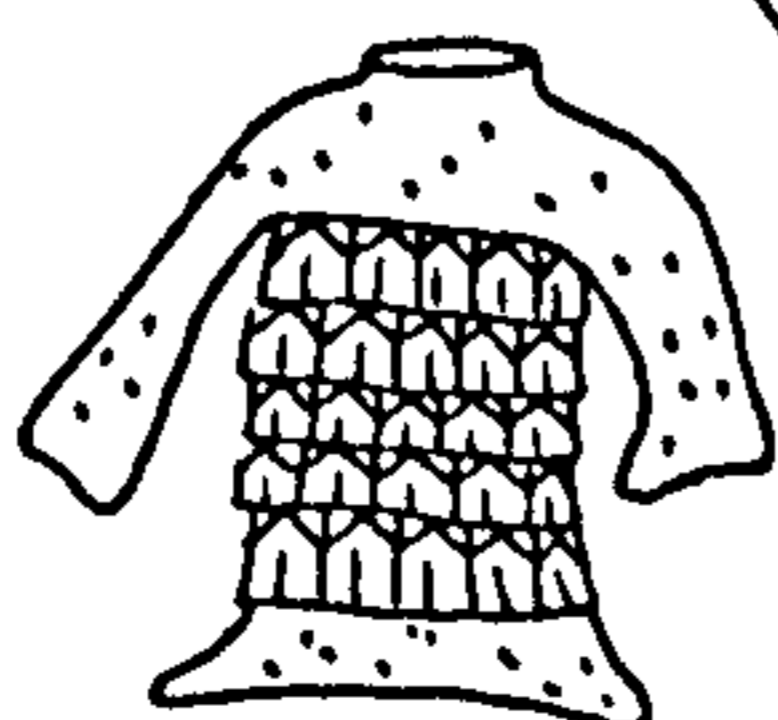
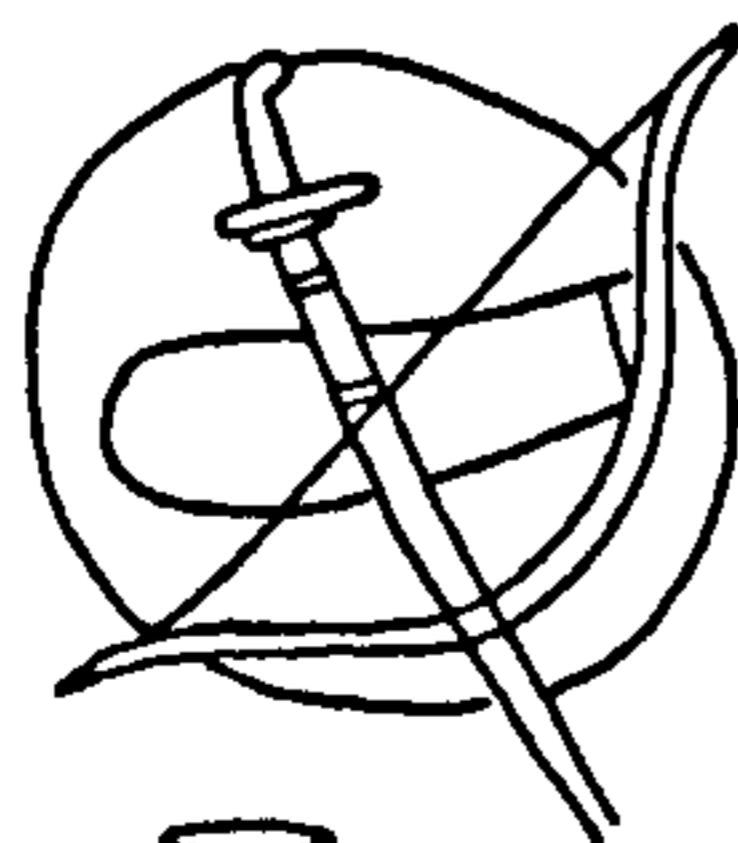
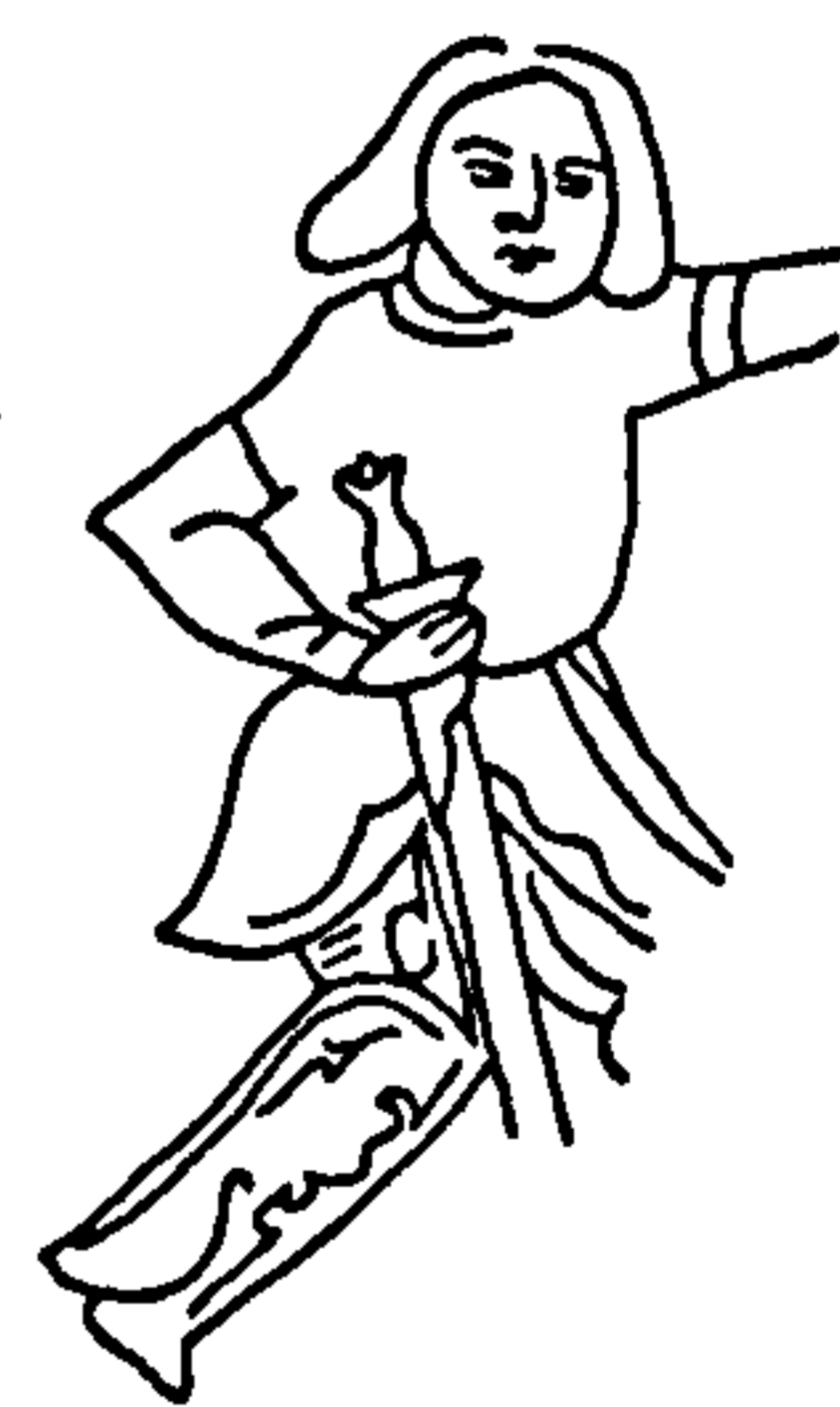
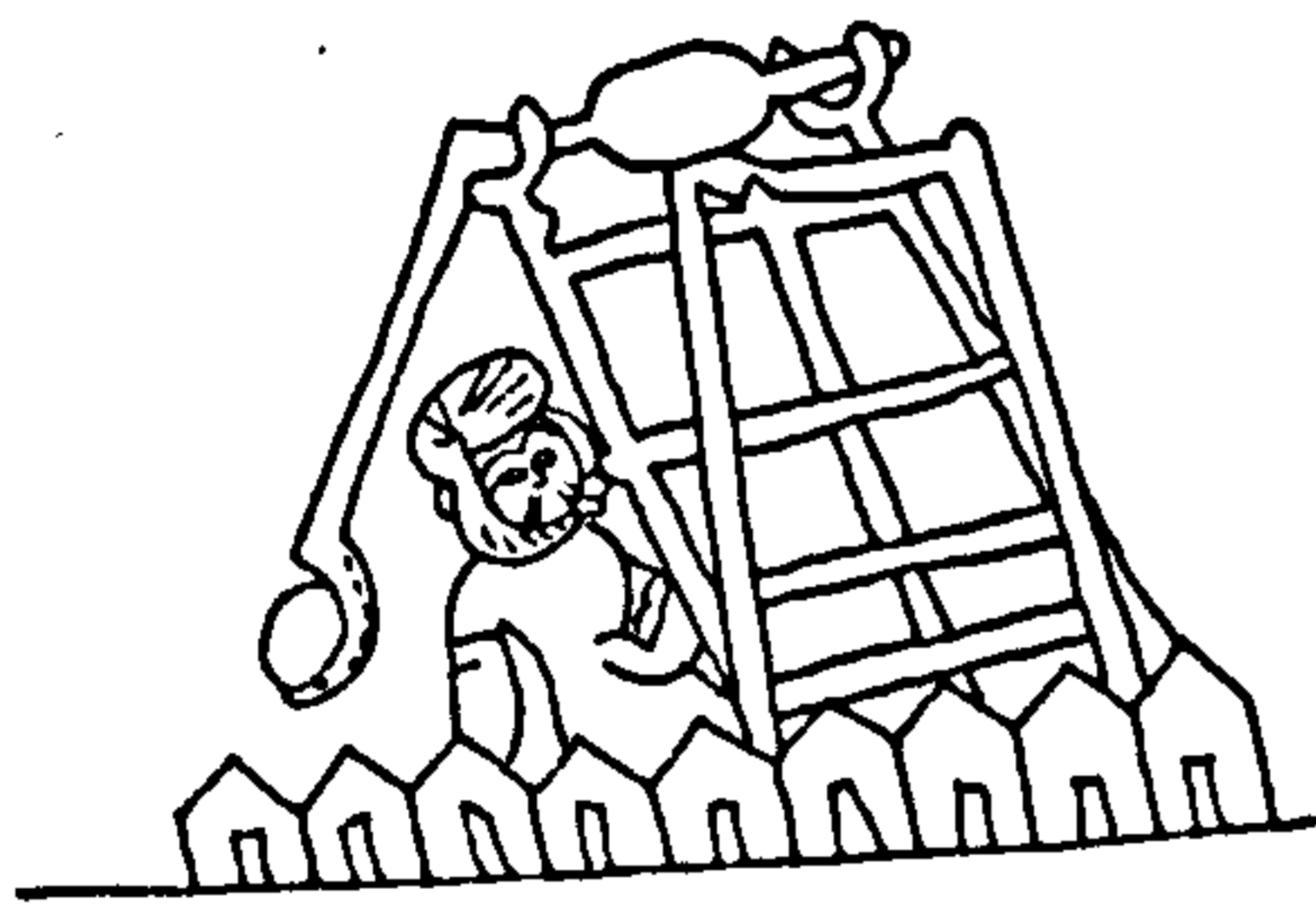

392





393

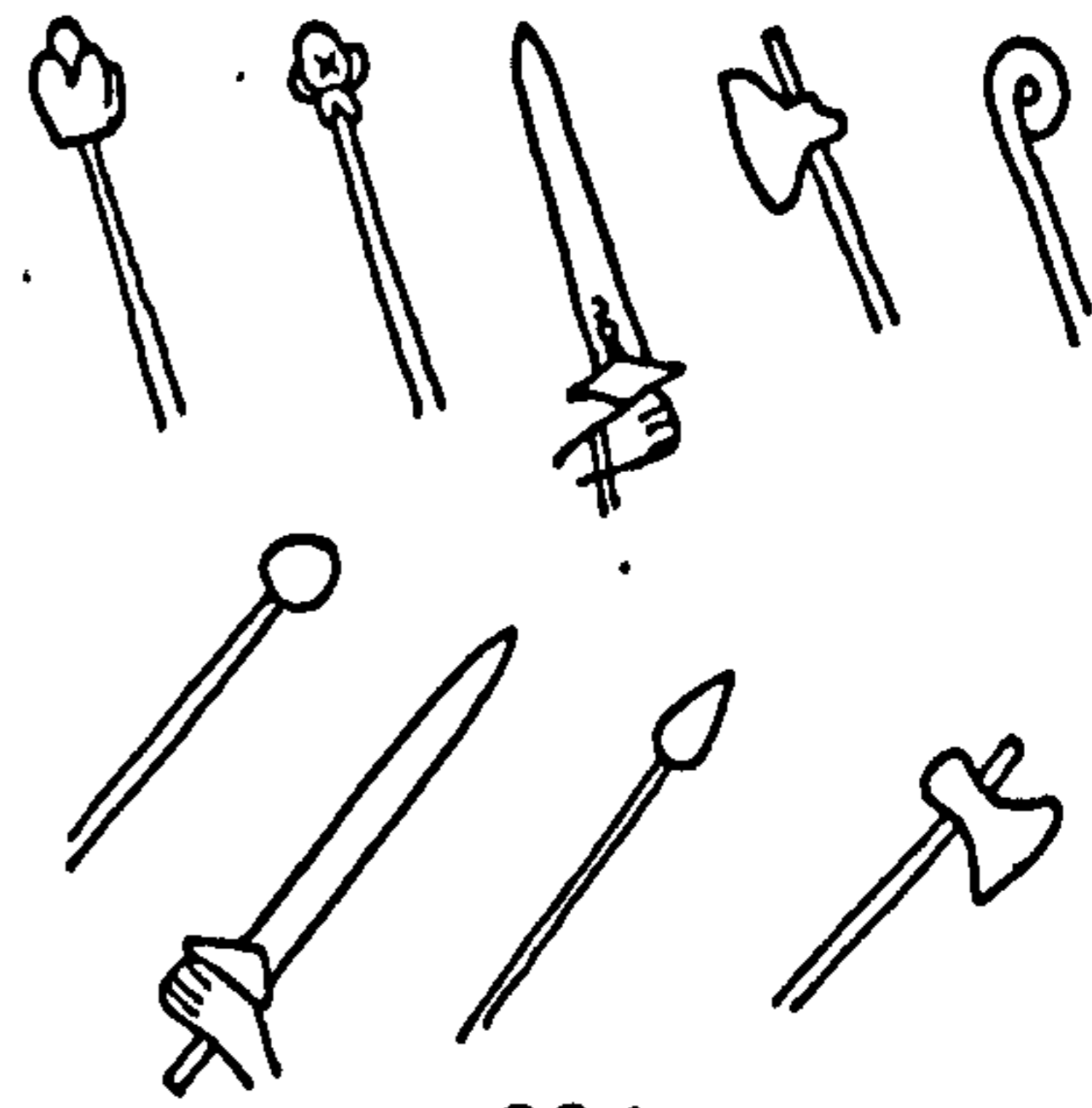

394

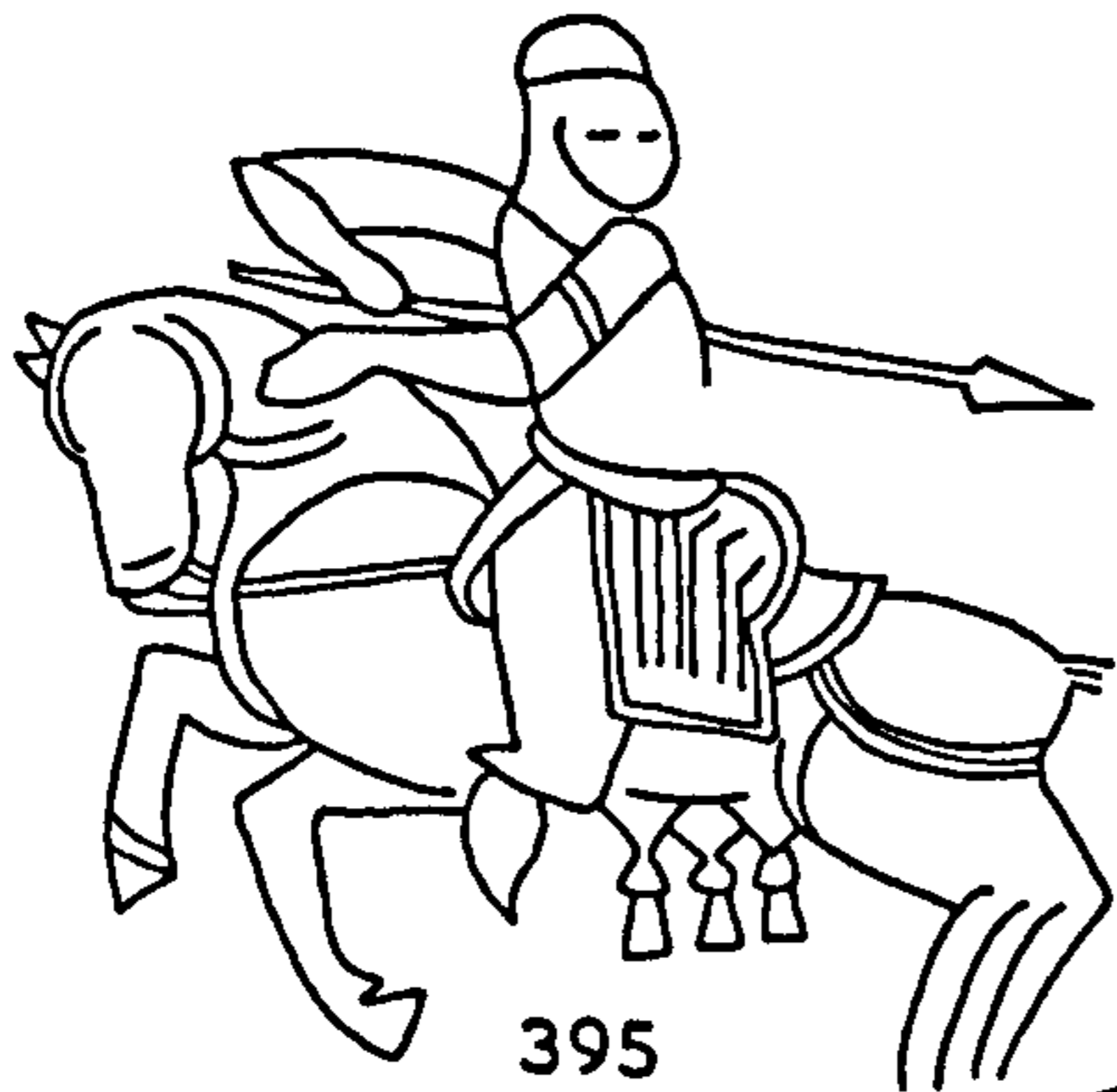

395



396



397

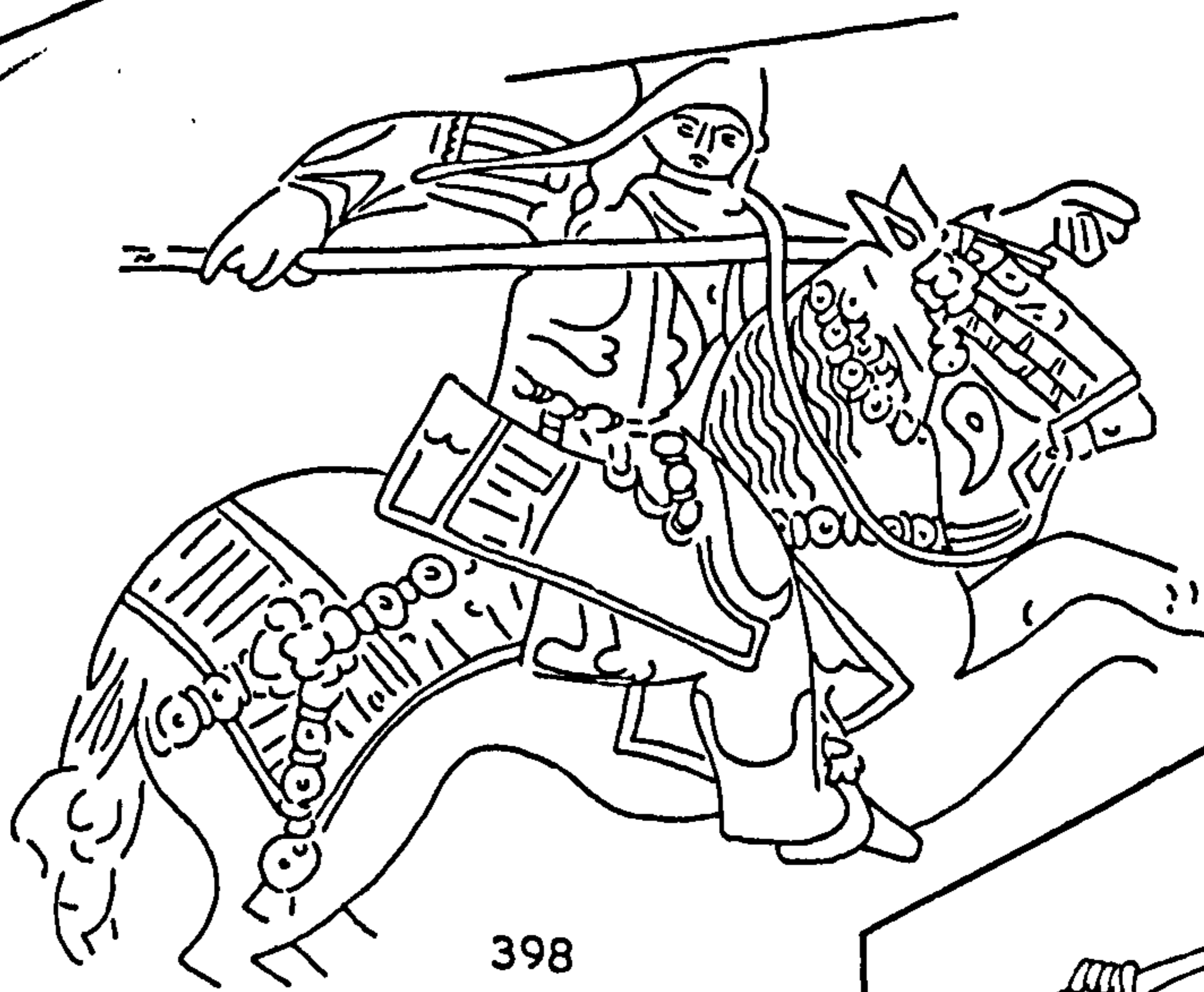

398

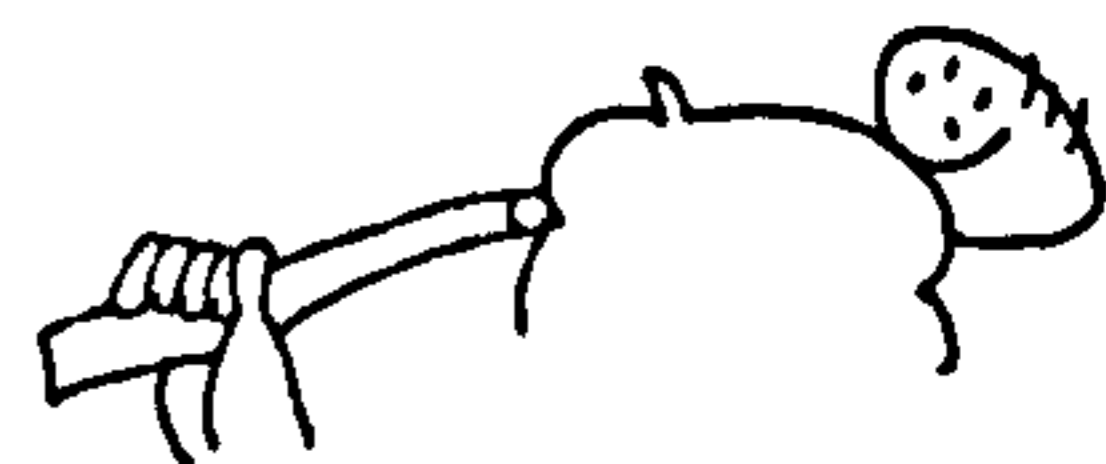

399



400

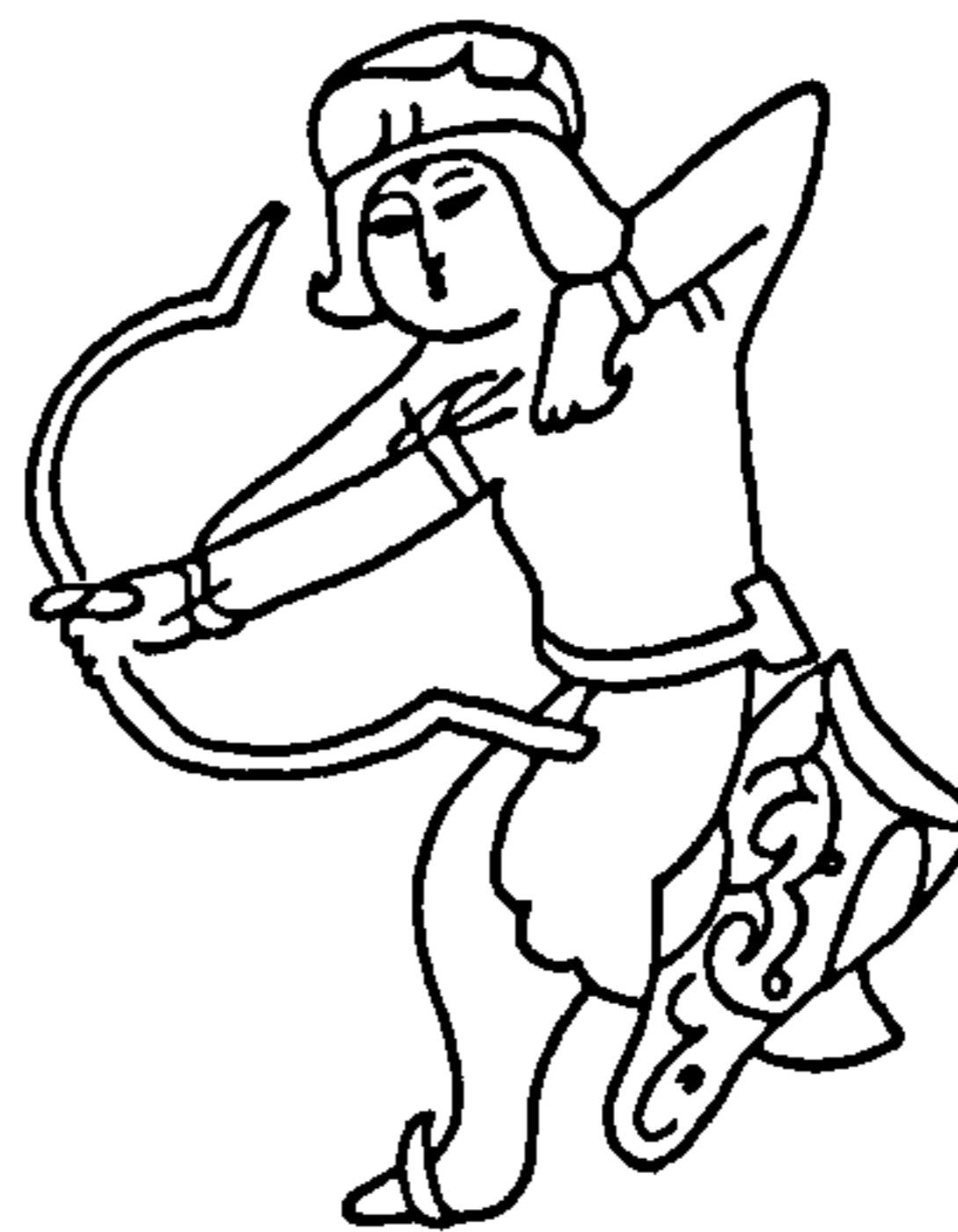

401

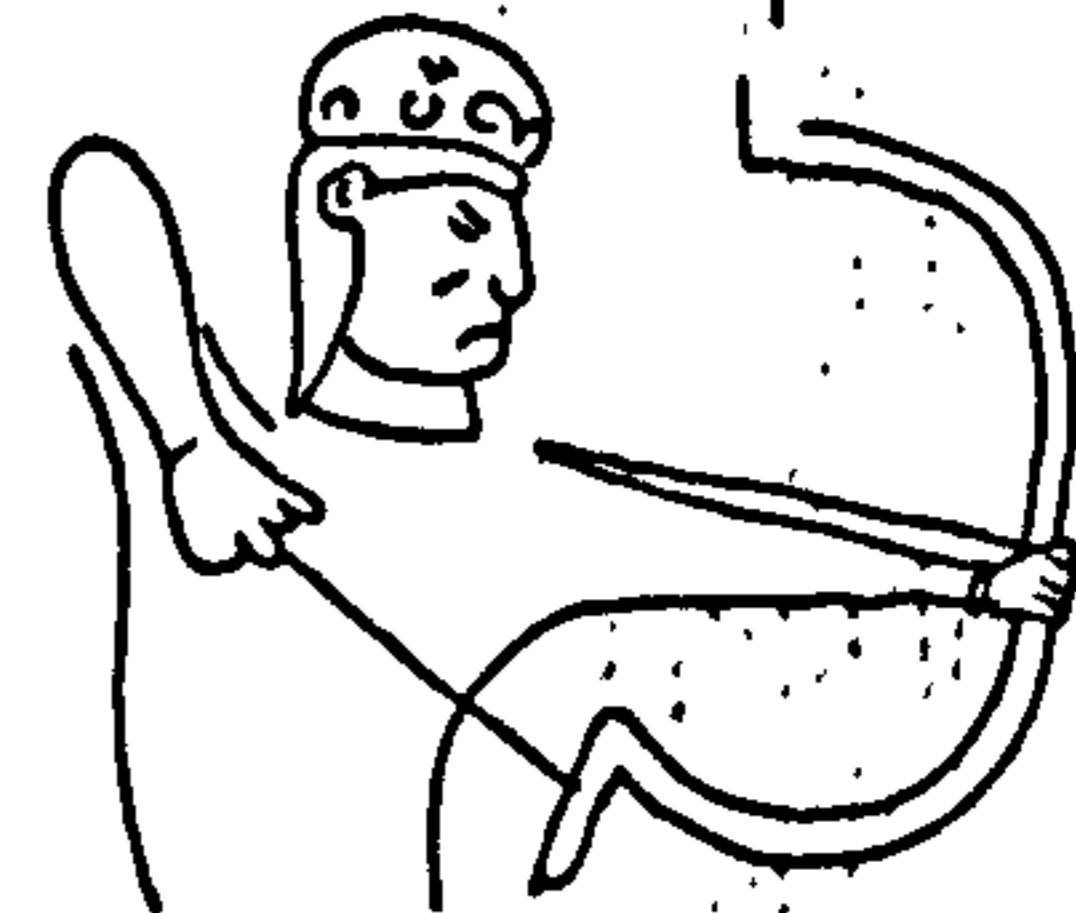

402

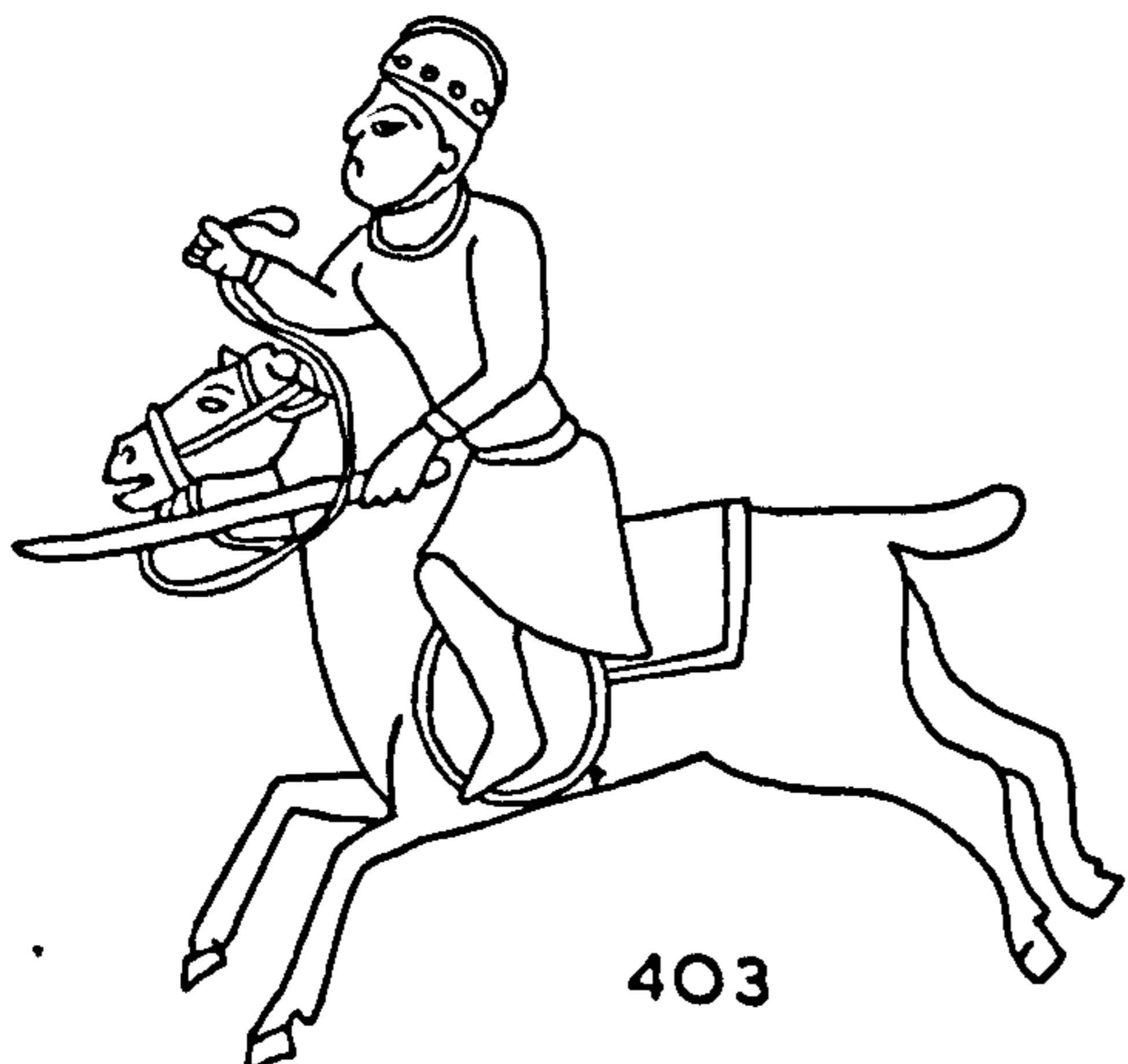

403

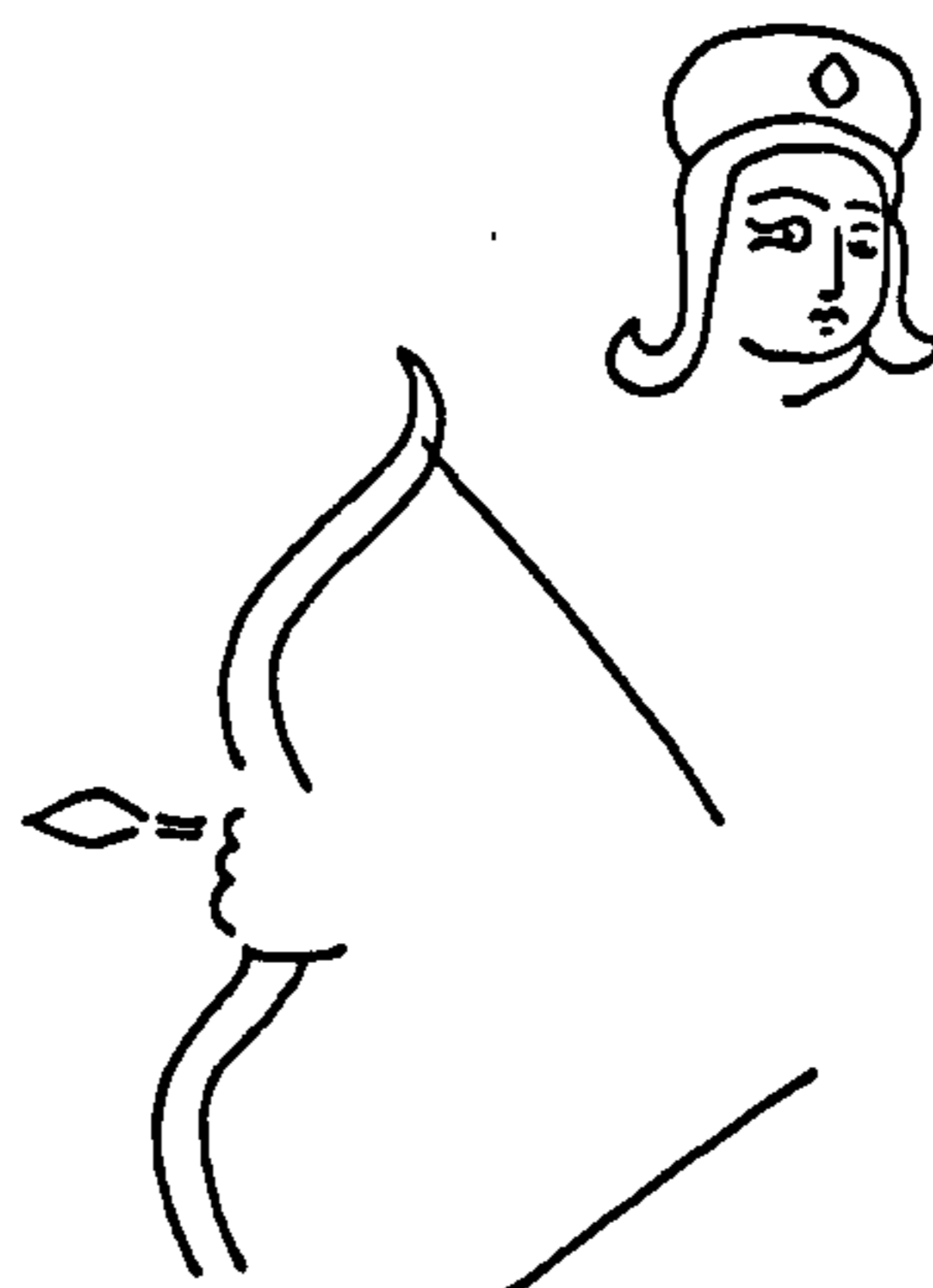

404

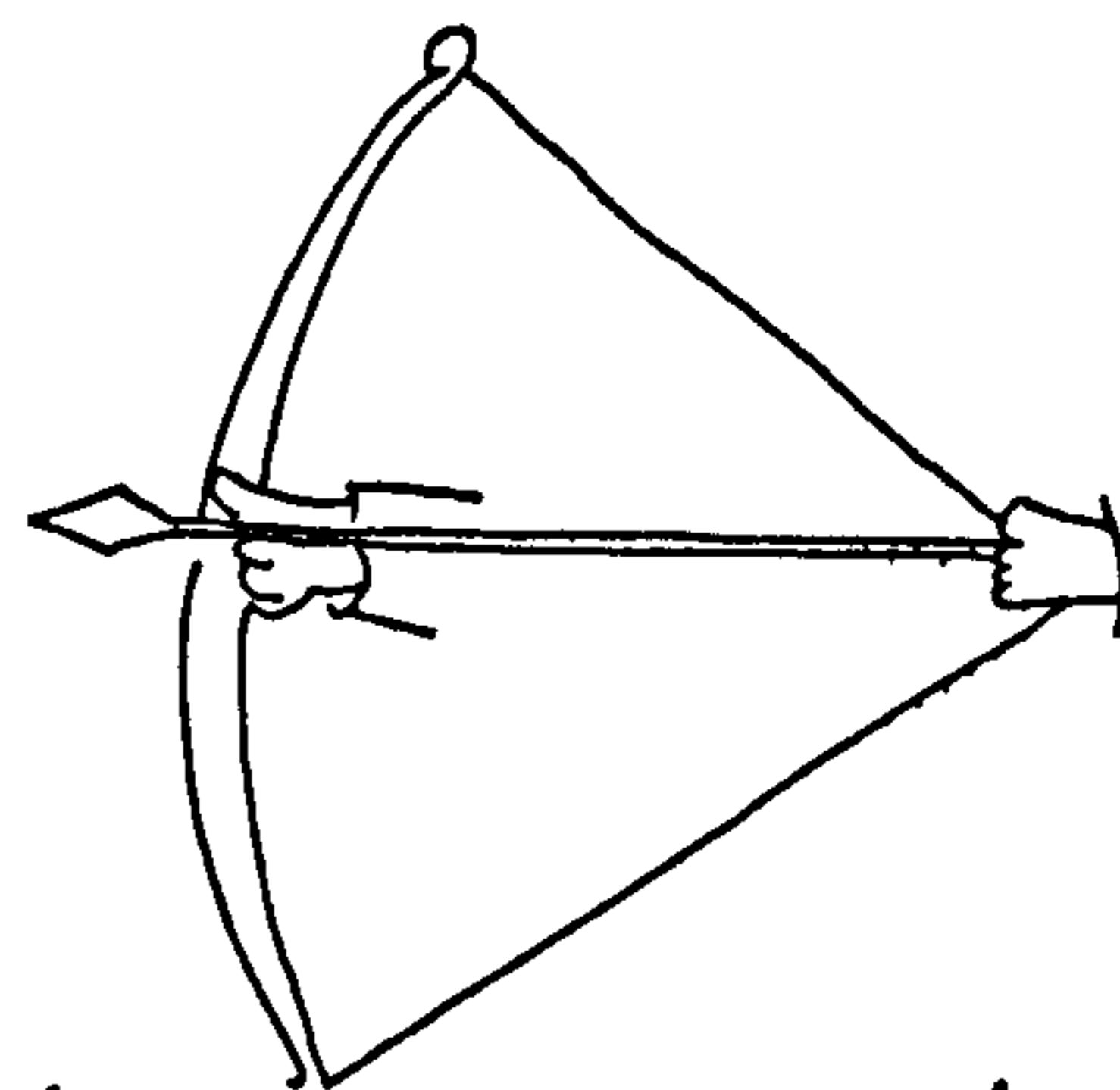



405

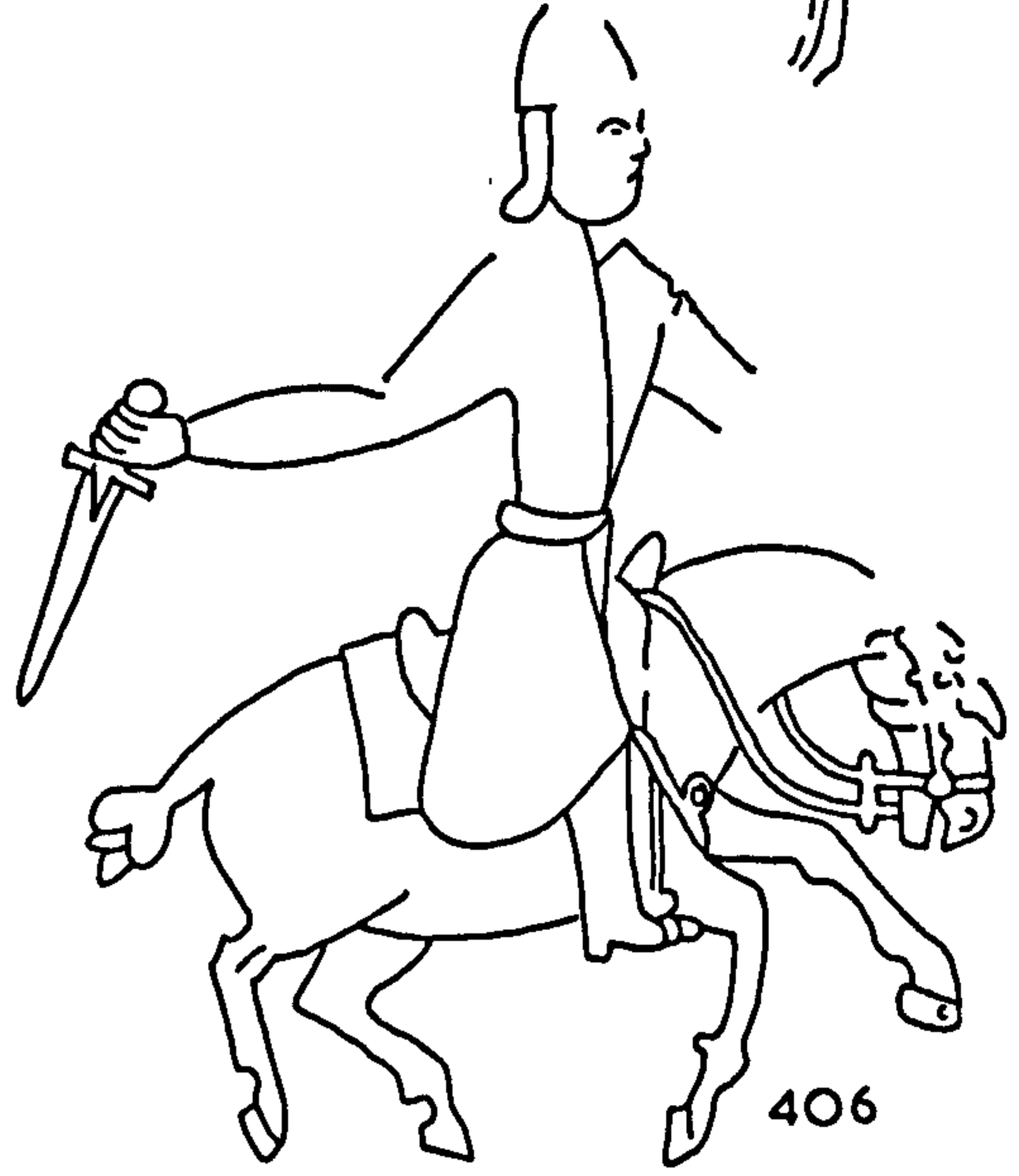
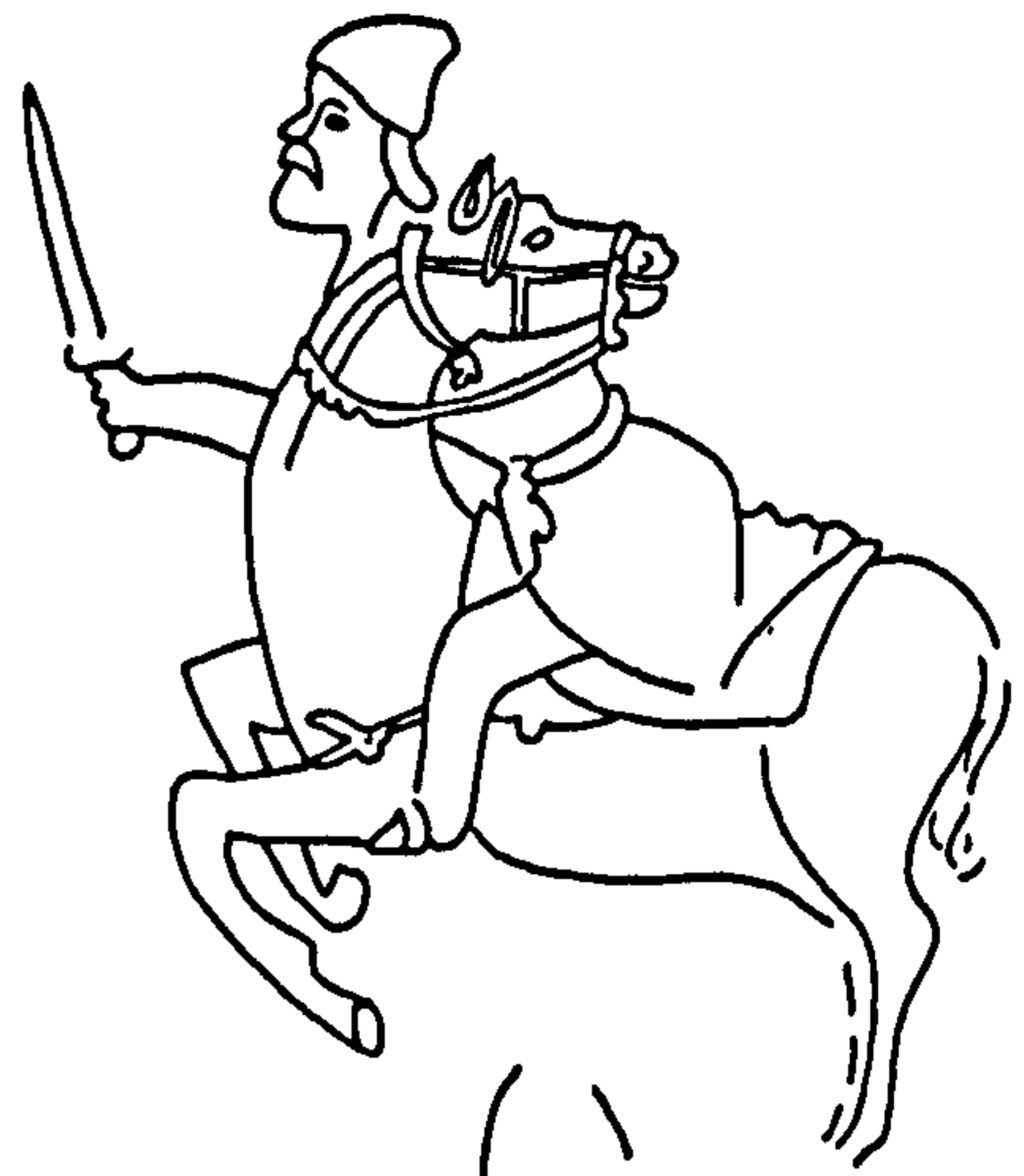

406

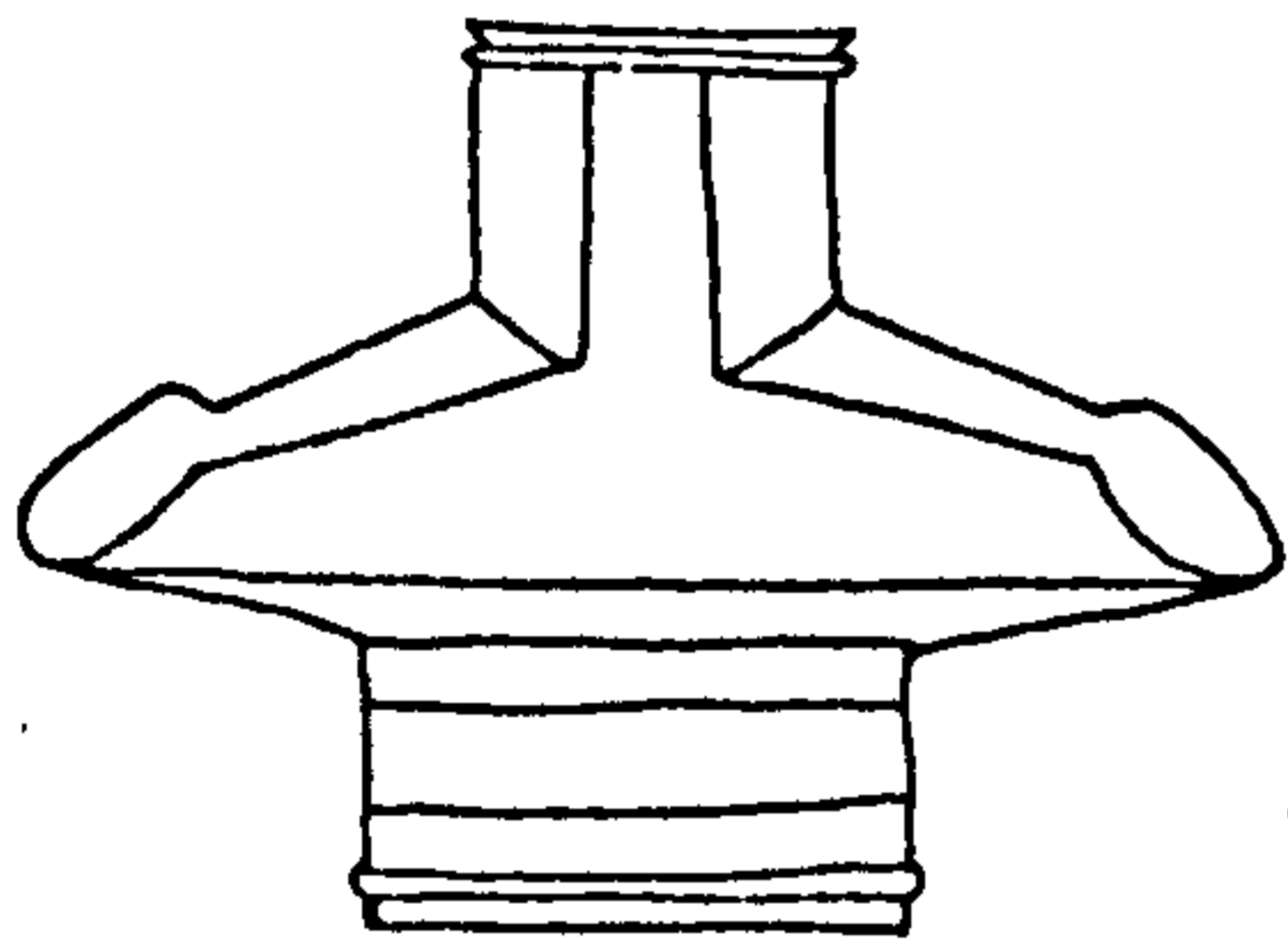

407

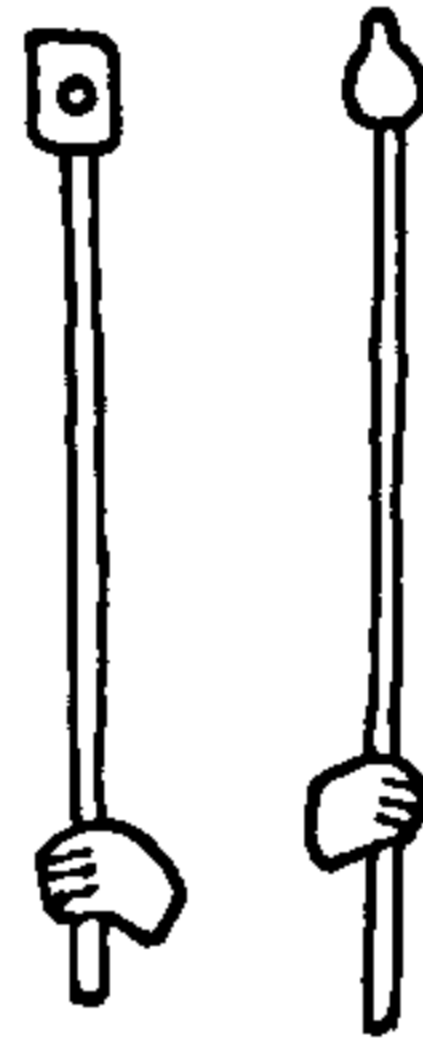

408

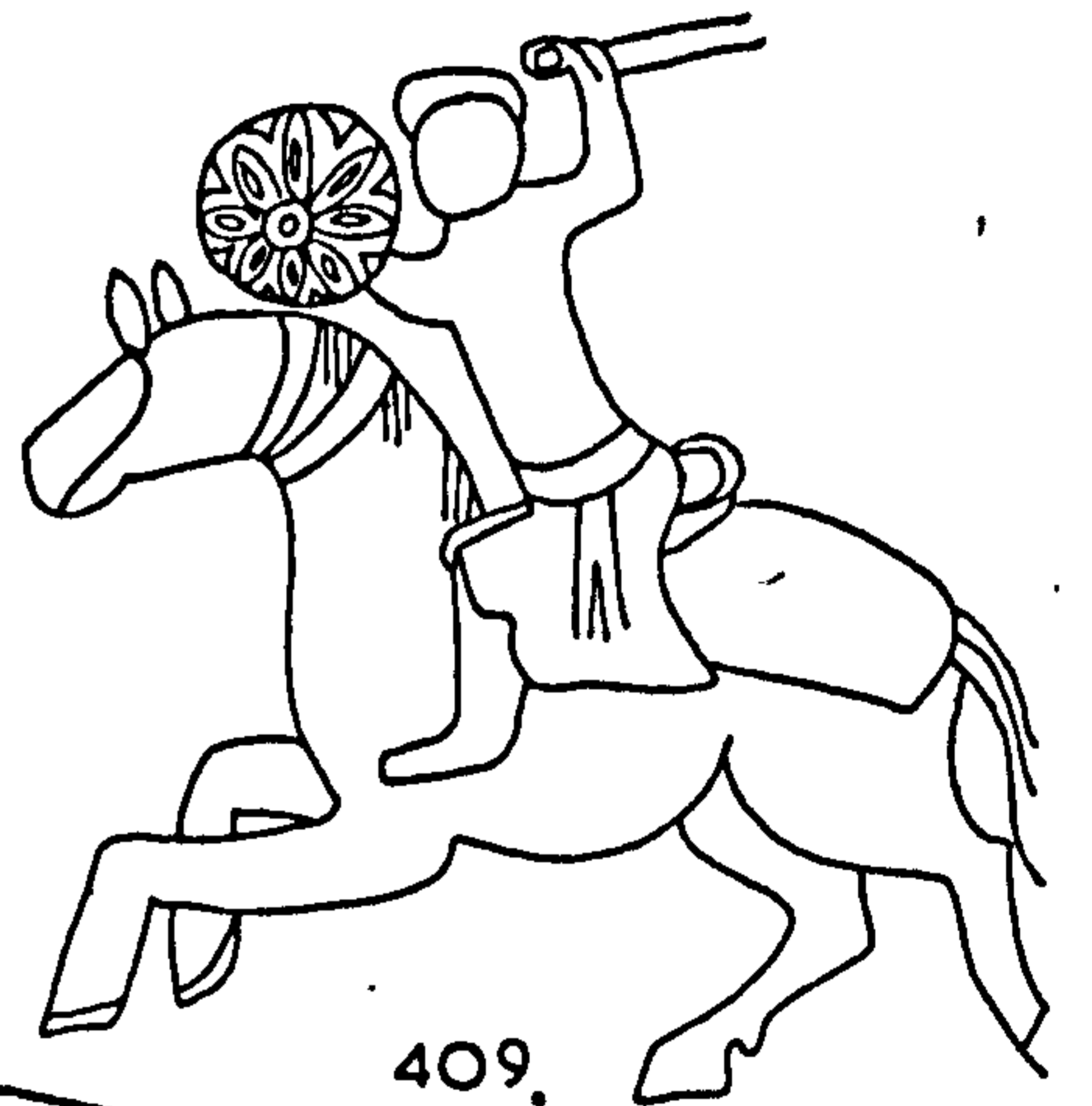

409

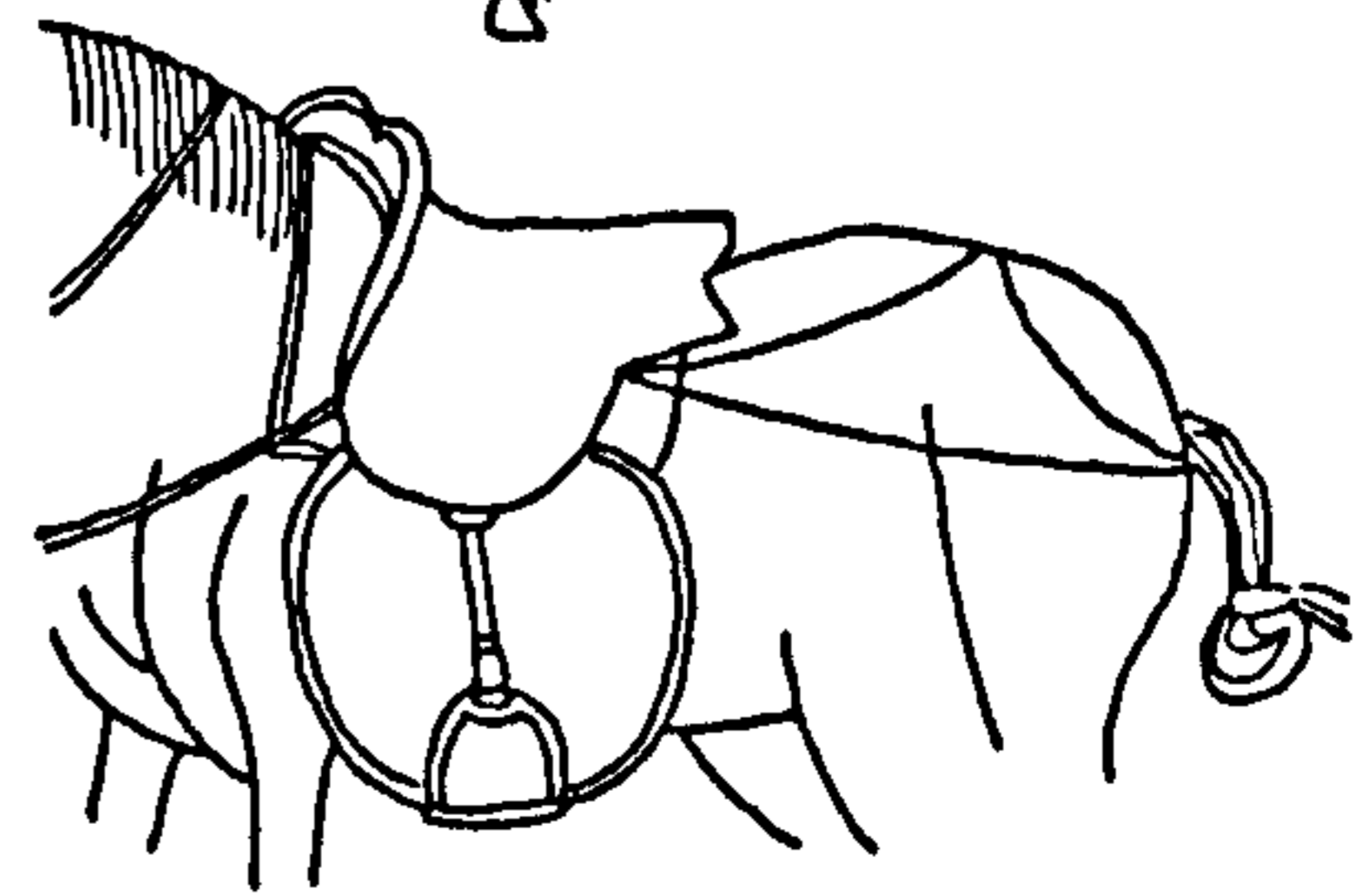
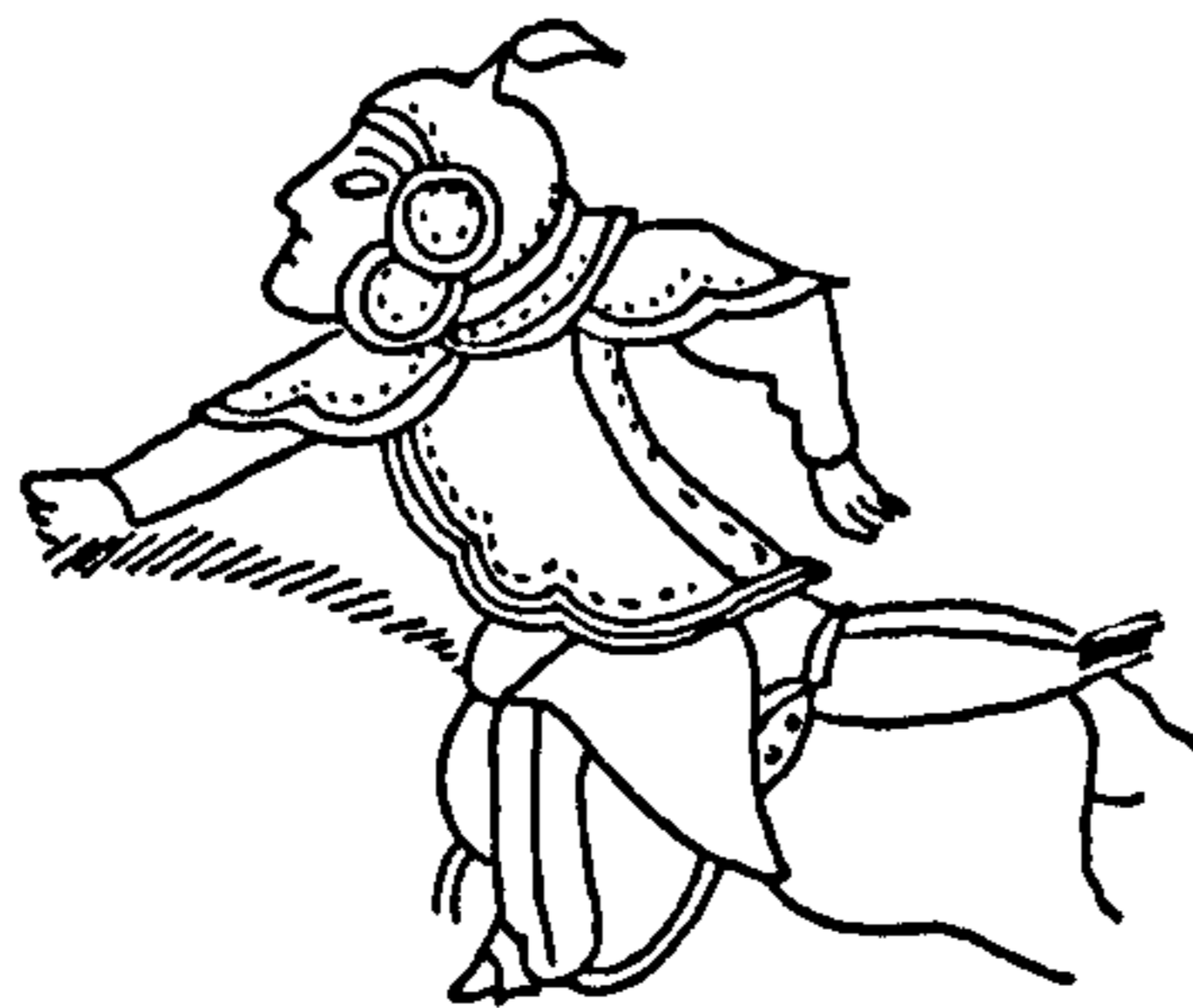

410

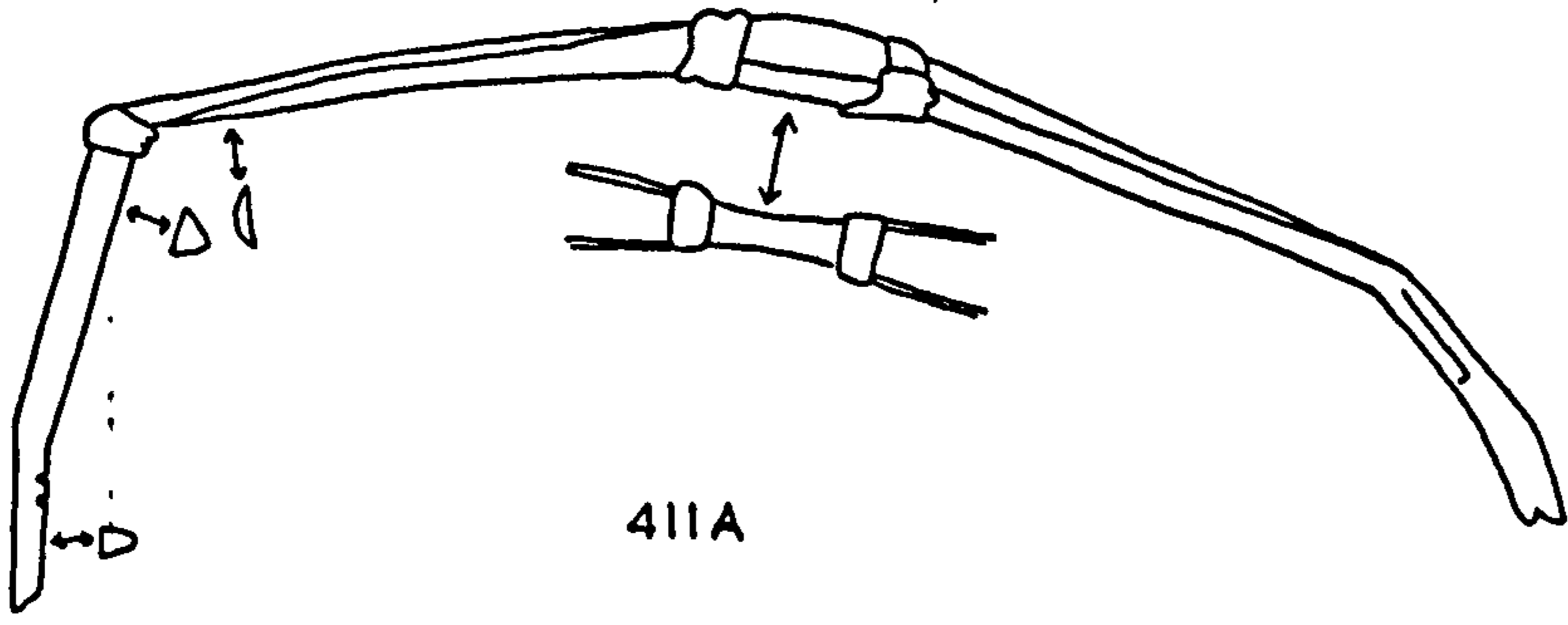

411A

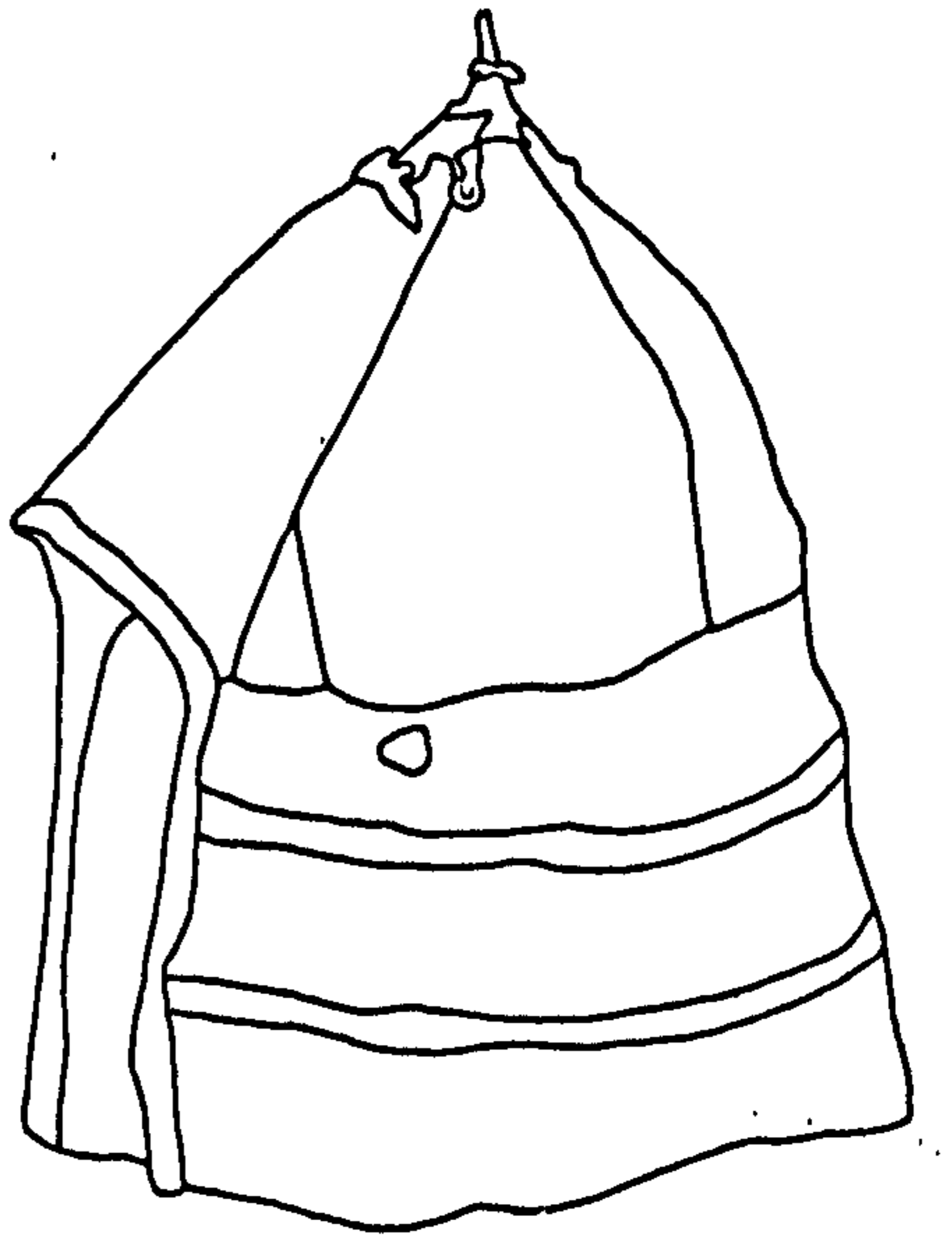

411B

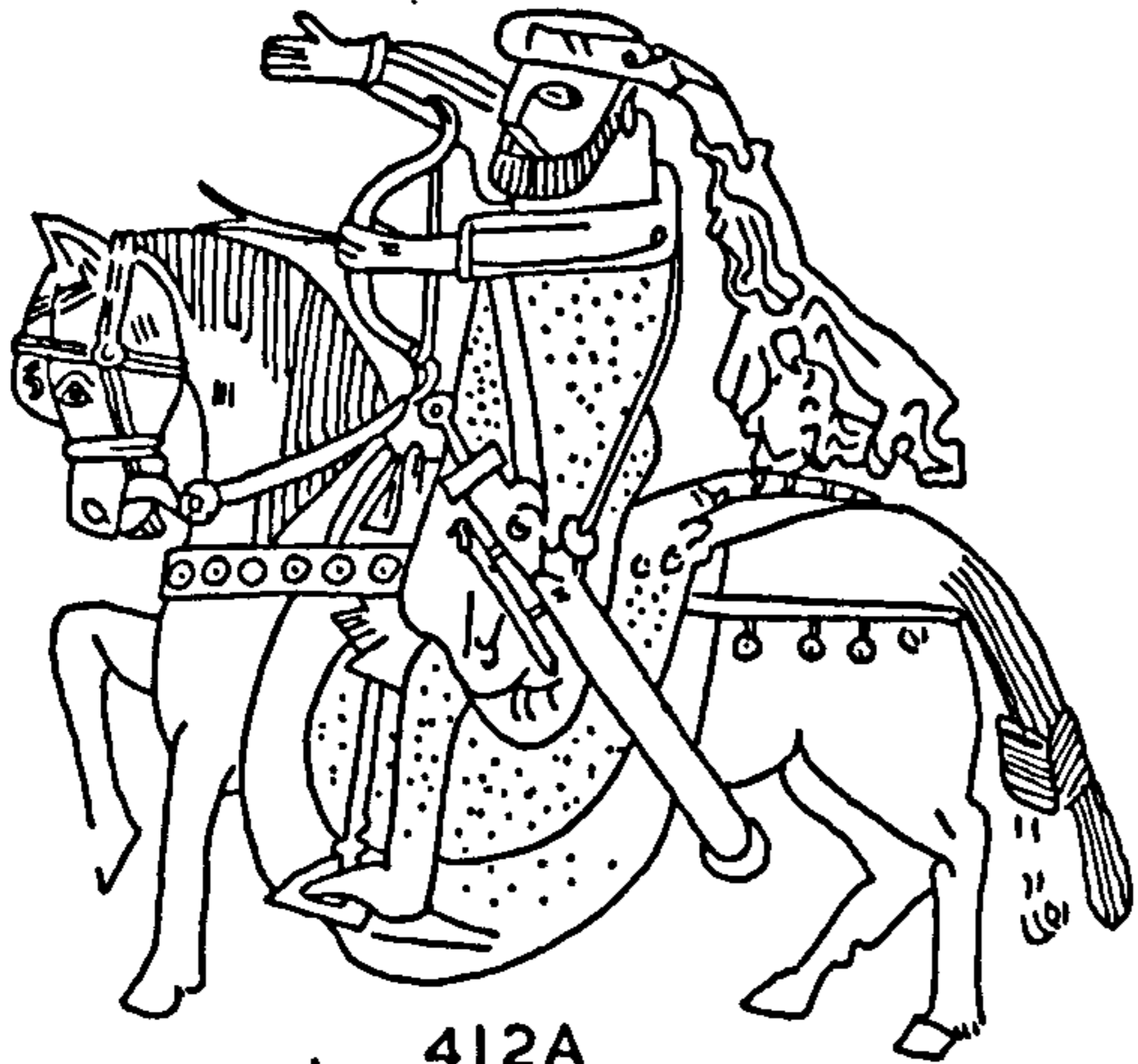

412A



413



414

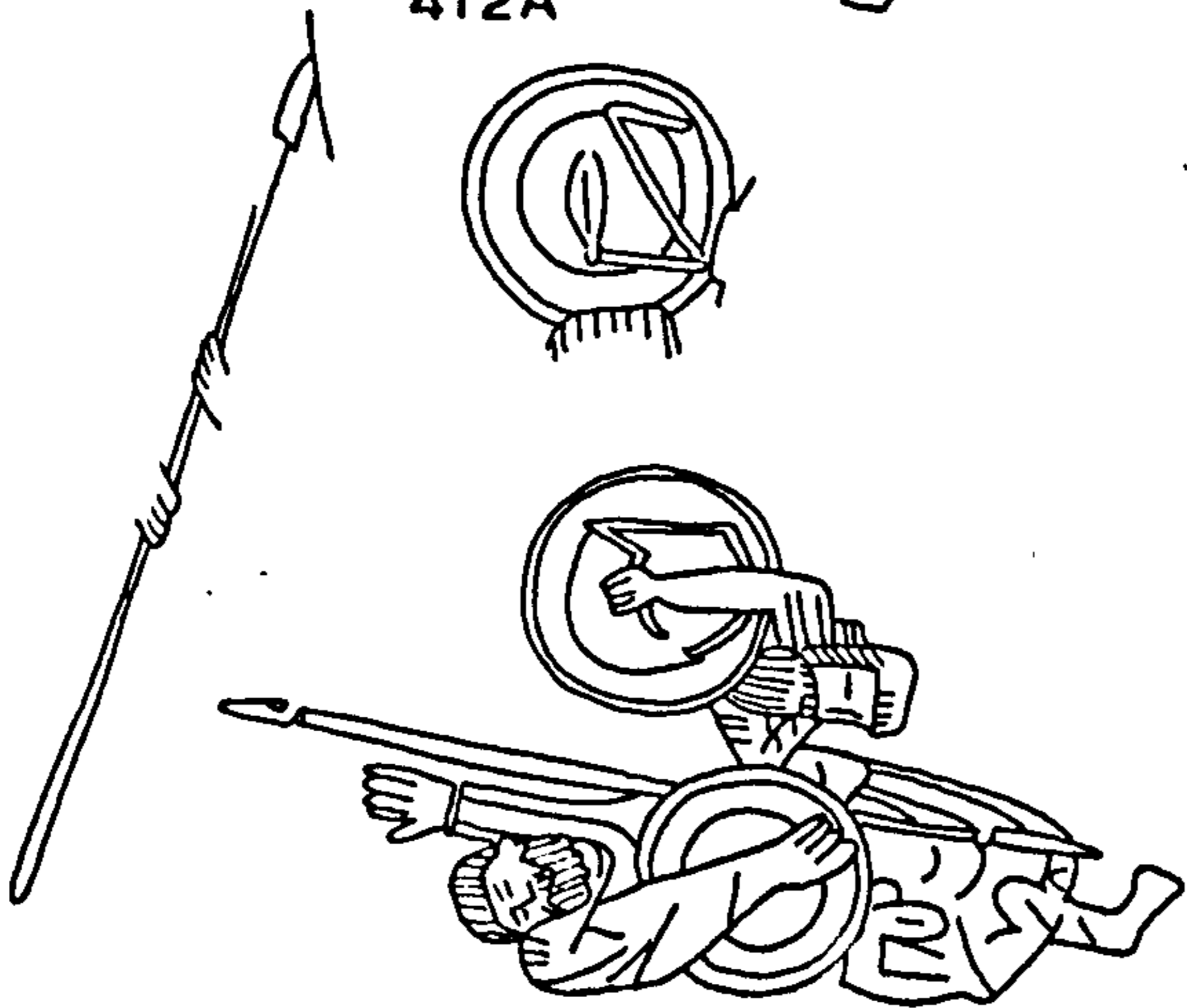

412B

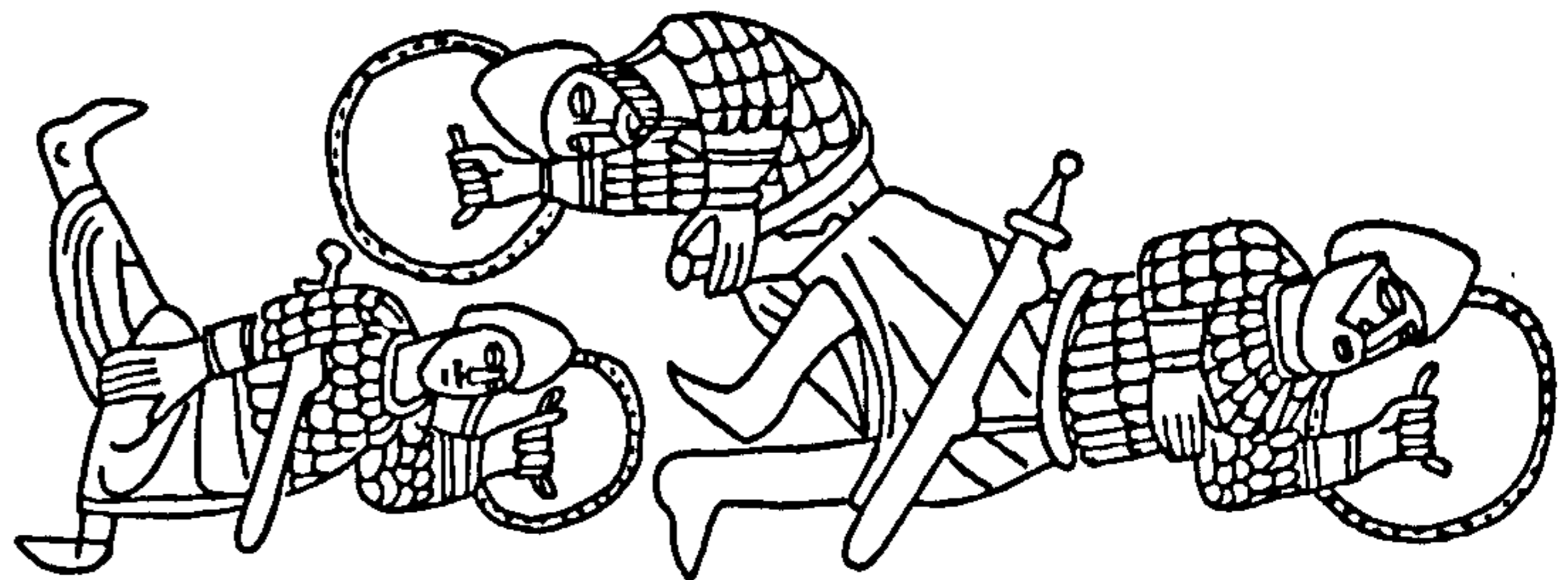

416

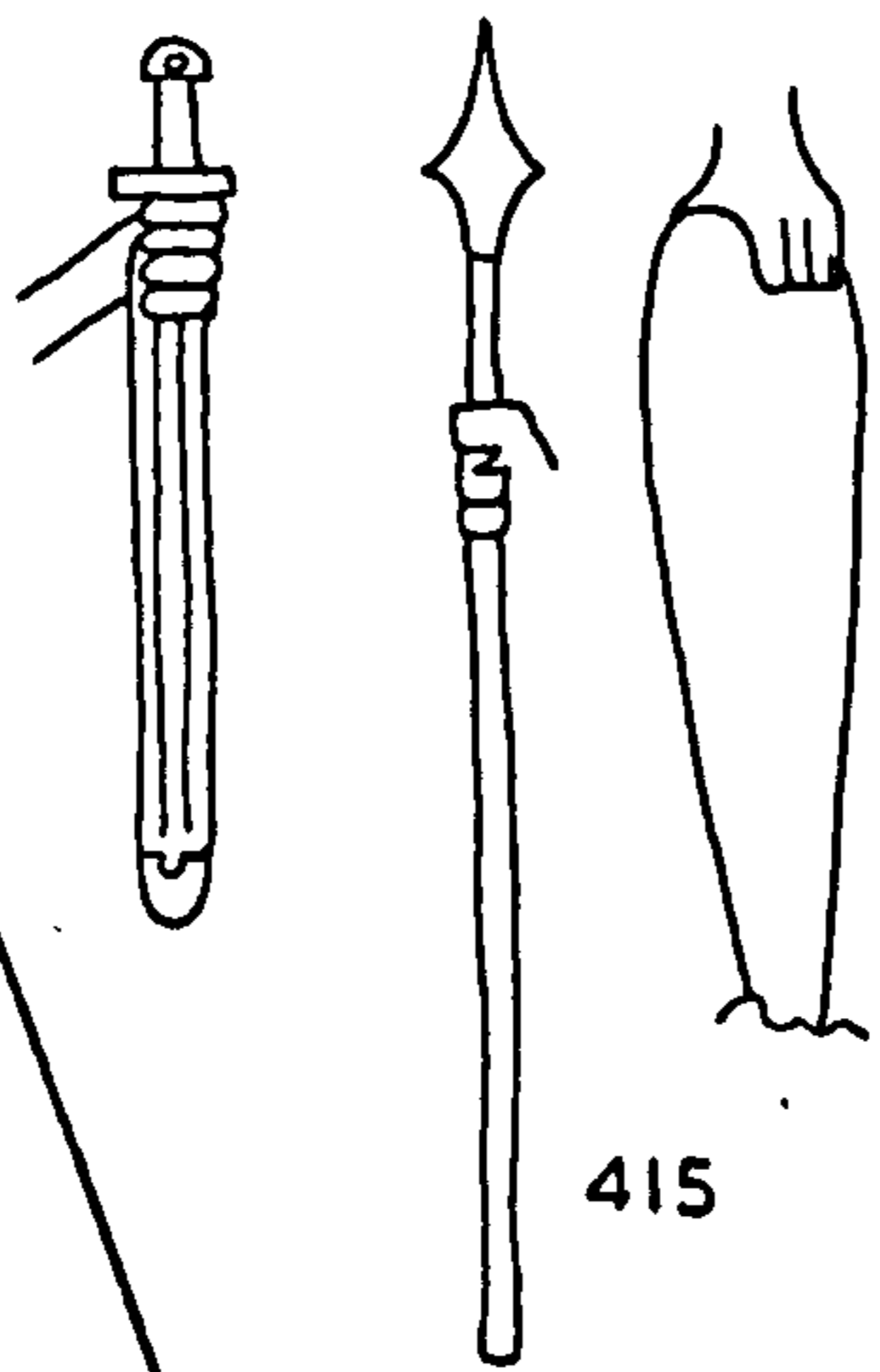

415



417



418





419

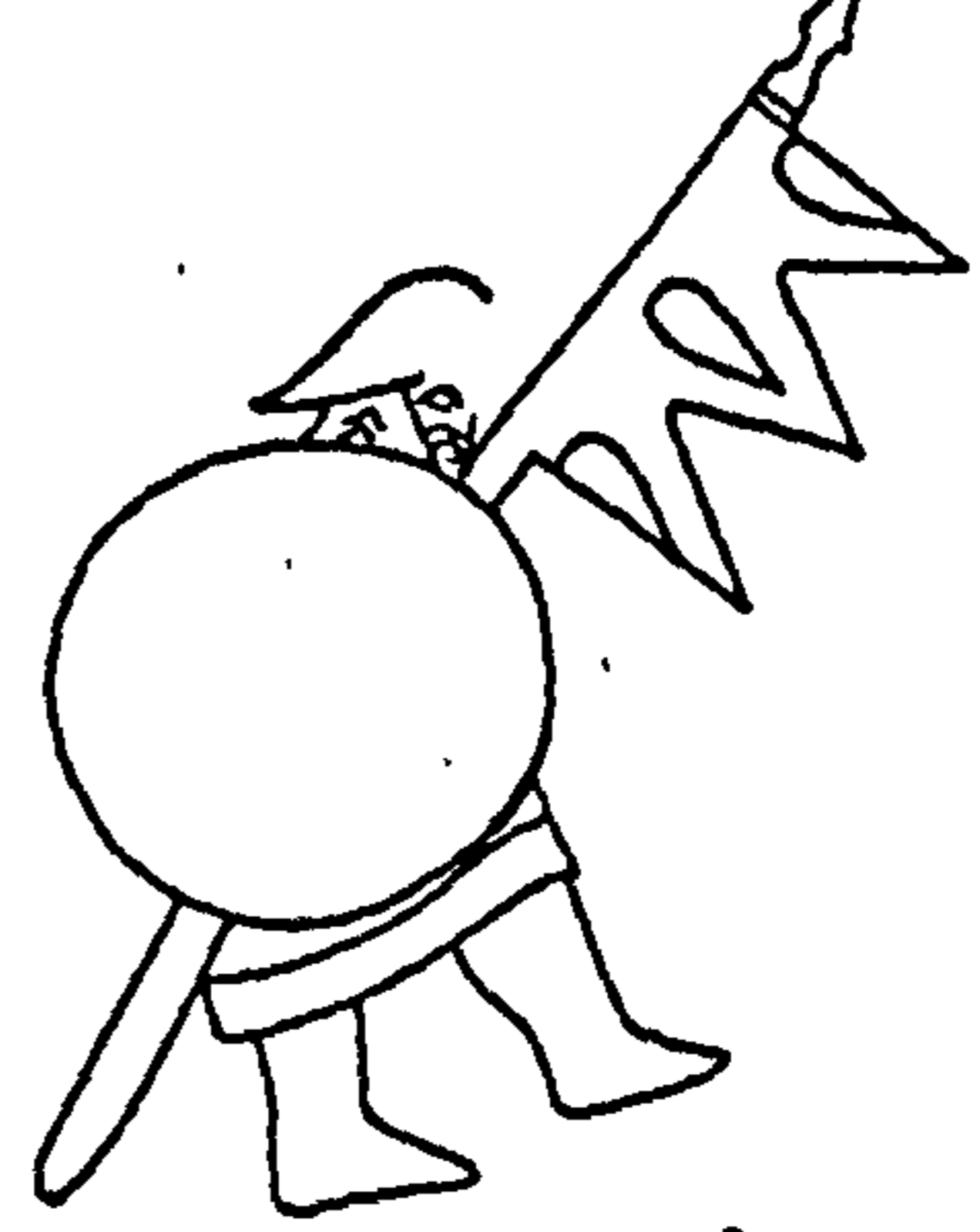

420

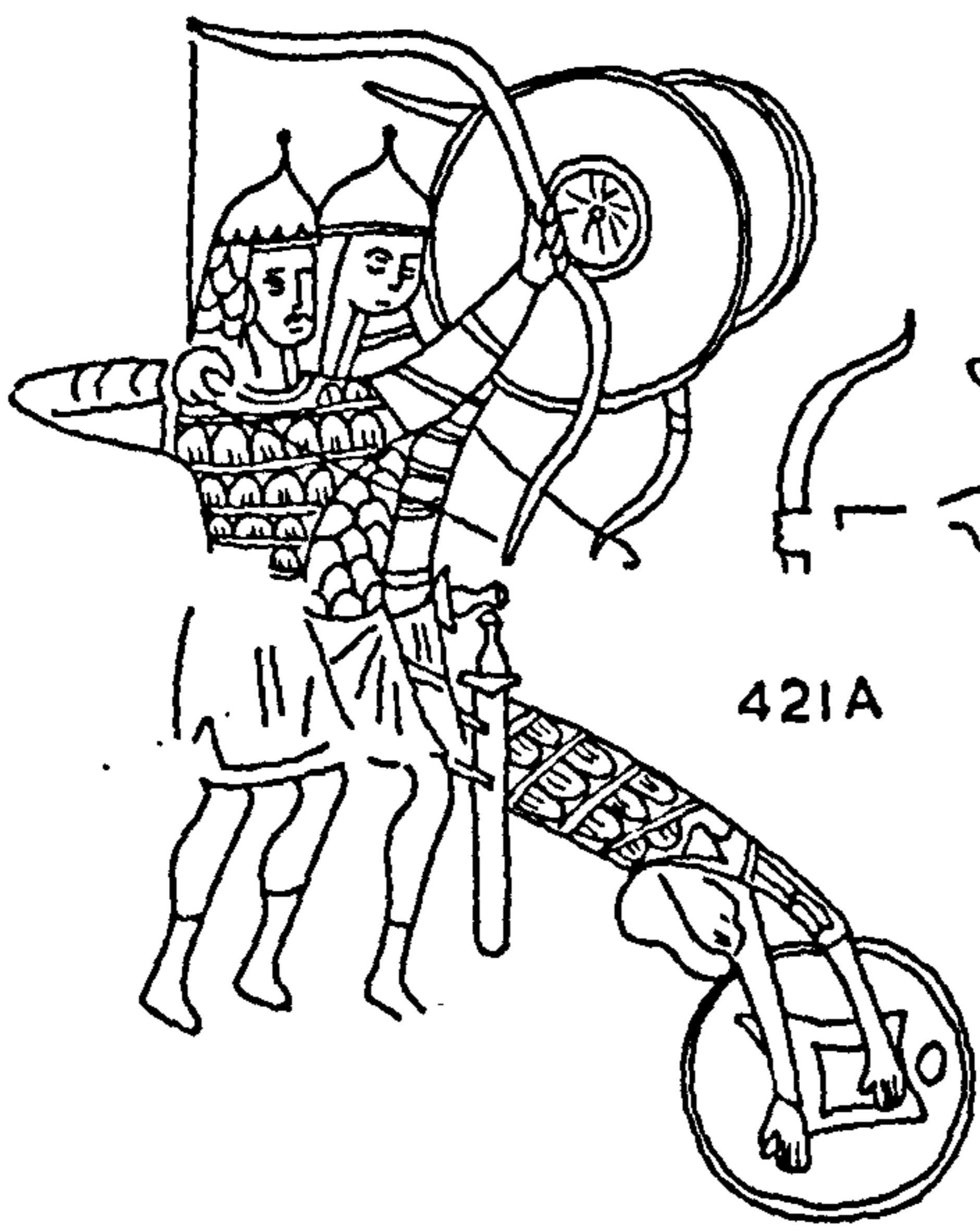

421A

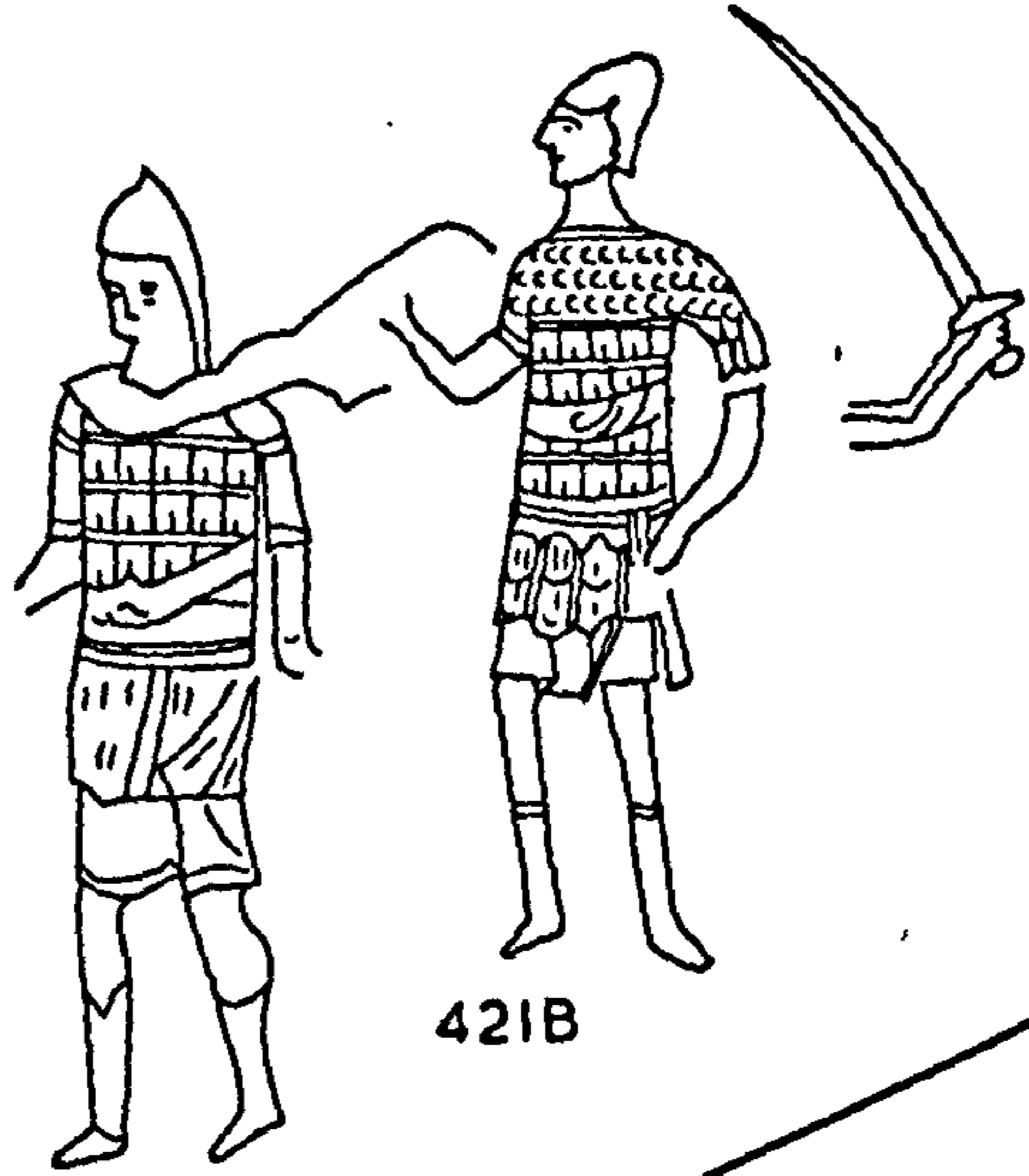

421B



422A



422B



422C

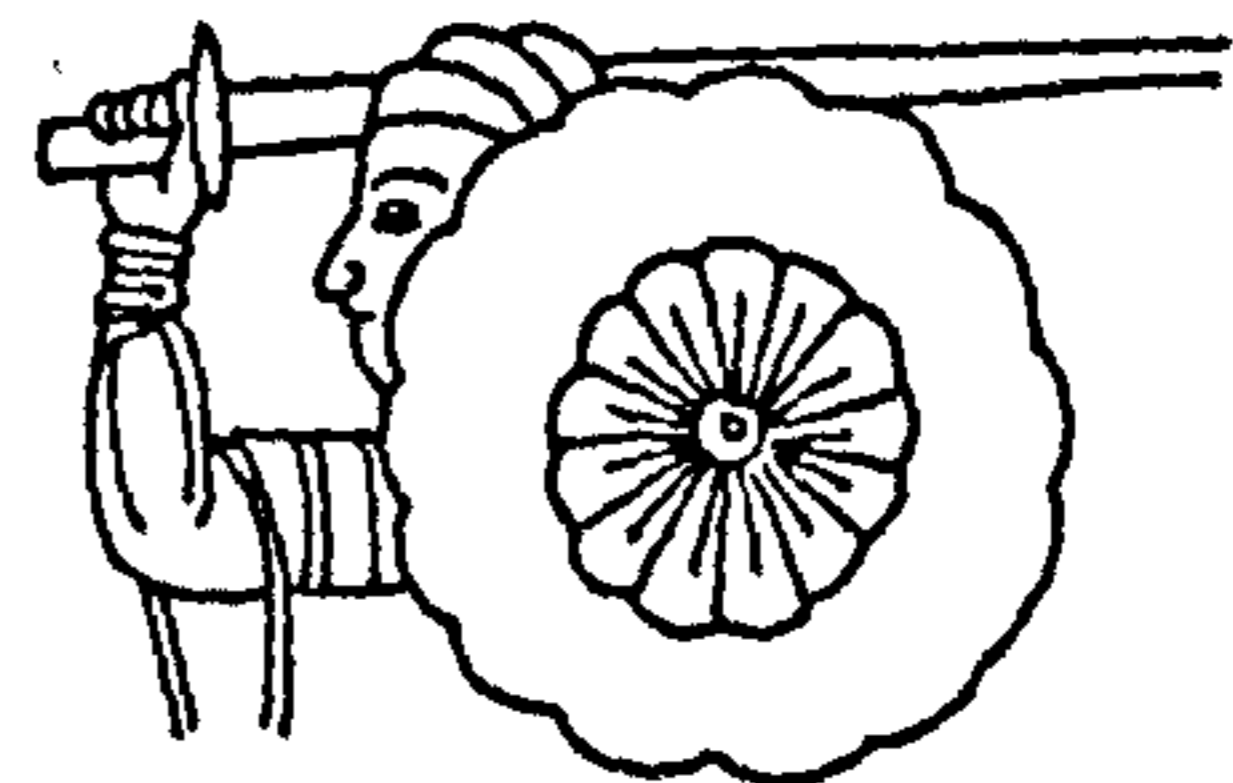

422D



422E

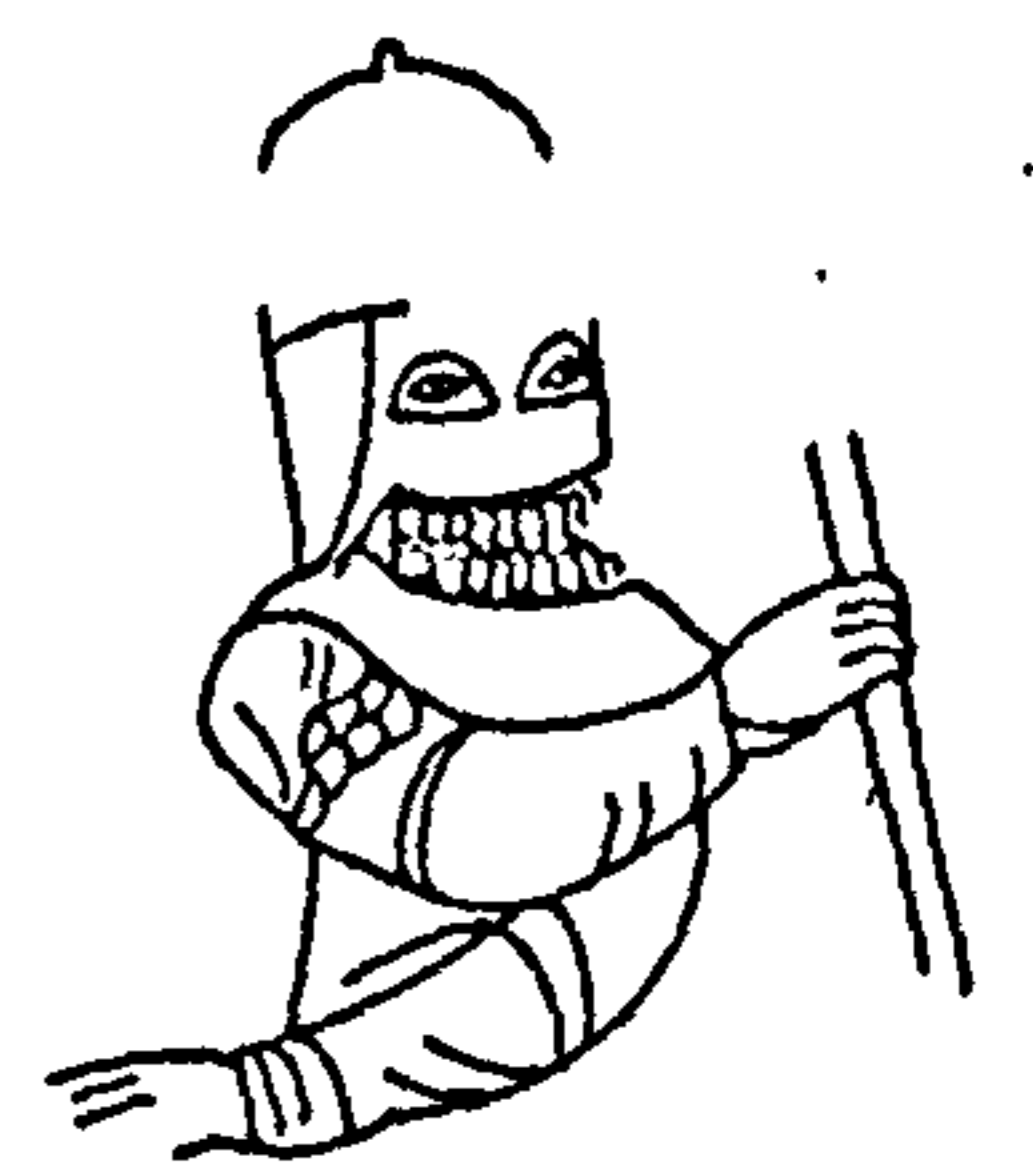
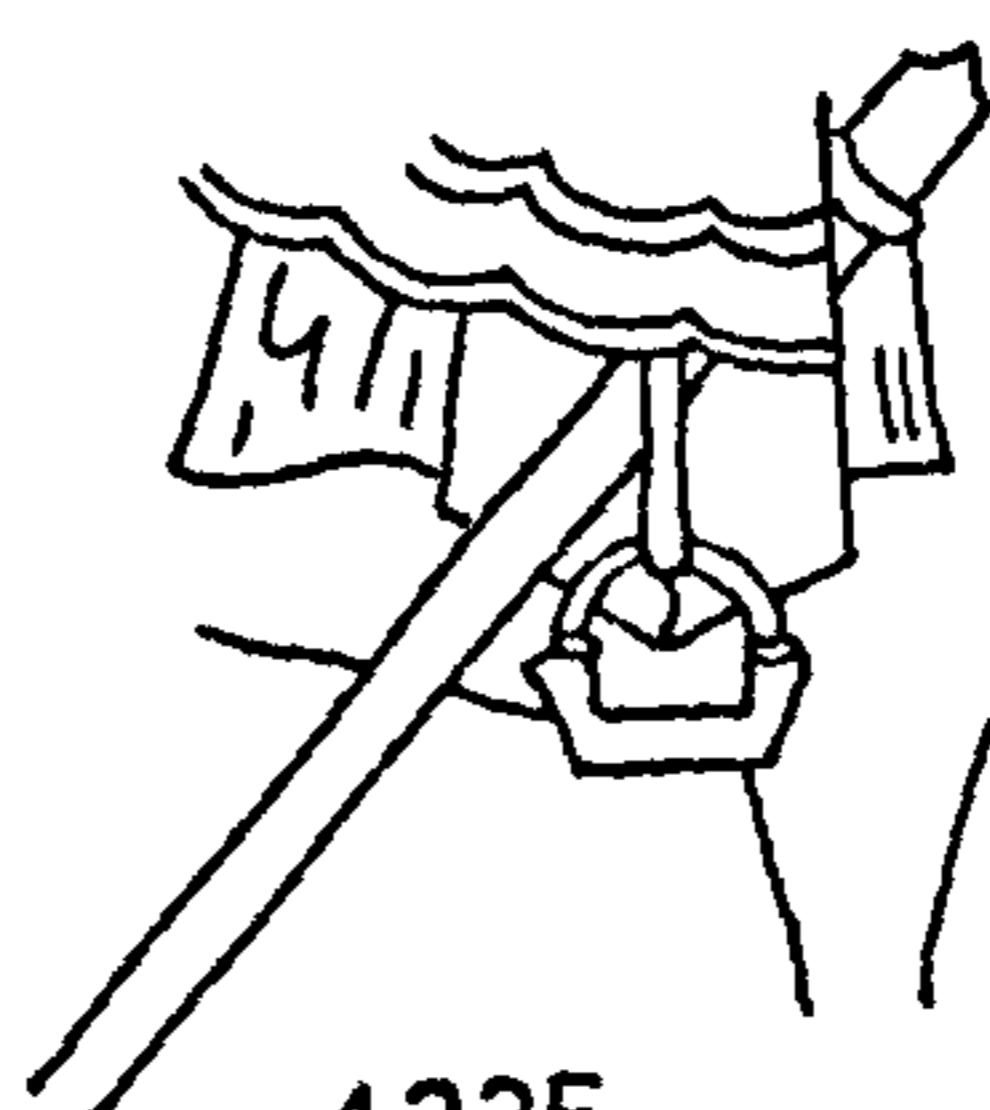

422F

(Continued)



422G

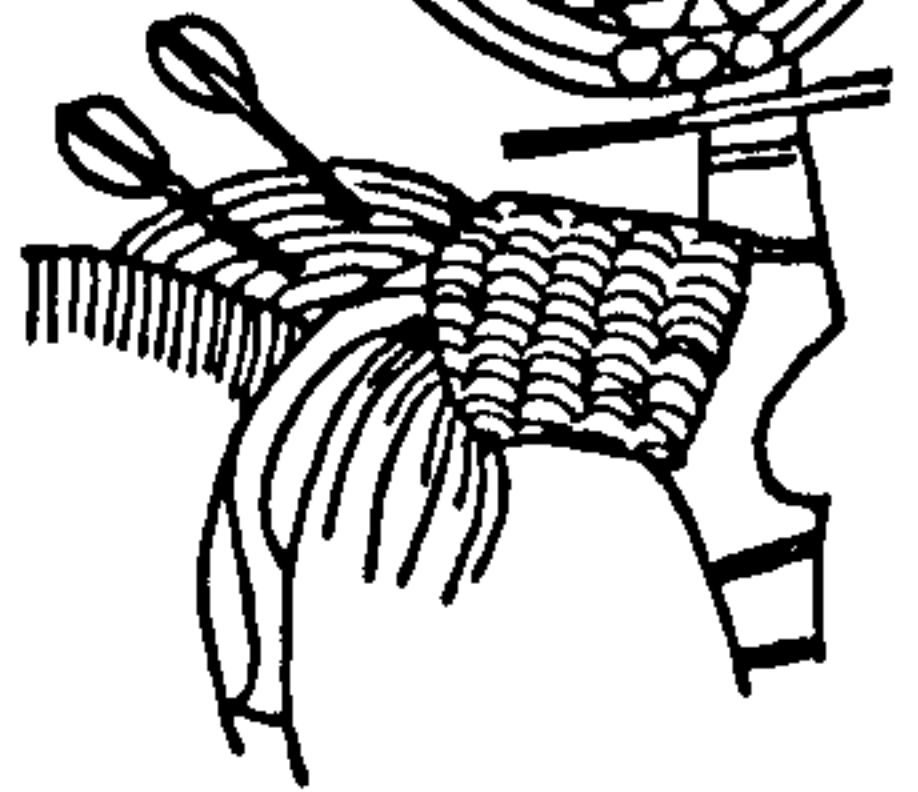
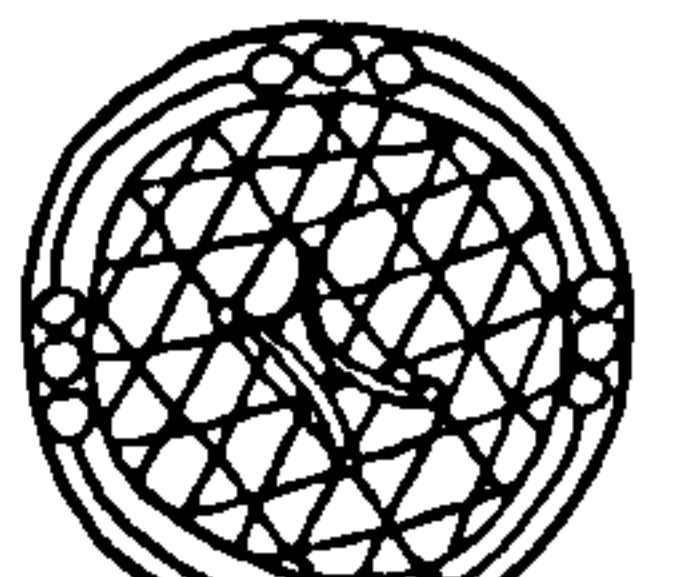
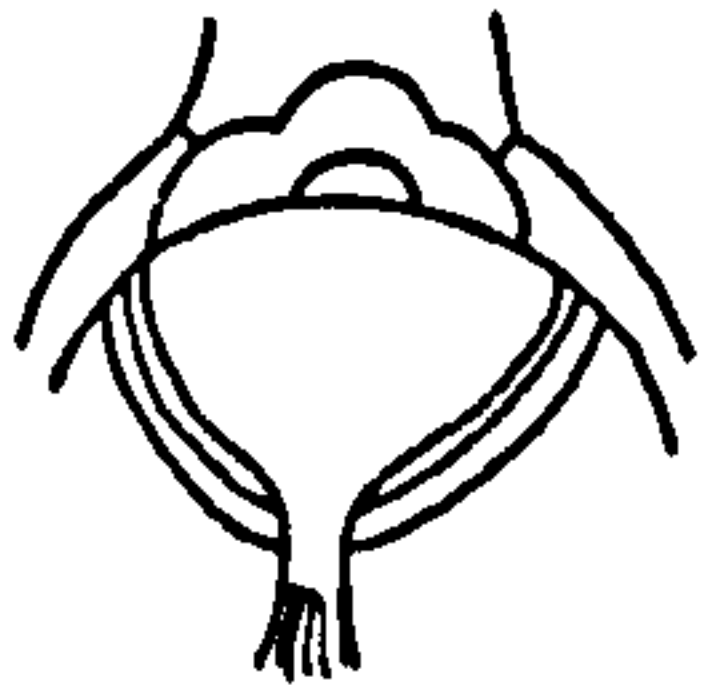

422H

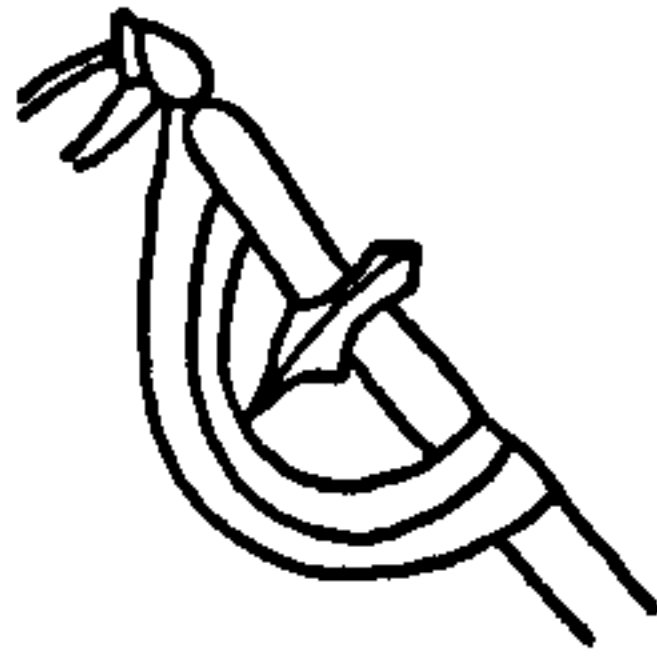

422J

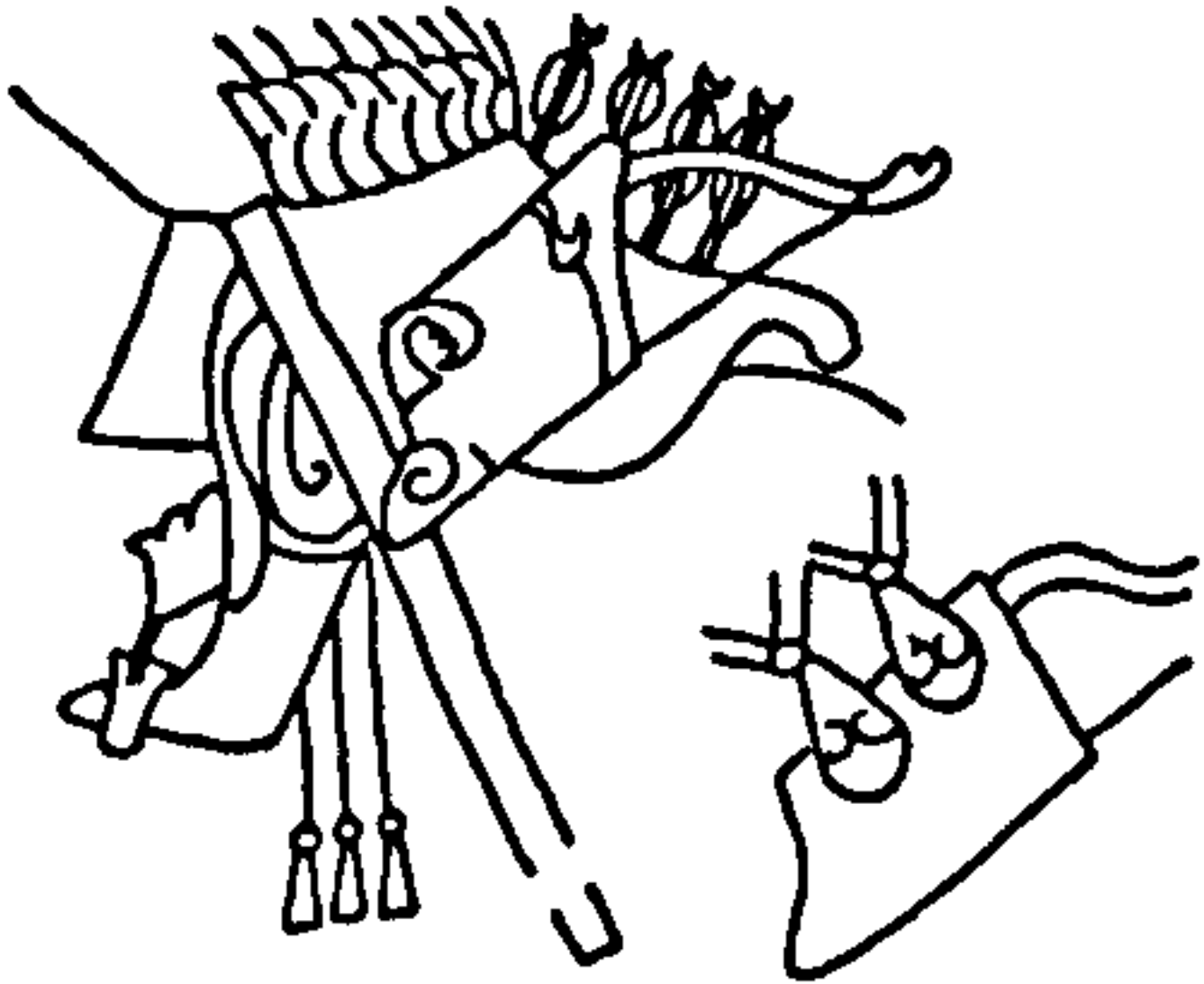

422I

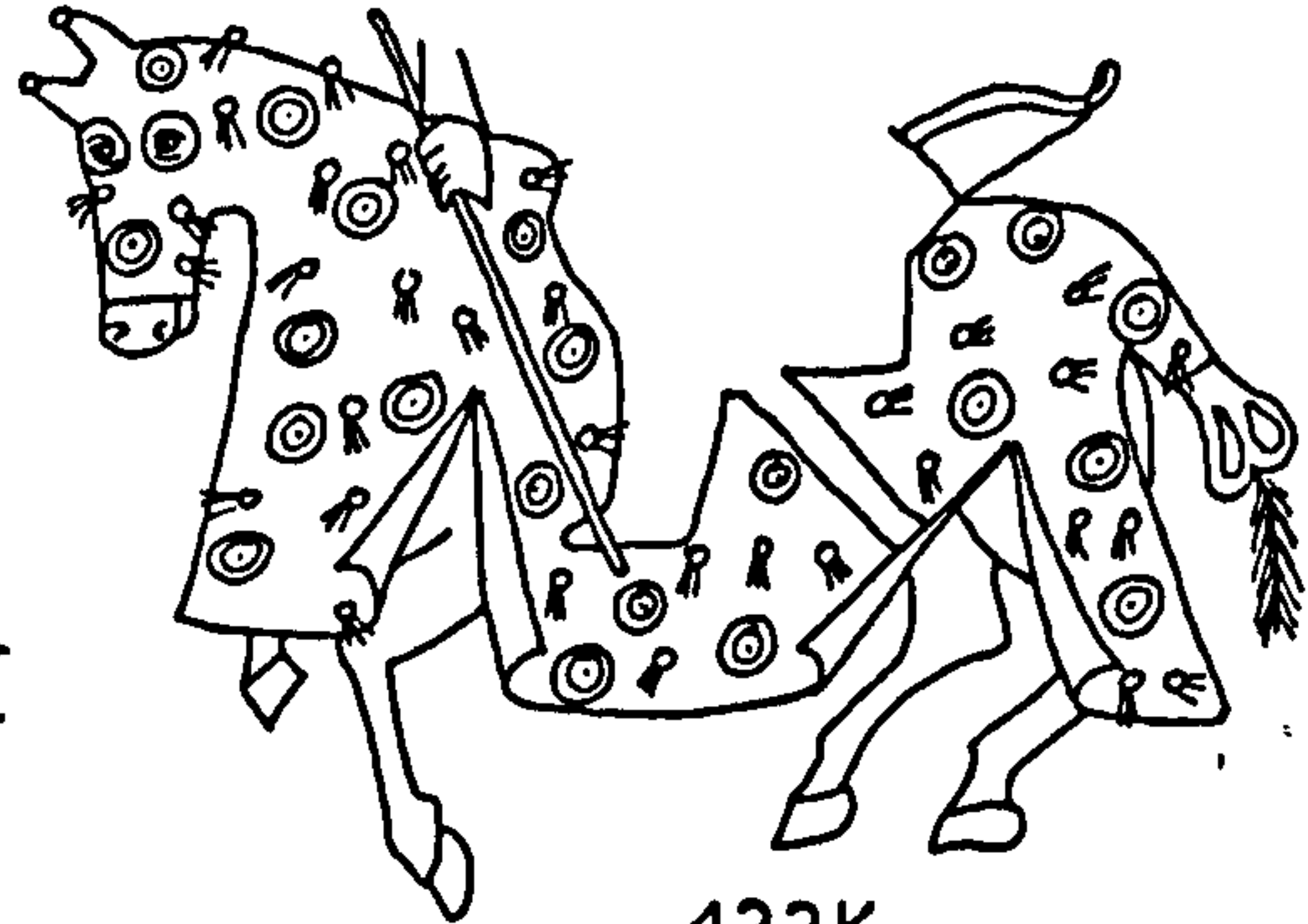

422K

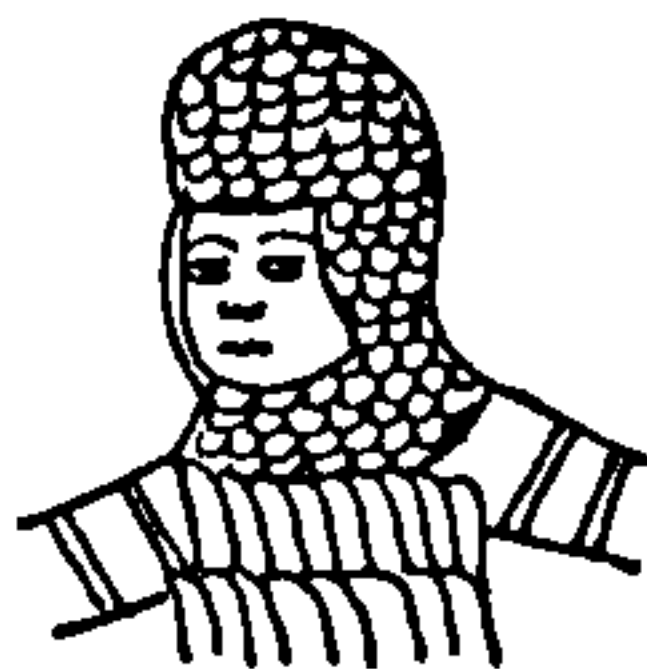

422L

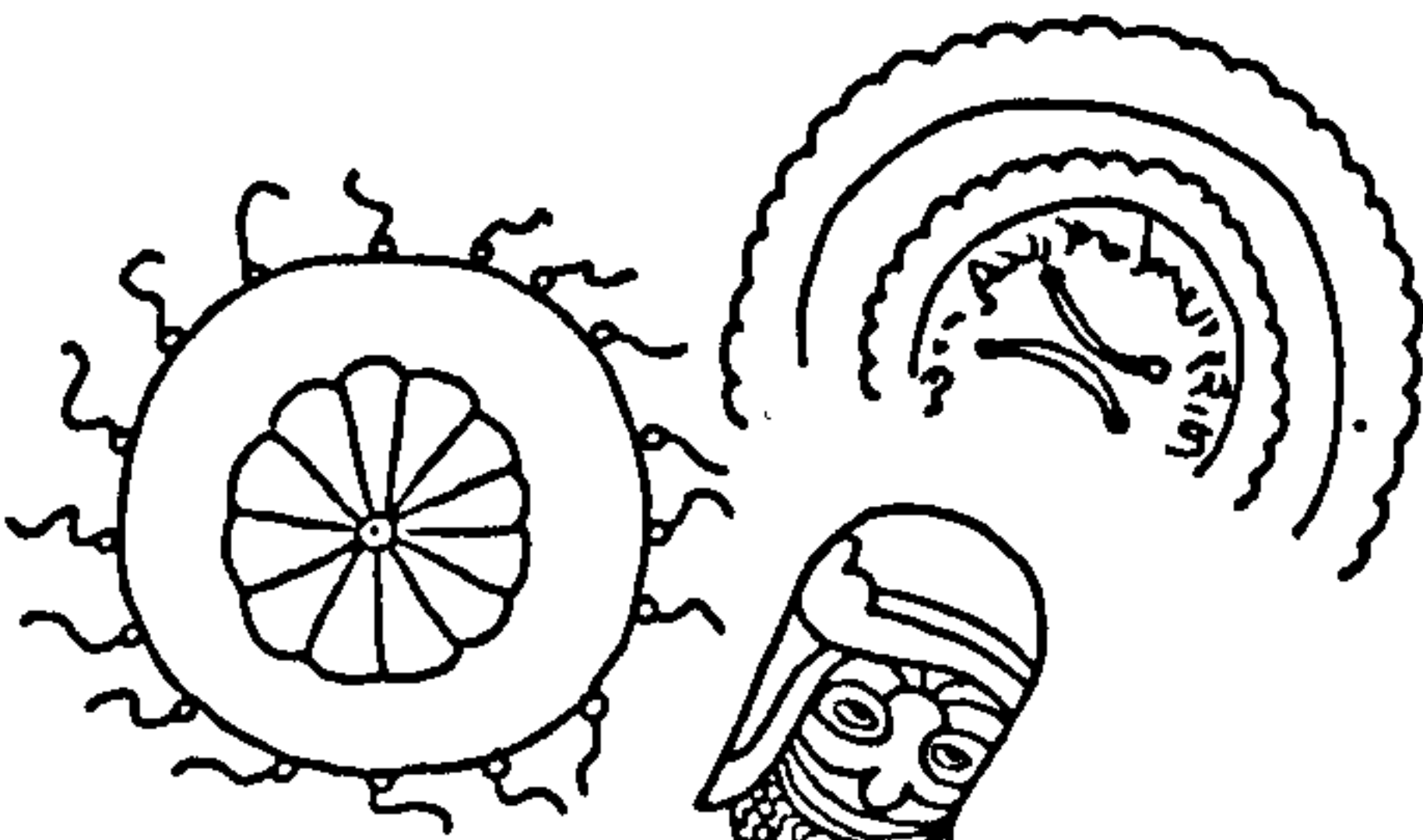

422M

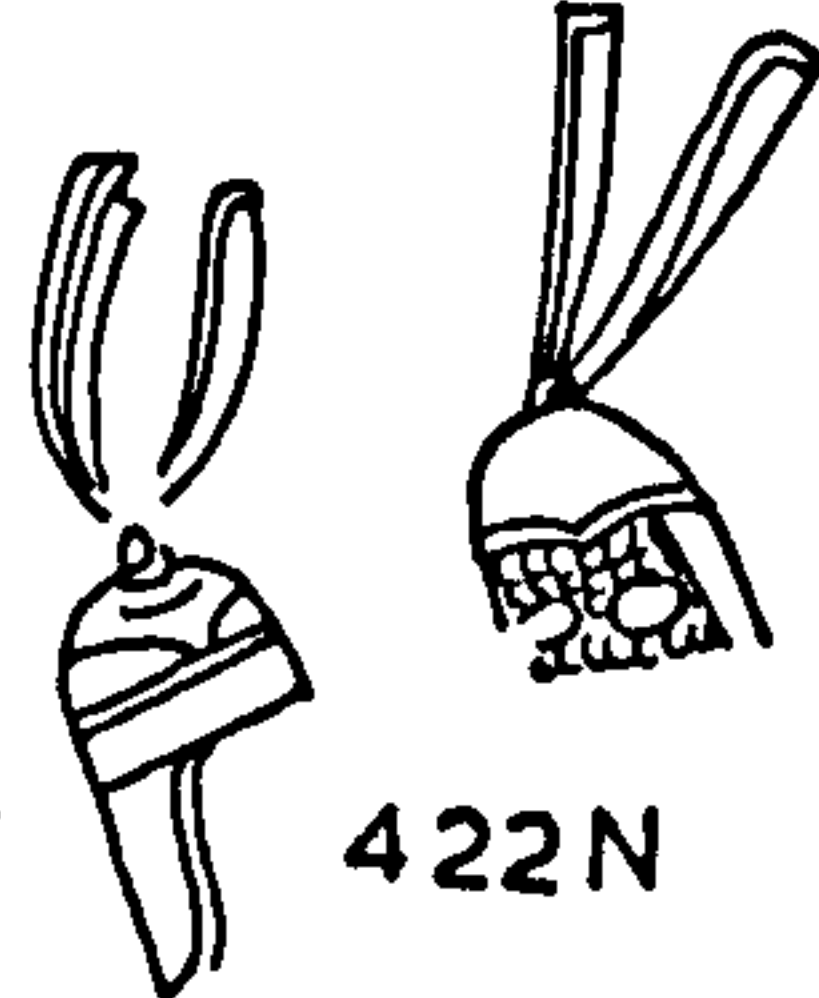

422N



422O



422P



422S



422Q

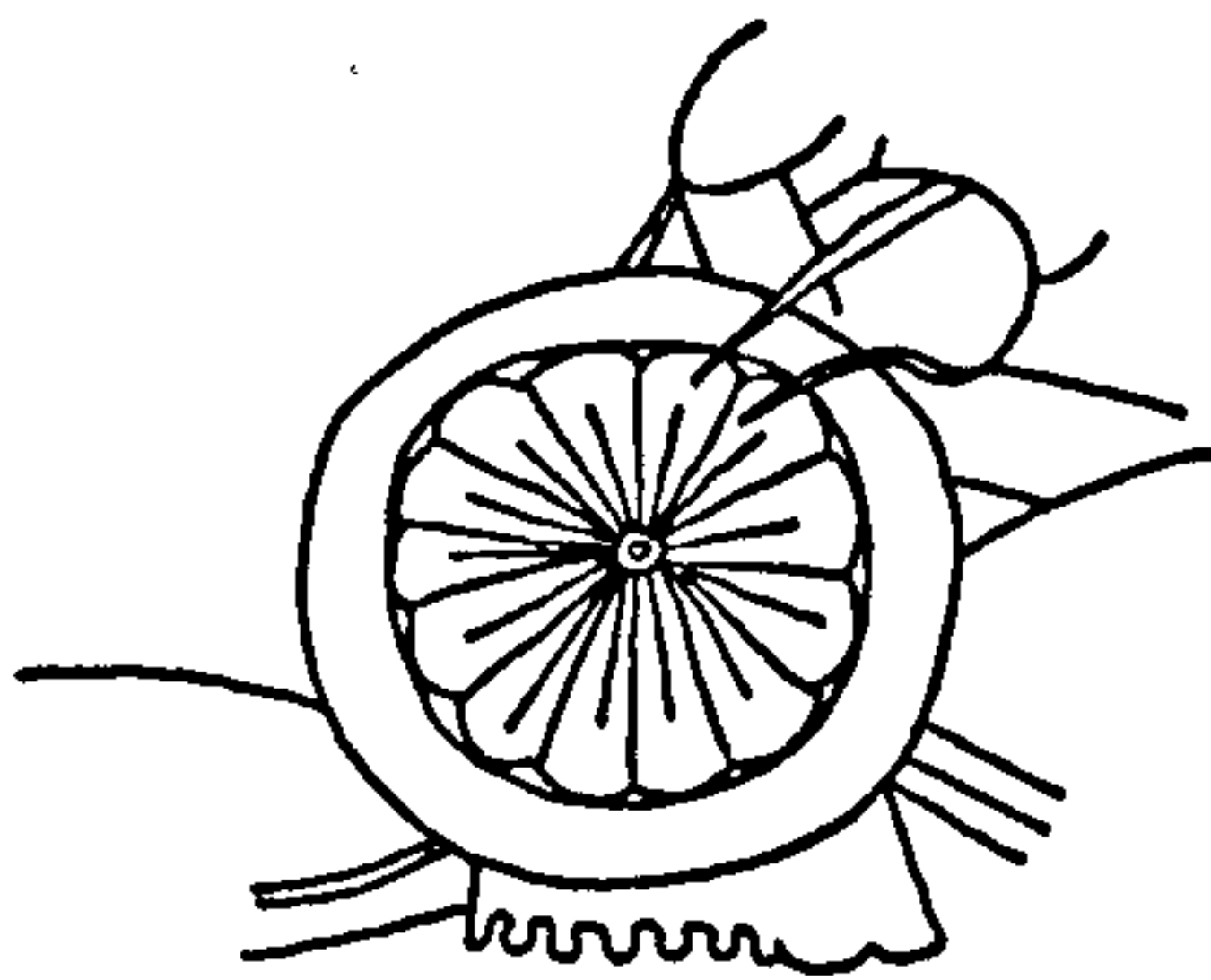

422R



422T



422X

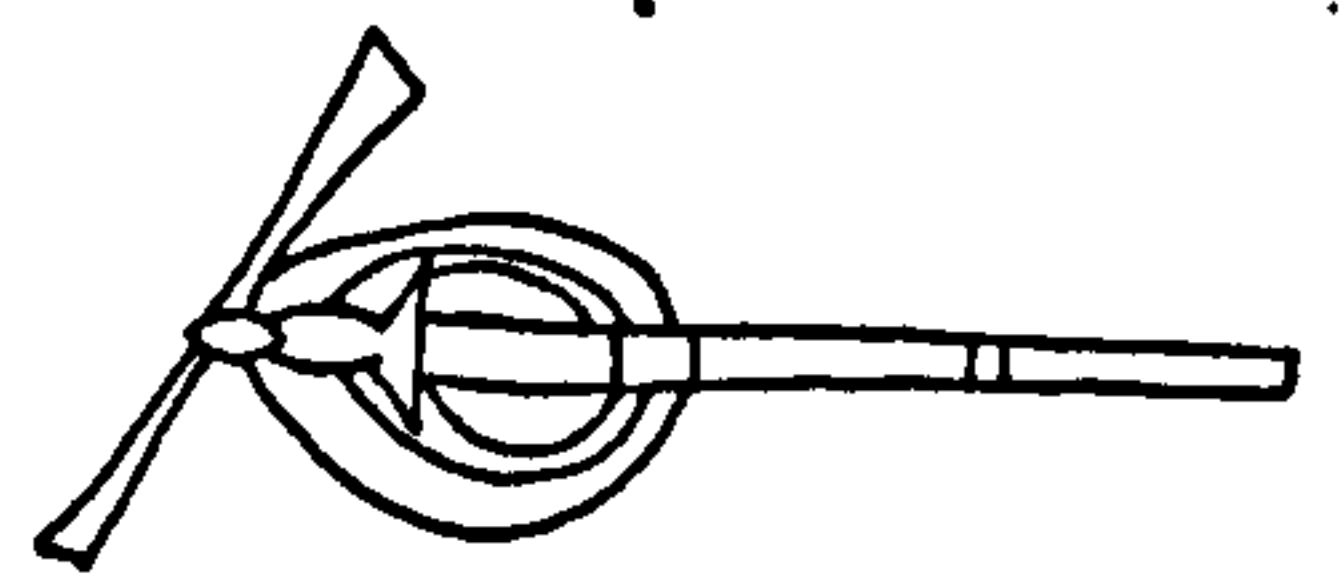

422U

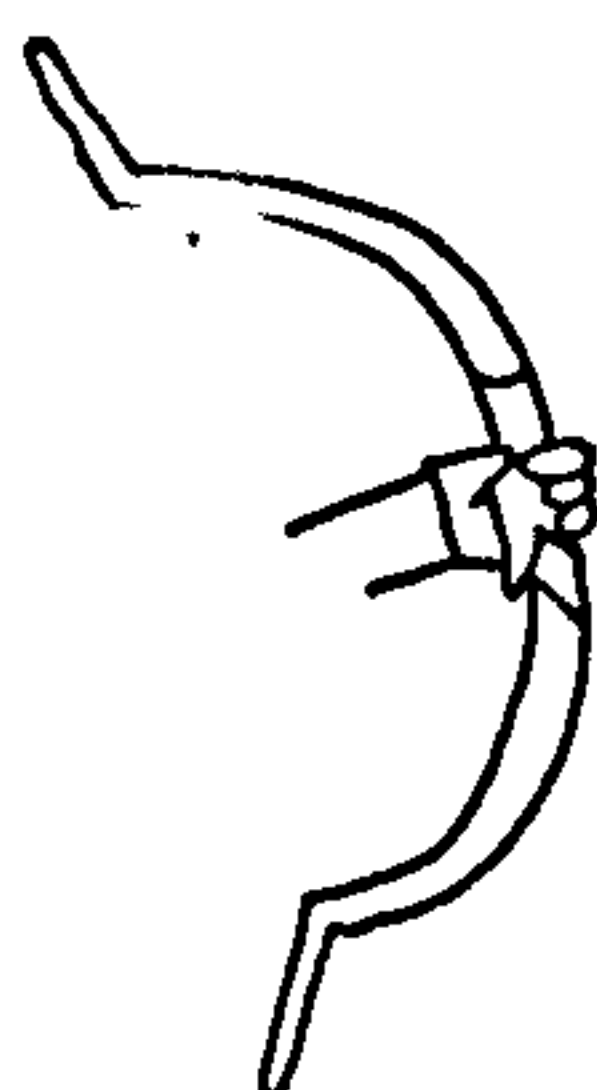

422V

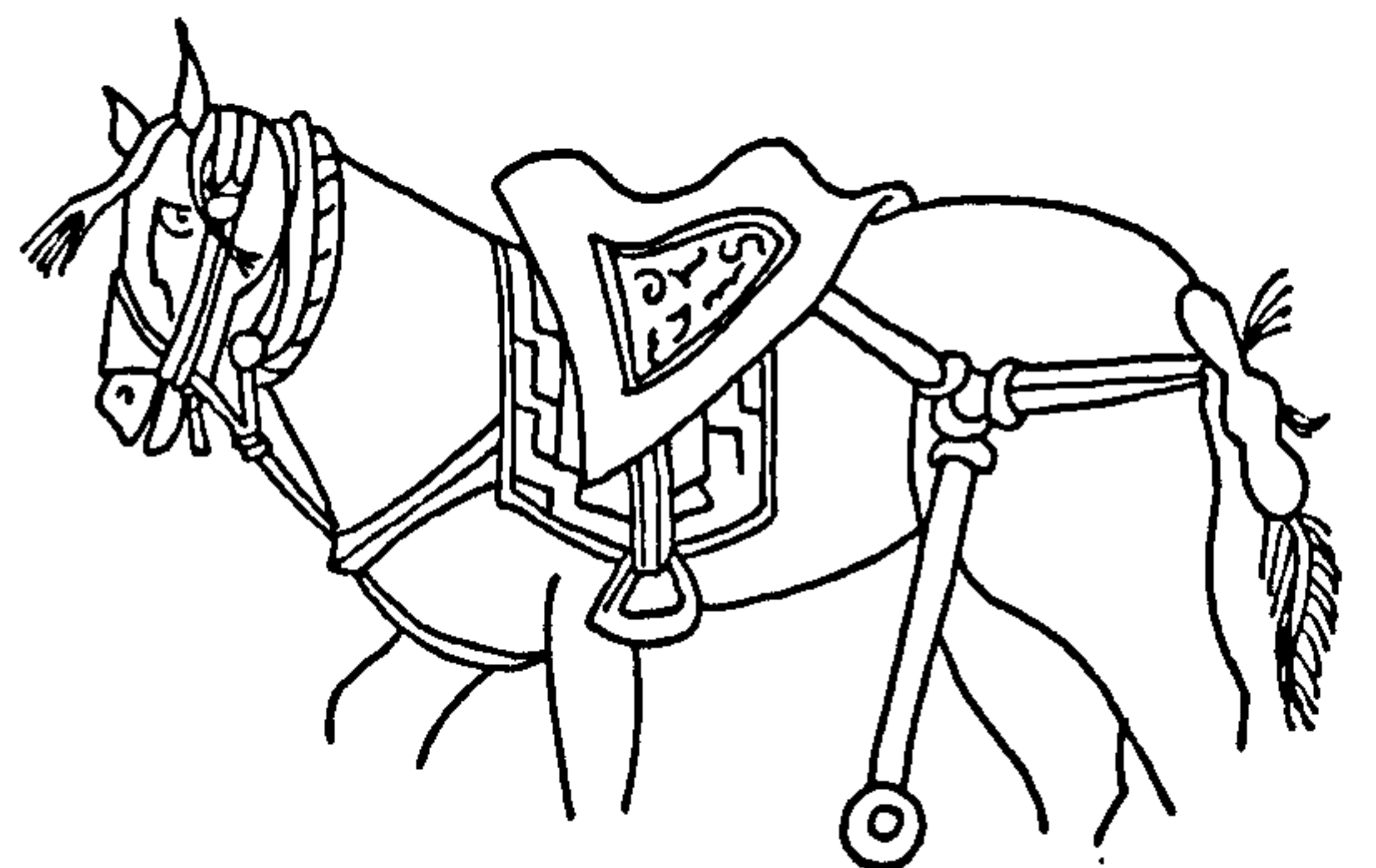
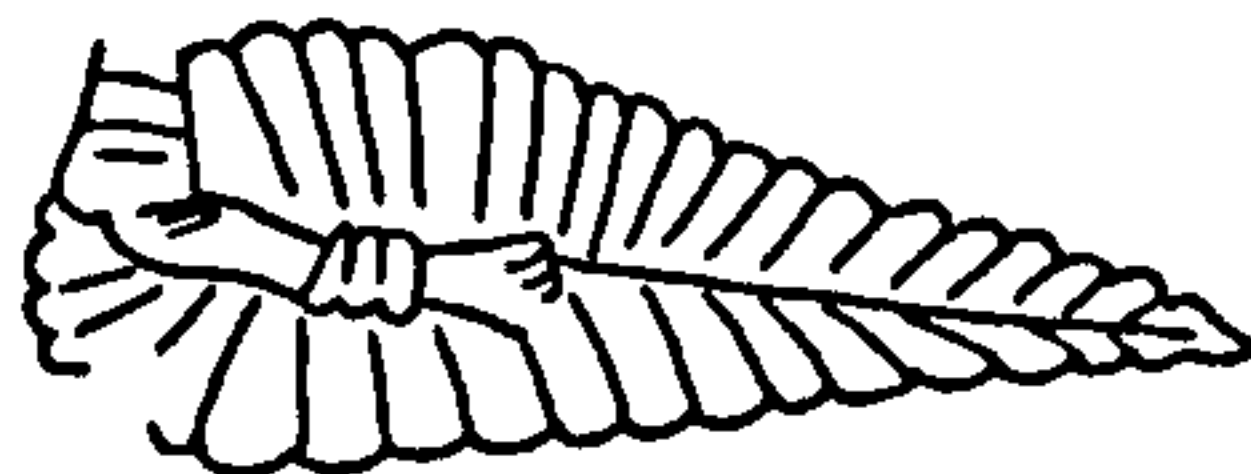

422W

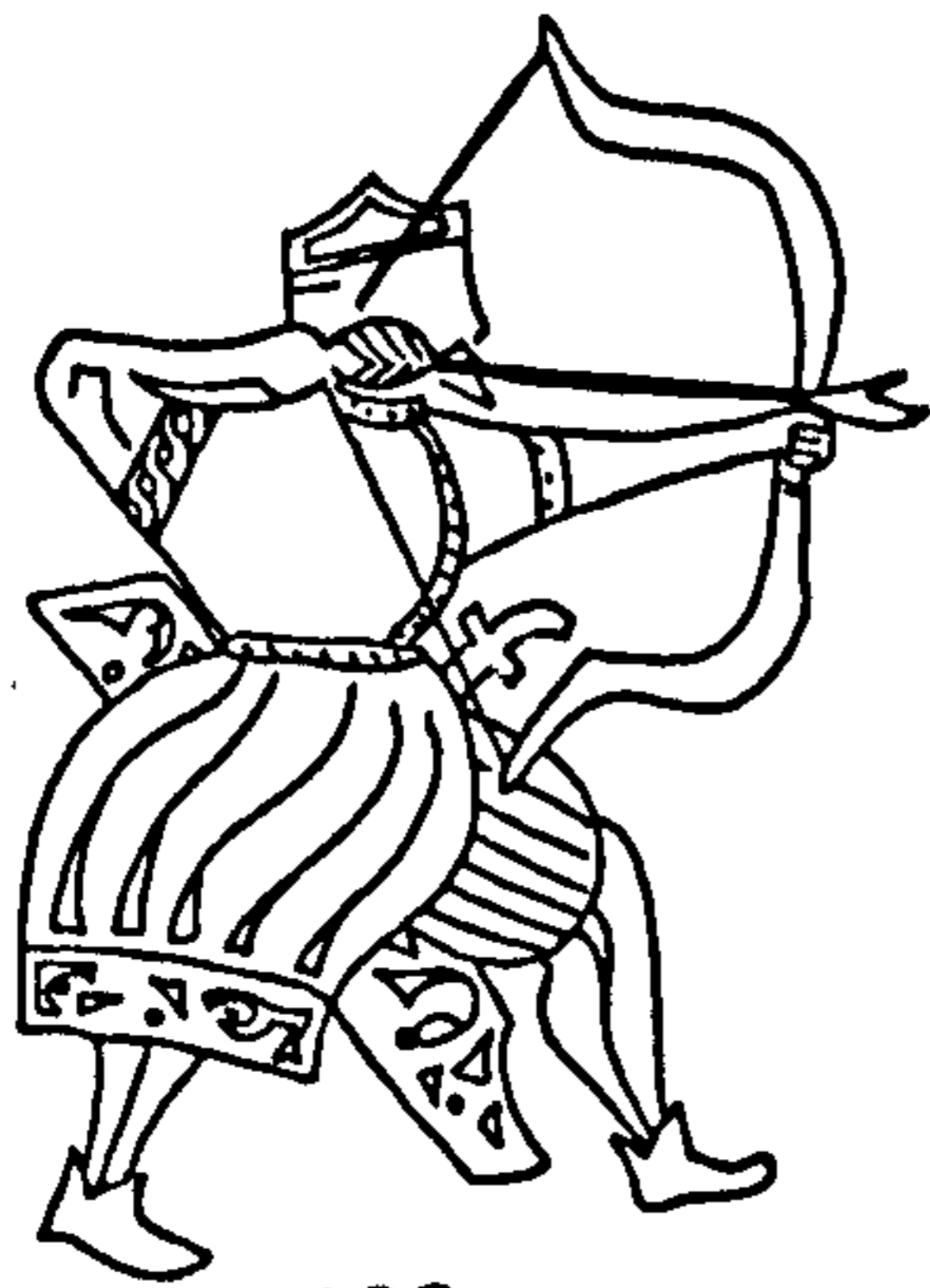

423



424

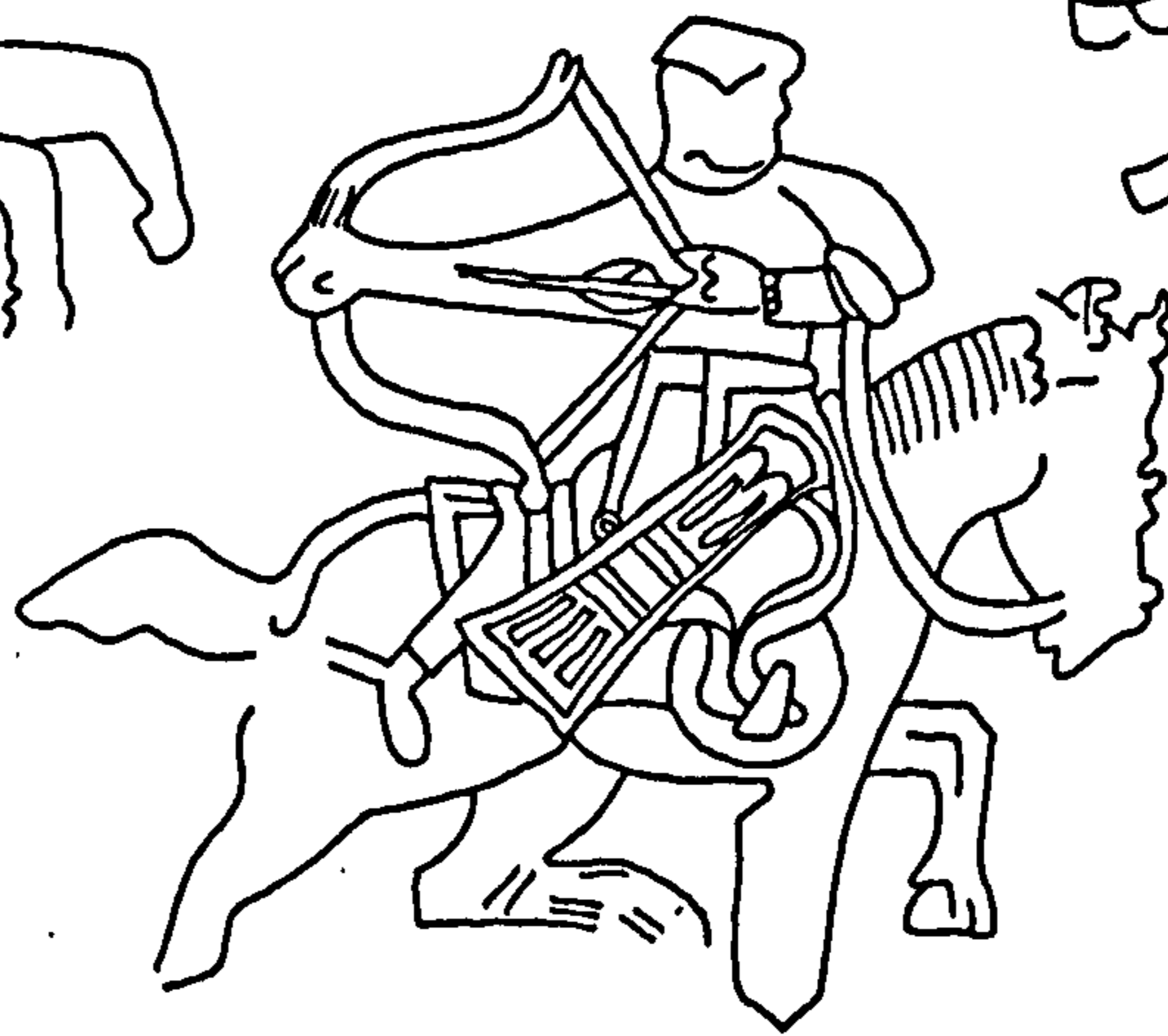
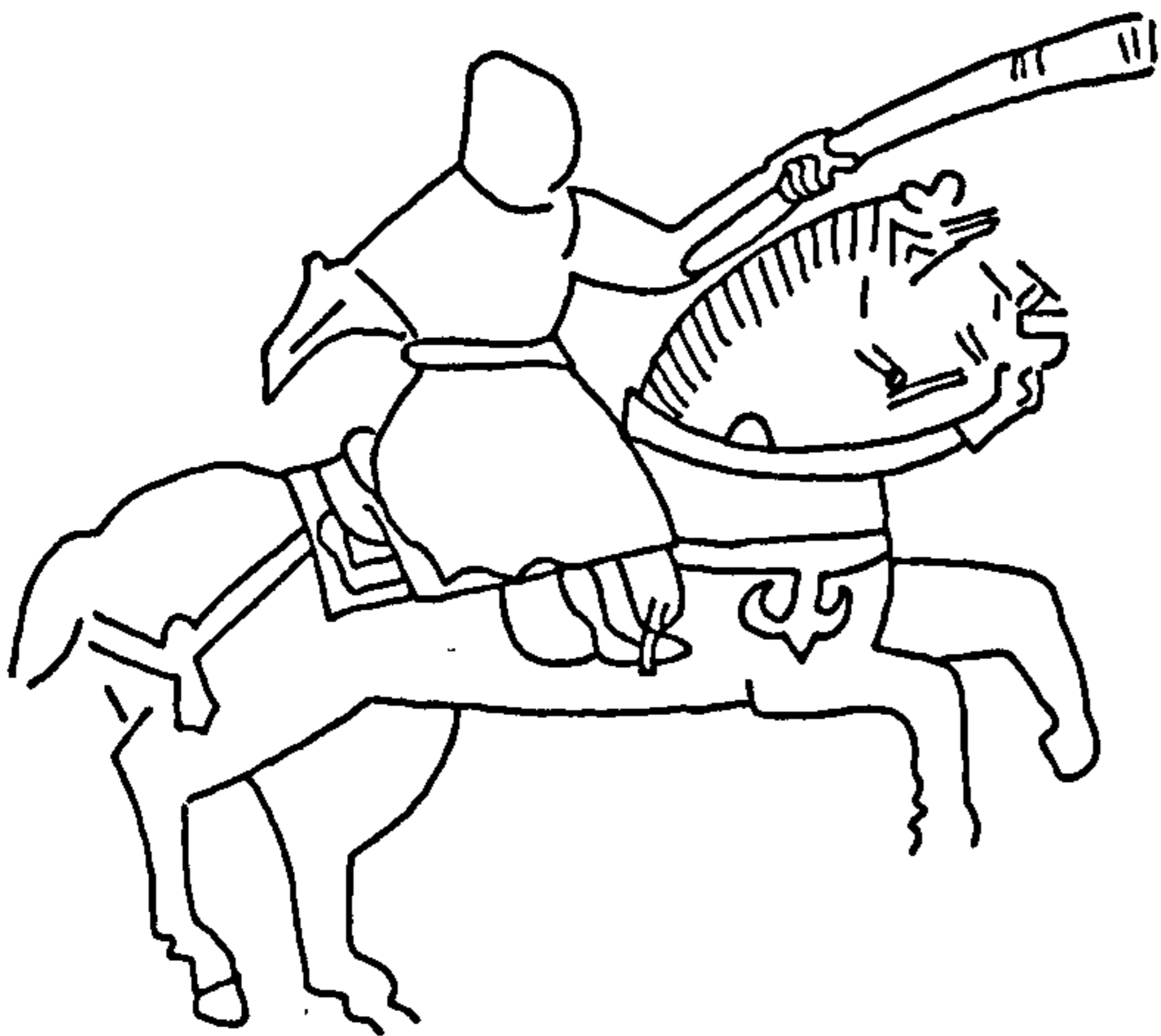
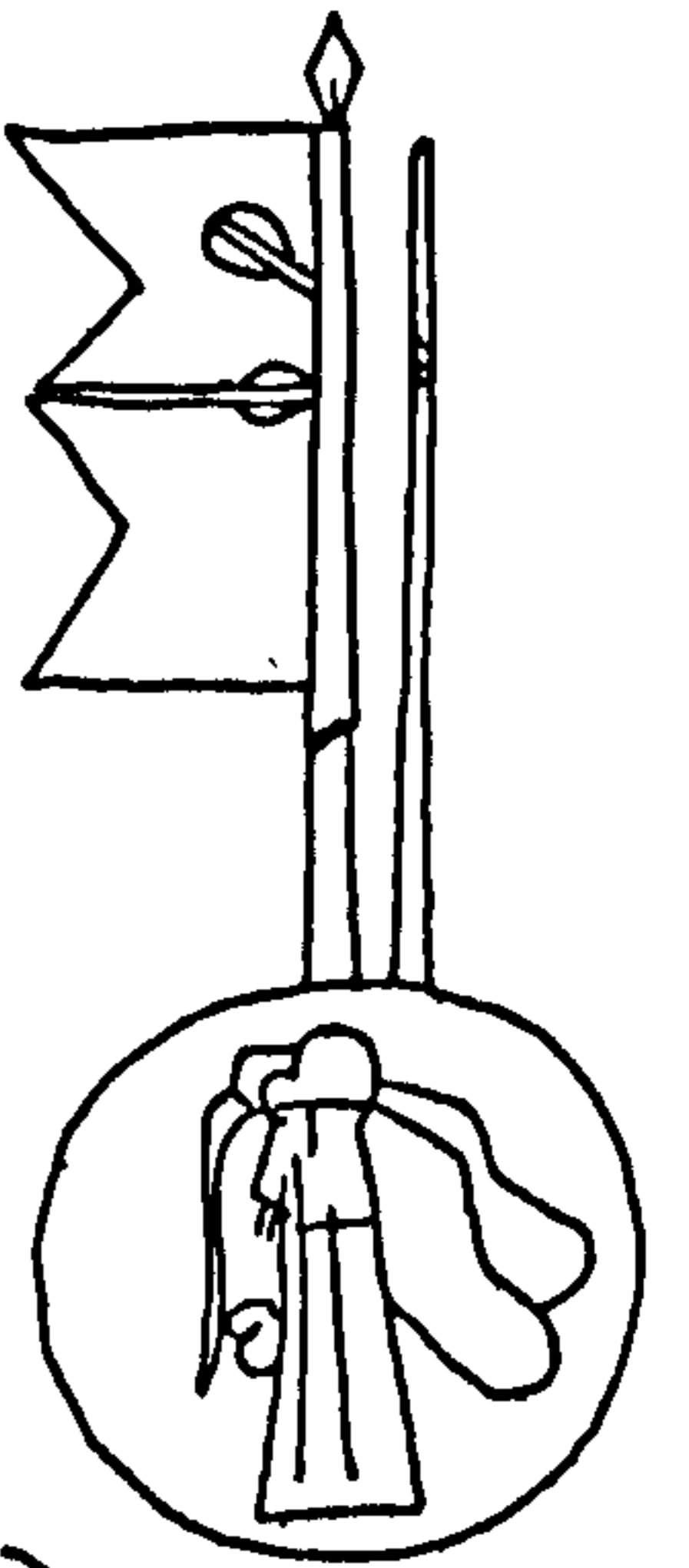

425

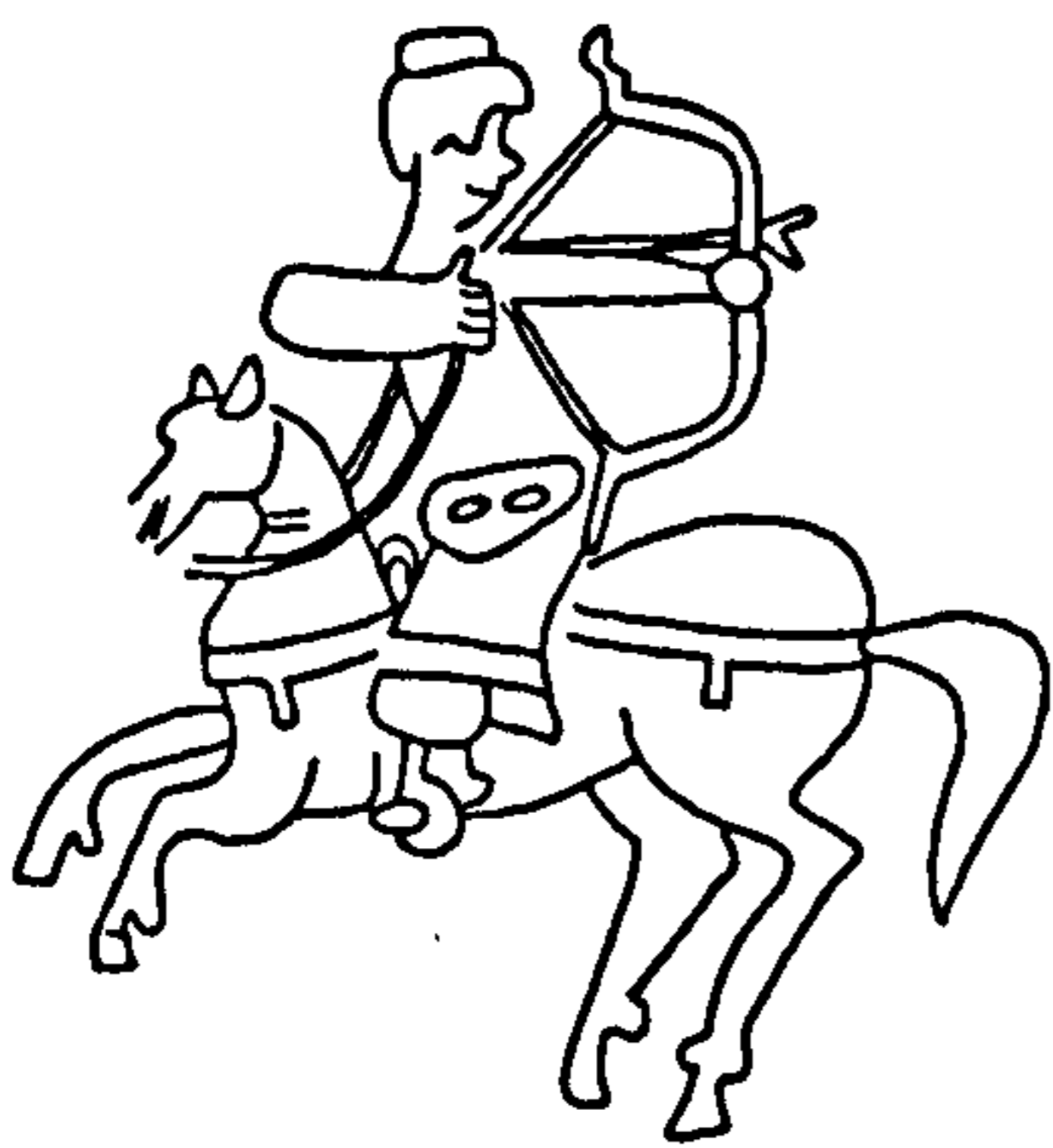

426



427

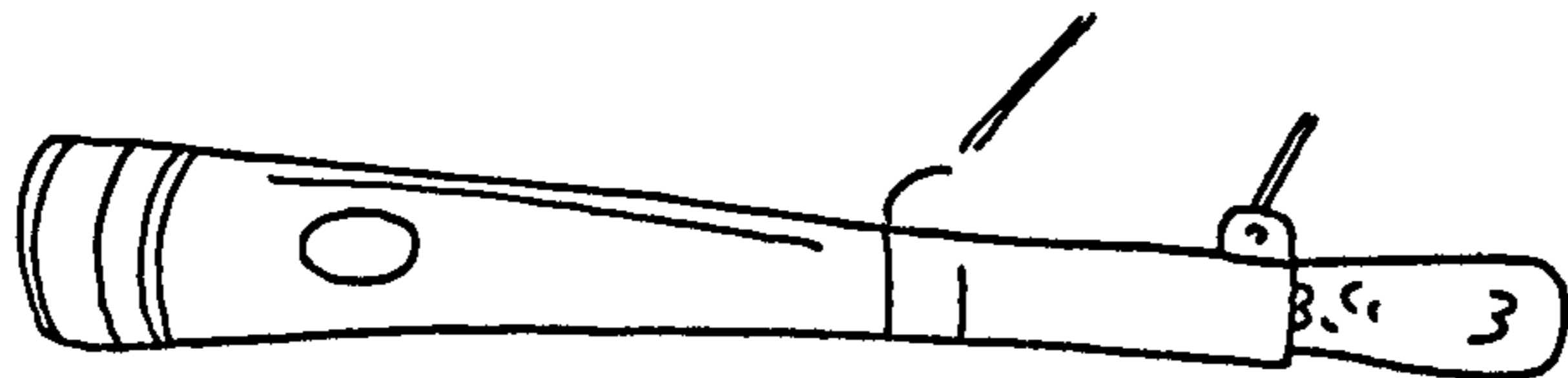
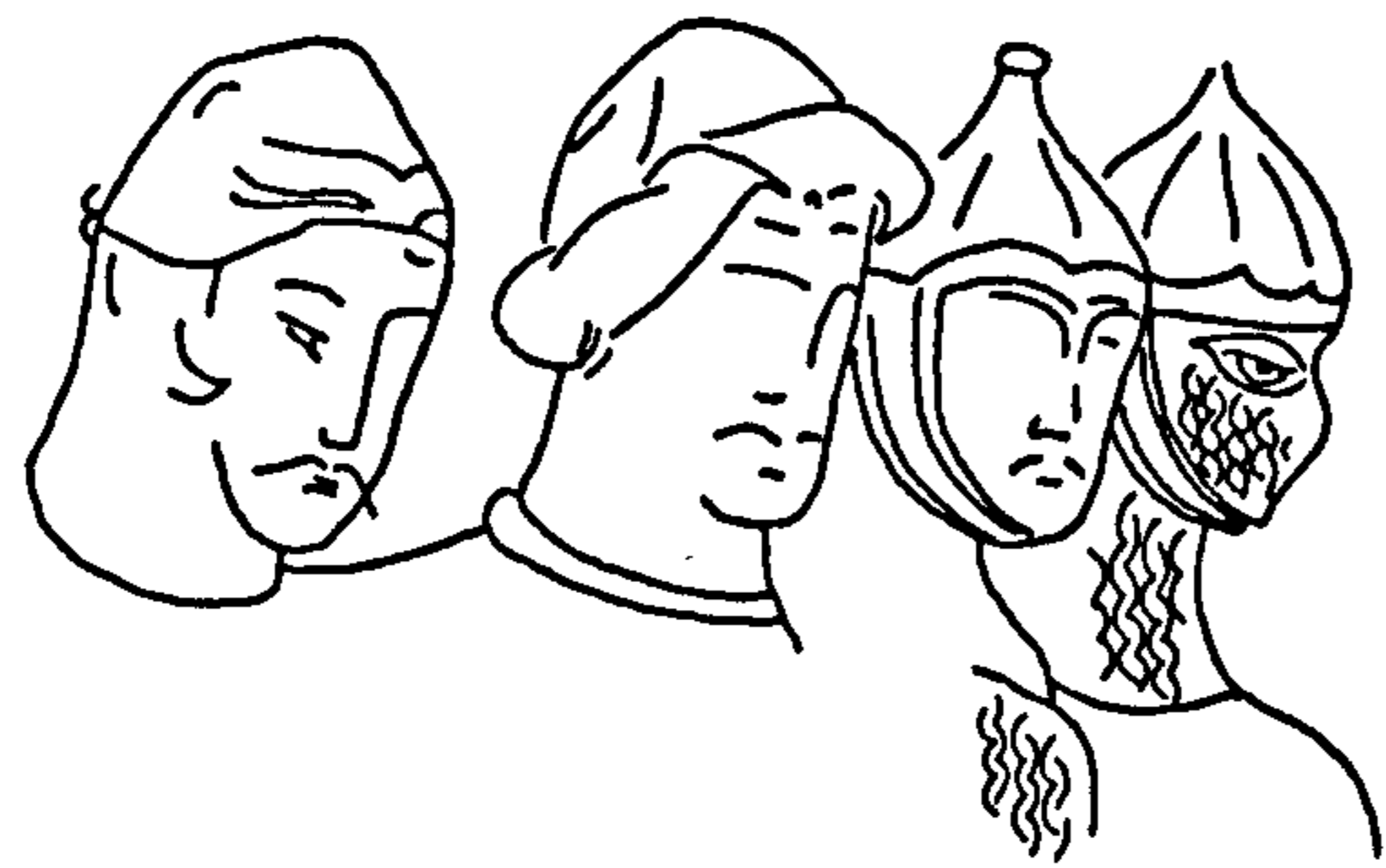
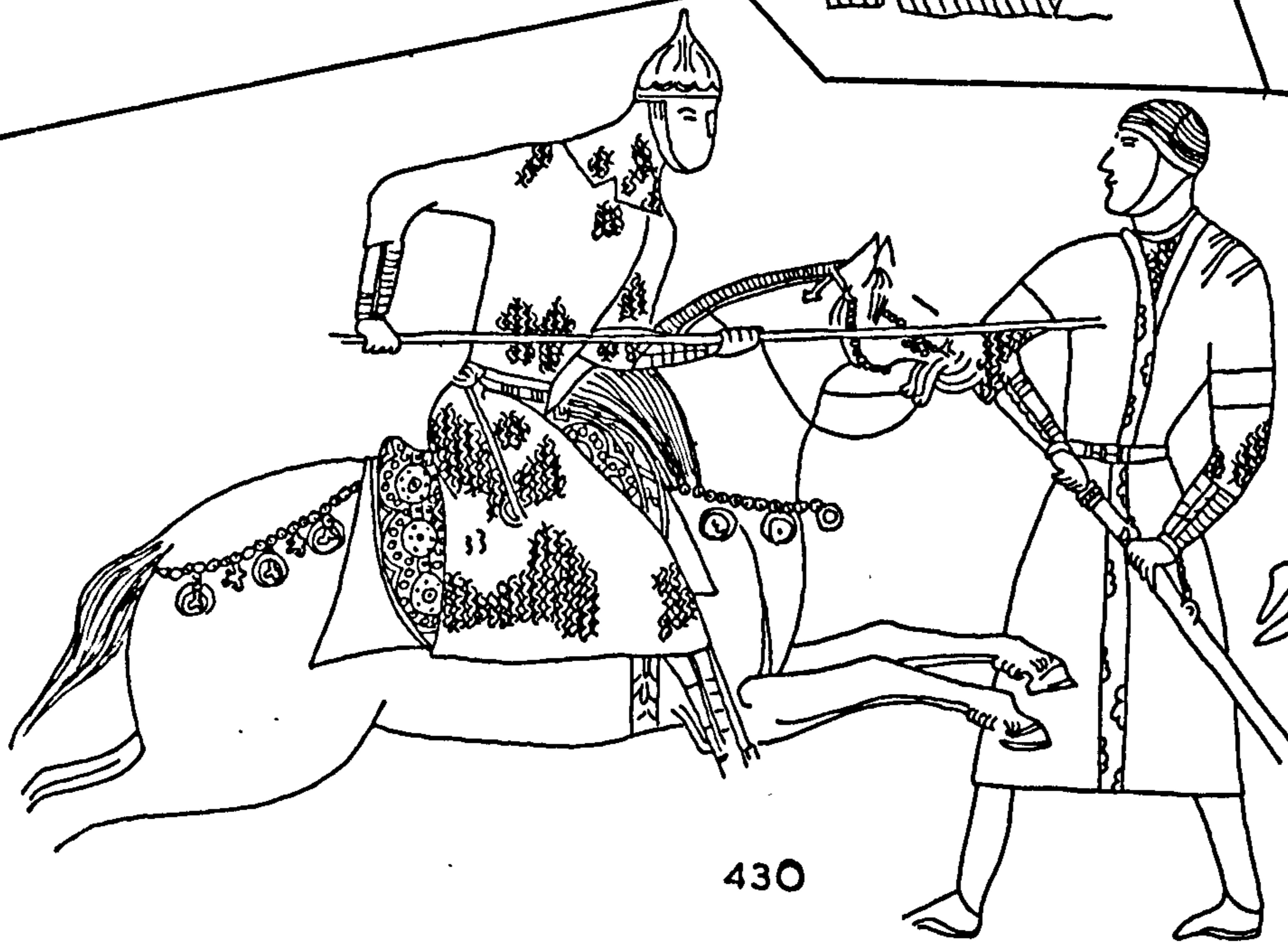
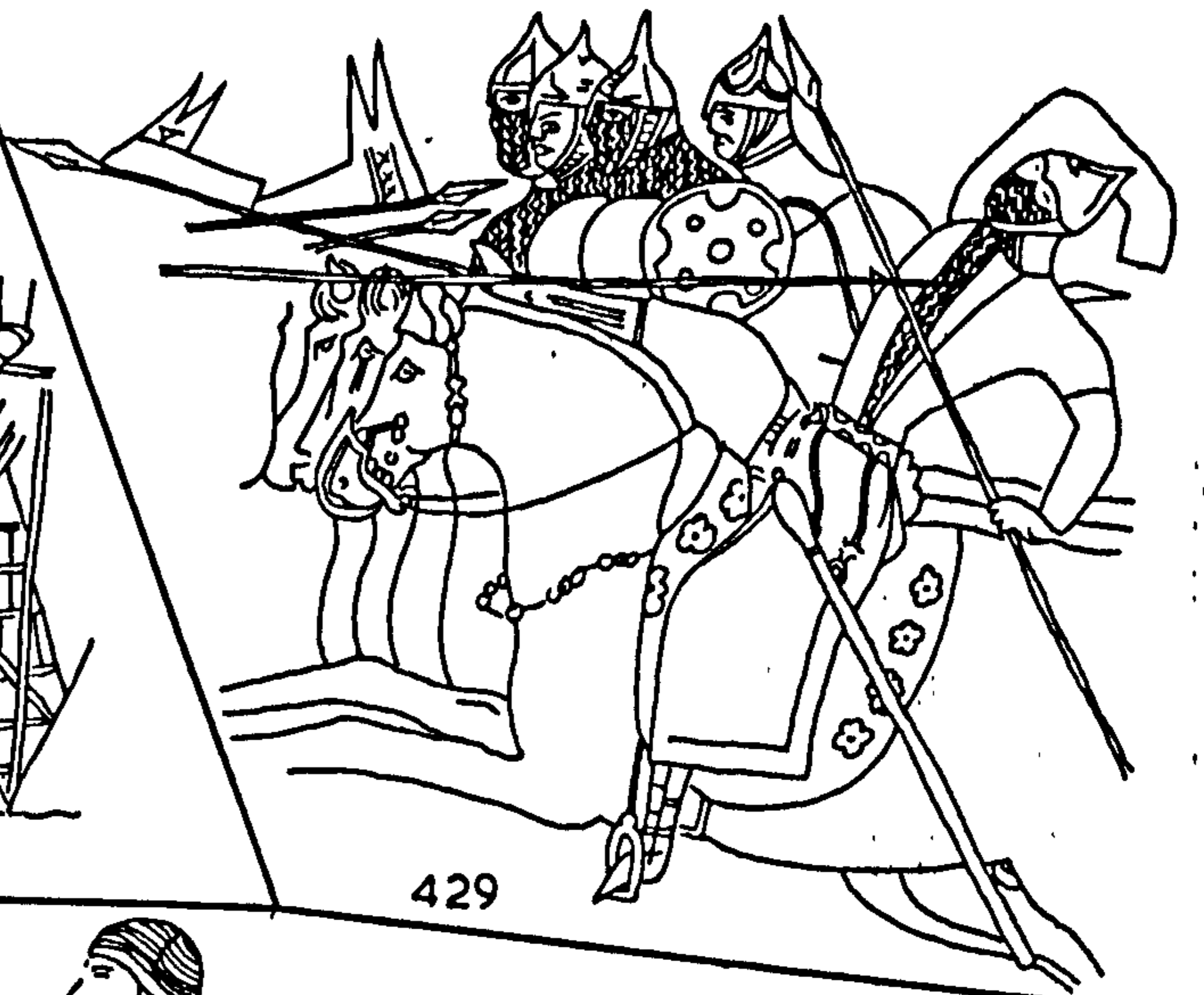
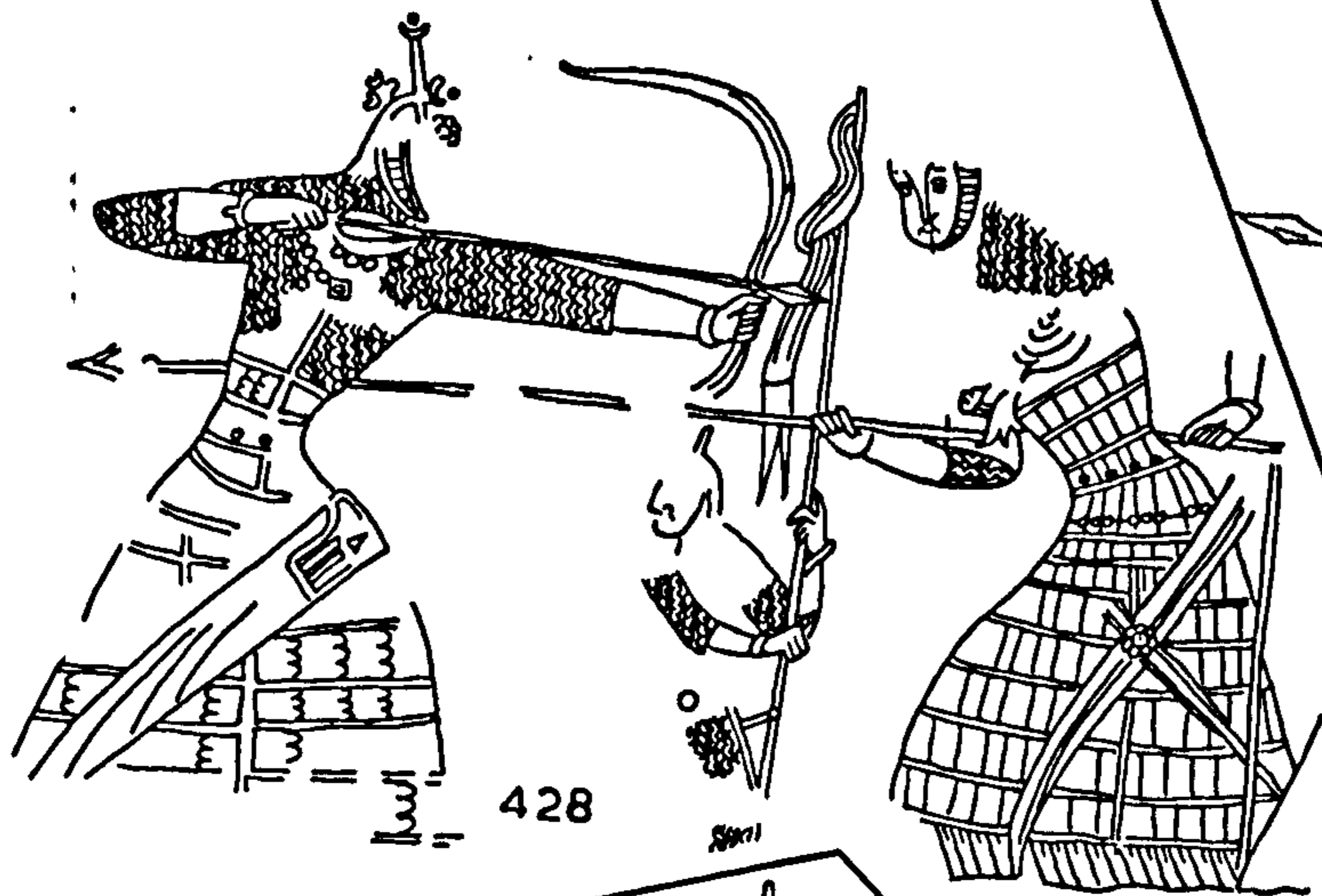

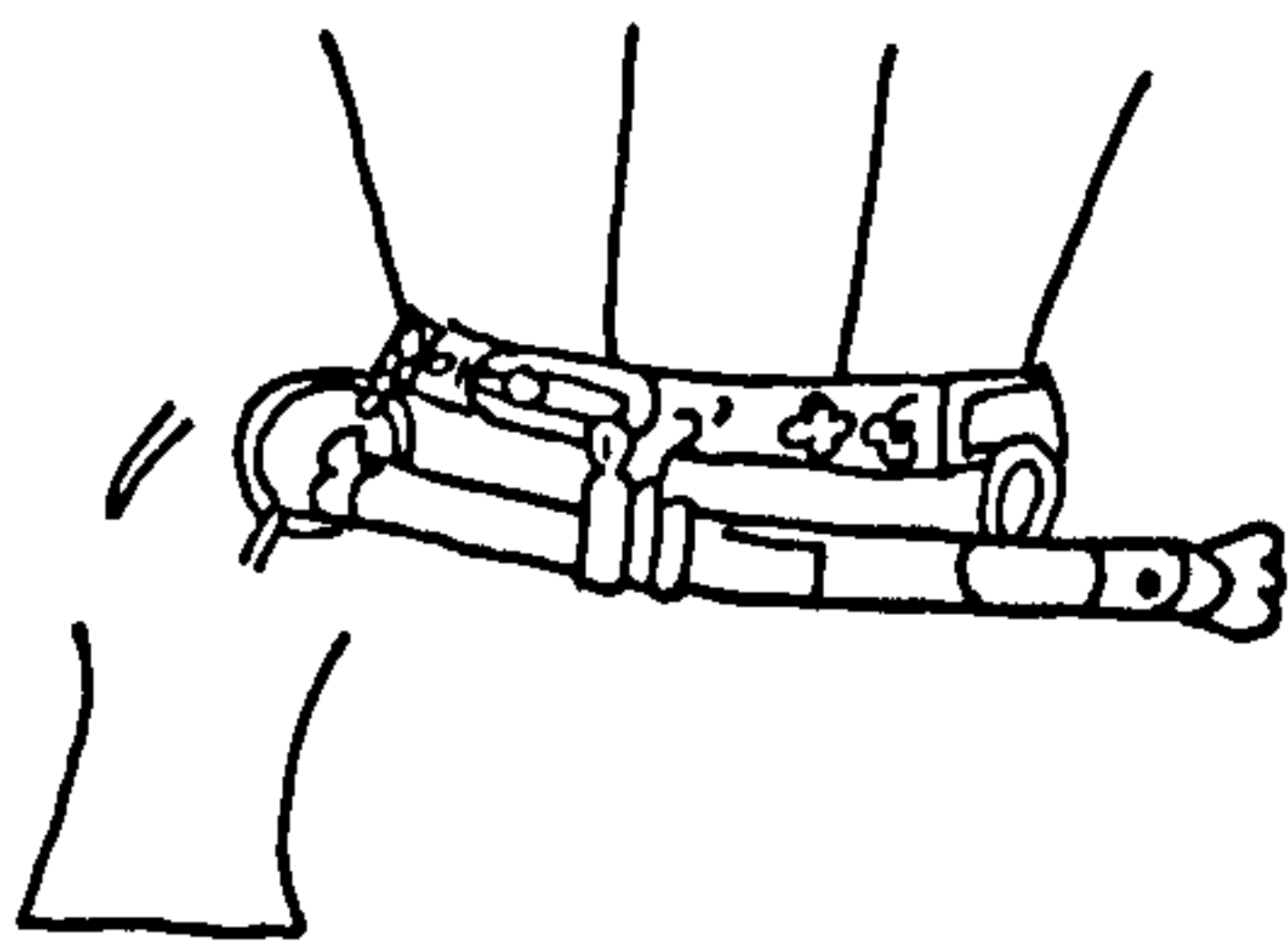
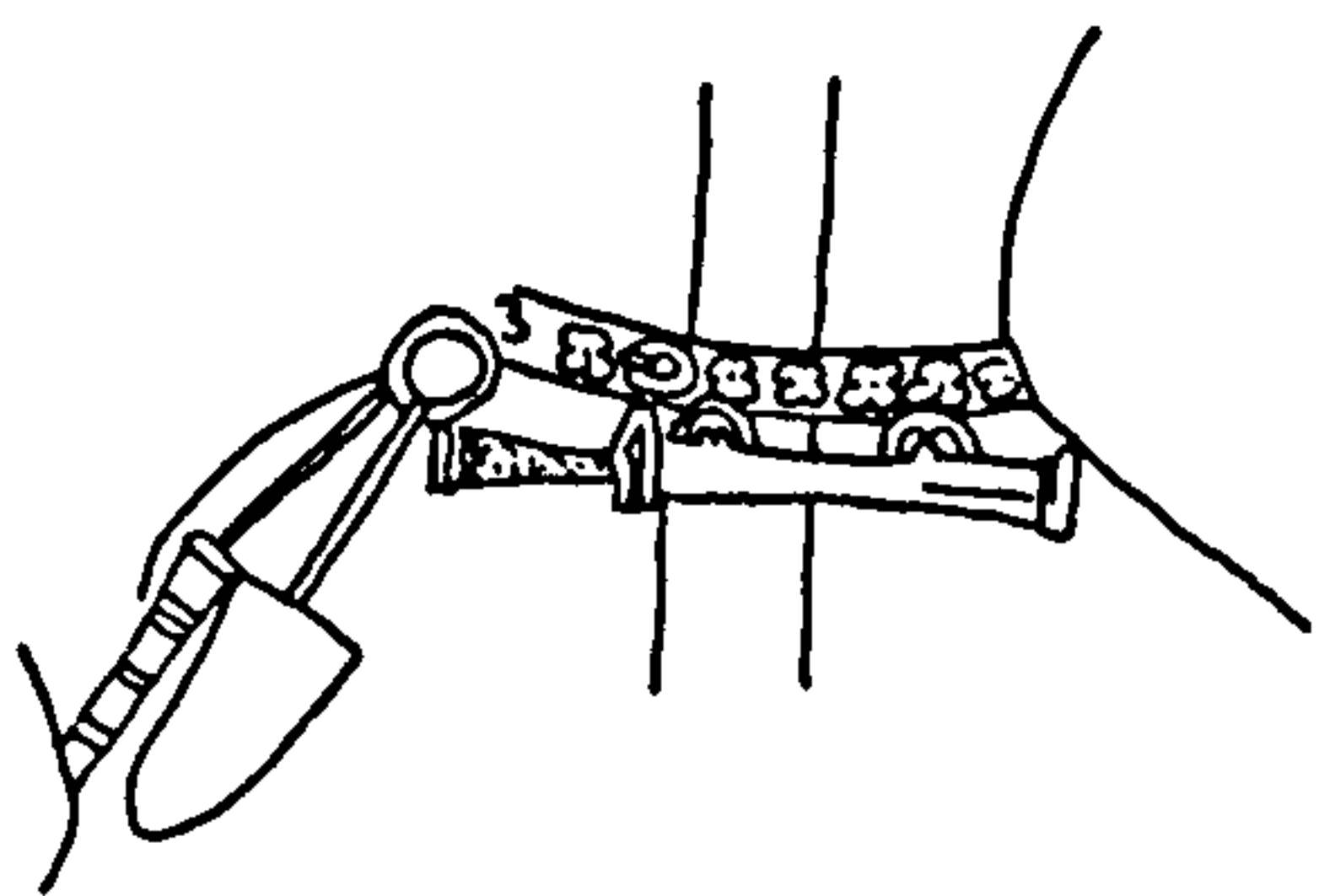

435

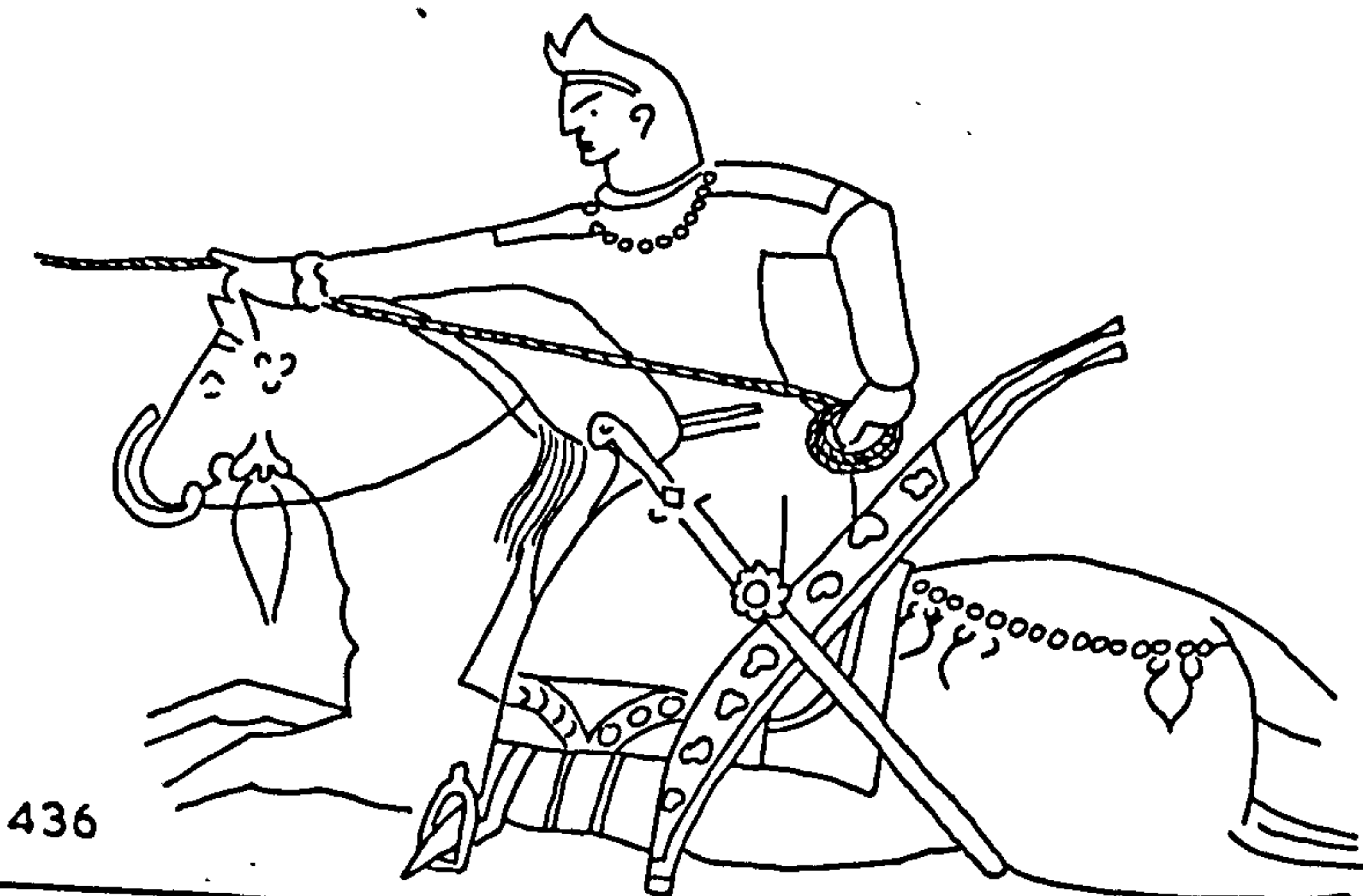
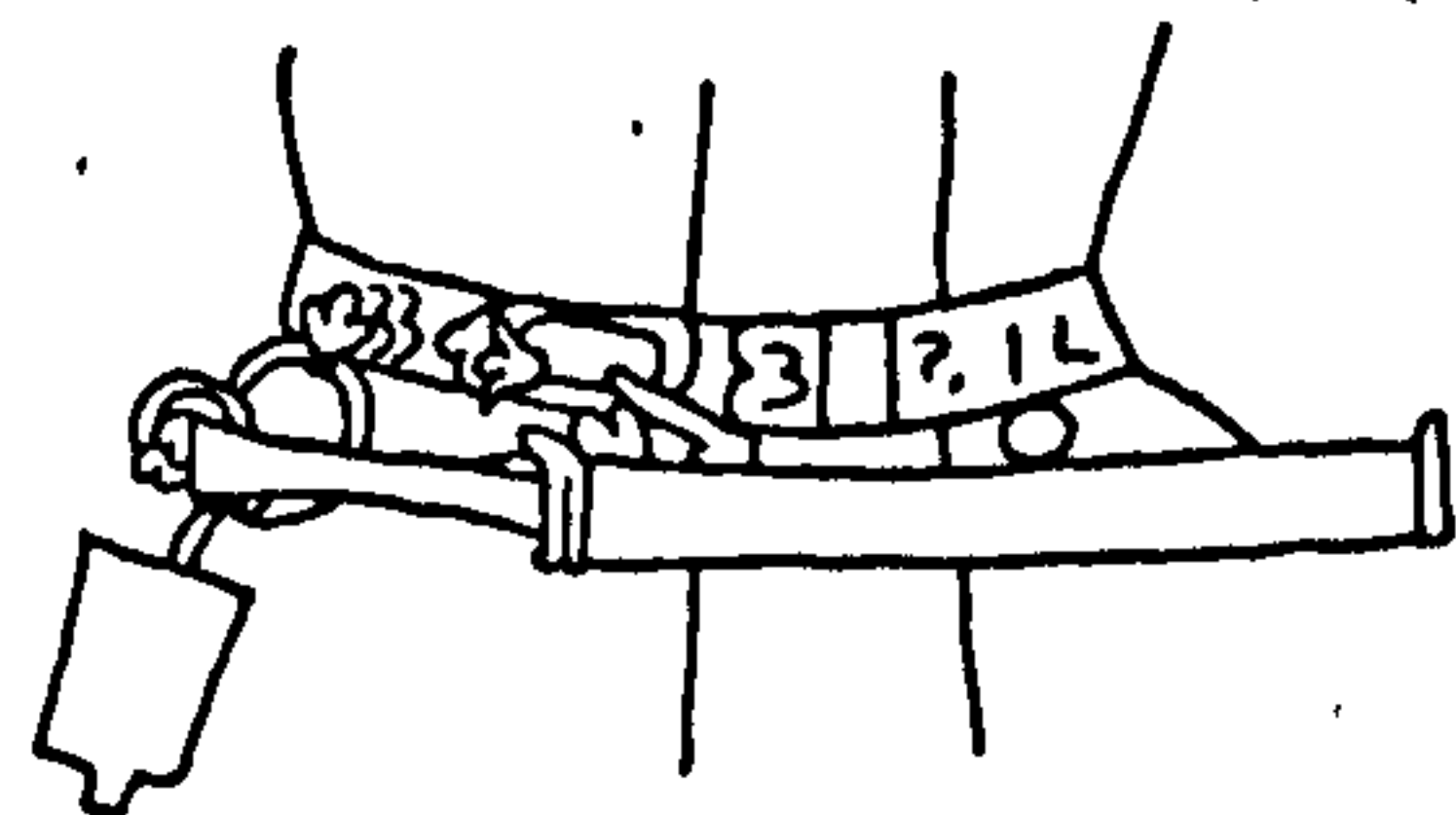

436

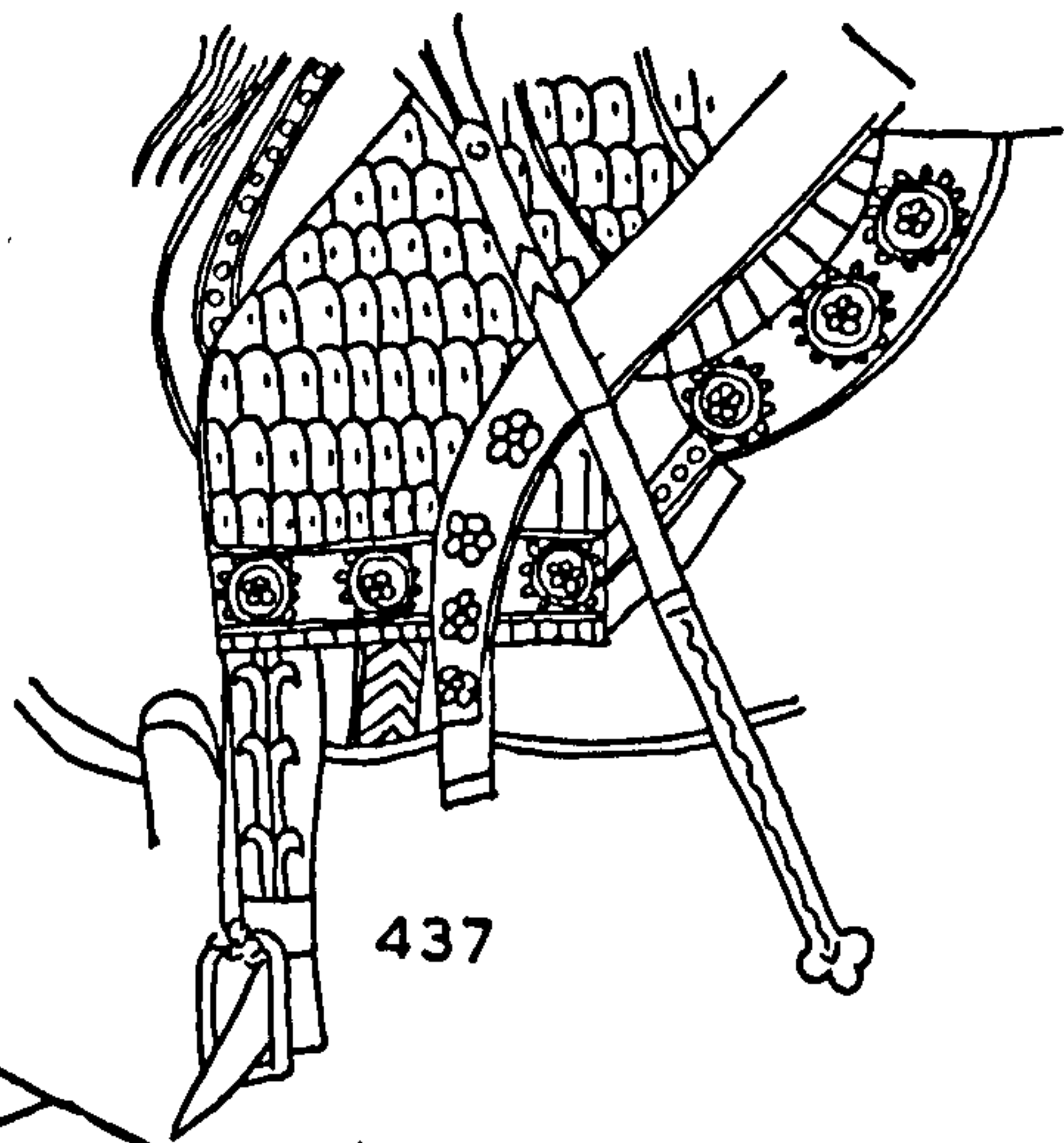

437

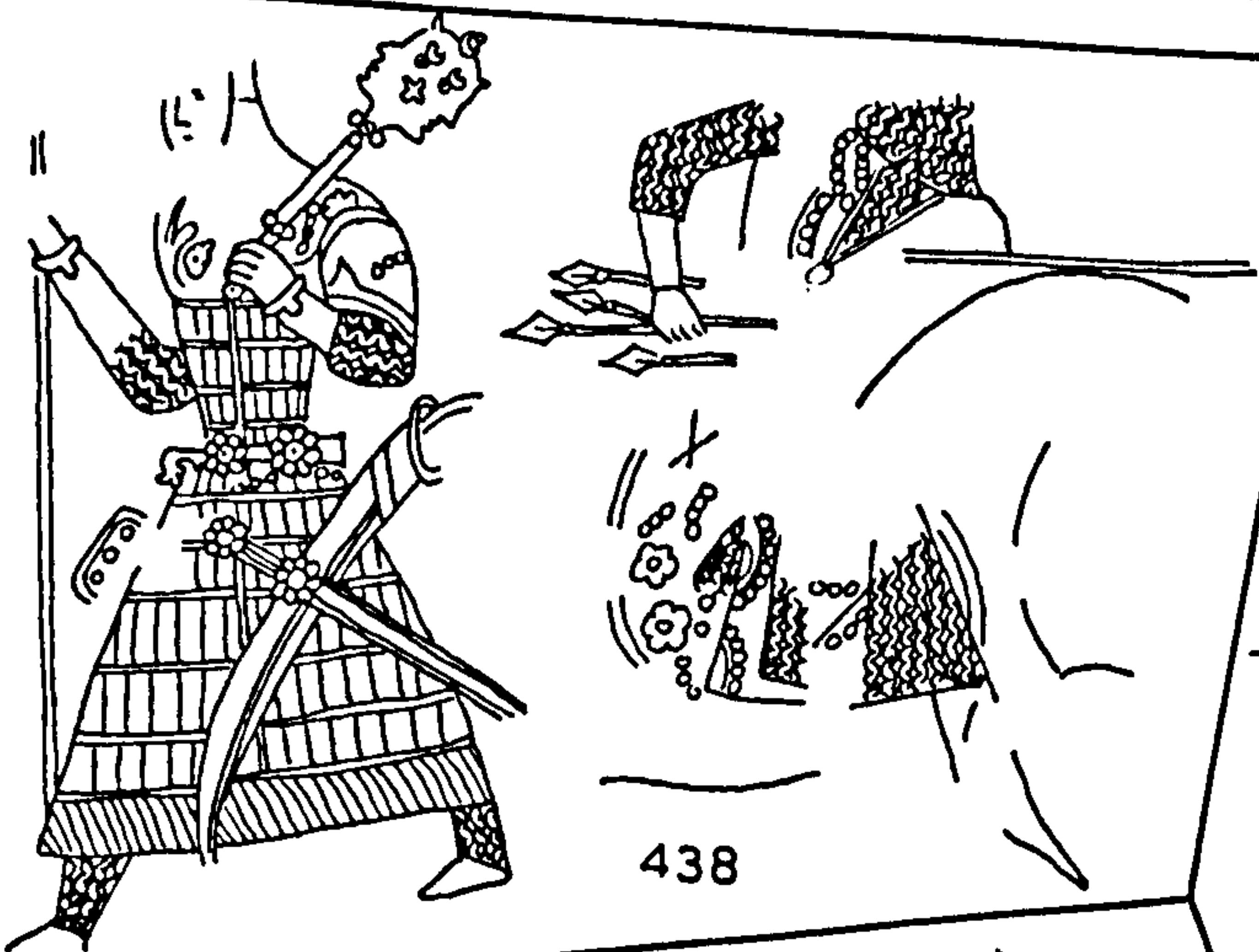

438

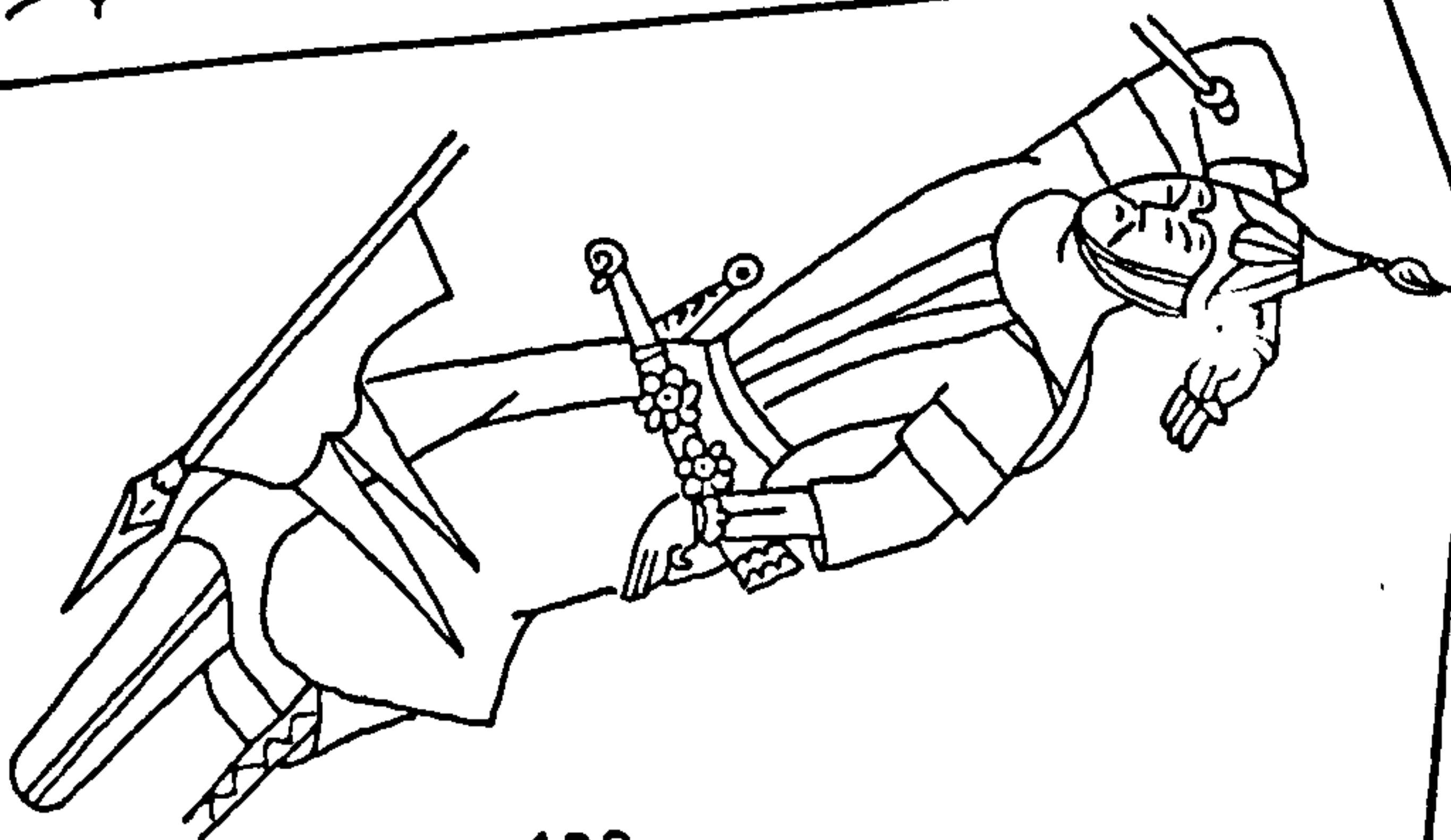

439

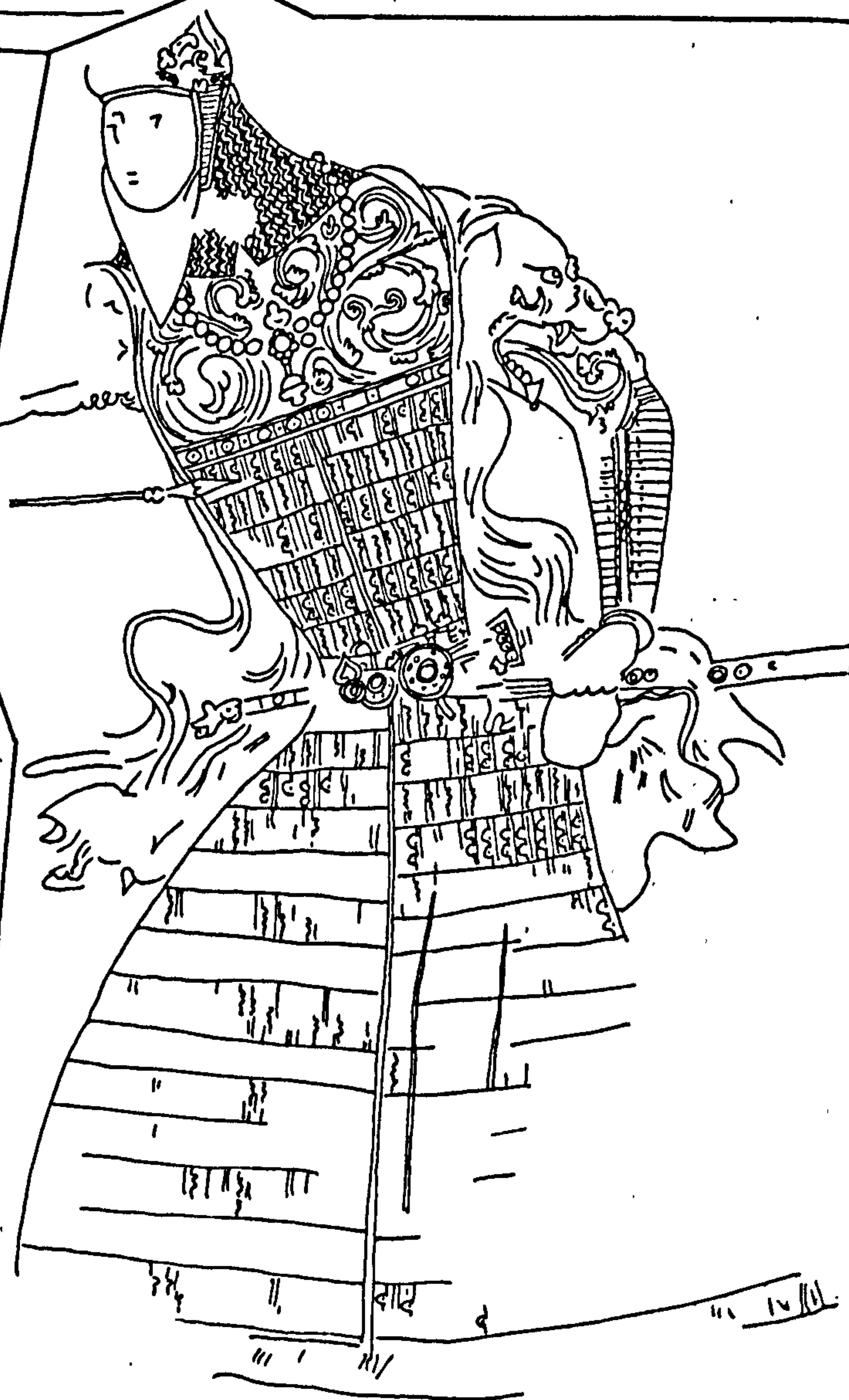

440



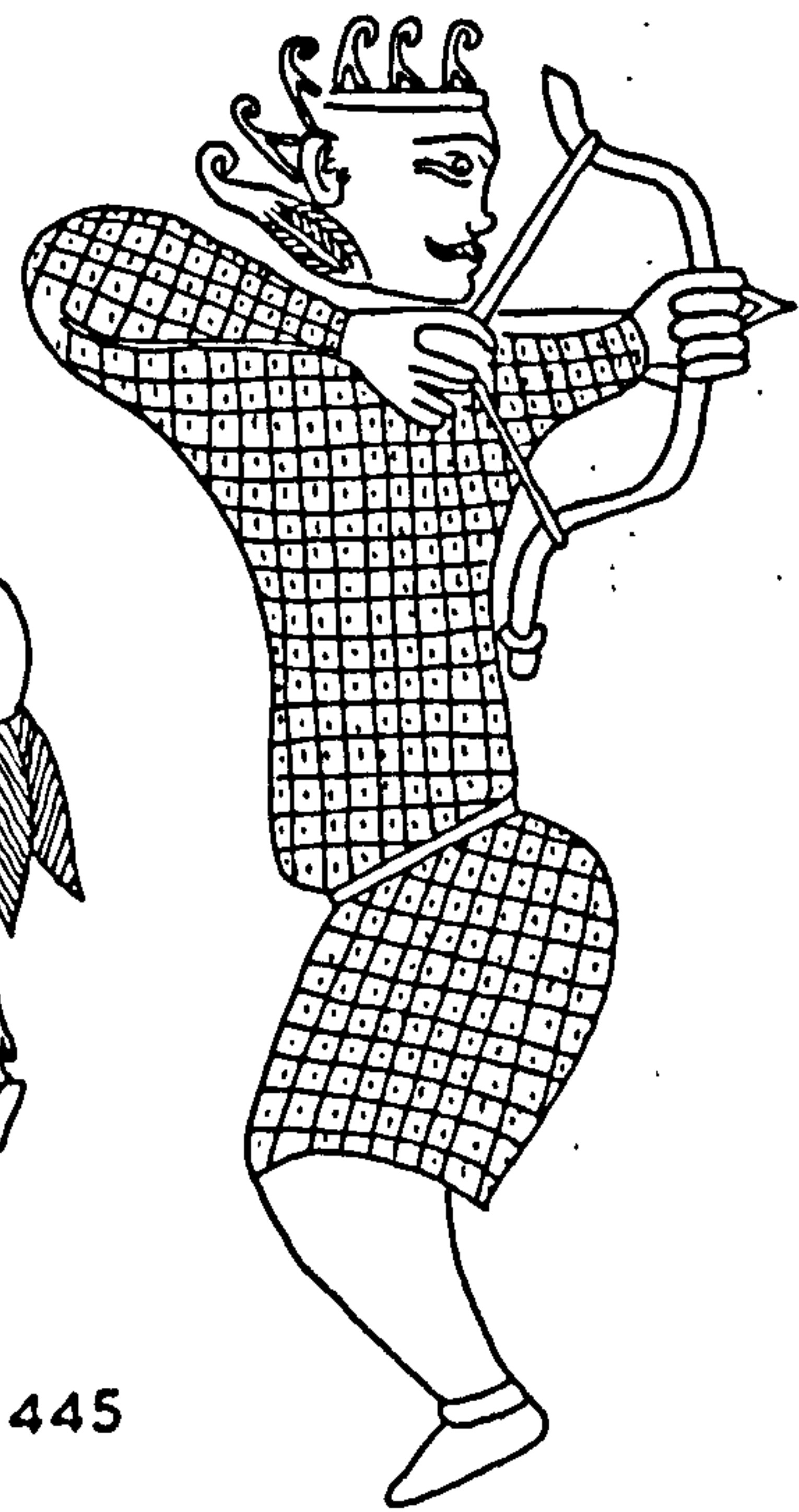
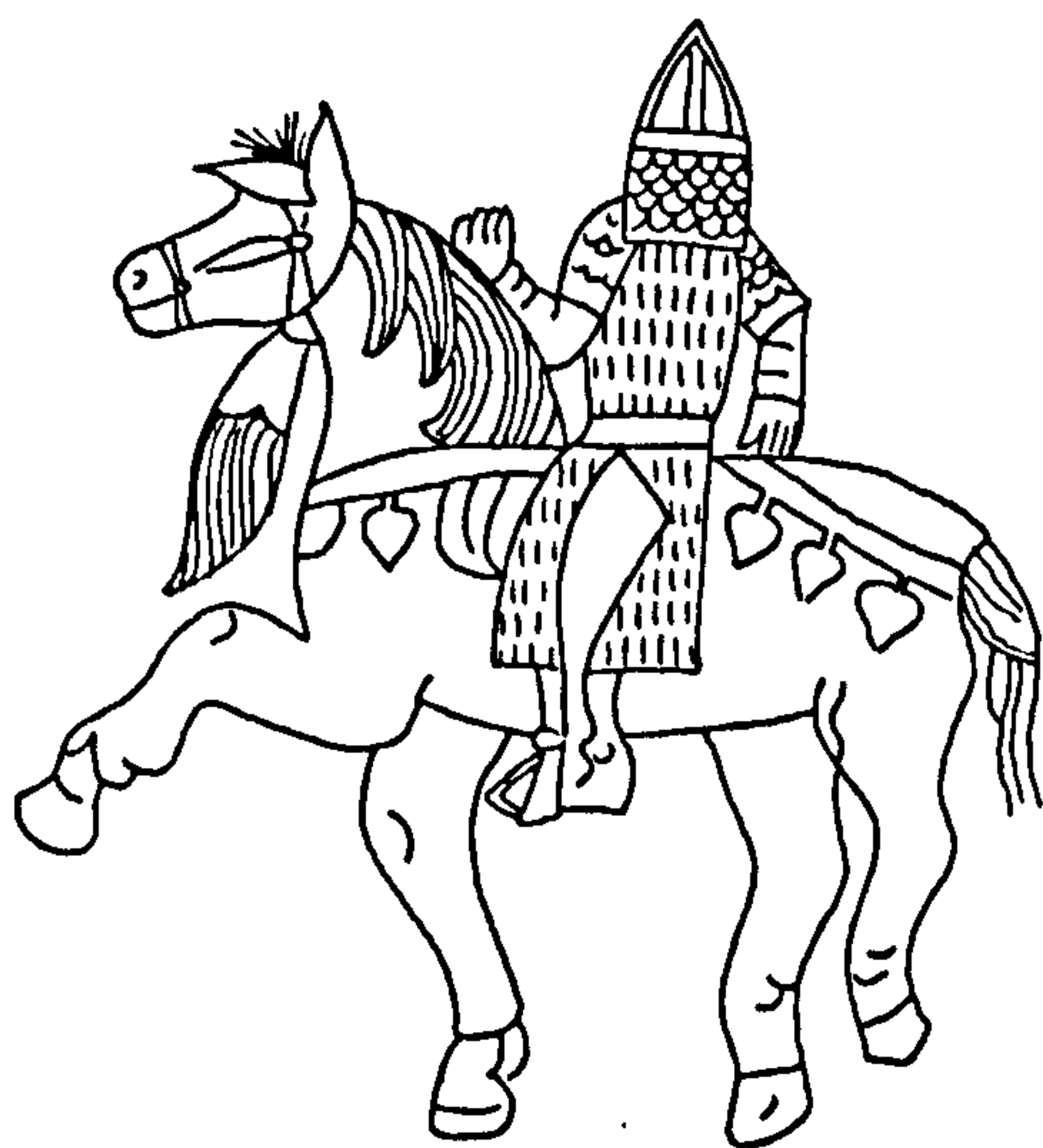
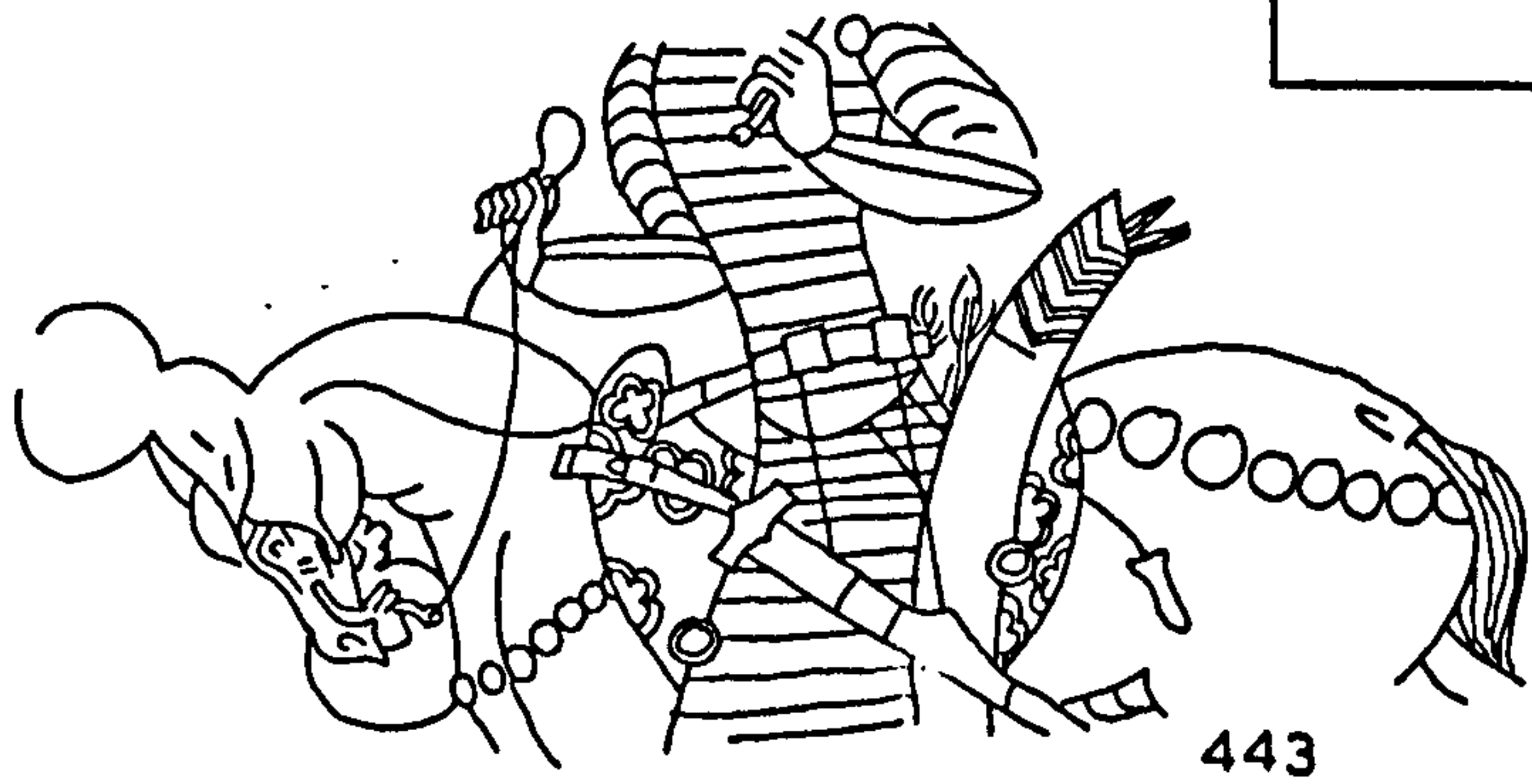
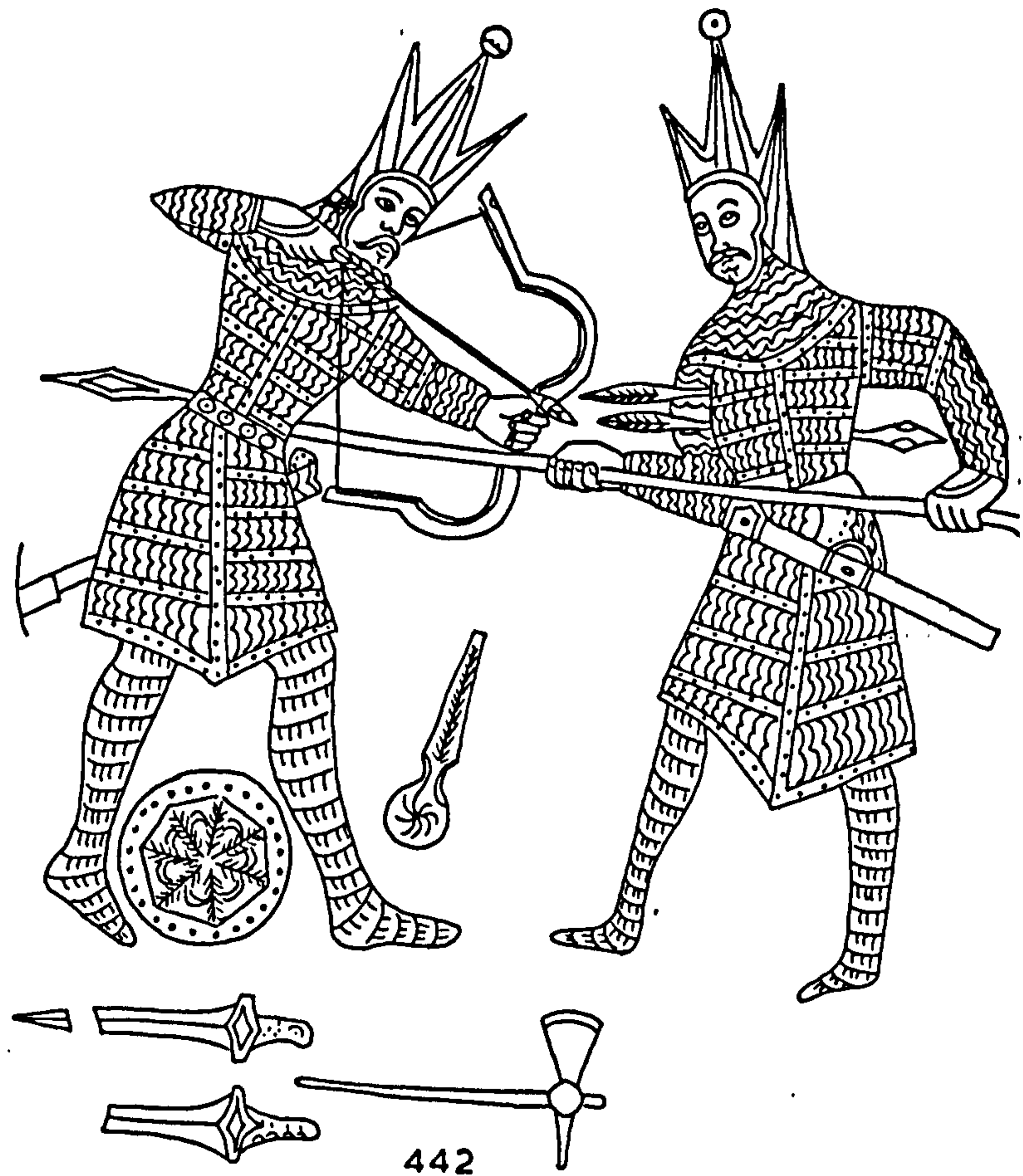
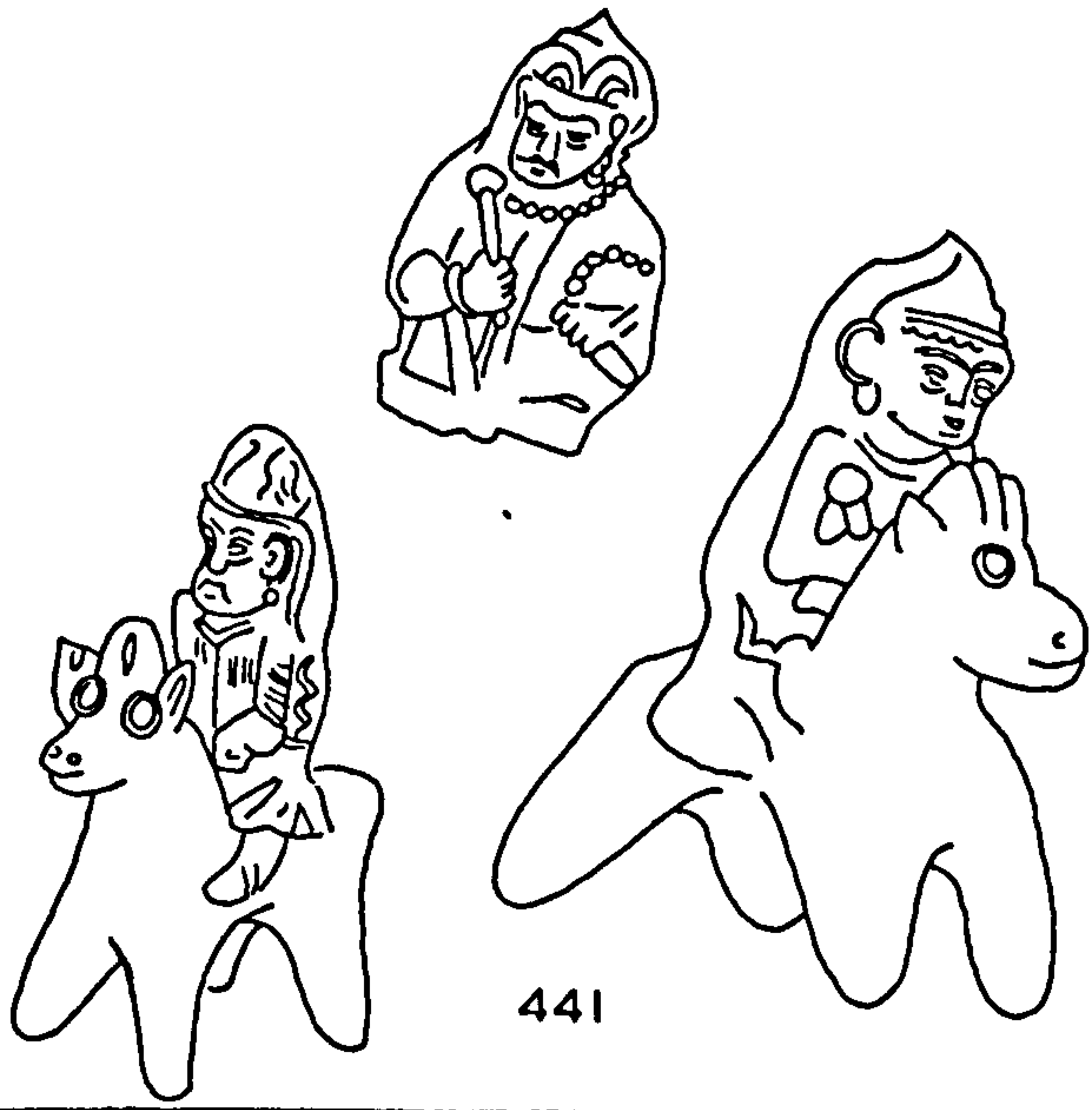



446

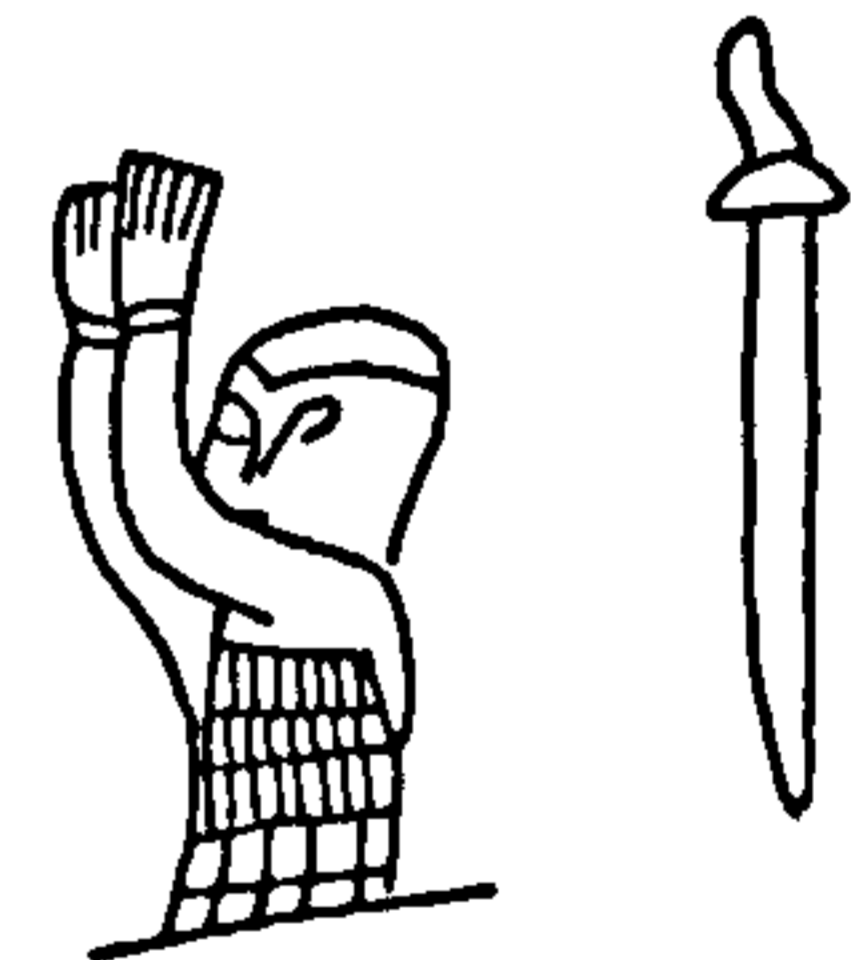
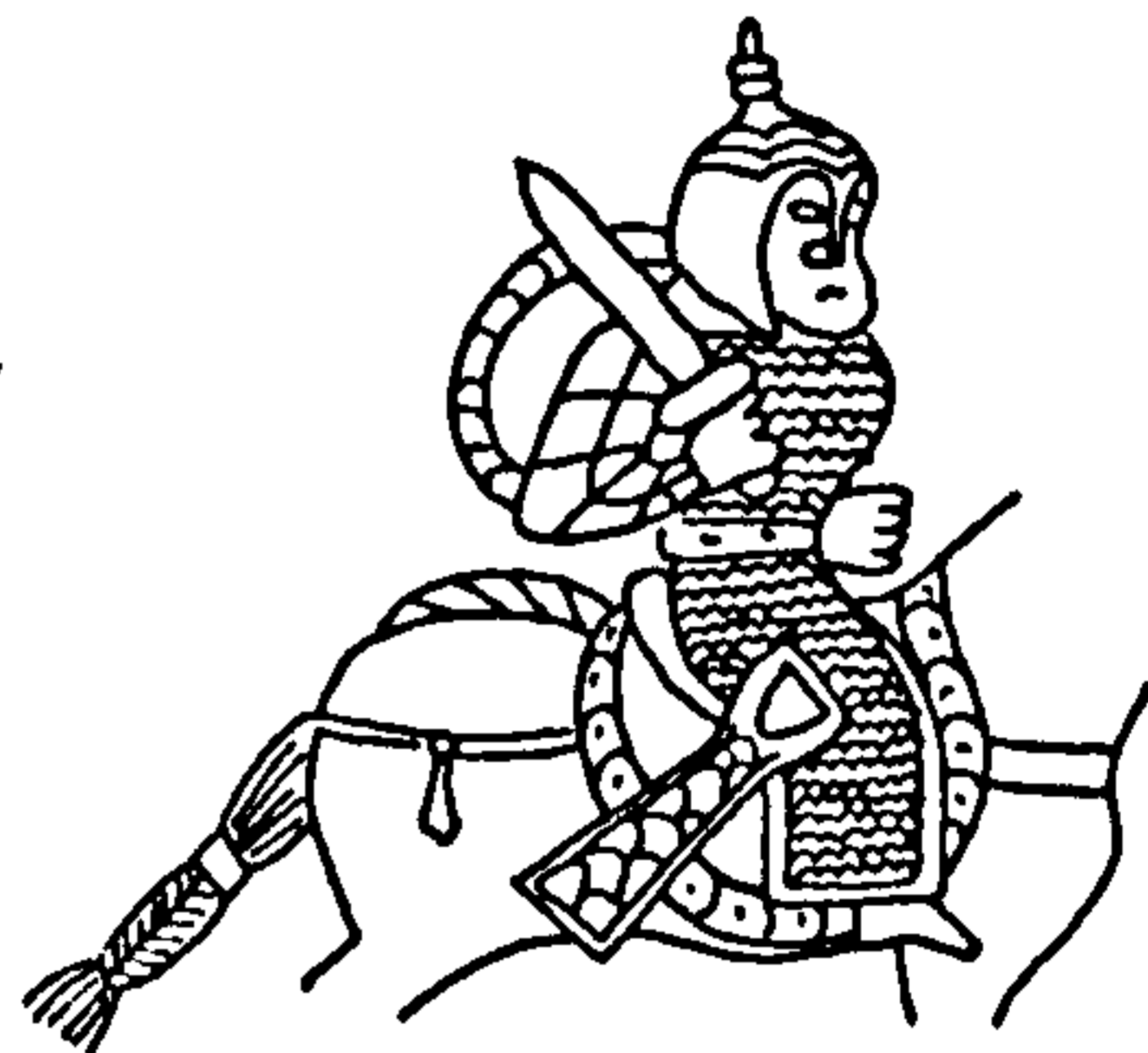

447



448

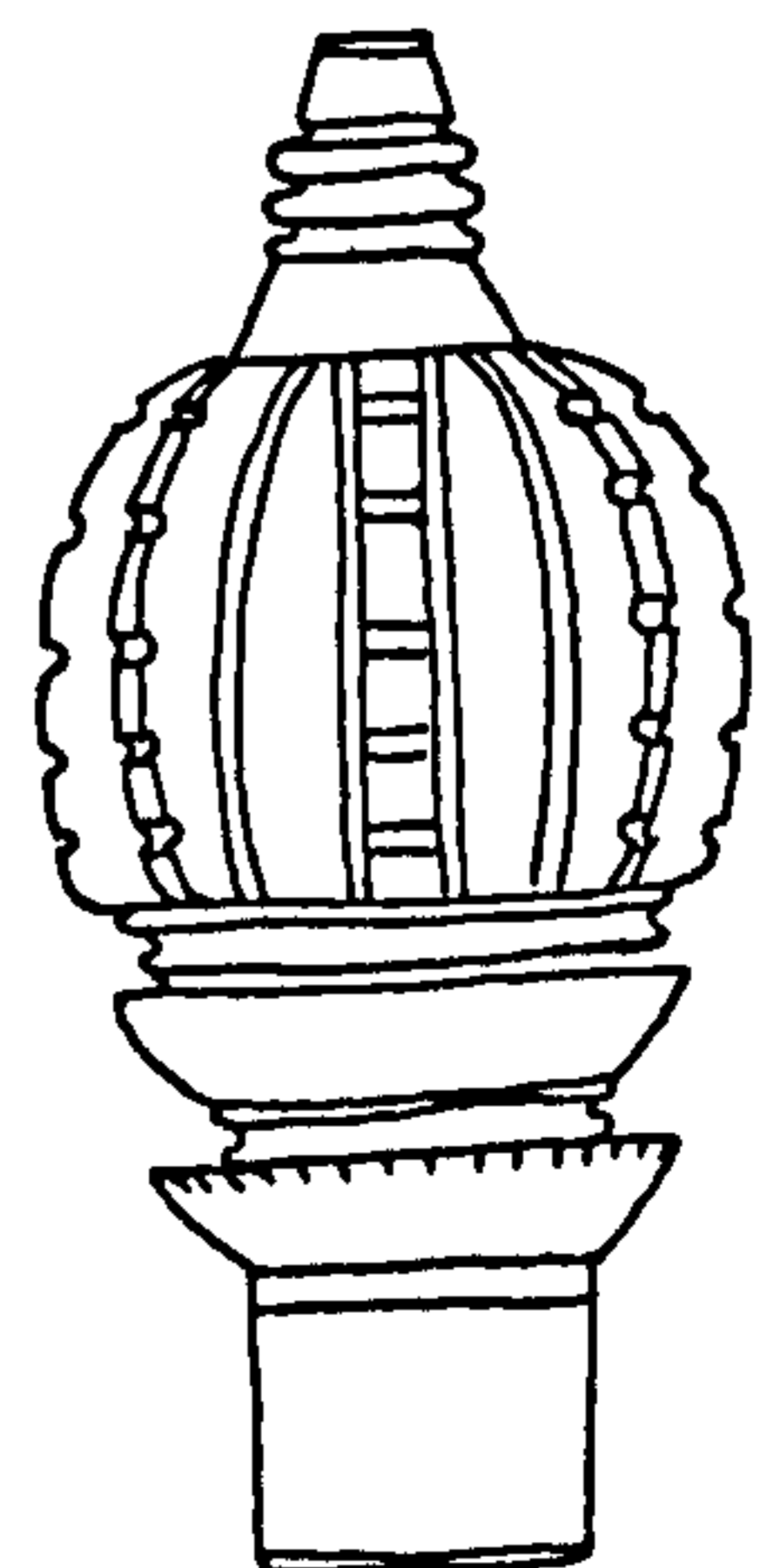

449

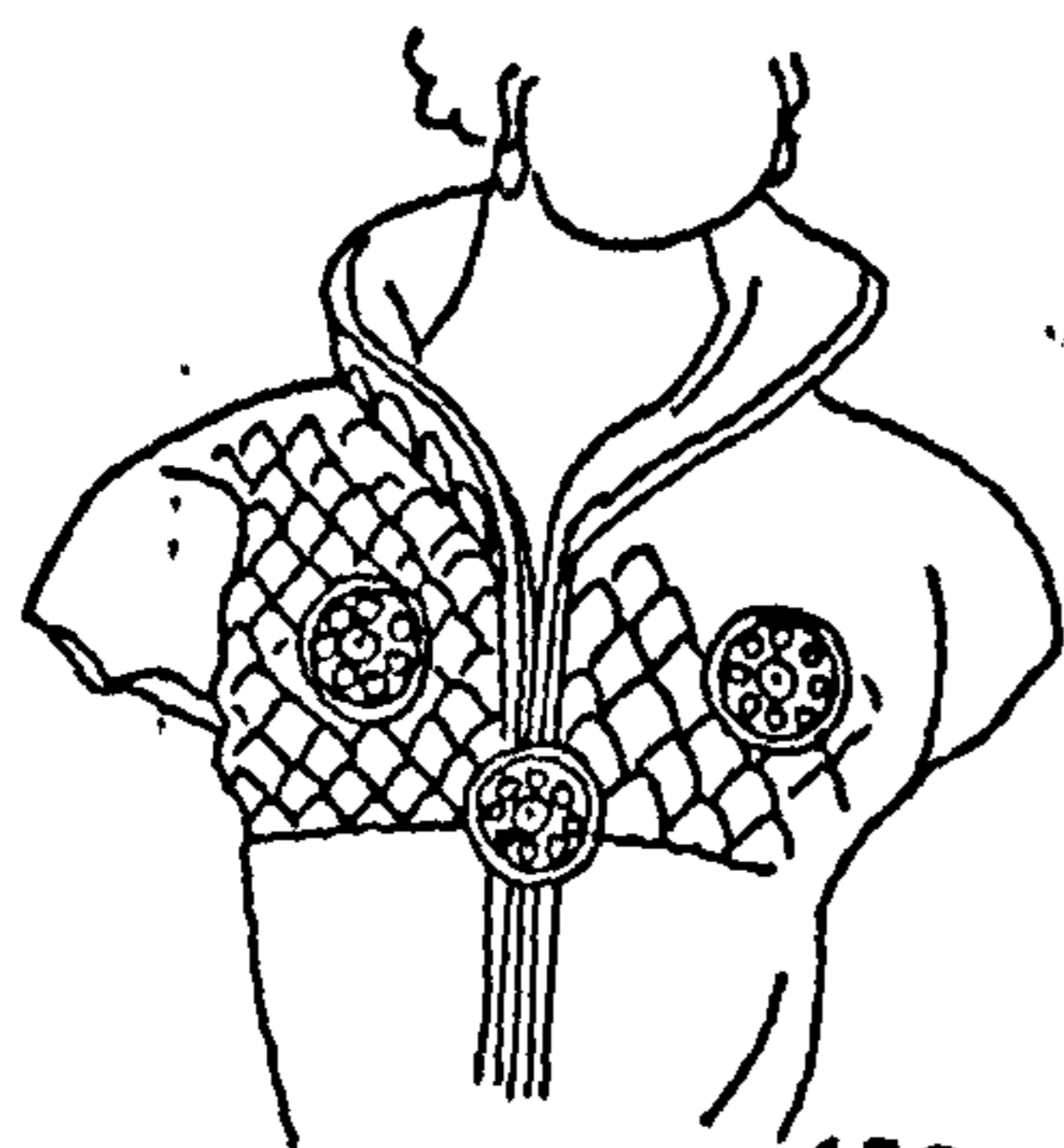

450

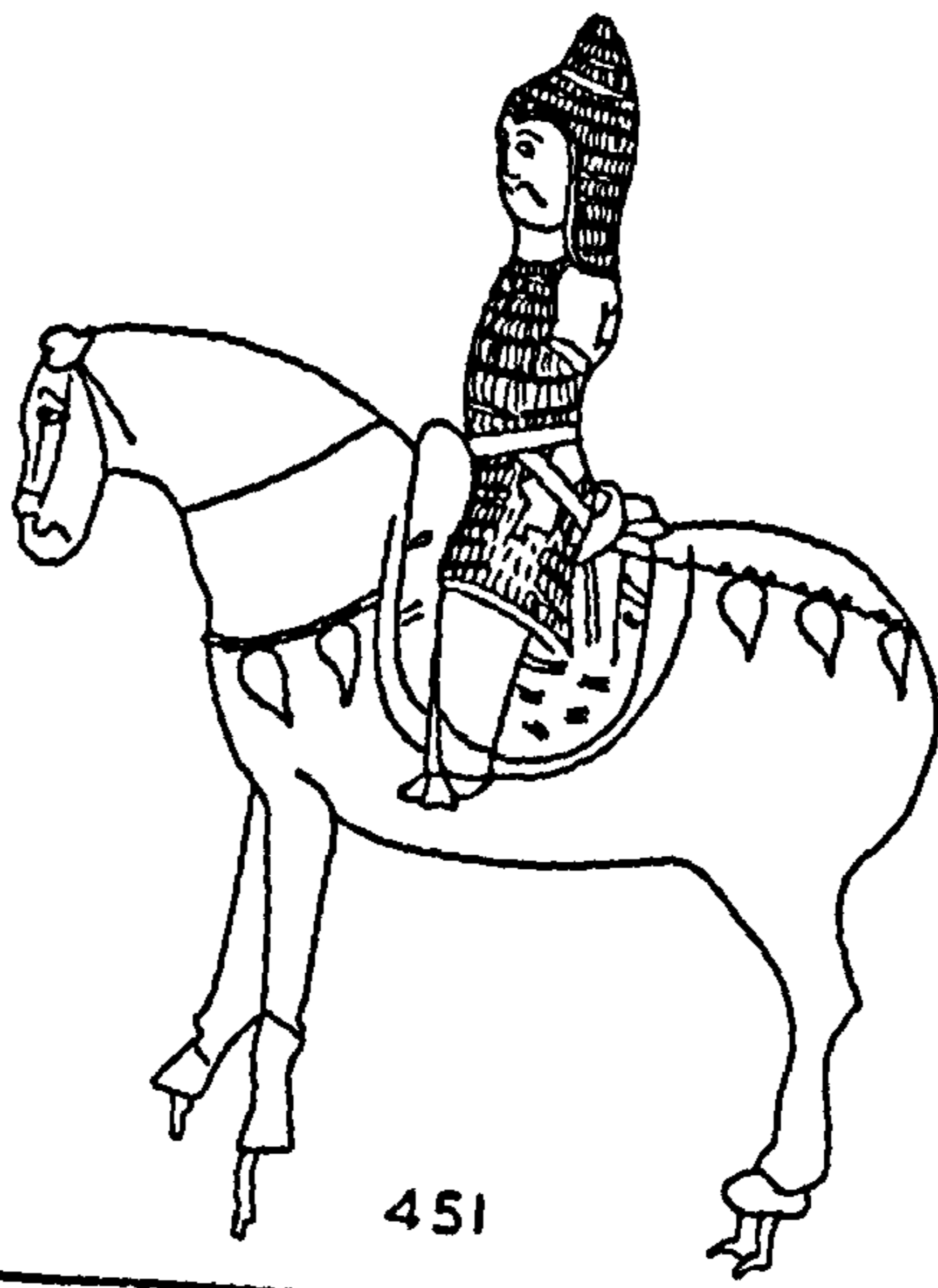

451

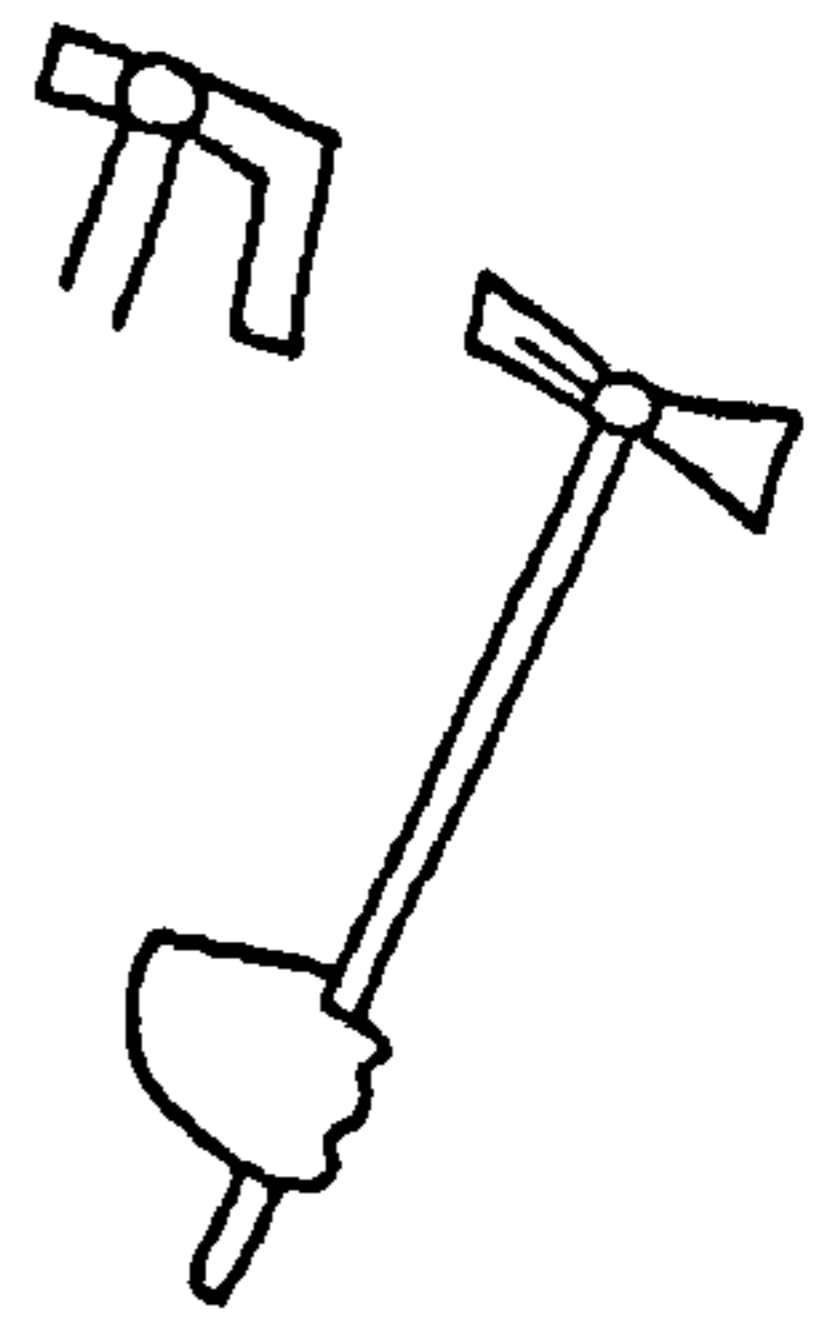

452



453

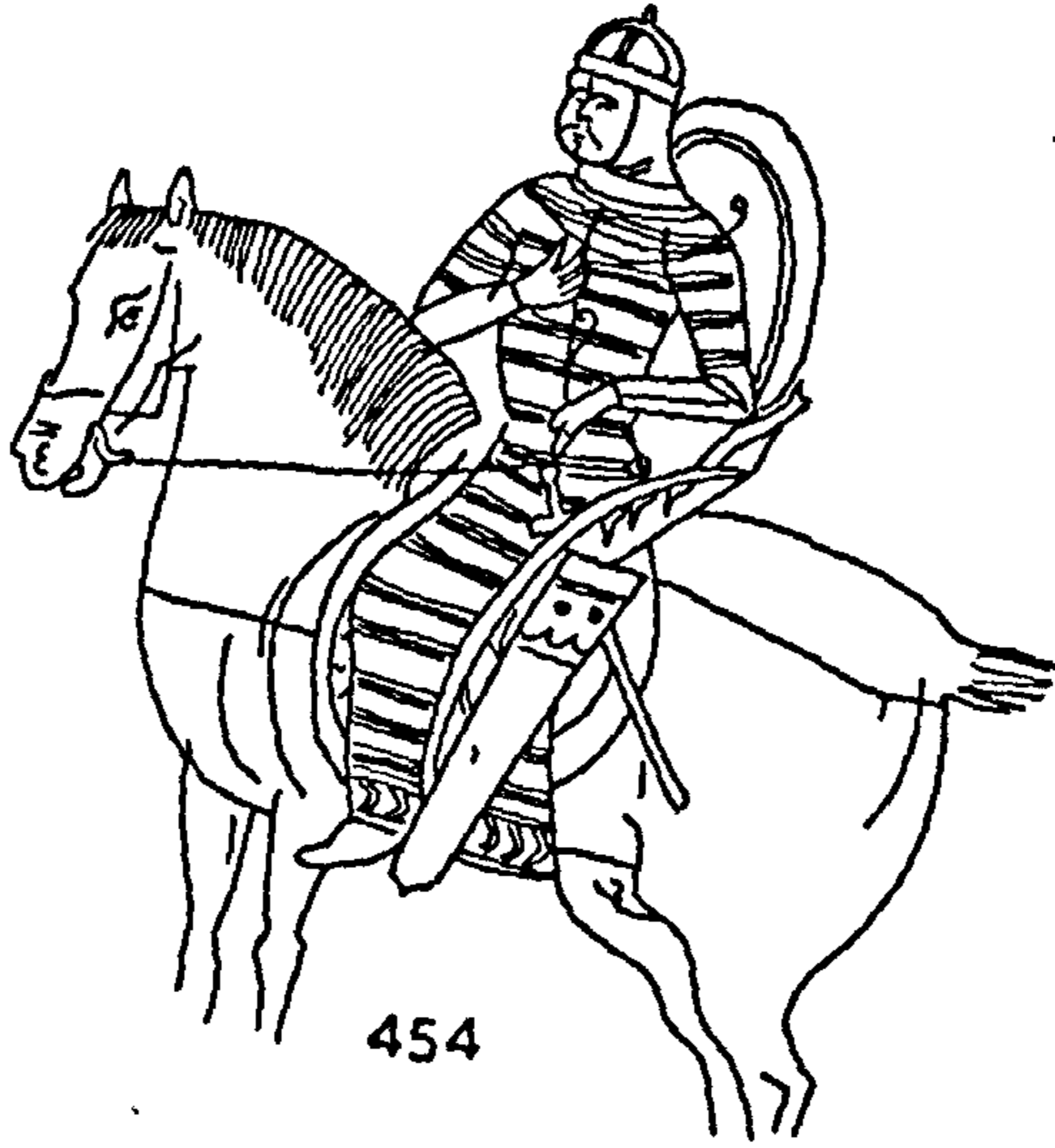

454

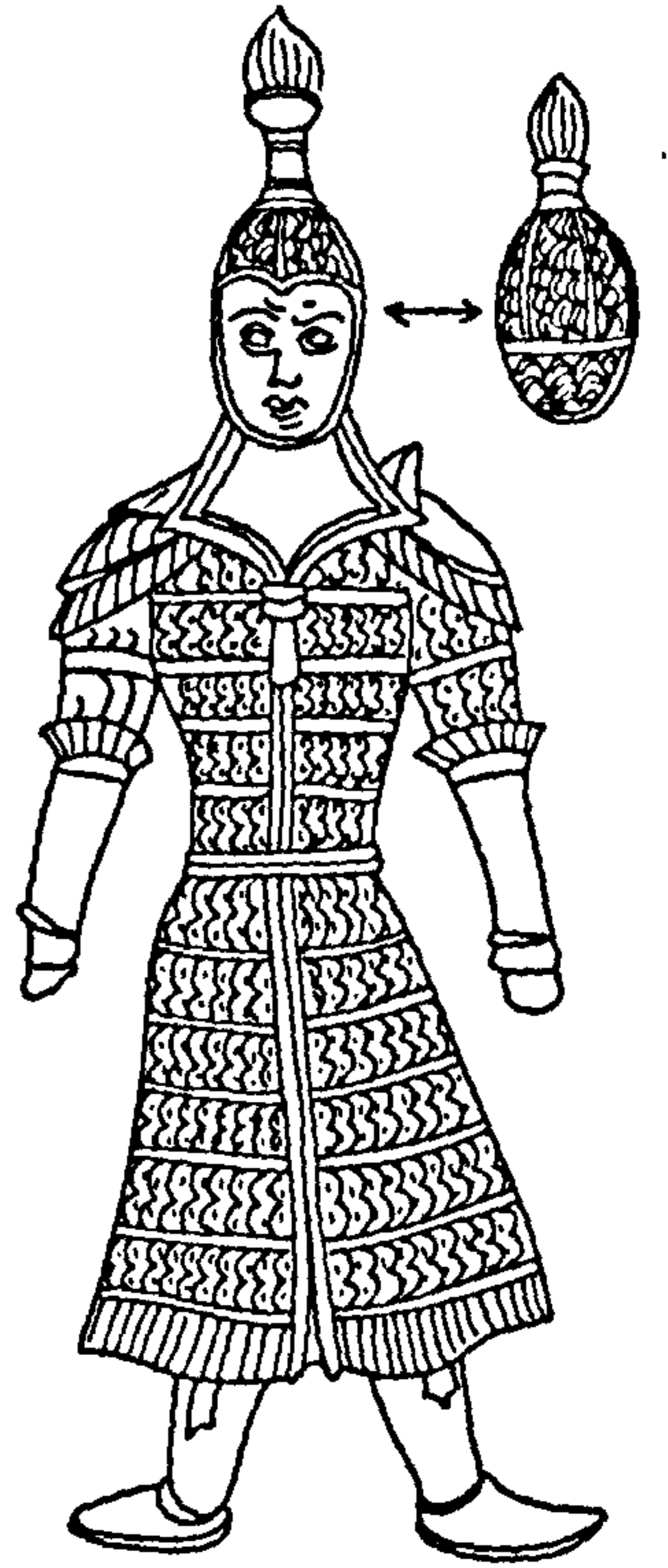

455

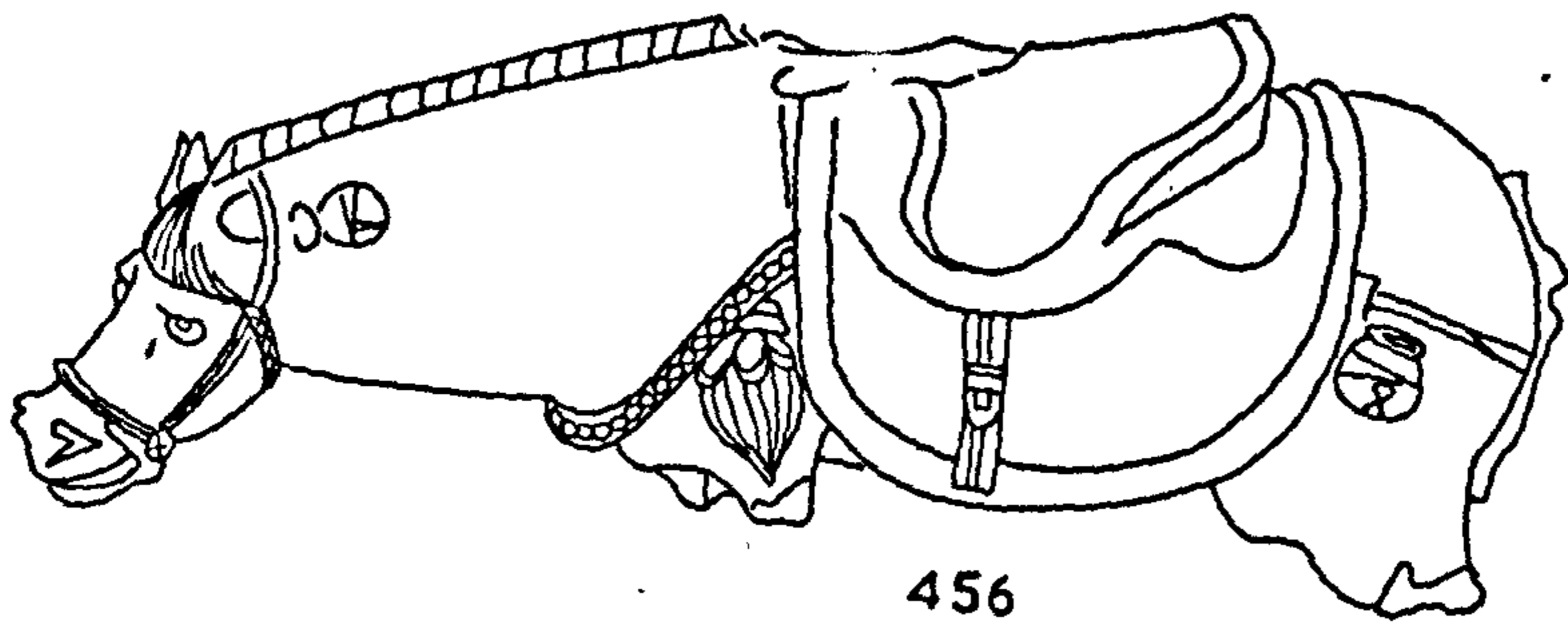

456

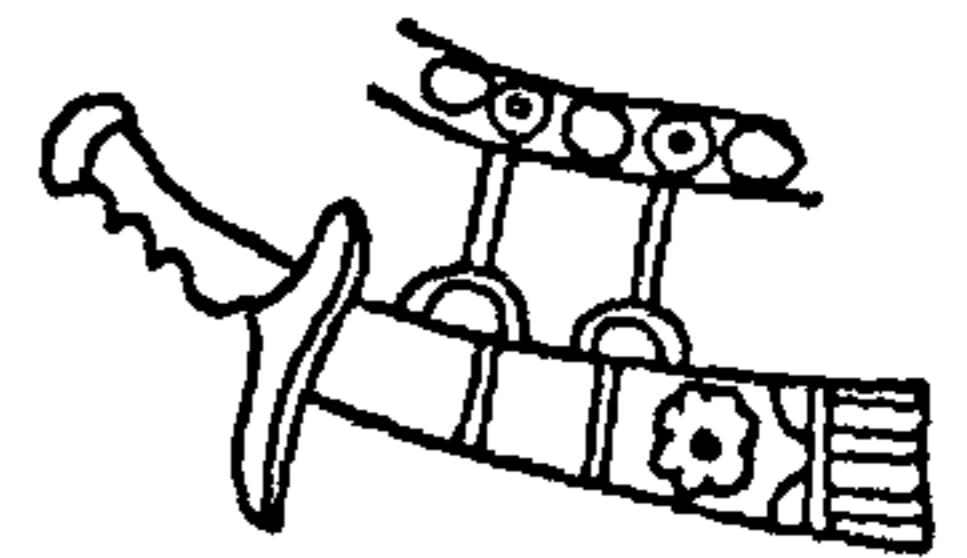

457



458

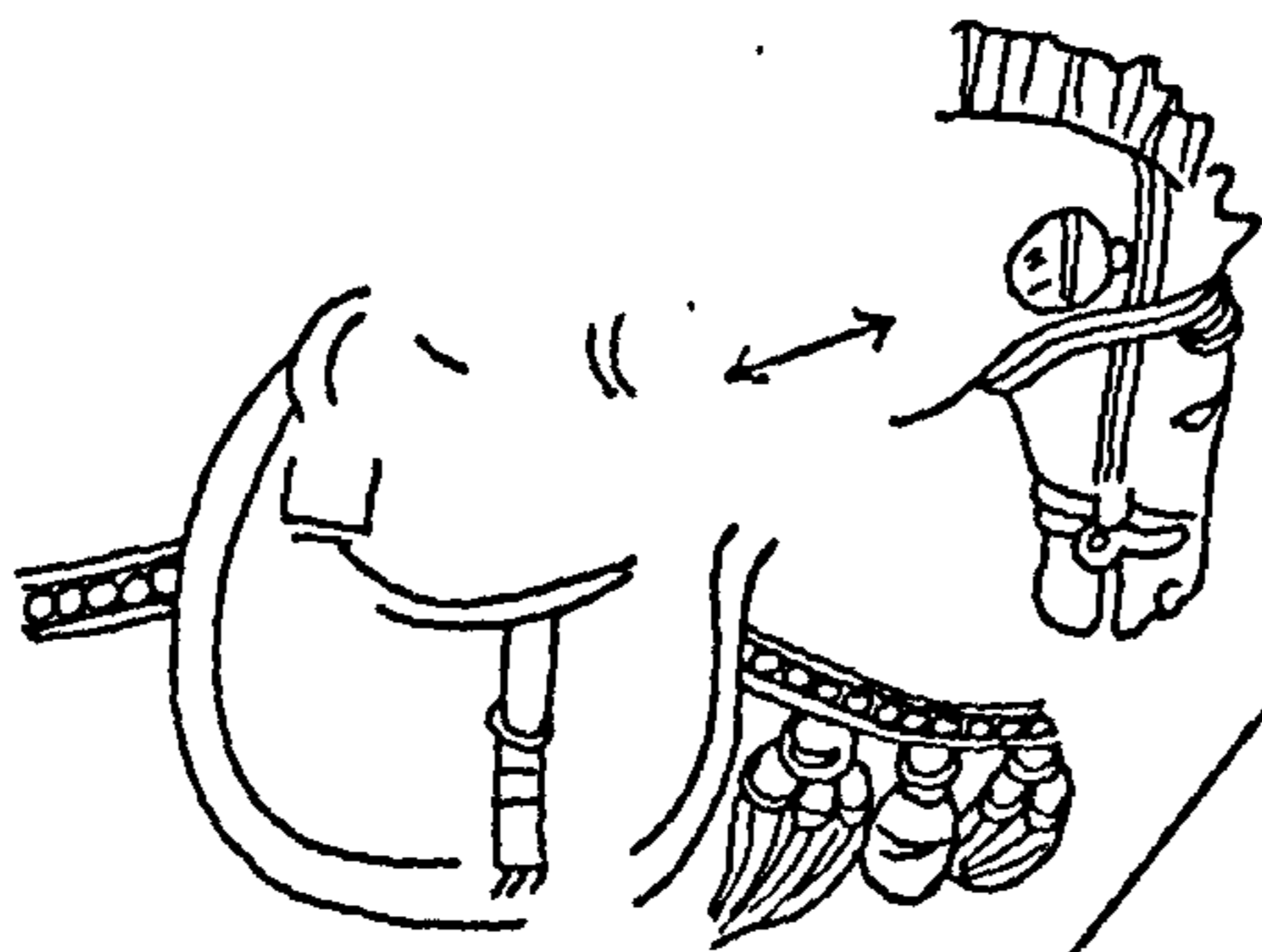

459

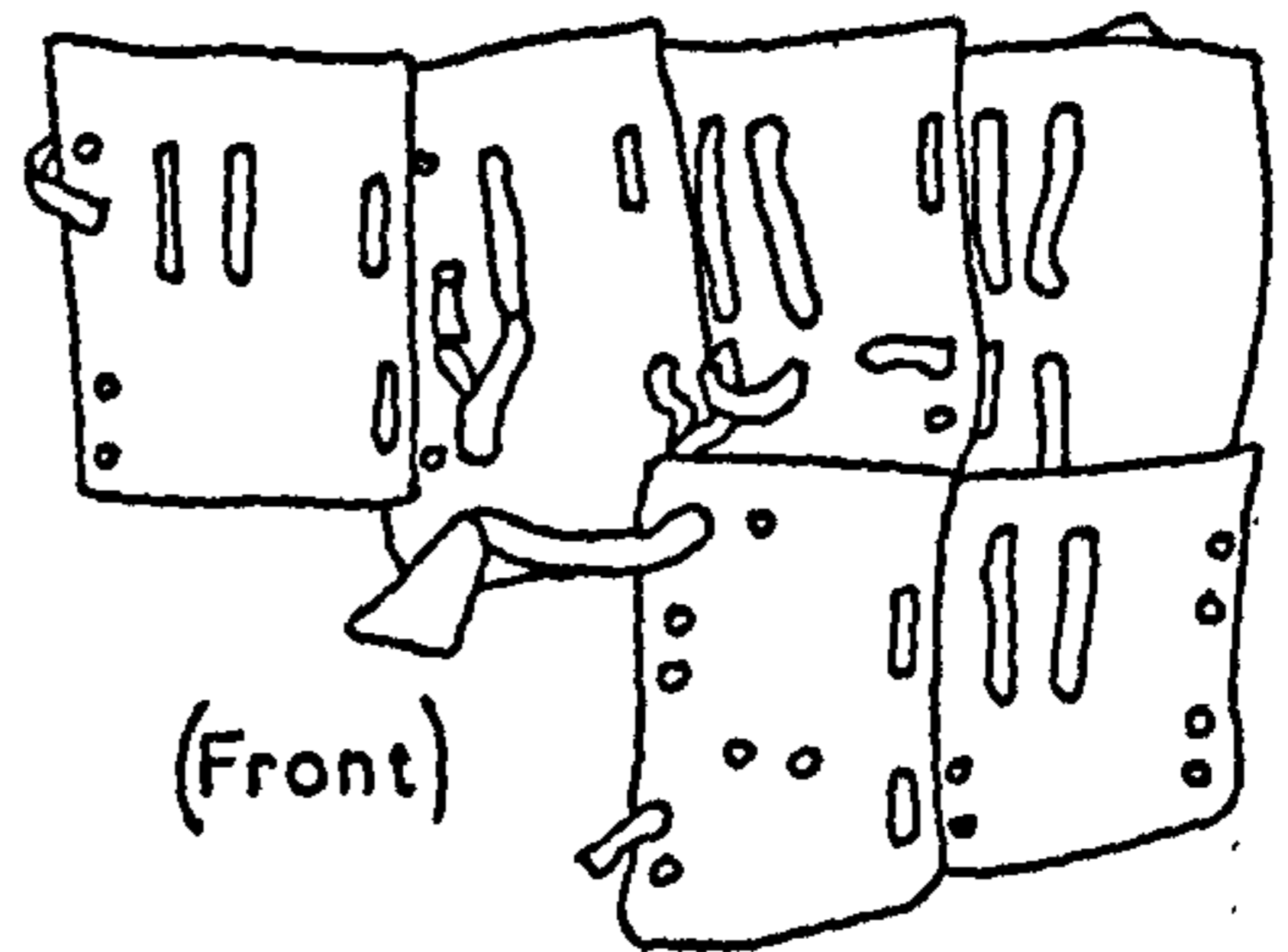

(Front)

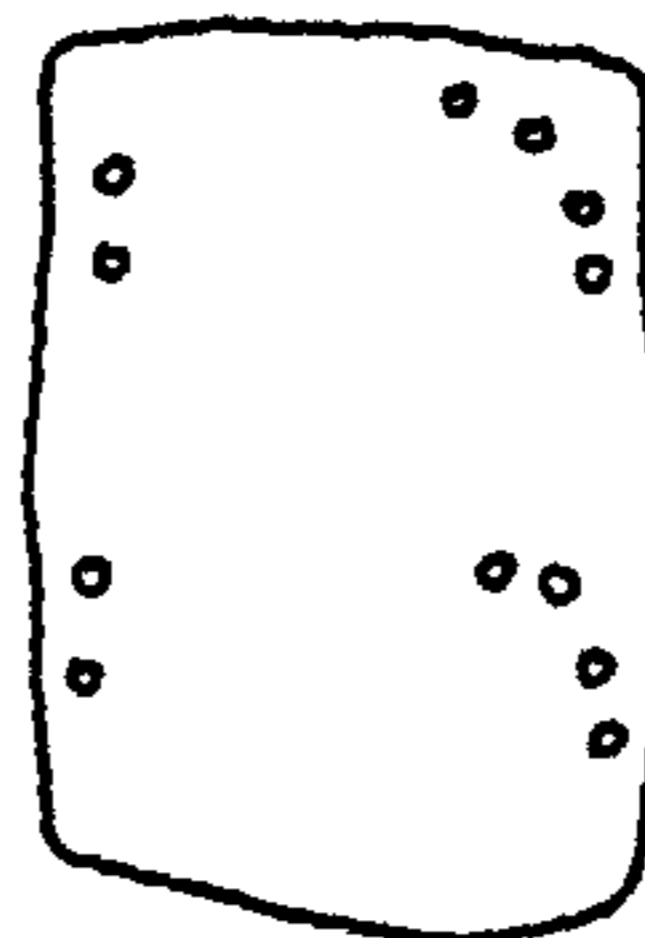

460

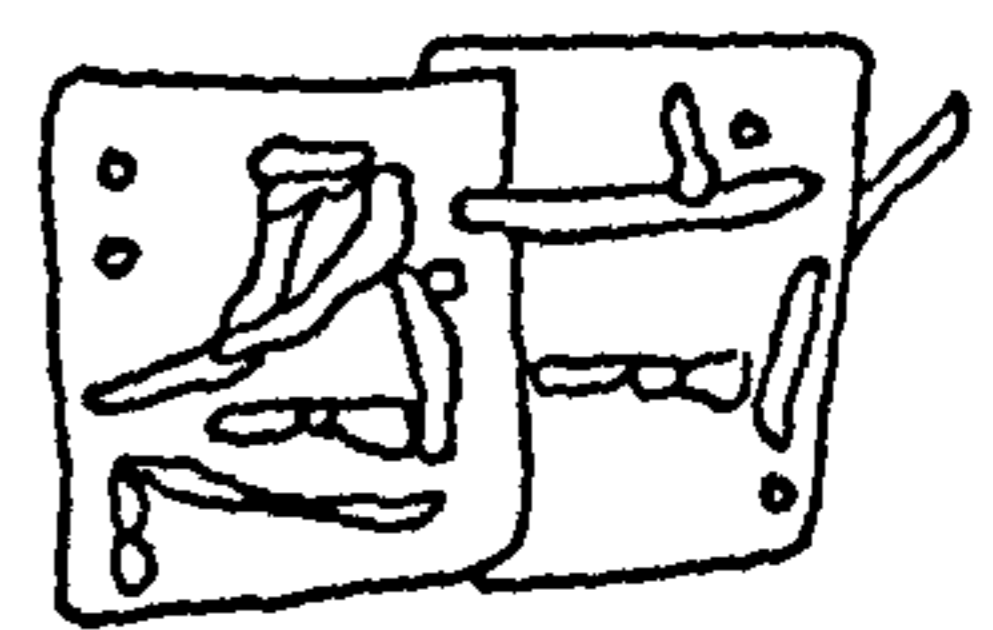

(Back)

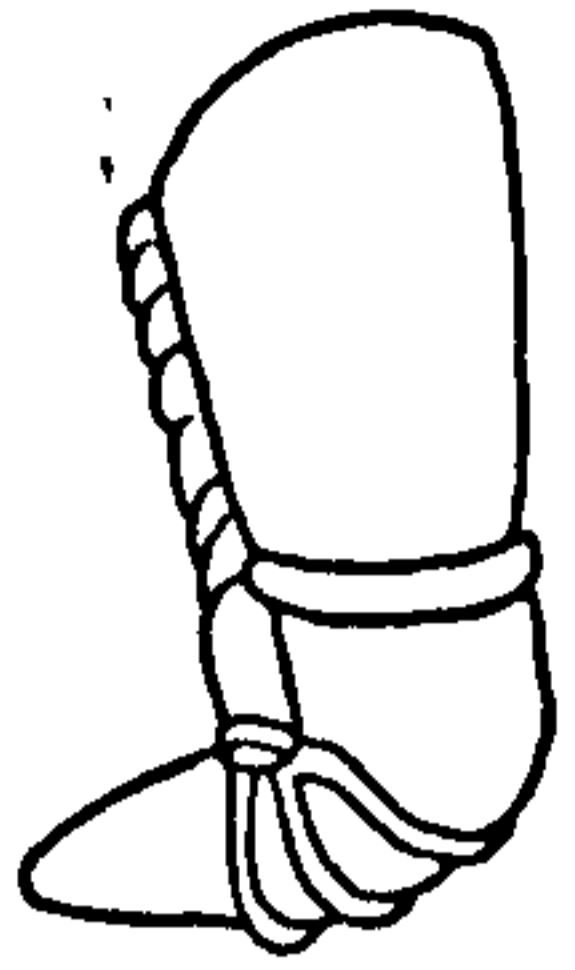

461

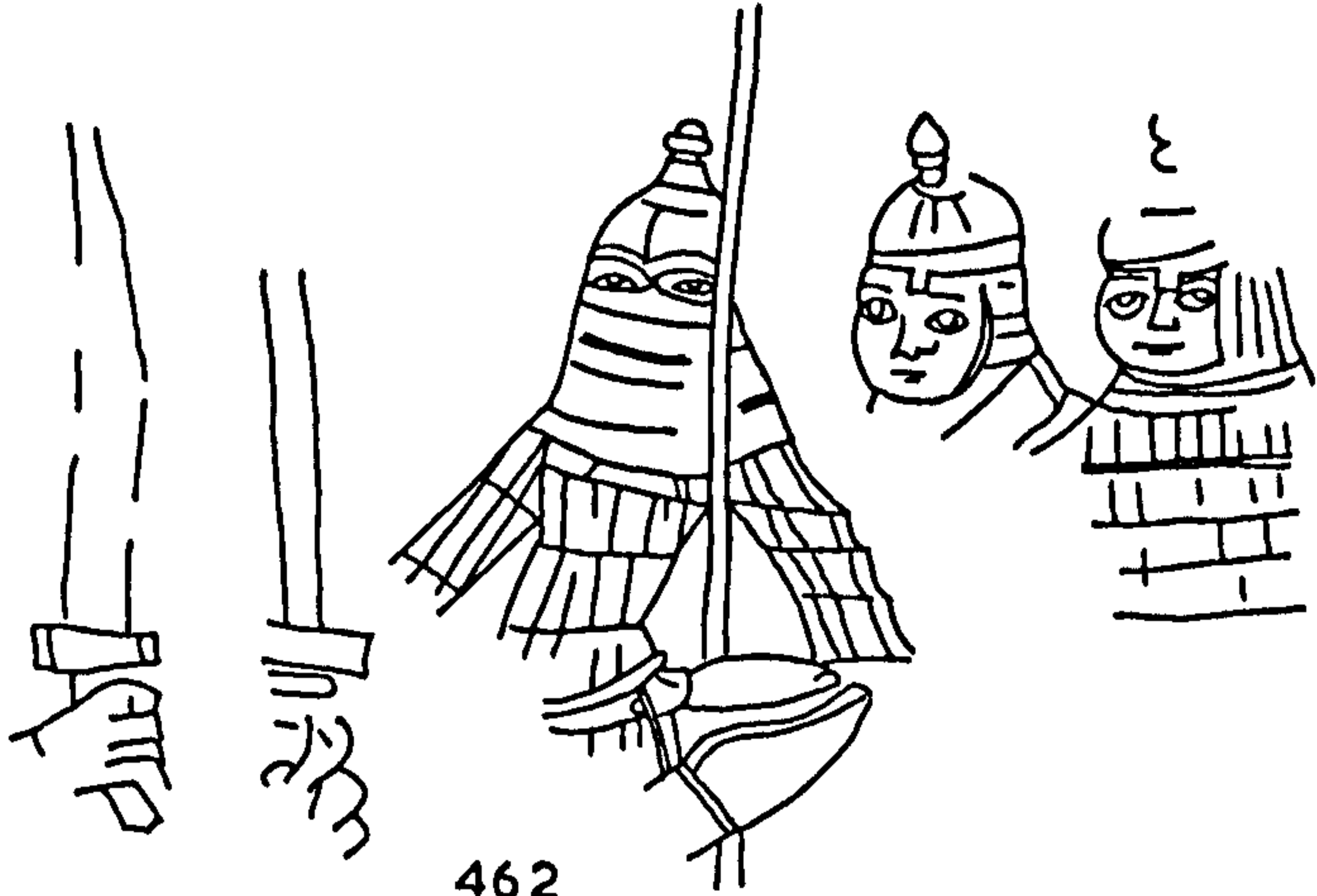

462

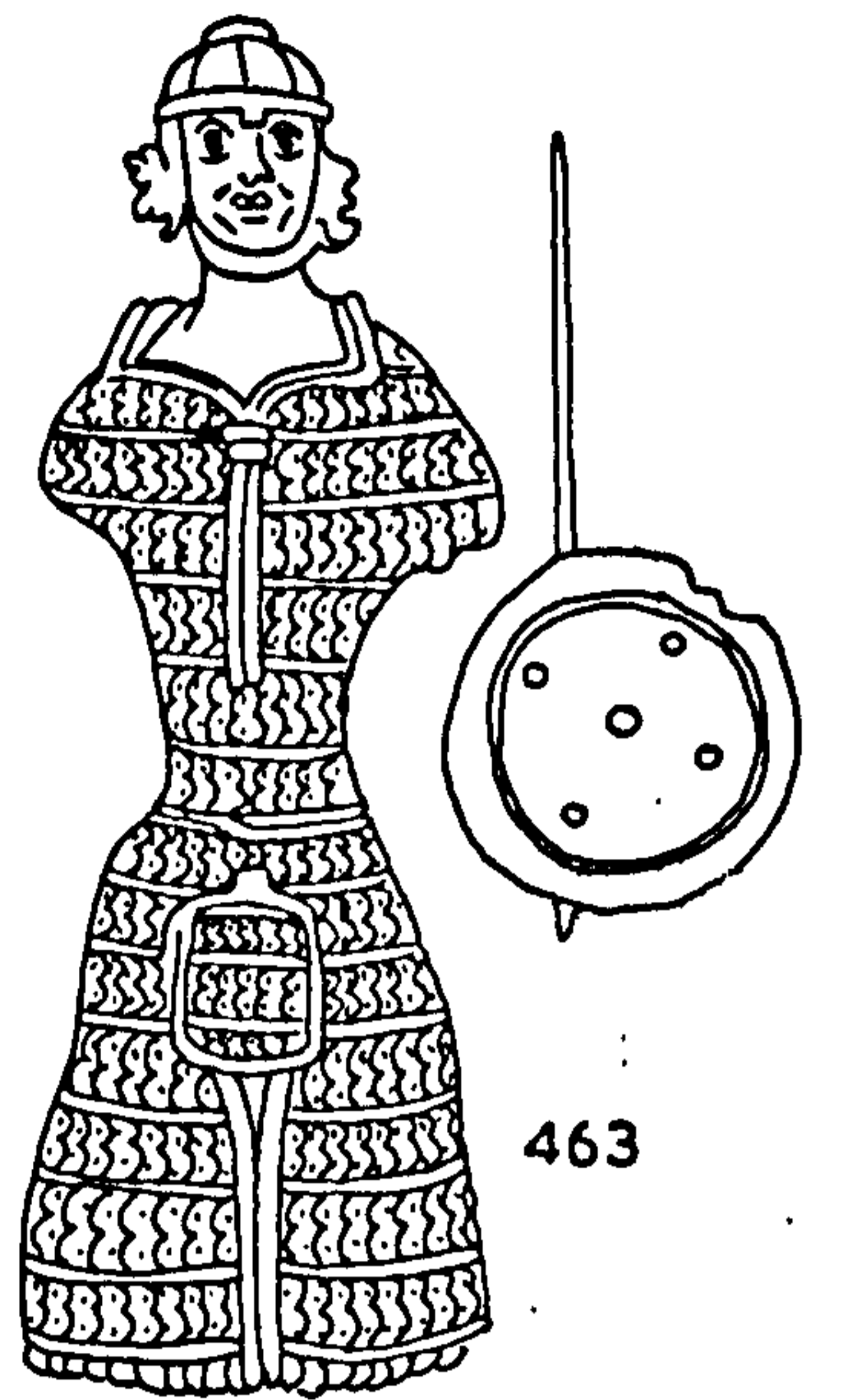

463



464



465

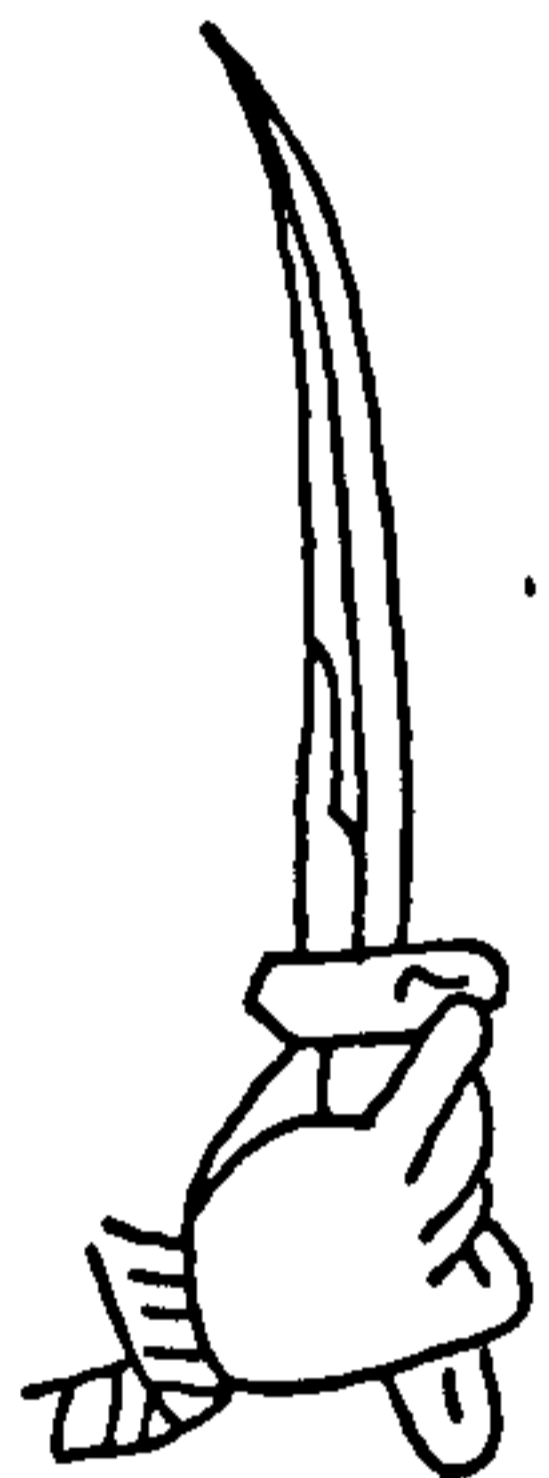

466



467



468

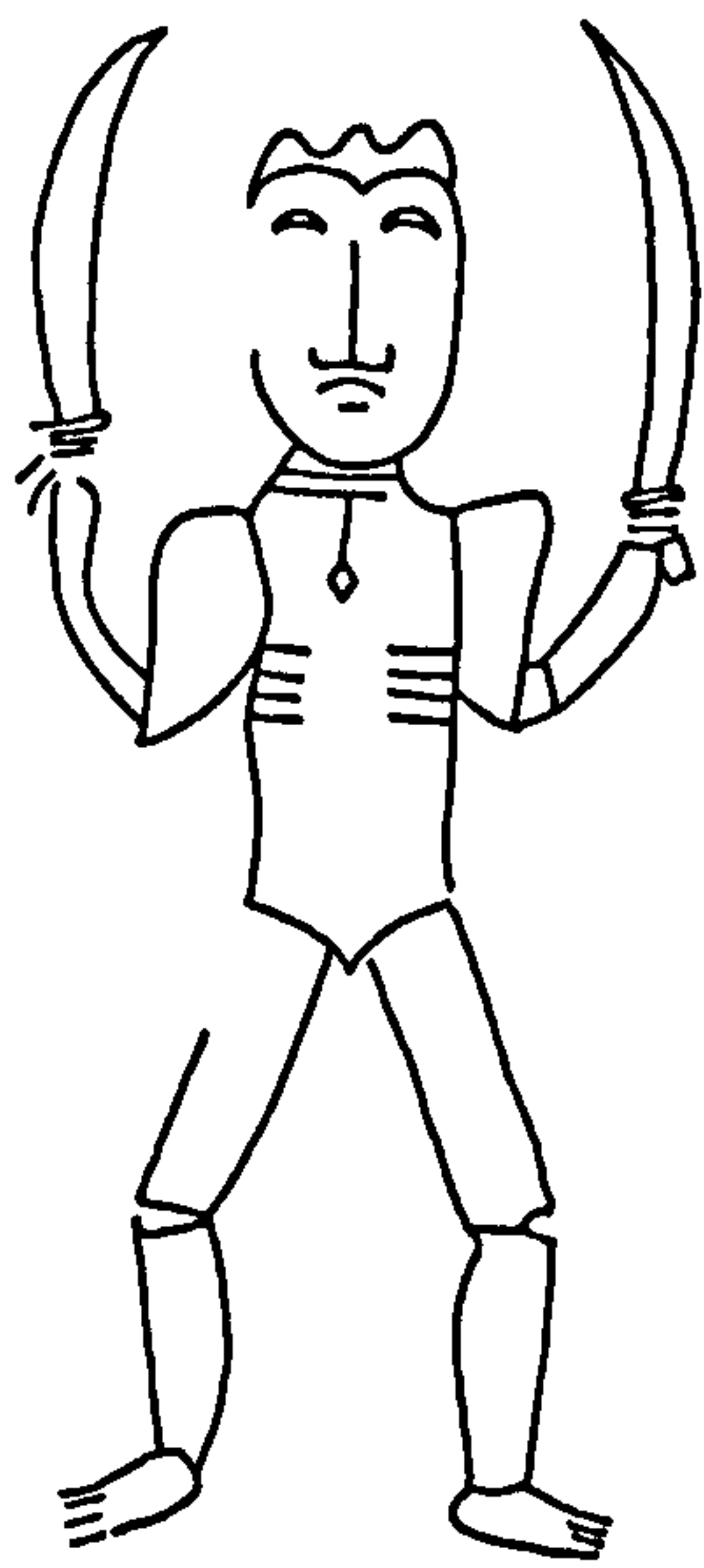

469



470

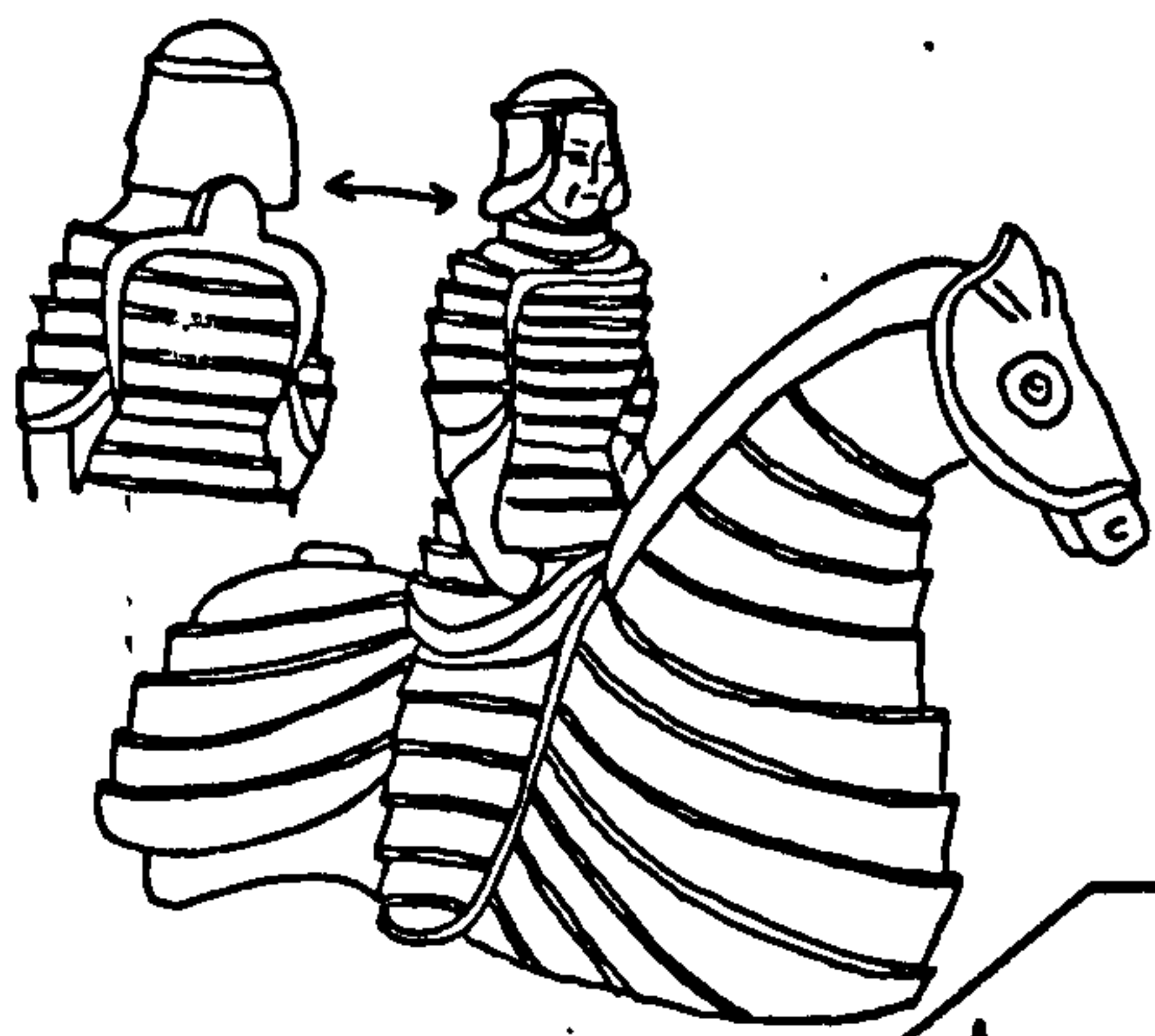

471

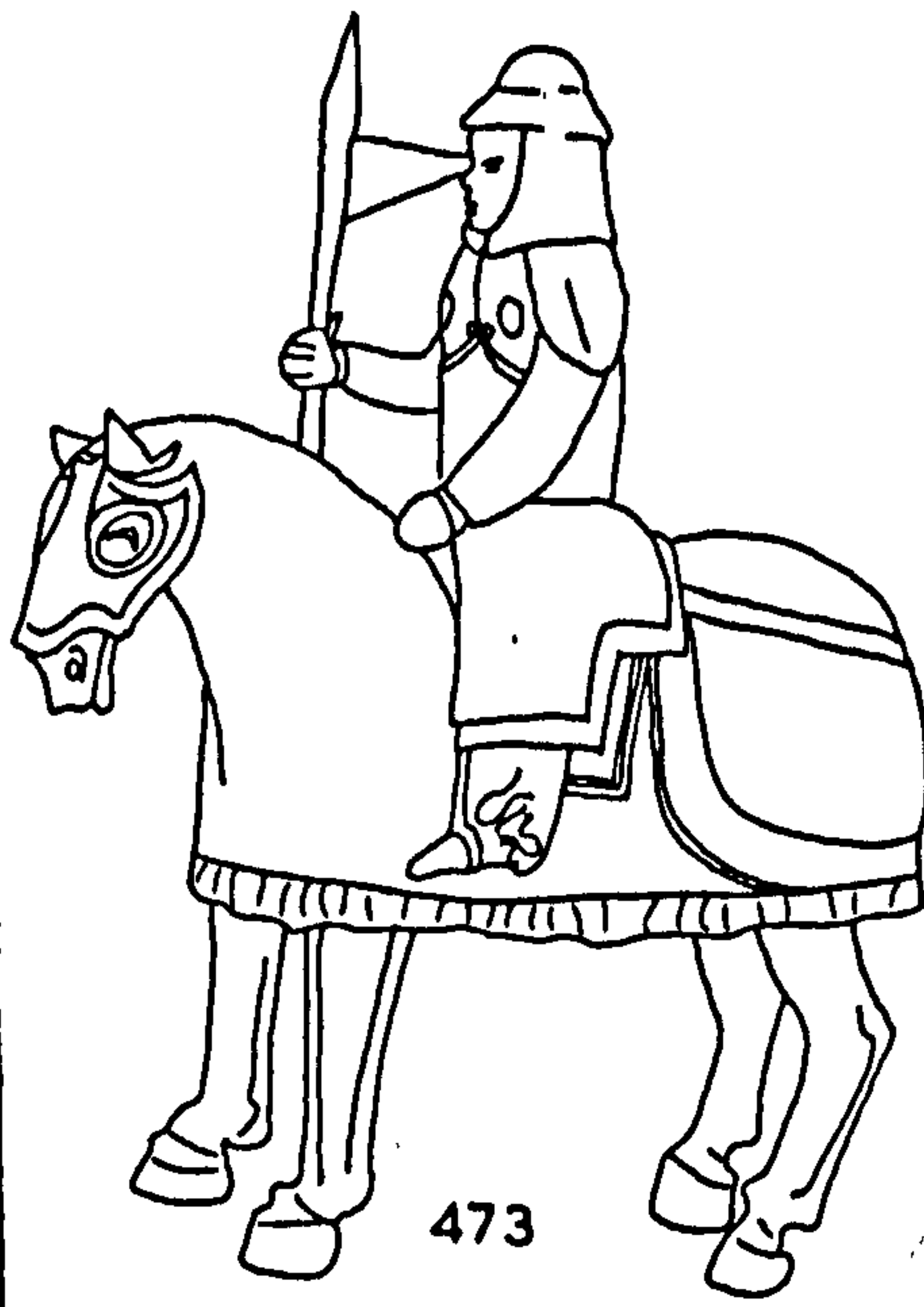

473

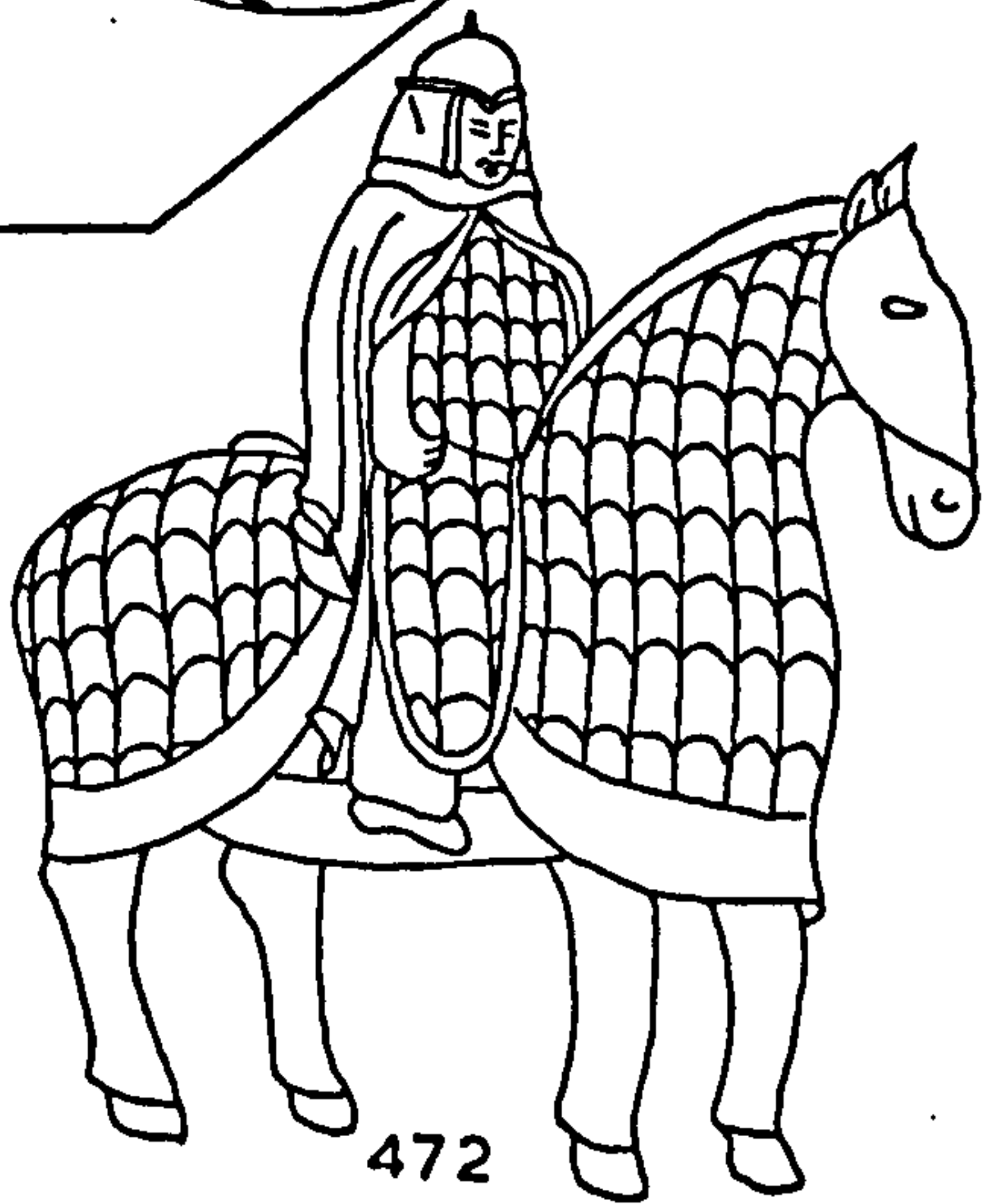

472

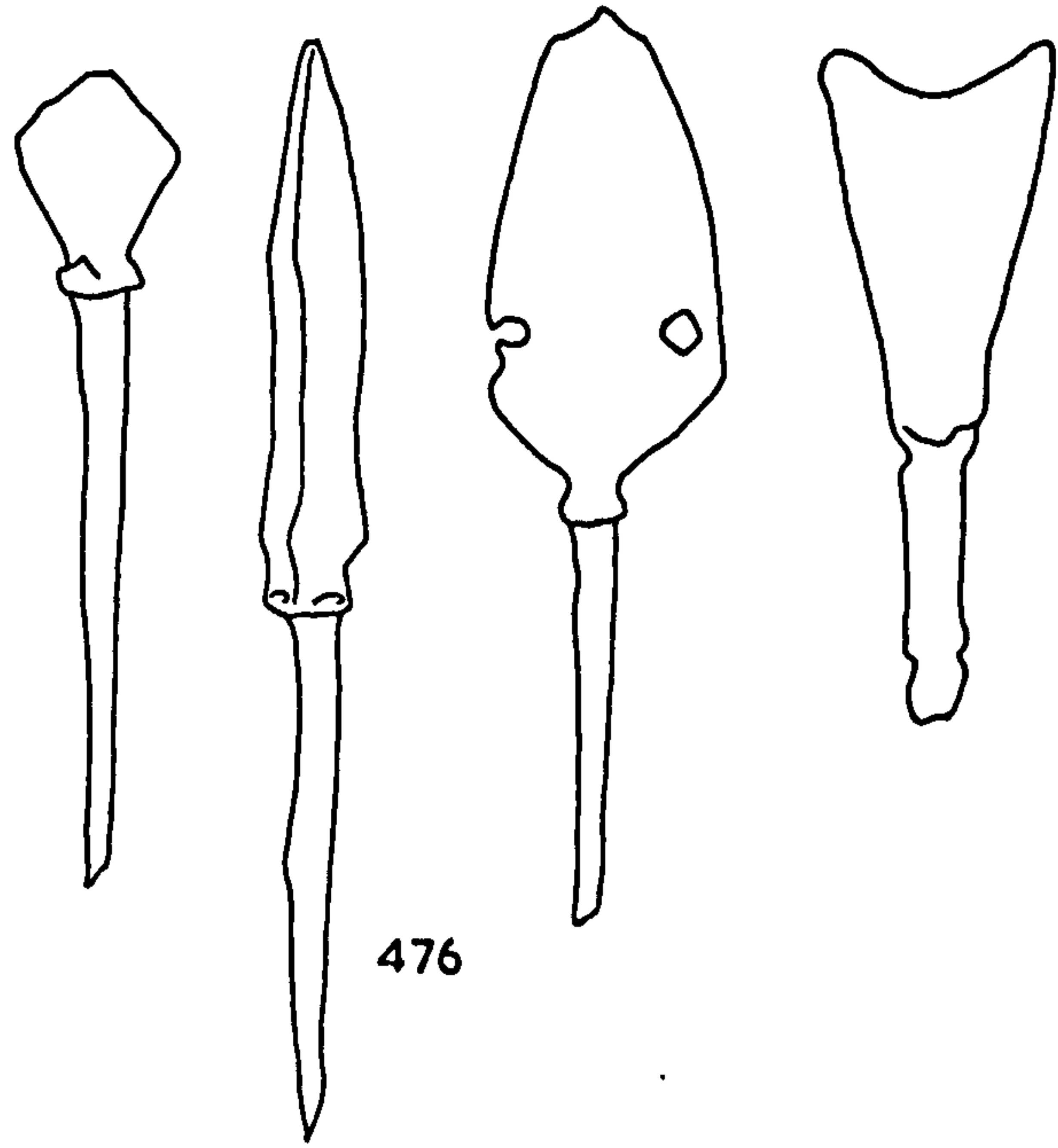

476



474



477

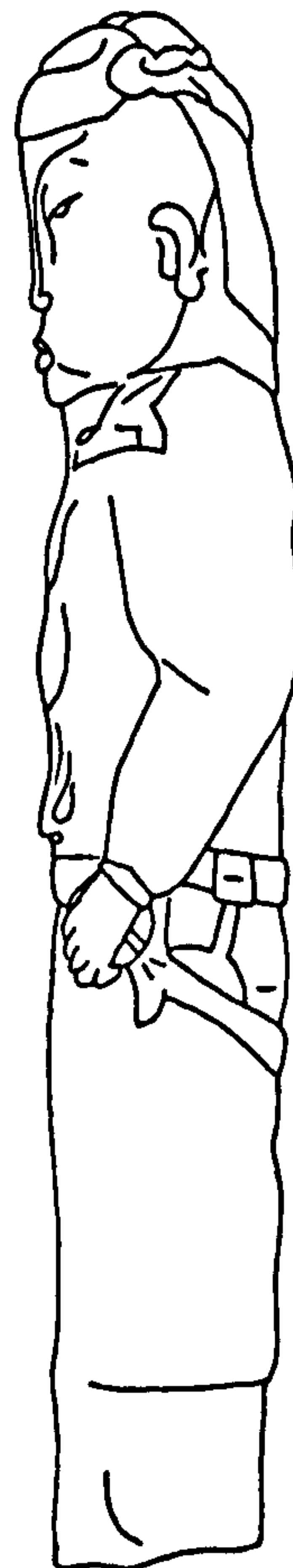

475

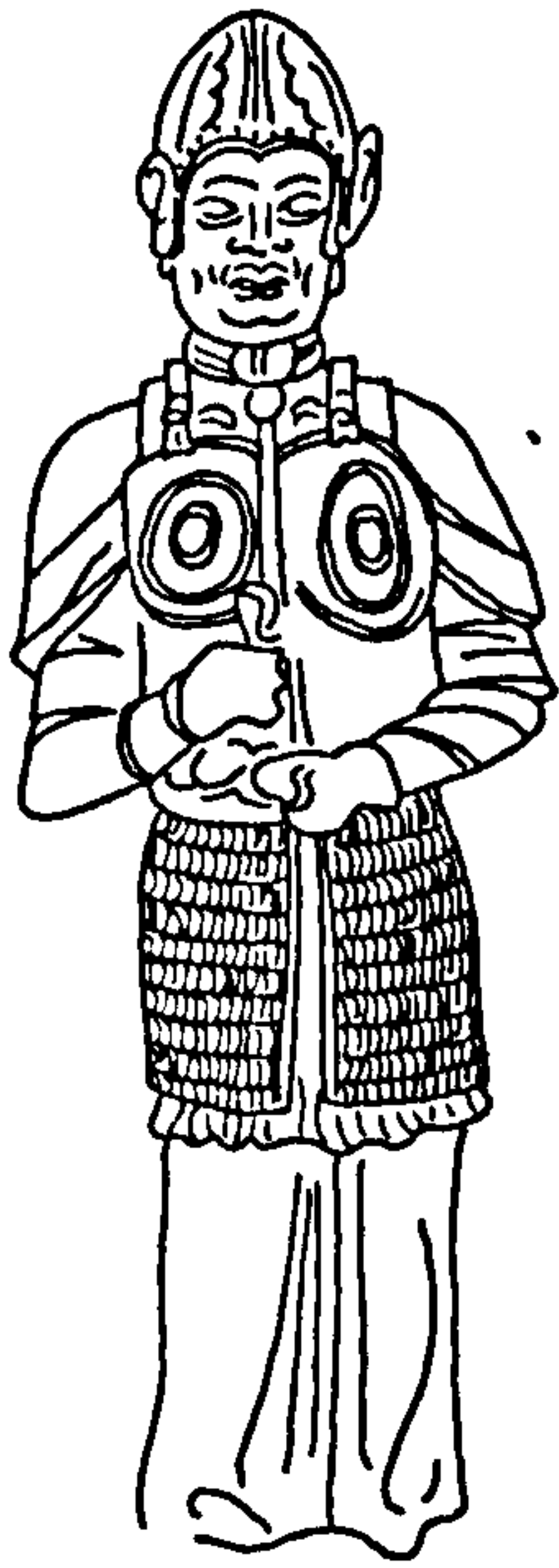

478

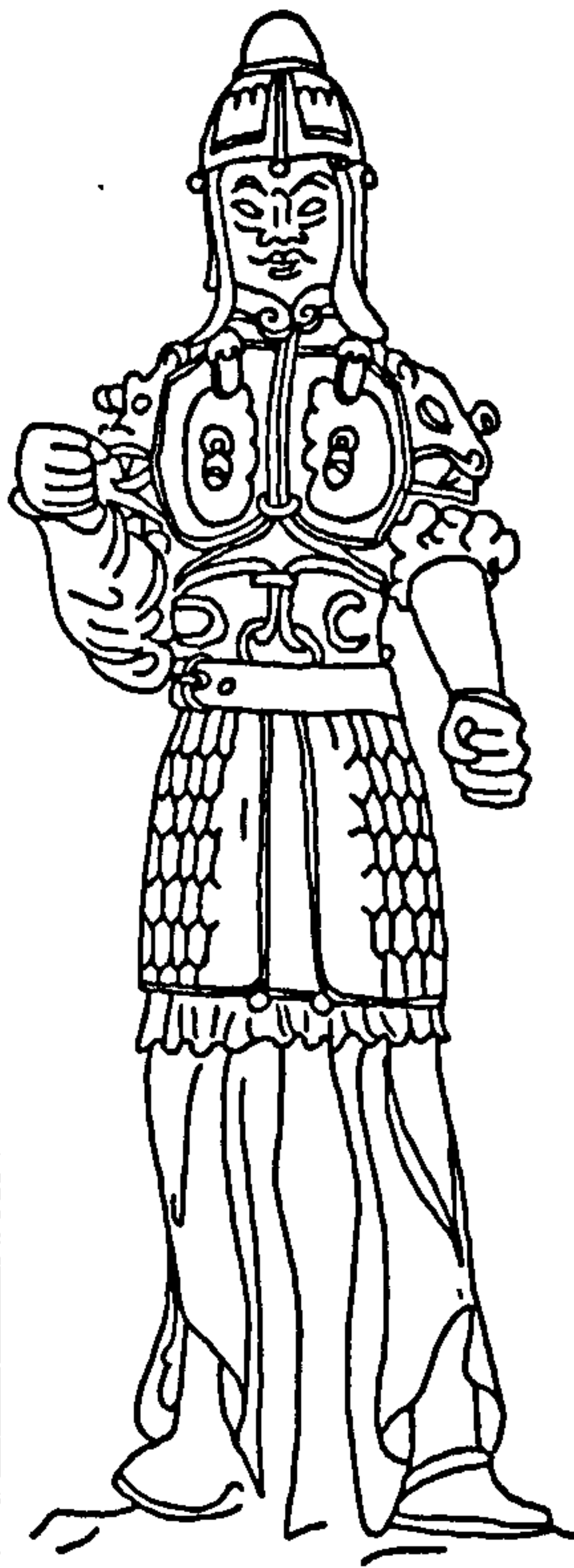

479



480

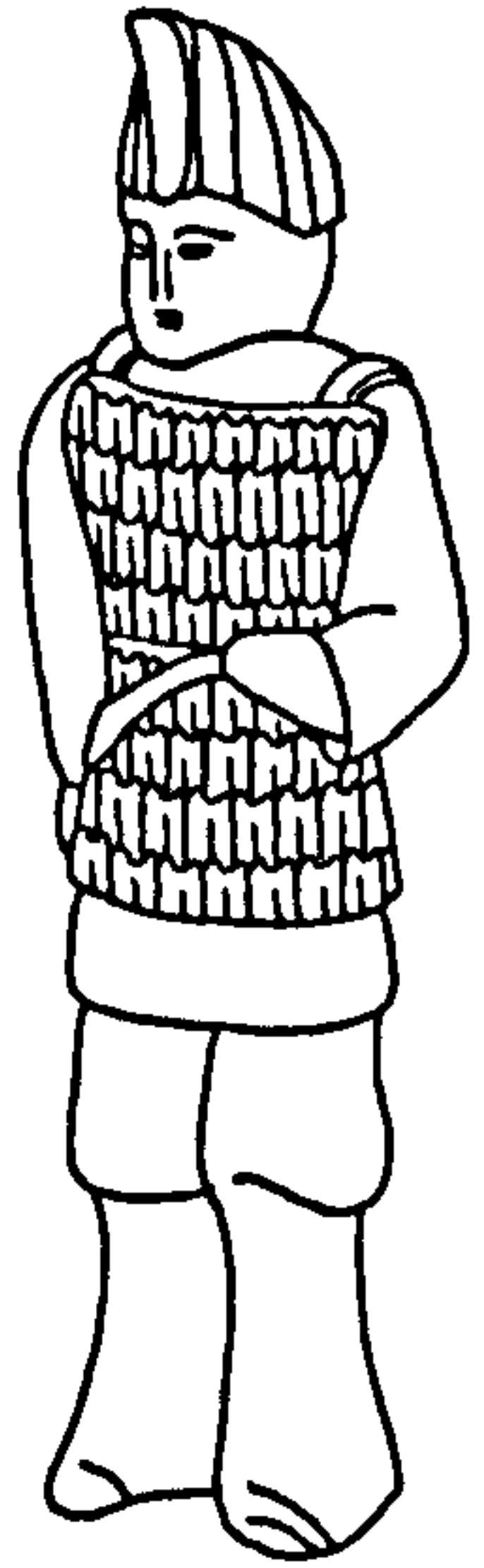

481

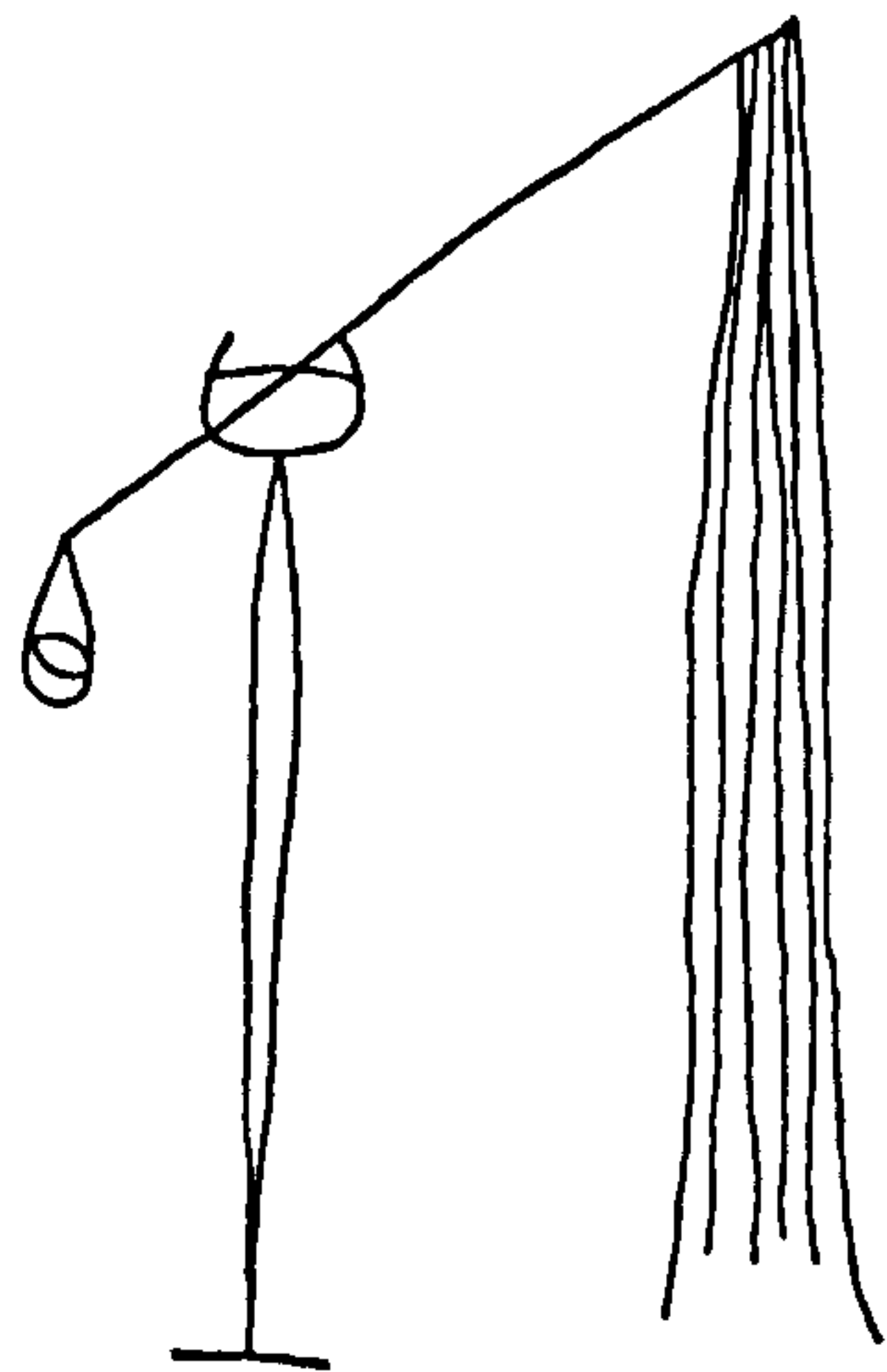

482

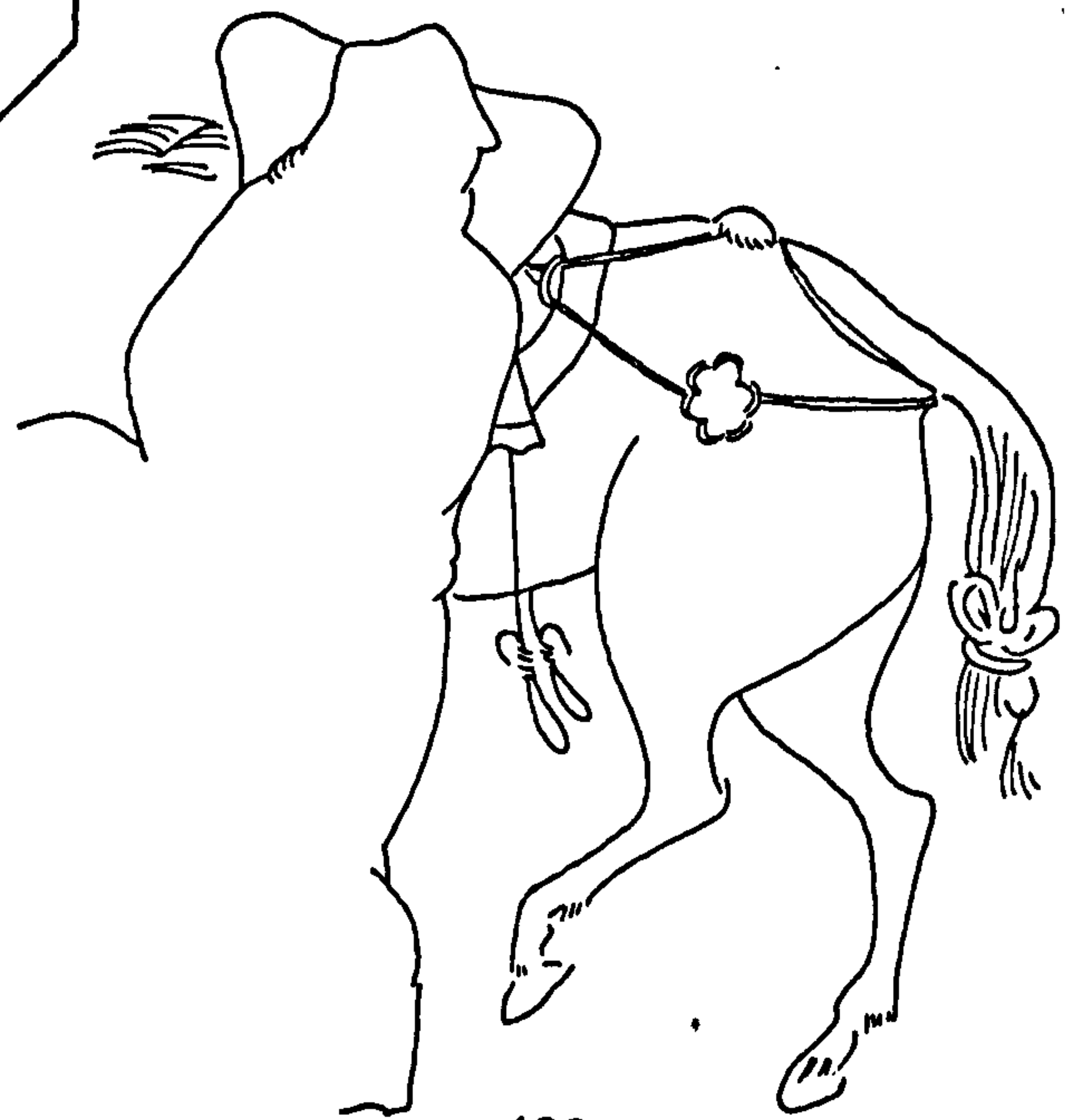

483

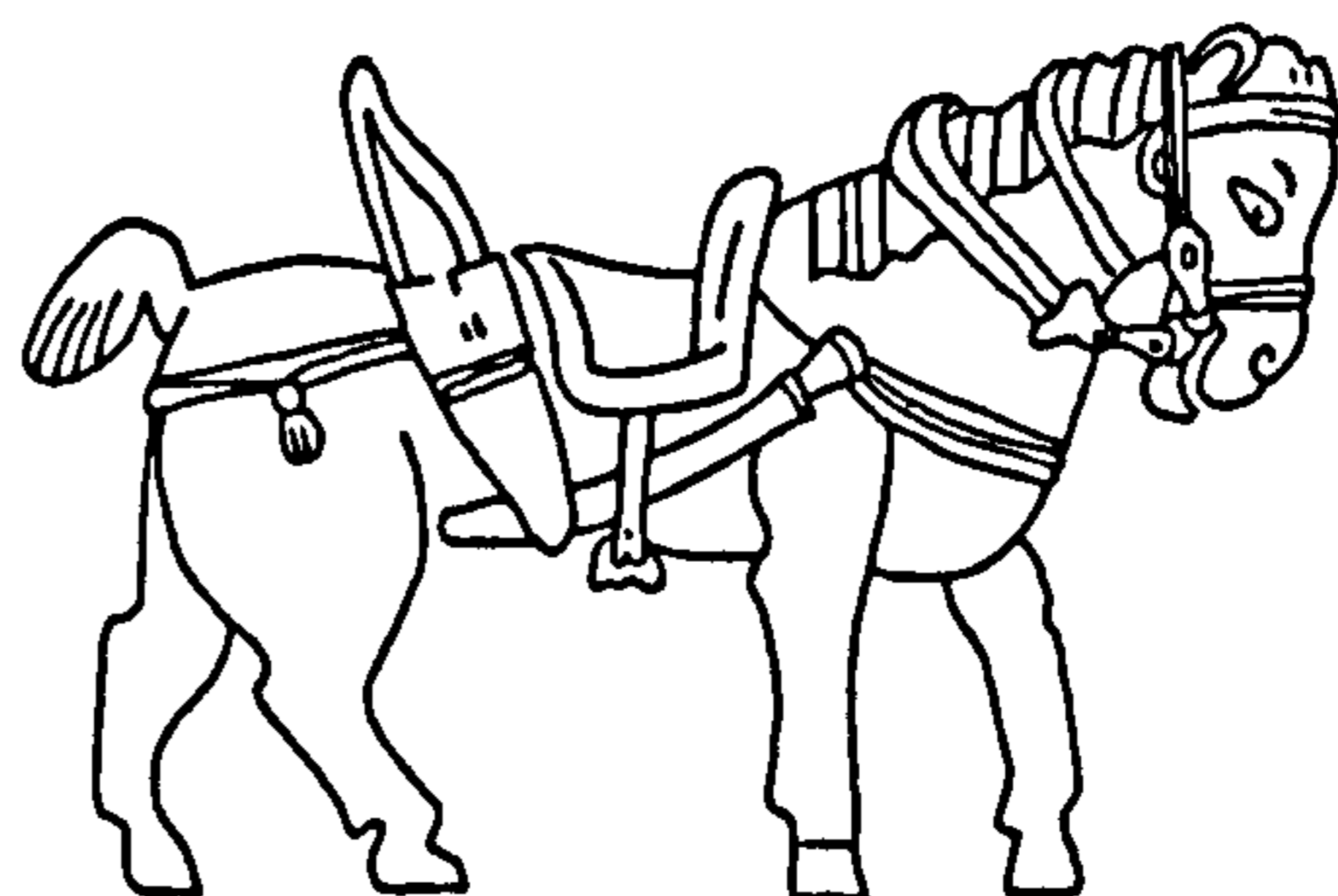
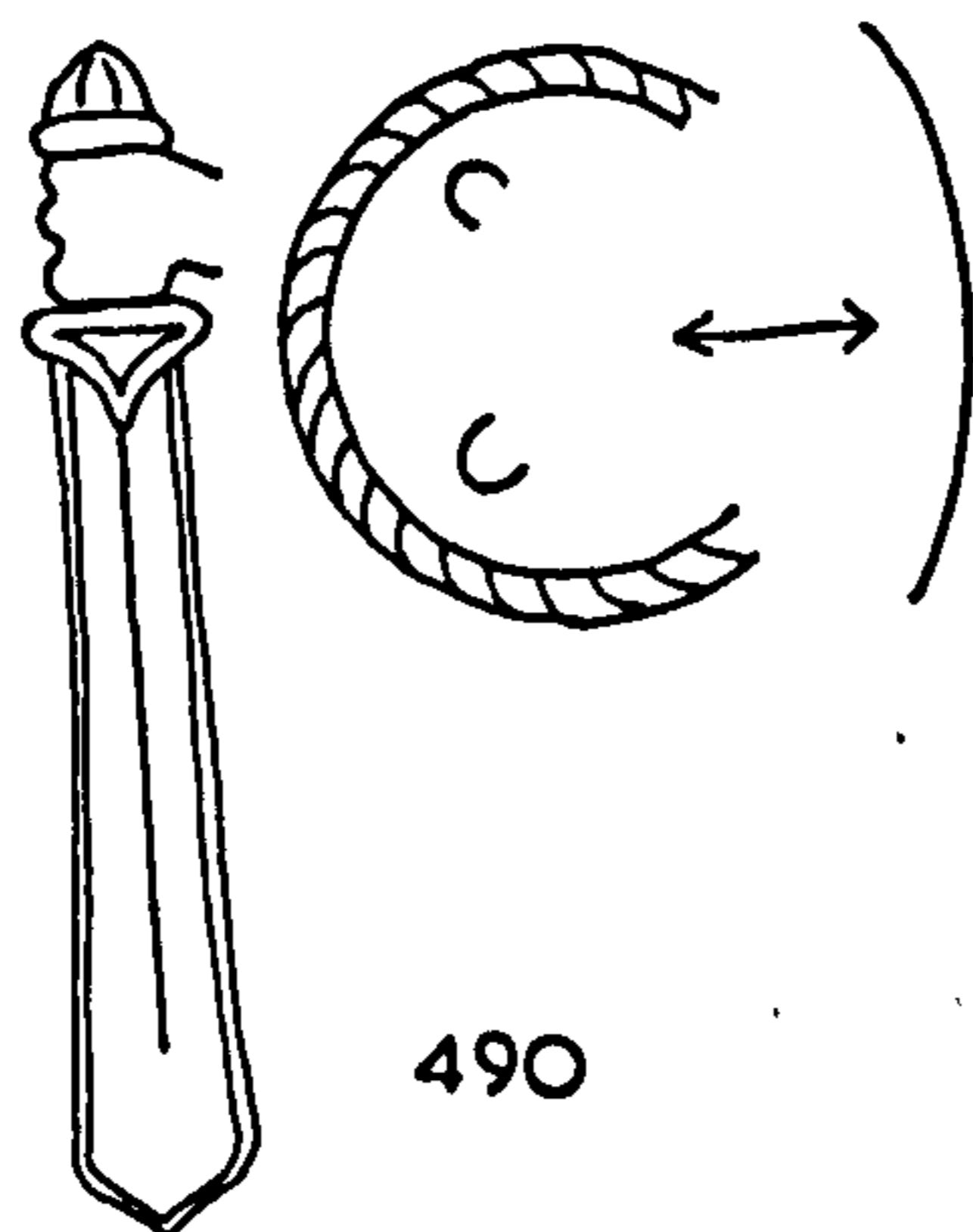
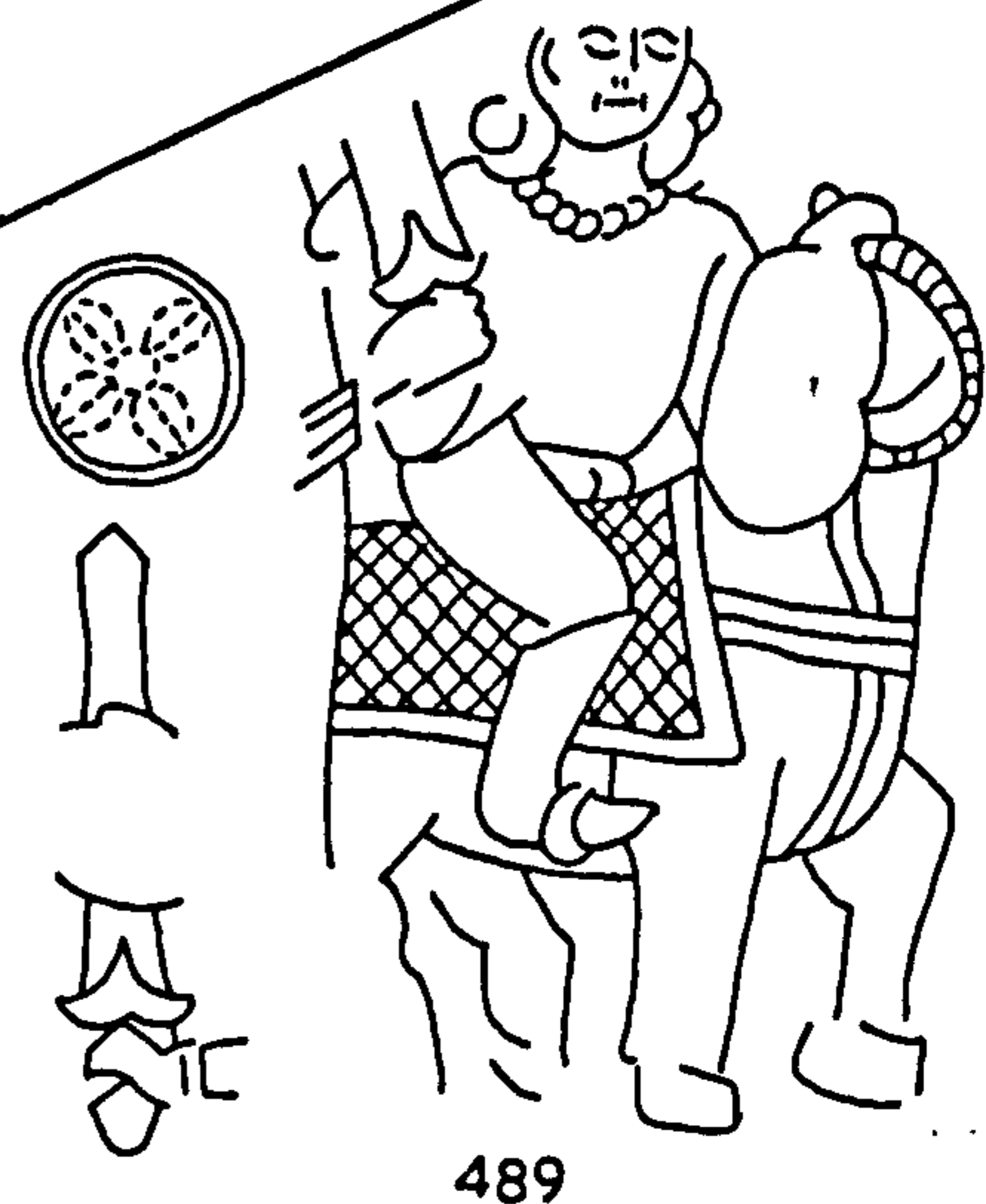
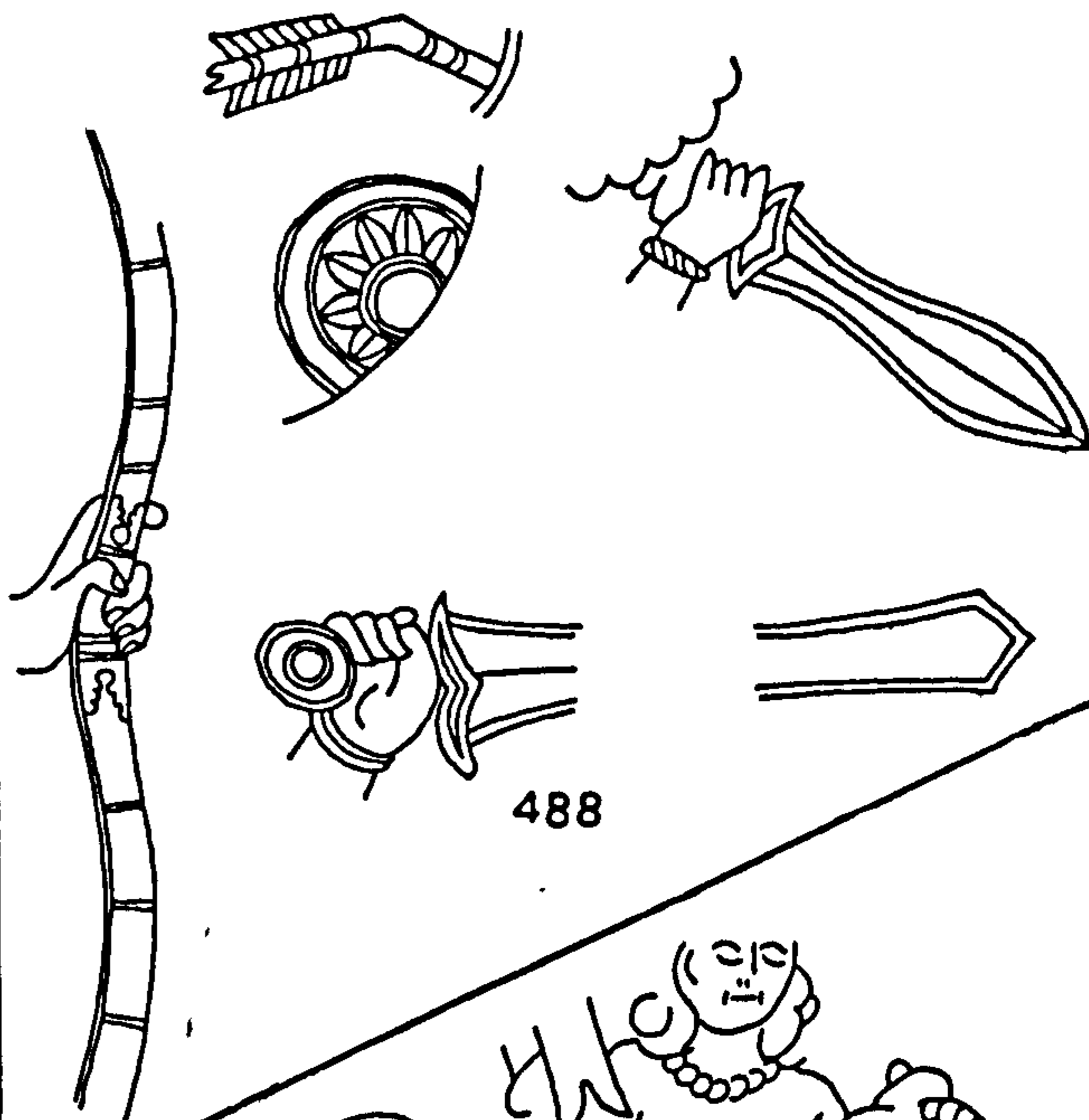
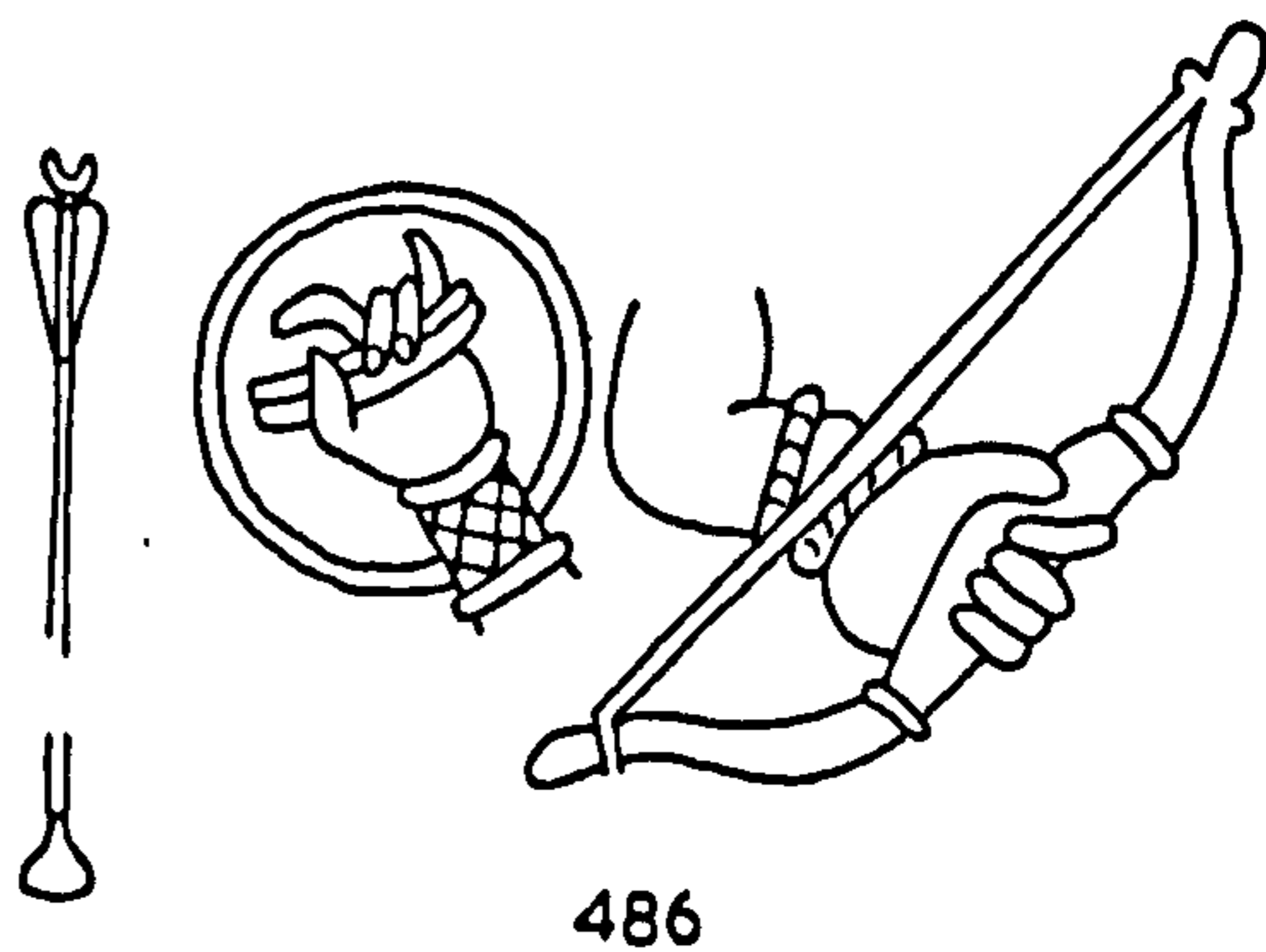
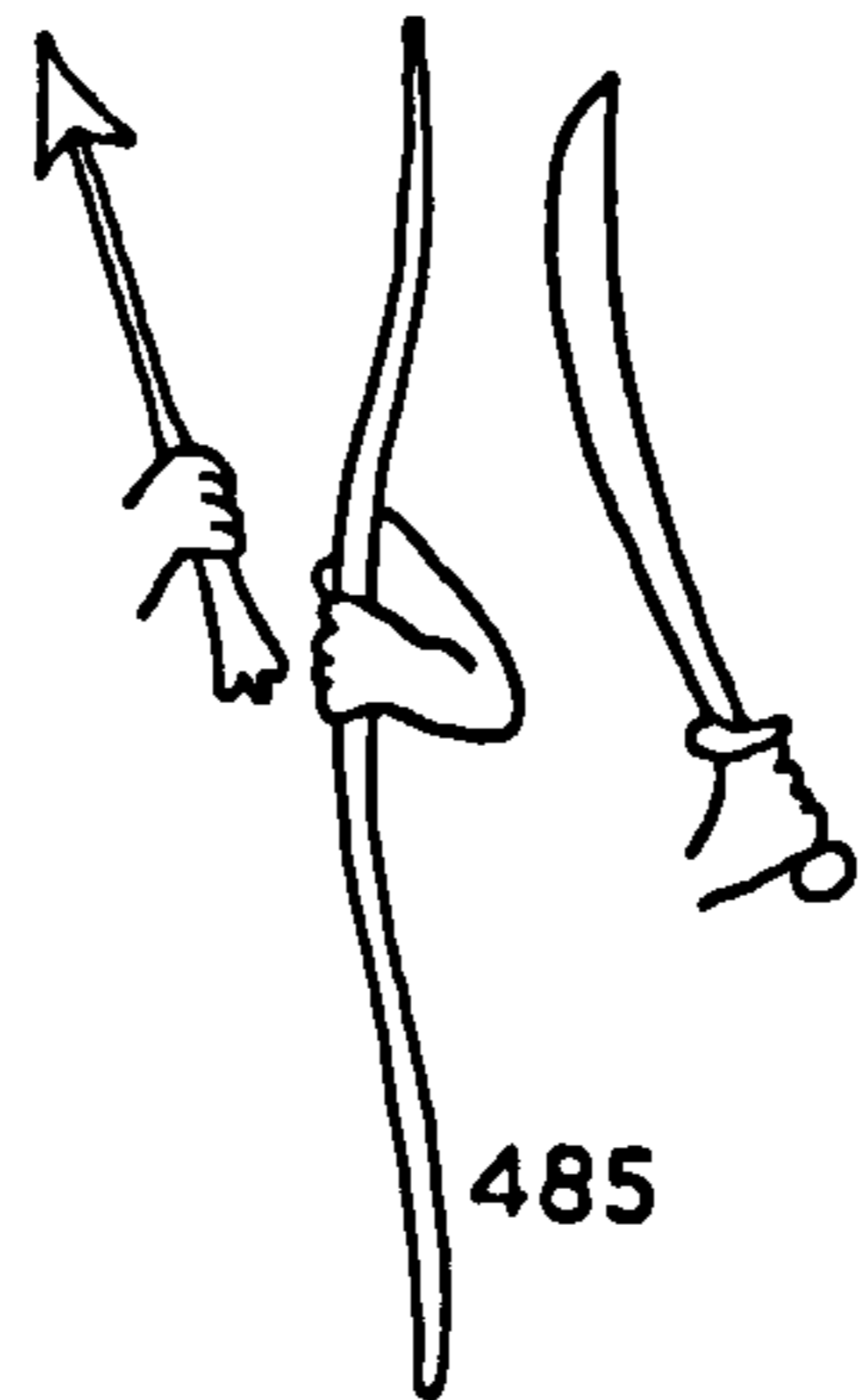
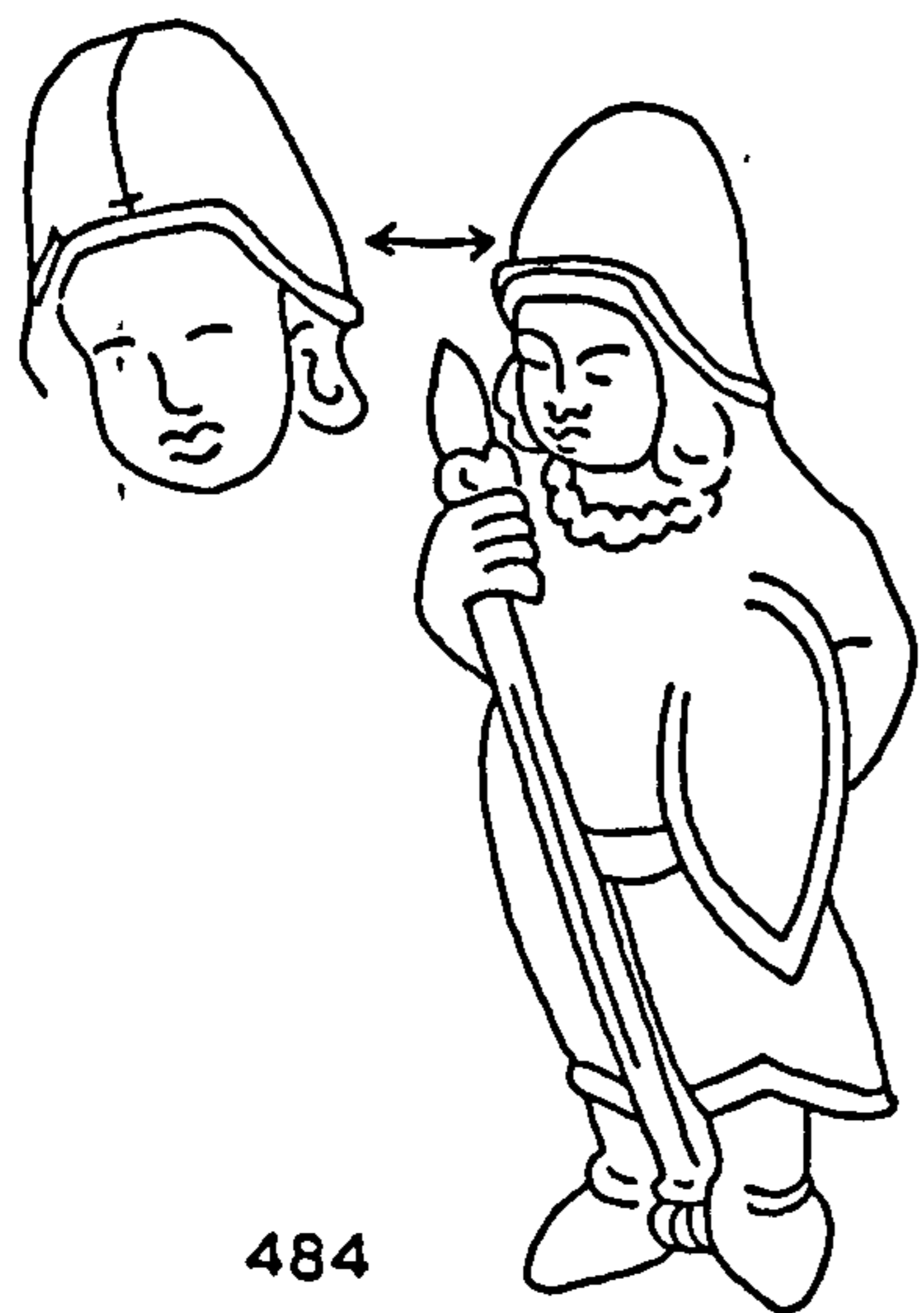



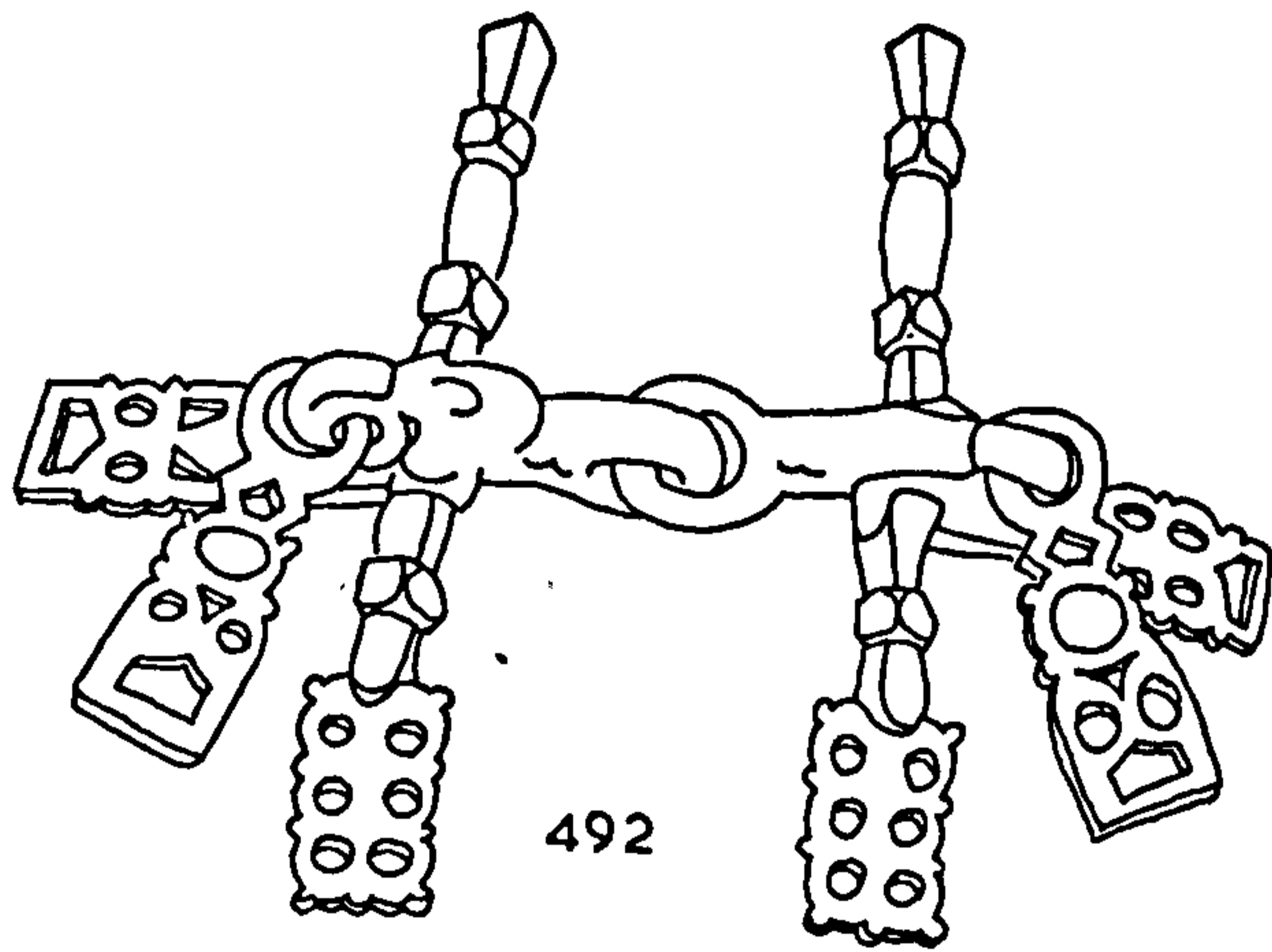

492

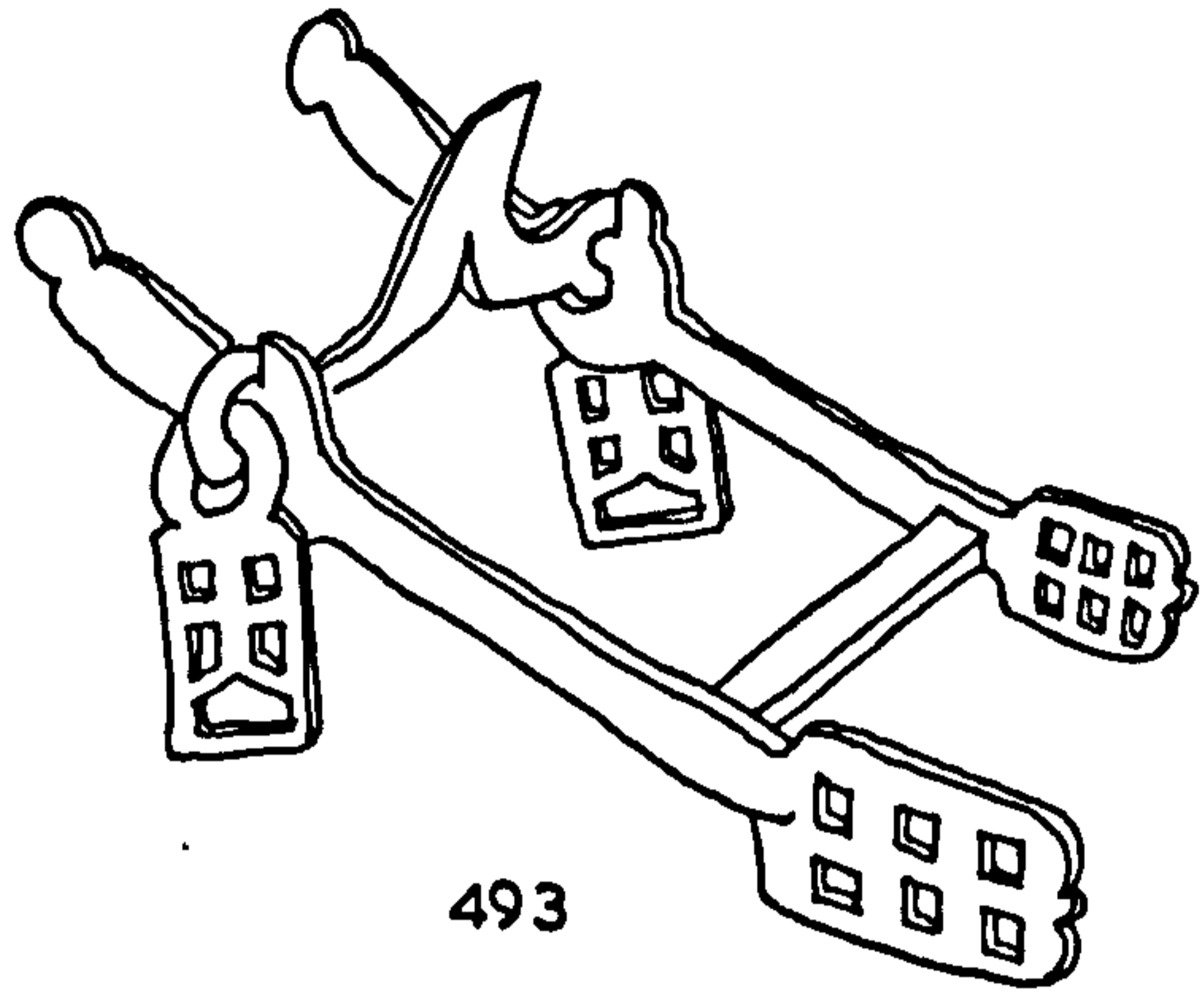

493



494

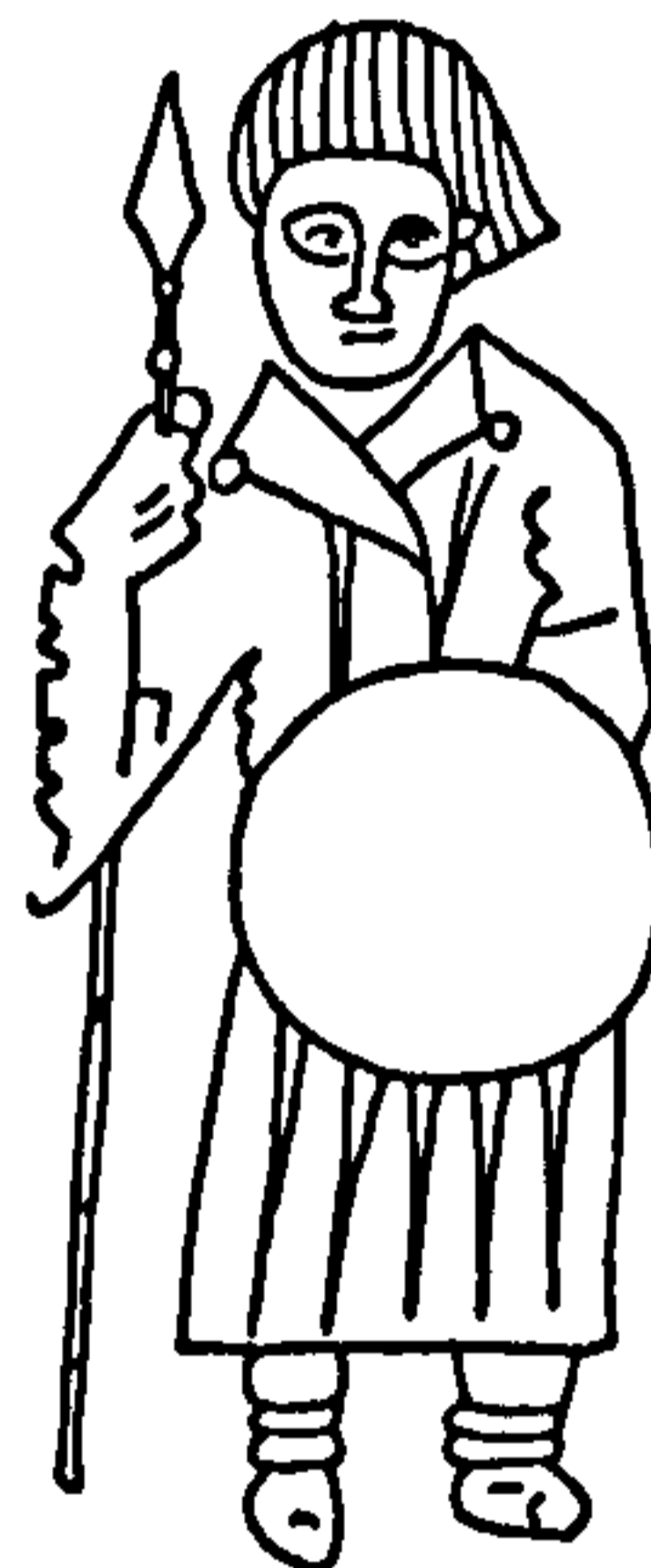

495

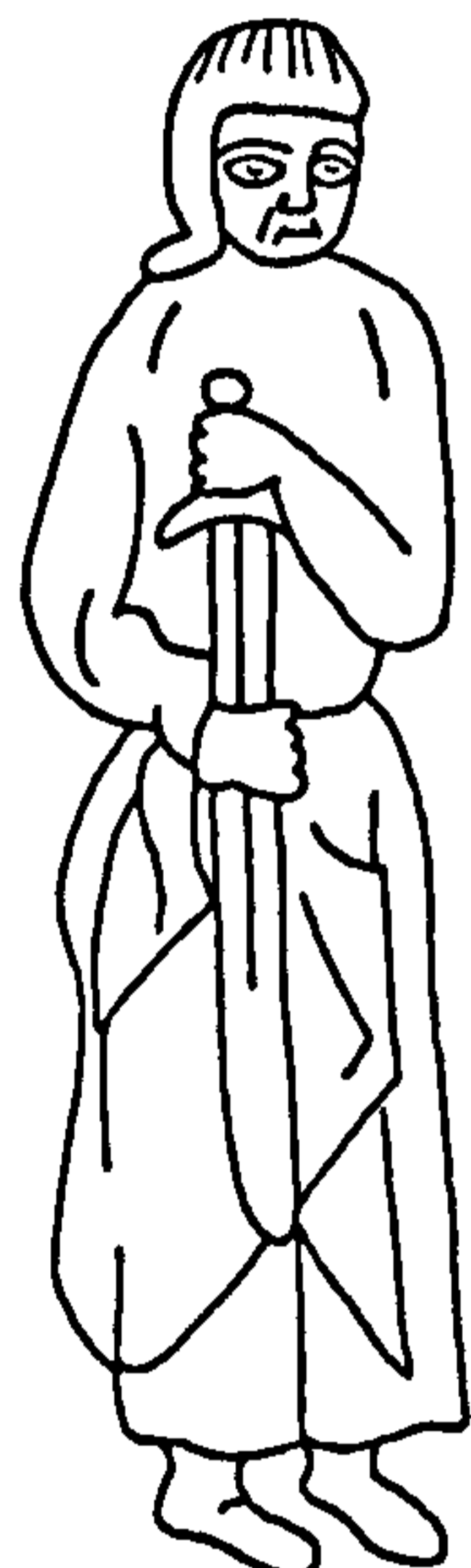

496

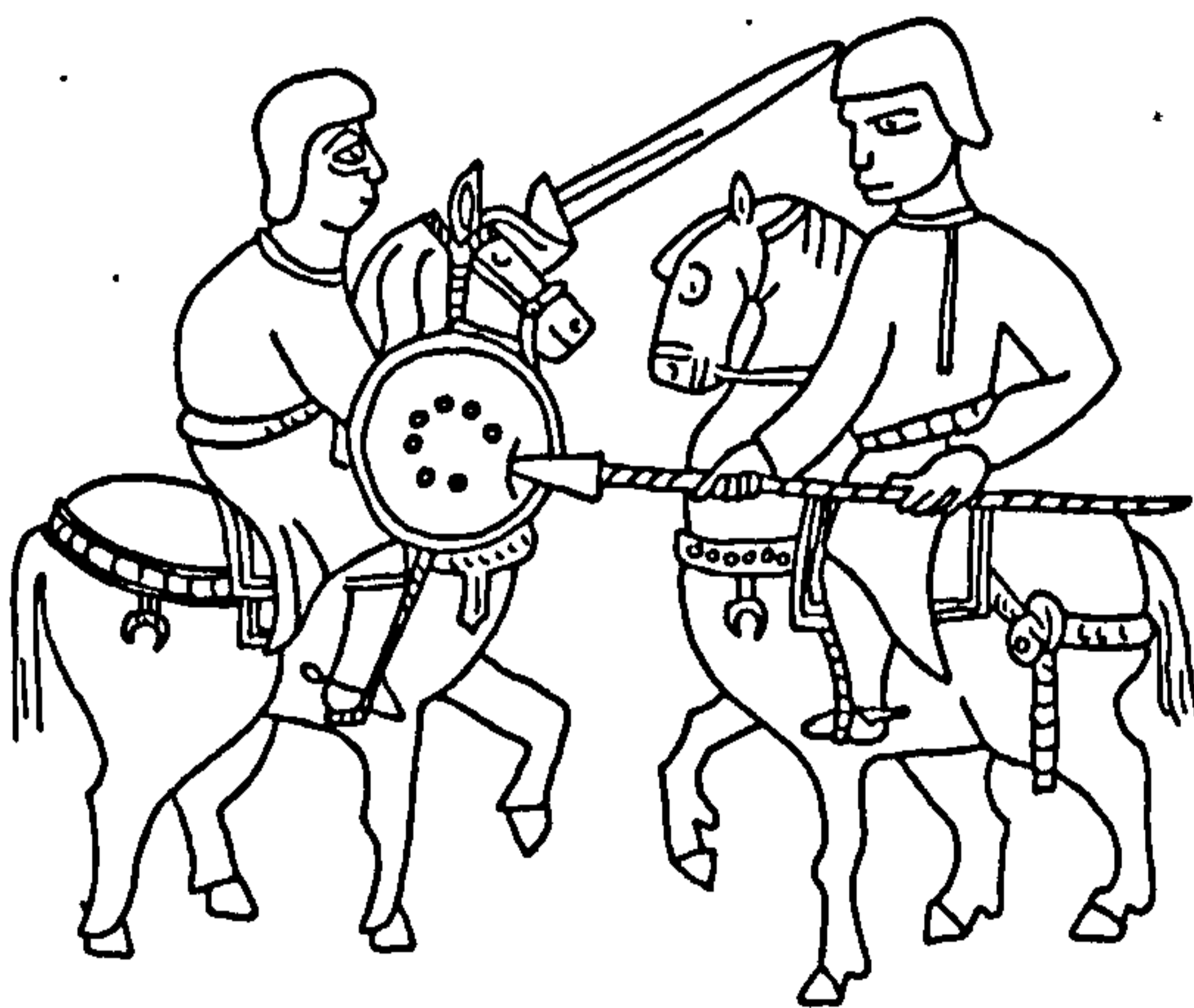

497





498

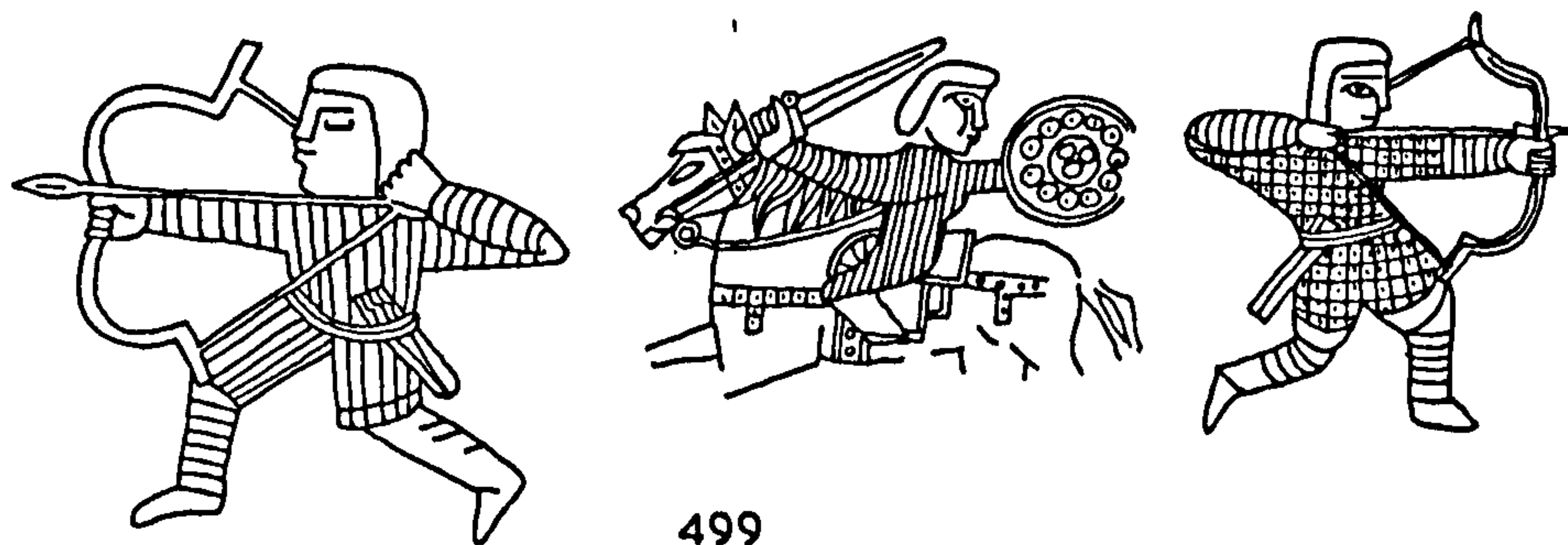

499



500

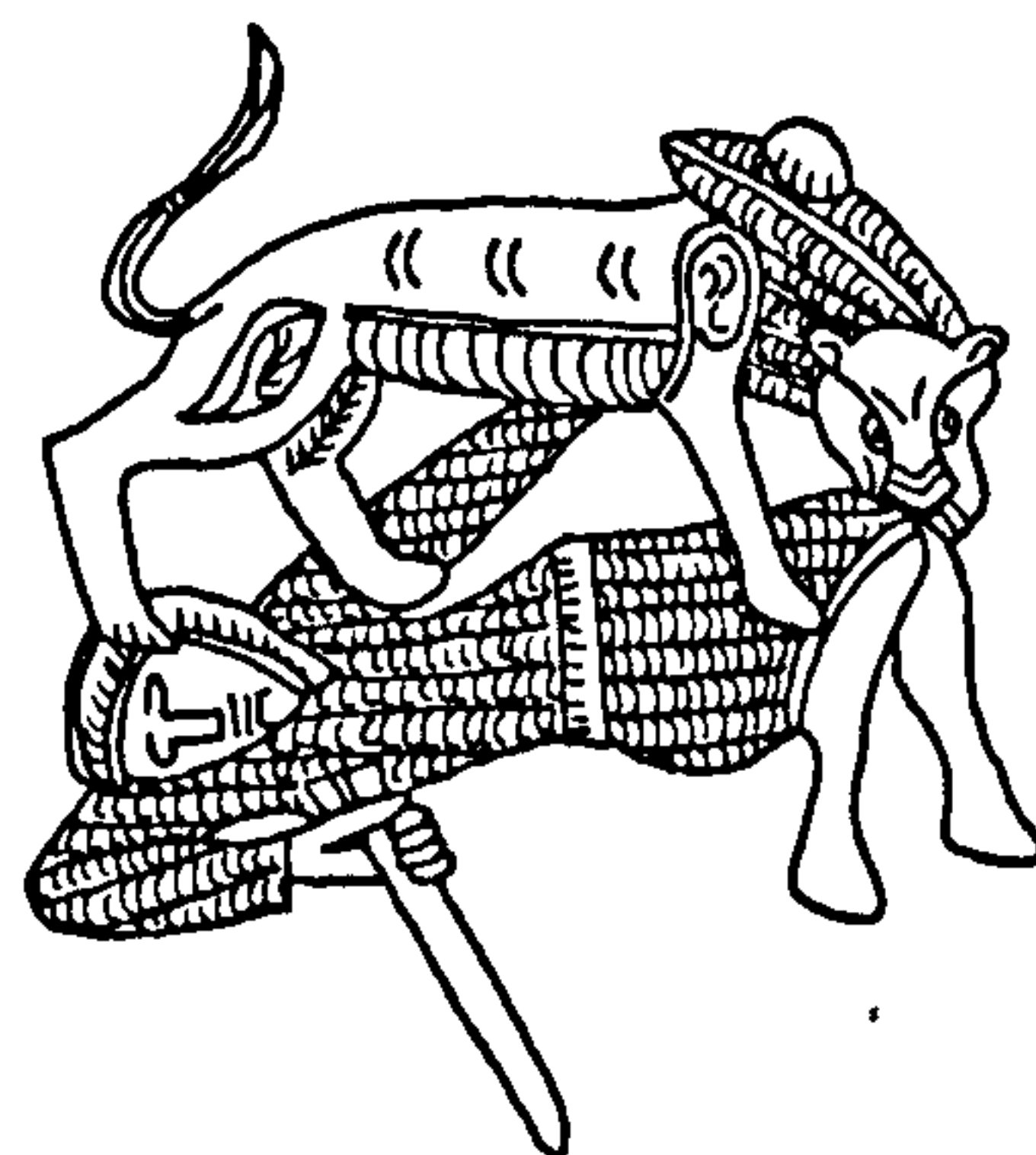

501

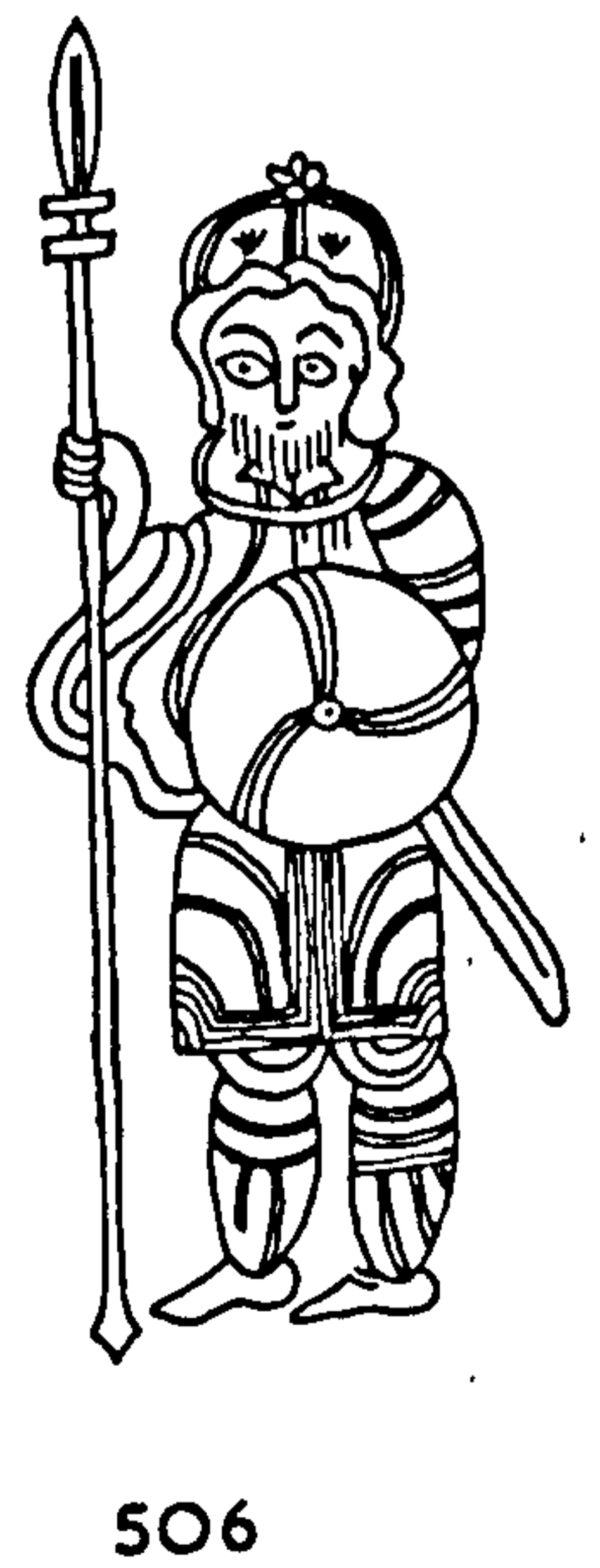
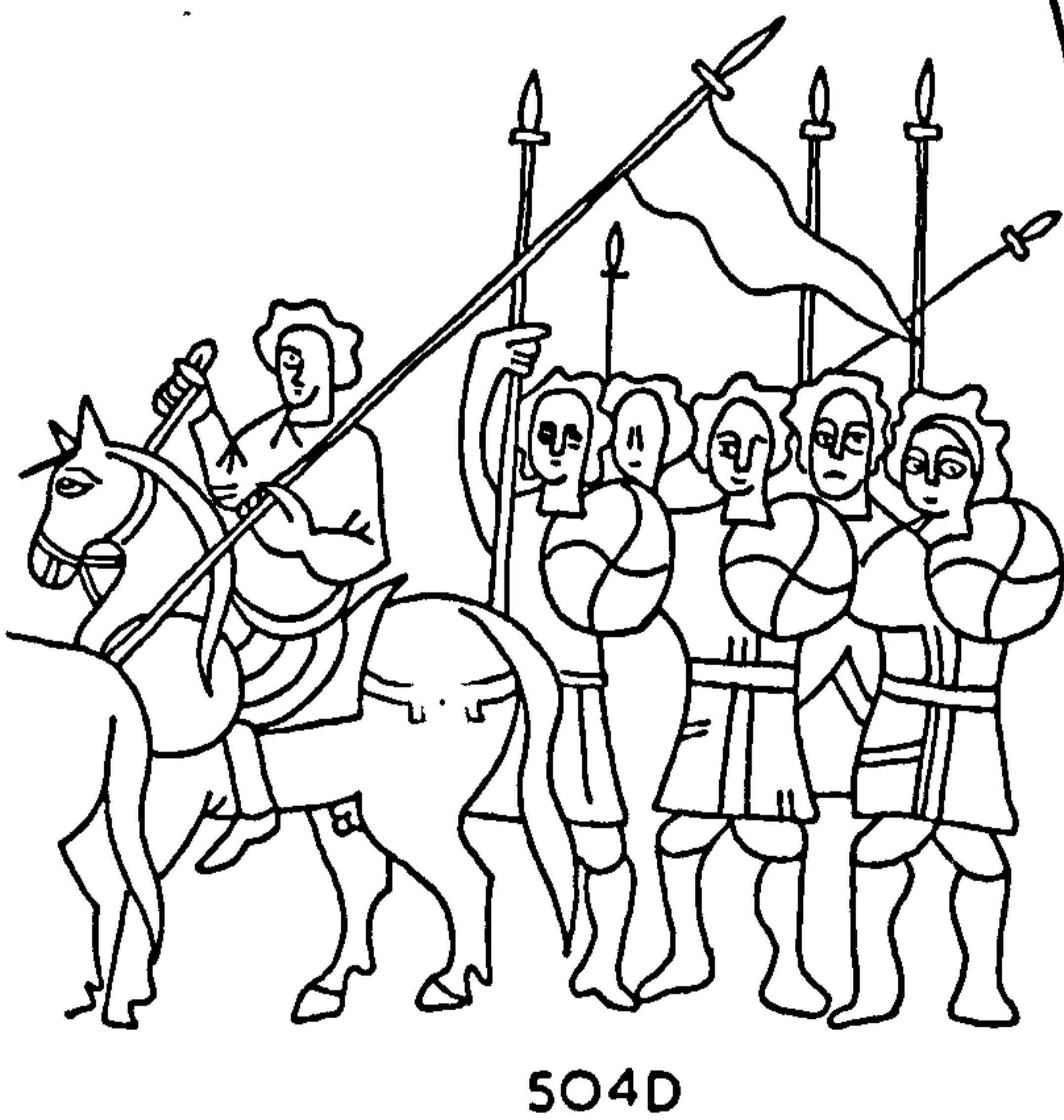
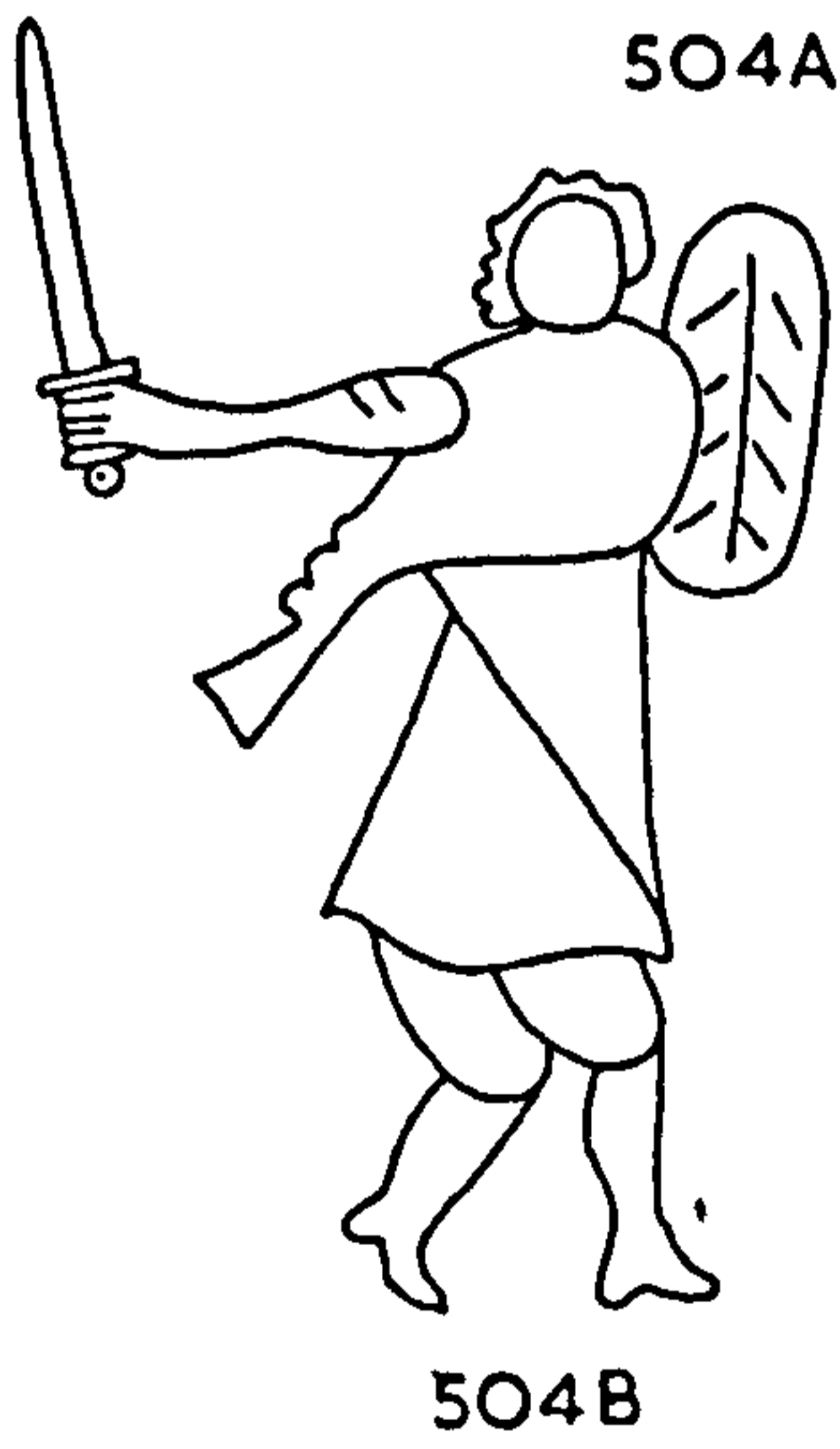
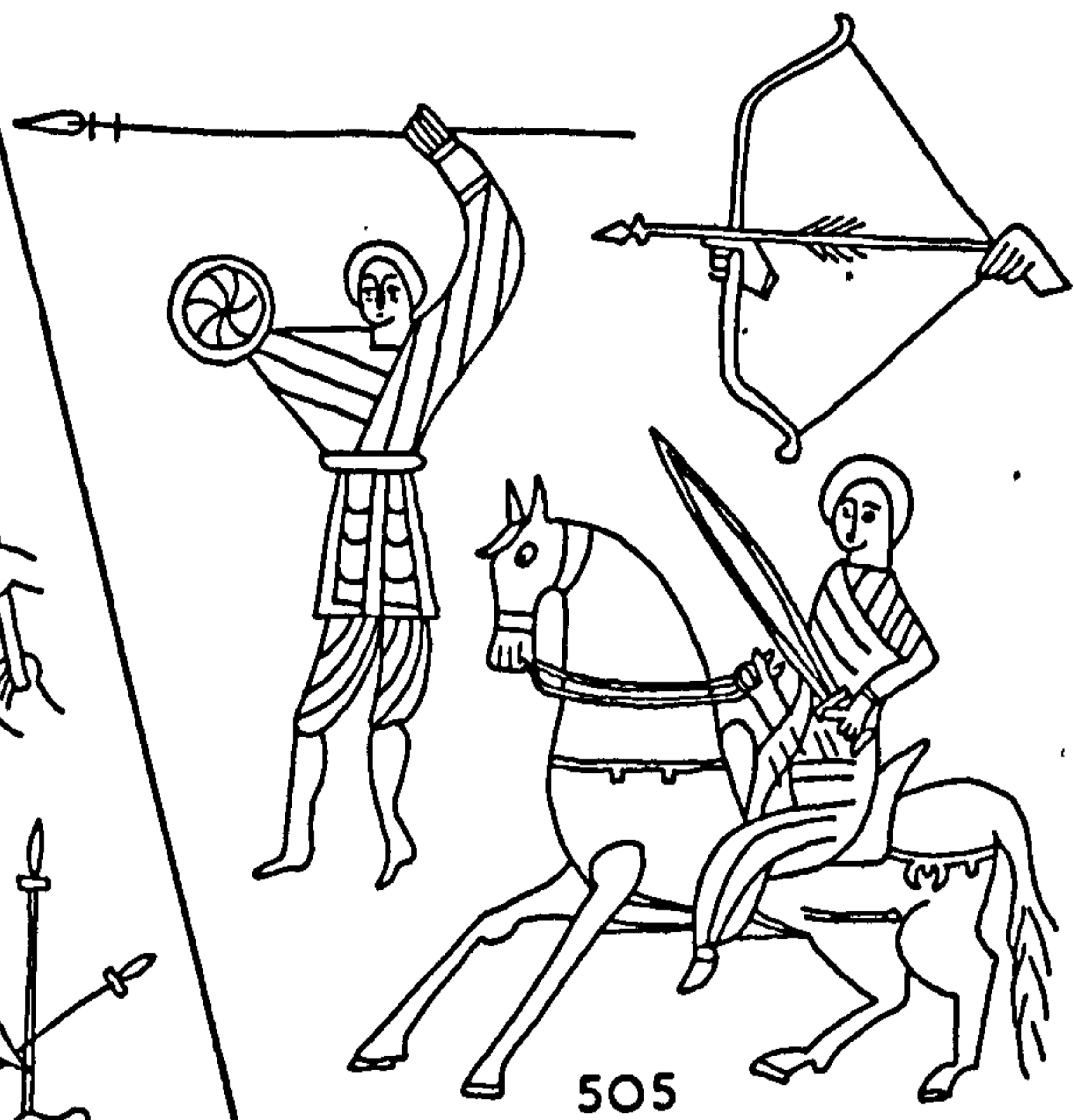
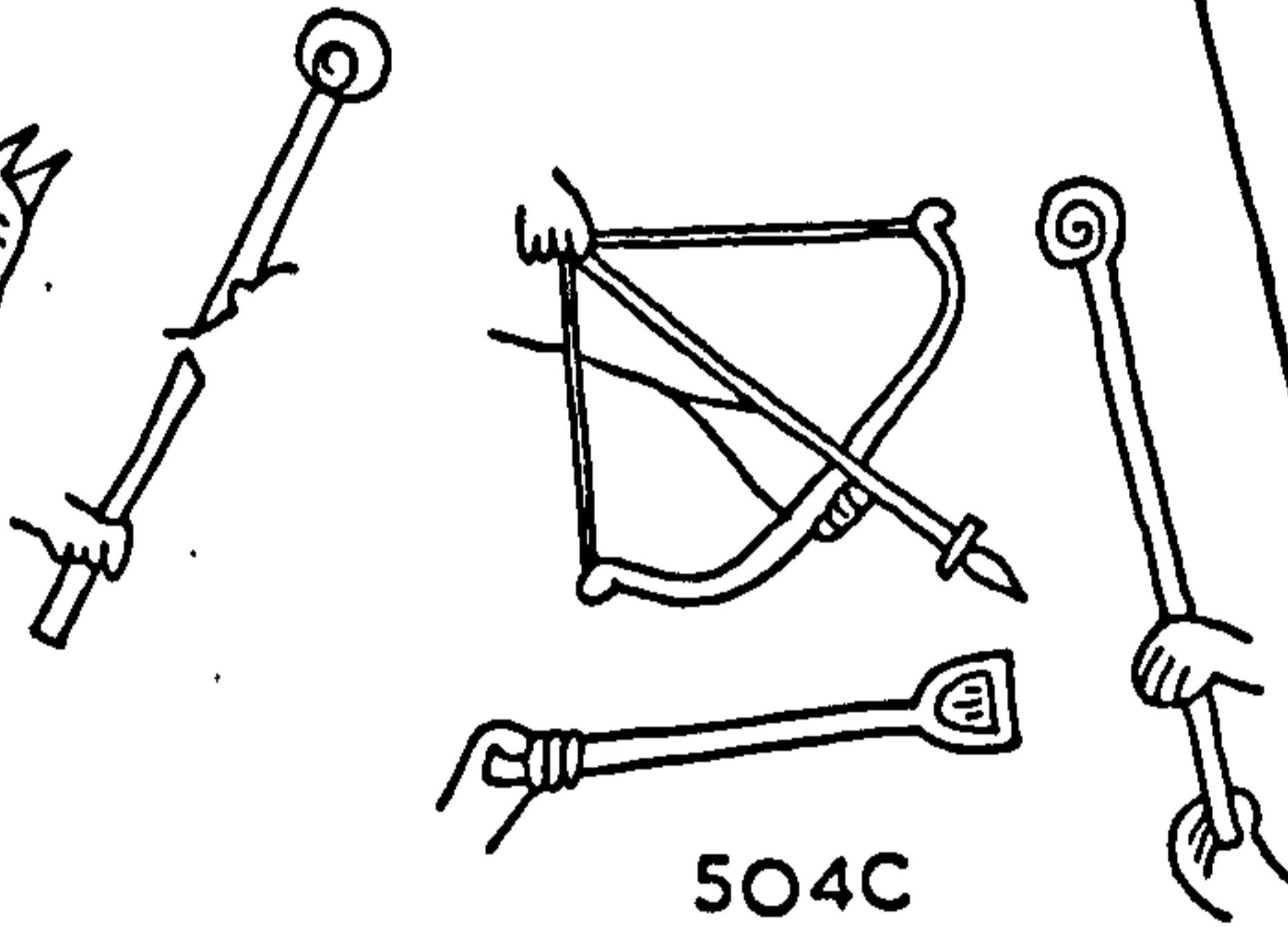
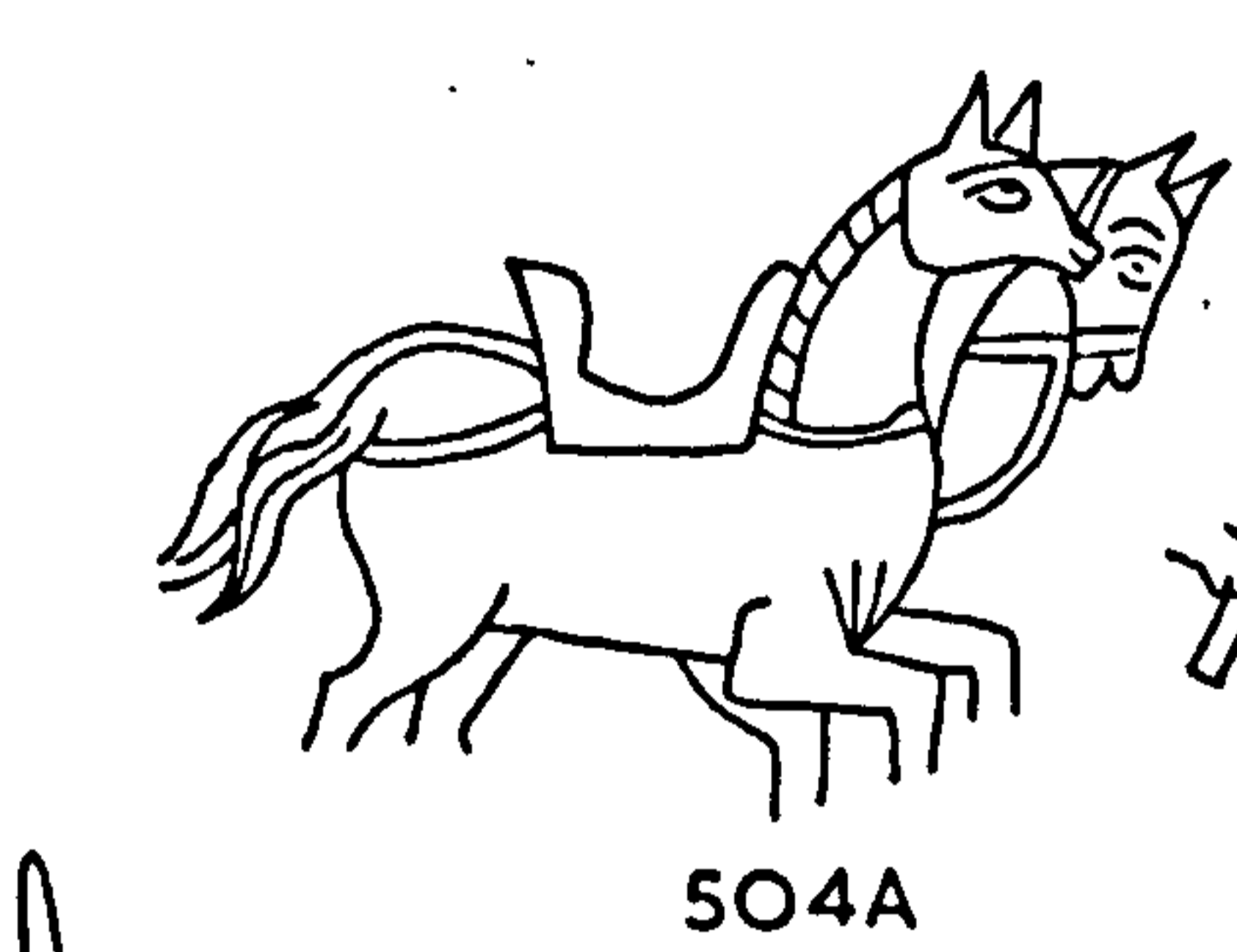
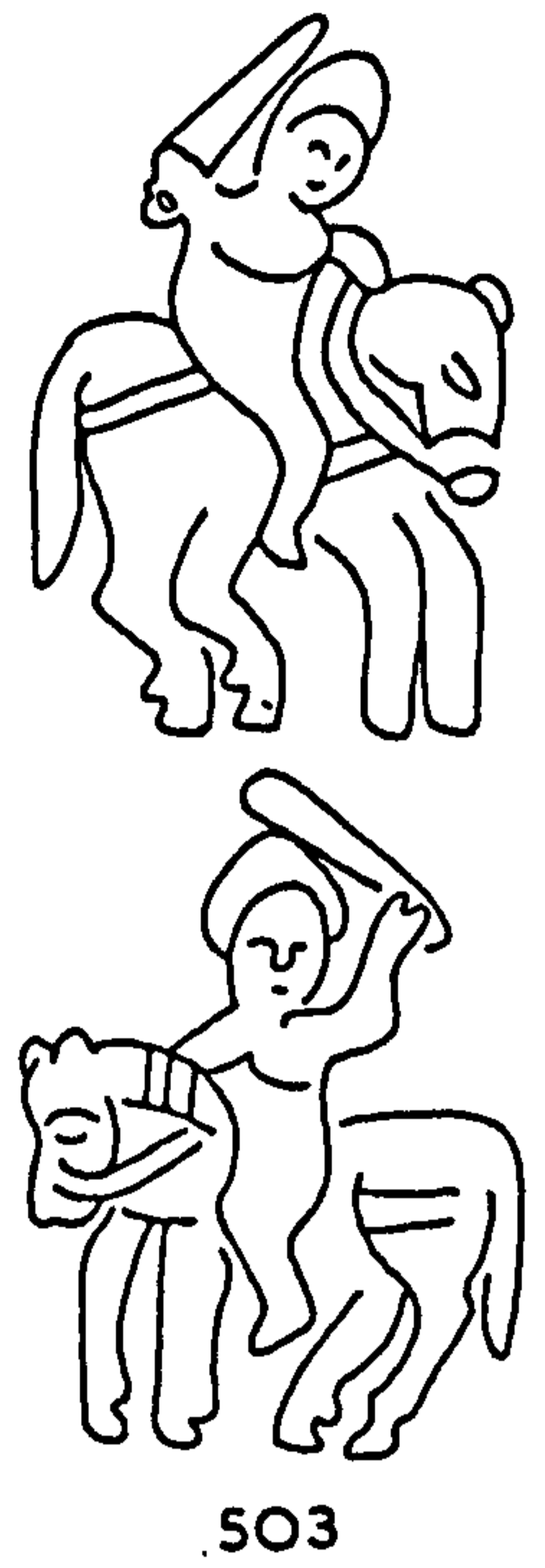



507A



507B



507C

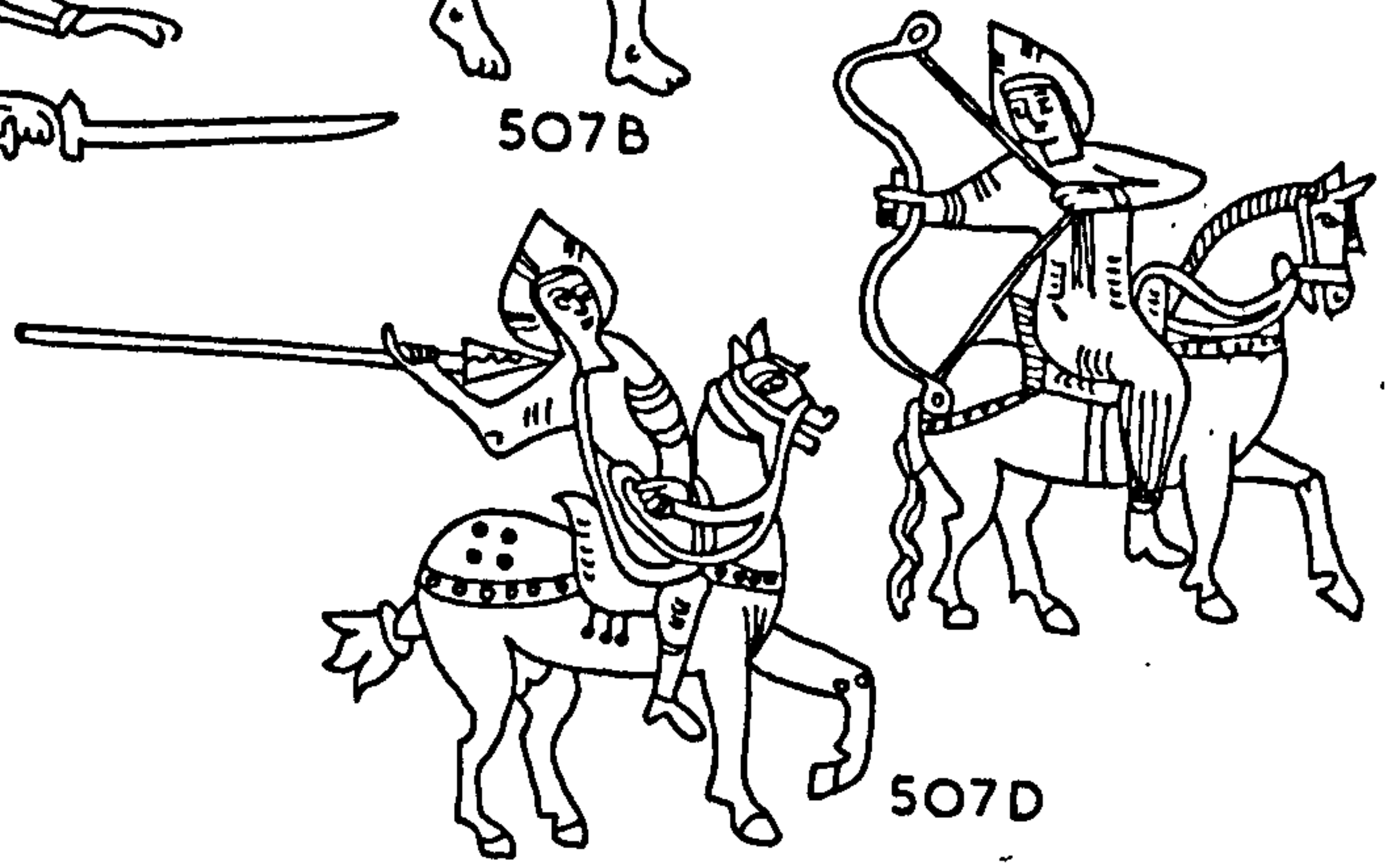

507D

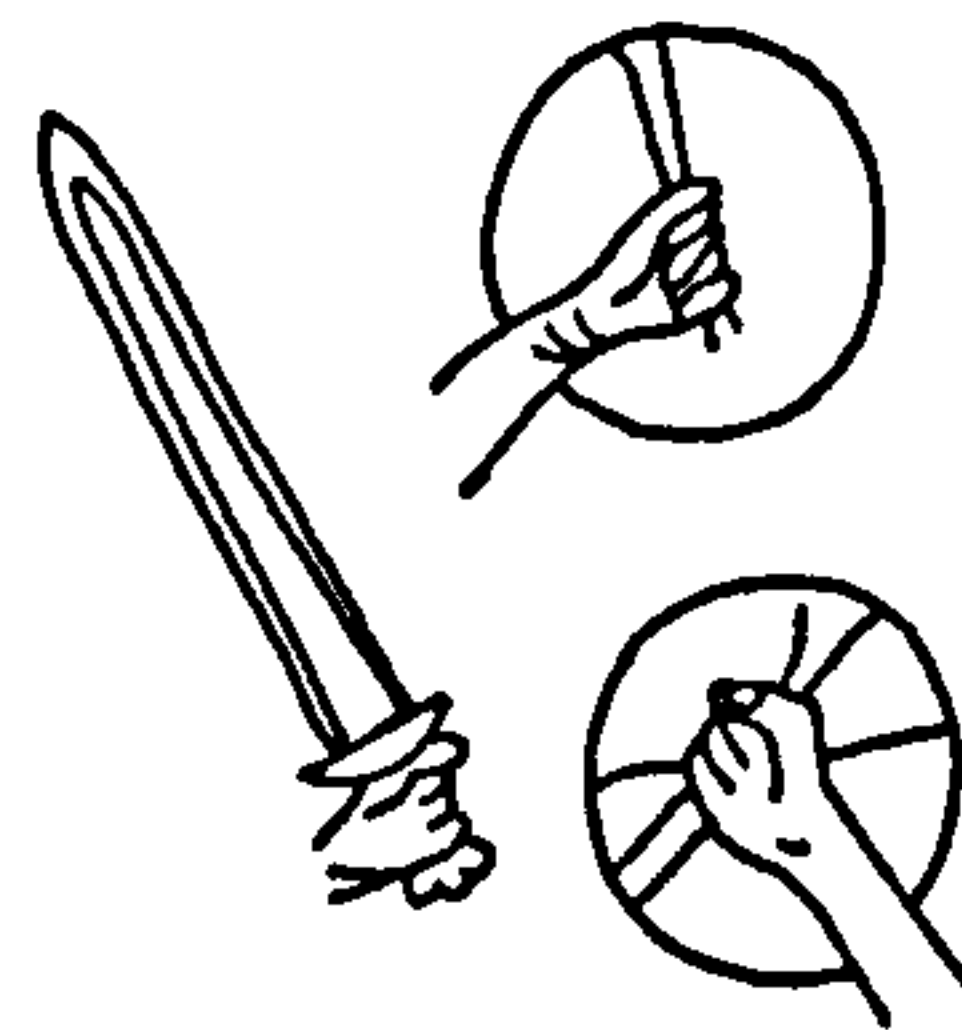

507E

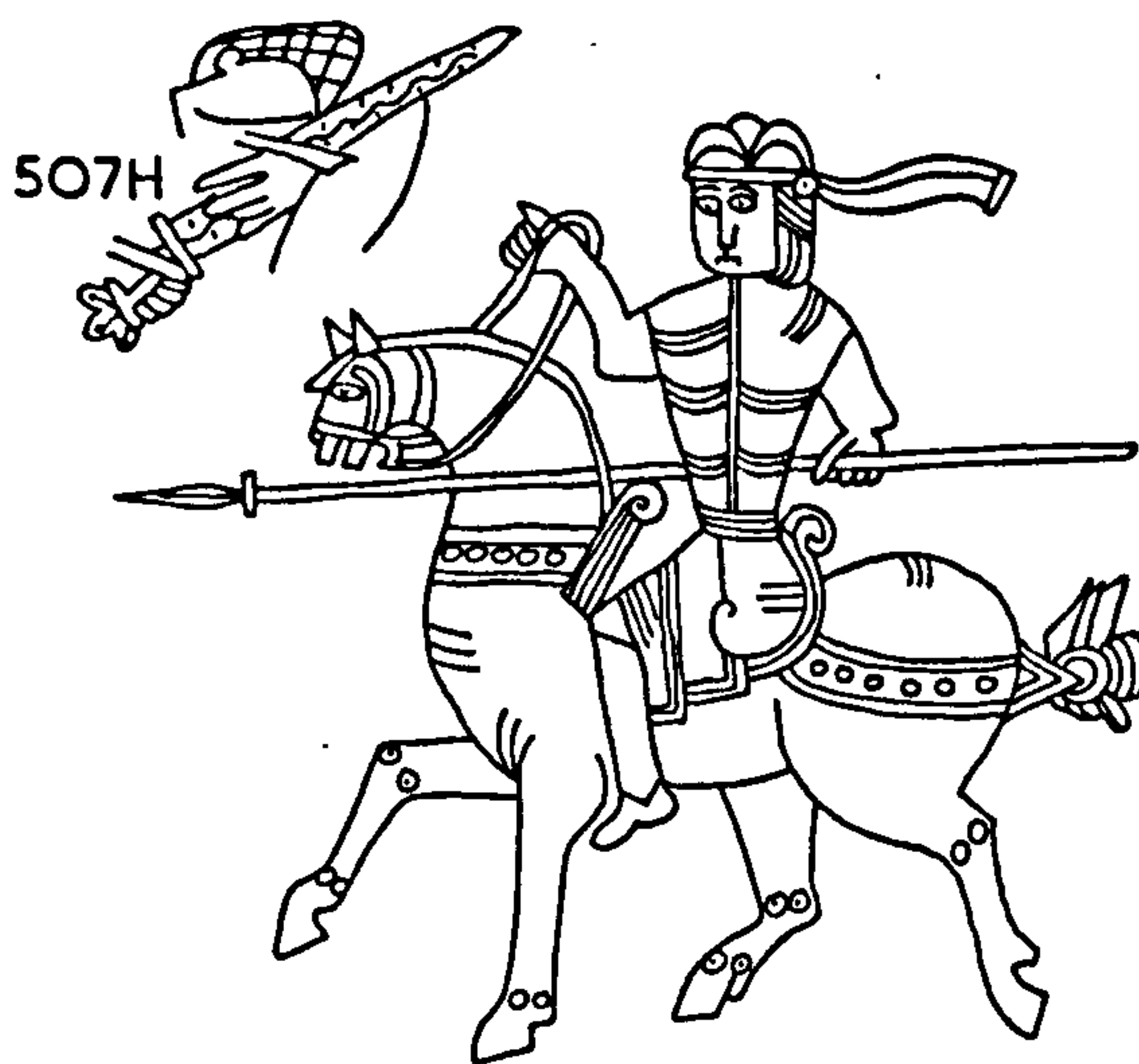

507H



507G



507F

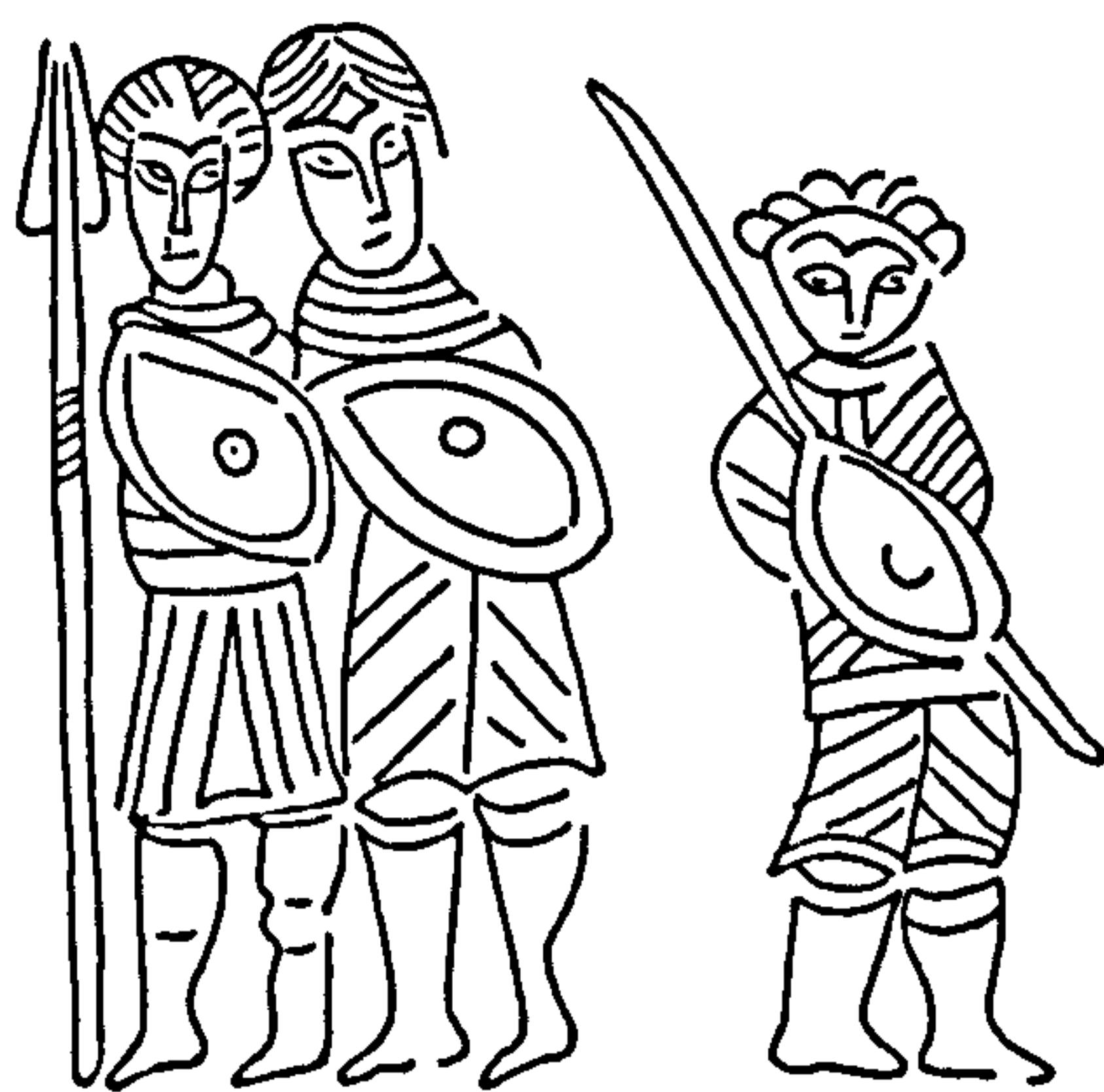

508

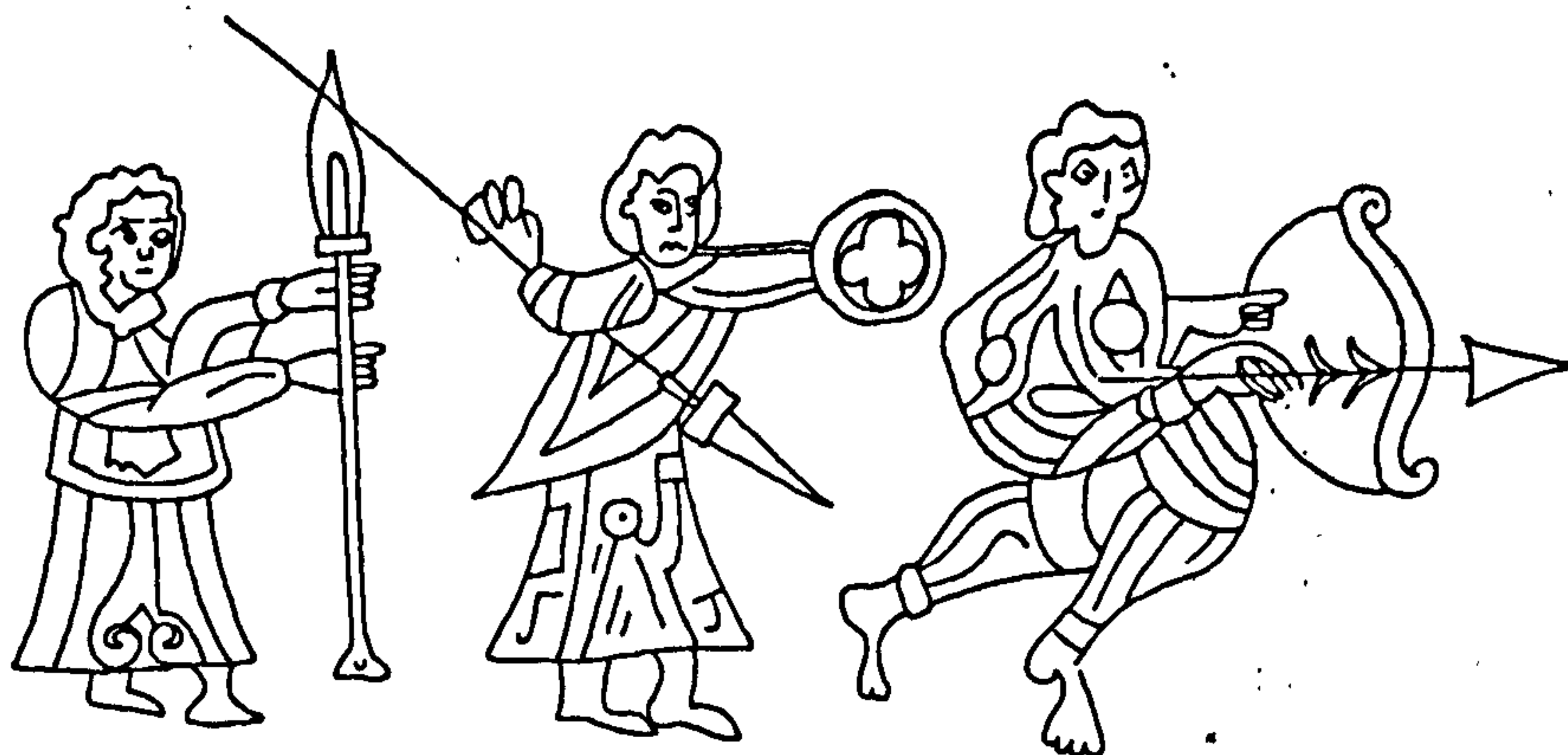

509

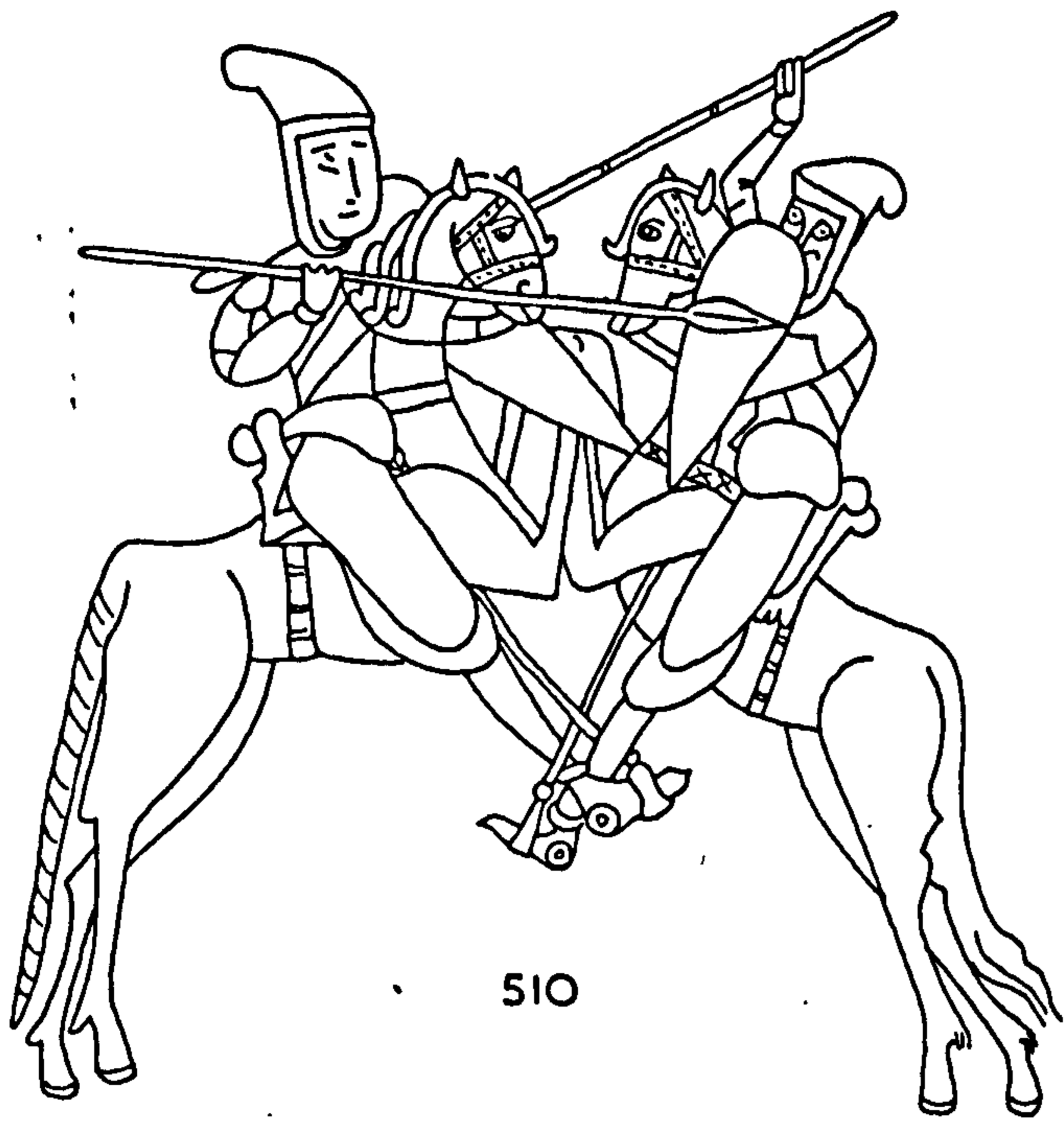

510

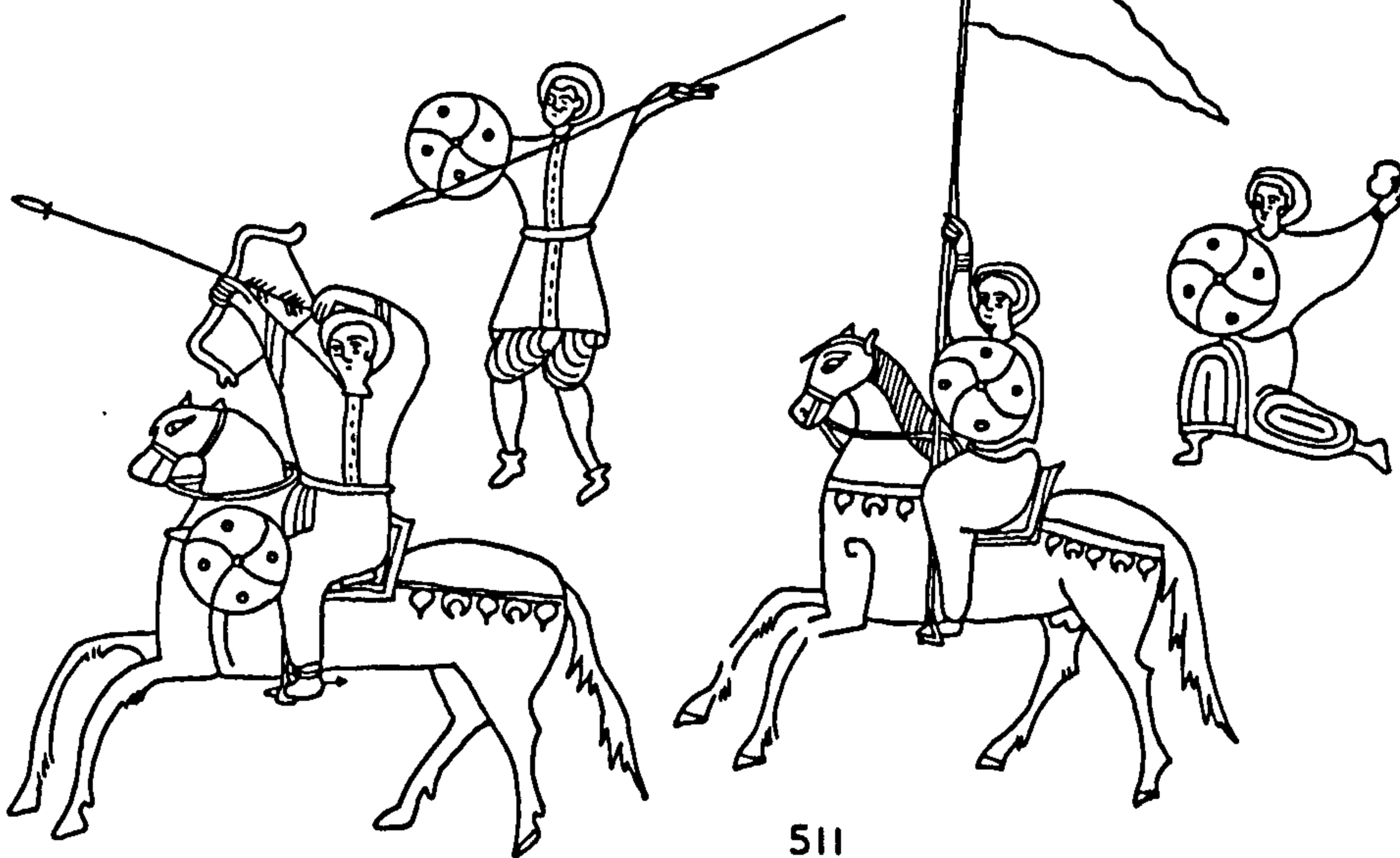
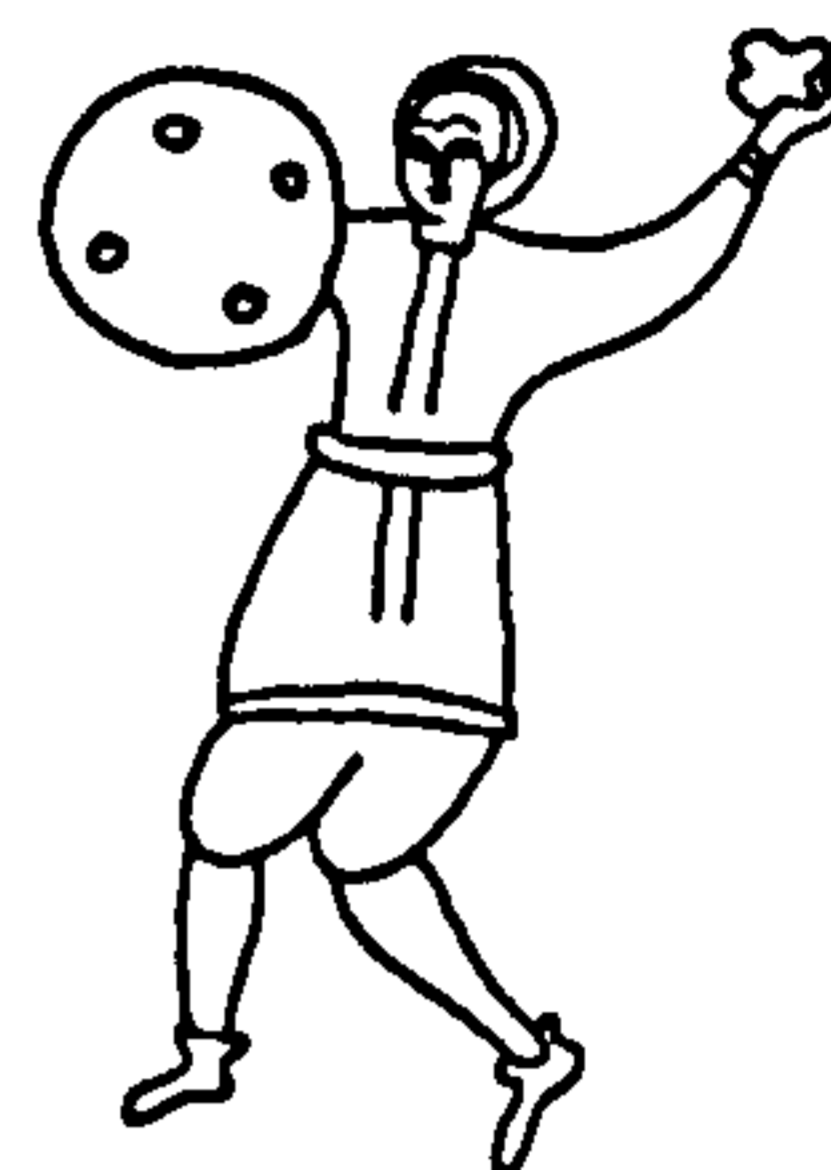

511

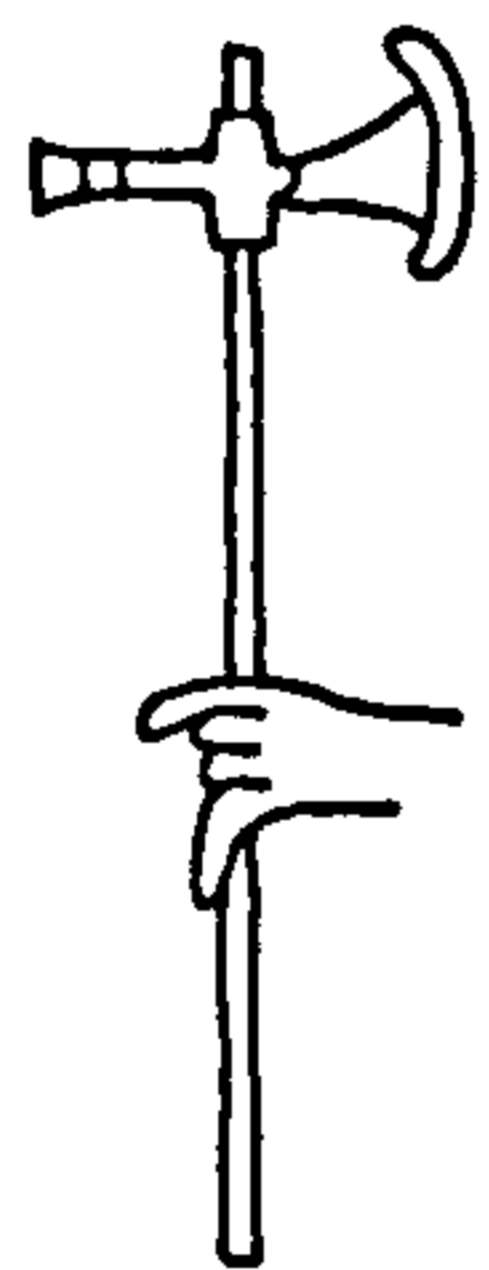

512

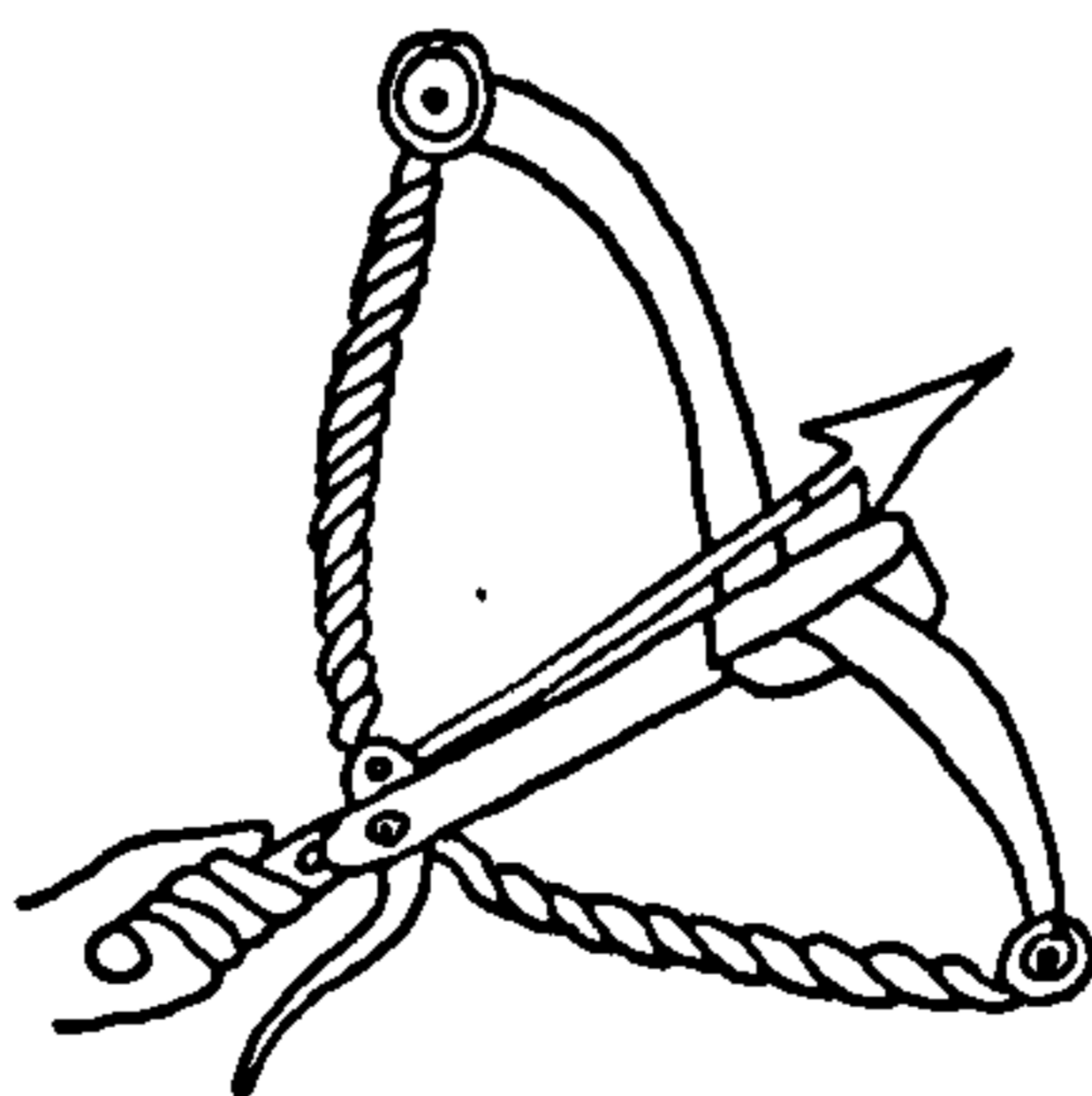

513



514

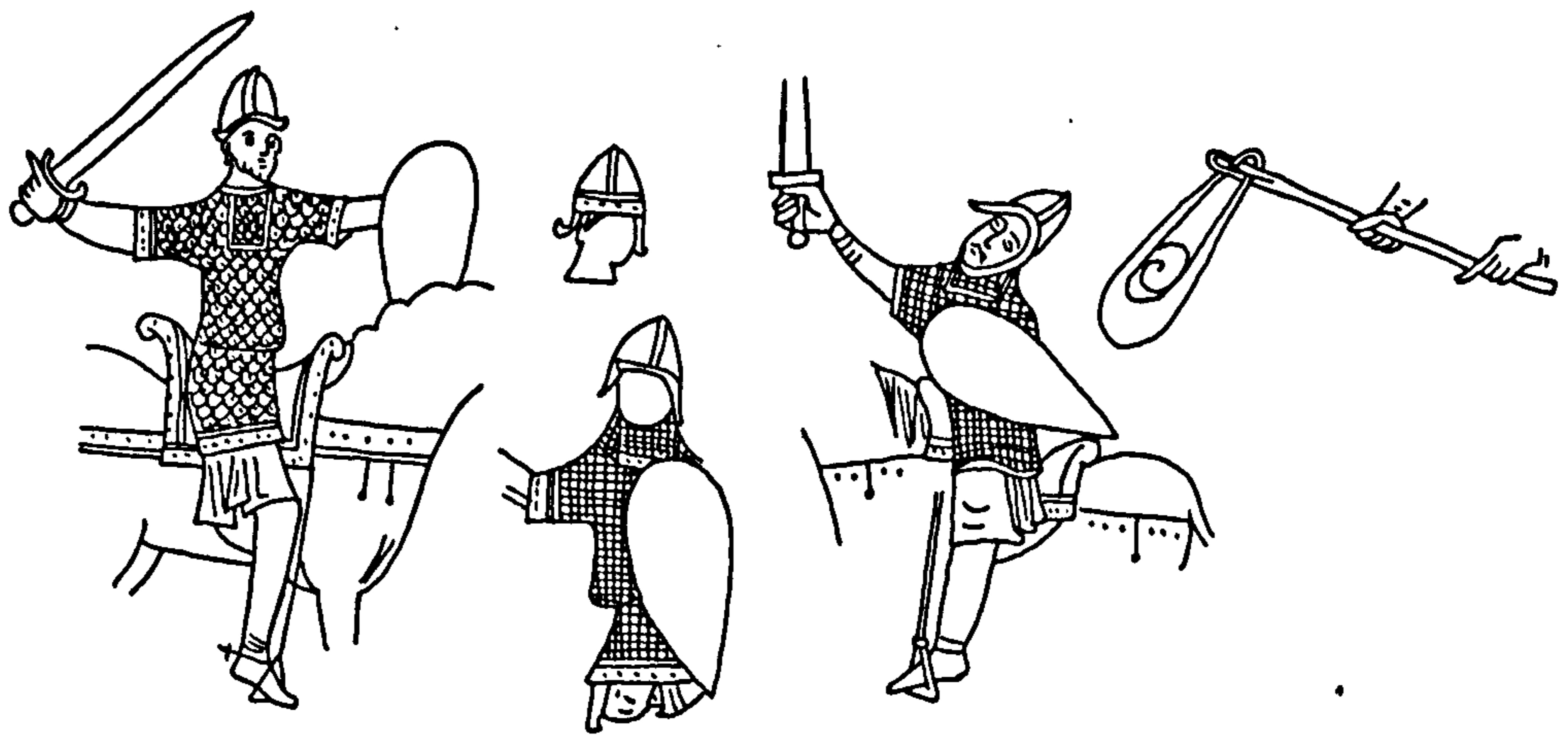
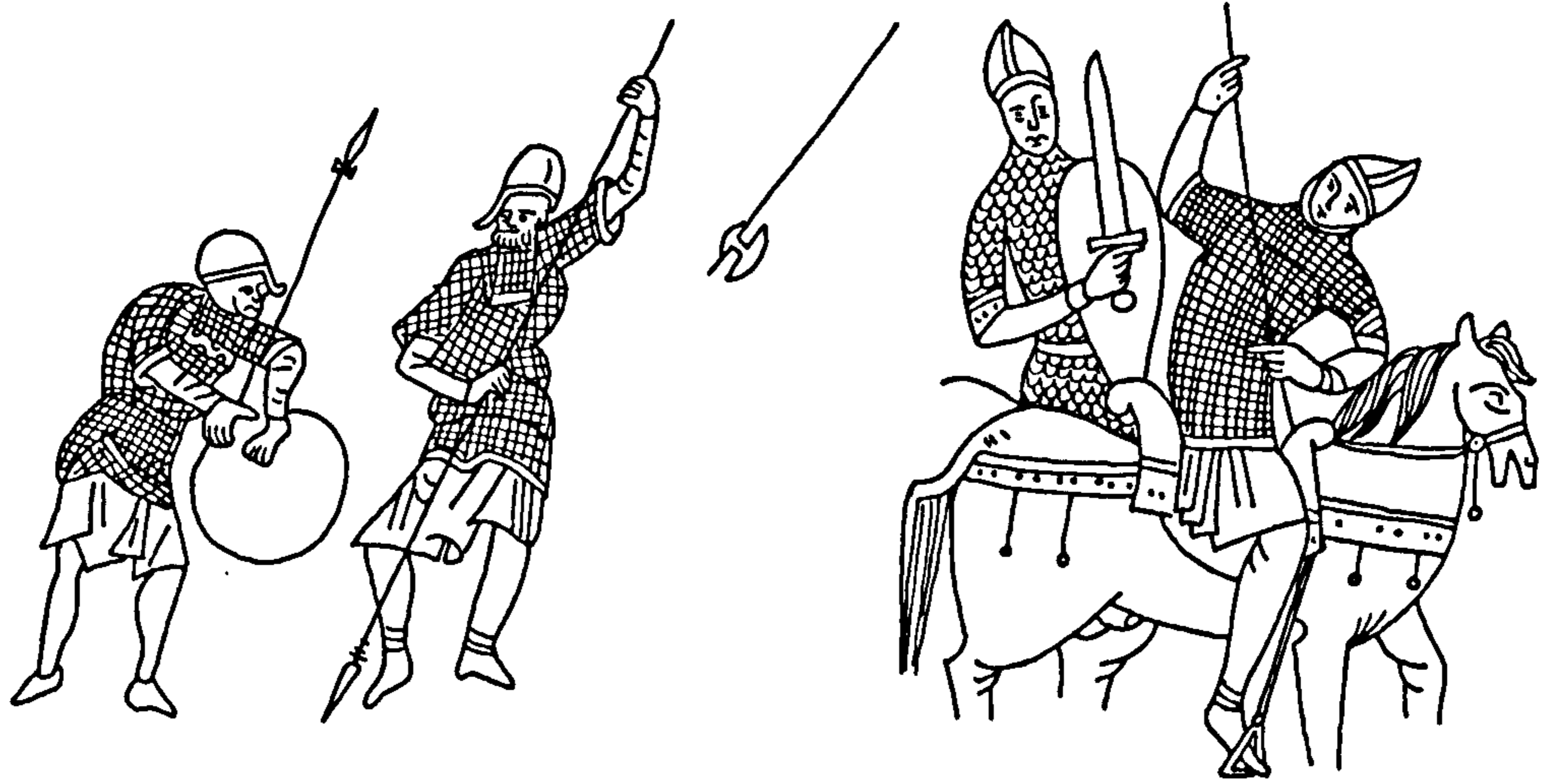

515

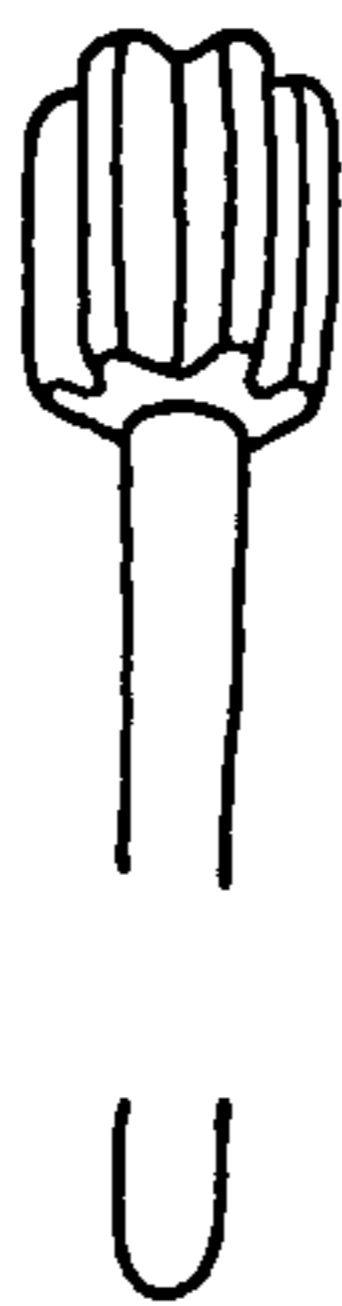

516

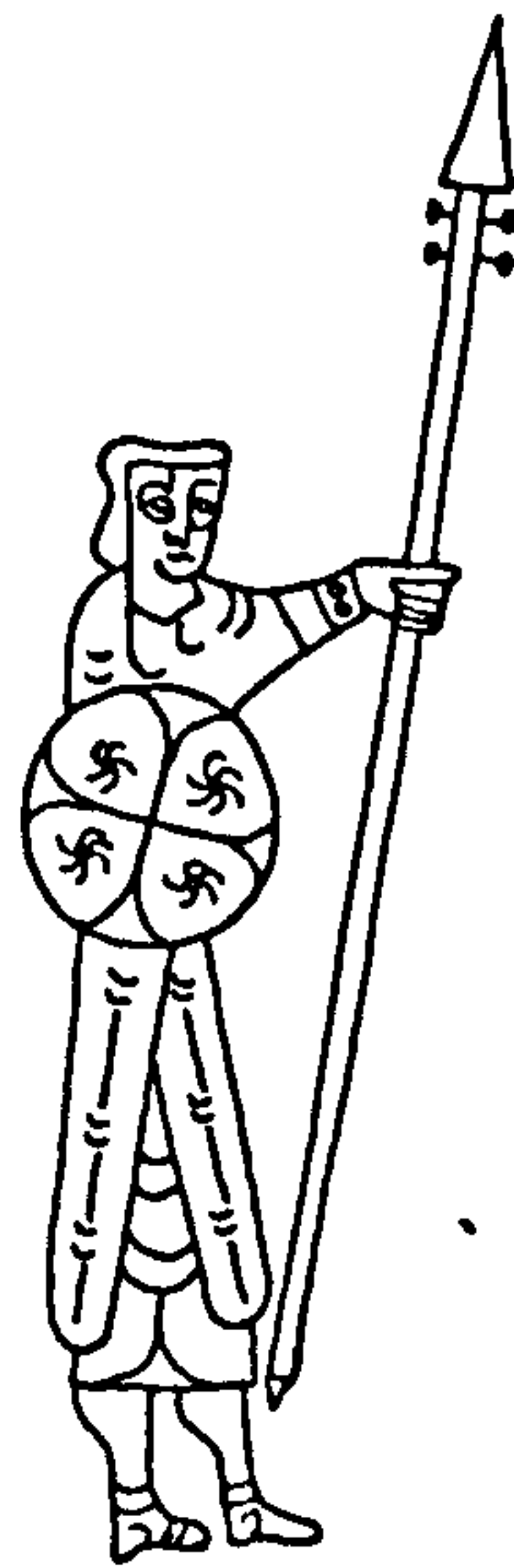

517A



517B

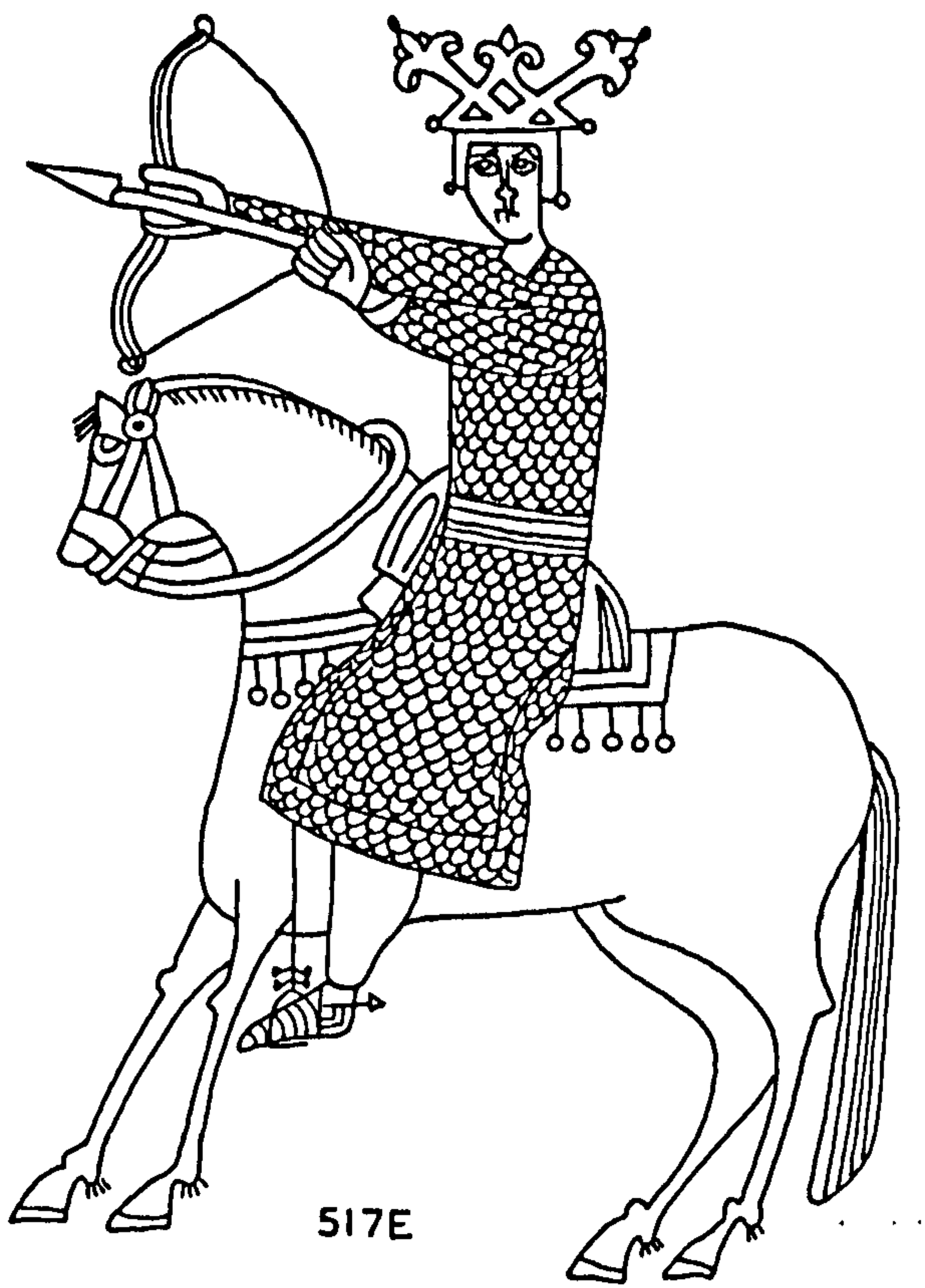

517E



517C



517D

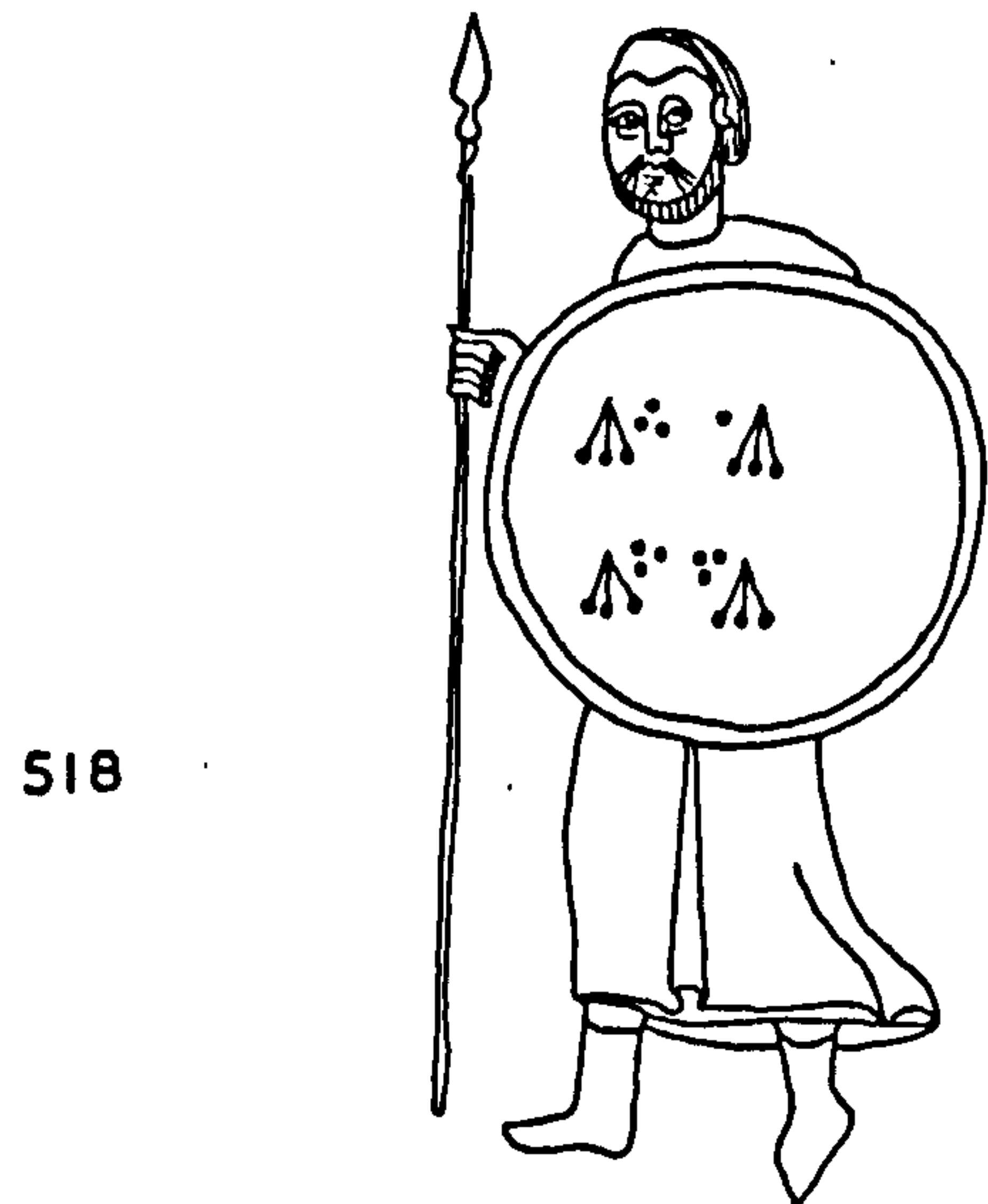

518



519



520



521A



521B



521C

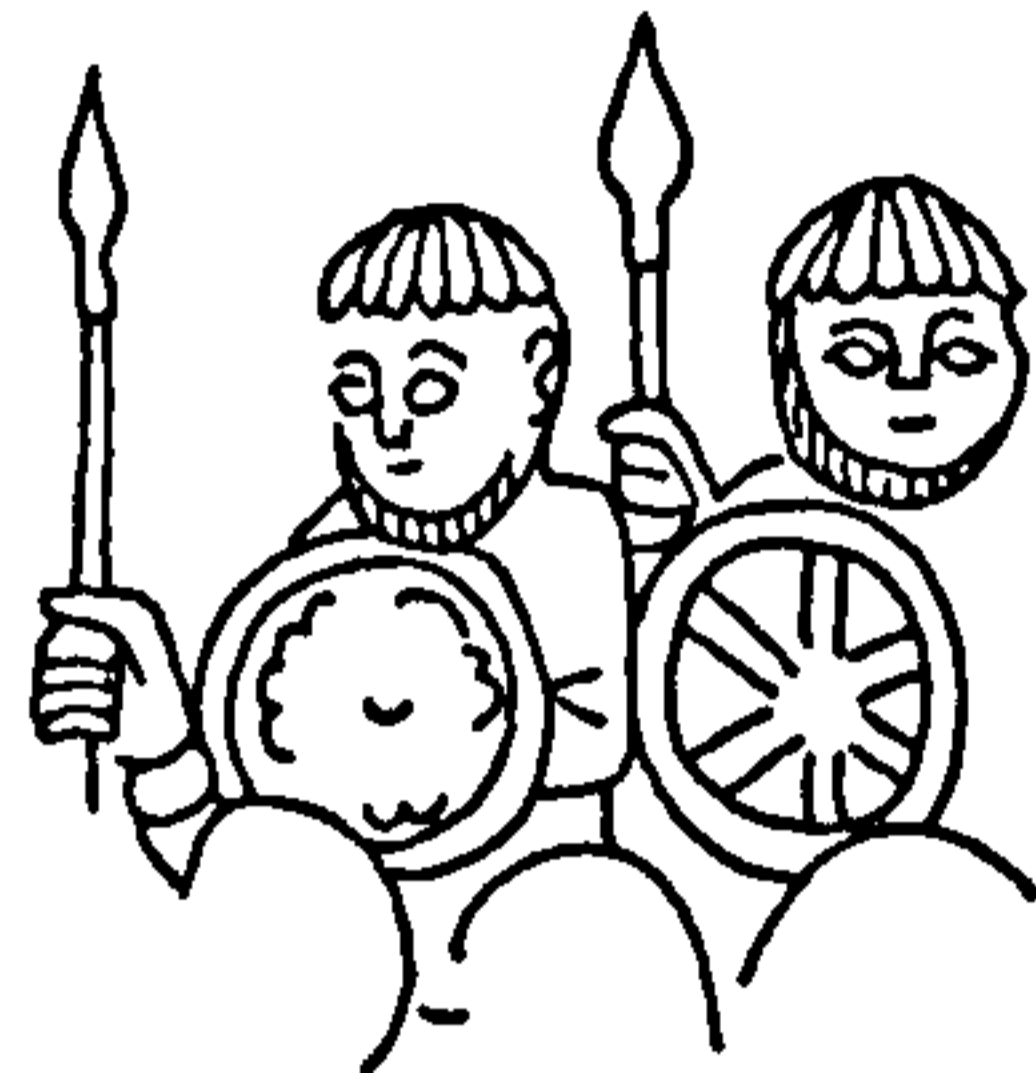

521D



521E

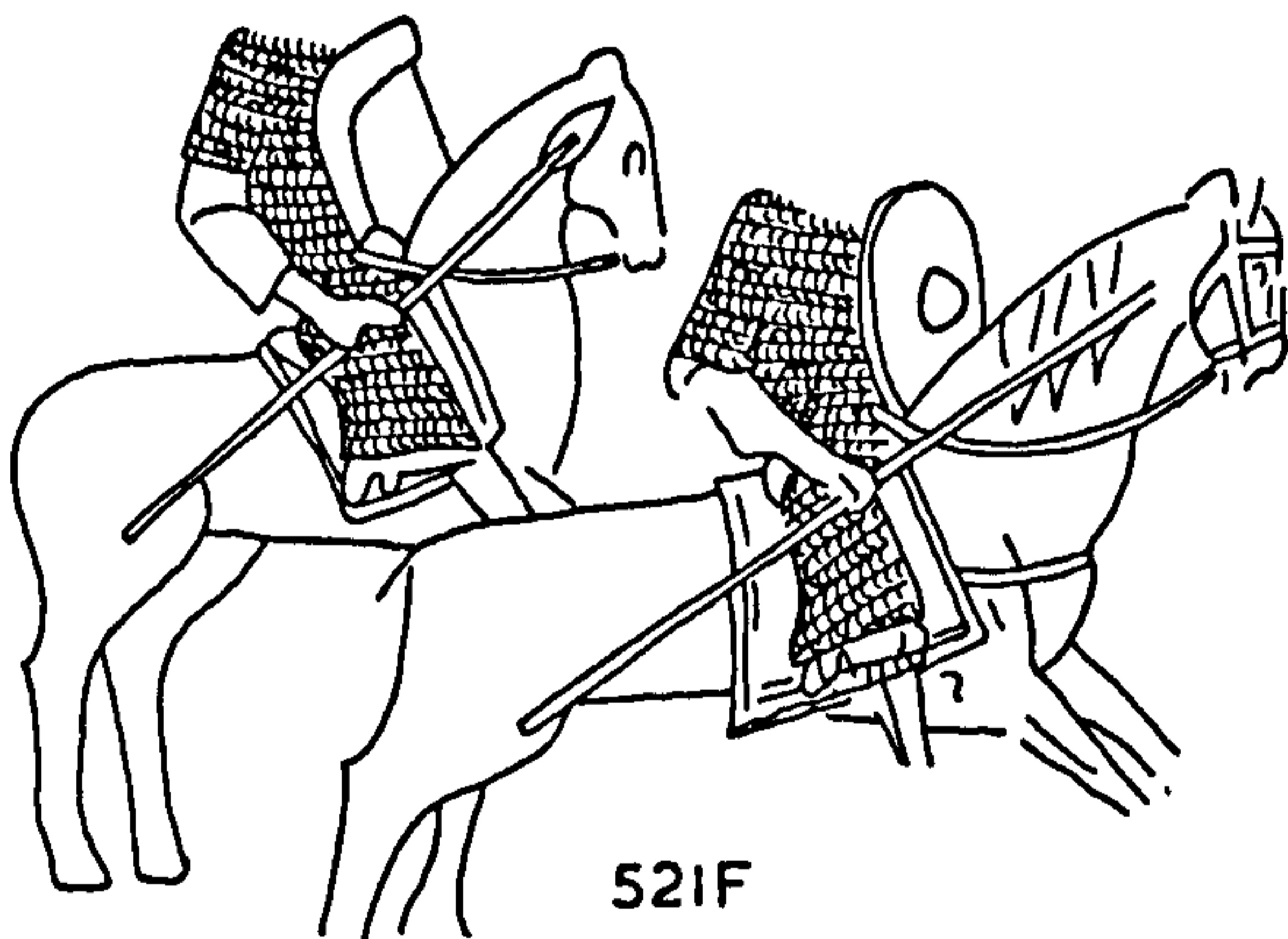
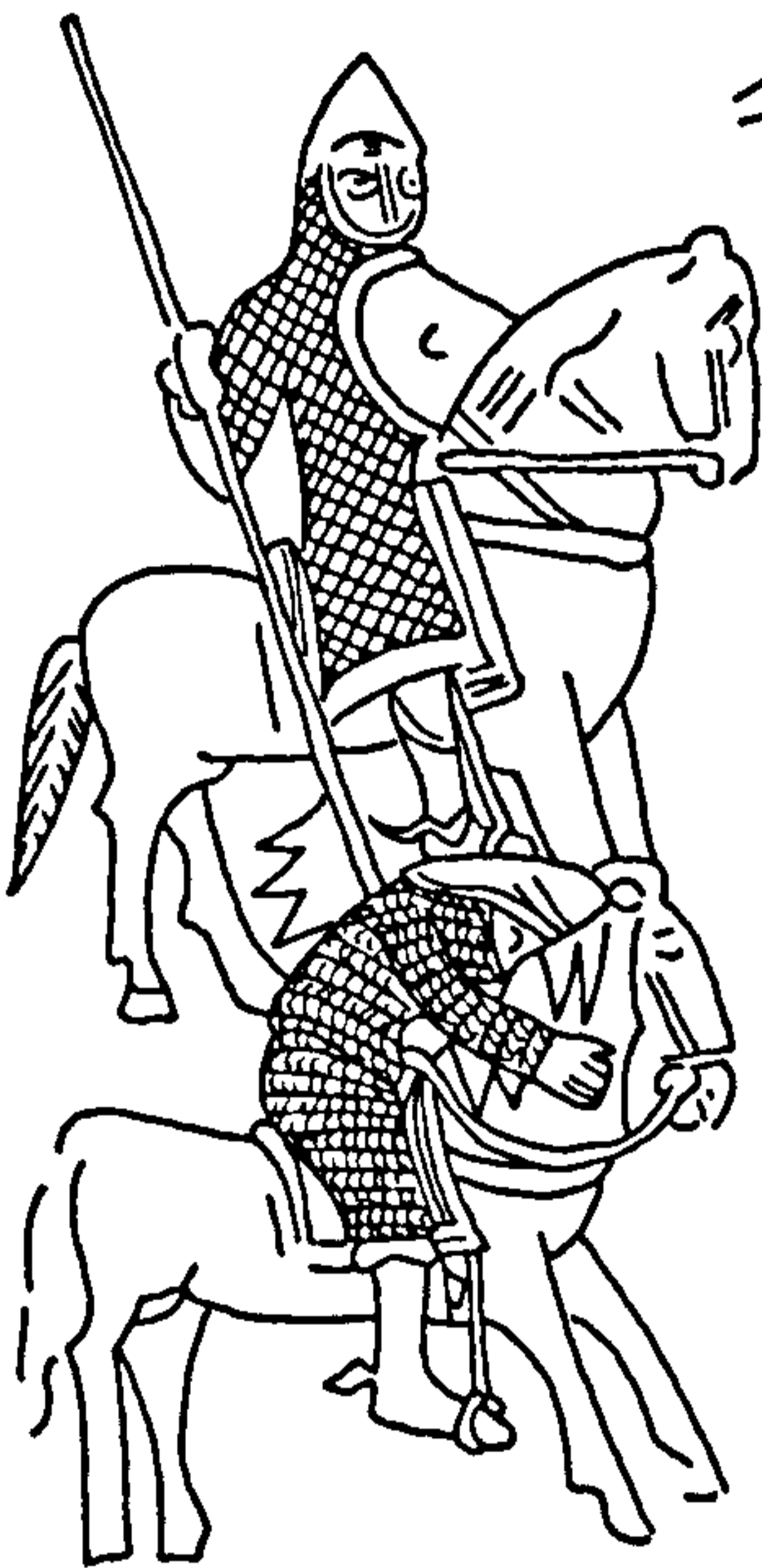

521F

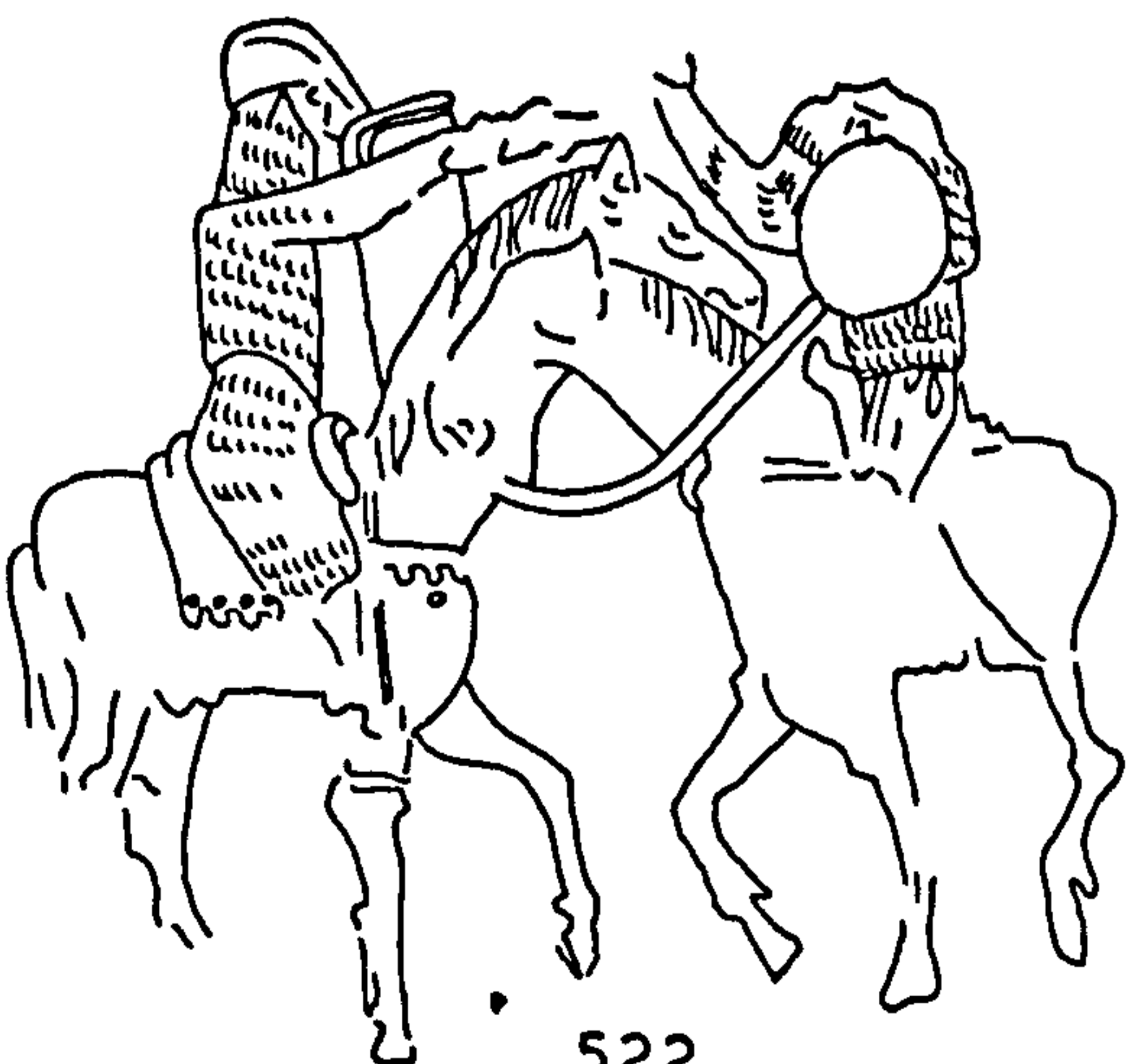
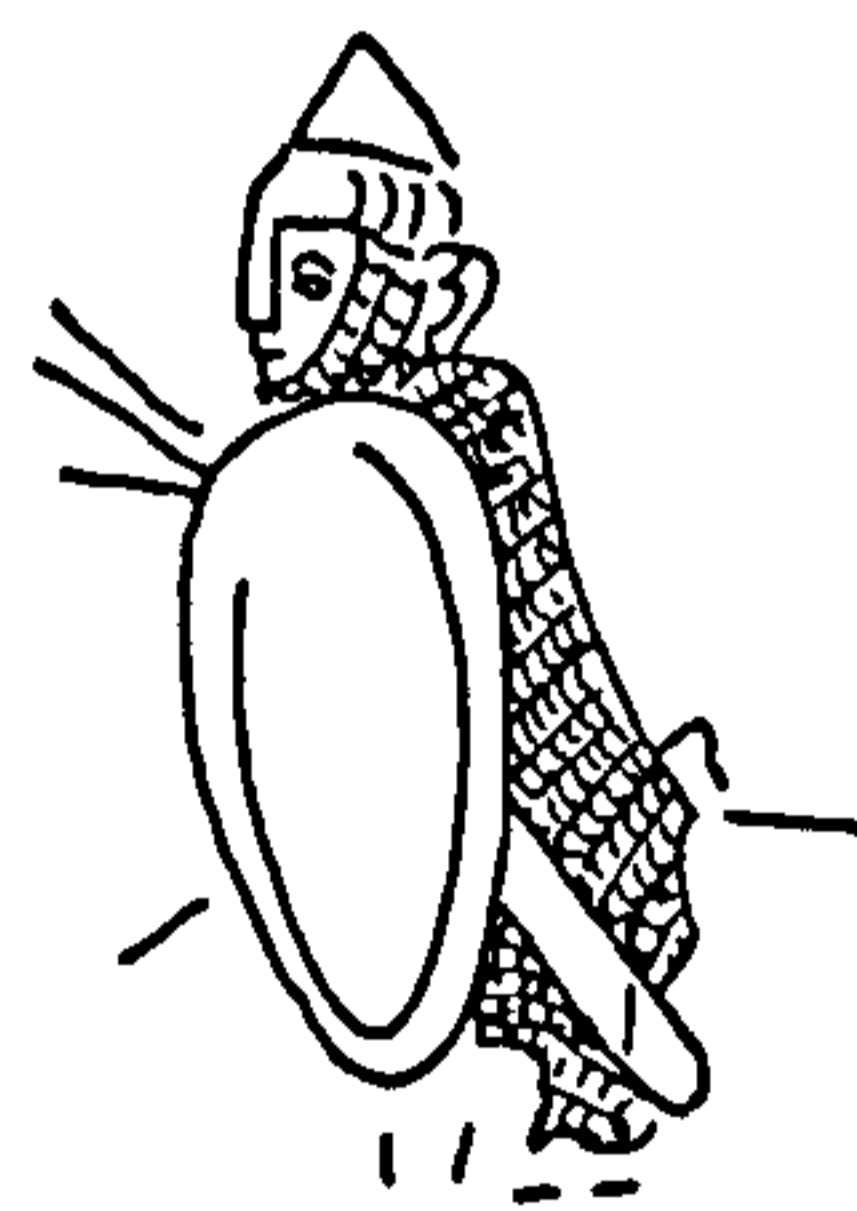

522



523





524

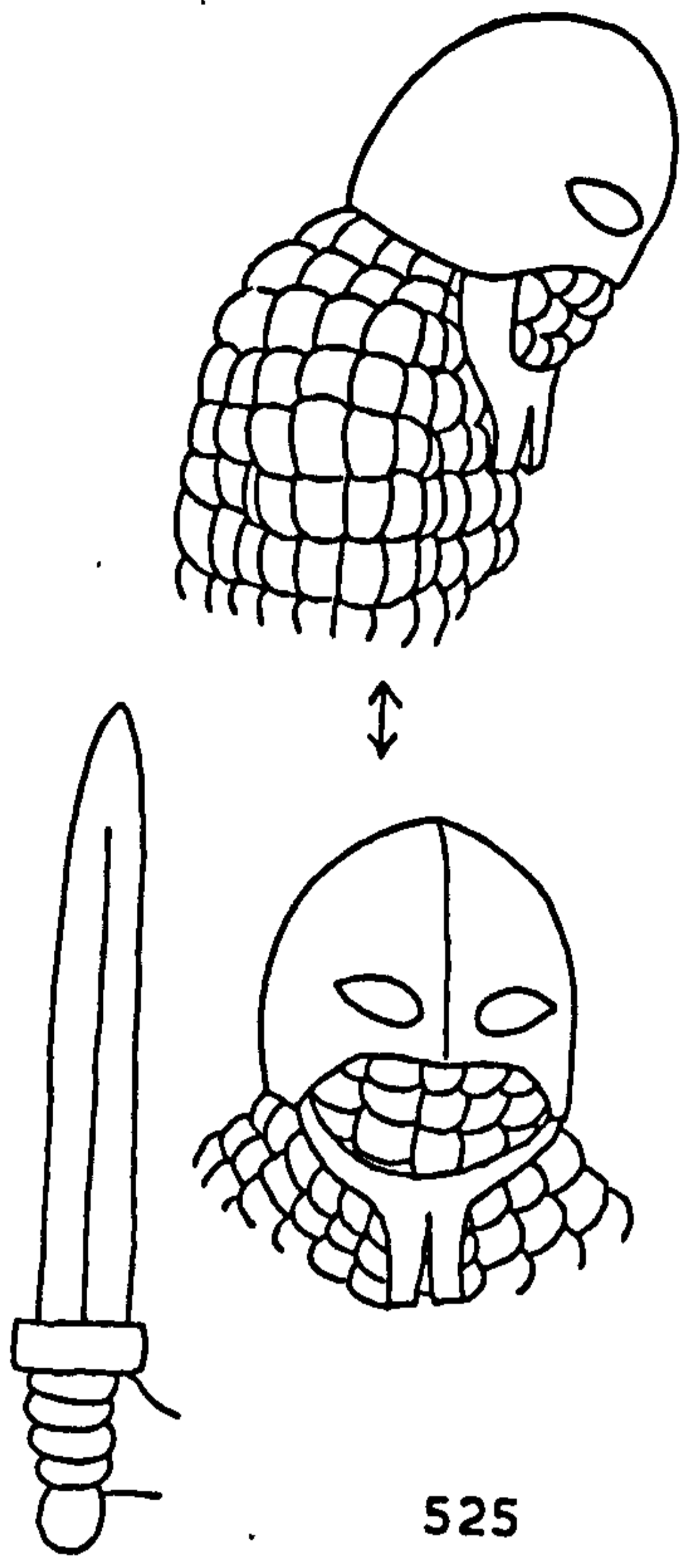

525



526



527

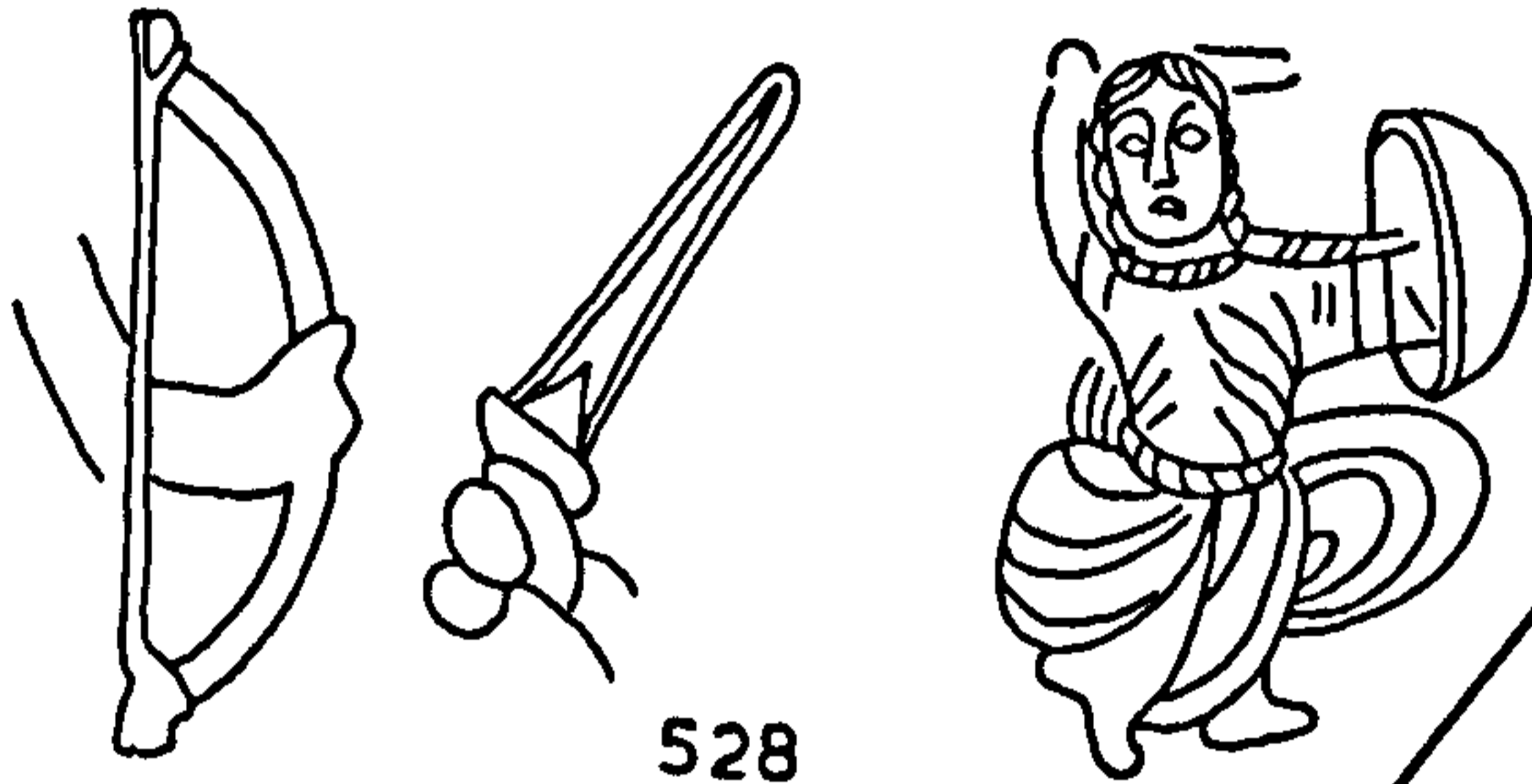

528



529

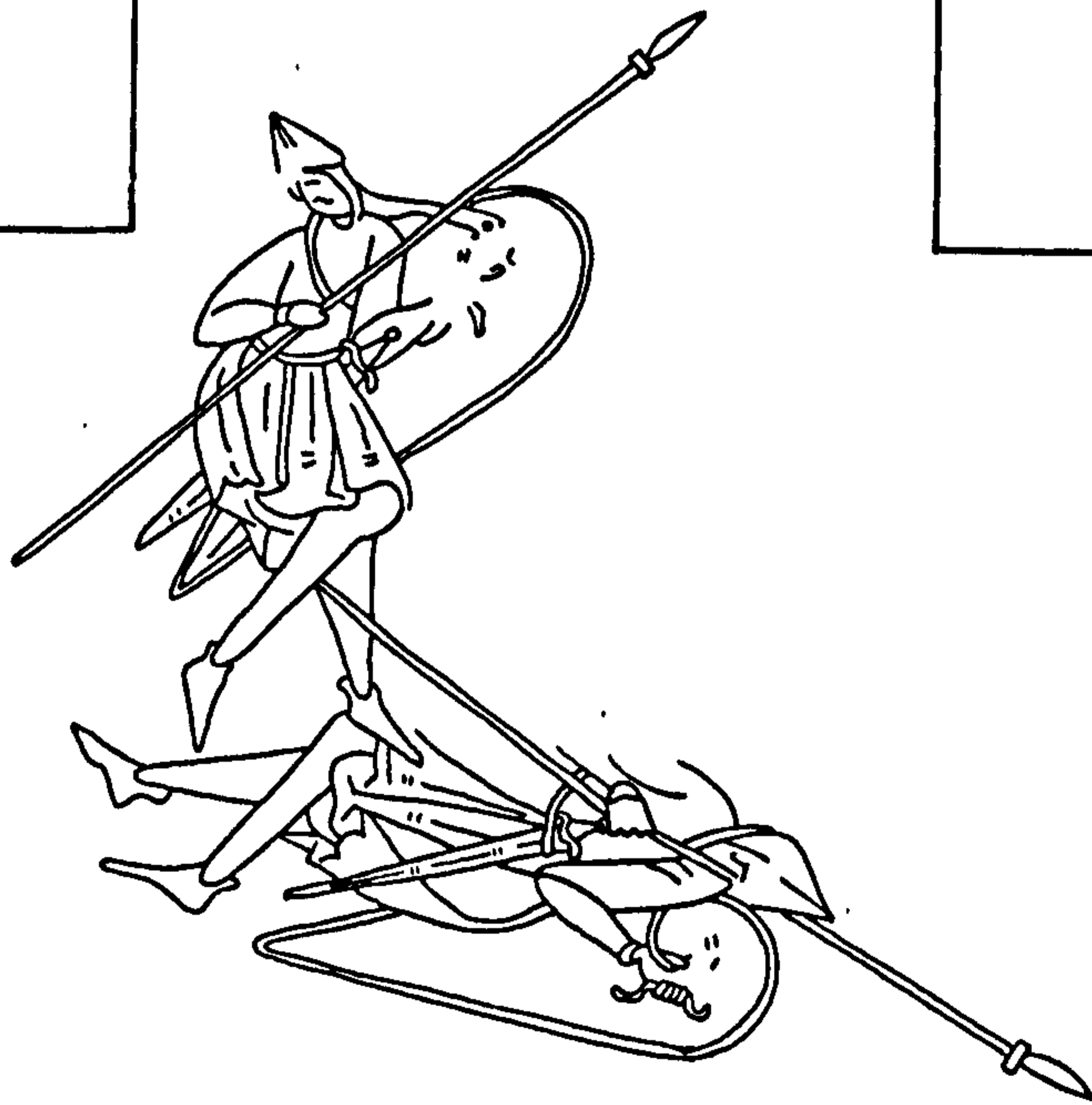

530

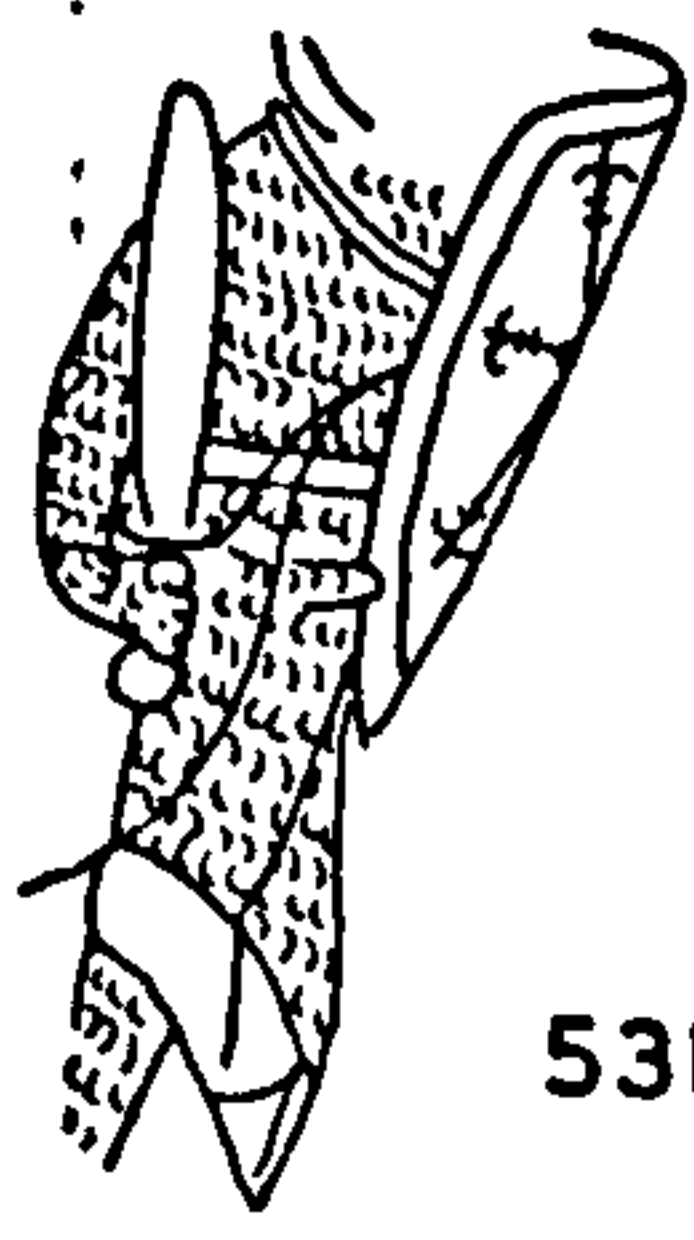

531A

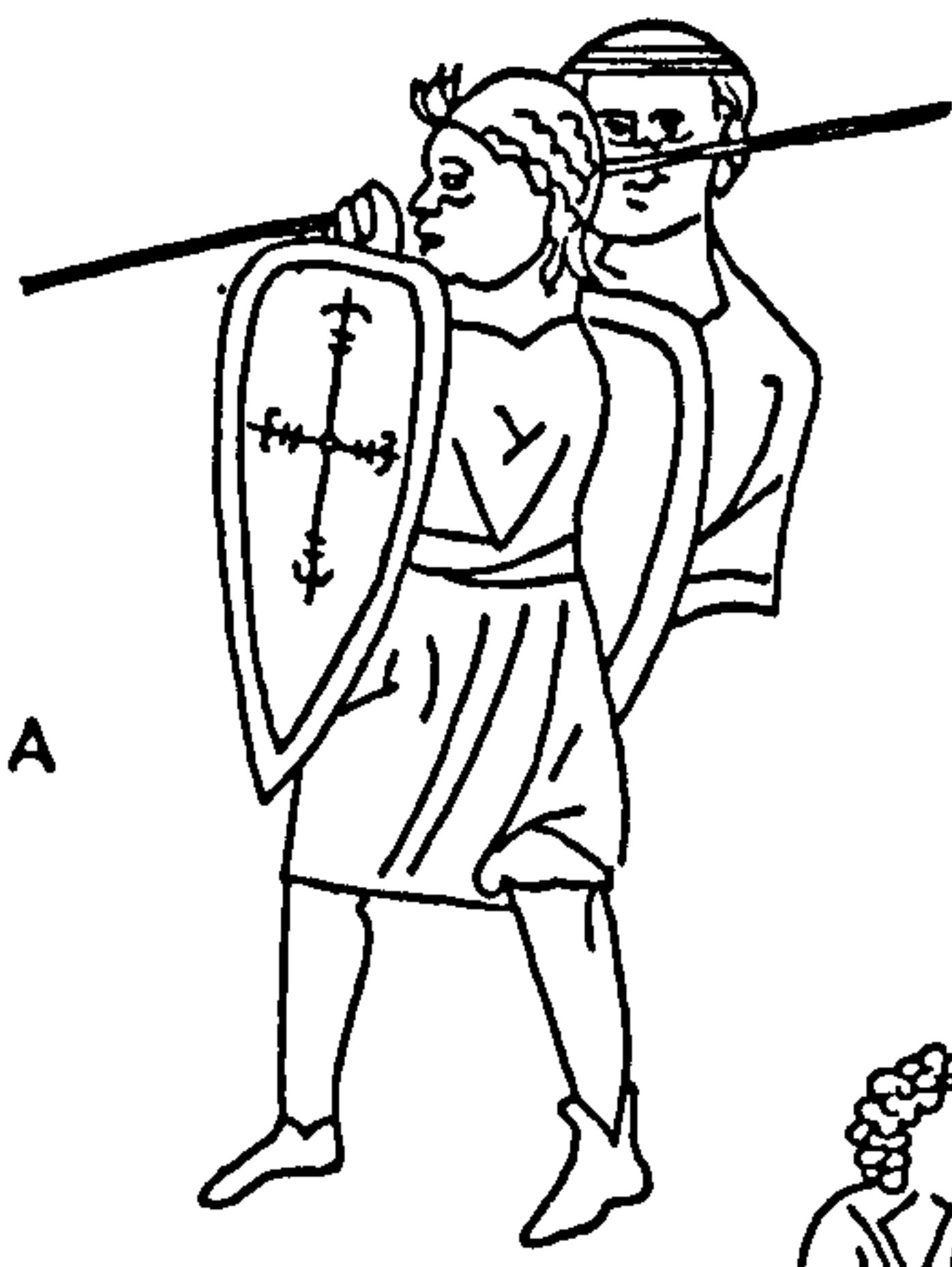

531B

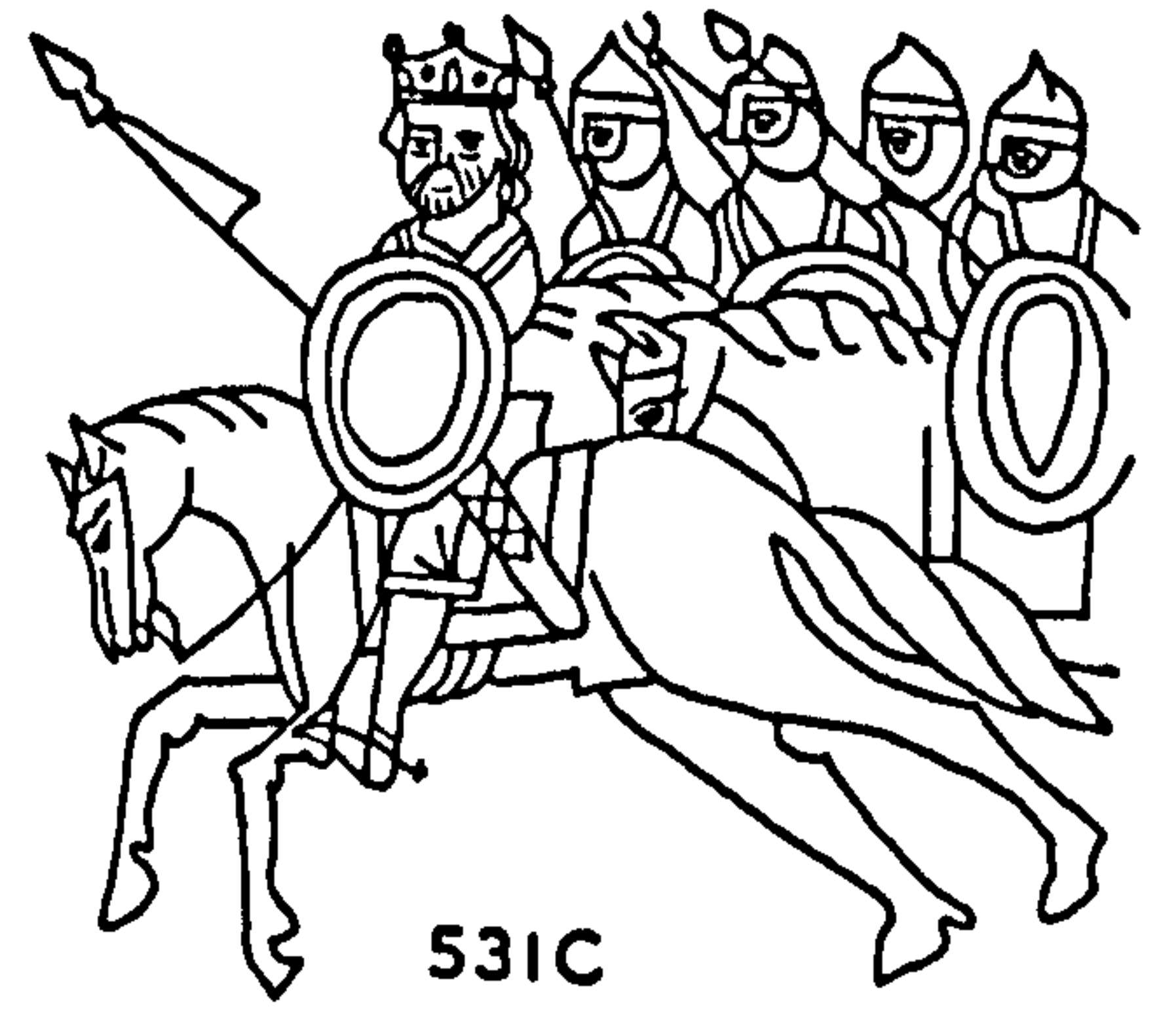

531C

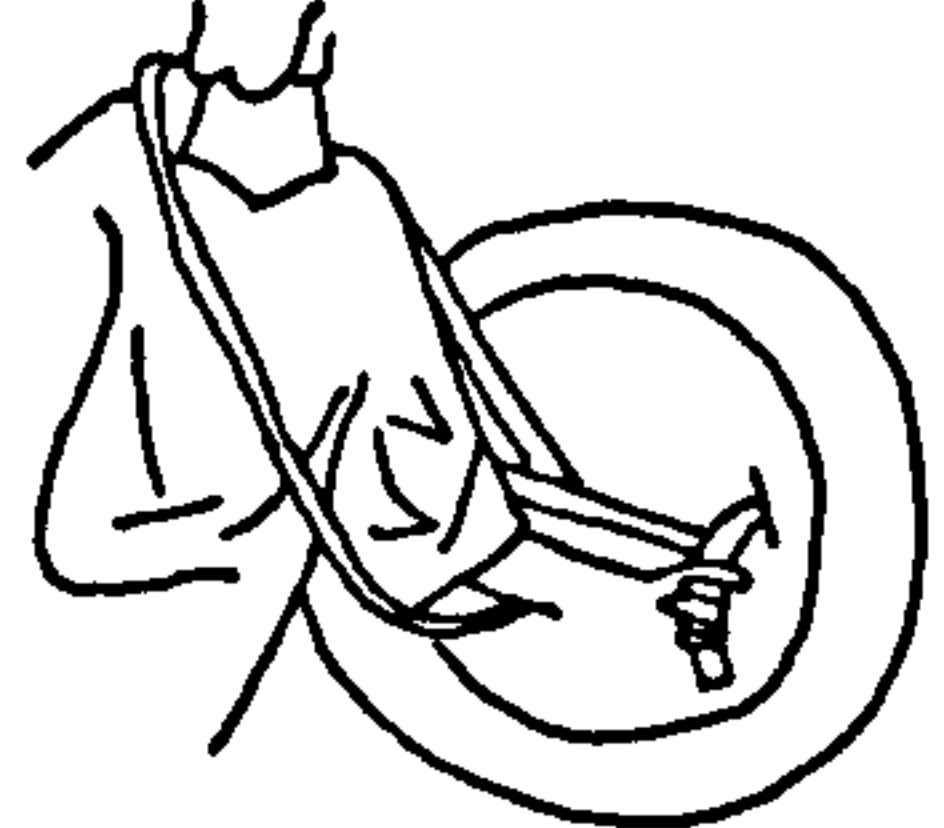

531D

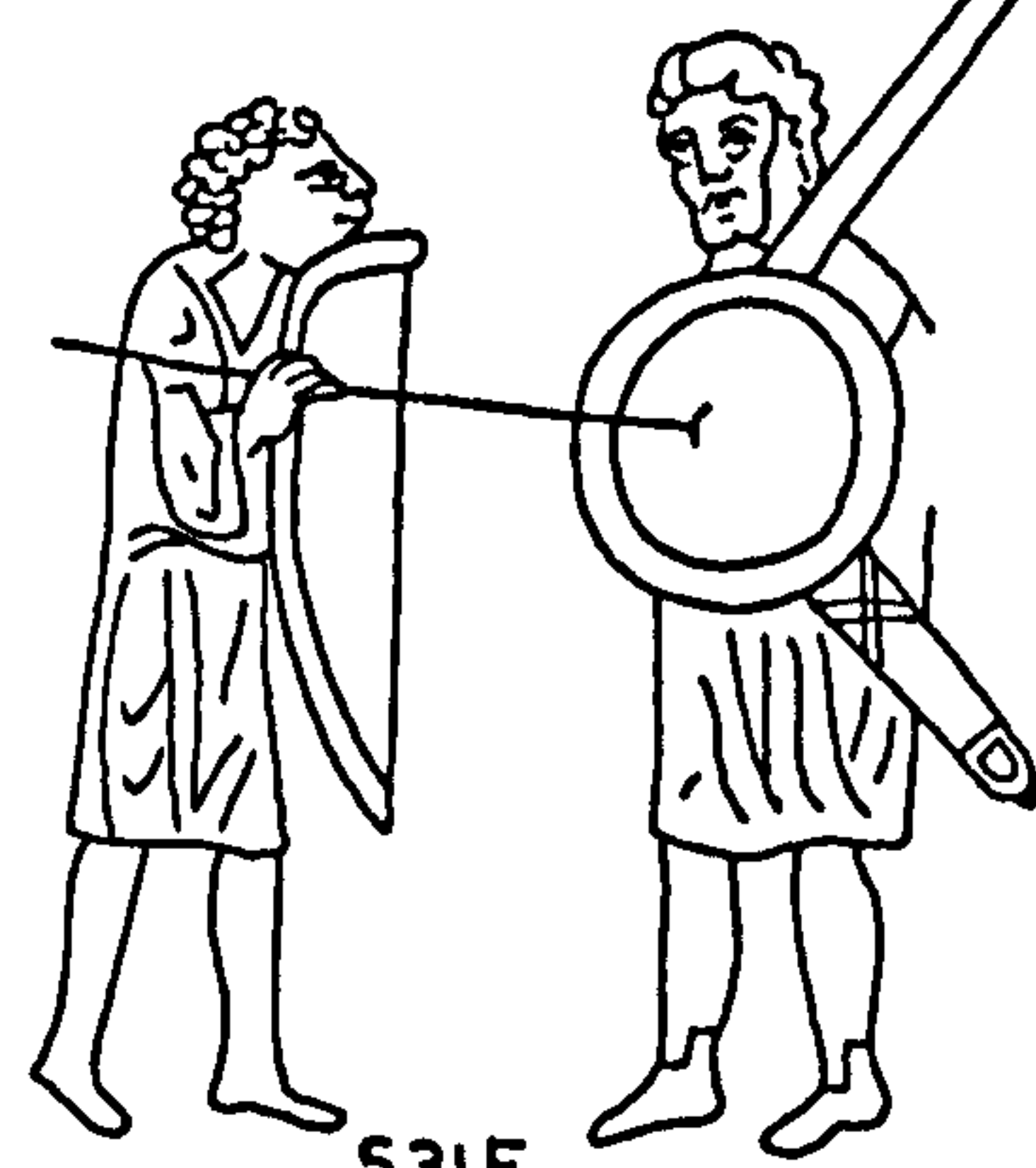
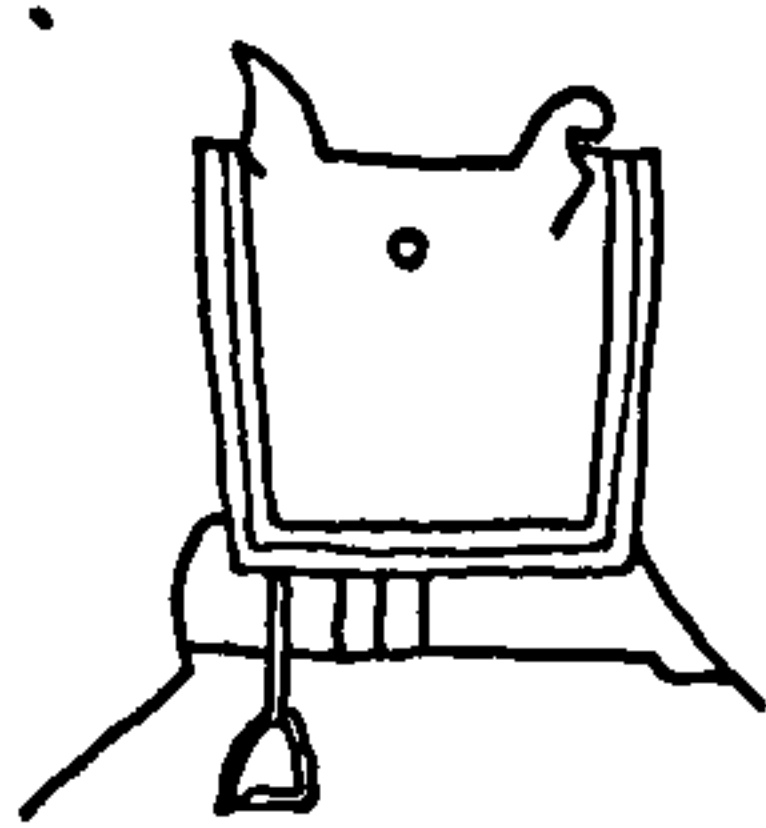

531E

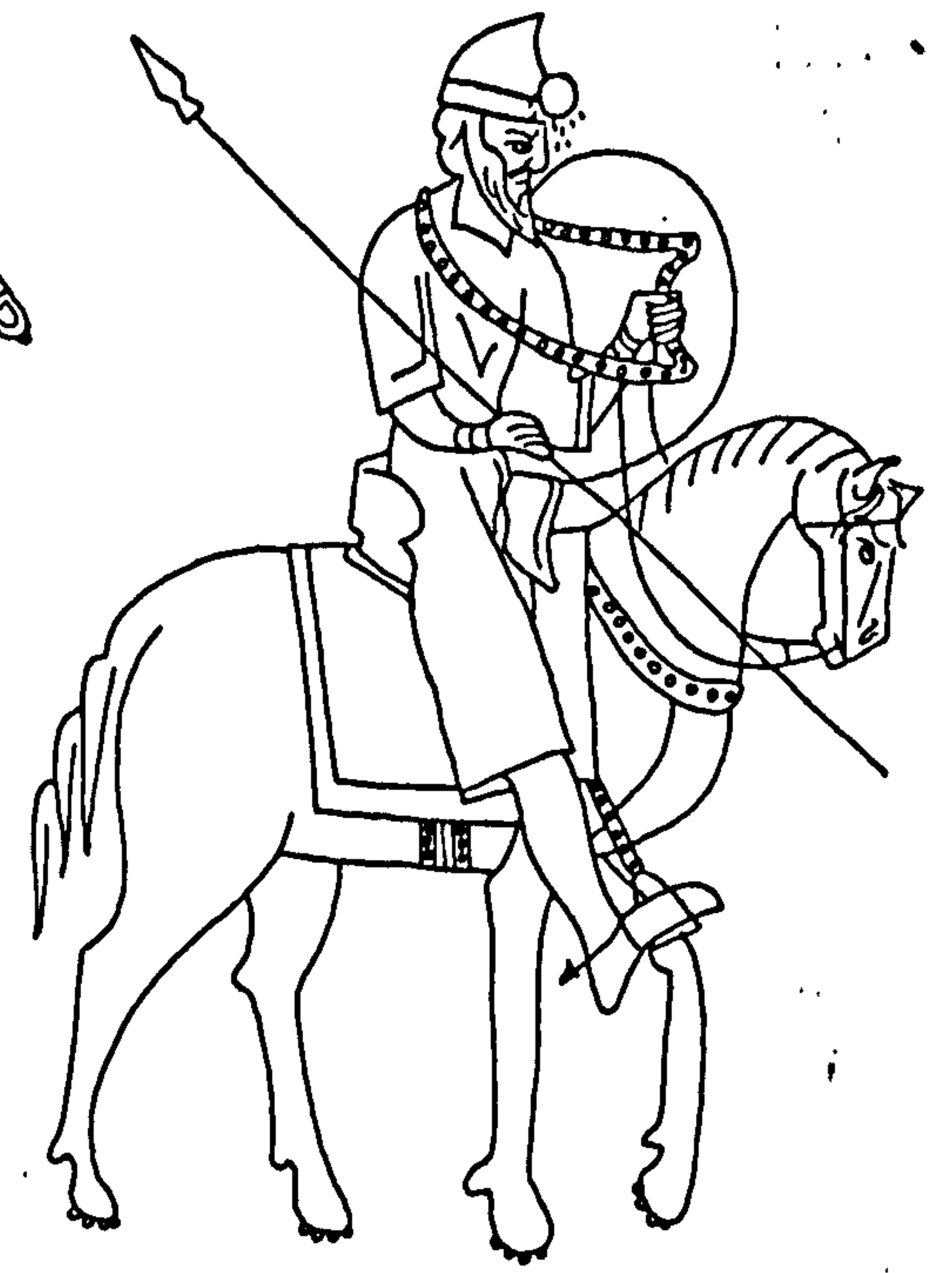

531F

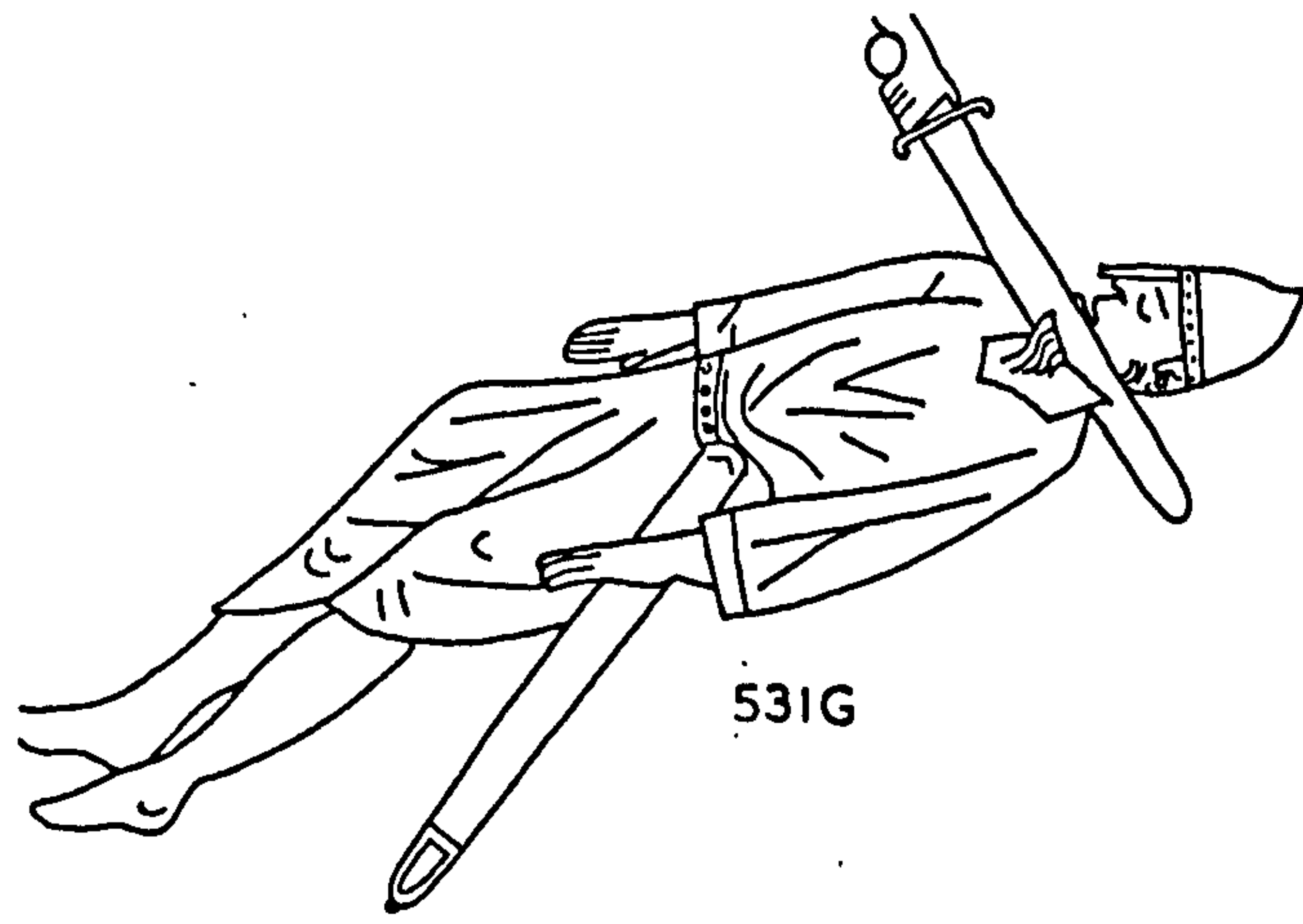

531G

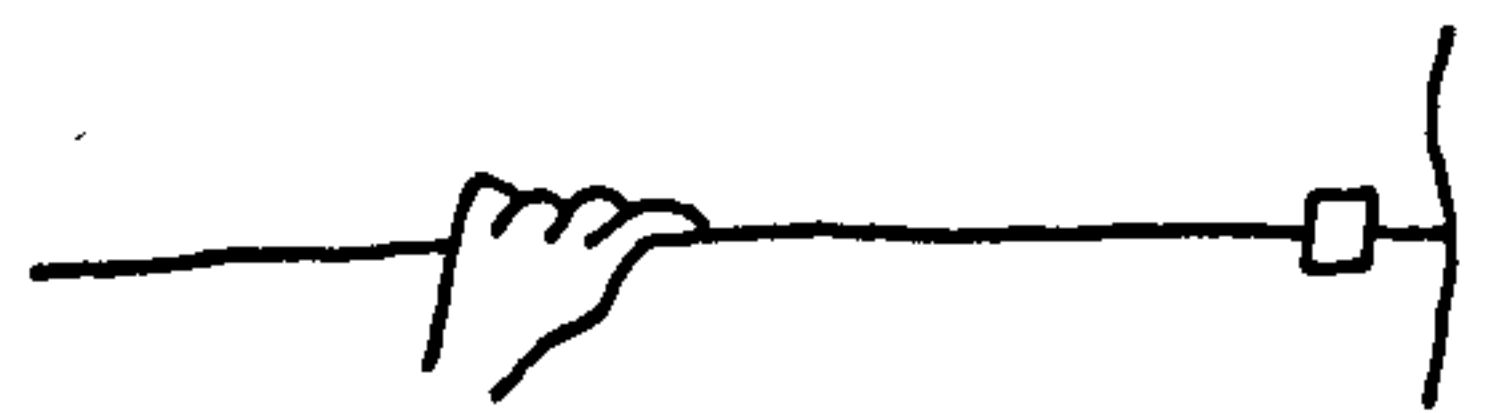

531H

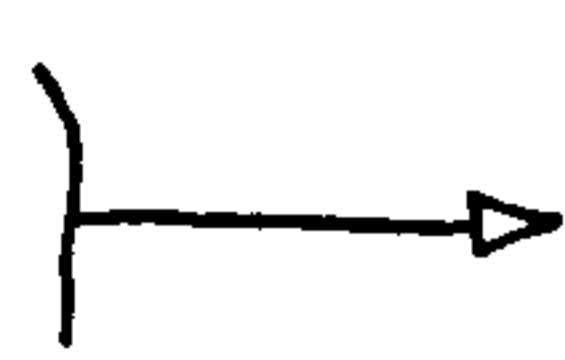

531K



531I

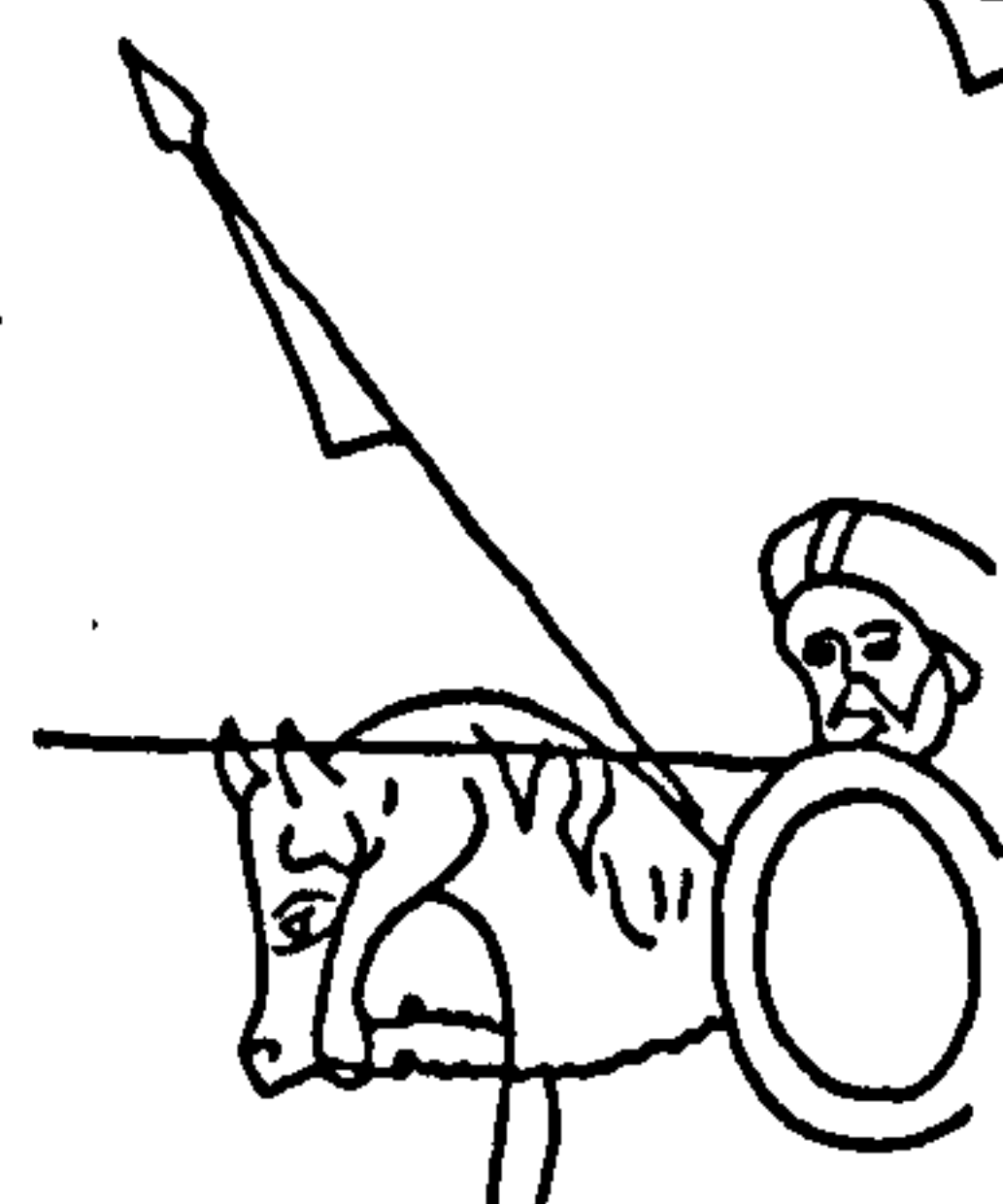

531J



531L

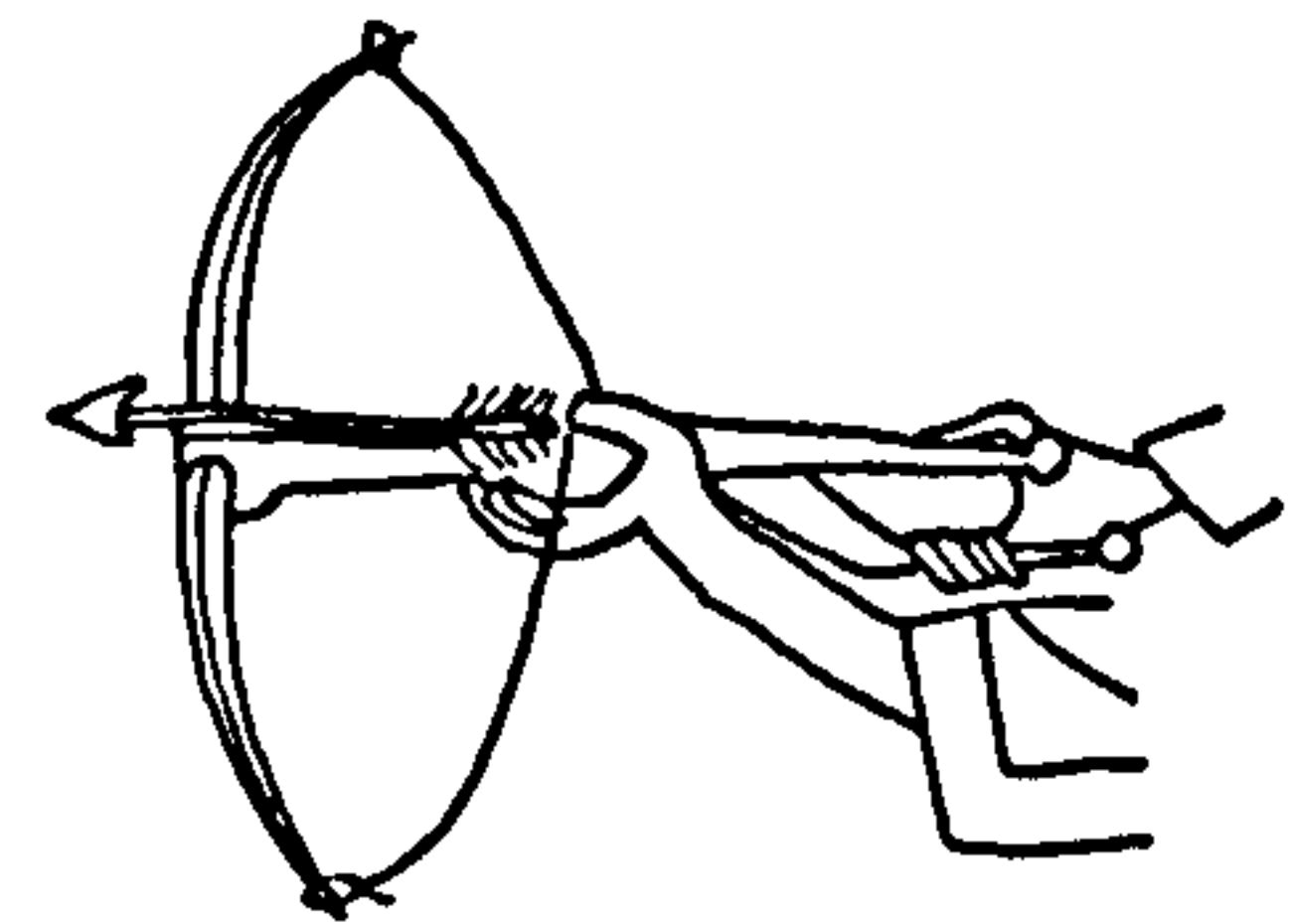

531M

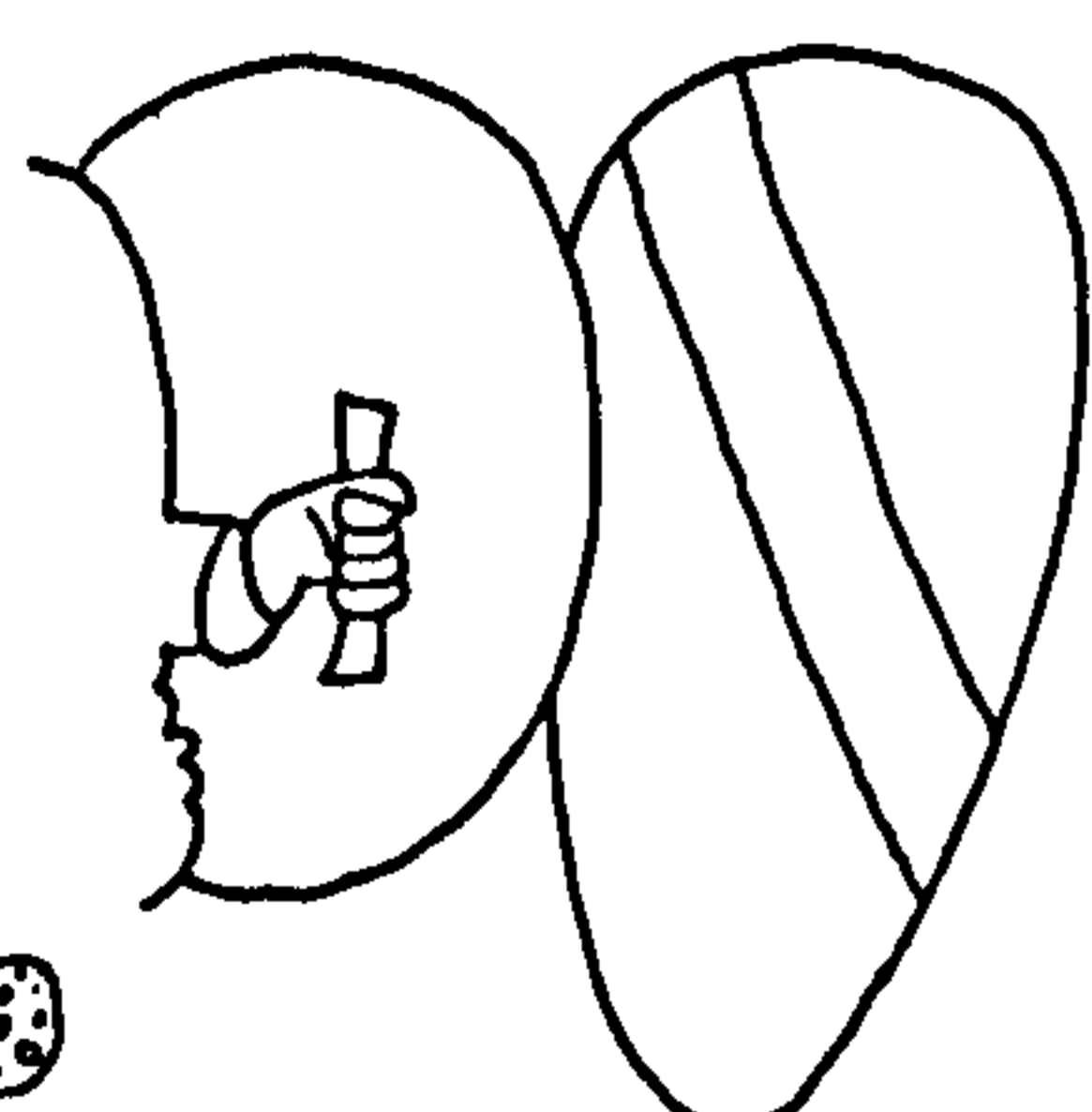

531N



531O

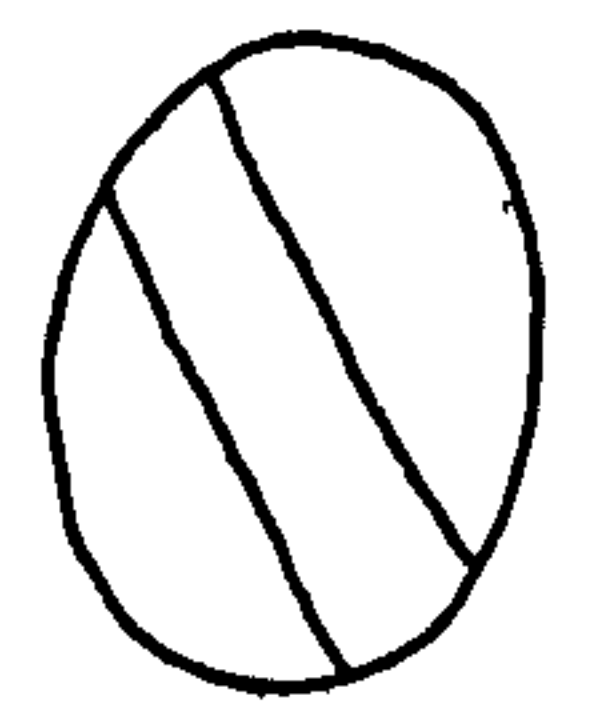
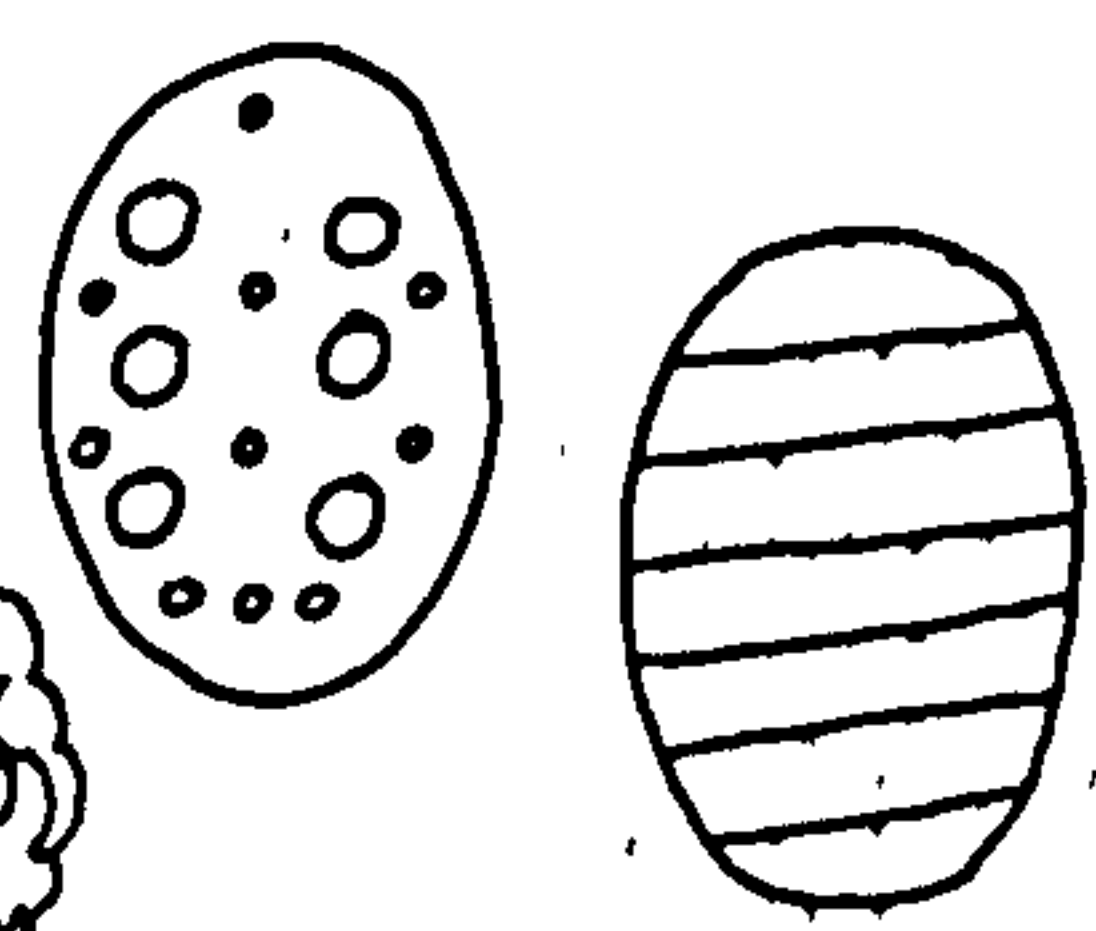



532



533

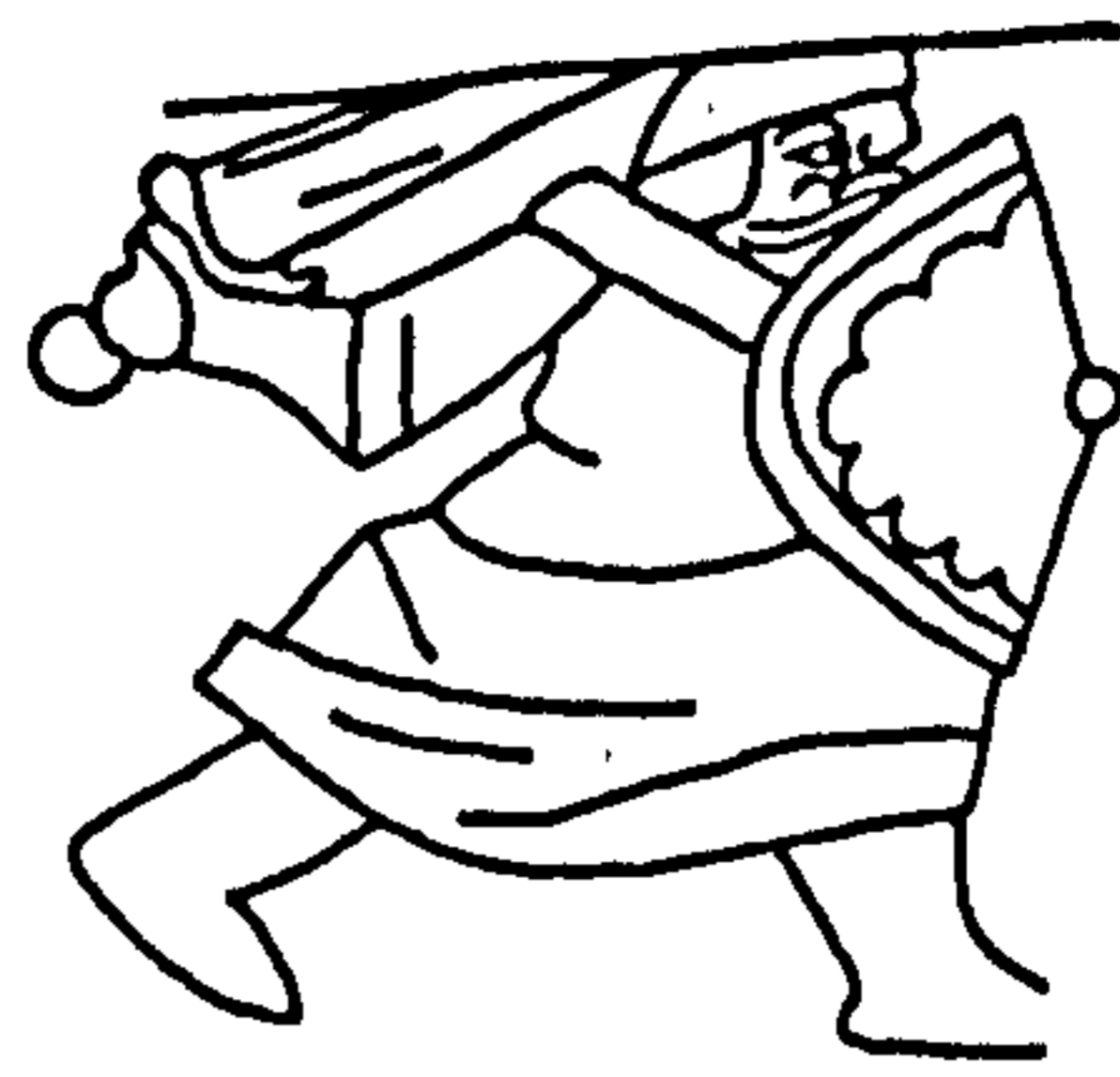

534

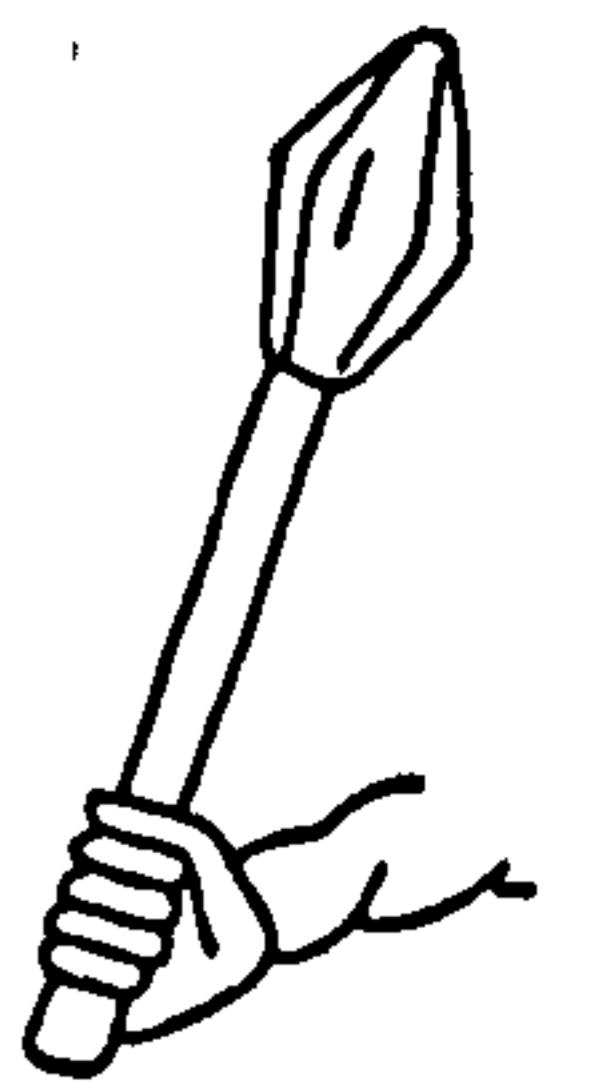

535

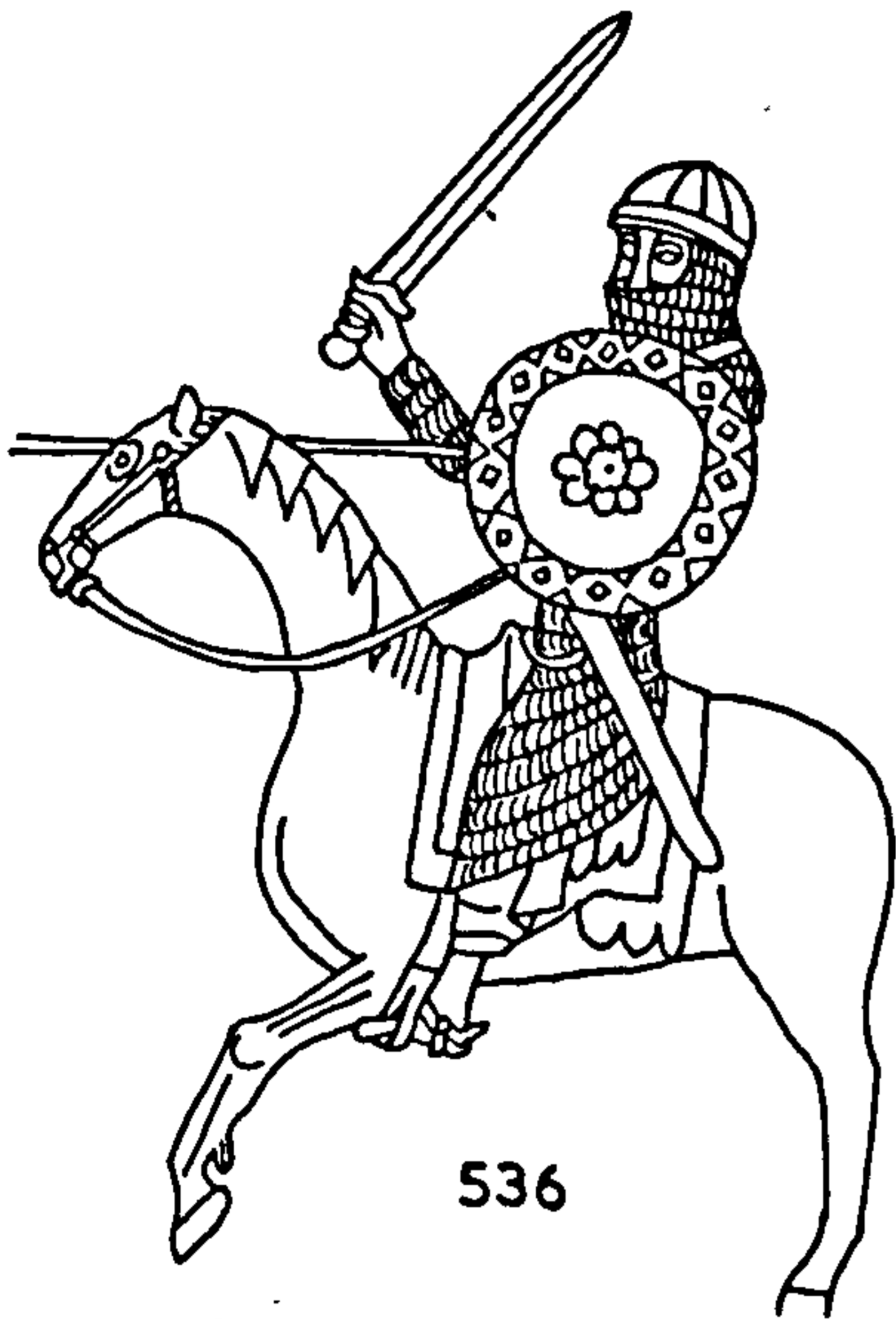

536

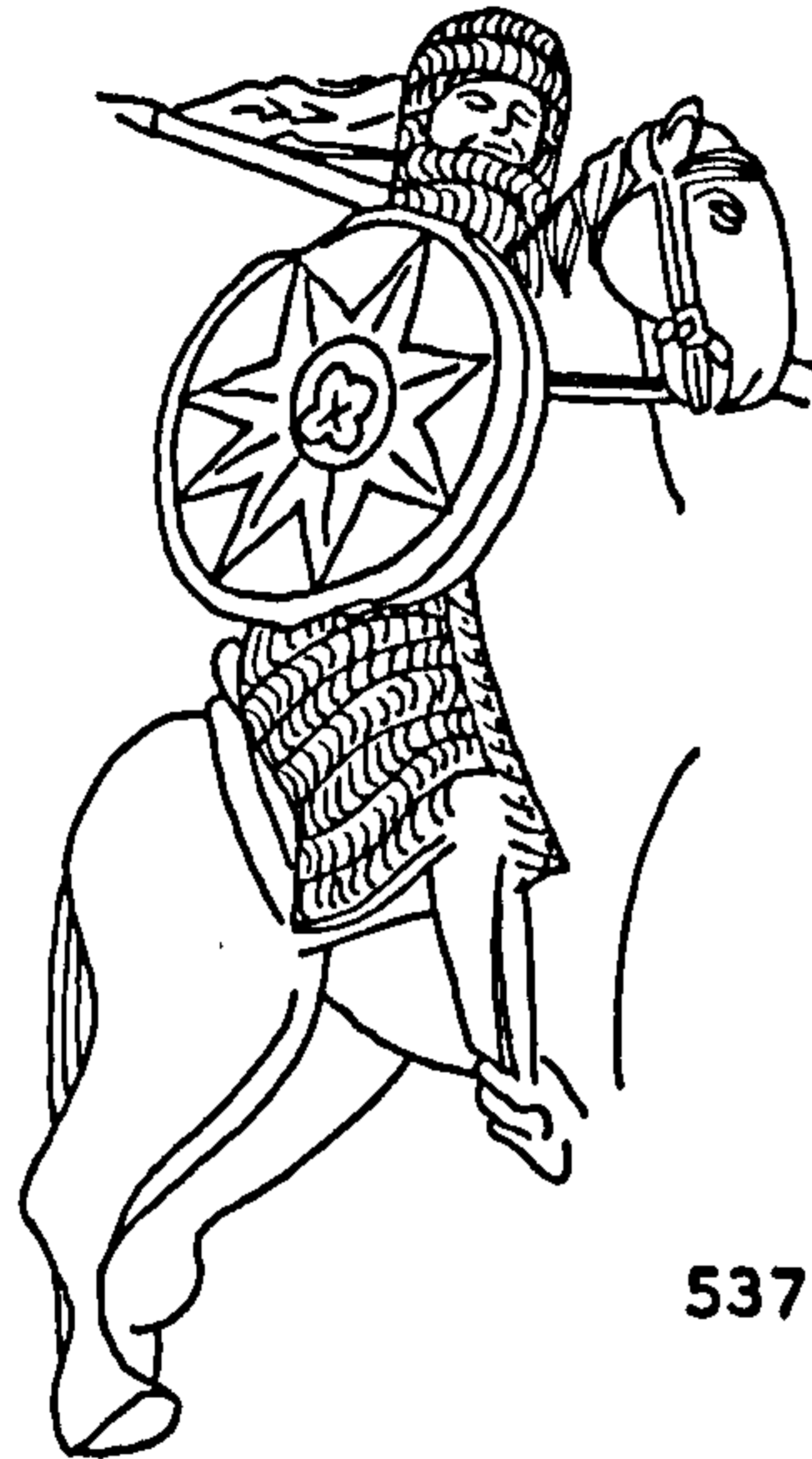

537

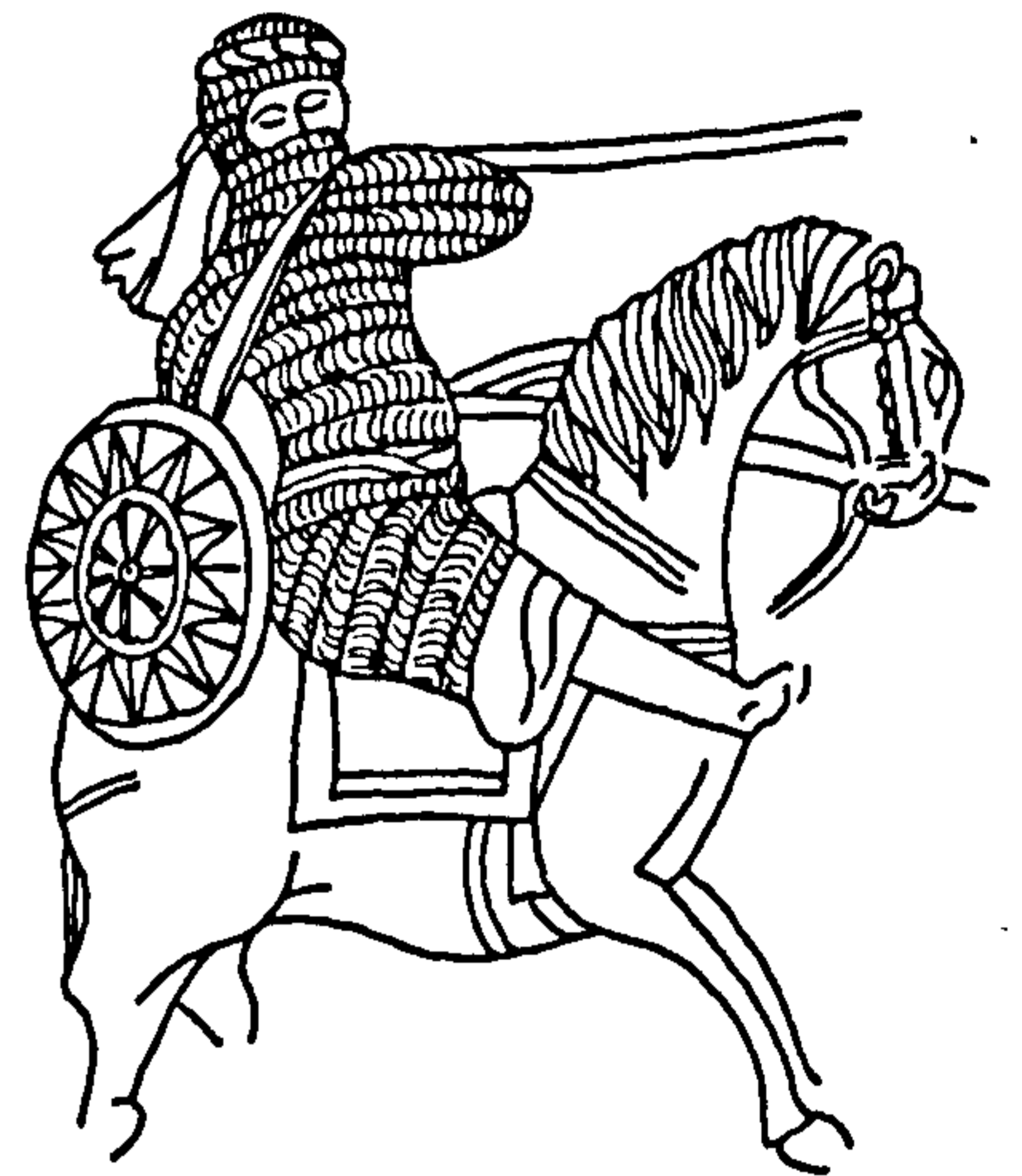

538



540



539



541

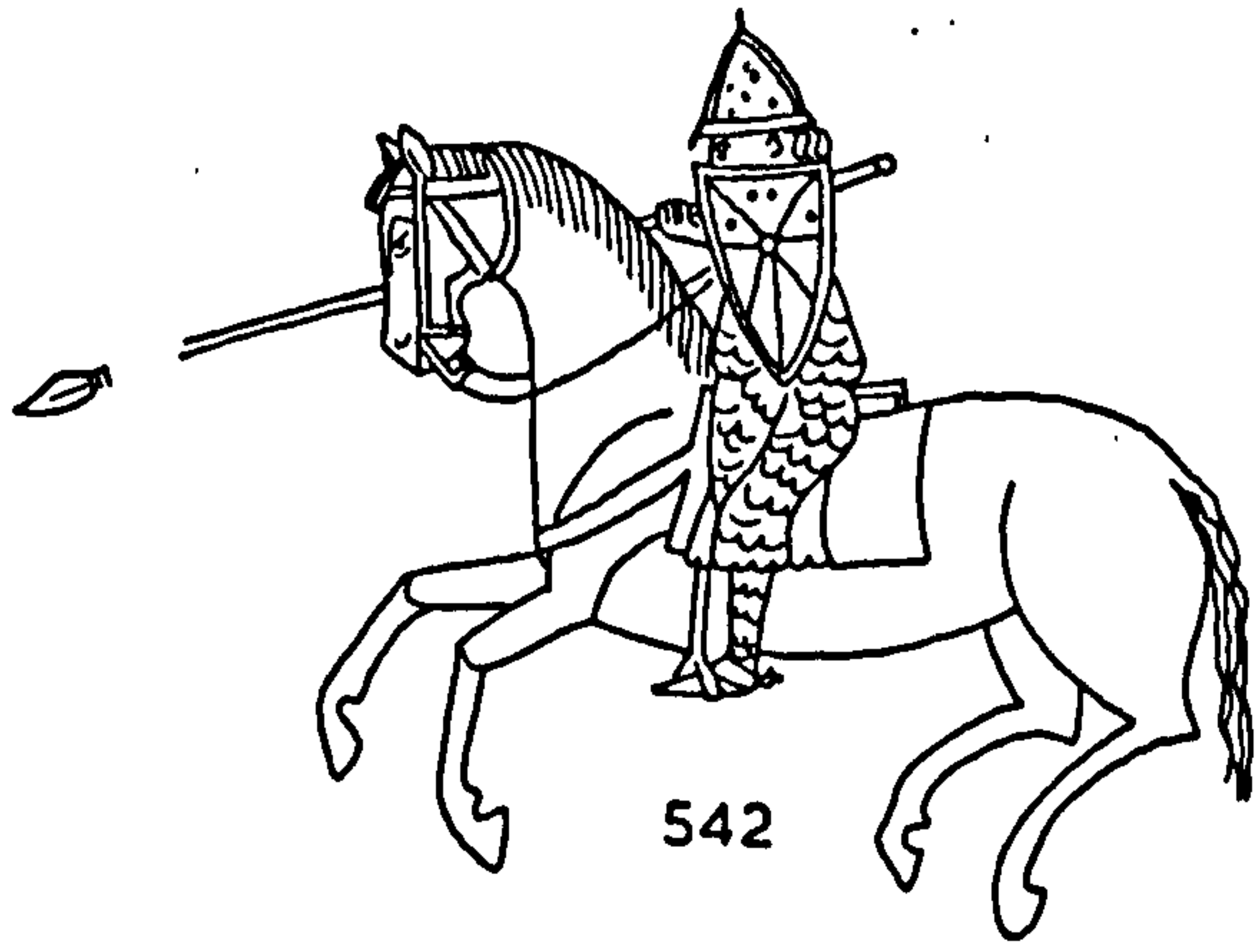

542



543A

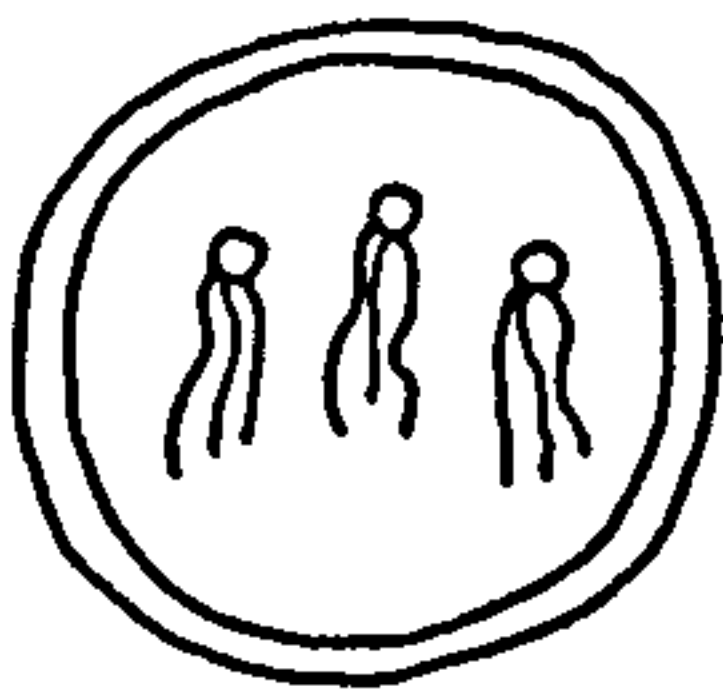
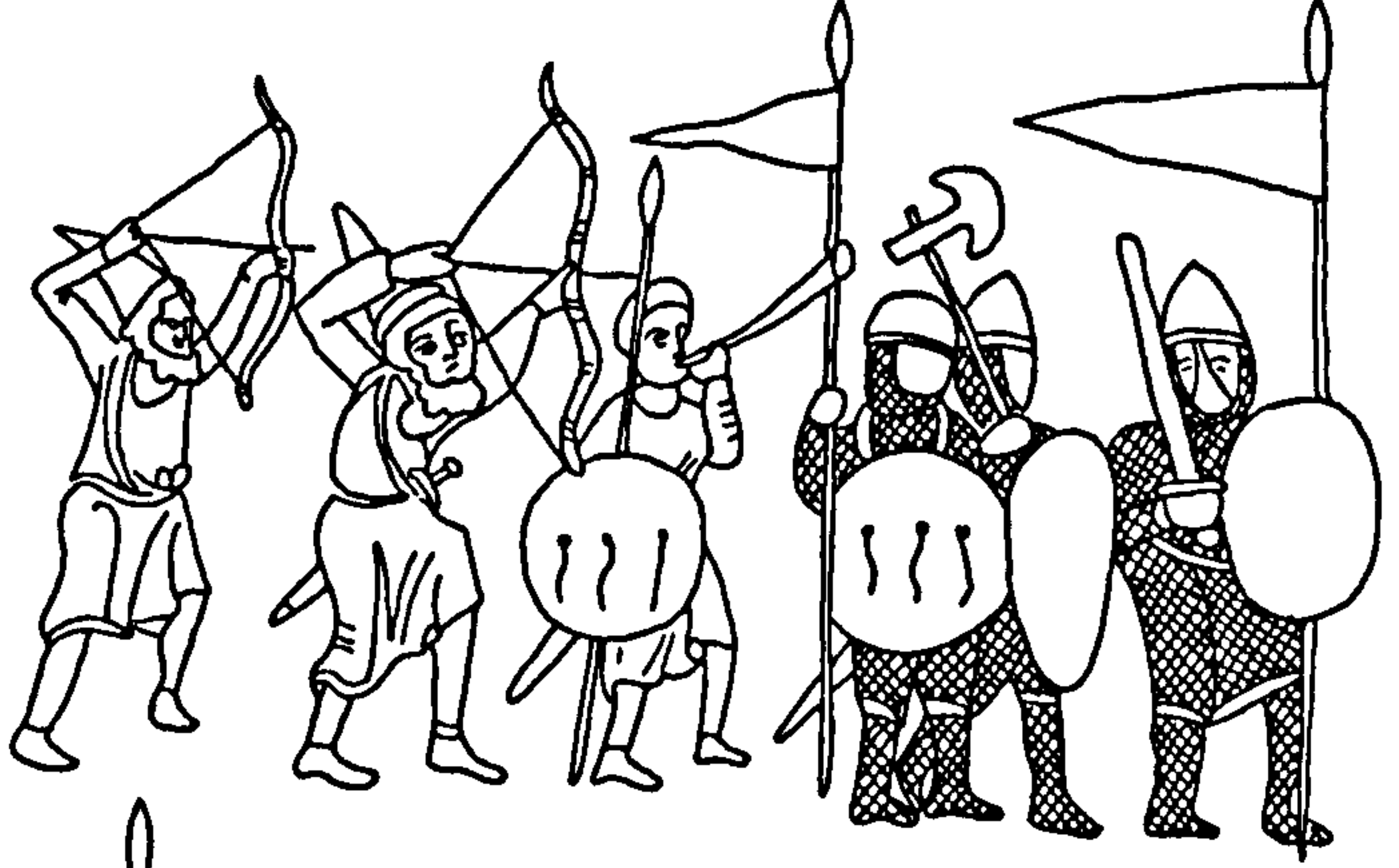

543C

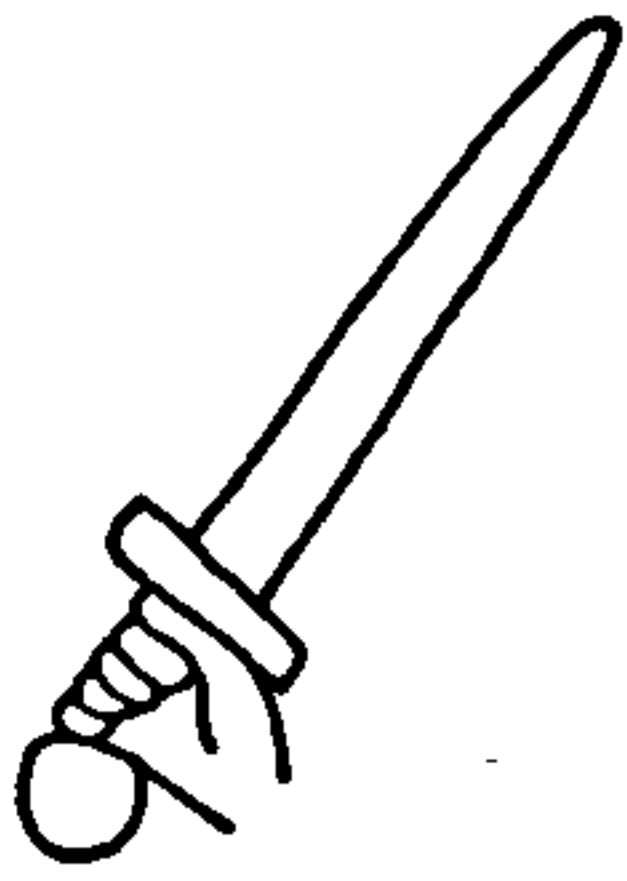

543B

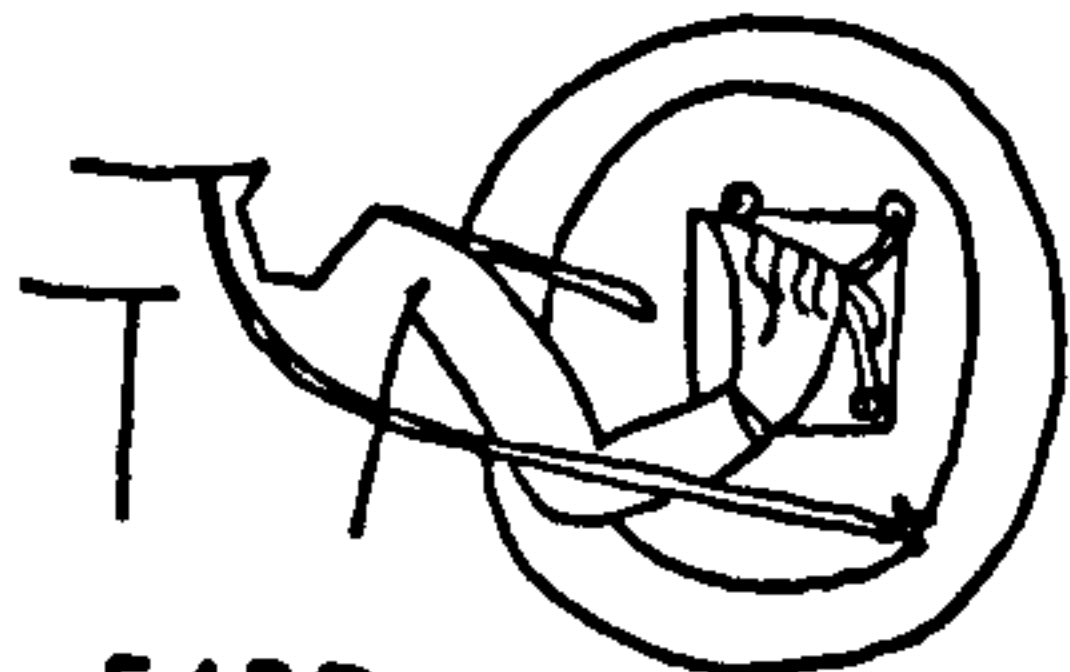
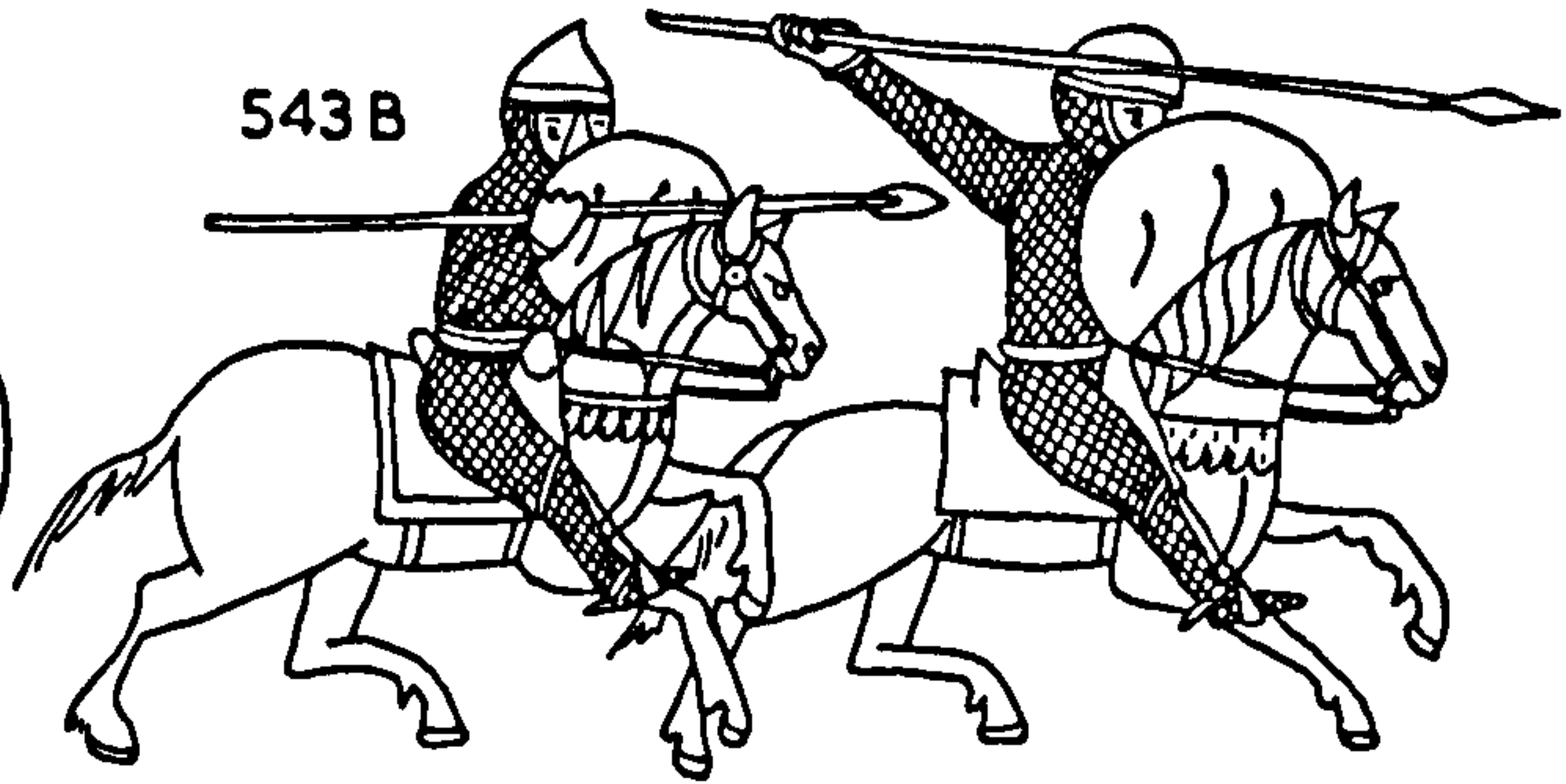

543D

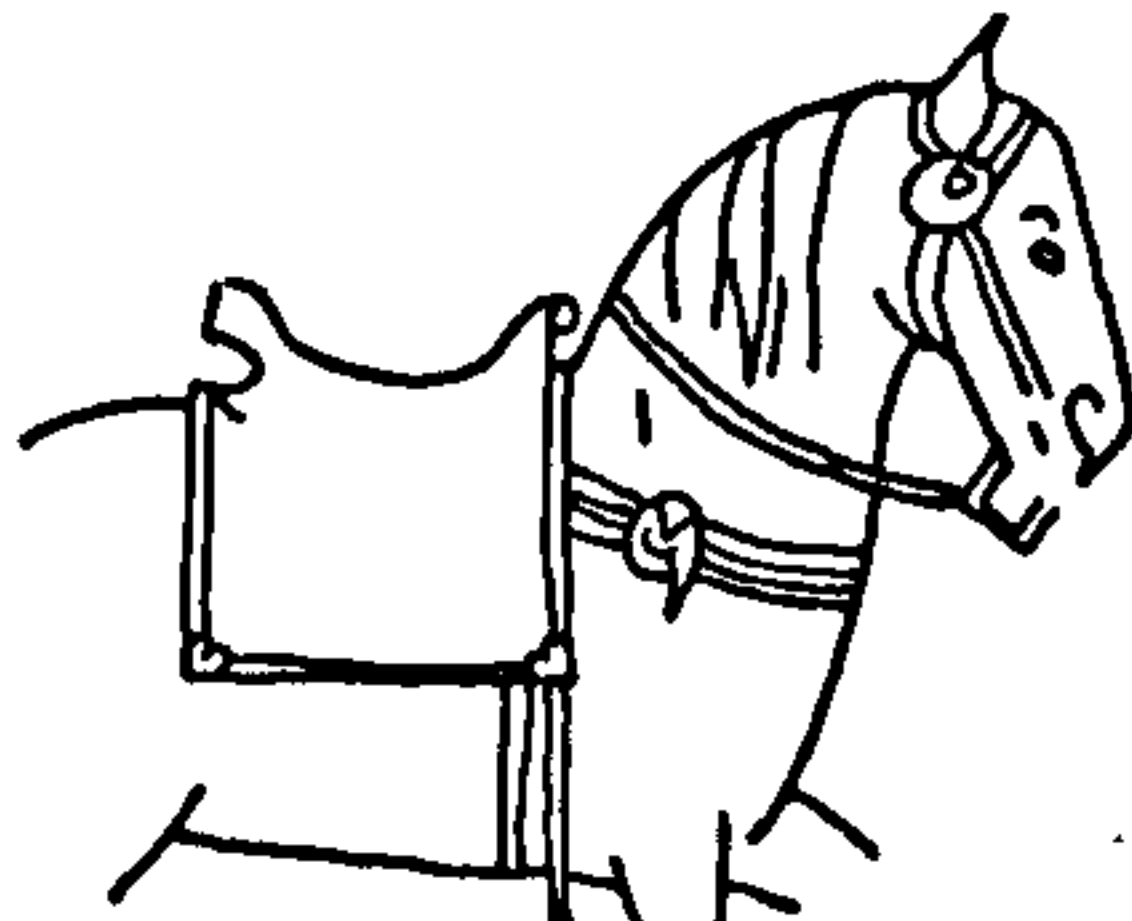

543E



543F



543G



544A

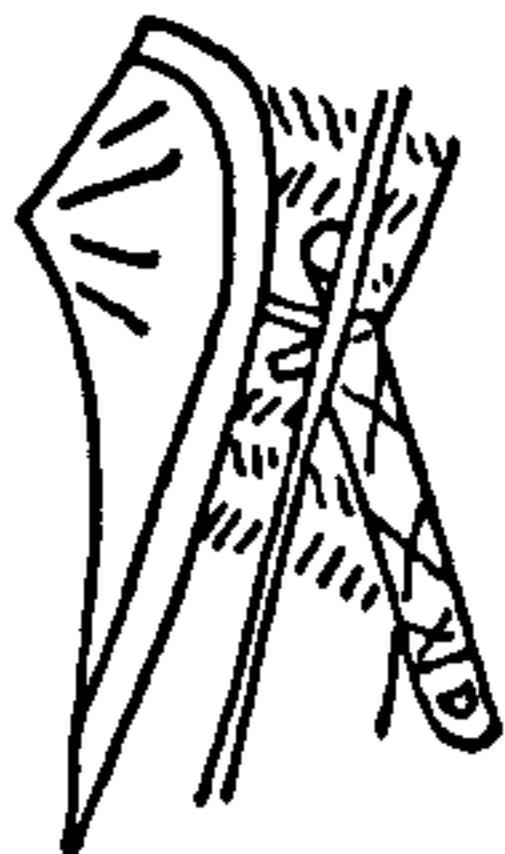

544B

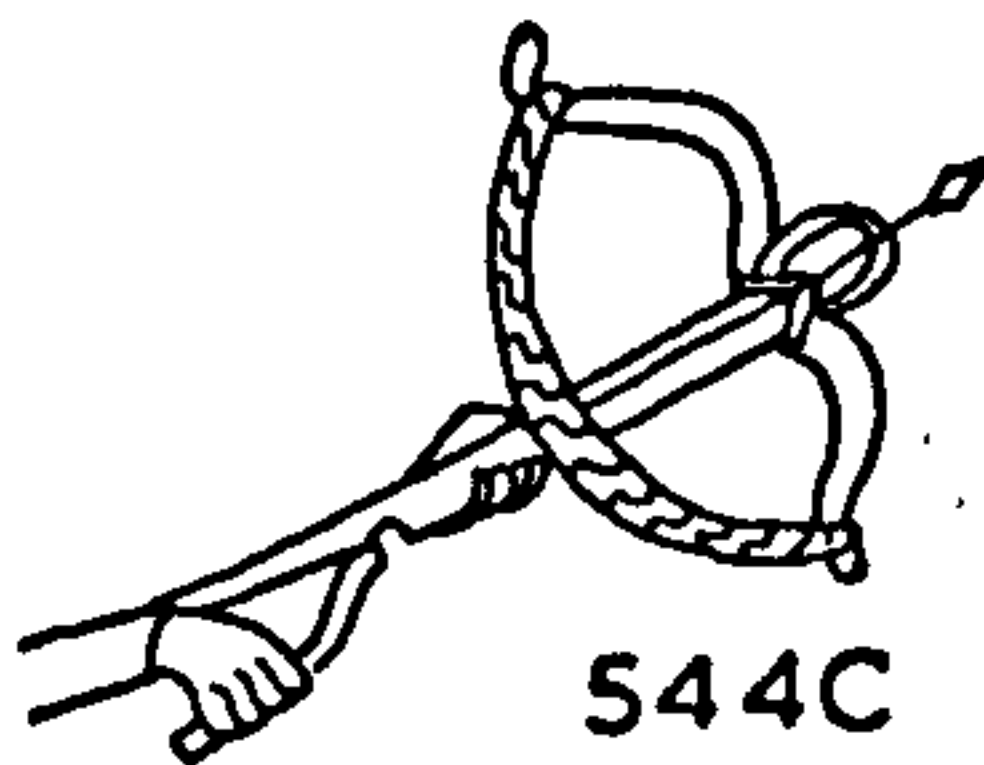

544C

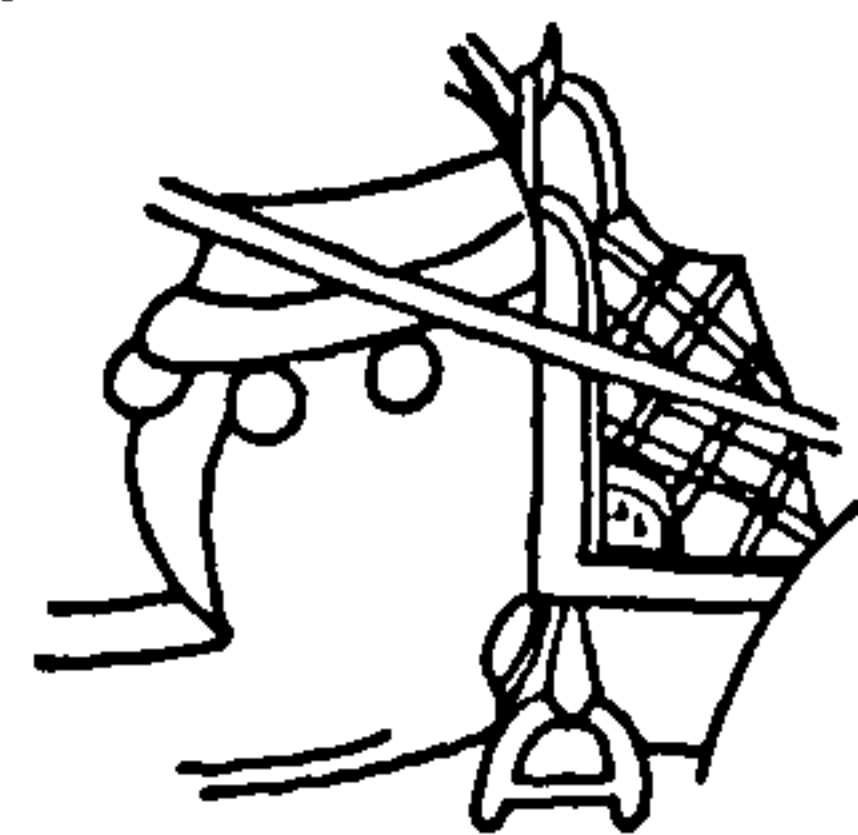

544E



544F



545A

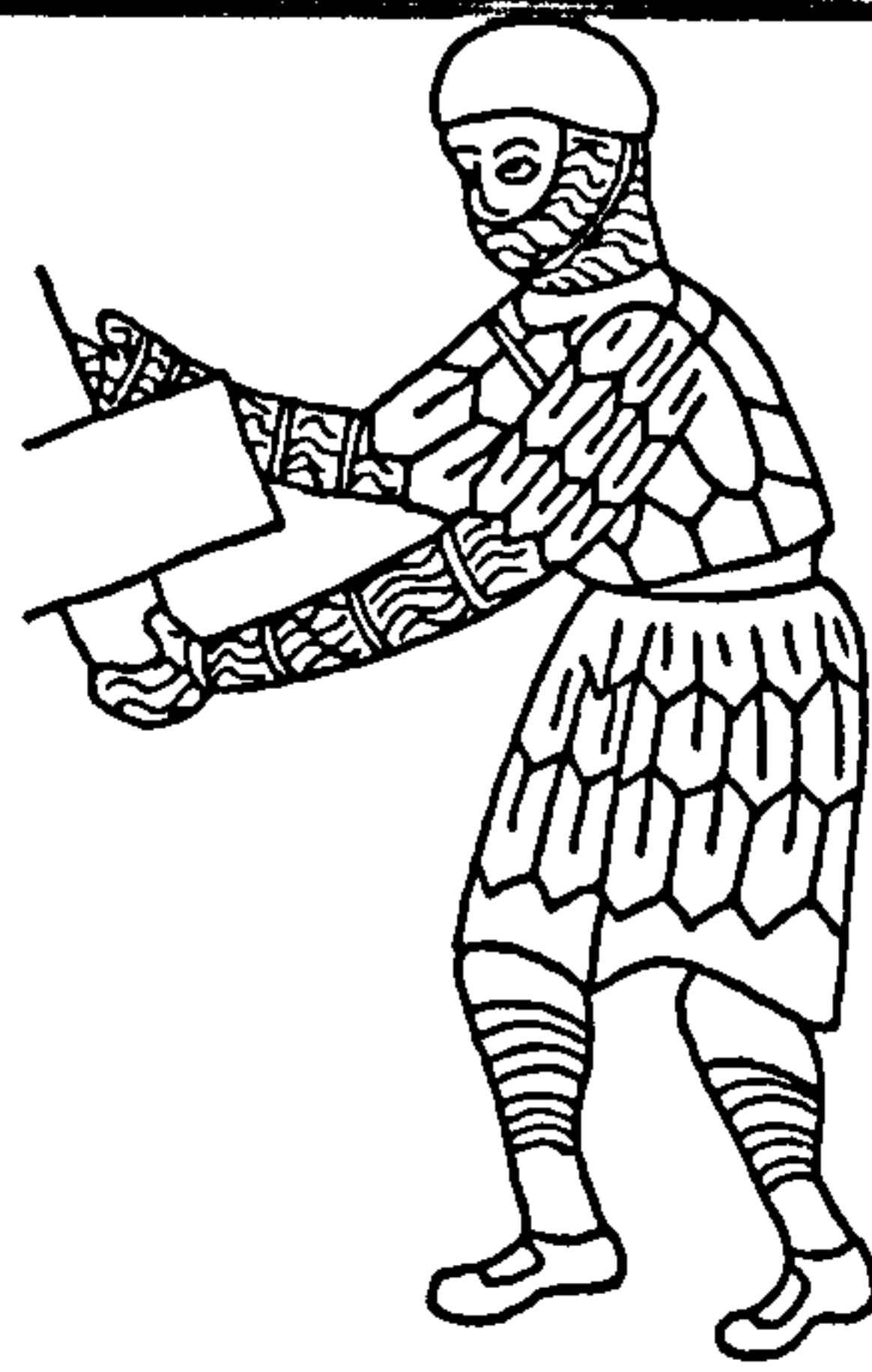

545B

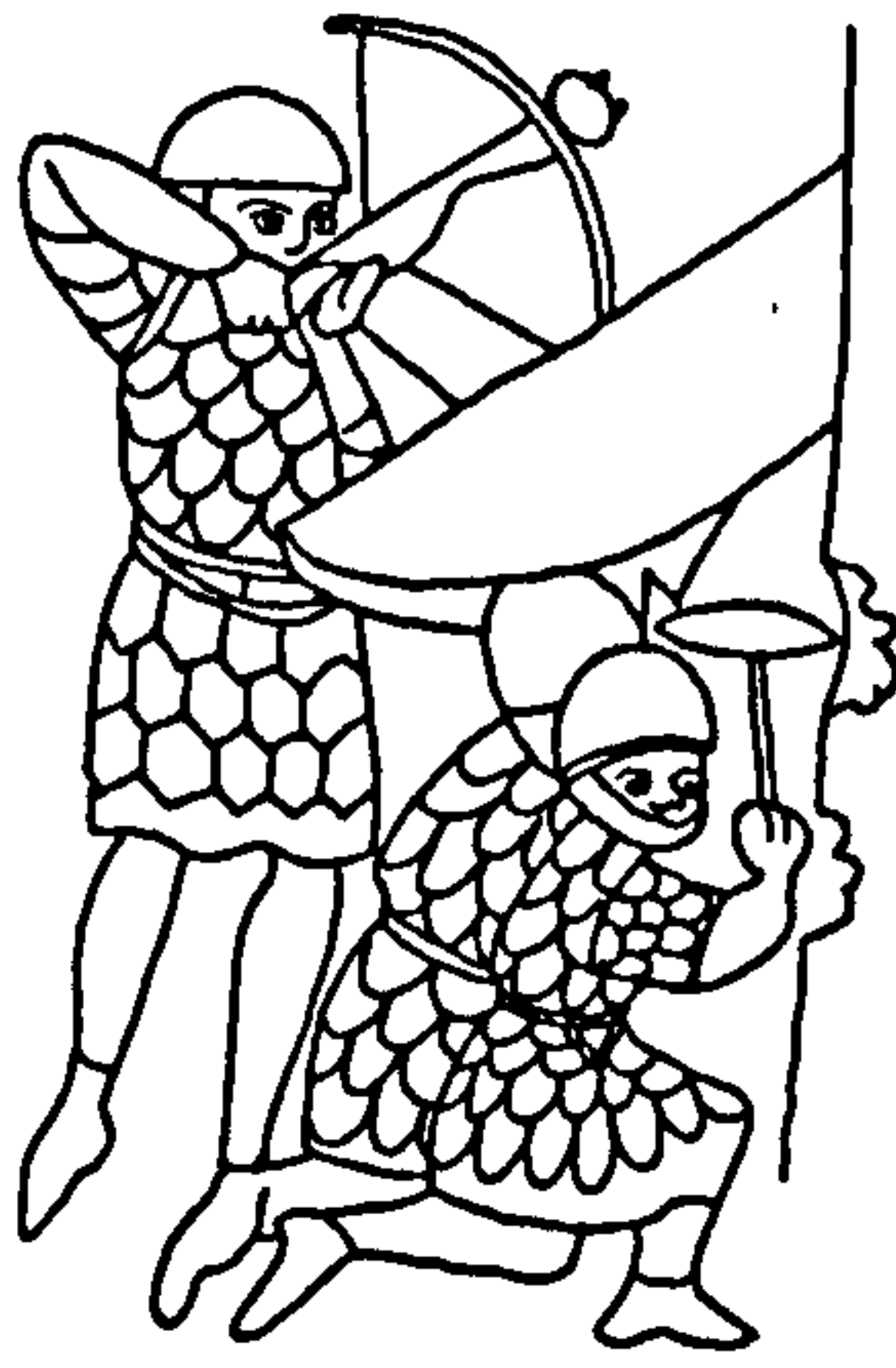

545D

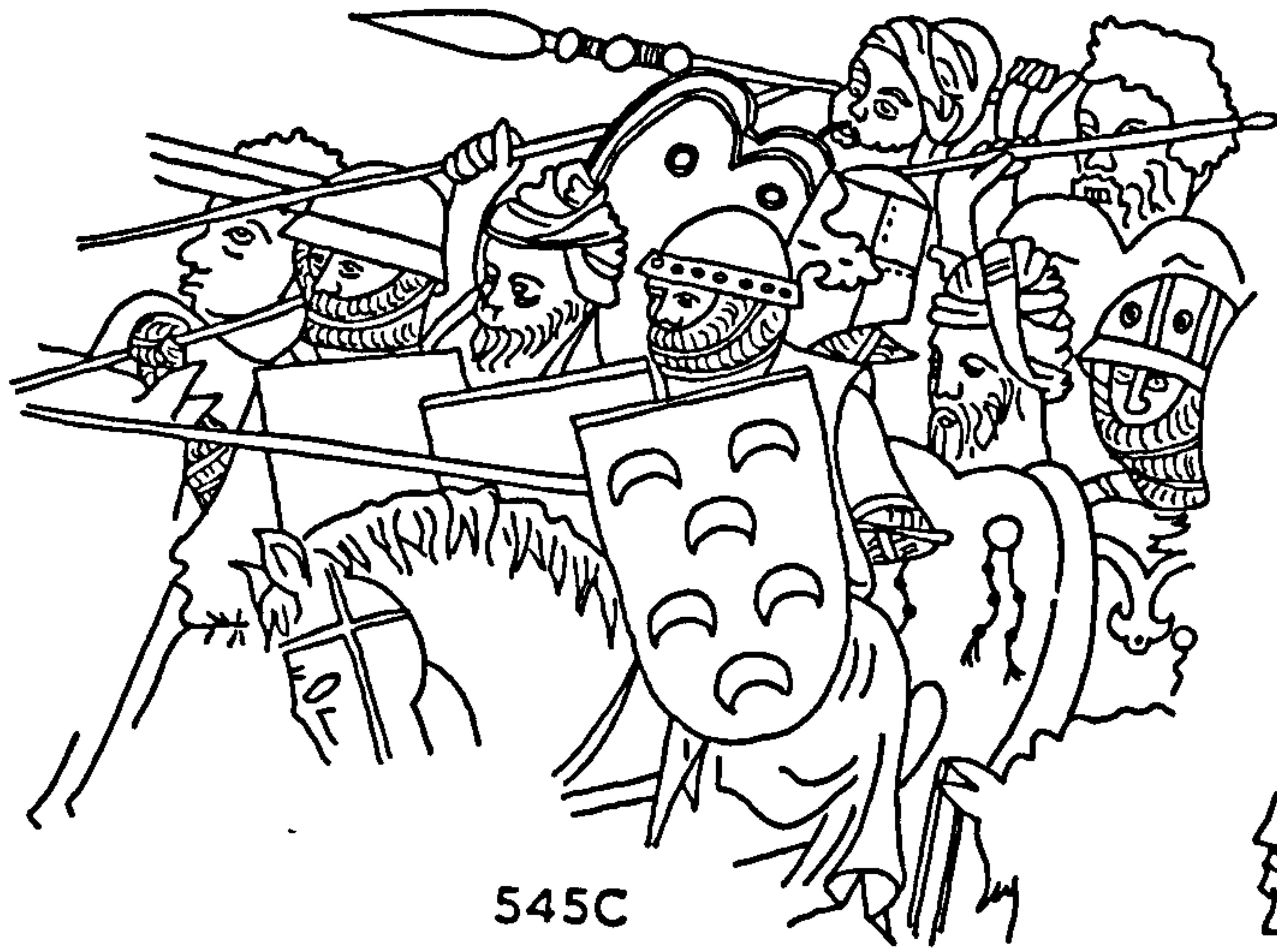
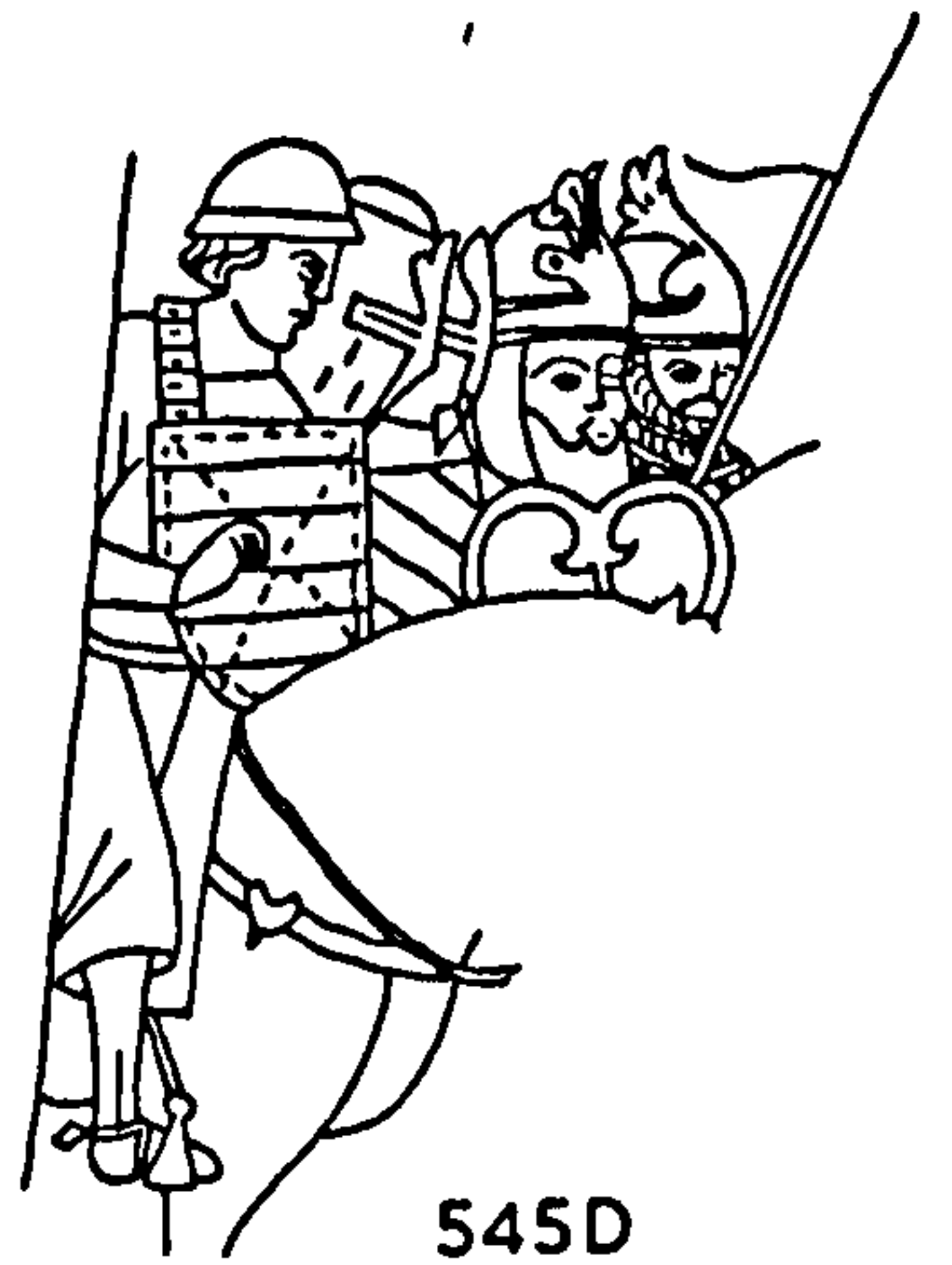

545C



545E

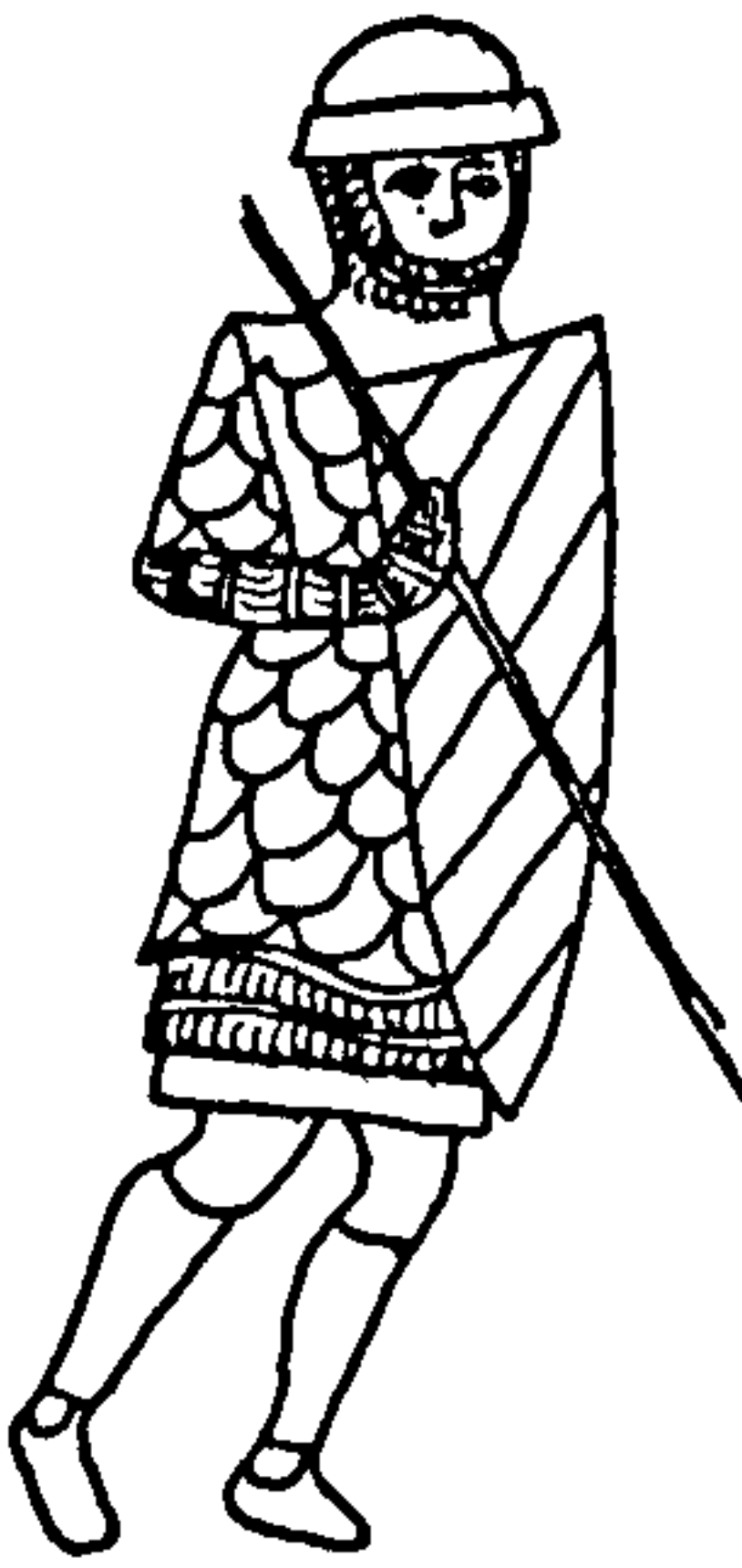

545F

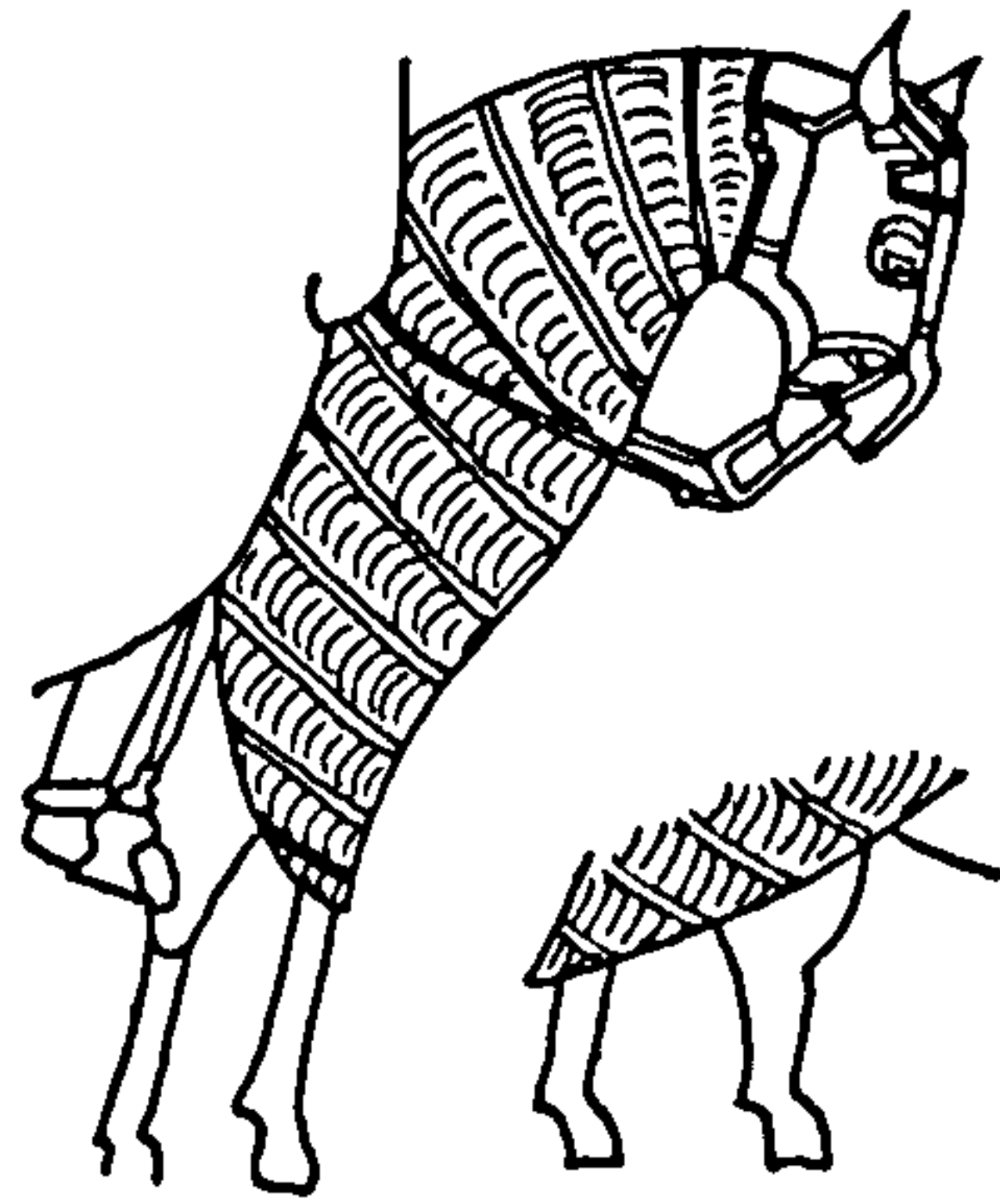

545G

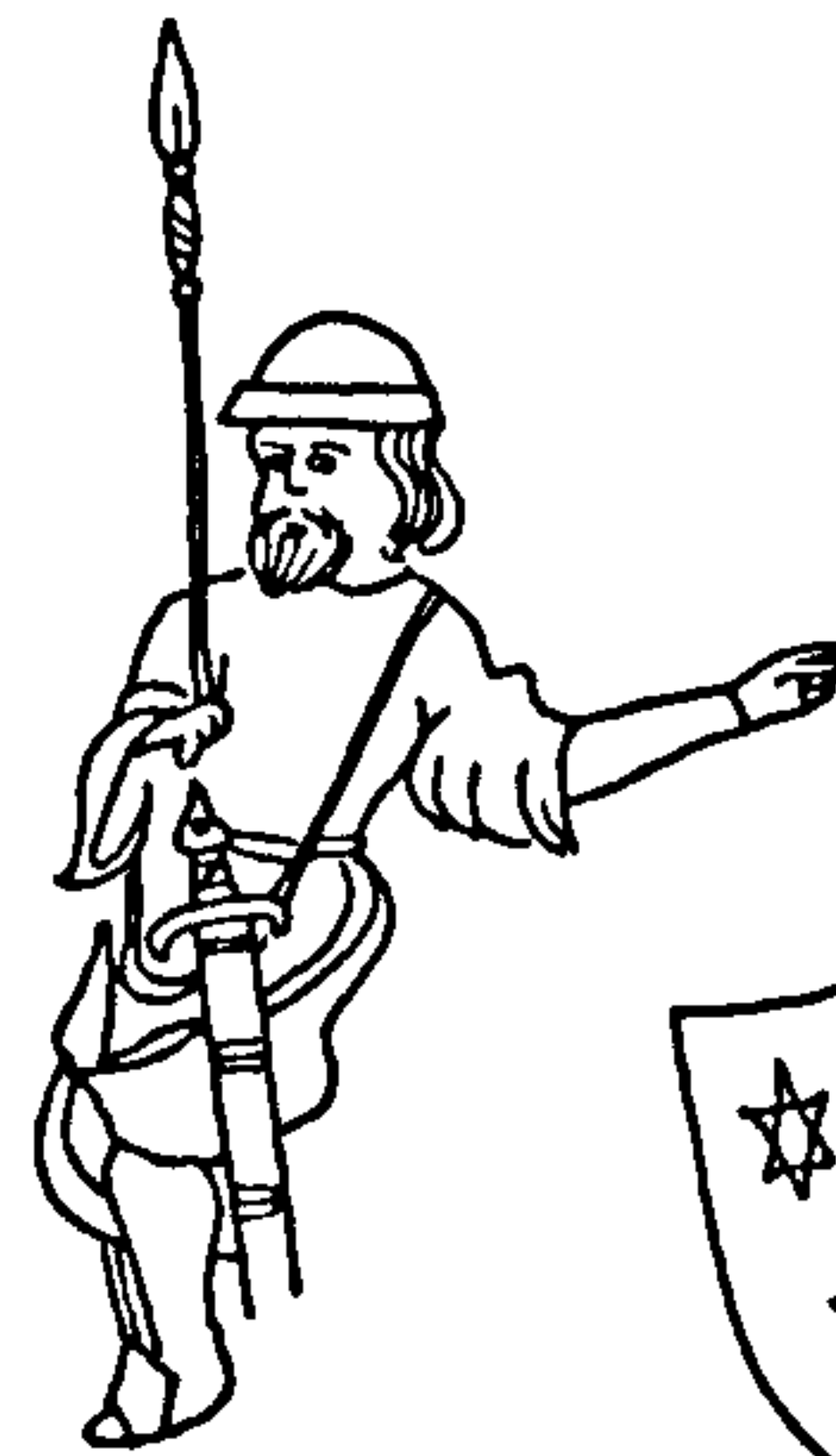

545H

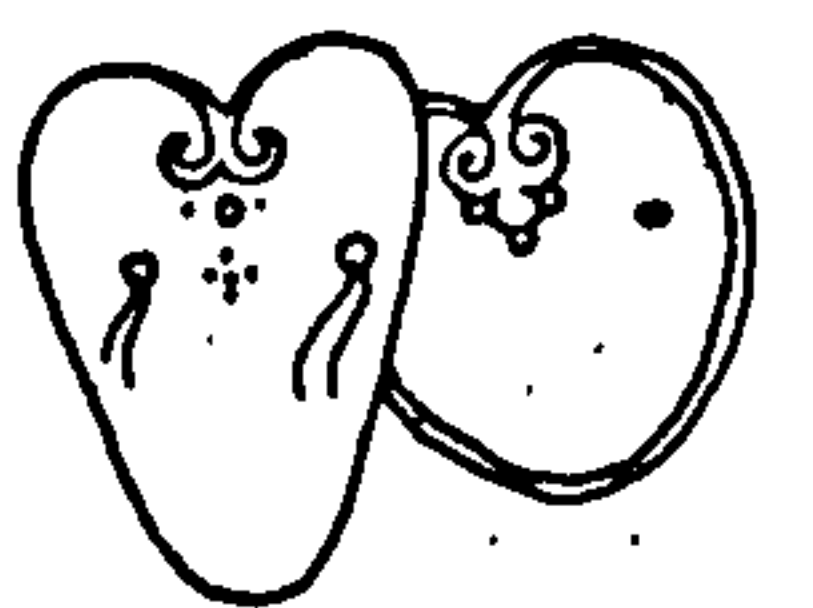
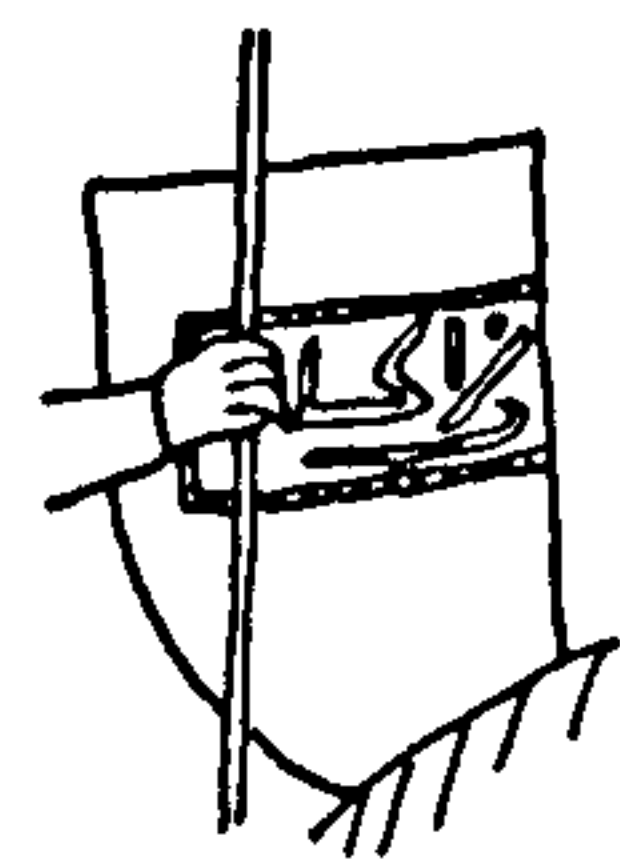

(Continued)



5451



546A

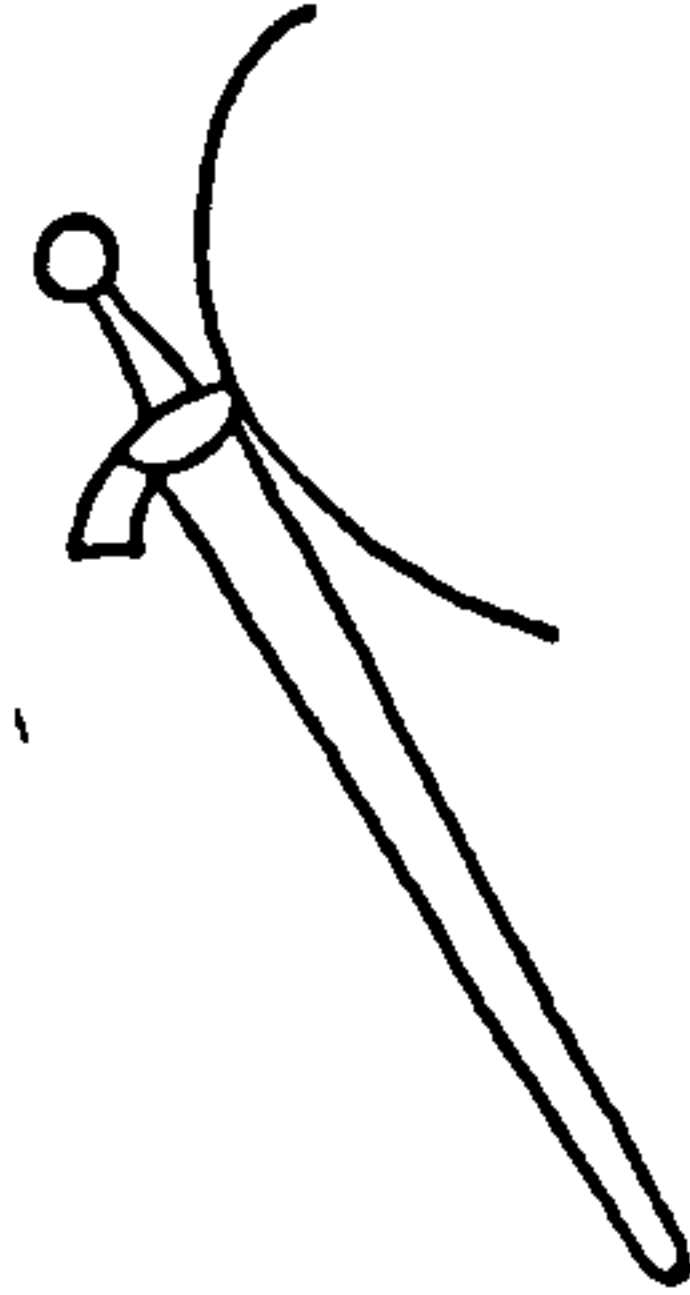

546B

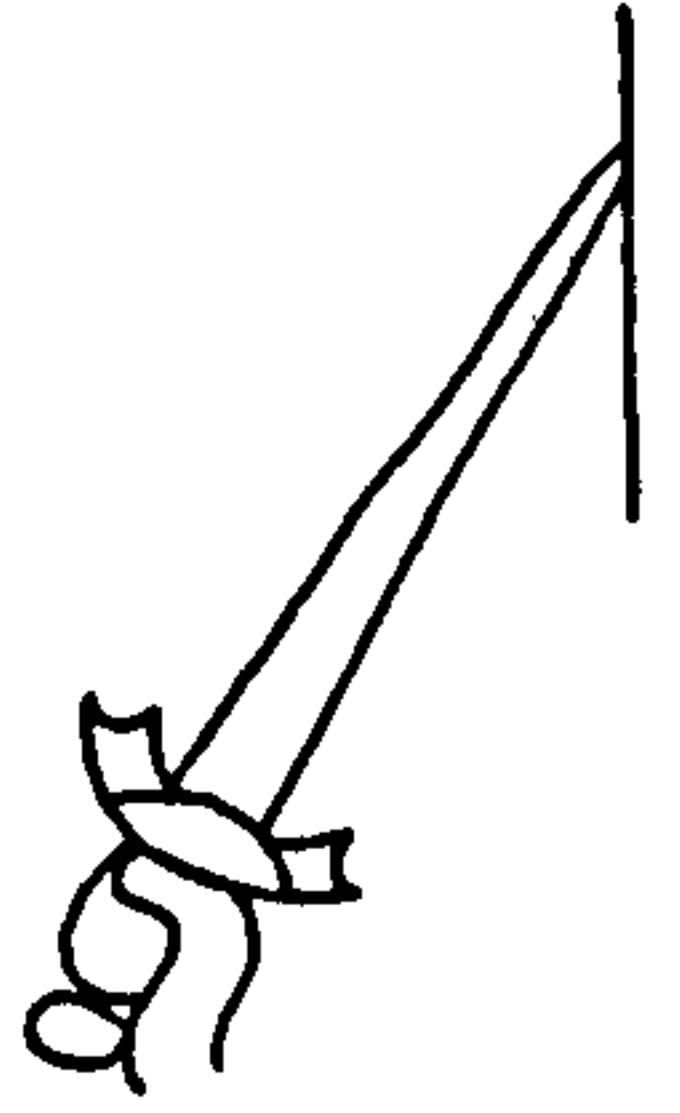

546C

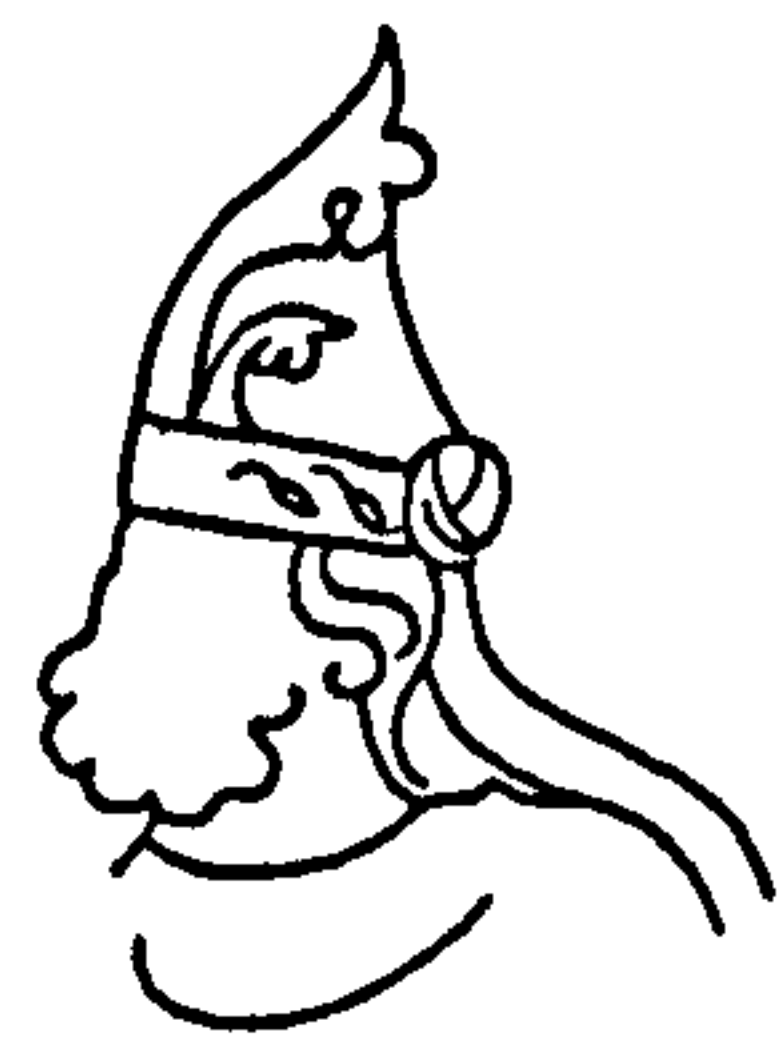
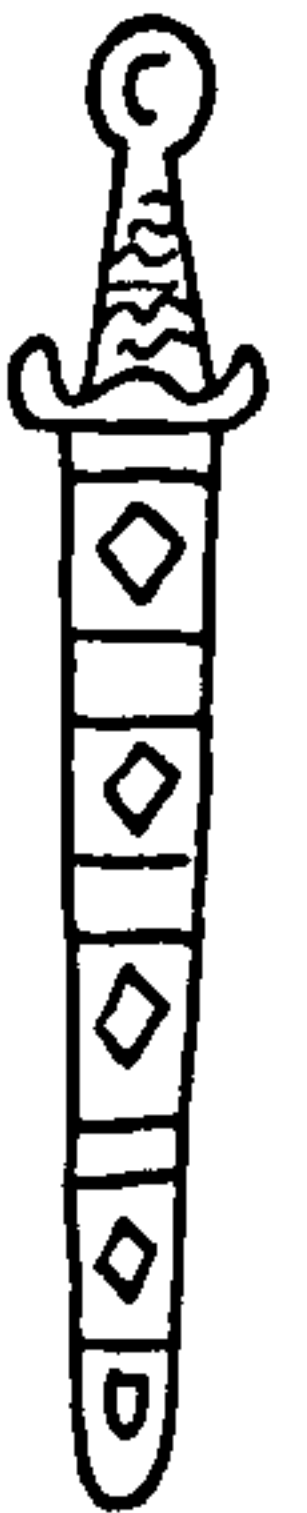
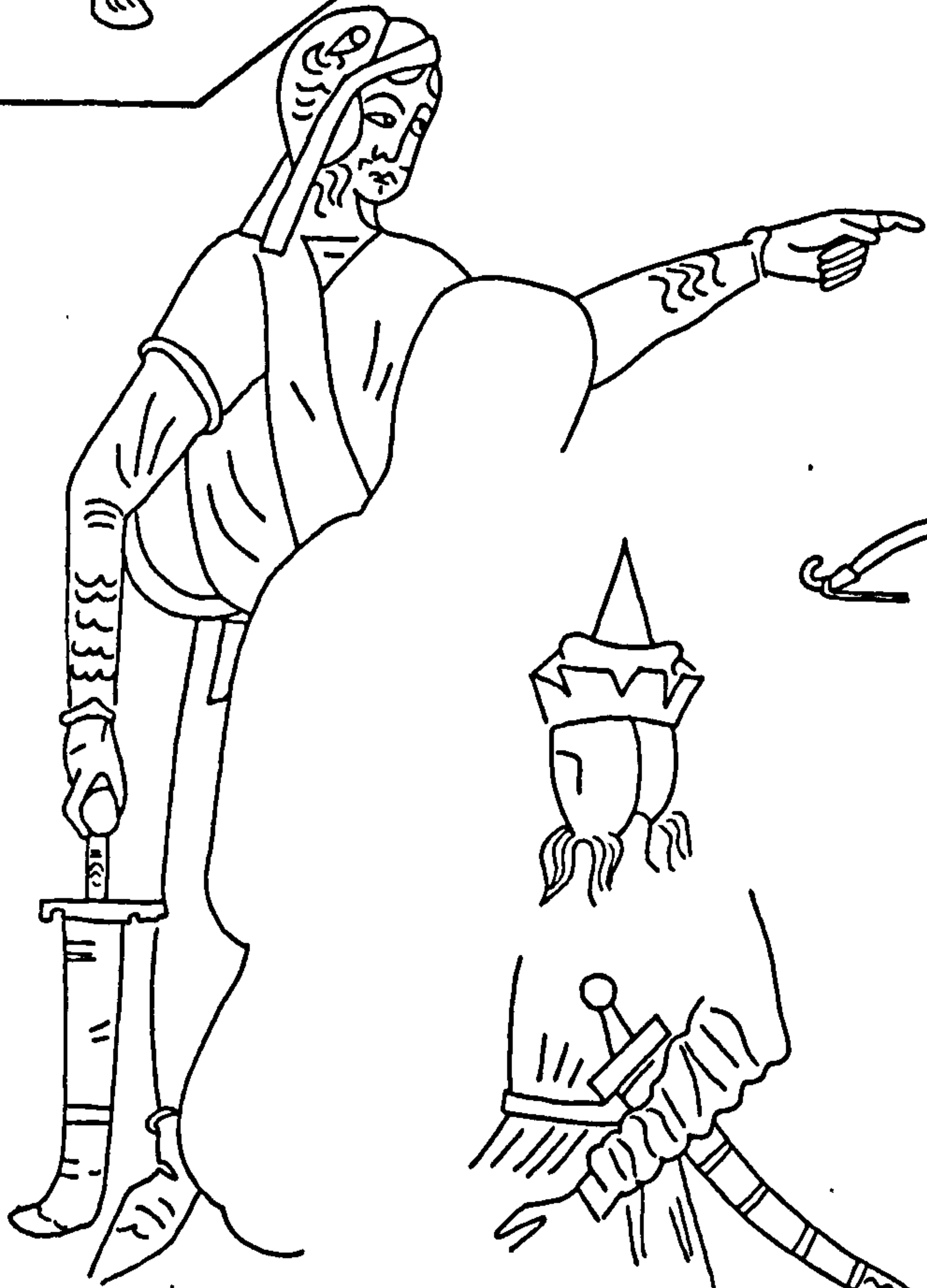

547

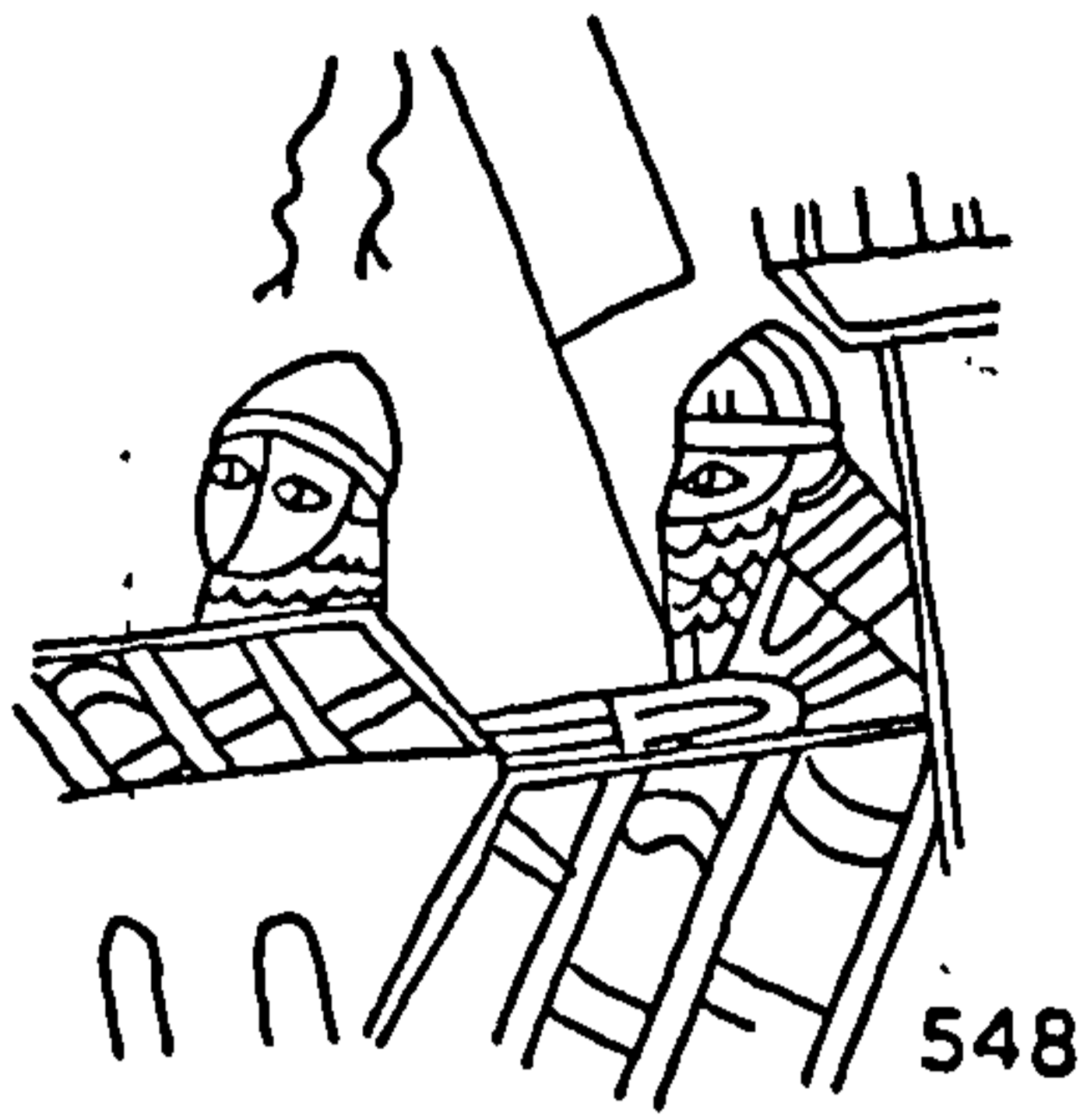

548

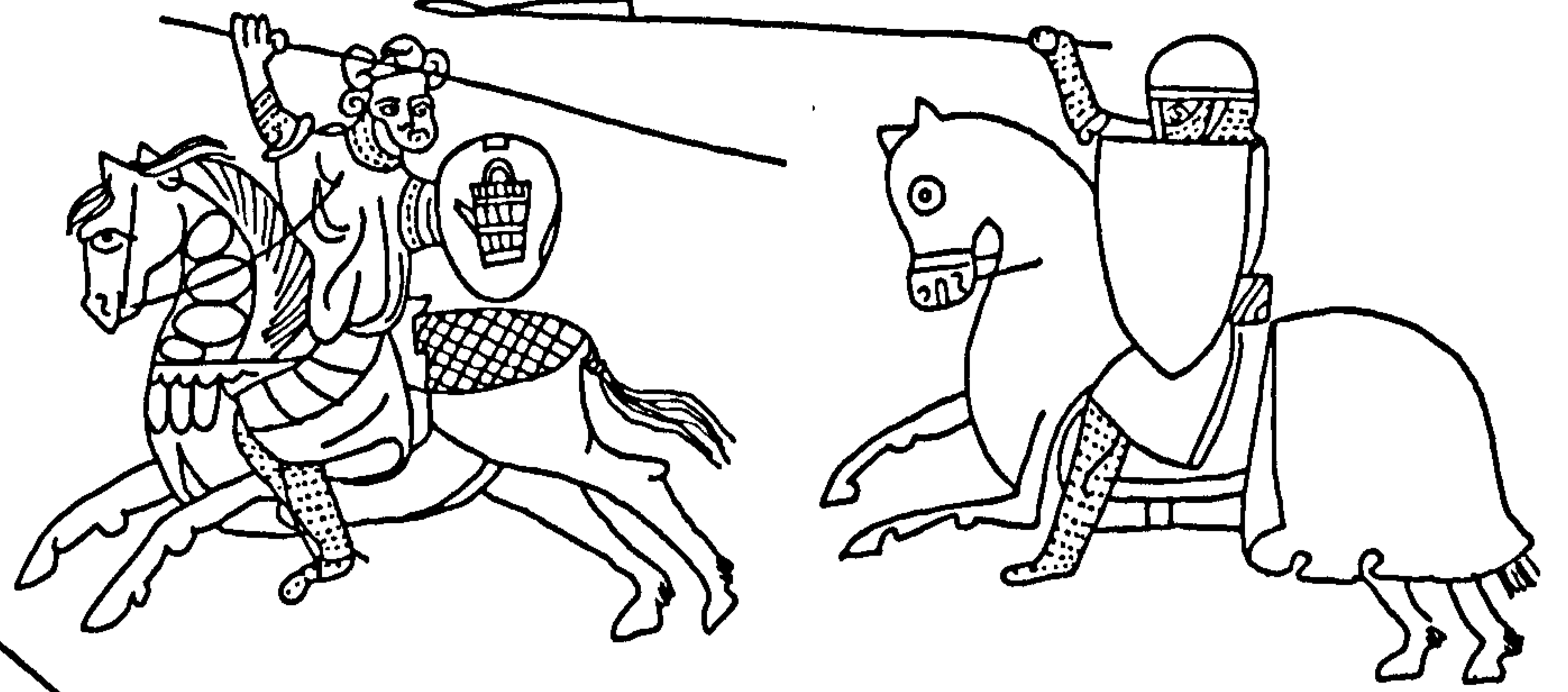

549



550

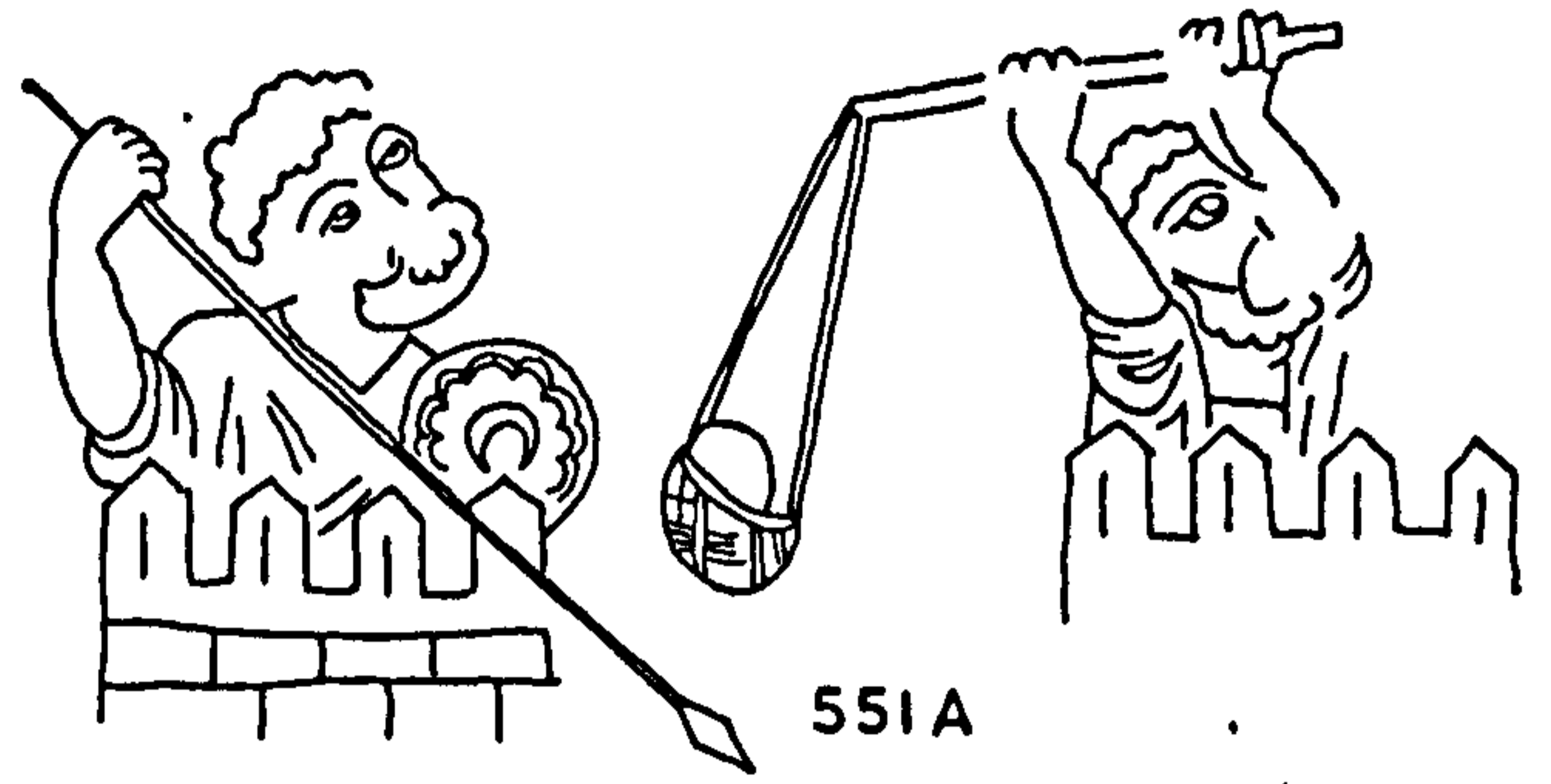

551A



551B

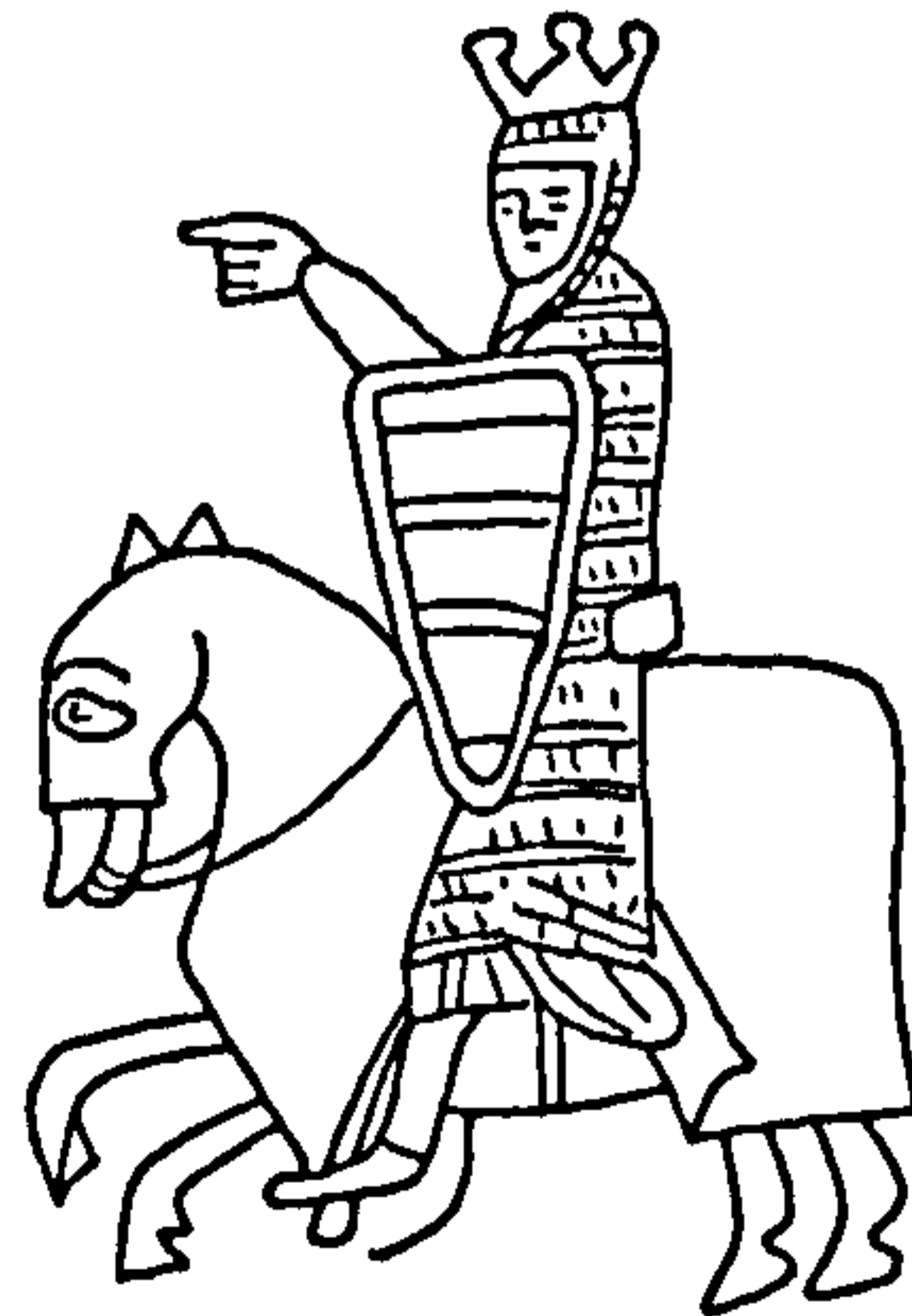
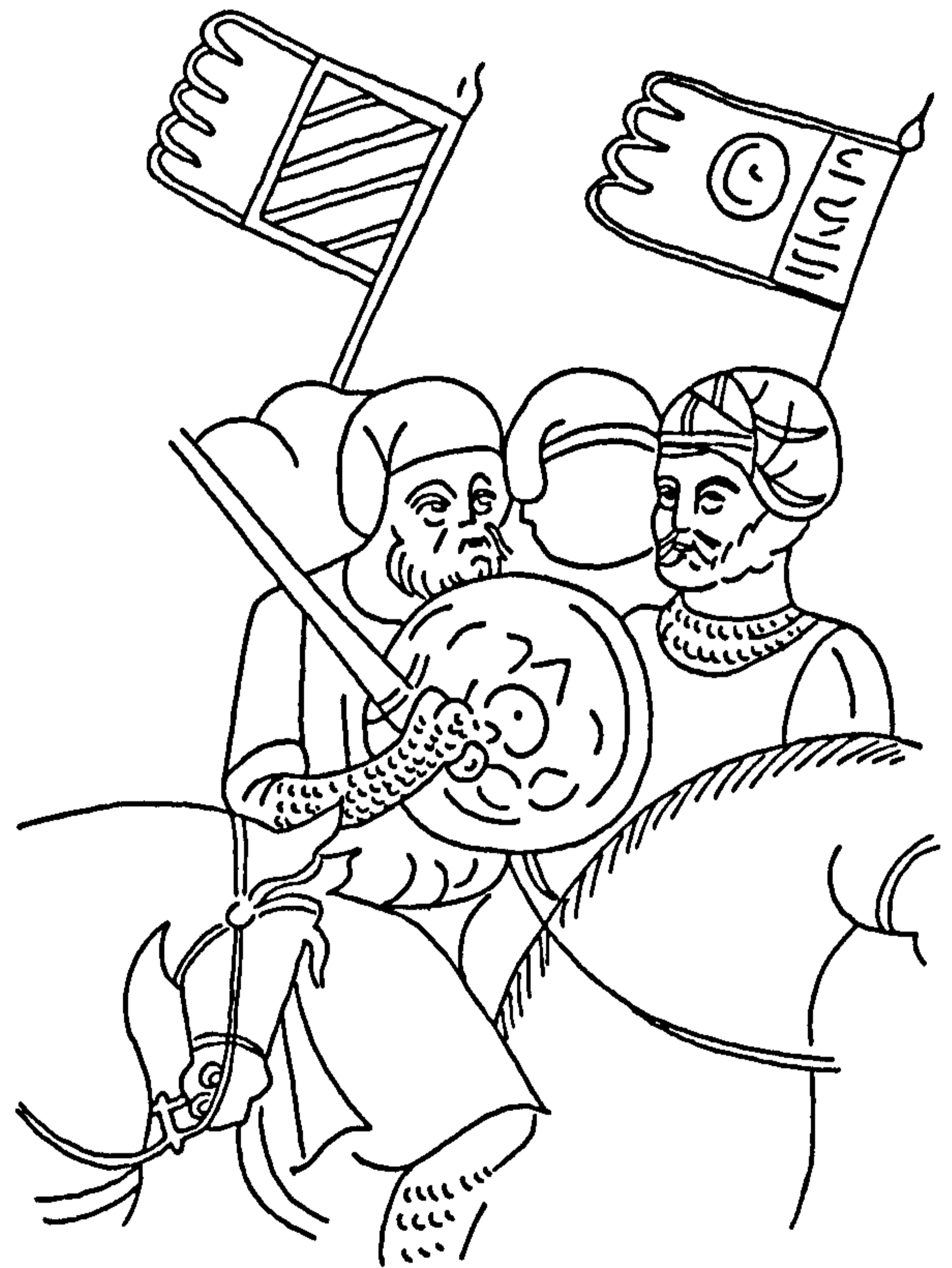

552

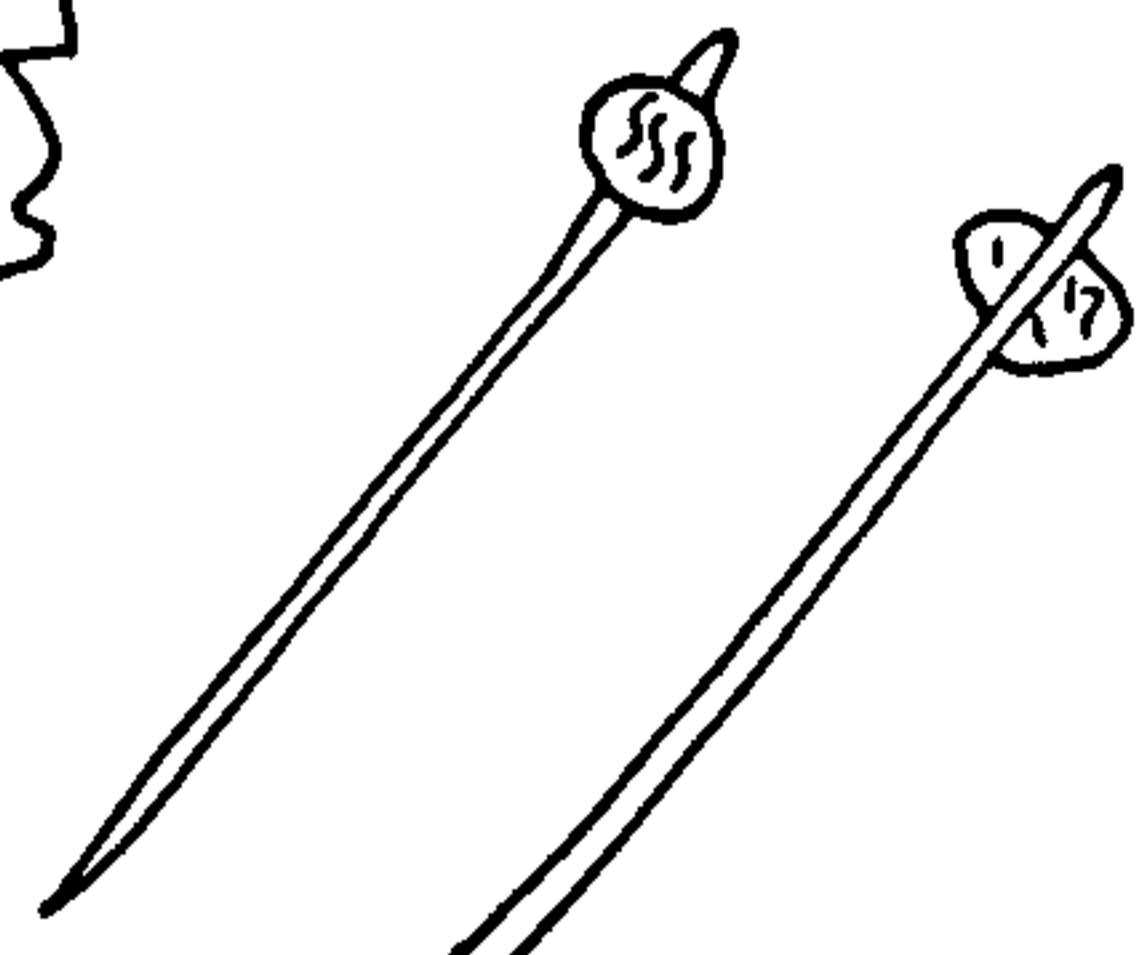

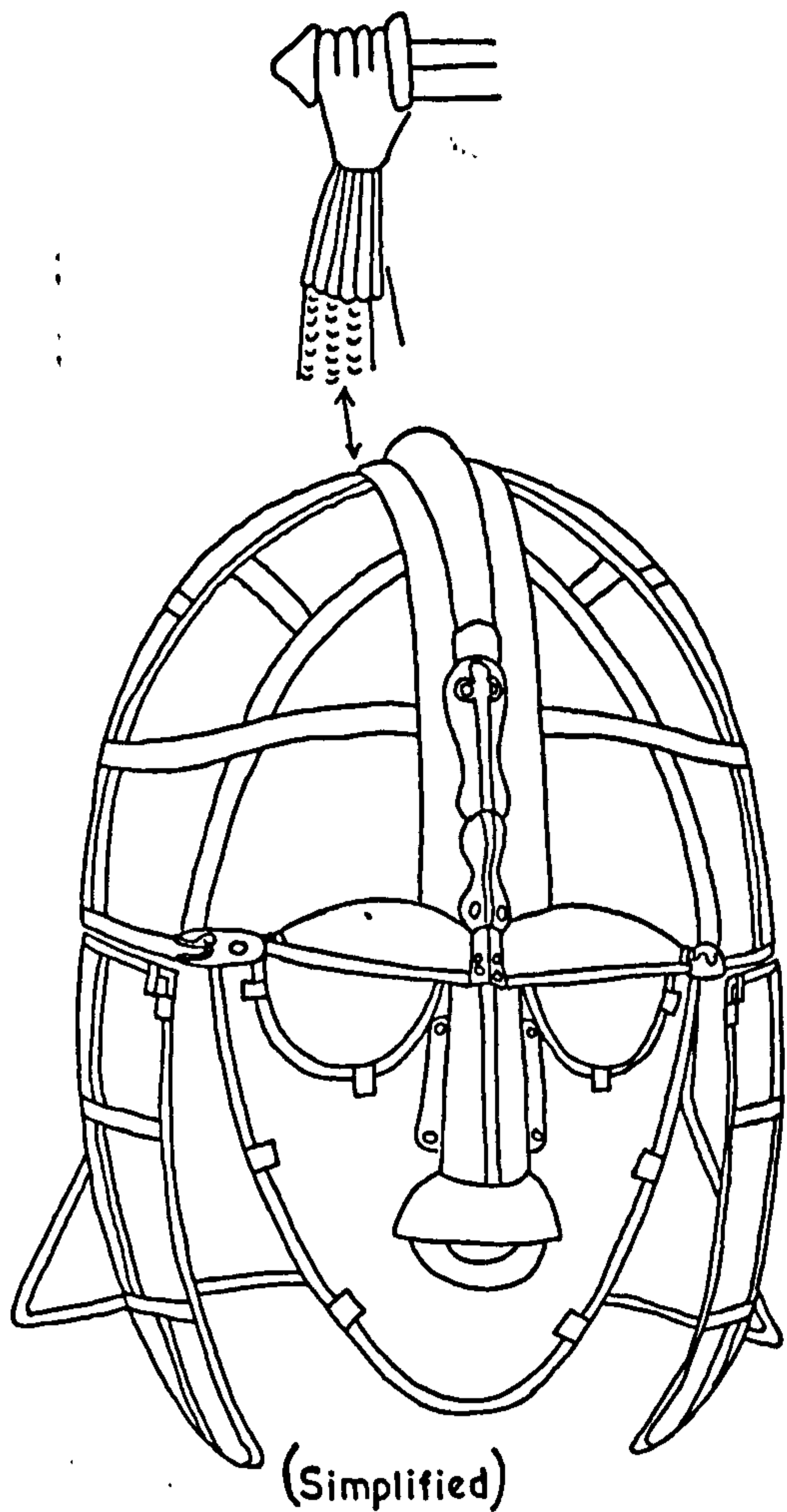

(Simplified)

553

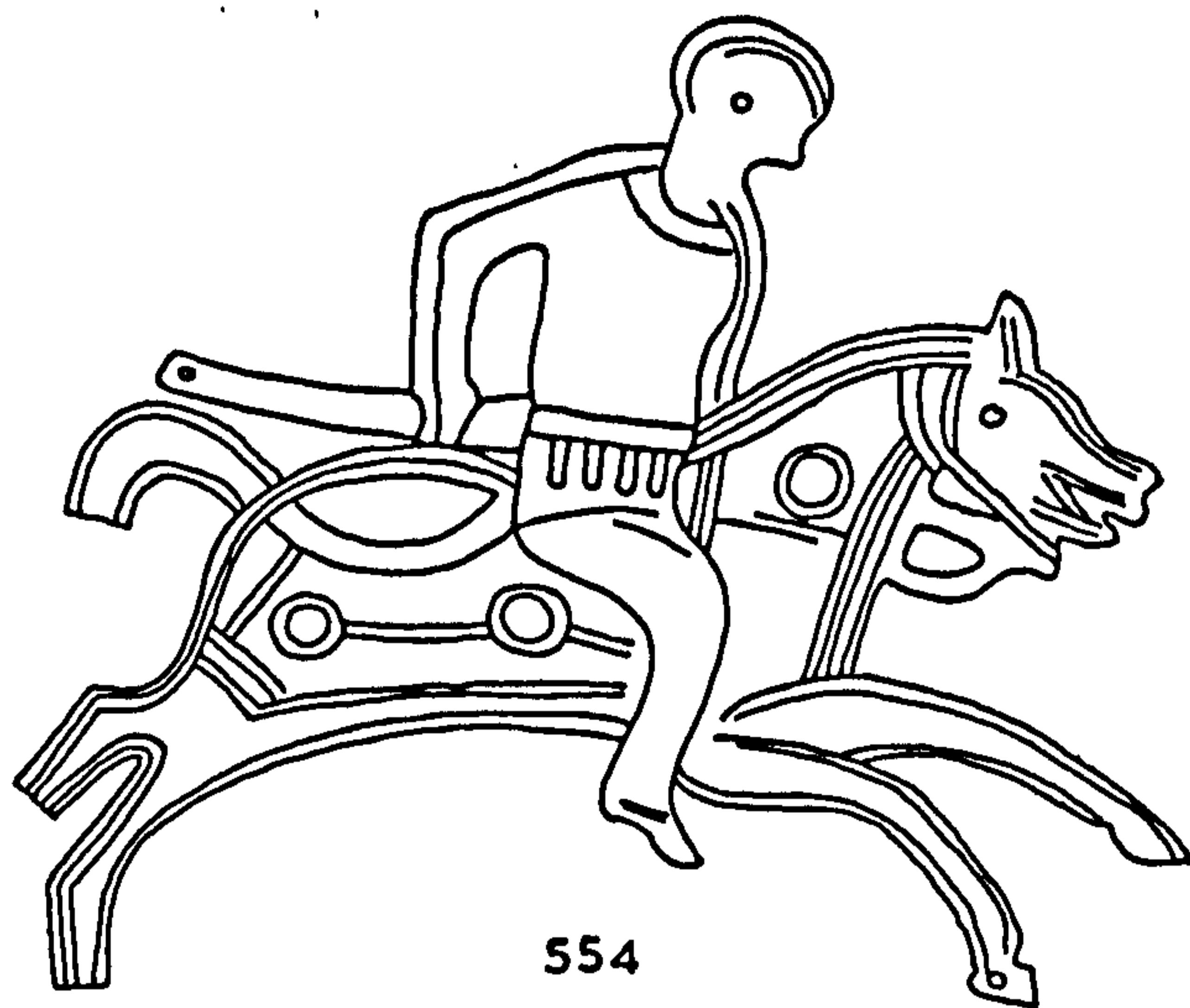

554

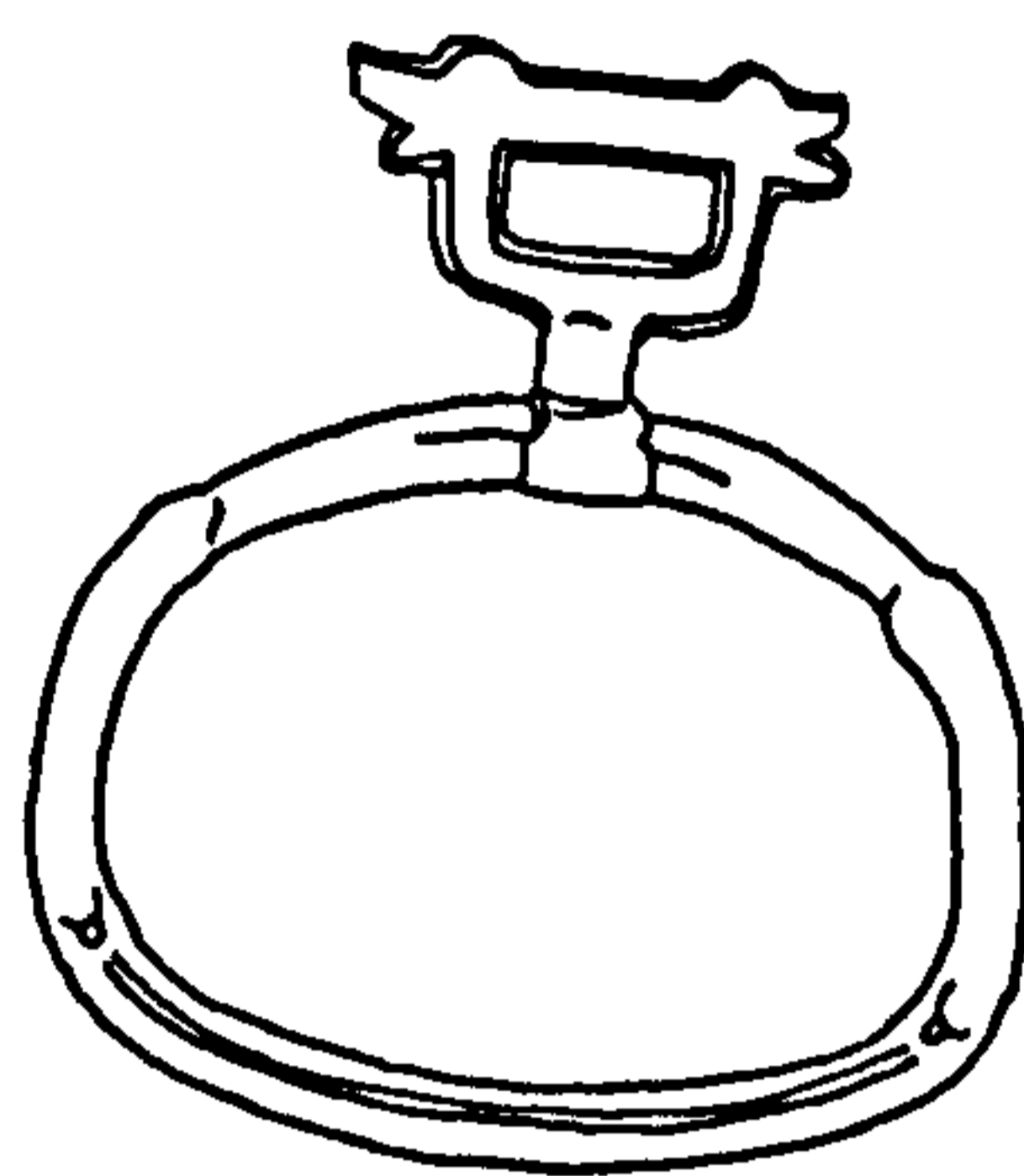

555

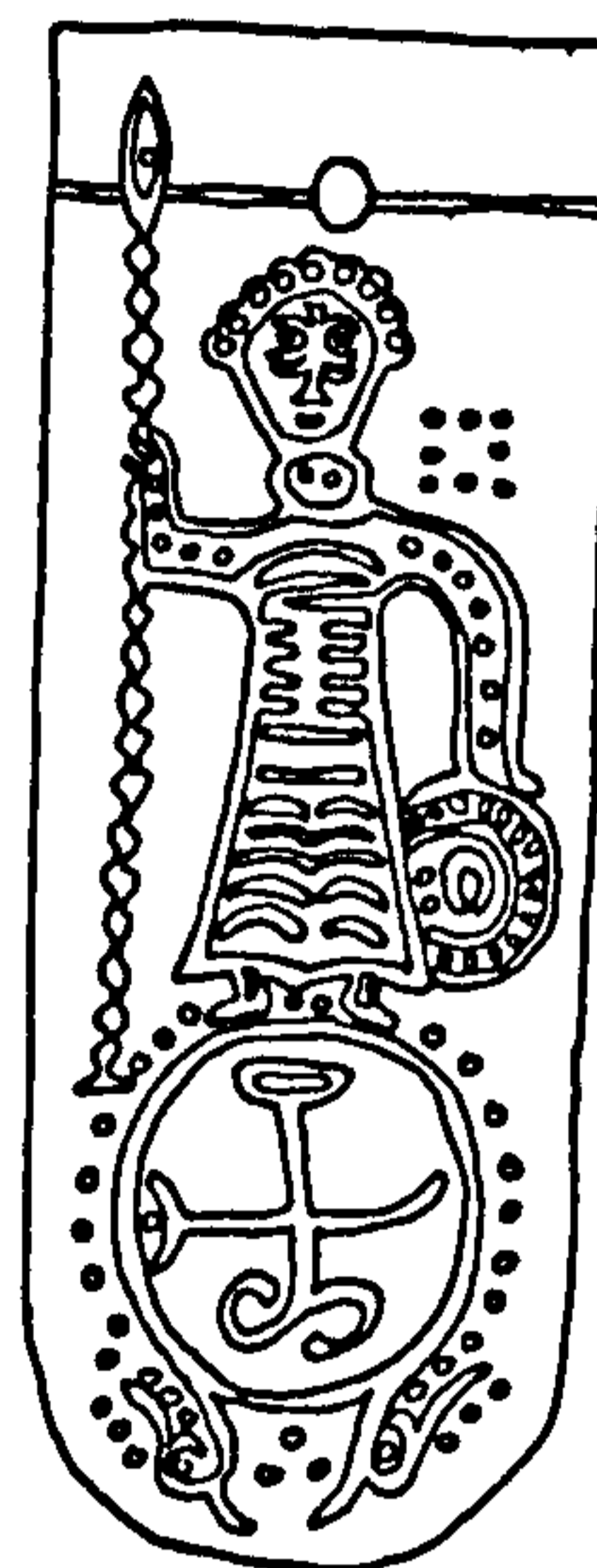

556



557

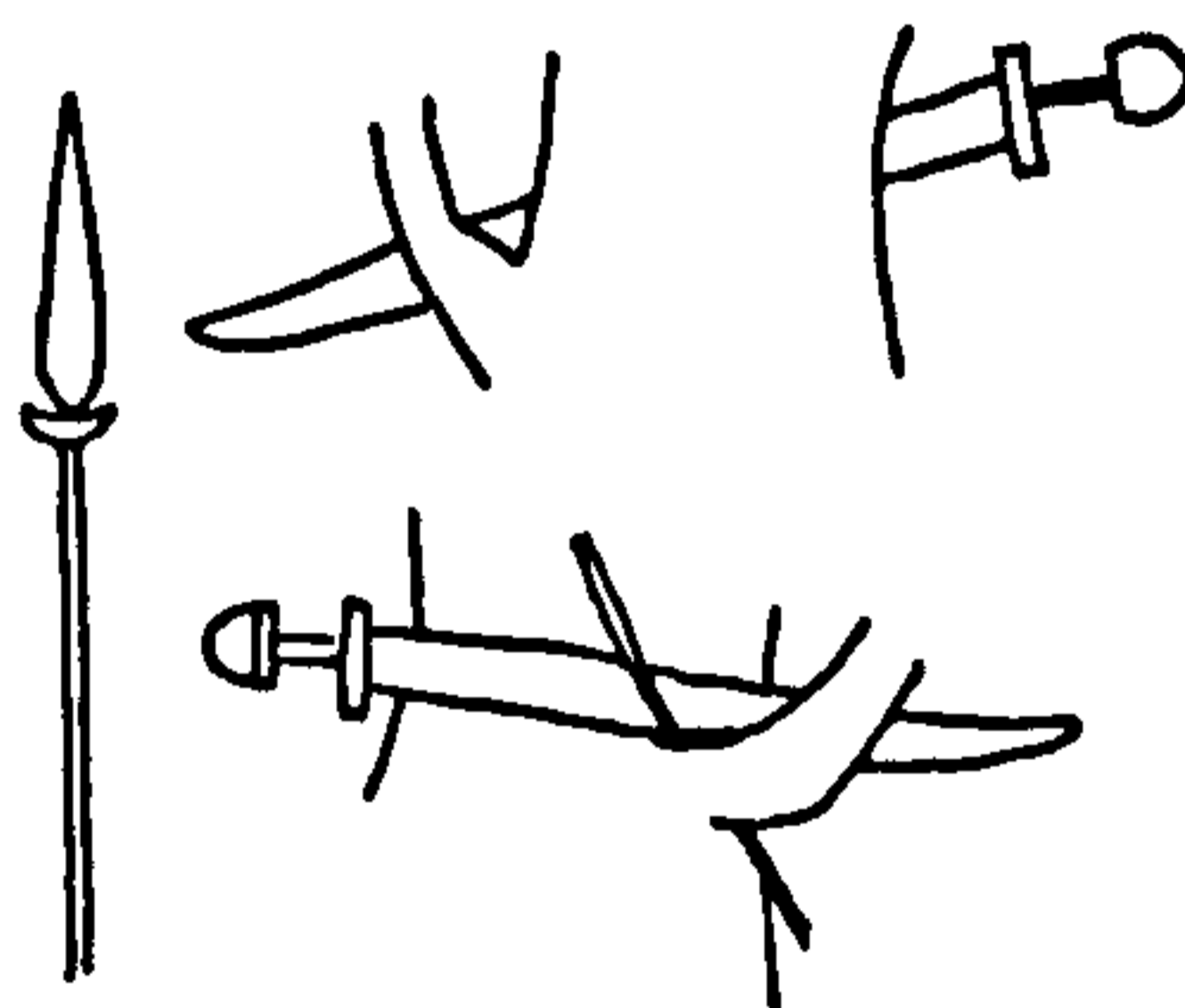

558



559



560



561

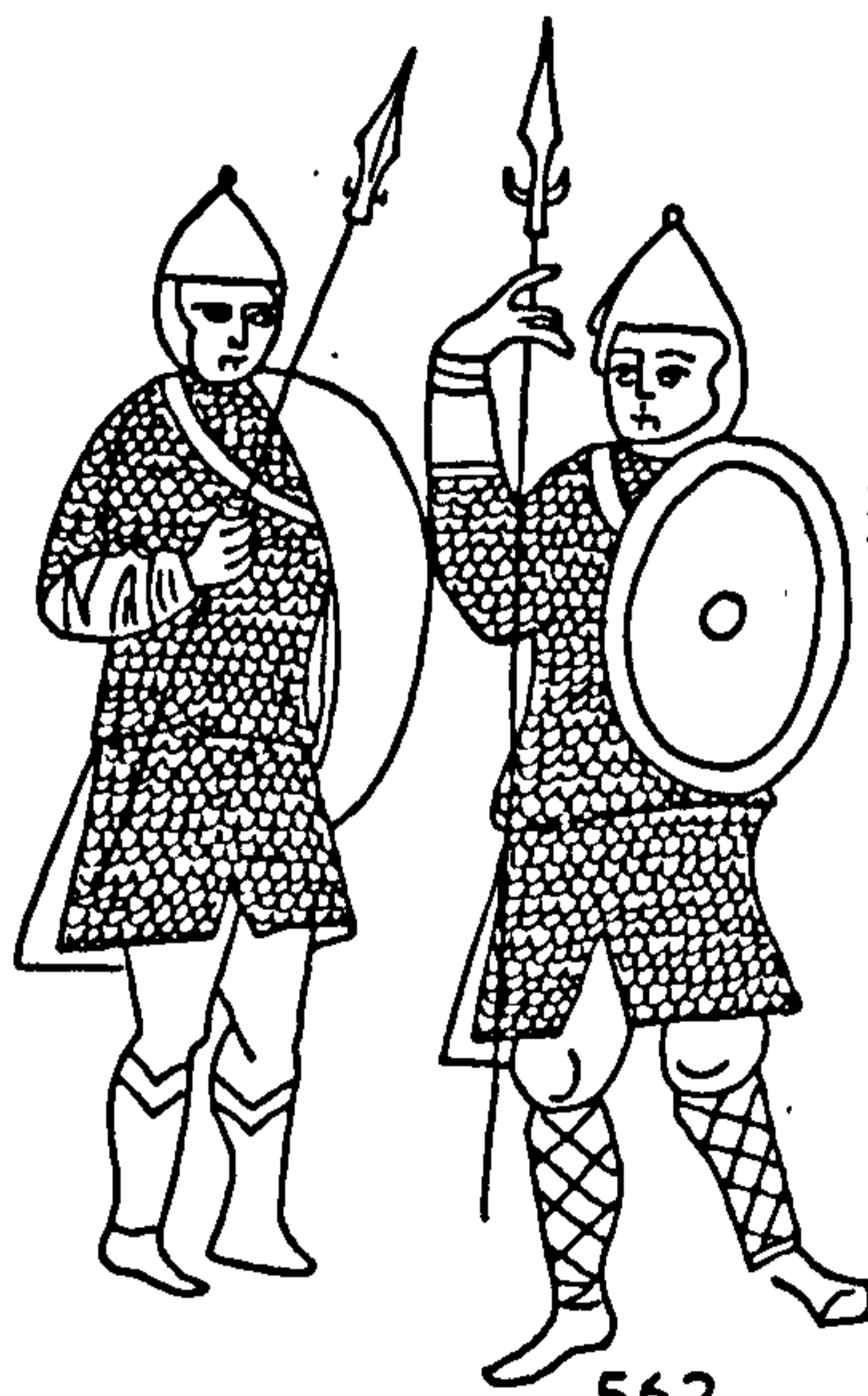

562





563

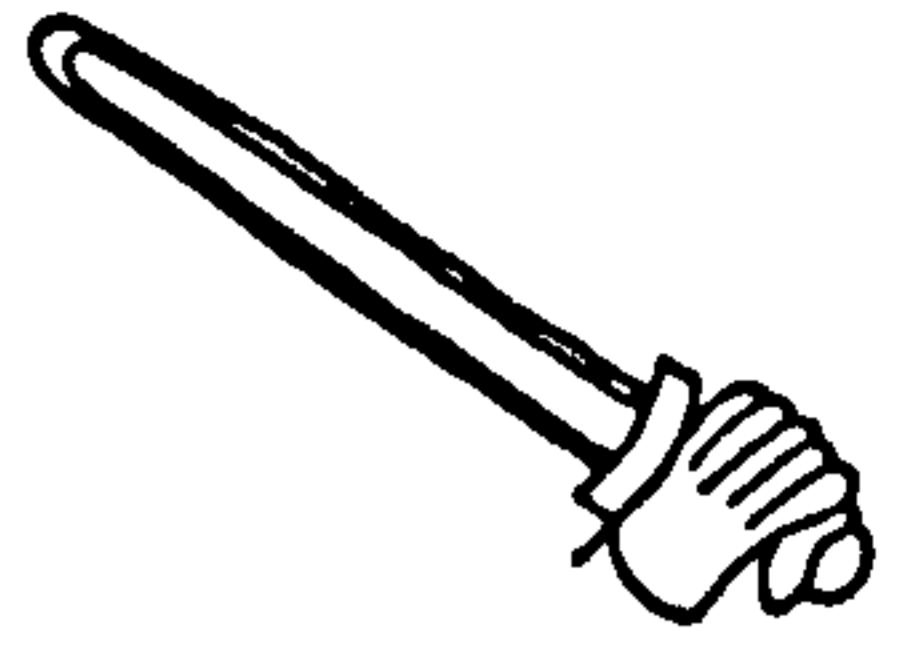

564A

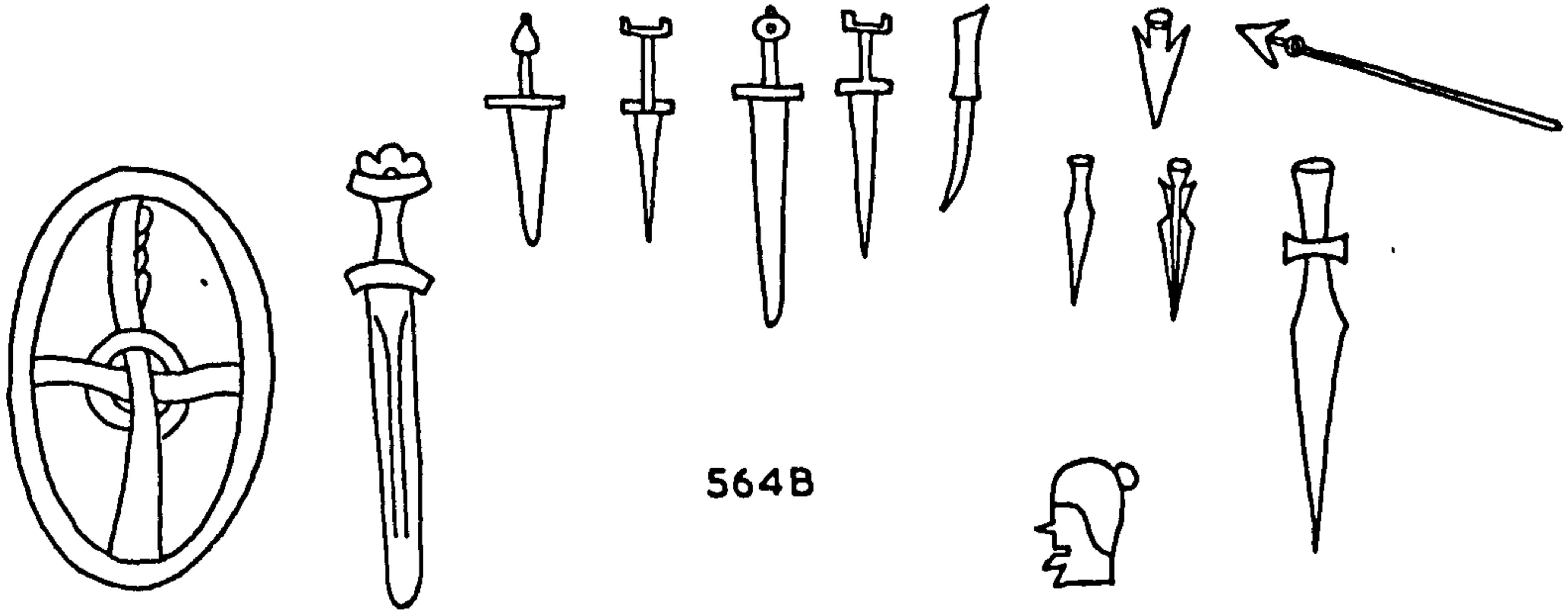

564B



565



566



567

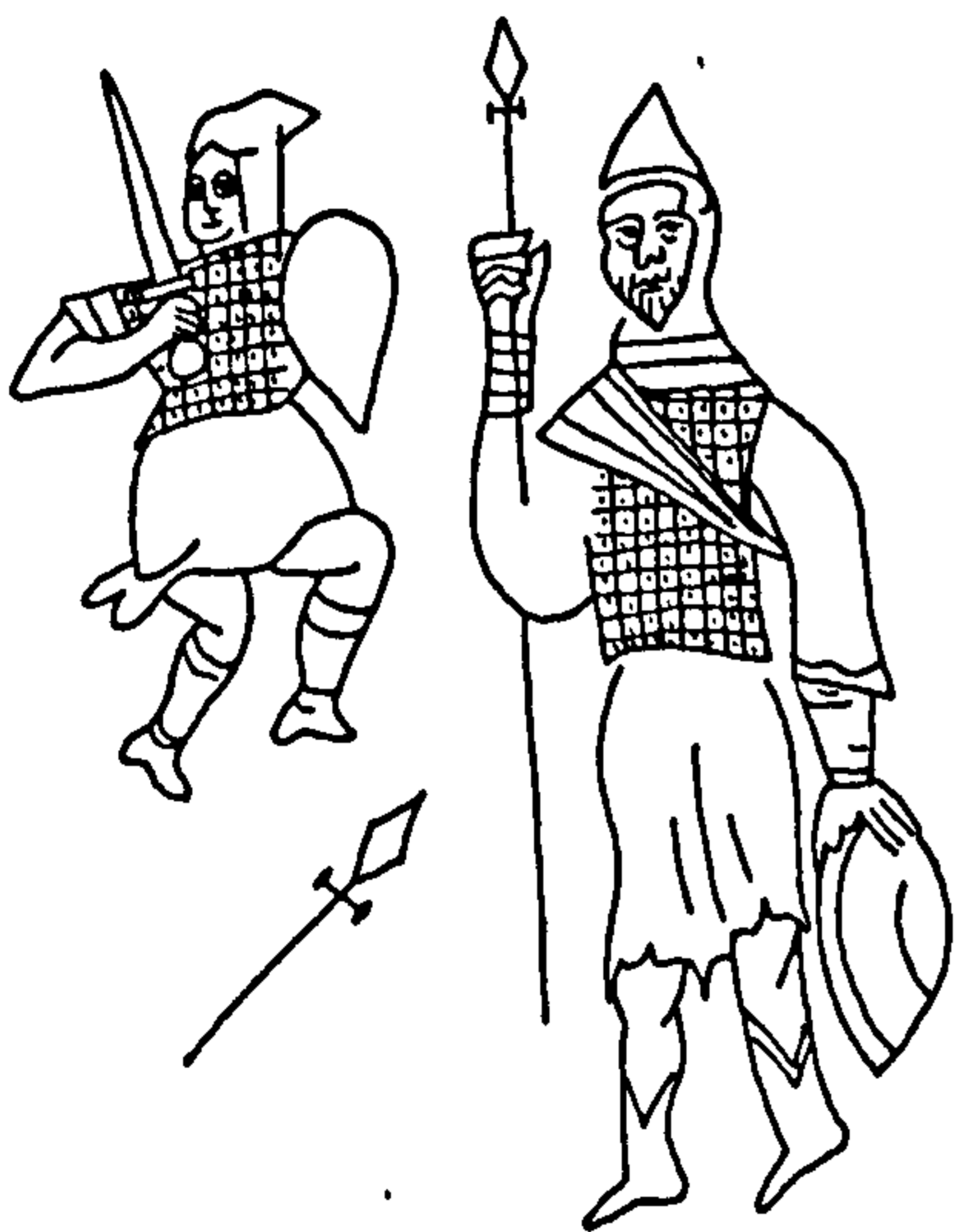

568

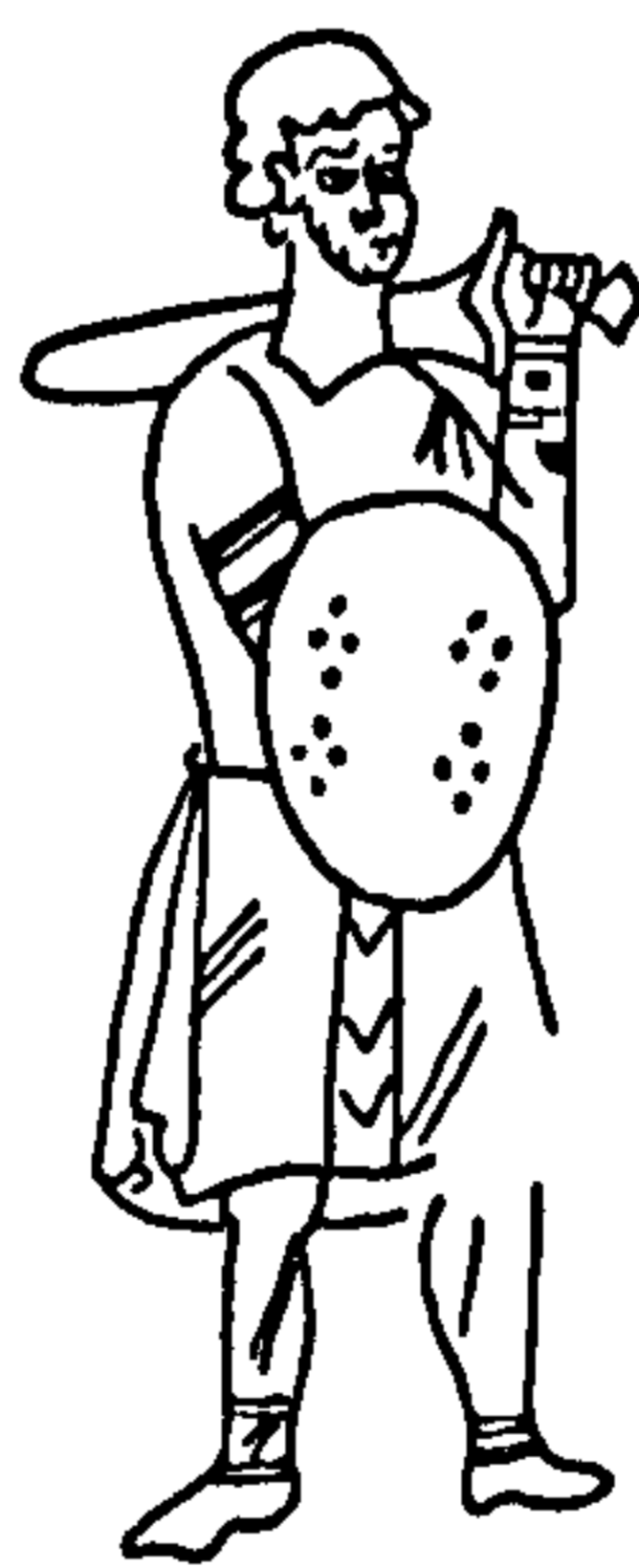

569

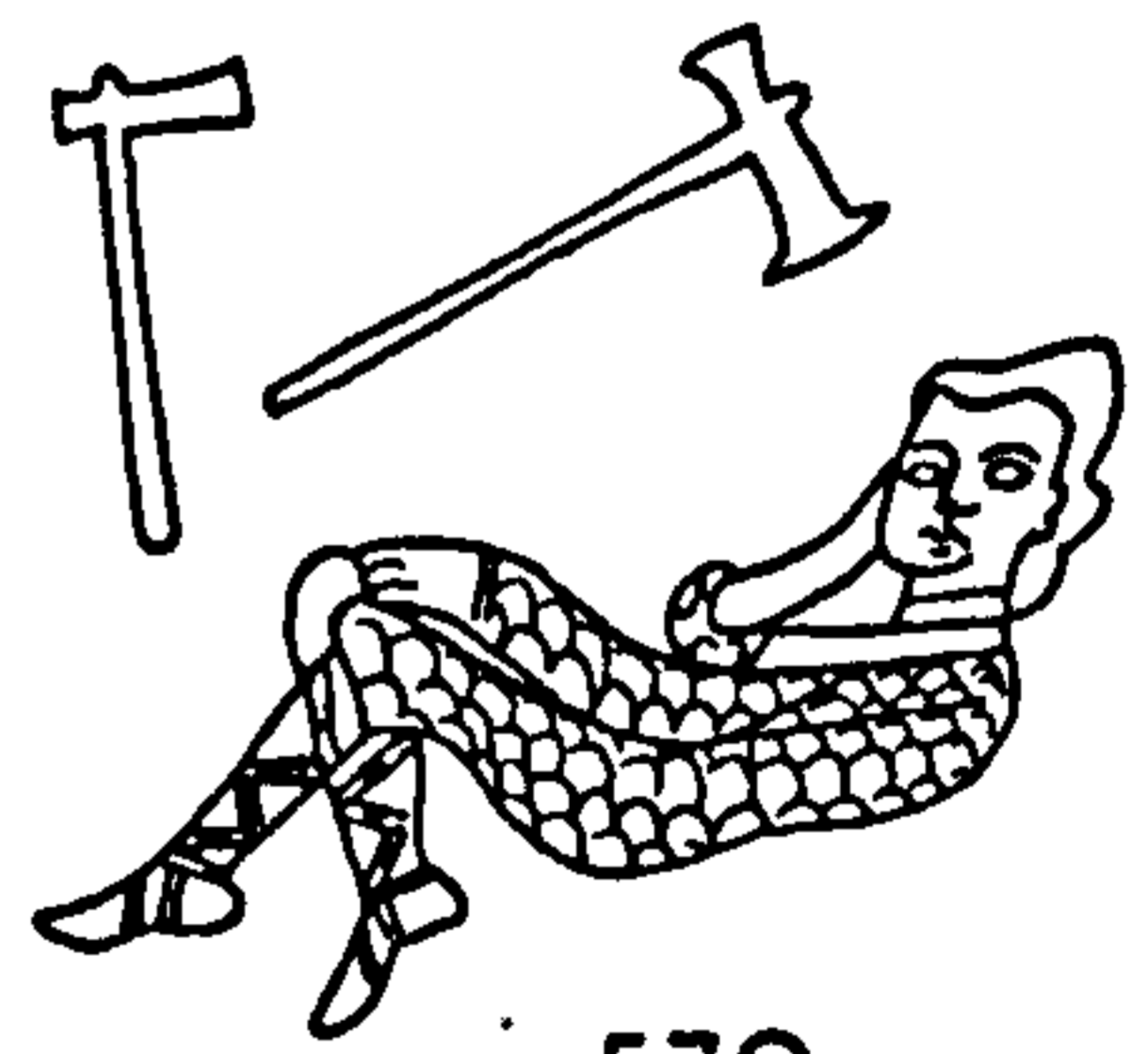

570



571

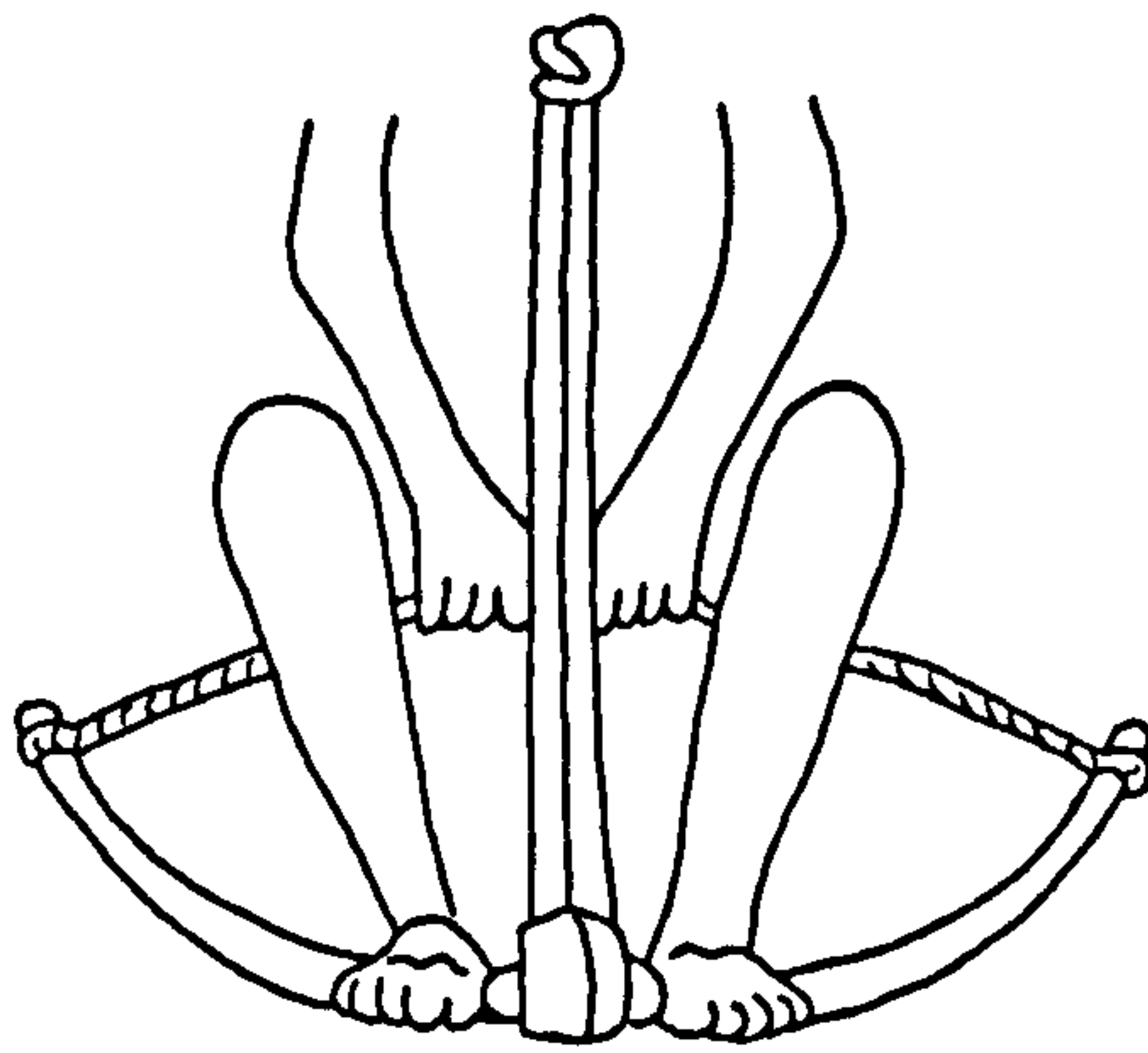

572

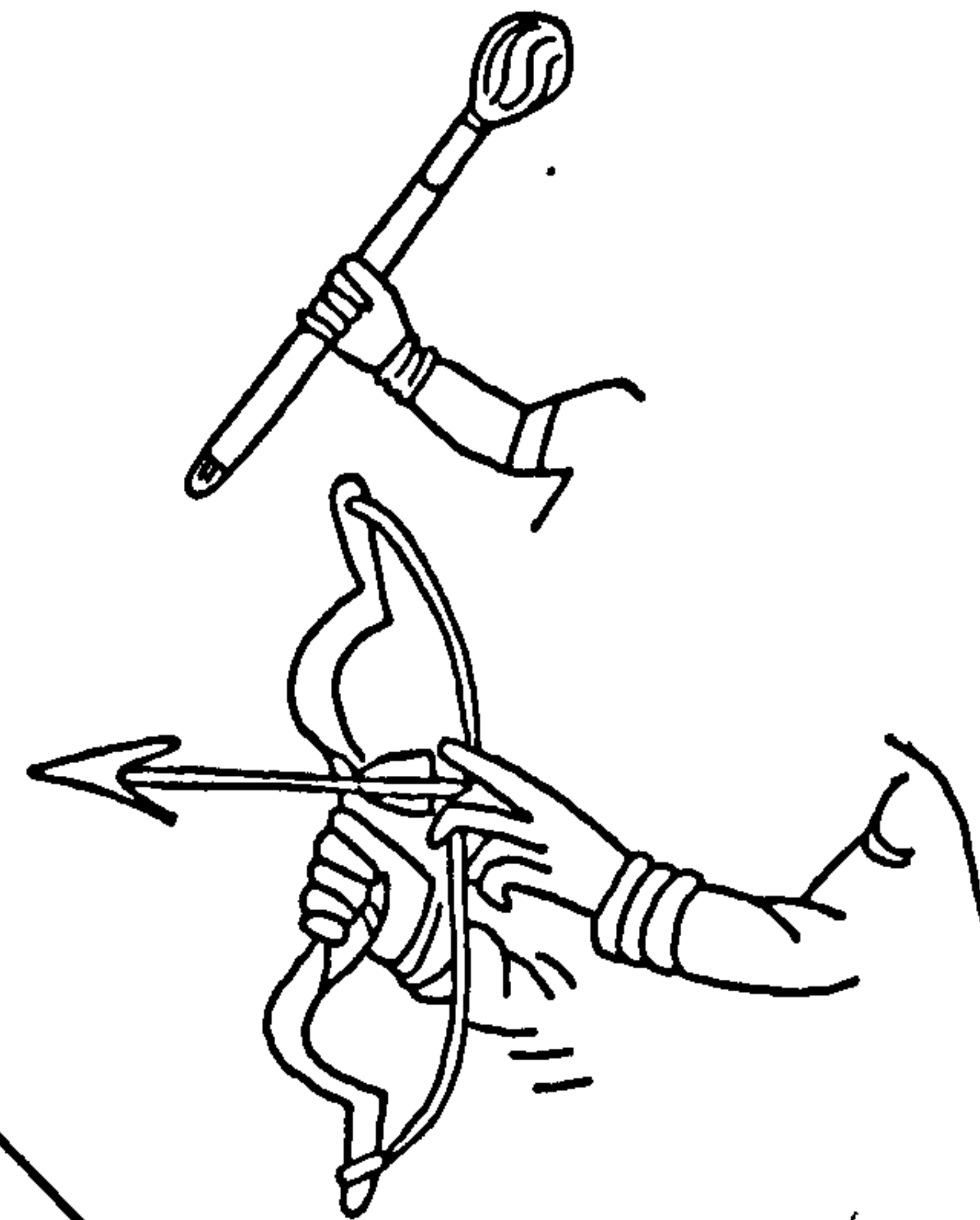

573



574

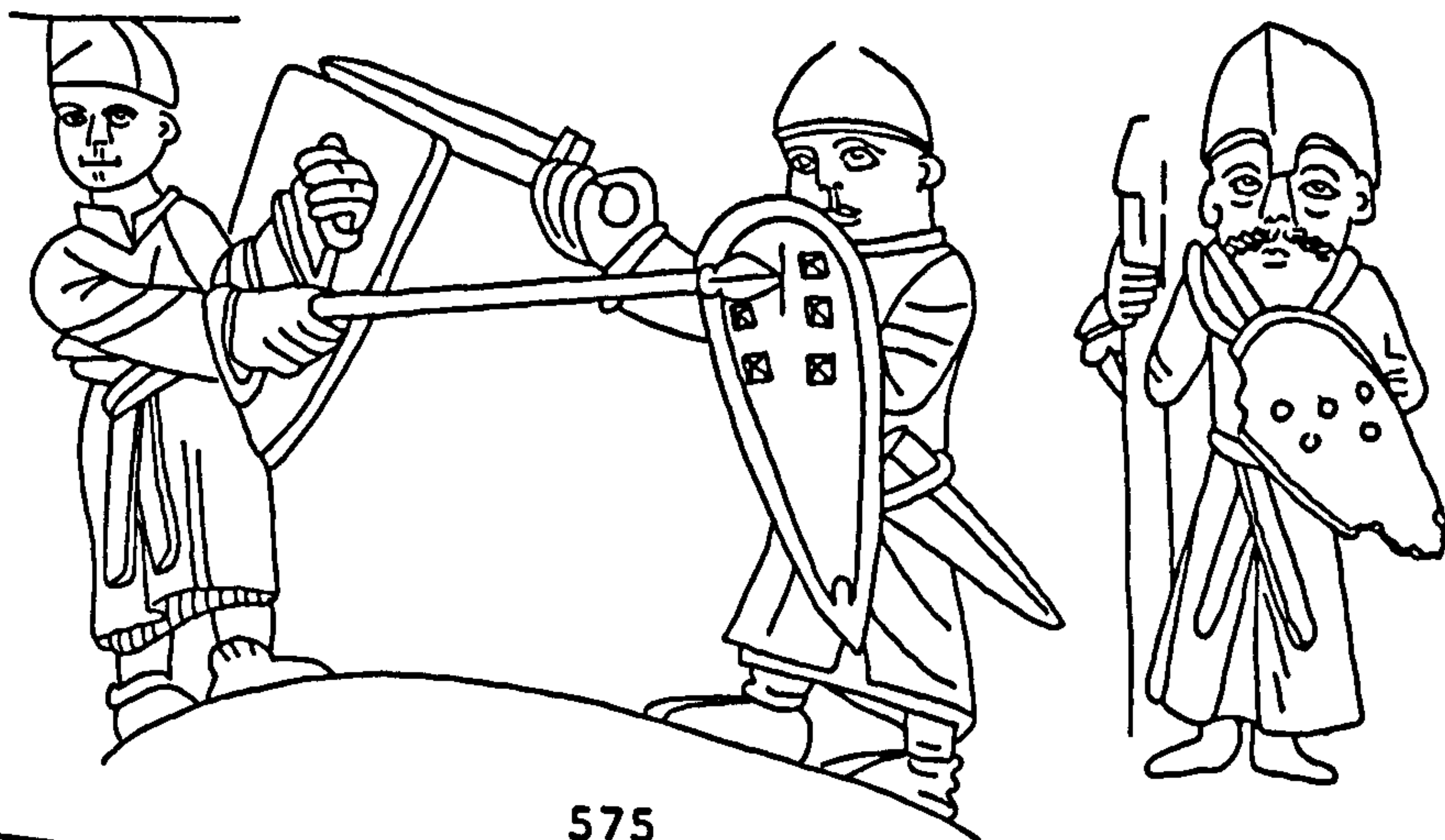

575



576



577A

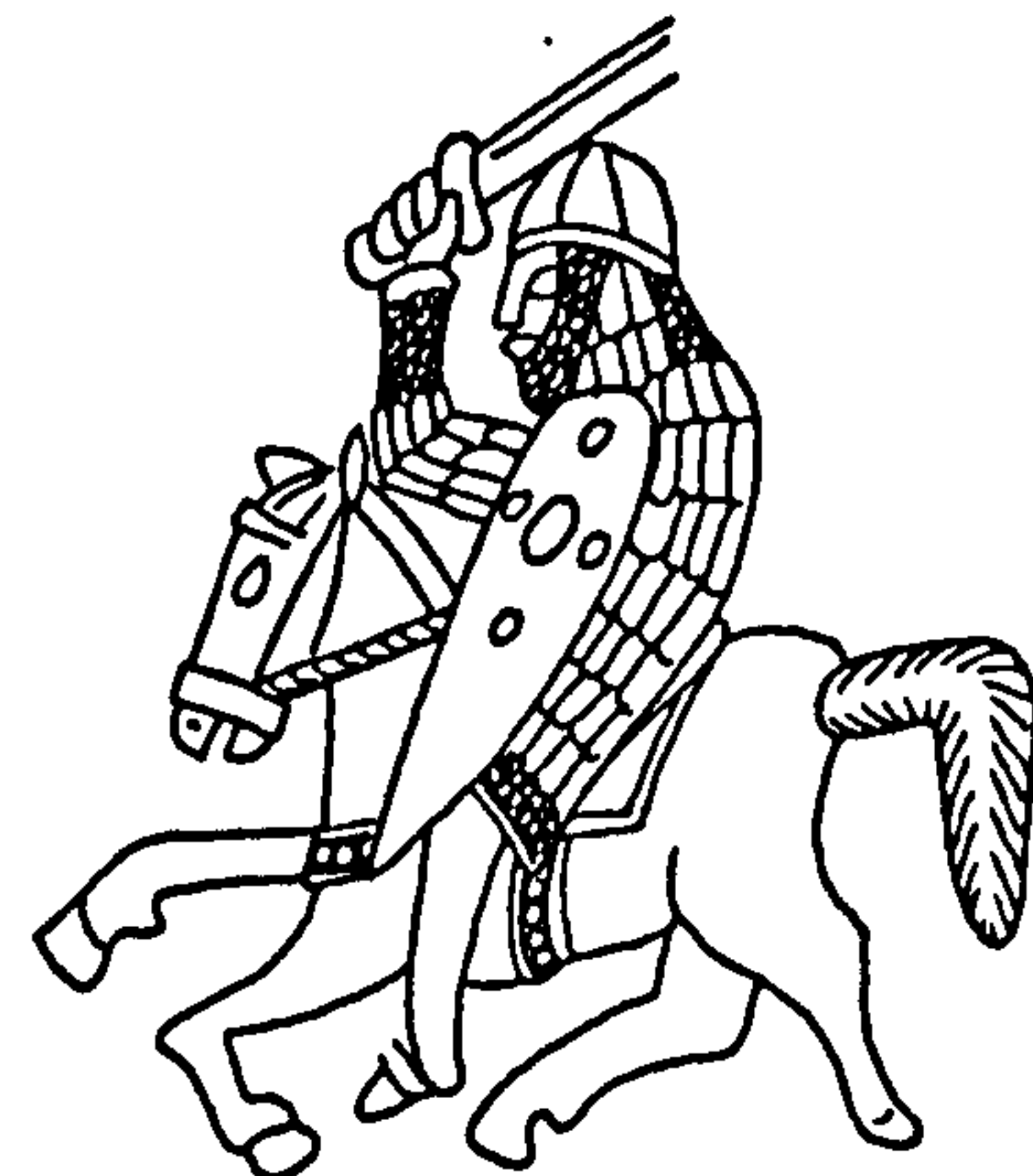

577A



578

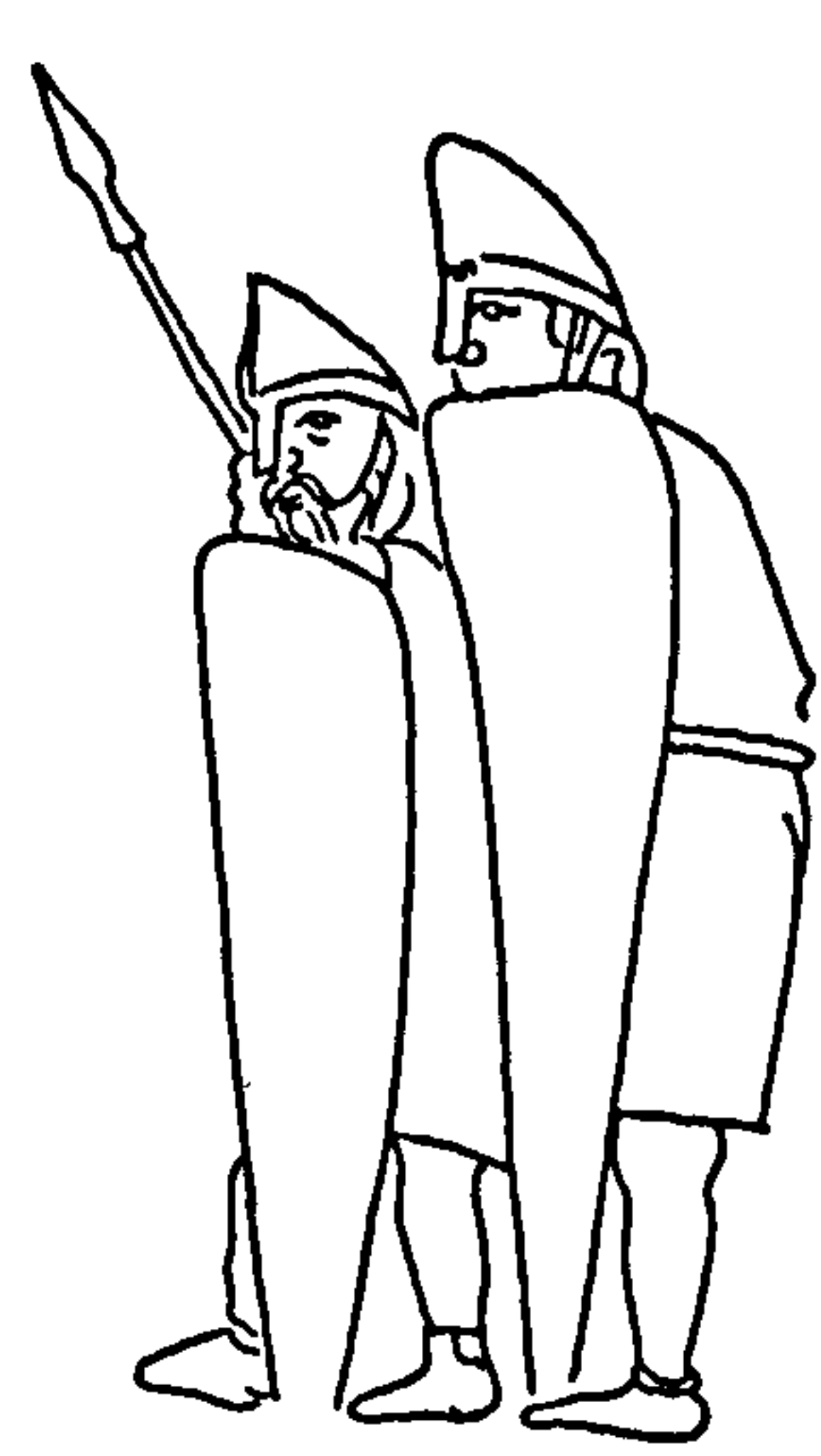

579

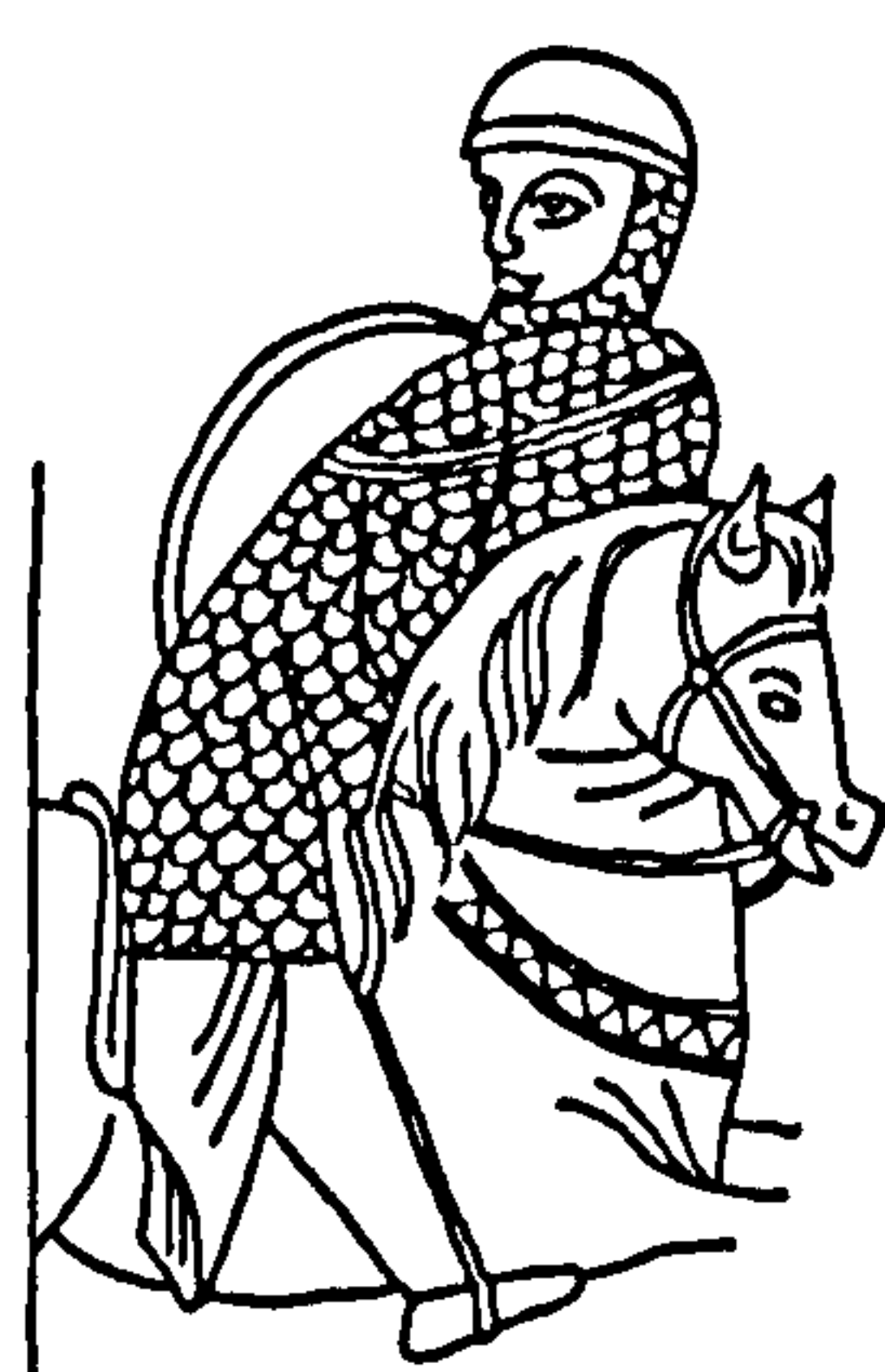
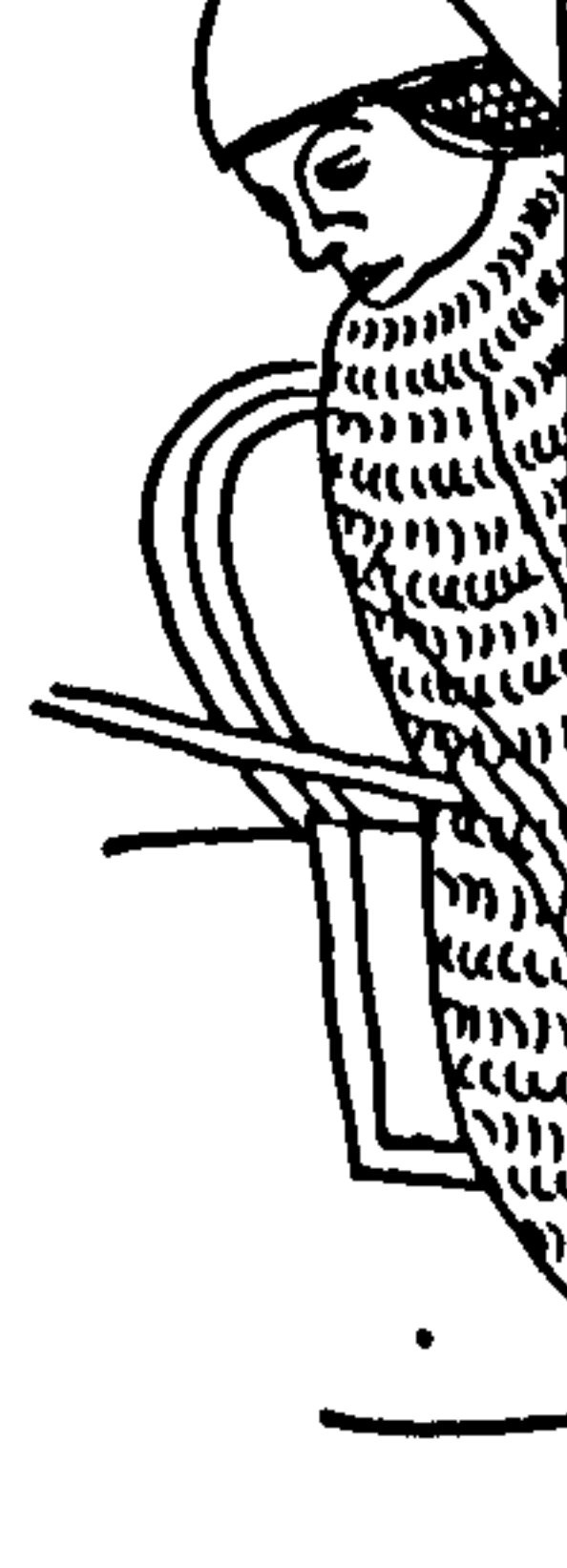

580A

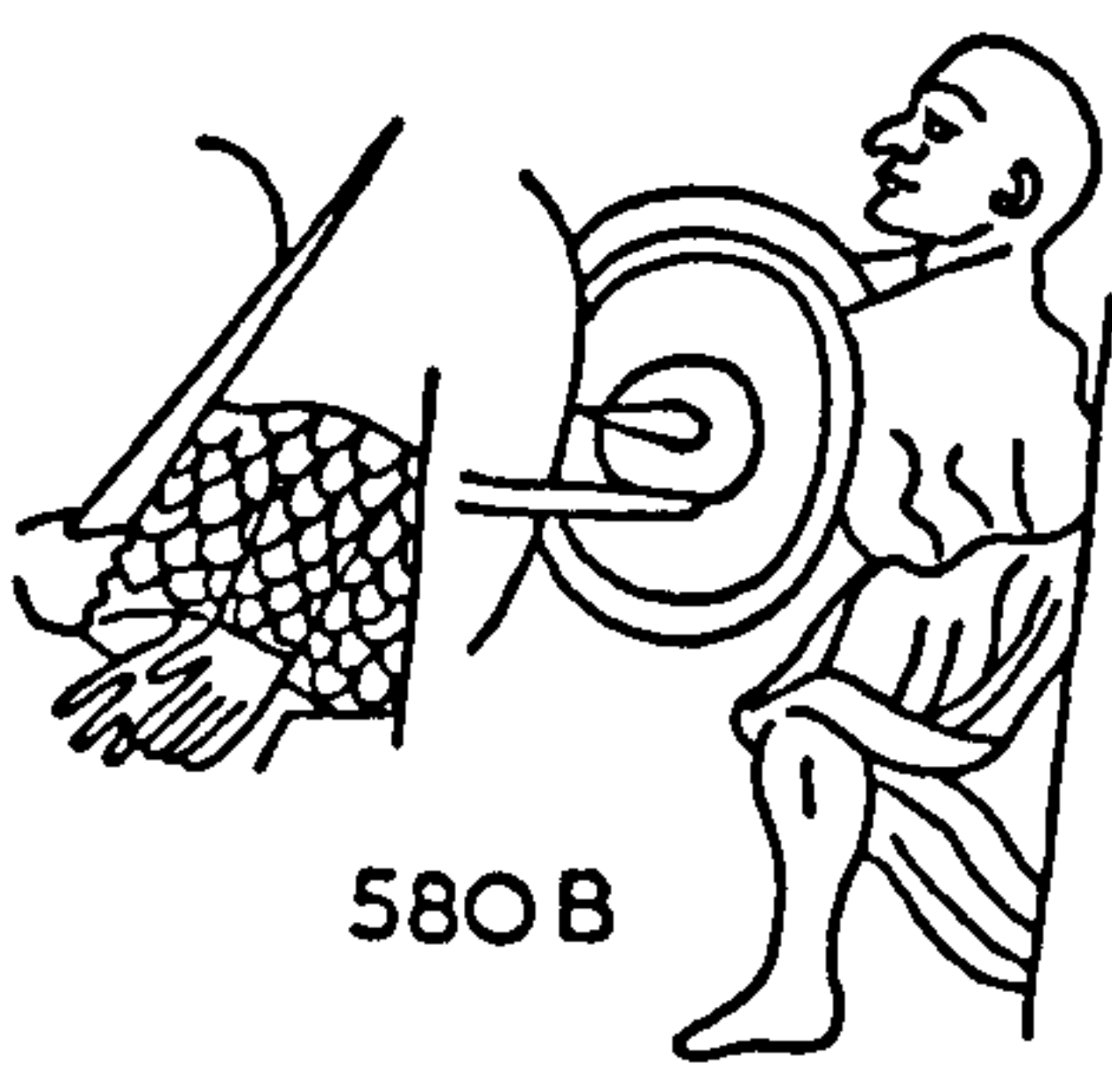

580B



580C

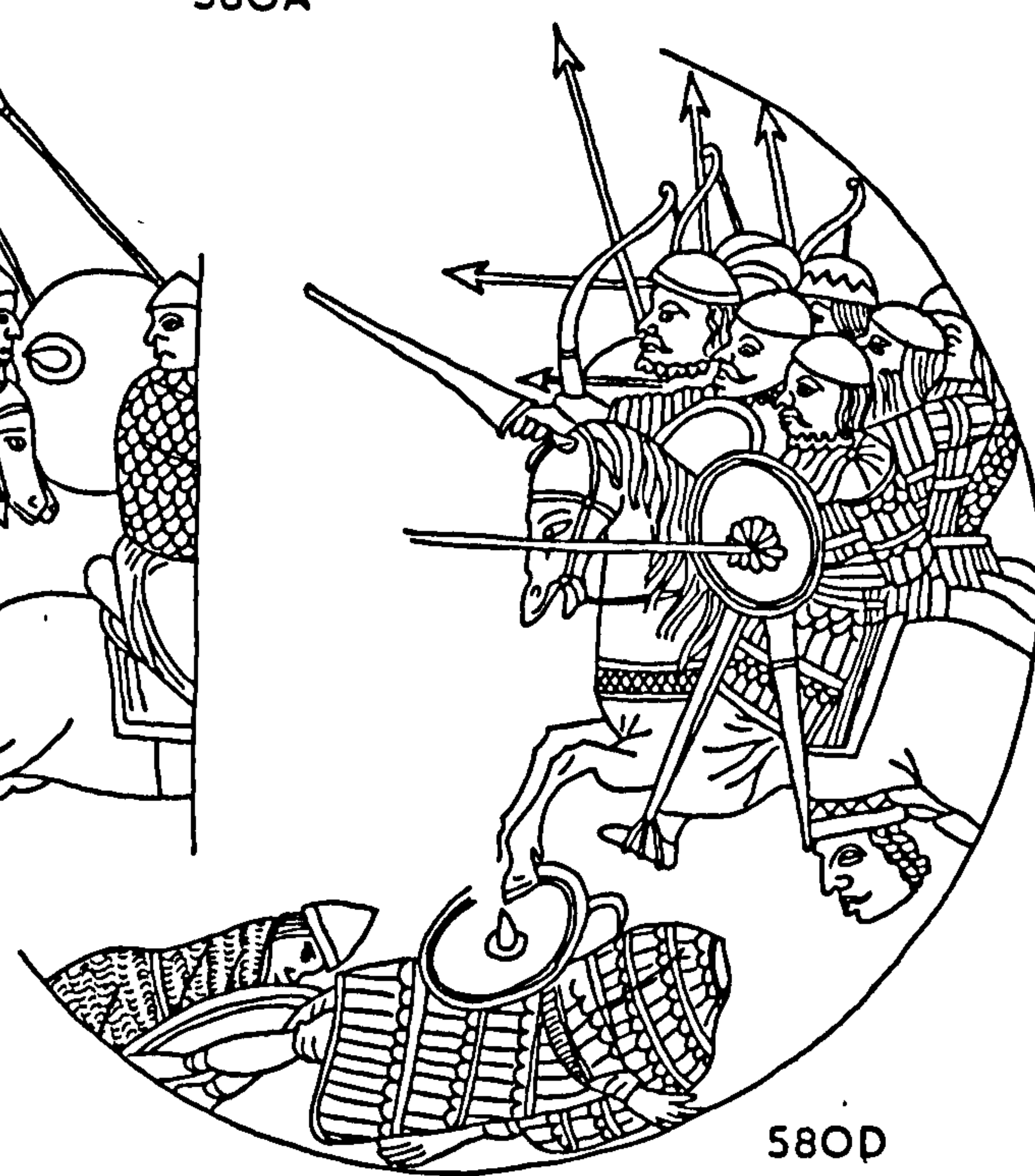

580D



580E

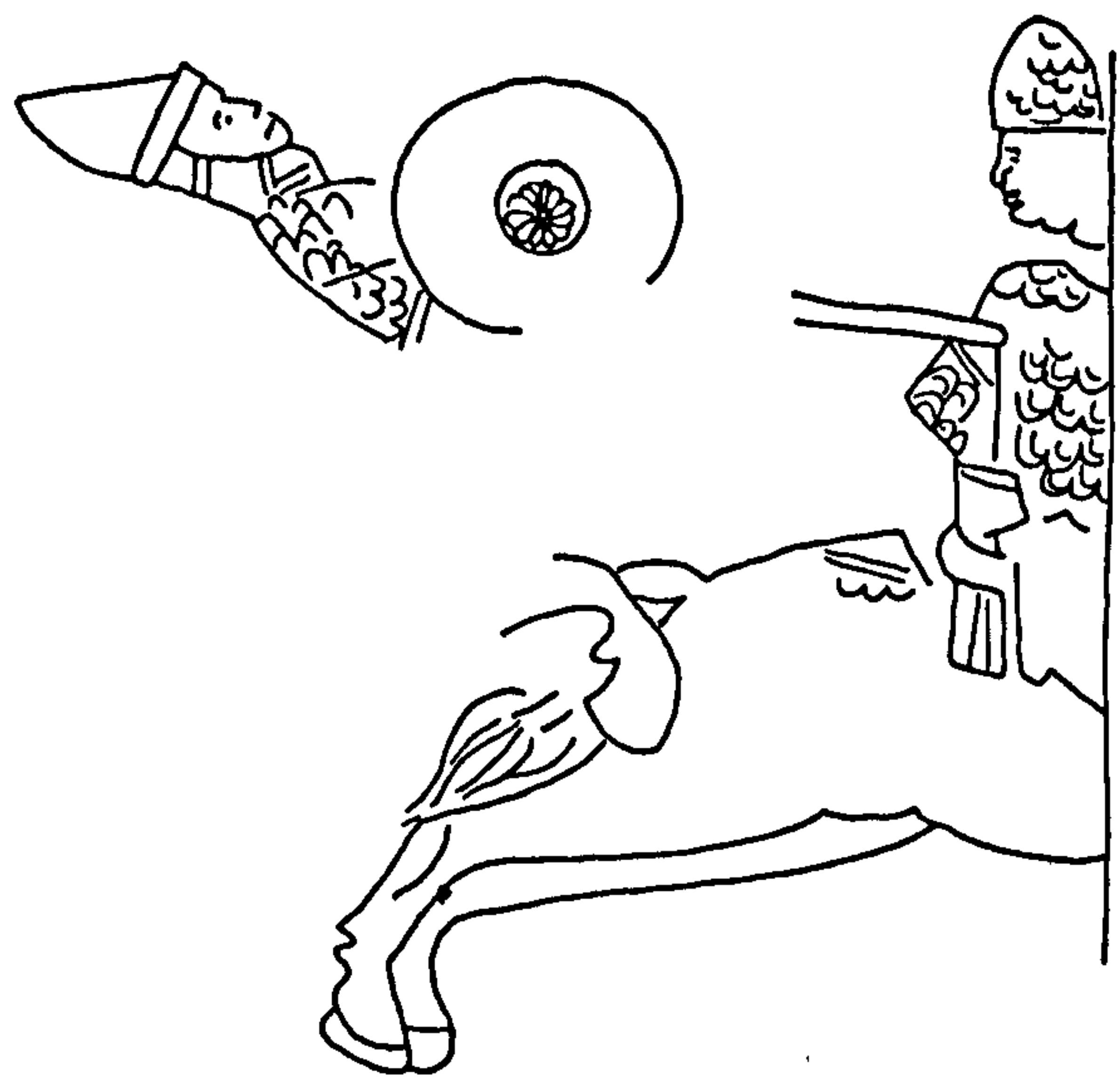
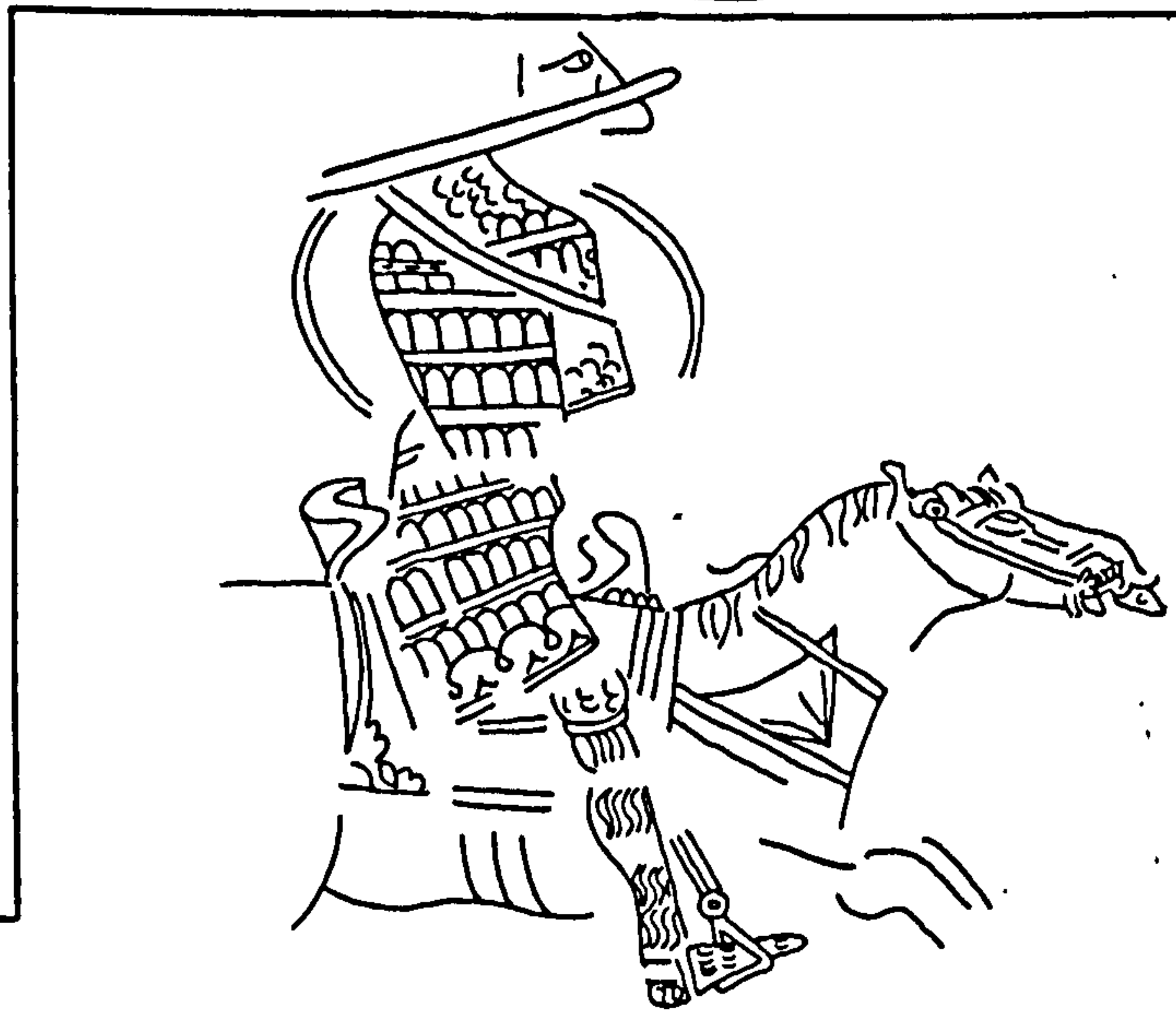

581



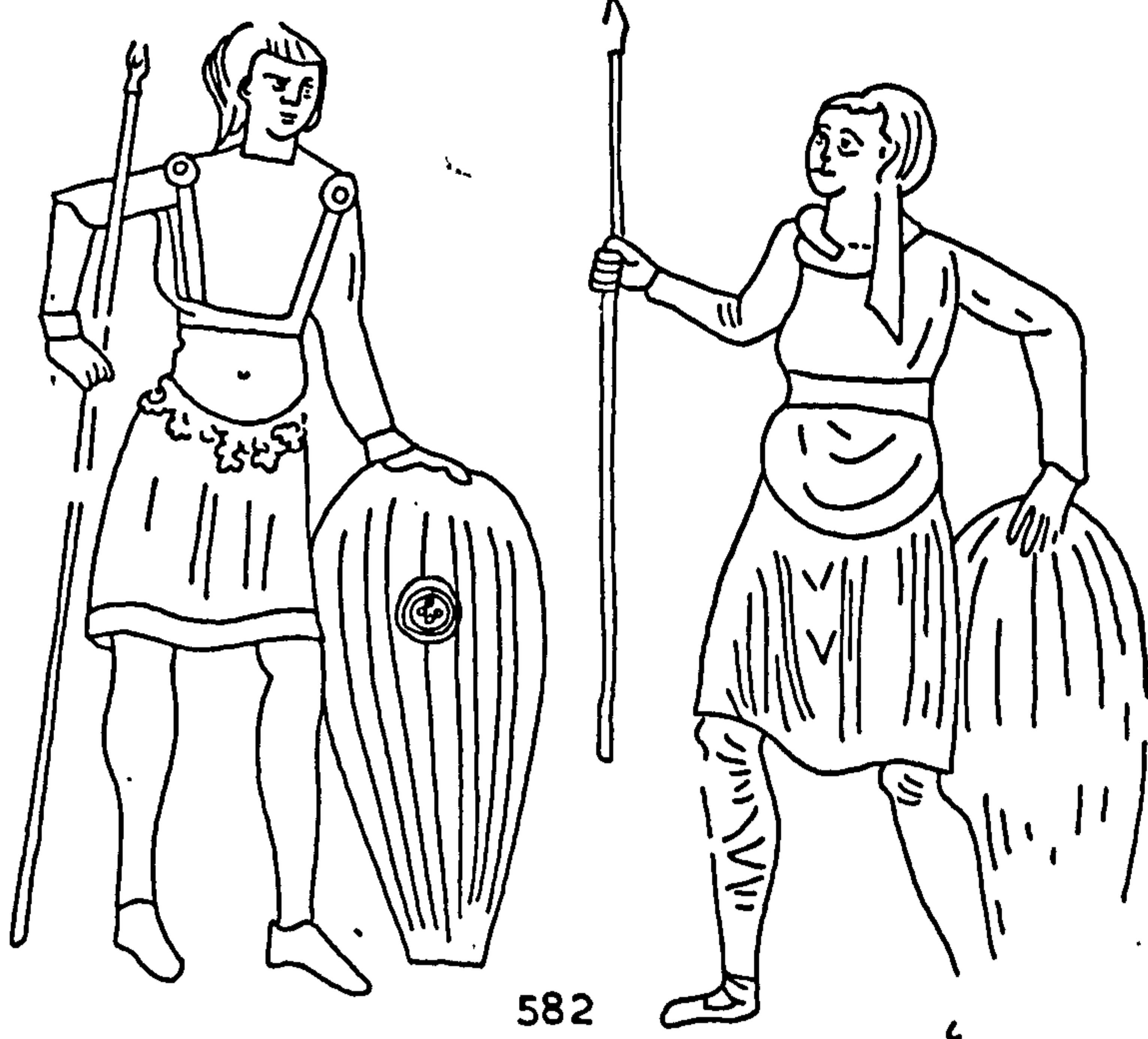

582

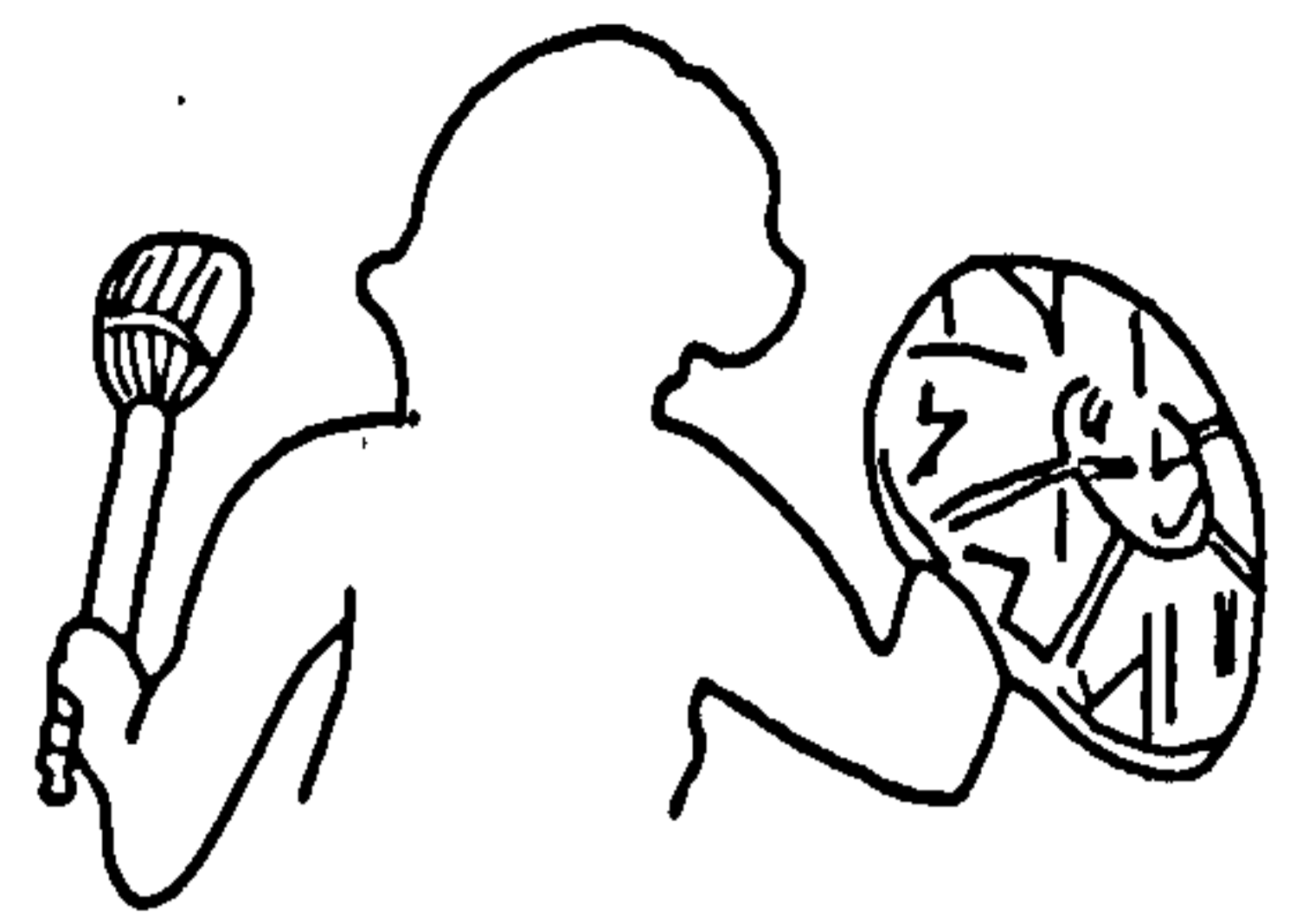

583

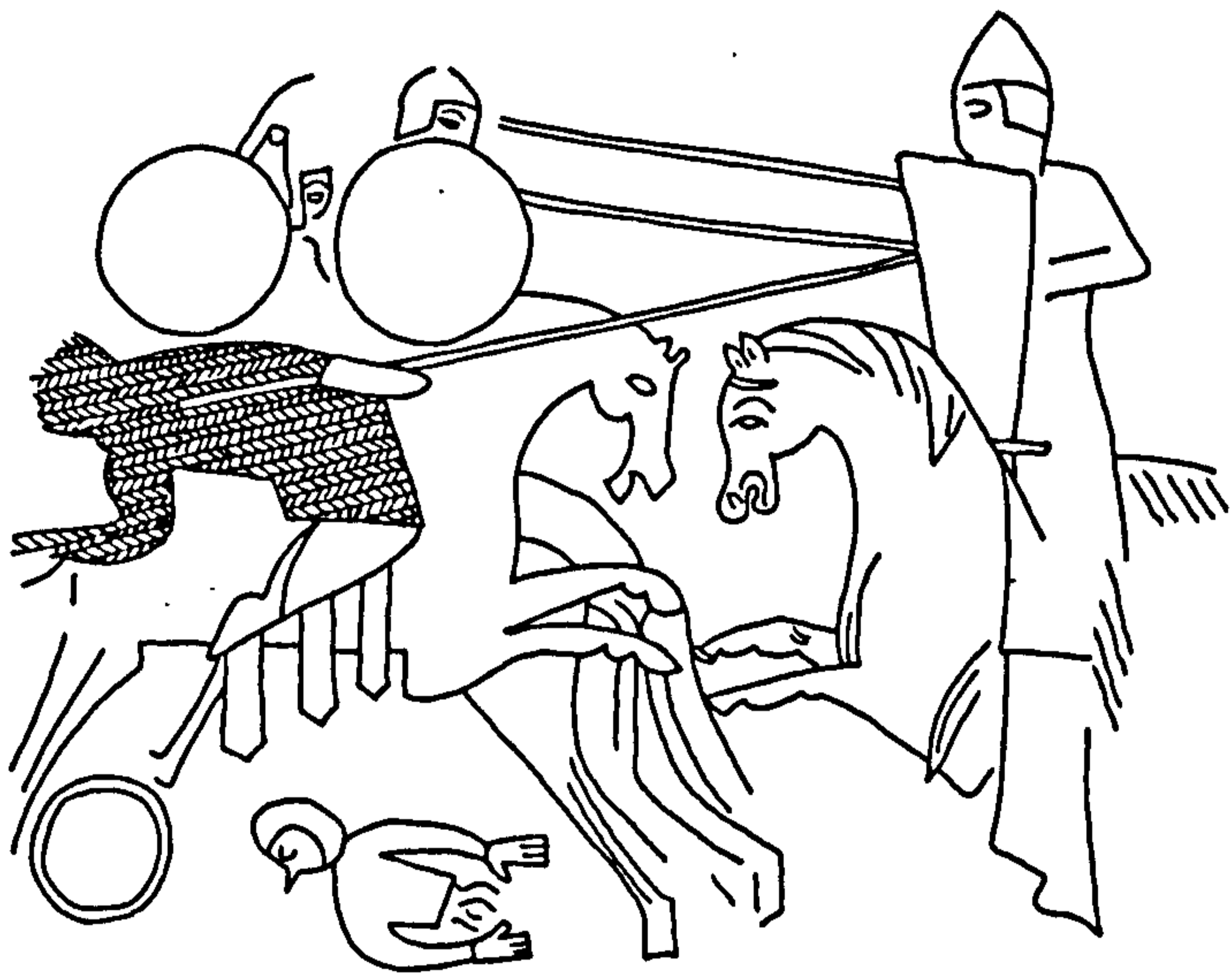

584

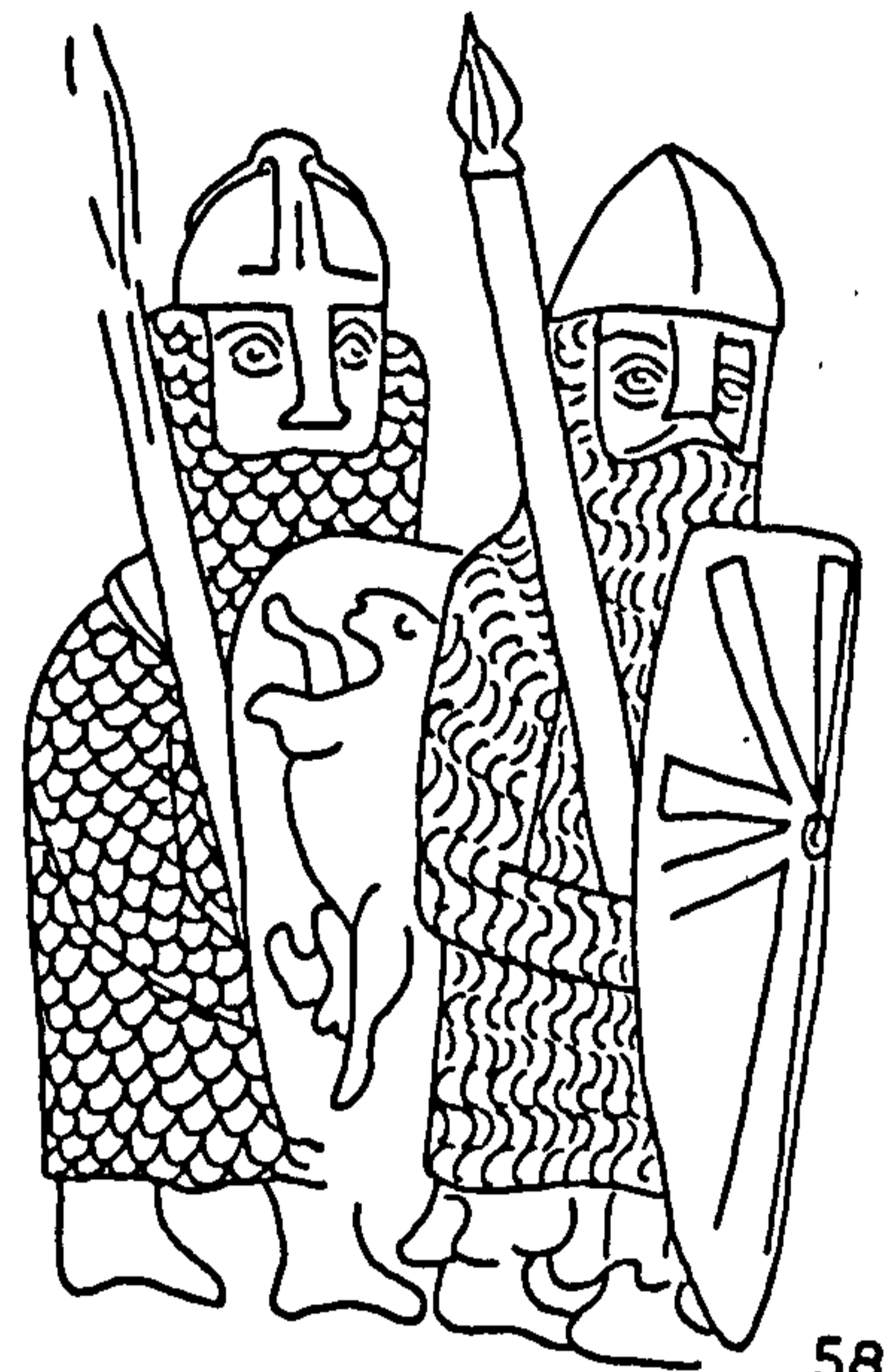

585

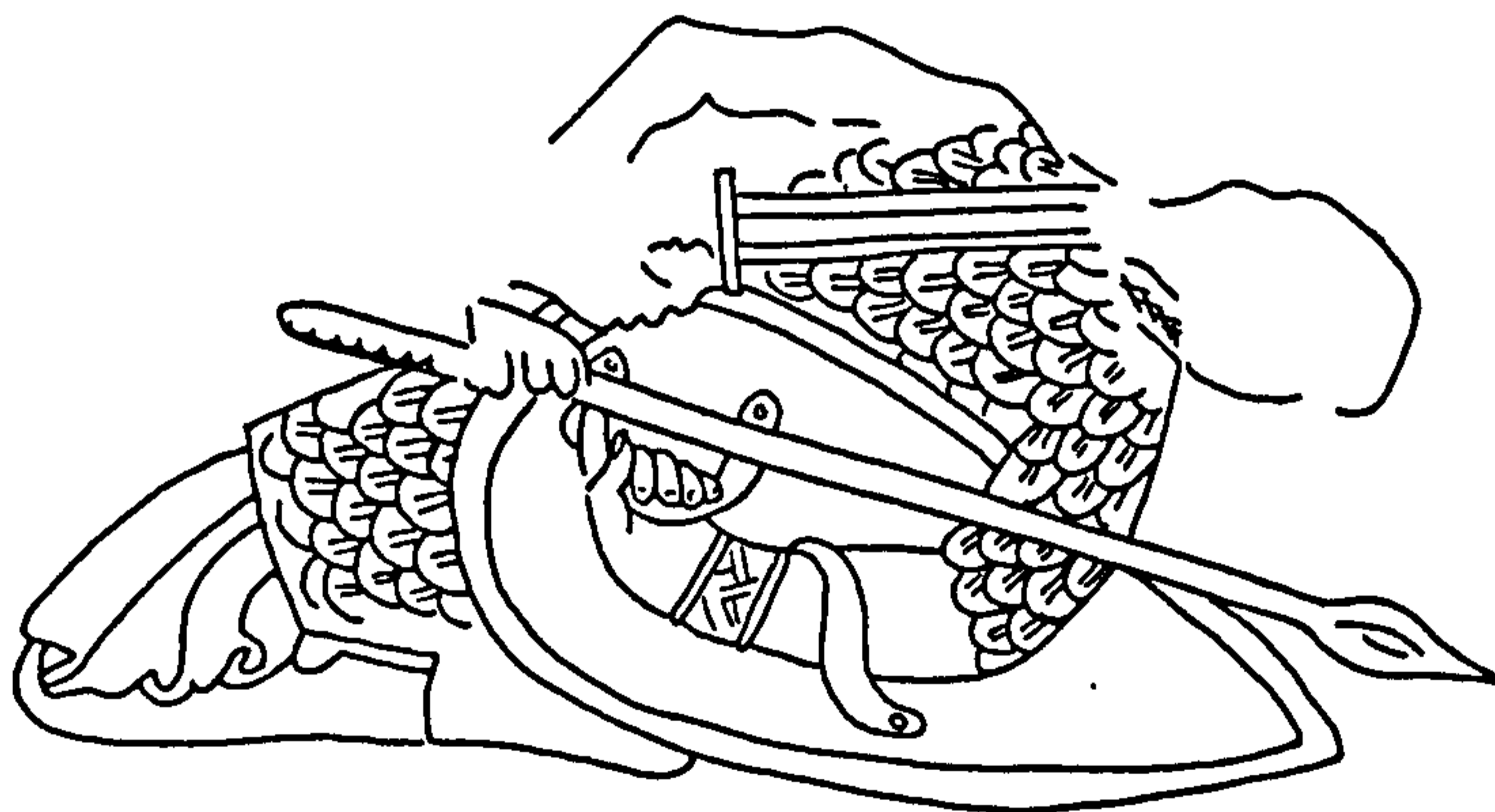

586



587

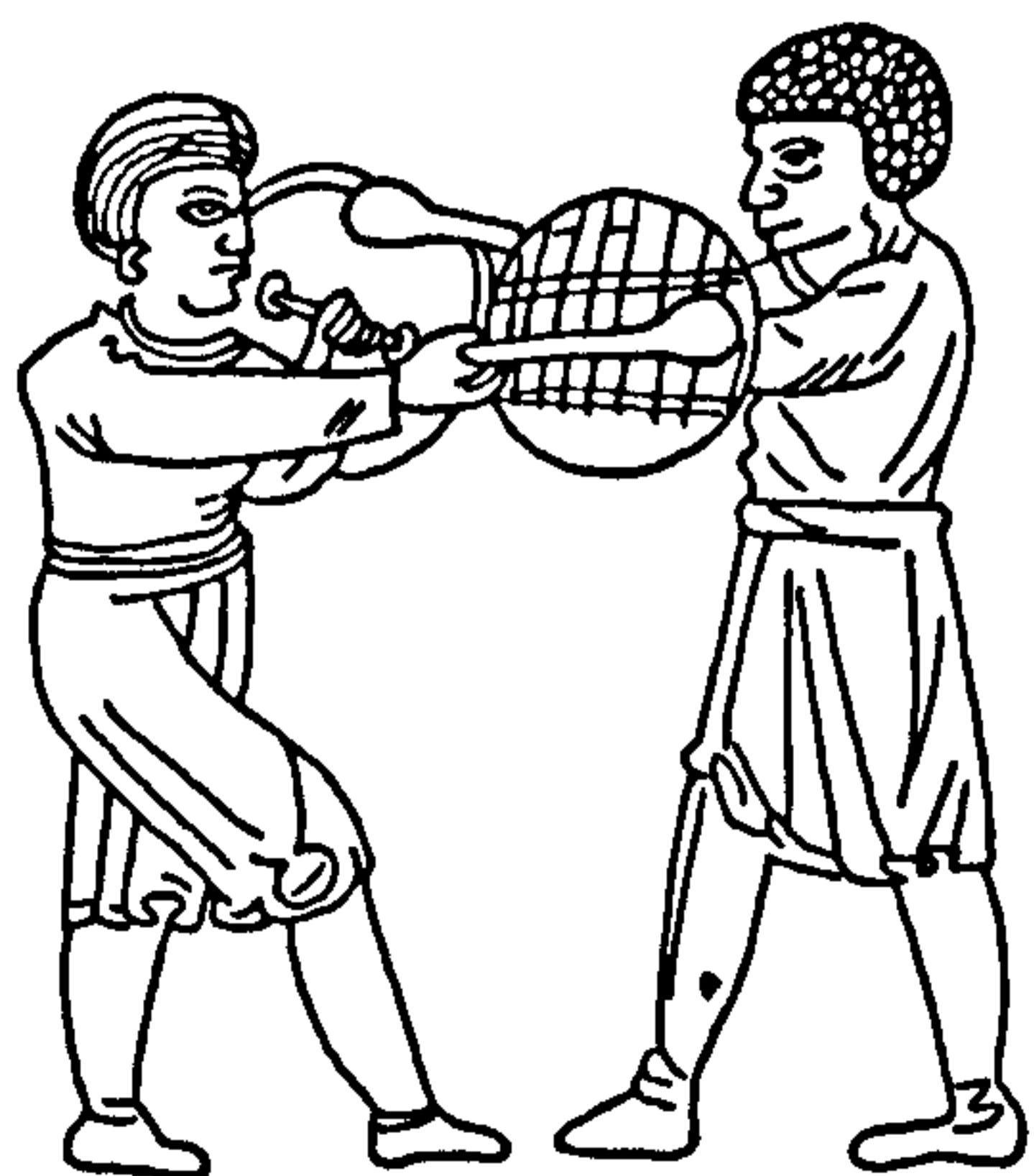

588

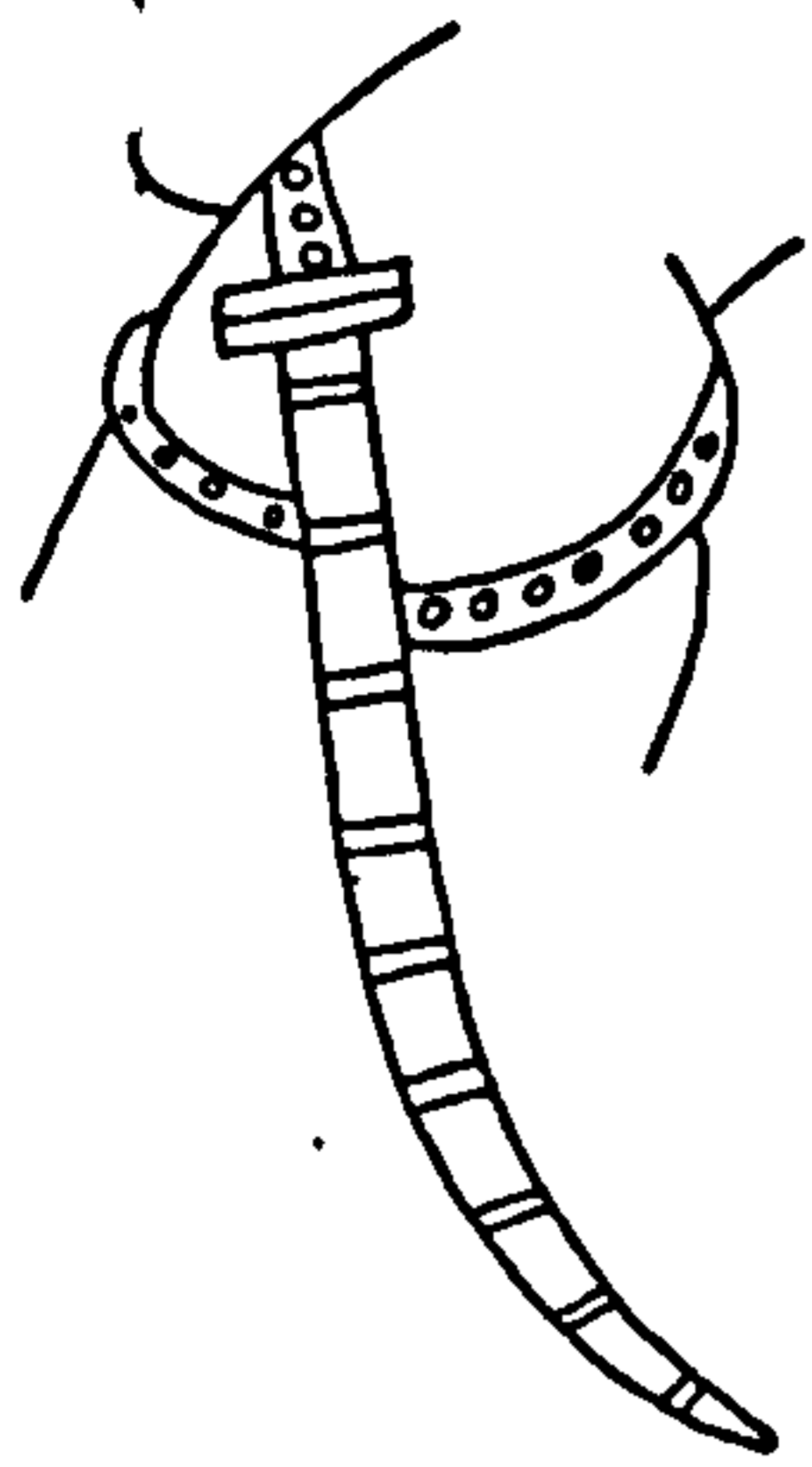

589

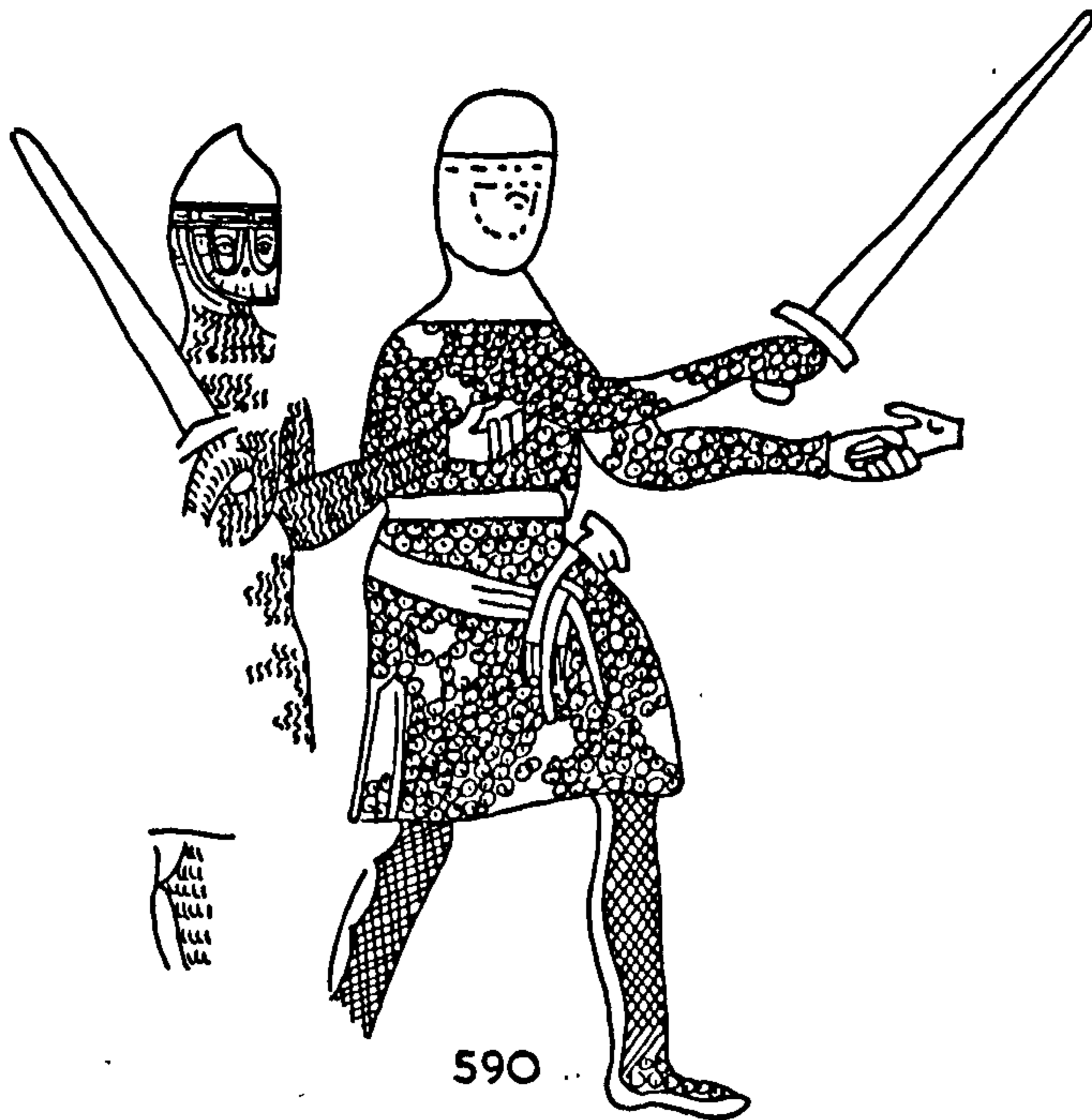

590



591

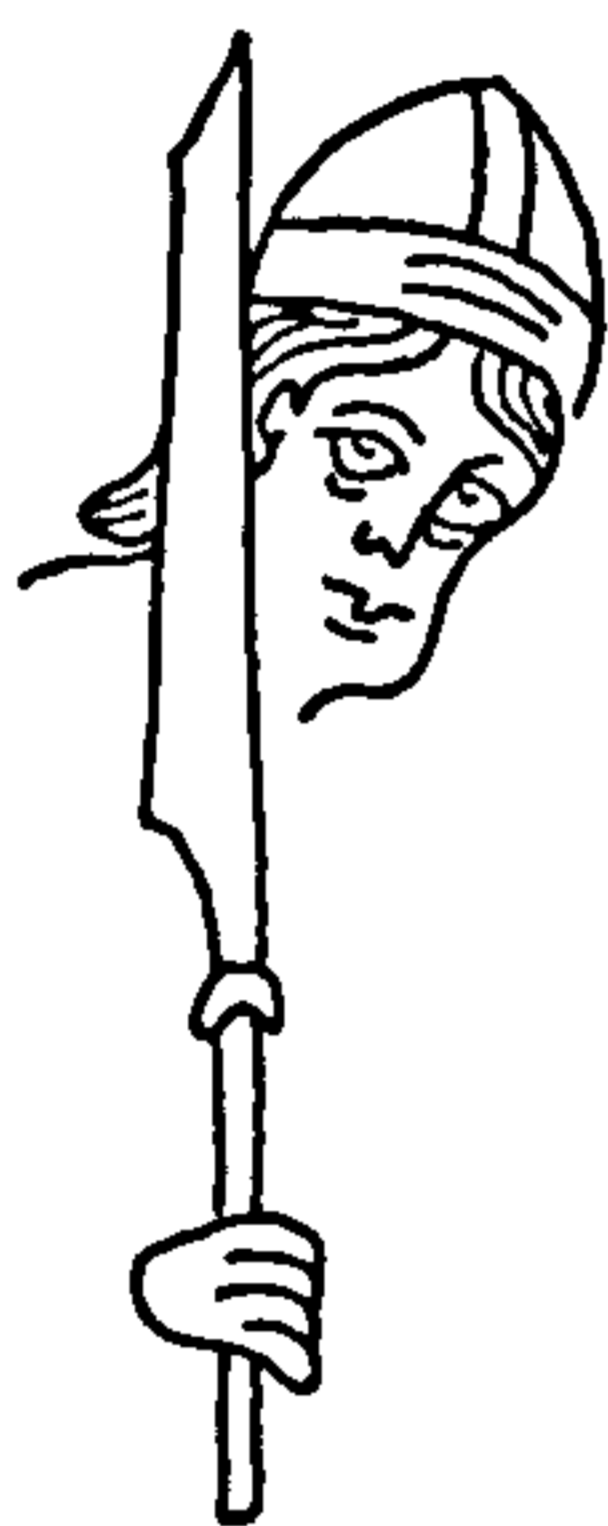

592

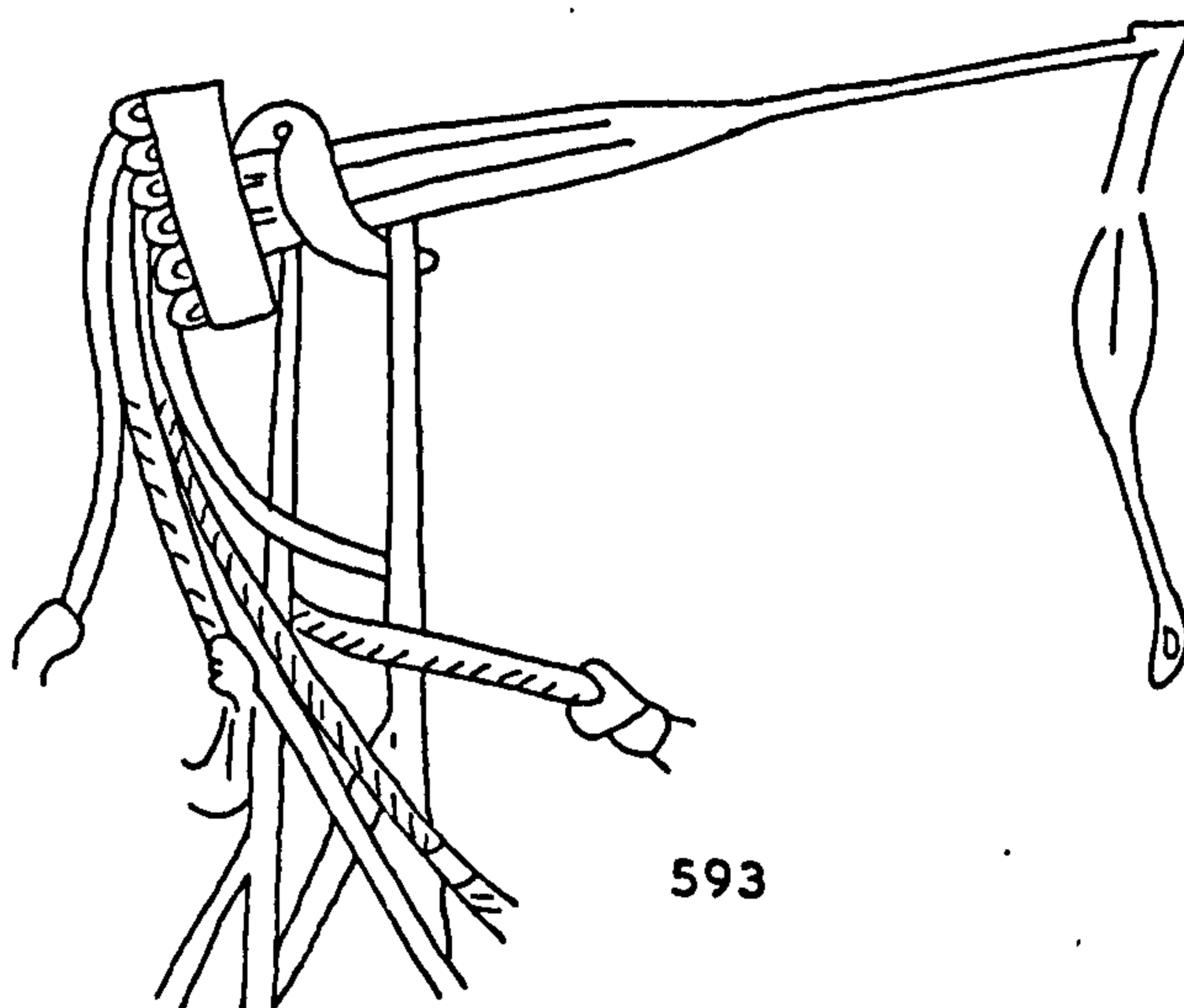

593

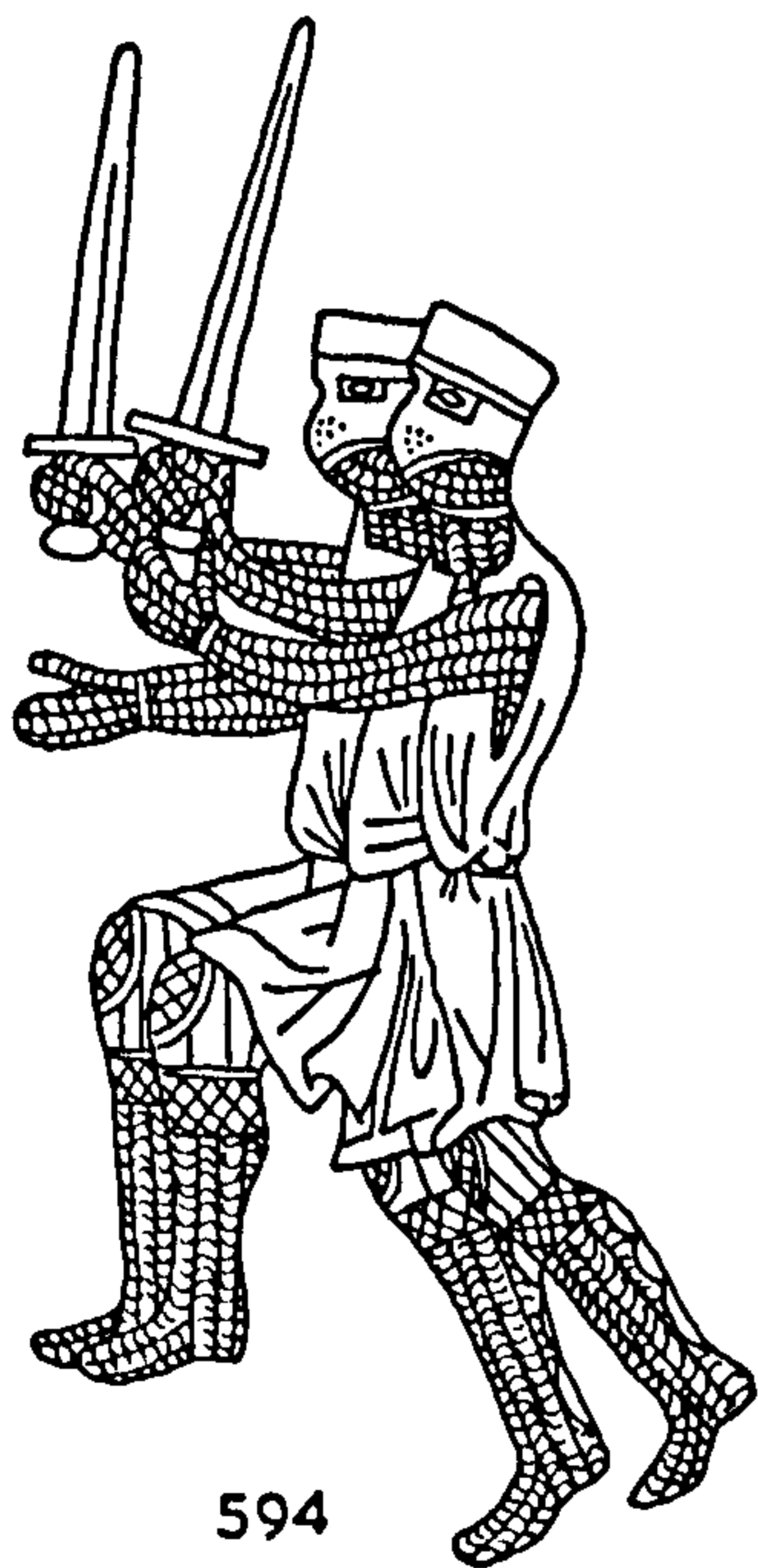

594



595

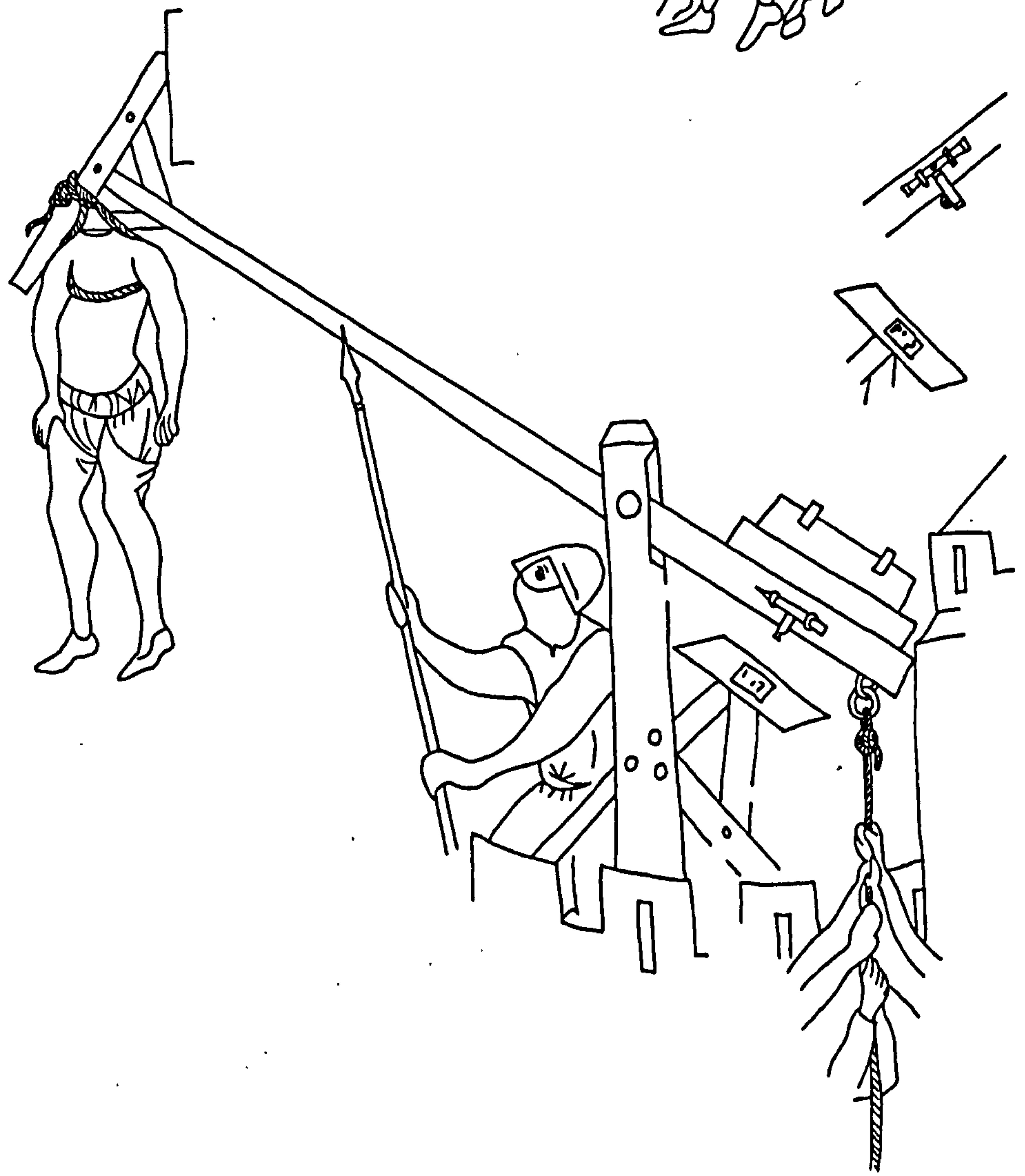

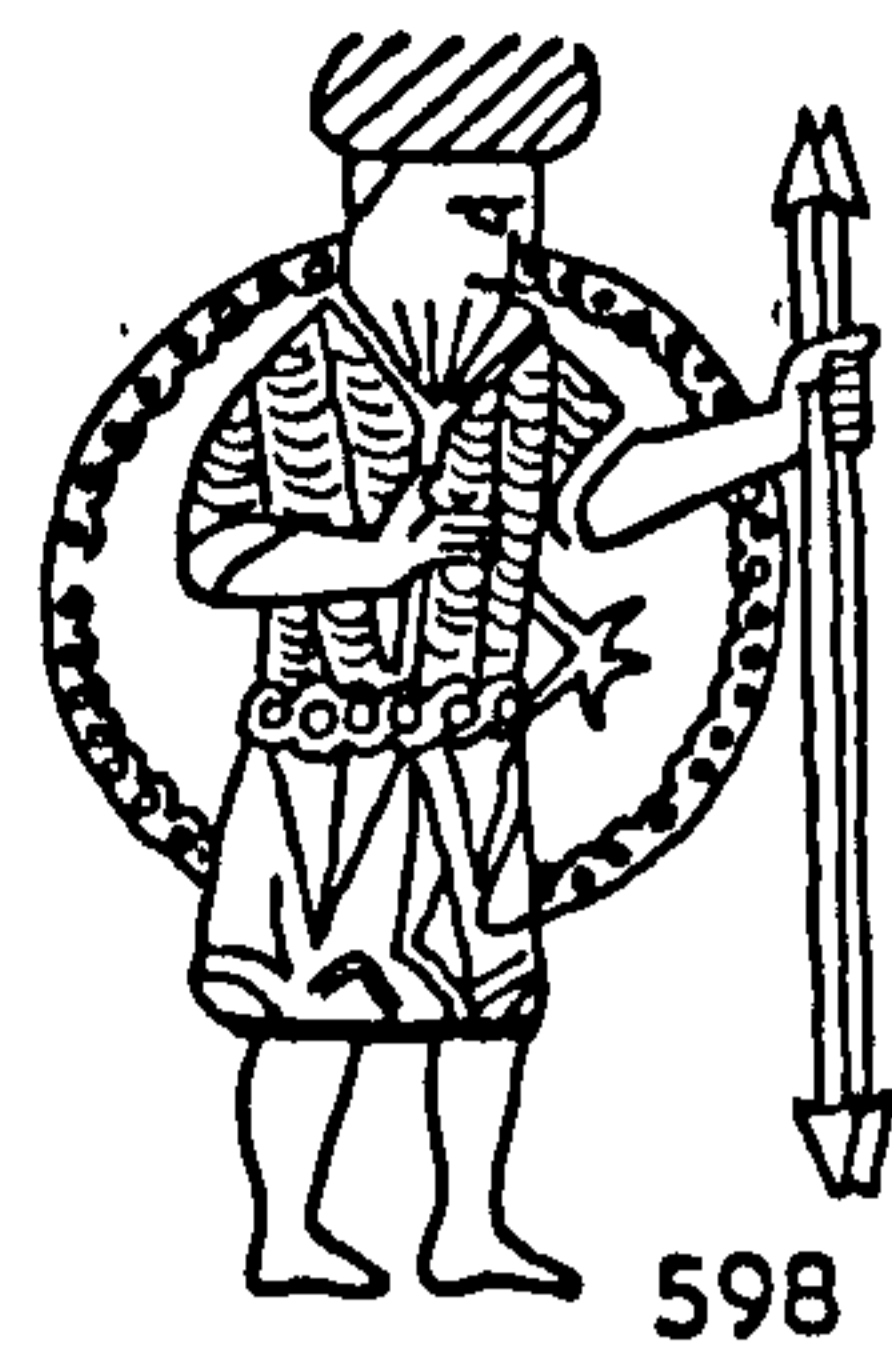
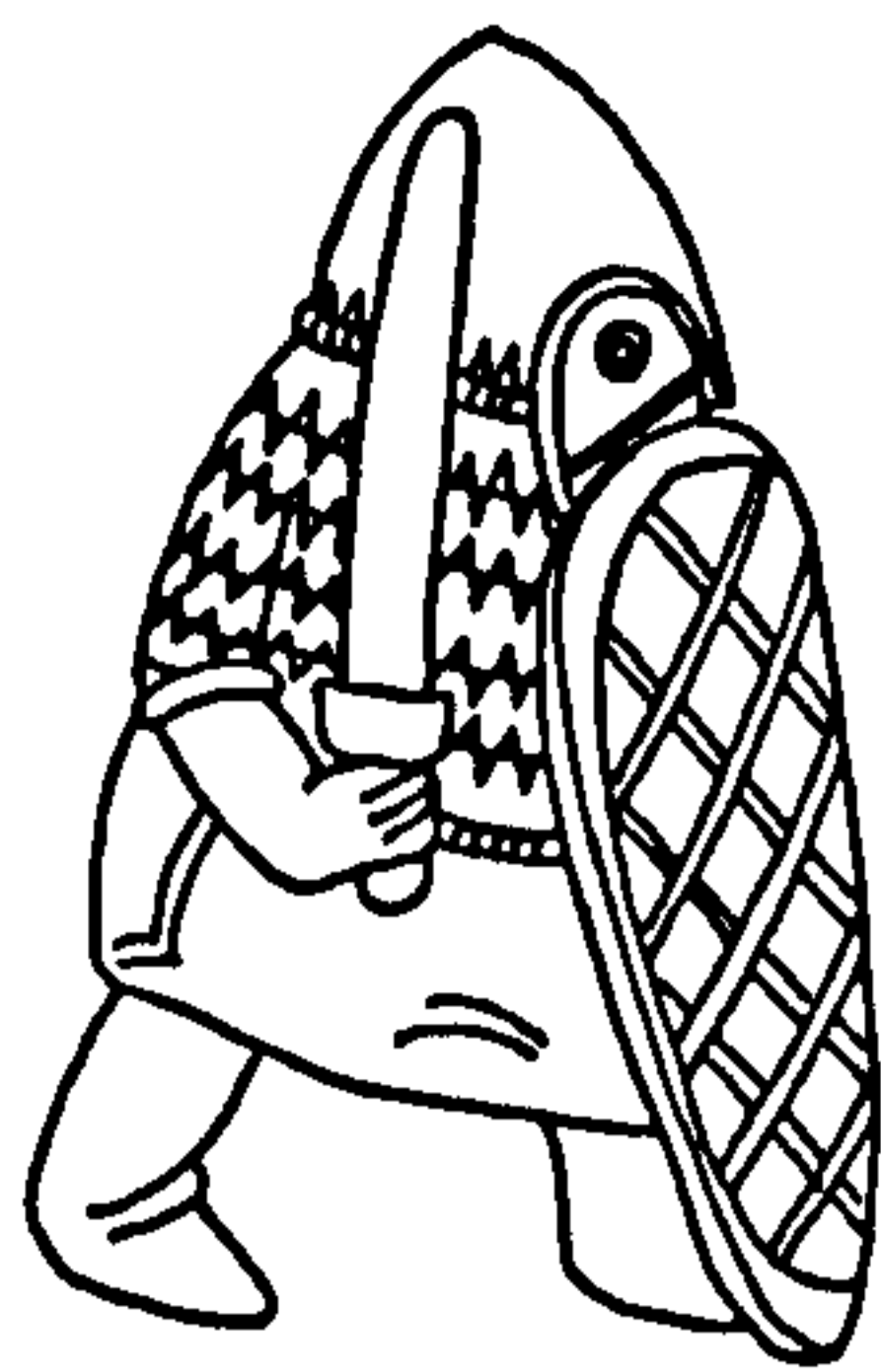
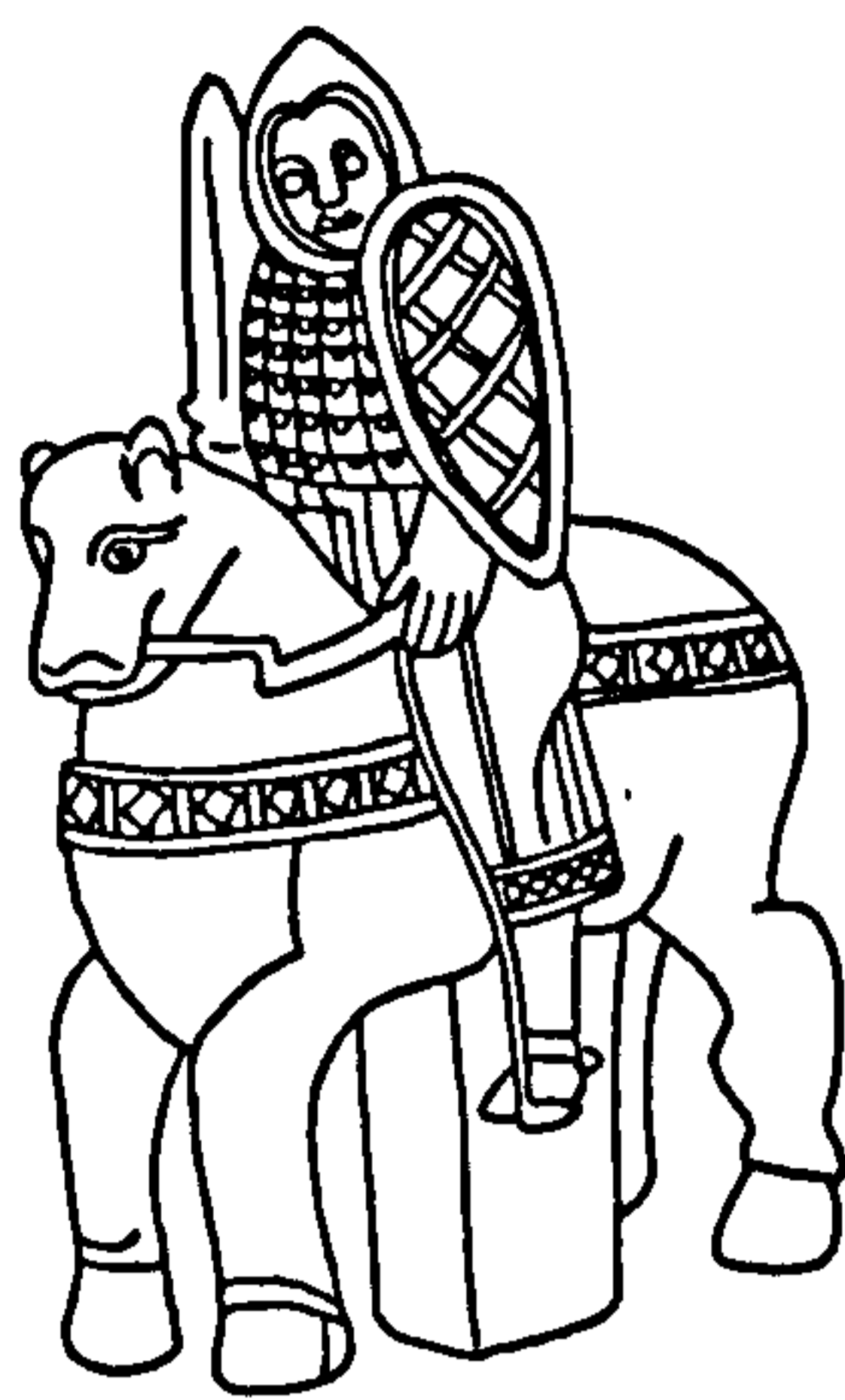
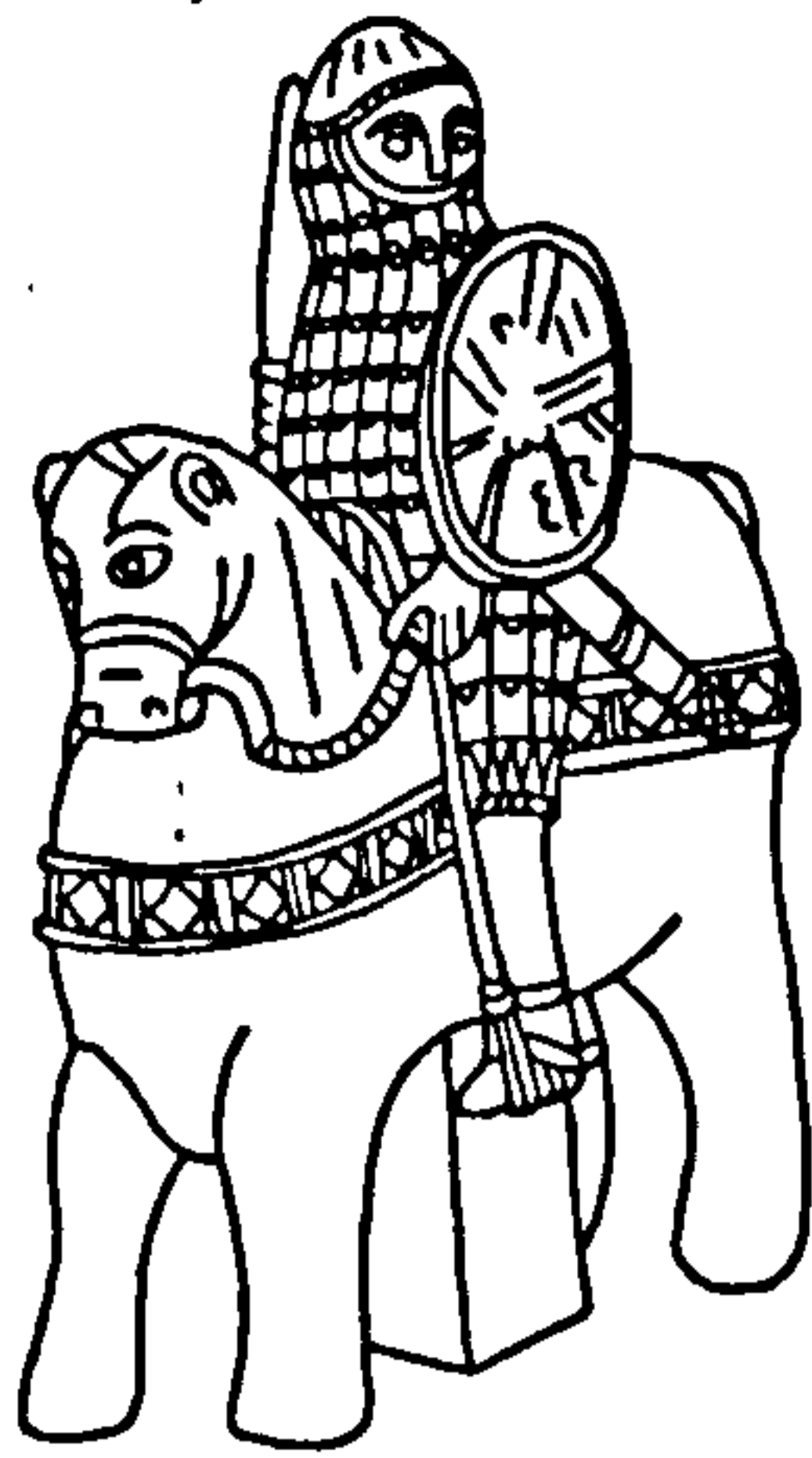

598

597



599



600



601



602



603A

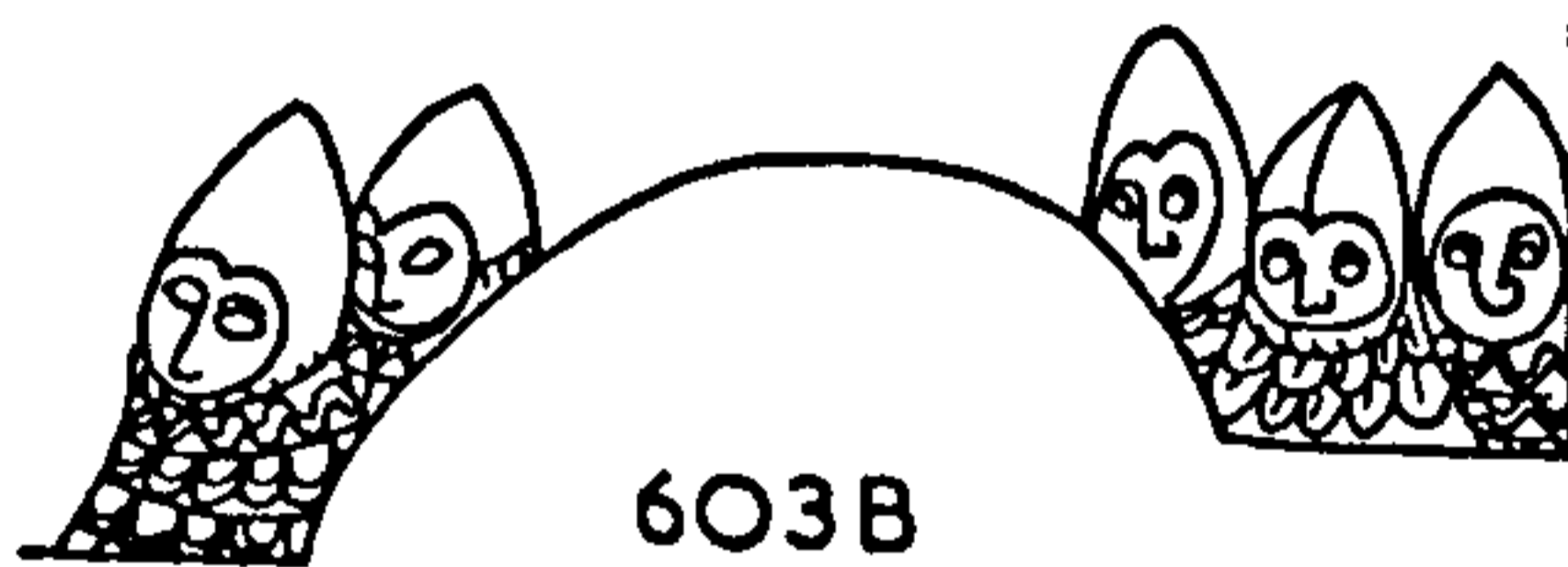
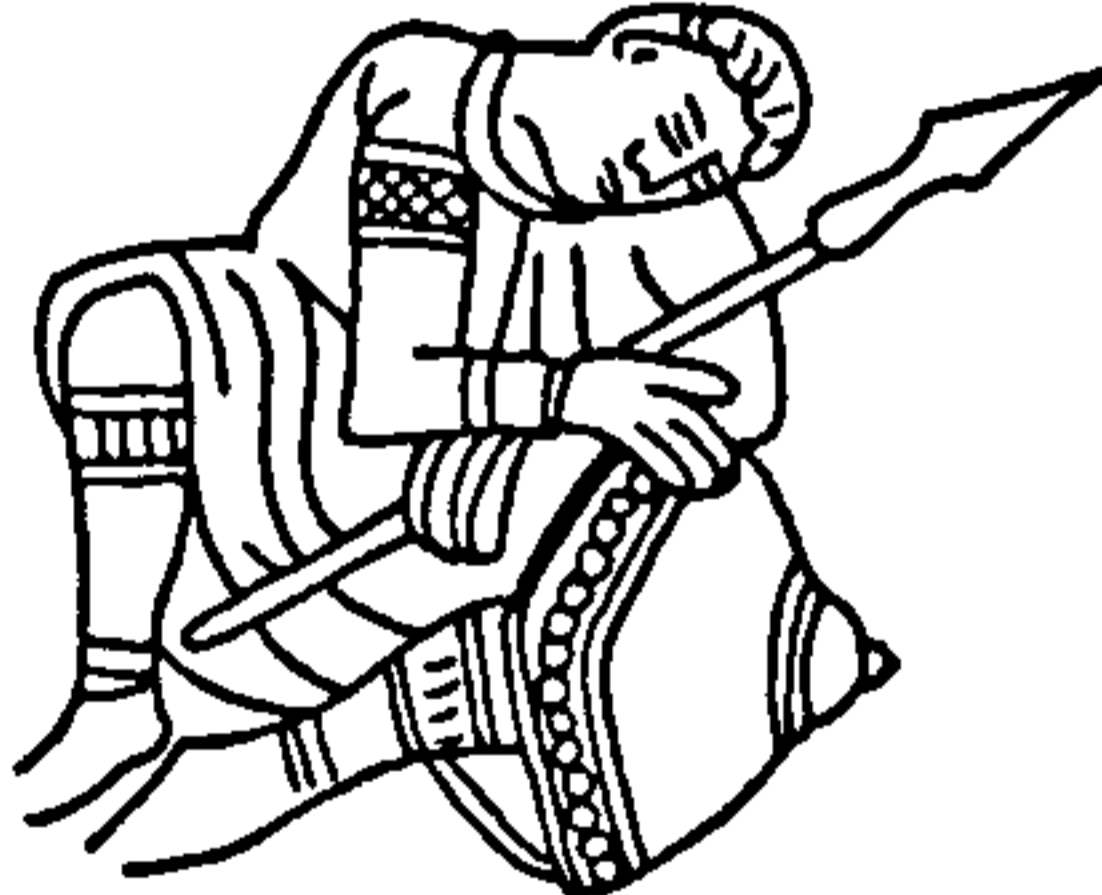

603B

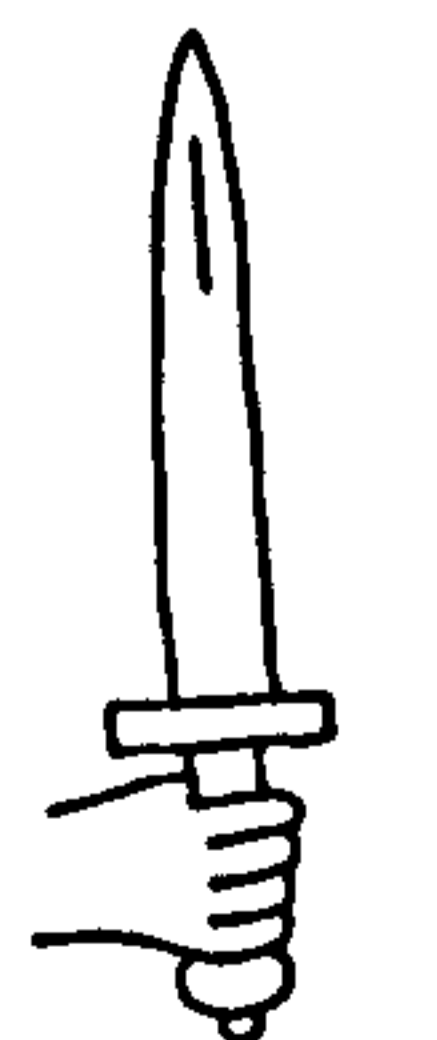

603C



603D

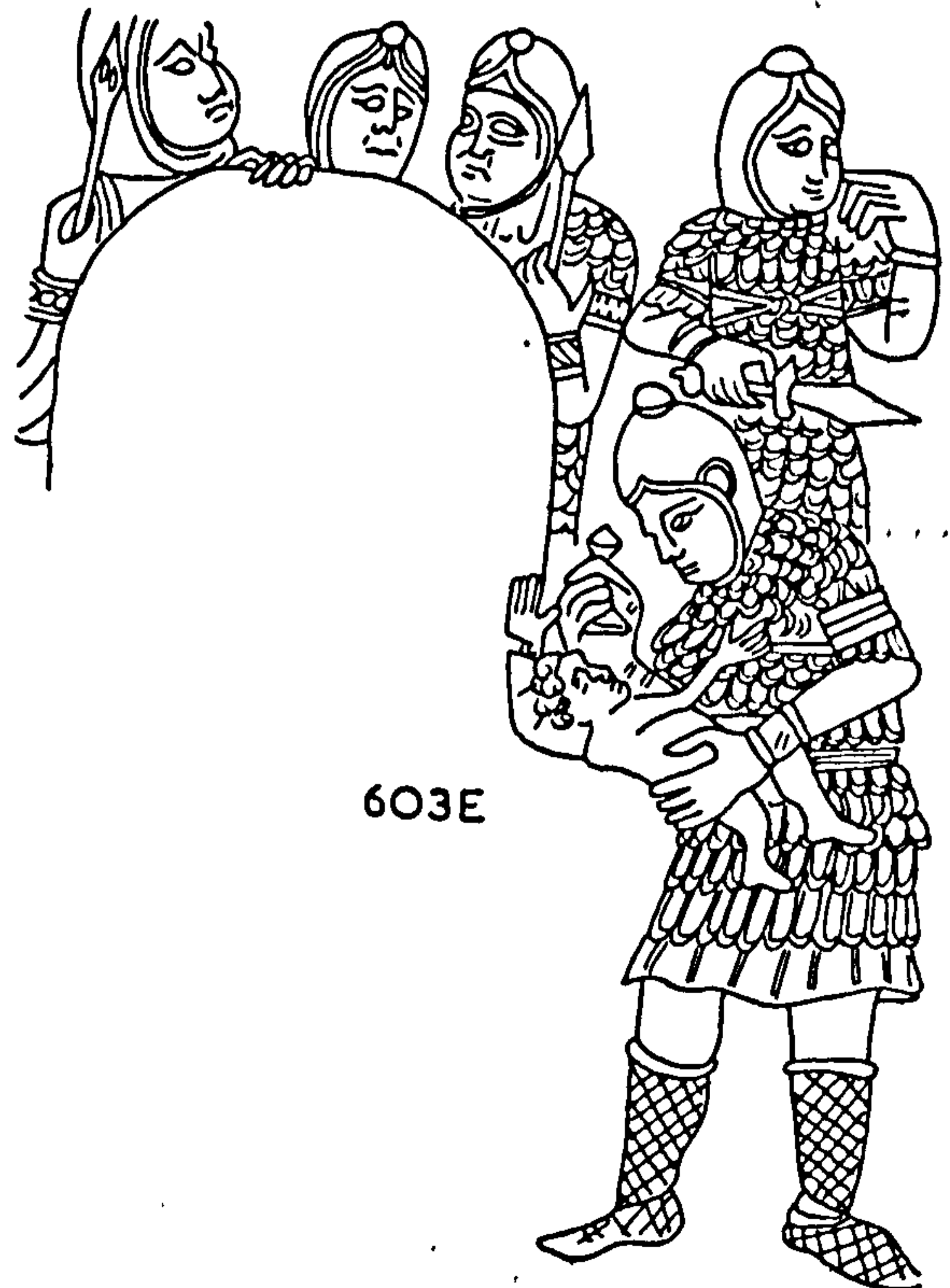

603E



604A

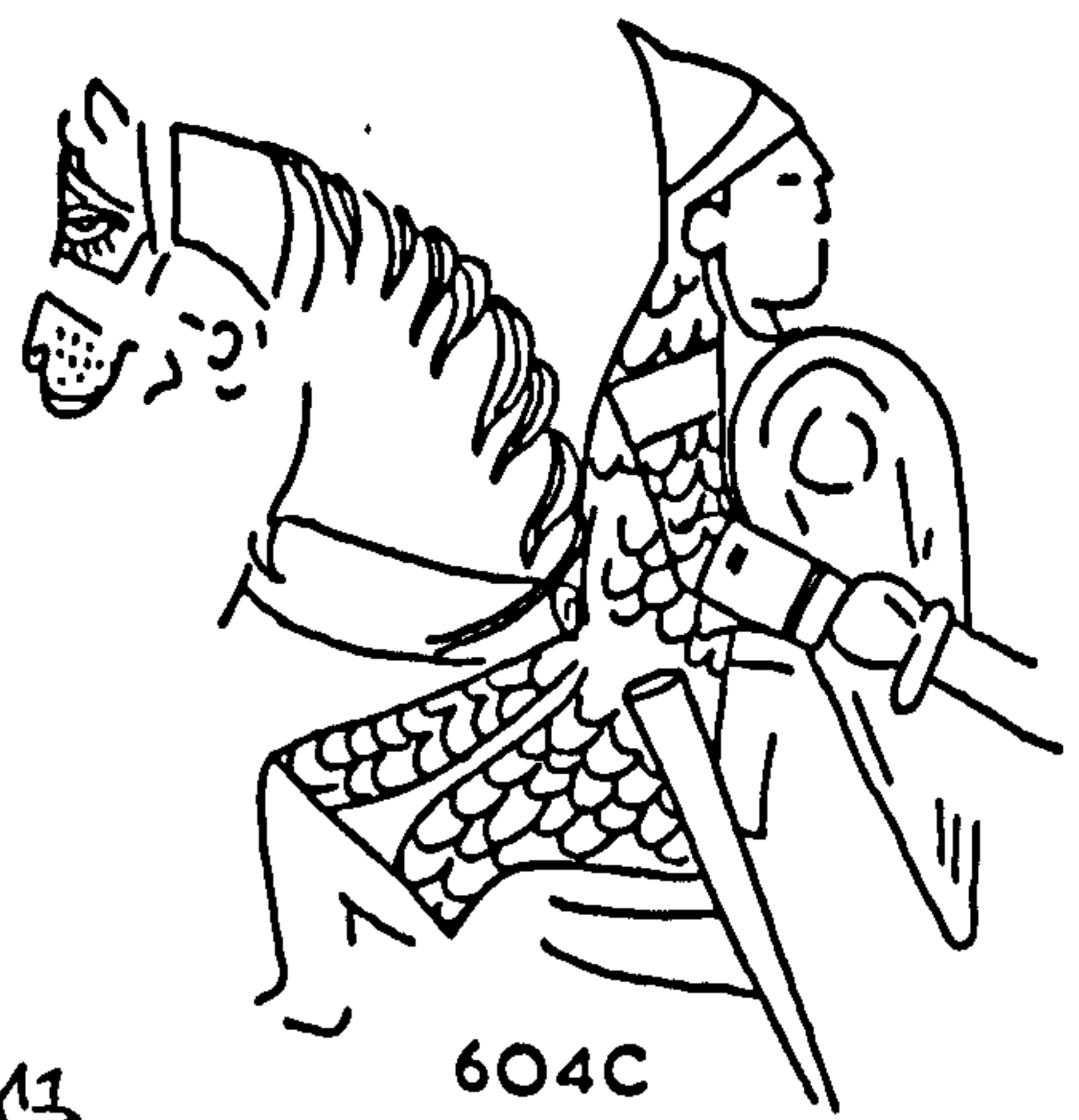

604C



604B



604D



604E



604F



604G

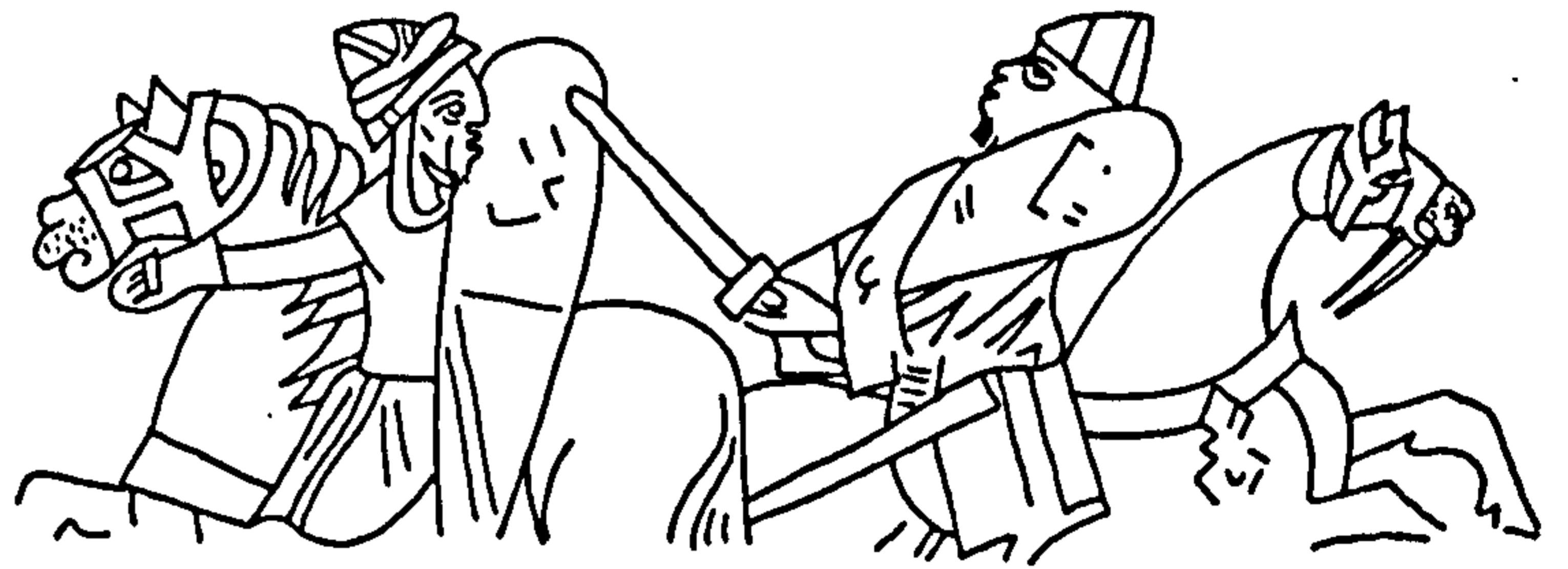

604I



604H



604J

(Continued)





604K



604L

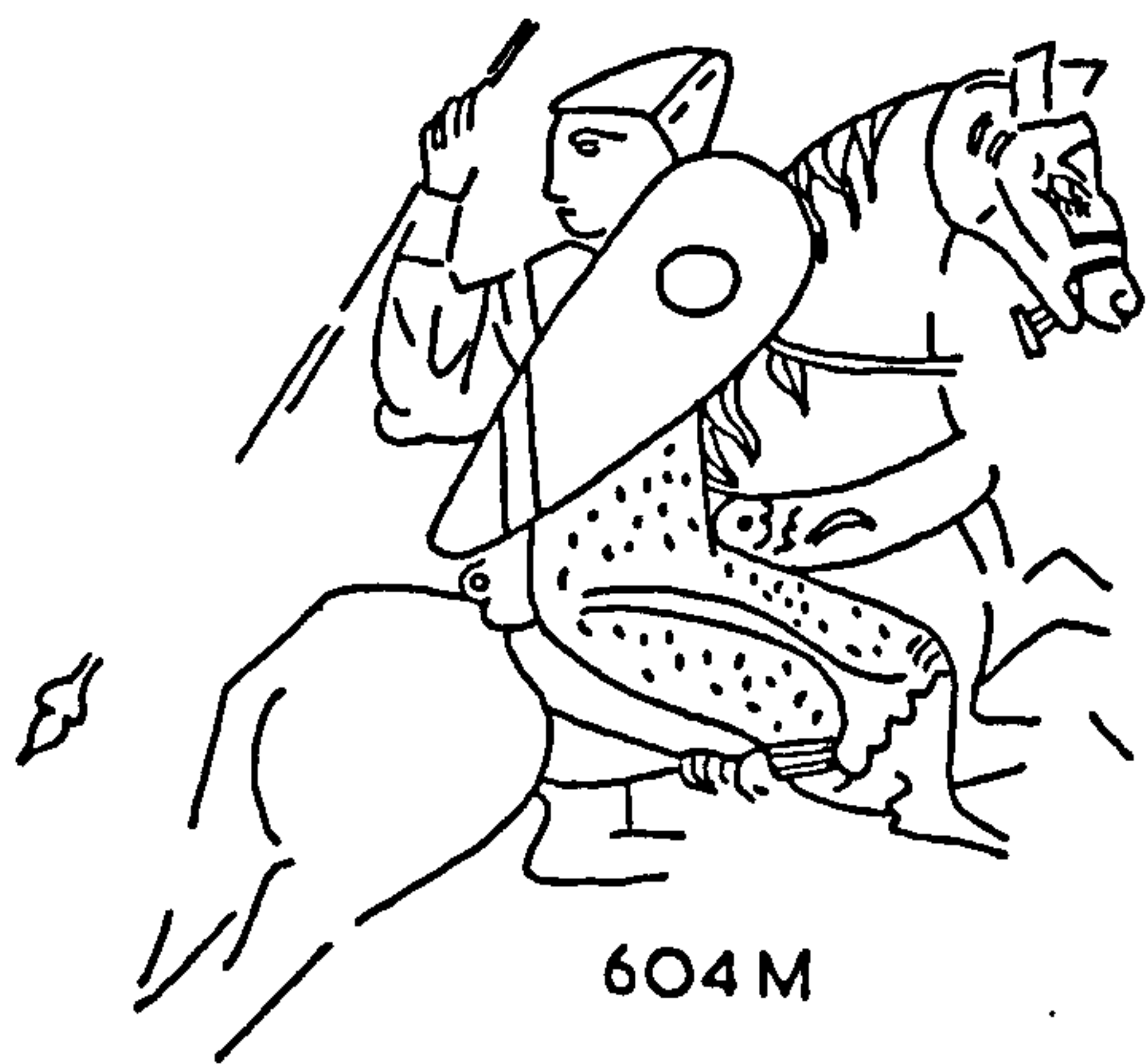

604M



604 N

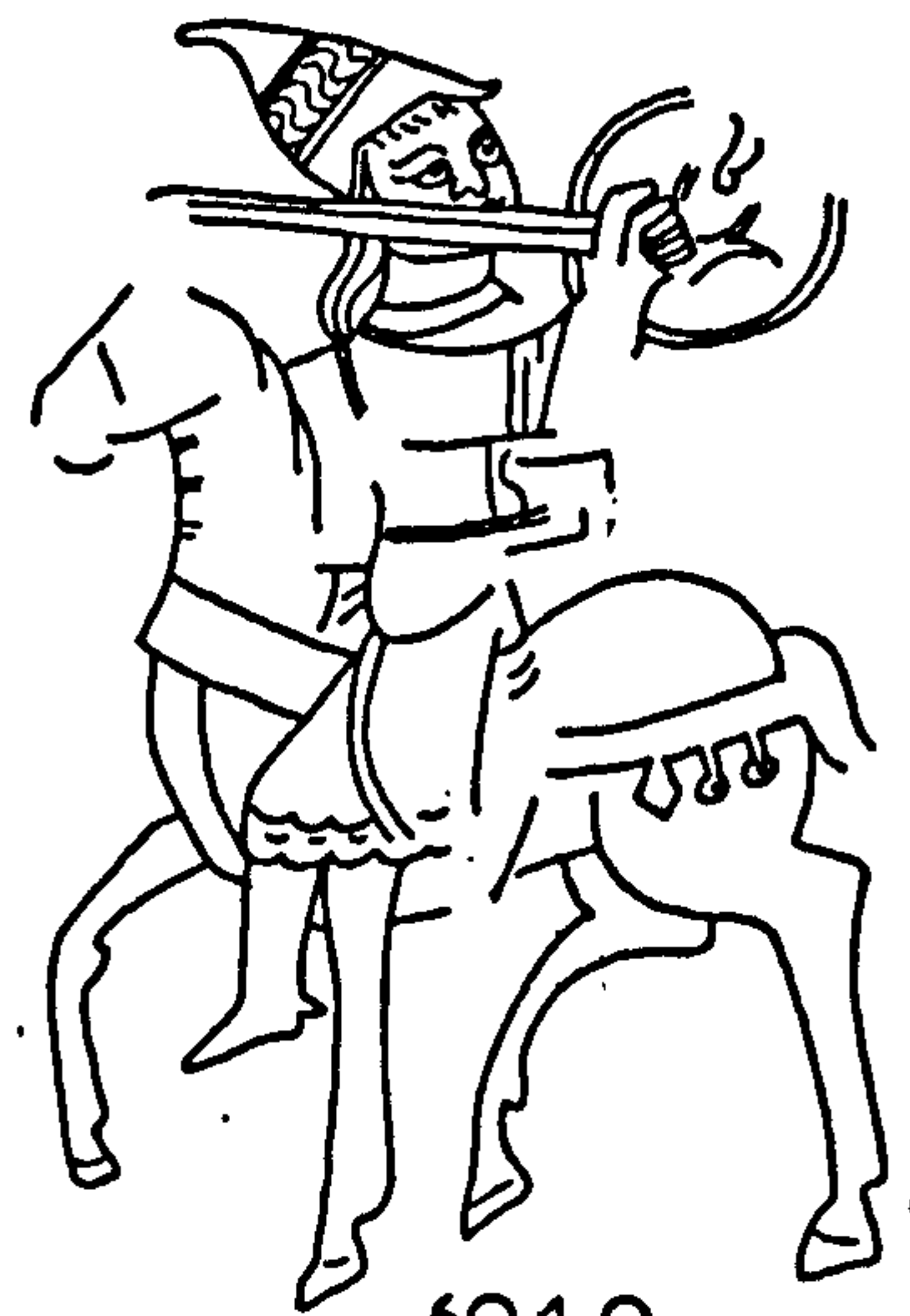

604 O

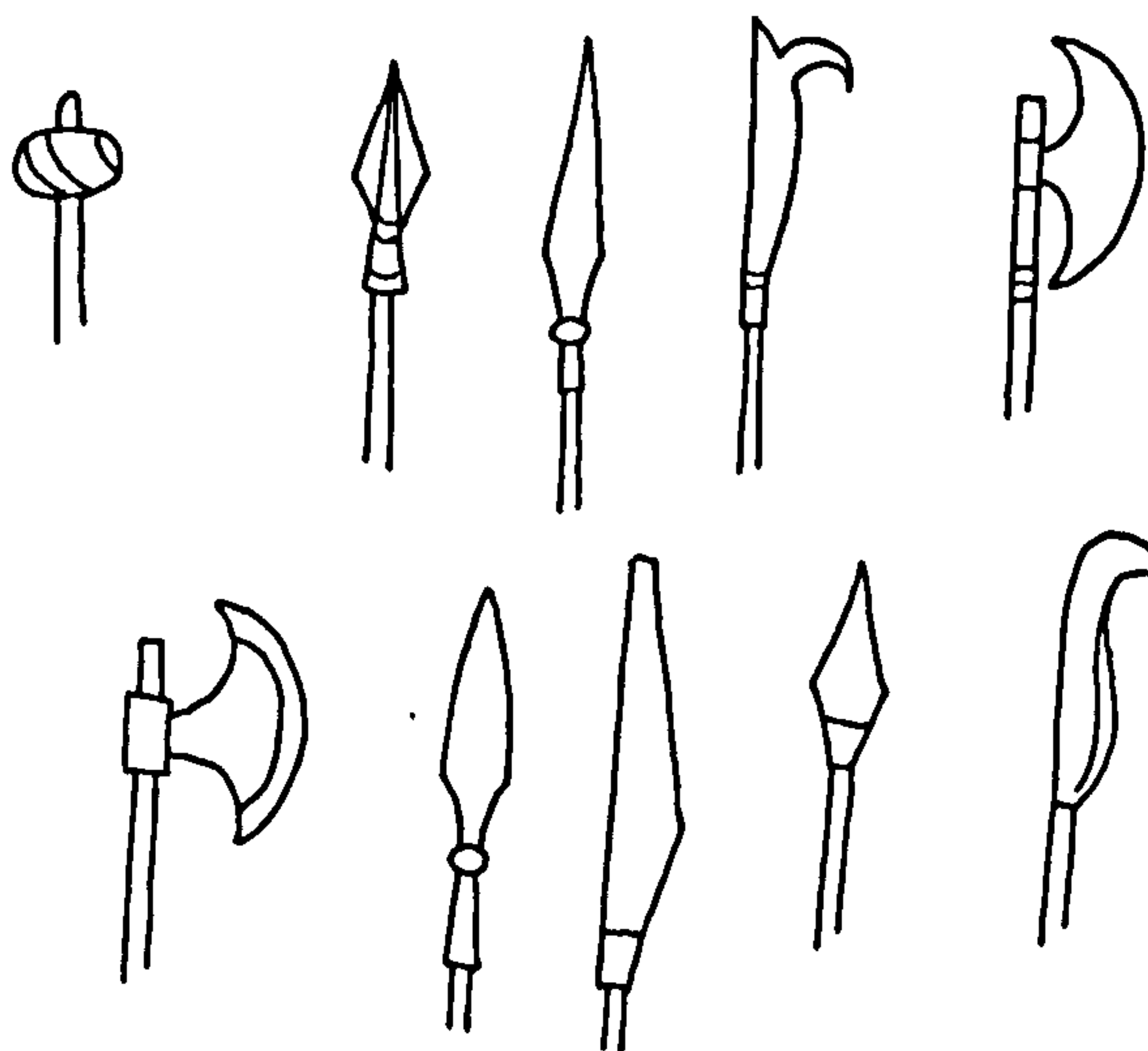

605

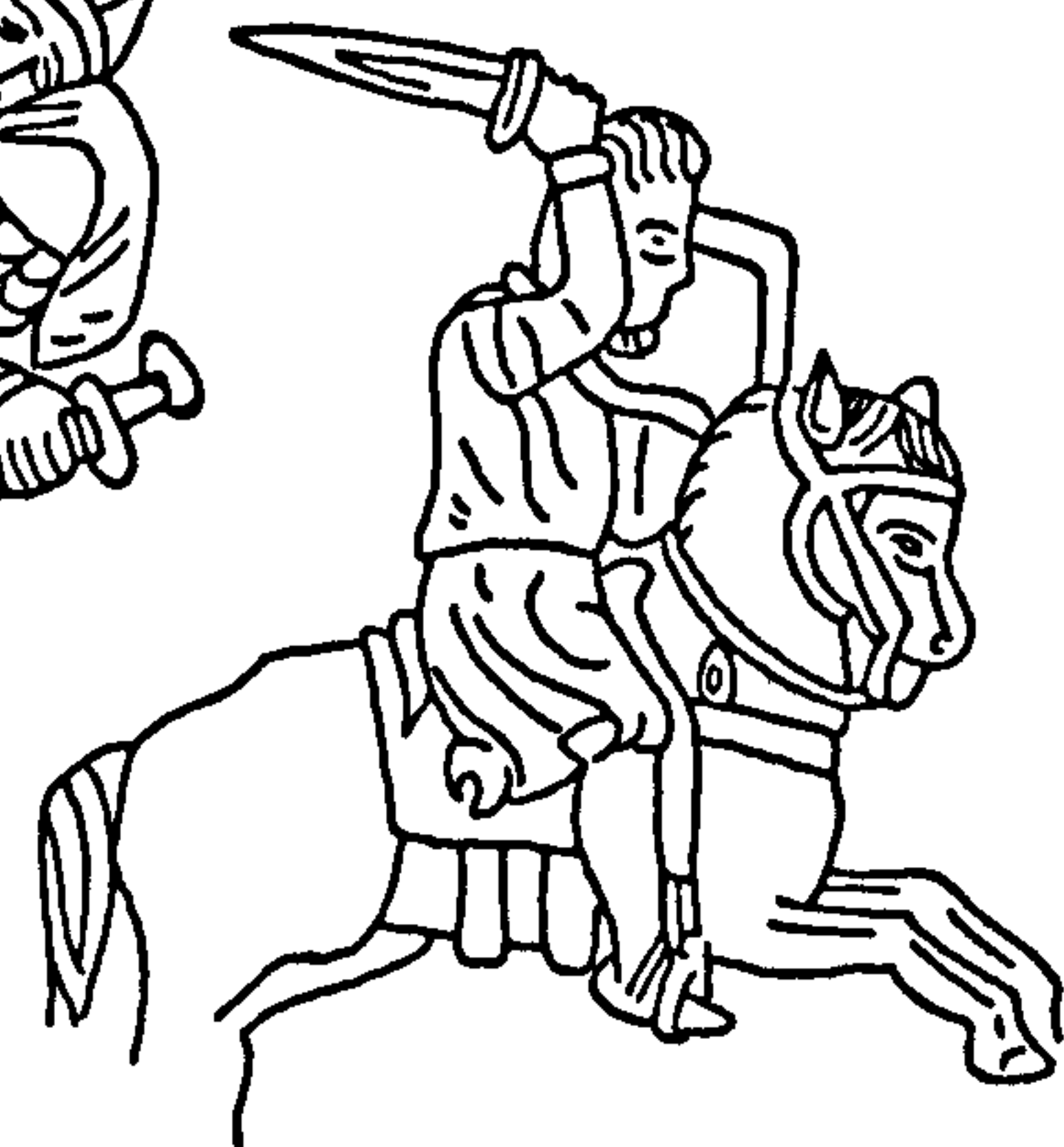

606

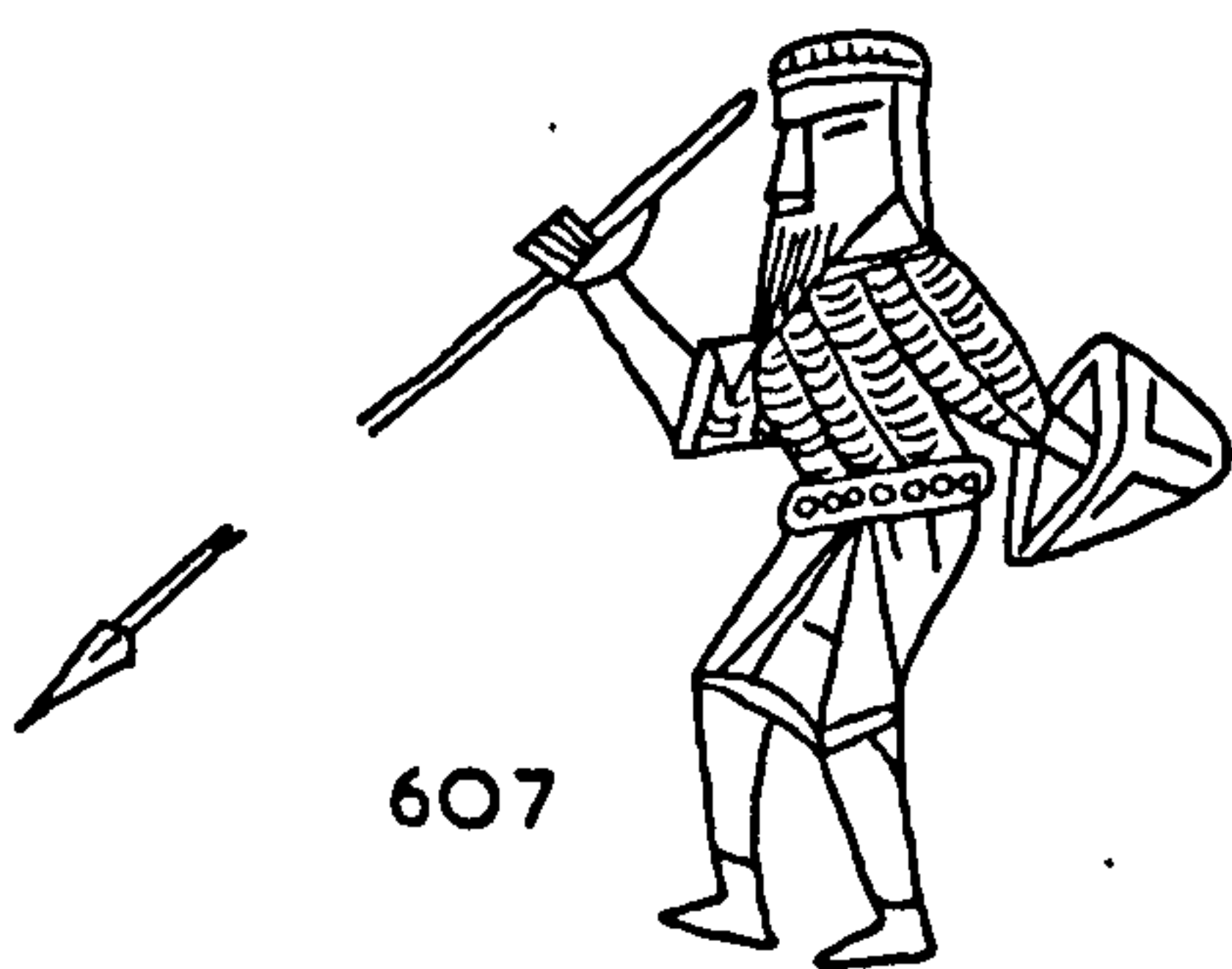

607



608A



608B



608C

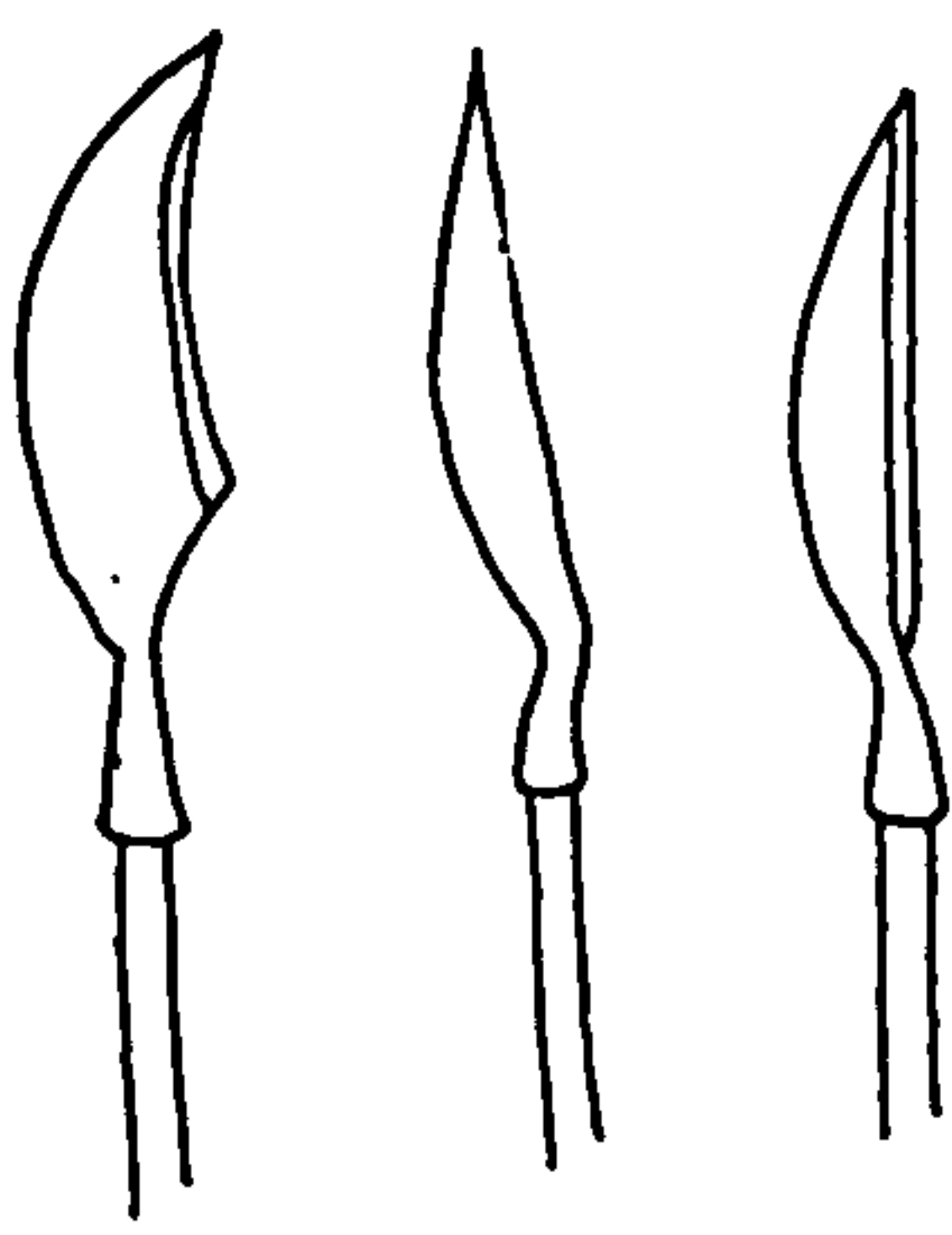

609A

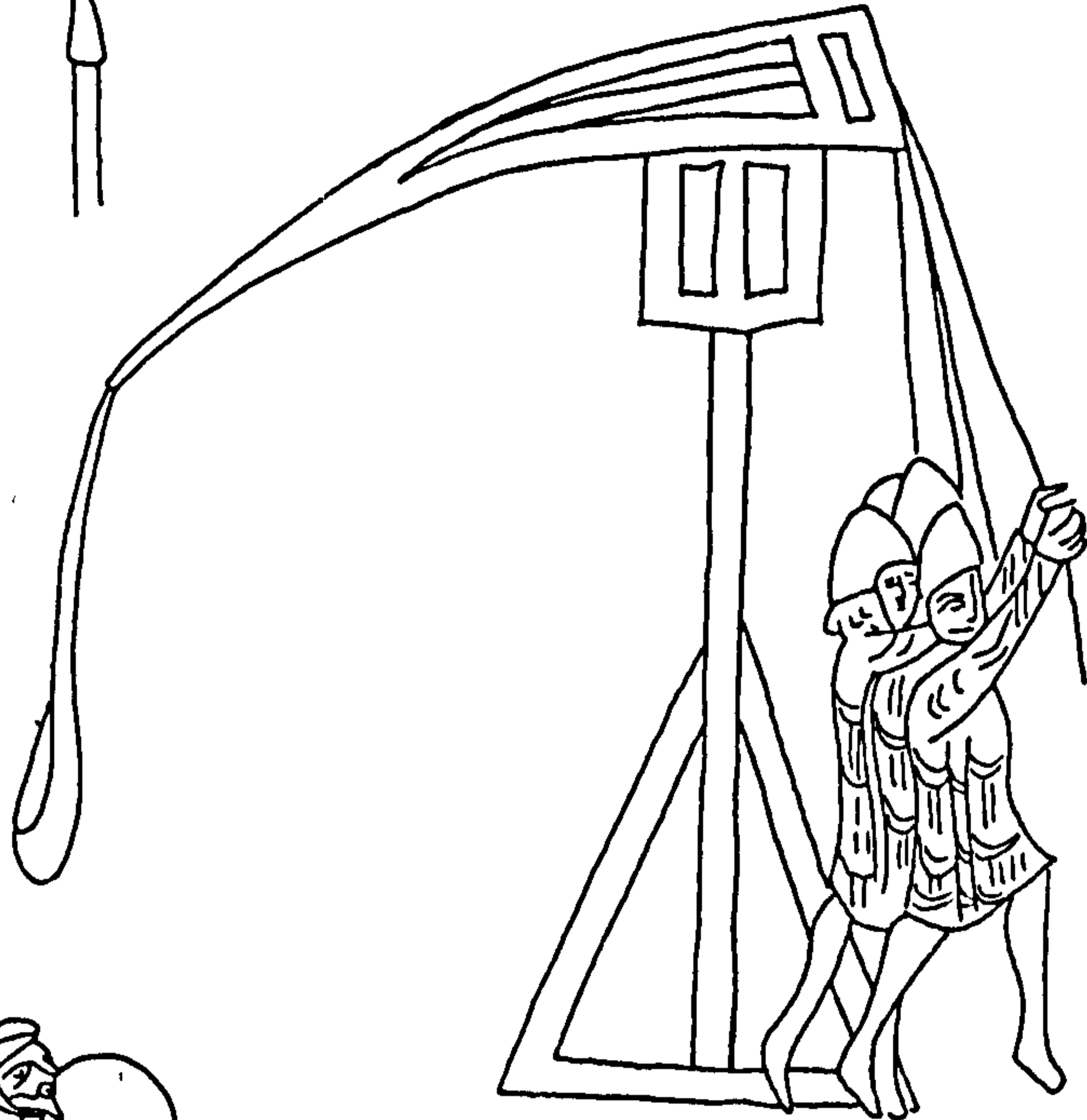

609B

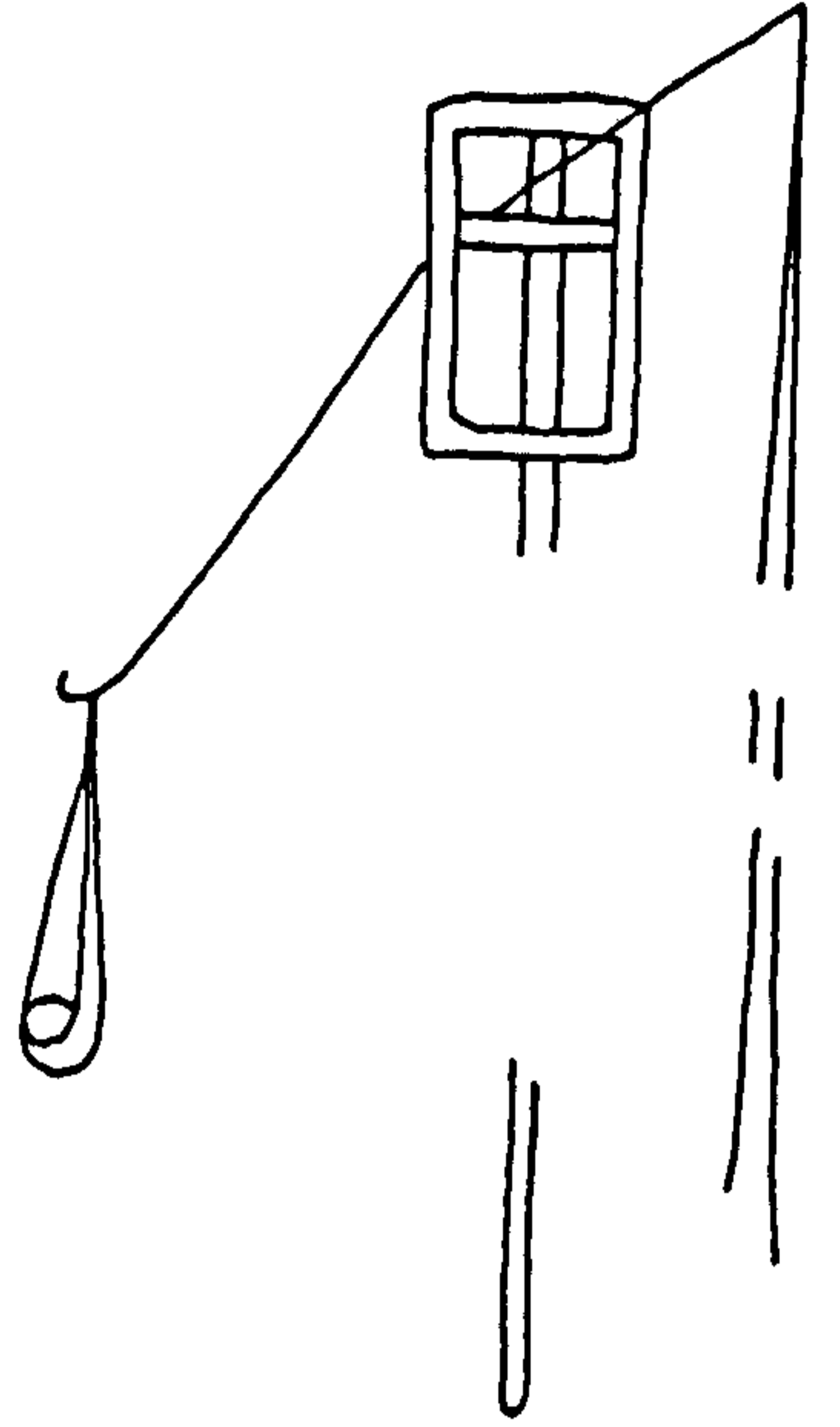

609C

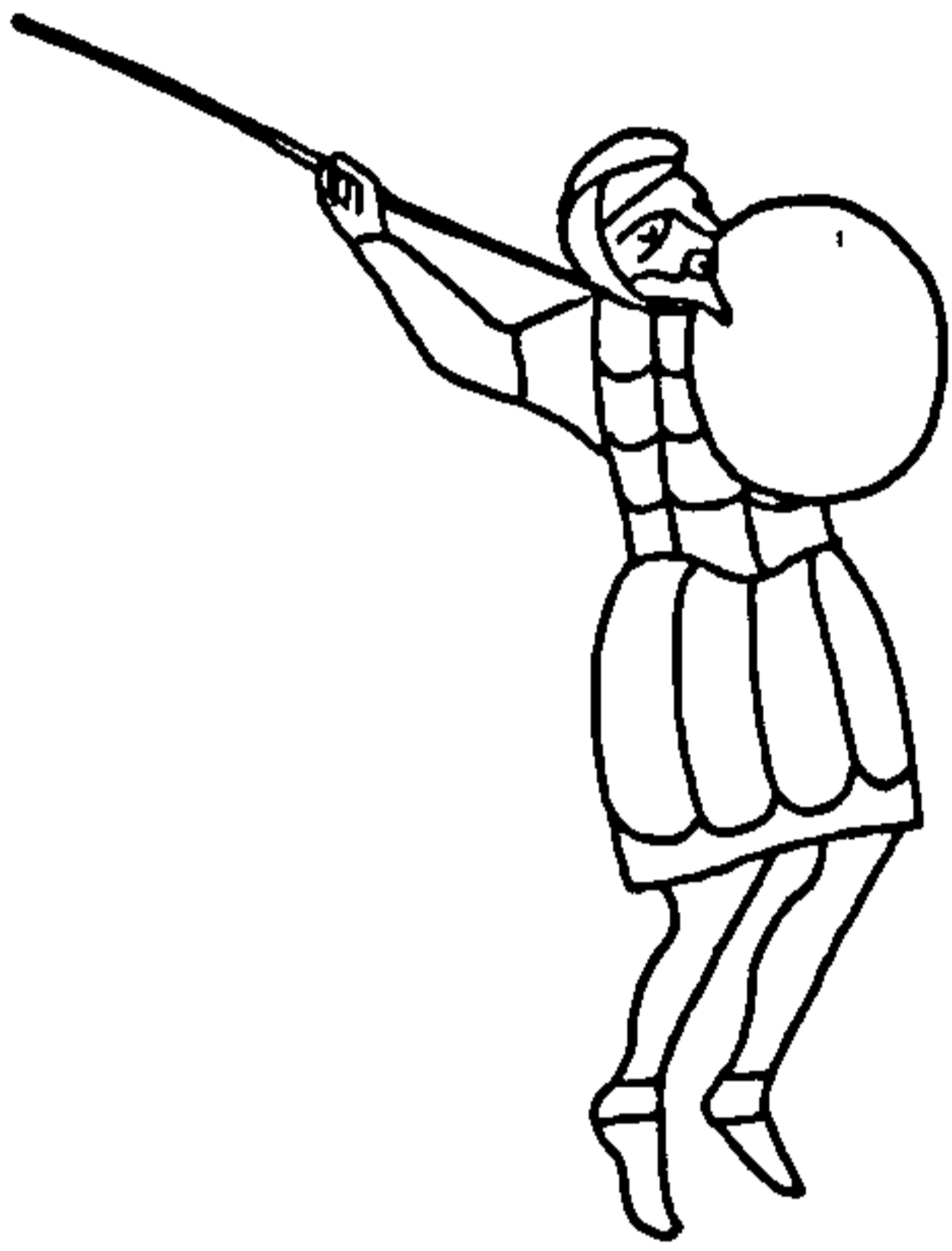

609D

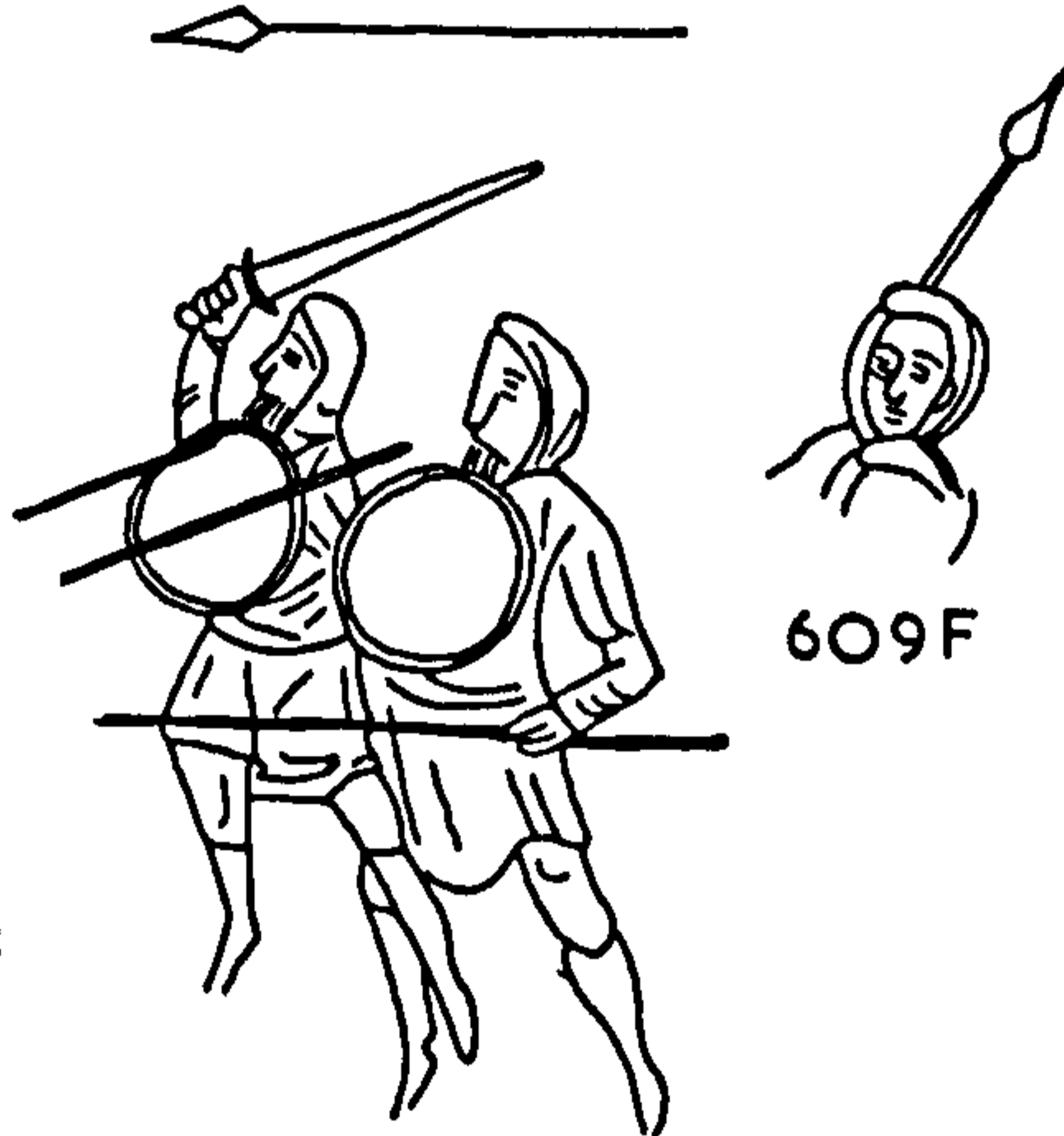

609E

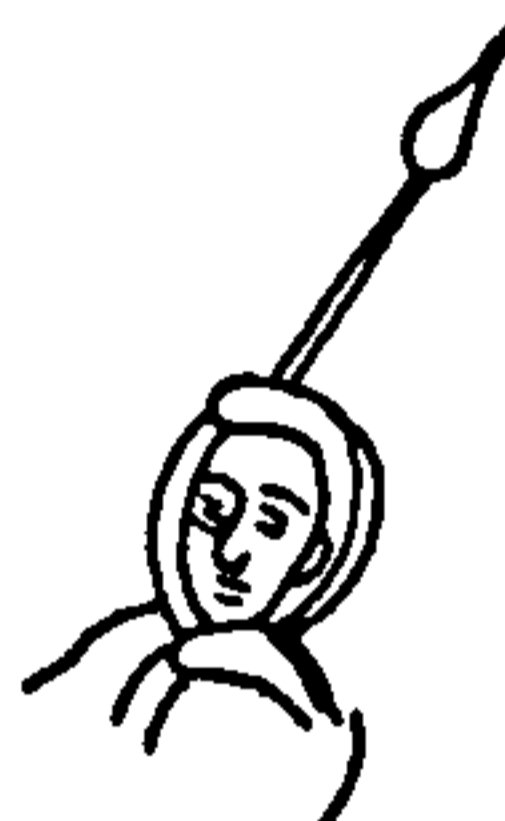

609F



609G

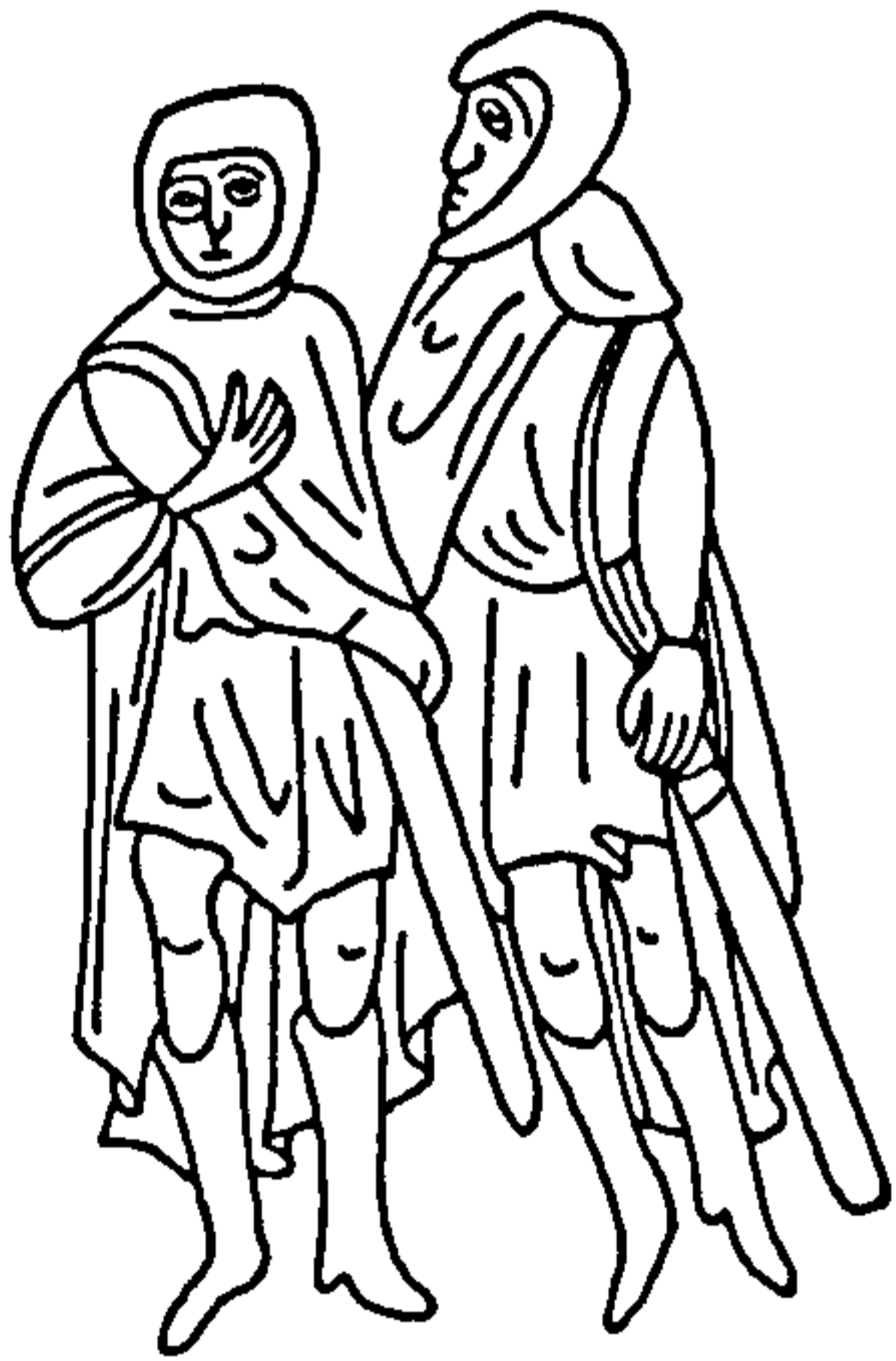

609H



609I

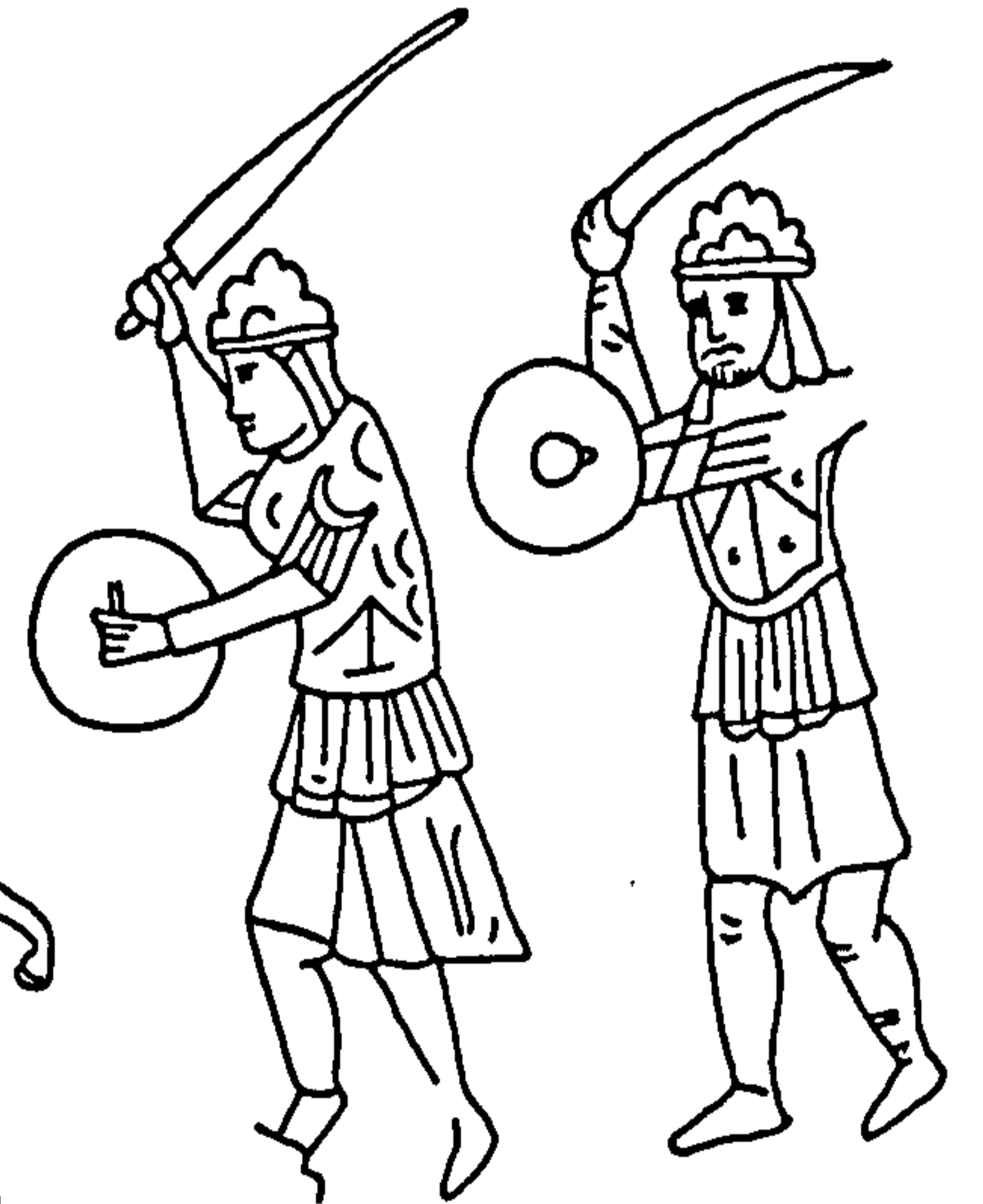

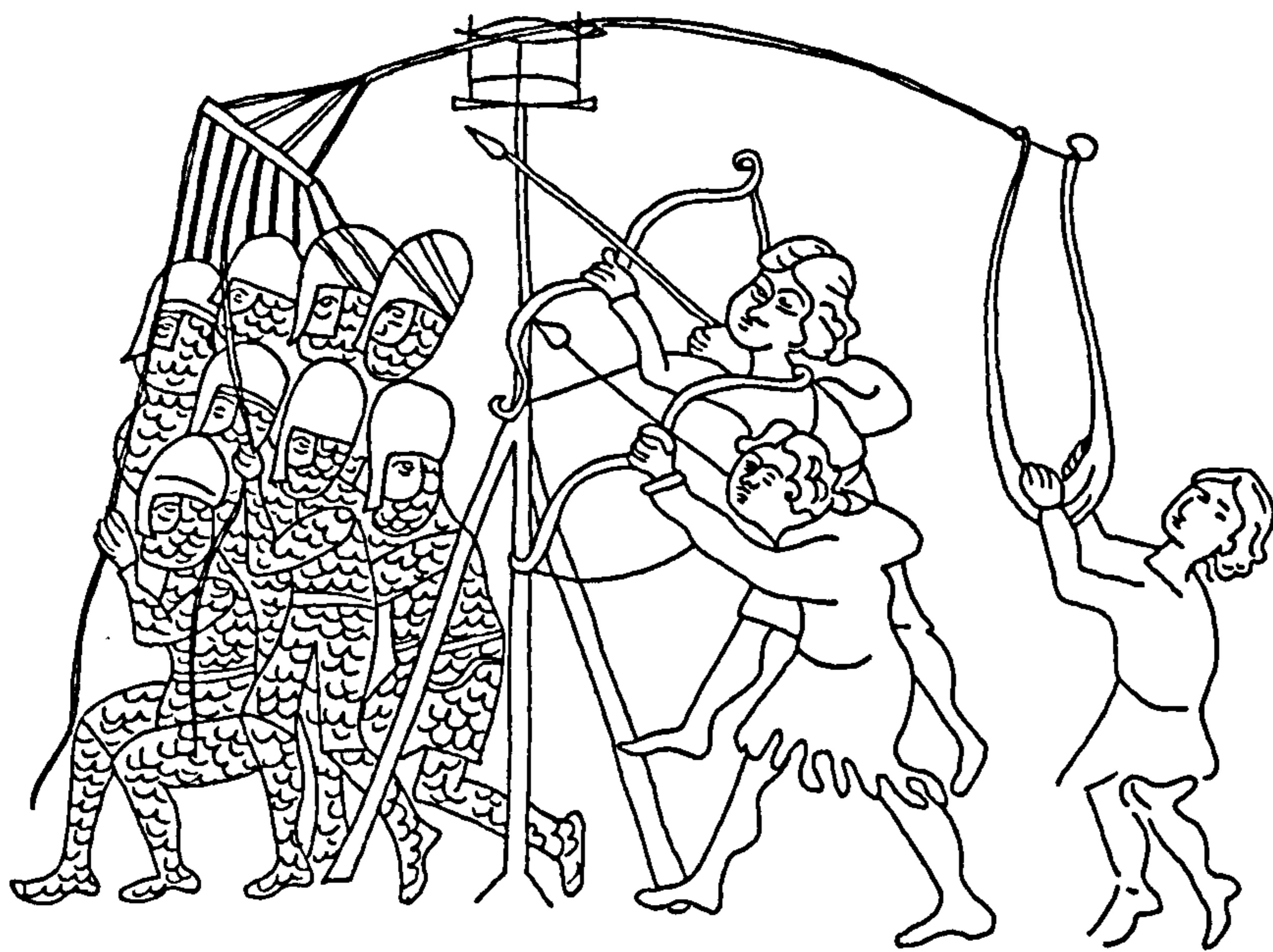

610A

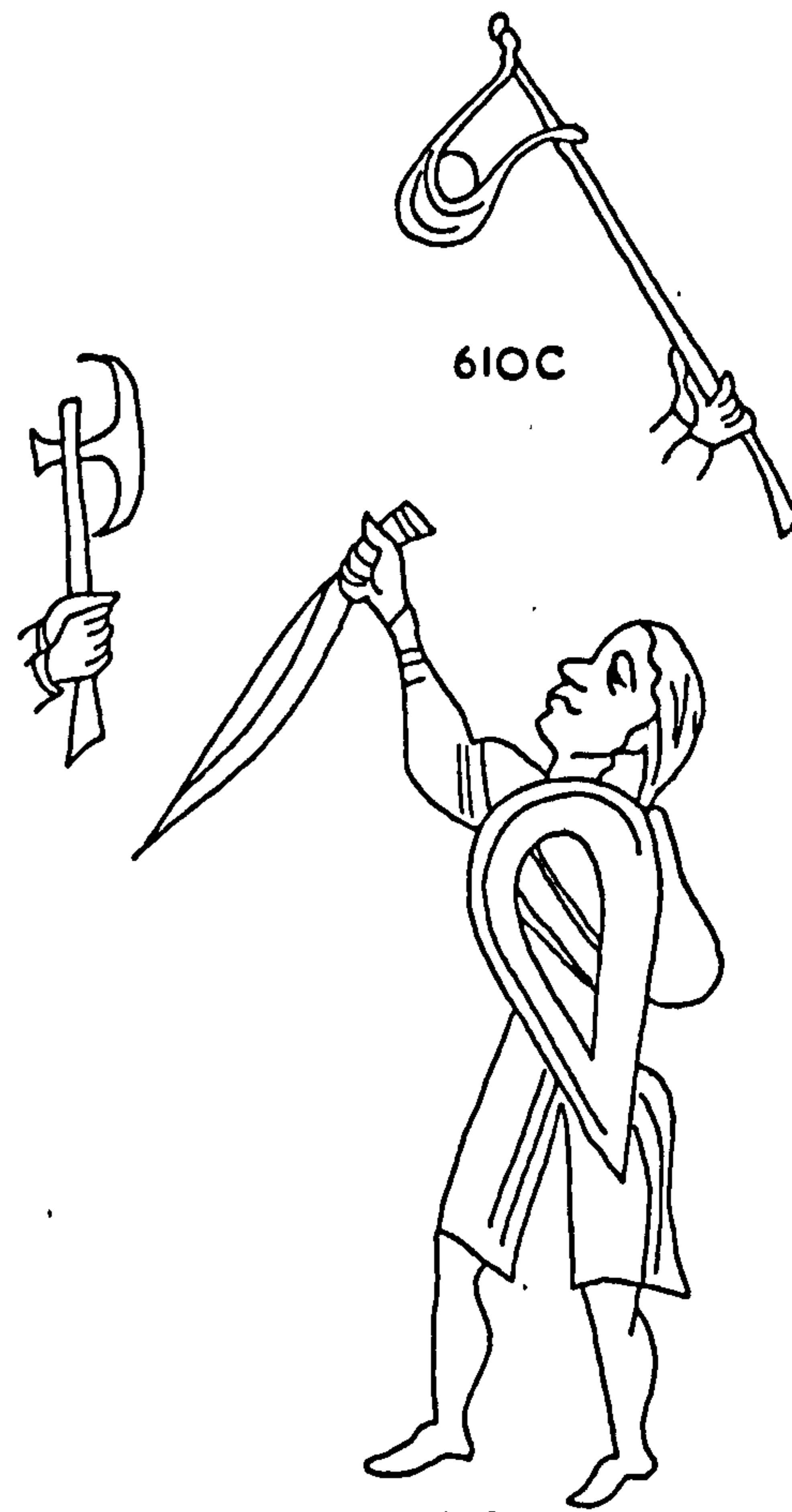

610C

610B

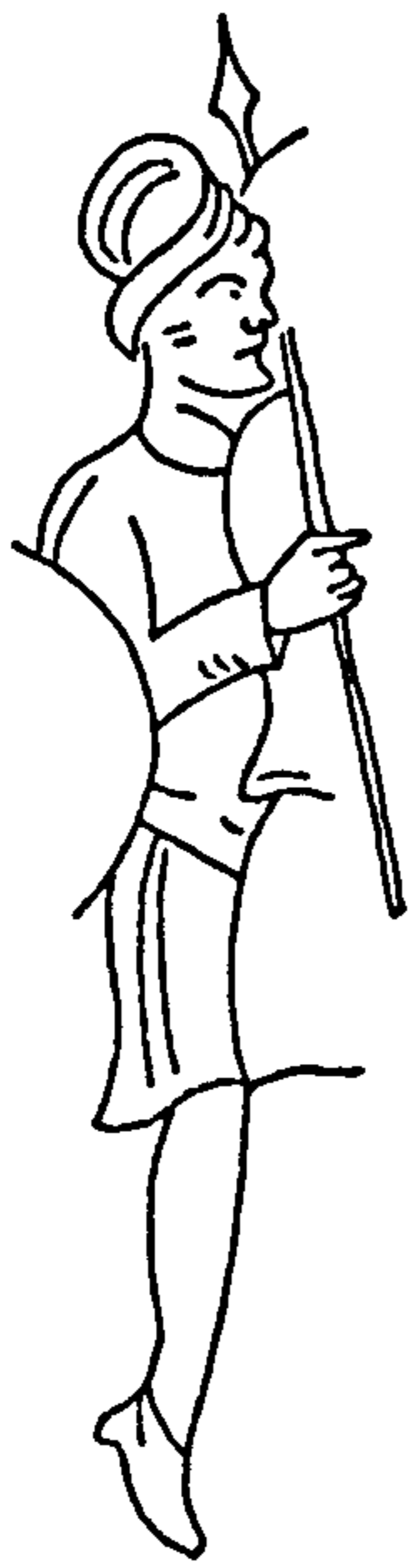

610D



610E



610F



610G

(Continued)

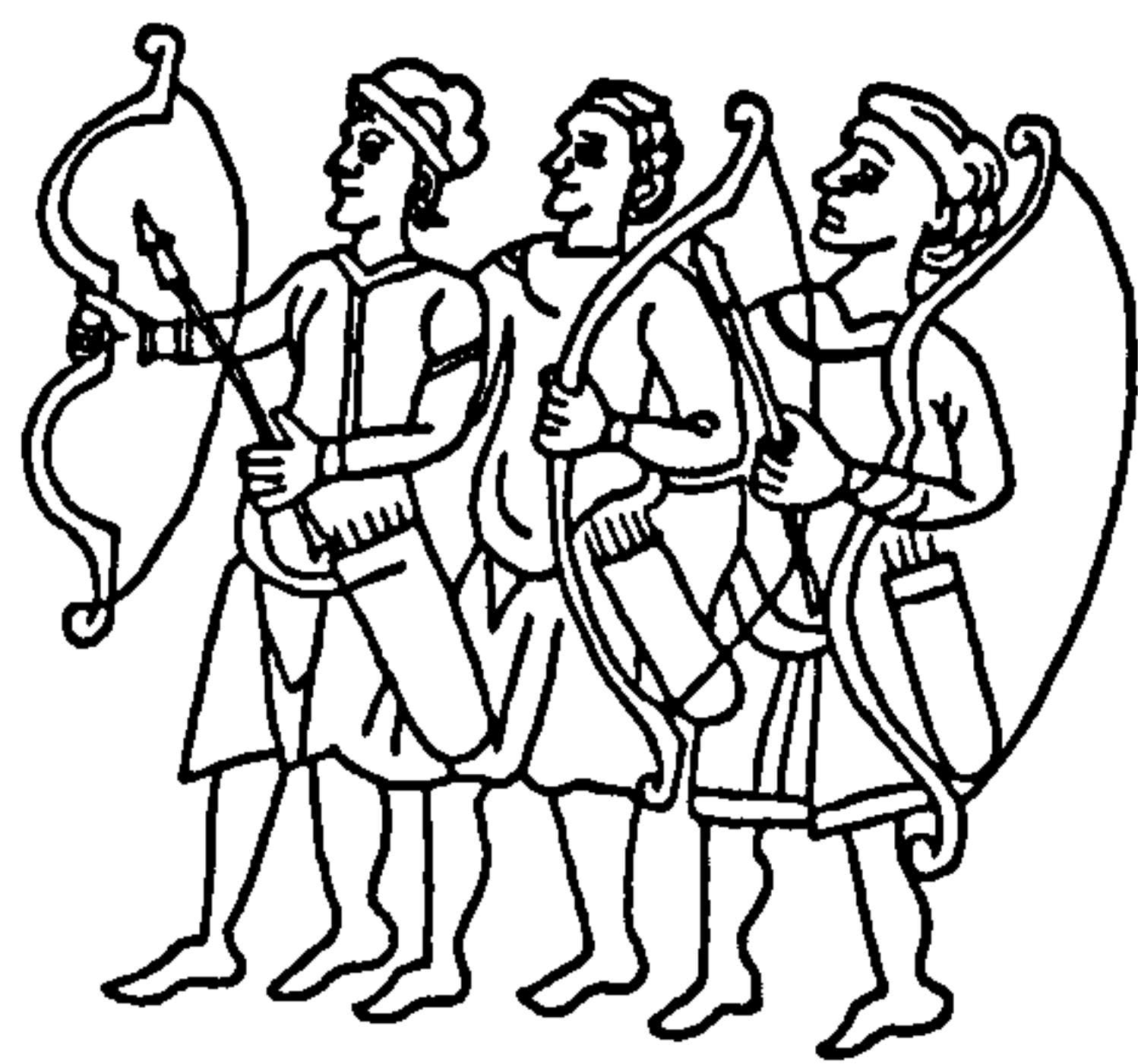

610G

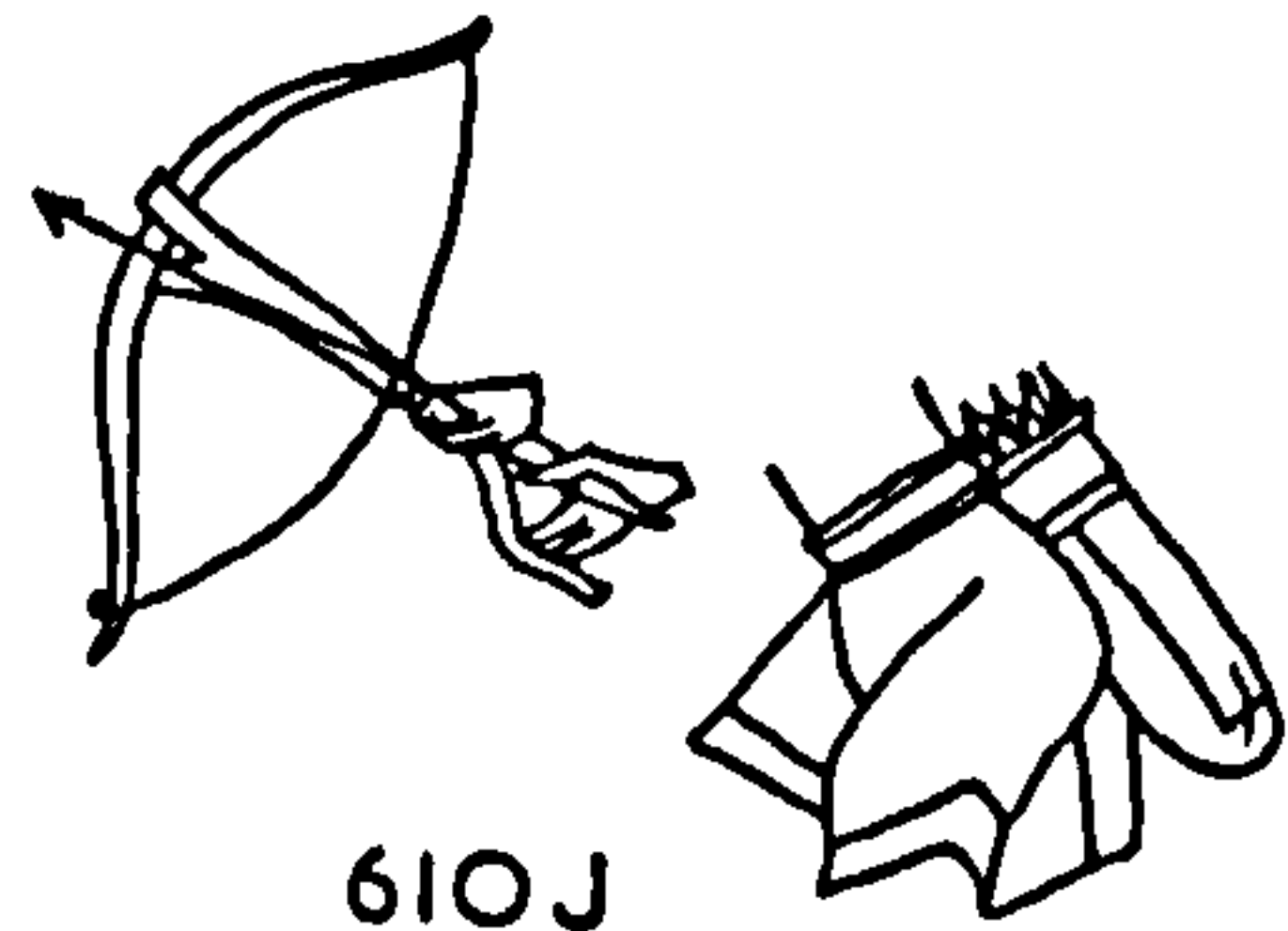

610J

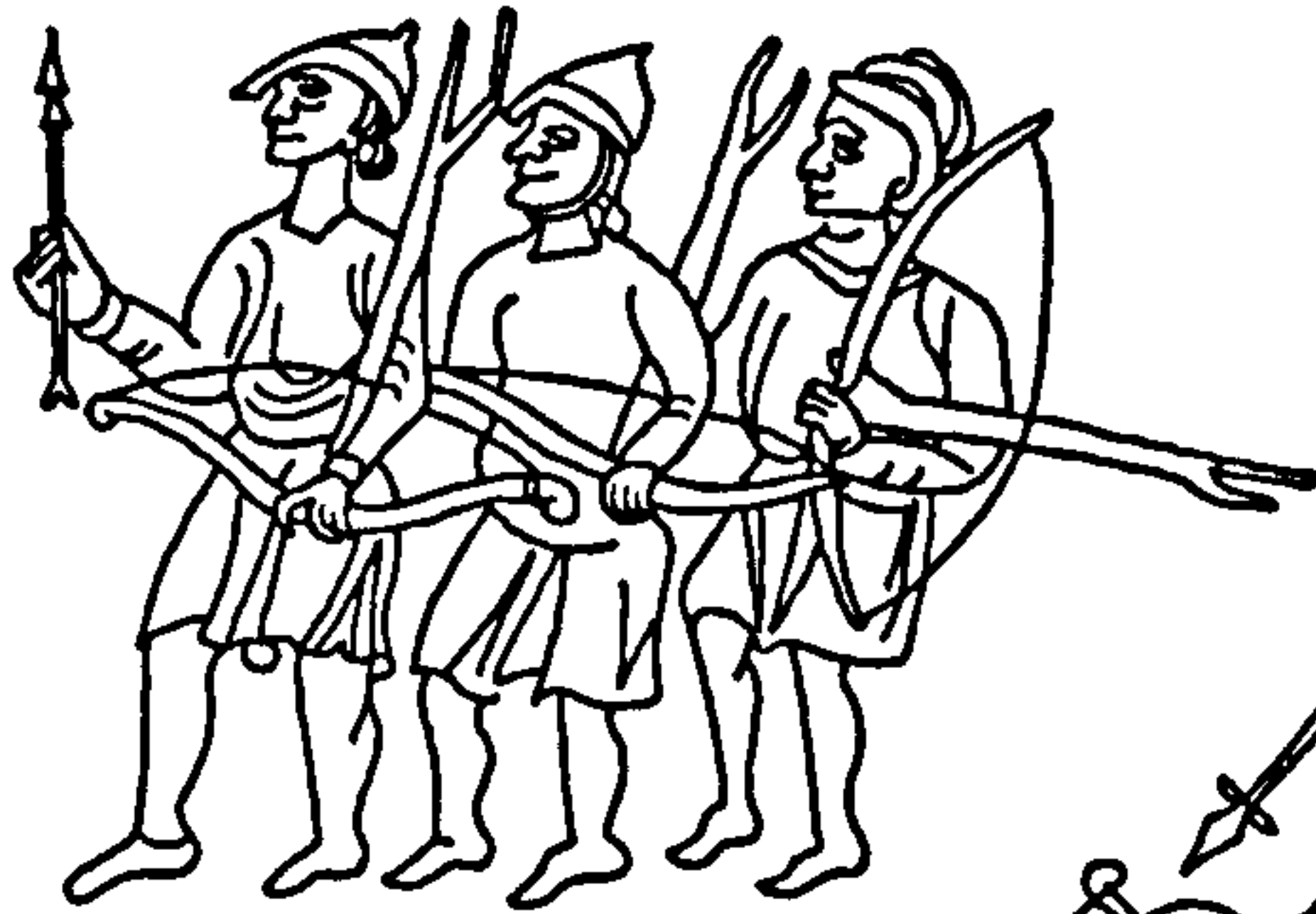

610H



610I

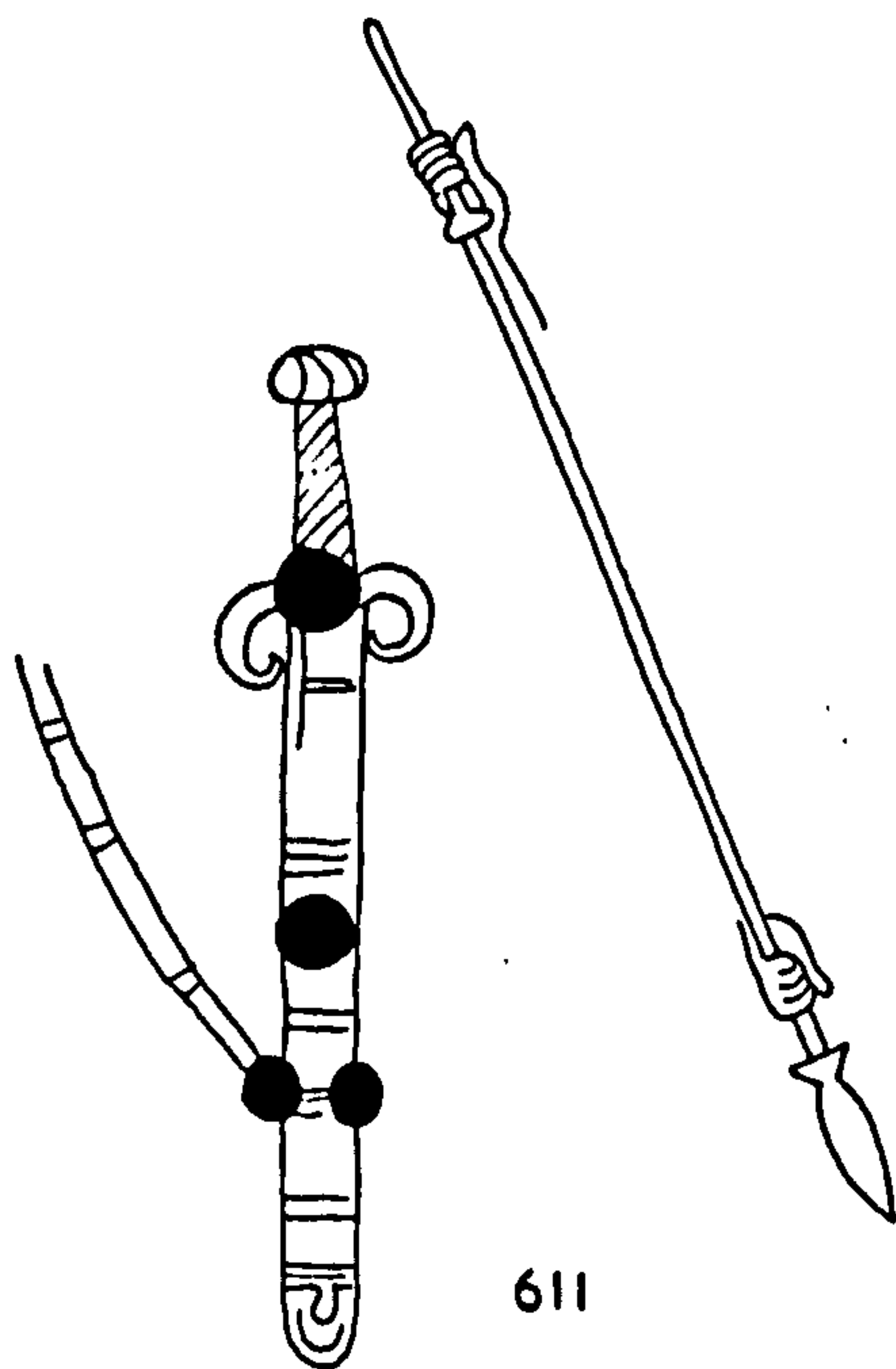

611

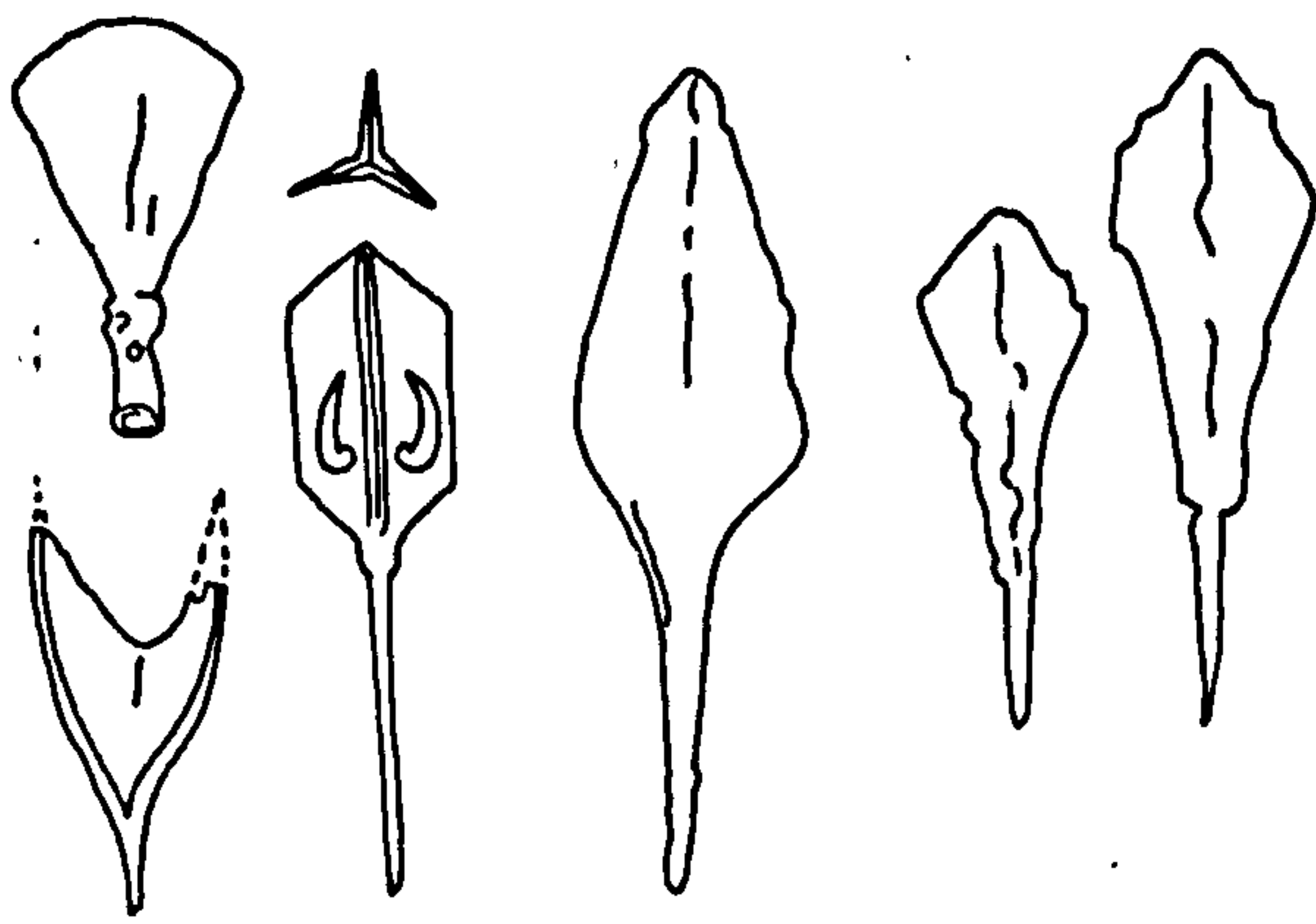

612

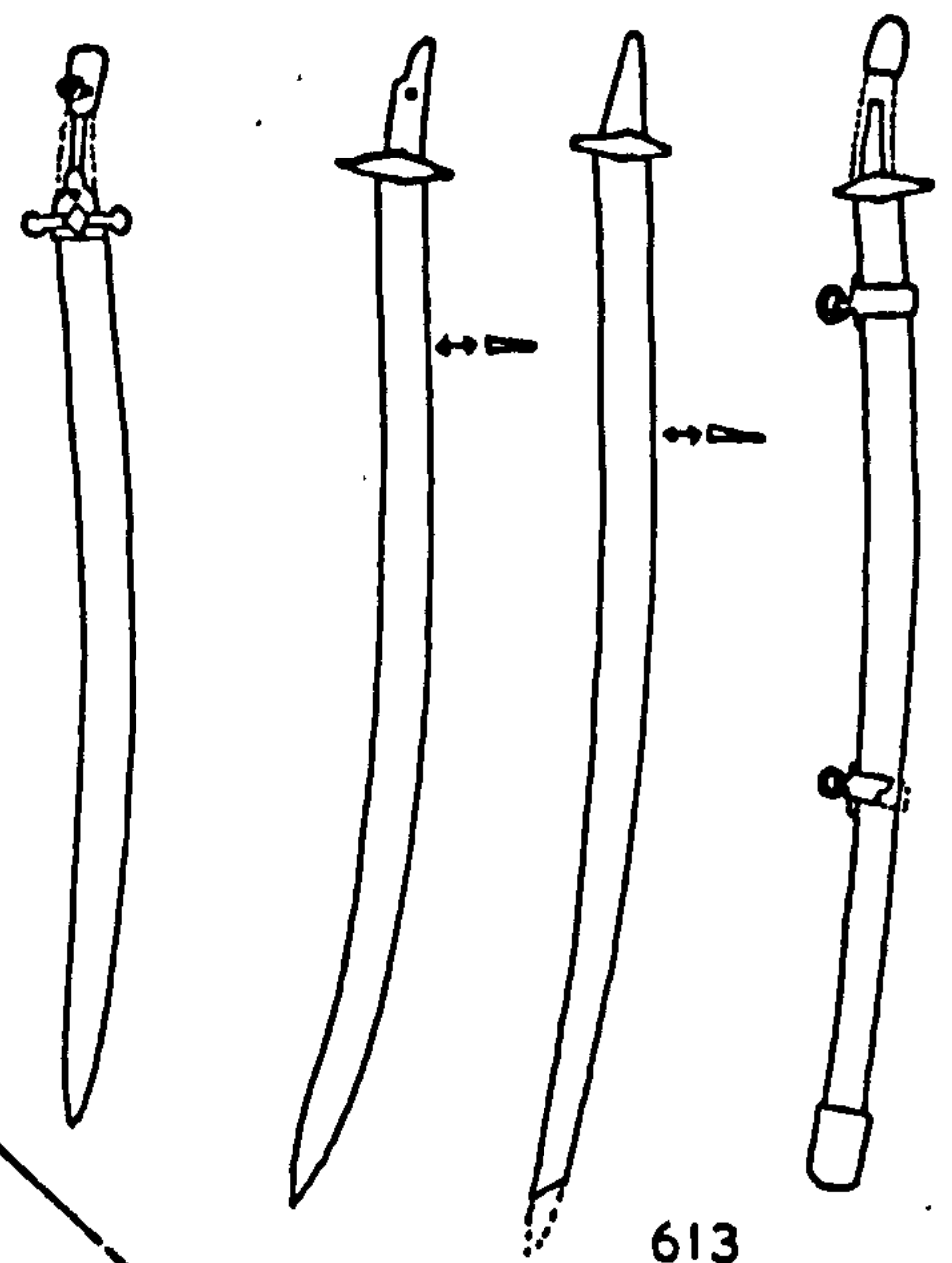

613

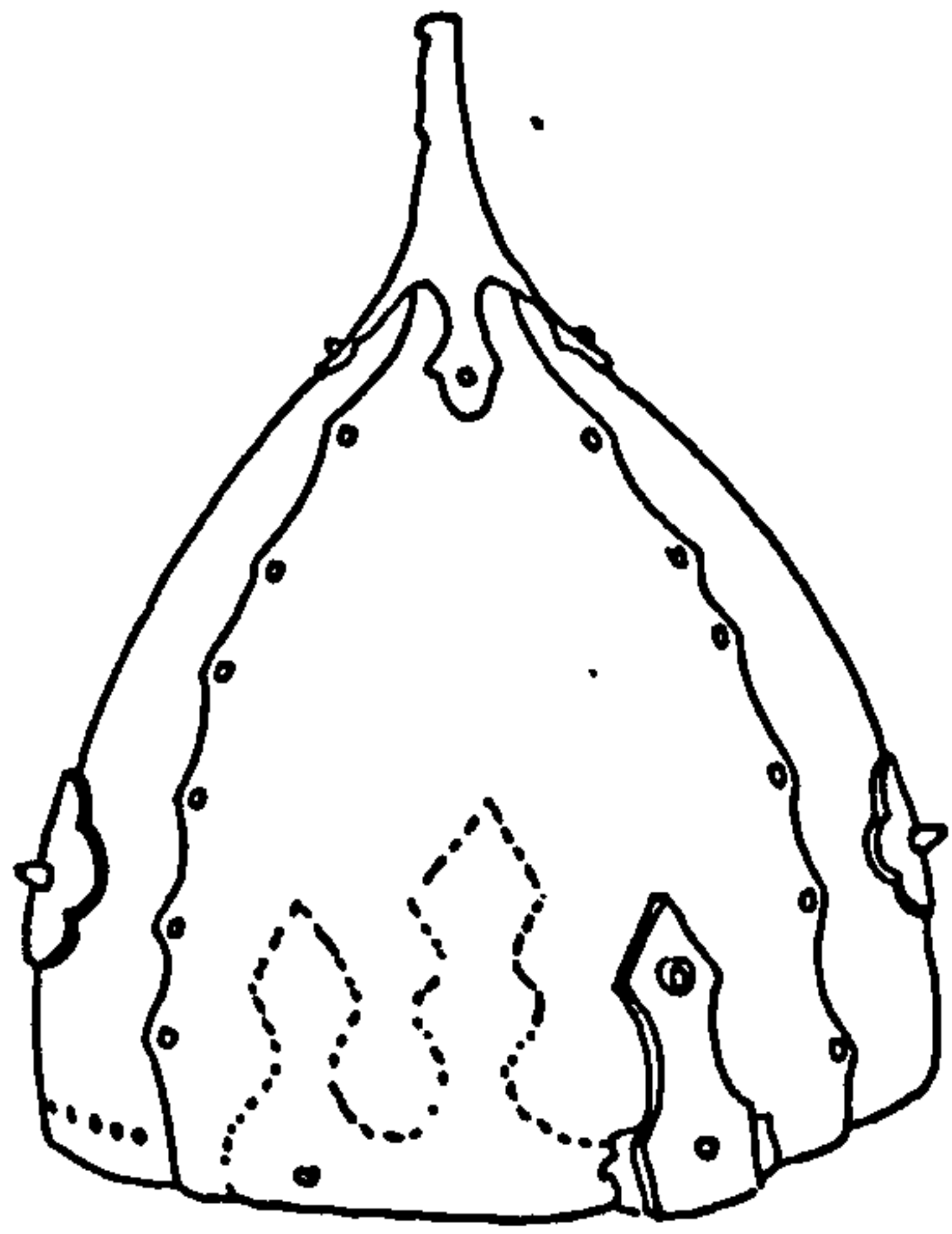

614

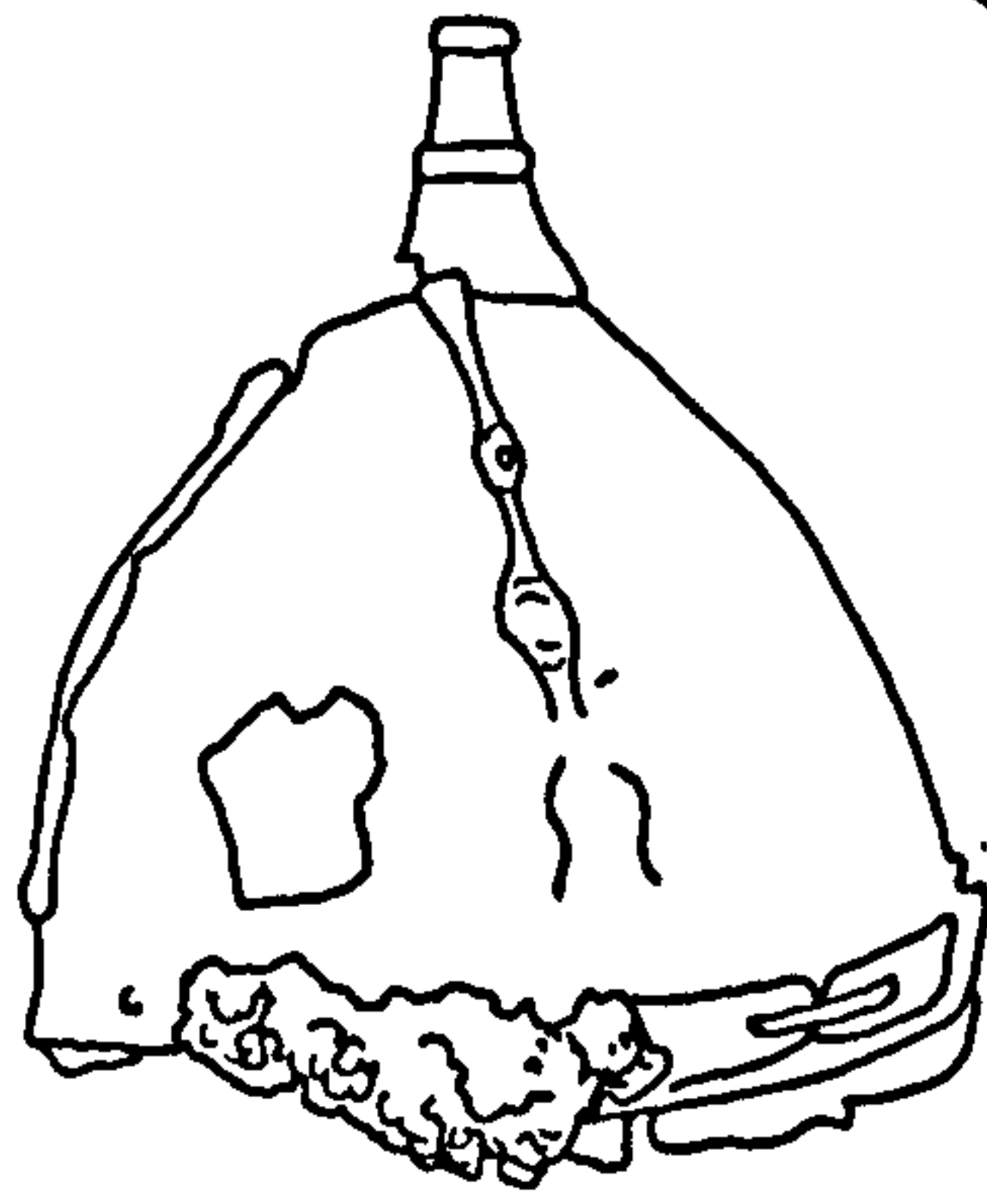

615

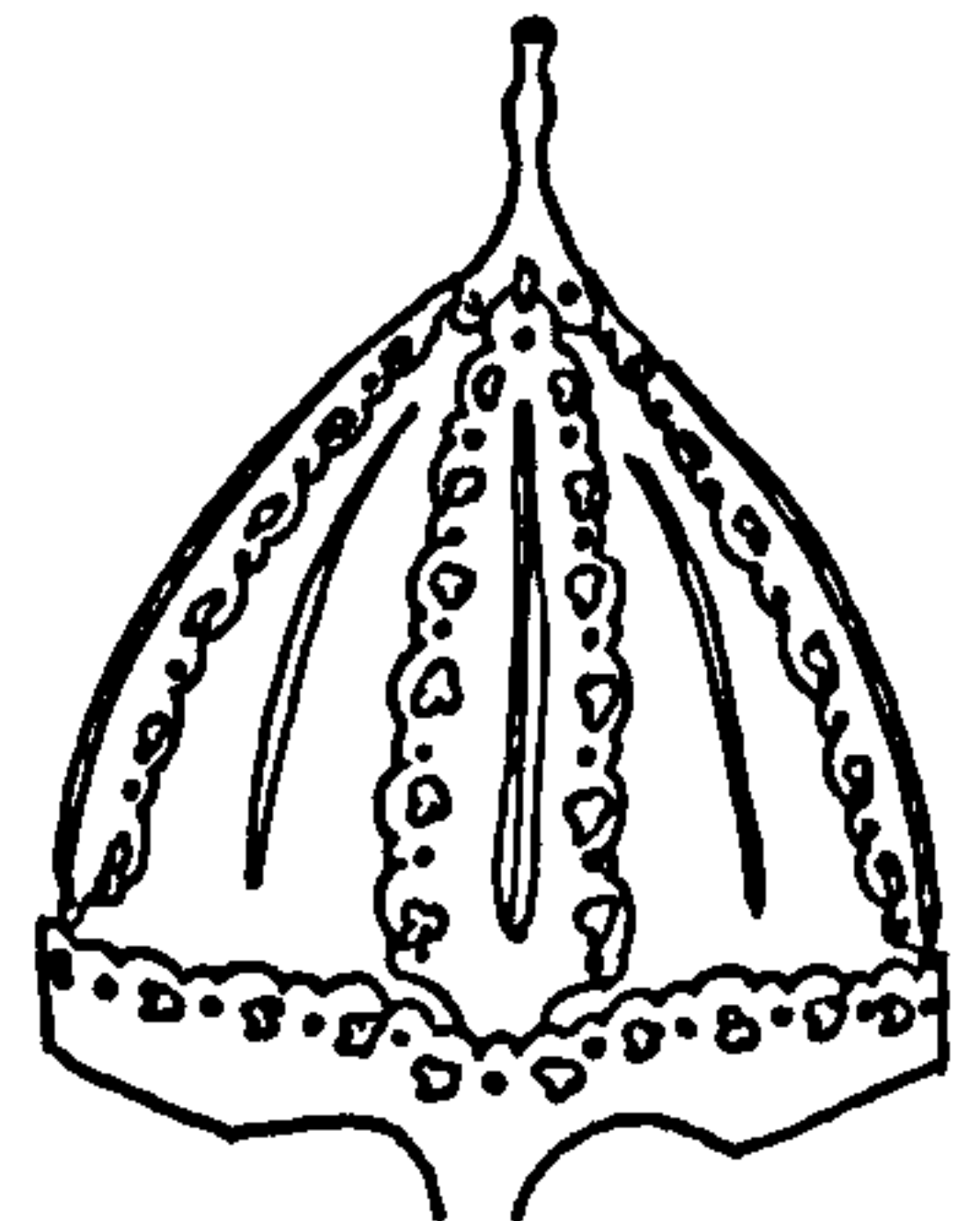

616

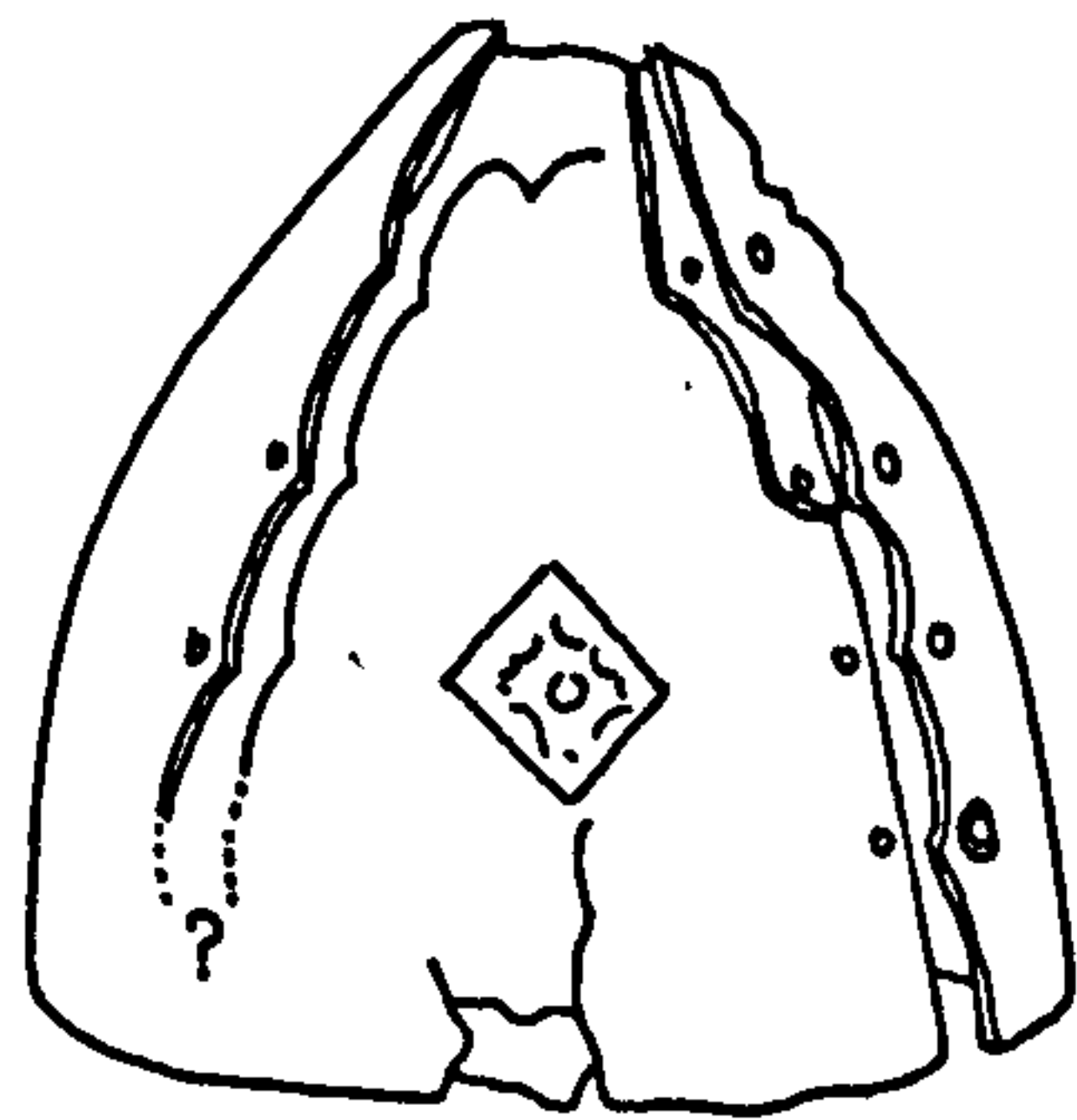

617

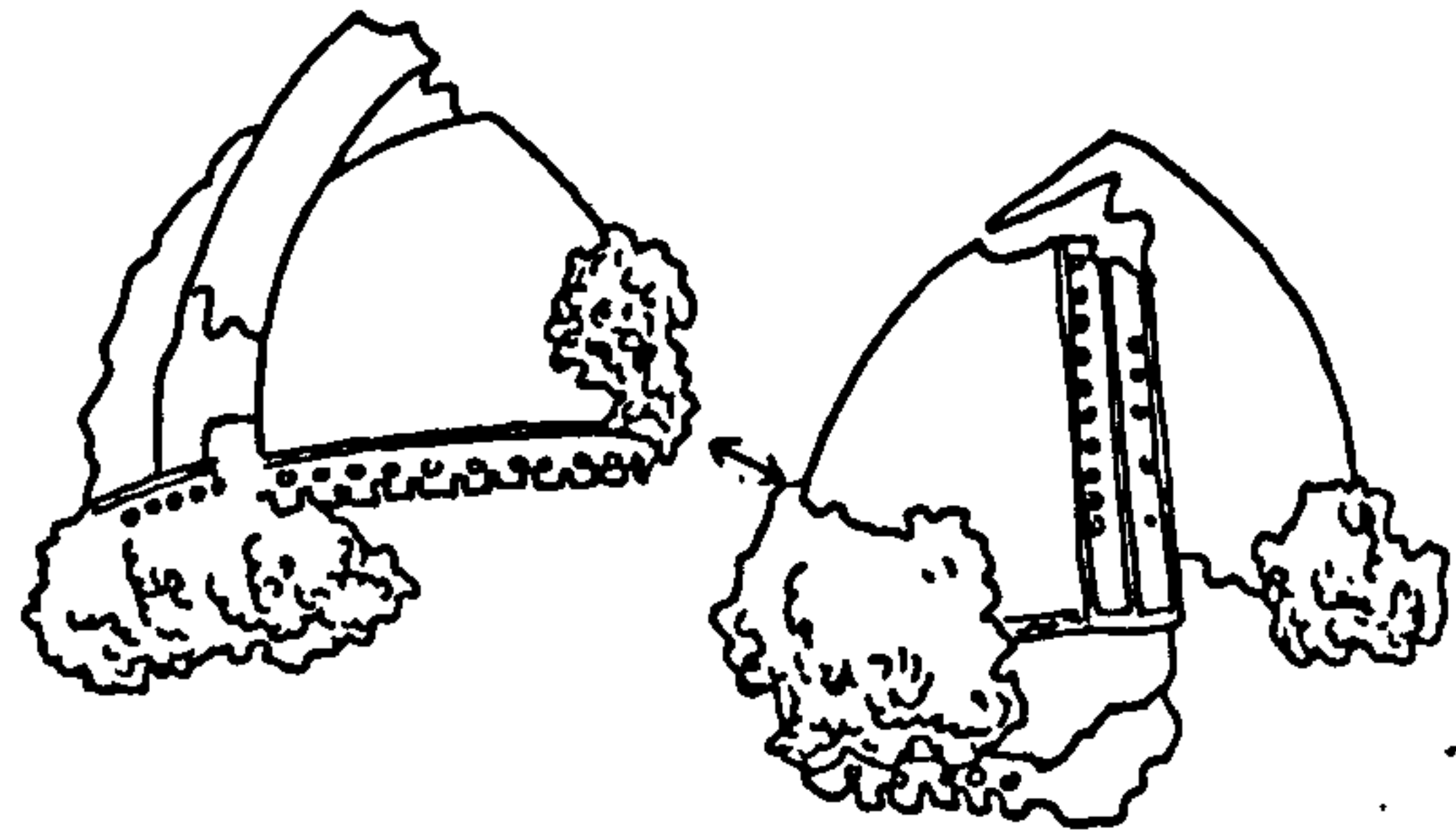

618

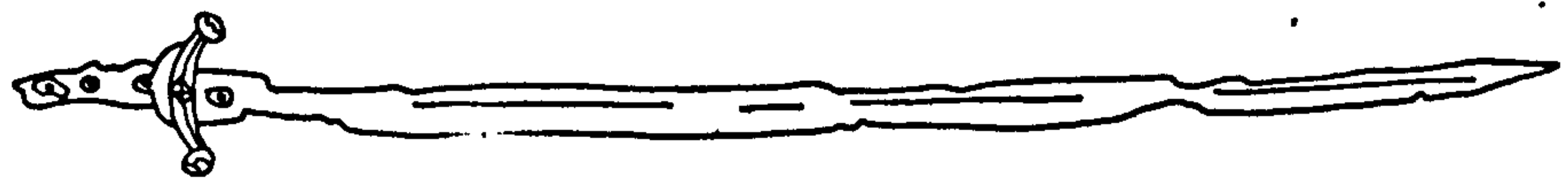

619

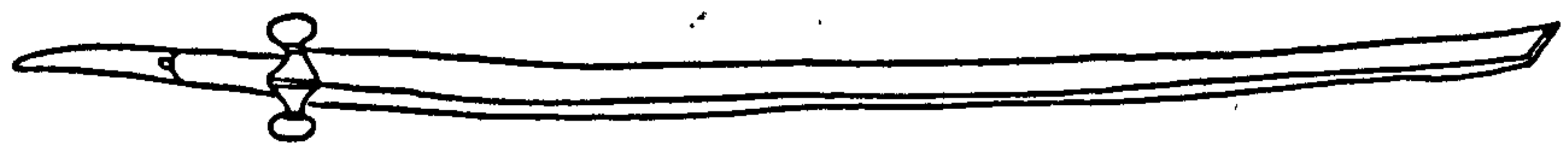

620

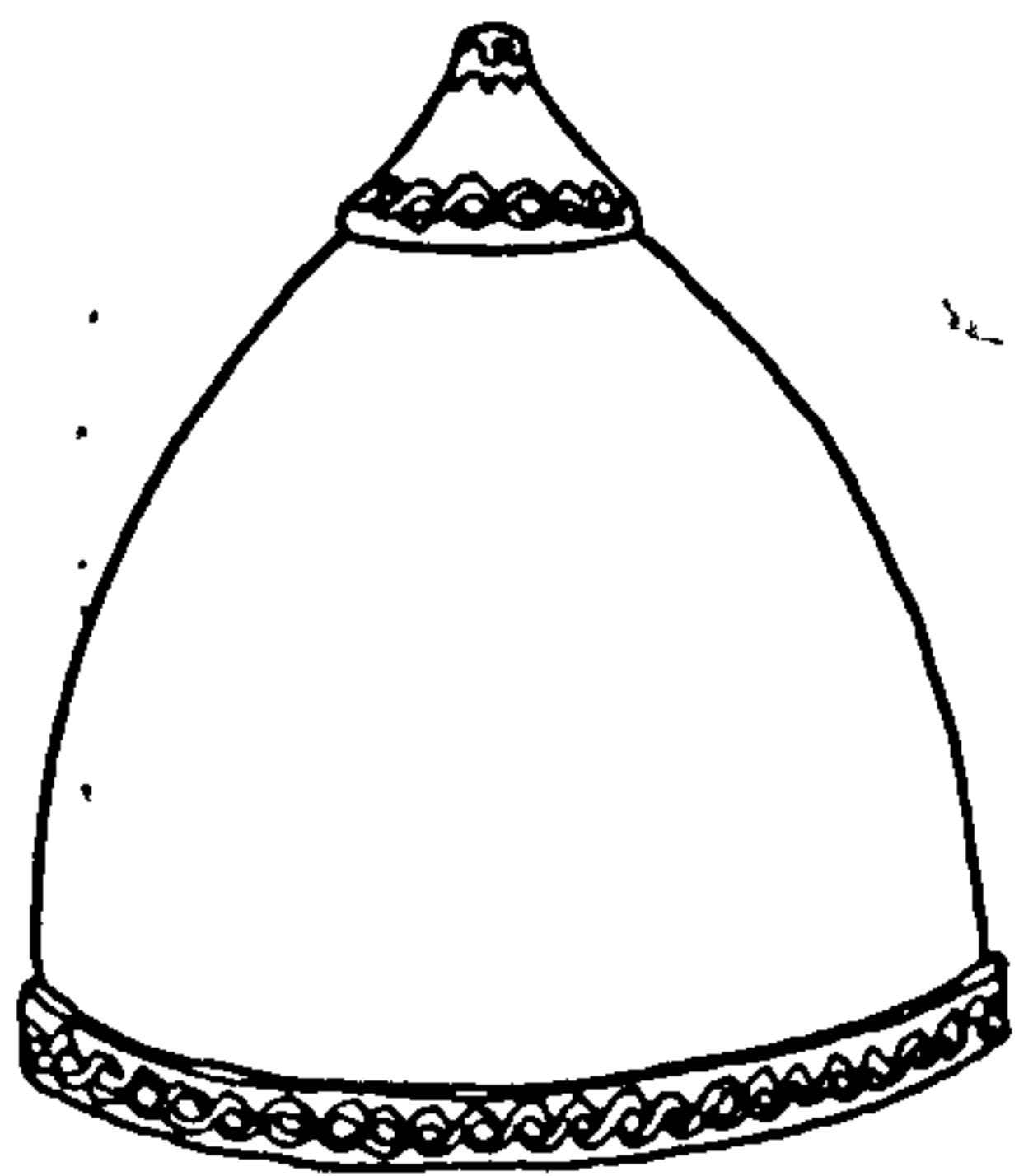

621

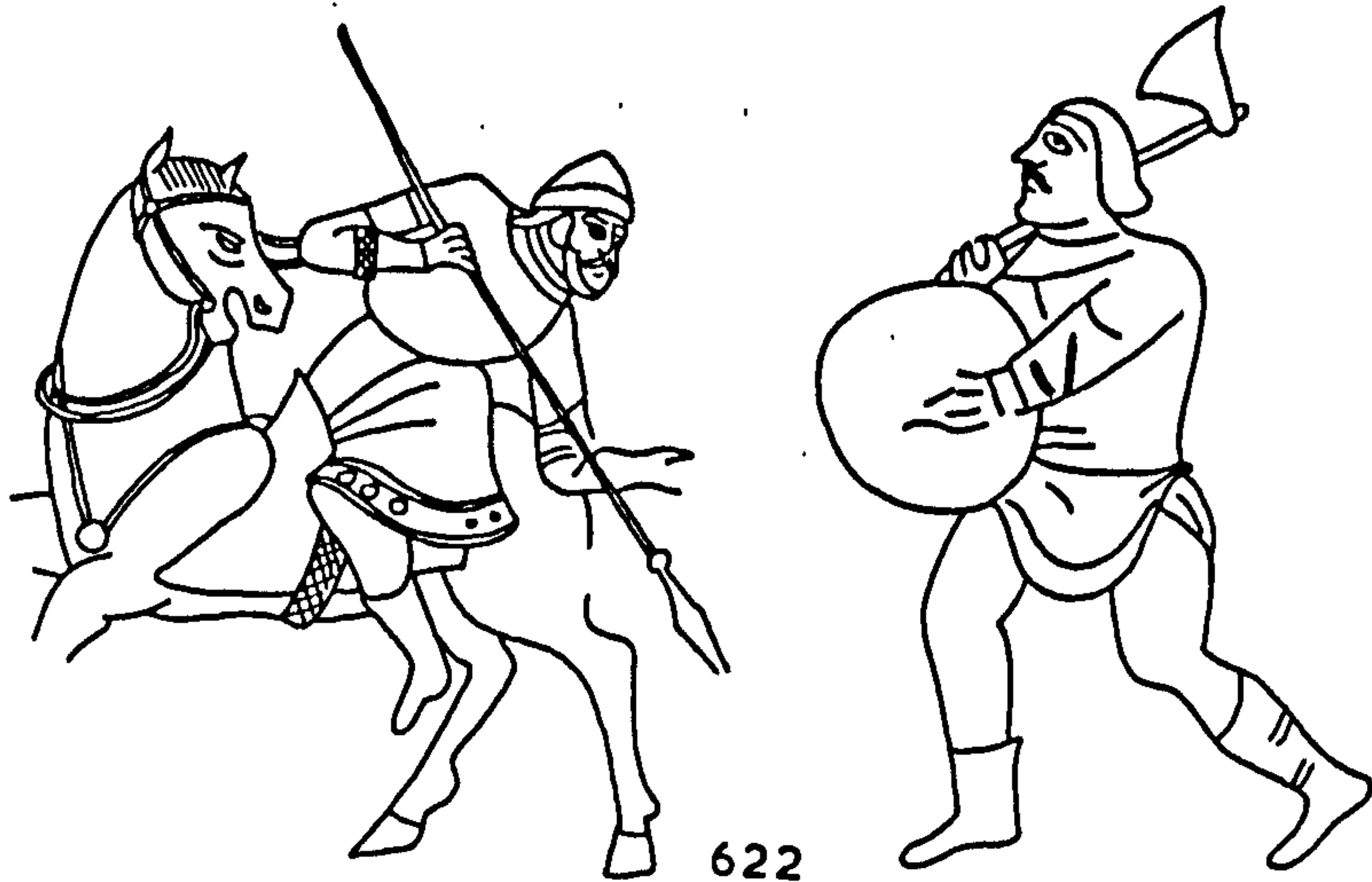

622



623

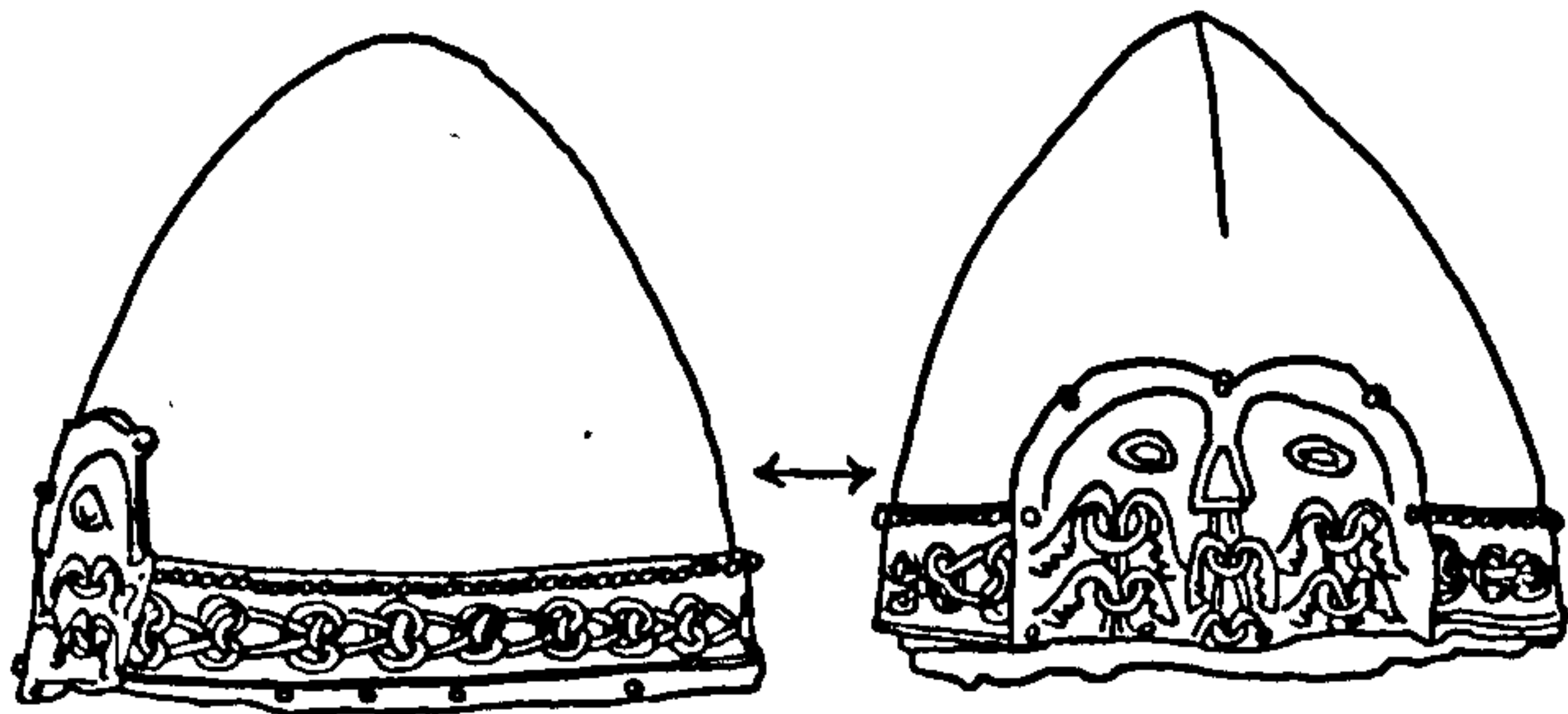

624

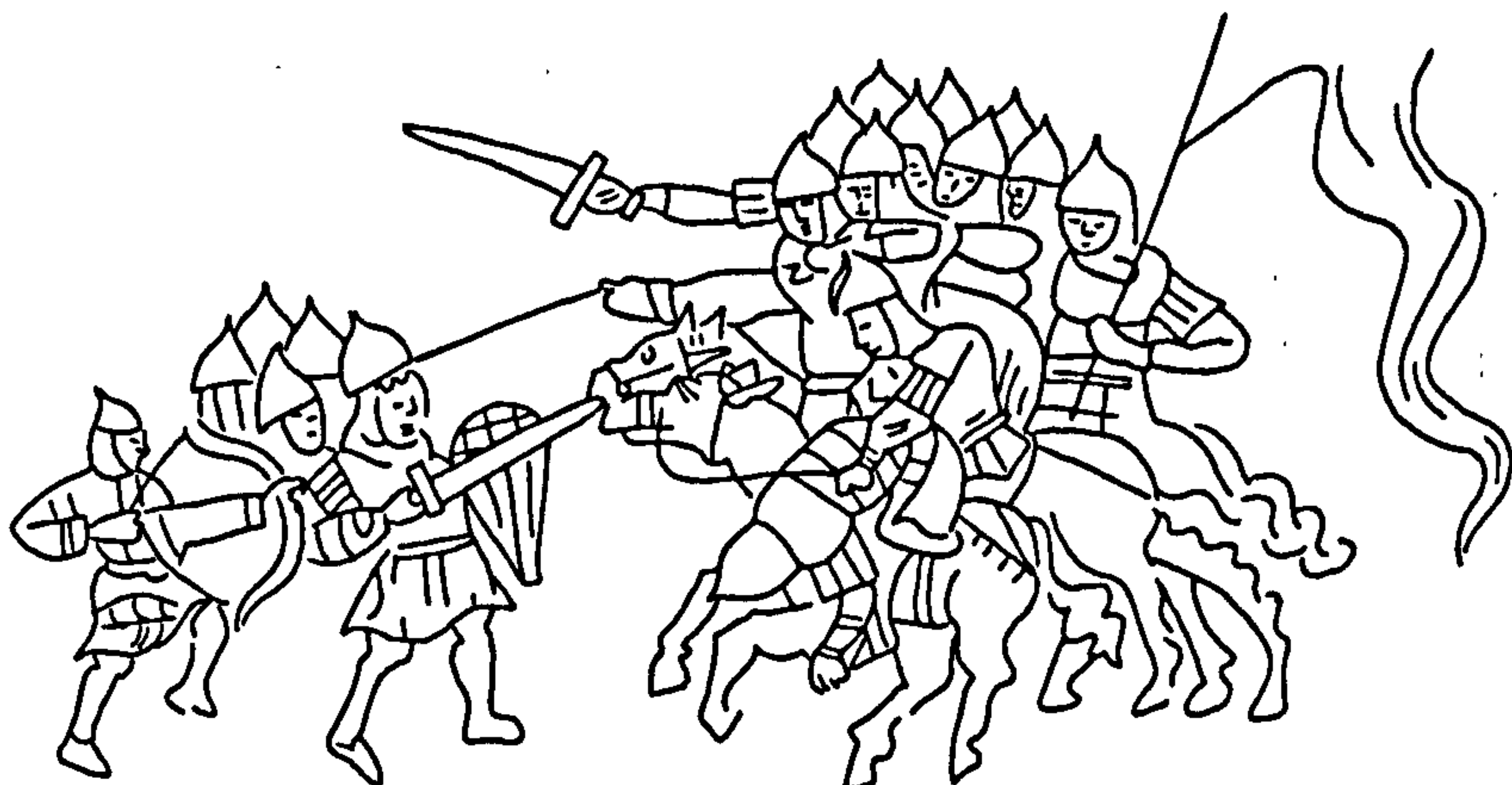

625

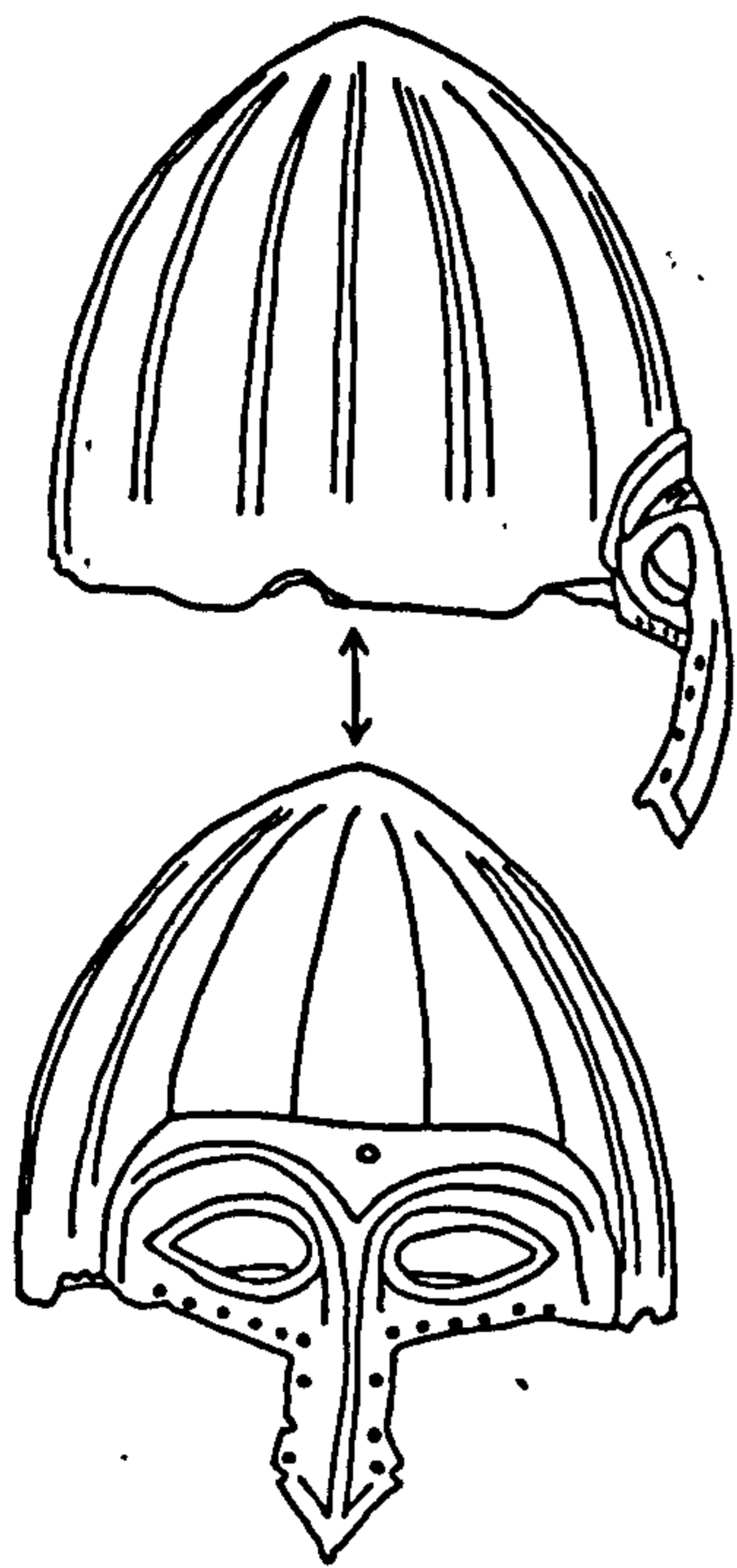

626

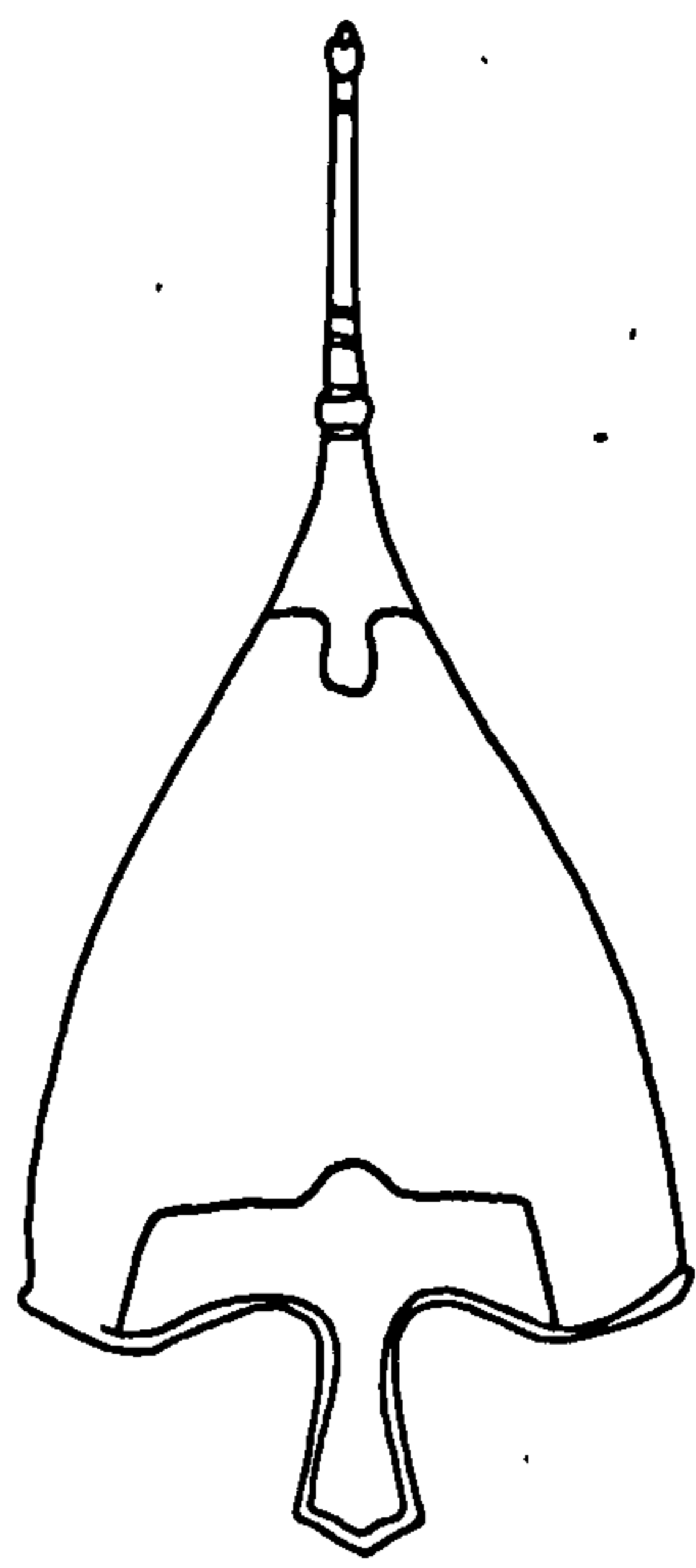

627

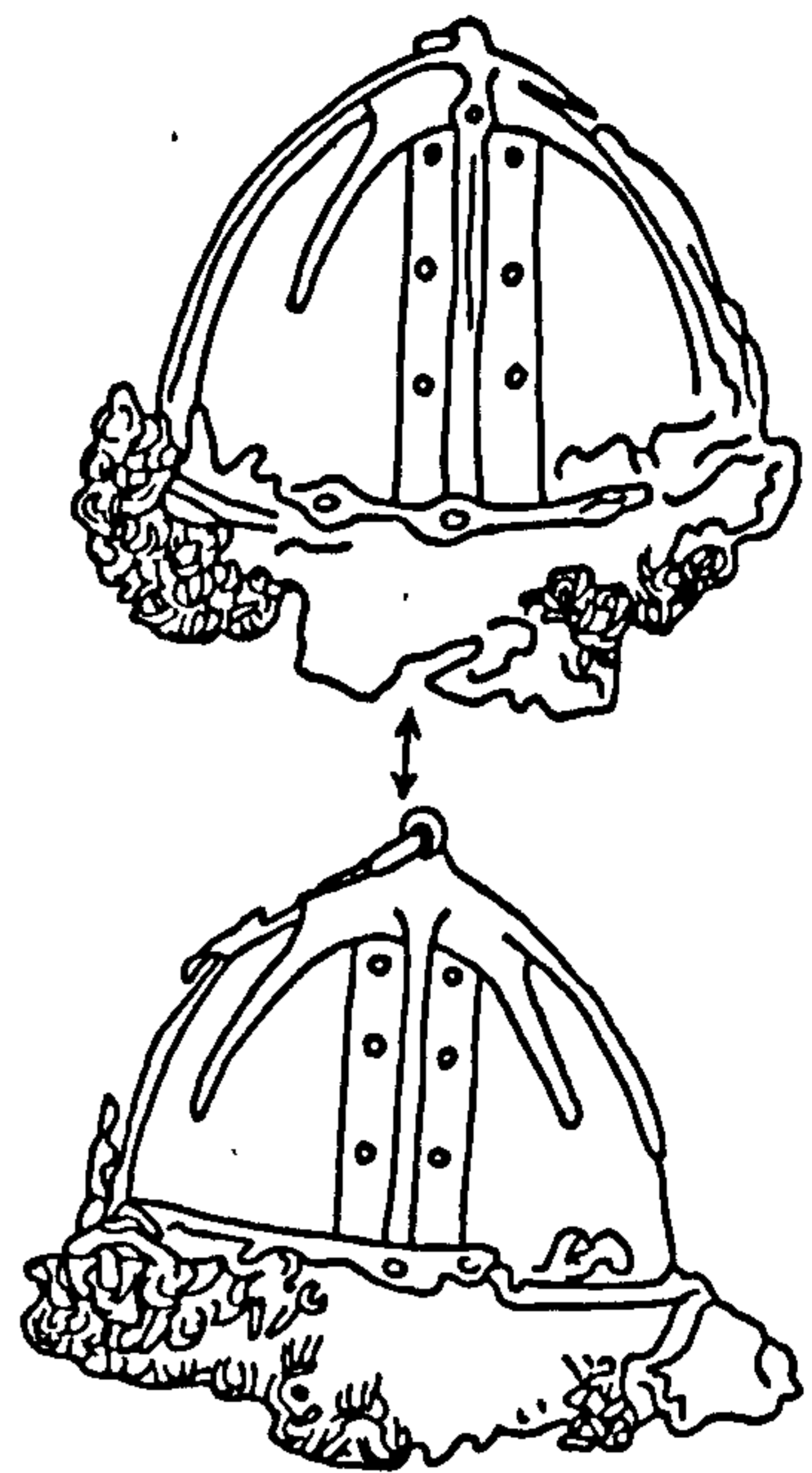

628



629

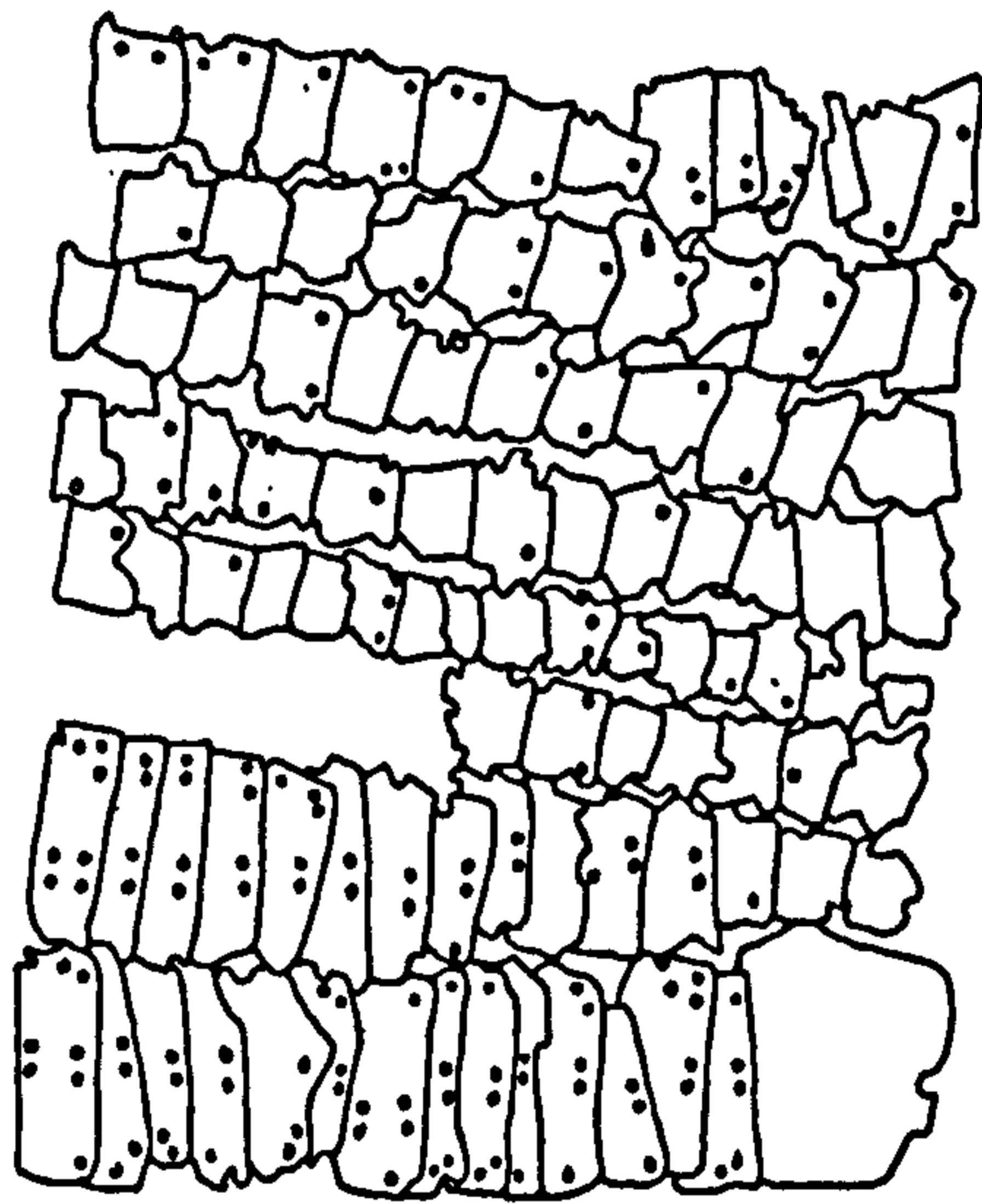

630

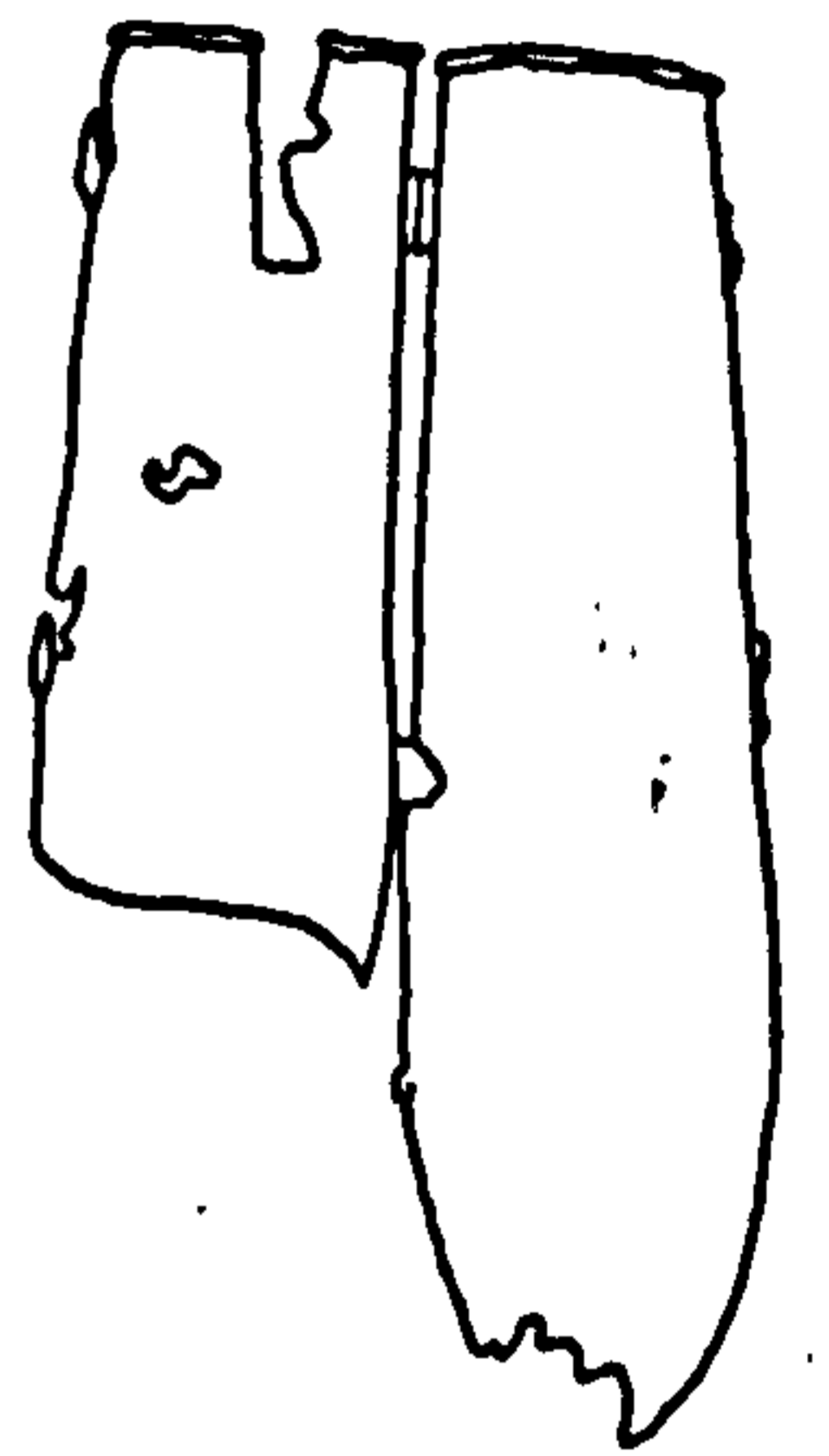

631

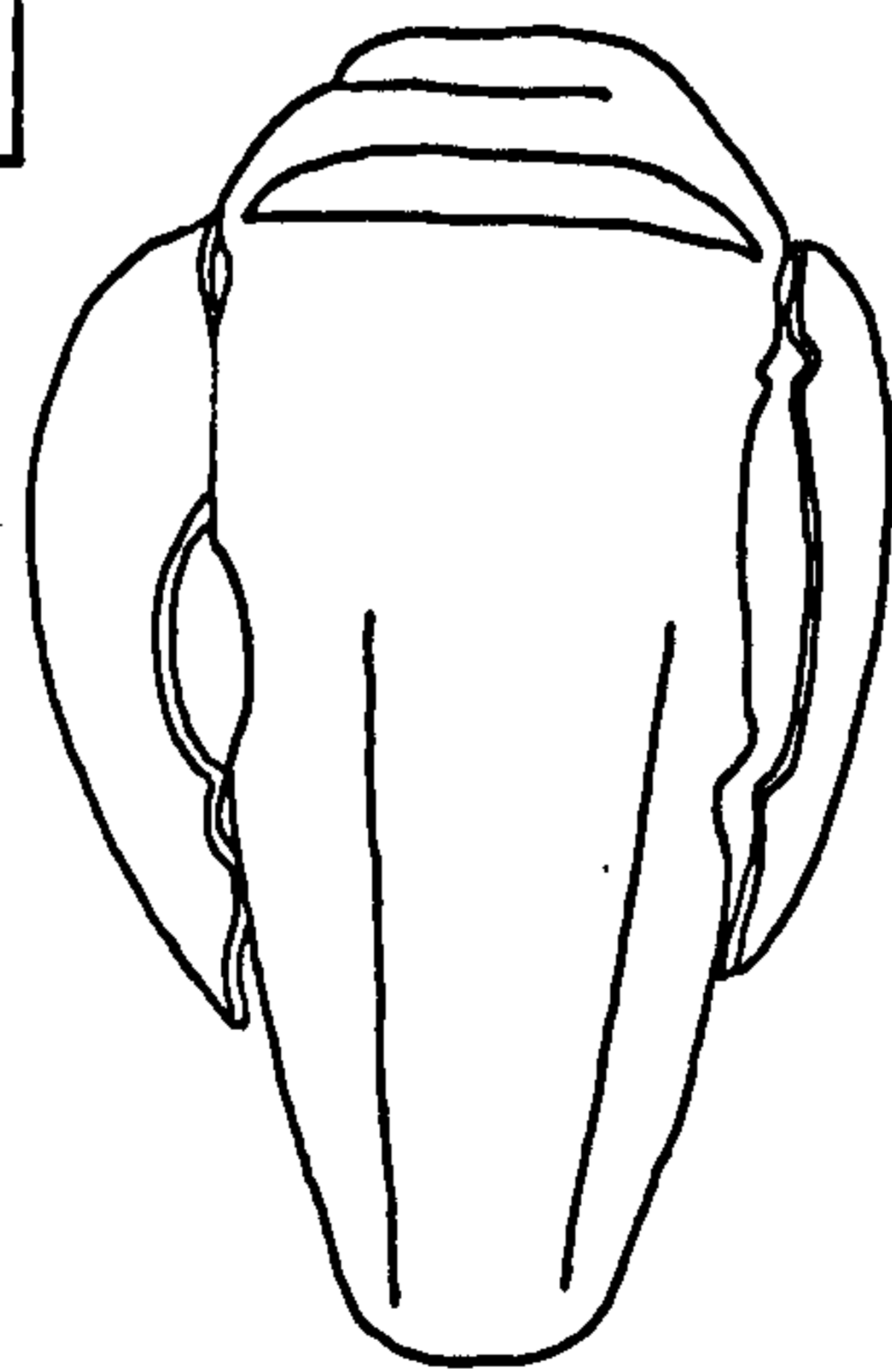

632

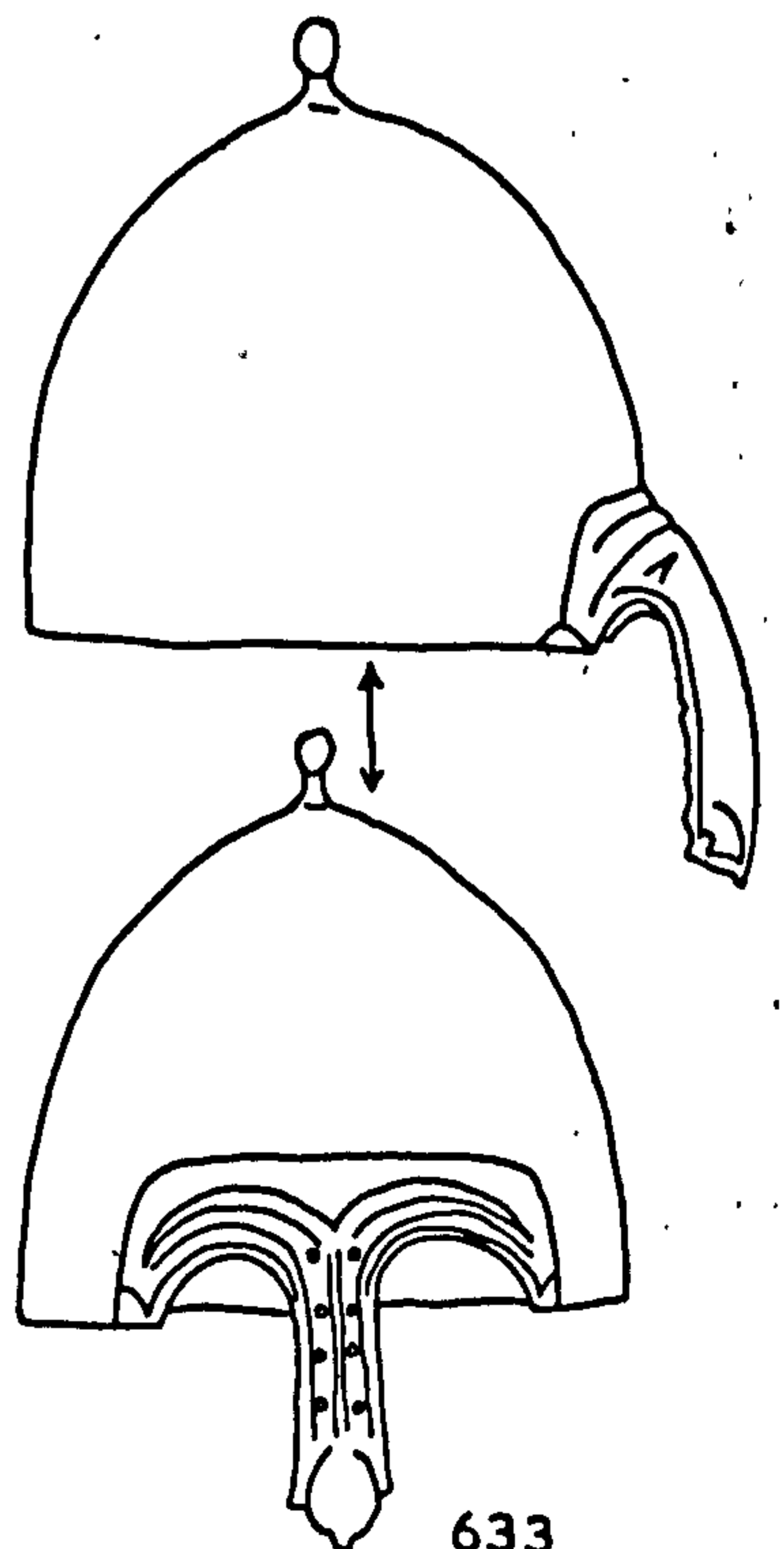

633



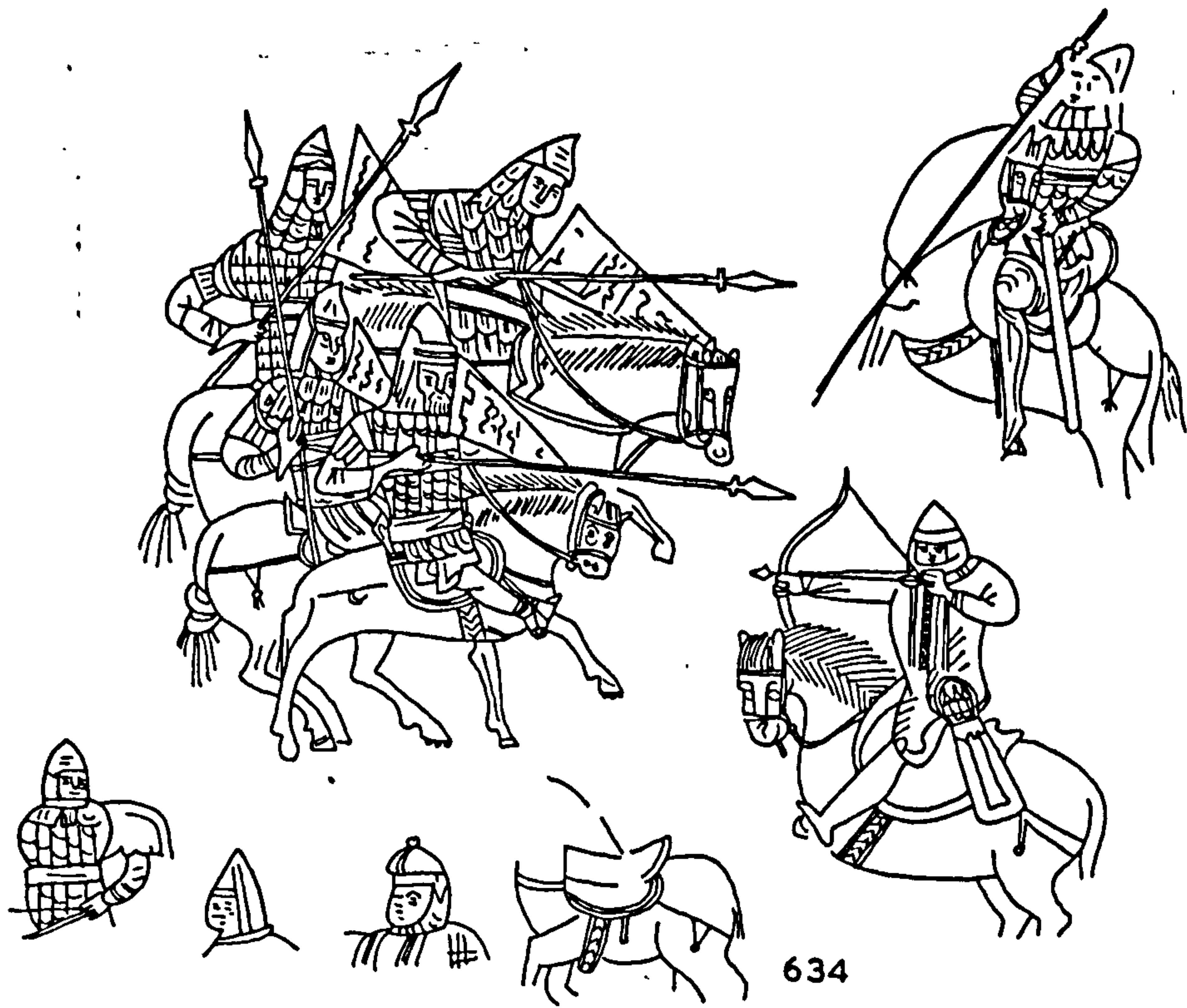

634

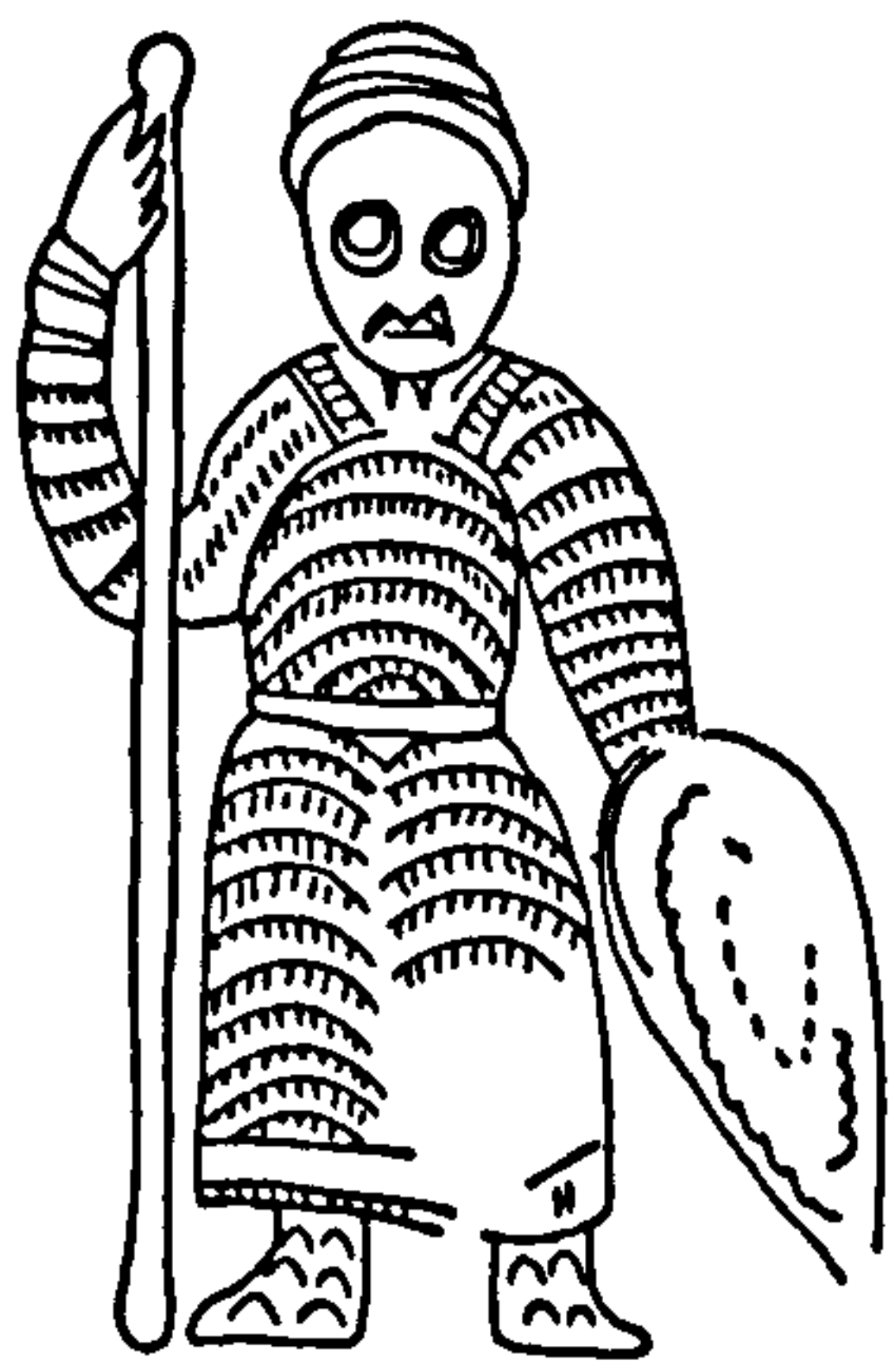

635

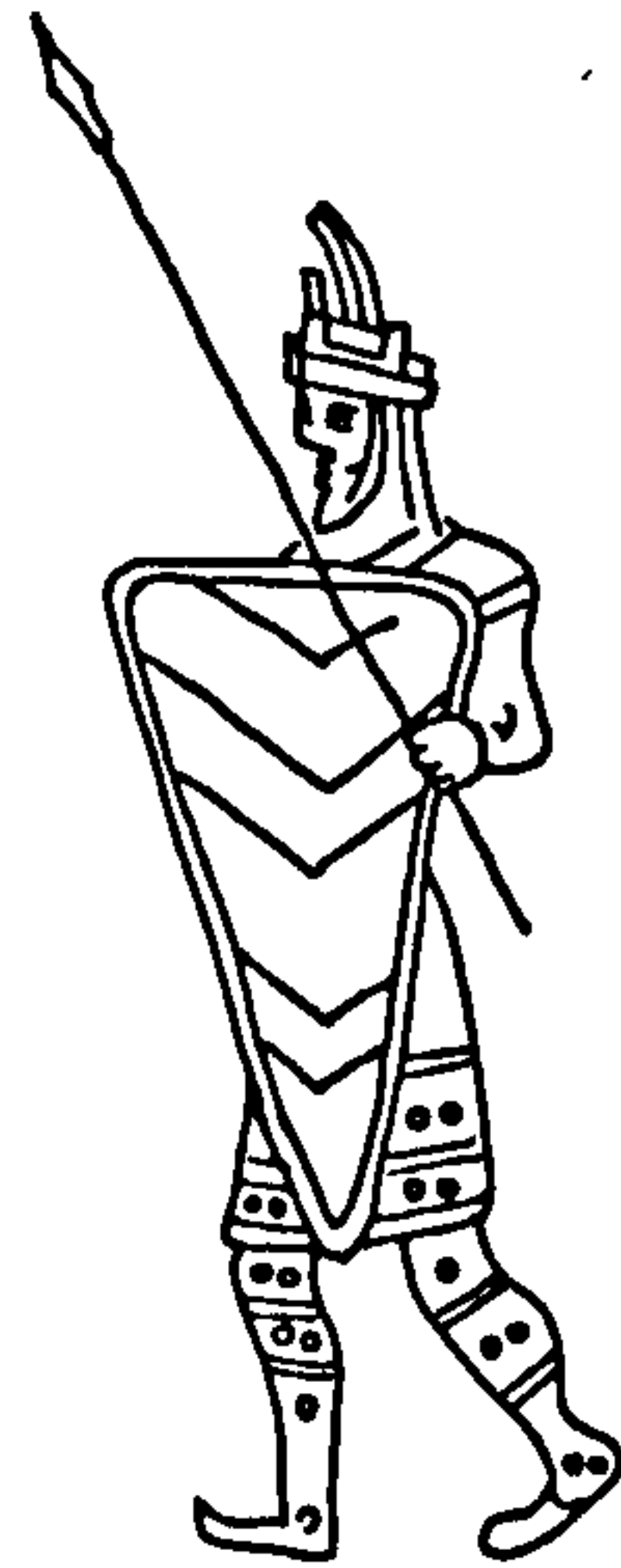

636A

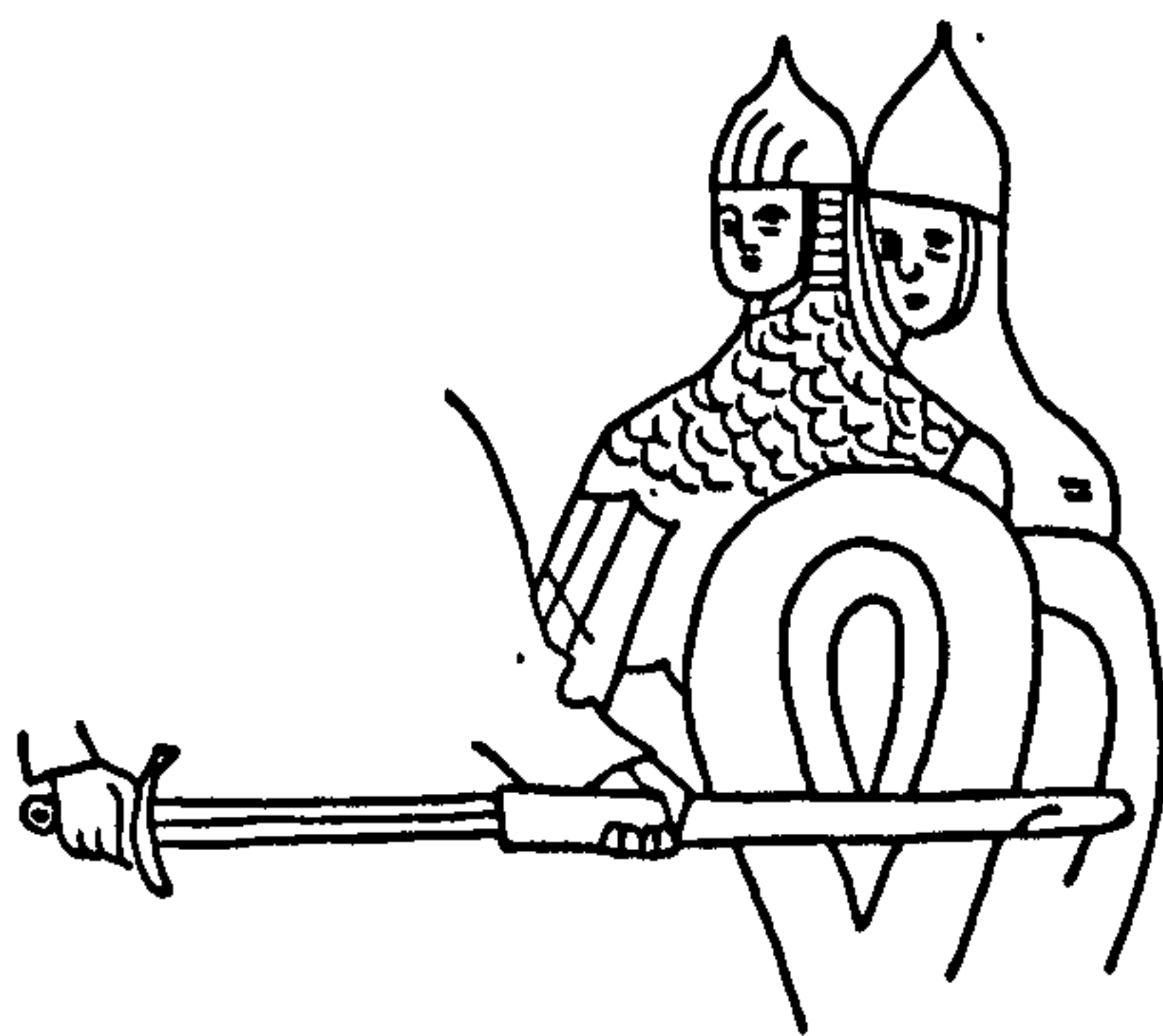

636B



636C

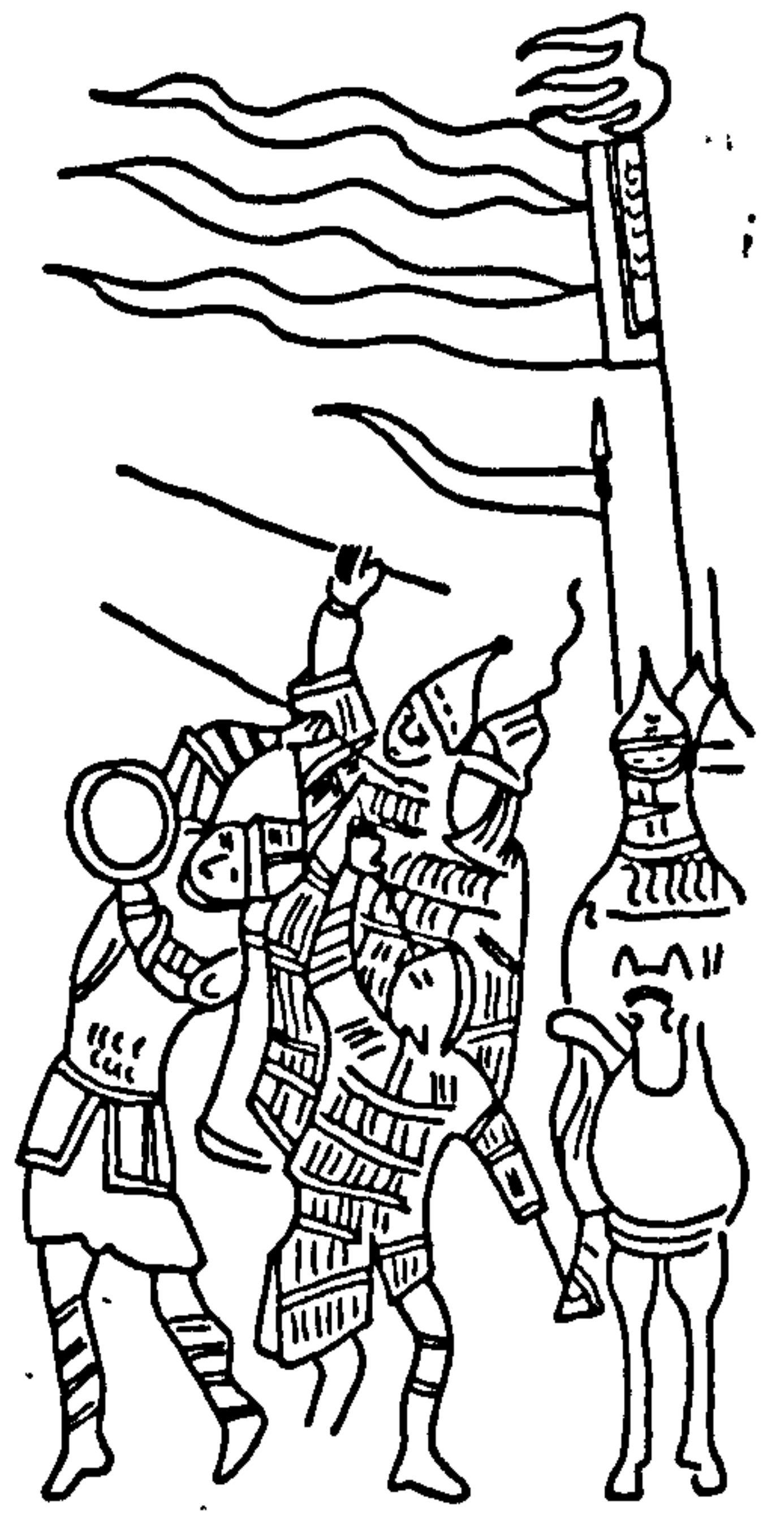

637A

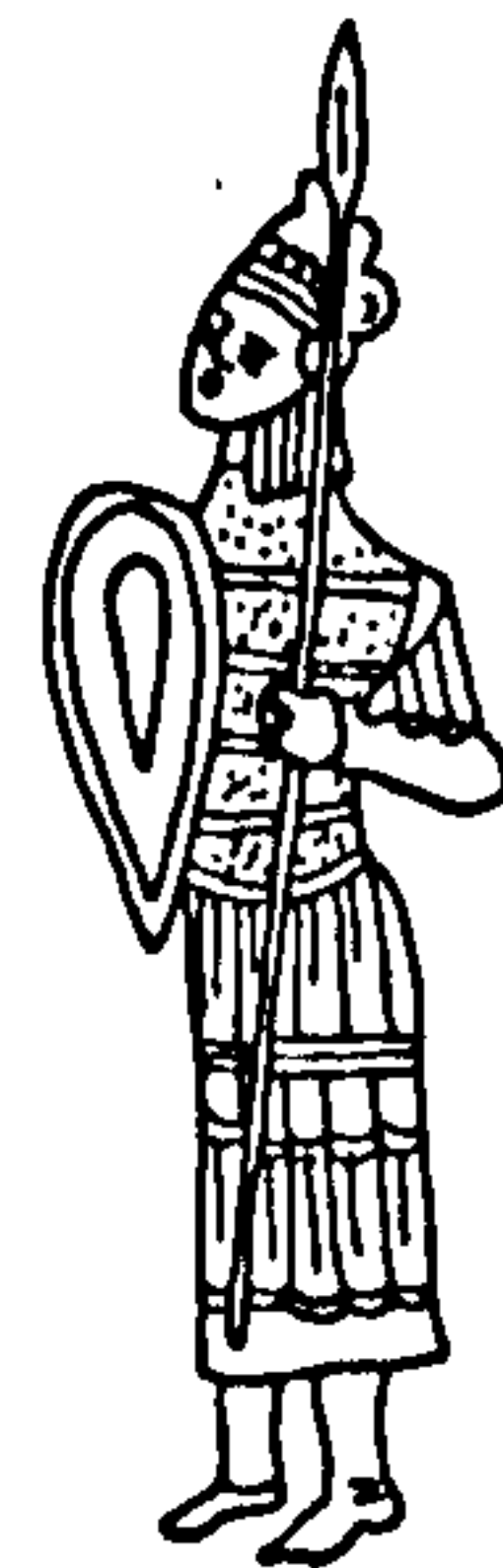

637B



637C

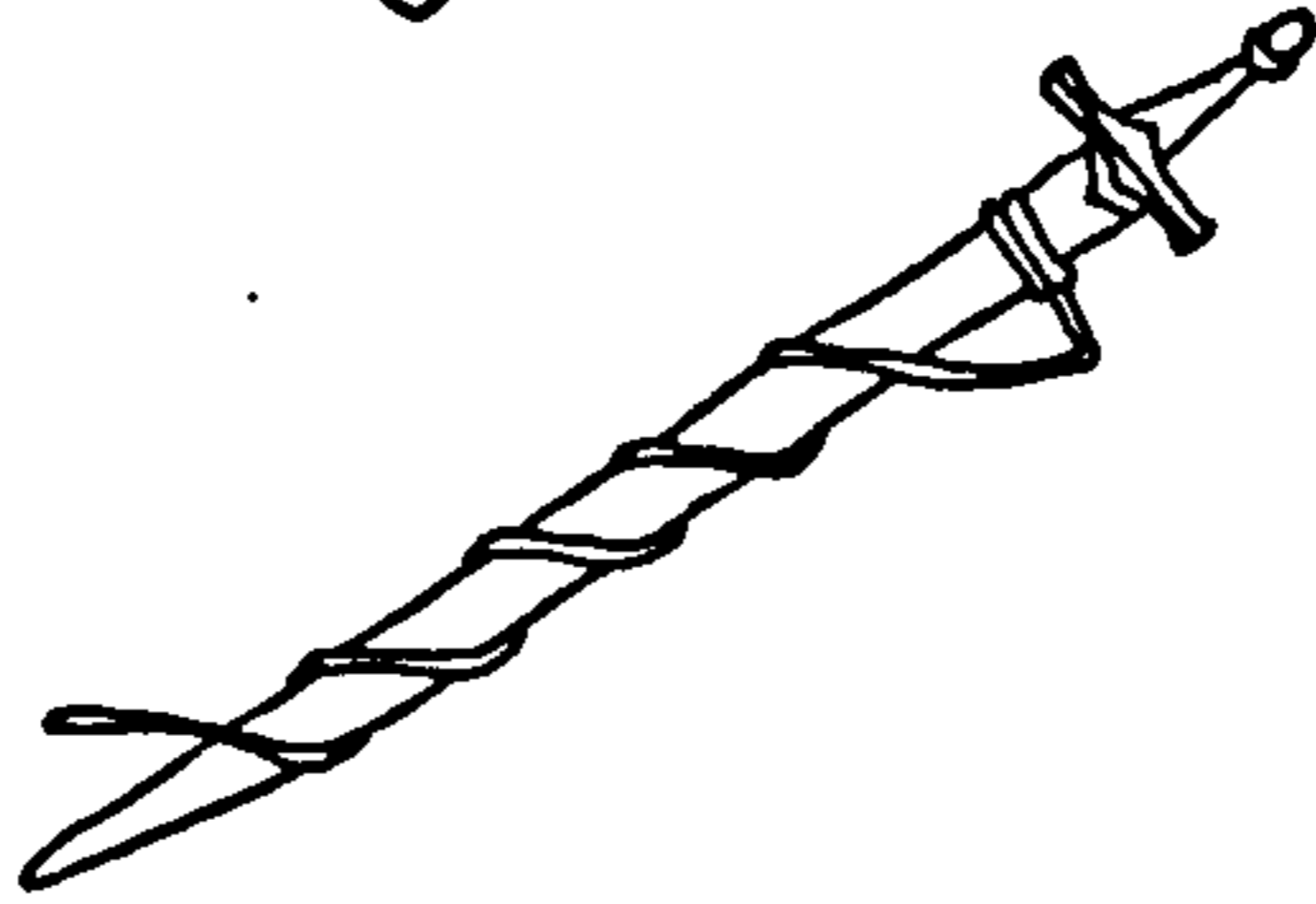
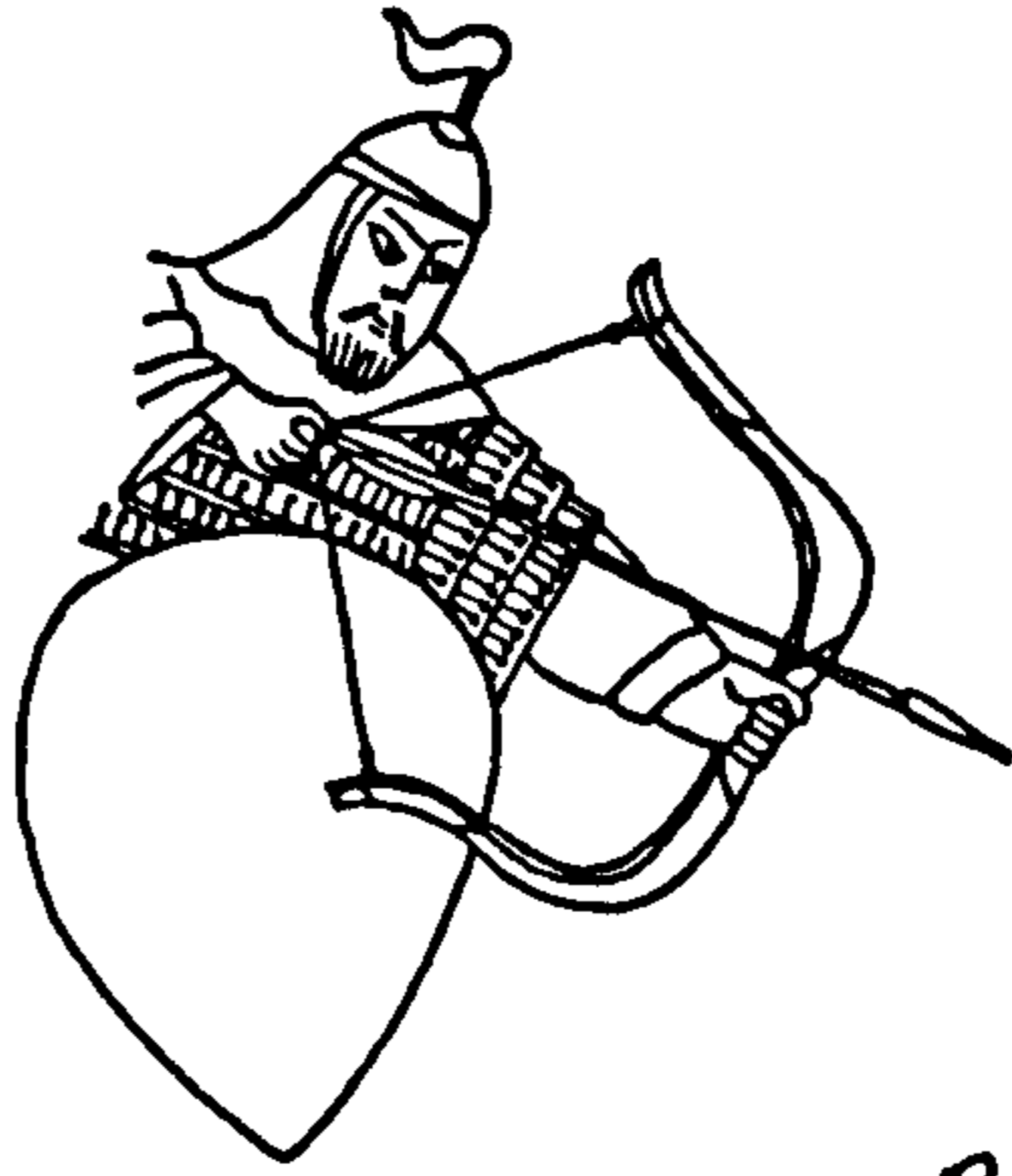
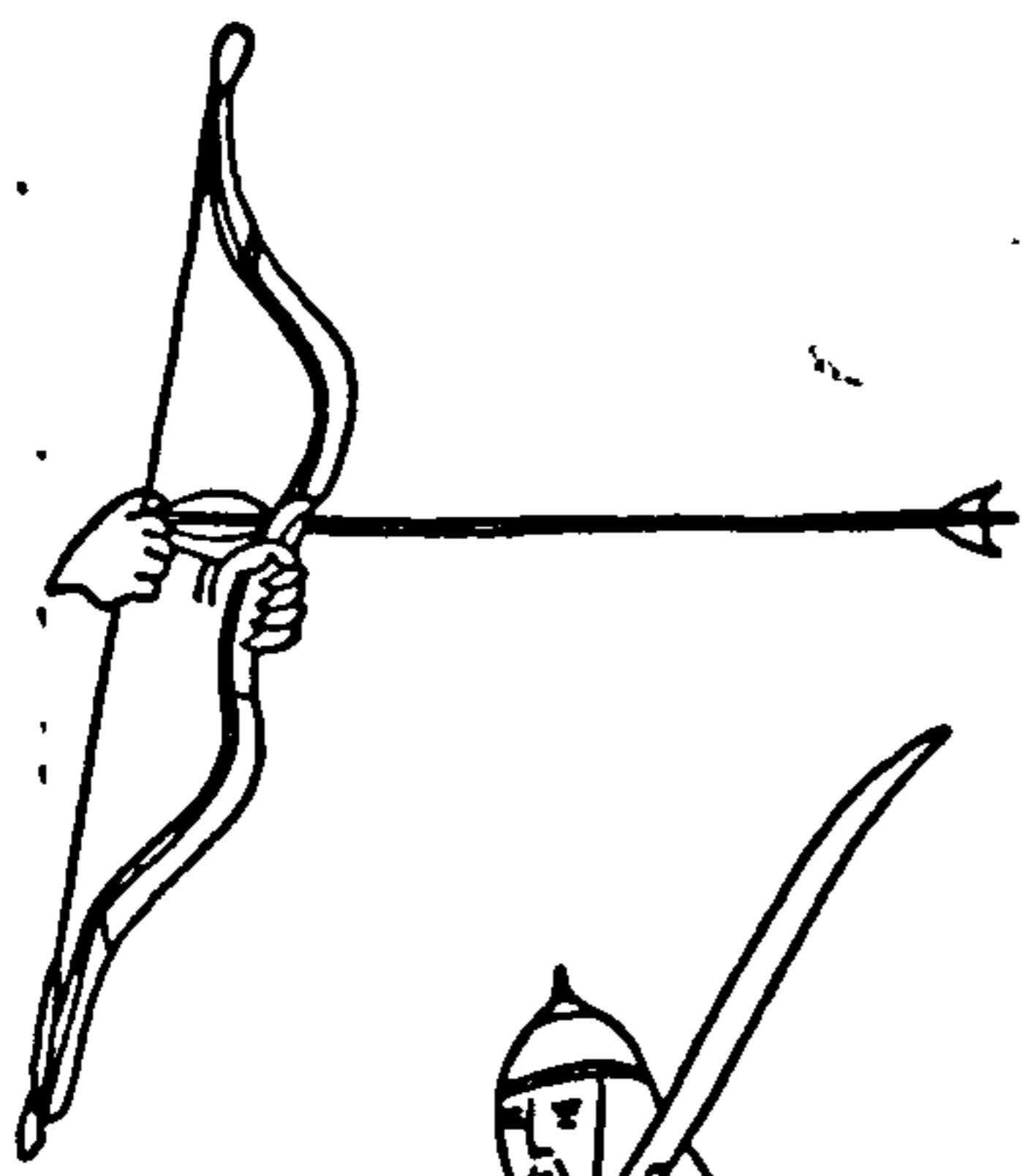

638

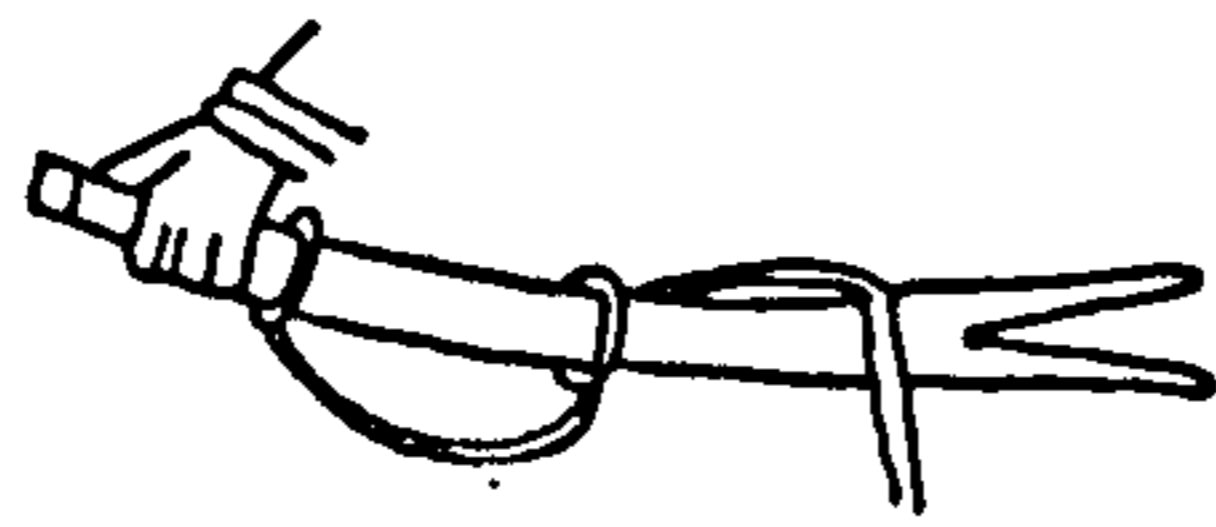
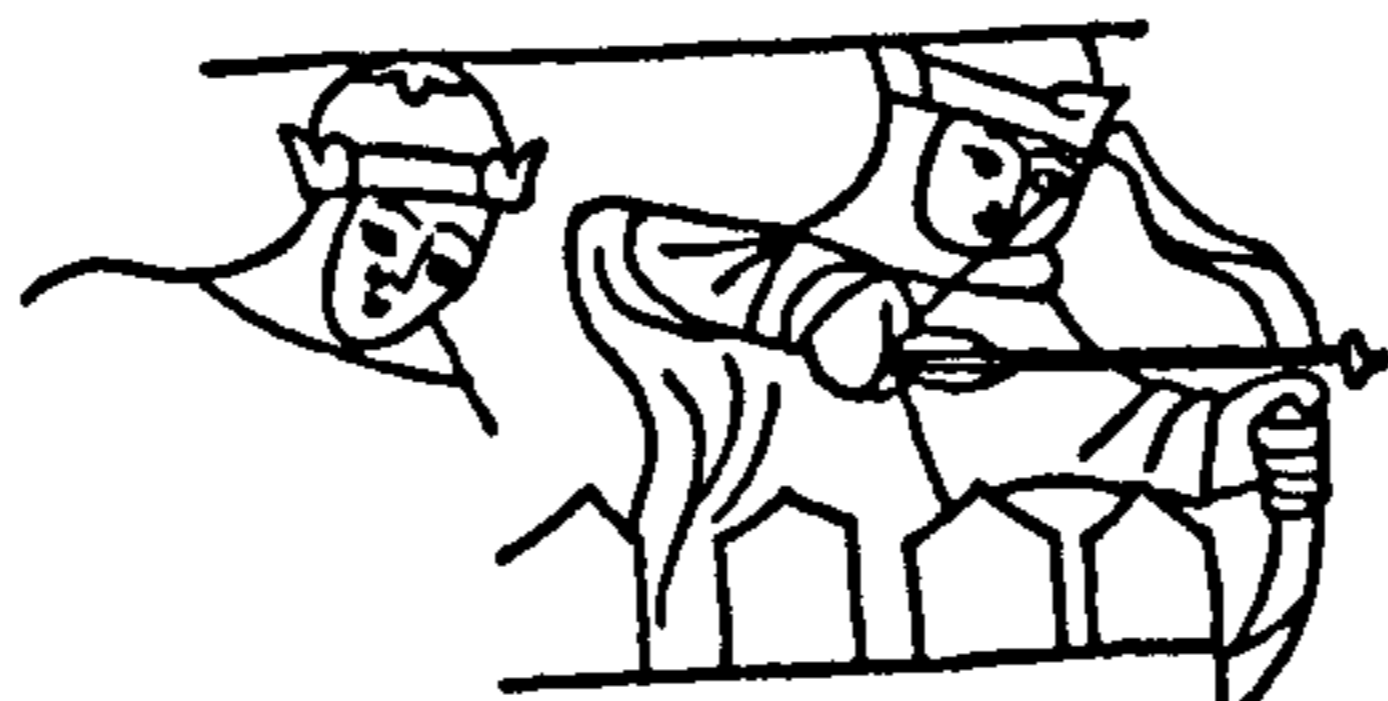

639A

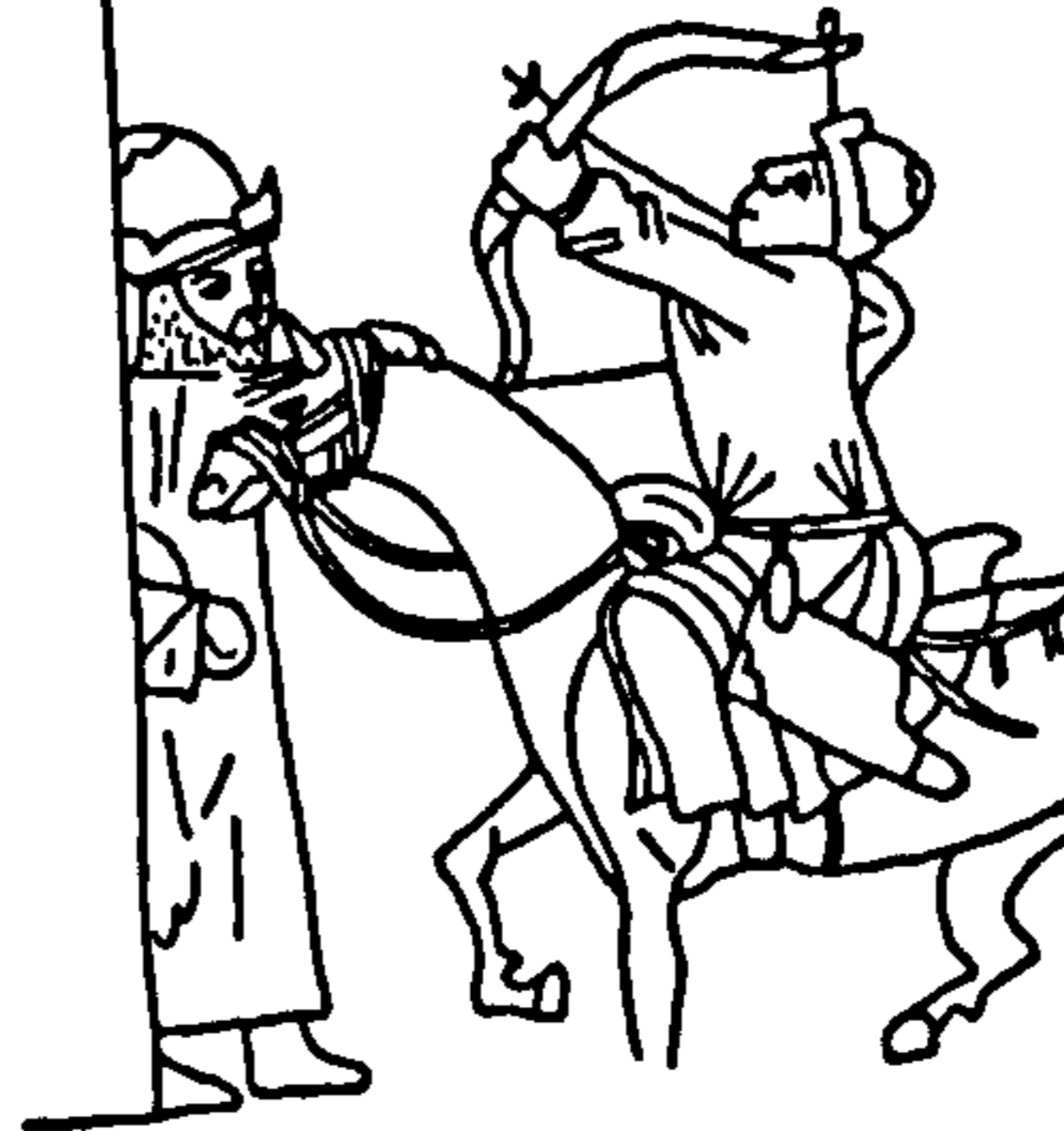

639B



639C

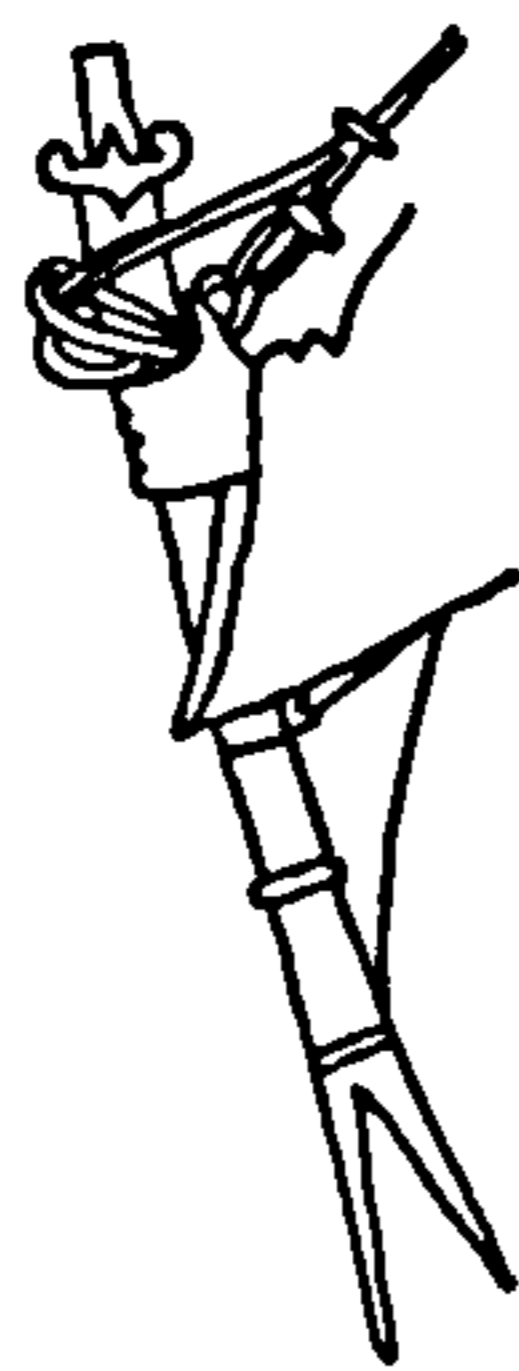

639D

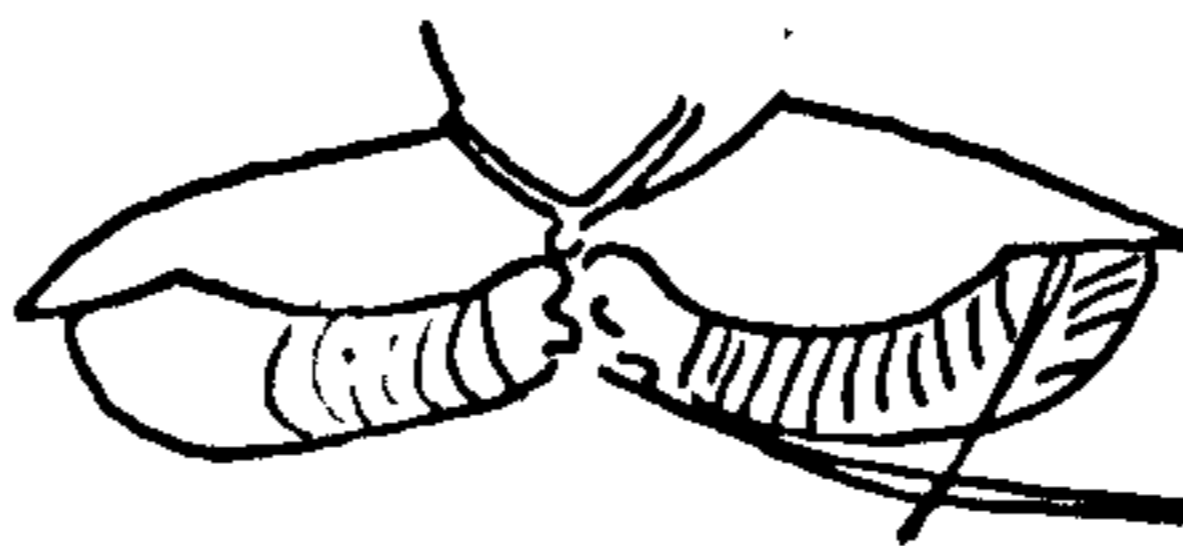

640



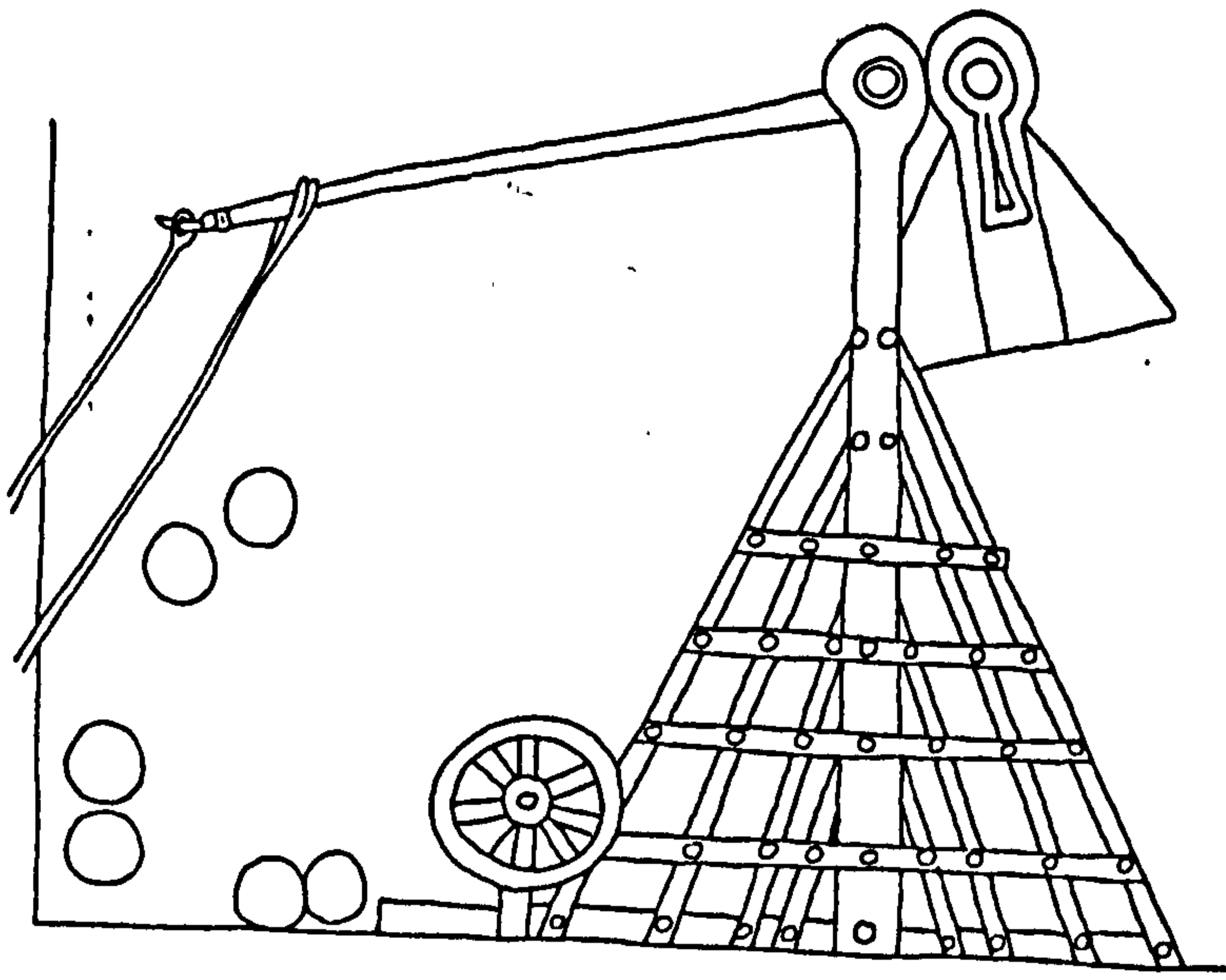

642A



642B

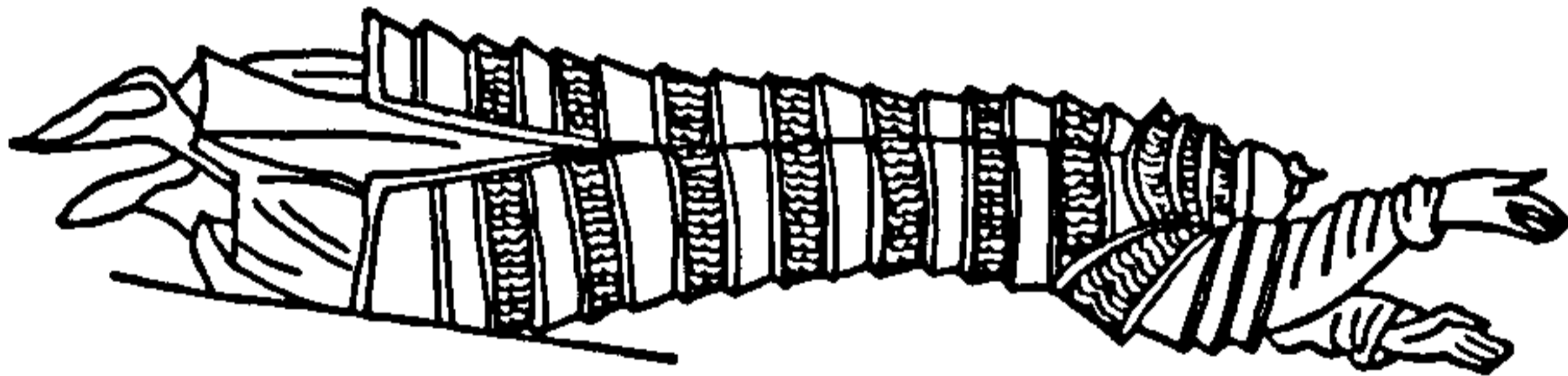
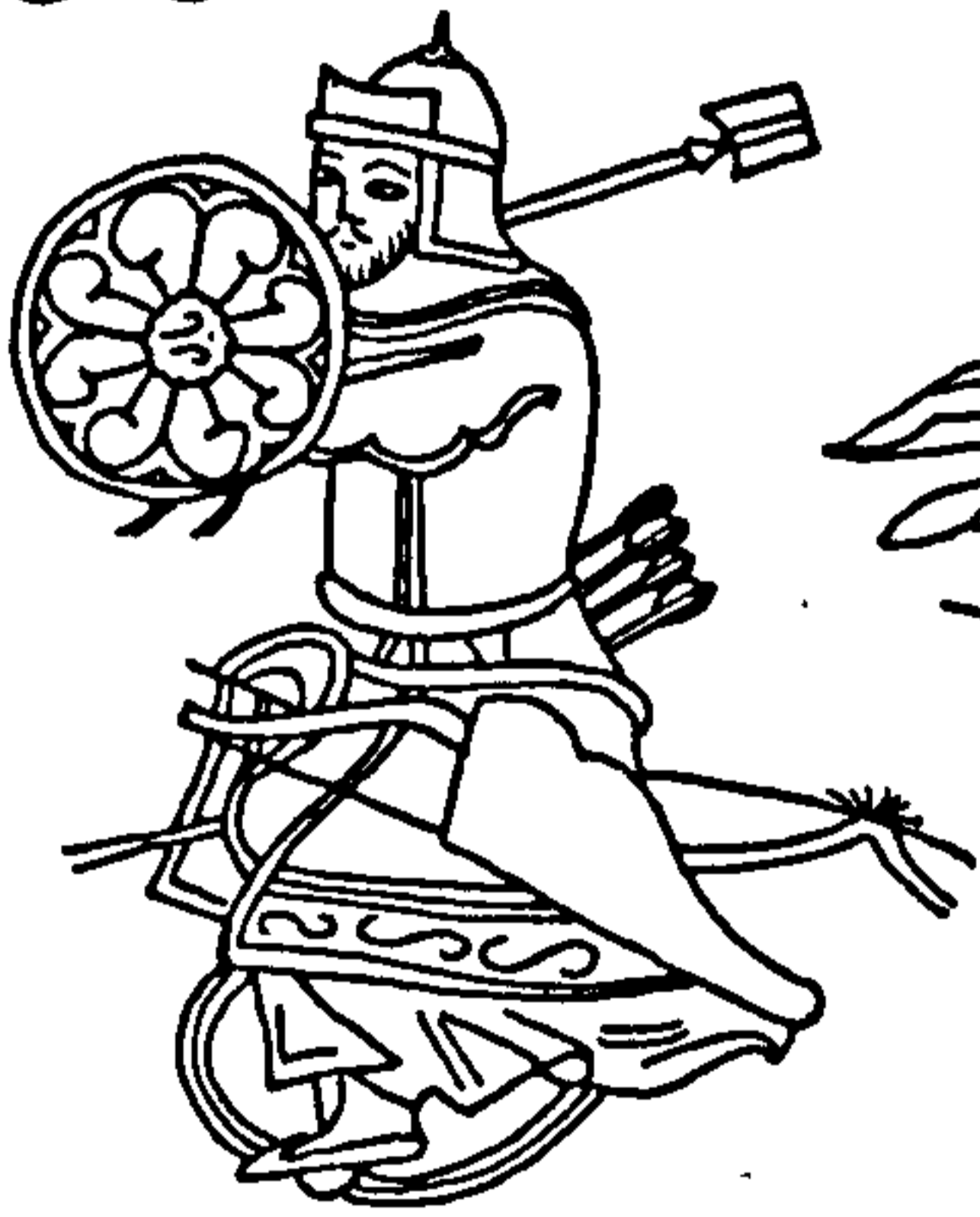
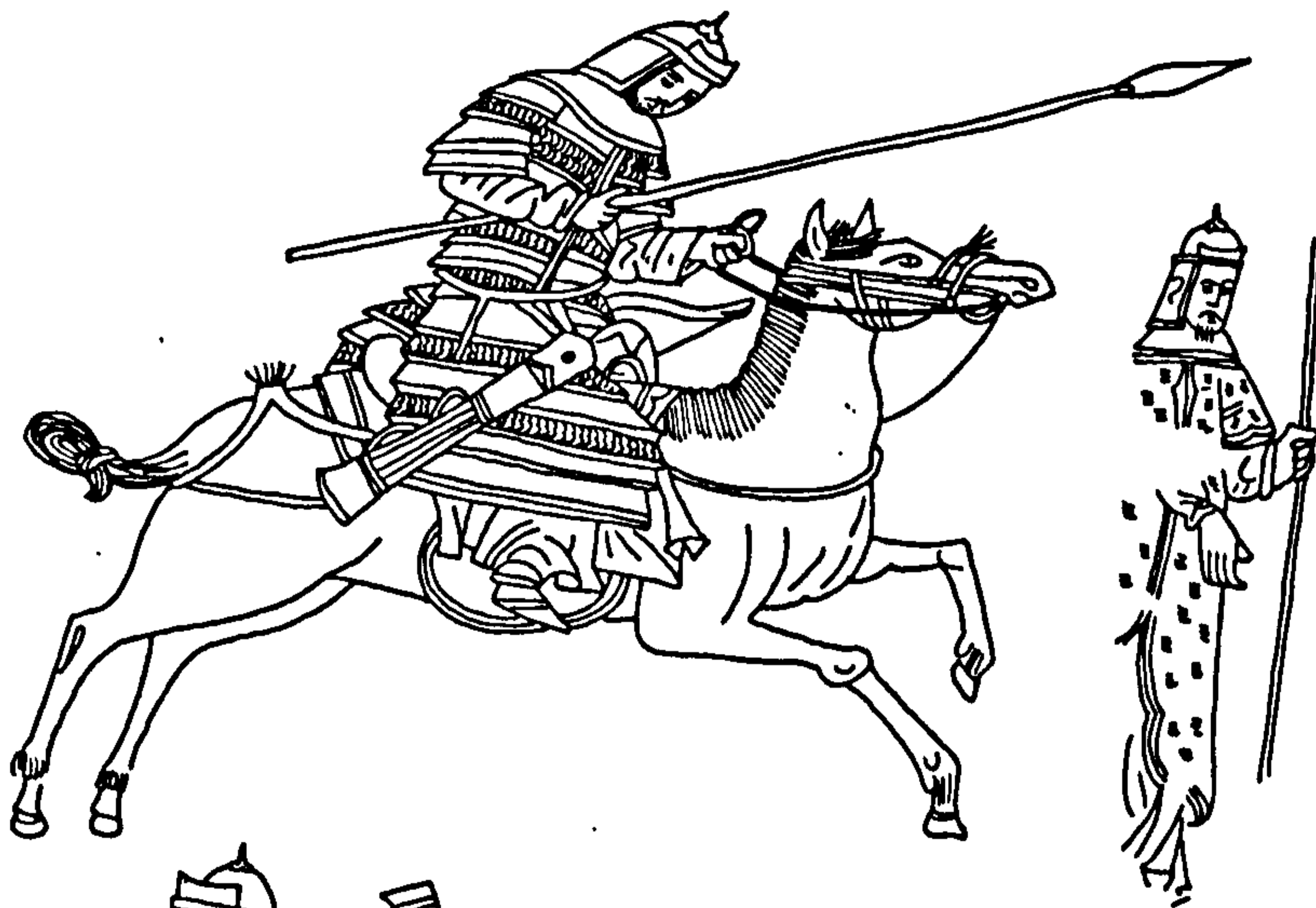

642C

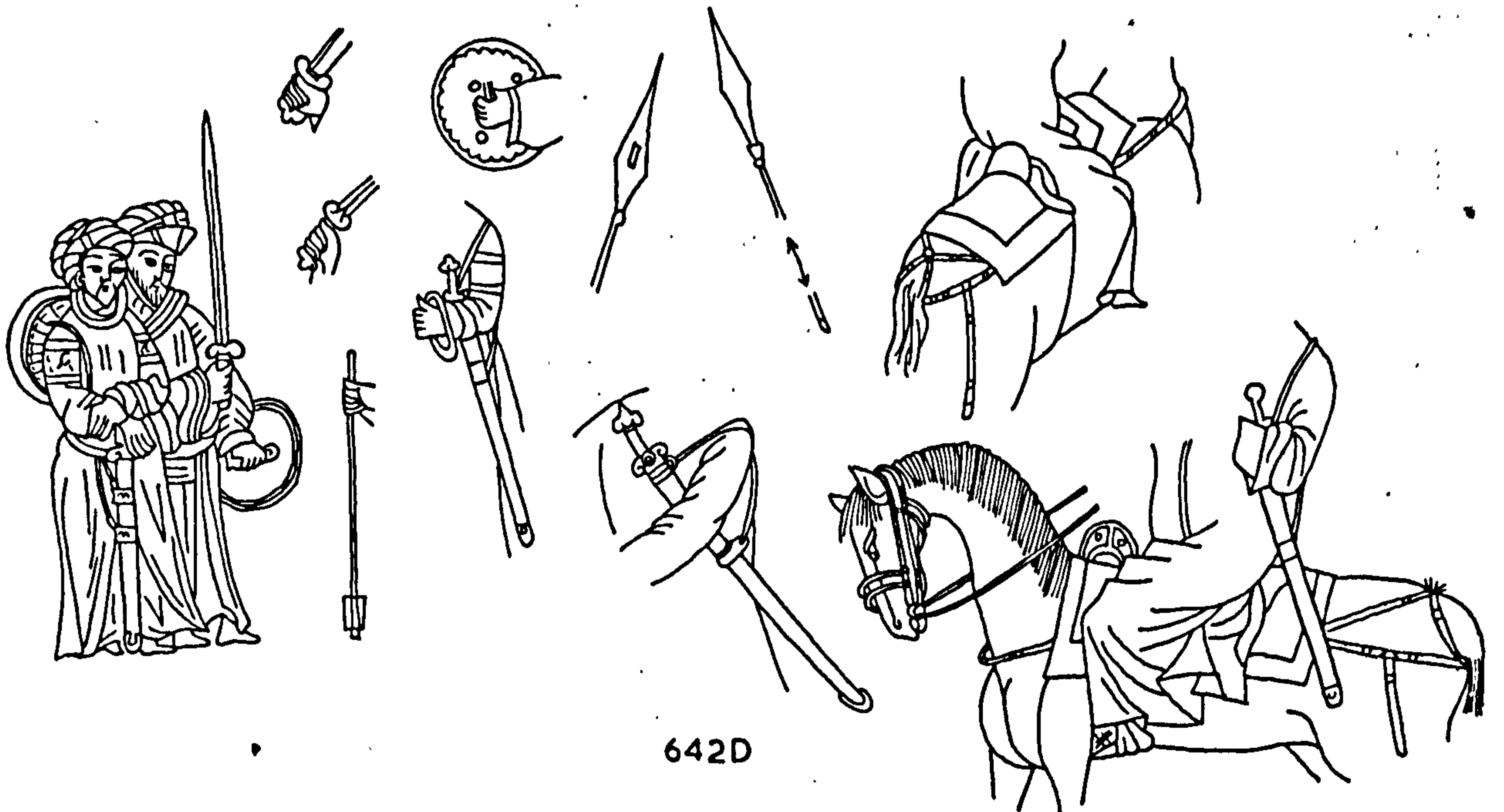

642D

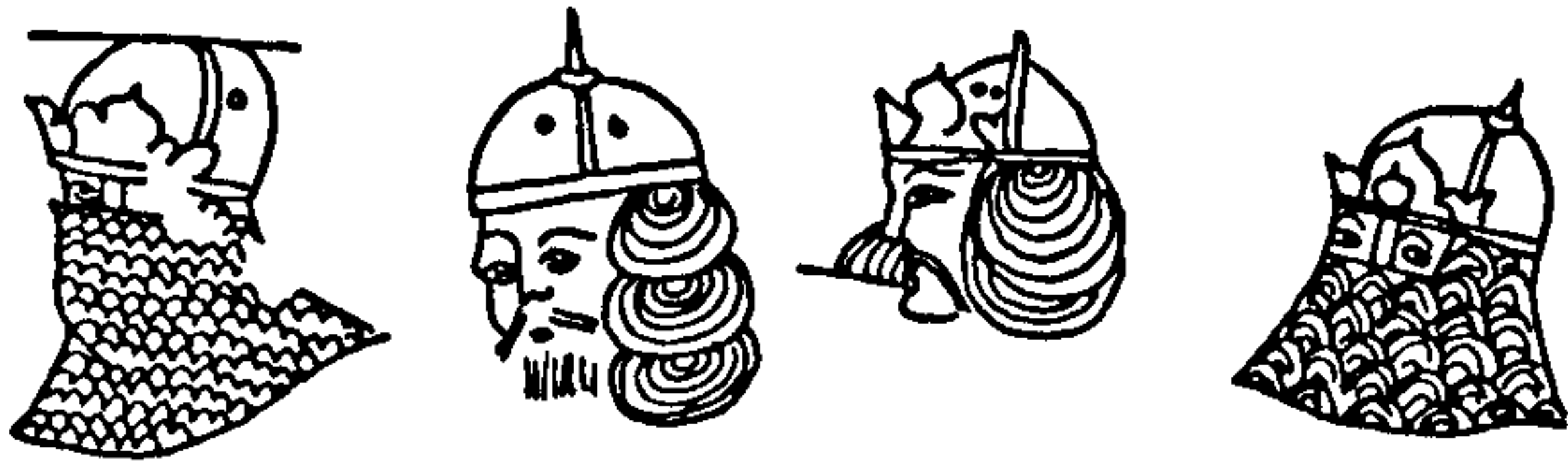

643



644



645A



645B

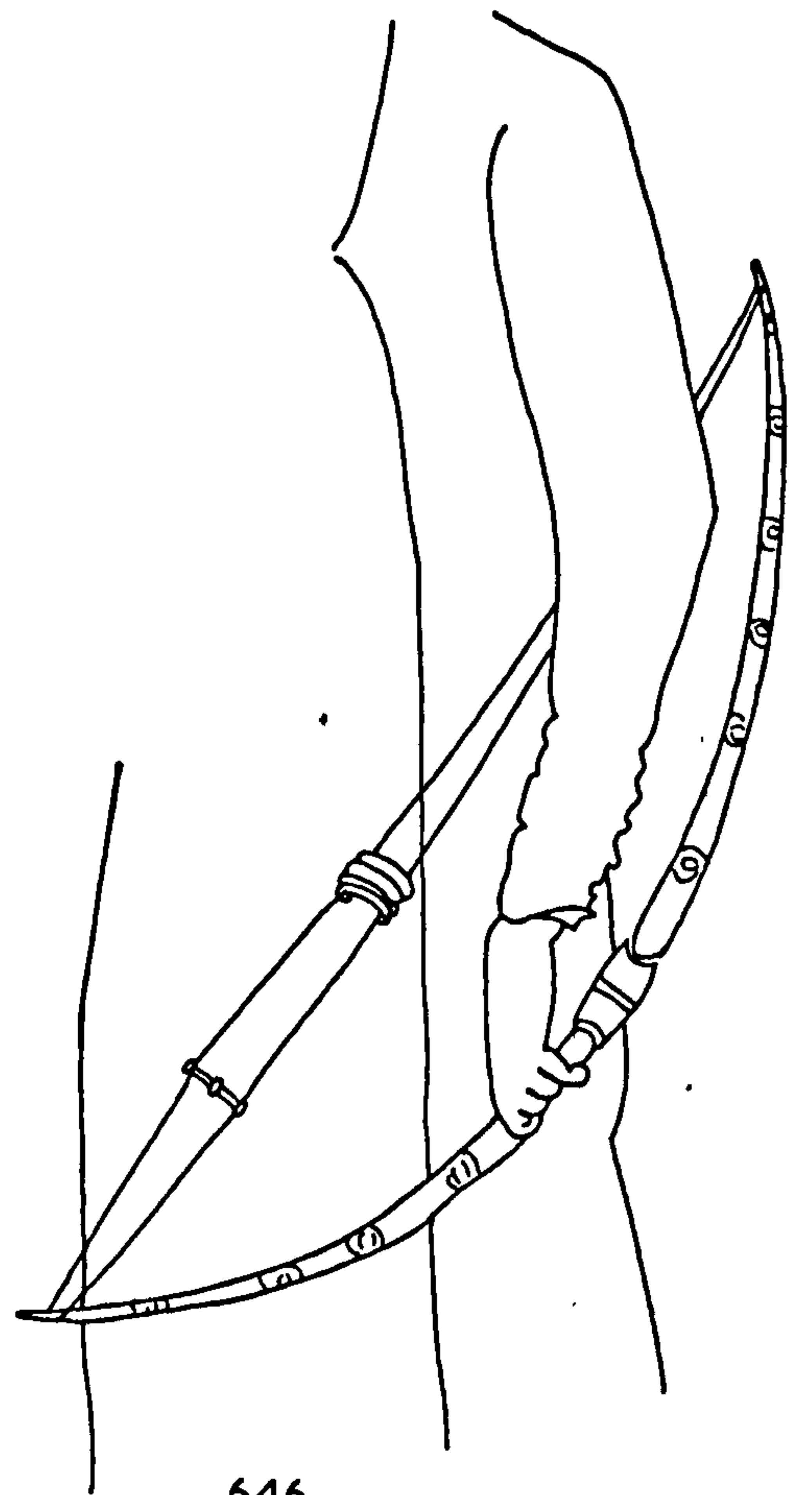

646

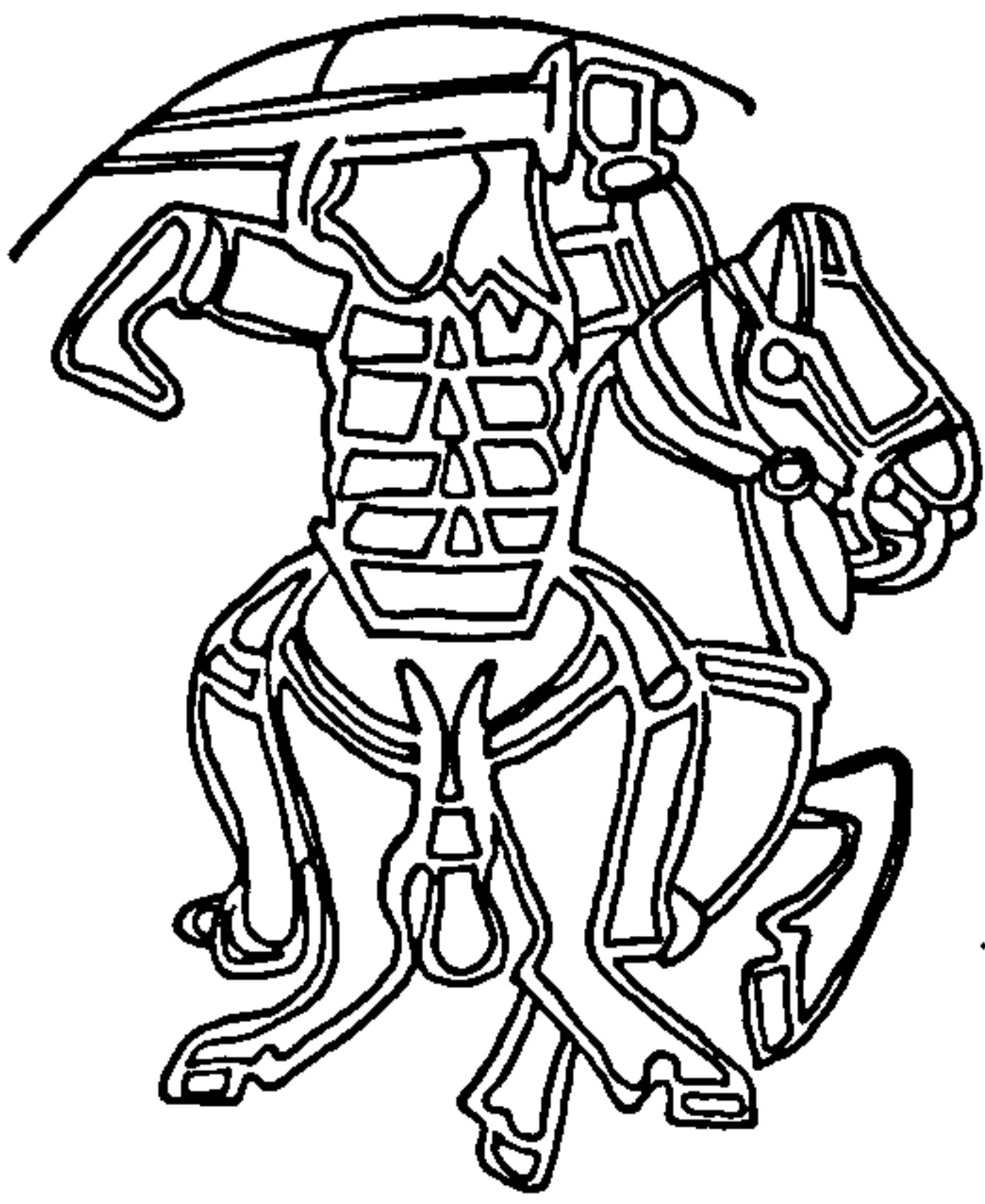

647

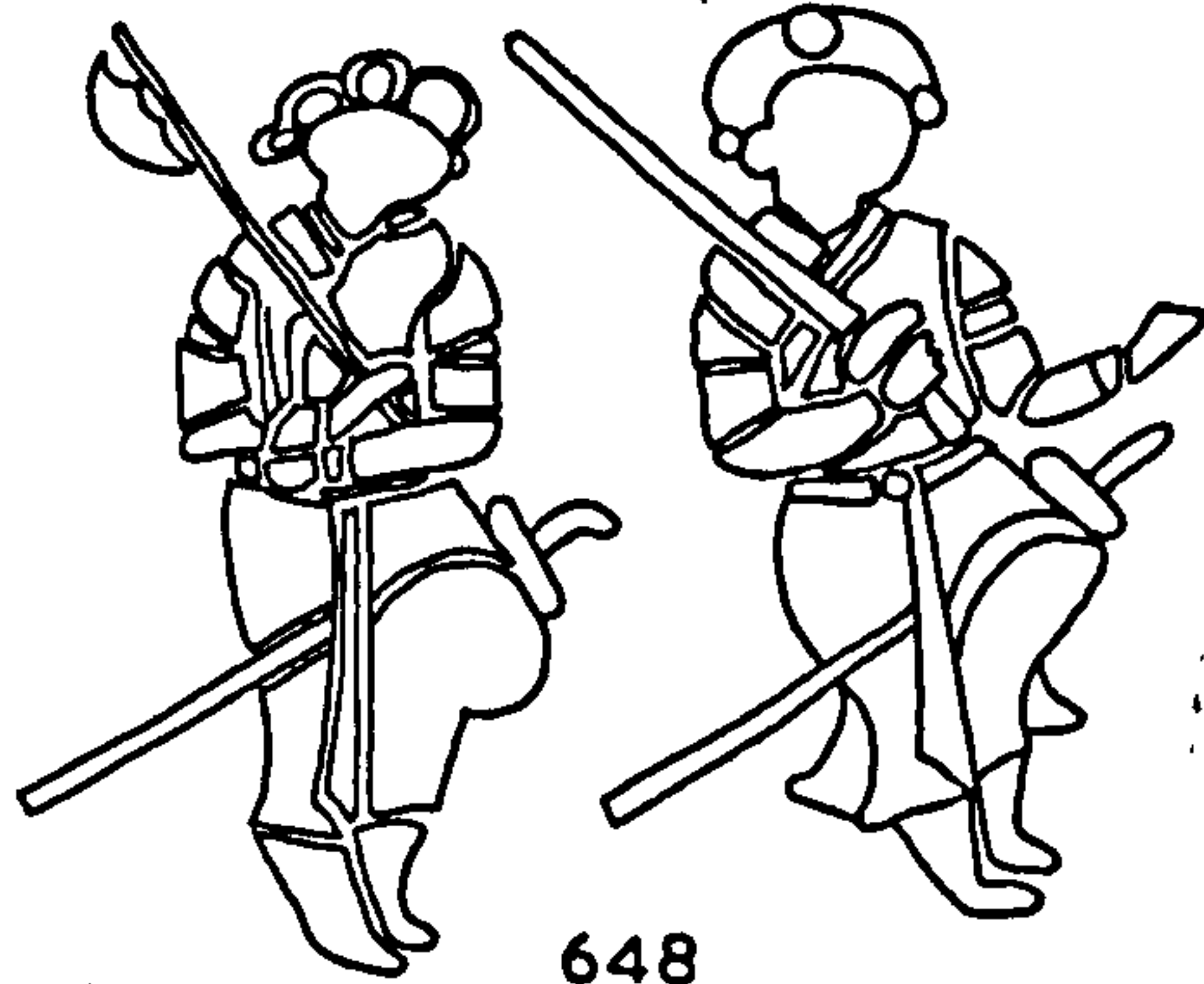

648



649

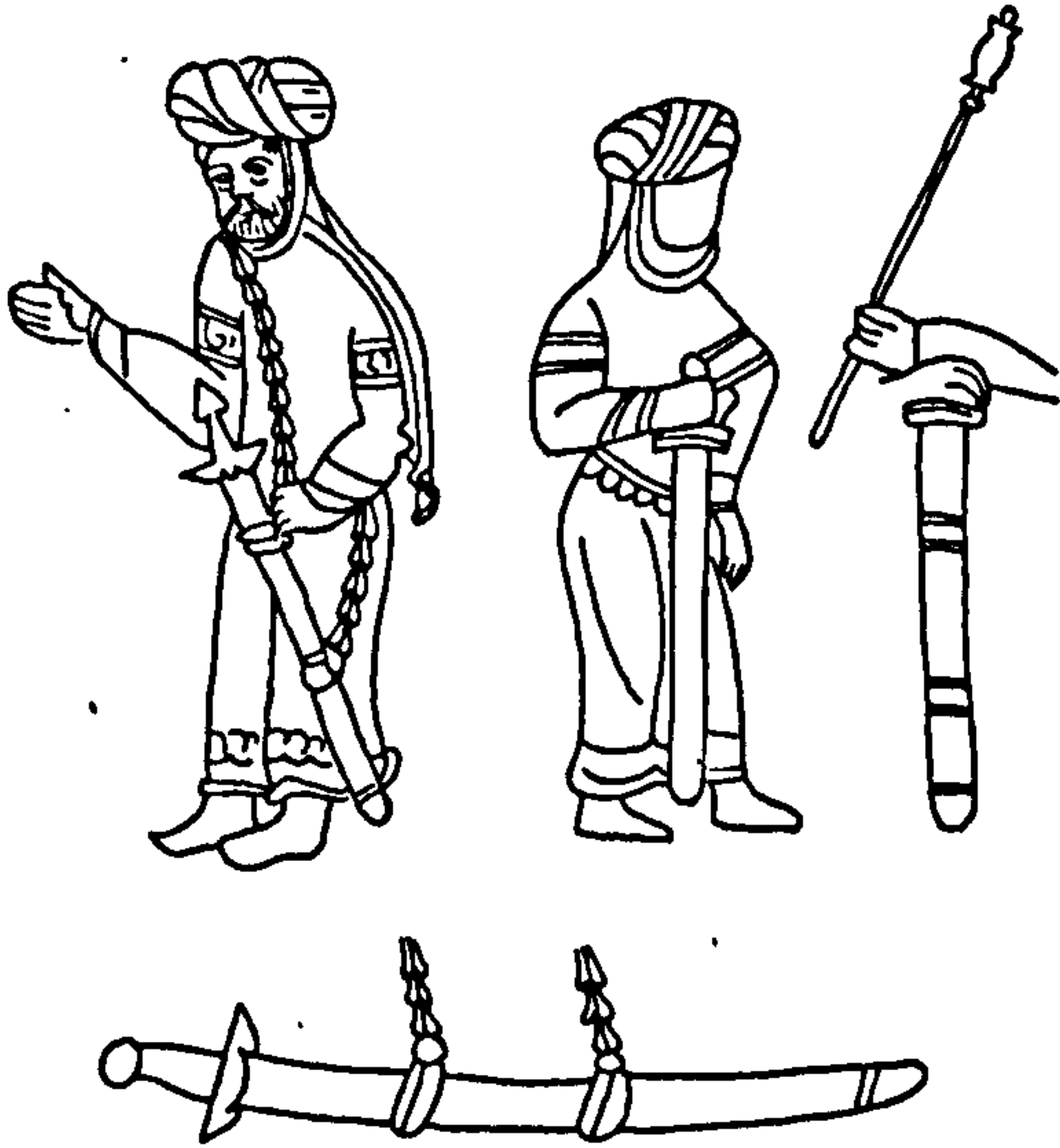

650A

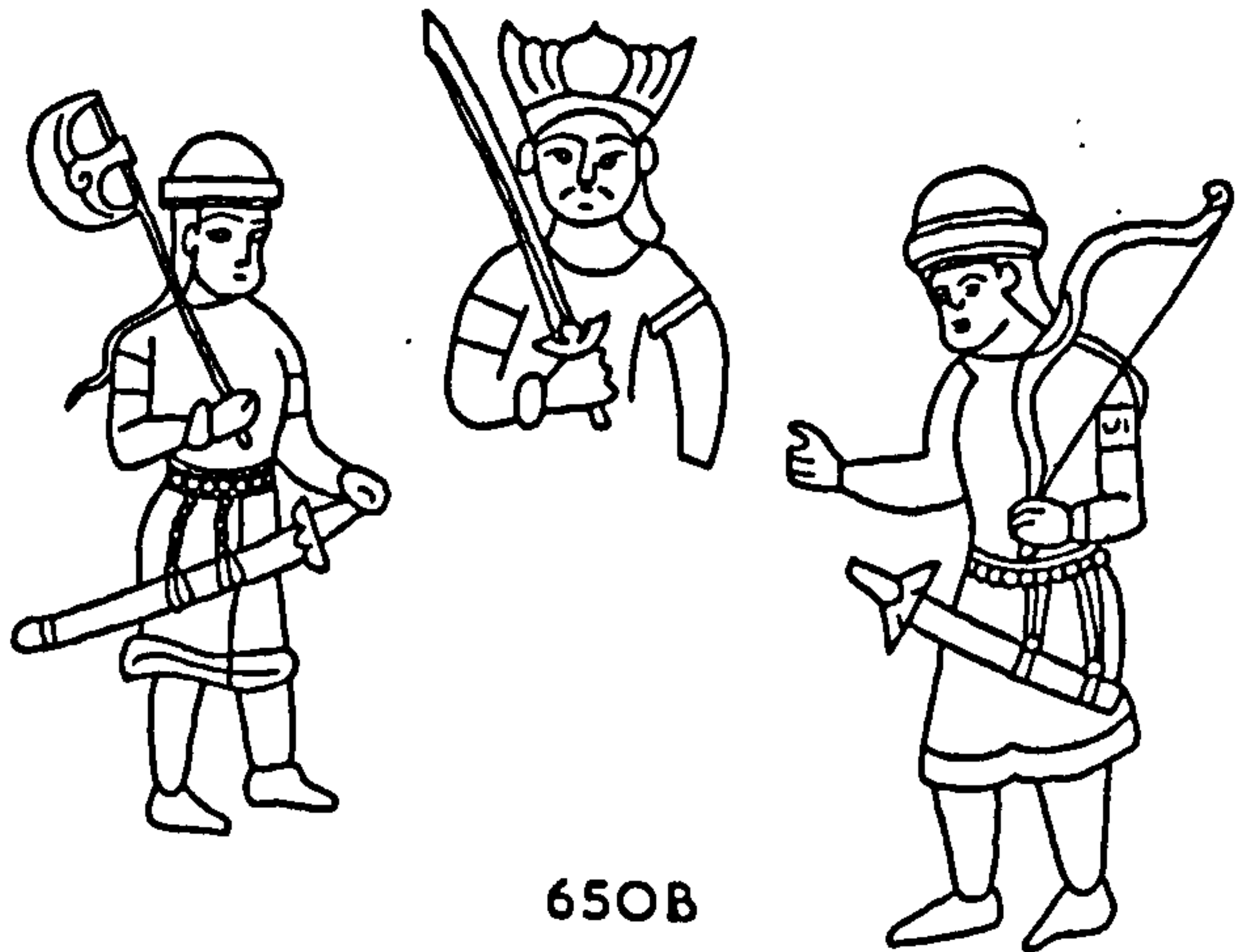

650B

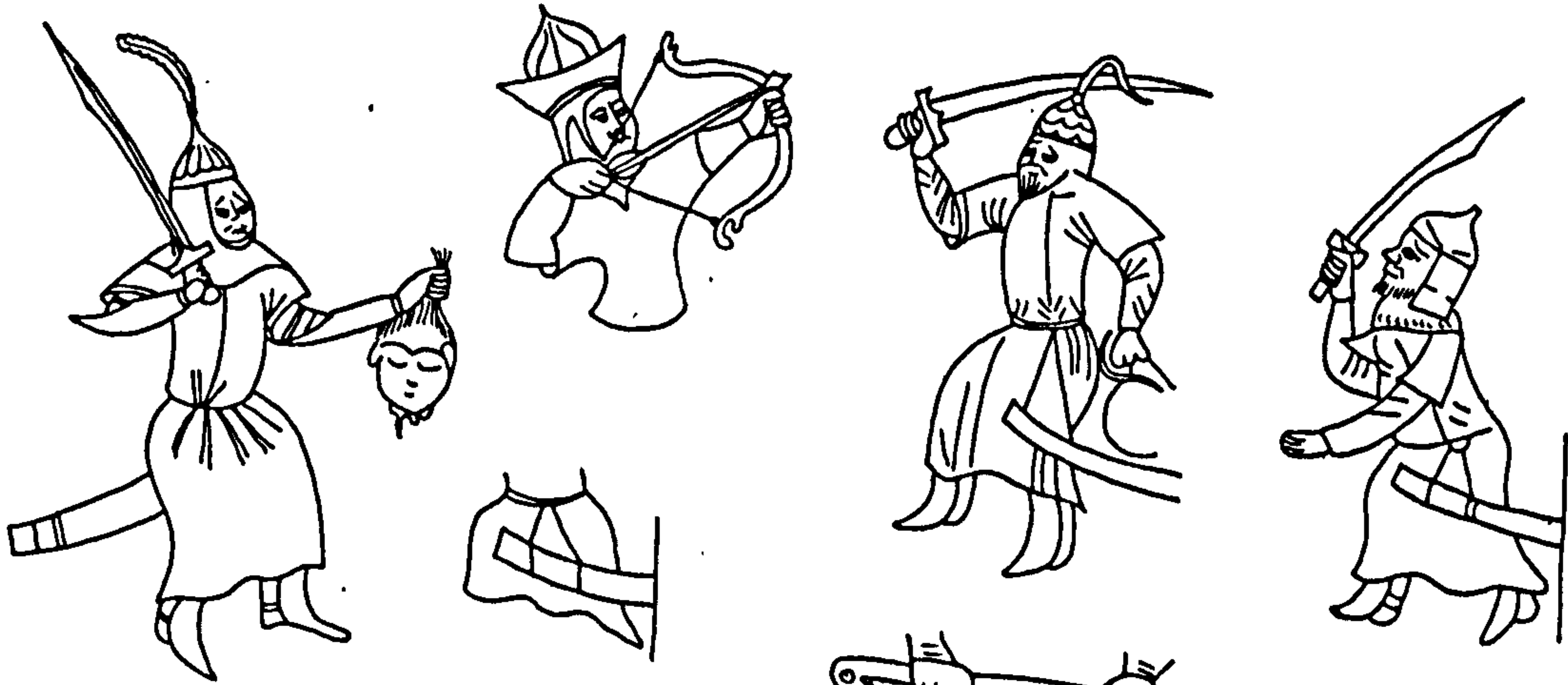

651

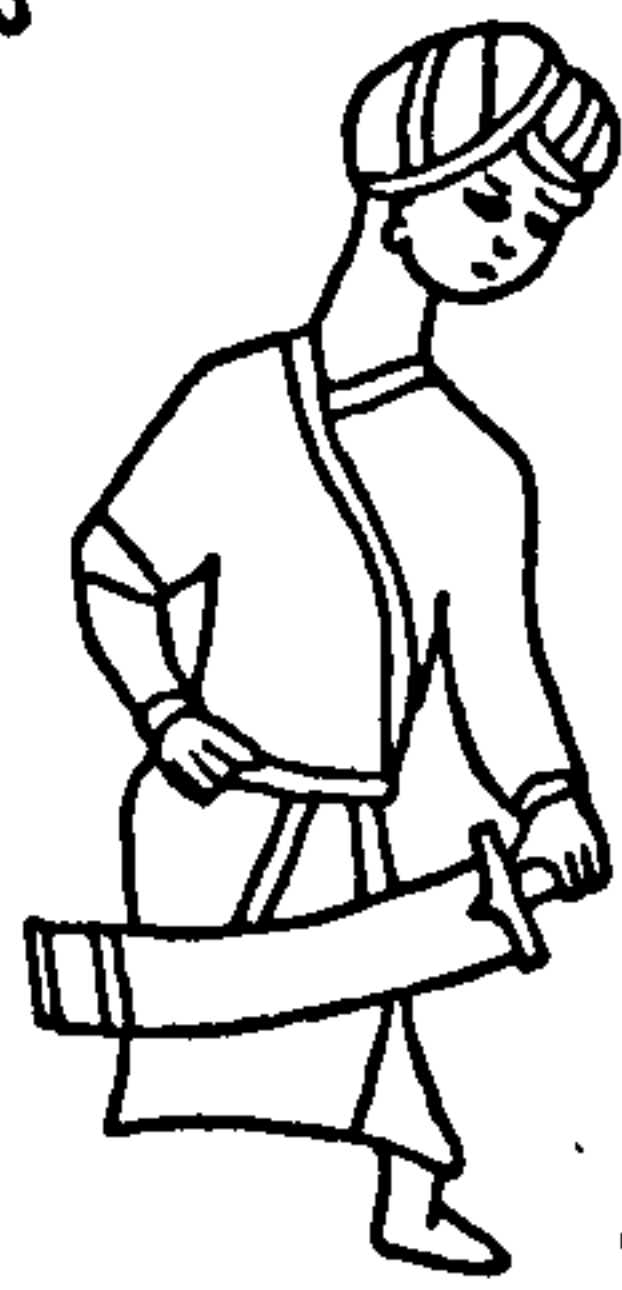
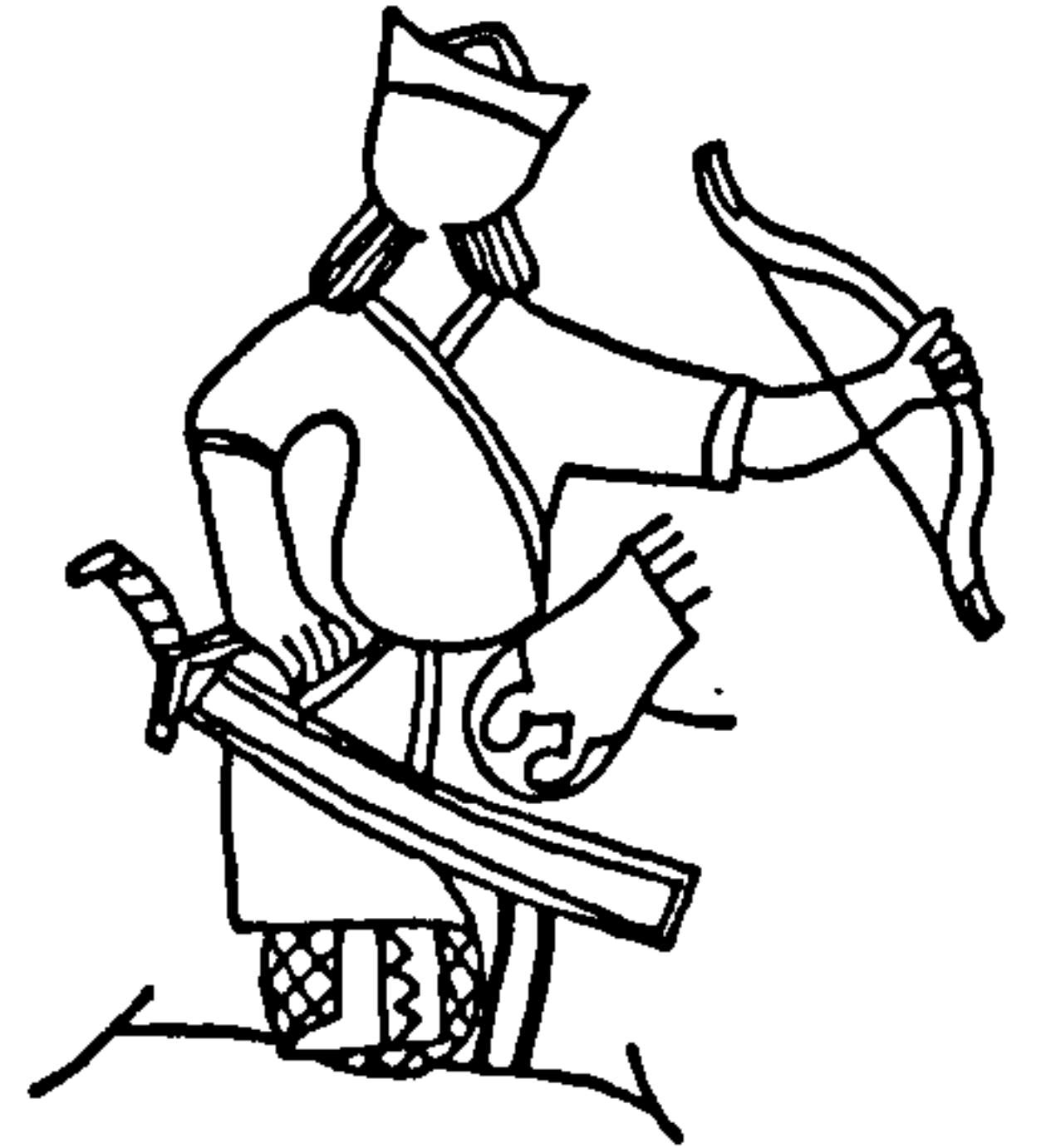
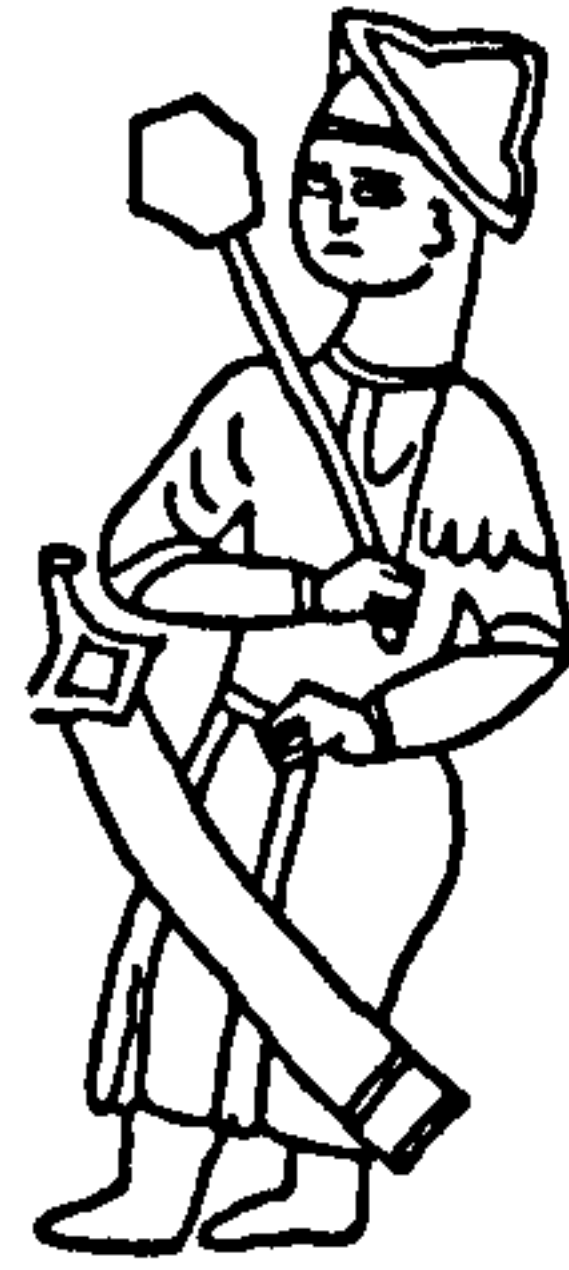
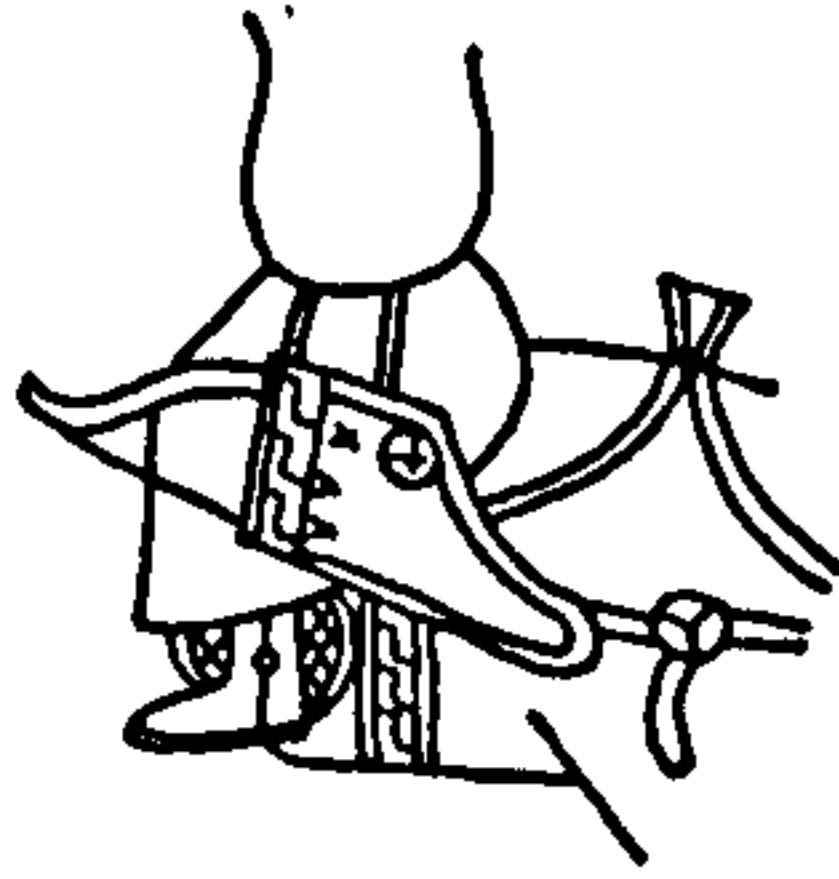
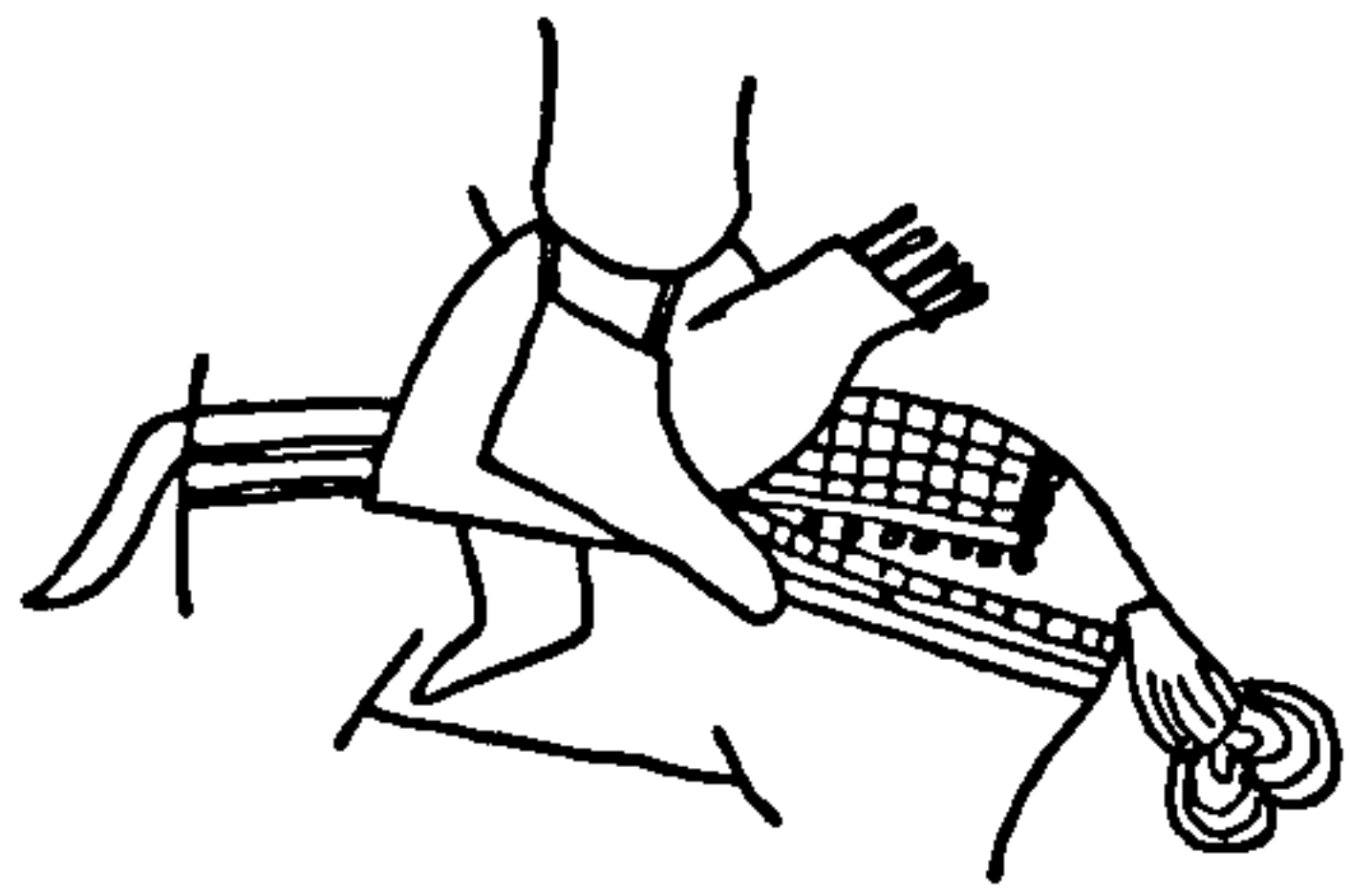

652

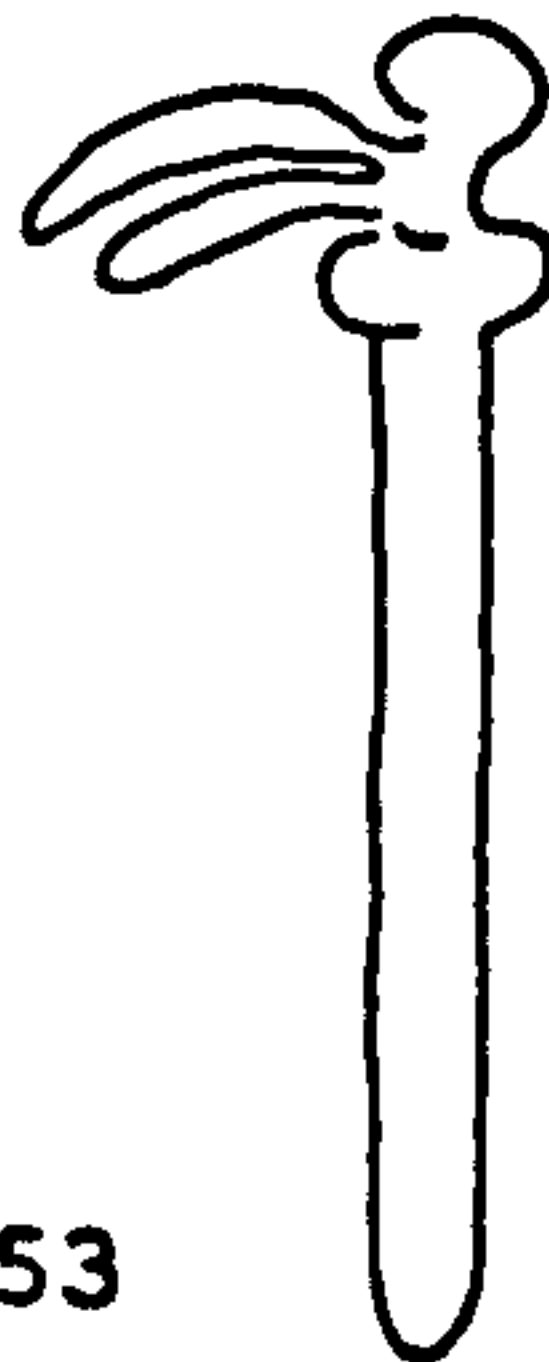
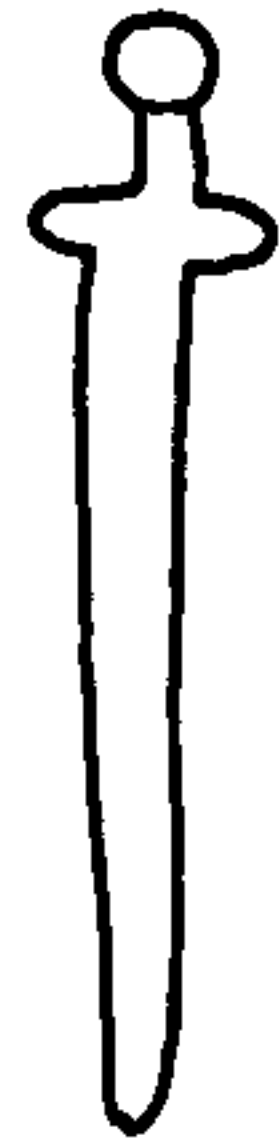
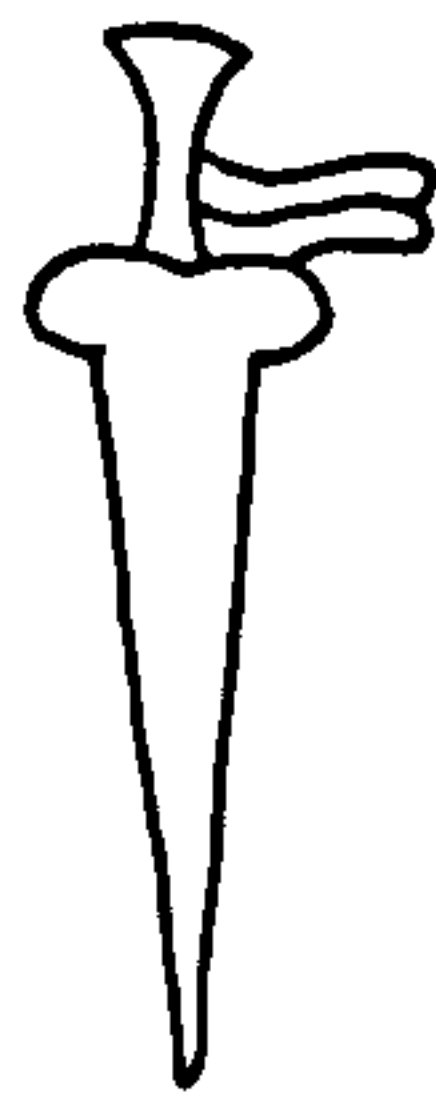

653

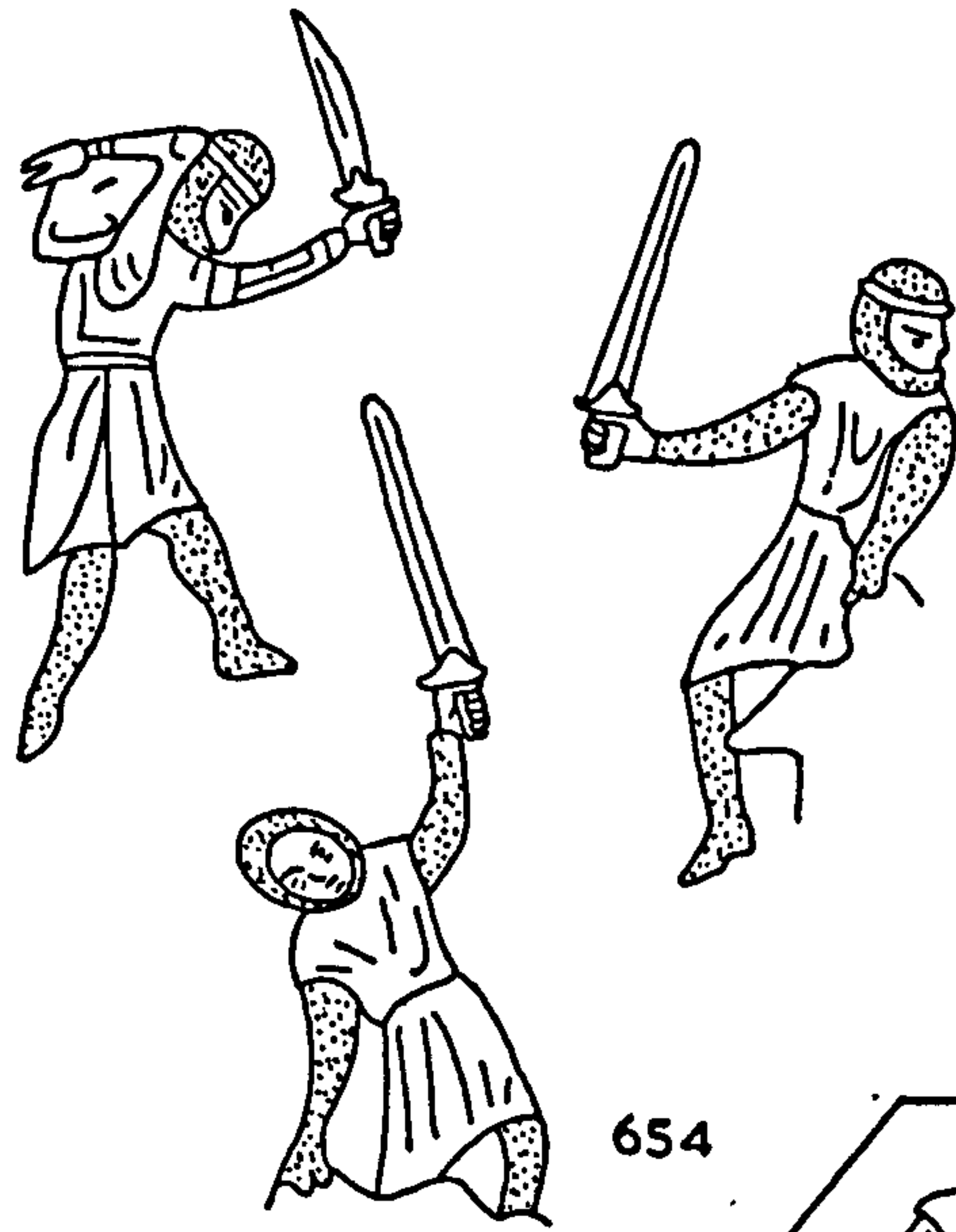

654

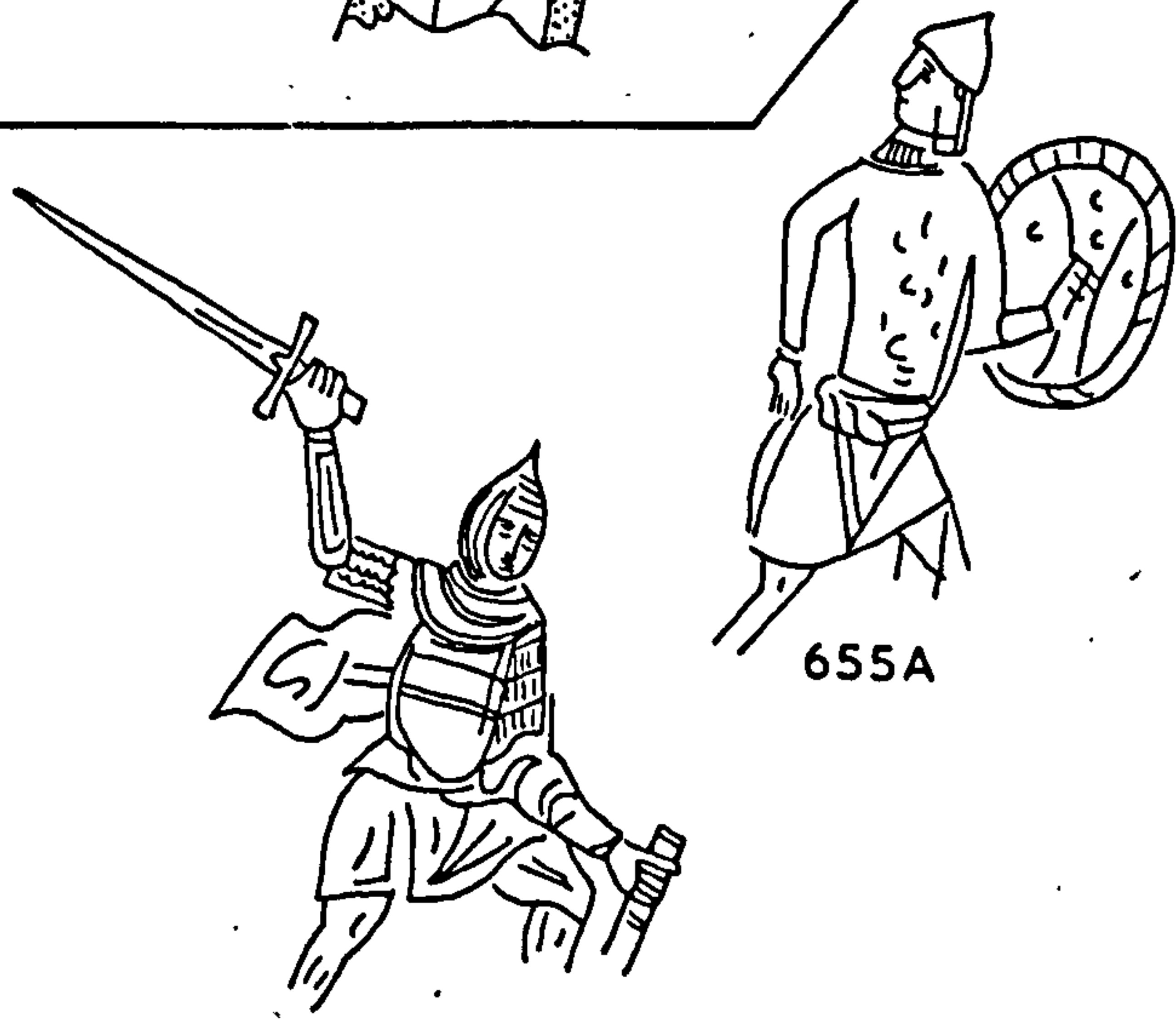

655A

655B



656







657

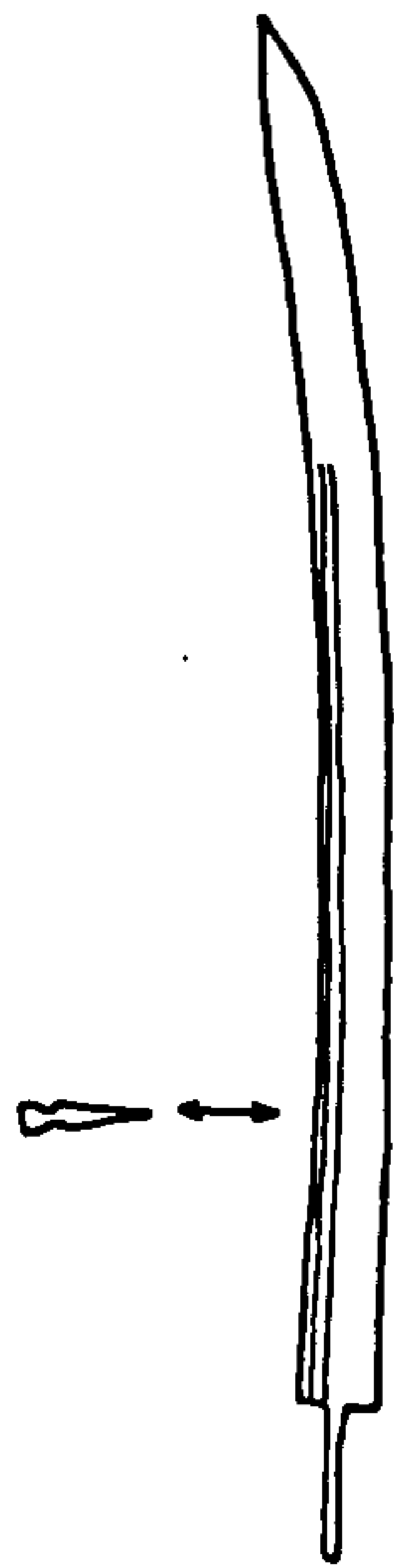

658

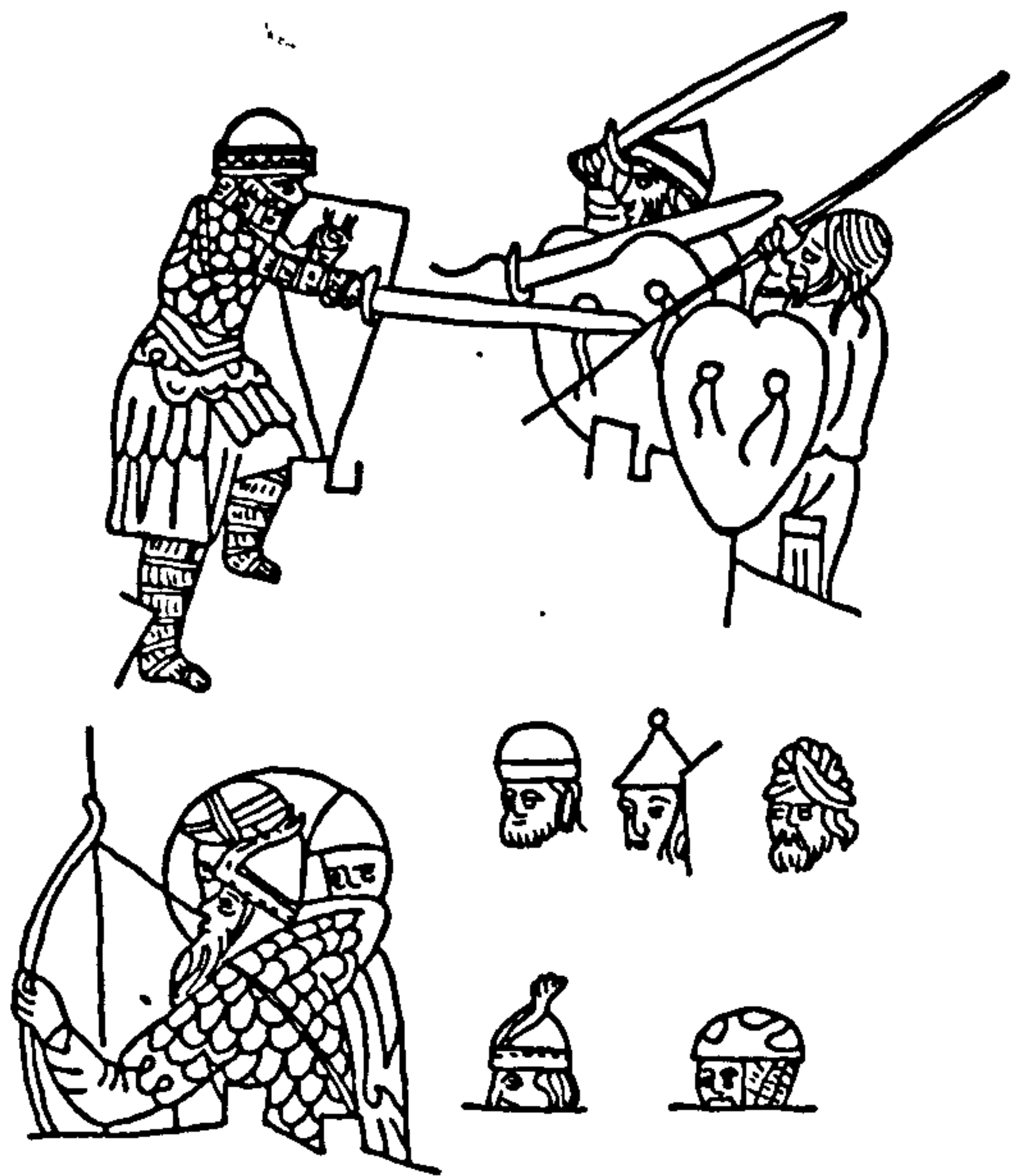

659

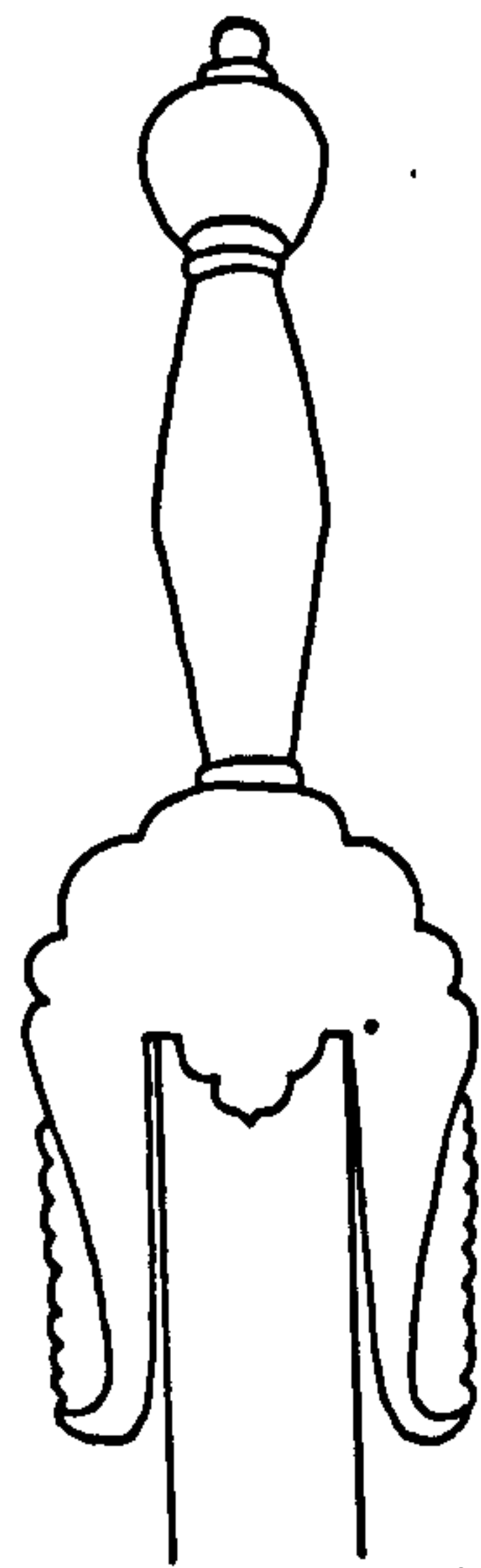

660



661



662

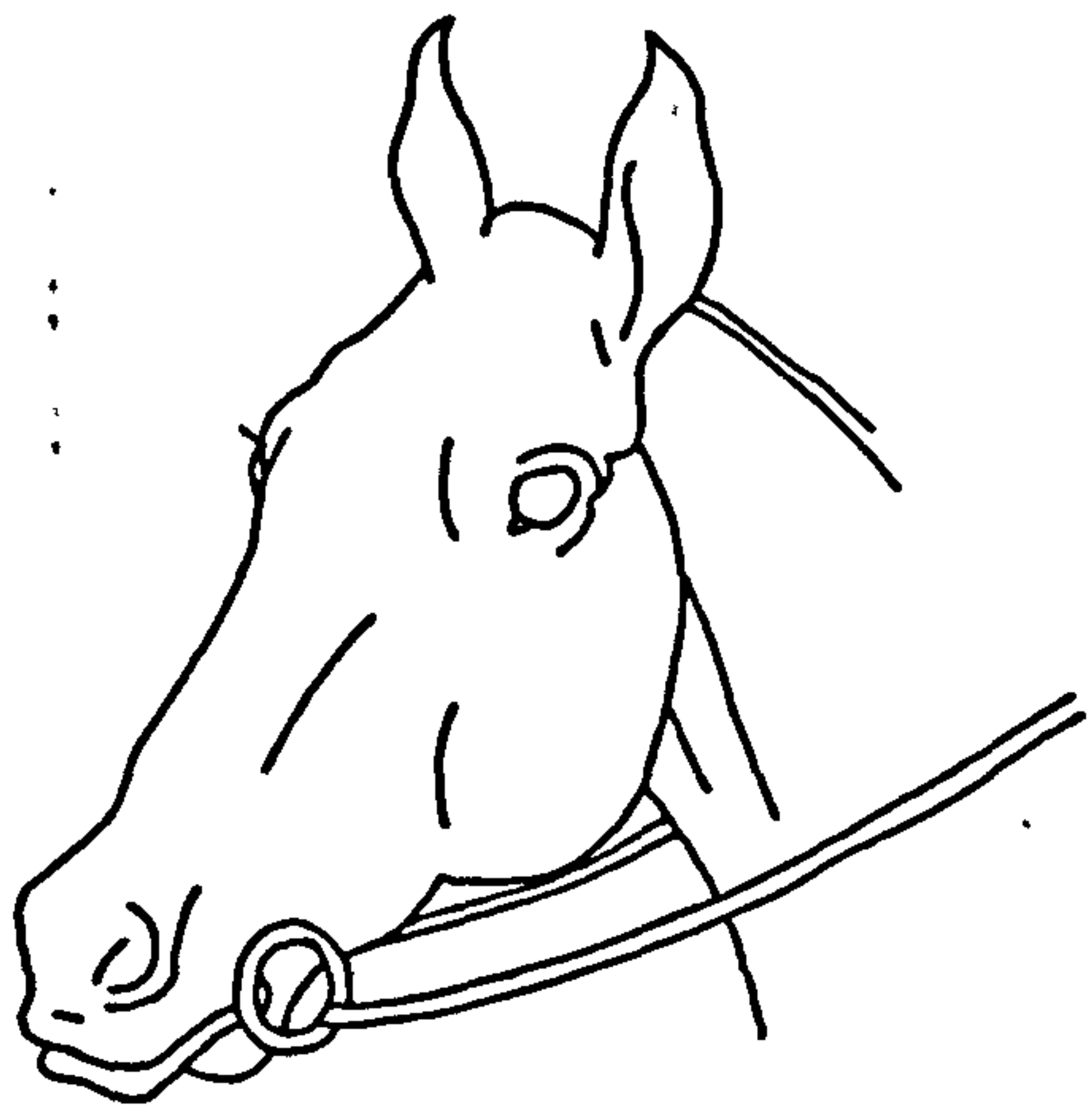

Snaffle

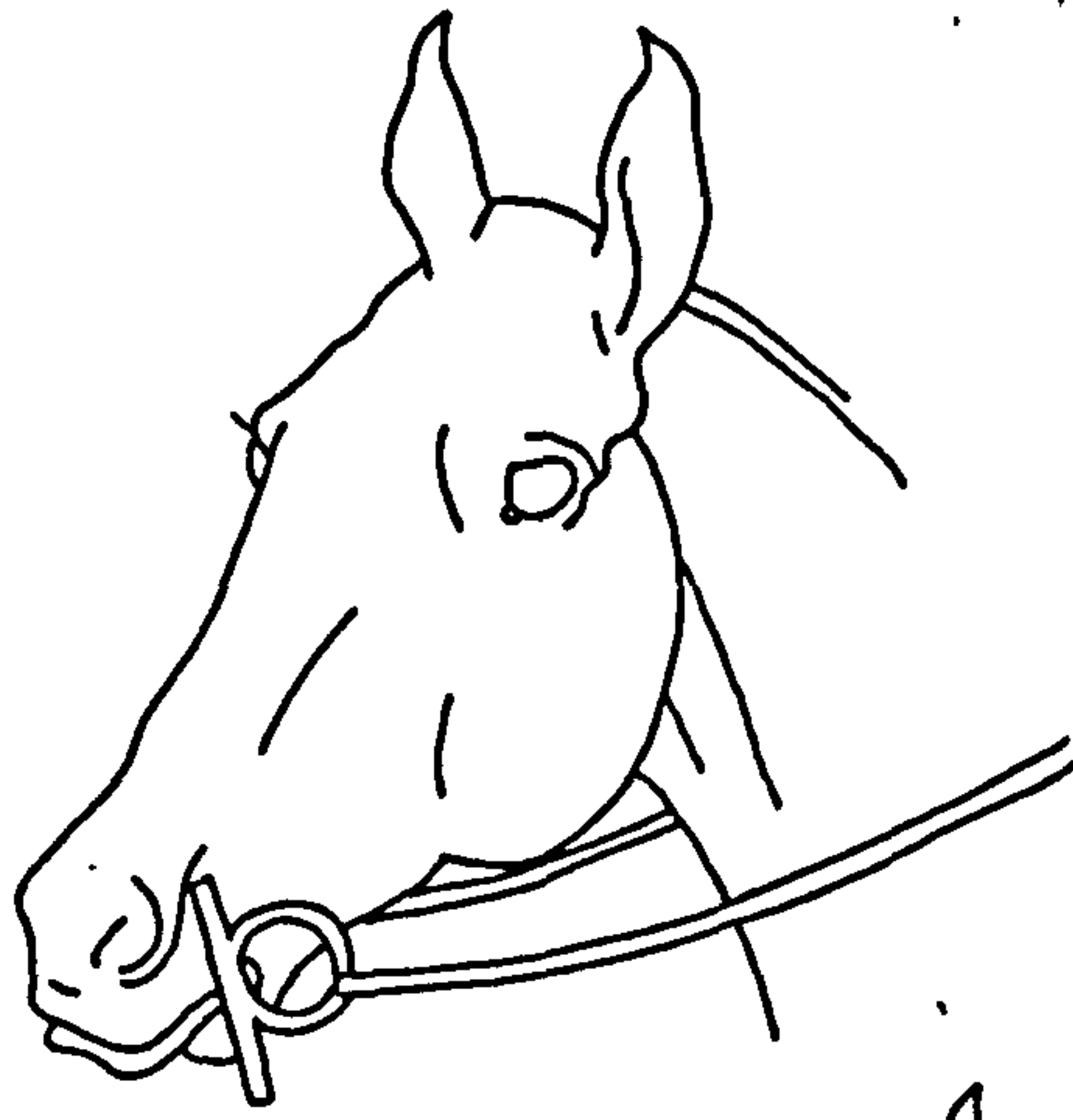

Snaffle-Psalion

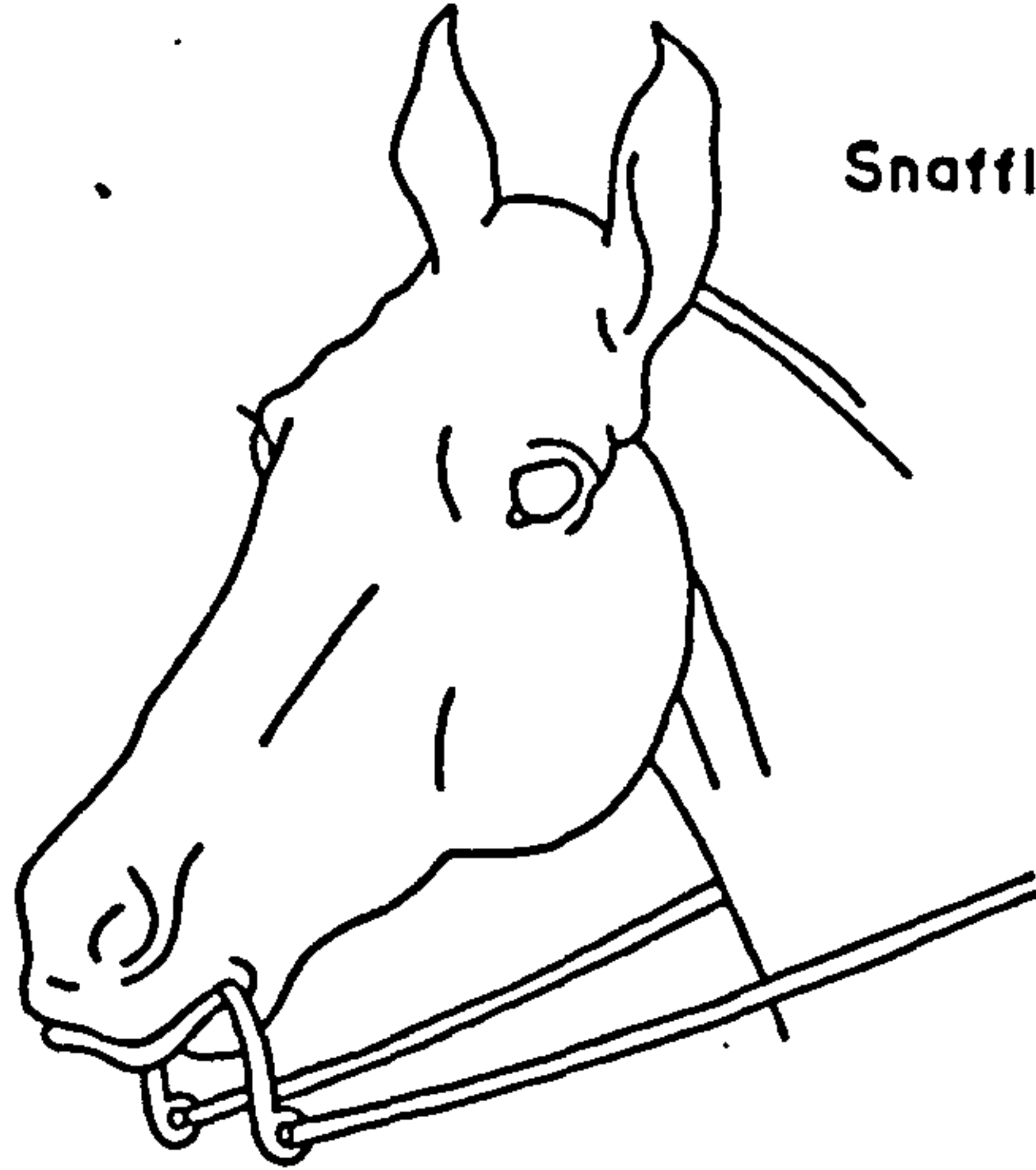

Curb

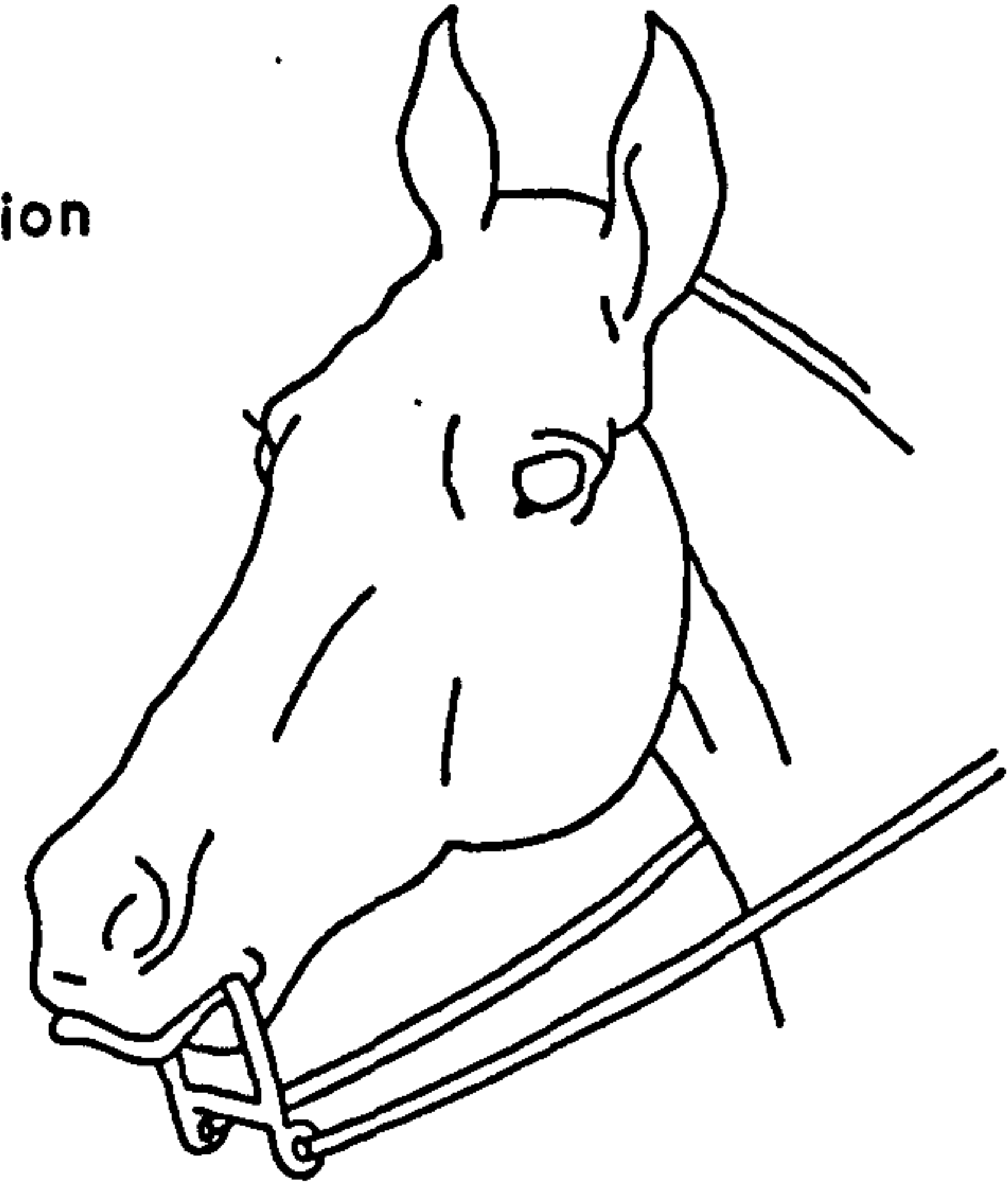

Curb-crossbar

663

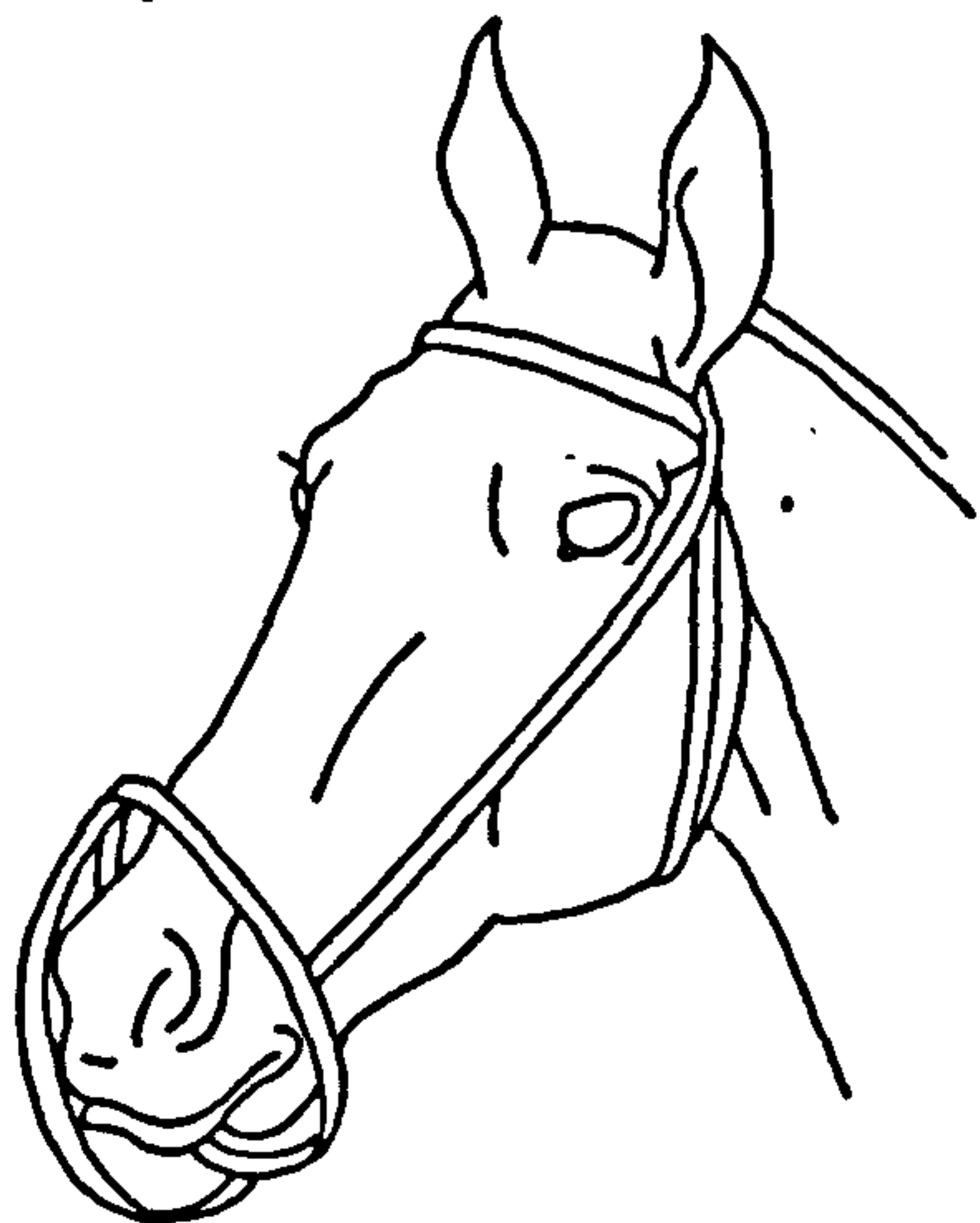

Muzzle

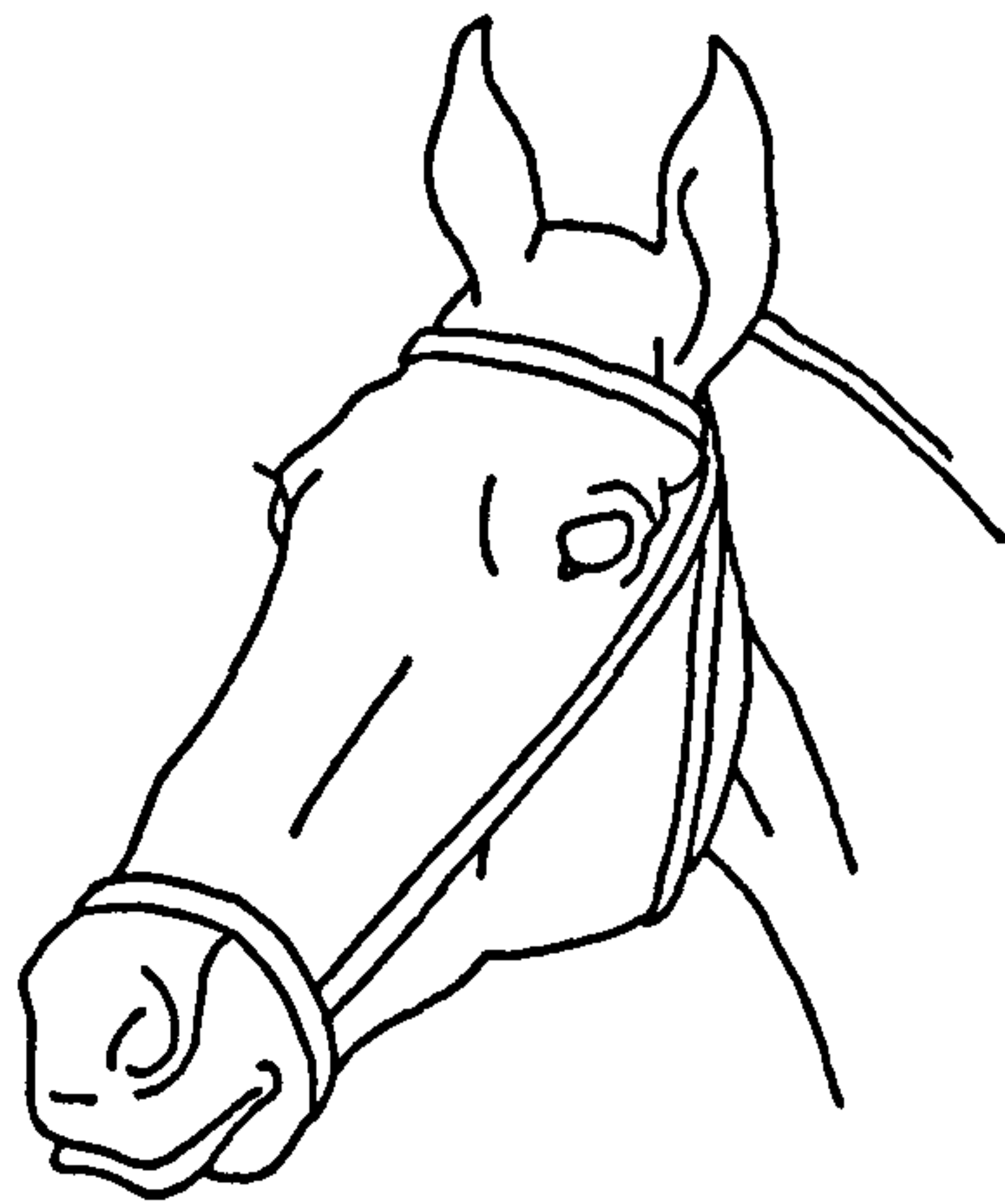

With Noseband

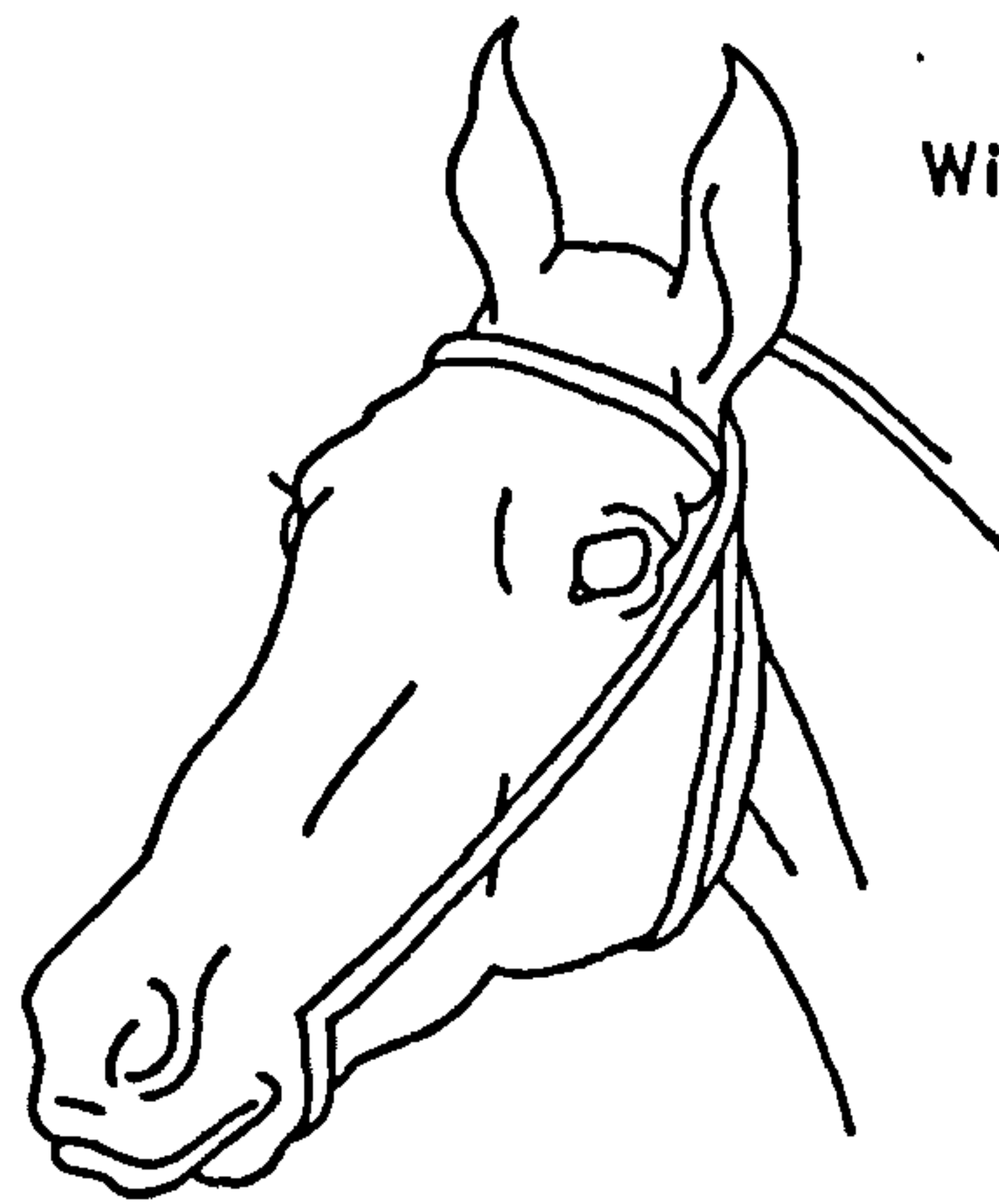

Without Noseband

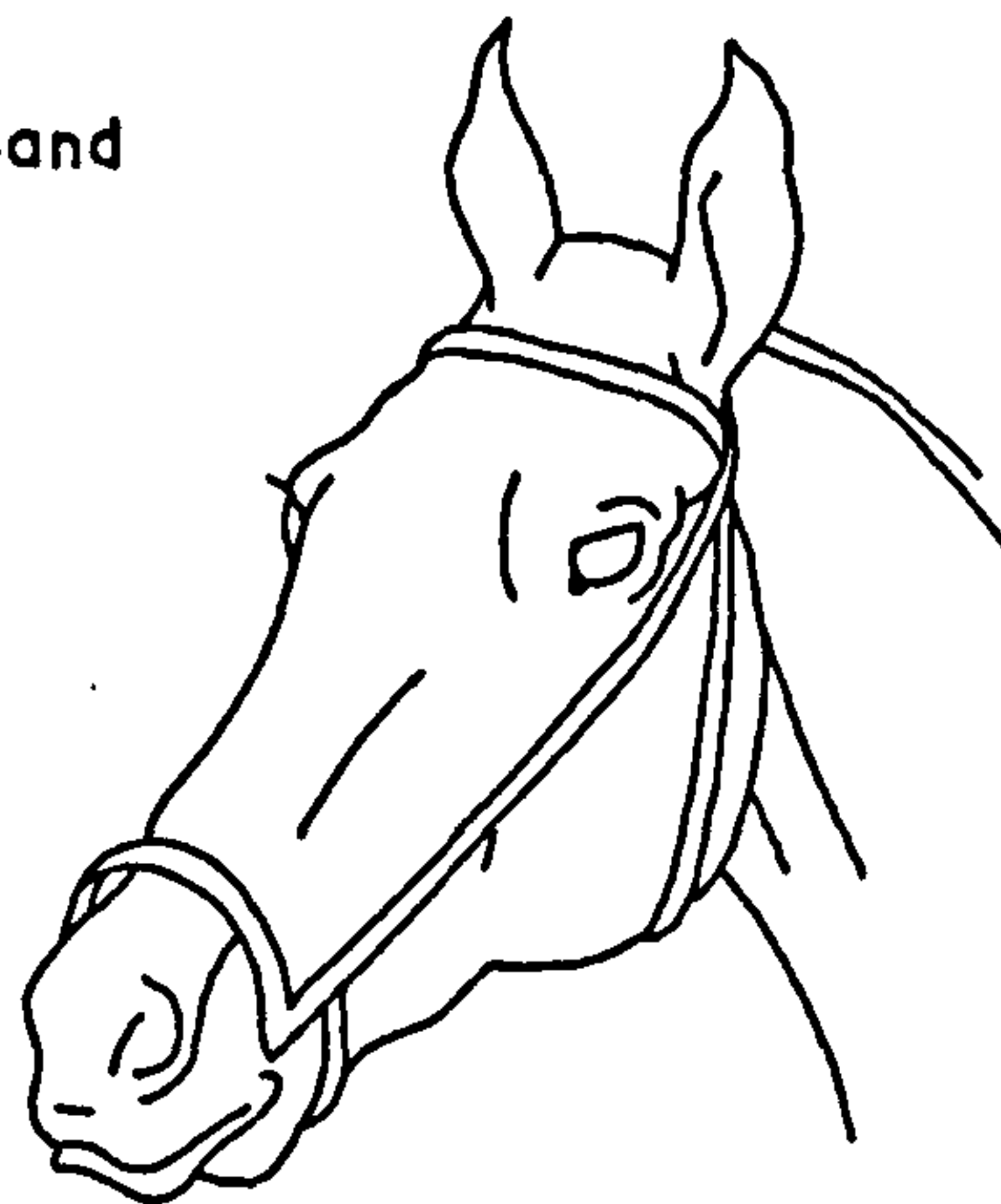

Rigid Noseband

664

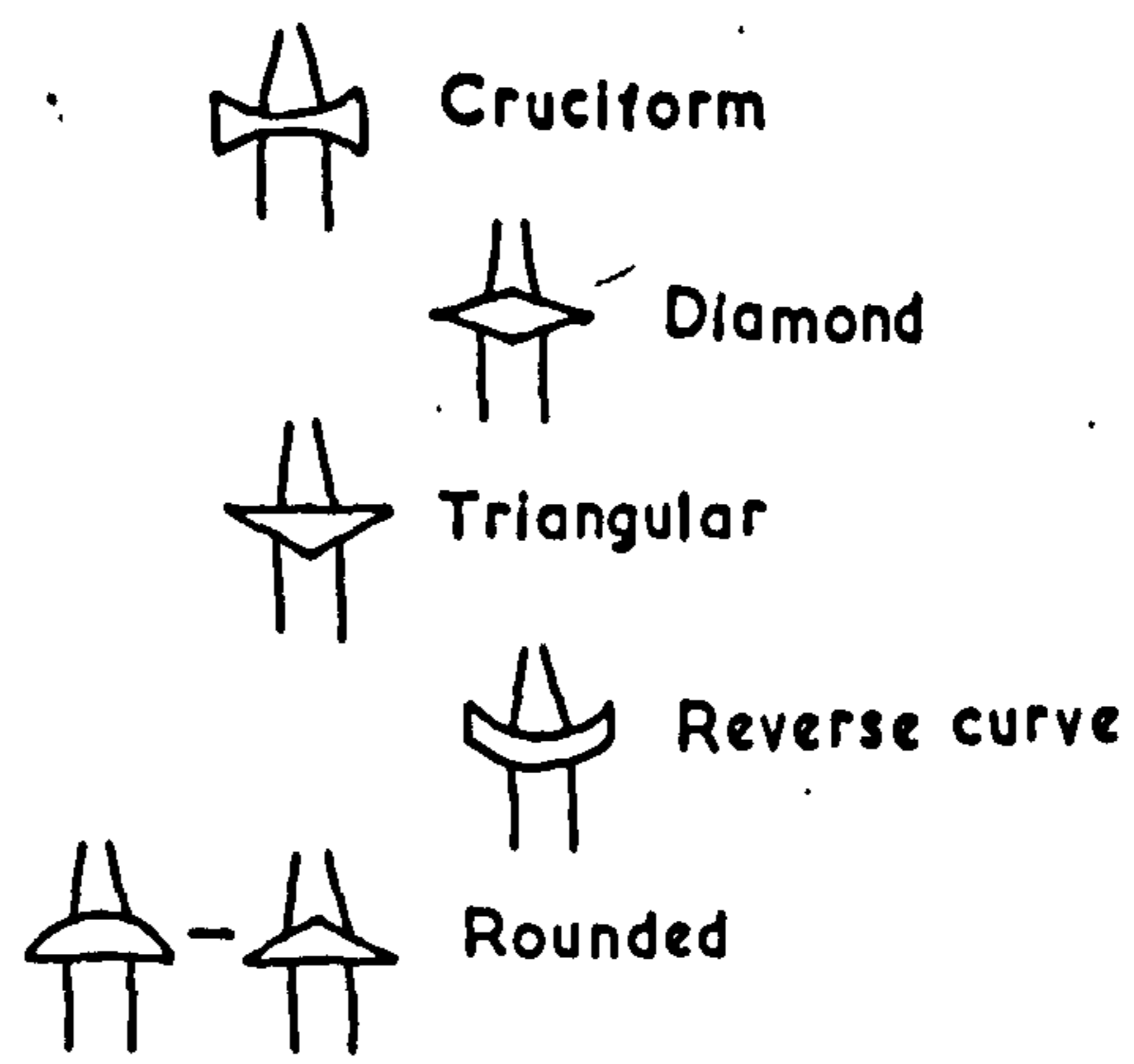
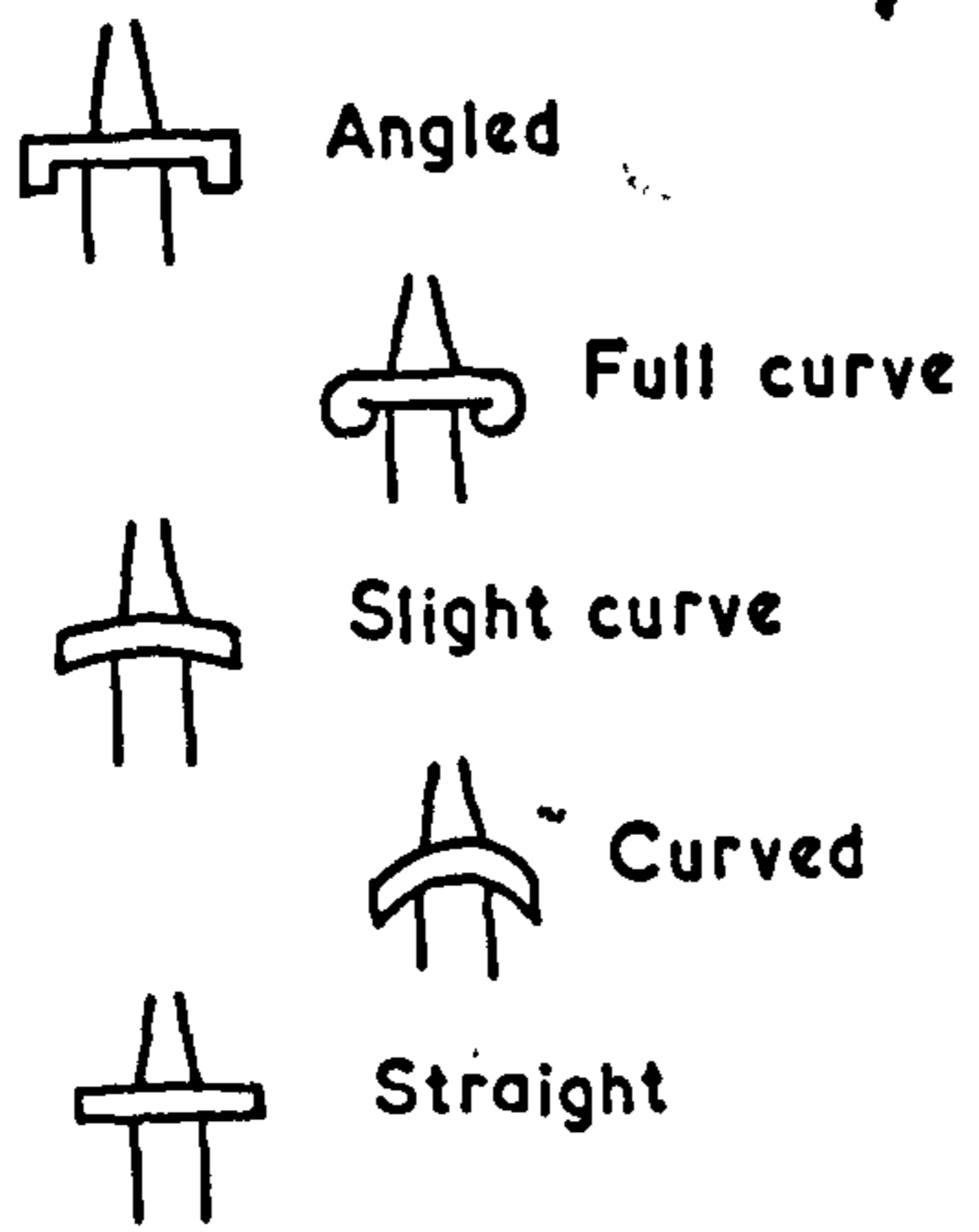

665

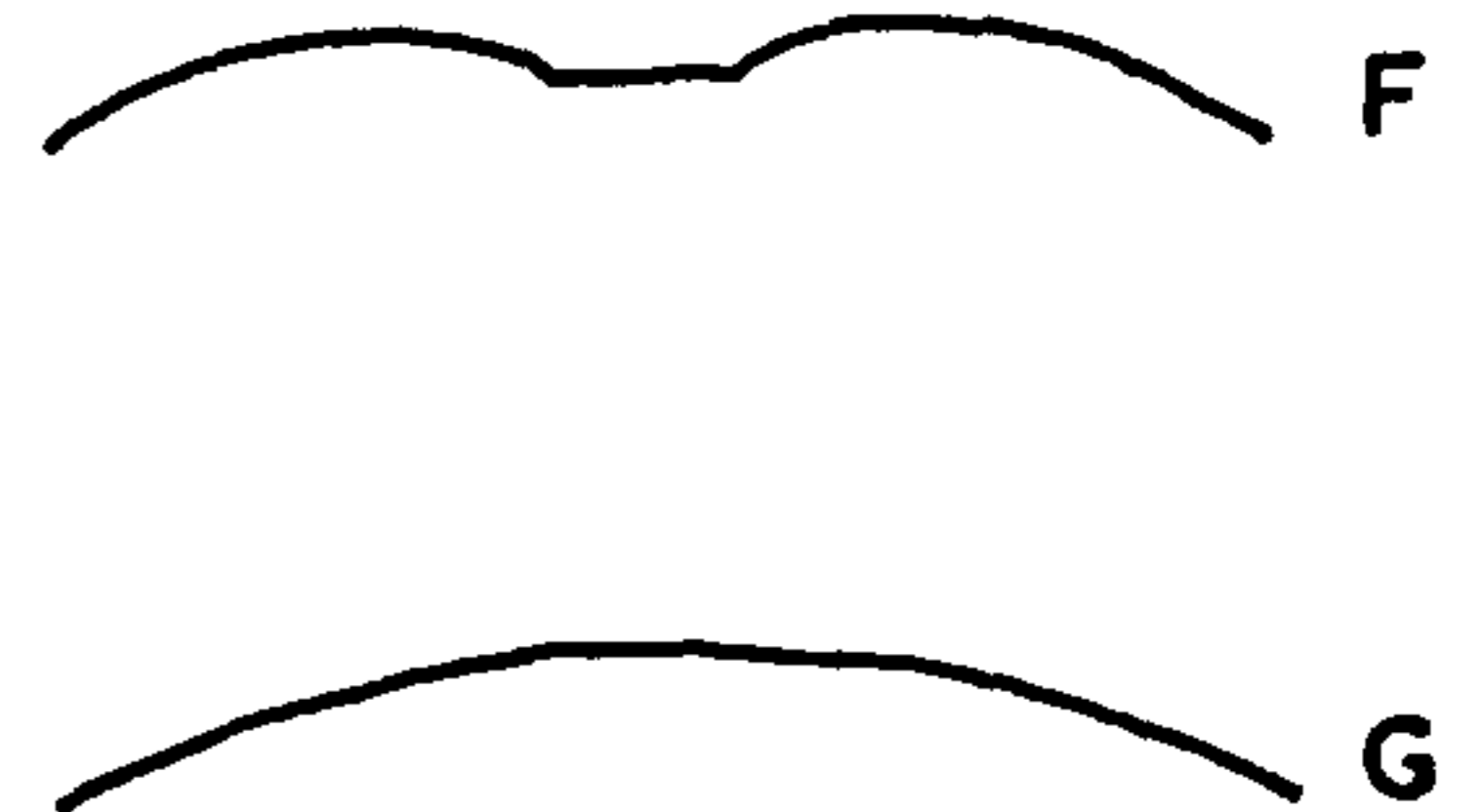
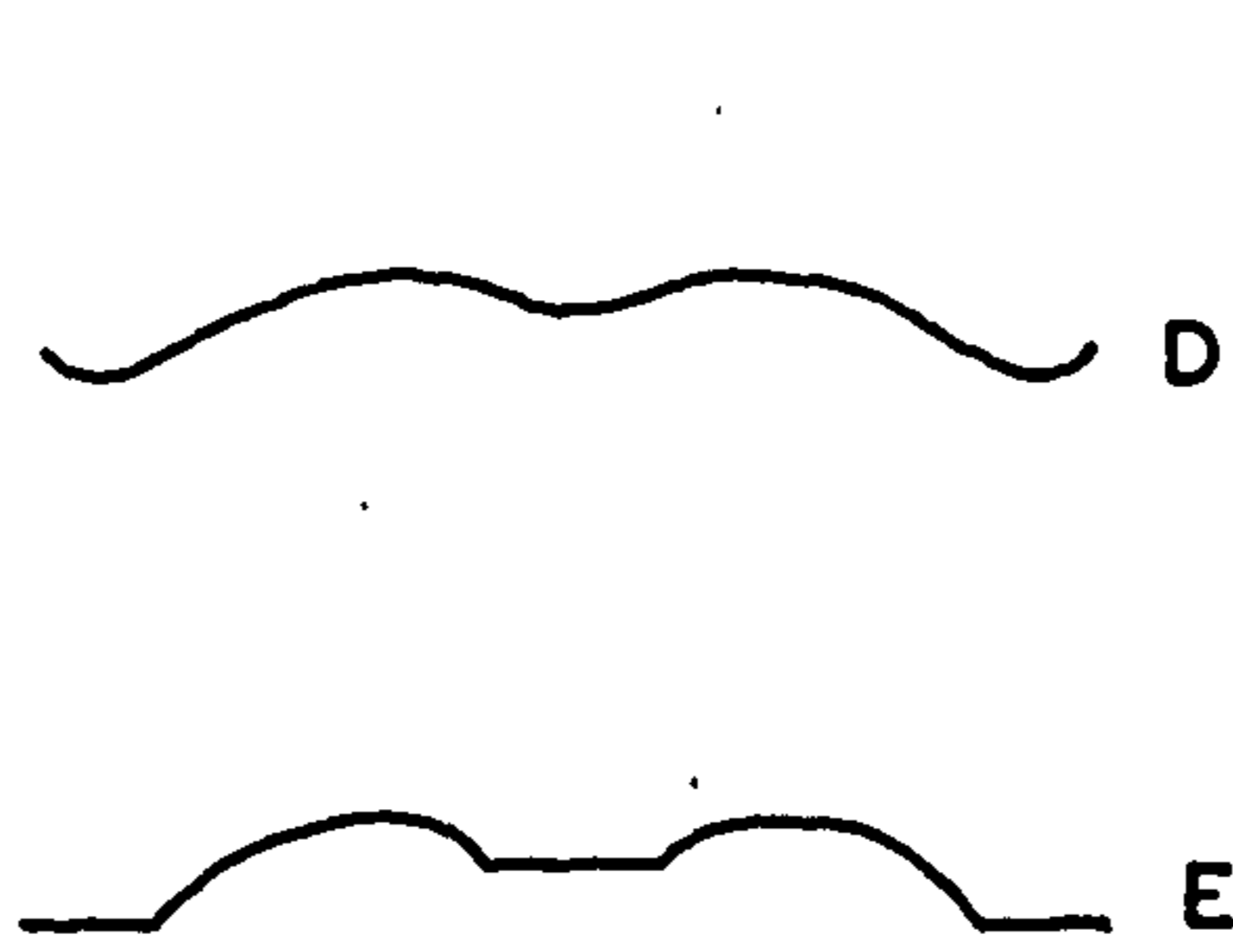
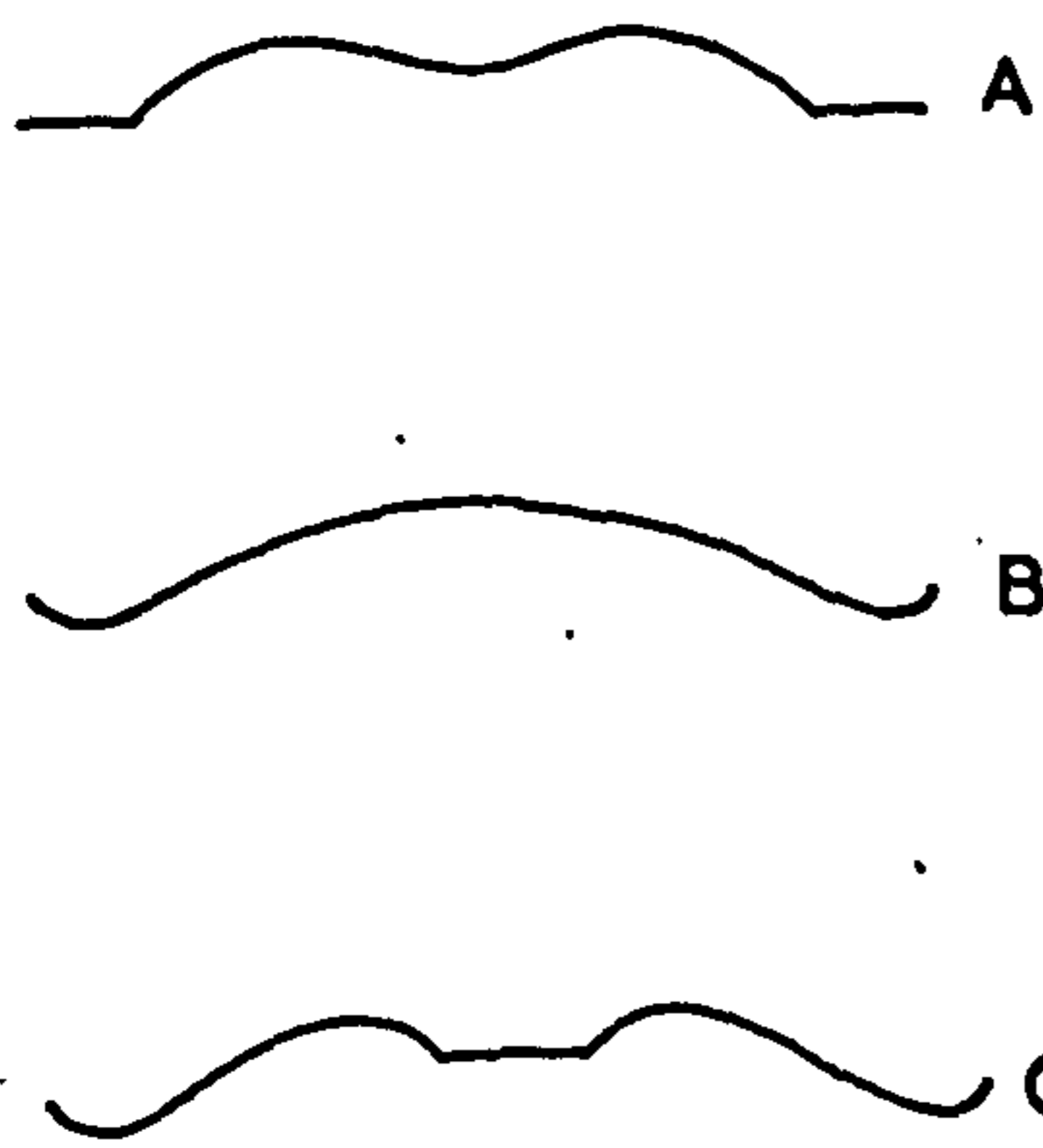

666

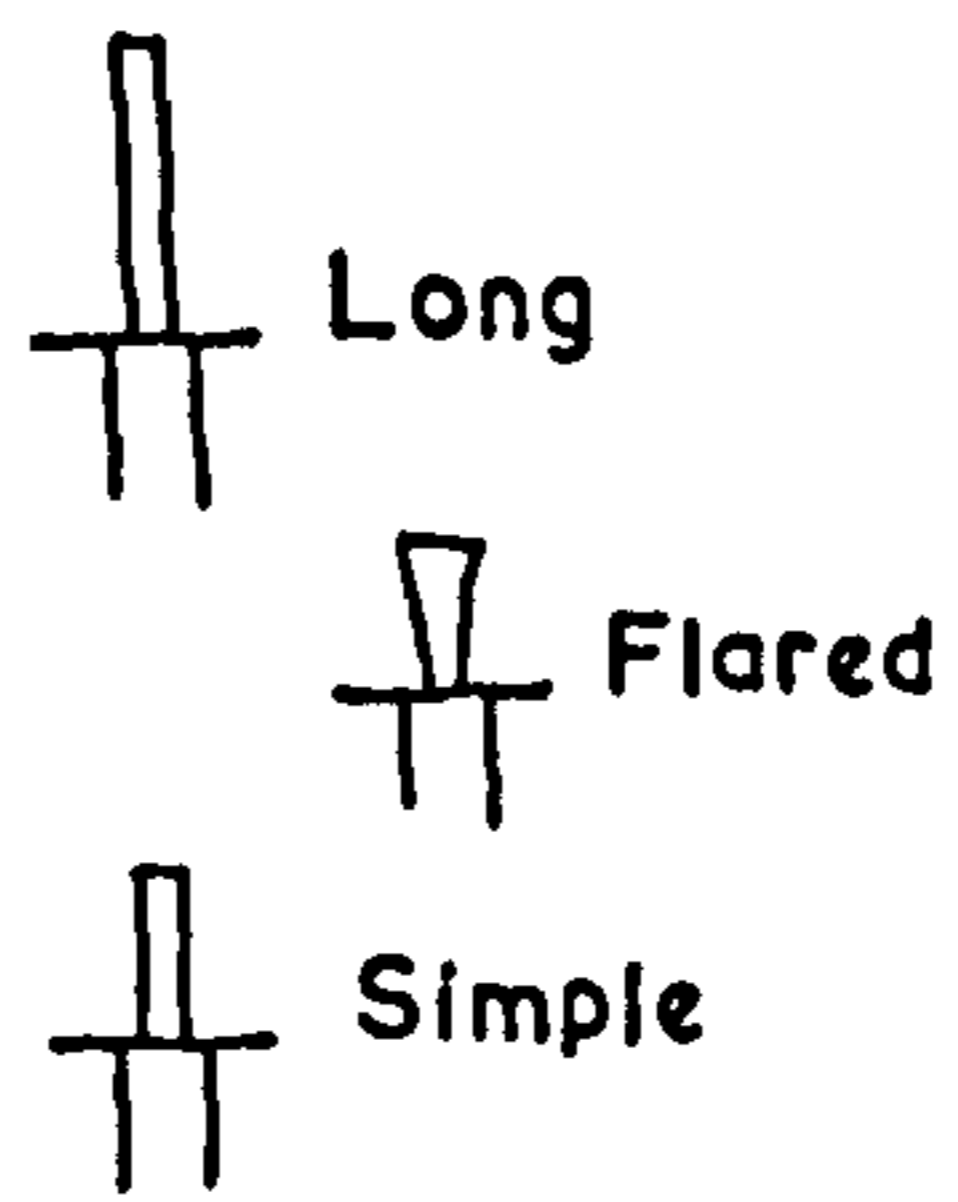
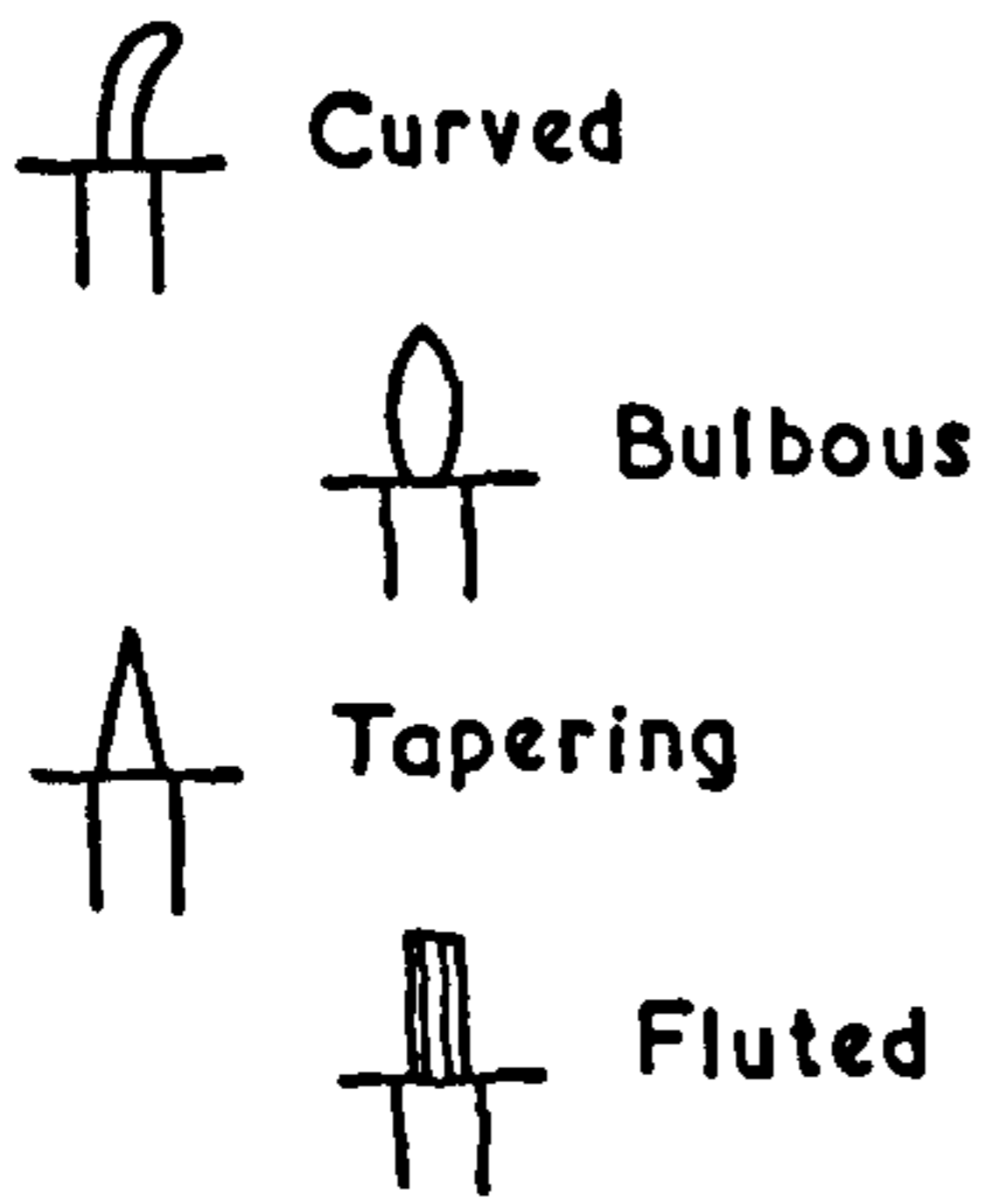

667

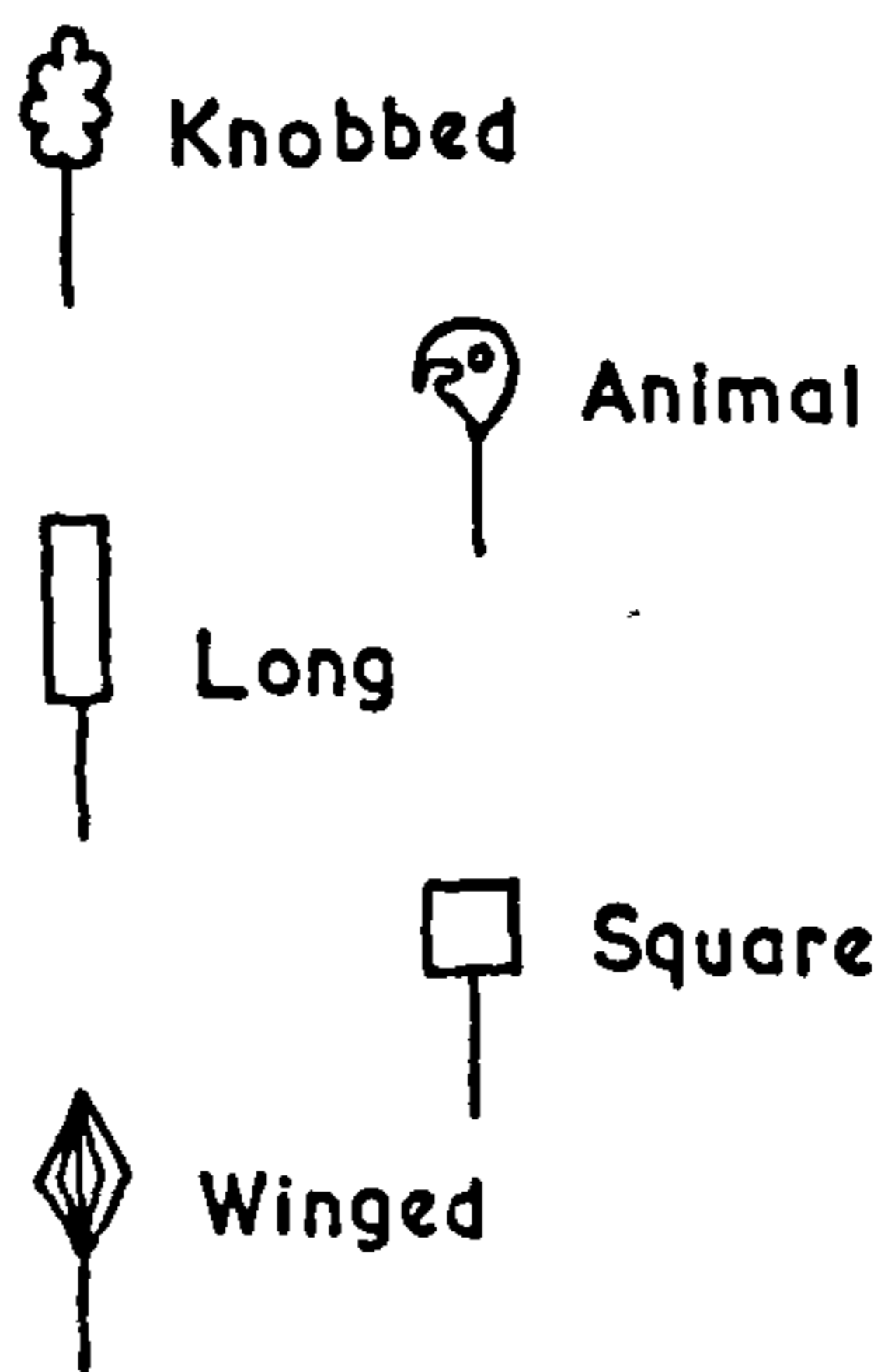

668

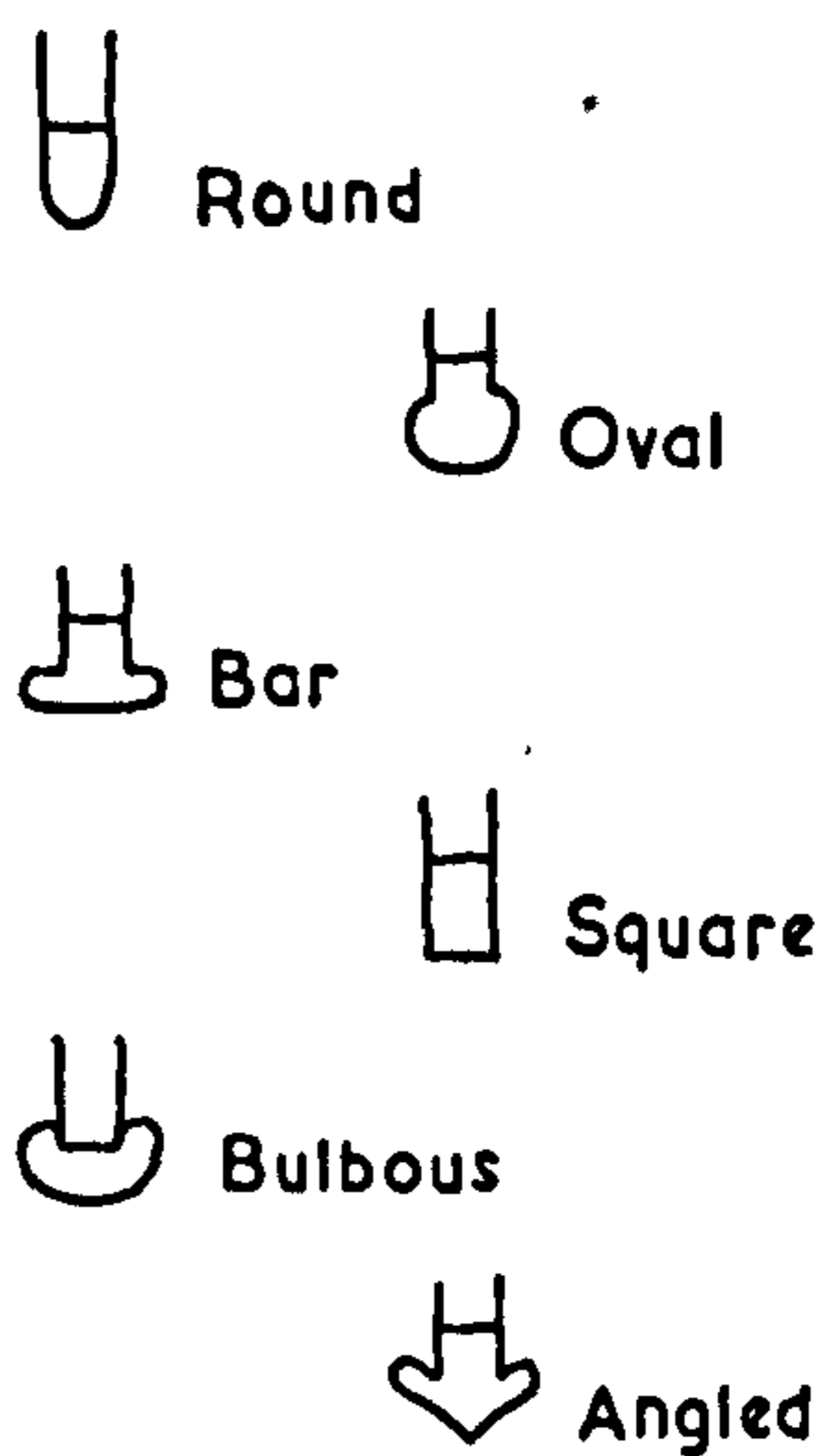

669

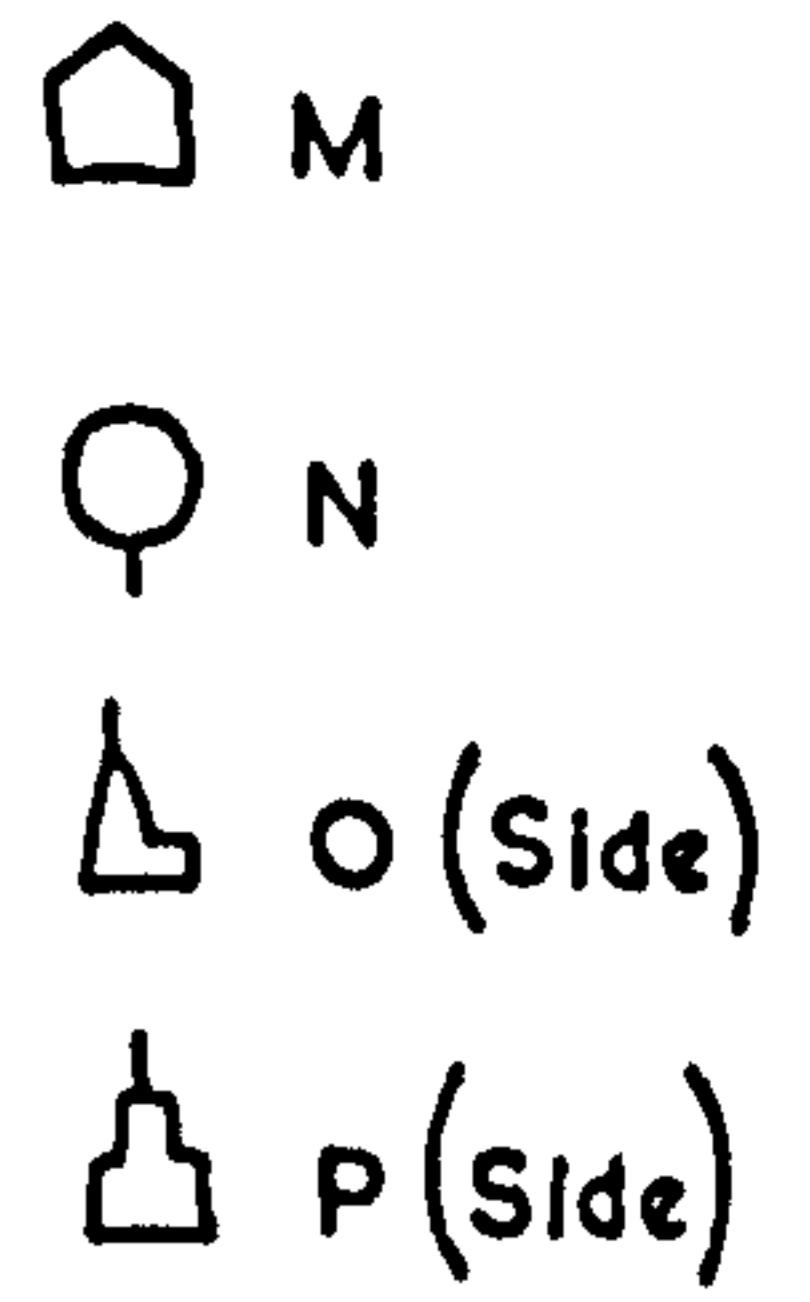
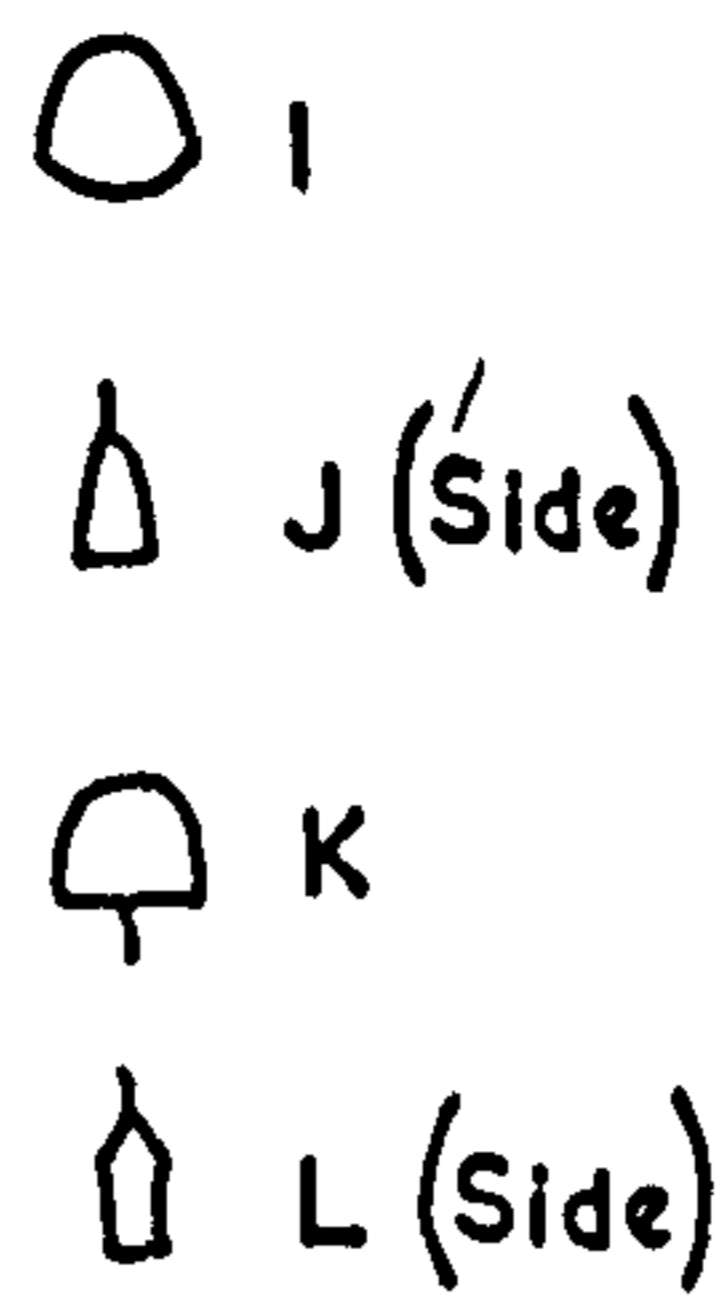
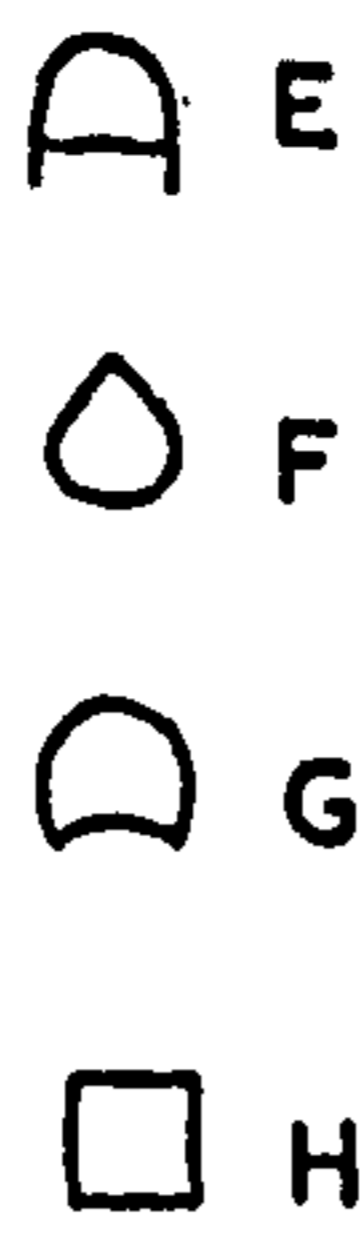
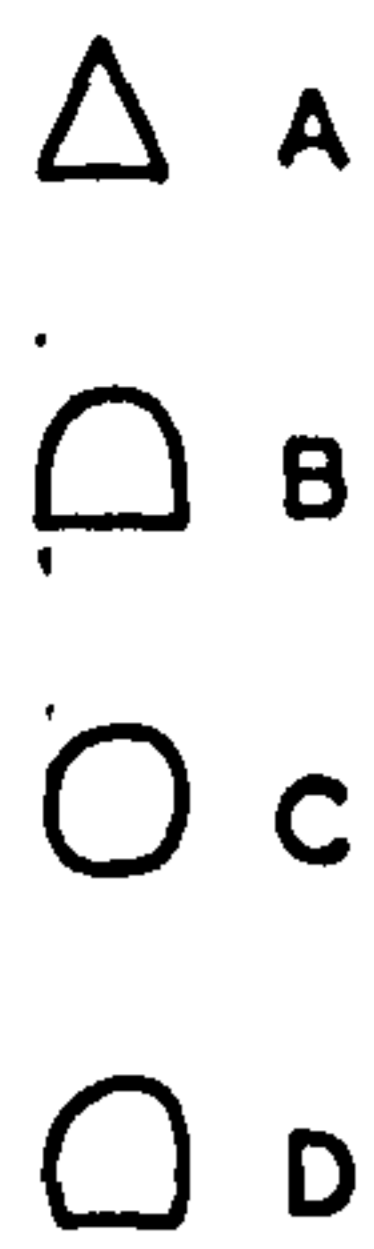

670



Egg



Nut



Ring



Round



Floriated



Bun



Hazel



Diamond



Trefoil

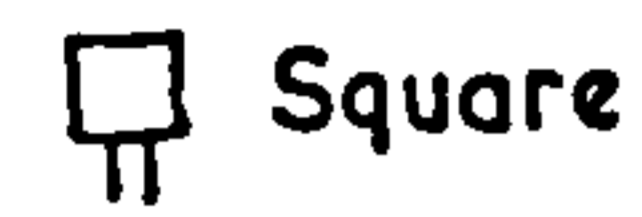

Square



Extended



Bar



Angled

671



Almond



Straight non-tapering

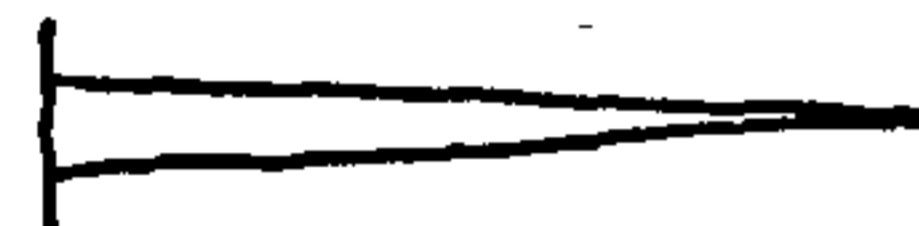

Straight tapering

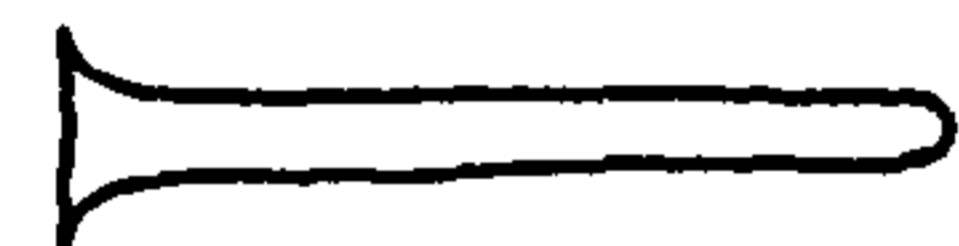

Straight non-tapering flared



Single curved edge



Curved non-tapering



Curved tapering

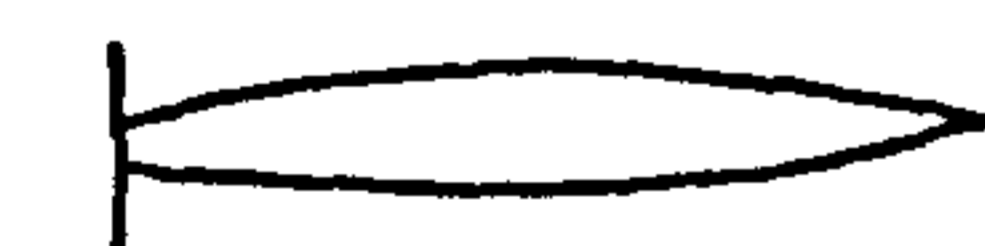

Leaf shaped



Expanding



Sickle

672



A



I

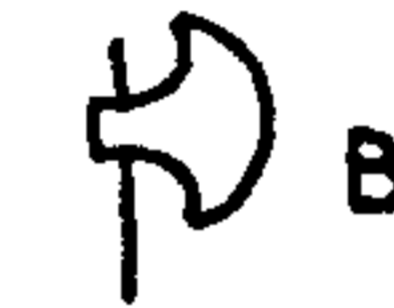

B



J

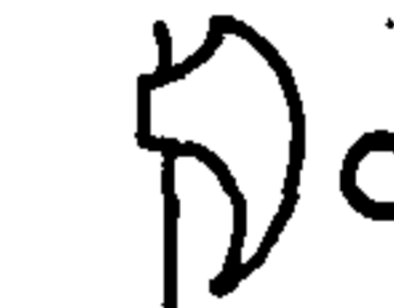

C



K



D



L



E



M



F



N



G



O



H

673



A



H



N



U



B

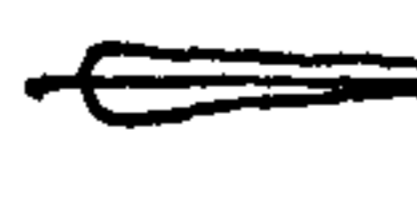

I



O



V



C



J



P



W



D



K



Q



X



E



L



R



Y



F



M



S

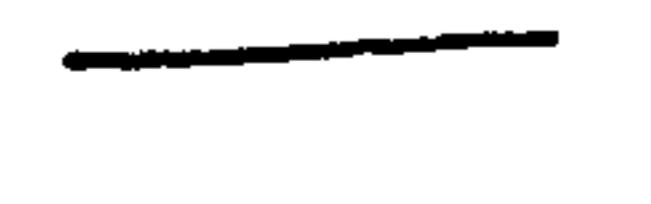

Z



G



T

674

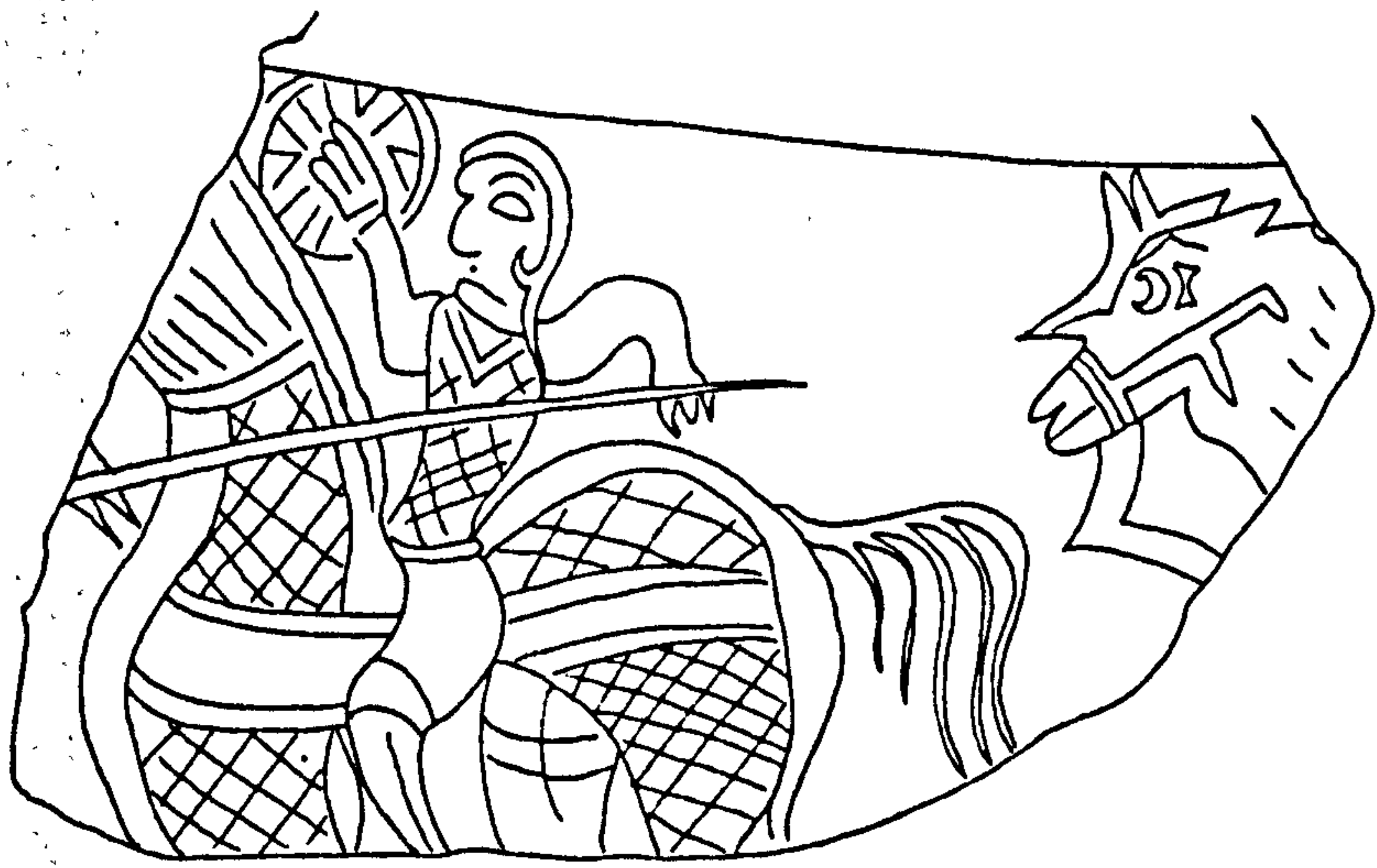

675



676



677

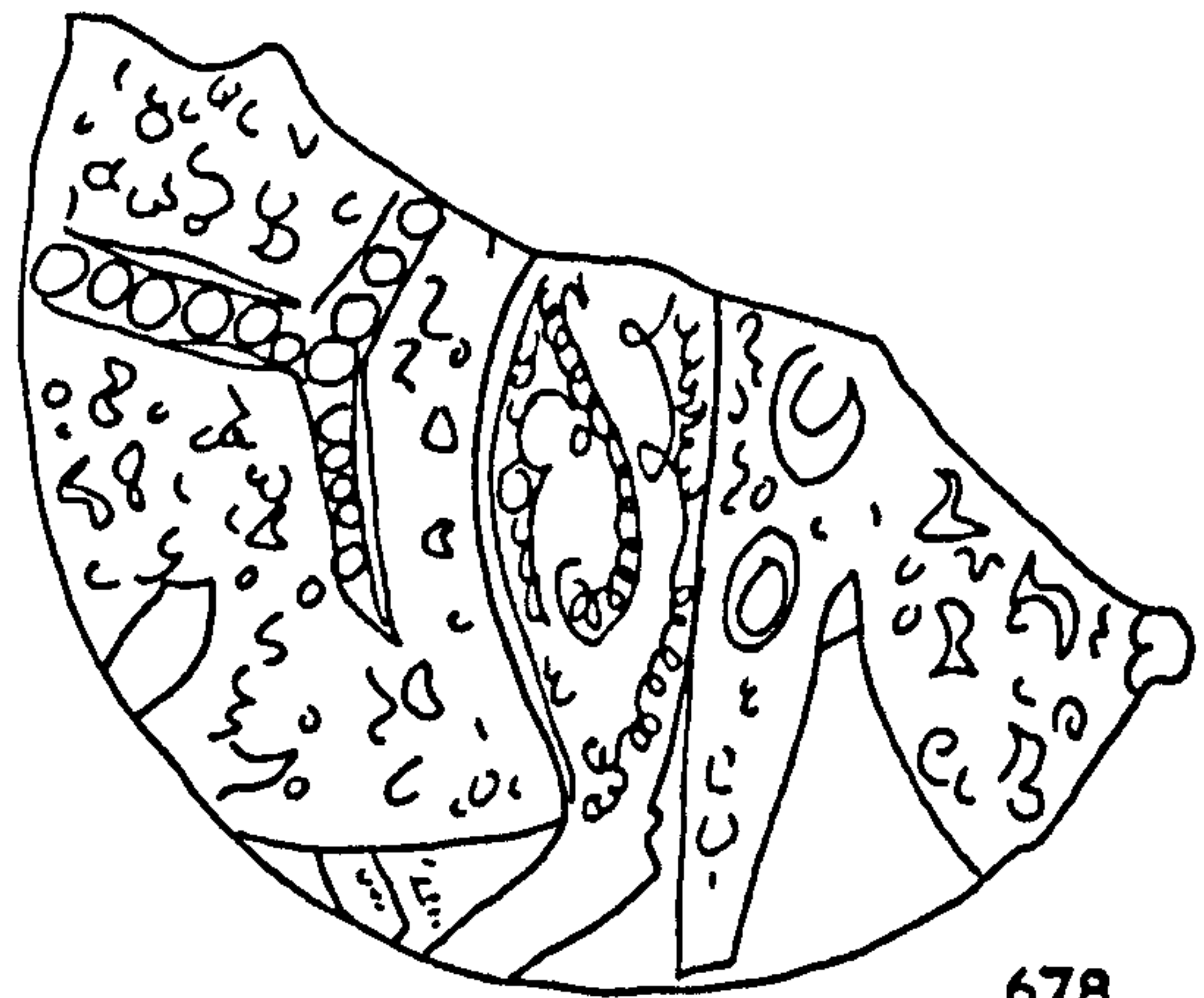

678



679

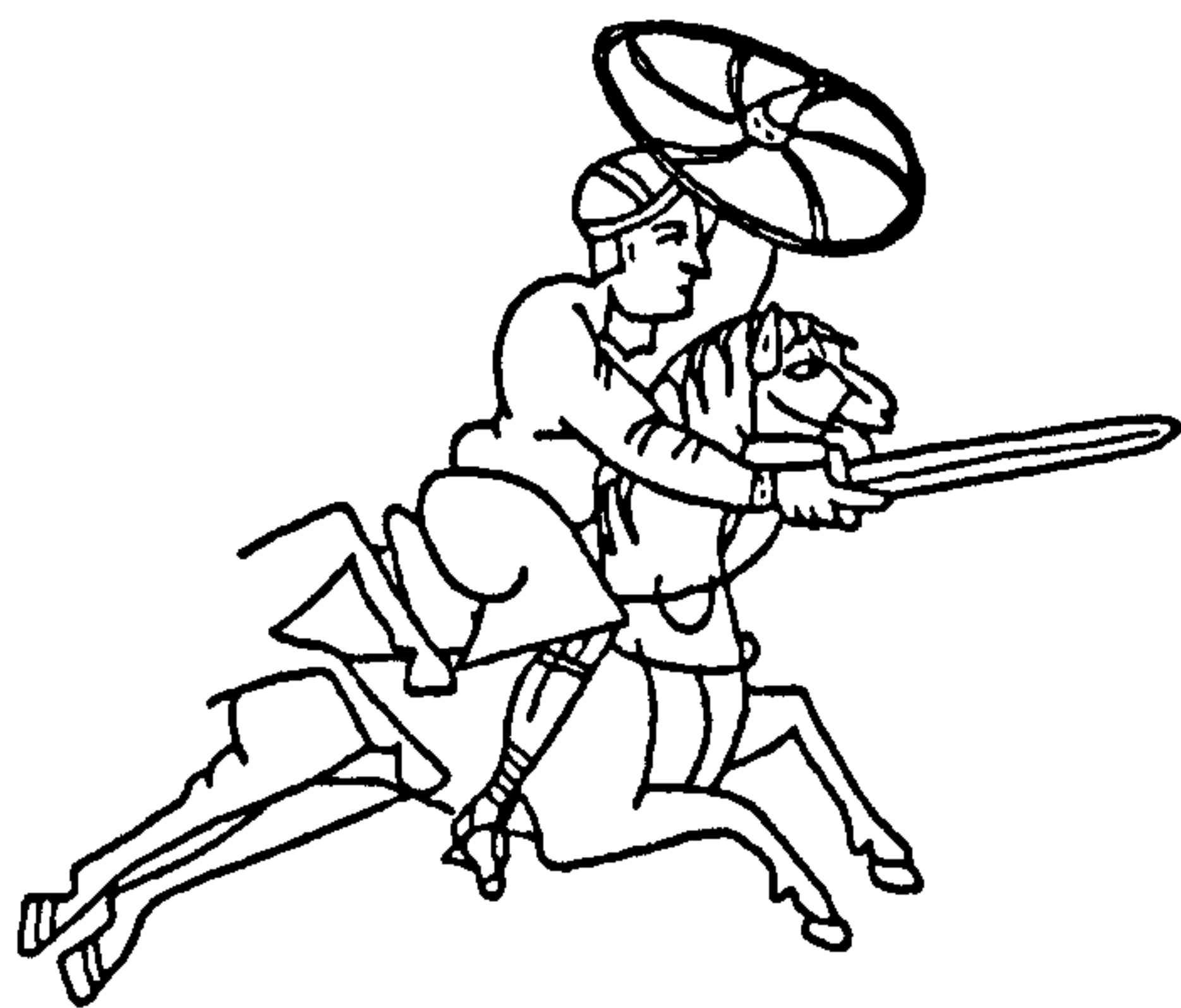

680