



**U15 EUROPEAN
CHAMPIONSHIPS**

KRAKOW 2019

FINAL RAPORT

RAPORT KOŃCOWY

KRAKOW, 27-30.06.2019

FREESTYLE
WOMEN'S WRESTLING
GRECO-ROMAN

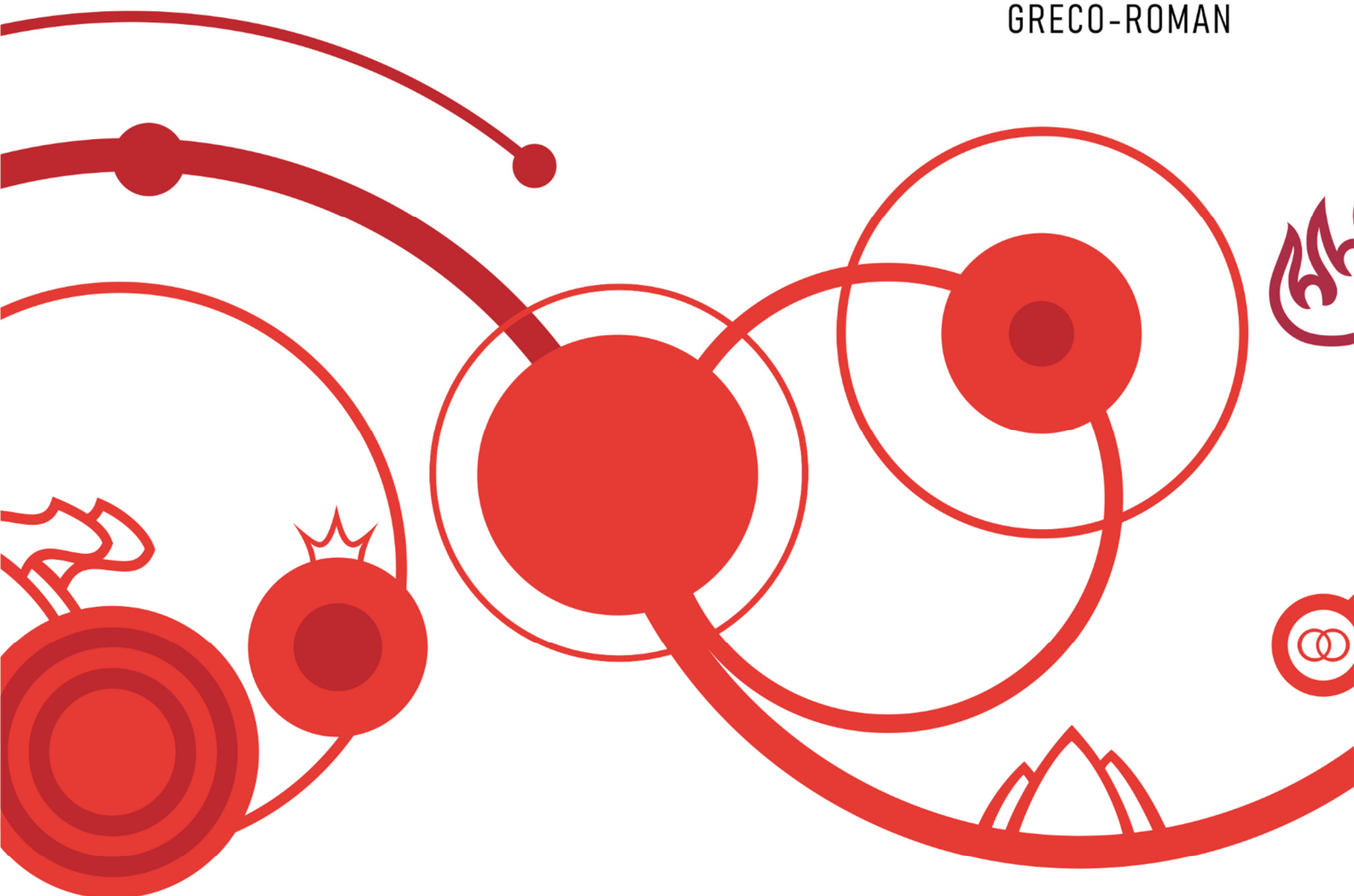



**U15 EUROPEAN
CHAMPIONSHIPS**
KRAKÓW 2019

U15 European Championships

Kraków /POL/

June 27-30, 2019

FINAL REPORT

FREE STYLE



U15 European Championships - Kraków /POL/

June 27-30, 2019



U15 EUROPEAN
CHAMPIONSHIPS
KRAKÓW 2019

List of participants FS

Number	COUNTRY	FS38	FS41	FS44	FS48	FS52	FS57	FS62	FS68	FS75	FS85	TOTAL
1	ARMENIA, Arm	2	1	1	2		2	2		1	1	12
2	AUSTRIA, Aut					1		1				2
3	AZERBAIJAN, Aze	1	2	2	2	2	1	2	2	1	1	16
4	BELARUS, Blr	2	1	2	2	2	2	2	2	2	1	18
5	BELGIUM, Bel					1						1
6	BULGARIA, Bul	2	2	2	2	2	2	2	2	2	2	20
7	ESTONIA, Est	1		1	1		1					4
8	FINLAND, Fin		1						1	1	1	4
9	FRANCE, Fra	1	1							1		3
10	GEORGIA, Geo	2	2	2	2	2	2	2	2	2	2	20
11	GREAT BRITAIN, Gbr			1								1
12	GREECE, Gre						2	1		1	1	6
13	HUNGARY, Hun	1	1	1	1	1	1	1	1	1	1	10
14	ISRAEL, Isr				1	1	1			1		4
15	ITALY, Ita	1	1	1	1	1	1	2	1	1	1	11
16	KOSOVO, Kos		1									1
17	LATVIA, Lat		1		1		1		1	1		5
18	LITHUANIA, Ltu	1			1		1	1				5
19	MOLDOVA, Mda	1	2	2	2	1	2	2	2			14
20	POLAND, Pol	1	2	1	2	2	2	2	2	2	2	18
21	ROMANIA, Rou	2	2	1	1	1	2	1	1	2	2	15
22	RUSSIA, Rus	2	2	2	2	2		1	1		1	13
23	SLOVAKIA, Svk	1			1		1	1	1	1	1	7
24	SPAIN, Esp							1				2
25	TURKEY, Tur	1	1	1	1	1	1	1	1	1	1	10
26	UKRAINE, Ukr	2	2	2	2	2	2	2	2	2	2	20
	TOTAL	24	25	22	27	23	28	26	22	24	21	242





U15 European Championships - Kraków /POL/

June 27-30, 2019

INDIVIDUAL CLASIFICATION FS

CATEGORY 38KG								
Place	Name & Surname	Country	Year of birth	CP	VT	ST	TP	TP GVN
1	Ramzan Israpilov	RUSSIA (Rus)	2004	19	0	2	41	5
2	Khalid Magomedov	RUSSIA (Rus)	2004	15	2	1	28	10
3	Sargis Begoyan	ARMENIA (Arm)	2005	15	0	2	33	15
3	Elman Mammadov	AZERBAIJAN (Aze)	2005	14	2	1	35	12
5	Ilia Labanich	UKRAINE (Ukr)	2004	15	2	1	22	13
5	Saba Kobuladze	GEORGIA (Geo)	2006	7	0	1	15	19
7	Tornike Asabashvili	GEORGIA (Geo)	2004	8	0	1	23	11
8	Boguslavskij Artemij	LITHUANIA (Ltu)	2004	8	0	0	9	22
9	Adil Ikhlov	FRANCE (Fra)	2004	5	0	1	16	7
10	Tigran Buniatyan	ARMENIA (Arm)	2006	4	0	0	13	12
11	Adrian Sikora	POLAND (POL)	2006	4	0	0	12	13
12	Jozsa Attila	HUNGARY (Hun)	2006	3	0	0	10	19
13	Savitski Mikita	BELARUS (Blr)	2005	1	0	0	9	10
14	Ahmed Ahmed	BULGARIA (Bul)	2005	1	0	0	4	6
15	Valeriu Ojog	MOLDOVA (Mda)	2005	1	0	0	4	14
16	Abdullah Top	TURKEY (Tur)	2005	1	0	0	2	7
17	Vitalii Honchar	UKRAINE (Ukr)	2005	0	0	0	6	14
18	Noel Horvath	SLOVAKIA (Svk)	2006	0	0	0	0	0
19-21	Vasilyeu Aliaksei	BELARUS (Blr)	2005	0	0	0	0	10
19-21	Yuseinov Serdzhan	BULGARIA (Bul)	2004	0	0	0	0	10
19-21	Oliver Grauen,	ESTONIA (Est)	2005	0	0	0	0	10
22	Valentin Balika	ROMANIA (Rou)	2005	0	0	0	0	11
23	Andrei Pacurar	ROMANIA (Rou)	2006	0	0	0	0	12
24	Nicolangelo Lotito	ITALY (Ita)	2004	0	0	0	0	20

CATEGORY 41KG								
Place	Name & Surname	Country	Year of birth	CP	VT	ST	TP	TP GVN
M	IMIĘ I NAZWISKO	KLUB	ROK	PKT	TUSZ	PRZEWAGA	pkt	STRACONE
1	Magomed Baitukaev	RUSSIA (Rus)	2004	16	0	4	43	1
2	Magomed Saipudinov	RUSSIA (Rus)	2005	16	1	2	36	17
3	Seyfulla ITAEV	FRANCE (Fra)	2004	11	0	2	28	12
3	Nikoloz Beshidze	GEORGIA (Geo)	2004	13	0	0	37	22
5	Edvard Lenard	ROMANIA (Rou)	2005	15	1	1	24	24
5	Davit Partenadze	GEORGIA (Geo)	2004	10	1	1	13	22
7	Joona Hakola	FINLAND (Fin)	2004	10	2	0	14	22
8	Hayk Navasardyan	ARMENIA (Arm)	2004	6	0	0	6	9
9	Ion Berghi	MOLDOVA (Mda)	2005	5	0	1	29	19
10	Benjamin Bojthe	ROMANIA (Rou)	2005	5	0	1	14	5
11	Dichkov Dilyan	BULGARIA (Bul)	2005	4	0	1	10	10
12	Ugurcan Şahin	TURKEY (Tur)	2004	4	0	0	6	12
13	Denis Cernelea	MOLDOVA (Mda)	2006	3	0	0	16	8
14	Pauer Szabolcs	HUNGARY (Hun)	2006	1	0	0	6	17
15	Adam Bagirov	AZERBAIJAN (Aze)	2005	1	0	0	4	4
16	Sabriev Umut	BULGARIA (Bul)	2004	0	0	0	2	18
17	Luan Nrecaj	KOSOVO (Kos)	2004	0	0	0	0	0
18	Bohdan Ustich	UKRAINE (Ukr)	2005	0	0	0	0	1
19	Mikołaj Żyto	POLAND (POL)	2006	0	0	0	0	6
20	Viarbitski Aliaksandr	BELARUS (Blr)	2005	0	0	0	0	8
21	Ruslan Abdullayev	AZERBAIJAN (Aze)	2004	0	0	0	0	9
22-24	Vaišnerovičs Romualds	LATVIA (Lat)	2005	0	0	0	0	10
22-24	Krzysztof Kulczycki	POLAND (POL)	2006	0	0	0	0	10
22-24	Illia Prus	UKRAINE (Ukr)	2004	0	0	0	0	10
25	Lorenzo Granata	ITALY (Ita)	2006	0	0	0	0	12



U15 European Championships - Kraków /POL/

June 27-30, 2019

INDIVIDUAL CLASIFICATION FS

CATEGORY 44KG								
Place	Name & Surname	Country	Year of birth	CP	VT	ST	TP	TP GVN
1	Adam Arkhiev	RUSSIA (Rus)	2004	15	2	0	32	6
2	Andranik Avetisyan	ARMENIA (Arm)	2004	14	1	2	30	5
3	Anzor Shamshukaev	RUSSIA (Rus)	2005	12	1	1	34	19
3	Ibrahim Metehan Yaprak	TURKEY (Tur)	2004	17	2	1	30	9
5	Saba Kobakhidze	GEORGIA (Geo)	2005	12	1	1	27	16
5	Dimitrov Ivan	BULGARIA (Bul)	2005	3	0	0	2	23
7	Ibrahim Musayev	AZERBAIJAN (Aze)	2005	7	1	0	17	15
8	Naim Denis	BULGARIA (Bul)	2005	6	1	0	12	7
9	Tural Niftiyev	AZERBAIJAN (Aze)	2005	5	1	0	12	8
10	Darla Zalikian	GEORGIA (Geo)	2005	4	1	0	10	8
11	Rostyslav Prus	UKRAINE (Ukr)	2004	4	0	0	18	10
12	Maxim Ma?cu	MOLDOVA (Mda)	2004	4	0	0	9	7
13	Misachenka Aliaksei	BELARUS (Blr)	2004	1	0	0	2	6
14	Serhii Yezhov	UKRAINE (Ukr)	2004	0	0	0	1	8
15	Charlie Meadows	GREAT BRITAIN (Gbr)	2005	0	0	0	0	8
16	Vasile Zanfusan	ROMANIA (Rou)	2005	0	0	0	0	9
17-20	Daniele Gubbiotti	ITALY (Ita)	2005	0	0	0	0	10
17-20	Mate Gyurasits	HUNGARY (Hun)	2004	0	0	0	0	10
17-20	Janar Lips,	ESTONIA (Est)	2005	0	0	0	0	10
17-20	Igor Krawczyński	POLAND (POL)	2004	0	0	0	0	10
21	Valiavaty Ivan	BELARUS (Blr)	2004	0	0	0	0	11
22	Gabriel Ojog	MOLDOVA (Mda)	2005	0	0	0	0	21

CATEGORY 48KG								
Place	Name & Surname	Country	Year of birth	CP	VT	ST	TP	TP GVN
M	IMIĘ I NAZWISKO	KLUB	ROK	PKT	TUSZ	PRZEWAGA	pkt	STRACONE
1	Abdulrahman Ibrahimov	AZERBAIJAN (Aze)	2004	18	2	1	46	8
2	Imam Umarov	RUSSIA (Rus)	2004	12	1	0	19	18
3	Lev Prolomov	RUSSIA (Rus)	2004	14	0	1	33	7
3	Musa Agayev	AZERBAIJAN (Aze)	2006	14	0	1	36	10
5	Edik Harutyunyan	ARMENIA (Arm)	2004	9	0	2	25	26
5	Davit Okropiridze	GEORGIA (Geo)	2004	6	0	1	24	22
7	Valentyn Hryhoryshyn	UKRAINE (Ukr)	2004	8	1	0	21	28
8	Komar Valery	BELARUS (Blr)	2004	7	1	0	20	7
9	RONEN KOLESNIK	ISRAEL (Isr)	2004	6	1	0	12	15
10	Bartłomiej Nowakowski	POLAND (POL)	2006	5	1	0	14	10
11	Alex Gombos	HUNGARY (Hun)	2004	5	1	0	8	12
12	Elvin Lupan	MOLDOVA (Mda)	2004	5	1	0	14	11
13	Herbet Hakobyan	ARMENIA (Arm)	2005	5	1	0	13	10
14	Momakov Nikolay	BULGARIA (Bul)	2005	5	1	0	12	12
15	Ibryam Deniz	BULGARIA (Bul)	2005	4	1	0	10	20
16	Goga Otinashvili	GEORGIA (Geo)	2005	4	0	0	9	13
17	Marian Sandu	ROMANIA (Rou)	2004	1	0	0	4	7
18	Daniel Caradjov	MOLDOVA (Mda)	2004	1	0	0	2	7
19	Kikurs Jekabs	LATVIA (Lat)	2004	1	0	0	1	12
20	Cvetkov Artiom	LITHUANIA (Ltu)	2004	0	0	0	2	12
21	Artur Voytovych	UKRAINE (Ukr)	2004	0	0	0	0	3
22	Emirhan Gizir	TURKEY (Tur)	2004	0	0	0	0	5
23-27	Turyhin Ivan	BELARUS (Blr)	2005	0	0	0	0	10
23-27	Ferenc Daniel Kovacs	SLOVAKIA (Svk)	2005	0	0	0	0	10
23-27	Gregorio Mainardi	ITALY (Ita)	2005	0	0	0	0	10
23-27	Brent Bürkland,	ESTONIA (Est)	2004	0	0	0	0	10
23-27	Rafał Szewc	POLAND (POL)	2004	0	0	0	0	10



U15 European Championships - Kraków /POL/

June 27-30, 2019

INDIVIDUAL CLASIFICATION FS

CATEGORY 52KG								
Place	Name & Surname	Country	Year of birth	CP	VT	ST	TP	TP GVN
1	Marat Fadzaev	RUSSIA (Rus)	2004	21	2	2	48	7
2	Ilkin Qanbarov	AZERBAIJAN (Aze)	2004	14	2	1	32	20
3	Elcan Nadirli	AZERBAIJAN (Aze)	2004	10	0	1	43	16
3	Amin Aliskantov	RUSSIA (Rus)	2004	16	1	2	44	27
5	Shalima Ihar	BELARUS (Blr)	2005	4	0	0	17	31
5	Luka Gvinjilia	GEORGIA (Geo)	2004	11	0	1	22	27
7	Bariş Ünsal	TURKEY (Tur)	2004	8	0	1	23	16
8	Luka Vanishvili	GEORGIA (Geo)	2005	7	1	0	18	22
9	David Manyik	HUNGARY (Hun)	2004	6	1	0	11	10
10	Dzhorov Bozhidar	BULGARIA (Bul)	2004	4	0	1	10	8
11	Atanasov Kaloyan	BULGARIA (Bul)	2005	4	0	0	12	19
12	Robert Biblia	ROMANIA (Rou)	2005	3	0	0	5	21
13	Pavel Domete	MOLDOVA (Mda)	2004	2	0	0	7	16
14	Muhamed Bektemirov	AUSTRIA (Aut)	2004	1	0	0	7	11
15	Ali Khasbulatov	BELGIUM (Bel)	2004	1	0	0	5	7
16	Danny Lubrano	ITALY (Ita)	2004	1	0	0	3	4
17	Konstantinos Papastamatiou	GREECE (Gre)	2005	1	0	0	3	5
18	Davyd Beskutsyki	UKRAINE (Ukr)	2005	1	0	0	2	9
19	Mikita Kasanouski	BELARUS (Blr)	2004	0	0	0	7	10
20	Antoni Majchrzak	POLAND (POL)	2006	0	0	0	2	6
21	Mykyta Burlakov	UKRAINE (Ukr)	2005	0	0	0	0	9
22-23	Dominiak Jagusz	POLAND (POL)	2005	0	0	0	0	10
22-23	Yan Yoni Grad	ISRAEL (Isr)	2004	0	0	0	0	10

CATEGORY 57KG								
Place	Name & Surname	Country	Year of birth	CP	VT	ST	TP	TP GVN
1	Aren Israyelyan	ARMENIA (Arm)	2004	21	4	0	42	8
2	Raul Caso	ITALY (Ita)	2005	12	0	0	23	15
3	Elnur Qadirov	AZERBAIJAN (Aze)	2004	15	2	0	31	7
3	Giorgi Abulashvili	GEORGIA (Geo)	2004	13	1	1	34	15
5	Ferrusola Milla Felipe	SPAIN (Esp)	2004	12	1	0	27	12
5	Gigi Marian Subtirica	ROMANIA (Rou)	2004	10	0	0	29	22
7	Danylo Synytskiy	UKRAINE (Ukr)	2004	9	1	0	28	25
8	Hazim Gyukan	BULGARIA (Bul)	2005	9	1	0	25	15
9	Vadym Tsurkan	UKRAINE (Ukr)	2004	7	0	0	15	14
10	Byshyk Valery	BELARUS (Blr)	2004	5	1	0	8	12
11	Cengizhan Ramazan Dogan	TURKEY (Tur)	2004	5	1	0	16	9
12	Georgios Ioakeimidis	GREECE (Gre)	2004	4	0	0	10	15
13	Alexandr Ialama	MOLDOVA (Mda)	2004	3	0	0	9	18
14	Szymon Ligocki	POLAND (POL)	2004	3	0	0	8	16
15	Hakob Davtyan	ARMENIA (Arm)	2004	2	0	0	5	15
16	Kirill Kanin	ESTONIA (Est)	2004	1	0	0	8	9
17	Otari Dokhnadze	GEORGIA (Geo)	2005	1	0	0	6	6
18	Bartosz Ochroński	POLAND (POL)	2004	1	0	0	6	8
19	Fekete Bence	HUNGARY (Hun)	2004	1	0	0	6	24
20	Georgios Kotanidis	GREECE (Gre)	2004	1	0	0	3	4
21	Anisim Zanet	MOLDOVA (Mda)	2004	1	0	0	2	6
22	Botond Agoston	ROMANIA (Rou)	2004	1	0	0	2	10
23	DANIEL KORKIN	ISRAEL (Isr)	2004	0	0	0	2	8
24-27	Marek Bazso	SLOVAKIA (Svk)	2004	0	0	0	0	10
24-27	Šumanis Reinis	LATVIA (Lat)	2004	0	0	0	0	10
24-27	Burmistrau Aliaksei	BELARUS (Blr)	2004	0	0	0	0	10
24-27	Kaunas Titto	LITHUANIA (Ltu)	2006	0	0	0	0	10
28	Dyankov Dyanko	BULGARIA (Bul)	2004	0	0	0	0	12



U15 European Championships - Kraków /POL/

June 27-30, 2019

INDIVIDUAL CLASIFICATION FS

CATEGORY 62KG								
Place	Name & Surname	Country	Year of birth	CP	VT	ST	TP	TP GVN
1	Ion Marcu	MOLDOVA (Mda)	2004	19	0	4	56	12
2	Yusuf Tatlidil	TURKEY (Tur)	2004	13	1	1	45	23
3	Ivanov Kostadin	BULGARIA (Bul)	2004	12	0	0	29	29
3	Serhii Kostyshyn	UKRAINE (Ukr)	2004	9	0	2	29	14
5	Suren Gevorgyan	ARMENIA (Arm)	2005	10	0	1	26	29
5	Alexander Seiwald	AUSTRIA (Aut)	2004	14	2	0	26	31
7	Edvard Pogosian	GEORGIA (Geo)	2004	8	0	1	23	15
8	Ashot Pogosian	ARMENIA (Arm)	2004	8	0	1	22	10
9	Salim Mammadov	AZERBAIJAN (Aze)	2005	6	1	0	10	12
10	Farman Huseynov	AZERBAIJAN (Aze)	2004	6	1	0	3	16
11	Giga Tsiklauri	GEORGIA (Geo)	2004	4	0	1	10	22
12	Vladislav Brazda	MOLDOVA (Mda)	2005	4	0	0	9	8
13	Nikolaos Makrigrannis	GREECE (Gre)	2004	4	0	0	8	12
14	Rein Vilmos	HUNGARY (Hun)	2004	4	0	0	7	10
15	Vassilj Guccini	ITALY (Ita)	2004	1	0	0	9	10
16	Mattia Bientinesi	ITALY (Ita)	2004	1	0	0	9	11
17	Mykyta Chulakov	UKRAINE (Ukr)	2004	1	0	0	4	4
18	Lescauskas Paulius	LITHUANIA (Ltu)	2004	1	0	0	4	8
19	Lych Dzmitry	BELARUS (Blr)	2004	1	0	0	3	5
20	Vladimir Sukhkh	RUSSIA (Rus)	2004	1	0	0	2	4
21	Robin Mikecz	SLOVAKIA (Svk)	2004	0	0	0	8	2
22	Mihai Farkas	ROMANIA (Rou)	2004	0	0	0	2	19
23	Mehmedov Lerkan	BULGARIA (Bul)	2004	0	0	0	0	8
24-26	Lukashuk Dzmitry	BELARUS (Blr)	2004	0	0	0	0	10
24-26	Igor Szucki	POLAND (POL)	2004	0	0	0	0	10
24-26	Wiktor Kudyba	POLAND (POL)	2004	0	0	0	0	10

CATEGORY 68KG								
Place	Name & Surname	Country	Year of birth	CP	VT	ST	TP	TP GVN
1	Oleksandr Mamrosh	UKRAINE (Ukr)	2004	13	0	1	35	13
2	Gabriele Niccolini	ITALY (Ita)	2004	12	0	2	33	14
3	Florin Tripon	ROMANIA (Rou)	2004	13	1	1	31	9
3	Ibragim Betelmurzaev	RUSSIA (Rus)	2005	17	0	4	52	12
5	Murat Dogan	TURKEY (Tur)	2004	5	0	0	11	25
5	Bohdan Voronin	UKRAINE (Ukr)	2004	9	0	1	24	31
7	Stoyanov Radomir	BULGARIA (Bul)	2004	11	2	0	11	16
8	Hajduch Nandor	HUNGARY (Hun)	2004	6	0	0	15	17
9	Krastev Kristiyan	BULGARIA (Bul)	2005	5	1	0	6	8
10	Anri Suramlishvili	GEORGIA (Geo)	2004	4	0	1	11	11
11	Hasan Palangov	AZERBAIJAN (Aze)	2004	4	0	1	10	5
12	Lukins Ralfs	LATVIA (Lat)	2005	4	0	0	15	11
13	Adam Jaksik	SLOVAKIA (Svk)	2004	1	0	0	7	18
14	Kacper Krawczak	POLAND (POL)	2004	1	0	0	4	9
15	Eryk Pacyna	POLAND (POL)	2004	1	0	0	1	8
16	Egor Neciporuc	MOLDOVA (Mda)	2005	1	0	0	1	11
17	Giorgi Vardzukashvili	GEORGIA (Geo)	2004	0	0	0	4	6
18	Mazaim Mardanov	AZERBAIJAN (Aze)	2005	0	0	0	2	6
19-21	Vladimir Anghelcev	MOLDOVA (Mda)	2004	0	0	0	0	10
19-21	Mirankou Mikita	BELARUS (Blr)	2004	0	0	0	0	10
19-21	Unto Haaslahti	FINLAND (Fin)	2004	0	0	0	0	10
22	Belavusau Artsiom	BELARUS (Blr)	2004	0	0	0	0	13



U15 European Championships - Kraków /POL/

June 27-30, 2019

INDIVIDUAL CLASIFICATION FS

CATEGORY 75KG								
Place	Name & Surname	Country	Year of birth	CP	VT	ST	TP	TP GVN
1	Batuhan Uzun	TURKEY (Tur)	2004	21	2	2	55	22
2	Mykhailo Dikhmyrov	UKRAINE (Ukr)	2004	11	0	2	36	13
3	Tornike Samkharadze	GEORGIA (Geo)	2004	8	0	1	19	8
3	Levan Lagvilava	FRANCE (Fra)	2005	18	2	1	40	27
5	Filip Błaszczyk	POLAND (POL)	2004	14	1	1	27	28
5	Gabriel Radu	ROMANIA (Rou)	2004	9	1	0	21	21
7	Gevorg Gabrielyan	GEORGIA (Geo)	2004	9	1	1	16	4
8	Patryk Szatkiewicz	POLAND (POL)	2004	6	1	0	16	17
9	Saliev Sali	BULGARIA (Bul)	2004	6	0	0	14	19
10	Peter Zsivnovszky	HUNGARY (Hun)	2005	5	1	0	18	14
11	Kostiantyn Zihanhirov	UKRAINE (Ukr)	2004	5	1	0	6	25
12	Nikita Goubarets	ISRAEL (Isr)	2004	5	1	0	4	6
13	Aliakseyeu Tsimafei	BELARUS (Blr)	2004	5	0	1	14	7
14	Skorodihns Rinalds	LATVIA (Lat)	2004	1	0	0	3	14
15	Simon Michalek	SLOVAKIA (Svk)	2004	1	0	0	2	12
16	Seid Niyazi	BULGARIA (Bul)	2005	0	0	0	6	11
17	Denis Chirica	ROMANIA (Rou)	2004	0	0	0	5	6
18	Angelos Apostolidis	GREECE (Gre)	2005	0	0	0	2	4
19	Bokhan Arseni	BELARUS (Blr)	2004	0	0	0	2	9
20-21	Edik Voskanyan	ARMENIA (Arm)	2004	0	0	0	0	4
20-21	Sattarxan Allahverdili	AZERBAIJAN (Aze)	2004	0	0	0	0	4
22-23	Pereira Martinez Pablo	SPAIN (Esp)	2004	0	0	0	0	10
22-23	Mirko De Nichilo	ITALY (Ita)	2004	0	0	0	0	10
24	Leevi Simojoki	FINLAND (Fin)	2004	0	0	0	0	11

CATEGORY 85KG								
Place	Name & Surname	Country	Year of birth	CP	VT	ST	TP	TP GVN
1	Mishiko Kalaijishvili	GEORGIA (Geo)	2004	13	0	1	35	7
2	Illia Plakhtyr	UKRAINE (Ukr)	2004	18	1	3	40	8
3	Darabos Laszlo	HUNGARY (Hun)	2005	16	0	4	44	12
3	Rifat Eren Gidak	TURKEY (Tur)	2004	13	1	1	24	8
5	Emir Mutsolgov	RUSSIA (Rus)	2004	7	0	0	22	23
5	Davit Nokarishvili	GEORGIA (Geo)	2004	9	0	0	19	38
7	Roope Kataja	FINLAND (Fin)	2004	8	0	1	24	14
8	Pavel Socea	ROMANIA (Rou)	2004	4	0	1	10	2
9	Emmanouil Chasampaliotis	GREECE (Gre)	2004	4	0	0	22	14
10	Khachatur Khachatryan	ARMENIA (Arm)	2004	4	0	0	15	19
11	Lucian Moldovan	ROMANIA (Rou)	2004	1	0	0	10	18
12	Tomas Barsamyan Armanis	LITHUANIA (Ltu)	2005	1	0	0	9	9
13	Marko Sipos	SLOVAKIA (Svk)	2004	1	0	0	7	13
14	Stankov Georgi	BULGARIA (Bul)	2004	1	0	0	3	22
15	Adalat Humbatov	AZERBAIJAN (Aze)	2004	1	0	0	2	8
16	Vadym Rudeniuk	UKRAINE (Ukr)	2004	1	0	0	2	21
17	Mateusz Pędzicki	POLAND (POL)	2004	1	0	0	1	11
18-20	Stefanenkau Mikalai	BELARUS (Blr)	2004	0	0	0	0	10
18-20	Dariusz Korczyński	POLAND (POL)	2005	0	0	0	0	10
18-20	Dzhevat Edis	BULGARIA (Bul)	2004	0	0	0	0	10
21	Denis Samuel Floro	ITALY (Ita)	2005	0	0	0	0	12



Feuille de compétition / Competition Sheet

Mistrzostwa Europy U15

Style: FS

38



QUALIFICATION		1/8 FINALE	1/4 FINALE	1/2 FINALE	FINALE	WINNER	
1	Saba Kobuladze (GEO)	P1 P2	1 4 10	GEO P1 P2 10 0	1 3 3	GEO P1 P2 1 2	
2	Vasilyeu Aliaksei (BLR)	P1 P2	2 0 0	BLR P1 P2 0 0	1 0 2	GEO P1 P2 1 2	
3	Valeriu Ojog (MDA)	P1 P2	3 1 4	MDA P1 P2 4 0	1 0 2	GEO P1 P2 2 0	
4	Adil Ikhfazov (FRA)	P1 P2	4 4 14	FRA P1 P2 4 10	4 1 2	FRA P1 P2 0 2	
5	Elman Mammadov (AZE)	P1 P2	5 5 14	AZE P1 P2 6 8	5 0 2	AZE P1 P2 2 0	
6	Vitalii Honchar (UKR)	P1 P2	6 0 8	UKR P1 P2 0 6	8 5 8	RUS P1 P2 4 4	
7	Nicolangelo Lotito (ITA)	P1 P2	7 0 0	ITA P1 P2 0 0	8 5 6	RUS P1 P2 2 4	
8	Khalid Magomedov (RUS)	P1 P2	8 4 10	RUS P1 P2 10 0	8 1 4	RUS P1 P2 0 4	
9	Abdullah Top (TUR)	P1 P2	9 1 2	ARM P1 P2 6 0	12 1 2	GEO P1 P2 0 2	
10	Tigran Buniatyan (ARM)	P1 P2	10 3 7	ARM P1 P2 1 6	12 1 2	GEO P1 P2 0 2	
11	Valentin Balika (ROU)	P1 P2	11 0 0	GEO P1 P2 7 3	16 1 1	ARM P1 P2 1 0	
12	Tornike Asabashvili (GEO)	P1 P2	12 4 11	GEO P1 P2 11 0	16 3 5	ARM P1 P2 3 2	
13	Jozsa Attila (HUN)	P1 P2	13 3 10	HUN P1 P2 0 0	16 3 5	ARM P1 P2 3 2	
14	Savitski Mikita (BLR)	P1 P2	14 1 9	ARM P1 P2 10 0	17 0 0	LTU P1 P2 0 0	
15	Yuseinov Serdzhani (BUL)	P1 P2	15 0 0	ARM P1 P2 10 0	17 0 0	LTU P1 P2 0 0	
16	Sargis Begoyan (ARM)	P1 P2	16 4 10	ARM P1 P2 10 0	22 4 11	RUS P1 P2 9 2	
17	Boguslavskij Artemij (LTU)	P1 P2	17 5 0	LTU P1 P2 0 0	22 4 11	RUS P1 P2 9 2	
18	Noel Horvath (SVK)	P1 P2	18 0 0	LTU P1 P2 2 7	22 4 12	RUS P1 P2 12 0	
19	Ahmed Ahmed (BUL)	P1 P2	19 1 4	POL P1 P2 4 2	22 4 12	RUS P1 P2 12 0	
20	Adrian Sikora (POL)	P1 P2	20 3 6	POL P1 P2 4 2	22 4 12	RUS P1 P2 12 0	
21	Andrei Pacurar (ROU)	P1 P2	21 0 0	RUS P1 P2 2 4	22 4 12	RUS P1 P2 12 0	
22	Ramzan Israpilov (RUS)	P1 P2	22 5 6	RUS P1 P2 6 0	22 4 12	RUS P1 P2 12 0	
23	Oliver Grauen, (EST)	P1 P2	23 0 0	UKR P1 P2 0 0	22 4 12	RUS P1 P2 12 0	
24	Ilia Labanich (UKR)	P1 P2	24 4 10	UKR P1 P2 0 0	22 4 12	RUS P1 P2 12 0	
						22	Ramzan Israpilov (RUS)

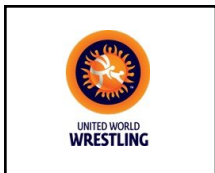

Feuille de compétition / Competition Sheet

Mistrzostwa Europy U15

Style: FS

38



"REPECHAGE"

"UPPER BRANCH"

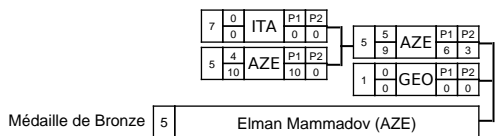

"LOWER BRANCH"

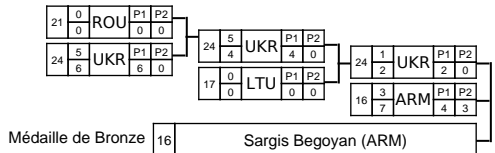

Classement

Cl	Pays	Nom
1	RUS	Ramzan Israpilov (RUS)
2	RUS	Khalid Magomedov (RUS)
3	ARM	Sargis Begoyan (ARM)
3	AZE	Elman Mammadov (AZE)
5	GEO	Saba Kobuladze (GEO)
5	UKR	Ilia Labanich (UKR)
7	GEO	Tornike Asabashvili (GEO)
8	LTU	Boguslavskij Artemij (LTU)
9	FRA	Adil Ikhlaov (FRA)
10	ARM	Tigran Buniatyan (ARM)
11	POL	Adrian Sikora (POL)
12	HUN	Jozsa Attila (HUN)
13	BLR	Savitski Mikita (BLR)
14	BUL	Ahmed Ahmed (BUL)
15	MDA	Valeriu Ojog (MDA)
16	TUR	Abdullah Top (TUR)
17	UKR	Vitalii Honchar (UKR)
18	SVK	Noel Horvath (SVK)
19-21	BLR	Vasilyeu Aliaksei (BLR)
19-21	BUL	Yuseinov Serdhan (BUL)
19-21	EST	Oliver Grauen, (EST)
22	ROU	Valentin Balika (ROU)
23	ROU	Andrei Pacurar (ROU)
24	ITA	Nicolangelo Lotito (ITA)



Feuille de compétition / Competition Sheet

Mistrzostwa Europy U15

Style: FS

41



QUALIFICATION		1/8 FINALE	1/4 FINALE	1/2 FINALE	FINALE	WINNER
1	Uğurcan Şahin (TUR)	P1 P2	1 3 4 TUR P1 P2 0 4	1 1 2 TUR P1 P2 0 2		
2	Adam Bagirov (AZE)	P1 P2	2 1 4 AZE P1 P2 3 1			
3	Illia Prus (UKR)	P1 P2	3 0 0 UKR P1 P2 0 0	4 0 0 FRA P1 P2 0 0		
4	Seyfulla ITAEV (FRA)	P1 P2	4 4 10 FRA P1 P2 10 0	4 3 8 FRA P1 P2 6 2		
5	Magomed Baitukaev (RUS)	P1 P2	5 4 10 RUS P1 P2 10 0	5 4 12 RUS P1 P2 12 0	5 4 11 RUS P1 P2 11 0	
6	Lorenzo Granata (ITA)	P1 P2	6 0 0 ITA P1 P2 0 0			
7	Davit Partenadze (GEO)	P1 P2	7 4 10 GEO P1 P2 10 0	5 4 10 RUS P1 P2 10 0		
8	Dichkov Dilyan (BUL)	P1 P2	8 0 0 BUL P1 P2 0 0	7 1 1 GEO P1 P2 1 0		
9	Krzysztof Kulczycki (POL)	P1 P2	0 0 0 POL P1 P2 0 0			
10	Mikołaj Żyto (POL)	P1 P2	0 0 0 POL P1 P2 0 0			
11	Joonas Hakola (FIN)	P1 P2	5 6 0 FIN P1 P2 0 0	13 5 10 RUS P1 P2 10 0		
12	Sabriev Umut (BUL)	P1 P2	0 0 0 BUL P1 P2 0 0			
13	Magomed Saipudinov (RUS)	P1 P2	4 10 0 RUS P1 P2 10 0	13 3 6 RUS P1 P2 2 4		
14	Denis Cernelea (MDA)	P1 P2	3 8 0 MDA P1 P2 8 0	17 0 2 ROU P1 P2 2 0		
15	Viarbitski Aliaksandr (BLR)	P1 P2	0 0 0 BLR P1 P2 0 0			
16	Luan Nrecaj (KOS)	P1 P2	0 0 0 KOS P1 P2 0 0	17 5 8 ROU P1 P2 2 6		
17	Edvard Lenard (ROU)	P1 P2	5 0 0 ROU P1 P2 0 0			
18	Hayk Navasardyan (ARM)	P1 P2	3 1 0 ARM P1 P2 1 3	18 0 0 ARM P1 P2 0 0		
19	Bohdan Ustich (UKR)	P1 P2	0 0 0 UKR P1 P2 0 0			
20	Vaišnerovičs Romualds (LAT)	P1 P2	0 0 0 LAT P1 P2 0 0	21 1 4 ROU P1 P2 2 2		
21	Benjamin Bojthe (ROU)	P1 P2	4 10 0 ROU P1 P2 4 6			
22	Nikoloz Beshidze (GEO)	P1 P2	3 9 0 GEO P1 P2 2 7	22 3 13 GEO P1 P2 8 5	22 1 4 GEO P1 P2 2 2	
23	Ruslan Abdullayev (AZE)	P1 P2	0 0 0 AZE P1 P2 0 0			
24	Ion Berghi (MDA)	P1 P2	4 17 0 MDA P1 P2 10 7	22 3 5 GEO P1 P2 1 4		
25	Pauer Szabolcs (HUN)	P1 P2	1 6 0 HUN P1 P2 4 2			
						5 Magomed Baitukaev (RUS)

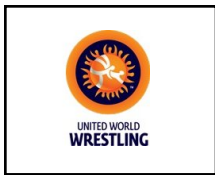

Feuille de compétition / Competition Sheet

Mistrzostwa Europy U15

Style: FS

41



"REPECHAGE"

"UPPER BRANCH"

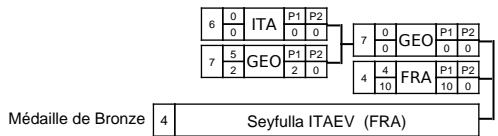

"LOWER BRANCH"

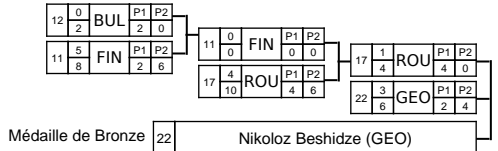

Classement

Cl	Pays	Nom
1	RUS	Magomed Baitukaev (RUS)
2	RUS	Magomed Saipudinov (RUS)
3	GEO	Nikoloz Beshidze (GEO)
3	FRA	Seyfulla ITAEV (FRA)
5	GEO	Davit Partenadze (GEO)
5	ROU	Edvard Lenard (ROU)
7	FIN	Joona Hakola (FIN)
8	ARM	Hayk Navasardyan (ARM)
9	MDA	Ion Berghi (MDA)
10	ROU	Benjamin Bojthe (ROU)
11	BUL	Dichkov Dilyan (BUL)
12	TUR	Uğurcan Şahin (TUR)
13	MDA	Denis Cernelea (MDA)
14	HUN	Pauer Szabolcs (HUN)
15	AZE	Adam Bagirov (AZE)
16	BUL	Sabriev Umut (BUL)
17	KOS	Luan Nrecaj (KOS)
18	UKR	Bohdan Ustich (UKR)
19	POL	Mikołaj Żyto (POL)
20	BLR	Viarbitski Aliaksandr (BLR)
21	AZE	Ruslan Abdullayev (AZE)
22-24	LAT	Vaišnerovičs Romualds (LAT)
22-24	POL	Krzysztof Kulczycki (POL)
22-24	UKR	Illia Prus (UKR)
25	ITA	Lorenzo Granata (ITA)



Feuille de compétition / Competition Sheet

Mistrzostwa Europy U15

Style: FS

44



QUALIFICATION		1/8 FINALE	1/4 FINALE	1/2 FINALE	FINALE	WINNER
1	Adam Arkhiev (RUS)	P1 P2	1 4 11 RUS P1 P2 11 0	1 3 6 RUS P1 P2 4 2	1 5 10 RUS P1 P2 8 2	1 Adam Arkhiev (RUS)
2	Dimitrov Ivan (BUL)	P1 P2	2 0 0 BUL P1 P2 0 0			
3	Tural Niftiyev (AZE)	P1 P2	3 4 10 AZE P1 P2 8 2	3 0 0 AZE P1 P2 0 0		
4	Daniele Gubbiotti (ITA)	P1 P2	4 0 0 ITA P1 P2 0 0			
5	Rostyslav Prus (UKR)	P1 P2	5 3 9 UKR P1 P2 5 4	5 1 9 UKR P1 P2 5 4		
6	Vasile Zanfusan (ROU)	P1 P2	6 0 0 ROU P1 P2 0 0			
7	Janar Lips, (EST)	P1 P2	7 0 0 EST P1 P2 0 0			
8	Anzor Shamshukaev (RUS)	P1 P2	8 5 10 RUS P1 P2 10 0	8 3 10 RUS P1 P2 9 1		
9	Gabriel Ojog (MDA)	P1 P2	9 0 0 MDA P1 P2 0 0			
10	Andranik Avetisyan (ARM)	P1 P2	10 4 11 ARM P1 P2 11 0	10 5 7 ARM P1 P2 7 0		
11	Valiavaty Ivan (BLR)	P1 P2	12 3 5 GEO P1 P2 2 3	12 0 0 GEO P1 P2 0 0		
12	Saba Kobakhidze (GEO)	P1 P2	12 4 11 ARM P1 P2 11 0			
13	Misachenka Aliaksei (BLR)	P1 P2	14 1 3 MDA P1 P2 0 3			
14	Maxim Mațcu (MDA)	P1 P2	16 5 8 TUR P1 P2 8 0	16 4 11 TUR P1 P2 9 2		
15	Serhii Yezhov (UKR)	P1 P2	17 0 0 GEO P1 P2 0 0			
16	Ibrahim Metehan Yaprak (TUR)	P1 P2	20 1 4 BUL P1 P2 4 0	21 0 0 AZE P1 P2 0 0		
17	Darla Zalikian (GEO)	P1 P2	21 4 6 AZE P1 P2 4 6			
18	Mate Gyurasits (HUN)	P1 P2	21 3 7 AZE P1 P2 5 2			
19	Charlie Meadows (GBR)	P1 P2				
20	Naim Denis (BUL)	P1 P2				
21	Ibrahim Musayev (AZE)	P1 P2				
22	Igor Krawczyński (POL)	P1 P2				



Feuille de compétition / Competition Sheet

Mistrzostwa Europy U15

Style: FS

44



"REPECHAGE"

"UPPER BRANCH"

2	3	BUL	P1	P2				
	2		2	0				
3	1	AZE	P1	P2				
	2		0	2				
2	0	BUL	P1	P2				
	0		0	0				
8	4	RUS	P1	P2				
	10		10	0				

Médaille de Bronze 8 Anzor Shamshukaev (RUS)

"LOWER BRANCH"

9	0	MDA	P1	P2				
	0		0	0				
12	4	GEO	P1	P2				
	10		5	5				
12	1	GEO	P1	P2				
	1		0	1				
16	3	TUR	P1	P2				
	3		1	2				

Médaille de Bronze 16 Ibrahim Metehan Yaprak (TUR)

Classement

Cl	Pays	Nom
1	RUS	Adam Arkhiev (RUS)
2	ARM	Andranik Avetisyan (ARM)
3	RUS	Anzor Shamshukaev (RUS)
3	TUR	Ibrahim Metehan Yaprak (TUR)
5	BUL	Dimitrov Ivan (BUL)
5	GEO	Saba Kobakhidze (GEO)
7	AZE	Ibrahim Musayev (AZE)
8	BUL	Naim Denis (BUL)
9	AZE	Tural Niftiyev (AZE)
10	GEO	Darla Zalikiani (GEO)
11	UKR	Rostyslav Prus (UKR)
12	MDA	Maxim Mațcu (MDA)
13	BLR	Misachenka Aliaksei (BLR)
14	UKR	Serhii Yezhov (UKR)
15	GBR	Charlie Meadows (GBR)
16	ROU	Vasile Zanfusan (ROU)
17-20	EST	Janar Lips, (EST)
17-20	POL	Igor Krawczyński (POL)
17-20	ITA	Daniele Gubbiotti (ITA)
17-20	HUN	Mate Gyurasits (HUN)
21	BLR	Valiavaty Ivan (BLR)
22	MDA	Gabriel Ojog (MDA)



Feuille de compétition / Competition Sheet

Mistrzostwa Europy U15

Style: FS

48

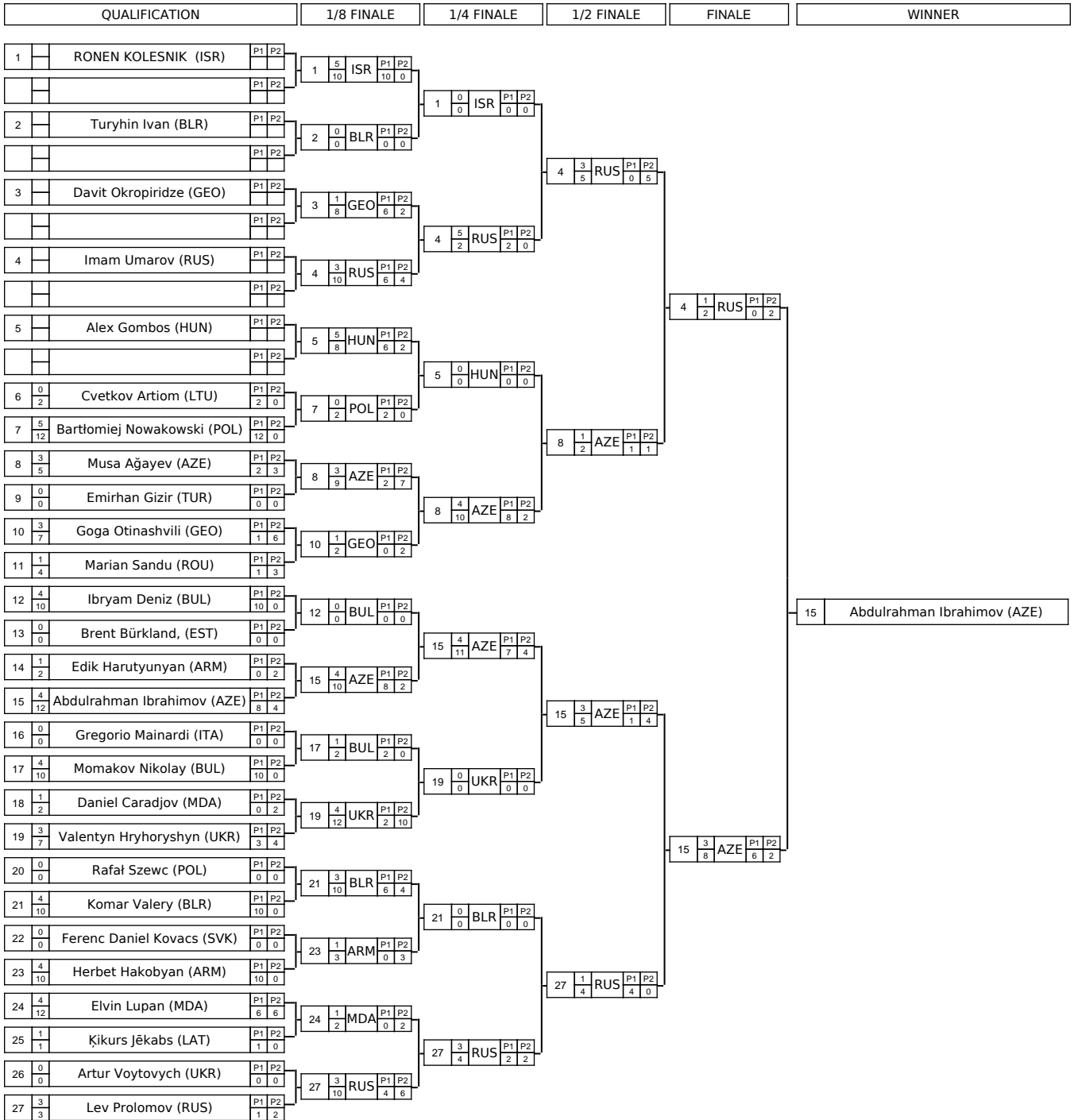



Feuille de compétition / Competition Sheet

Mistrzostwa Europy U15

Style: FS

48



"REPECHAGE"

"UPPER BRANCH"

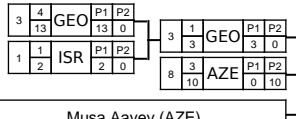

Médaille de Bronze 8 Musa Aayev (AZE)

"LOWER BRANCH"

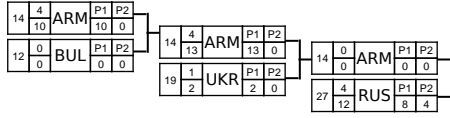

Médaille de Bronze 27 Lev Prolomov (RUS)

Classement

Cl	Pays	Nom
1	AZE	Abdulrahman Ibrahimov (AZE)
2	RUS	Imam Umarov (RUS)
3	RUS	Lev Prolomov (RUS)
3	AZE	Musa Ağayev (AZE)
5	ARM	Edik Harutyunyan (ARM)
5	GEO	Davit Okropiridze (GEO)
7	UKR	Valentyn Hryhoryshyn (UKR)
8	BLR	Komar Valery (BLR)
9	ISR	RONEN KOLESNIK (ISR)
10	POL	Bartłomiej Nowakowski (POL)
11	HUN	Alex Gombos (HUN)
12	MDA	Elvin Lupan (MDA)
13	ARM	Herbet Hakobyan (ARM)
14	BUL	Momakov Nikolay (BUL)
15	BUL	Ibryam Deniz (BUL)
16	GEO	Goga Otinashvili (GEO)
17	ROU	Marian Sandu (ROU)
18	MDA	Daniel Caradjov (MDA)
19	LAT	Ķikurs Jēkabs (LAT)
20	LTU	Cvetkov Artiom (LTU)
21	UKR	Artur Voytovych (UKR)
22	TUR	Emirhan Gizir (TUR)
23-27	EST	Brent Bürkland, (EST)
23-27	POL	Rafal Szewc (POL)
23-27	BLR	Turyhin Ivan (BLR)
23-27	SVK	Ferenc Daniel Kovacs (SVK)
23-27	ITA	Gregorio Mainardi (ITA)



Feuille de compétition / Competition Sheet

Mistrzostwa Europy U15

Style: FS

52



QUALIFICATION		1/8 FINALE	1/4 FINALE	1/2 FINALE	FINALE	WINNER
1	Ilkin Qanbarov (AZE)	P1 P2	1 5/12 AZE	P1 P2 8 4	1 4/10 AZE	P1 P2 2 8
2	Shalima Ihar (BLR)	P1 P2	2 0/3 BLR	P1 P2 1 2	1 5/10 AZE	P1 P2 0 10
3	Konstantinos Papastamatiou	P1 P2	3 1/3 GRE	P1 P2 2 1	4 0/0 ROU	P1 P2 0 0
4	Robert Biblia (ROU)	P1 P2	4 3/5 ROU	P1 P2 4 1	1 0/0 AZE	P1 P2 0 0
5	Yan Yoni Grad (ISR)	P1 P2	5 0/0 ISR	P1 P2 0 0	6 0/0 BUL	P1 P2 0 0
6	Dzhorov Bozhidar (BUL)	P1 P2	6 4/10 BUL	P1 P2 10 0	7 0/7 AZE	P1 P2 4 3
7	Elcan Nadirli (AZE)	P1 P2	7 3/9 AZE	P1 P2 4 5	7 3/8 AZE	P1 P2 4 4
8	Mykyta Burlakov (UKR)	P1 P2	8 0/0 UKR	P1 P2 0 0	9 0/7 BLR	P1 P2 5 2
9	Mikita Kasanouski (BLR)	P1 P2	9 0/7 BLR	P1 P2 5 2	10 4/13 RUS	P1 P2 8 5
10	Amin Aliskantov (RUS)	P1 P2	10 5/10 RUS	P1 P2 2 8	10 0/2 RUS	P1 P2 0 2
11	Ali Khasbulatov (BEL)	P1 P2	11 0/5 BEL	P1 P2 0 5	13 4/12 TUR	P1 P2 6 6
12	Davyd Beskutskiy (UKR)	P1 P2	12 1/2 UKR	P1 P2 0 2	13 1/2 TUR	P1 P2 0 2
13	Bariş Ünsal (TUR)	P1 P2	13 3/9 TUR	P1 P2 7 2	15 1/1 BUL	P1 P2 1 0
14	Muhamed Bektemirov (AUT)	P1 P2	14 1/7 AUT	P1 P2 6 1	17 0/0 GEO	P1 P2 0 0
15	Atanasov Kaloyan (BUL)	P1 P2	15 3/11 BUL	P1 P2 4 7	19 5/6 RUS	P1 P2 6 0
16	Danny Lubrano (ITA)	P1 P2	16 1/3 ITA	P1 P2 1 2	19 4/10 RUS	P1 P2 10 0
17	Luka Gvinjilia (GEO)	P1 P2	17 3/4 GEO	P1 P2 2 2	19 5/12 RUS	P1 P2 6 6
18	Pavel Domente (MDA)	P1 P2	18 1/5 MDA	P1 P2 5 0	20 0/0 GEO	P1 P2 0 0
19	Marat Fadzaev (RUS)	P1 P2	19 3/10 RUS	P1 P2 2 8	20 3/8 GEO	P1 P2 4 4
20	Luka Vanishvili (GEO)	P1 P2	20 4/10 GEO	P1 P2 10 0	22 0/0 HUN	P1 P2 0 0
21	Dominik Jagusz (POL)	P1 P2	21 0/0 POL	P1 P2 0 0	22 1/5 HUN	P1 P2 0 5
22	David Manyik (HUN)	P1 P2	22 5/6 HUN	P1 P2 6 0		
23	Antoni Majchrzak (POL)	P1 P2	23 0/2 POL	P1 P2 2 0		
						19 Marat Fadzaev (RUS)



Feuille de compétition / Competition Sheet

Mistrzostwa Europy U15

Style: FS

52



"REPECHAGE"

"UPPER BRANCH"

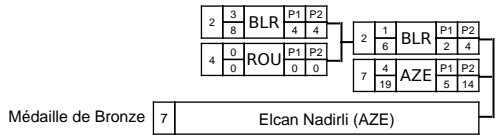

"LOWER BRANCH"

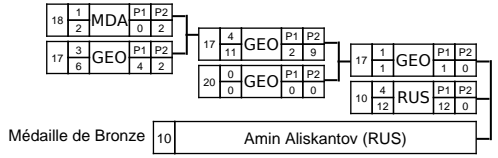

Classement

Cl	Pays	Nom
1	RUS	Marat Fadzaev (RUS)
2	AZE	Ilkin Qanbarov (AZE)
3	AZE	Elcan Nadirli (AZE)
3	RUS	Amin Aliskantov (RUS)
5	BLR	Shalima Ihar (BLR)
5	GEO	Luka Gvinjilia (GEO)
7	TUR	Bariş Ünsal (TUR)
8	GEO	Luka Vanishvili (GEO)
9	HUN	David Manyik (HUN)
10	BUL	Dzhorov Bozhidar (BUL)
11	BUL	Atanasov Kaloyan (BUL)
12	ROU	Robert Biblia (ROU)
13	MDA	Pavel Domente (MDA)
14	AUT	Muhamed Bektemirov (AUT)
15	BEL	Ali Khasbulatov (BEL)
16	ITA	Danny Lubrano (ITA)
17	GRE	Konstantinos Papastamatiou (GRE)
18	UKR	Davyd Beskutskyi (UKR)
19	BLR	Mikita Kasanouski (BLR)
20	POL	Antoni Majchrzak (POL)
21	UKR	Mykyta Burlakov (UKR)
22-23	POL	Dominik Jagusz (POL)
22-23	ISR	Yan Yoni Grad (ISR)



Feuille de compétition / Competition Sheet

Mistrzostwa Europy U15

Style: FS

57



QUALIFICATION		1/8 FINALE	1/4 FINALE	1/2 FINALE	FINALE	WINNER
1	Giorgi Abulashvili (GEO)	P1 P2	1 5 12 GEO	P1 P2 6 6	1 4 10 GEO	P1 P2 10 0
2	Dyankov Dyanko (BUL)	P1 P2	2 0 0 BUL	P1 P2 0 0	1 1 4 GEO	P1 P2 3 1
3	Bartosz Ochroński (POL)	P1 P2	3 1 8 POL	P1 P2 2 4	4 0 0 POL	P1 P2 0 0
4	Szymon Ligocki (POL)	P1 P2	4 3 8 POL	P1 P2 4 4	12 5 2 ARM	P1 P2 2 0
5	Georgios Ioakeimidis (GRE)	P1 P2	5 1 4 GRE	P1 P2 0 4	7 0 0 ROU	P1 P2 0 0
6	Otari Dokhnadze (GEO)	P1 P2	6 1 4 GRE	P1 P2 4 2	12 3 12 ARM	P1 P2 3 9
7	Gigi Marian Subtirica (ROU)	P1 P2	7 3 10 ROU	P1 P2 2 8	12 3 12 ARM	P1 P2 3 9
8	Botond Agoston (ROU)	P1 P2	8 1 2 ROU	P1 P2 1 1	10 1 2 UKR	P1 P2 2 0
9	Marek Bazso (SVK)	P1 P2	9 0 0 SVK	P1 P2 0 0	12 5 4 ARM	P1 P2 4 0
10	Danylo Synytskyi (UKR)	P1 P2	10 4 10 UKR	P1 P2 10 0	12 4 4 ARM	P1 P2 4 8
11	Fekete Bence (HUN)	P1 P2	11 0 0 HUN	P1 P2 0 0	14 1 6 TUR	P1 P2 6 0
12	Aren Israyelyan (ARM)	P1 P2	12 4 12 ARM	P1 P2 12 0	16 1 2 UKR	P1 P2 0 2
13	Burmistru Aliaksei (BLR)	P1 P2	13 0 0 BLR	P1 P2 0 0	16 3 9 UKR	P1 P2 4 5
14	Cengizhan Ramazan Doğan	P1 P2	14 4 10 Cengizhan Ramazan Doğan	P1 P2 10 0	17 1 1 AZE	P1 P2 1 0
15	Georgios Kotanidis (GRE)	P1 P2	15 1 3 GRE	P1 P2 1 2	17 3 5 AZE	P1 P2 3 2
16	Vadym Tsurkan (UKR)	P1 P2	16 3 4 UKR	P1 P2 0 4	19 0 0 MDA	P1 P2 0 0
17	Elnur Qadirov (AZE)	P1 P2	17 4 10 Elnur Qadirov (AZE)	P1 P2 10 0	21 1 2 ANISIM ZANET (MDA)	P1 P2 0 2
18	Sūmanis Reinis (LAT)	P1 P2	18 0 0 LAT	P1 P2 0 0	22 4 10 BUL	P1 P2 10 0
19	Alexandr Ialama (MDA)	P1 P2	19 3 9 Alexandr Ialama (MDA)	P1 P2 4 5	22 1 8 BUL	P1 P2 0 8
20	Kirill Kanin, (EST)	P1 P2	20 1 8 Kirill Kanin, (EST)	P1 P2 6 2	24 0 0 BLR	P1 P2 0 0
21	Anisim Zanet (MDA)	P1 P2	21 1 2 Anisim Zanet (MDA)	P1 P2 0 2	27 3 2 ITA	P1 P2 0 2
22	Hazim Gyukan (BUL)	P1 P2	22 3 6 Hazim Gyukan (BUL)	P1 P2 6 0	27 3 9 ITA	P1 P2 5 4
23	DANIEL KORKIN (ISR)	P1 P2	23 0 2 DANIEL KORKIN (ISR)	P1 P2 2 0	27 3 3 ITA	P1 P2 2 1
24	Byshyk Valery (BLR)	P1 P2	24 5 8 Byshyk Valery (BLR)	P1 P2 6 2	25 4 10 Ferrusola Milla Felipe (ESP)	P1 P2 10 0
25	Ferrusola Milla Felipe (ESP)	P1 P2	25 4 10 Ferrusola Milla Felipe (ESP)	P1 P2 10 0	26 0 0 Kaunas Titto (LTU)	P1 P2 0 0
26	Kaunas Titto (LTU)	P1 P2	26 0 0 Kaunas Titto (LTU)	P1 P2 0 0	27 3 7 Raul Caso (ITA)	P1 P2 1 6
27	Raul Caso (ITA)	P1 P2	27 3 7 Raul Caso (ITA)	P1 P2 1 6	28 1 2 Hakob Davtyan (ARM)	P1 P2 0 2
28	Hakob Davtyan (ARM)	P1 P2	28 1 2 Hakob Davtyan (ARM)	P1 P2 0 2		

12 Aren Israyelyan (ARM)



Feuille de compétition / Competition Sheet

Mistrzostwa Europy U15

Style: FS

57



"REPECHAGE"

"UPPER BRANCH"

11	1	HUN	P1	P2		
	6		2	4		
10	3	UKR	P1	P2		
	12		6	6		
10	1	UKR	P1	P2		
	4		2	2		
7	3	ROU	P1	P2		
	7		2	5		
7	1	ROU	P1	P2		
	3		3	0		
1	3	GEO	P1	P2		
	8		1	7		

Médaille de Bronze 1 Giorgi Abulashvili (GEO)

"LOWER BRANCH"

28	1	ARM	P1	P2		
	3		2	1		
25	3	ESP	P1	P2		
	8		4	4		
25	3	ESP	P1	P2		
	4		0	4		
22	1	BUL	P1	P2		
	1		1	0		
25	1	ESP	P1	P2		
	3		2	1		
17	3	AZE	P1	P2		
	5		4	1		

Médaille de Bronze 17 Elnur Qadirov (AZE)

Classement

Cl	Pays	Nom
1	ARM	Aren Israyelyan (ARM)
2	ITA	Raul Caso (ITA)
3	GEO	Giorgi Abulashvili (GEO)
3	AZE	Elnur Qadirov (AZE)
5	ROU	Gigi Marian Subtirica (ROU)
5	ESP	Ferrusola Milla Felipe (ESP)
7	UKR	Danylo Synytskyi (UKR)
8	BUL	Hazim Gyukan (BUL)
9	UKR	Vadym Tsurkan (UKR)
10	BLR	Byshyk Valery (BLR)
11	TUR	Cengizhan Ramazan Doğan (TUR)
12	GRE	Georgios Ioakeimidis (GRE)
13	MDA	Alexandr Ialama (MDA)
14	POL	Szymon Ligocki (POL)
15	ARM	Hakob Davtyan (ARM)
16	EST	Kirill Kanin, (EST)
17	GEO	Otari Dokhnadze (GEO)
18	POL	Bartosz Ochroński (POL)
19	HUN	Fekete Bence (HUN)
20	GRE	Georgios Kotanidis (GRE)
21	MDA	Anisim Zanet (MDA)
22	ROU	Botond Agoston (ROU)
23	ISR	DANIEL KORIKIN (ISR)
24-27	BLR	Burmistrau Aliaksei (BLR)
24-27	LTU	Kaunas Titto (LTU)
24-27	SVK	Marek Bazso (SVK)
24-27	LAT	Šūmanis Reinis (LAT)
28	BUL	Dyankov Dyanko (BUL)



Feuille de compétition / Competition Sheet

Mistrzostwa Europy U15

Style: FS

62



QUALIFICATION		1/8 FINALE	1/4 FINALE	1/2 FINALE	FINALE	WINNER
1	Lukashuk Dzmitry (BLR)	P1 P2 0 0	1 0 BLR P1 P2 0 0 0 0	2 0 GEO P1 P2 0 0 0 0	4 5 TUR P1 P2 8 4 4 4	17 Ion Marcu (MDA)
2	Giga Tsiklauri (GEO)	P1 P2 0 0	2 4 GEO P1 P2 10 4 6 6	4 4 TUR P1 P2 12 8 4 4	4 1 TUR P1 P2 11 5 6 6	
3	Serhii Kostyshyn (UKR)	P1 P2 0 0	3 1 UKR P1 P2 9 8 1 1	6 1 MDA P1 P2 5 2 3 3	9 0 ARM P1 P2 0 0 0 0	
4	Yusuf Tatlidil (TUR)	P1 P2 0 0	4 3 TUR P1 P2 14 8 6 6	7 1 AZE P1 P2 2 2 0 0	9 3 ARM P1 P2 6 4 2 2	
5	Vladimir Sukhkh (RUS)	P1 P2 0 0	5 1 RUS P1 P2 2 2 0 0	11 3 GEO P1 P2 8 3 5 5	17 4 MDA P1 P2 10 12 0 0	
6	Vladislav Brazda (MDA)	P1 P2 0 0	6 3 MDA P1 P2 4 0 4 4	14 1 AZE P1 P2 1 1 0 0	17 4 MDA P1 P2 10 12 0 0	
7	Salim Mammadov (AZE)	P1 P2 5 8	7 1 AZE P1 P2 4 4 4 4	15 0 AUT P1 P2 0 0 0 0	17 3 MDA P1 P2 14 8 6 6	
8	Mehmedov Lerkan (BUL)	P1 P2 0 0	9 3 ARM P1 P2 6 4 2 2	17 4 MDA P1 P2 10 12 0 0	21 3 BUL P1 P2 6 4 2 2	
9	Suren Gevorgyan (ARM)	P1 P2 3 8	9 4 ARM P1 P2 12 12 0 0	19 1 HUN P1 P2 0 2 0 2	21 0 BUL P1 P2 0 0 0 0	
10	Lescauskas Paulius (LTU)	P1 P2 1 4	11 3 GEO P1 P2 8 3 5 5	21 3 BUL P1 P2 6 4 2 2	24 1 GRE P1 P2 4 1 3 3	
11	Edvard Pogonian (GEO)	P1 P2 4 10	14 1 AZE P1 P2 1 1 0 0	26 1 ARM P1 P2 4 0 4 4		
12	Igor Szucki (POL)	P1 P2 0 0	15 0 AUT P1 P2 0 0 0 0			
13	Robin Mikecz (SVK)	P1 P2 0 8	17 4 MDA P1 P2 10 12 0 0			
14	Farman Huseynov (AZE)	P1 P2 5 2	19 1 HUN P1 P2 0 2 0 2			
15	Alexander Seiwald (AUT)	P1 P2 3 11	21 3 BUL P1 P2 6 4 2 2			
16	Mattia Bientinesi (ITA)	P1 P2 1 9	24 1 GRE P1 P2 4 1 3 3			
17	Ion Marcu (MDA)	P1 P2 4 10	26 3 ARM P1 P2 8 2 6 6			
18	Mihai Farkas (ROU)	P1 P2 0 0				
19	Rein Vilmos (HUN)	P1 P2 3 5				
20	Lych Dzmitry (BLR)	P1 P2 1 3				
21	Ivanov Kostadin (BUL)	P1 P2 3 10				
22	Vassilj Guccini (ITA)	P1 P2 1 9				
23	Mykyta Chulakov (UKR)	P1 P2 1 4				
24	Nikolaos Makrigiannis (GRE)	P1 P2 3 4				
25	Wiktor Kudyba (POL)	P1 P2 0 0				
26	Ashot Pogonian (ARM)	P1 P2 4 10				



Feuille de compétition / Competition Sheet

Mistrzostwa Europy U15

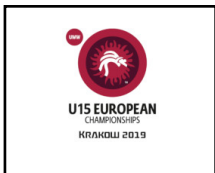

Style: FS

62

"REPECHAGE"

"UPPER BRANCH"



"LOWER BRANCH"

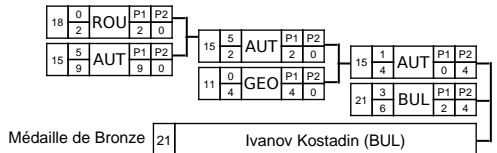

Classement

Cl	Pays	Nom
1	MDA	Ion Marcu (MDA)
2	TUR	Yusuf Tatlidii (TUR)
3	BUL	Ivanov Kostadin (BUL)
3	UKR	Serhii Kostyshyn (UKR)
5	AUT	Alexander Seiwald (AUT)
5	ARM	Suren Gevorgyan (ARM)
7	GEO	Edvard Pogolian (GEO)
8	ARM	Ashot Pogolian (ARM)
9	AZE	Salim Mammadov (AZE)
10	AZE	Farman Huseynov (AZE)
11	GEO	Giga Tsiklauri (GEO)
12	MDA	Vladislav Brazda (MDA)
13	GRE	Nikolaos Makrigrannis (GRE)
14	HUN	Rein Vilmos (HUN)
15	ITA	Vassij Guccini (ITA)
16	ITA	Mattia Bientinesi (ITA)
17	UKR	Mykyta Chulakov (UKR)
18	LTU	Lescauskas Paulius (LTU)
19	BLR	Lych Dzmitry (BLR)
20	RUS	Vladimir Sukhkh (RUS)
21	SVK	Robin Mikecz (SVK)
22	ROU	Mihai Farkas (ROU)
23	BUL	Mehmedov Lerkan (BUL)
24-26	BLR	Lukashuk Dzmitry (BLR)
24-26	POL	Igor Szucki (POL)
24-26	POL	Wiktory Kudyba (POL)



Feuille de compétition / Competition Sheet

Mistrzostwa Europy U15

Style: FS

68



QUALIFICATION		1/8 FINALE	1/4 FINALE	1/2 FINALE	FINALE	WINNER
1	Florin Tripon (ROU)	P1 P2	1 4 10	ROU P1 P2 2 8	1 5 5	ROU P1 P2 1 4
2	Mirankou Mikita (BLR)	P1 P2	2 0 0	BLR P1 P2 0 0		
3	Hasan Palangov (AZE)	P1 P2	3 4 10	AZE P1 P2 6 4	3 0 0	AZE P1 P2 0 0
4	Unto Haaslahti (FIN)	P1 P2	4 0 0	FIN P1 P2 0 0		
5	Bohdan Voronin (UKR)	P1 P2	5 4 10	UKR P1 P2 6 4	5 1 3	UKR P1 P2 1 2
6	Vladimir Anghelcev (MDA)	P1 P2	6 0 0	MDA P1 P2 0 0		
7	Adam Jaksik (SVK)	P1 P2	7 0 0	SVK P1 P2 0 0		
8	Gabriele Niccolini (ITA)	P1 P2	8 4 10	ITA P1 P2 10 0	8 3 6	ITA P1 P2 6 0
9	Murat Doğan (TUR)	P1 P2	9 1 2	TUR P1 P2 2 0		
10	Oleksandr Mamrosh (UKR)	P1 P2	10 4 12	UKR P1 P2 4 8	10 3 7	UKR P1 P2 1 6
11	Stoyanov Radomir (BUL)	P1 P2	11 5 4	BUL P1 P2 4 0	11 0 0	BUL P1 P2 0 0
12	Mazaim Mardanov (AZE)	P1 P2	12 0 2			
13	Giorgi Vardzukashvili (GEO)	P1 P2	13 0 4	BUL P1 P2 0 0		
14	Krastev Kristiyan (BUL)	P1 P2	14 0 2			
15	Kacper Krawczak (POL)	P1 P2	15 1 4	16 1 6	LAT P1 P2 4 2	
16	Lukins Ralfs (LAT)	P1 P2	16 3 9			
17	Hajduch Nandor (HUN)	P1 P2	17 3 2	HUN P1 P2 4 3	17 0 0	HUN P1 P2 0 0
18	Eryk Pacyna (POL)	P1 P2	18 1 1			
19	Egor Neciporuc (MDA)	P1 P2	19 1 1			
20	Anri Suramlishvili (GEO)	P1 P2	20 4 11	GEO P1 P2 0 0		
21	Ibragim Betelmurzaev (RUS)	P1 P2	21 4 13	RUS P1 P2 10 0	21 1 7	RUS P1 P2 6 1
22	Belavusau Artsiom (BLR)	P1 P2	22 0 0			
					8 1 4	ITA P1 P2 2 2
					8 3 6	ITA P1 P2 6 0
					10 3 10	UKR P1 P2 4 6
					10 3 6	UKR P1 P2 0 6
						10 Oleksandr Mamrosh (UKR)



Feuille de compétition / Competition Sheet

Mistrzostwa Europy U15

Style: FS

68



"REPECHAGE"

"UPPER BRANCH"

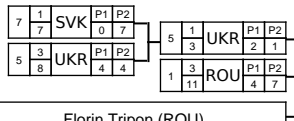

Médaille de Bronze 1 Florin Tripon (ROU)

"LOWER BRANCH"

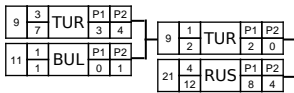

Médaille de Bronze 21 Ibragim Betelmurzaev (RUS)

Classement

Cl	Pays	Nom
1	UKR	Oleksandr Mamrosh (UKR)
2	ITA	Gabriele Niccolini (ITA)
3	ROU	Florin Tripon (ROU)
3	RUS	Ibragim Betelmurzaev (RUS)
5	UKR	Bohdan Voronin (UKR)
5	TUR	Murat Doğan (TUR)
7	BUL	Stoyanov Radomir (BUL)
8	HUN	Hajdуч Nandor (HUN)
9	BUL	Krastev Kristiyan (BUL)
10	GEO	Anri Suramlishvili (GEO)
11	AZE	Hasan Palangov (AZE)
12	LAT	Lukins Ralfs (LAT)
13	SVK	Adam Jaksik (SVK)
14	POL	Kacper Krawczak (POL)
15	POL	Eryk Pacyna (POL)
16	MDA	Egor Neciporuc (MDA)
17	GEO	Giorgi Vardzukashvili (GEO)
18	AZE	Mazaim Mardanov (AZE)
19-21	MDA	Vladimir Anghelcev (MDA)
19-21	BLR	Mirankou Mikita (BLR)
19-21	FIN	Unto Haaslahti (FIN)
22	BLR	Belavusau Artsiom (BLR)



Feuille de compétition / Competition Sheet

Mistrzostwa Europy U15

Style: FS

75



QUALIFICATION		1/8 FINALE	1/4 FINALE	1/2 FINALE	FINALE	WINNER
1	Kostiantyn Zihanhirov (UKR)	P1 P2	1 5/6 UKR	P1 P2	1 0/0 UKR	
		P1 P2				
2	Denis Chirica (ROU)	P1 P2	2 0/5 ROU	P1 P2		
		P1 P2				
3	Tornike Samkharadze (GEO)	P1 P2	3 1/8 GEO	P1 P2		
		P1 P2				
4	Mykhailo Dikhmyrov (UKR)	P1 P2	4 3/6 UKR	P1 P2	4 4/10 UKR	
		P1 P2				
5	Patryk Szatkiewicz (POL)	P1 P2	5 5/9 POL	P1 P2		
		P1 P2				
6	Bokhan Arseni (BLR)	P1 P2	6 0/2 BLR	P1 P2		
		P1 P2				
7	Edik Voskanyan (ARM)	P1 P2	7 0/0 ARM	P1 P2		
		P1 P2				
8	Gabriel Radu (ROU)	P1 P2	8 5/4 ROU	P1 P2	8 0/0 ROU	
		P1 P2				
9	Batuhan Uzun (TUR)	P1 P2	9 4/13 TUR	P1 P2		9 Batuhan Uzun (TUR)
10	Skorodihins Rinalds (LAT)	P1 P2		P1 P2		
11	Pereira Martinez Pablo (ESP)	P1 P2	12 1/2 POL	P1 P2		
12	Filip Błaszczyk (POL)	P1 P2		P1 P2		
13	Aliakseyeu Tsimafei (BLR)	P1 P2	13 1/2 BLR	P1 P2		
14	Simon Michalek (SVK)	P1 P2		P1 P2		
15	Sattarxan Allahverdiili (AZE)	P1 P2	16 3/5 BUL	P1 P2		
16	Saliev Sali (BUL)	P1 P2		P1 P2		
17	Nikita Goubarets (ISR)	P1 P2	17 0/0 ISR	P1 P2		
18	Angelos Apostolidis (GRE)	P1 P2		P1 P2		
19	Mirko De Nichilo (ITA)	P1 P2	20 5/4 GEO	P1 P2		
20	Gevorg Gabrielyan (GEO)	P1 P2		P1 P2		
21	Seid Niyazi (BUL)	P1 P2	22 0/7 HUN	P1 P2		
22	Peter Zsivnovszky (HUN)	P1 P2		P1 P2		
23	Leevi Simojoki (FIN)	P1 P2	24 5/8 FRA	P1 P2		
24	Levan Lagvilava (FRA)	P1 P2		P1 P2		

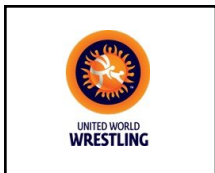

Feuille de compétition / Competition Sheet

Mistrzostwa Europy U15

Style: FS

75



"REPECHAGE"

"UPPER BRANCH"

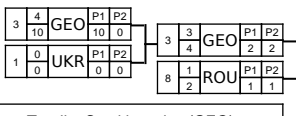

Médaille de Bronze 3 Tornike Samkharadze (GEO)

"LOWER BRANCH"

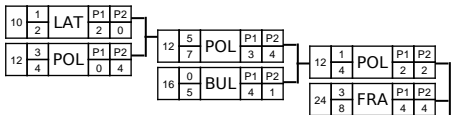

Médaille de Bronze 24 Levan Lagvilava (FRA)

Classement

Cl	Pays	Nom
1	TUR	Batuhan Uzun (TUR)
2	UKR	Mykhailo Dikhmyrov (UKR)
3	FRA	Levan Lagvilava (FRA)
3	GEO	Tornike Samkharadze (GEO)
5	POL	Filip Błaszczyk (POL)
5	ROU	Gabriel Radu (ROU)
7	GEO	Gevorg Gabrielyan (GEO)
8	POL	Patryk Szatkiewicz (POL)
9	BUL	Saliev Sali (BUL)
10	HUN	Peter Zsivnovszky (HUN)
11	UKR	Kostiantyn Zihanhirov (UKR)
12	ISR	Nikita Goubarets (ISR)
13	BLR	Aliakseyeu Tsimafei (BLR)
14	LAT	Skorodihins Rinalds (LAT)
15	SVK	Simon Michalek (SVK)
16	BUL	Seid Niyazi (BUL)
17	ROU	Denis Chirica (ROU)
18	GRE	Angelos Apostolidis (GRE)
19	BLR	Bokhan Arseni (BLR)
20-21	ARM	Edik Voskanyan (ARM)
20-21	AZE	Sattarxan Allahverdili (AZE)
22-23	ESP	Pereira Martinez Pablo (ESP)
22-23	ITA	Mirko De Nichilo (ITA)
24	FIN	Leevi Simojoki (FIN)



Feuille de compétition / Competition Sheet

Mistrzostwa Europy U15

Style: FS

85



QUALIFICATION		1/8 FINALE	1/4 FINALE	1/2 FINALE	FINALE	WINNER
1	Emir Mutsolgov (RUS)	P1 P2	1 3 RUS P1 P2 8 0 8	1 1 RUS P1 P2 2 0 0		
2	Adalat Humbatov (AZE)	P1 P2	2 1 AZE P1 P2 2 1 1			
3	Stankov Georgi (BUL)	P1 P2	3 0 BUL P1 P2 0 0 0			
4	Mishiko Kalajishvili (GEO)	P1 P2	4 3 GEO P1 P2 10 1 9			
5	Dariusz Korczyński (POL)	P1 P2	5 0 POL P1 P2 0 0 0			
6	Pavel Socea (ROU)	P1 P2	6 4 ROU P1 P2 10 0 0			
7	Rifat Eren Gidak (TUR)	P1 P2	7 4 TUR P1 P2 11 7 4			
8	Mateusz Pędzicki (POL)	P1 P2	8 1 POL P1 P2 1 1 0			
9	Marko Sipos (SVK)	P1 P2	9 1 SVK P1 P2 7 5 2			
10	Khachatur Khachatryan (ARM)	P1 P2	10 3 ARM P1 P2 13 4 9			
11	Stsefanenkau Mikalai (BLR)	P1 P2	11 0 BLR P1 P2 0 0 0			
12	Darabos Laszlo (HUN)	P1 P2	12 4 HUN P1 P2 12 10 0			
13	Denis Samuel Floro (ITA)	P1 P2	13 0 ITA P1 P2 0 0 0			
14	Lucian Moldovan (ROU)	P1 P2	15 1 GRE P1 P2 10 9 1			
15	Emmanouil Chasampaliotis	P1 P2	16 0 GEO P1 P2 18 12 6			
16	Davit Nokarishvili (GEO)	P1 P2	16 3 GEO P1 P2 9 4 5			
17	Tomas Barsamyan Armanis	P1 P2	21 4 UKR P1 P2 9 3 6			
18	Roope Kataja (FIN)	P1 P2	18 0 FIN P1 P2 10 0 0			
19	Dzhevat Edis (BUL)	P1 P2	21 4 UKR P1 P2 0 0 0			
20	Vadym Rudeniuk (UKR)	P1 P2	21 5 UKR P1 P2 0 0 0			
21	Illia Plakhtyr (UKR)	P1 P2	21 5 UKR P1 P2 10 8 2			
				4 3 GEO P1 P2 8 3 4		
				6 0 ROU P1 P2 0 0 0		
				7 1 TUR P1 P2 3 0 3		
				7 5 TUR P1 P2 2 2 0		
				10 1 ARM P1 P2 2 2 0		
				12 0 HUN P1 P2 0 0 0		
				12 4 HUN P1 P2 12 6 6		
				21 1 UKR P1 P2 2 0 2		
				21 4 UKR P1 P2 10 6 4		
					4	Mishiko Kalajishvili (GEO)



U15 EUROPEAN
CHAMPIONSHIPS
KRAKÓW 2019

U15 European Championships - Kraków /POL/

June 27-30, 2019

TEAM CLASIFICACION in FREE STYLE

M.	KLUB	# wrestlers	FS38KG	FS41KG	FS44KG	FS48KG	FS52KG	FS57KG	FS62KG	FS68KG	FS75KG	FS85KG	TOTAL
1	RUSSIA (Rus)	13	25	25	25	20	25	15	0	15	15	10	145
2	GEORGIA (Geo)	20	10	15	10	10	10	15	8	2	15	25	120
3	UKRAINE (Ukr)	20	10	0	0	8	0	8	15	25	20	20	106
4	TURKEY (Tur)	10	0	0	15	0	8	0	20	10	25	15	93
5	ARMENIA (Arm)	12	15	6	20	10	10	25	10	10	0	2	88
6	AZERBAIJAN (Aze)	16	15	0	8	25	20	15	4	0	0	0	87
7	ROMANIA (Rou)	15	0	10	0	0	0	10	0	15	10	6	51
8	BULGARIA (Bul)	20	0	0	10	0	2	6	15	8	4	0	45
9	ITALY (Ita)	11	0	0	0	0	0	20	0	20	0	0	40
10	FRANCE (Fra)	3	4	15	0	0	0	0	0	0	15	0	34
11	MOLDOVA (Mda)	14	0	4	0	0	0	0	25	0	0	0	29
12	HUNGARY (Hun)	10	0	0	0	0	4	0	0	6	2	15	27
13	BELARUS (Bir)	18	0	0	0	6	10	2	0	0	0	0	18
14	FINLAND (Fin)	4	0	8	0	0	0	0	0	0	0	8	16
15	POLAND (POL)	18	0	0	0	2	0	0	0	0	10	0	12
16-17	SPAIN (Esp)	2	0	0	0	0	0	10	0	0	0	0	10
16-17	AUSTRIA (Aut)	2	0	0	0	0	0	10	0	0	0	0	10
18	LITHUANIA (Ltu)	5	6	0	0	0	0	0	0	0	0	0	6
19-20	GREECE (Gre)	6	0	0	0	0	0	0	0	0	0	4	4
19-20	ISRAEL (Isr)	4	0	0	0	4	0	0	0	0	0	0	4
21-26	SLOVAKIA (Svk)	7	0	0	0	0	0	0	0	0	0	0	0
21-26	GREAT BRITAIN (Gbr)	1	0	0	0	0	0	0	0	0	0	0	0
21-26	KOSOVO (Kos)	1	0	0	0	0	0	0	0	0	0	0	0
21-26	BELGIUM (Bel)	1	0	0	0	0	0	0	0	0	0	0	0
21-26	LATVIA (Lat)	5	0	0	0	0	0	0	0	0	0	0	0
21-26	ESTONIA (Est)	4	0	0	0	0	0	0	0	0	0	0	0





**U15 EUROPEAN
CHAMPIONSHIPS
KRAKOW 2019**

U15 European Championships

Kraków /POL/

June 27-30, 2019

FINAL REPORT

WOMEN WRESTLING



U15 European Championships - Kraków /POL/

June 27-30, 2019



U15 EUROPEAN
CHAMPIONSHIPS
KRAKÓW 2019

List of participants WW

Number	COUNTRY	WW33	WW36	WW39	WW42	WW46	WW50	WW54	WW58	WW62	WW66	TOTAL
1	AUSTRIA, Aut					2	1	2	2	1	2	3
2	BELARUS, Bir	2	2	2	1	2	2	2	2	1	2	18
3	BULGARIA, Bul	1		2	1	2	1	1	1	1	1	11
4	CROATIA, Cro				1	1	2	2		2	1	9
5	ESTONIA, Est					1				1		2
6	FINLAND, Fin				1	1	2	1	2			7
7	FRANCE, Fra					1	2					3
8	GEORGIA, Geo					1						2
9	GREAT BRITAIN, Gbr									1		1
10	GREECE, Gre					1		1	2	1	1	6
11	HUNGARY, Hun		1	1	1	1	1	1	1	1	1	10
12	ITALY, Ita			2	2	2	2	2	1	1	2	14
13	MOLDOVA, Mda				1	1	2	1	1	1		7
14	Netherlands, Ned						2	1	1	1		2
15	POLAND, Pol	2	2	2	2	2	2	2	2	2	2	20
16	ROMANIA, Rou	1	1	1	2	2	2	2	1	1	1	12
17	RUSSIA, Rus	2	2	2	2	2	2	2	2	2	1	19
18	SERBIA, Srb									1		1
19	SLOVAKIA, Svk		1	1		1		1				4
20	SPAIN, Esp					1	1		1	1	1	5
21	TURKEY, Tur	1	1	1	1	1	1	1	1	1	1	10
22	UKRAINE, Ukr	2	2	2	2	2	2	2	2	2	2	20
23	(puste)											
	TOTAL	12	12	16	16	27	25	21	20	21	16	186





U15 European Championships - Kraków /POL/

June 27-30, 2019

INDIVIDUAL CLASIFICATION WW

CATEGORY 33KG								
Place	Name & Surname	Country	Year of birth	CP	VT	ST	TP	TP GVN
1	Anastasiia Polska	UKRAINE (Ukr)	2006	15	3	0	11	2
2	Elizaveta Kulakivska	UKRAINE (Ukr)	2006	11	1	0	21	10
3	Alexandra Voiculescu	ROMANIA (Rou)	2005	10	0	0	25	19
3	Eda Nur Ersoy	TURKEY (Tur)	2005	4	0	1	10	2
5	Valeryia Mikitsich	BELARUS (Blr)	2006	3	0	0	4	13
5	Ivaylova Boynova Viktoria	BULGARIA (Bul)	2006	4	0	0	10	12
7	Tana Tiuliush	RUSSIA (Rus)	2006	5	0	1	17	9
8	Diana Lysenko	RUSSIA (Rus)	2005	5	0	0	11	14
9	Veranika Prylouskaya	BELARUS (Blr)	2005	1	0	0	2	8
10	Dominika Konkol	POLAND (POL)	2006	1	0	0	1	4
11	Boha Angela	HUNGARY (Hun)	2006	0	0	0	0	8
12	Zuzanna Klata	POLAND (POL)	2006	0	0	0	0	11

CATEGORY 36KG								
Place	Name & Surname	Country	Year of birth	CP	VT	ST	TP	TP GVN
1	Olga Ovchinnikova	RUSSIA (Rus)	2006	16	1	2	30	0
2	Amelia Tomala	POLAND (POL)	2006	10	2	0	6	18
3	Snizhana Onufrieva	UKRAINE (Ukr)	2004	13	2	0	30	14
3	Millena Vinogradova	RUSSIA (Rus)	2005	8	0	2	26	6
5	Kapuvári Liliána	HUNGARY (Hun)	2006	0	0	0	4	12
5	Sviatlana Katenka	BELARUS (Blr)	2006	3	0	0	4	14
7	Cansu Özer	TURKEY (Tur)	2004	5	0	1	15	13
8	Reka Hegedus	SLOVAKIA (Svk)	2005	5	0	1	12	10
9	Anhelina Bardachevska	UKRAINE (Ukr)	2005	1	0	0	2	12
10	Maryia Shabeka	BELARUS (Blr)	2006	1	0	0	2	13
11	Catalina Goja	ROMANIA (Rou)	2005	0	0	0	2	11
12	Maja Kmiecik	POLAND (POL)	2005	0	0	0	0	10

CATEGORY 39KG								
Place	Name & Surname	Country	Year of birth	CP	VT	ST	TP	TP GVN
1	Mariia Yefremova	UKRAINE (Ukr)	2006	16	1	2	39	0
2	Nicoleta Bajan	ROMANIA (Rou)	2004	11	0	2	26	14
3	Diana Lats	UKRAINE (Ukr)	2004	10	0	0	18	12
3	Sofia Fedorchenko	RUSSIA (Rus)	2005	12	1	1	24	8
5	Dinara Tsyrenzhapova	RUSSIA (Rus)	2006	3	0	0	5	23
5	Fath Laura	HUNGARY (Hun)	2005	6	1	0	12	18
7	Şevval Çayır	TURKEY (Tur)	2005	6	1	0	6	15
8	Pancheva Dimcheva Megan	BULGARIA (Bul)	2004	5	1	0	1	18
9	Denise Piroddu	ITALY (Ita)	2006	5	0	1	12	5
10	Tsvetelina Dimitrova Yana	BULGARIA (Bul)	2005	3	0	0	5	12
11	Kamila Kasprów	POLAND (POL)	2004	1	0	0	2	5
12	Julia Dolna	POLAND (POL)	2006	0	0	0	2	8
13	Raffaella Silveri	ITALY (Ita)	2004	0	0	0	0	0
14-15	Valeryia Yerameeva	BELARUS (Blr)	2006	0	0	0	0	2
14-15	Yana Kastunova	BELARUS (Blr)	2004	0	0	0	0	2
16	Dorina Nemethova	SLOVAKIA (Svk)	2006	0	0	0	0	10



U15 European Championships - Kraków /POL/

June 27-30, 2019

INDIVIDUAL CLASIFICATION WW

CATEGORY 42KG								
Place	Name & Surname	Country	Year of birth	CP	VT	ST	TP	TP GVN
1	Anna Tielegina	UKRAINE (Ukr)	2005	16	1	2	34	2
2	Vlada Shmakova	RUSSIA (Rus)	2005	15	3	0	26	28
3	Fabiana Rinella	ITALY (Ita)	2006	11	1	0	32	22
3	Ilona Valchuk	UKRAINE (Ukr)	2006	9	1	0	14	13
5	Valeriia Karamchakova	RUSSIA (Rus)	2005	9	1	0	22	14
5	Krystsina Kurkina	BELARUS (Blr)	2006	6	0	0	12	18
7	Gabriela Secrieru	MOLDOVA (Mda)	2005	6	1	0	11	20
8	Wiktorija Jaroniek	POLAND (POL)	2004	5	0	1	12	5
9	Marina Satkoevi	GEORGIA (Geo)	2005	3	0	0	10	8
10	Maja Majdańska	POLAND (POL)	2006	1	0	0	2	3
11	Fanni Vettenranta	FINLAND (Fin)	2006	1	0	0	2	10
12	Tia Hršak	CROATIA (Cro)	2006	0	0	0	2	6
13-14	Elena Placenti	ITALY (Ita)	2005	0	0	0	0	8
13-14	Laszlo Nikolett	HUNGARY (Hun)	2005	0	0	0	0	8
15	Plamenova Dimitrova Krasimir	BULGARIA (Bul)	2004	0	0	0	0	10
DSQ	Kübra Yavuz	TURKEY (Tur)	2005	0	0	0	4	8

CATEGORY 46KG								
Place	Name & Surname	Country	Year of birth	CP	VT	ST	TP	TP GVN
1	Ekaterina Karpushkina	RUSSIA (Rus)	2004	19	0	4	42	1
2	Aida Kerymova	UKRAINE (Ukr)	2004	19	3	0	35	8
3	Kseniya Tsiarenia	BELARUS (Blr)	2004	11	1	0	12	12
3	Sofii Dzhumadilova	RUSSIA (Rus)	2004	17	2	0	25	13
5	Nazar Kaya	TURKEY (Tur)	2004	9	1	1	14	11
5	Volha Hardzei	BELARUS (Blr)	2004	12	1	0	18	15
7	Roberta Luostarinen	FINLAND (Fin)	2004	7	0	1	17	17
8	Amina Mukhamed	UKRAINE (Ukr)	2005	7	0	1	16	6
9	Nikola Drozdek	POLAND (POL)	2004	7	0	0	9	18
10	Agapi Ampelidov	GREECE (Gre)	2006	6	1	0	14	2
11	Terek Gerda	HUNGARY (Hun)	2005	6	1	0	8	8
12	Steluta Subtirica	ROMANIA (Rou)	2005	5	1	0	7	4
13	Nagy Vivien Nemes	ROMANIA (Rou)	2004	5	1	0	6	12
14	Kathy Carmela Klassen	ESTONIA (Est)	2004	3	0	0	7	14
15	Andrea ZENUCHOVA	SLOVAKIA (Svk)	2005	1	0	0	4	7
16	Cazalla Maria Torres	SPAIN (Esp)	2004	1	0	0	2	4
17-18	Emilia Hartmann	AUSTRIA (Aut)	2004	1	0	0	2	12
17-18	Mădălina Prisacari	MOLDOVA (Mda)	2006	1	0	0	2	12
19	Mariam Grigalashvili	GEORGIA (Geo)	2004	1	0	0	2	15
20	Alice Faccio	ITALY (Ita)	2005	0	0	0	4	4
21	Laurie Lesaffre	FRANCE (Fra)	2004	0	0	0	2	4
22	Emma Hartmann	AUSTRIA (Aut)	2004	0	0	0	0	4
23-24	Bruna Vančaš	CROATIA (Cro)	2004	0	0	0	0	6
23-24	Nikola Wiśniewska	POLAND (POL)	2004	0	0	0	0	6
25	Krasimirova Krumova Nikol	BULGARIA (Bul)	2005	0	0	0	0	7
26	Nikolova Kaleeva Magdalena	BULGARIA (Bul)	2005	0	0	0	0	12
27	Viola Nigi	ITALY (Ita)	2005	0	0	0	0	14



U15 European Championships - Kraków /POL/

June 27-30, 2019

INDIVIDUAL CLASSIFICATION WW

CATEGORY 50KG								
Place	Name & Surname	Country	Year of birth	CP	VT	ST	TP	TP GVN
1	Tuba Demir	TURKEY (Tur)	2005	15	0	3	38	2
2	Anna Karbovska	UKRAINE (Ukr)	2005	14	0	1	31	17
3	Immacolata Danise	ITALY (Ita)	2004	14	0	1	42	19
3	Romaissa El Kharroubi	FRANCE (Fra)	2005	11	1	0	14	16
5	Lotta Vettenranta	FINLAND (Fin)	2004	14	1	1	33	17
5	Daniela Vuivan	MOLDOVA (Mda)	2005	11	2	0	8	20
7	Anastasiia Kreschuk	UKRAINE (Ukr)	2004	12	2	0	19	22
8	Sukhareva Alena	RUSSIA (Rus)	2004	11	2	0	20	5
9	Ana Maria Puiu	ROMANIA (Rou)	2004	6	1	0	6	20
10	Viktoryia Yakubouskaya	BELARUS (Blr)	2004	5	1	0	8	13
11	Lilya Cohen	FRANCE (Fra)	2005	4	0	1	17	2
12	Alaksandra Bulava	BELARUS (Blr)	2004	4	0	1	10	4
13	Natalia Khramenkova	RUSSIA (Rus)	2005	4	0	0	9	12
14	Denisa Stefania Negoita	ROMANIA (Rou)	2004	1	0	0	2	8
15	Aleksandra Lewczyńska	POLAND (POL)	2004	0	0	0	4	13
16	Teuta Bišćan	CROATIA (Cro)	2005	0	0	0	3	8
17	Julia Ernst	AUSTRIA (Aut)	2004	0	0	0	2	4
18	Rubio Elena Torres	SPAIN (Esp)	2004	0	0	0	1	8
19	Sanni Sarkkinen	FINLAND (Fin)	2004	0	0	0	0	2
20	Denis Braykova Viktoria	BULGARIA (Bul)	2004	0	0	0	0	4
21	Mikle Hedi	HUNGARY (Hun)	2005	0	0	0	0	6
22-23	Katja Stopenja	CROATIA (Cro)	2005	0	0	0	0	10
22-23	Wiktoria Błoch	POLAND (POL)	2004	0	0	0	0	10
24	Eugenia Birdan	MOLDOVA (Mda)	2004	0	0	0	0	11
25	Asia Craparotta	ITALY (Ita)	2004	0	0	0	0	14

CATEGORY 54KG								
Place	Name & Surname	Country	Year of birth	CP	VT	ST	TP	TP GVN
1	Borsos Viktoria	HUNGARY (Hun)	2004	17	1	0	24	9
2	Georgiana Lirca	ROMANIA (Rou)	2004	14	2	0	15	2
3	Luciana Beda	MOLDOVA (Mda)	2004	15	2	1	15	4
3	Yuliia Pakhniuk	UKRAINE (Ukr)	2004	13	2	0	24	10
5	Bianca Contrafatto	ITALY (Ita)	2004	3	0	0	9	6
5	Georgieva Iana	RUSSIA (Rus)	2004	8	1	0	12	20
7	Ekaterina Pugach	RUSSIA (Rus)	2006	10	1	1	18	6
8	Karyna Shantsava	BELARUS (Blr)	2004	8	1	0	20	16
9	Florentina Rotaru	ROMANIA (Rou)	2005	6	1	0	5	12
10	Gaia Nappi	ITALY (Ita)	2004	5	0	1	12	12
11	Oleksandra Humeniuk	UKRAINE (Ukr)	2004	3	0	0	13	16
12	Nella Honkaniemi	FINLAND (Fin)	2006	3	0	0	8	17
13	Veronika Vilk	CROATIA (Cro)	2006	1	0	0	6	16
14	Martyna Skalec	POLAND (POL)	2004	1	0	0	4	10
15	Alina Kavalionak	BELARUS (Blr)	2005	1	0	0	2	5
16-17	Nikola Skórska	POLAND (POL)	2005	1	0	0	2	8
16-17	Dilan Tan	TURKEY (Tur)	2005	1	0	0	2	8
18	Stoyanova Taneva Mima	BULGARIA (Bul)	2004	0	0	0	4	2
19	Rebeka Kocsisova	SLOVAKIA (Svk)	2005	0	0	0	0	2
20	Sandra Besek	CROATIA (Cro)	2004	0	0	0	0	4
21	Olga Poutakidi	GREECE (Gre)	2005	0	0	0	0	10



U15 European Championships - Kraków /POL/

June 27-30, 2019

INDIVIDUAL CLASSIFICATION WW

CATEGORY 58KG								
Place	Name & Surname	Country	Year of birth	CP	VT	ST	TP	TP GVN
1	Elekes Eniko	HUNGARY (Hun)	2004	18	1	1	37	1
2	Iryna Bondar	UKRAINE (Ukr)	2004	11	0	2	38	12
3	Nadia Drahanova	UKRAINE (Ukr)	2004	11	0	1	29	18
3	Julia Reka	NETHERLANDS (Ned)	2004	14	2	0	14	18
5	Drosoula Tzianakopoulou	GREECE (Gre)	2005	12	2	0	24	26
5	Tyyne Lasanen	FINLAND (Fin)	2004	12	1	0	21	14
7	Ana Maria Crețu	MOLDOVA (Mda)	2005	5	1	0	4	18
8	Bianca Surloi	ROMANIA (Rou)	2005	5	0	1	12	8
9	Diana Khomutova	RUSSIA (Rus)	2004	4	0	0	11	9
10	Viktoryia Radzkova	BELARUS (Blr)	2004	3	0	0	14	12
11	Ilaria Salvaterra	ITALY (Ita)	2004	3	0	0	8	15
12	Selvii Lyasoglu	TURKEY (Tur)	2004	1	0	0	6	9
13	Pereda Natalia Gonzalez	SPAIN (Esp)	2004	1	0	0	3	9
14	Darya Bykhankova	BELARUS (Blr)	2004	1	0	0	1	16
15	Karolina Domaszuk	POLAND (POL)	2004	0	0	0	2	5
16	Mea Laakso	FINLAND (Fin)	2004	0	0	0	2	6
17	Ralina Bakieva	RUSSIA (Rus)	2004	0	0	0	2	8
18	Marielova Dragushkova Binka	BULGARIA (Bul)	2004	0	0	0	0	4
19-20	Anna Fofiadou	GREECE (Gre)	2005	0	0	0	0	10
19-20	Weronika Smaczyńska	POLAND (POL)	2005	0	0	0	0	10

CATEGORY 62KG								
Place	Name & Surname	Country	Year of birth	CP	VT	ST	TP	TP GVN
1	Alina Rybkina	RUSSIA (Rus)	2004	14	0	2	27	2
2	Halyna Oleksiivska	UKRAINE (Ukr)	2004	14	2	0	18	11
3	Vecseryes Maria	HUNGARY (Hun)	2004	12	1	1	24	14
3	Alina Shauchuk	BELARUS (Blr)	2005	14	0	2	32	6
5	Loli Kolitsopoulou	GREECE (Gre)	2004	8	1	0	19	21
5	Duygu Gen	TURKEY (Tur)	2006	8	1	0	18	27
7	Kateryna Palil	UKRAINE (Ukr)	2004	9	1	0	17	14
8	Ella Johnson	GREAT BRITAIN (Gbr)	2005	6	1	0	8	10
9	Nicola Wasilewska	POLAND (POL)	2005	5	1	0	10	6
10	Abigail Tikerpalu	ESTONIA (Est)	2004	5	1	0	6	4
11	Milla Anđelić	CROATIA (Cro)	2005	4	0	0	16	10
12	Alisa Chernyshkova	RUSSIA (Rus)	2004	2	0	0	6	10
13	Geny Lodder	NETHERLANDS (Ned)	2004	1	0	0	2	6
14	Stoyanova Georgieva Vanesa	BULGARIA (Bul)	2004	0	0	0	5	22
15	Emma Carri	ITALY (Ita)	2005	0	0	0	4	6
16	Petra Velez	SERBIA (Srb)	2005	0	0	0	2	5
17	Marcela Costișanu	MOLDOVA (Mda)	2004	0	0	0	0	6
18	Bernadett Tamas	ROMANIA (Rou)	2004	0	0	0	0	7
19	Alonso Ez Zair Yasmin	SPAIN (Esp)	2004	0	0	0	0	8
20	Alicja Nowosad	POLAND (POL)	2004	0	0	0	0	9
21	Gia Kastelan	CROATIA (Cro)	2004	0	0	0	0	10



U15 European Championships - Kraków /POL/

June 27-30, 2019

INDIVIDUAL CLASIFICATION WW

CATEGORY 66KG								
Place	Name & Surname	Country	Year of birth	CP	VT	ST	TP	TP GVN
1	Zlatoslava Stepanova	RUSSIA (Rus)	2005	15	1	1	31	7
2	Iryna Zablotska	UKRAINE (Ukr)	2004	12	1	0	23	8
3	Kseniya Patapovich	BELARUS (Blr)	2004	15	2	1	30	10
3	Osvath Nagy Noemi	HUNGARY (Hun)	2004	14	2	0	21	18
5	Karolina Jaworska	POLAND (POL)	2005	8	0	0	10	21
5	Barbara Sere	ROMANIA (Rou)	2005	9	0	2	26	8
7	Yvette Valentini	ITALY (Ita)	2004	6	1	0	8	5
8	Anastasiya Fralova	BELARUS (Blr)	2004	3	0	0	7	10
9	Patrycja Cuber	POLAND (POL)	2004	1	0	0	4	18
10	Bükrenaz Sert	TURKEY (Tur)	2005	1	0	0	1	12
11	Fabiana Dattilo	ITALY (Ita)	2004	0	0	0	4	12
12	Yevhania Siedykh	UKRAINE (Ukr)	2004	0	0	0	0	0
13-14	Alesia Marčelić	CROATIA (Cro)	2004	0	0	0	0	6
13-14	Nikoleta Barmpa	GREECE (Gre)	2005	0	0	0	0	6
15	Petrova Brasnarova Daniela	BULGARIA (Bul)	2004	0	0	0	0	10
16	Mestre Alejandra Lopez	SPAIN (Esp)	2005	0	0	0	0	14



Feuille de compétition / Competition Sheet

Mistrzostwa Europy U15



Style: FW 33

QUALIFICATION	1/4 FINALE	1/2 FINALE	FINALE	WINNER
---------------	------------	------------	--------	--------





Feuille de compétition / Competition Sheet

Mistrzostwa Europy U15



Style: FW

33

"REPECHAGE"

"UPPER BRANCH"

2	4	TUR	P1	P2
10	4		6	
3	0	BLR	P1	P2
0	0		0	0

Médaille de Bronze 2 Eda Nur Ersoy (TUR)

"LOWER BRANCH"

6	3	BUL	P1	P2
8	6		2	
7	1	RUS	P1	P2
2	2		0	
6	1	BUL	P1	P2
2	0		2	
11	3	ROU	P1	P2
6	2		4	

Médaille de Bronze 11 Alexandra Voiculescu (ROU)

Classement		
Cl	Pays	Nom
1	UKR	Anastasiia Polska (UKR)
2	UKR	Elizaveta Kulakivska (UKR)
3	ROU	Alexandra Voiculescu (ROU)
3	TUR	Eda Nur Ersoy (TUR)
5	BUL	Ivaylova Boynova Viktoria (BUL)
5	BLR	Valeria Mikitsich (BLR)
7	RUS	Tana Tiulush (RUS)
8	RUS	Diana Lysenko (RUS)
9	BLR	Veranika Prylouskaya (BLR)
10	POL	Dominika Konkel (POL)
11	HUN	Boha Angela (HUN)
12	POL	Zuzanna Klata (POL)



Feuille de compétition / Competition Sheet

Mistrzostwa Europy U15



Style: FW

36

QUALIFICATION	1/4 FINALE	1/2 FINALE	FINALE	WINNER
---------------	------------	------------	--------	--------

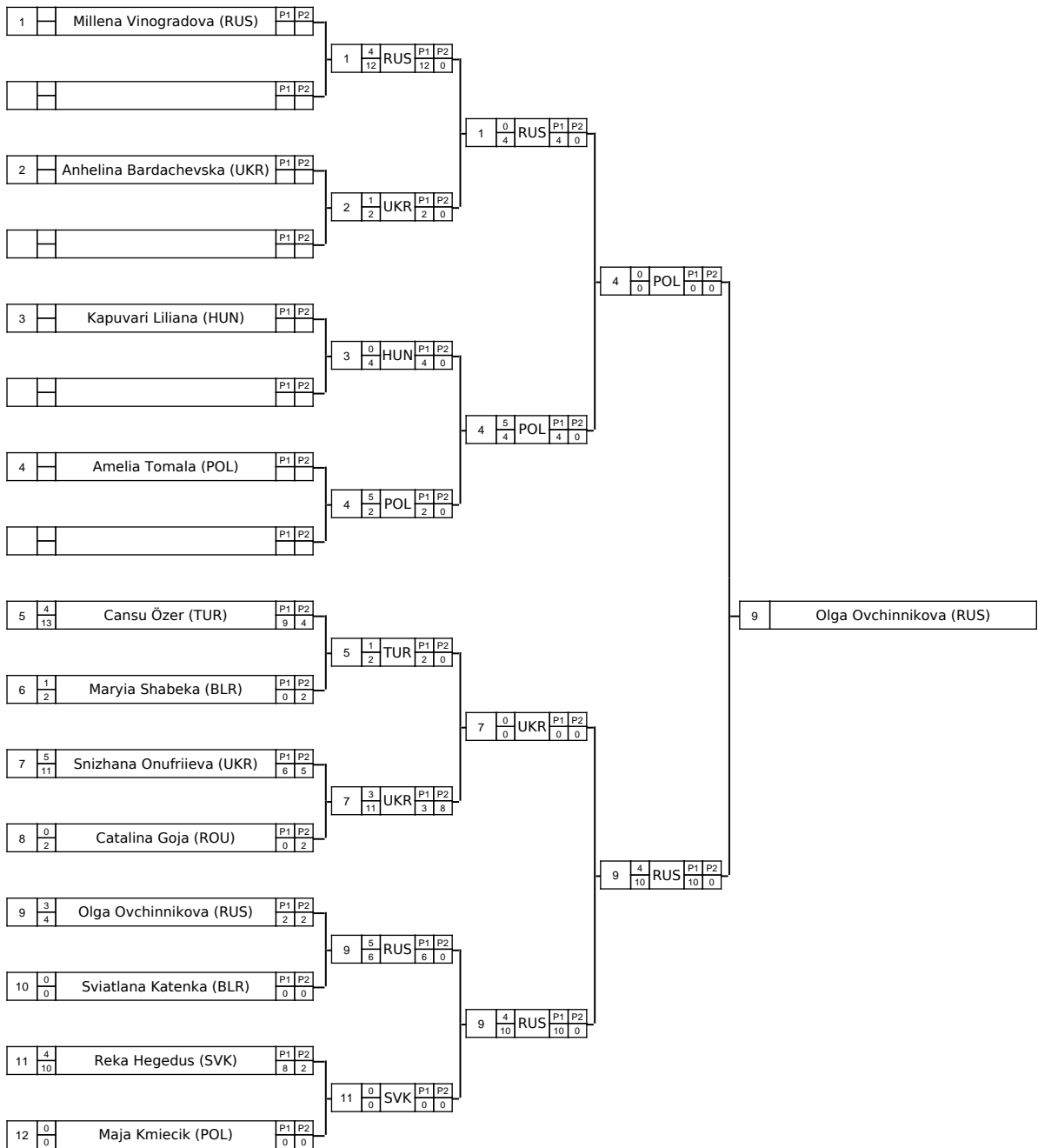

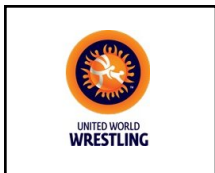

Feuille de compétition / Competition Sheet

Mistrzostwa Europy U15



Style: FW

36

"REPECHAGE"

"UPPER BRANCH"

3	0	HUN	P1	P2
	0		0	0
1	4	RUS	P1	P2
	10		10	0

Médaille de Bronze 1 Millena Vinogradova (RUS)

"LOWER BRANCH"

10	3	BLR	P1	P2
	4		2	2
11	1	SVK	P1	P2
	2		2	0
7	5	UKR	P1	P2
	8		8	0

Médaille de Bronze 7 Snizhana Onufrieva (UKR)

Classement		
Cl	Pays	Nom
1	RUS	Olga Ovchinnikova (RUS)
2	POL	Amelia Tomala (POL)
3	UKR	Snizhana Onufrieva (UKR)
3	RUS	Millena Vinogradova (RUS)
5	HUN	Kapuvári Liliána (HUN)
5	BLR	Sviatlana Katenka (BLR)
7	TUR	Cansu Özer (TUR)
8	SVK	Reka Hegedus (SVK)
9	UKR	Anhelina Bardachevska (UKR)
10	BLR	Maryia Shabeka (BLR)
11	ROU	Catalina Goja (ROU)
12	POL	Maja Kmiecik (POL)



Feuille de compétition / Competition Sheet

Mistrzostwa Europy U15



Style: FW

39

1/8 FINALE	1/4 FINALE	1/2 FINALE	FINALE	WINNER
------------	------------	------------	--------	--------

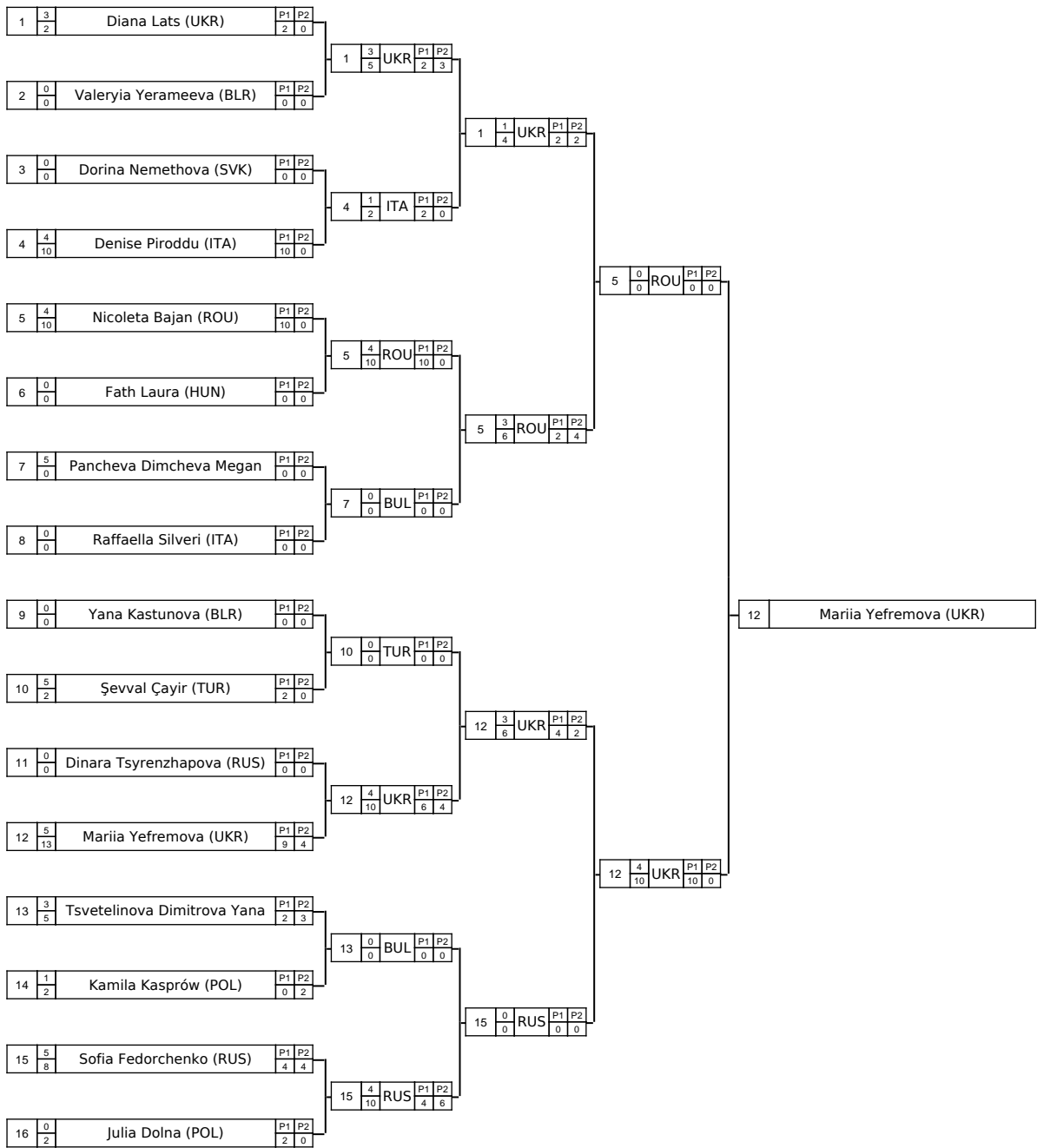

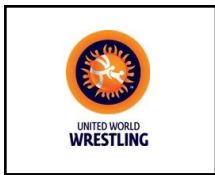

Feuille de compétition / Competition Sheet

Mistrzostwa Europy U15



Style: FW

39

"REPECHAGE"

"UPPER BRANCH"

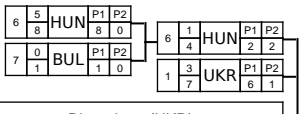

Médaille de Bronze 1 Diana Lats (UKR)

"LOWER BRANCH"

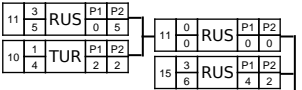

Médaille de Bronze 15 Sofia Fedorchenko (RUS)

Classement

Cl	Pays	Nom
1	UKR	Mariia Yefremova (UKR)
2	ROU	Nicoleta Bajan (ROU)
3	UKR	Diana Lats (UKR)
3	RUS	Sofia Fedorchenko (RUS)
5	RUS	Dinara Tsyrenzhapova (RUS)
5	HUN	Fath Laura (HUN)
7	TUR	Şevval Çayır (TUR)
8	BUL	Pancheva Dimcheva Megan (BUL)
9	ITA	Denise Piroddu (ITA)
10	BUL	Tsvetelinova Dimitrova Yana (BUL)
11	POL	Kamila Kasprów (POL)
12	POL	Julia Dolna (POL)
13	ITA	Raffaella Silveri (ITA)
14-15	BLR	Valeriya Yerameeva (BLR)
14-15	BLR	Yana Kastunova (BLR)
16	SVK	Dorina Nemethova (SVK)



Feuille de compétition / Competition Sheet

Mistrzostwa Europy U15



Style: FW

42

1/8 FINALE	1/4 FINALE	1/2 FINALE	FINALE	WINNER
------------	------------	------------	--------	--------

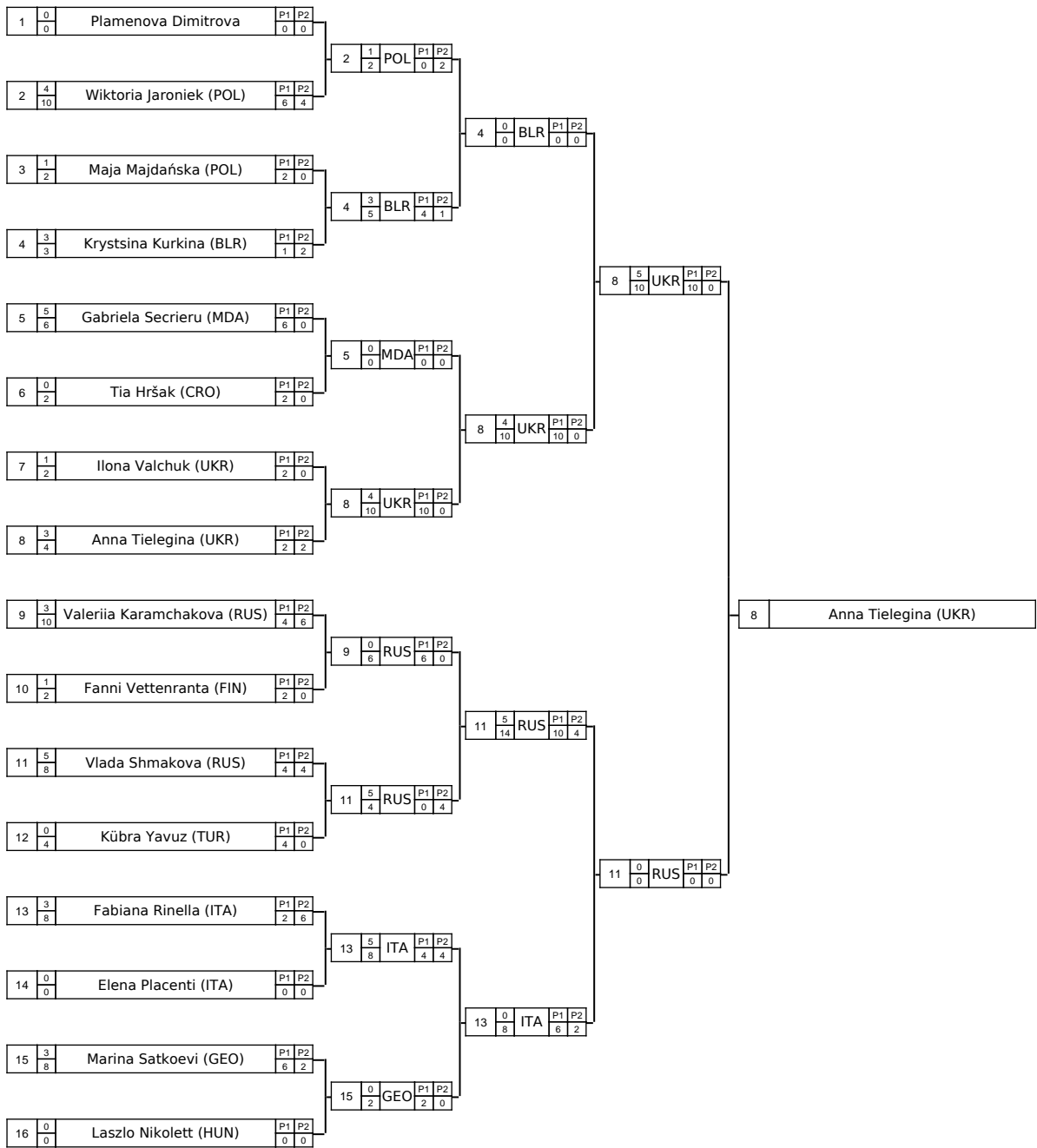

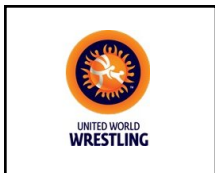

Feuille de compétition / Competition Sheet

Mistrzostwa Europy U15



Style: FW

42

"REPECHAGE"

"UPPER BRANCH"

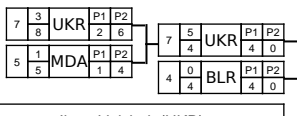

Médaille de Bronze 7 Ilona Valchuk (UKR)

"LOWER BRANCH"

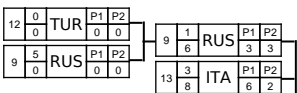

Médaille de Bronze 13 Fabiana Rinella (ITA)

Classement

Cl	Pays	Nom
1	UKR	Anna Tielegina (UKR)
2	RUS	Vlada Shmakova (RUS)
3	ITA	Fabiana Rinella (ITA)
3	UKR	Ilona Valchuk (UKR)
5	BLR	Krystsina Kurkina (BLR)
5	RUS	Valeriia Karamchakova (RUS)
7	MDA	Gabriela Secrieru (MDA)
8	POL	Wiktoria Jaroniek (POL)
9	GEO	Marina Satkoevi (GEO)
10	POL	Maja Majdańska (POL)
11	FIN	Fanni Vettenranta (FIN)
12	TUR	Kübra Yavuz (TUR)
13	CRO	Tia Hršak (CRO)
14-15	ITA	Elena Placenti (ITA)
14-15	HUN	Laszlo Nikolett (HUN)
16	BUL	Plamenova Dimitrova Krasimira (BUL)



Feuille de compétition / Competition Sheet

Mistrzostwa Europy U15

Style: FW

46



QUALIFICATION		1/8 FINALE	1/4 FINALE	1/2 FINALE	FINALE	WINNER
1	Nazar Kaya (TUR)	P1 P2	1 5 4 TUR P1 P2 4 0	1 4 10 TUR P1 P2 10 0	1 0 0 TUR P1 P2 0 0	11 Ekaterina Karpushkina (RUS)
2	Emma Hartmann (AUT)	P1 P2	2 0 0 AUT P1 P2 0 0			
3	Kathy Carmela Klassen (EST)	P1 P2	3 3 7 EST P1 P2 2 5	3 0 0 EST P1 P2 0 0		
4	Andrea ZENUCHOVA (SVK)	P1 P2	4 1 4 SVK P1 P2 0 4			
5	Kseniya Tsiarenia (BLR)	P1 P2	5 5 8 BLR P1 P2 2 6	5 0 0 BLR P1 P2 0 0		
6	Nagy Vivien Nemes (ROU)	P1 P2	6 0 2 ROU P1 P2 2 0			
7	Alice Faccio (ITA)	P1 P2	7 0 4 ITA P1 P2 4 0	11 4 10 RUS P1 P2 6 4		
8	Emilia Hartmann (AUT)	P1 P2	9 0 0 FIN P1 P2 0 0			
9	Roberta Luostarinen (FIN)	P1 P2	11 4 10 RUS P1 P2 4 6			
10	Mariam Grigalashvili (GEO)	P1 P2	11 4 10 RUS P1 P2 10 0			
11	Ekaterina Karpushkina (RUS)	P1 P2				
12	Cazalla Maria Torres (ESP)	P1 P2	13 3 2 POL P1 P2 0 2			
13	Nikola Drozdek (POL)	P1 P2	13 0 0 POL P1 P2 0 0			
14	Agapi Ampelidov (GRE)	P1 P2	14 1 2 GRE P1 P2 2 0			
15	Nikolova Kaleeva Magdalena	P1 P2		17 5 8 UKR P1 P2 2 6		
16	Viola Nigi (ITA)	P1 P2	17 3 8 UKR P1 P2 3 5			
17	Aida Kerymova (UKR)	P1 P2	17 5 8 UKR P1 P2 4 4			
18	Bruna Vancaš (CRO)	P1 P2	19 1 6 RUS P1 P2 6 0			
19	Sofiia Dzhumadilova (RUS)	P1 P2		17 1 1 UKR P1 P2 0 1		
20	Steluta Subtirica (ROU)	P1 P2	20 0 0 ROU P1 P2 0 0			
21	Krasimirova Krumova Nikol	P1 P2	22 0 0 UKR P1 P2 0 0			
22	Amina Mukhamed (UKR)	P1 P2	22 3 4 UKR P1 P2 2 2			
23	Mădălina Prisacari (MDA)	P1 P2		27 0 0 BLR P1 P2 0 0		
24	Laurie Lesaffre (FRA)	P1 P2	25 1 4 HUN P1 P2 0 4			
25	Terek Gerda (HUN)	P1 P2	27 3 4 BLR P1 P2 2 2			
26	Nikola Wiśniewska (POL)	P1 P2				
27	Volha Hardzei (BLR)	P1 P2				



Feuille de compétition / Competition Sheet

Mistrzostwa Europy U15

Style: FW

46



"REPECHAGE"

"UPPER BRANCH"

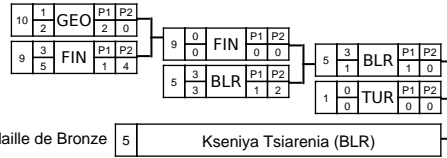

"LOWER BRANCH"

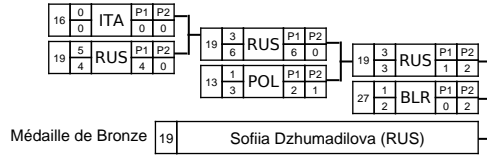

Classement

Cl	Pays	Nom
1	RUS	Ekaterina Karpushkina (RUS)
2	UKR	Aida Kerymova (UKR)
3	BLR	Kseniya Tsiarenia (BLR)
3	RUS	Sofia Dzhumadilova (RUS)
5	TUR	Nazar Kaya (TUR)
5	BLR	Volha Hardzei (BLR)
7	FIN	Roberta Luostarinen (FIN)
8	UKR	Amina Mukhamed (UKR)
9	POL	Nikola Drozdek (POL)
10	GRE	Agapi Ampelidov (GRE)
11	HUN	Terek Gerda (HUN)
12	ROU	Steluta Subtirica (ROU)
13	ROU	Nagy Vivien Nemes (ROU)
14	EST	Kathy Carmela Klassen (EST)
15	SVK	Andrea ZENUCHOVA (SVK)
16	ESP	Cazalla Maria Torres (ESP)
17-18	MDA	Mădălina Prisacari (MDA)
17-18	AUT	Emilia Hartmann (AUT)
19	GEO	Mariam Grigalashvili (GEO)
20	ITA	Alice Faccio (ITA)
21	FRA	Laurie Lesaffre (FRA)
22	AUT	Emma Hartmann (AUT)
23-24	CRO	Bruna Vančaš (CRO)
23-24	POL	Nikola Wiśniewska (POL)
25	BUL	Krasimirova Krumova Nikol (BUL)
26	BUL	Nikolova Kaleeva Magdalena (BUL)
27	ITA	Viola Nigi (ITA)



Feuille de compétition / Competition Sheet

Mistrzostwa Europy U15

Style: FW

50



QUALIFICATION		1/8 FINALE	1/4 FINALE	1/2 FINALE	FINALE	WINNER
1	Julia Ernst (AUT)	P1 P2 0 2	1 0 2 AUT P1 P2 2 0	2 5 2 MDA P1 P2 2 0	2 0 0 MDA P1 P2 0 0	7 Tuba Demir (TUR)
2	Daniela Vuivan (MDA)	P1 P2 5 4	2 5 4 MDA P1 P2 4 0	2 0 0 MDA P1 P2 0 0	7 3 6 TUR P1 P2 2 4	
3	Lilya Cohen (FRA)	P1 P2 4 11	3 4 11 FRA P1 P2 11 0	3 0 6 FRA P1 P2 6 0	7 4 10 TUR P1 P2 8 2	
4	Eugenia Birdan (MDA)	P1 P2 0 0	4 0 0 MDA P1 P2 0 0	6 0 0 FRA P1 P2 0 0	7 4 10 TUR P1 P2 10 0	
5	Denis Braykova Viktoria (BUL)	P1 P2 0 0	5 0 0 BUL P1 P2 0 0	6 0 0 FRA P1 P2 0 0	7 4 10 TUR P1 P2 10 0	
6	Romaïssa El Kharroubi (FRA)	P1 P2 5 4	6 5 4 FRA P1 P2 4 0	7 4 10 TUR P1 P2 8 2	7 4 10 TUR P1 P2 10 0	
7	Tuba Demir (TUR)	P1 P2 4 12	7 4 12 TUR P1 P2 8 4	7 4 10 TUR P1 P2 10 0	7 4 10 TUR P1 P2 10 0	
8	Sanni Sarkkinen (FIN)	P1 P2 0 0	9 0 0 ROU P1 P2 0 0	11 5 10 RUS P1 P2 4 6	15 1 6 ITA P1 P2 6 0	
9	Ana Maria Puiu (ROU)	P1 P2 5 2	9 5 2 ROU P1 P2 2 0	11 5 10 RUS P1 P2 4 6	15 1 6 ITA P1 P2 6 0	
10	Rubio Elena Torres (ESP)	P1 P2 0 1	11 0 1 ESP P1 P2 1 0	11 5 10 RUS P1 P2 4 6	15 1 6 ITA P1 P2 6 0	
11	Sukhareva Alena (RUS)	P1 P2 5 8	11 5 8 RUS P1 P2 4 4	11 5 10 RUS P1 P2 4 6	15 1 6 ITA P1 P2 6 0	
12	Viktoryia Yakubouskaya (BLR)	P1 P2 5 8	12 5 8 BLR P1 P2 6 2	11 5 10 RUS P1 P2 4 6	15 1 6 ITA P1 P2 6 0	
13	Teuta Biščan (CRO)	P1 P2 0 3	12 0 3 CRO P1 P2 0 0	11 5 10 RUS P1 P2 4 6	15 1 6 ITA P1 P2 6 0	
14	Wiktorja Błoch (POL)	P1 P2 0 0	15 0 0 ITA P1 P2 4 8	11 5 10 RUS P1 P2 4 6	15 1 6 ITA P1 P2 6 0	
15	Immacolata Danise (ITA)	P1 P2 4 10	15 4 10 ITA P1 P2 10 0	11 5 10 RUS P1 P2 4 6	15 1 6 ITA P1 P2 6 0	
16	Mikle Hedi (HUN)	P1 P2 0 0	17 0 0 RUS P1 P2 2 1	11 5 10 RUS P1 P2 4 6	15 1 6 ITA P1 P2 6 0	
17	Natalia Khramenkova (RUS)	P1 P2 3 6	17 3 6 RUS P1 P2 4 2	11 5 10 RUS P1 P2 4 6	15 1 6 ITA P1 P2 6 0	
18	Asia Craparotta (ITA)	P1 P2 0 0	19 0 0 UKR P1 P2 2 2	11 5 10 RUS P1 P2 4 6	15 1 6 ITA P1 P2 6 0	
19	Anna Karbovska (UKR)	P1 P2 4 10	19 4 10 UKR P1 P2 10 0	11 5 10 RUS P1 P2 4 6	15 1 6 ITA P1 P2 6 0	
20	Denisa Stefania Negoita (ROU)	P1 P2 1 2	21 1 2 FIN P1 P2 4 0	11 5 10 RUS P1 P2 4 6	15 1 6 ITA P1 P2 6 0	
21	Lotta Vettenranta (FIN)	P1 P2 3 8	21 3 8 FIN P1 P2 4 4	11 5 10 RUS P1 P2 4 6	15 1 6 ITA P1 P2 6 0	
22	Alaksandra Bulava (BLR)	P1 P2 4 10	22 4 10 BLR P1 P2 10 0	11 5 10 RUS P1 P2 4 6	15 1 6 ITA P1 P2 6 0	
23	Katja Stopenja (CRO)	P1 P2 0 0	22 0 0 BLR P1 P2 0 0	11 5 10 RUS P1 P2 4 6	15 1 6 ITA P1 P2 6 0	
24	Anastasiiia Kreschuk (UKR)	P1 P2 5 13	24 5 13 UKR P1 P2 7 6	11 5 10 RUS P1 P2 4 6	15 1 6 ITA P1 P2 6 0	
25	Aleksandra Lewczyńska (POL)	P1 P2 0 4	24 0 4 UKR P1 P2 4 0	11 5 10 RUS P1 P2 4 6	15 1 6 ITA P1 P2 6 0	

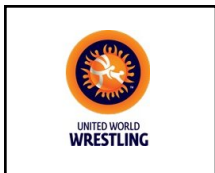

Feuille de compétition / Competition Sheet

Mistrzostwa Europy U15

Style: FW

50



"REPECHAGE"

"UPPER BRANCH"

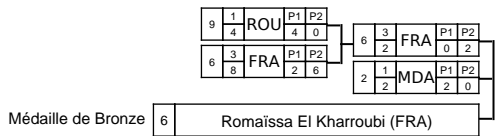

"LOWER BRANCH"

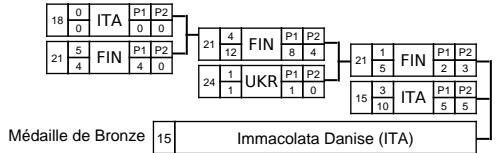

Classement

Cl	Pays	Nom
1	TUR	Tuba Demir (TUR)
2	UKR	Anna Karbovska (UKR)
3	FRA	Romaïssa El Kharroubi (FRA)
3	ITA	Immacolata Danise (ITA)
5	FIN	Lotta Vettenranta (FIN)
5	MDA	Daniela Vuivan (MDA)
7	UKR	Anastasiia Kreschuk (UKR)
8	RUS	Sukhareva Alena (RUS)
9	ROU	Ana Maria Puiu (ROU)
10	BLR	Viktoryia Yakubouskaya (BLR)
11	FRA	Lilya Cohen (FRA)
12	BLR	Alaksandra Bulava (BLR)
13	RUS	Natalia Khramenkova (RUS)
14	ROU	Denisa Stefania Negoita (ROU)
15	POL	Aleksandra Lewczyńska (POL)
16	CRO	Teuta Biščan (CRO)
17	AUT	Julia Ernst (AUT)
18	ESP	Rubio Elena Torres (ESP)
19	FIN	Sanni Sarkkinen (FIN)
20	BUL	Denis Braykova Viktoria (BUL)
21	HUN	Mikle Hedi (HUN)
22-23	POL	Wiktoria Bloch (POL)
22-23	CRO	Katja Stoponja (CRO)
24	MDA	Eugenia Birdan (MDA)
25	ITA	Asia Craparotta (ITA)



Feuille de compétition / Competition Sheet

Mistrzostwa Europy U15

Style: FW

54



QUALIFICATION		1/8 FINALE	1/4 FINALE	1/2 FINALE	FINALE	WINNER
1	Nikola Skórska (POL)	P1 P2	1 1 2 POL P1 P2 2 0	2 0 0 FIN P1 P2 0 0	4 3 5 ROU P1 P2 1 4	17 Borsos Viktoria (HUN)
2	Nella Honkaniemi (FIN)	P1 P2	2 3 8 FIN P1 P2 6 2	4 5 6 ROU P1 P2 6 0	4 1 2 ROU P1 P2 1 1	
3	Bianca Contrafatto (ITA)	P1 P2	3 0 0 ITA P1 P2 0 0	4 5 6 ROU P1 P2 6 0	4 1 2 ROU P1 P2 1 1	
4	Georgiana Lirca (ROU)	P1 P2	4 5 2 ROU P1 P2 2 0	4 5 6 ROU P1 P2 6 0	4 1 2 ROU P1 P2 1 1	
5	Martyna Skalec (POL)	P1 P2	5 1 4 POL P1 P2 3 1	6 0 3 UKR P1 P2 0 3	4 1 2 ROU P1 P2 1 1	
6	Oleksandra Humeniuk (UKR)	P1 P2	6 3 10 UKR P1 P2 4 6	6 0 3 UKR P1 P2 0 3	4 1 2 ROU P1 P2 1 1	
7	Yuliia Pakhniuk (UKR)	P1 P2	7 3 8 UKR P1 P2 4 4	7 0 0 UKR P1 P2 0 0	4 1 2 ROU P1 P2 1 1	
8	Dilan Tan (TUR)	P1 P2	8 1 2 TUR P1 P2 2 0	7 5 12 UKR P1 P2 4 8	4 1 2 ROU P1 P2 1 1	
9	Alina Kavalionak (BLR)	P1 P2	9 1 2 BLR P1 P2 0 2	7 0 0 UKR P1 P2 0 0	4 1 2 ROU P1 P2 1 1	
10	Georgieva Iana (RUS)	P1 P2	10 3 5 RUS P1 P2 3 2	10 5 6 RUS P1 P2 2 4	4 1 2 ROU P1 P2 1 1	
11	Stoyanova Taneva Mima (BUL)	P1 P2	11 0 4 BUL P1 P2 4 0	10 0 1 RUS P1 P2 1 0	4 1 2 ROU P1 P2 1 1	
12	Veronika Vilc (CRO)	P1 P2	13 5 2 BLR P1 P2 2 0	10 0 1 RUS P1 P2 1 0	4 1 2 ROU P1 P2 1 1	
13	Karyna Shantsava (BLR)	P1 P2	13 5 2 BLR P1 P2 2 0	10 0 1 RUS P1 P2 1 0	4 1 2 ROU P1 P2 1 1	
14	Rebeka Kocsisova (SVK)	P1 P2	15 1 3 ROU P1 P2 2 1	10 0 1 RUS P1 P2 1 0	4 1 2 ROU P1 P2 1 1	
15	Florentina Rotaru (ROU)	P1 P2	17 3 4 HUN P1 P2 4 0	10 0 1 RUS P1 P2 1 0	4 1 2 ROU P1 P2 1 1	
16	Luciana Beda (MDA)	P1 P2	17 3 8 HUN P1 P2 4 4	10 0 1 RUS P1 P2 1 0	4 1 2 ROU P1 P2 1 1	
17	Borsos Viktoria (HUN)	P1 P2	17 3 8 HUN P1 P2 4 4	10 0 1 RUS P1 P2 1 0	4 1 2 ROU P1 P2 1 1	
18	Ekaterina Pugach (RUS)	P1 P2	18 4 12 RUS P1 P2 8 4	17 5 6 HUN P1 P2 0 6	4 1 2 ROU P1 P2 1 1	
19	Sandra Besek (CRO)	P1 P2	18 4 12 RUS P1 P2 8 4	17 5 6 HUN P1 P2 0 6	4 1 2 ROU P1 P2 1 1	
20	Gaia Nappi (ITA)	P1 P2	20 1 2 ITA P1 P2 2 0	17 5 6 HUN P1 P2 0 6	4 1 2 ROU P1 P2 1 1	
21	Olga Poutakidi (GRE)	P1 P2	20 1 2 ITA P1 P2 2 0	17 5 6 HUN P1 P2 0 6	4 1 2 ROU P1 P2 1 1	



Feuille de compétition / Competition Sheet

Mistrzostwa Europy U15

Style: FW

54



"REPECHAGE"

"UPPER BRANCH"

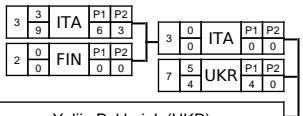

Médaille de Bronze 7 Yuliia Pakhniuk (UKR)

"LOWER BRANCH"

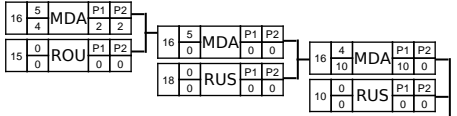

Médaille de Bronze 16 Luciana Beda (MDA)

Classement		
Cl	Pays	Nom
1	HUN	Borsos Viktoria (HUN)
2	ROU	Georgiana Lirca (ROU)
3	UKR	Yuliia Pakhniuk (UKR)
3	MDA	Luciana Beda (MDA)
5	ITA	Bianca Contrafatto (ITA)
5	RUS	Georgieva Iana (RUS)
7	RUS	Ekaterina Pugach (RUS)
8	BLR	Karyna Shantsava (BLR)
9	ROU	Florentina Rotaru (ROU)
10	ITA	Gaia Nappi (ITA)
11	UKR	Oleksandra Humeniuk (UKR)
12	FIN	Nella Honkaniemi (FIN)
13	CRO	Veronika Viik (CRO)
14	POL	Martyna Skalec (POL)
15	BLR	Alina Kavalionak (BLR)
16-17	POL	Nikola Skórska (POL)
16-17	TUR	Dilan Tan (TUR)
18	BUL	Stoyanova Taneva Mima (BUL)
19	SVK	Rebeka Kocsisova (SVK)
20	CRO	Sandra Besek (CRO)
21	GRE	Olga Poutakidi (GRE)



Feuille de compétition / Competition Sheet

Mistrzostwa Europy U15

Style: FW

58



QUALIFICATION		1/8 FINALE	1/4 FINALE	1/2 FINALE	FINALE	WINNER
1	Darya Bykhankova (BLR)	P1 P2	1 1 BLR P1 P2 1 1 1 0	2 4 16 UKR P1 P2 9 7	2 3 10 UKR P1 P2 4 6	20 Elekes Eniko (HUN)
2	Iryna Bondar (UKR)	P1 P2	2 4 12 UKR P1 P2 10 2	2 3 10 UKR P1 P2 4 6	2 0 0 UKR P1 P2 0 0	20 Elekes Eniko (HUN)
3	Drosoula Tzianakopoulou	P1 P2	3 5 8 GRE P1 P2 8 0	2 3 10 UKR P1 P2 4 6	2 0 0 UKR P1 P2 0 0	20 Elekes Eniko (HUN)
4	Ralina Bakieva (RUS)	P1 P2	4 0 2 RUS P1 P2 2 0	2 3 10 UKR P1 P2 4 6	2 0 0 UKR P1 P2 0 0	20 Elekes Eniko (HUN)
5	Weronika Smaczyńska (POL)	P1 P2	5 0 0 POL P1 P2 0 0	6 1 2 ROU P1 P2 0 2	2 0 0 UKR P1 P2 0 0	20 Elekes Eniko (HUN)
6	Bianca Surloi (ROU)	P1 P2	6 4 10 ROU P1 P2 10 0	6 1 2 ROU P1 P2 0 2	2 0 0 UKR P1 P2 0 0	20 Elekes Eniko (HUN)
7	Nadia Drahanova (UKR)	P1 P2	7 4 10 UKR P1 P2 6 4	7 1 3 UKR P1 P2 3 0	2 0 0 UKR P1 P2 0 0	20 Elekes Eniko (HUN)
8	Anna Fofiadou (GRE)	P1 P2	8 0 0 GRE P1 P2 0 0	7 1 3 UKR P1 P2 3 0	2 0 0 UKR P1 P2 0 0	20 Elekes Eniko (HUN)
9	Viktoryia Radzkova (BLR)	P1 P2	9 3 9 BLR P1 P2 2 7	7 3 8 UKR P1 P2 4 4	2 0 0 UKR P1 P2 0 0	20 Elekes Eniko (HUN)
10	Selvii Lyasoğlu (TUR)	P1 P2	10 1 6 TUR P1 P2 4 2	7 3 8 UKR P1 P2 4 4	2 0 0 UKR P1 P2 0 0	20 Elekes Eniko (HUN)
11	Mea Laakso (FIN)	P1 P2	11 0 2 FIN P1 P2 0 2	9 0 5 BLR P1 P2 5 0	2 0 0 UKR P1 P2 0 0	20 Elekes Eniko (HUN)
12	Julia Reka (NED)	P1 P2	12 5 6 NED P1 P2 2 4	9 0 5 BLR P1 P2 5 0	2 0 0 UKR P1 P2 0 0	20 Elekes Eniko (HUN)
13	Tyyne Lasanen (FIN)	P1 P2	13 3 6 FIN P1 P2 0 6	12 1 1 NED P1 P2 1 0	2 0 0 UKR P1 P2 0 0	20 Elekes Eniko (HUN)
14	Karolina Domaszuk (POL)	P1 P2	13 0 0 FIN P1 P2 0 0	12 1 1 NED P1 P2 1 0	2 0 0 UKR P1 P2 0 0	20 Elekes Eniko (HUN)
15	Diana Khomutova (RUS)	P1 P2	15 1 2 RUS P1 P2 1 1	12 5 6 NED P1 P2 6 0	2 0 0 UKR P1 P2 0 0	20 Elekes Eniko (HUN)
16	Pereda Natalia Gonzalez (ESP)	P1 P2	15 0 0 FIN P1 P2 0 0	12 5 6 NED P1 P2 6 0	2 0 0 UKR P1 P2 0 0	20 Elekes Eniko (HUN)
17	Marielova Dragushkova Binka	P1 P2	18 0 0 MDA P1 P2 0 0	20 3 10 HUN P1 P2 8 2	2 0 0 UKR P1 P2 0 0	20 Elekes Eniko (HUN)
18	Ana Maria Crețu (MDA)	P1 P2	18 0 0 MDA P1 P2 0 0	20 3 10 HUN P1 P2 8 2	2 0 0 UKR P1 P2 0 0	20 Elekes Eniko (HUN)
19	Ilaria Salvaterra (ITA)	P1 P2	20 4 10 HUN P1 P2 10 0	20 3 10 HUN P1 P2 8 2	2 0 0 UKR P1 P2 0 0	20 Elekes Eniko (HUN)
20	Elekes Eniko (HUN)	P1 P2	20 4 10 HUN P1 P2 10 0	20 3 10 HUN P1 P2 8 2	2 0 0 UKR P1 P2 0 0	20 Elekes Eniko (HUN)

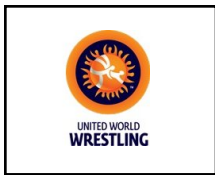

Feuille de compétition / Competition Sheet

Mistrzostwa Europy U15

Style: FW

58



"REPECHAGE"

"UPPER BRANCH"

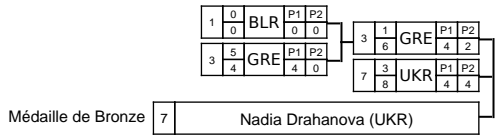

"LOWER BRANCH"

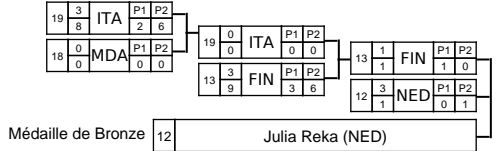

Classement

Cl	Pays	Nom
1	HUN	Elekes Eniko (HUN)
2	UKR	Iryna Bondar (UKR)
3	NED	Julia Reka (NED)
3	UKR	Nadia Drahanova (UKR)
5	GRE	Drosoula Tzianakopoulou (GRE)
5	FIN	Tyynne Lasanen (FIN)
7	MDA	Ana Maria Crețu (MDA)
8	ROU	Bianca Surlói (ROU)
9	RUS	Diana Khomutova (RUS)
10	BLR	Viktoryia Radzkova (BLR)
11	ITA	Ilaria Salvaterra (ITA)
12	TUR	Selvii Lyasoğlu (TUR)
13	ESP	Pereda Natalia Gonzalez (ESP)
14	BLR	Darya Bykhankova (BLR)
15	POL	Karolina Domaszuk (POL)
16	FIN	Mea Laakso (FIN)
17	RUS	Ralina Bakieva (RUS)
18	BUL	Marielova Dragushkova Binka (BUL)
19-20	GRE	Anna Fofiadou (GRE)
19-20	POL	Weronika Smaczyńska (POL)



Feuille de compétition / Competition Sheet

Mistrzostwa Europy U15

Style: FW

62



QUALIFICATION		1/8 FINALE	1/4 FINALE	1/2 FINALE	FINALE	WINNER
1	Gia Kastelan (CRO)	P1 P2	1 0 CRO P1 P2 0 0 0 0	2 0 HUN P1 P2 4 4 0 0	3 5 UKR P1 P2 6 6 2 4	10 Alina Rybkina (RUS)
2	Vecsernyes Maria (HUN)	P1 P2	2 4 HUN P1 P2 10 4 6 6	3 5 UKR P1 P2 6 6 0 0	3 1 UKR P1 P2 2 0 2 2	
3	Halyna Oleksiivska (UKR)	P1 P2	3 3 UKR P1 P2 4 4 0 0	5 1 CRO P1 P2 9 5 4 4	7 0 GRE P1 P2 0 0 0 0	
4	Alisa Chernyshkova (RUS)	P1 P2	4 1 RUS P1 P2 2 0 2 2	7 3 GRE P1 P2 5 6 4 4	10 3 RUS P1 P2 2 2 0 0	
5	Milla Anđelić (CRO)	P1 P2	5 3 CRO P1 P2 7 4 3 3	10 4 RUS P1 P2 10 4 6 6	10 3 RUS P1 P2 5 1 4 4	
6	Bernadett Tamas (ROU)	P1 P2	6 0 ROU P1 P2 0 0 0 0	11 0 TUR P1 P2 0 0 0 0	19 0 BLR P1 P2 0 0 0 0	
7	Loli Kolitsopoulou (GRE)	P1 P2	7 5 GRE P1 P2 5 3 2 2	11 3 TUR P1 P2 6 6 0 0	19 4 BLR P1 P2 12 12 0 0	
8	Petra Velez (SRB)	P1 P2	8 2 SRB P1 P2 2 2 0 0	13 1 GBR P1 P2 2 0 2 2	19 0 BLR P1 P2 0 0 0 0	
9	Stoyanova Georgieva Vanesa	P1 P2	9 0 BUL P1 P2 0 0 0 0	15 5 UKR P1 P2 6 6 0 0	19 4 BLR P1 P2 12 12 0 0	
10	Alina Rybkina (RUS)	P1 P2	10 4 RUS P1 P2 10 4 6 6	15 1 UKR P1 P2 2 2 0 0	19 0 BLR P1 P2 0 0 0 0	
11	Duygu Gen (TUR)	P1 P2	11 3 TUR P1 P2 6 6 0 0	17 0 POL P1 P2 2 2 0 0	19 0 BLR P1 P2 0 0 0 0	
12	Emma Carri (ITA)	P1 P2	12 0 ITA P1 P2 4 4 0 0	19 3 BLR P1 P2 4 4 0 0	19 0 BLR P1 P2 0 0 0 0	
13	Ella Johnson (GBR)	P1 P2	13 1 GBR P1 P2 2 0 2 2	19 4 BLR P1 P2 12 12 0 0	19 0 BLR P1 P2 0 0 0 0	
14	Alicja Nowosad (POL)	P1 P2	14 0 POL P1 P2 0 0 0 0	21 0 EST P1 P2 0 0 0 0	19 0 BLR P1 P2 0 0 0 0	
15	Kateryna Palii (UKR)	P1 P2	15 5 UKR P1 P2 6 6 0 0	21 0 EST P1 P2 0 0 0 0	19 0 BLR P1 P2 0 0 0 0	
16	Alonso Ez Zair Yasmin (ESP)	P1 P2	16 0 ESP P1 P2 0 0 0 0	21 0 EST P1 P2 0 0 0 0	19 0 BLR P1 P2 0 0 0 0	
17	Nicola Wasilewska (POL)	P1 P2	17 0 POL P1 P2 6 2 2 2	21 0 EST P1 P2 0 0 0 0	19 0 BLR P1 P2 0 0 0 0	
18	Geny Lodder (NED)	P1 P2	18 1 NED P1 P2 2 2 0 0	21 0 EST P1 P2 0 0 0 0	19 0 BLR P1 P2 0 0 0 0	
19	Alina Shauchuk (BLR)	P1 P2	19 3 BLR P1 P2 2 4 4 4	21 0 EST P1 P2 0 0 0 0	19 0 BLR P1 P2 0 0 0 0	
20	Marcela Costişanu (MDA)	P1 P2	20 0 MDA P1 P2 0 0 0 0	21 0 EST P1 P2 0 0 0 0	19 0 BLR P1 P2 0 0 0 0	
21	Abigail Tikerpalu (EST)	P1 P2	21 5 EST P1 P2 6 6 0 0	21 0 EST P1 P2 0 0 0 0	19 0 BLR P1 P2 0 0 0 0	

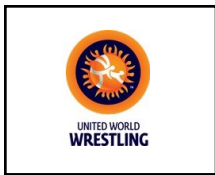

Feuille de compétition / Competition Sheet

Mistrzostwa Europy U15



Style: FW

62

"REPECHAGE"

"UPPER BRANCH"

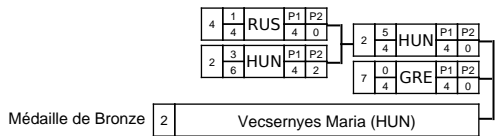

"LOWER BRANCH"

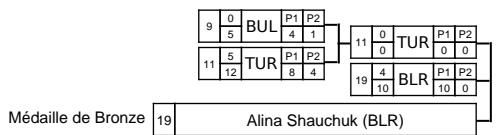

Classement

Cl	Pays	Nom
1	RUS	Alina Rybkina (RUS)
2	UKR	Halyna Oleksiivska (UKR)
3	BLR	Alina Shauchuk (BLR)
3	HUN	Vecsernyes Maria (HUN)
5	GRE	Loifi Koltisopoulou (GRE)
5	TUR	Duygu Gen (TUR)
7	UKR	Kateryna Palił (UKR)
8	GBR	Ella Johnson (GBR)
9	POL	Nicola Wasilewska (POL)
10	EST	Abigail Tikerpalu (EST)
11	CRO	Milla Andelić (CRO)
12	RUS	Alisa Chernyshkova (RUS)
13	NED	Geny Lodder (NED)
14	BUL	Stoyanova Georgieva Vanesa (BUL)
15	ITA	Emma Carri (ITA)
16	SRB	Petra Velez (SRB)
17	MDA	Marcela Costișanu (MDA)
18	ROU	Bernadett Tamas (ROU)
19	ESP	Alonso Ez Zair Yasmin (ESP)
20	POL	Alicja Nowosad (POL)
21	CRO	Gia Kastelan (CRO)

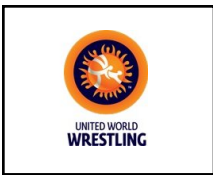

Feuille de compétition / Competition Sheet

Mistrzostwa Europy U15



Style: FW 66

1/8 FINALE 1/4 FINALE 1/2 FINALE FINALE WINNER





Feuille de compétition / Competition Sheet

Mistrzostwa Europy U15



Style: FW

66

"REPECHAGE"

"UPPER BRANCH"

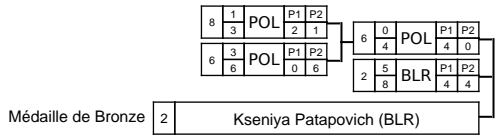

"LOWER BRANCH"

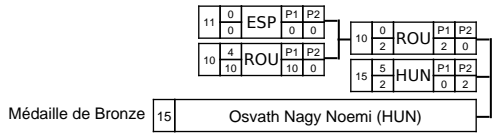

Classement		
Cl	Pays	Nom
1	RUS	Zlatoslava Stepanova (RUS)
2	UKR	Iryna Zablotska (UKR)
3	BLR	Kseniya Patapovich (BLR)
3	HUN	Osvath Nagy Noemi (HUN)
5	POL	Karolina Jaworska (POL)
5	ROU	Barbara Sere (ROU)
7	ITA	Yvette Valentini (ITA)
8	BLR	Anastasiya Fralova (BLR)
9	POL	Patrycja Cuber (POL)
10	TUR	Bükrenaz Sert (TUR)
11	ITA	Fabiana Dattilo (ITA)
12	UKR	Yevhania Siedykh (UKR)
13-14	CRO	Alesia Marčić (CRO)
13-14	GRE	Nikoleta Barmpa (GRE)
15	BUL	Petrova Brasnarova Daniela (BUL)
16	ESP	Mestre Alejandra Lopez (ESP)



U15 EUROPEAN
CHAMPIONSHIPS
KRAKÓW 2019

U15 European Championships - Kraków /POL/

June 27-30, 2019

TEAM CLASIFICACION in WOMEN WRESTLING

M.	KLUB	# wrestlers	WW33KG	WW36KG	WW39KG	WW42KG	WW46KG	WW50KG	WW54KG	WW58KG	WW62KG	WW66KG	TOTAL
1	UKRAINE (Ukr)	20	25	15	25	25	20	20	15	20	20	20	205
2	RUSSIA (Rus)	19	8	25	15	20	25	6	10	4	25	25	163
3	HUNGARY (Hun)	10	0	10	10	0	0	0	25	25	15	15	100
4	BELARUS (Bir)	18	10	10	0	10	15	2	6	2	15	15	85
5	TURKEY (Tur)	10	15	8	8	0	10	25	0	0	10	2	78
6	ROMANIA (Rou)	12	15	0	20	0	0	4	20	6	0	10	75
7	ITALY (Ita)	14			4	15	0	15	10	0	0	8	52
8	POLAND (POL)	20	2	20	0	6	4	0	0	0	4	10	46
9	MOLDOVA (Mda)	7				8	0	10	15	8	0		41
10	FINLAND (Fin)	7				0	8	10	0	10			28
11	GREECE (Gre)	6				0	2	10	0	10	10	0	22
12	BULGARIA (Bul)	11	10		6	0	0	0	0	0	0	0	16
13-14	FRANCE (Fra)	3					0	15					15
13-14	NETHERLANDS (Ned)	2								15			15
15-16	SLOVAKIA (Svk)	4		6	0		0		0				6
15-16	GREAT BRITAIN (Gbr)	1					0				6		6
17	GEORGIA (Geo)	2				4	0				2		4
18	ESTONIA (Est)	2					0				2		2
19-22	SPAIN (Esp)	5					0			0	0	0	0
19-22	SERBIA (Srb)	1									0	0	0
19-22	CROATIA (Cro)	9				0	0	0	0		0	0	0
19-22	AUSTRIA (Aut)	3					0	0					0





**U15 EUROPEAN
CHAMPIONSHIPS
KRAKOW 2019**

U15 European Championships

Kraków /POL/

June 27-30, 2019

FINAL REPORT

GRECO ROMAN STYLE



U15 European Championships - Kraków /POL/

June 27-30, 2019



U15 EUROPE
CHAMPIONSHIPS
KRAKÓW 2019

List of participants GR

Number	COUNTRY	GR38	GR41	GR44	GR48	GR52	GR57	GR62	GR68	GR75	GR85	TOTAL
1	ARMENIA, Arm	1	2	1	2	1	1	1	1	1	1	12
2	AUSTRIA, Aut					1						1
3	AZERBAIJAN, Aze	2	2		2	2	2	2		2		14
4	BELARUS, Blr	2	2	2	2	2	2	2	2	2	2	20
5	BELGIUM, Bel							1				1
6	BULGARIA, Bul	2	2	2	2	2	2	2	2	1	1	18
7	CROATIA, Cro	1	1	1	2	2	1	1	1	1	1	11
8	ESTONIA, Est	1		2	1	1		1	1	1	1	9
9	FINLAND, Fin			1		1			2	1		5
10	GEORGIA, Geo	2	2	2	2	2	2	2	2	2	2	20
11	GREECE, Gre	1	1			1	2	2	1	1	1	10
12	HUNGARY, Hun	1	1	1	1	1	1	1	1	1	1	10
13	ISRAEL, Isr	1	1								1	3
14	ITALY, Ita	1	1	2	1	2	1	2	2	1	2	15
15	LATVIA, Lat	1		1	1				1			4
16	LITHUANIA, Lit		1	1	1	1	2	2	1	1	1	11
17	MOLDOVA, Mda	2	1	2	2	2	1	2	2	1		15
18	NETHERLANDS, Ned						1					1
19	POLAND, POL	2	2	2	2	2	2	2	2	2	2	20
20	ROMANIA, Rou	1	1	2	1	2	2	2	2	1	2	16
21	RUSSIA, Rus	2	2	2	2	2	2	1	2	2	2	19
22	SERBIA, Srb		2	1	1	1	1	1	2	1	2	11
23	SLOVAKIA, Svk			1	1	1			1	1	1	6
24	TURKEY, Tur	1	1	1	2	2	1	1	1	1	1	12
25	UKRAINE, Ukr	2	2	2	2	2	2	2	2	2	2	20
	TOTAL	26	27	29	29	33	28	30	31	26	25	242





U15 European Championships - Kraków /POL/

June 27-30, 2019

INDIVIDUAL CLASSIFICATION GR

CATEGORY 38KG								
Place	Name & Surname	Country	Year of birth	CP	VT	ST	TP	TP GVN
1	Farahim Mustafayev	AZERBAIJAN (Aze)	2005	18	1	1	24	6
2	Imam Magomadov	RUSSIA (Rus)	2005	18	1	3	39	8
3	Nikita Dementiiev	UKRAINE (Ukr)	2005	10	0	1	27	22
3	Rahim Hasanov	AZERBAIJAN (Aze)	2004	16	0	4	35	2
5	Luka Javakhadze	GEORGIA (Geo)	2004	7	0	0	12	17
5	Constantin Lungu	ROMANIA (Rou)	2006	12	1	1	22	27
7	Geikins Konstantins	LATVIA (Lat)	2005	9	0	2	24	10
8	Maxim Sarmanov	MOLDOVA (Mda)	2006	6	1	0	11	16
9	Totok Peter	HUNGARY (Hun)	2006	5	0	1	11	11
10	Sashik Martirosyan	ARMENIA (Arm)	2004	4	0	1	12	4
11	Eminoglu Ahmet	TURKEY (Tur)	2006	4	0	1	12	11
12	Karnolski Radoslav	BULGARIA (Bul)	2004	4	0	1	9	17
13	Juhan Kristjuhan	ESTONIA (Est)	2005	4	0	1	8	9
14	Georgiev Dimitar	BULGARIA (Bul)	2005	4	0	0	13	30
15	Uladzimir Kastaronak	BELARUS (Blr)	2005	4	0	0	5	6
16	Sokratis Konstantinidis	GREECE (Gre)	2006	1	0	0	7	8
17	Anatolie Tincu	MOLDOVA (Mda)	2004	1	0	0	3	12
18	Anri Khozrevanidze	GEORGIA (Geo)	2005	1	0	0	2	4
19	Artem Zolotov	RUSSIA (Rus)	2005	1	0	0	1	2
20	Kajetan Jakubowski	POLAND (POL)	2006	0	0	0	0	6
21-25	Amare Fetene	ISRAEL (Isr)	2005	0	0	0	0	8
21-25	Jakub Wach	POLAND (POL)	2005	0	0	0	0	8
21-25	Dmytro Chubenko	UKRAINE (Ukr)	2006	0	0	0	0	8
21-25	Francesco Stopponi	ITALY (Ita)	2006	0	0	0	0	8
21-25	Maksim Razzhalavets	BELARUS (Blr)	2004	0	0	0	0	8
26	Matej Mihalic	CROATIA (Cro)	2004	0	0	0	0	9

CATEGORY 41KG								
Place	Name & Surname	Country	Year of birth	CP	VT	ST	TP	TP GVN
1	Ibragim Khakuev	RUSSIA (Rus)	2004	17	2	1	26	4
2	Bilal Bersanukaev	RUSSIA (Rus)	2004	16	1	1	27	14
3	Parviz Dadashov	AZERBAIJAN (Aze)	2004	16	0	3	32	8
3	Kirilov Borislav	BULGARIA (Bul)	2004	16	0	4	40	4
5	Luka Bendeliani	GEORGIA (Geo)	2004	11	0	2	22	18
5	Adomavičius Vilius	LITHUANIA (Ltu)	2005	8	0	2	20	18
7	Mahammad Qasimzada	AZERBAIJAN (Aze)	2005	9	1	0	12	9
8	Mishiko Aleksandria	GEORGIA (Geo)	2005	8	0	1	21	7
9	Keskin Abdullah	TURKEY (Tur)	2005	6	1	0	14	11
10	Valentin Gheorghie	ROMANIA (Rou)	2005	6	0	0	15	10
11	Serhii Kuznetsov	UKRAINE (Ukr)	2006	5	1	0	4	9
12	Hayk Lyudvigyan	ARMENIA (Arm)	2005	5	0	1	9	5
13	Mikita Tsiarokhin	BELARUS (Blr)	2004	5	0	1	9	10
14	Filip Mikulić	CROATIA (Cro)	2004	1	0	0	2	9
15	Alexandru Pani?	MOLDOVA (Mda)	2004	1	0	0	2	11
16	Dimitrios Papavasileiou	GREECE (Gre)	2006	1	0	0	2	18
17	Czuczor Dominik	HUNGARY (Hun)	2006	1	0	0	1	9
18	Suren Movsisyan	ARMENIA (Arm)	2004	0	0	0	1	4
19	Zelan Pek	SERBIA (Srb)	2005	0	0	0	1	10
20	Uladzislau Katsiuba	BELARUS (Blr)	2006	0	0	0	0	4
21	Kacper Łukasik	POLAND (POL)	2005	0	0	0	0	6
22-24	Daniel Berkec	SERBIA (Srb)	2004	0	0	0	0	8
22-24	Itay Serebnik	ISRAEL (Isr)	2005	0	0	0	0	8
22-24	Davyd Chulkovskiy	UKRAINE (Ukr)	2005	0	0	0	0	8
25	Dimitrov Vili	BULGARIA (Bul)	2005	0	0	0	0	9
26	Salvatore Giovanni Materia	ITALY (Ita)	2005	0	0	0	0	11
27	Igor Dąbrowski	POLAND (POL)	2006	0	0	0	0	18



U15 European Championships - Kraków /POL/

June 27-30, 2019

INDIVIDUAL CLASSIFICATION GR

CATEGORY 44KG								
Place	Name & Surname	Country	Year of birth	CP	VT	ST	TP	TP GVN
1	Valerii Mangutov	RUSSIA (Rus)	2004	18	0	3	39	11
2	Anri Tavartkiladze	GEORGIA (Geo)	2004	16	0	3	41	14
3	Usman Eskerkhanov	RUSSIA (Rus)	2004	14	1	2	19	2
3	Tamazi Glonti	GEORGIA (Geo)	2004	13	0	0	29	11
5	Eusebiu Tiba	ROMANIA (Rou)	2004	14	1	2	25	20
5	Oleg Bajura	MOLDOVA (Mda)	2004	12	2	0	11	23
7	Denys Kovshun	UKRAINE (Ukr)	2006	11	2	0	11	13
8	Saveliy Rashchynski	BELARUS (Blr)	2004	10	1	1	18	7
9	Levai Levente	HUNGARY (Hun)	2005	9	1	1	18	4
10	Dejan Berkec	SERBIA (Srb)	2006	9	1	1	18	18
11	Pavel Denisenco	MOLDOVA (Mda)	2004	4	0	1	13	12
12	Gaspar Terteryan	ARMENIA (Arm)	2005	4	0	1	12	10
13	Max Hristjuk	ESTONIA (Est)	2005	4	0	1	10	5
14	Dominik Partyka	POLAND (POL)	2004	4	0	1	9	9
15	Pleškans Ilja	LATVIA (Lat)	2004	4	0	1	8	8
16	Kewin Materna	POLAND (POL)	2004	1	0	0	6	22
17	Vikke Tarkkio	FINLAND (Fin)	2005	1	0	0	4	12
18	Čepauskas Rokas	LITHUANIA (Ltu)	2004	1	0	0	2	7
19	Ivan Stefanski	UKRAINE (Ukr)	2004	0	0	0	2	10
20-21	Cristian Murgui	ROMANIA (Rou)	2006	0	0	0	0	4
20-21	Adam Straka	SLOVAKIA (Svk)	2005	0	0	0	0	4
22-25	Michaił Kapytka	BELARUS (Blr)	2005	0	0	0	0	8
22-25	Sebastijan Čibarić	CROATIA (Cro)	2005	0	0	0	0	8
22-25	Todorov Angel	BULGARIA (Bul)	2005	0	0	0	0	8
22-25	Dimitrov Aleksandar	BULGARIA (Bul)	2004	0	0	0	0	8
26-28	Federico Sergio Caniglia	ITALY (Ita)	2005	0	0	0	0	9
26-28	Vittorio Bussano	ITALY (Ita)	2006	0	0	0	0	9
26-28	Muhammet Biyik	TURKEY (Tur)	2004	0	0	0	0	9
29	Patrick Nool	ESTONIA (Est)	2005	0	0	0	0	10

CATEGORY 48KG								
Place	Name & Surname	Country	Year of birth	CP	VT	ST	TP	TP GVN
1	Tavakgul Haziyeu	AZERBAIJAN (Aze)	2004	15	1	1	22	3
2	Tornike Shainidze	GEORGIA (Geo)	2004	13	0	0	25	16
3	Erik Shevchenko	UKRAINE (Ukr)	2004	7	0	1	13	12
3	Aleksandr Tugarev	RUSSIA (Rus)	2004	17	0	4	36	3
5	Valeri Titberidze	GEORGIA (Geo)	2005	13	1	1	31	14
5	Fedayi Murat Aydin	TURKEY (Tur)	2004	7	0	0	14	23
7	Renato Osmanović	CROATIA (Cro)	2004	10	2	0	11	12
8	Ashot Manukyan	ARMENIA (Arm)	2004	10	1	1	14	16
9	Balagha Mikailzada	AZERBAIJAN (Aze)	2004	10	1	0	19	15
10	Artush Aleksanyan	ARMENIA (Arm)	2004	8	0	2	23	15
11	Dzhanakai Dzhamukov	RUSSIA (Rus)	2004	6	1	0	12	6
12	Kostov Ivan	BULGARIA (Bul)	2004	6	1	0	7	10
13	Vasile Zabica	MOLDOVA (Mda)	2004	5	1	0	23	20
14	Berat Keskin	TURKEY (Tur)	2004	5	0	1	9	2
15	Rainer Plaser	ESTONIA (Est)	2005	4	0	1	11	10
16	Botos Dominik	HUNGARY (Hun)	2005	4	0	0	13	16
17	Mykhailo Kutsenko	UKRAINE (Ukr)	2004	1	0	0	5	8
18	Trāian Andronachi	MOLDOVA (Mda)	2005	1	0	0	5	13
19	Mate Toth	SLOVAKIA (Svk)	2005	1	0	0	2	11
20	Antonio Lukač	CROATIA (Cro)	2005	1	0	0	1	10
21	Elia Caresia	ITALY (Ita)	2004	0	0	0	14	21
22	Travins Nikita	LATVIA (Lat)	2004	0	0	0	2	5
23	Illia Valeuski	BELARUS (Blr)	2004	0	0	0	1	2
24	Piotr Zubelewicz	POLAND (POL)	2004	0	0	0	0	5
25-26	Viachaslau Zhehalau	BELARUS (Blr)	2004	0	0	0	0	8
25-26	Puikis Kipras	LITHUANIA (Ltu)	2005	0	0	0	0	8
27	Iulian Lungu	ROMANIA (Rou)	2004	0	0	0	0	9
28-29	Dermendzhiev Stilyan	BULGARIA (Bul)	2004	0	0	0	0	10
28-29	Piotr Skalik	POLAND (POL)	2004	0	0	0	0	10



U15 European Championships - Kraków /POL/

June 27-30, 2019

INDIVIDUAL CLASIFICATION GR

CATEGORY 52KG								
Place	Name & Surname	Country	Year of birth	CP	VT	ST	TP	TP GVN
1	Magomed Iarbilov	RUSSIA (Rus)	2004	18	0	3	37	5
2	Mahmut Yilmaz	TURKEY (Tur)	2004	15	0	2	28	8
3	Farid Khalilov	AZERBAIJAN (Aze)	2004	16	0	3	35	10
3	Takacs Zsolt	HUNGARY (Hun)	2004	17	0	2	30	13
5	Serhii Prytuliak	UKRAINE (Ukr)	2004	14	1	2	34	20
5	Artur Jeremejev	ESTONIA (Est)	2004	15	2	1	20	20
7	Vrublevskij Modestas	LITHUANIA (Ltu)	2006	11	2	0	11	20
8	Berati Inaç	TURKEY (Tur)	2004	9	1	0	19	25
9	Rati Khozrevanidze	GEORGIA (Geo)	2004	7	0	1	14	9
10	Alibek Amirov	RUSSIA (Rus)	2004	7	0	1	12	1
11	Artem Iskenderov	UKRAINE (Ukr)	2004	5	0	1	16	12
12	Henrik Gevorgyan	ARMENIA (Arm)	2005	5	0	1	9	3
13	Ramin Iremadze	GEORGIA (Geo)	2004	4	0	1	10	6
14	Farid Mammadov	AZERBAIJAN (Aze)	2004	4	0	1	9	5
15	Vladimir Pascari	MOLDOVA (Mda)	2005	4	0	1	8	9
16	Abdulmasih Abdulmasih	BELARUS (Blr)	2005	4	0	0	10	13
17	Antal Vamos	SERBIA (Srb)	2005	3	0	0	3	4
18	Matej Rebić	CROATIA (Cro)	2004	1	0	0	3	9
19	Oskari Talala	FINLAND (Fin)	2005	1	0	0	2	10
20-21	Davide Gasperini	ITALY (Ita)	2004	0	0	0	0	3
20-21	Polykarpos Angelos Patouchas	GREECE (Gre)	2004	0	0	0	0	3
22-23	Martin Belusik	SLOVAKIA (Svk)	2004	0	0	0	0	4
22-23	Artur Bor?	MOLDOVA (Mda)	2005	0	0	0	0	4
24-28	Mihael Lukač	CROATIA (Cro)	2005	0	0	0	0	8
24-28	Nikodem Zawadzki	POLAND (POL)	2004	0	0	0	0	8
24-28	Alex Kettmaier	ITALY (Ita)	2004	0	0	0	0	8
24-28	Mitev Borislav	BULGARIA (Bul)	2005	0	0	0	0	8
24-28	Rafał Wangin	POLAND (POL)	2004	0	0	0	0	8
29-31	Angelov Albert	BULGARIA (Bul)	2005	0	0	0	0	9
29-31	Aliaksei Shymanovich	BELARUS (Blr)	2004	0	0	0	0	9
29-31	Linus Häusle	AUSTRIA (Aut)	2004	0	0	0	0	9
32	Mihai Dragan	ROMANIA (Rou)	2006	0	0	0	0	12
33	Felix Dediu	ROMANIA (Rou)	2004	0	0	0	0	15

CATEGORY 57KG								
Place	Name & Surname	Country	Year of birth	CP	VT	ST	TP	TP GVN
1	Alperen Berber	TURKEY (Tur)	2005	19	1	2	35	9
2	Abdula Salimov	RUSSIA (Rus)	2004	15	0	2	30	5
3	Temuri Orjonikidze	GEORGIA (Geo)	2004	16	1	1	27	13
3	Ilias Zinnurov	RUSSIA (Rus)	2004	12	0	0	15	8
5	Giorgi Vertashvili	GEORGIA (Geo)	2004	13	0	3	28	13
5	Imed Khudzhadze	UKRAINE (Ukr)	2004	8	0	1	18	11
7	Georgios Athanasiou	GREECE (Gre)	2005	11	2	0	12	13
8	Kovacs Oliver	HUNGARY (Hun)	2005	6	1	0	12	3
9	Junior Mac Donald	NETHERLANDS (Ned)	2005	6	0	0	9	10
10	Asipauskas Nojus	LITHUANIA (Ltu)	2005	5	1	0	4	24
11	Stanislav Stoianov	MOLDOVA (Mda)	2004	5	0	1	17	12
12	Hakob Karapetyan	ARMENIA (Arm)	2004	5	0	1	10	1
13	Oskar Wawrzyszyn	POLAND (POL)	2004	4	0	1	12	11
14	Teodor Cosma	ROMANIA (Rou)	2005	3	0	0	8	8
15	Davud Mammadov	AZERBAIJAN (Aze)	2005	3	0	0	7	6
16	Mladenov Pavel	BULGARIA (Bul)	2005	1	0	0	3	12
17	Milos Perovic	SERBIA (Srb)	2005	1	0	0	2	6
18	Fizuli Abbasov	AZERBAIJAN (Aze)	2004	1	0	0	1	3
19	Anton Klymentov	UKRAINE (Ukr)	2004	1	0	0	1	7
20	Luka Ivancić	CROATIA (Cro)	2004	1	0	0	1	10
21	Alexandru Ionescu	ROMANIA (Rou)	2004	0	0	0	0	4
22	Zakhar Martsinkevich	BELARUS (Blr)	2004	0	0	0	0	5
23	Georgios Papageorgiou	GREECE (Gre)	2004	0	0	0	0	6
24-25	Gvozdas Kipras	LITHUANIA (Ltu)	2004	0	0	0	0	8
24-25	Nyamov Hristo	BULGARIA (Bul)	2004	0	0	0	0	8
26-27	Filip Loch	POLAND (POL)	2004	0	0	0	0	9
26-27	Alessandro Grespi	ITALY (Ita)	2005	0	0	0	0	9
28	Uladzislau Nemera	BELARUS (Blr)	2004	0	0	0	0	18



U15 European Championships - Kraków /POL/

June 27-30, 2019

INDIVIDUAL CLASIFICATION GR

CATEGORY 62KG								
Place	Name & Surname	Country	Year of birth	CP	VT	ST	TP	TP GVN
1	Achiko Bolkvadze	GEORGIA (Geo)	2004	20	1	3	34	0
2	Tural Bairamov	RUSSIA (Rus)	2004	15	0	3	32	7
3	Nihat Kara	TURKEY (Tur)	2004	15	0	3	28	9
3	Ibrahim Tabaev	BELGIUM (Bel)	2004	16	1	1	26	13
5	Davide Zilio	ITALY (Ita)	2005	12	1	1	31	21
5	Valentin Pascaru	MOLDOVA (Mda)	2004	6	0	0	10	18
7	Mickevičius Benas	LITHUANIA (Ltu)	2005	8	0	1	20	14
8	Kanan Abdullazada	AZERBAIJAN (Aze)	2004	7	0	1	17	9
9	Mykyta Khokhlachov	UKRAINE (Ukr)	2004	7	0	0	23	24
10	Tornike Mikeladze	GEORGIA (Geo)	2004	6	1	0	13	7
11	Vladislav Stoianov	MOLDOVA (Mda)	2005	6	1	0	9	20
12	Arman Melkonyan	ARMENIA (Arm)	2004	5	0	1	21	12
13	Artem Khutko	UKRAINE (Ukr)	2004	5	0	1	10	6
14	Yahor Novikau	BELARUS (Blr)	2004	4	0	1	9	16
15	Hasan Aliyev	AZERBAIJAN (Aze)	2004	4	0	1	8	9
16	Uladzislau Dubrouski	BELARUS (Blr)	2006	4	0	0	10	9
17	Alexandru Romaniuc	ROMANIA (Rou)	2004	1	0	0	7	12
18	Darkev Dobrin	BULGARIA (Bul)	2004	1	0	0	6	17
19	Lucian Cosma	ROMANIA (Rou)	2005	1	0	0	3	6
20	Dominik Djok	CROATIA (Cro)	2004	1	0	0	3	12
21	Alexandros Batzakidis	GREECE (Gre)	2004	1	0	0	2	10
22	Riccardo Crimi	ITALY (Ita)	2004	1	0	0	2	11
23	Dimitrios Papakostas	GREECE (Gre)	2004	0	0	0	1	4
24-27	Nikodem Godun	POLAND (POL)	2005	0	0	0	0	8
24-27	Atanasov Andrey	BULGARIA (Bul)	2005	0	0	0	0	8
24-27	Bodo Levente	HUNGARY (Hun)	2004	0	0	0	0	8
24-27	Cyprian Kowalik	POLAND (POL)	2004	0	0	0	0	8
28-30	Robin Samarüütel	ESTONIA (Est)	2004	0	0	0	0	9
28-30	Miljan Rajic	SERBIA (Srb)	2005	0	0	0	0	9
28-30	Knystautas Giedrius	LITHUANIA (Ltu)	2005	0	0	0	0	9

CATEGORY 68KG								
Place	Name & Surname	Country	Year of birth	CP	VT	ST	TP	TP GVN
1	Luka Gelashvili	GEORGIA (Geo)	2005	18	0	3	33	2
2	Alexandru Solovei	MOLDOVA (Mda)	2004	15	0	2	28	6
3	Islam Zaurav	RUSSIA (Rus)	2004	18	2	1	34	15
3	Mihai Gu?u	MOLDOVA (Mda)	2005	12	1	1	19	9
5	Bižna Sergejs	LATVIA (Lat)	2005	9	1	1	17	22
5	Kis Krisztian	HUNGARY (Hun)	2004	14	1	1	22	20
7	Florin Manolache	ROMANIA (Rou)	2005	10	1	1	21	29
8	Nodari Abramishvili	GEORGIA (Geo)	2004	8	0	2	22	4
9	Ramazan Pashaiev	UKRAINE (Ukr)	2004	8	0	1	17	5
10	Bartłomiej Myjak	POLAND (POL)	2004	7	0	1	17	16
11	Iliia Sorokin	RUSSIA (Rus)	2004	6	1	0	18	13
12	Toygun Aktop	TURKEY (Tur)	2004	5	1	0	24	13
13	Danylo Zahynailo	UKRAINE (Ukr)	2004	5	1	0	6	8
14	Nemanja Kimoski	SERBIA (Srb)	2004	5	0	1	14	14
15	Ivan Harnastayeu	BELARUS (Blr)	2004	4	0	1	10	12
16	Eleftherios Charitidis	GREECE (Gre)	2004	4	0	0	6	7
17	Yuseinov Ivaylo	BULGARIA (Bul)	2004	3	0	0	5	11
18	Abromavičius Arnas	LITHUANIA (Ltu)	2005	1	0	0	4	9
19	Kesiakov Ioan	BULGARIA (Bul)	2004	1	0	0	2	5
20	Artur Pik	POLAND (POL)	2005	1	0	0	2	10
21	Jegor Mossienko	ESTONIA (Est)	2004	1	0	0	1	5
22	Sevak Baghrmian	ARMENIA (Arm)	2004	0	0	0	6	6
23	Leevi Svartsjö	FINLAND (Fin)	2004	0	0	0	5	16
24	Josip Benko	CROATIA (Cro)	2005	0	0	0	0	6
25-26	Mark Szarvas	SLOVAKIA (Svk)	2004	0	0	0	0	8
25-26	Kasper Karpinen	FINLAND (Fin)	2004	0	0	0	0	8
27-28	Patric Gordan	ROMANIA (Rou)	2004	0	0	0	0	9
27-28	Aliaksandr Shvaikouski	BELARUS (Blr)	2004	0	0	0	0	9
29-30	Uros Krstin	SERBIA (Srb)	2006	0	0	0	0	10
29-30	Andrea Cremonin	ITALY (Ita)	2004	0	0	0	0	10
31	Massimo Manchia	ITALY (Ita)	2004	0	0	0	0	16



U15 European Championships - Kraków /POL/

June 27-30, 2019

INDIVIDUAL CLASSIFICATION GR

CATEGORY 75KG								
Place	Name & Surname	Country	Year of birth	CP	VT	ST	TP	TP GVN
1	Kamaludin Magomedov	RUSSIA (Rus)	2004	19	0	4	37	0
2	Joju Samadov	AZERBAIJAN (Aze)	2004	9	0	0	17	18
3	Nikoloz Shiukashvili	GEORGIA (Geo)	2004	13	0	1	21	5
3	Abubakar Khaslakhanau	BELARUS (Blr)	2004	16	0	3	40	11
5	Sait-Mukhammad Taipov	RUSSIA (Rus)	2004	12	0	3	30	19
5	Mert Çelik	TURKEY (Tur)	2004	5	0	1	12	14
7	Szinay Csaba	HUNGARY (Hun)	2004	9	1	0	14	30
8	Ivan Tsybanev	UKRAINE (Ukr)	2004	9	0	2	18	2
9	Riccardo Bufis	ITALY (Ita)	2005	5	1	0	2	19
10	Rachev Dimitar	BULGARIA (Bul)	2005	5	0	1	10	9
11	Ivan Pranchak	BELARUS (Blr)	2005	5	0	1	9	5
12	Arshak Geghamyan	ARMENIA (Arm)	2004	4	1	0	13	5
13	Ibrahim Mehraliyev	AZERBAIJAN (Aze)	2004	4	0	0	12	14
14	Andrija Mihajlovic	SERBIA (Srb)	2005	4	0	0	7	16
15	Ivan ?urcan	MOLDOVA (Mda)	2004	1	0	0	5	7
16	Aron Aun	ESTONIA (Est)	2004	1	0	0	4	7
17	Elias Lyyski	FINLAND (Fin)	2005	1	0	0	2	4
18	Gergo Szerencses	SLOVAKIA (Svk)	2004	1	0	0	2	18
19	Ponelis Paulius	LITHUANIA (Ltu)	2004	0	0	0	9	2
20-24	Mihael Salajec	CROATIA (Cro)	2004	0	0	0	0	8
20-24	Maximus Muncus	ROMANIA (Rou)	2004	0	0	0	0	8
20-24	Piotr Chelek	POLAND (POL)	2004	0	0	0	0	8
20-24	Odysseas Rouggeris	GREECE (Gre)	2004	0	0	0	0	8
20-24	Andrea Ratajczak	POLAND (POL)	2004	0	0	0	0	8
25	Naumi Gurgenidze	GEORGIA (Geo)	2004	0	0	0	0	9
26	Kyrylo Shcherbatiuk	UKRAINE (Ukr)	2004	0	0	0	0	10

CATEGORY 85KG								
Place	Name & Surname	Country	Year of birth	CP	VT	ST	TP	TP GVN
1	Nikita Maniukhin	RUSSIA (Rus)	2004	19	1	2	28	4
2	Borosi Henrik	HUNGARY (Hun)	2004	14	2	0	12	8
3	Daniil Kazlou	BELARUS (Blr)	2004	13	0	3	32	3
3	Timur Chernyshev	RUSSIA (Rus)	2004	16	0	3	32	4
5	Antonio Pascu	ROMANIA (Rou)	2004	8	1	0	15	21
5	Vladyslav Lub	UKRAINE (Ukr)	2004	12	0	3	26	17
7	Ivan Solodukha	UKRAINE (Ukr)	2005	8	0	1	16	12
8	Nurşat Taşci	TURKEY (Tur)	2004	7	0	1	15	17
9	Harutyun Kirakosyan	ARMENIA (Arm)	2004	6	1	0	14	13
10	Tommaso Virgili	ITALY (Ita)	2004	6	1	0	12	7
11	Łukasz Kłopotowski	POLAND (POL)	2004	5	1	0	7	15
12	Irakli Maisuradze	GEORGIA (Geo)	2005	3	0	0	11	15
13	Rasmus Liisma	ESTONIA (Est)	2004	3	0	0	6	10
14	Bogdan Flancea	ROMANIA (Rou)	2004	1	0	0	7	11
15	Maksim Masiukevich	BELARUS (Blr)	2004	1	0	0	5	15
16	David Molnar	SERBIA (Srb)	2004	1	0	0	2	6
17	Andrija Lubarda	SERBIA (Srb)	2005	1	0	0	2	10
18	Saba Bolkvadze	GEORGIA (Geo)	2004	0	0	0	3	7
19	Max Molochnikov	ISRAEL (Isr)	2004	0	0	0	2	6
20-21	Laszlo Szerencses	SLOVAKIA (Svk)	2004	0	0	0	2	8
20-21	Pironkov Hristomir	BULGARIA (Bul)	2004	0	0	0	2	8
22-24	Jermakov Nikita	LITHUANIA (Ltu)	2004	0	0	0	0	8
22-24	Alessandro Pucher	ITALY (Ita)	2004	0	0	0	0	8
22-24	Rafail Gkirmis	GREECE (Gre)	2004	0	0	0	0	8
25	Karol Staniewicz	POLAND (POL)	2005	0	0	0	0	10



Feuille de compétition / Competition Sheet

U15 European Championship

Style: GR

GR38



QUALIFICATION		1/8 FINALE	1/4 FINALE	1/2 FINALE	FINALE	WINNER
1	Anri Khozrevanidze (GEO)	P1 P2	1 1 2 2	GEO P1 P2 1 1	2 3 5 5	GEO P1 P2 3 2
2	Luka Javakhadze (GEO)	P1 P2	2 3 4 4	GEO P1 P2 0 4	2 0 0 0	GEO P1 P2 0 0
3	Uladzimir Kastaronak (BLR)	P1 P2	3 3 2 2	BLR P1 P2 0 2	3 1 3 3	BLR P1 P2 0 3
4	Artem Zolotov (RUS)	P1 P2	4 1 1 1	RUS P1 P2 1 0	9 1 4 4	RUS P1 P2 2 2
5	Sokratis Konstantinidis (GRE)	P1 P2	5 1 7 7	GRE P1 P2 4 3	6 0 0 0	BUL P1 P2 0 0
6	Georgiev Dimitar (BUL)	P1 P2	6 3 8 8	BUL P1 P2 8 0	9 4 9 9	RUS P1 P2 1 8
7	Maxim Sarmanov (MDA)	P1 P2	7 0 6 6	MDA P1 P2 0 0	9 4 9 9	RUS P1 P2 1 8
8	Kajetan Jakubowski (POL)	P1 P2	8 0 0 0		9 4 9 9	RUS P1 P2 1 8
9	Imam Magomadov (RUS)	P1 P2	9 4 5 4	RUS P1 P2 8 0	17 5 6 6	AZE P1 P2 2 4
10	Nikita Dementiev (UKR)	P1 P2	10 2 2 0		17 3 6 6	AZE P1 P2 0 6
11	Jakub Wach (POL)	P1 P2	11 0 0 0	12 0 0 0	EST P1 P2 0 0	
12	Juhan Kristjuhan (EST)	P1 P2	12 4 8 8		14 0 0 0	AZE P1 P2 0 0
13	Maksim Razzhalavets (BLR)	P1 P2	13 0 0 0		14 4 9 9	AZE P1 P2 0 0
14	Rahim Hasanov (AZE)	P1 P2	14 4 8 8		17 3 2 2	AZE P1 P2 1 1
15	Matej Mihalic (CRO)	P1 P2	15 0 0 0	16 0 0 0	BUL P1 P2 0 0	
16	Karnolski Radoslav (BUL)	P1 P2	16 4 9 9		17 3 2 2	AZE P1 P2 1 1
17	Farahim Mustafayev (AZE)	P1 P2	17 3 2 2		17 4 8 8	AZE P1 P2 6 2
18	Totok Peter (HUN)	P1 P2	18 1 2 2		17 3 6 6	AZE P1 P2 0 6
19	Francesco Stopponi (ITA)	P1 P2	19 0 0 0	20 5 4 4	ROU P1 P2 4 0	
20	Constantin Lungu (ROU)	P1 P2	20 4 8 8		20 3 10 10	ROU P1 P2 3 7
21	Amare Fetene (ISR)	P1 P2	21 0 0 0	22 0 4 4	ARM P1 P2 4 0	
22	Sashik Martirosyan (ARM)	P1 P2	22 4 8 8		20 0 0 0	ROU P1 P2 0 0
23	Anatolie Tincu (MDA)	P1 P2	23 1 3 3		24 0 0 0	TUR P1 P2 0 0
24	Eminoğlu Ahmet (TUR)	P1 P2	24 4 12 12		26 1 8 8	LAT P1 P2 4 4
25	Dmytro Chubenko (UKR)	P1 P2	25 0 0 0	26 4 8 8	LAT P1 P2 8 0	
26	Geikins Konstantins (LAT)	P1 P2	26 4 8 8			
						17 Farahim Mustafayev (AZE)

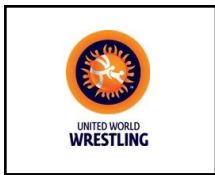

Feuille de compétition / Competition Sheet

U15 European Championship



Style: GR

GR38

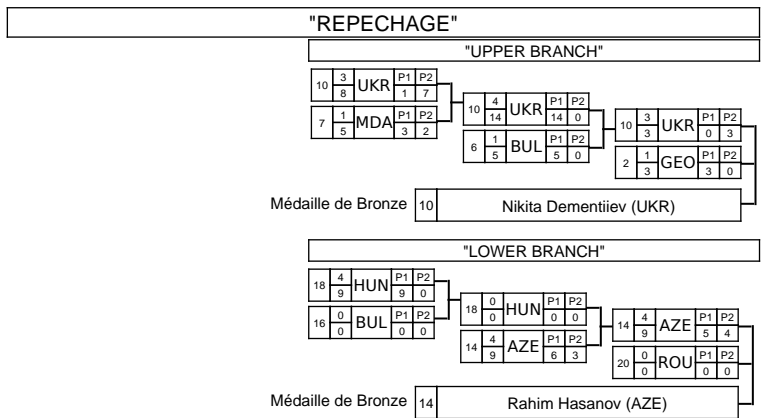

Classement		
Cl	Pays	Nom
1	AZE	Farahim Mustafayev (AZE)
2	RUS	Imam Magomadov (RUS)
3	UKR	Nikita Dementiev (UKR)
3	AZE	Rahim Hasanov (AZE)
5	ROU	Constantin Lungu (ROU)
5	GEO	Luka Javakhadze (GEO)
7	LAT	Geikins Konstantins (LAT)
8	MDA	Maxim Sarmanov (MDA)
9	HUN	Totok Peter (HUN)
10	ARM	Sashik Martirosyan (ARM)
11	TUR	Eminoğlu Ahmet (TUR)
12	BUL	Karnolski Radoslav (BUL)
13	EST	Juhan Kristjuhan (EST)
14	BUL	Georgiev Dimitar (BUL)
15	BLR	Uladzimir Kastaronak (BLR)
16	GRE	Sokratis Konstantinidis (GRE)
17	MDA	Anatolie Tincu (MDA)
18	GEO	Anri Khozrevanidze (GEO)
19	RUS	Artem Zolotov (RUS)
20	POL	Kajetan Jakubowski (POL)
21-25	POL	Jakub Wach (POL)
21-25	UKR	Dmytro Chubenko (UKR)
21-25	ITA	Francesco Stopponi (ITA)
21-25	BLR	Maksim Razzhalavets (BLR)
21-25	ISR	Amare Fetene (ISR)
26	CRO	Matej Mihalic (CRO)



Feuille de compétition / Competition Sheet

U15 European Championship

Style: GR

GR41



QUALIFICATION		1/8 FINALE	1/4 FINALE	1/2 FINALE	FINALE	WINNER
1	Adomavičius Vilius (LTU)	P1 P2	1 4 11	LTU P1 P2 4 7	1 0 0	LTU P1 P2 0 0
2	Alexandru Paniș (MDA)	P1 P2	2 1 2	MDA P1 P2 0 2	4 5 4	RUS P1 P2 4 0
3	Igor Dąbrowski (POL)	P1 P2	3 0 0	POL P1 P2 0 0	4 5 6	RUS P1 P2 6 0
4	Ibragim Khakuev (RUS)	P1 P2	4 4 9	RUS P1 P2 9 0	4 3 7	RUS P1 P2 4 3
5	Filip Mikulić (CRO)	P1 P2	5 1 2	CRO P1 P2 0 2	6 0 0	ROU P1 P2 0 0
6	Valentin Gheorghe (ROU)	P1 P2	6 3 9	ROU P1 P2 3 6	10 0 2	BUL P1 P2 2 0
7	Kacper Łukasik (POL)	P1 P2	7 0 0		8 0 0	UKR P1 P2 0 0
8	Serhii Kuznetsov (UKR)	P1 P2	8 0 0	UKR P1 P2 0 0	10 4 8	BUL P1 P2 8 0
9	Uladzislau Katsiuba (BLR)	P1 P2	9 0 0		12 1 1	BLR P1 P2 1 0
10	Kirilov Borislav (BUL)	P1 P2	10 4 11	BUL P1 P2 1 8	15 3 2	AZE P1 P2 2 0
11	Salvatore Giovanni Materia	P1 P2	11 0 0		15 4 10	AZE P1 P2 6 4
12	Mikita Tsiarokhin (BLR)	P1 P2	12 4 8	BLR P1 P2 1 0	15 1 3	AZE P1 P2 0 3
13	Itay Serebnik (ISR)	P1 P2	13 0 0		17 1 4	TUR P1 P2 4 0
14	Davyd Chulkovskiy (UKR)	P1 P2	14 0 0		18 1 2	GEO P1 P2 2 0
15	Parviz Dadashov (AZE)	P1 P2	15 4 8	AZE P1 P2 6 4	18 3 10	GEO P1 P2 2 8
16	Zelan Pek (SRB)	P1 P2	16 0 1		20 3 5	AZE P1 P2 0 5
17	Keskin Abdullah (TUR)	P1 P2	17 5 10	TUR P1 P2 4 0	20 0 2	AZE P1 P2 2 0
18	Mishiko Aleksandria (GEO)	P1 P2	18 4 9	GEO P1 P2 5 4	22 1 1	ARM P1 P2 1 0
19	Czuczor Dominik (HUN)	P1 P2	19 1 1		26 3 5	RUS P1 P2 1 4
20	Mahammad Qasimzada (AZE)	P1 P2	20 5 4	AZE P1 P2 4 0	26 1 2	RUS P1 P2 0 2
21	Suren Movsisyan (ARM)	P1 P2	21 0 1		26 5 3	RUS P1 P2 3 0
22	Hayk Lyudvigyan (ARM)	P1 P2	22 4 8	ARM P1 P2 1 0		
23	Daniel Berkec (SRB)	P1 P2	23 0 0			
24	Dimitrov Vili (BUL)	P1 P2	24 0 0	GEO P1 P2 0 0		
25	Luka Bendeliani (GEO)	P1 P2	25 4 9	GEO P1 P2 9 0		
26	Bilal Bersanukaev (RUS)	P1 P2	26 3 9	RUS P1 P2 7 2		
27	Dimitrios Papavasileiou (GRE)	P1 P2	27 1 2	RUS P1 P2 3 5		
						4 Ibragim Khakuev (RUS)

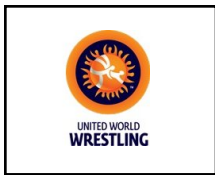

Feuille de compétition / Competition Sheet

U15 European Championship



Style: GR

GR41

"REPECHAGE"

"UPPER BRANCH"

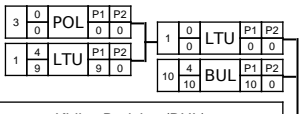

Médaille de Bronze 10 Kirilov Borislav (BUL)

"LOWER BRANCH"

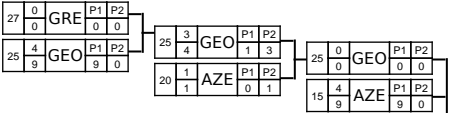

Médaille de Bronze 15 Parviz Dadashov (AZE)

Classement

Cl	Pays	Nom
1	RUS	Ibragim Khakuev (RUS)
2	RUS	Bilal Bersanukaev (RUS)
3	AZE	Parviz Dadashov (AZE)
3	BUL	Kirilov Borislav (BUL)
5	GEO	Luka Bendeliani (GEO)
5	LTU	Adomavičius Vilius (LTU)
7	AZE	Mahammad Qasimzada (AZE)
8	GEO	Mishiko Aleksandria (GEO)
9	TUR	Keskin Abdullah (TUR)
10	ROU	Valentin Gheorghe (ROU)
11	UKR	Serhii Kuznetsov (UKR)
12	ARM	Hayk Lyudvigyan (ARM)
13	BLR	Mikita Tsiarokhin (BLR)
14	CRO	Filip Mikulić (CRO)
15	MDA	Alexandru Paniș (MDA)
16	GRE	Dimitrios Papavasileiou (GRE)
17	HUN	Czuczor Dominik (HUN)
18	ARM	Suren Movsisyan (ARM)
19	SRB	Zelan Pek (SRB)
20	BLR	Uladzislau Katsiuba (BLR)
21	POL	Kacper Łukasik (POL)
22-24	SRB	Daniel Berkec (SRB)
22-24	ISR	Itay Serebnik (ISR)
22-24	UKR	Davyd Chulkovskyi (UKR)
25	BUL	Dimitrov Vili (BUL)
26	ITA	Salvatore Giovanni Materia (ITA)
27	POL	Igor Dąbrowski (POL)



Feuille de compétition / Competition Sheet

U15 European Championship

Style: GR

GR44

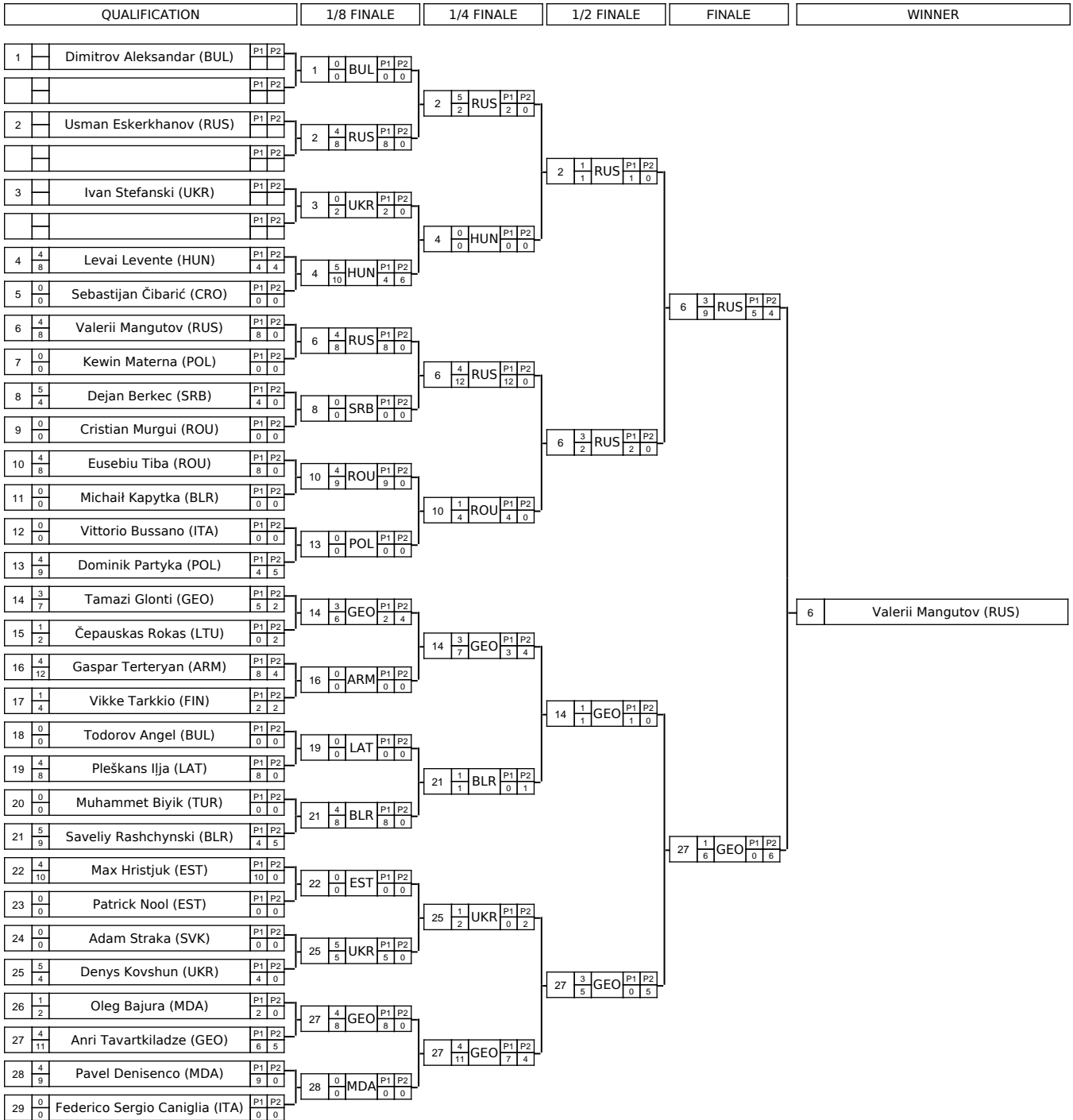

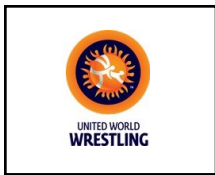

Feuille de compétition / Competition Sheet

U15 European Championship



Style: GR

GR44

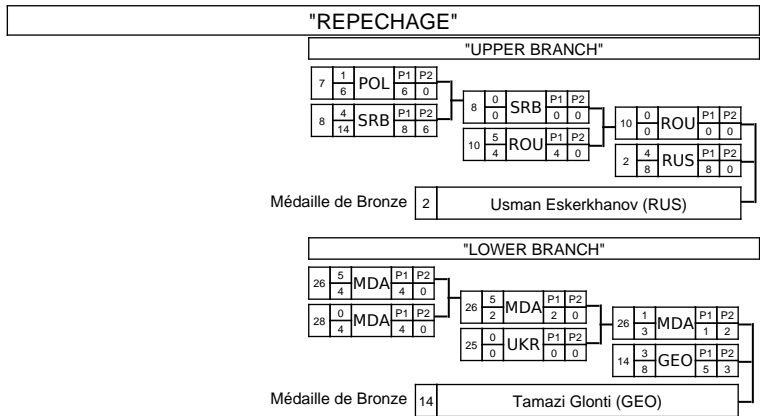

Classement		
Cl	Pays	Nom
1	RUS	Valerii Mangutov (RUS)
2	GEO	Anri Tavartkiladze (GEO)
3	RUS	Usman Eskerkhanov (RUS)
3	GEO	Tamazi Glonti (GEO)
5	ROU	Eusebiu Tiba (ROU)
5	MDA	Oleg Bajura (MDA)
7	UKR	Denys Kovshun (UKR)
8	BLR	Savelyi Rashchynski (BLR)
9	HUN	Levai Levente (HUN)
10	SRB	Dejan Berkec (SRB)
11	MDA	Pavel Denisenco (MDA)
12	ARM	Gaspar Terteryan (ARM)
13	EST	Max Hristjuk (EST)
14	POL	Dominik Partyka (POL)
15	LAT	Pleškans Ilja (LAT)
16	POL	Kewin Materna (POL)
17	FIN	Vikke Tarkkio (FIN)
18	LTU	Cepauskas Rokas (LTU)
19	UKR	Ivan Stefanski (UKR)
20-21	ROU	Cristian Murgui (ROU)
20-21	SVK	Adam Straka (SVK)
22-25	BLR	Michail Kapytka (BLR)
22-25	CRO	Sebastijan Čibarić (CRO)
22-25	BUL	Todorov Angel (BUL)
22-25	BUL	Dimitrov Aleksandar (BUL)
26-28	ITA	Federico Sergio Caniglia (ITA)
26-28	ITA	Vittorio Bussano (ITA)
26-28	TUR	Muhammet Bijik (TUR)
29	EST	Patrick Nool (EST)



Feuille de compétition / Competition Sheet

U15 European Championship

Style: GR

48



QUALIFICATION		1/8 FINALE	1/4 FINALE	1/2 FINALE	FINALE	WINNER
1	Tavakgul Haziyeu (AZE)	P1 P2	1 4 8 AZE P1 P2 8 0	1 3 6 AZE P1 P2 4 2	1 5 4 AZE P1 P2 4 0	1 Tavakgul Haziyeu (AZE)
2	Erik Shevchenko (UKR)	P1 P2	2 0 0 UKR P1 P2 0 0			
3	Antonio Lukač (CRO)	P1 P2	3 1 1 CRO P1 P2 1 0	4 1 2 ARM P1 P2 0 2		
4	Ashot Manukyan (ARM)	P1 P2	4 0 2 ARM P1 P2 8 2			
5	Illia Valeuski (BLR)	P1 P2	5 1 0 BLR P1 P2 5 0			
6	Kostov Ivan (BUL)	P1 P2	6 5 0 BUL P1 P2 1 1	8 0 0 ARM P1 P2 0 0		
7	Piotr Zubelewicz (POL)	P1 P2	7 0 0 POL P1 P2 0 0			
8	Artush Aleksanyan (ARM)	P1 P2	8 4 8 ARM P1 P2 2 8			
9	Trăian Andronachi (MDA)	P1 P2	9 1 5 MDA P1 P2 3 2	11 0 0 GEO P1 P2 0 0		
10	Puikis Kipras (LTU)	P1 P2	10 0 0 LTU P1 P2 0 0			
11	Valeri Titberidze (GEO)	P1 P2	11 5 8 GEO P1 P2 8 0			
12	Botos Dominik (HUN)	P1 P2	12 3 8 HUN P1 P2 1 7			
13	Mykhailo Kutsenko (UKR)	P1 P2	13 1 5 UKR P1 P2 2 3			
14	Berat Keskin (TUR)	P1 P2	14 4 8 TUR P1 P2 1 0			
15	Viachaslau Zhehalau (BLR)	P1 P2	15 0 0 BLR P1 P2 0 0	16 1 3 AZE P1 P2 0 3		
16	Balagha Mikailzada (AZE)	P1 P2	16 5 10 AZE P1 P2 4 6			
17	Piotr Skalik (POL)	P1 P2	17 0 0 POL P1 P2 0 0	19 3 3 GEO P1 P2 1 2		
18	Fedayi Murat Aydin (TUR)	P1 P2	18 1 5 TUR P1 P2 3 2			
19	Tornike Shainidze (GEO)	P1 P2	19 3 3 GEO P1 P2 1 2			
20	Dzhanakai Dzhamakov (RUS)	P1 P2	20 3 10 RUS P1 P2 2 0			
21	Dermendzhiev Stilyan (BUL)	P1 P2	21 0 0 BUL P1 P2 0 0			
22	Elia Caresia (ITA)	P1 P2	22 0 14 ITA P1 P2 8 6			
23	Vasile Zabica (MDA)	P1 P2	23 5 21 MDA P1 P2 7 14			
24	Renato Osmanović (CRO)	P1 P2	24 5 5 CRO P1 P2 5 0			
25	Travins Nikita (LAT)	P1 P2	25 0 2 LAT P1 P2 2 0	26 1 2 RUS P1 P2 0 2		
26	Aleksandr Tugarev (RUS)	P1 P2	26 4 9 RUS P1 P2 8 0			
27	Iulian Lungu (ROU)	P1 P2	27 0 0 ROU P1 P2 0 0			
28	Mate Toth (SVK)	P1 P2	28 1 2 SVK P1 P2 2 0			
29	Rainer Plaser (EST)	P1 P2	29 4 11 EST P1 P2 8 2			



Feuille de compétition / Competition Sheet

U15 European Championship



Style: GR

48

"REPECHAGE"

"UPPER BRANCH"

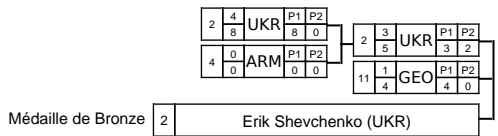

"LOWER BRANCH"

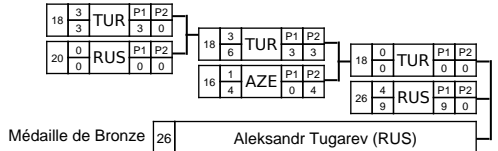

Classement

Cl	Pays	Nom
1	AZE	Tavakgul HaziyeV (AZE)
2	GEO	Tornike Shainidze (GEO)
3	UKR	Erik Shevchenko (UKR)
3	RUS	Aleksandr Tugarev (RUS)
5	GEO	Valeri Titberidze (GEO)
5	TUR	Fedayi Murat Aydin (TUR)
7	CRO	Renato Osmanović (CRO)
8	ARM	Ashot Manukyan (ARM)
9	AZE	Balagha Mikailzada (AZE)
10	ARM	Artush Aleksanyan (ARM)
11	RUS	Dzhanakai Dzhamukov (RUS)
12	BUL	Kostov Ivan (BUL)
13	MDA	Vasile Zabica (MDA)
14	TUR	Berat Keskin (TUR)
15	EST	Rainer Plaser (EST)
16	HUN	Botos Dominik (HUN)
17	UKR	Mykhailo Kutsenko (UKR)
18	MDA	Trăian Andronachi (MDA)
19	SVK	Mate Toth (SVK)
20	CRO	Antonio Lukač (CRO)
21	ITA	Elia Caresia (ITA)
22	LAT	Travins Nikita (LAT)
23	BLR	Iliia Vaieuski (BLR)
24	POL	Piotr Zubelewicz (POL)
25-26	BLR	Viasaslau Zhehalau (BLR)
25-26	LTU	Puikis Kipras (LTU)
27	ROU	Iulian Lungu (ROU)
28-29	BUL	Dermendzhiev Stilyan (BUL)
28-29	POL	Piotr Skalik (POL)



Feuille de compétition / Competition Sheet

U15 European Championship



Style: GR

52

QUALIFICATION				1/16 FINALE				1/8 FINALE			
1		Henrik Gevorgyan (ARM)	P1 P2	1	4	ARM	P1 P2	1	1	ARM	P1 P2
			P1 P2		8		4 4		1		0 1
2		Mihael Lukač (CRO)	P1 P2	2	0	CRO	P1 P2				
			P1 P2		0		0 0				
3		Alibek Amirov (RUS)	P1 P2	3	4	RUS	P1 P2	3	3	RUS	P1 P2
			P1 P2		9		9 0		3		1 2
4		Angelov Albert (BUL)	P1 P2	4	0	BUL	P1 P2				
			P1 P2		0		0 0				
5		Alex Kettmaier (ITA)	P1 P2	5	0	ITA	P1 P2	6	0	MDA	P1 P2
			P1 P2		0		0 0		0		0 0
6		Vladimir Pascari (MDA)	P1 P2	6	4	MDA	P1 P2				
			P1 P2		8		8 0				
7		Rafał Wangin (POL)	P1 P2	7	0	POL	P1 P2	8	4	HUN	P1 P2
			P1 P2		0		0 0		9		9 0
8		Takacs Zsolt (HUN)	P1 P2	8	4	HUN	P1 P2				
			P1 P2		8		8 0				
9		Berati İnaç (TUR)	P1 P2	9	5	TUR	P1 P2	9	3	TUR	P1 P2
			P1 P2		4		4 0		12		6 6
10		Martin Belusik (SVK)	P1 P2	10	0	SVK	P1 P2				
			P1 P2		0		0 0				
11		Artem Iskenderov (UKR)	P1 P2	11	4	UKR	P1 P2	11	1	UKR	P1 P2
			P1 P2		8		8 0		8		8 0
12		Mitev Borislav (BUL)	P1 P2	12	0	BUL	P1 P2				
			P1 P2		0		0 0				
13		Felix Dediu (ROU)	P1 P2	13	0	ROU	P1 P2	14	4	TUR	P1 P2
			P1 P2		0		0 0		8		8 0
14		Mahmut Yılmaz (TUR)	P1 P2	14	4	TUR	P1 P2				
			P1 P2		8		8 0				
15		Serhii Prytuliak (UKR)	P1 P2	15	4	UKR	P1 P2	15	0	UKR	P1 P2
			P1 P2		8		8 0		0		0 0
16		Nikodem Zawadzki (POL)	P1 P2	16	0	POL	P1 P2				
			P1 P2		0		0 0				
17		Davide Gasperini (ITA)	P1 P2	17	0	ITA	P1 P2	18	5	EST	P1 P2
			P1 P2		0		0 0		4		4 0
18		Artur Jeremejev (EST)	P1 P2	18	5	EST	P1 P2				
			P1 P2		3		3 0				
19		Antal Vamos (SRB)	P1 P2	19	3	SRB	P1 P2	19	0	SRB	P1 P2
			P1 P2		3		3 0		0		0 0
20		Polykarpos Angelos Patouchas	P1 P2	20	0	GRE	P1 P2				
			P1 P2		0		0 0				
21		Magomed İarbilov (RUS)	P1 P2	21	4	RUS	P1 P2	21	4	RUS	P1 P2
			P1 P2		8		8 0		8		8 0
22		Mihai Dragan (ROU)	P1 P2	22	0	ROU	P1 P2				
			P1 P2		0		0 0				
23		Vrublevskij Modestas (LTU)	P1 P2	23	5	LTU	P1 P2	23	0	LTU	P1 P2
			P1 P2		4		4 0		0		0 0
24		Artur Borş (MDA)	P1 P2	24	0	MDA	P1 P2				
			P1 P2		0		0 0				
25		Linus Häusle (AUT)	P1 P2	25	0	AUT	P1 P2	26	0	AZE	P1 P2
			P1 P2		0		0 0		0		0 0
26		Farid Mammadov (AZE)	P1 P2	26	4	AZE	P1 P2				
			P1 P2		9		9 0				
27		Farid Khalilov (AZE)	P1 P2	27	4	AZE	P1 P2	27	3	AZE	P1 P2
			P1 P2		10		10 0		5		5 0
28		Oskari Talala (FIN)	P1 P2	28	1	FIN	P1 P2				
			P1 P2		2		2 0				
29		Rati Khozrevanidze (GEO)	P1 P2	29	4	GEO	P1 P2	29	3	GEO	P1 P2
			P1 P2		9		9 0		5		1 4
30		Aliaksei Shymanovich (BLR)	P1 P2	30	0	BLR	P1 P2				
			P1 P2		0		0 0				
31		Ramin İremadze (GEO)	P1 P2	31	4	GEO	P1 P2	31	0	GEO	P1 P2
			P1 P2		10		10 0		0		0 0
32	1	Matej Rebić (CRO)	P1 P2								
	3		P1 P2								
33	3	Abdulmasih Abdulmasih (BLR)	P1 P2	33	1	BLR	P1 P2				
	9		P1 P2		1		1 0				



Feuille de compétition / Competition Sheet

U15 European Championship

Style: GR

52



"REPECHAGE"

"UPPER BRANCH"

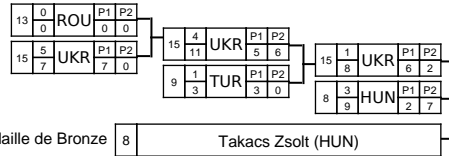

"LOWER BRANCH"

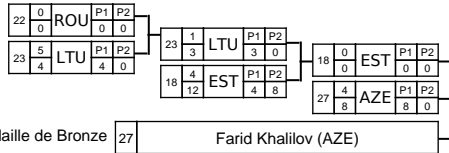

Classement

Cl	Pays	Nom
1	RUS	Magomed Iarbilov (RUS)
2	TUR	Mahmut Yilmaz (TUR)
3	AZE	Farid Khalilov (AZE)
3	HUN	Takacs Zsolt (HUN)
5	UKR	Serhii Prytuliak (UKR)
5	EST	Artur Jeremejev (EST)
7	LTU	Vrublevskij Modestas (LTU)
8	TUR	Berati Inaç (TUR)
9	GEO	Rati Khozrevanidze (GEO)
10	RUS	Alibek Amirov (RUS)
11	UKR	Artem Iskenderov (UKR)
12	ARM	Henrik Gevorgyan (ARM)
13	GEO	Ramin Iremadze (GEO)
14	AZE	Farid Mammadov (AZE)
15	MDA	Vladimir Pascari (MDA)
16	BLR	Abdulmasih Abdulmasih (BLR)
17	SRB	Antal Vámos (SRB)
18	CRO	Matej Rebić (CRO)
19	FIN	Oskari Talala (FIN)
20-21	ITA	Davide Gasperini (ITA)
20-21	GRE	Polykarpos Angelos Patouchas (GRE)
22-23	SVK	Martin Belusik (SVK)
22-23	MDA	Artur Borş (MDA)
24-28	CRO	Mihael Lukač (CRO)
24-28	POL	Nikodem Zawadzki (POL)
24-28	ITA	Alex Kettmaier (ITA)
24-28	BUL	Mitev Borislav (BUL)
24-28	POL	Rafal Wangin (POL)
29-31	BUL	Angelov Albert (BUL)
29-31	BLR	Aliaksei Shymanovich (BLR)
29-31	AUT	Linus Häusle (AUT)
32	ROU	Mihai Dragan (ROU)
33	ROU	Felix Dediu (ROU)



Feuille de compétition / Competition Sheet

U15 European Championship

Style: GR

57



QUALIFICATION		1/8 FINALE	1/4 FINALE	1/2 FINALE	FINALE	WINNER
1	Davud Mammadov (AZE)	P1 P2 5 7	1 3 7 7	AZE P1 P2 7 0	1 0 0 0	
2	Anton Klymentov (UKR)	P1 P2 5 7	2 1 1 1	UKR P1 P2 0 1	3 0 0 0	
3	Imed Khudzhadze (UKR)	P1 P2 5 7	3 4 10 6	UKR P1 P2 6 4	3 3 5 1	
4	Luka Ivančić (CRO)	P1 P2 5 7	4 1 1 1	CRO P1 P2 0 1	12 3 2 2	
5	Zakhar Martsinkevich (BLR)	P1 P2 0 0	6 5 6 5	GRE P1 P2 3 3	6 1 1 0	
6	Georgios Athanasiou (GRE)	P1 P2 5 5	7 0 1 5	ROU P1 P2 2 0	12 5 5 5	
7	Teodor Cosma (ROU)	P1 P2 1 5	8 1 2 2	SRB P1 P2 2 0	12 4 9 9	
8	Milos Perovic (SRB)	P1 P2 0 2	9 1 4 0	GEO P1 P2 6 1	12 3 10 6	
9	Temuri Orjonikidze (GEO)	P1 P2 4 0	10 0 0 0	ROU P1 P2 0 0	15 4 8 8	
10	Alexandru Ionescu (ROU)	P1 P2 0 0	11 0 0 0	BLR P1 P2 0 0	18 3 3 3	
11	Uladzislau Nemera (BLR)	P1 P2 0 0	12 4 9 9	TUR P1 P2 6 4	18 4 9 5	
12	Alperen Berber (TUR)	P1 P2 9 0	13 1 3 0	BUL P1 P2 3 0	18 1 1 1	
13	Mladenov Pavel (BUL)	P1 P2 3 0	14 4 12 12	POL P1 P2 12 0	24 3 7 5	
14	Oskar Wawrzyszyn (POL)	P1 P2 12 0	15 4 8 8	GEO P1 P2 8 0	24 0 0 0	
15	Giorgi Vertashvili (GEO)	P1 P2 8 0	16 0 0 0	LTU P1 P2 0 0	25 3 3 3	
16	Gvozdias Kipras (LTU)	P1 P2 0 0	17 3 8 8	RUS P1 P2 2 6	25 0 0 0	
17	Asipauskas Nojus (LTU)	P1 P2 0 0	18 4 9 9	RUS P1 P2 5 4	28 1 3 3	
18	Abdula Salimov (RUS)	P1 P2 9 0	19 4 8 8	MDA P1 P2 1 2		
19	Stanislav Stoianov (MDA)	P1 P2 8 0	20 0 0 0	BUL P1 P2 1 2		
20	Nyamov Hristo (BUL)	P1 P2 0 0	21 4 9 9	ARM P1 P2 1 0		
21	Hakob Karapetyan (ARM)	P1 P2 9 0	22 0 0 0	POL P1 P2 0 0		
22	Filip Loch (POL)	P1 P2 0 0	23 1 1 1	Fizuli Abbasov (AZE) P1 P2 0 1		
23	Fizuli Abbasov (AZE)	P1 P2 0 1	24 3 3 3	Ilias Zinnurov (RUS) P1 P2 1 2		
24	Ilias Zinnurov (RUS)	P1 P2 1 2	25 3 6 4	Junior Mac Donald (NED) P1 P2 4 2		
25	Junior Mac Donald (NED)	P1 P2 4 2	26 0 0 0	Georgios Papageorgiou (GRE) P1 P2 0 0		
26	Georgios Papageorgiou (GRE)	P1 P2 0 0	27 0 0 0	Alessandro Grespi (ITA) P1 P2 0 0		
27	Alessandro Grespi (ITA)	P1 P2 0 0	28 5 9 5	Kovacs Oliver (HUN) P1 P2 5 4		
28	Kovacs Oliver (HUN)	P1 P2 5 4				
					12	Alperen Berber (TUR)



Feuille de compétition / Competition Sheet

U15 European Championship

Style: GR

57



"REPECHAGE"

"UPPER BRANCH"

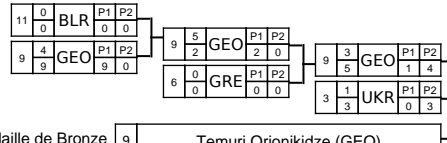

Médaille de Bronze 9 Temuri Orjonikidze (GEO)

"LOWER BRANCH"

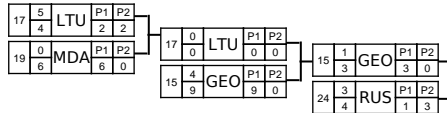

Médaille de Bronze 24 Ilias Zinnurov (RUS)

Classement

Cl	Pays	Nom
1	TUR	Alperen Berber (TUR)
2	RUS	Abdula Salimov (RUS)
3	GEO	Temuri Orjonikidze (GEO)
3	RUS	Ilias Zinnurov (RUS)
5	GEO	Giorgi Vertashvili (GEO)
5	UKR	Imed Khudzhadze (UKR)
7	GRE	Georgios Athanasiou (GRE)
8	HUN	Kovacs Oliver (HUN)
9	NED	Junior Mac Donald (NED)
10	LTU	Asipauskas Nojus (LTU)
11	MDA	Stanislav Stoianov (MDA)
12	ARM	Hakob Karapetyan (ARM)
13	POL	Oskar Wawrzyszyn (POL)
14	ROU	Teodor Cosma (ROU)
15	AZE	Davud Mammadov (AZE)
16	BUL	Mladenov Pavel (BUL)
17	SRB	Milos Perovic (SRB)
18	AZE	Fizuli Abbasov (AZE)
19	UKR	Anton Klymentov (UKR)
20	CRO	Luka Ivančić (CRO)
21	ROU	Alexandru Ionescu (ROU)
22	BLR	Zakhar Martsinkevich (BLR)
23	GRE	Georgios Papageorgiou (GRE)
24-25	LTU	Gvozdas Kipras (LTU)
24-25	BUL	Nyamov Hristo (BUL)
26-27	POL	Filip Loch (POL)
26-27	ITA	Alessandro Grespi (ITA)
28	BLR	Uladzislau Nemera (BLR)



Feuille de compétition / Competition Sheet

U15 European Championship

Style: GR

62



"REPECHAGE"

"UPPER BRANCH"

4	0	BUL	P1	P2		
4	4		4	0		
5	5	ITA	P1	P2		
5	12		6	6		
5	3	ITA	P1	P2		
10	4		4	6		
2	1	MDA	P1	P2		
5	2		2	3		
5	0	ITA	P1	P2		
0	0		0	0		
13	5	BEL	P1	P2		
4	0		4	0		

Médaille de Bronze 13 Ibrahim Tabaev (BEL)

"LOWER BRANCH"

26	3	MDA	P1	P2		
7	7		7	0		
23	0	BLR	P1	P2		
0	0		0	0		
26	3	MDA	P1	P2		
3	3		3	0		
28	1	LTU	P1	P2		
2	0		0	2		
26	0	MDA	P1	P2		
0	0		0	0		
18	4	TUR	P1	P2		
8	8		8	0		

Médaille de Bronze 18 Nihat Kara (TUR)

Classement

Cl	Pays	Nom
1	GEO	Achiko Bolkvadze (GEO)
2	RUS	Tural Bairamov (RUS)
3	TUR	Nihat Kara (TUR)
3	BEL	Ibrahim Tabaev (BEL)
5	ITA	Davide Zilio (ITA)
5	MDA	Valentin Pascaru (MDA)
7	LTU	Mickevicius Benas (LTU)
8	AZE	Kanan Abdullazada (AZE)
9	UKR	Mykyta Khokhlachov (UKR)
10	GEO	Tornike Mikeladze (GEO)
11	MDA	Vladislav Stoianov (MDA)
12	ARM	Arman Melkonyan (ARM)
13	UKR	Artem Khutko (UKR)
14	BLR	Yahor Novikau (BLR)
15	AZE	Hasan Aliyev (AZE)
16	BLR	Uladzislau Dubrouski (BLR)
17	ROU	Alexandru Romaniuc (ROU)
18	BUL	Darkev Dobrin (BUL)
19	ROU	Lucian Cosma (ROU)
20	CRO	Dominik Djok (CRO)
21	GRE	Alexandros Batzakidis (GRE)
22	ITA	Riccardo Crimi (ITA)
23	GRE	Dimitrios Papakostas (GRE)
24-27	POL	Nikodem Godun (POL)
24-27	BUL	Atanasov Andrey (BUL)
24-27	HUN	Bodo Levente (HUN)
24-27	POL	Cyprian Kowalik (POL)
28-30	EST	Robin Samarüütel (EST)
28-30	SRB	Miljan Rajic (SRB)
28-30	LTU	Knystautas Giedrius (LTU)



Feuille de compétition / Competition Sheet

U15 European Championship

Style: GR

68



QUALIFICATION		1/8 FINALE	1/4 FINALE	1/2 FINALE	FINALE	WINNER
1	Mihai Guțu (MDA)	P1 P2 4 12	MDA P1 P2 5 7	1 0 MDA P1 P2 0 0	7 3 MDA P1 P2 8 2	24 Luka Gelashvili (GEO)
2	Artur Pik (POL)	P1 P2 2 0	3 1 SRB P1 P2 4 4	7 3 MDA P1 P2 3 0	7 1 MDA P1 P2 1 0	
3	Nemanja Kimoski (SRB)	P1 P2 8 2	4 0 POL P1 P2 3 6	7 3 MDA P1 P2 3 0	8 1 HUN P1 P2 1 0	
4	Bartłomiej Myjak (POL)	P1 P2 3 6	8 4 HUN P1 P2 9 2	8 3 HUN P1 P2 4 4	8 1 HUN P1 P2 1 0	
5	Abromavičius Arnas (LTU)	P1 P2 4 0	10 0 BUL P1 P2 0 0	14 1 UKR P1 P2 3 0	22 1 RUS P1 P2 1 0	
6	Massimo Manchia (ITA)	P1 P2 0 0	12 1 GRE P1 P2 1 4	14 3 UKR P1 P2 6 0	22 5 RUS P1 P2 4 0	
7	Alexandru Solovei (MDA)	P1 P2 8 0	14 3 UKR P1 P2 6 6	22 3 RUS P1 P2 13 6	24 3 GEO P1 P2 5 5	
8	Kis Krisztian (HUN)	P1 P2 4 2	17 0 UKR P1 P2 0 0	18 0 GEO P1 P2 5 0	24 4 GEO P1 P2 8 0	
9	Sevak Baghrmryan (ARM)	P1 P2 2 4	18 4 UKR P1 P2 9 0	22 1 RUS P1 P2 1 0	27 0 BLR P1 P2 0 0	
10	Yuseinov Ivaylo (BUL)	P1 P2 4 1	18 8 UKR P1 P2 0 0	22 4 RUS P1 P2 8 0	27 4 BLR P1 P2 6 4	
11	Kesiakov Ioan (BUL)	P1 P2 2 0	20 1 RUS P1 P2 8 2	22 5 RUS P1 P2 4 0	29 0 ROU P1 P2 0 0	
12	Eleftherios Charitidis (GRE)	P1 P2 1 4	20 3 RUS P1 P2 13 6	24 3 GEO P1 P2 2 0	29 5 ROU P1 P2 6 2	
13	Jegor Mossienko (EST)	P1 P2 0 1	24 4 UKR P1 P2 8 0	24 8 GEO P1 P2 0 0	31 0 TUR P1 P2 4 4	
14	Ramazan Pashaiev (UKR)	P1 P2 8 0	24 8 UKR P1 P2 0 0	24 3 GEO P1 P2 2 0	31 5 TUR P1 P2 16 0	
15	Mark Szarvas (SVK)	P1 P2 0 0	24 8 UKR P1 P2 0 0	24 3 GEO P1 P2 2 0		
16	Josip Benko (CRO)	P1 P2 0 0	24 8 UKR P1 P2 0 0	24 3 GEO P1 P2 2 0		
17	Danylo Zahynailo (UKR)	P1 P2 6 0	24 8 UKR P1 P2 0 0	24 3 GEO P1 P2 2 0		
18	Nodari Abramishvili (GEO)	P1 P2 9 0	24 8 UKR P1 P2 0 0	24 3 GEO P1 P2 2 0		
19	Aliaksandr Shvaikouski (BLR)	P1 P2 0 0	24 8 UKR P1 P2 0 0	24 3 GEO P1 P2 2 0		
20	Ilia Sorokin (RUS)	P1 P2 10 0	24 8 UKR P1 P2 0 0	24 3 GEO P1 P2 2 0		
21	Uros Krstin (SRB)	P1 P2 0 0	24 8 UKR P1 P2 0 0	24 3 GEO P1 P2 2 0		
22	Islam Zaurav (RUS)	P1 P2 8 0	24 8 UKR P1 P2 0 0	24 3 GEO P1 P2 2 0		
23	Kasper Karppinen (FIN)	P1 P2 0 0	24 8 UKR P1 P2 0 0	24 3 GEO P1 P2 2 0		
24	Luka Gelashvili (GEO)	P1 P2 10 0	24 8 UKR P1 P2 0 0	24 3 GEO P1 P2 2 0		
25	Bižņa Sergejs (LAT)	P1 P2 0 0	24 8 UKR P1 P2 0 0	24 3 GEO P1 P2 2 0		
26	Andrea Cremonin (ITA)	P1 P2 0 0	24 8 UKR P1 P2 0 0	24 3 GEO P1 P2 2 0		
27	Ivan Harnastayeu (BLR)	P1 P2 6 4	24 8 UKR P1 P2 0 0	24 3 GEO P1 P2 2 0		
28	Patric Gordan (ROU)	P1 P2 0 0	24 8 UKR P1 P2 0 0	24 3 GEO P1 P2 2 0		
29	Florin Manolache (ROU)	P1 P2 9 0	24 8 UKR P1 P2 0 0	24 3 GEO P1 P2 2 0		
30	Leevi Svartsjö (FIN)	P1 P2 5 0	24 8 UKR P1 P2 0 0	24 3 GEO P1 P2 2 0		
31	Toygun Aktop (TUR)	P1 P2 16 0	24 8 UKR P1 P2 0 0	24 3 GEO P1 P2 2 0		



Feuille de compétition / Competition Sheet

U15 European Championship

Style: GR

68



"REPECHAGE"

"UPPER BRANCH"

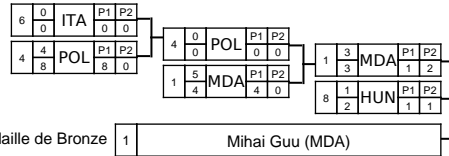

"LOWER BRANCH"

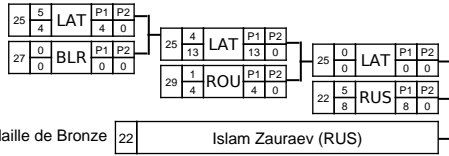

Classement

Cl	Pays	Nom
1	GEO	Luka Gelashvili (GEO)
2	MDA	Alexandru Solovei (MDA)
3	RUS	Islam Zaurav (RUS)
3	MDA	Mihai Guu (MDA)
5	LAT	Bižņa Sergejs (LAT)
5	HUN	Kis Krisztian (HUN)
7	ROU	Florin Manolache (ROU)
8	GEO	Nodari Abramishvili (GEO)
9	UKR	Ramazan Pashaiev (UKR)
10	POL	Bartłomiej Myjak (POL)
11	RUS	Iliia Sorokin (RUS)
12	TUR	Toygun Aktop (TUR)
13	UKR	Danylo Zahynailo (UKR)
14	SRB	Nemanja Kimoski (SRB)
15	BLR	Ivan Harnastayeu (BLR)
16	GRE	Eleftherios Charitidis (GRE)
17	BUL	Yuseinov Ivaylo (BUL)
18	LTU	Abromavičius Arnas (LTU)
19	BUL	Kesiakov Ioan (BUL)
20	POL	Artur Pik (POL)
21	EST	Jegor Mossienko (EST)
22	ARM	Sevak Baghramyan (ARM)
23	FIN	Leevi Svartsjö (FIN)
24	CRO	Josip Benko (CRO)
25-26	SVK	Mark Szarvas (SVK)
25-26	FIN	Kasper Karppinen (FIN)
27-28	ROU	Patric Gordan (ROU)
27-28	BLR	Aliaksandr Shvaikouski (BLR)
29-30	SRB	Uros Krstin (SRB)
29-30	ITA	Andrea Cremonin (ITA)
31	ITA	Massimo Manchia (ITA)



Feuille de compétition / Competition Sheet

U15 European Championship

Style: GR

75



QUALIFICATION		1/8 FINALE	1/4 FINALE	1/2 FINALE	FINALE	WINNER
1	Mert Çelik (TUR)	P1 P2	1 1 3 3	TUR P1 P2 1 2	2 3 5 5	AZE P1 P2 5 0
2	Joju Samadov (AZE)	P1 P2	2 3 6 6	AZE P1 P2 0 6	2 3 6 6	AZE P1 P2 5 1
3	Elias Lyyski (FIN)	P1 P2	3 1 2 2	FIN P1 P2 1 1	4 1 3 3	SRB P1 P2 0 3
4	Andrija Mihajlovic (SRB)	P1 P2	4 3 4 4	SRB P1 P2 0 4	2 0 0 0	AZE P1 P2 0 0
5	Ponelis Paulius (LTU)	P1 P2	5 0 9 9	LTU P1 P2 9 0	6 0 0 0	ITA P1 P2 0 0
6	Riccardo Bufis (ITA)	P1 P2	6 5 2 2	ITA P1 P2 2 0	8 1 4 4	BLR P1 P2 3 1
7	Odysseas Rouggeris (GRE)	P1 P2	8 3 0 0	BLR P1 P2 1 9	8 4 10 10	BLR P1 P2 10 0
8	Abubakar Khaslakhanau (BLR)	P1 P2	8 4 4 4	BLR P1 P2 10 0	9 1 5 5	AZE P1 P2 3 2
9	Ibrahim Mehraliyev (AZE)	P1 P2	9 3 7 7	AZE P1 P2 3 2	11 1 5 3	MDA P1 P2 2 3
10	Aron Aun (EST)	P1 P2	10 1 4 4	MDA P1 P2 2 3	12 3 7 7	HUN P1 P2 1 6
11	Ivan Tırcan (MDA)	P1 P2	11 1 5 5	HUN P1 P2 5 0	14 0 5 0	ARM P1 P2 5 0
12	Szinay Csaba (HUN)	P1 P2	12 3 7 7	HUN P1 P2 0 0	16 3 3 3	RUS P1 P2 1 2
13	Piotr Chełek (POL)	P1 P2	13 0 0 0	ARM P1 P2 5 0	16 4 8 8	RUS P1 P2 8 0
14	Arshak Geghamyan (ARM)	P1 P2	14 4 8 8	ARM P1 P2 5 0	18 0 0 0	RUS P1 P2 0 0
15	Gergo Szerencses (SVK)	P1 P2	15 0 0 0	RUS P1 P2 8 0	18 4 10 10	RUS P1 P2 7 3
16	Kamaludin Magomedov (RUS)	P1 P2	16 4 8 8	RUS P1 P2 7 3	19 0 0 0	GEO P1 P2 0 0
17	Kyrylo Shcherbatiuk (UKR)	P1 P2	17 0 0 0	RUS P1 P2 0 0	19 3 1 1	GEO P1 P2 0 1
18	Sait-Mukhammad Taipov (RUS)	P1 P2	18 4 10 10	RUS P1 P2 0 0	19 0 0 0	GEO P1 P2 0 0
19	Nikolozhi Shiukashvili (GEO)	P1 P2	19 4 8 8	GEO P1 P2 0 5	21 1 1 1	BLR P1 P2 1 0
20	Andrea Ratajczak (POL)	P1 P2	20 0 0 0	GEO P1 P2 0 1	24 1 1 1	BUL P1 P2 1 0
21	Ivan Pranchak (BLR)	P1 P2	21 4 8 8	BLR P1 P2 1 0	26 1 1 1	UKR P1 P2 1 0
22	Mihael Salajec (CRO)	P1 P2	22 0 0 0	BLR P1 P2 1 0	26 4 9 9	UKR P1 P2 9 0
23	Naumi Gurgenzidze (GEO)	P1 P2	23 0 0 0	BUL P1 P2 1 0	26 0 0 0	UKR P1 P2 0 0
24	Rachev Dimitar (BUL)	P1 P2	24 4 9 9	BUL P1 P2 1 0	26 0 0 0	UKR P1 P2 0 0
25	Maximus Muncus (ROU)	P1 P2	25 0 0 0	UKR P1 P2 1 0		
26	Ivan Tsybanev (UKR)	P1 P2	26 4 8 8	UKR P1 P2 9 0		
						16 Kamaludin Magomedov (RUS)



Feuille de compétition / Competition Sheet

U15 European Championship

Style: GR

85



QUALIFICATION		1/8 FINALE	1/4 FINALE	1/2 FINALE	FINALE	WINNER
1	Alessandro Pucher (ITA)	P1 P2 0 0	1 0 ITA 0 0	2 4 12 BLR 7 5	2 1 3 BLR 1 2	22 Nikita Maniukhin (RUS)
2	Daniil Kazlou (BLR)	P1 P2 0 0	2 4 8 BLR 8 0	2 1 3 BLR 1 2	7 1 1 HUN 0 1	
3	Łukasz Kłopotowski (POL)	P1 P2 0 0	3 5 7 POL 0 7	3 0 0 POL 0 0	7 3 3 HUN 0 3	
4	Saba Bolkvadze (GEO)	P1 P2 0 0	4 0 3 GEO 3 0	5 0 0 ROU 0 0	7 3 3 HUN 0 3	
5	Antonio Pascu (ROU)	P1 P2 0 0	5 5 8 ROU 4 4	5 0 0 ROU 0 0	7 3 3 HUN 0 3	
6	Pironkov Hristomir (BUL)	P1 P2 0 0	6 0 2 BUL 2 0	7 3 3 HUN 0 3	7 3 3 HUN 0 3	
7	Borosi Henrik (HUN)	P1 P2 0 0	7 5 4 HUN 4 0	7 5 4 HUN 4 0	7 3 3 HUN 0 3	
8	Harutyun Kirakosyan (ARM)	P1 P2 5 6 0 0	8 0 2 ARM 2 0	7 5 4 HUN 4 0	7 3 3 HUN 0 3	
9	Max Molochnikov (ISR)	P1 P2 0 2 0 0	8 0 2 ARM 2 0	7 5 4 HUN 4 0	7 3 3 HUN 0 3	
10	Tommaso Virgili (ITA)	P1 P2 5 8 0 0	10 1 4 ITA 4 0	13 1 1 UKR 0 1	15 1 2 RUS 2 0	
11	Laszlo Szerencses (SVK)	P1 P2 0 2 0 0	10 1 4 ITA 4 0	13 1 1 UKR 0 1	15 1 2 RUS 2 0	
12	Andrija Lubarda (SRB)	P1 P2 1 2 0 0	13 3 5 UKR 1 4	13 1 1 UKR 0 1	15 1 2 RUS 2 0	
13	Ivan Solodukha (UKR)	P1 P2 4 10 0 0	13 3 5 UKR 1 4	13 1 1 UKR 0 1	15 1 2 RUS 2 0	
14	Rafail Gkiris (GRE)	P1 P2 0 0 0 0	15 4 8 RUS 8 0	15 3 6 RUS 3 3	22 3 3 RUS 3 0	
15	Timur Chernyshev (RUS)	P1 P2 4 8 0 0	15 4 8 RUS 8 0	15 3 6 RUS 3 3	22 3 3 RUS 3 0	
16	Rasmus Liisma (EST)	P1 P2 3 6 2 4 0 0	16 0 0 EST 0 0	15 3 6 RUS 3 3	22 3 3 RUS 3 0	
17	David Molnar (SRB)	P1 P2 1 2 0 0	16 0 0 EST 0 0	15 3 6 RUS 3 3	22 3 3 RUS 3 0	
18	Irakli Maisuradze (GEO)	P1 P2 3 11 2 9 0 0	18 0 0 GEO 0 0	20 0 0 UKR 0 0	22 3 3 RUS 3 0	
19	Bogdan Flancea (ROU)	P1 P2 1 7 4 3 0 0	20 0 0 UKR 0 0	20 0 0 UKR 0 0	22 3 3 RUS 3 0	
20	Vladyslav Lub (UKR)	P1 P2 4 10 5 5 0 0	20 4 8 UKR 8 0	20 0 0 UKR 0 0	22 3 3 RUS 3 0	
21	Karol Staniewicz (POL)	P1 P2 0 0 0 0	20 4 8 UKR 8 0	20 0 0 UKR 0 0	22 3 3 RUS 3 0	
22	Nikita Maniukhin (RUS)	P1 P2 4 9 9 0 0 0	22 5 4 RUS 4 0	22 4 9 RUS 9 0	22 3 3 RUS 3 0	
23	Maksim Masiukevich (BLR)	P1 P2 0 0 0 0	22 5 4 RUS 4 0	22 4 9 RUS 9 0	22 3 3 RUS 3 0	
24	Nurşat Taşci (TUR)	P1 P2 4 8 8 0 0 0	24 0 1 TUR 1 0	22 4 9 RUS 9 0	22 3 3 RUS 3 0	
25	Jermakov Nikita (LTU)	P1 P2 0 0 0 0	24 0 1 TUR 1 0	22 4 9 RUS 9 0	22 3 3 RUS 3 0	



Feuille de compétition / Competition Sheet

U15 European Championship



Style: GR

85

"REPECHAGE"

"UPPER BRANCH"

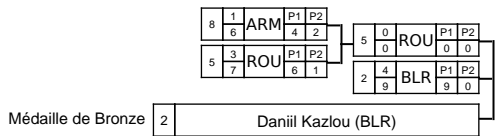

"LOWER BRANCH"

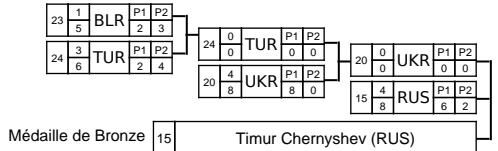

Classement

Cl	Pays	Nom
1	RUS	Nikita Maniukhin (RUS)
2	HUN	Borosi Henrik (HUN)
3	BLR	Daniil Kazlou (BLR)
3	RUS	Timur Chernyshev (RUS)
5	ROU	Antonio Pascu (ROU)
5	UKR	Vladyslav Lub (UKR)
7	UKR	Ivan Solodukha (UKR)
8	TUR	Nurşat Taşçı (TUR)
9	ARM	Harutyun Kirakosyan (ARM)
10	ITA	Tommaso Virgilii (ITA)
11	POL	Łukasz Kłopotowski (POL)
12	GEO	Irakli Maisuradze (GEO)
13	EST	Rasmus Liisma (EST)
14	ROU	Bogdan Flancea (ROU)
15	BLR	Maksim Masiukevich (BLR)
16	SRB	David Molnar (SRB)
17	SRB	Andrija Lubarda (SRB)
18	GEO	Saba Bolkvadze (GEO)
19	ISR	Max Molochnikov (ISR)
20-21	SVK	Laszlo Szerencses (SVK)
20-21	BUL	Pironkov Hristomir (BUL)
22-24	LTU	Jermakov Nikita (LTU)
22-24	ITA	Alessandro Pucher (ITA)
22-24	GRE	Rafail Gkirnis (GRE)
25	POL	Karol Staniewicz (POL)



U15 EUROPEAN
CHAMPIONSHIPS
KRAKÓW 2019

U15 European Championships - Kraków /POL/

June 27-30, 2019

TEAM CLASSIFICATION in GRECO ROMAN STYLE

M.	KLUB	# wrestlers	GR38KG	GR41KG	GR44KG	GR48KG	GR52KG	GR57KG	GR62KG	GR68KG	GR75KG	GR85KG	TOTAL
1	RUSSIA (Rus)	19	20	25	25	15	25	20	20	15	25	25	215
2	GEORGIA (Geo)	20	10	10	20	20	4	15	25	25	15	0	144
3	AZERBAIJAN (Aze)	14	25	15		25	15	0	6		20		106
4	TURKEY (Tur)	12	0	4	0	10	20	25	15	0	10	6	90
5	UKRAINE (Ukr)	20	15	0	8	15	10	10	4	4	6	10	82
6	HUNGARY (Hun)	10	4	0	4	0	15	6	0	10	8	20	67
7	MOLDOVA (Mda)	15	6	0	10	0	0	0	10	20	0		46
8	ROMANIA (Rou)	16	10	2	10	0	0	0	0	8	0	10	40
9	BELARUS (Bir)	20	0	0	6	0	0	0	0	0	15	15	36
10	LITHUANIA (Ltu)	11		10	0	0	8	2	8	0	0	0	28
11	LATVIA (Lat)	4	8		0	0				10			18
12	BULGARIA (Bul)	18	0	15	0	0	0	0	0	0	2	0	17
13	ITALY (Ita)	15	0	0	0	0	0	0	10	0	4	2	16
14	BELGIUM (Bel)	1							15				15
15	ARMENIA (Arm)	12	2	0	0	6	0	0	0	0	0	4	12
16	ESTONIA (Est)	9	0	0	0	0	10	0	0	0	0	0	10
17-18	CROATIA (Cro)	11	0	0	0	8	0	0	0	0	0	0	8
17-18	GREECE (Gre)	10	0	0			0	8	0	0	0	0	8
19	NETHERLANDS (Ned)	1						4					4
20-21	POLAND (POL)	20	0	0	0	0	0	0	0	2	0	0	2
20-21	SERBIA (Srb)	11		0	2		0	0	0	0	0	0	2
22-25	SLOVAKIA (Svk)	6				0	0			0	0	0	0
22-25	FINLAND (Fin)	5					0			0	0	0	0
22-25	ISRAEL (Isr)	3	0	0								0	0
22-25	AUSTRIA (Aut)	1					0						0

