

# Stereo Review®

NOVEMBER 1988 ● \$2.25

CHOOSING SEPARATES  
THE NEW CASSETTE DECKS  
WHOLE-HOUSE SYSTEMS

TESTED: NAD CD CHANGER,  
POLK SPEAKER SYSTEM,  
AND MORE...



MR DAVID S BUCHANAN  
8900 YELLOW WOOD PL  
LOUISVILLE KY 40222  
11#JX  
430492 BCH 8900Y091 741J JAN90  
\*259B\*\*\*\*\*5-DIGIT 40222  
\*8C48900Y091\*



*The RTA Series*



*"They provide smooth, fast and incredibly well detailed sound."*

# “Polk’s RTA Tower Loudspeakers Combine Legendary Polk Performance with Contemporary Style.”

*Big speaker performance with an efficient use of space.*

## RTA 11t

The RTA 11t is the finest conventional (non-SDA) speaker that Polk Audio manufactures. Its extremely high power handling (250 watts) and high efficiency (90dB) provide remarkable dynamic range from both large and small amplifiers. The RTA 11t utilizes the same technologically advanced fluid-coupled subwoofer design found in Polk’s flagship model. Dual 8” sub-bass radiators are coupled to two 6½” mid-bass drivers, resulting in a fast, powerful, deep, and ultra-accurate bass response, without the boomy, undetailed sound of large woofer systems.

## RTA 8t

In a slightly smaller package, the RTA 8t offers the same driver complement as the larger, more expensive RTA 11t, and thus shares its benefits of superior imaging, musicality, and detail.

Both Polk RTA series loudspeakers achieve the extremely rare combination of good looks and state-of-the-art performance. The tall, elegantly slender, and deep “tower” design cabinets allow for substantial internal volume for high efficiency and powerful bass, while requiring less than one square foot of floor space. The small baffle surface area around each driver minimizes diffraction (sonic reflections), thereby insuring outstanding imaging and low coloration.

Positioning the 1” silver-coil dome tweeter between the two 6½” trilaminate polymer bass/midrange drivers achieves what is called “coincident radiation.” This means that both the mid- and high-frequencies appear to radiate from the same place on the baffle resulting in perfect blending at the critical crossover point. (See illustration, below).

Polk RTA speakers have an uncanny ability to perfectly reproduce the human voice, pianos, guitars, and every other instrument whose faithful reproduction demands superlative midrange and high-frequency performance. Bass and percussion instruments are accurately reproduced with full visceral power and realism, without the heaviness, boominess, or lack of detail that plague lesser designs.

The discriminating listener who seeks state-of-the-art performance and design will find the quintessential combination of both in Polk’s RTA series loudspeakers.

## THE PRINCIPLES OF COINCIDENT RADIATION

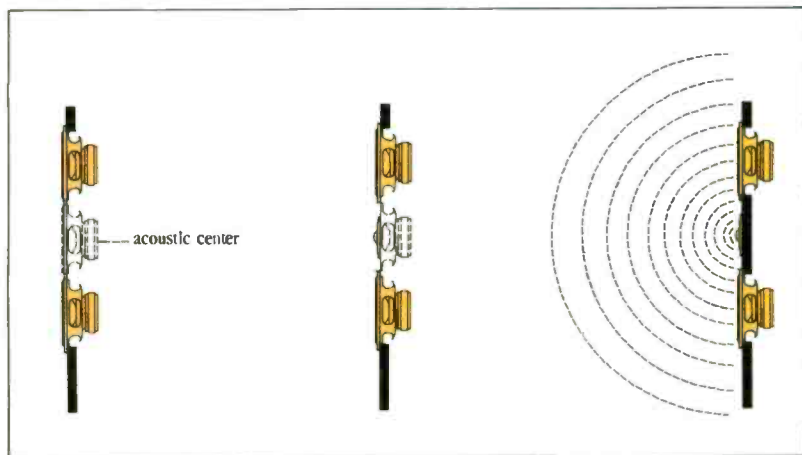

The perceived source of sound of two identical drivers is centered in the area between them.

The benefit of coincident waveform propagation resulting in precise imaging, uniform vertical dispersion and startling midrange accuracy.

In the Polk RTA loudspeaker, the tweeter is positioned at the acoustic center of the drivers.



Polk Audio's RTA 8t and RTA 11t High Performance Tower Speakers

**polkaudio**  
The Speaker Specialists®

5601 Metro Drive, Baltimore, Md. 21215

*The Monitor Series*



Monitor 10B

*"The best high performance speaker value on the market today."* Off The Record

# "Polk's Remarkable Monitors Redefine Incredible Sound/Affordable Price"

*"At their price, they're simply a steal"* Audiogram Magazine

## Monitor 10B

Considered one of the worlds' best sounding loudspeakers and, in the words of Audiogram magazine, "At the price they are simply a steal." The Polk 10B utilizes dual trilaminate polymer drivers coupled to a built-in subwoofer for accurate bass response and superior dynamic range. A 1" dome tweeter perfectly complements the other drivers to insure outstanding reproduction of every type of music.

## Monitor 7C

Basically a smaller, less expensive version of the Monitor 10B. By offering superlative performance whether mounted on a shelf or a speaker stand, the 7C is a highly versatile addition to any audio system. How good does it sound? Audio Alternative magazine said, "It is amazing."

## Monitor 5B

Similar in design and performance to the Monitor 7C, however it utilizes an 8" subwoofer (rather than 10") and is more compact. The 5B represents one of the best values of the entire Monitor Series.

## Monitor 5Jr. +

Called the best sounding speaker of its price in the world regardless of size. It achieves life-like three-dimensional imaging which 10 years ago was not available in any bookshelf speaker at any price.

## Monitor 4.5

Shares most of the high technology components and rewarding musical performance of the larger Polk speakers at a surprisingly low price. A critically tuned bass duct insures high efficiency and great bass performance despite its convenient compact design.

## Monitor 4A

Identical to the 4.5 in a smaller cabinet. Audio critic Lawrence Johnson called it, "an all around star of great magnitude." The 4A's affordable price means that no matter how small your budget, you can afford the incredible sound of Polk!

## Matthew Polk's Vision: Superior Sound for Everyone

Polk Audio is an American company that was founded in 1972 by three Johns Hopkins University graduates who were fanatical audiophiles with a common vision. They believed that it was possible to make speakers that performed as well as the most exotic and expensive systems at a fraction of the price. Starting with only \$200, they began by designing and manufacturing the Monitor Series loudspeakers. The Monitor Series combined the advantages of American high technology and durability with European styling and refinement. Over the years an unending stream of rave reviews, industry awards, and thousands of enthusiastic Polk customers have established the Monitor Series as the choice for those looking for both incredible sound and an affordable price. There is no better value in audio equipment today than a Polk Monitor series loudspeaker.

## Uncompromising Standards at Every Price

A limited budget does not mean a limited ability to appreciate fantastic sounding music. That's why we put our best engineering efforts and only the finest materials into every Polk product regardless of price.

Every Polk Monitor Series speaker uses the same trilaminate polymer cone technology as the flagship SDA-SRS 1.2. Every Polk Monitor utilizes a 1" polymer dome tweeter, and most use exactly the same tweeter found in the SRS 1.2. All Polk Monitors employ costly multi-component crossover networks and ¾" thick high density, non-resonant cabinets. Pick up a Polk Monitor 4A, then pick up a comparably priced but larger speaker from a different manufacturer. You'll notice that the Polk is heavier, more solidly built, and sports a superior fit and finish. Now compare the sound. We are sure you'll agree with Musician magazine, which said Polk Monitors are: "Vastly superior to the competition."



Matthew Polk with his incredible sounding/affordably priced Monitor Series loudspeakers. Front row (L to R) Monitor 5Jr. +, Monitor 4A, Monitor 4.5 Back row (L to R) Monitor 10B, Monitor 7C, Monitor 5B

## The Thrilling Sound of Polk Monitors

Polk Monitors achieve open, boxless, three-dimensional imaging surpassed only by the SDA's. Their silky smooth frequency response assures natural, non-fatiguing, easy to listen to sound, while their fast transient response results in music that is reproduced with life-like clarity and detail. In addition, dynamic bass performance, ultra-wide dispersion, high efficiency and high power handling are all hallmarks of Monitor Series performance.

## There is a Polk Monitor Perfect for You

Each time you advance through the six Monitor Series models, you'll immediately hear a remarkable improvement in efficiency, bass response, and output volume. They are designed so that a smaller Polk played in a small room will sound nearly identical to a larger Polk played in a large room. A larger Polk in a small room will, of course, play that much louder with even better bass. No matter what price range fits your budget, there is a spectacular Polk Monitor Series speaker waiting to fulfill your sonic dreams.

**polk audio**  
The Speaker Specialists®

5601 Metro Drive, Baltimore, Md. 21215  
CIRCLE NO. 90 ON READER SERVICE CARD



# For the Changing Times

## The New 6-Disc Realistic® CD Changer

Now there's a more convenient way to enjoy the best in sound—the new compact disc *changer* from Radio Shack. You can load up to six discs in its magazine, sit back, and enjoy hours of superb digital stereo. Or, program up to 32 selections from the six discs to play in any sequence. Either way, you can pause, replay, program and search, using the wireless infrared remote control.

The large LED display simplifies remote operation. Manual and automatic search make it easy to find selections.

This high-performance changer has a heavily cushioned deck mechanism and Tri-Spot laser pickup system for accurate tracking. Two-times oversampling provides superior sound. And Radio Shack stocks

extra magazines so you can protect all of your CDs and have them loaded in your preferred order, ready for play anytime.

Come in and try the Realistic CD-6000. It's affordably priced at only \$359.95—so you can enjoy the convenience of a changer for less than the price of some single-disc players. Sold only at Radio Shack. Low as \$18 per month\*.



# Radio Shack®

## The Technology Store™

A DIVISION OF TANDY CORPORATION

Prices apply at participating Radio Shack stores and dealers. • Radio Shack ValuePlus® Revolving Credit. Actual payment may vary depending upon account balance.

# Stereo Review

BULLETIN.....	8	TECHNICAL TALK.....	34
LETTERS.....	10	POPULAR MUSIC.....	115
NEW PRODUCTS.....	21	CLASSICAL MUSIC.....	132
AUDIO Q&A.....	30	THE HIGH END.....	160

## EQUIPMENT

HIRSCH-HOUCK LABS EQUIPMENT TEST REPORTS	41
NAD Model 5170 Compact Disc Player, page 41	
Polk Audio SDA-SRS 2.3 Speaker System, page 43	
Soundstream DA-1 Power Amplifier and C-1 Preamplifier, page 48	
NHT Model I Speakers and Octave Bass Module, page 58	
Sharp Optonica SM-A75 Integrated Amplifier, page 65	

SEPARATES	74
Is it time to replace your good old receiver with separate components?	<i>by Thomas R. Gillett</i>

CASSETTE DECKS	81
The new generation	<i>by Craig Stark</i>

MUSIC EVERYWHERE	88
Whole-house remote-control systems	<i>by Rich Warren</i>

SYSTEMS	102
A holographic heaven in Canada	<i>by Rebecca Day</i>

## MUSIC

THE SMITHEREENS	98
"We have never made a conscious attempt to be a Sixties band"	<i>by Steve Simels</i>

BEST RECORDINGS OF THE MONTH	107
Cinderella, Ives <i>Holidays</i> Symphony, Dwight Yoakam, and Shostakovich Symphonies Nos. 7 and 9	

RECORD MAKERS	158
The latest from Steve Miller, U2, Joan Sutherland, Buck Owens, Keith Jarrett, and more	



PAGE 81



PAGE 158



Cover: Soundstream's separates, the System-1 tuner, preamplifier, and power amplifier (see test report on page 48). Design by Sue Llewellyn, photo by Hing/Norton.

STEREO BUYER POLL, SEE PAGE 141  
Please fill in if you bought equipment in the past thirty days.  
READER SERVICE INFORMATION CARD, FACING PAGE 141  
Circle the items you want to know about.

COPYRIGHT © 1988 BY DIAMANDIS COMMUNICATIONS INC. All rights reserved. Stereo Review, November 1988, Volume 53, Number 11. Stereo Review (ISSN 0059-1220) is published monthly by Diamandis Communications Inc. at 1515 Broadway, New York, NY 10036; telephone (212) 719-6000. Also publishers of Car Stereo Review, Stereo Buyers' Guide, Compact Disc Buyers' Guide, and Video Buyers' Guide. One-year subscription rate for the United States and its possessions, \$13.94; Canada, \$18.94; all other countries, \$21.94, cash orders only, payable in U.S. currency. Second-class postage paid at New York, NY 10001, and at additional mailing offices. Printed in the U.S.A. Authorized as second-class mail by the Post Office Department, Ottawa, Canada, and for payment of postage in cash. POSTMASTER/SUBSCRIPTION SERVICE: Please send change-of-address forms and all subscription correspondence to Stereo Review, P.O. Box 55627, Boulder, CO 80322-5627. Please allow at least eight weeks for the change of address to become effective. Include both your old and your new address, enclosing, if possible, an address label from a recent issue. If you have a subscription problem, write to the above address or call (800) 525-0643; in Colorado, call (303) 447-9330. PERMISSIONS: Material in this publication may not be reproduced in any form without permission. Requests for permission should be directed to Ana Santiso, Product Merchandising, Diamandis Communications Inc., 1515 Broadway, New York, NY 10036. EDITORIAL CONTRIBUTIONS must be accompanied by return postage and will be handled with reasonable care, but the publisher assumes no responsibility for return or safety of unsolicited art, photos, or manuscripts.

ES

After inventing  
the Digital  
Compact Disc  
we weren't about  
to entrust its  
reproduction to  
anyone else.



# The New Sony ES Series: Superior Audio Components To Which We Proudly Entrust The Reproduction Of Digital Sound.

As the inventor of the Compact Disc format, Sony continues to expand the limits of digital reproduction. Yet, while proudly leading this revolution, the Sony ES engineers have been equally conscientious about designing analog components that fully realize the potential of the digital era. This uncompromising commitment defines the entire ES Series.



**The CDP-707ESD:**  
Simply stated... "the reference against which to judge" others.—*Len Feldman, Audio Magazine.*

Historically, Sony ES Compact Disc players have been the benchmark for advancing the state-of-the-art. The CDP-707ESD is no exception. As the world's first CD player to incorporate dual 18 bit linear D/A converters, along with a proprietary 8X oversampling digital filter, it brings the listener closer to the theoretical limits of Compact Disc performance. This advanced technology provides greater low level signal resolution and improved linearity, for more faithful reproduction of musical depth and detail.

And there's more to the ES Series than the CDP-707ESD, and its host of sophisticated features. You'll find our advanced 8X oversampling filter technology in the less costly CDP-507ESD, as well as the CDP-C15ESD, which combines 18 bit linear D/A converter performance with 10-disc changer convenience for the very first time.



**The STR-GX10ES:**  
The quality of separate components in a fully integrated design.

Traditionally, few receivers have offered the performance necessary to meet the demands of digital sources. These demands on receiver technology come at a time when the requirements for total audio and video integration have created more compromises than ever before.

To avoid those compromises, Sony created the STR-GX10ES, with 150 watts-per-channel. It, along with our

full line of receivers, achieves unsurpassed musicality, thanks to a unique Spontaneous Twin-Drive amplifier stage that eliminates power supply fluctuations, regardless of current demand. Add to this such refinements as discrete outputs and a non-resonating G-Chassis™ design, and you have accurate reproduction of music detail and dynamics even under the most demanding speaker load conditions.

Yet the STR-GX10ES also brings you the convenience of total integration with a supplied Remote Commander™ unit that allows for control of virtually any infrared audio or video component, regardless of brand. And with its special high resolution S-Video circuitry, the STR-GX10ES is compatible with components you might buy in the future.



**The TC-WR11ES:**  
Finally, a level of performance never before achieved in a dual-deck design.

Accurate reproduction of digital source material has placed a heavy burden on the finest analog cassette decks. A burden compounded in dual-deck designs, where compromises are often made for operating convenience.

The uncompromising new Sony TC-WR11ES is a magnetic and mechanical accomplishment that rises to the digital challenge by combining superb music reproduction with ultra-sophisticated operations. A unique 210 kHz Super Bias™ circuit extends frequency response, without the beat frequency noise that's typical of high speed dubbing decks. Even at normal speed, the TC-WR11ES, like all ES cassette decks, achieves clean, transparent recordings, plus an astoundingly uniform 20-20,000Hz (+/- 3dB) frequency response. Add to this the patented Laser Amorphous heads and 4-motor transport, and the TC-WR11ES indisputably demonstrates the technical refinement needed to triumph in the digital age.

### The Sony ES Commitment.

The Sony ES Series is a skillfully crafted line that not only includes the finest Compact Disc players, but superb analog components as well, all doing full justice to the ES engineers' exceedingly high standards. Further expression of this excellence is reflected in the 3 year limited warranty that backs each and every model (see your authorized Sony ES dealer for details).

For more information on where you can audition the full line of Sony ES components, call 201-930-7156.



**SONY**

THE LEADER IN DIGITAL AUDIO™

CIRCLE NO. 106 ON READER SERVICE CARD

by *Christie Barter*  
and *Rebecca Day*

## COMPACT DISC NEWS

MCA Records is launching a 3-inch-CD line in November with an initial release of twenty-four titles. . . . Capitol has just released a boxed set of seventeen CD's containing the fifteen Beatles albums reissued in that format last year as well as the two recent CD-only "Past Masters" volumes of songs omitted from the original British albums. . . . The first CD's from Warner Bros. are by Donald Fagen (*New Frontier*), Madonna (*Papa Don't Preach*), and Randy Newman (*I Love L.A.*). . . . Fantasy has just released the CD version of its Grammy-winning set "Thelonus Monk: The Complete Recordings." . . . Performances of Mahler symphonies with running times of up to eighty minutes are now available for the first time on single CD's. On the Hunt label, they include his Third, Sixth, and Eighth Symphonies in recordings from the mid-Fifties and Sixties by the New York and Vienna Philharmonic Orchestras under Dimitri Mitropoulos.

## THE QUIET DEATH OF THE LP

The major classical labels in this country have been quietly phasing out the LP as a format option, in both their full-price and budget or mid-price lines, but they are still reluctant to state categorically that they will cease releasing LP's altogether. By way of example, news from the U.K. has it that beginning in January Deutsche Grammophon will release its new, front-line recordings only on compact disc. An American representative of that company, however, could neither confirm nor deny that it would follow suit in the U.S.

## A NEW DISCOGRAPHY OF BASICS

*Discovering Great Music* is the title of a new book by STEREO REVIEW Contributing Editor Roy Hemming being published on November 7 by Newmarket Press in New York. It offers an up-to-date discography of the basic classical repertoire in all

three of today's record formats—CD's, cassettes, and LP's—with recommendations of favored recordings of each principal work in each format. Price: \$19.95.

## TECH NOTES

Toshiba plans to start selling car audio products in the U.S. in January. Cassette radios, speakers, amplifiers, and equalizers will make up the line, which is expected eventually to expand to include car navigation systems. . . . Zenith has submitted its proposal for a two-channel high-definition television system (HDTV) to the FCC's Advisory Committee on Advanced Television Services, which has ruled that any broadcasting system has to be compatible with current color TV sets. . . . Aiwa has agreed to incorporate into its audio products the patented signal-processing technology of BBE Sound, a company based in Huntington Beach, California, that is known for its outboard sound-enhancement products. The BBE system reduces the distortion inherent in loudspeakers. . . . Consumers who purchase Panasonic compact disc players through the end of the year are eligible to receive by mail a free pair of Panasonic headphones. A set of EAH-X80 headphones will be sent to consumers who submit proof of purchase, UPC code, and \$3 for postage and handling.

## TAPE NEWS

Agfa PEM 468 tape has been chosen by the Rogers and Hammerstein Archives of Recorded Sound at Lincoln Center as the mastering tape for the transfer of antique recordings for long-term storage. . . . BASF has upgraded and repackaged its line of videocassettes. The new line is said to provide better color modulation, fewer dropouts, and an improved signal-to-noise ratio.

## MORE IN STORE

Sears has announced plans to expand the audio products it carries beyond its branded lines of Sears, LXI, and Kenmore. New to

the aisles at Sears department stores will be Acoustic Research, Bose, Casio, Cerwin-Vega, General Electric, Koss, Magnavox, Marantz, Pioneer, Sharp, Sony, Soundesign, Technics, and Yamaha.

## MAN OF HIGH FIDELITY

David Hafler is the first recipient of the Armstrong Foundation's Man of High Fidelity Award. The Armstrong Foundation, dedicated to the memory of the inventor of the FM radio, Edwin Howard Armstrong, recognizes outstanding achievement in broadcasting and telecommunications. Hafler was cited for his long-time service to the hi-fi industry and his introduction of Dynaco kits.



## ANTI-PIRACY ACTION

The number of counterfeit/pirate cassettes confiscated in the first half of 1988 by law-enforcement officials jumped by 283 percent over the first six months of 1987, according to statistics released by the Recording Industry Association of America. The majority of the 308,184 counterfeit cassettes seized in January through June of this year were Hispanic, thanks to the RIAA's formation of the Hispanic Music Advisory Committee in October 1987.

**DENON**

PCM AUDIO TECHNOLOGY / COMPACT DISC

## WHAT MAKES ONE AUDIO BRAND SOUND BETTER.

**CD PLAYERS** have always been susceptible to errors in converting digital data to analog audio. In fact, academic researchers recently declared that error in converting the Most Significant Bit is a primary cause of audible problems. Every Denon Compact Disc Player since 1983 has corrected this problem with the Super Linear Converter.

Now, with the new "Delta" conversion circuit, Denon's DCD-3520 and DCD-1520 represent the closest approach yet to true 16-bit linearity. Denon's 20-bit 8x oversampling digital filter joined to a pair of true 20-bit Super Linear Converters quite simply elevate digital playback to a new level of musicality.

DCD-1520



But then, Denon built the world's first professional digital audio recorder back in 1972. And we've recorded digital master tapes of unsurpassed musical accuracy.

It's simply easier to make digital audio sound more like music when you know what music sounds like.

**DENON**

DESIGN INTEGRITY



CIRCLE NO. 27 ON READER SERVICE CARD

Denon America Inc., 222 New Road, Passaic, NJ 07054 (201) 525-7810  
Denon Canada, Inc., 17 Denison Street, Markham, Ont. L3R 1B5 Canada

## Stereo Review

LOUISE BOUNDAS  
Editor in Chief

MICHAEL SMOLEN  
Executive Editor

SUE LEWELLYN  
Art Director

WILLIAM WOLFE  
Technical Editor

CHRISTIE BARTER  
Music Editor

DAVID STEIN  
Managing Editor

REBECCA DAY  
WILLIAM GOLDMAN  
Senior Editors

LOREN FALLS  
Associate Art Director

LAURA KELLY  
Associate Editor

CATHERINE FLEMING  
Assistant Art Director

BARBARA AIKEN, ROCCO MATTERA  
MARK LAZARUS  
Editorial Assistants

WILLIAM LIVINGSTONE  
Editor at Large

Contributing Editors: Robert Ackart, Chris Albertson, Richard Freed, Phyl Garland, David Hall, Ron Givens, Bryan Harrell (Tokyo), Roy Hemming, Julian Hirsch, Ralph Hodges, Stoddard Lincoln, Ian Masters, Louis Meredith, Alanna Nash, Mark Peel, Henry Pleasants (London), Ken Pohlmann, Charles Rodrigues, Eric Salzman, Steve Simels, Craig Stark

Production Director: Karen Rosen  
Production Manager: Barbara Ross

WINSTON A. JOHNSON  
Vice President and Publisher

### ADVERTISING

Advertising Director: Nick Matarazzo

National Manager: Charles L. P. Watson  
(212) 719-6038

Consultant: Richard J. Halpern  
(212) 719-6025

Account Executive: Sharon Dube  
(212) 719-6037

Assistant to the Publisher: Nadine L. Goody  
Classified Advertising: (800) 445-6066

Midwestern Managers: Arnold S. Hoffman,  
Jeffrey M. Plaster, (312) 679-1100

Western Managers: Robert Meth,  
Paula Borgida, (213) 739-5130

Tokyo Office: Iwai Trading Co., Ltd.  
603 Ginza Sky Heights Building, 18-13,  
Ginza 7-Chome, Chuo-Ku, Tokyo, Japan 104  
Japan Representative: J. S. Yagi, (03) 545-3908



STEREO REVIEW is published by Diamandis Communications Inc., a wholly owned subsidiary of Hachette Publications, Inc.

President & CEO: Peter G. Diamandis  
Executive Vice President: Robert F. Spillane  
Senior Vice President, Finance, & CFO: Arthur Sukel  
Senior Vice President, Manufacturing & Distribution: Murray Romer

Senior Vice President, Operations & Administration: Robert J. Granata  
Vice President, Controller: David Pecker  
Vice President, General Counsel: Catherine Flickinger

Vice President, Circulation: Leon Rosenfield;  
Vice President, Communications: Phyllis Crawley;  
Vice President, Marketing: Anthony F. Incalcaterra;  
Vice President, Research: Bruce Gersfield;  
Senior Vice President, Sales: James A. Frahm

## LETTERS

### Systems

I am a long-time subscriber to STEREO REVIEW, and one of the things I like most about the magazine is that it covers not only the major equipment categories but also the "little" things that are important to music lovers like myself: for example, record-cleaning ideas, high-quality interconnect cables, speaker-placement guidelines, etc. In my experience, audiophiles are perfectionists and use any and all information available to get the most out of their systems. It takes a lot of research and effort (not to mention money) to put together a great sound system, and naturally the "creator" would like to show off the results.

What I'd like to see more of in STEREO REVIEW, and I'm sure I'm not alone, is ideas on how to display stereo systems in the home. Your "Systems" articles in the past have been pretty good, but there is an infinite number of ways to integrate a stereo system into the home, and I'd like to see some new ideas.

Why don't you ask your readers to send in photos of their systems, and choose a few to feature in the magazine? I'm sure there are thousands of readers who would love to have their systems in STEREO REVIEW.

STEPHEN G. EDWARDS  
Santa Maria, CA

I enjoy your "Systems" features even when they are devoted to the kind of top-of-the-line equipment that people can buy when money is no object, but I would like to see more realistic, down-to-earth home installations, too. Why don't you show component systems put together by ordinary readers? Their equipment might be more within my reach, and they would probably have some good ideas for fitting it into limited space.

MICHAEL LARSON  
Minneapolis, MN

*We are interested in hearing from readers about their component systems. If you think your installation should be featured in STEREO REVIEW, please send a couple of clear photographs and a description of the equipment to Rebecca Day—Systems, Stereo Review, 1515 Broadway, New York, NY 10036.*

### Thomas Dolby

Because I've rather enjoyed much of Thomas Dolby's music, I can't help but regret his boasting to Mark Peel (September): "I've never treated my listeners like morons. I've never written an 'Ooh, baby.'" I suppose he meant that he's never written a song of *that sort*,

but his use of the title only serves to point out that he's not yet written a song of *any sort* quite as exquisite as *Ooh Baby Baby* by Smokey Robinson and the Miracles, one of the most beautiful love songs of our time. Until Mr. Dolby creates a song that even approaches such lyrical sublimity, he should know that he has listeners who don't mind being "treated like morons," if songs about being in love *are* exclusively for morons.

Please! Give us an "Ooh, baby"—but give us a *good* one, if you can.

PAT JONES  
Tustin, CA

### Guessing Games

Thank you to Julian Hirsch for speaking out, in his September column, "Guessing Games," about the need for better and more understandable factory specs for consumer electronics products. Too often, I look in the manual only to find partial specs or no specs given, especially for the hi-fi sections of VCR's. We can't all test the products ourselves, and it's nice to have some idea of what the product is supposed to do before you buy it. If there is a lack of information, I view it as a reflection on the unit's performance and look at other models. I hope manufacturers listen to Mr. Hirsch and the rest of us and improve their product information. It might just improve their sales, too!

STEVEN A. BANKS  
Bellingham, WA

All of us well know what it is like to be left thoroughly confused by stereo instruction manuals, but after reading Julian Hirsch's September column about this annoyance, I didn't know whether to laugh or cry. If Mr. Hirsch thinks he's got a gripe with *stereo* equipment, God help his soul if he ever tackles *computers* and encounters the "documentation" and "compatibility" problems that forever confound users! At least all CD's will work on any player, nearly any amplifier will allow speakers to produce sound, and tuners always work in spite of the airwaves. I only wish the same could be said in the world of computers.

ED OKIE  
Lake Wales, FL

### Quality Time

Were Pioneer's compact disc player ads in September (page 31) and October (page 23) a sign of the times? Both used a black-and-white shot of an obviously proud dad cradling his baby in his arms and looking into the child's eyes while listening to headphones. The baby can't hear Dad's music, and Dad can't hear

# The road to perfection has no shortcuts.

Most CD marketing has turned into a numbers and gimmicks race, with many manufacturers suggesting that one single feature leads to superior sound. Instead of looking for shortcuts, the Akai engineers have focused on *everything* connected with reading and processing the digital signal accurately.

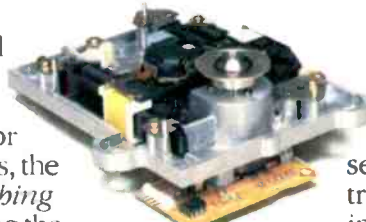

It is laser transport reflects Akai's 35 years of building tape transports.

The CD-93-B's excellence in design naturally extends to its circuitry, which features completely separate and shielded digital and analog sections. Independent and isolated power transformers prevent digital noise from interfering with the analog signal. Six stages of internal fiber optic coupling as

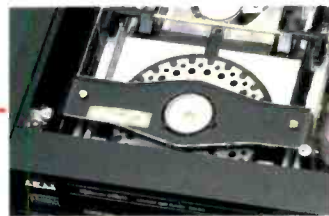

Akai's disc clamping: because more stable rotation means fewer playback errors.

The result? The CD-93-B Reference Master CD Player. The moment a CD is inserted, disc rotation is stabilized by an oversized, die-cast disc clamping. Its die-cast anti-resonant disc tray further reduces unwanted vibrations, as do the player's entire

aluminum honeycomb monocoque chassis and high-frequency absorbing ceramic pedestals.

The CD-93-B's die-cast 3-beam laser pick-up with "A" servo system further ensures that the disc is read with unsurpassed accuracy. By effectively minimizing playback errors, Akai engineers have reduced the distortion generated by error concealment.

well as optical outputs ensure that no signal degradation occurs. For optimum decoding of the digital signal, the CD-93-B uses an 18-bit digital filter, dual glitchless D/A converters and a highly linear 3rd order Butterworth GIC analog filter.

Akai's extra attention to engineering, design and construction quality is proven out by *Stereo Review's* recent lab tests.\* The CD-93-B had one of the flattest frequency responses and the best low-level linearity they ever measured.



With the Honeycomb Monocoque chassis, Akai puts digital audio on the firmest foundation.

Let the other manufacturers search for the one thing that will make their players sound better. At Akai, that one thing is everything.

\*Stereo Review, August, 1988



CD-93-B Reference Master CD Player

# AKAI

Where audio and video are one.

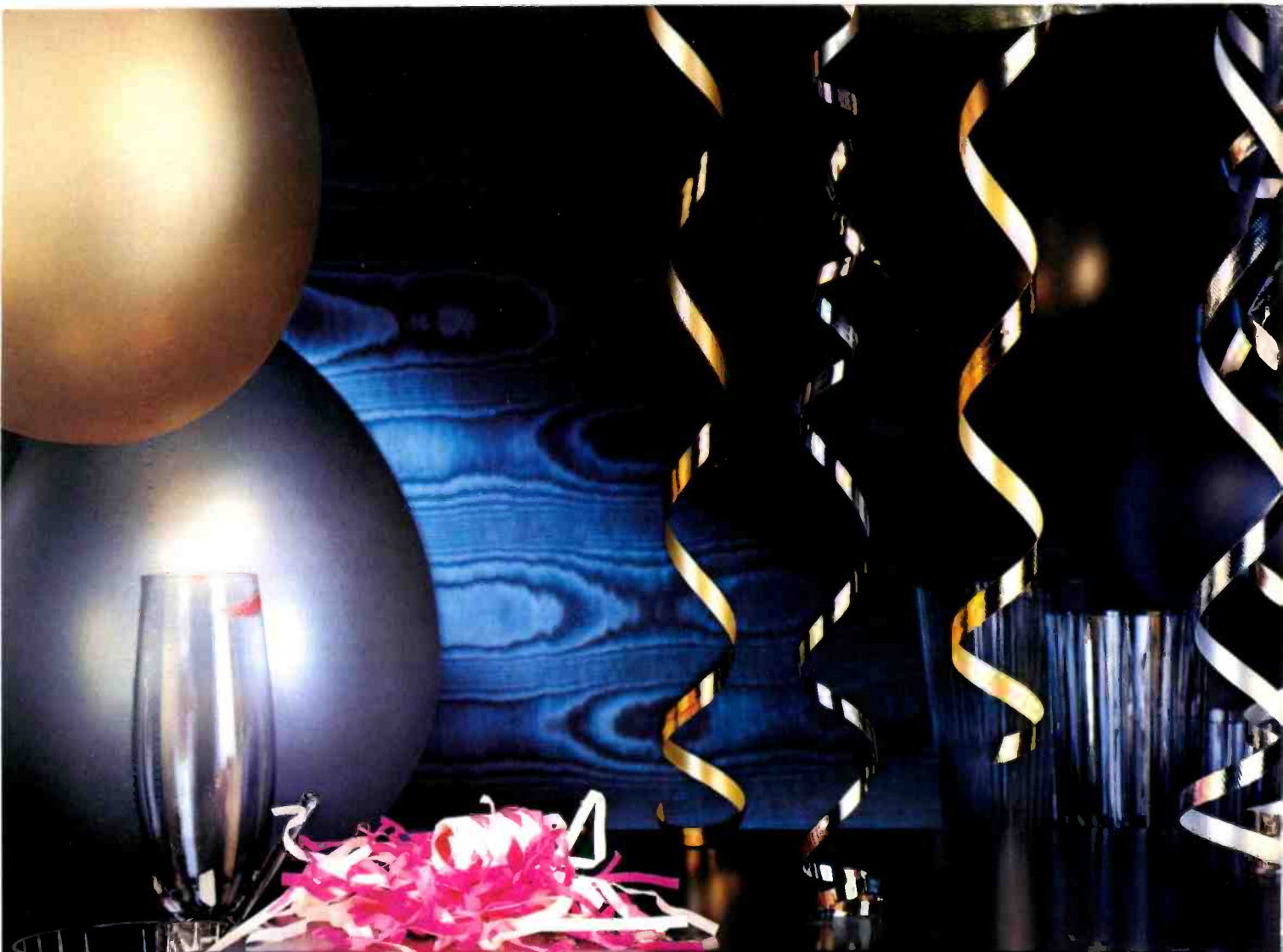

**Technics**

Multi Compact Disc Player

power



off on

phones level



min max

phones

remote sensor

6 Disc Magazine



DIGITAL

Digital Filtering System  
96 kHz Random Access Programming



**6 COMPACT DISCS**



eject

display

repeat

skip/prev

skip/next

Technics

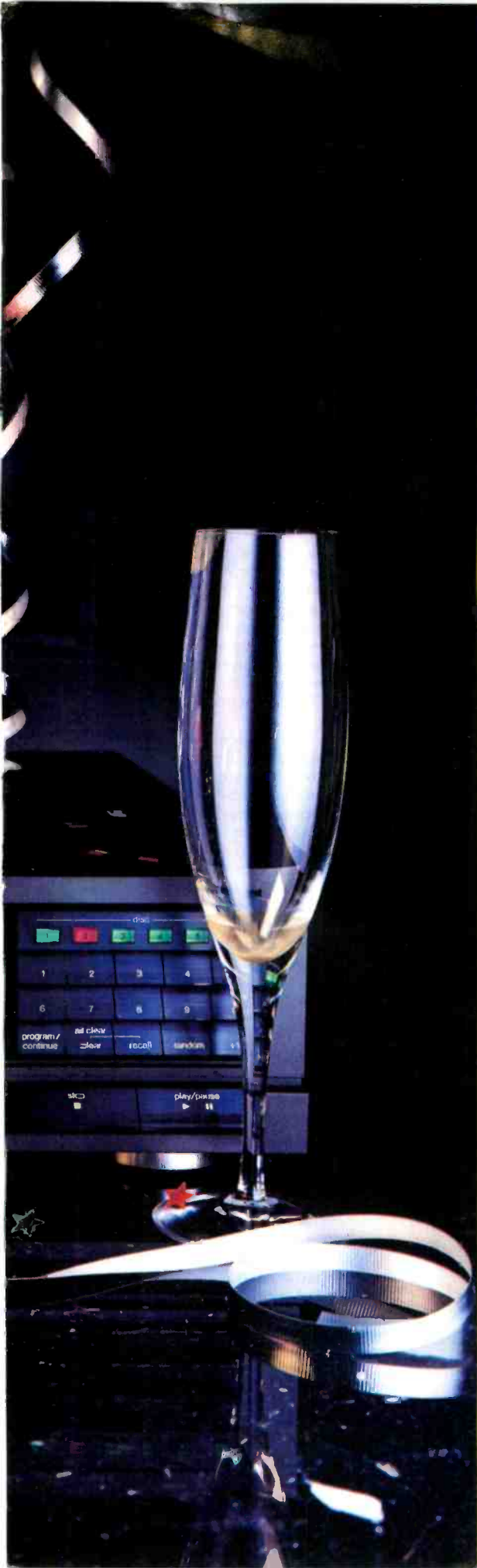

Those immortal words are **Technics** no longer merely just a song lyric. They're a reality. Thanks to stereo components like the Technics Six-Disc CD Changer.

This remarkable changer not only allows you to program up to six discs, but also lets you play any track from any disc in any order you like, for hours on end. Which means you can hear a little rock followed by a little Rachmaninoff. Or go to Motown, Mozart, then Mose Allison.

Naturally, a CD player like this has all the features you'd expect from Technics. But it also has something you don't expect. The same kind of thinking that goes into some of the most sophisticated CD players in the world. Our professional series. Things like quadruple oversampling for incredibly accurate sound. A high resolution laser pickup. A floating suspension that can permit you to rattle the walls without rattling the CD player. And a transport system that can access any spot on the disc quicker than you can say "Rock Around the Clock".

The Technics Six-Disc CD Changer. Now you can bop till you drop without bopping up and down to change the music every few minutes.

# ROCK AROUND THE CLOCK.

CIRCLE NO. 181 ON READER SERVICE CARD



Technics 6 Disc Changer With Remote

## LETTERS

his baby trying to talk to him. The caption read: "Quality time. Your moments together are too precious to waste."

HANK TEICH  
Asheville, NC

It's too bad that the "quality time" referred to in Pioneer's ad is the six hours of uninterrupted music that the father can enjoy with his headphones on. I am an audiophile myself, but listening to my newborn's little sounds is my idea of quality time. Please tell the guy in the advertisement to take off the headphones—he'll be delighted!

ROBERT C. GORSKI  
Detroit, MI

### Movie Sound

I simply cannot allow Ralph Hodges's "High End" column in September, "More on Movie Sound," to pass unchallenged. Mr. Hodges intimates that part of the reason movies have "dishonest" soundtracks is that sound engineers are old fogies who are unwilling or unable to change their ways to match the digital Eighties.

I am a thirty-four-year-old sound editor with more than thirty feature films to my credit. Almost without exception, my fellow editors are under thirty-five. Virtually all of us have state-of-the-art CD players, hi-fi VCR's, and videodisc players. We are anything but unformed, disinterested old fogies!

The bedrock of any soundtrack is the dialogue recording that is done on the set. I have worked many a miracle on a soundtrack, but no amount of wizardry can make a silk purse out of a sow's ear. I have worked on multimillion-dollar musicals where the dialogue sounded like it was recorded on a handheld Dictaphone! I have worked on feature films where the sound was recorded at 3¾ ips so the producer could "save money." I have had postproduction schedules slashed from forty-five to thirteen days. I have had weeks of elaborate and intricate editing thrown away because the director changed his mind.

I would *love* to edit a soundtrack entirely in the digital domain! I would *love* to provide Mr. Hodges with the aural experience he desires. But the bottom line is budget, and the producers' wishes are invariably "fast" and "cheap." We sound editors are simply doing the best we can using equipment developed in the Thirties that producers are loathe to replace. Considering that the sound you hear in the theater is a *minimum* of six analog generations away from the original tape, I don't think we are doing too bad a job!

DAVID M. ICE  
North Hollywood, CA

### Magneplanar Speakers

The caption for the photo of Magneplanar's MG-IIc speakers in Ian G. Masters's "Speaker Science" article in September incorrectly identifies them as "electrostatic" speakers. They are Magneplanar speakers, which are, of course, planar-magnetic systems, unless they include Magneplanar's line-source ribbon, in which case they are a combination of planar-magnetic and ribbon speakers. The one thing Magneplanar speakers are *not* is electrostatic.

Our trade name, "Magneplanar," comes from the words "magnetic" and "planar." I coined the word in 1971 when our first model, the Tympani-I, was introduced. The name "Tympani" was derived from the fact that our speakers utilize a stretched diaphragm, which in musical terms is a tympanic device.

JAMES M. WINEY  
President, Magneplanar Inc.  
White Bear Lake, MN



The Magneplanar MG-IIc speaker: The one thing it is not is electrostatic.

### No Bass

In the September issue, Ron Givens reviewed the Van Halen album "OU812." He rated the recording quality as "very good"; I rate it as "very bad." How can a rock recording with no audible low end (bass and bass drum)

qualify for anything other than a "very poor" rating in this regard? If Mr. Givens heard any low-end content from this recording, then either his sound system is generating huge amounts of harmonic distortion or he has a serious hearing disorder.

NICKEY SMITH  
Lamesa, TX

### Cambridge SoundWorks

We were pleased with Julian Hirsch's thoughtful review of Cambridge SoundWorks's Ensemble speaker system in the September issue. I have two comments, however.

First, the way the Ensemble was placed for Mr. Hirsch's frequency-response measurements should not be inferred to be "right" for all circumstances. As with conventional speakers, ideal placement of the Ensemble varies from room to room. Unlike conventional speakers, the Ensemble lets one readily find the "ideal" placement for the best performance, and because of the system's modular design, one can live comfortably with that placement thereafter.

Second, the Ensemble's sensitivity was dismissed in the test report as "rather low" without a much-needed reminder that sensitivity doesn't come free. The laws of physics (what we used to refer to as Hoffman's Iron Law) are such that higher sensitivity could be achieved *only* by sacrificing bandwidth (bass response) or by making the bass enclosures much larger and costlier. Given our bandwidth, size, and price objectives, we think the Ensemble's sensitivity is entirely appropriate at a time when it is hard to find receivers and amplifiers with less than 30 watts per channel.

HENRY E. KLOSS  
Chairman, Cambridge SoundWorks  
Newton, MA

### Service

Julian Hirsch's August column, "What Product Reviews Won't Tell You," was like a knife in my back. For thirty years I have cultivated the skill of repairing, restoring, and, on occasion, remanufacturing audio/video equipment. Even to suggest that my industry has been reduced to best-guess problem analysis and wholesale board swapping is irresponsible. In my shop, we troubleshoot and repair equipment at the discrete-component and integrated-component levels every day. We don't "shotgun" the equipment to make it operational, we use the latest and best test equipment available, and we keep nearly all of the needed parts on hand to effect a timely repair.



# Why settle for anything more?

Merit has everything you love about smoking.  
And something less. Thanks to Enriched Flavor,<sup>™</sup> Merit delivers  
the rich, rewarding taste and genuine satisfaction you enjoy in a cigarette. Yet it has  
even less tar than other leading lights. Less than Winston Lights. Less than  
Camel Lights. Less than Vantage. So if you want more taste  
without more tar, say nothing more than Merit.

**Enriched Flavor,<sup>™</sup> low tar. A solution with Merit.**



**SURGEON GENERAL'S WARNING: Smoking Causes Lung Cancer, Heart Disease, Emphysema, And May Complicate Pregnancy.**

© Philip Morris Inc. 1988

Kings: 8 mg "tar," 0.6 mg nicotine av. per cigarette by FTC method.

Replacing an older unit with a new one may well be attractive considering the cost of repair, but at what expense in performance? My own (well-maintained) components average eighteen years old, but dollar for dollar I can't buy better, or even comparable, equipment in today's market. When a customer brings me his 1964 McIntosh tube amplifier, I'm not about to convince him it isn't worth a new main filter cap.

Please don't count out a strong American service industry because of a misconception of our ability. Yankee ingenuity is not a dead art.

R. ED HUWA  
Senior Technician, Delta Electronics  
San Angelo, TX

### Search

In his September review of PolyGram's first compact disc videos, Ron

Givens said he had some problems getting his machine to switch back and forth between the audio and video tracks. I assume he was using a Pioneer CLD-1010 combi-player. All you need to do is push the "search" button on the remote control, and the machine will switch from the audio to the video portion of a CDV, or vice versa. This is explained in an insert to the owner's manual.

PETER SHALIT  
Seattle, WA

### Car Speaker Science

Although I've seen a fair number of articles on car stereo installations in STEREO REVIEW over the years, I've never seen anything about the phasing of speakers installed in the door panels. I usually avoid using the kick panels and door panels in installations unless there's absolutely no choice. Considering the incredibly complex waveforms present in a car, it makes no sense to complicate things further by mounting speakers facing each other, meaning that their output (leaving aside reflections off legs and such) will be 180 degrees out of phase.

I have always wired opposite speakers in the door panels *out of phase electrically* so that they would be *in phase acoustically*. The result is most evident in the bass region, but the difference in bass response can mean the difference between a happy customer and a long, tiresome line of people sitting in the car and commenting that, "Yeah, it does sound funny, and turning up the bass doesn't help."

DAVID J. SECORD, JR.  
Port Edwards, WI

Executive Editor Michael Smolen replies: *In the vast majority of car stereo installations, there is no way to avoid putting speakers in the door or kick panels. Mr. Secord's approach is an interesting one and worth trying, but you should listen to the result before the installation is completed, as wiring speakers out of phase could create other problems in the system.*

### Due Credit

In the biographical note for the "Magic Space" article in August, you attribute authorship of the manual for the Lexicon CP-1 to E. Brad Meyer, the author of the article. Without detracting from Mr. Meyer's contribution, it should be noted that this manual represents the efforts of the Lexicon engineering team. Credit should be given in particular to David Griesinger, whose original work makes up a significant portion of the manual.

B. WILLIAMS  
Lexicon Technical Publications  
Waltham, MA



The only wireless speaker system that puts stereo in every room.

Experience the latest in wireless space-age technology with Recoton's WIRELESS 100. Enjoy crisp, clean sound everywhere—minus the static!

Easy to install, just plug the WIRELESS 100's exclusive transmitter into your main



Winner of a Design and Engineering Award at the 1987 Consumer Electronics Show.

© 1988 Recoton Corp

stereo system or portable CD player and nearby AC outlet. Plug the companion speakers into any AC outlet—in your bedroom, kitchen, den, patio, basement—anywhere. Extra Recoton W101 companion speakers may be added to work from your main WIRELESS 100 system.

So don't restrict your stereo listening area. Set yourself free and move around with plug-in sound with Recoton's WIRELESS 100 stereo speaker system.



46-23 CRANE STREET, LONG ISLAND CITY, NY 11101

1-800-RECOTON

CIRCLE NO. 96 ON READER SERVICE CARD

# Heathkit®



## Anyone Can Buy Top Notch Audio. Now You Can Build It.

With Heath's new build-them-yourself stereo components, you create your own sound system.

Specially designed for Heath by industry leader Harman Kardon, our new stereo line exceeds the standards of even the most discerning audiophile. And because most of the components come in kit form, you experience firsthand how electronic craftsmanship results in premium hi-fi performance.

Build the power amplifier, preamplifier and stereo tuner. Prewired and pretested circuit boards and minimal soldering mean each component takes only a few evenings to build.

And, your success is guaranteed. Our precise, step-by-step manuals are industry-recognized, and our technical assistance team is just a phone call away.

To complete your sound system, add the remote control compact disk player, cassette deck and any of our fine speakers and headphones.

See Heath Company's wide assortment of innovative electronic products in our 108-page Heathkit Catalog. For your *FREE* copy, mail the coupon below or call 24 hours a day TOLL-FREE:

**1-800-44-HEATH** (1-800-444-3284)

Yes, send me a *FREE* Heathkit Catalog.

Send to: **Heath Company, Dept. 006-714**  
**Benton Harbor, Michigan 49022**

Name \_\_\_\_\_

Address \_\_\_\_\_ Apt. \_\_\_\_\_

City \_\_\_\_\_

State \_\_\_\_\_ Zip \_\_\_\_\_

**Heath Company**



Bose® engineers use advanced design technology to bring the benefits of new technologies to the constantly-refined 901® Direct-Reflecting® speaker. The Integraph InterAct 32 CAD/CAM system (above) at Bose corporation's Framingham, Massachusetts worldwide headquarters is part of this commitment to "better sound through research."

# The Bose® 901® Direct/Reflecting® speaker system: A technological breakthrough 20 years ago— pushed to the edge of *today's* technologies.

**"I am convinced that it ranks with a handful of the finest home speaker systems of all time."**

—Julian Hirsch, *Stereo Review*, 1968

**"The 901 VIs sound live and exciting the moment you fire them up . . . There are more than a few music lovers who won't listen to anything else . . ."**

—Daniel Kumin, *Digital Audio*, 1988

Twenty years ago, an MIT research project into the physics of sound produced its first tangible result: a design for a speaker system capable of accurately reproducing live music's balance of direct and reflected sound energy.

The professor in charge of the research project—Dr. Amar Bose—directed his engineering team to build such a speaker, making full use of the most advanced technologies available. The result was the original Bose 901 Direct/Reflecting® speaker system. The response from the public and the critics turned the Bose 901 system into a legend practically overnight.

**"There is no doubt that the much-abused and overworked term, 'breakthrough,' applies to the Bose 901 system and its bold new concepts."**

—Bert Whyte, *Audio*, 1969

**"Many people swear by these speakers as the ultimate."**

—*Complete Buyer's Guide to Stereo Hi-Fi Equipment*, 1975

Since then, Bose 901 systems have earned more critical acclaim and rave reviews than any other product in audio history. The reason? Bose research has continued to develop and refine the 901 system, pushing the system's concept to the very limits of advanced technology. In fact, the system's Acoustic Matrix enclosure and HVC driver, developed to dramatically improve power handling and efficiency, represent more research and development than other manufacturers invest in their entire speaker lines.

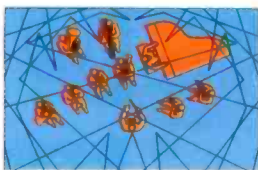

Live music is a combination of direct and reflected sound energy.



Bose Direct/Reflecting® speakers accurately reproduce live music's natural balance of direct and reflected sound energy, in full stereo (blue area) throughout the room.

**"Without doubt the Bose 901 . . . must rank among the very best speaker systems yet produced, one that can be called a speaker for all seasons' or for 'all reasons.'"**

*Ovation*, 1983

**"In terms of musical veracity, the Bose 901 ranks with the finest and is convincing with any type of music . . ."**

—Hans Fantel,

*The New York Times*, 1984

The technological concept behind the new 901 Series VI system is identical to the original for one reason: *the scientific principles*

*governing sound and its reproduction have not changed.* But since the introduction of the first 901 system, Bose engineers have worked continuously to develop and perfect new and diverse audio technologies with one common denominator: if they demonstrate the potential to improve performance, they

become part of the Bose 901 system. It's not surprising that today's Bose 901 Series VI system incorporates some 1,000 improvements over the original—and that 20 years after its introduction, the 901 speaker system remains the technological flagship of Bose Corporation.

**" . . . the 901 delivers a unique value for the money—both in terms of quantity and quality."**

—Daniel Kumin, *Digital Audio*, 1988

We submit that the research and development behind the Bose 901 system make it the most advanced, lifelike sounding speaker you can buy—regardless of size or price. The industry's most respected critics have echoed that sentiment. But the final judge is you. Audition the Bose 901 Direct/Reflecting® system. Once you listen, you'll know why it's "the speaker to which all others must be compared." Bose also makes an entire line of Direct/Reflecting® speakers

incorporating much of the audio technology developed for the 901 system.

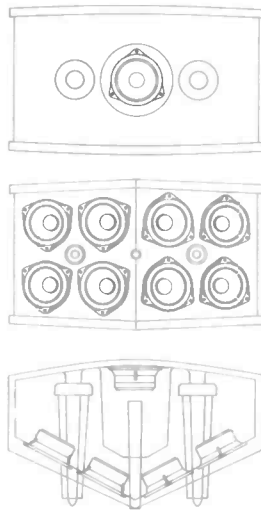

We invite you to audition the Bose line at a dealer nearest you. For more information, call 1-800-444-2673 between 9 a.m. and 5 p.m. EST.

**BOSE®**  
**Better sound through research.**

# What happens when you listen to a movie without the DSR-100 PRO.

Here's a graphic demonstration of what your ears are missing everytime you experience a movie at home.

All those distinctly riveting sound effects that make movies come alive in a theater, inevitably seem dull, muddled and dimensionless on your smaller screen and speakers at home.

Obviously, something has gotten lost in the process.

Well, not anymore.

Yamaha proudly introduces the new DSR-100 PRO with Dolby\* Pro Logic.



An advancement in soundfield processing so significant, it can make the sound system in your living room rival practically any movie theater you can name.

How it works is relatively straightforward.

The DSR-100 PRO decodes the surround information embedded in stereo TV broadcasts, laserdiscs and prerecorded videocassettes.

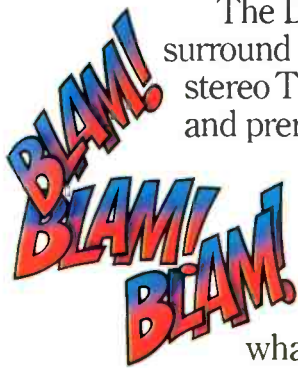

It even outperforms the great results you get with Dolby Surround by controlling the *placement* of sound to match precisely what you're watching.

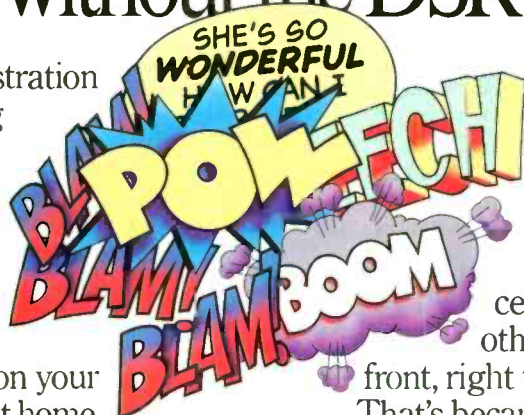

If a gun fires on the right, for example, you hear it on the right, just as the director intended.

Critical to this kind of directionality is the front/center channel. Which, among other things, keeps dialogue up front, right where it belongs.

That's because the DSR-100 PRO uses the exact same advanced Dolby decoder

used in commercial movie theaters.

## What happens when you do.



The result is an unprecedented audio/video experience that puts the viewer right smack dab in the middle of the action to a

degree seldom realized outside a movie theater.

And that's not all.

We also included an interface for our DSP-1 or DSP-3000 Digital Soundfield Processors.

Phenomenal components that allow you to enjoy the acoustic properties of the finest movie theaters and concert halls in the confines of your living room.

Drop by your Yamaha dealer today for a demonstration of the new DSR-100 PRO.

A demonstration so remarkable, your eyes won't believe your ears.



# YAMAHA®



Bring home the DSR-100 PRO and you can finally experience the proper placement of sound and dialogue you've been missing.

## NEW PRODUCTS

### Clarion

Clarion's Model 720EQ electronic equalizer/analyzer has three preset time delays that can be used to create a surround-sound effect in the car. The different delays, along with five programmable EQ curves, allow the user to adjust the sound exactly to taste. The control head is mounted on a flexible gooseneck arm that can be installed in a location convenient for the driver. The base unit can be mounted next to the amplifiers. The sensitivity of the seven-band spectrum display can be changed to focus on the most active regions, and seven different display patterns can be selected. A low-pass frequency selector allows the user to change the crossover frequency of the subwoofer amplifier for different subwoofers. An adjustable line-level control balances the subwoofer amp to the rest of the system. Price: \$499.95. Clarion, Dept. SR, 5500 Rosecrans Ave., Lawndale, CA 90260.

Circle 120 on reader service card



### Cambridge Audio

The Cambridge Audio C50/A50 is a preamp/power-amp combination. The A50 power amplifier is rated for 60 watts per channel into 8 ohms, with a peak current capability of 35 amperes. It can be connected for bridged mono operation by a rear-panel switch; in this mode it is rated to deliver 150 watts into 8 ohms. The A50 has loudspeaker-protection circuitry, and the output connections are through three-way binding posts.

The C50 preamplifier can accommo-

date four input sources plus a tape loop. Cambridge's passive tone controls are combined with a tone-bypass switch, and there are two outputs, one with and one without tone-control modification. The phono stage is switchable for an MM or MC cartridge. The headphone jack has its own amplifier. Price: A50/C50 combination, \$999; A50 alone, \$579. Cambridge Audio Systems, Dept. SR, 89 Doug Brown Way, Holliston, MA 01746.

Circle 121 on reader service card



### Sherwood

Sherwood's CD-1160R compact disc player has a three-beam laser and a quadruple-oversampling digital filter. It can be programmed to play up to twenty tracks in any order, and the display can be used to check the programmed sequence of tracks. Other features include an auto-space function to insert 3 seconds between tracks for taping, track skipping and fast search in both direc-

tions, repeat functions, and random play. The CD-1160R's remote control can command other Sherwood components. Frequency response is given as 2 to 20,000 Hz  $\pm$  0.5 dB, dynamic range as 93 dB, and total harmonic distortion as 0.005 percent at 1,000 Hz. Price: \$249.95. Sherwood, Dept. SR, 13845 Artesia Blvd., Cerritos, CA 90701.

Circle 122 on reader service card

### Harman Kardon

The hk330Vi is the latest version of Harman Kardon's entry-level hk330 AM/FM receiver. Its high instantaneous current capability, up to 18 amperes, enables it to deliver much more power on peaks than its rated 25 watts per channel. Total harmonic distortion is rated as no more than 0.09 percent from 20 to 20,000 Hz into 8 ohms. A low level of negative feedback (20 dB) is said to reduce distortion. The amplifier section's frequency response is given as 0.5 to 150,000 Hz; the ultrawide bandwidth



is said to give it a very fast transient response while virtually eliminating transient intermodulation distortion. The digital quartz-locked tuning section includes twelve FM and six AM presets. Other features include a loudness con-

tour, two tape-monitor loops, and separate CD and audio/video line inputs. Price: \$319. Harman Kardon, Dept. SR, 240 Crossways Park West, Woodbury, NY 11797.

Circle 123 on reader service card

## NEW PRODUCTS

### *Custom Woodwork & Design*

New to the Custom Woodwork & Design line of modular audio/video furniture is the Flexdrawer system. Flexdrawer slide-out drawers and shelves are designed to hold audio and video tape cassettes, compact discs, and computer disks. The drawers are available in three different heights, and all Flexdrawer shelves and drawers are available both in full-width fronts and in the previous CWD standard fronts that fit behind wood or glass doors. The small audio-cabinet drawer, which measures 4¾ inches tall, can hold ninety digital audio tape cassettes, seventy-two analog

tape cassettes, or sixty 8mm video tapes. Small drawers in the video cabinets can hold 108 DAT's, ninety audio cassettes, or seventy-five 8mm video tapes. Medium drawers, 7¾ inches tall, hold twenty-four videotapes, ninety CD's, or 180 3¼-inch floppy disks in the audio cabinets, thirty-six videotapes, 120 CD's, or 240 3¼-inch floppies in video cabinets. Large drawers, 11¼ inches tall, are designed to hold file folders. Price: \$100 to \$135. CWD, Dept. SR, 5200 W. 73rd St., Bedford Park, IL 60638.

**Circle 124 on reader service card**



### *Celestion*

The SL12 Si from Celestion is a three-way, floor-standing speaker with a 6-inch woofer, a 6-inch bass/midrange driver, and a 1¼-inch aluminum-dome tweeter. The plastic cone of each driver is matched to its surround for increased flexibility and quicker overall response. The wood cabinet utilizes a figure-eight brace and a locked back panel that are said to minimize the effect of box response. Equipped with gold-plated connectors and two pairs of input sockets, the system can be bi-wired or bi-amplified if desired. Finish is walnut veneer or black wood. Price: \$1,499 a pair. Celestion Industries, Dept. SR, 89 Doug Brown Way, Holliston, MA 01746.

**Circle 125 on reader service card**

### *Nakamichi*

Nakamichi's entry-level receiver is the 35-watt-per-channel TA-1A High Definition Tuner Amplifier. The TA-1A has custom-designed discrete output circuitry, which the company claims provides high peak-current capability and superior sound. The bass and treble controls provide a boost or cut of up to ±10 dB at the frequency extremes without changing the midrange response. At an output-level setting of -30 dB, the Loudness Contour provides a maximum boost of +10 dB at 20 Hz and +6 dB at 20,000 Hz. An infrasonic filter is built into the phono preamp to prevent tape and speaker overload when recording or playing a warped record. The AM/FM tuner includes manual or auto-seek tuning and ten station presets. Price: \$329. Nakamichi America Corp., Dept. SR, 19701 South Vermont Ave., Torrance, CA 90502.

**Circle 126 on reader service card**







Introducing  
the distinguished

**RZ**  
SERIES

from Sansui

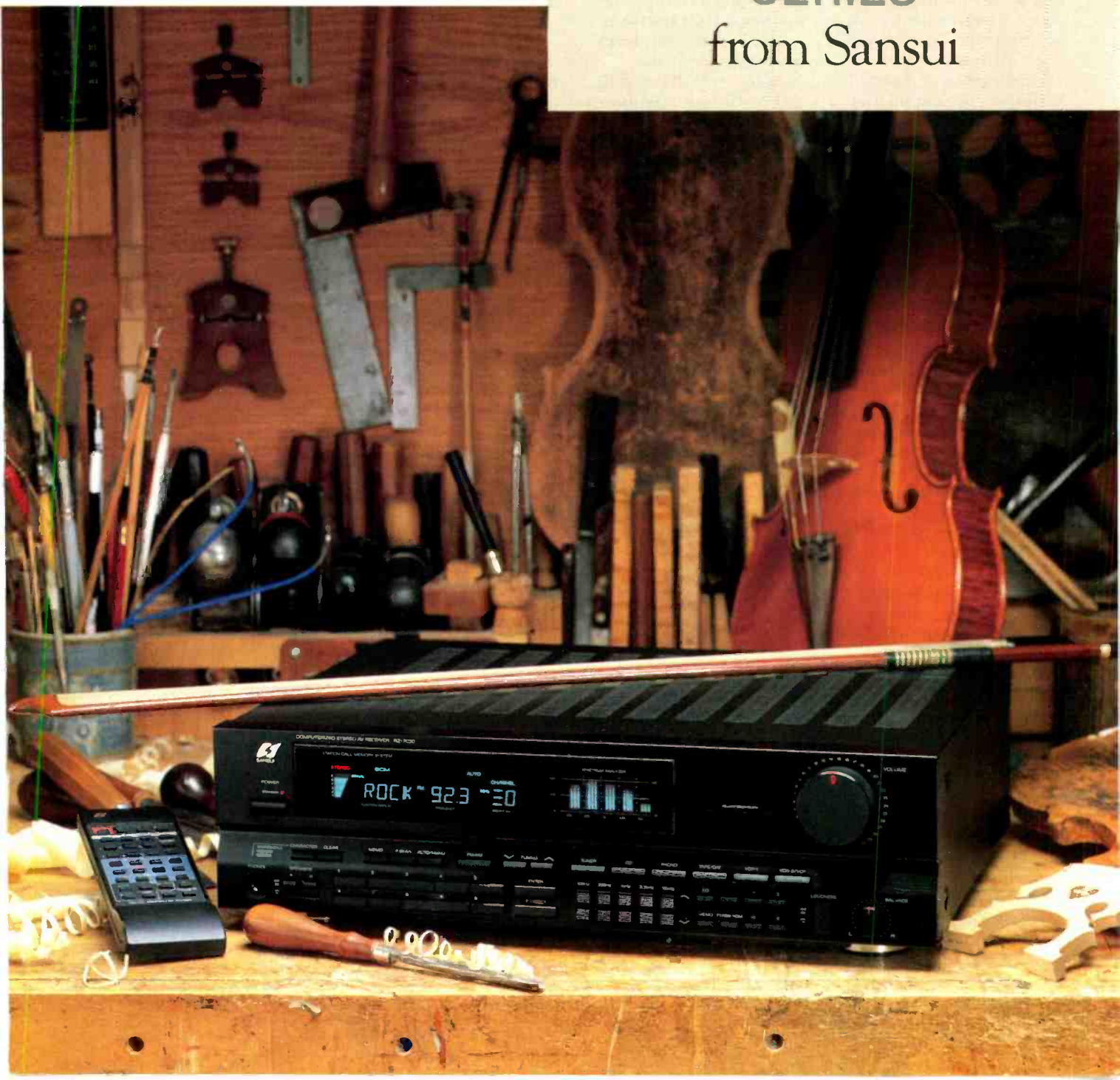

# CRAFTSMANSHIP

The legendary violin makers of Cremona, Italy – Stradivari, Guarneri, Amati – knew that even the most gifted performers could only produce magnificent sounds with great instruments. They crafted their instruments to complement a violinist's virtuosity by shaping the subtlest changes of tonal quality and dynamics.

Music lovers today rely on another class of great instruments. Electronic components designed and engineered by Sansui. These components bring the magnificence of your favorite music into your home with all delicate nuances intact.

**Introducing Sansui RZ-Series Receivers: RZ-7000, RZ-5000, RZ-3000, RZ-1000.**

Every music lover wants one of the four feature-packed Sansui RZ-Series receivers at the heart of his or her audio system.

From our top-of-the-line RZ-7000 to our highly affordable RZ-1000, the key to what makes the RZ-Series exceptional is *Sansui craftsmanship*. While many manufacturers profess quality construction, we back our claim with some very concrete evidence.

For starters, all receivers in the RZ-Series possess discrete outputs. Bass sounds are rich and accurate. High and transient sounds are far more lifelike, due to improved stereo imaging.

We build our amplifiers with unusually large heat sinks, broad power margins, and enough dynamic power to give them the low-impedance capability to drive 4-ohm speakers.

All RZ-Series receivers are engineered "user friendly" with these valuable features in common: fully computer-controlled quartz-PLL synthesizer tuners, precise tuning of 30 preset stations, a station call memory system, six inputs for virtually all audio and video components, outputs for two sets of speakers, and a front-panel headphone jack.

Finally, consider our chassis. They're metal. Other manufacturers of so-called "quality" receivers might switch to plastic and pressed cardboard, but Sansui won't.

Our metal chassis provide strength and rigidity, which significantly cut down RF interference and vibrations.

And the RZ-Series looks as great as it sounds. The receivers are elegantly styled in a rich matte-black finish offset by a blue fluorescent display of station and function.





### RZ-7000

#### Computerized Stereo A/V Receiver

- 70 watts per channel
- Compu-controlled Quartz-PLL Synthesizer Tuner
- 30 Random FM/AM station presets
- Preset Scan
- Station call memory system
- PECS (Personal Equalization Code System) – 5 fixed-sound menus plus 5 personal preset menus
- PETS (Programmed Equalization for Tuner System)
- Frequency-direct tuning
- 5-Band computer controlled equalization with spectrum analyzer
- 6 Inputs for TUNER, CD, PHONO, TAPE/DAT, VCR-1, VCR-2/VDP
- Separate input/output for signal processor
- Loudness switch
- Outputs for 2 sets of speakers and front-panel headphone jack
- Audio Muting
- Full-function 36-key Unified Remote Control
- Low impedance driving capability

### RZ-5000

#### Computerized Stereo A/V Receiver

- 60 watts per channel
- Compu-controlled Quartz-PLL Synthesizer Tuner
- 30 Random FM/AM station presets
- Preset Scan
- Station call memory system
- Frequency-direct tuning
- Variable loudness (switchable to variable bass) plus individual tone controls
- 6 Inputs for TUNER, CD, PHONO, TAPE/DAT, VCR-1, VCR-2/VDP
- Separate input/output for signal processor
- Outputs for 2 sets of speakers and front-panel headphone jack
- Audio Muting
- Full-function 36-key Unified Remote Control
- Low impedance driving capability

### RZ-3000

#### Computerized Stereo Receiver

- 50 watts per channel
- Compu-controlled Quartz-PLL Synthesizer Tuner
- 30 Random FM/AM station presets
- Preset Scan
- Station call memory system
- Frequency-direct tuning
- 6 Inputs for TUNER, CD, PHONO, TAPE-1, TAPE-2/MONITOR, VCR/VDP
- Variable loudness and individual tone controls
- Output impedance switch 4/8 ohms
- Audio Muting
- Outputs for 2 sets of speakers and front-panel headphone jack
- Full-function 20-key Unified Remote Control

### RZ-1000

#### Computerized Stereo Receiver

- 32 watts per channel
- Compu-controlled Quartz-PLL Synthesizer Tuner
- 30 Random FM/AM station presets
- Preset Scan
- Station call memory system
- Frequency-direct tuning with auto and manual tuning
- Loudness switch and individual tone controls
- 6 Inputs for TUNER, CD, PHONO, TAPE-1, TAPE-2/MONITOR, VCR/VDP
- Output impedance switch 4/8 ohms
- Outputs for 2 sets of speakers and front-panel headphone jack

	RZ-7000	RZ-5000	RZ-3000	RZ-1000
Power @ 8 ohms, 20-20kHz	70W	60W	50W	32W
THD	0.02%	0.05%	0.09%	0.09%
Dynamic Power	8 ohms 4 ohms 2 ohms	100W 140W 160W	90W 120W 135W	78W 100W 65W
Low-Impedance Speaker Driving Capability	4 ohms	4 ohms	4 ohms	4 ohms
Net Weight lbs (kg)	22 (10.0)	21 (9.5)	17 (7.7)	14 1/2 (6.6)
Discrete Outputs	yes	yes	yes	yes
Unified Remote Control	36 key	36 key	20 key	
MotORIZED Volume Control	yes	yes	yes	
Variable Loudness		yes	yes	
Loudness Switch	yes			yes
Station Call Memory	yes	yes	yes	yes
Frequency Direct Tuning	yes	yes	yes	yes
Random Presets	30	30	30	30
Preset Scan	yes	yes	yes	yes
PECS (Personal Equalization Code System)	yes			
PETS (Programmed Equalization for Tuning System)	yes			
EQ Menu (5 factory presets, 5 user presets)	yes			
5-Band Graphic Equalizer	yes			
Variable Bass and Treble Controls		yes	yes	yes
VCR Dubbing Capabilities	yes	yes		
VCR to TAPE AUDIO Dubbing Capabilities	yes	yes	yes	yes
VCR/Monitor Output	yes	yes		
Audio Muting	yes	yes	yes	



## The perfect companions to the distinguished RZ-Series: Sansui CD players and cassette decks.



The world's first twin magazine, multi-play CD changer: The CD-X510M

Settle in for a full day's listening enjoyment and never have to change a compact disc. The CD-X510M is so advanced that in its random mode it won't repeat a selection during 12 hours of continuous play. You can

program up to 30 tracks into memory for a personalized music mix.

The twin cartridges on the CD-X510M changer allow you to operate each magazine entirely independently of the other. You can reload one 6-disc cartridge while your CD continues to play in the other.

Naturally, a unit this advanced is state-of-the-art throughout: two separate digital-to-analog converters, and 2x oversampling digital filter.

Remote control? Of course. Or you can operate your CD-X510M with the Unified Remote Control featured with the RZ-Series receivers.



Remote controlled CD-X301i compact disc player

The exciting news about the CD-X301i is Sansui's dual digital-to-analog converters, the Dynamic Servo System,

and 2x oversampling digital filter. Even dirty or scratched discs track true, and our highly effective floating mechanism guards against vibrations—both inside and outside.

Other features include a 24-key remote control, 20-track random programming, and 3-way repeat mode.



The D-X301i cassette deck and the D-X301iR auto-reverse deck

Start with Sansui's exclusive Computerized Dual Function Control, which activates features without extra controls. Then add 20-song Automatic Music Program Search, bidirectional music scan, 2-way repeat mode, memory stop, and bias adjust.

Include Dolby B, C, and HX PRO for the best recording from digital sources and the closest thing to noise-free sound reproduction, and you have one of the premier cassette decks ever offered—the D-X301i. And, when you add auto-reverse to all this, you have Sansui's extraordinary D-X301iR.

Here are tape decks engineered to handle the dynamic range of CDs and other digitally-sourced material when dubbing.

And, of course, each operates by remote in complete harmony with the RZ-Series receivers. Both have full-logic controls, computerized bias tuning, timer, and electronic tape counter.



### Unified Remote Control

In addition to the RZ-7000, RZ-5000, and the RZ-3000\* receivers, the Unified Remote Control operates all the functions of compatible Sansui CD players and cassette decks.

\*Dedicated Unified Remote Control for the RZ-3000, not shown.

SPECIFICATIONS	RZ-7000	RZ-5000	RZ-3000	RZ-1000
<b>AUDIO SECTION:</b>				
<b>Power Output</b>	70 watts per channel into 8 ohms, min. RMS, both channels driven, from 20Hz to 20,000Hz, with no more than 0.02% total harmonic distortion.	60 watts per channel into 8 ohms, min. RMS, both channels driven, from 20Hz to 20,000Hz, with no more than 0.05% total harmonic distortion.	50 watts per channel into 8 ohms, min. RMS, both channels driven, from 20Hz to 20,000Hz, with no more than 0.09% total harmonic distortion.	32 watts per channel into 8 ohms, min. RMS, both channels driven, from 20Hz to 20,000Hz, with no more than 0.09% total harmonic distortion.
Frequency Response (at 1W)	10-70,000Hz + 1dB, -3dB	10-70,000Hz + 1dB, -3dB	10-70,000Hz + 1dB, -3dB	10-70,000Hz + 1dB, -3dB
Signal-to-Noise Ratio (A-Weight)	73dB	73dB	73dB	73dB
Phono (MM)	90dB	90dB	90dB	90dB
CD, Tuner, Tape, VCR				
<b>Tone Controls</b>				
Bass	(5-Band EQ, ±10dB at 100, 330, 1k, 3.3k, 10kHz)	±8dB at 50Hz ±7dB at 10kHz	±8dB at 50Hz ±7dB at 10kHz	±8dB at 50Hz ±7dB at 10kHz
Treble				
<b>Loudness</b>	+8dB at 50Hz +5dB at 10kHz	0dB - +8dB at 50Hz 0dB - +5dB at 10kHz Bass boost on +10dB at 100Hz	0dB - +10dB at 50Hz 0dB - +6dB at 10kHz	+8dB at 50Hz +5dB at 10kHz
<b>FM SECTION:</b>				
<b>Tuning Range</b>	88-108 MHz	88-108 MHz	88-108 MHz	88-108 MHz
50dB Quieting Sensitivity	17.2dB/38.2dBf	17.2dB/38.2dBf	18dB/40dBf	18dB/40dBf
Mono/Stereo				
Sensitivity	11.2dBf	11.2dBf	13.2dBf	13.2dBf
Mono				
Signal-to-Noise Ratio (at 65dB)	76dB/70dB	76dB/70dB	76dB/70dB	76dB/70dB
Mono/Stereo				
Frequency Response				
Stereo	30-15,000Hz + 1dB, -3.0dB	30-15,000Hz + 1dB, -3.0dB	30-15,000Hz + 1dB, -3.0dB	30-15,000Hz + 1dB, -3.0dB
Distortion (at 65dBf, 1,000kHz)				
Mono/Stereo	0.2%/0.3%	0.2%/0.3%	0.3%/0.5%	0.3%/0.5%
Capture Ratio	1.5dB	1.5dB	1.5dB	1.5dB
Stereo Separation (at 1,000 kHz)	40dB	40dB	40dB	40dB
<b>AM SECTION:</b>				
<b>Tuning Range</b>	530-1,600kHz	530-1,600kHz	530-1,600kHz	530-1,600kHz
Sensitivity (Loop Antenna)	55dB/m	55dB/m	55dB/m	55dB/m
<b>GENERAL:</b>				
<b>Dimensions (W x H x D)</b>	16-15/16" x 4-15/16" x 13-1/4" 430mm x 125mm x 355mm	16-15/16" x 4-15/16" x 13-1/4" 430mm x 125mm x 355mm	16-15/16" x 4-15/16" x 13-1/4" 430mm x 125mm x 355mm	16-15/16" x 4-15/16" x 13-1/4" 430mm x 125mm x 355mm
<b>Net Weight lbs. (kg)</b>	22 (10.0)	21 (9.5)	17 (7.7)	14½ (6.6)

Designs and specifications subject to change without notice for improvements.



SANSUI ELECTRONICS CORPORATION  
P.O. Box 625  
1250 Valley Brook Avenue  
Lyndhurst, New Jersey 07071, U.S.A.

SANSUI ELECTRIC CO., LTD.  
14-1, Izumi 2-Chome, Sugunami-ku, Tokyo 168, Japan  
CIRCLE NO. 99 ON READER SERVICE CARD

Violin crafted by Guy Rahut, New York, NY

## NEW PRODUCTS

### Arcam

The Arcam Delta Black Box, made by Britain's A&R Cambridge, Ltd., is an outboard 16-bit digital-to-analog (D/A) converter that can be connected to any CD player equipped with a standard coaxial digital output. It uses a custom-made integrated circuit, said to replace as many as twenty-five standard chips, dual quadruple-oversampling digital filters, and seven regulated DC power supplies. By shielding the D/A conversion stage from the CD player's electrically

noisy laser transport mechanism and signal-reading and error-correction circuits, the Arcam Delta is said to restore "musical subtleties" lost in ordinary players. Frequency response is rated as 10 to 10,000 Hz  $\pm$  0.1 dB, down 0.4 dB at 20,000 Hz. Unweighted signal-to-noise ratio is 101 dB, dynamic range 96 dB. Price: \$649. Arcam, Dept. SR, Audio Influx Corp., P.O. Box 381, Highland Lakes, NJ 07422-0381.

**Circle 127 on reader service card**

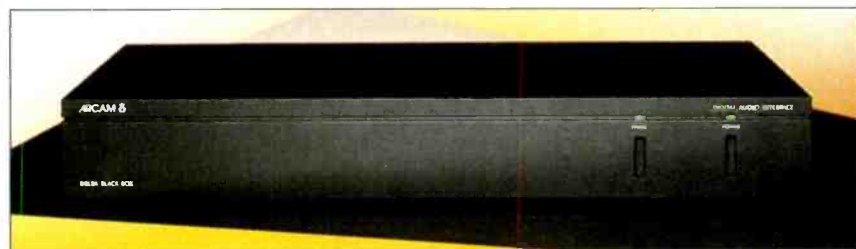

### Audio Concepts

Audio Concepts offers a varied line of speaker kits in two formats: parts kits and full kits. The parts kits include the drivers, assembled and tested crossovers, cabinet stuffing materials, silicone sealant for installing crossovers, foam tape, and plans for constructing the cabinets and installing the parts. Full kits also include assembled cabinets with grilles and mounting hardware. Photo shows, from left to right, the Saturn subwoofer, the Quartz II (on pedestal), the Model C on Model AC stand, and the Pulse subwoofer. Other systems available include the Model S compact monitor, the G2, and the Super Titan. The drivers used are the company's own or from Dynaudio, Eton, Focal, MB Electronics, Morel, or Seas. Cabinets are available in sanded but unfinished oak or walnut with black or beige grille cloths. Prices for full kits range from \$239.90 for the Model S to \$889.90 for the Super Titan. The kits come with a two-year warranty on all components. Audio Concepts, Dept. SR, P.O. Box 212, La Crosse, WI 54602.

**Circle 129 on reader service card**

### Technics

The Technics CQ-R9550 car stereo head unit has a touch-sensitive screen that controls functions of the tuner, the cassette player, and an optional twelve-disc external CD changer. Each source has its own illuminated function legends on the LCD panel. A wireless remote control is also included. The tuner has twelve FM and twelve AM station presets and manual tune and scan.

The cassette player has scan, repeat, blank-skip, and program-search functions. When the CQ-R9550 is used with the Technics CX-DP11 CD changer, it can control programming, track skip, intro scan, memory scan, and random play. Price: \$750. Technics, Dept. SR, One Panasonic Way, Secaucus, NJ 07094.

**Circle 128 on reader service card**



### Phase Linear

Phase Linear's Graphite PL2690 is a 6 x 9-inch car speaker with a graphite woofer cone and a polycarbonate tweeter. It can be bi-amplified for custom installation. Continuous power handling is rated as 80 watts, peak capacity as 180 watts. Frequency response is given as 38 to 24,000 Hz, and sensitivity is 92 dB. Price: \$150. Phase Linear, Dept. SR, 4134 N. United Parkway, Schiller Park, IL 60176.

**Circle 130 on reader service card**



# “Superb sound and virtual invisibility.”

—Stereo Review, Julian Hirsch



Acoustimass<sup>®</sup> array with optional mounting accessory for unobtrusive placement.

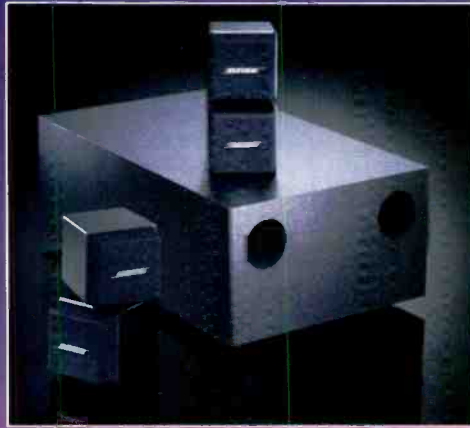

The Bose<sup>®</sup> Acoustimass speaker system.

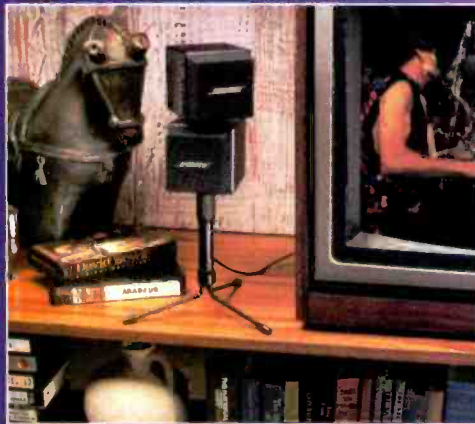

Both arrays are equipped with magnetic shielding for high-fidelity video listening.



The system's heart—the Acoustimass<sup>®</sup> module—can be completely hidden, providing virtual invisibility.



# Presenting the Bose® Acoustimass® Direct/Reflecting® Speaker System

"In our listening room, side by side with speakers costing three to five times as much, the AM-5 consistently produced the more exciting and listenable sound in A/B tests.

—Stereo Review, Julian Hirsch

"... a sonic standout."

—The New York Times, Hans Fantel

To hear the sound they're talking about, look for an Acoustimass® speaker system.

Take the room-filling, full fidelity sound you expect from full-sized speakers, and imagine it coming from two tiny arrays, each no larger than a quart carton of milk.

This is the Acoustimass speaker listening experience.

"Superb sound . . .

An Acoustimass speaker launches sound into the room by two air masses, producing the purest sound possible from any present-technology speaker design—regardless of size or price. Its purer sound, wider dynamic range and greater output mean that any sound source—music or video—will sound more lifelike, with much of its original realism and impact reproduced right in the listening room.

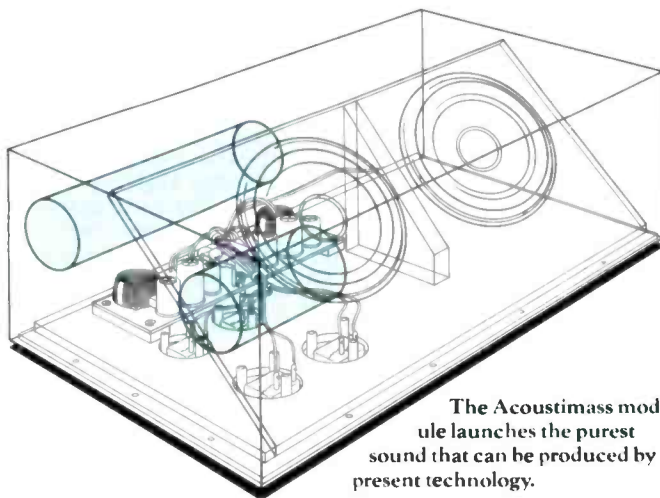

The Acoustimass module launches the purest sound that can be produced by present technology.

How an Acoustimass® speaker works.

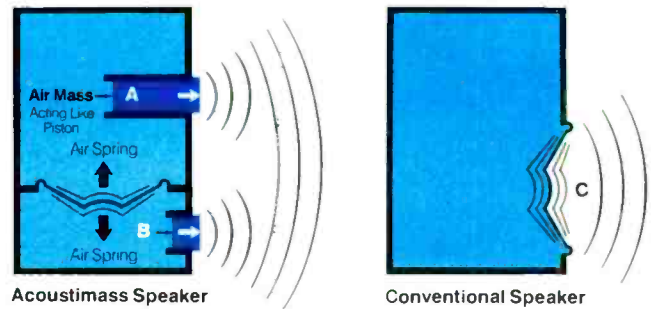

Improving speaker performance means first reducing distortion. The design of an Acoustimass® speaker substantially reduces distortion (see diagrams and graph). The benefits of this patented speaker technology are: purer sound and virtual invisibility, along with higher power handling and wider dynamic range.

**Left:** An Acoustimass speaker launches sound into the room using two masses of air working like pistons (A & B, darker blue), rather than by a surface vibrating directly into the room. The sound launched into the room by the Acoustimass speaker's air pistons is the purest sound that can be produced by present technology.

**Right:** A vibrating cone radiating directly into the room (C) produces unfiltered sound.

## Cone Excursion Comparison

(lower excursion means lower distortion)

**Graph:** This distortion produced by any speaker rises dramatically with cone motion, or excursion. At port-tuned frequencies, a typical Acoustimass speaker's cone has less than 1/16 the maximum excursion\* of sealed and ported cones. Inside an Acoustimass speaker, the interaction of the air springs with the air masses in the ports produces a very high pressure at the surface of the cone. This greatly reduces the cone's excursion, and therefore reduces distortion. The air springs act with their respective masses to form low-pass filters, removing any small distortion components generated by the cone.

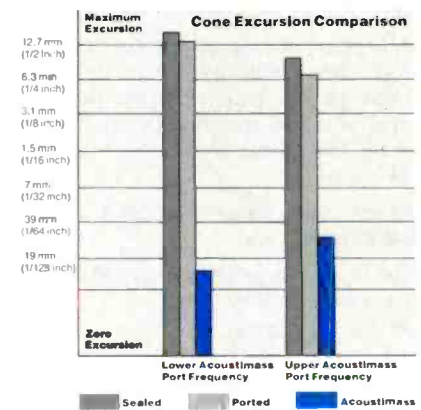

\*based on cone travel measurements at 128 watts input

## A difference you can see and hear.

There are a number of three-piece speakers available. But only Acoustimass speaker technology delivers the full benefits of "superb sound and virtual invisibility." Ask your Bose dealer to give you an A/B demonstration comparing the Acoustimass system to any other speaker on display—and judge for yourself. For more information call toll-free 1-800-444-2673.

**BOSE®**  
Better sound through research.

© Copyright 1988 Bose Corporation. All rights reserved. Covered by patent rights issued and/or pending. Julian Hirsch, Stereo Review, April 1987. Reprinted with permission from High Fidelity Magazine, March 1987. Copyright © All rights reserved. Copyright © 1987 by The New York Times Company. Reprinted by permission.

... and virtual invisibility?"

An Acoustimass system also leaves more of the listening room to enjoy. The Acoustimass module can be hidden out of sight, behind or under the furniture. All sound appears to come from two tiny arrays a fraction of the size of typical "satellite" speakers. Optional accessories allow them to be unobtrusively mounted in places beyond the reach of ordinary speakers—above the listening area like lighting fixtures, for example. The computer-optimized arrays precisely shape the sound, delivering the life-like spaciousness and clarity of a Bose Direct/Reflecting® speaker—while setting an open, natural stereo image listeners can enjoy throughout the room, regardless of where they sit or stand.

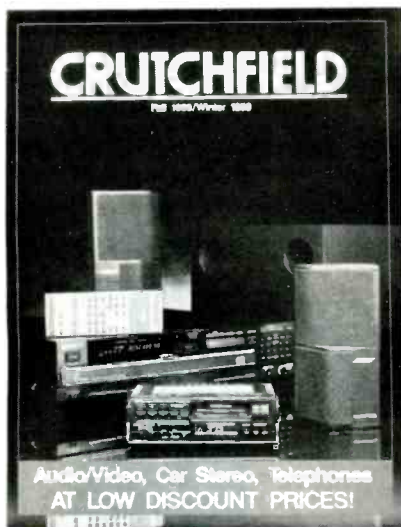

You'll find the most helpful shopping information in the 116 page Crutchfield catalog.

# FREE Stereo Catalog

Refer to the Crutchfield catalog before buying your next car stereo, home stereo, or video product:

- 116 pages of helpful articles, consumer tips, charts, and installation guides.
- Color photos, complete descriptions and technical specifications on hundreds of the finest brand name products.

You get more value shopping Crutchfield:

- Toll-free product advice, ordering, and customer service.
- 24 hour shipping.
- Absolute satisfaction guaranteed.
- Full 30-day return privileges.
- Discount prices on Sony, Pioneer, JVC, Teac, Proton, Advent, Clarion, Akai, Kenwood, Canon, AR, Infinity, Bose, and many more!

Call or send this coupon now for your FREE Catalog

## 800-336-5566

Be sure to mention *Stereo Review* when calling

Name \_\_\_\_\_

Address \_\_\_\_\_

Apt. # \_\_\_\_\_

City \_\_\_\_\_

State \_\_\_\_\_

Zip \_\_\_\_\_

# CRUTCHFIELD

1 Crutchfield Park, Dept. SR, Charlottesville, VA 22906

## AUDIO Q&A

by Ian G. Masters



### Mono Amplification

**Q** I have a fine speaker dating from the mono days of the 1950's, and I would like to use it in a workshop where stereo is unnecessary. The amplifier I intend to use is stereo, and it seems inefficient not to use both its channels if possible. Can I somehow connect the single speaker to both amplifier outputs?

CHARLES A. BUTZ, SR.  
Alexandria, KY

**A** No. Some amplifiers are designed for bridging to mono, but most are not. Attempting to connect the outputs of both channels to a single speaker would almost certainly cause severe damage. In any event, there would be little point in doing so. The most you would gain in doubling the power would be an extra 3 db of output, and that would be just barely audible. Your old speaker is very efficient anyway, so one channel should be more than sufficient to drive it to any level you might reasonably desire (remember to switch the amplifier to mono, though, or you will lose half the music).

If you really feel you need some extra oomph, you can probably get it simply by turning the amplifier's balance control all the way over to the channel you are using. Power outputs are specified with both channels operating equally; by turning one side off, the power supply can devote all its energy to driving the channel you do use. An increase of 3 db in power output would be quite likely, but without risk of damage.

### Bafflelab

**Q** In searching for new speakers, I have noticed that some models are called "monitors" while others claim to be "digital-ready." What do these terms mean?

CLIFF KAISER  
Edison, NJ

**A** Nothing, technically. Phrases like "monitor," "studio standard," and the like have long been used as marketing devices to lend a sense of professionalism to products that would, in fact, be unlikely ever to find their way into a recording or broadcasting studio—the only places where the word "monitor" has any real meaning. Actually, most speakers used for monitoring recordings are quite unsuitable for the home, and vice versa. "Digital-ready" simply means that a speaker can handle enough power to reproduce the dynamic range of a digital recording without blowing up. Any good speaker should be able to do that.

### Record Sleeves

**Q** I'm in the habit of replacing the paper inner sleeves that records come in with the plastic-lined sleeves obtainable in record and stereo stores because it seems to me that the store-bought sleeves are kinder to my records. Are they in fact better?

DAVID ENGLISH  
West Somerville, MA

**A** Yes. The plastic lining is good because it adheres slightly to the record surface, providing a seal against airborne dust. The plastic-only sleeves that some record companies provide do the same thing, but they often go awry when being slipped into the outer sleeve; a paper "frame" for the plastic sleeve prevents this.

### Equipment Cleaning

**Q** The appearance of my audio system is almost as important to me as its sound. Unfortunately, I live only a few hundred yards from a freeway, so my equipment looks ridiculous in a matter of days. I have found that cloth towels can't get into the tight spots and that paper ones leave their own particles. What do you suggest for daily external cleaning?

STACEY MCINTURE  
Columbus, OH

**A** In most situations, dusting occasionally with a soft cloth is all that is necessary. A medium-stiff artist's paintbrush, or a cotton swab, can be used to get into difficult spots. Once in a



# Receive without misgivings.

*Three ways to have it all and still have a receiver.*

"If you want performance, separates are the way to go." It's common advice. And considering Carver's innovative preamplifiers, power amplifiers and tuners, we've probably contributed too heavily to this opinion.

But, there *are* other equally high-performance alternatives: three Carver remote controlled receivers which give you the power, musicality and accuracy of our separates... yet which take up just 1.2 cubic feet of shelf space.

All three have Magnetic Field Power Amplifier sections that deliver astonishing dynamic power reserves without the heat, bulk and expenses of conventional designs.

Consider the AVR100. It's one of the most powerful receivers ever built. (150 watts per channel into 8 ohms 20 to 20kHz with less than 0.1% THD). But that's just the start. You get the finest FM section available on any receiver, thanks to what Audio magazine termed "...one of the few important circuitry developments in FM radio to come along in several years." We call it Asymmetrical Charge-Coupled FM Detection. You'll call it the clearest, most noise-free reception imaginable. Annoying multi-path interference is stilled; distant stations come in clean and quiet.

Naturally the full-feature preamplifier section includes a Sonic Hologram Generator to recreate the realism and 3-dimensionality of a live performance (from any stereo

source and over your existing speakers), as well as four video inputs (with switching and dubbing) and even variable surround sound that brings movie sound tracks alive.

Our 6250 and 6200 receivers continue the Carver tradition of power and accuracy. Other companies' 100-watt receivers are at or near the top of their line — with price tags to match. Our "smallest," most affordable receiver, the 6200, delivers 100 minimum continuous watts per channel (RMS), both channels driven into 8 ohms, from 20-20kHz, with less than 0.1% Total Harmonic Distortion with even more power for dynamic musical peaks! The 6250 (125 watts per channel, minimum output, both channels driven into 8 ohms from 20Hz to 20kHz with no more than 0.1% THD.) adds Sonic Holography<sup>®</sup>, Asymmetrical Charge Coupled FM Detection, video switching and an even more powerful Magnetic Field Power Amplifier section.

If you still have any misgivings about how much performance can be packed into a receiver, visit your nearest Carver dealer for a breathtaking demonstration of Sonic Holography<sup>®</sup>, silken FM reception and awesome power.

After all, the point isn't really whether to get a receiver or separates.

The point is to enjoy the finest in music reproduction. Carver.

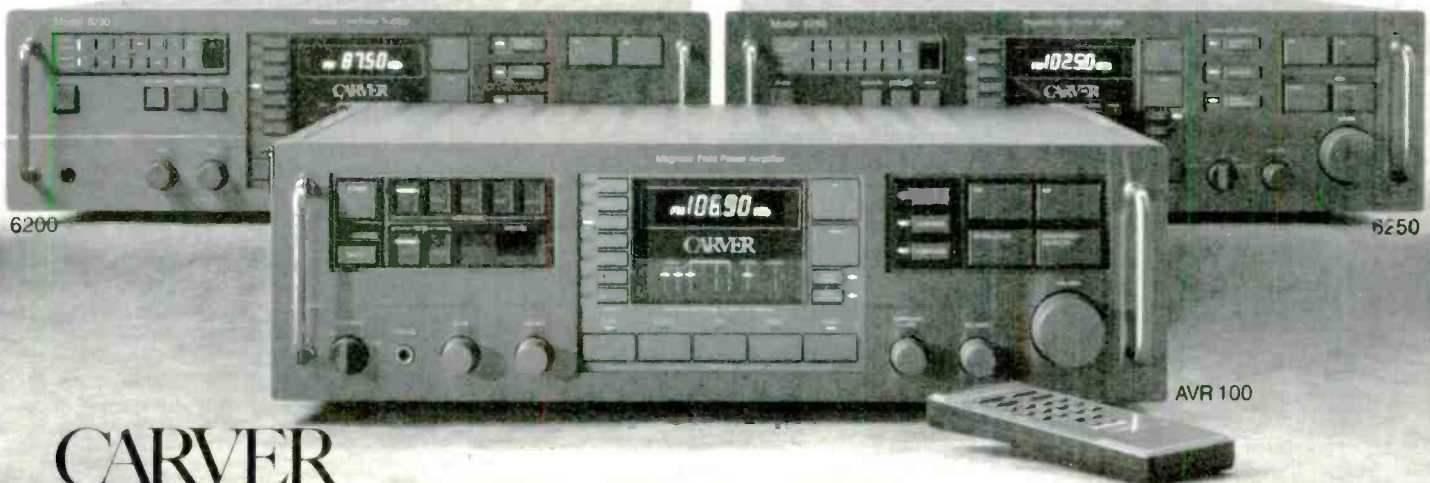

## CARVER

Powerful

Musical

Accurate

P.O. Box 1237, Lynnwood, WA 98046

CIRCLE NO. 168 ON READER SERVICE CARD

Distributed in Canada by: evolution technology

# Buy any Sony CD player and get a lot more than you paid for.



## 5 compact discs for the price of 1.

Plus membership in the CBS CD Club.

There's no better time to get a Sony CD player. By buying one now, you can take advantage of our new CD offer. Whether you enjoy rock, classical, jazz or anything else, it's a great way to start your very own CD collection.

Between **September 1, 1988** and **January 31, 1989**, buy any Sony home, car or portable compact disc player and receive any 5 of the CDs listed below for only \$12.98 along with membership in the CBS CD Club. Just mail the coupon below, together with a copy of the proof of purchase for your Sony Compact Disc Player and your check for \$12.98.

**How the Club works:** Every four weeks (13 times a year), you'll receive the Club's music magazine. In addition, up to six times a year, you may receive special offers for a total of

up to 19 buying opportunities. If you want only the Selection-of-the-Month, do nothing—it will be shipped automatically. If you prefer an alternate selection—or none at all—mail the response card, always provided, by the date specified. You will always have at least 10 days to make your decision. If you ever receive any Selection without having had at least 10 days, you may return the Selection at the Club's expense. The CDs you order as a member will be billed at regular Club prices, plus shipping and handling. You are under no obligation to buy anything and may cancel at any time.

**368357  
LYNYRD SKYNYRD BAND**  
*Southern By The Grace of God Lynyrd Skynyrd Tribute Tour—1987*  
MCA

**368027  
SADE**  
*Stronger Than Pride*  
Epic

**367094  
JULIO IGLESIAS**  
*Non-Stop*  
Columbia

**367037  
KIRK WHALUM**  
*And You Know That!*  
Columbia

**363739  
BRANFORD MARSALIS**  
*Renaissance*  
Columbia

**362525  
STEVE WINWOOD**  
*Chronicles*  
Island

**365825  
BILLY OCEAN**  
*Tear Down These Walls*  
Jive/Arista

**365619  
ROGER NORRINGTON**  
*Beethoven—Symphony No. 9 ("Choral")*  
*Kenny Walker/Power/Salomsa*  
*The Schulz Choir of London/The London Classical Players*  
Angel

**365494  
GEORGE HARRISON**  
*Cloud Nine*  
Dark Horse

**365189  
JAMES TAYLOR**  
*Never Die Young*  
Columbia

**365130  
DAVID LEE ROTH**  
*Skyscraper*  
Warner Bros.

**366872  
NADJA SALERNO-SONNENBERG**  
*Mendelssohn: Concerto in E Minor; Saint-Saens: Intr. & Rondo Capriccioso*  
*Massenet: Meditation From "Thais"*  
*N. Y. Chamber Sym. Gerard Schwarz*  
Angel

**364695  
WYNTON MARSALIS**  
*Baroque Music For Trumpets*  
*Vivaldi: Telemann/Pachalbelli*  
*M. Haydn/Biber*  
*English Chamber Orchestra*  
*Raymond Leppard*  
CBS Masterworks

**364018  
FOREIGNER**  
*Inside Information*  
Atlantic

**362293  
ANDRES SEGOVIA**  
**GUITAR**  
*The Segovia Collection (Vol. 1)*  
*Bach*  
MCA Classics

**362079  
MICHAEL JACKSON**  
*Bad*  
Epic

**361675  
STING**  
*Nothing Like The Sun*  
A & M

**361519  
INXS**  
*Kick*  
Atlantic

**361618  
TERENCE TRENT D'ARBY**  
*Introducing The Hardline According To Terence Trent D'Arby*  
Columbia

**361402  
TIFFANY**  
*Tiffany*  
MCA

**361048  
DIANE SCHUUR AND THE COUNT BASIE ORCH.**  
*Diane Schuur & The Count Basie Orchestra*  
GRP

**360115  
BRUCE SPRINGSTEEN**  
*Tunnel of Love*  
Columbia

**359018  
PAT METHENY GROUP**  
*Still Life (Talking)*  
Geffen

**354449  
U2**  
*The Joshua Tree*  
Island

**366716  
ROBERT PLANT**  
*Now and Zen*  
ES Paranza

## AUDIO Q&A

while, window cleaner may be applied to areas that come into contact with fingers or where there is a buildup of grime. In extreme cases like yours, however, housing the whole system in a reasonably airtight cabinet would seem to be the most practical answer. Alternatively, placing a sheet over the system when it's not in use may do the trick, although it might not look very good.

### Cable Choking

**Q** Using heavy-gauge speaker wire seems sensible enough, but even if I were to buy wire a foot in diameter the signal would have to pass through only a few strands or contact points once it reached the speaker terminals. Don't these "choke points" make many of the reasons for buying heavy cable invalid?

JOHN BUDRYS  
Leonard, MI

**A** Not at all. It is true that the thinner wire at the contacts will exhibit a greater resistance than the rest of the cable, but the few inches between the contacts and the speaker itself are negligible. Where it is desirable to reduce resistance is in long runs of cable—the longer the wire, the greater the overall resistance. This effect can be overcome most easily by using thicker cable, although whether it makes any audible difference is a topic that has been hotly debated among audiophiles for years.

### Surround Headphones

**Q** I recently bought a new system that includes surround-sound capability. Most of my listening over the years has been with headphones, and I find that with speakers I can hardly detect stereo from my new equipment, much less surround sound. Do surround-sound headphones exist?

JOE HUMPHREY  
Santa Fe, NM

**A** Not that I'm aware of. Back when four-channel sound looked like it might become a reality, one or two manufacturers did produce headphones with rear-channel transducers, and you might be able to find a pair on the secondhand market, but they were never more than a curiosity. While it is true that the shape of the outer ear does allow the brain to separate front and rear sounds to a small extent, by far the most important indications of "surround" or ambience sound are gained by slight, often unconscious, head movements. Because headphones move along with the head, these directional clues are lacking, making it almost impossible to distinguish front from rear signals. □

Mail this certificate, a copy of your sales receipt and a check for \$12.98 made payable to CBS CD Club to **SONY/CBS CD OFFER**, PO Box 1129, 1400 N. Fruitridge Ave., Terre Haute, IN 47811

CODE NO ONLINE CD AT \$12.98	CODE NO FREE CD NO 1	CODE NO FREE CD NO 2	CODE NO FREE CD NO 3	CODE NO FREE CD NO 4
------------------------------------	----------------------------	----------------------------	----------------------------	----------------------------

I have enclosed a copy of my dated sales receipt as proof of Sony CD player purchase plus a check for one CD at \$12.98. Rush my 5 CDs and enroll me in the Club under the terms outlined above. I understand I have absolutely no obligation to buy anything ever and may cancel at any time.

**Note these important offer terms:** Offer limited to one per household or address. A copy of your sales receipt must be dated between September 1, 1988 and January 31, 1989. All certificates must be postmarked by February 28, 1989. Void where prohibited by law. Offer valid only in continental U.S.A. (excluding Alaska and Hawaii). CBS Compact Disc Club reserves the right to reject any membership. Please allow 4-6 weeks for delivery.

Name \_\_\_\_\_  
Address \_\_\_\_\_  
City \_\_\_\_\_  
State \_\_\_\_\_ Zip \_\_\_\_\_  
CD Model No \_\_\_\_\_  
Date Purchased \_\_\_\_\_

My main musical interest is (check one) But I may always choose from any category.  
 HARD ROCK  SOFT ROCK  CLASSICAL  
 JAZZ  POP/EASY LISTENING

**SONY**  
THE LEADER IN DIGITAL AUDIO

© 1988 Sony Corporation of America. Sony and The Leader in Digital Audio are trademarks of Sony.

F167C

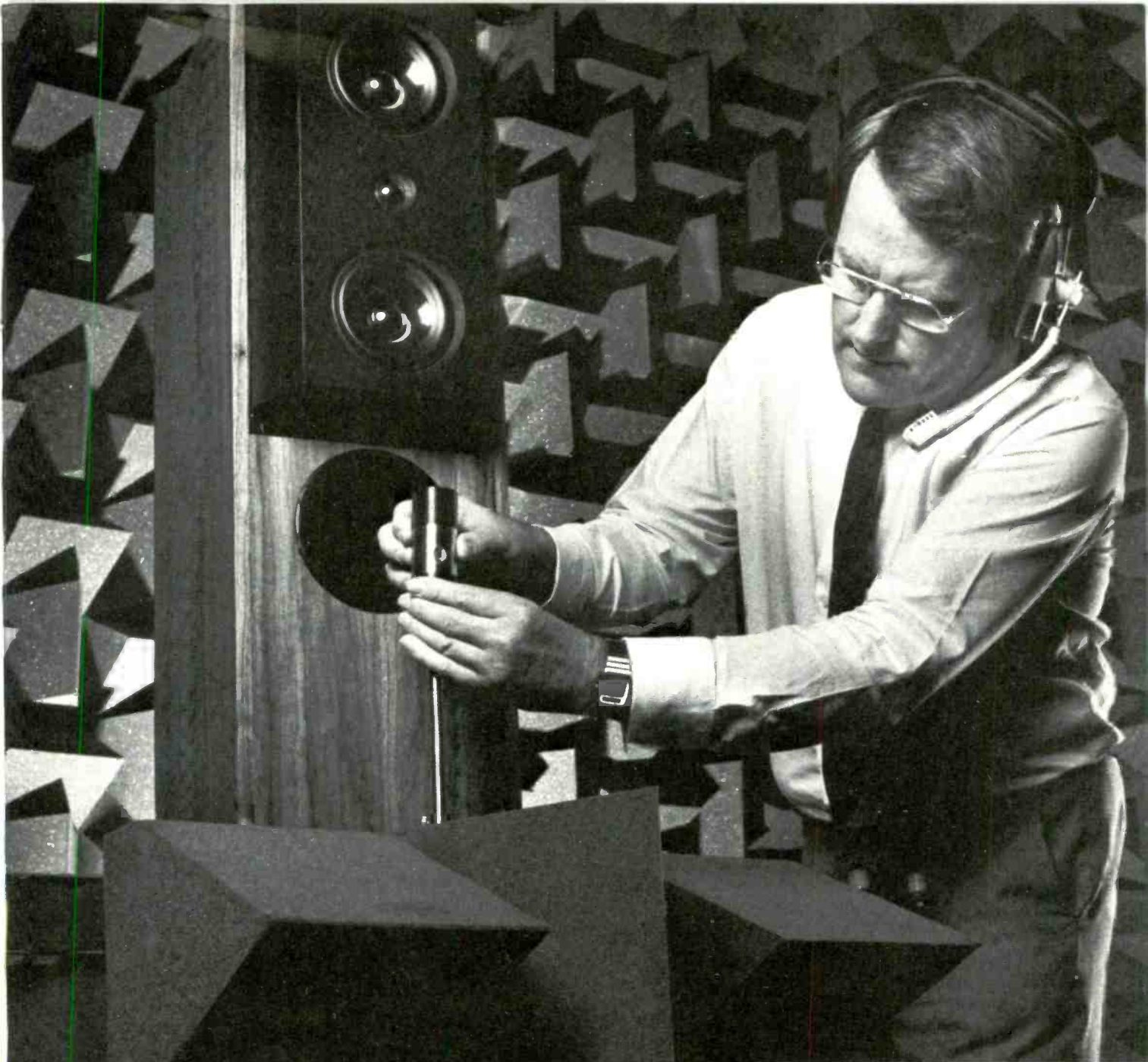

***'Before we could make our speakers better,  
we had to invent a better speaker test!'***

*— Laurie Fincham, DIRECTOR OF KEF RESEARCH AND DEVELOPMENT*

**ONE STEP IN THE MAKING OF A KEF**

'A speaker is usually measured by frequency response sweeps. But their proper interpretation is difficult at best — misleading at worst.

'So in 1971, KEF joined forces with Hewlett Packard and Bradford University to develop a more reliable test: computerised Fast Fourier Transform (FFT). Our computer

analyzes a series of pulse tones to produce a far more accurate, more detailed picture of frequency, phase, and transient time-domain behaviour.

'FFT testing has already spurred us to major advances in phase integrity and production consistency. It's certainly easier to make progress when you can see where you're going.'

KEF Electronics Ltd., Toleil, Maidstone, Kent ME15 6QP, England  
KEF Electronics of America Inc., 14120-K Sullyfield Circle, Chantilly, VA 22021 703/631 8811  
Smyth Sound Equipment Ltd., 395 Rue du Parc Industriel, Longueuil, Quebec, Canada 514/671-5490

**CIRCLE NO. 69 ON READER SERVICE CARD**

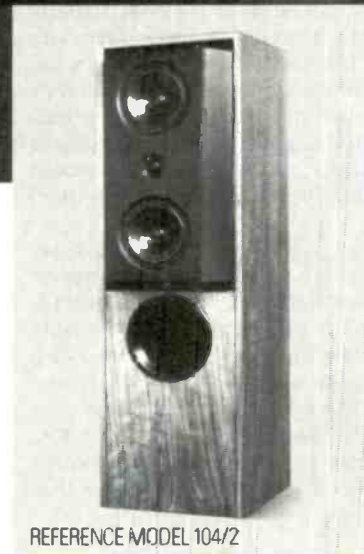

REFERENCE MODEL 104/2

**KEF**  
*The Speaker Engineers*

## TECHNICAL TALK

by Julian Hirsch

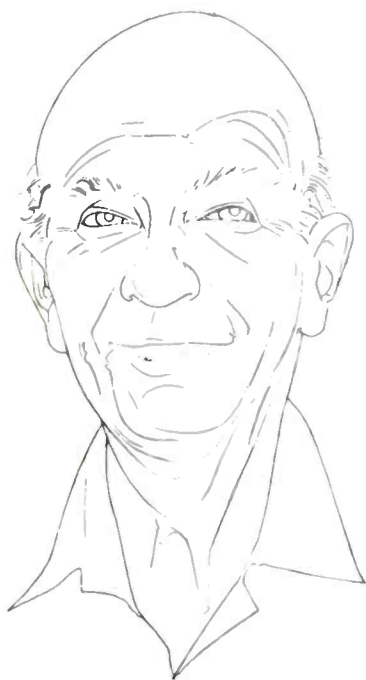

### Are "Separates" the Best Choice for You?

**H**I-FI, as we know it, began shortly after the Second World War as the assembly and connection, by the user, of a number of separate components to form a functioning system. The use of separates was the most obvious difference between a hi-fi system and the radio/phonographs of the time, which usually took the form of a large furniture cabinet or console containing a radio (what is today called a receiver), one or more speakers in open baffles, and an automatic record player or changer whose cartridge tracked at a force of 1 or 2 ounces—30 to 60 grams!

These consoles were usually selected more for their appearance as furniture than for their sound qualities. With programs available only from 78-rpm records and AM radio broadcasts, there was little incentive to improve the speakers or amplifiers. In fact, some of the most imposing and prestigious radio/phono consoles had amplifiers that

could deliver perhaps 5 or 10 watts with several percent distortion and speakers whose irregular response extended from perhaps 50 or 60 Hz to several kilohertz.

The high-fidelity industry began as a hobbyist activity in which home-built amplifiers and speaker systems played a major role. Small companies were soon created to manufacture system components, and before long the hi-fi enthusiast, or "audiophile," was able to assemble a system by purchasing manufactured components of his choice. That situation still exists today, more than forty years later, despite the occasional appearance of atavistic products such as rack systems or other totally integrated systems.

Whether manufactured in a garage or basement shop in this country, or on the assembly line of a giant Japanese company, the types of components available to the consumer are basically the same. A stereo system consists of one or more program sources (turntable, tape deck, CD player, tuner, etc.) and a preamplifier or control amplifier, which selects the program source, controls its level and (if desired) its frequency response, and sends it to a power amplifier and sometimes to one or more tape recorders. The power amplifier drives one or two pairs of speaker systems, each consisting of two or more drivers in some form of enclosure. Although there are numerous variations on this theme, it has survived with no fundamental changes.

### Tested This Month

*NAD Model 5170  
Compact Disc Player  
Polk Audio SDA-SRS 2.3  
Speaker System  
Soundstream C-1  
Preamplifier and  
DA-1 Power Amplifier  
NHT Model I Speaker and  
Octave Bass Module  
Sharp Optonica SM-A75  
Integrated Amplifier*

The physical arrangement of the system components can take several forms, however. The preamplifier and power amplifier are often combined in a single unit called an integrated amplifier. Perhaps the most popular component is the receiver,

*Very few separate preamps or integrated amps offer the variety of features available in today's more elaborate audio/video receivers, which may include surround-sound circuits and extra channels.*

a combination of a tuner (a radio without an amplifier), a preamplifier, and a power amplifier. Tuner/preamplifiers have been manufactured from time to time and are currently available from several manufacturers. At least one company makes a receiver with a built-in CD player, and "casseivers," with built-in cassette decks, are available from several sources.

Integrating a record player or speakers with the electronic components is possible, but this cannot be considered in the same light as the examples of integration given above. Although it is possible to combine a record player with other components, and this has been done in the past, it requires undesirable compromises in the physical isolation of the player from its surroundings. As for speakers, aside from considerations of size, isolation from microphonic components, and so forth, the close spacing between them in any single-chassis system would eliminate any possibility of effective stereo listening.

Where does all this leave you in your choice of system components? First, anyone living outside the primary service areas of the FM stations he wants to listen to will receive no benefit from the receiver format. Even if AM is available, the AM quality of most of today's stereo receivers is so far below minimal hi-fi standards that any portable or table radio is likely to be better. For the vast majority of users, however,

## ONE STEP IN THE MAKING OF A KEF

Anyone can build a good prototype. The real challenge is assuring the quality of everyday production. That's why KEF have the most stringent production test programme in the industry.

'We test each individual Reference Series driver for amplitude response with respect to frequency. The computer collates the tested drivers and crossovers into left and

right pairs that match to better than  $\pm 0.5\text{dB}$ . This accounts for KEF's spot-on stereo imaging. Then we test the completed pairs for frequency and phase response against the original prototype.

'We keep all this data by serial number on permanent file. If a driver should ever need replacement, we can supply an exact duplicate.'

***'Our testing may seem fanatical, but it's the only way to guarantee performance.'***

*—Fark Merricks, KEF PRODUCTION ENGINEER*



REFERENCE MODEL 107

**KEF**  
*The Speaker Engineers*



## TECHNICAL TALK

there are good receivers at a wide range of prices, ranging from the most basic to some that offer more operating features than many separate components. The advantages are that any receiver is simpler to install (though not necessarily to operate) than equivalent separate components and is likely to be less expensive for equivalent levels of performance.

Nonetheless, there are some users who might find a receiver, no matter how good, unsuitable for their needs. In general, the audio power of receivers is limited to about 100 watts per channel. A few go up to 120 watts or even more, but the size and weight of such a powerful receiver complicate its installation in a home environment. Some people who perceive *significant* quality differences between amplifiers might be unhappy with anything less than a specific high-end preamplifier and power amplifier and might never consider listening to FM radio. The measured performance of good receivers is often at least as good as that of separate amplifiers, however, and many users do not find any worthwhile sonic differences between a receiver and a good separate power amplifier or integrated amplifier with comparable ratings.

Apart from sound, there is the matter of features. Very few separate preamplifiers or integrated amplifiers offer the variety of features available in today's more elaborate receivers. A growing number of receivers, designated as audio/video components, are equipped to switch video sources as well as the usual audio sources and to control VCR's as well as audio tape recorders. More elaborate A/V receivers include surround-sound circuits for decoding Dolby Surround movie soundtracks or for enhancing the ambience characteristics of other sound sources, and some even include a pair of lower-powered amplifier channels for driving the surround (or rear) speakers.

You may, however, need to control several tape decks or to select either a moving-coil or a moving-magnet cartridge from the front panel, or you may require another special feature that is not available on an otherwise suitable receiver.

Such capabilities are likely to be found on some separate preamplifiers or even integrated amplifiers. An integrated amplifier can have virtually all the features and performance qualities of a separate preamplifier (at least, of one from

*Separate components offer the greatest flexibility with respect to features and performance. They have the fundamental advantage of enabling a system to be upgraded one part at a time.*

the same manufacturer). Its power, size, and weight limitations are comparable to those of a receiver, however.

In sum, separate components offer the greatest flexibility with respect to features and performance. They have the fundamental advantage of enabling a system to be upgraded one part at a time, without having to replace the parts that are still perfectly satisfactory. As components are integrated, the cost for any given level of performance decreases somewhat. The receiver, as might be expected, offers the best value for the money thanks to its

use of a common chassis and power supply for several components. But one of its most basic limitations is that upgrading any of its sections generally requires replacing the whole receiver. Also, a receiver is not your best choice if radio reception is not desired or available; the integrated amplifier is a logical substitute. And in marginal locations, where the tuner section of a receiver might not be adequate, a separate tuner with exceptional performance may make FM reception practical.

It might seem that choosing a receiver amounts to putting all your eggs in one basket, since when it is out of action the entire system is disabled. While that is true, losing the use of either the preamplifier or the power amplifier in a separate-component system has the same effect. A more serious criticism of some of the more elaborate, multi-featured receivers I have tested lately is the excessive complexity of their controls. A dedicated audiophile may have the incentive to master them, but other members of the family are not likely to enjoy their full benefits. A more basic receiver is less likely to suffer from excess complexity, but in many cases a system comprising a separate tuner, preamplifier, and power amplifier can be even simpler to operate and at the same time give better overall performance. □



*"I have no idea what it's all about, Christine. He puts them on his turntable, switches his receiver to 'AUX,' and listens."*

---

**TO ALL THOSE  
WHO ALREADY  
OWN A  
CD PLAYER,**

**OUR CONDOLENCES.**

---



# ACCULINEAR 18-BIT TEC



## ENTER THE NEW

Everything has limitations. Including conventional CD players.

That's because 16-bit digital processing simply isn't accurate enough to retrieve all the data that's on a disc. So some of the music is lost.

Onkyo's linear 18-bit technology, on the other hand, assures you that all the musical information gets processed. So you don't lose anything. Even the subtle clues that tell you about the space the music was recorded in. And how well the engineer chose the microphones.



Dual Acculinear D/A Converters with calibrated accuracy to the 4th Significant Bit.

But getting all the data off the disc is only the first step. Getting it to your ears is at least as important.

That's why Onkyo developed the Acculinear D/A Converter. And individually calibrates each one to minimize crossover distortion. This unprecedented accuracy means you'll be able to listen to music, even at low levels, and still hear the delicate harmonic structures that distinguish a Gibson guitar from a Martin.

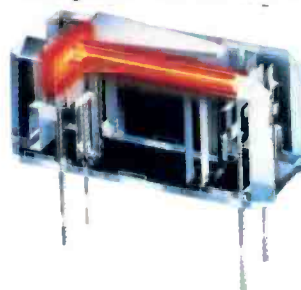

Exclusive Opto-Coupling Modules use light to transmit digital data and reduce harshness.

Onkyo's extensive use of optical transmission techniques instead of conventional wiring further increases musical enjoyment. Proprietary Opto-



# TECHNOLOGY FROM ONKYO.



## DIGITAL DOMAIN

Coupling Modules at critical circuit junctions eliminate Digital Signal Interference (DSI) and its consequent metallic harshness. So you can enjoy the sound of the Philadelphia Symphony without wondering if the entire string section was playing aluminum violins.

The power supply combines low impedance/low loss transformers, regulators, and capacitors for high stability and isolation.



Dual transformers in the DX-7500 thoroughly isolate digital and analog stages.

In addition, the critical D/A converters benefit from Opto-Drive, a new Onkyo technology that uses LED/phototransistor arrays for the ultimate in current stability and operating accuracy. Which

means that any sonic variations you hear will be in the music, not in the disc player.

And the best part? We didn't reserve these technical innovations for one outrageously expensive flagship model. All the musical benefits are affordable.

Yes, this is the New Digital Domain.

Audibly significant technology.  
Enhanced musical enjoyment.

The New Digital Domain.  
Starting at less than \$600.

Enter it today at your Onkyo dealer.

### ONKYO®

200 Williams Drive, Ramsey, N.J. 07446 201-825-7950

If you would like further information, write for the White Paper on digital technology.



For your convenience, ONKYO and STEREO REVIEW are providing this special toll free number so you can find out about our new 18 Bit Players. Just call 1-800-678-8237, and when asked, enter 34510.

# VANTAGE

ULTRA LIGHTS

SURGEON GENERAL'S WARNING: Cigarette  
Smoke Contains Carbon Monoxide.

5 mg. "tar", 0.5 mg. nicotine av. per cigarette by FTC method.



*ULTRA TASTE PERFORMANCE  
IN AN ULTRA LIGHT*





## NAD MODEL 5170 CD PLAYER/CHANGER

*Julian Hirsch, Hirsch-Houck Laboratories*

**T**HE Model 5170, one of NAD's Monitor Series components, is a full-featured CD player that includes a six-disc magazine-type changer for extended automatic playing. Since the magazine loader in the NAD 5170 supplements the usual single-disc drawer rather than replacing it, the user has a choice of either single- or multiple-disc play without having to load a single disc into a magazine. In automatic (changer) operation, all seven discs are accessible, and the playback can be programmed to include any or all of them. According to NAD, the six-disc magazines used in JVC and Toshiba changers are compatible with the Model 5170.

The basic playback system of the NAD 5170 includes a quadruple-

oversampling 16-bit digital filter, multiplexed between the channels, along with mild (four-pole) analog filtering to remove the higher ultrasonic frequencies from the audio outputs. The "most significant bit" of each player's digital-to-analog (D/A) converter circuit is individually trimmed at the factory to minimize distortion resulting from errors in that part of the D/A conversion process. Like amplifier crossover distortion, such conversion distortion becomes more serious as signal levels decrease.

The NAD 5170 is the first home multidisc CD player that includes a switchable dynamic compressor to reduce the dynamic range of compact discs for recording CD's onto cassettes for playback in a car or simply for adapting an uncomfort-

ably wide recorded dynamic range to a home listening environment. Called the Controlled Dynamic Range (CDR) circuit, the compressor increases the level of soft passages while leaving the highest-level signals unaltered. The resulting program falls within a dynamic range of about 70 dB (which can be accommodated by a good cassette recorder) without any change in its distortion levels or frequency response.

Like most home CD players, the NAD 5170 has extensive programming capabilities. It can be programmed to play up to thirty-two tracks from all seven discs in any order and to repeat any one disc, all seven discs, or a programmed sequence indefinitely. The Model 5170 comes on automatically in the play mode when power is supplied, a convenience when using it with an external timer.

The player's gray panel (which matches other NAD components) contains a number of round push-buttons and one knob control for adjusting headphone volume. The

# TEST REPORTS

open/close button operates the single-disc drawer, and the eject button affects only the magazine, which loads just above the drawer. There is no stop control, but the reset button performs that function.

The display window, in which all information appears in red against a black background, shows the number of the disc currently loaded. The current track number and its elapsed playing time are the default indications. Pressing the DISPLAY button below the window changes the readout to the number of tracks remaining and the remaining time on the disc. A row of symbolic discs across the bottom of the window shows which magazine slots are occupied; a triangle appears over the one in playing position.

The operation of the CDR circuit is indicated by a yellow bar at the right side of the display. Below this bar are three buttons used to program the player. Track selection from the front panel requires multiple operations of a skip button.

The NAD 5170 is supplied with a

wireless remote control that duplicates almost all of its front-panel controls and has a few additional functions. It has numbered buttons that allow direct access to any track or any loaded disc, an INTRO SCAN button that plays the first 15 seconds of every track on a disc, and a RANDOM button that plays all the tracks on a disc in a random order. Two volume buttons control the output from the pair of variable-level jacks on the rear of the player.

In addition to the fixed- and variable-level analog output jacks, the Model 5170 has a coaxial digital output jack for use with an external D/A converter. The player's dimensions are 17 $\frac{1}{8}$  inches wide, 14 $\frac{1}{2}$  inches deep, and 4 $\frac{1}{4}$  inches high. It weighs 13 $\frac{1}{2}$  pounds. Price: \$748. NAD, Dept, SR, 575 University Ave., Norwood, MA 02062.

## Lab Tests

The output level from the NAD 5170 is rated at 1.5 volts, less than the CD standard of 2 volts. It measured 1.59 volts, with a channel im-

balance of only 0.05 dB. The fixed-level and maximum variable-level outputs were identical. The frequency response was +0.15, -0 dB from 20 to 20,000 Hz. The CDR compression system reduced the 90-dB range of one of our test discs to a more manageable 72 dB.

The total harmonic distortion (THD), *excluding* noise, measured 0.01 percent at 0 dB, increasing to 0.016 percent at -20 dB. With noise included, the readings were slightly higher, 0.0115 and 0.032 percent, respectively. The A-weighted signal-to-noise ratio was 100 dB, and the dynamic range was 91.5 dB. In channel-separation measurements we found the left channel reading between 89 and 93 dB from 100 to 20,000 Hz and the right channel slightly exceeding 100 dB at 100 and 1,000 Hz, falling to 85 or 86 dB at 10,000 and 20,000 Hz.

In spite of the factory trimming of the D/A converter, its low-level linearity was not particularly good. From an error of less than 1 dB at -70 dB, and no measurable error at higher levels, the output error reading increased to 4.2 dB at -80 dB and 7.8 dB at -100 dB. Although these errors may not correlate with any audible qualities of the player, they are surprising in view of the special precautions claimed by the manufacturer. Interchannel phase shift increased linearly from less than 1 degree at 500 Hz to 25 degrees at 20,000 Hz.

The cueing accuracy of the Model 5170 was good, and its slewing time of 1.8 seconds (in our standard but unofficial test) compared well with most of today's high-quality CD players. When a disc change was involved, the cueing time averaged about 8 seconds, which is at least as good as we have measured from other magazine-loading CD changers. The player's resistance to impact on its sides was excellent, and it earned a good rating against top-cover impact.

The NAD 5170 had no difficulty tracking through the largest surface defects (black dots) on the Philips TS5A test disc, but the information-layer defects caused mistracking, with accompanying audible ticks and pops, at amplitudes exceeding 600 micrometers.

## FEATURES

- Single-disc drawer and six-disc magazine loader
- Quadruple-oversampling 16-bit digital filter and four-pole analog filter
- Programmed playback of up to thirty-two selections from seven discs
- Repeat mode for a single disc, all discs, or a program
- Track skipping in either direction
- Fast scan in either direction with audible sound
- Switchable Controlled Dynamic Range (CDR) compressor circuit
- Front-panel headphone jack with volume control
- Automatic play when power is applied
- Display of number of discs loaded, disc currently playing, track number, elapsed time, status of repeat function; switchable to show remaining tracks and remaining time on disc
- Wireless remote control of front-panel functions plus direct track access, Intro Scan, and random play
- Fixed and variable-level analog output jacks (variable controlled from remote)
- Digital output jack

## LABORATORY MEASUREMENTS

**Maximum output level:** 1.59 volts  
**Total harmonic distortion** at  
1,000 Hz: 0.01% at 0 dB, 0.014%  
at -10 dB, 0.032% at -20 dB.  
**Signal-to-noise ratio** (A-weighted):  
100 dB  
**Channel separation:** 93 dB at  
1,000 Hz, 89 dB at 20,000 Hz  
**Frequency response:** +0.15, -0  
dB from 20 to 20,000 Hz  
**Dynamic range:** 91.5 dB

**Maximum phase shift** (from 100  
to 20,000 Hz): 25 degrees at  
20,000 Hz  
**Cueing time:** 1.8 seconds  
**Cueing accuracy:** A  
**Impact resistance:** top, B; sides, A  
**Defect tracking** (Philips TS5A test  
disc): tracked 600-micrometer  
level of information-layer  
damage, 900-micrometer level  
of surface damage.

### Comments

In our tests, the NAD 5170 proved itself to be a very good performer, with measurements typically ranging from excellent to good. The major weaknesses disclosed by our measurements were a higher-than-normal susceptibility to information-layer damage on a CD—although we never encountered a tracking problem playing music discs, just with the Philips test disc—and a higher-than-expected linearity error at output levels below  $-70$  dB.

The player's front-panel controls appear, at first glance, to be quite different from those of the majority of CD players, but they are actually almost identical in their functions. Our only complaint concerns the programming operation, which works well enough but is unlike any other we have seen. It took some study of the manual, and some practice, to program it with confidence. We also missed the ability to access indexed points on a disc, which we would expect to find in a player at this price level. A very minor point of criticism is the lower-than-standard output level. This was one of the very few CD players out of the many we have tested over the years to fall so far short (and obviously by design) of the industry standard of 2 volts.

On the other hand, the CDR circuit worked very well. Since it does not affect the higher program levels, the immediate effect of switching it on is a pronounced increase in average volume level as the softer portions of the program are raised toward the peak output level of the system. Much of the time we preferred listening with the CDR in operation, since the jarring effects of a sudden crescendo are considerably eased by its action. We also used it part of the time with its digital output driving the D/A converters of an integrated amplifier equipped to process digital signals.

All in all, the NAD 5170 is an exceptionally versatile and functional CD player, combining all the advantages of magazine and single-disc loading in a very attractive package.

**Circle 140 on reader service card**



## POLK AUDIO SDA-SRS 2.3 SPEAKER SYSTEM

*Julian Hirsch, Hirsch-Houck Laboratories*

**P**OLK Audio's Stereo Dimension Array (SDA) loudspeakers are designed to compensate, at least in part, for the effects of interaural crosstalk, a phenomenon peculiar to loudspeaker listening. When you listen to a stereo program through a pair of speakers, each ear not only receives the signal from its associated channel, but the other channel is heard at about the same level with a slight time-delay (about half a millisecond,

and, the time required for sound to travel around the head to the opposite ear). The absence of interaural crosstalk is one reason listening through headphones is so different, since with phones each ear hears *only* its own channel.

One of the effects of interaural crosstalk is a sound stage essentially limited to the region between the two speakers. Polk SDA systems are designed to cancel interaural crosstalk acoustically and thereby pro-

## TEST REPORTS

vide some of the spatial quality of headphone listening to the loudspeaker user.

Basically, the Polk SDA design employs two distinct speaker systems in a common enclosure. The left and right speaker enclosures are constructed as mirror-image pairs, each having its normal stereo drivers closest to the center of the room and what is called the "dimension array" closest to the side walls. The two normal stereo systems are driven conventionally from the left and right channels of the amplifier. Each dimension array, however, is fed signals from the *opposite* channel through a special connecting cable. Because of the physical spacing of the drivers, and the internal crossover network of the overall system, the sound from each dimension array (ideally) reaches the listener's ear with the correct time delay and phase to cancel the interaural crosstalk from the stereo drivers of the opposite channel.

The audible result of this cancellation is a spreading out of the stereo sound stage, which appears to extend well beyond the limits of the speaker cabinets. This effect is heard only with stereo programs, and its magnitude is related to the degree of channel separation (discreteness, or lack of coherence) in the program. For optimum results, the listener must be located equidistant from the two speakers; the spatial-expansion effect diminishes as you move away from this line of symmetry. Programs with predominantly center-located signals, or mono sources, are not enhanced by the SDA system, although they will still benefit from the other special qualities of the Polk speakers.

In the original Polk SDA-SRS, the stereo and dimension arrays were essentially identical in their configuration and general performance. Subsequent research indicated that the spatial effects of the SDA technique could actually be *enhanced* by restricting the frequency range of the dimension array, and later SDA systems have developed this idea, improving performance at each stage of the evolutionary process.

The latest in the series, the SDA-SRS 2.3, was designed to increase the range of optimum listening posi-

tions and generally to improve the perceived depth and width of the sound image. Interference from room-boundary reflections has been reduced by controlling the directional properties of the system across the frequency range. Low-bass response has been extended, with negligible levels of distortion. Another characteristic of the earlier SDA designs was their requirement that the amplifier operate with a common ground connection between its speaker outputs. Most am-

*Polk designed the SDA Model 2.3 speakers to increase the range of optimum listening positions and generally to improve the perceived depth and width of the sound image.*

plifiers have no difficulty with this mode of operation, but a few do. Polk now offers an interface accessory that enables SDA speakers to be used with any type of amplifier.

Like Polk's original flagship system, the SDA-SRS, the Model 2.3 is a large and heavy speaker, though smaller and less expensive than its senior sibling or the current top-of-the-line model, the SDA-SRS 1.2. Instead of the essentially symmetrical driver layout used in the SDA-SRS and other earlier SDA models, the speaker board of the Model 2.3 contains six 6½-inch cone drivers, two for the stereo array and four for the dimension array. It uses the same single 15-inch flat passive radiator as the earlier models to help deliver floor-shaking bass below 50 Hz. The high frequencies are radiated by a single vertical row of three 1-inch dome drivers on the center line of the front panel.

The number of active drivers in the system decreases smoothly as the input frequency rises, reducing its effective radiating surface and linear dimensions to maintain constant vertical directivity at all frequencies. Below 50 Hz, all six cone drivers and the passive diaphragm are radiating, and their considerable combined area, roughly equal to a 19-inch-diameter cone, gives the

system its awesome deep-bass response. The passive radiator crosses over at 50 Hz to the driven cones, which continue to reproduce the bass register from 50 to 200 Hz. The upper and lower cone drivers of the dimension array, which are not identical to the other four cone drivers, reproduce the normal stereo signal from 50 to 100 Hz and then gradually shift to the dimension-array signal above 100 Hz. They begin to roll off altogether above 200 Hz.

The two cone drivers in the middle of the dimension array, operating from 200 to 1,000 Hz, actually provide most of the unique spatial qualities of the system. Above 1,000 Hz they are decoupled by the crossover network, leaving the stereo array's two cone drivers and three dome tweeters to deliver the system's output in the range up to 2,000 Hz. The next crossover, at 2,000 Hz, removes the cone drivers completely, leaving the three tweeters to operate from 2,000 to 3,500 Hz. The two uppermost tweeters continue from there to 8,000 Hz, and only the center dome tweeter operates in the entire range above 8,000 Hz.

This rather complex crossover system, involving some seven transitions between drivers, is the key to what Polk calls its Wavelength Optimized Line-Source. The continuous control of the system's vertical radiation pattern is designed to minimize floor and ceiling reflections, which can degrade stereo imaging.

Another innovation of the SDA-SRS 2.3 is the Bass Brace. A powerful low-bass signal would cause all seven bass diaphragms to operate in phase, and that might rock or vibrate the entire system back and forth slightly. Designer Matthew Polk was concerned that these shifts would cause frequency modulation of treble tones that might degrade the clarity and image focus.

To deal with the same problem, smaller speakers are often mounted on spiked feet to anchor them to the floor. This would probably be an impractical solution with the large, heavy SDA-SRS 2.3's, but Polk came up with an ingeniously simple alternative. Several lengths of

# Plain Vanilla

Not only do we design and build it, we know how to put it together

...simple as plain vanilla.

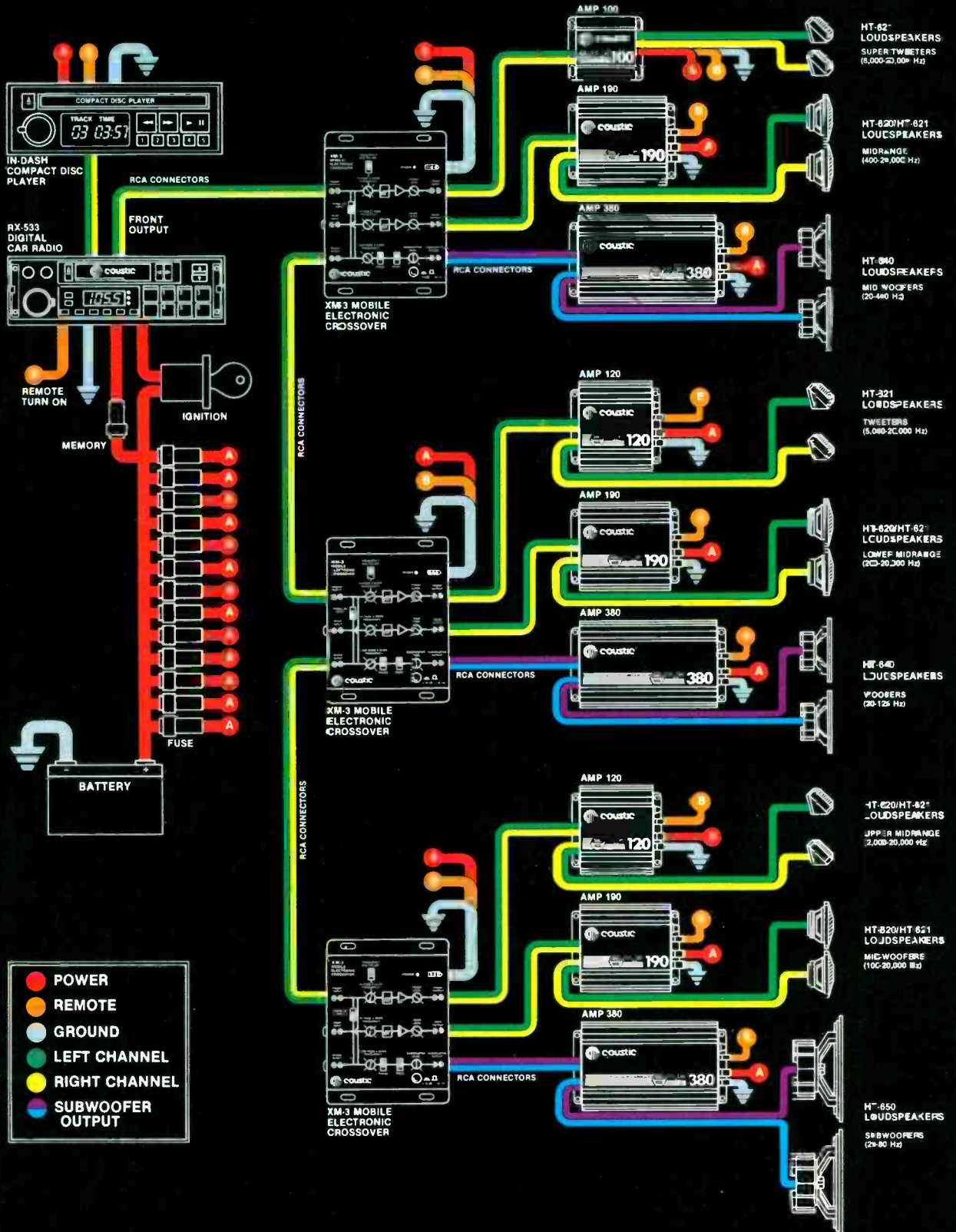

**cooustic<sup>®</sup>**  
...a sound investment.

CIRCLE NO. 68 ON READER SERVICE CARD

## TEST REPORTS

threaded steel rods are supplied that can be screwed into a fitting on the rear panel of the speaker, adjusted to fit between the speaker and the wall behind it, and screwed into a complementary wall fitting, which can be screwed in place or fastened to the wall with double-sided adhesive tape. With the Bass Brace installed, the cabinet is firmly restrained against rocking or vibration. According to Polk, it makes a definite improvement in the imaging stability of the system. (The Bass Brace is also now standard with the SDA-SRS 1.2.)

The Polk SDA-SRS 2.3 measures 55½ inches high, 20¾ inches wide, and 13½ inches deep (not counting the Bass Brace). Its top and bottom are finished wood (light oak on our test units), and the sides are covered in black cloth. A matching black removable grille covers the front of the speaker. Recessed into the rear panel are two pairs of five-way binding posts, for bi-amplification or bi-wiring (normally they are linked by jumpers), and the socket for the cable that joins the two speakers. The weight of each speaker is about 100 pounds. Price: \$2,200 a pair. Polk Audio, Dept. SR, 5601 Metro Dr., Baltimore, MD 21215.

### Lab Tests

The room-response curve and the close-miked woofer response curve spliced easily to form a composite response curve that was consistent with what we heard from the SDA-SRS 2.3 system. The response from 20 to 1,000 Hz was flat within  $\pm 2$  dB, and from 600 to 10,000 Hz it was flat within  $\pm 1$  dB but about 2.5 dB lower than the average bass level. At 13,000 Hz there was the same 5-dB peak we have measured from every Polk SDA speaker we have tested in the past six years, but the overall response variation of only +3, -5 dB from 20 to 20,000 Hz was very impressive.

The system's sensitivity was exactly as rated, with a 90-dB sound-pressure level (SPL) at 1 meter with an input of 2.83 volts of pink noise. The impedance averaged 5 to 8 ohms over most of the audio range, with a narrow dip to about 3 ohms at 1,600 Hz and a maximum of 15 ohms at 47 Hz.

With the system driven to a 90-dB SPL, the bass harmonic distortion was less than 0.7 percent from 100 Hz to below 30 Hz, reaching 3.2 percent at 20 Hz. In our experience this low level of bass distortion has been matched only by other Polk SDA speakers. In pulse power tests, the SDA-SRS 2.3 absorbed 660 watts at 100 Hz (into its 5.5-ohm impedance) before the cones began to rattle. At 1,000 and 10,000 Hz our amplifier clipped, at about 900 watts, before the speaker showed any significant nonlinearity.

Our FFT quasi-anechoic response measurements confirmed the essential features of the swept frequency-response curves. The system's horizontal dispersion was excellent, with the response curves on-axis and 45 degrees off-axis diverging less than 6 dB until the frequency exceeded 15,000 Hz. The group delay varied less than  $\pm 0.2$  millisecond from 2,000 to over 20,000 Hz.

### Comments

There is a striking similarity between the frequency-response and bass-distortion characteristics of the SDA-SRS 2.3 and those of the several other Polk SDA speakers we have tested. The Model 2.3 is a superb loudspeaker, with a listening ease and low-bass extension that are rarely found, especially in its price

range. And its bass performance is not obtained at a cost in high-frequency response; few other speakers have a treble output as smooth or as extended, reaching to the uppermost limits of human hearing, as the Polk SDA-SRS 2.3.

The SDA-SRS 2.3 comes so close to matching the original Polk SDA-SRS that I am not sure I could make a rational choice between them. It has virtually the same frequency response, ultra-low bass distortion, and general sound character as the original model, but it is little more than half the price. And, though the Model 2.3 is definitely not a compact speaker system, it is not quite as formidable to the eye as the original SDA-SRS or its updated successor, the SDA-SRS 1.2 (which we have not tested).

If memory serves, while the stereo-dimensional qualities of the SDA-SRS 2.3 may not match those of the new Model 1.2, they are at least as good as, and possibly better than, those of the original SDA-SRS. Certainly the 2.3 did not suffer in any comparison with other speakers we had on hand. It is the kind of speaker that can easily spoil you for listening to "ordinary" speakers, for there is nothing ordinary about the sound of the Polk SDA-SRS 2.3!

*Circle 90 on reader service card*



*"Good heavens! If I can't bury this awful subwoofer thing with him, then it's almost as though Edmund died in vain!"*



# Deceptive Engineering

Obvious but *very* deceptive...

You'll probably notice our 50-watt RX-533 offers obvious features such as Digital AM/FM cassette/radio with Dolby® B & C noise reduction, 24-preset stations, preset scan, tape program search, separate bass & treble tone controls, etc., and of course, it's **removable!**

But you'll probably overlook the not-so-visible but specially engineered features such as FM optimizer II circuitry designed for superior FM reception and built-in Automatic Radio Monitor for filling the void with music while you are fidgeting with your tape. Special cassette features such as "Auto Azimuth Correction System" rotates the tape head 180 degrees whenever tape direction changes to keep perfect azimuth alignment, Keyoff Pinch Roller Release minimizes wear and tear of tape pinch roller and DC servo motor accurately controls tape movement thus minimizing wow and flutter.

Plus pre-amp outputs and CD/AUX input capability designed for flexible system expansion, two-tone illuminated control panel guarantees easy viewing and identification and replaceable Lithium back-up battery helps contact and store information in the microprocessor.

Though not in plain view, these state-of-the-art engineering innovations are obviously what you have come to expect from a company with over 11 years of manufacturing experience.

Cooustic... a sound investment.



**cooustic**®

4260 Charter Street  
Vernon, CA 90058-2596  
(213) 582-2832



CIRCLE NO. 38 ON READER SERVICE CARD

© Cooustic 1987

® Dolby is a registered trademark of Dolby Laboratories.



## SOUNDSTREAM C-1 PREAMPLIFIER AND DA-1 POWER AMPLIFIER

*Julian Hirsch, Hirsch-Houck Laboratories*

**T**HE Soundstream name had been associated only with car stereo components until the company's recent introduction of a family of high-quality home audio components embodying several interesting and unusual design concepts. The Soundstream System-1 line consists of a tuner, a power amplifier, and a preamplifier that are linked by a novel digital control system operated through a programmable, wireless remote control. We tested the C-1 pre-

amplifier and the DA-1 dual-mono power amplifier; the photos here and on our cover also show the T-1 tuner, which we did not test. All three components can be used with products from other manufacturers as well as in the System-1 setup.

The C-1 preamplifier is the heart of the System-1. It has dedicated inputs for a tuner, two audio tape decks, a CD player, two VCR's and a videodisc player. There is also another high-level input, identified as PHONO/AUX, that can be used as a

phono input if an optional plug-in phono-preamp circuit card is installed in the C-1. The card is available in either a moving-coil or a moving-magnet version. (Our test sample was not fitted with a phono-preamp card.)

The C-1 has dedicated outputs for two audio tape recorders, two video recorders (both audio and video programs), a video output to a monitor or TV set, and two pairs of audio outputs to a power amplifier. Video facilities are limited to switching, and there are no video signal-processing circuits.

The rear apron of the Soundstream C-1 contains the gold-plated audio and video input and output jacks (thirty-four in all), a DIN socket marked "Auxiliary Remote," and two smaller sockets marked "Component Link" and "Amplifier/Accessory Link." The auxiliary-

# Prism Effect

What has prism effect, a refractive phenomenon, to do with audio equipment?

Nothing, except that it is the simplest analogy to describe what our sophisticated XM-3<sup>™</sup> Mobile Electronic Crossover does to audio signals.

When an ordinary ray of white light passes through a prism, it is systematically separated into the primary colors of the spectrum—optically much more aesthetic than the original light.

Similarly, when an audio signal enters the XM-3, the original signal is then separated, via various controls, to the front and/or rear tweeters, mid-ranges and sub-woofers, creating distinctive bands of the audio frequency spectrum that are space and user-specific.

Specially engineered features such as Front and Rear Pre-Amp Inputs and Front and Rear Outputs as well as a constant Sub-Woofer Output, Asymmetrical Electronic Crossover which has two high-pass (32-400 Hz variable)

crossover points for the front and rear outputs and a low-pass (32-400 Hz variable) crossover point for the sub-woofer output, Woofer/Enclosure Equalization engineered for optimizing bass response, Phase Inverter allowing the sub-woofer output to be shifted 180 degrees out-of-phase to compensate for in-vehicle acoustical abnormalities and Frequency Multiplier Switch which, by multiplying crossover points for the front channel, transforms the XM-3 from a **BI-AMP SYSTEM** to a **TRI-AMP SYSTEM**, etc., all contributed to create the **PRISM EFFECT** and make the XM-3 the most versatile electronic crossover ever manufactured for automotive use.

Coustic... a sound investment.



**coustic**<sup>®</sup>

4260 Charter Street  
Vernon, CA 90058-2596



\*Patent pending  
© 1987 Coustic

CIRCLE NO. 8 ON READER SERVICE CARD

## TEST REPORTS

remote jack is for connecting an optional infrared sensor, called the "Remote Eye," so that the system can be controlled through the R-1 remote control from a location not within view of the preamplifier. It can also be used for remote control through a DIN cable.

The other two connectors, which are standard modular-telephone jacks, are part of a unique feature of the Soundstream System-1. When

the C-1 is used with the Soundstream DA-1 power amplifier, which comes with a slim 3-foot matching cable and has a matching jack on its rear apron, the Amplifier/Accessory Link joins the two components with low-level digital control signals so that turning on the C-1 also switches on the DA-1. There is no AC line connection between the two components (and no power outlets on the C-1), sim-

plifying system wiring and reducing the likelihood of picking up extraneous power-line hum.

Since a music system normally has several components, Soundstream has also provided the Component Link, which operates like the Amplifier Link but switches AC power to an accessory AC strip from which the other system components are powered. Soundstream also has under development a Simul-Source accessory enabling the C-1 (with special remote power amplifiers) to feed any of seven different sources to up to five additional locations simultaneously.

The front panel of the C-1 contains two parallel rows of narrow, bar-shaped pushbuttons, one row selecting the "listen" source and the other the "record" source. The functions are clearly marked between the two rows. Small round buttons select the audio mute, mono mode, tone defeat, and Hi-Cut filter. A small LED in the center of each button glows green when the preamplifier is operating, changing to red if its function is selected. Knobs adjust the bass and treble tone controls, balance, and volume (the volume knob is motor driven in remote operation). The Soundstream C-1 measures 17 inches wide, 10 $\frac{1}{4}$  inches deep, and 3 $\frac{1}{2}$  inches high. It weighs 11 pounds.

The Soundstream R-1 programmable remote control, somewhat larger than average for such units, is more than just a controller for the three System-1 components, though it has dedicated keys that duplicate most of the functions of the C-1 and some of those of the T-1 tuner. Other buttons, however, are marked for the typical control functions of CD players and tape decks, and several more carry numerical or alphabetical designations. Most of the non-dedicated controls can learn commands used by the remote-control units of other components, making the R-1 a true system controller (it even has buttons for use with future Soundstream surround-sound accessories).

The Soundstream DA-1 is a compact, powerful dual-mono amplifier rated to deliver 200 watts per channel into 8-ohm loads from 20 to 20,000 Hz with no more than 0.05

### FEATURES

- C-1 Preamplifier and R-1 Remote Control**
  - Dual-mono construction
  - Inputs for tuner, CD player, two audio tape decks, two VCR's, videodisc player, auxiliary (convertible to MM or MC phono input with optional plug-in circuit card)
  - Outputs for two audio tape recorders, two VCR's, TV set or video monitor; two main audio outputs
  - Bass and treble tone controls with bypass switch
  - Hi-Cut filter
  - Audio mute
  - Headphone jack
  - Gold-plated phono-jack connectors
  - DIN socket for external infrared sensor
  - Digital switching link to DA-1 power amplifier
  - Accessory digital link to remote power strip to power other system components
  - Fully controllable from R-1
- wireless remote control; controllable from other rooms with Remote Eye infrared sensors and R-1
  - R-1 remote control programmable to replace remote controls for other components
- DA-1 Power Amplifier**
  - Dual-mono construction with complete isolation between channels
  - Six power output transistors for each channel
  - Turns on and off from C-1 preamplifier or by front-panel switch
  - Outputs switchable to either of two sets of speakers from R-1 remote control
  - Rear-apron switch for higher-power bridged mono operation
  - No current limiting; able to drive low-impedance loads
  - Separate front-panel LED overload indicator for each channel

### LABORATORY MEASUREMENTS

- C-1 Preamplifier**
- Frequency response** (EIA standard load): 20 to 20,000 Hz +0.15, -1.2 dB
- Output at clipping** (1,000 Hz): 8.3 volts
- Harmonic distortion** (THD + noise at 1,000 Hz): 0.01% at 1 volt, 0.017% at 2 volts, 0.03% at 5 volts
- Sensitivity** (for a 0.5-volt output): 73 mV
- A-weighted noise** (referred to a 0.5-volt output): -108 dB
- Tone-control range**: 100 Hz,  $\pm 7$  dB; 10,000 Hz, +11, -8 dB
- DA-1 Power Amplifier**
- 1,000-Hz output at clipping**: 220 watts into 8 ohms, 360 watts into 4 ohms, 500 watts into 2 ohms
- Clipping headroom** (relative to rated output): 0.4 dB into 8 ohms, 0.8 dB into 4 ohms, 1 dB into 2 ohms
- Dynamic power output**: 256 watts into 8 ohms, 480 watts into 4 ohms, 785 watts into 2 ohms
- Dynamic headroom**: 1.1 dB into 8 ohms, 2 dB into 4 ohms, 2.9 dB into 2 ohms
- Harmonic distortion** (THD + noise) at 1,000 Hz into 8 ohms: 1 watt, 0.01%; 10 watts, 0.0057%; 200 watts, 0.056%
- Maximum distortion** (20 to 20,000 Hz into 8 ohms): 0.12% at 200 watts (20,000 Hz)
- Sensitivity** (1-watt output into 8 ohms): 70 mV
- A-weighted noise** (referred to a 1-watt output): -87.5 dB
- Slew factor**: approximately 4

# Double Scoop

When one is plainly not enough ...indulge!

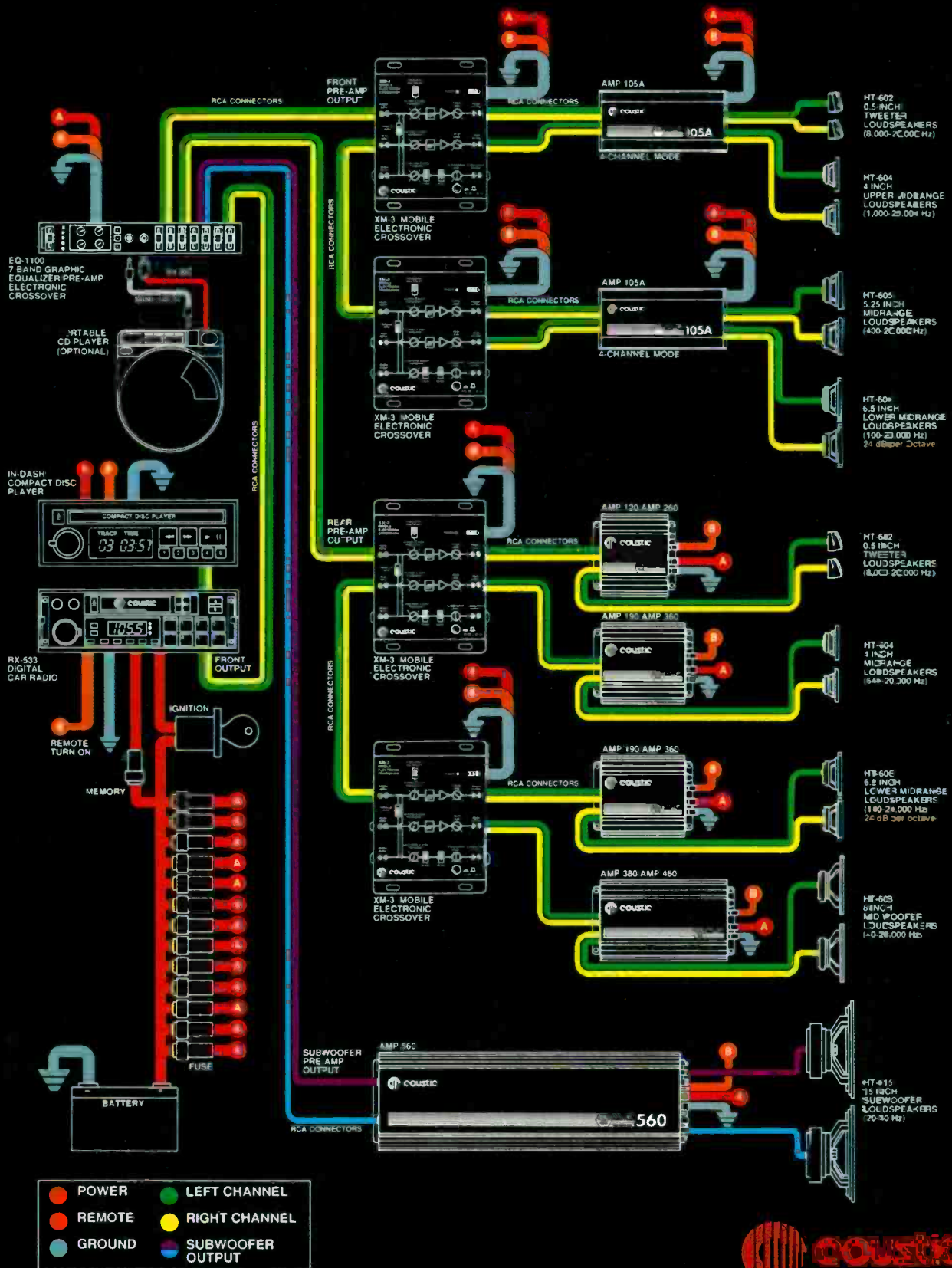

**COUSTIC**  
... a sound investment.

CIRCLE NO. 13 ON READER SERVICE CARD

# "If I Had It To Do All Of This Is Ho

"The technology for a new generation of loudspeaker systems was already here," says Henry Kloss. I was just the first one to put it together right."

"Right," in this case, meaning a stereo system that allows the integration of speakers into a room in a way that's never before been possible.

## Ensemble.

### The last loudspeaker of Henry Kloss.

Ensemble combines two bass units, two mid- to high-frequency units and something you won't find in any hi-fi store on earth.

Your living room. Which now, because of Ensemble's unique "system" design—becomes a seamlessly integrated part of the sound propagation process.

The result is a system that gives you perfectly balanced energy throughout the full ten octaves of music. And one which, at the same time, can be virtually invisible in your living room.

### The first speaker system that doesn't cheat you out of either bass or space.

The fundamental octaves that so much of music is built on...

The almost sub-audible but palpable

sounds generated by the big pipes of the organ, the bottom of the acoustic or electric bass, the low notes of the synth...

The frequencies completely ignored in the so-called "mini-speakers" now in vogue...

Ensemble provides them. With two dedicated, acoustic-suspension loudspeakers whose jobs are solely to reproduce the bottom two octaves of musical significance.

It is by design, not afterthought, that Ensemble comes with two, not one, bass units.

Because the human ear can't easily localize bass sound below about 150 Hz,

there is no need in a home music system for the bass to emanate from the same source as the higher frequencies. (And many acoustical reasons why it shouldn't.)

So to take advantage of this basic but vastly overlooked fact, the bass units are built small enough to be placed where they'll produce the best sound, without visually overpowering your room.

They are a compact 12" × 21" × 4.5". Yet they generate the low-frequency energy that would ordinarily require either a pair of very large conventional loudspeakers, or adding on a massive "subwoofer." Moreover, using two separate easily placed bass units dramatically reduces the creation of standing waves—the bane of pure hi-fi reproduction.

Without detriment to the sound, Ensemble's bass units can be placed beneath the couch, on top of the bookshelf, or under the potted plant.

And the result is a happy coincidence: Where the units sound the best is likely where they'll look the best. Even if that means not being able to see them at all.

*There is a wager you can make, if you don't mind taking money from house guests.*

*Place Ensemble's satellites where they're visible. Then hide one of the bass units under the sofa, and put the other on the floor with a plant on it. When your friends arrive, bet them to point out where the bass is coming from. They'll point to the satellites. Every time.*

### As for the other 8 octaves of music.

The rest of the sound spectrum, from a nominal crossover of 140 Hz, is reproduced by a stereo pair of two-way satellite units. Each incorporates a low-frequency driver, crossing over at 1,900 Hz to a direct-radiator tweeter that goes beyond audibility.

They are small enough (4" × 5" × 8" high) to set the sound stage (or so-called "imaging") wherever you want it.

Finished in scratch-proof, gunmetal grey Nextel, they will look good for a lifetime.



### What Henry Kloss tells his friends:

Every time I came out with a new speaker at AR, KLH, or Advent, my friends would ask me, "Henry, is it worth the extra money for me to trade up?" And every time I would answer, "No, what you've already got is still good enough!"

But today, with the introduction of Ensemble, I tell them, "Perhaps now is the time to give your old speakers to the children!"

### Overcoming the fear of paying too little.

This is more difficult than it may sound. Because the Ensemble System sells for an introductory price of only \$499.

And it can be jarring to accept the notion that a product actually outperforms others costing several times more. But think back on Henry Kloss' track record with AR, KLH, and Advent, the best selling high-performance speakers of their decades... Our commercial success will come not from excessive prices

# ...ver Again... And I Do... ...ow I'd Do It."

*Henry Kloss. Member of the Audio Hall of Fame. The creator of Acoustic Research in the 1950's, KLH in the 1960's, and Advent in the 1970's—the dominant speakers of their decades—now brings you Ensemble: the best-sounding speaker system of this era.*



on a small number of sales, but from selling a lot of systems to a lot of people. You, perhaps, among them.

The second thing you must overcome is the misdirected notion that you must go to a dealer showroom and listen to the speakers.

Because the fact is, the *only* way to appreciate the astonishing sound reproduction of this unconventional system is to audition it in your own room environment. Therefore, we sell only factory-direct. Either by phone, by mail, or by our front door, to make it as easy as possible to get the speakers to your front door.

They come with a straightforward 30-day money-back return policy.



## Speaking directly to the people who make the speaker.

To our knowledge, no other hi-fi manufacturer invites you to call, talk about, and buy the system. ("Hello, Mr. Sony?" Try that.)

We welcome you.

In fact, the easiest way to buy Ensemble is to call us with your credit card in hand, and speak with someone who will be happy to walk you through, talk you through, everything you might ever want to know about the system.

From why or why not to buy Ensemble, to questions about installation, room

*The Ensemble Stereo System: 2 bass units, 2 satellites, 100 feet of wire, mounting units, intelligent documentation, and a warm body. (Your Cambridge SoundWorks audio expert.)*

placement and other related audio equipment.

To get literature, to chat—or to order—the toll-free number is 1-800-252-4434, Mon.–Thurs., 9–9, Fri. and Sat., 9–6 Eastern Time. (In Canada, 1-800-525-4434.) Fax # (617) 332-9229.

CIRCLE NO. 157 ON READER SERVICE CARD

## CAMBRIDGE SOUNDWORKS

154 California St., Newton, Massachusetts 02158

- Send more information and Test Reports  
 Send Ensemble risk-free for 30 days, for \$499.  
I'm paying by  Check  MC  Visa  AmEx

Acct. Number \_\_\_\_\_ Exp. \_\_\_\_\_

Signature \_\_\_\_\_

Name \_\_\_\_\_

Address \_\_\_\_\_

City \_\_\_\_\_ State \_\_\_\_\_ Zip \_\_\_\_\_

Phone (Area Code) \_\_\_\_\_ Number \_\_\_\_\_

FOR IMMEDIATE SERVICE: 1-300-AKA-HIFI  
MA residents add 5% sales tax. Suite 102N

## TEST REPORTS

percent total harmonic distortion. Its power ratings into lower load impedances (which do not include bandwidth and distortion levels) are 300 watts per channel into 4 ohms and 400 watts into 2 ohms.

The DA-1 can also be operated as a mono amplifier in a bridged mode, selected by a small switch on its rear apron. Its mono ratings are 400 watts into 16 ohms from 20 to 20,000 Hz, 600 watts into 8 ohms, and 800 watts into 4 ohms. The physically and electrically separate channels also have separate power supplies, although they use separate windings on a common power transformer. The only circuits common to the two channels are the power transformer's primary winding and the 12-ampere line fuse.

The amplifier measures 17 inches wide, 11½ inches deep, not including the rear connectors or front handles, and 5¾ inches high. Although it gives the impression of being smaller than it is (the heat-sink fins on the sides contribute to this illusion), it weighs a solid 35 pounds. The front panel contains a recessed power button that looks like the control knobs of the companion C-1 preamplifier. Vertical green LED's above and below the power button indicate that the amplifier is on, and two red LED's above it are overload indicators for the two channels. There are no internal current-limiting circuits or DC power-supply fuses.

The rear apron of the DA-1 contains two pairs of heavy-duty multi-way binding-post outputs. These can accept up to 8-gauge wires and are thus suitable for use with virtually any exotic speaker cables. Also on the rear are two gold-plated input connectors and two telephone-type modular jacks like those on the C-1.

One of the modular jacks, the Amplifier/Accessory link, is used to connect the DA-1 to the corresponding jack on the C-1. The other jack, marked Remote Speaker Selector, connects to an optional Soundstream accessory that allows remote selection of either of two pairs of speakers from the C-1 preamplifier or the R-1 remote control. Suggested list prices: C-1 preamplifier and R-1 remote con-

trol, \$1,495; DA-1 power amplifier, \$1,195. Soundstream, Dept. SR, 2907 W. 182nd St., Redondo Beach, CA 90278.

### Lab Tests

The Soundstream C-1's frequency response was flat within +0.1, -1.2 dB from 20 to 20,000 Hz (the decrease was below 100 Hz). Its tone controls had conventional characteristics, with adequate range at the frequency extremes and a negligible effect in the midrange. The Hi-Cut filter rolled off the response by 3 dB at 10,000 Hz and at a gentle 8 dB per octave above that.

*It is the digital control facilities the Soundstream C-1 provides for other system components, and especially the DA-1 power amplifier, that really set it apart from other preamps.*

The preamplifier's 1,000-Hz clipping output was an ample 8.3 volts. The level at the headphone jack was approximately the same, providing excellent volume. Total harmonic distortion (THD) plus noise was 0.01 percent at a 1-volt output, increasing to 0.017 percent at 2 volts and 0.03 percent at 5 volts. At a constant 2-volt output, the distortion was between 0.016 and 0.019 percent from 20 to 20,000 Hz. The amplifier noise level was extremely low, -108 dB referred to a 0.5-volt output.

The channel separation was 75 dB at 1,000 Hz, narrowing to 52 dB at 20,000 Hz. Crosstalk between inputs (CD to tuner), with the unused input unterminated, was -64 dB at 1,000 Hz and -44 dB at 20,000 Hz. With the unused input shorted, the crosstalk was undetectable (less than -130 dB) at any frequency.

To conform to FTC requirements, we preconditioned the Soundstream DA-1 power amplifier by driving 8-ohm loads with 1,000-Hz signals in both channels at one-third rated power (67 watts) for 1 hour. At the end of the hour, the amplifier's exterior was uncomfortable to touch for more than a few

seconds, though not hot enough to be dangerous.

An input of 70 millivolts (mV) drove the amplifier to a reference output of 1 watt. The A-weighted noise level was -87.5 dB referred to 1 watt. The output at clipping was 220 watts into 8 ohms, 360 watts into 4 ohms, and 500 watts into 2 ohms. The corresponding clipping-headroom ratings were 0.4, 0.8, and 1 dB. In dynamic power measurements the maximum output was 256 watts into 8 ohms, 480 watts into 4 ohms, and 785 watts into 2 ohms, corresponding to dynamic-headroom ratings of 1.1, 2.0, and 2.9 dB, respectively.

With an 8-ohm load, the distortion (THD plus noise) at 1,000 Hz was between 0.006 and 0.01 percent from 1 to 30 watts output, rising to 0.56 percent at 200 watts. With a 4-ohm load, the distortion was under 0.02 percent up to 40 watts and reached 0.1 percent at 300 watts. A 2-ohm measurement could not be made because the amplifier's 12-ampere power-line fuse blew even at outputs well below clipping. At the rated 200 watts into 8 ohms, the distortion was about 0.05 percent from 20 to 7,000 Hz, rising to 0.145 percent at 20,000 Hz. At lower power levels (100 and 20 watts) the distortion was substantially less.

Attempts to measure the amplifier's slew factor were unsuccessful, since the output stage blew in the channel we were testing when the frequency reached about 80 kHz, corresponding to a slew factor of 4. A similar mishap occurred with another sample when we attempted to transfer the signal-cable connector from our regular audio generator to a tone-burst generator.

### Comments

The Soundstream C-1 is a very good preamplifier with attractive styling and well-designed controls, and it is very solidly built. All the switching and control operations were totally silent, both mechanically and electrically, and the two-color LED indicators in the control buttons give an instant picture of its operating status.

It is, however, the digital control facilities the C-1 provides for other system components, and most espe-



*Christmas presents for everyone!*

# TAKE ANY 6 CDs FOR ONE PENNY

plus shipping and handling with membership

- |  |  |   |   |
|--|--|---|---|
| <b>Huey Lewis &amp; The News</b> —Small World (Chrysalis) 371419   | <b>Steve Winwood</b> —Roll With It (Virgin) 371211   | <b>Elton John</b> —Reg Strikes Back (MCA) 370536                              | <b>Robert Palmer</b> —Heavy Nova (EMI-Manhattan) 370395                             |
| <b>Tracy Chapman</b> (Elektra) 369892  | <b>Van Halen</b> —OU812 (Warner Bros.) 369371  | <b>Merdelsohn Violin</b> —Concerto—(Angel) 366872                             | <b>Wynton Marsalis</b> —Baroque Music For Trumpets (CBS Master) 364695              |
| <b>Richard Marx</b> (EMI-Manhattan) 369611   | <b>Sade</b> —Stronger Than Pride (Epic) 368027   | <b>Gloria Estefan &amp; Miami Sound Machine</b> —Let It Loose (Epic) 356279   | <b>George Michael</b> —Faith (Columbia) 362228                                      |
| <b>Grover Washington, Jr.</b> —Then and Now (Columbia) 371476  | <b>Wynton Marsalis Quartet</b> —Live At Blues Alley (Columbia) 370080-390088   | <b>Whitney Houston</b> —Whitney (Arista) 356154                               | <b>Eagles</b> —Greatest Hits 1971-1975 (Asylum) 287003                              |
| <b>Schubert</b> —Quintet in C Major, Juilliard String Quartet, Bernard Greenhouse (CBS Masterworks) 371104                     | <b>Schumann</b> —Cello Concerto, Yo-Yo Ma; Davls, Bavarian Radio Sym. (CBS Masterworks) 369843                       | <b>Vladimir Horowitz, Piano</b> —Favorite Encores (CBS Masterworks) 355164    | <b>Simon &amp; Garfunkel</b> —Greatest Hits (Columbia) 219477                       |
| <b>Spyro Gyra</b> —Rites of Summer (MCA) 370767  | <b>Bob James</b> —The Scarlatti Dialogues (CBS Master) 369835  | <b>U2</b> —The Joshua Tree (Island) 354449                                    | <b>Vladimir Feltsman</b> —American "Live" Debut (CBS Master) 365254-395251          |
| <b>Randy Travis</b> —Old 8 x 10 (Warner Bros.) 370643  | <b>John Williams</b> —The Baroque Album (CBS Master) 369769  | <b>The Police</b> —Every Breath You Take... The Singles (A&M) 348318          | <b>Foreigner</b> —Inside Information (Atlantic) 364018                              |
| <b>Patti Smith Group</b> —Dream Of Life (Arista) 370478  | <b>Claude Bolling</b> —Piano Boling's Greatest Hits (CBS) 369751   | <b>Buddy Holly</b> —From The Orig. Master Tapes (MCA) 348110                  | <b>Pretenders</b> —The Singles (Sire) 362541  |
| <b>Europe</b> —Out of This World (Epic) 370403   | <b>Talking Heads</b> —Naked (Fly/Sire) 369397  | <b>The Beach Boys</b> —Made In U.S.A. (Capitol) 346445                        | <b>Neil Diamond</b> —Hot August Night II (Columbia) 362277-392274                   |
| <b>Stryper</b> —In God We Trust (Enigma) 370361  | <b>George Howard</b> —Reflections (MCA) 369314   | <b>Chuck Berry</b> —The Great Twenty-Eight (Chess) 343657                     | <b>10,000 Maniacs</b> —In My Tribe (Elektra) 361600                                 |
| <b>Hank Williams, Jr.</b> —Wild Streak (Warner Bros./Curb) 370320  | <b>Bobby McFerrin</b> —Simple Pleasures (EMI-Manhattan) 369306   | <b>Barbra Streisand</b> —The Broadway Album (Columbia) 342097                 | <b>Diane Schuur And Count Basie Orch.</b> (GRP) 361048                              |
| <b>David Sanborn</b> —Close Up (Warner Bros.) 370304   | <b>Murray Perahia, Piano</b> —Schubert: Sonata, Op. Posth., D. 959 Schumann: Sonata, Op. 22 (CBS Masterworks) 369207 | <b>Billy Joel</b> —Greatest Hits Vols. 1 & 2 (Columbia) 336396-396390         | <b>Billie Holiday</b> —From The Orig. Decca Masters (MCA) 354985                    |
| <b>Dvorak</b> —Piano Trios F minor Op. 65; E minor Op. 90 "Dumky" Yo-Yo Ma, Emanuel Ax, Young Uck KIm (CBS Masterworks) 370189 | <b>Prince</b> —Love Sexy (Paisley Park) 369124   | <b>Stevie Wonder</b> —Orig. Musiquarium I-Greatest Hits (Tamil) 314997-394999 | <b>Fleetwood Mac</b> —Tango In The Night (Warner Bros.) 354902                      |
| <b>Pat Benatar</b> —Wide Awake In Dreamland (Chrysalis) 370528   | <b>INXS</b> —Kick (Atlantic) 361519  | <b>Led Zeppelin IV</b> (Atlantic) 291435                                      | <b>Introducing The Hardline According To Terence Trent D'Arby</b> (Columbia) 361618 |
|  |  | <b>Crowded House</b> —Temple Of Low Men (Capitol) 370346                      |   |
|  |  |   |   |
|  |  |   |   |

Here's an exciting selection of new hits and all-time favorites... each one will make an ideal gift for someone on your Christmas list... or a welcome addition to your own collection.

To get any 6 CDs for 1¢, just fill in and mail the application—we'll send your CDs and bill you for 1¢ plus shipping and handling. You simply agree to buy 4 more CDs (at regular Club prices) in the next two years—and you may then cancel your membership anytime after doing so.

**How the Club works.** About every four weeks (13 times a year) you'll receive the Club's music magazine, which describes the Selection of the Month... plus new hits and old favorites from every field of music. In addition, up to six times a year, you may receive offers of Special Selections, usually at a discount off regular Club prices, for a total of up to 19 buying opportunities.

If you wish to receive the Selection of the Month, you need do nothing—it will be shipped automatically. If you prefer an alternate selection, or none at all, fill in the response card always provided and mail it by the date specified. You will always have

at least 10 days in which to make your decision. If you ever receive any Selection without having 10 days to decide, you may return it at our expense.

The CDs you order during your membership will be billed at regular Club prices, which currently are \$12.98 to \$15.98—plus shipping and handling. (Multiple-unit sets may be somewhat higher.) After completing your enrollment agreement you may cancel membership at any time; if you decide to continue as a member, you'll be eligible for our money-saving bonus plan. It lets you buy one CD at half price for each CD you buy at regular Club prices.

**10-Day Free Trial:** We'll send details of the Clubs operation with your introductory shipment. If you are not satisfied for any reason whatsoever, just return everything within 10 days and you will have no further obligation. So why not choose 6 CDs for 1¢ right now?

**ADVANCE BONUS OFFER:** As a special offer to new members, take one additional Compact Disc right now and pay only \$6.95. It's a chance to get a seventh selection at a super low price!

038/F88

**CBS COMPACT DISC CLUB, 1400 N. Fruitridge**  
P.O. Box 1129, Terre Haute, Indiana 47811-1129

Please accept my membership application under the terms outlined in this advertisement. Send me the 6 Compact Discs listed here and bill me 1¢ plus shipping and handling for all six. I agree to buy four more selections, at regular Club prices, in the coming two years—and may cancel my membership at any time after doing so.

My main musical interest is (check one):  
(But I may always choose from any category)

**Hard Rock** Robert Plant, Pat Benatar  
 **Soft Rock** Huey Lewis & The News, Steve Winwood  
 **Jazz** David Sanborn, Spyro Gyra  
 **Pop/Easy Listening** Neil Diamond, Barry Manilow, Johnny Mathis, Roy Conniff  
 **Classical\*** Vladimir Horowitz, Yo-Yo Ma

Mr. \_\_\_\_\_  
Mrs. \_\_\_\_\_  
Miss \_\_\_\_\_  
Print First Name Initial Last Name

Address \_\_\_\_\_ Apt. \_\_\_\_\_  
City \_\_\_\_\_  
State \_\_\_\_\_ Zip \_\_\_\_\_

Do you have a VCR? (04)  Yes  No  
Do you have a credit card? (03)  Yes  No BFF/XK BFG/XM

**ADVANCE BONUS OFFER:** Also send me one more CD right now at the super low price of just \$6.95, which will be billed to me.

Note: We reserve the right to reject any application or cancel any membership. These offers not available in APO, FPO, Alaska, Hawaii, Puerto Rico; write for details of alternative offer. Canadian residents serviced from Toronto. Applicable sales tax added to all orders. \*Classical members serviced by the CBS Classical Club.

## TEST REPORTS

cially for the DA-1 power amplifier, that really set it apart from other preamplifiers. The difference is underscored by the absence of any AC convenience outlets, either switched or unswitched, on its rear apron. Although the C-1 is not completely dedicated to use in a Soundstream System-1, it was obviously intended primarily for that role.

The R-1 remote control is more convenient to use as a full system controller than most others we have seen. It is not overcrowded with control buttons, and those it has are very clearly marked and have distinctive shapes as well. Since each button can be programmed, in effect, for up to ten different functions (most can serve different roles depending on which source is selected), the R-1 provides enormous operating flexibility with a minimum of operating difficulty.

The functions of the R-1 that are dedicated to controlling the C-1 preamplifier worked perfectly. The C-1's motor-driven volume knob turned at an ideal rate, adequate for any normal volume adjustment but not so fast as to outrun the user's intentions. Programming the R-1 for other components, however, requires a bit of technique. The instructions in the manual are basically correct, but after a number of unsuccessful attempts, we had to be "talked through" the procedure by a Soundstream engineer. It turned out that the *rate* of entering some keystrokes is important, though the manual says nothing about that.

We succeeded in programming the R-1 for most of the basic operations of a Sony CD player, but some of the memorizing times were disturbingly long (several minutes). With some of the commands, the multiple LED display of the R-1 never gave the proper "memorized" indication, but subsequent use revealed that it had indeed memorized the Sony controller's code.

Our tests of the Soundstream DA-1 showed it to be a very powerful amplifier with low noise and distortion levels and excellent sound quality. Used with the C-1 preamplifier, it operated with total silence even when being turned on or off; there were no audible relay sounds or any other indication of its opera-

tion other than the unobtrusive green lights framing the power button (which is not used when the two components are coupled).

The measurements that we were able to complete showed that the DA-1 had an enormous current-output capacity. As the load impedance decreased, it behaved very much like a constant-voltage source. Its six power transistors per channel delivered more and more current without any major waveform changes—until they failed without warning, taking the 12-ampere line fuse with them! In my view, the amplifier's greatest strength is also its most serious weakness, reminding me of a joke dating from the early days of the transistor: that the transistor is the fastest-acting fuse known to man and will reliably blow out before a "fast-acting" fuse that is supposed to protect it!

An ironic result of the DA-1's dual-mono design and lack of current-limiting circuits or power-supply fuses is that the amplifier is at *greater* risk when only one channel is being driven, which is a typical test condition, than when both are active during listening. Presumably an overdrive condition on *both* channels will blow the line fuse before the transistors are destroyed, but if only one is in use, the fuse is unable to save the amplifier from destruction.

We also found the DA-1 to be

unduly sensitive to having an input signal source connected or removed while the amplifier was on. As with most amplifiers, its manual warns against connecting speakers while the amplifier is on, but not against the greater hazard (to the amplifier) of disturbing a signal-input connection while it is powered.

Conversations with Soundstream engineers confirmed the self-destructive tendencies we had observed in our test units, which were either preproduction or early production samples. The design is being modified to make the DA-1 amplifier as "bullet-proof" as it appears to be and *should* be. In any case, as long as all input and output connections are made before the amplifier is turned on and not disturbed during its operation, and as long as the program material is limited to the audio range, there is no question about its ruggedness.

In normal operation, the Soundstream DA-1 performed like a real brute of an amplifier; I have no doubt that it can drive with aplomb the lowest speaker impedance that might be presented to it. It also worked well in combination with the C-1 preamplifier and R-1 remote control. Soundstream's digital control system is well executed, and these components represent an impressive debut in the home hi-fi marketplace.

*Circle 141 on reader service card*

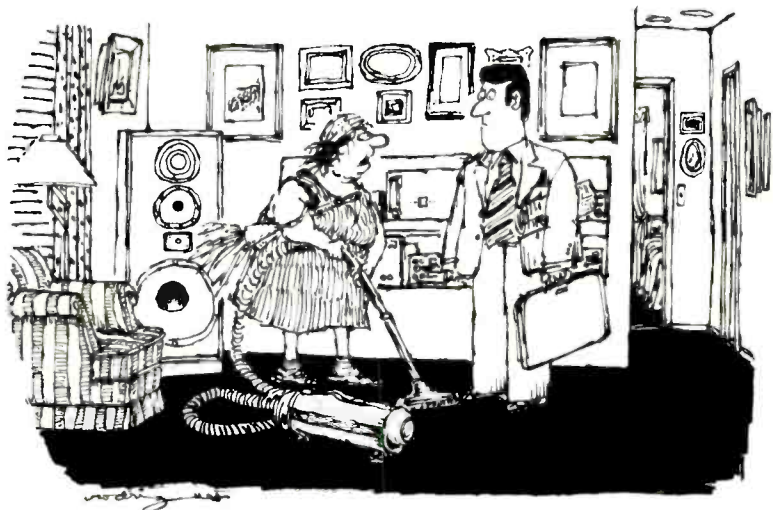

... No way, Mr. Segal! I made it clear to the agency—I don't clean tape heads!"

## Who we are. And how you can hear the difference.



NAD is the world's leading designer of reasonably priced audiophile-quality stereo components. From enormously powerful amplifiers to modest-appearing receivers. From unique multi-CD players to advanced tuners and cassette decks. NAD equipment is the best in design and performance, in value, in ease and simplicity of operation, and in genuine usefulness of features.

But there are so many good components out there, you might say. Well, consider this. Designed in Boston and London by American and European engineers, NAD equipment happens to be the insider's choice. It is the equipment secretly owned by the technicians and staff of other audio companies. It is the equipment those companies' engineers recommend to, and buy for, their parents, grandparents, even their in-laws. It is the equipment that journalists and audio-society members get for themselves. In fact, NAD has become the overwhelming choice of the most knowledgeable consumers.

Why? Because it performs brilliantly, it sounds superb, it's rugged and reliable, and it is utterly easy to understand and use.

We invite you to see and hear the difference at your local NAD dealer.



**For the music, pure and simple.**

NAD(USA), Inc., 575 University Avenue  
Norwood, MA 02062 (617) 762-0202



## NHT MODEL I SPEAKER AND OCTAVE BASS MODULE

*Julian Hirsch, Hirsch-Houck Laboratories*

**T**HE initial products from NHT (Now Hear This, Inc.), a new name in the roster of American loudspeaker manufacturers, include a compact and attractive bookshelf speaker system, the NHT Model I, and its companion bass module, the Octave. The Model I can be used separately or in combination with the Octave to form a three-piece system with a fuller bass response than the Model I can achieve alone.

Created by Ken Kantor (designer of the Acoustic Research MGC-1 speaker), the NHT Model I is a two-way acoustic-suspension speaker with a 6½-inch woofer and a ¾-inch hard-polymer dome tweeter; NHT describes it as a "semi-dome." The crossover, at 3,300 Hz, combines 6-dB-per-octave electrical slopes with the drivers' 12-dB-per-octave acoustical slopes to yield an effective crossover rate of 18 dB per octave.

The enclosure, which measures 12 inches high, 7 inches wide, and 10¼ inches deep, is made of ¾-inch-thick medium-density fiberboard. The exterior is entirely covered with

a ¼-inch polymer laminate in glossy black or a choice of three wood-grain finishes (white oak, maple, and walnut). A black cloth grille is retained by plastic snaps and is easily removable. Multiway binding-post terminals are recessed into the rear of the cabinet. The system is magnetically shielded and can be placed close to a TV set or video monitor without affecting its color. Each speaker weighs 11½ pounds.

The Model I speaker is sold in mirror-image pairs, and the speaker boards are angled forward by approximately 20 degrees. The purpose is to radiate their acoustic energy primarily into a defined area between the two speakers and at a distance of about 2 meters from them. According to NHT, this "Focused Image Geometry" minimizes internal standing waves, reduces wall reflections, which can degrade image localization and distort the sound stage, maintains a fixed sound stage as a listener moves around in the region between the two speakers, and minimizes interaural crosstalk in the central region,

equidistant from the two speakers, resulting in improved sound localization and ambience.

The NHT Model I has a rated frequency response of 65 to 22,000 Hz  $\pm$  3 dB. Its nominal impedance is 8 ohms, with a minimum of 5.2 ohms, and the sensitivity is given as 89 dB sound-pressure level (SPL) at 1 meter with an input of 2.83 volts of pink noise in the 1,000-Hz octave band. NHT recommends using the speakers with amplifiers rated between 20 and 150 watts per channel and placing them against the rear wall for best bass performance.

The NHT Octave bass-extension module is designed to add another octave of low bass to the effective range of the Model I. It is not a subwoofer but a convenient means of converting a pair of Model I speakers to a three-piece, three-way system with an overall frequency range of 49 to 22,000 Hz  $\pm$  3 dB.

The Octave is a rectangular box measuring 19½ inches high, 8 inches wide, and 12 inches deep and weighing 26½ pounds. It is identical in construction and finish to the Model I speakers. The Octave contains two 6½-inch acoustic-suspension woofers housed in separate sub-enclosures within the 9-liter box.

The Octave contains a passive crossover designed to complement the Model I system. It is driven directly from the amplifier, and the two Model I speakers are connected to it. (All the connectors—insulated clips that accept the stripped ends of speaker wires—are recessed into the rear of the Octave cabinet.) A 6-dB-per-octave rolloff below 70 Hz is introduced into the output to the satellite speakers. Together with their natural rolloff at 12 dB per octave, this results in an effective crossover slope of 18 dB per octave. The woofers of the Octave module are driven through a 6-dB-per-octave low-pass filter with a 70-Hz turnover frequency.

Since the two systems are designed to be used together, the Octave's specifications assume it is used with the Model I. The nominal impedance of the three-piece system is still 8 ohms, but the minimum is reduced to 4.4 ohms. The power rating is slightly increased, to a maximum of 175 watts, because the low-

Now that the picture on our  
big screen televisions is  
just about perfect, we decided to  
work on something else.



# SOI

*Our 35" direct-view monitor/receiver has our exclusive Diamond Vision® II picture tube and a wide band video amplifier capable of 560 lines of resolution, compared to the normal 340 lines.*

*The Home Theater System speakers have a 12" cast frame woofer, 5" midrange and a titanium dome tweeter. And individual controls let you vary the midrange and tweeter levels.*



It's not the easiest thing being perfectionists.

Just when you've developed a 35-inch television that's every bit as clear and sharp as conventional size sets, you see something else that could stand some improvement.

Or, in this case, you hear it.

Introducing Mitsubishi Home Theater Systems. Our new series of integrated components that does for sound what we've always done for sight: Make it larger than life.

Now, along with a panoramic picture, our Home Theater components can give

your favorite movies, sporting events and programs the kind of fidelity a television alone could never produce.

Thanks largely to our new M-AV1 audio/video receiver. Not only does it produce a wall-shaking 125 watts of power,\* but it comes equipped with the

# NO



Our new M-AV1 audio/video receiver delivers 125 W/Ch.\* with 25 W/Ch. rect. Dolby Surround.<sup>™</sup> The connectors are gold plated, and all functions are displayed on screen in an easy-to-read menu.

Our M-C5100 CD player features 8-times oversampling and 18-bit digital analog converters. And our M-T5100 dual cassette deck comes with both Dolby<sup>®</sup> B and C.

With horizontal resolution greater than 400 lines, our S-VHS/Hi-Fi VCR can generate an image that's 67% sharper than ordinary VCR's.



same kind of Dolby Surround<sup>™</sup> sound you hear in theaters.

On-screen displays give you simple instructions for switching from the VCR to the CD

*One remote controls everything in this ad.*

player to the cassette deck and so on. And a single illuminated remote lets you control everything from the comfort of your own recliner.

For a demonstration, minus the recliner, visit an authorized Mitsubishi Home Theater Systems dealer.

And see with your own ears how great it sounds.

For the name of your authorized Mitsubishi Home Theater Systems dealer, call (800) 556-1234 ext. 145. In California, (800) 441-2345 ext. 145. Cabinet colors and finishes may vary. Dolby and Dolby Surround are trademarks of Dolby Laboratories Licensing Corp. Diamond Vision II is a registered trademark of Mitsubishi Electric Corporation. \*120 watts/channel, min. RMS, both channels driven into 8 OHMS from 20Hz - 20kHz with no more than 0.05% THD. © 1988 Mitsubishi Electric Sales America, Inc.

 **MITSUBISHI**<sup>®</sup>

CIRCLE NO. 22 ON READER SERVICE CARD

## TEST REPORTS

est frequencies are diverted from the Model I to the more rugged woofers of the Octave, allowing somewhat more power to be applied safely. Although the Octave is also magnetically shielded, it should be no closer than 12 inches from a TV set or video monitor.

When the Model I is used with the Octave, it is recommended that the satellites be placed on stands between 0.5 and 1 meter from the back wall. The Octave can be placed almost anywhere in the room, although on the floor against the rear wall is usually the most convenient choice. Prices: Model I, \$299 a pair; Octave, \$230. NHT, Dept. SR, P.O. Box 1228, Fullerton, CA 92632.

### Lab Tests

We evaluated the NHT Model I and Octave as a system, although we also conducted some tests on the Model I alone. We placed the speakers in accordance with NHT's recommendations.

The room response (normally very irregular, at least in the frequency range below 500 Hz) was impressively uniform, varying only  $\pm 5$  dB from 50 to 20,000 Hz. The close-miked bass response of the NHT Model I reached its maximum at 120 Hz, falling at 12 dB per octave below 100 Hz and dropping off gradually at higher frequencies to about  $-5$  dB at 2,000 Hz. A similar measurement of the Octave's response showed a maximum at about 62 Hz and rolloffs of 18 dB per octave at lower frequencies and about 8 dB per octave at higher frequencies. The acoustic levels from the Octave and Model I were almost identical up to their effective crossover frequency of 63 Hz. As a result, the Octave raised the system's bass output by 3 dB over the full range from 20 to 70 Hz but had no effect on the response above 100 Hz.

The composite frequency response, formed by splicing the bass curve to the room curve, was within  $\pm 3.5$  dB from 50 to 20,000 Hz. The quasi-anechoic response measurements with our IQS FFT-analysis system were roughly similar, although the distribution of the small irregularities along the response curve was different with the two systems of measurement. The hori-

zontal dispersion of the Model I was excellent; over a 45-degree angle from the driver axis toward the center of the room, there was no significant change in response below 12,000 Hz. The phase linearity of the system was very good, with a group-delay variation of less than  $\pm 0.5$  millisecond (typically about half that) from 500 to 23,000 Hz.

System impedance was relatively uniform over the audio frequency range, with a minimum reading of 4.9 ohms at 70 Hz and a maximum of 12 ohms over the 2,000- to 3,000-Hz range. The Model I by itself had the same impedance characteristic above 300 Hz as the complete system, but its bass resonance was at 86 Hz (with an amplitude of 25 ohms). The minimum impedance of the Model I was 5.3 ohms at 20 Hz and from 200 to 300 Hz.

The system's sensitivity at a 1-meter distance measured 88 dB SPL with 2.83 volts of pink-noise input. We measured the bass distortion from the Octave module, and from the Model I's woofer without the Octave connected, at a drive level of 4.5 volts (equivalent to a 90-dB mid-range SPL). Interestingly, the Model I's woofer appeared to have less distortion, less than 1 percent from 100 Hz to below 50 Hz, but its output at the lowest frequencies was so low that this was of little practical value. The Octave's distortion reached 8 percent at its 50-Hz effective lower limit, but this was measured at a comfortably loud sound level.

In pulse power tests, the Model I's cone rattled with a 100-Hz input of 160 watts into its 7.8-ohm impedance. At both 1,000 and 10,000 Hz, our amplifier clipped, at about 800 watts, before there was any sign of speaker distortion.

### Comments

Used by itself, the NHT Model I was a very balanced, smooth-sounding system whose appearance and styling suit it for a wide variety of installations. Our test samples, finished in black, had a tough, glossy surface whose polished appearance suggested piano lacquer but which was more resistant to marring than any conventional finish.

As might be expected, most of the time there was very little difference

between the sound of the NHT Model I alone and the complete system including the Octave bass unit. The Model I had a bit more top end than a couple of other speakers with which we compared it, though not to the point of actually sounding bright. In general, it did not give any impression of thinness or lack of bass, especially when there was little program content below 70 Hz. On the other hand, with the Octave connected, the system took on the full-bodied character of a good conventional speaker. When bass was present, it was clearly audible, although—at least in our room, under typical conditions—it was not *felt*.

We were impressed by the absence of heaviness on male voices—our familiar FM station announcers sounded much more natural than through many speakers we have used. This impression is consistent with the measured absence of the usual upper-bass emphasis, a major weakness of most speakers we have heard. Of course, it might also have been related to the lack of a palpable bass—could it be that the system was really not putting out enough in the lower registers?

That question was answered by judicious use of amplifier bass boost (which did not affect the midrange significantly). Low organ-pedal notes produced the hoped-for pressure on the skin and in the ears, and only a confirmed bass junkie would have been disappointed with it.

It was no surprise to find that a similar experiment with the Model I's alone was unsuccessful. Long before the low bass reached usable levels, the woofer cones were rattling and fluttering. The experiment confirmed a major benefit of the Octave module: It removes the low-bass energy from the satellite woofers and lets them do their job without overload, delegating the lower frequencies to a speaker designed to handle them.

We have supported the concept of three-piece speaker systems for many years, and they have enjoyed a modest but ongoing growth in popularity. The NHT system is very compact, handsomely styled, and competitively priced. And it sounds good, too.

**Circle 142 on reader service card**





# Jensen sizzles.

Don't settle for a car stereo that's merely cool. Get one that's hot. Jensen car stereo. It's red hot sound. With enough power and high tech features to turn your car into a rock and roll inferno that will set the streets on fire.



SJS 9000 RECEIVER. 60 watts of power. Instaloc™ tuning. 24 presets. Dclby™ Music search. Ultra bias tape heads. Pull-out anti-theft chassis.

AMERICAN CLASSIC JTX 340 6" x 9" TRIAXIAL SPEAKERS. 150 watts peak/60 watts continuous power each. Made in the U.S.A. Dynamic cone tweeters. Long throw woofers. Bass optimized design.

## JENSEN®

*The most thrilling sound on wheels.*



© 1988 International Jensen Inc. Jensen is the registered trademark of International Jensen Inc.

CIRCLE NO. 174 ON READER SERVICE CARD



Introducing the one and only ...

ELIZABETH  
LINE

B

C

E

D

A

BENJAMIN  
LINE

SAMANTHA  
LINE

Universal, solid oak,  
adjustable storage cabinet.

For Compact Disc, Computer, Video, Cassette and D.A.T. all in one unit!

Jewels stored vertically or horizontally to your own impeccable taste, our rich colored Ivory shelves are removable to adapt to **any** collection. Our rotating Benjamin and Samantha line allows for multi-storage in tight quarters. The Elizabeth line is stackable, wall mounted or desk top suitable. All cabinets available in choice of 5 colors.

**ELIZABETH LINE**

- A. Holds 308 jewels vertically, 276 stored horizontally measures 6<sup>3</sup>/<sub>4</sub>" x 20<sup>1</sup>/<sub>4</sub>" x 48" \$298<sup>000</sup>
- B. Holds 154 Jewels vertically, 138 stored horizontally measures 6<sup>3</sup>/<sub>4</sub>" x 20<sup>1</sup>/<sub>4</sub>" x 24" \$149<sup>000</sup>
- C. Holds 102 Jewels vertically, 90 stored horizontally measures 6<sup>3</sup>/<sub>4</sub>" x 13<sup>3</sup>/<sub>4</sub>" x 24" \$119<sup>000</sup>
- D. Holds 52 Jewels vertically, 46 stored horizontally measures 6<sup>3</sup>/<sub>4</sub>" x 13<sup>3</sup>/<sub>4</sub>" x 13<sup>1</sup>/<sub>4</sub>" \$69<sup>000</sup>
- E. Holds 24 Jewels vertically, 22 stored horizontally measures 6<sup>3</sup>/<sub>4</sub>" x 7<sup>1</sup>/<sub>4</sub>" x 13<sup>1</sup>/<sub>4</sub>" \$39<sup>000</sup>

**BENJAMIN LINE**

- Stores 204 Jewels vertically, 180 stored horizontally measures 13<sup>3</sup>/<sub>4</sub>" x 13<sup>3</sup>/<sub>4</sub>" x 25" \$229<sup>000</sup>

**SAMANTHA LINE**

- Stores 104 Jewels vertically, 92 stored horizontally measures 13<sup>3</sup>/<sub>4</sub>" x 13<sup>3</sup>/<sub>4</sub>" x 14<sup>1</sup>/<sub>4</sub>" \$129<sup>000</sup>

- Finger touch bronze glass doors
- Acrylite adjustable shelves
- Solid brass hardware
- 100% solid oak casing
- 1 year warranty
- Satisfaction Guaranteed

Dk. Oak

Med. Oak

Lt. Oak

White

Black



*"Free Shipping"  
on 2 or more cabinets*

Call 1-800-458-1312 for easy ordering!

Call or write for further information  
147 Columbia Avenue • Holland, MI 49423





## SHARP OPTONICA SM-A75 INTEGRATED A/V AMPLIFIER

*Julian Hirsch, Hirsch-Houck Laboratories*

**S**HARP'S SM-A75, part of the Optonica line of audio components, is a compact, versatile surround-sound amplifier and audio/video control center. Each of its four channels is rated for at least 25 watts into an 8-ohm load with no more than 0.8 percent total harmonic distortion when all four are driven simultaneously, as they would be in a typical surround-sound system. The SM-A75 can also be operated in a standard two-channel

stereo mode, in which the power rating increases to 35 watts per channel. The specified frequency range at the rated power output and distortion level is 30 to 20,000 Hz for the front channels and 30 to 15,000 Hz for the rear ones.

The preamplifier section of the SM-A75 has inputs for a turntable, a CD player, a tape deck, a tuner, a TV set, two auxiliary sources, two VCR's and a videodisc player. There are also recording outputs for the audio

and video tape decks. The front panel has two small tone-control knobs and a pair of pushbutton volume controls. Digital circuits vary the gain in 2-dB steps. A small DUBBING MODE button connects the two VCR's for recording in either direction or for videodisc dubbing to VCR 1. RCA phono jacks on the front panel duplicate the VCR 2 jacks on the rear of the amplifier, simplifying the temporary connection of a second video recorder to the system. There are also two stereo headphone jacks, one for the front channels and the other for the rear.

A key feature of the Optonica SM-A75 is its surround-sound processor. The front-channel signals can be combined in a matrix to produce

# THEY DON'T PLAY DIRTY.



## THE ELITE M-91 AND C-91 REFERENCE COMPONENTS.

Hum, crosstalk, vibration: distortion in your audio signal.

Graininess, specks, flecks: extraneous noise in your video image.

Impurities.

The Elite C-91 pre-amp and M-91 power amp are no compromise components designed to give you more of the pure signal and less annoying noise. By keeping critical signal paths as short as possible. By providing honeycomb construction throughout to reduce excess vibration. By using separate twin cast-iron transformers to eliminate stray magnetic flux and dissipate heat quickly.

The C-91 not only controls up to six video components, its video-enhancing circuits actually improve your video image. You'll find unique processing controls like video noise reduction, sharpness and detail. To maintain audio and video signal purity, the C-91 includes a shielded, motorized volume control and three separate audio and video power transformers. There are also two Y/C inputs and three outputs to help you get the most out of the latest video technology, including SVHS™ and ED Beta®.

A sophisticated high-end A/V system wouldn't be complete without remote capabilities. The C-91's powerful Smart Remote™ unifies your existing components into a complete A/V system.

Where the C-91 takes off, the M-91 takes over. With 800 watts/channel into 2 ohms\* and 200 watts/channel into 8 ohms,\*\* and remarkably high current capability (47 amps) for driving low impedance reactive loads. And for unprecedented purity, the M-91 includes its own volume control for direct connection to your CD player.

The Elite M-91 and C-91 Reference Components. The difference between playing dirty and playing great.

For more information, call 1-800-421-1404.

ELITE  
BY PIONEER

\*Measured by EIA method.

\*\*Based on FTC rules regarding measurement of amplifier power ratings.

Super VHS is a trademark of Victor Corporation of Japan, Limited.

ED Beta is a registered trademark of Sony Corporation.

© 1988 Pioneer Electronics (USA) Inc., Long Beach, CA

CIRCLE NO. 92 ON READER SERVICE CARD

PIONEER  
C-91  
STEREO CONTROL AMPLIFIER

M-91  
PIONEER  
STEREO POWER AMPLIFIER

# THE ELITE REGISTER

## ALABAMA

Florence  
Ingram Audio

## ALASKA

Anchorage  
Magnum Electronics  
Kodiak  
Island TV

## ARIZONA

Phoenix  
Integrated Systems  
Jerry's Audio  
Prescott  
Audio  
Entertainment  
Systems  
Tucson  
Jerry's Audio

## ARKANSAS

Fayetteville  
Amp Audio  
Little Rock  
Walloch Home  
Center  
Pine Bluff  
Stereo Junction

## CALIFORNIA

Alamo  
Laser Faire  
Alhambra  
Audio Video Center  
Berkeley  
The Sounding  
Board, Inc.  
Beverly Hills  
Beverly Hills Audio  
Burbank  
The Lasers Edge  
Canoga Park  
The Lasers Edge  
Encino  
Audio Video  
Electronics  
Glendale  
Marconi Radio  
Goleta  
House of Audio  
Video  
Greenbrae  
Videola  
Irvine  
Sound Quest  
Los Angeles  
Royal Sound  
Mill Valley  
Videola  
Mission Viejo  
Videolaser  
Monrovia  
Video Place  
Palo Alto  
Western Audio  
Imports  
Riverside  
Speakercraft  
Sacramento  
Paradyne  
San Bernardino  
Video Mart  
San Diego  
Convoy Audio Video  
Stereo Design  
San Francisco  
Audio Excellence  
Wong's Hi Fi  
San Jose  
Quement  
Electronics

Santa Maria  
Lombards Discount  
Stereo

Santa Monica  
Jonas Miller Sound

Simi Valley  
House of  
Audio Video

Tustin  
Digital Ear  
Woodland Hills  
Wilson  
Audio Video  
Entertainment

## COLORADO

Colorado Springs  
U.S. Tech of  
Colorado Springs  
Denver  
Listen Up

## CONNECTICUT

Danbury  
Sounds Alive  
East Hartford  
Hi Fi Image  
Greenwich  
Aud Vid  
Groton  
Leiser Sound  
Newington  
Sound Playground  
Norwich  
Leiser Sound  
Orange  
Sounds Alive  
Stamford  
Sounds Alive  
Wallingford  
Best Buys  
Waterbury  
Zinno Music  
Westport  
Sounds Alive

## DELAWARE

Wilmington  
Laser Sight  
& Sound

## FLORIDA

Altamonte Springs  
Boss Audio  
& Video  
Boca Raton  
Verns Electronics  
Daytona  
Electronics  
Environment  
Ft. Lauderdale  
Sound Design &  
Engineering  
Melbourne  
Audio Mart  
Merritt Island  
Audio Mart  
Miami  
Audio Coll  
Audio Plus  
Kalu  
Overseas  
Electronics  
Victors International  
Pinellas Park  
Cooper For Stereo  
Royal Palm Beach  
Family Video Super  
Centers  
Stuart  
Sound & Vision

## GEORGIA

Doraville  
Ellie's Hi Fi  
Savannah  
Audio Visual  
Resources  
Tifton  
Berger's Audio  
& TV

## HAWAII

Honolulu  
Anderson's Camera  
& Hi Fi Store

## IDAHO

Idaho Falls  
Phase Four Stereo  
Pocatello  
Phase Four Stereo

## ILLINOIS

Burbank  
Digital TV  
Chicago  
Mills Recording  
Belmont Electronics  
Darien  
K-B TV  
Lansing  
Unitek Electronics  
Morton  
Northpoint  
Video, Audio  
& Appliance  
Quincy  
First in Video  
Music World

## INDIANA

Anderson  
Disc-O-Tech  
Angola  
King's Antenna  
Crown Point  
Crown Electronics  
Fort Wayne  
Lehman Electronics  
Huntington  
Lehman Electronics  
Logansport  
Todd's  
Warsaw  
Butterfly

## IOWA

Cherokee  
Wilson TV  
Fort Dodge  
Sound World  
Marion  
The Audio Room  
Orange City  
The Movie Express

## KANSAS

Overland Park  
Audio Video  
Electronics  
ESP Industrial  
Communications

Salina  
Del's TV & Tape  
Center

## KENTUCKY

London  
Sounds Around  
Town  
Louisville  
Audio Video by  
Design

## LOUISIANA

Baton Rouge  
Art Colley's Audio  
Specialties  
Metairie  
Alterman Audio  
New Orleans  
Alterman Audio

## MARYLAND

Annapolis  
H.A. Hi Tech  
Gaithersburg  
Audio Buys

## MASSACHUSETTS

Auburn  
Leiser Sound  
Cambridge  
Audio Video  
Environments  
Framingham  
Natural Sound  
Littleton  
Music Shack  
Nantucket  
Berts Electronics  
Seekonk  
Leiser Sound  
Shrewsbury  
Leiser Sound  
Waltham  
The Instant  
Replay

## MICHIGAN

Ferndale  
Jam Hi Fi Sound  
Specialists  
Plymouth  
Digital  
Entertainment

## MINNESOTA

Edina  
Laser Ware  
Scholes  
Enterprises  
Fairmont  
Bill's Radio & TV  
Minneapolis  
Peterson  
Entertainment  
Design  
Richfield  
Pro Line Audio  
St. Paul  
Robert Paul TV

## MISSISSIPPI

Meridian  
Hoopers Electronic  
Supply

## MISSOURI

Kirksville  
Wright Tire &  
Appliance  
Kirkwood  
Warner  
Communications  
Oakville  
Quality Sight and  
Sound

## MONTANA

Great Falls  
Rocky Mountain Hi Fi

## NEW JERSEY

Cherry Hill  
Soundworks  
Cliffside Park  
Entertainment  
Environment  
Hamilton Square  
Rock Dreams  
Livingston  
Electromedia Design  
Millburn  
Professional Audio  
New Brunswick  
Hi Fi Haven  
Woodbridge  
Woodbridge Stereo  
Wyckoff  
Conklin's Audio Video

## NEW YORK

Hicksville  
Designatron  
Huntington Station  
Audio Breakthrough  
Manhasset  
Audio Breakthrough  
Merrick  
Performance  
Audio & Video  
New York  
Audio Breakthrough  
Bryce Audio  
Custom Media  
Design  
East Side Stereo  
Hi Fi Electronics  
Lyric Hi Fi  
Sound by Singer

Rego Park  
Watts That Sound/  
Continental Sound

Rochester  
Rove Photo

Scarsdale  
The Listening Room

Watertown  
The Happy Ear  
White Plains  
Audio Design  
Lyric Hi Fi

## NORTH CAROLINA

Albemarle  
Music Mart  
Durham  
Kerr's Audio Visions

Fayetteville  
Rhudy's Camera  
& Video

Hickory  
Dacia Electronics

Lenoir  
Crowells

Reidsville  
Trent's Stereoland

## NORTH DAKOTA

Minot  
Einstein's  
Audio/Video  
John Iverson Co.

## OHIO

Beachwood  
Nutec  
Cincinnati  
Audio Vision Plus  
Cleveland  
Reserve  
Enterprises/  
Northwood Home  
Electronics  
Mansfield  
High Tech Video  
Maple Heights  
Eric Martins  
South Euclid  
Atlantis Home  
Entertainment  
System  
Westlake  
New Images  
Electronics

## OKLAHOMA

Oklahoma City  
Contemporary  
Sounds of  
Oklahoma  
Tulsa  
Budget Video

## OREGON

Astoria  
Greenburg's  
Furniture  
Salem  
Salem Sound Center

## PENNSYLVANIA

Berwyn  
Soundex Electronics  
Broomall  
Hi Fi House  
Lancaster  
Video Gallery Plus  
Natrana Heights  
Butch's Sound Shack

Philadelphia  
Music on the Square  
Willow Grove  
Soundex Electronics  
York  
The Electronics  
Place

## RHODE ISLAND

N. Providence  
Eastern Discount  
Westerly  
Leiser Sound, Inc.

## SOUTH CAROLINA

Columbia  
Laser Experience  
Hartsville  
Haynes  
Electronics

Georgetown  
Stereo Video  
Center

## SOUTH DAKOTA

Pierre  
Team Electronics  
Rapid City  
Team Electronics  
Sioux Falls  
Dakota Sound  
Yankton  
Team Electronics

## TENNESSEE

Knoxville  
Hi Fi House  
Memphis  
New Wave Audio  
and Video  
Nashville  
Hi Fi Buys

## TEXAS

Dallas  
Custom Video  
El Paso  
Casa Sonido  
Fort Worth  
Marvin  
Electronics Co.  
Houston  
Audio Video Plus  
Laredo  
Jett Sales  
Lubbock  
American Audio  
Video

## UTAH

Midvale  
Inkley's

## VIRGINIA

Alexandria  
Video Station of  
Virginia  
Franklin  
Audio Showroom  
Manassas  
Audio Buys  
Newport News  
Sound Approach  
Roanoke  
Lee Hartman  
& Sons  
Virginia Beach  
Digital Sound  
Winchester  
Sound City

## WASHINGTON

Redmond  
Home  
Entertainment  
by Design  
Seattle  
Definitive Audio

## WISCONSIN

East Troy  
Video Playground  
Glendale  
Sound Stage  
Green Bay  
Sound World  
Hayward  
M & M Video  
LaCrosse  
Team Electronics



CIRCLE NO. 92 ON READER SERVICE CARD

## TEST REPORTS

left and right difference signals (L - R and R - L). Each of these signals can then be processed through its own 16-bit digital delay system, which is variable in 1-millisecond steps from 1 to 92 ms. An adjustable fraction of each delayed signal can also be recirculated through the delay system ("feedback") to provide a more spacious sound. After amplification, the delayed signals drive the rear (surround) loudspeakers.

Digital memories in the SM-A75 store the key parameters (delay times, amount of feedback, frequency response, and relative level of the rear channels) of eleven preset surround modes and up to three user-

programmable modes. The factory presets include three modes for music programs, HALL, LIVE, and STAGE; two for movies, THEATER and SF (presumably meaning "science fiction," a genre in which unusual sound effects might be expected); three for sports, STADIUM, RINGSIDE, and GAME; two "basic" surround modes, MATRIX and PRESENCE; and standard Dolby Surround. The preset parameters are stored in a nonvolatile (permanent) memory bank. After any mode, preset or user-programmed, has been selected, its parameters can be varied, but the changes are not saved when the unit is switched off.

Obviously, such an extensive signal-modification system requires considerable user adjustment and selection, yet the front panel of the SM-A75 is almost free of controls. The supplied remote control serves as more than a mere convenience; it is actually the system's primary operating control, used for switching the amplifier on or off, selecting its input, and adjusting volume and speaker balance. It is also used to put the amplifier into its "pass" mode, which bypasses the delay system and silences the rear speakers, to select any one of the surround modes, or to vary a surround mode's delay times and amount of feedback. Other buttons on the remote control switch between mono and stereo, mute the audio, and provide a fixed bass boost called "Super Bass." Two video programs (MAIN and SUB) can be sent to different monitors and interchanged whenever desired.

Most of the front panel of the SM-A75 is devoted to a multifunction display, obviously a necessity in view of its operating complexity. At the far left of the display window, the name of the selected program source appears in large (half-inch) fluorescent letters, and beside it is a similar display of the selected surround-sound mode (or PASS in the stereo mode). The middle portion of the display shows the left and right rear-channel delay times together with a number from 0 to 9 indicating the amount of feedback selected.

On the right are graphic indications of output levels, balance adjustments, and relative overall volume setting. A number of other indicators appear in the display window as required so that the complete operating status of the amplifier is shown at all times. The entire display flashes on and off if the speaker-protection circuit shuts down the amplifier.

The rear apron contains all the signal input and output phono jacks. A pair of FRONT PRE-OUT jacks can carry the front-channel signals to an external power amplifier, leaving the SM-A75 to drive only the rear channels. The speaker connectors accept stripped wire ends. A slide switch changes the

### FEATURES

- Four-channel integrated amplifier, rated for 25 watts per channel into 8 ohms; 35 watts per channel in stereo mode
- Inputs for a tuner, audio tape deck, CD player, phono, two VCR's, TV set, videodisc player
- Outputs for tape recorders and two video monitors
- Single-button dubbing selection for video and audio programs
- Electronic volume control
- Bass and treble tone controls
- Separate front-panel headphone jacks for front and rear channels
- Audio and video inputs for one VCR on front panel as well as rear apron
- Infrared remote control for all functions except tone controls and dubbing selection
- Separate 16-bit digital delay systems for left and right rear (surround) channels; delay times adjustable from 1 to 92 ms from remote control
- Feedback (recirculation) of audio, for spatial enlargement, controllable from remote
- Eleven factory-set surround modes, including Dolby Surround, selectable from remote
- Three user-programmable modes, selected and controlled from remote
- Level balance of front and rear or side speakers controlled from remote
- Multifunction fluorescent display window to show complete operating status

### LABORATORY MEASUREMENTS

*(All power and distortion measurements on front channels only)*

**1,000-Hz output power at clipping:** 37.8 watts into 8 ohms, 49 watts into 4 ohms; 2 ohms not measured

**Clipping headroom** (relative to rated output): 0.33 dB

**Dynamic power output:** 45.5 watts into 8 ohms, 63.2 watts into 4 ohms, 63.9 watts into 2 ohms

**Dynamic headroom:** 1.14 dB

**Harmonic distortion** (THD + noise) at 1,000 Hz into 8 ohms: 1 watt, 0.1%; 10 watts, 0.04%; 35 watts, 0.055%

**Maximum distortion** (20 to 20,000 Hz) into 8 ohms: 0.12% at 35 watts (20,000 Hz)

**Sensitivity** (for a 1-watt output into 8 ohms): CD, 50 mV; phono, 1.85 mV

**Phono-input overload:** 90 mV at 1,000 Hz; 23 mV at 20 Hz, 63 mV at 20,000 Hz

**A-weighted noise** (referred to a 1-watt output): CD front, -82.2 dB; CD rear, -77 dB (92-ms delay), -80 dB (20-ms delay); phono front, -74.8 dB; phono rear, -65 to -71.5 dB depending on delay time

**Phono-input impedance:** 47,000 ohms in parallel with 185 pF

**RIAA equalization error:** +0.65, -1 dB from 20 to 20,000 Hz

**Tone-control range:** 100 Hz,  $\pm 8$  dB; 10,000 Hz, +10, -11 dB

**Super Bass:** +8.5 dB, 40 to 80 Hz (referred to 1,000 Hz)

**Frequency response:** -2.1 dB at 20 Hz, -1.1 dB at 20,000 Hz



Philips superiority is clear, from this graph showing deviation from ideal linearity (dB) vs. recorded level (dB).

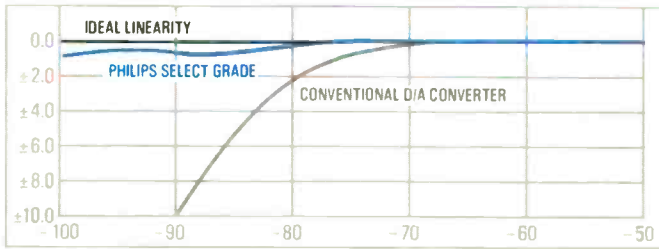



# THE PHILIPS CD960. CLOSE TOLERANCE COMPONENTS FOR PEOPLE WITH NO TOLERANCE FOR IMPERFECTION.

The CD960 compact disc player incorporates only the most uncompromising components because it has been designed by the world's most uncompromising audiophiles: Philips engineers. The same engineering experts who invented compact disc technology.

- Superior digital-to-analogue conversion. It comes as no surprise that the heart of the CD960 is the Philips dual 16-bit D/A converter chip. The TD-1541 select version. A chip so refined it substantially improves low-level linearity, flawlessly reproducing even the quietest passages with a clarity never before achieved.

This exceptional D/A converter is mated to a Philips 4X oversampling digital filter for superior performance. Philips pioneered 4X oversampling and our experience with digital filtering is unequalled.

- Broadcast standard "Radialinear" transport. Philips commitment to exacting specifications is also evident in the CD960's mechanical construction. It features a high-grade cast alloy chassis. A linear-design motor was chosen to drive the radial pivoting arm for fast track access and exceptional resistance to external vibrations.

- Multiple power supplies. To eliminate cross talk, the CD960 incorporates no less than four separate power supply sections. And the 100-watt main transformer is partitioned to further shield against magnetic and power line interference.

From the company that created the compact disc, Philips proudly offers the CD960 for those who won't tolerate anything less than perfection. To audition the CD960, call 1-800-223-7772 for your nearest Philips audio specialist.

WORLD-CLASS TECHNOLOGY. EUROPEAN EXCELLENCE.



**PHILIPS**

## TEST REPORTS

sensitivity of the balance/output-level display, and an adjustment is provided for channel balancing in the Dolby Surround mode. One of the three AC convenience outlets is switched.

The Optonica SM-A75 measures 17 inches wide, 12 $\frac{5}{8}$  inches deep, and 3 $\frac{3}{4}$  inches high. It weighs 15 $\frac{1}{2}$  pounds. Price: \$600. Optonica by Sharp, Dept. SR, Sharp Plaza, Mahwah, NJ 07430.

### Lab Tests

Our basic measurements, such as frequency response, power, and distortion, were made on the front channels only. In addition, we measured the rear channels' frequency response and phase shift relative to the corresponding front channels in each of the eleven factory-set surround modes.

The output clipped at 37.8 watts into 8 ohms and at 49 watts into 4 ohms (for which the amplifier is not rated). When we attempted to drive a 2-ohm load with a continuous signal, the protection circuit shut the amplifier down at a relatively low output. In dynamic power measurements, however, it delivered about the same power into 2 ohms and 4 ohms (63.9 watts).

The amplifier's sensitivity for a 1-watt reference output was 50 millivolts (mV) for a high-level input and 1.85 mV for the phono input. The phono input overloaded at 90 mV at 1,000 Hz, but the overload point fell to 23 mV at 20 Hz and 63 mV at 20,000 Hz. Because of the SM-A75's electronic volume-adjustment circuit, it is possible to overload the high-level inputs as well, but the CD input overloaded at a safe 5 volts.

The total harmonic distortion (THD) plus noise was about 0.05 to 0.06 percent over most of the audio range with outputs from 3.5 to 35 watts into 8 ohms. It rose slightly to 0.1 or 0.12 percent at the frequency extremes of 20 and 20,000 Hz. At 1,000 Hz into 8-ohm loads, the distortion decreased from 0.2 percent at 0.1 watt to 0.045 percent at 10 to 30 watts. With a 4-ohm load, the readings were slightly higher.

The tone-control characteristics were conventional, and the Super Bass circuit boosted the output below 1,000 Hz by a maximum of

+8.5 dB in the 40- to 100-Hz range. The basic frequency response of the front channels was +0, -2 dB from 20 to 20,000 Hz. The RIAA phono-equalization error was +0.65, -1 dB from 20 to 20,000 Hz.

Our phase and amplitude measurements on the left front and left rear channels revealed that only three different basic characteristics were used for the eleven preset surround modes. Two of the music

*The Optonica SM-A75's eleven preset surround modes include three for music programs, two for movies, three for sports, "basic" matrix and presence modes, and standard Dolby Surround.*

modes, LIVE and STAGE, as well as all three sports modes shared the same amplitude and phase responses. The rear channels were in opposite phase relative to the front channels, within a  $\pm 45$ -degree variation, from 20 to 20,000 Hz. The amplitude response, referred to the 1,000 Hz level, increased to +6 dB at 100 and 15,000 Hz.

The third music mode, HALL, had an essentially flat response, down 2 dB at 20 and 20,000 Hz, and its phase-variation curve remained within the same limits as the others. The two basic surround modes, MATRIX and PRESENCE, and the Dolby mode were essentially identical to the HALL mode in their amplitude and phase characteristics. A third characteristic was used for the two movie modes, THEATER and SF, in which the frequency response was rolled off above 5,000 Hz to -10 dB at about 15,000 Hz.

Since the three basic matrix characteristics were used with a variety of time-delay and feedback combinations, the eleven modes had distinctly different sound characters. The time delays ranged from a minimum of 1 millisecond for MATRIX to a maximum of 85 microseconds ( $\mu$ s) for STADIUM. The feedback settings ranged from 0 for the MATRIX, Dolby Surround, and THEATER modes to a maximum of 9 for SF.

### Comments

For our use tests, we connected the Optonica SM-A75 to four speakers, a tuner, a CD player, a VCR, and a TV monitor. We played a number of Dolby-encoded videocassettes and CD's as well as listening to FM broadcasts. With a minimum of difficulty, we were able to use the SM-A75 effectively to decode Dolby Surround video programs and to enhance a variety of stereo music programs. We did not use every feature, but all those we did try out worked properly. Its effect in the Dolby mode was as dramatic as one could hope for, given the constraints imposed by a temporary four-channel speaker setup in a room that is far from an ideal audio/video environment.

Although we customarily use amplifiers rated from 100 to 350 watts per channel, the Optonica SM-A75 never ran out of power or made us feel that we were listening to a "low-powered" amplifier. Its four channels were easily capable of delivering dynamic peaks of over 200 watts, more than enough for most users. The only measured characteristic that was definitely substandard was the phono-input overload. Tolerable at 1,000 Hz and still marginally acceptable at 20,000 Hz, it measured only 23 mV at 20 Hz—a clear invitation to distortion when playing a record with any deep bass content.

Most of the surround-sound amplifiers we have used were larger, heavier, and harder to operate than the Optonica SM-A75. We frequently find that excessive complexity discourages full use of a product's capabilities. Sharp has achieved an ideal compromise, we feel, in this deceptively simple-looking unit. It is not the full equivalent in performance (or price!) of a system comprising a separate digital sound processor, a full-featured preamplifier, and a pair of stereo power amplifiers, but it should come close enough to satisfy many people. Considering its modest size and price, its ease of use, and the degree of listening enjoyment it can provide, the Optonica SM-A75 earns high marks.

**Circle 143 on reader service card**

# The McIntosh XRT 22 Loudspeaker System delivers

The McIntosh XRT 22 is the purest expression of the loudspeakers scientist's endeavors. It is the one *right combination* of component parts that has eluded the diligent searcher for the loudspeaker bridge to the dominion of reproduced musical reality. The high-frequency radiator column is an illustration of the *right combination*. The 23 tweeter elements can reproduce 300 watts sine wave input power at 20 kHz, with the lowest measured intermodulation distortion. Because each tweeter mechanism handles a small quantity of the total power, extremely low quantities of distortion are developed. The total column radiates the energy in a half cylindrical time-coordinated sound field. The low distortion, transparency of sound, coherence of sound images, definition of musical instruments, and musical balance is simply a revelation that you must experience.

**Extra Realism**  
**Extra Depth**  
**Extra Spaciousness**  
**Extra Smoothness**



**Handcrafted with pride in the United States  
by dedicated, highly trained craftspeople.**

CIRCLE NO. 29 ON READER SERVICE CARD  
For information on the McIntosh XRT 22 SPEAKERS and  
other McIntosh products write:  
**McINTOSH LABORATORY INC.**  
P.O. Box 96 EAST SIDE STATION, DEPT. SR 127  
BINGHAMTON, NY 13904-0096

# SEPARATES

BY THOMAS R. GILLETT

**F**IRST, settle on a pair of speakers. Then think about separate electronic components." That's the advice of Rob Karp, manager of Audio Design, a store in Fairfield, Connecticut.

"Often," Karp told me, "customers buy a new pair of speakers and find that they sounded much better at the store than they do at home. Their ten-year-old receivers are too tired to breathe much life into the speakers. So they come back for separates. They want more detail, more depth. They want their speakers to sound dynamic, to play loud without sounding distressed."

Ken Furst, director of marketing for Denon America, agrees that speakers should come first. "You don't know what your power requirements are unless you know what speakers you'll be driving. Once you've established that, then the real questions start. Do you want economy? Remote control? Maybe you should buy a new, top-of-the-line receiver. Do you want tremendous flexibility? Performance? That probably means separate components."

## *Getting There*

Furst compares the receiver to the family sedan: It gets you where you're going, but you might not have all that much fun getting there. John Beyer, president of B&K Components, likens the receiver to the all-in-one kitchen tool: "You have a screwdriver, pliers, a wrench, all in one. It works, but separate tools work better."

A receiver is a single-chassis unit incorporating a tuner, a preampli-

fier, and a power amplifier. With separate components, these three sections stand alone. The main advantage of a receiver is economy: One chassis is cheaper to build than three. It also takes less shelf space. Convenience is a factor, too: Many receivers today come equipped with remote controls, while few separates have them.

A preamplifier is sometimes called a control amplifier. It takes audio signals from a phono cartridge, tuner, tape deck, or CD player, boosts the gain, or volume, and sends the signal to a power amplifier for further amplification. It's the power amplifier that drives your speakers.

In an integrated amplifier, preamplifier and power amplifier are combined on a single chassis. Integrated amplifiers are very popular in most of the world, but not in North America. "That's too bad," says Denon's Furst. "There are some excellent values in integrated amps."

## *Separate Paths*

Like Furst, Onkyo's national product manager, Len Schneider, underscored the value offered by integrated amplifiers. Both manufacturers readily admit, though, that separate tuners, preamplifiers, and power amplifiers perform, on the whole, significantly better than receivers.

Fewer compromises have to be made with separates, Schneider explained. "The manufacturer of separate components is under fewer cost restraints," he said. "Higher-quality parts can be used. Construction is better, too, because components have more room to breathe

Is it time  
to replace  
your good old  
receiver with  
separate  
components?



Conrad-Johnson uses vacuum tubes in its MV50 power amplifier and PV8 preamplifier. The MV50 is rated at 45 watts per channel into 4, 8, or 16 ohms from 30 to 15,000 Hz with no more than 1 percent distortion. The MV50 and PV8 feature minimal negative feedback, low output impedances, and low-impedance power supplies. Each of the hand-assembled units is priced at \$1,685.

The LK1 preamplifier from Linn Products (\$1,050) has volume-level presets for each input, facilities for listening to one source while recording another, keyboard lock-out to prevent unauthorized use, and remote control. Linn's LK2 power amp, rated at 60 watts per channel into 8 ohms, has just been upgraded to the LK280 (\$1,495), rated at 80 watts.

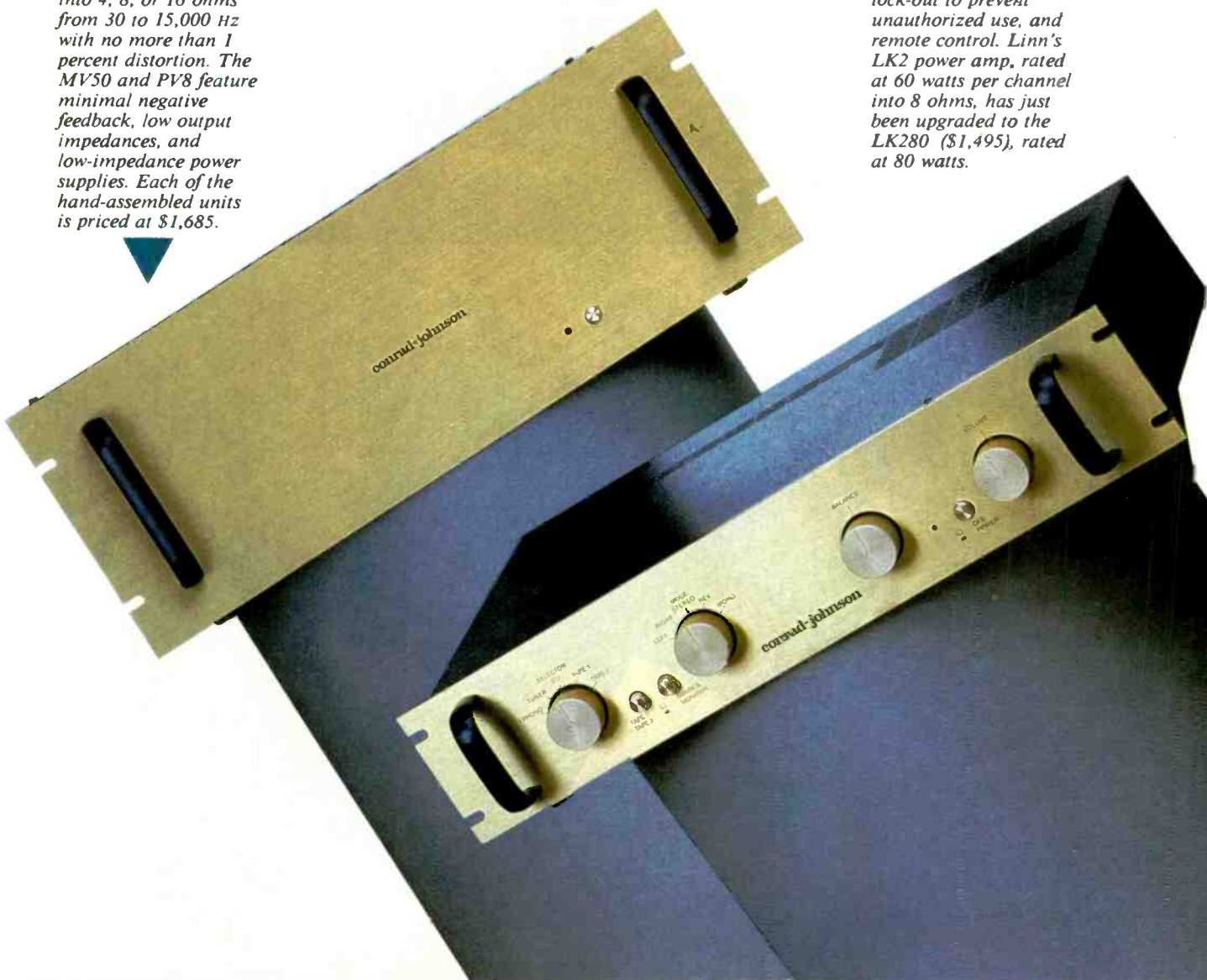



Carver's M-4.0i Magnetic Field power amplifier (\$799) has a two-color output display that responds within a millisecond to identify momentary clipping and impulse peaks. It is rated for up to 375 watts per channel continuous output into 8 ohms from 20 to 20,000 Hz with no more than 0.5 percent distortion.



The CT-Seven from Carver is a tuner/preamplifier that includes the company's Sonic Holography technology for three-dimensional sound. Priced at \$779, the CT-Seven has eight AM and eight FM station presets and a remote control.



The McIntosh MR 7082 (\$1,499) AM/FM tuner has a linear-phase piezoelectric IF filter that keeps stereo distortion at 0.03 percent or less. Mode memory restores all previous settings after shut-off. The Precision Step Attenuator on the McIntosh MA 6200 integrated amplifier is a 70-dB-range volume control with tracking accuracy within 1 dB. Price: \$1,795.



## SEPARATES

*Nakamichi's CA-5II control amplifier (\$1,095) has a tone-defeat switch that allows you to compare sound quality with and without tone alterations. The PA-5 power amplifier (\$1,195) uses Nelson Pass's Stasis circuit to eliminate the need for global feedback.*



*NAD's tuner/preamplifier, Model 1700 (\$798), has a bass equalizer that extends the deep-bass reach of many loudspeakers by a half octave. Output of the NAD 2600 power amplifier (\$798) is 150 watts per channel into 8 ohms, with dynamic headroom rated as +4 dB.*



on a circuit board. And separates offer greater control flexibility as you grow into a more complex system with video, surround sound, and subwoofers."

Joe Abrams, vice president of sales for Threshold, pointed to better sound quality as a reason to buy separates: "Separates deliver a sense of realism, a true depth and width of sound stage, a sense of image specificity, so that you can look through the electronics to the original performance."

It's not only better-quality parts that make the difference, according to Dean Smith, a salesman at Take Five Audio in New Haven, Connecticut. "Each separate unit has its own power supply—transformers and storage capacitors—which is optimized for its specific application in a tuner, preamplifier, or power amplifier," he said. "In a receiver, demands from the power-amplifier section can drain the single power supply and starve the preamplifier section for voltage. The sound becomes congested, compressed. Power is more of an issue now with digital sources."

John Beyer of B&K also noted that with separates the parts can be optimized for each specific application. "For a power amplifier you need a transformer with 50- to 100-volt taps, for a preamplifier 15- to 30-volt taps would be ideal, and for a tuner perhaps 5 to 15 volts. There's no way you can meet these conflicting requirements with a receiver, and the high voltages needed for the power-amplifier section may, and probably will, cause magnetic interference with the preamplifier section."

### Choices

Most of the major audio manufacturers produce separate components as well as receivers. Denon, Onkyo, and Yamaha offer an especially wide range of models. Some companies, such as NAD and Rotel, appear to put more emphasis on separates than they do on receivers. And recently Harman Kardon relaunched its high-performance Citation line of electronics, which includes only separates.

A number of smaller, mainly U.S.-based, companies also produce separates—in most cases, only separates. Some of these companies are known for high-performance, high-priced components that are distributed successfully throughout the



*Sansui's TU-X01 tuner (\$500) has a keypad for recall of thirty preset stations and facilities for programming two stations for unattended recording. A "Source Direct" circuit in the AU-X701 integrated amplifier (\$700) lets you skip the muting circuit, subsonic filter, and balance control, making the signal less susceptible to noise.*

*The Active Tracking circuitry in the Harman Kardon TU920 tuner (\$399) is said to make it immune to interference from broadcasts on nearby channels. The PM655 Vxi integrated amplifier's high current capability enables it to deliver up to 260 watts per channel under peak demand, 90 watts continuous output. Price: \$699.*





## SEPARATES

A separate tuner like the NEC T-610 (\$229) can enable you to pull in hard-to-reach stations. The T-610 has sixteen AM/FM presets and auto-seek tuning. NEC's A-610 integrated amplifier (\$469) is rated for 60 watts per channel into 8 ohms, 80 watts into 4 ohms, with no more than 0.006 percent distortion.



A five-segment meter indicates signal strength on the Akai AT-52-B AM/FM tuner, which lists for \$249. It has sixteen presets and station scan. The AM-52-B integrated amplifier, rated at 70 watts per channel, has two tape-monitor loops, separate CD and DAT inputs, and an MM or MC phono input. Price: \$399.



world, even in Japan. Threshold, for instance, is known for its flagship FET-10 preamplifier, which retails for \$3,550 if you want a phono stage and \$2,200 if you don't. A stereo pair of Threshold SA-1 monoblock power amplifiers retails for \$8,500 a pair.

Another U.S. company, Krell, is noted for the bullet-proof construction of its power amplifiers and preamplifiers. A pair of Krell Reference KRS-200 mono amplifiers commands \$16,000. Two strong bodies are required to set each one in place. By comparison, the Krell KSA-80 Class A stereo amplifier, rated at 80 watts per channel into 8 ohms, seems a bargain at \$3,700. Not many audiophiles upgrade from a ten-year-old receiver to brand-new Threshold or Krell separates, of course. But audio salesmen tell stories of people being "blown away" by the sound of such no-compromise components and spending ten times what they had intended.

Meanwhile, other U.S.-based companies have established reputations with more easily affordable equipment. Dan D'Agostino, the man responsible for designing the Krell components, recently designed a line of less pricy components for Mondial Design. The Aragon Model 2004 power amplifier, for instance, rated at 100 watts per channel into 8 ohms, retails for \$1,075. And Nelson Pass, Threshold's president, has designed equipment for his company's new subsidiary, Forte. The Forte Model 2 preamplifier retails for \$890, yet it incorporates some of the same design philosophy and even some of the same parts as the far more expensive Threshold FET-10.

High-end manufacturer Conrad-Johnson has established the lower-price Sonographe line of components, including a highly regarded CD player and turntable. Counterpoint, a California company known for its expensive audio esoterica, has also long offered more popularly priced equipment. Especially noteworthy is the Counterpoint SA-12 power amplifier (\$1,045), an 80-watt-per-channel tube and solid-state hybrid.

### Under a Kilobuck

B&K Components first made its mark with the \$495 ST-140 power amplifier, rated at 105 watts per channel into 8 ohms, and it also

offers an entry-level preamplifier, the Pro-5, for \$398. "For under \$1,000, you can own some very fine-sounding separates," according to B&K's Beyer.

Rob Ain, director of marketing for Adcom, points to his company's GFA-535 power amplifier, rated at 60 watts per channel into 8 ohms and retailing for only \$299. "So long as you don't exceed its power limitations, the sound quality is as good as with our more powerful, more expensive amplifiers."



ADCOM also offers an unusual combination component, the matching GTP-500 tuner/preamplifier; with wireless remote control, it lists for \$599. "You have the economy and convenience of a tuner and preamplifier combined on a single chassis, yet you keep the power amplifier separate," Ain explained. "It makes for better sound quality." NAD likewise offers a tuner/preamplifier, the Model 1700 (\$798).

### Upgrading in Stages

One of the main advantages of separates is that when you're ready to upgrade you don't have to upgrade your system all at once. You can do it in stages. "If you can't afford a separate tuner right now, use the tuner section of your old receiver," Rob Karp of Audio Design suggested. "Look at the back of your receiver to see if there's a pair of 'preamp-out' jacks. If so, you could use that receiver as a tuner or tuner/preamp and start your upgrade with a separate integrated amplifier or power amplifier."

For those who upgrade in stages, Rotel's line of power amplifiers is especially interesting. Each model can be bridged, at the flick of a switch, to become a mono amplifier capable of delivering more than twice the power into a single channel than it can into two. The Rotel RB850, for instance, is rated at 50 watts per channel into 8 ohms in stereo but is bridgeable for 150 watts in mono. Suggested retail price is \$299. You could purchase one of these amplifiers now, a second one later.

Perhaps the maximum in versatility is provided by the dbx BX1 configurable power amplifier (\$3,700), which can be switched for mono, two-, three-, or four-channel operation. Output varies between 100 and 800 watts.

# SEPARATES

## Tuning In

A tuner is probably the easiest component to choose. It's also a place where you might economize. If you live in a city or close-in suburb, you might do well with an inexpensive tuner. On the other hand, if you live in the sticks—a "deep-fringe" reception area—you will probably want all the tuner performance you can get.

It's reasonable to request that you borrow a demo tuner to take home and try out, and specialty dealers will often agree. It's not the reception in the store that counts; it's the reception where you live. A local dealer is probably knowledgeable about local reception conditions, so he can suggest some likely tuner candidates (and an antenna, if yours isn't adequate).

## More Power to You

In shopping for a power amplifier, you should have a specific pair of speakers in mind—either the pair you own or the ones you plan to purchase. The rated power (watts) into 8 ohms is only one specification to look at. Many speakers, including some of the most highly regarded, have impedances that drop to 4 ohms or less at certain frequencies. That's when you need what audiophiles call a "muscle amp," one capable of delivering abundant *current*. Current is like the pressure pushing water through a garden hose.

Fortunately, amplifier manufacturers have been paying more attention to current capabilities. Look to see how much power an amplifier is rated to deliver into 4 ohms, or even 2 ohms. For example, NEC's M-50 mono amplifier (\$375 each, \$750 a stereo pair) is rated at 50 watts per channel into 8 ohms, but it is said to deliver 100 watts into 4 ohms.

Another specification to consider is an amplifier's ability to deliver extra power on musical peaks. This may be expressed in watts as "dynamic power" or in decibels as "dynamic headroom." Your dealer can help you decipher the specs, but the very fact that the manufacturer provides them indicates an amplifier is able to deliver. Some manufacturers, such as Proton and NAD, have developed innovative circuitry specifically designed to produce extra peak power on demand. By whatever means it is achieved, such extra power comes in handy. It

shows up in practice as a sense of ease. Music sounds dynamic, not compressed. The sound stage doesn't collapse or seem congested. These benefits are precisely what many people seek when they replace a receiver with separates.

## The Heart of Your System

The heart of any audio system is the preamplifier—every signal source is routed through it. The most obvious requirement is enough inputs. Until recently, many models were equipped with inputs for a record player, a tuner, a tape deck, and one auxiliary source, which meant anything else. "Auxiliary" is where you connect your CD player. Today, preamplifiers typically feature three, four, or even five auxiliary inputs, sometimes called "line-level" inputs.

The phono stage of a preamplifier is *not* at line level. The output from a phono cartridge is very weak, especially if it is a low-output moving-coil model. This signal must be amplified by the phono stage to bring it up to line level like the signals from the tuner, CD player, etc. All these signals, in turn, are further boosted by the preamplifier's line-amplification stage.

A power amplifier is easy to choose because there are few special features. But no two preamplifiers from any two makers seem to have identical features. That makes choosing difficult, but it also means you can find the model that fits your particular needs.

If LP's are still important to you, you may want a preamplifier that accepts signals from the low-output moving-coil (MC) cartridges often favored by serious audiophiles. Not all preamplifiers provide enough gain to bring an MC input up to line level. If, on the other hand, you do not play vinyl records at all, you may want to dispense with the phono stage altogether.

**S**UPERPHON, a small company in Oregon, offers a device called the CD Maxx (\$329), which is essentially a preamplifier without a phono stage. The CD Maxx also has a switchable line-amplification stage. As Superphon's sales director, Steve Nelson, points out: "The extra gain is there if you need it, but it's defeatable if you don't. With the CD Maxx, you can run the output from your compact disc player to your power amplifier,

passing only through the CD Maxx's volume control. Most players will have enough output. If yours doesn't, switch in the line amp."

The CD Maxx's line-amplification stage is said to be of very high quality. But audiophiles are becoming increasingly keen on bypassing the line-amplification stage whenever possible, on the theory that the simpler the signal path, the purer and cleaner the sound. More and more preamplifiers, usually ones *with* a phono stage, offer defeatable line amplification—for example, the B&K Pro-5 mentioned above, the PS Audio Model 4.6 (\$659), and the Sumo Athena (\$795). And some audiophiles are so eager to dispense with line amplification that they "hot rod" their very expensive preamplifiers by connecting a tape output directly to a power amplifier. The penalty is that they give up a volume control!

**P**REAMPLIFIERS from small audio specialty firms usually have no tone controls—although some companies buck this trend by including defeatable tone controls, as on B&K's Pro-5 and Sonata MC-101 (\$898). Audio purists contend that tone controls detract from overall clarity and preciseness of imaging. Audio purity aside, however, there's another reason you tend to find fewer control features on the better preamplifiers. Nelson Pass, of Threshold and Forte, explains: "When you pile on features, you add to the cost. The same money might buy you metal-film resistors, polycarbonate capacitors, and higher-grade semiconductors than you could otherwise afford."

## Class Differences

Whichever separates you choose, you are likely to find that they do sound better than your hypothetical decade-old receiver. The key point about separates is that fewer compromises have to be made in their design and production. As B&K's Beyer put it: "Good receivers do exist, but separates, as a class, will always be better. When you design a tuner, for instance, all your energies go into producing the best tuner you can. You're not worried about fitting a preamp and a power amp into the same chassis. You're not so concerned about costs, either. Performance is what you're after." □

# JVC

Super Digifine  
Hi-Fi Components

## SUPER DIGIFINE

JVC's line of new-generation digital-ready audio components  
is opening a new age in super-high fidelity.

# The JVC Super Digifine Series — More accurate digital sound and more digital applications.

As super-fidelity digital becomes more and more established in the audio market, we find ourselves entering a new phase of the digital revolution — one in which the quality of sound is determined by much more than just the program source.

At JVC our leading-edge expertise in digital technology has helped us to develop newer, more diverse applications in which digital techniques have enhanced sound reproduction. We call the components that embody these new radical digital applications "Super Digifine." They are the successors to our original "Digifine" series of components that ushered in the first phase of the digital age.

Our "Super Digifine" series includes components from amplifiers to speaker systems, and even features a revolutionary digital acoustics processor designed to recreate a live performance ambience at home.

Enter the new age of digital with JVC.

**SX-911WD**  
3-Way Speaker  
System



**XP-A1000BK**  
Digital Acoustics Processor

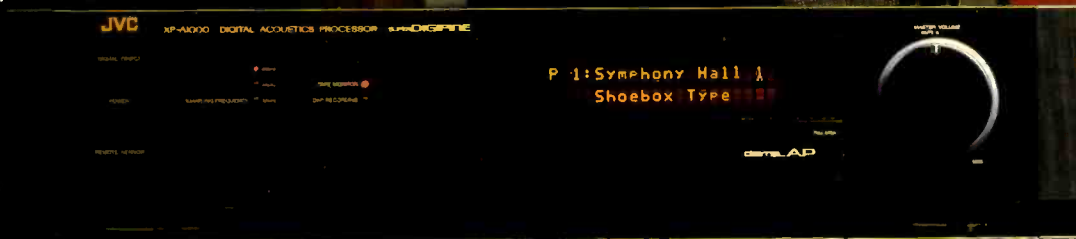

**AX-Z911BK**  
Digital Pure-A  
Integrated Amplifier

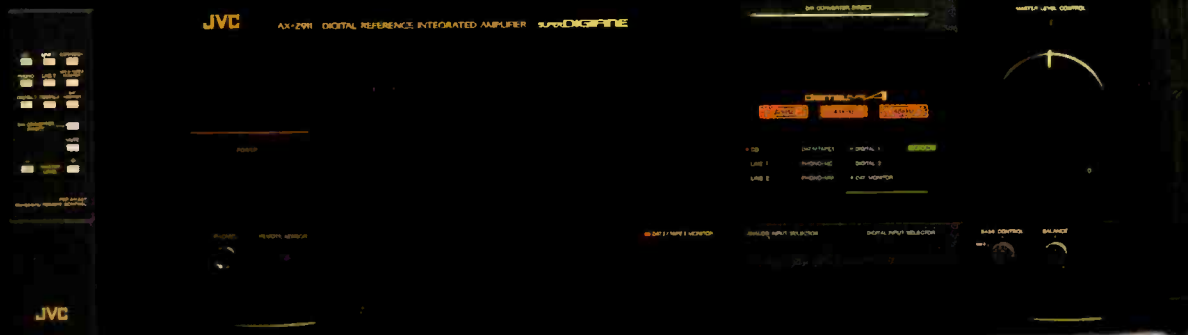

# SUPER DIGIFINE

JVC's line of new-generation digital-ready audio components  
is opening a new age in super-high fidelity.



**XL-Z555BK**  
Compact Disc Player



**TD-V711BK**  
Discrete 3-Head  
Cassette Deck



**RX-1001VBK**  
Programmable  
Remote/Computer-Controlled  
Receiver

# Digital Applications for Higher Sense of Power and Presence

## AX-Z911BK Amplifier — Digital Pure-A for pure and powerful sound



JVC's innovative Digital Pure-A Circuit provides both true class-A operation and a high power of 100 watts\*, thanks to the newly developed digital "signal prediction" circuit. As you may know, class-A amps have long been the serious audiophile's dream because, unlike common class-B amps, they don't allow output transistors to switch on and off, hence pure, low-distortion sound is possible. But because of their high cost, they have been out of reach of most music lovers until now.

\* Per channel, min. RMS, both channels driven into 8 ohms, from 20Hz to 20kHz with no more than 0.003% total harmonic distortion

### High-power class-A operation — that's Digital Pure-A

The new Digital Pure-A Circuit is a class-A amplifier combining pure sound, high power, high efficiency, and compact size. It takes advantage of the fact that digital signals can be stored in memory temporarily, without degrading phase response or frequency response.

During operation, our made-for-digital circuit takes digital signals direct from the output (optical or coaxial) of a CD player, and splits them into two: the main and the "prediction" signals. The main signal is sent to a time base processor where it's stored in memory for about 150msec. before it goes to the D/A converter. The other, the prediction signal, is sent to a prediction circuit where the level of the upcoming main signal is measured, and a prediction output signal is generated by analyzing the level of the D/A-converted main signal and the amplifier's output signal. Based on this prediction, the power-supply voltage control circuit adjusts the voltage supplied to the power amp.

### Programmable power supply for high efficiency

Most of the time, our Digital Pure-A Circuit provides the power amp with low power-supply voltage. But when the "predicted" power output exceeds the threshold of 20 watts, the circuit increases the power-supply voltage to provide higher power — no less than 100 watts.

Switching the power-supply voltage occurs approximately 120msec. before the temporarily stored main signal is read out of memory. In this way, signal prediction gives the power supply time enough for it to switch from low to high before the musical signal reaches the power amplifier.

Thus the power amplifier operates in low-distortion class-A most of the time, but without creating excessive heat. The result: both delicate and dynamic sounds are reproduced with

clarity and an extra sense of power.

Distortion Waveforms: Digital Pure-A and Class-B Operation

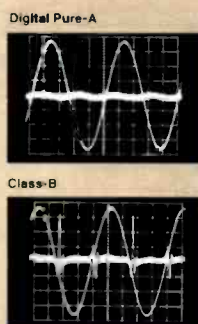

### Customized for digital reproduction

The AX-Z911BK is custom designed for superb digital reproduction. It's complete with a D/A converter featuring a 4X oversampling digital filter. There are terminals for direct connection of digital equipment: an optical input, a coaxial input and an in/output for DAT. A "D/A CONVERTER DIRECT" circuit directly connects the D/A converter to the power amp. And the digital and analog circuitry are completely separated to reduce digital noise.

Digital Pure-A Circuit

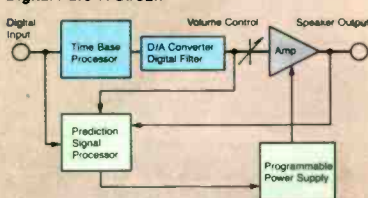

Conceptual Operation of Digital Pure-A Circuit

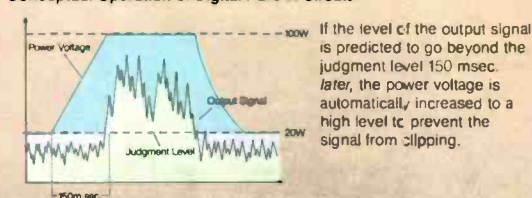

If the level of the output signal is predicted to go beyond the judgment level 150 msec. later, the power voltage is automatically increased to a high level to prevent the signal from clipping.

## AX-Z911BK Digital Pure-A Integrated Amplifier

- 100 watts per channel, min. RMS, both channels driven into 8 ohms, from 20Hz to 20kHz with no more than 0.003% total harmonic distortion
- Digital Pure-A Circuit for class-A operation to provide low-distortion digital sound (For digital signal)
- Dynamic Super-A with Gm Driver for better in-use performance (For analog signal)
- "D/A CONVERTER DIRECT" for direct D/A converter-to-amp connection
- Built-in D/A converter with quadruple oversampling digital filter
- 3 digital connections: one for optical, one for electrical (coaxial) and an in/output for DAT
- Separate layout for digital and analog circuits for reduced interference
- Circuit layout for shortest signal path to ensure "pure" signal transmission
- High-gain phono equalizer for MM/MC cartridges
- Low-noise motor driven volume control
- Bass response control
- Gold-plated terminals
- "Dimensional" multi-function display
- Wireless remote control

## XP-A1000BK Digital Acoustics Processor — life- like ambience



No matter how faithfully your stereo system reproduces music, there is one thing missing from the sound it plays back: that sensation of "being there." The acoustics of a hall produce certain reverberations that just can't be realistically reproduced with a standard stereo system. The new JVC Digital Acoustics Processor gives you a digital way to simulate the acoustics of a live performance, recreating a realistic "sound field" right in your own listening room. It's a revolutionary engineering concept that gives you all the pleasure of live music.

### The sound field — what makes the sound come alive

A sound field is simply the ambient characteristics of a live music environment. When a sound is generated it disperses in all directions. First you hear the direct sound from the source. That's followed by the early reflections — a group of sounds that are reflected by the walls and

ceiling. Finally, you hear reverberations from random directions over a relatively extended period. Each live music space has its own individual sound field, or pattern of reflections and reverberations. And it's basically this pattern that gives you a clue to the size of a space.

### JVC's Digital Acoustics Processor

Our Digital Acoustics Processor simulates the sound field where live music is performed, by accurately replicating directions and levels of reflections and reverberations in the digital way. To make it possible, JVC even developed the computerized way to measure live music environments: the "symmetrical 6-point sound field analysis method." The processor contains a ROM (Read-Only Memory) where the vast amount of data from actual measurements is stored. A newly-developed digital acoustics processing LSI synthesizes the early reflections with proper direction, timing and reverberation, according to data stored in the ROM. Digital processing is performed in 16-bit quantization at sampling rate of 48kHz, combining a 4X oversampling D/A converter and a 64X oversampling A/D converter. The entire process operates channel by channel, to ensure accurate recreation of sound fields.

### XP-A1000BK Digital Acoustics Processor

- Newly-developed LSI for digital signal processing
- Digital processing using 16-bit quantization and 48kHz sampling
- 4X oversampling D/A converter and 64X oversampling A/D converter
- 20 programmed sound field patterns in ROM and 20 user-programmable sound field patterns
- Adjustable acoustic parameters: Sound field size, liveness, frequency response, etc.
- Accurate compensation for ambience of listening room and source program
- Direct digital inputs and outputs: optical and coaxial
- 4/6-channel system configuration selectable
- 6-ganged motor-driven remote-controlled volume control
- Programmable fluorescent display

**Symmetrical 6-Point Sound Field Analysis Pattern**

In order to develop the XP-A1000BK, we first had to develop a computer-aided acoustics measuring system to analyze a variety of sound fields. In this analysis, the center of each circle represents the location of a "virtual image source" relative to the direct sound source, and the size is its intensity.

Symmetrical 6-Point Sound Field Measurement Device

Custom-Designed "Digital Acoustics Processing" LSI

### Accurate sound field pattern generation in any environment

Each recording site has its own sound field, and so does your listening room. To accurately reproduce a desired sound field in your room for a particular type of recording, therefore, ambience of the listening room must be "neutralized" when a program is played back. Otherwise, there may be excessive reflections and reverberations, which can totally ruin the sense of realism. Our Digital Acoustics Processor lets you adjust not only the parameters for the source program (size, liveness, etc.) but also those for the listening room and the recording site. As a result, our processor can recreate the ambience of any musical environment in any listening

room and from any kind of musical program — a feat no other similar processor can duplicate.

### 20 memory-resident and 20 user-programmable sound field patterns

Our Digital Acoustics Processor has 20 programmed sound field patterns in memory — patterns for concert hall, recital hall, church, jazz club, stadium, and so forth — so that you can choose the one that best suits the type of music you select. Moreover, you can create and store in memory twenty of your own sound field patterns, the patterns that are customized to the acoustic conditions of your listening room and to your listening habits.

### 20 Preset Sound Field Patterns

NO.	PROGRAM NAME	TYPE	NO.	PROGRAM NAME	TYPE
1	SYMPHONY HALL 1	SHOEBOX TYPE	11	LIVE CLUE 1	JAZZ CLUE
2	SYMPHONY HALL 2	SHOEBOX TYPE	12	LIVE CLUE 2	DISCOTHEQUE
3	SYMPHONY HALL 3	SHOEBOX TYPE	13	PAVILION	LIVE CONCERT
4	SYMPHONY HALL 4	VINEYARD TYPE	14	GYMNASIUM	HARD-FLOOR HALL
5	SYMPHONY HALL 5	VINEYARD TYPE	15	STADIUM	OUTDOOR LIVE CONCERT
6	SYMPHONY HALL 6	VINEYARD TYPE	16	MOVIE THEATER 1	SMALL SPACE
7	RECTAL HALL	SMALL MUSICAL SPACE	17	MOVIE THEATER 2	MEDIUM-SIZED SPACE
8	OPERA HOUSE	WITH TIERED SEATING	18	MOVIE THEATER 3	LARGE SPACE
9	CATHEDRAL	GOthic STYLE	19	MOVIE THEATER 4	EXTRA LARGE SPACE
10	CHURCH	HIGH-CEILINGED SPACE	20	MOVIE THEATER 5	STANDARD

### Adjustable Parameters

PARAMETER	ADJUSTABLE RANGE	PARAMETER	ADJUSTABLE RANGE
1 ROOM SIZE	0.5-2	7 REAR DELAY	15-30 ms
2 LIVENESS	0.5-2	8 SPREAD/POINT	SPREAD/POINT
3 LOW PASS FILTER	1-16kHz THRL	9 LISTENING ROOM REVERB	0.2-0.6 ms
4 REVERB LEVEL	0-2	10 LISTENING ROOM SIZE	10m <sup>2</sup> or less, 1G-16m <sup>2</sup> , 16m <sup>2</sup> or more
5 HIGH-FREQUENCY REVERB	0.1-1	11 SOURCE REVERB	0-5 sec
6 OFFSET DELAY	0-200 ms		

## **XL-Z555BK CD Player — high-tech features for better digital sound**

Some people seem to think that today's CD players have reached the limits of digital technology: after all, they say, digital is digital — so there's no difference in sound quality between players. We've found, however, that there is a difference between models, and it is intimately related with the digital and analog technologies built into the players. With our advanced engineering in audio behind, JVC has come up with a series of technologies to provide even better digital sound. And the XL-Z555BK is proof.

### **New high-precision 3-beam laser pickup design**

Our newly designed pickup combines high sensitivity, precision, stability and immunity to resonance and vibration.



New High-Precision 3-Beam Laser Pickup

### **XL-Z555BK Compact Disc Player**

- Quadruple oversampling digital filter for smooth, precise response
- Twin high-speed D/A converters for precise imaging
- JVC high-precision 3-beam laser pickup
- New Y Servo System for superior tracking ability
- JVC "Opticalink" system for low digital noise
- Digital outputs: one optical and one coaxial
- Double-floating Independent Suspension System
- Disc/track title indication to name tracks and discs
- Remote control with volume control and numeric keypad
- Ready to play 3-inch (8cm) "CD singles"
- Random access programming of up to 32 tracks
- Auto/multi-disc editing key for cassette recording
- Random play, intro-scan, 5-way repeat, index play

Stability and resistance to vibration and resonance are improved thanks to a new suspended actuator. The pickup is also compact and lightweight, improving tracking accuracy and reducing "servo noise."

### **4X oversampling digital filter**

Our 4X oversampling digital filter uses a sampling frequency that's four times higher than normal (176.4kHz instead of 44.1kHz). Used in combination with a gentle-attenuation quality analog filter, it reduces noise and phase distortion to give you clear, well-defined digital sound.

### **"New Y Servo System" for superior tracking ability**

Our new servo system uses two special tracking beams — one leading and one trailing the main beam. The difference between the two signals is compensated for, and they are compared so as to cancel each other out. The result: The pickup remains locked on the correct track, even when the disc is dirty or scratched.

### **Disc/track indication and multi-disc editing**

Two special features make the XL-Z555BK easier to use. You can give a name up to 10 characters long to a disc or a track, and store as many as 512 of them in memory for display on playback. And you can program up to 48 tracks chosen from six different discs so you can easily transfer them to tape.

## **RX-1001VBK Receiver — exquisite ease of use with computer control**

The JVC RX-1001VBK is a supreme example of how computers make your life easier. From remote operation to graphic equalizer, a computer takes charge to provide you with the exceptional operating versatility and flexibility that simply defy your imagination.

### **"Programmable" A/V remote control**

Our "programmable" A/V remote control means that you can operate not only the receiver itself but also other JVC audio components and video components from a single remote. What's more, it has capacities to learn more functions of any audio and video component, whatever its make. And the RX-1001VBK's remote even comes equipped with a touch-panel LCD (Liquid Crystal Display) that serves as a multi-page menu and convenient touch panel.



To Program, Place Our Remote End-to-End with Other Remote.

### **JVC's Digital Acoustics Processor**

The receiver features the Digital

### **RX-1001VBK Programmable Remote/Computer-Controlled Receiver**

- 4-channel amplifier for front/rear speaker operation
- 120 watts per channel, min. RMS, both channels driven into 8 ohms, from 20Hz to 20kHz with no more than 0.007% total harmonic distortion (2-channel operation)
- "Programmable" remote control with touch-panel LCD
- Digital Acoustics Processor for precise sound field control
- Digital-delay Dolby Surround with adjustable delay
- Ready to control 3 video inputs, with dubbing and "Sound Selector"
- Computer-controlled 7-band S.E.A. graphic equalizer with 5 user-created and 5 "namable" programmed preset equalizations
- Computer-controlled digital synthesizer tuner, with 40 FM/AM presets, auto memory, more
- Dynamic Super-A with Gm Driver
- Interactive CCS (COMPU LINK Communications System)

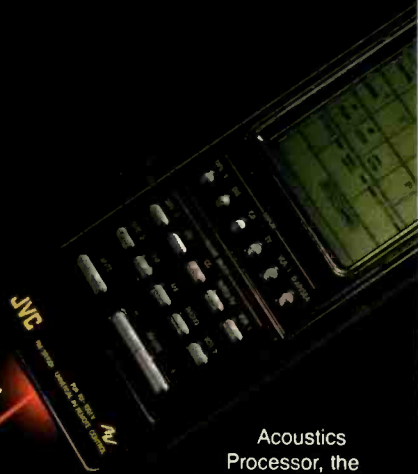

Acoustics Processor, the kind found in our

XP-A1000BK. The

realistic sound field it creates puts you where music is performed live — right in your own home. Conveniently, five types of sound fields (SYMPHONY HALL, RECITAL HALL, CHURCH, LIVE CLUB and STADIUM) are preset for instant recall.

### **Computerized S.E.A. graphic equalizer**

With a computer at command, our S.E.A. graphic equalizer is more versatile and easier to use than ever. You can equalize the sound from the remote, recall any from five "programmed" equalization curves, and create and put into memory the equalizations you've created, along with custom names.

### **Computerized digital tuner**

Again, by using a computer, we've improved ease of tuning and added new tuning conveniences. Up to 40 FM and AM stations may be preset and recalled instantly. Preset scan lets you "sample" stations. A signal strength indicator is dB-calibrated for accurate direct readout. It's even possible to give each station the name of your choice.



## TD-V711BK Cassette Deck — wider dynamic range, flatter response and purer sound

With extremely wide dynamic range and low distortion, digital sound has been a single program source that conventional cassette decks cannot compete in terms of specifications. The TD-V711BK, however, is the cassette deck expressly designed for recording digital sounds whole and complete.

### Closed-loop dual-capstan drive

With a sophisticated closed-loop dual-capstan drive, the portion of tape that runs across the heads is constantly held taut, pinched by two capstans/rollers. This



Discrete 3-Head Design Featuring SA Head and Amorphous Head

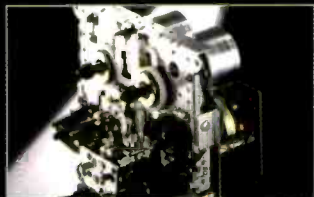

Two-Motor Full-Logic "Silent" Mechanism

### TD-V711BK Discrete 3-Head Cassette Deck

- Monitor-capable 3-head configuration: SA head for record and amorphous head for play
- Computer-controlled two-motor full-logic mechanism
- Closed-loop dual-capstan drive with direct-drive motor
- 2 "DIRECT" inputs for direct connection with CD players, etc.
- PCCOCC coil and lead wired in heads, and OFC plating on circuit boards for higher purity
- Straightforward circuit layout for clean signal transmission
- Separate circuit construction for low interference
- Low-impedance voltage-tracking regulated power supply
- High-rigidity chassis and large insulators for low resonance and vibration
- Dolby HX-Pro and double-Dolby B/C noise reduction

design improves the head-to-tape contact for better response, and also shuts out external disturbances from vibrating the tape. This results in reduced intermodulation noise. It's thanks to our solid tape drive (and the 3-head design) that you can enjoy pure and clean taped sound.

### Designs for purer sound

Another way we've ensured higher sonic purity is using a direct and straightforward circuit design, to reduce the chance of noise and distortion pickup. That's why input selector switches and the volume potentiometer are located at the back of the chassis, and operated by "remote shafts." For the same purpose, we also use PCCOCC (copper of highest purity) wire and OFC (Oxygen-Free Copper) in the heads and in the circuit board, and provide two direct inputs to accept outputs from source programs like a CD player. Dolby HX-Pro contributes to purer sound, too, by expanding the high-frequency dynamic range.

Frequency Responses With and Without Dolby HX-Pro

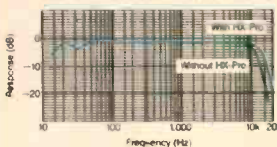

The Dolby HX-Pro circuit improves the tape's MOL (Maximum Output Level) at high frequencies. It lets you enjoy wider dynamic range at high frequencies as well as at others.

## SX-911WD Speaker System — designed for high purity and transparency

JVC has designed the SX-911WD from the ground up, with the sole purpose of making a speaker system matched with digital programs in every way. Now you can enjoy pure, clean and transparent sound, completely stripped of any trace of muddiness and fuzziness of conventional systems.

### Cloth carbon woofer and midrange

Light weight, high rigidity, high speed of sound and optimized internal loss — our new cloth carbon diaphragm for the woofer combines the most ideal properties demanded of a diaphragm material. The result is the bass sound that's extended, crisp and rich. The midrange uses a similar material called "fine" cloth carbon to provide clear and natural mids.



Rigid Pure-Aluminum Frame for SX-911WD Woofer

### Amorphous-diamond coated tweeter

Much of the reason for high

transparency of the SX-911WD lies in the high-tech tweeter design. It uses a dome diaphragm with a titanium base on which a thin layer of amorphous diamond is coated by chemical vapor deposition. Featuring uniform thickness, high purity and smooth surface, this coating increases the diaphragm's speed of sound to almost that of natural diamond. So the transient response is dramatically improved, as are purity and transparency.

### Unresonating, solid frames and enclosure

Every speaker unit is housed inside a solid, unresonating die-cast aluminum frame cylindrical in shape to disperse vibrations efficiently. The enclosure is constructed by solid 1-inch (25mm) particle boards. The panels are conifer-based to provide superb musical sonority. Front and rear baffles are mounted with additional cleats to increase the rigidity of the cabinet and make it resistant to resonance and vibration. And the front baffle has rounded corners to reduce diffraction and provide better definition.

Sound Radiation Response of the SX-911WD

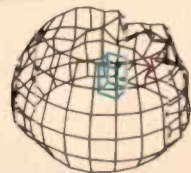

### SX-911WD 3-Way Speaker System

- 12-3/8-inch (31.5cm) cloth carbon woofer for the bass sound that's crisp, extended and rich
- 5-inch (12cm) "fine" cloth carbon midrange for rich and natural midrange sound
- 1-3/16-inch (3cm) amorphous-diamond coated tweeter — transparency and superior transient response
- Low-resonance/vibration die-cast aluminum speaker frames
- High-density conifer-based particleboard enclosure for musical sonority
- Round-cornered front baffle to provide razor-sharp definition
- 3-part crossover network to prevent interference
- Computer-optimized speaker layout for natural sound field reproduction and clear sonic imaging
- High power handling capacity: 150 watts/300 watts (music)

# SPECIFICATIONS

## AX-Z911BK

Digital Pure-A Integrated Amplifier

### OVERALL CHARACTERISTICS

Output Power	<b>100 watts per channel, min. RMS, both channels driven into 8 ohms from 20Hz to 20kHz, with no more than 0.003% total harmonic distortion</b> 105 watts per channel, min. RMS, into 8 ohms at 1kHz, with no more than 0.0005% total harmonic distortion
Total Harmonic Distortion AUX to SP OUT	0.003% at 100 watt output, 8 ohms, 20Hz to 20kHz 0.0005%* at 105 watt output, 8 ohms, 1kHz
PHONO to SP OUT	0.007% at 100 watt output, 8 ohms, 20Hz to 20kHz, -20dB volume
Power Bandwidth	7Hz to 60kHz (IHF, both channels driven, 8 ohms, 0.02% total harmonic distortion)
Frequency Response (8 ohms)	TUNER/AUX/CD/TAPE DC to 200kHz +0dB, -3dB
REC Output Level/Impedance	400mV/400 ohms (ANALOG) 2.0V/550 ohms (DIGITAL)
Input Sensitivity/Impedance (1kHz)	PHONO MM 2.5mV/47k ohms (+6dB) PHONO MC 200µV/470 ohms (+6dB) TUNER/AUX/CD/TAPE 400mV/30k ohms
Signal-to-Noise Ratio ('66 IHF/78IHF)	PHONO MM 90dB/80dB (REC OUT) PHONO MC 74dB (250µV Input)/73dB (REC OUT)
TUNER/AUX/CD/TAPE	112dB/85dB
PHONO EQUALIZER SECTION	
Phono Overload (1kHz): MM	100mV (0.007% total harmonic distortion)
MC	7mV (0.007% total harmonic distortion)
RIAA Phono Equalization: MM	±0.2dB (20Hz to 20kHz)
MC	±0.2dB (20Hz to 20kHz)
D/A CONVERTER SECTION	
Sampling Frequencies (Auto Selection)	32k, 44.1k, 48kHz
Total Harmonic Distortion	0.0035% (1kHz)
Dynamic Range (1kHz)	97dB
Signal-to-Noise Ratio	102dB
Dimensions (WXHXD)	18-3/4x6-9/16x17-7/16 inches 475x166x442mm
Weight	44.1 lbs. (20kg)

\* Measured by JVC Audio Analysis System.

## XP-A1000BK

Digital Acoustics Processor

Level/Impedance: Input	2V/47k ohms
Output	2V/500 ohms
Total Harmonic Distortion:	
MAIN OUT	0.002% (1kHz, 2V output)
D.A.P. OUT	0.005% (1kHz, 2V output)
Frequency Response:	
MAIN OUT	5Hz — 100kHz (+0, -3dB)
D.A.P. OUT	5Hz — 20kHz (±0.5dB)
Dynamic Range: MAIN OUT	110dB
D.A.P. OUT	94dB
Signal-to-Noise Ratio:	
MAIN OUT	110dB
D.A.P. OUT	94dB
Dimensions (WXHXD)	18-3/4x4x14-3/16 inches 475x101x360mm



THE CHICK COREA ELECTRIC BAND

JVC presents the best of international jazz festivals.

Newport Jazz Festival is a registered service mark of George Wein and Festival Productions.



# JVC®

JVC COMPANY OF AMERICA  
DIVISION OF US JVC CORP.  
41 Slater Drive, Elmwood Park, N.J. 07407

## RX-1001VBK

Programmable Remote/  
Computer-Controlled Receiver

### AMPLIFIER SECTION

Output Power:	<b>120 watts per channel, min. RMS, both channels driven into 8 ohms from 20Hz to 20kHz, with no more than 0.007% total harmonic distortion</b> (Front Channels) <b>110 watts per channel, min. RMS, both channels driven into 8 ohms from 20Hz to 20kHz, with no more than 0.007% total harmonic distortion</b> (Rear Channels)
2-Channel Operation	15 watts per channel, min. RMS, into 8 ohms at 1kHz, with no more than 0.07% total harmonic distortion
4-Channel Operation	
Total Harmonic Distortion (8 ohms, 1kHz)	0.003%* at 125 watt output
Input Sensitivity/Impedance	
PHONO MM	2.5mV/47k ohms
PHONO MC	250µV/100 ohms
VIDEO SOUND/AUX/CD/TAPE	230mV/47k ohms
Signal-to-Noise Ratio ('66 IHF/78 IHF)	
PHONO	80dB/80dB (REC OUT)
VIDEO SOUND/AUX/CD/TAPE	100dB/85dB
Frequency Response	
PHONO	20Hz — 20kHz (±0.5dB)
VIDEO SOUND/AUX/CD/TAPE	5Hz — 50kHz (+0, -1dB)
S.E.A. SECTION	
Center Frequencies	63, 160, 400, 1k, 2.5k, 6.3k, 16kHz ±10dB
Control Range	
FM TUNER SECTION (IHF)	
Usable Sensitivity	10.3dBf (0.9µV/75 ohms)
50dB Quieting Sensitivity:	
MONO	14.8dBf (1.5µV/75 ohms)
STEREO	38.3dBf (22.5µV/75 ohms)
Distortion (1kHz)	
MONO/STEREO	0.08%/0.08%
Signal-to-Noise Ratio (IHF-A Weighted)	
MONO/STEREO (at 85dBf)	84dB/78dB
Selectivity (±400kHz)	70dB
Capture Ratio	1.5dB (10mV/300 ohms)*
Frequency Response	30Hz — 15kHz (+0.5, -0.8dB)
AM TUNER SECTION	
Usable Sensitivity	250µV/m (Loop antenna) 30µV (External antenna) 50dB
Signal-to-Noise Ratio (100mV/m)	
Selectivity (±10kHz)	38dB
VIDEO INPUTS/OUTPUTS	
Output Signal Level	1Vp-p (at 1Vp-p input)
Impedance	75 ohms unbalanced
Synchronization	Negative
Signal-to-Noise Ratio	45dB
Crosstalk	45dB (3.58MHz)
Dimensions (WXHXD)	18-3/4x6-3/16x15-1/8 inches 475x156x383mm
Weight	29.8 lbs. (13.5kg)

\* Measured by JVC Audio Analysis System.

## XL-Z555BK

Compact Disc Player

Frequency Response	2Hz — 20kHz
Total Harmonic Distortion (1kHz)	0.0035%
Dynamic Range (1kHz)	97dB
Signal-to-Noise Ratio	100dB
Channel Separation (1kHz)	92dB
Wow and Flutter	Unmeasurable
Output Level	2.0V RMS
Dimensions (WXHXD)	18-3/4x4-9/16x11-1/2 inches 475x115x291mm
Weight	12.6 lbs. (5.7kg)

## TD-V711BK

Discrete Three-Head Cassette Deck

Frequency Response (at -20 VU)	
Metal Tape	10 — 22,000Hz (15 — 20,000Hz ± 3dB)
SA/Chrome Tape	10 — 20,000Hz (15 — 18,000Hz ± 3dB)
Normal Tape	10 — 20,000Hz (15 — 18,000Hz ± 3dB)
Signal-to-Noise Ratio	59dB (Metal)
Wow and Flutter	0.022% (WRMS)
Crosstalk (1kHz)	65dB
Channel Separation (1kHz)	40dB
Harmonic Distortion	
Total (0VU, 1kHz)	1.0% (Metal)
K3 (0VU, 1kHz)	0.5% (Metal)
Input Sensitivity/Impedance	
Line Input X2	80mV/50k ohms
Output Level/Impedance	
Line Output X2	300mV/600 ohms
Headphones	0 — 1mW/8 ohms (Matching Impedance: 8 — 1k ohms)
Dimensions (WXHXD)	18-3/4x5-1/4x13-1/4 inches 475x132x336mm
Weight	18.3 lbs. (8.3kg)

● Measured from peak level, weighted, without NR. The S/N is improved by about 15dB at 500Hz and by about 20dB above 1kHz with Dolby-C NR on, and by 5dB at 1kHz and by 10dB above 5kHz with ANRS/Dolby-B NR on.

## SX-911WD

3-Way Speaker System

Type	3-way, acoustic suspension
Speakers:	
Woofer	12" (30.5cm), cloth carbon cone
Midrange	4-1/2" (11.5cm), cloth carbon cone
Tweeter	1" (2.5cm), amorphous-diamond coated dome
Power Handling Capacity	150 watts 300 watts (Music) 6 ohms
Impedance	
Sensitivity (1m on axis)	91dB/W · m
Frequency Range	40 — 50,000Hz
Crossover Frequencies	500Hz, 4kHz
Dimensions (WXHXD)	15x26-3/16x13-7/8 inches 380x665x351mm
Weight	62.8 lbs. (28.5kg)

# CASSETTE DECKS

## The New Generation

BY CRAIG STARK

**T**HE unusually large number of cassette-deck introductions at the most recent Consumer Electronics Show will interest more tape enthusiasts than hearing yet another chapter in the tawdry legal soap opera that has made "DAT" stand for Deferred Audio Technology. The first digital audio tape decks, even when they do reach the market, will be beyond the economic reach of most music lovers. On the other hand, the new generation of cassette decks offers an appealing variety of features and performance at more attractive prices than the recent history of the yen would suggest was possible.

Out of the myriad products making their debuts at the Summer CES, I've had a chance to look informally at a dozen new cassette decks, seven of them three-head decks and five, including two auto-reverse units, two-head models. My impression of these representative machines, along with some hints on what to look for and at, may help you narrow your choices this season.

All of the decks, of course, include both Dolby B and Dolby C noise-reduction systems, which have become standard operating equipment in any hi-fi cassette deck.

Surprisingly, only one—the Yamaha KX-800U—includes the alternative dbx system, which seems to have lost some of its earlier popularity.

### *Dolby HX Pro*

What first surprised me as I looked over my list, however, was that ten out of these twelve decks—in all price ranges—include the Dolby HX Pro system. Although it's been around for several years, Dolby HX Pro has not been incorporated into so many tape decks that everybody is familiar with it. Despite the Dolby name it has nothing to do with noise reduction. Rather, it's a circuit that helps prevent high-frequency tape overload, which is one of the most intractable problems of the cassette medium.

The Dolby HX Pro system addresses this problem by continuously monitoring the high-frequency content of the signal going to the recording head. When this content reaches the danger point (near saturation), the system temporarily reduces the bias slightly, giving the tape more treble capacity. When the high-level high-frequency demand ceases, the normal bias level is restored. The bias modifications produced by the Dolby HX Pro system occur instantaneously and are

### A CLEAN DOZEN

#### THREE HEADS

Nakamichi CR-4A, \$995  
Akai GX-95-B, \$799  
Pioneer CT-S800, \$750  
Onkyo TA-2800, \$650  
Kenwood KX-1100HX, \$650  
Yamaha KX-800U, \$549  
Aiwa AD-F780, \$450

#### TWO HEADS

a/d/s/ C2/3, \$800  
SAE C102, \$499  
Luxman K-111, \$350

#### TWO HEADS, AUTOREVERSE

Sansui D-X301iR, \$380  
Sherwood DS-1630R, \$380



Onkyo's TA-2800 cassette deck has a record-calibration circuit that compensates for the varying sensitivity levels of different tapes for proper operation of Dolby B and Dolby C noise reduction. It also features Dolby HX Pro. Price: \$650.



Priced to retail for \$350, the Luxman K-111 cassette deck has Dolby HX Pro, a Hexalum record/play head that is said to allow high recording levels before saturation, and a double-gap erase head that is said to have an erase efficiency more than 10 percent higher than conventional heads.



"spot erase" system in the Akai GX-95-B enables users to mark the beginning and end of a particular musical passage or phrase and then erase the marked segment. It also has manual bias adjustment with a built-in tone generator. Price: \$799.



Logic circuitry such as that in the Aiwa AD-F780 lets you switch transport functions without first pressing the stop button. Priced at \$450, the AD-F780 includes Dolby HX Pro and Dolby B and Dolby C noise reduction.



completely automatic. The effect is to increase the tape's realizable treble response by several decibels ("headroom extension," as it is called) without increasing low-frequency distortion.

### User-Adjustable Bias

Not many years ago, user-adjustable bias controls were usually found only on decks designed for "purists." The bias and equalization settings for the three major tape types—ferric (Type I), chromium-dioxide or equivalent (Type II), and metal-particle (Type IV)—were set by each deck's manufacturer and could not be modified once a cassette was inserted into the machine. But the fact is that different brands of tape (and even lines within a brand) of the same overall type have different optimum bias requirements and even different basic tape sensitivities. Tape sensitivity—the signal level you get on playback from a given recording signal—affects the calibration, and thus the frequency response, of the Dolby noise-reduction systems.

Looking at these new decks, however, you can see that two-thirds of them, and *all* of the three-head models, offer some form of post-factory bias or sensitivity adjustment. The Nakamichi CR-4A, Akai GX-95-B, and Kenwood KX-1100HX take the full classic approach: Built-in test-tone generators and the decks' level indicators permit users to adjust bias and sensitivity for individual tapes. The Yamaha KX-800U does the same for bias only. Onkyo's TA-2800 has an automated, internal multilevel bias-optimizing procedure, which is followed by a manual tape-sensitivity adjustment. The Aiwa AD-F780 has a similar automatic sensitivity adjustment but requires the user to adjust the bias by ear so that low-level FM hiss sounds the same in tape and source positions, a less precise method. Pioneer's CT-S800 similarly relies on audible adjustment for bias, but the two-head Sansui D-X301iR uses an automated internal bias-optimizing routine.

Certainly not everyone wants to optimize his machine for every tape he records! But having the *means* to do so on critical occasions is an important feature for the serious recordist, and providing user-adjustable bias and sensitivity settings indicates serious purpose on the part of the manufacturer.

### Multiplex Filtering

Another indicator of a manufacturer's serious purpose is the seemingly insignificant provision of a *switchable* multiplex filter. Stereo FM broadcasting is a multiplex process that makes use of low-level 19-kHz subcarrier signals. These artificial elements of stereo FM broadcasts must be filtered out of the tuner's audio output before taping, however, because a Dolby noise-reduction circuit would treat the residual 19-kHz subcarrier as a normal musical overtone, which would

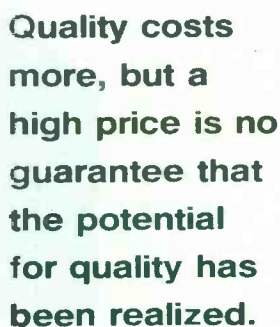

Quality costs more, but a high price is no guarantee that the potential for quality has been realized.

destroy the proper frequency response of Dolby-encoded FM dubs.

While the filters built into today's FM tuners and receivers are generally adequate for the purpose, some form of additional multiplex filter is always built into Dolby-equipped cassette decks. The filter is potentially *needed* only for taping stereo FM broadcasts, which have an upper frequency limit of 15 kHz.

It's fairly easy today to build a filter that will attenuate the residual 19-kHz multiplex signals adequately, yet maintain flat response at 15 kHz and just slightly above that. Unless you can switch the filter out, however, it will set the practical upper limit of the frequency response of your cassette deck. Looking at the specs on today's machines, would you pay more than \$300 for a Dolby-equipped cassette deck that had no usable response above, say, 16 kHz? The top half-octave of the musical overtone spectrum is the real price of not having a shut-off switch for the filter.

### Design Basics

The performance features discussed above are important indicators of good design, but the fundamental factors that determine a cassette deck's performance and cost

are its tape heads, its transport, and the quality of its electronics. In each case quality costs more, but a high price is no guarantee that the potential for quality has been realized.

Where the concern for excellence in recording and reproduction of music is paramount, there is simply no question that the separate record and playback heads of a so-called three-head deck are a better design choice than the combination record-playback head used in a two-head deck. For optimal recording, the record head's "gap"—the physical space between its two pole pieces—should be three or more times as wide as the 1-micrometer (or less) gap needed by a playback head to resolve the highest audible frequencies at the cassette speed of 1 $\frac{7}{8}$  inches per second. To use the same head for both recording and playback requires compromising on one or both of these incompatible requirements. Moreover, only a deck with separate record and playback heads lets you *instantly* compare the recorded result against the original signal. Tape/source switching is at once the simplest and the most meaningful test of recording quality.

Not all three-head designs are identical, however. The Nakamichi CR-4A is unique among the new decks I looked at in exemplifying the classic position that only physically discrete and separately adjustable record and playback heads can achieve the very highest quality. The other three-head units in the group all use "sandwich" heads, in which separate record and playback heads are put into a common casing but are separated by a shielding barrier designed to prevent magnetic and electrical interaction between the two elements. Among these, the Akai GX-95-B is said to have been designed with particular attention to the crucial shielding. The Akai deck also permits users with proper test tapes to gain access to its head azimuth, height, and tilt adjustments. But as with other sandwich designs, there is no way to guarantee that the record and playback head gaps are aligned perfectly parallel to each other.

Don't despair, however, if your budget dictates that you must shop for a two-head machine. There are some very good machines in this category. Indeed, in the vicinity of the crossover point between the least expensive three-head decks



The record and playback heads in the three-head, \$995 Nakamichi CR-4A are individually adjusted after manufacture for perfect azimuth alignment. Dolby B and Dolby C noise reduction and a defeatable multiplex filter are included.



At the top of Sherwood's new line of decks is the DS-1630R (\$380), a two-motor unit with twenty-selection automatic music search. Features include an EQ switch, bias fine-tune controls, and a connection for Sherwood's system remote control.



Pioneer's CT-S800 three-head, two-motor deck (\$750) has full logic controls, Dolby HX Pro headroom extension, Dolby B and Dolby C noise reduction, and bias fine-tuning. Individual power supplies are used for the amplifier, controls, and indicators.





Yamaha's  
KX-800U  
has Dolby  
B, Dolby

C, and dbx noise reduction. The \$549 three-head deck features random-access program play for up to nine selections, intro scan, music search, selectable high-speed fast forward or rewind, a twenty-eight-key remote control, a remaining-time indicator, and a linear-time counter.



The  
KX-1100HX  
from  
Kenwood

has Dolby HX Pro circuitry as well as bias-level calibration controls with a built-in signal generator. The \$650 deck has three independent tape heads for record, playback, and erase, and three motors independently drive the capstan and the reel hubs. It includes Dolby B and Dolby C.

and the most expensive two-head decks, you may very well get better sonic results with one of the latter.

### Transports

Clear, clean sound requires a smooth-running tape transport, and it was discovered long ago that a single motor could not, in practice, rotate a capstan steadily, supply the necessary pull for the take-up reel hub, and alternately drive each reel hub at high speed for fast-forward and rewind operations. Thus, all the decks considered here have at least two motors, one of which is dedicated just to turning the capstan that pulls the tape across the heads. Indeed, the tendency—exemplified even in our least expensive deck, the Luxman K-111—is to have *three* motors in the transport system, the third being used for a cam mechanism that moves the heads into position against the tape more smoothly than a solenoid can.

A "closed-loop" transport, which uses two capstans to isolate the section of tape actually passing across the heads, has been found to result in lower wow-and-flutter than the older single-capstan design. The five top-price decks on our list all use dual-capstan transports. If you can afford it, a three-motor, dual-capstan, closed-loop transport is the *best* way to go, but there are many very good less expensive options.

### Other Design Considerations

Other performance-related design claims for the new-generation cassette decks are more difficult to assess. Both the Pioneer CT-S800 and the Nakamichi CR-4A use copper plating to reduce the internal resistance of their metal chassis, for example, and the Akai GS-95-B has a rigid, shielded subchassis separating its transport from its electronic sections. Such techniques, along with the use in several decks of oxygen-free wire in the head and coil windings, and even on printed-circuit-board traces, all indicate commendable attention to small details in the constant effort to improve an overall design. On the other hand, how significant any particular technique may be is impossible to say without subjecting the decks to a battery of lab tests. (Nonetheless, I must confess to having been mightily impressed by the massive, cast shielding on the power transformer of the Pioneer CT-S800!)

Two special design features do

call for some discussion, however. One is the inclusion of an autoreverse function. It is *possible* to build an autoreverse cassette deck that performs as well as a good unidirectional cassette deck. As a ballpark figure, I'd guess that it costs about \$100 more to do so because of the added mechanical and electrical complications. When the list price of an autoreverse deck is already at the very low end of the scale, a prospective buyer must realize that top-quality performance—in *either* direction—cannot be expected. On the other hand, when your principal goal is to maximize uninterrupted background listening, such decks have a definite place.

In both the a/d/s/ C2/3 and the SAE C102, the traditional outward-opening cassette-well door has been replaced with a motorized slide-out drawer mechanism similar to that used in most home CD players. The drawer contains the entire tape-transport mechanism, and in terms of basic performance criteria (two heads, single-capstan design), it appears that this type of construction exacts a rather substantial price penalty. To me, at least, the \$800 a/d/s/ deck seems overpriced by a factor of two; the SAE, at \$499, seems about \$150 too high.

With respect to convenience features, in many cases what one user finds a help, another will find a nuisance. The ability to program a sequence of listening selections falls into this category. The Onkyo TA-2800, Yamaha KX-800U, and Pioneer CT-S800 are particularly versatile in this respect, though for me the almost universal "rewind to 0000 and stop" feature is quite enough. I do, however, find direct time-reading counters, whether they show elapsed or remaining time, or both, a distinct convenience, and they can be found on the Akai, Kenwood, Onkyo, Pioneer, and Yamaha decks. And anyone whose deck is more than arm's length away will certainly appreciate the wireless remote-control devices supplied with the Aiwa, Akai, Onkyo, and Yamaha machines.

Yes, DAT decks will eventually get here, and ultimately they will replace analog cassette decks the way CD players are in the process of replacing turntables. But that time is still years in the future. The latest generation of cassette decks will give you very solid enjoyment in the meantime. □

# **“In its price category, the Adcom GFA-535 is not only an excellent choice; it’s the only choice.”**

Sam Tellig, The Audio Cheapskate

**stereophile**

Vol. 10 No. November 1987



Adcom GFA-535 power amplifier.

## The complete report:

Sometimes products are too cheap for their own good, and people don't take them seriously: the Superphon Revelation Basic Dual Mono preamp, Rega RB300 arm, AR ES-1 turntable, Shure V15-V MR cartridge, and the B&K ST-140 power amp. They can't be any good because they cost so little, right?

Wrong, of course.

Adcom appears to be having the same problem with their \$299.95 GFA-535 amp. Credibility.

Now if this amplifier were imported from England and sold for \$599.95, then maybe it would be taken seriously. And highly praised, no doubt.

For the baby Adcom is one of the finest solid-state amps I have heard. No, not the best; I'm not sure what *is* the best. But it's an amplifier that is so good for so little money as to be practically a gift.

Actually, when Rob Ain from Adcom called, I was about as enthusiastic about the GFA-535 as you were before you finish reading this piece. But Rob insisted, "You've gotta hear this amp."

He brought it over the next day, along with the GFP-555 preamp (\$499.95), and we put both pieces into the rest of the system: a Shure Ultra 500 in a Rega RB300 arm on an AR ES-1 table, with Quad ESL-63 speakers on Arcici stands. Then we chatted for a half hour or so while the electronics warmed up.

And then, simultaneously, the two of us decided to shut up and listen.

"I've never heard the Quad ESL-63 sound better," Rob said. Of course, he was hardly an impartial observer, but the sound was extraordinarily clean, detailed, and musical. If it wasn't the best sound I have ever heard from Quads, it was pretty close.

This humble \$300 amplifier was driving a pair of very revealing \$3000 speakers and giving a very good account of itself. (We listened first to some Goran Sollscher classical guitar.)

"So how come this product isn't flying off the dealers' shelves?" I asked Rob.

"I don't know. Everyone wants the GFA-555 with 200 watts per channel. Including people who don't need it."

"Does the GFA-555 sound any better?" I asked.

"It's our aim to have all our amps sound pretty much the same. You pay more money, you get more power."

Rob pointed out that while the GFA-535 is rated at 60Wpc, it puts out more like 80. And while I did not do any measurements, my experience with other amps tells me Rob's right. I suppose Adcom doesn't want to steal sales from its GFA-545, rated at 100Wpc and selling for \$200 more.

After a couple of hours, Rob left, grinning from ear to ear, and I later sat down to listen alone. True, when I tried certain Telarc and pushed hard I could get the amplifier to clip—two LEDs quickly light up (very useful). But the Quads were running out of the ability to use the power anyway. My first impressions



were confirmed: the GFA-535 is one of the best amplifiers around for driving Quads. Spondor SP-1s, too.

Suddenly, it hit me what this meant. Conventional wisdom had been dealt a severe blow. You know, the old saw that you should never power a good pair of speakers with a

**“The GFA-535 reminds me of... amplifiers that sell... for about three and five times the price.”**

cheap amplifier. Here was a cheap amp—one of the cheapest on the market—that sounded good with Quads, Spondors, later Vandersteens. Probably Thiels, too—at least the CS1. What it means is you can stretch your speaker budget a bit and get the speakers you really want, then economize by buying an Adcom GFA-535 for \$299.95. True, you may be a little power shy, but probably not much. And to say the least, the GFA-535 would make a decent interim amp.

What does the GFA-535 sound like? (You thought I'd forget that part, right?) Well, this is one of the most neutral amps I've heard.

**“...the baby Adcom is one of the finest solid-state amps I have heard... so good for so little money as to be practically a gift.”**

While it doesn't sound particularly tubelike, it avoids the typical transistor nasties through the midrange and into the treble. I wouldn't call it sweet—there's no euphonic coloring—but it isn't cold or sterile. What it is, is smooth. And detailed. Far more detailed than I would ever imagine a \$300 amplifier could be. The GFA-535 reminds me of the Eagle 2A and PS Audio 200C, amplifiers that sell, respectively, for about three and five times the price. Of course, they have more power. And they *are* more detailed. The point is, the Adcom comes close. Very close.

The bass, like everything else, is neutral, certainly not fat and overdone. But it's here where

you notice that this amp is not a powerhouse. You just don't get the solidity and extension you get with a very powerful (and expensive) solid-state amp. Nor do you get the breadth and depth of soundstage that you often find with a very powerful amp. The Adcom GFA-535 sounds a wee bit small, which it is.

My only criticism, and it's more of a quibble, is that the speaker connectors are non-standard and unique (so far as I know). You insert bared speaker wire into a hole and twist the connector tight a quarter turn. Most speaker cables will fit, but some will not. Certainly MIT won't. Neither will the best Kimber, the kind with eight clumps of strands. The less costly four-clump Kimber will, and proved an excellent choice. My sample amp was quiet—

**“This amplifier is so good and so cheap that I think any CD owner who buys an integrated amp is nuts.”**

no hum—and ran cool. There are selectors for two sets of speakers. And the 535 looks nice.

And talk about economy: If you're not into LPs anymore, you could buy a Mod Squad, dbx, or Old Colony line-level switching box—or possibly a B&K Pro 5 preamp, with its switchable line amp section (only \$350), or the Adcom SLC-505 passive preamp (\$150)—and run it with a CD player. In fact, if you are into CD only (no tape, no tuner, no phono), you could buy a CD player with a variable volume output and run it directly into the Adcom. This amplifier is so good and so cheap that I think any CD owner who buys an integrated amp is nuts.

In its price category, the Adcom GFA-535 is not only an excellent choice; it's the only choice. The real question is whether you should buy one even if \$299.95 is much *less* than you planned to spend for an amp—*ie*, whether you should put the money into a better CD player or pair of speakers instead.

**ADCOM**<sup>®</sup>  
fine stereo components

11 Elkins Road, East Brunswick, NJ 08816  
U.S.A. (201) 390-1130 Distributed in Canada by:  
PRO ACOUSTICS INC. Pointe Claire, Quebec H9R 4X5

# MUSIC EVERYWHERE

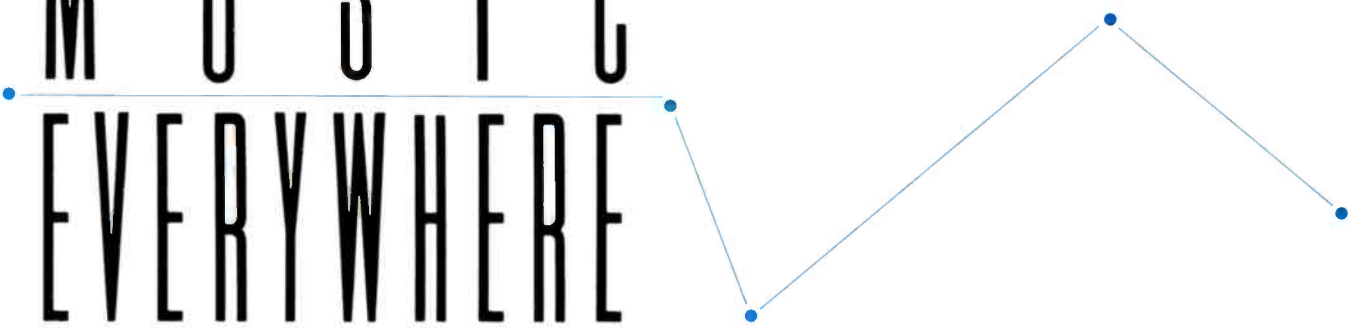

**I**N his book *Music in Every Room*, John Krich describes checking into a hotel advertising music in every room. Only after being shown to his humble accommodations does he discover the meaning of that promise: A table radio in the hotel's courtyard blares 24 hours a day. The closest thing to remote control is invoking a mute function by closing the window.

Too many people endure a similar whole-house music system. When they want music in the kitchen or bedroom, they turn up the stereo system in the living room. Of course, changing from CD player to tuner, or changing stations on the tuner, means traipsing across the house.

America's fitness craze exhausts itself at the front door. Cross the threshold into your home and you want convenience. What this country needs is a bracket to secure an audio/video remote control to the handlebars of an Exercycle. More than that, America wants remote-controlled music in every room.

Since the dawn of high fidelity people have fished wires through walls to extend the coverage of their sound systems. Tube amplifiers, with their massive, multi-impedance output transformers, could power several sets of speakers. Solid-state amplifiers, with their often less-stable direct-coupled outputs, were limited to a couple of pairs of speakers. You could place a pair of speakers in every room, but you'd only hear music in two rooms at the same time. Even if you went to the effort of installing an amplifier in every room, the only thing you would control remotely in each room was the volume.

Unlike the hotel in Krich's book, Bang & Olufsen, Revox, Kyocera, Soundstream, Audiophile Systems, and others now promise, and deliver, high-fidelity music in every room of your home—and with remote control. This pleasure costs considerably more than a table radio, but it also means you'll never *need* another table radio.

Every room can be a  
listening room  
with a sophisticated  
whole-house  
remote-control system.

**BY RICH WARREN**

Bang & Olufsen prides itself on style. A complete B&O system would look great in every room, but the expense adds up rapidly, so the Danish company engineered a way to provide sound throughout the house without putting a system in every room. It fashioned its Master Control Link (MCL) and Beolink long before the idea of whole-house systems became fashionable.

First B&O solved the problem of amplifier loading by modifying the amplifier circuitry of its receivers. The only penalty of connecting additional speakers was a drop in level, and recently B&O solved that problem with its add-on 30-watt-per-channel MCL 2P power amplifiers, designed to be hidden in every remote room as a part of the Beolink system.

The Beolink controller operates all Beosystem 5500 components, the Beocenter 9000 integrated one-piece system, and B&O's new video components. Beolink will also operate future B&O components as well as its new lighting modules, tiny black boxes that control house lighting from the Beolink 1000 remote. The modules can be programmed to "remember" various connections, such as dimming the lights in a room when you touch the TV button on the remote.

Wiring connects infrared sensors in each room with the central B&O Master Control Link 2AV. The system can be wired in a hub-and-spoke or daisy-chain configuration. The handheld Beolink 1000 remote terminal can communicate with the MCL 2AV through any infrared sensor. The MCL 2AV controls audio and video sources in up to sixteen

ILLUSTRATION BY PAUL LEITCH

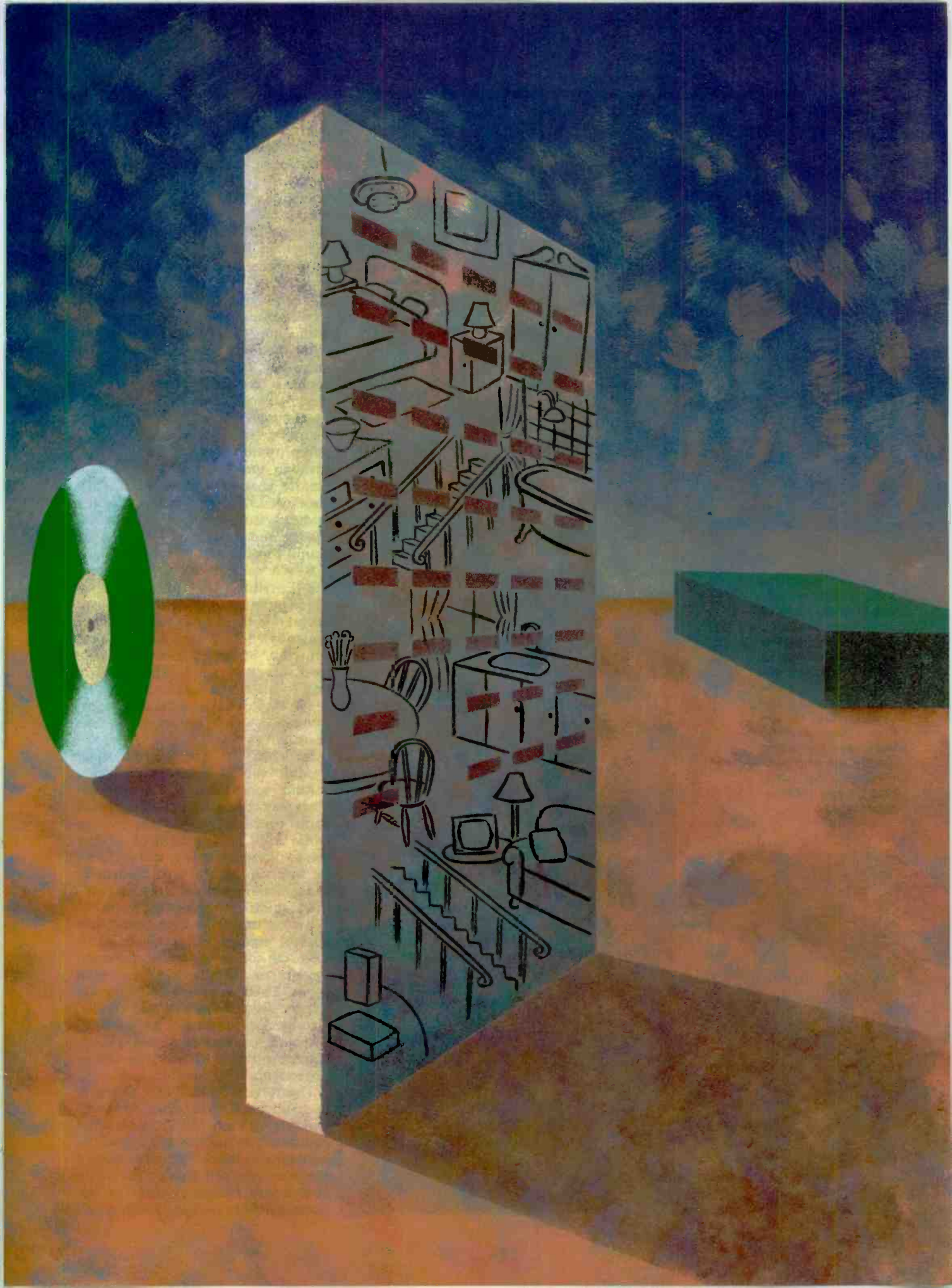



While a complete Bang & Olufsen system in every room of your house would be a treat, the Beolink system allows you to control selected audio and video components, or just a pair of speakers, in any room through the main system using remote infrared sensors and the handheld Beolink 1000 terminal (right).

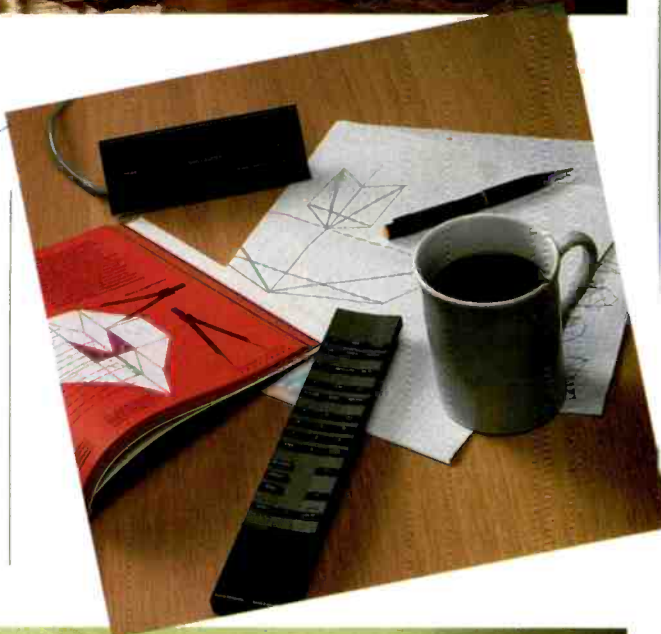

different rooms, and the Beolink 1000's thirty-eight buttons operate every feature.

The beauty of the B&O Master Control Link system stems from its two-way digital technology, which permits "smart" responses to commands. With optional MCL amplifiers, additional rooms can have their own B&O CD players or cassette decks controlled by the Beolink 1000. Thus, the main system can be playing in some rooms while local components fill other rooms with sound. You can even dispense with the additional amplifiers by using B&O's powered loudspeakers, such as the Beolab Penta and the new Beolab 3000 and 5000 flat wall speakers. With the introduction of its new video components, B&O will provide video switching as well through the MCL 2AV. A useful feature is the ability to use the TV speakers as remote speakers for the audio system without turning on the TV and, conversely, to pipe TV sound through the audio system.

Revox calls its B209 bus system the "Easyline." It permits both multiple sourcing, with different source programs from the main system playing in different rooms, and local sourcing, where each room has its own source of music. The speakers and local components need not be made by Revox, and the local components can also feed programs into the main system.

Switches on the Revox B209 module can be used to designate certain rooms for listening only. That way children can be prevented from operating the main system while still having control of the local volume. And to avoid accidental interruption of tape recording, the system can be set to block commands until the recording finishes.

Revox transmits both audio and control signals via a single cable from the connector box at the main system to "T-adaptors" in each room. These adaptors split the signal for feeds to additional rooms. Remote locations must have amplifiers and speakers or powered loudspeakers, plus a 15-volt power supply for the B209 module.

The Revox B203 Timer Controller connects Revox Series 200 components with any MS-DOS personal computer. With the B203 and its matching B205 remote-control module, you can totally automate your audio system. Using the optional software package you can eas-

IF SOMEONE TRIES  
TO SELL YOU A  
\$2,000 CD PLAYER,  
COVER YOUR EARS.

1988 Koss Corporation.



The new Koss Pro/450™ Stereophones deliver ultra-smooth, distortion-free sound and provide an excellent way of determining whether a high-priced audio component is really worth its high-price. It's all possible thanks to Koss' new dual-element design. Each earcup contains a neodymium element for crisp mids and highs, plus a low-frequency poly-driver for extraordinary bass response. Everything else about the Pro/450 is first-class, too. From the oxygen-

free copper wiring and two detachable cords, to the unique earcup spider assembly and genuine leather headband that make it as comfortable to wear as it is to listen to. So if high-end sound is what you're after, audition the new flagship of our professional stereo phone line. You'll find that the Koss Pro/450 has the high-end covered. • 4129 N. Port Washington Road, Milwaukee, WI 53212. Koss Limited: Burlington, Ontario. Koss Europe: Stabio-Switzerland. For more information call 1-800-USA-KOSS. **KOSS®** stereophones

CIRCLE NO. 55 ON READER SERVICE CARD



You can have remote-controlled music in two other rooms in your house with Kyocera's RC-101 remote-control center, RT-102 remote-control unit, and RS-103 infrared sensors (above).

With Mitsubishi's Home Automation System (right), you've got complete control over your audio/video equipment, security and energy devices, and appliances.

Revox's B203 Timer Controller and B205 remote control (below) interface with MS-DOS personal computers for automated control over Revox 200 Series components.

Linn's X-Tend System (bottom) is an infrared link that can relay remote-control signals from room to room to components hidden from sight.

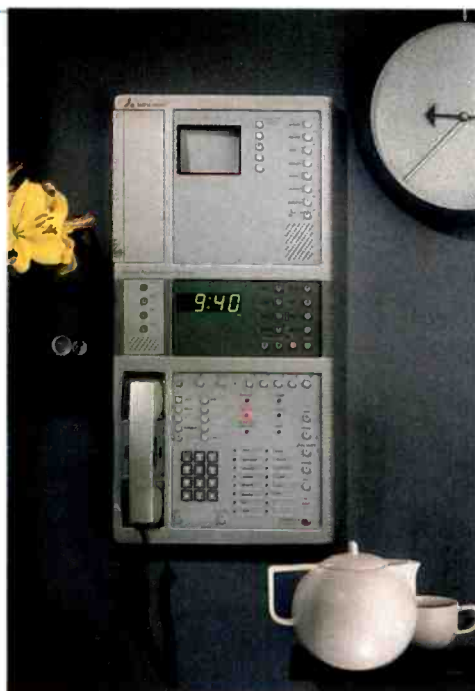

ily program virtually every function of your audio system. If you plan an intimate dinner party, for instance, you can program the music in advance, before your date arrives, to foster the mood for later in the evening. The system will switch between sources and vary the listening level at specified times. You'll still need to dim the lights manually.

A somewhat simpler system from Kyocera provides music in any room, but it has remote control from only two locations besides the main system. The system consists of the RC-101 receiving unit, with cables for each Kyocera component, the RT-102 remote-control unit, and the RS-103 infrared sensors for remote locations. The Kyocera full-system remote only operates Kyocera's top-of-the-line receiver, cassette deck, and CD player. A standard coaxial cable carries the control signals back to the main system from the remote locations.

Soundstream, until recently best known for its automobile sound systems, drives home its reputation with the System-1 "Simul-Source" multiroom remote-control network. The system consists of the C-1 audio/video preamp, DA-1 power amp, T-1 tuner, R-1 universal remote control, and soon-to-be-released remote sensors. With the full system, you can simultaneously feed any of seven audio and video components connected to the C-1 to as many as six different locations, or you can feed up to six different programs to different rooms. You can also add speakers in additional rooms, but without the control flexibility. You can listen to the main system in any room outfitted with remote sensors and amplifiers through your choice of speakers.

For example, Soundstream suggests that you could watch and listen to a videodisc on a large-screen TV set in the den, where the main system is located, while simultaneously playing FM music in the living room, a VCR through a TV set in the master bedroom, a CD in the second bedroom, a cassette in the dining room, and a different tape on the patio. Soundstream emphasizes that all of the source components can be different brands. The R-1 remote can learn nearly any company's infrared command signals.

Audio Design Associates (ADA) of White Plains, New York, markets primarily to the custom installer, so it's unlikely that you'll see much of

# Designing For Great Sound!



**P**aul Barton has centered his life on the real sound of music. As a symphony violinist, recording studio founder and Canada's foremost loudspeaker designer, the accurate reproduction of music is simply his highest priority.

PSB speakers are Paul Barton's signature. Therefore they must meet the high standards defined in the PSB design criteria:

**Performance:** accuracy, neutrality, powerful bass, freedom from resonance.

**Appearance:** fine craftsmanship in graceful cabinets that occupy minimum floor space.

**Value:** knowing through experience the balance required to achieve the best sound your dollar can buy.

**Reliability:** rigid quality standards, high power handling systems.

The latest PSB designs have been developed as a result of extensive studies in advanced materials and technologies including reaction molding and mineral filled polypropylenes. From the flagship model STRATUS to the newly introduced CIRRUS and MKII series, PSB speakers continue to be designed for one purpose and one purpose only...the real sound of music.

For your own copy of "Choosing and Using Loudspeakers" and the name of the PSB dealer nearest you call or write.

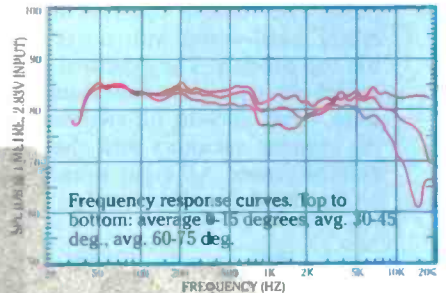

**psb**  
SPEAKERS

In the U.S.A.: Lincolnwood Ltd. 575 University Ave. Norwood, MA 02062 (617) 762-7450

In Canada: Lenbrook Industries Ltd. 633 Granite Ct. Pickering, ON L1W 3K1 (416) 831-6333

In Bermuda: Sound Advice Hamilton (809) 292-5500

the company's equipment on your local dealer's shelf. ADA designs only multiroom systems with audio and video switching. For example, the System 818 consists of the DSP-8 digital switching preamp, the MRA-808 multiroom power amp, the CPC-1 Central Program Controller, the ASU-10 AC-power switching unit, an MC-1600 remote control or MC-1700 deluxe controls for each room, and the appropriate wiring. Larger and smaller systems are also available. You choose the audio sources that feed the system. ADA offers its own tuner, equalizer, and series of power amplifiers for the main and remote systems, but any brand of source component will work. The remote locations need only speakers and remote terminals since the master multichannel amplifier provides the power.

The ADA IMC-85 Integrated Media Controller goes a step further by combining all cable and audio/video signals to your VCR's, monitors, and TV sets. It can switch up to eight audio/video inputs to any of eight audio/video outputs as well as three cable inputs to any of five cable outputs. The remote controls may be either hard-wired wall units or table-top models. They control source selection, transport functions, volume, tone, and on/off switching for the remote speakers and the main system power. All eight sources can be operated simultaneously.



**A**UDIOPHILE SYSTEMS, located in Indianapolis and best known for U.S. distribution of Linn products, has designed a simple, functional system called "X-Tend." It's an infrared extender that transmits commands back to the main system from other locations in the home. It works in conjunction with the Linn LK-1 preamp and matching power amp. Because the LK-1 includes an isolated tape-out function, you can listen to one source in the main listening room and a different source at one or several remote locations. Each remote location requires its own integrated amplifier and speakers. Any integrated amplifier will suffice, and using an integrated amp permits independent manual adjustment of tone and balance in each room.

Any brand of source components can be connected to the Linn preamp as long as they can be con-

trolled with an infrared remote. Audiophile Systems recommends purchasing a universal remote control that can learn the commands for the LK-1 and the source components you've chosen. It suggests the magnificently versatile but infuriatingly complex Core CL-9 (assuming you can get someone knowledgeable to program it).

Mitsubishi also makes the Core CL-9 the centerpiece of its audio/video remote-control system, which is only part of its larger home-automation system. Mitsubishi designed a custom interface between touch-tone telephones and the CL-9, and a telephone is used to control many of the functions of its system. You can call from anywhere in the world to program your VCR or to turn on the stereo system at 2 a.m. in order to drive your neighbors crazy or fool the local burglar into thinking you're home.

As currently designed, the Mitsubishi home-automation system doesn't offer speaker switching between rooms. You'll need to wire each room for sound in addition to the wiring for the home-automation system. Mitsubishi is investigating including whole-house audio/video switching in its future systems. In any case, you won't need to carry around a remote for the rooms you do wire since the audio (and video) can be controlled from any touch-tone phone.

Bose has attacked sound in every room from an acoustical standpoint. While most companies devoted their attention to the intricacies of remote control, Bose concentrated on the sonic aspects. The Bose Acoustimass Music System is based on the AM-5 three-piece speaker system, which uses two pairs of tiny cubical satellite speakers for the mid and high frequencies and a unique box for the bass. The diminutive, easily hidden Acoustimass bass module provides extended bass to supplement the unobtrusive satellite speakers, which can be mounted on a wall or shelf with a bracket or installed on a lighting track. Bose determines the optimal position of these speakers for each installation with a special computer program. A hidden amplifier powers each system. For places where the bass module is impractical, Bose compromises by offering its 102-S/E and 102-FB "background" speakers.

A flush, wall-mounted version of

the electronics in Bose's Acoustic Wave Music System forms the center of the system. It includes a tuner and a Sony D-15 CD player, but you can also select your existing audio system as a source. Bose intends to provide a more versatile, multifunction whole-house remote control for the system in the near future. For now, users must be satisfied with hard-wired independent volume controls in each room. The Bose Acoustimass Music System can be installed in older homes, but it is marketed mainly to builders of new homes by NuTone, a company that has specialized in wiring homes for such things as doorbells and furnace controls.



**I**N Japan, Misawa Homes, famous for its high-quality, even luxurious prefabricated homes, has designed an advanced home-automation system that includes hidden speakers in the walls of most rooms. Misawa provides a rudimentary audio system with the speakers, but people who want to upgrade have to buy B&O components, since that is the only brand of equipment compatible with the Misawa system.

All of the systems discussed here require some degree of professional installation. Fishing wires through walls demands not only competence but finesse. In many areas it also means hiring a licensed electrician to comply with building and fire codes. For music everywhere, your best bet is a good audio/video dealer who specializes in custom installation. Once you've destroyed a few feet of dry wall, you'll agree.

Having music at your fingertips, wherever you may be, yields almost indescribable pleasure, similar to what you probably felt when you connected your first stereo component system. Someday in the future, complete home-automation systems will connect and control all our electronic equipment and appliances. You can enjoy the essence of such a whole-house system today with these audio and audio/video systems. Not only are they better than a single radio in a courtyard, but they're more convenient and less expensive than a component system in every room. □

*Rich Warren is audio columnist for the Chicago Tribune.*



# HAPPY HOUR FOR YOUR EARS.



This could be the most important hour of your day. So don't leave anything to chance. Make sure you have the right company, the right music and components from Sherwood.

Because Sherwood's audio components combine the right balance of state-of-the-art electronics and legendary design for superior music reproduction.

They even feature theater-like *Dolby® Surround Sound* for a true-to-life musical experience. And our components are compatible with our exclusive *DIGI-LINK™* wireless remote, which allows you to command your entire Sherwood system from a single remote control.

But all you need to know is Sherwood lets you hear your music the way you want to hear it. So when it's time to unwind, treat yourself to a Sherwood.



RA-1340R



**BECAUSE YOUR MUSIC COMES FIRST**  
CIRCLE NO. 103 ON READER SERVICE CARD  
13845 Artesia Blvd. Cerritos, CA 90701  
©1988 Inkel Corporation  
Dolby is trademark of Dolby Laboratories Licensing Corporation.

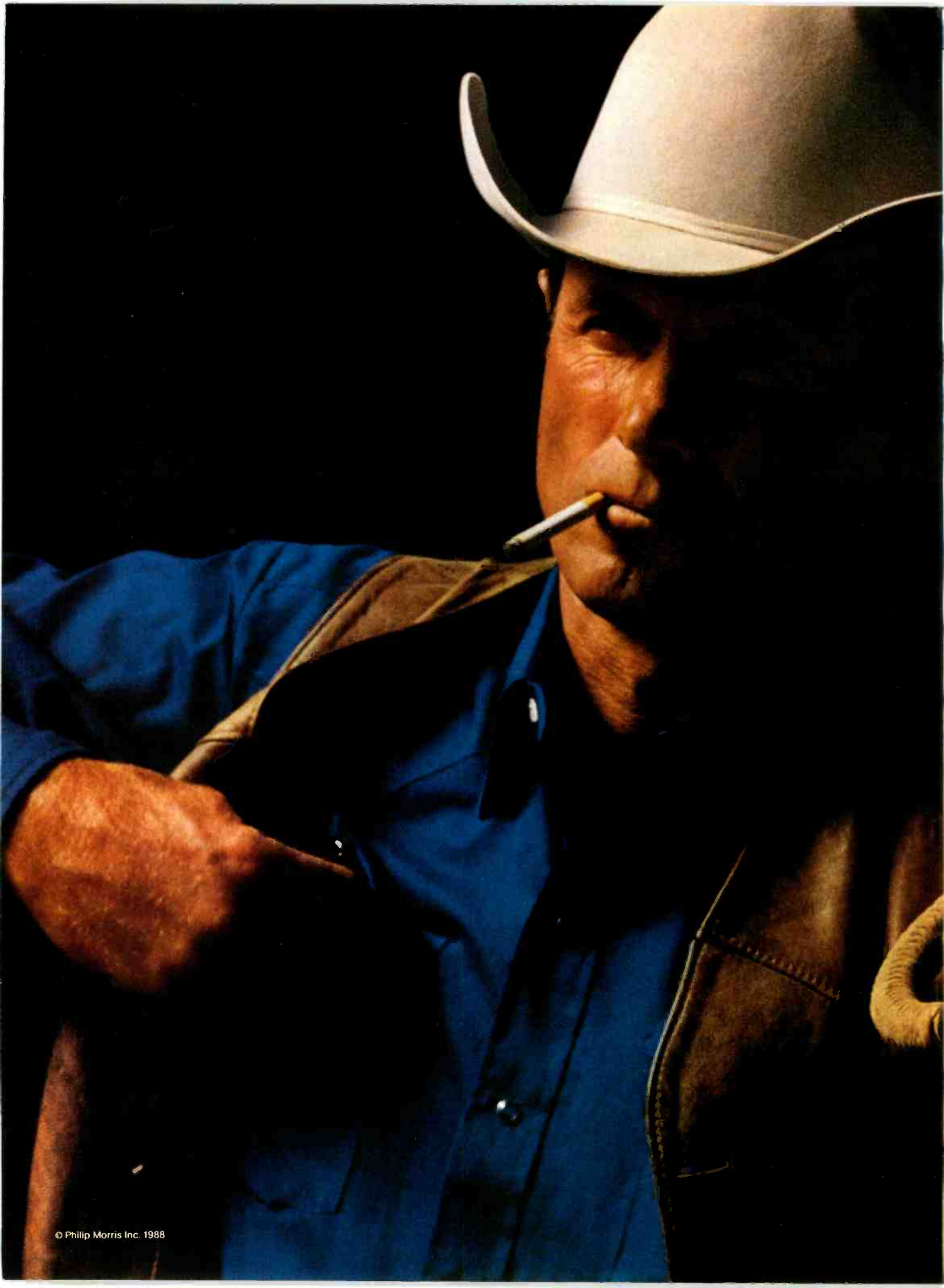

# Come to where the flavor is.



Marlboro Red or Longhorn 100's—  
you get a lot to like!

SURGEON GENERAL'S WARNING: Cigarette  
Smoke Contains Carbon Monoxide.

16 mg "tar," 1.0 mg nicotine  
av. per cigarette, FTC Report Feb. 85

# THE SMITHEREENS

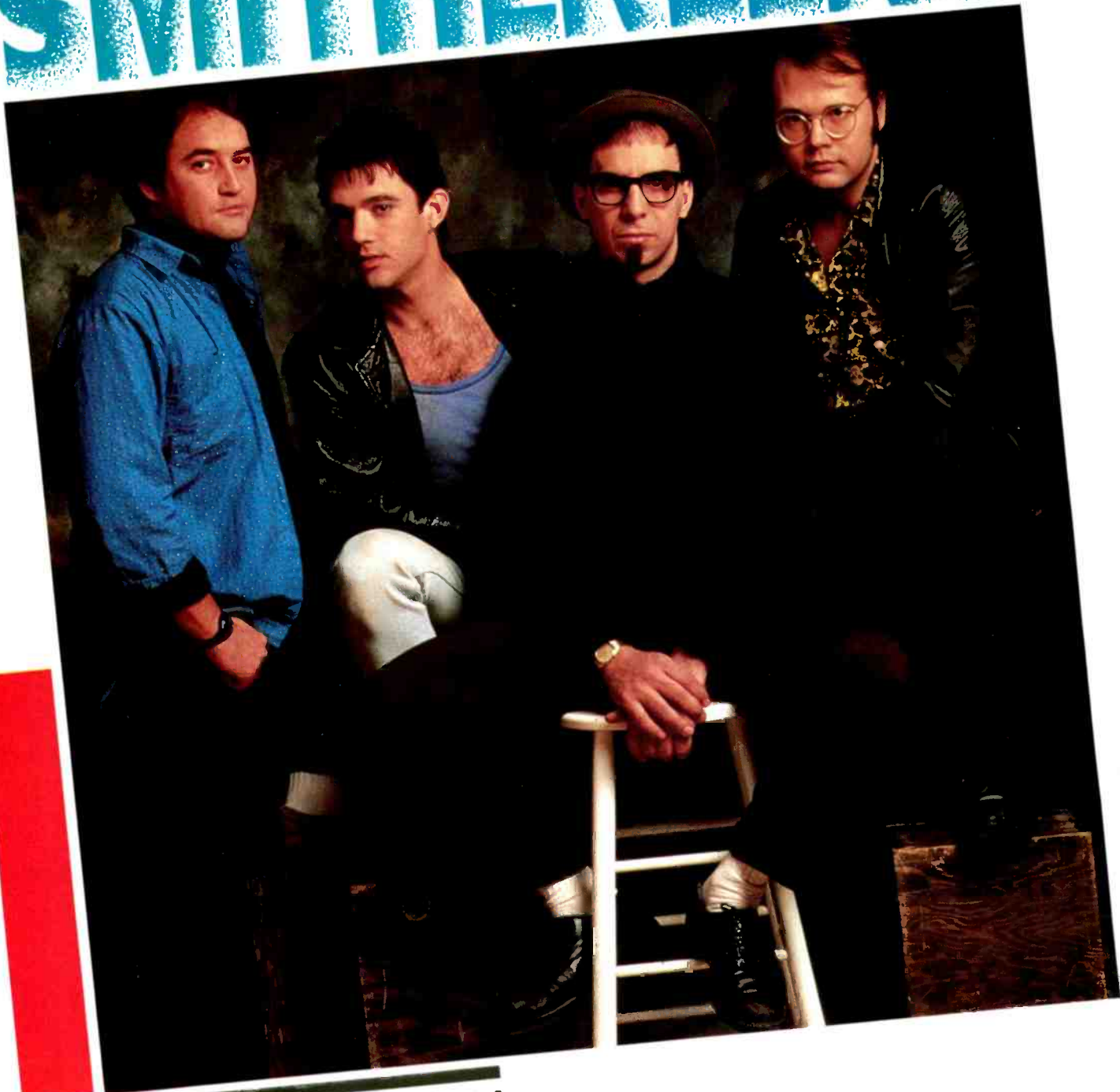

BY STEVE SIMELS

**"We have never made a conscious attempt to be a Sixties band. All we're trying to do is bring back the spirit."**

**D**OESN'T it seem, in retrospect, that the Eighties have been the least thrilling decade for commercial popular music since—well, since the Seventies? Look at what happened. Punk got co-opted almost immediately into safe, inoffensive, mostly unmemorable New Wave. And since then, apart from that Jackson kid, U2, and rap, there really hasn't been much above-ground stuff worth discussing.

That's one reason I'm so thrilled by the success of the Smithereens. That these guys have actually sold records on a major label—"Green Thoughts," on Capitol—proves that talent, an unwillingness to pander, a fondness for loud guitars, and an appreciation for rock-and-roll past and present are not totally out-moded.

In any case, I recently caught up with Pat DiNizio, head Smithereen and the band's principal songwriter. It was the first lengthy chat I'd had with him since the band broke on MTV, and I was curious to see if success had changed him. (Apparently not much. We chatted in a Ukrainian restaurant where the most expensive item on the lunch menu was \$4.)

But first a little background. The Smithereens—DiNizio, guitarist Jim Babjak, bassist Mike Mesaros, and drummer Dennis Diken—began playing their brand of formalist Sixties-influenced pop-rock professionally around New York City in the early Eighties. Much scuffling ensued, including a year as back-up band for Elvis Presley songwriter Otis Blackwell, and an independent mini-album, "Beauty and Sadness," got them a rave review in *Rolling Stone*, but not much else. Finally, in late 1985, the then-fledgling independent label Enigma, distributed by Capitol, took a chance on the band and released their "Especially for You" album. MTV picked up their video for *Blood and Roses*, the album began to sell, and the rest, as they say, is history.

When I talked to DiNizio, the group was in the middle of a tour, which would take them through the end of the year, to promote "Green Thoughts." A little tired from a show shared with Squeeze the night before, DiNizio was nonetheless eager to talk about his music and the changes in his life and in the band. And I was delighted to find that he was every bit as perceptive an observer—of both his band and the pop scene in general—as ever.

All four Smithereens grew up in New Jersey, DiNizio in Scotch Plains and the other three in Carteret. "I'd been playing guitar since I was seven," DiNizio told me, "and my high-school bands did things like Hendrix, Sly, and the Who, all the stuff that was popular around the Woodstock era. Eventually that evolved into my becoming a guitar player in the style of Jeff Beck or Tony Iommi of Black Sabbath."

I looked at him incredulously. DiNizio a heavy-metal guitarist?

He laughed. "Oh, yeah, I was in power trios, doing stuff like Uriah Heep and Budgie. Actually, I went through various phases. I played what used to be called jazz rock; I even took drum lessons from Tony Williams, who played with Miles Davis. So I'd been through every possible kind of thing in terms of band experience, whereas the other guys only had the experience of playing with each other.

"But the music I really loved, the music I grew up with, was mainly Sixties AM pop radio, which is the primary influence now on the sound of the band. Where my heart was in terms of songwriting was always Brian Wilson, Holland-Dozier-Holland, Burt Bacharach, Lennon and McCartney, Buddy Holly—that sort of thing."

Considering how good the band was already at "that sort of thing" when I first heard them at the Greenwich Village club Kenny's Castaways in 1981, it's hard to understand why it took them so long to break through. "The sad truth

was," DiNizio said, "that no one else in town would book us. Don Hill at Kenny's was the only guy who thought the band had potential. I mean, we tried to get other gigs, but we were never quite fashionable enough in terms of image or sound. We didn't fit into the scene, if only because we all still lived in Jersey at that point."

Ultimately, though, Enigma came through. DiNizio had sent a cassette demo of *Behind the Wall of Sleep, Blood and Roses*, and a few other songs to the record company, which had been recommended to him by a friend.

"At that point in my frustration," DiNizio said, "I sent the tape with just the name of the band and my phone number—no press information, no photo, nothing at all. To my astonishment, a week later the phone rang, and it was someone saying they wanted to sign us. We signed the contract before they saw us perform live. I think people were actually in shock that we got a record deal. Suddenly a lot of people who had rejected us came crawling out of the woodwork."

**H**OOKING up with producer Don Dixon, the Smithereens recorded "Especially for You" for Enigma at the Record Plant in New York City in December 1985. It took ten days, including the mixing, and cost a total of \$12,000—an unbelievably low figure at a time when the cost of a record can zoom into the high six digits. And the band's second full album, "Green Thoughts," DiNizio told me, "was recorded and mixed in sixteen days, with no preproduction at all. We did it at the Capitol Tower in Los Angeles, more for personal reasons than business reasons. I mean, it's the studio where Brian Wilson produced the early Beach Boys records."

DiNizio's reference to old Beach Boys records reminded me that one of the things I've always loved about the Smithereens is that they have the coolest repertoire of ob-

"In the old days I was writing from inspiration. Nowadays, I have to be more craftsmanlike."

scure cover songs in the business, including *Lust for Life* by Iggy Pop, *Ruler of My Heart* by Irma Thomas (which Otis Redding redid as *Pain in My Heart*), the surf tune *Miserlou* by Dick Dale, an instrumental version of *Harlem Nocturne*, and *Psychodaisies* by the Yardbirds.

"Depending on our frame of mind," DiNizio said, "we still do songs like that as encores. Lately we've been doing bits of Black Sabbath's *Iron Man*, and Jimmy sings the Kinks' *Death of a Clown*. Matter of fact, our first single in the States has a B-side cover version of the Who's *The Seeker*, which we're kind of proud of. Of course, the reason we know all of them is that in the old days we didn't have enough original material for an entire set."

Since none of these guys look like conventional pop stars, it's kind of ironic that their career as a band was helped by a video. But according to DiNizio, "It was timing and a fair amount of good luck. Actually, before we got signed, we had already been in a movie called *Class of Nuke 'Em High*. We played the live band in a disco scene. We did our bit and then forgot about it. Two years later, it turned up on cable television.

"Anyway, right after we got signed, Enigma worked out a distribution deal for soundtrack albums with Cannon Films. Cannon was producing a sort of serious film about adolescence (*Dangerously Close*) that was being marketed as a teen-exploitation movie, and they were putting together a soundtrack. The wife of the lawyer for Cannon heard *Blood and Roses* on a prerelease cassette and liked it. They played it for the director, and he liked it. So Cannon Films decided to do their first—and only—music video."

The Smithereens often get tagged as Sixties revivalists, sometimes as a putdown, but DiNizio doesn't buy that. "We've certainly worn our influences on our collective sleeve openly and proudly. But we have never made a conscious attempt to be a Sixties band. A lot of the groups in



VANESSA ADAMS

the so-called Paisley Underground and some of our contemporaries in New York were certainly more adept at bringing back the Sixties sound and image than we were. Obviously, we were doing something a little more timeless.

"I mean, look, anybody who's writing songs can't ignore the considerable influence of Lennon and McCartney, or Ray Davies, or any of the pre-eminent songwriters of the Sixties. Looking at the history of pop music of the last thirty, thirty-five years, and looking at songwriters who write in the style that I prefer, which is the classic three-minute pop song, you have to look at the Fifties and the Sixties, not the Seventies and Eighties. And all we're trying to do is bring back the spirit, the joy we felt listening to the music of that time."

Rock-and-rollers get a lot of flack these days if they're seen as careerists, so I asked DiNizio if he could see himself still doing this twenty years from now.

"There are people who are still doing it—the Kinks, Peter Townshend, even Brian Wilson. Who

knows? I mean, we're already nearing ten years together as it is. It only looks like a new band on the outside.

"My only ambition is to keep writing songs, to get better at it. It's a little tougher now. In the old days I was writing from inspiration. If I was inspired or had a particularly memorable melody, I would put it on tape, and it would evolve into something. There wasn't any pressure to write. Nowadays, there's a self-imposed pressure. I have to be more craftsmanlike in my approach, actually sit down and work on it. Because if you wait for inspiration, often you don't write a song for two years—which is what happened between 'Especially for You' and 'Green Thoughts.'"

He grinned. "I mean, if you're viewed by others as somebody who's supposed to be a professional songwriter, and you haven't written a song since 1985, you begin to have doubts."

Well, since they're pros, I wondered, have they ever indulged in any typical "rock-star behavior"?

DiNizio rolled his eyes sheepishly. "Once. We wrecked one hotel in Vancouver. We tried to throw a couch out the window, but it wouldn't fit—typical Smithereens bad luck, right? Anyway, we woke up after our drunken excess, and Jimmy and I stared at the smashed room around us, and we immediately picked up everything broken, stacked it in a closet, closed the door, swept up the room, and hoped nobody would notice.

"But that was it. The thing is, we feel a tremendous obligation to our audience to do our best. We're not jaded. The work is still very special—although you can get jaded sitting in a bus for eight hours a day, going to a town and not being able to see it because you have to go right to a gig. That aspect of it does get tiresome. But we have to appreciate what's going on; after all, so many of our friends have been trying for years to do what we're doing. That's not lost on us. It's really a gift, a ridiculous thing." □

# BACK TO THE FUTURE



At Marantz, we believe quality equipment should not become obsolete every six months. Which separates the Century Series of audio products from every other line on the market. Quite simply, our back is your system's future.

Introducing ESL, Environmental Sonic Linking. This exclusive Marantz achievement lets your system adapt to whatever technology comes down the pike. With more (and smarter) input/output devices than you'll find elsewhere at any price. ESL marks the end of audio obsolescence.

The Century SR3600 is a receiver so in tune with today's needs, you can build your entire entertainment system around it. It links the classic Marantz legacy of quality construction and unmatched audio purity with the futuristic world of advanced high-current electronics.

Imagine. Processor loops that can be inserted before or after the volume control. FM cable input, bridgeable power supplies, 20 AM/FM presets, even a Dolby Surround Sound processor. All in a powerful, 120 watt per channel receiver. With other models ranging from 110 to 35 watts.

It's the most realistic home theater experience you can imagine. Without compromising the purity of the audio signal. Without limiting the high transient current efficiency (TCE) so necessary for top speaker performance. And without making our front side look like Tokyo at night.

Audiophiles, your day has come again. From an American company that believes in traditional values like performance, reliability and the use of discrete components. Come back to the future. With Marantz.

**marantz**

20525 Nordhoff St. □ Chatsworth, CA 91313-2577  
Phone: 818-998-9333 □ Fax: 818-998-5475

CIRCLE NO 53 ON READER SERVICE CARD

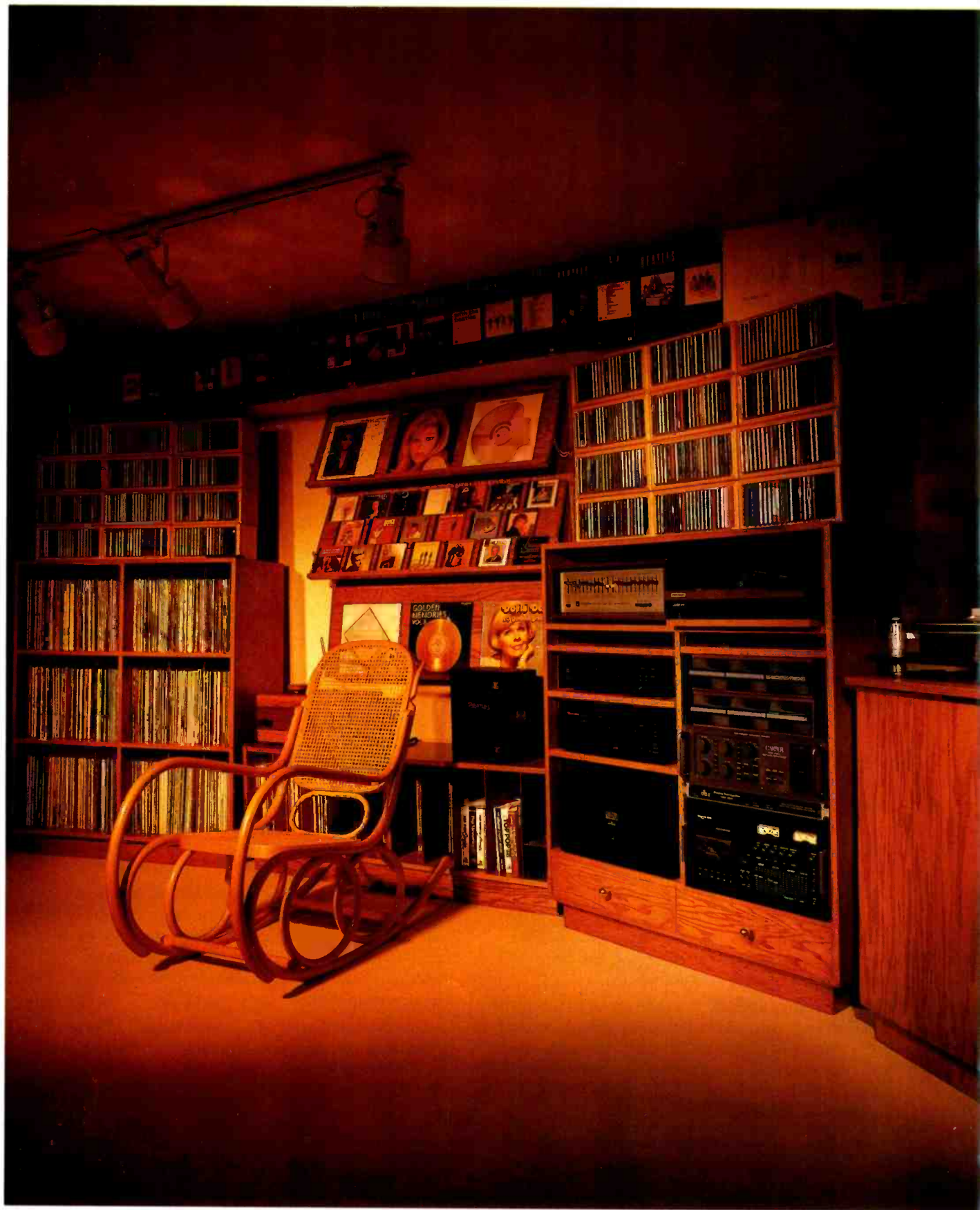



# SYSTEMS

A holographic heaven in Canada

by Rebecca Day

**Y**OU might call Dr. Joseph Lee of Toronto an audio pack rat. He has a tough time parting with old equipment when he upgrades to the state of the art, so instead he finds new uses for his older gear. When he decided to replace his two Carver M400a amplifiers, for example, he "retired" them to a video room where they now drive a pair of Magneplanar MG IIC front speakers, a central Dynaco A25 speaker (also a former part of the audio-room system), and a PSB subwoofer. He's even managed to find a job for his old Pioneer PL-51 turntable: It's used to play 45's and less-than-perfect LP's that friends bring to his house to audition his sound system.

Lee's pride and joy is his audio room or, as he calls it, his "holographic heaven." A custom-built, oak-veneered cabinet holds the heart of the system: a Carver M4000 Sonic Holography preamplifier. Also part of the main system are a Denon DCD-3300 CD player, a Nakamichi Dragon cassette deck, a Nakamichi 1000 dubbing deck, a

dbx Model 224X decoder (which Lee uses for his esoteric collection of ten dbx-encoded records), and a Soundcraftsman RP2212 graphic equalizer. Powering the system is a 120-pound, 200-watt Mark Levinson ML-3 amplifier, which drives a pair of KEF 105.2 speakers. Cabling is also by Mark Levinson.

Firmly planted against one wall of the hallowed audio room is another oak-veneered cabinet, which Lee filled by hand with cement blocks and 400 pounds of fine sand to reduce vibration. On top of the cabinet is an Oracle turntable with a Fidelity Research Silver tonearm and an Ortofon MC2000 cartridge.

Evidence of a satisfied audiophile, Lee's next project is to store information about his 750 CD's and thousand-plus LP's on a computer disk. One of his primary concerns is knowing which version—CD or LP—of a particular recording is better. With all of that information immediately available from his computer, he says, "I'll know exactly where to find it." □



RONALD BAXTER-SMITT

PIONEER

POWER MODE STEREO  
REV. INC. REV. F. +10 -100dB  
PHASE LOW F. SCALE  
+10 -100dB OFF 120  
FREQUENCY MID FREQUENCY  
-30dB +30dB OFF 3K 3K  
PHASE HIGH

PIONEER MULTI-CD CONTROL TUNER DEH-4000

FUNCTION ON/OFF VOLUME +/-  
BASS TREBLE  
BAND SEL. REV/ON PWR/UP  
1 2 3 4 5

INPUT LEVEL 2V 0.2V  
LOW BOOST LFP MODE LOAD IMPEDANCE  
OUT IN OUT IN 2CH 1CH 4Ω 8Ω

120 250 500 1k 2k 4k 8k 16k  
SUBWOOFER  
SUBBASS PHASE LEVELS  
OFF ON  
REV. +10 -10

# What To Look For In A High-Performance Car.

## INTRODUCING A COMPLETE LINE OF HIGH-PERFORMANCE AUDIO COMPONENTS FROM PIONEER.

This isn't a story about horsepower, torque, or coefficient of drag.

It's an inside look at a new line of car audio components from Pioneer so technically advanced it gives new meaning to the term "high-performance sound."



Tuner/6-disc CD Changers

Superior audio performance starts with the cleanest possible source. Like Pioneer's versatile new multi-play CD changer system with detachable controller. It features 6-disc magazine programmability, compact 3-beam laser pickup, 2X oversampling digital filter, and the incomparable sound of a Quartz-PLL Supertuner III.\*



Graphic Equalizers

We've designed our 9-band graphic equalizers with efficient low-noise circuitry so they don't add extraneous colorations to the signal. Controls are ergonomically designed for fast, precise operation.



Active Crossovers

Our new 2- and 3-way crossovers with adjustable crossover points provide optimum design flexibility. Selectable phase

controls permit precise adjustment of system phase characteristics. These crossovers are so remarkably clean, you can use them in series without altering the source signal.



Power Amplifiers

These high-powered bridgeable amplifiers are specially engineered with high-speed MOS-FET transistors for a truer, more musical sound. They feature PWM power supplies to provide a steady signal and internal fan cooling for reliable operation.

Pioneer offers a complete range of component speakers, including super-tweeters, tweeters, midranges, woofers, and subwoofers.

These high-fidelity speakers feature patented laminate cone construction and double damper design to neutralize resonances that interfere with accurate tonal quality. And efficient barium ferrite magnets take advantage of digital music's full dynamic range.

And to ensure the highest standards of quality and product reliability, we manufacture every element that goes into our speakers ourselves.

Now the first name in car audio is the last word in high-performance. Pioneer.



Pioneer Component Speakers



# PIONEER®

Models shown: DEX-M300/CDX-M100 Tuner/6-disc CD Changer, EQ-5090 Graphic Equalizer, CD-630 Active Crossover, TS-F87 3/4" Component Tweeter, TS-M120 5" Component Midrange, and TS-W300 12" Component Subwoofer. © 1988 Pioneer Electronics (USA) Inc., Long Beach CA

CIRCLE NO. 89 ON READER SERVICE CARD

# HOLOGRAPHIC SOUND



image



## CLOSE YOUR EYES...

Step beyond a fourth dimension where picture perfect sound is the only reality. Experience the ultimate live performance in your own living room.

Introducing HOLOGRAPHIC SOUND from IMAGE! Your doorway to great musical performances of past, present, and future has finally been opened. From the threshold of Sound Engineering Excellence, IMAGE captivates you with brilliant performances of listening pleasure.

— IMAGE — a product so special that simply owning it says you recognize the utmost in quality. The objective of the IMAGE Acoustical Engineers was to create a line of loudspeakers that would further the integrity of reproduced sound. Our **Commitment to Excellence** with constant improvement and innovation is the driving force behind IMAGE.

### THE HOLOGRAPHIC "IMAGE"

Instead of taking a back seat to the live musical performance, HOLOGRAPHIC SOUND from IMAGE makes you feel like a participant. Music has been given a 4 - Dimensional depth and clarity that is unwavering both on and off-axis. True, vibrant sound 'appears' in your listening window right out of thin air. HOLOGRAPHIC SOUND from IMAGE - for musical coherence and accuracy the name says it all!

CIRCLE NO. 47 ON READER SERVICE CARD

135 Torbay Road, Markham, Ontario, Canada L3R 1G7 (416) 475-0050 Telex 06-986689 Fax (416) 475-8643



image

## BEST RECORDINGS OF THE MONTH

*Stereo Review's critics choose the outstanding current releases*

### CINDERELLA RECASTS HEAVY METAL

**H**EAVY metal, like the blues that inspired it once upon a time, is a narrow genre. If you refine it too much, the music sounds like an arrangement of clichés. Once that happens, tighter playing or louder volume or flashier trashing cannot help. Most bands, however, don't have the imagination and courage to work outside the basic formula as it now exists. That's why Cinderella's second album, "Long Cold Winter," is special. The band has gone back to heavy metal's original elements—

blues and hard rock—and recast them in a powerful new alloy.

By looking backward, Cinderella risked sounding derivative. In fact, the new album contains a guitar solo that could have come from the Rolling Stones, a rhythmic shift that would have done Led Zeppelin proud, a crunchy tempo that's the essence of Aerosmith. But the music in "Long Cold Winter" is so rich that these references become the equivalent of quotations in an eloquent essay—sources of inspiration for the fresh developments that follow. The album begins with just such a reference: a brief blues sung to the sole accompaniment of acoustic bottleneck guitar. This tune, *Bad Seamstress Blues*, segues into a bluesy rocker, *Fallin' Apart at the Seams*, that features an electric bottleneck solo. Past and present come together in a thunderclap. The band shows the confidence of its convictions elsewhere, too, shifting effortlessly from one tempo to the next through song structures that,

for heavy metal, are fairly sophisticated. The rhythms are fluid and the solos are economical. Cinderella doesn't waste time or notes.

Cinderella's lead singer-guitarist, Tom Keifer, wrote the songs in "Long Cold Winter." His lyrics don't equal the sophistication of his music, but they show uncommon sensitivity for a heavy metalist. "I can't feel the things that cause you pain," he sings at one point. Keifer does his share of strutting here, but he isn't afraid to think sometimes, too. He may not be mature, but he is maturing. He and his band should only get better. *Ron Givens*

**CINDERELLA:** *Long Cold Winter.* Cinderella (vocals and instrumentals); other musicians. *Bad Seamstress Blues; Fallin' Apart at the Seams; Gypsy Road; Don't Know What You've Got (Till It's Gone); The Last Mile; Second Wind; Long Cold Winter; If You Don't Like It; Coming Home; Fire and Ice; Take Me Back.* MERCURY 834 612-1, © 834 612-4, © 834 612-2 (44 min).

*Cinderella: a powerful new alloy*



JIMOHY WHITE/POLYGRAM

### THOMAS'S ALL-AMERICAN IVES

**T**HE music of Charles Ives is one of the things Michael Tilson Thomas does best. His authority and enthusiasm have been apparent in his ongoing Ives cycle for CBS, but perhaps never quite so powerfully as in the newest installment, a magnificent performance of the *Holidays* Symphony with the Chicago Symphony Orchestra. As with the earlier releases, Thomas uses the Charles Ives Society's new critical edition of the score, and it is especially good to find him working this time with one of the great American orchestras instead of a European ensemble.

Ives said that his four holiday impressions—*Washington's Birthday, Decoration Day, The Fourth of July*, and *Thanksgiving and/or Forefathers' Day*—could be played separately or "lumped together to make a symphony." When "lumped together" they constitute a peculiarly American notion of the four sea-

## BEST RECORDINGS OF THE MONTH

sons, and at the same time a sort of Ivesian counterpart to Smetana's *Má vlast (My Country)*. The music is by no means mere patriotic ritual, but it seems to call for American voices, for musicians who share the idiom. In the haze that frames some of the reminiscences, the raucousness emerging from that haze in *The Fourth of July*, and, most strikingly, the entrance of Margaret Hillis's wonderful chorus at the end of *Thanksgiving*, the impact of this performance is quite beyond description.



Thomas: *New England Holidays*

The recording is filled out with the very seldom-heard *Central Park in the Dark* and, framing that performance, both the revised and the original versions of the better-known piece with which Ives originally paired it, *The Unanswered Question*, with the perdurable Adolph Herseth in the trumpet solos. CBS has put all of this in a marvelously realistic sonic frame—it is one of the best-sounding orchestral recordings yet to appear on this label—and the authoritative annotation by Paul C. Echols (one of the editors involved in the preparation of the scores) not only puts an imprimatur on the package but is a valuable part of it. *Richard Freed*

**IVES:** *A Symphony: New England Holidays; The Unanswered Question (two versions); Central Park in the Dark.* Chicago Symphony Chorus and Orchestra, Michael Tilson Thomas cond. CBS ● M 42381, © MT 42381, © MK 42381 (63 min).

## DWIGHT YOAKAM: DIGNITY AND GRACE

**I**N his first two Warner Bros. albums, Dwight Yoakam, his voice a smooth amalgam of hiccup and twang, took the stage in his tight *concha*-trimmed jeans, swiveled his hips, and showed the world that traditional country music could be simultaneously stalwart and sexy. Critics raved about his sleek, pared-down sound—so retro-Bakersfield, and yet so hip L.A.—and young audiences saluted him for bringing style to a genre that too often forgot about such things. But underneath it all, Yoakam's records were too mannered and self-consciously crafted, if also beautiful in their production and instrumental approach. And his songwriting, even in the songs that evoked the lean, sinewy characters of his Kentucky background, seemed too sparse to achieve the full emotional directness of his intent.

Now, in his third album, "Buenas Noches from a Lonely Room," Yoakam has put aside much of that earlier posturing and bravado to concentrate on songs of considerable substance, polishing his maturing songwriting gifts until they gleam with dignity and grace. In seven Yoakam originals and four well-chosen cover tunes, the singer and his producer, Pete Anderson, who work together with symbiotic zeal, have assembled a structured song cycle about a romance that blazes and thrives at first, but then quickly turns dark and dissolves into heartbreak and tragedy. By the album's end, with the gospel-flavored *Hold On to God*, the singer promises that the suffering of the ill-fated lovers and of all other mortals on this earth will find ease in redemption and spiritual rebirth.

Pride, an essential ingredient of the rural sensibility, and its continual, gnawing grip on the hillbilly consciousness dominate the second side. Yoakam is most effective in *I Sang Dixie*, which chronicles the death of a Southerner who long ago left his native region to find pros-

perity in the city, only to discover the city's emotional impoverishment. The scene, with the narrator clutching the old drunkard as he lies dying on the street, seems pulled from vintage Porter Wagoner. But Yoakam, in his finest piece of songwriting, eschews Wagoner's raw mawkishness for compassion, dignity, and respect. It is a small kernel of truth, but a large sampling of what is noble and ultimately pure about the art of country music.

Songs such as this, and the moving *Floyd County*, which details the death of a Kentucky coal miner and recalls *Miner's Prayer* in Yoakam's debut LP, have such an impact that they tend to overshadow the two guest appearances in the album, by Maria McKee of Lone Justice (in *Send Me the Pillow*) and by Yoakam's idol Buck Owens, who joins him in *Streets of Bakersfield*. Though written by Homer Joy in 1972, *Streets of Bakersfield* nonetheless parallels Yoakam's own early days of searching for acceptance by the country-music establishment. Despite his resounding success, Yoakam has still been denied that acceptance, mainly because of his boisterous criticism of the Nashville way of doing business. The irony, of course, is that most of the Old Guard who now treat the newcomer with disdain would give their right arms to turn out an album of this depth and commercial appeal. Like Willie Nelson, Yoakam will someday have all of Nashville at his feet. "Buenas Noches from a Lonely Room," a shivering, shimmering record, shows why. *Alanna Nash*

**DWIGHT YOAKAM:** *Buenos Noches from a Lonely Room.* Dwight Yoakam (vocals, acoustic guitar, percussion); vocal and instrumental accompaniment. *I*

Yoakam: *old country truth*



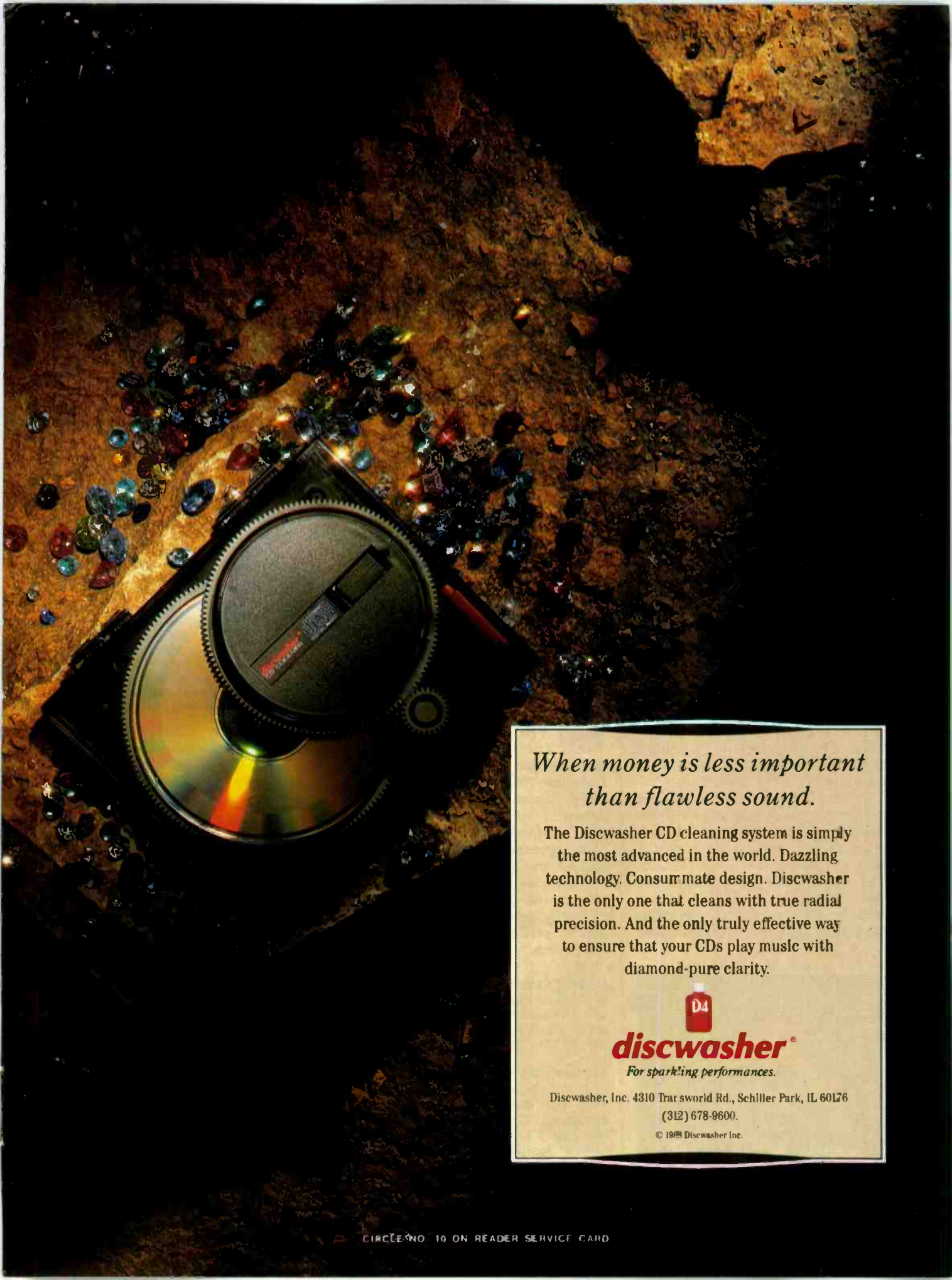

*When money is less important  
than flawless sound.*

The Discwasher CD cleaning system is simply the most advanced in the world. Dazzling technology. Consummate design. Discwasher is the only one that cleans with true radial precision. And the only truly effective way to ensure that your CDs play music with diamond-pure clarity.



**discwasher®**

*For sparkling performances.*

Discwasher, Inc. 4310 Trar sword Rd., Schiller Park, IL 60176  
(312) 678-9600.

© 1989 Discwasher Inc.

## BEST RECORDINGS OF THE MONTH

*Got You; One More Name; What I Don't Know; Home of the Blues; Buenas Noches from a Lonely Room (She Wore Red Dresses); I Hear You Knockin'; I Sang Dixie; Streets of Bakersfield; Floyd County; Send Me the Pillow; Hold On to God.* REPRISÉ 25749-1, © 25749-4 © 25749-2 (37 min).

### JÄRVI CONDUCTS SHOSTAKOVICH SYMPHONIES

**T**HE latest installments in Neeme Järvi's Shostakovich cycle for Chandos, the Symphonies Nos. 7 and 9, offer first-rate performances and interpretations in superb sound. The Seventh Symphony, the wartime *Leningrad*, fills an entire CD, and the Ninth is accompanied by a bag bag of shorter orchestral works.

Järvi's tempos for the second, third, and fourth movements of the *Leningrad* are close to those used by Toscanini in the symphony's 1942 American premiere, but the first movement, with its notorious goosestep variations suggesting the Nazi invasion of Russia in World War II, is more than three minutes faster. The music retains its impact at the faster tempo, which adds to the urgency of the movement.

In the intermezzo-like second movement, Järvi achieves an idyllic sweetness that sets off in sharper relief the sarcastic middle section with its prominent E-flat clarinet. The magnificent slow movement, one of the composer's finest achievements, comes off with all its passion, pathos, and fierceness. And

*Neeme Järvi: brilliant*



the finale conveys to the full its burden of anger, elegiac reflection, and savage triumph. The Scottish National Orchestra does itself proud throughout, and Chandos has provided fine, full-bodied sonics.

The Ninth Symphony and its accompanying works were recorded at the Henry Wood Hall in Glasgow, a brighter and somewhat more reverberant locale than Caird Hall in Dundee, where the Seventh was taped. The sound is magnificent, and the performances are brilliant.

Järvi has decidedly individual views on the Ninth, and he does not treat it as the largely frivolous makeweight it is often considered to be. His first movement is wonderfully peppery, the following moderate piercingly bittersweet. The central presto is spiky and sassy, which makes the largo fourth movement all the more poignant. The finale begins at a pace suggesting someone slowly coming out of a daze from the scarifying trauma of war. Järvi allows the music to take its time in achieving this "return to life," working up to a vibrant, celebratory close.

The enjoyable filler pieces include Shostakovich's amusingly smart-aleck arrangement of Vincent Youmans's *Tea for Two* (also called *Tahiti Trot*), the "pops"-style *Festive Overture* of 1947, and the suite from the 1962 revision of his lurid 1934 opera *Lady Macbeth of Mtsensk*, retitled *Katerina Ismailova*. The five opera entr'actes are by turns grotesquely sinister, rowdy, harshly tragic, frenetic to the point of mania, and just plain funny. The scoring and contrapuntal high jinks can only be described as devilish, and the performance does the music full justice.

*David Hall*

**SHOSTAKOVICH: *Symphony No. 7, in C Major, Op. 60 ("Leningrad")***. Scottish National Orchestra, Neeme Järvi cond. CHANDOS ● ABRD 1312, © ABTD 1312, © CHAN 8623 (69 min).

**SHOSTAKOVICH: *Symphony No. 9, in E-flat Major, Op. 70; Festive Overture, Op. 96; Suite from "Katerina Ismailova," Op. 114; Tea for Two ("Tahiti Trot"), Op. 16 (after Vincent Youmans)***. Scottish National Orchestra, Neeme Järvi cond. CHANDOS © CHAN 8587 (52 min).

### NOW ON CD Compact Discs of previously released LP's

#### POPULAR

- **JETHRO TULL: *Thick as a Brick***. MOBILE FIDELITY UDCC 510. Gold "Ultradisc" reissue. "Vigorous and adventurous" (Best of Month, September 1972).
- **JANIS JOPLIN: *Farewell Song***. COLUMBIA CK 37569. "Remarkably controlled and expressive" (April 1982).
- **JOHN MAYALL: *Archives to Eighties***. POLYDOR 837 127-2. Revision of the "Back to the Roots" project. "Ragged to rich" (July 1971).
- **LIZA MINELLI: *Liza with a "Z."*** COLUMBIA CK 31762. "Dazzling" (September 1974).
- **REO SPEEDWAGON: *Live—You Get What You Play For***. EPIC EK 34494. Recorded at Memorial Hall, Kansas City, and other locations in the mid-Seventies.
- **BOZ SCAGGS: *Moments***. COLUMBIA CK 30454. *Boz Scaggs & Band*. CK 30796. *My Times*. CK 31384. "Appealing and mellow" (April 1973).
- **STREET SCENE (Kurt Weill—Langston Hughes)** CBS MK 44668. Original-Broadway-cast recording of 1947, with Anne Jeffries, Polyna Stoska, and Brian Sullivan.
- **TRAFFIC: *Welcome to the Canteen***. ISLAND 90924-2. *Last Exit*. 90925-2. Both from the Sixties, long unavailable on LP.

#### CLASSICAL

- **ELGAR: *Symphony No. 1: Pomp and Circumstance March No. 5***. Haitink. ANGEL CDC-47673. A "loving performance" (June 1984).
- **MOZART: *Don Giovanni***. Pinza; Walter. LEGATO LCD-114-3 (three CD's). Recorded at the 1937 Salzburg Festival.
- **MOZART: *Quintet for Horn and Strings; Quintet for Piano and Winds; Sinfonia concertante (K. Anh. 9)***. Tuckwell, Ogdon. LONDON 421 393-2. Featuring "one of the finest horn players on the musical scene today" (Best of Month, April 1985).
- **PUCCHINI: *La Bohème***. Freni, Raimondi; Karajan. RODOLPHE RPC 32512 (one *mono* "double-length" CD, playing time 105 min). Recorded at the Vienna State Opera in 1963.
- **SAINT-SAËNS: *Piano Concertos Nos. 1-5***. Ciccolini, Baudo. ANGEL CDMB-69443 (two CD's). "The right blend of glitter and lyricism" (February 1973).
- **VERDI: *Il trovatore***. Caballé, Tucker; Schippers. LEGATO LCD-123-2 (two CD's). Recorded in Florence in 1968.





# FOR PEAK POWER HANDLING, YOU NEED SPEAKERS AND SUBWOOFERS THAT RISE TO THE OCCASION.

At Phase Linear, our new U.S. made graphite subwoofers and two-way speaker perform with amazing clarity, at any level.

Each is constructed, (as are all the speakers in our line) of our exclusive felted and molded graphite fiber. A material, because of its unsurpassed lightness and strength, that responds more quickly and accurately than heavier paper cones to intense fluctuations in the dynamic range and peak power levels of your amp.

The result? Car stereo music with such

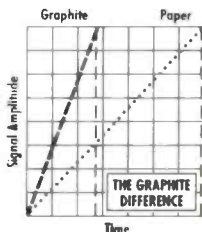

**HANDLE TREMENDOUS AMOUNTS OF POWER. TREMENDOUSLY QUICKLY.**

transient response it's brilliantly clear at rumbling lows and stratospheric highs.

**OUR GRAPHITE SPEAKERS AND SUBWOOFERS**

Both our new subwoofers, and all our speakers, boost their power handling on a moment's notice from an amp.

Our 8" PLS 800 handles 100 Watts RMS, 300 Watts Peak. Our 10" PLS 1000

an even more impressive 150 Watts RMS, 450 Watts Peak. In addition, both subwoofers have remarkable systems compatibility. Simply stated, they can be crossed over, up to 1000 Hz, to complement any other series of drivers.



This power and flexibility provide you with tremendous volume and depth of sound, as well as a tremendous variety of sound.

Our new PL 2690 6" x 9" two-way is not to be outdone, however. It handles an exceptional 80 Watts RMS, 180 Watts Peak. Plus we've built into it bi-amplification capabilities. Which means you can hook up a separate amp to each speaker for even clearer highs and lows than you'd normally get with our 2 1/2" polycarbonate dome tweeter, alone.

**THEY'RE DESIGNED TO PERFORM SUPERBLY NO MATTER HOW YOU MOUNT THEM.**

As a 6" x 9" speaker, the new PL 2690 two-way, (much lower priced than any previous Phase Linear 6" x 9") can be CIRCLE NO. 85 ON READER SERVICE CARD

mounted in almost any rear deck. Which makes it an excellent full range, or bi-amplified rear channel/rear fill/mid bass driver you can use in component systems.

Our graphite subwoofers can be mounted in rear decks, behind your seats, or in custom-built enclosures for deep rumbling bass well into the 20-30 Hz range. The graphite drivers are optimally designed for free air installations and are also great in ported or sealed enclosures if you want tighter bass response.

**WE ALSO BUILD A POWERFUL LINE OF AMPS.**

Luckily, at Phase Linear we build amps with enough power to give our speakers a good run for their money. Amps like our new PLT 150 Turbo, and its smaller companion, the PLA 15.



So if you've been thinking of buying speakers and subwoofers for your car take some time and listen to our Phase Linear line. With the right equipment, they'll not only raise your musical standards. They'll lift your spirits. On any occasion.

DIGITAL READY



© 1988 Phase Linear, a Division of International Jensen, Inc. Phase Linear is a registered trademark of International Jensen, Inc.

**phase linear**

GRAPHITE™

Making the best of sound technology.

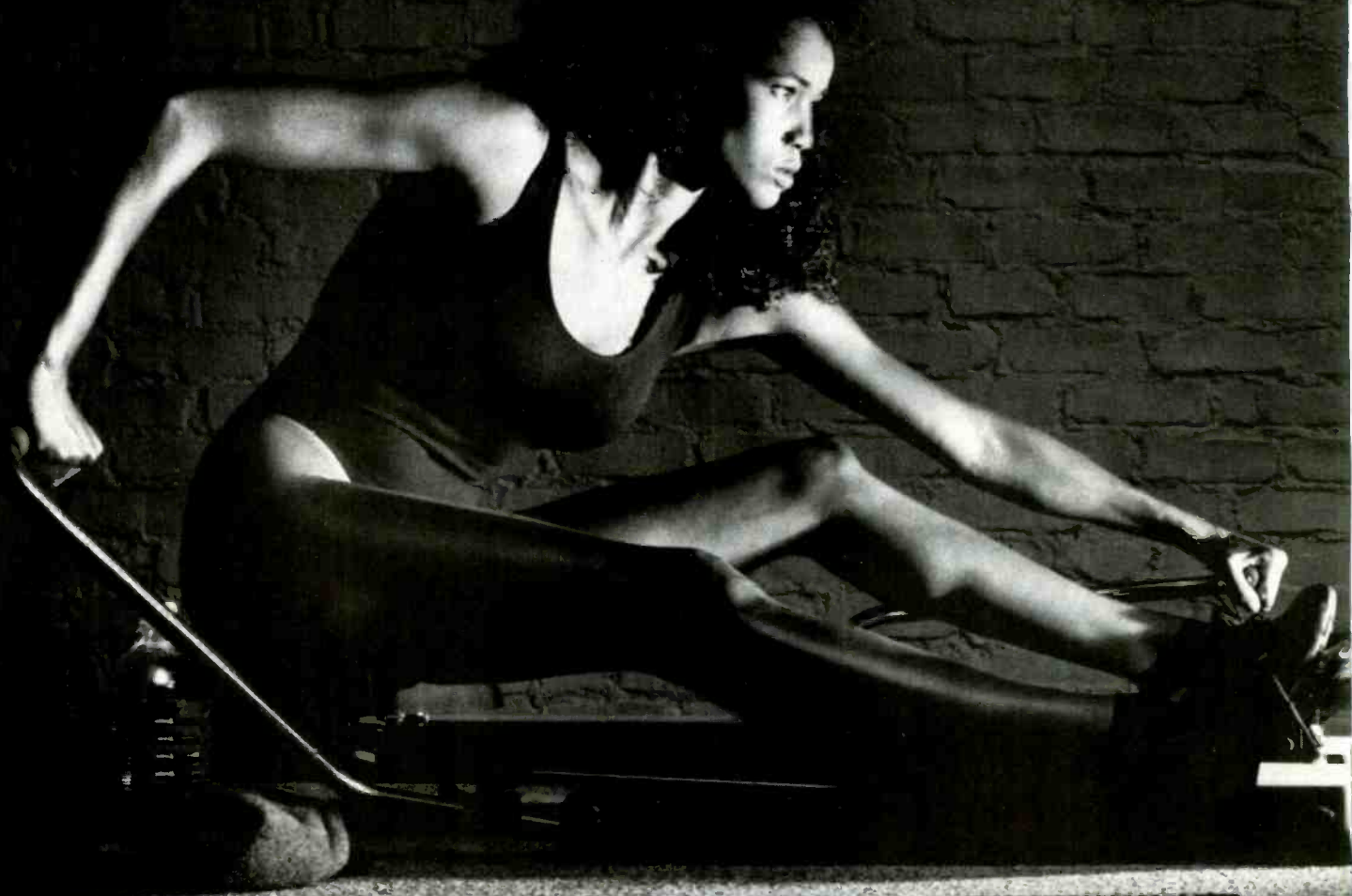

**Home Body.** This is your time. And you enjoy it most when your home entertainment system is performing at its best. Which is why Pioneer created the VSX-9300S audio/video receiver.

It actually improves the performance of *all* your components. The VSX-9300S features the latest innovation from Dolby Labs, Dolby Pro-Logic.<sup>™</sup> This surround sound experience rivals even the most sophisticated movie theaters. There is also a split-screen video enhancer that sharpens and focuses every video image. And a "Smart Remote"<sup>™</sup> control that turns your existing components into a unified A/V system.

Pioneer's VSX-9300S audio/video receiver. There is simply no better way to get it all out of your system.



 **PIONEER®**  
We Bring The Revolution Home.™

# DO SOMETHING CONSTRUCTIVE THIS WEEKEND.



Build a skill in the Army Reserve.

You can get valuable training in any one of hundreds of occupational fields. From heavy equipment to electronics.

Whether you're building a bridge, operating a 20-ton "earth mover" or repairing communications equipment, the Army Reserve gives you a chance to spend a weekend doing something out of the ordinary.

You'll usually serve one weekend a month and two weeks a year at a Reserve unit



close to home. You'll earn good pay and benefits. While you're getting the experience that can pay off in a full-time job.

If you're in high school, college or ready to start work, the Army Reserve has educational and financial assistance programs you may qualify for. With benefits that can provide a firm foundation to build your future on.

Interested? Talk to your local Army Reserve recruiter today. Or call, toll-free, 1-800-USA-ARMY.

**BE ALL YOU CAN BE.**

# ARMY RESERVE

*Discs and tapes reviewed by Chris Albertson, Phyl Garland, Ron Givens, Roy Hemming, Alanna Nash, Mark Peel, and Steve Simels*

**GREGG ALLMAN BAND: *Just Before the Bullets Fly.*** Gregg Allman Band (vocals and instrumentals). *Demons; Slip Away; Thorn and a Wild Rose; Can't Get Over You; Fear of Falling; Night Games;* and four others. EPIC OE 44033, © OET 44033, © EK 44033 (40 min).

Performance: *Strong*  
Recording: *Good*

Without a doubt, Gregg Allman is back. First with last year's "I'm No Angel," and now with "Just Before the Bullets Fly," he has produced powerful music squarely in the tradition of southern rock. The music of the Allman Brothers was a breathtaking combination of blues and rock, and its particular beauty came from the seamless way the two styles combined. The combination is just as seamless in this album as well, in the husky, expressive voice of Gregg Allman and in the rough-and-tumble songs he brings to life.

"Just Before the Bullets Fly" doesn't have the extended jams that were the hallmark of the Allman Brothers, simply because the Gregg Allman Band has only one principal soloist, guitarist Dan Toler. But he is a force to be reckoned with: His stinging leads and fluid, muscular solos kick the music into high gear. Gregg Allman has worked with two giants of blues-rock guitar, his brother Duane and Dickey Betts, and on this record Toler shows that he's clearly in their class. Together, Allman and Toler make it sizzle. *R.G.*

**PAT BENATAR. *Wide Awake in Dreamland.*** Pat Benatar (vocals); vocal and instrumental accompaniment. *All Fired Up; Let's Stay Together; Don't Walk Away; Cool Zero; Cerebral Man; Lift 'Em On Up;* and four others. CHRYSALIS OV 41628, © OVT 41628, © VK 41628 (50 min).

Performance: *Message in mind*  
Recording: *Very good*

In "Wide Awake in Dreamland," Pat Benatar, the loudest woman in rock-

EXPLANATION OF SYMBOLS:

- = DIGITAL MASTER LP
- Ⓢ = TAPE CASSETTE
- Ⓢ = COMPACT DISC (TIMINGS ARE TO NEAREST MINUTE)

ROMANTIC RANDY TRAVIS

As a boy growing up on a Marshville, North Carolina, turkey farm, Randy Travis (born Traywick) mused away the hours listening to his father's collection of old country 78's. While his brother and sisters tuned their radios to the more aggressive sounds of Kiss and ZZ Top, Travis shaped his notions of chivalry and love from the old-fashioned romantic croonings. Later, no matter how macho country music stomped and groaned across the *Billboard* charts of the Seventies and Eighties, Travis would not be swayed from his early ideas of sweetness between the sexes.

Travis's first two albums contained numerous paeans to hearth and home, but the portrait of the singer as Sensitive Romantic has never been plainer than in his latest one, "Old 8 x 10." Here, in strains as clean and refreshing as a new mountain stream, Travis confesses that his love is "deeper than the holler" and "honest as a robin on a springtime window sill." For further proof, he implores the object of his affections to come down to the riverside, where he had labored all night chiseling their names in stone—an eternal testament to their love. Later, when the relationship eventually loses its luster, Travis, in a performance of moving intensity, sings of clutching an old 8 x 10 photograph of his beloved as if only it can give sustenance to the hollow decay of his life.

Much of this would seem too sappy for consumption if Travis were not so gosh-darn earnest. He sings this material—some of it contemporary ballads, some of it updated western-swing and Thirties-style schmaltz—as comfortably as if he had known it all his life, covering the bucolic lyrics with a nasal icing that speaks volumes about his rural youth and values, and then delivering it all with the impeccable phrasing of a master.

Certainly producer Kyle Lehning is not above employing the familiar hit formula—who could resist a lyric such as this from *Is It Still Over?*: "Since my phone still ain't ringing, I assume it still ain't you"? But this is formula of the highest sort, with Bela Fleck's high, driving banjo stepping forward to take occasional bows, Jerry Douglas's sterling dobro work wending its way throughout, and enough good song hooks to reel in a whole sea of country-music converts.

In short, "Old 8 x 10" is a class act. Travis, who also co-wrote two of the most introspective songs, seems to have come into his own as an artist, committing himself to the soul of the material



as well as the heart. But then, maybe that's not so hard for an old romantic.

*Alanna Nash*

**RANDY TRAVIS: *Old 8 x 10.*** Randy Travis (vocals); Baillie and the Boys, Dennis Locorriere (background and harmony vocals); instrumental accompaniment. *Honky Tonk Moon; Deeper Than the Holler; It's out of My Hands; Is It Still Over?; Old 8 x 10; Written in Stone; The Blues in Black and White; Here in My Heart; We Ain't out of Love Yet; Promises.* WARNER BROS. 25738-1, © 25738-4, © 25738-2 (33 min).

JEFF KATZ/WARNER BROS.

and-roll, tries to distance herself from her old assertive, tough-as-leather poses in an effort to showcase her vulnerable, searching side. As usual, though, she sends mixed messages. On side one, she presents an impassioned plea for peace, harmony, and unity, both personal and global, in lyrics that stress the importance of communication among families and nations. But Benatar has always had trouble coordinating her "hard" and "soft" sides, and the knifing guitars and pounding drums in these songs are

at odds with the gentility of her lyrics. The music of *Let's Stay Together*, for example, calls for a rumble, while the words implore mothers not to turn their backs on their children and children not to leave the family unit.

On side two, Benatar puts aside her optimistic call for faith to focus on the reality of life, evoking characters facing oppression of various kinds (urban, political, physical, financial) in *Cool Zero*, *Lift 'Em On Up*, and *Suffer the Little Children* (a throwback to the anti-child-

abuse anthem, *Hell Is for Children*, in her 1980 "Crimes of Passion"). By the last cut, *Wide Awake in Dreamland*, Benatar seems to realize that her mission is futile—"chemical decisions never turn out like you planned." Oh, well. Nothing like getting your hopes up and having them trounced back down into rubble. The queen of pop sadomasochism strikes again. *A.N.*

**TONI CHILDS: *Union*.** Toni Childs (vocals, guitar, bass); Sibane Semaswati Singers, New Generation Singers (background vocals); additional vocal and instrumental accompaniment. *Don't Walk Away; Walk and Talk Like Angels; Dreamer; Let the Rain Come Down; Where's the Ocean;* and four others. A&M SP-5175, © CS-5175, © CD-5175 (45 min).

Performance: *Stellar*  
Recording: *Very nice*

Toni Childs has been getting a lot of press for this debut recording, and she deserves it. "Union," which she co-produced with David Tickle and David Ricketts (of "Boomtown" fame; he also collaborated with Childs in writing the most compelling material here), is a surprisingly deep, multilayered record, coursing through a full field of sophisticated rhythms, instrumental treatments, and emotions. Several reviewers, taking note of Childs's strong vocal style and her arresting emotional urgency, have compared her with Joan Armatrading and Van Morrison. But Childs is her own woman, managing to project an overwhelming strength and vulnerability at the same time. On occasion, in fact, as in *Dreamer*, where she assumes one of her more unusual voices—"the voice of a dream I had"—she gets downright scary.

Three years in the making, "Union" is both the personal story of Childs's ill-fated affair with Ricketts and a universal diary of the birth, maturation, and death of a relationship. This is no ordinary chronicling—Childs, thirty, writes with authority and grace, matching bold, intelligent lyrics (sometimes more impressionistic than communicative) with well-crafted instrumental hooks and inventive, tastefully ornate arrangements. In several songs she dresses up the backgrounds with African choirs she hand picked on trips to Swaziland and Zambia, resulting in a sound that's more mainstream and cohesive than the similar experiments of Paul Simon and Harry Belafonte.

As intense as her writing and rhythmic structures are, however, Childs's vocal performance is the riveting force here. She can be sweet one moment and formidable the next, then full-bodied, and then childlike—often within the same song. Most of all, though, Childs is gutsy, demanding, and even heart-breaking in her intimacy. For all her feistiness, she ends both sides of the record with affecting songs of resolve

# MUSIC BY INSPIRATION

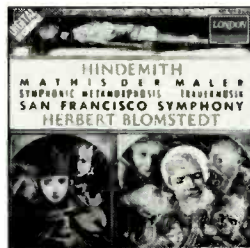
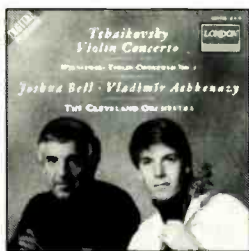
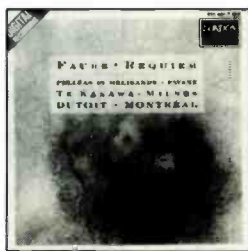
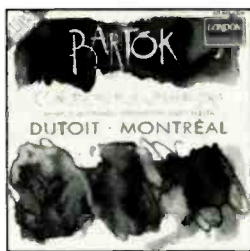

© 1988 London/PolyGram Records, Inc.



# SOUND BY LONDON

CIRCLE NO. 153 ON READER SERVICE CARD

# LÖGIK

## THE FINAL LINK



### THE FINAL LINK

As the year 2000 draws nearer, innovative audio technology is bringing music-in-the-home closer and closer to the real thing. From compact disc player, to electronics, to loudspeakers, all of the links in the audio chain are closing in on the goal of "perfect" sound. None of these links is more crucial, however, than the final one - the loudspeaker. Only a truly outstanding, accurate loudspeaker can translate the electrical impulses of today's [and tomorrow's] advanced componentry into the realistic and satisfying sound for which it was designed. Now Logik brings you that FINAL LINK. Four exceptional loudspeaker models that give you all of the detail, soundstaging impact and dynamic range of the real thing. Four loudspeaker models that turn musical source into musical sound.



Available now at **Silo** stores nationwide.

# LÖGIK

For additional information contact Audio Products International Corp., 3641 McNicoll Road, Scarborough, Ontario, Canada. M1X 1G5  
CIRCLE NO. 45 ON READER SERVICE CARD

# Share the Celebration of the 100th Birthday of the DISK RECORD

The invention of Emile Berliner of Washington D.C., patented 7 November 1887, first demonstrated at the Franklin Institute, Philadelphia, 16 May 1888.

## NOW YOU CAN OWN THE PERFORMANCES THAT MADE HISTORY

To commemorate the centenary of the gramophone, Oliver Berliner, grandson of the inventor, has formed the BERLINER GRAMOPHONE SOCIETY which will bring to its subscribers a unique historic selection of recorded performances from the first 60 years of the industry...the 78 rpm era. These recordings, carefully chosen from the archives of the world's oldest and most prestigious record companies, have been painstakingly produced on Compact Disc via the most modern reproduction and restoration techniques.

Throughout the ensuing year, Society members will receive the first dozen compact discs embodying performances by the greatest artists of the classical music world. Accompanying the records will be a unique printed history in words and pictures...a commentary on the times and world events that served to mould the history of the gramophone, its music and the lives of the artists that recorded for it, as well as that of the people who guided their careers — the world whose history the gramophone shared and even shaped. To house this collection of sights and sounds, a special album has been custom-created. All this comes exclusively to BERLINER GRAMOPHONE SOCIETY members for the price of the discs alone. Society products, for members only, are not sold in stores. No serious collection should be without these memorable revolutions in sound.

A year's membership brings you all this plus a bonus to charter members: The first 500 subscribers receive a complimentary copy of "The Story of Nipper & The 'His Master's Voice' Trade Mark." The first 1,500 subscribers receive the right to extend membership another year at the same US\$ price. Memberships subject to acceptance by the Society. Gift memberships are welcome.



Creator of the "His Master's Voice" trade mark, EMILE BERLINER (Ca. 1915), co-founder of British Gramophone Co., Deutsche Grammophon & Victor Records.



TO: Mr. Oliver Berliner

FROM: \_\_\_\_\_

ADDRESS: \_\_\_\_\_

Please enroll me as a Charter Member of the BERLINER GRAMOPHONE SOCIETY.

I enclose payment of one of the following:

US \$145 • £89 • DM295 • CAN \$180 • ¥19,950

Please include all applicable bonuses.

MBA#: \_\_\_\_\_

DEPT: C

(Let the Rain Come Down and Where's the Ocean). The message is not that she's given in to her anger and remorse, but that she has been renewed to start again.

"Union" may not seem irresistible on its first, or even second, trip around the turntable—the record is too opaque and multifaceted to be easily grasped. But whatever energy the listener expends in unfolding her world, Toni Childs—gritty, tough, and tender—pays back in spades. A.N.

**CINDERELLA: Long Cold Winter** (see Best of the Month, page 107)

**JOAN JETT AND THE BLACKHEARTS: Up Your Alley.** Joan Jett and the Blackhearts (vocals and instrumentals); instrumental accompaniment. *I Hate Myself for Loving You; Ridin' with James Dean; Little Liars; Tulane; I Wanna Be Your Dog; I Still Dream About You; Play That Song Again;* and four others. BLACKHEART/CBS ASSOCIATED FZ 44146, © FZT 44146. © ZK 44146 (41 min).

Performance: *Rugged rock*  
Recording: *Good*

With rock increasingly polarized into formatted camps—fleecy, defanged pop on one side and reptilian, self-caricaturing metal on the other—it's uncommon to find an artist who can connect with might and melody. "Up Your Alley," Joan Jett's sixth album, hits both targets, making a few contemporary concessions without straying from the glorious straight-and-narrow of hook-laden hard rock. Vocally she's in fine form, intimating vulnerability while still sounding as if she'd clobber anyone who did her wrong. And she goes for the gut on the guitar every time.

Jett's frequent quotes from various rock, pop, and punk forebears ground her originals (she co-wrote nine of the eleven songs here) in rugged, rootsy soil. From James Dean to Iggy Pop, the punks of several generations are saluted. *Ridin' with James Dean* is a tough-talking tribute with a nod and a wink to Led Zeppelin's *Good Times Bad Times*. Jett unleashes a raunchy cover of Iggy and the Stooges' *I Wanna Be Your Dog* that proves she's still got some dirt under her nails. The only bum tunes involve Desmond Child, a songwriter and fix-it man brought in by big-label acts to make selected tracks commercially palatable.

A Chuck Berry cover, *Tulane*, gets "Up Your Alley" back on track, and Berry rides again in *Desire*, with his classic chording from *Memphis* reprised in the solo. Still, Jett is at her absolute best in the whumping rock of *I Hate Myself for Loving You* and *Back It Up*, which are growled over a maelstrom of sluicing guitars and rumbling drums. In moments like these, you can console yourself that modern-day rock hasn't (Continued on page 122)



# Say "No" To Oatmeal

I've been a studio drummer for eight years. So, I'm very critical about speakers, mostly because I know what drums are supposed to sound like. Most speakers make a kick drum sound like someone's playing a bowl of oatmeal. I don't even like the way oatmeal tastes, let alone how it sounds.

One day, a friend and I stopped at a hi-fi store to pick up some cassette tapes. Off in one of the listening rooms, I heard some music that sounded live. It was the drums I noticed first. Forget oatmeal, what I heard was a really tight, clean, punchy sound.

We strolled into the room halfway expecting to find a jam going on. But it was a recording. I looked at one of the speakers. It was a KLIPSCH® CHORUS®.

This was a new KLIPSCH speaker. A speaker with professional drivers in a real dressy cabinet. A speaker with a surprisingly good price. A speaker good enough to qualify for the home of a most critical musician. Good enough for me. And that's very, very good.

---

For your nearest KLIPSCH dealer, look in the Yellow Pages or call toll free, 1-800-223-3527.

 **klipsch**<sup>®</sup>  
A LEGEND IN SOUND.™

P.O. BOX 688 • HOPE, ARKANSAS USA 71801

CIRCLE NO. 2 ON READER SERVICE CARD

# The Brains.

Carver's new CT-Seven Remote Control  
Preamplifier/Tuner with Asymmetrical  
Charge Coupled FM Detection and  
Sonic Holography.<sup>®</sup>

# The Brawn.

Your choice of four high power advanced  
Magnetic Field amplifier designs.



Powerful

Distributed in Canada by: **evolution**  
technology

Power and finesse. They've always been important factors in a serious listening system. Now there's a new way to achieve both without overpowering your budget.

Our new CT-Seven preamplifier/tuner combines a Sonic Holography\* preamplifier and Asymmetrical Charge-Coupled FM Detection tuner into one convenient component.

It makes beautiful music with our whole line of Magnetic Field Power amplifiers. Including the new M-4.0t with the same transfer function and power output as Bob Carver's \$17,500-pr. ultra-esoteric Silver Seven monoblock amplifiers.

**The CT-Seven as an audiophile preamplifier:** Like Carver's fine separate preamplifiers, the CT-Seven is designed as a "straight wire with gain," capable of perfectly passing input signals without adding or subtracting any musical nuances.

It includes a meticulously engineered, ultra-low noise phono stage that flawlessly duplicates the theoretical RIAA equalization curve.

**The CT-Seven as a complete sound control center:** From the comfort of your listening chair you can choose from six sound sources including dual tape monitors, CD input and video/auxiliary inputs (suitable for video sound or DAT). Unlike most remote volume adjustments which use distortion-inducing electronics, the CT-Seven employs a motorized volume control for smooth control and smoother sound quality. Also included are useful 3-band tone controls, mono switch, loudness equalization and a studio-quality headphone amplifier.

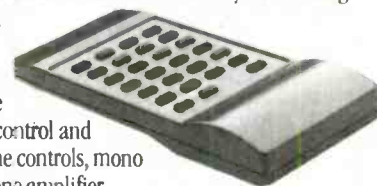

**The CT-Seven as your passport to musical reality:** The CT's Sonic Holography\* Generator is capable of redefining your perception of music by recreating the sound stage and 3-dimensional spatial characteristics of a live performance. According to some of America's top reviewers, Sonic Holography\* "... seems to open a curtain and reveal a deployment of musical forces extending behind, between and beyond the speakers. The effect strains credibility."

And you can create it from any stereo record, tape CD or even FM broadcast. With your existing speakers. At the touch of a remote button.

**The CT-Seven as a high performance quartz synthesized FM tuner:** You've simply never heard FM until you've heard it through the Carver Asymmetrical Charge-Coupled FM Detector circuit. Multipath distortion, interference and distant station noise are dramatically reduced. Weak stations emerge into dramatic clarity. Yet stereo separation, space, depth, and ambience were not only retained, but seemingly enhanced by the lack of background noise.

Choose 8 FM and 8 AM presets by remote control. Scan the broadcast band automatically or manually. With the CT-Seven's ACCD circuit on, you'll discover "new" stations which were previously unlistenable!

**The CT-Seven's power partners:** Only Carver gives you four high power amplifier choices from 140 watts to 375 watts per channel. Each is perfectly matched to the CT-Seven. And each uses Carver's cool-running Magnetic Field Technology which dispenses with bulky power supplies and power-wasting external heat sinks... yet which is so rugged it's used in the world's largest touring professional sound systems.

Choose from the new "modestly-powered" M-0.5t (140 watts per channel RMS 20-20kHz both channels driven into 8 ohms with less than 0.1% THD), the M-1.0t (200 watts/ch. per channel RMS 20-20kHz both channels driven into 8 ohms with less than 0.15% THD), M-500t (250 watts per channel RMS 20-20kHz both channels driven into 8 ohms with less than 0.15% THD), or the new M-4.0t (375 watts per channel RMS 20-20kHz both channels driven into 8 ohms with less than 0.5% THD).

**Hear brains and brawn together at your Carver dealer.** Switch the CT-Seven and the most expensive tuner in the room to hear Asymmetrical Charge-Coupled FM Detection work its magic. Put on your favorite CD, press the CT-Seven's Sonic Holography\* remote button and feel the sound room "disappear." Turn up the volume to live performance levels and discover the impact of true dynamic headroom.

And then get ready for another pleasant experience when you discover what a super value the CT-Seven and Carver power amplifiers are.

# CARVER

Musical

Accurate

P.O. Box 1237, Lynnwood, WA 98046

CIRCLE NO. 168 ON READER SERVICE CARD

# Take-out as good as you can get at home.

Toshiba's home/portable rechargeable CD player is one with everything to go.

It has three-beam laser pick-up, an LCD display with track, lap and remaining time indicators. And it can play 5" CDs and the new 3" CD singles. At home, there's 16-program random memory with repeat and wireless remote control. (Plus a wired remote for outdoors.)

Toshiba. For people whose taste for good sound doesn't go out the window when they go out the front door.

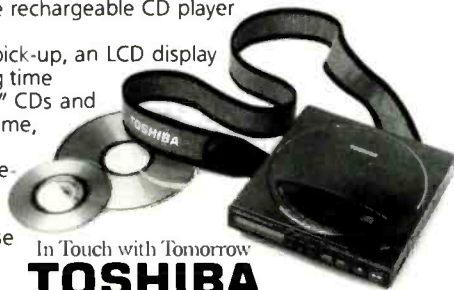

In Touch with Tomorrow  
**TOSHIBA**

Toshiba America, Inc., 82 Totowa Road, Wayne, NJ 07470

CIRCLE NO. 182 ON READER SERVICE CARD

## OUR BEST HEADPHONE—EVER!

Nothing in our past listening experience prepared us for our first audition of the new DM-90 Digital-Monitor headphones. We were absolutely stunned. We then took the sample to our "golden ear" dealers, and they too were amazed!

The verdict: THE DM-90 AT \$99.95 IS EQUAL TO, OR BETTER THAN ANY OTHER DYNAMIC HEADPHONE ON THE MARKET, AT ANY PRICE!

Some headphones can be said to have extended deep bass, others smooth midrange, some, transparent highs and superior dynamic range. Our new DM-90 has all of this, and more. It is unquestionably our best headphone—ever!

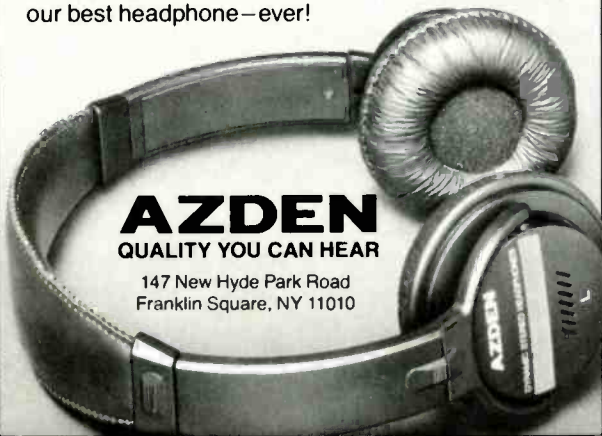

**AZDEN**  
QUALITY YOU CAN HEAR

147 New Hyde Park Road  
Franklin Square, NY 11010

Listen to the DM-90 at the following authorized dealers:

**CALIFORNIA**  
Fry's Electronics, Fremont • Down to Earth Stereo, San Diego • Wong's, San Francisco • Fry's Electronics, Sunnyvale • Digital Ear, Tustin  
**COLORADO**  
Sound Shop, Colorado Spgs • Soundtrack, Denver • Sound Company, Grand Junction • Soundtronix, Pueblo  
**DISTRICT OF COLUMBIA**  
The Equalizer  
**FLORIDA**  
Sound Advice, All locations • BrandsMart, Miami • La Mirage, Miami  
**GEORGIA**  
Atlanta Stereo, Atlanta  
**IDAHO**  
Sound Pro, Boise • Inkley's, Idaho Falls • Mel Quai's, Twin Falls  
**ILLINOIS**  
Musicraft, All locations • Stereo Systems, Aurora, Joliet, Naperville  
**MASSACHUSETTS**  
Cameras Inc., Arlington  
**MICHIGAN**  
Adray's, Dearborn  
**MINNESOTA**  
Campus Audio, Minneapolis  
**MONTANA**  
Sound Pro, Bozeman • Thirsty Ear, Bozeman  
**NEW HAMPSHIRE**  
Cuomos, Salem  
**NEW JERSEY**  
Wiz-Record Dept., All locations • Rand's Camera, Toms River • Sarm Sound, W. Caldwell • Consumer Electronics, Maple Shade  
**NEW YORK**  
Wiz-Record Dept., All locations • P.C. Richard, All locations • Albany Appliance, Albany • Focus Electronics, Brooklyn • Brothers Camera, Manhattan • Jems Sound, Manhattan • S&S Sound City, Manhattan • 6th Avenue Electronics, Manhattan  
**NEW MEXICO**  
Town Crier, Clovis  
**PENNSYLVANIA**  
Sound Advice, Doylestown • Studio One, Erie • Gola Electronics, Philadelphia • Sounds Good To Me, Sharon  
**UTAH**  
Inkley's, Logan, Ogden, Salt Lake City • Gadgets, Salt Lake City  
**WASHINGTON**  
Evergreen Audio, Bremerton • Stereo Shoppes, Tacoma  
**WYOMING**  
New Music Box, Laramie

CIRCLE NO. 164 ON READER SERVICE CARD

entirely lost its sense of abandon—and thank Joan Jett for keeping the faith.

Parke Puterbaugh

**JOHNNY KEMP: *Secrets of Flying*.** Johnny Kemp (vocals); vocal and instrumental accompaniment. *Just Got Paid; One Thing Led to Another; My Only Want Is You; Dancin' with Myself; Urban Times Medley;* and three others. COLUMBIA BFC 40770, © BCT 40770, © CK 40770 (41 min).

Performance: *Promising*  
Recording: *Very good*

Johnny Kemp has an exceptionally sweet voice and a personal appeal that shines through, even on songs that seem to have been cut from the same old urban-pop cloth. What also sets him apart is that a few of these songs, some of which he helped to write, happen to be very good. *One Thing Led to Another* is a better-than-average ballad, while the lyrics to *Dancin' with Myself* poke fun at some familiar emblems of pop culture. *Just Like Flyin'* has a refreshing flavor and a catchy melody. The main point of interest, however, is Kemp's refashioning of two classics from Marvin Gaye's "What's Goin' On" album of the Sixties. *Inner City Blues (Makes Me Wanna Holler)* suffers from the exclusion of melody in favor of a not-so-great beat, but *Mercy Mercy Me (Ecology)* retains some of the character of the original, with a little light rapping mixed in. The overall impression is that Kemp has much to offer, but he should feel free to depart from formulas a bit more. P.G.

**HUEY LEWIS AND THE NEWS: *Small World*.** Huey Lewis and the News (vocals and instrumentals); Tower of Power (horns); vocal and instrumental accompaniment. *Small World (Parts 1 and 2); Old Antone's; Perfect World; Walking with the Kid; Better Be True;* and five others. CHRYSALIS OV 41622, © OVT 41622, © VK 41622 (46 min).

Performance: *Unfocused*  
Recording: *Very good*

Is the Huey Lewis of "Small World" the same as the Huey Lewis of "Fore!" and "Sports"? The vocal nuances are the same, but aside from *Give Me the Keys (And I'll Drive You Crazy)*, the pumping energy and buoyant insouciance of old are nowhere to be found in this crazy quilt of an album. Lewis and the News were once the consummate hang-loose, good-time garage band, always ready for a rock-and-roll rave-up, but "Small World" abandons that mind-set for a more studied performance, one that ponders man's inhumanity to man and too soon grows "world-weary" (*Small World, Perfect World, World to Me*) in every way.

It's fine to branch out, of course. But by flitting from ska and reggae (*Bobo Tempo*) to white r-&-b (*World to Me*) and even ersatz zydeco (*Old Antone's*),



*Our engineering philosophy,  
simply stated.*

## ***Audio Dynamics***

High fidelity. Low complexity. Presenting the new face of performance art, pure and simple.

For the name of an Audio Dynamics dealer near you, call 1.800.541.5696.

Audio Dynamics Corporation, 851 Traeger, San Bruno, CA 94066  
© 1988 Audio Dynamics Corporation

CIRCLE NO. 192 ON READER SERVICE CARD

## THE REAL PATTI AUSTIN

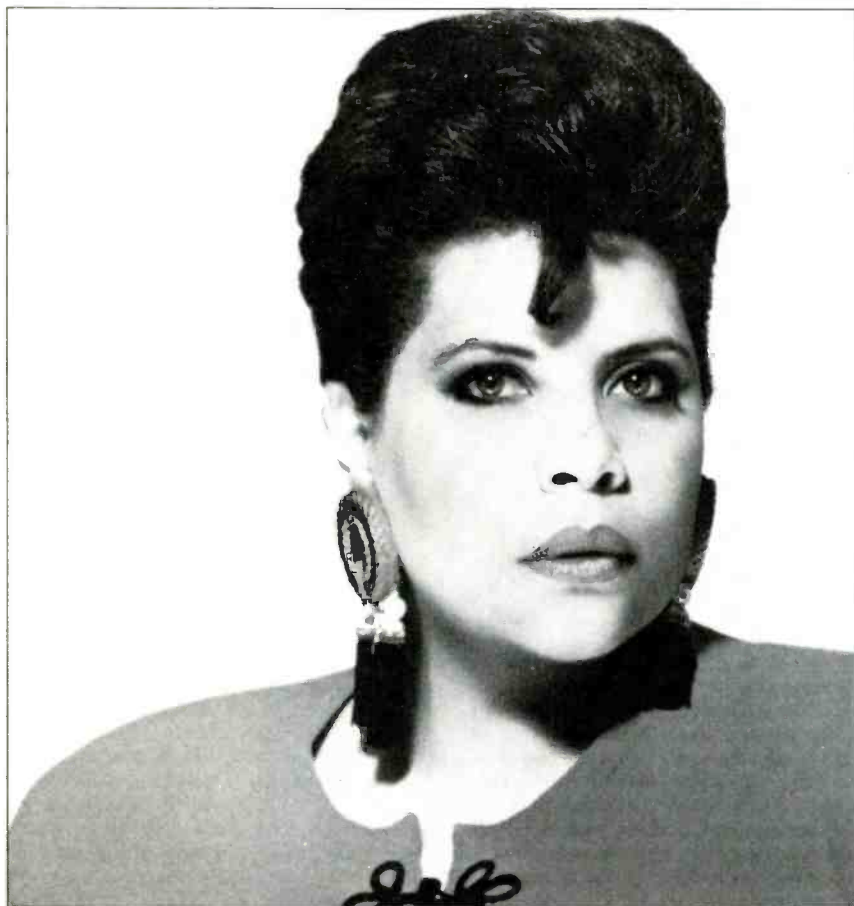

**P**ATTI AUSTIN'S success with urban pop hits like *Rhythm of the Streets* and *Heat of Heat* would be no cause for complaint if her artistic range didn't extend beyond such trite and easy fare. Gifted with a sweet, richly textured voice and an intelligent interpretive sensibility, she is too fine a singer to be locked into a limited groove. Her versatility was apparent in recordings made a decade ago for CTI, but in the Eighties her performances have generally been on a much higher level than her material.

With her new album, "The Real Me," however, Austin has boldly moved out from under the cloud of conformity to reveal what she *really* has to offer. The dozen selections are popular classics, reaching back as far as Duke Ellington's *Mood Indigo* and the Gershwins' *They Can't Take That Away from Me*, in contemporary settings that never compromise the integrity of the originals. Some of these songs have inspired Austin since she began singing professionally, at the age of four, and for listeners who can recall such hits as Ketty Lester's single of *Love Letters* or Julie London's recording of *Cry Me a River*. Austin's updatings make for a delightful stroll through the past. But each song takes on

new life through her interpretations and the imaginative arrangements, on which she collaborated with David Pack and David Benoit.

In *Lazy Afternoon*, for instance, Austin's soaring, bird-like singing is reminiscent of Morgana King's Sixties version, but she's shifted the beat to give the song a new feeling. She brings out the rollicking humor in the Comden and Green-Bernstein song *I Can Cook Too*, and she joins David Pack for a lyrical, lovely duet in Cole Porter's *True Love*.

Austin has said that she *had* to make this album or she could never make another. She had her priorities right: This is the best record of her career.

Phyl Garland

**PATTI AUSTIN: *The Real Me*.** Patti Austin (vocals); vocal and instrumental accompaniment. *I Can Cook Too*; *Stockholm Sweetnin'*; *Smoke Gets in Your Eyes*; *True Love*; *Across the Alley from the Alamo*; *How Long Has This Been Going On?*; *Lazy Afternoon*; *Love Letters*; *They Can't Take That Away from Me*; *Mood Indigo*; *Cry Me a River*; *Someone Is Standing Outside*. QWEST/WARNER BROS. 25696-1, © 25696-4, © 25696-2 (48 min).

Lewis comes across as something of a musical butterfly, lighting momentarily on this style and that, but never really settling down anywhere. Bruce Hornsby, who drops by for accordion accompaniment and backing vocals, contributes a bit of color in the Louisiana stomper, but Lewis's foray into jazz (*Small World, Part Two*) seems so wildly out of place that not even Stan Getz's soothing saxophone can help.

In its lyrics, too, this program seems lacking. The most promising song, about a father-and-son chat (*Walking with the Kid*), fails to capture anything of the essence of that bond. No wonder, then, that three of the cuts are essentially instrumentals. At this juncture of the story, Lewis's world turns out to be a small one indeed. *A.N.*

**KENNY LOGGINS: *Back to Avalon*.** Kenny Loggins (vocals, guitar); vocal and instrumental accompaniment. *Nobody's Fool*; *Tell Her*; *One Woman*; *Back to Avalon*; *She's Dangerous*; and six others. COLUMBIA OC 40535. © OCT 40535, © CK 40535 (47 min).

Performance: *Slick*

Recording: *Very good*

Kenny Loggins's brand of Top 40 pop is the musical equivalent of light beer: It might taste okay going down, but it has little substance and really won't satisfy your thirst for the real thing. Loggins is no great shakes as a songwriter, though he confidently acts the part, intimating insight with every breathless turn of phrase in the ballads and whooping it up like the social director aboard a cruise ship in the fast ones.

"Back to Avalon" is polished Beverly Hills pop, crafted by sessionmen in what sounds like a germ-free environment. The emotions conveyed are as synthetic as the music, with Loggins crooning such psychobabble as, "I need One Woman/With the same soul as my own." Even when he tackles a serious subject, like lost children (*Hope for the Runaway*) or the impending birth of a daughter (*Isabella's Eyes*), he might as well be singing about coaxing some leotard off the dance floor and back to the condo. To put it all into perspective, the album *opens* with Loggins's latest movie theme, *Nobody's Fool*, from the useless sequel *Caddyshack II*. Need more be said? *Parke Puterbaugh*

**JOHNNY MATHIS: *Once in a While*.** Johnny Mathis (vocals); vocal and instrumental accompaniment. *I'm on the Outside Looking In*; *Two-Strong Hearts*; *Once in a While*; *Fallen*; and six others. COLUMBIA OC 44156, © OCT 44156, © CK 44156 (40 min).

Performance: *Easy listening*

Recording: *Excellent*

As someone who still owns and loves the first album ever recorded by Johnny Mathis, a 1956 jazz set, I can fully appreciate the compromises this singer

# The **Boston** Acoustics

## Installation of the Month Contest



Steven Yaguchi's 1987 Mazda RX-7 Turbo didn't offer abundant space for his new car stereo system, but it all was expertly integrated into the car by Transonic of Walnut, CA.

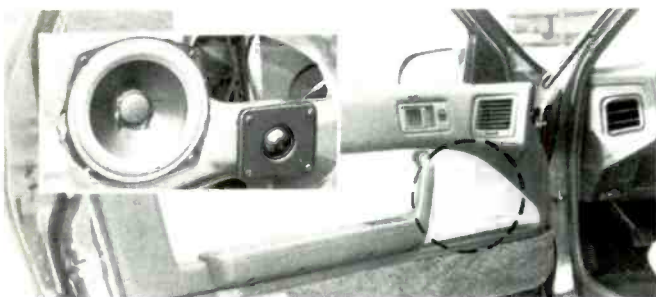

No one looking in can tell there's a Boston 751 system in each of the front doors. Each system includes a 5 1/4" woofer and a flush-mounted 1" Varimount ferrofluid-cooled dome tweeter (installed without the wedge housing). Inset: The 751 two-way component system in front door shown before being covered by the factory panel.



Varimount tweeters from the 761 system are on the sides behind the driver and passenger seats, concealed behind perforations.

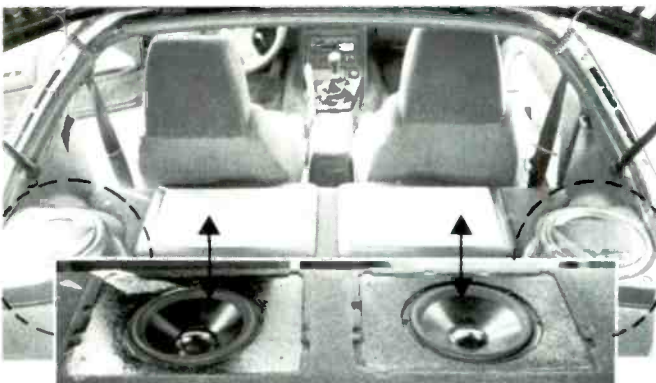

The 710LF 10" subwoofers (center) are installed in the storage bins, flanked by the 6 1/2" woofers (circled) of the 761 component systems. Inset: 710LF subwoofers with covers removed.



5 1/4" woofer from 751 two-way component system.

6 1/2" woofer from 761 two-way component system.

10" 710LF subwoofer.

Varimount CFT tweeter from 751 and 761 component systems.

Without housing for flush mounting.

Wedge housing also provided for surface mounting.

### The November winner: Steven Yaguchi, Monterey Park, CA

Steve's main goals for the new Boston Highway HiFi in his 1987 Mazda RX-7 Turbo were clarity and quality of the sound, rather than window-rattling levels. (Of course, his Boston system provides that too, if he wants!) His concern for aesthetics, plus security, carried over to the appearance of the installation: he wanted the interior of the car to look as stock as possible. (Many contest entrants tell us they don't want their new equipment to be obvious through the windows.) And since Steve plans to buy a CD player in the future, the new system had to be "digital ready"—that is, able to handle the deep bass and lightning-fast transients common in today's digital source material. Steve's report when the job was finished: "We were extremely pleased with the outcome. The sound quality was dynamite!"

The winner's dealer: Transonic, Walnut, CA

The winner's salesperson: Ed Lopez

The winner's installation experts: Tom Garoutte, Wayne Smedile

### The winning system:

#### Boston Acoustics speaker systems:

751 two-way component systems, with a 5 1/4" woofer and Varimount® tweeter concealed in each door panel. 761 two-way component systems, with 6 1/2" woofers in factory locations in rear shock towers, Varimount tweeters hidden in side pillars. 710LF 10" subwoofers in custom-made enclosures located in storage bins behind seats.

#### Electronics:

Alpine: 7385 cassette tuner and 3321 11-band equalizer in dash; two 3523 amplifiers (each 40 watts x 2), one driving the 751s and one driving the 761s. 3525 amplifier (60 watts x 2) driving the two 710LF subwoofers.

### You could still be a winner!

The final monthly-prize winner will be announced in the December issue of *Stereo Review* magazine. If we received your entry before October 5, you could still win. But you can surely be a "winner" by driving to your Boston Acoustics dealer to hear how much better your system can sound with Boston Acoustics speakers.

The prizes. Each month through December, we'll announce the winning Installation of the Month in *Stereo Review*. Each month's winner will receive our T830 tower design home loudspeakers. (\$500 suggested retail value.) What's more, the first 500 readers who submit qualified entries between now and October 5 will win a full year's subscription to *Car Stereo Review*. Free! (Newsstand value, \$23.70.)



## **Boston** Acoustics

247 Lynnfield Street, Peabody, MA 01960 (508) 532-2111

has made over the years in the name of popularity. Yet Mathis is such a conscientious craftsman that he can be counted upon to deliver easy listening several cuts above the average. Most of this album falls into that category. Mathis sings some sweet ballads, like *I'm on the Outside Looking In* and *Once in a While*, that are pleasantly fashioned with Fifties-style vocal arrangements, but he also slips into a delightful and hipper groove in the buoyant *Daydreamin'* and in *Two Strong Hearts*, a succulent duet with Dionne Warwick. While nothing here is truly adventurous the album clearly demonstrates why Mathis has remained a mainstream favorite for more than thirty years. *P.G.*

**ROBERT PALMER: *Heavy Nova*.** Robert Palmer (vocals); vocal and instrumental accompaniment. *Simply Irresistible; More Than Ever; Change His Ways; Disturbing Behavior; Early in the Morning*; and five others. EMI EI-48057, © E4-48057, © E2-48057 (38 min).

Performance: *Sharp*  
Recording: *Good*

Robert Palmer has been one of the more successful practitioners of blue-eyed soul, but he's never really done

much for me before his latest release, "Heavy Nova." His music was pleasant enough, I suppose, but I liked his suave approach better in his clothing than in his songs.

Palmer can still play it cool when he wants to. *Simply Irresistible* is in the same mildly funky vein as his hits *Addicted to Love* and *I Didn't Mean to Turn You On*. He even knows how to work up a well-tailored sweat—*More Than Ever* colors its dance-oriented rhythms with heavy-metal guitar work. But the Gap Band tune, *Early in the Morning*, shows Palmer, as never before, in a torrential sexual fever. The way he sings, "Got to get up/Early in the morning/Find me another lover," is *dirty*.

In addition to loosing his passions, Palmer has gone beyond his usual dabbling in musical exotica. *Change His Ways* crossbreeds Township jive and Appalachian string-band music, and in *Between Us*, Palmer croons to a bossa nova beat. There's even a swank, straight-on version of *It Could Happen to You*, a Jimmy Van Heusen-Johnny Burke tune. It couldn't have been easy for Palmer to stretch beyond his normal restrained style—and he doesn't succeed entirely in all of his experiments—but this album has some personality.

Here Robert Palmer is more than a singing suit. *R.G.*

**IGGY POP: *Instinct*.** Iggy Pop (vocals); instrumental accompaniment. *Cold Metal; High on You; Strong Girl; Tom Tom; Easy Rider; Power & Freedom*; and four others. A&M SP-5198, © CS-5198, © CD-5198 (44 min).

Performance: *Peculiar*  
Recording: *Rough*

Iggy Pop is a rocking self-contradiction—a thinking man's punk, a punk's thinking man, neither, both. As he puts it in this album's title track, he's "standing on the borderline/Between joy and reason." Up until last year, joy clearly held the upper hand. From his early days with the Stooges and through his collaborations with David Bowie, Iggy rocked first and thought later. He didn't compose so much as act musically. Sometimes he stank, and sometimes he was an avatar of the spirit of rock. But starting last year with "Blah-Blah," and now with "Instinct," Iggy has become more reflective. The music continues to rock out, but the singer seems distracted.

At times, the combination of hot band and cool singer is quite effective. *Cold Metal* works beautifully on any

# What Mozart Sounds Like On A



The Asti Collection. Amplifiers, Tuners And Receivers.



number of metaphoric levels, and Iggy's low-key performance gives the song an extra, ironic edge. Other times, the lyrics don't need much help, as in *Strong Girl*: "I need a strong girl/Who works on tension/I need a Jeanne d'Arc/Cause I'm after ascension." But too often here Iggy seems, well, flat. Maybe he's thinking more and enjoying it less; maybe his musical sensibilities have been somewhat outpaced by his intellect; maybe he's playing it much too cool; or maybe something completely different is going on. Whatever the cause, Iggy has lost some of his elemental force. *R.G.*

**THE PRIMITIVES:** *Lovely*. The Primitives (vocals and instrumentals). *Crash; Carry Me Home; Thru the Flowers; I'll Stick with You; Nothing Left*; and nine others. RCA 8443-1-R8, © 8443-4-R8, © 8443-2-R (36 min).

Performance: *Confused*  
Recording: *Poor*

The Primitives have too much regard for the frothy pop of the Sixties—way too much. They sometimes sound like the Beatles or the Byrds, but too often they sound like Herman's Hermits and Annette Funicello. These references, unfortunately, overpower the rest of the

music, so the overall effect is one of *déjà vu*—you recall the groups that are being quoted instead of listening to the Primitives. Lead singer Tracey Tracey's high, light voice and elfin phrasing further contribute to the weightless quality of this material. The only thing that cuts the sweetness is the extremely distorted sound of some of the guitar work, which gives some of the songs a punkish edge, but the gimmick wears thin. *R.G.*

**SADE:** *Stronger than Pride*. Sade Adu (vocals); Stuart Matthewman (guitars, saxophone); Andrew Hale (keyboards); Paul S. Denman (bass); and other musicians. *Love Is Stronger than Pride; Paradise; Nothing Can Come Between Us; Haunt Me; Give It Up; I Never Thought I'd See the Day*; and four others. EPIC OE 44210, © OET 44210, © EK 44210 (47 min).

Performance: *Satiny, but . . .*  
Recording: *Intimate*

After two remarkably successful albums ("Diamond Life" and "Promise"), Sade called it quits three years ago—sidelined, it was reported, by what is euphemistically referred to as "the pressures of fame." To anyone who finds such songs as *Smooth Operator* still emerging in memory now and then,

Sade's new album will undoubtedly be disappointing. The problem is twofold: "Stronger Than Pride" is so devoid of melody as to float aimlessly through the stratosphere, and the lyrics, which never approached profundity in her earlier efforts, now weigh in with the gravity of a meringue. Only one song attempts to construct any story line (about a young boy who dies in a robbery attempt); the rest of the program resembles sweet nothings whispered into a lover's ear, the hooks repeated over and over and set to a bossa-nova beat. Even Stuart Matthewman's soothing saxophone has been stripped of its inviting sensuality, the instrumental emphasis being placed on an ensemble sound anchored by Paul S. Denman's thumping bass.

Of course, Sade's appeal has never been much beyond mood setting and ambience anyway. But even for a woman who routinely substitutes cool composure for rippling emotion, this latest entry takes too many structural liberties, strikes too many hollow poses. Many more albums like this and Sade may not have to worry about the pressures of fame after all. *A.N.*

**DWIGHT YOAKAM:** *Buenas Noches from a Lonely Room* (see Best of the Month, page 108)

# A Nikko.

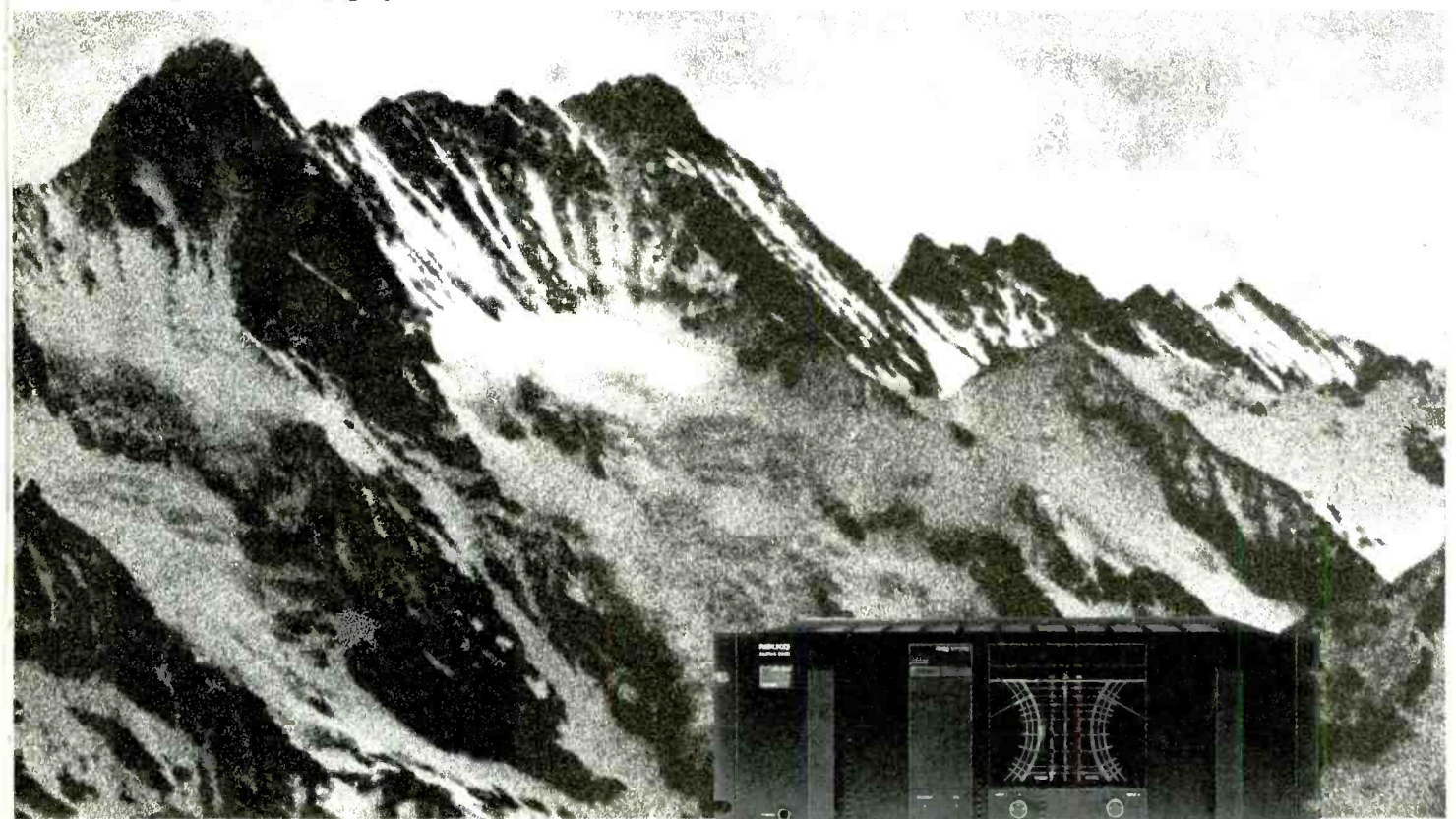

See What We Sound Like.

CIRCLE NO. 76 ON READER SERVICE CARD

## LIVE FOR IRELAND



*The Pogues: an Irish national treasure*

WITH a population smaller than Queens plus Brooklyn and with the poorest economy in Western Europe, Ireland would seem an unlikely place to serve as the staging area for the next invasion of the United States. Yet Irish music is making its presence felt in the U.S. with the same kind of muscle Australia exerted five years ago. Led by U2, the Irish invasion is characterized by music that's lyrical, sober, intense, often political. It's deep-rooted, reaching back to folk themes that are hundreds of years old and drawing inspiration from a literary tradition that is arguably the greatest in the West and a political climate that is certainly the worst.

"Live for Ireland" is noteworthy for bringing together many of the performers in the vanguard of Irish popular music. Conceived and promoted as yet another rock crusade on the model of Live Aid, Farm Aid, and the Amnesty International benefits, it's much more profitably viewed as a convenient introduction to a thriving music scene most of us might not otherwise discover.

The celebrities, of course, are led by U2 and Elvis Costello (a.k.a. Declan McManus). U2 contributes a brooding version of Bob Dylan's presciently titled *Maggie's Farm*. The Edge gives a performance of Woodstock proportions, indulging in Alvin Lee-styled sludge chording and reverb while Bono embellishes Dylan's bizarre vow of liberation with some home-rule affirmations of his own. Recorded speeches in the background and an extemporaneous improvisation on *Cold Turkey* make

this one of U2's more inscrutable performances.

On pennywhistles and fiddles, the Chieftains, already well known in America, are the voice of Celtic authenticity. They weigh in here with a thumping, spirited, fugue-like rendering of the traditional *Boil the Breakfast Early*, which features an impossible-to-sing-if-you're-not-Gaelic vocalise chorus that will leave you slack-jawed with admiration. The group called Clannad is less conventional and less well known in this country. Its too-short appearance—featuring a fascinating, supernatural vocal that sounds as though space visitors had plopped down into an eighth-century Irish monastery in time for vespers—is one of the high points of the album. It's a short slip twist Celt and clod for the Pogues, Ireland's raffishly charming answer to the Bowery Boys. Performing here with compassion and vision, the Pogues are one of Ireland's national treasures.

Among the troubadours, Chris De Burgh was by far the crowd's favorite. They knew every word of *Don't Pay the Ferryman* and sang it better than De Burgh himself. But Paul Brady's *The Island* and a duet by folk singers Christy Moore and Paul Doran, *Make It Work*, represent the protest tradition much more eloquently. More interesting to America's youth are Ireland's thrashers, among whom In Tua Nua is the best here. The galloping back beat, eerie violin, and seductive, growling vocals of Leslie Dowdall make *Seven into the Sea* the rock-and-roll high-water mark of this collection.

Where there's a cause, there's Bob

Geldof and the Boomtown Rats, but this band formed in a Dublin kitchen in 1975 belongs on an Irish stage, and the snarling *Joey's on the Street Again* is proof. The clone groups—Cactus World News (U2) and the Fountainhead (the Police)—are energetic if derivative. Given the state of rock in the U.S., they indicate Ireland's second-best is plenty good enough. Finally, in a category all his own, there's Van Morrison, the only person who can evoke the misty isles and Motown in the same song.

Add in Sinéad O'Connor, who's *not* on "Live for Ireland," and you'll begin to appreciate the incredible fertility of Irish pop today. These artists may not be the equals of Yeats, Joyce, O'Casey, and Shaw, but they're creating powerful, purposeful music at a time when we're in sore need of it. *Mark Peel*

**LIVE FOR IRELAND.** U2: *Maggie's Farm*. In Tua Nua: *Seven into the Sea*. Elvis Costello and the Attractions: *Many Rivers to Cross*. The Pogues: *Dirty Old Town*. Paul Brady: *The Island*. The Chieftains: *Boil the Breakfast Early*. Chris Rea: *Steel River* (cassette and CD only). Chris De Burgh: *Don't Pay the Ferryman*. Cactus World News: *The Bridge*. The Boomtown Rats: *Joey's on the Street Again*. Clannad: *Theme from Harry's Game*. The Fountainhead: *Feel It Now*. Van Morrison: *Here Comes the Knight*. Christy Moore and Paul Doran: *Make It Work*. MCA MCA-42113, © MCAC-42113. © MCAD-42113 (61 min).

*The Edge: Woodstock proportions*



GARY GERSHOFF, RETNA LTD

# JAZZ

**TERENCE BLANCHARD AND DONALD HARRISON:** *Black Pearl*. Terence Blanchard (trumpet); Donald Harrison (saxophone); Cyrus Chestnut (piano); Reginald Veal (bass); Carl Allen (drums). *Dizzy Gillespie's Hands; Selim Sivad; Infinite Heart; Somewhere; The Center Piece*; and four others. COLUMBIA FC 44216, © FCT 44216, © CK 44216 (53 min).

Performance: *Splendid*  
Recording: *Very good*

Trumpeter Terence Blanchard and saxophonist Donald Harrison, both Art Blakey alumni, get better with each album. Their latest, "Black Pearl," is a superb slice of modern jazz—sensibly structured, tightly woven ensemble performances laced delicately with intricate solos. Except for Leonard Bernstein's *Somewhere*, the music is all original, and it forms a pleasant and well-balanced whole. It does not attempt to go where no music has gone before, nor does it travel the treadmill that has trapped so much jazz. It is, simply put, a lesson in good taste and disciplined creativity, a youthful, spirited extension

of the great voices of the bop era. The Harrison/Blanchard group is one to which much more attention should be paid. *C.A.*

**BETTY CARTER:** *Look What I Got!* Betty Carter (vocals); instrumental accompaniment. *Look What I Got; That Sunday; That Summer; The Man I Love; All I Got; Just like the Movies (Time)*; and four others. VERVE 835 661-1, © 835 661-4, © 835 661-2 (47 min).

Performance: *Not her best*  
Recording: *Good*

For the past nineteen years, Betty Carter has been a feisty entrepreneur, producing and distributing her own high-quality jazz recordings. With this new release on Verve, she apparently has been lured back into a more commercial fold. Carter can be counted on to deliver creative, highly personal interpretations of her material, which is often offbeat, but there is an unevenness of quality here. At times her singing becomes so eccentric that the center doesn't hold, particularly in *Imagina-*

*tion and That Sunday, That Summer*. The latter is virtually unrecognizable as the Nat Cole hit from the Sixties. But Carter also has a tendency here to sing flat, which has not been apparent in her other recordings. There is adequate compensation for these flaws in the upbeat *All I Got*, where she scats her vocals with the fleetness of a spirited horn player, and in her own *Look What I Got*, with its cooed intimacy. The jewel is an absolutely stunning rendition of *The Man I Love*, in which she uses her vocal like an accompaniment to the splendid tenor sax of Don Braden. While this cannot rank among Carter's better efforts, it still yields much to enjoy. *P.G.*

**ORNETTE COLEMAN AND PRIME TIME:** *Virgin Beauty*. Ornette Coleman (saxophone, violin, trumpet); Al MacDowell, Chris Walker (bass guitars); Bern Nix, Charlee Ellerbe, Jerry Garcia (guitars); Denardo Coleman (drums, keyboards, percussion); Calvin Weston (drums); other musicians. *Bourgeois Boogie; Healing the Feeling; Honeymooners; Chanting; Unknown*

## Honesty. It's been a rare virtue in sound.

## Until now. *Introducing the new Design Acoustics PS•103 3-Way Loudspeaker*



While other speakers attempt to make their mark with bombast and sizzle, the Design Acoustics PS•103 loudspeaker system has been created to accurately reflect the actual sonic drama of the music. No more. And certainly no less.

### Hear the original acoustic space

The PS•103 starts with smooth, uniform response for every octave of music. That's basic. Dispersion at the higher frequencies is also enhanced by a tapered, sealed, independent Point Source enclosure for the 6" mid-range and 3/4" tweeter. The result of this combination is an appropriate spaciousness to the reproduced sound... neither collapsed, nor overextended. With the PS•103, the illusion of a live performance is more accurate, making possible a more intense reaction to the music.

### Bass you can feel

The illusion is enhanced by the extended bass performance from the 10" down-firing woofer, housed in its own cabinet with unique multi-element baffles that stiffen the enclosure while smoothing and extending useful sound output. You both hear and feel the deepest bass, while sensing the original room acoustics all around you.

### Honestly superior

Before you settle for an artificial sounding speaker, give our spectacular honesty a chance. Audition the Design Acoustics PS•103 loudspeaker system today. Write for the names of Design Acoustics dealers in your area. Like you, they are very serious about very good sound.

**DA** DESIGN<sup>®</sup>  
ACOUSTICS  
An Audio-Technica Company  
1225 Commerce Drive, Stow, OH 44224

## HARRY CONNICK, JR.



IT is as if someone recently woke up a sleeping jazz giant in New Orleans and unleashed a new school of players bent on rerouting modern jazz from its disastrous electronic course and onto other paths. New Orleans is, of course, the cradle of jazz, a city steeped in tradition, the place where it all came together before branching out across the world. Storyville—the city's infamous red-light district, which was a proving ground for early jazz—was closed by the U.S. Navy over seventy years ago, and that precipitated the first mass migration of musicians to points north. But as jazz found new homes and new forms, the old sounds lived on in New Orleans.

Over the years, new musicians occasionally emerged from the Crescent City, but not since 1917 have they done so on the scale we have seen in the Eighties. Those of us who see fusion as anything but an enhancement of the music we love can thank these modern jazz evangelists—men like Donald Harrison, Terence Blanchard, the Marsalis brothers, and Mulgrew Miller—for encouraging electronic musicians to pull the plug and for slowly, but surely, clearing up a blur that has many listeners unable to distinguish between jazz and pop.

Now add to the growing list of New Orleans flame-keepers a young pianist named Harry Connick, Jr. The son of a

New Orleans district attorney and a judge, he did not rise from the socioeconomic circumstances of early jazz men and women, but he breathed in the air of musical tradition, spending much of his time absorbing the sounds of that modern-day plantation called Preservation Hall. Connick learned the postwar bebop traditions from Ellis Marsalis, and he studied classical music as well. The result, as heard in Connick's debut album for Columbia, is an eclectic style that finds his fingers strutting and dancing across the keyboard in a most engaging Joplinesque, Monkish, Garnerish way that echoes an appealing array of influences. And it is influence, not imitation, that we hear in the young pianist's performances, with rhythmic assistance on all but one track from no less a talent than bassist Ron Carter.

Harry Connick, Jr. is an artist of immense promise. He has creatively absorbed the music of the jazz masters of the past, and it is often just such musicians who take jazz a step or two forward.

*Chris Albertson*

**HARRY CONNICK, JR.** Harry Connick, Jr. (piano); Ron Carter, Reginald Veal (bass); Herlin Riley (drums). *Love Is Here to Stay; Little Clown; Zealousy; Sunny Side of the Street; Vocation; On Green Dolphin Street; Little Waltz; E.* COLUMBIA FC 40702, © FCT 40702, © CK 40702 (39 min).

Artist: *Happy Hour*; and five others. PORTRAIT ● FR 44301, © FRT 44301, © RK 44301 (45 min).

Performance: *Mingus-like*  
Recording: *Very good*

It was almost thirty years ago that Ornette Coleman shocked the entire jazz world when he introduced a style that threw musical convention to the winds. Today, however, Coleman's sound seems remarkably traditional. It is indeed more conventional than it used to be, but over the years our ears have also been conditioned to accept music that once made difficult listening. I don't think you will have any difficulty with Coleman's new "Virgin Beauty," despite its unorthodox instrumentation: Coleman with two percussionists and five guitars, including Jerry Garcia. It may seem odd to find one of the Grateful Dead working with this group, but Coleman was flirting with rock music twenty-five years ago; others have tried to box him into specific idiomatic categories, but Coleman's music has always reflected his eclectic taste.

The new album is deeply rooted in the kind of infectious rhythms one hears from Louisiana, with its boppish overtones and sinewy saxophone bends, making for a combination of sounds reminiscent of Charles Mingus. Virgin? Who can tell. Beauty? The album is drenched in it.

*C.A.*

**BRANFORD MARSALIS:** *Random Abstract.* Branford Marsalis (saxophone); Kenny Kirkland (piano); Delbert Felix (bass); Lewis Nash (drums). *Yes and No; Crescent City; Lonely Woman; Broadway Fools;* and three others (five others on CD). COLUMBIA OC 44055, © OCT 44055, © CK 44055 (74 min).

Performance: *Superb*  
Recording: *Very good*

If anyone asks you what musicians mean when they say a group is "cooking," I suggest that you play them the opening track, *Yes and No*, of Branford Marsalis's new album, "Random Abstract." It is one thing to play at a rapid tempo and quite another to play with profundity, as the Marsalis group does. The tempo slows to a more relaxed pace for much of what follows, but there isn't a dull, uninspired moment. All the more reason to get the compact disc version, which has a couple of excellent "bonus" tracks, *Yesterday's (sic)* and *Crepuscle with Nellie*. The former—apostrophe notwithstanding—is the haunting Otto Harbach-Jerome Kern tune taken at a slow but effective pace, which continues through the latter, a Thelonious Monk classic.

Another highlight is Marsalis's Ben Websterish tenor reading of *I Thought About You*, which, according to producer (and brother) Delfeayo Marsalis's notes, marks the young saxophone player's farewell to the Webster in-

fluence. Ah, but he more than makes up for it with what can only be called the Branford Marsalis sound. C.A.

**YELLOWJACKETS: Politics.** Yellow-jackets (vocals and instrumentals); instrumental accompaniment. *Oz; Local Hero; Galileo (For Jaco); Foreign Correspondent; Helix; Evening Dance*; and four others. MCA ● MCA-6236, © MCAC-6236, © MCAD-6236 (49 min).

Performance: *Hyper*  
Recording: *Very good*

This album emphasizes composing and arranging over improvising. The Yellowjackets write tunes with bright melodies and abrupt tempo shifts, and they play these complex assignments with panache. If you're the kind of fusion fan who chooses catchy melodies over extended development, "Politics" will probably please you. Otherwise, you might find the record to be hyperkinetic. The solos are nice, but they seem like interstitial material—quick bursts that act as bridges between the tightly constructed sections dominating the music. In the tunes where basic melody is repeated, it can seem as if the band is simply vamping. R.G.

**ROB WASSERMAN: Duets.** Rob Wasserman (bass); other musicians. *Stardust; Brothers; Gone with the Wind; Angel Eyes; Over the Rainbow; Duet; The Moon Is Made of Gold*; and four others (five others on CD). MCA ● MCA-42131, © MCAC-42131, © MCAD-42131 (47 min).

Performance: *Curious assortment*  
Recording: *Very good*

Bassist Rob Wasserman obviously had fun making these recordings, but I'm not sure who he's aiming for with his new album, "Duets." The concept is simple: a collection of numbers in which Wasserman appears with one other artist. There is nothing wrong with that—it's been done before. But many of these recordings use multiple tracking to take them beyond a duet sound. That's okay, too. In fact, the sound is often winning, as in *Stardust*, which Aaron Neville sings in the true style of the Fifties. Wasserman could easily have dominated this album, but he is occasionally strictly supportive, and on some of those tracks you might wish he'd relegated his guest to the background. But I really have to say I like this album. It contains enough good things to make it more than a mere novelty. While *Stardust* is my favorite track, I also found pleasure in violinist Stéphane Grappelli's performance in *Over the Rainbow*, Bobby McFerrin's in *Brothers*, and even *The Moon Is Made of Gold*, a Rickie Lee Jones collaboration. The title tune, Wasserman's duet with himself, is fine, too. As a Wasserman demo, in fact, this album does succeed. C.A.

## Headphones that work with your ears, not against them.



DT 990 headphones use "diffuse sound field equalization," based on new studies of how the human ear affects sound. This design produces a flat frequency response, accurately recreating the experience of the listening environment.

Hostaphan™ diaphragms and Neodyne™ magnets are two more reasons DT 990s have won technical and critical acclaim in Europe and America. They "... delivered a superb sound" and were "... remarkably comfortable to wear" according to *Stereo Review*.

So if you enjoy losing yourself in the music, start by finding the Beyer dealer in your area. Call the reader response number below, or write — **beyerdynamic US, 5-05 Burns Avenue, Hicksville, NY 11801**



ACCURACY IN AUDIO

beyerdynamic

Canada: ELNOVA #190 rue Stee St. Laurent, Quebec H4T1A6 Tel. (514) 341-2933 Telex: 5E24086

CIRCLE NO. 51 ON READER SERVICE CARD

## Want more product information?

Whenever an advertised product sounds interesting, turn up the volume!

Use our FREE INFORMATION SERVICE to get the detailed facts and figures you need to make sound purchasing decisions.

Manufacturers are only too glad to send you their literature . . . free and without obligation.

Just make a note of the Reader Service Number at the bottom of an ad, and circle that number on the FREE INFORMATION SERVICE card facing page 141. Fill in your name and address and drop the card in the mail. No postage necessary.

THE NEXT TIME AN AD TURNS YOU ON, TURN TO THE

**FREE INFORMATION CARD!**

"Shure's most recent version of its top model, the V15 Type V-MR... strikes this listener as perhaps the most musical-sounding cartridge ever made."

Hans Fantel  
The New York Times



**SHURE®**

For more information, call 800-257-4873  
(In Illinois, 800-624-8522)

CIRCLE NO. 104 ON READER SERVICE CARD

# CLASSICAL MUSIC

*Discs and tapes reviewed by Robert Ackart, Richard Freed, David Hall, Stoddard Lincoln, and Eric Salzman*

**BACH: *The Well-Tempered Clavier, Book 1 (BWV 846-869)*.** Keith Jarrett (piano). ECM ● 835 246-1 two LP's, © 835 246-4 two cassettes, © 835 246-2 two CD's (104 min.)

Performance: *Plain-spoken*  
Recording: *Indifferent*

The famous rippling arpeggios of the C Major Prelude that opens Bach's *Well-Tempered Clavier* tell you a lot about what is going to follow in a performance. In Glenn Gould's recording for CBS, every note is like a chip of granite in a large, meticulously designed monument. With András Schiff on London, you think of intricately patterned, warmly colored stained-glass windows. But Keith Jarrett's coloristically austere approach suggests an ice sculpture, clear and glistening but occasionally opaque. This is Jarrett's first classical recording, and it's a triumph of sorts. The jazz pianist has successfully purged his playing of any jazz mannerisms, or any other personal fingerprints, in what would seem to be an attempt to take the easier, blander route to credibility in classical circles.

Yet while Jarrett abstains from characterizing details in the music, he does frame it with some basic interpretive choices. At best, his performance sounds something like the Bach recordings made by Wilhelm Kempff in the 1970's, in the sense that both performers attempted to make their interpretive art as invisible as possible.

Jarrett's recording certainly has its appealing moments, such as the natural luster he imparts to the D Major Prelude and the pathos he finds in the E Minor Prelude. Unfortunately, there are also many passages that sound rather too plain. Jarrett's basic lack of rhythmic spring makes the G-sharp Minor Fugue impossibly heavy-footed. Soon, you hunger for Sviatoslav Richter, whose *Well-Tempered Clavier* (now on Chant du Monde) is probably the most over-characterized modern recording, but he at least lets the music have light, shade, joy, and mystery. For more moderate tastes, the choice is still between Gould (with both books of *The Well-*

*Tempered Clavier* on three mid-priced CD's) and Schiff, whose natural, coloristically attractive response to the music makes him *the* Bach pianist of our time. *David Patrick Stearns*

**BEETHOVEN: *Symphony No. 1, in C Major, Op. 21; Symphony No. 7, in A Major, Op. 92*.** Symphony Orchestra of the North German Radio, Hamburg, Günter Wand cond. DEUTSCHE HARMONIA MUNDI/ANGEL © CDC-49622 (69 min).

Performance: *Fluent*  
Recording: *Good*

**BEETHOVEN: *Symphony No. 7, in A Major, Op. 92; Coriolan Overture, Op. 62; Prometheus Overture, Op. 43*.** Royal Philharmonic Orchestra, André Previn cond. RCA ● 7748-1-RC9, © 7748-4-RC9, © 7748-2-RC (54 min).

Performance: *Lyrical*  
Recording: *Decent*

Günter Wand is at his very best here in Beethoven's First Symphony. The first movement is lithe, athletic, and sharply accented in the best Toscanini manner, the slow movement is smooth as silk and wonderfully transparent in texture, the *menuetto* is rhythmically vital throughout, and the finale has a truly light touch. Less interesting is the Seventh, which gets a cool treatment with tempos generally hewing to the Toscanini pattern but with no comparable surge in the dynamics. I was much taken, however, with the precisely textured fugato midway through the slow

*Charles Dutoit: a dreamier Berlioz*



movement. Wand is generous with repeats in both works, and the CD has good, clear sound.

André Previn's approach to Beethoven's Seventh is in direct contrast with Wand's. "Mellifluous" might be the operative adjective for the first movement, and the allegretto is somber in tone with pacing to match. Things come to life in the scherzo, which goes at a brisk clip, and there is all the spirit one could want in the finale.

As for the fillers, the *Coriolan Overture* is slower than one usually hears it, with the lyrical elements very much to the fore, but the *Prometheus Overture* gets the best performance of the three works. Its opening pages assume an almost Gluck-like dignity, and the main portion comes off with enormous zest and brilliance. Overall, the orchestral playing is nicely honed if not altogether inspired, and the recorded sound is decent if not arresting. *D.H.*

**BERLIOZ: *Harold in Italy; Rob Roy Overture; Le Corsaire Overture*.** Pinchas Zukerman (viola); Orchestre Symphonique de Montréal, Charles Dutoit cond. LONDON © 421 193-4, © 421 193-2 (66 min).

Performance: *Atmospheric*  
Recording: *Sumptuous*

No matter how overrecorded some of Berlioz's output is, there is room for more from Charles Dutoit. Most modern conductors—Colin Davis, for instance—prefer to reveal Berlioz as a blazing, Romantic firebrand. Dutoit shows us the dreamier side of the composer's personality, making for better-rounded, more integrated interpretations. Davis presents the protagonist of *Harold in Italy*, the Byron-inspired Childe Harold, as being so mercurial that he strains credulity for even the most romantically fired imagination. Harold is really Berlioz, of course, and we know from the composer's writings what a charming companion Berlioz could be. So does Dutoit.

In the first movement, titled "Harold in the Mountains," Dutoit's peaks may not be especially rugged, but the landscape is lush. His performance of the second movement, "March of the Pilgrims," is perhaps unsurpassed for its sense of mysticism and general atmosphere, and the third-movement serenade has a wonderfully unpretentious rhythmic bounce. Dutoit is certainly not above fireworks, and he delivers them fully in the fourth movement, the "Brigands' Orgy." Pinchas Zukerman gives a well-studied interpretation of the solo-viola part, playing with a glistening tonal sheen that is quite compatible with Dutoit's geniality.

The two overtures included here make the release even more attractive.

#### EXPLANATION OF SYMBOLS:

- = DIGITAL-MASTER LP
- Ⓢ = TAPE CASSETTE
- Ⓢ = COMPACT DISC (TIMINGS ARE TO NEAREST MINUTE)

*Rob Roy* shows the *idée fixe* of *Harold in Italy* in an earlier incarnation, and while *Le Corsaire* has no thematic links with the other works, it too was inspired by Byron, completing a program that makes sense conceptually as well as musically. *David Patrick Stearns*

**FAURÉ:** *Violin Sonata in A Major, Op. 13.* **FRANCK:** *Violin Sonata in A Major.* **POULENC:** *Violin Sonata.* Beverly Somach (violin); Harriet Salerno (piano). NEWPORT CLASSIC © NC 60037 (73 min).

Performance: *Romantic*  
Recording: *Radiant*

Violinist Beverly Somach and pianist Harriet Salerno give inspired readings of the Fauré and Franck sonatas, and a slightly less inspired one of the Poulenc, in this beautifully engineered recording. The only thing that keeps me from recommending it without qualification is that Shlomo Mintz and Yefim Bronfman got there first with their two superb Deutsche Grammophon recordings of French violin sonatas (one has Fauré's two sonatas, the other the Franck, Debussy, and Ravel sonatas).

These Somach-Salerno performances aren't quite as extravagantly Romantic or as frankly seductive as the Mintz-Bronfman readings, but Somach and Salerno aren't shy about making big musical gestures, and they are just as convincingly impetuous, thanks to their elastic tempos, in the breast-heaving Franck and Fauré sonatas. Somach and Salerno don't miss any of the longing, yearning, and melancholy of the Franck, and they're probably a bit more idiomatically French than Mintz and Bronfman, playing with poise and stylishness. The Fauré fares just as well. Somach and Salerno capture the work's youthful ardor and volatility without ever seeming overly histrionic.

They seem to have somewhat less to say about the Poulenc sonata, which reflects a less Romantic, more dissonant, more anxious side of French music. The contrast it should make with the Franck and Fauré works isn't particularly telling here, but its inclusion on this disc may make it more attractive to those who aren't so enamored of the French violin repertoire as to buy the two Mintz-Bronfman recordings.

*David Patrick Stearns*

**FRANCK:** *Violin Sonata in A Major* (see FAURÉ)

**HANDEL** (arr. Mozart): *Acis und Galatea*. Edith Mathis (soprano). Galatea; Anthony Rolfe Johnson (tenor). Acis; Robert Gambill (tenor), Damon; Robert Lloyd (bass), Polyphemus; ORF Chorus and Symphony Orchestra, Peter (Continued on page 140)



## DE LARROCHA'S ALBÉNIZ

**H**ow many times must Alicia de Larrocha have played Isaac Albéniz's *Iberia*? Her newest recording of the suite, taped two years ago, is at least her fourth complete one, and her second for London/Decca. In listening to it, it is hard to keep from hearing, or at least imagining, a sense of "testament" on the part of the pianist who has been more closely identified with this fundamental work of modern Spanish keyboard music over a longer period than any other performer—Albéniz himself not excepted. What does not have to be imagined is De Larrocha's deep affection for the music, born of long and intimate acquaintance with it, or the superiority of this new recording to all of her previous ones—and, indeed, all others—musically as well as sonically.

In the recording De Larrocha made for London in 1973 there was a curious undercurrent of remoteness, as if she, of all pianists, was less than comfortable with the material; collectors who had her earlier stereo recording of *Iberia* on Epic (reissued on Musical Heritage Society) were well advised to hold on to it. There need be no reservations or back-up for this new one, though. Here her sense of identification with the music is

so complete that the listener's attention is focused entirely on the music, as it ought to be, rather than divided by considerations of execution. As in her earlier recordings, De Larrocha again includes *Navarra*, the "supplement" to *Iberia* that was completed by Déodat de Séverac (a still underappreciated composer of piano music in his own right). Instead of the *Cantos de España*, which filled out the earlier London set, the new one includes, rather more generously, the larger-scaled *Suite española*.

It would be difficult, if not impossible, to imagine any of this music brought to life more compellingly by either the performer or the recording team. The piano is not simply recorded well, but focused in such a way as to maximize the stunning balance of percussiveness and voluptuousness in this music and these performances. The annotation, worthy of the occasion, is by Lionel Salter, who, as always, is not merely informative but illuminating.

*Richard Freed*

**ALBÉNIZ:** *Iberia; Navarra; Suite española*. Alicia de Larrocha (piano). LONDON ● 417 887-1 two LP's, © 417 887-4 two cassettes, © 417 887-2 two CD's (126 min).

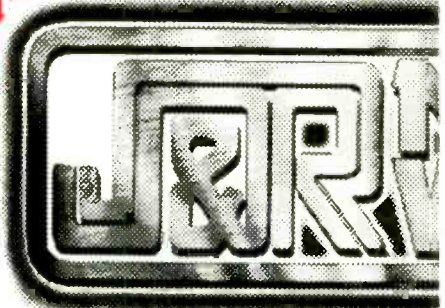

This Month's

**Stereo Receivers**

**Technics SA-290**  
**Digital AM/FM Stereo Receiver**  
 • 50 watts/channel • LED power meters  
 • AM/FM stereo tuner • 16 presets • Tape monitor • LCD digital display • Black finish

Sale Price **\$149<sup>95</sup>** Retail \$245



**Harman-Kardon HK-7951**  
**Digital Stereo Receiver**  
 • 70 watts/channel • Ultrawideband amplifier design provides wide flat frequency response  
 • Versatile input/output section

Sale Price **\$449<sup>95</sup>** Retail \$699

**Compact Disc Players**



**Sharp DX-650**  
**Programmable Compact Disc Player**  
 • 3-beam laser • 3-way repeat • (AFMS) 20-track programmable music selector  
 • Forward/reverse search • Repeat • Black

Sale Price **\$117<sup>95</sup>** Retail \$219



**Technics SL-P230**  
**Remote Control CD Player**  
 • Direct access remote • 4X oversampling • Digital filter • Dual D/A converters • 20 track programmable • Black finish

Sale Price **\$199<sup>95</sup>** Retail \$299

**Compact Disc Players**



**ADC CD16/2R**  
**Remote Control Compact Disc Player**  
 • Look at these features: • 3-beam laser pickup  
 • 16 selection programming • Wireless remote  
 • Advanced error correction • Black finish

Sale Price **\$149<sup>95</sup>** Retail \$329



**Toshiba XR-9057**  
**Compact Disc Changer**  
 • 6 disc changer plus single disc player  
 • Program up to 32 music tracks • 2X oversampling • Digital filter • Wireless remote

Sale Price **\$299<sup>95</sup>** Retail \$449

**Phono Cartridge Specials**



**Shure V-15 Type V-MR**  
**Deluxe Micro Ridge Phono Cartridge**  
 • Micro ridge stylus tip • Excellent trackability  
 • Dynamic stabilizer • Side-guard stylus protection • Duo-point alignment gauge

	Sale Price	Retail
Shure V15-IVMR Micro-ridge stylus	\$129 <sup>95</sup>	\$299
Shure M-111HE Hyperelliptical stylus, P-mount		\$69 <sup>95</sup>
Shure V15-HRP P-mount with Hyperridge stylus		\$49 <sup>95</sup>
Shure M-105E Universal mount with anti-static brush		\$49 <sup>95</sup>
Shure M-104E Universal or P-mount		\$37 <sup>95</sup>
Shure ME-95ED Standard mount, bi-radial stylus		\$27 <sup>95</sup>
Shure M-99E Universal or P-mount		\$24 <sup>95</sup>
Shure M-92E Universal mount, elliptical stylus		\$14 <sup>95</sup>
Pickering 625DJ Pro disco cartridge		\$9 <sup>95</sup>
Ortofon X5-MC High output moving coil		\$29 <sup>95</sup>
Grado MCX Top rated for sound		<b>IN STOCK</b>
Audioquest M-1 Great sound, standard mount		<b>IN STOCK</b>
		\$69 <sup>95</sup>

**Stereo Receivers**

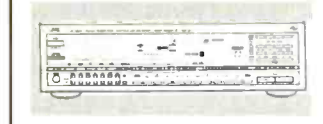

**JVC RX-950V BK**  
**High Power Audio/Video Receiver**  
 • Features 120 watts per channel RMS  
 • 7-band equalizer with spectrum analyzer display • 3-video inputs for complete dubbing  
 • Wireless remote control

Sale Price **\$499<sup>95</sup>** Retail \$749

Sherwood S273OCP 30 watt/ch digital receiver	\$119 <sup>95</sup>
Sherwood S275OCP 50 watt/ch receiver w/surround sound	\$149 <sup>95</sup>
Technics SA-130 35 watt/ch analog receiver	\$99 <sup>95</sup>
Technics SA-R230 50 watt/ch A/V receiver w/remote	\$249 <sup>95</sup>
Technics SA-R430 70 watt A/V receiver w/remote	\$399 <sup>95</sup>
Teac AG-55 50 watts/ch receiver	\$179 <sup>95</sup>

**Compact Disc Players**



**Teac AD-4**  
**CD Player/Cassette Deck Combo**  
 • Wireless remote control of both CD & cassette sections • 16-track random program dubbing & play • Dolby B & C • Auto reverse record/play • Synchro start dubbing

Sale Price **\$279<sup>95</sup>** Retail \$599

Teac PD-425 Programmable remote CD player	\$169 <sup>95</sup>
Teac AD-7 CD/Cassette w/Dolby B/C & dbx	\$439 <sup>95</sup>
Technics SL-P600C Programmable CD changer	\$329 <sup>95</sup>
Magnavox CD-B470 16 bit, 20-track programmable	\$149 <sup>95</sup>
Magnavox CD-B473 Programmable remote control player	\$229 <sup>95</sup>
Akai CD-B305CB Programmable remote CD player	\$199 <sup>95</sup>

**Compact Disc Players**



**Shure "Ultra" D-6000**  
**Remote Controlled CD Player**  
 • Features remote control with volume control  
 • 16 bit dual D/A converters • 2X oversampling  
 • Program 15 tracks in any order • Audible fast music scan

Sale Price **\$299<sup>95</sup>** Retail \$599

Technics SL-P250 4X oversampling, remote control	\$229 <sup>95</sup>
Technics SL-P350 Remote control, digital filter	\$259 <sup>95</sup>
Magnavox CD-B582 4X oversampling, remote control	\$199 <sup>95</sup>
Teac PD500M 6 disc CD changer, 16 bit D/A	\$259 <sup>95</sup>
Teac PD-155 3-beam laser, 16 bit, programmable	\$149 <sup>95</sup>
Aiwa XC-001 18 bit D/A, remote, programmable	\$299 <sup>95</sup>

**Speaker Systems**

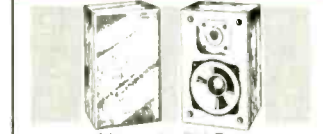

**Pinnacle PN-5 + 2-Way Mini Speakers**  
 • Super sound from a small speaker • Patent pending Diaduct port increases bass response  
 • 3/4" dome tweeter • 50 watt power handling • Designed & built in U.S.A.

Sale Price **\$129<sup>95</sup>** Retail \$199/PR

Pinnacle PN-6 + 2-Way Mid-size speaker	Pair \$179 <sup>95</sup>
Bose 101 High quality mini speaker	Pair \$179 <sup>95</sup>
Technics SB-L36 2-way speaker, 10-inch woofer	Pair \$99 <sup>95</sup>
Technics SB-L56 3-way speaker, 10-inch woofer	Pair \$149 <sup>95</sup>
Recoton W100 Wireless speaker system	Pair \$199 <sup>95</sup>
Koss M80 + 2-way mini speaker system	Pair \$139 <sup>95</sup>

**Audio Accessories**



**Audioquest Sorbothane Isolation Feet**  
 • Sorbothane has the remarkable ability to absorb and lose energy. For use under turntables or any equipment that needs to be vibration free. • Supports up to 35 lbs.

Sale Price **\$34<sup>95</sup>** Retail \$40

Audioquest Sorbothane record mat	\$34 <sup>95</sup>
Audioquest Sorbothane CD feet, set	\$22 <sup>95</sup>
Audioquest CD stabilizer ring kit	\$39 <sup>95</sup>
Tiptoes Speaker feet	Each \$6 <sup>95</sup>
Speaker Uppers 2040 Speaker stands	Pair \$44 <sup>95</sup>
Wood Technology W710 Ebony speaker stands	Pair \$49 <sup>95</sup>

**Portable CD Players**



**Sony D-T4**  
**Discman Portable AM/FM CD Player**  
 • New thin design • Built-in AM/FM stereo tuner  
 • 16 track programming • 4 repeat modes  
 • LCD display • Rechargeable battery pack  
 • AC adaptor & carry case included

Sale Price **\$249<sup>95</sup>** Retail \$349

Sony D-2 Portable CD Player	\$179 <sup>95</sup>
Sony D-4 Programmable CD Player	\$199 <sup>95</sup>
Sony D-15 Top-Of-The-Line CD Player	\$299 <sup>95</sup>
Technics SLXP5 Portable CD Player	\$249 <sup>95</sup>
Sony D-160 Removable Car CD Player, AC	\$199 <sup>95</sup>
Toshiba XR-9457 Portable CD Player	\$249 <sup>95</sup>

**Audio Equalizers**

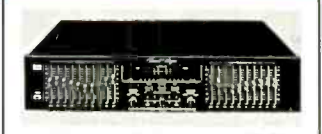

**ADC Sound Shaper SS-117EX**  
**Equalizer/Spatial Expander**  
 • 10-band per channel with 15 db range  
 • 2-way dubbing • EQ recording • Spatial expansion with level control • Multi-color LED display • Black finish

Sale Price **\$99<sup>95</sup>** Retail \$249

ADC SS-300SL 10-band EQ with real time analyzer	\$159 <sup>95</sup>
ADC SS-325 12-band EQ with real time analyzer	\$299 <sup>95</sup>
Teac EQ-A6 10-band EQ with spectrum display	\$79 <sup>95</sup>
Teac EQ-A30 10-band EQ with spectrum analyzer	\$199 <sup>95</sup>
Nikko EQ-30 Pro 30 band mono equalizer	\$249 <sup>95</sup>
ADC SS-525X 12 band EQ with auto equalization	\$369 <sup>95</sup>

SIX PAGES OF SUPER SPECIALS



ORDER TOLL-FREE **1-800-221-8180** IN NEW YORK, ALASKA & CANADA CALL: 1-718-417-3737  
 Mail Order Hours: Monday To Friday 8 AM to 8 PM, Saturday 9 AM to 6 PM, Sunday 10 AM to 4 PM  
 Dealer & Institutional Inquiries Call Toll-Free 1-800-221-3191 — In New York 1-718-417-3747  
 J&R Music World, Dept. SR1188, 23 Park Row, New York City, NY 10038





The items listed here are just a small sampling of our huge \$10,000,000 inventory.

# MUSIC WORLD

## Super Specials

### Stereo Phono Cartridges



**Audio Technica AT-231LP Universal Phono Cartridge**

• Standard or P-Mount • Linear contact stylus • 10-30K Hz frequency response • Improved the sound of your system with this top rated cartridge

Sale Price **\$39<sup>95</sup>** Retail \$130

- Audio Technica AT211EP Bi-radial stylus . . . . . \$19<sup>95</sup>
- Audio Technica AT216EP Universal mount . . . . . \$24<sup>95</sup>
- Audio Technica AT14OML Linear contact stylus . . . . . \$69<sup>95</sup>
- Audio Technica AT125LC Linear contact stylus . . . . . \$39<sup>95</sup>
- Audio Technica AT201EP Universal mount . . . . . \$14<sup>95</sup>
- Stanton 680EL Disco cartridge . . . . . \$54<sup>95</sup>
- Stanton 500AL Standard mount disco cartridge . . . . . \$19<sup>95</sup>
- Stanton 500ALDP Disco cartridge w/extra stylus . . . . . \$24<sup>95</sup>
- Stanton 681EEIHS Standard mount . . . . . \$49<sup>95</sup>
- Stanton 981HZIIS Stereohedron stylus . . . . . \$84<sup>95</sup>
- Stanton 1500AL P-mount disco cartridge . . . . . \$19<sup>95</sup>
- Pickering XV15-1200E Elliptical stylus . . . . . \$44<sup>95</sup>

### Double Cassette Decks



**Technics RS-T130 Double Stereo Cassette Deck**

• Add versatility to any system • High speed dubbing • Dolby B • Synchro start dubbing • Series play • Auto tape selector • Black

Sale Price **\$139<sup>95</sup>** Retail \$195



**Teac W-450R Auto Reverse Double Cassette Deck**

• Continuous playback • Auto reverse recording • Dolby B/C • Dolby HX Pro • Accurate rotary head reverse system • Black

Sale Price **\$199<sup>95</sup>** Retail \$289

### Turntable Specials



**Akai AP-A305B Belt Drive Turntable**

• Semi-automatic • Convenient front panel controls • Belt-drive • Anti-resonance cabinet to reduce rumble • Includes P-mount cartridge

Sale Price **\$89<sup>95</sup>** Retail \$149



**Technics SL-DD22 Direct Drive Turntable**

• Semi-automatic • Straight low mass bearing • Accepts P-Mount cartridge • Front panel controls • Hinged dust cover • Black finish

Sale Price **\$119<sup>95</sup>** Retail \$170

### Amplifiers and Tuners



**Nikko NA-2000 High Power Integrated Amplifier**

• 100 watts/channel • Recording output selector • 2-tape monitors • Bi-directional dubbing • MC input • DC amp section

Sale Price **\$199<sup>95</sup>** Retail \$330



**SAE T-101 Computer Direct Line AM/FM Tuner**

• 16 presets • Auto & manual tuning • Signal strength, multipath and level indicators • Fully electronic operation • 19" rack mountable

Sale Price **\$299<sup>95</sup>** Retail \$650

### Double Cassette Decks



**Teac W-990RX Stereo Double Reverse Cassette Deck**

• Dolby B/C and dbx • Cobalt amorphous tape heads • Record timer • 3-motor transport • Infra check • Random program dubbing system • Auto tape select • Wireless remote

Sale Price **\$499<sup>95</sup>**

- Technics RS-T55R Auto-reverse double cassette . . . . . \$349<sup>95</sup>
- Technics RS-T330R Auto-reverse, high speed dubbing . . . . . \$249<sup>95</sup>
- Teac W-350 High speed dubbing, Dolby B . . . . . \$99<sup>95</sup>
- Teac W-660R Auto-rev. double cassette, Dolby B/C . . . . . \$299<sup>95</sup>
- Sharp RT-W800 Auto-rev. double cassette, high speed . . . . . \$159<sup>95</sup>
- Sherwood S-289RDR Auto-rev. double cassette, Dolby B/C . . . . . \$199<sup>95</sup>

### Turntables



**Technics SL-J33 Direct Drive Programmable Turntable**

• Quartz locked drive system • LP jacket size • 8-step random access programming • Auto disc size selection • Record detector • Accepts P-mount cartridge

Sale Price **\$179<sup>95</sup>** Retail \$270

- ADC RC-1 Automatic record changer . . . . . \$59<sup>95</sup>
- ADC LT-34 Linear tracking turntable . . . . . \$79<sup>95</sup>
- Technics SL-BD20 Semiautomatic turntable . . . . . \$79<sup>95</sup>
- Technics SL-QD33K Fully-automatic, direct drive . . . . . \$139<sup>95</sup>
- Sherwood ST-887 Direct drive, semi-automatic . . . . . \$99<sup>95</sup>
- Gemini DJ-41500 Direct drive DJ turntable . . . . . \$259<sup>95</sup>

### Mixers and Tuners



**Gemini MX-5200 Disco Mixer with Equalizer**

• 7-band graphic equalizer • 3-phono inputs • 4-line inputs • 2-microphone inputs • Talkover switch • Precision components • Separate cue • Rack mountable

Sale Price **\$159<sup>95</sup>** Retail \$199

- Atus AM-100 4-input phono mixer . . . . . \$79<sup>95</sup>
- Gemini MX-6200 3-Phono inputs, 7-band EQ . . . . . \$179<sup>95</sup>
- Gemini MX-4200 2-phono inputs, echo, cueing . . . . . \$109<sup>95</sup>
- Technics SU-V450 50 watts X 2 Integrated amplifier . . . . . \$299<sup>95</sup>
- Technics SU-V650 90 watts X 2 Integrated amplifier . . . . . \$399<sup>95</sup>
- Technics ST-G50 AM/FM digital quartz tuner . . . . . \$189<sup>95</sup>

### Portable Digital Audio



**Panasonic RX-FD55 AM/FM Cassette CD Player**

• XBS extra bass system for big sound • Programmable CD player • Synchro tape/CD dubbing • 4-band EQ • Auto reverse

Sale Price **\$349<sup>95</sup>** Retail \$429

- Sharp QT-CD20 AM/FM cassette, CD portable . . . . . \$219<sup>95</sup>
- Sony CF-D66 AM/FM CD cassette portable . . . . . \$319<sup>95</sup>
- Sony CF-DD75 AM/FM CD cassette w/Mega Bass . . . . . \$499<sup>95</sup>
- Sony CF-D444 AM/FM CD cassette w/speakers . . . . . \$269<sup>95</sup>
- Panasonic RX-FD75 A/R double cassette, CD, XBS bass . . . . . \$529<sup>95</sup>
- JVC PC-V1J AM/FM double cassette, CD, 5-band EQ . . . . . \$479<sup>95</sup>

### Stereo Cassette Decks



**Teac V-285CHX Stereo Cassette Deck**

• Features include Dolby B & C noise reduction • Dolby HX Pro headroom extension system • Two tape head design • DC motor • Tape bias control • Black finish

Sale Price **\$99<sup>95</sup>** Retail \$160

- Teac R-425 Auto-reverse, Dolby B/C . . . . . \$119<sup>95</sup>
- Teac R-435X Auto-reverse, Dolby B/C & dbx . . . . . \$149<sup>95</sup>
- Teac R-616X Auto-reverse, Dolby B/C, HX Pro . . . . . \$299<sup>95</sup>
- Teac V-670 3-heads, 2-motors, Dolby B/C, HX Pro . . . . . \$279<sup>95</sup>
- Teac V-970X 3-heads/motors, Dolby B/C & dbx, HX . . . . . \$479<sup>95</sup>
- Technics RS-829R Auto-reverse Dolby B/C . . . . . \$199<sup>95</sup>

### Audio Accessories



**Terk FM-8500 Electronic Indoor FM Antenna**

• Omnidirectional design improves reception • Adjustable gain control • Amplifies incoming signal by up to 24 times • AC operated • One-year warranty

Sale Price **\$34<sup>95</sup>** Retail \$69

- Terk FM-9500 Electronic FM antenna . . . . . \$59<sup>95</sup>
- dbx 200XG Program route selector . . . . . \$79<sup>95</sup>
- dbx 224XD5 Type II tape noise reduction . . . . . \$179<sup>95</sup>
- dbx 1BXDS 1 band expander w/compression . . . . . \$179<sup>95</sup>
- Nikko CO-23 2-way stereo crossover . . . . . \$299<sup>95</sup>
- Nikko NPS-1R Add-on remote control . . . . . \$99<sup>95</sup>

### Portable Audio



**Toshiba KT-4087 Recording AM/FM Personal Cassette**

• Full record & play auto reverse • 3-band graphic equalizer • Dolby B • Voice activated recording • Detachable stereo microphone

Sale Price **\$149<sup>95</sup>** Retail \$189

- Sony WM-AF42 AM/FM auto-rev cassette Walkman . . . . . \$49<sup>95</sup>
- Sony WM-AF55 AM/FM cassette, A/Rev, Mega Bass . . . . . \$59<sup>95</sup>
- Toshiba KT-4568 AM/FM A/Rev cassette w/Dolby . . . . . \$119<sup>95</sup>
- Panasonic RX-SA255 Ultra small AM/FM cassette . . . . . \$199<sup>95</sup>
- Panasonic RX-SA78 AM/FM Cassette, A/R, EQ . . . . . \$89<sup>95</sup>
- Panasonic RX-SA79 AM/FM Cassette, A/R, Ultra Small . . . . . \$139<sup>95</sup>

SIX PAGES OF SUPER SPECIALS

TO ORDER BY MAIL: SEND MONEY ORDER, CERTIFIED OR CASHIER'S CHECK, MASTERCARD, VISA, AMERICAN EXPRESS OR DISCOVER CARD (Include Interbank No., expiration date and signature.) TO: J&R MUSIC WORLD, DEPT. SR1188, 23 PARK ROW, NEW YORK CITY, NY 10038. Personal and business checks must clear our Authorization Center before processing. Shipping, Handling & Insurance Charge is 5% of Total Order with a \$4.95 minimum. (Canadian Orders Add 15% Shipping, with a \$9.95 minimum charge.) For shipments by air, please double these charges. \$25 MINIMUM ORDER. DO NOT SEND CASH. SORRY, NO C.O.D.'s. NEW YORK RESIDENTS PLEASE ADD SALES TAX. WE ARE NOT RESPONSIBLE FOR TYPOGRAPHICAL ERRORS. ALL PICTURES SHOWN FOR VISUAL REPRESENTATION ONLY. ALL MERCHANDISE SHIPPED BRAND NEW, FACTORY FRESH, AND 100% GUARANTEED.



**RATED #1**  
**For Service and Reliability**



**This Month's**

**Stereo Headphones**



**Beyerdynamic DT-990**  
Audiophile Stereo Headphones

• Open style headphone with an unbelievable frequency response of 5-35k Hz • Unique moving coil assembly • Exceptional transient response

Sale Price **\$179<sup>95</sup>** Retail \$220

- Beyerdynamic DT-220**  
Closed ear headphones . . . . . \$99<sup>95</sup>
- Beyerdynamic DT-320**  
Semi-open ear headphone . . . . . \$69<sup>95</sup>
- Beyerdynamic DT-330MK-II**  
Lightweight semi-open air . . . . . \$74<sup>95</sup>
- Beyerdynamic DT-550**  
Semi-open air, lightweight . . . . . \$119<sup>95</sup>
- Beyerdynamic DT-770**  
Closed ear headphone . . . . . \$149<sup>95</sup>
- Beyerdynamic DT-880**  
Semi-open air headphone . . . . . \$139<sup>95</sup>
- Beyerdynamic DT-880/Studio**  
Pro studio headphones . . . . . \$184<sup>95</sup>
- Sennheiser HD-222**  
Closed ear headphone . . . . . \$69<sup>95</sup>
- Sennheiser HD-250**  
Studio quality headphone . . . . . \$169<sup>95</sup>
- Sennheiser HD-30**  
Lightweight mini headphone . . . . . \$34<sup>95</sup>
- Sennheiser HD-430**  
Open air headphone . . . . . \$99<sup>95</sup>
- Sennheiser HD-480**  
Digital ready . . . . . \$79<sup>95</sup>

**Portable Recorders**



**Sony WM-D6C Walkman "Pro"**  
Stereo Cassette Recorder

• Compact pro performance • Record level • Dolby B and C NR • Variable speed control • Quartz lock capstan drive • Carry case • MDR stereo headphones

Sale Price **\$329<sup>95</sup>** Retail \$479

- Sony WM-A39**  
Auto-reverse Walkman with Mega Bass . . . . . \$54<sup>95</sup>
- Sony TC-S430**  
Stereo recorder with speaker . . . . . \$89<sup>95</sup>
- Sony TC-DSM**  
Pro stereo recorder with Dolby . . . . . CALL
- Panasonic RN-15**  
2-speed microcassette recorder . . . . . \$149<sup>95</sup>
- Panasonic RC-382**  
Auto-rev. voice activated recorder . . . . . \$114<sup>95</sup>
- Toshiba KT-4188**  
Auto-rev. Dolby B, wired remote . . . . . \$149<sup>95</sup>

**Portable Audio**



**Panasonic RX-CW43**  
3-Piece Portable Component

• AM/FM tuner with 3-presets • Stereo double cassette deck • High speed dubbing • Auto reverse playback • Detachable 2-way speakers • Black

Sale Price **\$139<sup>95</sup>** Retail \$169

- Panasonic RX-FM14**  
AM/FM cassette portable . . . . . \$49<sup>95</sup>
- Sony CF-SW500**  
AM/FM double cassette . . . . . \$149<sup>95</sup>
- JVC PC-V33J**  
AM/FM cassette, Hyper Bass system . . . . . \$119<sup>95</sup>
- Sony CF-S930 "Sports"**  
AM/FM cassette portable . . . . . \$109<sup>95</sup>
- Sony CF-SDW80**  
AM/FM double cassette, Mega Bass . . . . . \$299<sup>95</sup>
- Sony CF-S1010**  
AM/FM cassette, auto-rev. 5band EQ . . . . . \$89<sup>95</sup>

**Accessories Specials**



**Memorex M-RX-60**  
Remote Control Extender

• Now you can put a VCR in every room without the added expense • Use your existing remote controls from any room in the house • Easy to install

Sale Price **\$59<sup>95</sup>** Retail \$99

- Nalad RF-2**  
Record storage system . . . . . \$18<sup>95</sup>
- Nalad CD-1**  
Compact disc storage system . . . . . \$14<sup>95</sup>
- Audio Technica AT-605**  
4-vibration absorbing feet . . . . . \$24<sup>95</sup>
- Monster Cable MV-2AV**  
2-meter video cables . . . . . \$39<sup>95</sup>
- Discwasher Wet**  
VHS head cleaner . . . . . \$9<sup>95</sup>
- Geneva PF-211**  
Pro bulk tape eraser . . . . . \$39<sup>95</sup>

**Audio/Video Add-On's**



**SSI M-360II**

Dolby Surround Sound Decoder  
• The ultimate decoder for Dolby Surround Sound encoded movies • Stereo synthesizer for use with non-encoded films • 45 watts X 2 rear channel • 4-video inputs

Sale Price **\$299<sup>95</sup>** Retail \$469

- Vidicraft**  
Video Digital Stabilizer . . . . . \$99<sup>95</sup>
- Memorex CP-8**  
Universal remote control . . . . . \$99<sup>95</sup>
- Multivision 1.1**  
Picture-in-picture video system . . . . . \$199<sup>95</sup>
- Parsec LS-4**  
Electronic FM Antenna . . . . . \$59<sup>95</sup>
- Ambico V-0805**  
10-hour belt powerpack . . . . . \$74<sup>95</sup>
- Parsec LS-3**  
Electronic FM Antenna . . . . . \$29<sup>95</sup>

**Audio Accessories**



**Memorex CS-40**

Cordless Stereo Headphone System  
• Now you can free yourself from headphone extension cords • AC powered transmitter • Battery powered receiver that goes with you • Headphones not included

Sale Price **\$69<sup>95</sup>** Retail \$109

- Audiosource LL-C1**  
Compact disc laser cleaner . . . . . \$24<sup>95</sup>
- Monster Cable 15/15**  
15 meters of speaker cable . . . . . \$29<sup>95</sup>
- Monster Cable ILC2-1M**  
1-meter of Interlink CD cable . . . . . \$38<sup>95</sup>
- Monster Cable INT300/1M**  
1 meter of Interlink 300 cable . . . . . \$19<sup>95</sup>
- DiscWasher DiscSet**  
Record cleaner system . . . . . \$14<sup>95</sup>
- DiscWasher Z-Stat**  
Anti-static device . . . . . \$18<sup>95</sup>

**Radio Specials**



**Sony ICF-PRO80**

Synthesizer World Band Receiver  
• Synthesizer tuner covers SW, MW, LW, FM, AIR, Public service and TV high bands • Direct access and scan tuning • 10-presets • LCD display

Sale Price **\$399<sup>95</sup>** Retail \$520

- KLH 200**  
AM/FM stereo table radio . . . . . \$199<sup>95</sup>
- KLH 100**  
AM/FM clock table radio . . . . . \$119<sup>95</sup>
- Sony ICF-9740**  
AM/FM table radio . . . . . \$44<sup>95</sup>
- Sony ICF-C80**  
AM/FM cassette clock radio . . . . . \$64<sup>95</sup>
- Sony ICF-2010**  
World band short wave radio . . . . . \$329<sup>95</sup>
- Panasonic RC-6190**  
AM/FM clock radio . . . . . \$35<sup>95</sup>

**Video Specials**

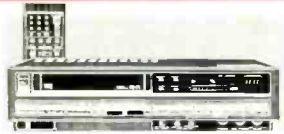

**Akai VS-565U**

Audio/Video Hi-Fi VCR  
• DX4 head with HQ and VHS Hi-Fi • 107-channel cable-ready MTS tuner with 32 presets • Remote control • On-screen programming • 10-watt stereo amplifier

Sale Price **\$499<sup>95</sup>** Retail \$649

- Panasonic PV-4860**  
4-Head VHS Hi-Fi video recorder . . . . . \$499<sup>95</sup>
- JVC HR-S8000**  
S-VHS Hi-Fi Digital video recorder . . . . . CALL
- Toshiba DX-900**  
PCM digital 4-head Hi-Fi Video recorder . . . . . CALL
- Sony SLH-F860D**  
Super Beta Hi-Fi with digital effects . . . . . CALL
- Akai VS-33U**  
Top rated 4-head VHS VCR . . . . . \$329<sup>95</sup>
- Pioneer CL-D3030**  
LaserVision, CD, CDV player . . . . . CALL

**Portable Video**



**Casio TV-400**

Pocket Color LCD Television  
• Pocket size television, more portable than ever • HQM high quality matrix system delivers crisp, clearer and brighter images than ever • 2-inch screen

Sale Price **\$139<sup>95</sup>** Retail \$199

- Casio TV-4000**  
2.7-Inch Color LCD TV . . . . . \$279<sup>95</sup>
- Sony FD10A**  
2-inch B&W Watchman . . . . . \$89<sup>95</sup>
- Sony FD-42A**  
4-inch B&W Watchman . . . . . \$109<sup>95</sup>
- Sony FD-L320**  
2.7-inch color LCD Watchman . . . . . \$449<sup>95</sup>
- Sony FD-270**  
2.7-Inch Watchman . . . . . \$149<sup>95</sup>
- Sharp JC-AV1**  
AM/FM cassette w/2-inch LCD TV . . . . . \$119<sup>95</sup>

**Television Specials**



**Sony KV27SXRI**

27" XBR Stereo Monitor/Receiver  
• Features high resolution 550 line resolution XBR picture tube • S-VHS input • 3-Audio video inputs • Variable output • MTS stereo tuner • Remote control

Sale Price **\$999<sup>95</sup>** Retail \$1500

- Toshiba CF-2648**  
26-inch stereo monitor w/remote . . . . . \$599<sup>95</sup>
- JVC AV-20575**  
20-inch stereo monitor w/S-VHS input . . . . . \$499<sup>95</sup>
- Panasonic PV-M2028**  
20-inch color TV/VCR combo . . . . . \$599<sup>95</sup>
- Panasonic CT-J2579R**  
25-inch stereo TV . . . . . \$499<sup>95</sup>
- Sony KV-13TRIO**  
13-inch color TV . . . . . \$299<sup>95</sup>
- Samsung TC-9850T**  
19-inch remote control color TV . . . . . \$229<sup>95</sup>

**Camcorder Specials**



**Panasonic PV-S350**

Super-VHS Camcorder  
• S-VHS system for 400 line resolution • Digital effects • High speed shutter • 8:1 power macro zoom • Infrared auto focus • Solid state CCD pickup

**CALL FOR BEST PRICE**

- Panasonic PV-110**  
VHS-C auto-focus camcorder . . . . . CALL
- Panasonic PV-400**  
VHS camcorder, 6:1 zoom, free case . . . . . CALL
- JVC GR-25U VHS-C**  
Camcorder, auto-focus, power zoom . . . . . CALL
- JVC GR-S55U S-VHS-C**  
Camcorder, power zoom . . . . . CALL
- Sony CCD-V5 8mm**  
Camcorder, auto-focus . . . . . CALL
- Sony CCD-F30 8mm**  
Camcorder, 6:1 zoom, 9 lux . . . . . CALL

SIX PAGES OF SUPER SPECIALS



ORDER TOLL-FREE **1-800-221-8180** IN NEW YORK, ALASKA & CANADA CALL: 1-718-417-3737  
Mail Order Hours: Monday To Friday 8 AM to 8 PM, Saturday 9 AM to 6 PM, Sunday 10 AM to 4 PM  
Dealer & Institutional Inquiries Call Toll-Free 1-800-221-3191 — In New York 1-718-417-3747  
J&R Music World, Dept. SRT188, 23 Park Row, New York City, NY 10038



The items listed here are just a small sampling  
 of our huge \$10,000,000 inventory.



# Super Specials

## Headphone Specials



**Koss Pro/450**  
 Studio Pro Stereophone

• Precise acoustical reproduction • Unique dual element dynamic driver delivers extended low end • Frequency response 10-30 kHz • Foam-filled earcups

Sale Price **\$138<sup>88</sup>** Retail Price \$175

Koss JC-K200 Wireless stereo headphones	\$118 <sup>88</sup>
Koss JC-K100 Lightweight stereo headphones	\$99 <sup>88</sup>
Koss Pro4AAA + Studio quality headphones	\$38 <sup>88</sup>
Koss PortaPro Lightweight portable	\$39 <sup>88</sup>
Koss SST/10 Digital ready headphones	\$99 <sup>88</sup>
Sony MDR-CD6 Lightweight digital ready	\$89 <sup>88</sup>
Sony MDR-E484 Portable digital ready buds	\$58 <sup>88</sup>
Sony MDR-A60 Lightweight portable design	\$59 <sup>88</sup>
Sony MDRM-66 High quality digital ready	\$69 <sup>88</sup>
Sony MDRE-464 Lightweight bud style	\$34 <sup>88</sup>
Sony MDR-V6 Top rated digital ready	\$79 <sup>88</sup>
Sony MDR-V4 Closed ear design	\$59 <sup>88</sup>

## Video Tape Specials



**Scotch T-160EG +**  
 High Grade VHS Video Tape

• We've slashed the price on Scotch's EG+ high grade video tape • Finer colors, detail and resolution • Great for all your recording needs

Sale Price **\$45<sup>95</sup>** 10-Pack Retail Price

TDK T120-EHG Extra high grade VHS	Each \$4 <sup>49</sup>
TDK T120-HS High standard VHS	Each \$3 <sup>49</sup>
Fuji T-120HQ Standard grade VHS	Each \$3 <sup>59</sup>
Fuji T-120XG High grade VHS	Each \$7 <sup>19</sup>
Sony L750-E5 Standard grade Beta	Each \$2 <sup>99</sup>
Sony L750ES-HG Extra high grade	Each \$4 <sup>49</sup>

## Musical Keyboards



**Yamaha PSS-680**  
 PortaSound Stereo PCM Keyboard

• 61 mid-size keys • 100 FM preset sounds • 100 PCM rhythms • 8 hand-percussion pads with 32 sounds • Programmable drums • Melody memory • MIDI in/out • Reverb

Sale Price **\$249<sup>95</sup>** Retail Price \$319

Yamaha PSS-130 32 key mini keyboard	\$39 <sup>95</sup>
Yamaha PSS-480 49 key mid-size keyboard, 100 sounds	\$179 <sup>95</sup>
Yamaha DD-5 4-pad electronic drums	\$94 <sup>95</sup>
Casio DH-100 Electronic wind instrument	\$144 <sup>95</sup>
Casio DG-20 Guitar style instrument	\$299 <sup>95</sup>
Casio PT-100 32 key mini keyboard	\$44 <sup>95</sup>

## Radar Detectors



**BEL Vector 3**  
 New 3-Band Radar Detector

• Detects X, K, and Ka band radar • IRT (image rejection technology) • GaAs diode • Computerized circuitry • Separate audio & video alerts • Visor or dash mount

Sale Price **\$168<sup>88</sup>** Retail Price \$300

Cobra RD-3168 Shift pocket size	\$159 <sup>95</sup>
Whistler Spectrum 2 Remote radar detector	\$218 <sup>95</sup>
Uniden RD-9XL Super small size	\$158 <sup>95</sup>
Uniden Talker Top-of-the-Line	\$188 <sup>88</sup>
Fox MicroFox-2000 X/K bands, LED readout	\$99 <sup>95</sup>
Fox MicroFox Super small design	\$149 <sup>95</sup>

## Car Stereo



**Claron 8825RT**  
 Digital AM/FM Cassette Auto Receiver

• New slide-out chassis • 18-station preset AM/FM tuner • Seek & scan tuning • Auto reverse cassette • Dolby B • Music search • 25 watts per channel • LCD display

Sale Price **\$259<sup>95</sup>** Retail Price \$429

Claron 100EQB/6 25 watts X 2 amplifier, 5-band EQ	\$69 <sup>95</sup>
Sherwood SCPI002 120 watts X 2 power amplifier	\$199 <sup>95</sup>
Sherwood XR-1604 Auto-rew, full logic car receiver	\$268 <sup>95</sup>
Claron 8200R Digital AM/FM cassette car receiver	\$124 <sup>95</sup>
Claron SE-5360 5-inch 3-way car speakers	Pair \$49 <sup>95</sup>
Sherwood CR-D165 AM/FM auto-reverse cassette	\$139 <sup>95</sup>

## Audio Tape Specials



**Maxell XLI-100**  
 Audiophile High Bias Cassette Tape

• Now 100 minutes for extended length and compact disc recording • New resonance-proof cassette mechanism for improved performance • 10-packs

Sale Price **\$24<sup>95</sup>** 10-Pack Retail Price

Maxell MX-90 Metal bias	Each \$2 <sup>49</sup>
Maxell XL-1190 High bias	Each \$1 <sup>99</sup>
TDK MA-XG90 High performance metal bias	Each \$5 <sup>79</sup>
TDK SD-90 New high bias	Each \$1 <sup>34</sup>
Sony UX-Pro90 Top rated high bias	Each \$2 <sup>39</sup>
Fuji Metal90 Metal bias	Each \$2 <sup>14</sup>

## Phone Answering Machines



**PhoneMate 7200**  
 Beeperless Remote Answering Machine

• Easy to use • Feature packed! • Voice synthesized time/date stamp & remote menu • One touch operation • Memo recording • Talking clock • Black finish

Sale Price **\$99<sup>99</sup>** Retail Price \$169

Panasonic KXT-1424 Beeperless remote answering machine	\$74 <sup>95</sup>
Panasonic KXT-1720 2-line beeperless remote	\$138 <sup>88</sup>
Code-A-Phone 5530 Beeperless remote with talker	\$99 <sup>95</sup>
Code-A-Phone 2690 Telephone with answering machine	\$109 <sup>95</sup>
PhoneMate 6750 Clock radio/answering machine	\$124 <sup>95</sup>
PhoneMate 7050 Telephone/answering machine	\$89 <sup>95</sup>

## Telephones



**Freedom Phone 1700**  
 Dual Dial Cordless Telephone

• Enjoy 1000-foot cordless convenience • Push button dialing from handset and base • Tone/pulse switchable • 9-number auto dialer • Speakerphone • Intercom

Sale Price **\$108<sup>88</sup>** Retail Price \$179

Cobra CP-460 10# memory cordless telephone	\$128 <sup>88</sup>
Cobra CP-4685 110/220 volt cordless telephone	\$88 <sup>88</sup>
PhoneMate 400 Trimline style phone	\$24 <sup>88</sup>
Panasonic KXT-2335 Auto dialing feature phone	\$48 <sup>88</sup>
Panasonic KXT-2355 Auto dialing speakerphone	\$48 <sup>88</sup>
Electronic Technology Trimline Tone/pulse phone	\$18 <sup>88</sup>

## Word Processors



**Panasonic KX-W1500**  
 Personal Word Processor

• Tufona diskette • 9" x 80 x 25 character display • Word wrap • Block/ing • Mail merge • 63K AccuSpell dictionary • 353K disk storage • 58K character memory

Sale Price **\$599<sup>95</sup>** Retail Price \$899

Panasonic KXR-340 Typewriter with accu-spell	\$209 <sup>95</sup>
Brother WP-55 Personal word processor	\$569 <sup>95</sup>
Brother AX-26 Electronic typewriter	\$259 <sup>95</sup>
Smith Corona PWP-40 Personal word processor	\$399 <sup>95</sup>
Smith Corona SL-500 Electronic typewriter	\$139 <sup>95</sup>
Smith Corona PWP80 Deluxe personal word processor	CALL

## FAX Machines



**Pactel Faxte 3300**  
 Fax Machine with Telephone

• 5 page auto document feeder • 15 second page transmission • Speed dialing • Auto redial • Polling • Tone/pulse • LCD display • G2 & G3 • Time & date stamp

Sale Price **\$1099<sup>95</sup>** Retail Price \$1699

Brother Fax60 Personal Fax machine	\$1099 <sup>95</sup>
Sharp FO-420 G1/2/3/Fax machine	\$1299 <sup>95</sup>
Sharp FO-300 Fax machine, 16 grey tones	\$1199 <sup>95</sup>
Cannon Fax8 5 page document feeder	\$799 <sup>95</sup>
Murata M1200 Fax machine, G2/3, LED display	CALL
Toshiba 30100 Fax machine with telephone	CALL

## Desktop Copiers

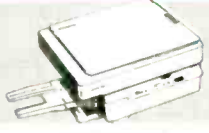

**Canon PC-7**  
 Desktop Zoom Copier

• The perfect desktop copier for your home office • Now you can reduce & increase copies from 70% to 122% in 1% increments • Compact size

Sale Price **\$1099<sup>95</sup>** Retail Price \$1899

Cannon PC-6RE Personal copier	CALL
Ricoh FT-2010 Personal copier	\$949 <sup>95</sup>
Ricoh LR-1 Compact personal copier	\$799 <sup>95</sup>
Sharp Z-50 Compact auto exposure copier	CALL
Sharp Z-70 Compact copier with reduction	CALL
Cannon PC-3 Manual feed personal copier	CALL

SIX PAGES OF SUPER SPECIALS

TO ORDER BY MAIL:  
 SEND MONEY ORDER, CERTIFIED OR CASHIER'S CHECK, MASTERCARD, VISA, AMERICAN EXPRESS OR DISCOVER CARD (Include Interbank No., expiration date and signature.) TO: J&R MUSIC WORLD, DEPT. 581188, 23 PARK ROW, NEW YORK CITY, NY 10038. Personal and business checks must clear our Authorization Center before processing. Shipping, Handling & Insurance Charge is 5% of Total Order with a \$4.95 minimum. (Canadian Orders Add 15% Shipping, with a \$9.95 minimum charge.) For shipments by air, please double these charges. \$25 MINIMUM ORDER. DO NOT SEND CASH. SORRY, NO C.O.D.'s. NEW YORK RESIDENTS PLEASE ADD SALES TAX. WE ARE NOT RESPONSIBLE FOR TYPOGRAPHICAL ERRORS. ALL PICTURES SHOWN FOR VISUAL REPRESENTATION ONLY. ALL MERCHANDISE SHIPPED BRAND NEW, FACTORY FRESH, AND 100% GUARANTEED.



**RATED #1**  
**For Service and Reliability**



*This Month's*



**24<sup>95</sup>**

**BOX OFFICE FAVORITES**  
On Sale For **\$18<sup>95</sup>** Each

- 9 1/2 Weeks
- An Officer And A Gentleman
- Big Chill
- Big Easy
- Children Of A Lesser God
- Color Of Money
- Dr. Strangelove
- Ferris Bueller's Day Off
- Hannah And Her Sisters
- Heartburn
- Hooliers
- Lethal Weapon
- Light Of Day
- Mona Lisa
- Prizzi's Honor
- Stand By Me
- Tin Men
- Top Gun
- Tough Guys
- West Side Story

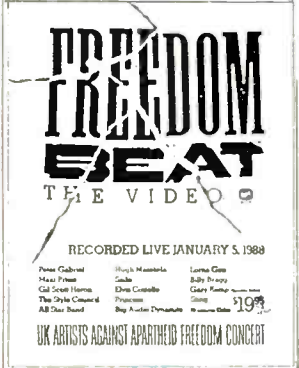

**18<sup>95</sup>**

**TOP SELLING MUSIC VIDEOS**

- |                                 |                    |
|---------------------------------|--------------------|
| George Michael Faith            | \$14 <sup>95</sup> |
| Dead Or Alive Rip It Up         | \$14 <sup>95</sup> |
| Terence Trent D'Arby            | \$18 <sup>95</sup> |
| Eurythmics Live                 | \$18 <sup>95</sup> |
| Tina Turner Rio '88             | \$22 <sup>95</sup> |
| Monterey Pop                    | \$18 <sup>95</sup> |
| B.B. King & Friends             | \$18 <sup>95</sup> |
| All-Star Reggae Session         | \$18 <sup>95</sup> |
| Beasties Live                   | \$15 <sup>95</sup> |
| Eric Clapton & Friends          | \$18 <sup>95</sup> |
| Charlie Parker Celebrating Bird | \$24 <sup>95</sup> |
| Joe Jackson Live In Tokyo       | \$18 <sup>95</sup> |

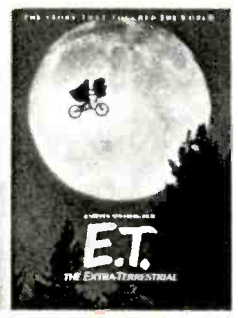

**14<sup>95</sup>**  
After \$5 Pepsi rebate

**BEST OF THE LOT**  
On Sale For **\$18<sup>95</sup>** Each

- Altered States
- Arthur
- Caddyshack
- Exorcist I or II
- Going Hollywood: The War Years
- Green Berets
- Heartbreak Ridge
- Killing Fields
- Little Shop Of Horrors
- Mad Max Beyond Thunderdome
- Pee Wee's Big Adventure
- Rio Bravo
- Road Warrior
- Shinning



**79<sup>95</sup>**

**BEST OF THE LOT**  
On Sale For **\$22<sup>95</sup>** Each

- All The President's Men
- Chariots Of Fire
- Clockwork Orange
- Dial M For Murder
- Mean Streets
- Strangers On A Train
- Wild Bunch

**STAR VALUE**

- |                               |                    |
|-------------------------------|--------------------|
| Aliens                        | \$27 <sup>95</sup> |
| Cocoon                        | \$27 <sup>95</sup> |
| The Fly (1986)                | \$27 <sup>95</sup> |
| Towering Inferno              | \$27 <sup>95</sup> |
| Spy Who Came In From The Cold | \$18 <sup>95</sup> |
| Rainmaker                     | \$18 <sup>95</sup> |
| Crocodile Dundee              | \$18 <sup>95</sup> |
| Beverly Hills Cop             | \$18 <sup>95</sup> |
| Raiders Of The Lost Ark       | \$18 <sup>95</sup> |

**VESTRON'S STARS**

- |                        |                    |
|------------------------|--------------------|
| Dirty Dancing          | \$22 <sup>95</sup> |
| Platoon                | \$22 <sup>95</sup> |
| Flamingo Kid           | \$18 <sup>95</sup> |
| Mad Max                | \$18 <sup>95</sup> |
| Salvador               | \$18 <sup>95</sup> |
| To Live And Die In LA  | \$18 <sup>95</sup> |
| Falcon And The Showman | \$18 <sup>95</sup> |
| Purple Rose Of Cairo   | \$18 <sup>95</sup> |
| Broadway Danny Rose    | \$18 <sup>95</sup> |
| Easy Money             | \$18 <sup>95</sup> |

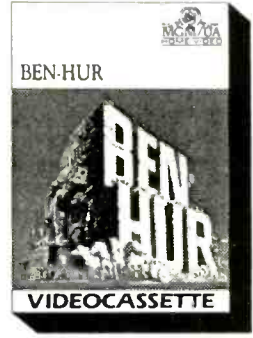

**27<sup>95</sup>**

**SCREEN EPICS**  
On Sale For **\$27<sup>95</sup>** Each

- Ben Hur
- Doctor Zhivago
- Fiddler On The Roof
- Great Escape



**79<sup>95</sup>**

**CLASSIC DRAMA**  
On Sale For **\$18<sup>95</sup>** Each

- Bishops Wife
- Four Feathers
- Little Foxes
- Richard III
- Summertime
- Wuthering Heights

**TOUGH GUYS**

- |                       |                    |
|-----------------------|--------------------|
| Bridges At Toko-Ri    | \$18 <sup>95</sup> |
| Strategic Air Command | \$18 <sup>95</sup> |
| Dogs Of War           | \$27 <sup>95</sup> |
| Rollerball            | \$27 <sup>95</sup> |
| Heartbreak Ridge      | \$18 <sup>95</sup> |
| Full Metal Jacket     | \$69 <sup>95</sup> |



**32<sup>95</sup>**

- |                      |                    |
|----------------------|--------------------|
| Untouchables         | \$32 <sup>95</sup> |
| Robocop              | \$37 <sup>95</sup> |
| Barfly               | \$32 <sup>95</sup> |
| Witches Of Eastwick  | \$37 <sup>95</sup> |
| Midnight Cowboy      | \$37 <sup>95</sup> |
| Beverly Hills Cop II | \$32 <sup>95</sup> |
| Platoon              | \$37 <sup>95</sup> |
| Less Than Zero       | \$32 <sup>95</sup> |
| Goldfinger           | \$32 <sup>95</sup> |
| Real Men             | \$37 <sup>95</sup> |
| Blow-Up (1966)       | \$32 <sup>95</sup> |
| Gone With The Wind   | \$47 <sup>95</sup> |
| Prayer For The Dying | \$34 <sup>95</sup> |
| Born In East LA      | \$32 <sup>95</sup> |



**27<sup>95</sup>**

**PARAMOUNT/WINDHAM HILL**  
On Sale For **\$27<sup>95</sup>** Each

- TIBET
- AUTUMN PORTRAIT
- WATER'S PATH
- WESTERN LIGHT
- CHINA
- IN CONCERT



**ORDER TOLL-FREE 1-800-221-8180** IN NEW YORK, ALASKA & CANADA CALL: 1-718-417-3737  
Mail Order Hours: Monday To Friday 8 AM to 8 PM, Saturday 9 AM to 6 PM, Sunday 10 AM to 4 PM  
Dealer & Institutional Inquiries Call Toll-Free 1-800-221-3191 — In New York 1-718-417-3747  
**J&R Music World, Dept. SRT188, 23 Park Row, New York City, NY 10038**



The items listed here are just a small sampling of our huge \$10,000,000 inventory.

# MUSIC WORLD

## Super Specials

### Little Bit Of Gold

**RHINO**



**4.49**  
Per CD

- The Four Seasons: Sherry, Let's Hang On, Working My Way Back To You, Rag Doll (RS 73010)
- Little Richard: Tutti-Frutti, Good Golly, Miss Molly, Slippin' And Slidin' (Peepin' And Hidin'), The Girl Can't Help It (RS 73014)
- The Ventures: Walk - Don't Run, Hawaii Five-O, Perfida, Wipe Out (RS 73020)
- Richie Valens: Donna, La Bamba, Come On, Let's Go, That's My Suzie (RS 73018)
- Jan & Dean: The Little Old Lady (From Pasadena), Surf City, Dead Man's Curve, Ride The Wild Surf (RS 73011)
- Little Anthony & The Imperials: Goin' Out Of My Head, I'm On The Outside (Looking In), Hurt So Bad, Take Me Back (RS 73013)
- Fats Domino: Blueberry Hill, I'm Walking, Ain't That A Shame, Walking To New Orleans (RS 73007)
- The Everly Brothers: Wake Up Little Suzie, Let It Be Me, Bird Dog, All I Have To Do Is Dream (RS 73008)
- Johnny Cash: I Walk The Line, Folsom Prison Blues, Guess Things Happen That Way, Ballad Of A Teenage Queen (RS 73002)
- Raspberries: Go All The Way, Let's Pretend, I Wanna Be With You, Tonight (RS 73016)

### Narada: Hear The Difference



**11.99**  
Per CD

- Also Available . . . .
- Tingstad/Rumbel: The Gift (62751)
  - David Lanz/Michael Jones: Solstice (61008)
  - David Lanz: Cristofori's Dream (61021)
  - Michael Jones: Panoscapes (61001)
  - Michael Jones: Seascapes (61004)
  - The Narada Collection: Extra Length Sampler (39100) 8.99 Per CD

### Music For The Next Wave



**11.99**  
Per CD

- Also Available . . . .
- David Friesen: Inner Voices (40718)
  - Steven Kindler & Teja Ball: Dolphin Smiles (40719)
  - Paul Greaver: Joy (40720)
  - Georgla Kelly: Seapeace (40724)
  - Ben Tavera King: Desert Dreams (40725)
  - Joaquin Lievano: One Mind (40726)
  - Bob Kindler: Waters Of Life (40727)
  - Tor Dietrichson: Global Village (40728)

### The World Of Private Music



**11.99**  
Per CD

- Also Available . . . .
- John Tesch: Tour De France (2040)
  - Andy Summers: Mysterious Baricades (2039)
  - Patrick O'Heam: Rivers Gonna Run (2029)
  - Patrick O'Heam: Between Two Worlds (2017)
  - Suzanne Ciani: Neverland (2036)
  - Yanni: Chameleon Days (2043)
  - Yanni: Keys To Imagination (2008)

### CBS Masterworks Odyssey Series



**5.99**  
Per CD

- Also Available . . . .
- Vivaldi: The Four Seasons: Isaac Stern, Jerusalem Music Center Chamber Orchestra (MBK 42526)
  - Bach: Partita No. 4 BWV 828; "Italian" Concerto; Toccata in E minor, BWV914 Glenn Gould (MBK 42527)

### Polygram Classics



**12.99**  
Per CD

- Also Available . . . .
- Brahms: German Requiem; Gullini (VP 423 574-2 GH)
  - Strauss: Also sprach Zarathustra; Sinopoli (NYP 423 576-2 GH)
  - Coloratura Spectacular: Sutherland (417 614-2H)
  - Mozart: Piano Concertos 26 & 27; Uchida, Tate, ECO (420 951-2PH)
  - Digital Jukebox: John Williams, Boston Pops (422 064-2PH)

### Nonesuch Explorer Series



**12.99**  
Per CD

- Also Available . . . .
- Korea: P'Ansoni (72049-2-K)
  - Japan: Traditional (72072-2-K)
  - Africa: Drum, Chant, etc (72073-2-K)
  - India: Ramanad Krishnan (72023-2-O)
  - Bulgaria: Village & Folk Music (79195-2-O)
  - Peru: Kingdom/Fiestas (79197-2-O)
  - Tibet: Buddhist Tantras (79198-2-O)

### Great Jazz From Blue Note



**8.99**  
Per CD

- Also Available . . . .
- John Coltrane: Blue Train (81577)
  - Dexter Gordon: The Other Side Of "Round Midnight" (85135)
  - Ellington/Roach/Mingus: Money Jungle (85129)
  - Herbie Hancock: Maiden Voyage (46339)
  - Billie Holiday: Billie's Blues (48786)
  - Stanley Jordan: Standards Volume I (46333)
  - Birell Lagrene: Inferno (48016)

### Compact Jazz From



**7.99**  
Per CD

- Also Available . . . .
- Jimmy Smith Plays The Blues: (829 537-2)
  - Ella Fitzgerald And Louis Armstrong: (835 313-2)
  - Gene Krupa And Buddy Rich: (835 313-2)
  - Oscar Peterson And Friends: (835 315-2)
  - Lester Young And The Piano Giants: (835 316-2)

### Impulse The Feeling Of Jazz



**9.99**  
Per CD

- Also Available . . . .
- Duke Ellington And John Coltrane: (MCAD-39103)
  - Gil Evans Orchestra: Inlo The Hot (MCAD-39104)
  - Johnny Hartman: I Just Dropped By To Say Hello (MCAD-39105)
  - Keith Jarrett: Treasure Island (MCAD-39106)
  - Sonny Rollins: Altie (MCAD-39107)



### FREE CATALOGUE

For a FREE catalogue call toll-free 800-426-6027, or Write:  
 J&R Music World  
 Department SR1188  
 59-50 Queens-Midtown Expressway  
 Maspeth, NY 11378.

Name \_\_\_\_\_

Address \_\_\_\_\_

City \_\_\_\_\_ State \_\_\_\_\_ Zip \_\_\_\_\_

CIRCLE NO. 39 ON READER SERVICE CARD

TO ORDER BY MAIL:  
 SEND MONEY ORDER, CERTIFIED OR CASHIER'S CHECK, MASTERCARD, VISA, AMERICAN EXPRESS or DISCOVER CARD (Include Interbank No., expiration date and signature.) TO: **J&R MUSIC WORLD, DEPT. SR1188, 23 PARK ROW, NEW YORK CITY, NY 10008.** Personal and business checks must clear our Authorization Center before processing. Shipping, Handling & Insurance Charge is 8% of Total Order with a \$4.95 minimum. (Canadian Orders Add 15% Shipping, with a \$9.95 minimum charge.) For shipments by air, please double these charges. **\$25 MINIMUM ORDER. DO NOT SEND CASH. SORRY, NO C.O.D.'s.** NEW YORK RESIDENTS PLEASE ADD SALES TAX. WE ARE NOT RESPONSIBLE FOR TYPOGRAPHICAL ERRORS. ALL PICTURES SHOWN FOR VISUAL REPRESENTATION ONLY. ALL MERCHANDISE SHIPPED BRAND NEW, FACTORY FRESH, AND 100% GUARANTEED.



**The funniest Rodrigues cartoons from Stereo Review have finally been collected in the audio/video book of the year!**

## TOTAL HARMONIC DISTORTION



Cartoons from Stereo Review  
by Charles Rodrigues

This handsome, 128-page paperback—with 118 classic cartoons, a foreword by William Livingstone, and an illustrated autobiographical sketch by Rodrigues himself—is only \$7.95. Enjoy your favorites again, catch the gems you missed, and share the laughs with friends!

**Makes a great gift!**

Get two copies for the full stereo effect!

Available only by mail

**TO ORDER:** Send check or money order for \$7.95 per copy, plus \$1.50 for postage & handling to:

Perfectbound Press  
Suite 4118K  
1120 Avenue of the Americas  
New York, NY 10036

Type or print mailing address with order.  
New York residents add 65¢ sales tax per copy.  
Outside U.S.: add \$1.75 postage & handling for first copy and 50¢ for each additional copy (U.S. bank funds only). Allow four to six weeks for delivery, longer outside the U.S.

Schreier cond. ORFEO/HARMONIA MUNDI USA © C 133 852 two CD's (99 min).

Performance: *Convincing*  
Recording: *Very good*

When the Baron van Swieten presented the music of his beloved Handel in Vienna toward the end of the eighteenth century, he felt that his audiences should hear both a language and an orchestral sound that they understood. In the case of *Acis and Galatea*, the well-meaning Baron translated the text into German and hired Mozart to "improve" the orchestral sound. Although Mozart's job was purely hackwork and should be considered a mere historical curiosity, our fetish for Mozart these days is so out of hand that the Van Swieten version is now being performed and has even reached CD's.

From the very start of the overture, as clarinets come in where Handel used oboes, one is keenly aware of the transformation from the Baroque to the Classical sound. It is, in fact, Mozart's use of woodwinds and horns that more than anything else achieves the metamorphosis. The effect is especially apparent in his orchestration of two movements from the seventh concerto grosso of Op. 6, which were played between the acts in the Viennese performance. The result, of course, is very beautiful but rather weak sounding when it is compared with the straightforward original.

Besides the Mozart orchestration, the music is also transformed by the use of German and the distinctly modern, Viennese vocal approach by all the singers, regardless of nationality. This approach comes naturally to Edith Mathis, who is right at home in the style and wrings out a particularly beautiful final lament. Anthony Rolfe Johnson, however, has gone so far overboard that he could be right out of *Zauberflöte*. Robert Gambill sings naturally and beautifully, but Robert Lloyd's Polyphemus is disturbing in its sinister qualities—in the coloratura passages he chews each note, then thrusts it up through his nose. The effect is ugly.

Nonetheless, overall the performance is convincing. You soon accept the new sounds and style, and Handel's music proves indestructible. Who knows, maybe if he had never left Germany the piece would have sounded like this originally. S.L.

**IVES:** *New England Holidays; The Unanswered Question; Central Park in the Dark* (see Best of the Month, page 107)

**LISZT:** *Vexilla regis prodeunt; Sursum corda; Abendglocken; Invocation* (see MUSSORGSKY)

**MOZART:** *The Marriage of Figaro: Overture; Non so più, cosa son. Eine* (Continued on page 144)

## DISTRIBUTOR PRICES

PAY THE SAME PRICE MANY DEALERS PAY ON AUDIO-VIDEO-VCR-CD'S. EAST COAST'S LARGEST SELECTION OF CD DISCS

**30% to 60% OFF**

- \*NO DEPOSIT! Pay nothing till order arrives
- \*SAME DAY SHIPPING (till 1 p.m.)
- \*ALL POPULAR CREDIT CARDS
- \*CALL TODAY FOR YOUR FREE AUDIO/VIDEO CATALOG

- \*CALL OR SEND FOR YOUR SCHWANN CD CATALOG WITH LISTING OF 17,000 CD DISKS. SEND \$3.95. WE'LL THEN DEDUCT THE COST FROM YOUR FIRST ORDER.



**INTERNATIONAL HI-FI DISTRIBUTORS**

MORAVIA CENTER INDUSTRIAL PARK  
BALTIMORE, MD.  
21206

**CALL (301) 488-9600**  
9 to 9 Daily  
Saturday Til 5pm

CIRCLE NO. 172 ON READER SERVICE CARD

HELP US HELP YOU!

# PARTICIPATE IN THE STEREO REVIEW BUYER POLL

Stereo Review wants to know more about our readers. How much equipment you buy (and how often), how much you spend on it, what sort of product features you like. That will help us create a better, more informative magazine, specially geared to your tastes and preferences.

To gather this important information, we've created the Stereo Review Buyer Poll. And we need your help to make it work.

If you've bought any equipment within the past 30 days, we'd like you to participate (see instructions below). We'll use the information you give us to keep manufacturers up to date on the buying habits of stereo enthusiasts—the most knowledgeable group of audio buyers in the country. And in the long run, that will mean better service for you.

## HOW TO PARTICIPATE

You can participate in the Stereo Review Buyer Poll by sending in the Reader Service Card appearing next to this page. We've provided space for you to list any equipment purchased in the past 30 days. Any kind of audio/video equipment qualifies.

For example:

### Home Audio Components

- Amplifier ▪ Receiver/Tuner
- Speakers ▪ Turntable
- Cassette Deck ▪ Equalizer
- CD player

### Portable Stereo

- Portable Cassette Player
- Portable CD Player
- Headphones

### Car Stereo

- Tuner ▪ Cassette Deck
- Speakers

### Home Video

- VCR ▪ Camcorder
- Videodisc Player
- Stereo TV

Fill in the type of equipment, manufacturer, model number, and price you paid. Include all the equipment you bought this month. Then print your name and address and drop it in the mail (we pay the postage). It's that simple!

**Free Information Service** ★ ★ ★

Get free literature on stereo products featured in this issue. Simply fill out your name and address, circle the number on the card that corresponds to the key number at the bottom of the advertisements and mail this card today.

1 2 3 4 5 6 7 8 9 10 11 12 13 14 15 16 17 18 19 20 21 22 23 24 25 26 27 28 29 30 31 32  
33 34 35 36 37 38 39 40 41 42 43 44 45 46 47 48 49 50 51 52 53 54 55 56 57 58 59 60 61 62 63 64  
65 66 67 68 69 70 71 72 73 74 75 76 77 78 79 80 81 82 83 84 85 86 87 88 89 90 91 92 93 94 95 96  
97 98 99 100 101 102 103 104 105 106 107 108 109 110 111 112 113 114 115 116 117 118 119 120 121 122 123 124 125 126 127 128  
129 130 131 132 133 134 135 136 137 138 139 140 141 142 143 144 145 146 147 148 149 150 151 152 153 154 155 156 157 158 159 160

**STEREO REVIEW BUYER POLL**

1. In the past 30 days, have you purchased any audio or video equipment or accessories?  
A  YES B  NO → Thank You

2. Which type(s) of equipment did you purchase in the past 30 days?  
A  Home audio B  Portable stereo  
C  Car stereo D  Video

3. In the space below, please write in the type (speakers, car CD player, stereo VCR, etc.), the make, the model number and the price paid for each item purchased in the past 30 days.

TYPE	MAKE	MODEL	PRICE PAID
CD player	Sony	SL-5923	\$ 379.00
Speakers	Boya	BS3-10	\$ 450.00
car radio/cassette deck	Sparker	KT 4372 (4)	\$ 1699.00

Indicate if you'd like to subscribe to STEREO REVIEW (you'll save 50% off our regular subscription rate!)  
 Please send me 12 issues of STEREO REVIEW for \$5.99 and bill me. (Full year subscription price \$11.99)

PLEASE PRINT CLEARLY

NAME STEVEN NELSON

ADDRESS 158 LORRAINE AVENUE STATE NEW YORK ZIP 10554

CITY NEW ROCHELLE

(Zip code must be included to insure delivery.)  
Void after October 31, 1987.

## LOOK FOR THE BUYER POLL EVERY MONTH

The Stereo Review Buyer Poll will appear in every issue—just check the Table of Contents for that month's location. You can participate in any month in which you purchased audio/video equipment. Of course, even if you don't join our Poll, you can still send in the Reader Service card to get information about products advertised in that month's issue.

We hope you'll participate regularly in the Stereo Review Buyer Poll. Your answers are important to us—and you'll find the resulting benefits important to you.

Thanks for helping us out!

# Stereo Review

# Why Pay More?

**WDS**  
 Wisconsin Discount Stereo  
 9417 W. Badger Road  
 Madison, WI 53713

**HOURS**  
 Mon-Thur 8-8  
 Fri-Sat 8-8  
 Sun 9-5  
 OR COD

**WDS**  
 Wisconsin Discount Stereo  
 9417 W. Badger Road  
 Madison, WI 53713

**HOURS**  
 Mon-Thur 8-8  
 Fri-Sat 8-8  
 Sun 9-5  
 OR COD

**WDS**  
 Wisconsin Discount Stereo  
 9417 W. Badger Road  
 Madison, WI 53713

**WDS**  
 Wisconsin Discount Stereo  
 9417 W. Badger Road  
 Madison, WI 53713

## SPEAKER SPECIALS

**WIRELESS 100** \$89 EA.  
 by Recoton  
 Extends your stereo to any room in your house!  



**EPI T/E 280 II** \$109 EA.  
 TOWER SPEAKER  
 TOP RATED!  

**EPI 12" 3-WAY 99 EA.**  
 HORN TWEETER AND MIDRANGE  
 WAY BELOW COST  

**EPI T/E 320II** \$149 EA.  
 TOWER SPEAKER  
 250 WATT  
 SPECIAL PURCHASE  

## CASSETTE DECK SPECIALS

**SPECIAL PURCHASE \$219**  
 Top Rated Cassette Deck, Black, Fresh.  
 WAY BELOW NORMAL PRICE.  



**TEAC AD4** \$279  
 Compressor CD Cassette with Dolby B/C, auto reverse, and auto-programming.  

**TEAC R616X** \$289  
 Bidirectional record/play with Dolby B, C, HX PRO, and dbx.  

**TEAC V970X** GUARANTEED LOWEST PRICE  
 Top rated remote control 3-head with Dolby B, C, HXPRO, and dbx.  

**SONY CFSW500** \$129  
 Digital tuner dual deck with high speed dubbing  

**SONY KV27SXR10** GUARANTEED LOWEST PRICE  
 Best 27" Television on the market.  

**TECHNICS SLQD33 WITH SHURE V715** \$189  
 Full line of Stanton, Shure, and Orton cartridges available  

**SONY WAF100 III** \$119  
 SUPER SALKMAN DOLBY B Auto reverse.  

**CASIO MT5200** GUARANTEED LOWEST PRICE  
 Wide assortment of Yamaha and Casio keyboards discounted.  

**ADC S5525** \$369  
 Automatic computerized equalizer with spectrum analyzer and MC.  

**AUDIOSOURCE SS-TWO** GUARANTEED LOWEST PRICE  
 Dolby surround sound with full function wireless remote.  

**SONY KV1380R** GUARANTEED LOWEST PRICE  
 TOP OF THE LINE Monitor/Receiver  

**4-HEAD DIGITAL** \$349  
 On screen programming LCD remote  

**JVC HRD750** GUARANTEED LOWEST PRICE  
 4-Head MTS HiFi with indexing  

**4-HEAD MTS HiFi** \$389  
 On screen programming with 87 function remote.  

**RCA VR640** \$689  
 Super VHS 4-Head MTS HiFi with on screen display  

## PORTABLE DISC PLAYER SPECIALS

**SONY D-4** \$179  
 PROGRAMMABLE OPTIONAL REMOTE SPECIAL PURCHASE  

**GE 3-7035** \$169  
 Compact Disc AM/FM stereo cassette music system  



**SONY D-160** \$169  
 CAR DISCMAN SPECIAL PURCHASE  

**GUARANTEED LOWEST PRICE**  
 SONY D-15 SMALLEST DISCMAN SPECIAL PURCHASE  



**GUARANTEED LOWEST PRICE**  
 6 + 1 STACKER \$299  
 SPECIAL PURCHASE WAY BELOW COST!  

## DISC PLAYER SPECIALS

**TEAC PD600M** GUARANTEED LOWEST PRICE  
 6 Disc stacker  
 WAY BELOW COST!  

**TOSHIBA XRP9** \$179  
 WIRELESS REMOTE  
 BELOW COST  

**TECHNICS SP350** GUARANTEED LOWEST PRICE  
 18 bit, 4 x oversampling and dual D/A converters.  



**UNIDEN RD9** \$135  
 RADAR DETECTORS  
 BEL 976 ..... 157  
 COBRA RD370 ..... 169  
 KOSK JCK 3005 ..... 109  

**SONY MDRCD6** \$77  
 TOP OF THE LINE  
 Sanyo SR885 ..... 579  
 KOSK JCK 3005 ..... 109  

## MISCELLANEOUS SPECIALS

**ALPHASONIC MA2101** \$279  
 BELOW COST!  
 SPECIAL PURCHASE! 100 WATTS / CHANNEL  

**LANON BR82KI** GUARANTEED LOWEST PRICE  
 Pullout DIN chassis with 18 presets, Dolby, and high power.  

**SHERWOOD XR1604** \$239  
 Pullout DIN chassis - loaded TOP OF THE LINE  
 Auto-reverse with CD inputs, Dolby B/C, and high power.  

**JVC RX950** GUARANTEED LOWEST PRICE  
 120 Watt Ch. A/V receiver  
 BELOW DEALER COST.  

**JVC RX550** GUARANTEED LOWEST PRICE  
 60 Watt Ch. A/V receiver.  
 BELOW DEALER COST.  

**VIDEO RECORDER SPECIALS**

**SONY VHS 4-Head MTS HiFi** \$599  
 on screen programming  

**HITACHI VT2600** \$599  
 Digital 4-Head MTS HiFi - LOADED!  

**PANASONIC PV4860** CALL!  
 4-Head MTS HiFi  
 On screen programming  

**PANASONIC PV4200** GUARANTEED LOWEST PRICE  
 Digital Super VHS HiFi 4-Head - TOP RATED!  

**SONY CDF30** GUARANTEED LOWEST PRICE  
 8 mm Zoom  
 CANON V4E708 ..... CALL  
 KYOCERA KD3010 ..... CALL  

**JVC GR55** GUARANTEED LOWEST PRICES  
 SUPER VHS-C TOP RATED  
 Toshiba SK580 ..... CALL!  
 Zenith VM6500 ..... CALL!  

**JVC GRC25** GUARANTEED LOWEST PRICE  
 HIGH SPEED SHUTTER TOP RATED  
 RCA CC300 ..... CALL!  
 Hirsch VM300A ..... CALL!  

**PANASONIC PV4200** GUARANTEED LOWEST PRICE  
 High Speed Shutter with Flying Erase-Head  
 GE GC9885 SUPER VHS ..... CALL!  
 GE GC9813 ..... CALL!  

**CAMCORDER SPECIALS**

**SONY CCD50** GUARANTEED LOWEST PRICE  
 8 mm Zoom  
 CANON V4E708 ..... CALL  
 KYOCERA KD3010 ..... CALL  

## SOME EXAMPLES OF OUR SPECIAL PRICING

**Discount Hotline**  
**1-800-356-9514**  
 or call 608-271-6889  
**BUYER'S GUIDES AVAILABLE STEREO \$3.95 — VIDEO \$3.95 — BOTH FOR \$7.00**

\* GUARANTEED LOWEST PRICE—Compared to any other factory authorized dealer delivered to your door with full warranty.

RETURN POLICY: Returns accepted within 10 days and must be enclosed in the proper authorization. All contracts must be in original factory packing, clean, unscratched in perfect working condition. Returns limited to electronic (VCR, CD player, Hi-Fi, Hi-Fi) — no returns on non-electronics.



# WDS

1-800-356-9514

Dear Stereo Review Reader:

**"At Wisconsin Discount Stereo, We Care."**

Most electronic discount mail order houses cut the price and cut out service completely —**NOT WDS**. We offer the best service of all the electronic discounters (in fact, better than most retailers).

Here at **WDS** we offer:

- ★ **\$40,000,000 Inventory**—Most orders shipped within 48 hours.
- ★ **Largest and Best Warranty Service Center**—over 100 people work in service alone.
- ★ **All items Factory Sealed**
- ★ **All products carry full Manufacturers Warranty**
- ★ **Buyer Protection Insurance Policy—No Charge**  
For first 30 days of ownership, we'll repair any item with which you have a problem—within 48 hours, excluding Saturday and Sunday, in our shop—Guaranteed or we'll replace it with a brand new factory sealed unit.
- ★ **10-Day Return Policy**. Your request must be phoned in for prior authorization. All products must be in original factory packing, clean, unscratched, in perfect working condition. Returns subject to 10% restocking fee. Shipping & Handling are non-refundable.
- ★ **Guaranteed Lowest Delivered Price**  
On most items, we guarantee a lower delivered price than any other factory authorized dealer. If you find a better price, call us and we'll beat it.
- ★ **Toll Free 800 # For All Your Needs:**
  - ☎ Product Information
  - ☎ Pricing
  - ☎ To Order (or, check on an order)
  - ☎ Repair Service
- ★ **Professional Sales Staff**—With an average of 9 years selling Audio/Video equipment

We invite you to compare our **Service** and our **Price** and we're sure you'll agree—

## WDS RATED #1!

So, Remember . . . **"AT WDS, WE CARE."**

Give us a chance to prove it to you.

Call: 800-396-9514



Glenn Roskilly  
General Manager

*kleine Nachtmusik: Rondo; Romanza. Symphony No. 34: Allegro vivace. Symphony No. 35 ("Haffner"): Andante. The Magic Flute: Overture. Horn Concerto No. 4: Rondo. Don Giovanni: Là ci darem la mano. A Musical Joke: Presto. Come, Sweet May; Rondo alla turca.* Sky (electronic and acoustic instruments); Academy of St. Martin-in-the-Fields, Neville Marriner cond. MERCURY 832 908-1, © 832 908-4, © 832 908-2 (49 min).

Performance: *Silly*  
Recording: *Schizophrenic*

This record supposedly "combines the timelessness and form of classical music with the drive and inventiveness of rock music. . . . the ethereal music of Wolfgang Amadeus Mozart provided the musical inspiration."

Inspiration? Inventiveness?

The inspiration and inventiveness are, I can assure you, purely Mozart's.

What does Sky provide besides the ability to sell a lot of records of Mozart's music?

Not much. Musical soft soap, mostly. Tea and crumpets. Anglo-kitsch arrangements with cutesy guitar strums, goeey electric basses, and wholly unnecessary ricky-tick drum parts. This is the sort of easy-listening makeover that gives rearranging the classics a bad name.

At the end of the album there is a silly bit of *The Musical Joke* and a *Rondo alla turca* that takes one of Mozart's few real bang-the-drum pieces and turns it into syrupy Debussian impressionism.

I am not, I assure you, a purist, but there is neither inspiration nor inventiveness here. No rock music either. No drive, no grit. It would never have occurred to me that if you turned Mozart over to rock musicians they would

prettify and pussyfoot, but that is exactly what has happened here. E.S.

**MUSSORGSKY: *Pictures at an Exhibition*. LISZT: *Vexilla regis prodeunt; Sursum corda; Abendglocken; Invocation*.** Alfred Brendel (piano). PHILIPS © 420 156-4, © 420 156-2 (55 min).

Performance: *Liszt best*  
Recording: *Resonant*

Alfred Brendel's *Pictures at an Exhibition* is a sober, well-played and extremely musical reading. It seems at times a bit too measured, as if the Central European pianist were determined to bring the mad, wild-eyed Russian under control. And indeed he almost does, but I miss the madness.

The move toward power and control works better on Liszt. There is a definite kinship between the two composers—particularly apparent in late Liszt of the sort performed here. But Liszt is more rhetorical. Mussorgsky shows us something to wonder at; Liszt *tells* us, and in no uncertain terms. Perhaps that is closer to Brendel's temperament. It is unusual for him to play music that is not German or Austrian, and it is not hard to understand why. Liszt's *Invocation*, the work that is closest to that Central European tradition, is the most sure-handed in performance. E.S.

**NIELSEN: *Symphony No. 4, Op. 29 ("The Inextinguishable"); Symphony No. 5, Op. 50*.** San Francisco Symphony Orchestra, Herbert Blomstedt cond. LONDON © 421 524-4, © 421 524-2 (72 min).

Performance: *Very good*  
Recording: *Very good*

Here is a recording that represents peak value in musicality, program content,

and playing time. To have fine performances of the two greatest Carl Nielsen symphonies on a single disc or tape is indeed a blessing!

The Fourth Symphony, *The Inextinguishable*, evokes Nielsen's vision of the life force triumphing in the face of the First World War, which was tearing European culture to shreds and decimating the continent's youth. The untitled Symphony No. 5 (1921-1922) carries a similar message, which one critic described as "the victory of the incorruptibles and the unafraid." The first of its two movements culminates in an all-out duel between the snare drum and the rest of the orchestra, and the second movement is, in effect, a hymn to life.

The American-born Swedish conductor Herbert Blomstedt made a major contribution to the Nielsen discography in 1975 with his set of eight LP's, with the Danish Radio Symphony Orchestra, encompassing Nielsen's entire orchestral output: six symphonies, three concertos, and various smaller pieces. The performances were all well conceived and unexaggerated. The new San Francisco recordings of the Symphonies Nos. 4 and 5 find Blomstedt's view of the music matured and perceptibly more expansive. There is no lack of drama, but there is a classical discipline, too, that I find benefits the music.

Two things I always listen for in performances of the Fourth are the tremendous orchestral outburst that brings the music from B-flat to A major, like a blaze of sun emerging from storm clouds, and the superb *sotto voce* episode for strings in canonic texture that follows. Blomstedt carries both off with flying colors, as he does with the symphony as a whole. If the first pages are improperly balanced they can sound congested—not so here. The second movement is wholly beguiling, and the great adagio is searingly eloquent. The timpani cannonades from opposite ends of the stage in the finale achieve a spine-tingling effect.

The Fifth Symphony is harder to bring off than No. 4 because of its sheer largeness of structure and variety of content—by turns pastoral, lyric, dramatic, and virtuosically polyphonic. The critical factors of snare-drum pitch in the early pages of the first movement and of the balance between percussion and orchestra in the sinister ostinato march episode are handled to perfection. Again, I find Blomstedt's classically disciplined view of the score eminently satisfying.

A major element in the success of this whole production is the acoustic of San Francisco's Davies Symphony Hall, which both contains and projects the complex textures and huge climaxes of these symphonies with crystalline clarity and full-bodied impact. Some may find more visceral excitement in Simon Rattle's intense reading of the Fourth Symphony on Angel and more volatility in the Myung-Whun Chung version

Herbert Blomstedt: Nielsen with drama and discipline



SAVE MONEY, TIME AND FREIGHT ON FAMOUS BRAND STEREO EQUIPMENT

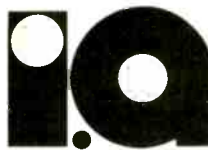

**illinois audio** (800) 621-8042 / (312) 664-0020

12 E. DELAWARE PLACE • CHICAGO, IL 60611

**LOUDSPEAKERS**



**TECHNICS SBL-35**  
Powerful Loudspeaker System  
• Linear Phase 2-Way System • Large Diam. 10" Woofer • Anti-resonance cabinet • Attractive Woodgrain Finish  
List: \$80.00 ea.  
**SALE: \$41.00 ea.**

**E.P.I. CD55**  
3-Way Speaker System

• 12" Bass Driver • Wide Frequency Response • Constant Dispersion Design • Specially Designed High Efficiency Cabinet  
List: \$250.00 ea.  
**SALE: \$99.00 ea.**



**TECHNICS SBK14**  
3-Way Speaker System



• 12" Woofer • Horn Super Tweeter • High Heat Resistance • Efficiency Bass Reflex Design • Heavy Duty Anti-Resonance Cabinet  
List: \$140.00 ea.  
**SALE: \$79.00 ea.**

**E.P.I. T/E 10011**  
2-Way Loudspeaker System

• Smoother High Freq. Response • Wide Dispersion • Oak Veneer Finish  
List: \$129.95  
**SALE: \$75.00 ea.**

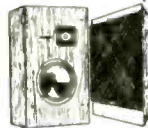

**PORTABLES**

**TOSHIBA RT4048**  
AM/FM Stereo Radio Cassette Player

• Dolby B NR • Auto Reverse • 3 Band EQ • Built-in Stereo Tuner • Auto Shut-Off • Lightweight headphones & Belt Clip Included  
List: \$89.95  
**SALE: \$55.00**



**SONY WMF-10011**  
Sony Super Walkman

• AM/FM Stereo Cassette Player • Xtra Small Size • Auto Reverse • Quick Charger • Dolby B NR  
List: \$199.95  
**SALE: \$129.95**

**SONY D-15**  
Discman Portable CD Player

• Ultra Small & Light Wt. • 24 Track Random Music Sensor • 4 Repeat Modes • Unilinear Converter w/Digital Filter  
**CALL FOR PRICE**



**AUTO**



**SONY ESS-93**  
6" x 9" 3-Way Car Speakers  
• Hi-Power • Oval Shape • 80 Watts Max Power Handling  
List: \$109.95 Pair **SALE: \$66.00 Pair**



**SHERWOOD CRD350**  
Car Stereo with Cassette Deck  
• AM Stereo/FM Stereo Receiver • Full Logic Controlled • Dolby B/C NR • Auto Reverse • Built-in Amp w/Balance & Fader • Local/Dist. Switch • Preset Scan • Clock • Security Cover  
List: \$329.95 **SALE: \$182.00**

**CASSETTE DECKS**



**TEAC V-285CHX**  
Stereo Cassette Deck  
• Dolby B, C & HX PRO NR • Bias FINE Tuning • Full Auto Stop Mech. • Metal Tape Compatible • 3-Pos. Tape Select. • 3-Digit Tape Counter  
List: 149.95 **SALE: \$99.95**



**TEAC R435X**  
Auto Reverse Cassette Deck  
• Bi-Directional record and playback • Dolby B, C & dbx Noise Reduction • 3-position tape selector • Output level controls  
List: \$265.00 **SALE: \$149.95**



**TECHNICS RST-55R**  
Double Quick Reverse Cassette Deck  
• Auto Reverse on Both Tape Drives • 24 Hr. Contin. Playback • Hi-Sp. Editing • Synchro Start, Stop & Mute • dbx, Dolby B & C  
**CALL FOR PRICE**



**TEAC W990RX**  
Auto Reverse Double Cassette Deck  
• Continuous Recording/Playback • 3-Motor IC Logic • Wireless Remote Control • Sync Reverse • 2-Speed Dubbing • Reverse Editing • Dolby B, C dbx NR  
**CALL FOR PRICE**

**RECEIVERS**



**TECHNICS SA-918**  
Quartz Synthesizer AM/FM Stereo Receiver  
• 70 Watts (35x2) • 16 Memory Presets • Tape Mon. Switch • Bass & Treble Controls • Quartz Clock • Low Distortion  
List: \$240.00 **SALE: \$127.00**



**TECHNICS SAR-310**  
Quartz Synthesizer AM/FM Remote Stereo Receiver  
• 5-Band EQ & Spectrum Analyzer • 24 Memory Presets • 40 Key Wireless Remote • 110 Watts (55x2)  
List: \$460.00 **SALE: \$249.95**



**AKAI AAV-405**  
Surround Sound Receiver  
• Remote Controlled • 200 Watts (100x2) • 7-Band EQ • Video Inputs • 16 Presets  
List: \$599.95 **SALE: \$389.00**



**JVC RX-999**  
Remote Controlled Receiver  
• 200 Watts (100x2) • Digital Dolby Surround Sound • 3 Video Inputs • Programm. 7 band EQ • Dig. Synth. Tuner • 80 presets • Preset Scan  
**CALL FOR PRICE**

**HEADPHONES**

**KOSS PRO 4X**  
Lightweight Design • Pros Choice • Digital Ready  
List: \$90.00 **SALE: \$49.95**

**SENNHEISER HD414SL**  
Open Air • Innovative Design • Sound Isolating  
List: \$89.95 **SALE: \$49.95**

**SONY MDR CD6**  
Adjustable • Open Air • Digital Ready  
List: \$119.95 **SALE: \$79.00**

**AUDIO TAPE**

**TDK SA-90**  
Ultra Quiet Hi-bias tape  
10 for **\$16.50**

**SONY UX-PRO 90**  
High bias, perfect for live or digital recordings  
10 for **\$24.89**

**MAXELL UDS1190**  
Standard Hi-Bias cassette  
10 for **\$16.95**

**MAXELL MX90**  
Maxellax 90 min. Cassette  
10 for **\$29.95**

**CARTRIDGES**

**SURE V15-IVMR**  
• Micro Ridge Standard Mount • Ultra Accurate Tracking • Dynamic Stabilizer  
List: \$110.00 **SALE: \$69.95**

**AT 122LP**  
Dual Magnet • Plug-In Connector • Linear Contact Diamond Stylus  
List: \$125.00 **SALE: \$49.95**

**SHURE V15MR**  
Ultra Accurate Tracking • Dynamic Stabilizer • Side-guard Protection  
List: \$275.00 **SALE: \$129.95**

**CD PLAYERS**



**SHARP DX-650**  
Compact Disc Player  
• 3-Beam Laser Pick-up • Programmable Memory • Cue/Review  
List: \$249.95 **SALE: \$119.95**



**TECHNICS SLP-420**  
Remote Controlled CD Player  
• High Resolution Digital Filter • Double Oversampling • High Speed Transport & Repeat • Programmable  
List: \$475.00 **SALE: \$219.95**



**SONY GCP-21**  
Compact CD Player  
• Unilinear Converter w/Digital Filter • Env. Diff. Detection Sys. • 16-Track Random Access Sensor • Auto Music Sensor • 4 Repeat Modes w/Shuffle Play  
List: \$250.00 **SALE: \$149.95**



**TECHNICS SLP400C**  
Multi-Disc CD Changer  
• Programmable 6-Disc Changer/Player • Remote Control • 36-Step Random Access Program • Quadruple Oversampling Digital Filter • High Resolution Laser Pick-Up  
**CALL FOR PRICE**



**JVC XLM600**  
CD Multi Changer  
• 6-Disc Capability • Remote Control • Random Access Program • up to 32 steps from 7 discs • Repeat • Memory back-up • 3 Beam Laser Pick-up and digital filter  
**CALL FOR PRICE**

**TURNTABLES**

**TECHNICS SLBD22**  
Belt Drive Semi-Automatic Turntable

• T4P Cartridge Connect Sys. • Highly Sens. Gimbal Suspension Tonearm • Anti-Vibr. Construction • Pitch Control • Illum. Stroboscope  
**CALL FOR PRICE**



**CALL FOR PRICE**

**TECHNICS SLDD33**  
Phase Locked Direct Drive Automatic Turntable

• Highly Sensitive Gimbal Sus. Tonearm • T4P Mount. Cart. Connector System • Front Panel Oper.  
**CALL FOR PRICE**



**CALL FOR PRICE**

**DUAL CS505-2**  
Belt Driven Semi-Automatic Turntable

• Ultra Low Mass Tonearm • Interchangeable 1/2" Mount Pick-up Head • Fine Speed Adjustment • Anti-Resonance Mat • Two Scale Anti-Skate Device • Floating Chassis  
List: \$299.00 **SALE: \$199.95**



**CALL FOR PRICE**



**illinois audio**

12 E. Delaware Pl., Chicago 60611

16 YEARS OF MEETING THE NATION'S STEREO NEEDS WITH THE ABSOLUTE BEST PRICES ON TOP NAME NATIONAL BRANDS  
Call Mon. thru Sat. 10 to 5 (312) 664-0020 • 1 (800) 621-8042



Prices in this ad are for mail-order only. Freight charges not included in prices. All merchandise shipped brand new, factory fresh with full warranty. Not responsible for typographical errors.



**NOTE:** This is just a partial listing of our extensive inventory, please call for quotes on additional items or to request a free price list.

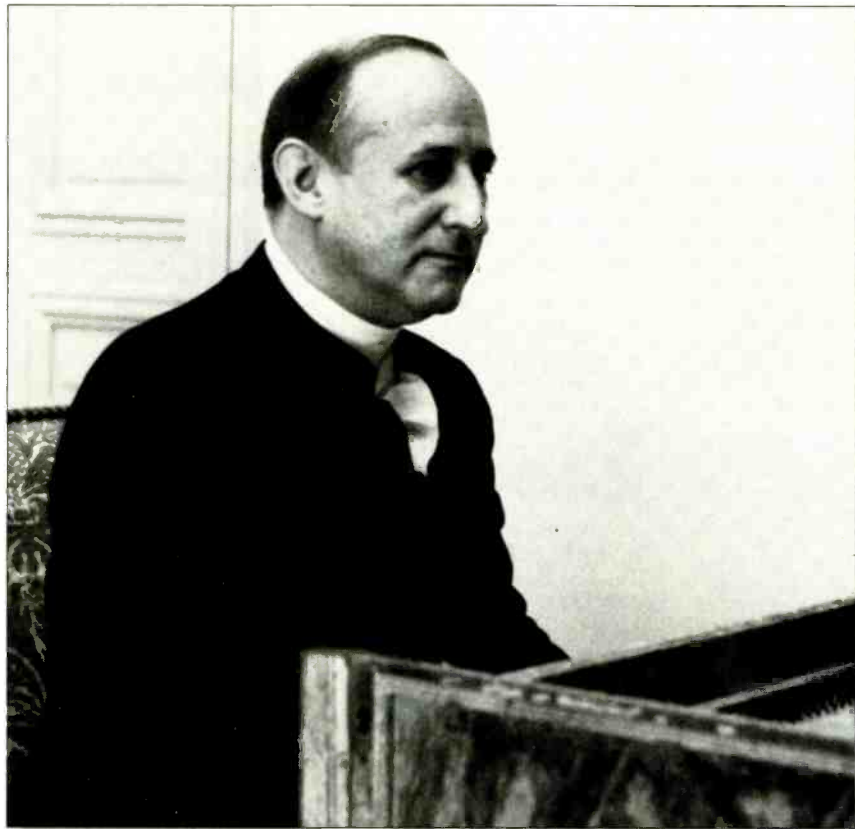

Rafael Puyana: Scarlatti in the grand manner

of No. 5 on Bis, but I think it will be to these Blomstedt recordings that I shall return most often. *D.H.*

**POULENC: *Sonata for Violin and Piano*** (see FAURÉ)

**PUCCHINI: *La Bohème***. Angelina Réaux (soprano), Mimi; Barbara Daniels (soprano), Musetta; Jerry Hadley (tenor), Rodolfo; Thomas Hampson (baritone), Marcello; James Busterud (baritone), Schaunard; Paul Plishka (bass), Colline; others. Chorus and Orchestra of the Accademia Nazionale di Santa Cecilia, Leonard Bernstein cond. DEUTSCHE GRAMMOPHON ● 423 610-1 two LP's, © 423 601-4 two cassettes, © 423 601-2 two CD's (180 min).

Performance: *Disappointing*  
Recording: *Excellent*

The fine technical quality of this recording is one of its chief virtues. Another is the venerable forces of the Academy of Santa Cecilia, which support the all-American cast superbly and respond unhesitatingly to the demands of the conductor. So far, so good.

In the notes, it is said that Leonard Bernstein felt it was "important to cast the characters credibly. . . [He] didn't want his singers simply to play their parts, but really to become the characters they were singing." A dangerous artistic concept that, if followed, would preclude any soprano's finishing an *Elektra* performance. No matter, the

idea is not realized here, anyway, for the emotions communicated are frequently out of focus with Puccini's score.

Bernstein's conducting is a case in point, with its sudden booming fortes and equally sudden ritards, near frenzy in the clowning of the Bohemians and in a good deal of Act II, and its rather soupy lyricism. His is a highly personal, not to say self-indulgent, reading. As Mimi, Angelina Réaux sings prettily enough, but her sometimes raw performance lacks depth; Mimi is no nineteenth-century *philosophe*, but she is a profoundly feeling character. Unfortunately, much of her singing here has the impact of a wordless vocalise. Jerry Hadley, possessor of a most beautiful lyric tenor, makes a youthfully romantic Rodolfo, but he sometimes sobs or croons for theatrical emphasis when the composer has already created the desired effect for him.

Both Bernstein and soprano Barbara Daniels are to be scolded for her Musetta. Her entrance is raucous and strident, and most of Act II—which is, after all, Musetta's—is marred by her projection of the role as a floozie. It is incredible that Marcello would look at her twice. Her work in Act IV, though considerably more in line with Puccini's intentions, does not dispel the initial impression. As Marcello, Thomas Hampson sings with warm, resonant ardor and is wholly commendable. The most finished performance, not unexpectedly, is Paul Plishka's Colline, which is sung

with an experienced sense of style and an involvement notably lacking elsewhere. *R.A.*

**D. SCARLATTI: *Sonatas: K. 518, 519, 443, 444, 206, 207, 159, 240, 241, 205, 7, 513, 380, 381, 54, 175, 33, 347, 348, 105, 106, 107, 441, 442, 96, 524, 525, 49, and 87; Sonata por el Señor Escarlata***. Rafael Puyana (harpsichord). HARMONIA MUNDI © HMC 901164/65 two CD's (136 min).

Performance: *Wonderful*  
Recording: *Fine indeed*

Years ago, in Paris, I saw a three-manual harpsichord built in 1740 by Hieronymus Albrecht Hass that was owned by Rafael Puyana. While visually stunning, it was, disappointingly, unplayable and badly in need of restoration. Since then, I have often wondered what happened to that magnificent machine. My question was answered when I received this CD of Puyana playing thirty Scarlatti sonatas on that very instrument, which has been put into playing condition by the painstaking work of Andrea Goble from the shop of Robert Goble and Son in Oxford, England. Besides boasting three manuals, the instrument has five sets of strings and six registers. In short, it is the Rolls Royce of harpsichords.

While there has been much debate about just what sort of harpsichord Scarlatti actually had, recent studies seem to agree that he was not limited to a single-manual instrument, as had long been thought, but more probably a French double. And in 1982, Beryl Kenyon discovered advertisements in Madrid in 1759 and 1762 for two three-manual harpsichords. Though this was a few years after Scarlatti's death, the appearance of such instruments, according to Puyana, "accredits the fact that a delight in dynamic changes was the trend of the time, at least in Germany and in Scarlatti's adopted country." Thus the circle has been closed—the colorful registrations used by Landowska and Kirkpatrick, which were made possible by the modern concert instruments of Pleyel and Chalice and later eschewed by the historic rebuilders and by the authentic-performance-practice crew, were possible in Scarlatti's day, if not widely practiced.

The delightful irony is that an authentic old three-manual instrument should fall into the hands of Puyana, a Landowska student who well understands its full possibilities. Fortunately, he is worthy of the inheritance. He is fully aware of the tremendous musical traditions reflected in Scarlatti's sonatas—the Portuguese fandango and the Spanish flamenco as well as the more refined court dances—and he brings them all to the fore. His colorful palette gives drama and contrast to the music. His playing is characterized by rhythmic thrust offset by lyricism and a sure sense of rubato. This is Scarlatti in the grand

**SUPER VHS CAMCORDERS 8mm CAMCORDERS HI-FI STEREO CAMCORDERS**

OLYMPUS  
VSX405



SONY  
CALL



MINOLTA 820C  
MINOLTA 810C  
PENTAX 850KY  
KD3010 KYOC  
KD1700V

PANASONIC



BUILT-IN  
ZOOM  
STABILIZER  
PV460



HITACHI  
RCA  
MINOLTA

- SUPER VHS 8:1 ZOOM w/FLYING ERASE HEAD INCLUDES ALL ACCESSORIES ..... **\$1199**
- SAME AS ABOVE w/DIGITAL ..... **\$1399**
- 8mm 6:1 ZOOM 5 LUX INCLUDES ALL ACCESSORIES ..... **\$799**
- VHS-C 6:1 ZOOM 7 LUX INCLUDES ALL ACCESSORIES ..... **\$699**
- VHS FULL-SIZE TAPE 7 LUX 6:1 ZOOM TIME/DATE (w/HARD CASE) ..... **\$799**
- SAME AS ABOVE w/FLYING ERASE HEAD ..... **\$899**

**We carry a complete inventory at very low prices:**

- GE 9815 • GE 9825 • PANASONIC PV420 • HITACHI VM3100 • MINOLTA V1400S
- PENTAX PVC66 • PVS350 PANA • VM27 QUASAR, \$1599 • PANASONIC PVS150, \$1390
- JVC GRC55U SVHS-C • PANASONIC PV110, \$1050 • VHS-C CAMCORDER 7 LUX 6xZ, \$699
- JVC GR25U, \$899 • CANON E70, 8mm MINI • RICOH 600S • SONY CALL

SONY BATTERY PACK NP 77 - CALL



OLYMPUS  
VX801 -  
VX802 - Call

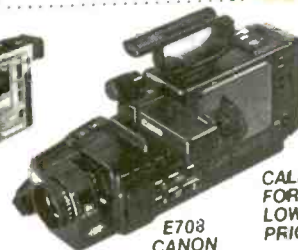

CALL  
FOR  
LOWEST  
PRICE  
E708  
CANON

**VCR's - VHS & BETA**

- FISHER FYH5550 4 Hd Hi-Fi MTS OSP ..... **\$359**
- MAGNAVOX YR1260 4 Hd Hi-Fi MTS OSP ..... **\$395**
- HRS 5000U ..... **BEST BUY!**
- JVC HRD630U - CALL
- JVC HRS8000U - NEW - IN STOCK
- SONY - NEC DS8000
- SLHF860D - Toshiba SV970
- SLHF360D - Zenith 5100
- Portable Hi-Fi



CANON 8mm DECK RECORDER PORT. PCM

BELL  
PHONES,  
PANASONIC  
and  
CAR  
PHONES



SONY SPP-110

**TV's**

PIONEER 502-401  
SONY / TOSHIBA  
SVHS TV  
JVC AV2658

SUPER  
TV



26"  
REMOTE  
\$319

560 LINES  
of RESOLUTION  
w/SURROUND  
SOUND

**VIDEO CASSETTE PLAYERS**



Tote Vision CV-7000  
VHS w/5" Color TV ..... **\$425**



Tote Vision GS 3000H.  
AC-DC ..... **\$199**

VHS w/19" QUASAR  
Color TV ..... **\$525**

VHS w/13" Color TV ..... **\$399**

- ZENITH Source Selector/PCA 5 in-3 out ..... **\$98**
- ZENITH Remote Tuner, 140 ch ..... **\$59**
- ZENITH Character Generator ..... **\$219**
- SANSUI Character Generator VCG99 ..... **Call**
- SANSUI AV99 Mixer ..... **Call**
- NEWMARK VAM2000 Digital Dsolv ..... **\$319**
- JVC JXW9 Special Effects ..... **\$199**
- JVC Color Corrector ..... **\$350**
- SANSUI VX99 ..... **Call**
- VAC301 ..... **\$69\*\***
- VAC311 ..... **\$199**

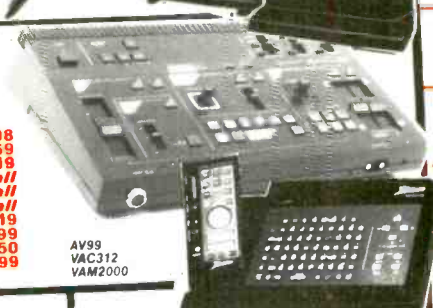

AV99  
VAC312  
VAM2000

**AUDIO HI-FI RECEIVERS**



**NEW MODELS**

LASER DISC

- Pioneer • Magnavox
- LDW1 • CLD3030 • CDV474

COMPACT DISC

- Pioneer • Magnavox • JVC • Teac
- PDM700 • XLM600 • CDB473

RECEIVERS

- VSX9300 • RX999

**FAX MACHINES**

TOSHIBA  
3100 ..... **\$945**  
3300 ..... **\$1150**

**PANASONIC  
TYPEWRITERS**

FOR MORE INFO, Call:  
(201) 696-6531

**WE WILL MATCH OR BEAT ANY LEGITIMATE PRICE**

Call Toll-Free: **1 (800) 444-6300**  
Orders: **1 (800) 247-4654**

We ship within 24 hours.  
All prices quoted included  
manufacturer's standard  
accessories & U.S. War-  
ranty. All units are factory  
sealed. Shipping & hand-  
ling extra. Not responsi-  
ble for typographical er-  
rors. S&H non-refundable



## POLYGRAM'S VIDEODISC CLASSICS

**P**OLYGRAM's first classical "CD video" release is indeed impressive—for the repertoire it embraces, ranging from Bach to Puccini, for its high artistic standards, and for its overall technical excellence. The company's commitment to the laser videodisc just may give this not-so-new medium the push it needs to win over serious music lovers in pursuit of better sound and a sharper video image than they can get on tape.

Calling these fourteen new opera, ballet, and orchestral releases "CD videos," however, is a bit misleading. They are laser-read discs, but they are not CD's. The sound is digitally encoded (and here, in every case, digitally remastered because the originals were analog), but the discs are not five inches across. They are a less-than-compact foot in diameter. And the audio-video contents occupy both sides of them, each side running to a maximum of about an hour in playing time. Technically, these releases are no different from Pioneer LaserDiscs and can be played on any existing LaserDisc player. They cost about \$35 apiece in major stores.

Like CD's, digital videodiscs have a particular advantage over analog tapes in that they allow for almost instant access to various program segments. To get to the second act of *La Bohème*, say—in this case a handsome La Scala production by Franco Zeffirelli featuring the enchanting Mimì of Mirella Freni—you simply punch it in as you would with a CD. If you want Act III, flip the disc. Similarly, if you want to

zero in on any one of the forty-four scenes in the elegant *Swan Lake* choreographed by Rudolf Nureyev, or the finale of Leonard Bernstein's expansive reading of Beethoven's *Pastoral* Symphony, just punch it in.

Nothing's perfect, of course. There are a few instances here where program breaks are not encoded the way the liner copy says they are—between the Grieg and Chopin concertos in the splendid Artur Rubinstein album, in the glistening performance of Beethoven's Seventh Symphony exuberantly conducted by Carlos Kleiber, and on the second side of the disc containing Nikolaus Harnoncourt's "authentic" treatment of Bach's *Brandenburg* Concertos.

Not surprisingly, the most compelling of these videodiscs are the ones devoted to opera and ballet. They are all familiar titles, and they all feature superstars in performances that generally catch them in peak form—performances that in most cases date back to the late Sixties and the Seventies. Less compelling, strictly as video, are the symphonic programs. Unlike conductors and soloists, who are apt to be camera-friendly, orchestra members are apt not to be. They can make for fairly dull watching. And it seems to me that after a few times around with a conductor's gymnastic (as opposed to musical) performance on videodisc, even one by Leonard Bernstein, the average music lover might begin to wish he'd saved a few bucks and invested in the CD instead.

Still, there are some wonderful orchestral performances on these video-

discs, performances worth having no matter what the format—the Beethoven symphonies conducted by Kleiber and Bernstein, Bernstein's Mahler Second, and Georg Solti's Wagner. It's good, too, to have visual records of performances by Artur Rubinstein and Karl Böhm. And opera lovers and balletomanes are especially well served. Judging from what PolyGram says of its future videodisc release plans, they will continue to be.

Christie Barter

**ADAM:** *Giselle*. American Ballet Theatre, with Carla Fracci and Eric Bruhn. Orchestra of the Deutsche Oper, Berlin, John Lanchbery cond. PHILIPS 070 202-1.

**BACH:** *Brandenburg Concertos*. Concentus Musicus Wien, Nikolaus Harnoncourt cond. LONDON 071 204-1.

**BEETHOVEN:** *Symphony No. 4, in B-flat major, Op. 60; Symphony No. 7, in A Major, Op. 92*. Concertgebouw Orchestra, Carlos Kleiber cond. PHILIPS 070 200-1.

**BEETHOVEN:** *Symphony No. 5, in C Minor, Op. 67; Symphony No. 6, in F Major, Op. 68 ("Pastoral"); Leonore Overture No. 3, Op. 72a*. Vienna Philharmonic Orchestra, Leonard Bernstein cond. DEUTSCHE GRAMMOPHON 072 201-1.

**BRAHMS:** *Violin Concerto in D Major, Op. 77; Concerto for Violin and Cello in A Minor, Op. 102*. Gidon Kremer (violin); Mischa Maisky (cello); Vienna Philharmonic Orchestra, Leonard Bernstein cond. DEUTSCHE GRAMMOPHON 072 203-1.

**CHOPIN:** *Piano Concerto No. 2, in F Minor, Op. 21*. **GRIEG:** *Piano Concerto in A Minor, Op. 16*. **SAINT-SAËNS:** *Piano Concerto No. 2, in G Minor, Op. 22*. Artur Rubinstein (piano); London Symphony Orchestra, André Previn cond. LONDON 071 200-1.

**LEONCAVALLO:** *Pagliacci*. Plácido Domingo (tenor), Canio; Teresa Stratas (soprano), Nedda; Juan Pons (baritone), Tonio; others. Chorus and Orchestra of La Scala, Milan, Georges Prêtre cond. PHILIPS 070 204-1.

**MAHLER:** *Symphony No. 2, in C Minor ("Resurrection")*. Sheila Armstrong (soprano); Janet Baker (mezzo-soprano); Edinburgh Festival Chorus; London Symphony Orchestra, Leonard Bernstein cond. DEUTSCHE GRAMMOPHON 072 200-1.

**MOZART:** *Piano Concerto No. 19, in F Major (K. 459); Piano Concerto No. 23, in A Major (K. 488)*. Maurizio Pollini

Edita Gruberova and Luciano Pavarotti in Verdi's *Rigoletto*



PHOTOS COURTESY OF UNITEL



Fracci and Bruhn in Giselle

(piano); Vienna Philharmonic Orchestra, Karl Böhm cond. DEUTSCHE GRAMMOPHON 072 202-1.

**PUCCINI: La Bohème.** Mirella Freni (soprano), Mimì; Gianni Raimondi (tenor), Rodolfo; Adriana Martino (soprano), Musetta; Rolando Panerai (baritone), Marcello; others. Chorus and Orchestra of La Scala, Milan, Herbert von Karajan cond. DEUTSCHE GRAMMOPHON 072 205-1.

**PUCCINI: Tosca.** Raina Kabaivanska (soprano), Tosca; Plácido Domingo (tenor), Cavaradossi; Sherrill Milnes (baritone), Scarpia; others. Ambrosian Singers; New Philharmonia Orchestra, Bruno Bartoletti cond. LONDON 071 502-1 (two discs, three sides).

**TCHAIKOVSKY: Swan Lake.** Vienna Opera Ballet, with Margot Fonteyn and Rudolf Nureyev; Vienna Symphony Orchestra, John Lanchbery cond. PHILIPS 070 201-1.

**VERDI: Rigoletto.** Ingvar Wixell (baritone), Rigoletto; Edita Gruberova (soprano), Gilda; Luciano Pavarotti (tenor), Duke of Mantua; Victoria Vergara (mezzo-soprano), Maddalena; Ferruccio Furlanetto (bass), Sparafucile; others. Vienna Opera Chorus; Vienna Philharmonic Orchestra, Riccardo Chailly cond. LONDON 071 501-1 (two discs, three sides).

**WAGNER: The Flying Dutchman: Overture. Tannhäuser: Overture. Tristan und Isolde: Prelude and Liebestod. BERLIOZ: Romeo and Juliet (excerpts).** Chicago Symphony Orchestra, Georg Solti cond. LONDON 071 201-1.

manner, an approach that is simply not heard today, but it is both thrilling and, we now know, historically authentic. This recording restores the old gleam to Scarlatti. Do not miss it if you love his music. *S.L.*

**SCHOENBERG: Ode to Napoleon Buonaparte, Op. 41. WEBERN: String Trio, Op. 20; Movement for String Trio, Op. posth.; Quintet for Strings and Piano; Rondo for String Quartet.** Kenneth Griffiths (speaker, in *Ode*); Stefan Litwin (piano); LaSalle String Quartet. DEUTSCHE GRAMMOPHON © 415 982-2 (46 min).

Performance: *Energetic*  
Recording: *Excellent*

Schoenberg's *Ode to Napoleon* is a real oddity: a long Byron poem about Napoleon set in *Pierrot Lunaire*-style speech-song for a reciter accompanied by a piano and string quartet with a juicy twelve-tone score that manages to include quotations from Beethoven's Fifth and the *Marseillaise* and has an E-flat major chord for a finish. The piece has a kind of mad dramatic power, although I have yet to hear an actor who can carry off the rather precise, rhythmic rising and falling of the music and still give a convincing recitation that does not sound like parody. In this recording Kenneth Griffiths, an actor with a definite American (as opposed to British) style, tries hard and comes as close as anyone I have heard.

The LaSalle Quartet is energetic and convincing both in the rather ungrateful Schoenberg (much fine detail and hard work is more than a bit lost behind the reciter's stentorian Byron) and in the two aspects of Webern represented by two pairs of works. The Webern of the 1927 String Trio and the 1925 Movement for String Trio is the Webern we know, at the height of his powers—mysterious, jewel-like, pithy, elusive. The Piano Quintet (really a single movement) of 1907 and the Rondo for String Quartet of a year earlier are taken from that remarkable treasure trove of early Webern that emerged only years after his death. It is still a jolt to have to rearrange one's hearing apparatus in order to go from Webern the advanced serialist to Webern the Romantic. But the two composers are clearly the same person, and no ensemble is better equipped to bring out the connections between the two styles than the veteran LaSalle Quartet, equally at home in late-Romantic and modernist styles. An excellent recording. *E.S.*

**SCHUBERT: Winterreise (D. 911).** Christa Ludwig (mezzo-soprano); James Levine (piano). DEUTSCHE GRAMMOPHON © 423 366-2 (74 min).

Performance: *Wonderful singing*  
Recording: *Excellent*

Few listeners today, when *Winterreise* is associated so strongly with a male

# HIGHVOLTAGE

AUDIO AND VIDEO AT WHOLESALE PRICES!

## RECEIVERS + AMPS

Pioneer VSX-9300S	.....New
Pioneer VSX-5300	.....Call
Pioneer VSX-3300	.....249
Pioneer YSA-910	.....Call
Sony STR AV1000	.....489
Sony STR AV900	.....369
Sony STR AV290	.....199
Nikko Alpha 650	.....949
Nikko Alpha 450	.....579
Technics SAR 530	.....485
Technics SAR 430	.....385
Technics SU AV55	.....520
Technics SU AV44	.....199
JVC RX 1001V	.....Call
JVC RX 777	.....399
JVC RX 333	.....199
JVC SWA30	.....175
SSI 4006 Pro Logic	.....New
SSI 360 II	.....299

## AZDEN HEADPHONES

DSR-90 Pro Digital	.....75
DSR-50 Digital	.....49

## CASSETTE DECKS

Pioneer CT W900R	.....New
Pioneer CT W700R	.....Call
Pioneer CT W300	.....145
JVC TDW 999 BK	.....325
JVC TDW 444 BK	.....205
Technic RST 33R	.....249

## CD PLAYERS

Pioneer PD M700	.....Call
Pioneer PD M600	.....Lowest
Pioneer PD 7100	.....Prices
Pioneer PD 4050	.....135
JVC XLM 600	.....369
JVC XLM 400	.....295
JVC XL 444	.....220
JVC XLV 222	.....159
Sony CDP C70	.....335
Sony CDP 350	.....189
Magnavox CDB 650	.....289
Magnavox CDB 473	.....249
Technics SLP 770	.....New
Technics SLP 550	.....325
Technics SLP 350	.....269



Call For Price!

## CAMCORDER SPECIALS

Panasonic PV S350	.....1689
Panasonic PV 420	.....989
RCA CPR 300	.....1049
RCA CPR 250	.....899
Sony CCD V9	.....Call
Sony CCD F40	.....1099
Minolta V2000	.....Call
Olympus VX 802	.....999
JVC GRC 55U	.....1289
JVC GRC 25U	.....949

## VCR SPECIALS

Panasonic PV S4864	.....699
Panasonic PV 4860	.....469
RCA VPT 695	.....899
RCA VR 595	.....New
RCA VR 475	.....Call
JVC HRS 8000U	.....995
JVC HRS 7000U	.....799
Mitsubishi U-70	.....New
Mitsubishi U-50	.....Call
Quasar VH 5677	.....Call
Quasar VH 5485	.....439

## PERSONAL STEREOS

Sony WMF-100II	.....115
Sony WMF-77	.....89
Sony WMF-45	.....69
Sony D-15	.....Call

## CAR STEREO

We Carry a Full Line of **Sony and Pioneer**

Call Us For Your Best Price!

## RADAR DETECTORS

Passport Equiv	.....189
Uniden RD9	.....139
Cobra RD-3170	.....175

**800-654-7787**

HIGHVOLTAGE, 39 W. 32nd St., New York, NY 10001  
VISA, MC and COD Accepted. All Products New, Factory Fresh and Subject to Availability. Customer Service Call 212-564-4410

CIRCLE NO. 66 ON READER SERVICE CARD

# FREE <sup>del.us</sup> A DIFFERENT KIND OF RECORD CLUB

**TREMENDOUS SAVINGS INCLUDING COMPACT DISCS...**  
on every record and tape in print—  
ne "agree-to-purchase" obligation of any kind.

**DISCOUNTS OF 20% TO 73%**  
off mfg. suggested list ... special catalog  
features hundreds of titles and artists.

**MOST LABELS AVAILABLE**  
including most imports through special custom  
ordering service—guarantees satisfaction

**SCHWANN CATALOG**  
lists thousands of titles.

**DISCOUNT DIVIDEND COUPONS**  
redeemable immediately for extra discounts.

**NEWSLETTERS**  
informational news and happenings in the  
world of music ... special super sale listings.

**DISCOUNT NEEDLE GUIDE**  
most mfg. replacements available.

**QUICK SERVICE**  
same day shipping on many orders...  
rarely later than the next several days.

**100% IRON-CLAD GUARANTEES**  
on all products and services—your total  
satisfaction is unconditionally guaranteed

Discount Music Club is a no-obligation membership club that guarantees tremendous discounts on all stereo records, tapes and CD's and let you buy what you want...when you want...or not at all if you choose. These are just a few of the money-saving reasons to write for free details. You can't lose so why not fill out and mail the coupon below for immediate information.

**DISCOUNT MUSIC CLUB, INC.** 009-1188  
481 Main Street, New Rochelle, N.Y. 10801

Name \_\_\_\_\_  
Address \_\_\_\_\_  
City \_\_\_\_\_  
State \_\_\_\_\_ Zip \_\_\_\_\_

CIRCLE NO. 71 ON READER SERVICE CARD

## INDEX TO ADVERTISERS

READER SERVICE NO.	ADVERTISER	PAGE NUMBER
60	Adcom	86-87
46	Akai	11
45	API-Logik	117
47	API-Image	106
70	Ariston Acoustics	Cover 3
192	Audio Dynamics Corporation	123
11	Audio-Technica/Design Acoustics	129
164	Azden	122
	Berliner Gramophone Society	118
51	Beyer Dynamic	131
	Bose	18-19, 28-29
	Boston Acoustics	125
157	Cambridge SoundWorks	52-53
168	Carver	31, 120-121
	CBS Columbia House	55
176	ComponentGuard	Cover 4
68	Coustic	45
38	Coustic	47
8	Coustic	49
18	Coustic	51
	Crutchfield	30
27	Denon	9
11	Design Acoustics/Audio-Technica	129
71	Discount Music Club	149
10	Discwasher	109
1	Electronic Wholesalers	147
151	Heath Corp.	17
66	Highvoltage	149
	Illinois Audio	145
172	Int'l Hi-Fi Distributors	140
174	Int'l Jensen/Car Audio	63
85	Int'l Jensen/Phase Linear	111
39	J&R Music World	134-139
7	JVC	following 80
69	KEF	33, 35
2	Klipsch	119
55	Koss	91
53	Marantz	101
29	McIntosh Laboratory, Inc.	73
22	Mitsubishi	59-61
	NAD USA	57
76	Nikko	126-127
154	Oak Tree	64
	Onkyo	37-39
	Perfectbound Press	140
85	Phase Linear/Int'l Jensen	111
	Philip Morris-Marlboro	96-97
	Philip Morris-Merit	15
	Philips	70-71
89	Pioneer-Car	104-105
92	Pioneer-Elite Home	66-68
31	Pioneer-Home	112-113
90	Polk Audio	Cover 2, 1-3
153	PolyGram	116
	PSB Speakers	93
	Radio Shack	4
96	Recoton	16
	R. J. Reynolds-Vantage	40
99	Sansui	23-26
103	Sherwood	95
104	Shure Bros.	131
	Sony	32
106	Sony-ES Series	6-7
181	Technics	12-13
182	Toshiba	122
	U.S. Army Reserve	114
	Wisconsin Discount	142-143
	Yamaha	20

# NOVEMBER

voice (and in most cases a baritone or bass rather than a tenor), may even be aware that women have been singing this cycle. But they have, and women even recorded it back in the days of 78's. In our own time Brigitte Fassbaender has made such an impression in performances of *Winterreise* that she might have been expected to have recorded it by now. In any event, here is Christa Ludwig's recording, and her persuasiveness in this material really ought to surprise no one who has heard her sing anything of Schubert's.

Perhaps no performance of twenty-four intense songs spanning an hour and a quarter can be entirely flawless. Surely the pacing of the opening "*Gute Nacht*" is too deliberate, and the last song, "*Der Leiermann*," struck me as a little wooden. James Levine's accompaniments, too, are seldom more than that. Sensitive musician that we know him to be, particularly in working with singers, the level of his contribution here is inconsistent, and in none of the songs does he achieve the full-partnership status of a Gerald Moore, a Brendel, or a Richter. But Ludwig herself is irresistible. The inherent richness of her voice perhaps inevitably mitigates the starkness some of the songs seem to call for, but except in the very first and the very last numbers, she is infallible in reaching to the dramatic essence and emotional core of each song. Just listen to the magical evocativeness of "*Frühlingstraum*" or the immediately succeeding "*Einsamkeit*," and you will receive an immediate and reliable impression of the sympathetic commitment and taste that characterize Ludwig's singing throughout the cycle. The recording itself is excellent, and texts and translations are provided. *R.F.*

**SHOSTAKOVICH:** *Symphony No. 7, in C Major, Op. 60; Symphony No. 9, in E-flat Major, Op. 70; other works* (see **Best of the Month**, page 110)

**R. STRAUSS:** *Le Bourgeois gentilhomme, Suite, Op. 60*. Paris Orchestral Ensemble, Armin Jordan cond. *Metamorphosen*. Chamber Orchestra of Lausanne, Armin Jordan cond. ERATO © MCE 75398, © ECD 75398 (66 min).

Performance: *Good*  
Recording: *Good*

The nine movements of the suite *Le Bourgeois gentilhomme* derive from the incidental music Strauss composed in 1912 for the Molière comedy, which preceded the original version of *Ariadne auf Naxos*. After the deletion of the play from the second version of *Ariadne* in 1916, Strauss put together the independent suite, which has led a healthy concert life of its own ever since its 1920 Vienna première under the composer's direction. The chamber-orchestra scoring represents Strauss at his most elegant, and the music ranges from the mock-pompous overture through pieces

"in olden style" that quote directly from Lully's original incidental music, to such witty and descriptive episodes as "The Fencing Master," "The Entrance and Dance of the Tailors," and the concluding "Banquet and Dance of the Assistant Cooks." It takes virtuoso players and a conductor of keen sensibilities to get the most out of the score; Beecham and Reiner stand out among the finest interpreters of the past.

Armin Jordan puts his Paris players through their paces, but I cannot say that I was wholly captivated. There is more neatness than wit in the performance. The bravura solo trumpet in the "Fencing Master" movement and the solo violin in the "Tailors" episode are the high points, and the sound is good.

The elegiac *Metamorphosen*, for twenty-three solo strings, recorded on analog tape in 1981, has much more of a true chamber sound here than in the more lush, intense treatments by Karajan and Previn. If less of the tragic import comes through in Jordan's reading than in theirs, the intricate tonal fabric of the work is certainly heard to better advantage. Again the sound is clean and transparent. *D.H.*

**STRAVINSKY:** *Petrushka (1947 version); Symphony in Three Movements*. City of Birmingham Symphony Orchestra, Simon Rattle cond. ANGEL © CDC-49053 (57 min).

Performance: *Good to excellent*  
Recording: *Bright*

This Angel release would seem to be in direct competition with a Nimbus CD with Gennadi Rozhdestvensky conducting the London Symphony Orchestra in the same two works. Actually, the program is not quite duplicated since Rozhdestvensky conducts the original 1911 version of *Petrushka* and Rattle favors Stravinsky's 1947 revision of that score. Which score is used makes more of a difference to some listeners than to others, but I think most would find that Rattle's somewhat more enlivening approach and Angel's brighter sonics provide a more appealing listening experience. The Birmingham orchestra's brilliant playing (and Peter Donohoe's in the important part for piano solo) also contributes toward making this the most fetching account of the 1947 score now available.

The performance of the *Symphony in Three Movements* is a very good one, too, but in this case not as convincing as Rozhdestvensky's. Those very qualities of vivacity and brightness that make Rattle's *Petrushka* so appealing tend to make the symphony seem a bit lighter than it should be. I would not say, however, that Rattle in any sense trivializes the symphony, and his approach is certainly to be preferred to a self-consciously monumentalizing one. *R.F.*

**WEBERN:** *Chamber Works* (see **SCHOENBERG**)



# STEREO REVIEW RETAIL MART



## YOU CAN AFFORD SOMETHING BETTER AT HIFI BUYS

WE CARRY THE BEST STEREO & VIDEO AT THE BEST PRICE!

- Advent
- Bang & Olufsen
- Bazooka
- Belles
- Carver
- Denon
- Infinity
- KEF
- Kenwood
- Kicker
- Magnavox
- Mitsubishi
- Monster Cable
- Nakamichi
- NEC
- Panasonic
- Pickering
- Sennheiser
- Sharp
- Signet
- Sony
- Stax
- Thorens
- Toshiba
- Velodyne
- Yamaha
- AND MORE!

**14 ATLANTA LOCATIONS**  
**(404) 436-1231**

## Audio Den Ltd.

Authorized Sales and Service  
Residential • Commercial  
AUDIO AND VIDEO COMPONENTS  
MEDIA ROOMS • SURROUND SOUND • ANTENNAS

- AOCOM (in store only)
- A R TURNTABLES
- CALIFORNIA LABS
- CAMBER
- CONRAD JOHNSON
- C W D
- DUAL
- GRADO
- HAFLER
- KLIPSCH
- M I T CABLES
- MONSTER CABLES

- MOTIF
- NAD
- NAKAMICHI
- N E C
- MAGNEPAN
- MERLIN

- NITTY GRITTY
- ORTOFON
- PARADIGM
- PIRNACLE
- ROGERS
- SENNHEISER

- SHURE ULTRA
- SONOGRAPHE
- SOTA
- SPECTRAL
- STAX
- SYNTHESIS
- TERK
- THORENS
- VELODYNE
- V P I
- WELL TEMPERED
- YAMAHA (in store only)

SMITH HAVEN PLAZA  
2021 NESCONET HWY. (RT. 347)  
LAKE GROVE, N.Y. 11755  
**(516) 360-1990**

## THE FINEST IN HOME AUDIO, CAR STEREO & VIDEO EQUIPMENT

### AUTHORIZED DEALER FOR

- ADS
- AKG
- ALTEC-LANSING
- AUDIO CONTROL
- AUDIO PRO
- AUDIO SOURCE
- B & W
- dbx
- DENON
- GUL
- INFINITY (CAR)
- JVC
- KENWOOD
- KICKER
- MINOLTA
- MISSION
- MONSTER CABLE
- ORION
- OLYMPUS
- POLK AUDIO (CAR)
- PROTON
- SAE
- SANSUI
- SURROUND SOUND
- SNOOPER
- SONANCE
- SOUND CRAFTSMEN
- TERK ANTENNAS
- CELESTION
- CERWIN VEGA

**Sound CITY**  
Meadow Shopping Center  
Route 23 South  
Kinnelon, N.J. (201) **838-3444**

## Audio Unlimited

### AUTHORIZED DEALER FOR:

- AR
- Altec
- Audio Control
- Audio Dynamics
- Audioquest
- B & K
- dbx
- Fried
- Grado
- Hafler
- JVC
- Monster Cable
- Pioneer Elite
- Proton
- Sony-Car
- Stax
- Superphön
- Thorens

**503-963-5731**  
1203 Adams Ave.  
La Grande, OR 97850  
10:00-5:30 M-Thurs.  
10:00-3:00 Fri.  
Pacific Time

# polkaudio

The Speaker Specialists®

## Where to buy Polk Speakers

### AUTHORIZED DEALER LIST

- CANADA** Call Evolution Technology, Toronto for nearest dealer 1-416-235-4422
- AK Anchorage:** Magnum Electronics • Fairbanks: Holt's
- AL Birmingham:** Audition • Dothan: International Audio • Huntsville: Sound Distributors
- MOBILE:** Hi-Fi Zone • Montgomery: The Record Shop • Tuscaloosa: Kincaid Stereo & TV
- AR Little Rock:** Leisure Electronics • Searcy: Softmart
- AZ Flagstaff:** Sound Pro • Phoenix/Mesa: Hi-Fi Sales • Tucson: Audio Emporium
- CA Bakersfield:** Casa Music • Campbell: Sound Goods • Canoga Park: Shelby's • Chico: Sounds By Dave • Corona Del Mar: Pacific Coast Audio Video • Davis: World Electronics • Eureka: Eureka Audio Video • Fresno: Bananas Hi-Fi • Lancaster: California Soundworks • Mountain View: Sound Goods • Napa: Fulminator • Orange: Absolute Audio • Penngrove: California Stereo • Redondo: Systems Design • Sacramento: Good Guys • San Diego: Sound Company • San Francisco & Suburbs: Good Guys Stereo Store • San Gabriel: Audio Concepts • San Jose: Good Guys • San Luis Obispo: Audio Ecstasy • Santa Barbara: Creative Stereo • Santa Cruz: Sound Wave • Santa Maria: Creation Stereo • Santa Monica: Shelby's Stereo • Sherman Oaks: Systems Design • Stockton: Gluskens • Thousand Oaks: Creative Stereo • Ukiah: Music Multiverture: Creative Stereo • Victorville: Interglobe: Soundworks
- CO Boulder:** Soundtrack • Colorado Springs: Samsone Audio • Denver & Suburbs: Soundtrix • Pueblo: Sunshine Audio
- CT Aveon:** Hi-Fi Stereo House • Danbury: Carlson's • Fairfield: Audio Design • Greenwich: Al Franklin's • Hartford: Al Franklin's • New Haven: Audio Etc. • Newington: Hi-Fi Stereo House • West London: Robert's • Norwalk: Audiotronics • Waterbury: Zingo Music
- DE Wilmington:** Bryn Mawr Stereo
- DC Wash. D.C.:** Hi-Fi Stereo House • Ft. Myers: Stereo Garage • Ft. Lauderdale: Sound Advice • Ft. Pierce: Sound Shack • Ft. Walton Beach: Audio International • Gainesville: Electronics World • Jacksonville: Audio Tech • Key West: Audio International • Lakeview: Sound Factory • Merritt Island: Southern Audio • Miami: Electronic Equipment Co. • Sound Advice • Naples: Stereo Garage • Orlando: Audio Spectrum • Panama City: WatSound Stereo • Pensacola: Fidler Hi-Fi • Sarasota: Sound Advice • St. Petersburg: Cooper for Stereo • Sound Advice • Tallahassee: Stereo Store • Tampa: Sound Advice • W. Palm Beach: Electronic Connection • Sound Advice
- GA Atlanta:** Hi-Fi Buys • Atlanta & Suburbs: Hi-Fi Buys • Augusta: Stereo City • Brunswick: Hi-Fi Service Store • Macon: Georgia Music • Savannah: Audio Warehouse • Valdosta: Stereo Connection
- HI Honolulu:** Honolulu Audio Video
- IA Davenport:** Gregg's Music • Des Moines: Audio Lab • EDGE City: Sound World • Iowa City: Hawk Eye Audio • Mason City: Sound World • Waterloo: Team
- ID Boise:** Stereo Shoppe • Sandpoint: Electracraft • Twin Falls: Audio Warehouse
- IL Alton:** Reliable Stereo • Aurora: Stereo Systems • Bloomington: Alan's Creative Stereo • Carbondale: Southern Stereo • Champaign: Good Guys • Decatur: J.R. Lloyd's • DeKalb: Audio Plus • Hoffman Estates: Simply Stereo • Highland Park: Columbia • Joliet: Stereo Systems • Kaneoka: Barrett Entertainment • Lansing: Audio Clinic • Naperville: Stereo Systems • Normal: Sunzown One • Peoria: Team Electronics • Rockford: Columbia • Schaumburg: Hi-Fi Hub • Springfield: Sunzown One
- Spring Valley:** Audio Labs • Sterling: Midwest Hi-Fi • Vernon Hills: Allan's • Villa Park: Hi-Fi Hub • Waukegan: Alan's
- IN Buffalo:** Big TV & Appliance • Evansville: Ripley's • Ft. Wayne: Classic Stereo • Indianapolis: Ovalton • Lafayette: Good Vibes • Marion: Classic Stereo • Michigan City: Audio Connection • Muncie: Classic Stereo • South Bend: Classic Stereo • Terre Haute: Stereo Crafters
- KS Junction City:** Audio Junction • Overland Park: Audio Electronics • Wichita: Audiovisions • Topeka: Nelson's
- KY Bowling Green:** Audio Center • Lexington: Ovalton Audio • Louisville: Audio Video • Boy Design • Owensboro: Paducah: Ripley's • Princeton: Mark's
- LA Alexandria:** Simpson's Electronics • Lafayette: Sound Electronics • Metairie & New Orleans: Alterman Audio • Opelousas: Sound Electronics
- MA Boston:** Waltham Camera & Stereo • Fitchburg: Fitchburg Music • N. Dartmouth: Sound • Pittsfield: H.B.S. Stereo • Worcester: O'Connell's
- ME Bangor:** Sound Source • Camden: Harbor Audio • Portland: New England Music
- MD Annapolis:** Soundways • Baltimore: Soundzacs • Rockville: Myr Emco
- MI Ann Arbor:** Absolute Sound • Birmingham: Almas Hi-Fi • Dearborn: Almas Hi-Fi • Farmington Hills: Almas Hi-Fi • Flint: Stereo Center • Grand Rapids: Classic Stereo • Iron Mountain: Sound North • Kalamazoo: Classic Stereo • Potosky: Kurtz Music • Royal Oak: Absolute Sound • Court St. Listening Room • Traverse City: Kurtz Music
- MN Duluth:** Me's TV & Audio • Minnetonka: Audio King • Rochester: Audio King • St. Paul: Audio King
- MO Cape Girardeau:** Stereo One • Columbia: Johnson Audio • Rolla: End of the Rainbow • St. Louis: Sound Central
- MS Columbus:** Audio Advantage • Hattiesburg: United TV • Jackson: Walters • Pascagoula: Impress
- MT Bozeman:** Thrifty Ear • Great Falls: Rocky Mountain Hi-Fi • Missoula: Aspen Sound
- NC Asheville:** Mr. Todd's Stereo Video • Boone: Holtons • Chapel Hill: Stereo Sound • Charlotte: Audio Video Systems • Greensboro: Stereo Sound • Winston: Stereo Concepts • Mooreshead City: Andrews Audio • New Bern: Anderson Audio • Raleigh: Audio Video • Rocky Mount: Micro Wave Audio • Wilmington: Atlantic Audio • Wilson: Modern Stereo • Winston-Salem: Stereo Sound
- ND Bismarck:** Pacific Sound • Langdon: Easy Way
- NE Kearney:** Midwest Audio • Lincoln: Stereo West • Omaha: Stereo West • York: Midwest Audio
- NH Concord:** Audio of New England • Exeter: Audio Source & Soundations • Lacota: Lakeside Stereo • New London: North Star • Salem: Cumos
- NJ East Brunswick:** Atlantic Stereo • Frankford: Stereo Concepts • Gladstone: Maple Shade • Bryn Mawr Stereo • Montclair: Perdue Radio • Raritan: AC Audio • Ridgewood: Standing Board • Shrewsbury: Moonmound Audio • Union: Stereo Concepts • Wall Twp.: Moonmound Stereo • West Caldwell: Perdue Radio
- NM Alamogordo:** D&K Electronics • Albuquerque: West Coast Stereo • Clovis: Towne Center • Santa Fe: West Coast Sound
- NV Las Vegas:** Upper Ear • Reno: The Audio Authority
- NY Albany:** Clark Music • Batavia: Unicorn Audio • Buffalo: Speaker Shop • Corning: Chemung • Elmira: Chemung • Fredonia: Studio One • Glens Falls: Audio Genesis • Hamilton: Impassible Stereo • Ithaca: Chemung • Jamestown: Studio One • Manhasset: Audio Breakthroughs • Massena: Hi-Fi Shop • Newburgh: Audio Expressions • New York City: Audio Breakthroughs • Electronic Workshop • Rochester: JS Sound • Scarsdale: Listening Room • Syracuse: Clark Music • Vestal: Hart Electronics • Woodbury: Audio Breakthroughs
- OH Akron:** Audio Craft • Canton: Berden Audio • Cleveland & Suburbs: Audio Craft • Cincinnati: Stereo Lab • Columbus: Stereo Lab • Dayton: Stereo Showcase • Findlay: Audio Craft • Lima: Classic Stereo • Toledo: Audio Craft
- OK Lawton:** Hi-Fi Shop • Oklahoma City: Audio Dimensions • Shawnee: Rare Sounds • Stillwater: Carline • Tulsa: Audio Advice
- OR Beaverton:** Stereo Superstore • Bend: Anderson • Eugene: University Hi-Fi • Grants: Pacific Specialty • Medford: Shackelford • Portland: Stereo Superstore
- PA Allentown:** Bryn Mawr Stereo • Blakely: Hart Electronics • Bryn Mawr: Bryn Mawr Stereo • Camp Hill: Bryn Mawr Stereo • Chambersville: Bryn Mawr Stereo • Erie: Studio One • Johnstown: Gary's Entertainment • Kingston: Hart Electronics • Lancaster: G.H.T. Stereo • Longhorns: Bryn Mawr • Marietta: Bryn Mawr Stereo • Meadville: Natrona Heights: Stereo Land • Philadelphia & Suburbs: Bryn Mawr Stereo • Pittsburgh: Audio Junction • Quakertown: Bryn Mawr Stereo • Reading: G.H.T. Stereo • Sellersville: Stereo Shoppe • State College: Paul & Tony's Stereo • Williamsport: Robert's Stereo
- PR PUERTO RICO:** Rio Piedras: Precision Audio
- RI N. Providence:** Eastern Audio
- SC Anderson:** John Brookshires • Charleston: Audio Warehouse • Greenville: Mitchell's Stereo • Greenville: Stereo Shop • Spartanburg: Stereo Shop
- SD Aberdeen:** Engel Music • Rapid City: Isom Electronics • Sioux Falls: Audio King
- TN Chattanooga:** Hi-Fi • Cookeville: Lindsey Ward • Jackson: New Wave Electronics • Johnson City: Mr. Todd's Stereo Video • Kingsport: Mr. Todd's Stereo Video • Knoxville: Lindsey Ward • McMinnville: Lindsey Ward • Memphis: New Wave Electronics • Nashville: Hi-Fi Buys
- TX Abilene:** Sound Effects • Amarillo: Sound Systems Ltd. • Arlington: Sound Idea • Austin: Audio Video • College Station: Audio Video • Corpus Christi: Iape Town • Dallas: Hillcrest Hi-Fidelity • El Paso: Soundquest • Ft. Worth: Grand Meadows • Sheffield Audio • Hurst: Sound Idea • Laredo: Meter International • Longview: Audio Tech • Houston • Lubbock: Electronics Superstore • Dallas • Dallas: Sound Boy • Dallas: Bill Case Sound • San Marcos: Discovery Audio Video • Sherman: Walowide Stereo • Temple: Audio Tech • Texarkana: Sound Tools • Tyler: Stereo Lab
- UT Logan store only:** Stereo Brothers • Salt Lake City: Broadway Music • St. George: Boulevard Home Furnishings
- VA Bristol:** Mr. Todd's Stereo Video • Char. Lottsville: Holdens • Sound Machine • Falls Church: Myr Emco • Franklin: Audio Showroom • Richmond: Gary's Stereo • Roanoke: Holdens • Virginia Beach: Digital Sound
- VT Essex Junction:** Creative Sound • Rutland: Mountain Music
- WA Bellingham:** QJ Stereo • Chelan: Music Store • Oak Harbor: QJ Stereo Center • Richland: Tin Ear Stereo • Spokane: Electracraft (Hi-Fi)
- WI Appleton:** Sound World • Eau Claire: Eau Claire Systems • Green Bay: Sound World • Lacrosse: Sound World • Madison: Happy Medium • Marinette: Sound Saver • Milwaukee: Audio Emporium • Wausau: Sound King
- WV Boursville:** Reclay • Charleston: Huntington • Pied Piper • Parkersburg: Video Warehouse • Piedmont: Sound Gallery • Wheeling: Stereo Lab
- WY Cheyenne:** Electronics Unlimited • Sheridan: Star Video

# STEREO REVIEW RETAIL MART

**TERK Π (Pi) 9600**  
Deluxe Powered  
Omnidirectional **\$79<sup>95</sup>**  
FM Antenna

(omnidirectional application) (unidirectional application)

**Sound CITY**  
Meadtown Shopping Center  
Route 23 South  
Kinnelon, N.J. (201) **838-3444**

## The Sound Seller

For the Musical Difference

Authorized Dealer For:

Acoustat	NAD (In store only)
Audio Control	Belles
Nitty Gritty	CWD
M&K	dbx
Nakamichi	Fried
Oracie	Harman Kardon
Polk	3D
PROAC	Orkyo
Proton	Grado
STAX	Audioquest
Thorens	Celestion
Dahquist	DCM
Hafler	Niles
Monster Cable	Kinergetics
Citation	Duntech

1706 Main St.  
Mannette, WI 54143  
(715) 735-9002

**PROTON**  
CLEARLY THE BEST

440 DIGITAL TUNER

1100 STEREO PREAMPLIFIER

D1200 STEREO POWER AMPLIFIER with DPD™

**CALL FOR PRICE!**

**Sound CITY**  
Meadtown Shopping Center  
Route 23 South  
Kinnelon, N.J. (201) **838-3444**

Come and Relax at  
**SOUTHERN CALIFORNIA'S  
Newest High-End Audio Store**

## Audio Haven

Fine Audio Components

TWO LIVING ROOMS DEDICATED TO THE DISCERNING LISTENER:

- State of the Art room
- State of the Wallet room

THRESHOLD	MIRAGE	POLK
APOGEE	VTL	FORTE
ROTEL	THORENS	SYSTEMDEK
	and growing...	

1937 W. 11th Street, Suite G  
Upland, California 91786  
(714) 982-8110

Off the 10 Fryw. where Los Angeles and San Bernardino counties meet

## The Best Price on Sound Advice

At SOUND STAGE you can talk to a knowledgeable salesperson who will advise you on the best audio or video equipment that meets your needs and budget. From our large selection you can compare performance specifications and prices.

ALL SOUND STAGE equipment Includes:

- 30-day best price protection
- free 3-year warranty with parts & labor
- free delivery

**PLEASE. NO MAIL ORDER**

NAD	CARVER	DENON	BANG & OLUFSEN
ADS	M&K	ENERGY	DBX SOUNDFIELD
CWD	GRADO	ELITE	AUDIO CONTROL
DCM	PULSAR	SIGNET	MONSTER CABLE
NEC	KLOSS	LINGO BOX	
	AMBRIA	TALISMAN	

Call for store hours  
(718) 961-9888  
173 Broadway  
NYC, NY 10007  
(NW corner of  
B'way & Cortlandt  
Enter on Cortlandt  
One light up.)  
OR  
184-10 Horace Harding Expwy  
Fresh Meadow, NY 11365 (Exit 25 L/E)

Stereo Review  
**MAIL ORDER MART**  
lets you turn up the volume  
where your customers are...

Want to beam your mail order message where the customers are? Sell surplus inventory? STEREO REVIEW'S new Mail Order Mart was designed with your marketing needs in mind. And this flexible new medium is so budget-wise, you can't afford not to use it!

Call Toll Free  
**(800) 445-6066**

# STEREO REVIEW CLASSIFIED

**AUTHORIZED**

High-end and hard-to-find audio components. Low, low prices! AUDIO AMERICA (Virginia). Call 1-703-745-2223.

HIGH-END LOUDSPEAKER systems, speaker kits and the widest selection of raw drivers from the world's finest manufacturers. For beginners and audiophiles. Free catalog. A&S SPEAKERS. 3170 23rd St., San Francisco, CA 94110. (415) 641-4573

## CALL US LAST

WE WILL  
**BEAT ANY PRICE**  
PRINTED IN THIS MAGAZINE ON  
**AUDIO & CAR STEREO**

**The SOUND Approach**  
6067 Jericho Tpke., Commack, NY 11725  
FAST DELIVERY (516) **499-7680**  
FULL WARRANTY

CABLE TV CONVERTERS/DESCRAMBLERS Guaranteed lowest prices in U.S., Jerrold, Hamlin, Zenith—many others! Lowest dealer prices! Orders shipped within 24 hours! MasterCard—Visa—C.O.D. accepted. Free catalog—call (800) 345-8927 only! Pacific Cable Co., Inc., 7325 1/2 Reseda Blvd., 1340, Reseda, CA 91335. All other information, call (818) 716-5914.

ORDER TOLL-FREE 1(800) 222-3465. DISCOUNTS! AR \* AUDIOQUEST \* BOSE \* BOSTON \* GRADO \* HAFLER \* HARMAN KARDON \* JBL \* LAST \* LIVEWIRE \* MONSTER CABLE \* NITTY GRITTY \* SONY \* STAX \* STRAIGHTWIRE \* PLUS MORE. HCM AUDIO, 1600 BX MANGROVE, CHICO, CA 95926. (916) 345-1341.

LOUDSPEAKER COMPONENTS—KITS. Eton, Dynaudio, Focal, Eclipse. Catalog \$1.00. Meniscus, 3275S Gladiola, Wyoming, Michigan 49509. (616) 534-9121.

WE SELL MORE HIGH PERFORMANCE SPEAKER KITS than anyone in the U.S. Free catalog: 1 (800) 346-9183. AUDIO CONCEPTS INC.









## SINGERS!

REMOVE VOCALS FROM RECORDS AND CDs!

**SING WITH THE WORLD'S BEST BANDS!**

An Unlimited supply of Backgrounds from standard stereo records! Record with your voice or perform live with the backgrounds. Used in Professional Performance yet connects easily to a home component stereo. This unique product is manufactured and sold Exclusively by LT Sound - Not sold through dealers. Call or write for a Free Brochure and Demo Record.

**LT Sound**, Dept. SR-3, 7980 LT Parkway  
Lithonia, GA 30058 (404) 482-4724  
Manufactured and Sold Exclusively by LT Sound  
**24 HOUR PHONE DEMO LINE: (404) 482-2485**

ortofon		SHURE		audio-technica	
				DYNVECTOR STANTON NITTY GRITTY	
<b>ORTOFON X5-MC</b> Std. Mount High Output M.C. 20-45k Hz response. FG II stylus tip. Highly detailed, transparent sound.	<b>ORTOFON OM-40</b> Std. Mount Moving Magnet 20-29k Hz response. VdH II stylus tip. Silky smooth sound with good channel separation.	<b>SHURE V15 V-MR</b> Std. Mount Moving Magnet 20-29k Hz response. Micro- Ridge stylus tip. Budget reference cartridge with excellent trackability.	<b>AUDIO TECH. AT160ML</b> Std. Mount Moving Magnet 5-35k Hz response. Microline stylus tip. Low distortion with reduced record & stylus wear.		
				BANG & OLUFSEN PICKERING	
<b>AUDIO TECH. AT152MLP</b> P-Mnt Moving Magnet 5.35k Hz response. MicroLine stylus tip. Top rated P-Mnt cartridge.	<b>SHURE V15HR-P</b> P-Mnt Moving Magnet 15-27k Hz response. Hyper- Ridge stylus tip. Lowest price V15 P-Mnt cartridge.	<b>PICKERING XV15 625 DJP</b> Std. Mount Pro D.J. Cartridge 20-20k Hz response. Includes extra stylus.	<b>DISC KIT \$19.95</b> w/purchase of any cartridge  *while supplies last		
We are the original mail order phono cartridge and stylus replacement specialists. Since 1972 Lyle Cartridges has helped audiophiles locate replacement styl for their cartridges at reasonable prices and with excellent service. Our goal is to help those who still prefer to play analog recordings.					
SEND SELF ADDRESSED STAMPED ENVELOPE FOR OUR FREE CATALOG.		<b>LYLE CARTRIDGES</b> Dept. B1, Box 158 Valley Stream, N.Y. 11582 Phones Open Mon-Sat 9 am-8 pm		CALL TOLL-FREE FOR FREE PRICE QUOTES AND VISA/MC ORDERS N.Y. STATE (516) 599-1112  (800) 221-0906	
MONSTER CABLE		TIPTOPS		LASC	

**GET LOW PRICES ON ALL** types of audio equipment — including high-end and esoteric products not normally discounted. Now we can **SAVE YOU MONEY** on the equipment you really want. Extensive selection — no need to settle for second choice. Thousands of satisfied customers world-wide. All products feature USA manufacturer's warranty. Call us for price quotes or friendly, expert advice. Catalog \$1.00. **616-451-3868**. Audio Advisor, 225 Oakes, S.W., Grand Rapids, MI 49503. We accept: **VISA/MC/AMEX/DISCOVER**.

"STEREO WORLD" IS YOUR DISCOUNT MAILORDER SOURCE WITH SUPER DEALS ON AUDIO/VIDEO AND CAR STEREO LINES INCLUDING: TECHNICS, PANASONIC, JVC, SONY, PYLE, PIONEER, SHERWOOD, PHILIPS, CLARION, DENON, SOUND STREAM, PRECISION POWER AMPS, JENSEN, AND MANY OTHERS. CALL OR WRITE FOR YOUR FREE CATALOG. FREE UPS IN 48 STATES. 10AM-6PM MON-FRI; WEDNESDAY TIL 10PM. VISA/MC (MO/CK MUST CLEAR)/COD-EXTRA. P.O. BOX 596. MONROE, NY 10950. (914) 782-6044.

LOW PRICES!! Yamaha, Denon, Carver, Adcom, Boston Acoustics, Luxman, Hafler, A/D/S, B&K, KEF, Onkyo, Proton, Bose, Snel, DCM, Counterpoint, M&K, P.S. Audio, AR & Many Others. SOUND ADVICE: (414) 727-0071.

ATTENTION KEF CUSTOMERS. KEF's Five Year Warranty, applies to the original purchaser only. Speakers imported by non-authorized dealers and resold are not covered under this or any other warranty. Technically, such equipment is secondhand, which both voids the warranty and reduces its value. For your nearest authorized KEF dealer call 1-800-533-0035.

**SAVE 40% ON HIGH-END home speakers, subwoofers, amplifiers. FREE CATALOG!** RTRD, 3021 Sangamon Ave., Springfield, IL 62702. (217) 529-8793.

**FOR SALE**

ARE YOU INTERESTED in Quality Preowned Audio Equipment? Subscribe to "The Sound Trek," published 6 x annually, your listings of items for sale or wanted. \$10/yr. Call or write: Play it Again Sam, 12611-R Madison Avenue, Lakewood, Ohio 44107, (216) 228-0040. MC/VISA.

CASH FOR ALL TYPES of used Stereo equipment. We buy by phone. THE STEREO TRADING OUTLET, 320 Old York Rd., Jenkintown, PA 19046. (215) 886-1650.

**Stereo Express**  **CALL NOW**   
(619) 578-9630

**CALL FOR PRICE FAST & FRIENDLY SERVICE**  
Most Orders Shipped Within 48 Hours  
**HOME AUDIO**  
YAMAHA ADS BOSE HAFLER HARMAN KARDON INFINITY AR SONY DBX JBL JVC AIWA TECHNICS AKAI SAE ADCOM STAX AUDIO SOURCE PIONEER MAGNAVOX AND MANY MORE

**CAR AUDIO**  
ADS ALPINE BLAUPUNKT CONCORD SONY KENWOOD PIONEER CLIFFORD TECHNICS

**VIDEO**  
SONY JVC RCA PANASONIC ZENITH GE  
7887 Dunbrook #G, San Diego, CA 92126

**SERIOUS AUDIOPHILES DESERVE SERIOUS SERVICE.**

And that's what you'll get at Reference Audio Systems. We offer the best in high-end audio and the best in friendly service by our knowledgeable staff. From the latest CD player to a classic mega-watt amplifier, you'll like our surprisingly affordable prices and fast shipping.

MAGNAVOX · DBX  
THORENS · NITTY  
CELESTION · HAUN  
STAX · AUDIOPRO  
SONANCE · ENER  
GRADO · MAGNUM  
DUAL · ORTOFON

**Reference Audio Systems**

Call Us... (213) 719-1500

Member Better Business Bureau  
18214 Dalton Ave, Dept. D, Gardena, CA 90248  
Hours: M-F 9 to 6, Sat. 9 to 1 Pacific Time

**LOWEST PRICES**  
On over 150 brands  
**Car - Home - Video**  
For Specials List and Catalog only  
**800-233-8375**

HIGH QUALITY BRANDS—Car, Home, Video including esoteric. Audio Unlimited, 1203D Adams Ave., La Grande, Oregon 97850. (503) 963-5731.

**DIRECT SIGHT AND SOUND, America's best kept audio and video secret, continues to please... Five years and over 40,000 customers later, we still offer the best in audio, video, and auto sound including esoterics at incredible prices! We sell and service only U.S. warranty merchandise! Our staff is not only knowledgeable, but helpful and courteous in choosing the right component for you. Become one of the ELITE! Call (404) 436-5611. Direct Sight and Sound, 3095 Bolling Way, Dept. S, Atlanta, GA 30305. MC/VISA/AMEX. COD with deposit.**

PHILIPS, AUDAX, PEERLESS, FOCAL, AND DYNAUDIO LOUDSPEAKERS in stock with good prices and competent services. Crossover components also. MADISOUND SPEAKER COMPONENTS. 8608 University Green, Box 4283, Madison, WI 53711. (608) 831-3433.

**CALL TOLL FREE! 1 (800) 826-0520. KINERGETICS, ACOUSTAT, HAFLER, HARMAN KARDON, PROTON, AUDIO CONTROL, NITTY-GRITTY, M&K, STAX, PROAC, DAHLQUIST, CELESTION, BELLES, dbx, FRIED, ORACLE, THORENS, MONSTER, CWD, ONKYO, 3D, GRADO, DCM, CITATION, NILES, AUDIO-QUEST. SOUND SELLER, 1706 MAIN, MARI-NETTE, WI 54143. (715) 735-9002.**

EXPERIENCED, FRIENDLY ADVICE! AUDIRE, PS, CWD, STAX, SUPERPHON, THORENS, MIRAGE, GRADO, FRIED, MONSTER CABLE, QUAD, SPICA, STRAIGHT-WIRE, more. Immediate, FREE Shipping! READ BROTHERS STEREO, 593-B King Street, Charleston, South Carolina 29403. (803) 723-7276.

SHURE • MONSTER CABLE • GRADO

We Are Proud To Offer  
A LARGE SELECTION OF:

**NEEDLES CARTRIDGES**

TOLL FREE  
**(800) 342-9969**  
High Quality Turntables & Accessories in Stock...

M&Y CO.  
8344 Me rose Ave  
Los Angeles, CA 90069

Featuring:

- ORTOFON
- SHURE
- GRADO
- DYNAVECTOR
- AUDIO TECHNICA
- PICKERING
- SINGNET
- NITTY GRITTY
- STANTON
- BEYERDYNAMIC
- AUDIOQUEST
- STAX
- CARNEQUE ONE
- THORENS
- AR
- MICRO SEIKI
- AND MANY MORE

DYNVECTOR • STANTON • NITTY GRITTY

SIGNET • ORTOFON • BEYERDYNAMIC

# Taskamichi Audio, P.O. Box 25583 Seattle, WA 98125

All equipment are factory fresh & USA warranted.  
For more info, and catalog call 1 (206) 747-9999  
2 weeks damage and defect replacement period.

To order, please call 1(800) 622-HiFi (4434); FAX 1 (206) 562-8720  
Accept all major credit cards and ship most equipment within 24 hrs  
Prices are subject to change without notice.

Receivers	Nakamichi	NAD	CX800U	559	Luxman	Adcom
Yamaha	SR-2A \$399	\$500	CS600U	359	LV-112 \$449	GFA555 \$629
RX1100U \$799	SR-3A \$609	\$520	DSP-1	799	LV-117 \$899	GFA545 419
RX900U \$639	SR-4A \$849	\$170	MVS-1	119	LV-109 \$1,249	GFA535 249
RX700U \$479	CD players		DSP3000	1,519	LV-105 \$819	GFP555 419
RX500U \$329	Yamaha	Yamaha	DSR-100	499	T-100 209	GFT555 249
RX300U \$239	CDX1110U \$959	KX1200U \$599	M-35	239	T-111 249	GTF500 .499
Carver	CDX910U \$559	KX500U \$319	MX600	429	T-117 509	
REC-2000 \$1,149	CDX810U \$439	KK500U \$269	MX800	679	T-407 309	
6200 \$589	CDX510U \$289	Luxman	MX1000	959	Denon	Monthly
6250 \$739	CDX410U \$259	K-105 \$489	TX-500	269	DAP5500 \$1,249	Specials
Luxman	Carver	K-106 \$489	TX-900	329	PF800 \$399	Yamaha
R-117 \$959	DTL50 \$459	K-111 \$239	TX-1000	439	TT500 \$199	
R-115 \$649	DTL200 II \$559	K-112 \$449	AVC-50	439	Denon	
R-113 \$369	Luxman	Denon	AVC-30	359	DP47F \$319	
Denon	D-112 \$419	DRM44HX \$529	SR-50B	279	We also carry	
DRA95A \$529	D-113 \$549	DRM30HX \$409	Carver	4000T \$999	KEF, MISSION &	
DRA625 \$449	D-107 \$729	DRM24HX \$369	C1	499	KYOCERA.	
DRA425 \$369	D-109 \$1,249	DRM12HR \$289	C9	369	Please call for	
NAD	Denon	Separates	M1.0T	209	NAD	
7600 \$1,299	DCD3300 \$1,349	Yamaha	M1.5T	499	TX550 \$219	
7250PE \$529	DCD1700 \$739	AX900U \$599	M4.0T	209	CALL \$219	
7240PE \$429	DCD1500 II \$559	AX700U \$479	M1.5T	499	M1.5T \$739	
7220PE \$259	DCD1400 \$409	AX500U \$329	M200T	309	CALL \$200PE \$479	
7175PE \$689	DCD810 \$CALL	AX400U \$229	M400T	459	M400T \$489	
	DCD610 \$CALL	AX1000U \$959	M500T	529	M500T \$499	
	DCM555 \$469	CX1000U \$959	TX2	349	TX2 \$349	
			TX11A	589	TX11A \$589	

WE SELL SECOND HAND high quality audio-video with money back guarantee! Send your name and address for FREE monthly inventory. Ross Stereo, 2423 Morena Blvd. San Diego, CA 92110. (619) 275-3632.

ACOUSTICAL MAGIC IS FLEXIBLE BOROSILICATE CERAMIC COATING. A MODERN DAY SPACE AGE PRODUCT, ADAPTED TO AUDIO. DESIGNED ESPECIALLY FOR SPEAKER ENCLOSURES. GONE IS THE MUFFLED, BLURRED, SOUND OF CONE SPEAKERS. FOR FURTHER DETAILS CALL: 1 (800) 654-4761.

IMPROVE YOUR HEARING with a pair of R.J.S. Pyramid I's. FREE INFORMATION: R.J.S. Acoustics, P.O. Box 20757, St. Pete, FL 33742.

CARVER, NAKAMICHI, BANG & OLUFSEN, A.D.S., CROWN, REVOX, TANDBERG, HAFNER, ADCOM, MISSION, N.A.D., HARMAN/KARDON, KYOCERA, YAMAHA, LUXMAN, DENON, KLIPSCH, B&W, KEF, D.C.M., E-V, J.B.L., INFINITY, D.B.X., AKG, AND OTHER QUALITY COMPONENTS. BEST PRICES—PROFESSIONAL CONSULTATION. ALL PRODUCTS COVERED BY MANUFACTURERS' U.S.A. WARRANTY. OPEN 24 HOURS A DAY. AMERISOUND SALES, INC., EAST: (904) 262-4000; WEST: (818) 243-1168.

## "GOLDSTANDS"

FULLY ASSEMBLED SPEAKER STANOS

GOLD STANDS ARE THE ONLY STANDS GUARANTEED TO MAKE AN AUDIBLE DIFFERENCE TO YOUR SATISFACTION OR YOUR MONEY BACK!!!

ANGLED STRAIGHT, TALL, SHORT, SAND-FILLED, SPIKED.

CUSTOM STANDS OUR SPECIALTY

"GOLDSTANDS"  
229 NASSAU RD., HUNTINGTON, NY 11743  
(516) 427-4813

MAGNAVOX CD PLAYERS at their lowest: CDB480 \$149, CDB482 \$165, CDB486, CHANGER \$279, CDB473 \$249, TV'S, VCR'S. TRADES WELCOME. American Acoustic, Soundcraftmen, Monster Cable, Heybrook, Apature. Call for best prices. Digital Sound Distributors; (219) 626-2756.

(707) 431-0636, Old Beatles and Dead tapes. Multi-Volumed-Stereo, plans \$15.00/Sunshine. Box 1027, Healdsburg, CA 95448.

ATTENTION DENON CUSTOMERS Not everyone offering Denon product for sale is an authorized Denon dealer. This has great significance to you as a potential Denon customer. Denon America's warranty applies to the original purchase only. Denon products sold by non-authorized dealers are not covered under this or any other warranty. Additionally, some of this equipment may have been designed for foreign markets and therefore will not meet Denon America's specifications. To find your nearest AUTHORIZED Denon Dealer call: 1 (201) 575-7810 (9:00am—5:00pm EST)

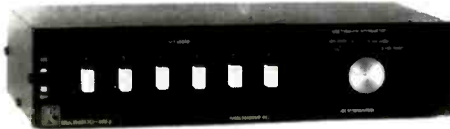

IMPEDANCE MATCHING PROBLEM??? SOLUTION! RUS-SOUND/FMP MM-6 • Connects up 6 pairs of 4, 8, or 16 ohm speakers! • Built-in impedance matching and level control transformers never allow impedance to fall below 4 ohms. • 5 year warranty! Dealer inquires. Many other products! RUS-SOUND/FMP Inc., 135 McDonough/St., Portsmouth, NH 03801. (603) 431-5282.

American Made Compact Stereo Speaker System—Perfect for Stereo/TV.—\$99 per pair. MONEY BACK GUARANTEE! —RPM AUDIO—(818) 627-1544.

### RECORDS

FREE RECORD, CASSETTE AND COMPACT DISC CATALOG: Features a tremendous selection of remaindered LP new releases at discount prices. Many imports and smaller labels offered. Prompt delivery. Rose Records, Dept SR.214 SO. Wabash Avenue, Chicago, IL 60604.

DIGITALLY ENHANCE albums, tapes and CD's for a GUARANTEED improvement! EXPERIENCE THE TRANSITION!! For newsletter send \$1.00 to PJ Sound P.O. Box 75, West Seneca, N.Y. 14224.

FROM EDISON TO ELVIS (AND BEYOND) LP'S 78's, 45's etc. Visit or mail-in wants. The Olde Time Music Scene, 915 Main Street, Boonton, NJ 07005. (201) 335-5040. Tuesday-Sunday.

RECORD COLLECTORS SUPPLIES. REPLACEMENT JACKETS, inner sleeves, 78 RPM sleeves, opera boxes, etc. COMPLETE CATALOG. Cabco, Box 8212, Room 640, Columbus, Ohio 43201.

SOUND TRACK & ORIGINAL CASSETTES COLLECTORS. Largest selection of in-print, out-of-print, foreign, and domestic records. CD's. Free Catalog. Soundtrack Album Retailers, Dept. SR21, Box 487, New Holland, PA 17557. (717) 656-0121.

A.S.Q. SOUNDTRACKS/O.C. DISCOUNT PRICES, RARE OUT-OF-PRINT, QUALITY GUARANTEED, FAST DEPENDABLE SERVICE, SEND FOR FREE MONTHLY CATALOG: A.S.Q. DEPT. A, P.O. Box 404, SEELYVILLE, IN 47878.

IN-PRINT & OUT-OF-PRINT RECORDS ALL CATEGORIES & NOSTALGIA VIDEO TAPES... Spectacular Catalog!! \$2.00 USA \$4.00 Foreign. Serendipity Records, 4775 Durham Road, Guilford, CT 06437 USA.

JUDY GARLAND RARE RECORDS. RECORDINGS. Also, Old-Time Radio. R. Herskowitz, P.O. Box 354, Kew Gardens, NY 11415.

RARE, UNUSUAL, HARD-TO-FIND RECORDS BOUGHT AND SOLD. MAIL-ORDER SPECIALISTS. RECORD GEMS, 486 MERRICK ROAD, OCEANSIDE, NY 11572. (516) 764-3355.

### COMPACT DISCS

GET NEW CD'S: Top selection, ALL music categories for \$5.90 ea. I'LL TELL YOU HOW! Send \$9.95 to M.J. Brown, P.O. Box 3171 AS Maple Glen, PA 19002.

OVER 8000 USED CD's MOST \$7.49 to \$9.49. Buy/Sell, monthly catalog, \$2.50 shipping per order UPS. Fast service for over 3 years. Visa MC. Audio House CD Club, 4304 Brayan, Swartz Creek, Michigan 48473. (313) 655-8639.

COMPACT DISC CENTER  
P.O. Box 6165, Clifton Park, NY 12065  
NY (518) 383-4855  
Outside NY—To Order Only  
Call 1-800-333-4422

STARTING DISCS AT \$12.99  
Quantity Discount Pricing.  
\$2.75 Cont. U.S. Shipping  
FREE CATALOGUE

COMPACT DISCS—At low warehouse prices. Now in our 5th year. FREE catalog! OZ ENTERTAINMENT, 1575 P Highway 29, Lawrenceville, GA 30244. (404) 962-6180.

LOW COMPACT DISC prices—Schwann CD and COLOR CATALOGS \$6.00—Mini-Catalogs \$1.00—DUWARS, P.O. Box 6662-D, Greenville, SC 29606.

USED CD'S \$6.95. UP. We pay you up to \$7.00. FREE CATALOG: CCM, 1105 Webster, Sandy, Utah 84094-3151. (801) 571-9767.

PRE-OWNED CD'S! Buy, sell, trade. Free catalog information. THE CD LINK, PO Drawer 5596, Greenville, SC 29606-5596.

WE'VE SLIPPED OUR DISC PRICES TO FIT YOUR BUDGET. PRICES START AT \$8.99! WRITE: LASER LOCKER, BOX 8611, SOMERVILLE, NJ 08876.

SAVE MONEY ON NEW CD'S. Free Details: WILBUR TASTAFL COMPANY, Box 308R, Middlefield, CT 06455-0308.

CD'S—CD'S—CD'S—CD'S 18,000 titles at 18,000 unbeatable prices. Call Digital Encounters at (312) 759-9565.

\*\*\*CD, CASSETTE STORAGE\*\*\* Elegant Wood Cabinetry...FREE Brochure!! \*\*\* GIFT OFFER!! \*\*\* CWCO, P.O. Box 747-F5, Nutley, NJ 07110. (201) 759-4939.

USED CD'S! Buy, Sell, Trade. FREE Catalog. MEDIA EXCHANGE, 1-312) 649-9582. P.O. Box 11057, Chicago, IL 60611-0057.

Elegant. AFFORDABLE. stackable, hangable CD/cassette/video display racks. Oak, walnut, pine, maple, CD Holders, 20562 Wackerend, Dept. A, Redford, MI 48240.

FREE CD/RECORD OFFER! FREE CATALOG! "World's Best Brass Catalog" (Fanfare). CRYSTAL RECORDS, Sedro-Woolley, WA 98284.

### TAPES

3.95 SHIPPING ANY SIZE ORDER. UPS 1-800-245-6000

TDK	T/120/1750	HG	MARELL
MAX 820	2.99	TDK MARELL 3.99	4.99
MAX 840	3.49	TDK MARELL 3.99	4.99
MAX 860	3.99	TDK MARELL 3.99	4.99
MAX 880	4.49	TDK MARELL 3.99	4.99
MAX 900	4.99	TDK MARELL 3.99	4.99
MAX 920	5.49	TDK MARELL 3.99	4.99
MAX 940	5.99	TDK MARELL 3.99	4.99
MAX 960	6.49	TDK MARELL 3.99	4.99
MAX 980	6.99	TDK MARELL 3.99	4.99
MAX 1000	7.49	TDK MARELL 3.99	4.99
MAX 1020	7.99	TDK MARELL 3.99	4.99
MAX 1040	8.49	TDK MARELL 3.99	4.99
MAX 1060	8.99	TDK MARELL 3.99	4.99
MAX 1080	9.49	TDK MARELL 3.99	4.99
MAX 1100	9.99	TDK MARELL 3.99	4.99
MAX 1120	10.49	TDK MARELL 3.99	4.99
MAX 1140	10.99	TDK MARELL 3.99	4.99
MAX 1160	11.49	TDK MARELL 3.99	4.99
MAX 1180	11.99	TDK MARELL 3.99	4.99
MAX 1200	12.49	TDK MARELL 3.99	4.99
MAX 1220	12.99	TDK MARELL 3.99	4.99
MAX 1240	13.49	TDK MARELL 3.99	4.99
MAX 1260	13.99	TDK MARELL 3.99	4.99
MAX 1280	14.49	TDK MARELL 3.99	4.99
MAX 1300	14.99	TDK MARELL 3.99	4.99
MAX 1320	15.49	TDK MARELL 3.99	4.99
MAX 1340	15.99	TDK MARELL 3.99	4.99
MAX 1360	16.49	TDK MARELL 3.99	4.99
MAX 1380	16.99	TDK MARELL 3.99	4.99
MAX 1400	17.49	TDK MARELL 3.99	4.99
MAX 1420	17.99	TDK MARELL 3.99	4.99
MAX 1440	18.49	TDK MARELL 3.99	4.99
MAX 1460	18.99	TDK MARELL 3.99	4.99
MAX 1480	19.49	TDK MARELL 3.99	4.99
MAX 1500	19.99	TDK MARELL 3.99	4.99
MAX 1520	20.49	TDK MARELL 3.99	4.99
MAX 1540	20.99	TDK MARELL 3.99	4.99
MAX 1560	21.49	TDK MARELL 3.99	4.99
MAX 1580	21.99	TDK MARELL 3.99	4.99
MAX 1600	22.49	TDK MARELL 3.99	4.99
MAX 1620	22.99	TDK MARELL 3.99	4.99
MAX 1640	23.49	TDK MARELL 3.99	4.99
MAX 1660	23.99	TDK MARELL 3.99	4.99
MAX 1680	24.49	TDK MARELL 3.99	4.99
MAX 1700	24.99	TDK MARELL 3.99	4.99
MAX 1720	25.49	TDK MARELL 3.99	4.99
MAX 1740	25.99	TDK MARELL 3.99	4.99
MAX 1760	26.49	TDK MARELL 3.99	4.99
MAX 1780	26.99	TDK MARELL 3.99	4.99
MAX 1800	27.49	TDK MARELL 3.99	4.99
MAX 1820	27.99	TDK MARELL 3.99	4.99
MAX 1840	28.49	TDK MARELL 3.99	4.99
MAX 1860	28.99	TDK MARELL 3.99	4.99
MAX 1880	29.49	TDK MARELL 3.99	4.99
MAX 1900	29.99	TDK MARELL 3.99	4.99
MAX 1920	30.49	TDK MARELL 3.99	4.99
MAX 1940	30.99	TDK MARELL 3.99	4.99
MAX 1960	31.49	TDK MARELL 3.99	4.99
MAX 1980	31.99	TDK MARELL 3.99	4.99
MAX 2000	32.49	TDK MARELL 3.99	4.99
MAX 2020	32.99	TDK MARELL 3.99	4.99
MAX 2040	33.49	TDK MARELL 3.99	4.99
MAX 2060	33.99	TDK MARELL 3.99	4.99
MAX 2080	34.49	TDK MARELL 3.99	4.99
MAX 2100	34.99	TDK MARELL 3.99	4.99
MAX 2120	35.49	TDK MARELL 3.99	4.99
MAX 2140	35.99	TDK MARELL 3.99	4.99
MAX 2160	36.49	TDK MARELL 3.99	4.99
MAX 2180	36.99	TDK MARELL 3.99	4.99
MAX 2200	37.49	TDK MARELL 3.99	4.99
MAX 2220	37.99	TDK MARELL 3.99	4.99
MAX 2240	38.49	TDK MARELL 3.99	4.99
MAX 2260	38.99	TDK MARELL 3.99	4.99
MAX 2280	39.49	TDK MARELL 3.99	4.99
MAX 2300	39.99	TDK MARELL 3.99	4.99
MAX 2320	40.49	TDK MARELL 3.99	4.99
MAX 2340	40.99	TDK MARELL 3.99	4.99
MAX 2360	41.49	TDK MARELL 3.99	4.99
MAX 2380	41.99	TDK MARELL 3.99	4.99
MAX 2400	42.49	TDK MARELL 3.99	4.99
MAX 2420	42.99	TDK MARELL 3.99	4.99
MAX 2440	43.49	TDK MARELL 3.99	4.99
MAX 2460	43.99	TDK MARELL 3.99	4.99
MAX 2480	44.49	TDK MARELL 3.99	4.99
MAX 2500	44.99	TDK MARELL 3.99	4.99

VISA MC NO EXTRA CHARGE  
FREE PACKAGED CASH WITH EVERY AUDIO ORDER  
Handling Charges by 1% 3.95 Shipping Any Size Order CDD Add 2.25  
All From New York Warehouse. Parcel Post 5.5% Call  
TAPES WORLD 220 SPRING ST. BUTLER PA 16001  
M-F 9:30-5:00  
412/283-8821  
800/245-8000

AMPEX OPEN REEL TAPE—USED ONCE, 1800' OR 2400' BOXED—10 Reels: \$25.00. Sample: \$2.50. FOUR 3600' 10 1/2 REELS: (Boxed): \$25.00. SAMPLE: \$6.00. Also: New MAXELL reels/cassettes, AUDIO TAPES, BOX 9584-R, ALEXANDRIA, VA 22304. (703) 370-5555 VISA MC.

### BUSINESS OPPORTUNITIES

MAILORDER OPPORTUNITY! Start profitable home business without experience or capital. Information Free. Mail Order Associates, Inc., Dept. 679, Montvale, NJ 07645.

YOUR OWN RADIO STATION! AM, FM, cable, licensed/unlicensed, transmitters! Broadcasting: Box 130-R6, Paradise, Ca 95969.

### FOR INVENTORS

INVENTORS! Can you patent and profit from your idea? Call AMERICAN INVENTORS CORPORATION for free information. Over a decade of service. 1(800) 338-5656. In Massachusetts or Canada call (413) 568-3753.

INVENTORS!! Call the INNOVATION CENTER in Washington D.C.—For FREE info call in U.S. & CANADA: 1 (800) 628-2828

**CAR STEREO**

**CAR STEREO—THE TRUE STORY.** Get the facts, not a sales pitch. 250 pages written by a professional installer. "HOW TO BUY CAR STEREO"—\$14.95. Satisfaction Guaranteed! Call 1(800) BE4-UBUY. 1(800) 234-8289.

**GOVERNMENT SURPLUS**

**IS IT TRUE** you can buy jeans for \$44 through the US government? Get the facts today! Call 1(312) 742-1142, ext. 4670.

**WANTED TO BUY**

**CASH PAID FOR CLASSICAL ALBUMS—RCA LIVING STEREO.** MERCURY LIVING PRESENCE (stereo). Also audiophile albums: MOBILE FIDELITY, NAUTILUS, CBS MASTER-SOUNDS, JAPANESE, etc. CHAD KASSEM, PO Box 2043, Salina, KS 67402-2043. (913) 825-8609.

**WE NEED QUALITY COLLECTINGS.** "TOP DOLLAR PAID" for LP's, Compact Discs, and Cassettes: Classical, Rock, etc. **USA'S LARGEST USED AND COLLECTOR SHOP.** PRINCETON RECORD EXCHANGE, 20 Tulane Street, Princeton, NJ 08542. (609) 921-0881.

**MOVIE FILM/VIDEO TAPE**

**CABLE TV CONVERTERS.** Scientific Atlanta, Jerrold, Oak, Zenith, Hamlin. Many others. "New" VIDEO HOPPER "The Copy Killer." Visa, M/C and AmEx. 1(800) 826-7623. B&B Inc., P.O. Box 21-327, St. Paul, MN 55121.

**CABLE TV CONVERTERS—FREE CATALOG—ARIZONA VIDEO.** 3661 N. Campbell, #310-D, Tucson, Arizona 85719. (602) 323-3330.

**RENTAL MOVIE STABILIZER.** Connect between VCRs or to Monitor. Satisfaction guaranteed. \$59.95 plus \$4. handling. 1 (800) 338-8751.

**SERVICES**

Attention GENESIS Owners—Repairs & Upgrades are possible!! Original Specification & Improved Parts by LRS. (603) 749-1904. (24 hrs.)

**INSTRUCTION**

**FREE CATALOG.** Institute of Audio/Video Engineering. 1831 Hyperion (SR), Hollywood, CA 90027. **RECORDING SCHOOL.** (800) 551-8877, (213) 666-2380. Approved for International Students. Member of NATTS.

**MISCELLANEOUS**

**CONFISCATED CARS,** trucks, boats, 4 wheelers, motorcycles, by FBI, IRS, DEA. Available in your area now. Call (805) 682-7555 EXT C-1005.

**TERMPAPER assistance.** 15,278 papers available! 306-page catalog—rush \$2.00 Research, 11322 Idaho 206SX, Los Angeles 90025. TOLL FREE HOTLINE: (800) 351-0222 (California - (213) 477-8226).

**WATCH REPLICAS! LOWEST PRICES GUARANTEED! NATIONWIDE!** Warranty! Exact Weight & Color! 18KT Goldplated! CALL (404) 963-3USA.

**TIPS FOR MAIL ORDER PURCHASERS**

It is impossible for us to verify all of the claims of advertisers. Therefore, the following information is provided for your protection:

1. Confirm price and merchandise information with the seller, including brand, model, color or finish, accessories and rebates included in the price.
2. Understand the seller's return and refund policy, including the allowable return period and who pays the postage for returned merchandise.
3. Understand the product's warranty. Is there a manufacturer's warranty, and if so, is it from a U.S. or foreign manufacturer? Does the seller itself offer a warranty? In either case, what is covered by warranty, how long is the warranty period, where will the product be serviced, what do you have to do, and will the product be repaired or replaced? You may want to receive a copy of the written warranty before placing your order.
4. Keep a copy of all transactions, including cancelled checks, receipts and correspondence. For phone orders, make a note of the order including merchandise ordered, price, order date, expected delivery date and salesperson's name.
5. If the merchandise is not shipped within the promised time or if no time was promised, 30 days of receipt of the order, you generally have the right to cancel the order and get a refund.
6. Merchandise substitution without your express prior consent is not allowed.
7. If you have a problem with your order or the merchandise, write a letter to the seller with all the pertinent information and keep a copy.
8. If you are unable to obtain satisfaction from the seller, contact the consumer protection agency in the seller's state or your local U.S. Postal Service.

**STEREO REVIEW MAIL ORDER MART**

**FOCUS Electronics (718) 871-7600**

MON.-THUR. 9-7  
FRI. 9-3  
SUN. 10-6

**COMPACT DISC PLAYERS**  
**GET A FREE CD WHEN YOU BUY A CD PLAYER & CLEANER —MAGNAVOX—**  
 CDB 650 TOP REMOTE 279.95  
 CDB 473 REMOTE VOLUME 199.95  
 —DENON—  
 DCD 300 REFERENCE 1199.95  
 DCD 1700 2K SL CONV 699.95  
 DCD 1500 H REMOTE 599.95  
 DCD 400 REMOTE 429.95  
 DCD 800 REMOTE 329.95  
 DCD 600 REMOTE 269.95  
 —YAMAHA—  
 CDX 1100 TOP PLAYER 279.95  
 CDX 510 NEW 289.95  
 CDX 410 NEW 259.95  
 —PIONEER—  
 PDM 700 NEW STACKER LOW  
 PDM 500 NEW STACKER LOW  
 PDM 400 NEW STACKER LOW  
 PD 700 NEW TOP SINGLE LOW  
 PD 5100 NEW RMT SINGLE LOW  
 PD 4100 NEW SINGLE LOW  
 CLD 1030 NEW LASER LOW  
 —JVC—  
 XLM 600 NEW TOP STACKER 579.95  
 XLM 400 NEW REMOTE STACKER 299.95  
 XLM 300 & DISC STACKER 289.95  
 XLS 555 NEW TOP SINGLE 359.95  
 XLS 444 NEW REMOTE 229.95  
 XLS 222 NEW 179.95  
 —NAKAMICHI—  
 DMS 3A REMOTE CD 229.95  
 DMS 2A REMOTE CD 459.95  
 DMS 1A REMOTE CD 289.95  
 —NAD—  
 5240 TOP CD PLAYER 379.95  
 5220 CD PLAYER 279.95  
 —SONY—  
 COP 670 RMT CAROUSEL 339.95  
 COP 650 CAROUSEL 289.95  
 —RECEIVERS—  
 RX 1000 125 WATT RMT 699.95  
 RX 900 85 WATT RMT 599.95  
**WHEN ORDERING ASK ABOUT CASH DISCOUNT PRICING FOR ADDITIONAL SAVINGS**  
 RX 700 60 WATT RMT 529.95  
 RX 500 50 WATT RMT 349.95  
 R 9 CLOSEOUT 120W RMT 579.95  
 R 8 CLOSEOUT 85 WATT 469.95  
 —JVC—  
 RX 1001 NEW SURR 120 RMT 939.95  
 RX 999 NEW 100W RMT 539.95  
 RX 777 NEW 80W RMT 419.95  
 RX 555 NEW 60W RMT 279.95  
 RX 333 NEW 45W RMT 219.95  
 RX 222 NEW 35W RMT 189.95  
 RX 150 GREAT RECEIVER 189.95  
 —PIONEER—  
 VSX 9300 NEW 125W PRO SURR LOW  
 VSX 7300 NEW 125W RMT LOW  
 VSX 5300 NEW 100W RMT LOW  
 VSX 3300 NEW 80W RMT LOW  
 VSX 2300 NEW 50W PC LOW  
 VSX 1300 NEW 40W PC LOW  
 —NAKAMICHI—  
 SR 4A 60W STEREO RMT 249.95  
 SR 3A 45W STEREO 389.95  
 SR 2A 30W STEREO 389.95  
 —DENON—  
 DRA 625 85W REMOTE 469.95  
 DRA 625 65W RMT 469.95  
 DRA 425 45W PER CHNL 389.95  
 DRA 35 40W PER CHNL 229.95  
 DRA 25 30W PER CHNL 229.95  
 —NAD—  
 7600 PE BEST EVER 150W LOW  
 7125 PE HI 75W PC 689.95  
 7240 PE HI 40W PC 419.95  
**FOCUS ELECTRONICS - STORE** 4329 13th Avenue, Binghamton, NY 13919. **MAIL ORDER** 1225 59th Street, Binghamton, NY 13919. **ORDERS ONLY** 1(800) 223-3411. **FOR INFORMATION OR NEW YORK STATE ORDERS PLEASE CALL** 1(716) 731-1000. **FOR CUSTOMER SERVICE PLEASE CALL** 1(716) 734-3011. **MONDAY THROUGH SATURDAY** 9:00 AM - 5:00 PM. **SUNDAY** 10:00 AM - 4:00 PM. **WE ARE A FULLY LICENSED AND ACCEPTED DEALER. OUR UNITS CARRY AN EXCLUSIVE NATIONAL ONE YEAR PARTS AND LABOR WARRANTY THROUGH FOCUS ELECTRONICS. OTHERS CARRY STANDARD MANUFACTURER'S WARRANTY. EXTENDED WARRANTY IS AVAILABLE. SOME ALLOCATED PRODUCTS MAY TAKE 2-6 WEEKS OR MORE FOR DELIVERY. PLEASE ASK AT TIME OF PURCHASE. FOURTEEN DAY RETURN POLICY. A RESTocking FEE MAY BE CHARGED FOR ITEMS RETURNED AFTER 14 DAY PERIOD. ALL ITEMS ARE SHIPPED NEW. ITEMS THAT ARE ACCEPTED FOR RETURN MAY BE CHARGED A RESTOCKING FEE. IF PRECIOUS AND/OR ITEM IS NOT AS NEW WHEN RETURNED. SHIPPING, HANDLING AND INSURANCE ARE EXTRA AND NON-REFUNDABLE. NOT RESPONSIBLE FOR TYPOGRAPHICAL ERRORS. PRICES AND AVAILABILITY SUBJECT TO CHANGE WITHOUT NOTICE. APPLICABLE FREE GIFTS MUST BE REQUESTED AT TIME OF PURCHASE. ALL PRICES IN THIS AD ARE FOR MAIL ORDER ONLY. ADS ARE PLACED 2 WEEKS IN ADVANCE OF PUBLISHED DATE AND WE STRIVE TO MAINTAIN STOCK & PRICES. SOME CHANGES MAY BEYOND OUR CONTROL. WE'VE BEEN IN BUSINESS FOR 22 YEARS AND OUR MANY SATISFIED CUSTOMERS ARE OUR BEST ADVERTISEMENT.**

**COMPACT DISC PLAYERS**  
 MAGNAVOX CDB-610  
 COMPACT DISC PLAYER, REMOTE CD PLAYER W/ETS & FULL PROGRAMMING  
 1/2" 5" 1/8" FULL PROGRAMMING  
 16 BIT OVERSAMPLING 18 BIT  
 4 CONVERTERS  
 1/2" 5" 1/8" FULL PROGRAMMING  
 SPECIAL 299.95  
 AZDEN DSR-400 BRAND NEW TOP OF THE LINE DIGITAL HEADPHONES FULL SIZE & VERY COMFORTABLE SAVING OF THE SUMMER CONSUMER ELECTRONICS SHOW INTRO SPECIAL 79.95  
 DENON PR1010 REMOTE RECEIVER 1/2" 5" 1/8" FULL PROGRAMMING 125W PC W/ FULL REMOTE CONTROL MOTORIZED VOLUME CONTROL 1/2" 5" 1/8" SELECTOR AUDIO & VIDEO CONTROLS & PROG TOPS AROUND ONLY 699.95  
 YAMAHA MY-1 MASTER SYSTEM CONTROLLER SELECTOR & C/M & 3 INPUT SELECTORS AFTER SETTING VOLUMES CD SEPARATES WILL UNUSUALLY ADJUST VOLUME ONLY 164.95  
 MAGNAVOX CDB-473 FEATURE LRS 16 BIT COMPACT DISC PLAYER WITH 16 BIT D/A CONVERTERS, QUAD OVERSAMPLING, REMOTE WITH VOLUME CONTROL & MORE SPECIAL PRICED 199.95  
**CASSETTE DECKS**  
 DAT 1999.95  
 SONY DTC 500 1699.95  
 CASIO DAI 1699.95  
 —NAKAMICHI—  
 DRAGON THE ULTIMATE LOW  
 RX 505 UNIDIRE AIR 1199.95  
 CR 3A NEW HI END 429.95  
 CR 2A NEW 429.95  
 CRIA NEW FAVORITE 329.95  
 —YAMAHA—  
 RX1200 3 Mos BC HX ORX 589.95  
 K 640 BC HX PRO AIR 469.95  
 RX 400 BC HX PRO 249.95  
 RX 200 2 MOTOR DOLBY 199.95  
 RXW 900 TOP DOUBLE CASS 539.95  
 RXW 500 DOUBLE BC AIR 349.95  
 —DENON—  
 DRM 44HX COMPUTER 3 HEADS 449.95  
 DRM 30HX RMT 3 HC HX PRO 429.95  
 DRM 14HX HX PRO RMT 319.95  
 RX 900 130W PC INTG AMP 509.95  
 RX 500 85W PC INTG AMP 279.95  
 RX 300 30W PC INTG AMP LOW  
 RX 100 HI END TUNER 389.95  
 AVC 50 AV CONTROLLER 369.95  
 AVC 50 AV CONTROLLER 439.95  
 SR 50 SURROUND PROCESSOR 239.95  
 ED100 GE W/MIC 529.95  
 DSP 3000 NEW  
 DSP 000 NEW  
**HI END CD PLAYER**  
 —MISSION—  
 700 249.95 PR 707 349.95 PR  
 737 459.95 PR 770 699.95 PR  
 —JBL—  
 LG21 219.95 PR 1 827 299.95 PR  
 LG207 199.95 PR 1 6307 439.95 PR  
 LG307 159.95 PR 1 007 999.95 PR  
 —BOSE—  
 AM 5 ACOUSTIC SYSTEM 649.95  
 B 2 3 WAY PORTED 729.95 PR  
 Z 2 BOOKSHELF 729.95 PR  
**MINI**  
 SUBWOOFER IN STOCK  
 BABY HI PRODUCY TOWER IN STOCK  
 LEGACY IN STOCK  
 MAESTRO IN STOCK  
 —PINNACLE—  
 PN2 NEW TINY EXQUISITE 99.95 PR  
 PN5 4 TOP RATED SHELF 119.95 PR  
 PN6 LARGER BETTER 159.95 PR  
 PN8 LARGEST BETTER 179.95 PR  
 PN MONITOR 200 TOPS 199.95 PR  
 —YAMAHA—  
 NS100 2 WAY BOOKSHELF 319.95  
 NS 20W 3 WAY SHELF 359.95  
 NS 2W SUBWOOFER 229.95  
**HI END ADDITIONS**  
 —AZDEN—  
 DSR 0800 BRAND NEW TOP OF THE LINE DIGITAL HEADPHONES THE SAVING OF THE SUMMER CES SHOW INTRO SPE 79.95  
 DSR 50 DIG FULL SIZE 49.95  
 DSR 48 DIGITAL TWR 34.95  
 DSR 88 DIGITAL LARBUD 24.95  
 —KOSS—  
 KCN 100 TPO CASSETTE CORDELESS HEADPHONES WITH BUILT IN REPRODUCTION HEADSET TRU HI-FI REPRODUCTION WITH NO AORD RESTRICTION ONLY 119.95  
 JCK 100 3 PIECE CORDELESS 99.95  
 —SONYS IN STOCK—  
 DCA 3500 399.95 DCA 3400 329.95  
 DCA 3280 239.95 DCA 3150 159.95  
 —JVC—  
 KSRX 518 349.95 KSRX 518 309.95  
 KSRX 418 269.95 KSRX 408 LOW  
 KSRX 308 LOW KSRX 208 LOW  
 KSR 139.95 KLC 30 499.95  
 KSA 20 219.95 KSE 75 169.95  
 —JBL—  
 TL 900 619 3 WAY DOW SPEAKERS 199.95 PR  
 BOSTON ACOUSTICS  
 C 1001PR 169.95 763 PR 229.95  
 791 AROUND WIN 619 3 WAY 189.95 PR  
 CALL FOR PILE, AWA, CLARON  
 —YAMAHA—  
 YCR 550 299.95 YCT450 239.95  
 YCR 350 229.95 YCR 150 199.95  
**HI END SPECIALS**  
 FREE AVENUE 650 HEADPHONE WITH ANY BOOKSHELF PURCHASE  
 —JVC—  
 PCV 1 DUAL A/R RECORDING CASSETTE DECK WITH 2 BAND GRAPHIC EQ AND BLUEMATIC COMPACT DISC PLAYER CD IS REMOTE CONTROLLED AND PROGRAM MABLE FOR 16 TRACS CONCERT FOR THE BEACH OR HOME ONLY 419.95  
 PCV 2 SINGLE CASS W/ CD PLAYER 199.95  
 PCV 71 CASSETTE WITH DIGITAL TUNER RADIO TOPS 199.95  
 CDF 444 AM/FM CASSETTE WITH CD PLAYER OF TACHABLE SPEAKERS & GRAPHIC EQ LOW  
 CDF 66 AM/FM CASSETTE CD LOW  
 CDF 177 AM/FM A/R CASSETTE CD LOW

**Stereo Review MAIL ORDER MART**

lets you turn up the volume where your customers are...

Advertising to prime, heavy spending STEREO REVIEW customers is no longer a luxury! Now, with mail order marketer's needs in mind, STEREO REVIEW has launched a Mail Order Mart, a new ad program to enable you to heavy up where the customers are. To sell surplus inventory, for example.

Set up shop in Mail Order Mart at economical regional rates!

In today's crowded, competitive market, you can't afford not to be heard by STEREO REVIEW subscribers who spent \$400 million on equipment in 1983 alone. And now, the economical new Mail Order Mart lets you tune in profits at surprisingly affordable rates.

To place your ad in Mail Order Mart, (800) 445-6066



38th & 39th St

38th & 39th St

**TO ORDER BY PHONE CALL  
(212) 575-4792**

STORE MON-SAT: 10am-6pm  
HOURS: SUN 11am-4pm EST

**TO ORDER OUR NEW  
FALL CATALOG SEND 'S OR  
FREE W/ORDER!**



**TO ORDER BY PHONE CALL  
(212) 575-4792**

**• WE SHIP C.O.D.  
• NO DEPOSIT REQUIRED  
• EXTENDED SERVICE POLICIES  
• AVAILABLE ON ALL PRODUCTS**

### RECEIVERS

**NAD 7240 \$389**

- 40 W/PIC
- SCHOTZ TUNER
- DIGITAL TUNER

ADS R4	869	NAD 7230	CALL
AR X10	769	NAD 7220	239
CARVER AVR-100	959	NAD 7600	1198
CARVER 150	589	NAKAMICHI SR2A	329
CARVER 6200	CALL	NAKAMICHI SR4A	739
CARVER 6250	689	PIONEER VSX9300	619
DENON DRA625	419	PROTON 940	449
DENON DRA825	CALL	SONY TRAV1000	489
DENON DRA425	349	YAMAHA RX500	299
LUXMAN R115	625	YAMAHA RX700	CALL
LUXMAN R117	929	YAMAHA RX1100	729
NAD 7175PE	629	YAMAHA RX300	229

### HI-END SPEAKERS

**KEF C55 \$429**

- JUST ARRIVED!
- ENGLISH MONITOR

ADS M15	2149	DESIGN ACOUSTIC CS P510	429
ADS CM7	987	INFINITY KAPPA6	CALL
ADVENT BABY CLASSIC	149	KEF 104.2	1850
ADVENT LEGACY	CALL	KEF 107	IN STOCK
AR POWER PARTNER	CALL	KEF C95	1149
BOSE 2.2	199	KINDEL PLSA	2149
B. ACOUSTIC A70	249	MISSION 737	439
B. ACOUSTIC T830	384	POLK SDA28	969
B&W Dm220	429	POLK RTA 11T	689
B&W MATRIX I	799	SEATTLE SOUND 36	349
CELESTION DL4 II	289	YAMAHA NS10M	269

**POLK AUDIO IN STOCK**

### TELEVISIONS

**SONY KV-1380R \$349**

- STEREO COLOR TV
- CABLE READY
- DIGITAL
- FULL FUNC. REMOTE

G&E 13" RMTE	179	PROTON VT210	CALL
JVC AV20575	419	PROTON VT290	CALL
JVC AV26575	629	RCA 19" COLOR	189
MAGNAVOX RH4350CH	499	SONY KV20T10	CALL
NEC CT2700S	CALL	SONY KV27SKR10	899
NEC CT2620A	649	SONY KV27TS20	679
NEC CT2015A	419	SONY KV27HFR	829
NEC CT3000S	CALL	SONY FD500	139
NEC DT2680A	1149	SONY XBR-PRO	1699
PIONEER SDP401	2295	TOSHIBA CX2078	399
PIONEER SDP501	2789	TOSHIBA CX2768	CALL
PROTON 6135	319	V. RESEARCH VTM26	899

### CD PLAYERS

**DENON DCD-610 \$269**

- JUST ARRIVED!
- WIRELESS REMOT

ADS CD3	549	MARANTZ CD94G	1620
DENON 1500MKII	549	NAD 5300	599
DENON DCD800	298	NAKAMICHI OMS2A	419
DENON DCM555	439	NAKAMICHI OMS3A	CALL
DENON DCD910	CALL	NAKAMICHI OMS7A	1349
DENON DCD810	329	PIONEER PDM700	469
DBX DX5	549	PROTON AC300	369
LUXMAN D109	975	SONY CDPX50	CALL
MAGNAVOX CDB582	179	SONY CDPX70	IN STOCK
MAGNAVOX CDB586	269	TECHNICS SLP1200	799
MAGNAVOX CDB650	289	YAMAHA CDX510	259

### TURNTABLES

**DUAL CS-5000 \$319**

- SEMI AUTOMATIC
- 4 POINT FULL FLOATING SUSPENSION

ADS P4	549	THORENS TD320	549
AR EB101	495	THORENS TD316	299
AR E51	749	TECHNICS SL1200MKII	339
AUDIOQUEST MC3	129	YAMAHA TT400	169
B&O RX2	198	YAMAHA PFB0C	399
DUAL CS505	179	YAMAHA TT500	229
DENON DP7F	149	CARTRIDGES	
DENON DP23F	199	AZDEN GM1E	119
DENON DP59L	429	ORTOFON X1MC	59
DENON DP47F	CALL	ORTOFON X5MC	CALL
LUXMAN P102	297	GRADO SIGNATURE 8	CALL

### VIDEO RECORDERS

**PANASONIC PV4860 \$479**

- HEAD STEERING
- MIS CABLE READY
- WIRELESS REMOTE

G&E 7785	549	RCA VPT695HF	949
JVC HRD237U	319	SONY SLHF-1000	CALL
JVC HRD630U	CALL	TOSHIBA DX900	769
JVC HRD8000U	999	TOSHIBA SV950	CALL
PANASONIC PV2800	269	TOSHIBA SV970	CALL
PANASONIC PV4800	299	LASER PLAYER	
MAGNAVOX VR9770	CALL	PIONEER CLD1030	619
NEC N956U	CALL	PIONEER LDW1	1189
NEC N966U	519	MAGNAVOX CDV47A	799
NEC DX5000U	769	SONY MDP200	699
NEC DX-8000U	CALL	YAMAHA CDV1000	699

### TAPE DECKS

**DENON DRM14HK \$289**

- DOLBY B&C
- HX PRO

ADS C4	980	NAKAMICHI CR1A	297
AIWA ADWX709	464	NAKAMICHI CR3A	669
AIWA ADWX909	509	NAKAMICHI CR7A	1295
AIWA ADWX808	389	PROTON 740	319
DENON DR10HX	179	SONY TCWR900	CALL
DENON DRM30HX	399	TEAC W990RX	489
DENON DRM14HX	289	TEAC AD4	249
DENON DRM24HX	389	YAMAHA KX200	179
LUXMAN K106	449	YAMAHA KX800	CALL
LUXMAN K105	389	YAMAHA KXW900	CALL
MARANTZ SD565	349	YAMAHA KXW500	305
NAD 6300	699	YAMAHA KX1200	CALL

### CAR STEREO

**ALPINE 7280 \$339**

- 16-15 W/PIC
- PULL OUT
- DIGITAL TUNER
- AUTO REVERSE

ADS PQ20	598	NAKAMICHI RD350	329
ADS PQ10	369	NAKAMICHI RD450	429
ADS 300I	259	NAKAMICHI PA300	CALL
ALPINE PULLOUT DAT	CALL	POLK MM1001	89
ALPINE 7156	189	POLK MM6902	189
ALPINE 7905	629	PROTON 275	299
B. ACOUSTIC 797	149	PROTON 214CD	369
CARVER M240	289	SONY XR7150	429
DENON DCR5520	439	SONY CDXA20	CALL
DENON DCC8920	698	SOUNDSTREAM TC303	349
INFINITY R562K	CALL	SOUNDSTREAM TC308	569
KENWOOD KRC858	439	SOUNDSTREAM D200	CALL

### CAMCORDERS

**PANASONIC PV400 \$899**

- FULL SIZE VHS
- LOW LIGHT
- 3 ZOOM
- AUTO FOCUS

CANON E70	CALL	PANASONIC PVS350	CALL
G&E 9806	CALL	PANASONIC PVS150	CALL
G&E 9715	999	PANASONIC PV420	999
JVC GR25	984	PANASONIC PV460	1680
JVC GR355	1289	PENTAX PWC15A	1299
MAGNAVOX CV2320	CALL	RCA CPR250	1089
MAGNAVOX VR9246AV	1649	RCA CPR350	1299
MINOLTA CR1400	989	SONY CCDVS	849
MINOLTA CR8100	1199	SONY CCDV9	1099
OLYMPUS VX802	1089	SONY CCDV30	CALL
OLYMPUS VX4055	CALL	SONY CCDV220	NEW

### SEPARATES

**YAMAHA AX400 \$229**

- 55 W/PIC
- MM-MC PHONO
- VARIABLE LOUDNESS

ADCOM GFA545	CALL	LUXMAN T117	429
ADCOM GTP500	CALL	PROTON D1200	629
ADS A2	529	NAD 1700	689
AUDIO LAB 8000C	595	NAD 2200	459
AUDIO LAB 8000P	895	NAD 3300	CALL
CARVER M4000T	899	NAKAMICHI S17	549
CARVER M1.0T	499	NAKAMICHI PA7	CALL
CARVER TX11A	549	YAMAHA AX700	398
CARVER TX11A	589	YAMAHA DSP1	CALL
DENON POA6600	349	YAMAHA AX400	229
DENON PMA720	369	YAMAHA TX900	279
DENON TUB800	349	YAMAHA DSR100 PRO	429
LUXMAN LV109	1149		

### PORTABLE CD/WALKMAN

**AIWA HSJ800 \$189**

- AM/FM CASSETTE
- AUTO REVERSE

**Accessories**

AIWA HSJ700	149	AUDIOQUEST CD RINGS	39
AIWA HSJ800	189	PARSEC LS4	59
CITIZEN 1000	219	SENNEHEISER HD414	69
MARANTZ PMD430	389	SORBOETHANE FEET	38
SONY D3	169	THORENS Q-UP	17
SONY WMD3	199	8" SPEAKER STANDS	39
SONY WMF100	119	1 METER GOLD ENDS	11
SONY D10	269	2 METER GOLD ENDS	18
SONY D15	299	50 FT SPEAKER CABLE	49
TECHNICS SCX95	259		
TOSHIBA 9437	239		

### FAX/TELEPHONE ANSWERING MACHINES

**SHARP FO500 \$1149**

BROTHERS FAX100	CALL	CODEPHONE 3530	110
CANON FAX20	1199	FREEDOM 1700	106
CANON FAX8	849	G&E 2-9860	129
MURATA F30	CALL	PANASONIC KXT1424	78
SANYO F100	CALL	PANASONIC KXT3880	139
SHARP F0700	1799	PANASONIC KXT1423	66
SHARP LX160	CALL	PANASONIC KXT1427	99
SHARP LX80	899	PHONEMATE 8000	94
SHARP FO300	1149	SONY ITA650	189
TOSHIBA 3010	1049	SONY SPP80	129
TOSHIBA 3300	CALL	SONY SPP100	CALL

**3 SOUND ROOMS • CAMRECORDER VIDEO ROOM • 7 DAY NO-QUESTIONS-ASKED DEFECTIVE EXCHANGE • 30 DAY HOME TRIAL SPEAKER AUDITION • DELIVERY & SET-UP AVAILABLE.**  
6th Ave. Electronics is conveniently located at 1030 & 1024 Ave. of the Americas, NY, NY 10018 (Between 38th and 39th Sts.)

**RETAIL ONLY  
212-391-2777**  
STORE HOURS:  
MON-SAT 10am-7pm  
SUN 11am-6pm EST

We carry a full line of Acoustic Research, Audio Lab, Audio Quest, ADS, Advent, Bose, B&W, Celestion, Citation, DBX Soundfield & Electronics, Dual, Harman Kardon, Infinity, J.A. Michell, JBL, Kindel, Kenwood Car, Luxman, Magnavox, Marantz 94 series, Nakamichi NAD, Proton, Revolver, RH Labs, Sansui, Sony, Teac, Thorens, and Vintage, ALL PRODUCTS WARRANTED

**ALL MAJOR CREDIT CARDS ACCEPTED.**



Consumer affairs license #805697. Ad represents small percentage of inventory. Price and availability subject to change. Checks accepted w/credit card authorization. Some sale items limited in availability & quantities. We ship C.O.D., no deposit required. Extended service policies avail. on all products.



by Christie Barter  
& Ron Givens

**V**ETERAN rocker Steve Miller is celebrating his twentieth anniversary as a recording artist with a record that takes him in a new musical direction. "Born 2B Blue," his eighteenth album on Capitol, is steeped in jazz. Included are such classic tunes as *God Bless the Child*, *When Sunny Gets Blue*, and *Willow Weep for Me*. Among the jazz musicians who contributed to the album are vibist Milt Jackson and alto saxophonist Phil Woods. Miller has always been a smooth, jazzy type of rocker, and this record is his second tribute to his musical roots. His last album, "Living in the 20th Century," took a personal excursion through the blues. "Born 2B Blue" is a similar voyage. □

**R**OCK stars are taking to movie screens like never before. Soon U2 will be seen in *Rattle and Hum*, a full-length documentary about the band's "Joshua Tree" tour in the U.S. last year. In addition to performances filmed in Denver and San Francisco and at Arizona State University, there are scenes shot on the streets of Harlem and at Sun Studios in Memphis. Island Records will release a soundtrack.

Phil Collins makes his fea-

Miller: into jazz



UB40: dancing with the devil

ture-film acting debut in *Busster* (about England's famous Great Train Robbery), which opened in England earlier this fall. Atlantic Records has released a soundtrack. And UB40 has produced *Dance with the Devil*, which incorporates videos for the band's latest A&M album into a longer fictional narrative. Chrissie Hynde and Robert Palmer have cameo roles. □

**W**ITH early-November concert dates in Akron and Detroit, the doyenne of French organists, Marie-Claire Alain, begins the final leg of her current, month-long American tour. It started in Pittsburgh on October 16 and ends in Pensacola in the middle of November. The wide-ranging tour includes recitals as far west as Seattle and as far east as Worcester, Massachu-

setts. But Alain is reputed to have an almost invincible work ethic. Her discography embraces over two hundred records, prominent among them the complete organ music of Bach, which her record company, Erato, recently released in France in a set of seventeen CD's.

Alain's latest American releases, distributed by BMG Music and all in Erato's mid-price "Bonsai" line of compact discs, include a small sampling of her Bach—one album of trio sonatas and another of toccatas and fugues—as well as a coupling of the Poulenc Organ Concerto with Saint-Saëns's Third, or *Organ*, Symphony conducted by Jean Martinon. □

**A**LSO on tour in November is the twenty-six-voice Bulgarian State Female Vocal Choir, which is playing concert dates in New York,

Los Angeles, and a dozen American and Canadian cities in between. The choir is visiting this country in the wake of the phenomenal success of its Nonesuch album "*Le Mystère des voix bulgares*," which is being followed up this fall by a second album. The first was released in the U.S. toward the end of 1987 after a remarkable climb up the U.K. pop charts, and it has become one of the cult records of this year here, gaining support from a number of American rockers. Bits of "*Le Mystère*" have been used by Robert Plant, the Grateful Dead, and 10,000 Maniacs as opening material for their respective tour concerts. Graham Nash, apparently a devoted fan, has been quoted as saying that "every musician [who] considers himself accomplished should listen to this record and re-think everything he knows." □

**A**COLLABORATION between new traditionalist Dwight Yoakam and old traditionalist Buck Owens was probably inevitable. Yoakam has been a long-time fan of Owens, and he likes to joke that "Buck stole my style twenty-five years ago." When Yoakam's career was just beginning to catch fire, he appeared on the *Austin City Limits* TV show and dedicated a song to "Buck Owens and all the boys of Bakersfield." It seems particularly appropriate, therefore, that Yoakam and Owens got together to sing a duet in *Streets of Bakersfield* from Yoakam's new Warner Bros. album, "Buenas Noches from a Lonely Room." A video based on that song featuring

Alain: into Bach



SIMON FOWLER/LONDON FEATURES

JACQUES SARRAT/ERATO DISQUES





both country stars was shot in Bakersfield, and they were so pleased with the result that Owens has performed with Yoakam in nearly twenty concerts over the past few months. Owens, whose clas-

from a concert given by the Pops at Cincinnati's Music Hall this summer, and it wasn't the first time that Kunzel had worked with jazz musicians. He's still remembered by concertgoers in Cincinnati for his performance with the orchestra of a Brubeck cantata, *Truth Is Fallen*, back in the Seventies. And more recently he conducted the Houston Symphony in Gerry Mulligan's "Symphonic Dreams" album, which was released by Pro Acoustic Recordings late last year.

For Telarc, predominantly a classical label, "Big Band Hit Parade" represents yet another entry in the popular entertainment field. One of the label's greatest hits last year was "Liza Minnelli at Carnegie Hall," and this summer Telarc released Rodgers and Hammerstein's *The Sound of Music* conducted by Kunzel, with a cast headed by Frederica von Stade and Håkan Hagegård. □

U2's *the Edge* is an album called "Big Band Hit Parade" featuring the Cincinnati Pops Orchestra under Erich Kunzel and solos by some of the biggest names in jazz—

**S**ET for release on October 27, by Telarc, is an album called "Big Band Hit Parade" featuring the Cincinnati Pops Orchestra under Erich Kunzel and solos by some of the biggest names in jazz—

**J**AZZ pianist Keith Jarrett, who's moved "beyond jazz" in many different directions in recent years, has just recently taken a turn in the direction of the "classics." □



Big Band Hit Parade

poser Lou Harrison, who wrote it for Jarrett. The pianist is accompanied by the New Japan Philharmonic under Naoto Otomo.

Meanwhile, some of Jarrett's most celebrated recordings in the contemporary jazz field are being reissued on CD. Among them are 1973's "In the Light," on two ECM discs, and "The Survivor's Suite" from 1976, with tenor sax player Dewey Redman, bassist Charlie Haden, and drummer Paul Motian. □

*The Mikado* opens this season's PBS Great Performances series. . . . GRP Records has come up with a gift set of three CD's called "The Digital Big Bands," containing albums by the Glenn Miller Orchestra, the Duke Ellington Orchestra, and the Count Basie Orchestra with Diane Schuur. . . . Arista's four-piece band Hurrah! ("Tell God I'm Here") was the first Western rock band to perform in Iraq, according to the label, when it visited that country in September as part of a Mideast tour that also took in Egypt and Jordan. . . . The soundtrack success of the year is undoubtedly RCA's *Dirty Dancing*, which has already sold well over nine million units. □

Jarrett: beyond jazz



MARK ALEXANDER/PETER LEVINSON

ROSE ANNE COLAVITO/ECM



U2's *the Edge*

ARMANDO GALLO/RETNA



Yoakam and Owens: buenas noches from Bakersfield

ROBEKI MATHIEU/RETNA

Doc Severinsen on trumpet, Gerry Mulligan on baritone saxophone, Eddie Daniels on clarinet, Buddy Marrow on trombone, Dave Brubeck on piano, Ray Brown on bass, and Ed Shaughnessy on drums. Vocals are by Cab Calloway.

The new album derives

One of his latest releases on the ECM label was a two-record set containing the First Book of Bach's *Well-Tempered Clavier* (reviewed in this issue). And it has been followed, this fall, by his premiere recording, on the New World label, of a piano concerto by American com-

## THE HIGH END

by Ralph Hodges

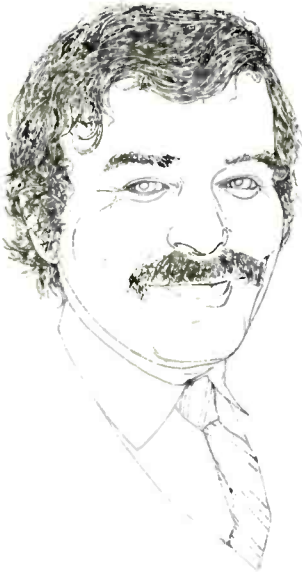

### \$10,000 Home Movies

**H**OW much are enthusiasts willing to spend for authentic first-run cinema sound at home? It is a question that had to be asked, and now the Home Theater Sound division of Shure Brothers has asked it in the most direct way possible: by introducing a new product that should have all of us testing the depths of our convictions.

In fact, the HTS Theater Reference System is not just one product but the whole shebang, lacking only the video appurtenances. The \$9,600 system includes a control/decoder unit, three power amplifiers, and six speakers—front left, center, and right, rear (surround) left and right, and a below-80-Hz subwoofer—as well as remote-control essentials and options and fancy interconnects. The components offer specialized modes of operation that enable them to complement each other. For example, the loudspeakers, which are on the smallest side, have their crossover characteristics enhanced and their responses mildly equalized by circuitry within the amplifiers. Additional circuitry respects the speakers' driver-excitation capabilities with gentle drive-

signal limiting when appropriate. There's nothing new in such "active" speaker manipulation, of course, but Shure considers it mandated for speakers that can play loud and yet won't be so big as to crowd out the picture.

Of most immediate interest is probably the HTS 5300 decoding and control facility, which makes up \$1,250 worth of the \$9,600 package. Its format holds no surprises for those familiar with earlier Shure surround-sound decoders, but there are some welcome internal augmentations. The logic steering associated with the matrix decoding circuitry has been made more powerful by deriving additional control signals from the inputs, and the digital delay line (variable, of course) serving the surround signal has been doubled in sampling rate, with the expected improvements in bandwidth and noise characteristics.

From the outset, Shure's aim has been to duplicate exactly the processing employed by Dolby Labs for theater presentations, or at least to duplicate the experience thereof. This is hardly an unreachable goal, since the technology is not at all baffling. But politics have interfered.

It seems that Peter Scheiber, who first suggested matrixing to the audio industry in the early Seventies, has kept various patented schemes of logic enhancement close to his bosom. Recently, and independently, both Shure and Dolby cut deals with Scheiber, and both went on their merry ways to implement audio logic circuitry.

The results have been Pro Logic from Dolby Labs and Acra Vector from Shure. The primary objective of both systems is accurate decoding of Dolby matrix-encoded information, but they are also reasonably compatible with Ultra Stereo, a process being used vigorously for, largely, "B" pictures.

But enough of details. What does Acra Vector sound like? Frankly, even after listening to more than an hour of it, I remain unsure—which is not surprising, since it usually takes me about three passes to work out the details of an ambitious soundtrack anyway. I was confused by the big aerial dogfight from *Top Gun* (a legitimate cinematic tech-

nique, confusion, but it has its limits), fascinated by the pinpoint accuracy of a helicopter fly-by in *Back to the Future*, and distracted by the leakage of high-hat cymbal and trumpet transients into the surround channel on material that had not been encoded with surrounds (in common with all such decoders, the HTS 5300 can simulate surround effects with much ordinary stereo material).

Because of the logos it bears, the HTS 5300 has been evaluated by Dolby Laboratories. But since Dolby's direct involvement in the product involves only the half-strength Dolby noise reduction employed in the surround path, the technicians limited their close scrutiny to that area only and merely listened to the rest of its operation. Nevertheless, a Dolby spokesman has guardedly pronounced Acra Vector a satisfactory equivalent to Dolby Pro Logic, although the schemes differ significantly in detail.

Fair enough. I have only one reservation, and that concerns what Shure calls its Acoustic Space Generator. Knowing that a proper Dolby Stereo theater employs a minimum of six surround speakers, and realizing that it would be hard pressed to talk the average householder into buying even two, Shure set about simulating additional loudspeakers electronically. From listening, the Dolby team's impression was that this involved phase manipulation, comb filtering, recycling, and possibly cross feeds. Shure's Paul Jenrick assured me, however, that the only thing going on is two additional short delays summed into the surround signal. I can sympathize with Dolby's seeming misconception because that was my guess too, and I wonder if the effect should really sound as "busy" as it often does. Notwithstanding its clear necessity in this application, artificially generated delay continues to trouble me with some of its inevitable side effects.

But, quibbles aside, it's hats off to Shure for this daring plunge into the very much unknown. Plainly, this amount of commitment has only come about because the company's engineers genuinely like what they're hearing. So do I. □



## The Affordable Hi End Alternative

Born out of a tradition of fine craftsmanship in Scotland, Ariston Acoustics is proudly introducing the Ariston System, a sophisticated yet elegantly simple expression of technology at the service of music. The Ariston System was designed to produce superb sound quality and offer maximum convenience by means of a full function remote control that comes standard with our amplifier.

Founded in 1969, Ariston Acoustics has enjoyed a steadily increasing reputation over the years for their innovative, quality products. Ariston components have been critically acclaimed for their sheer musicality by reviewers on both sides of the Atlantic. Ariston's commitment for the future is to develop new components which both complement and expand upon the existing system while maintaining the concept of true music reproduction at eminently affordable prices.

Visit your nearest authorized Ariston dealer and hear our complete line of turntables, speakers and electronics.



ARISTON ACOUSTICS LTD.

12 Rte 17 N., Ste. 309 Paramus, N.J. 07652  
(201) 845-9265 Telex: 4970296 SAP Fax: 2018450719  
CIRCLE NO. 70 ON READER SERVICE CARD



This product accepted for the  
ComponentGuard  
Product & Performance Guarantee Program

# Performance Assurance.

The next time you buy audio/video equipment, be sure to choose a brand that's been accepted for the ComponentGuard Product & Performance Guarantee Program. It's your assurance of a product's excellence in design and manufacture.

Equipment purchased with the ComponentGuard Program comes with all its key performance specifications guaranteed, plus an extension of the original warranty, for up to 5 years! From CD players to cassette decks, VCRs to MTS televisions, all important specs are covered: frequency response, power output, signal-to-noise, tracking,

channel balance, color purity, and more. As proof of protection, you receive our Gold GuardCard, honored at our more than 500 service centers. Then, if you're concerned about your equipment not being up to spec, or if it breaks (the ultimate non-performance spec), you can have it checked out, tuned up, repaired, etc., absolutely free of charge, parts & labor included!

Only ComponentGuard can guarantee that your home entertainment system will always work as well as the day you bought it. And, that's the best performance assurance you can have.



## COMPONENTGUARD™

**Product & Performance Protection**

928 Broadway New York, NY 10010

For the name of the dealer nearest you call  
1-800-421-9820 In NY, call 212-420-9820

CIRCLE NO. 176 ON READER SERVICE CARD

Program acceptance subject to approval. Certain restrictions apply.