

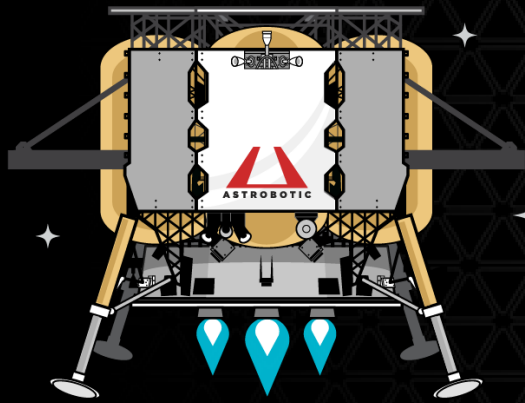

 **ASTROBOTIC**
MAKING HISTORY WITH PEREGRINE



Augmented Reality By
JOE ZEFF DESIGN



BOARDING PASS

 **ASTROBOTIC**

PEREGRINE MISSION 1

PEREGRINE LUNAR LANDER

LAUNCH SITE
Cape Canaveral, FL

ROCKET
ULA's Vulcan

LANDING SITE
Gruithuisen Domes

NATIONS ON BOARD





WHO IS ASTROBOTIC?

Astrobotic is an employee-owned space company that develops advanced navigation, operation, power, testing, and computing systems for spacecraft. Our fleet of lunar landers and rovers deliver payloads (cargo) to the Moon for companies, governments, universities, non-profits, and individuals. Our test facilities and fleet of terrestrial landers create America's proving ground for suborbital and lunar exploration.

To date, we have two fully funded lunar lander missions on the books, and more than 60 prior and ongoing NASA and commercial technology contracts worth upwards of \$450 million. Astrobotic was founded in 2007 and has headquarters in both Mojave, California and Pittsburgh, PA.

OUR MISSION

Astrobotic is making space accessible to the world. We are committed to empowering a thriving human presence beyond Earth.



PEREGRINE MISSION ONE

Astrobotic's Peregrine Mission One (PM1) is carrying 21 payloads (cargo) from governments, companies, universities, and NASA's Commercial Lunar Payload Services (CLPS) initiative.

It is also slated to be one of the first U.S. lunar landings since the final mission of the Apollo program – Apollo 17 – over 50 years ago. Astrobotic is truly opening the door to the next phase of space science, exploration, and commerce on the Moon.

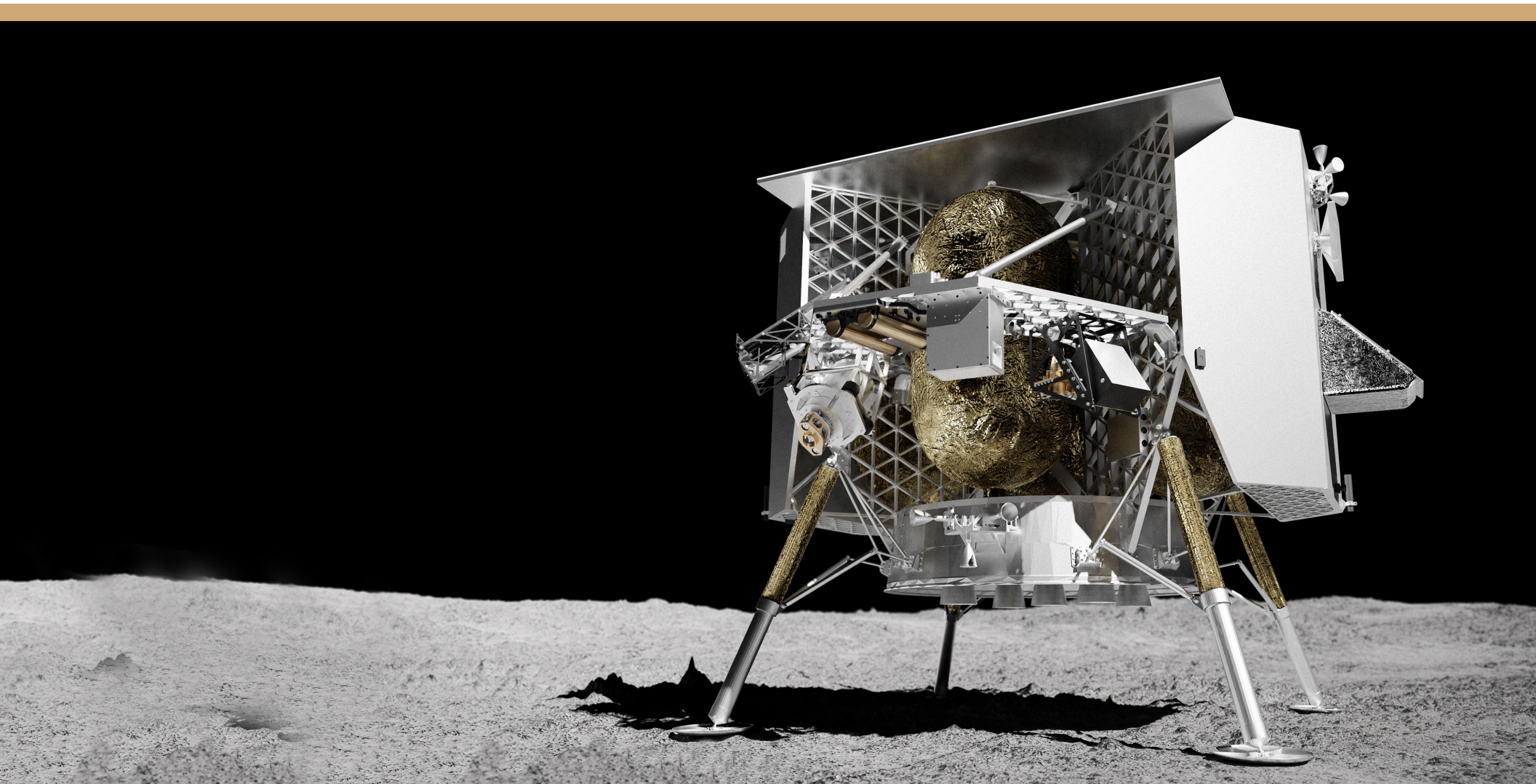

WHAT DOES PEREGRINE DO?

Peregrine is a lunar lander – a spacecraft that, once separated from a rocket (United Launch Alliance’s Vulcan launch vehicle), will power on and continue its journey to the Moon solo. Peregrine was developed at Astrobotic to serve as a delivery vehicle that will fly to the Moon, land safely, and provide power and communications for payload customers..

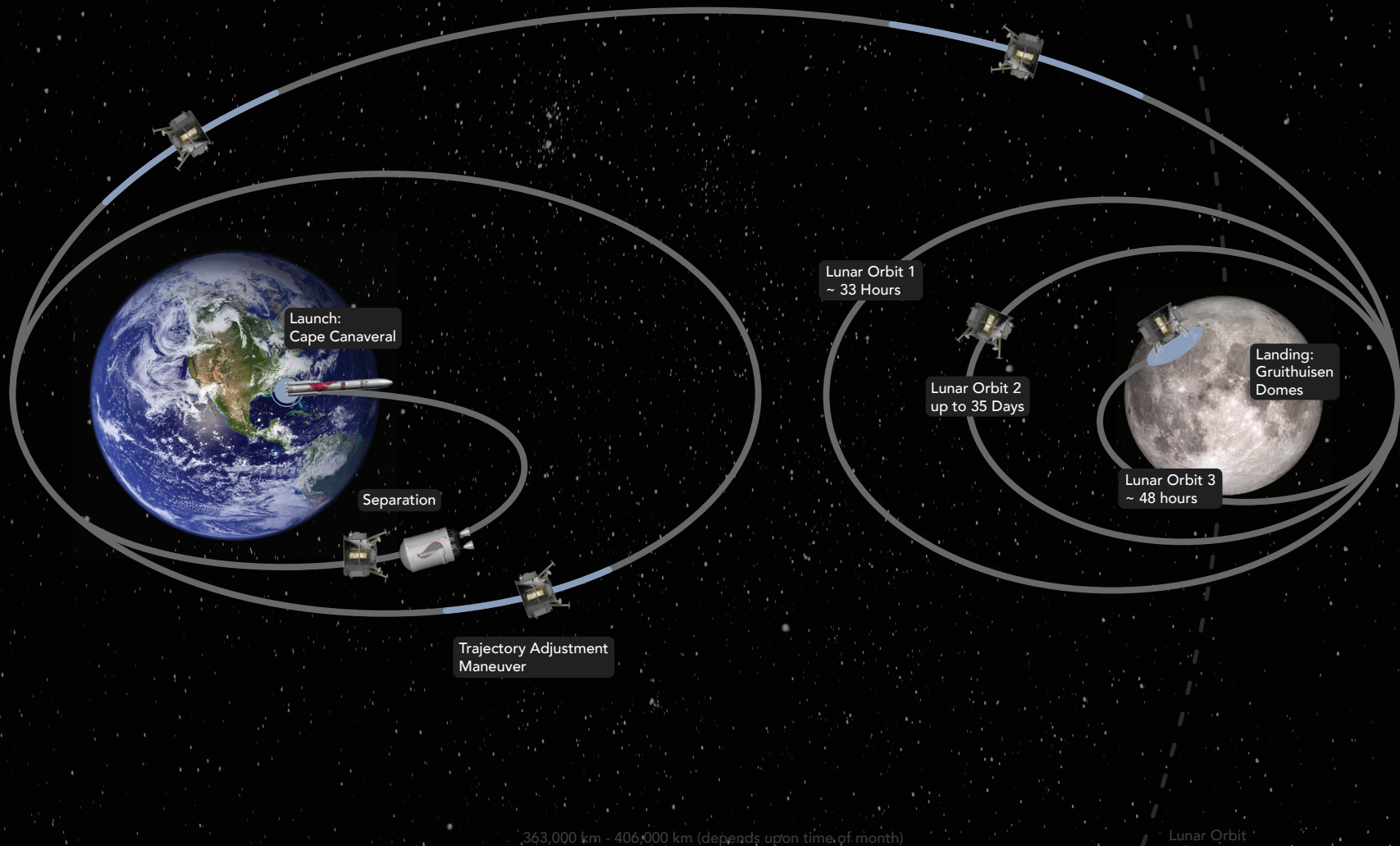

WHAT'S ABOARD PEREGRINE?

Think of the Peregrine spacecraft as a delivery vehicle in space. Just as shipping companies like DHL send packages around the world, Astrobotic sends items to the Moon. Governments, universities, nonprofits, and individuals can all purchase room aboard Peregrine and work with the Astrobotic team to meet their lunar goals. On this first mission, Peregrine will carry a diverse suite of scientific instruments, technologies, mementos, and other payloads (or cargo) from seven different countries, dozens of science teams, and thousands of individuals. You can find more about the Peregrine spacecraft and our other technologies at [Astrobotic.com](https://astrobotic.com).



AEM
AGENCIA ESPACIAL MEXICANA

NASA

DLR

DHL MoonBox

ELYSIUM SPACE

IRIS LUNAR ROVER

AstroScale

BitMEX

CELESTIS

SPACEBIT

ASTROBOTIC

MOONARK

BTC

puli space technologies



MISSION PATCH

Astrobotic's maiden voyage is Peregrine Mission One (PM1). This commemorative mission design emphasizes upward movement, exploration, and strength. The peregrine falcon lifts toward the Moon, capturing the spirit of the team as they develop and prepare the Peregrine lander for PM1.



WHY PEREGRINE

The peregrine falcon is the most widely distributed bird of prey on Earth, with a presence on every continent but Antarctica. In parallel, countless people and cultures from around the world are represented on Astrobotic's Peregrine lander.

Peregrine falcons are also nimble and quick, clocking in at over 200 mph and earning the title as fastest animal on the planet (yes, even faster than cheetahs). "Our Peregrine lander is aptly named to represent how Astrobotic has nimbly adapted to the many challenges and changing landscapes of the space sector," says John Thornton, Astrobotic CEO. "This design tells our PM1 story every time it's sewn onto a jacket or projected onto a screen."

HIDDEN MEANINGS

- The focal point of the patch is the peregrine falcon, majestically jetting towards its lunar destination.
- There are seven craters in the patch's Moon design, representing the six nations (with one crater representing the world through the DHL MoonBox program) that are joining Astrobotic on its mission.
- The phase on the patch's Moon graphic matches the real Moon's phase that people will see at the time of Peregrine's touchdown.
- Utilizing our peregrine bird imagery was a nod to NASA's Apollo 11 patch – highlighting the historic significances and firsts that PM1 could accomplish.

PEREGRINE MISSION ONE

PAYLOADS

WHAT IS ABOARD?

PAYLOAD MANIFEST

NASA PAYLOADS ABOARD

Descriptions courtesy of NASA



Near-Infrared Volatile Spectrometer System (NIRVSS)

NASA's Ames Research Center

NIRVSS will measure surface and subsurface hydration, carbon dioxide and methane – all resources that could potentially be mined from the Moon -- while also mapping surface temperature and changes at the landing site. It is being developed at NASA's Ames Research Center in Silicon Valley, California.

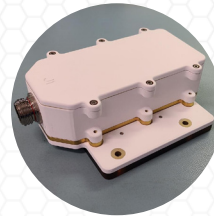

Linear Energy Transfer Spectrometer (LETS)

NASA's Johnson Space Center

The LETS radiation sensor will collect information about the lunar radiation environment and relies on flight-proven hardware that flew on the Orion spacecraft's inaugural uncrewed flight in 2014.

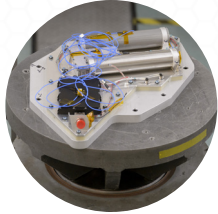

Neutron Spectrometer System (NSS)

NASA's Ames Research Center

NSS will search for indicators of water-ice near the lunar surface by measuring how much hydrogen-bearing materials are at the landing site and determining the bulk composition of the regolith there.

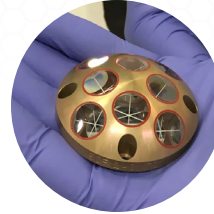

Laser Retroreflector Array (LRA)

NASA's Goddard Space Flight Center

LRA is a collection of approximately half-inch (1.25 cm) retroreflectors – a unique kind of mirror that is used for measuring distance – mounted to the lander. This mirror reflects laser light from other orbiting and landing spacecrafts to precisely determine the lander's position.



Peregrine Ion-Trap Mass Spectrometer (PITMS)

NASA's Goddard Space Flight Center and ESA

PITMS will characterize the lunar exosphere after descent and landing and throughout the lunar day to understand the release and movement of volatiles. PITMS is a partnership between NASA Goddard Space Flight Center, The Open University (OU), NASA, and the European Space Agency (ESA).

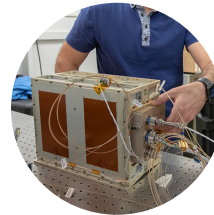

Navigation Doppler Lidar (NDL)

NASA's Langley Research Center

NDL will determine the Peregrine spacecraft's exact velocity and position to land on the Moon using LiDAR (light detection and ranging). NDL was developed by NASA over 10 years ago for precise, safe landings on the Moon and in other challenging environments.

PAYLOAD MANIFEST



Agencia Espacial Mexicana (AEM)

Mexico | Scientific instrument

Agencia Espacial Mexicana (AEM), the Mexican Space Agency, will fly COLMENA, the first Latin American scientific instrument to the surface of the Moon.



BitMEX

Seychelles | Lunar Bitcoin

A unique physical coin destined for the Moon, loaded with one Bitcoin.



Astrobotic

USA | Terrain Relative Navigation

Astrobotic will demonstrate its standalone Terrain Relative Navigation (TRN) sensor as a payload on its first mission to the Moon. TRN will enable spacecraft to perform landings on planetary surfaces with an unparalleled accuracy of less than 100 meters. The TRN sensor is being developed under a \$10 million NASA Tipping Point contract with NASA Johnson Space Center, Jet Propulsion Laboratory, and Moog.



BTC INC.

USA | Bitcoin Magazine Genesis Plate

This plate includes a copy of the Genesis Block, the first block of bitcoin (BTC) to be mined. This cornerstone of the Bitcoin network provides the foundation for an ecosystem that would challenge our perception of how money is valued and managed in the digital age.



Astroscale

Japan | Lunar Dream Capsule

Astroscale will send the Pocari Sweat Lunar Dream time capsule to the Moon, which contains messages from more than 80,000 children from around the world.



Carnegie Mellon University

USA | Iris Lunar Rover

Carnegie Mellon University (CMU) students, staff, and professors collaborate with Astrobotic to develop space robotics technology. CMU is currently developing the Iris rover for Astrobotic's inaugural lunar mission. CMU is also a subcontractor on Astrobotic's MoonRanger lunar rover mission.

PAYLOAD MANIFEST



Carnegie Mellon University

USA | MoonArk

The MoonArk, an epochal collaborative space project at Carnegie Mellon University, embodies the arts, humanities, sciences, and technologies in a set of intricately designed objects intended to spark wonderment and discovery for future generations.



Elysium Space

USA | Memorial Space Flight Services

Elysium is providing lunar memorial services to deliver a symbolic portion of remains to the surface of the Moon.



Celestis

USA | Memorial Spaceflight

Celestis is the first company to have successfully conducted Memorial Spaceflight Missions, the only company to have been selected by NASA to honor one of its scientists, and for more than two decades an iconic pioneer and global leader of the commercial space age.

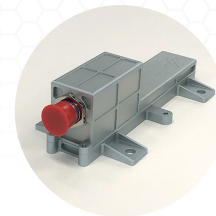

German Aerospace Center (DLR)

Germany | M-42

This radiation detector is a complement to another scientific experiment riding aboard NASA's Artemis I mission. These sensors will precisely measure the level of radiation a human body will encounter on a trip to the Moon and back. The data from both Artemis I and Peregrine Missions will improve our understanding of lunar spaceflight environmental conditions with respect to astronaut health, as space radiation will be one of the key risks in the future of Human Space Exploration.



DHL MoonBox

Germany & Worldwide | Mementos to the Moon

Astrobotic accepted small personal mementos for inclusion on Peregrine Mission One. "Moon Capsules" containing payloads from around the world will be stored aboard Peregrine on the Moon for centuries to come. From photographs and novels to student work and a piece of Mount Everest — life's most meaningful moments will be forever linked with the our nearest celestial neighbor.



Lunar Mission One

USA | Digital Art Gallery

Lunar Mission One will send the first digital storage payloads to the Moon. The payload will support Lunar Mission One's "Footsteps on the Moon" campaign.

PAYLOAD MANIFEST

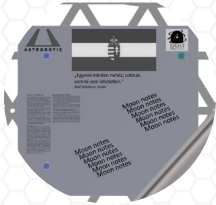

Puli Space Technologies

Hungary | Memory of Mankind on the Moon

Team Puli, from Hungary, will send a unique plaque for the “Memory of Mankind (MoM) on the Moon” project. The plaque contains archival imagery and texts readable with a 10x magnifier.



Spacebit

United Kingdom | Spacebit Plaque

Spacebit is a privately held UK company that is working on space data analytics tools and robotic concepts of space exploration that include AI and advanced microrobotics. The company believes in creating a commercially sustainable data and robotics business in space exploration. Its goal is to create new opportunities for industry and academia by developing infrastructure for commercial resource exploration on the Moon and beyond.

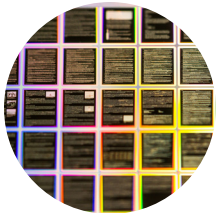

The Arch Mission Foundation

USA | The Arch Libraries

The Arch Mission Foundation designs, builds, delivers, and maintains curated, long-term archives that are housed in specially designed devices called Arch Libraries, or Archs (pronounced “Arks”). Archs are being developed with a variety of form factors to survive for long durations in space, as well as on the surfaces of planets, moons, and asteroids.

PEREGRINE MISSION ONE

LAUNCH

LAUNCH FROM CAPE CANAVERAL, FLORIDA



Peregrine Mission One (PM1) will launch on its voyage to the Moon aboard the inaugural flight of the United Launch Alliance (ULA) Vulcan rocket, a next-generation system that uses proven technologies with new innovations to unlock exciting opportunities in spaceflight. The mission will launch from Space Launch Complex-41 at Cape Canaveral Space Force Station, Florida. The launch is planned for December 2023.

After a choreographed countdown, Vulcan will launch and place PM1 on a lunar trajectory outside of the Earth's atmosphere. Once the spacecraft separates from the world's highest-energy upperstage, the Centaur V, Peregrine will use its engines to continue to lunar orbit in preparation for landing on the Moon.

As with any launch into space, factors such as favorable weather and public safety considerations must be met before liftoff can occur. If the mission delays for any reason, a backup launch date will be announced. To learn more about the Vulcan rocket and the launch of PM1, please visit www.ulalaunch.com



VIRTUALLY VIEWING THE LAUNCH

LIVE ONLINE BROADCAST

Astrobotic is partnering with ULA and NASA to stream a live online broadcast for the launch. Instructions on how to watch, and when to tune in, will be announced soon. Keep an eye on Astrobotic's social media channels for updates and more information.



 [@Astrobotic](#)

 [@Astrobotictechnology](#)

 [Astrobotic](#)



VIEWING THE LAUNCH

AT CAPE CANAVERAL, FLORIDA*



PLACES TO WATCH

TITUSVILLE RIVERFRONT: a cluster of outdoor parks

- **Sand Point Park:** 10. E Max Brewer Causeway, Titusville
- **Max Brewer Bridge:** 101 N. Washington Ave., Titusville
- **Parrish Park:** 1 A. Max Brewer Memorial Pkwy, Titusville
- **Space View Park:** 17 Orange St. Titusville
- **Rotary Riverfront Park:** 4141 S. Washington Ave., Titusville
- **Marina Park:** 1510 Marina Rd. Titusville
- **William J. Manzo Memorial Park:** 3335 S. Washington Ave., Titusville
- **Playalinda Beach:** 1000 Playalinda Beach Rd., Canaveral National Seashore; Entrance to National Seashore is \$20 which gives you access for 7 days

PORT CANAVERAL: a cluster of outdoor parks

- **“The Cove”:** Port Canaveral’s Dining and Entertainment District
- **Jetty Park Beach & Pier:** 400 Jetty Park Rd., Cape Canaveral; Parking \$15
- **Exploration Tower:** 670 Dave Nisbet Dr. 7th Floor, Port Canaveral; Tickets Required
- **Cherie Down Park:** 8330 Ridgewood Ave., Cape Canaveral

COCOA BEACH: pier and coastline views

- **Cocoa Beach Pier:** 401 Meade Ave., Cocoa Beach
- **Beach & State Parks** have over 1600 parking bays; \$10-15 a day; live music and restaurants nearby

RESTAURANTS: with launch views

- **Rising Tide Tap & Table:** 523 Glen Cheek Dr, Port Canaveral
- **The Space Bar:** 6245 Riverfront Center Blvd, Titusville
- **Shiloh’s Steak & Seafood:** 3665 S Washington Ave, Titusville
- **El Leoncito Mexican and Cuban:** 4280 S Washington Ave, Titusville
- **Orleans Bistro & Bar:** 2204 S Washington Ave, Titusville
- **New York New York:** 5401 Riveredge Dr, Titusville
- **Old Florida Grill & Oyster House:** 5370 US-1, Cocoa
- **Sage Bistro:** 6615 N Atlantic Ave A1A, Cape Canaveral

UNIQUE LAUNCH VIEWING EXPERIENCES:

- **Beachside Helicopters:** Florida Rocket Launch by Helicopter
- **Star Fleet Tours:** Cape Canaveral Rocket Launch by Boat
- **Adventures in Florida:** Watch a Florida Rocket Launch by Kayak
- **Ocean-side view** will be south of the exclusion zone and will give you a spectacular view that is nearly right under the trajectory of the rocket launch. This is as legally close as you can get to rocket launches. You will have a clear line of sight towards the launch and landing pads.
- **River-side view** will be along the Banana River, which is not as close as the ocean view, but it still offers a unique and scenic viewing location and is much closer than any land locations.

**Astrobotic is not affiliated with or responsible for any locations, businesses, or experiences listed on pages 16-18 of this packet. Astrobotic is not liable for these experiences and does not guarantee launch visibility. This list is meant as a starting point to schedule your personal viewing plans.*

VIEWING THE LAUNCH

AT CAPE CANAVERAL, FLORIDA*



TIPS & TRICKS

GET THERE EARLY

Arriving hours in advance of the launch time is very common and highly recommended. If you want to secure a spot, make sure you arrive a few hours before the launch is scheduled. You can always set up your spot then explore the surrounding areas.

PACK FOOD & DRINK

If your viewing location does not have amenities, make sure you take plenty of snacks and drinks – particularly water! Stay hydrated. Several of the areas in this launch guide offer picnic locations, covered pavilions and grills. Don't forget soft-sided coolers or lunch boxes, ice packs, and folding chairs!

MAKE A DAY OF IT

You can easily make a full day trip of visiting the Space Coast. Traffic will be heavy for several hours before and after the launch. Staying and exploring will help avoid sitting in and contributing to the traffic.

AVOID THE TRAFFIC

On a busy launch it can take several hours to get back to the Orlando/Kissimmee areas. Plan lunch or dinner after the launch to give traffic time to lessen. Or, head along the coast to explore a little more before heading back.

MAKE A QUICK DASH

If you want or need a speedy exit post-launch, there are spots further away that will give you easy access to avoid a lot of the traffic. The views are still good, however, the roar and rumble and 'feel' of the launch will be diminished.

BRING

- Hats
- Umbrellas
- Insect repellent
- Camera
- Tripod
- Binoculars
- Folding chairs
- Blankets

STAY INFORMED

For updated launch and mission information visit the ULA mission web page at www.ulalaunch.com

**Astrobotic is not affiliated with or responsible for any locations, businesses, or experiences listed on pages 16-18 of this packet. Astrobotic is not liable for these experiences and does not guarantee launch visibility. This list is meant as a starting point to schedule your personal viewing plans.*

EXPERIENCES

AT CAPE CANAVERAL, FLORIDA*



VISIT & ENJOY

MUSEUMS:

- Kennedy Space Center Visitor Complex
- Cape Canaveral Space Force Museum
- Exploration Tower

TOURS:

- Kennedy Space Center Visitor Complex
- Kennedy Space Center Astronaut Training Experience
- Cocoa Beach dolphin watching and sightseeing catamaran sail
- Fin Expeditions: Daytime and Sunset guided kayak tour

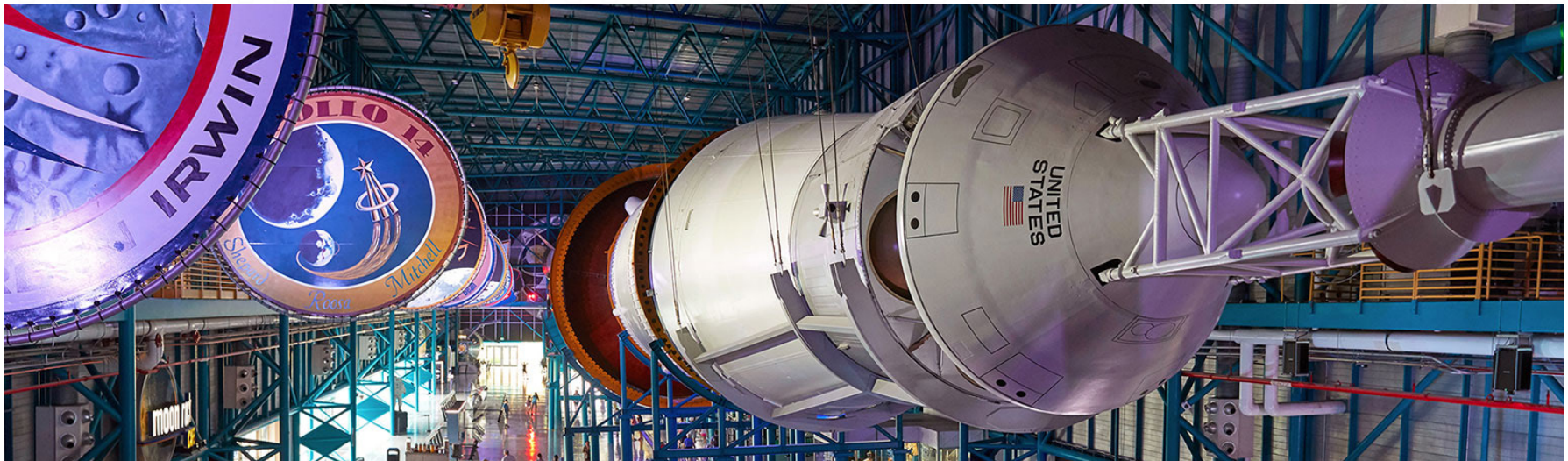

Kennedy Space Center Visitor Complex

**Astrobotic is not affiliated with or responsible for any locations, businesses, or experiences listed on pages 16-18 of this packet. Astrobotic is not liable for these experiences and does not guarantee launch visibility. This list is meant as a starting point to schedule your personal viewing plans.*

PEREGRINE MISSION ONE

POST- LAUNCH

POST-LAUNCH

WHAT HAPPENS NEXT?

POWER ON

Soon after Vulcan launches and exits the Earth's atmosphere, Peregrine will separate from the Vulcan rocket. The Peregrine spacecraft will then "power on" electronically.

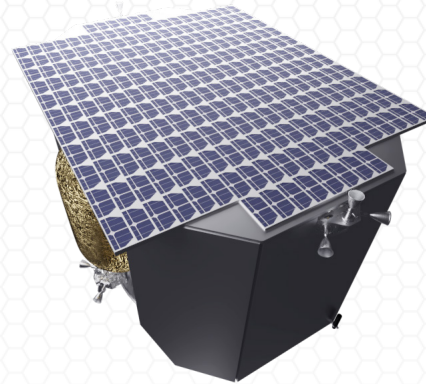

Peregrine Mid-Latitude Solar Panel Configuration

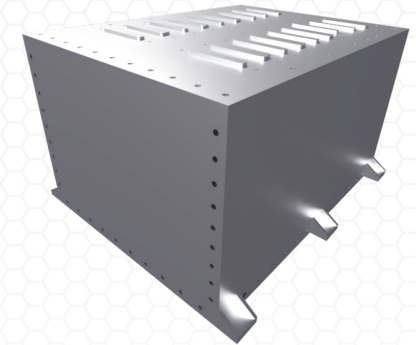

Integrated Avionics Unit (IAU) Enclosure

COMMUNICATIONS

After Peregrine "powers on", it will establish a space-to-ground communications connection. This connection helps engineers in Astrobotic's Mission Control Center pass commands, receive telemetry, and determine the location of Peregrine in space.

Peregrine will be utilizing NASA's Deep Space Network (DSN)'s 34-meter dishes at Canberra, Australia; Madrid, Spain; and Goldstone, California. These dishes are the same suite used to communicate with the James Webb Telescope, as well as historic missions such as New Horizons, Solar Parker Probe, InSight, Juno, and MAVEN.

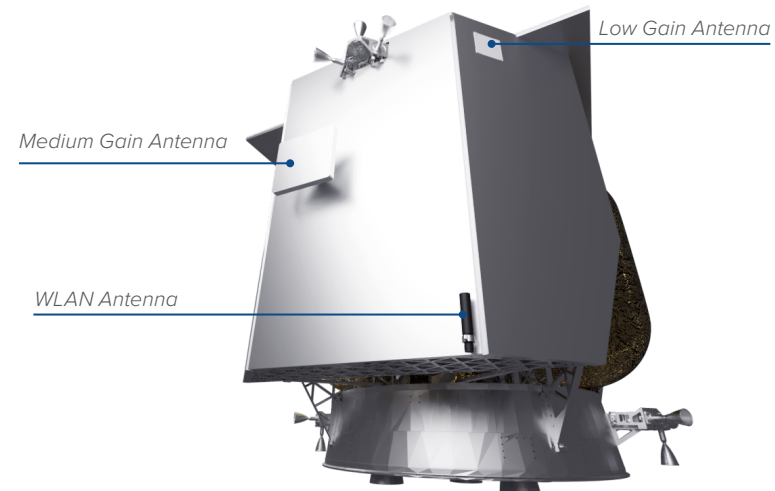

Peregrine Communications Bus

POST-LAUNCH

WHAT HAPPENS NEXT?

CRUISE

Peregrine will then use its own fuel and propulsion system to guide it through space. Peregrine's Guidance, Navigation, and Control (GNC) system orients and flies the lander throughout the mission to facilitate operations. GNC processes the inputs from an array of sensors, correcting for idiosyncrasies, and uses them to revise the internal estimate of the lander's position, attitude, and velocity during flight. Commands to maneuver the lander are updated based on this estimate of the spacecraft's state. Earth-based ranging informs position and velocity state estimates for orbital and trajectory correction maneuvers. Input from the star tracker, sun sensors, and inertial measurement unit aid the GNC system in maintaining a sun-pointing orientation, with the solar panel facing the Sun, during nominal cruise operations.

LANDING

During landing operations, a Doppler LiDAR provides range and range rate information that guides the lander to a safe landing at the target site. Rugged, radiation-tolerant computing enables autonomous landing and safety in the demanding space environment. Four legs absorb shock and stabilize Peregrine on touchdown.

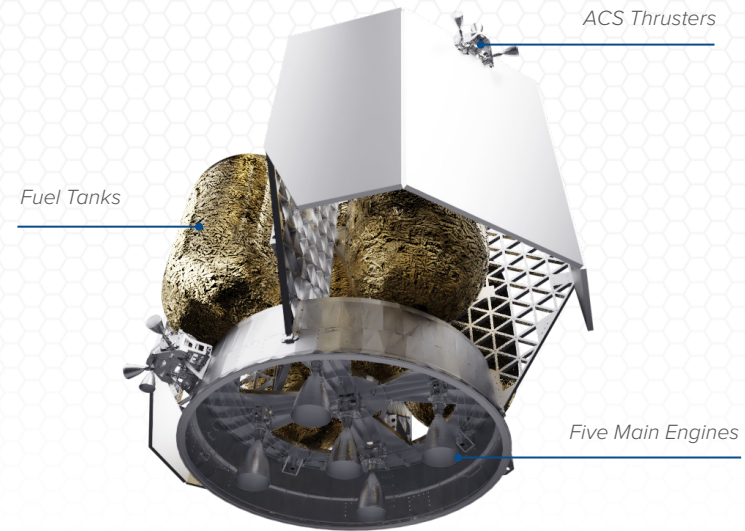

Peregrine Propulsion Bus



OPAL Sensor Assembly

LANDING

Peregrine Mission One will land on the lunar surface at Sinus Viscositatis (Bay of Stickiness) adjacent to the Gruithuisen Domes. This is on the northeast border of Oceanus Procellarum (Ocean of Storms) and considered to be a geologic enigma.

PEREGRINE'S FUTURE

Starting with Mission Two, Peregrine will incorporate technology like Astrobotic's Optical Precision Autonomous Landing (OPAL) Sensor, a terrain relative navigation system to enable precision landing. This sensor, flown as a technology demonstration on Mission One, will enable polar landings and other missions requiring precision landing capabilities.

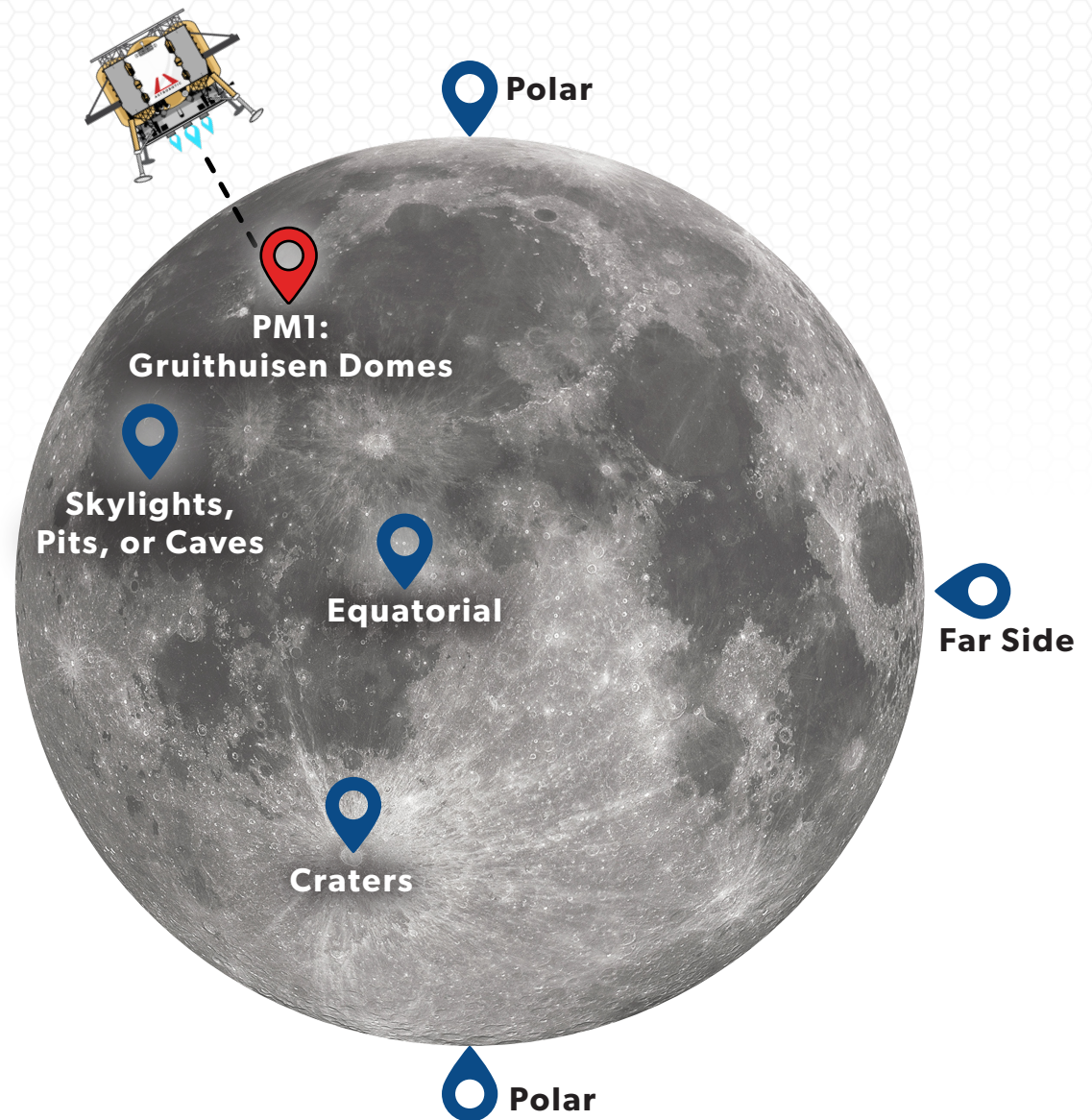

PEREGRINE MISSION ONE

**3-2-1
Liftoff!**

