

# Barriera fotoelettrica di sicurezza

F3SG-R



- Resistente alle torsioni per un facile allineamento
- Utilizzo del codice QR per una facile risoluzione dei problemi
- Cavi smart-click per una facile installazione

# Installazione facile e veloce

Le barriere fotoelettriche di sicurezza possono essere utilizzate per soddisfare gli standard di sicurezza dei macchinari, ma possono essere difficili da installare e mantenere. Per questo abbiamo ripensato, riprogettato e reinventato la nostra serie F3SG-R, con caratteristiche speciali e funzioni intelligenti che ti aiutano a selezionare, installare e mantenere la barriera fotoelettrica in poco tempo e con la minima fatica. Per esempio, ora utilizziamo attacchi a baionetta a scatto (Smart-click) per un'installazione rapida. Inoltre, i nuovi corpi resistenti alla torsione contribuiscono a garantire un allineamento senza problemi. Ma non è tutto...

## Altre caratteristiche essenziali

- Versione avanzata con quattro muting diversi, ideale per la massima flessibilità
- Versione semplice per il facile rilevamento ON/OFF
- 100 m di cavo per agevolare l'installazione e il cablaggio
- Distanza di rilevamento fino a 20 m
- Sincronizzazione ottica per un facile allineamento
- Protezione IP67 per garantire affidabilità in ambienti polverosi e di lavaggio



### Resistente alle torsioni per un facile allineamento

La costruzione estremamente rigida elimina i problemi di torsione dall'alto verso il basso. Questo consente di installare la barriera in modo più semplice e veloce e previene il disallineamento incrementale dell'asse ottico causato dalle vibrazioni nel tempo.



### Codice QR per una facile risoluzione dei problemi

In caso di problemi, potrai semplicemente scansionare con lo smartphone il codice QR riportato per andare direttamente alla pagina Web dedicata alla risoluzione dei problemi, disponibile in otto lingue: cinese, coreano, francese, giapponese, inglese, italiano, tedesco e spagnolo.

Smartclick

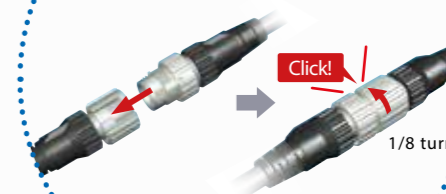

### Connessione dei cavi Smartclick® per una rapida installazione

Non richiede controllo della coppia di serraggio: i connettori Smartclick collegano i cavi con una semplice torsione di 1/8 di giro del connettore impermeabile M12. Questa connessione riduce il tempo necessario per collegare tra loro numerosi dispositivi.

# Caratteristiche e vantaggi della gamma

## EASY ADVANCED

### Facile regolazione, anche dopo il montaggio

Le staffe di montaggio fisse fornite in dotazione consentono di regolare verticalmente la barriera fotoelettrica di sicurezza facendola scorrere verso l'alto o verso il basso; le staffe di montaggio regolabili opzionali consentono regolazioni orizzontali e verticali di  $\pm 15^\circ$ .

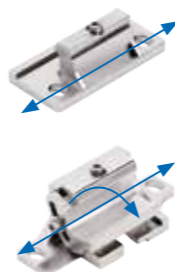

## EASY ADVANCED

### Scelta della capacità di rilevamento

- Due versioni disponibili: protezione mano (30 mm) e protezione dito (14 mm)
- Le distanze di rilevamento vanno da 0,3 m a 20,0 m
- Altezze da 160 mm a 2.500 mm

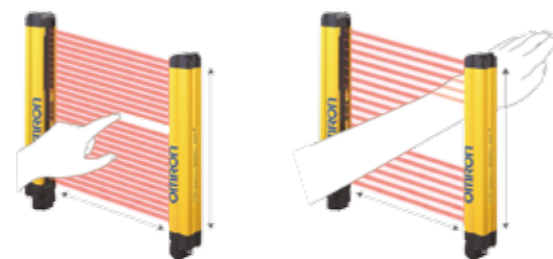

## EASY ADVANCED

### Allineamento estremamente semplice grazie al controllo di solo 2 raggi

È sufficiente mettere in posizione la barriera fotoelettrica di sicurezza e controllare quando si accendono i LED inferiori e superiori per completare la regolazione.

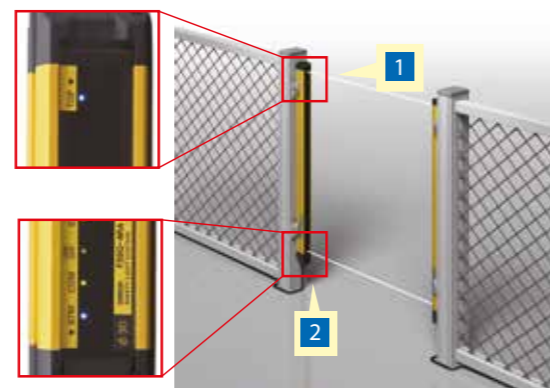

## EASY ADVANCED

### Protezione aggiuntiva opzionale

Puoi aggiungere un'ulteriore protezione alla superficie ottica della barriera fotoelettrica di sicurezza F3SG-R con la nostra copertura speciale (F39-HGA e/o F39-HGB) per evitare graffi e altri impatti meccanici.

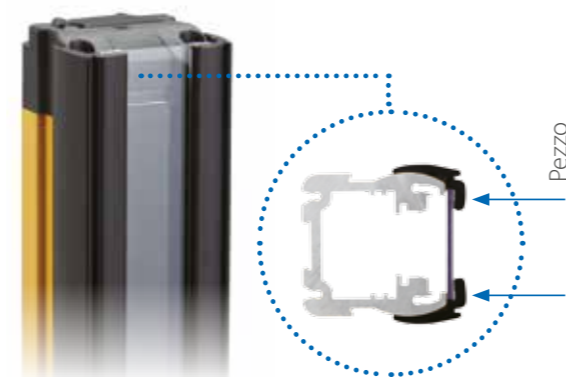

## EASY ADVANCED

### Costruita per ambienti polverosi e di lavaggio

La barriera fotoelettrica di sicurezza serie F3SG-R soddisfa i criteri di protezione IP67 per l'uso in applicazioni con polvere o lavaggio.



## EASY ADVANCED

### Sincronizzazione automatica emettitore-ricevitore

La nostra sincronizzazione ottica in due fasi non rende più necessario sincronizzare i cavi tra l'emettitore e il ricevitore: un altro risparmio di tempo. Inoltre, il cablaggio flessibile che ne risulta riduce il rischio di disconnessione ed evita le sorgenti di rumore.



## EASY

### F3SG-RE - Versione semplice per la massima convenienza

Abbiamo sviluppato una versione ON/OFF di base ideale per le applicazioni più semplici.

- Tempo di risposta più veloce sul mercato (5 ms) per l'altezza più corta della barriera fotoelettrica di sicurezza
- Cablaggio ridotto grazie ai connettori pre-cablati per un'installazione rapida
- Risoluzione dei problemi semplice e veloce tramite codici QR
- Chiara indicazione ON/OFF mediante LED



# Ottimizza la sicurezza in tutta la linea di produzione con F3SG-RA

## ADVANCED Blanking

Il modello F3SG-RA offre funzioni di blanking flottante e fisso. L'impostazione del numero di raggi può essere configurata specificando il numero di raggi manualmente mediante SD Manager 2 o in utilizzando i DIP switch. Nel caso di utilizzo dei DIP switch, spostando un oggetto opaco nell'area di rilevamento, è sufficiente utilizzare l'interruttore a pressione per eseguire l'azione di programmazione.

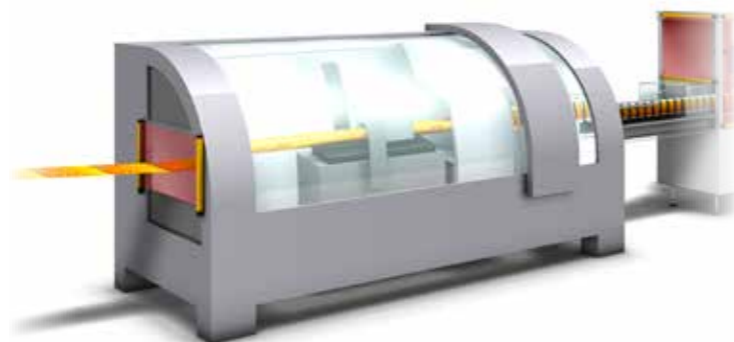

## ADVANCED Risoluzione ridotta

Con la risoluzione ridotta, il modello F3SG-RA è in grado di ignorare alcuni raggi interrotti (da 1 a 3 raggi mobili). Questo modifica la capacità di rilevamento della barriera e contribuisce a una sicurezza più flessibile, ad esempio quando ci sono oggetti in movimento all'interno dell'area di rilevamento.



## ADVANCED Connessione a cascata

È possibile connettere in serie fino a tre coppie di F3SG-R. La connessione a cascata consente di utilizzarli come una singola barriera fotoelettrica di sicurezza, soluzione che richiede la connessione ad un unico controllore. Se uno dei gruppi di F3SG-R connessi in serie viene bloccato, entrambe le uscite di sicurezza vengono aperte (OFF).

- Numero di connessioni: fino a 3 coppie
- Numero totale di raggi: fino a 255 raggi
- Lunghezza complessiva dei cavi tra i segmenti connessi a cascata: max 10 m

## ADVANCED Pre-reset

Il pulsante Pre-reset impedisce che una macchina venga riavviata quando una persona (non visibile) si trova ancora all'interno della zona pericolosa.

- A** È necessario premere un pulsante Pre-reset locale all'interno della macchina prima che il sistema di sicurezza possa essere ripristinato
- B** Barriera fotoelettrica di sicurezza per un facile accesso, ad esempio con un carrello elevatore
- C** Pulsante Reset per confermare e avviare.

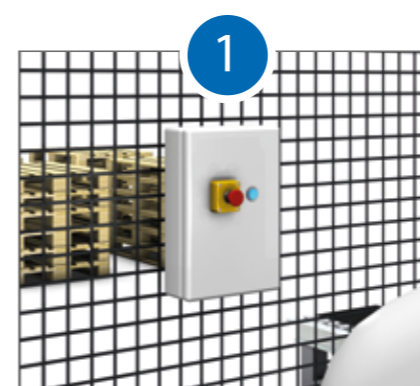
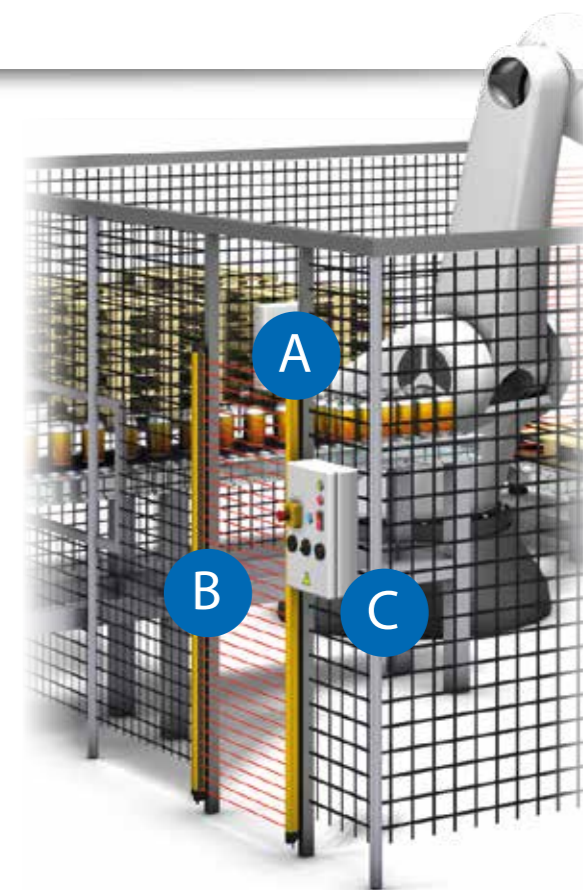

Premere il pulsante Pre-reset all'interno della macchina

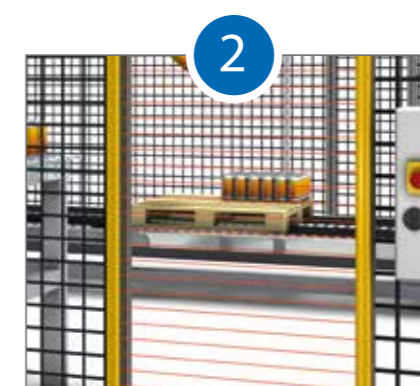

Attraversare la barriera fotoelettrica di sicurezza per uscire dall'area pericolosa



Premere il pulsante Reset fuori dall'area pericolosa

# Muting con barriere F3SG-RA

## ADVANCED

È possibile proteggere i sistemi di produzione automatizzata servendosi di elementi fissi; tuttavia, se il materiale entra ed esce da una zona di pericolo, il muting può rappresentare un aiuto sostanziale senza mettere a rischio la sicurezza dell'operatore.

Una gamma completa di opzioni di muting è disponibile con le barriere fotoelettriche di sicurezza F3SG-RA utilizzando accessori standard Omron.

### F3SG-RA offre quattro diverse modalità di muting:

- Modalità di muting standard (muting a T e muting a X)
- Modalità di muting solo uscita (muting a L)
- Modalità di rilevamento della posizione (ad es. il robot è arrestato in una posizione sicura)

### Le seguenti impostazioni sono disponibili per mettere in stato di muting un intervallo di raggi.

- Muting intervallo completo
- Muting intervallo parziale
- Muting intervallo dinamico

### Muting dinamico

Quando sulla stessa linea vengono trasportati pezzi in lavorazione con altezze diverse, la funzione di muting dinamico imposta automaticamente i raggi appropriati in base all'altezza del pezzo in lavorazione.

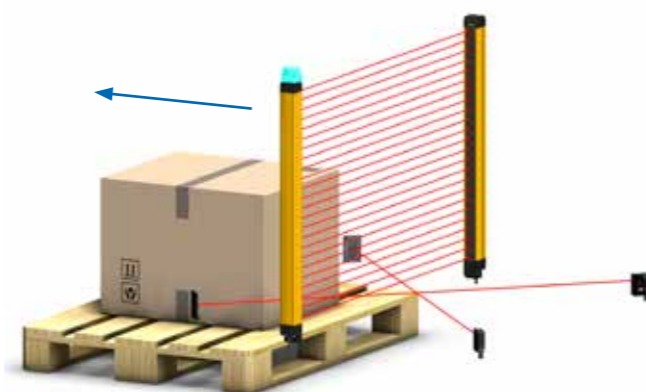

Muting a X

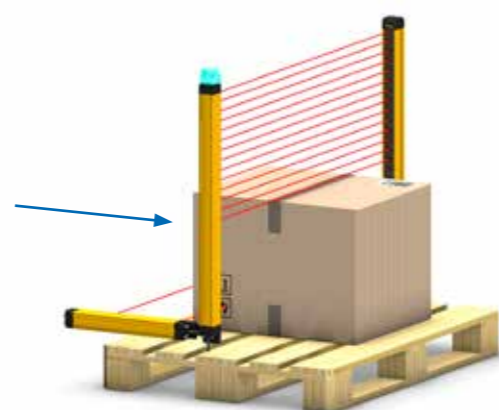

Muting dinamico utilizzato nel muting a L

### Attuatore di muting intelligente

L'attuatore di muting intelligente estende le funzioni del modello F3SG-RA nelle applicazioni in cui un pezzo in lavorazione vibra avanti e indietro o in cui le merci sul pallet presentano piccoli spazi vuoti.

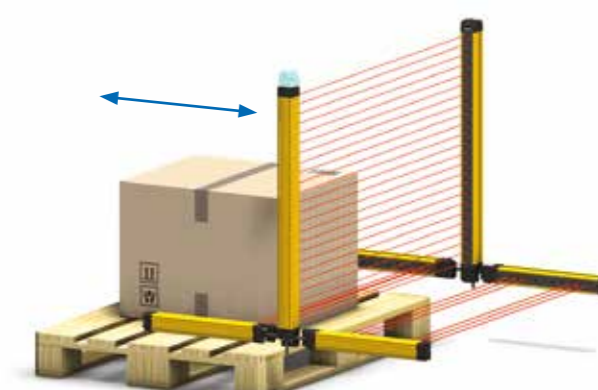

Attuatore di muting intelligente utilizzato nel muting a T

### Strumento di configurazione SD Manager2

#### Riduzione di errori di impostazione e rilevamento

Lo strumento di configurazione SD Manager2 permette di monitorare lo stato della barriera e programmare le funzioni della barriera. È inoltre possibile analizzare qualsiasi arresto dovuto a errori di muting utilizzando i dati memorizzati nell'unità F3SG-R, per minimizzare i tempi di inattività imprevisti della macchina.

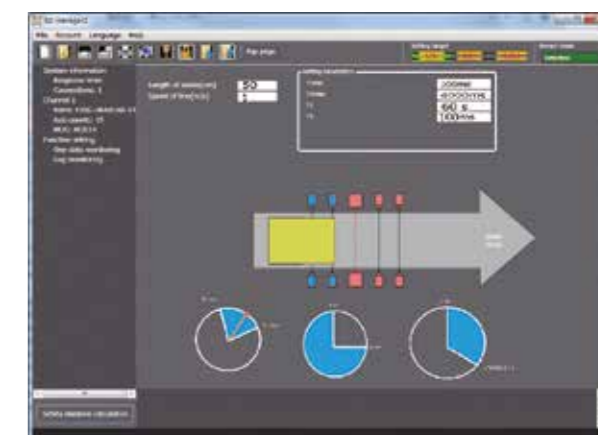

# Elenco di caratteristiche

Funzione	Tipo Advanced F3SG-RA	Tipo Easy F3SG-RE	Impostazione di fabbrica predefinita
Selezione PNP/NPN	●		Uscita PNP
Test esterno	●		Attivo 24 V
Interblocco	●	■	Modalità Auto Reset
Pre-reset	●	■	Disabilitato
Funzione di monitoraggio di un dispositivo esterno (EDM)	●	■	Disabilitata
Uscita ausiliaria		■	Informazioni di muting/override
Muting		■	Modalità di muting standard
Override		■	Abilitato
Blanking fisso	●	■	Disabilitato
Blanking mobile	●	■	Disabilitato
Risoluzione ridotta		■	Disabilitata
Zona di allarme		■	Disabilitata
Selezione codice di scansione	●		CodiceA
Selezione intervallo di funzionamento	●		Modalità a corta distanza
Regolazione tempo di risposta		■	Modalità standard
Spia		■	Rossa: disabilitata Arancione: disabilitata Verde: informazioni di muting/override
Fascio predeterminato		■	Disabilitato

- Impostazione mediante DIP switch
- Impostazione mediante strumento di configurazione
- Impostazione mediante cablaggio

## F3SG-RA

## Safety light curtain



### Advanced type for complex safety solutions

The F3SG-RA advanced safety light curtain provides simplicity in mounting, daily use and maintenance.

- Torsion-resistant for fast and simple alignment
- Smart-click cable connection for fast set-up and proper torque to ensure IP67
- QR code indication for easy online troubleshooting
- PNP/NPN output selection by DIP switch
- Cascading connection up to 3 segments and up to 255 beams
- Built in blanking, muting and reset functions

### Ordering information

#### Sensors

Application	Type	Detection capability	Operating range	Protective height	Order code
Finger detection	Type 4 / Type 2	14 mm	0.3 to 10 m	160 to 2,080 mm	F3SG-RA__-14
Hand detection	Type 4 / Type 2	30 mm	0.3 to 20 m	190 to 2,510 mm	F3SG-RA__-30

#### F3SG-RA\_14 models (14 mm detection capability)

Protective height	Number of beams	Order code	
		Type 4	Type 2
160 mm	15	F3SG-4RA0160-14	F3SG-2RA0160-14
240 mm	23	F3SG-4RA0240-14	F3SG-2RA0240-14
320 mm	31	F3SG-4RA0320-14	F3SG-2RA0320-14
400 mm	39	F3SG-4RA0400-14	F3SG-2RA0400-14
480 mm	47	F3SG-4RA0480-14	F3SG-2RA0480-14
560 mm	55	F3SG-4RA0560-14	F3SG-2RA0560-14
640 mm	62	F3SG-4RA0640-14	F3SG-2RA0640-14
720 mm	71	F3SG-4RA0720-14	F3SG-2RA0720-14
800 mm	79	F3SG-4RA0800-14	F3SG-2RA0800-14
880 mm	87	F3SG-4RA0880-14	F3SG-2RA0880-14
960 mm	95	F3SG-4RA0960-14	F3SG-2RA0960-14
1040 mm	103	F3SG-4RA1040-14	F3SG-2RA1040-14
1120 mm	111	F3SG-4RA1120-14	F3SG-2RA1120-14
1200 mm	119	F3SG-4RA1200-14	F3SG-2RA1200-14
1280 mm	127	F3SG-4RA1280-14	F3SG-2RA1280-14
1360 mm	135	F3SG-4RA1360-14	F3SG-2RA1360-14
1440 mm	143	F3SG-4RA1440-14	F3SG-2RA1440-14
1520 mm	151	F3SG-4RA1520-14	F3SG-2RA1520-14
1600 mm	159	F3SG-4RA1600-14	F3SG-2RA1600-14
1680 mm	167	F3SG-4RA1680-14	F3SG-2RA1680-14
1760 mm	175	F3SG-4RA1760-14	F3SG-2RA1760-14
1840 mm	183	F3SG-4RA1840-14	F3SG-2RA1840-14
1920 mm	191	F3SG-4RA1920-14	F3SG-2RA1920-14
2000 mm	199	F3SG-4RA2000-14	F3SG-2RA2000-14
2080 mm	207	F3SG-4RA2080-14	F3SG-2RA2080-14

#### F3SG-RA\_30 models (30 mm detection capability)

Protective height	Number of beams	Order code	
		Type 4	Type 2
190 mm	8	F3SG-4RA0190-30	F3SG-2RA0190-30
270 mm	12	F3SG-4RA0270-30	F3SG-2RA0270-30
350 mm	16	F3SG-4RA0350-30	F3SG-2RA0350-30
430 mm	20	F3SG-4RA0430-30	F3SG-2RA0430-30
510 mm	24	F3SG-4RA0510-30	F3SG-2RA0510-30
590 mm	28	F3SG-4RA0590-30	F3SG-2RA0590-30
670 mm	32	F3SG-4RA0670-30	F3SG-2RA0670-30
750 mm	36	F3SG-4RA0750-30	F3SG-2RA0750-30
830 mm	40	F3SG-4RA0830-30	F3SG-2RA0830-30
910 mm	44	F3SG-4RA0910-30	F3SG-2RA0910-30
990 mm	48	F3SG-4RA0990-30	F3SG-2RA0990-30
1070 mm	52	F3SG-4RA1070-30	F3SG-2RA1070-30
1150 mm	56	F3SG-4RA1150-30	F3SG-2RA1150-30
1230 mm	60	F3SG-4RA1230-30	F3SG-2RA1230-30
1310 mm	64	F3SG-4RA1310-30	F3SG-2RA1310-30
1390 mm	68	F3SG-4RA1390-30	F3SG-2RA1390-30
1470 mm	72	F3SG-4RA1470-30	F3SG-2RA1470-30
1550 mm	76	F3SG-4RA1550-30	F3SG-2RA1550-30
1630 mm	80	F3SG-4RA1630-30	F3SG-2RA1630-30
1710 mm	84	F3SG-4RA1710-30	F3SG-2RA1710-30
1790 mm	88	F3SG-4RA1790-30	F3SG-2RA1790-30
1870 mm	92	F3SG-4RA1870-30	F3SG-2RA1870-30
1950 mm	96	F3SG-4RA1950-30	F3SG-2RA1950-30
2030 mm	100	F3SG-4RA2030-30	F3SG-2RA2030-30
2110 mm	104	F3SG-4RA2110-30	F3SG-2RA2110-30
2190 mm	108	F3SG-4RA2190-30	F3SG-2RA2190-30
2270 mm	112	F3SG-4RA2270-30	F3SG-2RA2270-30
2350 mm	116	F3SG-4RA2350-30	F3SG-2RA2350-30
2420 mm	120	F3SG-4RA2430-30	F3SG-2RA2430-30
2510 mm	124	F3SG-4RA2510-30	F3SG-2RA2510-30

Accessories (Sold separately)

Single-end connector cable

Appearance	Type	Specification	Cable length	Order code		
	Emitter cable M12 connector 5-Pin Color: Gray	 Female	1 + 24 VDC	Brown	3 m	F39-JG3A-L
			2 TEST	Black	7 m	F39-JG7A-L
			3 0 VDC	Blue	10 m	F39-JG10A-L
			4 Not used	White	15 m	F39-JG15A-L
			5 Not used	Yellow	20 m	F39-JG20A-L
	Receiver cable M12 connector 8-Pin Color: Black	 Female	1 Reset	Yellow	3 m	F39-JG3A-D
			2 + 24 VDC	Brown	7 m	F39-JG7A-D
			3 MUTE A	Gray	10 m	F39-JG10A-D
			4 MUTE B	Pink	15 m	F39-JG15A-D
			5 OSSD 1	Black	20 m	F39-JG20A-D
			6 OSSD 2	White		
			7 0 VDC	Blue		
			8 AUX(Lamp)	Red		

Double-end connector cable

Appearance	Type	Specification	Cable length	Order code			
	Emitter cable M12 connector 5-Pin Color: Gray	 Female	0.5 m	F39-JGR5B-L			
			1 m	F39-JG1B-L			
			3 m	F39-JG3B-L			
			5 m	F39-JG5B-L			
			7 m	F39-JG7B-L			
			10 m	F39-JG10B-L			
			15 m	F39-JG15B-L			
			20 m	F39-JG20B-L			
				Receiver cable M12 connector 8-Pin Color: Black	 Female	0.5 m	F39-JGR5B-D
						1 m	F39-JG1B-D
3 m	F39-JG3B-D						
5 m	F39-JG5B-D						
7 m	F39-JG7B-D						
10 m	F39-JG10B-D						
15 m	F39-JG15B-D						
20 m	F39-JG20B-D						

Y-joint Plug/Socket Connector

Appearance	Type	Specification	Cable length	Order code
	M12 connectors. Used for reduced wiring.	 Y-Joint Plug/Socket Connector for Advance F39-GCNY2	0.5 m	F39-GCNY2

Cascading cable

Appearance	Type	Specification	Cable length	Order code
	Cascading cable set Set including: Emitter cable: Cap (5-pin), M12 connector (5-pin) Receiver cable: Cap (8-pin), M12 connector (8-pin)	 F39-JG-RA Emitter (Secondary sensor 1) F39-JG-RA Receiver (Secondary Sensor 1) F39-JG-RA Emitter (Primary sensor) F39-JG-RA Receiver (Primary sensor) Cascading cable set F39-JGR2W Emitter cable F39-JG__-L Receiver cable F39-JG__-D	0.2 m	F39-JGR2W

Mounting brackets

Appearance	Type	Specification	Order code
	Standard fixed bracket set (Two brackets per set)	Bracket to mount the F3SG-R. Side mounting and backside mounting possible. (Included in the F3SG-R product package <sup>*1</sup> )	F39-LGF
	Standard adjustable bracket set (Two brackets per set)	Bracket to mount the F3SG-R. Beam alignment after mounting possible. The angle adjustment range is ±15°. Side mounting and backside mounting possible.	F39-LGA

\*1 F3SG-RA\_\_-14: Protective height of 0160 to 1200: 2 sets, protective height of 1280 to 2080: 3 sets  
F3SG-RA\_\_-30: Protective height of 0190 to 1230: 2 sets, protective height of 1310 to 2270: 3 sets, protective height of 2350 to 2510: 4 sets

Interface units and configuration tool SD Manager 2

Appearance	Type	Specification	Order code
	SD Manager2	The configuration tool SD Manager2 is available to download from our website at <a href="http://www.ia.omron.com/f3sg-r_tool">http://www.ia.omron.com/f3sg-r_tool</a> . To change the settings of the F3SG-RA using SD Manager 2, it is necessary to set the receiver's two DIP switches No. 8 to ON.	-
	Interface unit	F39-GIF interface unit to connect the F3SG-RA receiver to a USB port of the PC	F39-GIF

Lamp

Appearance	Type	Specification	Order code
	Lamp unit	The lamp unit can be connected to a receiver and turned ON based on the operation of F3SG-RA. The lamp can indicate red, orange, and green colors, to which three different states can be assigned.	F39-LP

Test rod

Appearance	Type	Specification	Order code
	Test rod 14mm	14 mm diameter	F39-TRD14
	Test rod 30mm	30 mm diameter	F39-TRD30

Spatter protection cover (Two covers per set, for emitter and receiver)

Spatter protection covers include mounting brackets.

For safety light curtain models of the protective height of 2,000 mm or longer, use two spatter protection covers of different lengths.

Appearance	Safety light curtain model		Order code
	Finger protection	Hand and arm protection	
	F3SG_RA0160-14	F3SG_RA0190-30	F39-HGA0200
	F3SG_RA0240-14	F3SG_RA0270-30	F39-HGA0280
	F3SG_RA0320-14	F3SG_RA0350-30	F39-HGA0360
	F3SG_RA0400-14	F3SG_RA0430-30	F39-HGA0440
	F3SG_RA0480-14	F3SG_RA0510-30	F39-HGA0520
	F3SG_RA0560-14	F3SG_RA0590-30	F39-HGA0600
	F3SG_RA0640-14	F3SG_RA0670-30	F39-HGA0680
	F3SG_RA0720-14	F3SG_RA0750-30	F39-HGA0760
	F3SG_RA0800-14	F3SG_RA0830-30	F39-HGA0840
	F3SG_RA0880-14	F3SG_RA0910-30	F39-HGA0920
	F3SG_RA0960-14	F3SG_RA0990-30	F39-HGA1000
	F3SG_RA1040-14	F3SG_RA1070-30	F39-HGA1080
	F3SG_RA1120-14	F3SG_RA1150-30	F39-HGA1160
	F3SG_RA1200-14	F3SG_RA1230-30	F39-HGA1240
	F3SG_RA1280-14	F3SG_RA1310-30	F39-HGA1320
	F3SG_RA1360-14	F3SG_RA1390-30	F39-HGA1400
	F3SG_RA1440-14	F3SG_RA1470-30	F39-HGA1480
	F3SG_RA1520-14	F3SG_RA1550-30	F39-HGA1560
	F3SG_RA1600-14	F3SG_RA1630-30	F39-HGA1640
	F3SG_RA1680-14	F3SG_RA1710-30	F39-HGA1720
	F3SG_RA1760-14	F3SG_RA1790-30	F39-HGA1800
	F3SG_RA1840-14	F3SG_RA1870-30	F39-HGA1880
	F3SG_RA1920-14	F3SG_RA1950-30	F39-HGA1960
	F3SG_RA2000-14	F3SG_RA2030-30	F39-HGA1480 F39-HGA0550
	F3SG_RA2080-14	F3SG_RA2110-30	F39-HGA1560 F39-HGA0550
	-	F3SG_RA2190-30	F39-HGA1640 F39-HGA0550
	-	F3SG_RA2270-30	F39-HGA1720 F39-HGA0550
	-	F3SG_RA2350-30	F39-HGA1800 F39-HGA0550
	-	F3SG_RA2430-30	F39-HGA1880 F39-HGA0550
	-	F3SG_RA2510-30	F39-HGA1960 F39-HGA0550

Note: The operating range of the safety light curtain attached with the product is 10% shorter than the rating.

Spare parts

Appearance	Type	Specification	Order code
	End cap	Housing color: Black For both emitter and receiver (Attached to the F3SG-R. The end cap can be purchased if lost.)	F39-CNM

Specifications

Item	F3SG-4RA -14 F3SG-2RA -14	F3SG-4RA -30 F3SG-2RA -30
Type of ESPE (IEC 61496-1)	Type 4 Type 2	F3SG-4RA -14/-30 F3SG-2RA -14/-30
Detection capability (Opaque objects)	14 mm dia.	30 mm dia.
Protective height	160 to 2080 mm	190 to 2510 mm
Operating range (Dip switch option)	0.3 to 3.0 m or 0.3 to 10.0 m	0.3 to 7.0 m or 0.3 to 20.0 m
Effective aperture angle (EAA) (IEC 61496-2)	Type 4: ±2.5° max., emitter and receiver at operating range of 3 m or greater Type 2: ±5.0° max., emitter and receiver at operating range of 3 m or greater	
Light source	Infrared LEDs, Wavelength: 870 nm	
Power supply voltage (Vs)	SELV/PELV 24 VDC ±20% (ripple p-p 10% max.)	
Safety outputs (OSSD)	2 PNP or NPN transistor outputs (PNP or NPN selectable by DIP switch), load current of 300 mA max.	
Cascade connection	Number of cascaded segments: 3 max., total number of beams: 255 max. Total sum of cable lengths between sensors: 10 m max.	
Test function	Self-test (at power-on, and during operation), External test (light emission stop function by test input)	
Safety-related functions	Interlock, pre-reset, external device monitoring (EDM), fixed blanking/floating blanking, reduced resolution, muting/override, scan code selection, PNP/NPN selection, response time adjustment	
Response time	ON to OFF (normal mode): 8 to 18 ms max., OFF to ON: 40 to 90 ms max.	
Ambient temperature	Operating: -10 to 55°C (non-icing) Storage: -25 to 70°C	
Ambient humidity	Operating: 35% to 85% (non-condensing) Storage: 35% to 95%	
Degree of protection (IEC 60529)	IP65 and IP67	
Material	Housing: Aluminum, Cap: PBT, Front window: PMMA, Cable: Oil resistant PVC, Mounting bracket: ZDC2, FE plate: SUS	
Performance level (PL)/ Safety category	Type 4: PLc/Category 4 (EN ISO 13849-1:2008) Type 2: PLc/Category 2 (EN ISO 13849-1:2008)	
PFHd	≤ 9.9 × 10 <sup>-8</sup> (IEC 61508)	
Proof test interval T <sub>M</sub>	Every 20 years (IEC 61508)	

Note: For more information, please check the user manual Z352-E1

Connections (Basic wiring diagram)

Standalone F3SG-RA using PNP outputs

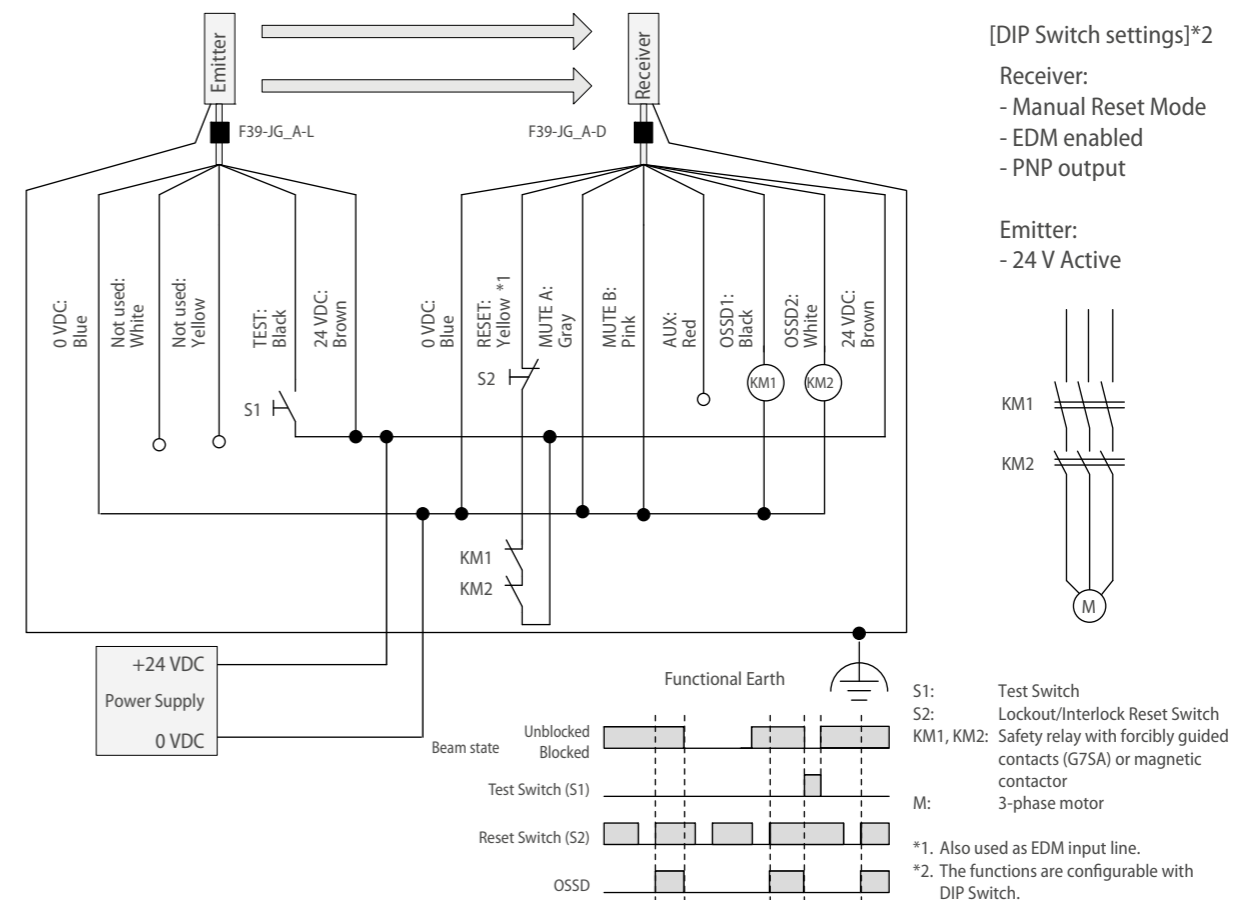





**Easy type for simple ON/OFF detection applications**

The F3SG-RE easy safety light provides simplicity in mounting, daily use and maintenance.

- Torsion-resistant for fast and simple alignment
- Smart-click cable connection for fast set-up and proper torque to ensure IP67
- QR code indication for easy online troubleshooting

**Ordering information**

**Sensors**

Application	Type	Detection capability	Operating range	Protective height	Order code
Finger detection	Type 4 / Type 2	14 mm	0.3 to 10 m	160 to 2,080 mm	F3SG-RE__-14
Hand detection	Type 4 / Type 2	30 mm	0.3 to 20 m	190 to 2,510 mm	F3SG-RE__-30

**F3SG-RE\_P14 models (PNP and 14 mm detection capability)**

Protective height	Number of beams	Order code	
		Type 4	Type 2
160 mm	15	F3SG-4RE0160P14	F3SG-2RE0160P14
240 mm	23	F3SG-4RE0240P14	F3SG-2RE0240P14
320 mm	31	F3SG-4RE0320P14	F3SG-2RE0320P14
400 mm	39	F3SG-4RE0400P14	F3SG-2RE0400P14
480 mm	47	F3SG-4RE0480P14	F3SG-2RE0480P14
560 mm	55	F3SG-4RE0560P14	F3SG-2RE0560P14
640 mm	62	F3SG-4RE0640P14	F3SG-2RE0640P14
720 mm	71	F3SG-4RE0720P14	F3SG-2RE0720P14
800 mm	79	F3SG-4RE0800P14	F3SG-2RE0800P14
880 mm	87	F3SG-4RE0880P14	F3SG-2RE0880P14
960 mm	95	F3SG-4RE0960P14	F3SG-2RE0960P14
1040 mm	103	F3SG-4RE1040P14	F3SG-2RE1040P14
1120 mm	111	F3SG-4RE1120P14	F3SG-2RE1120P14
1200 mm	119	F3SG-4RE1200P14	F3SG-2RE1200P14
1280 mm	127	F3SG-4RE1280P14	F3SG-2RE1280P14
1360 mm	135	F3SG-4RE1360P14	F3SG-2RE1360P14
1440 mm	143	F3SG-4RE1440P14	F3SG-2RE1440P14
1520 mm	151	F3SG-4RE1520P14	F3SG-2RE1520P14
1600 mm	159	F3SG-4RE1600P14	F3SG-2RE1600P14
1680 mm	167	F3SG-4RE1680P14	F3SG-2RE1680P14
1760 mm	175	F3SG-4RE1760P14	F3SG-2RE1760P14
1840 mm	183	F3SG-4RE1840P14	F3SG-2RE1840P14
1920 mm	191	F3SG-4RE1920P14	F3SG-2RE1920P14
2000 mm	199	F3SG-4RE2000P14	F3SG-2RE2000P14
2080 mm	207	F3SG-4RE2080P14	F3SG-2RE2080P14

**F3SG-RE\_P30 models (PNP and 30 mm detection capability)**

Protective height	Number of beams	Order code	
		Type 4	Type 2
190 mm	8	F3SG-4RE0190P30	F3SG-2RE0190P30
270 mm	12	F3SG-4RE0270P30	F3SG-2RE0270P30
350 mm	16	F3SG-4RE0350P30	F3SG-2RE0350P30
430 mm	20	F3SG-4RE0430P30	F3SG-2RE0430P30
510 mm	24	F3SG-4RE0510P30	F3SG-2RE0510P30
590 mm	28	F3SG-4RE0590P30	F3SG-2RE0590P30
670 mm	32	F3SG-4RE0670P30	F3SG-2RE0670P30
750 mm	36	F3SG-4RE0750P30	F3SG-2RE0750P30
830 mm	40	F3SG-4RE0830P30	F3SG-2RE0830P30
910 mm	44	F3SG-4RE0910P30	F3SG-2RE0910P30
990 mm	48	F3SG-4RE0990P30	F3SG-2RE0990P30
1070 mm	52	F3SG-4RE1070P30	F3SG-2RE1070P30
1150 mm	56	F3SG-4RE1150P30	F3SG-2RE1150P30
1230 mm	60	F3SG-4RE1230P30	F3SG-2RE1230P30
1310 mm	64	F3SG-4RE1310P30	F3SG-2RE1310P30
1390 mm	68	F3SG-4RE1390P30	F3SG-2RE1390P30
1470 mm	72	F3SG-4RE1470P30	F3SG-2RE1470P30
1550 mm	76	F3SG-4RE1550P30	F3SG-2RE1550P30
1630 mm	80	F3SG-4RE1630P30	F3SG-2RE1630P30
1710 mm	84	F3SG-4RE1710P30	F3SG-2RE1710P30
1790 mm	88	F3SG-4RE1790P30	F3SG-2RE1790P30
1870 mm	92	F3SG-4RE1870P30	F3SG-2RE1870P30
1950 mm	96	F3SG-4RE1950P30	F3SG-2RE1950P30
2030 mm	100	F3SG-4RE2030P30	F3SG-2RE2030P30
2110 mm	104	F3SG-4RE2110P30	F3SG-2RE2110P30
2190 mm	108	F3SG-4RE2190P30	F3SG-2RE2190P30
2270 mm	112	F3SG-4RE2270P30	F3SG-2RE2270P30
2350 mm	116	F3SG-4RE2350P30	F3SG-2RE2350P30
2420 mm	120	F3SG-4RE2430P30	F3SG-2RE2430P30
2510 mm	124	F3SG-4RE2510P30	F3SG-2RE2510P30

Note: Optional NPN models are available for the F3SG-RE easy types. Please contact your OMRON representative.

**Accessories (Sold separately)**

**Single-end connector cable**

Appearance	Type	Specification	Cable length	Order code
	Emitter/receiver cable M12 connector 4-Pin Color: Gray	 Female	1 m 2 m 3 m 5 m 10 m	XSSF-D421-C80-F XSSF-D421-D80-F XSSF-D421-E80-F XSSF-D421-G80-F XSSF-D421-J80-F

**Double-end connector cable**

Appearance	Type	Specification	Cable length	Order code
	Emitter/receiver cable M12 connector 4-Pin Color: Gray		1 m 2 m 3 m 5 m 10 m	XSSW-D421-C81-F XSSW-D421-D81-F XSSW-D421-E81-F XSSW-D421-G81-F XSSW-D421-J81-F

**Y-joint Plug/Socket Connector**

Appearance	Type	Specification	Cable length	Order code
	M12 connector (4-pin) on both ends	 Using the Y-joint connector the F3SG-RE is set to long operation mode	0.5 m	F39-GCNY1

**Mounting brackets**

Appearance	Type	Specification	Order code
	Standard fixed bracket set (Two brackets per set)	Bracket to mount the F3SG-R. Side mounting and backside mounting possible. (Included in the F3SG-R product package <sup>*1</sup> )	F39-LGF
	Standard adjustable bracket set (Two brackets per set)	Bracket to mount the F3SG-R. Beam alignment after mounting possible. The angle adjustment range is ±15°. Side mounting and backside mounting possible.	F39-LGA

<sup>\*1</sup> F3SG-RE\_\_-14: Protective height of 0160 to 1200: 2 sets, Protective height of 1280 to 2080: 3 sets  
F3SG-RE\_\_-30: Protective height of 0190 to 1230: 2 sets, Protective height of 1310 to 2270: 3 sets, Protective height of 2350 to 2510: 4 sets

**Test rod**

Appearance	Type	Specification	Order code
	Test rod 14mm	14 mm diameter	F39-TRD14
	Test rod 30mm	30 mm diameter	F39-TRD30

Spatter protection cover (Two covers per set, for emitter and receiver)

Spatter protection covers include mounting brackets.

For safety light curtain models of the protective height of 2,000 mm or longer, use two spatter protection covers of different lengths.

Appearance	Safety light curtain model		Order code
	Finger protection	Hand and arm protection	
	F3SG_RE0160-14	F3SG_RE0190-30	F39-HGB0180
	F3SG_RE0240-14	F3SG_RE0270-30	F39-HGB0260
	F3SG_RE0320-14	F3SG_RE0350-30	F39-HGB0340
	F3SG_RE0400-14	F3SG_RE0430-30	F39-HGB0420
	F3SG_RE0480-14	F3SG_RE0510-30	F39-HGB0500
	F3SG_RE0560-14	F3SG_RE0590-30	F39-HGB0580
	F3SG_RE0640-14	F3SG_RE0670-30	F39-HGB0660
	F3SG_RE0720-14	F3SG_RE0750-30	F39-HGB0740
	F3SG_RE0800-14	F3SG_RE0830-30	F39-HGB0820
	F3SG_RE0880-14	F3SG_RE0910-30	F39-HGB0900
	F3SG_RE0960-14	F3SG_RE0990-30	F39-HGB0980
	F3SG_RE1040-14	F3SG_RE1070-30	F39-HGB1060
	F3SG_RE1120-14	F3SG_RE1150-30	F39-HGB1140
	F3SG_RE1200-14	F3SG_RE1230-30	F39-HGB1220
	F3SG_RE1280-14	F3SG_RE1310-30	F39-HGB1300
	F3SG_RE1360-14	F3SG_RE1390-30	F39-HGB1380
	F3SG_RE1440-14	F3SG_RE1470-30	F39-HGB1460
	F3SG_RE1520-14	F3SG_RE1550-30	F39-HGB1540
	F3SG_RE1600-14	F3SG_RE1630-30	F39-HGB1620
	F3SG_RE1680-14	F3SG_RE1710-30	F39-HGB1700
	F3SG_RE1760-14	F3SG_RE1790-30	F39-HGB1780
	F3SG_RE1840-14	F3SG_RE1870-30	F39-HGB1860
	F3SG_RE1920-14	F3SG_RE1950-30	F39-HGB1940
	F3SG_RE2000-14	F3SG_RE2030-30	F39-HGB1460
			F39-HGA0550
	F3SG_RE2080-14	F3SG_RE2110-30	F39-HGB1540
			F39-HGA0550
		F3SG_RE2190-30	F39-HGB1620
			F39-HGA0550
		F3SG_RE2270-30	F39-HGB1700
			F39-HGA0550
		F3SG_RE2350-30	F39-HGB1780
			F39-HGA0550
		F3SG_RE2430-30	F39-HGB1860
			F39-HGA0550
		F3SG_RE2510-30	F39-HGB1940
			F39-HGA0550



Specifications

Item	F3SG-4RE -14 F3SG-2RE -14	F3SG-4RE -30 F3SG-2RE -30
Type of ESPE (IEC 61496-1)	Type 4 Type 2	F3SG-4RE -14/30 F3SG-2RE -14/30
Detection capability (Opaque objects)	14 mm dia.	30-mm dia.
Protective height	160 to 2080 mm	190 to 2510 mm
Operating range (Wiring connection option)	0.3 to 3.0 m or 0.3 to 10.0 m	
Effective aperture angle (EAA) (IEC 61496-2)	Type 4	±2.5° max., emitter and receiver at operating range of 3 m or greater
	Type 2	±5.0° max., emitter and receiver at operating range of 3 m or greater
Light source	Infrared LEDs, Wavelength: 870 nm	
Power supply voltage (Vs)	SELV/PELV 24 VDC±20% (ripple p-p 10% max.)	
Safety outputs (OSSD)	F3SG_RE_P_: 2 PNP transistor outputs, load current of 300 mA max. F3SG_RE_N_: 2 NPN transistor outputs, load current of 300 mA max.	
Test function	Self-test (at power-on, and during operation)	
Response time	ON to OFF (normal mode): 5 to 15ms, OFF to ON: 25 to 75ms	
Ambient temperature	Operating	-10 to 55°C (non-icing)
	Storage	-25 to 70°C
Ambient humidity	Operating	35% to 85% (non-condensing)
	Storage	35% to 95%
Degree of protection (IEC 60529)	IP65 and IP67	
Material	Housing: Aluminum, Cap: PBT, Front window: PMMA, Cable: Oil resistant PVC, Mounting bracket: ZDC2, FE plate: SUS	
Performance level (PL)/ Safety category	Type 4	PLe/Category 4 (EN ISO 13849-1:2008)
	Type 2	PLc/Category 2 (EN ISO 13849-1:2008)
PFHd	≤ 9.9 × 10 <sup>-8</sup> (IEC 61508)	
Proof test interval T <sub>M</sub>	Every 20 years (IEC 61508)	

Note: For more information, please check the user manual Z352-E1

Connections (Basic wiring diagram)

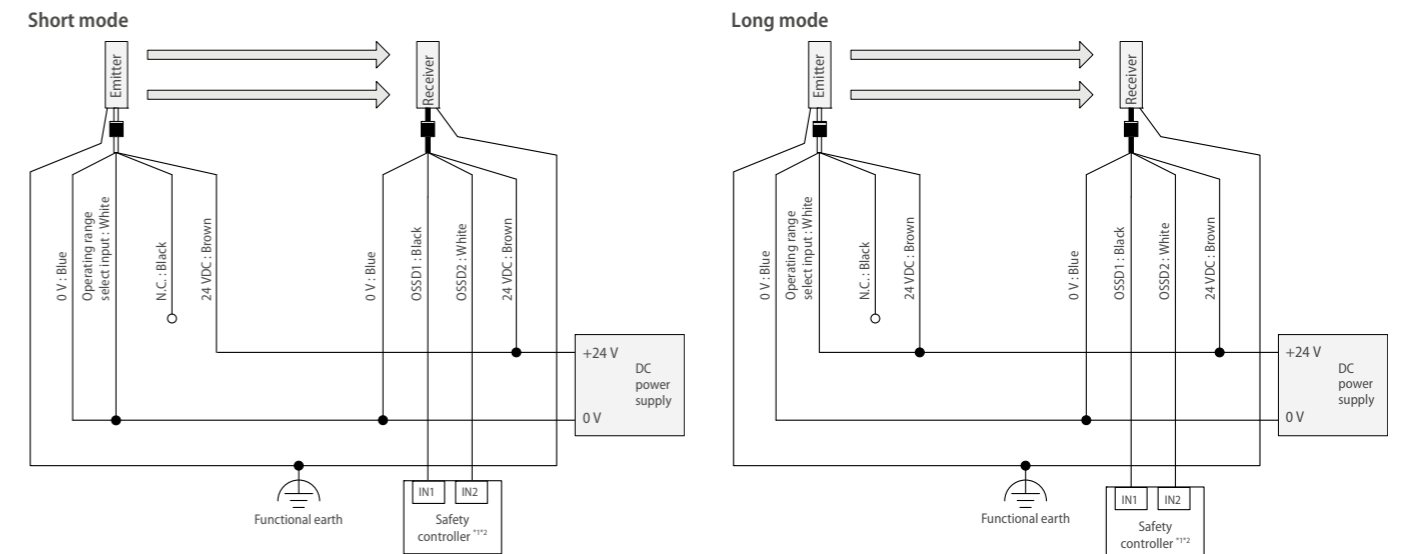

\*1 Refer to user's manual Z352-E1 for more information.

\*2 The safety controller and the F3SG-R must share the power supply or be connected to the common terminal of the power supply.



Smart muting actuator for muting applications

The F3W-MA smart muting actuator is an integrated sensor system utilizing multiple-beam sensor technology to configure muting systems in combination with the safety light curtain.

- Point-to-point detection mode for workpieces with constant shape
- Chattering/void space prevention mode to prevent impact of small object holes





Ordering information





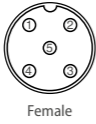

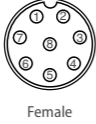
Application	Type	Specification	Order code
	Smart muting actuator for small objects detection	100 mm beam gap between muting trigger beams	F3W-MA0100P
	Smart muting actuator for objects detection	300 mm beam gap between muting trigger beams	F3W-MA0300P

Accessories (Sold separately)

Single-end connector cable

Appearance	Type	Specification	Cable length	Order code		
	Emitter cable M12 connector 5-Pin Color: Gray		1 +24 VDC	Brown	3 m	F39-JG3A-L
			2 TEST	Black	7m	F39-JG7A-L
			3 0 VDC	Blue	10 m	F39-JG10A-L
			4 Not used	White	15 m	F39-JG15A-L
			5 Not used	Yellow	20 m	F39-JG20A-L
	Receiver cable M12 connector 8-Pin Color: Black		1 Reset	Yellow	3 m	F39-JG3A-D
			2 +24 VDC	Brown	7m	F39-JG7A-D
			3 MUTE A	Gray	10 m	F39-JG10A-D
			4 MUTE B	Pink	15 m	F39-JG15A-D
			5 OSSD 1	Black	20 m	F39-JG20A-D
			6 OSSD 2	White		
			7 0 VDC	Blue		
			8 AUX(Lamp)	Red		



Double-end connector cable

Appearance	Type	Specification	Cable length	Order code			
	Emitter cable M12 connector 5-Pin Color: Gray	Connected to power cable or double-ended cable  Connected to single-ended cable, or double-ended cable 	0.5 m	F39-JGR5B-L			
			1 m	F39-JG1B-L			
			3 m	F39-JG3B-L			
			5 m	F39-JG5B-L			
			7 m	F39-JG7B-L			
			10 m	F39-JG10B-L			
			15 m	F39-JG15B-L			
			20 m	F39-JG20B-L			
				Receiver cable M12 connector 8-Pin Color: Black	Connected to power cable or double-ended cable  Connected to single-ended cable, or double-ended cable 	0.5 m	F39-JGR5B-D
						1 m	F39-JG1B-D
3 m	F39-JG3B-D						
5 m	F39-JG5B-D						
7 m	F39-JG7B-D						
10 m	F39-JG10B-D						
15 m	F39-JG15B-D						
20 m	F39-JG20B-D						

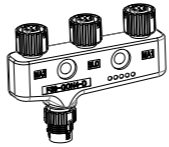
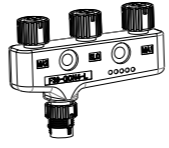
4-joint plug/socket connector

Appearance	Type	Specification	Order code
	4 joint connector for receivers	Muting 4-joint connector for connection of F3W-MA and F3SG-RA receivers	F39-GCN4-D
	4 joint connector for transmitters	Muting 4-joint connector for connection of F3W-MA and F3SG-RA transmitters	F39-GCN4-L

Mounting brackets

Appearance	Type	Specification	Order code
	Standard fixed bracket set (Two brackets per set)	Bracket to mount the F3SG-R. Side mounting and backside mounting possible.	F39-LGF
	Standard adjustable bracket set (Two brackets per set)	Bracket to mount the F3SG-R. Beam alignment after mounting possible. The angle adjustment range is ±15°. Side mounting and backside mounting possible.	F39-LGA

Specifications

Item	F3W-MA0300P	F3W-MA0100P
Beam gap between muting trigger beams	300 mm	100 mm
Operating range (Dip switch option)	0.3 to 7.0 m or 0.3 to 20.0 m	
Light source	Infrared LEDs, Wavelength: 870 nm	
Power supply voltage (Vs)	SELV/PELV 24 VDC ±20% (ripple p-p 10% max.)	
Functions	Scan code selection, operation mode selection (Point to point detection/chattering and void space prevention), Off-delay, muting enable, muting trigger beam allocation, operating range selection	
Ambient temperature	Operating	-10 to 55°C (non-icing)
	Storage	-25 to 70°C
Ambient humidity	Operating	35% to 85% (non-condensing)
	Storage	35% to 95%
Degree of protection (IEC 60529)	IP65 and IP67	
Material	Housing: Aluminum, Cap: PBT, Front window: PMMA, Cable: Oil resistant PVC, Mounting bracket: ZDC2, FE plate: SUS	

Note: For more information, please check the user manual Z355-E1

## Omron in breve

Figura tra le 2000 aziende più grandi del mondo secondo Forbes  
 Quotata al NASDAQ come OMRNY  
 Ai primi posti nell'indice Dow Jones Sustainability  
 Presente nell'elenco dei 100 principali innovatori del mondo di Thomson Reuters



### 200.000 prodotti di input, logica, output e sicurezza

Sensori, sistemi di controllo, visualizzazione, azionamenti, robot, sicurezza, ispezione e controllo qualità, componenti di controllo ed elettromeccanici

# 6%

Il fatturato investito ogni anno nel settore Ricerca e sviluppo

### 80 anni di innovazione

1.200 dipendenti impegnati nel settore Ricerca e Sviluppo  
 Oltre 12.500 brevetti emessi o in attesa di approvazione

# 37.500

dipendenti nel mondo

# 200

sedi nel mondo

# 22

paesi EMEA

### Il nostro lavoro al servizio della società

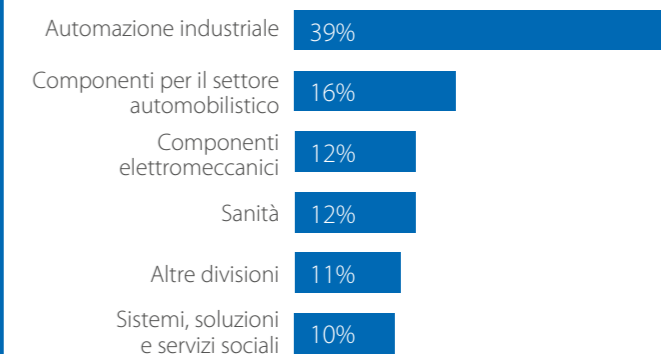

### Vicina alle tue esigenze

Formazione tecnica e seminari, supporto tecnico, centri per le tecnologie di automazione, comunità online (MyOmron), cataloghi e documentazione tecnica online, assistenza clienti e supporto alle vendite, laboratori per l'interoperabilità (Tsunagi), servizi di sicurezza, riparazioni.

Vuoi saperne di più?

OMRON ITALIA

 +39 02 326 81

 [industrial.omron.it](http://industrial.omron.it)

## Uffici vendite e supporto tecnico

### **Austria**

Tel: +43 (0) 2236 377 800  
[industrial.omron.at](http://industrial.omron.at)

### **Belgio**

Tel: +32 (0) 2 466 24 80  
[industrial.omron.be](http://industrial.omron.be)

### **Danimarca**

Tel: +45 43 44 00 11  
[industrial.omron.dk](http://industrial.omron.dk)

### **Finlandia**

Tel: +358 (0) 207 464 200  
[industrial.omron.fi](http://industrial.omron.fi)

### **Francia**

Tel: +33 (0) 1 56 63 70 00  
[industrial.omron.fr](http://industrial.omron.fr)

### **Germania**

Tel: +49 (0) 2173 680 00  
[industrial.omron.de](http://industrial.omron.de)

### **Norvegia**

Tel: +47 22 65 75 00  
[industrial.omron.no](http://industrial.omron.no)

### **Paesi Bassi**

Tel: +31 (0) 23 568 11 00  
[industrial.omron.nl](http://industrial.omron.nl)

### **Polonia**

Tel: +48 22 458 66 66  
[industrial.omron.pl](http://industrial.omron.pl)

### **Portogallo**

Tel: +351 21 942 94 00  
[industrial.omron.pt](http://industrial.omron.pt)

### **Regno Unito**

Tel: +44 (0) 1908 258 258  
[industrial.omron.co.uk](http://industrial.omron.co.uk)

### **Repubblica Ceca**

Tel: +420 234 602 602  
[industrial.omron.cz](http://industrial.omron.cz)

### **Russia**

Tel: +7 495 648 94 50  
[industrial.omron.ru](http://industrial.omron.ru)

### **Spagna**

Tel: +34 902 100 221  
[industrial.omron.es](http://industrial.omron.es)

### **Sud Africa**

Tel: +27 (0)11 579 2600  
[industrial.omron.co.za](http://industrial.omron.co.za)

### **Svezia**

Tel: +46 (0) 8 632 35 00  
[industrial.omron.se](http://industrial.omron.se)

### **Turchia**

Tel: +90 (216) 556 51 30  
[industrial.omron.com.tr](http://industrial.omron.com.tr)

### **Ungheria**

Tel: +36 1 399 30 50  
[industrial.omron.hu](http://industrial.omron.hu)

### **Altri rappresentanti commerciali Omron**

[industrial.omron.eu](http://industrial.omron.eu)