



# 2024

## AUS Stock Selector & Prices

Industry 4.0 is underway - allow us to support your implementation



Robotics & assembly automation



Food & beverage manufacturing



Water processing technology



Energy generation



Packaging automation



Facilities automation



Mining automation



Mobile machine controls



Logistics automation



Free shipping on  orders <10kg!

Purchasing via ifm's webshop is fast, convenient, open 24/7.

[www.ifm.com/au](http://www.ifm.com/au)

Service Centre:  
sales.au@ifm.com  
ph. 1300 365 088





# Acting sustainably is ifm's motto

CHAIRMEN OF THE BOARD AND CO-CEOS: MARTIN BUCK AND MICHAEL MARHOFER



Chairmen of the Board and co-CEOs:  
Martin Buck and Michael Marhofer

What will the world look like in the future? We at ifm ask ourselves this question not only when it comes to product development, innovative technologies and new ways of working. Environmental issues also play a leading role in our daily decisions and actions.

*"Because we are all responsible for the future which takes social, economic, and ecological aspects into consideration."*

We can only fulfill this responsibility when we are aware of the consequences of our actions and in time start looking for solutions and new ways to minimise their impact. For us, this also means responsibly and reliably following long-term goals instead of resting on short-term successes. In the course of this, we would like to recommend our fourth [Sustainability report \(reporting year 2022\)](#) which contains a comprehensive sustainability programme in addition to our strategic approaches and measures.



**Climate neutrality by 2030**  
in our operating business



**100% green electricity**  
since 2020



**Long-term CO<sub>2</sub> savings**  
in the area of business  
travel and journeys



**100% of our suppliers**  
signed the ifm suppliers  
code of conduct

Acting sustainably is the motto - and in all respects. This is already stated in the corporate philosophy, first written down in 1990:

*"ifm demands and promotes ecologically conscious decisions and conduct." **ifm corporate philosophy***

The group of companies has been following this guiding principle for over 50 years. In doing so, we often go beyond the legal requirements and feel further encouraged in our thinking by the increasing attention to issues such as the protection of biodiversity, energy and mobility, which are emerging, among other things, from a global climate movement and also from pioneering measures of the European Green Deal.



# The 3 pillars of sustainability

One thing is certain for us:

*"Efficient, socially balanced and ecologically compatible development is needed, whereby social interaction, economic strength and environmental protection are not contradictory for us."*  
**ifm corporate philosophy**

At the same time, we are aware that we must contribute more. Only then can we master the global social and ecological challenges. Up until now, we have seen ourselves as a company that operates sustainably in an integrated manner. Now we want to actively advance our sustainability activities and pursue the issues that are essential for us in the coming years. You can find out here what this means in detail for the ifm group.



As a company that operates sustainably, we at ifm set ourselves the goal of harmonising economic, ecological and social aspects and anchoring them more firmly in our organisation.

The guiding principle of corporate sustainability describes a principle of action which is based in a balanced way on the three pillars of sustainability - **Economy**, **Environment** (ecology) and **Social issues** - in all corporate decisions and actions. Issues such as environmental protection, upholding social principles and economic stability are not fundamentally new, but they have become much more important in the past years.

ifm acts according to the principle of economic optimum and against this background strives for balance as well as commitment in all three dimensions.

**"Looking to the future, we are also following our guiding principle  
growing successfully in security."**



# ifm is committed to help your business succeed!

German quality industrial product, ex-stock AU

## **Personal service:**

*Either by phone, email, in person or via an MS Teams online meeting, ifm is always there for you – anywhere, anytime. We process your purchase orders, issue test samples and provide accurate technical and pricing information to support your business as efficiently as we can.*

## **Workshops / Seminars:**

*To help introduce the pipeline of new ifm products and technology innovations, we can support you with hands-on workshops at your company, or at our training centre.*

## **Meet an ifm engineer:**

*Interested in discovering new possibilities for your business or production process? Wish to discuss advanced technologies and solve technical problems? Or seek practical insights into the latest automation practices? Why not meet one of our engineers - either at your premises, or at our customer service centre. Or visit us at a Tradeshow. Whichever is your preference - we will look forward to hearing from you!*

## Go ifmonline!

Browse, select, order  
in the ifm webshop

[ifm.com/au](http://ifm.com/au)



Free shipping on orders <10kg!

Purchasing via ifm's webshop is fast, convenient, open 24/7.

## Overview

ifm's wide product range is clearly structured via individual Product Groups.

## Product Selector:

Allows you to select important technical data. Narrowing options for the optimum product selection.

## Compare:

The "comparator" function, allows you to compare 3 products simultaneously, with differences highlighted!

## Search engine:

The "full-text" search function, selects all products & topics related to your area of interest.

## Purchase 24/7:

Log-in and purchase on-line 24/7 @ [www.ifm.com/au](http://www.ifm.com/au)

Save time & reduce courier costs!





**ifm:**



The company now employs a dedicated team of 68 local employees, committed to help you and your business succeed. Located throughout the country in Melbourne, Sydney, Brisbane, Adelaide, Hobart and Perth, servicing 6,000 local businesses, and delivering 76% of all PO's overnight via couriers - nationwide!



**ifm - global:**



ifm electronic gmbh remains a family owned private business, founded in Germany in 1969. From the start, the company has continuously invested in R&D product development & automated manufacturing.

While marketing an incredible range of electronic sensors, control products & connection solutions for industrial automation and process control applications. The company now supports customers from virtually every industry, especially those where quality and reliability are not negotiable!

Now employing 7,600 dedicated staff, located in 90 countries and servicing >180,000 customers worldwide. But despite having grown into a large company, we maintain the virtues of the founding years. The flexibility and individuality of a small enterprise, with quality and professionalism central to the group. Our customers remain today in the centre of our work - close to you.



**ifm Innovation:**

As one of the worlds' largest manufacturers of industrial sensors & control products, ifm made its name by developing robust, compact industrial quality products with user friendly interfaces, and flexible electronic outputs. With massive annual investments in R&D, ifm currently owns >1000 registered world-wide patents. Regularly winning numerous prestigious design awards for innovations & break-through technologies!



**Our commitment to you:**







ifm products are distinguished by the highest precision & reliability. You have our word on that – hence the 5-year factory under written warranty!

We want you to use our products, confident that ifm is the right partner for your automation goals.

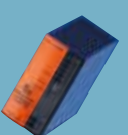
**ifm – close to you!**





 <p><b>IO-Link products</b></p>	<p><b>Industry 4.0 - why and how explained</b>  <b>IO-Link masters &amp; accessories</b>                  Pages: 4  <i>A point-to-point communication interface that connects smart sensors and actuators to a control system.</i></p>			
 <p><b>Power supplies</b></p>	<p><b>IO-Link masters, accessories and ethernet cables</b>                  Pages: 12</p>	<p><b>IO-Link signal converters</b>                  Pages: 16</p>	<p><b>Circuit Breakers</b>                  Pages: 18  <i>Programmable circuit breakers using IO-Link technology.</i></p>	<p><b>Power supplies</b>                  Pages: 19  <i>Power supplies provide the voltage for sensors, actuators, and other electronic loads.</i></p>
 <p><b>ifm controllers &amp; software solutions</b></p>	<p><b>ifm PLC and HMI controllers</b>                  Pages: 20</p>		<p><b>Moneo Software</b>                  Pages: 22  <i>IIOT platform for industry</i></p>	
 <p><b>Wiring technology</b></p>	<p><b>M12 cordsets</b>                  Pages: 28  <i>4 - 5 - 8-pin DC cordsets and field wirable connectors.</i></p>	<p><b>M8 cordsets</b>                  Pages: 37  <i>3 - 4-pin DC cordsets. Quick disconnect M8 cordsets and field wirable connectors for electrical wiring.</i></p>	<p><b>M12 splitter block systems</b>                  Pages: 40  <i>Four port and eight port M12 wiring blocks, patch cords and Y-splitters.</i></p>	<p><b>M12 control cables</b>                  Pages: 41-42  <i>Ethernet &amp; CAN bus connection cables</i></p>
 <p><b>Position sensors</b></p>  <p><b>Motion control</b></p>	<p><b>Inclination sensors</b>                  Pages: 52</p>	<p><b>Magnetic sensors</b>                  Pages: 43  <i>Non-contact magnetic sensors detect metallic targets.</i></p>	<p><b>Inductive sensors</b>                  Pages: 44  <i>Non-contact inductive sensors detect metallic targets.</i></p>	<p><b>Valve sensors</b>                  Pages: 50  <i>Continuous position feedback and open closed feedback options.</i></p>
<p><b>Speed monitors</b>                  Pages: 53  <i>Self-contained speed monitors detect rotational speed conditions.</i></p>	<p><b>Rotation and standstill monitors</b>                  Pages: 53  <i>The speed monitors calculate rotational speed by evaluating pulses.</i></p>	<p><b>Encoders</b>                  Pages: 54  <i>Incremental and absolute encoders use magnetic technology to provide accurate position feedback of a rotating shaft.</i></p>		
<p><b>Capacitive sensors</b>                  Pages: 56  <i>Capacitive sensors detect non-metallic targets, e.g. plastic, glass and wood.</i></p>	<p><b>Capacitive touch buttons</b>                  Pages: 57  <i>Capacitive touch sensors.</i></p>	<p><b>Cylinder sensors</b>                  Pages: 58  <i>Low-profile T-slot and C-slot cylinder sensors detect cylinder position.</i></p>		
 <p><b>Position sensors</b></p>	<p><b>Photoelectrics &amp; lasers</b>                  Pages: 60  <i>Visible red and laser provide long-range detection.</i></p>	<p><b>Distance, colour and contrast</b>                  Pages: 66  <i>Photoelectric solutions for long ranges, color and contrast applications</i></p>	<p><b>Lasers</b>                  Pages: 67</p>	<p><b>Light Grids</b>                  Pages: 70  <i>Fast object monitoring in intralogistics</i></p>



### Vision sensors

#### Code reader & pixel counter

Pages: 72

For automated packaging codes.

#### 2D contour sensor

Pages: 74

For automated packaging 2D profiles.

#### 3D image sensor

Pages: 76

Volumetric control, missing goods applications.

#### Contour profiler

Pages: 79

PMD profiler for precise detection and QA checks.

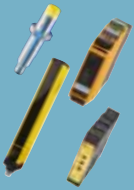

### Safety products

#### Light curtains

Pages: 80

Light curtains offer a hands-free solution to protect personnel.

#### Safety sensors

Pages: 84

Non-contact, fail-safe safety sensors detect metal targets.

#### Safety relays

Pages: 85

Multi-function safety relays connect safety devices.



### Process displays

#### Light towers

Pages: 80

Single or multiple segments.

#### Process displays & Signal evaluation

Pages: 87

#### Ultrasonic

Pages: 86

Ultrasonic object detection for transparent objects.



### Process sensors

#### Pressure sensors

Pages: 90

Sensors to monitor pressure in hydraulics and pneumatic systems. Also Hydrostatic level applications

#### Level sensors

Pages: 100

Point and continuous level sensors detect level of liquids, powders, granular solids and plastics.

#### Liquid flow sensors

Pages: 108

Flow sensors, mag-meters, and ultrasonic flow meters detect the flow rate of liquids.

#### Gas flow sensors

Pages: 114

Flow sensors for compressed air and industrial gases.

#### Temperature sensors

Pages: 116

Modular temperature monitoring products provide feedback in temperature control applications.

#### Humidity sensor

Pages: 124

#### Conductivity sensors

Pages: 126

Conductivity application case study



### Machine condition

#### Vibration sensors & Condition Monitoring

Pages: 128

Continuously monitor machine's vibration level to prevent equipment failure.



### Industrial networks & Identification systems

#### CAN BUS controllers & sensors for mobile machines

Pages: 134

#### Mobile machine connectors & control cables

Pages: 139 - 140

#### AS-i networking

Pages: 141

Networks sensors and actuators with plug-and-play functionality.

#### RFID

Pages: 144

A high frequency or UHF platform. The antennas are able to read/write multiple tags up to 10 meters.

## Appendix

### Appendix A - Z

Pages: 145





# IO-Link

Industrial communications  
networking standard IEC 61131-9



## IO-Link: Why, What and How?

### Why?

After 40 years of traditional plc communication, IO-Link is the new global communication standard (IEC 61131-9) transforming how we connect and communicate with digital sensors and actuators.

Using wired or wireless configurations, this advanced technology overcomes integration challenges, allowing devices to seamlessly share enriched data sets.

#### Unlock potential of your machines with digital communication

Operators can now get more information, without increasing cost, engineering time or complexity.

In fact, existing infrastructure can already provide more insights! Sensors and actuators are the "eyes and ears" of equipment.

Enhanced digital communication unlocks the existing data in your system. With IO-Link data, you get access to real-time process data, parameter data, and predictive data that's more reliable and accurate than what an analog signal has traditionally provided via HART and older conventional controller communication protocols.

### What is IO-Link?

IO-Link is an open standard communications protocol that is supported globally by sensor and controls companies.

The digital, bi-directional, point-to-point interface integrates with virtually any automated system. Resulting in a 100% digital path to your PLC from field-mounted sensors.

Unlike a fieldbus system, it works using a straightforward point-to-point communication method, using conventional 3-wire sensor and actuator connections.

### What is an IO-Link Master?

IO-Link masters replace traditional analog input cards, with a digital communication path between the IO-Link master and IO-Link device.

Up to 8 IO-Link devices such as sensors, actuators, valve feedback, and I/O modules, can be connected to a single master, depending on the configuration of the master.

The master transmits machine data, process parameters, and diagnostic information to a PLC controller, or directly to a higher level IIoT controls system.

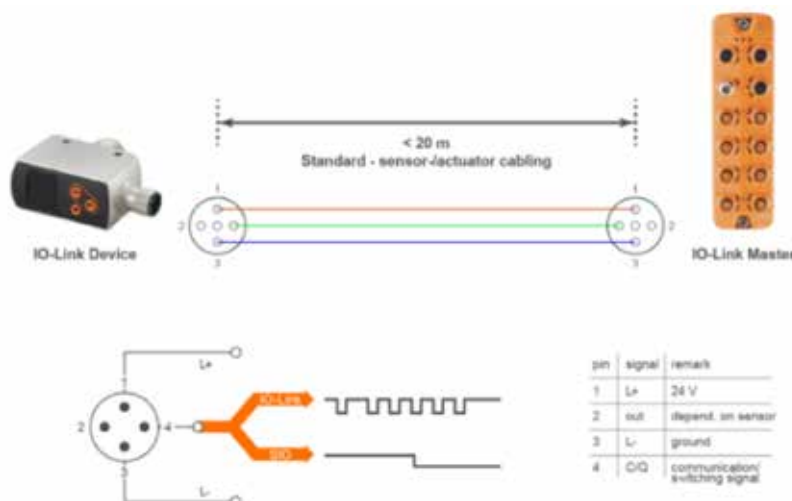





# Why has this technology been accepted so quickly?

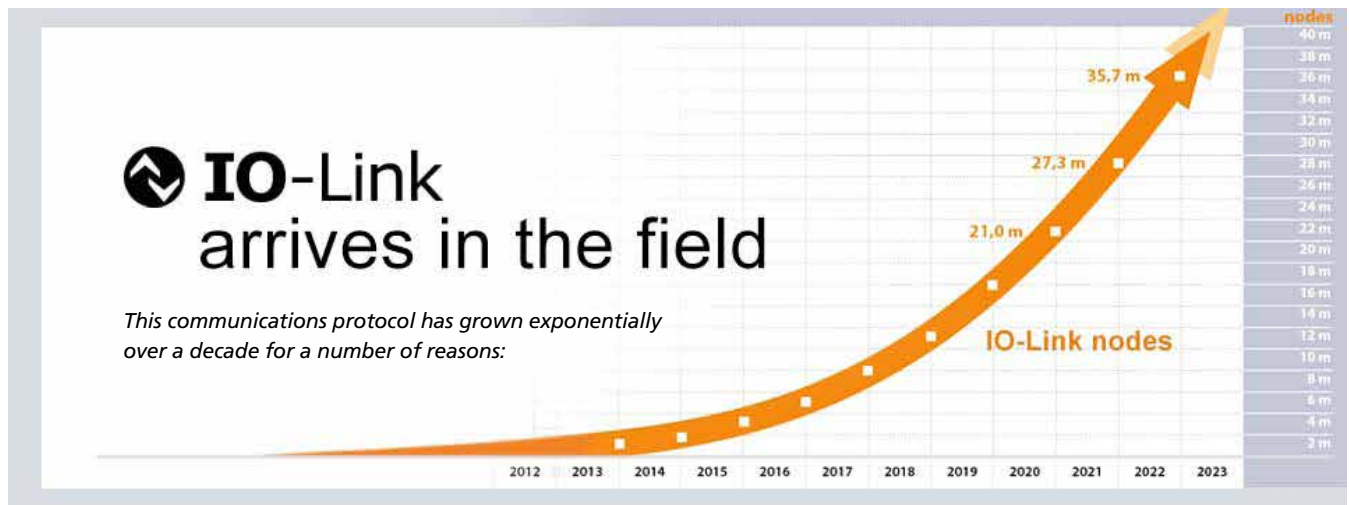

## IO-Link Benefits

Digital real-time communication, and easy data retrieval is a major benefit of IO-Link's implementation in today's machines, across all industries.

### Higher product quality

100% digital communication is more reliable, and accurate, compared to analog signals. Predictive information from sensors improves product quality and instrument verification processes.

### Lower costs

Are gained by eliminating analog input cards, while reducing the control cabinet size.

### Increased efficiency

Reduce cycle time for recipe changes with bi-directional communication between process instruments and a higher level controller.

### Improve machine up-time

Using the automatic device replacement feature of IO-Link enabled sensors. Parameters from an existing device are automatically downloaded into the new replacement device. Minimizing unplanned downtime.

### Reduced complexity

Scalable technology from simple binary On/Off devices up to smart IO-Link enabled sensors, provides complete process transparency that quickly integrates into existing controls architecture.

### Reduced cost

Savings of approximately 50% per point on input cards, without the need for analog PLC cards.

With ifm, there is no impact on sensor cost because the communication is already available in virtually all of our sensors.

### Minimal changes

Replacing analog communication requires few changes to controls architecture. And each device can be connected using standard 3-wire unshielded cabling.

## MONEO CONFIGURE SA



### Universal parameter setting software

- Finds all IO-Link masters in the Ethernet network and creates an overview of the whole plant.
- Automatic identification of the connected IO-Link sensors and actuators from all IO-Link consortium suppliers.
- Quick and easy parameter setting.
- Optimum validation via graphic visualisation.



## Comparisons to other communication technologies

IO-Link combines the best of all worlds with the functionality of analog signals and intelligence of Ethernet communication at the cost of binary On/Off points.

	Sensor communication			
	Binary On/off	Analog	IO-Link	Ethernet based
Amount of data	1 bit	16 bit	32 bytes	Many bytes
Sensor diagnostics			✓	✓
Remote sensor parameter replacement			✓	✓
Automatic sensor parameter replacement			✓	✓
Standard sensor cordsets	✓	✓	✓	
Digital communication			✓	✓
Complexity to integrate	✓	✓ ✓	✓ ✓	✓ ✓ ✓
Cost	\$	\$ \$	\$	\$ \$ \$

## IO-Link vs. Standard Analog Wiring

Analog systems are still in use at many facilities and are less expensive to install than IO-Link. However, they suffer from data losses when the signal converts from analog to digital so it can integrate with modern software. The data losses become more severe in setups with multiple conversion points. IO-Link is fully digital, avoiding any data losses even connections spanning large distances. In a new installation, cost is equivalent.

### IO-Link vs. HART

HART protocol is well-known, especially in the food and beverage, pharmaceutical, and chemical industries. Like IO-Link, it provides bidirectional communication of data between sensors and the controls system. Digital and analog signals are transmitted over cables. Integrating HART requires specific programming knowledge.

### ifm and IO-Link

In the rapidly-evolving landscape of industrial technology and automation, ifm is committed to innovation, efficiency, and conserving resources. We're dedicated to universal protocols and advancing interconnection between ecosystems.

ifm is a founding member of the global IO-Link development consortium. This group works with industry leaders to further the technology and integration, upholds quality standards, holds workshops, and more. The consortium has more than 520 members and counting.

### Connected ecosystems

ifm offers one of the largest selections of sensors and other IO-Link-compatible devices. Our broad offering allows you to implement a comprehensive digital communication system on all your machines and processes.

### What is IO-Link? Introduction video

<https://youtu.be/jv-Xiv3GcLc?si=8hRzPcw2VvqQUd7p>

Credit: RealPars control engineering training provider



# IO-Link System - User benefits

THE TECHNOLOGY JUMP FROM ANALOGUE TO DIGITAL, EXPLAINED

## ► Analog vs. IO-Link digital

**Conventional:** Analog signals require multiple analog-to-digital conversions that affect the accuracy of the sensor's output signal.



**IO-Link:** Requires only one analog-to-digital conversion. This avoids conversion losses of up to 1% accuracy.



**Pure digital signal:** IO-Link transmits a pure digital signal value that is noise-immune and more reliable than conventional analog signals.



**Recipe changes:** Recipe changes can be made to multiple sensors from your controller. Downtime and production changeover is minimized.



**Remote parameterization:** Access to all available parameters of the sensors can be reached through the plc without the need for external software and local sensor display.



**Sensor health:** On existing wiring, additional diagnostic information can be transferred for easier fault location and predictive indication.



**Simple plug-and-play sensor replacement:** IO-Link restores the sensor or actuator parameters automatically when replacing and servicing the sensors.



**Not a fieldbus dependent system:** IO-Link can be added to most existing control architectures with minimal cost.

## ► Sensor parameterization

**Conventional:** Change parameters via on-board pushbuttons.



**IO-Link:** Sensors can be parameterized remotely by PLC.



## ► Automatic device replacement

**Conventional:** If a sensor needs to be replaced, the sensor must be re-programmed with pushbuttons.



**IO-Link:** Data is automatically uploaded to a sensor. No need for manual parameterization.

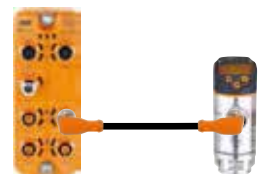

## ► Diagnostic information for predictive maintenance

**Conventional:** It is not possible to obtain diagnostic information without changing or adding wiring in the PLC.



Ex. Clean lens 100% excess gain

**IO-Link:** Transfers diagnostic information on existing wiring allowing for predictive maintenance.



Ex. Dirty lens 40% excess gain



# IO-Link System - Technology improvements

TYPICAL CONTROLS ARCHITECTURE - PROCESS TANK MONITORING

In a standard ethernet architecture, sensors can only transmit simple on /off or analog signals to the plc.

Process instruments use multiple analog cards which increase costs and limit the number of I/O.

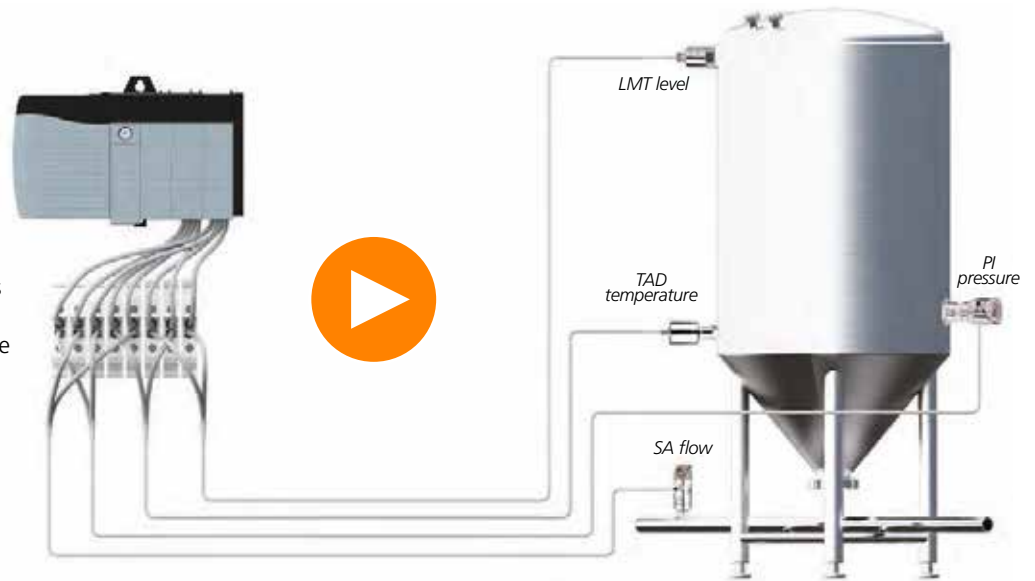

# IO-Link CONTROLS ARCHITECTURE - PROCESS TANK MONITORING



IO-Link is a communication interface that unlocks trapped data in sensors and transmits the data via a pure digital signal to the plc.

An IO-Link IP69k Master located in the field near the sensors, uses existing fieldbus protocol, such as Ethernet IP.

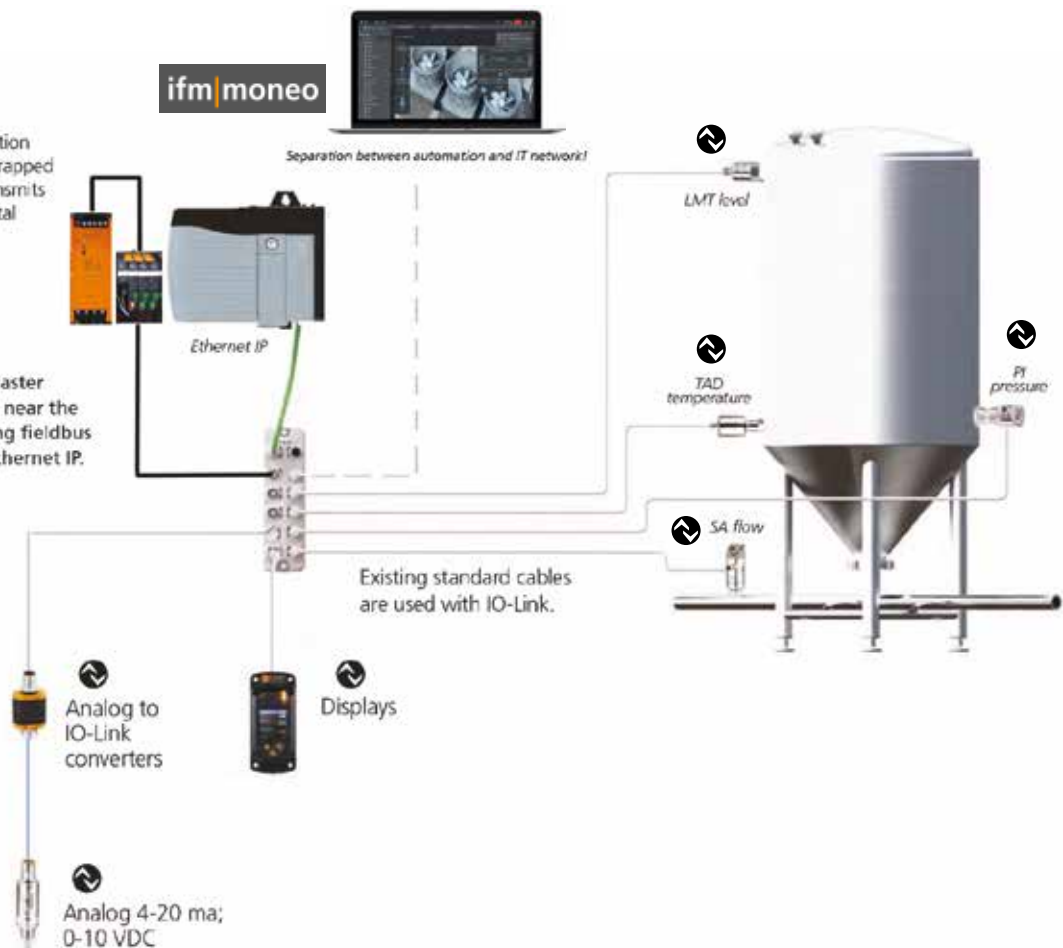



# IO-Link System - IIoT or Industry 4.0

ETHERNET I/O MODULES - DATALINE

For more insights:

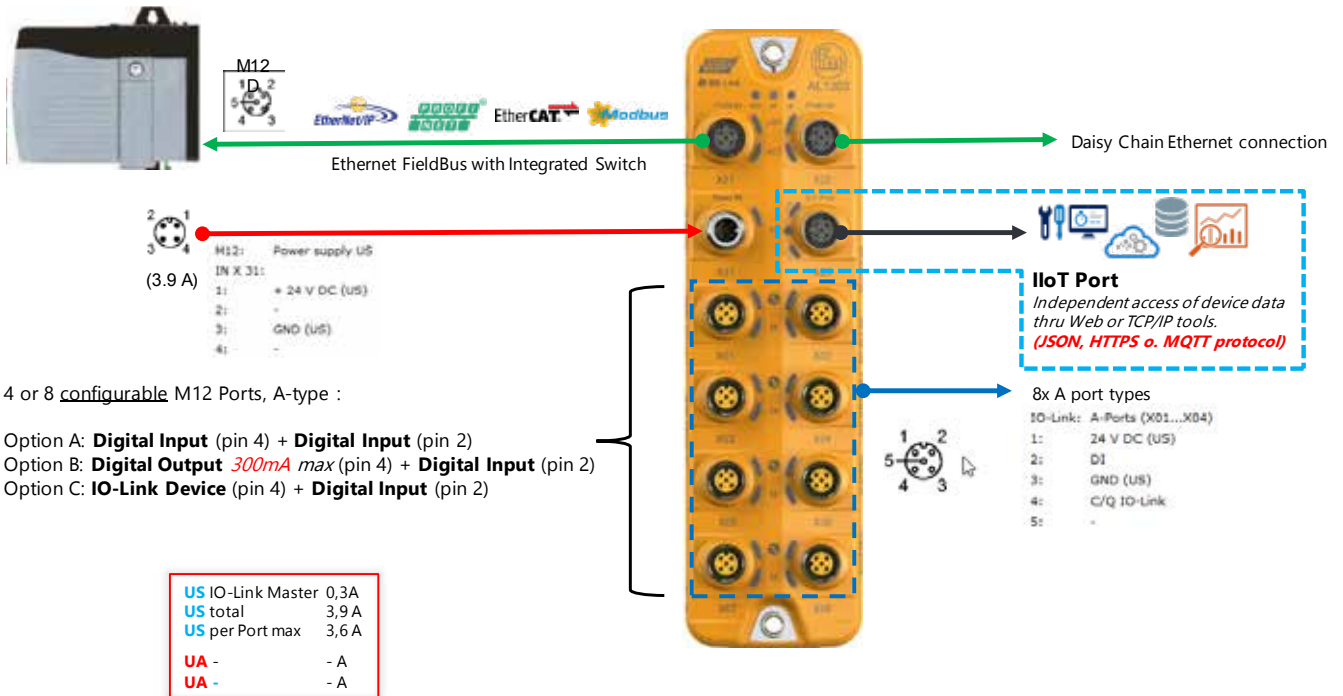

## AL19 Series - Cabinet Line In-panel Ethernet Modules

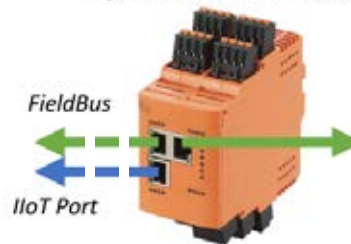

## IO-LINK SYSTEM APPLICATION REPORT



New Zealand Water Treatment plant employing Dataline Masters ifm IO-Link fuses, process sensors and precision MVQ IO-Link valve actuator position feedback. This site includes legacy 4...20 mA instruments using IO-Link signal converters.

# IO-Link System - Topology with IIoT

ETHERNET I/O MODULES - DATALINE

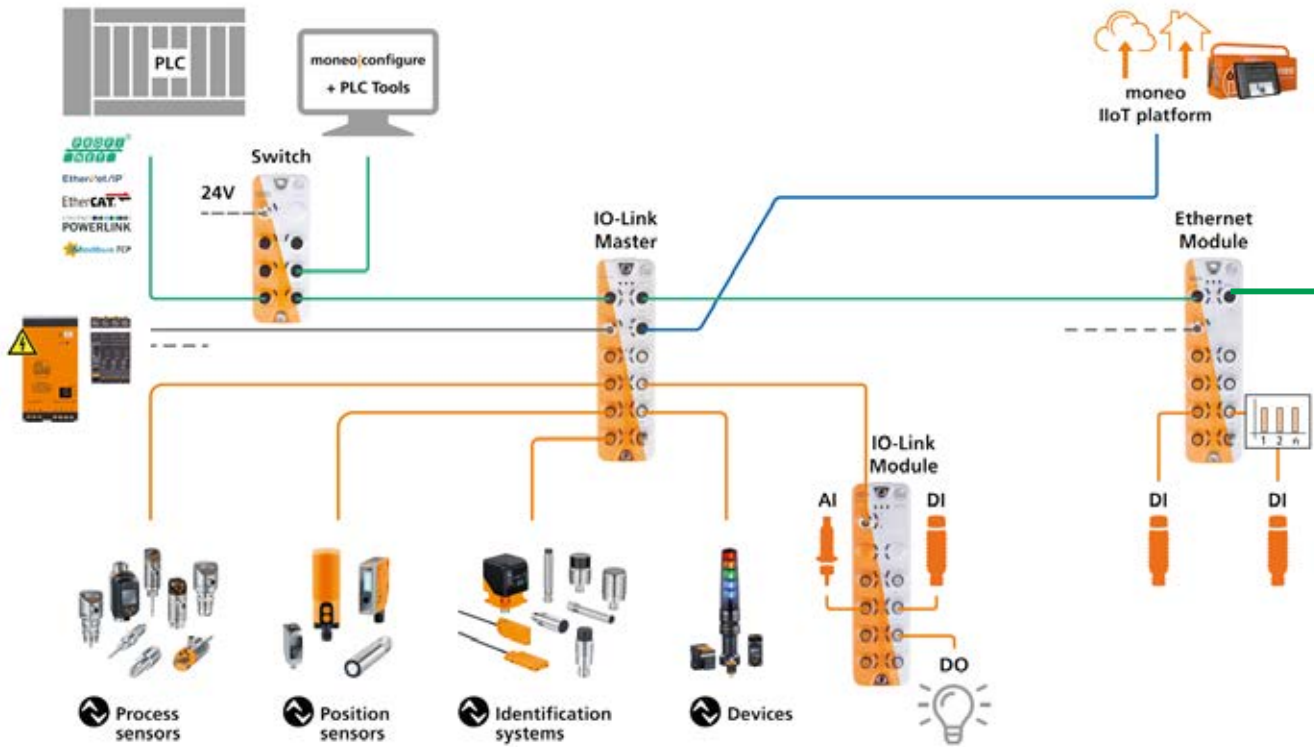

## IO-LINK SYSTEM APPLICATION REPORT

When a major Australian wine group set out to build a new winery located remotely from their technical support team, a key requirement was for operation with limited on-site technical support. IO-Link was chosen for the tank farm temperature control and waste water control systems to provide remote monitoring and diagnostics, as well as sensor parameter back up to enable technical support requirements to be handled remotely. The use of IP69K IO-Link modules installed close to the sensors and valves in the tank farm simplified the installation and reduced cabling costs.



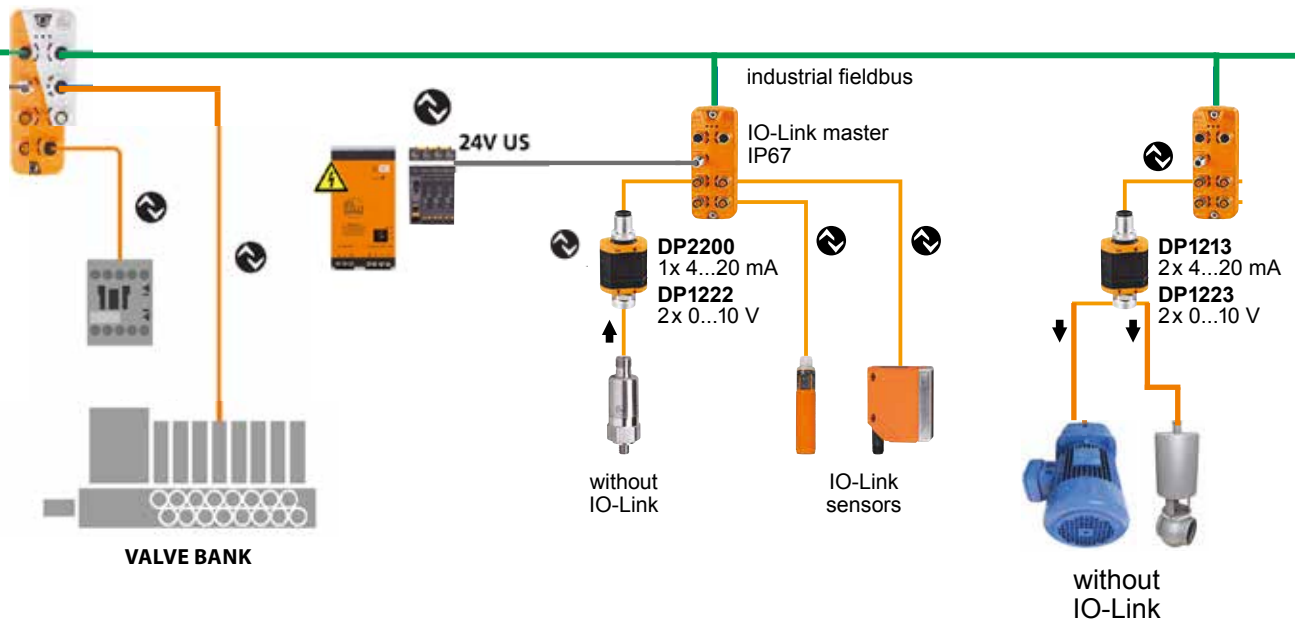

### IO-LINK SYSTEM APPLICATION REPORT

Nelspray manufacture spraying solutions for the global panel-board industry. Their Systems feature, advance flow and pressure control technology. High accuracy IO-link magnetic flow meters, pressure sensors with PLC control & IO-Link communication protocol to parameterize their sensors.







Type	Description	Order no.	Price	Order no.	Price
<b>IO-Link Master - CabinetLine</b>					
	PROFINET+ IoT 8 ports	AL1901	\$991.98	AL1900	\$991.98
	EtherNet/IP + IoT 8 ports	AL1921	\$991.98	AL1920	\$991.98
	EtherCat + IoT 8 ports	-	-	AL1930	\$991.98
	Modbus TCP + IoT 8 ports	-	-	AL1940	\$991.98
	PowerLink + IoT 8 ports	-	-	AL1970	\$991.98
	IoT only 8 ports	-	-	AL1950	\$964.65

<b>IO-Link Master - Data Line (MQTT, JSON)</b>					
	Profinet + IoT 4-ports	AL1304	\$723.87	AL1300	\$723.87
	EtherNet/IP + IoT 4-ports	AL1324	\$723.87	AL1320	\$723.87
	EtherCat + IoT 4-ports	-	-	AL1330	\$723.87
	Modbus TCP + IoT 4-ports	-	-	AL1340	\$723.87
	Profinet + IoT 8-ports	AL1306	\$845.44	AL1302	\$845.44
	EtherNet/IP + IoT 8-ports	AL1326	\$845.44	AL1322	\$845.44
	EtherCat + IoT 8-ports	-	-	AL1332	\$845.44
	Modbus TCP + IoT 8-ports	-	-	AL1342	\$845.44

New functionalities, refer p.7

<b>IO-Link Master - Standard Line</b>					
	Profinet 4-port	-	-	AL1100	\$695.25
	EtherNet/IP 4-port	-	-	AL1120	\$695.25
	Profinet 8-port	-	-	AL1102	\$810.15
	EtherNet/IP 8-port	-	-	AL1122	\$810.15

## IO-Link PARAMETER SETTING SOFTWARE, MONEO | CONFIGURE FREE



Type	Description	Order no.	Price
	moneo configure SA License <ul style="list-style-type: none"> <li>For all IO-Link devices and IO-Link masters</li> <li>Integrated, manufacturer-independent <b>IODD management</b> for time-saving sensor parameter setting.</li> <li>Cockpit for parallel display of parameters and process values.</li> </ul>	QMP010	FREE
	IO-Link Master USB 1P IP67	AL1060	\$559.47
	USB/M12 CABLE	E12689	\$47.34
	Connection cable	EVC012	\$45.83

With moneo configure, a large number of IO-Link devices and ifm IO-Link masters can be configured with just a few clicks. An integrated connection to the IODD database (online search function) also facilitates the integration of third-party devices. Convenient management of your own parameter data sets, including import and export functions, further accelerates the integration of new sensors.



# IO-Link System Components

INDUSTRIAL









Type	Description	Order no.	Price
<b>PROFIsafe module</b>			
	PROFIsafe 8 port module. Using "PROFIsafe" transmission protocol, safety sensors and actuators can now be operated via IO-Link. When connected to a PROFIsafe IO-Link Master. Features 8x safe digital inputs (OSSD) and 4x safe outputs. The PROFIsafe transmission telegram ensures a "tunneled" connection with the safety controller within the normal IO-Link communication. Complying to safety levels SIL 3 to IEC 61508 / EN 61508.	<b>AL2005</b>	<b>\$1,587.60</b>



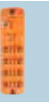
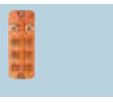

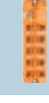
**Note:** An Ethernet/IP safety master is in development by the IO-Link consortium.

## IO-LINK CONFIGURABLE MULTI-PORT MODULES



Type	Inputs	Outputs	Order no.	Price
<b>IO-Link Configurable Multi-port modules</b>				
	DI, 0...10V, 4...20mA*	DO 1...16*	<b>AL2605</b>	<b>\$841.78</b>
	DI, 0...10V, 4...20mA*	DO 1...16*	<b>AL2303</b>	<b>\$683.20</b>
	DI 1...16*	DO 1...16*	<b>AL2325</b>	<b>\$637.79</b>
	DI 1...16*	DO 1...16*	<b>AL2321</b>	<b>\$624.88</b>
		DO 12: (6x2)	<b>AL2330</b>	<b>\$418.74</b>
	DI 12: (6x2)		<b>AL2340</b>	<b>\$329.23</b>
	DI 20: (10x2)		<b>AL2341</b>	<b>\$552.80</b>
<b>Ethernet 6 Port Switches (unmanaged)</b>				
	TCP/IP networks; for Profinet networks; for Modbus TCP networks		<b>AL3000</b>	<b>\$572.81</b>
	TCP/IP networks; for EtherNet/IP networks; for Modbus TCP networks		<b>AL3050</b>	<b>\$572.81</b>

## INDUSTRIAL ETHERNET D-CODE CABLE (FIELD BUS) GREEN, PUR / NI PL BRASS CONNECTORS

		Price		Price		Price		Price
	RJ45 - M12, 4-pole		RJ45 - M12, 4-pole		Jumper . M12/M12 . 4-pole		Plug . M12 flying lead, 4-pole	
0.5 m	EVC924	\$38.52	EVC930	\$38.52	EVC904	\$37.66	-	-
1.0 m	-	-	-	-	EVC905	\$43.04	-	-
2.0 m	EVC926	\$54.01	EVC932	\$54.01	EVC906	\$53.36	EVC893	\$32.06
5 m	EVC927	\$83.92	EVC933	\$83.92	EVC907	\$83.71	EVC894	\$62.83
10 m	EVC928	\$134.70	EVC934	\$134.70	EVC908	\$134.70	EVC895	\$113.40
20 m	-	-	EVC935	\$235.41	EVC909	\$236.05	EVC896	\$214.96
50 m	-	-	-	-	-	-	EVC897	\$520.31



# IO-Link System Components

F&B INDUSTRY - WASH DOWN PLANT



Type	Description	Order no.	Price
<b>IO-Link Master - Data Line (MQTT, JSON), IP69K</b>			
	Profinet + IoT 4-ports	AL1305	\$816.61
	EtherNet/IP + IoT 4-ports	AL1325	\$816.61
	EtherCat + IoT 4-ports	-	-
	Modbus TCP + IoT 4-ports	-	-
	Profinet + IoT 8-ports	AL1307	\$964.87
	EtherNet/IP + IoT 8-ports	AL1327	\$964.87
	EtherCat + IoT 8-ports	-	-
	Modbus TCP + IoT 8-ports	-	-

New functionalities, refer p.7



Type	Description	Order no.	Price
<b>IO-Link Master - Standard Line, IP69K</b>			
	Profinet 4-port	-	-
	Profinet 8-port	-	-
	EtherNet/IP 4-port	-	-
	EtherNet/IP 8-port	-	-

Type	Description	Order no.	Price
<b>IO-Link Master - Standard Line, IP69K</b>			
	AS-i 4-port	-	-

## IO-Link PARAMETER SETTING SOFTWARE, MONEO | CONFIGURE FREE



Type	Description	Order no.	Price
	moneo configure SA License <ul style="list-style-type: none"> <li>For all IO-Link devices and IO-Link masters</li> <li>Integrated, manufacturer-independent <b>IODD management</b> for time-saving sensor parameter setting.</li> <li>Cockpit for parallel display of parameters and process values.</li> </ul>	QMP010	FREE
	IO-Link Master USB 1P IP67	AL1060	\$559.47
	USB/M12 CABLE	E12689	\$47.34
	Connection cable	EVC012	\$45.83



With moneo configure, a large number of IO-Link devices and ifm IO-Link masters can be configured with just a few clicks. An integrated connection to the IODD database (online search function) also facilitates the integration of third-party devices. Convenient management of your own parameter data sets, including import and export functions, further accelerates the integration of new sensors.

# IO-Link System Components

F&B INDUSTRY - WASH DOWN PLANT



Type	Inputs	Outputs	Order no.	Price
<b>IO-Link Configurable Multi-port modules</b>				
	DI, 0...10V, 4...20mA*	DO 1...16*	AL2205	\$828.87
	DI, 0...10V, 4...20mA*	DO 1...16*	AL2203	\$768.62
	DI 1...16*	DO 1...16*	AL2225	\$726.66
	DI 1...16*	DO 1...16*	AL2221	\$713.97
	-	DO 12: (6x2)	AL2230	\$485.88
	DI 12: (6x2)	-	AL2240	\$394.86
	DI 20: (10x2)	-	AL2241	\$644.89
<b>Ethernet 6 Port Switches (unmanaged)</b>				
	TCP/IP networks; for Profinet networks; for Modbus TCP networks		AL3001	\$664.69
	TCP/IP networks; for EtherNet/IP networks; for Modbus TCP networks		AL3051	\$664.69
<b>Passive power distributor</b>				
	ProcessLine 4SB IP69K		AC2950	\$191.30
	ProcessLine 8SB IP69K		AC2951	\$237.99
<b>Accessories</b>				
Type	Description		Order no.	Price
	M12 316SS Protective caps (4 pieces per bag)		E12542	\$25.82
	Ethernet adapter M12 / RJ45		E21140	\$116.84
	Ethernet RJ45 connector		E12514	\$68.00

## WASHDOWN ETHERNET D-CODE CABLE (FIELD BUS), GREY, MPPE, SS316L CONNECTORS (INDOOR F&B)

		Price		Price		Price		Price
	RJ45 - M12, 4-pole		RJ45 - M12, 4-pole		Jumper . M12/M12 . 4-pole		Plug . M12 flying lead, 4-pole	
0.25 m	-	-	-	-	EVF528	\$51.21	-	-
0.5 m	EVF549	\$53.58	-	-	EVF529	\$53.80	-	-
1.0 m	EVF550	\$59.17	-	-	EVF530	\$59.82	-	-
2.0 m	EVF551	\$70.36	EVF557	\$67.78	EVF531	\$71.01	EVF518	\$46.26
5 m	EVF552	\$102.86	EVF558	\$99.41	EVF532	\$103.93	EVF519	\$79.62
10 m	EVF553	\$157.51	EVF559	\$152.13	EVF533	\$159.02	EVF520	\$134.70
20 m	EVF554	\$267.47	EVF560	\$257.79	EVF534	\$269.19	EVF521	\$245.09
50 m	-	-	-	-	-	-	EVF522	\$576.90



# IO-Link Ethernet Cable Connectors

MONITOR AND CONFIGURE IO-LINK DEVICES VIA BLUETOOTH ADAPTER



- New IO-Link Bluetooth adapter allows access to sensors via smartphone\*
- Easy parameter setting and reading of process values and events of all IO-Link devices connected to the master
- ifm moneo|blue available free of charge for iOS and Android
- Convenient parameter setting of many sensors thanks to graphic representation



FREE DOWNLOAD VIA THE APP STORE!

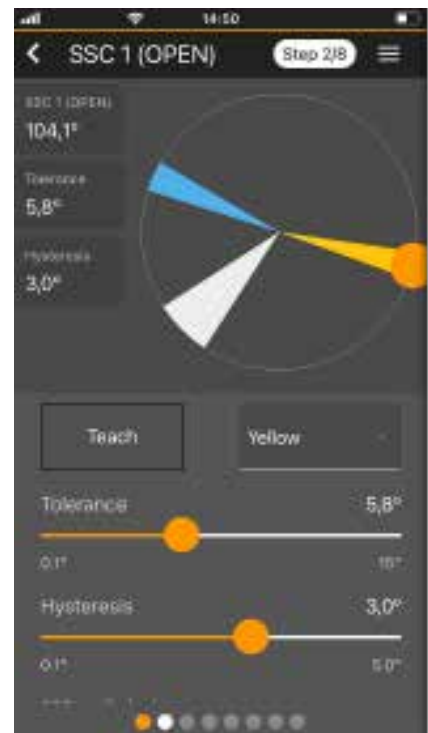
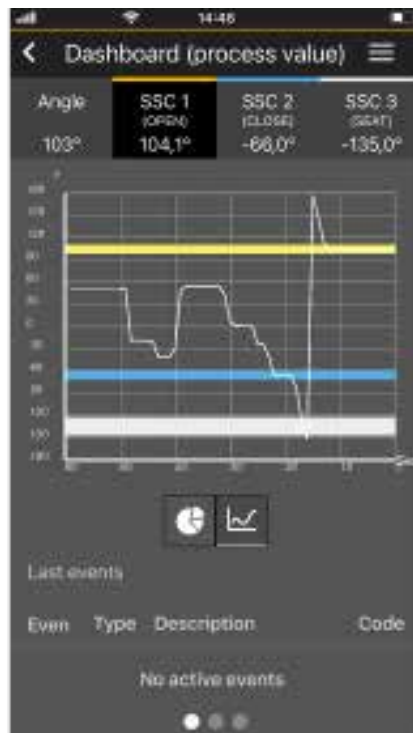



# IO-Link Accessories

SIGNAL CONVERTERS & ADAPTORS



Type	Function	Input	Output	Industrial	Price	Wash-down	Price
				IP67		IP69K	
	Converter IO-Link » Analogue output	IO-Link	2x analog 4...20 mA	DP1213	\$336.97	DP3213	\$348.59
	Converter IO-Link » Analogue output	IO-Link	2x analog 0...10 V	DP1223	\$311.37	DP3223	\$324.92
	Converter Analogue » IO-Link	2x analog 0...10 V	IO-Link	DP1222	\$311.37	DP3222	\$324.92
	Relay-Adapter	2x digital PNP	2x Solid state relay normally open	DP1603	\$198.18	DP3603	\$225.94
	Relay-Adapter	2x digital PNP	2x solid state relay normally closed	DP1613	\$198.18	DP3613	\$225.94
	Speed monitor	1x digital PNP	2x digital PNP/NPN	DP2122	\$310.07	DP4122	\$294.80
	Limit switch	1x analog 4...20 mA	1x digital, 1x analog	DP2200	\$265.53	DP4200	\$251.76
	Counter	2x digital PNP	2x digital PNP/NPN	DP2302	\$316.10	DP4302	\$299.10
	Pulse extender	2x digital PNP	2x digital PNP	DP2402	\$277.80	DP4402	\$271.13
	IO-Link inline bluetooth adaptor	-	-	-	-	EIO330	\$322.34
	IO-Link Data Splitter PNP, use with EVC843 (below)	-	-	E43406	\$337.40	-	-

## ACCESSORIES



Type	Description	Order no.	Price
	Mounting Clip <ul style="list-style-type: none"> <li>Reliable fixing of the IO-Link mini display</li> <li>Easy, quick and secure mounting</li> <li>Robust design for use in harsh industrial environments</li> </ul>	E89208	\$23.67
	IO-Link repeater <ul style="list-style-type: none"> <li>Extension of IO-Link range up to 80 m</li> <li>Series connection of max. 3 repeaters possible</li> </ul>	E30444	\$464.79

## IO-Link MASTER SENSOR VALUE DISPLAY



Type	Description	Order no.	Price
<b>128 x 128 resolution, 1.44" TFT LED display</b>			
	IO-Link display · Connection to master · Assignment of the values displayed by the controller ·	E30391	\$281.67
	IO-Link inline display · Connection between master and sensor Visualisation of the values of the connected sensor	E30430	\$331.81
	IO-Link display · Shows all sensor process values connected to a master	E30443	\$441.12



# IO-Link System Components

## ELECTRONIC CIRCUIT BREAKER

- Modular, selective protection in plant and machinery
- Reliable circuit protection allows reduction of wire cross sections
- Fast replacement using innovative connection technology
- Detection of triggering cause (via IO-Link)
- Current and voltage measurement in each channel (via IO-Link)

### Modular installation

The system has a modular structure and consists of a supply module to feed max. 40 A. The protection modules can be mounted side by side. This is done via a simple clip mechanism, completely without any bridges, jumpers or the like. Potential modules are used to distribute the circuits and wire the ground lead. Easy mounting and minimised wiring complexity save cost and time. With the standard version the user can connect up to 10 and with the IO-Link version up to 8 safety modules to the head module.

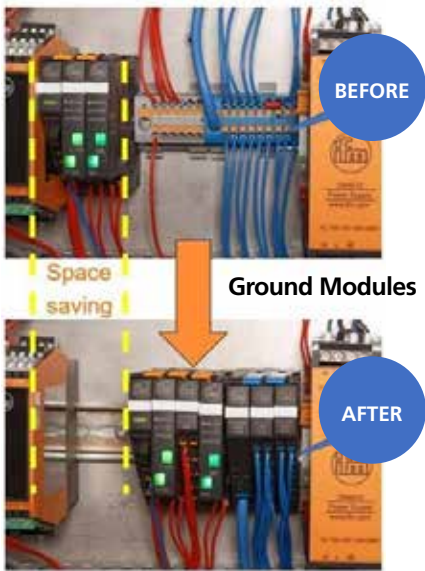

### Products

	Inputs [V DC]	Nominal current [A]	Order no.	Price	Order no.	Price
1	Supply modules		IO-Link		standard	
	24, 40 A	–	DF2101	\$162.25	DF1100	\$66.92
2	Protection modules		IO-Link		standard	
	–	2 x 2	DF2212	\$131.69	DF1212	\$118.56
	–	2 x 4	DF2214	\$131.69	DF1214	\$118.56
	–	2 x 6	DF2216	\$131.69	DF1216	\$118.56
	–	1 x 8	DF2208	\$115.12	DF1208	\$104.36
	–	1 x 10	DF2210	\$115.12	DF1210	\$104.36
	–	2 x 1...10	DF2220	\$150.41	DF1220	\$140.73
GND and load modules						
3	Feed module GND, 1 x 10 mm <sup>2</sup>				DF3100	\$26.90
4	Potential module GND, 10 x 2,5 mm <sup>2</sup>				DF3110	\$66.28
5	Potential module LOAD 2 x 5 x 2,5 mm <sup>2</sup>				DF3200	\$72.73
6	Feed module				DF3210	\$53.58

### Accessories

Type	Description	Order no.	Price
	IO-Link connection cable, 0,5 m, M12 connector	E12613	\$55.95
	IO-Link connection cable, 2 m, open end	E12614	\$56.59





# Power supplies

24V DC SWITCHED MODE POWER SUPPLIES - HIGH EFFICIENCY, SPACE SAVING



Permanent output current / peak at 24 V	Input voltage [V AC]	Buffer time (120/230 V AC) [ms]	Order no.	Price
<b>24 V DC switched-mode power supplies for control cabinet installation</b>				
1.25 A	100...240	-	DN1030	\$215.18
2.5 A	100...240	-	DN1031	\$255.20
3.3 A / 3.3 A	100...240	30 / 128	DN4011	\$335.47
4.1 A / 60 A	100...240	27 / 27	DN1022	\$401.96
5 A / 6 A	100...240	80 / 78	DN4012	\$444.35
10 A / 12 A	100...240	46 / 47	DN4013	\$580.56
20 A / 24 A	100...240	26 / 26	DN4014	\$757.65
5 A / 6 A	2 x 380...480	27 / 48	DN4032	\$517.08
10 A / 12 A	3 x 380...480	34 / 54	DN4033	\$618.64
20 A / 30 A	3 x 380...480	22 / 22	DN4034	\$828.23
40 A / 60 A	100...240	27 / 27	E84016	\$1,313.24
40 A / 60 A	3 x 380...480	-	E84036	\$1,119.15
<b>24 V DC switched-mode power supplies for FIELD MOUNTING IP67</b>				
12 A, 1 PH	100...240	44 / 44	DN4218	\$1,544.78
20 A, 3 PH	400...480	24 / 24	DN4234	\$1,605.67
20 A, 3 PH	400...480	24 / 24	DN4237	\$1,711.54

## IO-LINK SYSTEM APPLICATION REPORT: PURE AND ULTRA-PURE WATER TREATMENT SYSTEMS

For more than 30 years, EnviroFALK GmbH has been designing, manufacturing and selling pure and ultra-pure water systems for a wide range of industries worldwide. Fundamentally, water as it comes out of the tap does not present a challenge for process sensors. Ultra-pure water, however, is a whole different story. The sensors used in these treatment processes have to be much more efficient and robust.

With IO-Link, we have full transparency right down to each individual sensor via the HMI and the controller.

In pure and ultra-pure water systems, ifm sensors allow stream-lined yet precise process monitoring. IO-Link reduces the storage costs and mounting complexity, which results in significant costs savings, while also creating complete transparency of all processes as companies move into the digital age. In a nutshell: a clean solution!



The IO-Link communication protocol provides access down to each individual sensor. This creates maximum transparency and facilitates troubleshooting.



Decentralised IO-Link masters save space in the control cabinet and offer the possibility to connect sensors and actuators. Connection to the plant controller is made via Profinet.



# IO-Link System - with HMI PLC controller

FIELD PROGRAMMABLE LOGIC CONTROLLER FOR INDUSTRIAL ENVIRONMENTS

Free up electrical cabinet space while improving ergonomics for operators

### Example controls architecture

1. HMI Controller
2. 16 IO-Link Masters
3. 90 IO-Link Inputs
4. 38 Digital Outputs
5. CODESYS V3.5 Software
6. IIoT Software Connectors

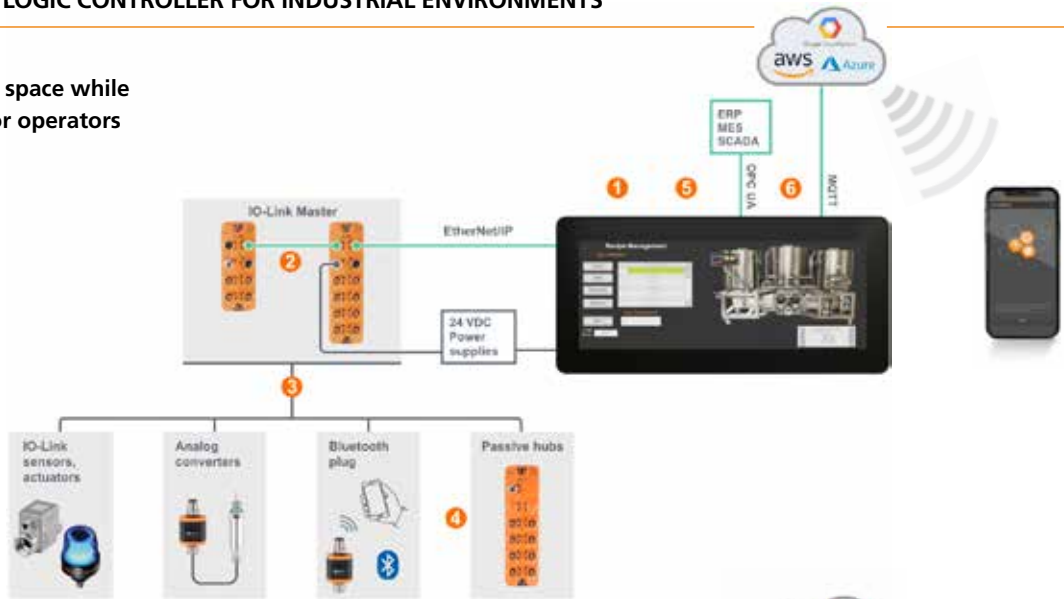

For more insights:



## PANEL PROGRAMMABLE LOGIC CONTROLLER

Robust 2 in 1 cloud connector and powerful controller, refer page 21

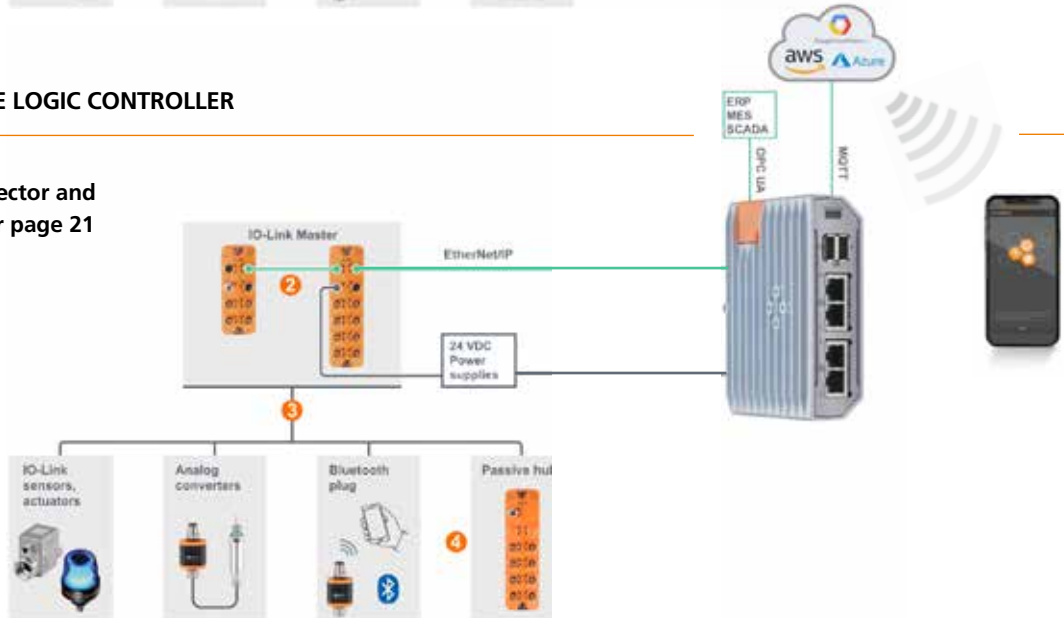

## CODESYS SOFTWARE FOR II.0 INDUSTRIAL CONTROLS

Easy to use software for application programming and configuration setting





# Fully functional PLC with integrated HMI



Free up space in your electrical cabinets and improve ergonomics for your operators! Reduce the size of your electrical cabinets by field mounting your HMI controller close to your process within easy reach of operators.

LED displays with optical bonding	Order No.		
	CR1152	CR1077	CR1203
Display	5.0"	7.0"	12.3" (wide)
Prices	\$2,850.27	\$4,510.17	\$5,669.35
Aspect ratio	16:10	16:10	8:3
Resolution	800 x 480	800 x 480	1280 x 480
Colour depth	24 bit	18 bit	24 bit
Touch	●	●	●
Controller with GPU	dual core, 800 Mhz	quad core, 1.2 GHz	quad core, 1.2 GHz
Memory (RAM) [GByte]	1	1	1
Memory (flash) [GByte]	4	8	8
Buttons (RGB backlit)	4	6	-
Navigation element	cross	cross	-
<b>COMMUNICATION INTERFACE</b>			
Ethernet	1	2	2
CAN	4	4	4
USB 2.0	1	2	2
Analogue video interfaces	2	4	4
<b>AUDIO INTERFACES</b>			
Stereo Out (amplified)	1	1	1
Line In	-	1	1
Headphones Out	-	1	1
<b>INPUTS / OUTPUTS</b>			
Digital In BL	2	2	2
Digital Out 2.5 A	2	2	2

## HMI controllers

HMI controllers	CR1140 - 4.3"	CR1077 - 7"	CR1152 - 10"	AE1300 - 12x4"
Codesys 3.5	✓	✓	✓	✓
Modbus	✓	✓	✓	✓
EDP	✓	✓	✓	✓
EtherCat	✗	✗	✗	✓
Profinet	✗	✗	✗	✓
Ethernet	1	2	2	2
USB	1	1	1	1
CAN	1	4	4	4

## POWERFUL, VERSATILE CABINET PROGRAMMABLE LOGIC CONTROLLER



- 2-in-1: cloud connector and powerful controller
- Perfect IO-Link integration
- Plug & Work access to the I/O level via Ethernet
- Can be mounted on the DIN rail in different orientations
- CODESYS 3.5

Description	Order no.	Price
<b>IIoT Controller IP20 1S</b>		
Communication interface Ethernet; USB, Number of Ethernet interfaces 4, Number of USB interfaces 2	AE3100	\$1,382.96





# Moneo: IIoT platform for industry and production



A new approach to collecting sensor data

## TALK DIRECTLY TO YOUR IIoT SYSTEM WITHOUT PLC INTERVENTION

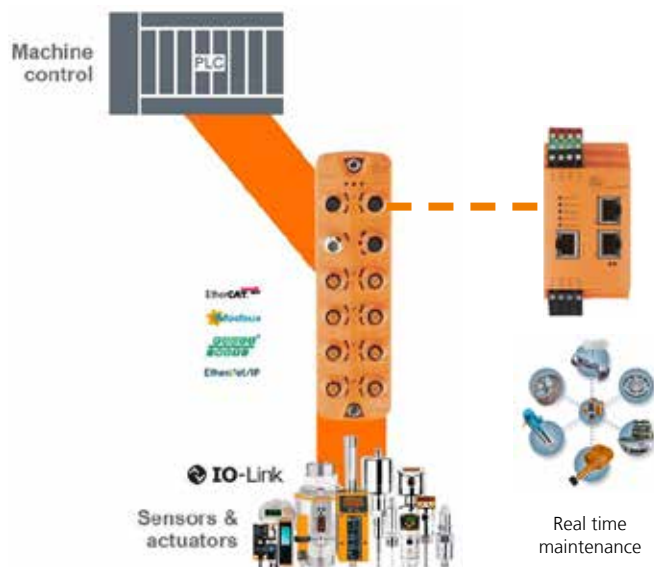

Digital communication technology allows you to get more detailed information from your sensors. But, overloading your PLC will limit the amount of that data you can actually receive and use.

Using IO-Link technology with a Y-path connection gives you full access to real-time machine information without overloading your system.

### Don't let your PLC carry the entire burden!

The PLC has been a mainstay of automation since the 1970's and it is used to control industrial automated equipment. With the advent of Ethernet technologies and IIoT applications, the PLC has been forced to carry more and more information that is not necessarily used to control the machines.

The PLC only uses 5% of the sensor information.  
Data size is in bytes and cycle time in msec.

## Y-PATH CONNECTIVITY

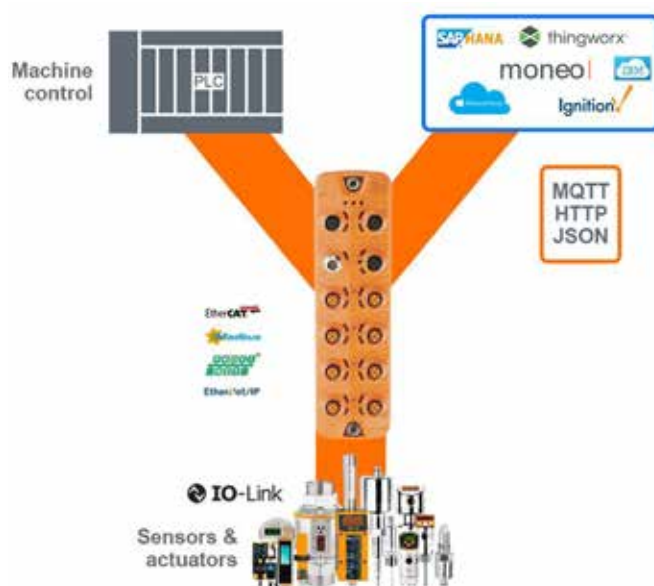

Imagine if your sensors could talk directly to your SCADA, MES, ERP, CMMS systems directly without the PLC intervention and still send the information to the PLC for machine control?

### This is now possible with the Y-path from ifm.

Our IO-Link masters come with a separate IIoT port with a dedicated IP address for the IT infrastructure. This works in any number of industrial applications without affecting the machine control side of the system. This unique approach allows you to send information and data directly to where it is needed.

HMI, visualization computers, servers, PCs, etc. use 95% of the sensor information.  
Data size is in Mbytes and cycle time is in seconds.



# moneo | application reports

## CONTINUOUS CONDITION MONITORING OF SLUDGE AND DRAINAGE PUMPS IN THE WASTE WATER INDUSTRY



### Waste water treatment plant Kressbronn, Germany

At the waste water treatment plant Kressbronn, numerous pumps with various characteristics are used to convey liquid media through the various areas of the waste water treatment plant. Unplanned downtime can have severe repercussions, potentially disrupting the entire municipal waste water disposal system or even causing a complete halt to its operations.

In the case of liquid pumps, bubbles can form if the pressure difference between the inlet and outlet side is too high: Resulting in cavitation. The tiny bubbles filled with vapour collapse suddenly due to the high pressure. This sudden collapse creates shock waves that repeatedly erode the pump element and the pump housing from the inside. If the damage becomes too great, the pump can no longer work properly. In the worst case, expensive repairs or even the replacement of the pump may become necessary.

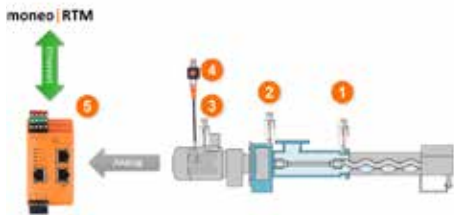

1. Vibration sensor pump bearing NDE VSA001
2. Vibration sensor pump bearing DE VSA001
3. Vibration sensor motor bearing VSA001
4. Temperature sensor motor TP3232 + TS2229
5. Diagnostic electronics for vibration sensors VSE150



1. Vibration motor bearing [mg]
2. Cavitation recognition pump DE [mg]
3. Time counter cavitation DE [h]
4. Vibration pump bearing DE [mg]
5. Cavitation recognition pump NDE
6. Time counter cavitation NDE [h]
7. Vibration pump bearing NDE [mg]
8. V-effective pump bearing NDE [mm/s]
9. V-effective pump bearing DE [mm/s]
10. V-effective motor bearing [mm/s]
11. Motor temperature [C°]

## CONTINUOUS RADAR LEVEL MEASUREMENT OF CIP TANKS, WITH MONEO RTM



The non-contact level measurement principle with radar offers many advantages for monitoring a CIP system. Contact with media (acids, alkalis) and heating coils is avoided so that the measurement is independent of the temperature and density of the media. These advantages complete the quality assurance of the CIP cleaning process.

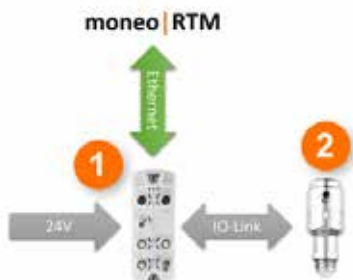

1. IO-Link master (e.g. AL1351)
2. 1 LW2720 level sensor LW2720



1. Level in metres
2. Volume in litres



# moneo | application guide

## MONEO | APPLIANCE STANDALONE SYSTEM

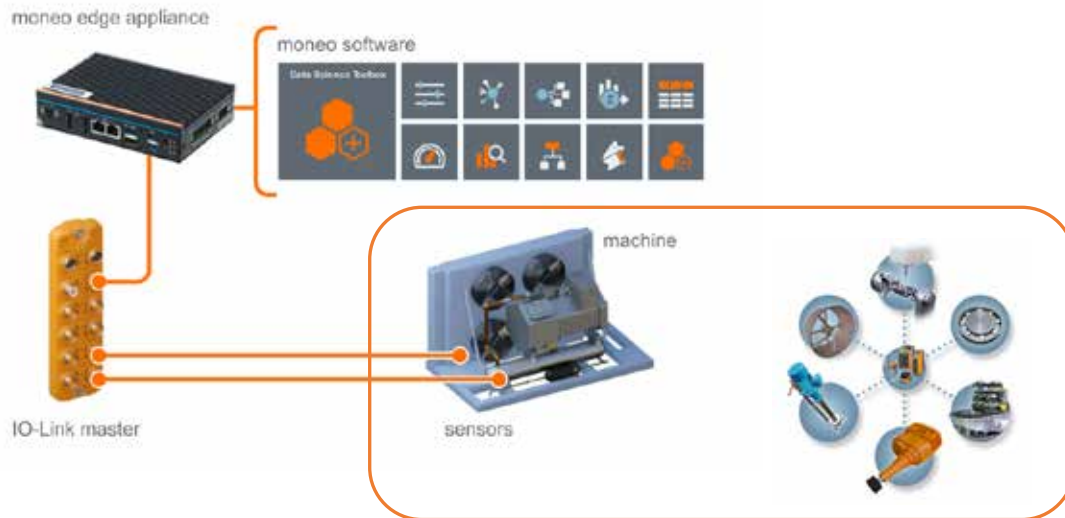

The moneo | appliance is an industrial PC (IPC) preloaded with all moneo software products (license sold separately). The onboard appliance management system (AMS) allows for data backup, software updates, and other administrative tasks.

The appliance provides a standalone environment you can use for a condition based monitoring proof-of-concept of the moneo platform. It can be implemented locally without connecting to your existing IT infrastructure until you are ready to integrate into your SCADA system



### moneo Appliance

IT hardware for operation of moneo  
 providing memory capacity and processing power  
 moneo software preinstalled  
 Easy set-up without requiring special IT knowledge

QHA210

\$4,048.18

## MONEO | VAPPLIANCE

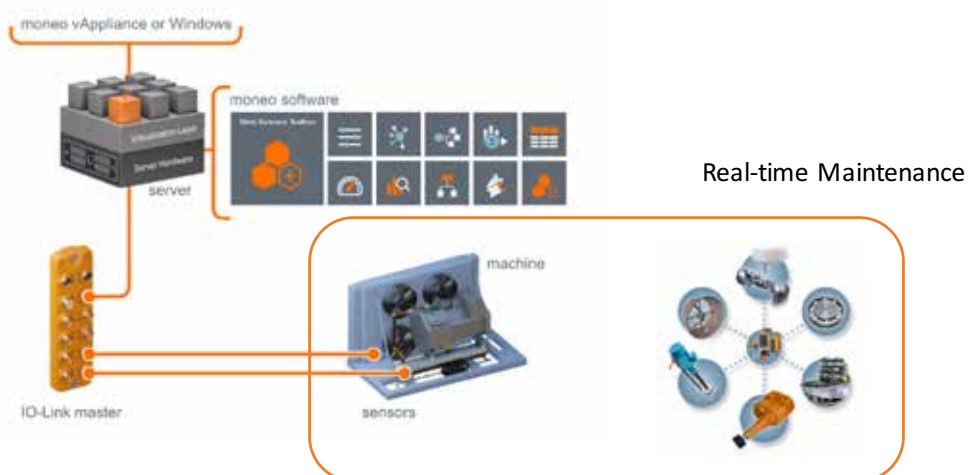

With the moneo | vAppliance, you can use virtual technology and computing power, network connection and storage capacity of the existing servers and storage systems of your current IT infrastructure.



### Moneo vAppliance

For the operation of moneo in virtualisation environments

QVA200

\$10,737.48



# moneo | application report

CONTINUOUS CONDITION MONITORING OF A REFRIGERATION SYSTEM COMPRESSOR SET



- **Continuous diagnostics:** Detection of motor damage with full coverage of the real operating hours.
- **Early detection:** Monitoring of unbalance, wear and overall vibration. Detection of unbalance vibration, shaft misalignment and rotor wear in the compressor.
- **Maximum efficiency:** Permanent diagnostics of winding problems or dirt accumulation in the electric motor by temperature measurement.
- **Easy integration:** ifm provides individual solutions suited for different types of compressors.

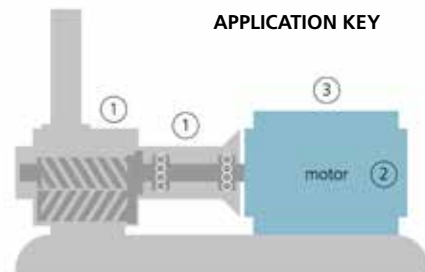

Application for 1 compressor		Without additional service	
Sensors for installation on the motor Variable design		Preconfigured hardware and software	
<p>① Vibration sensor screw mounting or vibration sensor adhesive mounting with cable</p>	<p>③ Temperature sensor and measured signal converter for temperature sensors</p>	<p>moneo appliance</p>	<p>moneo vAppliance</p>
<p>② Inductive sensor for rotational speed detection</p>	<p>Connection cable with socket (cable length selectable)</p>	<p>Diagnostic unit</p>	<p>Power supply</p>





**Explore the future.**  
Try out the IIoT software  
moneo.



**moneo OS: the IIoT platform**

The heart and management tool for all moneo apps. Intelligent device integration enables a digital image of the system. Tool for calculating data flow models and with automatic alarm function.

QMS001

\$1,054.38



**moneo infopoints: The data volume**

Scalable applications through licensing of data and information points.

QMI001

\$26.47



**moneo edgeConnect: the communication interface**

Translates sensor data into readable information and bridges the gap between OT and IT.

QMC206

\$1,118.94

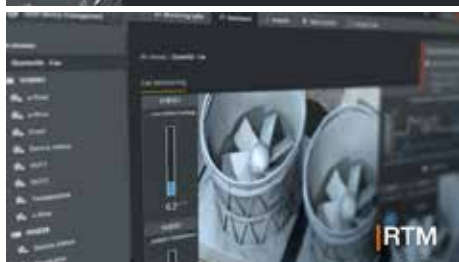

**moneo RTM: the analysis software**

The condition monitoring app for plant monitoring and real-time maintenance. Comprehensive data analysis, less downtime, more efficient maintenance planning and cost-optimised production processes.

QMR001

\$1,764.48



**moneo DataScience Toolbox: the artificial intelligence**

The intelligent toolbox for intelligent monitoring and optimisation of manufacturing processes via early warnings and alarms.

QM9103

\$5,379.50



**moneo configure: the parameter setting software**

The app for parameter setting and management of IO-Link devices and ifm IO-Link masters. Integrated, manufacturer-independent IODD management for time-saving sensor parameter setting. Cockpit for parallel display of parameters and process values.

FREE



# moneo | software modules

## PERFORMANCE FEATURES

	<p><b>Configure device</b></p> <ul style="list-style-type: none"> <li>Find all devices connected to the network</li> <li>Configure IP addresses of IO-Link masters</li> <li>Adjust parameters of IO-Link sensors</li> <li>Quickly view real time process values from sensors</li> </ul>
	<p><b>IODD management</b></p> <ul style="list-style-type: none"> <li>View local and online IODD catalog</li> <li>Install updates</li> <li>Import IODD files</li> </ul>
	<p><b>Device management</b></p> <ul style="list-style-type: none"> <li>View all devices and calculated values</li> <li>Select desired infopoints from each sensor or calculated value</li> <li>Manually add new devices by IP address</li> </ul>
	<p><b>Calculated values</b></p> <ul style="list-style-type: none"> <li>Simple drag and drop interface for logic/math functions</li> <li>Preconfigured templates available or create your own</li> <li>Produces additional infopoints from sensor values</li> </ul>
	<p><b>Monitoring table</b></p> <ul style="list-style-type: none"> <li>Displays all process values with time/date stamp from devices currently on the network</li> <li>Provides verification that devices have been properly added</li> </ul>
	<p><b>Dashboard</b></p> <ul style="list-style-type: none"> <li>Drag and drop interface to quickly create custom dashboards for a machine or process</li> <li>Images and drawings of equipment or processes can be uploaded             <ul style="list-style-type: none"> <li>Selectable visualizations – thermometer, gauge, traffic light, chart, etc.</li> </ul> </li> </ul>
	<p><b>Data Science Toolbox</b></p> <ul style="list-style-type: none"> <li>Smart machine learning algorithms</li> <li>Models trained using normal operating conditions, no fault conditions needed</li> <li>Easy guided templates for configuration</li> <li>Automatic machine evaluation and alert settings</li> </ul>
	<p><b>Analysis</b></p> <ul style="list-style-type: none"> <li>Provides tools to view historical data from the system as graphical trends</li> <li>Simply drag in process values and select the time range</li> <li>Export data for further analysis</li> </ul>
	<p><b>Settings &amp; rules</b></p> <ul style="list-style-type: none"> <li>Define thresholds for warning and alarm conditions</li> <li>Establish rules for actions when threshold values are reached including raw data recording &amp; e-mail/text notification</li> </ul>
	<p><b>Tasks &amp; tickets</b></p> <ul style="list-style-type: none"> <li>Review warning/alarm history and check current status</li> <li>Acknowledge and clear open warnings and alarms</li> </ul>
	<p><b>Raw data recording</b></p> <ul style="list-style-type: none"> <li>Set rules for triggering of raw vibration sensor data recording</li> <li>Recording can be triggered by a warning/alarm or time based</li> </ul>
	<p><b>edgeConnect</b></p> <ul style="list-style-type: none"> <li>Transfer time stamped process data and information to higher level systems either on-premise or in the cloud</li> <li>Uses standardized interfaces like MQTT &amp; OPC UA for on-premise connection</li> <li>Ready-to-go cloud connectors for easy integration</li> </ul>

**moneo | software license bundle**  
 Package with all software licenses for a condition monitoring application, including 150 infopoints. Additional infopoints (up to a total of 5000) may be purchased separately using part number QMI001.

QM9102

\$8,002.54

**Data Science Toolbox / Smart Limit Watcher license.**  
 Requires QM9102 moneo | software bundle sold separately.

QM9103

\$5,379.50

**moneo | infopoints license, priced per point.**  
 Purchase additional infopoints up to 5000 total.

QMI001

\$26.47

## CREATE A MONEO SYSTEM TO SUIT YOUR NEEDS





# Connection technology



## Selection Guide



Note: refer to ifm product datasheet for operating voltage range and max. current load data!



## Technology

### Select the right connector for your application!



**EVC series black PUR rubber**, Halogen-free, nickel-plated brass nut. Designed for industrial applications, esp. where cables contact oil/grease



**EVT series orange PVC**, SS316L nut. Designed F&B industry use, where cables contact water & plant washdown cleaning chemicals



**EVF series grey MPPE**, Halogen-free, SS316L grip nut. Designed F&B industry use, where cables contact water & plant washdown cleaning chemicals (avoid outdoor UV exposure)



**EVM series black PUR rubber**, Halogen-free, SS316L nut. Designed for harsh environments, ie. mobile machines, -40degC. Refrigeration, Outdoor UV exposure.



**EVC D-Coded ethernet connectors Green PUR rubber**, Halogen-free, nickel-plated brass nut. Designed for industrial applications, esp. where cables contact oil/grease



**EVF D-Coded ethernet connectors grey MPPE**, Halogen-free, SS316L grip nut. Designed F&B industry use, where cables contact water & plant washdown cleaning chemicals (avoid outdoor UV exposure)



**EVC CAN bus connectors rubber**, Halogen-free, SS316L nut. Designed for harsh environments, ie. mobile machines, -40degC. Refrigeration, Outdoor UV exposure.

## ANGLED M12 SOCKET, 4PIN, IP69K, 4 AMP (MAX)

Wiring	EVC		EVT		EVF		EVM	
	EVC Industrial	Price	EVT F&B	Price	EVF F&B	Price	EVM Outdoor	Price
	Black, TPU		Orange, PVC		Grey, MPPE		Black, TPU	
Nut Material	Ni Pl brass		SS 316 L		SS 316 L		SS 316 L	
2 m	EVC004	\$32.92	EVT067	\$37.87	EVF067	\$46.91	EVM004	\$41.74
5 m	EVC005	\$38.52	EVT004	\$43.25	EVF004	\$47.77	EVM005	\$49.06
10 m	EVC006	\$47.34	EVT005	\$53.15	EVF005	\$58.96	EVM006	\$58.10
15 m	EVC086	\$67.78	EVT094	\$60.04	EVF094	\$73.16	EVM019	\$67.35
20 m	EVC087	\$78.54	EVT095	\$70.36	-	-	-	-
25 m	EVC088	\$83.71	EVT006	\$83.06	EVF006	\$92.31	EVM012	\$91.02
40 m	-	-	EVT066	\$113.40	-	-	-	-
50 m	EVC715	\$139.87	-	-	EVF479	\$160.74	EVM010	\$146.54
60 m	-	-	EVT068	\$153.64	-	-	-	-

## STRAIGHT M12 SOCKET, 4PIN, IP69K, 4 AMP (MAX)

Wiring	EVC		EVT		EVF		EVM	
	EVC Industrial	Price	EVT F&B	Price	EVF F&B	Price	EVM Outdoor	Price
	Black, TPU		Orange, PVC		Grey, MPPE		Black, TPU	
Nut Material	Ni Pl brass		SS 316 L		SS 316 L		SS 316 L	
2 m	EVC001	\$32.92	EVT064	\$37.87	EVF064	\$46.48	EVM001	\$41.74
5 m	EVC002	\$38.52	EVT001	\$43.25	EVF001	\$47.77	EVM002	\$49.06
10 m	EVC003	\$47.34	EVT002	\$53.15	EVF002	\$58.96	EVM003	\$58.10
15 m	EVC082	\$67.78	EVT092	\$60.04	EVF092	\$76.39	EVM018	\$67.35
20 m	EVC083	\$78.54	EVT093	\$70.36	-	-	-	-
25 m	EVC084	\$83.71	EVT003	\$83.06	EVF003	\$92.31	EVM014	\$91.02
40 m	EVC759	\$114.26	EVT418	\$113.40	-	-	-	-
50 m	EVC710	\$139.87	-	-	EVF484	\$186.99	-	-
60 m	-	-	EVT343	\$153.64	-	-	EVM065	\$174.51
70 m	-	-	EVT438	\$221.85	-	-	-	-

## ANGLED M12 SOCKET, 5PIN, IP69K, 4 AMP (MAX)

Wiring	EVC		EVT		EVF		EVM	
	EVC Industrial	Price	EVT F&B	Price	EVF F&B	Price	EVM Outdoor	Price
	Black, TPU		Orange, PVC		Grey, MPPE		Black, TPU	
Nut Material	Ni Pl brass		SS 316 L		SS 316 L		SS 316 L	
2 m	EVC073	\$35.50	-	-	-	-	EVM039	\$43.90
5 m	EVC074	\$43.90	EVT013	\$48.42	EVF013	\$54.66	EVM040	\$54.01
10 m	EVC075	\$60.04	EVT014	\$64.55	EVF014	\$72.95	EVM041	\$71.87
15 m	EVC423	\$67.78	EVT104	\$80.48	-	-	-	-
25 m	-	-	-	-	EVF015	\$127.60	-	-



## STRAIGHT M12 SOCKET, 5PIN, IP69K, 4 AMP (MAX)

	EVC		EVT		EVF		EVM	
	EVC Industrial	Price	EVT F&B	Price	EVF F&B	Price	EVM Outdoor	Price
<b>Cable Material</b>	Black, TPU		Orange, PVC		Grey, MPPE		Black, TPU	
<b>Nut Material</b>	Ni Pl brass		SS 316 L		SS 316 L		SS 316 L	
2 m	EVC070	\$35.50	EVT235	\$44.11	-	-	EVM036	\$43.90
5 m	EVC071	\$43.90	EVT010	\$48.42	EVF010	\$54.66	EVM037	\$54.01
10 m	EVC072	\$60.04	EVT011	\$64.55	EVF011	\$72.95	EVM038	\$71.87
15 m	EVC197	\$67.78	-	-	-	-	-	-
20 m	EVC198	\$76.82	-	-	-	-	-	-
25 m	EVC199	\$92.10	EVT012	\$113.18	EVF012	\$127.60	-	-
30 m	EVC561	\$182.69	-	-	-	-	-	-
40 m	-	-	EVT420	\$152.13	-	-	-	-
50 m	EVC562	\$304.91	-	-	-	-	-	-
60 m	EVC591	\$365.16	-	-	-	-	-	-

## STRAIGHT M12 PLUG, STRAIGHT M12 PLUG, 4PIN, IP69K, 4 AMP (MAX)

	EVC		EVT		EVF	
	EVC Industrial	Price	EVT F&B	Price	EVF F&B	Price
<b>Cable Material</b>	Black, TPU		Orange, PVC		Grey, MPPE	
<b>Nut Material</b>	Ni Pl brass		SS 316 L		SS 316 L	
1m	EVC556	\$31.42	-	-	-	-
2 m	EVC076	\$28.83	EVT071	\$41.53	EVF071	\$46.05
5 m	EVC077	\$37.66	EVT072	\$47.34	EVF072	\$53.15
10 m	EVC078	\$55.95	EVT073	\$56.38	EVF073	\$69.93
20 m	EVC177	\$78.11	-	-	-	-
25 m	-	-	EVT350	\$80.91	-	-

## ANGLED M12 PLUG, STRAIGHT M12 PLUG, 4PIN, IP69K, 4 AMP (MAX)

	EVC		EVT	
	EVC Industrial	Price	EVT F&B	Price
<b>Cable Material</b>	Black, TPU		Orange, PVC	
<b>Nut Material</b>	Ni Pl brass		SS 316 L	
2 m	EVC079	\$28.83	EVT088	\$41.53
5 m	EVC080	\$37.66	EVT090	\$47.34
10 m	EVC081	\$55.95	EVT327	\$53.15

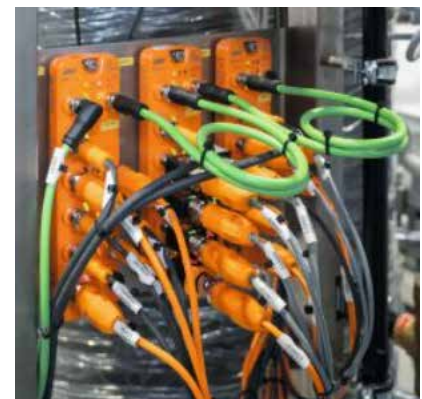

## WIRABLE - INDUSTRIAL M12 SOCKETS & M12 PLUGS, 4PIN, IP69K, 4 AMP (MAX)

Wiring	EVC		EVC		EVC		EVC	
	EVC Industrial	Price	EVC Industrial	Price	EVC Industrial	Price	EVC Industrial	Price
<p>1 — BN 2 — WH 3 — BU 4 — BK</p>	Orange, PA		Orange, PA		Orange, PA		Orange, PA	
Cable Material	Orange, PA		Orange, PA		Orange, PA		Orange, PA	
Nut Material	Ni Pl brass		Ni Pl brass		Ni Pl brass		Ni Pl brass	
-	EVC810	\$34.64	EVC811	\$34.64	EVC812	\$34.64	EVC813	\$34.64

## WIRABLE - INDUSTRIAL M12 SOCKETS & M12 PLUGS, 5PIN, IP69K, 4 AMP (MAX)

Wiring	EVC		EVC		EVC		EVC	
	EVC Industrial	Price	EVC Industrial	Price	EVC Industrial	Price	EVC Industrial	Price
<p>1 — BN 2 — WH 3 — BU 4 — BK 5 — GY</p>	Orange, PA		Orange, PA		Orange, PA		Orange, PA	
Cable Material	Orange, PA		Orange, PA		Orange, PA		Orange, PA	
Nut Material	Ni Pl brass		Ni Pl brass		Ni Pl brass		Ni Pl brass	
-	EVC814	\$37.23	EVC815	\$37.23	EVC816	\$37.23	EVC817	\$37.23

## WIRABLE - WASHDOWN M12 SOCKETS & M12 PLUGS, 4PIN, IP69K, 4 AMP (MAX)

Wiring	EVF		EVF		EVF		EVF	
	EVF F&B	Price	EVF F&B	Price	EVF F&B	Price	EVF F&B	Price
<p>1 — BN 2 — WH 3 — BU 4 — BK</p>	Grey, PA		Grey, PA		Grey, PA		Grey, PA	
Cable Material	Grey, PA		Grey, PA		Grey, PA		Grey, PA	
Nut Material	SS316L		SS316L		SS316L		SS316L	
-	EVF565	\$52.07	EVF566	\$52.07	EVF567	\$52.07	EVF568	\$52.07

## WIRABLE - WASHDOWN M12 SOCKETS & M12 PLUGS, 5PIN, IP69K, 4 AMP (MAX)

Wiring	EVF		EVF		EVF		EVF	
	EVF F&B	Price	EVF F&B	Price	EVF F&B	Price	EVF F&B	Price
<p>1 — BN 2 — WH 3 — BU 4 — BK 5 — GY</p>	Grey, PA		Grey, PA		Grey, PA		Grey, PA	
Cable Material	Grey, PA		Grey, PA		Grey, PA		Grey, PA	
Nut Material	SS316L		SS316L		SS316L		SS316L	
-	EVF569	\$56.38	EVF570	\$56.38	EVF571	\$56.38	EVF572	\$56.38

## JUMPER, STRAIGHT M12 SOCKET, STRAIGHT M12 PLUG, 4PIN, IP69K, 4 AMP (MAX)

Wiring	EVC		EVT		EVF		EVM	
	EVC Industrial	Price	EVT F&B	Price	EVF F&B	Price	EVM Outdoor	Price
<b>Cable Material</b>	Black, TPU		Orange, PVC		Grey, MPPE		Black, TPU	
<b>Nut Material</b>	Ni Pl brass		SS 316 L		SS 316 L		SS 316 L	
0.3 m	EVC010	\$43.25	EVT040	\$66.71	EVF040	\$77.25	-	-
0.6 m	EVC011	\$44.54	EVT041	\$67.57	EVF041	\$78.11	-	-
1 m	EVC012	\$45.83	EVT042	\$72.95	EVF042	\$83.71	-	-
2 m	EVC013	\$49.06	EVT043	\$73.81	EVF043	\$85.00	EVM089	\$57.02
5 m	EVC014	\$60.90	EVT044	\$80.26	EVF044	\$92.53	EVM090	\$70.79
10 m	EVC108	\$78.11	EVT045	\$91.24	EVF045	\$105.22	-	-
15 m	EVC117	\$95.54	EVT109	\$97.26	-	-	-	-
20 m	EVC118	\$111.46	-	-	-	-	-	-
25 m	-	-	EVT359	\$116.63	-	-	-	-

## JUMPER, ANGLED M12 SOCKET, STRAIGHT M12 PLUG, 4PIN, IP69K, 4 AMP (MAX)

Wiring	EVC		EVC		EVF		EVT	
	EVC Industrial	Price			EVF F&B	Price	EVT F&B	Price
<b>Cable Material</b>	Black, TPU				Grey, MPPE		Orange, PVC	
<b>Nut Material</b>	Ni Pl brass				SS 316 L		SS 316 L	
0.3 m	EVC015	\$43.25	-	-	EVF046	\$77.25	-	-
0.6 m	EVC016	\$44.54	-	-	EVF047	\$78.11	-	-
1 m	EVC017	\$45.40	-	-	EVF048	\$83.71	-	-
2 m	EVC018	\$49.06	-	-	EVF049	\$85.00	-	-
3 m	EVC103	\$50.35	-	-	EVF445	\$85.43	-	-
5 m	EVC019	\$60.47	-	-	EVF050	\$92.53	-	-
10 m	EVC109	\$78.11	-	-	EVF051	\$107.16	-	-
15 m	EVC133	\$94.46	-	-	-	-	-	-
20 m	EVC134	\$111.46	-	-	EVF503	\$141.16	-	-

## JUMPER, STRAIGHT M12 SOCKET, ANGLED M12 PLUG, 4PIN, IP69K, 4 AMP (MAX)

Wiring	EVC	
	EVC Industrial	Price
<b>Cable Material</b>	Black, TPU	
<b>Nut Material</b>	Ni Pl brass	
0.3 m	EVC025	\$43.25
0.6 m	EVC026	\$44.54
1 m	EVC027	\$45.83
2 m	EVC028	\$49.06
3 m	EVC140	\$53.36
5 m	EVC029	\$61.11
10 m	EVC342	\$68.43
20 m	EVC175	\$111.46

Other jumpers available on request:



Wiring		EVF		EVF		EVF			
	EVF F&B	Price	EVF F&B	Price	EVF F&B	Price	EVF F&B	Price	
<b>Cable Material</b>	Grey, MPPE		Grey, MPPE		Grey, MPPE		Grey, MPPE		
<b>Nut Material</b>	SS 316 L		SS 316 L		SS 316 L		SS 316 L		
0.25 m	EVF490	\$88.01	-	-	-	-	-	-	
0.5 m	EVF491	\$88.65	-	-	-	-	-	-	
1 m	EVF492	\$95.54	-	-	-	-	-	-	
2 m	EVF493	\$97.91	-	-	EVF480	\$49.71	EVF485	\$49.71	
5 m	EVF494	\$105.65	-	-	EVF481	\$57.02	EVF486	\$57.02	
10 m	EVF495	\$120.07	-	-	EVF482	\$70.15	-	-	
20 m	EVF496	\$141.16	-	-	EVF483	\$92.31	-	-	
50 m	-	-	-	-	EVF484	\$186.99	-	-	

JUMPER · M12 / M12 · 4-POLE (1 MM2 FOR REDUCED VOLTAGE DROP)

Wiring		EVC		EVC		EVC	
	EVC Industrial	Price	EVC Industrial	Price	EVC Industrial	Price	
<b>Cable Material</b>	Black, TPU		Black, TPU		Black, TPU		
<b>Nut Material</b>	Ni Pl brass		Ni Pl brass		Ni Pl brass		
0.3 m	-	-	-	-	-	-	
0.6 m	-	-	-	-	-	-	
1 m	-	-	EVC725	\$47.77	-	-	
2 m	EVC719	\$52.29	EVC726	\$52.29	EVC706	\$36.37	
5 m	EVC720	\$64.12	EVC727	\$64.12	EVC707	\$42.39	
10 m	EVC721	\$79.19	-	-	EVC708	\$53.15	
15 m	-	-	-	-	-	-	
20 m	EVC722	\$100.70	-	-	EVC709	\$86.50	
50 m	-	-	-	-	EVC710	\$139.87	





## JUMPER, STRAIGHT M12 SOCKET, STRAIGHT M12 PLUG, 5PIN, IP69K, 4 AMP (MAX)



Wiring	EVC	EVT		
	EVC Industrial	Price	EVT F&B	Price
Cable Material	Black, TPU		Orange, PVC	
Nut Material	Ni Pl brass		SS 316 L	
0.6 m	EVC056	\$63.69	-	-
1 m	EVC057	\$64.55	EVT060	\$71.87
2 m	EVC058	\$68.43	EVT061	\$72.95
5 m	EVC059	\$79.19	EVT062	\$74.02
10 m	EVC189	\$97.05	EVT063	\$88.22
15 m	EVC190	\$113.62	-	-
20 m	EVC201	\$132.55	-	-
25 m	EVC202	\$168.27	-	-

## M12 SOCKET, 8PIN, IP69K, 2 AMP (MAX)

Wiring	E11		E11		E11	
Cable Material	Black, TPU	Price	Black, TPU	Price	Black, PUR	Price
Nut Material	Ni Pl brass		Ni Pl brass		Ni Pl brass	
2 m	E11231	\$77.46	E11950	\$60.90	E12281	\$86.93
5 m	E11232	\$95.54	E11807	\$92.74	E11230	\$111.25
10 m	E12169	\$97.91	E11311	\$123.51	E12360	\$153.85

## WIRABLE - INDUSTRIAL M18 SOCKETS, 4PIN, IP68, 4 AMP (MAX)

Wiring	E11		E11	
Material	Black, PA	Price	Black, PA	Price
-	E10137	\$25.82	E10013	\$25.82

## M12 SOCKET PNP/NPN INVERTER MODULE

## AC POWER 1/2 " SOCKET, 3PIN, IP67

Wiring	EVC Industrial	Price
Cable Material	Black, PUR	
Nut Material	Ni Pl brass	
2 m	EVC01E	\$45.19
5 m	EVC05E	\$78.54

Wiring	E11 Industrial	Price
Cable Material	Black, PUR	
Nut Material	Ni Pl brass	
2 m	E12282	\$33.35
5 m	E10210	\$46.91



### SCREENED (TO THE NUT) M12 SOCKET, 8PIN, IP69K, 2 AMP (MAX)

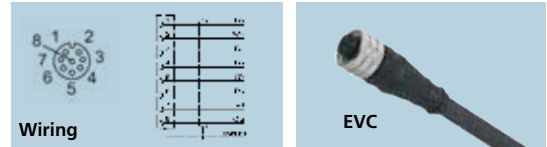

	EVC Industrial	Price
Cable Material	Black, TPU	
Nut Material	Ni Pl brass	
2 m	E12402	\$83.71
5 m	E12403	\$101.56
10 m	E12404	\$130.40

### SCREENED M12 SOCKET, 4PIN, IP69K, 4 AMP (MAX)



	EVC Industrial	Price	EVT F&B	Price	EVC Industrial	Price	EVT F&B	Price
Cable Material	Black, TPU		Orange, PVC		Black, TPU		Orange, PVC	
Nut Material	Ni Pl brass		SS 316 L		Ni Pl brass		SS 316 L	
2 m	-	-	EVT385	\$37.66	-	-	-	-
5 m	EVC542	\$49.06	EVT386	\$44.76	EVC539	\$49.06	EVT382	\$44.76
10 m	EVC543	\$62.40	EVT387	\$57.67	EVC540	\$62.40	EVT383	\$57.67
20 m	-	-	EVT441	\$86.72	-	-	-	-
25 m	EVC767	\$115.55	EVT388	\$97.48	-	-	EVT384	\$97.48
35 m	-	-	EVT442	\$127.60	-	-	-	-
50 m	-	-	EVT443	\$167.63	-	-	-	-

### SCREENED M12 SOCKET, 5PIN, IP69K, 4 AMP (MAX)



	EVC Industrial	Price			EVC Industrial	Price		
Cable Material	Black, TPU				Black, TPU			
Nut Material	Ni Pl brass				Ni Pl brass			
5 m	EVC548	\$54.01	-	-	EVC545	\$54.01	-	-
10 m	EVC549	\$72.73	-	-	EVC546	\$72.73	-	-
15m	EVC563	\$94.25	-	-	-	-	-	-



**Problem**  
Traditional cordsets with transparent housings are hard to see.



**ifm Solution**  
ifm cordsets have high visibility LEDs with good contrast.

## LED - M12 SOCKET, 4PIN, IP69K, 4 AMP (MAX)

Wiring	EVC		EVT		EVC		EVM	
	EVC Industrial	Price	EVT F&B	Price	EVC Industrial	Price	EVM Outdoor	Price
<b>Cable Material</b>	Black, TPU		Orange, PVC		Black, TPU		Black, TPU	
<b>Nut Material</b>	Ni Pl brass		SS 316 L		Ni Pl brass		SS 316 L	
2 m	EVC007	\$39.59	EVT069	\$44.76	EVC644	\$37.01	EVM007	\$49.28
5 m	EVC008	\$45.19	EVT007	\$50.57	EVC645	\$41.96	EVM008	\$55.30
10 m	EVC009	\$54.87	EVT008	\$60.04	EVC646	\$51.00	EVM009	\$65.41
25 m			EVT009	\$91.67			EVM011	\$97.91

## LED - M8 SOCKET, 3PIN, IP69K, 3 AMP (MAX)

Wiring	EVC		EVT	
	EVC Industrial	Price	EVT F&B	Price
<b>Cable Material</b>	Black, TPU		Orange, PVC	
<b>Nut Material</b>	Ni Pl brass		SS 316 L	
5 m	EVC148	\$45.19	EVT131	\$59.82
10 m	-		EVT132	\$71.01

## LED - M12 JUMPER CABLE WITH VALVE PLUG (TYPE A, B, C)

	EVC		EVC		EVC	
	M12 A type	Price	M12 B type	Price	M12 C type	Price
<b>Cable Material</b>	Black, TPU		Orange, PVC		Grey, MPPE	
0.3 m	E11416	\$47.55	E11421	\$47.55	E11426	\$53.36
0.6 m	E11417	\$48.63	E11422	\$48.63	E11427	\$55.09
1 m	E11418	\$50.57	E11423	\$51.86	E11428	\$56.16
2 m	E11419	\$54.01	E11424	\$54.01	E11429	\$60.47
5 m	E11420	\$66.28	E11425	\$66.28	E11430	\$71.22

## EX RATED SOCKETS FOR HAZARDOUS AREAS

Wiring	EVC	EVT
	<b>EVC Industrial</b>	<b>EVC Industrial</b>
	<b>Price</b>	<b>Price</b>
<b>Cable Material</b>	Blue, PUR	Blue, PUR
<b>Nut Material</b>	Ni Pl brass	Ni Pl brass
2 m	ENC01A	ENC04A
5 m	ENC02A	ENC05A
10 m	ENC03A	ENC06A



## JUMPER 1 X M12 PLUG, 2 X M12 SOCKET

Wiring	EVC	EVC	EVF	EVF
	<b>EVC Industrial</b>	<b>EVC Industrial</b>	<b>EVF F&amp;B</b>	<b>EVF F&amp;B</b>
	<b>Price</b>	<b>Price</b>	<b>Price</b>	<b>Price</b>
<b>Cable Material</b>	Black, TPU	Black, TPU	Grey, MPPE	Grey, MPPE
<b>Nut Material</b>	Ni Pl brass	Ni Pl brass	SS 316 L	SS 316 L
1 m	EVC431	EVC434	EVF329	EVF332
2 m	EVC432	EVC435	EVF330	-
5 m	EVC433	EVC436	EVF331	-

Note: For 8-pole sockets the core colours are not standardised. Refer to the ifm product datasheet.

## JUMPER, ANGLED M12 SOCKET, STRAIGHT M8 PLUG, 3PIN

## JUMPER, STRAIGHT M8 SOCKET, STRAIGHT M12 PLUG, 3PIN

Wiring	EVT
	<b>EVT F&amp;B</b>
	<b>Price</b>
<b>Cable Material</b>	Orange, PVC
<b>Nut Material</b>	SS 316 L
0.6 m	EVT266
1 m	EVT267
2 m	EVT268
5 m	EVT269

Wiring	EVT
	<b>EVT F&amp;B</b>
	<b>Price</b>
<b>Cable Material</b>	Orange, PVC
<b>Nut Material</b>	SS 316 L
0.3 m	EVT236
0.6 m	EVT237
1 m	EVT238
2 m	EVT239





Socket		Plug		E11		E11	
Wiring				EVC Industrial		Price	
Cable Material		Black, PA		EVC Industrial		Price	
Nut Material		Ni PI brass		E11552		\$28.19	
-				E11550		\$28.19	

WIRABLE - INDUSTRIAL M8 SOCKETS & M8 PLUGS, 4PIN, IP68, 4 AMP (MAX)

Note: Cable sheath 3.0...5.0 mm range

Socket		Plug		E11		E11	
Wiring				EVC Industrial		Price	
Cable Material		Black, PA		EVC Industrial		Price	
Nut Material		Ni PI brass		E11553		\$26.90	
-				E11551		\$26.90	

STRAIGHT M8 SOCKET, 3PIN, IP69K, 3 AMP (MAX)

Wiring		EVC		EVT		EVF		EVM	
		EVC Industrial		EVT F&B		EVF F&B		EVM Outdoor	
		Price		Price		Price		Price	
Cable Material		Black, TPU		Orange, PVC		Grey, MPPE		Black, TPU	
Nut Material		Ni PI brass		SS 316 L		SS 316 L		SS 316 L	
2 m		EVC141	\$32.92	EVT122	\$37.66	EVF122	\$36.80	-	-
5 m		EVC142	\$38.52	EVT123	\$48.63	EVF123	\$47.77	EVM021	\$49.28
10 m		EVC143	\$47.34	EVT124	\$57.67	EVF124	\$56.59	EVM022	\$59.39
15 m		-	-	-	-	-	-	EVM023	\$74.67
20 m		EVC501	\$66.71	-	-	-	-	-	-
25 m		-	-	EVT125	\$87.58	EVF125	\$85.43	-	-
45 m		EVC502	\$111.03	-	-	-	-	-	-

ANGLED M8 SOCKET, 3PIN, IP69K, 3 AMP (MAX)

Wiring		EVC		EVT		EVF		EVM	
		EVC Industrial		EVT F&B		EVF F&B		EVM Outdoor	
		Price		Price		Price		Price	
Cable Material		Black, TPU		Orange, PVC		Grey, MPPE		Black, TPU	
Nut Material		Ni PI brass		SS 316 L		SS 316 L		SS 316 L	
2 m		EVC144	\$32.92	EVT126	\$37.66	EVF126	\$36.80	-	-
5 m		EVC145	\$38.52	EVT127	\$48.63	EVF127	\$47.77	-	-
10 m		EVC146	\$47.34	EVT128	\$57.67	EVF128	\$56.59	-	-
25 m		-	-	EVT129	\$87.58	EVF129	\$85.43	-	-

## STRAIGHT M8 SOCKET, 4PIN, IP69K, 3 AMP (MAX)

Wiring	EVC	EVT	EVF	EVM				
	EVC Industrial	Price	EVT F&B	Price	EVF F&B	Price	EVM Outdoor	Price
Cable Material	Black, TPU		Orange, PVC		Grey, MPPE		Black, TPU	
Nut Material	Ni Pl brass		SS 316 L		SS 316 L		SS 316 L	
2 m	EVC150	\$34.64	EVT134	\$38.73	EVF134	\$37.87	EVM028	\$44.54
5 m	EVC151	\$40.67	EVT135	\$45.83	EVF135	\$44.76	EVM029	\$51.00
10 m	EVC152	\$50.14	EVT136	\$55.30	EVF136	\$54.23	EVM030	\$60.68
15 m	EVC387	\$58.96	EVT274	\$73.16	-	-	EVM031	\$77.25
25 m	-	-	EVT137	\$85.21	EVF137	\$83.49	-	-

## ANGLED M8 SOCKET, 4PIN, IP69K, 3 AMP (MAX)

Wiring	EVC	EVT	EVF	EVM				
	EVC Industrial	Price	EVT F&B	Price	EVF F&B	Price	EVM Outdoor	Price
Cable Material	Black, TPU		Orange, PVC		Grey, MPPE		Black, TPU	
Nut Material	Ni Pl brass		SS 316 L		SS 316 L		SS 316 L	
2 m	EVC153	\$34.64	EVT138	\$38.73	EVF138	\$37.87	-	-
5 m	EVC154	\$40.67	EVT139	\$45.83	EVF139	\$44.76	-	-
10 m	EVC155	\$50.14	EVT140	\$55.30	EVF140	\$54.23	-	-
25 m	-	-	EVT141	\$85.21	EVF141	\$83.49	-	-









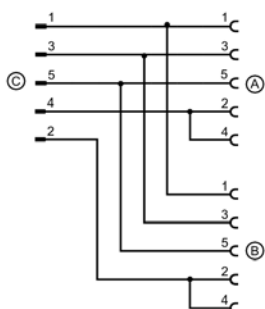
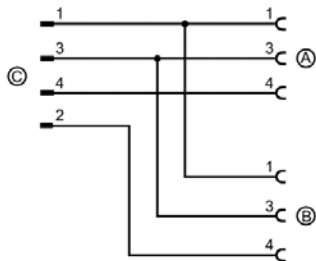
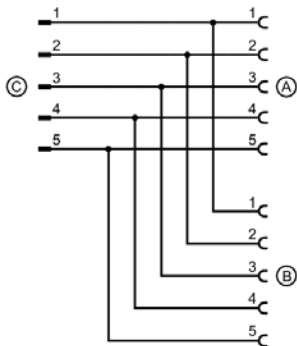
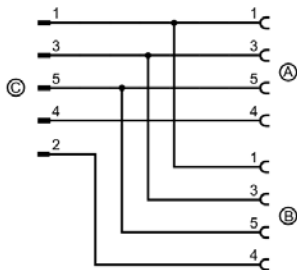
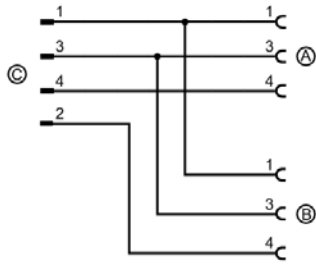



## JUMPER, STRAIGHT M8 SOCKET, STRAIGHT M8 PLUG, 3PIN, IP69K, 3 AMP (MAX)

Wiring	EVC	EVT		
	EVC Industrial	Price	EVT F&B	Price
Cable Material	Black, TPU		Orange, PVC	
Nut Material	Ni Pl brass		SS 316 L	
0.3 m	EVC265	\$42.61	-	-
0.6 m	EVC266	\$43.90	-	-
1 m	EVC267	\$45.83	EVT144	\$72.73
2 m	EVC268	\$49.06	EVT145	\$73.59
5 m	EVC269	\$60.90	EVT146	\$79.83
10 m	EVC467	\$73.16	-	-
15 m	EVC518	\$88.22	-	-



### Wiring Diagrams

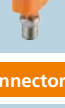

Type	Description	Order no.	Price
<b>Connector: 2 x M12 Sockets, 1x M12 Plug</b>			
	Housing: PA orange; Sealing: FKM, brass, nickel-plated	<b>EBC113</b>	<b>\$42.39</b>
	Housing: PA orange; Halogen-free; Sealing: EPDM, stainless steel (1.4404 / 316L)	<b>EBT006</b>	<b>\$47.34</b>
	Housing: PA grey; Halogen-free; Sealing: EPDM, stainless steel (1.4404 / 316L)	<b>EBF006</b>	<b>\$48.42</b>
<b>Connector: 2 x M12 Sockets, 1x M12 Plug</b>			
	Housing: PA orange; Sealing: FKM, brass, nickel-plated	<b>EBC115</b>	<b>\$42.39</b>
	Housing: PA grey; Halogen-free; Sealing: EPDM, stainless steel (1.4404 / 316L)	<b>EBF008</b>	<b>\$48.42</b>
<b>Connector: 2 x M12 Sockets, 1x M12 Plug</b>			
	Housing: PA orange; Sealing: FKM, brass, nickel-plated	<b>EBC116</b>	<b>\$42.39</b>
	Housing: PA orange; Halogen-free; Sealing: EPDM, stainless steel (1.4404 / 316L)	<b>EBT009</b>	<b>\$47.34</b>
	Housing: PA grey; Halogen-free; Sealing: EPDM, stainless steel (1.4404 / 316L)	<b>EBF009</b>	<b>\$48.42</b>
<b>Connector: 2 x M8 Sockets, 1x M12 Plug</b>			
	Housing: PA orange; Sealing: FKM, brass, nickel-plated	<b>EBC112</b>	<b>\$40.24</b>
	Housing: PA grey; Halogen-free; Sealing: EPDM, stainless steel (1.4404 / 316L)	<b>EBF012</b>	<b>\$48.20</b>
	Housing: PA orange; Halogen-free; Sealing: EPDM, stainless steel (1.4404 / 316L)	<b>EBT012</b>	<b>\$45.19</b>
<b>Connector: 2 x M12 Sockets, 1x M12 Plug</b>			
	Housing: PA orange; Sealing: FKM, brass, nickel-plated	<b>EBC114</b>	<b>\$42.39</b>

## M12 L-CODED



Wiring	EVCA	EVCA	Wiring	EVCA	EVCA				
	EVCA Industrial	Price	EVCA Industrial	Price	EVCA Industrial	Price	EVCA Industrial	Price	
Cable Material	Grey, TPU		Grey, TPU		Cable	Grey, TPU	Grey, TPU		
Nut Material	Ni Pl brass		Ni Pl brass		Nut	Ni Pl brass	Ni Pl brass		
2 m	EVCA15	\$94.46	EVCA20	\$94.46	0.25 m	EVCA25	\$129.11	EVCA32	\$129.11
5 m	EVCA16	\$135.78	EVCA21	\$135.78	0.5 m	EVCA26	\$133.41	EVCA33	\$133.41
10 m	EVCA17	\$202.27	EVCA22	\$202.27	1 m	EVCA27	\$142.66	EVCA34	\$142.66
20 m	EVCA18	\$342.14	EVCA23	\$342.14	2 m	EVCA28	\$156.44	EVCA35	\$156.44
50 m	EVCA19	\$722.79	EVCA24	\$722.79	5 m	EVCA29	\$193.66	EVCA36	\$193.66
					10 m	EVCA30	\$239.50	EVCA37	\$239.50
					20 m	EVCA31	\$354.83	EVCA38	\$354.83

## M12 PASSIVE SPLITTER BOX, IP68



Type	Ports	Signals on contact	LED	Output	Connection	Order no.	Price
	4	2 and 4	•	PNP	5 m	EBC016	\$255.42
	4	2 and 4	•	PNP	10 m	EBC028	\$320.62
	6	2 and 4	•	PNP	5 m	EBC020	\$320.62
	6	2 and 4	•	PNP	10 m	EBC032	\$437.03
	8	2 and 4	8	PNP	M12	EBC138	\$177.74
	8	2 and 4	–	–	5 m	EBC022	\$330.52
	8	2 and 4	–	–	10 m	EBC034	\$414.01
	8	2 and 4	•	PNP	5 m	EBC024	\$360.64
	8	2 and 4	•	PNP	10 m	EBC035	\$336.11
	16	2 and 4	•	PNP	10 m	EBC036	\$442.41

## PANEL WALL CONNECTORS



Type	Size	Pins	Length	Mounting Thread	Order no.	Price
<b>M12 Plug, brass, nickel-plated</b>						
	M12	4 Wire	120 mm	M20	E11295	\$28.19
	M12	4 Wire	500 mm	M20	E11293	\$28.19
	M12	5 Wire	500 mm	M16	E11588	\$28.19
	M12	8 Wire	500 mm	PG9	E11194	\$29.69
<b>M12 Socket, brass, nickel-plated</b>						
	M12	4 Wire	500 mm	PG9	E11067	\$32.71
	M12	5 Wire	500 mm	M16	E12408	\$24.10
	M12	8 Wire	500 mm	PG9	E11601	\$50.14

## WALL PASSAGE CONNECTORS



Type	Size	Pins	Length	Mounting Thread	Order no.	Price
<b>M12 - M12 Plug, 5-wire</b>						
	M12	5 Wire		Brass, nickel-plated	E73008	\$41.74
	M12	5 Wire		Stainless steel	E73009	\$54.44



Type	Description	Order no	Price
<b>M12 cable plug · 4 poles · straight</b>			
	2.0 m	EVC893	\$32.06
	5.0 m	EVC894	\$62.83
	10.0 m	EVC895	\$113.40
	20.0 m	EVC896	\$214.96
	50.0 m	EVC897	\$520.31
<b>M12 cable plug · 4 poles · angled</b>			
	2.0 m	EVC898	\$32.06
	5.0 m	EVC899	\$62.83
	10.0 m	EVC900	\$113.40
	20.0 m	EVC901	\$214.96
	50.0 m	EVC902	\$520.31
<b>M12 connection cable · 4 poles · straight-straight</b>			
	0.25 m	EVC903	\$35.50
	0.5 m	EVC904	\$37.66
	1.0 m	EVC905	\$43.04
	2.0 m	EVC906	\$53.36
	5.0 m	EVC907	\$83.71
	10.0 m	EVC908	\$134.70
	20.0 m	EVC909	\$236.05
<b>M12 cable plug · 4 poles · straight-angled</b>			
	0.25 m	EVC910	\$35.50
	0.5 m	EVC911	\$37.66
	1.0 m	EVC912	\$43.04
	2.0 m	EVC913	\$53.36
	5.0 m	EVC914	\$83.71
	10.0 m	EVC915	\$134.70
	20.0 m	EVC916	\$236.05
<b>M12 connection cable · 4 poles · angled-angled</b>			
	0.25 m	EVC917	\$35.50
	0.5 m	EVC918	\$37.66
	1.0 m	EVC919	\$43.04
	2.0 m	EVC920	\$53.36
	5.0 m	EVC921	\$83.71
	10.0 m	EVC922	\$134.70
	20.0 m	EVC923	\$236.05

Type	Description	Order no	Price
<b>Connection cable M12 connector</b>			
	2.0 m	EVC943	\$75.74
	5.0 m	EVC944	\$153.64
	2.0 m	EVC945	\$75.74
	5.0 m	EVC946	\$153.64
<b>Connection cable M12 socket</b>			
	2.0 m	EVC939	\$79.19
	5.0 m	EVC940	\$157.08
	2.0 m	EVC941	\$79.19
	5.0 m	EVC942	\$157.08
<b>Connection cable with terminating resistor 120 Ω, M12 socket</b>			
	2.0 m	EVC957	\$91.45
	5.0 m	EVC958	\$169.35
	2.0 m	EVC959	\$91.45
	5.0 m	EVC960	\$181.18
	10.0 m	EVC961	\$270.05
<b>Connection cable M12 connector / M12 socket</b>			
	1.0 m	EVC947	\$91.45
	2.0 m	EVC948	\$110.39
	5.0 m	EVC949	\$187.42
<b>Connection cable M12 connector / M12 socket</b>			
	1.0 m	EVC950	\$91.45
	2.0 m	EVC951	\$110.39
	5.0 m	EVC952	\$187.42
<b>Connection cable M12 connector / M12 socket</b>			
	1.0 m	EVC953	\$91.45
	2.0 m	EVC954	\$110.39
	5.0 m	EVC955	\$187.42
	10.0 m	EVC956	\$273.92
<b>Connection cable with terminating resistor 120 Ω, M12 connector / M12 socket</b>			
	2.0 m	EVC962	\$122.65
	5.0 m	EVC963	\$199.26
	10.0 m	EVC964	\$285.76
<b>Connection cable with terminating resistor 120 Ω, M12 connector / M12 socket</b>			
	2.0 m	EVC965	\$122.65
	5.0 m	EVC966	\$199.26
	10.0 m	EVC967	\$285.76

## Wiring diagram

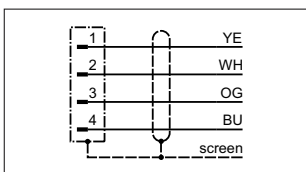

Example EVC898

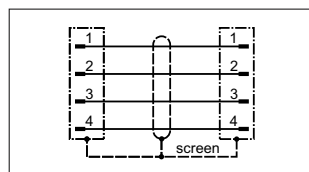

Example EVC917

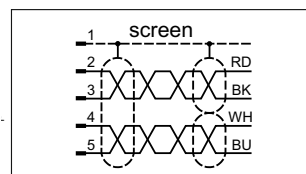

Example EVC943

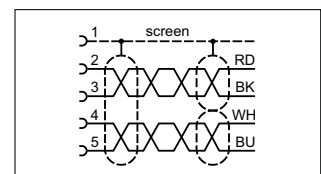

Example EVC939



# Magnetic Sensors

## Selection Guide



### MAGNETIC SENSORS



- Long sensing range even through non-magnetisable metals
- Temperature-stable and reproducible switch point
- High protection rating ideal for the food and beverage industry
- Wide operating temperature range
- Food-grade full-metal housing

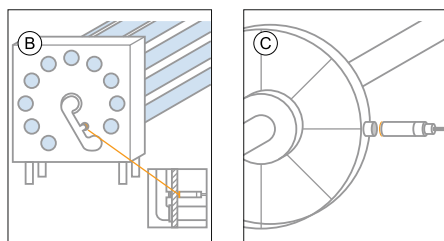
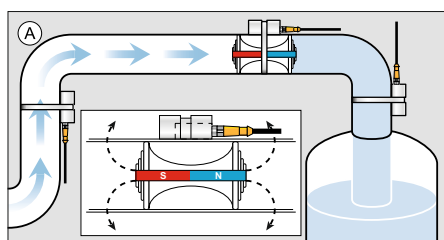

Type x Length	Sensing range [mm]	Output function	Electrical design	Order no.	Price
<b>4-pole</b>					
M8 x 60	60	NO	DC, PNP	ME5010	\$156.87
M8 x 60	60	NO	DC, PNP	ME5011	\$152.13
M12 x 60	60	NO	DC, NPN	MFS209	\$139.87
M12	60	NO	DC, PNP	MFS211	\$139.87
M12	60	NO	DC, PNP	MFT202	\$170.64
<b>4-pole</b>					
M18 x 60	70	NO	DC, PNP	MG5204	\$139.87
M18	70	NO	DC, PNP	MGT203	\$170.64

### Accessories

Type	Description	Order no.	Price
	Damping element M3.0, barium ferrite	E10751	\$17.86
	Damping element M5.0, barium ferrite	E10753	\$30.13



# Inductive sensors

- K1 sensors detect all metals at the same range
- IO-Link sensors are configurable in every way!



## Long Range Inductive Sensors

### M5 INDUCTIVE SENSORS

Size (mm)	Material	Range (mm)	Operating Voltage (V)	Output Function	Temp Range (°C)	Max. Freq'y (Hz)	Max. Load (mA)	Electrical Connection	Note	Order No.	Price
<b>Industrial Applications, IP67</b>											
M5, L=30	SS-316L	0.8f	10-36 DC	PNP, NO	-25 70	2,000	100	2m Cable		IY5029	\$176.45
M5, L=30	SS-316L	0.8f	10-36 DC	NPN, NO	-25 70	2,000	100	2m Cable		IY5034	\$187.42
M5, L=45	SS-316L	0.8f	10-36 DC	PNP, NO	-25 70	2,000	100	M8 3w		IY5036	\$189.14

### M8 INDUCTIVE SENSORS

Size (mm)	Material	Range (mm)	Operating Voltage (V)	Output Function	Temp Range (°C)	Max. Freq'y (Hz)	Max. Load (mA)	Electrical Connection	Note	Order No.	Price
<b>Industrial Applications, IP67</b>											
M8, L=30	Metal	2f	10-36 DC	PNP, NO	-25 70	800	100	M8		IE5366	\$142.88
M8, L=40	Metal	3f	10-30 DC	PNP/NPN	0 60	800	100	M8		IE5338	\$126.74
M8, L=40	Metal	5nf	10-30 DC	PNP/NPN, NO	-25 70	600	100	M8		IE5340	\$126.74
M8, L=50	Metal	2f	10-36 DC	PNP, NO	-25 70	1,300	300	M8		IE5287	\$164.40
M8, L=50	Metal	2nf	10-36 DC	PNP, NO	-25 70	2,000	100	M8		IE5295	\$176.66
M8, L=50	Metal	2f	10-36 DC	PNP, NC	-25 70	1,300	200	M8		IE5319	\$190.00
M8, L=50	Metal	2f	10-36 DC	PNP, NO	0 100	1,000	100	M12		IE5379	\$154.07
M8, L=60	Metal	4nf	10-36 DC	PNP, NO	-25 70	1,000	100	M8		IE5391	\$136.42
M8, L=60	Metal	2f	10-36 DC	PNP, NO	0 100	1,000	100	M12		IE5392	\$168.92
M8, L=62	Metal	2f	10-36 DC	PNP, NO	-25 70	1,000	250	M12		IE5257	\$160.52
M8, L=62	Metal	4nf	10-36DC	PNP, NO	-25 70	300	200	M12		IE5288	\$160.52
<b>F&amp;B Applications, IP69k</b>											
M8, L=40	SS-304	5nf	10-30 DC	PNP/NPN	0 60	600	100	M8		IE5340	\$126.74
M8, L=40	SS-316L	3f	10-30 DC	PNP, NO	-40 85	2,000	100	M8	K1	IES200	\$121.58
M8, L=40	SS-316L	6nf	10-30 DC	PNP, NO	-40 85	2,000	100	M8	K1	IES201	\$121.58
M8, L=50	SS-316L	2f	10-36 DC	PNP, NO	-25 70	100	100	M8	Coolant	IEC201	\$132.34
M8, L=50	SS-316L	2f	10-36 DC	NPN, NO	-25 70	100	100	M8	Coolant	IEC202	\$132.34
M8, L=55	SS-316L	2nf	10-36 DC	PNP, NO	-25 80	2,000	200	M12		IE5295	\$176.66





# Inductive sensors

## M12 INDUCTIVE SENSORS

Size (mm)	Material	Range (mm)	Operating Voltage (V)	Output Function	Temp Range (°C)	Max. Freq'y (Hz)	Max. Load (mA)	Electrical Connection	Note	Order No.	Price
<b>Industrial Applications, IP67</b>											
M12, L=40	Metal	4f	10-30 DC	PNP, NO	-40 85	700	100	2m Cable		IFS256	\$113.40
M12, L=43	Metal	2f	20-36 DC	PNP, NO	-25 80	1,500	200	M12		IFS538	\$140.08
M12, L=45	Metal	4f	10-30 DC	PNP, NO	-25 70	700	100	M12		IFS204	\$111.46
M12, L=50	Metal	7nf	10-36 DC	PNP, NO	-25 70	700	100	M12		IFS205	\$111.46
M12, L=45	Metal	4f	10-30 DC	PNP, NC	-25 70	700	100	M12		IFS206	\$111.46
M12, L=45	Metal	4f	10-30 DC	PNP, NO	-40 85	700	100	M12		IFS244	\$110.82
M12, L=60	Metal	4f	10-36 DC	PNP, NO	-25 70	700	100	M12		IFC229	\$131.47
M12, L=60	Metal	4f	10-60 DC	PNP, NO	-40 85	700	100	M12		IFS240	\$110.82
M12, L=60	Metal	4f	10-30 DC	NPN, NO	-40 85	700	100	M12		IFS242	\$110.82
M12, L=60	Metal	4f	10-30 DC	PNP, NC	-40 85	700	100	M12		IFS248	\$110.82
M12, L=60	Metal	10nf	10-30 DC	PNP, NO	-40 85	2,000	100	M12		IFS306	\$116.63
M12, L=65	Metal	8nf	10-30 DC	PNP, NO	-25 70	2,000	100	M12	Coolant	IFC246	\$116.41
M12, L=65	Metal	3f	10-30 DC	PNP, NO	-25 70	2,000	100	M12	Weld	IFW200	\$125.02
M12, L=73	Metal	4f	20-140 AC	NO	-25 80	25	200	M12		IF0311	\$223.79
M12, L=72	PBT	4f	20-250 AC	NO	-25 80	25	200	2m Cable		IF0003	\$198.61
M12, L=80	Metal	2f	10-30 DC	PNP, NO	-25 80	800	200	M12		IFS580	\$140.08

Size (mm)	Material	Range (mm)	Operating Voltage (V)	Output Function	Temp Range (°C)	Max. Freq'y (Hz)	Max. Load (mA)	Electrical Connection	Note	Order No.	Price
<b>F&amp;B Wash-down Applications, IP69K</b>											
M12, L=45	SS-316L	4f	10-30 DC	PNP, NO	-40 85	2,000	100	M12	K1	IFS297	\$116.63
M12, L=45	SS-316L	10nf	10-30 DC	PNP, NO	-40 85	2,000	100	M12	K1	IFS299	\$116.63
M12, L=45	SS-316L	4f	10-30 DC	PNP, NO	0 100	800	100	M12	FDA	IFT203	\$128.46
M12, L=50	SS-316L	7nf	10-36 DC	PNP, NO	0 100	800	100	M12	FDA	IFT200	\$128.46
M12, L=60	SS-316L	3f	10-36 DC	PNP, NO	-40 60	100	100	M12	3D,3G	IF503A	\$163.32
M12, L=60	SS-316L	4f	10-30 DC	PNP, NO	-40 85	2,000	100	M12	K1	IFS304	\$116.63
M12, L=60	all SS-316L	3f	10-30 DC	PNP, NO	0 100	100	100	M12	FDA	IFT240	\$145.46
M12, L=60	all SS-316L	3.6f	10-30 DC	PNP/NPN,NO/NC	0 100	100	100	M12	IO-Link	IFT258	\$145.89
M12, L=70	SS-304	7nf	10-36 DC	PNP/NPN	-40 85	300	100	M12	Mobile	IFM204	\$116.84
M12, L=70	SS-304	4f	10-60 DC	PNP, NO	-40 85	400	200	M12	Mobile	IFM205	\$132.98
M12, L=70	SS-304	7nf	10-60 DC	PNP, NO	-40 85	300	200	M12	Mobile	IFM206	\$132.98
M12, L=70	SS-316L	7nf	10-30 DC	PNP/NPN, NO	0 100	700	100	M12	FDA	IFT202	\$145.25
M12, L=70	SS-316L	4f	10-30 DC	PNP/NPN, NO	0 100	500	100	M12	FDA	IFT205	\$145.25
M12, L=70	SS-316L	4f	10-36 DC	PNP, NO	0 100	700	100	M12	FDA	IFT216	\$143.74



### Accessories

Type	Description	Order no.	Price
	Angle bracket for type M12, stainless steel	E10735	\$6.46





# Inductive sensors

## M18 INDUCTIVE SENSORS



Size (mm)	Material	Range (mm)	Operating Voltage (V)	Output Function	Temp Range (°C)	Max. Freq'y (Hz)	Max. Load (mA)	Electrical Connection	Note	Order No.	Price
<b>Industrial Applications, IP67</b>											
M18, L=45	Metal	8f	10-30 DC	PNP, NO	-25 70	400	100	M12		IGS204	\$111.46
M18, L=45	Metal	8f	10-30 DC	PNP, NO	-40 85	400	100	M12		IGS236	\$123.94
M18, L=45	Metal	12nf	10-30 DC	PNP, NO	-40 85	300	100	M12		IGS237	\$123.94
M18, L=45	Metal	8f	10-30 DC	PNP, NC	-40 85	400	100	M12		IGS252	\$123.94
M18, L=45	Metal	8f	10-30 DC	PNP, NC	-25 70	400	100	M12		IGS206	\$111.46
M18, L=50	Metal	12nf	10-30 DC	PNP, NO	-25 70	300	100	M12		IGS205	\$111.46
M18, L=60	Metal	12nf	10-30 DC	PNP/NPN, NO	-40 85	300	100	M12	IO-Link	IG6616	\$141.59
M18, L=60	Metal	8f	10-30 DC	PNP, NO	-40 85	400	100	M12		IGS232	\$123.94
M18, L=60	Metal	12nf	10-30 DC	PNP, NO	-40 85	300	100	M12		IGS233	\$123.94
M18, L=60	Metal	8f	10-30 DC	NPN, NO	-40 85	400	100	M12		IGS234	\$123.94
M18, L=60	Metal	12nf	10-30 DC	NPN, NO	-40 85	300	100	M12		IGS235	\$123.94
M18, L=60	Metal	8f	10-30 DC	PNP, NC	-40 85	400	100	M12		IGS240	\$123.94
M18, L=60	Metal	7.5f	10-30 DC	PNP/NPN, NO	-40 85	100	100	M12	IO-Link	IGC260	\$157.30
M18, L=65	Metal	5f	10-30 DC	PNP, NO	-25 70	2,000	100	M12	Coolant	IGC232	\$151.49
M18, L=65	Metal	12nf	10-30 DC	PNP, NO	-25 70	2,000	100	M12	Coolant	IGC233	\$151.49
M18, L=70	Metal	8f	10-36 DC	PNP/NPN, NO/NC	-25 70	400	100	M12		IG5953	\$145.46
M18, L=70	Metal	8f	10-30 DC	PNP/NPN, NO	-25 70	400	100	M12		IGS208	\$125.23
M18, L=70	Metal	12nf	10-30 DC	PNP, NO	-25 70	300	100	M12		IGS213	\$115.12
M18, L=70	Metal	8f	10-30 DC	PNP, NO	-25 70	400	100	M12		IGS212	\$115.12
M18, L=70	Metal	12nf	10-30 DC	PNP, NO	-25 80	300	200	M12		IG5841	\$174.51
M18, L=72	Metal	12nf	10-36 DC	PNP/NPN, NO/NC	-25 70	250	100	M12		IG5954	\$145.46
M18, L=77	Metal	8nf	10-36 DC	PNP, NO	0 180	400	150	5m Cable	HIGH TEMP	IG6119	\$529.34
M18, L=80	PBT	5f	20-250AC/DC	NO	-25 80	50	100	2m Cable		IG0005	\$206.79
M18, L=80	Metal	5f	20-250AC/DC	NO	-25 80	50	100	2m Cable		IG0011	\$213.89
M18, L=80	PBT	5f	20-250AC/DC	NC	-25 80	50	100	10m Cable		IG0097	\$223.36
M18, L=80	PBT	8f	10-55 DC	PNP/NPN, NO	-25 80	300	400	2m Cable		IG5533	\$123.51
M18, L=80	Metal	8nf	10-55 DC	PNP/NPN, NO	-25 80	300	400	2m Cable		IG5596	\$129.54
M18, L=80	Metal	8nf	10-30 DC	PNP, Complmtry	-25 80	300	200	M12		IG5842	\$138.15
M18, L=90	Metal	8nf	10-36 DC	PNP, NO	-25 80	300	250	M12		IG5602	\$134.49
M18, L=90	Metal	8f	10-55 DC	PNP/NPN, NO/NC	-25 80	700	400	M12		IG5806	\$137.72



### Accessories

Type	Description	Order no.	Price
	Angle bracket for type M18, stainless steel	E10736	\$7.32



# Inductive sensors

## M18 INDUCTIVE SENSORS

Size (mm)	Material	Range (mm)	Operating Voltage (V)	Output Function	Temp Range (°C)	Max. Freq'y (Hz)	Max. Load (mA)	Electrical Connection	Note	Order No.	Price
<b>F&amp;B Wash-down Applications, IP69K</b>											
M18, L=45	SS-316L	8f	10-30 DC	PNP, NO	-40 85	2,000	100	M12	K1	IGS287	\$131.47
M18, L=45	all SS-316L	8f	10-30 DC	PNP, NO	0 100	100	100	M12	FDA	IGT258	\$161.39
M18, L=45	all SS-316L	10qf	10-30 DC	PNP, NO	0 100	200	100	M12	FDA	IGT203	\$142.02
M18, L=50	SS-316L	12nf	10-36 DC	PNP, NO	0 100	300	100	M12	FDA	IGT201	\$142.02
M18, L=50	SS-316L	12nf	10-36 DC	PNP, NO	0 100	300	100	M12	FDA	IGT200	\$142.02
M18, L=57	SS-316L	8f	10-36 DC	PNP, NO	0 100	600	100	6m Cable	FDA	IGT206	\$162.89
M18, L=60	all SS-316L	8f	10-30 DC	PNP, NC	-40 85	2,000	100	M12	K1	IGS306	\$116.63
M18, L=60	SS-316L	8f	10-30 DC	PNP, NO	-40 85	2,000	100	M12	K1	IGS290	\$131.47
M18, L=60	SS-316L	15nf	10-30 DC	PNP, NO	-40 85	2,000	100	M12	K1	IGS292	\$131.47
M18, L=60	SS-316L	8f	10-30 DC	PNP, Complmtry	-40 85	2,000	100	M12	K1	IGS300	\$142.88
M18, L=60	all SS-316L	7.5f	10-30 DC	PNP/NPN, NO/NC	0 100	100	100	M12	IO-Link	IGT260	\$157.30
M18, L=70	SS-316L	5f	10-36 DC	PNP, NO	-40 60	100	100	M12	3D,3G	IGS10A	\$163.32
M18, L=70	SS-316L	5f	10-36 DC	PNP, NC	-40 60	100	100	M12	3D,3G	IGS12A	\$163.32
M18, L=70	SS-304	8f	10-36 DC	PNP/NPN, NO	-40 85	200	100	M12	Mobile	IGM200	\$116.84
M18, L=70	SS-304	12nf	10-36 DC	PNP/NPN, NO	-40 85	200	100	M12	Mobile	IGM201	\$116.84
M18, L=70	SS-304	8f	10-60 DC	PNP, NO	-40 85	200	200	M12	Mobile	IGM204	\$132.98
M18, L=70	SS-304	12nf	10-60 DC	PNP, NO	-40 85	200	200	M12	Mobile	IGM205	\$132.98
M18, L=70	SS-316L	5f	20-140AC/DC	NO	0 100	25	80	1/2"		IGT002	\$183.55
M18, L=70	SS-316L	12nf	10-30 DC	PNP/NPN, NO	0 100	300	100	M12	FDA	IGT202	\$160.74
M18, L=70	SS-316L	8f	10-36 DC	PNP/NPN, NO	0 100	400	100	M12	FDA	IGT205	\$160.74
M18, L=70	SS-316L	5f	10-36 DC	PNP, NO	0 100	100	100	M12	FDA	IGT247	\$161.39
M18, L=70	all SS-316L	12nf	10-36 DC	PNP, NO	0 100	500	100	M12	FDA	IGT249	\$188.28
M18, L=76	SS-316L	5f	10-36 DC	PNP, NO	-25 80	500	250	M12		IGS513	\$134.49
M18, L=81	SS-316L	8nf	20-250AC/DC	NO	-25 80	25	250	M18		IG0303	\$257.79
M18, L=81	SS-316L	12nf	10-30 DC	PNP/NPN, NO	0 100	300	100	10m Cable	FDA	IGT213	\$179.03
M18, L=90	SS-316L	8f	10-36 DC	PNP, NO	0 100	400	100	M12	FDA	IGT241	\$152.78

## F&B WASHDOWN SENSOR APPROVALS

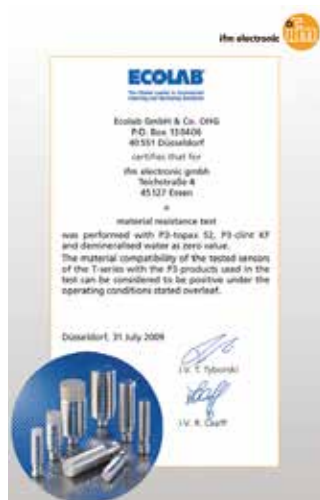

### High-pressure cleaning test IP 69K:

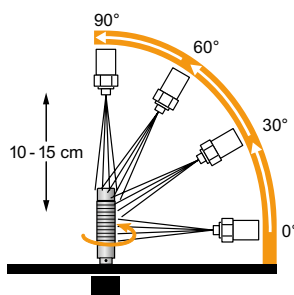

Fine jets of water is sprayed with 100 bar from a distance of 10 to 15 cm. The hot water at 80 °C is sprayed in cycles of 30 seconds.

### Temperature shock test:

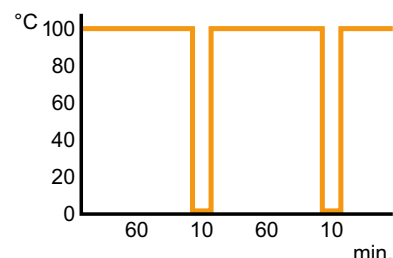

The products are subjected to temperature fluctuations from 0 to 100 °C in short intervals.





# Inductive sensors

## M30 INDUCTIVE SENSORS



Size (mm)	Material	Range (mm)	Operating Voltage (V)	Output Function	Temp Range (°C)	Max. Freq'y (Hz)	Max. Load (mA)	Electrical Connection	Note	Order No.	Price
-----------	----------	------------	-----------------------	-----------------	-----------------	------------------	----------------	-----------------------	------	-----------	-------

### Industrial Applications, IP67

M30, L=60	Metal	15f	10-30 DC	PNP, NO	-40 85	100	100	M12		IIS226	\$139.65
M30, L=60	Metal	22nf	10-30 DC	PNP, NO	-40 85	100	100	M12		IIS227	\$139.65
M30, L=65	Metal	22nf	10-30 DC	PNP, NO	-40 70	2,000	100	M12		IIC219	\$154.93
M30, L=65	Metal	12f	10-30 DC	PNP/NPN, NO/NC	-40 85	100	100	M12	IO-Link	IIS973	\$155.58
M30, L=70	Metal	15f	10-36 DC	PNP/NPN, NO	-25 70	100	100	M12		IIS206	\$156.44
M30, L=70	Metal	12f	10-60 DC	PNP/NPN, NO	-40 85	100	100	M12	Mobile	IIM200	\$154.71
M30, L=70	Metal	22nf	10-60 DC	PNP/NPN, NO	-40 85	100	100	M12	Mobile	IIM201	\$154.71
M30, L=70	Metal	12f	10-60 DC	PNP, NO	-40 85	100	100	M12	Mobile	IIM208	\$170.85
M30, L=70	Metal	12f	10-36 DC	PNP/NPN, NO	-40 85	100	100	M12		IIS920	\$149.98
M30, L=70	Metal	22nf	10-36 DC	PNP/NPN, NO	-25 70	200	100	M12		IIS861	\$156.01
M30, L=72	Metal	15f	10-36 DC	PNP/NPN, NO/NC	-25 70	200	100	M12		IIS860	\$156.01
M30, L=75	Metal	15nf	10-36 DC	PNP, NO	-40 70	100	250	M12		IIS910	\$143.53
M30, L=81	PVC	10f	20-250AC/DC	NC	-25 80	50	250	M12	2m cable	IIO094	\$218.62
M30, L=81	Metal	10f	20-250AC/DC	NO	-25 80	50	250	M12	2m cable	IIO011	\$218.62
M30, L=81	PVC	10f	20-250AC/DC	NO	-25 80	50	250	M12	2m cable	IIO005	\$212.60
M30, L=81	PVC	15nf	20-250AC/DC	NO	-25 80	50	250	M12	2m cable	IIO006	\$212.60

### F&B Wash-down Applications, IP69K

M30, L=45	SS-316L	15f	10-30 DC	PNP, NO	-40 85	2,000	100	M12	K1	IIS281	\$145.46
M30, L=60	Metal	15f	10-30 DC	PNP, NC	-40 85	100	100	M12		IIS234	\$139.65
M30, L=60	Metal	22nf	10-30 DC	PNP, NC	-40 85	100	100	M12		IIS236	\$139.65
M30, L=60	SS-316L	15f	10-30 DC	PNP, NO	-40 85	2,000	100	M12	K1	IIS282	\$145.46
M30, L=60	SS-316L	30nf	10-30 DC	PNP, NO	-40 85	2,000	100	M12	K1	IIS284	\$145.46
M30, L=60	SS-316L	15f	10-30 DC	PNP, Complimentary	-40 85	2,000	100	M12	K1	IIS291	\$155.79
M30, L=65	SS-316L	12f	10-30 DC	PNP/NPN, NO/NC	0 100	50	100	M12	IO-Link	IIT244	\$187.64
M30, L=70	SS-316L	22nf	10-36 DC	PNP/NPN, NO	0 100	100	100	M12	FDA	IIT202	\$179.03
M30, L=70	SS-316L	10f	10-36 DC	PNP, NO	-40 60	50	40	M12	2D,3G	IIS04A	\$207.86
M30, L=70	SS-316L	14f	10-36 DC	PNP/NPN, NO	0 100	100	100	M12	FDA	IIT204	\$179.03
M30, L=92	SS-316L	10f	10-55 DC	PNP/NPN, NO/NC	-25 80	450	400	M12	FDA	IIS751	\$147.40

### Accessories



Type	Description	Order no.	Price
	Angle bracket for type M30, stainless steel	E10737	\$9.04



# Inductive sensors

## RECTANGULAR INDUCTIVE SENSORS



Size (mm)	Material	Range (mm)	Operating Voltage (V)	Output Function	Temp Range (°C)	Max. Freq'y (Hz)	Max. Load (mA)	Electrical Connection	Note	Order No.	Price	
<b>Industrial Applications, IP67</b>												
	40x40x120	20nf	20-250AC/DC	NO/NC	-25	80	20	250	M20		IM0010	\$234.76
	40x40x120	15nf	20-250AC/DC	NO/NC	-25	80	20	250	M20		IM0011	\$234.76
	40x40x54	35nf	20-250AC/DC	NO	-25	70	50	100	M12		IM0053	\$145.68
	40x40x54	20nf	10-36 DC	PNP, NO	-25	70	100	200	M12		IM5115	\$108.45
	40x40x54	35nf	10-36 DC	PNP, NO	-25	70	80	200	M12		IM5116	\$111.68
	40x40x54	40nf	10-36 DC	PNP, NO	-25	70	60	200	M12		IM5117	\$111.68
	40x40x54	20nf	10-36 DC	PNP, NO	-25	70	200	200	M12	K1	IM5119	\$129.54
	40x40x54	40nf	10-36 DC	PNP, Complmtry	-25	70	200	200	M12	K1	IM5126	\$146.97
	40x40x54	40nf	10-36 DC	PNP, Complmtry	-25	70	200	200	M12	K1	IM5135	\$126.10
	40x12x26	2nf	20-250AC/DC	NO	-25	80	80	100	2m Cable		IN0073	\$199.90
	40x12x26	4nf	20-250AC/DC	NO	-25	80	50	100	2m Cable		IN0081	\$199.90
	40x12x26	4nf	10-36 DC	PNP, NO	-25	80	1300	250	2m Cable		IN5129	\$138.15
	40x12x26	4nf	10-55 DC	PNP/NPN, NO/NC	-25	80	1200	300	2m Cable		IN5208	\$138.15
	32x20x8	8f	10-30 DC	PNP, NO	-40	85	400	100	2m Cable		IQ2000	\$154.93
	32x20x8	8f	10-30 DC	PNP, NC	-40	85	400	100	2m Cable		IQ2001	\$154.93
	32x20x8	8f	10-30 DC	PNP, NO	-40	85	400	100	M12		IQ2002	\$165.26
	32x20x8	8f	10-30 DC	PNP, NC	-40	85	400	100	M12	IO-Link	IQ2003	\$165.26
	32x20x8	8f	10-30 DC	PNP/NPN, NO/NC	-40	85	300	100	2m Cable	IO-Link	IQ2008	\$181.83
	32x20x8	8f	10-30 DC	PNP/NPN, NO/NC	-40	85	300	100	M12	IO-Link	IQ2009	\$192.16
	32x20x8	8f	10-30 DC	PNP, NO	-40	85	2000	100	M12		IQ2010	\$150.41
	32x20x8	8f	10-30 DC	PNP, NC	-40	85	2000	100	0.3m, M12		IQ2013	\$160.09
	60x36x10	8f	10-36 DC	PNP, NO	-20	80	300	250	2m Cable		IW5058	\$130.40
	60x36x10	8f	10-36 DC	PNP, NC	-20	80	300	250	M8, 3W		IW5062	\$154.71
	60x36x10	8f	10-36 DC	PNP, NO	-20	80	300	250	M8, 3W		IW5064	\$168.27
	60x35x20		10-35 DC	PNP, NO/NC	-25	70	200	200	M12	Ring Sensor	I7R215	\$300.39



# Valve actuator position feedback



## Continuous position feedback



- Valve Open
- Valve closed
- Warning: valve not completely closed



- Great all-round position visibility from a distance
- Easy setting via teach button or IO-Link
- Diagnostic functions: cycle time and count, seal monitoring

### Diagnostic functions

The IO-Link communication interface allows the identification of different wear conditions. On the one hand, the sensor features seal monitoring indicating a change of the closed position, which can point to deposits or wear of the seal, for example. On the other hand, the different positions can be counted and the time taken can be measured.

U <sub>b</sub> [V DC]	Shaft, height vs dia	Output function	IP Rating	Order no.	Price
Smart valve sensor - M12 connector					
10...30 DC	20mm < 38mm	3xNO/NC(selectable)	IP 67	MVQ101	\$581.63
10...30 DC	20mm < 38mm	2xNC/NO (selectable) 2xNO for valve control	IP 67	MVQ201	\$615.85

### Automation set for pneumatic valve actuators

Description	IP Rating	Order no.	Price
Added value package MVQ 80x30x20	IP67	ZZ0628	\$808.65
Added value package MVQ 80x30x30	IP67	ZZ0629	\$829.73
Added value package MVQ 130x30x30	IP67	ZZ0630	\$840.06



### Accessories

Design	Description	Order no.	Price
	Adapter 80 x 30 x 10 mm	E12569	\$33.14
	Adapter 130 x 30 x 10 mm	E12573	\$47.77
	Mounting bridge shaft height 20...40mm	E12674	\$112.11
	Mounting bridge shaft height 30...50mm	E12628	\$105.01
	2 m black, PUR cable, 5 x 0.34mm	EVC070	\$35.50
	5 m black, PUR cable, 5 x 0.34mm	EVC071	\$43.90
	10 m black, PUR cable, 5 x 0.34mm	EVC072	\$60.04
	2 m black, PUR cable, 5 x 0.34mm	EVC073	\$35.50
	5 m black, PUR cable, 5 x 0.34mm	EVC074	\$43.90
	10 m black, PUR cable, 5 x 0.34mm	EVC075	\$60.04



# Valve position feedback switches

FAST RETRO FIT SOLUTIONS



Connection	U <sub>b</sub> [V]	Output function	IP Rating	Order no.	Price
M12	10...36 DC	2x PNP/NPN - NO	IP67	IN5224	\$302.54
M12	10...36 DC	2x PNP - NO	IP67	IN5225	\$302.54
2m cable	10...36 DC	2x PNP - NO	IP67	IN5251	\$298.89
M12	10...36 DC	2x PNP - NO	IP67	IN5327	\$304.26
2m cable	20...140 AC/DC	2x NO	IP67	IN0100	\$380.01
M18	20...250 AC/DC	2x NO	IP67	IN0108	\$358.92

## Accessories

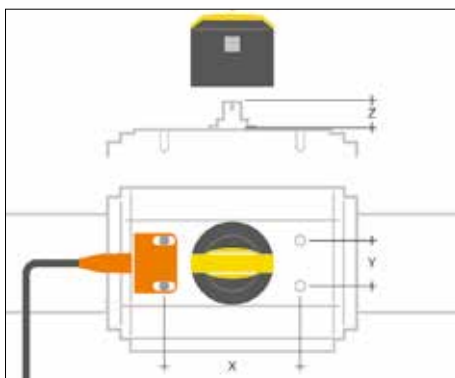

Type	Mounting dimensions [X / Y mm]	Height of the actuator shaft [Z mm]	Shaft diameter	Order no.	Price
	80 / 30	30	Dia. 53 mm	E12517	\$33.14
	80 / 30	30	Dia. 66 mm	E12724	\$39.16
	Switching amplifier, dual channel, transistor			N0534A	\$526.98

### M12 sockets 4-pole (0.34mm sensor)

	2 m black, PUR cable	EVC004	\$32.92
	5 m black, PUR cable	EVC005	\$38.52
	10 m black, PUR cable	EVC006	\$47.34
	25 m black, PUR cable	EVC088	\$83.71

### IECEx cables for NN5008

	5 m blue, PUR cable	ENC05A	\$46.69
	10 m blue, PUR cable	ENC06A	\$72.30



## MANUAL VALVE FEEDBACK



Type	Description	Top Flange Dia	Order no.	Price
	Manual valve mounting set (F04/M5)	42mm	E12519	\$163.75
	Manual valve mounting set (F05/M5)	50mm	E12520	\$163.75
	Manual valve mounting set (F05/M6)	50mm	E12521	\$163.75
	Manual valve mounting set (F07/M6)	70mm	E12522	\$163.75
	Manual valve mounting set (F07/M8)	70mm	E12523	\$168.49
	Manual valve mounting set (F10/M8)	102mm	E12524	\$180.97



# Motion control sensors and monitors

Precise motion monitoring









Robust ifm inclination sensor detects the angle of a rocker

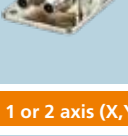

## INCLINATION SENSOR



Type	Description	Order no.	Price
<b>2 axis - IO-Link comms</b>			
	2x Axis. Angular range $\pm 90^\circ$ . Output 1 IO-Link NO/NC prog. Output 2 - NO/NC prog. PNP/NPN. Analogue 4...20 mA. Output 3 and 4 analogue	JN2200 	\$720.21
	2x Axis. Angular range $\pm 45^\circ / \pm 90^\circ$ , IO-Link. Output 1 - IO-Link NO/NC prog. Output 2 - NO/NC prog. PNP/NPN. Analogue 4...20 mA	JN2201 	\$800.25
<b>1 or 2 axis (X,Y) - CAN bus</b>			
	Inclination sensor; 27 x 59 x 118.5 mm; CAN; Ambient temperature $-40...85^\circ\text{C}$ ; M12 Connector; [inclination measurement]: $\pm 90^\circ$	JD2120	\$1,339.50
	Inclination sensor; 27 x 59 x 105.3 mm; CAN; Ambient temperature $-40...85^\circ\text{C}$ ; M12 Connector; [inclination measurement]: $0...360^\circ$	JD1111	\$1,296.46

### Accessories

Type	Description	Order no.	Price
	2 m black, PUR cable	EVC004	\$32.92
	5 m black, PUR cable	EVC005	\$38.52
	10 m black, PUR cable	EVC006	\$47.34
	25 m black, PUR cable	EVC088	\$83.71



# Motion control sensors & controllers

MULTI-FUNCTIONAL TFT DISPLAY FOR IMPULSE SIGNALS, ANALOGUE SIGNALS & TEMPERATURE



Power supply	Inputs	Outputs	Order no.	Price
<b>IP65 multi-function TFT display</b>				
24 VDC	V, mA, kHz, °C, PT100, PT1000, thermocouple	2 x relays	<b>DX1063</b>	<b>\$531.49</b>

## ROTATION & SPEED MONITORS



Type	U <sub>b</sub> [V]	Setting range [Hz]	Outputs relay	Output	Order no.	Price
<b>1 pulse input PNP</b>						
	110...240 AC / 27 (TYP. 24) DC 50...60 Hz	0.1...10 / 10...1,000	1	1 DO	<b>DD0203</b>	<b>\$489.53</b>
	110...240 AC / 27 (TYP. 24) DC 50...60 Hz	0.1...1,000	2	4...20 mA	<b>DD2503</b>	<b>\$727.74</b>



<b>1 pulse input PNP, IO-Link</b>							
(available from april)			-	-	-	<b>DN3003</b>	<b>TBA</b>



Type	Installation Range	Setting Range [pulses/min]	Startup delay [s]	Order no.	Price
<b>IO-Link Communication Interface</b>					
M12	3.5 f	5...24,000	0...30	<b>DI5027</b>	<b>\$263.38</b>
M18	7 f	5...24,000	0...30	<b>DI5029</b>	<b>\$274.57</b>
<b>Compact speed monitors</b>					
M18	12 nf	3...6,000	0...15	<b>DI6001</b>	<b>\$406.26</b>
<b>Compact speed monitors, IO-Link</b>					
M18	12 nf	1...32,000	0...30	<b>DI6004</b>	<b>\$387.32</b>
M18	7 f	1...32,000	0...15	<b>DI6005</b>	<b>\$387.32</b>

## SPEED MONITOR WITH IO-LINK



Type	Inputs / Outputs	Setting range [Hz]	Output	Order no.	Price
<b>Speed monitor IO-Link - 0...2000 Hz</b>					
	1 x DI 2 x DO	0...2,000	PNP/NPN	<b>DP2122</b>	<b>\$310.07</b>
<b>Counter IO-Link - 0...2000 Hz</b>					
	2x digital PNP	2x digital PNP/NPN	PNP/NPN	<b>DP2302</b>	<b>\$316.10</b>



# Rotary Encoders



## Encoder control



Encoders use the wear-free photoelectric or magnetic detection. A pulse disc firmly attached to the shaft or a movable magnet carrier ensures this detection. A distinction is made between incremental and absolute encoders. Incremental encoders generate a precisely defined number of pulses per revolution. They are a measure of the angular or linear distance moved. Absolute encoders provide an absolute numerical value for each angular position even over several revolutions.

### INCREMENTAL ENCODERS - 1...10,000 RESOLUTION



Housing Ø [mm]	Shaft Ø [mm]	Design shaft	Flange	Order no.	Price
<b>PerformanceLine 4-digit display, integrated pulse evaluation , 8 core</b>					
58	6	solid shaft	servo	RUP500	\$567.43
58	10	solid shaft	clamp flange	RVP510	\$559.25
58.5	12	hollow shaft	direct	ROP520	\$599.28
58.5	12	hollow shaft	direct	ROP521	\$612.62
58.5	15	hollow shaft	direct	ROP522	\$612.62
58.5	15.875	hollow shaft	direct	ROP524	\$621.01



<b>BasicLine Basic design without display, 5 core</b>					
36.5	6	solid shaft	universal	RB3100	\$414.44
36.5	6	solid shaft	flange	RB3500	\$418.74
36.5	6	hollow shaft	flange	RA3100	\$438.11
58	10	solid shaft	clamp flange	RV3100	\$416.37
58	10	solid shaft	clamp flange	RV3110	\$953.46
42	12	hollow shaft	-	RA3101	\$447.36
58.5	12	hollow shaft	direct	RO3100	\$438.11
32.3	12	hollow shaft	flange	RA3110	\$849.53
58.5	15	hollow shaft	direct	RO3102	\$459.62
58.5	15	hollow shaft	direct	RO3110	\$1,036.74

### SAFETY ENCODERS



Housing Ø [mm]	Shaft Ø [mm]	Design shaft	Flange	Order no.	Price
<b>Safety encoder</b>					
-	-	(Available in April)	-	RM90XS	TBA

### ABSOLUTE ENCODERS - 8,192 RESOLUTION, 4...20 mA OUTPUT

Length	Connector	Design shaft	Pulses	Order no.	Price
1.9 m	M12	Draw wire encoder	8,192	RMS001	\$1,281.61
3.0 m	M12	Draw wire encoder	8,192	RMS002	\$1,690.45



# Rotary encoders

## ABSOLUTE MULTI-TURN ENCODERS



Housing Ø [mm]	Shaft Ø [mm]	Flange	Resolution	Order no.	Price
<b>Absolute position traceability</b>					
58	10	clamp	15/16 bits	<b>RMV300</b>	<b>\$1,158.74</b>
36.5	12	direct	15/16 bits	<b>RMA300</b>	<b>\$1,214.26</b>
58	15	hollow	15/16 bits	<b>RMO300</b>	<b>\$1,226.10</b>

## DRAW-WIRE



Length	Shaft Ø	Design shaft	Max Speed	Order no.	Price
1.9 m	6 mm	solid shaft	2.0 m / sec	<b>E61439</b>	<b>\$641.02</b>
2.4 m	6 mm	solid shaft	1.0 m / sec	<b>E61440</b>	<b>\$878.36</b>
3.0 m	6 mm	solid shaft	0.8 m / sec	<b>E61441</b>	<b>\$1,139.16</b>
5.0 m	6 mm	solid shaft	2.0 m / sec	<b>E61442</b>	<b>\$1,613.85</b>

## Accessories

Type	Description	Order no.	Price
<b>M12 sockets 8-pole</b>			
	5 m, 8-pole, black, PUR cable	<b>E12403</b>	<b>\$101.56</b>
	10 m, 8-pole, black, PUR cable	<b>E12404</b>	<b>\$130.40</b>
	5 m, 5-pole, black, TPU cable	<b>EVC545</b>	<b>\$54.01</b>
	10 m, 5-pole, black, TPU cable	<b>EVC546</b>	<b>\$72.73</b>
	Flexible coupling with adjusting screws, Ø 10 mm / 10 mm, aluminium	<b>E60022</b>	<b>\$111.46</b>
	Flexible coupling with clamp connection, Ø 10 mm / 10 mm, aluminium	<b>E60067</b>	<b>\$109.96</b>
	Flexible coupling with clamp connection, Ø 6 mm / 10 mm, aluminium	<b>E60066</b>	<b>\$109.96</b>
	Angle bracket RU,RN,RM,RMU	<b>E60034</b>	<b>\$144.39</b>
	Angle bracket encoders RV,RMV	<b>E60035</b>	<b>\$144.39</b>
	Spring arm	<b>E61438</b>	<b>\$458.55</b>
	Aluminium surface measuring wheel External diameter 63.6 mm	<b>E60095</b>	<b>\$130.40</b>
	Aluminium surface measuring wheel External diameter 159.15 mm	<b>E60098</b>	<b>\$156.44</b>
	Rubber surface measuring wheel External diameter 63.66 mm	<b>E60138</b>	<b>\$130.40</b>
	Rubber surface measuring wheel External diameter 159.15 mm	<b>E60110</b>	<b>\$156.44</b>





# Capacitive sensors



Detect non-metallic targets

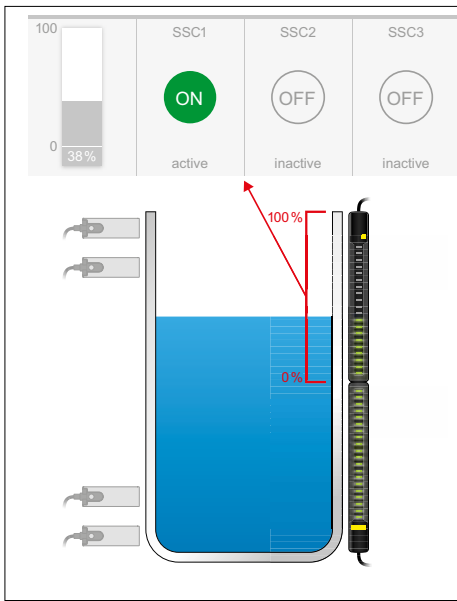

- Continuous level monitoring from outside the process
- No stress caused by the medium thanks to non-contact detection
- Three point level positions in one sensor
- Deposits can be detected and signalled to improve quality of the process
- Several KQ10 units can be linked via IO-Link

## KQ10 FOR CONTINUOUS LEVEL MONITORING - 3 PROGRAMMABLE SET POINTS



Type	Power Supply	Ambient temp	Protection rating	Connection	Order no.	Price
Capacitive point level via continuous level monitoring - PNP/NPN						
	18-30 vDC	-20...80°	IP67	2m cable, 5-pole	KQ1000	\$540.10
	18-30 vDC	-20...80°	IP67	0.1m cable, M12 connector, 5-pole	KQ1001	\$540.10



### Accessories

Type	Description	Order no.	Price
	Mounting adapter for flat surfaces	E12675	\$51.00
	Mounting adapter for pipes	E12676	\$48.20
	Surface mount tape for KQ10	E12677	\$97.05
	PA cable tie, 760mm long (5 piece pack)	E10880	\$13.13
	2m, Black, PUR jumper, 5-pole	EVC058	\$68.43
	5m, Black, PUR jumper, 5-pole	EVC059	\$79.19



# Capacitive sensors

PROGRAMMABLE RANGES



Design	Power Supply	Output	Sensing range [mm]	Housing material	Order no.	Price
<b>PerformanceLine - M12 connector -3 wires, IO-Link Com 2</b>						
M12	10...36 VDC	PNP, NO	1...6 f	SS316S12	KF5001	\$267.90
M12	10...36 VDC	PNP, NO	3...12 nf	SS316S12	KF5002	\$267.90
M18	10...36 VDC	PNP, NO/NC	5...30 nf	PBT	KG6000	\$245.31
M30	10...36 VDC	PNP, NO/NC	5...40 nf	PBT	KI6000	\$245.31
M30	20...250 AC/DC	NO/NC Prog	5...40 nf	PBT	KI0054	\$301.04
M30	10...36 VDC	PNP, NO/NC	8 f	SS316S12	KI5085	\$302.33
M30	10...36 VDC	PNP, NO/NC	15 nf	SS316S12	KI5087	\$302.33
M30	NAMUR	NC	15 nf	PBT	KI5031	\$293.29



## Accessories

Type	Description	Order no.	Price
	Mounting adapter for M30 types, G 1 1/2", POM, gasket EPDM	E11033	\$94.68
	Mounting adapter for M18 types, G 3/4", POM	E43900	\$64.55
	2 m black, PUR cable	EVC004	\$32.92
	5 m black, PUR cable	EVC005	\$38.52
	10 m black, PUR cable	EVC006	\$47.34
	25 m black, PUR cable	EVC088	\$83.71

## TYPE KQ POINT LEVEL SENSORS



Capacitive sensors in small plastic rectangular housing. Easy installation with mounting adapters and fixing straps.

Design	Output stage	Sensing range [mm]	Housing material	Connection	Order no.	Price
<b>PerformanceLine - M12 connector -3 wires, IO-Link Com 2</b>						
48 x 20 x 14	PNP	12 nf	PBT	2 m cable	KQ6002	\$189.57
48 x 20 x 7	PNP	12 nf	PBT	2 m cable	KQ5100	\$111.25
<b>Connection cable with M12 connector - 3-wire</b>						
48 x 20 x 14	PNP	12 nf	PBT	M12	KQ6005	\$214.75

## MULTI COLOURED TOUCH SENSORS WITH IO-LINK



Type	Housing Material	Ambient temp	Protection rating	Connection	Order no.	Price
<b>Multi-coloured touch sensors with IO-Link</b>						
	Plastic PA	-20...80°	IP69K	2m cable	KT6100	\$162.68
	Plastic PA	-20...80°	IP69K	0.3m cable, M12 connector	KT6101	\$162.68
	303SS	-20...80°	IP69K	2m cable	KT6300	\$203.78
	303SS	-20...80°	IP69K	0.3m cable, M12 connector	KT6301	\$203.78





# Cylinder sensors Magnetic T and C slot



## Robust connection and mounting system

### MOUNTING COMPARISON



**Conventional sensors:**  
Cable and mounting screw are placed at opposite ends of the housing. If the cable is pulled, the sensor can be dislodged.



**ifm top-loading sensors:**  
Cable and mounting screw are at the same end. If the cable is pulled, the sensor stays put.



**Traditional versus IO-link switches:**  
Traditionally two magnetic switches are used for short stroke cylinders. Now one IO-link magnetic switch provides both end outputs. Resulting in a 50% cost reduction!

Cylinder Type	Type	Description	Order no.	Price
<b>Protective Bracket for Smooth Cylinders</b>				
Smooth Cylinder	Protective Bracket	Outside Ø 11...19 mm. Bore size 10-16 mm	E11975	\$17.00
		Outside Ø 18...29 mm. Bore size 20-25 mm	E11976	\$17.00
		Outside Ø 28...39 mm. Bore size 32 mm	E11977	\$17.86
		Outside Ø 38...49 mm. Bore size 40 mm	E11978	\$17.86
		Outside Ø 48...59 mm. Bore size 50 mm	E11979	\$19.15
		Outside Ø 58...69 mm. Bore size 63 mm	E11980	\$20.01
		Outside Ø 78...89 mm. Bore size 80 mm	E11981	\$20.66
<b>Protective Bracket for Tie-Rod Cylinders</b>				
Tie-Rod Cylinder	Protective Bracket	Adapter for tie rod / profile cylinders, clamping range 3...7 mm, aluminium	E11913	\$12.48
		Adapter for tie rod / profile cylinders, clamping range 5...7 mm, aluminium	E11912	\$11.83
		Adapter for tie rod / profile cylinders, clamping range 5...11 mm, aluminium	E11797	\$12.70
		Adapter for tie rod / profile cylinders, clamping range 9...15 mm, aluminium	E11799	\$12.70
<b>Integrated Profile Bracket for Integrated Profile Cylinders</b>				
Integrated Profile Cylinders	Integrated Profile Bracket	Integrated profile thickness diameter 9...15 mm	E11799	\$12.70
		Integrated profile thickness diameter 14...20 mm	E11801	\$13.77



# Cylinder sensors

## MAGNETIC T AND C SLOT

Application	No. Wires	Operating Voltage (V)	Max Switching Freq'y (Hz)	Output	Connection	Order No.	Price
-------------	-----------	-----------------------	---------------------------	--------	------------	-----------	-------

### T-Slot, F&B Industry IP69k Types

Washdown	3	10-30 DC	10,000	PNP NO	2m cable	MK5110	\$96.40
Washdown	3	10-30 DC	10,000	PNP NO	0.3m cable M8 plug	MK5111	\$107.81
Washdown	3	10-30 DC	10,000	PNP NO	6m cable	MK5128	\$110.39
Washdown	3	10-30 DC	6,000	PNP NO	0.3m cable M12 plug	MK5157	\$107.81
Washdown	3	10-30 DC	6,000	PNP NO	0.3m cable M12 plug	MK5177	\$107.81

### T-Slot, Industrial Cylinder Sensors, IO-link

Industrial	4	10-30 DC	200	2 x PNP / NPN	2m cable	MK5904	\$194.52
Industrial	3	10-30 DC	200	1 x PNP / NPN	0.3m cable M8 plug, 3 wire	MK5905	\$198.61
Industrial	3	10-30 DC	200	1 x PNP / NPN	0.3m cable M8 plug, 3 wire	MK5906	\$201.62
Industrial	4	10-30 DC	200	2 x PNP / NPN	0.3m cable M8 plug, 4 wire	MK5907	\$201.62
Industrial	4	10-30 DC	200	2 x PNP / NPN	0.3m cable M12 plug	MK5908	\$204.85
Industrial	4	10-30 DC	200	2 x PNP / NPN	6m cable	MK5909	\$205.93



### T-Slot, Industrial Cylinder Sensors

Industrial	3	10-30 DC	10,000	PNP NO	2m cable	MK5100	\$89.08
Industrial	3	10-30 DC	10,000	PNP NO	0.3m cable M8 plug	MK5101	\$95.54
Industrial	3	10-30 DC	10,000	PNP NO	0.3m cable M8 plug	MK5102	\$98.77
Industrial	2	10-30 DC	4,000	PNP/NPN NO	2m cable	MK5103	\$97.05
Industrial	2	10-30 DC	4,000	PNP/NPN NO	0.3m cable M8 plug	MK5104	\$106.30
Industrial	2	10-30 DC	10,000	PNP NO	0.3m cable M12 plug	MK5107	\$101.35
Industrial	3	10-30 DC	10,000	PNP NO	0.3m cable M12 plug	MK5108	\$105.01
Industrial	3	10-30 DC	10,000	PNP NO	6m cable	MK5117	\$101.35
Industrial	2	10-30 DC	4,000	PNP/NPN NO	6m cable	MK5123	\$110.39
Industrial	2	10-30 DC	6,000	NPN NO	0.3m cable M8 plug	MK5137	\$95.54
Industrial	3	10-30 DC	6,000	PNP NO	0.3m cable M8 plug	MK5138	\$95.54
Industrial	3	10-30 DC	6,000	PNP NO	M8 plug	MK5900	\$104.79

### T-Slot, ATEX

Industrial	3	10-30 DC	10,000	PNP NO	0.3m cable M12 plug	MK501A	\$114.69
Industrial	2	8.2 DC	2,000	NAMUR	6m cable	MK502A	\$111.68

### T-Slot, AC/DC Versions

Industrial	2	5-120 AC/DC	1,000	PNP/NPN NO	2m cable	MR0100	\$54.23
Industrial	2	5-50 AC/DC	1,000	PNP/NPN NO	0.3m cable M8 plug	MR0101	\$59.60
Industrial	3	5-50 AC/DC	1,000	PNP NO	0.3m cable M8 plug	MR0119	\$59.60
Industrial	2	5-50 AC/DC	1,000	PNP/NPN NO	M8 plug	MR0901	\$67.78

### C-Slot, Cylinder Sensors

Industrial	3	10-30 DC	10,000	PNP NO	0.3m cable M8 plug	MK5310	\$110.82
Industrial	3	10-30 DC	10,000	PNP NO	0.3m cable M8 plug	MK5311	\$114.26

### C-Slot, Cylinder Sensors, IO-Link

					(Available from April)	MK5800	\$215.83
					(Available from April)	MK5801	\$217.12
					(Available from April)	MK5802	\$218.62
					(Available from April)	MK5803	\$223.79
					(Available from April)	MK5804	\$222.50



# Photoelectric sensors overview

## APPLICATION SELECTION GUIDE

		Function Principle	Range
	O8 series & Fibre Optics Miniature design, infrared and red light sensors	Retro-Reflective	0...1.8m
		Through- Beam	0...3m
	O6 Series Compact rectangular plastic housing Wetline for Hygenic Wet Areas	Diffuse	0...0.5m
		Retro-Reflective	0...5m
		Through- Beam	0...10m
	OF & OG Series M12 & M18 Threaded for Wet Areas M18 Cube in Metal housing	Diffuse	0...1.5m
		Retro-Reflective	0...15m
		Through- Beam	0...60m
	O1D, OID, OGD Series PMD Distance Sensor for Precise Measurement	Diffuse	0...1.5m
	O5/O4 Series Rectangular design for industrial applications	Diffuse	0...2m
		Retro-Reflective	0...10m
		Through- Beam	0...25m
	PMD Profiler Precise contour monitoring	Diffuse	150...300m
	Light Grid for interlogistics Safety Light Curtains and Grids		20m
	UG Series Object Detection for transparent targets	Diffuse	0.03...8.0m
	2D & 3D Vision Solutions	Diffuse	4 m

## Correct selection of Optical Sensor Outputs

MODE	LIGHT ON	DARK ON	MODE	LIGHT ON	DARK ON
<b>Diffuse</b> 			<b>DIFFUSE</b>	OUTPUT ON 	OUTPUT ON 
				OUTPUT OFF 	OUTPUT OFF 
<b>Retroreflective</b> 				OUTPUT ON 	OUTPUT ON 
				OUTPUT OFF 	OUTPUT OFF 
<b>Thru-Beam</b> 			OUTPUT ON 	OUTPUT ON 	
			OUTPUT OFF 	OUTPUT OFF 	

# Photoelectric sensors and mounting accessories



## FIBRE OPTIC SENSORS



Range [mm]	Connection	Operating Voltage (V)	Output Function	Order no.	Price
<b>Select fibre optics from "Accessories"</b>					
100 diffuse	M12	10...30 DC	PNP/NPN, LO/DO (prog)	<b>OBF500</b>	<b>\$268.11</b>
2,000 T beam				<b>OBF500</b>	<b>\$268.11</b>

## O8 SERIES MINIATURE PLASTIC - BEST BACKGROUND SUPPRESSION AVAILABLE!



### Miniature sensors, short range

Note: BGS = Background Suppression

Range	Connection	Order no.	Price
<b>Diffuse reflection sensor with background suppression · 24 vDC, PNP IO-Link</b>			
15mm	0.3 m PVC cable / M8 connector, 3 poles, light on	<b>O8H202</b> ☺	<b>\$235.19</b>
30mm	2 m PVC cable, 3 poles, light on	<b>O8H206</b> ☺	<b>\$235.19</b>
50mm	2 m PVC cable, 3 poles, programmable LO/DO	<b>O8H212</b> ☺	<b>\$235.19</b>
50mm	0.3 m PVC cable / M8 connector, 3 poles, light on	<b>O8H214</b> ☺	<b>\$235.19</b>
80mm	2 m PVC cable, 3 poles, light on	<b>O8H218</b> ☺	<b>\$235.19</b>
80mm	0.3 m PVC cable / M8 connector, 3 poles, light on	<b>O8H222</b> ☺	<b>\$235.19</b>
80mm	0.3 m PVC cable / M12 connector, 4 poles, light on	<b>O8H273</b> ☺	<b>\$235.19</b>
<b>Retro reflective sensor · 3 wires 24 vDC, PNP IO-Link</b>			
1.8m	2 m PVC cable, 3 poles	<b>O8P200</b> ☺	<b>\$202.70</b>
1.8m	0.3 m PVC cable / M8 connector, 3 poles	<b>O8P202</b> ☺	<b>\$202.70</b>
1.8m	0.3 m PVC cable / M8 connector, 3 poles	<b>O8P204</b> ☺	<b>\$202.70</b>
<b>Through beam transmitter · 2 wires 24 vDC, PNP, IO-Link,</b>			
1.8m	0.3 m PVC cable / M8 connector, 2 poles	<b>O8S201</b> ☺	<b>\$141.80</b>
<b>Through beam receiver · 3 wires 24 vDC, PNP, IO-Link</b>			
1.8m	0.3 m PVC cable / M8 connector, 3 poles, PNP, LO/DO, Prog	<b>O8E202</b> ☺	<b>\$164.61</b>

## Accessories



Whether flat, shiny, matte, dark or light, the O8 offers reliable optical performance independent of target color and is ideal for assembly automation and robotic applications.

Type	Description	Order no.	Price
	O8 Standard Angle L-bracket	<b>E21291</b>	<b>\$19.15</b>
	O8 Clamp Bracket 10 mm	<b>E21298</b>	<b>\$41.96</b>
	Rod Mounting Straight D10mm	<b>E21081</b>	<b>\$25.18</b>
	Prismatic reflector Ø 50 mm, plastic	<b>E20004</b>	<b>\$13.77</b>
	Prismatic reflector Ø 80 mm, plastic	<b>E20005</b>	<b>\$15.92</b>
	Prismatic reflector 48 x 48 mm, PMMA, ABS	<b>E20744</b>	<b>\$32.71</b>
	Mounting set for reflector E20744, clamp mounting, SS, 61 x 51 mm	<b>E20724</b>	<b>\$9.47</b>
	Adjustable mounting set,	<b>E20950</b>	<b>\$23.02</b>
	Mounting cube (for aluminium profiles)	<b>E20951</b>	<b>\$23.02</b>





# Photoelectric sensors

## O6 SERIES IP67, PHOTOELECTRIC SENSORS



\* at maximum range.  
 \*\* referred to prismatic reflector Ø 80 mm  
 \*\*\* 4-wire, complementary output  
 # infared



Easy alignment – Powerful visible red light source with precise spot enables easy alignment and quick setup.

Range [mm]	Light spot dia [mm]	Connector	Order no.	Order no.	Price
Diffuse reflection sensor · 3-wire DC, programmable output			PNP	NPN	
2...200	8*	M12, 3-pole (BGS)	O6H201	-	\$217.98
2...200	8*	M8, 3-pole (BGS)	O6H202	-	\$217.98
5...500	15*	M12, 3-pole	O6T201	-	\$190.22
5...500	15*	M8, 3-pole	O6T202	O6T206	\$190.22
5...600	24*	M8, 4-pole	O6T215#	O6T216#	\$190.22
Retro-reflective sensor polarisation filter · 3-wire DC			PNP	NPN	
50...5,000	150**	M12, 3-pole	O6P201	O6P205	\$190.22
50...5,000	150**	M8, 3-pole	O6P202	O6P206	\$190.22
50...5,000	150**	M8, 4-pole	O6P203	O6P207	\$190.22
Through-beam sensor transmitter · 2-wire DC					
0...10,000	300*	M8, 3-pole	O6S202		\$99.41
Through-beam sensor receiver · 3-wire DC			PNP	NPN	
0...10,000	-	M8, 3-pole	O6E202	O6E206	\$121.15

### Accessories

Type	Description	Order no.	Price
Prismatic reflector			
	Ø 50 mm, plastic, -10...60° C	E20956	\$16.35
	Ø 80 mm, plastic, -10...60° C	E20005	\$15.92
	48 x 48 mm, PMMA, ABS, -10...60° C	E20744	\$32.71
	Reflector mounting bracket E20744, SS, 61 x 51 mm	E20724	\$9.47
	Adjustable mounting set,	E20946	\$33.14
	Mounting cube for aluminium profiles	E20951	\$23.02
	96 x 96 mm, plastic, -10...60° C	E20454	\$35.07
	Reflector mounting bracket E20454, SS, 100 x 100 mm	E20935	\$59.17

## O6 SERIES MINIATURE PLASTIC - LASER



Range [mm]	Connection	Order no.	Price
Diffuse reflection sensor with background suppression, 3-wire DC, IO-Link			
100	0.3 m PUR cable / M12, 4-pole	O6H701	\$419.60
100	M8, 4-pole	O6H702	\$419.60
Retro-reflective sensor with polarisation filter, 3-wire DC (reflector E20722)			
75...8,000	0.3 m PUR cable / M12 connector, 4-pole	O6P701	\$392.92
Through-beam sensor transmitter, DC			
15,000	2 m PUR cable, 3-pole	O6S700	\$316.10
15,000	0.3 m PUR cable / M12 connector, 4-pole	O6S701	\$316.10
Through-beam sensor receiver, 3-wire DC			
15,000	0.3 m PUR cable / M12 connector, 4-pole	O6E701	\$199.26



# Photoelectric sensors

## O6 SERIES IP69K, PHOTOELECTRIC SENSORS



IP 67  
IP 68  
IP 69 K

High-grade stainless steel

\* at maximum range.  
\*\* referred to prismatic reflector Ø 80 mm  
\*\*\* 4-wire, complementary output



Range [mm]	Light spot dia [mm]	Connector	Order no.	Order no.	Price
<b>Diffuse reflection sensor · 3-wire DC, programmable output</b>			<b>PNP</b>	<b>NPN</b>	
2...200	8*	2m PVC cable (BGS)	<b>O6H300</b>	-	\$308.14
2...200	8*	M12, 3-pole (BGS)	<b>O6H301</b>	-	\$308.14
2...200	8*	M8, 4-pole (BGS)	<b>O6H303</b>	<b>O6H307</b>	\$308.14
2...200	8*	M8, 4-pole (BGS)	<b>O6H309</b>	-	\$319.76
2...200	8*	M8, 4-pole (BGS)***	<b>O6H310</b>	-	\$308.14
5...500	15*	M12, 4-pole	<b>O6T301</b>	<b>O6T305</b>	\$267.90
5...500	15*	M8, 4-pole	<b>O6T309</b>	-	\$278.44
<b>Retro-reflective sensor polarisation filter · 3-wire DC</b>			<b>PNP</b>	<b>NPN</b>	
50...5,000	150**	M12, 4-pole	<b>O6P301</b>	<b>O6P305</b>	\$280.59
50...5,000	150**	M8, 3-pole	<b>O6P302</b>	<b>O6P306</b>	\$280.59
50...5,000	150**	M8, 4-pole	<b>O6P303</b>	-	\$280.59
50...5,000	150**	M8, 4-pole	<b>O6P309</b>	-	\$287.70
50...5,000	150**	M8, 4-pole***	<b>O6P310</b>	-	\$275.86
<b>Through-beam sensor transmitter · 2-wire DC</b>			<b>PNP</b>	<b>NPN</b>	
0...10,000	300*	M12, 4-pole	<b>O6S301</b>	-	\$159.02
0...10,000	300*	M8, 3-pole	<b>O6S302</b>	-	\$159.02
0...10,000	300*	M8, 4-pole	<b>O6S303</b>	-	\$159.02
0...10,000	300*	M8, 4-pole	<b>O6S305</b>	-	\$169.78
<b>Through-beam sensor receiver · 3-wire DC</b>			<b>PNP</b>	<b>NPN</b>	
-	-	2m PVC cable	<b>O6E300</b>	-	\$188.93
-	-	M12, 4-pole	<b>O6E301</b>	<b>O6E305</b>	\$188.93
-	-	M8, 3-pole	<b>O6E302</b>	<b>O6E306</b>	\$188.93
-	-	M8, 4-pole	<b>O6E303</b>	-	\$188.93
0...10,000	-	M8, 4-pole	<b>O6E309</b>	-	\$198.83

### Accessories

Type	Description	Order no.	Price
<b>Solidchem Prismatic reflectors for the food industry (up to 140° C)</b>			
	56 x 38 mm	<b>E21268</b>	\$36.15
	46 x 48 mm	<b>E21269</b>	\$58.10
	96 x 96 mm	<b>E21270</b>	\$82.20
	Mounting set for clamp mounting, stainless steel, Ø 10 mm	<b>E21272</b>	\$41.96
	Mounting set for clamp mounting, stainless steel, Ø 12 mm	<b>E21275</b>	\$40.45
	Adjustable mounting set	<b>E20716</b>	\$13.77
	Mounting cube (for aluminium profiles)	<b>E20951</b>	\$23.02
	Mounting rod, 120 mm, Ø 10 mm, M8 thread, stainless steel	<b>E21081</b>	\$25.18
	Mounting rod, 100 mm, Ø 12 mm, M10 thread, stainless steel	<b>E20938</b>	\$15.49
	Bracket for free-standing mounting, stainless steel	<b>E21271</b>	\$16.78

ifm electronic

**ECOLAB**  
The Global Leader in Laboratory Chemicals and Reagents for Life Sciences

ECOLAB Deutschland GmbH  
Ecolab-Allee 1  
D-40781 Monheim am Rhein

certifies that for  
ifm electronic gmbh  
Friedrichstraße 1  
45128 Essen

a  
material resistance test  
was performed with P3-topax 19, P3-topax 58,  
P3-topax 66, P3-topax 990, P3-topactive 200,  
P3-topactive DGS and demineralised water as  
zero value.

The material compatibility of the tested sensors  
from the serie O6c3xx with the P3 products used  
in the test can be considered to be positive  
under the operating conditions stated overleaf.

Monheim, 19 August 2014

I.V. T. Tyboriski

I.V. R. Lauff



# Photoelectric sensors

## M18 OG-CUBE SERIES - STANDARD APPLICATIONS, ZINC ALLOY BODY



Range	Light-on / dark-on mode	Switching output	Order no.	Order no.	Price
Diffuse reflection sensor with BGS · M12 connector · 3 wires			PNP	NPN	
15...200 mm	programmable	24v DC PNP	<b>OGH580</b>	-	\$302.54
100 mm (fixed)	Light On	24v DC PNP	<b>OGH280</b>	-	\$283.39
200 mm (fixed)	Light On	24v DC PNP	<b>OGH281</b>	-	\$283.39
200 mm (fixed)	Light On	24v DC NPN	-	<b>OGH283</b>	\$278.44
Retro-reflective sensor with polarisation filter · M12 connector · 3 wires					
100 mm...4 m	Dark On	24v DC PNP	<b>OGP280</b>	-	\$251.98
100 mm...4 m	Dark On	24v DC NPN	-	<b>OGP282</b>	\$247.24
100 mm...4 m	Light On	24v DC PNP	<b>OGP281</b>	-	\$251.98
Through beam sensor					
15 m	-	Transmitter	<b>OGS280</b>	-	\$170.42
15 m	Dark On	Receiver	<b>OGE280</b>	-	\$216.26
15 m	Light On	Receiver	<b>OGE281</b>	-	\$216.26



### Robust metal housings

ifm's OG Series photoelectrics are far more robust than cheap plastic housings, which suffer from stripped mounting threads over time and the M12 connectors are a weak point that lead to maintenance problems!



## M18 OG-CUBE SERIES - IP69K APPLICATIONS, STAINLESS STEEL BODY



Range	Light-on / dark-on mode	Switching output	Order no.	Order no.	Price
Diffuse reflection sensor with BGS · M12 connector · 3-wire DC			PNP	NPN	
100 mm (fixed)	light-on	24v DC PNP	<b>OGH380</b>	-	\$290.28
200 mm (fixed)	light-on	24v DC PNP	<b>OGH381</b>	-	\$290.28
Through-beam sensor - transmitter · M12 connector			PNP	NPN	
15 m	-	-	<b>OGS380</b>	-	\$202.70
Through-beam sensor - receiver · M12 connector · 3 wires			PNP	NPN	
15 m	dark-on	24v DC PNP	<b>OGE380</b>	-	\$224.65
15 m	light-on	24v DC PNP	<b>OGE381</b>	-	\$224.65

IP 67  
IP 68  
IP 69 K

High-grade stainless steel

Vibration and shock resistant



# Photoelectric sensors

M18 OG SERIES - STAINLESS STEEL BODY



## Bracket system offers accurate alignment



Innovative mounting brackets offer quick installation and setup. The bracket rotates 360° in each of two axes to achieve the most accurate alignment.

## F&B applications, stainless steel body

Range [mm]	Light-on / dark-on mode	Protection	Function	Order no.	Price
<b>Diffuse reflection sensor, M12 connector · 3-wire DC</b>					
100	PNP, Light On	IP69k	BGS	OGH300	\$315.67
250	PNP, Light On	IP65	BGS	OGH200	\$282.53
300	PNP, Prog LO/DO	IP69k	BGS	OGH312	\$329.23
300	PNP, Prog LO/DO	IP67	BGS	OGH500	\$302.33
300	NPN, Prog, LO/DO	IP67	BGS	OGH504	\$310.94
600	PNP, Light On	IP65	-	OGT200	\$205.71
800	PNP, Prog LO/DO	IP69k	-	OGT300	\$275.86
800	PNP, Prog LO/DO	IP67	-	OGT500	\$224.65
<b>Retro reflective sensor, M12 connector · 3-wire DC</b>					
4,000	PNP, Dark On	IP69K	-	OGP300	\$287.27
4,000	PNP, Light On	IP69K	-	OGP301	\$287.27
4,000	PNP, Dark On	IP67	-	OGP200	\$253.27
4,000	PNP, Light On	IP67	-	OGP201	\$253.27
5,000	PNP, Prog LO/DO	IP67	-	OGP500	\$282.96
<b>Through-beam sensor, M12 connector · 3-wire DC</b>					
20,000	PNP, Dark On	IP67	Receiver	OGE200	\$219.91
20,000	-	IP67	Transmitter	OGS200	\$180.32
20,000	PNP, Dark On	IP69K	Receiver	OGE300	\$253.05
20,000	PNP, Light On	IP69K	Receiver	OGE301	\$253.05
20,000	-	IP69K	Transmitter	OGS300	\$212.60
20,000	PNP, Prog LO/DO	IP69K	Receiver	OGE500	\$244.66
20,000	-	IP69K	Transmitter	OGS500	\$202.27

## Accessories

Type	Description	Order no.	Price
	Clamp for Free-standing M10, capscrew, high-grade stainless steel	E20870	\$39.81
	Clamp for mounting rod Ø 12 mm, high-grade stainless steel	E21206	\$32.28
	Mounting rod, 100 mm, Ø 12 mm, M10 thread, stainless steel	E20938	\$15.49
	Mounting cube (for aluminium profiles)	E20951	\$23.02
	Prismatic reflector, Ø 80 mm, plastic	E20005	\$15.92
	48 x 48 mm, PMMA, ABS	E20744	\$32.71
	96 x 96 mm, plastic	E20454	\$35.07





# Photoelectric sensors

M12 OF SERIES - INDUSTRIAL APPLICATIONS



Range [mm]	Light-on / dark-on mode	Protection	Function	Order no.	Price
<b>Diffuse reflection sensor, M12 connector - 3-wire DC PNP</b>					
200	Prog LO/DO	IP67	-	OF5010	\$307.92
200	Prog LO/DO	IP65	-	OF5012	\$340.20
400	Prog LO/DO	IP65	-	OF5027	\$340.20
<b>Through beam sensor, M12 connector - 3-wire DC PNP</b>					
4,000	-	IP65	Transmitter	OF5021	\$231.96
4,000	Prog LO/DO	IP65	Receiver	OF5022	\$272.85

## 05 SERIES LONG RANGE PHOTOELECTRICS



### Standard applications

Ranges [mm]	Spot Ø at max. range [mm]	Light-on / dark-on	Output function	Order no.	Price
<b>Diffuse reflection sensor with BGS - M12 connector - 3-wire DC</b>					
50...1,400	50	Light On	PNP	O5H200	\$318.68
50...1,800	50	Prog LO/DO	PNP	O5H500	\$412.93
<b>Retro-reflective sensor - red light 624 nm - M12 connector - polarisation filter</b>					
75...10,000	250	Prog LO/DO	PNP	O5P500	\$315.88
<b>Through-beam sensor - transmitter - M12 connector</b>					
0...25,000	625	Prog LO/DO	Transmitter	O5S500	\$242.08
0...25,000	-	Prog LO/DO	Receiver (PNP)	O5E500	\$310.94
<b>Contrast sensor, M12 connector - 3-wire DC PNP / NPN</b>					
18...22	1.5 x 5	Prog LO/DO	PNP/NPN	O5K500	\$601.86
<b>Glass sensor, M12 connector - 3-wire DC PNP / NPN</b>					
0...3,000	80	Prog LO/DO	PNP/NPN	O5G500	\$439.83



### Innovative 'Teach Mode' operation



#### Step 1: OUT-off

Mount and align the sensor in the application. The sensor's visible red light simplifies adjustment. Press the OUT-off (output off) button for two seconds.



#### Step 2: OUT-on

Position the object to be detected. Press the OUT-on (output on) button. The sensor is now ready for operation.

### Accessories

Type	Description	Order no.	Price
	Universal angle bracket	E21085	\$34.64
	Mounting set for clamp mounting, high-grade stainless steel, diecast zinc clamp	E21211	\$16.78
	Mounting set for clamp mounting, high-grade stainless steel	E21212	\$30.56
	Clamp for mounting rod, Ø 12 mm, diecast zinc	E20717	\$13.77
	Clamp for mounting rod, Ø 12 mm, high-grade stainless steel	E21110	\$23.02
	Mounting rod, 100 mm long, Ø 12 mm, M10 thread, stainless steel	E20938	\$15.49
	Mounting cube (for aluminium profiles)	E20951	\$23.02
	Mounting rod, 200 mm, Ø 12 mm, M10 thread, stainless steel	E20940	\$47.12
	Prismatic reflector 48 x 48 mm, plastic	E20744	\$32.71
	Prismatic reflector Ø 42 mm, plastic	E20004	\$13.77
	Prismatic reflector Ø 80 mm, plastic	E20005	\$15.92



# Laser sensors

M18 OG-CUBE SERIES - LASERS

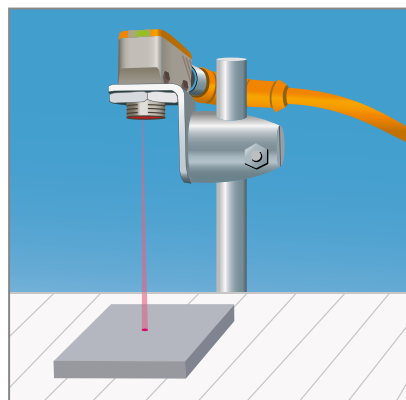

## High performance background suppression

The OG background suppression sensor uses diode array technology that enables the sensor to differentiate between the target and the background regardless of background color.

Range [mm]	Housing material	Output	Connection	Order no.	Price
<b>Mid range laser distance sensor - M12 connector</b>					
50...2,000	Plastic	2x PNP/NPN Programmable, <b>target reflectivity</b>	M12, 4-pole	OGD250	\$598.20
50...2,000	Plastic	1x PNP/NPN 1x Analogue, <b>target reflectivity</b>	M12, 4-pole	OGD251	\$641.24
50...2,000	316 SS	2x PNP/NPN Programmable, <b>target reflectivity</b>	M12, 4-pole	OGD550	\$727.31
50...2,000	316 SS	1x PNP/NPN 1x Analogue, <b>target reflectivity</b>	M12, 4-pole	OGD551	\$770.34
<b>Mid range laser distance sensor - M12 connector, complementary output</b>					
25...1,500	316 SS	2x PNP outputs	M12, 4-pole	OGD580	\$538.38
25...1,500	316 SS	2x NPN outputs	M12, 4-pole	OGD581	\$538.38
25...1,500	316 SS	1x PNP output, 1x PNP output for <b>target reflectivity</b>	M12, 4-pole	OGD582	\$712.03
25...1,500	316 SS	2x PNP outputs, <b>plastic lens for F&amp;B industry</b>	M12, 4-pole	OGD583	\$712.03
<b>Short range precision laser distance sensor - M12 connector, complementary output</b>					
25...300	316 SS	2x PNP	M12, 4-pole	OGD592	\$731.83

## Accessories

Type	Description	Order no.	Price
	Clamp for Free-standing M10, capscrew, high-grade stainless steel	E20870	\$39.81
	Clamp for mounting rod Ø 12 mm, high-grade stainless steel	E21206	\$32.28
	Mounting rod, 100 mm, Ø 12 mm, M10 thread, stainless steel	E20938	\$15.49
	Prismatic reflector, Ø 80 mm, plastic	E20005	\$15.92
	48 x 48 mm, PMMA, ABS	E20744	\$32.71
	96 x 96 mm, plastic	E20454	\$35.07

## HIGH PRECISION LASER SENSOR MEASURES DISTANCES IN THE µM RANGE



Range	Resolution	Outputs	Order No.	Price
30...80 mm	0.01 mm	0.5 2x PNP/NPN (selectable)	OMH550	\$1,226.10
30...80 mm	0.01 mm	0.5 1x PNP/NPN 1x analogue	OMH551	\$1,270.85
50...200 mm	0.05 mm	1 2x PNP/NPN (selectable)	OMH552	\$1,226.10
50...200 mm	0.05 mm	1 1x PNP/NPN 1x analogue	OMH553	\$1,270.85
50...500 mm	0.5 mm	1 2x PNP/NPN (selectable)	OMH554	\$1,226.10
50...500 mm	0.5 mm	1 1x PNP/NPN 1x analogue	OMH555	\$1,270.85



# Laser sensors

## OG SERIES LASER SENSOR, WITH PRECISE BACKGROUND SUPPRESSION



Range [mm]	Laser class	Outputs	Order no.	Price
<b>M18 design, M12 connector, PNP programmable output</b>				
20...200	1	DC PNP, IP67	OGH700	\$539.89
20...200	1	DC NPN, IP67	OGH701	\$539.89
200...15m	1	DC PNP, IP67	OGP700	\$534.94
60m	1	Transmitter, DC PNP, IP67	OGS700	\$415.08
60m	1	Receiver, DC PNP, IP67	OGE700	\$285.97

## OI SERIES LASER SENSORS WITH BACKGROUND SUPPRESSION



Range [mm]	Laser class	Outputs	Protection	Order no.	Price
<b>M30 design, (with setting ring) M12 connector, complementary output</b>					
30...2,000	2	DC PNP, IO-Link prog	IP67	OID200	\$448.65
30...2,000	1	DC PNP, IO-Link prog	IP67	OID250	\$448.65
<b>M30 design, M12 connector, complementary output</b>					
30...2,000	2	DC PNP, IO-Link prog	IP69K	OID204	\$443.49
30...2,000	1	DC PNP, IO-Link prog	IP69K	OID254	\$443.49

## O5 SERIES LASER SENSORS



Range [mm]	Laser class	Outputs	Order no.	Price
<b>O5 design, M12 connector, complementary output (class 2 laser)</b>				
30...2,000	2	DC PNP, IO-Link prog	O5D100	\$445.42
30...2,000	2	DC NPN, IO-Link prog	O5D102	\$445.42
<b>O5 design, M12 connector, complementary output (class 1 laser)</b>				
30...2,000	1	DC PNP, IO-Link prog	O5D150	\$445.42



CLASS 1  
LASER  
PRODUCT  
IEC60825-1:2007  
IEC60825-1:2014  
21CFR PART1040

Class 1  
Laser



Class 2  
Laser

### Accessories

Description	Order No.	Price
Mounting set Ø 30.2 mm, clamp mounting, material die cast zinc	E20873	\$18.94
Mounting set Ø 30.2 mm, clamp mounting, high-grade stainless steel	E20874	\$39.81
v2 m black, PUR cable	EVC001	\$32.92
5 m black, PUR cable	EVC002	\$38.52
10 m black, PUR cable	EVC003	\$47.34
25 m black, PUR cable	EVC084	\$83.71
2 m black, PUR cable	EVC004	\$32.92
5 m black, PUR cable	EVC005	\$38.52
10 m black, PUR cable	EVC006	\$47.34
25 m black, PUR cable	EVC088	\$83.71



# Laser sensors

## O1D SERIES LASER DISTANCE SENSORS



Range [mm]	Laser class	Outputs	Sample rate	Order no.	Price
<b>Long Distance laser sensor</b>					
200...10,000	2	PNP + 4...20 mA / 0...10V	1...50 Hz	<b>O1D100</b>	<b>\$802.19</b>
200...10,000	2	DC 1 x PNP	1...5 Hz	<b>O1D101</b>	<b>\$802.19</b>
200...10,000	2	2 x PNP or 4...20 mA / 0...10V	1...33 Hz	<b>O1D105</b>	<b>\$802.19</b>
300...6,000	1	2 x PNP or 4...20 mA / 0...10V	1...33 Hz	<b>O1D155</b>	<b>\$802.19</b>
200...10,000	2	DC PNP, IO-Link prog	1...50 Hz	<b>O1D120</b>	<b>\$802.19</b>
<b>Level detection</b>					
200...10,000	2	2 x PNP or 4...20 mA / 0...10V	1...33 Hz	<b>O1D300</b>	<b>\$810.37</b>
<b>Retro-reflective distance detection</b>					
75m	2	2 x PNP + 4...20 mA / 0...10V	1...33 Hz	<b>O1D106</b>	<b>\$879.66</b>
Use with Retro-Reflector 226 x 262 mm				<b>E21159</b>	<b>\$253.91</b>



The sensor's 4-digit alphanumeric display precisely indicates the measured distance. Models available with simple teach function or parameter setup via pushbutton.

### Accessories



Description	Order No.	Price	
O1D Alignment + Mounting adapter SS316L	<b>E2D101</b>	<b>\$61.33</b>	
O1D alignment swivel bracket complete with M10-Ø12mm x 130mm long mounting pole, SS316L	<b>E21079</b>	<b>\$97.91</b>	
Process flange adapter G1 for O1D	<b>E21224</b>	<b>\$327.72</b>	
Plastic cover for O1D	<b>E21133</b>	<b>\$64.55</b>	
Glass cover for O1D	<b>E21171</b>	<b>\$73.81</b>	
Cooling box / Protective cover	<b>E21248</b>	<b>\$622.52</b>	
2 m black, PUR cable	<b>EVC001</b>	<b>\$32.92</b>	
	5 m black, PUR cable	<b>EVC002</b>	<b>\$38.52</b>
	10 m black, PUR cable	<b>EVC003</b>	<b>\$47.34</b>
	25 m black, PUR cable	<b>EVC084</b>	<b>\$83.71</b>
2 m black, PUR cable	<b>EVC004</b>	<b>\$32.92</b>	
	5 m black, PUR cable	<b>EVC005</b>	<b>\$38.52</b>
	10 m black, PUR cable	<b>EVC006</b>	<b>\$47.34</b>
	25 m black, PUR cable	<b>EVC088</b>	<b>\$83.71</b>







Position sensors



# Measuring light grids for easy object monitoring in intralogistics.



Photoelectric sensors



Simple object dimensioning in intralogistics without complex programming.

High resolution for precise object detection.

- ↻ Ease of integration due to a standardised IO-Link interface.
- ↻ Selective evaluation of beams to determine the dimensions or distances between objects.

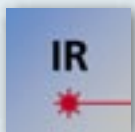
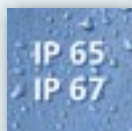

## For optimised logistic processes

The measuring light grids are perfectly suitable for monitoring intralogistics processes. An evaluation of how many and which light beams are obstructed is provided and can be used to detect whether the conveyed objects are in the correct and safe transport position.

With a beam distance of 10 millimetres, the height and width of pallets, packages and boxes, too, can be precisely detected.

## Precise monitoring with IO-Link

Five different measured values in total can be transmitted via IO-Link using the multi-beam system. The height, position, but also the contour of one or several objects can be derived from these values. What is more, diagnostic information on operating hours are determined and transmitted digitally for needs-based maintenance.



# Light grids

## Products

Height Light grids [mm]	Height Measuring range [mm]	Number of beams	Order no.	Price
<b>Measuring light grids with IO-Link</b>				
213	140	15	OY5100	\$1,511.85
663	590	60	OY5103	\$2,976.58
1113	1040	105	OY5106	\$4,465.20
1713	1640	165	OY5110	\$6,355.13
2163	2090	210	OY5113	\$7,796.19
2613	2540	255	OY5116	\$9,589.28

### Common technical data

Operating voltage	[V DC]	24 +/- 20%
Ambient temperature	[°C]	-10...55
Max. range* (distance from transmitter to receiver)	[m]	10
Protection rating, Protection class		IP 65 / IP 67 III
Type of light		infrared
Distance of beams	[mm]	10
Output**		PNP / NPN
Output		H / D
H = light-on / D = dark-on mode		

\* with Y splitter cable EY5053, \*\* switchable via IO-Link

## Functional principle

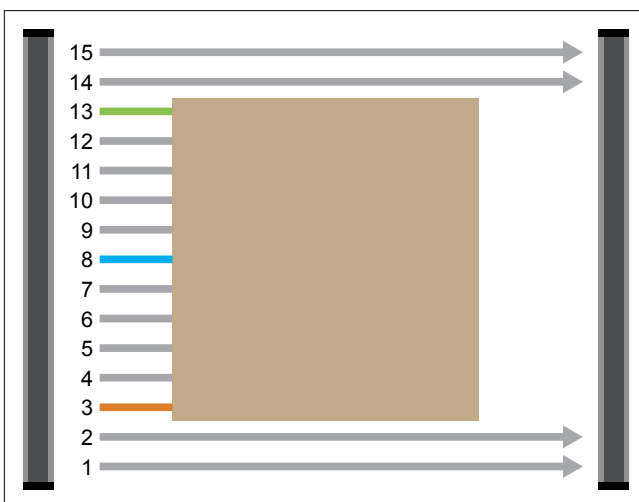

## Accessories

Design	Description	Order no.	Price
<b>Mounting accessories</b>			
	Mounting and fine adjustment unit	EY3013	\$95.97
	Adjustable brackets	EY3004	\$60.47
	Laser adjustment aid	EY3099	\$1,024.47
	USB IO-Link master set	ZZ1060	\$602.50
<b>Connection technology</b>			
	Socket, M12, 5 poles 1 m, black, PUR cable	EVC196	\$32.06
	Socket, M12, 5 poles 2 m, black, PUR cable	EVC070	\$35.50
	Socket, M12, 5 poles 5 m, black, PUR cable	EVC071	\$43.90
	Socket, M12, 5 poles 10 m, black, PUR cable	EVC072	\$60.04
	Y splitter cable Range: 1...10 m	EY5053	\$84.78
	Y splitter cable Range: 0...2 m	EY5054	\$84.78

## Multi-beam system with 5 measured values

The five different measured values in total are used to derive the height, position and but also the contour of one or several objects.



- FBO First beam occupied: 3
- LBO Last beam occupied: 13
- CBO Central beam occupied: 8
- NBO Number of beams occupied: 11
- NCBO Number of consecutive beams occupied: 11



# Multi-code reader with text recognition



Optical identification of 1D/2D codes and text



- Evaluation of various codes and texts in a single image
- Easy integration and configuration via IO-Link
- Ready to use out of the box, only the codes need to be taught
- Reliable detection even in case of extraneous light and demanding surfaces

## Versatile solution for production and logistics

The O2I multicode reader detects 1D and 2D codes as well as text elements. Even in case of multiple codes and text sections or combinations thereof, the O2I provides accurate evaluations in a single image capture. This makes the multicode reader a universally applicable solution for production and logistics processes where codes and text information are to be checked for quality or used for product tracking.

Thanks to the integrated and customisable RGBW lighting, even difficult colour combinations of code / text and background can be read with ease.



## Several codes, one image

The auto-find code function of the Vision Assistant automatically recognises several different codes in one image. The user can easily assign these codes in the Vision Assistant.



## Identification and verification of text (OCR)

(With new firmware version - from 05/30/2022)

### Target / example applications:

- Detection and type designation
- Serial numbers of components
- Expiry date and/or production date
- Product identification



The logic integrated in the ifm VisionAssistant compares the information received from a control system with the code contents read and evaluates them as "OK" or "not OK". The production step is checked by comparing the serial number with a specification.

Based on the contour of the company logo and by tracking the position of the corresponding text, the device reads always the correct text line - irrespective of the orientation of the product.

Use our free firmware update and equip your device with the new functions.



# Camera / Vision solutions

VISION SENSORS FOR RECOGNITION AND ASSESSMENT OF OBJECTS AND SCENES.



Type of light	Image Resolution (px)	Inputs / Outputs	A. Wide Angle Lens	B. Standard Lens	C. Telephoto Lens	Price
Ethernet TCP/IP; EtherNet/IP, Operating Distance 5,000mm (max)						
RGB-W	1,280 x 960	1 / 2	O2I402	-	-	\$2,044.21
Infrared light	1,280 x 960	1 / 2	O2I422	-	-	\$2,044.21
Red light	1,280 x 960	1 / 2	O2I412	-	-	\$2,044.21
RGB-W	1,280 x 960	1 / 2	-	O2I400	-	\$2,044.21
Infrared light	1,280 x 960	1 / 2	-	O2I420	-	\$2,044.21
Red light	1,280 x 960	1 / 2	-	O2I410	-	\$2,044.21
RGB-W	1,280 x 960	1 / 2	-	-	O2I404	\$2,044.21
Infrared light	1,280 x 960	1 / 2	-	-	O2I424	\$2,044.21
Red light	1,280 x 960	1 / 2	-	-	O2I414	\$2,044.21

## APPLICATION GUIDELINE

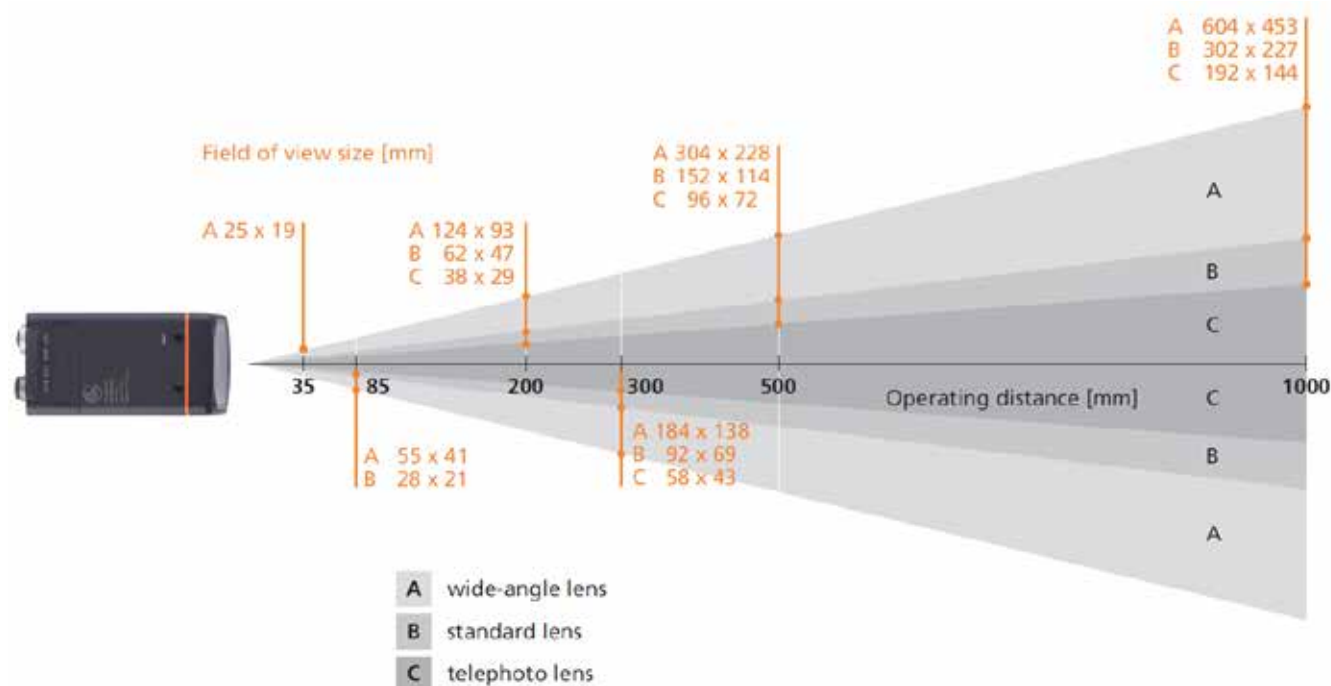

For mounting and connection accessories refer to page 82.





# Dualis: Inspect, measure and control objects

## 2D vision sensors



- 2D vision sensor ensures process and object quality
- Surface and contour detection for targeted robot arm navigation
- User-friendly software simplifies set-up
- Reliable functioning in changing light conditions

### Simply solve your application step by step:

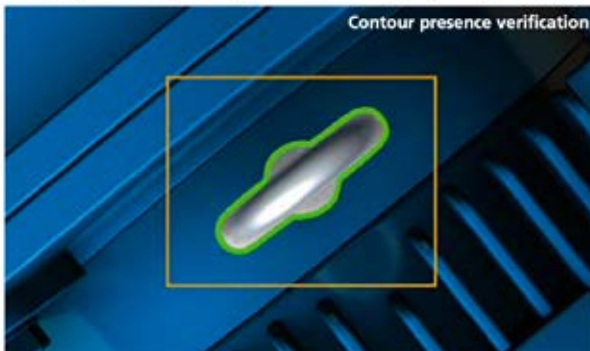

A contour presence verification wizard supports you in solving simple contour presence checks. Even inexperienced users can set up the application within 2 minutes.

#### Robot sensor calibration

The Robot sensor calibration wizard enables precise control of an object by a robot arm. By means of marker calibration, the coordinate systems of the sensor and the robot are precisely adapted to each other.

#### Measurement

The wizard for measurement allows determination of contours and surfaces of objects. These can be set in relation to each other and their distance determined as absolute values.

#### User-defined mode

With the user-defined mode more complex applications with combinations of all functions can be solved.

#### Simple connection to robots

The ProfiNet version with an L-coded connector for power supply facilitates direct connection to industrial robots.

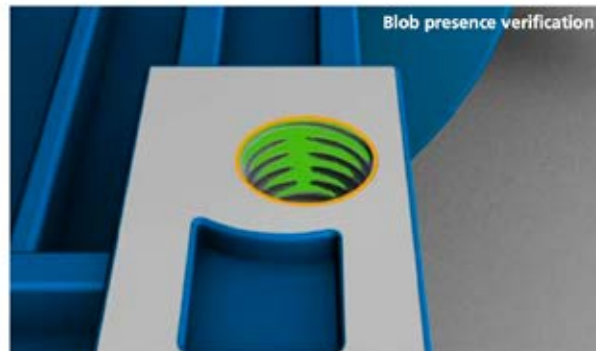

Using the blob presence verification wizard, you can easily set up an application to analyse blobs. Blobs are contiguous pixels that form an area. These areas can be checked for their size, shape or other properties.

#### Many options for perfect quality control

The Dualis is available with infrared or RGB-W illumination. The latter makes it possible to distinguish objects by their colour. Highly reflective objects can also be detected easily thanks to the polarisation filter.

In strongly fluctuating light conditions, it takes up to 5 images with different exposure times and then selects the optimally illuminated image for quality control.

Thanks to the daylight filter, the Dualis is extremely resistant to extraneous light.

#### Fast replacement thanks to memory stick

The Dualis is equipped with an ifm memory stick on which the parameters and settings are stored. In the event of a device replacement, the stick can be used to easily transfer the data to the new Dualis.



# Camera / Vision solutions

VISION SENSORS FOR RECOGNITION AND ASSESSMENT OF OBJECTS AND SCENES.



Type of light	Field of view size [mm]	Pixel size [mm]	Wide Angle Lens	Standard Lens	Telephoto Lens	Price
Ethernet TCP/IP; EtherNet/IP, Operating Distance 5,000mm (max)						
RGB-W	3,004 x 2,253	2.35	O2D502	-	-	\$3,074.92
Infrared light	3,004 x 2,253	2.35	O2D522	-	-	\$3,074.92
RGB-W	1,502 x 1,127	1.17	-	O2D500	-	\$3,074.92
Infrared light	1,502 x 1,127	1.17	-	O2D520	-	\$3,074.92
RGB-W	960 x 720	0.75	-	-	O2D504	\$3,074.92
Infrared light	960 x 720	0.75	-	-	O2D524	\$3,074.92

## Application examples

### Object and contour detection

- Checks objects based on defined contours
- Ideal solution for applications where shapes are repeated



### Object inspection and blob analysis

- Analyses objects based on their surface area
- Ideal solution for applications where shape and size vary

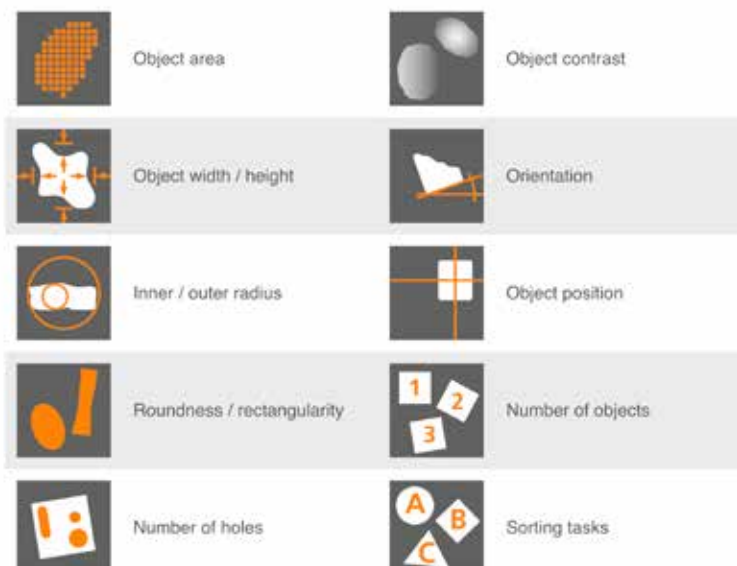

For mounting and connection accessories refer to page 82.



# Camera/vision solutions



## 3D vision sensors

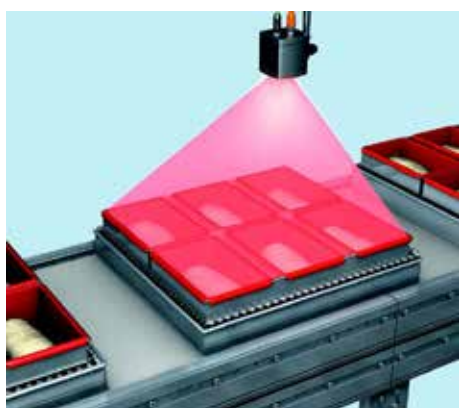

- Up to 38500 distance values per measurement for a detailed assessment of the application
- Different output functions configurable
- Visual assessment of distance, level or volume
- Predefined function blocks
- Reliable function due to time-of-flight measurement

Photoelectric 3D sensors have a wide range of applications including the detection of volume, distance and level. They measure the distance between the sensor and the nearest surface point by point using the time-of-flight principle. The units illuminate the scene with an internal or external infrared light source and calculate the distance by means of the light reflected from the surface.

The sensors for industrial applications can be used for completeness checks, volume determination or sorting tasks. Sensors for use in mobile machines offer outstanding shock and vibration resistance.

### 3D OBJECT RECOGNITION SENSOR = MISSING GOODS; LEVEL DETECTION & VOLUME MEASUREMENT



Material housing	Material front pane / LED window	Max. field of view size [m]	Order no.	Price
<b>PMD 3D sensors · Type O3D · M12 connector</b>				
Aluminium	Gorilla glass / polyamide	2.61 x 3.47	<b>O3D300</b>	<b>\$3,193.06</b>
Aluminium	Gorilla glass / polyamide	3.75 x 5.00	<b>O3D303</b>	<b>\$3,193.06</b>
SS316L	PMMA (acrylic) / polyamide	2.61 x 3.47	<b>O3D310</b>	<b>\$3,512.60</b>
SS316L	PMMA (acrylic) / polyamide	3.75 x 5.00	<b>O3D312</b>	<b>\$3,512.60</b>

#### Accessories

Type	Description	Order no.	Price
	Mounting set for clamp mounting, Ø 14 mm, stainless steel	<b>E3D103</b>	<b>\$75.74</b>
	Parameter setting cable, 2 m, M12 D-coded / RJ45, cross-link	<b>E11898</b>	<b>\$105.44</b>
	Socket, M12, 2 m PUR cable, 8-pole	<b>E11950</b>	<b>\$60.90</b>
	Socket, M12, 10 m PUR cable, 8-pole	<b>E11311</b>	<b>\$123.51</b>



# APP set-up for standard applications

## COMMON APPLICATIONS



### Volumetric control

International airport conveyer company Beumer use ifm's 3D sensor to calculate the volume of baggage prior to loading onto a plane. This improves space allocation within storage containers designed for the aircraft.



### (De)palletisers

Robots help with palletising and depalletising. The 3D sensor detects the exact position and orientation of the packages. The sensor is set up by the user in a few steps via an app.



### Completeness monitoring

The 3D sensor detects overfill or underfill of goods. The time of flight technology used allows evaluation of volume, distance or level and provides the data as switch point or via the Ethernet interface.



### Packaging industry: Incomplete shipments, never again!

In the packaging industry, automation must be particularly flexible. A great number of different products, outer packaging and packing units is produced and must reach the customer without any damage or missing parts. Using many individual sensors is often a reliable solution, but replacing a product or a unit often takes a lot of time and can be a source of errors. Using only one sensor that handles many tasks at once makes a lot more sense. The 3D sensor ensures flexible detection of different situations. The integration into the controller is quick and intuitive thanks to the unique configuration software, "Vision Assistant": The configuration only requires 7 steps.



### Logistics: Optimise your storage space and transport planning

Constantly increasing freight volumes require efficient solutions for logistics and intralogistics. If each centimetre counts in your storage space and transport planning, the 3D sensor can determine the current volume or the correct position of the freight within milliseconds. This accelerates the warehouse operation and reduces the costs. Autonomous logistics systems are used in transport, handling, packaging and sorting processes and for the shipping of goods. The 3D sensor supports, for example, the precise handling of a forklift truck and thereby reduces possible damages while ensuring a constant material flow.





# Camera/vision solutions

1D/2D MULTI-CODE READER, WITH TEXT RECOGNITION

Available on request:



## Accessories

Type	Description	Order no.	Price
	External illumination unit	O2D930	\$1,887.77
	Mounting set	E2D501	\$71.22
	External illumination unit	O2D917	\$1,471.83
	Diffuser for illumination units diffuser window ringlight	E2D202	\$410.35
	Mounting set for illumination unit mounting set ringlight / CC	E2D506	\$68.21
	Mounting set	E2D500	\$66.06
	Y splitter, adapter cable for O2I5xx, trigger sensor, 0.4 m PUR cable	EVC847	\$64.12
	Y connection cable for external illumination	EVC848	\$64.12
	Rod, 150 mm, Ø 12 mm, stainless steel	E21111	\$24.32
	Rod, 200 mm, Ø 12 mm, stainless steel	E21112	\$27.76
	Rod, 300 mm, Ø 12 mm, stainless steel	E21113	\$33.78
	Clamp linking ring, high-grade stainless steel	E21076	\$24.75
	2 m, Industrial Ethernet D-code cable (fieldbus) Green, PUR / Ni Pl brass	EVC893	\$32.06
	5 m, Industrial Ethernet D-code cable (fieldbus) Green, PUR / Ni Pl brass	EVC894	\$62.83
	Socket, M12, 2 m PUR cable, 8-pole	E80021	\$52.72
	Socket, M12, 5 m PUR cable, 8-pole	E11807	\$92.74
	Socket, M12, 10 m PUR cable, 8-pole	E11311	\$123.51



# Profiler for precise contour detection

Laser sensor



- Quality control analysis to ensure correct assembly of parts
- Intuitive setup; no software required
- Two simple modes for optimizing the application
- Immunity to extraneous light – no screening or external illumination required
- Optional contour visualization via Vision Assistant software to simplify trouble-shooting

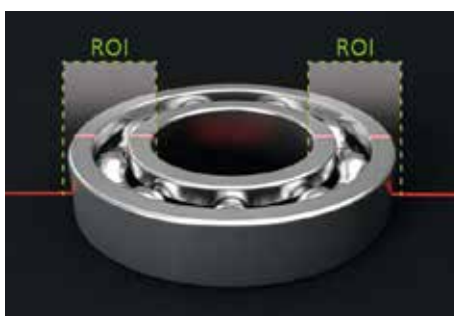
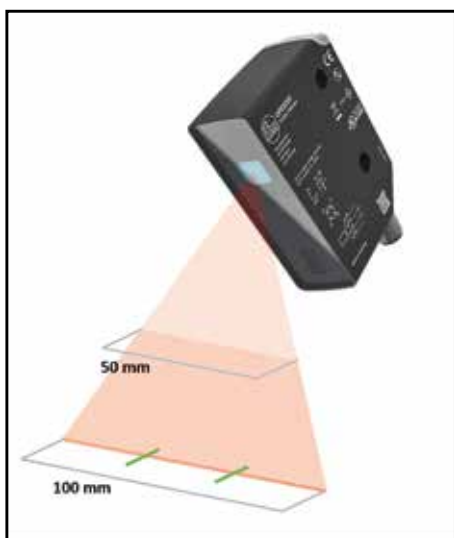

Measuring distance (z direction)	Width of the measuring range (X direction)	Output	Order no.	Price
<b>PMD profiler · M12 connector, Protection Class 1 Laser</b>				
150...300mm	100 (at a maximum distance of 300mm)	PNP/NPN	<b>OPD100</b>	<b>\$1,835.92</b>
150...300mm	100 (at a maximum distance of 300mm) Multiple profiles	PNP/NPN	<b>OPD101</b>	<b>\$1,940.49</b>

## Accessories

Type	Description	Order no.	Price
	Mounting set OPD, 12 mm	<b>E2D118</b>	<b>\$59.82</b>
	Rod, 100 mm, Ø 12 mm, M10 thread, stainless steel	<b>E20938</b>	<b>\$15.49</b>
	Mounting cube (for aluminium profiles)	<b>E20951</b>	<b>\$23.02</b>
<b>M12 sockets 5-pole (0.34mm sensor)</b>			
	2 m black, PUR cable	<b>EVC070</b>	<b>\$35.50</b>
	5 m black, PUR cable	<b>EVC071</b>	<b>\$43.90</b>
	10 m black, PUR cable	<b>EVC072</b>	<b>\$60.04</b>
	15 m black, PUR cable	<b>EVC197</b>	<b>\$67.78</b>
	20 m black, PUR cable	<b>EVC198</b>	<b>\$76.82</b>



# Configurable LED signal light towers



Signalling, indication and perfect visibility



- Highly visible even in bright lighting conditions
- Loud buzzer (90 dB) with selectable melodies
- High protection rating, also with buzzer. Suitable for wet areas
- Simple installation with M30 fixing nut
- 🔗 **Control via IO-Link or digital inputs**



## COMPACT SIGNAL LAMPS



Function	Buzzer	Feedback button	IP rating	Order no.	Price
<b>1-segment signal lamp · M12 connectors, Digital inputs / IO-Link</b>					
IO-Link	-	-	IP67	DV2120	\$301.68
IO-Link	-	Yes	IP67	DV2121	\$351.92
IO-Link	max. 90 dB	-	IP65	DV2130	\$351.92
IO-Link	max. 90 dB	Yes	IP65	DV2131	\$401.95

<b>3-segment signal lamp · M12 connectors, Digital inputs / IO-Link</b>					
IO-Link	-	-	IP67	DV1300	\$523.75
IO-Link	max. 90 dB	Yes	IP65	DV1310	\$625.10
IO-Link	-	-	IP67	DV2300	\$500.08
IO-Link	max. 90 dB	Yes	IP65	DV2310	\$577.33



Function	Inputs	Dimensions Ø x h [mm]	IP rating	Order no.	Price
<b>5-segment signal lamp · M12 connectors, Digital inputs / IO-Link</b>					
Mounting base	6	70 x 344	IP 65	DV1500	\$818.76
Mounting base	5	70 x 344	IP 65	DV1501	\$818.76
Mounting base and siren	6	70 x 384	IP 54	DV1510	\$926.35
Mounting base and siren	6	70 x 384	IP 54	DV1511	\$926.35
-	5	70 x 244	IP 65	DV1521	\$724.94
-	6	70 x 284	IP 54	DV1530	\$832.32
Siren	6	70 x 284	IP 54	DV1531	\$832.32

<b>5-segment signal lamp · M12 connectors, IO-Link</b>					
Mounting base	5	70 x 344	IP 65	DV2500	\$792.29
Mounting base and siren	5	70 x 384	IP 54	DV2510	\$899.02
-	5	70 x 244	IP 65	DV2520	\$698.26
Siren	5	70 x 284	IP 54	DV2530	\$805.42





# Configurable LED signal light towers

## FIVE SEGMENT SIGNAL LAMP



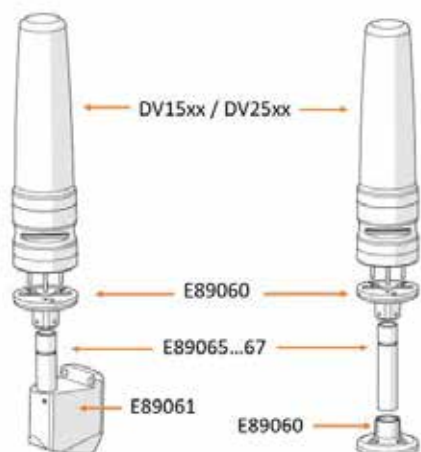



DV15xx / DV25xx



 adapter for side outlet of the cable direct mounting to DV15xx DV25xx  
E89064

### Accessories

Type	Description	Order no.	Price
<b>Assembly</b>			
	Mounting base for pole mount, 22 mm / Ø 22 mm	E89080	\$66.28
	Standard bracket for pole mounting	E89060	\$33.14
	Wall bracket for pole mounting	E89061	\$76.82
	Spacer pole 100 mm	E89065	\$26.90
	Spacer pole 300 mm	E89066	\$37.01
	Spacer pole 800 mm	E89067	\$63.48
<b>M12 sockets 4-pole (0.34mm<sup>2</sup> sensor) IP69K, 4A max</b>			
	2 m black, PUR cable	EVC001	\$32.92
	5 m black, PUR cable	EVC002	\$38.52
	10 m black, PUR cable	EVC003	\$47.34
<b>M12 sockets 5-pole (0.34mm<sup>2</sup> sensor) IP69K, 4A max</b>			
	2 m black, PUR cable	EVC070	\$35.50
	5 m black, PUR cable	EVC071	\$43.90
	10 m black, PUR cable	EVC072	\$60.04
<b>M12 sockets 8-pole (0.25mm<sup>2</sup> sensor) IP69K, 4A max</b>			
	5 m black, PUR cable	E12166	\$68.43
	10 m black, PUR cable	E12167	\$97.91
<b>M12 jumper 8-pole (0.25mm<sup>2</sup> sensor) IP69K, 4A max</b>			
	5 m black, PUR cable	E11230	\$111.25
	10 m black, PUR cable	E12360	\$153.85
	Linerecorder Sensor, software for parameter setting and set-up of IO-Link sensors	QA0011	\$289.20

### FLEXIBLE LED STRIP FOR ILLUMINATION AND SIGNALING



Type	Description	Order no.	Price
	LED-Stripe-RGBW-250mm-IP68	DV1001	\$457.04
	LED-Stripe-RGBW-500mm-IP68	DV1002	\$543.54
	LED-Stripe-RGBW-750mm-IP68	DV1003	\$630.26
	LED-Stripe-RGBW-1000mm-IP68	DV1004	\$716.76



# Safety light curtains & light grids



To the highest safety standard

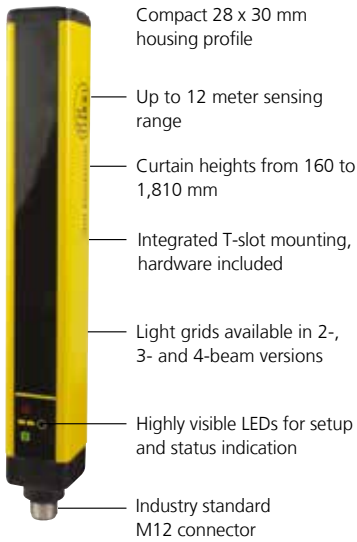

Compact 28 x 30 mm housing profile

Up to 12 meter sensing range

Curtain heights from 160 to 1,810 mm

Integrated T-slot mounting, hardware included

Light grids available in 2-, 3- and 4-beam versions

Highly visible LEDs for setup and status indication

Industry standard M12 connector

## Why choose ifm for your safety products?



- ifm's Type 4 safety light curtains provide an optical solution for protecting plant personnel in unsafe work areas. ifm Type 4 light curtains provide continuous protection, tighter effective aperture range, redundant circuitry and the highest maximum achievable safety level requirements.
- ifm has taken the complexity out of selecting light curtains by offering only Type 4 light curtains.
- ifm offers the optimal resolution models for finger, hand and body protection applications.



### Perimeter guarding of palletizing area

Corner mirrors allow a single pair of safety light curtains to be used in perimeter guarding applications. Up to three corner mirrors may be used to "bend" the light into shapes that protect multiple sides of the dangerous area.



### Palletizer

A palletizer erects a pallet of kegs and places it on a conveyor. Muting sensors are tripped and the pallet is allowed to bypass the light curtain and leave the area. If an operator attempts to enter the palletizing area from the opposite direction, the light curtain will detect his presence and cut power to the machine.

## BODY PROTECTION



### Type 4 light curtains for body protection

Type	Resolution (mm)	No. of Beams	Protected Area Height (mm)	Protected Area Width (m)	Part No.	Price
Protected area width 0...4 m / 3...12 m - Type 2 / SIL1 / PLc						
	500	2	510	12	OY1115	\$1,878.95
	400	3	810	12	OY1125	\$2,110.70
	300	4	910	12	OY1135	\$2,342.66
Protected area width 0...4 m / 3...12 m - Type 4 / SIL3 / PLe						
	500	2	510	12	OY1145	\$2,393.23
	400	3	810	12	OY1155	\$2,771.95
	300	4	910	12	OY1165	\$3,233.73



# Safety light curtains & grids



Type	Resolution (mm)	Protected Area Height (mm)	Protected Area Width (m)	Part No.	Price
<b>HAND Protected area width 0...4 m / 3...12 m - Type 4 / SIL3 / PLc</b>					
	30	160	12	OY041S	\$2,631.87
	30	310	12	OY042S	\$3,167.88
	30	460	12	OY043S	\$3,621.05
	30	610	12	OY044S	\$4,146.30
	30	760	12	OY045S	\$4,647.03
	30	910	12	OY046S	\$5,150.55
	30	1060	12	OY047S	\$5,666.55
	30	1210	12	OY048S	\$6,169.86
	30	1360	12	OY049S	\$6,660.25
	30	1510	12	OY050S	\$7,600.59
	30	1810	12	OY454S	\$8,171.46



Type	Resolution (mm)	Protected Area Height (mm)	Protected Area Width (m)	Part No.	Price
<b>FINGER Protected area width 0...3 m / 1...6 m - Type 4 / SIL3 / PLc</b>					
	14	160	6	OY001S	\$3,185.74
	14	310	6	OY002S	\$3,977.60
	14	460	6	OY003S	\$4,767.10
	14	610	6	OY004S	\$5,570.15
	14	760	6	OY005S	\$6,370.83
	14	910	6	OY006S	\$7,174.10
	14	1060	6	OY007S	\$7,988.13
	14	1210	6	OY008S	\$8,814.63
	14	1360	6	OY009S	\$9,604.99
	14	1510	6	OY010S	\$10,996.34
	14	1810	6	OY011S	\$11,932.16



## Carton erecting

Carton machines can jam during the erecting process. Once the operator breaks the protective area of the safety light curtain, the machine stops to allow the operator to clear the jam.







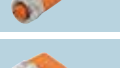

## Accessories

Type	Safety Outputs	Non-safe Outputs	Order no.	Price
<b>Safety relays</b>				
	Safety relay, 2 relay outputs, muting function	Relay	G2001S	\$1,220.29
	3 x relay (N.O.) 2 x relay (N.O.) with time delay	1 x relay (N.O.) 1 x relay (N.C.) 1 x PNP with time delay	G1502S	\$786.27



## Woodworking Power Saws

Operators are denied access to power saws any time the saws are in motion. Finger protection safety light curtains allow operators to work in close proximity to power saws without risk of injury.

Description	Order No.	Price
<b>Connection Sockets . M12</b>		
 Transmitter, 5 m, 5-pole, black, PUR cable	EVC071	\$43.90
 Transmitter, 10 m, 5-pole, black, PUR cable	EVC072	\$60.04
 Transmitter, 5 m, 5-pole, black, PUR cable	EVC074	\$43.90
 Transmitter, 10 m, 5-pole, black, PUR cable	EVC075	\$60.04
 Receiver, 2 m, 8-pole, black, PUR cable	E11231	\$77.46
 Receiver, 5 m, 8-pole, black, PUR cable	E11232	\$95.54
 Receiver, 10 m, 8-pole, black, PUR cable	E12169	\$97.91
 Receiver, 2 m, 8-pole, black, PUR cable	E11950	\$60.90
 Receiver, 5 m, 8-pole, black, PUR cable	E11807	\$92.74
 Receiver, 10 m, 8-pole, black, PUR cable	E11311	\$123.51



# Safety sensors

## MAGNETICALLY-CODED SENSORS



Type	Dimensions [mm]	Range	Connection	Contacts	Order no.	Price
<b>Magnetically coded - actuator is supplied</b>						
	36 x 26 x 13	5 mm	2 m, PVC	2 x NO	<b>MN200S</b>	<b>\$114.26</b>
	36 x 26 x 13	5 mm	M8, 4-pin, integrated	2 x NO	<b>MN202S</b>	<b>\$114.26</b>
	36 x 26 x 13	5 mm	M12, 0.1 m, PVC	2 x NO	<b>MN203S</b>	<b>\$114.26</b>
	36 x 26 x 13	5 mm	6 m, PVC	2 x NO / 1 x NC	<b>MN205S</b>	<b>\$125.02</b>
	88 x 25 x 13	8 mm	2 m, PVC	2 x NO	<b>MN500S</b>	<b>\$117.06</b>
	88 x 25 x 13	8 mm	M8, 4-pin, integrated	2 x NO	<b>MN502S</b>	<b>\$117.06</b>
	88 x 25 x 13	8 mm	M12, 0.1 m, PV	2 x NO	<b>MN503S</b>	<b>\$117.06</b>
	88 x 25 x 13	8 mm	6 m, PVC	2 x NO / 1 x NC	<b>MN505S</b>	<b>\$128.03</b>



- Activation from different directions aids installation
- Conceal behind stainless steel for enhanced tamper prevention
- Connect in series and still identify which door is open
- Meets highest safety level to ISO 13849-1 and SILCL 3 to IEC 62061

## HIGHEST PROTECTION, CODED RFID SENSORS



Type	Dimensions [mm]	Range	Connection	Coding	Series connection possible	Order no.	Price
<b>RFID-coded - actuator is supplied (right cable entry)</b>							
	72 x 25 x 18	12 mm	M12, 5-pole	coded	–	<b>MN700S</b>	<b>\$249.82</b>
	72 x 25 x 18	12 mm	M12, 8-pole	uniquely coded	•	<b>MN701S</b>	<b>\$262.73</b>
	72 x 25 x 18	12 mm	M12, 8-pole	codable	•	<b>MN702S</b>	<b>\$262.73</b>

(Note: Left cable entry on request)



- Unique actuator coding prevents tampering
- Connect up to 32 sensors in series with the safety integrity remaining at the same level
- Flashing LEDs monitor sensing area
- Programme the sensor as often as desired ensuring easy set-up









# Safety sensors

## FAIL-SAFE INDUCTIVE SENSORS





Type	Size mm	Enable zone	Order no.	Price
<b>Safety sensors</b>				
	M12, L = 70	0.5...4 mm, nf	GF711S	\$223.57
	M18, L = 90	3...6 mm, nf	GG505S	\$313.09
	M18, L = 60	1...7.5 mm, nf	GG855S	\$230.89
	M18, L = 70	1...8 mm, nf	GG711S	\$251.33
	M18, L = 60	1...8 mm, nf	GG712S	\$258.86
	M18, L = 60	1...11.5 mm, nf	GG854S	\$230.89
	M30, L = 70	1...10 mm, nf	GI712S	\$259.08
	M30, L = 65	1...14.5 mm, nf	GI855S	\$237.99
	M30, L = 65	1...21.5 mm, nf	GI854S	\$231.75
	40 x 40 x 66 mm	10...20 mm, nf	GM505S	\$329.01
	40 x 40 x 66 mm	4...20 mm, nf	GM705S	\$582.71

## SAFETY RELAYS



ifm's multi-functional safety relay is compatible with industry standard devices

Type	Safety Outputs	Non-safe Outputs	Order no.	Price
<b>Safety relays</b>				
	2 x relay (N.O.)	1 x PNP	G1501S	\$454.03
	3 x relay (N.O.) 2 x relay (N.O.) with time delay	1 x relay (N.O.) 1 x relay (N.C.) 1 x PNP with time delay	G1502S	\$786.27
	For the safe monitoring of protective systems Areas of application: door monitoring, light grids, E-STOP, two-hand control Monitoring of up to 31 safe AS-i slaves Replacement for a large variety of standard safety relays Can be integrated into the AS-i network at any position		AC041S	\$1,475.70







# Ultra-sonic sensors

RANGES VARY FROM 40mm...8m - FOR TRANSPARENT TARGETS



Design	Range [mm]	Output	Setting	Order no.	Price
<b>Diffuse sensor · 3-wire DC, 4-pole, stainless steel</b>					
M18 x 60mm	40...300	PNP, NO/NC Prog	Wire	<b>UGT500</b>	<b>\$408.63</b>
M18 x 60mm	40...300	4...20 mA	Wire	<b>UGT501</b>	<b>\$453.17</b>
M18 x 60mm	40...300	PNP, NO/NC Prog	IO-Link	<b>UGT524</b>	<b>\$412.50</b>
M18 x 60mm	80...1,200	4...20 mA	Wire	<b>UGT507</b>	<b>\$453.17</b>
M18 x 60mm	80...1,200	PNP, NO/NC Prog	IO-Link	<b>UGT526</b>	<b>\$412.50</b>
<b>Diffuse sensor · 4-wire DC, 4-pole, stainless steel</b>					
M18 Cube	40...300	PNP + 4...20 mA	Button	<b>UGT580</b>	<b>\$453.17</b>
M18 Cube	40...300	PNP, NO/NC Prog	Button / IO-Link	<b>UGT592</b>	<b>\$457.47</b>
M18 Cube	60...800	PNP + 4...20 mA	Button	<b>UGT582</b>	<b>\$453.17</b>
M18 Cube	80...1,200	PNP + 4...20 mA	Button	<b>UGT584</b>	<b>\$453.17</b>
M18 Cube	80...1,200	NPN + 4...20 mA	Button	<b>UGT590</b>	<b>\$453.17</b>
M18 Cube	80...1,200	PNP, NO/NC Prog	Button / IO-Link	<b>UGT594</b>	<b>\$457.47</b>
<b>Diffuse sensor · 4-wire DC, 4-pole, IO-Link, PBT plastic</b>					
M18 x 98mm	150...1,600	2 x PNP, NO/NC Prog	Button, IO-Link	<b>UGT203</b>	<b>\$495.34</b>
M18 x 98mm	150...1,600	PNP + 4...20 mA	Button, IO-Link	<b>UGT204</b>	<b>\$495.34</b>
M18 x 98mm	150...1,600	PNP + 0...10 V	Button, IO-Link	<b>UGT205</b>	<b>\$495.34</b>
<b>Diffuse sensor · 4-wire DC, 4-pole, stainless steel</b>					
M18 x 98mm	200...2,200	2 x PNP, NO/NC Prog	Button, IO-Link	<b>UGT510</b>	<b>\$551.94</b>
M18 x 98mm	200...2,200	PNP + 4...20 mA	Button, IO-Link	<b>UGT511</b>	<b>\$551.94</b>
M18 x 98mm	200...2,200	2 x PNP, NO/NC Prog	Button, IO-Link	<b>UGT512</b>	<b>\$551.94</b>
M18 x 98mm	200...2,200	PNP + 4...20 mA	Button, IO-Link	<b>UGT513</b>	<b>\$551.94</b>
M18 x 98mm	200...2,200	PNP + 0...10 V	Button, IO-Link	<b>UGT514</b>	<b>\$551.94</b>
M18 x 98mm	200...2,200	NPN + 4...20 mA	Button	<b>UGT519</b>	<b>\$546.77</b>

## Accessories

Type	Description	Order no.	Price
	Mounting set, Ø 18.5 mm clamp mounting, high-grade stainless steel (M10 cap screw)	<b>E20870</b>	<b>\$39.81</b>
	Mounting set, Ø 30.2 mm clamp mounting, high-grade stainless steel	<b>E20874</b>	<b>\$39.81</b>
	Mounting rod, 100 mm, Ø 12 mm, M10 thread, stainless steel	<b>E20938</b>	<b>\$15.49</b>
	Angle bracket for type M30, stainless steel	<b>E10737</b>	<b>\$9.04</b>
	Sound tube, M18, POM	<b>E23000</b>	<b>\$59.82</b>
	Sound tube, M30, POM	<b>E23007</b>	<b>\$66.28</b>
	Sound deflection angle for sensors with a range of ≤ 1,2 m, stainless steel	<b>E23001</b>	<b>\$53.36</b>
	Sound deflection angle for sensors with a range of ≤ 2,2 m, stainless steel	<b>E23002</b>	<b>\$59.17</b>



# Process values from sensors at a glance



## Multifunction display for analogue signals

- Universal measurement input for various types of signals (current, voltage, frequency, pulses, PT100/PT1000 and thermocouples)
- Colour TFT display with extensive digital labelling
- Intuitive menu structure with help texts for easy parameter setting
- 8 adjustable alarms and 2 relay outputs
- Low installation depth with standard panel cut-out

## Clear representation

The TFT display offers various possibilities and colours to visualise the measured value. The unit of measurement also displayed, the signal name and the location tag clearly explain the meaning of the displayed value.

The different font and background colours of the definable alarms help to evaluate the measured value. Via the two relay outputs, individual alarms can be transferred to higher-level systems, or simple controls can be realised.

## MULTI-FUNCTIONAL TFT DISPLAY FOR IMPULSE SIGNALS, ANALOGUE SIGNALS & TEMPERATURE



Power supply	Inputs	Outputs	Order no.	Price
<b>IP65 multi-function TFT display</b>				
24 VDC	V, mA, kHz, °C, PT100, PT1000, thermocouple	2 x relays	<b>DX1063</b>	<b>\$531.49</b>

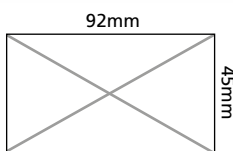

Panel cut-out



# Application diagrams

## CONTROL DEVICES FOR DETECTION & PROCESSING OF ANALOGUE VALUES



Nominal voltage [V]	Inputs	Outputs	Order no.	Price
<b>Multifunction display with IO-Link - touch display and clear text</b>				
115 / 230 AC; 24 DC	2 x analogue	4	<b>DX2045</b>	<b>\$899.02</b>
24 DC	2 x analogue	4	<b>DX2055</b>	<b>\$842.43</b>
<b>Multifunctional analogue display</b>				
115 / 230 AC 18...30 DC	2 x analogue	-	<b>DX2041</b>	<b>\$694.82</b>
115 / 230 AC 18...30 DC	2 x analogue	4	<b>DX2042</b>	<b>\$757.86</b>
115 / 230 AC 18...30 DC	2 x analogue	4 + 4...20 mA	<b>DX2043</b>	<b>\$830.38</b>
<b>Multifunctional display: speed, time, counter</b>				
115 / 230 AC 24 DC	2 x pulse	4 transistor, 1x analogue	<b>DX2022</b>	<b>\$687.28</b>

## FILTER MONITORING SYSTEM FOR INDUSTRIAL PLANTS

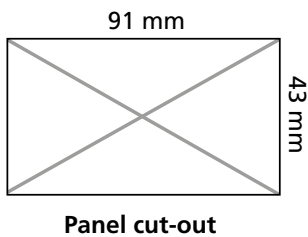

## TRANSMITTER - SYSTEM LAYOUT

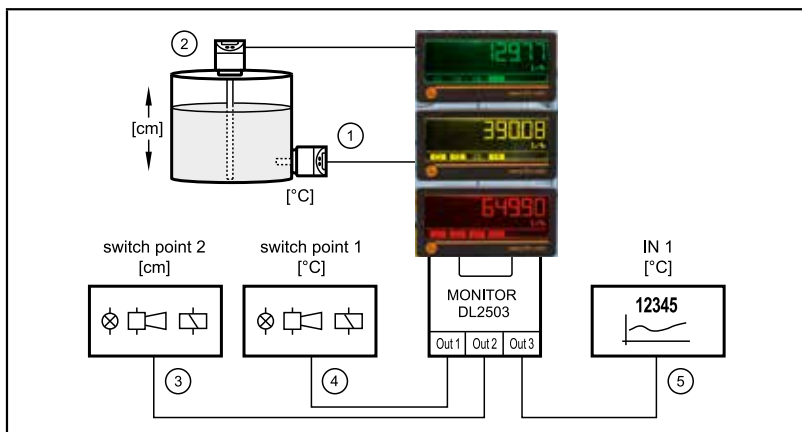

Principle 2CH mode

Limit value monitoring of 2 independent, different process values (here e.g. temperature [°C] and level [cm])

- 1: Temperature sensor [°C]
- 2: Level sensor [cm]
- 3: Switching output 2, here limit value 2 for level [cm]
- 4: Switching output 1, here limit value 1 for temperature [°C]
- 5: Analogue output for display, evaluation or recording of IN1, here [°C]



# Process displays

DISPLAY FOR 4-20 mA SIGNALS

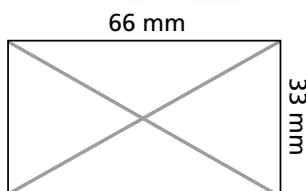

Panel cut-out



Power Supply	Input / output	Display range	Order no.	Price
<b>Loop powered display for 4...20mA signals</b>				
Analogue signal	4...20 mA loop powered	-1,999...1,999	<b>DX1041</b>	<b>\$355.05</b>





## EVALUATION FOR ANALOGUE SIGNALS



Nominal voltage [V]	Inputs	Outputs	Order no.	Price
<b>2-channel analogue threshold relay for analogue standard signals</b>				
110...240 AC, 24 DC	2 x 0/4...20 mA transmitters	2x switching, 1x 0/4...20 mA	<b>DL2503</b>	<b>\$849.96</b>
110...240 AC, 24 DC	2 x PNP	1 x relay, 1 x transistor	<b>DL0203</b>	<b>\$423.90</b>
<b>Power supply and signal evaluation</b>				
110...240 AC, 24 DC	2x PNP/NPN	2x relay	<b>DN0220</b>	<b>\$375.27</b>

## IO-LINK MASTER DISPLAY



Type	Length	Order no.	Price
<b>128 x 128 resolution, 1.44" TFT LED display</b>			
	IO-Link display · Connection to master · Assignment of the values displayed by the controller ·	<b>E30391</b>	<b>\$281.67</b>
	IO-Link inline display · Connection between master and sensor Visualisation of the values of the connected sensor	<b>E30430</b>	<b>\$331.81</b>
	IO-Link display · Shows all sensor process values connected to a master	<b>E30443</b>	<b>\$441.12</b>
<b>Accessories</b>			
Type	Length	Order no.	Price
	DIN rail clip	<b>E30429</b>	<b>\$19.80</b>



# Pressure sensors and mounting accessories



## Selection Guide

Contents	Applications										Pages
	Sensor type	Measuring range [bar]	Medium temperature [C]	Integrated temperature measurement	Hydraulic applications	Ship-building (DNV-GL approval)	Machine tools	Hydrous media	Gaseous media	Viscous media and media containing solids	
With display for industrial applications	PN	-1...600	-25...80		✓	✓	✓	✓	✓		96
	PE PG24	-1...250 -1...400	-25...80 -25...80		✓		✓	✓			97
Without display for industrial applications	PA	-1...600	-25...90		✓		✓	✓			99
	PK	0...400	-25...80		✓		✓		✓		98
	PT/PU	-1...600	-40...90 <sup>9)</sup>		✓	✓	✓		✓		97
	PS PV	0...1 -1...600	-10...85 -40...90	✓	✓		✓	✓	✓		106 98
Flush for industrial applications	PL54	0...400	-25...90				✓	✓		✓	98
	PL15	-1...160	-25...110	✓			✓	✓		✓	-
For pneumatic applications	PQ3	-1...10	0...60				✓		✓		99
	PQS/ PQC	-1...16	0...60				✓		✓		99
For mobile applications	PT/PU	0...600	-40...125		✓				✓		97
With display for hygienic applications	PG27/28	-1...25	-25...125	✓				✓	✓	✓	97
	PI	-1...100	-25...150/200					✓	✓	✓	93
Without display for hygienic applications	PM	-1...100	-25...150	✓				✓	✓	✓	92
Process adapters and mounting accessories for pressure sensors											94
Calibration*											

\* German factory calibration must be ordered separately when placing a pressure sensor PO  
 This service will result in 4 - 6 weeks delivery delay  
 For local calibration by a certified laboratory, we can provide partner information on request



# Pressure Sensor technology

## WHY CERAMIC CAPACITIVE CELLS ARE BEST IN MOST APPLICATIONS

After >50 years of R&D in pressure sensor technology, ifm electronic now offer the most advanced electronic sensor technology available.

Ifm pressure sensors operate in virtually every application. With the majority working in non-Ex rated Industrial plants - monitoring Hydraulics, Pneumatic, Water and Hygienic F&B applications. While withstanding harsh and often rapid fluctuations in process temperature & pressure.

ifm leads the development of pressure sensors utilizing Ceramic Capacitive diaphragms. With advanced electronic circuitry, ifm now produce and offer extremely high accuracy pressure sensors, matching traditional liquid filled types, while overcoming most application issues experienced in daily use of thin metal diaphragm types. These issues include hydraulic pressure spikes, metal corrosion, vacuum effects & surface abrasion.

Following is a summary of the pros & cons of each technology, to assist optimum selection for your application:

## PROS AND CONS OF DIFFERENT MEASURING CELL TECHNOLOGY

### Appropriate application

#### 1. Pressure Surge resistance



#### Ceramic-capacitive measuring cell

PM15, PM17, PI27, PI17, PG27, PN2, PL5, PA3

Advantages	Disadvantages
• Good chemical resistance (99,9% ceramic)	• Separate sealing required
• High pressure rating	
• Long term stability	
• No tiring of ceramic material	
• Less temperature influence	

#### 2. Corrosion resistance



#### Thick film strain gauge measuring cell

Stainless steel measuring cell: PC, PT, PV with 22 mm housing, PK

Advantages	Disadvantages
• No sealing required	• Temperature compensation required
• High burst pressure	
• Stainless steel membrane	

#### 3. Abrasion resistance



#### Piezoresistive measuring cell

PN78, PQ, PS3, PS4:

Advantages	Disadvantages
• Mass product, therefore cost-effective	• Temperature adjustment required
	• Only for gaseous media, as the measuring element is open
	• Lower pressure rating

#### 4. Vacuum Proof



#### Thin film measuring cell

PC, PT, PU, PV with 19 mm housing, PN new generation >100 bar

Advantages	Disadvantages
• Good repeatability	• Lower pressure rating
• No sealing required	
• Small size	



# Hygienic Ceramic Pressure Sensors/Viscus Media

PM SERIES - G1/2 CONNECTION - COMES WITH INTEGRATED TEMPERATURE MEASUREMENT VIA IO-LINK



Type	Factory setting measuring range relative pressure [bar]	Measuring range relative pressure [bar]	P <sub>overload max.</sub> [bar]	Order no.	Price
<b>G 1/2 male sealing cone, 4...20 mA, IO-LINK</b>					
	0...40	-1...40	200	PM1543	\$998.22
	0...25	-1...25	160	PM1503	\$998.22
	0...16	-1...16	110	PM1514	\$998.22
	0...10	-1...10	75	PM1504	\$998.22
	0...6	-1...6	50	PM1515	\$998.22
	0...4	-1...4	40	PM1505	\$998.22
	0...2.5	-0.125...2.5	30	PM1506	\$998.22

## PM SERIES - G1 CONNECTION

IP 67  
IP 68  
IP 69 K

High-grade stainless steel

For process adapters and accessories see pages 96



Type	Factory setting measuring range relative pressure [bar]	Measuring range relative pressure [bar]	P <sub>overload max.</sub> [bar]	Order no.	Price
<b>Aseptoflex Vario, 4...20 mA, IO-Link</b>					
	0...25	-1...25	100	PM1703	\$1,032.22
	0...16	-1...16	75	PM1714	\$1,032.22
	0...10	-1...10	50	PM1704	\$1,032.22
	0...6	-1...6	30	PM1715	\$1,032.22
	0...4	-1...4	30	PM1705	\$1,032.22
	0...2.5	-0.125...2.5	20	PM1706	\$1,032.22
	0...1.6	-0.1...1.6	15	PM1717	\$1,032.22
	-1...1	-1...1	10	PM1709	\$1,062.77
	0...1	-0.05...1	10	PM1707	\$1,062.77
	0...400 mB	0...400 mB	6	PM1718	\$1,062.77
	0...250 mB	12.5...250 mB	6	PM1708	\$1,062.77
	0...100 mB	5...100 mB	4	PM1789	\$1,062.77

## PM WITH WELDED 1.5" TRI-CLAMP CONNECTION



Tri Clamp DN25...DN40 (1...1.5")

IP 67  
IP 68  
IP 69 K

High-grade stainless steel

Type	Factory setting measuring range relative pressure [bar]	Measuring range relative pressure [bar]	P <sub>overload max.</sub> [bar]	Order no.	Price
<b>1.5" Tri-Clamp, 4...20 mA, IO-Link</b>					
	0...40	-1...40	100	PM1143	\$1,031.14
	0...25	-1...25	100	PM1103	\$1,031.14
	0...16	-1...16	75	PM1114	\$1,031.14
	0...10	-1...10	50	PM1104	\$1,031.14
	0...6	-1...6	30	PM1115	\$1,031.14
	0...4	-1...4	30	PM1105	\$1,031.14
	0...2.5	-0.125...2.5	20	PM1106	\$1,031.14
	0...1.6	-0.1...1.6	15	PM1117	\$1,031.14
	0...1	-0.05...1	10	PM1107	\$1,062.13
	0...400 mB	0...400 mB	6	PM1118	\$1,062.13
	0...250 mB	12.5...250 mB	6	PM1108	\$1,062.13

# Hygienic Ceramic Pressure Sensors/Viscus Media

PG SERIES - G1 CONNECTION



IP 67  
IP 68  
IP 69 K

High-grade stainless steel

Vibration and shock resistant

Type	Factory setting measuring range relative pressure [bar]	Measuring range relative pressure [bar]	P <sub>overload max.</sub> [bar]	Order no.	Price
Programmable PNP/NPN NO/NC + 4...20 mA / 20...4mA, -25...+125° C					
	0...25	-1...25	100	PG2793	\$1,426.64
	0...10	-1...10	50	PG2794	\$1,426.64
	0...4	-1...4	30	PG2795	\$1,426.64
	0...25	-0.124...2.5	20	PG2796	\$1,426.64
	-1...1	-1...1	10	PG2799	\$1,465.59
	0...1	-0.05...1	10	PG2797	\$1,465.59
	0...250 mB	-12.4...250 mB	10	PG2798	\$1,465.59
	0...100 mB	-5...100 mB	4	PG2789	\$1,465.59

- PI17 series
- Highest resolution sensor, 32 bit via IO-Link
- Accuracy +/- 0.2% of span
- 150°C continuous temperature rating

## PI SERIES - G1 CONNECTION



Type	Factory setting measuring range [bar]	Measuring range [bar]	Order no.	Price	Order no.	Price
1 switching output and 1 analogue output 4...20 mA / 20...4 mA G 1 male Aseptoflex Vario						
	0...25	-1...25	PI1703	\$1,295.17	PI2793	\$1,426.43
	0...16	-1...16	PI1714	\$1,295.17	PI2714	\$1,426.43
	0...10	-1...10	PI1704	\$1,295.17	PI2794	\$1,426.43
	0...6	-1...6	PI1715	\$1,295.17	PI2715	\$1,426.43
	0...4	-1...4	PI1705	\$1,295.17	PI2795	\$1,426.43
	0...2.5	-0.124...2.5	PI1706	\$1,295.17	PI2796	\$1,426.43
	0...1.6	-0.1...1.6	PI1717	\$1,295.17	PI2717	\$1,426.43
	-1...1	-1...1	PI1709	\$1,334.12	PI2799	\$1,468.17
	-0.05...1	-0.05...1	PI1707	\$1,334.12	PI2797	\$1,468.17
	0...400 mB	-50...400 mB	PI1718	\$1,334.12	-	-
	0...250 mB	-12...250 mB	PI1708	\$1,334.12	PI2798	\$1,468.17
	0...100 mB	-5...100 mB	PI1789	\$1,334.12	PI2789	\$1,468.17

## PI SERIES - FOR HIGH TEMPERATURE APPLICATIONS



For process adapters and accessories see pages 96





Type	Factory setting measuring range relative pressure [bar]	Measuring range relative pressure [bar]	P <sub>overload max.</sub> [bar]	Order no.	Price
1 switching output and 1 analogue output 4...20 mA / 20...4 mA Clamp 1.5" (200°)					
	0...25	-1...25	80	PI2203	\$1,744.89
	0...10	-1...10	50	PI2204	\$1,744.89
	0...4	-1...4	30	PI2205	\$1,744.89
	0...2.5	-0.0124...0.25	20	PI2206	\$1,744.89
	-1...1	-1...1	10	PI2209	\$1,795.46
	0...1	-0.05...1	10	PI2207	\$1,795.46



# Pressure sensor mounting accessories

Process adapters	Device connection	Process connection	Sealing	For sensor type	Order no.	Price		
<b>High-grade stainless steel adapter (316L/1.4435) for hygienic applications</b>								
	G 1 male Aseptoflex Vario	① Clamp 1 - 1.5"	sealing ring	PG27xx, PI27xx	E33201	\$117.27		
			sealing ring		E33208	\$126.31		
			metal-to-metal		E33701	\$103.50		
		Clamp 2"	sealing ring		E33202	\$137.07		
			sealing ring		E33209	\$145.03		
		② pipe fitting DN40 (1.5")	metal-to-metal		E33702	\$123.73		
			sealing ring		E33212	\$117.27		
② pipe fitting DN50 (2")	metal-to-metal	E33712	\$109.31					
	sealing ring	E33213	\$137.07					
③ G 1/2	metal-to-metal	E33713	\$123.73					
	sealing ring	E30131	\$139.65					
<b>High-grade stainless steel welding adapters for hygienic applications</b>								
	G 1 male Aseptoflex Vario	welding adapter D50	sealing ring	PG27xx, PI27xx	E30122	\$94.46		
					④ G 1 male Aseptoflex Vario sealing cone	welding mandrel	E30130	\$120.29
							E30435	\$88.44
<b>Adapter accessories for hygienic applications</b>								
	G 1 male Aseptoflex Vario	sealing plug	sealing ring	PG27xx, PI27xx	E30128	\$103.72		
					⑤ FKM O-ring	E30123	\$10.33	
						PEEK ring	E30124	\$38.73

## INDUSTRIAL PRESSURE SENSOR MOUNTING ACCESSORIES

Process adapters	Device connection	Process connection	Material	Order no.	Price	
<b>Adapters for industrial applications -For sensor type PN, PA with internal thread</b>						
	G 1/4	G 1/4	high-grade stainless steel (316L/1.4404) FKM	E30143	\$40.02	
		G 1/2	stainless steel (303/1.4305), FPM (Viton)	E30050	\$43.90	
		G 1/2	high-gr. stainl. steel (316L/1.4404) FPM (Viton)	E30002	\$56.81	
		M20 x 1.5	stainless steel (303/1.4305), FPM (Viton)	E30010	\$42.18	
		1/4" NPT	high-grade stainless steel (316Ti/1.4571)	E30058	\$51.43	
		1/2" NPT	high-grade stainless steel (316L/1.4404)	E30133	\$60.04	
<b>Accessories for industrial applications</b>						
	Damping screw for PN with G 1/4 internal thread			E30419	\$22.16	
	Protective cover			PN	E30420	\$10.76
	Angle bracket				E30421	\$14.63
	Damping screw for sensors with G 1/4 external thread			PN, PK, PA35xx	E30057	\$14.20
	Syphon G 1/4				E30140	\$54.23
	Syphon G 1/2			PG24	E30141	\$89.51
	Protective cover			PK	E30094	\$11.40
	Cable clamp fastener				E30399	\$54.66
	Filter element			PS	E30400	\$14.85
	Splitter box with ventilation and terminal block				E30401	\$201.19
	DIN rail clip			PQ	E37340	\$14.20
	Adapter R 1/8 - R 1/8 rotatable				E37350	\$46.05





# Industrial Pressure Sensors

IFM CERAMIC CAPACITIVE MEASURING CELL - ADVANCED TECHNOLOGY

## PN Series



Large bright LEDs can be seen from all angles indicate output status

2-color digital display is easier to see from a distance

Simple pushbutton setup allows the sensor to be parameterized in less than 5 minutes with new scroll and enter buttons

Robust 316 stainless steel construction

QR code for quick access to technical data and installation instructions

Laser etched part numbers will not fade for future referencing

Atmospheric reference is achieved via the electrical connection for high IP67 rating

Sensor can be rotated 345° for optimum visibility after installation

Process connection, G1/4" = 1/4" PSP-P

Ceramic diaphragm withstands pressure spikes

## PA & PP Series

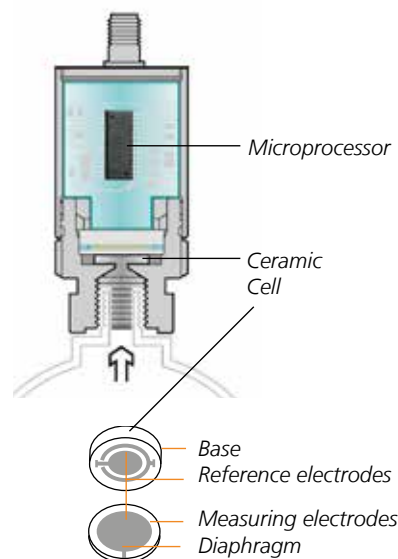

## PG transmitter features highly visible gauge with the functionality of a pressure sensor

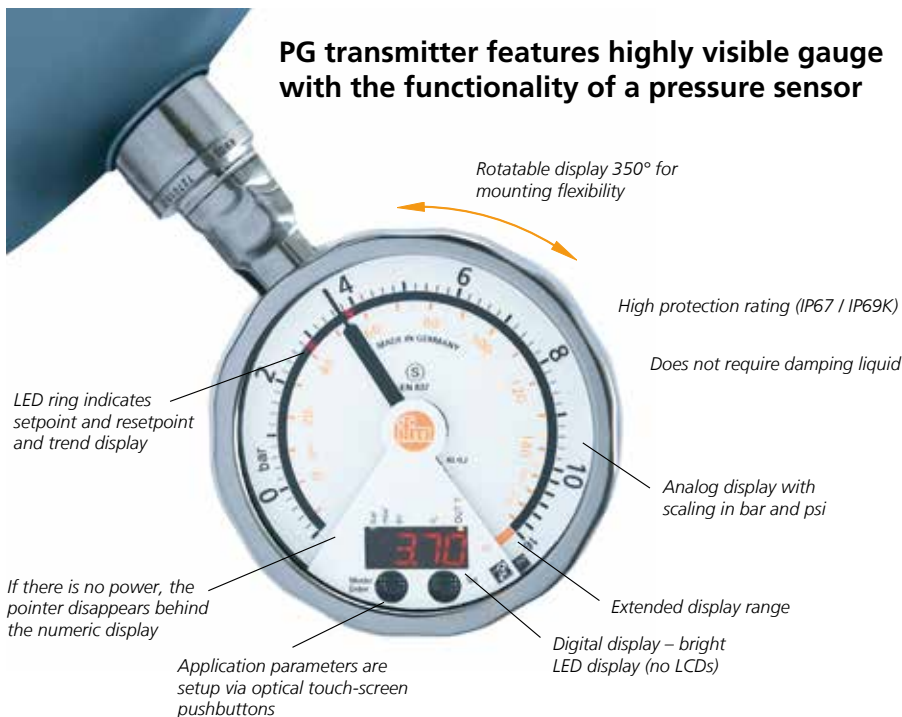

Rotatable display 350° for mounting flexibility

High protection rating (IP67 / IP69K)

Does not require damping liquid

LED ring indicates setpoint and resetpoint and trend display

Analog display with scaling in bar and psi

Extended display range

Digital display – bright LED display (no LCDs)

If there is no power, the pointer disappears behind the numeric display

Application parameters are setup via optical touch-screen pushbuttons

## High-precision measurement



ifm's PG Series pressure family offers a 3-in-1 solution for pressure applications. The PG is a transmitter, switch and gauge in a light-weight, stainless steel housing.



# Pressure sensors type PN & PY

UNIVERSAL APPLICATION AREAS: HIGH OVERLOAD, IP 67 IN PRESSURE RANGES OF -1...600 BAR.



- **Red - green ranges:** "Good ranges" or switching states can be identified quickly via the display colour.
- **Quick setting:** Easy to use via 3 pushbuttons.
- **Optimum orientation:** Process connection rotatable by approx. 345°.



Measuring Cell	Process connection	Pressure range [bar]	P <sub>overload max.</sub> [bar]	Order no. G 1/4 female	Price
<b>M12 connector - output function programmable, 2 x NO/NC</b>					
Stainless steel chamber	G 1/4" female	0...600	800	PN7160	\$796.38
Stainless steel chamber	G 1/4" female	0...400	800	PN7070	\$796.38
Stainless steel chamber	G 1/4" female	0...250	500	PN7071	\$773.57
Ceramic capacitive	G 1/4" female	0...100	300	PN7092	\$773.57
Ceramic capacitive	G 1/4" female	0...25	150	PN7093	\$773.57
Ceramic capacitive	G 1/4" female	-1...10	75	PN7094	\$773.57
Ceramic capacitive	G 1/4" female	0...2,5	20	PN7096	\$773.57
Ceramic capacitive	G 1/4" female	0...1	10	PN7097	\$796.38
Ceramic capacitive	G 1/4" female	-1...1	20	PN7099	\$796.38

<b>M12 connector - output function programmable, 1 x NO/NC + 4...20 mA/0...10V</b>					
Stainless steel chamber	G 1/4" female	0...600	800	PN2160	\$955.83
Stainless steel chamber	G 1/4" female	0...400	800	PN2070	\$955.83
Stainless steel chamber	G 1/4" female	0...250	500	PN2071	\$927.86
Ceramic capacitive	G 1/4" female	0...100	300	PN2092	\$927.86
Ceramic capacitive	G 1/4" female	0...25	150	PN2093	\$927.86
Ceramic capacitive	G 1/4" female	-1...10	75	PN2094	\$927.86
Ceramic capacitive	G 1/4" female	-0.125...2,5	20	PN2096	\$927.86
Ceramic capacitive	G 1/4" female	-0.05...1	10	PN2097	\$955.83
Ceramic capacitive	G 1/4" female	-1...1	10	PN2099	\$955.83
Ceramic capacitive	G 1/4" female	-0.5...0.5	10	PN2169	\$955.83

**NOTE: For gases and pressures >25 bar ONLY use Stainless Steel Chamber sensors**

<b>Designed for refrigeration applications (EPDM seals)</b>					
Ceramic capacitive	G 1/4" female	0...100	300	PE2092	\$946.36
Ceramic capacitive	G 1/4" female	-1...25	150	PE2093	\$946.36
Ceramic capacitive	G 1/4" female	-1...10	75	PE2094	\$946.36

Type	Description	Order no.	Price
	Damping screw, for surge pressure protection. For PN / PA sensors with G1/4 fittings	E30419	\$22.16



# Pressure sensors type PG, PT & PV

PY SERIES - PRECISE MONITORING OF HOMOGENISER PROCESSES



Type	Process Connection	Measuring range [bar]	P <sub>overload max.</sub> [bar]	P <sub>bursting min.</sub> [bar]	Order no.	Price
M12 connector · Output function 2 x NO / NC prog or 1 x normally NO / NC prog + 1 x analogue (4...20 mA / 0...10 V; scaleable 1:4)						
	-	0...400	600	1000	PY9070	\$2,865.55
	Clamp fitting	0...600	800	1200	PY9060	\$2,016.24

## PG SERIES - G1/2 (BSP) CONNECTION



Type	Factory setting measuring range relative pressure [bar]	Measuring range relative pressure [bar]	P <sub>overload max.</sub> [bar]	Order no.	Price
Programmable PNP/NPN NO/NC + 4...20 mA/20...4mA					
	0...400	0...400	800	PG2450	\$1,110.54
	0...250	0...250	600	PG2451	\$1,079.77
	0...100	0...100	300	PG2452	\$1,079.77
	0...25	-1...25	100	PG2453	\$1,079.77
	0...10	-1...10	50	PG2454	\$1,079.77
	0...4	-1...4	30	PG2455	\$1,079.77
	0...2.5	-0.125...2.5	20	PG2456	\$1,079.77
	0...1	-0.05...1	10	PG2457	\$1,110.54
	0...250 mB	-12.5...250 mB	6	PG2458	\$1,110.54
	0...100 mB	-5...100 mB	4	PG2489	\$1,110.54

## COMPACT FIXED RANGE PRESSURE TRANSMITTERS WITHOUT DISPLAY

**Pressure transmitters type PT**  
 Pressure transmitters with fixed measuring range.  
 Fast response time of 1 ms.  
 Stainless steel measuring cell without any seal.

Type	Measuring range Relative pressure [bar]	P <sub>overload max.</sub> [bar]	Order no.	Price
Gauge pressure transmitter, G1/4 Connection Output function 4...20 mA, Loop power				
	0...600	1,500	PT5460	\$265.75
	0...400	1,000	PT5400	\$265.75
	0...250	625	PT5401	\$258.22
	0...160	400	PT5412	\$258.22
	0...100	250	PT5402	\$258.22
	0...40	100	PT5443	\$258.22
	0...25	65	PT5403	\$258.22
	0...16	40	PT5414	\$258.22
	0...10	25	PT5404	\$258.22
	0...6	15	PT5415	\$258.22
	-1...10	25	PT5494	\$258.22



# Pressure sensors type PL, PT, PK & PQ

## PV SERIES - PRESSURE SENSOR WITH INTEGRATED TEMPERATURE MEASUREMENT

### Pressure sensors type PV

Programmable IO-Link pressure sensor with switching outputs.

Stainless steel measuring cell without any seal IO-Link.



Type	Measuring range Relative pressure [bar]	P <sub>overload</sub> max. (static) [bar]	P <sub>bursting</sub> min. [bar]	Order no.	Price
Pressure / Temperature Sensor – 2x IO-Link Outputs, G 1/4" Male					
	0...600	1,500	2,500	PV8060	\$349.67
	0...400	1,000	1,700	PV8000	\$349.67
	0...250	625	1,200	PV8001	\$340.41
	0...100	250	1,000	PV8002	\$340.41
	0...60	150	900	PV8023	\$340.41
	-1...25	65	600	PV8003	\$340.41
	-1...10	25	300	PV8004	\$340.41

### PL SERIES - G1/2 FLUSH CONNECTION

### Pressure sensors type PL

Programmable IO-Link pressure sensor with switching outputs.

Robust ceramic flush measuring cell.



Type	Measuring range factory setting [bar]	Measuring range relative pressure [bar]	Order no.	Price
Pressure / Temperature Sensor – 2x IO-Link Outputs, G 1/2" Male				
	0...160	0...160	PL1512	\$658.02
	0...100	0...100	PL1502	\$658.02
	0...60	0...60	PL1523	\$658.02
	0...40	-1...40	PL1543	\$658.02
	0...25	-1...25	PL1503	\$658.02
	0...16	-1...16	PL1514	\$658.02
	0...10	-1...10	PL1504	\$658.02
	0...6	-1...6	PL1515	\$658.02
	0...2.5	-0.125...2.5	PL1506	\$658.02

### PL SERIES - G1/4 FLUSH CONNECTION



Type	Measuring range Relative pressure [bar]	P <sub>overload</sub> max. (static) [bar]	P <sub>bursting</sub> min. [bar]	Order no.	Price
G 1/4 male sealing cone, 4...20 mA, IO-LINK					
	0...400	1,000	1,700	PL5400	\$566.57
	0...250	625	1,200	PL5401	\$566.57
	0...160	400	1,100	PL5412	\$566.57
	0...100	250	1,000	PL5402	\$566.57
	0...60	150	900	PL5423	\$566.57

### PK SERIES - PRESSURE SWITCH

### Pressure sensors type PK

Easy switch point adjustment via two setting rings allowing optimum read-out.

Mechanical locking prevents inadvertent switch point manipulation.

Stainless steel measuring cell without any seal.



Type	Measuring range Relative pressure [bar]	P <sub>overload</sub> max. (static) [bar]	Order no.	Price
Adjustable Pressure Switch, M12 connector · output adjustable. 2 x NO, PNP				
	0...400	600	PK7520	\$421.75
	0...250	400	PK7521	\$410.13
	0...100	200	PK7522	\$410.13
	0...10	25	PK7524	\$410.13
M12 connector · output adjustable. 2 x NO/NC, PNP (complimentary)				
	0...400	600	PK6520	\$421.75
	0...250	400	PK6521	\$410.13
	0...100	200	PK6522	\$410.13
	0...25	60	PK6523	\$410.13
	0...10	25	PK6524	\$410.13



# Pressure sensors type PP & PA

## PP SERIES

### Pressure sensors type PP

Pressure sensors with fixed measuring range.

High resistance to overload due to ceramic measuring cell.

Type	Measuring range Relative pressure [bar]	P <sub>overload</sub> max. [bar] static	Order no.	Price
Pressure sensor, fixed range, G1/4 (female) , 2x IO-Link Outputs.				
	0...400	1,000	PP7550	\$519.23
	0...250	850	PP7551	\$504.60
	0...100	650	PP7552	\$504.60
	0...25	350	PP7553	\$504.60
	0...10	150	PP7554	\$504.60

## PA SERIES

### Pressure transmitters type PA

Pressure transmitters with fixed measuring range.

High resistance to overload due to ceramic measuring cell.

Note: PA3589 is male connection

Type	Measuring range Relative pressure [bar]	P <sub>overload</sub> max. [bar] static	Order no.	Price
Pressure transmitter, fixed range, G1/4 (female) , Output function 4...20 mA				
	0...10	75	PA3024	\$563.34
	0...2.5	20	PA3026	\$563.34
	-1...0	10	PA3029	\$579.69
	0...1	10	PA3027	\$579.69
	0...0.25	6	PA3028	\$634.14
	0...0.1	4	PA3589*	\$639.95



# Pneumatic pressure sensors

## PQ SERIES - IO-LINK PRESSURE TRANSMITTER & SWITCH



NOTE: PQ orange series have been upgraded to the new PQC and PQS series (black cube)

PQ3 and PQ7 series are available on request

Type	Measuring range Relative pressure [bar]	Connection	Order no.	Price
Output function 1 x NO/NC programmable + 1 x 4...20 mA output				
	0...16	M8 connector	PQC810	TBA
	-1...10	M8 connector	PQC812	TBA
	-1...1	M8 connector	PQC816	TBA
	-1...0	M8 connector	PQC819	TBA
Output function 2 x NO/NC programmable				
	0...16	M8 connector	PQS810	TBA
	-1...10	M8 connector	PQS812	TBA
	-1...1	M8 connector	PQS816	TBA
	-1...0	M8 connector	PQS819	TBA

# Absolute pressure sensors

## PT SERIES

### Pressure transmitters type PT

For absolute pressure measurement.

Transmitters with fixed measuring range.

Stainless steel measuring cell without any seal.

Type	Measuring range Relative pressure [bar]	P <sub>overload</sub> max. [bar] static	Order no.	Price
Absolute pressure transmitter, G1/4 Connection , Output function 4...20 mA				
	0...1	2	PT0507	\$289.20
	0...1.6	3.2	PT0517	\$280.81



# Level sensors and mounting accessories



## Selection Guide

	Contents	Sensor type	Max measuring range	Analogue output	Switching output	Approvals	Pages
Point Level Detection	Impedance spectroscopy in contact with the medium Alternative to the turning fork, suppresses deposits and foam	LMT, LMC	-	-	✓	EHEDG, 3A, FDA, EC1935, WHG, ATEX, DNV/GL, FCM	101
	Capacitive in contact with the medium For overflow prevention and leakage monitoring	LI	-	-	✓	WHG	102
	Capacitive without contact For the detection through non-metallic tank walls	KG KI KQ	25	✓	✓		57 57 103
continuous level measurement	Capacitive in contact with the medium For applications on hydraulic and coolant tanks	LK LT	73	✓	✓	WHG	- 102
	Contactless radar For non-contact level measurement in tanks up to 10m	LW	1000	✓	✓	EHEDG, 3A, FDA, EC1935, USP VI	105
	Guided wave radar in contact with the medium For industrial and hygienic applications	LR	200	✓	✓	EHEDG, 3A, FDA, EC1935, WHG	104
	Hydrostatic in contact with the medium For industrial and hygienic applications on tanks and in free-flowing waterways	PG, PI, PA PS, PN, PE, PM	-	✓	✓	EHEDG, 3A, FDA, EC1935, ATEX, DNV/GL, FCM	97 93 99 106 96 96 94
	Ultrasonic without contact For long distances and difficult surfaces	UGT, UIT	800	✓	✓		107
	Photoelectric without contact For long distances, angle-independent measurement with focused light spot	O1D	980	✓	✓		106
	Photoelectric 3D For bulk materials and for completeness monitoring	O3D	800	✓	✓		76
	Calibration						

\* German factory calibration must be ordered separately when placing a level sensor PO  
This service will result in 4 - 6 weeks delivery delay  
For local calibration by a certified laboratory, we can provide partner information on request



# Level sensors type LMT & LMC

## LMT HYGIENIC POINT LEVEL SENSORS

### LMT level sensors

Flexible mounting.

Shock & vibration resistant in a robust stainless steel housing.

Hygienic approvals EHEDG, 3A, FDA.

Versions available as overflow prevention to WHG\*.

Complementary switching outputs.



Process connection	Installation length [mm]	Medium temp [°C]	Order no.	Price
<b>M12 connection - output function 2 x NO/NC complimentary (water based media)</b>				
G 1/2	11	-40...100	LMT100	\$450.16
G 1/2	38	-20...100	LMT102	\$493.41
G 1/2	153	-20...100	LMT104	\$573.24
G 1/2	253	-20...100	LMT105	\$583.78
<b>M12 connection - output function 2 x NO/NC complimentary (viscous media and powders)</b>				
G 1/2	11	-40...100	LMT110	\$450.16
G 1/2	11	-40...100	LMT121	\$469.74

### Accessories

Type	Description	Order no.	Price
	Screw-in adapter, G 1/2 female – G 3/4 male	E43302	\$81.98
	Screw-in adapter, G 1/2 female – G 1 male	E43303	\$148.26
	Screw-in adapter, G 1/2 female – 3/4 NPT	E43313	\$92.31
	Aseptoflex Vario adapter Clamp 1-1.5" O-ring EPDM*	E33401	\$109.10
	Aseptoflex Vario adapter Clamp 2" O-ring EPDM*	E33402	\$109.10
	Welding adapter for process sensors G1/2-welding spherical	E30055	\$81.55

## LMC INDUSTRIAL POINT LEVEL SENSOR

### LMC level sensors

Flexible mounting.

Shock & vibration resistant in a robust stainless steel housing.

Versions available as overflow prevention to WHG\*.

Complementary switching outputs.



Process connection	Installation length [mm]	Medium temp [°C]	Order no.	Price
<b>Applications: water, hydrous media M12 connector - output function NO/NC complimentary</b>				
G 1/2	12	-25...100	LMC100	\$336.33
G 1/2	21	-25...100	LMC400	\$336.33
1/2 NPT	34	-25...100	LMC500	\$336.33
<b>Applications: oils, oil-based media M12 connector - output function NO/NC complimentary</b>				
G 1/2	12	-25...100	LMC110	\$336.33
1/2 NPT	34	-25...100	LMC510	\$336.33

### Accessories

Type	Description	Order no.	Price
	Welding adapter, G 1/2, Ø 26.4 mm	E43375	\$28.19
	Flat seal, 26.5 x 21.3 x 1.5 mm	E43376	\$9.25
	Adapter, process connection G 1A	E43383	\$112.97

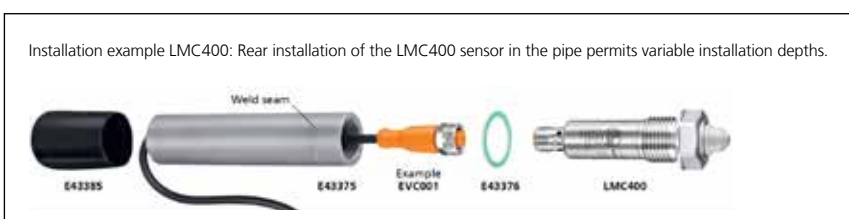



# Maintenance-free capacitive level measurement

## CAPACITIVE LEVEL SENSORS



- Optimised for use in hydraulic oils and coolants
  - No maintenance necessary, free from mechanical parts
  - Easy adjustment and setting of the output function via inductive teach button
- 2 configurable switching outputs defined by media or temperature**
- Adjustment to different media (e.g. water/oil)**



Type	Probe length (mm)	Medium	Output	Order no.	Price
------	-------------------	--------	--------	-----------	-------

### Hydraulic level probe for oil or water, -25...85°C

	132	Oil	2 DO	LI5131	\$299.53
	273	Oil	2 DO	LI5132	\$316.31
	481	Oil	2 DO	LI5133	\$332.88
	737	Oil	2 DO	LI5134	\$349.88
	132	Water	2 DO	LI2131	\$397.44
	273	Water	2 DO	LI2132	\$412.50
	481	Water	2 DO	LI2133	\$426.92

Type	Probe length (mm)	Temperature [°C]	Output	Order no.	Price
------	-------------------	------------------	--------	-----------	-------

### Combined level and temperature hydraulic level probe

	472 mm	0...70 (90 for 1 hr)	1xDO, 1x4-20	LT3023	\$1,028.13
	262 mm	0...70 (90 for 1 hr)	4 x DO	LT8022	\$980.79
	472 mm	0...70 (90 for 1 hr)	4 x DO	LT8023	\$1,035.66
	728 mm	0...70 (90 for 1 hr)	4 x DO	LT8024	\$1,090.53

## Accessories

Type	Description	Order no.	Price
------	-------------	-----------	-------

### Mounting accessories

	Mounting clamp for level sensors Ø 16 mm	E43000	\$10.11
	Mounting clamp for level sensors Ø 16 mm	E43016	\$36.15

### Mounting adapters

	Mounting adapter, G 3/4, stainless steel	E43003	\$90.38
	Installation adapter for level sensors, D16, stainless steel	E43004	\$98.34
	Flange plate for level sensors, 65-80 mm, anodised aluminium	E43006	\$80.91



# Maintenance-free capacitive level measurement

## CAPACITIVE LEVEL SENSORS

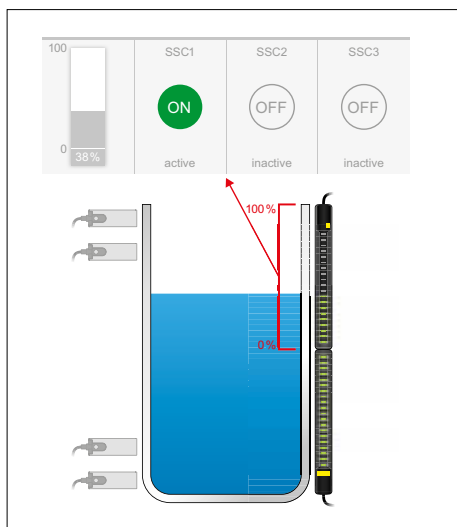

- Continuous level monitoring from outside the process
- No stress caused by the medium thanks to non-contact detection
- Three point level positions in one sensor
- Deposits can be detected and signalled to improve quality of the process
- Several KQ10 units can be linked via IO-Link

### KQ10 FOR CONTINUOUS LEVEL MONITORING - 3 PROGRAMMABLE SET POINTS



Type	Power Supply	Ambient temp	Protection rating	Connection	Order no.	Price
<b>Capacitive point level via continuous level monitoring - PNP/NPN</b>						
	18-30 vDC	-20...80°	IP67	2m cable, 5-pole	<b>KQ1000</b>	<b>\$540.10</b>
	18-30 vDC	-20...80°	IP67	0.1m cable, M12 connector, 5-pole	<b>KQ1001</b>	<b>\$540.10</b>

#### Accessories

Type	Description	Order no.	Price
	Mounting adapter for flat surfaces	<b>E12675</b>	<b>\$51.00</b>
	Mounting adapter for pipes	<b>E12676</b>	<b>\$48.20</b>
	Surface mount tape for KQ10	<b>E12677</b>	<b>\$97.05</b>
	PA cable tie, 760mm long (5 piece pack)	<b>E10880</b>	<b>\$13.13</b>
	2m, Black, PUR jumper, 5-pole	<b>EVC058</b>	<b>\$68.43</b>
	5m, Black, PUR jumper, 5-pole	<b>EVC059</b>	<b>\$79.19</b>



### TYPE KQ POINT LEVEL SENSORS



Capacitive sensors in small plastic rectangular housing. Easy installation with mounting adapters and fixing straps.

Design	Output stage	Sensing range [mm]	Housing material	Connection	Order no.	Price
<b>PerformanceLine - M12 connector - 3 wires, IO-Link Com 2</b>						
48 x 20 x 14	PNP	12 nf	PBT	cable 2 m	<b>KQ6002</b>	<b>\$189.57</b>
48 x 20 x 7	PNP	12 nf	PBT	cable 2 m	<b>KQ5100</b>	<b>\$111.25</b>
<b>Connection cable with M12 connector - 3-wire</b>						
48 x 20 x 14	PNP	12 nf	PBT	M12	<b>KQ6005</b>	<b>\$214.75</b>



# Level sensors type LR

## CONTINUOUS MEASUREMENT LEVEL SENSORS

### Type LR level sensors

Display and handling on the unit or via IO-Link.

As an option with analogue output or up to four switching outputs.



### LR type level transmitter

For industrial applications.

Analogue output scalable 4...20 mA / 0...10 V.

Protection rating IP 69K.

Easily adjustable via IO-Link.

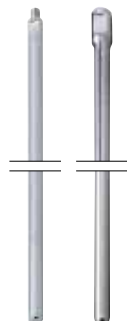

Coaxial pipes for LR level sensors with G 3/4 male, industrial applications. Material stainless steel (1.4301 / 304)



Note: Ensure the probe you select is compatible with the amplifier!

\*Note: for use with Hygienic probes



Process connection	Outputs	Display	IP Rating	Order no.	Price
<b>M12 connector - I/O Link Programmable</b>					
G 3/4	2 Sw points	4 Digit LED	IP67	LR7000	\$775.29
G 3/4	2 Sw points	-	IP69k	LR7020	\$660.60
G 3/4	4 Sw points	4 Digit LED	IP67	LR8000	\$899.45
G 3/4	4 Sw points	-	IP69k	LR8020	\$757.22
G 3/4	1 Sw, 1 analogue	4 Digit LED	IP67	LR3000	\$917.96
G 3/4	1 Sw, 1 analogue	-	IP69k	LR3020	\$775.51
<b>M12 connector - I/O Link Programmable, SS316L</b>					
G 3/4	1 Sw, 1 analogue	-	IP69k	LR9020	\$804.13
G 3/4	1 Sw, 1 analogue	4 Digit LED	IP69k	LR2050	\$1,212.75
<b>M12 connector - I/O Link Programmable, IP69K, SS316L ,G1 Aseptoflex vario</b>					
G 3/4	1 Sw & 1 analogue, or 2 Sw	4 Digit LED	IP69k	LR2750	\$1,782.34

### Accessories

Standard Sensor. Probes	Order no.	Price	Hygienic Sensor. Probes	Order no.	Price
<b>Industrial LR level sensor probes</b>			<b>Hygienic LR2750 level sensor probes</b>		
240 mm	E43203	\$36.80	150 mm	E43345	\$120.72
450 mm	E43204	\$51.86	300 mm	E43346	\$145.25
700 mm	E43205	\$68.64	500 mm	E43340	\$179.24
1,000 mm	E43207	\$97.05	700 mm	E43347	\$208.94
1,200 mm	E43208	\$115.77	1,000 mm	E43341	\$244.01
1,400 mm	E43209	\$137.07	1,500 mm	E43348	\$276.94
1,600 mm	E43210	\$156.01	-	-	-
2,000 mm	E43353*	\$206.14	2,000 mm	E43342	\$325.78

\*Only for LR2050

### Coaxial Tubes

Industrial LR level sensor probes	Hygienic LR2750 level sensor probes
240 mm	1,200 mm
450 mm	1,400 mm
700 mm	1,600 mm
1,000 mm	

Description	Order no.	Price
Flange plate, LR 65-80, stainless steel 303	E43202	\$83.49
G 3/4" Welding adaptors, ø50mm	E30009	\$83.06
Sealing plug (FDA G1)	E30128	\$103.72
Aseptoflex Vario adapter Clamp 1-1.5" O-ring EPDM*	E33201	\$117.27
Aseptoflex Vario adapter Clamp 2" O-ring EPDM*	E33202	\$137.07





# Radar sensor



DESIGNED FOR F&B, WATER TREATMENT APPLICATIONS\*



- Continuous level monitoring
- 10m range, high accuracy
- Polished stainless steel housing, sealed to IP69K
- Designed for CIP/SIP applications



Type	Measuring Range [m]	Outputs	Temperature [°C]	IP Rating	Order no.	Price
------	---------------------	---------	------------------	-----------	-----------	-------

Designed for F&B, water treatment enclosed tank applications

	10m (15m possible)	IO-Link, 4...20 mA binary switch	-40°C...80°C	IP69k	<b>LW2720</b> 	<b>\$3,056.85</b>
---	-----------------------	-------------------------------------	--------------	-------	---	-------------------



Designed for F&B, water treatment open air applications

(Awaiting approval for New Zealand)

	10m (15m possible)	IO-Link, 4...20 mA binary switch	-40°C...80°C	IP69k	<b>LW2120</b> 	<b>\$2,685.45</b>
---	-----------------------	-------------------------------------	--------------	-------	---	-------------------



## Accessories

Description	Order no.	Price
 Weld socket Ø50 mm – G 1 Aseptoflex Vario, with leakage port	<b>E30130</b>	<b>\$120.29</b>
 Tri-clamp DN25...DN40 (1...1.5") – G 1 Aseptoflex Vario, with leakage port	<b>E33208</b>	<b>\$126.31</b>
 Tri-clamp DN50 (2") – G 1 Aseptoflex Vario, with leakage port	<b>E33209</b>	<b>\$145.03</b>

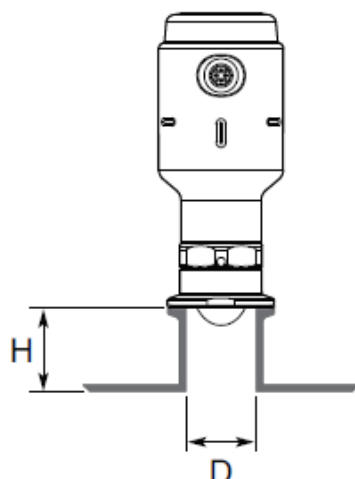
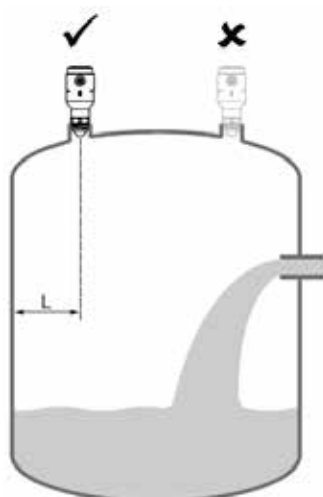

## Installation guidelines

Distance to Tank Wall (L): 8 in. (200 mm), recommended ½ of tank radius

Nozzle Diameter (D)	Maximum nozzle height (H)
40 mm	150 mm
50 mm	200 mm
80 mm	300 mm
100 mm	400 mm
150 mm	600 mm







# Submersible pressure transmitters type PS

PS SENSORS



Measuring range [bar]	Output	Cable [m]	Order no.	Price
<b>For high resistance to media, CE approval</b>				
0...0.25	4...20 mA	FEP, 5 m	PS4208	\$1,379.09
0...0.25	4...20 mA	FEP, 10 m	PS4408	\$1,471.40
0...0.25	4...20 mA	PUR, 5 m	PS3208	\$981.22
0...0.6	4...20 mA	PUR, 10 m	PS3407	\$1,080.42
0...0.6	4...20 mA	PUR, 15 m	PS3427	\$1,114.20
0...0.6	4...20 mA	FEP, 10 m	PS4407	\$1,471.40
0...0.6	4...20 mA	FEP, 20 m	PS4506	\$1,656.67
0...0.6	4...20 mA	PUR, 30 m	PS3607	\$1,190.38
0...1	4...20 mA	PUR, 15 m	PS3417	\$1,114.20
0...1	4...20 mA	FEP, 15 m	PS4417	\$1,563.93
0...1	4...20 mA	FEP, 30 m	PS4607	\$1,841.51
<b>For hazardous areas, CE, Ex, GL approvals</b>				
0...1	4...20 mA	FEP, 15 m	PS317A	\$2,035.39

## Accessories





Description	Order No.	Price
 Cable clamp fastener	E30399	\$54.66
 Filter element for submersible pressure transmitters	E30400	\$14.85
 Splitter box	E30401	\$201.19
 Additional weight for submersible pressure transmitters	E30402	\$122.87

## LASER DISTANCE SENSORS - FOR OPAQUE LIQUIDS (NOT TRANSPARENT)



Range [mm]	Laser class	Outputs	Order no.	Price
<b>Distance detection</b>				
200...10,000	2	PNP + 4...20 mA	O1D100	\$802.19
200...10,000	2	DC 1 x PNP	O1D101	\$802.19
200...10,000	2	PNP + 4...20 mA	O1D105	\$802.19
300...6,000	1	PNP + 4...20 mA	O1D155	\$802.19
200...10,000	2	PNP + 4...20 mA, IO-Link prog	O1D120	\$802.19
<b>Level detection</b>				
200...10,000	2	PNP + 4...20 mA	O1D300	\$810.37

## Accessories

Description	Order No.	Price
 O1D Alignment + Mounting adapter SS316L ø12mm	E2D101	\$61.33
 O1D Hygienic Mounting adapter SS316L/G1	E21224	\$327.72
 O1D Hygienic Tri-Clamp adapter, SS316L, clamp 1-1.5"	E33601	\$138.58
 O1D Protective window: PMMA transparent	E21133	\$64.55
 O1D Hygienic Weld adapter, SS316L, G1 ø50mm	E30013	\$87.15





# Ultra-sonic sensors

RANGES VARY FROM 40mm...8m



Design	Range [mm]	Output	Setting	Order no.	Price
<b>Diffuse sensor · 3-wire DC, 4-pole</b>					
M18 x 60mm	300	4...20 mA	Wire	<b>UGT501</b>	\$453.17
M18 x 60mm	300	PNP	IO-Link	<b>UGT524</b>	\$412.50
M18 x 60mm	1,200	4...20 mA	Wire	<b>UGT507</b>	\$453.17
M18 x 60mm	1,200	PNP, prog	IO-Link	<b>UGT526</b>	\$412.50
<b>Diffuse sensor · 4-wire DC, 4-pole</b>					
M18 Cube	300	PNP + 4...20 mA	Button	<b>UGT580</b>	\$453.17
M18 Cube	300	PNP	Button / IO-Link	<b>UGT592</b>	\$457.47
M18 Cube	1,200	PNP + 4...20 mA	Button	<b>UGT584</b>	\$453.17
M18 Cube	1,200	NPN + 4...20 mA	Button	<b>UGT590</b>	\$453.17
M18 Cube	1,200	PNP, prog	Button / IO-Link	<b>UGT594</b>	\$457.47
<b>Diffuse sensor · 4-wire DC, 4-pole, IO-Link, PBT plastic</b>					
M18 x 98mm	150...1,600	2 x PNP, NO/NC Prog	Button, IO-Link	<b>UGT203</b>	\$495.34
M18 x 98mm	150...1,600	PNP + 4...20 mA	Button, IO-Link	<b>UGT204</b>	\$495.34
M18 x 98mm	150...1,600	PNP + 0...10 V	Button, IO-Link	<b>UGT205</b>	\$495.34
<b>Diffuse sensor · 4-wire DC, 4-pole</b>					
M18 x 98mm	2,200	2 x PNP	Button, IO-Link	<b>UGT512</b>	\$551.94
M18 x 98mm	2,200	PNP + 4...20 mA	Button, IO-Link	<b>UGT513</b>	\$551.94
M18 x 98mm	2,200	PNP + 0...10 V	Button, IO-Link	<b>UGT514</b>	\$551.94
M18 x 98mm	2,200	NPN + 4...20 mA	Button	<b>UGT519</b>	\$546.77
<b>Diffuse sensor · 4-wire DC, 4-pole</b>					
M30 X 1.5	3,500	2 x PNP	Button, IO-Link	<b>UIT500</b>	\$725.16
M30 X 1.5	3,500	PNP + 4...20 mA	Button, IO-Link	<b>UIT501</b>	\$804.13
M30 X 1.5	6,000	PNP + 4...20 mA	Button, IO-Link	<b>UIT504</b>	\$936.25
M30 X 1.5	8,000	PNP + 4...20 mA	Button, IO-Link	<b>UIT507</b>	\$1,094.41
<b>Diffuse sensor · 4-wire DC, 4-pole - stainless steel, IP69K</b>					
M30 X 1.5	2,500	2 x PNP	IO-Link	<b>UIT300</b>	\$1,041.47
M30 X 1.5	2,500	PNP + 4...20 mA	IO-Link	<b>UIT301</b>	\$1,089.24

## Accessories

Type	Description	Order no.	Price
	Mounting set, Ø 18.5 mm clamp mounting, high-grade stainless steel (M10 cap screw)	<b>E20870</b>	\$39.81
	Mounting set, Ø 30.2 mm clamp mounting, high-grade stainless steel	<b>E20874</b>	\$39.81
	Mounting rod, 100 mm, Ø 12 mm, M10 thread, stainless steel	<b>E20938</b>	\$15.49
	Angle bracket for type M30, stainless steel	<b>E10737</b>	\$9.04
	Sound tube, M18, POM	<b>E23000</b>	\$59.82
	Sound tube, M30, POM	<b>E23007</b>	\$66.28
	Sound deflection angle for sensors with a range of ≤ 1,2 m, stainless steel	<b>E23001</b>	\$53.36
	Sound deflection angle for sensors with a range of ≤ 2,2 m, stainless steel	<b>E23002</b>	\$59.17

# Flow sensors and mounting accessories



## Selection Guide

	Contents	Sensor type	Max measuring range	Medium temperature [°C]	Max. pressure rating [bar]	Approvals	Pages
Absolute measurement	Magnetic-inductive	SM SM Automation	0,005...900 l/min 0,05...250 l/min	-10...70 -20...90	1616	<ul style="list-style-type: none"> <li>• EC1935/2004, KTW, ACS, Reg31</li> <li>• Reg31, ACS</li> </ul>	111
	Vortex	SV display SV	1...100 l/min 0,5...150 l/min	-10...90 -40...100	12 12	<ul style="list-style-type: none"> <li>• WHG</li> </ul>	112
	Mechatronic	SB water SBT SBU SBZ SB oil	0,2...200 l/min	-10...100	80	<ul style="list-style-type: none"> <li>• Reg31, ACS, KTW</li> </ul>	113
			0,3...200 l/min	10...180	30		113
			0,3...75 l/min	0...60	200		-
			1...50 l/min	-10...100	-		-
			0,03...200 l/min	-	-		-
Ultrasonic	SU	1...1000 l/min	-20...100	100	<ul style="list-style-type: none"> <li>• Reg31, ACS, KTW</li> </ul>	112	
Thermal compressed air meters	SD SDG	0,05...700 m3/h	-10...60	16	<ul style="list-style-type: none"> <li>• EHEDG, 3A, FDA, EC1935, USP VI</li> </ul>	117	
		8...17480 m3/h	-10...60	16		-	
Thermal air gap sensor	SDP	0...400 µm	-10...60	16	<ul style="list-style-type: none"> <li>• EHEDG, 3A, FDA, EC1935, WHG</li> </ul>	-	
Relative measurement	Thermal flow sensors	SI	3...100 cm/s	-25...80	√300	<ul style="list-style-type: none"> <li>• EHEDG, FDA, FCM, 3-A, EC1935/2004, ACS, DNV-GL, KTW, ATEX II 3G, ATEX II 3D</li> <li>• Reg31, ATEX II (1G, 2G)</li> <li>• FDA, Reg31, KTW, ACS, FCM, DNV-GL, EC1935/2004</li> </ul>	114-
		SR/SN/SF	3...100 cm/s	-25...120	300		115
SA		3...300 m/s	-20...100	100	113		
Thermal airflow monitors	SL	100...3000 cm/s	-10...50	1		117	
Accessories			√	√			
Calibration *			√	√			

\* German factory calibration must be ordered separately when placing a flow sensor PO  
 This service will result in 4 - 6 weeks delivery delay  
 For local calibration by a certified laboratory, we can provide partner information on request



# Hygienic Flow sensors type SMF

HYGIENIC FLOW SENSORS TYPE SMF



Measuring range Flow [l/min]	Process Connection	Medium Temperature [C]	Order no.	Price
<b>ifm's NEW magnetic flow meter for hygienic applications</b>				
(TBA)	1/2" (DN12)	-	-	-
(TBA)	1" (DN25)	-	-	-
5...750	1.5" (DN40)	150	<b>SMF320</b>	<b>\$4,836.60</b>
10...1,200	2" (DN50)	150	<b>SMF420</b>	<b>\$4,990.88</b>
20...2,000	2.5" (DN65)	150	<b>SMF520</b>	<b>\$5,347.87</b>
30...3,000	3" (DN80)	150	<b>SMF620</b>	<b>POA</b>
50...5,000	4" (DN100)	150	<b>SMF720</b>	<b>POA</b>
(TBA)	5" (DN125)	-	-	-
(TBA)	6" (DN150)	-	-	-

## HYGIENIC SMF ACCESSORIES



NOTE: RJT, BSM adaptors available on request.

Pipe Connection Adaptors				Seal Ring Material		
Size	Description	Order No.	Price	Description	Order No.	Price
DN40	ISO2852	<b>E40482</b>	<b>\$505.46</b>	EPDM	<b>E40562</b>	<b>\$133.41</b>
DN50	ISO2852	<b>E40483</b>	<b>\$539.67</b>	EPDM	<b>E40563</b>	<b>\$144.82</b>
DN65	ISO2852	<b>E40484</b>	<b>\$590.88</b>	EPDM	<b>E40564</b>	<b>\$158.37</b>
DN80	ISO2852	<b>E40485</b>	<b>POA</b>	EPDM	<b>E40565</b>	<b>\$164.61</b>
DN100	ISO2852	<b>E40486</b>	<b>POA</b>	EPDM	<b>E40566</b>	<b>\$195.60</b>
DN40	DIN11851	<b>E40502</b>	<b>POA</b>	VMQ	<b>E40572</b>	<b>POA</b>
DN50	DIN11851	<b>E40503</b>	<b>POA</b>	VMQ	<b>E40573</b>	<b>POA</b>
DN65	DIN11851	<b>E40504</b>	<b>POA</b>	VMQ	<b>E40574</b>	<b>POA</b>
DN80	DIN11851	<b>E40505</b>	<b>POA</b>	VMQ	<b>E40575</b>	<b>POA</b>
DN100	DIN11851	<b>E40506</b>	<b>POA</b>	VMQ	<b>E40576</b>	<b>POA</b>
DN40	DIN32676-A	<b>E40492</b>	<b>POA</b>			
DN50	DIN32676-A	<b>E40493</b>	<b>POA</b>			
DN65	DIN32676-A	<b>E40494</b>	<b>\$590.88</b>			
DN80	DIN32676-A	<b>E40495</b>	<b>POA</b>			
DN100	DIN32676-A	<b>E40496</b>	<b>POA</b>			

## SM ACCESSORIES

Process adaptors  
for type SM



Grounding  
clamp for  
type SM



Process connection	Device connection	Material	Order no.	For sensor type	Price
R 1/2	G 1/2	high-grade stainless steel	<b>E40199</b>	SM6xxx	<b>\$130.18</b>
G 1/2	G 1/2	high-grade stainless steel	<b>E40213</b>	SM6xxx	<b>\$150.20</b>
G 3/4	G 1/2	high-grade stainless steel	<b>E40189</b>	SM6xxx	<b>\$111.89</b>
R 1/2	G 3/4	high-grade stainless steel	<b>E40178</b>	SM7xxx	<b>\$128.89</b>
G 1/2	G 3/4	high-grade stainless steel	<b>E40214</b>	SM7xxx	<b>\$152.56</b>
G 3/4	G 3/4	high-grade stainless steel	<b>E40216</b>	SM7xxx	<b>\$155.58</b>
R 1/2	G 1	high-grade stainless steel	<b>E40179</b>	SM8xxx	<b>\$130.18</b>
G 3/4	G 1	high-grade stainless steel	<b>E40215</b>	SM8xxx	<b>\$135.13</b>
G 1	G 1	high-grade stainless steel	<b>E40217</b>	SM8xxx	<b>\$166.12</b>
1,5" Victaulic	G 2	high-grade stainless steel	<b>E40227</b>	SM9xxx, SM2xxx	<b>\$492.55</b>
R 2	G 2	high-grade stainless steel	<b>E40231</b>	SM9xxx, SM2xxx	<b>\$491.47</b>
G 1 1/2	G 2	high-grade stainless steel	<b>E40230</b>	SM9xxx, SM2xxx	<b>\$431.87</b>
Flange DN50	G 2	high-grade stainless steel	<b>E40240</b>	SM9xxx, SM2xxx	<b>\$473.40</b>
Description	Material	Order no.	For sensor type	Price	
SM Grounding clamp	stainless steel	<b>E40234</b>	SMxxxx	<b>\$20.44</b>	





# Flow sensors type SV & SU

VORTEX WATER FLOW METER - LOW COST!

## Flow meters type SV

Electronically rotatable multi-colour display.

Pressure-resistant up to 12 bar.

Medium temperature -10...90 °C.

Rotatable process connection.



Measuring range [l/min]	Medium temperature [°C]	Nominal diameter [Ø]	Process connection	Order no.	Price
<b>M12 connector - electrical design DC, 2 x IO-Link Programmable</b>					
1.0...20	-10...90	DN8	G 1/2	SV4200	\$772.71
2.0...40	-10...90	DN10	G 1/2	SV5200	\$789.28
5.0...100	-10...90	DN20	G 3/4	SV7200	\$838.56
<b>M12 connector - electrical design DC 2 x analogue 4...20 mA</b>					
1.0...20	-10...90	DN8	G 1/2	SV4204	\$767.76
2.0...40	-10...90	DN10	G 1/2	SV5204	\$795.09
5.0...100	-10...90	DN20	G 3/4	SV7204	\$844.80

Note: Versions with Rc process connection option are available on request.

## SV ACCESSORIES

Mounting plate	Material	Order no.	For sensor type	Price
	high-grade stainless steel	E40249	SV Series <sup>1)</sup>	\$15.49

## ULTRASONIC FLOW METER - IDEAL FOR NON CONDUCTIVE LIQUIDS - OIL, DIESEL, GLYCOL SOLUTIONS



Measuring range [l/min]	Medium temperature [°C]	Process connection	Order no.	Price
<b>IO-Link, Output function 2 x  or analogue (4...20 mA / 0...10 V) · DC PNP/NPN</b>				
0.5...65	-20...100	G 1/2 (DN15)	SU6020	\$1,023.40
0.5...75	-20...100	G 3/4 (DN20)	SU7020	\$1,078.48
<b>Note: Available from April 2024</b>				
1...275	-20...100	G 1 1/4 (DN32)	SU9020	\$1,188.65
1...240	-20...100	G 1 (DN25)	SU8020	\$1,133.57
5...1000	-20...100	G 2 (DN50)	SU2020	\$1,353.91



Measuring range flow [l/min]	Pulse value	Process connection	Order no.	Price
<b>Output function 2 x  or analogue (4...20 mA / 0...10 V) · DC PNP/NPN</b>				
0...50	0.1 l...1,000,000 m <sup>3</sup>	G 3/4	SU7000	\$1,745.97
0...100	0.1 l...1,000,000 m <sup>3</sup>	G 1	SU8000	\$1,817.41
0...200	0.1 l...100,000 m <sup>3</sup>	G 1 1/4	SU9000	\$2,572.05

## SU ACCESSORIES

### Process adapters for type SU



Process connection	Device connection	Material	Order no.	For sensor type	Price
1/2" NPT	G 3/4	SS316L	E40191	SU7xxx	\$128.89
G 1/2	G 3/4	SS316L	E40214	SU7xxx	\$152.56
G 3/4	G 3/4	SS316L	E40216	SU7xxx	\$155.58
R 1/2	G 1	SS316L	E40179	SU8xxx	\$130.18
R 3/4	G 1	SS316L	E40180	SU8xxx	\$147.61
1/2" NPT	G 1	SS316L	E40192	SU8xxx	\$130.18
3/4 NPT	G 1	SS316L	E40193	SU8xxx	\$147.61
G 3/4	G 1	SS316L	E40215	SU8xxx	\$135.13
G 1	G 1	SS316L	E40217	SU8xxx	\$166.12



# Flow sensors type SA & SBT

CONFIGURABLE INDUSTRIAL FLOW SENSOR FOR WATER, OILS, EMULSIONS & AIR



Measuring range [l/min]	Medium temperature [°C]	Process connection	Order no	Price
<b>Water, coolants, oil and glycol solutions</b>				
<b>IO-Link configurable, Digital outputs 2, Analogue outputs 1</b>				
0.3...15	0...80	G 1/2	<b>SBG232</b>	\$709.45
0.5...25	0...80	G 1/2	<b>SBG233</b>	\$709.45
2...100	0...80	G 3/4	<b>SBG246</b>	\$852.11
4...200	0...80	G 1 1/4	<b>SBG257</b>	\$1,018.66
<b>Water, glycol solutions, 4...20 mA Analogue output</b>				
0.3...15	10...180	Rp 3/4	<b>SBT633</b>	\$760.66
0.5...25	10...180	Rp 3/4	<b>SBT634</b>	\$729.46
2...100	10...180	Rp 1	<b>SBT646</b>	\$909.78
4...200	10...180	Rp 1 1/2	<b>SBT657</b>	\$1,226.31

## CONFIGURABLE INDUSTRIAL FLOW SENSOR FOR WATER, OILS, EMULSIONS & AIR

### Flow sensors type SA

Sensing head rotatable by 345°.

2 switching outputs.

Easy switch-point setting via display

3-pushbutton operating concept.

Fast response time for flow and temperature measurement.

Individual serial number.



Type	Measuring range liquid / gaseous [cm/s]	Medium temp [°C]	Probe length [mm]	Order no.	Price
<b>IO-Link Programmable - electrical design DC PNP/NPN, analogue 4...20 mA</b>					
M18	4...300 / 200...10000	-20...90	45	<b>SA5000</b>	\$766.69
Progressive ring	4...300 / 200...10000	-20...100	100	<b>SA4100</b>	\$794.87
Progressive ring	4...300 / 200...10000	-20...100	200	<b>SA4300</b>	\$822.63



%  
m/s  
l/min.  
m³/h  
°C

### ACCESSORIES



Process connection	Device connection	Material	Order no.	Price
<b>Screw Fitting - for SA5xxx series flow sensors</b>				
G 1/4	progressive ring	SS316L	<b>E40099</b>	\$49.28
G 1/2	progressive ring	SS316L	<b>E40096</b>	\$63.48
G 3/4	progressive ring	SS316L	<b>E40134</b>	\$73.38
1/2 NPT	progressive ring	SS316L	<b>E40107</b>	\$55.95
<b>Progressive Ring Fitting - for SA41xx &amp; SA43xx series flow sensors</b>				
G 1/4	progressive ring	SS316L	<b>E40259</b>	\$55.73
G 1/2	progressive ring	SS316L	<b>E40258</b>	\$92.31
G 3/4	progressive ring	SS316L	<b>E40260</b>	\$91.67
R 1/2	progressive ring	SS316L	<b>E40263</b>	\$73.81



# Flow sensors type SI5 & SI6

## INDUSTRIAL FLOW MONITOR

Flow sensors type SI  
Protection rating IP 67.  
Robust housing.  
Easy to set.



Operating voltage [V]	(Liquids) Largest sensitivity [cm/s]	Material	Pressure [bar]	Order no.	Price
<b>M12 connector</b>					
24vDC, PNP	3...100	SS316L	30	SI5000	\$696.75
24vDC, NPN	3...100	SS316L	30	SI5001	\$714.18
24vDC, 2xNO/NC	3...100	SS316L	300	SI5002	\$740.65
24vDC, 4...20mA	3...100	SS316L	300	SI5004	\$693.31
240vAC, relay	3...100	SS316L	300	SI5006	\$772.07
24vDC, PNP	3...100	SS316L	300	SI5010	\$744.31
24vDC, PNP	3...100	(Titanium)	100	SI5100	\$1,107.75

### ACCESSORIES



Process connection	Device connection	Material	Order no.	Price
G 1/4	M18	SS316L	E40099	\$49.28
G 1/2	M18	SS316L	E40096	\$63.48
G 3/4	M18	SS316L	E40134	\$73.38
G 1	M18	SS316L	E40119	\$77.90

## HYGENIC FLOW MONITOR

Flow sensors type SI  
Modular adaptation for hygienic applications.  
Protection rating IP 67 and IP 69K.



Probe length [mm]	(Liquids) Largest sensitivity [cm/s]	Material	Pressure [bar]	Order no.	Price
<b>M12 connector · G1A / Aseptoflex Vario adapter, -25...95, for SIP process: ...140° c</b>					
20	3...100	SS316L	30	SI6600	\$832.53
38	3...100	SS316L	30	SI6700	\$845.01
55	3...100	SS316L	30	SI6800	\$856.85

### ACCESSORIES



Process connection	Device connection	Material	Order no.	Price
Clamp 1...1.5"	Aseptoflex Vario	SS316L	E33201	\$117.27
Clamp 2"	Aseptoflex Vario	SS316L	E33202	\$137.07



# Flow sensors

## CONTROL MONITOR FOR SF SERIES FLOW SENSORS



### Component guide

Select a control monitor depending on your application. Next, determine an electrical connection, flow probe and process connection.

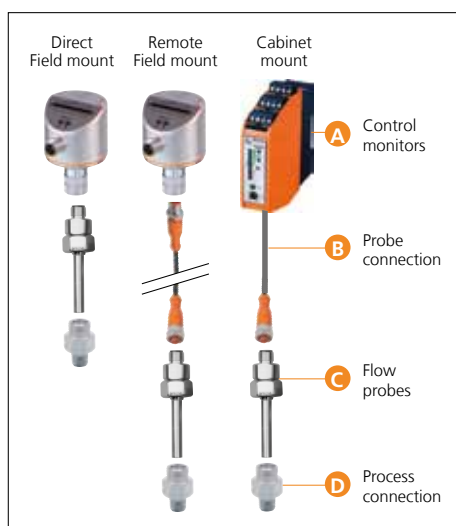

Mounting	Output	Power Supply	Order no.	Price
<b>Remote control monitor</b>				
DIN Rail	Relay	24 VDC	SR0127	\$466.08
DIN Rail	Relay	90-240 VAC	SN0150	\$694.82

### Control monitor for flow sensors of the SF series

Operating voltage [V]	Material	Pressure [bar]	Order no.	Price
<b>M12 connector · electrical design DC PNP / AC, relay</b>				
19...36 DC	SS304S15		SR5900	\$547.85
90...240 AC	SS304S15		SR5906	\$599.28

### Sensors for connection to control monitor

Sensor length [mm]	Setting range (liquids) [cm/s]	Material	Pressure [bar]	Order no.	Price
<b>M12 · process connection clamp adapter · with flexible immersion depth</b>					
44	3...300 [cm/s]	SS316L	300	SF5200	\$420.46
191	3...300 [cm/s]	SS316L	30	SF6200	\$477.70
<b>M12 · process connection G 1/4 male, adapter · for aggressive media</b>					
12	3...60 [cm/s]	ceramics*	30	SF2405	\$536.01
15,5	3...60	ceramics*	30	SF3405	\$649.41
44	3...300	titanium	100	SF5700	\$898.81
63	3...300	titanium	100	SF5701	\$943.78
93	3...300	titanium	100	SF5702	\$1,069.66
143	3...300	titanium	100	SF5703	\$1,226.74
243	3...300	titanium	100	SF5704	\$1,299.47

## EX RATED APPROVED UNITS FOR HAZARDOUS AREAS



ATEX approval	Output	Power Supply	Order no.	Price
<b>Remote control monitor</b>				
Group II, category (1) G	Relay	24v DC	SR2301	\$1,643.11
ATEX approval	Process fitting	Material	Order no.	Price
<b>ATEX Rated Flow Sensors, connect to control monitor (see above)</b>				
Group II, category (2) G	G1/4" A	stainless steel (316L)	SF220A	\$552.58







# Compressed air meter ifm energy management systems



Compressed air supply system solutions



- Energy management system to DIN EN ISO 50001
- **Measures flow, pressure and temperature simultaneously removing the need for multiple sensors**
- Production and transport of compressed air are the second largest cause of energy costs.
- A compressed air system offers many opportunities to reduce operating costs.

## WHERE DO THE HIGH ENERGY COSTS ORIGINATE?

### Energy savings

Identified saving potentials be implemented partly by fundamental, partly by small measures.

The chart shows common energy savings potential

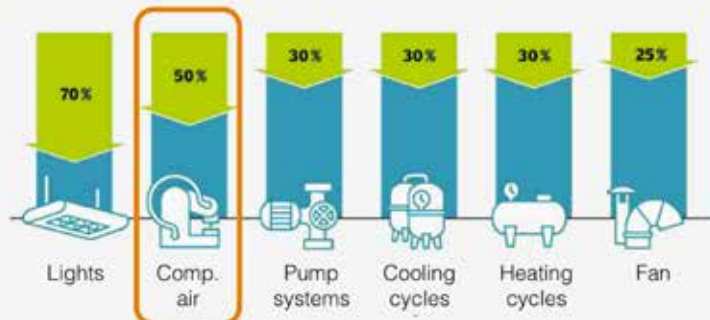

## Measurement instrumentation from ifm

### Secure benefits with ifm

- Maximum potential for savings using high quality measurement instrumentation
- Use IO-Link independent of higher bus systems
- Documentation available at a click thanks to co-ordinated software
- Simple trend analysis supported by graphics in the monitoring software
- Parameter setting and condition monitoring on the control level for each sensor which has been installed.

Certified energy management system

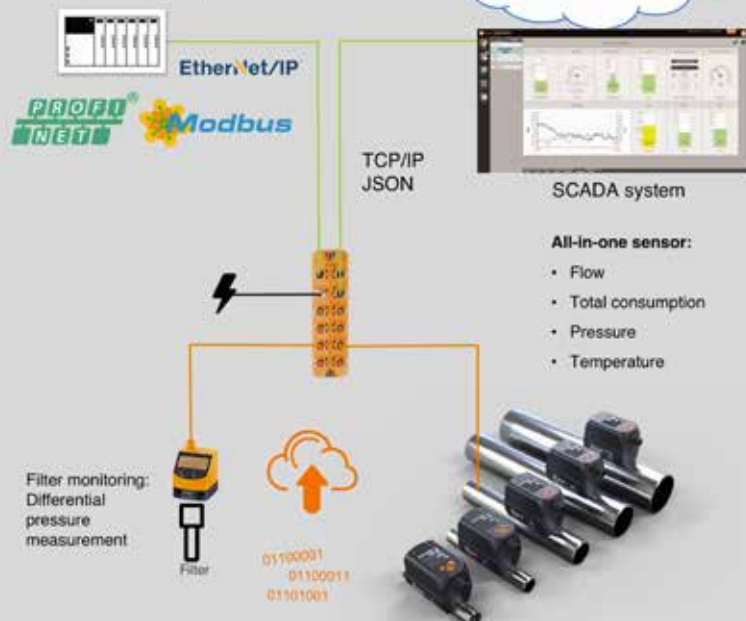





# Compressed air meters

4 IN 1: FLOW METER DETERMINES THE CONSUMPTION OF FOUR INDUSTRIAL GASES



Measuring range [Nm <sup>3</sup> /h]	Pressure rating [bar]	Process connection	Order no.	Price
<b>Defined pipe length for compressed air in industrial use</b>				
0.05...15	16	G 1/4 (DN8)	SD5500	\$1,663.56
0.25...75	16	R 1/2 (DN15)	SD6500	\$1,663.56
0.8...225	16	R 1 (DN25)	SD8500	\$1,762.32
1.4...410	16	R 1 1/2 (DN40)	SD9500	\$2,184.08
2.5...700	16	R 2 (DN50)	SD2500	\$2,289.95
8...2,110	16	G1	SD1540	\$1,749.84
<b>Defined pipe length for industrial gases</b>				
N <sub>2</sub> : 0.04...15 Ar: 0.08...24.04 CO <sub>2</sub> : 0.04...14.36	16	G 1/4 (DN8)	SD5600	\$1,809.45
N <sub>2</sub> : 0.24...73 Ar: 0.39...118.2 CO <sub>2</sub> : 0.24...71.7	16	R 1/2 (DN15)	SD6600	\$1,809.45
N <sub>2</sub> : 0.8...225.0 Ar: 1.2...366.6 CO <sub>2</sub> : 0.8...223.6	16	R 1 (DN25)	SD8600	\$1,906.06

## Accessories

Calibration certificate for flow sensors (SD)	Order no.	Price
ISO calibration certificate (6 x calibration points)	ZC0020	\$644.46
DAKKS calibration certificate (6 x calibration points)	ZC0075	\$1,297.75

## LARGE DUCT AIR FLOW MONITOR

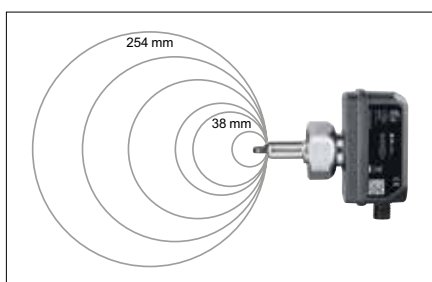

Adjustable internal pipe dia. of 38 - 254 mm.

Measuring range [Nm <sup>3</sup> /h]	Pressure rating [bar]	Process connection	Order no.	Price
<b>Adjustable pipe diameter</b>				
8...2,110	16	G 1 female	SD0523	\$2,448.32

## Accessories

Type	Description	Order no.	Price
	Process connection, weld adapter	E40195	\$111.03

## BASIC AIR FLOW SWITCH



Application	Output	Power Supply	Order no.	Price
<b>Remote Amplifiers</b>				
Air, -10...50 c	3A Relay	24v DC	SL5101	\$250.90
Air, -10...50 c	3A Relay	80-250 AC/DC	SL0301	\$277.80

# Temperature sensors and mounting accessories



## Selection Guide

	Contents	Sensor type	Max measuring range [°C]	Max installation depth	Display	One piece design	Approvals	Pages
Temperature sensors in contact with the medium	Compact temperature sensors for industrial applications	TA TN TK TV	-50...150 -50...150 -20...140 -50...150					118 119 119 119
	Compact temperature sensors for mobile applications	TA / TU TM	-50...150 -40...150					118-119
	Compact temperature sensors for hygienic applications	TA TD TCC	-50...200 -50...150 -25...160					122-123
	Sensors with fast response times for hygienic applications	TA TR TP	-50...200					14 – 15
	Temperature sensors – the modular concept for industrial and hygienic applications	TM TS TT	-40...150 -100...600 -40...150					120-121
	Accessories Process adapters, thermowells, connection cables and certificates							125
Without contact	Infrared temperature sensors for hot objects & accessories	TW TW	50...1350 -30...2500					124
	Calibration *							

\* German factory calibration must be ordered separately when placing a temperature sensor PO  
 This service will result in 4 - 6 weeks delivery delay  
 For local calibration by a certified laboratory, we can provide partner information on request



# Temperature sensor technology

TIME FOR AN UPGRADE?



## PROBLEM

- Temperature head transmitters can lead to condensation build-up in poorly sealed terminal heads.
- A serious issue in F&B plant, routinely washed with high pressure hot water. Moisture laden air leads to water condensation accumulation inside the terminal chamber, as temperatures vary.
- Also experienced in outdoor applications. Moisture is a serious problem that leads to calibration loop changes, short circuits and eventually instrument failure.

## AWARD WINNING IFM TEMPERATURE SENSOR TECHNOLOGY



Green = OK    Blue = Pre-alert    Red = Error!



reddot winner 2020

## SOLUTION - ifm technology



- ifm have addressed this issue with state of the art welded head temperature instruments sealed to IP69k.
- The PT1000 sensor element, evaluation electronics and LED display are calibrated to operate as a system solution for your process monitoring
- The one-piece device eliminates wiring issues and moisture ingress, with protection to IP69k



# Temperature sensors

## INDUSTRIAL TEMPERATURE TRANSMITTERS, 4...20 mA OUTPUT

### Type TA temperature transmitter

Scalable analogue output 4...20 mA

IO-Link. T05 / T09: 1 / 3 s.

Pressure-resistant up to 400 bar.

Accuracy [K]: ± 0.3 + (± 0.1 % Ms).



Measuring range [°C]	Process connection	Installation depth [mm]	Factory setting [°C]			Price
			0...200 Order no.	-50...150 Order no.	0...100 Order no.	
Analogue output 4...20 mA						
-50...150	G 1/4	25	-	TA2105	-	\$360.43
		50	-	TA2115	-	\$364.30
		100	-	TA2135	-	\$370.97
		150	-	TA2145	-	\$377.86
	G 1/2	30	-	TA2405	-	\$382.81
		50	-	TA2415	TA2417	\$386.03
		100	-	TA2435	TA2437	\$392.49
		150	-	TA2445	TA2447	\$399.16
		Process connection, probe Ø 6 mm				
-50...200	Ø 6 mm	50	TA2212	-	-	\$376.57
		100	TA2232	-	-	\$383.24
		150	TA2242	-	-	\$389.91
		250	TA2262	-	-	\$403.25
		350	TA2292	-	-	\$417.45

## HYGIENIC TEMPERATURE TRANSMITTER, 4...20 mA OUTPUT

### Type TA temperature transmitter

Operating status indication via LED.

Scalable analogue output 4...20 mA.

Hygienic process connections.

Installation depths of 25 to 150 mm.

IO-Link. T05 / T09: ≤ 0.5 / ≤ 2 s.

Accuracy [K]: ± 0.3 + (± 0.1 % Ms).



Measuring range [°C]	Process connection	Installation depth [mm]	Factory setting [°C]			Price
			0...200 Order no.	-10...150 Order no.	0...100 Order no.	
Process connection G1/2 with sealing cone						
-50...200	G 1/2 with hygienic sealing cone	30	TA2502	-	-	\$432.73
		50	TA2512	-	-	\$435.95
		50	-	-	TA2517	\$435.95
		50	-	TA2511	-	\$435.95
		100	TA2532	-	-	\$442.41
		100	-	-	TA2537	\$442.41
		100	-	TA2531	-	\$442.41
		150	TA2542	-	-	\$449.51

### Accessories TA25 series hygienic weld fittings

Type	Description	Order no.	Price
	G1/2 - weld fitting (for Tanks)	E43300	\$59.39
	G1/2 - weld fitting (or Pipes)	E43301	\$69.72
	G1/2 - weld fitting (for deep insertion)	E30055	\$81.55

## HYGIENIC TEMPERATURE TRANSMITTER, 4...20 mA OUTPUT

### Type TA132x temperature transmitters

Are spring loaded for a perfect connection to a thermowell.

Accessories  
Process adapters,  
thermowells  
Page 113



Measuring range [°C]	Process connection	Installation depth [mm]	Factory setting [°C]			Price
			0...200 Order no.	-10...150 Order no.	0...100 Order no.	
Process connection G 3/8 with coupling nut Ø 3 mm						
-50...200	G 3/8 internal thread	83	TA1322	TA1321	TA1327	\$513.85



# Temperature sensors

## HYGIENIC TEMPERATURE TRANSMITTER, 4...20 mA OUTPUT



Measuring range [°C]	Process connection	Installation depth [mm]	Factory setting [°C]			Price
			0...200 Order no.	-10...150 Order no.	0...100 Order no.	
Process connection 1 - 1.5" Tri clamp						
-50...200	Tri-clamp 1 - 1.5"	30	TA2802 ☺	-	-	\$404.54
		50	TA2812 ☺	-	-	\$407.34
		100	TA2832 ☺	-	-	\$413.79
		150	TA2842 ☺	-	-	\$420.68

## INDUSTRIAL TEMPERATURE SWITCH

**Type TK temperature sensor**  
 Easy adjustment of the switch points via two setting rings allowing optimum read-out.  
 Mechanical lock to prevent accidental adjustment.  
 T05 / T09: 1 / 3 s.  
 Pressure-resistant up to 400 bar.  
 Accuracy [K]: ± 0.3.



Measuring range [°C]	Process connection	Installation depth [mm]	Order no.	Price
Normally open / normally closed complementary				
-20...140	G 1/4	50	TK6110	\$331.59
2 x NO				
-20...140	G 1/4	50	TK7110	\$331.59
1 x NO / 1 x NC				
-20...140	G 1/2	250	TK7460	\$380.01

## CONFIGURABLE TEMPERATURE SWITCH

**Type TV temperature sensor**  
 Two solutions: Continuous transmission of measured values via IO-Link – and two switching outputs.  
 Tamper free.  
 T05 / T09: 1 / 3 s.  
 Pressure-resistant up to 400 bar.  
 Accuracy [K]: ± 0.3.



Measuring range [°C]	Process connection	Installation depth [mm]	Order no.	Price
2 switching outputs				
-50...150	G 1/4	25	TV7105 ☺	\$342.78
	G 1/2	30	TV7405 ☺	\$364.51

## INDUSTRIAL TEMPERATURE TRANSMITTER AND SWITCH - LOCAL DISPLAY & CONFIGURATION

**Type TN temperature sensor**  
 Selectable colour display. Operation via 3 buttons. 2 x NO / NC or 1 x NO / NC and 1 analogue output 4...20 mA / 0...10 V, scalable. T05 / T09: 1 / 3 s.  
 Pressure-resistant up to 400 bar.  
 Accuracy [K]: ± 0.3 + (± 0.1 % Ms).



Measuring range [°C]	Process connection	Installation depth [mm]	Factory setting [°C]	Price
			-50...150 Order no.	
2 switching outputs or 1 switching and 1 analogue output 4...20 mA or 0...10 V				
-50...150	G 1/2	30	TN2405 ☺	\$767.55
		50	TN2415 ☺	\$770.34
		100	TN2435 ☺	\$777.23
		150	TN2445 ☺	\$783.04

**Accessories**  
 Process adapters, thermowells  
 Page 113







# Temperature sensors

## TEMPERATURE TRANSMITTER AND SWITCH ASSEMBLY

### COMPONENT GUIDE TR

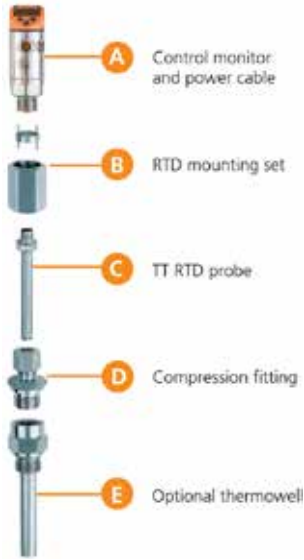

Evaluation electronics type TR



TR evaluation with E30017 mounting set on PT100 / PT1000 probe sensors type TT

Direct connection TR evaluation on PT100 / PT1000 cable sensors type TS

TR or TP evaluation with connection cable on PT100 / PT1000 sensors type TM, TT or TS

Measuring range [°C]	Factory setting [°C]	Process connection	Order no.	Price
<b>1 switching and 1 analogue output 4...20 mA or 0...10 V</b>				
-100...600	-40...300	G 1/2	<b>TR2439</b>	<b>\$702.35</b>
<b>2 switching outputs</b>				
-100...600	-40...300	G 1/2	<b>TR7439</b>	<b>\$611.33</b>

PT100 / PT1000 probe sensors type TT  
Cable sensors high temperature type TS



Measuring range [°C]	Ø probe / installation depth [mm]	Order no.	Price	Order no.	Price
<b>Applications</b>		<b>Industry</b>		<b>Hygienic</b>	
-40...150	6 / 100	<b>TT0281</b>	<b>\$188.93</b>	<b>TT0291</b>	<b>\$202.27</b>
	6 / 150	<b>TT1281</b>	<b>\$196.03</b>	<b>TT1291</b>	<b>\$208.51</b>
	6 / 250	-	-	<b>TT2291</b>	<b>\$215.61</b>
	6 / 350	-	-	<b>TT3291</b>	<b>\$228.74</b>
-40...150	10 / 160	<b>TT1081</b>	<b>\$206.79</b>	-	-
	10 / 260	<b>TT2081</b>	<b>\$220.77</b>	-	-
	10 / 360	<b>TT3081</b>	<b>\$234.33</b>	-	-
	10 / 560	<b>TT5081</b>	<b>\$261.23</b>	-	-
<b>Industrial applications</b>					
-100...600	6 / 100	<b>TS2451</b>	<b>\$243.58</b>	-	-
	6 / 150	<b>TS2452</b>	<b>\$250.25</b>	-	-
	6 / 200	<b>TS2453</b>	<b>\$257.14</b>	-	-
	6 / 250	<b>TS2454</b>	<b>\$264.03</b>	-	-

<sup>1)</sup> PT1000 sensor element

PT100 / PT1000 cable sensors type TS



Process connection	Measuring range [°C]
<b>Industrial applications</b>	
Ø 6 mm	-40...90
	-50...250
	-50...250
	-100...600 °C
Bolt-on sensor 12 x 8.7 x 51 mm	-40...90
Bolt-on sensor 12.5 x 8.7 x 47 mm	-40...90
Bolt-on sensor ATEX 10 x 18 x 48 mm	-20...115
M5 screw-in sensor	-30...180
M6 screw-in sensor	-30...180
M8 screw-in sensor	-20...115
M12 x 1,5 external	-30...150



Measured signal converter type TP



Direct connection TP evaluation on PT100 / PT1000 probe sensors type TT, TS or TM

Measuring range [°C]	Factory setting [°C]	Connection	Order no.	Price
<b>Industrial Analogue output 4...20 mA</b>				
-50...300	-50...150	M12	TP3231	\$219.05
	-50...300		TP3232	\$219.05
	0...100		TP3237	\$219.05
<b>Wash down area (IP69k), Analogue output 4...20 mA</b>				
-100...600	-100...600	M12	TP2009	\$256.71
	-50...300		TP2008	\$256.71
	-50...150		TP2005	\$256.71
	-10...150		TP2001	\$256.71
	0...100		TP2007	\$256.71
<b>Industrial Analogue output 0...10 V</b>				
-50...300	0...100	M12	TP9237	\$219.05

### COMPONENT GUIDE TP

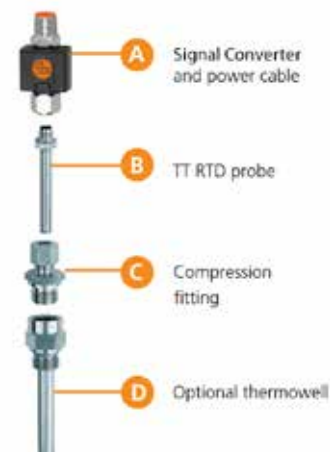

Cable / connector / length [m]	Order no.	Price
PUR / M12 / 5m	TS5289	\$134.06
PTFE / M12 / 0.15m	TS9256 <sup>1)</sup>	\$194.74 <sup>1)</sup>
PTFE / M12 / 2m	TS2256	\$236.70
PTFE / M12 / 2m	TS2451	\$243.58
PUR / M12 / 2m	TS2229	\$126.96
PUR / - / 2m	TS2239	\$86.72
silicone / - / 5m	TS502A <sup>1)</sup>	\$303.19 <sup>1)</sup>
silicone / M12 / 2m	TS2759	\$144.39
silicone / M12 / 2m	TS2659	\$176.45
silicone / - / 2m	TS285A	\$287.27
silicone / wire end ferrules / 5 m	TS5951	\$162.89

PT100 with process connection type TM



Process connection	Measuring range [°C]	Installation depth [mm]	Order no.	Price
<b>Industrial applications</b>				
G 1/4	-40...150	25	TM4101	\$197.10
	-40...150	25	TM5101 <sup>1)</sup>	\$197.10 <sup>1)</sup>
G 1/2	-40...150	50	TM4411	\$223.14
	-40...150	50	TM5411 <sup>1)</sup>	\$223.14 <sup>1)</sup>
	-40...150	100	TM4431	\$228.52
	-40...150	150	TM4441	\$235.41
	-40...150	250	TM4461	\$248.75
Internal thread M18 x 1.5	-40...125	60	TM9950	\$249.18
<b>Hygienic applications</b>				
G 1/2 with sealing cone	-50...140	Flush mount	TM4599	\$262.95
G 1/2 with sealing cone	-40...150	50	TM4511	\$272.20
	-40...150	100	TM4531	\$278.87
Clamp 1 - 1.5"	-40...150	150	TM4541	\$285.11
	-40...150	30	TM4801	\$244.23
	-40...150	50	TM4811	\$246.81
Clamp 1 - 1.5"	-40...150	100	TM4831	\$253.91
	-40...150	150	TM4841	\$260.80

<sup>1)</sup> PT1000 sensor element



# Temperature sensors

HIGH ACCURACY HYGIENIC TEMPERATURE TRANSMITTER FOR CCP APPLICATIONS



- CCP = Critical Control Point!
- Immediate LED and electronic output alarm when accuracy deviates from calibration limits



Green = OK      Blue = Pre-alert      Red = Error!

- Improved quality assurance in between calibration intervals
- Robust design for permanently precise measurements even in demanding environments
- 🔍 **Transparent sensor monitoring thanks to logging of the diagnostic values**
- 🔍 **Simulation function simplifies installation**



**Self-monitoring temperature transmitter type TAD**  
 Free 5-point calibration certificate.  
 Diagnostic and backup function.  
 Scalable analogue output 4...20 mA.  
 T05 / T09: 3 / 6 s.  
 Accuracy [K]: 0.2 (at -10...130 °C).

Measuring range [°C]	Process connection	Installation depth [mm]	Factory setting [°C]	Price
			0...150 Order no.	
<b>Analogue output 4...20 mA</b>				
-25...160	G 1/2 Sealing Cone	33	TCC501	\$934.31
		50	TCC511	\$936.46
		100	TCC531	\$943.35
		150	TCC541	\$950.23
	1-1.5" Tri Clamp	50	TCC811	\$911.50
		100	TCC831	\$918.17
	2" Tri Clamp	50	TCC911	\$936.46
		100	TCC931	\$943.35
	Ø 6 mm	250	TCC261	\$891.92
		350	TCC291	\$905.05
		450	TCC281	\$918.39
		550	TCC201	\$932.16

## Accessories

Type	Description	Order no.	Price
	G1/2 - weld fitting (for Tanks)	E43300	\$59.39
	G1/2 - weld fitting (or Pipes)	E43301	\$69.72
	G1/2 - weld fitting (for deep insertion)	E30055	\$81.55
	Welding adapter for process sensors; stainless steel (1.4404 / 316L); clamping ring: PEEK; Pressure rating 10 bar; welding adapter Ø 25 mm; Approval EC 1935/2004, EHEDG, FDA	E30407	\$88.01





# Temperature sensors

## HYGIENIC TEMPERATURE TRANSMITTER

Temperature transmitter with type TD display 4-digit LED display. Scalable analogue output 4...20 mA. Hygienic process connections. Installation depths of 30 to 350 mm.

T05 / T09: 1 / 3 s.

Accuracy [K]:  
± 0.3 + (± 0.1 % Ms).



Factory Setting (configurable with IO-Link) [°C]	Process connection	Installation depth [mm]	Factory setting [°C]		Price
			-10...150	Order no.	
<b>Process connection 1.5" Tri-clamp, analogue output 4...20 mA</b>					
-50...150	Clamp 1 - 1.5"	30	<b>TD2801</b>	☉	<b>\$543.76</b>
		50	<b>TD2811</b>	☉	<b>\$546.13</b>
		100	<b>TD2831</b>	☉	<b>\$552.80</b>
		150	<b>TD2841</b>	☉	<b>\$559.90</b>
<b>Process connection 1.5" Tri-clamp, analogue output 4...20 mA</b>					
0...100	Clamp 1 - 1.5"	30	<b>TD2807</b>	☉	<b>\$543.76</b>
		50	<b>TD2817</b>	☉	<b>\$546.13</b>
		100	<b>TD2837</b>	☉	<b>\$552.80</b>
		150	<b>TD2847</b>	☉	<b>\$559.90</b>
<b>Process connection G1/2, analogue output 4...20 mA</b>					
0...100	G1/2 (BSP-P)	100	<b>TD2531</b>	☉	<b>\$577.54</b>
		150	<b>TD2541</b>	☉	<b>\$584.43</b>



### Accessories

Type	Description	Order no.	Price
<b>Cable . M12 . 4pole (0.34mm sensor) . IP69K, 4A max</b>			
	2.0 m, grey, MPPE cable	<b>EVF064</b>	<b>\$46.48</b>
	5.0 m, grey, MPPE cable	<b>EVF001</b>	<b>\$47.77</b>
	10.0 m, grey, MPPE cable	<b>EVF002</b>	<b>\$58.96</b>
	15.0 m, grey, MPPE cable	<b>EVF092</b>	<b>\$76.39</b>
	25.0 m, grey, MPPE cable	<b>EVF003</b>	<b>\$92.31</b>
	2.0 m, grey, MPPE cable	<b>EVF067</b>	<b>\$46.91</b>
	5.0 m, grey, MPPE cable	<b>EVF004</b>	<b>\$47.77</b>
	10.0 m, grey, MPPE cable	<b>EVF005</b>	<b>\$58.96</b>
	15.0 m, grey, MPPE cable	<b>EVF094</b>	<b>\$73.16</b>
	25.0 m, grey, MPPE cable	<b>EVF006</b>	<b>\$92.31</b>
	5.0 m, grey, MPPE cable, PNP, LED	<b>EVF007</b>	<b>\$56.38</b>
	10.0 m, grey, MPPE cable, PNP, LED	<b>EVF008</b>	<b>\$66.71</b>
	25.0 m, grey, MPPE cable, PNP, LED	<b>EVF009</b>	<b>\$101.56</b>
<b>M12 Wirable plugs and sockets, 4-pole, IP69K, 4A max</b>			
	M12, Wirable socket, angled	<b>EVF566</b>	<b>\$52.07</b>
	M12, Wirable socket, straight	<b>EVF565</b>	<b>\$52.07</b>
	M12, Wirable plug, angled	<b>EVF568</b>	<b>\$52.07</b>
	M12, Wirable plug, straight	<b>EVF567</b>	<b>\$52.07</b>



Accessories  
Process adapters,  
thermowells  
Pages 113



# Temperature sensors

## NON-CONTACT TEMPERATURE SENSORST



- IO-Link, analogue output 4...20 mA and switching output, freely programmable
- Adjustable for different target materials
- Scratch-resistant precision lenses for minimum sensitivity to ambient light
- LED pilot light for alignment and control
- Simulation function: activated on the sensor or by external control signal



Measuring range [°C]	Output 4...20 mA and switching output	Order no. without LED pilot light	Price
<b>Measuring system</b>			
0...1000	8...14	TW2000	\$2,366.55

## AIR HUMIDITY SENSOR



Temperature Measuring Range [°C]	Output	IP rating	Order no.	Price
<b>Humidity measuring sensor</b>				
-40...60	2 x 4...20 mA	IP 20, III	LDH290	\$364.08
-40...80	IO-Link	IP 20, III	LDH292	\$354.62

## OIL HUMIDITY SENSOR (CAPACITIVE PRINCIPLE)



Connection	Temperature Measuring Range [°C]	Output	IP rating	Order no.	Price
<b>Humidity measuring sensor</b>					
G 3 1/4	-40...105	2 x 4...20 mA	IP 67	LDH100	\$1,278.81
G 1/2	-40...120	2 x 4...20 mA	IP 68	LDH110	\$1,057.88

## Accessories

Type	Description	Order no.	Price
	2 m, 8 pole, M12, black, PUR cable	E11231	\$77.46
	5 m, 8 pole, M12, black, PUR cable	E11232	\$95.54
	10 m, 8 pole, M12, black, PUR cable	E12260	\$106.51





# Temperature sensor accessories



① Progressive ring fitting

No.	Type	Device connection	Process connection	Order no.	For sensor type				Price
<b>Industrial applications</b>									
①	Progressive ring fitting	Ø 6 mm	G 1/2	<b>E30047</b>	TA	TD	TCC	TT	<b>\$60.25</b>
①	Progressive ring fitting	Ø 10 mm	G 1/2	<b>E30016</b>				TT	<b>\$59.17</b>



② Clamp adapter

No.	Device connection	Process connection	Installation depth [mm]	Order no.	For sensor type				Price
<b>Hygienic applications</b>									
②	Clamp adapter	Ø 6 mm	G 1/2 with sealing cone	<b>E30144</b>	TA	TD		TT	<b>\$112.97</b>



③ Screw-in thermowell up to 16 bar

No.	Device connection	Process connection	Installation depth [mm]	Order no.	For sensor type				Price
<b>Industrial applications</b>									
③	G 1/2	G 1/2	27	<b>E37600</b>	<b>TA241x</b>	<b>TN2415</b>	<b>TM4411</b>	<b>TT0281<sup>1)</sup></b>	<b>\$102.00</b>
			74	<b>E37610</b>	<b>TA243x</b>	<b>TN2435</b>	<b>TM4431</b>	<b>TT1281<sup>1)</sup></b>	<b>\$108.67</b>
			82	<b>E35010</b>				<b>TT1081<sup>4)</sup></b>	<b>\$120.07</b>
			124	<b>E37620</b>	<b>TA244x</b>	<b>TN2445</b>	<b>TM4441</b>	<b>TT2281<sup>1)</sup></b>	<b>\$115.12</b>
			174	<b>E37630</b>				<b>TT2281<sup>1)</sup></b>	<b>\$121.79</b>
			182	<b>E35020</b>				<b>TT2081<sup>4)</sup></b>	<b>\$133.63</b>
			224	<b>E37640</b>			<b>TM4461</b>	<b>TT3281<sup>1)</sup></b>	<b>\$128.68</b>
			282	<b>E35030</b>				<b>TT3081<sup>4)</sup></b>	<b>\$147.61</b>
			482	<b>E35050</b>				<b>TT5081<sup>4)</sup></b>	<b>\$174.30</b>



⑦ Screw-in thermowell up to 16 bar

No.	Device connection	Process connection	Installation depth [mm]	Order no.	For sensor type				Price
<b>Hygienic applications</b>									
④	G 1/2 with sealing cone	G 1/2 with sealing cone	68	<b>E37511</b>	<b>TA253x</b>	<b>TD253x</b>	<b>TM4531</b>	<b>TT1291<sup>2)</sup></b>	<b>\$152.56</b>
			118	<b>E37521</b>	<b>TA2542</b>	<b>TD254x</b>	<b>TM4541</b>	<b>TT2291<sup>2)</sup></b>	<b>\$159.45</b>
⑤	G 1/2 with sealing cone	Ø 34 mm	49	<b>E37411</b>	<b>TA2512</b>	<b>TD251x</b>	<b>TM4511</b>	<b>TT0291<sup>2)</sup></b>	<b>\$162.89</b>
			99	<b>E37421</b>	<b>TA253x</b>	<b>TD253x</b>	<b>TM4531</b>	<b>TT1291<sup>2)</sup></b>	<b>\$169.78</b>
			149	<b>E37431</b>	<b>TA2542</b>	<b>TD254x</b>	<b>TM4541</b>	<b>TT2291<sup>2)</sup></b>	<b>\$177.09</b>



⑥ Welding thermowell up to 300 bar



⑥ Adapter

No.	Type	Device connection	Process connection	Order no.	For sensor type		Price
⑥	Stainless steel adapter	M18 x 1.5	G 1/2	<b>E30073</b>	TM	TN	<b>\$92.96</b>
	Titanium adapter	M18 x 1.5	G 1/2	<b>E40114</b>	TM	TN	<b>\$272.20</b>

# Conductivity Sensors



A new approach to analytical sensors

## MEDIA DIFFERENTIATION SENSOR



- Reduce inaccuracies associated with a time-based cleaning process
- Improve process performance with flexible measurement points
- Compact, high-quality sensor design prevents failures and unplanned downtime
- Simplify your installation and commissioning processes
- Loss-free signal transmission of measurement values



Process connection	Measurement range conductivity [ $\mu\text{S}/\text{cm}$ ]	Measurement range [ $^{\circ}\text{C}$ ] medium temperature	Accuracy conductivity	Order no.	Price
<b>Application: Media differentiation between product /rinsing water / cleaning agent</b>					
G 1/2	100...15,000	-25...100; ( $< 1$ h: 150)	10 % MW $\pm 25 \mu\text{S}/\text{cm}$	LDL100	\$1,274.94
<b>Application: Media ultra pure water</b>					
G 1/2	0.04...1,000	-25...100; ( $< 1$ h: 150)	10 % MW $\pm 25 \mu\text{S}/\text{cm}$	LDL101	\$1,791.59

## Accessories

Type	Process connection	Order no.	Price
	G 1/2 I – G 3/4 A adaptor	E43302	\$81.98
	G 1/2 I – G 1 A adaptor	E43303	\$148.26
	G 1/2 into 1-1.5" Tri clamp adaptor with leakage port	E43311	\$141.16
	G 1/2 into 2" Tri clamp adaptor with leakage port	E43312	\$194.52
	G 1/2 into 1-1.5" Tri clamp adaptor	E33401	\$109.10
	G 1/2 into 2" Tri clamp adaptor	E33402	\$109.10



# High Accuracy Conductivity Sensors



- Reduce inaccuracies associated with a time-based cleaning process
- Improve process performance with flexible measurement points
- Compact, high-quality sensor design prevents failures and unplanned downtime
- Simplify your installation and commissioning processes
- Loss-free signal transmission of measurement values
- Accuracy conductivity 2 % MW ± 25 µS/cm



Image	Process connection	Measurement range conductivity [µS/cm]	Measurement range [°C] medium temperature	Order no.	Price
<b>Application: Media differentiation between product /rinsing water / cleaning agent</b>					
	G 1	100...1,000,000	-25...100; (< 1 h: 150)	LDL200	\$2,554.62
<b>Inductive conductivity measurement like LDL200 with extended probe length for tri clamp</b>					
	G 1	100...1,000,000	-25...100; (< 1 h: 150)	LDL201	\$2,664.20
	G 1/2	100...1,000,000	-25...100; (< 1 h: 150)	LDL220	\$2,564.99

## Accessories

Type	Description	Order no.	Price
	Tri-clamp – G 1 Aseptoflex Vario 1.5" with leakage port	E33208	\$126.31
	Tri-clamp – G 1 Aseptoflex Vario 2" with leakage port	E33209	\$145.03
	D50 – G 1 external thread Aseptoflex Vario with leakage port	E30130	\$120.29
	D38 – G 1 external thread Aseptoflex Vario with leakage port	E30500	\$120.29

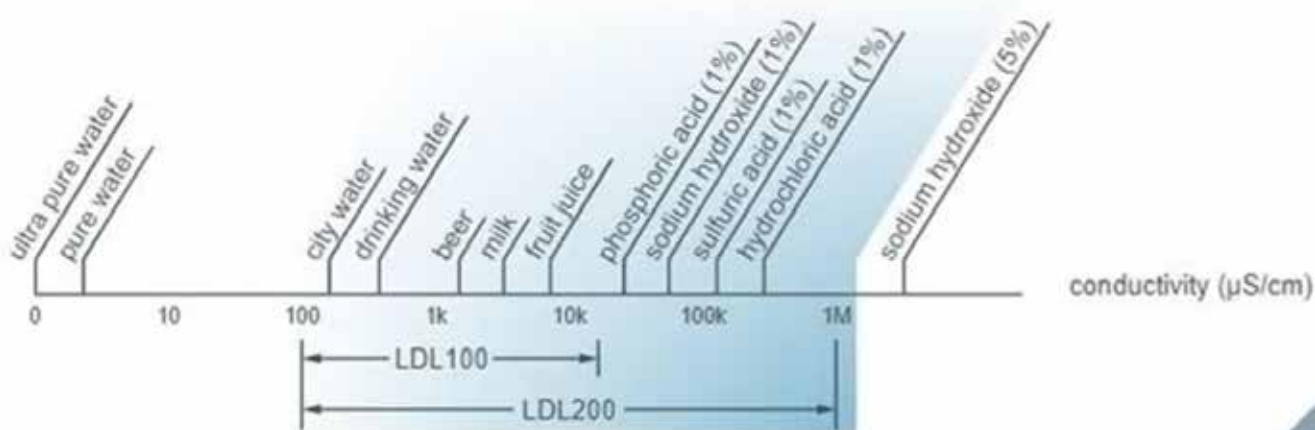

# Plant condition monitoring



Vibration accelerometers for all applications

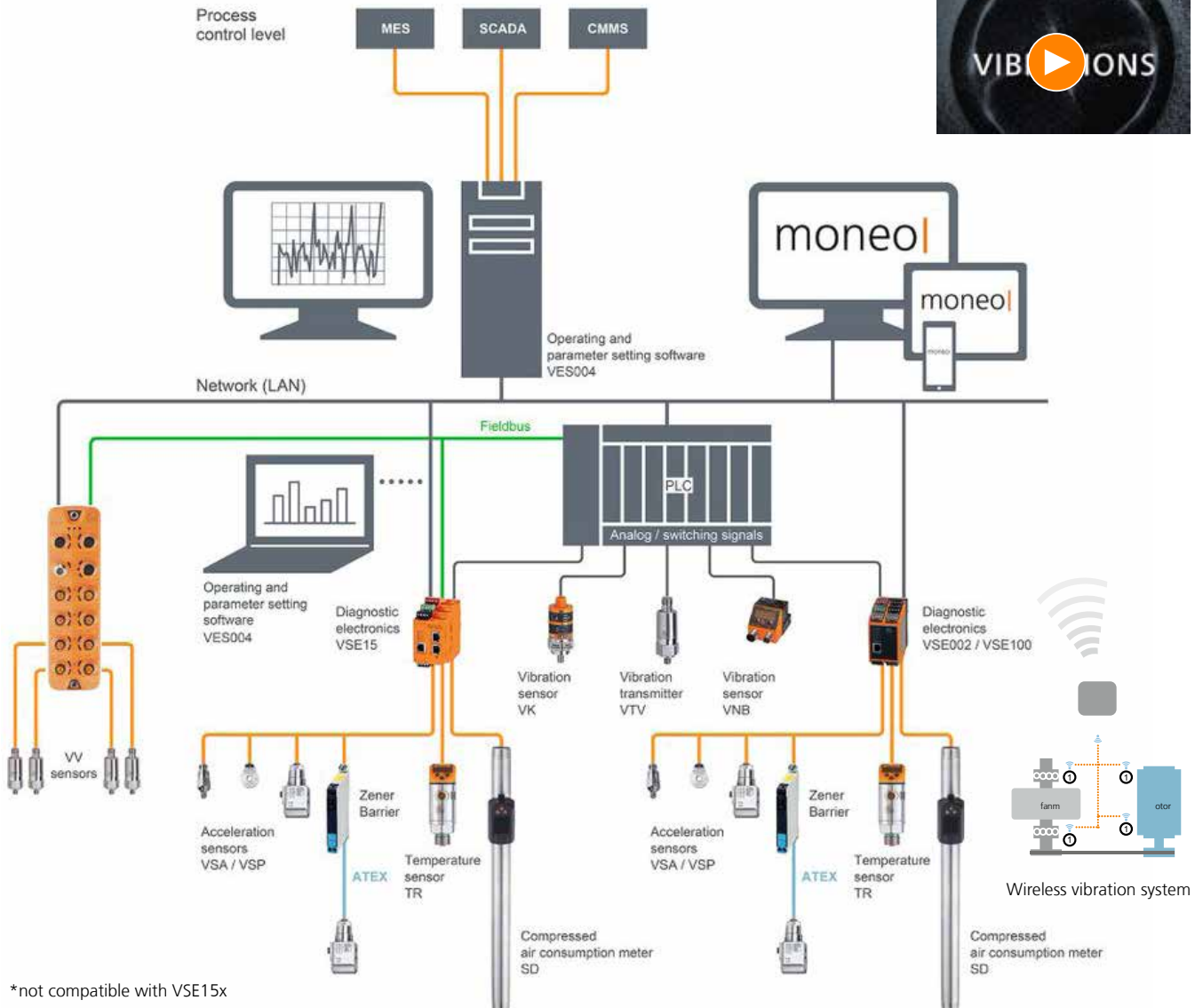

\*not compatible with VSE15x



Vibration sensors on the drives detect even smallest vibrations.



The VSE100 evaluation unit evaluates the signals from up to four vibration sensors.

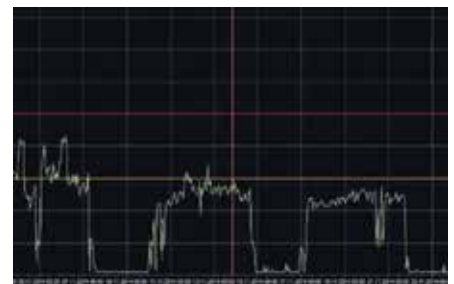

Vibration characteristics can be visualised via PC in a control room. Operators can set limits (yellow and red lines for pre-alarm and main alarm).



# Plant condition monitoring

## MOTOR MONITORING



Electric motors drive nearly all industrial machines and processes. We depend on motors to run without interruption. Like any machine, motors are subjected to damaging forces such as misalignment, shaft overload, and lack of lubrication to name a few.

### How could you improve your overall operational effectiveness?

Motors are often overlooked or are located in inaccessible locations. Implementing RtM strategy can safeguard your motors and prevent common failures. This reduces unplanned downtime and secondary damage which, in turn, reduces your maintenance cost and loss of production.

## DUCTED FAN MONITORING

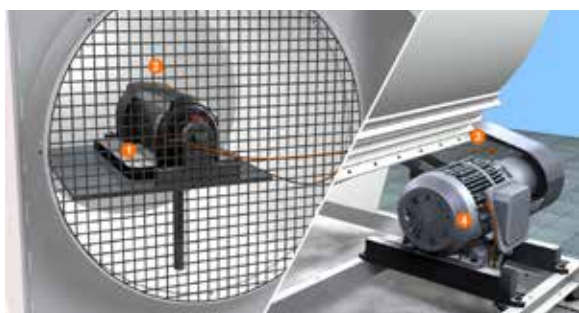

Fans are used in virtually every manufacturing plant and typically, they are located out of sight of normal daily traffic. Remote monitoring for wear on bearings, shaft or blade unbalance, etc. can reduce unplanned downtime events and improve your overall plant efficiency.

## CENTRIFUGAL PUMP MONITORING



Pumps are one of the most common pieces of equipment in all sectors of industry. Uninterrupted flow from pumps is vital to keep operations running in applications from heating and cooling systems to product storage and delivery.

How can you improve your overall operational effectiveness? Most often, pumps are overlooked until they stop working. Remote monitoring for wear on motors, bearings, shafts, impeller unbalance, or cavitation can reduce unplanned downtime events.

## SUBMERSIBLE PUMP



Submersible pumps do the essential – but dirty work – of transporting sewage to treatment plants. Prone to blockages, ragging, and general wear and tear, pumps need to be monitored to avoid events such as overflow and environmental contamination of public and residential areas.

## WIRELESS VIBRATION MONITORING SYSTEM + IoT CORE FOR MONEO IMPLEMENTATION



### Battery-powered vibration sensor VVV

For overall vibration and temperature monitoring in places that are difficult to access

Radio technology with intelligent mesh topology for efficient data transmission

Easy implementation from sensor to data visualisation





# Plant condition monitoring

## SOLUTION SELECTION



### VIBRATION

What if your equipment could provide alarms before it fails? The detection and integrated evaluation of vibration signals serves as the basis for the seamless integration of online condition monitoring and real-time maintenance into automation and control systems.

### ELIMINATE UNPLANNED DOWNTIME DUE TO EQUIPMENT FAILURES.

Monitor key machine condition indicators to predict and plan maintenance activities. Implement advanced real-time vibration monitoring without the complexity of traditional systems.

Integrate easily into your process systems

Vibration sensor platform					
		Single point	Multiple points	IO-Link monitoring	Programmable Edge controller
Application	Machines	VK VT	VN	VV	VSE
<b>Type 1 machines</b> <b>Basic monitoring</b> Simple machines, single switch / analog output	Simple motors and fans	++	++	+++	
<b>Type 1 machines</b> <b>Multiple measurements and locations</b> Multiple indicators for broad range of fault conditions	Indirect driven fans and pumps		++	+++	+
<b>Type 1 / Type 2 machines</b> <b>Multiple measurement Ethernet system</b> Easy to deploy, multiple points, networking capability	Blowers and simple speed reducers			++	+++
<b>Type 3 machines</b> <b>Complex machine and process monitoring</b> Machines requiring multiple points with root cause capability and process monitoring	Multi-stage compressors and machine tools * -- use VV for process force monitoring only			+	+++





# Plant condition monitoring

WHY PREDICTIVE MAINTENANCE MAKES SENSE

## VIBRATION CAUSES:



*Looseness,  
unbalance*



*Misalignment*



*Rolling element  
bearing*

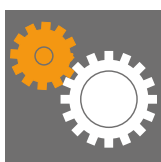

*Gearbox  
Meshing,  
tooth fault*



*Pump  
Eccentricity,  
cavitation*

- What if your production equipment was always available as planned?
- What if your cycle time was never compromised because of a damaged machine?
- What if your production equipment self-detected and alerted you of quality defects?

Applying Real-time Maintenance (RtM) technologies to your production equipment increases equipment availability, maintains machine throughput, and minimizes material losses.

## COMMON INDUSTRIAL MAINTENANCE STRATEGIES

There are 3 basic types of industrial maintenance processes and each have costs associated with them.

Reactive maintenance -- highest total cost of ownership. Run-to-failure strategy and unplanned downtime is usually more expensive than planned downtime and typically there is secondary damage to other components.

Preventative maintenance -- downtime is scheduled prior to failure. Carries a high cost because parts and labor are consumed prematurely.

Predictive or Condition-based maintenance -- uses RtM technology to optimize equipment use. Maintenance is performed only when necessary without production loss.

## TOTAL COST OF OWNERSHIP BY MAINTENANCE STRATEGY

Total cost of ownership by maintenance strategy

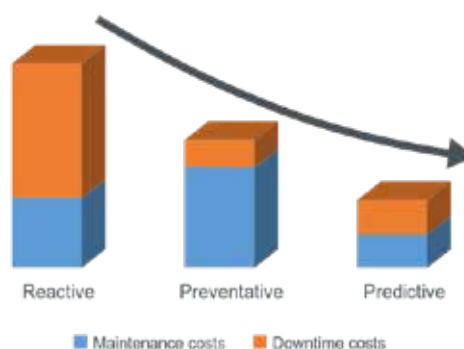

## RTM TECHNOLOGIES FOR PREDICTIVE MAINTENANCE

Advances in technologies for industrial networks, reduction in size and cost of computational power, and advances in smart sensors are making predictive systems a reality. These innovations are changing the way companies manage their equipment maintenance. Operational worthiness in real time is key to improving OEE (Overall Equipment Effectiveness) and increasing profits. Implementing RtM is at the core of any Industry 4.0 initiative. With ifm RtM products, machines can communicate their operational status in real time, automatically plan maintenance, reduce downtime, and improve quality – all improving your bottom line.



# Plant condition monitoring

## VIBRATION MONITORING WITH IO-LINK

VVB001 sensor Industrial-grade machine protection integrates directly into your existing control platform. Machine condition is continually monitored for common fault conditions of impacts, component fatigue, and friction. This allows predictable scheduling of maintenance, before major damage or failure and production downtime.

### Machines are continuously and permanently protected.

- Simple installation
- No control cabinets or extensive wiring required
- Accurate equipment condition assessment
- Automated alerts
- Root cause analysis tools without the complexity and high price
- Leverage your existing control network for process and Real-time Maintenance

### Measurements

The VVB001 design aims to simplify the primary categories of machine failure. Unlike typical single measurement systems, VVB001 simultaneously monitors equipment for the (5) categories of machine problems:

1. Impact 2. Fatigue 3. Friction 4. Severity 5. Temperature.

Embedded IO-Link technology provides this data in real time, giving the VVB001 sensor the capability to predict pending failures & mitigate catastrophic damage.



Part No.	Machine optimization
VVB001	Fast (> 600 rpm) and large (> 400 hp)
	Slow (120...600 rpm) and large (> 400 hp)
	Fast (> 600 rpm) and small (< 400 hp)
	Slow (120...600 rpm) and small (< 400 hp)
	Industrial machines



## IO-LINK SYSTEMS FOR CONTINUOUS VIBRATION MONITORING AND DIAGNOSTICS



Description	Order no.	Price
Vibration sensor; PNP/NPN; (configurable); normally open / normally closed; (parameterisable); Measuring range of vibration 0...50 g; Measuring range of vibration 0...45 mm/s; Frequency range 2...10000 Hz; Protection to IP69K; M12 Connector	VVB001	\$843.72



North Otago Irrigation pump station, employs ifm IO-Link condition monitoring systems. This state of the art pump station transfers 2 m<sup>3</sup> /s



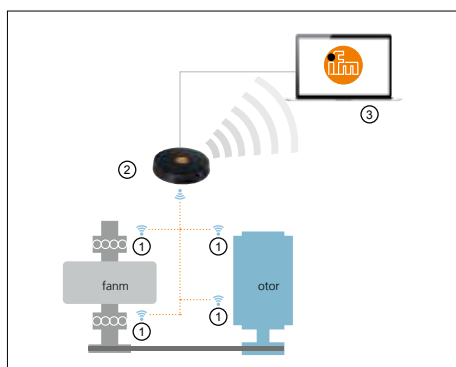
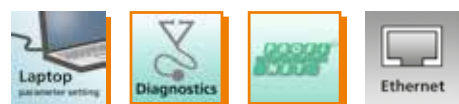

# Plant condition monitoring

## SYSTEMS FOR CONTINUOUS VIBRATION MONITORING AND DIAGNOSTICS





1) VW Vibration sensor  
2) ZB0929 Gateway  
3) moneoRTM

Type	Description	Order no.	Price
	Profinet IO Device Class C	VSE150	\$2,311.25
	Ethernet/IP (available from Q2, 2018)	VSE151	\$2,311.25
	Modbus TCP (available from Q2, 2018)	VSE153	\$2,311.25
	Diagnostic electronics for vibration sensors VSE, Input/Output Total: 8	VSE003	\$1,398.67

### Accelerometer

Type	Description	Order no.	Price
	Vibration Sensor, IP68/69K, 0 to 10mA output	VSA001	\$445.42
	Acceleration sensor; Measuring range of vibration -50...50 g; Frequency range 2...10000 Hz; Ambient temperature -55...125 °C; IP 67; Connector	VSP001	\$533.65
	Vibration sensor ATEX for hazardous areas	VSP01A	\$1,002.95
	Vibration sensor submersible: Large operating temperature range and high protection rating for the requirements of harsh industrial environments	VSP004	\$1,023.83
	Vibration sensor: Large operating temperature range and high protection rating for the requirements of harsh industrial environments	VSP003	\$635.86
	3 measurement axis. Acceleration sensor; Measuring range of vibration -40...40 g; Frequency range 0...4500 Hz; Ambient temperature -30...85 °C; IP 69K; cable	VSM101	\$1,133.78
	Measuring range of vibration [g] -16...16 Measuring range of vibration [mm/s] 0...25 Frequency range [Hz] 10...1000	1 Axis VWV001 3 Axis VWV002	\$519.23 \$554.73
	Wireless vibration sensors gateway	ZB0929	\$1,052.45
	2 switching outputs, or 1 switching output and 1 4...20 mA (set via pushbuttons), 1 input 4...20 mA (VNA001)	VNB001	\$1,005.97

### Accessories

Type	Description	Order no.	Price
	Parameter software	VES004	\$327.72
	octavis OPC server software German / English	VOS001	\$1,053.52
	Mounting Accessory (for electrical isolation)	E30132	\$52.07

### VIBRATION TRANSMITTER AND SWITCH



Description	Order no.	Price
Vibration transmitter to ISO 10816, measuring range RMS: 0...25 mm/s, analogue output 4...20 mA, 24VDC, M12 connector + switching output.	VKV021	\$460.49
Vibration transmitter to ISO 10816, measuring range RMS: 0...50 mm/s, analogue output 4...20 mA, 24VDC, M12 connector + switching output.	VKV022	\$460.49

# Products for mobile automation.



Systems for mobile machines

ALWAYS THE FIRST CHOICE. ROBUST, FLEXIBLE, RELIABLE.



Construction machines



Agriculture and forestry



Transport and logistics



Municipal vehicles

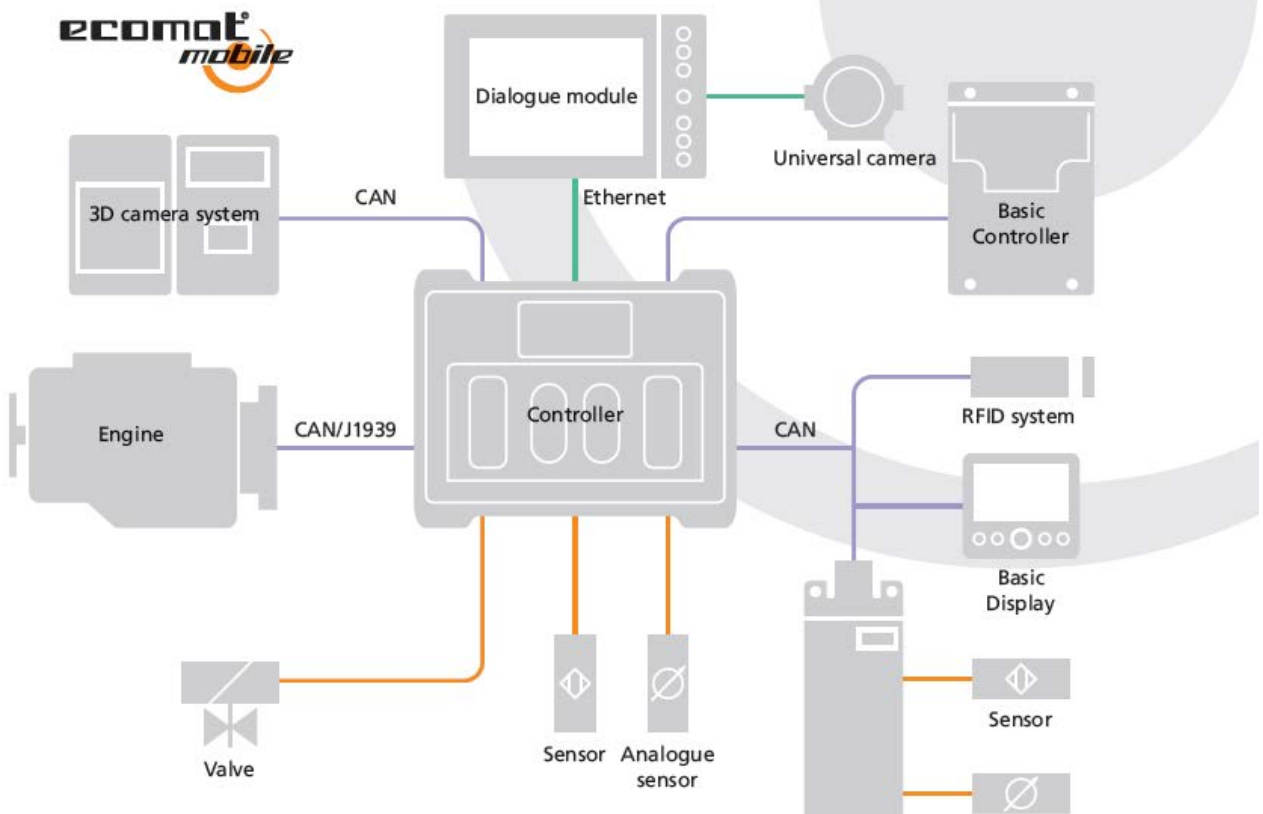





LED displays with optical bonding	Order No.		
	CR1152	CR1077	CR1203
Display	5.0"	7.0"	12.3" (wide)
Prices	\$2,850.27	\$4,510.17	\$5,669.35
Aspect ratio	16:10	16:10	8:3
Resolution	800 x 480	800 x 480	1280 x 480
Colour depth	24 bit	18 bit	24 bit
Touch	●	●	●
Controller with GPU	dual core, 800 Mhz	quad core, 1.2 GHz	quad core, 1.2 GHz
Memory (RAM) [GByte]	1	1	1
Memory (flash) [GByte]	4	8	8
Buttons (RGB backlit)	4	6	-
Navigation element	cross	cross	-
<b>COMMUNICATION INTERFACE</b>			
Ethernet	1	2	2
CAN	4	4	4
USB 2.0	1	2	2
Analogue video interfaces	2	4	4
<b>AUDIO INTERFACES</b>			
Stereo Out (amplified)	1	1	1
Line In	-	1	1
Headphones Out	-	1	1
<b>INPUTS / OUTPUTS</b>			
Digital In BL	2	2	2
Digital Out 2.5 A	2	2	2

## BASIC DISPLAY WITH ADDED FEATURES



Display size	Input functions	Operating elements	Interfaces	Order no.	Price
4.3" colour display	1 x digital input	6 prog. backlit function keys 1 x navigation key with push button	1 x CAN, 1 x EtherNet	CR1140	\$1,226.53
4.3" colour display	1 x digital input	6 prog. backlit function keys 1 x navigation key with push button	1 x CAN, 1 x USB	CR1141	\$1,226.53
10" colour display	2 x digital input, 2 x digital output	6 prog. backlit function keys 1 x navigation key, touch screen	4 x CAN: 2 x EtherNet: 2 x USB, 4 x Video (CVBS)	CR1102	\$4,938.38
12" colour display	2 x digital input, 2 x digital output	6 prog. backlit function keys 1 x navigation key, touch screen	4 x CAN: 2 x EtherNet: 2 x USB, 4 x Video (CVBS)	CR1204	\$5,662.68

## ECOMATCONTROLLER



Safety				
I/O total	Inputs	Outputs	Order No.	Price
60	32x Digital, 16x Analogue 8x Frequency, 4x Resistance	27x Digital, 1x Analogue 3x PWM 4.0A, 9x PWM 2.5A, 3x H-Bridge	CR7115	\$2,854.96
98	60x Digital, 24x Analogue 16x Frequency, 4x Resistance	36x Digital, 2x Analogue 4x PWM 4.0A, 12x PWM 2.5A, 4x H-Bridge	CR7205	\$3,678.37
124	68x Digital, 24x Analogue 16x Frequency, 4x Resistance	54x Digital, 1x Analogue 6x PWM 4.0A, 18x PWM 2.5A, 6x H-Bridge	CR7215	\$4,594.74

## CONTROLLER STARTER SET FOR MOBILE MACHINES



Description	Order No.	Price
ecomatController/Starterkit	EC2121	\$1,717.14

### BASIC CAN BUS CONTROLLERS, IP20



I/O total	Input functions	Output functions	Interfaces	Order no.	Price
20	12 x digital, 4 x analogue (U/I) 4 x frequency, 4 x resistance	8 x digital, 8 x PWM	2 x CAN	CR0401	\$454.89
24	12 x digital, 4 x analogue (U/I) 4 x frequency, 4 x resistance	12 x digital, 2 x PWM-I 10 x PWM	2 x CAN	CR0403	\$607.02
16	8 x digital, 4 x analogue (U/I) 4 x frequency, 4 x resistance	8 x digital, 8 x PWM-I 8 x PWM, 4 x H bridge	2 x CAN	CR0411	\$628.11
14	8 x digital, 4 x analogue (U/I) 4 x frequency, 4 x resistance	6 x relay	2 x CAN	CR0431	\$635.00

#### Relay modules, IP20



Locations	Order no.	Price
6 automotive relays, 10 automotive fuses	CR0421	\$74.24

#### Dialogue modules, IP65/67



Display size	Inputs / outputs	Operating elements	Interfaces	Order no.	Price
2.8" colour display	-	5 freely programmable backlit function keys, cursor key	1 x CAN	CR0451	\$749.90
4.3" colour display	-	6 freely programmable backlit function keys, cursor key	1 x CAN	CR0452	\$1,072.67

### FIELD CAN BUS MODULES, IP67



I/O Total	CompactModule, IP 67				Order no.	Price
16	-	16x Digital, 16x PWM, 8x PWM-I	DEUTSCH Connector	2 x CAN	CR2051	\$854.69
16	8x Digital, 4x Analogue	8x Digital, 8x PWM, 8x PWM-I	DEUTSCH Connector	2 x CAN	CR2052	\$834.04
8	-	16x Digital, 16x PWM, 8x PWM-I	M12	2 x CAN	CR2041	\$802.19
16	16x Digital, 4x Analogue	8x Digital, 8x PWM, 8x PWM-I	M12	2 x CAN	CR2042	\$782.61
16	16x Digital, 8x Analogue	-	M12	2 x CAN	CR2040	\$665.55

### BASIC CAN BUS CONTROLLERS, IP67



I/O total	Input functions	Output functions	Interfaces	Order no.	Price
<b>ClassicController, IP 67</b>					
32	16 x digital, 16 x analogue (U/I) 16 x frequency	16 x digital, 16 x PWM-I 16 x PWM, 2 x H bridge	4 x CAN, 1 x USB 1 x RS-232	CR0032	\$3,345.40
32	16 x digital, 12 x analogue (U/I) 12 x frequency, 4 x resistance	16 x digital, 16 x PWM-I 16 x PWM, 2 x H bridge	4 x CAN, 1 x USB 1 x RS-232	CR0033	\$3,345.40
<b>SmartController, IP 67</b>					
32	16 x digital, 4 x analogue (U/I) 4 x frequency, 2 x resistance	16 x digital, 2 x PWM-I 12 x PWM, 2 x analogue 0.2...10 V	2 x CAN	CR2530	\$1,121.52
64	32 x digital, 8 x analogue (U/I) 8 x frequency, 4 x resistance	32 x digital, 4 x PWM-I 24 x PWM, 4 x analogue 0.2...10 V	3 x CAN	CR2532	\$1,969.97
<b>PDM360 NG, IP 65/67</b>					
7" colour display	1 x digital / analogue-In 1 x digital-Out	9 freely programmable backlit function keys, key with pushbutton, touch screen	4 x CAN, 2 x USB 1 x Ethernet 2 x video	CR1082	\$5,372.83
7" colour display	1 x digital / analogue-In 1 x digital-Out	8 freely programmable backlit function keys, key with pushbutton	4 x CAN, 2 x USB 1 x Ethernet 2 x video	CR1083	\$5,076.96



Automatic collision avoidance: 3D camera at the rear automatically warns of obstacles and possible collisions.

### MULTI-FUNCTION INPUT MODULE



Description	Order no.	Price
Multi-functional input module, LED, multi-colour. CAN protocol J1939	CR1300	\$447.14
Multi-functional input module, 4 part segment ring, LED, multi-colour. CAN protocol J1939	CR1301	\$495.77

### CAN BUS DEVICES



Type of sensor	Image resolution	Angle of aperture [°]	Order no.	Price
O3M 3D smart sensor, CAN interface				
Mobile	64 x 16	70 x 23	O3M251	\$4,478.11
O3M illumination unit - for the operation of O3M250 / O3M251				
infrared light 850 nm	-	70 x 23	O3M950	\$1,606.96



Absolute multiturn encoder	Order no.	Price
Resolution = 4096 steps; 4096 revolutions; 24 bit, Communication interface = CAN, Solid shaft = 10mm dia.	RM9000	\$650.92



Description	Order no.	Price
<b>2 axis</b>		
2x Axis. Angular range ± 180°. Output 1 IO-Link NO/NC prog. Output 2 - NO/NC prog. PNP/NPN. Analogue 4...20 mA. Output 3 and 4 analogue	JN2200	\$720.21
2x Axis. Angular range ± 45° / 90°, IO-Link. Output 1 - IO-Link NO/NC prog. Output 2 - NO/NC prog. PNP/NPN. Analogue 4...20 mA	JN2201	\$800.25



Description	Order no.	Price
<b>1 or 2 axis</b>		
Inclination sensor; 27 x 59 x 118.5 mm; CAN; Ambient temperature -40...85 °C; M12 Connector; [inclination measurement]: ± 90 °	JD2120	\$1,339.50
Inclination sensor; 27 x 59 x 105.3 mm; CAN; Ambient temperature -40...85 °C; M12 Connector; [inclination measurement]: 0...360 °	JD1111	\$1,296.46

## Inductive sensors - temperature range -40...85° C



Design / length [mm]	Sensing range [mm]	Connection	Output	Order no.	Price
M12 / 70	7 nf	M12	3 / 2-wire; DC PNP/NPN; NO	IFM204	\$116.84
M12 / 70	4 f	M12	3-wire; DC PNP; NO	IFM205	\$132.98
M18 / 70	8 f	M12	3 / 2 -wire; DC PNP/NPN; NO	IGM200	\$116.84
M18 / 70	12 nf	M12	3 / 2 -wire; DC PNP/NPN; NO	IGM201	\$116.84
M18 / 70	12 nf	M12	3-wire; DC PNP; NO	IGM205	\$132.98
M30 / 70	12 f	M12	3 / 2 -wire; DC PNP/NPN; NO	IIM200	\$154.71
M30 / 70	22 nf	M12	3 / 2 -wire; DC PNP/NPN; NO	IIM201	\$154.71

## Magnetic sensors - pressure resistance 500 bar



Design / length [mm]	Sensing range [mm]	Connection	Output	Order no.	Price
M12 / 93	1.8 f	M12	PNP; normally open	MFH200	\$247.24

## Pressure sensors



Pressure range [bar]	Process connection	Electrical connection	Temperature [C°]	Output	Order no.	Price
0...10	G 1/4	M12 connector	-40...125	4...20 mA	PT5504	\$280.81
0...250	G 1/4	DEUTSCH connector	-40...125	4...20 mA	PT5701	\$280.81
0...250	G 1/4	AMP connector	-40...125	4...20 mA	PT5601	\$280.81
0...250	G 1/4	DEUTSCH connector	-40...125	0.5...4.5 V	PU8701	\$280.81

## Temperature sensors



Measuring range [C°]	Process connection	Electrical connection	Installation depth [mm]	Output	Order no.	Price
-50...150	G 1/4	M12 connector	25	4...20 mA	TA3105	\$356.98
-50...150	G 1/4	M12 connector	50	4...20 mA	TA3115	\$360.86
-50...150	G 1/4	M12 connector	25	0.5...4.5 V	TU3105	\$356.98
-50...150	G 1/4	DEUTSCH connector	25	0.5...4.5 V	TU4105	\$370.76

## RFID system sensors 13.56 MHz



Design	Range referred to Ø 30 mm ID Tag	Order no.	Price
DTM evaluation unit / antenna, CAN interface			
M18, nf	40	DTM425	\$490.61
40x40 x54mm	≤ 60, nf	DTC510	\$558.39
Description		Order no.	Price
ID TAGs (selection) for 13.56 MHz system			
Ø 30 x 2.5 / 06 - 896 bits		E80371	\$23.24

## ECOMATCONTROLLER ACCESSORIES

Type	Description	Order no.	Price
	Wireable AMP connector, 81 poles, A-coded	EC0701	\$70.36
	Wireable AMP connector, 81 poles, B-coded	EC0702	\$81.98





Type	Description	Order no.	Price
	CAN devices to the USB interface of a PC, R360/CAN-Interface/CANFox	EC2112	\$484.80
	Programming cable set for CAN interface, R360/CABLE/CANfox-Basic	EC2114	\$242.08

### MOBILE MACHINE M12 CONNECTOR CABLES - TEMPERATURE RANGE -40...85° C



Type	Description	Order no.	Price
<b>M12 sockets 4-pole (0.34mm² sensor) - IP69k, 4A max</b>			
	2 m black, PUR cable	EVM001	\$41.74
	5 m black, PUR cable	EVM002	\$49.06
	10 m black, PUR cable	EVM003	\$58.10
	15 m black, PUR cable	EVM018	\$67.35
	25 m black, PUR cable	EVM014	\$91.02
	60 m black, PUR cable	EVM065	\$174.51
	2 m black, PUR cable	EVM004	\$41.74
	5 m black, PUR cable	EVM005	\$49.06
	10 m black, PUR cable	EVM006	\$58.10
	15 m black, PUR cable	EVM019	\$67.35
	25 m black, PUR cable	EVM012	\$91.02
	50 m black, PUR cable	EVM010	\$146.54
<b>M12 sockets 5-pole (0.34mm² sensor) - IP69k, 4A max</b>			
	2 m black, PUR cable	EVM036	\$43.90
	5 m black, PUR cable	EVM037	\$54.01
	10 m black, PUR cable	EVM038	\$71.87
	2 m black, PUR cable	EVM039	\$43.90
	5 m black, PUR cable	EVM040	\$54.01
	10 m black, PUR cable	EVM041	\$71.87

### A-CODED, M12 WIRABLE PLUGS AND SOCKETS, 4 & 5-POLE, IP69K



Type	Description	Order no.	Price
<b>M12 Wirable Plugs and Sockets, 4-pole &amp; 5-pole, IP69k, 4A max</b>			
	Wirable socket, straight, 4-pole	EVC810	\$34.64
	Wirable socket, straight, 5-pole	EVC814	\$37.23
	Wirable socket, angled, 4-pole	EVC811	\$34.64
	Wirable socket, angled, 5-pole	EVC815	\$37.23
	Wirable plug, straight, 4-pole	EVC812	\$34.64
	Wirable plug, straight, 5-pole	EVC816	\$37.23
	Wirable plug, angled, 4-pole	EVC813	\$34.64
	Wirable plug, angled, 5-pole	EVC817	\$37.23





- Large cable cross-section for voltage drop reduction
- Permanent vibration protection due to saw tooth contour
- Optimum sealing even when fastened by hand
- The mechanical end stop protects the O-ring against destruction

### Technical data:

Operating voltage: 30 V AC / 36 V DC  
 Current rating: 4 A  
 Protection rating: IP 65, IP 67, IP 68, IP 69K  
 in locked condition with the matching counterpart.  
 Tightening torque: 0.6 Nm – 1.5 Nm  
 Vibration / shock: 750 g, 1 million cycles

### Cable:

Drain wire (screen): 0.75 mm<sup>2</sup>  
 Voltage supply: 2 x 0.75 mm<sup>2</sup>  
 CAN: 2 x 0.5 mm<sup>2</sup>  
 Drag chain: > 5 million cycles

### Approvals:

cULus

### Applications:

EVC factory automation and mobile machines

Type	Description	Order no	Price
<b>Connection cable M12 connector</b>			
	2.0 m	EVC943	\$75.74
	5.0 m	EVC944	\$153.64
	2.0 m	EVC945	\$75.74
	5.0 m	EVC946	\$153.64
<b>Connection cable M12 socket</b>			
	2.0 m	EVC939	\$79.19
	5.0 m	EVC940	\$157.08
	2.0 m	EVC941	\$79.19
	5.0 m	EVC942	\$157.08
<b>Connection cable with terminating resistor 120 Ω, M12 socket</b>			
	2.0 m	EVC957	\$91.45
	5.0 m	EVC958	\$169.35
	2.0 m	EVC959	\$91.45
	5.0 m	EVC960	\$181.18
	10.0 m	EVC961	\$270.05
<b>Connection cable M12 connector / M12 socket</b>			
	1.0 m	EVC947	\$91.45
	2.0 m	EVC948	\$110.39
	5.0 m	EVC949	\$187.42

Type	Description	Order no	Price
<b>Connection cable M12 connector / M12 socket</b>			
	1.0 m	EVC950	\$91.45
	2.0 m	EVC951	\$110.39
	5.0 m	EVC952	\$187.42
<b>Connection cable M12 connector / M12 socket</b>			
	1.0 m	EVC953	\$91.45
	2.0 m	EVC954	\$110.39
	5.0 m	EVC955	\$187.42
	10.0 m	EVC956	\$273.92
<b>Connection cable with terminating resistor 120 Ω, M12 connector / M12 socket</b>			
	2.0 m	EVC962	\$122.65
	5.0 m	EVC963	\$199.26
	10.0 m	EVC964	\$285.76
<b>Connection cable with terminating resistor 120 Ω, M12 connector / M12 socket</b>			
	2.0 m	EVC965	\$122.65
	5.0 m	EVC966	\$199.26
	10.0 m	EVC967	\$285.76





# AS-i Bus system components

## AS-I MASTERS



### AS-I IO-LINK MASTER

Description	Order no	Price
<b>AS-i controller / gateways (colour display for clear diagnosis &amp; set-up)</b>		
AS-i Profibus gateway, 2 AS-i masters with M4 profile	AC1412	2,703.31
ifm SPS Profisafe over Profinet gateway / safety master	AC4045	\$3,701.10
EtherNet/IP devise interface, 2x AS-i masters with M4 Profile	AC1424	\$3,063.09
AS-i EtherNet/IP gateway; Number of AS-i masters 1; terminals	AC1421	\$2,323.30
AS-i EtherNet/IP gateway; Number of AS-i masters 2; terminals	AC1422	\$2,875.24
AS-i EtherNet/IP gateway with safe preprocessing	AC4225	\$3,545.52



Type	Description	Order no.	Price
<b>AS-i IO-Link master</b>			
	4-port (AS-i and AUX)	AC2950	\$191.30
	2-port (AS-i)	AC2951	\$237.99

### AS-i SYSTEM POWER SUPPLIES







Current / peak at 24 V	Input voltage [V AC]	Order no.	Price
2.8 A	100...120 / 200...240	AC1256	\$600.78
4 A	100...120 / 200...240	AC1254	\$746.89
4 A	24v DC	AC1257	\$855.34
8 A	380...480	AC1253	\$1,245.03
8 A	115 / 230	AC1258	\$1,053.52
2 x 4 A	115 / 230	AC1212	\$1,341.22

### PASSIVE POWER SUPPLIES

Type	Description	Order no.	Price
	ProcessLine 4SB IP69K	AC2950	\$191.30
	ProcessLine 8SB IP69K	AC2951	\$237.99

### AS-i I/O FIELD MODULES - IP69K



Type	Description	Order no	Price
<b>Modules</b>			
	IP 69K, 4 in / 3 out. Active ProcessLine module, V 2.1, SS316L, Sockets M12	AC2904	\$797.89
	IP 69K, 8-way splitter box. Passive ProcessLine module, SS316L, Sockets M12	AC2900	\$393.78
	Active ProcessLine module; ProcessLine 8DI IP69K; Connector; IP 69K	AC2910	\$774.22
	FC splitter · M12 socket · SS316L / 1.4404 / Blanks: FPM / O-ring: EPDM	E70354	\$91.67
	FC splitter · SS316L / 1.4404 / Blanks: FPM / O-ring: EPDM	E70377	\$82.41



# AS-i Bus system components

## SMARTLINE MODULES



Type	Description	Order no.	Price
	SmartLine25 4AO (C) C IP20	AC2218	\$1,205.01
	SmartL25 4DI 2DO R C	AC2256	\$260.37
	SmartL25 4DI 4DO T C	AC2257	\$293.94
	Active AS-i module, 4 inputs	AC2250	\$220.34
	Active AS-i module, 4 inputs / 4 outputs	AC2251	\$304.26
	SmartL25 4DI 4DO T C	AC3200	\$320.62
	SmartL25 4DI AUX 4DO T C	AC3201	\$320.62
	SmartL25 4DI 4DO R C	AC3220	\$353.33
	SmartL25 4DI AUX 4DO R C	AC3221	\$353.33
	SmartL25 AS-i Repeater III	AC3226	\$605.73
	SmartL25 4DI 4DO T C	AC3251	\$302.11
	SmartL25 4DI 2DO R C	AC3256	\$266.82
	SmartL25 4DI AUX 4DO T C	AC3257	\$265.75

## COMPACT MODULES - IP67



Type	Description	Order no.	Price
	CompactModule 4DI M12	AC2410	\$318.04
	CompactModule 2DI 2DO T M12	AC2411	\$410.13
	CompactModule 4DI 4DO T M12	AC2412	\$526.98
	CompactModule 4DI M12 V4A	AC2451	\$360.21
	CompactModule 4DI 4DOT M12 V4A	AC2452	\$600.35
	CompactLM12 4DI M12 IR IP67	AC2457	\$298.02
	CompactLM12 4DI 4DO T M12 IR	AC2459	\$490.83
	CompactLineM12 4DI4DO T M12	AC2466	\$563.56
	CompactLineM8 4DI 4DO T	AC2490	\$426.27



Type	Description	Order no.	Price
	AS-Interface flat cable seal	AC3003	\$42.39
	Flat cable insulation displacement connector; Connector	AC5005	\$27.97

## ELECTRONIC MODULES

Type	Description	Order no.	Price
	AS-Interface PCB module AS-i pcb 2-DI/1-DO	AC2729	\$223.57
	AS-Interface PCB module PCB 4DI 4DO T W A/B	AC2750	\$277.58
	AS-Interface PCB module PCB 4DI 4DO T C A/B	AC2752	\$277.58



# AS-i Bus system components

AS-I SAFETY

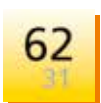

Type	Description	Order no	Price
------	-------------	----------	-------

### AS-i controller and gateways (colour display for clear diagnosis & set-up)

	AS-i EtherNet/IP gateway with safe preprocessing	AC4325	\$3,753.60
--	--	--------	------------

Type	Safety Outputs	Non-safe Outputs	Order no.	Price
------	----------------	------------------	-----------	-------

	SmartLine SafetyModule		AC009S	\$465.22
	SmartLine Module 2SO IP20		AC030S	\$852.54
	ClassicL 2SI 2DOT 2LO OSSD		AC507S	\$415.51
	ClassicLine 4DI-Y II 3D		AC515A	\$347.73
	AS-i Safety Platine		AC015S	\$241.22
	E-stop illuminated IP67		AC010S	\$489.53

### Accessories

Type	Description	Order no.	Price
------	-------------	-----------	-------

	AS-i addressing unit	AC1154	\$836.19
	AS-i Tuner IP67, diagnostic module; Connector	AC1146	\$1,272.36
	AS-Interface passive bus termination	AC1147	\$218.19
	Flat cable connector M12	E70096	\$15.71
	Flat cable 100 m EPDM (yellow), 2 x 1.5mm²	E74000	\$497.50
	Flat cable EPDM (yellow) 2x 1.5mm, cut/meter	ZE1732	ZE1732
	Flat cable 50 m EPDM (yellow), 2 x 1.5mm²	E74002	\$284.90
	Flat cable 500 m EPDM (yellow), 2 x 1.5mm²	E74003	\$2,342.45
	Flat cable EPDM 100 m (yellow), 2 x 1.5mm²	E74005	\$553.44
	Flat cable 100 m EPDM (black), 2 x 1.5mm²	E74010	\$556.24
	Flat cable EPDM (black) 2x 1.5mm, cut/meter	ZE1733	ZE1733
	Flat cable 500 m EPDM (black), 2 x 1.5mm²	E74013	\$2,635.31
	Flat cable 100 m TPE (yellow), 2 x 1.5mm²	E74200	\$630.26
	Flat cable 100 m TPE (black), 2 x 1.5mm²	E74210	\$730.11
	Flat cable 100 m TPE (red), 2 x 1.5mm²	E74220	\$1,133.14
	Flat cable 200 m EPDM (yellow), 2 x 2.5mm²	E74406	\$1,446.44
	Flat cable 200 m EPDM (black), 2 x 2.5mm²	E74416	\$1,446.44
	FC Splitter AS-i UL	E70581	\$41.31
	FC Splitter AS-i M12 FC top UL	E70585	\$27.76
	FC Splitter AS-i / AUX M12 UL	E70587	\$68.64
	QUAD M12 AS-i/24V 4A	E70588	\$97.48
	FC Splitter AS-i 2 m UL	E70598	\$44.11















# RFID antennas with IO-Link

Wide selection available



The ID tag chip is installed at the base of the workpiece carrier. The chip can store up to 224 bits.

Type	Description	Part No	Price
<b>IO-Link RFID Antennas</b>			
	Read/write head; 13,56 MHz; IO-Link; 40 x 40 x 54 mm; Ambient temperature -20...60 °C; IP 67; IP 69K	<b>DTI513</b>	<b>\$472.10</b>
	Read/write head; 13,56 MHz; IO-Link; 20 x 7 x 48 mm; Ambient temperature -20...60 °C; IP 67; IP 69K	<b>DTI515</b>	<b>\$410.99</b>
<b>RFID Antennas</b>			
	RFID antenna 13.56 MHz, M30 design, flush	<b>ANT430</b>	<b>\$503.74</b>
	RFID antenna 13.56 MHz, M30 design, non-flush	<b>ANT431</b>	<b>\$503.74</b>
	RFID antenna 125 KHz	<b>ANT512</b>	<b>\$505.89</b>
	RFID antenna 13.56 MHz, ISO 15693	<b>ANT513</b>	<b>\$533.65</b>
<b>RFID Evaluation Units</b>			
	RFID evaluation unit, EtherNet/IP interface	<b>DTE102</b>	<b>\$1,409.86</b>
	RFID evaluation unit, EtherCAT interface	<b>DTE103</b>	<b>\$1,335.62</b>
<b>Accessories</b>			
	ID tag; 13,56 MHz; Ø 30 / L = 2.8 mm; Ambient temperature -25...85 °C; IP 68	<b>E80370</b>	<b>\$53.58</b>
	ID tag; 13,56 MHz; Ø 30 / L = 3 mm; Ambient temperature -40...85 °C; IP 68; IP 69K	<b>E80371</b>	<b>\$23.24</b>
	ID tag; 13,56 MHz; Ø 50 / L = 3 mm; Ambient temperature -25...85 °C; IP 68; IP 69K	<b>E80383</b>	<b>\$58.10</b>





# Product Index

IFM ARTICLE NUMBER & PAGE NUMBER

AC1146	143	AC0155	143	AL1970	12	CR2530	136	DP1603	17	DX2043	88
AC1147	143	AC0305	143	AL2203	15	CR2532	136	DP1613	17	DX2045	88
AC1154	143	AC0415	85	AL2205	15	CR7115	135	DP2122	17	DX2055	88
AC1212	141	AC4045	141	AL2221	15	CR7205	135	DP2200	17	E10013	34
AC1253	141	AC4225	141	AL2225	15	CR7215	135	DP2302	17	E10137	34
AC1254	141	AC4325	143	AL2230	15	DD0203	53	DP2402	17	E10210	34
AC1256	141	AC5075	143	AL2240	15	DD2503	53	DP3213	17	E10735	45
AC1257	141	AE3100	21	AL2241	15	DF1100	18	DP3222	17	E10736	46
AC1258	141	AL1060	12	AL2303	13	DF1208	18	DP3223	17	E10737	48
AC1412	141	AL1100	12	AL2321	13	DF1210	18	DP3603	17	E10751	43
AC1421	141	AL1101	14	AL2325	13	DF1212	18	DP3613	17	E10753	43
AC1422	141	AL1102	12	AL2330	13	DF1214	18	DP4122	17	E10880	56
AC1424	141	AL1103	14	AL2340	13	DF1216	18	DP4200	17	E11033	57
AC2218	142	AL1120	12	AL2341	13	DF1220	18	DP4302	17	E11067	41
AC2250	142	AL1121	14	AL2605	13	DF2101	18	DP4402	17	E11194	41
AC2251	142	AL1122	12	AL3000	13	DF2208	18	DTC510	138	E11230	34
AC2256	142	AL1123	14	AL3001	15	DF2210	18	DTE102	144	E11231	34
AC2257	142	AL1300	12	AL3050	13	DF2212	18	DTE103	144	E11232	34
AC2410	142	AL1301	14	AL3051	15	DF2214	18	DTI513	144	E11293	41
AC2411	142	AL1302	12	AL2005	13	DF2216	18	DTI515	144	E11295	41
AC2412	142	AL1303	14	ANT430	144	DF2220	18	DTM425	138	E11311	34
AC2451	142	AL1304	12	ANT431	144	DF3100	18	DV1001	81	E11416	36
AC2452	142	AL1305	14	ANT512	144	DF3110	18	DV1002	81	E11417	36
AC2457	142	AL1306	12	ANT513	144	DF3200	18	DV1003	81	E11418	36
AC2459	142	AL1307	14	CR0032	136	DF3210	18	DV1004	81	E11419	36
AC2466	142	AL1320	12	CR0033	136	DI5027	53	DV1300	80	E11420	36
AC2490	142	AL1321	14	CR0401	136	DI5029	53	DV1310	80	E11421	36
AC2729	142	AL1322	12	CR0403	136	DI6001	53	DV1500	80	E11422	36
AC2750	142	AL1323	14	CR0411	136	DI6004	53	DV1501	80	E11423	36
AC2752	142	AL1324	12	CR0421	136	DI6005	53	DV1510	80	E11424	36
AC2900	141	AL1325	14	CR0431	136	DL0203	89	DV1511	80	E11425	36
AC2904	141	AL1326	12	CR0451	136	DL2503	89	DV1521	80	E11426	36
AC2910	141	AL1327	14	CR0452	136	DN0220	89	DV1530	80	E11427	36
AC2950	15	AL1330	12	CR1077	21	DN1022	19	DV1531	80	E11428	36
AC2951	15	AL1331	14	CR1082	136	DN1030	19	DV2120	80	E11429	36
AC3003	142	AL1332	12	CR1083	136	DN1031	19	DV2121	80	E11430	36
AC3200	142	AL1333	14	CR1102	135	DN4011	19	DV2130	80	E11550	38
AC3201	142	AL1340	12	CR1140	135	DN4012	19	DV2131	80	E11551	38
AC3220	142	AL1341	14	CR1141	135	DN4013	19	DV2300	80	E11552	38
AC3221	142	AL1342	12	CR1152	21	DN4014	19	DV2310	80	E11553	38
AC3226	142	AL1343	14	CR1203	21	DN4032	19	DV2500	80	E11588	41
AC3251	142	AL1351	23	CR1204	135	DN4033	19	DV2510	80	E11601	41
AC3256	142	AL1900	12	CR1300	137	DN4034	19	DV2520	80	E11797	58
AC3257	142	AL1901	12	CR1301	137	DN4218	19	DV2530	80	E11799	58
AC5005	142	AL1920	12	CR2040	136	DN4234	19	DX1041	89	E11801	58
AC6001	14	AL1921	12	CR2041	136	DN4237	19	DX1063	53	E11807	34
AC515A	143	AL1930	12	CR2042	136	DP1213	17	DX2022	88	E11898	76
AC009S	143	AL1940	12	CR2051	136	DP1222	17	DX2041	88	E11912	58
AC010S	143	AL1950	12	CR2052	136	DP1223	17	DX2042	88	E11913	58



# Product Index

## IFM ARTICLE NUMBER & PAGE NUMBER

E11950	34	E20874	68	E30094	94	E37431	125	E43209	104	E70588	143
E11975	58	E20935	62	E30122	94	E37511	125	E43210	104	E70598	143
E11976	58	E20938	63	E30123	94	E37521	125	E43211	104	E73008	41
E11977	58	E20940	66	E30124	94	E37600	125	E43212	104	E73009	41
E11978	58	E20946	62	E30128	94	E37610	125	E43213	104	E74000	143
E11979	58	E20950	61	E30130	94	E37620	125	E43214	104	E74002	143
E11980	58	E20951	61	E30131	94	E37630	125	E43216	104	E74003	143
E11981	58	E20956	62	E30132	133	E37640	125	E43217	104	E74005	143
E12166	81	E21076	78	E30133	94	E40096	111	E43300	118	E74010	143
E12167	81	E21079	69	E30140	94	E40099	111	E43301	118	E74013	143
E12169	34	E21081	61	E30141	94	E40107	111	E43302	101	E74200	143
E12260	124	E21085	66	E30143	94	E40114	125	E43303	101	E74210	143
E12281	34	E21110	66	E30144	125	E40119	112	E43311	126	E74220	143
E12282	34	E21111	78	E30391	17	E40134	111	E43312	126	E74406	143
E12360	34	E21112	78	E30399	94	E40178	109	E43313	101	E74416	143
E12402	35	E21113	78	E30400	94	E40179	109	E43334	104	E80021	78
E12403	35	E21133	69	E30401	94	E40180	110	E43340	104	E80370	144
E12404	35	E21140	15	E30402	106	E40189	109	E43341	104	E80371	138
E12408	41	E21159	69	E30407	122	E40191	110	E43342	104	E80383	144
E12514	15	E21171	69	E30419	94	E40192	110	E43345	104	E84016	19
E12517	51	E21206	65	E30420	94	E40193	110	E43346	104	E84036	19
E12519	51	E21211	66	E30421	94	E40195	115	E43347	104	E89060	81
E12520	51	E21212	66	E30429	89	E40199	109	E43348	104	E89061	81
E12521	51	E21224	69	E30430	17	E40213	109	E43353	104	E89065	81
E12522	51	E21248	69	E30435	94	E40214	109	E43375	101	E89066	81
E12523	51	E21268	63	E30443	17	E40215	109	E43376	101	E89067	81
E12524	51	E21269	63	E30444	17	E40216	109	E43383	101	E89080	81
E12542	15	E21270	63	E30500	127	E40217	109	E43406	17	E89208	17
E12569	50	E21271	63	E33201	94	E40227	109	E43900	57	E2D101	69
E12573	50	E21272	63	E33202	94	E40230	109	E60022	55	E2D118	79
E12613	18	E21275	63	E33208	94	E40231	109	E60034	55	E2D202	78
E12614	18	E21291	61	E33209	94	E40234	109	E60035	55	E2D500	78
E12628	50	E21298	61	E33212	94	E40240	109	E60066	55	E2D501	78
E12674	50	E23000	86	E33213	94	E40249	110	E60067	55	E2D506	78
E12675	56	E23001	86	E33401	101	E40258	111	E60095	55	E3D103	76
E12676	56	E23002	86	E33402	101	E40259	111	E60098	55	EBC016	41
E12677	56	E23007	86	E33601	106	E40260	111	E60110	55	EBC020	41
E12689	12	E30002	94	E33701	94	E40263	111	E60138	55	EBC022	41
E12724	51	E30009	104	E33702	94	E43000	102	E61438	55	EBC024	41
E20004	61	E30010	94	E33712	94	E43003	102	E61439	55	EBC028	41
E20005	61	E30013	106	E33713	94	E43004	102	E61440	55	EBC032	41
E20454	62	E30016	125	E35010	125	E43006	102	E61441	55	EBC034	41
E20716	63	E30017	120	E35020	125	E43016	102	E61442	55	EBC035	41
E20717	66	E30047	125	E35030	125	E43202	104	E70096	143	EBC036	41
E20722	62	E30050	94	E35050	125	E43203	104	E70354	141	EBC112	40
E20724	61	E30055	101	E37340	94	E43204	104	E70377	141	EBC113	40
E20744	61	E30057	94	E37350	94	E43205	104	E70581	143	EBC114	40
E20870	65	E30058	94	E37411	125	E43207	104	E70585	143	EBC115	40
E20873	68	E30073	125	E37421	125	E43208	104	E70587	143	EBC116	40



# Product Index

IFM ARTICLE NUMBER & PAGE NUMBER

EBC138	41	EVC071	30	EVC266	39	EVC811	31	EVC935	13	EVCA32	41
EBF006	40	EVC072	30	EVC267	39	EVC812	31	EVC939	42	EVCA33	41
EBF008	40	EVC073	29	EVC268	39	EVC813	31	EVC940	42	EVCA34	41
EBF009	40	EVC074	29	EVC269	39	EVC814	31	EVC941	42	EVCA35	41
EBF012	40	EVC075	29	EVC342	32	EVC815	31	EVC942	42	EVCA36	41
EBT006	40	EVC076	30	EVC387	39	EVC816	31	EVC943	42	EVCA37	41
EBT009	40	EVC077	30	EVC423	29	EVC817	31	EVC944	42	EVCA38	41
EBT012	40	EVC078	30	EVC431	37	EVC843	17	EVC945	42	EVF001	29
EC0701	138	EVC079	30	EVC432	37	EVC847	78	EVC946	42	EVF002	29
EC0702	138	EVC080	30	EVC433	37	EVC848	78	EVC947	42	EVF003	29
EC2112	139	EVC081	30	EVC434	37	EVC893	13	EVC948	42	EVF004	29
EC2114	139	EVC082	29	EVC435	37	EVC894	13	EVC949	42	EVF005	29
EC2121	135	EVC083	29	EVC436	37	EVC895	13	EVC950	42	EVF006	29
EIO330	17	EVC084	29	EVC467	39	EVC896	13	EVC951	42	EVF007	123
ENC01A	37	EVC086	29	EVC501	38	EVC897	13	EVC952	42	EVF008	123
ENC02A	37	EVC087	29	EVC502	38	EVC898	42	EVC953	42	EVF009	123
ENC03A	37	EVC088	29	EVC518	39	EVC899	42	EVC954	42	EVF010	30
ENC04A	37	EVC103	32	EVC539	35	EVC900	42	EVC955	42	EVF011	30
ENC05A	37	EVC108	32	EVC540	35	EVC901	42	EVC956	42	EVF012	30
ENC06A	37	EVC109	32	EVC542	35	EVC902	42	EVC957	42	EVF013	29
EVC001	29	EVC117	32	EVC543	35	EVC903	42	EVC958	42	EVF014	29
EVC002	29	EVC118	32	EVC545	35	EVC904	13	EVC959	42	EVF015	29
EVC003	29	EVC133	32	EVC546	35	EVC905	13	EVC960	42	EVF040	32
EVC004	29	EVC134	32	EVC548	35	EVC906	13	EVC961	42	EVF041	32
EVC005	29	EVC140	32	EVC549	35	EVC907	13	EVC962	42	EVF042	32
EVC006	29	EVC141	38	EVC556	30	EVC908	13	EVC963	42	EVF043	32
EVC007	36	EVC142	38	EVC561	30	EVC909	13	EVC964	42	EVF044	32
EVC008	36	EVC143	38	EVC562	30	EVC910	42	EVC965	42	EVF045	32
EVC009	36	EVC144	38	EVC563	35	EVC911	42	EVC966	42	EVF046	32
EVC010	32	EVC145	38	EVC591	30	EVC912	42	EVC967	42	EVF047	32
EVC011	32	EVC146	38	EVC644	36	EVC913	42	EVCO1E	34	EVF048	32
EVC012	12	EVC148	36	EVC645	36	EVC914	42	EVC05E	34	EVF049	32
EVC013	32	EVC150	39	EVC646	36	EVC915	42	EVCA15	41	EVF050	32
EVC014	32	EVC151	39	EVC706	33	EVC916	42	EVCA16	41	EVF051	32
EVC015	32	EVC152	39	EVC707	33	EVC917	42	EVCA17	41	EVF064	29
EVC016	32	EVC153	39	EVC708	33	EVC918	42	EVCA18	41	EVF067	29
EVC017	32	EVC154	39	EVC709	33	EVC919	42	EVCA19	41	EVF071	30
EVC018	32	EVC155	39	EVC710	29	EVC920	42	EVCA20	41	EVF072	30
EVC019	32	EVC175	32	EVC715	29	EVC921	42	EVCA21	41	EVF073	30
EVC025	32	EVC177	30	EVC719	33	EVC922	42	EVCA22	41	EVF092	29
EVC026	32	EVC189	34	EVC720	33	EVC923	42	EVCA23	41	EVF094	29
EVC027	32	EVC190	34	EVC721	33	EVC924	13	EVCA24	41	EVF122	38
EVC028	32	EVC196	71	EVC722	33	EVC926	13	EVCA25	41	EVF123	38
EVC029	32	EVC197	30	EVC725	33	EVC927	13	EVCA26	41	EVF124	38
EVC056	34	EVC198	30	EVC726	33	EVC928	13	EVCA27	41	EVF125	38
EVC057	34	EVC199	30	EVC727	33	EVC930	13	EVCA28	41	EVF126	38
EVC058	34	EVC201	34	EVC759	29	EVC932	13	EVCA29	41	EVF127	38
EVC059	34	EVC202	34	EVC767	35	EVC933	13	EVCA30	41	EVF128	38
EVC070	30	EVC265	39	EVC810	31	EVC934	13	EVCA31	41	EVF129	38



# Product Index

## IFM ARTICLE NUMBER & PAGE NUMBER

EVF134	39	EVF560	15	EVT011	30	EVT146	39	IE5288	44	IG5806	46
EVF135	39	EVF565	31	EVT012	30	EVT235	30	IE5295	44	IG5813	47
EVF136	39	EVF566	31	EVT013	29	EVT236	37	IE5319	44	IG5841	46
EVF137	39	EVF567	31	EVT014	29	EVT237	37	IE5338	44	IG5842	46
EVF138	39	EVF568	31	EVT040	32	EVT238	37	IE5340	44	IG5953	46
EVF139	39	EVF569	31	EVT041	32	EVT239	37	IE5366	44	IG5954	46
EVF140	39	EVF570	31	EVT042	32	EVT266	37	IE5379	44	IG6119	46
EVF141	39	EVF571	31	EVT043	32	EVT267	37	IE5391	44	IG6616	46
EVF329	37	EVF572	31	EVT044	32	EVT268	37	IE5392	44	IG510A	47
EVF330	37	EVM001	29	EVT045	32	EVT269	37	IEC201	44	IG512A	47
EVF331	37	EVM002	29	EVT060	34	EVT274	39	IEC202	44	IGC232	46
EVF332	37	EVM003	29	EVT061	34	EVT327	30	IES200	44	IGC233	46
EVF445	32	EVM004	29	EVT062	34	EVT343	29	IES201	44	IGC260	46
EVF479	29	EVM005	29	EVT063	34	EVT350	30	IF0003	45	IGM200	47
EVF480	33	EVM006	29	EVT064	29	EVT359	32	IF0311	45	IGM201	47
EVF481	33	EVM007	36	EVT066	29	EVT382	35	IF5538	45	IGM204	47
EVF482	33	EVM008	36	EVT067	29	EVT383	35	IF5580	45	IGM205	47
EVF483	33	EVM009	36	EVT068	29	EVT384	35	IF503A	45	IGS204	46
EVF484	29	EVM010	29	EVT069	36	EVT385	35	IFC229	45	IGS205	46
EVF485	33	EVM011	36	EVT071	30	EVT386	35	IFC246	45	IGS206	46
EVF486	33	EVM012	29	EVT072	30	EVT387	35	IFM204	45	IGS208	46
EVF490	33	EVM014	29	EVT073	30	EVT388	35	IFM205	45	IGS212	46
EVF491	33	EVM018	29	EVT088	30	EVT418	29	IFM206	45	IGS213	46
EVF492	33	EVM019	29	EVT090	30	EVT420	30	IFS204	45	IGS232	46
EVF493	33	EVM021	38	EVT092	29	EVT438	29	IFS205	45	IGS233	46
EVF494	33	EVM022	38	EVT093	29	EVT441	35	IFS206	45	IGS234	46
EVF495	33	EVM023	38	EVT094	29	EVT442	35	IFS240	45	IGS235	46
EVF496	33	EVM028	39	EVT095	29	EVT443	35	IFS242	45	IGS236	46
EVF503	32	EVM029	39	EVT104	29	EY3004	71	IFS244	45	IGS237	46
EVF518	15	EVM030	39	EVT109	32	EY3013	71	IFS248	45	IGS240	46
EVF519	15	EVM031	39	EVT122	38	EY3099	71	IFS256	45	IGS252	46
EVF520	15	EVM036	30	EVT123	38	EY5053	71	IFS297	45	IGS287	47
EVF521	15	EVM037	30	EVT124	38	EY5054	71	IFS299	45	IGS290	47
EVF522	15	EVM038	30	EVT125	38	G1501S	85	IFS304	45	IGS292	47
EVF528	15	EVM039	29	EVT126	38	G1502S	83	IFS306	45	IGS300	47
EVF529	15	EVM040	29	EVT127	38	G2001S	83	IFT200	45	IGS306	47
EVF530	15	EVM041	29	EVT128	38	GF711S	85	IFT202	45	IGT002	47
EVF531	15	EVM065	29	EVT129	38	GG505S	85	IFT203	45	IGT200	47
EVF532	15	EVM089	32	EVT131	36	GG711S	85	IFT205	45	IGT201	47
EVF533	15	EVM090	32	EVT132	36	GG712S	85	IFT216	45	IGT202	47
EVF534	15	EVT001	29	EVT134	39	GG854S	85	IFT240	45	IGT203	47
EVF549	15	EVT002	29	EVT135	39	GG855S	85	IFT258	45	IGT205	47
EVF550	15	EVT003	29	EVT136	39	GI712S	85	IFW200	45	IGT206	47
EVF551	15	EVT004	29	EVT137	39	G1854S	85	IG0005	46	IGT213	47
EVF552	15	EVT005	29	EVT138	39	G1855S	85	IG0011	46	IGT241	47
EVF553	15	EVT006	29	EVT139	39	GM505S	85	IG0097	46	IGT247	47
EVF554	15	EVT007	36	EVT140	39	GM705S	85	IG0303	47	IGT249	47
EVF557	15	EVT008	36	EVT141	39	I7R215	49	IG5533	46	IGT258	47
EVF558	15	EVT009	36	EVT144	39	IE5257	44	IG5596	46	IGT260	47
EVF559	15	EVT010	30	EVT145	39	IE5287	44	IG5602	46	I10005	48



# Product Index

## IFM ARTICLE NUMBER & PAGE NUMBER

I10006	48	IQ2009	49	LMT102	101	MK5804	59	O5D150	68	O6P205	62
I10011	48	IQ2010	49	LMT104	101	MK5900	59	O5E500	66	O6P206	62
I10094	48	IQ2013	49	LMT105	101	MK5904	59	O6E202	62	O6P207	62
I15751	48	IW5058	49	LMT110	101	MK5905	59	O6E206	62	O6P301	63
I15860	48	IW5062	49	LMT121	101	MK5906	59	O6E300	63	O6P302	63
I15861	48	IW5064	49	LR2050	104	MK5907	59	O6E301	63	O6P303	63
I15910	48	IY5029	44	LR2750	104	MK5908	59	O6E302	63	O6P305	63
I15920	48	IY5034	44	LR3000	104	MK5909	59	O6E303	63	O6P306	63
I15973	48	IY5036	44	LR3020	104	MK501A	59	O6E305	63	O6P309	63
I1504A	48	JD1111	52	LR7000	104	MK502A	59	O6E306	63	O6P310	63
I1C219	48	JD2120	52	LR7020	104	MN200S	84	O6E309	63	O6P701	62
I1M200	48	JN2200	52	LR8000	104	MN202S	84	O6E701	62	O8P200	61
I1M201	48	JN2201	52	LR8020	104	MN203S	84	O8E202	61	O8P202	61
I1M208	48	KF5001	57	LR9020	104	MN205S	84	O5G500	66	O8P204	61
I1S206	48	KF5002	57	LT3023	102	MN500S	84	O5H200	66	O5S500	66
I1S226	48	KG6000	57	LT8022	102	MN502S	84	O5H500	66	O6S202	62
I1S227	48	KI0054	57	LT8023	102	MN503S	84	O6H201	62	O6S301	63
I1S234	48	KI5031	57	LT8024	102	MN505S	84	O6H202	62	O6S302	63
I1S236	48	KI5085	57	LW2120	105	MN700S	84	O6H300	63	O6S303	63
I1S281	48	KI5087	57	LW2720	23	MN701S	84	O6H301	63	O6S305	63
I1S282	48	KI6000	57	ME5010	43	MN702S	84	O6H303	63	O6S700	62
I1S284	48	KQ1000	56	ME5011	43	MR0100	59	O6H307	63	O6S701	62
I1S291	48	KQ1001	56	MFH200	138	MR0101	59	O6H309	63	O8S201	61
I1T202	48	KQ5100	57	MFS209	43	MR0119	59	O6H310	63	O6T201	62
I1T204	48	KQ6002	57	MFS211	43	MR0901	59	O6H701	62	O6T202	62
I1T244	48	KQ6005	57	MFT202	43	MVQ101	50	O6H702	62	O6T206	62
IM0010	49	KT6100	57	MGS204	43	MVQ201	50	O8H202	61	O6T215	62
IM0011	49	KT6101	57	MGT203	43	N0534A	51	O8H206	61	O6T216	62
IM0053	49	KT6300	57	MK5100	59	NN5008	51	O8H212	61	O6T301	63
IM5115	49	KT6301	57	MK5101	59	O1D100	69	O8H214	61	O6T305	63
IM5116	49	LDH100	124	MK5102	59	O1D101	69	O8H218	61	O6T309	63
IM5117	49	LDH290	124	MK5103	59	O1D105	69	O8H222	61	OBF500	61
IM5119	49	LDH292	124	MK5104	59	O1D106	69	O8H273	61	OF5010	66
IM5126	49	LDL100	126	MK5107	59	O1D120	69	O2I400	73	OF5012	66
IM5135	49	LDL101	126	MK5108	59	O1D155	69	O2I402	73	OF5021	66
IN0073	49	LDL200	127	MK5110	59	O1D300	69	O2I404	73	OF5022	66
IN0081	49	LDL201	127	MK5111	59	O2D500	75	O2I410	73	OF5027	66
IN0100	51	LI2131	102	MK5117	59	O2D502	75	O2I412	73	OGD250	67
IN0108	51	LI2132	102	MK5123	59	O2D504	75	O2I414	73	OGD251	67
IN5129	49	LI2133	102	MK5128	59	O2D520	75	O2I420	73	OGD550	67
IN5208	49	LI5131	102	MK5137	59	O2D522	75	O2I422	73	OGD551	67
IN5224	51	LI5132	102	MK5138	59	O2D524	75	O2I424	73	OGD580	67
IN5225	51	LI5133	102	MK5157	59	O2D917	78	O5K500	66	OGD581	67
IN5251	51	LI5134	102	MK5177	59	O2D930	78	O3M250	137	OGD582	67
IN5327	51	LMC100	101	MK5310	59	O3D300	76	O3M251	137	OGD583	67
IQ2000	49	LMC110	101	MK5311	59	O3D303	76	O3M950	137	OGD592	67
IQ2001	49	LMC400	101	MK5800	59	O3D310	76	O5P500	66	OGE200	65
IQ2002	49	LMC500	101	MK5801	59	O3D312	76	O6P201	62	OGE280	64
IQ2003	49	LMC510	101	MK5802	59	O5D100	68	O6P202	62	OGE281	64
IQ2008	49	LMT100	101	MK5803	59	O5D102	68	O6P203	62		





# Product Index

## IFM ARTICLE NUMBER & PAGE NUMBER

OGE300	65	OY5103	71	PG2458	97	PL5402	98	PN7099	96	QMI001	26
OGE301	65	OY5106	71	PG2489	97	PL5412	98	PN7160	96	QMP010	12
OGE380	64	OY5110	71	PG2789	93	PL5423	98	PP7550	99	QMR001	26
OGE381	64	OY5113	71	PG2793	93	PM1103	92	PP7551	99	QMS001	26
OGE500	65	OY5116	71	PG2794	93	PM1104	92	PP7552	99	QVA200	24
OGE700	68	OY001S	83	PG2795	93	PM1105	92	PP7553	99	RA3100	54
OGH200	65	OY002S	83	PG2796	93	PM1106	92	PP7554	99	RA3101	54
OGH280	64	OY003S	83	PG2797	93	PM1107	92	PS3208	106	RA3110	54
OGH281	64	OY004S	83	PG2798	93	PM1108	92	PS3407	106	RB3100	54
OGH283	64	OY005S	83	PG2799	93	PM1114	92	PS3417	106	RB3500	54
OGH300	65	OY006S	83	PI1703	93	PM1115	92	PS3427	106	RM9000	137
OGH312	65	OY007S	83	PI1704	93	PM1117	92	PS3607	106	RMA300	55
OGH380	64	OY008S	83	PI1705	93	PM1118	92	PS4208	106	RMO300	55
OGH381	64	OY009S	83	PI1706	93	PM1143	92	PS4407	106	RM5001	54
OGH500	65	OY010S	83	PI1707	93	PM1503	92	PS4408	106	RMS002	54
OGH504	65	OY011S	83	PI1708	93	PM1504	92	PS4417	106	RMV300	54
OGH580	64	OY041S	83	PI1709	93	PM1505	92	PS4506	106	RO3100	54
OGH700	68	OY042S	83	PI1714	93	PM1506	92	PS4607	106	RO3102	54
OGH701	68	OY043S	83	PI1715	93	PM1514	92	PS317A	106	RO3110	54
OGP200	65	OY044S	3	PI1717	93	PM1515	92	PT0507	98	ROP520	54
OGP201	65	OY045S	83	PI1718	93	PM1543	92	PT0517	98	ROP521	54
OGP280	64	OY046S	83	PI1789	93	PM1703	92	PT5400	97	ROP522	54
OGP281	64	OY047S	83	PI2203	93	PM1704	92	PT5401	97	ROP524	54
OGP282	64	OY048S	83	PI2204	93	PM1705	92	PT5402	97	RUP500	54
OGP300	65	OY049S	83	PI2205	93	PM1706	92	PT5403	97	RV3100	54
OGP301	65	OY050S	83	PI2206	93	PM1707	92	PT5404	97	RV3110	54
OGP500	65	OY111S	82	PI2207	93	PM1708	92	PT5412	97	RVP510	54
OGP700	68	OY112S	82	PI2209	93	PM1709	92	PT5414	97	SA4100	111
OGS200	65	OY113S	82	PI2714	93	PM1714	92	PT5415	97	SA4300	111
OGS280	64	OY114S	82	PI2715	93	PM1715	92	PT5443	97	SA5000	111
OGS300	65	OY115S	82	PI2717	93	PM1717	92	PT5460	97	SBG232	111
OGS380	64	OY116S	82	PI2789	93	PM1718	92	PT5494	97	SBG233	111
OGS500	65	OY454S	83	PI2793	93	PM1789	92	PT5504	138	SBG246	111
OGS700	68	PA3024	99	PI2794	93	PN2070	96	PT5601	138	SBG257	111
OGT200	65	PA3026	99	PI2795	93	PN2071	96	PT5701	138	SBT633	111
OGT300	65	PA3027	99	PI2796	93	PN2092	96	PU8701	138	SBT634	111
OGT500	65	PA3028	99	PI2797	93	PN2093	96	PV8000	98	SBT646	111
OID200	68	PA3029	99	PI2798	93	PN2094	96	PV8001	98	SBT657	111
OID204	68	PA3589	99	PI2799	93	PN2096	96	PV8002	98	SD0523	115
OID250	68	PE2092	96	PK6520	98	PN2097	96	PV8003	98	SD1540	115
OID254	68	PE2093	96	PK6521	98	PN2099	96	PV8004	98	SD2500	115
OMH550	67	PE2094	96	PK6522	98	PN2160	96	PV8023	98	SD5500	115
OMH551	67	PG2450	97	PK6523	98	PN2169	96	PV8060	98	SD5600	115
OMH552	67	PG2451	97	PK6524	98	PN7070	96	PY9060	97	SD6500	115
OMH553	67	PG2452	97	PK7520	98	PN7071	96	PY9070	97	SD6600	115
OMH554	67	PG2453	97	PK7521	98	PN7092	96	QA0011	81	SD8500	115
OMH555	67	PG2454	97	PK7522	98	PN7093	96	QHA210	24	SD8600	115
OPD100	79	PG2455	97	PK7524	98	PN7094	96	QM9102	27	SD9500	115
OPD101	79	PG2456	97	PL5400	98	PN7096	96	QM9103	26	SF2405	113
OY5100	71	PG2457	97	PL5401	98	PN7097	96	QMC206	26	SF3405	113



# Product Index

## IFM ARTICLE NUMBER & PAGE NUMBER

SF5200	113	TA2115	118	TD2841	123	TT1281	121	VSE153	133
SF5700	113	TA2135	118	TD2847	123	TT1291	121	VSM101	133
SF5701	113	TA2145	118	TK6110	119	TT2081	121	VSP001	133
SF5702	113	TA2212	118	TK7110	119	TT2291	121	VSP003	133
SF5703	113	TA2232	118	TK7460	119	TT3081	121	VSP004	133
SF5704	113	TA2242	118	TM4101	121	TT3291	121	VSP01A	133
SF6200	113	TA2262	118	TM4411	121	TT5081	121	VVB001	132
SF220A	113	TA2292	118	TM4431	121	TU3105	138	VWV001	133
SI5000	112	TA2405	118	TM4441	121	TU4105	138	VWV002	133
SI5001	112	TA2415	118	TM4461	121	TV7105	119	ZB0929	133
SI5002	112	TA2417	118	TM4511	121	TV7405	119	ZC0020	115
SI5004	112	TA2435	118	TM4531	121	TW2000	124	ZC0075	115
SI5006	112	TA2437	118	TM4541	121	UGT203	86	ZZ0628	50
SI5010	112	TA2445	118	TM4599	121	UGT204	86	ZZ0629	50
SI5100	112	TA2447	118	TM4801	121	UGT205	86	ZZ0630	50
SI6600	112	TA2502	118	TM4811	121	UGT500	86	ZZ1060	71
SI6700	112	TA2511	118	TM4831	121	UGT501	86		
SI6800	112	TA2512	118	TM4841	121	UGT507	86		
SL0301	115	TA2517	118	TM9950	121	UGT510	86		
SL5101	115	TA2531	118	TN2405	119	UGT511	86		
SM2100	109	TA2532	118	TN2415	119	UGT512	86		
SM4100	109	TA2537	118	TN2435	119	UGT513	86		
SM6120	109	TA2542	118	TN2445	119	UGT514	86		
SM7120	109	TA2802	119	TP2001	121	UGT519	86		
SM8120	109	TA2812	119	TP2005	121	UGT524	86		
SM9100	109	TA2832	119	TP2007	121	UGT526	86		
SN0150	113	TA2842	119	TP2008	121	UGT580	86		
SR0127	113	TA3105	138	TP2009	121	UGT582	86		
SR2301	113	TA3115	138	TP3231	121	UGT584	86		
SR5900	113	TCC201	122	TP3232	23	UGT590	86		
SR5906	113	TCC261	122	TP3237	121	UGT592	86		
SU2020	110	TCC281	122	TP9237	121	UGT594	86		
SU6020	110	TCC291	122	TR2439	121	UIT300	107		
SU7000	110	TCC501	122	TR7439	121	UIT301	107		
SU7020	110	TCC511	122	TS2229	23	UIT500	107		
SU8000	110	TCC531	122	TS2239	121	UIT501	107		
SU8020	110	TCC541	122	TS2256	121	UIT504	107		
SU9000	110	TCC811	122	TS2451	121	UIT507	107		
SU9020	110	TCC831	122	TS2452	121	VES004	133		
SV4200	110	TCC911	122	TS2453	121	VKV021	133		
SV4204	110	TCC931	122	TS2454	121	VKV022	133		
SV5200	110	TD2531	123	TS2659	121	VNA001	133		
SV5204	110	TD2541	123	TS2759	121	VNB001	133		
SV7200	110	TD2801	123	TS5289	121	VOS001	133		
SV7204	110	TD2807	123	TS5951	121	VSA001	23		
TA1321	118	TD2811	123	TS285A	121	VSE003	133		
TA1322	118	TD2817	123	TT0281	121	VSE100	128		
TA1327	118	TD2831	123	TT0291	121	VSE150	23		
TA2105	118	TD2837	123	TT1081	121	VSE151	133		

ifm – close to you!



Go **ifm**online!

Browse, select, order  
in the ifm webshop

[www.ifm.com/au](http://www.ifm.com/au)



National Phone: 1300 365 088

#### HEAD OFFICE

Melbourne  
ifm efector pty ltd  
Suite 3, 745 Springvale Road  
Mulgrave VIC 3170

#### SOUTH AUSTRALIA

Adelaide  
Suite 22-T8 Tonsley  
6 MAB Eastern Prom,  
Tonsley SA 5042

#### NEW SOUTH WALES

Sydney  
Quad 1, Level 1, Suite 1.01  
8 Parkview Drive  
Sydney Olympic Park NSW 2127

#### QUEENSLAND

Gold Coast  
Unit 1, Level 1, 1 Zupp Drive  
Ormeau QLD 4208

#### TASMANIA

Launceston  
City Mill Business Centre  
76 York Street  
Launceston TAS 7250

#### WESTERN AUSTRALIA

Perth  
Allendale Square,  
Ground Floor Plaza  
79 St Georges Terrace  
Perth WA 6000  
Australia

**5** YEARS  
Warranty  
on ifm products

**Disclaimer:**

While every effort has been made to ensure the accuracy and usefulness of this document please note that contents including prices may change without notice. You are advised to refer to [www.ifm.com/au](http://www.ifm.com/au) for comprehensive technical data current prices and our Australia terms and conditions of trade. No liability will be accepted for errors, omissions or amendments to product specifications or prices. Prices shown are AU\$ ex. ifm's Mulgrave store and exclude freight charges and GST.